

50 PAGES ABOUT CARS - PLUS ALL REGULAR FEATURES

POPULAR MECHANICS MAGAZINE

WRITTEN SO YOU CAN

In Color—America's Most Significant Cars . . . Which Gas Is Best For Your Engine? . . . The '58 Cars and Their Specifications . . . Foreign Cars . . . Will Success Spoil Volkswagen?

FEBRUARY 1958
35 CENTS

*1909 Model T—
page 144*



*1958 Thunderbird—
170*

performance out of this world...



STARFLITE V-4

*with Evinrude's mighty V-4 power
and magic "Seal of Silence"*

For starry-eyed dreamers... Starflite is a dream come true! Its very name suggests performance out of this world. Its low, sweeping V-shape of tomorrow hints of fun to come.

You'll feel its solid take-hold power the moment you touch the throttle. Instant action! Remarkably quiet! Incredibly smooth!

Starflite's compact, perfectly balanced 90° V-engine floats on rubber mounts in a sound-tight nacelle. Power pulsations are wiped out. Engine noise is sealed in.

See the most remarkable outboard motor ever built... Evinrude's mighty 50 hp Starflite... *now* at your Evinrude dealer's. Look for his name under "Outboard Motors" in your phone book.

Thrilling V-4 performance is also yours in the new Four-Fifty, at low, low cost. There's a glamorous new Lark with Starflite quiet! Power-packed new "35's" and "18's" with key switch starting! A sweet-trolling streamlined "10"! And 3 handy take-along motors! Catalog *free*—write Evinrude Motors, 4228 N. 27th Street, Milwaukee 16, Wisconsin.

*A Division of Outboard Marine Corporation
In Canada: Mfd. by Evinrude Motors, Peterborough*

EVINRUDE *quiet outboard motors*



Rolls Royce is known the world over as an automotive masterpiece.
Like 35 other great makes of cars, Rolls Royce uses Champions.

Q. Why do over twice as many car makers—including Rolls Royce—specify Champion spark plugs?

A. Champions give full-firing power. Put new Champions in your car every 10,000 miles. You'll get an *immediate* boost in horsepower...and save gasoline, too!



World's favorite spark plug on land, on sea, and in the air

CHAMPION



How to get more light on the road from your present headlamps!



1. Since headlamps are detachable, they are subject to road shock and vibration which can jar them out of position and mis-direct their light.

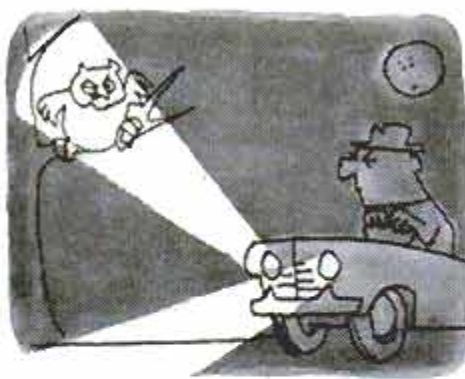

2. A very slight change in their position (so insignificant you can't even see the change) makes a big difference in the light you get down the road.

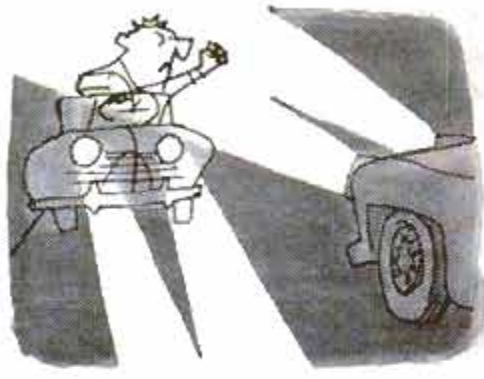

3. Ever have oncoming motorists "flash" their lights...believing you were driving with your "brights"?—when it was your *lower* beam... aimed high!

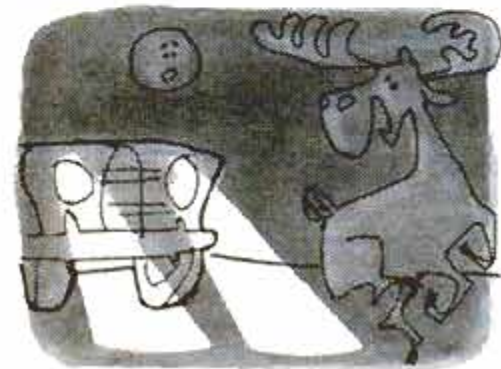

4. When headlamps are aimed low, the beam is too short... and you might not see in time to stop in time.



5. Your dealer can tell if headlamps are mis-aimed, and he can aim them accurately in minutes, even in daytime.

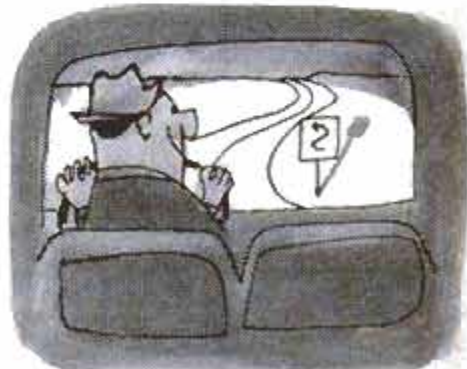

6. So, to get *more* light where it is needed... from your present headlamps... have them aimed *today!*

... and, if your headlamps are over 2 years old,
here's how to get even more light!

Take a look at your *unlighted* headlamps. If they look like those at right, even re-aiming won't give you all the light you need. They should be replaced with new G-E *All-Weather* Headlamps that are all glass... their reflectors always stay shiny. When driving on the *lower* beam, G-E *All-Weather* Headlamps let you see better in fog, rain or snow and against the glare of oncoming traffic. Their *upper* beam reaches far and wide for safer driving on the open road.

Get a pair of G-E *All-Weather* Headlamps today—and have your dealer aim them when he puts them in. You'll see the difference tonight. General Electric Co., Miniature Lamp Dept., Nela Park, Cleveland 12, Ohio.



WATER DROPLETS inside the lens not only scatter the light, but they also help discolor metal reflectors. This can't happen with G-E *All-Weather* Headlamps—moisture can't possibly get inside.



DISCOLORED REFLECTORS absorb light rather than reflect it, causing a loss of up to 50% of the original light output. Dirt and moisture can never enter G-E *All-Weather* Headlamps so the reflectors always stay shiny.



BLACKENED BULBS in old-style headlamps block out the light from the filament and cause a dangerous drop in light output. This can't happen with G-E *All-Weather* Headlamps because there are no inner bulbs!

Progress Is Our Most Important Product

GENERAL  ELECTRIC

Popular Mechanics Magazine

Registered in U. S. Patent Office and Canada

H. H. WINDSOR, Founder

H. H. WINDSOR, JR., Editor and Publisher

Managing Editor
RODERICK M. GRANT

Assistant Managing Editor
WAYNE WHITTAKER

Shop Notes and Crafts Editor
JAMES R. WARD

Associate Editors, General Features
CLIFFORD B. HICKS
KENNETH N. ANDERSON
ARTHUR R. RAILTON, Automotive

Associate Editors, Shop Notes and Crafts
WAYNE C. LECKEY W. CLYDE LAMMEY

Radio-Television, Electronics Editor
LOTHAR STERN

Assistant Editors
SHELDON MIX, General Features
JAY W. HEDDEN, EARL WOBCEK, Crafts
JOHN DALEN, DICK ZYLSTRA, Makeup

Art Staff
FRANK BEATTY, Director
HENRY NEHRBASS, Assistant Director
RALPH LINNENBURGER, Art Editor

Eastern Editor
RICHARD F. DEMPEWOLFF
Empire State Bldg., Room 2906, N.Y.C. 1

Western Editor
THOMAS E. STIMSON, JR.
Suite 1010, 3460 Wilshire Blvd.,
Los Angeles 5, Calif.

London Manager
DOUGLAS W. WEDDERSPOON
Eagle House, Jermyn St.,
London S.W. 1, England

Director, Bureau of Information
ALLAN CARPENTER

Advertising Offices

Chicago: 200 E. Ontario St., Whitehall 4-0100;
New York: Empire State Bldg., 350 Fifth Ave.,
LOngacre 5-7580; Detroit: General Motors
Bldg., Room 5-118, TRinity 5-8711; Cleveland:
Hanna Bldg., 1422 Euclid Ave., PRospect
1-0456; Los Angeles: 3460 Wilshire, DUnkirk
2-8458; San Francisco: Russ Bldg., Room
468, 235 Montgomery St., YUKon 2-0823.

Published monthly by Popular Mechanics Company,
200 E. Ontario St., Chicago 11, Ill. H. H. Windsor,
Jr., President; Wm. Harrison Petridge, exec.
vice-pres.; Franklin S. Forsberg, operations vice-
pres.; D. F. Windsor, vice-president and secretary-
treasurer; H. H. Windsor III, vice-president; W. T.
Windsor, vice-president; Joseph R. Buell, Jr., ad-
vertising manager; Alan M. Deyoe, circulation
manager. Single copy in the United States and
Canada, 35 cents; subscription rates in the United
States and possessions, Canada and countries of
the Pan-American Postal Union, 1 year \$3.50; 2
years, \$6.00; 3 years, \$8.00. To all other coun-
tries add \$1.00 a year over United States prices
for overseas postage. If you plan to move, notify us
at least 30 days in advance so you will not miss
an issue. Give both your old and new addresses.
Entered as Second Class Matter, September 15,
1903, at the Post Office at Chicago, Illinois, under
Act of March 3, 1879. Entered as Second Class
Matter at Post Office Dept., Canada. Registered
as Second Class Matter at the Post Office at
Mexico, D.F., Mexico, June 20, 1950.
Copyright 1958 by Popular Mechanics Company,
Copyright under International Copyright Union,
Copyright in France. All rights reserved under
Pan-American Copyright Union. Printed in the
United States of America.

FOREIGN EDITIONS: MECANIQUE POPULAIRE (French) MECANICA POPULAR (Spanish) POPULAER MEKANIK (Danish) POPULAR MEKANIK (Swedish) POPULARE MECHANIK (German)

Volume 109 FEBRUARY 1958 Number 2

Address all communications to: 200 E. Ontario St., Chicago 11, Ill.

In This Issue...

Atomic Revolution in the Shipyards	- - -	97
Squaw Valley Prepares for the Winter Olympics	- - -	106
The Weird Things They Do With Heat!	- - -	116
Air Traffic School	- - -	122
Why Burglars Can't Win	- - -	134
The Saga of the USS Princeton	- - -	139

ANNUAL AUTO SECTION

America's Most Significant Cars—	
A Historical Portfolio—in Color	- - - 144
The 1958 Parade of Cars	- - - 155
The Imports: Climbing Sales	- - - 162
This Year's Crop of Engines	- - - 167
The 1½-Car Family	- - - 170
Which Gas Is Best for Your Car?	- - - 174
The T's a Big Bird Now	- - - 178
Will Success Spoil Volkswagen?	- - - 180
How a Professional Recores an Auto Radiator	- - - 185
Do-It-Yourself Auto-Body Repair	- - - 189
Servicing Ignition Systems Electronically	- - - 245

For the Craftsman...

Fold-Away Sewing Center	- - - 193
You Will Be Proud of These Power Tools	- - - 198
How to Work With Hardboard	- - - 203
One for Your Scrapbook	- - - 211
Motorized Wheelbarrow Converts to Sprayer	- - - 221
Finish That Shop Project with a Pad Sander	- - - 227
Hand Taps Are Precision Tools	- - - 234

Regular Departments...

What's New for Your Home	- - - 130
On the Market	- - - 225
Shopping for Tools	- - - 241
Radio, TV and Electronics	- - - 245
Clinic for Homemakers	- - - 250

Turn to detailed index on page 92. Sources of additional information on items in this issue are shown on the Where-to-Buy-It List, available without charge by writing the Bureau of Information, Popular Mechanics, 200 E. Ontario St., Chicago 11, Ill.

Next Month...

THIS IS Swish, one of the trimmest and sleekest runabouts ever designed. Plans for building the 15-footer are included in next month's 25-page section devoted exclusively to boating





POPULAR MECHANICS first passed the word along—"Front or rear, coming or going, (the Edsel) is distinctive." Now Edsel owners are doing the reporting, in ever-growing numbers: The more you drive an Edsel, the more you realize just how new and different it is on every count. **Have you driven a 1958 Edsel yet? Your Edsel Dealer invites you to drive it, now.**

SPECIFICATIONS: Edsel E-475—horsepower, 345 @ 4600 rpm; displacement, 410 cu. in.; torque, 475 ft.-lbs. @ 2900 rpm; 10.5:1 compression. E-400—horsepower, 303 @ 4600 rpm; displacement, 361 cu. in.; torque, 400 ft.-lbs. @ 2800 rpm; 10.5:1 compression.

Carburetor cleaning used to take hours!



That's right. Carburetor cleaning used to be a long, costly job. Today, it takes minutes. That's why the scene above is a familiar one in thousands of service stations and service shops. GUMOUT and the handy GUMOUTER Service Kit does the job in 20 minutes—and the carburetor stays right on the engine. You get a better tune-up job—and save money too. Ask your serviceman to give your car this quick, complete carburetor clean-out. Makes every car run better.

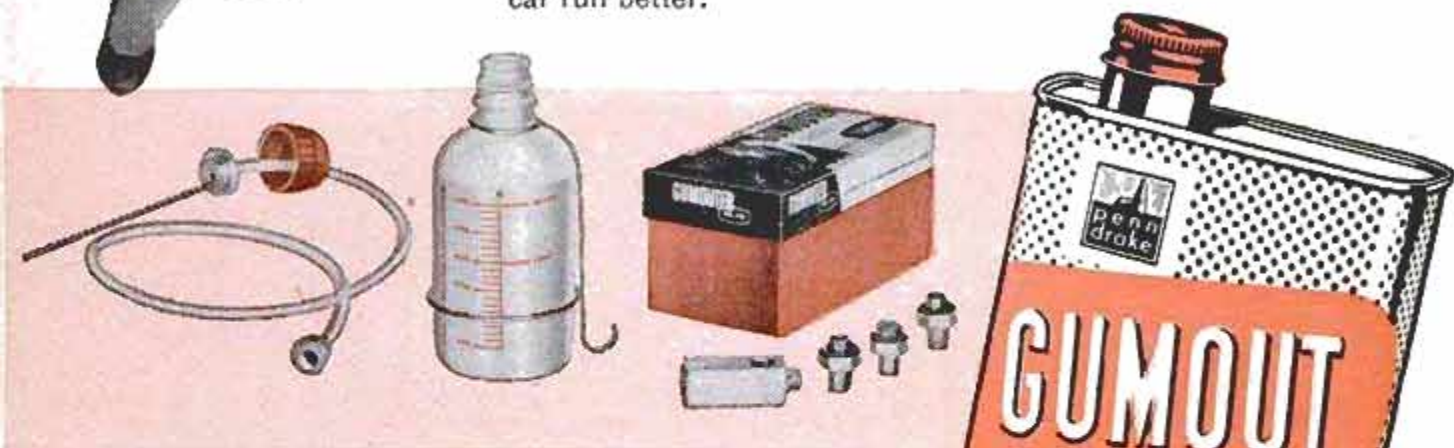

GUMOUTER Service Kit No. 610. The same kit your serviceman uses to clean your carburetor. Send for FREE 46-page Carburetor Handbook. It's full of helpful information about your car's fuel system.

YOU CAN CLEAN YOUR CARBURETOR, too . . . simply by adding GUMOUT to your gas tank regularly. It cleans as you drive. Available at auto supply stores, or wherever automotive products are sold.

THERE'S NOTHING LIKE IT!

GUMOUT DIVISION

Pennsylvania Refining Company • 2670 Lisbon Road, Cleveland 4, Ohio

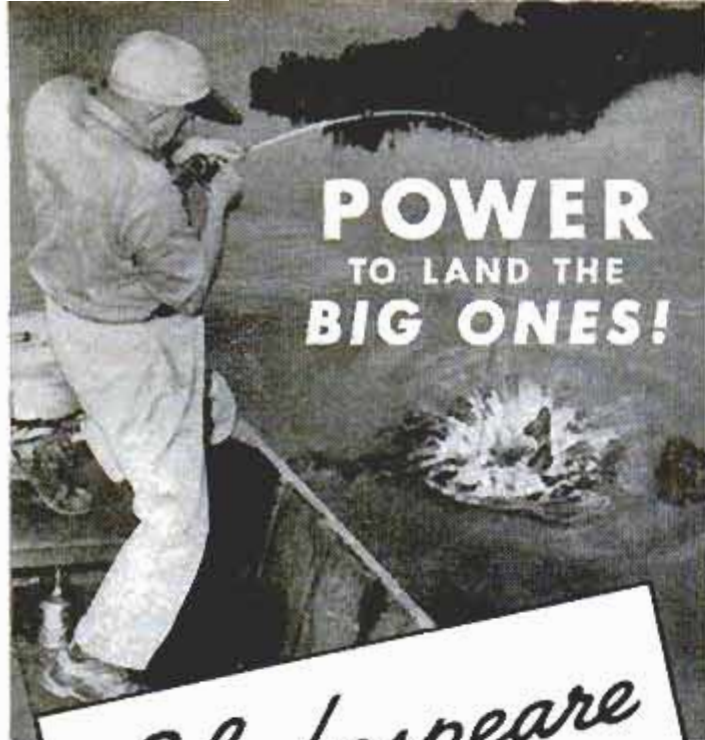

**POWER
TO LAND THE
BIG ONES!**

Shakespeare

**DIRECT
FOR POWER
DRIVE**

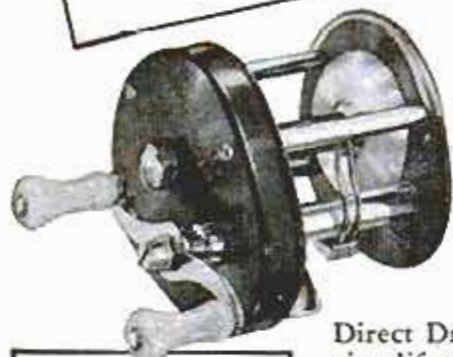

No. 1926 Feather-light, sporty, in green anodized aluminum or No. 1924 in chromed brass for fresh or salt water. Each \$13.50

*Lighter
Quieter
Tougher*

NYLON GEARS
Lighter than metal—far tougher—quiet as a cat on a carpet. Gruelling tests in actual performance prove nylon's amazing resistance to abrasive wear and tear.

Direct Drive—Shakespeare's simplified system of transmitting power to the spool gives you more power to turn, control and land the fighting fish. 2 gears do the work of 3 or 4. Fewer parts mean less wear and tear. Rugged construction for years of fishing enjoyment under toughest conditions.

No. 1924 S
Heavily chromed brass with star drag \$15.00



FREE! 5 Colorful New Booklets

AND FISHING CALENDAR
Latest in fishing ideas and equipment. Write today for these 5 brand new booklets on salt water, bait casting, spinning, fly and push-button fishing.



SHAKESPEARE COMPANY
Dept. PM-2, Kalamazoo, Mich.

Please send me absolutely free your 5 new fishing booklets and calendar.

Name _____
Address _____
City _____ State _____

**ACROSS THE
DESK**



Introducing an Artist

New to our pages is the artist who painted the portraits of America's most significant automobiles, the color feature opening our Sixth Annual Automobile Section on page 145. He is Ed Vebell of Westport, Conn., Chicago-born and schooled, 36 years old, married and the father of two children.



During World War II he was feature illustrator on the *European Stars and Stripes*, and afterward remained in Paris working in his own studio for more than five years.

Between family and art jobs, he tells us, "I squeeze in as much fencing as I can. . . . I first became interested in fencing from an article in *Popular Mechanics* and have been at it ever since. I've since represented the United States on two Olympic teams and also made it the third time, which was the Melbourne games. But I was hurt in training and was flat on my back in a hospital when the team departed for Australia. I've since bounced back and took fourth place in (1957) National Championships."

To the Editor:

Enclosed you will find a photo of an item we have received here. It is of brass and the end to the right of the picture is similar to a mouthpiece. The tube extending from that is hollow and is pivoted in the yoke in the center. The tube can be adjusted, permitted to slide through the center pivot, by a setscrew barely visible behind one side of the yoke. The piece

(Continued to page 10)

5 reasons why ACCOUNTING

FINE CAR



A NICE HOME



offers you

MORE MONEY and SUCCESS



**SEND FOR FREE
SAMPLE LESSON**

REASON #1. If you were an expert accountant right now, chances are you would find yourself in one of the best paid fields of business.

REASON #2. The demand for accountants is great—everywhere. All businesses must have trained accountants to cope with ever-growing requirements. It's a field offering wide opportunity—always—to the man who knows.

REASON #3. You can fit into any business, anywhere in the country—because accounting principles are universal. Think what this means in terms of security and independence!

REASON #4. Accounting is open to all. Any man or woman of good intelligence, who enjoys figure work and is willing to follow LaSalle's systematic "problem method" plan, can rapidly qualify for a highly profitable, enjoyable lifetime career . . . and he doesn't have to finish his training before beginning to "cash in."

LASALLE
417 S. Dearborn St.,
CHICAGO 5, ILL.



REASON #5. Without losing a day from your present work, you can prepare in spare hours at home, at low cost, under LaSalle's step-by-step "Problem Method" of "learning by doing." This famous plan accounts for LaSalle's remarkable record of having trained one out of every 13 of all Certified Public Accountants in the U. S. . . . and of having put many thousands of others into high-paying careers.

Send today for Free Sample Lesson and "Opportunities in Accounting." Learn about the several great fields of opportunity . . . and LaSalle's time-tested plan for helping men and women to rapid advancement, higher income and greater prestige. The coupon below will bring this information to you—without cost or obligation.

Accredited Member, National Home Study Council

SEND FOR FREE BOOK

LaSalle Extension University
A Correspondence Institution

Dept. 264H, 417 S. Dearborn St., Chicago 5, Ill.

Please send me, free of all cost or obligation, free sample lesson and your latest book, "Opportunities in Accounting."

Name.....Age.....

Address.....

City, Zone, State.....

BURIED ALIVE!



SIX YEARS ON THE SAME JOB WITH NEVER AN ACCIDENT...
AND THEN ONE MORNING...

2 A CAVE-IN PUT ME SIX FEET UNDER FOR SIX LONG MINUTES



3 IN THE HOSPITAL, I HAD PLENTY OF TIME TO THINK



4 I'D PASSED OVER DOZENS OF I.C.S. ADS IN POPULAR MECHANICS. BUT I SAW THIS ONE IN A NEW LIGHT



FREE!

I.C.S. CAREER KIT
Send coupon now...
get all three books

INTERNATIONAL CORRESPONDENCE SCHOOLS
BOX 21299B
SCRANTON 15, PA.

HOW'S IT GOING, DARLING?

FAST! I'M INTO HYDRAULICS ALREADY. AND I THOUGHT I WAS TOO OLD TO LEARN

5 SIGNING UP FOR THAT I. C. S. COURSE WAS THE SMARTEST THING I EVER DID

8 THEN A FEW DAYS LATER, MR. WALSH CALLED ME IN...

JIM, I'M KEEPING YOU HERE AND PUTTING YOU ON SALARY. YOU'LL BE GETTING ABOUT \$20 MORE A WEEK. AND AT THE RATE YOU'RE GOING, I EXPECT I'LL HAVE TO RAISE THAT IN SIX MONTHS

HERE'S WHERE YOU COME IN! LET I. C. S. SHOW YOU THE WAY TO MORE PAY, RAPID ADVANCEMENT, REAL JOB SECURITY! MAIL THIS COUPON TODAY!

6 ONE MONTH LATER... GOOD TO SEE YOU BACK ON YOUR FEET, JIM. IT'LL BE AWHILE BEFORE YOU'RE BACK IN THE FIELD. SO WE'LL FIX A TEMPORARY DESK FOR YOU IN THE OFFICE WHEN YOU'RE READY

I'M READY NOW, MR. WALSH

9 THAT EVENING, JANE AND I WENT HOUSE HUNTING

OH, JIM! IT'S A DREAM HOUSE!

AND THANKS TO I. C. S. IT'S A "DREAM" THAT CAN COME TRUE!

MODEL HOUSE

7 THEY GAVE ME SOME SIMPLE ASSIGNMENTS... AND I SURE SURPRISED THEM!

SAY, WHERE DID YOU LEARN ABOUT PUMPS?

SAME PLACE YOU DID, JOE... I. C. S.

1 "HOW TO SUCCEED" A 32-page gold mine of ideas

2 CAREER CATALOG Opportunities in the field that interests you most

3 SAMPLE LESSON (MATH) Shows the famous step-by-step I. C. S. teaching method

INTERNATIONAL CORRESPONDENCE SCHOOLS



BOX 21299B, SCRANTON 15, PENNA.

(Partial list of 257 courses)

- Without cost or obligation, send me "HOW to SUCCEED" and the opportunity booklet about the field BEFORE which I have marked X (plus sample lesson):
- | | | | | |
|--|--|--|--|---|
| <p>ARCHITECTURE and BUILDING CONSTRUCTION</p> <ul style="list-style-type: none"> <input type="checkbox"/> Air Conditioning <input type="checkbox"/> Architecture <input type="checkbox"/> Arch. Drawing and Designing <input type="checkbox"/> Building Contractor <input type="checkbox"/> Building Estimator <input type="checkbox"/> Carpentry and Millwork <input type="checkbox"/> Carpenter Foreman <input type="checkbox"/> Heating <input type="checkbox"/> Interior Decoration <input type="checkbox"/> Painting Contractor <input type="checkbox"/> Plumbing <input type="checkbox"/> Reading Arch. Blueprints <p>ART</p> <ul style="list-style-type: none"> <input type="checkbox"/> Commercial Art <input type="checkbox"/> Magazine & Book Illus. <input type="checkbox"/> Show Card and Sign Lettering <input type="checkbox"/> Sketching and Painting <p>AUTOMOTIVE</p> <ul style="list-style-type: none"> <input type="checkbox"/> Automobiles <input type="checkbox"/> Auto Body Rebuilding and Refinishing <input type="checkbox"/> Auto Engine Tuneup <input type="checkbox"/> Auto Technician | <p>AVIATION</p> <ul style="list-style-type: none"> <input type="checkbox"/> Aero-Engineering Technology <input type="checkbox"/> Aircraft & Engine Mechanic <p>BUSINESS</p> <ul style="list-style-type: none"> <input type="checkbox"/> Accounting <input type="checkbox"/> Advertising <input type="checkbox"/> Business Administration <input type="checkbox"/> Business Management <input type="checkbox"/> Cost Accounting <input type="checkbox"/> Creative Salesmanship <input type="checkbox"/> Managing a Small Business <input type="checkbox"/> Professional Secretary <input type="checkbox"/> Public Accounting <input type="checkbox"/> Purchasing Agent <input type="checkbox"/> Salesmanship <input type="checkbox"/> Salesmanship and Management <input type="checkbox"/> Traffic Management <p>CHEMICAL</p> <ul style="list-style-type: none"> <input type="checkbox"/> Analytical Chemistry <input type="checkbox"/> Chemical Engineering <input type="checkbox"/> Chem. Lab. Technician <input type="checkbox"/> Elements of Nuclear Energy <input type="checkbox"/> General Chemistry <input type="checkbox"/> Natural Gas Prod. and Trans. <input type="checkbox"/> Petroleum Prod. and Engr. <input type="checkbox"/> Professional Engineer (Chem) <input type="checkbox"/> Pulp and Paper Making | <p>CIVIL ENGINEERING</p> <ul style="list-style-type: none"> <input type="checkbox"/> Civil Engineering <input type="checkbox"/> Construction Engineering <input type="checkbox"/> Highway Engineering <input type="checkbox"/> Professional Engineer (Civil) <input type="checkbox"/> Reading Stroc. Blueprints <input type="checkbox"/> Structural Engineering <input type="checkbox"/> Surveying and Mapping <p>DRAFTING</p> <ul style="list-style-type: none"> <input type="checkbox"/> Aircraft Drafting <input type="checkbox"/> Architectural Drafting <input type="checkbox"/> Drafting Machine Design <input type="checkbox"/> Electrical Drafting <input type="checkbox"/> Mechanical Drafting <input type="checkbox"/> Sheet Metal Drafting <input type="checkbox"/> Structural Drafting <p>ELECTRICAL</p> <ul style="list-style-type: none"> <input type="checkbox"/> Electrical Engineering <input type="checkbox"/> Elec. Engr. Technician <input type="checkbox"/> Elec. Light and Power <input type="checkbox"/> Practical Electrician <input type="checkbox"/> Practical Lineman <input type="checkbox"/> Professional Engineer (Elec) <p>HIGH SCHOOL</p> <ul style="list-style-type: none"> <input type="checkbox"/> High School Diploma | <ul style="list-style-type: none"> <input type="checkbox"/> Good English <input type="checkbox"/> High School Mathematics <input type="checkbox"/> Short Story Writing <p>LEADERSHIP</p> <ul style="list-style-type: none"> <input type="checkbox"/> Industrial Foremanship <input type="checkbox"/> Industrial Supervision <input type="checkbox"/> Personnel-Labor Relations <input type="checkbox"/> Supervision <p>MECHANICAL and SHOP</p> <ul style="list-style-type: none"> <input type="checkbox"/> Diesel Engines <input type="checkbox"/> Gas-Elec. Welding <input type="checkbox"/> Industrial Engineering <input type="checkbox"/> Industrial Instrumentation <input type="checkbox"/> Industrial Metallurgy <input type="checkbox"/> Industrial Safety <input type="checkbox"/> Machine Design <input type="checkbox"/> Machine Shop Practice <input type="checkbox"/> Mechanical Engineering <input type="checkbox"/> Professional Engineer (Mech) <input type="checkbox"/> Quality Control <input type="checkbox"/> Reading Shop Blueprints <input type="checkbox"/> Refrigeration and Air Conditioning <input type="checkbox"/> Tool Design <input type="checkbox"/> Tool Making <p>RADIO, TELEVISION</p> <ul style="list-style-type: none"> <input type="checkbox"/> General Electronics Tech. | <ul style="list-style-type: none"> <input type="checkbox"/> Industrial Electronics <input type="checkbox"/> Practical Radio-TV Eng'r'g <input type="checkbox"/> Practical Telephony <input type="checkbox"/> Radio-TV Servicing <p>RAILROAD</p> <ul style="list-style-type: none"> <input type="checkbox"/> Car Inspector and Air Brake <input type="checkbox"/> Diesel Electrician <input type="checkbox"/> Diesel Engr. and Fireman <input type="checkbox"/> Diesel Locomotive <p>STEAM and DIESEL POWER</p> <ul style="list-style-type: none"> <input type="checkbox"/> Combustion Engineering <input type="checkbox"/> Power Plant Engineer <input type="checkbox"/> Stationary Diesel Engr. <input type="checkbox"/> Stationary Fireman <p>TEXTILE</p> <ul style="list-style-type: none"> <input type="checkbox"/> Carding and Spinning <input type="checkbox"/> Cotton Manufacture <input type="checkbox"/> Cotton Warming and Weaving <input type="checkbox"/> Loom Fixing Technician <input type="checkbox"/> Textile Designing <input type="checkbox"/> Textile Finishing & Dyeing <input type="checkbox"/> Throwing <input type="checkbox"/> Warming and Weaving <input type="checkbox"/> Worsted Manufacturing |
|--|--|--|--|---|

Name _____ Age _____ Home Address _____
 City _____ Zone _____ State _____ Working Hours _____ A.M. to P.M. _____

Canadian residents send coupon to International Correspondence Schools, Canadian, Ltd., Montreal, Canada. . . . Special tuition rates to members of the U. S. Armed Forces.

OPTICAL BARGAINS

3" ASTRONOMICAL REFLECTING TELESCOPE

(Famous Mt. Palomar type)

See the Stars, Moon, Planets Close Up!
60 & 120 Power — An Unusual Buy!

Assembled and Ready to Use! You'll see the Rings of Saturn, the fascinating planet Mars, huge craters on the Moon. Aluminized and overcoated 3" diameter high-speed f/10 astronomical mirror. Telescope comes equipped with a 60X eyepiece and a mounted Barlow Lens, giving you 60 & 120 power. Optical Finder Telescope, included. Sturdy, hardwood, portable tripod. Free with scope: Valuable STAR CHART and 272 page "Astronomy Book." Stock No. 85,050-M.....\$29.50 f.o.b. (Shipping wt. 10 lbs.) Barrington, N. J.



4 1/4" ASTRONOMICAL TELESCOPE

Mt. Palomar type! Up to 270 Power. A fine Reflector Telescope complete with real Equatorial Mount and Tripod and 6X Finder. Aluminum tube, 4 1/4" dia. mirror, rack and pinion focusing eye-piece holder, 2 eyepieces and mounted Barlow Lens for 40X, 90X, 120X and 270X. Shipping weight approx. 25 lbs. Stock No. 85,006-M... complete. \$74.50 f.o.b. Barrington, N. J.



DIRECT MEASURING POCKET MICROSCOPE

— 50 POWER

Fountain pen size, makes direct reading measurements; for checking small parts and dimensions under powerful magnification. Precision, glass etched reticle calibrated for measurements up to 1/10" by .001" divisions.

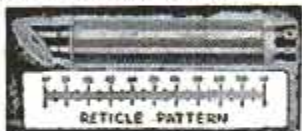

Stock No. 30,225-M.....\$7.95 Pstpd.

New! 2 in 1 Combination! Pocket-Size

50 Power MICROSCOPE and 10 Power TELESCOPE

Useful Telescope and Microscope combined in one amazing, precision instrument. Imported! No larger than a fountain pen. Telescope is 10 Power. Microscope magnifies 50 Times. Sharp focus at any range. Handy for sports, looking at small objects, just plain snooping. Send Check or M.O. Satisfaction Guaranteed. Order Stock No. 30,059-M.....\$4.50 Pstpd.



Geophysical Year Scoop REAL 150 POWER ASTRONOMICAL TELESCOPE ONLY \$16.95 Postpaid

Refractor type! Clear, razor-sharp viewing of stars, planets, craters on moon, etc. 32mm achromatic objective lens! First surface mirror diagonal lends "stoop" viewing. Removable eyepiece—interchangeable. 50, 75, and 150 power! Tube length 27 1/2". Special attachment clamp for vibrationless viewing. Money back guarantee. Included free: 273 page "Handbook of the Heavens", Star Chart—and 16 page Star Booklet.

Stock No. 80,060-M.....\$16.95 Postpaid

Larger 42mm objective model—67, 100, 200 power—same features as above, with 38" tube length—(included free: "Handbook of the Heavens", Star Chart and 16 page Star Booklet).

Stock No. 80,061-M.....\$19.95 Postpaid

See The Satellites

NEW, LOW PRICE "SATELLITER" TELESCOPE

Get ready for a terrific sky show as more Satellites are vaulted into space. See thrilling sights with our amazing Satellite Scope at unheard of low cost. Also view comets—use as a Rich-field Scope for viewing star clusters. 5 power—wide 12° field. Use of high quality war surplus optics makes possible this bargain.

Stock No. 70,150-M.....\$9.95 Postpaid

We are the mfr. of the famous "Moonwatch" Satellite Telescope!



BUILD A SOLAR ENERGY FURNACE

A fascinating new field. Build your own Solar Furnace for experimentation—many practical uses. Easy! Inexpensive! We furnish instructions. This sun powered furnace will generate terrific heat—2000° to 4000°. Fuses enamel to metal. Sets paper aflame in seconds. Use our Fresnel Lens—14 3/4" diameter... f.l. 14".

Stock No. 70,130-M—package of 1.....\$ 6.00 Pstpd.

Stock No. 70,131-M—package of 2.....\$11.00 Pstpd.

Stock No. 70,132-M—package of 4.....\$20.00 Pstpd.



INFRARED SNIPERSCOPE TELESCOPE & PARTS

See in the dark—without being observed. War Surplus Sniperscope M-2. Gov't. cost about \$1200. Instrument complete, ready to use. Includes Power Pack, infrared light source. Will operate from 6 V auto battery. Battery or transformer available. Stock No. 85,053-M...\$150.00 f.o.b.

Save still more money! Build your own Sniperscope! We will furnish instructions—parts, including: Power Packs, 1P25A image tubes, light units, filters, etc. For details—request FREE Catalog "H."



WRITE FOR FREE CATALOG "H"!

Complete Line of Astronomical Telescope Parts and Assembled Telescopes. Also huge selection of lenses, prisms, war surplus optical instruments, parts and accessories. Telescopes, microscopes, satellite telescopes, binoculars, etc. Request Catalog "H"!

ORDER BY STOCK NUMBER, SEND CHECK OR MONEY ORDER. SATISFACTION GUARANTEED.

EDMUND SCIENTIFIC CO., BARRINGTON, N. J.

extending downward from the yoke is 1/4-inch-square material.

The smaller fitting, also of brass, to the lower left of the photo, does not fit the larger piece but must be part of it.

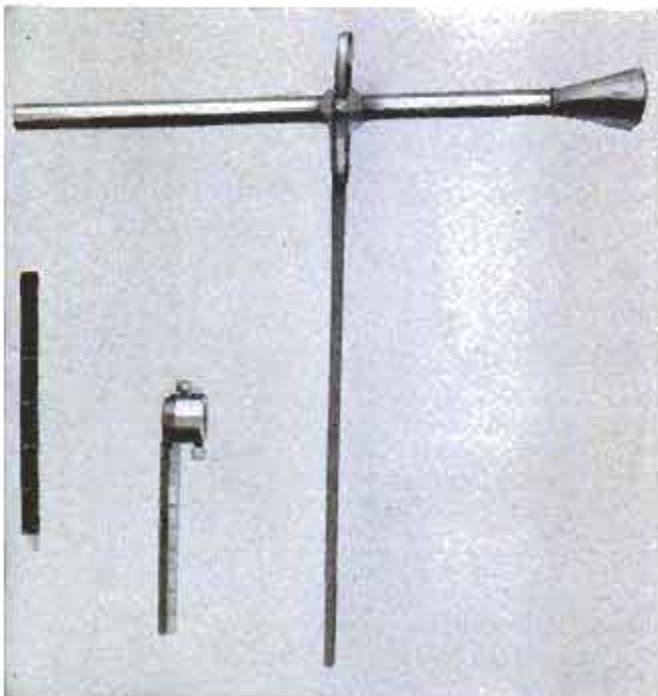

We thought you or some of your readers might be able to identify it. We were informed that during a TV program which featured the inventor, De Forest, he used a similar instrument, so it may be used in electronics. We cannot associate it with any nautical usage.

Any information you can supply will be appreciated.

Robert H. Burgess,
Curator of Exhibits,
The Mariners Museum,
Warwick, Va.

Who knows?

To the Editor:

I have hesitated in writing to you ever since I received my July copy of *Popular Mechanics*, but I have read and reread the article in that issue on Hiller's Aerial Sedan many times and I do agree that it has many possibilities for the military, but also it would be the answer to a rural mail carrier's prayer. My route is 58 miles, all dirt roads. You don't know how many times I have longed for something like that; I wouldn't care if it didn't rise but just a few feet above the ground—you would be out of the mud (mud that even a Jeep can't go through at times). I certainly hope they can get something developed in the near future.

I have hired a Flying Farmer to drop the mail for me, but that doesn't prove too

(Continued to page 14)

Make More Money Soon Fixing Electric Appliances



**Actual Lesson
FREE**

Fast Growing
Field Offers
Good Pay, Security
Interesting Work

Learn at Home in Spare Time

Earn more money. Enjoy doing important, interesting work. Learn Electrical Appliance Servicing. This is a field of increasing opportunity. Today there is an average of 8 appliances in every wired home. More than eighty million additional appliances, valued at about 8 billion dollars sold in one year. Find out more about this great, growing field. Find out how NRI can train you, at home and in spare time to be an Appliance Service Technician. See how you can start soon to make extra money servicing appliances.

Add to Your Income Soon After Enrollment Opportunities Increasing for Service Technicians

NRI Training is practical, thorough. You get easy-to-understand lessons, and NRI supplies parts to build professional type Multi-Use Tester. Use it to get practical experience. Soon, you can add to your income by servicing appliances. Build a profitable *sideline* for your spare time—qualify for a good job—develop a business and be your own boss. As an Appliance Service Technician, your opportunities are broad—your services wanted, gladly paid for, highly regarded in your community.

Appliances are necessary to comfortable, convenient living. Owners pay well to keep them in repair. The field is amazingly big. In addition to major appliances such as electric ranges, air conditioners, refrigerators, there are over 40,000,000 electric irons, 5,000,000 electric blankets, 15,000,000 coffee makers, plus more millions of vacuum cleaners, fans, toasters, mixers, etc.

Learn and Earn With Tester Diploma When You Finish

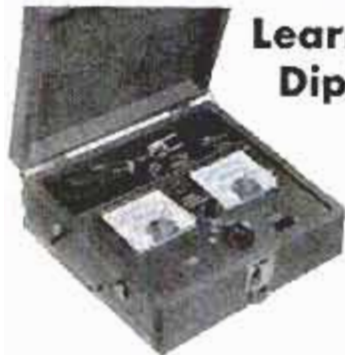

Locate appliance troubles easily with Portable Appliance Tester you build. You use it to learn and do actual electric appliance repair jobs. For only \$2.50 with enrollment and \$5 per month, get training including Tester—a small price to pay for increased earnings. Mail coupon for Sample Lesson and Book—your first step toward more interesting work, bigger earnings. **NATIONAL RADIO INSTITUTE, Dept. ABB, Washington 16, D. C.**

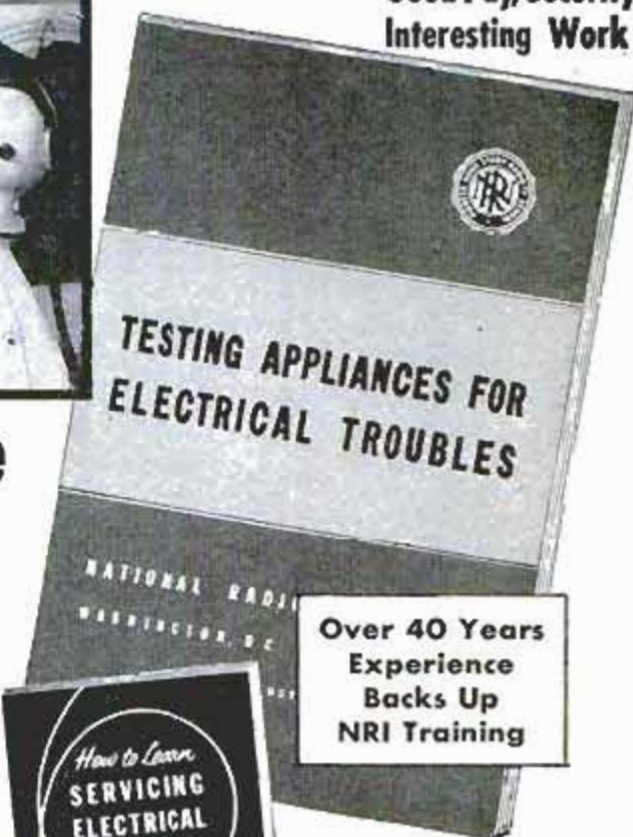

Over 40 Years
Experience
Backs Up
NRI Training



Find Out What
Appliance Repair
Offers You

Mail Coupon FOR LESSON AND BOOK FREE

National Radio Institute
Dept. ABB, Washington 16, D. C.

Please send me Electric Appliance Servicing Lesson and Book FREE. (I understand no salesman will call.)

Name _____ Age _____

Address _____

City _____ Zone _____ State _____

ACCREDITED MEMBER NATIONAL HOME STUDY COUNCIL



SMASH THRU SPACE BARRIERS!

POWERHOUSE German Telescope!

4.98

Free!

POWERHOUSE German Binoculars

Our Regular \$4.98 Seller!

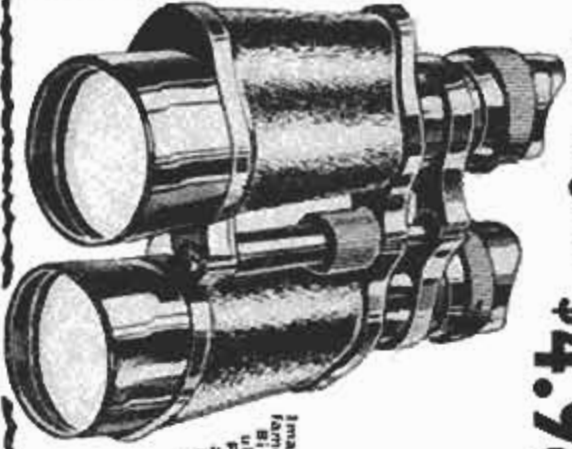

Keep FREE In Any Case!

Imagine! You get the famous Powerhouse 1.77 Binoculars—our regular \$4.98 seller—FREE through our 1958 Powerhouse Telescope. Keep binoculars FREE even if you ask for refund on Telescope. This offer limited to the first 10,000 orders. Only one FREE binocular to a family! Mail coupon now.

- SEE Craters on the Moon! SEE Mars!
- SEE Ships at Sea! SEE Zooming Jets!

NOW—for a limited time only—we are giving away FREE our famous \$4.98 Powerhouse 1.77 Binoculars with every trial order for our new 1958 Powerhouse German Telescope! Keep the binoculars FREE even if you return Telescope for full and prompt refund! But you must act fast. This sensational FREE GIFT offer will be withdrawn as soon as our stock of binoculars is depleted—and they are going fast! Rush coupon below today. SEND NO MONEY unless you wish to!

5 SYNCHRONIZED LENSES!

Most low cost telescopes use 2 lenses—but this new 1958 Powerhouse uses 5—yes FIVE genuine synchronized Rothbar lenses—all ground and polished with meticulous precision. They are not glued, but ANCHORED in sturdy STEEL RINGS! The draw tubes are heavy duty METAL. Here is a quality optical instrument—the crowning achievement of the renowned 102-year-old Rothbar plant in West Germany—famed for their precision camera, telescopes, binoculars, etc. Never before so many quality features in one moderately priced model! Interior Objective Lens coating with genuine magnesium fluoride! Strong metal draw tubes, beautifully plated! Contoured eyepiece! Quintuple synchronized lens system! Smooth, easy, fast focusing! Now 225 TIMES BIGGER AREA! What power! What range! What clarity!

MOST PUBLICIZED TELESCOPE!

You have seen this famous Powerhouse Telescope in his national magazines, Outdoor Life, Field & Stream, Equus, Sports Illustrated, Popular Science, Mechanics Illustrated, Popular Mechanics, Moose, VFW & ELKS Magazines to mention a few!

HOW DO WE DO IT?

The answer lies in highly skilled German craftsmen who work with pride and efficiency. They are backed with the most advanced scientific machinery which helps them produce 9 to 10 times more per worker. But that's only half the story. The magic of the American dollar abroad and our vast purchasing power (we import by BOATLOADS) enable us to bring you this unbelievable value—direct from importer to you! (Never, but never do you pay for needless distribution costs and high middlemen's profits. Direct sales mean direct savings FOR YOU!)

SEND NO MONEY NOW! Deposit \$4.98

plus postal fees with your postman when he delivers your package. Examine the telescope 10 full days and then return it for a full refund. This is the unbeatable beauty of the Milky Way; the unforgettable brilliance of the Big Dipper; the eerie, yet romantic grandeur of the moon's peaks and craters; the solemn majesty of Jupiter with its 4 tiny moons. Focus your Powerhouse on distant stars at sea, on natural wonders, on far-off villages. Whether it's 10 miles or 10,000 miles, you get sharper, better, closer-up views you never dreamed possible!

FREE BINOCULARS!

Seeing is believing! You must be excited about the new 1958 Powerhouse or your money back. But you keep the famous Powerhouse German Binoculars FREE. These are our regular \$4.98 seller. Thousands already sold here and in Canada. Use the binoculars for sports, hunting, racing, bird watching, get views up to TWENTY-FIVE MILES AWAY—day or night! Imported directly to you from Germany! Don't let this good thing slip! You must act fast! If you don't apply fast! Keep FREE in any case. You can't lose in a deal like this! MAIL COUPON NOW for prompt delivery! POWERHOUSE IMPORT DIVISION, DEPT. 6-B-40, 585 Water Street, New York 2, N. Y.

- New 1958 Model!
- Now . . . 225 Times BIGGER AREA!

FREE GIFT COUPON!

POWERHOUSE IMPORT DIV., Dept. 6-B-40
585 Water Street, New York 2, N. Y.

Rush new Powerhouse Telescopes at only \$4.98. Include Powerhouse German Binoculars FREE. Even if I return telescope after 10 days for refund. I keep binoculars FREE!

Send COD plus postal fees.

Check, cash, money order for \$4.98 enclosed. Send everything prepaid.

PRINT NAME _____

ADDRESS _____

CITY & STATE _____

ZONE _____

Check here for all-aluminum Tripod for any telescope. Folds for carrying; sets up fast anywhere. Only \$1. Money-back guarantee. (No. T)

Canadian: Address 439 King St., W., Toronto 2B

INVENTORS

Learn how to protect your invention. The U. S. Patent Laws provide that any new and useful art, machine, article of manufacture, or composition of matter, or any new and useful improvement thereof, may be patented if the act of invention is involved. Therefore, every inventor with a valuable invention should take advantage of the Patent Laws and proceed for patent protection in order to safeguard his rights.

A patent gives the inventor the exclusive right to prevent others from making, using, or selling the invention claimed in the patent for a period of seventeen years.

The Patent Laws were enacted for the benefit of the inventor to give him protection for the features of his invention which are patentable. These features must be properly and concisely set forth and claimed in a formal application for patent, in order to comply with the requirements of the Patent Laws. For that reason, unless the inventor is familiar with patent matters, he should engage a competent registered patent attorney or agent to represent him. We are registered to practice before the U. S. Patent Office and are prepared to serve you in the handling of your patent matters.

A specially prepared booklet entitled "Patent Guide for the Inventor", containing detailed information with respect to patent protection and procedure, together with a "Record of Invention" form will be promptly forwarded to you without obligation upon request.

CLARENCE A. O'BRIEN & HARVEY JACOBSON

Registered Patent Attorneys

81-B DISTRICT NATIONAL BUILDING

WASHINGTON 5, D. C.

Check the Kind of Body YOU Want!

RIGHT IN THE COUPON BELOW

... and I'll Show How EASILY You Can Have It!

Charles Atlas

Twice winner and holder of the title "The World's Most Perfectly Developed Man."



JUST tell me where you want it—and I'll add **SOLID INCHES** of powerful muscle **SO FAST** your friends will grow bug-eyed with wonder. I'LL SHOW HOW you can be a new man in just 15 minutes a day—in your own home—or it won't cost you a penny!

I myself used to be a 97-lb. weakling. Men called me "Skinny." Girls made fun of me. THEN I discovered my great new muscle-building system—"Dynamic Tension." It turned me into such a specimen of **MANHOOD** that today I hold the title "**THE WORLD'S MOST PERFECTLY DEVELOPED MAN.**"

"Dynamic Tension" is the easy, **NATURAL** method you can practice in your own room—**JUST 15 MINUTES A DAY**—while your chest and shoulder muscles begin to swell . . . those arms and legs of yours bulge . . . and your whole body starts to feel "alive," full of zip and go!

FREE My 32-Page Illustrated Book Just Mail the Coupon

Send **NOW** for my famous book showing how "Dynamic Tension" can make me a new man. 32 pages, packed with photographs, valuable advice, answers many vital questions. This book is a real prize for any fellow. Yet I'll send you a copy absolutely **FREE**. Just glancing through it may change your life. Rush coupon to me personally: **CHARLES ATLAS, Dept. 82, 115 East 23rd St., New York 10, N. Y.**



CHARLES ATLAS, Dept. 82, 115 East 23rd St., New York 10, N. Y.

Dear Charles Atlas: Here's the Kind of Body I want: (Check as many as you like)

- | | |
|--|--|
| <input type="checkbox"/> More Weight—Solid—in The Right Places | <input type="checkbox"/> Powerful Arms and Grip |
| <input type="checkbox"/> Broader Chest and Shoulders | <input type="checkbox"/> Slimmer Waist and Hips |
| | <input type="checkbox"/> Powerful Leg Muscles |
| | <input type="checkbox"/> Better Sleep, More Energy |

Send me absolutely **FREE** a copy of your famous book showing how "Dynamic Tension" can make me a new man. 32 pages, crammed with photographs, answers to vital health questions, and valuable advice. I understand this book is mine to keep and sending for it does not obligate me in any way.

NAME _____ (please print or write plainly)

ADDRESS _____

CITY _____ STATE _____

(Continued from page 10)
satisfactory because you cannot pick up the outgoing mail; in one of these you could.

Glenn C. Hitchcock,
Renfrow, Okla.

To the Editor:

I am enclosing herewith a photo which I think will be of particular interest to you. I recently constructed this boat following the plans which appeared on page 287 of the August 1938 issue of *Popular Mechanics* magazine. The one modification of the plans I made was to cover the hull with glass fiber instead of canvas. Although the



photo shows my four-year-old daughter, Sheila, in the boat, it is large enough for one man. I have found it an ideal craft for fishing on nearby mountain lakes.

E. R. McCafferty,
Star Route,
Naches, Wash.

Our thanks to Mr. McCafferty for the picture of Sheila aboard the Sheila. The plans for the boat, published almost 20 years ago, still look good!—Ed.

To the Editor:

May a woman driver reply to your recent article concerning cheaper-operating cars or is *Popular Mechanics* strictly a man's mag?

I'm referring to the article quoting the motor companies as saying the American public won't buy a cheaper car. I have three questions to ask them: 1. Who wants necessarily a cheaper-priced car? 2. If so, why are so many foreign cars seen on the road? 3. Is it possible the motor companies are sticking their heads in the sand or do they make a bigger profit from the foreign-made cars they all seem to sell?

If they would produce a beautiful car with better gas mileage but not necessarily a cheaper-priced car, it would sell. Ask any dealer for a cheaper-running car and he invariably shows you a car stripped of

(Continued to page 168)

Wanted: Men of Vision

Men 17-55

Prepare Now for a Profitable
Career in the Opportunity-
Packed Fields of

ELECTRONICS as used in GUIDED MISSILES ETC.



**NO ADVANCED EDUCATION OR PREVIOUS
TECHNICAL EXPERIENCE NEEDED!**

Men who are planning a solid future and are anxious for a brighter tomorrow will find real opportunities in the big, fast-growing field of Electronics. Imagine being able to prepare for the advantages offered in Electronics without having advanced education—or previous technical experience! And what's so important, you can get this preparation in your spare time at home without interfering with your present job . . . following the same basic method used in our Chicago and Toronto training laboratories. Send coupon for FREE booklet NOW!

An INDEX
To A Better Job,
A Brighter Future

- Industrial Electronics
- Automation Electronics
- Guided Missiles
- Micro-Waves Communications
- Radio Radar
- Computers
- Remote Control Systems
- Broadcasting
- Electronics Television
- Your Own Service Shop



Live-Wire Employment Service

Puts you in touch with job opportunities
— or helps you toward a better
position in the plant where
you are now employed.

"One of North America's Foremost Electronics Training Centers"



Accredited Member
of National Home
Study Council

Draft Age?

We have valuable information for every man of draft age, so if you are subject to military service, be sure to check the coupon.

DEVRY TECHNICAL INSTITUTE CHICAGO 41, ILLINOIS FORMERLY DEFOREST'S TRAINING, INC.

MAIL TODAY FOR FREE FACTS

DeVry Technical Institute
4141 Belmont Ave., Chicago 41, Ill., Dept. PM-2-0
Please give me your FREE booklet, "Electronics and YOU," and tell me how I may prepare to enter one or more branches of Electronics as listed above.

Name _____ Age _____
Street _____ Please Print Apt. _____
City _____ Zone _____ State _____

Check here if subject to Military Training.
DeVry Tech's Canadian Training Center is located at
2023 626 Roselawn Avenue, Toronto 12, Ontario



FREE BOOKLET

We'll give you a free copy of an interesting booklet, "Electronics and YOU." See for yourself how you may take advantage of the opportunities in this fast-growing field.



Olds on the R. F. D. Route

One of America's "most significant cars," shown on page 146, was the 1901 Oldsmobile, and its adoption on the rural routes of the post-office department is credited to the founder of *Popular Mechanics*, H. H. Windsor, Sr., who was also publisher of *R. F. D. News*.

E. L. Warner, Jr., present Oldsmobile Publicity Director, reported this to us when he learned of the inclusion of the 1901 model in our color feature this month.

"I believe," wrote Mr. Warner, "that *Popular Mechanics* can take some credit for helping initiate the use of automobiles for mail delivery. . . . Following is an excerpt from an early history of Oldsmobile:

"Even on this dot-and-go schedule, extraordinary strength and durability marked the Oldsmobile curved-dash runabout. We have seen that in 1901 Oldsmobile was the first light car to make the rough passage from Detroit to New York. In that year Milford M. Weigle and F. F. Faurote introduced into the United States postal service a wire-wheeled Oldsmobile runabout which is said to be the first gasoline car used in any postal service in the world. It carried mail on contract under tests so successfully that a fleet of Oldsmobiles was soon being used for that purpose. Credit for initiating this idea of the automobile in postal delivery, belongs to H. H. Windsor, editor of *Popular Mechanics* and the *R. F. D. News*, who invited F. L. Faurote, then advertising manager of the Oldsmobile works, to address the annual convention of rural letter carriers at Indianapolis in 1906."

NEWEST
ALUMA
Craft
CATALOG
NOW READY



● Send for this complete presentation of the newest in boats, runabouts and canoes. Shows 26 models, including 2 new Aluma Glass runabouts, in full color exactly as you would see them at the big boat shows. See new styles, new ideas, new sizes with a range of prices to fit every pocketbook. Now ready. Write for your free copy.

Our design and construction have set many new boating industry standards for style, performance, safety and strength. Aluma Craft require practically no upkeep. Write for catalog.

ALUMA CRAFT BOAT COMPANY • 1519 Central Ave. N.E., Minneapolis 13, Minn.

Making as High as \$1,000 A Month

A message to all men who are looking for a way to make more money faster, with one of America's greatest inventions wanted by millions

Folks Are Amazed when you Tell Them This New Kind of Protection Costs Only

\$4.95



Here's Your Opportunity to Get into the BIG MONEY CLASS FASTER with Sensational PRESTO FIRE EXTINGUISHER. Over 3,000,000 sold for Homes, Offices, Autos, Service Stations, Stores, Farms, Boats

Wouldn't you like to be making as much as \$1,000 in a month? Of course not everybody makes such profits starting out, but look at these profit reports: A Florida salesman earned \$600 in 1 month. An Ohio man earned \$2100 in 2 months. A New

York salesman earned \$1500 in one month. A New Hampshire man added the Presto as a sideline and picked up an extra \$1800 in 20 months. Men everywhere, even in off hours, are rolling up amazing profits. How about you?

WHAT'S THE SECRET?

PRESTO contains an amazing new chemical—"Chlorobromomethane" or "C.B." The Germans developed "C.B." as a secret defense against fire during the war. After the war, a famous American firm, The Dow Chemical Company, acquired the formula from the U. S. Government and began manufacturing it here. Then we (Merlite Industries) designed a handy, yet amazingly effective, fire extinguisher to contain and release this new wonder-chemical. In comparing the effectiveness of "C.B." in fighting fires, The Dow Chemical Company's report states, "It has been proved that 'C.B.' is about 1.5 to 6 times as effective as other common extinguishing agents on an equal weight basis." This means that Presto can be made light and handy so even a woman or child can use. No pumping, no heavy tank. Just twist the knob, and flames disappear!

WHY LARGE PROFITS ARE EASY

Everyone is terrified by FIRE! Every year fires kill more than 11,000 persons, destroys over SEVEN BILLION DOLLARS of property. Millions of people have been waiting for this sure, simple, inexpensive safeguard. Most people who see the dramatic, five-second demonstration want one or more. At the low price of \$4.95. You make as much as \$2.70 on every one. Get started in this rich new field now. Don't put it off. Every day you hesitate may cost you \$10, \$15, or even \$50 you could otherwise be making. Get the facts FREE. Simply mail postcard in this ad—no stamp needed. But do it now!

Only Presto Has ALL These Features

- Ends Fire as Fast as 2 Seconds
- Chemical Contents 1.5 to 6 times More Effective than Others
- Weights Less Than 1 lb.
- Easily Held in One Hand—Even by a Child
- Needs No Inspection or Re-Charging—Does Not Corrode or Deteriorate
- Costs Only \$4.95—Yet Outperforms Bulky Extinguishers Costing Several Times as Much
- Automatic Pressure—No Pumping
- Guaranteed for 20 Years—Certificate is Packed With Every Presto

Big Money Like This Even in Spare Time

Charles Kama Reports \$1,000 in One Month
"I think I've succeeded pretty well. I'm making more than \$1,000 a month, and I haven't touched bottom yet."
Charles Kama, Texas

William F. Wydallis Reports \$15.20 an Hour
"For every hour I devoted to the Presto, I find I have earned an average of \$15.20 an hour."
William F. Wydallis, Ohio

Walter Gable Reports \$75 to \$80 a Week
"My selling time has averaged less than a day or two a week. These part time sales have brought me as much as \$75 to \$80 a week."
Walter Gable, Md.

FREE Full Details of this Truly Amazing Money-Making Opportunity
JUST MAIL CARD BELOW

IMPORTANT! Be sure to print your name and address in space on card below. Then simply cut out this card along dotted lines and drop in the mail box. No stamp necessary. We'll rush all facts to you at once, free and without obligation.

PRINT YOUR NAME AND ADDRESS HERE

BE SURE TO PRINT YOUR NAME AND ADDRESS ON SPACES BELOW

NAME _____
ADDRESS _____
CITY _____ STATE _____

BUSINESS REPLY CARD
NO POSTAGE STAMP NECESSARY IF MAILED IN THE UNITED STATES

3c — POSTAGE WILL BE PAID BY —

MERLITE INDUSTRIES, INC.

114 EAST 32ND STREET

NEW YORK 16, N. Y.

Dept. X-15F

FIRST CLASS PERMIT NO. 52914 NEW YORK, N. Y.

MERLITE INDUSTRIES, INC. DEPT. X-15F

(Continued from page 14)

all good looks. Why? Does a bit of chrome and better interior raise the gas consumption automatically?

Each year the emphasis seems to be on more speed, and why, I don't know. Each safety-check report says speed is one primary cause of accidents, speed laws are being lowered, not raised, and our roads are not improving to take this speed. Yet it continues to increase.

Most of us women drivers aren't too wild for more speed. Safety for our families causes us more concern. This has been ignored.

Gasoline prices here in California are going up rapidly. How long can we afford to drive a gas hog?

It seems to me a challenge worthy of any auto company to make a car that doesn't cost a fortune to run but that we can still be proud to own. It can be done and I'm waiting to purchase one. Aren't you?

Yours for cheaper gasoline bills,
Mrs. Howard Underwood,
San Joaquin, Calif.

Radial Engine for Air or Water

From Ray Stits of Stits Aircraft, Riverside, Calif., comes news of a lightweight, two-stroke radial engine being developed

by W. C. Johnson, engineer, of 6631 Elgin St., Los Angeles, Calif. Intended for small aircraft, helicopters or boats, the three-

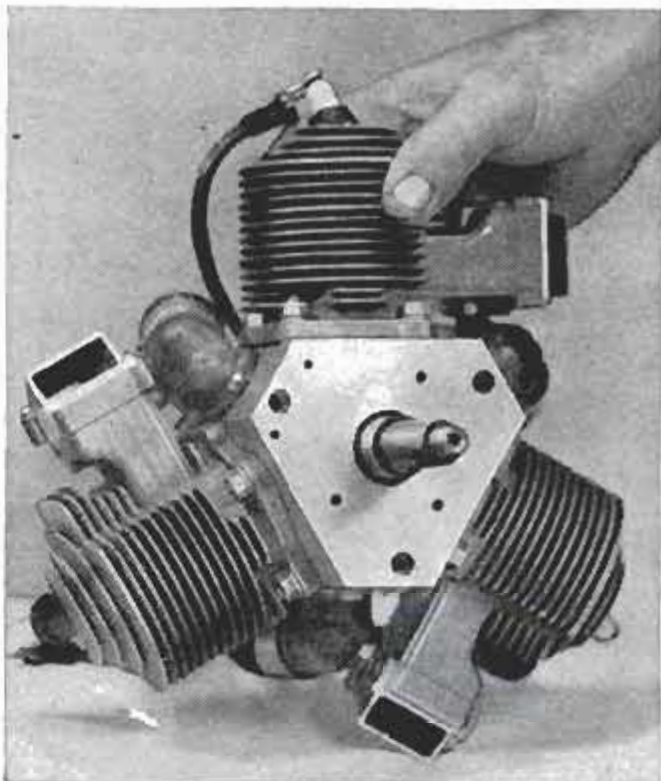

cylinder prototype shown here weighs 14 pounds, develops 13 horsepower with 15-cubic-inch displacement. A self-contained

(Continued to page 16D)

ENJOY

your boating . . . starting now!



Free!

1958 Starcraft Catalog

Now's the time to pick out your Starcraft Boat. Twenty-four pages in color showing sixteen new aluminum and fiberglass models. Get your copy now. Write:

STARCRAFT BOATS

Department Q-2, Goshen, Indiana

TELEPHONES

and ALL SUPPLIES

Room to room, house to garage, private telephone service. **HANDSET CRADLE TELEPHONES (2)** Complete outfit with 100' wire, 2 dry cells, instructions. **\$14.95**

WORM HARVESTER—Dan Mac Magneto—gathers fish-worms by electricity. Complete with instructions. **\$6.50**

FREE illustrated bulletin "AA-112"

TELEPHONE REPAIR & SUPPLY CO.
Dept. AA-112 • 1760 Lunt Ave., Chicago 26, Ill.



SHORTHAND

IN 6 WEEKS

Write 120 words per minute
Age no obstacle—LOWEST COST

Famous **SPEEDWRITING** shorthand. No symbols; no machines; uses ABC's. Easiest to learn and use. Fast preparation for a better position. Nationally used in leading offices and Civil Service. 120 words per minute—50% **FASTER** than Civil Service requirements. Over 350,000 taught by mail or through classroom instruction. The very low cost will surprise you. Typing available. 35th Year. Schools in over 400 cities in U.S., Canada, Cuba, and Hawaii.

Write for Free Booklet To: School of

Speedwriting
Dept. 1502-B, 55 W. 42 St., N.Y. 36

DID YOU SEE
READER'S DIGEST
ARTICLE ON

Learn Radio

Service by Post

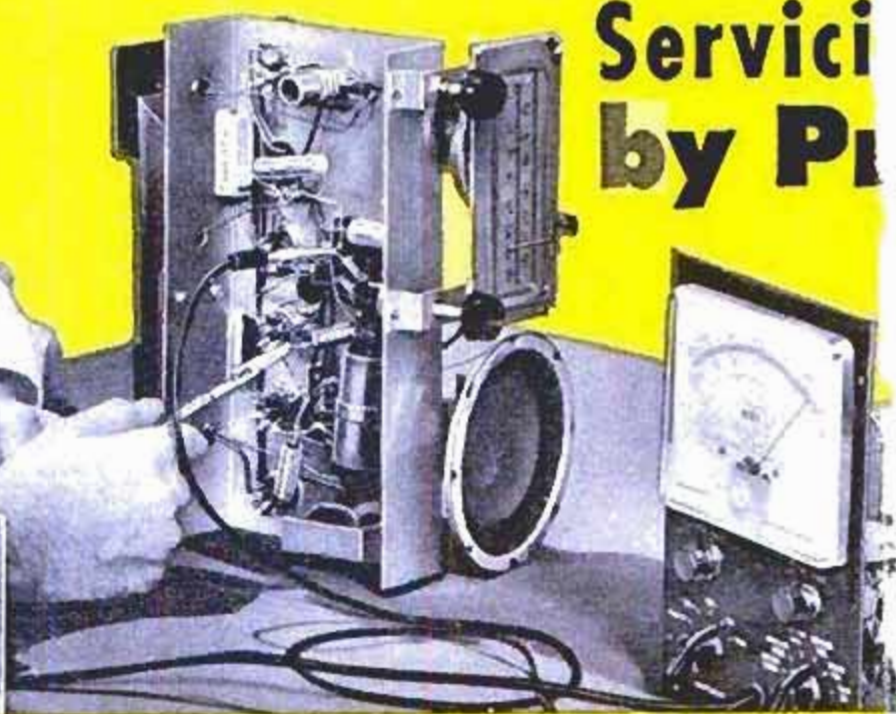

Fast Growing Field Offers Good Pay, Success, Bright Future

**Jobs Like These Go to the
Radio-Television Technician**



J. E. SMITH
Founder

Bigger than ever and still growing. That's why Radio has special appeal to men not satisfied with their earnings. More than 4,000 Radio and TV stations on the air. More than 150 million home and auto Radios. 40 million TV sets. **Training PLUS OPPORTUNITY** is the ideal combination for success. Plan now to get into Radio-TV. National Radio can train you at home in your spare time. N.R.I., the oldest and largest home study Radio-TV school.

Easy to understand, well-illustrated lessons teach basic principles. And you **LEARN-BY-DOING**, by practicing with kits of equipment N.R.I. sends.



Start Soon to Make \$10—\$15 a Week in Spare Time

Soon after enrolling many N.R.I. students start to earn \$10, \$15 a week extra fixing sets in spare time. You get the benefit of National Radio's more than 40 years' experience training men. Make a move toward becoming one of that select group—a Radio-TV Technician. Send Postage-Free card today for actual Lesson and 64-page manual, **BOTH FREE**. NATIONAL RADIO INSTITUTE, Dept. 8BA, Washington 16, D. C.

NRI Trained these Men



"I knew practically nothing about Electronics. After 15 lessons I started repairing sets. My future looks bright."
—D. B. ACKERMAN, Minneapolis, Minn.

"Thanks to NRI, I operated a successful Radio Repair shop. Then got a job with WPAQ; now I am an engineer for WHPE."—V. W. WORKMAN, High Point, N. C.



"Have good job in TV repair shop plus a small business in my home. In one year I went from lowest paid to head technician."
V. BARR, Toronto, Ohio.

You Practice Communication with Equipment NRI Sends

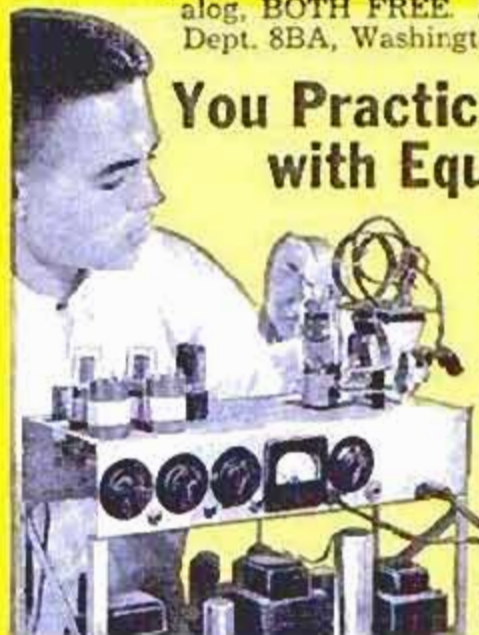

Nothing takes the place of practical experience. As part of NRI's Communications Course you build a Broadcasting Transmitter; train for FCC License.

You Practice Servicing with Equipment Sent

As part of NRI's Servicing Course you build AC-DC Superheterodyne Receiver, Vacuum Tube Voltmeter, many other pieces of equipment for practical experience.

MAIL POSTAGE FREE CARD ➔

94.6% OF BAILEY GRADUATES ARE EMPLOYED AT TOP PAY IN THE FIELDS WHICH THEY WERE TRAINED!



DIESEL-AUTO MECHANICS DESPERATELY NEEDED!

We have a far greater demand for our students than we can fill!

We can show you an actual waiting list of leading companies throughout the world who have tried Bailey graduates — found them outstanding, and are coming back for more!

Bailey Graduates are Successful . . . RECEIVE BIG PAY — HAVE SECURE FUTURE!

The Famous Bailey Course prepares you for BOTH Diesel and Gasoline Mechanics.

This is a **must**-due to the advent of using Diesel principles, such as 'Fuel Injection' on passenger cars . . . use of gasoline engines for starting Diesel engines, etc. You learn all this at Bailey in the amount of time ordinarily required to learn just one of these subjects, **ALL FOR THE PRICE OF ONE.**

Don't be satisfied with a 'futureless', one-type job — learn how you can make **big money** now! Write today for Free Booklet that takes you on a step-by-step camera tour through our spacious, modern shops — See Bailey students in action as they Learn-by-doing with the Famous Bailey Method of training!

We provide you with housing and part time jobs while in school, plus nation-wide placement service for graduates.

BAILEY Technical SCHOOLS

1634 S. GRAND ST. LOUIS 4, MO.

MAIL TODAY!

Please mail immediately this free booklet without obligation.

FREE BOOKLET



Name _____

Address _____

City _____ State _____

APPROVED FOR VETERAN . . . NON-VETERAN

blower system eliminates crankcase compression problems, he reports, assures easy starting and smooth operation. A production model now undergoing tests weighs 24 pounds and develops 28 horsepower with 21-cubic-inch displacement.

To the Editor:

A familiar sight in South Hampshire in England is this well-preserved 1911 Model-T Ford belonging to local garage owner, George Hammond. It is probably one of the best-maintained Fords of its age in the



country and is in constant daily use, not just kept for gala occasions! It is typical of George Hammond and his veteran car that during a recent summer he answered a call for towing from a stranded motorist with it. Despite the look of absolute astonishment on the waiting motorist's face, the ancient Ford towed him in quite safely and efficiently! George Hammond is seen here at the wheel outside the Kings Head Hotel, Wickham, Hants. Without a doubt, every British motorist wishes that the prices shown on that board were applicable to present-day motoring.

J. Gray,
4, The Pightle,
Maids Moreton,
Buckingham, Bucks.,
England.

To the Editor:

The *Popular Mechanics* "History of Speed" paintings (Feb. 1957) were shipped back to you yesterday. We certainly appreciate the privilege of displaying these originals in our museum during the last six months. They have been viewed by more than 5000 visitors each week during that time and we are planning to have the set of smaller replicas framed attractively as a part of our permanent museum display. Thanks for your cooperation.

Al Bloemker,
Indianapolis Motor Speedway Corp.,
Indianapolis, Ind.

INVENTORS

If you believe that you have an invention, you should find out how to protect it. The first step is to have a search made of the prior pertinent U. S. patents. If a report on this search indicates that the invention appears patentable you can apply for a patent, and the specifications and claims should be prepared.

The firm of McMorrow, Berman & Davidson, with offices in Washington, D. C., is qualified to take the necessary steps for you. We can make a preliminary search on your invention, advise you whether we think it can be patented, and prepare your application for patent.

Unless you are fully familiar with the U. S. Patent Laws, we recommend that you engage the services of a Registered Patent Attorney to protect your interests. The patent laws are *your* laws. A patent gives you the right to prevent others from making, using or selling the invention claimed in your patent for a period of 17 years.

Use these patent laws for your protection. Investigate whether your invention can be patented. If you have what you believe to be an invention, we suggest that you have this firm make a search for you.

Send for a copy of our Patent Booklet entitled "How To Protect Your Invention," containing information about patent protection and patent procedure. Along with this we will also send you an "Invention Record" form, for your use in writing down and sketching details of your invention. We will mail them promptly. No obligation. They are yours for the asking.

McMORROW, BERMAN & DAVIDSON

Registered Patent Attorneys

PATENTS • COPYRIGHTS • PATENTS

135-S VICTOR BUILDING, WASHINGTON 1, D. C.

**You can start a
\$40⁰⁰ A DAY BUSINESS
in Your Spare Time!**



**MAKE BIG CASH PROFITS IN YOUR OWN HOME
SHARPENING HOUSEHOLD, GARDEN AND SHOP TOOLS**

Now you can turn your spare time into Big Cash Profits with new BELSAW SHARP-ALL. Sharpen knives, scissors, shears, snips, ice skates, mower blades, hedge trimmers, grass whips, axes, chisels, screw drivers, scrapers and saws . . . just about any household, garden and shop tool. Your own CASH business in 15 square feet of your basement or garage . . . all your prospects in your own neighborhood. No calls to make. No experience needed. No inventory. SHARP-ALL quickly pays for itself.



**FREE BOOK tells how to start
you own cash business.**

Learn how easily you can start your own spare time business. Amazing low cost, easy-payment plan. Send coupon today for FREE BOOK.

BELSAW SHARP-ALL CO

718 Field Building • Kansas City 11, Mo.

Send me your FREE BOOK.

Name _____

Address _____
City and _____
State _____

SAVE 75%

ON



WORK CLOTHES!

Terrific values you've got to see to believe!

SHIRTS.....4 for \$2.99.....79c

The used, they're sterilized and ready for tough wear. Blue, green or tan. Send neck size.

PANTS to match. Were \$3.95, now only . . . 99c

Send waist measure and inside leg length. 4 for \$3.75

COVERALLS \$2.29 SHOPCOATS \$1.79

3 for \$6.75 3 for \$5.00

Wear 'em used, save plenty! Send chest measurement.

MONEY BACK GUARANTEE . . . if not satisfied! Order

TODAY! Send \$1.00 deposit on C.O.D. orders. Add 25c for postage on prepaid orders.

GALCO SALES CO. Dept. 132

7120 HARVARD AVE. CLEVELAND 5, OHIO



**WORLD'S LOWEST PRICED
ADDING MACHINE**

Vest Pocket Size
FREE TRIAL

\$2⁹⁵

COUNTS UP TO 999,999,999
IDEAL FOR BUSINESS AND PERSONAL USE—GUARANTEED ACCURATE. Not a toy. Operates with only a finger flick. Adds, subtracts, multiplies, divides. Counts up to one billion. Pays for itself over and over. Ideal Gift—for Business, Income Tax and School use. **MONEY BACK GUARANTEE.** Send name and address. Pay postman only \$2.95 plus postage. Beautiful rich-looking Leatherette Case included at no extra cost. Money back in 10 days if not delighted. AGENTS WANTED.

CALCULATOR MACHINE COMPANY
P.O. Box 126, Dept. F-81, Huntingdon Valley, Penna.



SHEET METAL MACHINES

Brakes form angles, locks, pans, etc. Quick eccentric clamp. All steel construction.

- 15"–18 gauge steel.....\$28.00
- 36"–22 gauge steel.....\$37.00
- 48"–24 gauge steel.....\$52.00
- Floor stand.....\$ 8.00
- 15"–24 gauge Folder.....\$17.50
- 36" Pan and Box brake.....\$60.00
- 1/4 x 3 Adjustable Iron Bender.....\$14.00
- 16 gauge 7" Bench Shear 3 adj. gauge \$16.50
- 8 ft. Brake, 28 gauge.....\$135.00

ORDER DIRECT OR SEND FOR FREE CATALOG

YKYE MFG. CO., P-4158 Jason St., Denver 11, Colo.

SCIENTIFIC CRIME DETECTION



IT'S EASY TO LEARN

Let us teach you in your own home. Learn Finger Printing, Firearms Identification, Police Photography, Criminal Investigation Methods thoroughly, quickly, at small cost. Over 800 Bureaus of Identification in the U. S. employ I. A. S. students or graduates. Write today, stating age.

INSTITUTE OF APPLIED SCIENCE, 1920 Sunnyside Ave., Dept. 1352
(A Correspondence School Since 1916) Chicago 40, Ill.

**Gypsy Bait Oil
MAKES FISH BITE OR NO COST**

Mysterious aroma of Gypsy Fish Bait Oil Compound makes smell feeding fish wild through thousands of smell organs covering their bodies. One potent drop on artificial or live bait draws in fresh or salt water whether you still fish with pole, cast, spin or troll. Really works. Only \$1.98 (3 for \$4.98). Cash orders postpaid. If C.O.D. postage extra. Draws fish to your bait or money back. FREE. Handy large water resistant pouch with every bottle. Order from:



WALLING KEITH CHEMICALS, Inc.
Dept. 49-B Birmingham 1, Alabama

Train yourself to be a top-pay mechanic in Air Conditioning and Refrigeration by practicing at home with real equipment!

R. C. ANDERSON
President
COMMERCIAL TRADES
INSTITUTE



Job experts agree that opportunities for success are best in old, established industries *which continue to grow*. This is very true of the Air Conditioning and Refrigeration field. It is expanding so rapidly that thousands of good jobs are created each year. Yet, there's practically no competition for many of these well-paid openings because *not enough trained men are available!*

It's easy to get that vital training. You need not give up your present work nor leave your family. You can learn at home in spare time by practicing with real equipment. Yes, CTI sends you 23 big training kits, along with valuable "here's how" instruction. For full information, just fill out and mail coupon below.

Why thousands of mechanics are needed

Over 150 million refrigerating units are in use today— are in need of repair and service. And the industry keeps booming! Each year, 3 million refrigerators, 1 million freezers and 2 million air conditioners are produced. You see these units in homes, stores, offices, restaurants, hotels—the applications are endless. Even autos now come with built-in air conditioners. *No wonder trained refrigeration mechanics are in demand—*are so well-paid!

CTI offers a quick, easy way to learn

You learn *fast*—you learn *right*—because you get all parts and tools to build a complete, heavy-duty, commercial-type, 1/4 h.p. condensing unit (shown at left). You do 10 service and troubleshooting jobs. You keep this equipment.

You get experience by training with kits

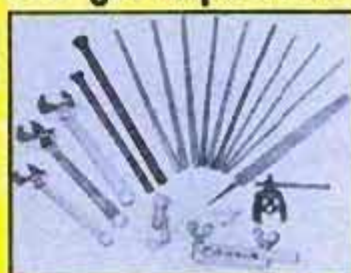

Above left is photo of tools in just *one* kit. You get other tools, tubing, much equipment. In another kit (right), you get motor, fan, pulley, service tools. Kits are sent on planned schedule so that you learn in easy stages. Kits develop skill, speed training. *No extra cost for kits!*

You may earn extra cash as you train

CTI training is so practical that many students do repairing in spare time. They work with local dealers or "on their own." They earn extra cash, get added experience. Some land full-time jobs while students, others open shops.

Mail coupon for two FREE booklets

The story on job and business opportunities in the vast Air Conditioning and Refrigeration industry is fascinating. It's told in an interesting booklet which you can have free. We'll send it, along with training information, if you mail coupon. *Act today!*



BE YOUR OWN BOSS

The Air Conditioning and Refrigeration industry is one of the easiest in which to start a repair and sales business. You mail coupon—we'll send facts.

Get all the facts first—Then decide

COMMERCIAL TRADES INSTITUTE

1400 GREENLEAF AVENUE
CHICAGO 26, ILLINOIS

DEPT. R-452

Tell me how I can qualify for a better job or a business of my own. Send booklet, *Success in Air Conditioning & Refrigeration*, and Lesson Sample. Both FREE

Name _____ Age _____

Address _____

City _____ Zone _____ State _____



DRAFTSMEN



CASH BIG PAY CHECKS!

Train Now for more success, greater security

LEARN AT HOME IN SPARE TIME (or at college in Chicago)

Check the want ads in any newspaper—SEE the big-pay opportunities open to you as a draftsman. What's more, you can learn this well-paid, prestige profession at home—quickly, easily! No special talent needed. Get complete, step-by-step Chicago Tech lessons in the mail, spend a few pleasant hours studying each week. In a short time you'll be a well-trained draftsman, ready to take your pick of many good jobs. Act now!



Free Information—Mail Coupon Today!

Get FREE TRIAL LESSON plus information about C.T.C. practical training. Learn what successful Chicago Tech graduates say about high pay and opportunities in drafting. No charge, or obligation.

CHICAGO TECHNICAL COLLEGE

B-216 Tech Bldg., 2000 So. Michigan Ave. Chicago 16, Illinois

Mail me FREE lesson with facts about big opportunities in DRAFTING.

Name _____ Age _____

Address _____

City _____ Zone _____ State _____

Earn \$217 a Month EXTRA With My FREE SHOE OUTFIT!

Just 2 Sales a Day Does It!

Rush a postcard today for my powerful FREE Shoe Selling Outfit. It contains everything you need to start a steady profit, repeat-order shoe business! Just 2 sales a day earns you up to \$217 a month EXTRA! It's amazingly easy! Just show friends, relatives Mason's famous shoes with comfortable Air-Cushion innersoles. People like buying the Mason way because they choose from over 160 dress, sport, work styles for men and women—including Nylon mesh, Cush-N-Crepe and Safety Toe work shoe styles. Because you draw from stock of 200,000 pairs, in an amazing range of sizes and widths, customers get the exact size, width and style they order! Our shoes are not sold in stores... people must buy from YOU! Start making BIG MONEY now... send for your FREE Special Outfit TODAY!



Write TODAY!

MASON SHOE MFG. CO. DEPT. A-136 CHIPPEWA FALLS, WIS.

NEW WONDER AUTO GLAZE with Miracle DOW CORNING 200 Fluids



FREE SAMPLE

Gives You \$1.35 Clear Profit... and More on Each \$2.00 Sale!

GUARANTEED to outshine, outlast and outperform ANY wax polish on the market today — or money back! FAST, REPEAT SELLER! Needed by 45,000,000 car owners. Demonstrates like magic. Just apply, wipe off. No hard rubbing. Keeps car and chrome like new for months!

RUSH NAME for FREE money-making sales plans and FREE sample. Exclusive franchises available.

WANT A DEMONSTRATOR? Send only \$1.50 for pint can (retail \$2.00) or get 2 pints for \$2.00 (retail \$4.00).

ROYALTONE CORP., Dept. P-2 1035 E. 10th St., Brooklyn 30, N. Y.

LAW FREE BOOK THE LAW TRAINED MAN

Write today for a FREE copy of illustrated law book, "THE LAW-TRAINED MAN," which shows how to earn the professional Bachelor of Laws (LL.B.) degree through home study of the famous Blackstone Law Course. All necessary books and lessons provided. Moderate cost; convenient monthly terms. Write for FREE law training book today.

Blackstone School of Law, 307 N. Michigan Ave.

Founded 1890

Dept. 52, Chicago 1, Illinois

REAL ESTATE BE A BROKER

PAYS BIG! SEND FOR FREE, BIG, ILLUSTRATED CATALOG NOW! Graduates report making substantial incomes. Start and run your own business quickly. Men, women of all ages, learn easily. Course covers Sales, Property Management, Appraising, Loans, Mortgages, and related subjects. STUDY AT HOME or in classrooms in leading cities. Diploma awarded. Write TODAY for free book! No obligation.

Approved for World War II and Korean Veterans
WEAVER SCHOOL OF REAL ESTATE (Est. 1936)
2020R Grand Avenue Kansas City, Mo.



make your own Gems 36.50

The Gem Maker comes complete with all necessary equipment, including a super-charged diamond blade for sawing, and all the wheels for grinding, shaping and polishing; also complete instructions. The complete equipment as shown, less motor and belt for only \$36.50, f.o.b., Burlington, Wisconsin. Write today for information and literature.

B&I MANUFACTURING CO. Dept. P. Burlington, Wis.

FIX OUTBOARD MOTORS POWERMOWERS, AND ALL SMALL 2 & 4-CYCLE GASOLINE ENGINES

Repair your own equipment or MAKE EXTRA MONEY in this growing field. Fully illustrated, easy-to-understand, Home Study Course. Write for FREE information.

LINCOLN TECHNICAL INSTITUTE SUITE 2-E, 472 MARKET STREET, NEWARK 5, N. J.

RUPTURED

BE FREE FROM TRUSS SLAVERY

Now there is a new modern Non-Surgical treatment designed to permanently correct rupture. These Non-Surgical treatments are so certain, that a Lifetime Certificate of Assurance is given.

Write today for our New FREE Book that gives facts that may save you painful and expensive surgery, and tells how non-surgically you may again work, live, play and love and enjoy life in the manner you desire. There is no obligation. Excelsior Hernia Clinic, Dept. 8305, Excelsior Spgs., Mo.

Get into

TELEVISION

RADIO-ELECTRONICS



LEARN ALL 8 PHASES BY SHOP METHOD

1. Television ... including Color TV
2. Radio ... AM, FM
3. Industrial Electronics
4. Communications

OF THE INDUSTRY HOME TRAINING

5. Sound Recording & Hi-Fidelity
6. Automation
7. FCC License Preparation
8. Radar & Micro Waves

Let National Schools of Los Angeles, a Practical Resident Technical School for over 50 years, train you at home by Shop-Method for unlimited opportunities in All phases of TV, Electronics, Radio.

You get 19 big kits of equipment!

GOOD JOBS ... MORE MONEY SECURITY ... ALL CAN BE YOURS

YOU are needed in the great modern Television-Electronics industry. Trained technicians are in growing demand, at excellent pay, in sales and service, manufacturing, broadcasting, telecasting, communications, research, and many other important branches of the field. National Schools Master Shop-Method Training, with newly added lessons and equipment prepares you in your spare time right in your own home for these fascinating opportunities. **OUR OUTSTANDING METHOD IS PROVED BY THE SUCCESS OF GRADUATES ALL OVER THE WORLD!**

YOUR TRAINING IS ALL INCLUSIVE

We prepare you for a long list of job opportunities. Thousands of TV and Radio receivers are being sold every day—more than ever before. And, now, Color TV is here. Applications of Electronics in industry—AUTOMATION—are growing in tremendous strides. The whole field is alive—opening up new, important jobs rapidly. National Schools complete training program qualifies you in all phases of the industry.

YOU EARN WHILE YOU LEARN

Many students pay for their entire training—and more—with spare time earning. We'll show you how you can, too! Early in your course you receive material that shows you how to earn extra money servicing TV and Radio receivers, appliances, etc., for friends and acquaintances.

YOU GET EVERYTHING YOU NEED

Clear, profusely illustrated lessons, shop-tested manuals, modern circuit diagrams, practical job projects—all the valuable equipment shown above—many other materials and services—consultation privilege with our qualified staff, and Graduate Employment Service. **EVERYTHING YOU NEED** for outstanding success in Electronics.

INDUSTRY NEEDS YOU. NATIONAL SCHOOLS WILL TRAIN YOU. SEND FOR FACTS TODAY NO OBLIGATION.

YOU LEARN BY SHOP METHOD ... you do servicing, circuit analysis, and do over 100 down-to-earth experiments. You build a Superbet Receiver and a modern TV Receiver, from the ground up, including a new, big screen picture tube. You also receive a professional, factory-made **MULTI-TESTER**. All of this standard equipment is yours to keep ... at just one low tuition.

RESIDENT TRAINING AT LOS ANGELES

If you wish to take your training in our Resident School at Los Angeles, the world's TV capital, start NOW in our big, modern Shops, Labs and Radio-TV Studios. Here you work with latest Electronic equipment—professionally installed—finest, most complete facilities offered by any school. Expert, friendly instructors. Personal attention. Graduate Employment Service. Help in finding home near school ... and part time job while you learn. Check box in coupon for full information.

Approved for GI Training  **NATIONAL SCHOOLS**
LOS ANGELES 37, CALIF

FREE!
VALUABLE BOOK & SAMPLE LESSON
—Just Send Coupon!



NATIONAL SCHOOLS
TECHNICAL TRADE TRAINING SINCE 1905
LOS ANGELES 37, CALIFORNIA

GET FAST SERVICE—MAIL NOW TO
NATIONAL SCHOOLS, DEPT. RB-28
4000 S. Figueroa St., Los Angeles 37, Calif.

Rush free TV-Radio "Opportunity" Book and sample lesson. No salesman will call.

NAME _____ AGE _____
ADDRESS _____
CITY _____ ZONE _____ STATE _____

Check if interested ONLY in Resident School training at Los Angeles.
VETERANS, Give date of Discharge _____

\$1 BRINGS YOU \$18

Discover Flok-Kraft and Earn \$\$\$\$\$ AT HOME

Earn up to \$15.00 per hour spare time. Amazing new Velvet-fiber spray instantly makes any object (Lamps, Radio & TV Cabinets, Figurines, Signs, Auto dash boards, Toys, furniture, draperies—anything) worth expensive \$\$\$\$ Prices... like magic, you can spray anything with this beautiful new suede-like finish that feels like rich Velvet.

EARN UP TO \$300.00 PER WEEK SPARE TIME

Imagine, materials cost only 3c per square foot. (Average TV or radio cabinet can be beautifully sprayed with this startling new 3-dimensional Velvet finish in 15 minutes at a cost of only 34c in materials. Your charge for this job is at least \$10.00.)

REPRESENTATIVES IN YOUR AREA URGENTLY NEEDED

Own your own business. Work at home in your spare time. Help fill the huge growing demand for this amazing new beautiful Velvet-fiber finish. Orders come from stores, offices, homes, architects, auto dealers, everywhere. Possible \$20,000,000.00 worth of jobs to be done. Investigate today—be first in your area! Actual samples in 16 Radiant Colors. Booklet of 50 Home Business Opportunities and Confidential Details all sent free! Write: Coast Industries, Los Angeles 61, Calif., Dept. B-2.

NEW 12 FT. \$99⁵⁰
RUNABOUT ^{frt.} inc.



Mass production economy makes for lowest price anywhere! Rugged oak frame and marine plywood construction.

FREE 1958 CATALOG

TAFT MARINE WOODCRAFT

Dept. PM258, 636-39th Ave. N.E., Minneapolis, Minn.

SEPTIC TANK TROUBLE?

NORTHEL Reactivator keeps septic tank and cesspool clean. Bacterial concentrate breaks up solids and grease—prevents overflow, back-up, odors. Regular use saves costly pumping or digging. Simply mix dry powder in water, flush down toilet. Non-poisonous, non-caustic. Guaranteed to reactivate septic tank, cesspool. Six months supply (28 ozs.) only \$2.95 postpaid.

NORTHEL DISTRIBUTORS, PM-2

P. O. Box 1103

Minneapolis 1, Minnesota

FREE AMAZING NEW BOOK "HOW TO ANSWER ADS"



Never before have you seen anything like this. Tells you in simple language the correct way to answer ads. Gets you quicker replies—better results, and greater satisfaction. Will save you time and money and it's ABSOLUTELY FREE. No obligation whatever. Every reader of advertising should have this booklet. Send a postcard for your copy NOW. F. W. JOHNSON, Popular Mechanics Magazine, Room 600-A, 204 East Ontario Street, Chicago 11, Ill.

Now! TEST YOUR OWN TV & RADIO TUBES ALL OF THEM—EVEN PICTURE TUBE



Nearly half of TV service calls are due to defective filaments. Tester shows if filaments are good. Insert tube in tester. Light shows if tube is burned out. Easy, safe. One service call saved pays for tester. Metal case. AC or DC. Checks fuses, appliances, etc. Only \$3.95 ppd. or C.O.D. plus charges. Deluxe Model \$4.95. Instructions. Guaranteed. GEIGER ENGINEERING CORP., Dept. AB-106 3738 West Lawrence Avenue, Chicago 28, Ill.

RUPTURED? Write for New Relief FACTS FREE!

ENJOY NEW FREEDOM . . .

of action, peace of mind and comfort at work or play. Proven, patented MILLER holds your rupture back Day & Night—will bring you lasting relief! Has helped thousands of others!

For FREE facts in plain wrapper—Send Name and Address to

FRED B. MILLER, DEPT. 1-B

Manufacturer, HAGERSTOWN, MARYLAND



YOU can acquire

LAW NIGHTS AT HOME! LL. B. DEGREE

LaSalle's famous Law Library—used as reference in many Law libraries and Law offices—has enabled thousands to master Law surprisingly fast, in spare hours at home, for business and professional advancement.

These 14 remarkable volumes, compiled by leading professors and lawyers, cover the whole basic field of Law in condensed, orderly, simplified manner.

You advance rapidly with this great library, plus special lectures furnished. We guide you step-by-step with personalized Problem Method of instruction . . . you learn by doing—handling legal problems—not by memorizing rules.

Send for two FREE booklets, "Law Training for Leadership," and "Evidence," answering questions about Law and its value to you, and telling how LaSalle Law graduates are winning rapid advancement in business and public life. Mail coupon below. No obligation.

LA SALLE EXTENSION UNIVERSITY

A Correspondence Institution

417 S. Dearborn St. Dept. 264L Chicago 5, Ill.

Send me your two FREE booklets described above, without obligation.

Name.....Age.....

Street.....

City, Zone & State.....

PRESTO MASTER GLAZE --FOR ALL CARS--



Car Owners! Meet Master Glaze—the sensationally different luster for new and used cars! Not a wax—not an oil polish—not a paint!—nothing that "smears" over the surface.

AGENTS

An unusual opportunity! Quick, flashy demonstrator. Big profits. Good territory. Write today!

MASTER GLAZE is a unique discovery—quick and easy to apply! Gives a hard, glass-like surface. Even gasoline cannot dull it! Lasts six months to a year! Amazing luster—beautiful, sparkling clean and brilliant! Doesn't finger-mark—doesn't smear! A match box full glazes an entire car. Seals the pores, protects! NOTHING LIKE IT!

FREE SAMPLE

Send name, address on postcard for details and free sample

MASTER GLAZE, 7720-879 Hardwood Ave., Milwaukee 13, Wis.

WHAT ALL AUTO MECHANICS WANT TO KNOW



This Big Practical Book gives full information, with working diagrams, covering the principles, construction, ignition, service and repair of modern cars, trucks and buses.

Diesel Engines, Hydromatic and Fluid Drives Fully Explained.

A complete guide of 1696 Pages, with over 1300 Illustrations showing inside views of working parts, with instructions for service jobs. Completely up-to-the-minute! Priced at only \$6.



CIRCLE No. 1 IN COUPON

HOW TO FIX HOME APPLIANCES

REFRIGERATORS WASHERS TOASTERS DRYERS IRONERS RANGES VACUUMS FREEZERS

Many other GAS AND ELECTRIC APPLIANCES

Handy Reference for Electric & Gas Servicemen, Mechanics, Dealers and Homeowners. Explains clearly and simply how to locate troubles, how to test, reassemble and connect. Wiring diagrams, 1000 Facts, Easy to read. Answers ALL your questions. 864 Pages. Illustrated. Only \$6.

CIRCLE No. 2 IN COUPON



TV TELLS HOW TO ANSWER RADIO RADIO TV QUESTIONS SERVICE LIBRARY

HERE IS LATE INFORMATION IN A HANDY FORM FOR RADIO AND TELEVISION REPAIRMEN, SERVICEMEN AND STUDENTS

TWO COMPLETE VOLUMES - 1568 Pages - 1088 Illustrations and Diagrams. 1001 Important Facts and Figures on Modern TV, Radio, Electronic Devices. INCLUDES TRANSISTORS & Transistor Circuits, Rectifiers, Record Changers, P.A. Systems, Phonograph Pick-ups, F.M., Auto Radio, Short Wave.

Basic principles, Construction, Installation, Operation, Troubleshooting, How to get Sharp, Clear T.V. Pictures. Install Aerials. How to Test. Explains COLOR SYSTEMS, Methods of Conversion, Terms, etc. Includes Ultra High Frequency. Quick ready reference or use as a home study course. Only \$8 for BOTH volumes.

CIRCLE No. 3 IN COUPON

KNOW YOUR TRUCK

The TRUCK & TRACTOR GUIDE for Mechanics & Drivers, Foremen, Garagemen, Helpers, Owners, Trouble Shooters, Farmers, etc. Covering Gas & Diesel Motor Principles - Construction - Operation - Maintenance - Repair - Brakes - Service of all Parts. 1376 Pages. FULLY ILLUSTRATED. Index. Only \$5.

CIRCLE No. 5 IN COUPON

PLUMBERS AND STEAMFITTERS GUIDES

Practical Trade Assistant & Reference Set. Explains in plain language and by clear illustrations, diagrams, charts, graphs and pictures the principles of modern plumbing practice including Pipe Fitting and Air Conditioning. 4 Vols. - 2624 Pages - 3642 Diagrams & Illustrations. Only \$8 for the complete set of 4 vols.

CIRCLE No. 6 IN COUPON

PAINTING & DECORATING MANUAL

Inside Trade information on outside and inside work; how to mix paints, preparation of surfaces, paper hanging, wood finishes, tools, synthetic paints, color (with color chart), spray equipment, costs, estimating, etc. A COMPLETE guide to easier, better painting and decorating. 464 Pages. Fully Illustrated. Only \$2.

CIRCLE No. 7 IN COUPON

7-DAY FREE EXAMINATION

SEND NO MONEY - Pay the postman nothing! We are glad to send you any of the Audel Guides for absolutely FREE examination in your own home. We take all the risks and leave all the decisions up to YOU. There is no obligation! If you decide to keep the books of your choice you may pay for them under our astounding easy-pay plan of only \$2 a month.

HERE IS ALL YOU DO

IT'S EASY TO ORDER: In the No-Risk Mail Order Coupon at the right just draw a circle around the number of Audel Guides you want us to send you for FREE EXAMINATION. We will send them to you at once to help you build a brighter future by increasing your SKILL. If for any reason at all you are not COMPLETELY satisfied, return the books to us, and that will end the matter! NO STRINGS OR CATCHES TO THIS OFFER.

THEO. AUDEL & CO.
49 West 23rd Street, New York 10, N.Y.

FEBRUARY 1958

CARPENTERS AND BUILDERS GUIDES



PRACTICAL STOREHOUSE OF MODERN CONSTRUCTION INFORMATION (4 vol. set) for carpenters and all woodworkers. Explains in easy language and by profuse illustration principles, advanced, short cuts, trade secrets, all based on the NEWEST information.

Vol. 1 - Tools, steel square, saw filing, joinery, furniture, etc.; Vol. 2 - Builders' mathematics, drawing plans, specifications, estimates, etc.; Vol. 3 - House and roof framing, laying out, foundations, etc.; Vol. 4 - Doors, windows, stair building, millwork, painting, etc. 4 vols. 1904 Pages. 3700 Illustrations. Whole set only \$8.

CIRCLE No. 8 IN COUPON

PRACTICAL ELECTRICITY

A COMPLETE HANDBOOK - Quick, simplified, ready reference. Complete instruction and practical information on the rules and laws of electricity - Maintenance of Machinery - A.C. and D.C. Motors - Armatures - Wiring Diagrams - House Lighting - Power Wiring - Meters - Batteries - Transformers - etc. Simple to understand. 1520 Pages. 2600 Illustrations. Priced at \$5.

CIRCLE No. 4 IN COUPON

DIESEL

ALL THERE IS TO KNOW ABOUT MODERN DIESEL ENGINES - Basic principles, starting valves, timing, fuel pumps, fuel injection compressor, air compressors, pistons, cylinders, lubrication, cooling systems, etc. Answers on operation, calculations. 640 Pages. Fully Illustrated. Priced \$3.

CIRCLE No. 9 IN COUPON

WELDERS GUIDE

Covers Electric, Oxy-acetylene, Thermit, Unionmet welding for sheet metal, spot and pipe welds, pressure vessels and aluminum, copper, brass, bronze and other metals. Airplane work, surface hardening, hard facing, cutting, brazing, etc. 608 Pages. Fully Illustrated. Only \$3.

CIRCLE No. 10 IN COUPON

MATHEMATICS MADE EASY

A COMPLETE HOME STUDY COURSE - Starting with the first principles of arithmetic, advancing step by step through the various stages of mathematics, including the rules and calculations for mechanical and electrical problems. New EASY correct methods. Includes plane and solid geometry, trigonometry, algebra, calculus, etc. Practical tests, reference tables and data. How to use slide rule. 752 Pages. 550 Illustrations. Priced at only \$3.

CIRCLE No. 11 IN COUPON

NEW MACHINISTS AND TOOLMAKERS HANDBOOK

MODERN MACHINE SHOP PRACTICE - 5 PRACTICAL BOOKS IN ONE. New from cover to cover. Tells how to set up and operate lathes, screw and milling machines, chapers, drill presses and all other machine tools. A COMPLETE INSTRUCTOR AND REFERENCE BOOK. 1728 Pages. Fully Illustrated. Priced at only \$6.

CIRCLE No. 12 IN COUPON

WIRING DIAGRAMS

This book gives the practical facts on wiring of electrical apparatus. It explains clearly and SIMPLY how to wire apparatus for all fields of electricity. Each diagram is complete and self-explaining. Know your HOOK-UPS! 304 Pages. Illustrated. Only \$2.

CIRCLE No. 13 IN COUPON

REFRIGERATION & AIR CONDITIONING

FOUR BOOKS IN ONE - basic principles, servicing, operation, repair of: 1. Household Refrigeration. 2. Special Refrigeration Units. 3. Commercial & Industrial Refrigeration. 4. Air Conditioning Systems. A GOLD MINE of essential information. Completely up-to-date. 1360 Pages. Fully Illustrated and Indexed. Priced at only \$6.

CIRCLE No. 14 IN COUPON

THE NEW ELECTRIC LIBRARY

A COMPLETE ENCYCLOPEDIA explaining in the simplest terms the fundamental principles, rules and applications of applied electricity.

A COMPLETE COLLEGE EDUCATION!

Fully illustrated with diagrams and sketches, calculations and tables for ready reference. Questions and answers. Trial tests for practice study and review. All based on the most modern theory.

Vol. 1 - Principles and rules of electricity, magnetism, armatures, repairs. No. 15

Vol. 2 - Dynamos, DC Motors, construction, installation, maintenance, etc. No. 16

Vol. 3 - Testing instruments and tests, storage battery constr. and repairs. No. 17

Vol. 4 - Alternating current, power factor, alternators, transformers. No. 18

Vol. 5 - A.C. Motors, windings, maintenance, converters, switches, fuses, etc. No. 19

Vol. 6 - Relays, condensers, regulators, rectifiers, meters, switchboards, etc. No. 20

Vol. 7 - Wiring, house light and power, circuits, high

tension, plans, code, etc. No. 21

Vol. 8 - Railways, signals, elevators, ignition, etc. No. 22

Vol. 9 - Radio, telephone, telegraph, television, motion pictures. No. 23

Vol. 10 - Refrigeration, illumination, welding, x-ray, electrical appliances, Index. No. 24

7,000 fully illustrated pages. Priced at only \$30 for the ENTIRE SET. Also sold individually for \$2 each.



ALL TYPES OF BLUEPRINT READING

How to read scales, the standard symbols, detail and assembly prints, working drawings, short cuts, helps, hints and suggestions. THE MAN WHO CAN READ BLUEPRINTS IS IN LINE FOR A BETTER JOB. This book gives you the secret language, step by step in easy stages. 448 Pages, Very Fully Illustrated. Priced at \$3.

CIRCLE No. 25 IN COUPON

MASONS & BUILDERS GUIDES

A PRACTICAL ILLUSTRATED 4 VOL. SET - Explaining in clear, simple language and profuse illustration, principles, advanced, short cuts, trade secrets, based on modern practice - including how to figure and calculate various jobs.

Vol. 1 - Brick work, bricklaying, bonding, designs. Vol. 2 - Brick foundations, arches, tile setting, estimating. Vol. 3 - Concrete mixing, placing forms, reinforced stucco. Vol. 4 - Plastering, stone masonry, steel construction, blueprints. 4 Vols. 1440 Pages. 2067 Illustrations. Complete Set only \$8.

CIRCLE No. 26 IN COUPON

ELECTRIC MOTORS

THIS GUIDE covers the construction, hook-ups, control, maintenance and trouble shooting of all types of motors. Includes armature winding. Explains entire subject in great detail in simple language. Over 1056 Pages of information. 517 Diagrams. All types of motors fully illustrated and indexed for ready reference. Priced at only \$5.

CIRCLE No. 27 IN COUPON

OIL BURNERS

New, complete, explaining in detail both domestic and industrial oil burners. Includes electrical hook-ups and wiring diagrams. Fully covering the theory, construction, installation, operation, testing, servicing and repair of all equipment. Indexed for ready reference. Over 416 Pages. 320 Illustrations and Diagrams. Only \$2.

CIRCLE No. 28 IN COUPON

ADDITIONAL IMPORTANT TITLES

The following Audel Guides are all the best in their field, written in clear simple fashion, all lavishly illustrated. Circle the numbers wanted in the MAIL ORDER COUPON below. All books are sent for FREE EXAMINATION.

No. 29 SHEET METAL PATTERN LAYOUTS. 1152 Pages. \$7.50
No. 30 SHEET METAL WORKERS HANDBOOK. 448 Pages. 2.00
No. 31 MECHANICAL DRAWING GUIDE. 192 Pages. 2.00
No. 32 MECHANICAL DRAWING AND DESIGN. 480 Pages. 3.00
No. 33 ELECTRICIAN'S DEVICES. 304 Pages. 3.00
No. 34 ELECTRICIANS EXAMINATIONS. 272 Pages. 2.00
No. 35 ELECTRIC POWER CALCULATIONS. Page 480. 3.00
No. 36 ELECTRIC DICTIONARY. 9000 Terms. 3.00
No. 37 POWER PLANT ENGINEERS GUIDE. 1568 Pages. 5.00
No. 38 ENGINEERS AND FIREMANS EXAMS. 544 Pages. 2.00
No. 39 OPERATING ENGINEERS LIBRARY. 3 Book Set. 12.00
No. 40 PUMPS, HYDRAULICS AND AIR COMPRESSORS. 1760 Pages. 6.00
No. 41 HOUSE HEATING GUIDE. 1008 Pages. 5.00

MAIL THIS NO-RISK COUPON TODAY!

THEO. AUDEL & CO. - Self Improvement Publishers Since 1879 - P2

49 W. 23rd Street, New York 10, N.Y.

Please mail me for 7 days' FREE EXAMINATION the books I have circled at right. I agree to mail \$2 in 7 days on each book or set ordered, and to further mail \$2 a month on each book or set ordered until I have paid the purchase price, plus shipping costs. If I am not completely satisfied with my Audel Guides I may return them.

NAME _____

ADDRESS _____

OCCUPATION _____

SAVE SHIPPING COSTS! Check here if you enclose complete payment with order. We pay postage charges. You have some return privilege.

1	2	3	4	5	6
7	8	9	10	11	
12	13	14	15	16	
17	18	19	20	21	
22	23	24	25	26	
27	28	29	30	31	
32	33	34	35	36	
37	38	39	40	41	

**"TOOK IN \$217
FIRST 10 DAYS"**

Some make more, some less...

**We help you to start Your
Own All-Year Business**



Make Big Money! With our easily operated, highly efficient wall washer, Charles Stelle took in \$217 gross in first ten days. E. L. Goss took in more than \$10,000 in one year. E. C. Taber wrote, "I made \$400 gross in two weeks."

And no wonder... this machine washes walls 6 times faster and better than by hand.

Your Money-making Opportunity. We want more men to go into this profitable business for themselves and enjoy independence—freedom from bosses, layoffs. Customers everywhere—homes, offices, schools, churches, hotels, etc. How much you earn depends largely on you. What you take in is mostly profit. No need to rent shop or office; operate business from home. Can start spare time until your full time is available.

Lose no time. Get all facts without obligation

FREE BOOK! MAIL COUPON TODAY!

• **VON SCHRADER MFG. CO.**
• 210 "W" Pl., Racine, Wisconsin

• Send at once (no obligation) your FREE booklet containing information about your WALL WASHING MACHINE and how I can start my own permanent, profitable business.

• Name _____
• Address _____
• City _____ Zone _____ State _____

**ACCORDION PRICES
SMASHED**

**SAVE 50%
AND MORE DURING
THIS GREAT SALE**

5 Days' FREE TRIAL

Hurry! Get in on these sensational accordion values. America's largest exclusive accordion dealer selling out finest brand new accordion overstock! Fabulous savings. Leading brands in more than 80 new models. Small down payment. Easy terms. Trade-ins accepted. Chance of a lifetime.

**FREE COLOR CATALOG
& Wholesale Prices**

Learn how easily you may own and play a fine accordion. Rush name and address for big FREE Color Catalog and new low wholesale price list. No obligation. **WRITE TODAY!**

FREE
for promptness...
• FREE Lessons
• Music Stand
• Deluxe Case
• Lifetime Guarantee

ACCORDION MANUFACTURERS AND WHOLESALE OUTLET
2003 W. CHICAGO AVE., Dept. R-28, CHICAGO 22, ILLINOIS



**college graduates
get ahead faster!**

You see it in your own city. They have higher incomes... advance more rapidly. Grasp your chance for a better life. Industrial growth... automation... technical advances create career opportunities for engineers, accountants, management experts. Share rewards awaiting college men. Important firms visit campus regularly to employ Tri-State College graduates. Start any quarter in this world-famed college. Approved for veterans.

Bachelor of Science degree in 27 months

In Mechanical, Civil, Electrical, Chemical, Aeronautical, Radio (TV-Electronics) Engineering. In 36 months a B.S. in Business Administration (General Business, Accounting, Motor Transport Management majors). Superior students may accelerate. 36-weeks course in Drafting. Intensive program: technical fundamentals stressed; comprehensive courses with more professional class hours. Small classes: personalized instruction. Enrollment limited. Preparatory courses. Beautiful campus. Well-equipped, new and modernized buildings and laboratories. Enter Mar., June, Sept., Jan. Earnest, capable students (whose time and budget require accelerated courses and modest costs) are invited to write Jean McCarthy, Director of Admissions, for catalog and book "Your Career in Engineering and Commerce."



TRI-STATE COLLEGE

428 College Avenue • • • Angola, Indiana

**2 cent postcard PUTS YOU IN A
\$10,000 BUSINESS!**

Run your own business from home. We train. 3 deliveries a day earns you up to \$10,000 a year selling magnificent Bibles with hundreds of full color pictures... versions for all faiths... gold and red ever-lasting cover... so beautiful it sells itself! Every family a prospect... not sold in stores. Sell on easy terms. Rush card for money making plan.

**BIBLE HOUSE / Dept. 1214 • 1135 N. Tyron Street
Charlotte, N. C.**

TASOPE PHOTO-ENGRAVING PLANTS



Material Cost
Of This Cut 54c
Selling Price
\$1.00 And Up

Establish your own profitable PHOTO-ENGRAVING business. Make cuts for newspapers, printers, and advertisers. Make etched name plates, plaques, etc. Instructions furnished, no experience necessary. Sold direct from factory since 1931. First five hundred cuts sold locally or by mail will pay for plant and pay you well for your time. Write for FREE catalog.

TASOPE, DEPT. PM-2, AURORA, MO.

MONEY in WORMS

Big money made raising crickets, hybrid red wigglers and 12 inch African fishworms—Sell by mail—We teach you how to raise and where to sell. Free Literature. Start now for big season beginning next spring. **CARTER WORM RANCH, PLAINS, GEORGIA**

**EXCLUSIVE! PRE-ASSEMBLED KITS!
FREE CATALOG... SEND TODAY!**



New! Pre-assembled kits save up to 2/3 assembly time. Send for Free Catalog
New! Cruisers, Runabouts. 12 NEW Models 12-18'. Supermart selection of Fiberglass & Accessories.

BOAT KITS INC.

1415 W. 92nd St., Dept. B-2

Bloomington 20, Minn.

Now a
**BETTER
SHOE**

in sizes 9 to **16**

Write for FREE
Catalog

TALL Men

Big men need the stamina and quality of a better shoe. We specialize in finer footwear in sizes 9 thru 16, AAA to EEE... dress, casual, canvas, bowling, boat shoes, slippers. Satisfaction guaranteed.

TALL MEN, 707 Brockton, Mass.

POPULAR MECHANICS

INVENTORS

The preparation of an application for patent and the conducting of the proceedings in the Patent Office to obtain the patent is an undertaking requiring knowledge of patent law and Patent Office practice as well as knowledge of the scientific or technical matters involved in the particular invention.

Unless you are familiar with these matters, you are advised to call upon the knowledge, experience and skill available to you from a registered patent attorney or agent in order that the patent, if obtained, will adequately protect your invention.

The firm of Victor J. Evans & Co. is registered to practice before the United States Patent Office and is available to advise and assist you in all steps necessary to the preparation and prosecution of patent applications.

Let us send you a copy of our instructive booklet "Patent Protection for Inventors" which explains pertinent points concerning procedures which must be followed and how this firm acts in your behalf. We also will send "Evidence of Invention" disclosure form (with instructions for proper use) to help you take the first step toward securing a patent—a search among previously granted U. S. patents for similar types of inventions to determine probable patentability. Booklet and form sent without obligation.

VICTOR J.
EVANS & Co. *Merlin M. Evans*
REGISTERED PATENT ATTORNEY

430-B MERLIN BUILDING

WASHINGTON 6, D. C.

AMAZING STAMP OFFER!

Free

TO GET NAMES FOR OUR MAILING LIST

- 1 WORLD MAP**—authentic 3 ft. sq. Mercator projection map, used by air and sea navigators—yours FREE!
- 2 STAMP FINDER**—identifies stamps around the world—no matter how strange their script letters—yours FREE!
- 3 ENCYCLOPEDIA OF STAMP-ISSUING COUNTRIES**—Tells area, location, population, parent country, etc.—yours FREE!

Also FREE: 30 MUCH-WANTED FOREIGN STAMPS

NOW you can identify even the strangest stamps—at a glance—with this GIANT world map and stamp guide. Opens up to 3 SQUARE FEET to make a big handsome wall map you'll be proud to display in your room. THE PHILATELIC WORLD MAP & GUIDE is well-known among stamp fans all over the country. Complete and up-to-date. Locates the tiniest, most remote stamp-issuing countries in the world. While our supply lasts—we'll send it to you FREE. But that's not all! You also get—FREE—30 colorful foreign stamps—from exciting, far-off places like San Marino, Djibouti, etc. Included is Chi-

nese anti-Communist stamp with face value of \$10,000 in Nationalist money! Also interesting stamp offers for your inspection. No obligation. But hurry. Offer may be withdrawn at any time. Send your name and address, with 10c to cover postage and handling, to **LITTLETON STAMP CO., Dept. PM-2, Littleton, New Hampshire.**



DRAFTING and BLUE PRINTING pay BIG MONEY

LEARN AT HOME IN SPARE TIME

You will be sent professional drafting instruments, drafting equipment, drafting lesson manuals, portable drafting table, etc. You learn by making actual drawings. Everything furnished on a **PAY AS YOU LEARN PLAN.**

REVOLUTIONARY NEW METHOD

Teaches you quickly the hows and whys of Mechanical, Machine, Structural, Architectural, Electrical Drafting, etc.

LIGHT PLEASANT WORK

and Drafting and Blue Printing in addition to paying good wages often lead to top managerial positions.

MAIL COUPON for FREE BOOK

CHRISTY TRADES SCHOOL, Dept. DB-3903
4804 N. Kedzie Ave., Chicago 25, Ill.

Mail me at once your big FREE book on Drafting and Blue Printing. Tell me how I can get your Home Training and Professional Drafting Instruments, Drafting Table, Drafting Equipment, etc., on a **PAY AS YOU LEARN PLAN.**

Name _____ Age _____

Address _____

City _____ Zone _____ State _____

INSURED TIRE SERVICE
POPULAR BRANDS
FREE INSURANCE POLICY given with each used tire sold. We guarantee the amount of service you pay for.
NOWHERE CAN SUCH QUALITY BE FOUND AT SUCH LOW PRICE!

GOODYEAR SUBURBANITE TYPE SHOW TIRES
New Tire Guarantee—Factory Rebuilt
BEST WINTER TRACTION OF ALL!
670x15 \$9.95 710x15 650x16 650x15 \$10.90
600x16 760x15 800-820x15

Super Quality — Rugged Performance — 6 Months Insured Service		Supreme Quality — Nothing Finer — 12 Months Insured Service	
600x16	\$3.65-670x15	\$3.95-700x16	\$4.45-760x16
650x15	3.85-670x16	4.05-710x15	4.35-820x15
650x16	4.25-700x15	3.95-760x15	4.45-550x17
600x16	\$5.25-475x19	\$5.45-700x15	\$10.45-700x20
600x16	6.75-640x18	4.95-750x16	15.95-750x20
650x16	5.75-670x15	5.25-700x17	11.95-750x20
650x16	7.25-710x15	5.45-750x17	16.45-825x20
700x16	6.35-760x15	5.95-750x15	10.95-900x20
750x16	8.45-800x15	6.35-30x5	11.25-1000x20
550x18	4.95-820x15	6.35-600x20	10.95-1100x20
550x17	4.75-550x15	5.35-650x20	11.75-1000x22
650x15	5.25-670x16	5.15-32x6(8)	11.95-1100x22
700x15	5.35-700x16	6.10-32x6(10)	12.75-1100x24

MIDLAND TIRE SALES
3701 S. Normal, Dept. PM-67, Chicago 9, Ill.

WHEELS WHEELS WHEELS

- 6" Disc Wheel 1.50 semi-pneum. T. B.B. \$1.35 ea.
- 7" Disc Wheel 1" tire 1/2" ball bearing .80c ea.
- 8" Disc Wheel 1 1/4" tire 1/2" sleeve .70c ea.
- 8" Disc Wheel 2" semi-pneum. T. 1/2" B.B. \$1.50 ea.
- 10" Disc Wheel 1.75 semi-pneum. T. 1/2" B.B. \$1.50 ea.
- 10" Disc Wheel 2.75 semi-pneum. T. 1/2" B.B. \$3.50 ea.
- 12" Disc Wheel 1.75 semi-pneum. T. 1/2" B.B. \$1.85 ea.
- 16" Disc Wheel 4.00 x 8 pneum. T. 3/4" B.B. 2 ply, 4" hub \$11.50 ea.

Postage extra. C.O.D.'s accepted. Axles extra. Sizes 5/16"-3/8"-1/2" dia. cut to size per inch long. End holes drilled.

UNITED WHEEL STAMPING COMPANY
11915 S. MARSHFIELD AVE. PM-258 CHICAGO 43, ILL.

WHOLESALE Electric Guitars - Parts - Factory to You
Solid-body Spanish, amplifiers, tone changer guitars, double-necks, single-necks, triple necks, solid-body mandolin, pickup mikes, non-electric instruments, etc. 1958 Models wholesale. FREE CATALOG. Free home study course with instruments. Parts & plans available to build your own.
CARVIN CO., Box 287, PM-2, Covina, Calif.

Learn ACCOUNTING
Business Administration
Bookkeeping, secretarial and allied subjects at home in your spare time or attend nationally approved resident school. Write for FREE Success Book giving complete details on courses, plans, rates and employment opportunities. G.I. approved. Write Dept. A.

Hills BUSINESS UNIVERSITY AND EXTENSION SCHOOL
629 W. MAIN ST. OKLAHOMA CITY 2, OKLAHOMA

Shrinks Hemorrhoids New Way Without Surgery

Science Finds Healing Substance That Relieves Pain—Shrinks Hemorrhoids

For the first time science has found a new healing substance with the astonishing ability to shrink hemorrhoids and to relieve pain—without surgery.

In case after case, while gently relieving pain, actual reduction (shrinkage) took place.

Most amazing of all—results were so thorough that sufferers made astonishing statements like "Piles have ceased to be a problem!"

The secret is a new healing substance (Bio-Dyne®)—discovery of a world-famous research institute.

This substance is now available in suppository or ointment form under the name **Preparation H.** Ask for it at all drug counters—money back guarantee. *Reg. U. S. Pat. Off.

IMAGINE! The "Meat" of 176 Official Shop Manuals...in This One Giant Illustrated Repair Guide!



- Covers All Models - 1949 thru 1958
- | | |
|-------------|-------------|
| Buick | Jag |
| Cadillac | Lincoln |
| Chevrolet | Mercury |
| Chrysler | Nash |
| Clipper | Oldsmobile |
| Continental | Packard |
| De Soto | Plymouth |
| Dodge | Pontiac |
| Edsel | Rambler |
| Ford | Studebaker |
| Hudson | Thunderbird |
| Imperial | Willys |

No wonder beginners and experts agree—
This is the Easy way to

FIX ANY PART OF ANY CAR

THERE'S one sure way to "lick" any auto repair job — and that's to get the advice of a real auto expert. That's why Motor's Auto Repair Manual is so widely used (over 2½ million copies sold!). It brings you the expert guidance of the engineers who made the cars and know them "inside out." Yes, packed into this giant volume is the "know how" from 176 OFFICIAL SHOP MANUALS, hundreds of factory bulletins, boiled down in easy-to-follow words and pictures.

Factory-tested procedures show how to fix any part of any popular make car — 1949 thru 1958. No guesswork! Manual "starts from scratch" — leads you through entire job with easy step-by-step directions, clear "how-to" pictures. You CAN'T go wrong.

OVER 1000 BIG PAGES — 2900 PICTURES
NEW, REVISED, ENLARGED Edition covers everything you need to know to repair over 600 different car models — including ALL 1958 CARS. Over ONE THOUSAND giant pages, 2,900 "This-is-How" pictures, 291 "Quick-Check" charts—25,436 essential repair specifications. Over 225,000 service and repair facts.

Not only do you get big separate illustrated sections covering every one of the 24 car makes — you also get detailed chapters on servicing car parts: Transmissions, Air Suspensions, Rear Ends, Generators and Regulators, Fuel

Pumps, Ignition Systems, Overdrives, Automatic Transmissions, Brakes, Valves, Pistons, Rings, Water Pumps, Distributors, Dash Gauges, Power Steering, Power Brakes, and more.

PLUS Factory Specifications and Adjustment Tables, Tune-Up Charts, etc. In addition, big TROUBLE-SHOOTING SECTION helps you spot any of 2,300 car troubles in a jiffy.

Try Book FREE 7 Days

SEND NO MONEY! Just mail coupon (paste it to a post card if you prefer.) Use the Manual for a whole week, free. If you don't agree that it is the greatest time-saver and work-saver you've ever seen — return book in 7 days and pay nothing. Mail coupon today! Address: MOTOR BOOK DEPT., Desk 18, 250 West 55th St., New York 19, N.Y. (Schools, Bookstores: Write for discounts.)

FREE 7-DAY TRIAL

Return and Pay Nothing
If Not Delighted

OVER 2½ MILLION COPIES SOLD! USED BY U.S. ARMED FORCES

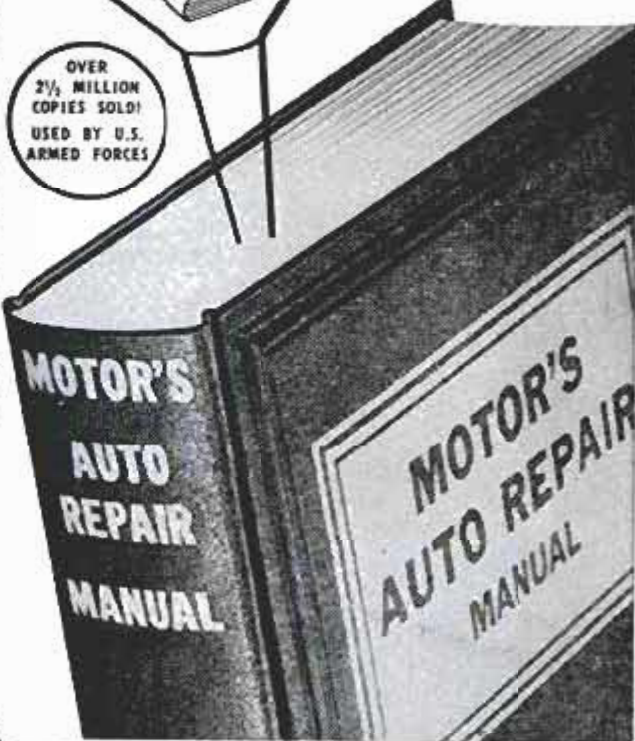

MAIL COUPON NOW FOR 7-DAY FREE TRIAL
(Attach to postcard if more convenient)

MOTOR BOOK DEPT.
Desk 18, 250 W. 55th St., New York 19, N. Y.

Rush to me at once (check box opposite book you want!):

MOTOR'S New AUTO REPAIR MANUAL. If O.K., I will remit \$3 in 7 days, \$2 monthly for 2 months and a final payment of \$1.95 (plus 35¢ delivery charges) one month after that. Otherwise I will return the book postpaid in 7 days. (Foreign price, remit \$10 cash with order.)

MOTOR'S New TRUCK REPAIR MANUAL. If O.K., I will remit \$3 in 7 days, and \$2 monthly for 3 months, plus 35¢ delivery charges with final payment. Otherwise I will return book postpaid in 7 days. (Foreign price, remit \$11 cash with order.)

Print Name Age.....

Address

City State.....

Check box and save 35¢ shipping charge by enclosing WITH coupon in envelope entire payment of \$7.95 for Auto Repair Manual (or \$9 for Truck Repair Manual). Same 7-day return-refund privilege applies.

Same FREE 7-Day Offer on MOTOR'S Brand-New TRUCK REPAIR MANUAL

Covers EVERY job on EVERY gasoline-powered truck made since 1949 — PLUS GM and Cummins Diesels. Over 2,000 illustrations; over 300,000 facts. Check proper box in coupon for FREE 7-DAY TRIAL.

Amazed Self and Friends — "I amazed myself and my friends, too. Now do jobs that stumped me before." — Michael Ballesky, Newark, N. J.

So Complete and Easy to Understand — "So complete, easy to understand — have done jobs with Manual I would not have attempted without it." — C. L. Vanerstrom, Mich.

LEARN UPHOLSTERY

in your spare time
run your own
business
AT HOME



FREE TOOLS WITH COURSE!

FREE BOOK
with
sample
lessons

BE YOUR OWN BOSS

Earn more from the start! Set up your own profitable business, in your own home, enjoy steady income, independence for life—in the booming field of Custom Furniture Upholstery. Right off you start learning and earning with tools, complete frames, fabrics and materials, included FREE with practical UTS course. You learn skilled professional custom upholstery, reupholstery, furniture finishing, repairs, how to make beautiful slip covers, window cornices, cushions and draperies. **EARN WHILE YOU LEARN**, in your spare time **AT HOME**... the UTS easy way.

FREE ILLUSTRATED BOOK—FREE SAMPLE LESSON
Get ready for well-paid job and big profits, from steady work, as your own boss, running your own business. Mail coupon NOW for FREE BOOK! Training in N. Y. School also available.

APPROVED FOR VETERAN TRAINING

UPHOLSTERY TRADES SCHOOL
Dept. GB-310, 721 E'way, N. Y. 3, N. Y.

Please send me FREE book, "Your Now Way to a Successful Career," and FREE sample lesson. No obligation—no salesman will call.

Home Study N. Y. School Training

Name _____ (Please Print Plainly)

Address _____

City _____ Zone _____ State _____

Check if Korean Veteran

with course

YOU MAKE

SLIPPER

CHAIR

CLUB

CHAIR

OTTOMAN

PLUS

SLIP COVERS

Yours to Keep

or Sell



WARN HUBS on your

Patented



Jeep

STOP FRONT
DRIVE WEAR
in 2-Wheel Drive!



Over 100,000 now in use!

That is real proof of their many advantages and rugged dependability. Warn Hubs on 4-wheel drives make steering easier, increase power, speed in high; add life to gears, tires, because the front drive stands still in 2-wheel drive—there is no drag! Use free-wheeling 2 w.d. or tractive 4 w.d. as needed, automatically,

as you shift, with Warn Lock-O-matics, through fingertip controls with Warn Locking Hubs. Factory approved. Iron-clad guarantee. Models for all 4 w.ds. to 1½ tons. See your dealer now! Write for free literature.

WARN MFG. CO.

Riverton Box 6064-A2
Seattle 88, Wash.

WHAT TREASURES WILL YOU FIND?



Exciting Treasure Hunt! Big cloth bag contains over 1,000 genuine foreign postage stamps from more than 30 strange countries in far-away Asia, Europe, Africa, South Seas, etc.! Unpicked, unsorted—just as received from foreign natives, banks, missionaries. Nobody knows what's inside! Guaranteed worth over \$10 at Catalog prices. Money back if not delighted.

Only \$1.00 ppd

H.E. HARRIS & CO., 4607 Transit Bldg., Boston 17, Mass.



"I Made \$14,839 in 1 Year SERVICING RADIATORS!"

Are you earning under \$8,000 a year? Hundreds now making \$10,000-\$12,000-\$15,000 a year servicing auto-truck-tractor radiators the Inland way. Easy to learn. Inland, largest radiator equipment mfr., offers complete package—equipment, merchandising, "Pay-for-itself" financing, free training, \$305 down for equipment starts you. Profitable dept. for garage or service station. Write to:

INLAND MFG. CO., Dept. PH-2, 1108 Jackson St., Omaha 2, Nebr.



SEND FOR THIS FREE!

Make money. Know how to break and train horses. Write today for this book FREE, together with special offer of a course in Animal Breeding. If you are interested in Galting and Riding the saddle horse, check here () Do it today—now.

BEERY SCHOOL OF HORSEMANSHIP
Dept. 1102 Pleasant Hill, Ohio

Learn PHOTOGRAPHY at Home

Splendid opportunities. Prepare in spare time. Practical basic training. Long-established school. Send for free book, "Opportunities in Photography." No obligation.

American School of Photography, 635 Diversay Parkway, Dept. 1252, Chicago 14, Ill.

JEEP OWNERS

RE-POWER NOW WITH A V-8 ENGINE — Use FORD • CHEVROLET • MERCURY

in 2 or 4 Whl-Dr. Jeeps, Jeeps, Sta-Wgn, Trucks, H. J. and Kaiser cars. Conversion Kits \$43.25 to \$59.85. If you want fast action tell us which engine you wish to use, give us year, Model (2 or 4 Whl-Dr) of your vehicle. Send Min. \$15.00 Dep. and we will ship correct kit, Bal. COD. Send full amt. for Prepaid shipment. Wire, phone or write for free details. Also Kits for FORD 6 engine.

HOOSIER MACHINE PRODUCTS CO.
312 S.E. 6th St. Phone CR 6-3442 Pendleton, Oregon, U.S.A.

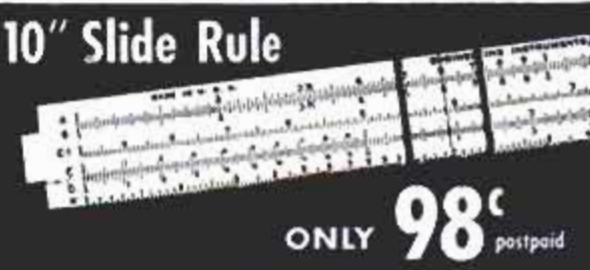

ONLY 98¢ postpaid

ANYONE WHO UNDERSTANDS SIMPLE 7TH GRADE ARITHMETIC CAN USE THIS STANDARD SLIDE RULE! Be modern—use this quick easy way of figuring. For business men, students, carpenters, machinists, salesmen, printers and engravers, office workers, farmers, merchants, time keepers, plumbers, electricians—everyone who does figuring can save time and labor with this slide rule.

FREE Illustrated instruction book shows you how to get correct answers instantly without pencil and paper. (You get BOTH slide rule and instruction book for only 98¢ postpaid. Satisfaction guaranteed or refund.)
NELSON-HALL CO., 210 S. Clinton, Dept. BS-2, Chicago 6

NOW READY! McGraw-Hill's New Train-Yourself Course

TELEVISION AND
RADIO REPAIRING

REPAIRING
RECORD CHANGERS

PROFITABLE RADIO
TROUBLESHOOTING

PRACTICAL RADIO
SERVICING

PROFITABLE
TELEVISION
TROUBLESHOOTING

6 BIG VOLUMES
Including
Home Course
Outline!
Shows how
to Get
Ahead Fast.

FIX TV RADIO and RIGHT AWAY RECORD CHANGERS

—even if you've never looked inside a set before!



AT LAST — at Amazing LOW COST — The Most Complete TV-Radio Repair Course Ever Published. TELLS and SHOWS How to Do Every Job Quickly and Easily — Make GOOD MONEY, Full or Spare Time in the BOOMING Repair Business

AFTER 10 YEARS OF PREPARATION — McGraw-Hill's new 6-Volume Course brings you everything you need to know to "cash in" on the TV-RADIO boom. Over 3,350 pages of money-making "know-how" by top factory engineers and electronic experts. **THREE** giant REPAIR MANUALS tell and show how to FIX every trouble the easy way. **TWO** huge TROUBLESHOOTERS tell exactly WHERE to begin, WHAT tools to use, HOW to "polish off" every job. Complete Home Study Volume guides you every step of the way, tells how to get ahead fast as a repairman — build up your own business, full or spare time, for **BIG PROFITS!**

EARN While You Learn

Tested — and now used in top schools, and repair shops — Course volumes are simple enough for green beginners, amazed "pros" with new easy methods. Starts you doing simple repairs — and earning money — from very first chapter. ABC pictures and directions make tougher jobs a "snap." Before you finish you can earn many times its cost.

NO previous training needed. NO complicated formulas. **PLAIN ENGLISH**

pictures and directions cover ANY job on EVERY set — tubes, circuits, speakers, new a-c/d-c portables, Color TV, even what to charge for every job!

BIG MONEY — Spare or Full Time

Forget lack of experience. Forget your age. Over 40 MILLION TV sets, 180 MILLION radios — and the shortage of repairmen — mean big money for you. Course makes it easy to "cash in," spare time or full, start your own business, enjoy your work and a big bank account!

SEND NO MONEY

Try Course 10 days FREE. (We pay shipping!) If you don't agree it can get you started in a money-making repair business — return it, pay nothing. Otherwise keep it. Earn while you learn; and pay the low cost on easy terms. Mail coupon NOW. McGraw-Hill Book Co., Dept. PM-2, 327 West 41st St., New York 36, N. Y.

Examine
Entire Course
FREE
for 10 Days!

PARTIAL CONTENTS

- 1 Television and Radio Repairing — Testing, repairing, replacing parts, 566 pages. 700 "This-Is-How" pictures, diagrams. By John Markus, Feature Ed., Electronics Magazine.
- 2 Practical Radio Servicing — Easy-to-follow directions, diagrams, drawings — with job sheet for every repair job. 509 pages. 473 illus. By William Marcus, Alex Levy, Electronic Training Experts.
- 3 Profitable Radio Troubleshooting — WHERE to look and WHAT to do for every trouble. How to avoid costly mistakes, handle customers profitably. 330 pages. 153 "how-to" illus. By William Marcus, Alex Levy.
- 4 Profitable TV Troubleshooting — Short-cuts to SPOT and FIX every trouble — fast, for big profits. By Eugene A. Anthony, Service Consultant, General Elec. Co.
- 5 Repairing Record Changers — Step-by-step pictures and directions — how to set up service bench, etc. 278 pages. 202 A-B-C pictures. By Eugene Ecklund, Eng. DuMont Lab., Inc.
- 6 Complete Home Course Outline — Getting started in television and radio servicing. How to get the most out of your Course. How to get ahead FAST. By John Markus.

THIS AMAZING OFFER SAVES YOU \$11.85!

Free ALL THREE Valuable Repair Aids: TV, RADIO, and CIRCUIT Detect-O-Scopes (Total Retail Value \$3.00)



FREE — whether you keep the Course or not — **THREE** amazing DETECT-O-SCOPE Charts. TV and RADIO Scopes enable you to spot all tube troubles in a jiffy. CIRCUIT Scope spots all circuit troubles. Make fix-it jobs easier, faster. 16 x 21 inches. **ALL THREE** (worth \$3.00) yours FREE while they last on this introductory offer.

THIS COUPON SAVES YOU \$11.85

McGraw-Hill Book Co., Dept. PM-2, 327 West 41st St., New York 36, N. Y.

Send me — postpaid — for 10 DAYS' FREE TRIAL the 6-Vol. McGraw-Hill TV, Radio and Changer Servicing Course. If okay, I'll remit only \$4.95 in 10 days; then \$5.00 monthly for 5 months. (A total savings of \$11.85 on the regular price of the Course and Detect-O-Scopes.) Otherwise, I'll return Course in 10 days; pay nothing.

ALSO send FREE (to keep whether or not I keep the Course) the 3 TV, RADIO, and CIRCUIT DETECT-O-SCOPES CHARTS, — total value \$3.00.

Name (Please Print Clearly)

Address

City Zone No. (if any) State.....

CHECK HERE if you prefer to enclose first payment of \$4.95 with coupon. Same easy pay plan; same 10-day return privilege for full refund. PM-2

**I DARE YOU TO FIND AN EASIER WAY
TO MAKE UP TO \$1,500⁰⁰ IN A MONTH!**



**Astounding New Improved
MOTOR OVERHAUL**

**Hands You Big-Volume REPEAT
Business . . . Even Spare Time!**

Introduce amazing new 16-oz. MOTOR OVERHAUL to fellow-motorists, fleet owners . . . make big money fast! Just add to engine oil and get immediate increases in compression (up to 58%), gas mileage (up to 54%), oil-saving efficiency (up to 900%) . . . and freedom from costly repairs . . . proved by astonishing Independent Laboratory Road Tests. Now contains oil-stabilizer Formula X-303 for instant cold-weather starting, cooler engine in summer. Customers order time and again, hand you a high-profit re-order business you can run in just your spare time! Sells for \$2.98 each; you make up to \$1.78 profit on every can.

GUARANTEES IMPROVED POWER AND ECONOMY! Motorists, large-quantity-buying fleet operators order at once on daring no-risk "You-Be-The-Judge" Unconditional Guarantee, are amazed, delighted when MOTOR OVERHAUL makes good on every promise, re-order time and again!

FREE! Rush coupon with name, address TODAY for big Illustrated Sales Kit, big-profit plans, actual copy of startling Lab Road Test Report, daring "You-Be-The-Judge" Guarantee . . . all FREE, no obligation. POPE CHEMICAL CO., 224 W. Huron, Dept. D-3, Chicago 10, Ill.

POPE CHEMICAL CO., 224 W. Huron St., Dept. D-3, Chicago 10, Ill.

Rush, Entirely FREE and without obligation, Illustrated MOTOR OVERHAUL Sales Kit, Lab Report, daring Guarantee.

Name _____

Address _____

City _____ Zone _____ State _____

**High School
at Home**

MANY FINISH IN 2 YEARS

No classes. No time wasted going to and from school. Progress as fast as your time and abilities permit. Standard H.S. texts supplied. Thousands enroll each year in this 61-year-old school. Send for FREE descriptive booklet.

**AMERICAN SCHOOL, Dept. H245
Drexel at 58th St., Chicago 37, Ill.**

Without obligation, please send FREE descriptive booklet.

Name _____

Address _____

AMMUNITION

for a fraction
of regular cost

Reload a whole carton for the cost of a few rounds of factory ammunition. New 200-page Lyman Reloading Hand Book shows you how, safely and easily. Ten big sections loaded with data and pictures show you how to have more fun with rifles, pistols, and shotguns. \$2.00 at your dealer, or sent direct postpaid.



THE LYMAN GUN SIGHT CORP.
MIDDLEFIELD • CONN.

EARN \$7,500 OR MORE

. . . first year operating heavy equipment. Dozer, Dragline, Grader & Scraper operators urgently needed everywhere as result of money appropriated for vast new road program. 755,278 miles now eligible for federal grants. Up to \$3.50 per hour for operating one of these earthmoving machines. 13 to 20 year program now underway. Send \$1.00 for booklet explaining this vast program & how to become an operator of some of this equipment in approximately 30 days. We pay postage. No C.O.D.'s.

NATIONAL CONSTRUCTION CO.
321 11th ST. DEPT. B DES MOINES, IOWA

75c ea. for Finest Imported PRECISION PLIERS!

• Flat Nose • Combination • Diagonal Cutter • End Cutting Nippers • Round Nose • One Side Flat • One Side Round • Snipe. FOR JEWELERS, OPTICAL WORKERS, HOBBYISTS, CRAFTSMEN OF ALL KINDS! These superb European instruments are of deep-forged, heat-treated high quality tool steel, fabricated to most exacting specifications. All-over ground and polished to smooth, hard surfaces. Smooth working joints with just the right tension. Jaws meet perfectly to safely and securely hold even the most delicate objects in the hard-to-reach corners and angles. Each plier is 4" long and a veritable gem of precision and strength. 75c each . . . ALL 7 for \$5.00 p.p.d. Send check or m.o. C.O.D. fee extra. Money Back Guarantee.

SCOTT-MITCHELL HOUSE, Inc. DEPT. F-2, 611 BROADWAY
NEW YORK 12, N. Y.

**GET RESULTS!
RUPTURE RELIEF GUARANTEED!**



RESULTS—OR YOUR MONEY BACK
Write now for free booklet and pictures of rupture care. You can be helped . . . work steady, with low cost, easy-to-wear Web Truss. Thousands satisfied.

WEB TRUSS CO. Dept. M-2, Hagerstown, Maryland

YOU MAKE 'EM WE SELL 'EM!



Let me show you how to build a big pay business of your own without canvassing, without house-to-house selling!

I'll show you a simple easy way to make dozens of "Made-to-Order" cases for musicians, salesmen, hunters, manufacturers, fishermen, gun collectors, phonographs and 1001 other portables. I'll supply instructions, tools, materials — everything you need. My plan is absolutely safe! You risk nothing! Keep your present job and work sparetime until you decide to devote full time to this big pay work that is so fascinating . . . Set up your shop wherever you have

MY NATIONWIDE SALES ORGANIZATION WANTS TO WORK FOR YOU!

a few spare feet. With my plan anyone can have his own business without a big investment and without previous experience; and remember you don't have to worry about sales because my National Sales Staff sells for you.

I am very satisfied to make a small profit because I can count on big volume on the supplies I sell to Casecrafters, yet home workers make a big profit because the finished cases sell for up to ten times the cost of materials . . . Write for full, FREE, details today

ABARSI CASECRAFT Dept. BB Los Angeles, Calif.



JACK STEARNS
made \$450.00 on his first order for cases.
SO CAN YOU!
POSITIVE PROOF SENT TO YOU FREE!!!

Train in Big
COYNE
Shops

GREAT OPPORTUNITY FIELDS!



Instructor helping students check the wiring and trace the circuits of television receivers.

This big fire-proof building is occupied entirely by Coyne.

Instructor explaining operation and testing of a large Motor Generator.

TELEVISION-RADIO COLOR TV

Here at COYNE you're trained for Testing, Trouble-Shooting and Servicing on AM and FM Radio Units, Auto Radio, Television, etc. Thousands of Coyne trained men in good jobs or own well paying TV-Radio businesses.

ELECTRICITY ELECTRONICS

Big opportunities everywhere—city, town and country, in Power Plant Work, Motors, Industrial Electronics, Armature Winding, Home and Factory Wiring, Appliances, Refrigeration, Maintenance, Illumination, etc.

**OLDEST AND BEST
EQUIPPED SCHOOL OF
ITS KIND IN THE U.S.**

Send Coupon
Below for
**BIG FREE
BOOK**

"Guide to Careers in
ELECTRICITY-ELECTRONICS
and TELEVISION-RADIO"
Book and details come to
you by return mail. No
salesman will call.



WE TRAIN YOU IN CHICAGO

Our famous Practical-Technical method gives you practical experience on a massive outlay of equipment plus necessary technical training right here in the great Coyne shops.

Training in Refrigeration and Electric Appliances can be included.

**Training offered
to VETERANS and
NON-VETS alike**

START NOW—PAY LATER

Enroll now, pay most of tuition later. Part time employment help for students. Lifetime employment service to Graduates. Frequent starting dates.

B. W. COOKE, JR., President

COYNE
ELECTRICAL SCHOOL

FOUNDED 1899

A TECHNICAL TRADE INSTITUTE OPERATED NOT FOR PROFIT

500 S. PAULINA STREET, CHICAGO, Dept. 28-3C

ELECTRICITY ★ RADIO ★ TELEVISION ★ REFRIGERATION ★ ELECTRONICS

MAIL COUPON TODAY

COYNE ELECTRICAL SCHOOL
500 S. Paulina St., Chicago 12, Ill., Dept. 28-3C

Send BIG FREE book and details of all the training you offer. This does not obligate me and no salesman will call. I am especially interested in:

ELECTRICITY-Electronics TELEVISION-Radio-Color TV

Name.....

Address.....

City..... State.....

Draw Lincoln

YOU MAY WIN A \$430.00 SCHOLARSHIP IN COMMERCIAL ART

Winner gets a complete art course—free training for a money-making career in commercial art, illustrating or cartooning.

You are coached, individually, by professional artists on the staff of world's largest home study art school. Many successful artists have studied with this school, founded over 40 years ago. It's an accredited member of the National Home Study Council. Contest winner also gets a drawing outfit and valuable art textbooks. Try for this free art course!



ART INSTRUCTION, INC., STUDIO 2138
500 South 4th Street, Minneapolis 15, Minn.

Please enter my attached drawing in your contest. (PLEASE PRINT)

Name _____ AGE _____ Phone _____
Address _____ City _____ Zone _____
State _____ County _____ Occupation _____

DRAW LINCOLN'S HEAD

5 inches high. Use pencil. Drawings for March 1958 contest must be received by March 31. None returned. Winner notified. Amateurs only. Our students not eligible.

NEVER AT THIS LOW PRICE! GENUINE 135-POWER ACHROMATIC TELESCOPE

with Achromatic Lens and
4-POWER FINDER attached
ONLY
\$18.95
PREPAID

EXTRA BONUS GIFTS:

- 273 page book, "Handbook of the Heavens"
- Magic Star Finder Dial
- 220X & 400X Eyepiece lenses

5 Magnifications 18X—35X—65X—85X—135X Brings the Moon, Planets, Stars, Satellites, People 135 Times Closer, Clearer, Sharper

Never before has an ACHROMATIC 135X telescope with range finder and tripod sold for anywhere near this amazing low price! Now you can not only explore the heavens and bring the moon, planets, stars, satellites 135 times closer, but you can observe all distant objects, people, ships too, because all pictures are erect, not upside down as in all astronomical telescopes. The kind of needle-sharp color-free viewing only a genuine achromatic lens can bring you. Ready for immediate use. 5 precision lenses bring you viewing at 18X—35X—65X—85X—135X. Tubes extend to 43" made of bakelite, finished in camera bellows black, trimmed with gleaming brass. 4 power finder scope (30mm Lens) mounted on main tube is feature usually found on more expensive telescopes—brings difficult objects on target before observing with main scope. For extra stability 5 ft. hardwood folding tripod is equipped with heavy cast iron head fitted with Criterion's famous 360 degree all aluminum mount that locks instantly in any position. Obtainable only from Criterion Co. shipped prepaid. 4 famous gifts—273 page book "Handbook of the Heavens," Magic star finder dial that aids in locating stars ANYWHERE at ANYTIME of the year. 220X & 400X eyepiece lenses included free for experiments. You must be completely satisfied with this super offer or your money back in full. Shipped Complete, nothing else to buy at amazingly low price of **\$18.95**. Without tripod **\$14.95**. Send Cash, Check, or Money Order today
Dept. PMA21, CRITERION CO., 331 Church St., Hartford, Conn.

LEARN WHILE ASLEEP!



Exciting details free!

Sleep-Learning Research Association
P.O. Box 610-A Omaha, Nebraska

DRAINS cellars, cisterns, wash tubs; \$7.95 IRRIGATES - CIRCULATES - SPRAYS



Up to 3,000 GPH; 450 GPH 80' high; or 1800 GPH from 25' well. Use 1/6 to 3/4 HP motor. Coupling included free. 1" inlet; 3/4" outlet. Stainless steel shaft. Won't rust or clog. Type P—\$7.95.

CELLAR DRAINER KITS (less motor)
"Low Boy"—15" high, 1500 GPH. \$12.95
"High Boy"—32" high, 3,000 GPH. \$15.95
Postpaid if cash with order. MONEY BACK GUARANTEE
LABAWCO PUMPS, Belle Mead 7A, N. J.

Sharpen ALL CIRCULAR SAWS THE QUICK-WAY

patented

Model
PG-12
Complete
No
extras
to buy.
\$19.95
Postage
Paid



Sharpen, joints, gums and retools all cross-cut, rip, standard and master combinations, miter, planer and radial saw blades to 12" diameter. Precision sharpening guaranteed by special Index Dials. New safety guide prevents tilting or gouging. Mounting block and special \$3.00 grinding wheel furnished. Fits bench, table and radial swing saws.

Thousands of satisfied users. Featured in leading publications. Order today. Send check, cash or money order. We pay postage in U.S.A. Free Booklet "How to Sharpen Circular Saws."

QUICK-WAY SAW CO.
136 Tompkins Street Cortland, N.Y.



RCA INSTITUTES



OFFERS YOU THE FINEST OF HOME STUDY TRAINING



The equipment illustrated and text material you get with each course is yours to keep. Practical work with very first lesson. Courses for the beginner and the advanced student. Pay-as-you-learn. You need pay for only one study group at a time.



SEND FOR THIS FREE BOOK NOW

RCA Institutes, Inc. Home Study Dept. ZPM-28
A Service of Radio Corporation of America
350 West Fourth Street, New York 14, N. Y.

Without obligation, send me **FREE 52 page CATALOG** on Home Study Courses in Radio, Television and Color TV. No Salesman will call.

Name.....
Please print

Address.....

City..... Zone... State.....

Korean Vets! Enter discharge date.....

IN CANADA — RCA VICTOR COMPANY, LTD.
5001 Cote de Liesse Rd., Montreal 9, Que.

[RESIDENT SCHOOL courses in New York City offer comprehensive training in Television and Electronics. Day and evening classes start four times each year. Detailed information on request.

To save time, paste coupon on postcard



You can make money in

WATCH REPAIR

Learn at home the low cost Sweazey Way

Watch repairing pays up to \$6 an hour, part time watch makers report on survey. Unique and modern Sweazey home study System starts you making repairs right away on Swiss and American watches. Professionally prepared training. No previous experience needed. Special tools provided for practice. Tuition only \$5 a month. Free sample lesson and opportunity book give all facts. Write today. No obligation.

CHICAGO SCHOOL OF WATCHMAKING

2330 N. Milwaukee Ave., Dept. 128, Chicago 47, Illinois

FREE BOOK and SAMPLE LESSON

CHICAGO SCHOOL OF WATCHMAKING
2330 N. Milwaukee Ave., Dept. 128, Chicago 47, Illinois
Please rush FREE BOOK and Sample Home Study Lesson.

Name _____ Age _____
Address _____
City _____ Zone _____ State _____

BE A CLAIM INVESTIGATOR



INVESTIGATE ACCIDENTS! Many earning \$750 to \$1000 a month. Thousands of insurance companies, airlines, steamship lines and Government Offices need Claim Investigators. Also big opportunities for your own spare time business. We train you at home. National Placement Service FREE of extra charge. Bill King writes: "Your course has paid off for me with large earnings. You can quote me—your Adjuster Training Course is worth many times the cost." Write TODAY for FREE book.

UNIVERSAL SCHOOLS

University Park, Dept. PM-2, Box 8202, Dallas 5, Texas

G2

You Can Be a Manufacturer of Gardencrete

Set of 18 Flagstones (below). Sells for \$8.25; Costs to make, \$3.00. Your markup, \$5.25.

Your spare-time manufacture of Gardencrete can lead to a full-time business, with broad sales potentials and generous income possibilities. A small investment buys the Colorglazing machine and a few molds. Add more molds as your business continues to expand.

Gardencrete has wide sales appeal wherever people have pride of lawn and garden. Colors are fused on under air pressure. Stay put for years and years. Choice of 30 colors.

Your mark-up on basic costs is 200%—300%. Products easily made in shed or garage. We supply full instructions. Write for literature and information on costs and selling prices on complete line.

Colorcrete Industries, Inc.
710 Ottawa Ave., Holland, Mich.



Bird Baths
Jars and Vases
Flower Boxes
Flagstones
Lawn Seats



Do you have a "RICH MAN'S" FOOT?



SAVE on SIZES 10 to 16 — AAA to EEE

We specialize in LARGE SIZES ONLY—sizes 10 to 16; widths AAA to EEE. Dress, sport, casual and work shoes; golf shoes; insulated boots; sox, slippers; rubbers; overshoes; shoe trees. Also . . . sport shirts in your exact, extra-long sleeve length. Enjoy perfect fit in your hard-to-find size at amazingly low cost. Satisfaction Guaranteed. Sold by mail only. Write for FREE Style Book TODAY!

SEND FOR FREE CATALOG

KING+SIZE, INC. 556 Brockton, Mass.

Be an industrial designer

Combine your design abilities with technical aptitudes in Industrial Design training at Art Center School in California. Work under practicing professionals for upper level jobs as automotive stylists, product and package designers. Design offices, stores, motels, showrooms, shopping centers. Constant demand for graduates. Recent placements with Ford, G.M., Kaiser Aluminum, G.E., Raymond Loewy and other leading design studios. 700 students. Co-ed. Accredited. B.P.A. Degree. Four-year course can be completed in 2 yrs. 8 mos. by year-round training. New terms Feb., June, Sept. Enroll early. Write Mr. Mace for new catalog. 5353 West 3rd St., Los Angeles 5, California.

ART CENTER SCHOOL

"How to Make Money with Simple Cartoons"



A book everyone who likes to draw should have. It is free; no obligation. Simply address

FREE BOOK

CARTOONISTS' EXCHANGE

Dept. 92-D Pleasant Hill, Ohio

MEN WANTED

Earn \$100 Per Week and up

AUTO DIESEL MECHANICS

Master a trade with a future—learn Auto-Diesel mechanics in our shops. You learn with tools on real equipment. Earn while you learn. Many of our graduates earn \$100 per week and up. No previous experience necessary. Day and night courses. Approved for veterans. Write for free bulletin.

NASHVILLE AUTO-DIESEL COLLEGE

226 7th Ave., N., Dept. 75

Nashville 3, Tenn.

Hotels Call for Trained Men

Record-breaking travel means nation-wide opportunities and a sound substantial future for trained men in hotels, motels, clubs, apartment house positions. Fascinating field; fine living; quick advancement. You can qualify at home or through resident classes in Washington. Previous experience proved unnecessary. Placement Service FREE. Write for FREE Book. Course Approved for ALL Veteran Training. 42nd Year. LEWIS HOTEL TRAINING SCHOOL, Room DB-312, Wash. 7, D.C.



Let me show you

HOW TO SPEAK AND WRITE LIKE A COLLEGE GRADUATE

I have helped thousands of men and women who have not had college training in English to become effective speakers, writers, and conversationalists. With my new C. I. METHOD, you can stop making mistakes, build up your vocabulary, speed up your reading, develop writing skill, learn the "secrets" of conversation. You don't have to go back to school. Takes only 15 minutes a day at home. Costs little. 32-page booklet mailed FREE upon request. Send me a card or letter TODAY!

Don Bolander, Career Institute

Dept. 1052

25 East Jackson

Chicago 4, Illinois

Just Tell Us *Which* Instrument You Would Like to Play...

and We'll Show You How You Can Learn to
Play it at Home, in Spare Time, Even if You
Don't Know a Single Note Now!

THOUSANDS NOW PLAY WHO NEVER DREAMED THEY COULD!



17-Year-Old Student
Now Plays Professionally
and Teaches

"Have completely mastered the piano accordion. I teach at my fully-equipped studio, and play my accordion at big affairs that pay. I have learned to play any song ever written. You will never realize the amount of training you have given me." — Howard D. Arnold, Bloomingdale, N.J.

WHAT'S YOUR favorite instrument? Which is the one you would like most to play well, by note, from regular sheet music? Just name it in the coupon below—and we'll show you how easily and quickly you can now learn to play it.

Even if you don't know one note from another today, you can start playing right away. No "special talent" needed. Thanks to our famous "Easy As A-B-C" print-and-picture lessons, thousands who never dreamed they could are now experiencing the thrill of playing. They're making new friends, becoming more popular.

900,000 Others Have Taken Up Music This Quick, Easy Way

Yes, over 900,000 people—including housewives, businessmen, children, semi-invalids and elderly retired folks—have chosen this streamlined way to master a musical instrument.

Unlike the old-fashioned way of learning, there are no boring scales and exercises to practice. Clear explanations and simple "this-is-how" pictures guide your fingers every step of the way. Even children "catch on" quickly. And, sooner than you would ever dream possible, you find yourself playing hymns, waltzes, folk songs, popular hits, classical numbers—anything you wish or anyone asks for.

Costs Only A Few Cents A Lesson

Let this well-known home-study method bring the many joys of music into YOUR life! New friends. Extra earnings or perhaps even a brilliant career. (For example, Lawrence Welk, famous TV star, is one of our famous graduates.) But best of all, the deep personal satisfaction of being able to make your own music—to provide entertainment for yourself and others. The cost is only a few cents a lesson. Friends or other members of the family can also learn—for the price of one.

- PIANO
- ACCORDION
- GUITAR
- STEEL GUITAR
- VIOLIN
- SAXOPHONE
- TRUMPET, CORNET
- PIPE, HAMMOND,
or REED ORGAN
- TENOR BANJO
- UKULELE
- CLARINET
- TROMBONE
- FLUTE
- PICCOLO
- MANDOLIN

Mail Coupon for FREE BOOK

We have published a 36-page book describing our methods and telling about our 60 years of successful experience. You may have a copy FREE

simply by mailing the coupon below. No obligation; no salesman will call on you. Mail the coupon at once.
U. S. SCHOOL OF MUSIC, Studio 302, Port Washington, N. Y.
(Reduced Prices on instruments to our students.)



Group of Friends Enthusiastic
Miss Mildred Cade of Houston, Texas, and a number of her friends are so enthusiastic about this quick, easy way of learning piano that they've ALL taken it up!



Now Gets Many Invitations
"It's been fun—and hasn't cost anywhere near as much as having a private teacher. Now invited to all kinds of party affairs, dances." —Howard Hopkins, East Syracuse, N. Y.

U. S. SCHOOL OF MUSIC Studio 302, Port Washington, N. Y.

I am interested in learning to play, particularly the instrument checked at right. Please send me your free illustrated booklet, "How to Learn Music at Home." NO SALESMAN IS TO CALL UPON ME.

Do you have the instrument? _____

Mr. _____
Mrs. _____
Miss _____ (Please Print Carefully)

Address _____

City _____ State _____

(Insert Zone Number, If Any)

NOTE: If you are under 18 years of age check here for booklet "A."

- Piano
- Guitar
- Steel Guitar
- Violin
- Piano Accordion
- Saxophone
- Trumpet, Cornet
- Pipe, Hammond, Reed Organ
- Tenor Banjo
- Ukulele
- Clarinet
- Trombone
- Flute
- Piccolo
- Mandolin
- Modern Elementary Harmony
- Practical Finger Control

Free! AIRMAIL COLLECTION



Get this spectacular collection of all-different, genuine Airmails from strange, far-away countries in Asia, Africa, Europe, the exotic Orient! World's largest airmail, scarce \$27 stamp, old Zeppelin, many, many others. A truly remarkable collection containing stamps worth up to 40c each at catalog prices! PLUS Bargain Catalog and other unusual offers. Send 10c for mailing costs. ACT NOW!

JAMESTOWN STAMP CO. Dept. H28PM Jamestown, N. Y.

RUSH my Free Airmail Collection and other offers. I enclose 10¢ for mailing costs.

Name _____
Address _____
City & State _____

Find HIDDEN TREASURES

GOLD, SILVER, PRECIOUS METALS with the Famous Model 27 Metal Detector. Lightweight, ultra-sensitive, low cost. None finer. Also GEIGER COUNTERS for uranium and the VIOLITE for tungsten. INFORMATION FREE

THE *Detectron* CORP.
5528 Vineland Ave., No. Hollywood, Calif.



ENGINEERING DEGREE IN 27 MONTHS

B. S. DEGREE IN

Aeronautical, Chemical, Civil, Electrical, Mechanical and Electronic Engineering (inc. Radio and TV)

Also B.S. DEGREE in 36 mo. in Mathematics, Chemistry, Physics (inc. Nuclear Physics), Engineering Science prep. courses. Thorough, practical program. Individualized instruction emphasized. Government approved for G.I.'s.

Keeping pace with progress in science and engineering

Spacious campus, 20 bldgs.; dorms, gym, playing field. Modern, well-equipped labs including new physics lab and wind tunnel. Low tuition. New terms start quarterly. Enter March, June, September or December. Big demand for graduates. Students from 48 states and 40 foreign countries. Many earn a major part of their college expenses in this large industrial center. Send coupon for free catalog and full information. Enroll now!

INDIANA TECHNICAL COLLEGE

528 E. Washington Boulevard, Fort Wayne 2, Indiana

Please send me free information on 27 MO. B.S. DEGREES in:

Aeronautical Chemical Civil Electrical
Mechanical Electronics

on 36 MONTH B.S. DEGREES in:
Mathematics Chemistry Physics

Name _____

Address _____

INVENTORS

PROTECT YOUR INVENTION BY A U. S. PATENT. SEND FOR FREE "INVENTION RECORD" FORM AND "PATENT INFORMATION EVERY INVENTOR SHOULD HAVE."

CARL MILLER

REGISTERED PATENT ATTORNEY

WOOLWORTH BLDG., 36th FLOOR, 28A
NEW YORK CITY



INVENTORS

U. S. Patents protect your inventions. Our free book of "Instructions on Patent Procedure for Inventors," also "Certificate of Invention" form sent without obligation.

C. A. SNOW & CO.
REGISTERED PATENT ATTORNEYS
428 SNOW BUILDING WASHINGTON 1, D. C.

INVENTORS

Whether an invention is patentable can be substantially determined by a search of the U. S. Patent records. Without obligation, write for information explaining the steps you should take to secure a patent.

JOHN N. RANDOLPH

Registered Patent Attorney
201 Columbian Building, Washington 1, D. C.

INVENTORS

Send for **PATENT INFORMATION** Book and **INVENTOR'S RECORD** without obligation

GUSTAVE MILLER
28-PM WARNER BUILDING
WASHINGTON 4, D. C.

REGISTERED PATENT ATTORNEY
ASSOCIATE EXAMINER
U.S. PAT. OFF. 1922-1929
Patent Attorney & Advisor
U. S. NAVY DEPT. 1930-1947
PATENT LAWYER

GET THE HABIT OF READING

OUR CLASSIFIED ADS.

Wonderful Opportunities Amazing Bargains

INVENTORS NEEDED AT ONCE

If you have an invention you wish to sell outright or license on royalty, write us at once. We are seeking inventions of household items, games, toys, sports items, tools, and mechanical and technical devices. Patented or unpatented. For further information and free brochure outlining manufacturers' requirements, royalty rates, send name (no drawings, please) on letter or postcard at once.

KESSLER CORPORATION, Dept. 52D, Fremont, Ohio

INVENTORS

I shall be pleased to furnish you, upon request, with full information relative to patent procedure—without any obligation on your part.

PATRICK D. BEAVERS

Registered Patent Attorney
934 Columbian Building Washington 1, D. C.

Get into...

PLASTIC LAMINATING AT HOME!

Sensational New
**"ONE MAN
BUSINESS"**
...pays \$10 to \$20 profit
for each dollar of cost.

Make \$20 to \$30 a day by our
MAGIC MAIL PLAN... get
orders and cash from your mailman!

Here's the newest and most fascinating of all home-operated businesses. For the first time, a simplified machine brings the fabulous profits of Plastic Sealing and Plastic Laminating within the reach of the small operator. Can be

operated in a corner of the kitchen, basement, or garage. And any man or woman, regardless of age, education, or experience—can learn this interesting work in a few minutes of reading—can turn out professional jobs after one hour's practice.

TWO EXCITING FIELDS FOR BIG PROFITS!

No house-to-house canvassing. No face-to-face selling. We not only supply the equipment you need for the work, but also show you exactly how to cash in big daily profits from two big demand fields.

A FORTUNE IN PLASTIC SEALING

Millions of people want to protect valuable cards, photographs, documents and papers against wear, soil, and damage. By our MAGIC MAIL Plan you get this business through the mails. Open envelopes and take out money and orders. Details of this plan will amaze you. It will be sent free. Just mail coupon.

ENORMOUS PROFITS IN LAMINATING

A creative, artistic business. Gift shops sell your entire output. Just a few of thousands of giftwares illustrated on this page. Beautiful colors. Endless designs. Exclusive "one of a kind" appeal brings sales at ten to twenty times the cost of materials. Beautiful illustrations and instructions for making these artistic novelties sent free.

**NO MONEY—
Just Send Name!**

WARNER ELECTRIC CO.
1512 Jarvis, Dept. L-2-B, Chicago 26, Illinois

The opportunities in Plastic Laminating are so big that space here does not permit even skimming the surface. To get any idea

FREE

at all of the size of these markets and your place in this sensational business you must read the details. See for yourself how easy it is to do the work—how you can put plastic sheets into your machine and take out a fortune—how money and orders come to you in the mail—how gift shops clamor to get more and more of your creations—how you can start with one machine and build up a big production plant with others doing the work—how you can get money and business from every State in the Union—how you can achieve independence without study or experience.

RUSH COUPON

Never before has such an opportunity been offered the small, home-operator—an opportunity to gain complete personal independence in a big money business of your own. Don't lose a minute. Get the facts at once. All information, fully illustrated with pictures, is free. Send the coupon—or send your name and address on a postcard. There is no charge now, or at any other time. Send for the information on this exciting opportunity today.



\$5-\$10-and \$20 BILLS COME TO YOU IN THE MAIL

By our MAGIC MAIL Plan you sit at home, send out mail, and get back money and orders. Additional profits in supplying lifetime protection for SNAPSHOTS—IDENTIFICATION CARDS—DISCHARGE PAPERS—DRIVERS' LICENSES—SOCIAL SECURITY CARDS—VOTERS REG. CARDS—MENUS—BIRTH CERTIFICATES—CREDIT CARDS—BIRTH AND WEDDING ANNOUNCEMENTS—PASSES—DOCUMENTS.

Lifetime protection. See how laminating prevents soiling, wear, and moisture damage with flexible, plastic covers.



Thousands of Beautiful ART CREATIONS

Made by Laminating as explained in our Free information. Send coupon for list and pictures of COSTUME JEWELRY—JEWELS—CIGARETTE BOXES—CUFFLINKS—NOVELTY BUTTONS—TRAYS—CANDLESTICKS—COASTERS—CLOCK CASES—LAMP BASES—PICTURE FRAMES—BOOK ENDS—CHARMS—ADVERTISING SIGNS—NAME PLATES—BELT BUCKLES—CHECKERS—PAPER KNIVES—CHESSMEN—BOOKMARKS—TIE RACKS—KEEPSAKES OF ALL KINDS.

WARNER ELECTRIC CO., Dept. L-2-B
1512 Jarvis Avenue, Chicago 26, Illinois

Please mail, postage prepaid, complete information with illustrations showing the things I can make and the money possibilities in Plastic Laminating. All this is free. No Salesman is to call. Also, tell me how I get orders and money from my Postman by the MAGIC MAIL Plan.

NAME _____
ADDRESS _____
CITY _____ ZONE _____ STATE _____

The 6-Transistor
Portable That Plays
Anywhere!



build
your own **HEATHKIT** radio
and **SAVE**



**HEATHKIT TRANSISTOR
PORTABLE RADIO KIT**

MODEL XR-1 **\$34.95**

(with cabinet, less batteries)

FREE HEATHKIT CATALOG AVAILABLE

Describes many more
"do-it-yourself" kits for
hobby—hi-fi—ham radio—
and experimenting. Get
your copy now for complete
selection of fun projects
that save you money.



Pioneer in
"do-it-yourself"
electronics

HEATH COMPANY

BENTON HARBOR 17, MICHIGAN A SUBSIDIARY OF DAYSTROM, INC.

Please send **FREE** Heathkit Catalog

NAME _____

ADDRESS _____

CITY & STATE _____

Million Dollar Inventory — All Famous Brands

TIRE SALE
AT LESS THAN WHOLESALE!

SAVINGS NEVER LESS THAN 50% UP TO 70% OFF REGULAR PRICES
HEADQUARTERS FOR ALL SPORTS CAR TIRE SIZES
SEND FOR YOUR **FREE CATALOG!**

RELIABLE TIRE CO. 728 MORGAN BLVD.
CAMDEN 4, N. J.

Tells How You Can Learn to

FREE BOOK MOUNT BIRDS!
FUN! RECREATION! PROFIT!
Learn At Home
Men, Boys, Hunters, Fishermen, mount and save your lovely wild-game trophies. Be a Taxidermist. Mount Birds, Animals, Heads, Fish, Tan skins. YOU learn easily, quickly in spare time. Have a grand home-museum. The finest and the greatest hobby known, for sportsmen. Fun, real profits.

FREE BOOK Yes, **FREE**. Beautiful strange, valuable **Book**, telling all about Taxidermy. Contains over 100 beautiful game-pictures. And it's yours **FREE**, if you rush your request. You can mount

all kinds of wild-game, and common specimens too. We can positively **TEACH YOU**. So **GRASP** this opportunity. **RUSH** letter or postal for this amazing **FREE BOOK**. Don't delay. State your **AGE**.
N. W. SCHOOL OF TAXIDERMY, 2502 Elwood Bldg., Omaha 2, Neb.

Make more **ELECTRONICS!**
money in

The key to better jobs and higher pay in electronics is a 1st class commercial (not amateur) F.C.C. license—Federal Gov't evidence of your qualifications as an operator-technician. We train you quickly—by mail or in resident classes. Get your 1st class F.C.C. license in 12 weeks—NO previous training necessary. Our schools are located in Hollywood and Washington. Write to the school nearest you for our **FREE** booklet of details.

GRANTHAM SCHOOL OF ELECTRONICS, Desk 87-B

1505 N. Western Ave. OR 821—19th Street, N.W.
Hollywood 27, Calif. Washington 6, D.C.

NEW For Scientists — Engineers — Students
Hobbyists—Mechanics... **LOW COST**

NO **CIRCLE DRAFTING KIT REPLACES BEAM COMPASS**
Fast, neat... draw up to 12" circle, circular designs, special effects. Set 30°, 45°, 60°, angles. Protractor, French Curves, Scales.

W **F. E. WILLIAMS ASSOCIATES INC.** **ONE DOLLAR**
1003A San Mateo Blvd. S.E. prepaid
Albuquerque, New Mexico

"**MINIATURE MACHINE SHOP**

No Bigger Than A Typewriter, Outperforms Machines Many Times Its Size!"



That's what a popular publication says about UNIMAT in their 3 page feature story in the May issue. If you want a reprint of this story plus complete information about this amazing 10 in 1 combination precision tool write to:

AMERICAN EDELSTAAL, INC., UNIMAT DIV., Dept. 328, 350 B'way., N.Y. 13

FREE GERMAN STEEL HUNTING KNIFE



4-INCH BLADE

We give you handiest hunting and fishing knife you've ever had! Has 4-INCH LONG highly tempered steel blade—VERY SHARP! Attractive handle. We send knife **FREE** to acquaint you with our below-wholesale bargains. Please send 25c for handling. **NO LIMIT**—but send 25c handling for each knife. Order **TODAY!**
HUNTING KNIFE, Dept. K-296, Box 881, St. Louis, Mo.

SPUTNIK Stamp - Free!

PLUS MANY OTHERS — Big, Exciting. Historic Earth-Satellite Issue Complete Included in German Set Collection! New Multi-Colored Cpl. Set showing Revolution, Schumann-Schubert Music Error, Plants & Flowers Issue, Cycle Races, Nazi Airplane, etc. All this is yours **FREE**, to introduce our Bargain approval offers. **EXTRA: 48 Page Stamp Dictionary** also included. Send 10c to cover mailing costs.
STAMPEX CO. White Plains, N. Y.

FREE TO HOME PLANNERS

Get your **FREE** copy of "Split Level Homes" book (value 50c) **FREE** with your order for the 3 large Garlinghouse Plan Books described below. These books show hundreds of new plans for "custom built" homes. All sizes and styles pictured from photos and colored drawings. Floor plan and accurate description of each plan.

- Ranch & Suburban. 126 plans most practical for town and country. Many in color. 50c
- Homes in Brick. Many of these 115 beautiful tested designs are in full color. \$1.00
- Blue Ribbon Homes. 118 of our most popular designs. 32 in full color. 50c

Complete working plans, specifications, lumber and mill lists available for every plan at **LOW COST**. All books mailed postpaid on **ORDER TODAY** — from America's largest home plan service.

L. F. GARLINGHOUSE CO., INC., Box PM-28 TOPEKA, KANSAS

DO YOU REALLY WANT SUCCESS IN BUSINESS— —AND WILL YOU PAY THE PRICE?

Success and security come to the man who has "trained ability." Specialized ability commands promotion. Business is glad to pay—and pay well for real "know-how."

So—if you are the man who wants success in business, we urge you to immediately take stock of yourself. If an opening should occur, either in the company who now employs you or with another company—a job which would be a definite promotion with more money—could you fill it?

If so, you are fortunate. If not, you had better do something about it, or be satisfied to stay at your present salary level.

PREPARE FOR A HIGH-PAY POSITION

Fortunately, there is something you can do about it—if you will pay the price of investing leisure hours. You can, in your spare time at home, quickly, economically, and thoroughly, without interference with your present work, prepare yourself for a brighter future—more money and a better job.

For nearly 50 years LaSalle has been helping ambitious men and women help themselves. During that time we have enrolled more than 1,380,000 students—helping them on their way to more money—a better job.

We believe we can help you too. The coupon is for your convenience. We suggest that you check the career of your choice and mail the coupon today. By return mail, and without obligation, we will send you full information on that field—the opportunities, and what you must know to be successful.



It's true—there's always room at the top for the trained man.

Don't delay. MAIL THE COUPON NOW.



MEMBER, NATIONAL HOME STUDY COUNCIL

→ SEND FOR FREE BOOK ←

- Accounting
- Law: LL.B. Degree
- Traffic and Transportation
- Business Management
- Stenotype (Machine Shorthand)
- Stenographic-Secretarial
- CPA Training
- Salesmanship

LaSalle Extension University

— A Correspondence Institution —

Dept. 264R, 417 S. Dearborn St., Chicago 5, Ill.

Please send me your FREE illustrated booklet describing the course of training I have checked.

Name..... Age.....

Address.....

City, Zone, State.....

NOW The Short Cut to Learning You've Been Waiting for



Learn "By Ear" with the DORMIPHONE

The Scientific Discovery

That Works for You . . .

Awake and Asleep

Now, at last, science gives you an easy shortcut to learning. With this amazing new tool, you "start" to learn while awake—then the university-tested Dormiphone takes over, continues the learning process for you while you go off to sleep.

Do you want to learn a language—memorize a speech or an array of important facts, figures, formulas—Correct your speech—Break bad habits? The Dormiphone SAVES YOU TIME—EFFORT. So simple to use, children benefit—so helpful and practical it is used by educators, psychologists, people of all ages, occupations all over the world.

Break Down Barriers to Learning

Find out HOW the Dormiphone works FOR YOU—how it can help you learn anything in less time, without intensive self-application. Write for FREE Book, "A New Dimension in Learning," or call for FREE DEMONSTRATION—Get the Scientific Evidence Today.

MODERNOPHONE, INC. Circle 7-0830
236-028 Radio City, New York 20, N. Y.

Gentlemen: Please send me your FREE Booklet. I am interested in learning more about the DORMIPHONE and what it can do for me. No obligation—no salesman will call.
 If under 18, check here for Special Booklet A.

NAME _____

ADDRESS _____

CITY _____ ZONE _____ STATE _____

My main interest in the Dormiphone is for:

- | | |
|--|---|
| <input type="checkbox"/> Learning a Language | <input type="checkbox"/> Speech Improvement |
| <input type="checkbox"/> Memorization | <input type="checkbox"/> Sleep Inducement |
| <input type="checkbox"/> Habit Correction | <input type="checkbox"/> School or College Work |

MAKE STRIPES with new PAINT PEN



Straight, curved, single or double
With any color paint, stripe furniture, bikes, autos, model planes, toys, linoleum, wall-board. Clean, crisp decorative lines. Can't clog or smear. Also use with glue, tempera, textile paint or underglaze. . . on wood, glass plastic, ceramics, metals, fabrics and paper.
Ask your dealer or order direct.

DEALERS Master paint striping tool in display carton. Write for discounts.	HOBBY "Professional" results every time. Simple, easy to use. Order now.	MFRS Ask about heavy duty industrial striping tools.
--	--	--

DOUBLE STRIPE MODEL \$3.25
8 COMBINATIONS. . . .

WENDELL MFG. CO.

4234 LINCOLN AVE., Dept. 337
CHICAGO 18, ILLINOIS

Single
1/16"
stripe
model
\$1.25

Other single \$1.75
stripe models EA
1/64", 1/32", 3/64",
5/64", 3/32" & 1/8"

Complete Kit \$5.00
(all 7 tips)

Extra tips 90c ea.

Extra 1/4" tip..\$1.20

Get Paid For Your ART

Train at Home This Famous Way

IMAGINE GETTING PAID for doing something you love! Thousands have artistic ability — and don't know it. With proper professional training you can make good money, full time or spare time. Do Illustrations, Commercial Art, TV. Learn at home this famous easy way. Individual supervision. TWO ARTIST OUTFITS at no extra cost. FREE BOOK describes our easy method. No obligation. No salesman will call. Just send your name, address to: WASHINGTON SCHOOL OF ART, Studio 142, Port Washington, N. Y. (Estab. 1914). Tear out as reminder.



TOP SPEED BETTER SKIING or FUN



MICHIGAN AQUA-JET propellers win twice as often in the "National Stock Outboard Championship" as all other wheels, custom-built included. Inexpensive stock propellers, requiring no alteration of lower unit, each specifically engineered for motor used (5 HP and larger). Send card for FREE 1958 catalog — the Outboarder's Bible. Shows how to get better performance from specific motor-boat-load combination for racing, skiing, cruising, pleasure — also fine line of boat fittings. Michigan Wheel Co., Dept. PM-2, Grand Rapids 3, Mich.

BUILD FINE GRANDFATHER CLOCK NOW

The simple sensible SPEEDE Red-i-Kut way as thousands have—FOR YOURSELF OR SELL AT A GOOD PROFIT. SAVE HUNDREDS OF DOLLARS. SHOP TESTED PLANS "SPIRIT OF THE CENTURY" Narrow waist 53" tall or stately straight side "SPIRIT OF AMERICA." EASY-TO-FOLLOW photopack PLANS & LIFE SIZE PATTERNS tell all—plus MOVEMENT BROCHURE \$40 up, of heavy brass weight (Kuempel original Westminster, tube BELL chime, movements, gorgeous bronze-silver MOVING MOON dials, 3/4" solid-mahogany Jiffy Joint-Kwik-Bilt case kits. Send \$1.00 today—Both plans RUSH \$1.50 as folks have for over forty years.

Kuempel Chime Clock Works, 214 Kuempel Bldg., Minneapolis 16, Minn.

LEARN
AT
HOME
IN
SPARE
HOURS

BE A LOCKSMITH

Learn fascinating, profitable trade from experts in spare time at home! Age or physical handicap no disadvantage. Year around, steady income. Full or part time. Practical, illustrated lessons. Make money even while learning! All materials and special tools supplied. Free Booklet.

INSTITUTE OF LOCKSMITHING, Dept. P-99
150 PARK AVENUE E. RUTHERFORD, N.J.
Lic. by N.J. State Board of Ed. Approved for Vets

FIGHT HEART DISEASE

Give to your
HEART FUND

1957 WINNER - INDIANAPOLIS

SAM HANKS, famous race driver and mechanic says:
"I'd like a NATIONAL SCHOOLS
trained mechanic on my crew anytime!
Any employer would!"

Few racing drivers are as qualified to advise future mechanics as Sam Hanks, who builds and repairs his own racing cars. He holds the American Closed Course record (182.554 m.p.h.) and a host of state and national titles, including the National Midget Championship in '49 and the National A.A.A. crown in '53. At Indianapolis, he placed third in '52 and '53 last year, he was runner-up.



MASTER ALL ENGINES IN ONE MODERN, SHOP-METHOD HOME TRAINING COURSE **AUTO-MECHANICS & DIESEL**

"NUMBER ONE COURSE IN ITS FIELD," says Sam Hanks, who predicts bright future for men who clip coupon now.

"I've worked alongside National Schools Trained mechanics," reports Sam Hanks. "They're top-notch mechanics, up on the newest advances in automotive engines — even diesel jobs and fuel injection never faze them. That kind of all-around training really pays off — no matter where you work. And take it from me, National Schools Trained mechanics are in big demand everywhere. They command top pay, because they learned how to repair fast and right the first time. Do I recommend National Schools Home Training in Auto Mechanics & Diesel? You bet I do."

Prove it to yourself, Men. National Schools of Los Angeles, a leader since 1905, brings its famous training shops into your home — gives you everything you need to make more money in today's big, opportunity filled Auto-Mechanics & Diesel industry.

Earn as you learn. We show you how. Easy to understand lessons, diagrams, manuals. Free Placement Assistance.

APPROVED FOR G. I. TRAINING



Home of National Schools' world-famous Shops

RESIDENT TRAINING AT LOS ANGELES

If you wish to take your training in our Resident School at Los Angeles, start NOW in our big, modern Shops and Labs, work with the latest Auto and Diesel engines — all types — fuel injection, automatic transmissions, all power equipment — most complete facilities offered by any school. Expert, friendly instructors. Graduate Employment Service. Help in finding home near school—and part time job while you learn. Check coupon for information.

YOU GET AND KEEP ALL THIS EQUIPMENT!



Complete set of professional Tools and All-Metal Tool Box. Same top-quality equipment used by expert mechanics everywhere. Use them, display them proudly.



"Motor Analyzing Set" contains Standard Engine Vacuum Fuel Pump Tester, Remote Starter Switch, Modern Timing Light, Standard Compression Tester. Plus compact carrying case & instructions.



Top-quality Socket Wrench with Fittings. Real professional tools you'll use during your lifetime career in repairing, all types of engines, from foreign cars to big diesel jobs.

- COURSE COVERS**
- All engines
 - Fuel injection
 - Automatic Transmissions
 - Overhauling
 - Customizing
 - Servicing
 - Maintenance

- PREPARES YOU FOR:**
- Auto-mechanic jobs
 - Airplane mechanics
 - Farm machinery repair
 - All diesel jobs
 - Experimental Labs
 - Government work
 - Engine specialist
 - All-around mechanic

GET THE BENEFITS OF OUR 50 YEARS' EXPERIENCE!



NATIONAL SCHOOLS
 LOS ANGELES 37, CALIF

NATIONAL SCHOOLS

TECHNICAL TRADE TRAINING SINCE 1905
 LOS ANGELES 37, CALIFORNIA

MAIL NOW TO
NATIONAL SCHOOLS, Dept. DB-28

4000 S. FIGUEROA ST.
LOS ANGELES 37, CALIF.

Send for FREE Auto-Diesel Opportunity Book and Sample Lesson.

NAME _____ AGE _____

ADDRESS _____

CITY _____ ZONE _____ STATE _____

Check if interested ONLY in Resident School training at Los Angeles.

VETERANS: Give date of Discharge _____

FREE!
 VALUABLE BOOK & SAMPLE LESSON
 — Just Send Coupon!



FREE 1958 CATALOG!

Over 15,000 bargains
in the fields of Hi-Fi,
Radio, Television
and Electronics!

Send for Your
Copy Today!

E-Z TERMS!

Only 10% Down
Top Trade-Ins
Up to 50% Savings
on More Than
800 Guaranteed
Reconditioned
Eqpt. Items!



WORLD RADIO LABORATORIES
The World's Largest Distributor of Amateur Radio Eqpt.
3415 W. Broadway — Council Bluffs, Iowa
Leo J. Meyerson **PERSONALIZED SERVICE**

MAIL HANDY COUPON

WORLD RADIO LABORATORIES, INC. PM-72
3415 W. Broadway — Council Bluffs, Iowa
PLEASE RUSH ME: Free Catalog Hi-Fi Booklet
 Info on Kits Recond. Eqpt. List
NAME _____
ADDRESS _____
CITY _____ STATE _____

EARN BIG PAY

COURSES OPEN IN SHOP METHOD TRADES TRAINING

THE TRAINED MAN GETS THE BREAKS
PRACTICAL & HOME STUDY COURSES

- WELDING
- ELECTRONICS
- DRAFTING
- REFRIGERATION
- AUTO MECHANICS
- DIESEL
- AIR CONDITIONING
- RADIO
- TELEVISION
- PHOTOGRAPHY
- COMMERCIAL ART

DIPLOMAS
AWARDED
GRADUATES



PLACEMENT
SERVICE
MAINTAINED
TO ASSIST
GRADUATES

For Full Details without obligation write to our information office: Department AW, 3330 University Ave. S.E., Minneapolis, Minn.

IN CANADA:

English—935 Weston Road, Toronto 9, Ontario.
French—65 Jean Talon St., W. Montreal, Quebec.

OPERATING FOR A QUARTER CENTURY
COAST TO COAST

SAVE 1/2 - 2/3 THE PRICE OF FACTORY-BUILT BOATS

BOAT KIT CATALOG Free!

Write:

Runabouts, cruisers, convertibles, fishing; 43 models, 8 through 18 ft. Freight paid, \$39.25 up. Assembled and finished by experienced owners, Luger boats equal factory-built in speed, handling, style, beauty; yet save you 1/2 to 2/3. Owners say: "Fastest boat on river." "Pleasure to assemble." . . . "Everyone admires my Luger." Thousands in use. Send for big, free boat kit catalog; also lists fiberglass, hardware, accessories, trailers, paint. Write for catalog today.



LUGER INDUSTRIES, INC. DEPT. B-2 3404 Lyndale S.
Minneapolis 8, Minn.

BRONZE FOUNDRY



Schools • Home Workshops • Inventors

Make your own castings of aluminum, copper, bronze, silver. Foundry sets are available in three sizes including 2400 Deg. F. blast furnaces. \$26.50; \$33.50; and \$46.00 f.o.b. Marysville or Lakewood. Free Circular.

KANSAS CITY SPECIALTIES CO. (Dept.) Box 6022, Marysville, Kans. P-2 or Box 7543, Lakewood, Colo.

Secrets of VENTRILOQUISM Now Revealed!



Easy to learn in 60 to 90 days with our Home Study Course. **RESULTS GUARANTEED.** Make Money! Be Popular! Have Fun! Big Opportunity! Radio, Television, Stage Appearances! For FREE Information regarding price and terms **WRITE.** You must state your age. Dummy Catalog 25c.
MAHER HOME COURSE OF VENTRILOQUISM
Box 36, Studio E, PM-2, Kensington Station
Detroit 24, Michigan

YES! SEND



directly
to my door
every month

I am enclosing

- \$3.50 for 1 year
 \$8.00 for 3 years

name _____

address _____

city _____

zone _____

state _____

Hand this order to your newsdealer or send it to
POPULAR MECHANICS
200 East Ontario St. Chicago 11, Ill.

POPULAR MECHANICS

● We will show you how to earn **\$8,750 PROFIT** first year on just **2 jobs** a day. We furnish all equipment and supplies . . . personally train you in your town to run:

World-Wide Services

Your OWN

Nationally-Advertised Business

YOU BECOME AN EXPERT IN THE CLEANING & PROTECTING OF RUGS & UPHOLSTERY

Even if you are now employed you may start enjoying the prestige and financial independence of your OWN business. We are ready to expand our world-wide organization and offer an unusual lifetime opportunity to reliable and diligent men. You will be trained in your town by a Duraclean dealer, who will reveal the Duraclean System and plans for building business. He will help you get quickly established. Just 2 average jobs a day earns \$8,750 NET profit first year. Employ others and MULTIPLY profits. Business grows from recommendations and repeat orders. Under our guidance you become an expert in the care of rugs and upholstery, a profession for which there is now great demand. Easy to learn. We furnish everything required. No shop needed.



28th year

Even if now employed you can start from home!

WE PROVIDE 25 SERVICES TO HELP YOU BUILD BUSINESS

These are full-time dealerships, but you can start part-time from home. All work is done with portable equipment in homes, offices, hotels, institutions and to revive used car upholstery for auto dealers. Furniture stores, cleaning shops, etc., turn over work to you. We work with you 12 months of the year and provide 25 regular services to help you build business: National Advertising in McCall's, House & Garden, a dozen others. Products Insurance. Complete Advertising Kit including cuts, mats, folders, radio & TV musical recording. Publicity Program gets free local newspaper stories. Monthly Magazine. Sales Book. National & Regional Conventions. Prizes, Pocket Demonstrators. Many others.



1st Process to Win This Honor

Your services are backed by this famous seal of quality, proof that Duraclean has passed rigorous tests. (First in field to do so!) Duraclean also bears the Tested-Certified Seal of the American Research & Testing Laboratories.

5 WAYS TO MAKE MONEY

A Duraclean Dealership qualifies you to offer five different services. Thus on many jobs you multiply profits.

- 1. DURACLEAN:** Unique ABSORPTION process for cleaning rugs, carpets, upholstery. Recommended by leading stores and manufacturers. No scrubbing, soaking, shrinkage. Aerated foam manufactured by portable electric Foamovator safely removes dirt, grease, unsightly spots. Dries so fast customers use furnishings in few hours.
- 2. DURASHIELD:** soil-retarding treatment that KEEPS furnishings clean MONTHS longer. So new you may be the first in town to offer this type service.
- 3. DURAPROOF:** Protects against damage by moths, carpet beetles. Only such treatment backed by an International 6-year Warranty!
- 4. DURAGUARD:** Another new service exclusively developed for Duraclean dealers. A flame-proofing treatment

which reduces fire damage by retarding charring and the tendency of fires to flame up. Theaters, restaurants, and hotels, as well as homes, offer a huge potential.

5. SPOTCRAFT: Special chemical products which enable you to handle most all spot or staining problems means extra business, greater customer satisfaction, and added prestige for you as a professional craftsman.

Easy Terms

A moderate payment establishes your own business—pay balance from sales. If needed, we help finance you. We furnish electric machines, complete sales and advertising material and enough supplies to return your TOTAL investment.

Send for FREE Booklets

Our first letter and illustrated booklets explain the urgently needed services, waiting market, your large profit, easy terms and PROTECTED territory. Send coupon for free facts today.

What Dealers Say

- L. B. Hayes: First month I grossed \$770.17. Duraclean proved so popular, I'm now full-time.
 R. M. Ritter: Seldom go under \$200 per week by myself.
 L. Johnson: Every customer leads to 2 or 3 more.
 W. Abbott: In past 7 months I've taken in over \$12,000.
 M. Lassancke: Original investment returned in 2 months.
 W. Lookiebill: We've had 20 years of pleasant dealings. I'm 65 but setting sights for 20 more years.
 More dealer comments in our literature. Send coupon today.

"OWN a Business" Coupon

DURACLEAN CO., 8-162 Duraclean Bldg., Deerfield, Ill.

Please rush free booklets and letter giving full details of how I may OWN a growing, lifetime business and start while still employed.

Name _____

Address _____

City _____ State _____

Duraclean Co. 8-162 Duraclean Bldg. DEERFIELD, ILLINOIS

FREE!

**100
WORLD-WIDE
STAMPS...**
just
released!



Rush coupon for scarce, beautiful stamps shown, and more — FREE! Asia, Africa, Europe — every corner of the world. The newest, hardest-to-find stamps issued in a year — some not even cataloged yet! All genuine, all different, mint and used, pictorials, bi-colors from Antarctica, Siam, Israel, everywhere. Because this offer is unique, it may never be offered again. Due to scarcity, only one packet to each collector. So add this rare offer to your collection, plus helpful FREE "Stamp Collector's Guide" and other offers for your free inspection. RUSH name, 10c for postage, handling to GARCELON STAMP CO., Dept. 2PMW, Calais, Maine.

Stamp Collector's Guide

GARCELON STAMP CO., Dept. 2 PMW

Calais, Maine. Rush FREE World-Wide Stamps, Collector's Guide, other offers. Enclosed 10c for postage, handling. (PLEASE PRINT)

SALE 20 X 50
REGULARLY \$74.50
SAVE \$44.55!

High powered, whisper-weight (27 oz.) color corrected, Achromatic binoculars. 7" high! EZ to hold, EZ to focus. Instant finger-tip adjustment. Made in Japan. **USE 30 DAYS.** If not satisfied return for refund. Add \$1 postage, handling. Add 10% Tax

UNITED BINOCULAR CO., 9043 S. Western, CRP-2008, Chicago 20. DEALERS WANTED



c.o.d.'s require \$2 deposit.

**EARN \$100
A WEEK AND UP**

**BE AN AUTO-DIESEL
MECHANIC — EARN
WHILE YOU LEARN**

Many of our graduates earn \$100 a week and up. You learn fast in our school and shops because you learn with tools on real equipment. Experienced instructors explain WHY and show you HOW, then you DO IT YOURSELF. One of the best equipped technical schools in the United States. Thirty-nine years' experience training men. Successful graduates in 48 states and many foreign countries. Approved for veterans. Day and evening classes. Free bulletin—write today.

NASHVILLE AUTO-DIESEL COLLEGE
226 7th Ave. N., Dept. 86, Nashville, Tenn.

**WANT MORE MONEY?
GET INTO
PHOTOGRAPHY**



You can become a skilled photographer by training at home in your spare time. With the NYI Home Study Course, backed by our 50 years experience, you'll learn quickly and easily with our famous Learn-by-Doing Method. You get personal, helpful criticism, advice and loads of ideas from our teaching staff—

who are as close to you as your mailbox. Do what hundreds of others are doing—Earn While You Learn! Opportunities are tremendous in Advertising, Portraits, News, Fashion, Commercial, Industrial, Color Photography, Weddings, etc.

No previous experience necessary. Enroll anytime. Big FREE Illustrated Book gives you all the facts and it's yours for the asking. Resident Training (Personal Attendance) is also available in our New York Studios. All Courses Approved for Veterans.

NEW YORK INSTITUTE OF PHOTOGRAPHY
Dept. 49, 10 West 33 Street, New York 1, New York

**ENGINEERING
DEGREE IN
27 MONTHS**

B.S. Degree. Aero., Chem., Civil, Elec., Mech. & Electronic Engineering (inc. Radio, TV), 36 mo. B.S. degree in Math., Chem., Physics. Prep courses. Demand for grads. Spacious campus. 20 bldgs.; dorms, auditorium, gym. Low rate. Earn board. G.I. approved. Enter March, June, Sept., Dec. Catalog. 1628 E. Washington Blvd. Fort Wayne 2, Indiana. Keeping pace with progress

INDIANA TECHNICAL COLLEGE

CABINET MAKING



**LOW COST HOME TRAINING COURSE
FOR BEGINNERS & ADVANCED CRAFTSMEN**

Make money. Learn skills and secrets of fine woodworking and tool use. Professionally prepared shop method training tells and shows how. Covers everything. Easy to master.

Write for **INTERSTATE TRAINING SERVICE**
Free Booklet DEPT. F3, PORTLAND 13, OREGON



MECHANICAL DENTISTRY

A profession offering unlimited opportunities. Most modern and complete course embracing every branch from Plate to Porcelain Work, which prepares you to work for Dentists or start your own business. Individual instruction—practical training in day or night school. No books—no classes. Catalog upon request.

McARRIE SCHOOL OF MECHANICAL DENTISTRY
207 N. Broad Street Dept. 73 Philadelphia 7, Penna.

**ARTHRITIS—RHEUMATISM
VITAL FACTS EXPLAINED**

FREE DESCRIPTIVE BOOK

How crippling deformities may be avoided. This amazing FREE BOOK explains why ordinary methods give only temporary relief—if that. Describes a drugless method of treatment successfully applied in thousands of cases. Write for this 36-page FREE BOOK today. No obligation.

BALL CLINIC, DEPT. 758, EXCELSIOR SPRINGS, MO.

Better Than
Your Own

**SHOE STORE
AT HOME**



Two-
Eyelet
Hit With
Cushioned
Comfort

No investment, no experience needed. Just show magic cushion comfort to friends, neighbors, co-workers. Advance commissions to \$4.00 a pair, plus Cash Bonus, Paid Vacation, \$25.00 Reward Offer. Outstanding values for men, women, children. Money back guarantee. Shoe samples supplied without cost. Write TODAY for FREE new 84 page catalog and full details.

TANNERS SHOE CO., 618 BROCKTON, MASS.

POPULAR MECHANICS

"THIS WISDOM MUST DIE!"



Truths That Have Been Denied Struggling Humanity

FOR every word that has left the lips of bishops or statesmen to enlighten man, a thousand have been withheld. For every book publicly exposed to the inquiring mind, one hundred more have been suppressed — *damned to oblivion*. Each year of progress has been wilfully delayed centuries. Wisdom has had to filter through biased, secret sessions or ecclesiastical council meetings, where high dignitaries of state and church alone proclaimed what man should know.

Are you prepared to demand the hidden facts of life? Will you continue to believe that you are not capable of weighing the worth of knowledge that concerns your personal freedom and happiness? Realize that much that can make your life more *understandable* and *livable* has been left unexplained or intentionally destroyed. At first by word of mouth only, and *now* by private discourses, are *revealed* those truths which secret brotherhoods preserved in ancient temples and hidden sanctuaries, from those who sought to selfishly deprive humanity of them.

THIS free BOOK OF EXPLANATION

Let the Rosicrucians, one of these ancient brotherhoods of learning, tell you about these amazing truths, and explain how you, too, like thousands of others, may now use them to enjoy the fullness of life. The Rosicrucians, (not a religious organization) invite you to send today for your Free copy of "The Mastery of Life" with its startling tale of *self help*. Use the coupon opposite or address: Scribe L.O.X.

The ROSICRUCIANS (AMORC)
SAN JOSE, CALIFORNIA, U. S. A.



Scribe L.O.X.
THE ROSICRUCIANS (AMORC)
Rosicrucian Park, San Jose, California, U. S. A.
Please send me your FREE Book. I am sincerely interested in learning how I may receive these long-concealed facts of life.

Name _____

Address _____

GENUINE
360 POWER
3" REFLECTING
TELESCOPE

COMPLETE WITH
50X, 120X, 150X, 360X
magnifications. 4X finder scope,
folding tripod, plus "Handbook
of Heavens" & Magic Star Finder



Only
\$26⁹⁵

Never before a precision reflecting telescope sold with all these features, for anywhere near this low price. Professional observations guaranteed with this powerful astronomical telescope. Equipped with special WIDE-ANGLE lens for observing satellites, stars, nebulae, comets, Saturn's rings, Jupiter, Mars, Moon's detail, other celestial phenomena with observatory clearness, amazing closeups guaranteed on all objects. Will "split" close double stars. Acclaimed by experts. Optically & scientifically correct, for serious astronomical work. Comes completely assembled ready to use. Eyepieces give full range of powers, 50X, 120X, 150X, 360X. 3 inch f12.5 mirror aluminized & overcoated, guaranteed to resolve to Dawes limit. Special ventilated aluminum mirror housing for use in all climates. 3 foot hardwood folding tripod. Equatorial, alt-azimuth mount. Aluminum head compensates for earth's rotation & permits automatic tracking of astronomical objects. 36" Bakelite phenolic tube. 4X finder scope sights target fast. Completely portable; scope instantly removable from tripod for easy storage & carrying to remote areas. Also included with this amazing precision instrument, 270 page book "Handbook of the Heavens," Magic Star Finder. Satisfaction completely guaranteed or money refunded. Sent complete, nothing else to buy at the amazing low price of only **\$26.95**. Send cash, check, or money order. Shipped by express F.O.B. Shipping weight 10 lbs. Dept. DPM 3, OPTIK INSTRUMENTS CO., 509 Fifth Ave., N. Y. 17, N. Y.

NOW, AIM TO DO DOZENS OF
HOUSEHOLD AND WORKSHOP JOBS
EASIER AND BETTER
BECKER
SPRAY GUN

No hoses, no cords, no attachments necessary. Inexpensive CO2 cartridge supplies all the power needed to spray paints, insecticides, stains, liquid fertilizers, and more. Nozzle adjusts from mist to stream. Container holds 21 ounces. Ask your dealer, or order direct. Remit in full, and we pay postage. Or send \$2, and pay postman balance plus COD fee.



ONLY
\$19.95
Complete with 10 cartridges

SULLIVAN BECKER CO., Dept. 118-B, Kenosha, Wis.

**I'll Send You This Handsome
SAMPLE CASE-FREE**



and Show You How to Make
Up to \$30.00 in a Day

Mail coupon for this Free Tailoring Sample Case packed with 100 beautiful, big-value suits and overcoat fabrics. Take orders from friends, fellow-workers, others, for fine quality, made-to-measure clothes. Pocket big cash profits in advance. Because wearing our suits and overcoats brings more orders, we make it easy for you to get your own clothes without 1c cost. No experience is needed. **SATISFACTION GUARANTEED.** SEND NO MONEY. Just fill out and mail coupon - today!

**W. Z. GIBSON, INC., 500 South Throop Street
DEPT. U-516 CHICAGO 7, ILLINOIS**

**W. Z. GIBSON, INC., Dept. U-516
500 S. Throop St., Chicago 7, Ill.**

Dear Sir: I WANT A MADE-TO-MEASURE SUIT TO WEAR AND SHOW, without paying 1c for it. Rush details and Sample Kit of actual fabrics, ABSOLUTELY FREE.

NAME _____ AGE _____

ADDRESS _____

CITY _____ STATE _____



**NOW'S THE TIME TO
BUILD THAT *BOX
FOR**

- * FISHING TACKLE
- * BAIT
- * TOOLS
- * PARTS
- * CAMPING
- * INSTRUMENTS
- * ART SUPPLIES
- * REPAIR KIT
- * SAMPLES
- * SEWING KIT
- * SCREWS & NAILS
- * BOAT
- * TRAILER
- * ODDS & ENDS

Rugged
SOLID BRASS
Box Hardware
ALL FOR \$1.00
BRASS WILL LAST

We can now offer POPULAR MECHANICS readers the famous KADA'S SOLID BRASS "Building a Box?" HARDWARE direct from our factory at the amazingly low price of \$1.00, postpaid, for a complete set, less screws. Set consists of a pair of sturdy hinges, unique new adjustable tension bolt-action latch, lay-down handle, bracket for boxtop, and 8 corner buttons. You can use a single latch for box and load up to 15 lbs. Use a pair for up to 35 lbs. Extra latch 20c. If you have a box that was made of material more durable than the hardware applied, replace it with KADA. Better order extra sets at this low price.

SEND CASH, CHECK OR MONEY ORDER NOW
KADA MFG. CO., 2332 SUL ROSS AVE., HOUSTON 6, TEX.

GET INTO ELECTRONICS

V.T.I. training leads to success as technicians, field engineers, specialists in communications, guided missiles, computers, radar, automation. Basic & advanced courses in theory & laboratory. Assoc. degree in 29 mos. B.S. obtainable. ECPD accredited, G.I. approved. Graduates with major companies. Start Feb., Sept. Dorms, campus. H. S. graduate or equivalent. Catalog.

VALPARAISO TECHNICAL INSTITUTE
DEPT. D VALPARAISO, INDIANA

do you know

**THE
FACTS
OF
LIFE**

about cancer?

It's time you did! Last year cancer claimed the lives of 250,000 Americans; 75,000 of them lost their lives *needlessly* because they didn't know the facts of life about cancer. 800,000 Americans are alive today . . . cured of cancer . . . because they went to their doctors *in time*. They knew that a health checkup once a year is the best insurance against cancer. Make an appointment right now for a checkup . . . and make it a habit for life.

AMERICAN CANCER SOCIETY

Superior's New Model 70 UTILITY TESTER®

FOR REPAIRING ALL ELECTRICAL APPLIANCES MOTORS • AUTOMOBILES • TV TUBES



As an electrical trouble shooter the Model 70:

- Will test Toasters, Irons, Broilers, Heating Pads, Clocks, Fans, Vacuum Cleaners, Refrigerators, Lamps, Fluorescents, Switches, Thermostats, etc.
- Will test all TV tubes for open filaments, inter-element shorts, burned out tubes, etc.
- Measures A.C. and D.C. Voltages, A.C. and D.C. Current, Resistances, Leakage, etc.
- Will measure current consumption while the appliance under test is in operation.
- Incorporates a sensitive direct-reading resistance range which will measure all resistances commonly used in electrical appliances, motors, etc.
- Leakage detecting circuit will indicate continuity from zero ohms to 5 megohms (5,000,000 ohms).

As an Automotive Tester the Model 70 will test:

- Both 6 Volt and 12 Volt Storage Batteries • Generators • Starters • Distributors • Ignition Coils • Regulators • Relays • Circuit Breakers • Cigarette Lighters • Stop Lights • Condensers • Directional Signal Systems • All Lamps and Bulbs • Fuses • Heating Systems • Horns • Also will locate poor grounds, breaks in wiring, poor connections, etc.

IT'S SO EASY!!



With tester's cord in outlet, current consumption of appliance is read direct on meter when line cord is connected to receptacle on panel. This typical iron takes 7 amperes (Good).



Small electric fan motor indicates 80 ohms (normal resistance).



Control circuits of most furnaces use 24 volts obtained from step-down transformer. Here's how to check room thermostat to see if wires to it are live.



Manual supplied with Model 70 shows meter needle moves to right when test leads are connected to pins 3 and 4 of this 6AU6 tube. Procedure for testing all tubes used in TV are detailed in manual.

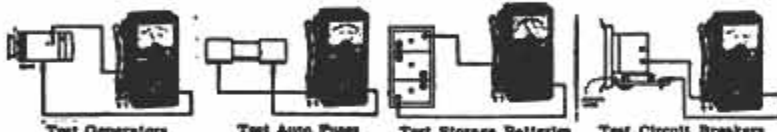

Test Generators

Test Auto Fuses

Test Storage Batteries

Test Circuit Breakers

READ THIS!

READ THIS!

READ THIS!

You don't pay for the Model 70 until AFTER you have examined it in the privacy of your home! Model 70 is

SHIPPED ON APPROVAL NO MONEY WITH ORDER — NO C.O.D.

Try it for 10 days before you buy. If completely satisfied then send \$3.85 and pay balance at rate of \$4.00 per month for 3 months — No Interest or Finance Charges Added! If not completely satisfied, return to us, no explanation necessary.

MOSS ELECTRONIC DIST. CO.

Dept. D-429 3849 Tenth Ave., New York 34, N. Y.

Please rush me one Model 70. If satisfactory I agree to pay \$3.85 within 10 days and balance at rate of \$4 per month until total price of \$15.85 plus postage is paid. If not satisfactory, I may return for cancellation of account.

Name _____

Address _____

City _____ Zone _____ State _____



INCLUDED FREE!!

This 64-page book—practically a condensed course in electricity. Learn by doing.

Just read the following partial list of contents:

- What is electricity? • Simplified version of Ohms Law • What is wattage? • Simplified wattage charts • How to measure voltage, current, resistance and leakage • How to test all electrical appliances and motors using a simplified trouble-shooting technique.
- How to test all TV tubes; also simple procedure for determining which specific tube (or tubes) is causing the trouble.
- How to trace trouble in the electrical circuits and parts in automobiles and trucks.

Model 70 comes complete with above book and test leads. Only ...

15⁸⁵

\$690 gross in single
MONTH
IN MY OWN BUSINESS!



Start your own business!

Here's YOUR chance to start a money-making, year-'round business of your own and make the success you've dreamed about. R. O. Donnelly took in \$40 in seven hours. O. W. Ware landed a \$750 hotel job. J. S. Corbit grossed \$279.50 his first month. Homes, hotels, offices, clubs, offer you big profit possibilities. Auto upholstery also.

NO SHOP OR OFFICE NECESSARY. You clean furniture on customers' premises. No hauling. No high rents. Supplies inexpensive; operate from your home. What you take in is mostly profit.

● If you want to be your own boss—free from layoffs, strikes and bosses, we will help you to start and succeed. Don't delay...read the facts, then decide for yourself.

MAIL COUPON TODAY FOR FREE BOOK

VON SCHRADER MFG. CO.
210 "D" Pl., Racine, Wisconsin

Without obligation rush your **FREE** booklet about how I can start my own permanent, profitable electric Upholstery Cleaning business.

Name _____
Address _____
City _____ Zone _____ State _____

STUDY TO BE A DOCTOR
of Psychology or Metaphysics

Obtain a Ps.D., Ms.D., or Ph.D. Be a Teacher, Lecturer or Accredited Practitioner. Teach others how to achieve Health, Happiness and Contentment. Chartered by State. Correspondence Courses only. Write for **FREE** book telling how.

THE NEOTARIAN FELLOWSHIP
Desk 8, Pickwick Building Kansas City 6, Missouri

YOU CAN MAKE
AS MUCH AS
\$20,000 A YEAR
WITH YOUR OWN BUSINESS!

Here's your opportunity to make big money on a small investment! Open your own RICHARDSON Roadside Stand, backed by our proven formula and franchise plan. Our 35 years of experience in merchandising root beer at stands, parks, fountains and two world fairs is passed on to you. Let us show you—without obligation—how you can go into business for yourself with a minimum investment and join the successful franchised RICHARDSON Roadside Stand operators earning up to \$20,000 and more a year! A RICHARDSON franchise permits you to build a modern, nationally advertised RICHARDSON patented stand. Here's your chance to set up a nice business that's easy to operate, simple to maintain, designed to give you big seasonal profits or income all year 'round. Write for further information, now!

RICHARDSON Corp. Box 790 Dept. P. M.—1
Rochester 3, New York

POSITIVELY NO SELLING!



I made \$20,000 a year without selling a thing—door to door, over the counter, by mail, or any other way. All I did was pick up junk jewelry. Then Uncle Sam paid me \$35.00 an ounce for the gold in it, less a small handling and refining charge. Send me your name and address and I'll show you how it's done.

I claim there never was an easier way to make money. There is positively no selling because the U. S. Government is eager to buy all the old gold you turn in—at the established price. Just follow my plan and you can pick up gold in any street in your town. I show you where to find it, what to pay for it, how to test it and how to mail it to Uncle Sam for immediate cash. I'll teach you the secrets by which I made \$20,000 a year with absolutely no selling. No charge for facts. No salesman will call. Send no money—just your name and address on a postcard. Write today to: **LESLIE PATTON, 335 West Madison Street, Dept. 9-B, Chicago 6, Ill.**

If Your Child Is a Poor Reader

See how The Sound Way To Easy Reading can help him to read and spell better in a few weeks. New home-tutoring course drills your child in phonics with records and cards. Easy to use. University tests and parents' reports show children gain up to full year's grade in reading skill in 6 weeks. Write for free illustrated folder and low price. Bremner-Davis Phonics, Dept. R-57, Wilmette, Ill.



HIGH SCHOOL DIPLOMA

Earn a High School Diploma at home! Prepare for better job, more pay. Study in spare time. No classes. Materials furnished. Certified teachers. Valuable diploma awarded.

Write Today for Complete Information
SOUTHERN STATES ACADEMY
Box 5344-A Sta. E Atlanta, Georgia



2 FOR \$14.95
MAGNETO HANDSET INTER-COMM

(rebuilt). For house to barn etc., included 100 ft. of wire and 4 batteries. Additional wire 1¢ per ft. Any number can be connected in same line. Write for **FREE** List. All shipments FOB Simpson, Pa.

TELEPHONE ENGINEERING CO.
DEPT. 288 SIMPSON, PA.

MAKE BIG MONEY—ALL PROFIT—AT HOME

INVISIBLE MENDING

Pays up to \$10 in an Hour! **BEFORE**
Make moth holes, cigarette burns, tears, rips, disappear from all fabrics. Little-known craft pays extra spare-time profits at home. Write today for exciting details **FREE!**
FABRICON, 6238 Broadway
DEPT. 322. - CHICAGO 40, ILLINOIS **AFTER**

Now Many Wear FALSE TEETH
With More Comfort

FASTEETH, a pleasant alkaline (non-acid) powder, holds false teeth more firmly. To eat and talk in more comfort, just sprinkle a little **FASTEETH** on your plates. No gummy, gooey, pasty taste or feeling. Checks "plate odor" (denture breath). Get **FASTEETH** at drug counters everywhere.

HERE'S A READY-MADE FUTURE FOR YOU

MILLIONS OF HOMES IN U.S.
HAVE 6-12 SMALL APPLIANCES
MORE SOLD EVERY
YEAR - MILLIONS
NEED REPAIR NOW
WITH THE NEED
INCREASING
DAILY!

Start Your Own Business IN

ELECTRICAL APPLIANCE REPAIRING

EARN WHILE YOU LEARN

"Only had your course a few short weeks and have already made \$800.00."

J.D.S., St. Louis, Mo.

"I work day times at the shipyard and after 4:00 P.M. I operate from my cellar and garage. I average \$10.00 to \$15.00 clear every day."

W. H. Brookline, Mass.

"Make \$15.00 Saturdays and more. Am only able to operate in my spare time. It is just what a mechanically minded man needs." G.O.F., Thomasville, Ga.

IN YOUR OWN KITCHEN, BASEMENT OR GARAGE

Learn at home in your spare time this fascinating, big paying profession.

If you are mechanically inclined, can hold and use tools, we can give you the training and time saving kits that will enable you to . . . Command More Money At Work . . . A Better Paying Job

Elsewhere . . . Or A Business Of Your Own! New Shop Method Home Training teaches you both the technical and practical side of Electricity by having you work with your hands Building, Testing, Repairing. All instruction manuals are written in easy-to-understand language, chock full of hundreds of detailed photos and drawings. We show you how to quickly locate the trouble, how to fix it and what to charge. ALSO, how to do House Wiring, Welding, Nickel Plating, Sharpen Lawn Mowers, Skates, etc. and how to build power tools you need from spare parts.

\$5.00 TO \$6.00 AN HOUR

Often charged for making ordinary repairs. We show you how to repair refrigerators, vacuum cleaners, washing machines, motors, irons, etc.

CHRISTY TRADES SCHOOL, Dept. D-6703
4804 N. KEDZIE AVE. CHICAGO 25

SEND FOR FREE BOOK!

CHRISTY TRADES SCHOOL, Dept. D-6703
4804 N. Kedzie Ave., Chicago 25, Ill.

Please send me FREE Illustrated Book on Electrical Appliance Repairing and Special form for Paying Later from Earnings.

NAME _____ AGE _____

ADDRESS _____

CITY _____ ZONE _____ STATE _____



WE GIVE
YOU THIS
ELECTRONIC
KIT TROUBLE
FINDER



FREE 10-DAY TRIAL More than 100,000 copies sold!



DO YOUR OWN HOUSE CARPENTRY
Save Time and Money This Easy Way

Every step of carpentry in and around a house is clearly explained and illustrated in this big, useful book. If you have a hammer, saw, and a set of plans, just follow the step-by-step directions and do any house carpentry job from foundation forms to interior trim. Shows you how to build forms for foundations, footings, walls, steps, walks—How to build sills, girder supporting posts and girders—How to figure loads for house framing—How to lay out, cut and erect floor joists—How to lay flooring—How to frame outside and inside walls, allowing for openings—How to check the plumb of studs—How to brace and sheathe up outside walls—How to erect ceiling joists—How to frame around a chimney and stair well—How to lay out rafters for a gable roof, former roof, porch roof—How to sheathe gable ends and rafters—How to build cornices—How to lay shingles—How to build porches and bays—How to apply siding—How to frame up inside walls—How to construct stairs—How to place trim around windows and doors—How to fit and hang sash—How to hang doors—How to make closets, shelving and built-in equipment—How to lay finished wood flooring, linoleum flooring—How to hang a set of garage doors—How to insulate.

Over 1100 Illustrations Show You Just What To Do and How To Do It

"I built my entire 5-room house myself with no other instruction except your book," writes James Sidwell, Twin Falls, Idaho. Here, in one remarkable volume, is the practical know-how that SAVES YOU TIME AND MONEY on house carpentry jobs of every description. New 5th Edition, just published, gives you the latest information on materials, equipment, and carpentry techniques for every job from cellar to attic, inside and out.

USE IT FOR TEN DAYS FREE
 Don't send us a penny. Just mail coupon and get "HOUSE CARPENTRY" for 10 days FREE trial. If not delighted, send book back to us and owe nothing. If you keep it, entire cost is only \$5.95, plus few cents postage. Mail coupon below for your free-trial copy.

Send No MONEY

MAIL THIS COUPON

SIMMONS-BOARDMAN PUBLISHING CORP., Dept. PM-258
 30 Church Street, New York 7, N. Y.

Send me for 10 DAYS' FREE TRIAL, "House Carpentry Simplified." I will either return it in 10 days and owe nothing, or send only \$5.95 (plus shipping charges) in full payment.

Name _____
 Address _____
 City _____ Zone _____ State _____

SAVE! Send \$5.95 with this coupon and we pay postage. Same return and refund privilege.

ENGINES "Sing"!
 WITH **MILESMASTER**[®]

FUEL PRESSURE REGULATOR

For smooth running, quick starting, better mileage . . . install a genuine MILESMASTER. Prevents flooding. Only \$6.95

MILESMASTER, INC., Dept. K, Exeland, Wisconsin

WAR SURPLUS BARGAINS

WAR SURPLUS BARGAINS

\$500,000.00 INVENTORY for QUICK LIQUIDATION

Surplus items—hundreds of them for home, shop, factory, farm and outdoor use. New items, used items, reconditioned items—all at tremendous savings—all priced for quick sale.

Page After Page of Values

This big catalog shows page after page of amazing money saving values. Write for your copy today. Send 10c to cover postage, mailing, etc. Write today! **SEND TODAY FOR YOUR COPY**

10c

STARK'S 212 W. Madison St.
 Dept. PM-582
 CHICAGO 6, ILL.

BARBELLS

100 POUND SET \$11.80

140-Pound, CHROME DELUXE Barbell-Dumbbell set only \$18.80. This is our feature set and is the finest ever manufactured.

Training with adjustable weight is the BEST way to keep fit; the ONLY way to develop great strength and a perfect body. As the oldest and best equipped barbell company, BUR gives value and prices no one can equal.

SEND FOR FREE CATALOG.
BUR BARBELL CO.
 Lyndhurst 9, New Jersey

FREE BERRY'S NEW POULTRY BOOK

Gorgeously illustrated, describing DAY-OLD and 4-WEEK CHICKS, 50 varieties, sexed or unsexed. AMERICA'S FINEST; also Ducks, Geese, Guinea, and Pigeons. THE ORIGINAL BERRY'S FARM, since 1896. Beautiful book and LOW PRICE LIST FREE, stamps appreciated. BERRY'S POULTRY FARM, Box 26, Clarinda, Iowa

Every Boy Should Have This Build-It-Yourself Book for Boys!

It's natural for boys to want to make things—to fuss with tools—to fashion the kind of things "kids" want. So give boys the Build-It-Yourself Book for Boys. Encourage a youngster to express himself through the sensational new Popular Mechanics book that shows how to make 56 different things every boy dreams about. It covers science, mechanics, electricity, modeling and other fields. 192 pages of easy-to-follow instruction and 469 how-to-do-it pictures.

56 Toys, Games, Gadgets, Models, Boats, Electrical Devices, Cars and Other Things Boys Can Make at Home

How to make—Airplane Models, Aquaplane, Archery Kit, Bird Houses and Shelter, Boats, Bobsleds, Boomerangs, Cannon Toy, Electric game, Electric Motors, Garage Toy, Helicopter Toy, Hunting Knife, Hydroplane Model, Kites, Log Cabins, Marble Game, Microscope, Printing Press, Radio Sets, Rafts, Railroad Modeling, Shooter, Scooter, Sidewalk Cars, Sprinkler

Truck, Squirt Gun, SS United States Model, Surfboard, Tank Toy, Taxidermy, Telegraph Set, Telephone, Tree House, Water Skis, Weather Instruments, Toboggan, Worktable.

Build-It-Yourself for Boys sent postpaid for \$2.50 or COD, charges additional. Money refunded if you are not pleased after 5 days' use. Mail order to address below.

Toy motors
 Boomerangs
 "Ju-be"—the punt

POPULAR MECHANICS PRESS
 Dept. 258, 200 E. Ontario St., Chicago 11

Choose the Allied Way for Best Pay

TRAIN AT HOME

in Your Spare Time or in the Great Allied School



- Drafting—All Branches
- Tool & Machine Design
- Tool Engineering (Bachelor Degree TE)
- Mech. Engineering (Bachelor Degree ME)
- Master Machinist
- Tool & Die Making
- Auto Mechanics
- Air Conditioning
- Refrigeration

Prepare for the best jobs in your spare time at home. With ALLIED'S practical Home Study program you can progress so rapidly that big new opportunities will soon be open to you. ALLIED'S Home Training methods are the finest ever designed for they are based on the successful programs developed in the ALLIED School for more than a quarter of a century.

Your Home Training entitles you to two weeks of training at the great Allied shops at no additional tuition cost, should you desire it. You get many advantages and additional services when you enroll for ALLIED training.

More Jobs Than Graduates

As an Allied trained man you can go up fast—to higher and still higher pay or you can build your success in a business of your own. Due to great industrial expansion industry has been clamoring for Allied trained men to fill important jobs. Shortages of Draftsmen, Designers, Tool Engineers, Machinists, Air Conditioning, Refrigeration and Heating Technicians, and Auto Mechanics are so widespread you can pick a high paying field and look forward to Achievement and Security. You can begin your training in short courses at Home or at Allied Institute, and continue progressively toward an Engineering Degree in 31 months.

Allied is approved by industry, National Home Study Council, Department of Education, Office of Public Instruction, State of Illinois, U. S. Department of Justice. **BE AN ALLIED TRAINED MAN—GET THE FACTS—MAIL COUPON TODAY.**

Mail Coupon for Free Sample Lesson

ALLIED INSTITUTE of TECHNOLOGY

1338-42 South Michigan Avenue, Dept. PM-28, Chicago 5, Illinois

Gentlemen:

Mail me FREE BOOKS explaining ALLIED'S courses of instruction and FREE SAMPLE

Lesson. Vets write date of discharge _____

I am interested in the training I have checked below: Resident Home Study

- | | | |
|---|--|---|
| <input type="checkbox"/> DRAFTING—All Branches | <input type="checkbox"/> MECH. ENGINEERING
Bachelor Degree (ME) | <input type="checkbox"/> AUTO MECHANICS |
| <input type="checkbox"/> TOOL & MACHINE DESIGN | <input type="checkbox"/> MASTER MACHINIST | <input type="checkbox"/> AIR CONDITIONING |
| <input type="checkbox"/> TOOL ENGINEERING
Bachelor Degree (TE) | <input type="checkbox"/> TOOL & DIE MAKING | <input type="checkbox"/> REFRIGERATION |

NAME _____

ADDRESS _____

CITY _____ COUNTY _____ STATE _____



FREE BOOKS

tell how YOU can become an ALLIED TRAINED MAN. Write TODAY!

ALLIED INSTITUTE OF TECHNOLOGY, Div.
ALLIED School of Mechanical Trades
1338-42 South Michigan Avenue
Dept. PM-28, Chicago 5, Illinois

EARN EXTRA MONEY

IN YOUR SPARE TIME . . . AT HOME

New Plastic-Fiberglass Process opens up excellent opportunities

if

. . . you like to work with new ideas and materials and can use some extra cash, you'll be interested in our new manual "How to Earn Extra Money in Your Spare Time." It shows you what others have done, how they got started, what they make. Tells about how one man earned \$1800.00 net profit in 6 weeks in his home shop and how you can do the same.

Illustrated Directions Show You How to embed real flowers, brilliant fall leaves, butterflies, sea shells, coins, photos in clear liquid plastic to make novelties and other fast selling items. How to laminate translucent glass panels with embeddings of unusual fabrics, grasses, seaweed and other interesting materials. How to use these panels for room dividers and screens, or fine lamps, bowls and trays. Also shows a new way of coating tiles and mosaics that is Really New and Different.

No Equipment is Required because neither heat nor pressure are needed . . . just small hand or power tools. This process is made to order for the smaller operator with a garage or basement shop. The same basic materials used for laminating decorative glass panels are also used for repair work. If you are in the right location, for example, you may find your big opportunity "glassing" boat hulls, tanks, pools or develop a specialized, highly profitable industrial maintenance business.

How to Get Started

Get all the facts before you do anything else and send for "How to Earn Extra Money in Your Spare Time." It is a mighty valuable source book of ideas. Clear-cut directions and over 100 photos explain new methods of using plastic and fiberglass you can adapt to your own requirements. No other book like it has ever been published before. To cover mailing costs, send 25c to:

Commercial Craft Division, Dept. B-1
THE CASTOLITE COMPANY
Woodstock, Illinois



"TI-NEE" BATTERYLESS TUBELESS LIFETIME RADIO

"TI-NEE" RADIO IS GUARANTEED TO WORK FOR YOUR LIFETIME! USES NO TUBES, BATTERIES OR ELECTRICAL PLUG-INS. Never runs down! SMALLER THAN A PACK OF CIGARETTES! RECEIVES LOCAL RADIO STATIONS MOST ANYTIME, ANYWHERE WITHOUT EXTRA ANTENNA. Uses semi-conductor crystal diode Hi-Q Tuner. Beautiful black gold plastic cabinet. Built-in Speakerphone.

SEND ONLY \$2.00 (bill, c.k. mo.) and pay postman \$4.99 COD on arrival or send \$6.99 for postpaid delivery. SENT COMPLETE READY TO LISTEN—NOTHING EXTRA TO BUY EVER! Extra long distance Aerial kit included free to receive stations up to 1,000 miles away. Available only from:

MIDWAY COMPANY, Dept. GPM-2, Kearney, Nebraska



I'll Set You Up For Life In Your Own BIG PAY SHOE BUSINESS

Only 8 Orders a Day Can Make You Up to \$32.00 a Day \$180.00 a week \$600.00 a month



It's no trick at all to make big money FULL OR SPARE TIME with America's most comfortable shoes. Amazing new "Spring-Step"

cushion design proves it by actual demonstration. Only ORTHO-VENT has it. No other shoe in the world like it. Profits are BIG—repeat orders are sure and easy with amazing 2-minute demonstration. No experience needed. No investment to make. Everything furnished free, including finest sales outfit and actual demonstrators! Be the big pay ORTHO-VENT man in your territory. Send Today for free outfit.

Amazing 2-MINUTE DEMONSTRATION Does Your Selling Job for You FAST!



I Give Producers Their Own Shoes AS A BONUS!

ORTHO-VENT SHOE CO. • 1162 BRAND ROAD SALEM, VIRGINIA

New Isotronic Training Method

LEARN TV REPAIR IN ONE SHORT WEEK!

Now, after 5 year's research—a streamlined training system that *obsoletes all others!* In just 7 days you may earn \$150 weekly, without paying up to \$250 for training, studying long months! Developed by electronic scientists in cooperation with major TV mfr's., the new Isotronic method is the most practical ever devised! For conclusive proof, write for details and FREE SAMPLE LESSON. Use it on your own set or a friend's—repair it—convince yourself you can make big money immediately in your own TV business! Hurry—Free Lesson supply limited. Write: Electronic Engineering Co., Dept. B-172 1038 So. La Brea, Los Angeles 19, Calif.

Millions have done it to cash YOU!



Stop being SKINNY like I was

Quickly GAIN 25 LBS. of HANDSOME POWER-PACKED MUSCLES like I did

Send for these 5 AMAZING PICTURE COURSES AT 5 FREE before \$1 price goes back

1. How to GAIN MIGHTY ARMS
2. How to GAIN A BIG CHEST
3. How to GAIN A MIGHTY BACK
4. How to GAIN POWERFUL LEGS
5. How to GAIN A GRIP OF STEEL

Also FREE Photo Book of Strong Men

Send 10c for postage for all 6 items

Jowett Institute, Dept. PM-82, 220 Fifth Avenue, N.Y. 11, N.Y.

FREE WHOLESALE CATALOG

MAKE MONEY! SAVE MONEY!! Buy Tools, Hardware, appliances, photo equipment, sporting goods, power tools, paints and thousands of other nationally advertised products at WHOLESALE COST TO YOU.

SEND FOR FREE 1958 WHOLESALE CATALOG TODAY!

SILVO HARDWARE COMPANY Dept. PM-2, P.O. Box 266, Philadelphia 5, Pa.

BUILD THE NEW ECONOLAXER

Relaxes and soothes ragged nerves! More complete relaxation, sleeping or resting. Installs underside of bed springs or in lower part of lounge chair. Do-it-yourself instructions for making parts and installing. ONLY \$1.00

Or, instructions and kit of factory-made parts only 9.95 (Postpaid in U.S.)

SOONERLAND INDUSTRIES P. O. Box 6102, Oklahoma City, Okla.



LEFAX TECHNICAL DATA BOOKS

POCKET SIZE • LOOSE LEAF

Printed on loose leaf, 6 hole, 6 3/4" x 3 3/4" bond paper, each book contains about 140 pages of technical data, condensed, accurate, essential, for engineer, technical worker, teacher, student, business man \$1.25 each

- | | | | |
|--------------------|------------------|-----------------------------|--------------------------|
| Architecture | Surveying Tables | Machine Design | Radio |
| Home Heating | Highway Eng'g. | Machinist's Data | Television & FM |
| Illumination | General Math | Mech. of Materials | Electricity, AC |
| Electrician's Data | Math Tables | Pwr. Trans. Mach. | Electricity, DC |
| Builder's Data | Physics | Thermo. Tbls. & Charts | AC Motors and Generators |
| Lumber Data | Trig-Log Tables | Phys. & Thermo-dynamic Data | Conversion Tabl. |
| Air Conditioning | Gen'l Chemistry | Analytical Chem. | Steel Forms |
| Building Constr. | Chemical Tables | Metallurgy | Welding Data |
| Reinf. Concrete | Analytical Chem. | Hydraulics | Transformers, |
| Piping Data | Mech'Drawing | Metals | Relays & Meters |
| Surveying | | | |

Write for FREE catalogs (2000 listings). See how helpful LEFAX can be to you. Send \$1.25 book, or \$6 for any five books to

LEFAX PUBLISHERS, Dept. PM-28, PHILADELPHIA 7, PA.

NEW! MODEL 400 SIMPLEX Lawnmower Sharpener

Many Exclusive Features . . .

The NEW SIMPLEX is the fastest, most accurate straight-line lawnmower grinder ever built . . . gives you all these advantages:

- Grinds all mowers—reel type, rotary, hand or power, any size.
- No dis-assembly needed, gas and oil remain in engine, support bar rotates.
- Grinding head feeds both horizontally and vertically, turns 90° for bed knives.
- Fast, positive adjustments, 4-point support on steel base with leveling screws.
- Rugged, long life construction and many other features.



Small investment
returns
Big Profits!

THE FATE·ROOT·HEATH COMPANY

Dept. PM-2 • Plymouth, Ohio

Get the facts on the new Simplex 400
before you buy any sharpener.

Send for free brochure today!

250 POWER



Complete Telescope Lens Kit only **\$3.49** postpaid
Conquer Space, Explore the Universe, Planets, Moon Craters, New Stars, etc. Complete Lens Kit consists of 80 inch focal length ground and polished objective lens, eyepiece lenses for 50 POWER, 100 POWER, 150 POWER, 200 POWER, 250 POWER, and all necessary lens fittings. Easy to make from simple step by step instructions. (Tripod and mount not included.) Money back guarantee.
BUSSE SALES CO., Hartford, Conn., Dept. PM 66

\$1 METAL Pocket Rubber Stamp

Nickel-plated, indestructible. Any 3-line text, 1/2" x 2" area. Inked and ready for instant use. Send Check or M.O. Mailed POSTPAID.
SAMUEL H. MOSS, Inc. 36 E. 23rd St., N.Y.C. 10 Dept. MEC-2



Auto Parts Whole- sale!

Cheapskate Chandler
DISTRIBUTOR OF UNNECESSARY
GADGETS FOR YOUR CAR

Everything For New Cars Texas Size Stocks Of Hard-To-Find Parts For Old Timers

RUSH 10¢ IN COIN OR STAMPS FOR CATALOG!

Just Address: "Cheapskate"-Brownwood, Texas

24 YEARS IN BUSINESS AT THE SAME ADDRESS.



Our entire stock of very slightly used EXTRA MILEAGE TOP GRADE Tires. (Written Insurance Guarantee). SEND AD

EVERYBODY 10% off ON EVERY TIRE

Free—Tube With Each Passenger Tire

FREE If you buy 2 or more Passenger 4-ply tires, WE GIVE ONE tire FREE, on each order. Does not include W.W or Truck Tires, or Snow Tires. Write for other sizes.

12 MOS. WRITTEN GUARANTEE. WHITE WALLS \$1.00 EACH.	
600-16 \$5.22	670-15 \$5.22
600-16(6) 6.02	710-15 5.22
650-16(6) 6.92	760-15 5.42
750-14 8.22	800-15 6.02
800-14 8.42	820-15 6.02
750-16(6) 8.22	700-16(6) 10.02
	700-20 11.02
	750-20(8) \$12.22
	825-20 18.72
	900-20 18.82
	1000-20 18.82
	1100-20 18.82
	1000-22 19.92

"EXTRA SPECIAL" TOP QUALITY all size 4-ply pass. FREE TIRE with 2 or more of these also.—W.W. \$1.00 EA. Extra Factory Tested Tube given — GIANT TIRE SALE.

Thousands of tires shipped all over the U.S.A. All tires shipped F.O.B. Phila. Send Check or M.O. with this ad. Dept. 2. No C.O.D.
STANDARD 834 N. Broad St., Philadelphia 30, Pa.

PREPARE FOR BETTER JOB, BIGGER PAY IN SPARE TIME AT HOME

Today, choose the job you want—and prepare for it in time you might otherwise waste. Or if you are already in the work you like best, start training now for quicker promotion and increased pay. During the past 61 years AMERICAN SCHOOL has helped ambitious people to reach higher goals. Check subject that interests you and mail coupon for full information.

AMERICAN SCHOOL, Dept. G245, Drexel at 58th, Chicago 37, Ill.

Without obligation, please send FREE and postpaid, full particulars about the subject checked below.

<input type="checkbox"/> Accounting	<input type="checkbox"/> Contracting	<input type="checkbox"/> Mechanical Engineering
<input type="checkbox"/> Apprenticeship Courses	<input type="checkbox"/> Diesel Technician	<input type="checkbox"/> Mechanical Technology
<input type="checkbox"/> Architecture & Building	<input type="checkbox"/> Drafting—Building Trades	<input type="checkbox"/> Metalworking Courses
<input type="checkbox"/> Automotive Technician	<input type="checkbox"/> Drafting—Machine Trades	<input type="checkbox"/> Plumbing—Practical
<input type="checkbox"/> Better Foremanship	<input type="checkbox"/> Electrical Engineering	<input type="checkbox"/> Private Secretary
<input type="checkbox"/> Blueprint Reading	<input type="checkbox"/> Electricity—Practical	<input type="checkbox"/> Retail Merchandising
<input type="checkbox"/> Bookkeeping	<input type="checkbox"/> Electronics—Industrial	<input type="checkbox"/> Salesmanship—Outside
<input type="checkbox"/> Business Management	<input type="checkbox"/> HIGH SCHOOL COURSES	<input type="checkbox"/> Sheet Metal Work
<input type="checkbox"/> Civil Engineering	<input type="checkbox"/> Machinists	<input type="checkbox"/> Tool Making

NAME _____ OCCUPATION _____
HOME ADDRESS _____ AGE _____
CITY _____ STATE _____

MAIL COUPON NOW

ENGINEERING



Photo of Heald
Electrical Laboratory
Approved for Veterans

Heald College Ranks **FIRST**
West of the Mississippi
in "Who's Who" in America

Send for **FREE** Information
Heald Engineering College
Est. 1862

Van Ness at Post, Dept. P.M.
San Francisco, California

Enroll Now for New Term

American Industry Steps Up Its
Demand for Trained Engineers.
Train Now at Healds

BACHELOR OF SCIENCE DEGREE, 27 MONTHS

Degree Courses:

- Electronic Engineering
- Electrical Engineering
- Highway Engineering
- Mechanical Engineering
- Structural Engineering
- Civil Engineering
- Architecture

Diploma Courses:

- TELEVISION Color TV
- Electronic Technician
- Industrial Electronic Tech.
- Tool & Die Design
- Architectural Drafting
- Mechanical Drafting
- Structural Drafting
- Surveying
- Estimating
- Master Electrician

Approved for Veterans

NAME _____
STREET _____
CITY _____
STATE _____

WE DON'T NEED ENGINEERS

... but they write to us daily to order our
GENIAC Electric Brain Construction Kits.

So do TEACHERS, SCIENTIFIC AMATEURS, INDUSTRIAL FIRMS
and schools. (See list below.)

THOUSANDS OF SATISFIED CUSTOMERS have bought
GENIACS on a **7 DAY REFUND** guarantee

We are proud to offer our 1958 Model, with up to the minute
improvements for the thousands of new customers who can use them.

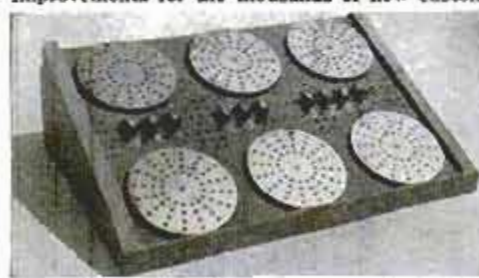

WHAT IS A GENIAC?

Here is a picture of
the 1958 Model GENIAC
in the display rack
(\$8.00 separately) which
comes with every kit.

GENIAC stands for
Genius Semi-Automatic
Computer. A kit of
specially designed switch
decks and racks which
permit the user to con-
struct more than thirty
different machines (fol-
lowing directions and

wiring diagrams) and as many more as he is able to design himself. These
machines demonstrate the applications of electric circuitry.

APPLICATIONS OF GENIAC

SIMPLE COMPUTER CIRCUITS for binary, decimal adding, subtracting,
dividing, multiplying machines. **PROBLEMS** in symbolic logic, reason-
ing, comparing. **PSYCHOLOGICAL TESTING** and **EXPERIMENT GAME**
PLAYING CIRCUITS for tic-tat-toe and nim. **ACTUARIAL ANALYSIS.**

SOME OF OUR CUSTOMERS

Allis-Chalmers • Remington-Rand • International Business Machines
• Manual Missionary College • Barnard College • Westinghouse
Electric • Phillips Laboratories • General Insurance Co. of America
• Lafayette Radio • Rohr Aircraft Co. • Albert Einstein Medical Col-
lege • Naval Research Laboratories • Board of Education, Tecumseh,
Nebraska • Los Angeles Public Schools • Jefferson Union High
School • Oklahoma A & M • Courtland Jr. High School • Bell
Telephone Laboratories.

WHAT COMES WITH THE KIT?

BOOKS—1. SIMPLE ELECTRIC BRAINS, AND HOW TO MAKE THEM
... 64 page experiment manual.—NEW! 2. MINDS and MACHINES.
100 page text on computers, automation and cybernetics.—NEW!
3. WIRING DIAGRAMS for basic GENIAC circuits.—NEW! 4. Beginners
Manual for the person who has little or no familiarity with electric
circuits.—NEW! 5. GENIAC study guide ... the equivalent of a full
course in computer fundamentals, lists additional readings.
PARTS—PANELS, DISCS, RACK (for easy assembly and display). Hard-
ware, wire, tools, battery, holder etc. for more than thirty machines.
SEND for your GENIAC now. At only \$19.95, a bargain, comes
complete with over 400 parts and components, 5 books and manuals.
We guarantee that if you do not want to keep GENIAC after one week
you can return it for full refund.

Add 80¢ west of Miss. \$2 outside U.S. Mail Name & Address with
check or Money Order to

**OLIVER GARFIELD CO., DEPT. PM-28 126 LEXINGTON AVE.
NEW YORK 16, N.Y.**



Veeder-Root Inc., Hartford 2, Conn.

"Push Button" Gas Pump Fills Order Automatically

If you drive into a service station in
East Hartford, Conn., and order a dollar's
worth of gasoline, the attendant simply
pushes a button on the side of the pump.
The pump automatically delivers the
amount ordered. It's part of a field test for
a Veeder-Root "push button" system that
allows the attendant more time to clean
the windshield and check the oil. The ex-
perimental preset device being tested has
one row of push buttons to control delivery
of one, two, three or four dollars' worth of
gasoline. Another row of buttons controls
delivery of five, eight, ten or twelve gallons.
The pump also can be operated manually
for intermediate amounts.

Plants Protected From Smog By Vitamin-C Spray

Scientists in southern California claim
that a light spray of vitamin C protects
plants from smog damage. After six months
of tests, they report the vitamin, commonly
obtained from citrus fruits, prevents the
burning and bronzing of leaves caused by
oxidant agents in smog. The tests were
conducted on lettuce, celery, pinto beans
and petunias. Similar tests are now under
way on spinach, alfalfa and orchids.

Navy's Annual Appetite— A Billion Pounds of Food

Last year the Navy consumed over one
billion pounds of food, enough to fill a
freight train reaching almost from Boston
to Baltimore.

HOW TO FIX ANY AIR COOLED ENGINE!

New - Third Edition Now Available

GET THE SMALL ENGINES SERVICE MANUAL Edited by Engineers and Professional Mechanics CONTAINS: 22 makes, 5 more than in 2nd Edition, including Lawn Boy, Lycoming and the famous Italian Vespa Scooter engine and British J.A.P. NEW AUTHORITATIVE SECTIONS COVER: Gas Engine Fundamentals, Troubleshooting and servicing of ignition and carburetor equipment... plus a section on troubleshooting for beginners.

246 pages of practical, down-to-earth information on 2 and 4 cycle engines, 1, 2, and 4 cylinder models. Parts information on more than 17,000 items. Fits and clearances... oversizes and undersizes... addresses of Parts Distributors... Tool requirements. Order now. Price \$4.65. Satisfaction guaranteed or your money back. Send check or money order. Clip this.

SMALL ENGINES SERVICE MANUAL 1014 Wyandotte Street, Dept. G, Kansas City 5, Mo.



**MEN! Make up to
\$1,000⁰⁰
IN A MONTH!**

without "SELLING"

Sensational Demand for Low-Priced Fire Alarm PLUS Sure-Fire "No-Selling" Plan Offers Ambitious Men Huge Profit Opportunities

AMAZING NEW INVENTION



Even beginners who never sold anything in their lives are cleaning up unbelievable profits with the first practical effective, low priced Fire Alarm ever invented... needed, wanted in homes, factories, offices, stores, on farms, for boats, everywhere. Professional salesmen are making biggest profits in years! Later in this ad I'll tell you about the plan that's producing orders for 1 to 12 Fire Alarms per sale from 8 out of 10 prospects... without selling. Here are the facts about the Fire Alarm. It hangs on the wall like a picture—no wiring, no installation. It's always on guard... It 'smells' a fire before danger point. When temperature rises, Fire Alarm goes off automatically howls loud warning that can be heard 1/5 mile wakes up soundest sleeper, give precious time to put out fire, call fire department, or escape. And it sells for only \$4.95 with profit up to \$2.70 on each one.

Nearest Thing to AUTOMATION SELLING

With our field-tested plan customers sell themselves. No cold canvassing. No hard selling. It's the nearest thing to 'Automation Selling.' Imagine a sales plan even a child can use successfully because the sales tools we give you (and which you leave with your prospects) do all your selling even while you sleep! No room here to give you all the details but if you want big money fast rush the coupon now.

Make This Lighted-Match Demonstration

Sensitive! Lighted match triggers Alarms in 3 seconds.

Free Sales Kit

Send no money. Just rush coupon below for all the exciting moneymaking facts, complete Illustrated Sales Kit, everything you need to make money your first day. Learn how selling only 20 Fire Alarms a day pays

Made \$26.52
in 3 hours!

"Received first shipment about noon. Worked 3 hours and made \$26.52 profit. It's a terrific seller!"
—Stanley



you \$1,080.00 profit in a month. No competition anywhere. Get in on the ground floor now. Rush this coupon.

MERLITE INDUSTRIES, Inc.

(ALARM DIVISION)

114 E. 32nd St., Dept. S-15F

New York 16, N. Y.

ALVIN WESLEY, Sales Manager
Merlite Industries, Inc. (Alarm Division)
114 E. 32nd St., Dept. S-15F, New York 16, N. Y.

Rush FREE SALES KIT and full details about your "No-Selling" plan which gives me opportunity to make up to \$1,000.00 in a month without cold canvassing and hard selling—automatically. I am not obligated.

Name _____

Address _____

City _____ Zone _____ State _____

In Canada: Mopa Co., Ltd., 371 Dowd St., Montreal 1, P.Q.

NEW MAGIC RADIO WALKIE TALKIE!

YOUR OWN POCKET SIZE RADIO STATION!

BROADCASTS TO ANY HOME OR CAR RADIO WITHOUT WIRES OR HOOKUPS! Wt. only 5 oz. Size, 1 1/2 x 2 1/2 x 4 1/2". Built-in telescoping antenna. Powerful Transistor-sensitive microphone, frequency setter, break-in switch! Runs for weeks on self-contained flashlight batteries. Durable plastic case. With this Radio Talkie you CAN TALK TO YOUR FRIENDS UP TO A BLOCK OR MORE AWAY! Talk up to 1 mile or more between two automobiles. INSTANT OPERATION! Just push button to talk! No license needed. Uses inductive field magnetic radiation. Useful and real fun in a million ways! GUARANTEED TO WORK. 1 YEAR SERVICE GUARANTEE.

SEND ONLY \$3.00. (cash, ck, mo) and pay postman \$9.98 COD postage or send \$12.99 for prepaid delivery. COMPLETE READY TO OPERATE with instructions and hundreds of ways and tricks for broadcasts thru any radio you desire. Price may go up soon, so get your NEW POWERFUL RADIO WALKIE TALKIE NOW. Available only from:

WESTERN RADIO, Dept. RPM-2, KEARNEY, NEBR.



\$\$\$ TREASURE \$\$\$

Find lost or hidden treasure with new, improved metal detector. Works around salt water. Has no ground pick-up. Find coins, jewelry, gold and silver... Civil War relics. A profitable hobby. Also Scintillation Counters. Free literature.

GARDINER ELECTRONICS, Dept. 14
2545 E. Indian School, Phoenix, Arizona



TV DAN, THE
MUSCLE MAN
SAYS

I'LL GUARANTEE YOU RIPPLING MUSCLES

IN 8 WEEKS OR MONEY BACK
You can have tremendous power, look bigger, have more confidence this tested way. Revolutionary new "Body Mold" courses builds your body in a way no other method can match. Get course FREE with order. Lowest factory price.

DAN LURIE BARBELLS
50 lb. set \$ 9.98 • 100 lb. set \$14.98
150 lb. set \$21.98 • 200 lb. set \$27.98
Extra wts - 14¢ per lb. 50% cash,
balance C.O.D. FOB Plant

DAN LURIE BARBELL CO.
52-M-2 Bristol St., Dept. 859-B, Bklyn 12, N. Y.

FREE! SEND FOR NEW SPORTS & HEALTH CATALOG



Finish HIGH SCHOOL

AT HOME
Complete 4 Years in 12 Months
diploma

Learn More! Earn More!
Enter College, profes-
sional or technical schools.
Advance Socially. Live a

Happier, Fuller Life. Individual Courses
or complete schedule.

WRITE FOR SCHOOL BULLETIN, Dept. PM-28

ACADEMY FOR ADULTS 30 W. Washington
Chicago 2, Illinois





LEARN TO OPERATE EARTH MOVING EQUIPMENT

Good pay for men trained to "boss" crawler tractors, front end loaders, motor graders, cranes, etc. on the 41,000 mile, road improvement program and other construction jobs; building; terracing; grading; land clearing; excavating, etc., plus comprehensive maintenance, in a 200 hour, 5 week course. . . . Special weekend instruction available. School located 50 miles from Chicago. Economical housing and boarding available. Get in on a good paying future NOW.



OR LEARN TO BE A CONSTRUCTION EQUIPMENT MECHANIC

Greer also teaches complete, separate, Mechanics Training Course covering Diesel engine transmissions; torque converters; fuel injection systems; track assemblies; final drive assemblies; steering systems; idlers; rollers; power transfer systems; cable control systems; hydraulic control cylinders & welding pertaining to heavy equipment such as bulldozers, scrapers, loaders off highway trucks, etc. Course time—540 hours—18 weeks. Enroll today to earn top pay.

Please send FREE information on

- HEAVY EQUIPMENT OPERATORS TRAINING
 CONSTRUCTION EQUIPMENT MECHANICS TRAINING

NAME _____ AGE _____

ADDRESS _____

CITY _____ STATE _____



Greer TECHNICAL INSTITUTE
ATT. M. B. Hutchinson, Box 278, Braidwood, Ill.

OPPORTUNITY KNOCKS LOUDEST IN SELLING

**Get out of the financial rut!
MAKE BIG MONEY IN SELLING!**

**Train at home for sales jobs that
pay up to \$25,000.00 a year! . . .**

America is, indeed, the land of opportunity. And in no field does opportunity knock louder than in selling. If you can talk you can sell . . . and if you can sell . . . you can command a five-figure income! I can teach you to SELL and EARN MORE MONEY with my famous "Sell the Sizzle" sales techniques that have shown thousands of men and women the quick way to selling success. Give me just 10 minutes a day at home and I'll guarantee to teach you to sell!

Learn at Home—in Spare Time—Earn While You Learn!

Start selling part time . . . we'll tell you how. Add dollars and dollars to your present income while you learn and practice the famous Elmer Wheeler "Sizzle Selling" secrets. Then, almost before you realize it, you'll be a top-notch Wheeler-trained salesman and be making the big money that comes to the man who knows HOW TO SELL!

WRITE TODAY for FREE DETAILS!

It doesn't cost a cent to discover what Elmer Wheeler Sales Training can do for you and your future. Rush your name and address and we'll send you complete, thrilling details. Read what Wheeler training has done for other salesmen — old-timers and beginners alike. Learn what money-making miracles Elmer Wheeler training can perform for your income. The entire, exciting story is yours FREE. Write today!

ELMER WHEELER SALES TRAINING INS'T., Dept. B-25
Home Study Division, 644 N. Michigan Ave., Chicago 11, Ill.



**ELMER
WHEELER**



CAR OWNERS!

Make Your Own Repairs 
Save Money  **with these Expert
How-To Books from** **POPULAR MECHANICS**



MANUAL FOR FORD OWNERS

Get the most out of your Ford . . . and do the work yourself! This brand new edition of the Manual for Ford Owners covers every mechanical operation and even includes a special section on trouble shooting on the road. The book explains how various moving parts of the Ford operate, what can possibly go wrong . . . and what to do about it if it does. Devotes considerable space to exclusive Ford features such as Fordomatic transmission. This is complete and official factory information, specially and comprehensively presented for the layman who may or may not have auto experience. Good maintenance of your Ford is not only desirable for your own convenience, safety and pleasure . . . but also pays off at trade-in time.
Covers all models 1950 to 1958. **\$3.50**



MANUAL FOR PLYMOUTH OWNERS

If you're a Plymouth owner . . . order a copy of this new Plymouth Manual and keep it handy in your glove compartment. It's the best insurance you can buy for keeping your car in tip top condition. Enables you to meet any road emergency. Today's cars, Plymouths included, are complex machines . . . many parts and areas can give trouble under certain conditions. The Plymouth Manual, carefully and thoroughly indexed, can help you locate the trouble and provide the solution in short order. Has hundreds of tips on Plymouth maintenance and suggestions for keeping performance at a peak. Written by C. E. Packer, Member of the Society of Automotive Engineers, in close cooperation with Chrysler Corporation engineers. This book will help you enjoy your fine Plymouth car even more than you thought possible.
Covers all models 1950 to 1957. **\$3.50**



MANUAL FOR CHEVROLET OWNERS

To be published in April. Will help every Chevrolet owner save on repair bills and get the kind of top performance the factory designers intended. To be written by long-experienced automotive engineer, C. E. Packer with the aid of General Motors Factory engineers. Every word will be official factory information, covering your Chevrolet from bumper to bumper. Explains what can go wrong and how to diagnose every condition. Explains the repair procedure thoroughly to save you time and money. Hundreds of photos, drawings and "exploded" views will aid in understanding the carefully written text. Vitally helpful whether or not you have mechanical experience. Completely indexed for easy reference. Order your copy now. We'll send immediately upon publication. Covers all models 1950-1956. **\$3.50**



AUTO REPAIR MANUAL

This book was prepared by a panel of experts to apply to every make, model and year of car. With hundreds of photographs and diagrams it explains exactly how your car is supposed to run, just why it breaks down, how to repair it and how to prevent breakdowns in the future. Covers both automatic and manual transmissions; tells the "why" of the 12-volt ignition, explains motor tune-up, brakes, cooling systems, ignition-distributor, lubrication, etc. Tells how to buy a used car; how to build your own car cooling system; how to save money on auto vacations—and many more time-saving, money-saving articles.
Over 500 illustrations, drawings and photographs. . . . **\$2.50**

Satisfaction Guaranteed or Your Money Back

POPULAR MECHANICS PRESS, Dept. 258
200 E. Ontario St., Chicago 11, Ill.

RUSH book(s) I have checked below. If not pleased, I can return in good order within seven days for full refund.

- Remittance enclosed. Send C.O.D.: U.S.A. only.
 Ford Manual Plymouth Manual Chevrolet Manual
 Auto Repair Manual

Name _____

Address _____

City _____ Zone _____ State _____



224 STAMPS 25¢

Mongolia
Argentina flying horse
New Caledonia

What a bargain! You get the stamps shown here—plus Brunei sultan; Cayman cat boat; Ethiopia red cross; Greece earthquake; Timor; Bahrain; etc. Grand total of 224 stamps—all different! You also receive 88 Flags of the World in full color—plus Boy Scout Souvenir Sheet, an unusual tribute to the 1957 Jamboree. All this for only 25¢ to introduce our Bargain Approvals. Midget Encyclopedia of Stamps included. **Send 25¢ Today. ASK FOR LOT F0-29**

ZENITH CO., 81 Willoughby St., Brooklyn 1, N. Y.

ELECTROPLATE
on any object
ANY OBJECT IN HOME SHOP GARAGE.

NOW with our NEW ELECTROCHEMICAL outfit. You can easily do your own plating. Not a paint. But a hard durable metal plate, equal to commercial plating. Get your own plating kit with instructions on plating metal and non-metal objects as Tools, Auto Parts, Silverware, Jewelry, Baby Shoes and 1001 other articles with Chrome, Nickel, Copper, Gold, etc. **SEND NO MONEY.** Everything sent C.O.D. for the low price of ONLY \$5.95 or send \$5.95 now and receive it postpaid. Money back in 7 days if not satisfied. **M. Z. SALES CO., Dept. G-18, 113 West 42nd St., New York 36, N. Y.**

KEEP DRIVING STRAIGHT IN '58

HULL AUTO COMPASS

America's favorite motoring guide for 25 years. At your dealer's or write for literature.

Ever-Dependable Bouting Guides, Too **\$6.95 and \$5.50**

HULL MFG. CO., P. O. Box 246-D2, Warren, O.

Give to
CRUSADE FOR FREEDOM
which supports
RADIO FREE EUROPE • FREE EUROPE PRESS
address: CRUSADE FOR FREEDOM, c/o Local Postmaster

FREE LAFAYETTE CATALOG
JUST OFF THE PRESS!
NEW 180 PAGE ELECTRONIC CATALOG FEATURING THE BEST BUYS IN THE BUSINESS

Packed with the largest selection of Electronic, Radio and T.V. Parts, and equipment, PA, Hi-Fi systems, tubes, antennas, Transistor Kits, parts and components. Test Equipment, new build your own kits, tools, books, Microscope, drafting equipment, Binoculars, Telescopes, All Radio, TV and Ham supplies—**ALL AT GREAT SAVINGS**—For the economy minded servicemen, dealer, engineer and technician. **CHUCK FULL OF BUYS! SEND FOR YOUR FREE COPY TO-DAY.**

LAFAYETTE RADIO

Name _____
Address _____
City _____ Zone _____ State _____

Lafayette Radio 165-08 LIBERTY AVE. JAMAICA 33, N. Y.

Bob Eaton, says:
HOW WOULD YOU LIKE TO "BE BOSS" OF YOUR OWN \$10,000 A YEAR SHOE BUSINESS?
(and you can start in *spare time!*)

No investment, no overhead, no stock to carry—yet you can easily do a \$10,000 business your first year! Steady repeats build your business bigger. If now employed, take orders spare time for *Guaranteed Comfort* dress, work, casual shoes and boots. Over a quarter million pairs in stock. Simple 2-finger demonstration makes shoe selling a snap. Immediate Commissions, Cash Bonus, Paid Vacation, FREE Shoe Offers, Cash Awards.



ORDINARY SOLE IS "STIFF AS A BOARD!" Every step is like a hammer blow. You feel worn out all day.



CHESTER PATENTED AIR CUSHION SOLE is soft — comfortable — flexible. Like "floating on a cloud" all day.

NEW COMFORT DISCOVERY!

"Foot-Shaped" Shoes



Give Greater Toe Freedom—Never Tire Feet!

Over 180 other smart styles for men, women, children. Ripple Soles, Ventilated, etc. Sizes 4 to 18, widths AAAA to EEEE. Fast direct-from-factory service.

"TRADE-IN SALE OF OLD SHOES"

SELLS NEW SHOES FOR YOU!

Only Charles Chester Offers your customers cash for old worn-out shoes! It's dramatic, different, appeals to "trade-in" conscious

America—helps you get profitable orders faster. No pick-up or delivery on your part. We handle all details and donate serviceable old shoes to charity.

Send for FREE New Selling Outfit! Write NOW if you want the security, independence and big steady income of a business of your own. You can't lose! Write to: **Bob Eaton, CHARLES CHESTER SHOE CO.** Dept. B-583, Brockton 64, Mass.

MAIL COUPON RIGHT THIS MINUTE!

Mr. Bob Eaton, CHARLES CHESTER SHOE CO. Dept. B-583, Brockton 64, Mass.

I'd like to own a prosperous, independent business with Chester Shoes. Send all equipment I need **ABSOLUTELY FREE**—without obligation.

Name _____

Address _____

City _____ Zone _____ State _____

HOW TO GROW ORCHIDS AT HOME!

Learn about special conditions of light, temperature, humidity orchids need

SUCCESSFUL HOME GROWER Says:
 "I'll Show You How Mrs. Schirmer & I Raised Orchid Plants Worth a Fortune Starting at Home in Spare Time!"



Purple — White
 Green — Yellow
 Every Rainbow Color

THRILLING HOBBY—Imagine the delight of watching gorgeous Orchids burst into radiant bloom—to be snipped fresh from the plant for personal corsages, for gifts, or to sell at fine profits! Big lavender or white Cattleya Orchids like those sold in every flower shop—exquisite Cymbidiums often 25 to 30 flowers on a stem. Dozens of others. Many Orchids grow without soil, getting food from the air.

PROFITABLE HOME BUSINESS—Schirmer Course explains how to market Orchids for profit, spare or full time—from small town, big city, even a farm. Big year-round demand from individuals, florists, hotels, etc.

Hundreds of Families Growing Orchids at Home with our help... Millions sold by mail order. Learn how Orchids multiply—one plant may become many, each valuable as the first. No big investment. Takes only few minutes a day.

COMPLETE INSTRUCTIONS AND REAL ORCHID PLANT—YOURS TO EXAMINE AT HOME BEFORE YOU DECIDE!

Nearly 300 pages of Instructions—the "Know-How" of the experts—in simple language, jam-packed with "show-how" drawings and photographs, many in natural color. Real blooming-size Orchid Plant included in same shipment with Course. All for you to examine at home—No obligation to buy a thing unless you wish. **FREE**—full details. **SEND NO MONEY.** Just name & address on Coupon or post card. Write today. Airmail is quickest.

TROPICAL FLOWERLAND, Dept. 32-A
 100 S. Vermont Ave., Los Angeles 4, Calif.

"Most enjoyable hobby I know. People drove 100 miles to see this plant—10 flowers, 8½" across."
 Thomas Hurst, Utah

"I sell many blooms, and haven't really started yet. Owe my success to the Schirmers."
 Mrs. Frank Harwood, Ore.

"I have standing orders for future flowers. Will always be grateful to you."
 Mrs. Robert E. Lee, Ohio

MAIL COUPON NOW!

TROPICAL FLOWERLAND, Dept. 32-A
 100 S. Vermont Ave., Los Angeles 4, Calif.

Rush me, absolutely **FREE** and postage paid, complete details on your offer of Louis & Gladys Schirmer's Instructions which show how to grow Orchids at home. The Instructions will include a real blooming-size Orchid Plant and valuable "Quick Profit" Plan. All sent for me to examine at home before I make any decision whatever.

Name _____
 Street _____
 Town _____ Zone _____ State _____



American Forest Products Industries, 1816 M Street, N.W., Washington 6, D.C.

Portable Tree Stripper Chops Branches Into Chips

Developed for tree farming and pulpwood operations is a machine that strips all the branches from a pine tree and chops them into small chips. The machine, which is portable, handles trees up to nine inches in diameter. It contains an adjustable circle of cutting blades that spin at a rate of 10,000 revolutions per minute. A circular saw at the end of the machine cuts the stripped logs into desired lengths for use in fireplaces or as fence posts.

Ionized Air Is Pain Killer For Patients With Burns

Electrically charged air may eliminate the need for large doses of narcotics to relieve the pain of burns caused by excessive heat. Dr. Theodore A. David of Philadelphia reported he used negatively ionized air on 75 burn cases and the patients seldom needed narcotics after two 20-minute exposures to the air. How the ionized air kills pain is a mystery but studies of brain waves of the patients indicate the effects are similar to those caused by tranquilizing drugs.

Automatic Pencil

No twisting, clicking or other hand adjustment is required for a new kind of mechanical pencil. It uses regular thin lead but automatically feeds the correct writing length through a stainless-steel tip. The act of handwriting, according to the manufacturer, advances the lead as it is used.

Tru-Tip Writing Instrument Corp., 153-09 10th Ave., Whitestone 57, New York

WEAR THE SHOE THAT'S ALIVE WITH COMFORT!



No. 444

FREE!

Write for helpful booklet — "Better Foot Care with Better Footwear"



Are your feet complaining? Do your working days seem long and tiring? Then isn't it time to try a pair of Red Wing's rugged lightweights with genuine Wedge-Crepe soles and the Original RED WING'S "Sweat-Proof" Leather Insoles? Makes mighty soft walking.

RED WING SHOE COMPANY
197 MAIN STREET
RED WING, MINNESOTA

TWO WAYS TO BUY BETTER

Your dealer knows the right products for your needs—quality products that are nationally advertised. POPULAR MECHANICS brings you a monthly roundup of valuable "how to" information and product advertising. Read POPULAR MECHANICS every month—then talk to your dealer.



ARBO-GASTERS PAY OFF BIG AT LAS VEGAS



Abe Schiller, executive vice president of The Flamingo Hotel, Las Vegas, Nevada, writes: "Our cruiser always carries a full set of Arbo-gasters to insure our guests success with the big lunkers of Lake Mead." Arbo-gaster dives like a jet, runs right over stumps and rocks. Easy to control running depth. Perfect for trolling, won't twist line. NEW 1/8-oz. size, also 1/4-oz. and 5/8-oz.—all \$1.35 each. 15 Colors.

FLOATS • DIVES DEEP • RUNS DEEP

ARBO-GASTER



For Spinning
For Spin-Casting
For Bait-Casting

MAIL FOR BIG FREE CATALOG

Fred Arbogast CO., INC.

2222 W. North St., Akron 3, Ohio

Please send my FREE copy of latest Arbogast color catalog of baits—full of pictures of catches.

Name _____
Address _____
City _____ State _____



BECOME A ... Machine Tool DRAFTSMAN & DESIGNER

Mail Coupon For Free Brochure

Simplified home study training program. Learn every phase of Machine Drafting and Tool Designing. Step up to a better job—big-pay. Use spare hours—no interference with present work. Diploma awarded. Low Tuition.

American Technical Society
Dept. PM-258, 850 E. 58th St.
Chicago 37, Ill.

Please send me your FREE BROCHURE and full details about Machine Draftsman and Tool Designer training program.

Name _____
Address _____
City _____ State _____

FREE Tyler SPYRAL HACKSAW BLADE!

MAIL COUPON FOR FREE BLADE!

TYLER MFG. CO., INC., Dept. PM-2
1005 W. Arbor Vitae Ave., Inglewood, Calif.

Your Name _____
Address _____
City & State _____
Name & address of my Saw Dealer is: _____

Demonstrate for yourself why Tyler SPYRAL Hack-saw & Coping Saw Blades are America's number 1 choice for making precision & intricate CLEAN cuts of wood, metal, plastic, tubing, etc. Saw in circles, right or left, up or down. Available at your dealer. OFFER LIMITED! Since you will receive your FREE blade from your local dealer, you must fill out the coupon to the right & mail it to us. Offer is not valid unless you give us your name & address as well as that of your dealer. When dealer receives your FREE Tyler Blade, he will notify you by postcard.

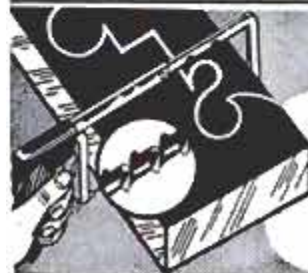

YOU NEED THIS

FREE GIANT 1958 B-A CATALOG

A COMPLETE BUYING GUIDE FOR EVERYTHING IN

RADIO · TV ELECTRONICS

BA 1958
ANNUAL CATALOG 581

SINCE 1937

BURSTEIN-APPLEBEE CO.

Dept. PM, 1012 McGee St., Kansas City 6, Mo.

Send Free 1958 B-A Catalog No. 581.

Name.....

Address.....

City..... State.....

172 KING-SIZED PAGES

EVERYTHING IN RADIO TV AND ELECTRONICS

100'S OF NEW ITEMS LISTED HERE FOR 1st TIME

21 PAGES OF BARGAINS NOT IN ANY OTHER CATALOG

SEND FOR IT TODAY

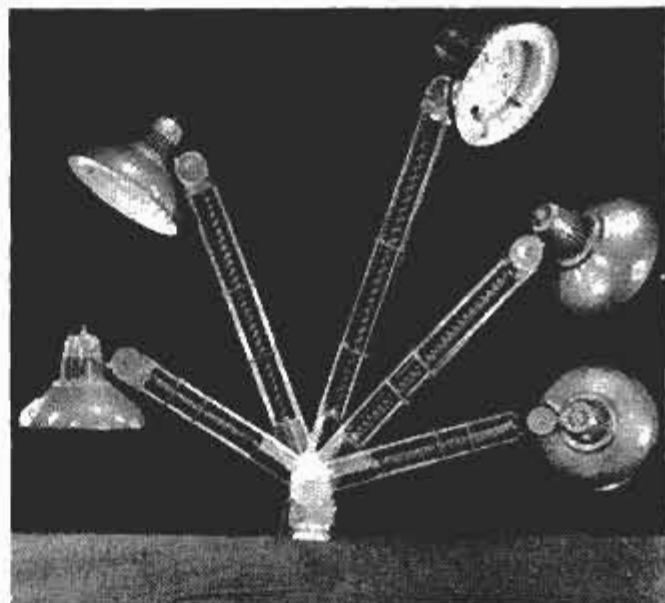

Amplex Corporation, 111 Water Street, Brooklyn 1, N.Y.

Three Kinds of Light From Swivel Desk Lamp

Almost any desk-lighting problem can be solved with a new lamp that adjusts to any angle. A swivel joint just above the attaching clamp permits a full 360-degree rotation. The arm itself can be shortened or lengthened and twisted or turned to any position desired. The lamp contains both an incandescent bulb and a fluorescent ring usable separately or in combination.

Test Chamber Simulates Atomic Explosions

Pressure waves of an atomic explosion can be simulated in a test chamber being built for the Navy laboratory at Port Hueneme, Calif. High explosives are detonated in a firing tube and the resulting high-pressure gases are metered through small holes into a pressure chamber. The device will be used to test the strength of steel and concrete building materials that may be used in air-raid shelters.

Moisture Detector for Jets Prevents Icing of Fuel

Formation of ice in jet-aircraft fuel can be prevented by an instrument developed in England. The British instrument can detect five parts of water in a million parts of jet fuel. When water is detected, the instrument automatically turns on the tank de-icing equipment. Previously, it was necessary to test the fuel with a color indicator before takeoff.

☐ Southern-pine forests of America contain an estimated 36 billion trees, enough to support a permanent lumber industry plus naval stores and pulp and paper industries.

NEW 1958 CATALOG 200 MODELS—SAVE 2/3

BOAT KITS EASY TO BUILD—Designed for the amateur. Over 200 Models. Prows to Cruisers, 8 to 21 ft. Formed hulls Semi and Custom finished. Save 50%... Now NEW Sea Ray Molded FIBERGLAS BOAT KITS. Truly professional results. NO upkeep. SAVE 2/3 assembly time. 12 to 16 ft. Utilities and Runabouts. SEND 35c for 64 page Boat Kit & 24 page Sea Ray Catalogs. SEND \$1.00 for both plus "Boating Handbook". Dealers inquire for franchise.

BOAT PLANS & PATTERNS World's largest selection; over 200 plans, full-size patterns, frame-pac kits! Designed strictly for amateurs! All types: prams, kayaks, racers, runabouts, catamarans, houseboats, cruisers - inboard-outboard 6-40' wood-plywood-steel!

Frame-Pac Kits Send 35c for PLAN CATALOG Catalog PLUS "Boatbuilding Handbook" \$1.00

WRITE NOW! CUSTOM CRAFT, BUFFALO 7L, N. Y.



TRAIN TO OPERATE HEAVY EQUIPMENT CONTRACTORS NEED MEN NOW

The big federal and state super highways program is now in progress. Trained to operate bulldozers, shovel, motor-grader, scrapers, etc. YOU can make big pay in the construction industry if you learn these skills. NOW contractors WANT our graduates.

Write or call TODAY for full information.
THE MIDDLE-WEST SCHOOL OF HEAVY EQUIPMENT OPERATION
SAXTON, KENTUCKY
(Phone Jellico, Kentucky—Harrison 4-6653)

NEW INVENTION REPLATES AUTO CHROME

with PERMANENT PLATING
MAKE MONEY! SAVE MONEY!

FACTORY-NEW BRILLIANCE FOR CAR CHROME

Here at last is the car-owner's answer to all chrome problems . . . a dramatic new invention—SPEEDPLATER. It actually plates NEW METAL as you brush. And the plating you apply becomes an INDESTRUCTIBLE part of the bumper, grille or trim itself. How your car will shine! You'll be mighty proud when you remove ugly rust spots and replating metal to a NEW SPARKLE . . . when you bring new, gleaming beauty to worn, dull, even blistered chrome areas of your car. This fast sensational method of brush-plating gives FACTORY-NEW BRILLIANCE that bonds itself onto your car. It forms a hard, sparkling surface that defies all elements!



Quickly Builds-up a Thick, New, Plating With Each Application



SPEED PLATES YOUR CAR!

Enough Solution to plate 3 entire cars

BUMPERS—GRILLWORK—ALL CAR TRIM RESTORED TO NEW BRILLIANCE!

Here is how easily you replating your car . . . You simply attach SPEEDPLATER'S clamps to your car's battery, then dip SPEEDPLATE Brush into miracle solution. You PLATE WITHOUT REMOVING PARTS FROM YOUR CAR. Works Fast — yet uses less battery juice than the faintest light on your car.

CAR DEALERS & SERVICE STATIONS— Make BIG Profits with Special HEAVY-DUTY OUTFIT!

FACTORY RESULTS and Big Volume Business can make Terrific Profits For You with this Heavy-Duty Outfit. Do your own replating without removing bumpers or grillwork! Increase the value of used cars! Heavy-Duty Outfit Electroplates on current from standard 12 volt storage battery. ENTIRE KIT COMPLETE—Only \$34.95 with enough material to plate dozens of cars! You quickly make back cost on your very first job! Re-order solutions always available from us at rock-bottom cost to you. MONEY-BACK GUARANTEE. Order Now—If C.O.D. send \$5 deposit.

TRY AT OUR RISK
If you want to put a new permanent gleam on YOUR CAR'S CHROME—you can do it right away and not risk a dime. If you are not satisfied with great results it doesn't cost you a penny! Just mail coupon with only \$1 deposit—then pay postman \$13.95 plus postage when your kit arrives. If you send \$14.95 we ship prepaid. Either way you must be COMPLETELY SATISFIED or you may return all in 10 days for FULL CASH REFUND. ACT NOW—Here's What You Get: SPEED-PLATER Brush with Permanent Anode; Wires and Clamps for battery hook-up; Special Buffs and Buffing Compound; Special Metal Polish; Full, Simple Instructions.

EMPIRE MERCHANDISING CO.,
4 North 3rd Ave., Mt. Vernon, N. Y. Dept. P-28
Please rush the electroplating kit I have checked
 Regular Kit, \$14.95 (If C.O.D. send \$1 deposit)
 Heavy-Duty Service Station Outfit, \$34.95 (If C.O.D. send \$5 deposit)
 I enclose full price, send postpaid.
I understand that I must be COMPLETELY SATISFIED or I may return kit in 10 days for immediate CASH REFUND.

Name _____
Address _____
City _____ State _____

Make Big Money Plating Other Cars!

Now you can add to your income during spare time . . . because 8 out of 10 cars on the road today NEED REPLATING. You can charge from \$5 for touching-up to \$50 for replating an entire car. It's easy and there's good money in it for you. When your neighbors see the brilliant plating on your car, they'll surely want you to do the job for them! Replate other things for profit too—faucets, tools, home appliances, cutlery, doctor's and dentist's instruments.

ALSO NEW
ESHELMAN
JET DESIGN
ROCKET
BOAT
Write for
FREE
Literature

ESHELMAN GOLF CARS COST FAR LESS
CHOICE! ELECTRIC OR GASOLINE POWER
Both at same low price! Both feature new extra power, dependability, enjoyment! Handles like big car. Holds 2 adults and 3 bags comfortably. Also ideal cars for sport use. Write for FREE Literature.
Dept. 524
ESHELMAN
Balto. 2, Md. Patented

SPARE-TIME MONEYMAKING OPPORTUNITIES
READ OUR CLASSIFIED ADS
HUNDREDS OF BARGAINS AMAZING OFFERS

MAKE UP TO \$20 A DAY WITH EASISHARP
Big profits in your spare time sharpening scissors. We show you how to start making money immediately. This is your chance now to have your own business and a steady income. Sharpen a pair of scissors in less than two minutes. A child can operate it. Weighs only 10 lbs. Every home, barber, tailor, dressmaker—everybody uses scissors and all need sharpening two to four times a year. Don't let some one else beat you to this opportunity. Write immediately to
SERR-EDGE MACHINE CO., 9731 Lorain Ave., Cleveland, Ohio

MONEY MAKING SALES PLAN FREE

\$SAVE \$ ON US GOV'T \$URPLUS\$

Our publication "Government Surplus Sales" lists hundreds of items for sale by the U. S. Government at tremendous savings, as low as 1c on a \$1.00.

These are samples of the savings that are being made:

LIFE BOAT . . . \$12.00	GRINDER . . . \$4.69	SHAPER . . . \$15.00	DUMP TRUCK . . . \$76.77
TRACTOR . . . \$75.00	TYPEWRITER . . . \$7.51	FREEZER . . . \$50.00	SPRAY PAINTER . . . \$15.25
MOTOR . . . \$4.00			

Hundreds others listed in our bulletin "Government Surplus Sales" and may be purchased direct from U. S. Government. Hunting, Fishing, Camping, Sporting Equipment, Photographic Equipment and Supplies, Radio and Electronic Equipment, Amphibious Trucks, Jeeps, Boats, Motors, Binoculars, Plumbing, Electrical Equip., Cars, Power Tools, Machinery, Chemicals, Furniture, Office Equipment, Supplies, Scrap, Etc.

How may you receive our bulletin "Government Surplus Sales?" By sending \$1.00 to
GOVERNMENT SURPLUS SALES, P. O. Box 169, Department 8-5, East Hartford 8, Conn.

ENJOY LIFE MORE!

Take up a relaxing, rewarding hobby

Develop skills in exciting crafts

"Do-it-yourself" for fun, satisfaction

These Popular Mechanics Books offer you and your family new horizons in fuller, richer living . . .



Toys You Can Make

Your children love toys . . . every child does. You'll become a very special kind of hero to your children by making their toys instead of buying them. Here are more than 140 wonderful toys to delight boys and girls of every age, easily made from inexpensive materials. Just a few examples are: pull toys, grand piano, figures that move on a string, rocking animals, play guns, kites, play cars, a slide, oil drum teeter-totter, merry-go-round that's motorized, play cottage, doll furniture, plus loads of games and puzzles. These toys will be perfect for all holidays, birthdays, to make as a hobby . . . or just to remember that special "someone" in your neighborhood. Each is designed for easy building by even the amateur. No special skill . . . or experience needed. Use simple tools and follow the amazingly clear drawings and plans. . . . \$2.00



23 Boats You Can Build

Boating is tremendously popular with literally millions of people . . . build your own boat and join the fun! This new book contains over 500 pictures, drawings and diagrams and detailed step-by-step plans. Only limited tools and no previous experience needed. Materials lists are supplied wherever required and they include the lumber needed, hardware, sail cloth and fittings, etc. There are also hundreds of hints for building boats right, boats for beginners and tips for servicing boats after they are built. Contents include 11 1/2-ft. Cartop Rowboat, 10-ft. Plywood Dinghy, 16-ft. Canadian Type Canoe, 15-ft. Sailing Knockabout, 14-ft. Sailing Dinghy, 21-ft. Sloop, 6-ft. Boat for young sailors, 25-ft. Seacraft Cabin Cruiser, 12-ft. Plywood Outboard, V-Bottomed Inboard, Motor-Driven Paddle Board, Duckboat, Bicycle Powered Pontoon Boat. . . . \$2.75



Modern Furniture You Can Build

This is the book that do-it-yourself home craftsmen have been asking Popular Mechanics to publish. Here you will find pieces of modern furniture you can build for every room in the home . . . and it's a lot easier than you think! What's more you'll build exactly the pieces you want and need most . . . and have worlds of fun doing it. This new book includes detailed step-by-step instructions for dozens of new designs by leading craftsmen and furniture designers. Projects range from a telephone stand to a beautiful desk-room divider. Each project is accompanied with a full and complete list of materials. Besides latest designs for all types of modern furniture, this new book offers full chapters on upholstering and remodeling furniture in modern style. Many pages are produced in true-to-life color. A wealth of pictures and drawings too! . . . \$2.95



200 One-Evening Projects

An "evening" is a relative period . . . many of these projects can be finished in a couple of hours . . . others might keep you up till the clock strikes 12! But by morning, the paint will have dried and your handiwork will be put into admiring use by the family. Lots of these simpler projects make ideal gifts! Far too many to list here . . . the projects range from a handy spice rack to a garden wishing well. There are project ideas for mother, sister and for brother . . . and we're not forgetting dad either! The jig saw projects are illustrated with scale plans for laying out on the board or other materials. All the projects are completely illustrated. Materials is also given. Here's loads of fun for all! Paper-bound only. . . . \$5.00



100 Best Woodworking Projects

Outstanding woodworking projects selected by a board of Popular Mechanics magazine editors. Each is easy to make and accompanied by full instructions. The projects include: secretary desk, Colonial bookcase, bar-b-que chuck wagon, Dutch cradle, miniature bowling game, vegetable bin, magazine tables, clothes hamper, built-in shelves and cabinets, kitchen step stool, disappearing attic ladder, bric-a-brac wall cabinet, smoking stand, ironing board with folding legs, china cabinet, phono-radio, modern corner desk of plywood, garden lounge, spice drawer, work table, tie rack, baby's swing and many, many others. If you are a woodworking craftsman, or wish to build only a single project, you will be thrilled with this book. . . . \$2.00



All About Upholstering

Author John Bergen tells how you can reupholster any piece of furniture yourself and save large amounts of money! No need to throw away that old threadbare furniture. Chances are the frame is as good as new . . . and reupholstering will make it look like new. With some 648 photos, diagrams, and drawings, this book reviews every single step and operation of upholstering any new or old piece, from kitchen chairs to sofas, into smart, up-to-date furnishings. You learn the three basic forms of upholstered work; learn to recognize the various styles of furniture construction and the type of work best suited to each. Each step is covered so completely you can't go wrong . . . using only simple tools and recommended materials. . . . \$3.50



How To Take Better Photographs

Amateur, advanced or professional photographers alike will profit from this up-to-date and complete handbook which gives the reader a quick, basic grasp of lighting, composition, developing and enlarging as practiced by the most outstanding craftsmen. The latest camera equipment is discussed—covering exposure, and special effects. Includes darkroom procedure, setting up the darkroom, process prints and toning. Discussions by Wellington Lee, Americo Grasso, George T. Hillman, Glenn Dixon and Ted Farrington add to your knowledge. Over 200 excellent photos are reproduced, each with complete technical data, explaining how each picture was taken. If you take photography seriously, you'll profit from this outstanding book. . . . \$2.50



Ornamental Casting

Cast from life! Preserve the facial features of your children and other loved ones literally forever! Casting from life is a relatively simple procedure. The casts you make can be left in white plaster of Paris or tinted in natural flesh tones. May be used as a wall plaque or fashioned into a bust for table mounting. Here is everything there is to know about figure casting—clay mold—plaque casting—how to cast from life—whole heads and busts—how to model in clay—coloring and waxing. Explains how to work with marble—ivory—bronze—concrete—papier-mache. It's great fun to make your own "novelties" . . . work with liquid marble. Also, a complete and detailed directory for obtaining supplies, materials and tools required for ornamental casting is listed. . . . \$1.98



You Can Make A Stradivarius Violin

The author, Joseph V. Reid, has made hundreds of fine, highly praised violins, following his studies of the methods of Stradivari and the other violin master craftsmen of the 16th and 17th Centuries. These methods, amazingly, are well within anyone with patience, the ability to use common hand shop tools and true pride in his personal craftsmanship. Here are all the secrets of the ages unfolded. This book tells what woods to select, how to fashion the belly, back, sides, neck and scroll as well as the other basic parts of the fine violin. Full size plans accompany the book . . . merely trace them and cut out the pieces. Finishing is covered completely. Full materials lists are also included. Making your own violin is a project worthy of your craftsmanship! . . . \$3.50

POPULAR MECHANICS PRESS, Dept. 256, 200 E. Ontario St., Chicago 11

RUSH books I have checked below (postage prepaid). If not pleased, I can return in good order within seven days for full refund.

Remittance enclosed Send C.O.D.; U.S.A. only

- Toys You Can Make 23 Boats 200 One-Evening Projects
 100 Best Projects Upholstering Modern Furniture
 Better Photographs Casting Stradivarius Violin

Name _____
 Address _____
 City _____ Zone _____ State _____

all from

POPULAR MECHANICS

Satisfaction Guaranteed or Your Money Refunded

← MAIL THIS COUPON

POPULAR MECHANICS

... TURN CONCRETE INTO GOLD!



MAKE UP TO \$75 A DAY IN YOUR OWN BUSINESS

If you want to have your own business - to start a business on your own - here's your big opportunity! New high speed, low cost General block machine produces up to 1,000 concrete blocks a day. Sell all you make to builders, supply houses, and others for homes, factories, buildings, garages. Cash in on the building boom! You can make profits of 100% to 150% - up to \$75. a day! General block machine equipped with 1/2 h.p. electric motor - or can be supplied with gasoline engine - works anywhere, in little space, indoors or out. Operates from ordinary house light socket. Simple, foolproof 3 step operation - so easy a child can do it. Makes superior 3 core blocks any size from 4" to 12". Also makes chimney, sash, corner and other types. Blocks meet any building code anywhere in the country. Materials - sand, water, cement, available anywhere. Simple illustrated operating instructions and mixing formulas for cement and cinder blocks supplied with each machine. Write for FREE folder with full information.

MOTOR DRIVEN

R. L. T. of New York City reports: "MY GENERAL BLOCK MACHINE PAID FOR ITSELF IN FIRST 2 WEEKS!" Hundreds now in use the world over! Write for FREE details today!

EXTRA

Amazing illustrated book gives floor plans for 6 sensational concrete block bungalows. Tells how to lay blocks, lay out building lines, mix concrete, build steps, porch and concrete floors all at great savings. Written by experts. Can save many times the cost of the machine! Get it now! No strings attached. Send \$1.

BOOK SENT FREE IF YOU BUY MACHINE.
\$1 REFUNDED IF YOU BUY LATER.

GENERAL ENGINES CO.

DEPT. M-28, ROUTE 130, THOROFARE, N. J.

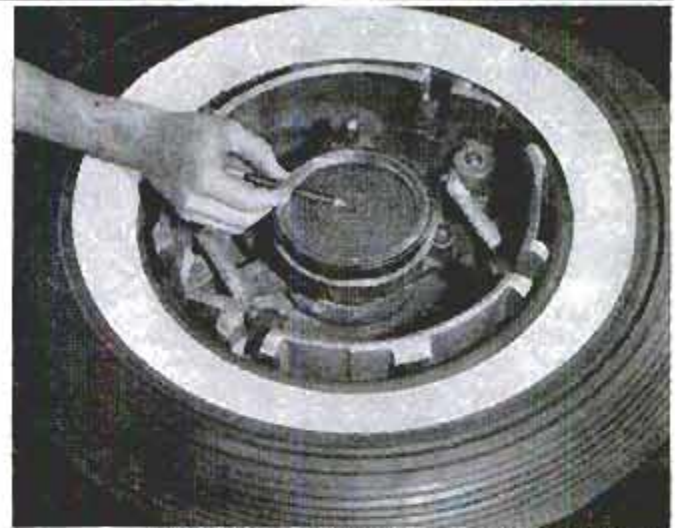

United States Rubber Company, Rockefeller Center, 1230 Avenue of the Americas, New York 20, N.Y.

Vulcanized Inner Strip Permanently Balances Tire

Available in a new eight-ply tubeless tire is a thin, wide strip of rubber that gives permanent tire balance, even at high speeds. The strip is vulcanized to the lining and runs completely around the tire. The new tire is said to be nearly blowout proof because the balancing strip provides an extra grip to prevent sudden air loss. An air bubble in the center of the testing dial indicates the precise balance of the tire.

choose a career in MECHANICAL ENGINEERING

Bachelor of Science Degree-4 yrs.
Associate in Applied Science Degree-2 yrs.



Prepare for a rewarding career as an engineer or engineering technician at the Milwaukee School of Engineering—located in the machine shop of the world. At MSOE, you can earn an Associate in Applied Science degree in 2 years, or continue without loss of credit to your Bachelor's degree in 4 years.

All courses are approved by an Industrial Advisory Committee. Previous training and experience are evaluated for credit. Scholarships and part-time work available. Placement service for graduates.

New Classes Begin in SEPTEMBER, JANUARY, MARCH, and JUNE

- Choose from these courses:
- MECHANICAL ENGINEERING**
BSME degree in 4 years
Plant Engineering, Metallurgical or Industrial Technology
 - ENGINEERING TECHNICIAN**
AAS degree in 2 years
Air Conditioning, Metallurgical or Industrial Technology
- For more information, mail coupon today!



MILWAUKEE SCHOOL OF ENGINEERING

Dept. PM-258, 1025 N. Milwaukee St., Milwaukee 1, Wisconsin

Send FREE career booklet (please print)

I am interested in _____ (name of course)

Name _____ Age _____

Address _____

City _____ Zone _____ State _____

I am I am not eligible for veterans educational benefits _____ (discharge date)

YOUR NEIGHBORHOOD NEEDS AN ELECTRICAL APPLIANCE



TROUBLE SHOOTER

Men needed to repair and service all kinds of Electrical Appliances—**AUTOMATIC WASHERS · DRYERS · IRONS · VACUUMS · TOASTERS · REFRIGERATORS · FANS · HOME FREEZERS · AIR CONDITIONERS**—home and industrial motors, etc., also home and industrial wiring.

Big, Year-'Round Profits!
HELP US FILL HUGE DEMAND

MODERN BIG PROFIT ONE-MAN BUSINESS YOURS AT HOME — SPARE OR FULL TIME.

No previous experience needed. New, visual "Shop-Practice" method quickly shows you how. Hundreds of plain-as-day "How to" photos and drawings make it easy. A corner of garage, porch, attic, or basement is all the space needed. No costly leases—no big overhead. We show you how to make business come to you.

BIG MONEY, SECURE FUTURE—INDEPENDENCE.

F. V. in N. Y. says, "I made \$800 in 3 months while studying." T. E. H. in W. Va. says, "Made \$14 a day while learning."

EVERYTHING FURNISHED—Including BIG TOOL KIT

Instructions are complete and include a Tool Kit and Appliance Tester. Everything furnished to help you build your own big-profit business at home. Our new 30-day income plan shows you how to start making money almost at once. Send no money—just your name and address on coupon below. I will rush you FREE complete success plan with full details. Do it NOW—BE FIRST!

PACIFIC TRAINING SCHOOL, Dept. P-582
11029 So. Vermont Ave., Los Angeles 44, Calif.

PACIFIC TRAINING SCHOOL, Dept. P-582
11029 So. Vermont Ave., Los Angeles 44, Calif.

Gentlemen: Rush me postpaid your FREE plan for success in the Appliance Repair Business and the Free Book Entitled "The Appliance Repair Business and You" and remember I am under no obligation.

Name _____

Address _____

City _____ Zone _____ State _____

ONLY RECLAIMO

gives you 4-WAY FILTERING ACTION...

A Wm. Schwalge Product

FILTERS out Dirt and Solids
EVAPORATES Water & Gas Dilution
PREVENTS Acid-Sludge Formation
STABILIZES oil in peak condition!



ENDS NEEDLESS OIL CHANGING! Provides lasting benefits and substantial savings on operation and maintenance of car, truck, tractor motors. 90 days FREE TRIAL. You are the judge!

MAIL COUPON FOR DESCRIPTIVE FOLDER. Re-refining Oil Filter

Old model Reclaims accepted for trade-in

RECLAIMO MFG. CO., Dept. M-28

6251 Touhy Ave., Chicago 31, Ill.

Send Reclaimo folder and free trial offer. No obligation.

Name _____

Address _____

City _____ Zone _____ State _____



Infrared Detector Spots Hotboxes on Trains

Automatic hotbox spotters have been developed by the Servo Corporation of America to detect overheated journals on speeding trains. The detector is installed at an angle that permits a lens to scan every journal box from bottom to top as the train passes. Infrared waves generated by friction in the journal boxes are received by the detector and amplified 100,000 times. These signals move a pen on a sheet of graph paper and draw a "pip" for each box. When a hotbox passes the detector it makes a pip five to ten times larger than normal. A metal disk covers the lens when the detector is not in use. When train approaches, a solenoid magnet opens the lens.

Flashlight Magnifier Has Seven-Power Lens

For people whose job or hobby requires close examination of small parts, a combination flashlight and seven-power magnifier is now available. An opening in the housing below the lens permits the use of probes, tweezers or other instruments. The illuminated magnifier also has a removable calibrated plate for measuring.



Gayle's, 440 West 24th St., New York 11, N. Y.

Ⓢ Synthetic chicle is now being made from petroleum products by a process like that for making synthetic rubber.

KEY PURSE 50c



NEW! Practical, compact KEY PURSE with card case, snap coin purse and 6 key hooks that positively holds keys in place. Natural tooling goat LEATHER, pre-cut ready to tool or stamp, has that "expensive look" Size: 2 1/2" x 3 3/4". KIT complete, holes punched, snaps and key plate attached, goat lacing, easy instructions and pattern. 50c postpaid.

FREE - 100 PAGE LEATHERCRAFT CATALOG
TANDY LEATHER CO. (Since 1919)
 P. O. BOX 791-EC FORT WORTH 1, TEXAS

VETERINARY GUIDE

FARM MANUAL

ARTIFICIAL BREEDING

DAIRY HERD

HOG PROFITS

MAKE MONEY EASILY!

Demonstrate These Valuable Profit Making FARM BOOKS by POPULAR MECHANICS

Just show these vital books to farmers, let them see the profit-building information on every page, and get a quick sale that builds profits for you, too. Sell separately at \$3 to \$3.95, or complete set at money-saving \$14.95, and make big, fast profit, up to 40% and more. No "sales talk", no previous experience needed. Books sell themselves on sight. Make up to \$6.75 profit per farm.

Authoritatively Written by Experts

Published by world-famous Popular Mechanics Press, written by renowned authorities. Titles are: Veterinary Guide, Farm Manual, Developing a Profitable Dairy Herd, Hog Profits for Farmers, Artificial

Breeding. Contain everything farmers need and want to know.
FREE! Demonstration Book Set Offer... Illustrated Sales Kit... and Money-Making Details
 Rush name, address today for full information on how you can make good money with PM Press Farm Books. All FREE, no obligation.

POPULAR MECHANICS PRESS, DEPT. 22-B
 200 East Ontario Street, Chicago 11, Illinois

WORKBENCH PARTNERS

POPULAR MECHANICS for helpful "how-to" information and YOUR DEALER for quality products that do the job best. He stocks and displays nationally advertised products — products advertised in POPULAR MECHANICS

PM TAG of INTEGRITY

GET INTO RADIO • TELEVISION



Prepare for Big Pay Jobs or Your Own Business — TRAIN AT HOME IN SPARE TIME!
Earn While You Learn

Good pay jobs are waiting for men who know RADIO-TELEVISION. Learn at home, get valuable, interesting, actual, practical experience with kits and equipment we send. Earn extra cash servicing sets while learning. No previous experience needed. Rush coupon for big book and Sample Lesson... FREE! No salesman will call. Our 27th year.

FREE!

60 Page Catalog and Sample Lesson

Sprayberry Academy of Radio-Television
 1512 Jarvis Ave., Dept. 10-D, Chicago 26, Ill.
 Rush catalog and complete lesson... no obligation.

NAME.....
 ADDRESS.....
 TOWN..... STATE.....

"I'll Show You How to Have Giant Strength, Health and Success"

Says:

Paul Anderson

THE WORLD'S STRONGEST MAN,
 GOLD MEDAL OLYMPIC CHAMPION,
 OFFICIAL WORLD RECORD HOLDER

MAIL COUPON for FREE Book

"I built myself up from skin and bones; almost died as a youth. The prayers of my parents

and my own determination to gain strength pulled me through and led me to the discovery of the four great secrets of body building might.

"Let me show you how you, too, can have the body you want with full muscular development, giant strength, robust health and regularity, right weight, perfect poise and mental control. No obligation — learn how you can transform your life with my course and a few minutes each day. You can make a new man of yourself — build power, spring, endurance and coordination into all your muscles. My system improves your style and performance in any sport. You 'win friends and influence people' — both sexes, amazingly. Don't delay — act NOW!"



YOU TOO CAN WIN MEDALS & TROPHIES

"I have many medals and trophies won in National and World competitions in Russia, Germany and Australia. Let me fit you for weight lifting competition greatly growing in favor."



PAUL ANDERSON
 Yoccoa, Ga.

PM2

Send me without obligation your fully illustrated book giving full details of "Easy Steps to Giant Strength." Check marks show the body I want.

- Muscular Development Poise
 More Weight Mental Control
 Less Weight Strength Health

Name..... (Please Print)

Address.....

City..... Zone..... State.....

BIG MONEY

IN THE 4 CORNERS OF THE WORLD!

in TELEVISION, RADIO, ELECTRONICS, RADAR, SONAR
ONLY CHRISTY OFFERS COMPLETE TRAINING!

Investigate the Christy Complete Course. Why be satisfied with less? OTS Shop Method, Home Training makes learning easy. You learn by working with actual equipment. You receive Comprehensive training from the start. Can EARN AS YOU LEARN. You become qualified to open your own Electronics Repair business or to gain high pay as a TV, Radio, Electronics, etc., Technician.

19 TRAINING KITS INCLUDED! You receive a Multi-Tester, Oscillator, Signal Tracer, Oscilloscope, Signal Generator, Electronic Timer, Regenerative Radio, 24" TV set (optional) and other valuable testing equipment. **FREE BOOK and TWO FREE LESSONS** yours for the asking! No obligation.

CHRISTY TRADES SCHOOL
 Dept. T-1303, 4804 N. Kedzie Ave., Chicago 25, Ill.



CHRISTY TRADES SCHOOL, Dept. T-1303
 4804 N. Kedzie Ave., Chicago 25, Ill.

Please send me the 3 FREE BOOKS and Special Form for PAYING LATER from EARNINGS MADE WHILE LEARNING.

NAME AGE.....

ADDRESS

CITY ZONE..... STATE.....

A FEW OF THE REALLY RARE GERMAN SUBMACHINE GUNS \$19.95



The famous super rapid fire "burp" guns. If you were with Bradley or Patton in Normandy, you remember the coughing bark of those guns that were so tough to root out of the hedgerows. All complete and in fair to good condition. A real "conversation piece" and souvenir for your trophy wall, den or fireplace. These are the extra fine precision automatic submachine guns of early WW II. Barrels are plugged to conform with federal law on war trophies. Triggers snap, actions function perfectly and can be disassembled. **YOUR CHOICE** of German Bergmann, German Schmeisser, German Erma, German Steyr Solothurn, Italian Beretta and a few British Lanchesters. All \$19.95 each FOB Los Angeles. (Any two for \$37.50.) Send check, cash or money order. Send \$10 per gun for COD. 10-day money-back guarantee.

THE ELLNER COMPANY
 Dept. 76, 1206 Maple Avenue, Los Angeles 15, Calif.

NEW - MIDGET SHORT WAVE RADIO



GETS STATIONS 12,000 MILES AWAY!

Tunes ALL foreign short wave bands. London, Paris, Moscow, Australia. ALL Amateur bands 160 to 10 meters! ALL long distance Air Force and Air Line aircraft. Ships at Sea, AF overseas broadcasts. State-County Police, Industrial bands—U.S. Radio broadcasts. Tunes 500 KC to 40 mc.—600 to 7 meters! **NOTHING LIKE IT ON THE MARKET ANYWHERE AT ANY PRICE.** Super-regenerative Receiver. Short antenna included—Hook up in 1 second! **PORTABLE SELF-CONTAINED—POWERED WITH RADIO BATTERIES SOLD EVERYWHERE. NO AC PLUG-INS!** Size only 4 1/2" x 6" x 4". Wt. complete

—3 lbs. Calibrated hi-ratio easy tuning dial. Wonderful for Boy Scouts, tourists, vacations, amateurs, short wave listeners. **EVERYONE CAN NOW HEAR THE WHOLE WORLD TALKING!**

SEND ONLY \$4.00 (bill, ck, mo) and pay postman \$12.95 COD postage on arrival or send \$16.95 for post-paid delivery. Complete easy to wire kit includes all parts, tubes, broadcast coil, plastoid cabinet, instructions—set of long life batteries \$2.99 extra. **COMPLETELY WIRED AND TESTED — POSTPAID IN USA \$21.95.** Easily a \$49.95 value. Order now before price goes up — **GUARANTEED — AVAILABLE ONLY FROM: WESTERN RADIO Dept. BRM-2 KEARNEY, NEBR.**

SEWS LEATHER

AND TOUGH TEXTILES LIKE A MACHINE

With **SPEEDY STITCHER** Automatic Sewing Awl, anyone can quickly and skillfully sew or repair anything made of **LEATHER, CANVAS, NYLON, PLASTIC**, or other heavy materials. Sews firm, even lock-stitches like a machine. Gets into hard-to-reach places. Specially made for heavy duty sewing on **LUGGAGE, FOOTWEAR, RUGS, AWNINGS, SAILS, SADDLERY, UPHOLSTERY, OVERALLS, AUTO-TOPS, SPORTS GEAR**, and other tough sewing jobs. Here's the handiest tool you'll ever own. Will save you many times its small cost. Comes ready for instant use... complete with bobbin of waxed thread and 3 different types of diamond-pointed needles. Easy-to-follow directions will make you an expert in minutes. Extra needles and waxed-thread always available. Save money, send \$1.98 for post-paid delivery. If C.O.D., \$1.98 plus postage. **MONEY BACK GUARANTEE.**



SPORTSMAN'S POST
 366 Madison Ave., Dept. A-82, New York 17

ONLY **1.98**

MONEY... IN HIDDEN TREASURES

Find it... with a **GOLDAK Treasure Finder**. Send for **FREE** literature on complete line of mineral & metal locators, underwater detectors, etc., priced as low as \$64.50.

In celebration of its 25th year, **GOLDAK CO.** introduces new transistor instruments for greater sensitivity — less weight — low cost flashlight batteries. Write for information today!

GOLDAK CO. 1542-2 GLENOAKS BLVD., GLENDALE, CALIFORNIA

ALSO
 Eshelman Gasoline Engine GOLF CARS Write for FREE Literature

ESHELMAN ROCKET BOAT



NEW JET PLANE DESIGN

- Airtight Compartments prevent sinking.
 - 14 ft. Holds Four adults.
 - Leakproof, 16-gauge all-steel construction.
- Write for FREE literature

Pat. Pend. Operates with any suitable outboard motor

Dept. 404 ESHELMAN Balto. 2, Md.

SEND ME



every month so I am sure to see each new issue. Here's

- \$3.50 for 1 year
 \$8.00 for 3 years

name

address

city zone state

Hand this order to your newsdealer or send it to
POPULAR MECHANICS
 200 East Ontario St. Chicago 11, Ill.

LEARN MEAT CUTTING AT NATIONAL

Pay After Graduation



The steady dependable trade of Meat Cutting taught easily in 8 short weeks. YOU LEARN BY DOING under actual meat market conditions in big modern school at Toledo.

For beginners or men with experience. Get a profitable store of your own. Remember, PEOPLE MUST EAT! Big pay jobs. Free employment help. Thousands of successful graduates.

Buying, cutting, percentage, pricing, advertising, selling, etc. A complete retail meat education. National School established 35 years. Get National training NOW. Pay your tuition in easy weekly

payments after you graduate. Send coupon for FREE 52 page school catalog — TODAY. G.I. approved.

National School of Meat Cutting, Inc., Dept. 50-A, Toledo 4, Ohio

Send me your FREE school catalog on National Training at Toledo in Meat Cutting, Meat Merchandising and Self Service Meats. No obligation. No salesman will call.

Name _____ Age _____

Address _____

City _____ State _____

Approved for training Korean Veterans

HELPFUL BOOKS

Send post card asking for FREE catalog

Popular Mechanics Press, 200 E. Ontario, Dept. 601, Chicago 11

8" TILT ARBOR SAW 1957 MODEL—BELOW COST!

BLADE TILTS—TABLE REMAINS LEVEL

Heavy duty all cast iron and steel construction. Precision ground cast iron table. Price includes massive cast iron mitre gauge and patented motor drive that fits any motor. Cross cuts, rips, bevels,



mitres, dadoes, cuts compound angles — everything expected of saws costing four times as much. Depth of cut adjustable; 0" to 2 1/4" — table always level. Send check or M.O. \$1.00 deposits on C.O.D.'s.

SPECIAL BARGAIN — This saw is our 1957 model. Each saw is brand new — sent to you in factory sealed cartons. Sold and guaranteed direct from the factory to you at a fantastic bargain.

FREE 10 DAY TRIAL — MONEY BACK GUARANTEE

Try this famous saw 10 days. If you are not satisfied that it does the work of any tilt arbor saw, regardless of price, return for immediate money back refund.

Sent Express Collect

We reserve right to refund money if stock is exhausted
AMERICAN MACHINE & TOOL CO.
ROYERSFORD 1, PA.

MONOGRAM!

- CAR DOORS • LUGGAGE
- TOOLS • LUNCH-BOXES
- TELEPHONES • WALLETS

Separate letters, black on silver. Weatherproof, durable, removable.

1/2 Size—Pressure Sensitive

SIX LETTERS 50c. Specify quantity and assortment.

FABRI-PRINT, Inc. • Dept. G • 801 S.E. 8th St. • Mpls. 14, Minn.

BUY BELOW WHOLESALE

Start Your Own HOME-IMPORT Business

Make big profits on thousands of exotic imports. No experience or investment in products needed. Famous world trader guides men and women—shows how to pocket profits in advance, how to start full or spare time home mail order business.

Open cash orders, take out the money, deduct your profits, then have the imports shipped direct from abroad. NO STOCKS TO CARRY on new plan, no face to face selling. Or handle volume orders for wholesalers, gift or department stores, etc. Export opportunities also.

FREE SAMPLES—CONTACTS ABROAD

Following our plan you receive free, 8 imports—and membership in International Traders which provides you with monthly bulletins revealing foreign products with names and addresses of overseas suppliers.

HUGE UNCROWDED OPPORTUNITY

Each year more imports are offered in U. S. and snapped up by mail order and store buyers alike. And the word "imported" is like magic to the millions who want new, rare, romantic and unusual gifts at big savings. And there seems to be no end to this demand. Others using our plan are now importing at low foreign costs products that sell here at handsome profits. Why not you? GET FULL DETAILS and list of 167 imports showing amazing low foreign prices — ALL FREE! There's no obligation whatever. No salesman will call on you. Air mail reaches us over night. Write today.



EXAMPLES OF LOW PRICES ABROAD

THE MELLINGER CO.
1717 Westwood Blvd., Dept. P252
LOS ANGELES 24, CALIF.

America Is Short 100,000 Auto Mechanics!

WHY NOT
BE ONE?



It's easy to train at home for a
TOP-PAY JOB with a BIG FUTURE!

Stop worrying because you need a better job—or because you need more pay! Over 100,000 jobs are waiting right now for newly-trained auto mechanics. Here's why: There are 60 million cars and trucks on the road—and one-third need heavy repairs. Over 7 million new vehicles are made annually—also need service. No wonder the demand is big for auto mechanics—why pay is tops, work is steady!

YOU CAN LEARN AUTO MECHANICS in months, at home in spare time. Let CTI train you with its famous Shop Method. It's easy. It's fast. *Mail coupon for free details.*

You Practice with Tune-Up Kit and Tools

(Included with training)



CTI training is practical. You get a valuable Tune-Up Kit, the kind that experienced mechanics use to locate engine troubles. You receive a Compression Tester; Vacuum Gauge & Fuel Pump Tester; Ignition Timing Light; portable steel case. You also get a set of professional mechanic's tools, including socket set with extension. You'll use instruments and tools to practice, to make repairs, to earn money as you train. (Note: Diesel Mechanics or Body-Fender Repair instruction too—at no extra cost.)

Many Students Make Money as They Train

Soon after they begin training, many students fix cars for others. They not only acquire useful experience—they also earn money. Their earnings help pay tuition, buy shop equipment, start many in business. *Mail coupon for details.*

COMMERCIAL TRADES INSTITUTE

1400 GREENLEAF AVENUE DEPT. A-738
CHICAGO 26, ILLINOIS

Send booklet, *Big Money in Auto Mechanics*,
and Sample Lesson. BOTH FREE.

Name _____ Age _____

Address _____

City _____ Zone _____ State _____



HEATING PROBLEMS SOLVED INSTANTLY
FORCED HEAT!
VENTILAIRE
HEATER BLOWER
INSTANT HEAT WHEN AND WHERE YOU WANT IT
Heat room, office, store, workshop, garage, Lab. Industrial warming and drying; textiles, paper, plastics, chemicals, printing. Preheat car engine. For doctors, veterinarians, dentists, hospitals. Gives over 400% greater performance than average fan heater, yet costs no more to use. 5" blower wheel moves air 350 C.F.M.—150° heat at outlet. Safety screen guards over openings. 1200 watts. Chrome bracket. Mount or stand anywhere to blow in desired direction. Sturdy steel housing, neat enamel finish. Self-contained unit. Assembled, ready to plug into AC-110 volt. No installation. No interference with present heating system. Powerful, continuous duty enclosed motor. Cord-plug-switch, 8"x9"x5" wt. 8 lbs. Send Check or M.O. Plus 96c P.F. GUAR. ONE YEAR.
Send for Bargain Sheet "Mit" on Fans, Blowers, Compressors, Motors
ELECTRIC TRADING CO. 313 CANAL ST., PM11
NEW YORK 13, N. Y.
REG. LIST PRICE \$39.50
\$24.95

FREE Details write today
MAIL ORDER Opportunity!
START FROM HOME... SPARE TIME
We want a limited number of intelligent men and women to work at home on an exclusive mail order business proposition. No selling—we furnish everything including literature, names, addresses, stock and ship items for you. All you do is mail for us and receive money coming to your own mail box. write: **MAIL ORDER DISTRIBUTORS (Franchise Division)**
15201 South Broadway Dept. A-2, Los Angeles 61, Calif.

75 POWER TELESCOPE \$3.98
25X-45X-75X
NEW 3 in one telescopes, 3 variable 25X. 45X-75X magnification. Brass bound. 25 power for ultra bright images. 45 & 75 power for long range. Guaranteed to bring distant stars, moons, objects, sports 75 times closer.
Most powerful scope sold anywhere near this amazing low price. American made, 5 sections. Opens 36", closes 1 ft.; contains 4 ground & polished lenses. Can also be used as powerful compound microscope. Mass production enables us to offer telescope complete at \$3.98 postpaid. Money back guarantee.
CRITERION CO., Dept. PMB 54, 331 Church St., Hartford, Conn.

EXTRA MONEY PART TIME!
Sell famous Doublewear Shoes to friends, neighbors, co-workers!
Full line dress, sport, work shoes for men. Priced for fast sale—you collect **BIG COMMISSIONS** on the spot! Sell evenings, lunch hour, etc. Up to **\$25 an evening SPARE TIME!** Sell for oldest firm in field—since 1908.
FREE! Big 1958 Catalog, all details of special **SPARE-TIME PROFIT PLAN!**
DOUBLEWEAR SHOE CO.
315 E. Lake Dept. 35 Minneapolis 8, Minn.

DRAW The First Day!
NO LESSONS! NO TALENT!
New Amazing Invention—"Magic Art Reproducer." You can DRAW Your Family, Friends, Anything From REAL LIFE—Like An Artist Even If You CAN'T DRAW A Straight Line! Anything you want to draw is automatically seen on any sheet of paper thru the "Magic Art Reproducer." Then easily follow the lines of the "picture image" with a pencil for an original "professional looking" drawing. Also reduces or enlarges. **SEND NO MONEY!** Free Trial! Pay Postman on delivery \$1.98 plus postage. Or send only \$1.98 with order and we pay postage. Money Back Guarantee.
NORTON PRODUCTS, Dept. 200, 296 Broadway, N. Y.

\$1,000,000.00 CASH \$2.98
IN CONFEDERATE MONEY
Be a deep south millionaire! Have money to burn! We'll send you exactly one million bucks in honest-to-goodness authentic reproductions of genuine Confederate money and bonus bills—and all you pay is \$2.98! You can do everything with this money but spend it. Amaze and amuse your cotton-pickin' friends. Win bar bets by the barrel! Light your cigars and cigarettes with \$10.00 bills! Live it up! It's a million dollars worth of laughs and fun—all for only \$2.98.
You get one million bucks in \$10's, \$20's, \$50's, \$100's etc. denominations—enough to keep your friends laughing and happy for months—This offer is limited. Only \$4 million dollars to a customer. Our supply of this loot is limited—so rush your order.
One Million dollars only \$2.98. Four Million Dollars only \$10.00. If not delighted keep \$100,000 for your trouble and return the rest of the money for a full and prompt refund. Send to—**BEST VALUES CO., Dept. M-253, 403 Market St., Newark, N.J.**



Advertisements in this section \$1.25 per word, each insertion, minimum 10 words, payable in advance.

To be inserted under proper classification, copy must be in our office the 20th of the second month preceding date of issue

F. W. Johnson, Manager, Classified Advertising
Popular Mechanics Magazine, 200 East Ontario Street, Chicago 11, Illinois

YOU'LL PROFIT

By reading and answering the classified ads in this section. Hundreds of opportunities for you to make and save money

AUTOMOBILES, MIDGET CARS

CHEVROLET V8 Owners. Secrets now available on power, acceleration and performance. Dynamometer proven. Information in detail. Send \$1.00 to Palmini Eng. s.a.e., P.O. Box 126, So. San Gabriel, California. Money back guarantee.

BULLDOZER Midget for boys 8 to 16. Gas or electric drive. Plans and photographs \$3.00. J. Bickford, 25 Pershing Dr., Plainville, Conn.

HUNDREDS of automobile catalogs—Old, new and foreign; dealer books, glossy photographs, shop manuals; free motor magazines listed by non-profit club. Write to get on free mailing list. Auto Maniacs, Stockbridge, Mich.

MIDGET Sport car with reverse. Low price. Powermij, 940 North 23rd St., Omaha 2, Nebraska.

WHOLESALE Costs of any American made car and equipment \$1.00 each make. Briggs, Box 52, Hempstead, N. Y.

AUTO SUPPLIES AND EQUIPMENT

HEADLIGHT Glare! Stop it when night driving with our Glare-Bars. DuPont Distributors, Box 695, New York 1, N. Y.

RING-Valve Job while driving, \$6.00. Literature. Motaloy, Grantham, Penna.

NEW And used parts at savings. Complete guaranteed parts service for all models cars and trucks, 1924 and later. Largest in the West. Jeep and army parts specialists. Newest type shifting hubs for all jeep and all military and latest production front end drive vehicles. \$27.50 and up. Write. Pioneer Auto and Truck Parts Co., 734 W. 13th Avenue, Denver 17, Colo.

DO-It-Yourself booklets. 24 different booklets each covering an interesting subject. Free catalog. Popular Mechanics Press, 631 N. St. Clair St., Chicago 11.

SAVE Money on Jeep and army truck parts. Large inventory. Catalogs for Jeep or G.M.C. owners. American Auto Parts Co., 1830 Locust, Kansas City, Mo.

AUTOMOTIVE Books. Free catalog. Popular Mechanics Press, 631 N. St. Clair St., Chicago 11.

RECHROMING Kit for automobiles. \$2.98. Details. Fairmont Chemical, East Syracuse, New York.

FORD "T" parts headquarters. Free catalog. Ernie Hemmings, Quincy, Illinois.

AUTO Accessory and parts catalog. 1958 edition—All new! 229 pages. Save up to 50%. 75,000 items, including Hollywood accessories, hi-speed equipment, rebuilt engines, all parts and accessories for all cars and trucks! Hard-to-get parts! Send 25¢ (refundable). J. C. Whitney, 1919 PM-2 Archer, Chicago 16, Ill.

FREE Giant 1958 parts catalog. Thousands scarce accessories stores don't have. Gadgets, custom equipment. Send 25¢ postage (refundable). Newhouse Automotive Industries, 5805-PM-2 Beverly, Los Angeles 22, Calif.

WELDING Capsules. Repairs leaking radiators. One dollar prepaid. Chemical Products, Box 2, Brooklyn 22, New York.

DAMP Wires, Miracle Glaze ignition seal, etc. It's flexible, transparent. Lasts for years. Easy to apply. 8 oz. \$5. Postpaid. Send check or money order. T. Deluca, 429 Hendrix St., Brooklyn 8, N. Y.

FREE! New catalog. Speed, power, mileage increasing equipment. Discounts! Almquist Engineering, Milford PM5, Penna.

WINDSHIELD And window tinting, do it yourself kit complete \$9.95 postpaid. National Glass Tinting Corp., 908 Truxillo, Houston 6, Texas.

FOR Every auto, boat, and home owner! The life you save may be your own. World famous Presto Midget Miracle fire extinguisher only \$4.95 prepaid. Guaranteed 20 years by manufacturer. Lamar Womack, 155 Ponce de Leon Court, Decatur, Ga.

STATION Wagon traveler. Family, business, recreation. Doubles inside luggage and bed areas. Salesman wanted. Lown & Co., 211 Harvard S.E., Minneapolis 14, Minn.

HARD Starting auto and marine engines need Fastart. Simple unit easily installed. Big help with weak battery, dampness, bad plugs, points. Lifetime guarantee. Send only \$4.95. Fastart Co., Barrington, R. I.

AMAZING Invention. Money saver. Makes batteries more powerful and many years longer, better, serviceable. Easily applied. Literature 10 cents coin. Henry Outman, 255 West 98 St., New York 25, New York.

SAVE Expensive metal parts with easy-to-install Davis Ball Boot. Encloses drive shaft coupling on 1941-1954 Chevrolets, all models. Stops dirt intrusion, stops lubricant loss, stops wear on metal parts. Other models for later Chevrolets and Fords. Write for free literature. Davis Ball Boot Company, Inc., 2301 Yale Street, Houston, Texas.

AUTO TRAILERS

BUILD Expanding eight foot trailer. Accommodates five. Literature 10¢. Framar Company, Wilmington, Mass.

TRAILER Building manual \$1.00. Booklet 30¢. Kamcraft, Box 1153, Milwaukee 1, Wis.

CABIN Trailer kits. Pleasure or business. Write Burlington Manufacturing Company, Burlington, Iowa.

ALUMINUM Pickup coach kits. Blueprints. Literature 10¢. Comstock Trailers, Parsons, Kansas.

MOTORCYCLES, BICYCLES, MOTORSCOOTERS AND SUPPLIES

RECONDITIONED Motorcycles and motors. Chromium accessories. Complete stock Indian parts. Expert rebuilding. Fast service. Indian Motorcycle Sales, Kansas City 27, Missouri.

WHIZZER Motors, \$20.00; midget race car reasonable; motorscooter \$6.00; Cushman two-speed \$20.00. Send 25¢ (35¢ first class mail) for catalog #32 jammed with sensational bargains in wheels, motors, motorscooters, midget cars, motorbikes, construction plans, etc. Gail, 1213 Jefferson, Toledo, Ohio.

50 MOTORCYCLES, Thousands of parts. Tell us your needs. Wichita Cycle Co., 813 Ohio, Wichita Falls, Texas. Our 32nd year.

HARLEY - Davidsons — Used bargains. New, used parts, accessories for all models. Bulletin, catalog 25¢. Knuth's (Factory Dealer), 1753 Muskego, Milwaukee, Wis.

RACING Power cams for Cushman, Whizzer, Mustang, Hiawatha, Continental. Send your cam and \$10. Weber Cams, Box 33175, Los Angeles 33, Calif.

MIDGET Car \$10, quarter midget \$55. Doodlebug motorscooter \$20, less engines. Engines \$2.50 up, Whizzer \$15. Servicecycle \$35. (Mailorder only.) Send 25¢ (35¢ for first class mailing) for new directory-catalogue number 81, listing these and hundreds of other bargains in new and used motorscooters, midget cars, homebuilders parts, plans, etc. Midget Motors Directory, Athens, Ohio.

SAVE 20% On genuine H.D. parts. Used parts for Harley, Indian, Cushman, Whizzer, Servicecycles. Used outboard parts. Est. 32 yrs. Bill's Cycle Shop, 1005 S. State, Syracuse 3, N. Y.

AVIATION

SMALL Helicopters theory and guide manual. Drawings. Construction data. \$2.00. Sandhill Aircraft, Box 336, Atkinson, Nebraska.

PROPELLERS, Plans, supplies for airboats and snowplanes. Latest designs. prompt delivery. Catalog 25¢. Banks-Maxwell, Box 3301E, Ft. Worth 5, Texas.

AVIATION Surplus bargain catalogue. One dime. Box 22PM3, Thomasville, Penna.

GOVERNMENT Sells: Surplus aircrafts; fuselages; assemblies; accessories; engines; instruments; electronics; misc. Buy direct now from U. S. government. Depot list and procedure \$1.00. Brody, Box 8-PMB, Sunnyside 4, New York.

ELECTRICAL SUPPLIES

ELECTRIC Pencil: Engraves all metals \$2.00. Beyer Mfg., 10511-H Springfield, Chicago 43.

LAMPS—Parts catalog containing wiring instructions. 25¢. Gyro Lamps, 3438P N.W. 54 Street, Miami, Fla.

MAGNETIZER — Magnetizes screwdrivers, etc., only \$1.00 postpaid. Kubiak, Huntingdon Valley, Penna.

LAMP, Electrical parts, wholesale. Thousands of items for repairing, converting. Catalog 25¢. Brown Lamp, Box 305, Clayton 5, Mo.

WELDING, SOLDERING, PLATING

WELD, Solder, cut, braze. $\frac{1}{8}$ " welder complete \$7.95. Flame-torch \$3.95. Postage 50¢. 75 ampere transformer welder $\frac{1}{2}$ " \$24.95 complete. F.o.b. Essay Mfg. Co., Quincy 69, Mass.

WELDERS. 110/220, \$39.50. Morris, 1070 Inner Drive, Schenectady 3, New York.

BUILD-Your-own welder or welder and power combination. Low cost unit connected to used engine lets you weld anywhere. Free booklet tells how. Get into profitable welding business. Write Hobart-weld, Box M-282, Troy, Ohio.

NEW, Timesaving oxy-acetylene outfit welds, cuts, heats, brazes. Just change tips. Light, compact, portable. Thrifty to operate, ruggedly built. Complete outfit and instructions, only \$84.50. Special economy plan for supplying gas cylinders. Write for free literature: Dept. M. Linde Company, 30 East 42nd Street, New York 17, New York.

FREE Catalog, welders, welder kits. Build 300-ampere welder using aircraft generator, plans 25¢. Dunbar Manufacturing, Houston 23, Texas.

MACHINERY, TOOLS, SUPPLIES

ABRASIVE Wheels. 3/32" by 8". Two for dollar. Lyonel Electric, 2229 Estes, Muskegon, Mich.

WANT To level it? Use a Harlevel. Accurate to 1/64". No skill required. \$5.00. Burnhard Co., 1114 N.E. Cleveland St., Clearwater, Fla.

ACCURATE Lathe, \$38.25 postpaid, English model engineers. Science Now Company, Catskill, New York.

NEW All bronze gear water pumps $1\frac{1}{4}$ " connections, 56 g.p.m. @ 3000 r.p.m. Also 1" connections, 30 g.p.m. @ 3000 r.p.m., \$23.50 each, two for \$40.00. Write Sterling Engine Co., Menominee, Michigan.

MINIATURE Taps, dies, screws, tools. Free folder. Morris, Southbridge, Mass.

McCULLOCH Chain saw parts for all model saws $\frac{1}{2}$ price. Used but guaranteed okay. Barnett Equipment Co., So. Glens Falls, N. Y.

POWER Tools, not toys. Discounts. Factory catalogs. World Tool Supply, Box 4404, Joyfield Station, Detroit 28, Mich.

RUBBER Tired disc wheels. All sizes, capacities, for home, farm, industry. Roller, ball, oilite bearings. For wheelbarrows, hand trucks, coaster wagons, scooters, lawn furniture, barbecues. Hundreds of other applications. Free information, sizes, specifications, prices. Write Mobile Wheel Products, 1510 McClellan Ave., Detroit 14, Mich.

OIL Drum cement mixer assembly kit. Circular. Nu-Way-Do Co., Newaygo, Mich.

ENGINES, MOTORS, DYNAMOS

MOTORS— $1\frac{1}{2}$ -6 V. d.c. to power models, \$2.00. Variable speed kits with motor, \$4.00. Garwood, Box 9237B, Fort Worth 7, Texas.

REWIND Motors yourself. Complete instructions \$1.00. Lewis Mfg., Howell, Michigan.

WINDING Data. 275 motors, single and three phase, \$1.10. Data Company, Box 7631, Kansas City 28, Mo.

$\frac{1}{2}$ HORSEPOWER Electric motors, a.c. 110, used, good \$5.00 each, f.o.b. Plant Machinery Corp., Richmond & Norris Sts., Philadelphia 25, Penna.

DIESEL Injector parts wanted. GM51-71-110. Bares, 7120 Carnegie, Cleveland 3, Ohio.

AIR Compressors, light plants, half price. Free folder. IMSCO, 1829 South State, Chicago 16.

BOATS, OUTBOARD MOTORS

PROPELLERS, Plans, supplies for airboats, snowplanes. Catalog 25¢. Banks-Maxwell, Box 3301F, Ft. Worth 5, Texas.

FIBERGLASS Your boat! Wholesale prices. Send for information, sample. Aqua Glas, Box 99, Altadena, Calif.

BOAT Plans—Full size patterns, frame kits. Modern inboards and outboards for amateur builders. Complete new catalog 50¢ or specify requirements. Glen Designs, 9152 Rosecrans, Bellflower, California.

BRASS Vents stop dry rot. 4 samples 25¢. Blaco Mfg. Co., Cleveland 3, Ohio.

SAVE money, new, used, outboard motor parts. Send wants. Stamp appreciated. Outboard Motor Mart, 229-M State, Boston 9, Mass.

MARINE Conversions for Ford and Jeep engines. Catalog 25¢. Lehman Manufacturing Company, 972D Broad Street, Newark 2, New Jersey.

FULL Size, cut-to-shape boat patterns, blueprints, 7 $\frac{1}{2}$ -38 feet. Big new 88 pg. illustrated "Build a Boat" catalog of naval architect-designed cruisers, runabouts, skiffs, outboard boats, sailing, racing, houseboats, 50¢. "How to Build a Boat" booklet, \$2.50. Hardware and equipment catalog, \$2.00. Cleveland Boat Blueprint Co., Dept. A-66, Box 1651, Cleveland, Ohio.

FORDS And Jeeps 100% marine engines with famous Convo-Kits. Deluxe catalogue 25¢ coin. Oscomotors, 3627B Lawrence, Philadelphia 40, Penna.

NEW, Used, rebuilt marine motors. Marine conversions, fittings. Free catalog. Stokes Marine Supply, Dept. 24, Coldwater, Michigan.

PERMANENT Lettering for boats, vehicles, homes, businesses, cast bronze, polished natural or chrome. Three sizes in script and three in block letters. Write for circular. Boat Names Company, 426 West 5th St., Kansas City, Mo.

FREE Catalog! Boat kits, trailers, fiberglass, marine hardware. Luger Industries, Dept. M-2, 9200 Access Rd., Minneapolis 20, Minnesota.

REBUILT Marine, industrial engines, gasoline, diesel. Parts. Helwege, 741 Ocean, Freeport, N. Y.

BOAT—Motor combinations: Plywood, \$135.00! Molded lapstrake, \$205.00! 260 powerboat plans, catalog 50¢. Marinecraft, Box 161-M, Brighton, Mass.

FIBERGLASS Polyester bonding kit, boat repairs, strong, durable, light. Illinois Blow Pipe, 2800 Halfday Road, Deerfield, Ill.

OUTBOARD Motors used and rebuilt—new 1957 Johnsons at discount prices. Send dime for list. Outboard Motor Mart, 229 State Street, Boston 9, Mass.

BUILD Small boats. Booklet 25¢. Catalog free. Popular Mechanics Press, 633 N. St. Clair St., Chicago 11.

ATHLETIC EQUIPMENT, BODY BUILDING COURSES

OUTSTANDING Physical development! Any age. New guaranteed discovery uses only a rope! Strength, health, muscles. Gain-reduce. Free details. Ropercise, 4834-A Art, San Diego 15, California.

BARBELLS, Dumbbells, Courses. Free catalogue. Good Barbell Co., Siloam Springs, Arkansas.

BE Taller! Coach's "Inch-At-A-Time" system—\$1.00 complete. Satisfaction guaranteed. Marty Snyder, Box 195-EB, Union City, New Jersey.

FEET, Leg muscles hurt? Athletes, salesmen, active men and women know you're only as young as your feet and legs. Amazing Ferrin method helps activate, stimulate and intensifies basic circulation without electricity or expensive equipment. Benefits are quick and lasting. Send only \$3 for full kit. Satisfaction guaranteed. Write Ornin Company, 1017-13th St., Des Moines, Iowa.

SPORTING GOODS, GUNS, FISHING TACKLE, ARCHERY, TRAPPING

FREE 152 Page fishing catalog—Includes latest "do it yourself" kits. Netcraft Company, Dept. B2, Toledo 13, Ohio.

BOWLERS—Professionally proven tips, tricks. Marvelous. \$1.00. Bowlaid, Box 383, Hellertown, Penna.

SCOUTERS—Promote camping. Unique patch and program, 25¢ handling, sample, instructions. Campfire, 2717 E. 73rd, Kansas City, Mo.

FREE—Below wholesale fishing catalog. Fishing Tackle Mart, Dept. 52, Box 6737, Chicago 80, Illinois.

FISHERMAN'S Compact \$1.00. Catalog. Park Products, 47th St., New Brighton, Penna.

MOLDS For fisherman's sinkers, jigs, squids, casting and spinning lures. Free catalog. Sweet's Molds, Tonawanda 1, New York.

FREE Catalog. Newest items. Bargains. Gadgets, beads, spinners, lure parts, sinker molds. Finnyports MD, Toledo 6, Ohio.

HOW To catch rian with smelt. Secret recipes, formulas, methods, 25¢. Johnson's, 312 Lake Avenue, Ithaca, New York.

SAMPLE: 25¢ Copy of "The Archers Magazine." Send 10¢. 1200 Walnut Street, Philadelphia 7, Pennsylvania.

LUGERS! Mausers! Colts! P-38s! Kentuckies! Weatherbys! Antique-modern guns, guncrossies! Super bargain catalog only 50¢. Agramonte's, Yonkers 20, N. Y.

RIFLES, Shotgun, pistols, scopes, ammunition. Dealers prices. Berkshire Gun Rack, Six Lakes, Michigan.

BIG Money raising crickets and 12 inch African fishworms. Free literature. Carter Ranch, Plains, Georgia.

5000 BARGAINS, Firearms, binoculars, war relics. Catalog 50¢. Smith Firearms, Rummene, N. J.

FREE Sporting goods catalogs! Save 70%. Econ-O-Mart, Whippany 2, New Jersey.

JAP Rifle altering to 30-06, \$6.00. Jap-shells, \$3.95. Catalog 5¢. T. P. Shop, West Branch 11, Mich.

BUILD Barbecue. Complete plans. Booklet 25¢. Free catalog. Popular Mechanics Press, 633 N. St. Clair St., Chicago 11.

TAXIDERM Y

TAXIDERM Y Instructions complete in four volumes. \$5.00. "Amateur Tanning" \$1.50. Grants, 322 N. 15th, Allentown, Penna.

EARTHWORMS

\$10,000 YEAR Possible, earthworms, 32 page booklet tells how 35¢. Missouri Earthworm Research, Box E-6851, Kansas City, Mo.

\$1000 MONTHLY Possible, raising earthworms—African Giants! Backyard, garage, basement. Complete illustrated booklet, explains raising, feeding, packing, marketing. Only 25¢! Ozark Worm Farm-J, Willow Springs, Missouri.

\$800.00 MONTHLY Raising earthworms, 32 page instruction booklet, 35¢. Mississippi Valley, PM2, 1805 Central, Memphis, Tenn.

RAISE Nightcrawlers, redworms. Soil-less method. Three Oaks Ranch, Dresden, Tenn.

RAISE Domesticated earthworms. Instruction booklet 35¢ postpaid. Frank H. Barnhart, 209 Lamont, San Antonio, Tex.

LARGE Native earthworms. Tough, active, breeders or bait. 100, \$1.00; 1000, \$6.00 prepaid. Worm Ranch, Buchanan, Tenn.

FREE Folder, "How to Make \$3,000 Yearly. Sparetime, Backyard, Raising Earthworms!" Oakhaven 56, Cedar Hill, Texas.

FREE Literature—Amazing profits raising giant fishworms and crickets. Carter Redworms, Plains, Georgia.

BINOCULARS, TELESCOPES, MICROSCOPES, MAGNIFIERS

BUILD Your own reflector telescope. Complete kit: Mirrors, eyepieces, tripod, all other accessories. Request free illustrated literature. Criterion Manufacturing, Dept. DPM 38, Hartford, Conn.

MICROSCOPE Catalog free. Research Scientific Supplies, 126 West 23rd Street, New York 11, N. Y.

REFLECTING Telescope, 60X, completely assembled \$29.75. Guaranteed observatory clearness. Free information. Skyscope, 476 Fifth Avenue, New York City 17.

DYNASCOPE—Sensational new reflector telescope. Send for details. Criterion Co., Dept. DP 41, Hartford, Conn.

REFLECTOR Telescope kits \$7.25 (3") to \$175 (12"). Mirrors, cells, focusing mounts, tripods, eye systems. Anything, everything in telescopes. Free catalog. Also ready to use telescopes from \$25. Esco Products, Oakridge, N. J.

WAR Surplus bargains: Millions of lenses, instruments, telescopes, binoculars, components and complete line of astronomical telescope items. World's greatest optical market-place! Send only \$1.00 for beginner's 10-lens kit and big instruction booklet Stock 2-CH. Write for catalog "CH," free! Edmund Scientific Co., Barrington, New Jersey.

BINOCULARS, Telescopes, microscopes. Terrific values \$3.98 up. Request free money-saving catalog. Criterion, Dept. P 63, Hartford, Conn.

SATELLITE Spotter. Aluminum telescope, 6X, \$2.95. Importer, 3218 SE122, Portland, Oregon.

MIDWINTER Sale, amazing prices precision binoculars. Folder "Binocular Selecting," catalog free. Prentiss Importers, Mercury Bldg., West Los Angeles 25, Calif.

REFRACTOR And reflector telescopes. Also mirrors, lenses, tripods, etc., for making your own telescope. Free illustrated catalog. Suffolk Science, Mattituck, N. Y.

MICROSCOPE Slides. Anatomical. Free list. Bay, 409 Roosevelt, San Francisco 14, California.

PLANTS, SEEDS, BULBS, NURSERY AND GARDEN SUPPLIES

WORLD'S Greatest cash crop. Free information. Write Ginseng Gardens, Asheville, N. C.

RAISE Your shrubs, trees from seed. Free planting guide, price list. Woodlot Seed Co., Norway 9, Michigan.

PETS—DOGS, BIRDS, RABBITS, HAMSTERS, ETC.

RACCOONS, Minks. Bred females. Baby skunks. Catalog, 25¢. Shady Fur Farm, Springfield, Minnesota.

RAISE Rabbits or mink on \$500 month plan. Free details. White's Rabbitry, Delaware, Ohio.

HAMSTERS—Ideal pets. \$2.95 pair. Free booklet. Jer-Fre's Hamstery, 2425 Hoyt, Muskegon Heights 13, Michigan.

WE Pay \$3.50 lb. dried. Grow mushrooms, cellar, shed and outdoors. Spare, full time, year round. We have 25,000 customers. Free book. Washington Mushroom Ind., Dept. 171, 2954 Admiral Way, Seattle, Wash.

BEAUTIFUL Pure white pedigree police puppies. Ansonia Kennels, McHenry, N. Dak.

RAISE Rabbits successfully by knowing facts. 48 page illustrated book describing 25 breeds. Housing, feeding, breeding, marketing, etc. Plus bulletin. 25 cents. American Rabbit Association, 36 Arba Building, Pittsburgh, Penna.

MAKE Money raising chinchillas, mink, nutria, rabbits, cavy for us. Free catalog. Keeney Brothers, New Freedom 2, Penna.

DESCENDED Skunks, monkeys, hawks, reptiles. Illustrated catalogue, 25¢. Trails End Zoo, St. Stephen, S. C.

WHY Ordinary trade? Receive squab prices. Thousands wanted daily. Write Ledford Farm, Box 685P, Gaffney, S. C., for free secret-revealing book.

HAMSTERS—Golden: Young. \$3.00 pair, breeders, \$4.00 pair. New mutation, \$5.00 pair. Adirondack Hamstery, Prospect 10-B, New York.

RAISE Rabbits for us—Profitable Angoras, Chinchillas, New Zealands. Particulars free. Grinsteads, Edwardsville, Ill.

GERMAN Shepherds. Registered. Large, husky pups. \$25 up. Picture 10¢. Onahill Kennels, New Hartford, Iowa.

SQUIRREL Monkeys \$19.95. Spider monkeys \$35.00. Baby alligators \$2.50 postpaid. Cash with order. "Gators," Box 7241, Miami 55, Florida.

MONKEYS \$22.50. Baby raccoons, descended skunks, pigmy skunks, alligators. Animals, birds, reptiles, all kinds. Free list. Thompson Wild Animal Farm, Clewiston, Fla.

WHITE German Shepherd puppies. Theatrical dog tricks. Knoff, Nashotah, Wisconsin.

TROPICAL Fish—Color pictures of 55 species swimming in their natural habitat. Send 10¢. Miracle Filter Co., Dept. W, Box 9128, Long Beach, California.

FUR BEARING ANIMALS

RAISE Mink: Free booklet, pen plans, inside secrets, feed, care. Mink are money makers. Investigate today. Lawrence Mould, Brigham City 12, Utah.

1000 BRED Mink—Booklet, plans 25¢. Lake Ontario Ranch, Gravel Road, Webster, N. Y.

BRED Females, mink-nutria. Finest quality. Reasonable prices. Voight Farms, Atlanta 2, Texas.

MINK Raising information free. Complete. Lake Superior Mink Farm, Superior, Eel, Wisconsin.

FARMS, FARM LANDS, REAL ESTATE

FLORIDA'S Most desirable secluded fishing and hunting homesites in new Lake Center development. Surrounded by lakes. In famous Panama City gulf resort area. Ideal for sportsman's and family vacations. Only \$10 monthly. Booklet free. Wendell Wood, Fountain, Florida.

CALIFORNIA Investment bonanza. 40 to 640 acre tracts state land, \$5 acre minimum. 10¢ brings brochure. Pioneer Ranches, 8228 Sunset, PM, Hollywood 46, Calif.

TEXAS Resort and retirement property at 5 beautiful lakes. Climate ideal year round. 2 lots adjoining total cost \$145.00, \$10.00 down, \$10.00 month. Folder free. GS-12, Box 50, Kingsland, Texas.

CANADIAN Tax sale lands for three dollars an acre and up. Small monthly payments. Farms, timber, hunting and fishing camps, minerals. Limited number of properties. Write at once for free catalogue. Tax Sale Service, Room 105, 120 Bloor St., W., Toronto 5, Canada.

FLORIDA—2½ Acres; \$15 down, \$15 monthly; full price, \$695. High elevation, near Gulf of Mexico. Suitable farming, citrus, poultry. Free information. Florida Sunshine Coast Development Co., Brooksville, Florida, Dept. PM-1.

FARMS \$195. \$10 Monthly. Descriptions free. Write: Armstrongs, Shook, Mo.

OPPORTUNITIES! Government land. U. S., Alaska, Canada. Sledge Surveys, Macon, Mississippi.

FLORIDA Trailer homesites. Water system. \$495.00, \$10.00 monthly. Lake privileges. Box 2005, Deland, Florida.

FREE Strout catalog! Farms, homes, businesses, resorts, retirement properties. Over 2900 values in 34 states. 57 years' service. World's largest! Write Strout Realty, 7-MP So. Dearborn, Chicago 3, Ill.

HOMESITES \$15 Monthly—California's finest garden section. Morro Bay's scenic shores. Wonderful fishing, boating. Fertile soil, softest water, temperate climate, congenial community. Free literature. Richard Otto, Department M, San Luis Obispo, California.

\$5.00 MONTHLY Buys 40 acres productive land. Near town. Price \$250.00. Free list. Box 425-P, Carthage, Mo.

FLORIDA. Nice homesites, \$345 at \$10 monthly. Folder free. Howard Vernor, DeLand, Florida.

FLORIDA Homesites, new lakeside development. Moderate prices, monthly payments. Pine hunting, fishing. Adjoins Ocala National Forest. Literature, Grace Parker, Paisley, Florida.

PROFITABLE OCCUPATIONS

HOME Mailorder beginner's manual, sources, methods, opportunities, 25¢. Carnahan Bros., 9610 Acacia, Fontana, Calif.

\$60.00 WEEKLY, Sparetime — Easy! Home Venetian blind laundry. Free book. Burt, 2434ES, Wichita 13, Kansas.

FREE Book "990 Successful, Little-Known Businesses." Work home. Plymouth, 1610-43 Street, Brooklyn 4, N. Y.

WE Pay \$3.50 lb. dried. Grow mushrooms. Cellar, shed and outdoors. Spare, full time, year round. We have over 25,000 customers. Free book. Washington Mushroom Ind., Dept. 99, 2954 Admiral Way, Seattle, Wash.

SAVE Money! Buy wholesale! Free catalog general merchandise. Norris, 487-M Broadway, New York City.

SPARETIME Repeat profits taking magazine subscriptions. Special offers. Cassell Agency, Boynton Beach, Florida.

FREE Folio "\$5,000-\$45,000: Unlimited Vacations." No merchandise. Unknown! Work home, sparetime! Haylings, Carlsbad, Calif.

BE The Popular Mechanics representative in your neighborhood and earn big profits in your spare time. Write Popular Mechanics Magazine, Room 305M, 200 E. Ontario St., Chicago 11.

BIG Money raising fishworms and crickets. Free literature. Carter Wormery, Plains, Georgia.

BAKE New greaseless doughnuts in kitchen. Sell stores. Free recipes. Michael Ray, 3605 South 15th, Minneapolis 7, Minn.

FREE Book "505 Odd, Successful Businesses." Work home. Pacific, Oceanside, Calif.

RAISE Pheasants on \$100 week plan. Little capital and space can make you independent. Free details. Great Central System, Columbus 1, Kansas.

MAKE Flexible molds. Cast plaques, figurines. Free sample. Tooker, 1045-M Fairview, Hamilton, Ohio.

VENDING Machines—No selling. Operate a route of coin machines and earn amazing profits. 32-page catalog free. Parkway Machine Corporation, Dept. 25, 715 Ensor Street, Baltimore 2, Maryland.

AUCTIONEERING—Home study course. Diploma granted. Auction School, Ft. Smith, Ark.

BUY Wholesale! Over 10,000 nationally advertised products. Appliances, cameras, sporting goods, housewares, watches, typewriters, tools, clothing, etc. Send postcard today. Buy-Rite, Box 258, Hawthorne 3, New Jersey.

AMERICA'S Largest wholesale supply. Buy, sell. Amazing profits. New free plan. Associated Wholesalers, Box 52-DX, Burlington, Iowa.

EARN \$240.00 A month at home, spare time doing only two \$5.00 invisible mending jobs a day. Big money paid for service that makes cuts, tears disappear from fabrics. Steady demand. Details free. Fabricon, 6236 Broadway, Chicago 40, Ill.

FOOD Supplements booming! Sell super-potent "Supervite." Vitamin Specialties, 5522½ Hollywood, Los Angeles 28.

MAGAZINE Subscriptions—Largest commissions, bonus. Qualified Agency, 451EA Kingston, Brooklyn 25, N. Y.

BIG Profits in welding. Easy to learn. Low cost training in completely equipped non-profit school. GI approved. Write for free booklet. Hobart Trade School, Box M-283, Troy, Ohio.

FREE Information, mail order business. Write Box 8382-A, Albuquerque, New Mexico.

PLAYER Piano repairing, easy directions, \$2.00. Pine, Box 162Ri, Glenburnie, Maryland.

INVESTIGATE Accidents—Earn \$750 to \$1,000 month. Thousands of airlines, insurance companies, steamship lines urgently need claim investigators. We train you home spare time. Placement counsel and help. Free book, now! No obligation. Universal Schools, T-2, Box 8202, Dallas 5, Texas.

START Mail order discount business at home selling gifts, appliances, books, housewares, watches, jewelry, cookware, tableware, dinnerware, cutlery, etc., at discounts to 75%! Invest nothing in stock. We ship orders under your name. Self-selling catalogs printed with your name, names of mailorder buyers supplied. Catalog, details free. Topval Corp., Lindenhurst 917, N. Y.

MONEY Plans! "Secret Journal." Grandpa, two daughters made \$2500 first month! Work home. Publiccos, Oceanside, Calif.

HOMEWORKERS, Copublishers. Details 10¢. Smith, 10 Adelphi Street, Brooklyn 5, N. Y.

START Your own magazine subscription agency. Write: Sub. Service, 126 W. Third, Los Angeles 13.

CHARACTER Analysis. Free brochure. Lucas System, 2419 Sunset, Los Angeles 26, California.

HOUSEWIVES, Others. \$30-\$100 weekly assembling pre-polished rockhound jewelry at home spare time. Free details. Viking, Dept. 21, Box 2066, Inglewood, Calif.

GUARANTEED. Double your money selling imports. \$1 brings sample, prices. Refunded if not delighted. Vogel House, Box 851, Madison 1, Wis.

BOOKS, PERIODICALS, PICTURES, POSTCARDS

JOHN Friend, bookfinder, can get the books you want. Free search service. Box 2570PM, Long Beach 1, California.

DISPOSAL Sale: New-used books. List sample free. Persil, 436 New York Ave., Brooklyn 25, N. Y.

NATIONAL Geographic Magazines, 1888-1956. Periodical Service, Box 465-PM, Wilmington, Delaware.

RARE Magazines, catalog 10¢. Nationwide Exchange, Box 1375-P, San Antonio 6, Texas.

BRITISH Book bargains — Any subject, Catalog free. Transbooks, Box 1-PMT, Wantagh, N. Y.

BOOKFINDERS! All subjects. Send wants! Jaher Book Service, 183 Hazelwood Drive, Westbury, N. Y.

FREE: Exciting catalog packed with books covering most everything. Think of it—From cover to cover you will find described and illustrated hundreds of books telling how to fix and how to build almost anything. How to remodel your home; do your own decorating, plumbing, electrical work. Simplified books covering concrete work, carpentry, painting, furniture making and refinishing. How to build your own boat, home workshop tools. Best books on photography, welding, hobbies, homecraft. How to make a home freezer. Send for your free copy now. Popular Mechanics Press, 300-BC East Ontario St., Chicago 11, Ill.

MAGIC TRICKS, PUZZLES, JOKER NOVELTIES

PROFESSIONAL Catalog, 175 pages, 25¢. Williams, 900 Plymouth, Ellwood City, Penna.

WHOLESALE! Thirty 10¢ trick novelties \$1.00! Profits! 1746-W Market, Philadelphia 3.

SMOKEBOMBS 25¢. 7 For \$1.00. Terrific! 4463-PM Greene, Philadelphia 44.

ONLY 10¢ Brings you magic's greatest value, Douglas famous catalog, 500 tricks. Tricks for amateur and professional, for pocket, parlor, club, stage, with balls, coins, cards, cigarettes, silks, apparatus. Fastest service to magicians everywhere for over 30 years. Amaze your friends, send 10¢ today. Douglas Magicland, Dept. 10, Dallas, Texas.

SENSATIONAL Magician's wand 25¢. Vanishes handkerchief! Catalog included. Box 1352-PM, Philadelphia 5.

LIGHTED Candle from pocket trick (including 100 refills) \$1.00. Lonergan, 672 North Dearborn, Chicago 10, Illinois.

279 MAGICIANS' Secrets, vanishing cards, magic catalog. All for 25¢. Wizard, Box 391, Jackson Heights 72, New York.

MAGICIAN'S Headquarters! Catalog 25¢. Hocus Focus, 317 North State, Jackson, Mississippi.

EARN Money—Be a mechanical magician. Complete coin and card tricks outfit, \$1 guaranteed. Scinta, Box 82, Detroit 32, Mich.

STINKBOMBS. Potent aroma! 12/\$1. Kits, 1452 Drake, San Pablo 10, California.

3100 NOVELTIES, Jokes, tricks, gadgets, funmakers, hobbies. Big catalog 10¢. Johnson-Smith, D-424, Detroit 7.

VENTRILOQUISM, easiest method. Details free. Smith, 2125 N. Bigelow, Peoria, Ill.

VENTRILLO, Professional voice-throwing instrument and catalog 25¢. Box 971-PM, Philadelphia 5.

WORLD'S Finest professional magic. Joker novelties. Giant illustrated catalog 10¢. Top Hat, Evanston 12, Illinois.

DOLLAR Magic set free with catalog 25¢. 4462-PM Germantown, Philadelphia.

COINS, TOKENS, CURRENCY

WANTED! Coins! Highest paid! Confidential catalog, \$1. Huber's, National Building, Minneapolis, Minn.

WHAT Are your coins worth? Amazing Fell's new 1958 U.S. coin book by Jacques Del-Monte. Everything on every single coin minted; worth, value, how to sell, speculating, investment; other valuable facts. Cloth bound, 150 illustrations. Send no money. Pay postman \$2.00 (plus postage) or \$2.00 postpaid (refundable). Fell Publishers, 386-H2 Fourth Ave., New York City 16.

OLD Money wanted. Do you know that coin collectors pay up to \$100.00 for all U.S. cents? And high premiums for all rare coins? We buy all kinds. Send 5¢ for large coin folder. May mean much profit to you. Numismatic Co., Dept. 20, Fort Worth, Texas.

PAYING \$30.00 For Lincoln sets. \$4.00 hundred for Indian heads. Fred Carpenter, Manti, Utah.

20 DIFFERENT Indian cents \$2.00. Rhode, 105 Windsor, Reading, Penna.

LINCOLN, Indian and Canadian cents, buffalo nickels. Bargain list 10¢. Hughes, 21 Ottawa, Grand Rapids, Michigan.

44 DIFFERENT Coins, \$1.00. 100 different coins, \$2.50. 68 coins and bills, \$1.00. Oddehon, Box 482, St. Louis, Mo.

U.S. Commemorative half dollar and bargain list, only \$1. Delmaco, Box 1123, Wilmington 99, Delaware.

10 DIFFERENT Indian Cents \$1.00. Coins, Box 6184, Albuquerque, New Mexico.

NEWS And bargains "Canadian Bulletin" 10¢. Maries, Box 833, Calgary, Canada.

FREE! Every serious collector wants our free circular. Write: Keepsake, Wenona, Illinois.

WANTED — 1822 \$5.00 Gold pay \$10,000.00. 1913 liberty head nickel \$4,000.00. 1894-S dime \$2,000.00. 1876-C.C. 20¢ piece \$1,000.00. 1901-S quarter \$60.00-\$500.00. 1922 50¢, \$6.00-\$80.00. 1885 trade dollar \$1,000.00. Uncirculated dollars 1804-1839. 1893-S, 1895-P, 1903-O \$100.00-\$5,000.00. Certain dates Lincoln cents before 1932, \$100.00; flying eagle cents, \$500.00; Indian cents, \$140.00; dimes before 1943, \$300.00; quarters before 1924, \$1,000.00; half dollars before 1905, \$1,000.00; halfcents, \$500.00; 2¢ pieces, \$100.00; 3¢ pieces, \$130.00; half-dimes, \$500.00. Hundreds of others worth \$10.00-\$1,000.00. Canadian coins: 1921 5¢ silver, \$100.00. 1889 dimes, \$50.00. 1875 quarters, \$75.00. 1921 50¢, \$500.00. Wanted — Large cents, gold coins, paper money, etc. Know their true value. Our large illustrated guarantee buying-selling catalogue, send \$1.00. Purchase catalogue giving complete allcoin information before sending coins. Catalogue dollar refunded on \$20.00 sale. Thousands of persons have sold us coins. Worthycoin Corporation Incorporated 1938. Leaders Numismatic Quotations, K-412-C, Boston 8, Mass.

PAYING \$4.00 Hundred Indian head cents. Box 5, Oxford, Nebraska.

10 UNITED Nations countries coins, \$1.00; bargain lists, interesting coin, 10¢. Elliott, 235 Juniper, Coraopolis, Penna.

WHAT Nickel is worth \$3,500? Send 25¢ for latest book showing values of rare American coins. Stack's, 125 West 57 St., New York City.

\$1,000,000.00 CASH in honest to goodness authentic reproductions of genuine Confederate money in 10's, 20's, 50's, 100's, etc. Only \$2.98. Best Values Co., Dept. 2M-252, 403 Market Street, Newark, New Jersey.

LARGEST Lincoln cent dealer. Singles, rolls. List .06 stamps. Gem Coin, 3008 Queen, Fort Wayne 5, Indiana.

32 PAGE Informative U.S. illustrated coin list 25¢. Stoney, 192 Washington, Boston 8, Mass.

START Cent collection. We send you 10 new Lincoln cents. Different dates and mints, and coin book to hold entire set 1909-1957, for \$2.00, cash or stamps. Texas Coin Exchange, Inc., 2017 Cedar Springs, Dallas 1, Texas.

PROOF-Sets. 1958 set only \$2.50; 1957, \$3.00; 1956, \$4.00; 1955, \$6.00; 1954, \$7.00; 1953, \$12.00; 1952, \$18.00; 1951, \$29.00; 1950, \$47.00. Complete set 1950-1958 inclusive, \$120.00. Postpaid. Prompt shipment. Money-back guarantee. Dan's — Dan Morafka, A.N.A., 432-P 23rd Ave., San Francisco 21, California.

LINCOLN, Indian cents, all dates. 1955-S cent uncirculated and complete pricelist 25¢. Penny Mart, PL-9, Box 629, Chicago 90.

RAREST Carson City mint dollar 1885. Uncirculated, \$3.00. Illustrated coin catalogue 25¢. Shultz, Salt Lake City 10, Utah.

21 DIFFERENT Indianhead cents \$3.00. Bargain lists free. Sayers, 1000 Unaka, Johnson City, Tennessee.

WHOLESALE Coins for dealers, investors. Lists 10¢. Al Johnson, Box 35, Colorado Springs, Colo.

SAN Francisco mint closed! Made only cents and dimes in 1955. In short supply and great demand. One each, brilliant uncirculated, for 25¢. Free coin lists with order. Bryson Stamp & Coin Company, 612 White, Toledo 5, Ohio.

BARGAINS, U.S. coins: 1893 Columbian world's fair half dollar, \$1.00. Ten different Indian pennies, 75¢. Two-cent piece, and 3-cent piece, \$1.00. Gold ¼ eagle, \$9.00. Gold ½ eagle, \$12.50. Beautiful coin bracelet, \$1.00. Many coins available. What do you need? Rare Coin Company, 31 North Clark, Chicago 2.

LARGEST Coin magazine, 190 pages, 35¢. Scrapbook, 7320-J Milwaukee, Chicago 31.

COINS From Formosa, Vatican, etc., plus foreign banknote, 10¢ with coin approvals. Littleton Coin Co., Littleton 61, New Hampshire.

LINCOLN Cents 1910-S, 1913-S, 1921-S, 1923-S, 1924-S, all for \$2. Gasser's, Box 34615, Los Angeles 34, California.

GET Profit and pleasure in collecting old coins. Send 10¢ for 56-page illustrated coin catalog. You'll be delighted with it. Send for it now. B. Max Mehl, 370 Mehl Building, Fort Worth, Texas. Largest rare coin establishment in U. S. Established 40 years.

OLD United States gold coins bought. John J. Firpo, 120 Santa Ana Ave., San Francisco 27, Calif.

COMPLETE United States coin bargain lists, Indianhead cent, 10¢. Economy Sales, 156-A Dean, Mansfield, Mass.

SILVER Dollars; Uncirculated. 1879p through 1891p, 1897p \$2.00 each. 1893co \$15.00. Retail lists 10¢. Holden's, Garwin, Iowa.

COIN Albums and accessories. Send dime for new 24-page illustrated catalog. Coin Care Corp., 1627 West Anaheim, Long Beach 13, Calif.

INDIAN Cent plus Bargain Lists 10¢. Hutchinson's, Box 4747, Philadelphia 34, Penna.

FOREIGN Coin, banknote and large illustrated coin list for 3¢ postage. Bargains: Indian head cent, 10¢; wooden nickel, 10¢; Chinese dollar, 53¢. Approvals included with every order. Tatham Coin Company, Springfield 30, Massachusetts.

U. S. Large cent and two cent piece and coin list only \$1.00. Pounds, North Wales, Penna.

GIGANTIC 82-Page bargain catalogue \$1.00 (deductible on \$10.00 order). Large dollar bill (new) \$7.50. \$5 gold \$11.95 (paying highest prices all gold coins, any quantity). Guidebook \$1.75; Premium handbook \$1.00. Currency catalogue \$1.00. Fast service. Bebee's, 4514 North 30th, Omaha 11, Nebraska.

STAMP COLLECTING

FREE—Airmails, commemoratives, pictorials. Approvals. H. P. Wischart, Frankfurt, Ohio.

FREE United States commemorative list. H & S, 45 Bromfield, Boston, Mass.

320 DIFFERENT 25¢. Includes everything: Worldwide collection, pictorials, airmails, sets, Vatican, Israel, Philippines, Bolivia, Albania (Roosevelt), Indonesia (Famous American), topicals, bird, flower, fish, others. Everything 25¢ to those requesting approvals. Century Stamps, Box 7-M, New York 71, New York.

FIRST U. N. set. Among world's prettiest. Only 10¢. Approvals. Welles, Box 1246-R, New York City 8.

10¢ DIFFERENT China 10¢ with approvals. Plymouth, Dept. A-9, Bell, Calif.

7 CANAL Zone 10¢. Approvals. Merkel Stamps, 30 Grandview, South Hadley Falls, Mass.

TEN Israel, free! Popular-priced, attractive approvals accompany. Nymedl, Box 503, Biloxi, Mississippi.

SUPERIOR Worldwide mission mixture. Amazing variety! Half pound \$1.60 postpaid. Bay Nielsen, 4545B Harvard, Montreal 28, Canada.

300 DIFFERENT Given free with approvals. Particulars. Windsor Stamps, 8834 Cornell Ave., Chicago 17.

FREE, Surprise assortment, 50 different world wide. With attractive approvals, popular prices. Banner, Box 85-M, Park Forest, Illinois.

GIANT Approvals, thousands different, 1¢ and 2¢ each. Wahl's Stamp Exchange, 7008P Farragut, Chicago 31, Ill.

60 DIFFERENT U. S., included 30 commemoratives 25¢. No approvals. Seidenberg, Appleton, Wisconsin.

WONDERFUL Offer. 7 complete mint sets only 10¢ with approvals. Reich (M26), 1033 Lawrence, Chicago 40.

UNITED Nations. Five different 10¢. Approvals. Anderson, 1112 Harrison, San Francisco 3, Calif.

Two feet long! Stampart, Hartford 1, Conn.

14,000 DIFFERENT! Amazing new plan builds your collection systematically, country by country. Only 50¢ weekly. Free details. L. G. Ware, Stepney 75, Conn.

INTRODUCING Our better United States approvals, we offer 15 United States stamps including Columbian, Pan-Pacific, famous American, airmail, others; only 10¢. Ocean Stamps, Box 64-PM, Brooklyn 29, New York.

UNITED States price list, 116 pages, price 25¢. Mark Hanna, 335 Fifth Ave., Pittsburgh 22, Penna.

U. S. Mint flag set, complete, \$1.00. Free list. Brooks, 2323 Avenue X, Brooklyn 35, New York.

SPACEOPHOBIA? Our 1¢-2¢ approvals cure quickly. BKJ. Astor, Boston 23, Mass.

"ABE Lincoln" giant diamond, rainbow colored flag set, Israel, South Korea, 50 others different only 10¢. Approvals. Champlain, Isle La Motte, Vermont.

FREE United States illustrated catalog. Bailey, 45 Bromfield, Boston, Mass.

U. S. approvals. Low prices. Eagle Stamps, Romine Ave., Pittsburgh 26, Penna.

ECONOMICAL 1/2¢-3¢ Approvals, 33,000 varieties. Dresel, Box 128-N, West Englewood, New Jersey.

TWO \$5.00 U.S. stamps plus 30 different, 10¢ with U.S. approvals. Irwin, Box 1105, Brooklyn 30, N. Y.

FREE! 107 British Colony stamps. All different, from Britain's farflung colonial empire. Catalog value \$2.50. Free stamp magazine, approvals. Send 10¢ for handling. Act now! Niagara Stamp Co., St. Catherine's 71, Ontario.

UNITED States commemorative collection containing 33 different—10¢. Approvals. White, 516-A Avenue L, Brooklyn 30, New York.

BELL Your surplus good grade stamps. Write, describing fully what you have. Vanroy Shirk, Lebanon, Pennsylvania.

50 DIFFERENT Argentine 10c. Approvals. Reuter, 611 W. 40th Pl., Los Angeles 37.

AMAZING Offer! 200 United States stamps—including commemoratives, airmails, high denominations to \$1.00. Only 10¢ to approval applicants! Illustrated bargain lists free. Mystic Stamp Co., Dept. 80, Camden, New York.

100 STAMPS, 10¢ With approvals. Smith, 508A Brooks, College Station, Texas.

OLD Scarce U.S. seconds on approvals. Slight imperfections, lowest prices. Hernefield, Clintonhill Sta., Newark 8, N. J.

100 OLD United States between 1861 and 1935, \$1.00. Roush Stamps, 51 Chestnut, Mansfield, Ohio.

UNITED States approvals. Select copies, used—mint. Kingsbury, Fairfax, Vermont.

ICELAND 10 Different beautiful stamps for only 10 cents to applicants for our good old fashioned approvals. Old Colony Stamp Co., Dept. A, Milford, Connecticut.

1-2¢ EACH! Thousands of exciting worldwide stamps. Free examination. Cole, Box 223-A, Buffalo 21, N. Y.

225 STAMPS For only 10¢! This mammoth value includes airmails, pictorials; stamps from strange countries cataloging up to 25¢ each! Also approvals. Mystic Stamp Company, Camden 80, New York.

100 DIFFERENT Austria, 10¢. Approvals. Aronson, Box F, Newton Centre 59, Mass.

WEIRD Diamond shape coffee stamps. Lovely flower triangle! First American big commemorative. Greenland, Idol dancer, etc. Free with approvals. Capital Stamp Co., Ferrysburg 2, Mich.

25 DIFFERENT Commemoratives 1893 up 10¢. U. S. approvals. K&B, Box 70, Brooklyn 23, N. Y.

MINT U. S. at face! Older commemoratives only in 25¢ packet. Limit one with request for mint U.S. approvals. Western, Box 1689P, Salinas, California.

500 DIFFERENT Stamps only 50¢ with approvals. Littleton Stamp Company, Littleton T1, New Hampshire.

135 DIFFERENT U.S. commemoratives \$1.00. 50-25¢. Request approvals. Harold Holub, 18 East 198th Street, New York 68, N. Y.

200 WORLDWIDE 10¢ To approval applicants. Collins', P.O. Box 125, Shell Beach, Calif.

gain approvals. K. S. Holmes, London, Canada.

QUALITY Approvals at 2¢ each. Hadrian, 22 East 29th, New York City 16.

FREE! Over 100 different, \$2.50 value, including Israel, British Colonies, U. S., First U. N., Siberia; triangles, animals, sports. Approvals, illustrated catalogue accompany. Send 10¢ for mailing. Gatewood, Box 346, Winston-Salem, N. C.

FREE Sample! Interesting, informative, illustrated. National Stamp News, Anderson, South Carolina.

ITALY—100 Different 10¢ with approvals. DeRespini, G.P.O. Box 771A, New York 1, N. Y.

RUSSIA, 25 Exciting gems or 2 Hawaii 5¢ with approvals. Belmont Stamps, Washington 15, D. C.

100 DIFFERENT, 10¢ To approval applicants. Cochran, 1814 West Corona, Phoenix, Ariz.

FREE, Singapore, Borneo, Sarawak, Nyasaland pictorials. 5¢ handling. Approvals. Murrays, 1020 Rademacher, Detroit 9, Michigan.

FREE! 15 Mint French Colonies; interesting approvals accompany. Tropicana, Box 624-M, Oakland Park, Fla.

BRITISH Colonies, 100 different 10¢, also free albums, catalogs for purchasing approvals. Coast, P. O. 2187A, Santa Ana, California.

FREE! Eight sided stamp, triangle, diamond, midget, mammoth, to approval buyers. Downey, Box 70-A, Bell, Calif.

1250 STAMPS \$1.00. World wide. Good variety, off paper. Many pictorials and commemoratives. No approvals follow. Harrison's Stamps, 1435 1st Ave., Oakland 6, Calif.

FREE Stamp wallet, perforation gauge sent to new approval customers. Robert J. Clark, Box 728-P, Evanston, Ill.

PICTORIALS. The world's most beautiful and prized postage stamps. 75 different, 10¢. Approvals. Adults. Farmer, 6919 Camrose, Los Angeles 28.

100 STAMPS, 100 Countries, \$1.00. Imports, 2209 Clement, San Francisco 21, California.

100 DIFFERENT Stamps, 10¢ with approvals. Finney, Box 89, El Monte, Calif.

U.N., U.S. free with approval purchases. Stamp Farm, Oxford, Wis.

500 U.S. Stamps 25¢; 300 foreign 25¢. Carlton's 10243 Silverton, Tujunga, Calif.

NEXT Ten 3¢ F.D. arcraft covers \$1.00. Aufderheide, Box 224, Trenton 8, N. J.

EXCITING Strange countries packet. Free with approvals; Saxon, Orange, California.

TEN Alaska wartime censored covers plus rare Alaska dog team cover and copy of Alaska magazine, only \$1.00. Arctic Cachet Company, Box 81, Ketchikan, Alaska.

12,000 PENNY Approvals waiting for you. Many from exotic countries, pictorials, airmails, new issues. Tilbury, Box 862, Newark 1, N. J.

STAMP Collecting outfit, includes packet worldwide stamps, package hinges, watermark detector, millimeter gauge. Everything 10¢ with approvals. Lorain Brown, Marion, Michigan.

PENNY Approvals. Thousands. Bargains for pennies. Gifts with purchases. Penny Stamps, Orange 1, California.

PONY Express centennial first-day covers. Send stamped self-addressed envelope for details. Kirby, 1657 Pennsylvania, Denver 3, Colorado.

FREE 60 Different stamps. Request approvals. Stanley Zajac, 159 Emerson Ave., Toronto, Canada.

505 DIFFERENT 35¢. Cape of Good Hope triangle commemorative; darkest Africa jungle flower set; multicolored Portuguese West Africa map stamp. 505 stamps, catalogues over \$15.00 to approval applicants. Jayne, Box 44-P, Brooklyn 23, N. Y.

FREE—100 Different stamps if you request approvals. I. J. Stamp Co., Box 644, Bloomington, Ill.

ATTRACTIVE World-wide collection 10¢. approvals. Coley, 3606 Lazywood, Houston 23, Texas.

CUBA—25 Different 10¢. Approvals. Dopko, 3482 Laura Lane, Riverside, Calif.

100 WORLD-Wide 10¢. Approvals. Box 64Z, No. Attleboro, Mass.

provals. Jack Clancy, Box 2187, Portland, Ore.

WORLDWIDE Stamp exchange. Details free. ISL, Box 3374, Sheungwan, Hong Kong.

FIRST Day covers, original cachets—Only 100 produced. Mission Stamp Dept., Teutopolis, Illinois.

FREE, 100 Different stamps with approvals. Jeans Stamps, 42 Evergreen Rd., North Fort Myers, Florida.

BULGARIA: Fifty different exciting pictorials. Animals, trucks, flowers. This valuable collection, only 15 cents with approvals. Boger, Box 152, North Wales, Penna.

AROUND The world with 80 stamps from 80 countries 10¢, approvals. Carmody, Box 562, Appleton, Wis.

29 DIFFERENT, Giant diamond, Timor, midget triangle 3¢. Approvals. Carpenter, Box 310, Claremont, Calif.

TWELVE Different souvenir sheets. \$3.28 value, only \$2.00. Ward Brothers, 69 Harvey Street, Cambridge 40, Mass.

WOW! 110 All different Germany 10¢ Zeppelins, semi-postals, airmails, high values, etc. Giant catalog, bargain lists included with beautiful approvals. Jamestown Stamp. Dept. A28PM, Jamestown, N. Y.

103 FOREIGN Stamps, including Pakistan, Scandinavia, Newfoundland, Australia, Africa, Russia, Japan, China, oddities, rarities. Only with approvals. Enclose 10¢ for handling. Lincoln Stamp Company, St. Catherine's 318, Ontario.

SPACE Satellite commemorative, Vietnam, Liberia, Azerbaijan, Boy Scout, many others in beautiful collection, only 25¢ with approvals. Cranston Company, Box 3583, Cranston, R. I.

GIGANTIC Collection free. Includes triangles, early United States, animals, commemoratives, British Colonies, high value pictorials, etc. Complete collection plus big illustrated magazine all free. Send 5¢ for postage. Gray Stamp Company, Dept. PM, Toronto, Canada.

LIBERIA. Beautiful set of four native flowers, priced at 60¢ in standard catalog, only 10¢. Approvals. Goliath Company, Bethlehem Pl., New Hampshire.

FREE Stamp collection. 100 different stamps from Europe, Africa, Asia, Scandinavia, Balkans, etc. 3¢ to approval applicants. Tatham Stamp Company, Springfield 30, Massachusetts.

TOPS! Free book, "How to Collect Stamps." Send for your copy today! Approvals. Littleton Stamp Co., Littleton El, N. H.

U.S. Commemoratives and regulars, catalog \$5.87 for 25¢. James Valliere, 28 Thorndike St., Concord, N. H.

FREE: Mint British Colonies from North Borneo, Caymans, Seychelles, Dominica, Papua, New Guinea, Sarawak, Brunel. Free with approvals. Viking, Great Neck 8, New York.

110 USED United States commemoratives. Many obsolete. Send \$1.00. Lincoln Club, Box 211M, Chatham, New Jersey.

U.S. Mint #907 through 1099 face plus 1¢ each and postage. Wilhelm, 16566 Mendota, Detroit 21, Michigan.

100 BRITISH Colonials 10¢. Approvals. Tillicum Co., 6 Hythe Ave., Vancouver, Canada.

FREE Israel set with approvals. Mehl Stamps, 1201 Nowland, Peoria, Ill.

150 DIFFERENT Large commemoratives \$1.00. Vaccari, 1431-43rd, North Bergen, N. J.

GIGANTIC Packet list free to approval applicants. Salsman, 1729 Milvia, Berkeley, Calif.

SPUTNIK Commemoratives from Russia, plus triangle. 25 others, dime with approvals. Taylor, 106 Prospect, Nutley 1, N. J.

110 DIFFERENT Stamps 5¢ postage. Approvals. Bellet, Mapledale, Hazel Park, Mich.

JOIN Bargain Packets Club! Free packets monthly! Approvals. Guild, Box 407, Anniston, Alabama.

69 COLOMBIA. Beautiful! 25¢ with worldwide approvals. Cooper, 6018 Harcourt, Los Angeles 43, California.

Stampco, 5151 Princeton, Memphis 17, Tennessee.

100 FOREIGN, 20 U. S. commemoratives, 10¢. Approvals. Weckerling, 1304H Choquette, Austin 5, Texas.

EXOTIC Packet 50 Orient stamps free. Exciting, inexpensive approvals. Holiday, Box 773, Miami 35, Florida.

FREE! Giant bargain catalog—New edition listing thousands of bargains including U. S. and B. N. A. stamps, packets, mixtures, albums, accessories and supplies; sent with beautiful approvals. Jamestown Stamp, Dept. E28PM, Jamestown, N. Y.

510 DIFFERENT 50¢; 1024, \$1.00. Approvals. Klondike, 682 Jefferson, Elgin, Illinois.

115 DIFFERENT 10¢. Free lists. Newberry, 1509 S. 10th, Burlington, Iowa.

100 DIFFERENT U.S.—50¢. Approvals. Utechs, 1134D North Keeler, Chicago 51.

FINE United States, mint and used. Illustrated price list free. Stampland, Box 2003, Miami 11, Florida.

FREE, Everything free—Mammoth collection cataloging \$20.00 also 50 valuable complete sets. 54 gigantic multicolor commemoratives. All volumes Scott's International albums, catalogues, even Master Global albums. Free when you buy our sensational foreign approvals. Bargain Stamps, Redlands, California.

WORLDWIDE New issues on approval. Wago, Box 54, Hempstead, N. Y.

MOSQUITO And Olympic stamps, plus Brazil George Washington, 10¢ with approvals. Hill Company, Box 51, Defiance, Ohio.

15 BUTTERFLIES, Beetles: all multicolored 10¢ with topical approvals. Sierra Sales, 2322 North Hayes, Fresno, Calif.

FREE Packet! Angola, Azores, Mongolia, Nepal, Palestine. Fascinating approvals. Coral, Box 7095 (Ludlum), Miami 55, Fla.

75 YEAR Old U.S., famous Americans, flags, presidents, commemoratives, approvals plus surprise packet, 10¢ handling. Metropolitan Stamps, Box 312CP, Jackson Heights, N. Y.

SCARCE Souvenir sheet free with approvals. Variety Stamps, Box 98-E, Newton Highlands 61, Mass.

FREE — Valuable U.S.A.! (1) Scarce genuine postage stamp picturing first U.S.A., issued in 1847! (2) Big collection 30 all-different United States; ancient 19th century, valuable \$1 stamp, etc. (3) Collection beautiful commemoratives. (4) Collectors guide; big 64-page bargain catalog including all U.S. postage issues; other exciting offers! Send 10¢ for mailing expenses. Harrisco, 4164 Transit Bldg., Boston 17, Mass.

SATISFACTION Guaranteed — Lightly cancelled U.S. commemoratives. Any 3¢ issue, 934 Army to 1092 Oklahoma, 2¢ each; sixty for dollar. Tom Riley, 1439 Verna, New Orleans 19, Louisiana.

MOZAMBIQUE Company bicolored triangles, airplanes (ten) given approval buyers. William Deem, 226 Race, Ravenswood, West Virginia.

INTERESTING Approvals, mailed with United Nations stamps. BH Stamp Exchange, Box 64, New York City 34, N. Y.

800 MIXED U. S. Various issues 25¢. Monjar, Fairmount, Cincinnati 14, Ohio.

FREE. San Marino, Mozambique, Czechoslovakia, Australia, Argentina. Approvals. May, Box 986-Y, Coral Gables 34, Florida.

125 DIFFERENT Foreign, 10¢. Approvals! Connelly, 404 North Andrews, Fort Lauderdale, Florida.

WALLET Filled old issues plus 100 different, 25¢. Approvals. Whitman Studio, 17 W. Lyons, Huntington Station, N. Y.

LATIN American stamps on approval. Priced low. Fletcher, 540 Madison, Covington, Ky.

FREE! \$1.00 Packet, following approval purchase. Preference, please. Rogers, Box 485, Albany 1, New York.

FREE! Free! Round the world packet to approval applicants. Stevison, 131 Dryden Dr., Meriden, Conn.

FRENCH Military stamps 10¢ to approval applicants. Willard Snyder, 6904 Henley St., Philadelphia 19, Penna.

Contractive, 11th Ave., Montreal 36, Canada.

SEND Two dimes for the best U. S. catalogue you have ever received. New-Way Stamp, Lawrence, Mass.

FREE! Five bicolored triangles; super approvals. Satellite Stamps, Box 7248, Miami 55, Florida.

FREE! Illustrated list of 10¢ sets. Write today. Smith, 6 Greencroft, Champaign, Illinois.

25 DIFFERENT Nudes \$1.00. Max Kaplan, Box 115, Hollis 23, New York.

SPUTNIK Stamp, 50 stamps free with approvals. Baiter, Box 19464, Los Angeles 19, California.

85 PAGE U.S. list free. Stone, 192 Washington, Boston 8, Mass.

50 DIFFERENT Stamps from 50 different countries 25¢ with approvals and price lists. Tower Stamps, 74 O'Hara Avenue, Toronto 3, Canada.

WANTED—Stamp collections, accumulations. Murray Gold, 62-95p Saunders, Rego Park 74, N. Y.

EXCEPTIONAL—125 Different including triangles, commemoratives, catalog \$3.00, dime, approvals. Reeves, Box 597, Miami 37, Florida.

UNITED States. Fine mint airmails, #C7, #C8, #C9, #C10. Only \$1.15. Approvals accompany. Whiton Paine, Westport 11, Connecticut.

LUXEMBOURG, 25 Different 5¢. approvals. Neal, 5950 Tower, Riverside, California.

SENSATIONAL! Famous scientists, pictorials, etc., 10¢. Approvals. Federal Stamps, 120 Liberty, New York City 6.

FREE! Stamps galore! To approval buyers. Steele, Box 451-U, Long Beach, Calif.

PRICE List, foreign and U. S. No approvals. Stamps, 5000 Miami, St. Louis 9, Mo.

FREE! Russia Sputnik, Monaco triangles. Approvals. Keating, 2520-P Boulevard, Jersey City, New Jersey.

50 BRITISH Colonies 10¢. Attractive approvals accompany. Rocket Valley, Box 328, Canoga Park, Calif.

SPUTNIK. The world's first Sputnik stamp plus 50 all different free with approvals. Stamp Imports, Peterborough, Ontario, Canada.

"WORLD'S Oldest man" (airmail), Katango commemoratives, Indonesia (cat. 50¢), plus famous "Picard Balloon" stamp, all, 10¢, with approvals. Mark Stamps, 4628 North Hollywood Ave., Milwaukee 11, Wisconsin.

LEARN Mailorder selling. Pays big Free Colliers' reprint! Elliott, 216-A W. Jackson, Chicago 6.

ANTIQUES, RELICS, INDIAN GOODS, CURIOS

SCALPING Knife, spearhead, thunderbird \$4.00. Catalog free. Arrowhead, Glenwood, Arkansas.

ANCIENT Grooved stone tomahawk \$3.00. Indian relic list free. Lear's, Glenwood, Arkansas.

INDIANCRAFT, 40 Page illustrated catalog 15¢. Grey Owl, 4518½ Seventh, Brooklyn 20, N. Y.

ILLINOIS: Gesundheit—For sale: several hundred Revolutionary, Civil War, Indian muskets, rifles, carbines, swords, bayonets, powder-horns, bullet molds, holsters, canteens, Kentucky rifles, frontiers, dueling pistols. Stagecoach guns, 50,000 collectors cartridges. Many Confederate items. 10,000 coins, Confederate money. 100,000 Indian relics, arrowheads, spearheads, tomahawks, bannerstones, discoidals. Mounted birds, squirrels, deerheads, steer-horns. Violin wood, agates, fossils, minerals. Gold dollars. Illustrated catalog 35¢. Heike (Dadeville), Wenona, Illinois.

3 BIRD Arrows \$1.00. Smith, 841 N. Tacoma, Indianapolis 1, Indiana.

ARROWHEADS Made easy! Improved professional arrowhead making kit with photos and detailed instructions only \$2.00. Lobo A.C., Box 144, Carlsbad, New Mexico.

PRECIOUS STONES, MINERALS

64 MINERALS, \$6.00. Details free. Minerals Unlimited, 1724 University, Berkeley 3, California.

AGATES, Gems, machines. Free list. Northwest Gems, 2819 North Warner, Tacoma 7, Washington.

AGATES, Gems, machines. Free list. Northwest Gems, 2819 North Warner, Tacoma 7, Washington.

LARGEST Gem and mineral magazine tells how to have profitable fun with rocks, gems, jewelry. Monthly, \$3.00 year. Sample 25¢. Gems & Minerals, Dept. A1, Mentone, California.

SAPPHIRE, Topaz, tourmaline, garnet, peridot. Five uncut gem specimens, \$1.00. Ten polished gems, baroque shaped, \$1.00. Free bargain list jewelry, gems. Profitable, easy "do-it-yourself" projects. O'Brien's, 1116M Wilcox, Hollywood 38, Calif.

CUT Gems, make jewelry—For profit or fun. 100 page magazine tells how: where to get supplies. Sample 25¢ or request free literature. Lapidary Journal, Del Mar 2, Calif.

HOBBIES AND COLLECTIONS

NAZI Insignia, 12 different \$1.00. Medals, patches, armbands, flags, daggers. Illustrated lists, 15¢. Hobbyland, 1207 1st St., W., Calgary, Canada.

COLLECTORS Matchbook covers. 100 different unused, \$1.00. Catalog 25¢. Album \$3.00. Charles Edelman, 1311-C East 84, Cleveland 3, Ohio.

INVENTING Can be an interesting and profitable hobby. Write for complete particulars. Institute of American Inventors, Dept. 40-E, 635-P St., N.W., Washington 4, D. C.

FLORIDA Shells, 16 named boxed, \$1.25 postpaid. W. C. Hartney, Box 364, Daytona Beach, Fla.

EXCITING New hobby with micro organic crystals. Catalog 10¢ or send \$1.00 for samples. Riklin Research Laboratories, Box 3295-P, Seattle, Wash.

OREGON Beach agates, polished, 20 assorted, \$1.00. Robert Brandt, 518 Oak Terrace, Sweet Home, Oregon.

HOBBIES, Supplies. 270 page catalog \$1.00. Refundable. Joyner's, 221 N. Limestone, Lexington, Ky.

CAMERAS, PHOTO SUPPLIES

CAMERAS Repaired. Any make. Fast service. Reasonable rates. Work guaranteed. Correspondence invited. Camera Hospital, Goshen, N. H.

"SLIDE News" color slide samples 25¢. Eddings, 8 Roberts, Corning, N. Y.

FREE! Free! Send for your new 53 page photographic bargain book. Over 5000 new and used items at huge savings. For your free bargain book, write to Dept. 112, Central Camera Co., Chicago 4, Ill.

KODAK, Bell-Howell, discounts to 40% Photo equipment, appliances, free catalog. Mailers Mart, Box 135-MP5, 3 Pelham, New York.

PHOTOGRAPHY For pleasure or profit. Learn at home. Practical basic training. Long established school. Free booklet. American School of Photography, 835 Diversey Parkway, Dept. 3441, Chicago 14.

LEICA, Contax, Nikon, Minox, Exakta. All leading brands. Trade, buy, sell. Free catalog. Write Mr. Gallagher, Wall St. Camera Exchange, 80 Wall St., New York 5, N. Y.

PHOTO FINISHING

COLOR Processing—High quality, fast service and low prices. Kodachrome developing 85¢; prints 27¢. Kodachrome: 35mm. processing, 20 exposures: \$1.45; 36 exposures, \$2.25. Send for complete price list and free mailers. Photo-Mail, Box 216M, Madison Square Station, New York City 10.

KODACHROME Processing—8mm roll or 35mm 20 exp., \$1.25. Prompt service. Write for mailer and prices. Color Pix, Dept. P, CPO Box 30, Kingston, N. Y.

FREE! Color snapshot folder. Offers, lists, mailers. Houghton's, Erving, Mass.

12 EXPOSURE Rolls, 39¢, jumbo prints. Guaranteed work, one day service. Lincoln Studios, Dept. K, Box 13, Lincoln, Nebraska.

PARTICULAR? 8 Jumbos—40¢, 12—50¢. Special; 35 mm., 36 exposures \$1.25. Introductory offer. Flash Foto, Box 36M, Brooklyn 4, N. Y.

8-HOUR Service on deluxe jumbo prints. 8-exposure roll developed and 8 jumbo prints 40c, 13 exposure 55c, 16 exposure 70c; 35mm. 20 exposure 75c, 36 exposure \$1.25. Jumbo deckle reprints 4c each. Contact prints made if specified. Bay Photo Service, P.O. Box 210, Oakland, California.

SUPERIOR Quality. Prompt service. 8 jumbo in album 40¢, 16 contacts 50¢. Jumbo reprints 5¢. Satisfaction guaranteed. Also complete color film finishing service. Write for free circulars and mailers. Fast-X-Photo, Box A, Jersey City, N. J.

KODACHROME Processing 20 exposure. 8mm. roll movie \$1.00. 36 exposure \$1.75. Anscochrome, Ektachrome \$1.00. Kodachrome developing \$.65, \$.25 per print. Free mailers and price list. Nu-Color Laboratories, Box 191, Hartford 1, Connecticut.

ENLARGEMENTS. Heavyweight seven 5x7's or four 8x10's \$1.00. Jack Koons, Huntington Mills, Luzerne County, Penna.

25 **WALLET** Size silk finish photos from any picture, \$1.00 with this ad. Original returned unharmed. Studio, Box 701E, Springfield, Missouri.

MOTION PICTURES AND SOUND EQUIPMENT

AMAZING New projector of 16mm. to life size, double focusing lens, attaches to any flashlight, and 100 color film Bible story. \$2.98. Doyle, 6849 Burns Street, Forest Hills 75, New York City.

CATHOLIC Missionary, parish-Amazon jungle, needs any amount used 16mm. movies. Silent, sound. Any condition. Father Fisher, Redemptorist Fathers, Oconomowoc, Wisconsin.

8MM Movies, 50 ft. \$1.00—Special offer. Animals, cartoons, travel, comedies. Send \$1.00, or \$5.00 for six assorted. Movie-land Films, Inc., 16121-M Sherman Way, Van Nuys, Calif.

FREE Catalog. Save dollars. Fresh 8mm., 16mm. b&w and color film. Home processing equipment. Superior Bulk Film Company, 448 No. Wells, Chicago 10.

RECORDERS, Hi-Fi. Free catalogue. Carstan, 215 E. 88 St., New York City 28.

5,000 **8-16MM.** Movie films. Free catalogues. International, Greenvale, N. Y.

FREE! Blackhawk's big new 1958 sale catalog new and used 16mm., 8mm. movies; 2" x 2" color slides; used 16mm. sound projectors! Biggest stock in U.S.A.! Cameras, accessories, supplies, too! Blackhawk Films, Davenport 14, Iowa.

MOVIE Camera film: 8mm. roll \$1.50, 16mm. 100' \$3.00. Free processing. Better Films, 742 New Lots, Brooklyn, N. Y.

8-16MM. Films. Free catalogue, with sample film 10¢. Garden, 690 Howard Avenue, Brooklyn, N. Y.

SAVE 50%! Guaranteed-fresh color, b&w. movie film! 8mm., 16mm. Free catalog! Eso-R, 47th Holly, Kansas City 12, Missouri.

NEW 1958 Bargain discount 8 mm catalogue also 16 mm sound. Write National Cinema, 71 Dey Street, New York City. Specify 8 or 16 mm.

MUSIC AND MUSICAL INSTRUMENTS

COMPLETE Music service for amateur songwriters. Jerry Colonna, Box 888-M, Burbank, Calif.

1958 ACCORDIONS—Direct from importer. Save 50% and more! Free trial. Lifetime guarantee. Trades accepted. Free catalog. Write Accordion Manufacturers Outlet, Dept. 28-R, 2003 Chicago, Chicago 22.

SONG Poems wanted. Free examination. Send poems. McNeil, Master of Music, 1112 PM Wilshire, Santa Monica, Calif.

ACCORDIONS Wholesale—10 day trial. Free catalog. American Accordion Center, 5329-PM-2, Belmont, Chicago.

\$2 GUITARISTS' Book of knowledge, \$1.00 chord finder, \$1.00 book "How to play any instrument," \$1.00 discount guitar catalog. All \$1.00 p.p. Ed. Sale, Bradley Beach, N. J.

SWISS Musical movements, \$1.90. Helax, 218 West 72nd Street, New York City 23.

VIOLIN Makers supplies. Free catalog. 309 W. Fourth, Los Angeles 13.

GUITAR Tuning for playing hits, licks and chords easy. Information. Will Hughes, Box E, Depoe Bay, Ore.

YOUR Songs arranged and recorded for publisher's presentation. For information write: Vance Studios, 3409 Grand Ave., Oakland, Calif.

POEMS, Lyrics, songs wanted! Cleveland Music, 162 Boylston St., Boston 16, Mass.

SONGS And lyrics wanted for recording nationally advertised record label broadcasts to millions assured. Cooperate with composer. C. Isabel Mayer, Box 3896, Portland 8, Oregon.

SONGWRITERS! Don't mail poems or songs anywhere! Write for safe procedure! Song Service P, 333 West 56th, New York City 19.

POEMS Wanted for new songs. Send poems. Free examination. Immediate consideration. Songcrafters, 2724 Arcade Station, Nashville, Tenn.

POEMS Wanted for new songs. Send poems. Immediate consideration. Crown Music Company, 49-C West 32 Street, New York City.

ELECTRIC Guitars, amplifiers, wholesale. Free catalog. Carvin P.M.M. Covina, California.

ACCORDIONS, Wholesale to everyone. Save up to 60%. All national known brands. Free catalogue. Del Principe, 29 South Cicero, Chicago 44.

POEMS, Songs wanted! Publishing, recording, Bengol, 93 Jefferson, Chelsea 50, Massachusetts.

SONG Request guarantees royalties. Instructions two dollars. Howard Olenik, Mt. Morris, Mich.

PLAY Guitar, any instrument. Guaranteed shortcut courses 60% off. Free catalog. Staff School 10-A, Bradley Beach, New Jersey.

SACRED Music composed. Song printed. Reginald Belcher, Box 354, Morristown, New Jersey.

VIOLINMAKERS, Repairers. Fine tone wood, and all violin supplies. Send for free wholesale new price list. International Sales, 414-MPM E. Baltimore St., Baltimore 2, Maryland.

RECORDS, Hi-Fi. Big discounts. Noelson, Box 211, Wall Street, New York City 5.

WRITE Songs. Big money and reputation. Write for information. J. Gordon Pub. Co., 4700 South California Avenue, Chicago.

SONGS Into dollars. Share \$29 million dollars yearly for new songwriters, song-poets. Songs composed, published, promoted by famous firm. Information, appraisal free. Send to Nordyke Publishing, 6000 Sunset, Hollywood 28PM, California.

SONGS And poems wanted. U. S. Music Studios, Box 222A, Belmont, Mass.

SONG Poems wanted. Five Star Music Masters, 630 Beacon Building, Boston.

SONGPOEMS And lyrics wanted. Mail to: TinPan Alley, Inc., 1650 Broadway, New York 19, N. Y.

RADIO, TELEVISION AND ELECTRONICS

ELECTRONIC Kits and projects wired. Glenn White, Box 607, Draper, N. C.

TOWER Replace roof antenna, improve reception. Be ready for color. Send 25¢ for catalog. KTV Tower Co., P.O. Box 294-PM, Sullivan, Illinois.

GUARANTEED, Super sensitive crystal detectors, mixed, twenty, \$1.00. Six germanium diodes \$1.00 postpaid. Small Radio Lab., 1331 Tyler, Topeka, Kansas.

GOVERNMENT Surplus radios, parabolic reflectors, sniperscopes, mine detectors, parts. Catalog 10¢. Meshna, Malden 48, Mass.

"20 **DX** Crystal Set Plans" handbook with catalog. 30¢. Laboratories, 328-C Fuller, Redwood City, California.

RADIO Course only \$22.95. Includes all tubes, parts, tools, instructions. Write for full information. Progressive "Edu-Kits" Inc., Dept. 551B, 497 Union Ave., Brooklyn 11, N. Y.

16 $\frac{3}{4}$ **ADAPTER**—\$1.95. Change 3 speed record player to 4! Details free. Album Sales, Box 121, Cincinnati 24, Ohio.

CRYSTAL Radio experimenters write to Hulet, 305 Hope, Lakewood, N. J.

FREE! Giant bargain catalog. Transistor, "Sun" radios, kits, portables, audio, electronics, photographic, optics, tools, household. Write Lektron, 131M Everett Ave., Chelsea, Mass.

TUBES-TV, radio, transmitting, special purpose types. Bought, sold, exchanged. Send details to P. M. Gensler, W2LNI, 512 Broadway, New York 12, N. Y.

CRYSTAL Radio kit \$1.00, preassembled \$1.25, phone \$1.75; catalogue. Clearco Crystal Company, 2968 North 4th, Milwaukee 12, Wisconsin.

GOVERNMENT Surplus. Radios, parabolic reflectors. Amazing picture list 10¢. Meshna, Malden 48, Mass.

TAPE Recorders, hi fi components, tapes. Unusual values. Free catalog. Dressner, 69-02M 174 St., Flushing 65, N. Y.

BUSINESS OPPORTUNITIES

MARKETS Everywhere. Make artistic concrete birdbaths, pottery. Chemical coloring. Home workshop. Hundred varieties. Hollywood Cementcraft, 8527-K Wonderland, Hollywood 46, California.

INVISIBLE Reweaving: \$5 in one hour possible reweaving burns, tears, moth-holes. Spare-full time. Free details. Skill-Weave, Dept. C-162, 335 W. Madison, Chicago 6.

MAKE \$3 To \$5 hour sparetime at home. Sharpen hand, band, circular saws for homes, hardware stores, farmers, factories. No experience needed with machine accuracy of Foley saw filer. Small investment, quick cash returns. Free book shows how to start. Victor C. Foley Co., Columbia Heights, Minn.

SELL By mail. Book 25¢. Berryman, 153 Victoria, Northlake, Illinois.

MAKE Extra money. Cash commissions. Everybody buys easy-to-sell advertising book matches. Union label. All sizes. Cuts for all businesses. Powerhouse selling kit free. Steady repeat business. No experience necessary. Superior Match Co., Dept. MX-258, 7528 S. Greenwood, Chicago 19.

\$400.00 **DAY** in aviation. Secrets money making methods \$2.00. Aero Advertising, 3030 W. Pierce, Milwaukee 15, Wis.

SHARPEN Scissors, plinkers, knives. Inexpensive, precision outfit. Blackhaws, Sheldahl, Iowa.

GROW A living miniature forest or orchard (only inches high), that bears tasty tiny fruit at home. Learn amazing dwarfing secrets! Sensational fascinating hobby, profitable home-business opportunity. Free details! Miniature Nurseries, Dept. FY, Gardena, California.

BUY At wholesale prices! Resell at big profits. Brand name merchandise—Appliances, cookware, housewares, watches, jewelry, rings, dry goods, clothing, luggage, tools, sporting goods, toys, gifts, etc. Free 1958 color catalog. Write today. Merit Home Products, Dept. PM-2, 107 Manhattan Ave., Brooklyn 6, New York.

MAKE Exciting toys for boys. Tremendous market. Toycraft, Box 123, North Little Rock, Arkansas.

GROW Expensive herbs for us! Big profits home-business of your own. Year around profitability! We supply everything necessary! Send for free amazing facts and revealing plan. National Herb Exchange, Box FY, Gardena, California.

"**HOW** To Start a Business" booklet sent free! If you know any trade, go into business for yourself! Learn the 9 easy steps to follow. We've guided 5,000 others to success. Revealing free booklet yours for the asking! Write! National Business Consultants, Office FY, Los Angeles 61, Calif.

MAIL Order advertising agency executive reveals sensational no-risk advertising and merchandise methods. Start in office or home; minimum capital; positive profits. Free details: Impact! 3407 Prospect Avenue, Dept. 11-2, Cleveland 15, Ohio.

BREED Rare tropical fish at home. Earn big money! Learn secrets! Help fill huge demand. Amazing opportunity! Free plan. Tropical Fish Breeders FY, Los Angeles 61, Calif.

LET Me sell your products nationally. I'll send you free information on how to establish sparetime-full time Casecraft business. You build! We sell! Everything supplied. Abaris, 807-SH Sunset, Los Angeles 12, Calif.

FREE! Complete mail order business! Terrific profits! No investment. Vita-Mins, 4801Pm Cedardale, Wichita 10, Kans.

"MAIL Order Business" magazine. Most comprehensive mail trade journal in the world! 2 sample issues \$1. Refunded if unsatisfactory. Box 591, CR, Lynn, Mass.

"15 WAYS To make money raising herbs." Growing, processing, mailorder marketing instructions. 16 different herb seeds packets included. Complete money-making kit \$2. Refundable. Nichols Nursery, Crabtree, Oregon.

HOME-Import mail order business—Import profitable items below wholesale. Experience and product investment unnecessary. Full, spare time. Famous world trader guides you. Free list "157 Imports," details. Mellinger, P702, Los Angeles 24.

GROW Christmas trees from seed. 2000 seed, four kinds, \$1.00 postpaid. Christmas Tree Seed Co., Sabinsville, Penna.

UNUSUAL Opportunity. Free literature. Quill Industries, 3607 South Hamilton, Chicago 9, Illinois.

\$250.00 WEEK Spare time profit possible. Earn at home with new fascinating printing method. \$5 starts you. Send no money now. Free confidential facts and valuable samples. Screen-Print, FY, Los Angeles 61.

WE Establish you in your own mail order discount business. Sell appliances, gifts, books, housewares, watches, jewelry, cookware, tableware, dinner, cutlery, etc., at discount to 75%. No stock needed. We ship orders under your name. Self-selling catalogs printed with your name, advertising postcards, circulars, names of mail order buyers supplied. Catalog, details free. Topval Corp., Lindenhurst 118, N. Y.

BECOME Tax consultant. Graduates earn to \$3,000 every tax season preparing returns evenings. State approved. Union Institute, Hoboken 2H, N. J.

WORLD'S Greatest instant bathroom odor banish. Costs penny, sells \$1. Write By-Lo Products, Blythe, Calif.

OPERATE Mailorder business—Import merchandise. No inventory. Earnings unlimited. Free details. Write Whitaker, 101 Ramona, Vacaville, Calif.

ABUNDAVITA Means better living. bigger bank balances! Campo, 391(A) Grand, Long Beach 14, California.

OPERATE Profitable mail order business. Write Walter Service, 4159A East 112th, Cleveland 5, Ohio.

"RAPIDSTONE"—New building material. Resurface old homes, build new ones. Composition floors, colored tile. Particulars free. Marbleized Service, Edwardsville, Illinois.

"50 NEW Home-Business Ideas" booklet, sample free. Spray exotic velvet-suede on anything. Flockcraft-FY, Los Angeles 61.

\$34.70 TWO Hours. Manufacturing concrete products. No selling. Carlayne Castings, 1803 Fremont, Rapid City, So. Dak.

\$6000 FOR Mister. Mrs.—\$3500! Free "Secret Journal" plan. Magical! Work home! Publicae, Oceanside, Calif.

SELL Merlin electronic garage door operators. Make from \$50 to \$75 on every sale. Operate from your home. M. J. Fitzgerald Co. B-1, 2815 West Vliet Street, Milwaukee 8, Wisconsin.

LEARN Landscaping and growing of plants. Latest information on propagation, soil testing, plant growth regulators, garden design. Start a profitable business or wonderful hobby. Unique and modern home study course. Earn your diploma at home! National Landscape Institute, Dept. MC-28, 11826 San Vicente Blvd., Los Angeles 49, Calif.

45 THREE And five-in-one machines vending 1¢ worth of merchandise \$6.95. John Hoff, 1920 Rose, Baltimore 13, Md.

TYPISTS Make money at home. Unlimited profits. Order today. "Profits With Your Typewriter" \$1.00. Juan-Studio, P.O. Box 3053 Mdse. Mart, Chicago 54, Ill.

START Your own business on credit (U.S. only). Be your own boss. 1527 dealers sold \$5,000 to \$32,000 in 1956. We supply stock, equipment on credit. 200 home necessities. Sales experience unnecessary. Pleasant, profitable business backed by world-wide industry. Write Rawleigh's, Dept. B-U-PPM, Freeport, Illinois.

MADE \$10,000.00 Typing at home. Guaranteed proof. Amazing information 10¢. Lenore Feigen, Box 1125-PM, Oak Park, Illinois.

NEW International Mailorder Manual. Big, illustrated book, 232 pages, jam-packed with real money makers. Profitable, scientific mailorder plans and methods. Amazing how-to chapters, photos, news. Import without capital. Confidential secrets of 10 successful mailorder experts will help you step-by-step to enter the fabulous international mailorder business. Complete business set-up service. Send \$2 today for this comprehensive handbook. Airmailed. Money-back guarantee. Peter Borsch, Hillerod, Denmark.

WANTED—Limited number intelligent men and women to work at home on exclusive mail order business proposition. No selling, we furnish everything including literature, names, addresses, stock and ship items for you. Free details. Mail Order Distributors (Franchise Division), FY, Los Angeles 61.

OPERATE Profitable home business. Free details. Service, Box 636PM, Newport News, Virginia.

CLEANS Windows without mess. Strange dry cleaning-cloth. Replaces liquids. Windows gleam. Samples sent on trial. Kristee 116, Akron, Ohio.

REBUILD Batteries; repair dolls; make rubber stamps. "75 ideas" free. Universal. Box 1076-A, Peoria, Ill.

CLEAN Clogged drains by electric machine. Do it yourself. Details. Electric Sewer Cleaning Co., Allston 34, Mass.

BRAND-New wholesale books directory. 800% profit. Sell by mail. Goldland, 13913 Doty, Hawthorne, California.

MAKE Money taking orders on leading name brand electric drills, saws, sanders, vises, pliers, screwdrivers, micrometers, etc. No inventory to carry. \$1,000,000.00 stock to draw on. Profits up to 50%. Send \$1.00 for giant wholesale catalog. \$1.00 refunded first purchase. U. S. Supply, Dept. 112, 149 Church Street, New York, New York.

"FLOCKON" New profitable way to beautify anything. Automobiles, signs, novelties. Make \$15.00 hourly. Send for material, complete instructions. Introductory offer \$3.00. United Flockon Company, 820 Taunton Ave., Seekonk, Massachusetts.

MAKE Money operating penny games, sparetime. Cash business, no selling, no merchandise, no overhead. Free details. Kahm Co., Cherry Plaza, Orlando, Fla.

YOUR Own successful business. Big profits. Repeat sales. Free information. Laircraft, Box J-5008, Detroit 35, Mich.

YOUR Photo on stamps. No investment, no stock. Big profits. Free samples. Miniature Photostamps, Box 44-R, New York City 67.

WHOLESALE! Appliances, tools, clothing, everything! Free catalogs! United Wholesalers, 1265-F Broadway, New York 1, N. Y.

MONEY In scrap dealing. Amazing booklet \$1.00. Business, 60 Ormes, Quebec 3, P.Q., Canada.

CASH From sawdust, tin-cans, newspapers. Over 200 methods. Instructions \$1.00. Charles Company, 12-XAC, Norwood, Ohio.

FREE Details tell how to make fast, easy, spare-time profits with wonderful foreign imports. Gift merchandise. Terrific bargains. SM Products, 7401 Woodston, Philadelphia, 38E, Penna.

BUILD Fascinating hobby-business engraving plastics! Profits to \$5 hour! Sample, details 25¢. Engraved aluminum door emblems \$1.00. Desco Distr's., 5262-F Van Nuys, Van Nuys, California.

SPECIALIZED Magazines—Free list. Over 5,100 publications, current copies, over 1,100 self-help books. All trades, businesses, vocations, hobbies, sports. Commercial Publications, Box 44C, Franklin, Indiana.

\$1000.00 MONTHLY Possible. Sparetime. home mailorder business. Write Stevens Company, Box 188, Ft. Gibson, Oklahoma.

WANTED: Home producers, to be subcontractors. Cast plastic products for manufacturers in our clearing house service. Thousands of easily made items required. Cash in at home, without previous experience. Plastic Service Associates, Dept. 2-PM, East Boston 28, Massachusetts.

READ "Mailorder Laws and Regulations" and "Mailorder Rules for Beginners". Learn about necessary licenses, different taxes, legal requirements, etc. Both books, \$2.00. Tasker, 1603 Peach Street, Alexandria, Virginia.

BIGGEST Money makers in the field: Acme saw and lawn mower sharpeners. Free literature. Max Mfg. Co., 138 Stockton Ave., San Jose 26, Calif.

FREE "Franchise Profit Letter," describes nationwide opportunities. Exclusive distributorships, dealerships, agency operations. Write today. National Franchise Reports, 333 North Michigan, Chicago 1.

EXCLUSIVE Distributorship available in most areas for world-famous cadmium battery guaranteed to outlast your car. Tremendous profit opportunity. Investment for merchandise only. Free franchise. Cadmium Battery, Corporation Dept. 102, El Segundo, California.

TO \$100.00 Weekly. Sparetime, home operated mailorder business. Successful beginner's plan. Everything supplied. Lynn, 10420-M National, Los Angeles 34.

\$60.00 WEEKLY, Sparetime—Easy! Home Venetian blind laundry. Free book. Burt, 2434EP, Wichita 13, Kansas.

LEARN Real estate by listening to records. Lee Institute, Brookline 46, Mass.

CAMERA Owners! Earn \$50.00 weekends! Instructions \$1.00, information free! Kline, 935-PM North Austin, Chicago 51, Illinois.

SELL Books by mail. Details free. Berryman, 153 Victoria, Northlake, Ill.

COLORGLAZED Concrete pottery made without molds. Patented method. Cemetery products, novelties, tiles. Basement leak-sealing. Money-making projects. Booklet, details free. Men only. National Potteries Company, Grand Rapids, Minnesota.

PLASTERCRAFT Molds and supplies. Follet Studios, Box 362, Moorhead, Minn.

PIANO Tuning learned quickly at home. Tremendous field! Musical knowledge unnecessary. Information free. Empire School of Piano Tuning, Champaign, Ill. (Founded 1935).

BUY Direct from factories—Appliances, cameras, watches! Free details! Cam Company, 6810PM-20th Ave., Brooklyn 4, N.Y.

MIMEOGRAPHING Services pay sensational local profits. Exciting secret plans exposed! Write: Mozelle Mimeo Shop, Bonham 7, Texas.

SELL Books by mail. 400% profit. Royal, Box 368-X, Cleveland 27, Ohio.

BRUSH Plating outfits for plating articles in the home and shop. No tanks necessary, silvering mirrors, spare or full time. Free particulars. Gunmetal Co., Ave. H, Decatur, Illinois.

BUY Wholesale! Over 10,000 nationally advertised products. Appliances, cameras, sporting goods, housewares, watches, typewriters, tools, clothing, etc. Send postcard today. Buy-Rite, Box 258, Hawthorne 1, New Jersey.

WANT To make big money at home? \$10.00 profit in an hour possible with invisible mending. Make tears, holes, disappear from clothing, fabrics. Steady year-round demand from cleaners, laundries, homes. Details free. Fabricon, 6234 Broadway, Chicago 40, Illinois.

WHOLESALE—Thousands nationally advertised products. Buy, sell. Amazing profits. New, free plan. Associated Wholesalers, 1016-D Starr, Burlington, Iowa.

OPERATE Mailorder folio business! Free details. Ballard's, 425 East Catherine, Louisville 3, Ky.

MAKE Flexible molds. Cast plaques, figurines. Free sample. Tooker, 1045-R Fairview, Hamilton, Ohio.

NATURAL Molding rubber, extra thick. Free sample. W. Wooley, 1016-A Donald, Peoria, Illinois.

BIG Money raising fishworms and crickets. Free literature. Carter Farms, Plains, Georgia.

VENDING Machines—No selling. Operate a route of coin machines and earn amazing profits. 32-page catalog free. Parkway Machine Corporation, Dept. 26, 715 Ensor Street, Baltimore 2, Maryland.

\$70 WEEKLY—Home, spare time. Simplified mail bookkeeping. Immediate income—easy! Auditax, 34757A, Los Angeles 34.

WANT More business? Here's an amazing opportunity to increase your sales. Talk to thousands of interested readers of "Mechanica Popular." Our Spanish Edition covers the Latin American countries like a blanket. They're real mailorder buyers. Classified rate 75¢ per word. Try an ad in our next issue. Classified Advertising Department, Popular Mechanics Magazine, 200 East Ontario Street, Chicago 11, Ill.

START Home business making statuary, plaques, novelties, garden furniture, artificial marble flooring, liquid marble. Make your own flexible molds. Amazing profits. Only \$1.98. Free literature. Popular Mechanics Press, 631 No. St. Clair St., Chicago 11.

MINK Raising information free. Complete. Lake Superior Mink Farm. Superior, E.E.I., Wisconsin.

COPUBLISH Mail Sale Advertiser, leading mail order paper. Details, latest copy, dime. Vanroy Shirk, Lebanon, Penna.

LEARN Photo-negative portrait retouching. Men, women. \$5 hour possible spare or full time at home. Easy, glamorous. Work for photographers by mail order. Full details sent free. Duval, 100 So. Vermont, Los Angeles 4.

YOUR Own name brand business. No investment; no inventory. Part time or full time. Sell famous brands of appliances, housewares, silverware, radios, vacuum cleaners, lamps, tools, clocks, watches, jewelry, etc., etc., over 1000 items. Join thousands of successful independent dealers. Send for free catalog and dealer price list. H. B. Davis Corp., Dept. 11, 145 W. 15 St., New York City.

11,000 NEW Prospects daily. Baby record books, shoes, albums. Sell mailorder. Use our literature. Write: No-Co-Ro, Capitola, California.

BAKE New greaseless doughnuts in kitchen. Sell stores. Free recipes. M. Ray, 3605 South 15th, Minneapolis 7, Minnesota.

FIX Typewriters. Inexpensive home course teaches factory secrets. Free booklet. Athey, Tarentum, Penna.

MONEY For you! Big profits! Cast plaster figurines, bookends, plaques at home with XL rubber molds. No experience needed! Write for illustrated, 40-page catalog, only 25¢! Plastic Arts Studios, 3403 So. Madison Street, Department 6, Muncie, Indiana.

PLATE Baby shoes, jewelry, gifts, bronze and colored pearl. Free booklet. Platex, 11029 South Vermont, Los Angeles 44.

FREE Catalog. Contains hundreds of businesses, farms and income properties throughout U.S., Canada. Specify type and location desired. Deal direct with owners. U. I. Buyers Digest, 1608 Hillhurst, Dept. PM-3, Los Angeles 27, Calif.

LIQUID Rubber. Make flexible molds. Free sample. Chaney, 1907-A East Road, Jacksonville 11, Florida.

BOOKKEEPERS, Accountants. Operate a bookkeeping service. Part or full time. Amazing simplified system. Wonderful money-making opportunities. Complete information free. National Bookkeeping Publishing Co., Suite 307, 3435 Broadway, Kansas City 11, Mo.

WE Pay \$3.50 lb. dried. Grow mushrooms. Cellar, shed and outdoors. Spare full time, year round. We have 25,000 customers. Free book. Washington Mushroom Ind., Dept. 172, 2954 Admiral Way, Seattle, Wash.

\$250 WEEK Cleaning venetian blinds. Patented machinery. Free literature. Robinson, 7213B, Indianapolis 1, Indiana.

FREE Book "505 Odd, Successful Businesses." Work home. Pacific, Oceanside, Calif.

I Want to send you proof of the wonderful pulling power of Popular Mechanics classified pages. What's your proposition? Write me today. Include literature if possible. F. W. Johnson, Manager Classified Advertising, Popular Mechanics Magazine, 200 E. Ontario St., Chicago 11, Ill.

INTERNATIONAL Mailorder business. Complete setup service—Not just instructions. Hermes, 152 West 42, New York City 36.

PLASTERCRAFT Molds, liquid rubber, plasters, flocks, candle supplies. Catalog and manual free. Blue Rapids Supply, Blue Rapids, Kansas.

MARY-Mac agency—motorized vibrator. Cushions, chairs, tables, belts. Mary-Mac Factory, 1012 Powhattan, Dallas, Texas.

FREE Pollo "\$5,000-\$45,000. Unlimited Vacations." No merchandise. Unknown! Work home, sparetime! Haylings, Carlsbad, Calif.

FREE Folder. "How to Make \$3,000 Yearly. Sparetime. Backyard. Raising Earthworms!" Oakhaven 38, Cedar Hill, Texas.

MAKE \$46 From square foot plywood;igsaw necessary. Free details. Woodart, Bridgewater, Mass.

\$5,000 YEARLY. Spare time at home. Nothing to buy. No local selling. Dignified. Guaranteed. Home Harvest, Rt. 3, Box 3491-A, Albuquerque, New Mexico.

MINIATURE Golf plans \$1.00. Lil-Putt, Box 294, Rock Island, Illinois.

GROW Orchids at home. Profitable, fascinating. Successful home grower explains special light, temperature and humidity conditions orchids need. Free: Full details, Orchids, 100 S. Vermont, Los Angeles 4.

EARN \$10,000 Yearly raising Angora rabbit wool for us. Information 25¢ coin. American Angora Company, Malta 12, Montana.

IMPORTING. Modern dropship method. Details free. The Hazen Company, 6601M—8th Avenue N, St. Petersburg 10, Florida.

DOLLARS In every mail. Profitable mail order operates in your home, farm, or office. Send for free details. Webb Imports, 8729½ Warvale, Rivera, Calif.

\$100.00 WEEKLY Spare room. Raise redworms soilless way. Odorless. Charlie Morgan, Box 116E, Bushnell, Florida.

MAKE Strange plastic building material of waste, easily. Water, fire, wear and termite resistant. Bays Laboratory, Oklahoma City, 9.

TYPIST Operate profitable mail-order business. Stamp brings details. General Sales, 336 Roosevelt St., Creve Coeur, Ill.

BIG Money in mailorder. Merrill Hilstad, Box 182AP, Hatfield, Penna.

SELLING By mail fascinating. Profitable. Free information. Alfano, 19 Pine, Closter, New Jersey.

EARN \$50 To \$60 daily repairing typewriters, write New England Training Service, Carmel 2, Maine.

MAKE New perfume creations. Highly profitable, clean, dignified, easy. Write Dharma Perfume Company, 224 South Michigan, PM7, Chicago 4, Illinois.

OPERATE Profitable mailorder business! Write: Thomas Bond, 1637H West Vernon, Phoenix, Arizona.

RUBACREAM! Concentrated latex cream! Makes molds quicker! Thicker! Instructive literature free! Castcraft Studios, 508-PM Marion St., Brooklyn 33, N. Y.

OPERATE Mail-order printing brokerage. Details free. Advisory Service, Hartsdale, N. Y.

QUICK Profits, with no capital! Take orders for magazines your neighbors like, want. Make cash on the spot! We show how with free kit. Get yours now. Write McGregor Magazine Agency, Dept. 310, Mount Morris, Ill.

EVERYBODY Likes candy. Make professionally home. (Our 47th year.) Ragsdale Candies, B107, East Orange, New Jersey.

WE Love our mailman—He leaves over \$1000.00 monthly in our rural mailbox. My college professor husband drafted a scientific home mailorder method. We bought a Texas ranch, live as we always wanted. Now we sell the Ranch Mailorder Method. Operates anywhere. Inquire: Eveningshade Ranch, Boerne, Texas.

CANDIED Popcorn and potato chip equipment. Eakins, Box 933-A8, Springfield, Ohio.

BE Appointed state notary public now. Write, Stationers, Boerne, Texas.

MAKE Big money. Work from home. Ground floor opportunity. Booming business. Art-Stone, Box 856, St. Louis, Mo.

MONEYMAKING OPPORTUNITIES

MAILORDER Opportunities, offers, plans. Armstead, 512M Pamcoe Street, Tallahassee 3, Florida.

EARN At home. Details free. Hauser House, 2308-P Grand Ave., Phoenix, Ariz.

HOW To gain quick promotion—More money; right where you work. Absolutely foolproof. Write: Ern-Mar Company, Clermont 1, Florida.

SELL Hi-Fi, complete systems only \$69.50. Home dealership plan. Big profits. Small investment. Dynamic Electronics, Box 188, Forest Hills, N. Y.

WIN Contest money. General Contest Bulletin gives hundreds of tips. Lists current contests, rules. Sample magazine 25¢. General Contests, 1609½ East 5th, Duluth, Minnesota.

\$1 To \$20 Checks daily! Write simple sentences, paragraphs, poetry for pay! No experience necessary. I tell you what to write, how to write, supply large list of buying editors. Begin writing for pay, today! Will Herman, 1726 W. 25th St., Cleveland 13, Ohio.

KILL Pests for profit! \$1200.00 monthly proved! Rid homes, farms, business of termites, rodents, pests. New shortcut methods! Learn everything two weeks! Free success plan. APCOA, Dept. 1F, 15015 Ventura Blvd., Sherman Oaks, Calif.

CIGARETTES—Improved roller makes 20 for 9¢. Facts free. Moberly, Box 821, Owensboro, Kentucky.

\$36-\$200 WEEKLY Plating baby shoes, making jewelry, novelties, etc. at home. Details free. JO-CA Electroplater, 7840-D Northwest Sixth Court, Miami 50, Florida.

MAKE Money gathering wild roots, herbs, weeds, leaves, tree seeds, flowers, plants! Over 200 varieties! Listed buyers for all you can ship! Sensational free-books offer! Revealing details, 25¢. Fortune Mart: 221-A Lincoln, Worcester 5, Mass.

HOTTEST Mail order plan ever! Sell photos, films, art novelties. Huge proven profits! Free details! Profits Unlimited, Dept. 1F, 15015 Ventura Blvd., Sherman Oaks, California.

MAKE \$5,000 Yearly sparetime raising mink, chinchillas, nutria, etc. Free booklet reveals proved plans. Write Furs, 588 Mt. Pleasant Road, Toronto 1, Canada.

MAKE Big easy profits making costume jewelry at home in spare time! Quick, easy to make; easier to sell! Details free! Don-Bar, 3511 W. Armitage, Dept. B-192, Chicago 47, Ill.

EARN At home with your telephone. Details free. Kendon Company, 635-A Main, Hartford 3, Conn.

\$6000 FOR Mister. Mrs.—\$3500! Free "Secret Journal" plan. Magical! Work home! Publicas, Oceanside, Calif.

MAKE Money mailing sample business cards. Vosacek Printing, 4444A Ute, San Diego 17, Calif.

PRINTING, Office supplies wholesale. Save 50%. Royal, Box 368-A, Cleveland 27, Ohio.

SPARETIME Profits, opportunities. Free information. Ed. Polaski, Box 372, Miami 47, Fla.

\$5,000.00 ANNUALLY Possible for you in mailorder. Free information. Ransie, Box 1719-A, Richmond 14, Virginia.

TYPISTS! Make money at home! Mailers, 2 Madison, Greencastle, Indiana.

BIG Money earned while asleep! Neighbors think I struck oil! They've hunted my big secret 8 years. Not another scheme, but legitimate, sound proposition easily handled by anyone. Nothing like it! No selling! Details \$1.00 (refundable). Grant, Grantham 1, Penna.

NET \$50,000 A year, at home. Plans free. Fortune Enterprises, Addison, Illinois.

"NEWEST Products Report," popular mail order magazines, interesting mails 25¢. Burke & Brown, 61 Haven, New York City 32.

RECEIVE \$4.00 Mail orders. You keep the \$4.00, orders filled free. Complete information, sample \$1.00 (refundable). Linco, 5117 East 22, Tulsa 14, Okla.

BRONZED Baby shoe mountings. Prompt delivery! Foster, 1520 Ardmore, Chicago 26.

JOIN Cooperative moneymaking mail opportunities service. Free literature. Bayou Enterprises, 119 North Sterling, Lafayette, Louisiana.

WIN Contest prizes. Contests—Helps. Contests, 25 Earl, Red Bank, N. J.

START Big-pay business at home in spare time. No experience needed to operate little table-top machine for bronzing baby shoes. Make \$5.46 profit on every pair. Full particulars free. Send postcard to Mason, 1512 Jarvis, Room CM2A, Chicago 26, Ill.

TAPE Recording—Fabulous new business! \$500.00 monthly spare time! Entire country wide-open. Free facts. Dixieland Publishers, Asheboro 2A, N. C.

137 BUSINESS Plans collection. For home or outside, sparetime possible. Little or no capital, big profits potential, practical, diversified. Mandry and Tous, 216 West Jackson Boulevard, Chicago 6.

MAKE MONEY writing short paragraphs! No tedious study. I tell you what to write, where and how to sell; and supply list of editors buying from beginners. Many small checks add up quickly. Write to sell, right away. Send for free facts. Benson Barrett, Dept. C-27-N, 7464 Clark, Chicago 26.

EARN Cash at once, sending us easy orders for magazines your friends, neighbors want. Instant profits! We show how. For free kit, everything you need, write McGregor Magazine Agency, Dept. 320, Mount Morris, Ill.

START Home mail order business. I made enough money to retire. Now own \$18,000 home, Cadillac car, have money in bank. Amazing facts free. Norris Cole, 217 49th Street West, Bradenton, Florida.

YOUR Name on giant mailing list. Hundreds of opportunity offers. Send 25¢ and state offers or mds. desired. Direct Mail Service Co., Box 581, Bakersfield, Calif.

MEN - Women! Start money-making plastic laminating business at home in spare time. Material that costs 11¢ brings back \$2.58. No canvassing or selling but mail orders bring in \$20 a day. Write for full particulars free. Rush name on postcard to Warner, Room CL2A, 1512 Jarvis, Chicago 26, Ill.

AMAZING Successes through franchises! Become exclusive franchise holder your territory. Information rushed. National Franchise Reports, 333 North Michigan, Chicago 1.

\$60.00 WEEKLY, Sparetime — Easy! Home Venetian blind laundry. Free book. Burt, 2434ER, Wichita 13, Kansas.

ESTABLISH Your own business. Simplified instruction qualifies you to prepare income tax forms for others. No experience. Unlimited income. Full time or part time. Full details free. International Tax Institute, 524-26th Avenue, San Francisco 21.

\$15,000 PROFIT in one year possible, on \$5.00 cash and just 3 hours attention weekly! Experience unnecessary! Fabulous but true! Proof, complete detailed plan, only \$1.00. Satisfaction or refund! Columbia Enterprises, 8203-P, Grubb Road, Silver Spring, Maryland.

"HOME Business Digest" has money-making opportunities galore. Sample 25¢. Donovan, 79-PM Greenbelt, Levittown, New York.

ATTENTION Typewriter owners. Make handsome profits. Write today. Groves Company, 682, Hastings 8, Nebraska.

DO IT YOURSELF. What? Repair TV, build furniture, make barbecue, plumbing repairs, build boats, do house wiring, remodel home, lay tile, modernize kitchen, repair home, and scores of other things you can do yourself. Books covering each subject, only 25¢. Send for descriptive list. It's free. Popular Mechanics Press, 200-LB East Ontario St., Chicago 11, Ill.

BUY Wholesale! 30-80% discounts! Appliances, gifts, typewriters, tools, watches, sporting goods, jewelry, cameras, housewares, etc. Consolidated Distributors, Clifton 28, New Jersey.

FREE Folio "\$5,000-\$45,000. Unlimited Vacations." No merchandise. Unknown! Work home, sparetime! Haylings, Carlsbad, Calif.

READ Progressive Mailtrade, the magazine that tells how to make money by mail. Dime brings sample and special offer. Progressive Mailtrade, Box 357, Sheboygan, Wisconsin.

BIG Money raising, fishworms and crickets. Free literature. Carter Hatchery, Plains, Georgia.

EARN Money evenings copying and duplicating comic cartoons for advertisers. Adservice, Argyle 1, Wisconsin.

SELL Titania gems. Far more brilliant than diamonds. Catalog 10¢. Diamonte, 2420-M 77th, Oakland 5, California.

VENDING Machines—No selling. Operate a route of coin machines and earn amazing profits. 32-page catalog free. Parkway Machine Corporation, Dept. 27, 715 Ensor Street, Baltimore 2, Maryland.

FREE Book "505 Odd, Successful Businesses." Work home. Pacific, Oceanside, Calif.

DOLLARS Every day! It's magical—You keep all the dollars. Setup free. Otto Miller, Box 588-W, Oshkosh, Wis.

JOIN the prosperity parade with a mail order bookshop in your own home. Valuable information free. Practical Publications, 3974-F Milwaukee, Chicago 41, Ill.

WE Pay \$3.50 lb. dried. Grow mushrooms. Cellar, shed and outdoors. Spare, full time, year round. We have 25,000 customers. Free book. Washington Mushroom Ind., Dept. 173, 2954 Admiral Way, Seattle, Wash.

EXPORT — IMPORT

FREE Information—How to start an importing business from your home. Direct Mail Service Co., Box 581, Bakersfield, Calif.

BIG Profits importing gems. Free info. 5761 Zelzah, Encino, Calif.

FORMULAS, PLANS, ETC.

FORMULAS For latest money-making discoveries. New! Good! Valuable literature free! Miller, Chemist, 1517-D, Tampa, Florida.

FORMULAS; All kinds, latest, best. Literature free. Kemikal, Park Ridge, Ill.

PRACTICAL Formulas. Lists free. Cummings, Chemist, Gordon Ave., Syracuse 4, N. Y.

LATE, Modern manufacturing formulas. List free. Moon Chemical, Martville, New York.

PLASTICS

PLASTIC Casting and mold supplies. Catalog includes instruction in mold construction, casting, manufacturing methods. Liquid glass, steel, rubber. Send 25¢. GEL, Box 261, Union, N. J.

PLEXIGLAS. Square foot cost, 1/16", \$1.20; 1/8", \$1.52; 3/16", \$1.86; 1/4", \$2.21; 3/8", \$3.23; 1/2", \$4.36. Colors add 10%. Send 15¢ for postage. Artistocrat Plastics, 23 Sussex Avenue, Newark, N. J.

LEARN Plastics fabrication for spare time income. Low cost home training now available. Write for free booklet. Interstate Training Service, Dept. D-3, Portland 13, Ore.

LAMINATING Supplies. Free price list. Solomson, 46 Cornhill, Boston 8, Mass.

BOXES, Plastic. Free list. Althor, 170 Bay 23 Street, Brooklyn, N. Y.

PLEXIGLAS. Acetate, vinylite, polyester, fiberglass, epoxy, styrofoam, mold materials. 28 page instructive, informative wholesale-retail catalog. 25¢. Gem-O-Lite, 5527 Cahuenga Blvd., North Hollywood, California.

FREE! Beautiful plastic novelty and catalog. Casting plastics, clear, colors, marble, jewelry and supplies. Write today. Castcraft Corp., Dept. M-280, P.O. Box 555, Palo Alto, Calif.

NEW Liquid casting plastic, clear, colors. Embed real flowers, coins, photos. New Manual shows fine things you can make at home and sell at big profit. Send 25¢. Castolite, Dept. B-101, Woodstock, Illinois.

PLASTIC Sealing cards, photos, etc. Billfold size 50¢. Machine method. Permaize, 330 E. Center St., Kalamazoo, Mich.

CHEMISTRY

CHEMICALS, Glassware. Catalog 25¢. Laboratory Sales, Box 161-A Brighton, Mass.

CHEMICALS And apparatus for industrial, analytical, and private laboratories. Catalog 25¢. Dept. M-50. Biological Supply Co., 1178 Mt. Hope Ave., Rochester 20, N. Y.

EXPERIMENTERS: Bargains catalog. 25¢ (refundable). Hagenow Laboratories, 2414 Clark, Manitowoc, Wisconsin.

ILLUSTRATED Catalog: Chemistry, mineralogy, biology 25¢. Tracey Laboratories, Evanston, Illinois.

CHEMICALS In small quantities. Chemistry and apparatus sets. 27th year. Catalog 25¢. John H. Winn Co., Inc., 124M West 23 Street, New York 11, N. Y.

AMAZING New Book of Science. Experiments, formulas, and catalogue of laboratory supplies. Only 25¢. National Scientific Co., Dept. PM-2, 500 West Road, Lombard, Illinois.

CHEMISTRY-Science magazines. Literature free. Lankton, Box 5126-C8, Lansing 6, Mich.

AGENTS WANTED

AMAZING New liquid. Discovery mends, repairs fabrics of all kinds in 60 seconds. Astounding demonstration. Everyone buys. Free sample offer. Write No-Sew, Dept. PM-2, 330 South Wells, Chicago 6.

CASH Commissions at once, taking orders for magazines every family wants! No experience needed. For free money-making kit, with everything you need, write McGregor Magazine Agency, Dept. 300, Mount Morris, Ill.

AMAZING Greeting card money-maker—Make \$75.00 on 100 deluxe \$1.25 assortments. Newest 21 for \$1 tall cards, gift novelties, 133 fast sellers. Gift bonuses besides biggest profits. Experience unnecessary. Stationery samples free, others on approval. \$1.25 gift for prompt action. Creative Cards, 4401 Cermak, Dept. 514-H, Chicago 23.

FREE Sample! Beautiful feather pictures. Sylviak, Apartado 9036, Mexico 1, D. F.

AGENTS — 300% Profit selling genuine gold window letters; stores and offices. Free samples. Metallic Sign Letter Co., 1217-D West Newport, Chicago.

YOUR Ad in this space will get some good agents for you. Yes, I'll prove it. Write for Folder "A" right now. F. W. Johnson, Classified Advertising Manager, Popular Mechanics Magazine, 200 E. Ontario St., Chicago 11, Ill.

GOLD Or silver letters, numbers. Windows, doors, trucks. 1" to 6". 500% profits. Free samples. Atlas-T, 544 West 79th, Chicago 20.

PRINTING, Advertising salesmen—Excellent moneymaking sideline selling decalcomania name plates, small quantities. Automobile initials, sign letters. Free samples. Ralco, XL, Boston 19, Mass.

YOUR Own business—Used suits \$1.50, overcoats 65¢, mackinaws 35¢, shoes 12½¢, ladies coats 30¢, dresses 15¢. Enormous profits. Catalog free. Nathan Portnoy Associates, 605-AA West 12th Place, Chicago 7.

EASY Handwork makes fast-selling useful articles. Sample free. Sunmade Company, Brockton 64, Massachusetts.

GOLDMINE Of 600 money makers. Free copy. Specialty Salesman Magazine, Desk 5B, 307 North Michigan, Chicago 1, Ill.

\$20 DAILY Easy selling world's finest bibles. Star-Brite, Box 1165, Lakeland, Fla.

STEADY Big profits in nationally advertised unbreakable plastic housewares, tablecovers, utility covers. Tremendous selection, lowest prices! Free catalog PM82, Acclaim, Box 4, New York 40, New York.

\$25 DAY, Easy. New fire extinguisher. Retails \$2.95. Profit \$2.00. Free sales kit. Edconco, 155 East 44th Street, Dept. P2, New York 17, New York.

MAKE Big money selling the Security hand pressure dry chemical fire extinguisher. First time offered for direct sales. Write today for free information. Big commissions. Hudson Mfg. Co., Sheridan 4, Michigan.

SELL Ties and household items, made by blind people. Terrific moneymakers! Blind Workers, 1511-P Lawrence, Chicago 40, Illinois.

EARN \$10,000 Yearly—Only two sales daily. World's best seller, the Holy Bible. (Illustrated) Protestant or Catholic. Margareta's, P.O. Box 92, Hazelton 7, Penna.

IT'S Easy to sell our big line business printing, calendars, advertising specialties and political advertising. Big cash commission each sale, even first day. Full or part time. Experience unnecessary. Prospects unlimited. Big sales kit free. National Press, Dept. 6, North Chicago, Illinois.

IF You want to earn money fast, I'll send you free sample stocking of newest stretch duPont nylons to sell at only \$1 a pair. American Mills, Dept. 644, Indianapolis 7, Ind.

EARN \$50.00 Daily operating a world's drop-ship business at home. No capital required. Up to 1000% profit. K. Glass, Ellwood City, Penna.

\$1000 A Month for making dramatic 1-second demonstration of amazing lightweight Presto fire extinguisher. New chemical, used by airforce snuffs out fires instantly. Only \$4.95. Terrific commissions. Millions want it. Free kit. Merlite, 114 E. 32nd, Dept. P-66F, New York City 16.

gift shop at home. Show friends samples of our wonderful new 1958 all-occasion greeting cards and gifts. Take their orders and earn up to 100% profit. No experience necessary. Costs nothing to try. Write today for samples on approval. Regal Greetings, Dept. 42, Ferndale, Michigan.

MEN, Women, make money spare time plus new car as bonus for encouragement. Amazing hosiery guaranteed to wear without holes, snags and runs, or replaced free. For example, lovely 60 gauge nylon guaranteed for as long as 1 1/4 years, or replace free. Write Wilknit, 1782 Washington, Greenfield, Ohio.

60% PROFIT On cosmetics—Famous nationally advertised Hollywood cosmetics pay 60%. Make \$25 day up. Hire others. For free samples, details, write Studio Girl, Glendale, Calif. Dept. 1282G.

WANTED, Part-time fire extinguisher salesman. Out-O-Matic, 1737D E. 31st, Denver, Colorado.

MAKE Big profits selling household items at discounts. Clausens, 26 Maple, Litzitz, Penna.

EARN Big money full or part-time. Quickie Spray shines all leather instantly without buffing, brushing. Be first! Rush refundable \$1.00 for demonstrator, selling kit. Franchises available. James R. Barnett Co., Dept. PM-28, Wellesley Hills 81, Mass.

SEEKING New products? Get my outfit 47 money-making specialties. Latest conveniences for home, car. Send no money. Just your name. Kristee 77, Akron, Ohio.

AGENTS 100% Profit selling the only modern envelope sealer in existence. Sell offices, factories, homes direct and by mail. Free details and sample refer Amberland, 277 W. 2nd St., S. Boston, Mass.

MAKE \$75 to \$500 spare time showing friends, neighbors "newest of the new" sensational, exclusive modern-design, studio-style all occasion greeting cards for birthdays, anniversaries, getwell, friendship, etc. Everybody orders. Keep up to 50¢ of every \$1.00. Send no money. 2 beautiful assortments on approval. Rush name. Wallace Brown, 11 E. 26th St., Dept. A-242, New York City 10.

BIG Profits selling Hold-Tite car trunk holder 98¢. Ohlaco, North Madison 5, Ohio.

FREE Catalogue. Hawaiian candy, gifts. Mater Products, 3049 Kapiolani, Honolulu.

NITE-Glo road signs. Sells on sight. Prospects everywhere. Wonderful profits. Details free. AA Sign Service, 2914 W. 43rd St., Chicago 32, Illinois.

\$78 WEEKLY—Plus cash bonus from one fast easy order daily, showing low-priced cookware. Get amazing details now! Write: Swanson's Housewares, Box 848-B, Station A, St. Petersburg 1, Florida.

SHINE Cars without polish. New invention. Lightning seller. Cars gleam like mirror. Samples sent on trial. Kristee 76, Akron, Ohio.

WHOLESALE Clothing catalog plus real merchandise samples. Bostonian 14-B Dock Square, Boston 8, Mass.

MAKE Big profits fast. Sell Messko tire gauges. Imported, precision-engineered, quick sales assured. Every motorist a customer. Omega Service Parts Corporation, Empire State Building, New York City.

\$300 WEEKLY Possible selling auto-club membership like AAA. Exclusive franchise: no competition. 60,000,000 buyers. Free sales kit. Travelers, Monroe, New York.

\$13.50 HOURLY Profits possible, introducing 5 valuable farm books your area. Published by Popular Mechanics. Farmers buy on sight. Details free. Popular Mechanics Press, 200 E. Ontario, Dept. 64-B, Chicago.

AUTOMOBILE Specialty salesman: Patented Davis Ball Boot protects drive line parts and transmission. Saves repair bills, saves lubricant. Every Chevrolet and Ford owner, every garage and parts dealer a logical prospect. Attractive, exclusive territories now open. Write for details. Davis Ball Boot Company, Inc., 2301 Yale Street, Houston, Texas.

BUY IT WHOLESALE

BUY Wholesale! Discounts to 80%! Gifts, appliances, housewares, tools, watches, etc. Midwest, IMP-156, Pontiac, Illinois.

Southern Watches, 5-PM So. Wabash, Chicago 3.

ELECTRIC Guitars, amplifiers, wholesale. Free catalog. Carvin PMW, Covina, Calif.

JOHN Catalog club. Send \$1.00 (refundable) for 8 wholesale catalogs. Stark, Box 9897, Houston 15, Texas.

BUY Wholesale! Thousands nationally advertised products! Send postcard! Southland Products, Lincolnton, N. C.

BUY Wholesale! Over 10,000 nationally advertised products. Appliances, cameras, sporting goods, housewares, watches, typewriters, tools, clothing, etc. Send postcard today. Buy-Rite, Box 258, Hawthorne 4, New Jersey.

BIG Multicolor wholesale catalog! Housewares, appliances, clothing, silverware, cookware, luggage, binoculars, radios, phonographs, cameras, recorders, projectors, typewriters, shavers, sporting goods, toys, tools, sewing machines, watches, jewelry. Name brands. Huge discounts. Postcard: Selbyco, Decatur 153, Illinois.

FREE Wholesale catalog. Gifts, appliances, books, housewares, watches, jewelry, cookware, tableware, dinnerware, cutlery, etc. Discounts to 80%. Topval Corp., Lindenhurst 924, N. Y.

FREE Wholesale catalog. L. A. Isenberg, R.R. 1, Dorsey, Illinois.

WHOLESALE Catalog clothing, shoes, linens, housewares. Bostonian 14-C Dock Square, Boston 8, Mass.

BIRCH Kitchen cabinets. Free catalogue. Charlotte Wood Products, Charlotte, Michigan.

TWENTY Wholesale catalogs—List 50¢. A-to-Z, Box 422, Fallon, Nevada.

WHOLESALE! Appliances, tools, clothing, jewelry, everything! Free catalogs! United Wholesalers, 1265-M Broadway, New York 1, N. Y.

1958-1959 AUTOMOBILES! 40% off! Jakiela, 2644-NNO Western, Chicago 47.

BUY Wholesale! Nationally known brands. Catalog \$1. (Refundable). D'Auria Sales, Box 355-PM, Jackson, Michigan.

SALESMEN—DISTRIBUTORS

AMAZING Discovery, Master Glaze, puts brilliant glass like surface on cars. Free sample, information. Big commissions. Master Glaze, Dept. 883, 7720 Harwood, Milwaukee, Wis.

MAKE Extra money. Cash commissions. Everybody buys easy-to-sell advertising book matches. Union label. All sizes. Cuts for all businesses. Powerhouse selling kit free. Steady repeat business. No experience necessary. Superior Match Co., Dept. M-258, 7528 S. Greenwood, Chicago 19.

MONEY Back low priced trading stamp plan pays you bigger spot cash profits with steady year 'round income from reorder commissions. Every grocery, gas station, drug store, etc., are quick buyers. Free pocket sales kit. Worth, P-2, 1825 South Michigan Avenue, Chicago 16, Ill.

REPRESENTATIVE To handle auto gasoline additive. Ring and valve job in 30 minutes. Laboratory tested. Unconditionally guaranteed. \$6.00 for sample. Motanu, Inc., 1101 May St., Fort Worth, Texas.

MAKE Money. Sell sensational dwarf trees, bear giant-size apples, peaches, pears. Ornamental. Also Stark-Burbank standard trees, roses, shrubs, vines, etc. Outfit free. Stark, Desk 30728, Louisiana, Mo.

AD Matches! Sell amazing designs—10, 20, 30, 40 and 240-light book matches. Bigger spot cash commissions; every business a prospect. Low prices for high quality. Repeats. Start without experience; men, women; full, part time. Buy nothing! Sales kit furnished. Match Corp., Dept. PM-98, Chicago 32, Illinois.

BUSINESS Kit free! Postcard puts you in business! Complete line 230 shoe styles, also jackets! New discoveries pay big commissions. No investment. Send for free kit. Mason, Chippewa Falls 69, Wis.

EARN \$100 Weekly part time. Embossed business cards, 14 styles. 40% commission. Large 9x12 catalogue, samples, supplied free. Pinson, 6770-M Yellowstone, Forest Hills, N. Y.

MANUFACTURER Offers metal specialty product line for direct salesmen and mail order dealers. Practical products. Good profits. Fast reorders. Flinson, 708-A East 19th, Kansas City 8, Missouri.

Call see famous Hoover uniforms for beauty shops, waitresses, nurses, doctors, others. All popular miracle fabrics, nylon, dacron. Exclusive styles, top quality. Big cash income now, real future. Equipment free. Hoover, Dept. B-100, New York 11, N. Y.

SELL "Grease that won't melt," including Moly products in a complete line of heavy duty lubricants. Our leading salesmen now earning over \$12,000 in a year. Write immediately to E. B. Baker, P.O. Box 676, Dayton, Ohio.

\$1000 A Month for making dramatic 3-second demonstration of amazing lightweight Presto fire extinguisher. New chemical used by airforce snuffs out fires instantly. Only \$4.95. Terrific commissions. Millions want it. Free kit. Merlite, 114 E. 32nd, Dept. P-66F, New York City 16.

WILL You wear new suits and topcoats without one penny cost and agree to show them to friends? You can make up to \$30.00 in a day even in spare time, without canvassing. W. Z. Gibson, Inc., 500 South Throop Street, Dept. U-626, Chicago 7, Illinois.

IF You're interested in making money in selling, see the hundreds of exceptional opportunities in Salesmen's Opportunity Magazine. Send name for your copy, absolutely free. Tell us what you're selling now. Opportunity, 848 N. Dearborn, Dept. 17, Chicago 10, Illinois.

NEON Window signs—custom made. 100% profit to salesmen. Merchants save 50%. Write Neon Tube Co., 1758 S. Cleve. Ave., Canton, Ohio.

SIMPLE Demonstration of our new invention amazes business and professional men. Write to Frank Brown, Jr., Dept. P-1, Box 97, Milan, Missouri.

INCREASE Present income. Build growing sideline, fulltime business. No investment. Farmers, agents, dealers. Take orders for Campbell's Gro-Green Liquid Fertilizer Concentrates. Free sample, sales kit. Campbell Co., Rochelle 332, Illinois.

EMPLOYMENT INFORMATION

LOS Angeles employment, housing and business opportunity information \$1.00. Letter remains 25¢. Rains, 5621 Gracewood, Arcadia, California.

SOUTHERN California needs skilled, unskilled workers. Los Angeles, San Diego employment lists \$1.00 each. "Be prepared to move!" Cal employment, 844 Oaklawn, Chula Vista 1, Calif.

COPYRIGHTED Reports on best paying jobs with travel, adventure, promotions. Construction, aviation, shipping, laborers, clerical, trades, supervisory, factory, unusual opportunities. Many types of work. Skilled and unskilled. Foreign and state-side openings for men and women. Only \$2.00 (\$2.25 airmail), including registration-advisory service. Satisfaction guaranteed. Included absolutely free: Special reports on Alaska, Spanish airbase construction, South American opportunities and husband-wife foreign jobs. Research Services, Suite 514-PMZ Meramec Building, St. Louis 5, Missouri.

FOREIGN Jobs—Latin America, Alaska, Canada, up to \$1500 monthly. Up-to-date 1958 foreign service directory gives complete information; hot list of firms hiring for military and civilian construction, aircraft, oil, exporters-importers, mining. How-when-where to apply. 11th successful year. \$1.00. Global Reports, Box 8873-S, Los Angeles 8, Calif.

MIAMI Beach, Miami, Hialeah, classifieds \$1. Chamar Service, Box 594, Hialeah, Fla.

FOREIGN, Alaskan, U.S.A., jobs! To \$1500.00 monthly! Million Americans employed overseas. Copyrighted reports. Who to contact for highest paying jobs. Laborers, trades, truck drivers, office, engineers, many others. 52 countries—St. Lawrence project, Spain, Latin America, Northern project, Europe. Year registration-advisory service. Application forms. Unconditional money-back guarantee! \$2.00 (airmailed \$2.25). C.O.D.'s accepted. International Reporter, St. Louis 1-PP, Missouri.

WANTED: Experienced Chevrolet mechanic to work in long established Chevrolet dealership. Ernest Allen Motor Company, 615 Commerce St., Fort Worth, Tex.

COMING To California? 15 page booklet: Jobs, housing, opportunities, \$1.00. Free state map! Chesley, 3977 1/2 Texas Street, San Diego 4, California.

AMERICAN Overseas jobs. High pay, men, women. Transportation paid. Free information. Transworld, Dept. M, 200 West 34th St., New York City 1.

FLORIDA Jobs pay big. Special copyrighted analysis airmailed \$2.00. Free contacts. Sun-Glo Service, Perry 4, Florida.

FLORIDA—Job listings, housing, food \$1.00. Buhanman's, 2221 Corliss, Orlando, Florida.

BOOMING Venezuela—Only hours from the States. New data regarding jobs, opportunities, conditions, etc. Salaries to \$1650 monthly U. S. tax exempt. Bonuses, living allowances extra. First-hand information direct \$2.00 (\$3.35 air mailed) checks or money orders only. Paul B. Smith, Apartado 172, Maracaibo, Salina, Venezuela.

JOBS On merchant ships. Big pay. Box 4092, Jacksonville, Florida.

JOBS Overseas! Janeczek Development Co., 1090 Hub Station, New York 55, N. Y.

FREE Information: Earn high pay. All trades. Foreign and U.S.A. job opportunities. Travel paid. Applications, write Dept. 61J, National Employment Information, 1030 Broad, Newark, N. J.

SPECIAL SERVICES

INFORMATION On anything. Ferguson Research Specialists, 116-14 141 St., South Ozone Park 36, N. Y.

EUROPEAN New products and inventions. We keep you informed. Whatever your interests are, consult us without obligation. Buessenschuett, Box 2029, Bremen, Germany.

EDUCATIONAL AND INSTRUCTION

HANDWRITING Analysis now accepted in college, business, industry. Our men, women who use grapho analysis spare, full time earning more money, getting prestige, success, happiness. Uncrowded, fascinating field for intelligent men, women anxious to get ahead. We need more members. Investigate this growing field where you give a real service to your fellow man. Opportunities unlimited. Free sample lesson and information to all over 21. Write today! IGAS, 2307 National Station, Dept. 1013, Springfield, Missouri.

WELDERS Earn big money. Easy to learn arc, gas, automatic welding. New equipment, low cost training in non-profit school. GI approved, free booklet. Hobart Welding School, Box M-281, Troy, Ohio.

LEARN! Dance! Right away! Free "automatic instructor" proves you can! Castle's Homestudies, 507 Fifth Avenue, New York City 17.

FINISH High School at home, spare time. No classes. Diploma awarded. Write for free catalog. Wayne School, Catalog HF-83, 2527 Sheffield, Chicago 14.

DRAFTING, Design, blueprint reading. Good paying. Easy to learn at home. Minimum age 17. Write Utilities Engineering Institute, Dept. TC-11, 2525 Sheffield, Chicago 14.

MEN Wanted age 19 to 45 to train as builders, estimators and contractors at home in spare time. Big pay opportunities. Write for free brochure. American Technical Society, 850 E. 58th St., Dept. PM-582, Chicago 37, Illinois.

BLUEPRINT Reading—Train at home. Learn to read blueprints with confidence in 10 easy lessons. Write today Belton School, 1059-W North Lawndale, Chicago 61.

PIANO Tuning pays. Big money in spare time. Learn at home in 30 days. No musical knowledge necessary. Phonograph, records, tools and instructions furnished. Personal instructions available. Free catalog. Capital Piano Tuning School, 3160 S.W. 16th Court, Fort Lauderdale, Fla.

LEARN Mail order publishing. Free details. Rainone Printer, Middle Village 79, New York.

ENGINEERING Degrees earned through home study. Residence courses also available. Pacific International University, (operating as a College of Engineering only at present), 5719-B Santa Monica Boulevard, Hollywood 38, California.

HIGH School diploma at home. Licensed teachers—Approved materials. Southern States Academy, Box 5344-MX, Station E, Atlanta, Georgia.

WE Pay \$3.50 lb. dried. Grow mushrooms. Cellar, shed and outdoors. Spare, full time, year round. We have 25,000 customers. Free book. Washington Mushroom Ind., Dept. 174, 2954 Admiral Way, Seattle, Wash.

EARN Degree. Free bulletin. Home-study only. Midwestern Bible School, 1060 Broadripple, Indianapolis.

BOOKKEEPERS! Increase your earnings! Operate your own simplified "Dollar-A-Week" bookkeeping and tax service. Full or spare time. Details free. No obligation. Ellis, Box 300, Cedar Grove, North Carolina.

BE A real estate broker. Study at home. Send for free catalogue. Midwest School of Real Estate, 68 North Chicago Street, Joliet, Illinois.

TIMESTUDY—Your key to positive personal profits. Associated Techniques, Box 235, Hollidaysburg, Penna.

EARN College degrees, correspondence. Metropolitan University, Box 86, Glendale 5, California.

LEARN Appliance service and repair. Motors, washers, refrigeration, cleaners, everything. Free booklet. Armstrong, 11027-A South Vermont, Los Angeles 44.

STUDY For Doctor's degree of psychology, metaphysics and divinity. Correspondence courses only. College of Divine Metaphysics, Dept. P-M, 2811 North Illinois, Indianapolis 8, Indiana.

BE A real estate broker. Study at home. Write for free book today. GI approved. Weaver School of Real Estate, 2018P Grand, Kansas City, Missouri.

USED Correspondence courses and books sold and rented. Money back guarantee. Catalog free. (Courses bought.) Lee Mountain, Pisgah, Alabama.

EARN While you learn. Auto and diesel mechanics master this top paying trade. Many graduates earn \$100 a week and up. Approved for Korean veterans. For free information write Dept. No. 256, Nashville Auto-Diesel College, Nashville 3, Tenn.

LEARN While asleep! Details free. Research Association, Box 610-MC, Omaha, Nebraska.

WANT A diesel job? New opportunities to increase income. Higher pay. More money. We can help you qualify. Tools. Shop method home training. Write today! Diesel, Tractor, Heavy Equipment Division, Interstate Training Service, Dept. B-3, Portland 13, Oregon.

INVESTIGATOR Training. Phillips Secret Service System, 1917-B North Kenneth, Chicago 39.

PIANO Tuning pays. Learned easily at home. GI approved. 59th year. Free booklet. Niles Bryant School, Dept. P, 3731 Stockton, Sacramento 20, Calif.

SECRET Investigation. Experience unnecessary. Investigators particulars free. George Wagner, M126 West 96th, New York 24.

SHORTHAND In four days. Learn at home. \$2.98 ppd. Take notes three times faster. Pineline Company, 303-PM Fifth Avenue, New York 16, N. Y. Free literature available.

SING, Speak, with power, personality. Self-training records. Amazing details. Canfield, 2018-A 5th Ave., South, Minneapolis 4, Minn.

PHYSICAL Therapy and massage. Home training. Practice privately or work with doctors and hospitals. Free catalogue. National Institute, Desk 4, 159 E. Ontario, Chicago, Ill.

LEARN By ear with Dormiphones. While you sleep, amazing new scientific invention works for you. Revolutionary Dormiphonic tools give you a shortcut to learning languages, correct speech; memorizing facts, figures; ideal for self-improvement, relaxation, habit training. Saves time, effort. So simple to use, children benefit. Used by educators, psychologists. Write for fascinating free book. No obligation. Modernophone, Inc., 320-028 Mezz., Radio City, New York City 20.

ENGINEERING, Home study. Midwest Engineering School, 10923 Hillcrest, Hickman Mills 34, Missouri.

COMPLETE Your high school at home in spare time with 61-year-old school. Texts furnished. No classes. Diploma. Information booklet free. American School, Dept. H245, Drexel at 58th, Chicago 37, Illinois.

LEARN Civil and criminal investigation at home. Earn steady good pay. Institute Applied Science, 1920 Sunnyside, Dept. 162, Chicago 40, Ill.

GET Rich scientifically. Amazing proven technique. Guaranteed. Free test. Frederick C. Lane and Associates, 1337 Curragh Ave., Burnaby 1, British Columbia.

JOIN Science parade. Be an electrical draftsman. Easily understood, high pay. Inexpensive course. Thomas, Box 154, Concord 2, New Hampshire.

IT'S Fun learning a language by Linguaphone, world's standard conversational method. At home, quickly, easily learn to speak French, Spanish, German, Japanese, Russian, Modern Greek—Your choice of 34 languages. It's like living in another country. Complete recorded courses on free trial. Send for free book and details. No obligation. Try, don't buy! Linguaphone Institute, T-83-028 Radio City, New York City 20.

LEARN The Bible—Self training records. Free literature. Album Sales, Box 121, Cincinnati 24, Ohio.

FREE College education (resident, correspondence). Free books. Other graduating opportunities (courses or tests). Aurem, Central Valley, New York.

LATE Used correspondence school courses bought. Educational Exchange, Menlo, Ga.

BE An investigator. Write for free details. State age. National Detective Academy, Dept. P, P.O. Box 1082, Scottsdale, Arizona.

HELP Yourself to abundant living. Our courses have aided students to richer, fuller lives. Learn secret of contentment, happiness. Earn degrees Ph.D., M.S.D. Write for free book. College of Universal Truth Correspondence School, 23-O E. Jackson, Chicago.

SWEDISH Massage, learn at home. Diploma. Dr. Swanson School Swedish Massage, Illinois licensed vocational school. 3809 Alta Vista Terrace, Chicago, Ill.

FREE: "Your Amazing Subconscious"; Six steps to success. Box 847 (H-2), Ocean Park, Calif.

PLAYS, STORIES, MANUSCRIPTS

WANTED: Book manuscripts, all subjects considered. Greenwich Book Pub., Atten. Mr. Zealand, 489 Fifth Ave., New York City.

WANT Your book published? Learn how we publish, advertise, promote, distribute. Many successes. Free booklet PM. Vantage, 120 West 31, New York City. Midwest office: 220 S. Michigan Ave., Chicago, Ill.

CARTOONING, COMMERCIAL ART, SHOWCARD & SIGN PAINTING, TATTOOING

"HOW To Make Money With Simple Cartoons"—A book everyone who likes to draw should have. It is free; no obligation. Simply address Cartoonists' Exchange, Dept. 92-C, Pleasant Hill, Ohio.

BOOKLET, "Cartoon Hints" plus 4, 8 1/2 x 11 sample cartoon drawings \$1.00. M. D. Gaetano, 119 Bradford Ave., Mamaroneck, N. Y.

FREE Facts about our famous cartooning course. No obligation. Cartoons-of-the-Month, Roslyn, New York.

CARTOON Your way to success! Internationally known instructor, Raye Burns, will personally teach you to create original, salable cartoons at home. Cost of course is very low. Write for free details. Raye Burns School, Box 3583-P, Cleveland 18, Ohio.

LEARN Profitable, fascinating tattooing. Free illustrated information. Zeis, 728-O Leslie, Rockford, Illinois.

SIGN Painting—Lessons by mail. Books on lettering, gold leaf, show cards, pictorial. Write: Sign Instruction, 4304 Virginia, Kansas City 10, Missouri.

PAINT Signs—Master die cut, outline letter patterns. Complete assortment 1 1/2" to 12" high, prepaid \$3.00. Eyerly, 583, Newton, Iowa.

LEARN Sign painting at home. Free talent test. Ben Kerns, Box 812-PM, Greenville, S.C.

YOU Can entertain with chalk talks. Catalog 10¢. Balda The Cartoonist, Oshkosh, Wis.

LEARN Sign painting with fascinating system. Straley, 410 E. Western, Springfield, Ohio.

MAKE Money with comic strips and news pictures. Complete details \$1.00. Vernon Jones, 4120 Elliot St., Denver, Colo.

ADVERTISING AGENCIES, LETTER WRITERS, FOR ADVERTISERS

BEFORE Advertising—Get instructive Ad-Guide and newspaper-magazine rate-book, free. Chicago Advertising Agency, Chicago 4.

SALESMEN: Agents: Known mailorder buying consumers (men, women) gummed labels, \$9.00 thousand. Other classifications. Free folder. Brunell, 241 Grove, Montclair, N. J.

NEW Mothers, gummed labels, 1000—\$7.00. George Lucas, Bellevue 1, Wash.

YOUR 20 Word ad in 30,000 copies "Mail Gazette" \$2.40 (extra words 12¢) covers mail order trade U.S., Canada. Lindsay, 5117 East 22, Tulsa 14, Okla.

FREE! 1958 Advertisers Rate and Data Directory, 52 pages! E. H. Brown Advertising Agency, 20 N. Wacker, Chicago 6.

ADVERTISE: 24 Words, 100 Canadian newspapers \$5.50. Lists free. Advertising Bureau, 10511-C Springfield, Chicago 43.

ADVERTISING, Result-getting ads prepared, placed newspapers, magazines, radio, anywhere! Lowest rates. Catalogue free. Baker Advertising Agency, 189 W. Madison, Chicago 2.

MAILING Lists most any classification \$5.00 1000. Your circulars mailed with ours \$4.00 1000. Write for our literature. Dixie Mailers, King, N. C.

WANT More business? Here's an amazing opportunity to increase your sales. Talk to thousands of interested readers of "Mechanics Popular." Our Spanish Edition covers the Latin American countries like a blanket. They're real mailorder buyers. Classified rate 75¢ per word. Try an ad in our next issue. Classified Advertising Department, Popular Mechanics Magazine, 300 East Ontario Street, Chicago 11, Ill.

RUBBER STAMPS AND OFFICE SUPPLIES

QUALITY Rubber stamps! 3 lines \$1.00. Signature stamp \$3.50. Prompt service. Money-back guarantee. Campfield, 14 Beaufort Circle, Springfield 4, Mass.

3 LINE 2 Inch knob handle cushion mount indexed rubber stamp \$1.98. Catalog 35¢. Nelsons', Box 412, Oskaloosa, Iowa.

THREE Line name and address metal or plastic pocket case \$1.00. Mated Mailers, P.O. Box 494-3, Buffalo 5, N. Y.

RUBBER Stamps. Hundreds of styles. 17¢ up. Free sample, illustrated folders. Send stamp. Manhattan Business Supply, 520 Fifth Ave., New York 36-O, N. Y.

TYPEWRITERS, DUPLICATORS, OFFICE DEVICES

RECONDITIONED Typewriters, duplicating, printing devices. \$25.00 up. Supplies. Appliances. DixieGraph, King, N. C.

PRINTING, MULTIGRAPHING, MIMEOGRAPHING, GUMMED LABELS

UNIQUE Printing catalog, free. Klifford, 545 North Oakland, Pasadena 4, California.

FINEST Printing—Lowest prices! Bargain catalog. Decco, Box 3315M, St. Louis 3.

MIMEOGRAPHING, Printing. Quality work, reasonable prices. Frajimidot, formerly Currier, New Lebanon Center, N. Y.

YOUR Name and address printed on gummed labels. 500—3 lines \$1.00, 15¢ each extra line. 1/2 x 1 1/4. Print clearly. No c.o.d.'s. Addison Mail Order, PMA-2, 1840 Addison, Chicago 13.

MIMEOGRAPHING, 250 sheets, 8 1/2x11, \$2.00. Samples, prices free. Western, Box 567, Memphis, Texas.

PHOTO—Offset printing, letterpress, mimeographing. Free samples. Litho, Madison, Tenn.

1,000 BUSINESS Cards. Raised letters, \$3.50. Samples. Pioneer, Island Park 5, New York.

CIRCULARS Are salesmen. They reinforce correspondence, too. Any copy, thousand 3x5, \$3.00 postpaid. Also other printing bargains. Lively Circulars, 332 Buford, Montgomery, Alabama.

100 LETTERHEADS, 8 1/2x11. Watermarked, and 100 6 1/2 envelopes, carefully printed. \$2.00. Postpaid. Race Printers, Hudson, New York.

QUALITY Business cards. Free samples. Gerald Porter, 123 E. Robinson, Jackson, Michigan.

10,000 ATTRACTIVE 2 Color circulars \$20. Samples. Fame, 291 Ellis, San Francisco 2, Calif.

100 6 1/2 ENVELOPES, 100 5 1/2x8 1/2 Sheets printed, \$2.00. M. Fortney, R3, Dillsburg, Penna.

FAST Service! 100—8 1/2x11 letterheads \$2.00. Raco Press, (PM), 818 West Gift, Peoria, Illinois.

OPPORTUNITY, Own profitable repeat business, part, full time, or mail. Franchise details from Henford, Dept. HT, P.O. Box 525, Fair Lawn, N. J.

1000 CARDS—\$2.75. Eldan Business Service, 507 Fifth Ave., New York 17, N. Y.

BUSINESS And personal printing. Catalog on request. Fred the Printer, P.O. Box 623, Englewood Plaza Station, Independence, Missouri.

OFFSET Printing—\$6.75 1000 8 1/2x11, 24 hour service. National Letter, 251 W. 42 St., New York City 36.

1000 HIGHEST Quality embossed business cards, \$3.75. M. Pinson, 6770 Yellowstone, Forest Hills 75, N. Y.

PRINTING—Expert craftsmanship. Free samples. Walp, Box 4308P, Mobile, Ala.

OFFSET Printing at mimeograph prices. Write Perkins Printing Service, Fremont, Nebraska.

FREE Catalog, postpaid printing. D M Press, Sebastopol, California.

BUSINESS, Personal printing—Labels, rubber stamps, accessories. Illustrated catalog, free! Brosse, 196-A, Clerk, Jersey City 5, N. J.

LETTER Heads and envelopes. Send samples for quotations. F & F, 104 James Ave., East McKeesport, Penna.

SPECIAL 50% Discount. Write Randolph Press, Box 3406-C, Detroit 3, Mich.

1500 PERSONALIZED 1/4"x1 1/2" Labels \$1.00. Your 3 line name and address printed with blue ink on fine quality white gummed paper. Money back guarantee. Hamilton-Ward, Dept. 10B, Westfield, Mass.

ADS Running under this heading sell printing. Ask me for proof, I'll gladly send you amazing facts. Ask for Folder "P." F. W. Johnson, 200 E. Ontario St., Chicago 11, Ill.

CIRCULARS, Booklets, letterheads, envelopes. Estimates, anything! Lonelm Printers, Paulding, Ohio.

MIMEOGRAPHING—Letters, pricelists, formulas, instructions. Lowest prices. Lem's Letter Shop, 5710 Stanton, Detroit 8.

BETTER Grade printing. Reasonable. Estimates. Hamel-Printer, 210 5th Avenue, Suite 1104, New York City 10, N. Y.

BUSINESS Cards. Printing. Reasonable. Free catalog. Edmondson, Box 4865-P, Atlanta 2, Georgia.

MIMEOGRAPHING, Offset printing, letter heads, business cards. Mary's, 1126 10th St., Des Moines 14, Iowa.

PRINTING OUTFITS AND SUPPLIES

PRINTING Presses, type, supplies, lists 3¢. Turnbaugh Service, Mechanicsburg, Penna.

MAKE Your own self-molding rubber stamps and printing cuts. Flexirubber, Argyle 1, Wisconsin.

DO Your own printing. Save money. Simple rules. We supply everything. Print for others; good profit. Raised printing like engraving too. Have home shop. Details free. Kelsey Presses, V-11, Meriden, Connecticut.

PATENT ATTORNEYS

C. A. Snow & Co.—M427, Snow Building, Washington 1, D. C. Registered Patent Attorneys. Write for information.

PATENTS, "Proof of Invention" free. E. E. Vrooman, Registered Patent Attorney, 507 McKim Building, Washington 5, D. C.

"INVENTOR'S Guide" and "Record of Invention" free on request. Frank P. Ledermann, Registered Patent Attorney, 154 Nassau Street, New York City.

INVENTORS: When you are satisfied that you have invented something of value, write me, without obligation, for information as to what steps you should take to secure a patent. Write Patrick D. Beavers, Registered Patent Atty., 835 Columbian Bldg., Washington 1, D. C.

INVENTORS—Take these preliminary steps toward patent protection. Sketch and describe your invention. Sign, date and have this disclosure witnessed by two people who understand your invention. Have us make a preliminary search among U.S. patents already granted for similar types of invention. We report on the probable patentability of your invention and recommend your further course of action. Write for our instructive booklet, "Patent Protection for Inventors" and convenient "Evidence of Invention" disclosure form. Victor J. Evans & Co., 431-B Merlin Building, Washington 6, D. C.

INVENTION Record form free and "Patent Information Every Inventor Should Have." Carl Miller, Registered Patent Attorney, Woolworth Building, New York.

INVENTORS: Learn how to protect your invention. Unless the inventor is familiar with patent matters, he should engage a competent registered patent attorney or agent to represent him. We are registered to practice before the U. S. patent office and prepared to serve you in handling your patent matters. "Patent Guide for the Inventor" containing detailed information concerning patent protection and procedure with "Record of Invention" form will be forwarded to you upon request—without obligation. Clarence A. O'Brien & Harvey Jacobson, Registered Patent Attorneys, 81B-A District National Building, Washington, D. C.

INVENTORS: Without obligation, write for information explaining the steps you should take to secure a patent. John Randolph, Registered Patent Attorney, 203 Columbian Bldg., Washington 1, D. C.

INVENTORS—If you believe you have an invention, you should find out how to protect it. The firm of McMorrow, Berman & Davidson with offices in Washington, D. C., is qualified to take the necessary steps for you. Send for copy of our Patent Booklet "How to Protect Your Invention." We will also send you an "Invention Record" form. No obligation. They are yours for the asking. McMorrow, Berman & Davidson, Registered Patent Attorneys, 134-D Victor Building, Washington 1, D. C.

FOR INVENTORS

INVENTORS: Learn how to protect your invention. Unless the inventor is familiar with patent matters, he should engage a competent registered patent attorney or agent to represent him. We are registered to practice before the U. S. Patent Office and prepared to serve you in handling your patent matters. "Patent Guide for the Inventor" containing detailed information concerning patent protection and procedure with "Record of Invention" form will be forwarded to you upon request—without obligation. Clarence A. O'Brien & Harvey Jacobson, Registered Patent Attorneys, 81A-A District National Building, Washington, D. C.

INVENTIONS Wanted—27 years experience promoting patented, patent pending inventions. National Service Bureau, 3130 Meramec, St. Louis 18, Mo.

WHY Let your ideas remain idle simply because you lack equipment and facilities to complete development? Our technical staff and fully equipped electrical, electronic, electro-chemical, physics, and mechanical laboratory now offers inventors service to perfect, analyze, or test your ideas. For information write Connecticut Research Company, Box 168, Old Lyme, Conn.

INVENTIONS And ideas designed for your profit and patented for your best protection at low definite fees. Thirty years experience in developing and patenting inventions in U.S. and foreign countries. Patent searches with valuable report \$15.00. Joseph O'Brien, 132 Nassau Street, New York 38, N. Y.

PATENT Searches \$5.00. 48-hour airmail service. Invention protection forms free. Write Patent Engineering Service, 711 14th Street N. W., Washington 5, D. C.

INVENTORS: Test the commercial value of your patented or unpatented inventions, quickly and inexpensively. Write for free information. Institute of American Inventors, Dept. 40-B, 635-F St., N.W., Washington 4, D. C.

INVENTORS. Don't sell your invention patented or unpatented until you receive our offer. Write Cowgill, Box 298, Marion, Ohio.

INVENTION Record form free and "Patent Information Every Inventor Should Have." Carl Miller, Registered Patent Attorney, Woolworth Building, New York.

PATENT Searches \$5.00. 48-hour service. Free invention protection forms. Write Raymond L. Smith, Patent Searcher, 630 Sheraton Building, Washington 5, D. C.

PATENT Searches. Including copies of nearest patents, \$6.00. Reports airmailed within 48 hours. More than 100 registered patent attorneys use my service. For free invention protection forms, write Miss Ann Hastings, P.O. Box 176, Washington 4, D. C.

INVENTIONS Wanted now by my manufacturer-clients. Patented, unpatented. Write Gilbert Adams, Patent Broker, 80-S Wall Street, Financial District, New York City.

INVENTORS—This firm is registered to practice before the United States Patent Office and available to assist you in the preparation and prosecution of your patent application. "Patent Protection for Inventors" booklet containing detailed information and steps to take toward patent protection sent promptly upon request. No obligation. Victor J. Evans & Co., 432-B Merlin Building, Washington 6, D. C.

GET Your invention on the market. You will meet manufacturers looking for new products at the International Gadget Show. Write to International Gadget Show, Inventors Div., 304 East 23rd Street, New York City.

SEARCHES—Put your patent searches in the hands of a registered patent attorney or agent, as he qualifies to give a worthwhile patentability report. Record of invention form upon request and information on patent protection. Patrick D. Beavers, Registered Patent Attorney, 936 Columbian Bldg., Washington 1, D. C.

INVENTORS: Information on patent procedure furnished on request, without obligation. John Randolph, Registered Patent Attorney, 202 Columbian Building, Washington 1, D. C.

INVENTORS—If you believe you have an invention, you should find out how to protect it. The firm of McMorro, Berman & Davidson with offices in Washington, D. C., is qualified to take the necessary steps for you. Send for copy of our Patent Booklet "How to Protect Your Invention." We will also send you an "Invention Record" form. No obligation. They are yours for the asking. McMorro, Berman & Davidson, Registered Patent Attorneys, 134-E Victor Building, Washington 1, D. C.

"**INVENTOR'S** Guide" and "Record of Invention" free on request. Frank P. Ledermann, 154 Nassau Street, New York 38, N. Y.

INVENTORS! Have you good patentable ideas? Write Mr. Metzler, 11 West 42nd, New York City.

INVENTORS—Send for free Patent Information book and Inventor's Record. Registered Patent Attorney, Associate Examiner, Patent Office 1922-29, Patent Attorney & Advisor, Navy Department 1930-47. Gustave Miller, 28A Warner Building, Washington 4, D. C.

INVENTIONS WANTED

IF Your invention is adaptable to promoting we will contract for selling on cash or royalty. Free booklet outlines royalty rates, requirements. Kessler Corporation, 521W, Fremont, Ohio.

ATTENTION Inventors. We extend our invitation to exhibit your invention at the largest International Inventors Exhibition being held during the 1958 world's fair at Brussels, Belgium. Non-profit world-wide market facilities. Contact Otto Witt, Official American Correspondent, Box 1481, Milwaukee 1, Wis.

INVENTIONS Wanted now by my manufacturer-clients. Patented, unpatented. Write Gilbert Adams, Patent Broker, 80-S Wall Street, Financial District, New York City.

INVENTORS: Hundreds of manufacturers have requested our assistance in locating marketable new products. Complete information free. Institute of American Inventors, Dept. 40-D, 635-F St., N.W., Washington 4, D. C.

INVENTORS. Don't sell your invention patented or unpatented until you receive our offer. Write Cowgill, Box 298, Marion, Ohio.

SUPERIOR Promotions. Patented; unpatented inventions. Information booklet, free. Superior, 338-344 North Rodeo, Beverly Hills, Calif.

INVENTIONS Wanted: Patented, patent pending. 27 years experience promoting inventions. National Service Bureau, 3120 Meramec, St. Louis 18, Mo.

INVENTIONS Wanted. Patented; unpatented. Tremendous manufacturers lists. Global Marketing Service, 2420 77th, Oakland 5, California.

ARE You interested in offers from reliable manufacturers for your invention? Patented, unpatented. Harvey Engineers, Cambridge, Maryland.

SELL Or license your invention, show it in America's largest invention catalogue serving manufacturers. Write publishers: A. J. Murphy & Associates, 681 Market Street, San Francisco 5, California.

AA-1 Manufacturer wants proven items. Complete steel fabrication, machine shops. Royalty or negotiated. Valley Manufacturing Co., Valley, Nebraska.

BEST Market for selling your invention is "Gadgets Patents Invention News" readers. Inventors' Service, 107 W. Van Buren, Chicago 5, Illinois.

MANUFACTURING

MODELS—Small lot manufacturing. Metals, plastics, etc. Milburn, Burlington, Kentucky.

MODELS, MODEL SUPPLIES

BUILD Miniature passenger hauling live steam locomotive, with file and drillpress. We do machine work, you bolt it together. Catalog 50¢. Little Engines, Lomita, Calif.

LIONEL Trains—Appliances. Big discounts. Bulletin free. Catalog 25¢. Mack Bros., 2043P Chicago Ave., Chicago 22.

SHIP Models. Most complete line in New England. Kits, fittings, plans, books, tools, engines, motors. 1958 illustrated catalog 35¢. James Bliss & Co., Inc., Dept. SM, 342 Atlantic Ave., Boston 10, Mass.

BALSA Wood and model aircraft. 40-page catalog 25¢. Sig Co., Montezuma, Iowa.

SHIP And yacht model fittings; blueprints. Send 35¢ for illustrated catalog listing hundreds of items. A. J. Fisher, 1002-1 Etowah Ave., Royal Oak, Mich.

CATALOGS: 84 Page ships fittings 50¢ with refundable coupon, trains 50¢, collectors soldiers 25¢, radio control 15¢, vehicles, guns 20¢, airplanes 20¢, general hobby 15¢, leathercraft 10¢. Polks, 314M Fifth Ave., New York City 1.

SHIP Model kits, fittings and plans including clippers, trawler, fishermen, frigates, privateer, etc. Towboat of 1900 for HO gauge \$3.95. 1958 catalog 25¢. Model Shipways, Box 85, Bogota, N. J.

POWER Models. Unusual steam, gasoline and traction engines, fittings, metals. New comprehensive catalog \$1.00. Chas. Cole, Ventura, Calif.

HOME CRAFTSMEN

OVER 900 Woodworking projects. Books and patterns. Free catalog. Craftsman, 115-C Worth Street, New York City 13.

FREE Catalog. 2150 artist-drawn patterns, designs. Craftplans, 1322-A Wabash, Chicago 5.

129 FULL-Size artist drawn jigsaw patterns. \$1.00. Craftplans, 1322-A Wabash, Chicago 5.

AMERICA'S Most complete home craft supply company. Send 10¢ for big colored catalog. Giles & Kendall Co., Huntsville, Alabama.

LEARN Art metalcraft and jewelry making. Complete, inexpensive, home training course now available. Special tools and materials furnished. Write for free booklet. Interstate Training Service, Dept. L-3, Portland 13, Oregon.

KNOCKDOWN Cedar chests and lumber. Free price list. Bedford Lumber Company, Shelbyville, Tennessee.

WOODWORKING And cabinetmaking course for beginning and advanced home craftsmen. Only complete low-cost home training program available. Write for free booklet. Interstate Training Service, Dept. G-3, Portland 13, Ore.

ALL Crafts, supplies. Large free catalog. National Handicraft, 199 William Street, New York City 38.

STYLECRAFT "Pretraced" leather kits. Handbags, billfolds, filigree belts. Patterns on leather. Just carve, assemble and lace. "Pre-carved" kits also available. Send 25¢ for catalog, free folder. Refunded first order. Apache Leather Company, 2804 E. Washington St., Phoenix, Arizona.

LEATHERCRAFT. Imported and domestic leather, tools, kits, complete catalog, 25¢ refundable. Midas, Box 1255, Dept. J7, Huntington Park, California.

FREE "Do-it-yourself" leathercraft catalog. Tandy Leather Company, Box 791 P25, Fort Worth, Texas.

BIG Money making-selling floralcraft. Flower kit and big catalog \$1.10. Hauser House, 2308 Grand Ave., Phoenix, Arizona.

FREE. New big illustrated catalog, leathercraft, metalcraft, woodcraft kits and supplies. Complete stock, top values, latest ideas. Write today. J. C. Larson Co., Dept. 7827, 820 S. Tripp, Chicago 24.

101 PATTERNS of smart gifts, novelties, shelves, action windmills, plus "Make Money Jig Sawing," \$1.00. Mastercraft, 25M, 7041 Olcott, Chicago 31, Illinois.

LEATHERCRAFT. Send 10¢ for new 76-page catalog of tools, supplies, kits, including metalcrafts, enameling, ceramics, all other crafts. Complete stock. Reasonable. Since 1910. Sax Bros., Dept. PM-2, 1111 N. 3rd, Milwaukee, Wis.

LEATHERCRAFT. Copper enameling, mosaic tile, metal tooling, many more crafts. Complete illustrated catalog free. Kit Kraft, 282, Studio City, Calif.

COSTUME And shell jewelry supply catalog loaded with fast selling designs, 25¢. Modern Craft, Box 11088, St. Petersburg 33, Florida.

89 JIG Saw patterns. Beautiful shelves, ornaments, novelties. Plus "How, Where to Sell," \$1.00. Mastercraft, 24M, 7041 Olcott, Chicago 31, Illinois.

BRASS Ventilators stop rot, mildew, paint peeling. 4 samples 25¢. Blaco Mfg. Co., Cleveland 3, Ohio.

VIOLIN Making supplies. Free catalog. Fred Artindale, Box 71992, Los Angeles 1, Calif.

MOSAICS. Illustrated catalog and instructions, 25¢ refundable. Mosaic-Arts Co., Dept. 7197-PM, Pittsburgh 13, Penna.

WOODCRAPTERS—We buy what you make from our patterns! Easy to make, no special tools needed. Send \$1.00 for patterns and complete instructions. Satisfaction guaranteed. Wm. Rice, 87 Washington Ave., Kingston 12, N. Y.

DO IT YOURSELF

BUY Picture frames from us in mitered pieces, you do gluing and nailing yourself. Save big money on frames, also get free delivery. Chesapeake Picture Frame Co., Box 533, Baltimore 3, Maryland.

REMOVE Rust with "Metal Treat." \$1.00 bottle makes one gallon. At leading hardware and paint stores or prepaid from Klean-Strip Co., P.O. Box 10083-C, Memphis, Tenn.

BUILDING Plans for block homes \$1.00. Thompson, P.O. Box 8245, Tampa 4, Fla.

HOME Banquet table — Lightweight, sturdy, economically and easily built from our plans. Send \$1.00 to Build Your Own, George West, Texas.

MAKE A mobile. 10 easy steps, \$1.00. Mobiles, 4602 B St., S. E. Washington 19, D. C.

SWIMMING Pool—Are you thinking of building your own swimming pool? Learn the facts first. Send \$2.00 for complete instructions on concrete pools, illustrated literature, blueprints. United Swimming Pools, Inc., 820 Taunton Avenue, Seekonk, Mass.

BUILD Inexpensive concrete blockmaker. Motor or hand operated. Write. C. Lee, Mountain View, Oklahoma.

SAVE From \$10-\$350! Refinish your old furniture. Hardest part of the job used to be removing the old finish. Now TM-4 Remover makes finish removing easiest in the world. Just wash paint and varnish away with water after using TM-4. 100% money back guarantee. Government approved. Postage prepaid. Prices: Pints \$1.49, quart \$2.49, gallon \$7.98. Order today. Department PM, Chesterton Sales Co., 53 State St., Boston, Mass.

BE Your own plumber. You can. Few inexpensive tools and our instructive book, "Home Plumbing Guide," shows and tells you how. Hundreds of photographs and diagrams. Easy to follow. 160 pages. \$3.50. Catalog free. Popular Mechanics Press, 200PG East Ontario St., Chicago 11, Ill.

WASHING Machine parts. Bendix, Thor, others. Exchange units available. Discounts. Bendix Service of New York, 3956 Broadway, New York 32, N. Y.

ELECTRICAL Appliance factory replacement parts, every part, all makes, discounts. Consolidated Service Centers, 1115 St. Nicholas Avenue, New York 32, N. Y.

GRANDFATHER Clock movements, barometers, blueprints, kits. Wholesale catalog 25¢. Mason-Sullivan, Noroton, Conn.

AWNINGS. Build your own. Fiberglass, aluminum. Write for literature. Lustergio, Inc., Wickliffe, Ohio.

BUILD Rotary tiller and mower combined or separate. Kits and parts. Mass production low prices. 2½ and 3 h.p. engines \$35.00 and \$38.00. Circulars free. Shaw Du-All (PM), Galesburg, Kansas.

18 FULL-Size patterns. Save money with easy-to-use, professionally designed full-size patterns. Make money selling beautiful, useful furniture. Make modern step and cocktail tables; metal lamps; cupola; 12-foot outboard. All patterns test-built; sold with money-back guarantee. Get your free list of these convenient, economical patterns today. Popular Mechanics Press, 200-HH E. Ontario Street, Chicago 11, Ill.

WATCHES, OLD GOLD, JEWELRY

COSTUME Jewellery supplies, settings, rhinestones, etc. 88 page illustrated catalog. 25¢. Milady, Box 1328, G.P.O., New York City.

HIGHEST Cash for old gold, broken jewelry, gold teeth, watches, diamonds, silverware, spectacles, platinum, mercury. Free information. Rose Refiners, Heyworth Building, Chicago 2.

WATCHMAKERS' Jewelers' supplies. Largest Encyclopaedic catalog 25¢. Bengal Wholesalers, Culver City, California.

FREE. Illustrated catalog. Costume jewelry parts, supplies. Folsom's, Box 52, Medford 55, Mass.

HIGHEST Cash paid for old gold, jewelry, watches, diamonds, silver, gold teeth. 100% full value paid immediately. Satisfaction guaranteed. Mail articles today. Information free. Established 1900. Chicago Gold Smelting Co., 6 E. Monroe St., Dept. 358, Chicago 3, Ill.

WATCH And clock repairing books. Free catalog. North American, 2320-AP Milwaukee, Chicago 47, Illinois.

TOBACCO, SMOKERS' SUPPLIES

PIPE Smokers! Write today for free eye-opening facts about smoking. A surprise awaits you. E. A. Carey, Dept. 12-B, Chicago 40.

RAZORS, BLADES, SHARPENING

FREE. Sample Barber keen double edge blade. Stewart, 1345-A Washington, New York City 56.

FOR THE HOME

WAND-A-Matic humidifiers are guaranteed dependable, abundantly effective. Only \$13.95 prepaid. Wand-A-Matic Humidifier Company, 20631 Moross, Detroit 6, Michigan.

CORKY Cleans, polishes aluminum storm doors and windows like magic. Removes oxidation, supplies bright, satiny protective coating. Easy to apply, safe on hands, very economical. \$1.95 p.p.p.d., no c.o.d. Money back guarantee. Corky, 337 Washington Ave., Newport, Ky.

POWER Oil burner fire alarm shut off, connects to oil burner, \$2.95. Hangup models \$4.95. Thermal Switch Co., Peter-sham, Massachusetts.

FREE. Discount catalog! Save on gifts, housewares, books, jewelry. Postage prepaid. Carvet Enterprises, 232 Normandy Rd., Massapequa, N. Y.

"HOME Improvement Guide." New, amazing 192 page volume. Packed with ideas, plans for remodeling, decorating, landscaping, built-in projects. \$2.50 prepaid. Popular Mechanics Press, 200-HG East Ontario St., Chicago 11.

OF INTEREST TO WOMEN

STAMPED Linens for embroidery or painting. Buy direct from manufacturer and save. Send for free catalog. Merrilee, 18 West 19th St., Dept. 681, New York 11, N. Y.

COLGATE'S Lustre-Creme shampoo, 4 lbs., \$4.85 postpaid. Geller, 2089P Matthews, 62, New York City.

"8 MISTAKES Parents Make." Every parent should have this new book about child training. It is free; no obligation. Simply address Parents Association, Dept. 672, Pleasant Hill, Ohio.

DRESSES 24¢; Shoes 39¢; men's suits \$4.95; trousers \$1.20. Better used clothing. Free catalog. Transworld 164-S Christopher, Brooklyn 12, N. Y.

60% PROFIT On cosmetics — Famous nationally advertised Hollywood cosmetics pay 60%. Make \$25 day up. Hire others. For free samples, details, write Studio Girl, Glendale, Calif. Dept. 1282G.

GOOD Money in weaving. Weave rugs at home for neighbors on \$89.50 Union loom. Thousands doing it. Booklet free. Carcraft Co., Polk St., Boonville, N. Y.

READY To sew aprons, \$9.00 dozen. Sample \$1.00. Ann Johnson, 212 Gulf Street, Milford, Conn.

WE Pay \$3.50 lb. dried. Grow mushrooms. Cellar, shed and outdoors. Spare, full time, year round. We have 25,000 customers. Free book. Washington Mushroom Ind., Dept. 176, 2954 Admiral Way, Seattle, Wash.

SELL Fine fabrics. Get yours wholesale. Box 863, Norwalk, Conn.

WANT To make big money at home? \$10.00 profit in an hour possible with invisible mending. Make tears, holes, disappear from clothing, fabrics. Steady year-round demand from cleaners, laundries, homes. Details free. Fabricon, 6270 Broadway, Chicago 40, Illinois.

PERSONAL

PAY Your bills now. Borrow \$100 to \$600 cash by mail. Easy, quick, private. Repay in small monthly installments over 20 months. Your payments may run ½ less than now; have money left over to spend. Loan order blank mailed free in plain envelope. Advise amount needed. State Finance Co., 323 Securities Bldg., Dept. B-227, Omaha 2, Nebr.

STARTLING. Revealing book can change your life. \$1.00. Swan, P.O. Box 1194, Paradise, California.

BORROW Money by mail. \$100-\$600. Anywhere. Air mail service. Postal Finance, 200 Keeline Building, Department #658B, Omaha 2, Nebraska.

YOUR Handwriting analyzed \$1.00. Helpful facts given. Questions answered. Grapho-Analyst PBH, 215 Silver, Ontonagon, Michigan.

HANDWRITINGS Analyzed, vocational guidance, personnel selection. Write Schreiner, P.O. Box 343, Birmingham, Michigan.

LOANS By mail. Borrow \$50 to \$500. Employed men and women over 25, eligible. Confidential, no co-signers, no inquiries of employers or friends. Up to 2 years to repay, monthly payments. Supervised by State of Nebraska. Loan application sent free in plain envelope. Give occupation. American Loan Plan, City National Bank, Dept. PM-2, Omaha, Nebraska.

VITAMINS—Save 45%. Buy direct. All formulas. Free catalogue. Vitaspec, Box 4435P, Philadelphia 40, Penna.

ENJOY Health. Free booklet. Ruth's Nutrition, 152 Kearny, PM, San Francisco, Calif.

BIBLE Questions answered. Stamped envelope. Bylon, 17167 Bentler, Detroit 19, Michigan.

"HOW Can I find out?" You can! Information confidentially developed. Any matter, person, problem, worldwide. Officially licensed. Established 1922. William Herman, 170 Broadway, New York City.

REMAILING SERVICE

PHOENIX Mail forwarding-receiving address. Details free. Al Hauser, 2308 Grand Ave., Phoenix, Arizona.

UNALAKLEET, Alaska, remails 25¢. Albert Bell, Box 87, Unalakleet, Alaska.

MIAMI Beach, Miami, remailing. 25¢ J. Matasovsky, 623 S.W. 9th St., Hallandale, Florida.

LAS Vegas, Nevada. Confidential remails 25¢, \$3.00 month, classifieds \$1.00. Unique, Box 1376.

VALENTINES, Letters remailed from Loveland, 25¢ each. R. Kourad, Box 144-R3, Loveland, Ohio.

PHILADELPHIA Remails 25¢. Classifieds \$1.00. F. Jankauskas, Crum Lynne, Penna.

TACOMA, Remailing 25¢: Receiving, forwarding. Monthly rates. Sund. 3602 Ferdinand St., Tacoma 7, Washington.

REMAILS 25¢. Month \$3.00. Patrick Kennedy, R.P.D. #2, Box 175, St. Clair, Michigan.

TEXAS Remails 25¢. Gemb, 2422 W. Hulsache, San Antonio 1, Texas.

RENO Remails — Forwarding address. Sunday classified. Details. Box 422, Fallon, Nevada.

COLUMBUS Mailing, receiving-forwarding address for rent. Details free. William McLaughlin, 800 Stewart, Columbus 6, Ohio.

MAIL Received-forwarded. \$3 month. Hedgpath, Box 830, Alhambra 23, Calif.

LETTERS Remaild 25¢. J. Love, 1419 E. 83d, Los Angeles 1, California.

SEATTLE Remails — 25¢. Forwarding \$3.00 monthly. Dorman, P.O. Box 42, University Station, Seattle 5, Washington.

REMAILING Miami, Miami Beach, 25¢. Scenic postcards. R. Shay, 103 Marion, Hollywood, Florida.

TREASURE FINDERS

SEARCHING For treasure? Coins, bullion, M-scope locates them for you. Lightweight, transistors, fiberglass case. Terms, Catalog. Fisher Research, Dept. C-1, Palo Alto, Calif.

PROSPECTORS, Mineralogists, save. Build your own portable far ultra violet lamp. Detects tungsten, uranium ores, etc., where "black light" can't. Directions \$2.00. Vamadco, Box 5534, Arlington 5, Va.

FREE Literature—Light weight, guaranteed metal detectors. Geiger counters and mineralights. Kits and assembled models. Electronic Applications, Dept. M, Box 8, Arlington 10, Virginia.

GOLD, Silver metal detectors. Geiger counters for uranium. Violites. Sensational new fully guaranteed models. None finer. Information free. Detectron Corp., 5528 Vineland Ave., North Hollywood, Calif.

FIND Buried treasure, gold and silver, with Goldak's sensational 3½ lb. "find-it" locator, only \$64.50. Write for free literature on complete line of mineral metal locators; Geiger and scintillation counters. Goldak, 1541 W. Glenoaks Blvd., Glendale, Calif.

TREASURE Hunters. Proof of gold. 3 reproductions authentic Arizona Territory maps from 1879 showing mines, placer diggings, vicinity Weavers Needle in Superstition Mts. before "Lost Dutchmans" time. Send \$2.95. Maps, Box 85, Keansburg, New Jersey.

FOR SALE—MISCELLANEOUS

SHOP On wheels. Inexpensive wheel kit. Free catalog. Ripplinger's, 1926 Gravois, St. Louis 4, Mo.

HEARING Aid batteries, wholesale. Free list. Habs, Box 51, York, Penna.

WANTED—MISCELLANEOUS

QUICKSILVER. Platinum, silver, gold. Ores analyzed. Wholesale Terminal, Norwood, Mass.

SCRAP Mercury (quicksilver) containers supplied — Tantalum, tungsten, silver, platinum. Metallurgical Products Company, Established 1909, 35th & Moore Sts., Philadelphia 45, Penna.

MISCELLANEOUS

FREE Folder: "Income Ideas." Ramco, P.O. Box 25, Alhambra, Calif.

LEOITIMATE Big mail 25¢. John Butterworth, 489 Henry, Detroit 1, Mich.

MICROFILM Viewer free, microfilm personal papers. Insure against loss. Details. Merrico, Merrill, Wisconsin.

WATERBIKE Plans, working parts set. Famous Selleck design. Details 10¢. Waterbike Corp., Boca Raton, Florida.

WINDPROOF Lighters. Special \$1.50. Dameron, 1102 Glenwood Road, Brooklyn 30, New York.

100,000 PRODUCTS Wholesale — Free catalog! Send postcard. Econ-O-Mart, Whippany 15, New Jersey.

FREE! Retractable ball pen with your name engraved in golden letters. Send 25¢ for postage, handling. Speedy, Uleta 219, North Miami Beach, Fla.

WEAVERS Newest winding device. Write for information. Sava Rugila, 158 Victor Street, Highland Park 3, Michigan.

RECEIVE Opportunities, magazines, samples, 25¢. Jones, 8448-PM Kavanagh Rd., Baltimore 22, Maryland.

EXPOSED! "How to Win Prize Contests" \$1. Guaranteed. Erickson, 250-B McLaughlin, Muskegon, Mich.

FABULOUS Royal jelly capsules. Now available. Hipotency; dietary food supplement. No doctor's prescription necessary. 30 day supply \$4.95. Satisfaction guaranteed or money refunded in 10 days. Globe Vitamin Co., Macon 3, Georgia.

OUTDOOR Toilets, cesspools, septic tanks cleaned, deodorized with amazing new product. Safe, harmless, easy to use. 150,000 customers your guarantee of satisfaction. Money-back guarantee. Postcard brings free trial offer. Burson Laboratories, Dept. D-21, 951 Willard Ct., Chicago 22, Ill.

BARGAIN! Copy of Alaska magazine, map, checkako certificate with your name inscribed; deed to Good Enough mine and Alaska pocket guide. All for \$1.00. The Alaska Sportsman, Ketchikan, Alaska.

JAPAN: Buy direct. 24 page catalogue. Kimono, jewelries, gifts, novelties, etc., makers' list, business informations. Send \$1.00 money order. Clarence Yamagata, 202 Naka 7 Bldg., Marunouchi, Tokyo.

RECEIVE Free moneymaking offers galore. Baker, Box 108-P Sugarland, Tex.

RECEIVE—Sample magazines, malls, offers everywhere. Get listed. 25¢. Rorick, Box 86P, Cincinnati 26, Ohio.

STUPENDOUS Mental power. Adults. Details—3¢. Wisdom, 846 Sunnyside, Chicago 40.

I want to send you proof of the wonderful pulling power of Popular Mechanics classified pages. What's your proposition? Write me today. Include literature if possible. F. W. Johnson, Manager Classified Advertising, Popular Mechanics Magazine, 200 E. Ontario St., Chicago 11, Ill.

LEARN While asleep! Details free. Research Association, Box 610-MC, Omaha, Nebraska.

YOUR Name wanted. We'll send 1000 publishers, mailers, wholesalers your name, on our list one year 25¢. Dixie Mailers, King, N. C.

BOOKS On antiques and their prices. Free circular! P. Warman Publishers, Uniontown, Penna.

SADDLES, Boots, western wear, leather supplies. Free catalog. Silver Spur, Box 1785-N1, Ft. Worth, Texas.

WE Pay \$3.50 lb. dried. Grow mushrooms. Cellar, shed and outdoors. Spare, full time, year round. We have 25,000 customers. Free book. Washington Mushroom Ind., Dept. 175, 2954 Admiral Way, Seattle, Wash.

"HOME Improvement Guide." New, amazing 192 page volume. Packed with ideas, plans for remodeling, decorating, landscaping, built-in projects. \$2.50 prepaid. Popular Mechanics Press, 200-HG East Ontario St., Chicago 11.

BUY Wholesale! Over 10,000 nationally advertised products. Appliances, cameras, sporting goods, housewares, watches, typewriters, tools, clothing, etc. Send postcard today. Buy-Rite, Box 258, Hawthorne 2, New Jersey.

CIGARETTES—Make 20 for 9¢. Facts free. Moberly, Box 810, Owensboro, Kentucky.

CESSPOOLS, Septic tanks, clogged drains. How they function and how to keep them working. Free literature. Chemical Cesspool & Drain Cleaning Co., Boston 34, Mass.

WANT More business? Here's an amazing opportunity to increase your sales. Talk to thousands of interested readers of "Mechanica Popular." Our Spanish Edition covers the Latin American countries like a blanket. They're real mailorder buyers. Classified rate 75c per word. Try an ad in our next issue. Classified Advertising Department, Popular Mechanics Magazine, 200 East Ontario Street, Chicago 11, Ill.

Catalog of 3100 Novelties 10c

Send 10c for amazing catalog of novelties, live animals, scientific supplies, hobbies, funmakers, planes & boats, looms, magic tricks, joke articles, unusual seeds, gadget timesavers, cameras, optical goods, projectors, movies, lucky jewelry, religious novelties, disguises, musical instruments, stamps, coins, puzzles, fortune tellers, radios, auto & bike accessories, telescopes, magnifiers, compasses, banks, smokers' gadgets, artists' supplies, printing sets, engines, motors, shockers, knives, billfolds, guns, rifles, sports, books, games, plants, etc. Send 10c (3 for 25c—get for friends!). **JOHNSON SMITH & CO.** Dept. 439 Detroit 7, Michigan

U-MAK-IT BOAT KITS



NEW LAPSTRAKE SKIFF KITS

Now added to our great line of kits, new easy to assemble Lapstrake Skiffs.

30 years of boat kit pioneering. 30 models. Prams, Rowboats, Outboards, Cabin Cruisers and Skiffs.

SEND FOR ILLUS. CATALOG

Showing all models from 8' to 23'. Const. details, paints, access., etc. All you need to build your own.

MAIL 35c (coin) for Postage & Handling.



U-MAK-IT products

DELAND, FLORIDA — DEPT. 12

Live Modern-- FOR LESS!

The Popular Mechanics books below show how to save many dollars by building your own modern . . .

- hi-fi set
- home recorder
- transistor radio
- short-wave set
- intercom system
- TV, radio repair



ELECTRONICS MADE EASY. Build your own hi-fi set. Make a pocket-size transistor radio. This new FM book shows you how to construct and operate these and many other electronic devices at amazingly low cost. Contains plans for dozens of valuable electronic and radio units, with pictures and schematic diagrams so clear even the beginner can do perfect work on a battery-operated intercom system, a record player, a photoelectric "eye," a five-tube radio, a wireless broadcaster, just to name a few. All principles involved are explained in simple language and diagrams. Includes complete data on radio repair. . . . **\$2.95**

FIX-IT-YOURSELF TELEVISION MANUAL. Do you know you can make 9 out of every 10 TV repairs yourself? This book both tells and shows how—how to make part replacements . . . how to replace picture tubes . . . how to install antennas . . . how to correct a picture that is fuzzy, or snowy . . . how to fix most TV troubles. It can save you as much as \$30 when replacing a single picture tube, and even more when purchasing a new set. You learn how to choose the best set for your area, etc. Covers, too, every phase of transmission and reception and the latest developments in color television and UHF networks. . . . **\$3.00**

Don't delay. Live better now! Order books below. Satisfaction guaranteed or your money refunded.

MAIL COUPON TODAY

POPULAR MECHANICS PRESS, Dept. 258
200 E. Ontario St., Chicago 11, Illinois

RUSH book(s) I have checked below, postage prepaid. If not pleased, I can return in good order within seven days for full refund.

Remittance enclosed Send C.O.D.: U.S.A. only
 Electronics Made Easy Television Manual

Name _____
Address _____
City _____ Zone _____ State _____

**IT'S EASY
WITH ...**

**THE BEST
ALL-PURPOSE GLUE FOR
ALL-AROUND THE HOUSE**

Glue everything from a broken dish to intricate woodworking projects. See your dealer for Evans Adhesive products. If he doesn't carry it... send his name and address along with 25c (to cover mailing and handling) for generous sample of Evans Welsh Glue. You'll receive it by return mail. Evans produces more than 100 adhesive products.



THE COMMERCIAL PASTE CO.

520 Buttes Ave. • Columbus 15, Ohio • Since 1902

**TERRIFIC: 200 Miles p. Gal. 50 Miles p. Hr.
NO MONEY DOWN - 2 Yrs. To Pay**



Safe, inexpens. transport'n. for work and play. Heavy-duty 1-Cyl. German precision Motor 2-wheel brake Control. Guarntd.

\$11.00
per M'th.

LEOPARD

New '58 MOTORCYCLETTE
Made by German PANTHER Factory
Write for FREE BOOKLET C-1

Never before at this low price
Dealers' inquiries Solicited
505 5th AVENUE
NEW YORK 17, N.Y.

MOTORCYCLE IMPORT CORP.

BARGAINS



Lists Every Month Hundreds of Terrific Buys in—
• BANKRUPT, Closeout, Surplus Goods • New and UNUSUAL items • WHOLESALE ITEMS • BELOW WHOLESALE • Sources of 100,000 items wholesale • Rare Money-Makers opportunities • HUNDREDS of TERRIFIC offers in Toys, Books, Household goods, Jewelry, Greeting cards, etc.!

SAMPLE BARGAINS • Famous \$16.00 Perfume at 80c • 50c boxes Everyday, Xmas cards, 7c box • \$1.00 toys, 20c • \$1.95 silk ties, 12 1/2c • Pencils, 99c gross • \$17.50 talking dolls at \$7.50! PLUS MANY, MANY OTHERS!

BIG SPECIAL ISSUE NOW OUT! Subscribe NOW! BARGAINS let you BUY BETTER, CHEAPER, NEWER things for yourself or for resale at TREMENDOUS PROFITS.
\$1.00 Buys 6 Big Issues—1 Yr. \$2, Reg. Price \$3 year, Spec. Limited time offer to get 10,000 new subscribers.
The only magazine of its kind published!
TOWER PRESS, INC., P.O. Box 591-DDH, Lynn 882, Mass.

MR. FARMER!

Here's What Every Farm Family Should Know About Taking Care of Farm Animals in the **NEW, ENLARGED 3rd EDITION**



BIGGER! BETTER! EVEN MORE USEFUL!
"VETERINARY GUIDE For Farmers"

Now you can know many of the things the veterinarian knows. You'll learn how to recognize the symptoms of diseases dangerous to your farm animals, and how to treat them yourself. The Veterinary Guide For Farmers is all you need. Completely revised, it's the most useful book of its kind. It tells what the causes of diseases are and how you can prevent them. Included is a full chapter on artificial breeding.

Simplified • Non-Technical
Written by G. W. Stamm, Edited by Dallas S. Burch, former executive, Bureau of Animal Industry. Presented in the most simple, non-technical terms, its 384 pages are packed with how-to-do-it instruction, pictures, charts, etc., needed on every farm.

Easily Worth Many Times Its Cost
By preventing the loss of only one animal this book can easily be worth a hundred times its cost. Today's high market value of farm animals, together with the high cost of feeding and raising them, makes losses extremely expensive. Stop losses. Step up your profits with the Veterinary Guide For Farmers.

Order today from address below.
WINDSOR PRESS (div. of Popular Mechanics)
Dept. 258, 200 E. Ontario St., Chicago 11, Ill.

384 Pages • Illustrated \$3.95
Information You Can Use Every Day
Covers Cattle, Horses, Swine, Sheep, Poultry
It pays to know what diseases can strike your herd; what must be done for stricken animals; how healthy ones in the herd can be protected; how outbreaks can be prevented. Get the Vet Guide. Only \$3.95.

**FABULOUS, NEW
5 FOOT LONG
BALLOONS**

Twist Into A Thousand Shapes!
GIRAFFES-DACHSHUNDS—Pets of All Kinds
Made of **200 \$1** Live Latex Add 25c Postage and Handling

Delight Kiddies — Grown-Ups, Too!
Fantastically flexible Live Latex! Like no other balloons you've ever seen! Twist 'em, bend 'em — they won't break! Cut them in half or any size — twist, and they reseal! The kiddies will have a whale of a time making them into Dovy Crockett hats, pretzels, giraffes, lions, fish — a whole zoo! You'll want them for unusual party or recreation room decorations! Live up a party with a contest for making the funniest shape of all! Complete instructions.

Almost 5 feet long when inflated. Balloons this size usually sell up to 25c each!

Send only \$1 now. Plus 25c postage and handling for 200 in a variety of gay colors! Supply limited at this low price, so order several sets NOW for **GUARANTEED PROMPT DELIVERY. MONEY BACK GUARANTEE.**

MURRAY HILL HOUSE
Dept. B-17, P.O. Box 251, Bethpage, L.I. N.Y.

Millions of 'RUPTURED Helped!
Since 1880 our low-cost rupture device has helped **MILLIONS** of reducible rupture patients forget their rupture worries. Our 77 years of experience may help you. Why not see? **WRITE** for free facts: **BROOKS CO., 373-G State St., Marshall, Michigan.**

**EARN MORE—LEARN TO BE AN
AUTO
MECHANIC**

OR TRAIN WITH OTHER GREER DIPLOMA COURSES

- AUTO MECHANICS
- DIESEL MECHANICS
- BODY & FENDER REPAIR
- GAS-ARC WELDING
- REFRIGERATION
- AIR CONDITIONING
- MACHINIST TRADE
- ADVANCED MACHINIST
- PIANO TUNING & REPAIR

Skilled men are needed in every part of the country. Earn top pay in established shops or start your own business. Greer's expert instruction and actual shop training teaches you how. You learn by doing—quick, easy courses using the latest tools and equipment. Day, evening and part time instructions available.

Job placement and convenient living accommodations are yours while training. Contact GREER'S FREE JOB PLACEMENT SERVICE when you enroll if you wish part time or full time employment.

ENGINEERING DEGREE COURSES

- DIESEL AUTOMOTIVE ENGINEERING 27 MOS.
- REFRIGERATION & AIR COND. ENGINEERING 18 MOS.
- WELDING ENGINEERING 18 MOS.

All Courses Approved Civ. or G.I.
Please rush me free literature on Auto Mechanics, or on the trade indicated, at no obligation.

NAME _____ AGE _____
STREET _____
TOWN _____ ZONE _____ STATE _____

Established 1902
**GREER SHOP
TRAINING**
Box B, 2236 S. Michigan Ave.
Chicago 16, Illinois

REACH, PODNER!

... for one of the 1,003 CASH PRIZES currently offered in the Home Improvement Council's "Better Your Living" contest!



\$25,000 first prize
\$10,000 second prize
\$3,000 third prize

and 1,000 other awards
totaling \$87,000

\$125,000
IN ALL!

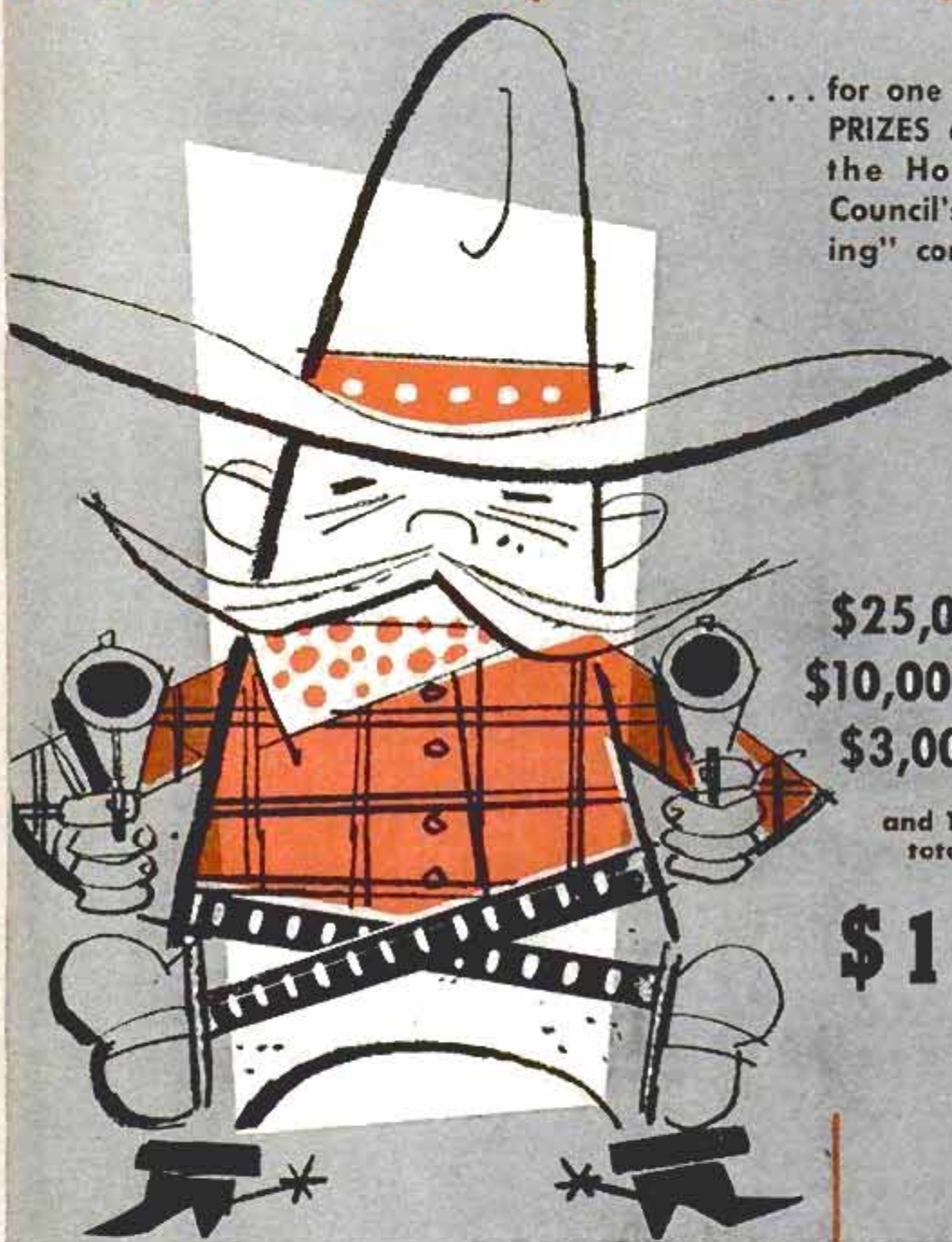

HOME IMPROVEMENT COUNCIL
c/o POPULAR MECHANICS
200 E. Ontario, Chicago 11, Illinois

Gentlemen:

Please send me full particulars on the "Better your living"
contest sponsored by the HOME IMPROVEMENT COUNCIL.

Name _____

Address _____

City _____ State _____

Get full details from the
dealer displaying the Home
Improvement Council em-
blem — or send the en-
closed coupon to POPULAR
MECHANICS

*Reach out now for your
prize.*



Diane Rides in Style

When little Diane Harrison of Moose Creek, Alaska, goes anywhere, she travels in style. Her parents made her a baby carrier out of a packboard, an apple box and some birch poles. Diane even goes moose and caribou hunting riding the back of one of her parents.



1000 AND 1 USES!

Pliobond by
GOOD YEAR

Super-glues "anything to anything" — super-quick!
At chain, hardware and hobby stores everywhere.
Pliobond—T.M. The Goodyear Tire & Rubber Company, Akron, Ohio

MANUFACTURE THIS BEAUTIFUL CONCRETE OUTDOOR FIREPLACE

Right In Your
Own Backyard

\$4.00 Worth of
Sand & Cement
produces this
Attractive
Fireplace.

Sells on Sight
from \$60. to \$80.
Easy to start your
own Profitable
Business.

The General Fireplace
Molds and Process are the most
amazing and foolproof ever invented.
Simple to operate. Two men can produce five fireplaces a day.

BIG DEMAND!!

Sell all you produce to Department Stores, Homeowners, Parks, Nurseries and Picnic Groves. Fireplaces sell on sight. No experience necessary. We supply full operating instructions and equipment plus the know-how that spells BIG PROFITS. This is an outstanding opportunity for men of vision and small capital to get into a busy rich paying field. Don't delay, be the only exclusive manufacturer in your own home town. Mail coupon at once for full details as to how you can reserve your territory. Molds sold only on exclusive franchise.

GENERAL ENGINES CO., Inc., Dept. MF-28
ROUTE 130, THOROFARE, N. J.

Mr. Tor of Philadelphia writes:
Sold 250 in first 4 months. Selling to Sears Roebuck, John Wanamaker, and Gimbel Bros. in Philadelphia area.

Name
Address
City Zone
State

Jet King
POCKET-SIZE

**BUTANE
BLOW
TORCH**

**SOLDERS!
BRAZES!
FIXES LEAKS!**



ONLY
\$1.95
WITH CHARGER

Every do-it-yourself and hobby fan needs this Kidde JET KING butane Blow Torch. Just the tool you've been looking for to do dozens of jobs in home or hobby...TV, appliance, lamp, radio or plumbing repairs...precision soldering, brazing or metal craft. Useful, too, for starting charcoal fires. A tiny, clean, safe charger does the job.

Each charger gives 30 minutes of intense 3500° pinpoint flame; turns on and off. Extra chargers, 49¢ per box of 2. Money back guarantee. At leading hardware and hobby stores...or send check or money order, we pay postage.

Kidde

KIDDE MANUFACTURING CO., INC.
Dept. PM-24

42 Farrand Street, Bloomfield, N. J.

Please send me _____ JET KING BLOW TORCHES plus:
_____ boxes extra chargers (limit 2 boxes per torch).
My check , money order for \$_____ is enclosed.

Name _____
Street _____
City _____ State _____



STOCKHOLM, SWEDEN

Big news on the road today is Quaker State. This highest quality motor oil is preferred the world over by people who really care for their cars. It's refined from only the purest Pennsylvania oil stocks and specially fortified to give cleaner, longer-lasting engine protection. Why not treat *your* car to

it's the best motor oil money can buy!

QUAKER STATE OIL REFINING CORPORATION, OIL CITY, PA.
Member Pennsylvania Grade Crude Oil Association

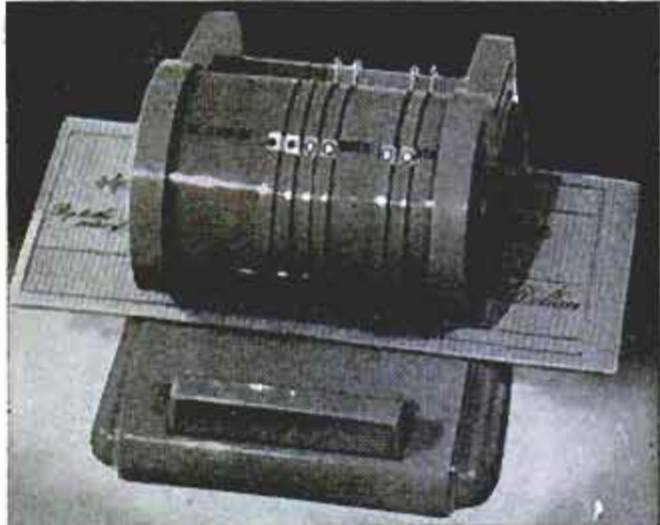

Applied Research Corp., P.O. Box 1316, Erie, Pa.

Small Check Protector Has Ink-Holding Type

Using an indelible ink, a new check-protecting machine can print 10,000 checks without re-inking. The rubber type of the protector contains microscopic honey-combed cells which hold a large ink supply. The inexpensive machine is simple to operate. You just write the amount of the check by setting six levers, then depressing the printing bar. The machine is small enough to fit in a desk drawer.

Quick-Change Photo Easel Makes Prints in Many Sizes

Making enlargements of different sizes is easy with a new easel equipped with a series of trays that accommodate standard sizes of enlarging paper. You attach to the easel the size of tray needed and insert the paper in the bottom of the tray. Turning one of the levers on the front of the easel holds the paper flat. An electric cord attached to the easel permits the use of an automatic timer.

Best Photos Mfg. Co., 5801 Beeds Rd., Mission, Kans.

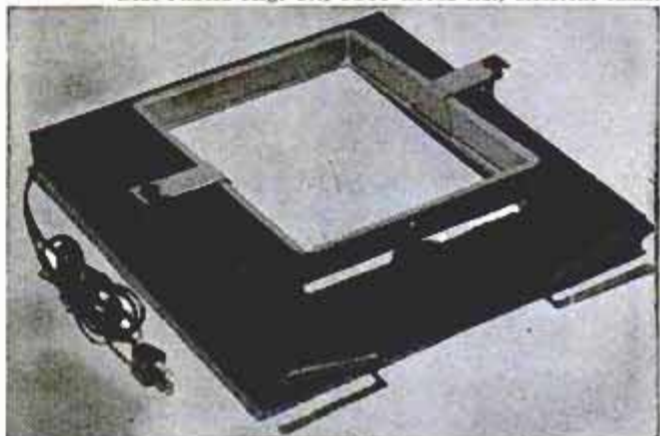

Gobs Eat 115 Tons of Gobbler

Christmas dinner for the U.S. Navy last year (1957) required 230,000 pounds of turkey.

The ONLY spark plug in the world
with the PATENTED* AUTOMATIC
"BUILT-IN-BRAIN"

ALDOR SPARK PLUGS
THERMO-REACTOR
PATENTED

AVAILABLE IN 2 TYPES

1 **Thermo "SPECIAL" Reactor**

Engineered SPECIFICALLY for today's new car, high compression, high horsepower engine, or the older car with a tight, high compression engine in good condition!

2 **Thermo "REGULAR" Reactor**

(OIL FIRING—NON FOULING)
Engineered SPECIFICALLY for older engines, and worn engines using excessive amounts of oil.
SELF-CLEANING—WILL NOT FOUL!
Actually FIRES IN OIL!

Aldor's specially designed single hi-efficiency "D-H" electrode can be instantly and accurately adjusted to perfect gap, unlike many so-called multiple electrode "miracle" plugs!

Millions in daily use in the U.S. and in over 30 foreign countries; Designed to outlast and outperform any other plug!

Patent #2442945*

Thermo-Reactor plugs also sold under the following trade name



Some plugs are designed for stop-and-go city driving, and will misfire, cause pre-ignition and dangerous power loss when used in higher speed highway driving:

Other plugs are designed for higher speed driving and become fouled, cause misfiring and power loss when used in stop-and-go city driving!

ONLY Aldor has the answer—and has it patented!

The Aldor "THERMO-REACTOR" IS the ONLY spark plug that AUTOMATICALLY adjusts its spark to any and every DRIVING SPEED or ENGINE CONDITION!

At low speed stop-and-go city driving the Thermo-Reactor AUTOMATICALLY moves away from the electrode producing a spark so HOT that it completely burns away ALL lead and carbon deposits CLEAN!



At higher speeds the Thermo-Reactor again AUTOMATICALLY moves back to the electrode producing the COLD plug that PREVENTS power-robbing pre-ignition!



Aldor's patented Thermo-Reactor is an engineering marvel that AUTOMATICALLY adjusts spark when your engine ASKS for it—SOMETHING NO OTHER PLUG CAN DO!

For instant starting, faster power response, smoother trouble free driving, install a set of Patented Thermo-Reactor spark plugs—do it TODAY!

On sale at better auto accessory stores, garages, and service stations—Ask for them by name!

If not available locally send check or money order, or C.O.D. (state year, make and model of car or type of engine) IMPORTANT: Request either the "SPECIAL" or "REGULAR".

A. L. DOERING SPARK PLUG CORP.
2 STATION PLAZA, BAYSIDE 61, N. Y.

Manufacturers of spark plugs exclusively since 1914!

MONEY for MEN ALL FREE

THE PLASTEX Industry needs manufacturers on small scale and for big production of Lamp and Clock Stands, Art Goods and Novelties in Plastex and Marble imitation. Experience unnecessary. 1/2¢ material makes regular 10¢ store sellers. Rubber moulds furnished for speed production. Small investment brings good returns. We are now placing big Chain Store Orders with manufacturers. Ambitious men have chance for real prosperity. Our Free booklet will interest and benefit you.

PLASTEX INDUSTRIES, Dept. A

3400 Third Ave. New York 56, N. Y.

Design and finish to high-lustre own Nickel-Chromium (stainless) steel ring. Bored stock has extra large flat head. Instructions and polishing papers included. State hole size: 1/2" — 9/16" — 5/8" — 11/16" — 3/4" — 13/16". \$1 postpaid. No C.O.D.

SOLAR MASTER PRODUCTS, BOX 94-R, Midland Park, N. J.

2 WAY PORTABLE RADIO SET

SENDS — RECEIVES UP TO 10 MILES AS SHOWN with built-in antenna or hundreds of miles with outside antennal Works on 80 and 40 meter (Novice) amateur radio-bands—also Aircraft and overseas broadcast (3 to 8 mc). PORTABLE SELF-CONTAINED POWERED WITH STANDARD PORTABLE RADIO BATTERIES. NO AC PLUG-INS NEEDED! Take it with you everywhere you go—on trips, vacations, camping—Keep in contact with home, friends. Has 3 watt crystal controlled transmitter—Sensitive Regenerative Receiver. Send-Receive switch, W.L., only 3 lbs. Size, only 6"x4"x4". TESTED — PROVEN—SIMPLIFIED—PRACTICAL—Full information given on quick easy to get license.

SEND ONLY \$3.00 (bill, ck, mo) and pay postman \$11.95 COD postage on arrival or send \$14.95 for postpaid delivery. Complete kit includes all parts, tube, coils, plastoid cabinet, easy instructions. (Set of batteries \$2.95; crystal \$1.25.) COMPLETELY WIRED AND TESTED POSTPAID \$19.95. A regular \$49.95 value—Order now before price goes up. GUARANTEED—AVAILABLE ONLY FROM: DEPT. BNM-2 KEARNEY, NEBR.

WESTERN RADIO

"OLD IRONSIDES" MODEL KIT!

Historic U.S. Frigate. Every detail accurate—armaments, spars, longboats with oars. Precision plastic parts, cement, plans. 16 3/4". For catalog send 10c, Dept. PF, 4223 Glencoe, Venice, Calif.



\$2.98

wherever hobby kits are sold



KEEP YOUR... **BENJAMIN** "First in POWER and ACCURACY"
for HIGH H C COMP

AIR GUNS & CO, GAS GUNS—Top Quality at LOWEST PRICES!



All Models Benjamin CO₂ Carbine Gas Rifles and Benjamin CO₂ Rocket Gas Pistols Use Standard Size CO₂ (Soda) Cartridges (available everywhere). 2-Stage HI-LO Jet Power—High for Small Game—Low for Target—Up to 50 Shots from Each Cartridge. No Pumping—Safe—Accurate—Economic—Non-Toxic—12 Models—BB or 177 or 22.

Benjamin Air Rifles and Benjamin Air Pistols are Recognized All Over the World for Finest Workmanship and Highest Quality at Lowest Prices. Adjustable Power with Amazing Optimum Force. Fully Guaranteed—Safe—Accurate—Economic. Easy to Use Anywhere—12 Models for Target and Small Game 22 or 177 or BB from \$18.50.

FREE Catalog All Models Benjamin Air Guns & CO₂ Guns & Supplies. Also, Money-Saving Offer on Hunting & Fishing Knives, Accessories, etc.

Send Gun Catalog and Special Knife Offer!

BENJAMIN AIR RIFLE CO., MAIL TODAY
896 MARION ST., ST. LOUIS 4, MO., U.S.A.

Name _____
Address _____
City _____ State _____



Factory service schools and field-extension training programs have been set up nation-wide by many automobile and automotive parts manufacturers in order to supply the industry's demand for all-round mechanics and specialists. Expert instruction and working practice are stressed in classroom and service laboratories. This photo shows the excellent facilities for training provided by one of these schools.

Carter Carburetor Factory Service School, St. Louis

SKILLS for AMERICA

CAREER SERIES TWO

THE AUTOMOBILE MECHANIC

"America moves on wheels"* is a familiar expression to all of us. It is the answer to the growth of our commerce and communications, the spread of our cities and suburbs, and the extension of travel horizons from coast to coast and beyond. It also explains why the automotive industry provides more jobs than any other single American manufacturing and service industry.

To keep the 62,000,000 passenger cars, trucks and buses in use today moving smoothly and surely is the job of the automobile mechanic. His responsibility is great; and is one on which we all depend. His trade is skilled and specialized, requiring a large measure of training and experience. America is able to move only because of the automobile mechanic. It's no wonder that this trade is the largest repair occupation in the labor force, employing over 700,000 mechanics.

Of all the skilled mechanical trades to choose from, the opportunities for immediate employment are most real for automobile mechanics who are trained and competent in their work.

Car dealers, independent auto repair shops, fleet truck, bus and taxi operators need more skilled mechanics than ever before. One estimate by The Automobile Manufacturers Association states that U.S. garages are now short 40,000 good mechanics, and that 40,000 new ones will have to be trained each year to keep up with the motoring public.

The demand for mechanics will continue indefinitely with population growth, automobile production, trend toward 2-car families, and increased farm mechanization. This is an excellent trade for any young man with mechanical ability. Advancement possibilities provide an attractive future for mechanics who are capable and experienced. Whereas beginning mechanics earn from \$1.00 to \$1.50 per hour, experienced men are earning from \$2 to \$3 per hour and more. A few highly skilled body-repair men and supervisors are earning more than \$10,000 per year. In a large repair shop, a mechanic may advance to supervisory positions, such as foreman, service

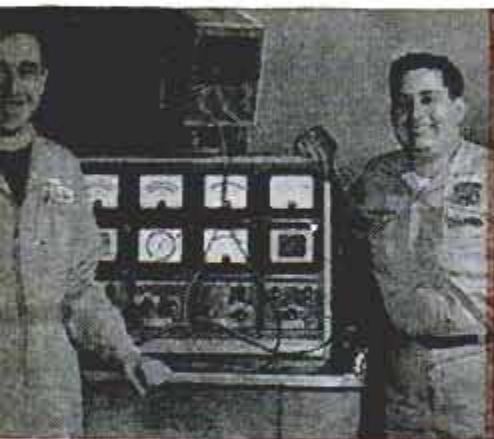

"The combination of training and experience on the job is the only way to personal success in the automotive service trade today. The mechanics we hire must be trained to meet our standards of service. We believe wholeheartedly in the value of trade courses." Ross J. Arbisi, Partner (left); Sam A. Carvana, Partner (right), Winn-Mor Auto Service, Rockford, Illinois.

"Skilled mechanics are hard to find when needed today. Yet, a trained, experienced man can do well in this business—own his own garage or repair shop. Our mechanics must be trained, that's our policy. To help supply our business and community with skilled mechanics, my brother and I have devoted 11 months to our own training and the teaching of specialized repair work to service station operators and other garage mechanics. This is how much we believe in trade education." Donald E. Carlyle, Owner, Carlyle Auto Service, Rockford, Illinois.



salesman, or service manager. Many experienced mechanics eventually open their own independent repair shops.

The automobile mechanic today is a highly skilled craftsman whose work of necessity must be exact and whose training must be thorough since motor vehicles of all types have become increasingly complex. To keep up to date on yearly model changes in equipment, parts and motor design and operation, the mechanic must constantly study trade journals and new instruction manuals issued by manufacturers. Because of the complexity of automotive systems and increased maintenance requirements, the automobile mechanic trade has developed its own specialists. Specialists are particularly in demand in such fields as automatic transmission, ignition and carburetor work.

Every phase of the automobile mechanic field offers challenging opportunity and interesting, varied work to the young man today. However, proper training and education in this skilled trade is absolutely necessary to be successful. In fact all of the mechanics and repair garage owners Popular Mechanics has talked with state that trade education and the experience it provides is the first and most important point on which they judge a new mechanic. A mechanic is only as good as his training.

The future is ready for you in the automobile service and repair industry if you train to meet the requirements. Employers are looking for your ability; advancement and an independent business of your own can be had. If this skilled trade holds interest for you, we suggest you begin your training at the earliest opportunity.

Vocational or factory service schools are particularly qualified to educate the automobile mechanic. They offer expert instruction, equipment, tools, and service laboratories in which to study. Many of these trade schools are represented in the pages of Popular Mechanics. We suggest you contact them directly. They will be glad to offer you the same thorough instruction that has been given to many thousands of other expert mechanics who have graduated from their schools.

• American Trucking Associations

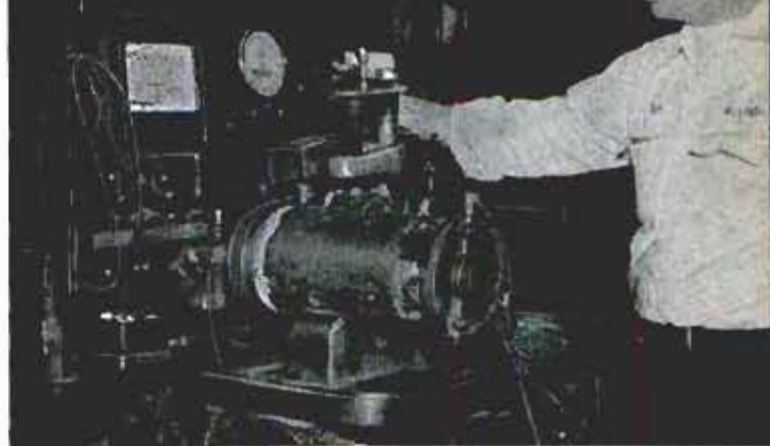
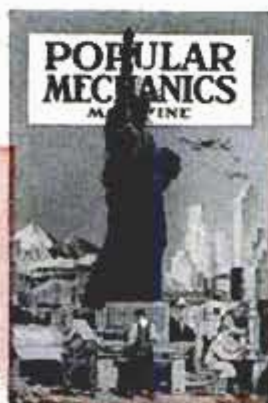

Automobile servicing has become a specialist's trade today. Here, an automotive electrician tests a heavy duty generator against manufacturer's specifications.

Keeping automobiles operating at peak performance requires the use of sensitive instruments such as the Distributor Tester, an important tool of the tune-up specialist.



Do Your Part to Develop SKILLS for AMERICA

"We are automotive service-distributors. Our firm started in 1940 with five employees and three regular customers. Now we employ 31 and serve 700 separate accounts including truck fleets and car dealers. Our company has grown because of our firm belief that trade education is the only answer to offering modern service considering yearly model changes in equipment, parts and accessories. Personally, I have attended nine automotive industry trade courses; other members of our company have taken 16 courses. Each year, our best mechanics spend eight weeks taking trade courses. I'd advise any man who wants to become a mechanic to train to acquire your skill, and then continue training while you work. It's the only way to get ahead in this field." Victor H. Braun, President, Braun's Auto Electric, Inc., East St. Louis, Illinois.

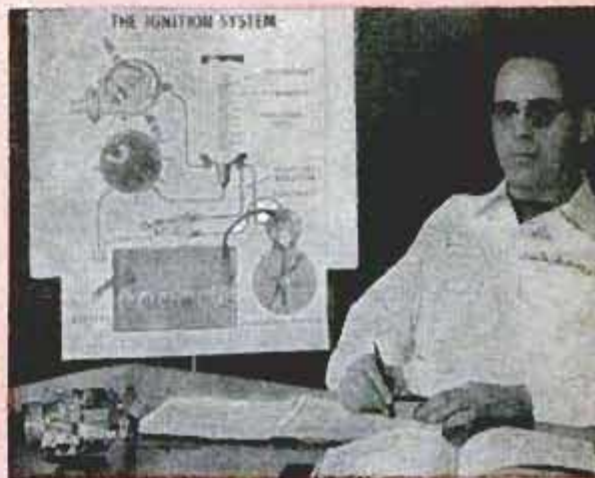

HI-FI TOOLS

by **UTICA**

Now for the Hi-Fi enthusiast, a complete set of quality hand tools designed for the assembly of Hi-Fi components.

Backed by famous full guarantee. Use UTICA, the tools the experts use.

UTICA DROP FORGE & TOOL DIVISION
Kelsey-Hayes Co., Utica 4, N.Y.



46-4
midget diagonal

819-12" long shank screwdriver



262-5 1/2 — transverse end-cutter



654-6 — long nose with cutter

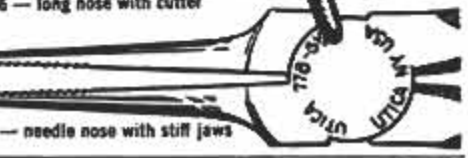

778-6 1/2 — needle nose with stiff jaws

START A BUSINESS

this quick way

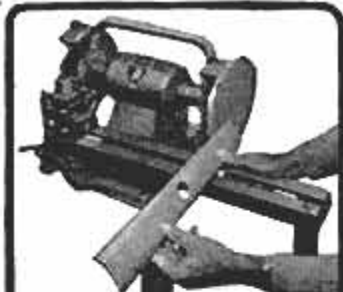

FOR ROTARY POWER MOWER BLADES

The Foley 314 Grinder puts a perfect cutting edge on all rotary power mower blades.



with these 2 machines you can sharpen ALL HAND AND POWER LAWN MOWERS

Here's a business you can start in spare time, and begin to make a CASH PROFIT right away. The Foley Lawn Mower Sharpener handles up to 3 or 4 reel type mowers per hour. Prices run \$2.00 to \$3.00 for hand mowers. \$5.00 to \$8.00 for power mowers. You get 99c profit out of each dollar.

With the Foley Grinder you can sharpen rotary power mower blades, rip, cross-cut and combination circular saws, dado heads, ice skates, knives, scissors, shears, all sharp-edged tools.



FREE PLAN tells how to put yourself right into a home business that will pay you \$3 to \$5 an hour. Send coupon today for **FREE BOOK** on how to sharpen power mowers and Special Combination Money Saving Offer. No obligation — no salesman will call.

FOLEY MFG. CO., 207-4 Foley Bldg., Minneapolis 18, Minn.
Send Free Plan on lawn mower business and Special Combination Offer.

NAME _____
ADDRESS _____

WHAT-TO-BUY-IT INDEX

AUTOMOTIVE

Model-A "Dune Bugs" beat dig-in problem of driving on sand127
Side bars protect car finish when parked in tight spot.....127
Four-passenger three-wheel car runs on motorcycle engine...129
Pivoted cylinder reduces trailer-jackknifing threat.....138

AVIATION

Boeing 707 jet stratoliner rolls from production line104
Flying fire extinguishers fill water tanks on the run105
Gantry riveting machine speeds aircraft jobs112
First supersonic basic trainer gets wind-tunnel tests113
Jetstar for training or transport cruises at 550 miles per hour.113
Folding pontoons on amphib swing to wing tips132
Tire-skid detector thumps pilot's foot139
Solid-propellant rockets won't drop burned booster283

MISCELLANEOUS

Rocket-assisted torpedo "homes" on enemy submarine103
Army's infrared camera has 30-mile range104
Bar of alloy in oil tank stops sludge and corrosion (Johns Mfg. Co., Middlesex, N. J.)104
Electronic machine "memorizes" depositor's account105
Smokestack takes a trip111
Winter sun-bathing shelter covered with plastic sheet (American Sisalkraft Corp., Attleboro, Mass.)112
Flash bulbs are smaller (Sylvania Electric Products, Inc., 1740 Broadway, New York City 19)114
Sensitive Sidewinder missile tracks "hot" enemy targets114
Two-way snow remover features brush and blade (Empire Brushes, Inc., Port Chester, N. Y.)114
Six-cylinder outboard motor packs 70 horsepower (Kiekhaefer Corp., Fond Du Lac, Wis.)115
Army machine automatically plants land mines under turf...121
Missiles toted on rough terrain121
Outrigger skis balance snow sleigh121
The cheetah—world's fastest animal?128
Drier handles four wagonloads to make "hay in a day" (New Holland Machine Co., New Holland, Pa.)129
Telescope in door aids meter reader129
Austrian watergoing "busses" link Danube River cities132
Cantilevered carport displayed in Germany133
Power-mower engine operates dry gold-mining machine (Fletcher D. Slater, 4145 Chicago St., Omaha 31, Neb.)133
Push-button guide shows location of stores133
Bird trips feeder by landing on perch (Helen Hume Co., 584 South Ave., Bradford, Pa.)138
Backhoe operator always faces work (Massey-Harris-Ferguson Industrial Div., 1009 S. West St., Wichita, Kans.)139
Patterns on plywood (Douglas Fir Plywood Assn., Tacoma 2, Wash., and Stetson-Ross, Seattle, Wash.)139
Is population outgrowing the world?143
Brighter fluorescent lamp (Large Lamp Div., Westinghouse Electric Corp., Bloomfield, N. J.)283
Colored storm sash made of rigid plastic (Falako Corp., 788 Evans Ave., Akron, Ohio)288

SCIENCE

Molten metals "float" in high-frequency electric field103
Fuel cell changes chemical energy into electricity111
"Wonder" metal for rockets111
2600-m.p.h. turbojet engine in "theoretical" model112
First atom power plant gets nuclear "furnace"126
Swivel-mounted mirror tracks sun for Stanford solar furnace138
Control device aids eye surgery (G. M. Basford Co., 60 E. 42nd St., New York City 17)297

WHAT'S NEW FOR YOUR HOME

Ceiling heater130
Ice-cube ejector130
Cutting-board bowl130
Fold-away ironing board130
Cabinet kitchen131
Peeler sharpener131
Mattress extender131
Soften bumps with doorknob cushion131

Radio-Television, Electronics

Servicing engine ignition systems electronically (Heath Co., Benton Harbor, Mich.)245

Craftsman and Shop Notes Index

AUTOMOTIVE

Causes and cures for cool-weather engine stalling188
"Roll off" map holder mounts on car instrument panel188
Tractor-trailer fleet equipped with two-voltage lighting189
Improving windshield-defroster efficiency for driver191
Oil prevents frozen trunk lid191
Turn signal indicates emergency191
U-shaped "clamps" simplify installing tire chains191
Auxiliary ignition battery for cold-weather starting192
Guard rails protect children in rear of station wagon192
Temporary gas-leak repair202
"Noiseproofing" leather seats215
Polish renews weathered rubber223
Use pipe cleaner to open drain holes in bottom of car door ..239

(Continued to page 94)

For clean oil all the time
call for

 **HASTINGS**

Only Hastings Oil Filter Cartridges keep oil clean *all the time*, because only Hastings has Densite filtering material.

Densite is different! Millions of selected cotton fibres—pressure packed—trap even the most microscopic dirt particles. Only Densite keeps oil clean from filter change to filter change, when replaced as normally recommended.*

Next filter change, call for Hastings—for clean oil *all the time!* Hastings Manufacturing Co., Hastings, Mich. Also makers of Piston Rings, Casite, Wear Reducer, Spark Plugs.

*Proved by tests conducted in accordance with U.S. Bureau of Standards procedures.



U. S. Patent
No. 2,797,811

see the amazing new
EASY-TO-BUILD ELECTRONIC



ALLIED knight-kits

in ALLIED'S 1958

ELECTRONIC SUPPLY CATALOG

FREE!

BUILD YOUR OWN!
SAVE MONEY—HAVE FUN

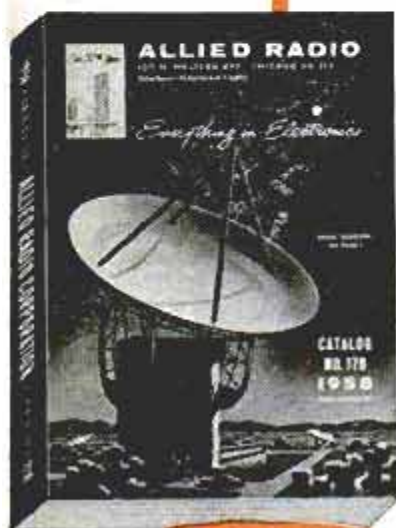

404 value-packed pages



HI-FI KITS



HOBBY KITS



INSTRUMENT KITS



HAM KITS

SAVE on Everything in Electronics

WORLD'S LARGEST STOCKS

Everything for Experimenters, Builders, Amateurs, Servicemen, Engineers and Hi-Fi Hobbyists. Get more for your money in Hi-Fi systems and components; build-your-own KNIGHT-KITS; recorders and phono equipment; TV tubes, antennas, accessories; Amateur station equipment; test instruments; industrial electronic equipment—plus the world's largest stocks of parts, tubes, transistors, tools and books. Send today for your FREE 1958 ALLIED Catalog!

Everything in Electronics From One Reliable Source

our 37th year

EASY TERMS AVAILABLE

ALLIED RADIO

ALLIED RADIO CORP., Dept. 109-B8
100 N. Western Ave., Chicago 80, Ill.

Rush FREE 1958 ALLIED 404-Page Catalog

Name _____

Address _____

City _____ Zone _____ State _____

send for
FREE
Catalog

(Continued from page 92)

HOUSE AND HOME

Hardboard window cornice	210
Hobby cabinet provides both storage and work surface	216
Brace for clothes pole adds storage space in closet	226

HOUSEHOLD HINTS

How to mend a sink stopper	208
Household glue made from starch	210
"Taped" waterproof labels	220

MISCELLANEOUS

Two simple lathe projects for the smoker	196
Snow cylinders form walls of "Fort Preezer"	197
Bandage repair salvages model	202
Rubber band holds pail handle	208
Stay-level rocking horse	214
Watering tank used as cage	215
Layout blue container	216
Ring-binder photo "album"	216
First aid for your trophies	217
Cardboard stereo viewer	218
Picture framing the easy way	218
Cleaning small brass articles	220
Rocks gripped by tire chain	220
Emergency shirt-collar stays	224
Party game tests eye and hand coordination	224
Drawing-board surface renewed	226
Dust plugs for rifle barrels	226
Hoist uses washing-machine motor, gearbox	238
Portable feed rack	240

OFFICE, SHOP AND STORE

Improvised vacuum-cleaner attachment permits cleaning inside typewriter	202
Sheet-metal easels for displaying wallpaper rolls	210
Ink bottles won't tip	213
Simple way to make scratch pads	213
Tape protects file-card edges	216
Moistureproof paper-tape roll	223

ON THE MARKET

Decorative acoustical tile	225
Grained finish	225
Pocket-size soil tester	225
Protective coating	225

PHOTOGRAPHY

Wall rack for roll-film adapter	196
"Rack" supports ferrotype tins	202
Handy darkroom safe for enlarging paper has self-closing door	218
Scoop measures dry chemicals	226

SHOPPING FOR TOOLS

Engine stand of universal type	241
Hand-operated spinner	241
Layout fluid	241
Parts cleaner	241
Combination tool	242
Lightweight masonry drill	242
Multipurpose machine vise	242
Special hammer	242
Novel paint roller	243
Portable saber saw	243
Portable scaffold	243
Thread inserts	243

WORKSHOP HINTS

Improvised timing light aids home auto mechanic	192
Square held in sawhorse leg	196
Hinged blocks hold sandpaper	208
"Teardrop" drawer pulls	208
Drying oven for hobby work	209
Putty used as pipe-joint seal	210
Power-tool cord padlocked	215
Tape-spool reel stores line	216
Cut sheet metal with hacksaw	218
Driving screws in plaster wall	220
Magnets aid in paint-dipping	220
Oiled felt rustproofs cutters	220
Aluminum-foil screw anchors	226
Screw-eye cabinet latch	226
Milling squares of varying size on end of round work	231
Prevent chatter in deep bore	231
Bushing serves as bearing when filing in lathe	232
Safe push stick for saw rides ripping fence	232
Simple jig makes spiral dowels accurately on your bandsaw	232
Accessories kept in order	233
Fly cutter handles those special milling jobs	233
Indicator shows tool position	233
Timesaving jig for end-drilling round work in quantity	238
4 handy shop hints	239
Drilling cotter-pin holes	240
Hand tap used to make edge-knurling wheel	240
Spring prevents drill breakage	240
Stop on bottoming tap	240
Floor mat catches dust	244
V-block serves as center punch guide on simple layout	244

NOTICE—It is the intention of this magazine to provide its readers with information regarding the latest developments in the mechanical arts. Except where otherwise indicated, this magazine has no information as to any unexpired patent in respect of the developments reported herein. In the event that commercial use is to be made of any of the developments reported herein, it is suggested that legal counsel be consulted to avoid liability for patent infringement. It is not the purpose of this magazine to encourage patent infringement but, as indicated, it is the intention of this magazine to report on the latest developments in the mechanical arts.

the one saw
that does almost
any cutting job
3 times faster!

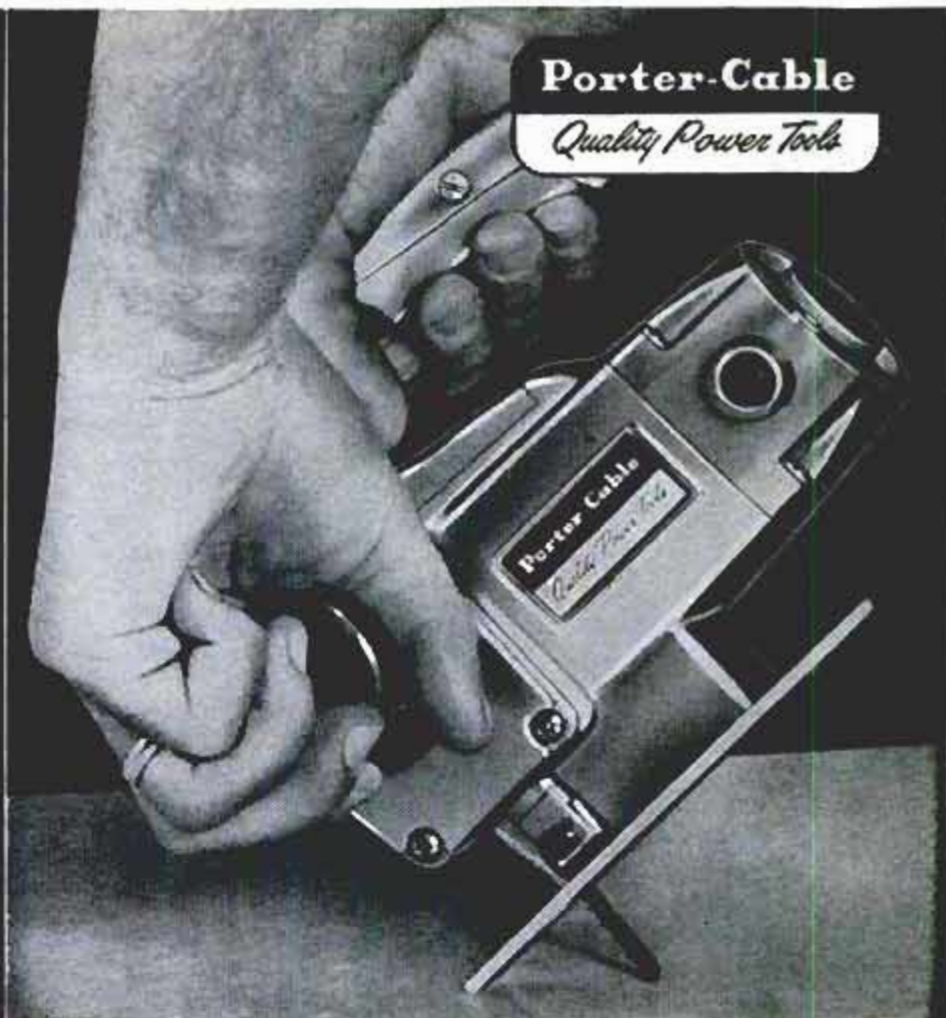

Porter-Cable Electric Hand Saw with *ORBITAL ACTION!*

This versatile tool is actually seven saws in one... it's a rip saw, cross-cut saw, coping saw, keyhole saw, scroll saw, jig saw and hack saw! It makes inside cuts without drilling a starting hole—has a comfortable handle, and cuts 2" dressed lumber, 1/4" aluminum and 1/8" steel. For hundreds of jobs—from rough-cutting to intricate scroll work, Porter Cable's Model 152 Saw has no equal!

Only **\$54.95**

(Handy wall kit with accessories, \$5 extra)

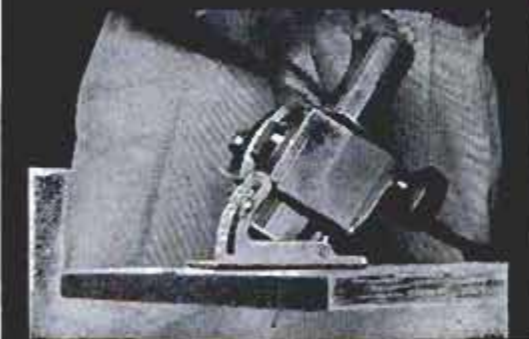

Easily cuts accurate angles up to 45°

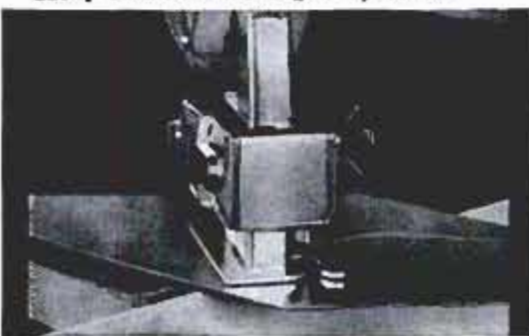

Cuts sheet metal, pipe, bar stock quickly.

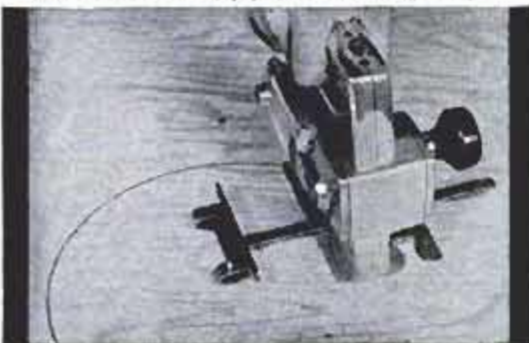

Circle cuts, too, perfectly and quickly.



WORLD'S ONLY ORBITAL ACTION HAND SAW

Most efficient cutting cycle known! Blade moves ahead on cutting stroke—moves back and away on relief stroke. No dulling "drag"—blade runs cooler, lasts far longer, cuts faster.

IT CUTS lumber, plywood, steel, plastics, masonite, plexiglas, aluminum, asphalt tile, brass, bronze, copper, linoleum, rubber, lucite, leather.

Porter-Cable Machine Company
8142 Marcellus Street, Syracuse 4, N. Y.

Please send me literature and complete information on your new electric Hand Saw.

Name.....

Address.....

City..... Zone..... State.....

In Canada: write Porter-Cable, Ltd., Box 5019, London, Ont.
Canadian prices slightly higher.



Since 1903

PARTNER IN PROGRESS

to the

AUTOMOTIVE INDUSTRY

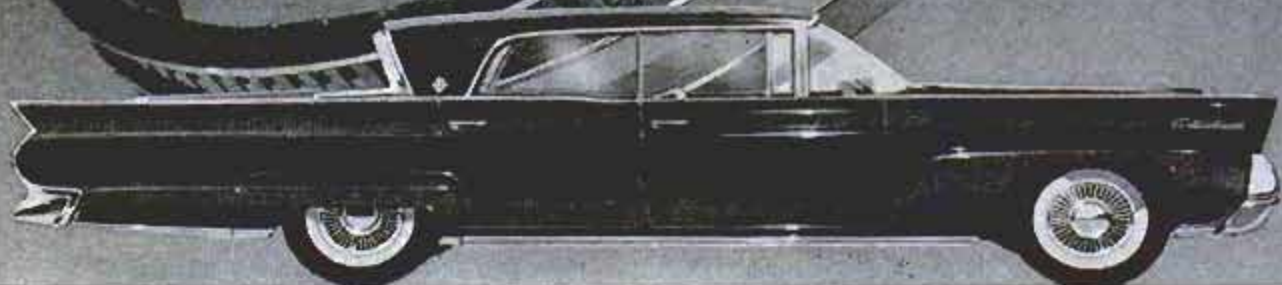

CONTINENTAL MARK III—one of the many great motor cars equipped with Perfect Circle piston rings

Much history has been written since the early days when Perfect Circle began making parts to put horsepower into the "horseless carriage". Year after year, we have been privileged to take an active part in the development of the wonderful vehicle that is today's automobile.

Because they are specifically engineered to meet the exacting demands of modern high-compression engines, Perfect Circle piston rings are preferred by more engine manu-

facturers for original equipment and for replacement service than any other brand.

When the time comes to overhaul *your* car, do as the manufacturers do! Specify Perfect Circles. PC 2-in-1 Chrome piston rings more than *double* the life of cylinders, pistons and rings, assure thousands of extra miles of sustained power with lasting oil economy. Perfect Circle Corporation, Hagerstown, Indiana. The Perfect Circle Co., Ltd., 888 Don Mills Road, Don Mills, Ontario.

PERFECT CIRCLE  **PISTON RINGS**

POPULAR MECHANICS

FEBRUARY
1958

WRITTEN SO YOU CAN UNDERSTAND IT
VOL. 109 NO. 2

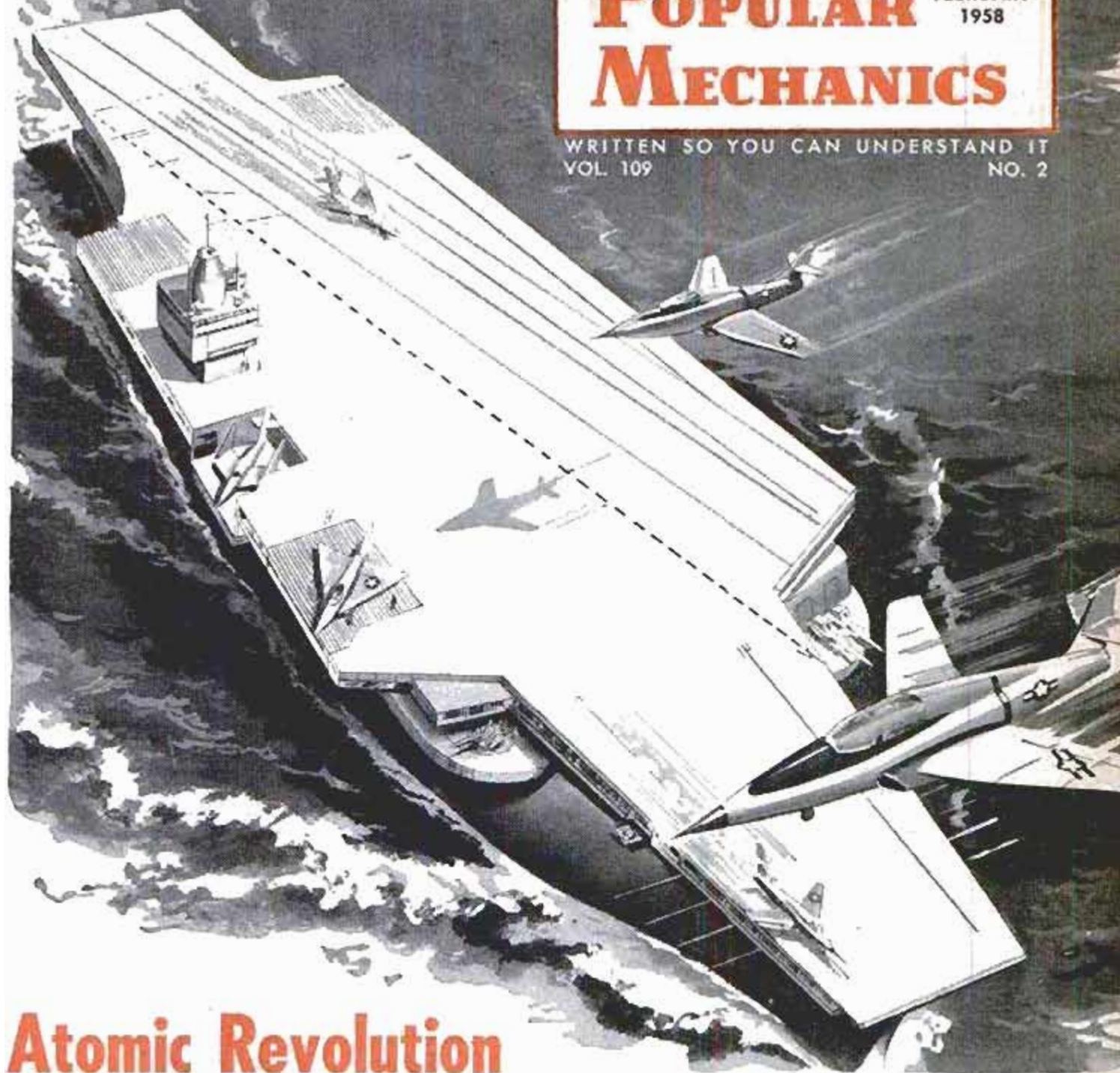

Atomic Revolution In the Shipyards

By Michael Day

*Richard
Dempsey*

IT WAS 75 YEARS after the invention of steam power before the first steamship appeared," Rear Adm. Albert G. Mumma, chief of the Navy's Bureau of Ships, pointed out recently. "But in just 12 years after atomic power was unleashed, our first nuclear subs were operating. In another five years we will be well on our way to a complete nuclear fleet. This spells a real revolution in ship design."

Only protrusion on deck of the big nuclear-powered carrier above will be "electronic" island, at right

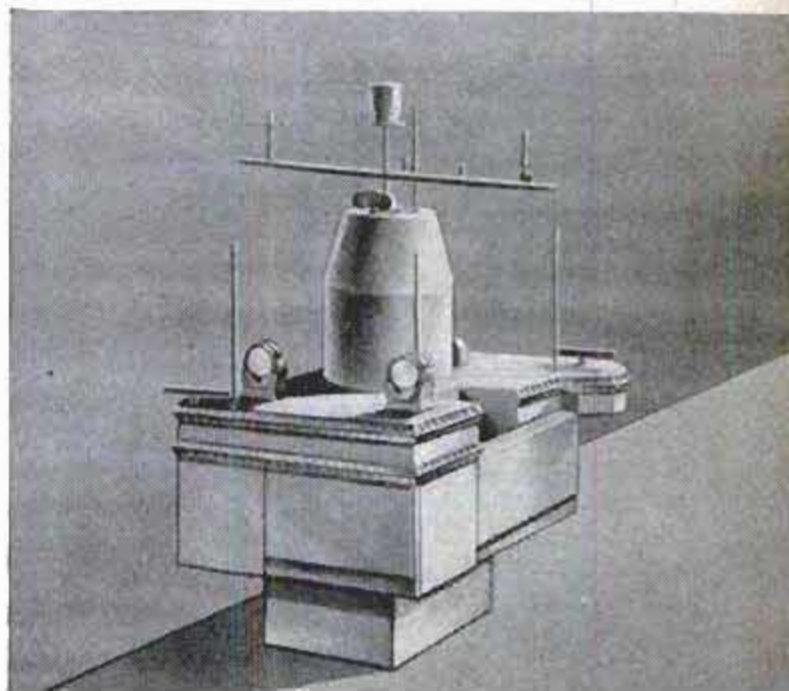

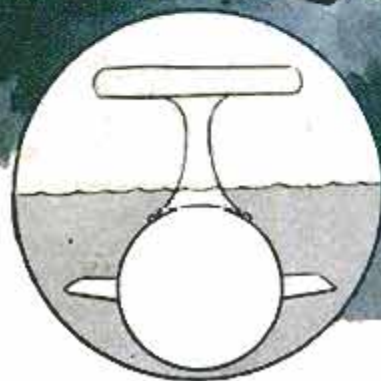

Still in the realm of "dreams and schemes" is this plan of Maritime engineers for a whale-shaped craft with superstructure for crew above water, cargo and reactor area below

Even a nautically minded Buck Rogers might boggle before the new breed of ship that is destined to thunder down the world's ways in the next half decade as a result of this "revolution."

In the United States alone, the *Nautilus* and *Seawolf*, our operating nuclear-powered submarine prototypes, already have spawned a whole new seagoing family of atomic ships that will start hatching this year. By 1961, nineteen atomic subs will be launched or a-building. Whale-shaped nuclear "attack subs" will "fly" at phenomenal speeds under the sea the way a plane flies through the air, pilot and co-pilot strapped to bucket seats while crew members grab for leather loops like subway straphangers as the weird craft executes high-speed turns at a 30-degree bank. We're building small hunter-killer A-subs; a giant radar picket sub powered by two reactors and displacing a thumping 5450 tons (biggest World War I fleet-type subs displaced only 1900 tons); guided-missile A-subs, each housing a Regulus stinger in a below-decks missile hangar that is itself the size of a current fleet submarine; fast, fleet-type A-subs with minimum shielding, in which crews will crawl through lead-lined tunnels around the reactor section. Besides

undersea craft, a mammoth keel will soon be laid for the biggest ship in the world—our 85,000-ton atomic super carrier, driven by eight separate nuclear power plants. And within three years, the fantastic two-reactor guided-missile cruiser *Long Beach*, her stackless deck bristling with weird launchers and rakish "birds," will take to the water with an estimated speed potential of 40 miles per hour. In addition to Navy plans, a joint Atomic Energy Commission-Maritime Administration program will put our first atomic cargo-passenger liner afloat sometime early in 1960.

Though sponsoring the most spectacular atomic splash in the ocean, the United States isn't the only entry in the A-ship race by any means. The British Royal Navy's first atomic submarine is already on the drawing boards and her engineers are studying the economics of a 65,000-ton nuclear-powered oil tanker. Sweden is also building an A-tanker.

In a Leningrad shipyard, Russia early in December launched a 22-knot atomic ice breaker whose 16,000-ton displacement would make her the world's mightiest. More recent announcements over Radio Moscow hint at a winged A-ship that will ride about a foot above the water.

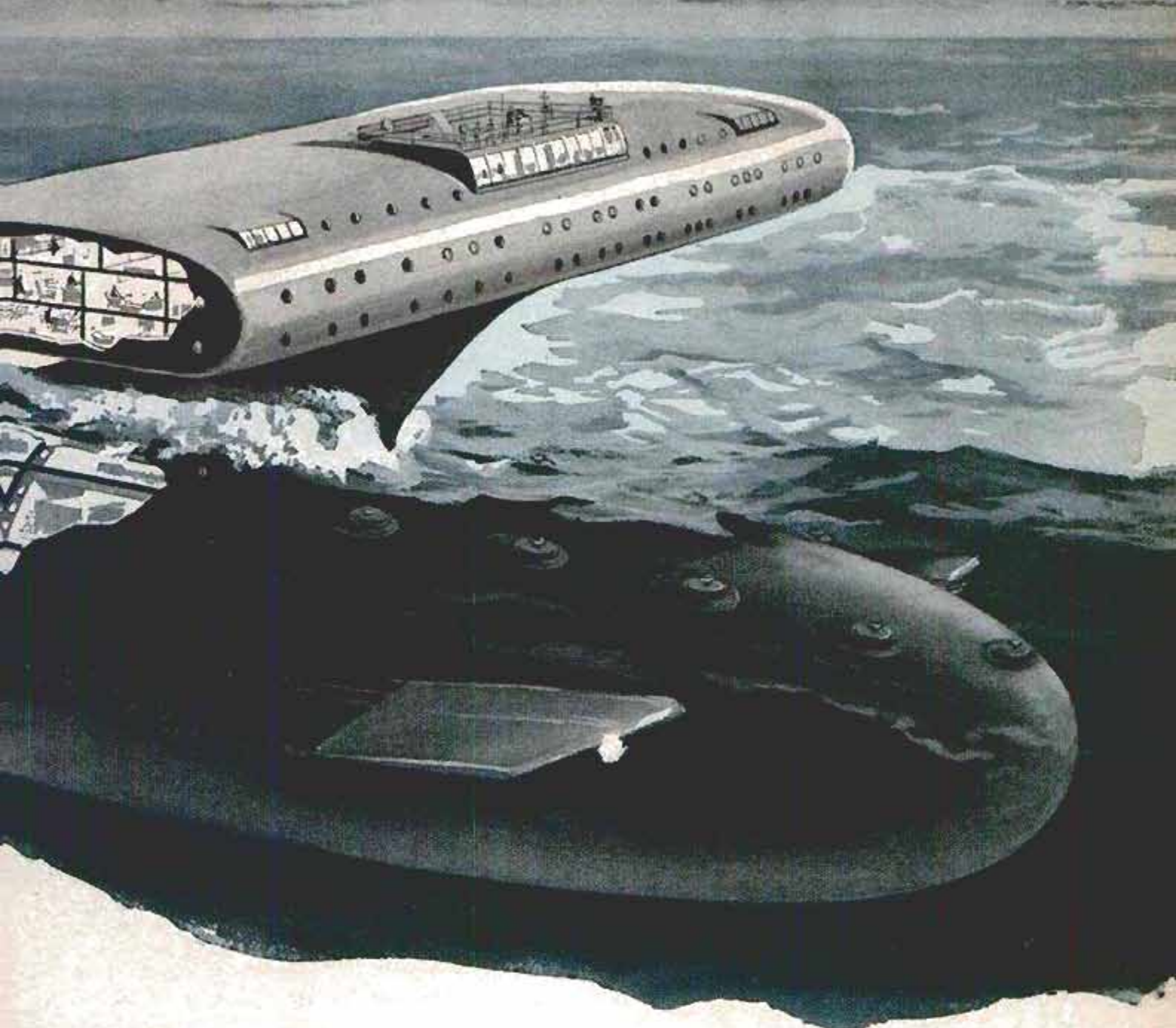

Japan has already blueprinted plans for one of the most unusual A-ships of all—a 30,000-ton submarine atomic tanker, 540 feet long, that can run its cargo smoothly beneath the surface in any weather. Snorkel-type intake and exhaust equipment will provide air for the crew, enabling the unique A-tanker to ride submerged for a month at a crack.

Just what these ships will be able to do, what it will be like to ride them, how their seagoing atomic piles will change their appearance and performance, still is partly veiled in secrecy. But curious details keep emerging. Scouting through the Navy's Bureau of Ships and the busy design section of the Maritime Administration you begin to feel the impact of atomic

Artist's conception of the USS Skipjack, an atomic-powered submarine with diving planes on the tower

U. S. Navy drawing from Westinghouse

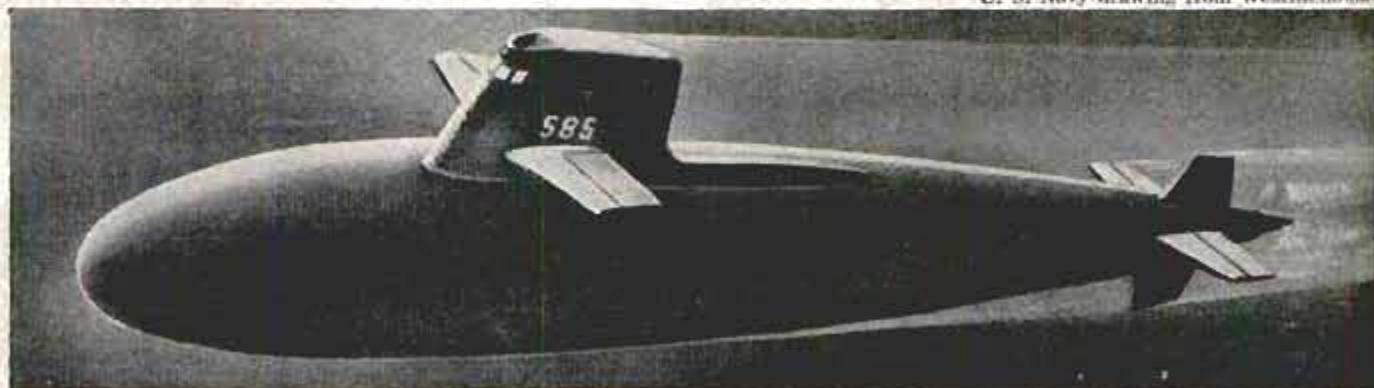

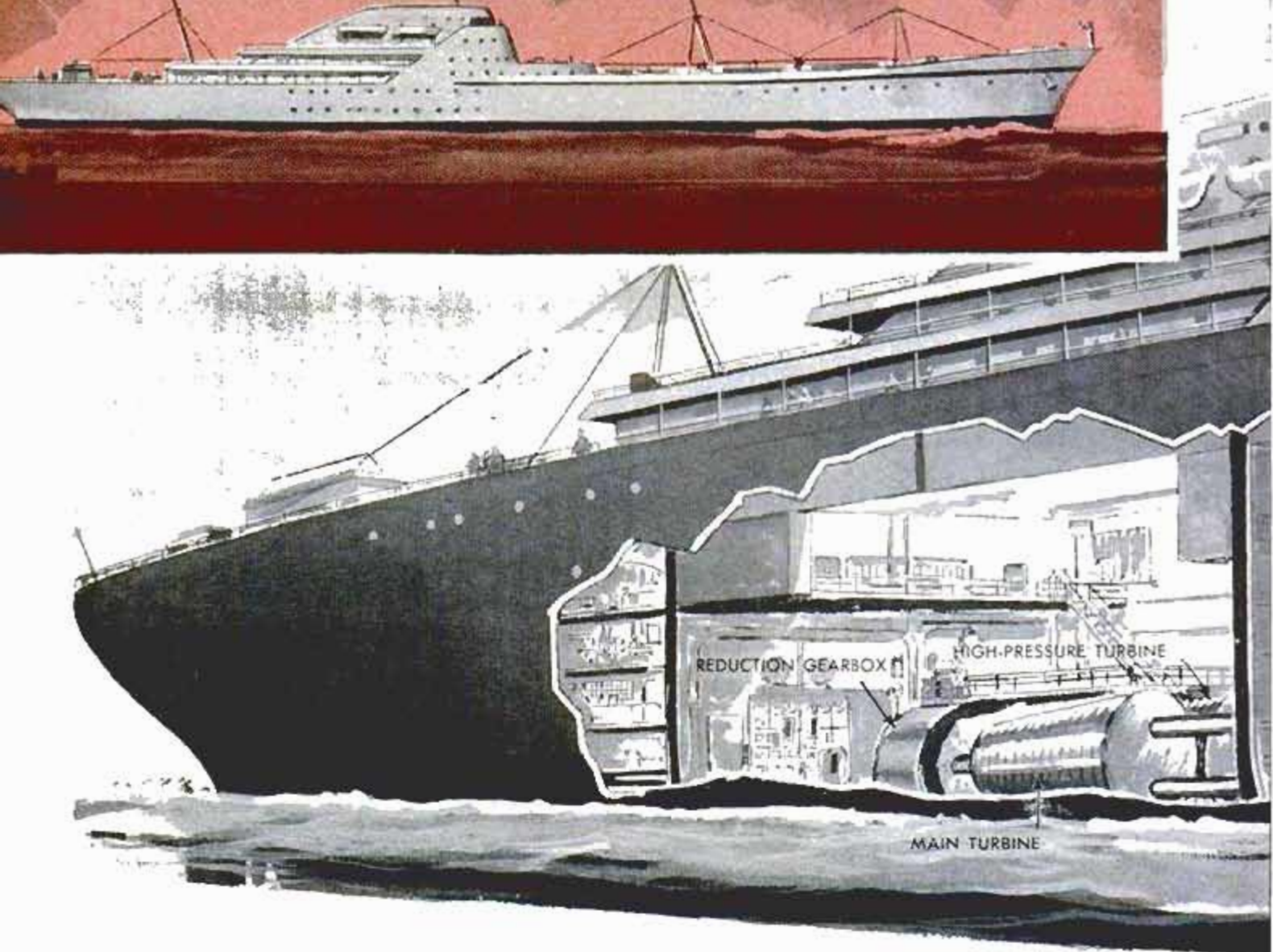

Drawings of atomic merchant ship show (top) how it will look at sea and cutaway of atom-power plant

revolution as stories of some of these fantastic ships fall upon your ears.

Most exciting to the Navy of all its atom

Richard P. Godwin, project director of the atomic merchant ship, inspects model of reactor for tanker

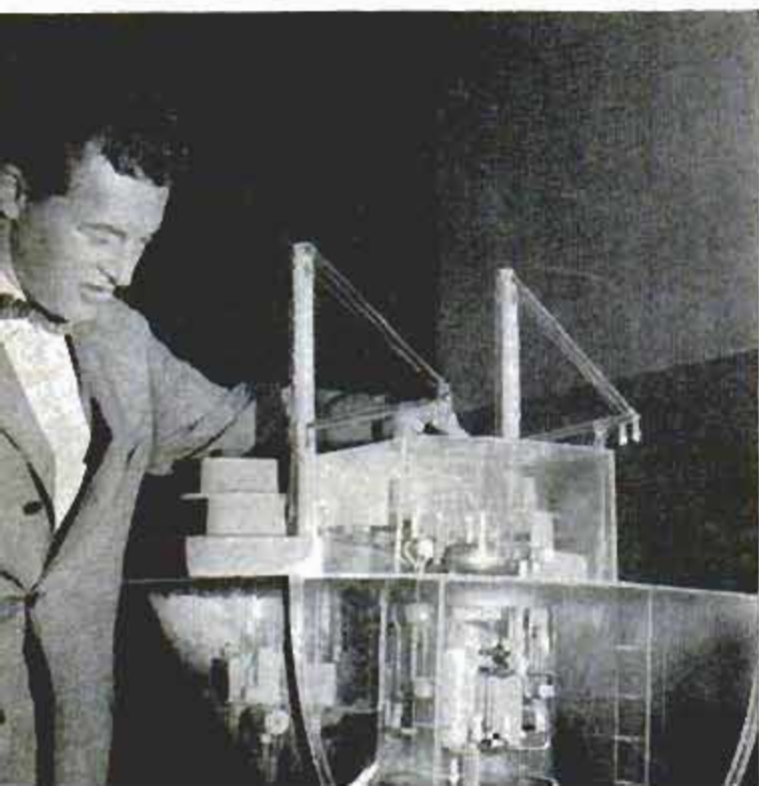

ships is the nuclear super carrier. This \$314,000,000 seagoing airport is due to start building this year. Without doubt it is the most complex weapon ever contrived by man. Stretching more than a long city block (1100 feet) from stem to stern with an over-all width of 251 feet, and 25 stories high from keel to the top of the odd lid on its island, this Gargantua surpasses the mighty *Forrestal*-class carriers that it will eventually outmode. She has 4000 square feet more flight deck and 2000 square feet more hangar deck than her *Forrestal*-type forerunners. A crew of more than 4000 will be needed to man her, and her eight separate reactors, hitched in tandem pairs via geared turbines to each of four massive shafts, would be capable of producing electricity for a city of a million people—with enough juice left over to push the ship as well. Each reactor, labeled LSR (for "Large Ship Reactor"), will be an expanded version of the pressurized water reactor that has so successfully powered the *Nautilus*. How fast these fabulous power sources will push the floating airfield through the water no one will tell—if

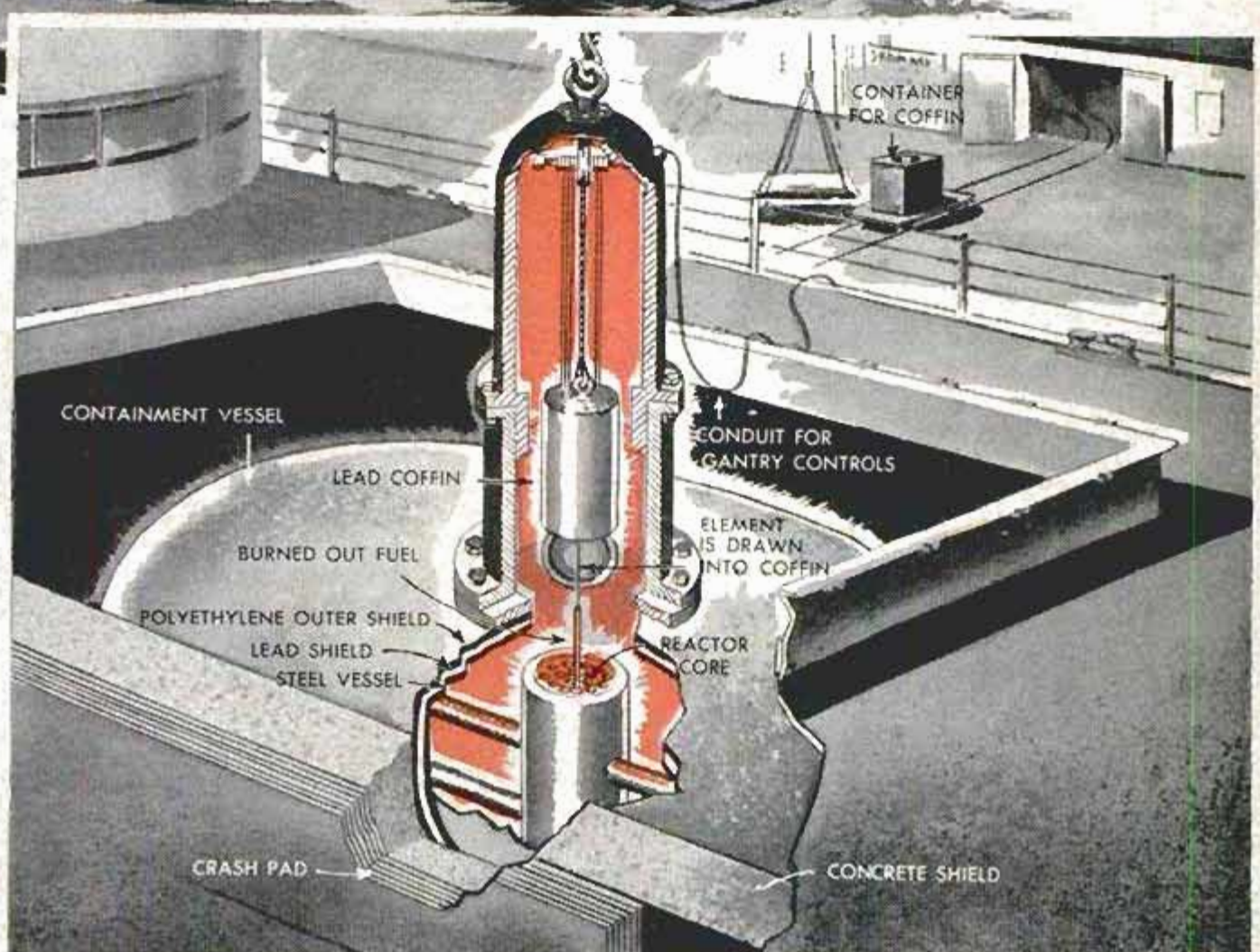
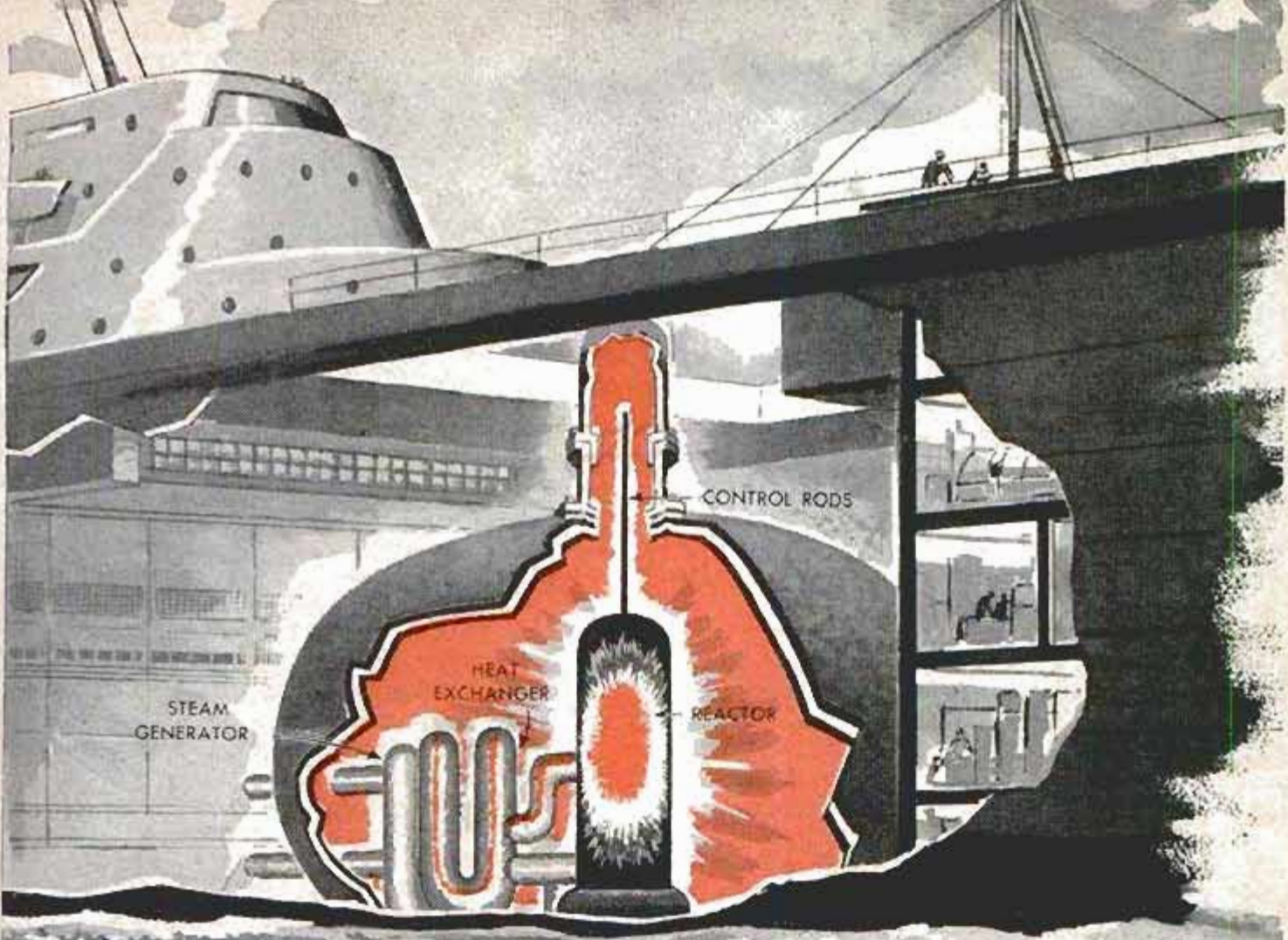



Drawing shows nuclear-powered guided-missile cruiser. Keel for Long Beach, first of type, was laid Dec. 2

they know—but educated guesses have placed her speed at 30 miles per hour or better. Like the atomic-powered *Nautilus*, which steamed nearly 70,000 trouble-free miles before her first refueling, the atomic carrier reportedly will be capable of similar range between core loadings. Her exact endurance is secret.

A look at the big scale model of the CVA(N) (the "N" is for nuclear) in the glass case outside Adm. Mumma's office makes the difference between it and a *Forrestal*-class ship immediately apparent. Along each side, from streamlined sponsons (spoon-shaped bulges built to deflect slamming action of the sea) sprout strange-looking Terrier guided-missile launchers instead of guns. New-type cranes fold away in wells beneath flight-deck level. Instead of a complex array of mechanically revolving antennas, air intakes and stack, an unadorned island juts from the flight deck like an old frontier blockhouse on a prairie. That strangely shaped affair cloaks one of the big atomic vessel's most closely guarded secrets. It is, as one admiral put it, "the first electronically integrated island." A few guarded statements by Navy experts carry a hint of what this means.

Under its three-tiered cap, which designers already have dubbed "the layer cake," a powerful type of radar scans horizons in a brand-new way. On older ships masts were festooned with cumbersome rotating "bedsprings." Big metal smokestacks blocked signals. Using new radar techniques to compete with all that plumbing would have required massive antenna systems. "In the nuclear carrier the island is stackless," explains Capt. W. I. Bull, Buship's Assistant Chief for Electronics, "and thus can be used to maximum extent by radar antennas . . . that scan electronically rather than mechanically."

Hence, on the atomic carrier, you'll see no jungle of weird-shaped gadgets in the superstructure. Beneath its layer-cake dome, electronic beams, circling the horizons under guidance of electronic sweeps, will maintain powerful, uninterrupted vigilance. It will, according to Capt. Bull, "increase our acquisition range by a factor of three or four."

Removal of the smokestack will make living on the new carrier different for jet squadrons and ship's personnel. There's no smoke problem, according to Rear Adm. A. M. Morgan, assistant chief of Bureau for Ship Design and Research. When older conventional carriers head into the wind to take on aircraft, hot stack gases sometimes drift back over the angled deck into the path of the landing planes, producing turbulence and affecting the lift factors. Corrosion caused by those gases won't be bothersome anymore. From a bubble on the inboard side of the island, the flight officer will have a view of the whole flight deck—unblocked by stacks or masts.

Though it looks small, the island actually towers 11 stories from hangar deck to the top of its strange dome. A small personnel elevator will rush top brass from hangar spaces to pilot house on the 010 level when they're needed in a hurry.

Jet pilots on the new ship will be briefed in ready rooms on the gallery deck and below the hangar deck. There's more space on this ship's gallery deck since her flight deck is the "strength deck." No expansion joints will mar its surface. Climbing into heavy, high-altitude gear, pilots will walk, like men from Mars, to elevators that will lift them to the flight deck. The same elevators will move stretcher cases to sick-bay areas without danger of jostling on stairs or Escalators.

(Continued to page 274)

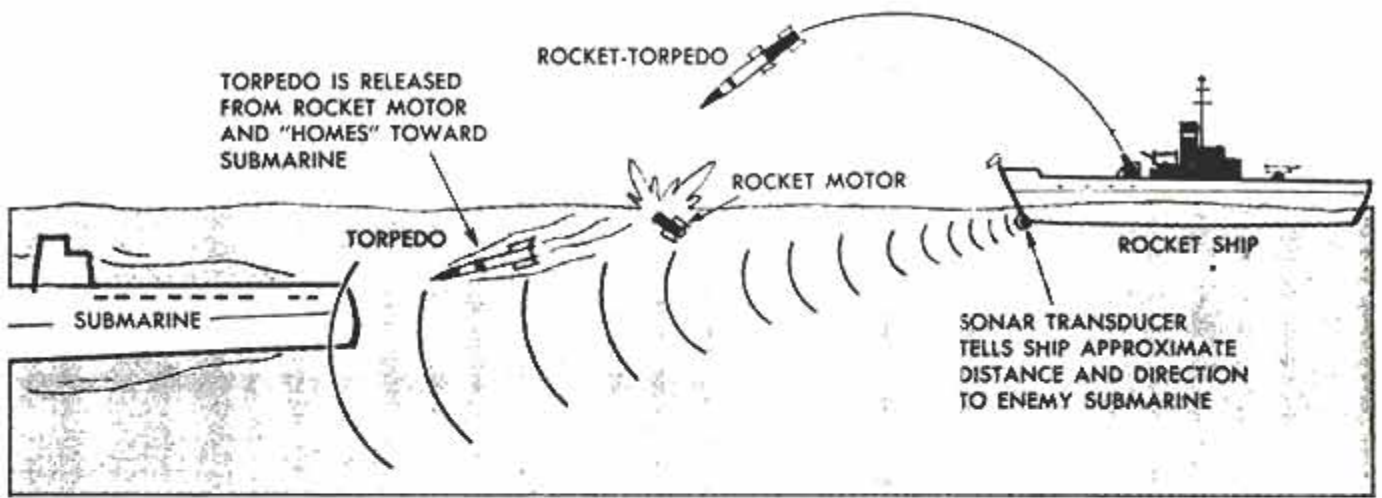

Fired from deck of ship, rocket-assisted torpedo, equipped with homing device, seeks out enemy submarine

Rocket-Assisted Torpedo "Homes" on Enemy Submarine

Reported to be the Navy's newest weapon for knocking out enemy submarines, is a rocket-assisted torpedo equipped with a homing device. The RAT (for Rocket-Assisted Torpedo) eliminates the old process of pinpointing the submarine's location by sonar and then dropping a depth charge in its vicinity. When the launching ship's sonar detects a submarine in the distance, the RAT is fired in that direction. As the

torpedo drops into the water it separates from the rocket motor and steers in a circle, its sonar head sending out pings. When sonar connection is made with the target the torpedo heads directly toward it. It is also believed possible to drop the torpedo from an airplane without the rocket motor. Many types of ships, in fact any kind of floating platform, could be equipped with a RAT launcher.

Molten Metals "Float" in High-Frequency Electric Field

Temperatures up to 5000 degrees F. are generated in half a minute by the "levitation melting" process developed in the Westinghouse Research Laboratories. Small, highly purified ingots of metals such as niobium and titanium are made by this process. Compressed metal powder is

placed inside a copper coil in which electricity changes direction a million times a second. The field of force created by the current causes the metal to float as it is melted. When the electricity stops, the metal drops into a container. The melting is done in a chamber filled with inert gas.

Melting by levitation, left, is done in chamber of inert gas. Close-up shows ingot floating inside coils

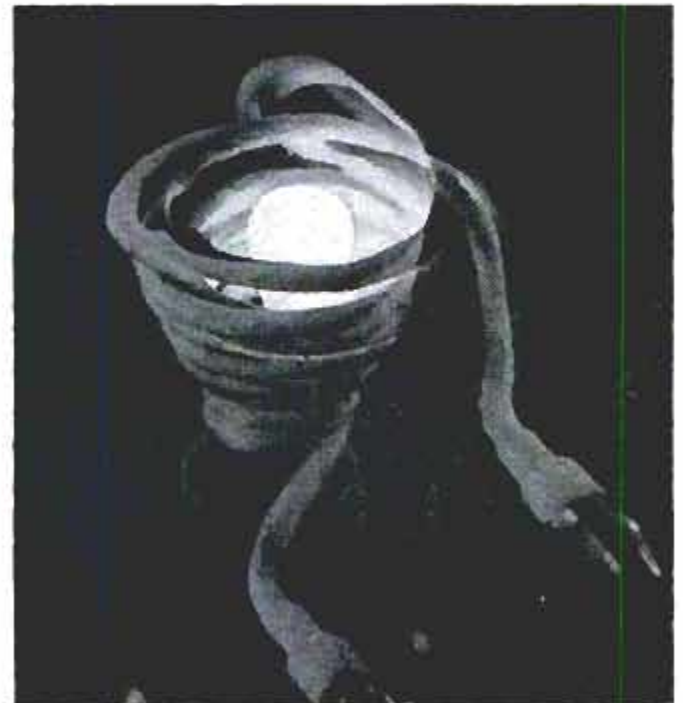

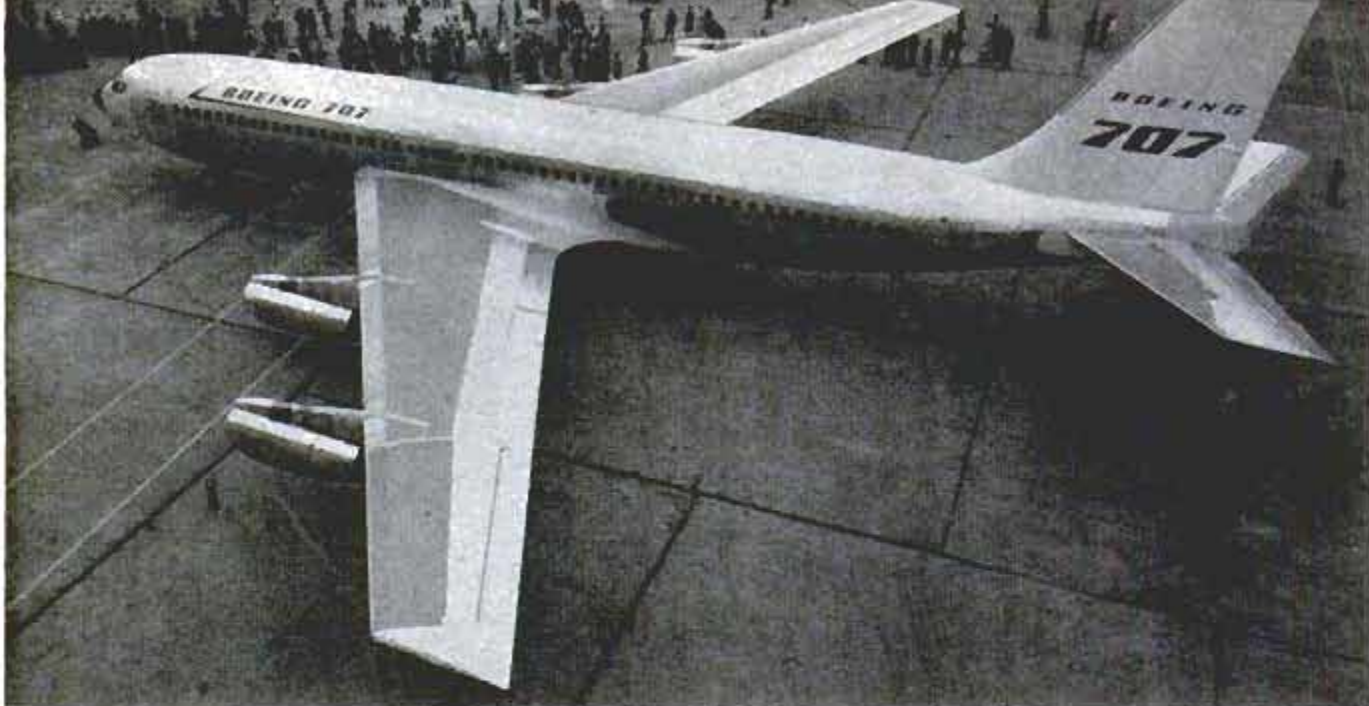

Boeing 707 Jet Stratoliner Rolls From Production Line

First production-line jet airliner built in the U.S. is the Boeing 707, which has been ordered by 13 airlines. Powered by four Pratt and Whitney JT-3 turbojet engines with a maximum output of 10,000 pounds'

thrust, the 707 has a speed of 600 miles per hour. A prototype of the 707 has logged about 800 hours in the more than three years it has been tested. A military version of the 707 is the KC-135 jet tanker.

Army's Infrared Camera Has 30-Mile Range

Operating in the infrared range of the spectrum, the U.S. Army's new long-range ground-reconnaissance camera can photograph terrain features as far as 30 miles away. Infrared equipment allows soldiers to see enemy movements despite smoke, darkness or fog over a target or battle area.

Bar of Alloy in Oil Tank Stops Sludge and Corrosion

Installed in an oil-storage tank in about 30 seconds, a bar of special alkaline-alloy metal eliminates varnish and sludge in heating oils. The four-inch metal bar is suspended by a wire from the tank cap. It works by a chemical reaction that neutralizes impurities that would cause corrosion.





Electronic Machine "Memorizes" Depositor's Account

Magnetic strips attached to the back of the ledger card serve as a "memory" device for a new electronic accounting machine designed for commercial banks. The magnetic strips preserve in magnetic code all the necessary information about a depositor's account. The machine reportedly cuts posting time by 50 percent and reduces the

time spent in locating and correcting errors by 75 percent. It automatically determines if the depositor's account is overdrawn or if he has ordered payment stopped on a check. It picks up and verifies the old balance and the accumulated check amount. And if the operator selects the wrong account, the machine rejects it.



Canadian Otter aircraft sprays water from pontoon tanks, above, during test at Sault Ste. Marie. Refill pipes force water into tanks as plane taxis

Flying Fire Extinguishers Fill Water Tanks on the Run

Equipped with 100-gallon water tanks on their pontoons, fire-fighting planes of Ontario's Department of Lands and Forests can taxi along the surface of a lake and refill the tanks without stopping. The tanks have refill pipes which drag through the lake and force water into the tanks at a rate of 10 gallons per second. The pilot takes off again and, when over the brush fire, turns a switch which causes the tanks to rotate, dumping a spray of water.

Ontario Dept. of Lands and Forests photo





Aerial view of Squaw Valley where the State of California is spending \$10,000,000 to get ready for the 1960 Olympic Winter Games. Squaw Peak is at left center. The valley will become a permanent sports area

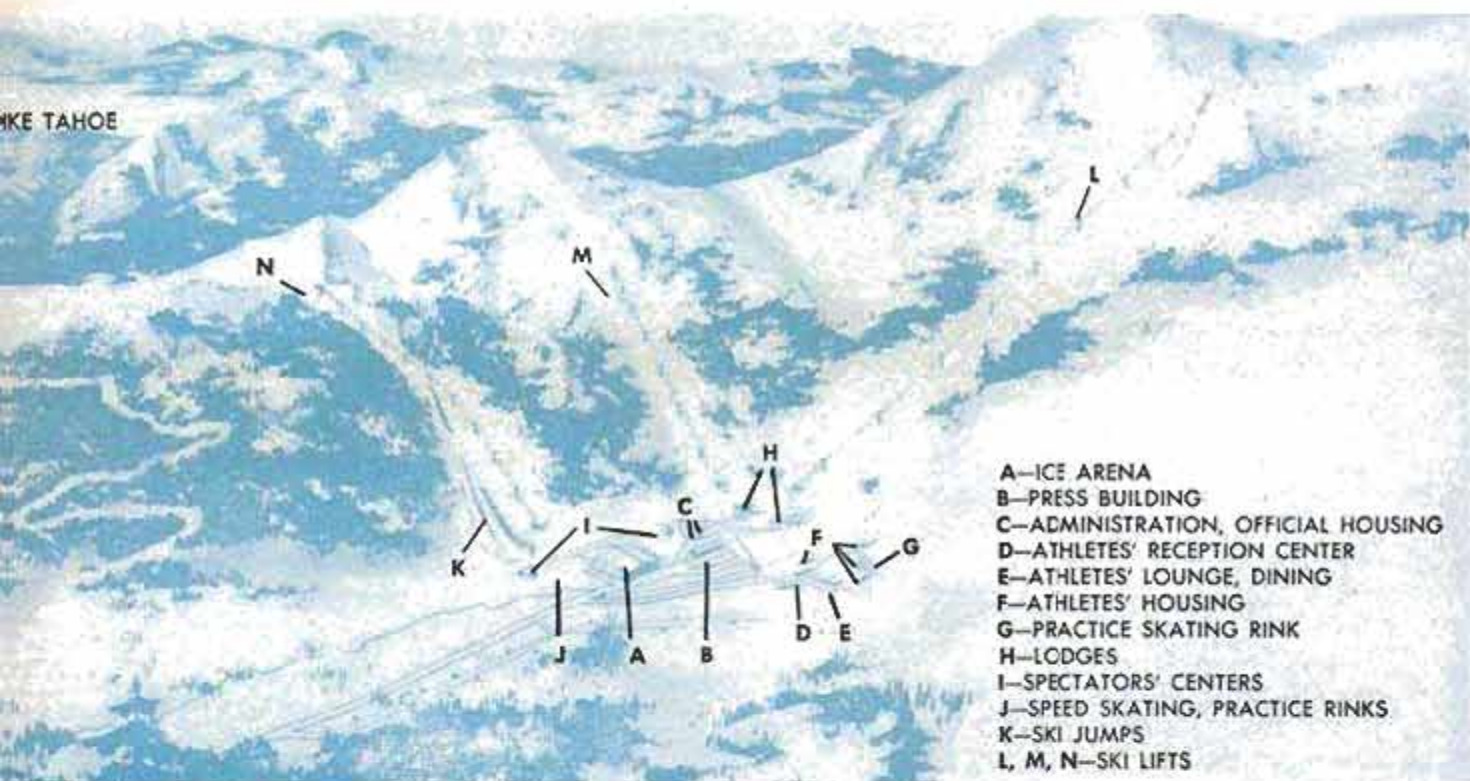

Olympic officials expect 30,000 spectators a day will flock to this remote valley with its "Olympic Village" when games are on. Below, model of the ice arena which seats 8000. Speed-skating rink is in foreground

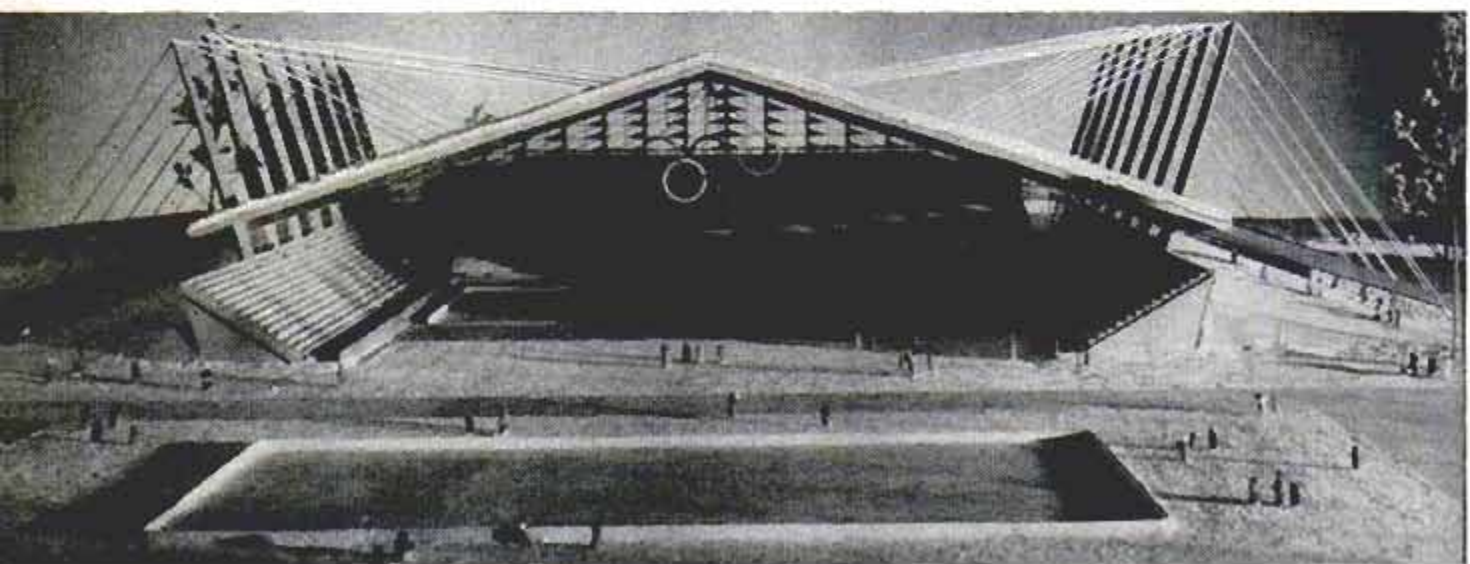



There's lots of snow on slopes of Squaw Valley which averages 10 feet a year and stays on until July 4

IN SQUAW VALLEY, Calif., engineers are installing heating ducts under parts of the valley floor. Later they will build sidewalks on top of the ducts. The hot air in the ducts will keep the sidewalks free of ice and snow all winter long.

This job is part of the task of transforming a little-known mountain valley into a tailor-made site for the Eighth Olympic Winter Games, scheduled for early 1960. In the past these international games have been held at old and famous winter resorts where the competition areas were not always ideal. At Squaw Valley, for the first time, all facilities are being designed from the start to Olympic specifications. The State of California is spending \$10,000,000 on the job.

Squaw Valley is a few miles north of Lake Tahoe and about 10 miles from Truckee, a town on the U.S. 40 trans-continental highway. The valley floor is at an elevation of 6200 feet and is surrounded by mountains that include Squaw Peak with an elevation of 9000 feet, Granite Chief, KT-22 and Papoose Hill. The valley was the scene of the 1957 National Alpine Championships. There are three ski lifts in addition to rope tows.

The main ski lift, called the world's largest although not the world's longest, is 8200 feet long. It carries pairs of skiers up the side of Squaw Peak and has a capacity of 600 skiers per hour. From its upper terminal, an upper tram carries 300 skiers per hour to the top of the peak itself.

Another lift, on KT-22, is called the "flying saucer" because of its speed. The chairs travel at the rate of 925 feet per minute,

SQUAW VALLEY PREPARED FOR THE WINTER GAMES



more than twice the speed of most lifts, yet each chair comes to a stop to pick up passengers.

At the 1956 Olympic Winter Games at Cortina, Italy, there wasn't enough snow for many of the events. Tons of it were brought in by rail and wagon and spread on the slopes. Squaw Valley doesn't expect to run out of snow. An average of 10 feet per year falls in the valley and a tough winter is apt to lay down more than 20 feet of snow. The winter-sports season starts before Thanksgiving and is still going strong on the Fourth of July. For the Olympics, snow removal from the roads and spectator areas is going to be a big task.

The area is not regarded as avalanche country, but to avoid any chance of disastrous snowslides the Forest Service will maintain an avalanche guard and plans to knock down any snowdrifts with a 75-millimeter recoilless rifle before the drifts grow large and possibly hazardous.

Today the games are a good two years away, but from the standpoint of preparing



This scale model of Squaw Valley was constructed to help work out the locations of the Olympic buildings

the facilities they are only 10 months in the future. That's because there are only five months each summer in which construction can be carried on. The building program is proceeding on a tight, rush schedule.

Here are some of the facilities, designed by Corlett & Spackman, and by Kitchen & Hunt, architects, for the Olympics:

Main chair lift at Squaw Valley is 8200 feet long and has maximum capacity of 600 skiers per hour

Olympic Arena. This will be an enclosed structure the size of a football field, with a 300-foot, clear-span roof rising 90 feet above the skating rink. The roof is supported by overhead beams and cables in somewhat the manner of a guy derrick. Seating capacity, including temporary bleachers, accommodates 8000 spectators around the 85 by 190-foot skating and ice-hockey rink.

Heated sidewalks in the Olympic Village will provide easy access to buildings despite deep snowfall





It's a long way down from top of main chair lift to valley. Lift is called largest but not world's longest

The rink will be artificially refrigerated. Waste heat from the refrigeration equipment will be used to melt snow that otherwise would collect on the roof, to help heat the building and to reduce condensation. In addition to the skating contests, the arena will be used for the opening and closing ceremonies of the games. A large speed-skating rink, out of doors, may be viewed through the glass that walls one end of the arena.

"Olympic Village." The 1200 athletes and their coaches and trainers will be housed in beautiful lodges located on a secluded and private meadow less than 600 yards from the arena. The lounge and dining areas for the village are to be built on a natural knoll that looks out over the valley. Facilities include boot shop, barber shop, beauty shop, post office and laundry. Roofs of the buildings are designed to take snow loads of 100 pounds per square foot.

Spectator Centers. Two or more large glass-walled structures are to contain such facilities as restaurants, lounging areas, information centers and ticket counters. The spectator centers are to be located on the valley floor adjacent to the finish lines of many of the competitive events, and it will be possible to watch the competitions from inside the buildings.

Auxiliary Structures and Services. These include an administration building, hotel for officials, a special building for the press, radio and TV representatives, and a complete system of roads, parking lots for officials and the necessary public utilities.

Courses Laid Out

The competition courses were laid out with the help of the International Olympic Committee and include a spectacular, breath-taking, downhill ski run that begins just below Squaw Peak's summit. The course drops 2500 feet to the finish gate some two miles downhill. The first quarter mile of the course is down a 60-percent grade and the skiers will make speeds of 75 or 80 miles per hour over this portion of the route. The second phase crosses a forested slope that averages 34 percent, and continues down a 49-percent face to a sharp turn. From here, control gates will mark the course down a roller-coaster creek bed to the finish. One bump halfway down this part of the course spilled half the contestants at the recent Alpine championships. Other bumps are to be graded into the course before 1960.

Slalom courses have been laid out on KT-22, the mountain that gets its name from the fact that a skier needs to make 22



At midday the sun is so warm at Squaw Valley that bathers enjoy the heated pool with snow all around them

kick turns in descending its steep face. Two ski jumps are planned for Papoose Hill.

California had planned a mile-long, championship bobsled run but not enough countries expressed interest in bobsled competition to warrant the cost of construction. Already designed, it was to have been the longest and fastest in the world, with four sharp hairpin turns. Including artificial refrigeration for maintaining the slick ice on the floor and walls of the run, the cost was estimated at close to \$1,000,000.

30,000 Spectators Daily

Officials expect 30,000 spectators a day during the games, with as many as 60,000 people on week ends. There's no space in the valley for public parking, and spectators will leave their cars in huge auto parks at Truckee or Tahoe City, then ride into the valley on shuttle buses that will operate on virtually a 24-hour basis. The roads leading into the valley will be closed to private cars. Overnight accommodations for thousands of spectators are available at the numerous resorts at nearby Lake Tahoe and at motels and hotels at Truckee and at Reno, Nev., about 30 miles distant.

From the valley floor, spectators will be able to watch many of the events merely by turning their heads in the right direction. The ski jumps on Papoose Hill will be

visible through the glass wall of the Olympic Arena, and large-screen, closed-circuit TV will be used in the arena to bring spectators the start, progress and finish of the slalom, downhill and cross-country competitions. Other large TV screens will be installed in the spectator centers.

For close-up viewing of the events, there will be bleachers and terraced areas alongside the ski jumps, and spectator areas adjoining the slalom and downhill events. Spectators will use the ski lifts to reach these viewing points.

California expects to stage the most successful winter games in the history of the Olympics, but its interest won't end when the games are over. Squaw Valley is to become a permanent sports area in winter and recreation area in summer. All the improvements that are being built by the state are permanent in nature. The Olympic Arena is suitable for recreational skating and for figure-skating carnivals all year 'round. The Olympic Village will be transformed into a 300-room hotel. After the Olympics are over, too, public parking for more than 1500 cars will always be available in the valley. The ski lifts and jumps are to be maintained. California expects that five years after the Olympics, a quarter to one million people per year will be enjoying the sports facilities at Squaw Valley. ★ ★ ★

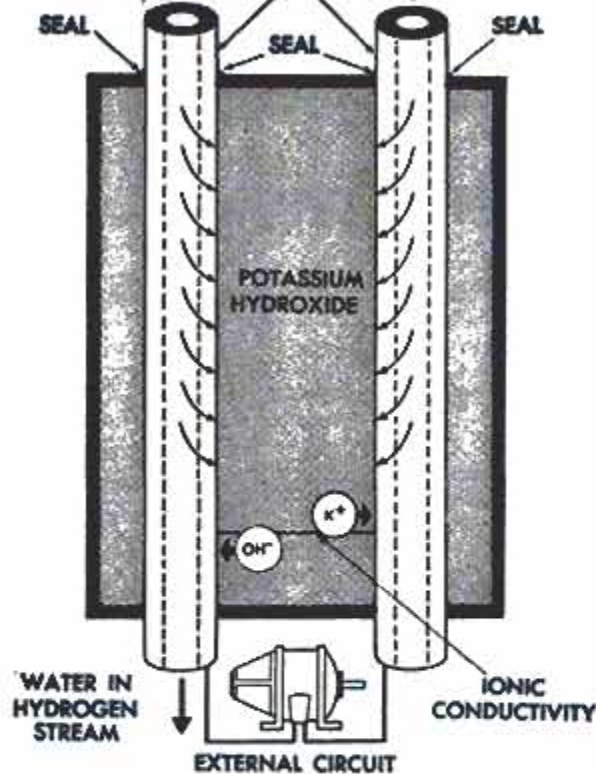

Fuel Cell Changes Chemical Energy Into Electricity

Capable of producing thousands of watts of electric power economically is a new type of chemical fuel package that is portable and virtually maintenance-free. It consists of specially treated, hollow porous carbon electrodes in a cell filled with

potassium hydroxide. Hydrogen and oxygen gases enter the cell through the electrodes and the chemical reaction releases electrons at the hydrogen electrode. As the electrons reach the oxygen electrode they provide electric power.

"Wonder" Metal for Rockets

Scientists refine samples of the "wonder" metal niobium by heating it to nearly 4400 degrees Fahrenheit in a vacuum. The high-purity niobium is studied as a possible structural metal for future rockets, missiles, jet engines and nuclear reactors.

Smokestack Takes a Trip

About three times the length of many trailers you see on the highway is a special rig used to haul a 40-ton metal smokestack. The 115-foot-long stack was photographed in Philadelphia as it was being trucked to a chemical company in New Jersey.



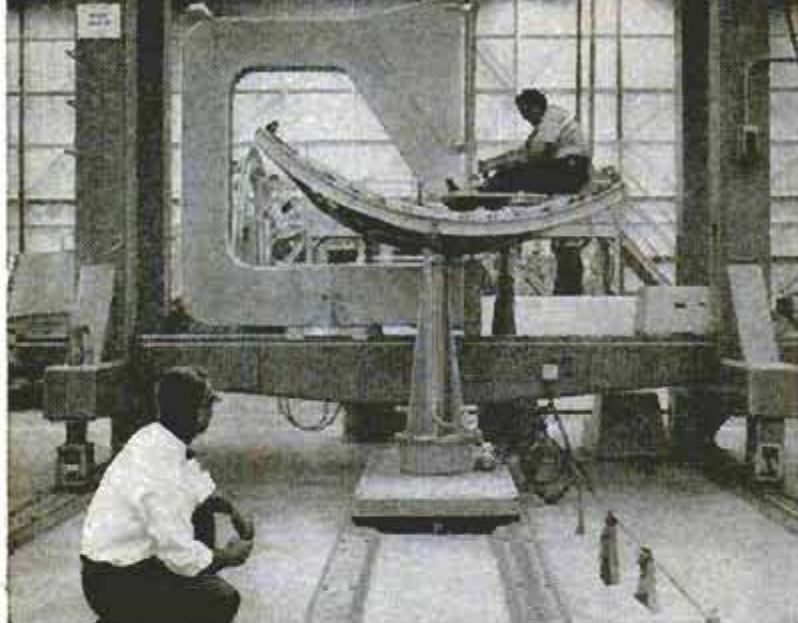

Gantry Riveting Machine Speeds Aircraft Jobs

Quicker and better riveting for DC-8 jetliners is possible with a new type of fastening machine developed by Douglas Aircraft Company engineers. A wing or fuselage panel on a simple platform is placed between the rails of a gantry. A sensing unit keeps the curved panels at right angles to the riveting mechanism as the rivets are set. The new machine also has a device which shaves off the excess rivet metal. The riveter is hand-positioned.

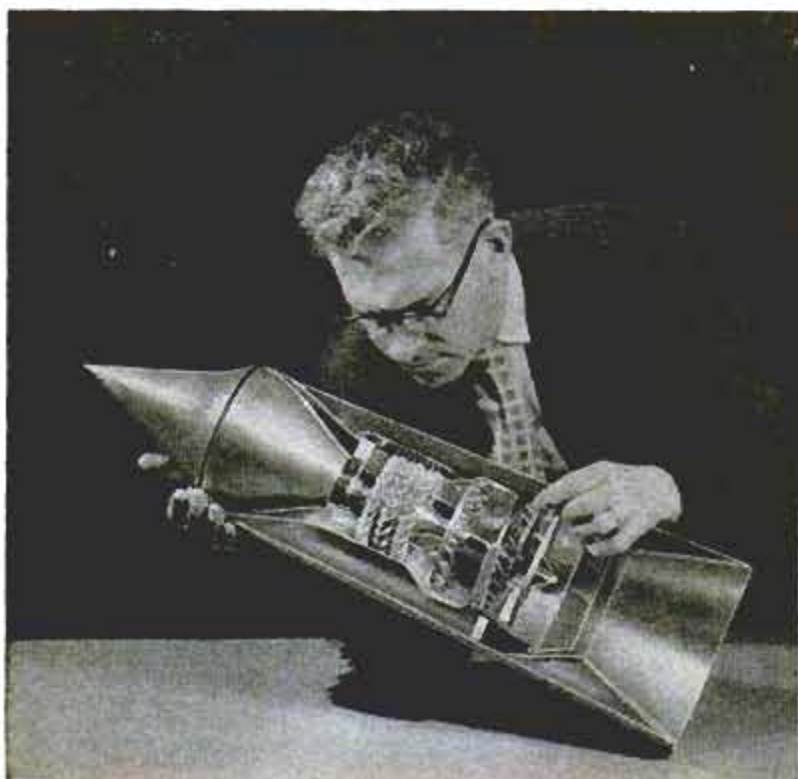

2600-M.P.H. Turbojet Engine In "Theoretical" Model

Scientists at the Lewis Flight Propulsion Laboratory, in Cleveland, have developed a model of a turbojet engine which theoretically could move airplanes at a speed of 2600 miles per hour. The design of the Mach-4 engine is based on studies of aerodynamic and combustion factors needed to power an aircraft at speeds four times that of sound. The Mach-4 engine is still in the idea stage. But the model indicates it would have a highly expanded exhaust nozzle and a large air inlet. It would be much shorter than present engines, utilizing only three instead of a dozen compressor-blade rows. The engine could be very short if it burned high-energy fuels.

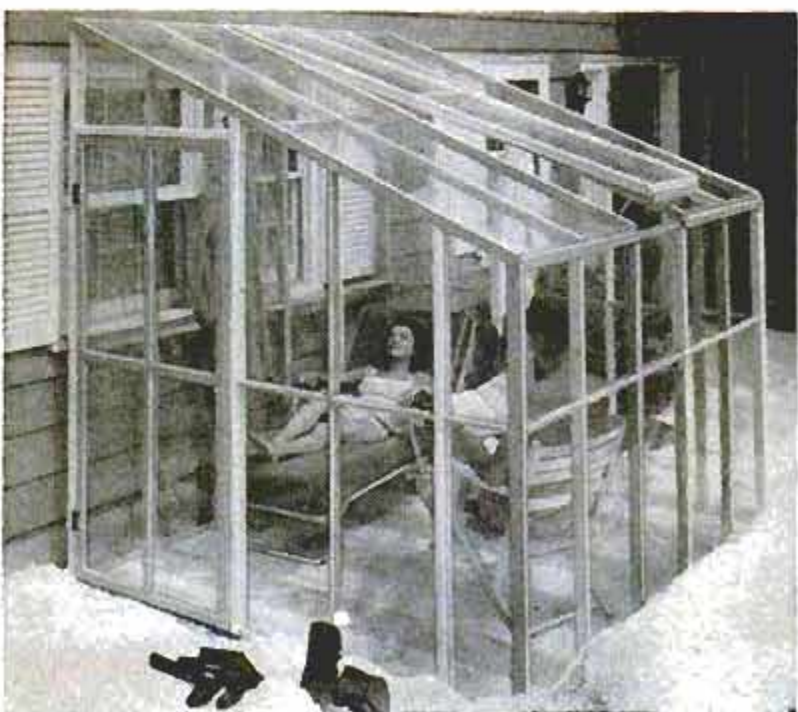

Winter Sun-Bathing Shelter Covered With Plastic Sheet

Sheets of semirigid plastic are used to cover a sun-bathing shelter made of two by fours and attached to the south side of a house. The tough plastic sheet is not only unbreakable but is more transparent than glass and is superior in transmitting ultraviolet light. Sheeting of this type can also be used as cover for starting frames for seedlings, for carports, windbreaks on patios, as storm sash, to enclose porches or as an inner liner for greenhouses. The plastic is available in 36 and 42-inch widths in rolls of 100 or 300 feet.

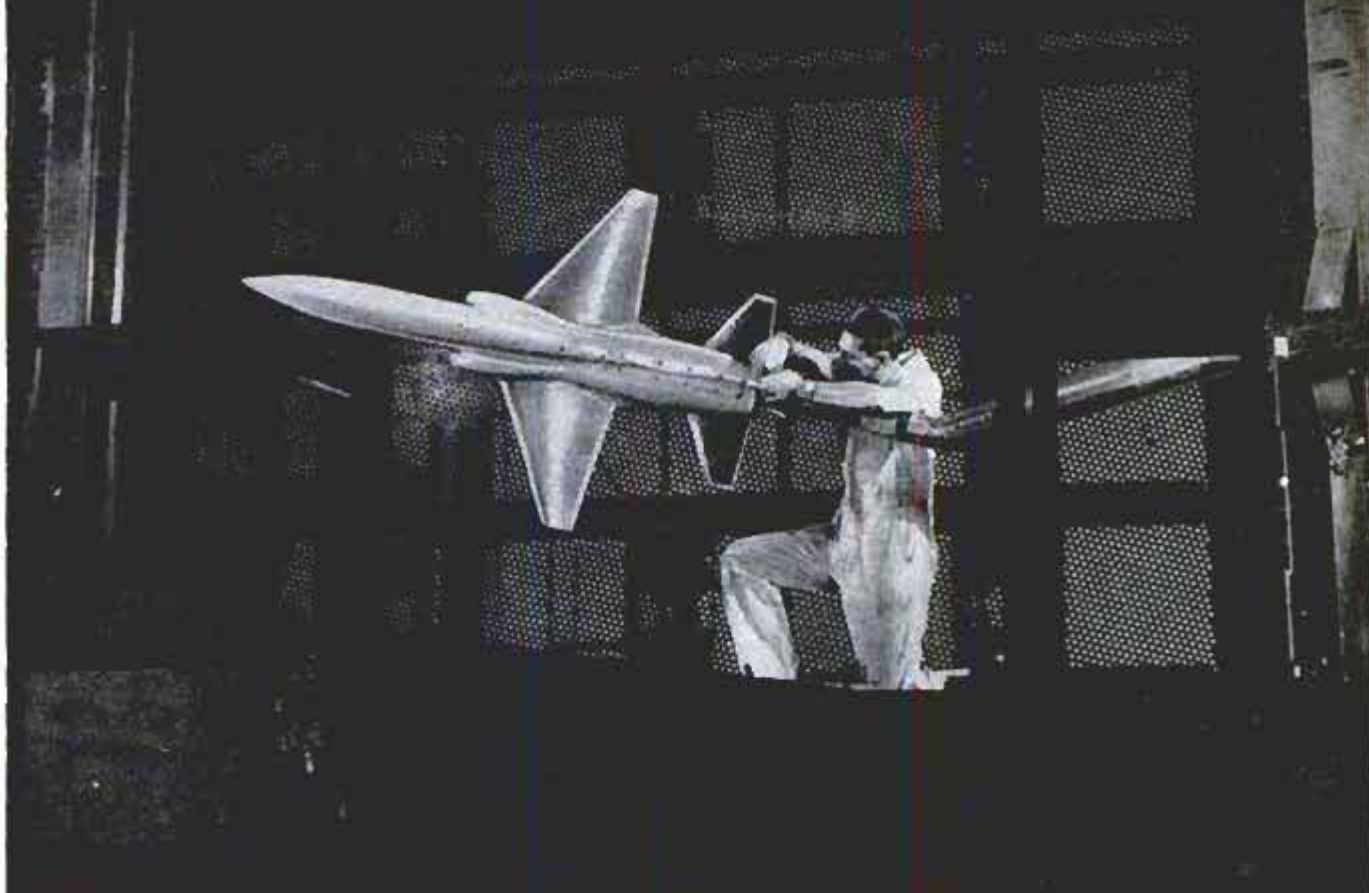

First Supersonic Basic Trainer Gets Wind-Tunnel Tests

Cornell Aeronautical Laboratory's 1000-mile-per-hour wind tunnel is being used to test a model of the world's first supersonic basic trainer. The Northrop T-38,

developed for the Air Force, is scheduled for actual flight tests this year. Extensive wind-tunnel tests of the stability of the trainer have already been performed.

Jetstar for Training or Transport Cruises at 550 Miles Per Hour

Cruising speeds up to 550 miles per hour were recorded by the 10-passenger Lockheed Jetstar during recent flight tests over California. The new aircraft will be used

as a jet "utility" plane to train pilots, bombardiers and navigators. It's also designed to rush top brass and high-priority cargo from one military site to another.

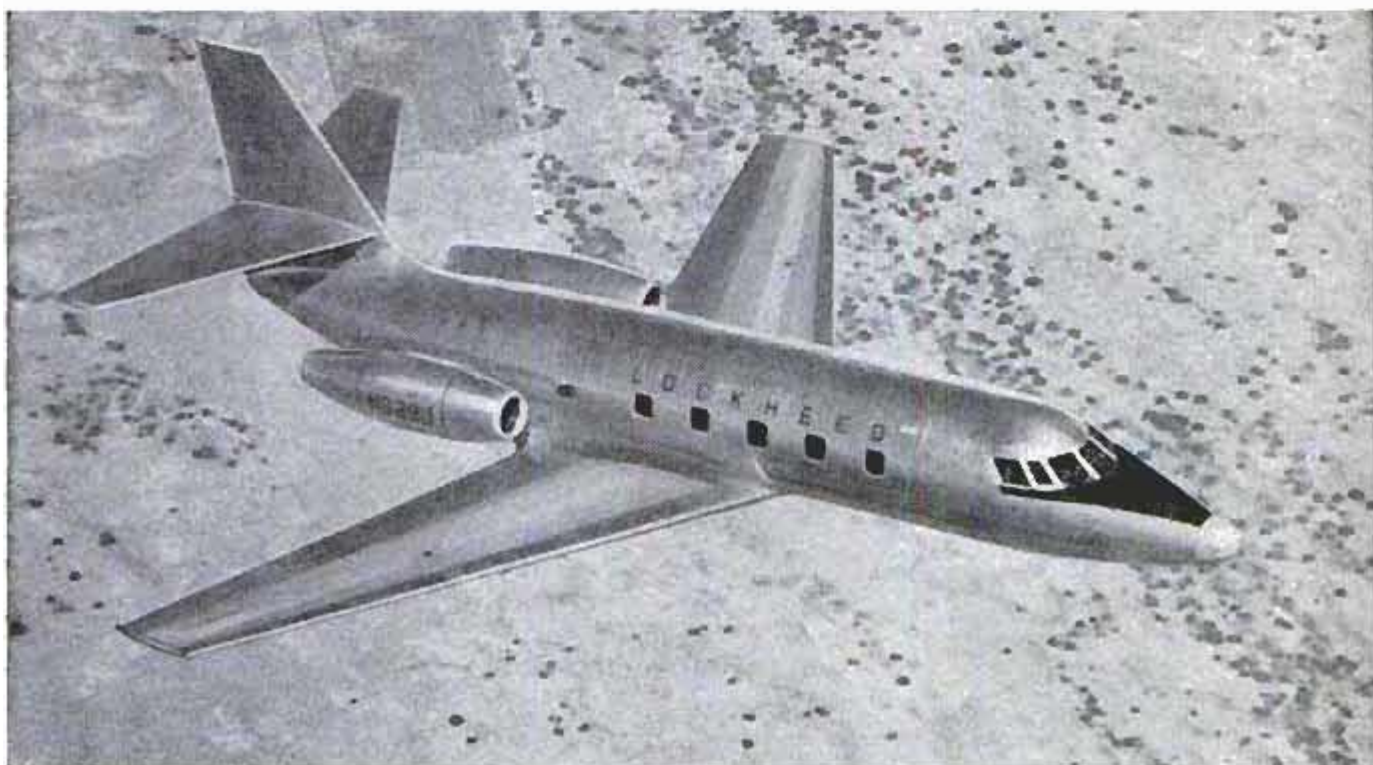



Two-Way Snow Remover Features Brush and Blade

Among this winter's new products designed for cleaning the snow and ice off sidewalks and driveways is a combination brush and blade on a long pole. For light, powdered snow you can sweep the pavement with the brush side, which has long, plastic bristles. For heavier, wet snow, slush puddles and patches of ice, you just flip it over and use the 14-inch steel blade. The two-way snow-and-ice-removal tool is lightweight.



Flash Bulbs Are Smaller

Shredded zirconium foil replaces aluminum as the combustible element in a new flash bulb that's only one fourth the conventional size but produces the same amount of illumination. Both clear and blue bulbs will be available in the new size.

Sensitive Sidewinder Missile Tracks "Hot" Enemy Targets

Infrared guidance is the secret of the Sidewinder's accuracy. The Navy recently announced that its air-to-air missile is able to hit a flare pot on the wing of a target plane. The missile can track a target through any series of evasive actions. It

simply runs down the source of infrared energy emitted by hot engines and exhausts of military equipment. Although its detection system is extremely sensitive, the Sidewinder is simple enough for technicians to handle without special training.

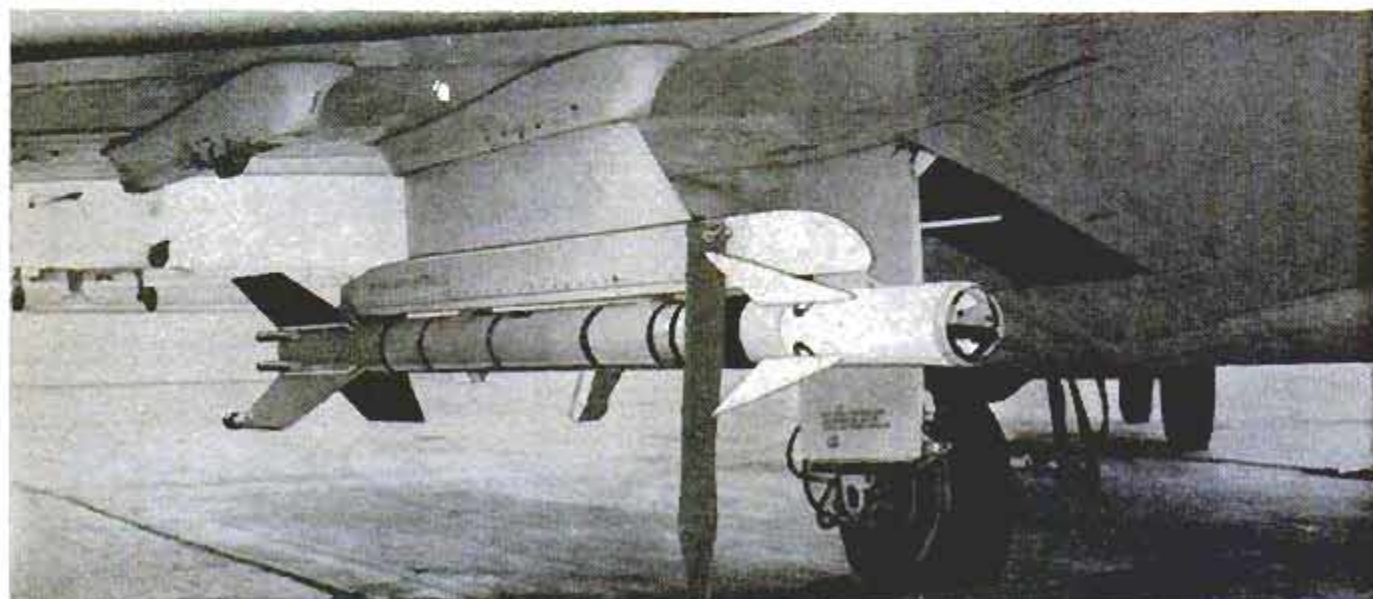

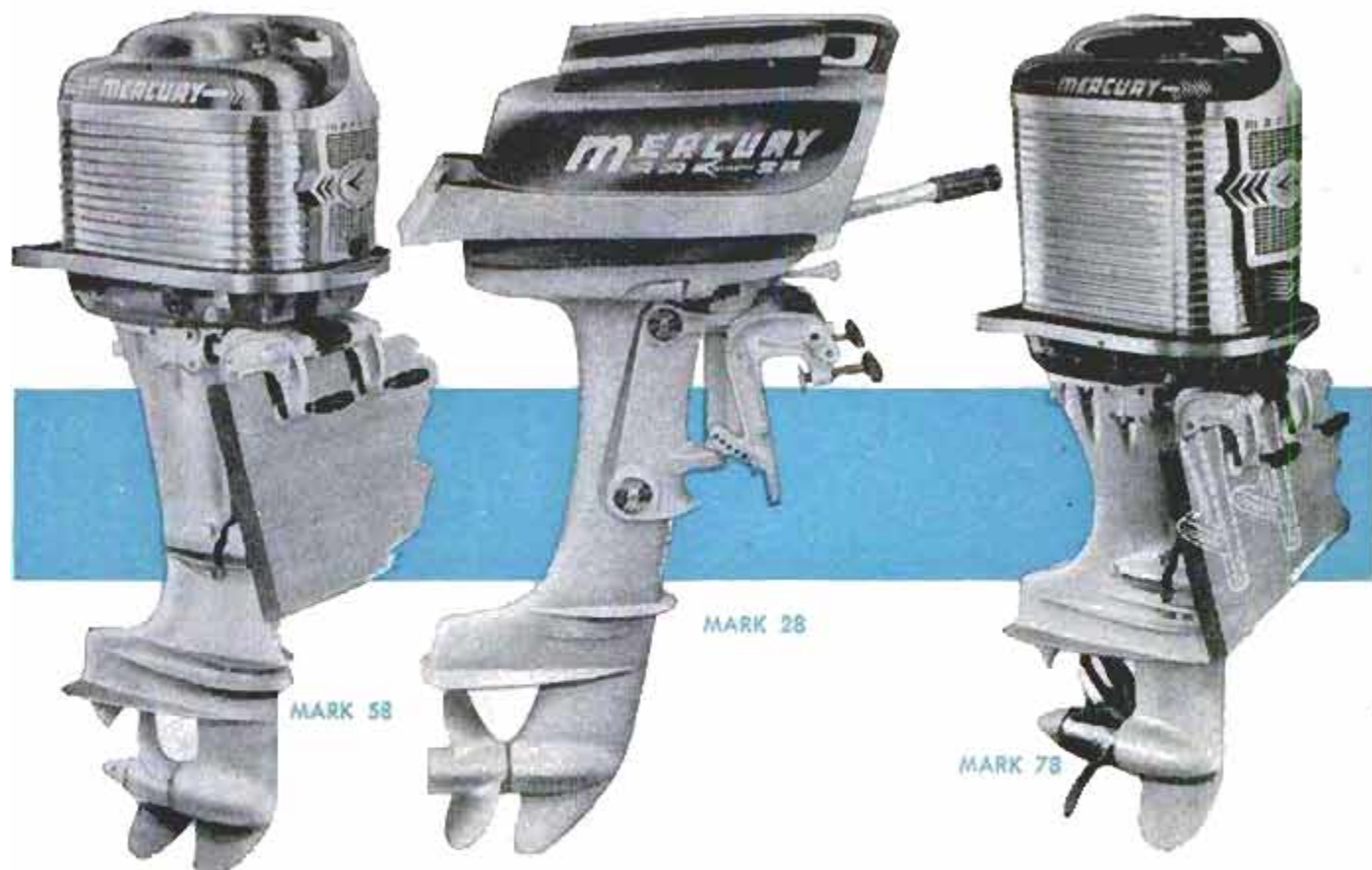

Six-Cylinder Outboard Motor Packs 70 Horsepower

MOST POWERFUL outboard motor for 1958 is the new Mercury Mark 78, a six-cylinder, in-line engine packing 70 horsepower. The new motor is an example of the trend by the entire industry toward larger motors to power family cruisers. Two other new Mercury motors have also been announced: The four-cylinder Mark 58 rated at 45 horsepower, and the two-cylinder Mark 28 at 22 horsepower. A feature of the Mark 78 is a single-lever control that combines starting, speed and shifting. The lever has a thumb button on top of the handle. The operator pushes

the lever forward and presses the button to start the motor. As the lever is pushed farther forward, speed increases. To reverse, he pulls the lever back, stopping the motor. Pressing the button again starts the motor in reverse. Another innovation in this motor is a piston-type shock absorber which absorbs most of the impact energy when the lower unit strikes a submerged object. The '58 line of Mercury accessories features a single-lever control for smaller motors and a steering system operating through a flexible steel cable instead of ropes and pulleys.

Single lever with a thumb button combines starting, accelerating and shifting

Another single control is available for small motors

"Automatic transmission" drum replaces twist grip for remote control



The Weird Things

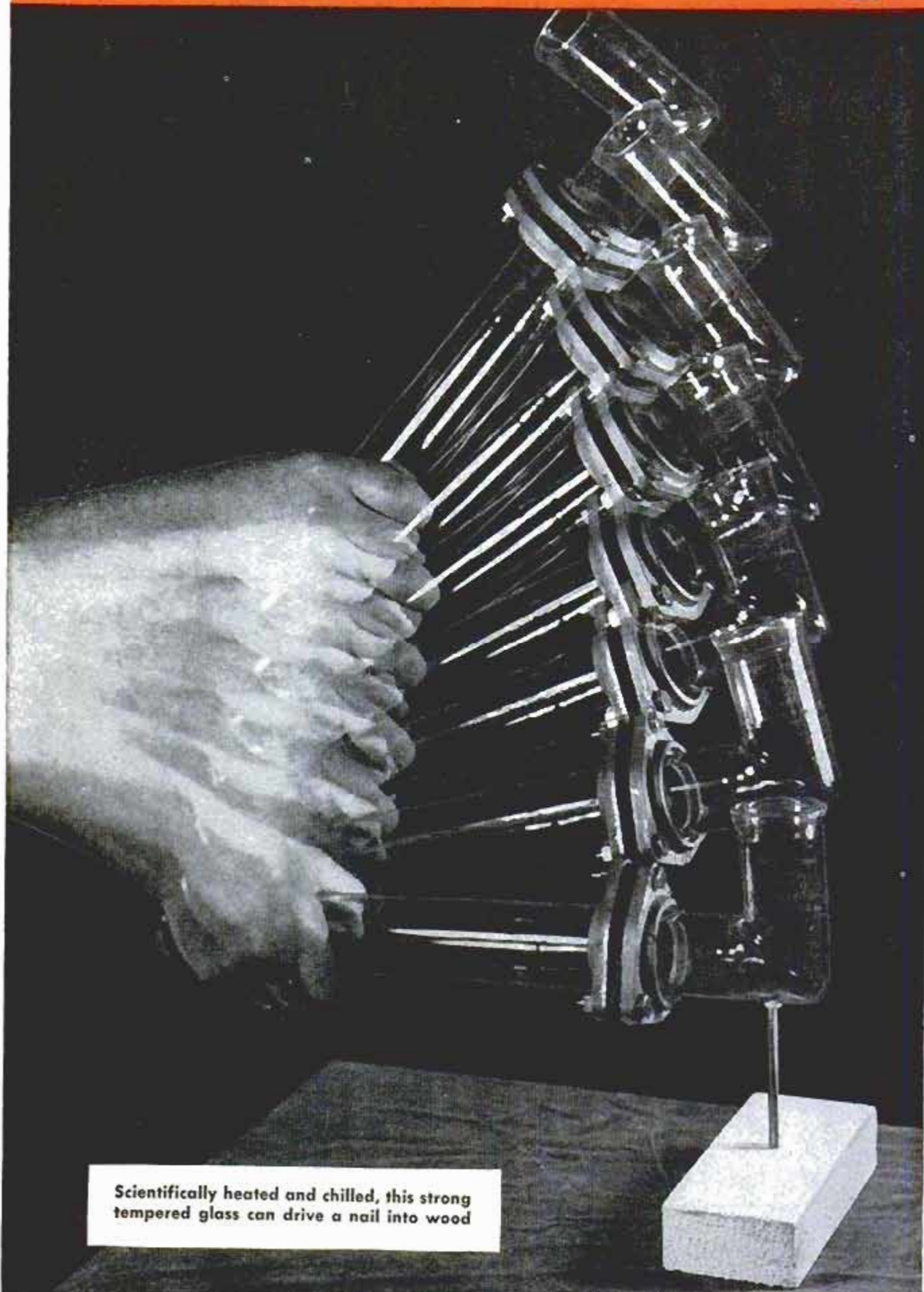

Scientifically heated and chilled, this strong tempered glass can drive a nail into wood

Photo by Corning Glass Works, Corning, N. Y.
POPULAR MECHANICS

They Do With Heat!

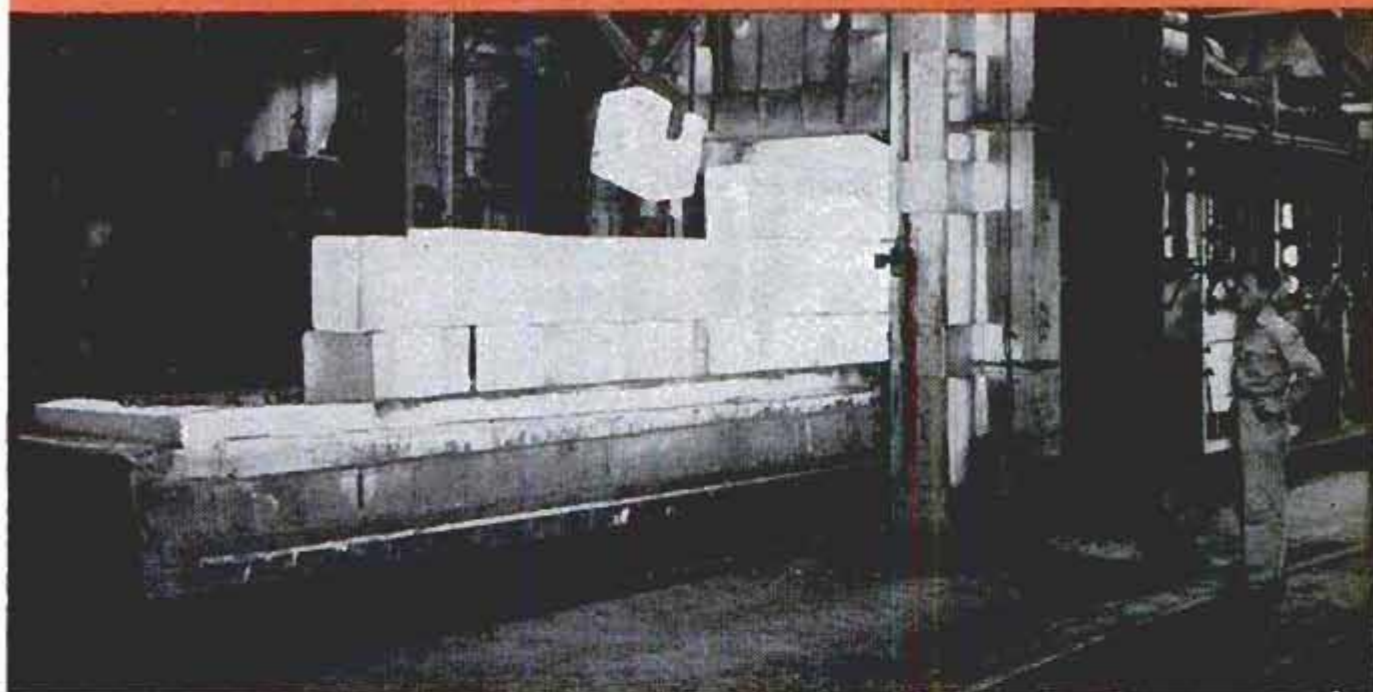

Modern heating methods now harden steel-die blocks for presses in three hours instead of usual 30 hours

By **Richard F. Dempewolff**

FRED HESS RUNS a bake shop in suburban Dresher outside Philadelphia. Like any other baker, his primary tools are ovens and heat, but that's where the comparison ends. His ovens vary in size from ceramic bowls no bigger than teacups to vast firebricked tunnels totaling a mile in length. They measure their fierce, gas-fired flames in thousands, not hundreds of degrees. Inside a chain of sprawling new million-dollar buildings that resemble a modern university, his "chefs," dressed in everything from dungarees to asbestos-lined aluminum suits, are silhouetted by the white incandescence of the infernos they create, as they ply their specialty of using heat as a tool for solving people's problems.

If, for instance, you want to peel a carload of onions without shedding a tear, put 30 million holes in a square inch of material, take the fuzz off a mile of fabric, remove the bristles from 100,000 hogs without searing their skin, bend glass around a sharp corner, or dry printer's ink faster than the flick of an eyelash—Fred Hess's "kitchen help" will show you how to "cook" your way out of your dilemma.

The Selas Company, of which Hess is president, began as a gaslight-equipment company in Germany in 1901. Today, it is a specialist in heat engineering—a master chef to modern industry. Its job is to use controlled heat as a tool in producing things that would be impossibly expensive by

Radiant-heat burners that are the size of teacups focus furnace heat to harden "selectively" the teeth of a tractor gear

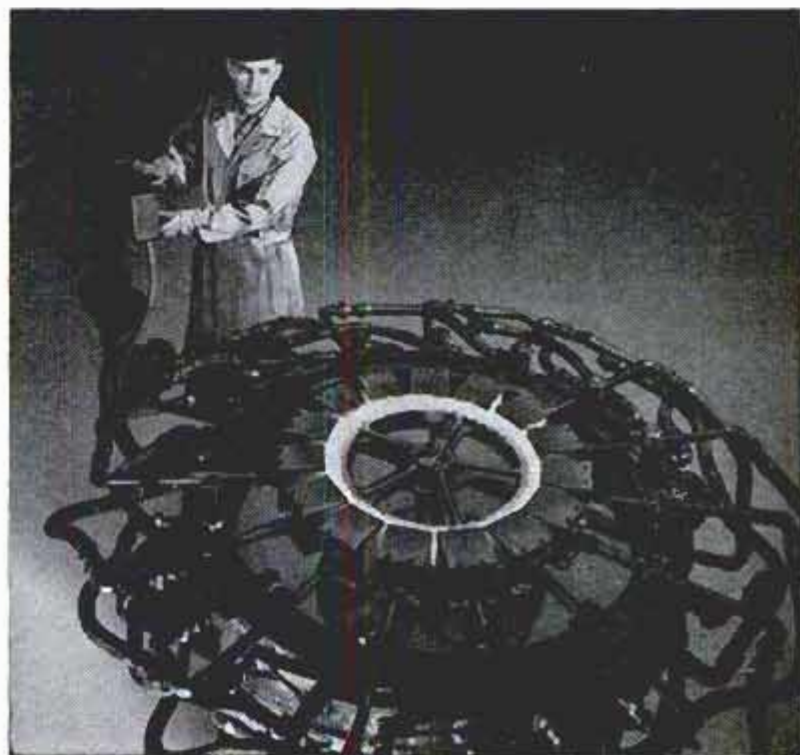

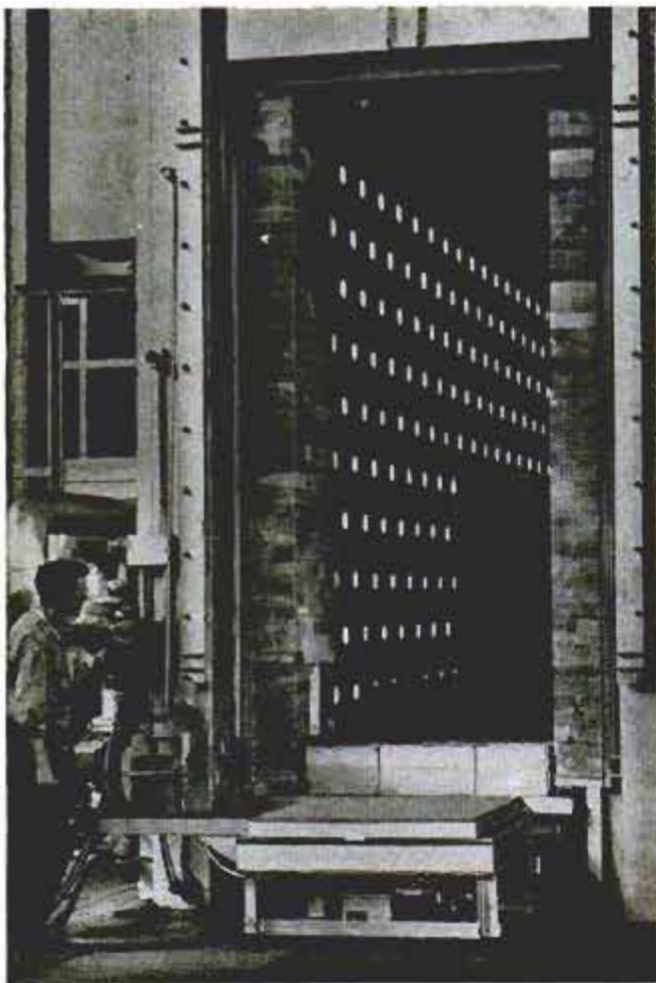

Inside the furnace where the die blocks are cooked, the radiant burners show up as blinding white disks

other means — or just plain impossible.

Heat, Hess will tell you as you stroll past long rows of roaring kilns and ovens, is the processing tool that is developing the new materials for tomorrow's satellites, space rockets and electronic gear. Blades in a modern jet turbine reach about 1650 degrees F., and present alloys with nickel, iron or cobalt bases can take up to 1800 degrees. But already engineers are designing engines that will have to stand much greater temperatures. So the heat wizards are working on new alloys of molybdenum and chromium they hope will not melt or lose strength at the super heats they'll encounter. Radomes that house delicate steering mechanisms on our new supersonic missiles will melt under friction with the atmosphere unless our industrial "cooks" come up with a material for them which is better than we have today. But they will. They're hot on the trail of a ceramic—alumina—which will not melt until it reaches a toasty 3720 degrees F. The heat experts are also working toward new ceramics for TV vacuum tubes, which must stand higher and higher temperatures as power output goes up. Nuclear physicists are crying for special materials to withstand not only the intense heat of atomic piles but also to hold up against radiation and corrosion.

Selas' big secret is heat precision. For

Hot exhaust gases waft away threads of glass fiber to be gathered as glass wool for draperies, insulation





Above, man is about to strike splinterproof tempered glass that has been heated and chilled on schedule

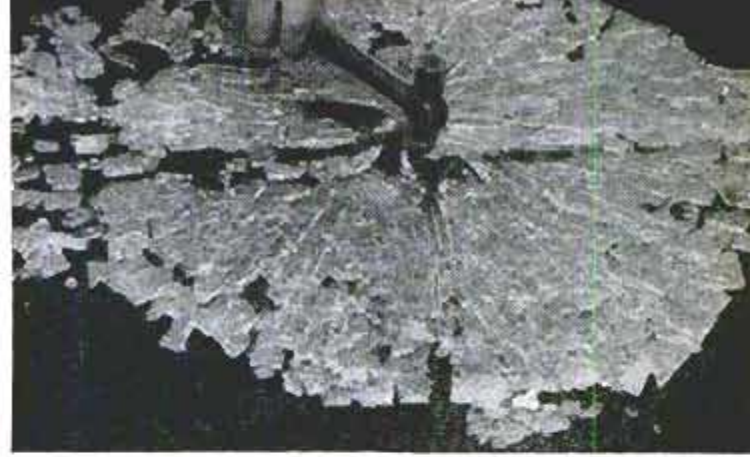

Above, on being hit by hammer, this splinterproof glass breaks into thousands of harmless fragments

while the chefs in those roaring kitchens may cook with 5000 degrees F., the recipes they use may be done to the proper turn within a particle of a second. A little more might set everything afire; less might not do the job.

Take the pigs, for instance. Some time ago a meat packer came to Hess with a problem. Hair on the hog carcasses couldn't be entirely removed without a time-consuming searing job being performed on each individual pig. And the incidence of scorched flesh was pretty high. Selas built the packer a radiant-gas oven through which the carcasses move on a mass-production trolley line. Radiant burners inside are positioned so that they outline the contours of a typical hog carcass; hence all parts of the beast are the same distance from the flames. "Each carcass," says Hess,

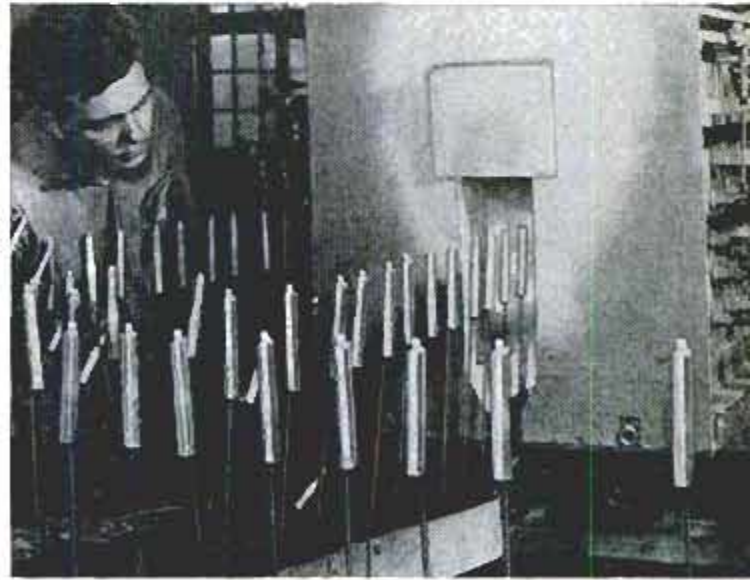

Above, annealed aluminum tubes for toothpaste made by heat-treating methods that eliminate brittleness

Below, fuzz is singed from corduroy fabric by automatically drawing it through burners at preset heat

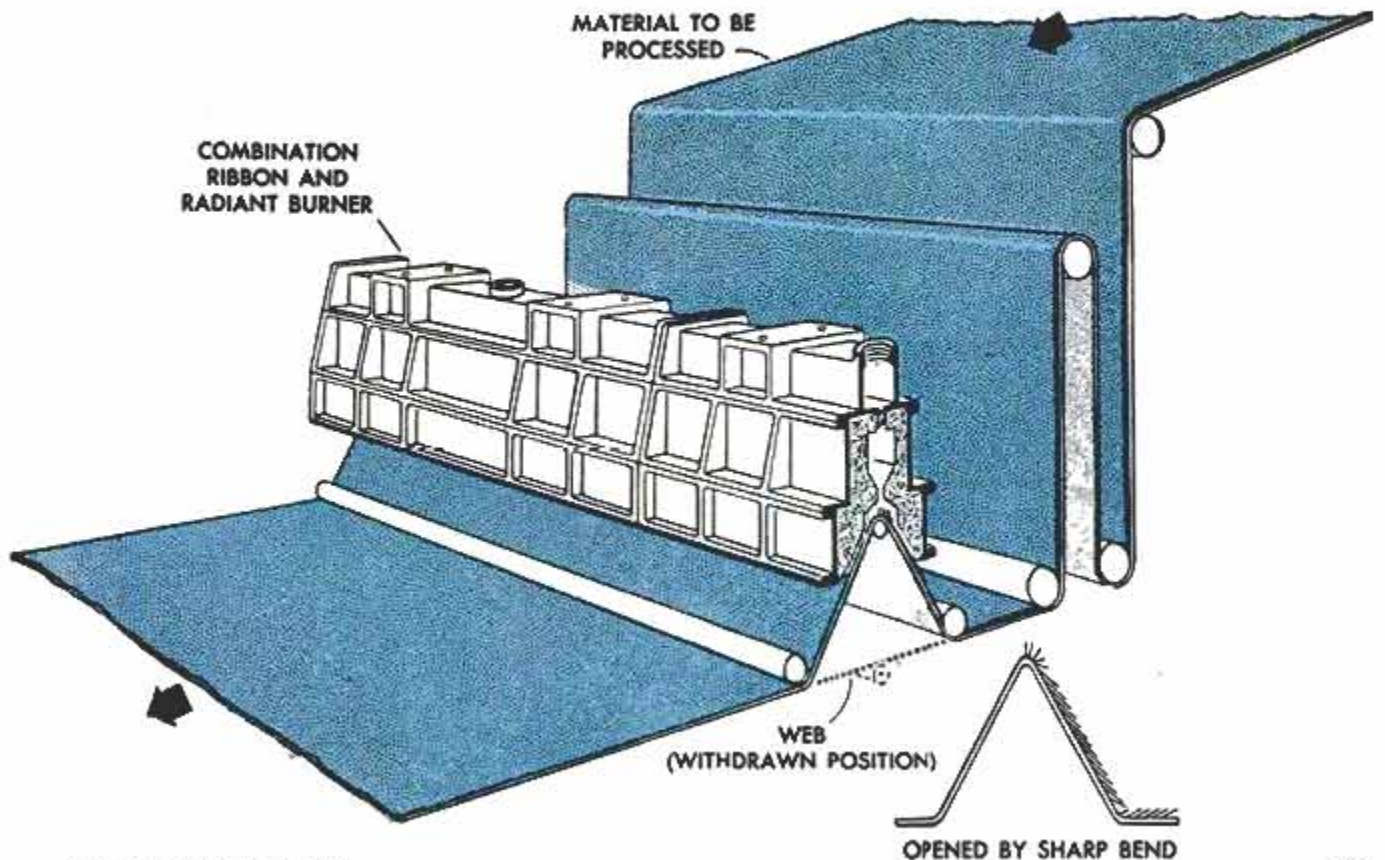

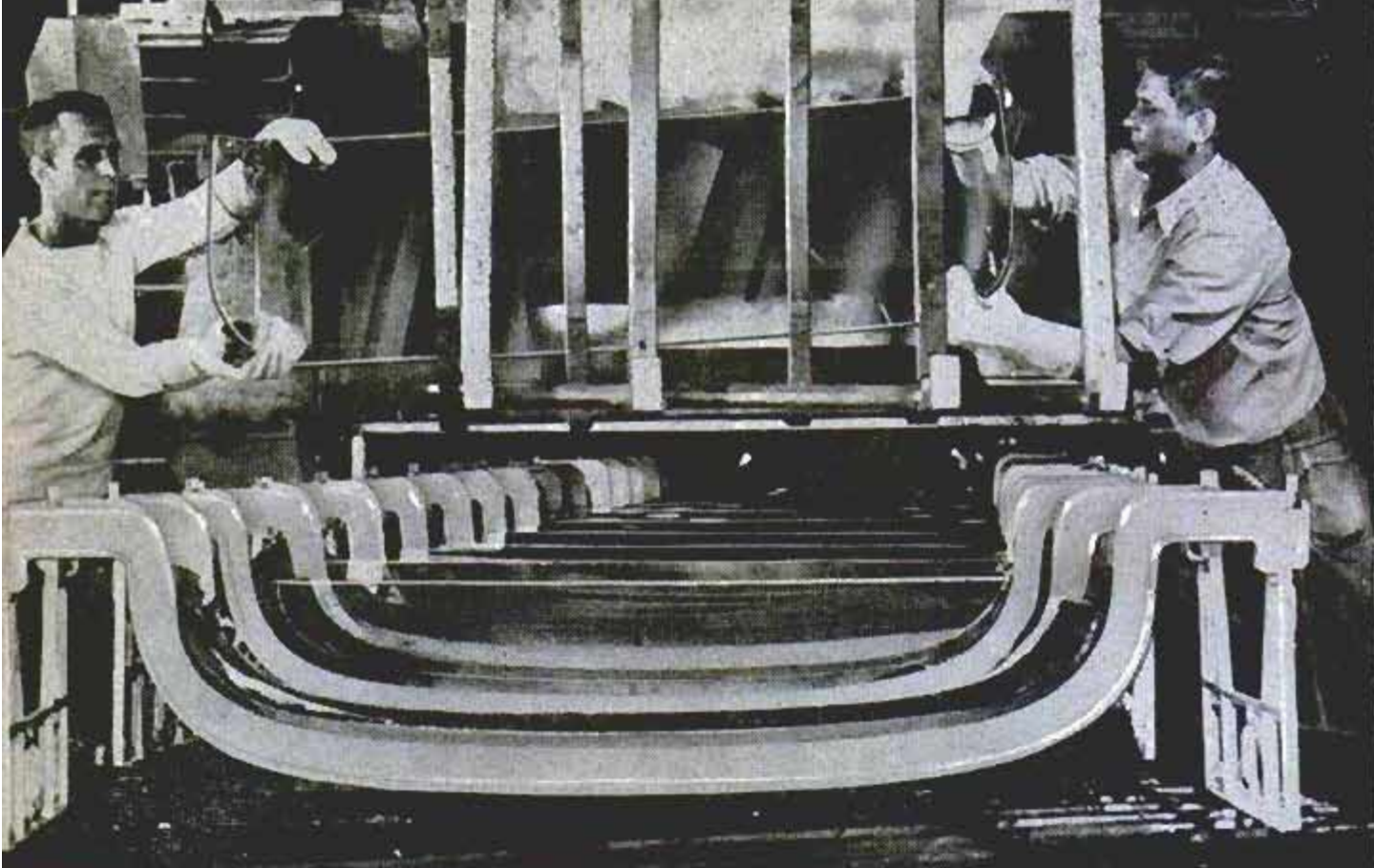

Wrap-around windshields and rear windows for cars are molded by heat-softened glass that drops into forms

"is exposed to a blast of 3400 degrees for a fraction of a second. A switch, activated by the leg of the hog going through, lights and extinguishes the burners. It burns off every hair—without raising the temperature of the skin a single degree!"

Later, a similar oven was devised for a large canner, to burn the pinfeathers from

Its fabrication made possible by heat, the ceramic filter under test here has 100 billion pores, so fine that even bacteria cannot pass through them

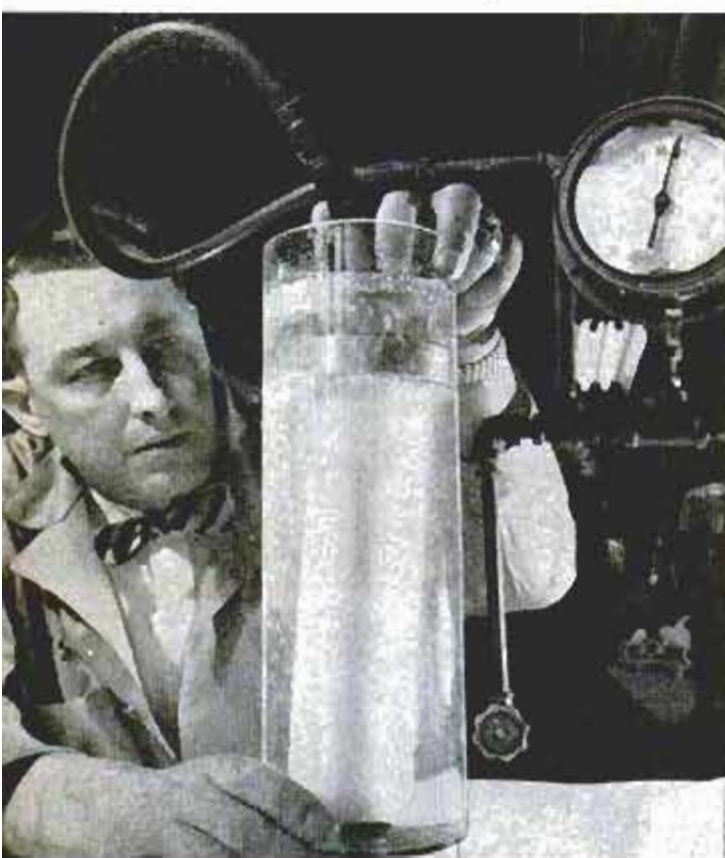

chickens. The same canner had the onion-peeling problem. Peeling onions mechanically in abrasion machines is messy, time-consuming and causes tearing in the crews that have to clean the machines. By subjecting the ornery vegetables to open gas flames in a kiln, Selas was able to sear off the hard outer layers without scorching those beneath. Today one oven is peeling onions at a rate of two tons per hour, and nobody has to sweep up any crumbs.

Typical of the touchy heat jobs Hess's experts have put their talents to was the business of defuzzing fabrics. Most newly loomed cloth has a surface of fuzz and may be covered with bits of thread and "fly" that must all be removed before the material is sold. Mechanical means of doing the job were tedious and costly, so the textile people came to Hess. Could he do anything about it? Selas' kitchen help went to work on a row of gas burners under which the loomed fabric would pass on its regular rounds to the rollers. After days of research, the cloth—corduroy—was flash-heated at 1800 degrees for exactly seven seconds. Six wouldn't do it, and eight would scorch it or set it afire. So close are tolerances for this burner, that when black cloth, which absorbs more heat, is passed over burners set for white material, it burns to a crisp. Today, however, these burners are singeing fuzz from fabric in most of the nation's mills faster than any

(Continued to page 256)

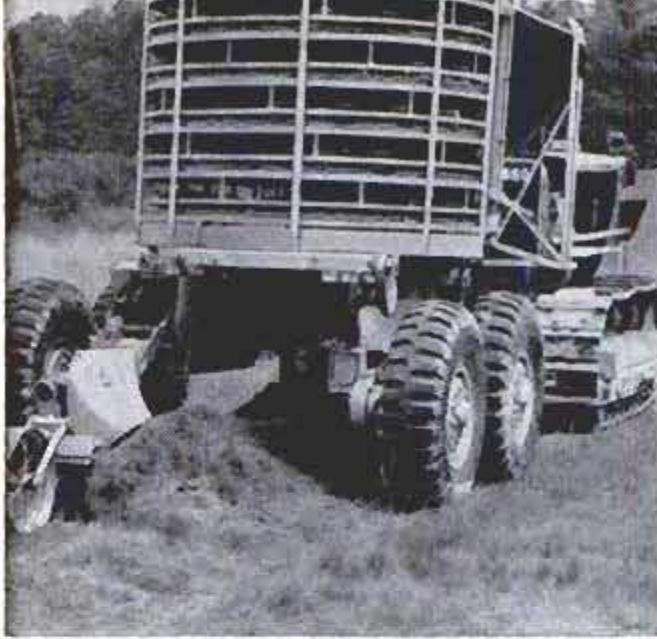

Army Machine Automatically Plants Land Mines Under Turf

With minimum disturbance of the natural cover, a new machine developed by the U. S. Army slices the turf and conceals a string of antitank mines under it. Only

the tractor operator is needed to plant the automatically armed mines at a predetermined rate. The round magazine is removed for reloading by a conveyor system.

Outrigger Skis Balance Snow Sleigh

Cruising over snow-covered terrain at speeds up to 60 miles per hour, a propeller-driven sleigh can bank on sharp turns and steep hills like an expert skier. An outrigger connecting the rear skis to the fuselage and directional control of the front ski help simulate the ankle movements and body twisting of a man on skis. The sleigh uses a 65 to 125-horsepower aircraft-type engine.



Missiles Toted On Rough Terrain

Carrying three Hawk Bird missiles at a time, a tractor-driven Army missile loader can move the weapons quickly over rough or muddy terrain.

☐ For dessert, we have instant seaweed pudding. A New Bedford, Mass., inventor has patented the recipe, a dry-powder mix combining a seaweed extract, salts, flavor and color. Cold milk is added.

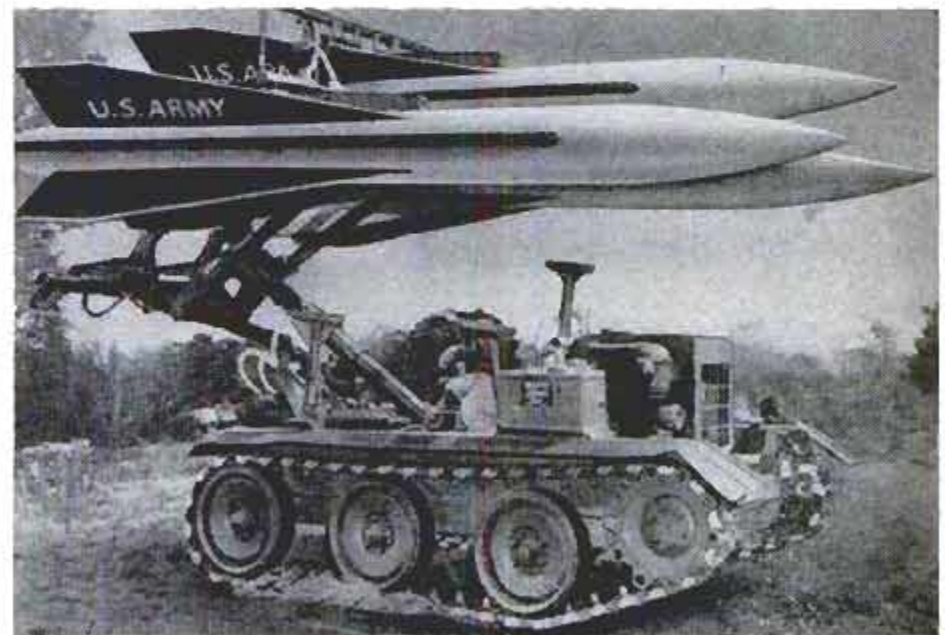



Control-tower operations are taught from this mockup of an airport control tower

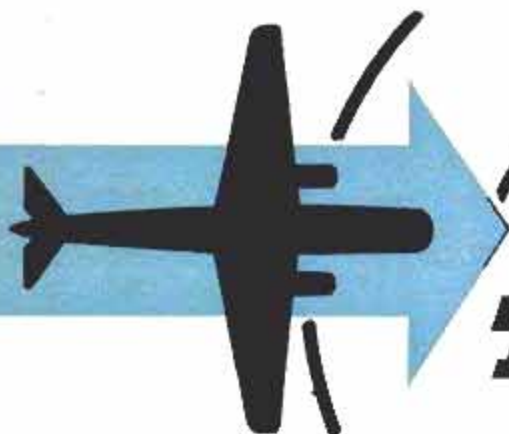

Air Traffic School



By
Thomas E. Stimson, Jr.

CAA instructor is at the console of a jet-aircraft trainer where he can set up problems for student to solve in nearby cockpit



Students are "pilots" of "aircraft" approaching the field, landing or departing. "Tower" gives instructions

YOUR SAFETY as an airline passenger is based in part on a collection of models, mockups and gadgets that is housed in a group of old buildings alongside the Oklahoma City airport.

Here, at the Aeronautical Center of the Civil Aeronautics Administration a wide array of rebuilt and homemade contrivances are used as training aids for the more than 500 CAA engineers and safety agents who supervise all aspects of air transportation.

These men never finish going to school. They are recalled from their ordinary duties on regular schedules to take refresher courses at Oklahoma City or to receive special instruction in the newest navigational aids being developed.

One big classroom contains nine Link trainers, each rebuilt to simulate some special aspect of air travel. In one trainer a student agent may acquaint himself with using the high-intensity approach-light system installed at some airports. In another Link he learns how to use the omnidirectional radio range. Later, he may switch to a third trainer to become familiar with ADF, the automatic-direction-finding system.

An entire building is devoted to teaching the use of modern airport-radar equipment. On the newest types of radar the usual

ground "return" can be eliminated, leaving only a picture of the runways, the adjacent navigational facilities and aircraft that are in flight or that are in motion on the ground.

One classroom contains a table-top model of a typical airport complete to runways and hangars. In the same room is a full-size "control room," such as is found in an airport's control tower. Students wearing earphones and seated around the model

Model of aircraft on the swinging arm demonstrates the VOR (very high frequency omnirange) radio-navigation system



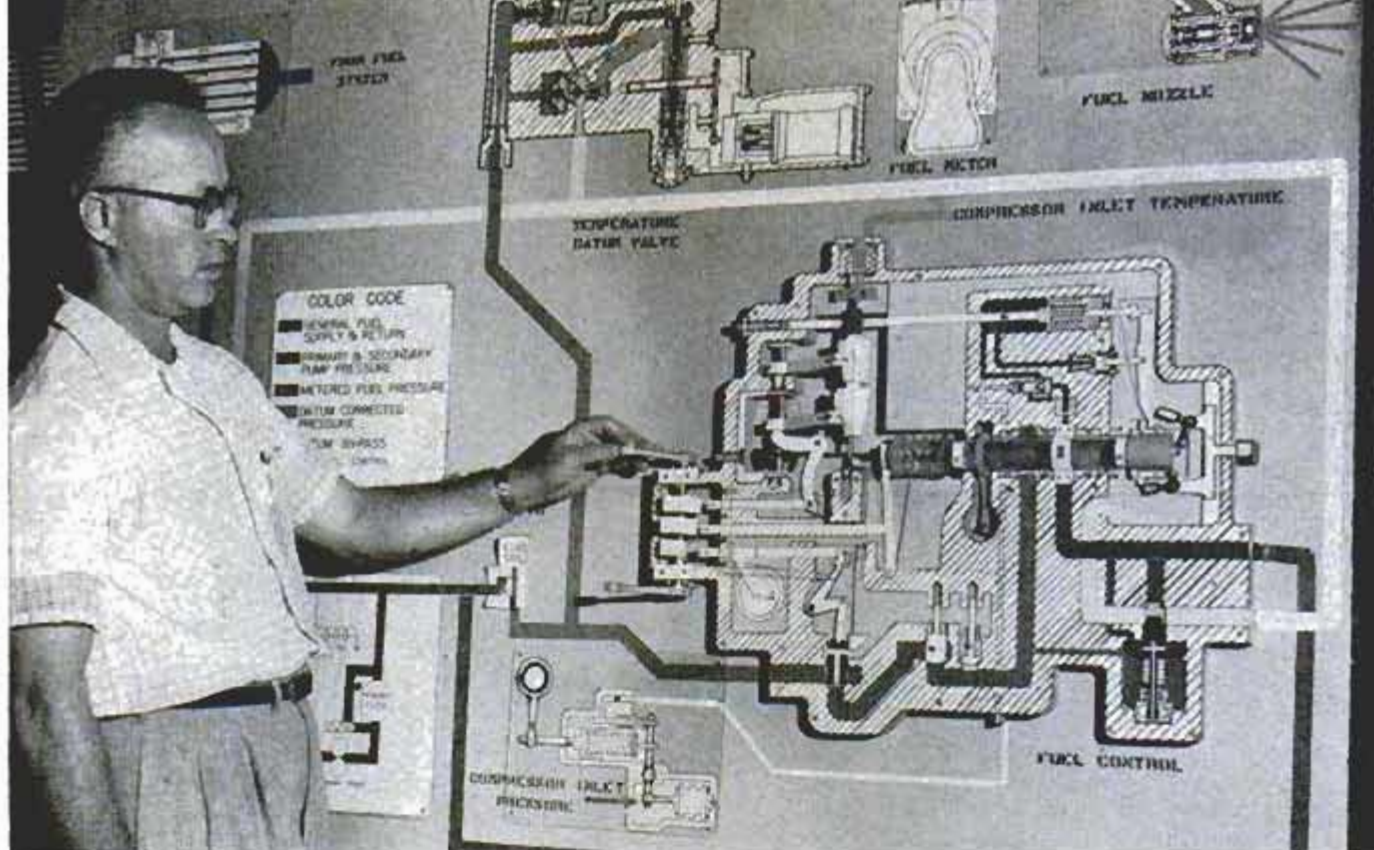

CAA technician checks the operation of the fuel system for Lockheed Electra turboprop passenger transport



Above, students assign airspace to planes in traffic-control studies. Below, plane traffic is "stacked" at a busy airport



airport operate tiny planes in conformity with orders phoned them from the "tower"; later, they take their places in the control room itself to be drilled in all aspects of control-tower operation.

Forty-One Courses Given

In still other classrooms the students learn how to dispatch aircraft along the airways, how much airspace to assign to each plane and the altitudes at which the aircraft are to be flown. Forty-one courses in all, ranging from advanced electronics to the operation of the newest types of aircraft, are taught at the Aeronautical Center.

Getting ready for the jet transports that will be flying soon, the CAA is beginning to familiarize its agents and engineers with jet flight. A new kind of trainer at the center consists of an enclosed cockpit in which a student sits, and a large control board at which an instructor sets up flight problems for a jet transport. On his control board the instructor feeds in such conditions as wind direction and velocity, altitude, air temperature and jet-engine condition. The student "flies" his cockpit to conform to the situations that are presented to him.

Fuel systems, control systems and electrical systems that are to

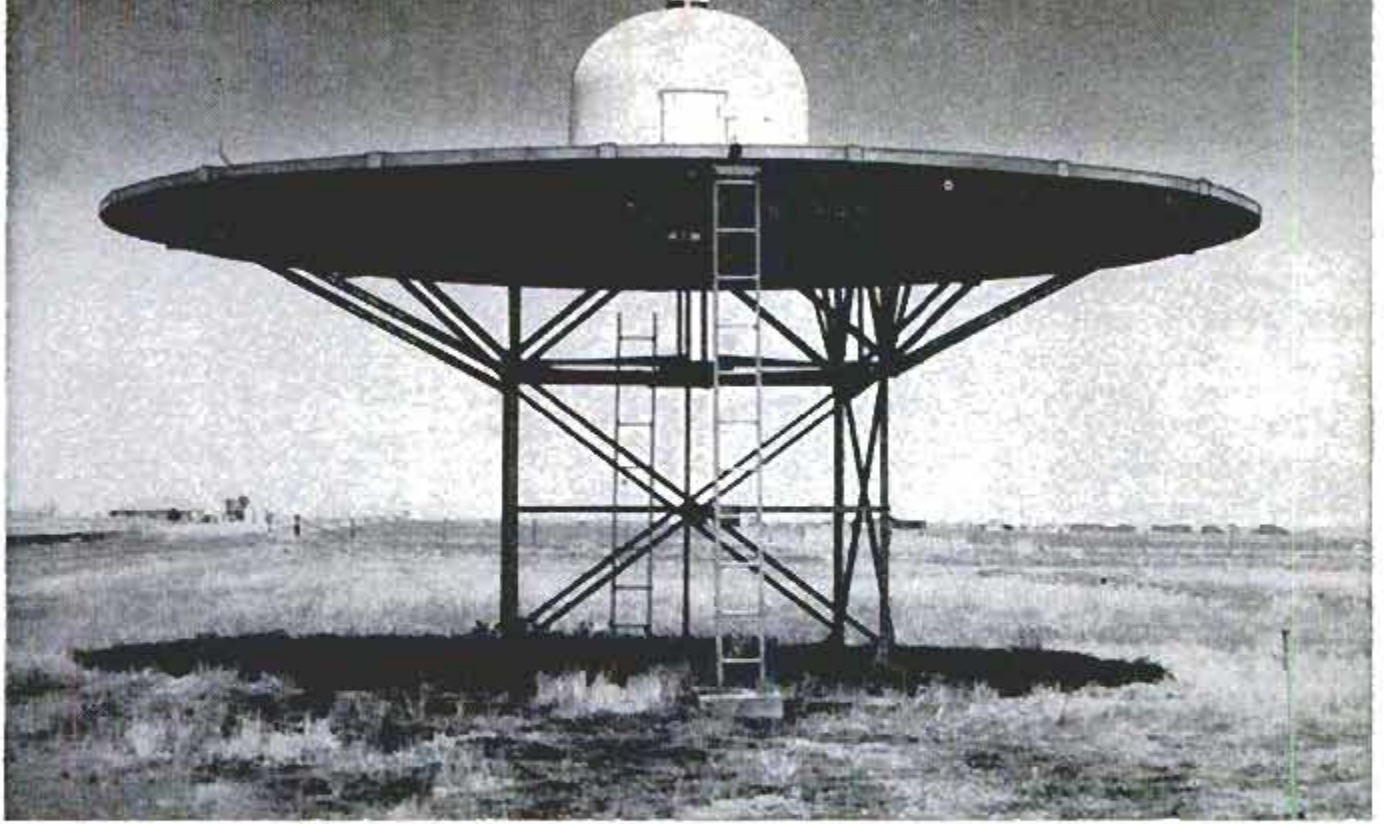

VOR (very high frequency omnirange) transmitting antenna at Oklahoma City aids air-navigation training

be used for the new fast transports are subjects of study. Conferences are held in which the reliability of each system is studied. The new traffic problems that the jets will bring also are being considered and procedures are being worked out for handling them.

In addition to CAA employees, several hundred students from the airlines and the armed forces are instructed in air-traffic control and associated subjects every year. "Standard procedure" is the keynote of all instruction. Each student is trained to handle every situation according to the rules. As a dispatcher, he directs incoming and departing traffic with standard phrases. The result is that, no matter where a pilot goes, he receives the same familiar service from the local control tower, with no chance of misunderstandings.

Standardization is applied to radio aids for navigation as well as to control-tower and airway procedures. Every radio range must be identical in operation. Every instrument-landing system must give the same familiar signals. Every omnirange must have the same accuracy. One of the jobs at the center is that of maintaining the electronic equipment on about 65 patrol planes used for checking the radio aids on the 90,000 miles of federal airways.

Sometimes a radio aid changes its characteristics without apparent cause; then a CAA patrol pilot cruises around the entire area searching for a source of interference. Often, it is found that a new bridge or a metal barn or silo has been built in the vicinity, causing the signals from the radio

aid to be absorbed or reflected. Once the source of interference is found, the radio apparatus can be readjusted to its original performance.

During the last few years several hundred traffic-control and communications experts from foreign countries have attended school at the Aeronautical Center, then returned to their own countries to align their systems to U. S. standards. Today, traffic control in most parts of the world operates on a common system based on the instruction at Oklahoma City. ★ ★ ★

Odd-shaped antenna is located inside the plastic dome of VOR equipment shown at top of this page

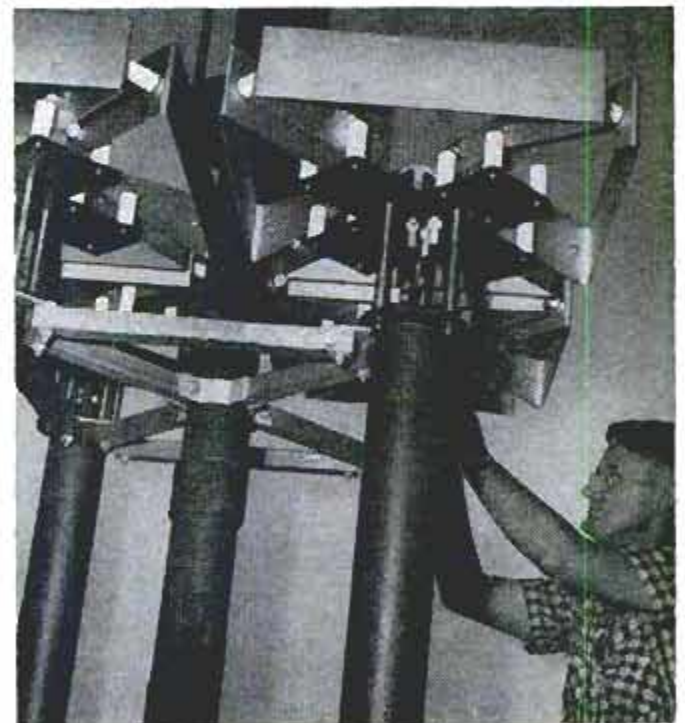

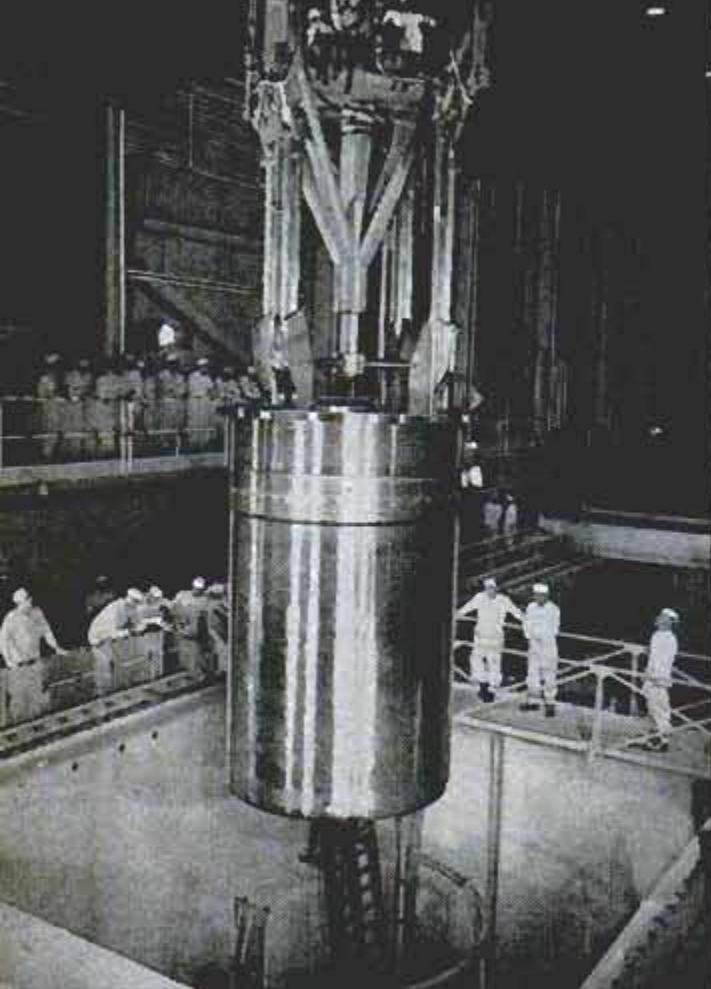

Atomic-power scientists supervise delicate maneuvering of nuclear core containing 14 tons of uranium

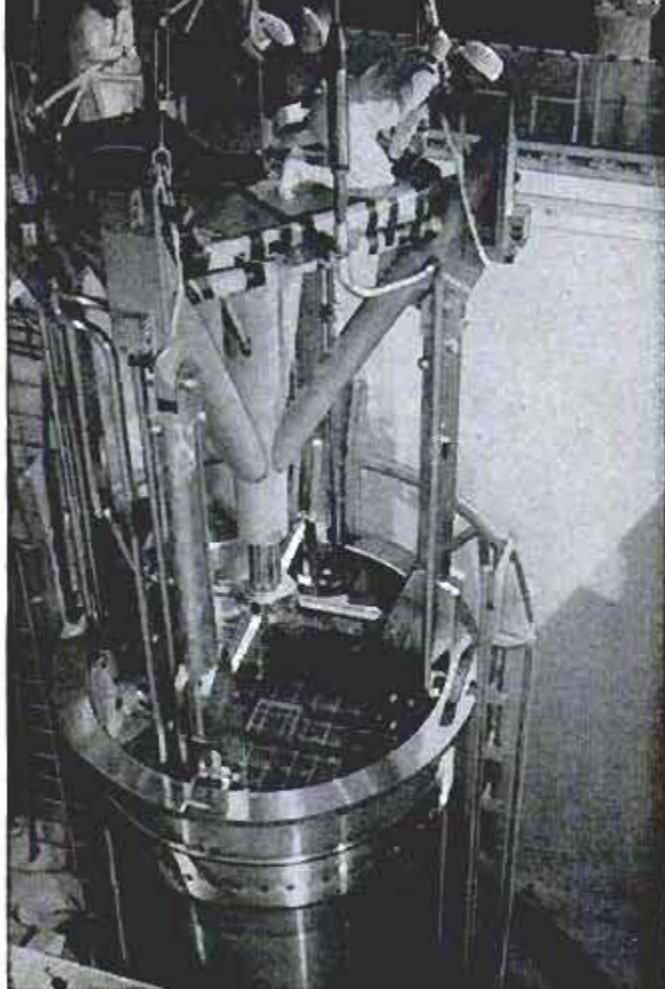

Multimillion-dollar nuclear core has less than inch clearance as it's lowered into pressure vessel

First Atom Power Plant Gets Nuclear "Furnace"

Resembling tray of cupcakes fresh from the oven, these rows of pads supported core before installation



CAREFULLY LOWERED into position in the nation's first full-scale atomic electric generating station, at Shippingport, Pa., is the nuclear core which is the heart of the system. The big stainless-steel cylinder contains 14 tons of natural uranium and 165 pounds of highly enriched uranium. The "hot" nuclear reaction that will take place within the core will, indirectly, produce steam to turn a turbine electric generator. The electricity produced by the station will go to industry and homes in the Pittsburgh area. Within the nuclear reactor will be 32 control rods for regulating the atomic splitting which produces heat for the process. When the rods, made of a rare metal called hafnium, are inserted, the atomic reaction is slowed. Withdrawing the rods speeds up the reaction. Water will flow through coolant loops in the plant at a temperature of about 525 degrees F. and under a pressure of 2000 pounds per square inch. The heated high-pressure water will be used to convert a second supply of water into steam which will produce a minimum of 60,000 kilowatts of power in the same way that coal-heated steam is used to generate electricity. Operation of the plant will be handled from a single control center.

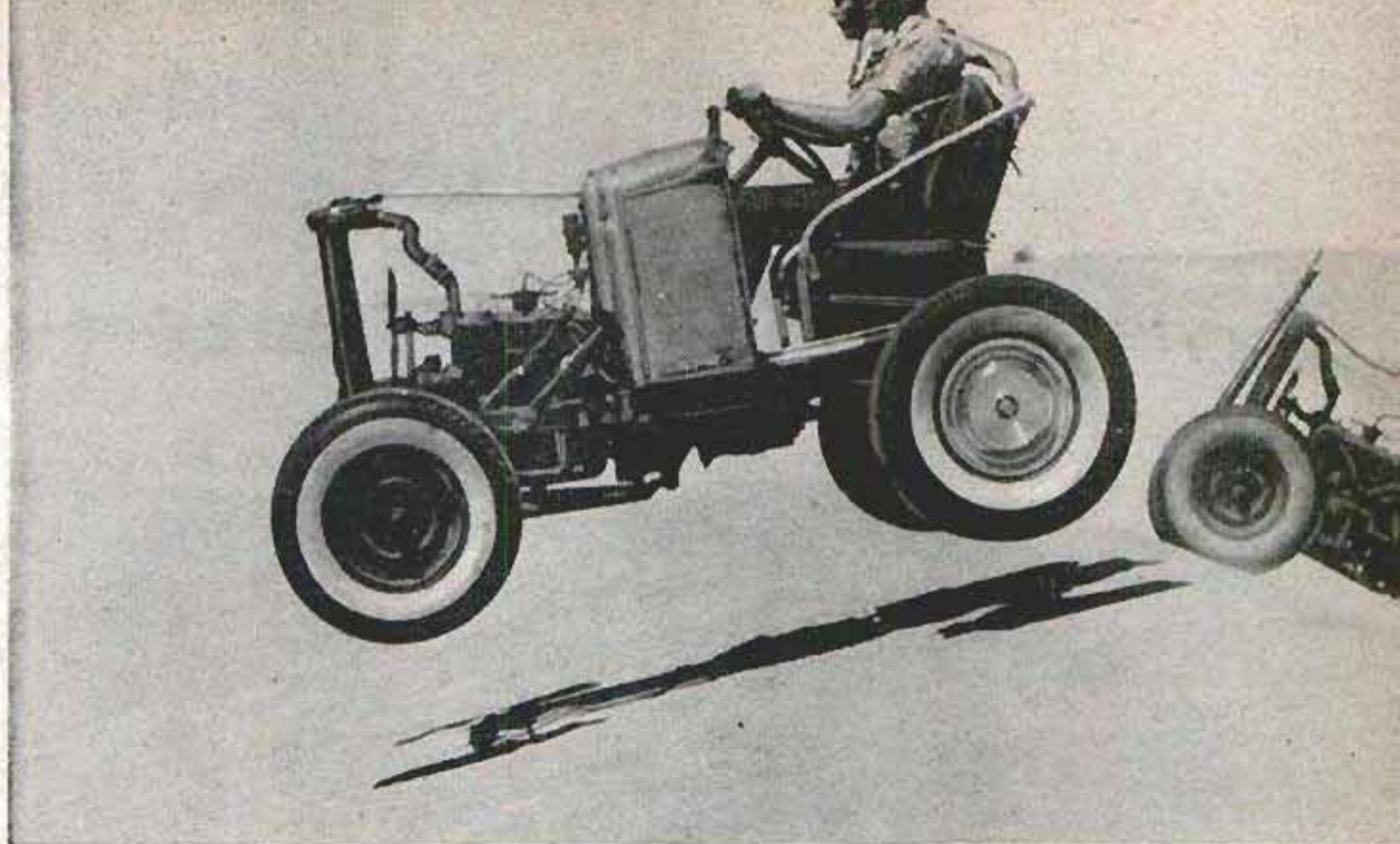

Model-A "Dune Bugs" Beat Dig-In Problem of Driving on Sand

Cut a Model-A Ford down to an over-all length of eight feet, strip it to bare essentials, put dual rear wheels on it and you have a "Dune Bug." High-school boys in the Yuma, Ariz., area use that formula to build a \$30 car that will scoot over the

shifting sand dunes of the desert Southwest where even Jeeps are trapped when the wheels dig into the sand. The rear wheels have smooth 7.50 by 16 tires that spin instead of digging in when a stall threatens. Air pressure is limited to eight pounds.

Side Bars Protect Car Finish When Parked in Tight Spot

Annoyed by the time and cost of touching up dents and scratches put on his car in parking lots, Tracy Carrigan of Lansing, Mich., designed a set of side bars that help protect the finish. Besides preventing damage from opened doors of cars parked

alongside his, Tracy reports the side bars warn the driver when he is too close to a wall, a post, high curb or another car. Carrigan, manager of an automotive service-equipment company, says the bars could be produced commercially.



THE CHEETAH— *World's Fastest Animal?*



"On your mark, get set, go!" says John Hamlet to his pet cheetah, Ocala, in test to learn cat's speed

IS THE CHEETAH the fastest animal on earth? The dispute has raged for centuries among the experts. John N. Hamlet of Ocala, Fla., operates an animal exhibit and runs cheetahs to demonstrate their speed. Curious to know how fast they go, he rigged a meat-scented lure to be pulled by a cord attached to an up-ended bicycle wheel. Ocala, an almost full-grown male,

Ocala follows meat-scented lure pulled by line on bicycle wheel, as photographer gets ready for shot

was selected for the test. Timekeepers and photographers recorded the run. The result: Ocala was clocked from a trotting start to a top speed of 54 miles per hour in $2\frac{3}{4}$ seconds! He attained the same speed in a little over three seconds from a standing start. Zoo officials say cheetahs can run at a top speed of about 70 miles per hour.

Coming at you . . . Ocala makes quick stop at end of record run, kicking sand in photographer's face



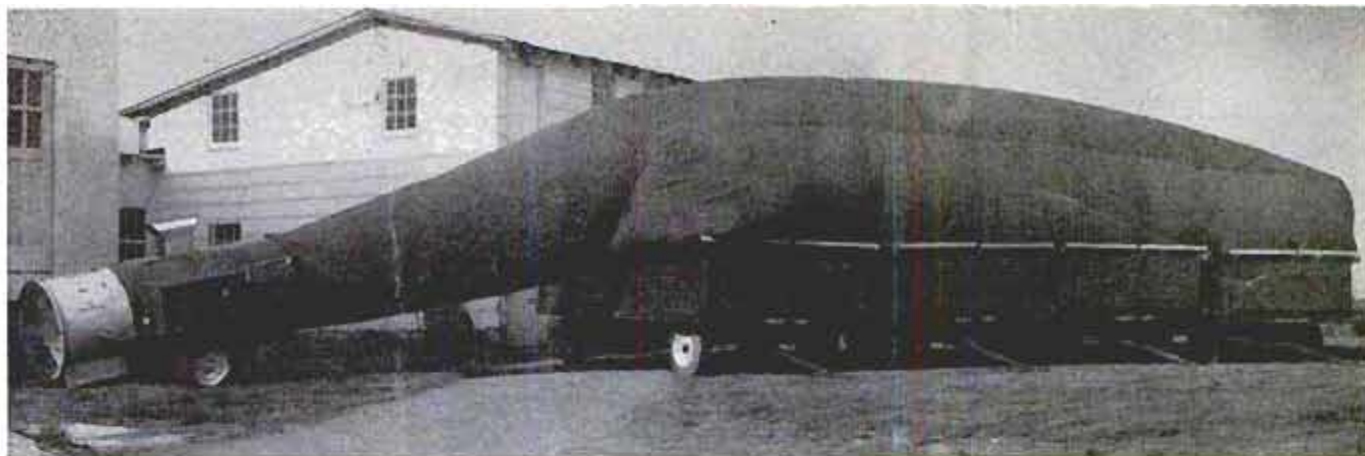

Drier Handles Four Wagonloads to Make "Hay in a Day"

Bales of hay are dried right in the wagons through a system of making "hay in a day." In this system, a mower-crusher cuts the hay, a rake rolls it into windrows and

a baler deposits the bales in a crop-drying wagon. Then a single drier handles four wagonloads under a huge canopy. Up to 10 tons of hay can be dried at once.

Telescope in Door Aids Meter Reader

When the meter reader comes to the Earl L. Crabb home in Howell, Mich., he uses a built-in telescope to read the figures on a gas meter 15 feet away. The two-section toy telescope is mounted at eyelevel in the center of the service door. When the telescope is extended for focusing, an electric switch automatically turns on a light above the meter. The light is turned off by pushing in the extended section.

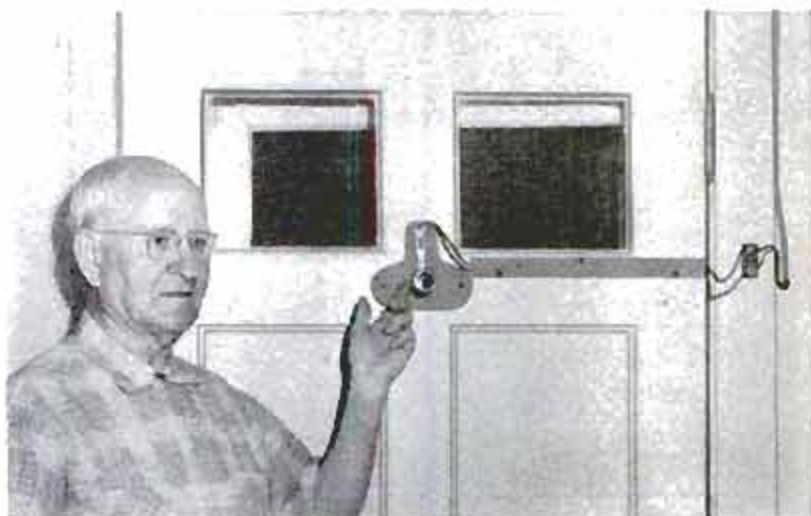

Four-Passenger Three-Wheel Car Runs on Motorcycle Engine

Powered by a single-cylinder air-cooled motorcycle engine, a four-passenger car built by a Belgian designer has a top speed of 40 miles per hour. Fuel consumption for the vehicle is 60 miles per gallon. A roller

chain drives the single rear wheel from the 1936-model DKW engine. It has three forward gears but no reverse. The seats are arranged back-to-back with the luggage compartment between seats.



WHAT'S NEW FOR Your Home

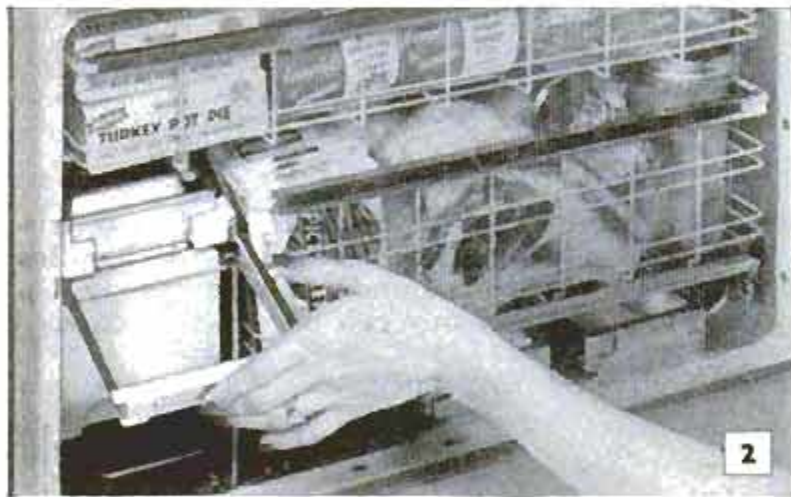

1. CEILING HEATER radiates warmth in bathrooms or other areas where wall space is scarce. It's controlled by a wall switch and uses 1000 watts of electricity from either a.c. or d.c. The ceiling location eliminates danger of shock or burns.
Modern Development Co., Box 196, Encino, Calif.

2. ICE-CUBE EJECTOR empties contents of ice trays into the refrigerator bin when handle is pushed. The ice trays are inserted upside down in a slot above the bin when the cubes are frozen. The slide-out bin keeps the cubes ready for serving.
Frigidaire Div., General Motors Corp., Dayton 1, Ohio



3. CUTTING-BOARD BOWL slides out on grooves to catch the slices of vegetables, fruits and meats. The bowl, made of plastic, can be used to store the sliced food in the refrigerator. The hardwood slicing board has a 10 by 14-inch working surface.
Mastercraft Products, 273-285 Congress St., Boston 10, Mass.

4. FOLD-AWAY IRONING BOARD has three self-locking sections that hold rigidly under ironing pressure. An asbestos-lined shelf beneath the board permits storage of the hot iron. The base is only 24 inches wide but the board opens to standard size.
Mutschler Brothers Co., Nappanee, Ind.



5. CABINET KITCHEN contains everything from three-burner range to food freezer in a unit that occupies only 5.4 square feet of floor space. Various models offer gas or electric cooking, oven, broiler, twin-basin sink and garbage disposer. Cabinet exteriors have a simulated-wood finish

General Air Conditioning Co., 4542 E. Dunham St.,
Los Angeles, 23, Calif.



6. PEELER SHARPENER will restore cutting edges if they become dull from peeling potatoes, carrots or other produce. The sharpener, made of carbon-treated steel, is drawn across the peeler blade. Tool has nylon handle, two kinds of sharpening edges and scored surface for honing

Adel Tool Co., 4013 Milwaukee Ave.,
Chicago 41



7. DOORKNOB CUSHION softens bumps on walls. The cushion is made of rubber and needs only be pulled over the knob. An inner ring makes an air pocket between the knob and cushion to reduce the noise and damage of doors banging against walls. They're sold in two sizes and colors

Clover Products, 1141 Atlantic Ave.,
Rochester 9, N. Y.

8. MATTRESS EXTENDER for tall people who find Hollywood-style beds too short. The extender attaches to the foot end of the box spring and lengthens the bed by six inches. It's easily removable if you want to take it along on trips. It's also handy to have when tall relatives visit

Better Sleep, Inc., New Providence, N. J.

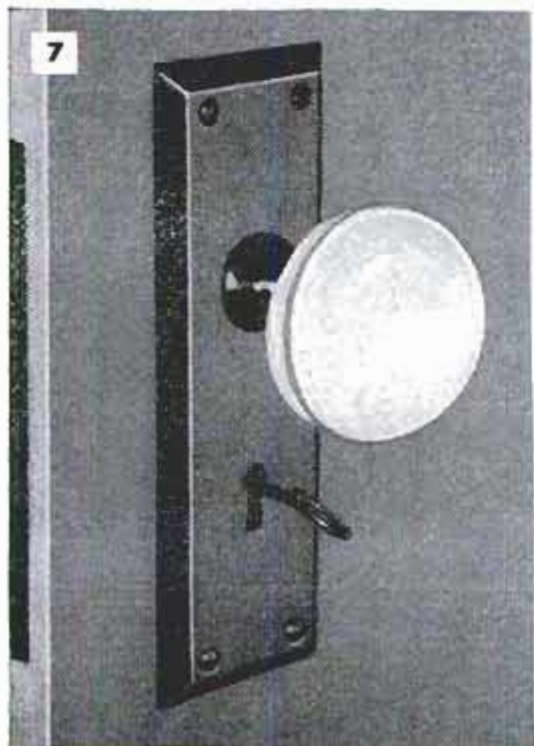



Folding Pontoons on Amphib Swing to Wing Tips

Balancing pontoons on the Italian Fiat amphibian, above and left, swing into the wing tips. The problem of sealing the hull around the landing gear is solved by folding the retractable wheels into the body. Wheel hinges are well above the water line. The pusher prop reduces cabin noise.

Austrian Watergoing "Buses" Link Danube River Cities

Three 72-foot boats recently started service in Austria as Danube River "buses." One of the boats, the *Maria*, shown below, carries 56 passengers under the canopy and 37 on deck. Powered by two four-cycle, 150-horsepower diesel en-

gines, the boats travel upstream at eight miles per hour and make a little better than 18 miles per hour on downstream trips. Each has two three-blade propellers. The Danube "bus stops" include the cities of Linz, Ottensheim, Krems and Melk.





Push-Button Guide Shows Location of Stores

When shoppers in Caracas, Venezuela, want to know where a particular store is located they push a button on an electronic directory. This causes a light to flash on a map of the city, showing exactly where the store is. The directory is in Caracas' new Centro Bolivar business center.



Cantilevered Carport Displayed in Germany

Driving in and out of a carport on display in West Berlin is easy—this one has fewer posts to hit. The cantilevered structure is made of attractive corrugated plastic on a frame of steel pipe. The arched garage was part of the International Building Exhibition.

Power-Mower Engine Operates Dry Gold-Mining Machine

Something new for prospectors is a portable dry gold-mining machine powered by a mower-type gasoline engine. Gold-bearing gravel is shoveled onto a screen which permits small particles to drop

through a trough to a riffleboard. A bellows, with flap valves, forces air through the blower box beneath the riffleboard. The air gusts boost dust and sand over cleats which hold back the heavier gold.

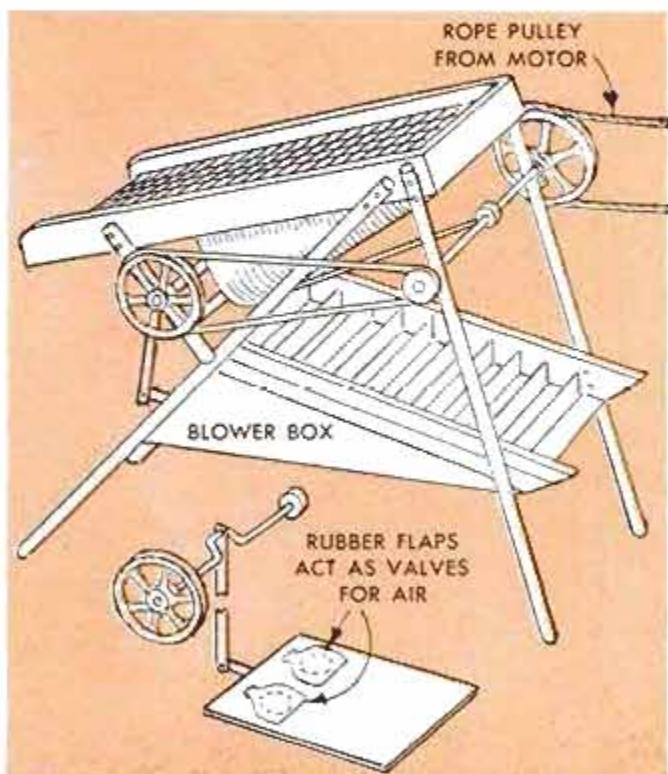

Why

By *Kenneth Anderson*

SHORTLY AFTER THE START of a recent holiday week end, a gang of burglars equipped for leisurely looting climbed to the roof of a safe-deposit company on Chicago's southwest side. They carried acetylene torches, tanks of gas and oxygen, goggles, sledge hammer, crowbars, chisels, electric fan, police radio, two brief cases and a supply of sandwiches and coffee. The yeggs crawled through a skylight and went to work on the ceiling over the vault.

Up to that point, the operation followed the same pattern as an earlier safe-deposit burglary in Seattle. With sandwiches, coffee and plenty of time, the Seattle safecrackers battered through an eight-inch-thick brick wall, burned the locks from two steel doors and cut through a steel-vault wall. They emptied 400 safe-deposit boxes and vanished.

The difference was that in Chicago the burglars never reached the vault. The sound of the first sledge-hammer blow was detected by an ADT Phonetalarm—a supersensitive microphone—concealed within the vault. It caused a red light to flash at an American District Telegraph central station and pin-pointed the scene of the crime by making a colored disk pop into a window of a box on the

In Seattle, burglars had sandwiches and coffee while they emptied 400 safe-deposit boxes. Vault lacked electronic alarms



Burglars Can't Win

Modern electronic alarm systems give crooks a rough time. Ultrasonic waves, infrared rays and supersensitive detectors can stop a safecracker before he gets his tools unpacked.

panel. (Labels on the box identify the protected property and the type of alarm.) Police converged on the building as the burglars, who had intercepted the police radio call, fled over neighboring roof tops.

The Phonetalarm is one of many electronic devices used to guard approximately \$53,000,000,000 worth of property in this country—including the gold at Fort Knox. They function without alerting the crook and help trap hundreds of criminals each year. ADT claims its electronic curtain of protection has proved 99⁹⁹/₁₀₀ percent effective over the past 10 years. A combination of electronic alarms will summon police if a burglar lifts his arm, takes a step, strikes a wall or floor, breaks a pane of glass, or lights an acetyle torch.

One of the newest devices, the ultrasonic alarm, floods a room with sound waves that are beyond the range of hearing for most humans. Any movement within the room upsets the pattern of the 19,200-cycle sound waves and trips an alarm at the central station. The burglar is not aware that he has "recorded" his presence in the room. The ultrasonic alarm often traps a thief who has concealed himself in a store before closing time. This invisible watchman has an added benefit: Rats and mice leave the property because they can't endure the high-frequency sound.

Another swift but silent burglar trap is ADT's Telapproach, which surrounds a safe or other object with an invisible electric field. The body capacity of a person approaching the electronic curtain upsets the balance of the system and trips an alarm. If you are old enough to remember the early radio sets, you may recall that the



In the days before electronic alarms, thieves could put holes in brick walls without being detected. Noise now trips alarm

Detective looks for evidence in a rifled safety-deposit vault. In pre-electronic days, thieves smashed in concrete floor





Engineer checks an experimental model of a new electronic alarm system designed for a bank vault. These alarm systems are so sensitive they are activated by the slightest sound

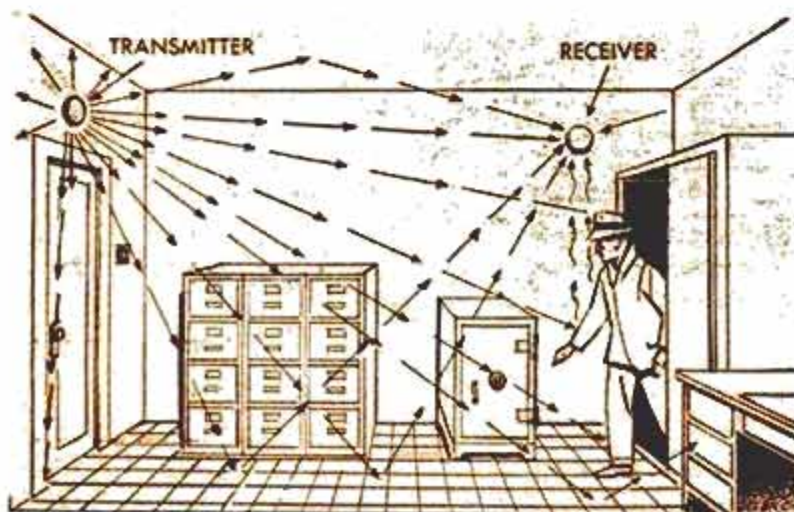

Drawing shows how ultrasonic waves trap burglar. The waves are sent from transmitter above door to receiver at right, being bounced off walls and floor. Intruder disturbs pattern

Photoelectric system below triggers burglar alarm when an intruder passes through the invisible beams. Silent alarm automatically notifies the police without alerting the burglar

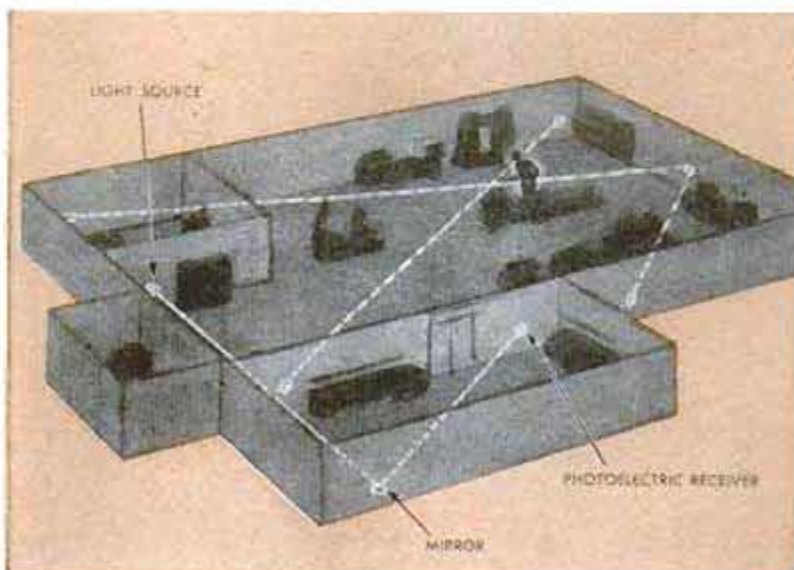

set sometimes squealed when you put your hand near the tuning dial. The same principle is used in the Telapproach alarm but the burglar doesn't hear the telltale "squeal."

Also Protect Against Fire

Some other devices employed to trap burglars also protect property against fire damage. ADT engineers have developed a heat-detection instrument so sensitive it can spot a man 100 feet away lighting a cigarette. It has been adapted to both fire-alarm systems and vault-protection systems, where it detects the use of cutting torches.

Invisible-ray alarm systems, which use beams of infrared light and photoelectric cells, also may double in burglar and fire protection. A careless guest in a Chicago hotel recently tossed a lighted cigarette from his window and started a blaze on the roof of an adjoining haberdashery. A cloud of smoke wafted through the invisible-light beam and activated the alarm. Similarly, at a Detroit lithographing plant, ADT guards answered an invisible-ray burglar alarm and discovered a smoky, overheated electric motor was the culprit. Many industries now have photoelectric beams focused directly into their heating or air-conditioning ducts. A puff of smoke passing through the duct alerts the central station and causes the dampers to close and the air-circulation fans to stop.

Used as an anti-intrusion device, the photoelectric beam is effective both day and night. In outdoor systems, the beam can be projected for distances up to 350 feet. The usual practice is to build a maze of infrared rays by using mirrors to zigzag beams from several light sources. Some beams are close to the ground or floor so a burglar can't crawl under them while other beams are too high to jump over.

Perhaps the most common burglar-alarm system depends on a thin strip of metal foil, such as you see on many department-store windows and office doors. If the glass is broken, the foil tears and the alarm is tripped. A hoodlum might think it would be simple to smash a small hole in the center

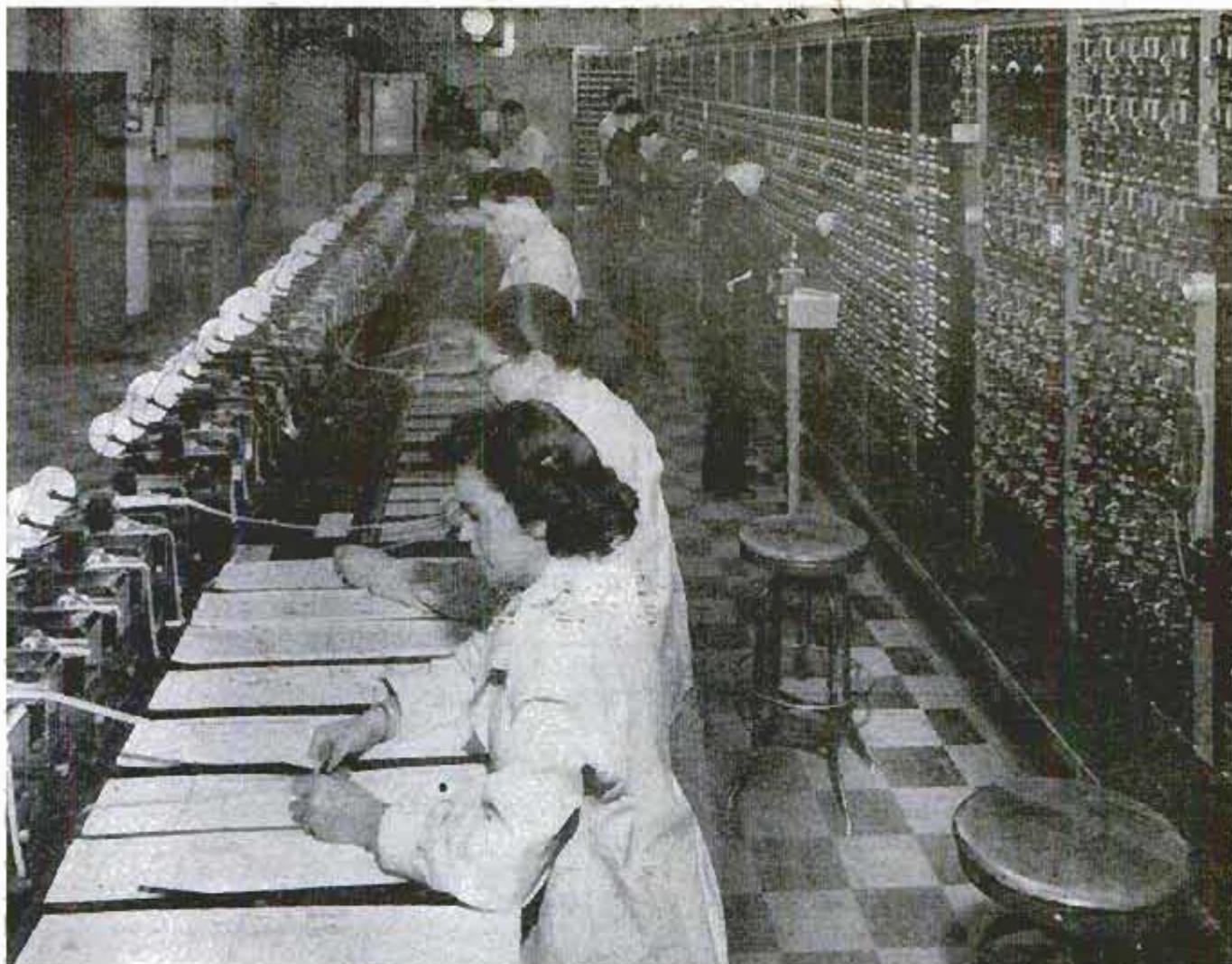

More than a thousand burglar-alarm systems in St. Louis are connected to this busy ADT central station

of the glass without breaking the strip of foil. But ADT engineers and insurance underwriters have learned from experiments that it's virtually impossible to break a pane of glass without breaking the foil if the foil is placed a certain number of inches from the center of the pane. And even a crack in the glass can trip the alarm.

A couple of years ago a turtle escaped from his pen in the pet department of a store. He waddled upstairs and started an alarm by scratching the foil on a door.

Since time is of the essence in trapping a burglar, one of the simplest yet most effective types of protection for a steel safe is a foil-lined wooden cabinet built around the safe. A yegg cannot reach the safe without first forcing an opening in the cabinet and he can't crack the cabinet without disturbing the electric circuit in the foil lining. Most burglars carry tools that can easily batter through the wooden panels, but the extra few minutes it takes for this task give the police the time they may need to catch the criminal.

Burglar Throws Switch

A burglar who entered a Louisville, Ky., department store tried the apparently

"easy" way of getting through a foil-lined cabinet. He simply threw the ADT burglar-alarm control switch from "night" to "day" position, thinking that would prevent the alarm from sounding at the central station. He didn't know that ADT alarm circuits can't be turned off or on without the knowledge of the men on duty at the central station. In fact, each alarm circuit is tested when a subscriber closes his office, store or factory—just in case some would-be burglar has tampered with the wiring. When the subscriber sets his alarm for "night" position, central-station employees check the circuit. If it is working, they signal the subscriber, usually by causing a bell to ring in the switch box. Opening and closing the alarm-wired door immediately after that tells the central station the owner has "locked up" for the night. ADT employees also make routine checks of the alarm circuits and test the sensitivity of certain devices, such as the Phonetalarm. The Phonetalarm in a fur-storage vault, must be adjusted to the number of furs protected since the pelts absorb some of the sound. The Phonetalarm ordinarily is so sensitive that ADT claims no bank vault equipped with the device

(Continued to page 270)

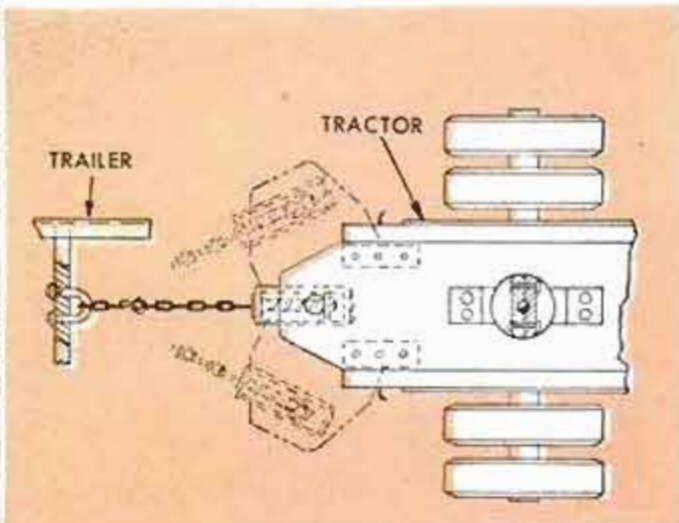

Pivoted Cylinder Reduces Trailer-Jackknifing Threat

Extra protection against tractor-trailer jackknifing on curves and sudden stops is promised by a device that holds the trailer on its pivot. It consists of a cylinder mounted in a pivoting framework which,

in turn, is attached to the tractor's pivot plate. The cylinder has a powerful coil spring which controls a piston rod. A chain connects trailer and piston, which counteracts the trailer's momentum.

Swivel-Mounted Mirror Tracks Sun for Stanford Solar Furnace

Generating heat up to 6000 degrees F., a solar furnace at the Stanford Research Institute uses mirrors mounted on a swivel to track the sun automatically. The sun-

light is reflected to a curved aluminum mirror, 32 feet above, which concentrates the rays. This permits the furnace to remain fixed instead of following the sun.

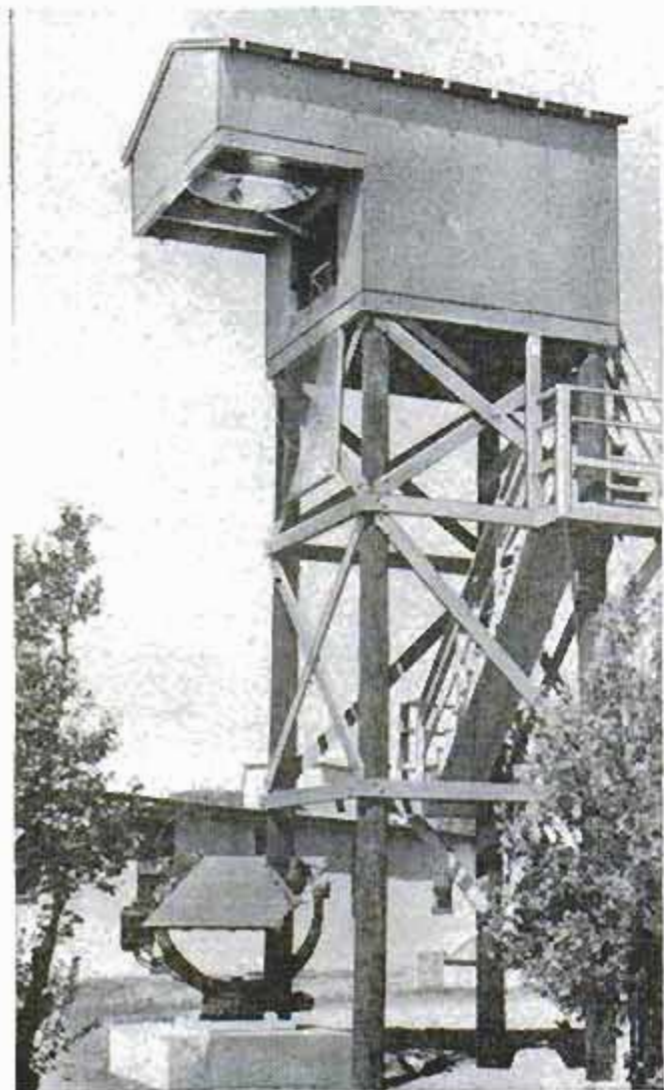

Bird Trips Feeder By Landing on Perch

Something new for the birds is a self-service "cafeteria" feeder. When a bird lands on the perch, it trips a lever to dispense an average meal. Several pounds of feed can be stored in it. The device is made of steel, comes painted and ready to hang.

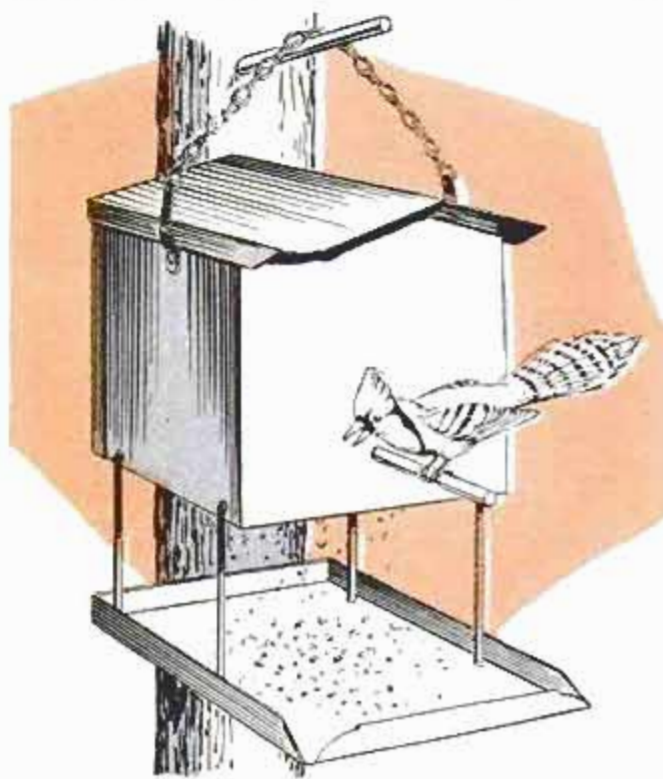

Tire-Skid Detector Thumps Pilot's Foot

Triggered by a sensory device in the airplane's wheel axle, a new kind of antiskid system warns the pilot of an impending skid by rapidly thumping the bottom of his foot. The foot thumper, a vibrating plunger that projects through a hole in the brake pedal, signals the pilot to ease his brake pressure to allow the wheel to rotate again. Pilots of high-speed aircraft may not be aware that the wheels are skidding during a braked stop unless the plane is equipped with a warning device.



Backhoe Operator Always Faces Work

Problems of excavating around pipes and other underground objects are solved with power equipment that allows the operator to see where the bucket is digging. The seat travels with the boom so the man at the controls of the backhoe always faces his work, whether digging or loading trucks.

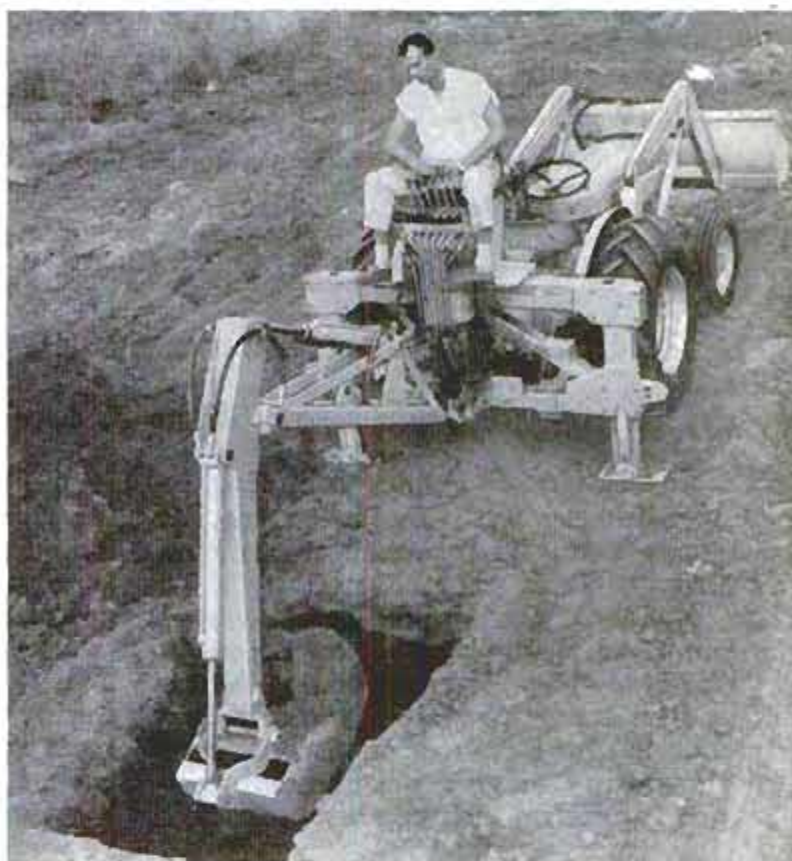

Patterns on Plywood

Now the do-it-yourself fan can buy a sheet of plywood with the project pattern already printed on the material. Photographs below show the machine used to print cutting lines on a 4 by 8 sheet of plywood and the outdoor serving wagon made from the pattern.

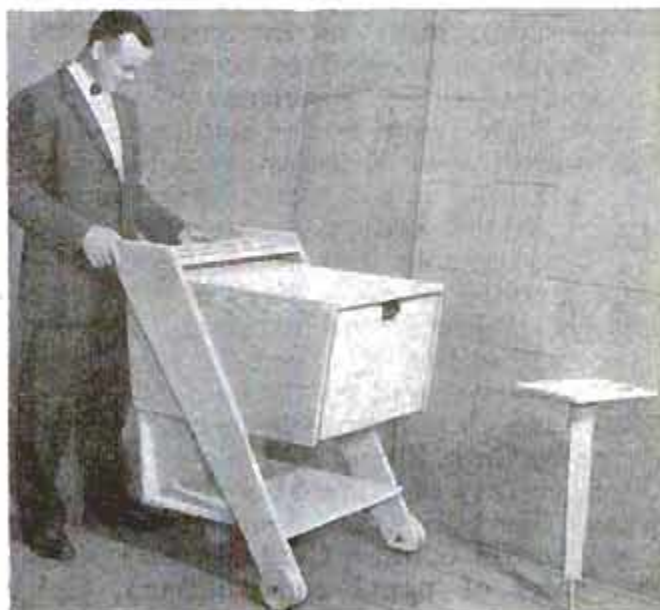
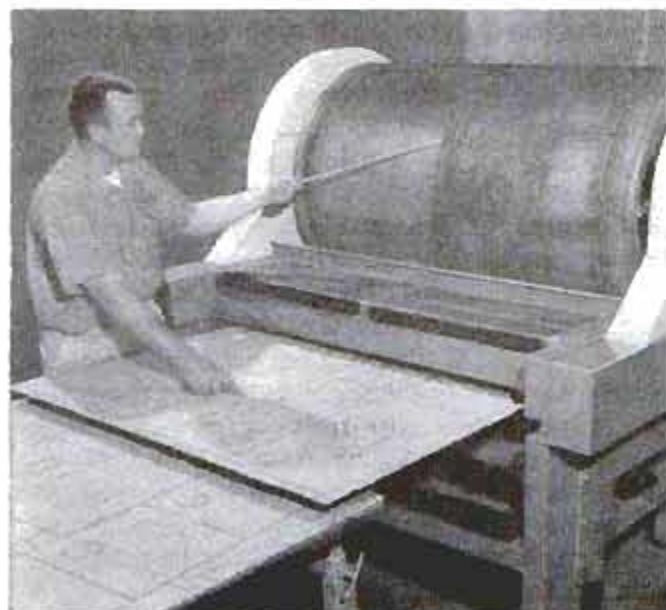

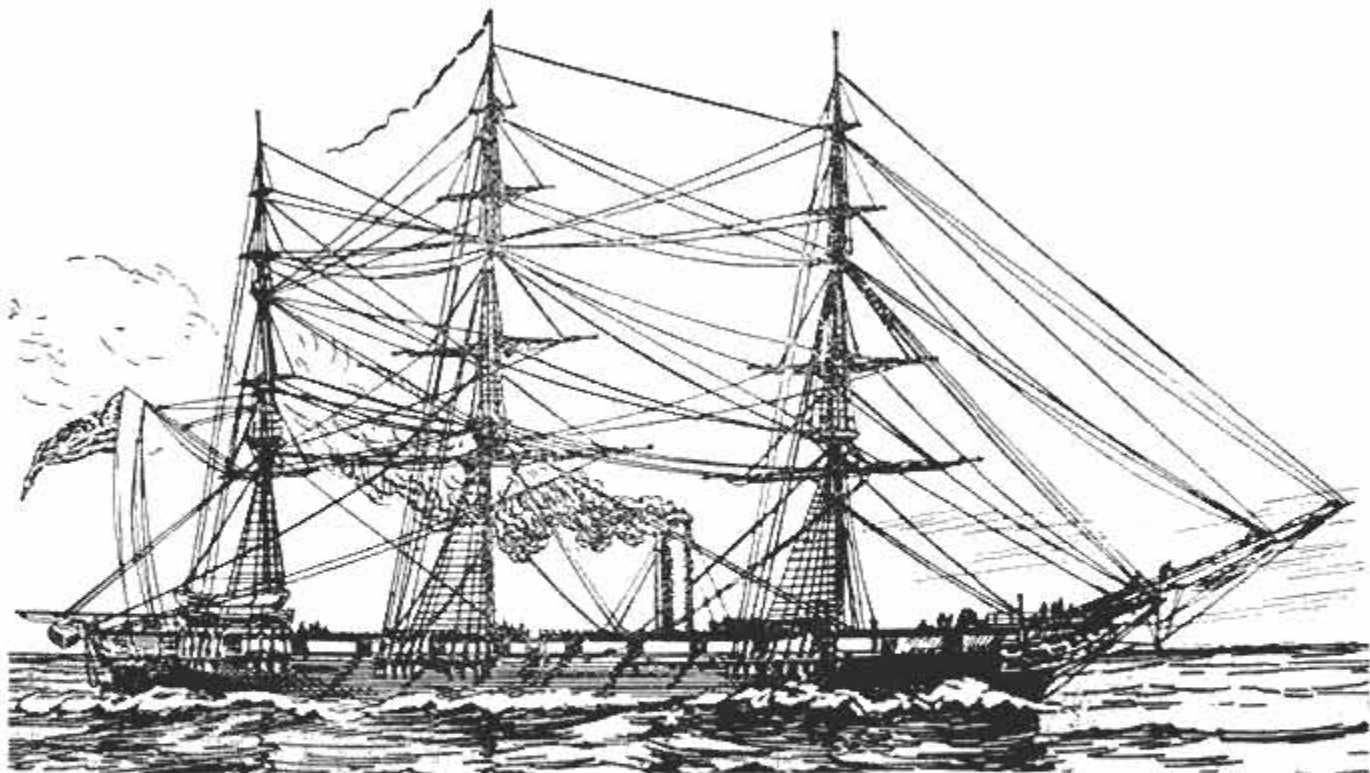

The Bettman Archive

Princeton, fitted for conversion to auxiliary sail, was launched in 1843 and changed course of naval history

The Saga of the USS *Princeton*

The world's first screw-propelled warship

By William R. Graydon

STOCKTON, CALIF., came within inches of winding up with another name. It might have been Woonsocket, Kearny or Shickshinny. Take your choice.

The incident that almost eliminated Stockton from the running took place on Feb. 28, 1844, when the USS *Princeton*, the world's first screw-propelled warship, lay at anchor in the Potomac off the nation's Capital, waiting to give a command performance for distinguished guests.

Commanded by Capt. Robert Field Stockton, the amazing propeller ship boasted something quite as intriguing as its steam-driven engines: Two huge, wrought-iron guns called the "Peacemaker" and the "Oregon." Designed by the brilliant Swedish inventor, John Ericsson, who also had originated the ship's plans, these extraordinary naval cannon reportedly could fire 213-pound shot up to three miles.

The promise of witnessing the big guns in action while cruising down the Potomac was a magnet for Washington's top brass. Marines were drawn to attention as President John Tyler was piped on board to be greeted by Capt. Stockton. Following Tyler were Secretary of State Abel Upshur, Sen. Thomas Hart Benton, Secretary of the Navy Thomas Gilmer, Capt. Beverly Kennon (chief of naval construction), Col.

David Gardiner (the president's father-in-law) and a host of other dignitaries. Mrs. James Madison, nearly 80, joined 200 prominent ladies who added a splash of color to the scene.

It was a proud day for Robert Stockton. The *Princeton*, which promised to revolutionize world shipping, would have remained nothing more than a blueprint if Stockton had not used all his zeal to bring her into existence.

Years earlier, Ericsson had offered his invention to the world's ranking sea power, England, and even built a screw-propelled barge to demonstrate his idea. But the British Admiralty tossed the invention aside, dismissing it as impractical. Stockton met Ericsson while visiting the U. S. consul at Liverpool. One excursion down the Thames on Ericsson's barge was enough to convince Stockton. The American asked Ericsson to build two iron boats of a similar design for the United States.

Earlier, Sir William Simonds, chief contractor for the British Navy, summed up the Admiralty's opinion by remarking, "Even if the propeller had the power of moving a vessel, it would be found useless in practice, because with power applied in the stern, it would be absolutely impossible to make the vessel steer."

Other British naval engineers put it more graphically: "When people can walk on their hands or horses are harnessed to the back of a wagon, then the Swede's outlandish idea might be practical."

Fortunately, Stockton had ample private means, because he had to shell out large sums on plans and models before he could convince his own Navy Department of the propeller's value. Ericsson joined him in the United States in 1839, but their initial efforts met a brusque reception. Crusty commodores eyed the project coldly. Paddle-wheelers might blunder their way about in river traffic, but a screw-driven man-of-war was something else. And nothing could replace sail in crossing the ocean.

Eventually Stockton wore them down, and in 1841 he was permitted to build the Navy's first steam-driven warship utilizing the propeller. Two years later, the *Princeton* was launched at Philadelphia.

Little wonder Capt. Stockton glowed with pride that mild winter day as his unique craft made its way down the Potomac with its distinguished guests. In turn, the visitors found much to interest them. Outfitted for conversion to auxiliary sail, the *Princeton* was the fastest steamship afloat. Her engines, snug below decks, were almost invulnerable to enemy gunfire, and could take her in and out of port at will.

Remarkable though the engines were, the ladies and gentlemen found themselves eyeing the two huge cannon with awe. Devised by Ericsson, the powerful cannon were the first of their type to be built of wrought iron. The "Oregon," on the stern, weighed seven tons while the "Peacemaker," a 10-ton gun, was on the bow.

Ericsson's inventiveness had not ceased



Courtesy U.S. Navy

Robert Stockton saw importance of Ericsson's invention. His efforts brought *Princeton* into existence

with the guns proper. He designed a new type of gun carriage to handle their terrific recoil, and also a self-acting lock that allowed the cannon to be elevated or deflected, a giant stride in naval armament. The soundness of the guns was revealed in a test-firing run when they were brought to bear on a dummy-ship target. Using only light charges of powder, the shots passed through timbers 57 inches thick. Six shots struck the same horizontal plank in the target at a distance of more than a half mile. The exhibition affected naval

Explosion of the big gun killed two cabinet officers. President Tyler escaped because he was below deck

The Bettman Archive





The Bettman Archive

John Ericsson designed the screw-propelled *Princeton* and the two huge guns which affected naval warfare

warfare as dramatically as Ericsson's propeller.

In addition to her heavy cannon, the *Princeton* carried twelve 42-pound carronades. With the ship gliding along between open reaches, Stockton demonstrated its firepower by firing each piece in rapid succession, winding up with an earth-shaking roar from the "Peacemaker." The ship shook with the concussion and the deck was clouded in smoke. Stockton commented, "It's nothing but honest gunpowder, gentlemen. It has a strong smell of the Declaration of Independence, but it's none the worse for that."

The guns made a favorable impression on the President, his party and the other guests. During the cruise down the river, the big guns were discharged time and again until the guests' curiosity had been satiated. Then the passengers went below. Passing under Fort Washington's battlements on the right, below Alexandria, the guests were treated to dinner.

After the meal the ladies remained at their tables while several male guests went topside for a smoke and stroll about the decks. Capt. Stockton, who had stayed below with the President, was preparing to offer a toast to Tyler when an officer informed him that some of the company wanted one of the guns fired again.

Stockton dismissed the aide with "No more guns tonight." A moment later the officer returned with a message from Secretary of Navy Gilmer, expressing his de-

sire to see the "Peacemaker" in action once more. The *Princeton's* captain took the request at face value, as an order, and went on deck to carry it out. When preparations had been made, Stockton placed himself on the breech of the gun, aimed and fired.

The blast came with a blinding flash as the "Peacemaker" burst with a roar, shattering 20 feet of the bulwark as it blew up.

Col. Gardiner and Mr. Moxey, former chargé d'affaires at The Hague, were killed outright, while Capt. Kennon fell back mortally wounded. Sen. Benton was felled by a head wound, and a servant standing next to him was killed. Secretary of State Upshur, uncertain of the guns all day and half-hidden by the foremast, was killed by a chunk of hot shrapnel, while Navy Secretary Gilmer was slammed to the deck in a lifeless heap.

President Tyler, about to join his friends topside, had been detained by one of the ladies and was on the point of excusing himself when the blast shook the *Princeton*.

Stockton, standing at the gun, had a miraculous escape, although he was badly scorched and temporarily blinded. Groping on the deck, he managed to retain command, even making sure the seriously wounded received immediate care. The ship was met at Alexandria by the *Joseph Johnston*, which carried the dead and injured back to Washington.

Sen. Benton and the other wounded, including Stockton, eventually recovered. The blast could have been a deathblow to the career of the *Princeton's* captain, but a naval court of inquiry absolved Stockton and Ericsson of blame.

Fully recovered by mid-1846, Stockton, now a commodore, was dispatched to New Orleans with the *Princeton* to transport the 3rd Infantry, including Lieut. Ulysses S. Grant, to the east coast of Mexico. Later he was assigned to relieve Commodore Sloat at Monterey, Calif.

A veteran of the War of 1812, Stockton played a vital role with Frémont and Kearny in the conquest of California, but in perspective these exploits were dwarfed by his staunch support of John Ericsson. Stockton's unyielding belief in his friend's inventions literally changed the course of U. S. Naval history.

Yet it almost turned out otherwise. The fatal blast that snuffed out the lives of cabinet members and missed killing or wounding President Tyler by a whim of fate, also came within inches of removing Capt. Robert Field Stockton from the scene.

Except for that narrow margin, the folks at Stockton, Calif., might find themselves writing another name on their return address. Say Shickshinny. ★ ★ ★



Is Population Outgrowing The World?

ONE TENTH of all the persons who have ever lived on our earth are alive today. That statement, more than any other, dramatizes the rapid growth of world population in our day.

Any precise census of the entire world is an impossibility. The sociologists who study the problem on a global basis, however, estimate today's population somewhere in the neighborhood of 2.7 billion persons and predict that it will reach 4 billion by the year 2000.

They estimate the daily net growth—new births minus deaths—between 110,000 and 130,000.

Is it time we became alarmed? More than 100 years ago the problem concerned the Rev. T. R. Malthus (1766-1834), political

(Continued to page 264)

BEGINNING WITH this page, *Popular Mechanics* presents its Sixth Annual Automotive Section—your yearbook of the industry. Highlighting the section this year is a full-color portfolio of the 16 most significant cars in American automobile history. These are cars of great social, mechanical or economic significance. This is just one of the many articles about all phases of the industry, ranging from the all-new Thunderbird to the Sputnik-like Heinkel.

America's Most **SIGNIFICANT CARS** *a Historical Portfolio*

Paintings by Ed Vebell

IT'S DIFFICULT to think of any material object of greater significance in American life than the automobile. It has influenced our cities, our farms, our homes, our recreation and our work.

It has permitted us to travel more than any people ever traveled in history before us. It has permitted cities to spread out and overflow into suburbs. It has, tragically, provided a means of involuntary manslaughter that makes predicting holiday death tolls a national pastime.

The automobile, we all must admit, has and will continue to have great significance.

Among the many thousands of makes and models of cars that have been manufactured in this country, most have had no lasting influence on either the nation or the industry. Like fashions in dress and architecture, they have often come noisily and gone quietly.

But there have been cars of great influence. These are the significant ones. *PM* asked five automotive historians (see page 153) to help us select the 16 cars that have been the most significant. The following eight-page color insert presents their choices. A longer list appears on page 153 so you can match your selections against those of the experts.

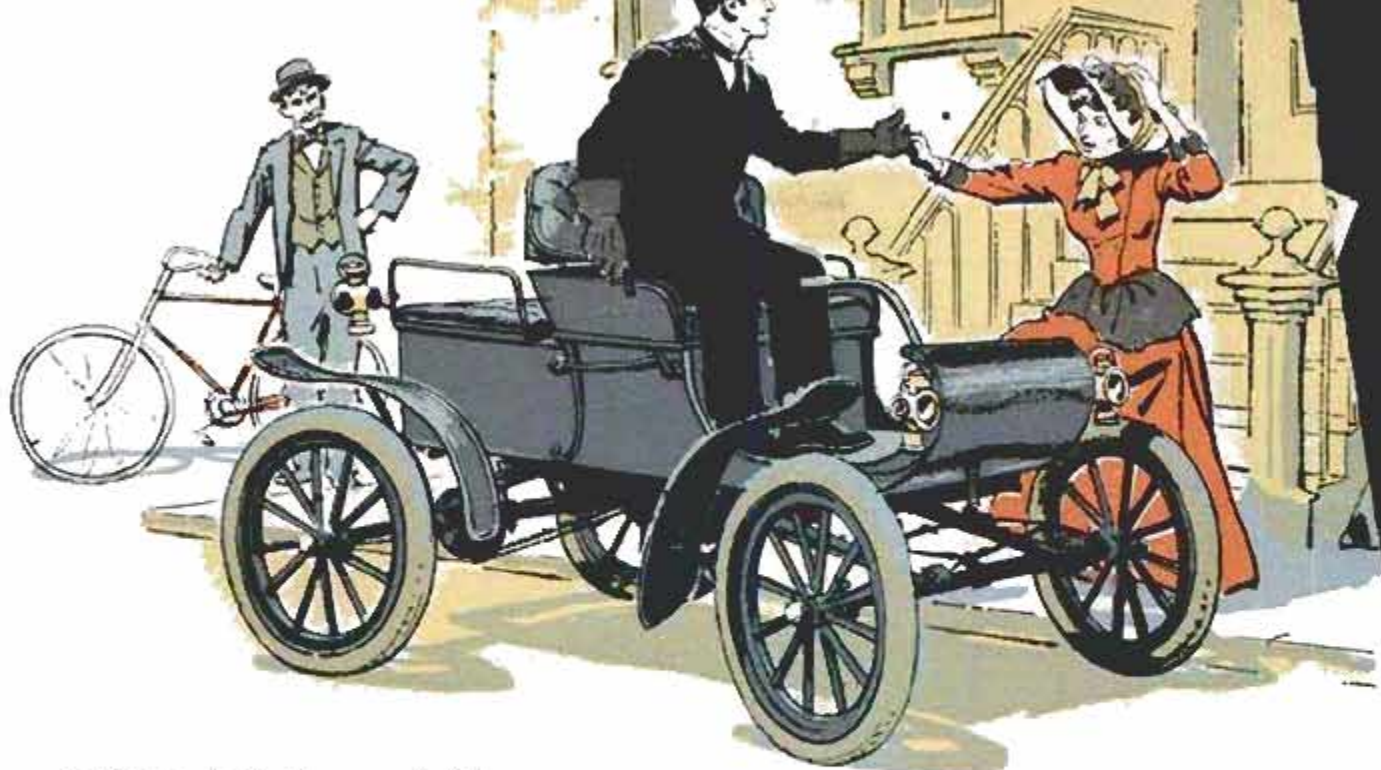

1902 Oldsmobile

Although primitive in design, the curved-dash Olds was our first mass-produced gasoline car. Reliable, quiet, it sold in volume. Production jumped from 425 in 1901, to 3299 in 1902, 5000 in 1904

1905 Pierce Great Arrow

Proving that cars could be top-quality machinery, this touring car established a reputation for reliability. It had a cast-aluminum body with rear doors, steering-column gear shift, battery ignition

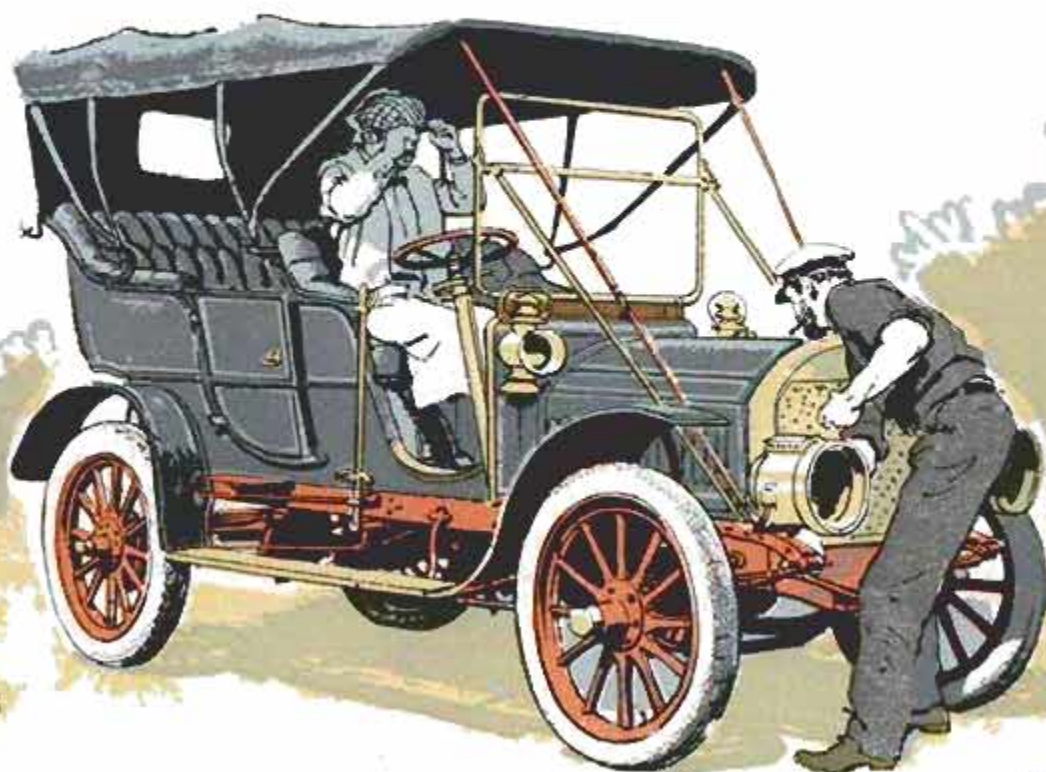

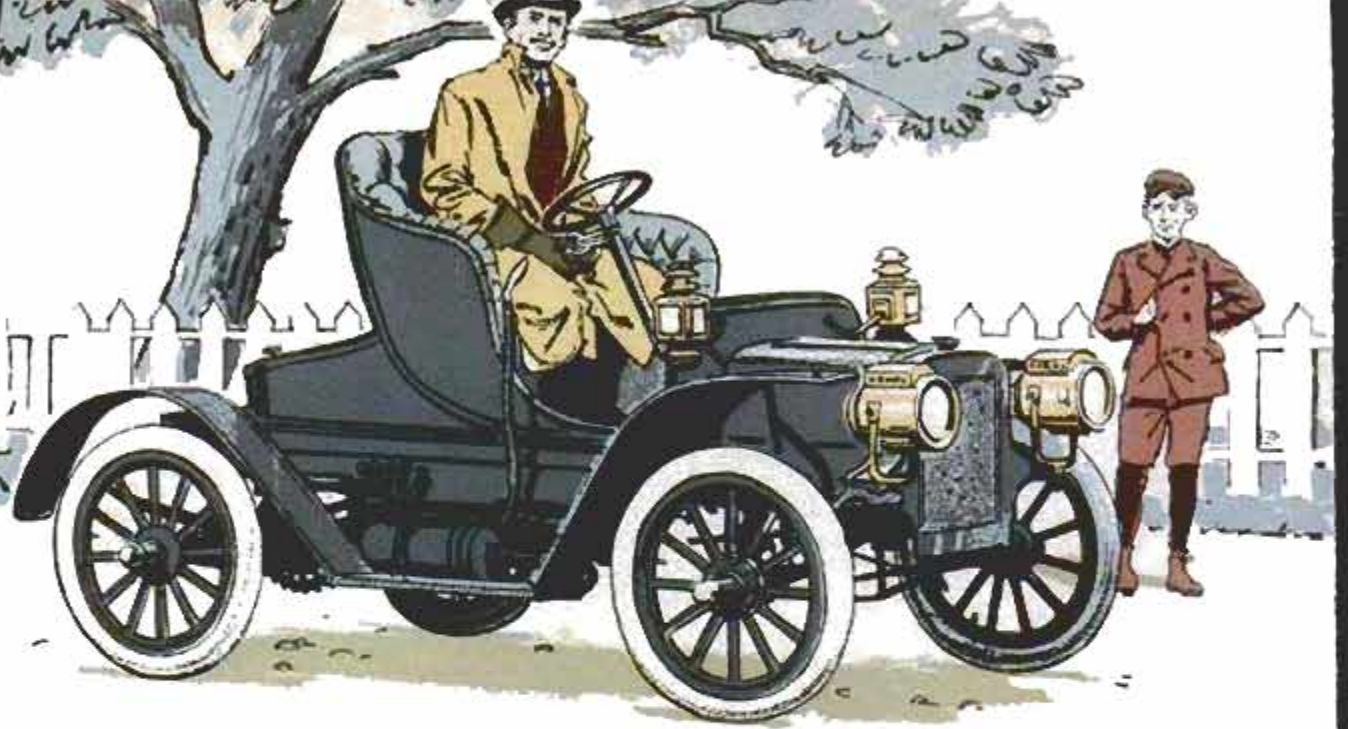

1908 Cadillac

Interchangeability of parts was proved when three 1908 Cadillacs were torn down, the parts of all three scrambled and the cars reassembled to run perfectly and win the famed DeWar Trophy

1909 Ford Model T

More than a car, the legendary Model T was a symbol of America on wheels. Over 15,000,000 were produced in 19 years. It was a simple, reliable machine with many minor faults, few major ones

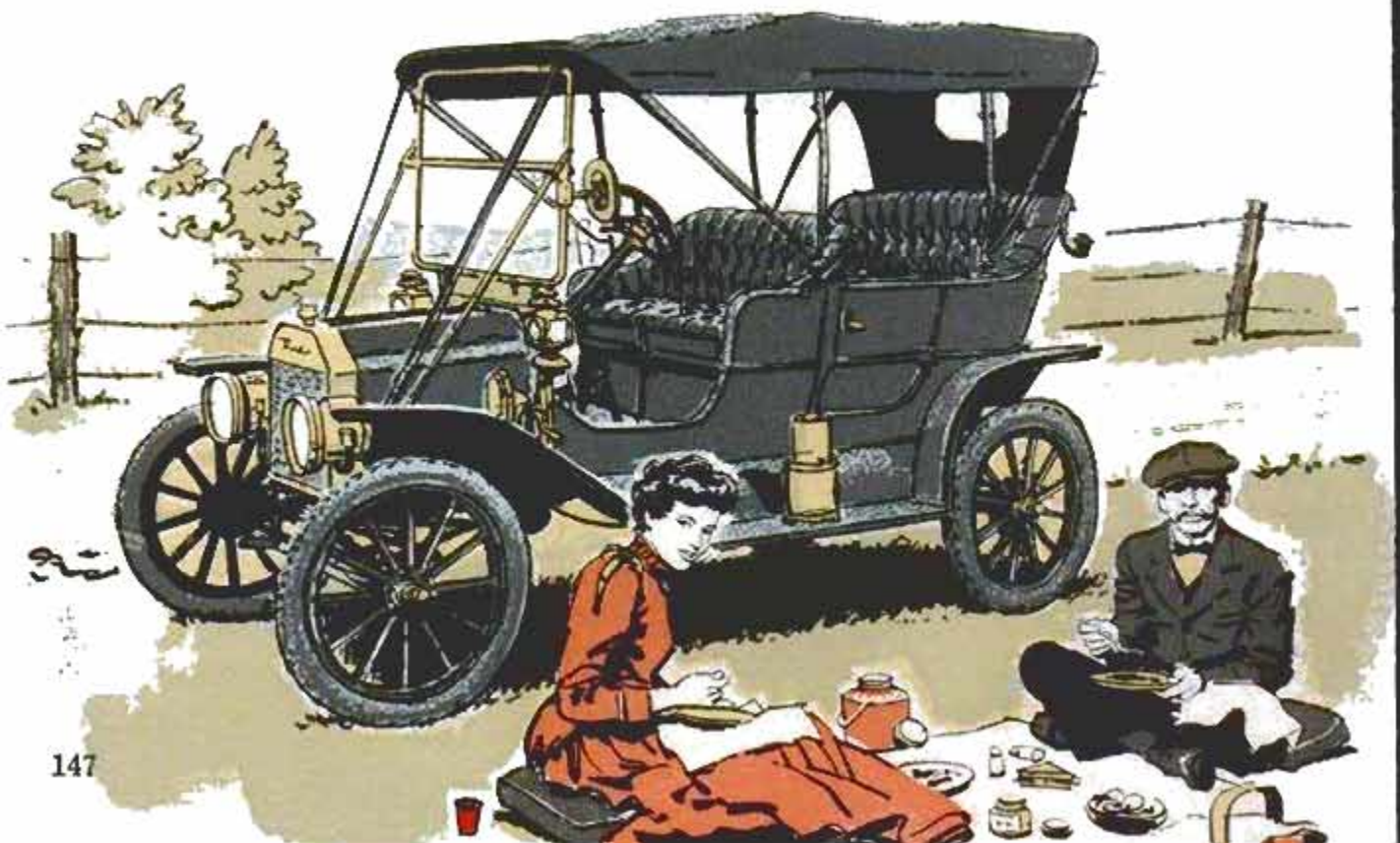

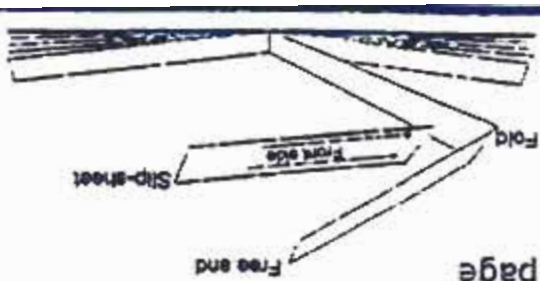

1. Open the foldout page
2. Insert this sheet with
 1. Front side touching the free page
 2. Arrow pointing to the fold
3. Slice the folded edge
4. Close the page and slip-sheet

Inverted Foldout slip-sheet



GbsSlipSheet-001

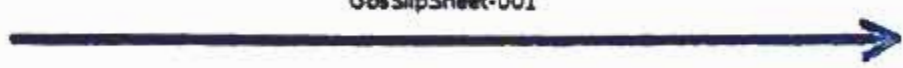

Foldout slip-sheet

Folded edge of the page

1. Open the foldout page
2. Insert this sheet with
 1. Front side touching the free page
 2. Arrow pointing to the fold
3. Slice the folded edge
4. Close the page and slip-sheet

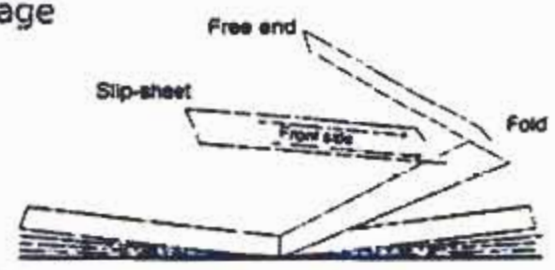

1. Follow instructions on the other side

Inverted Back



GbsSlpBack-001B

Back

1. Follow instructions on the other side



1896 Duryea

With this car, an industry began. First to be produced in quantity (13 were built in Springfield, Mass.), first to be sold to a customer, it was designed by J. Frank Duryea, now living in Connecticut

Box 4, MADISON, CONN.

1898 Columbia Mark VIII

Basic design has changed little since this car. It had left-hand steering by a wheel, front engine behind a radiator, sliding-gear transmission with clutch, shaft drive. Designer: Hiram Percy Maxim

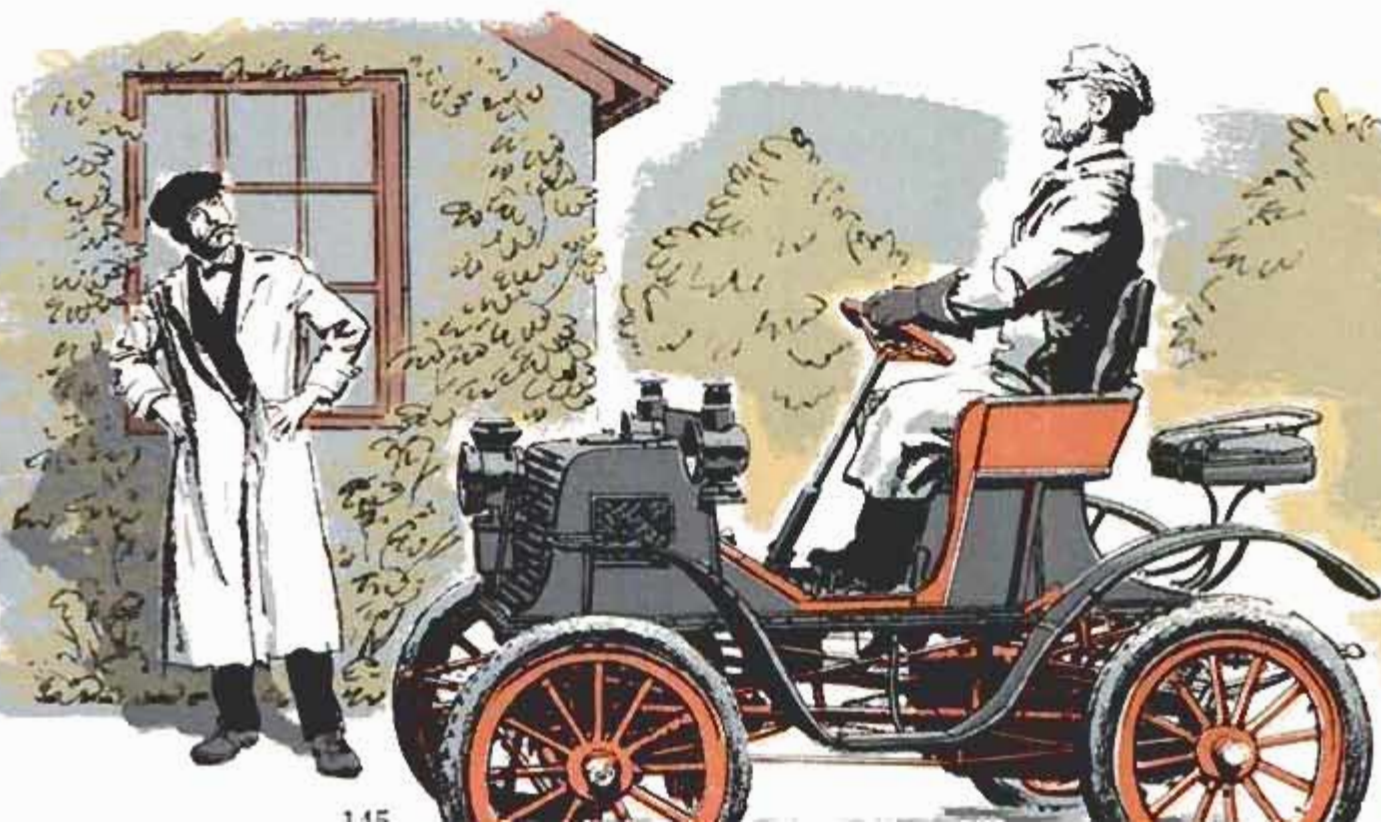

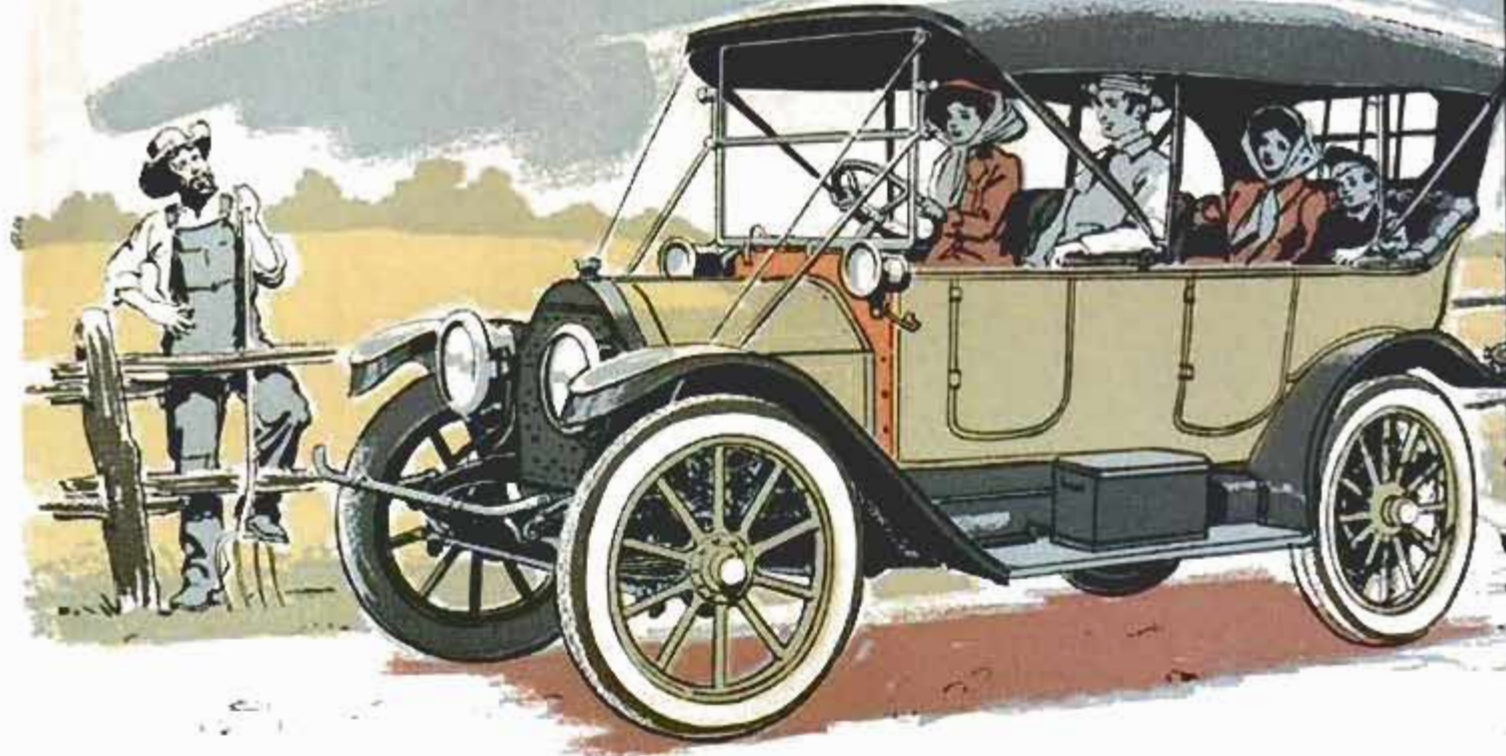

1912 Cadillac

Cadillac's self-starter of 1912 began the feminization of man's plaything, the automobile. Not the first nor the best self-starter, it was the first to be installed as standard equipment in America

1915 Cadillac

Forerunner of today's power plants, the Cadillac V8 was the first high-speed V8 engine in America. The reliable and well-designed engine was concealed beneath a stodgy, lackluster body

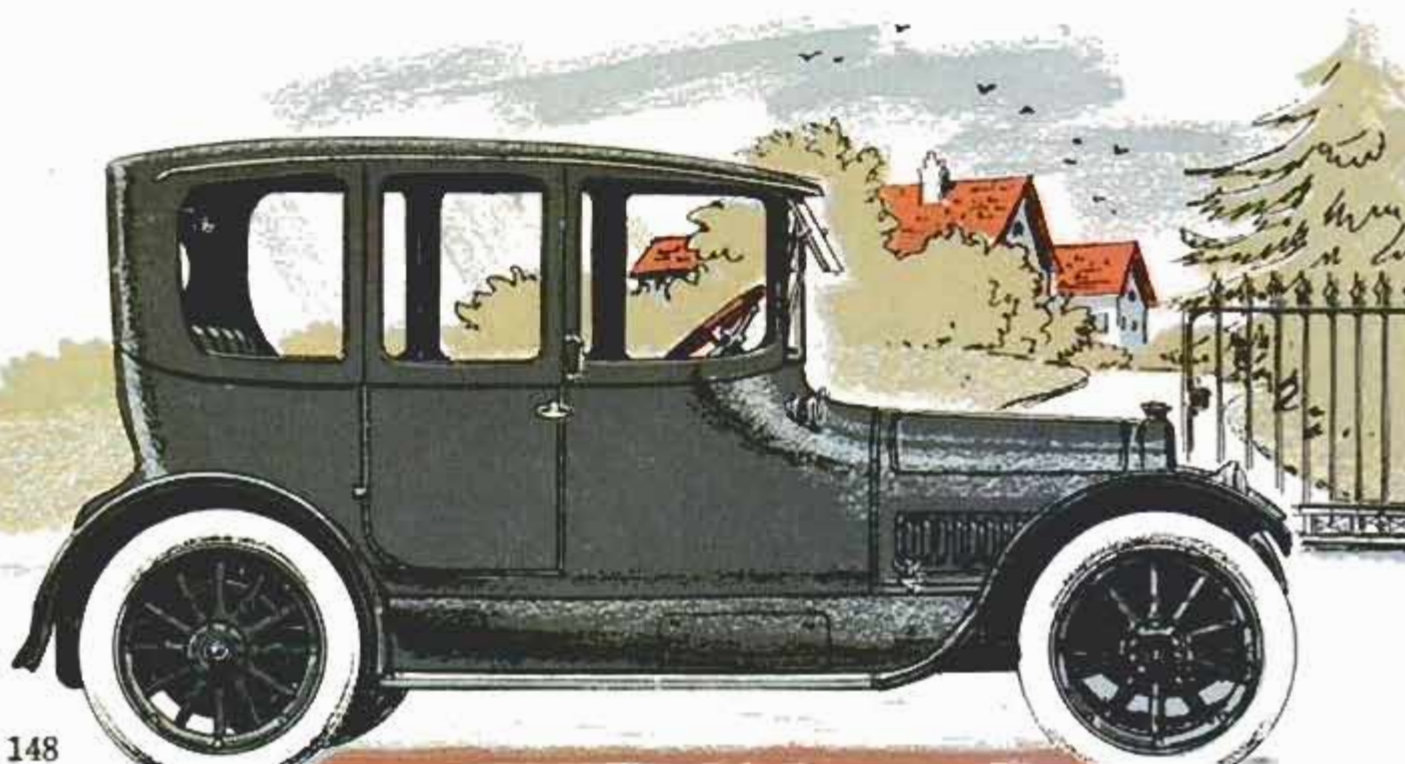

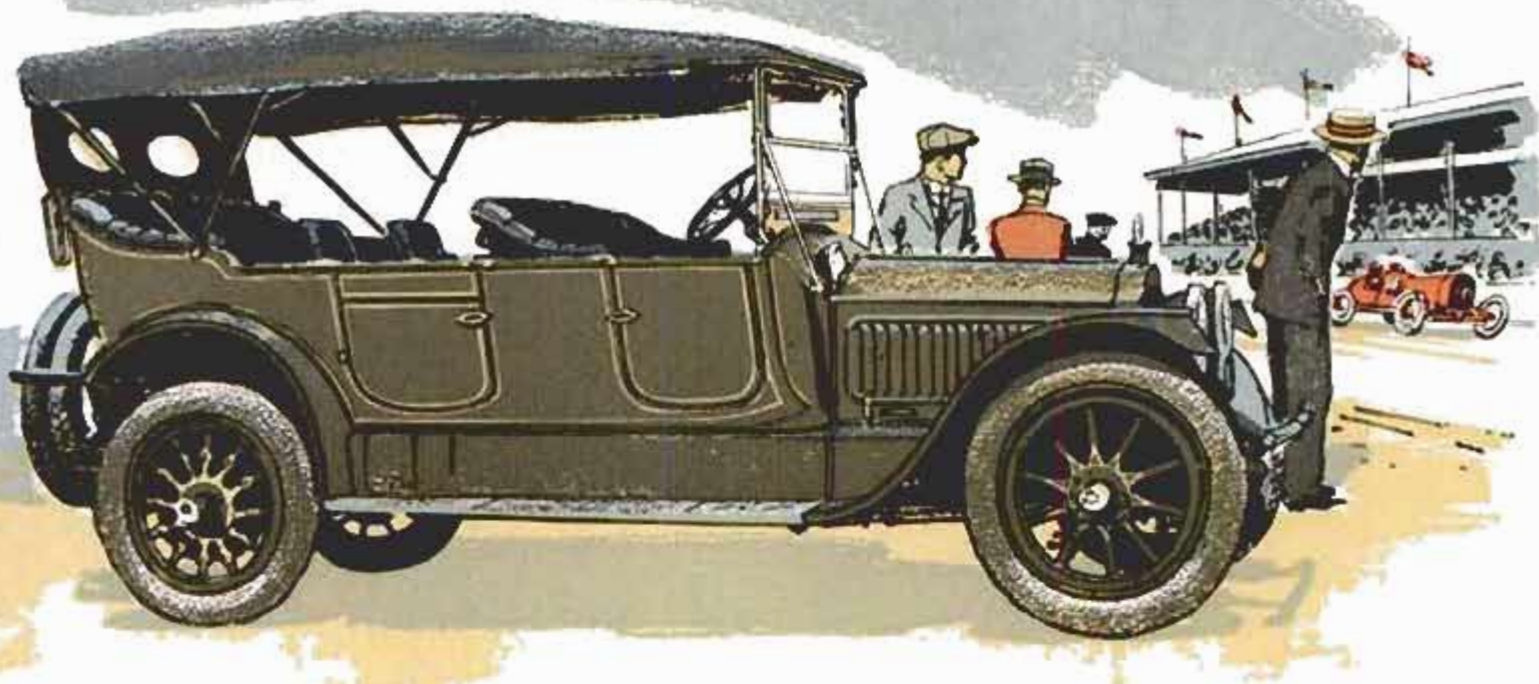

1916 Packard Twin-Six

SEE AUG 58, 12
+ OCT 58, 8

Smoothness and power were combined in the thrilling Packard Twin-Six, best of the 12-cylinder designs. Performance of this elegant car proved that there could be more to driving than transportation

1921 Essex Coach

When Essex offered the glassed-in comfort of a coach for a price just a bit higher than its open model, a revolution began. After 1921, the days of the windy and dusty open car were numbered





1934 Chrysler Airflow

Significant in failure, this pioneer attempt at streamlining taught that change must be gradual—a lesson still remembered. It also proved that no matter how advanced, an ugly design won't sell

1940 Oldsmobile

Nothing since the self-starter has been as significant as the automatic transmission. The 1940 Olds was the first to offer a reliable unit, an important step toward the fully automatic car

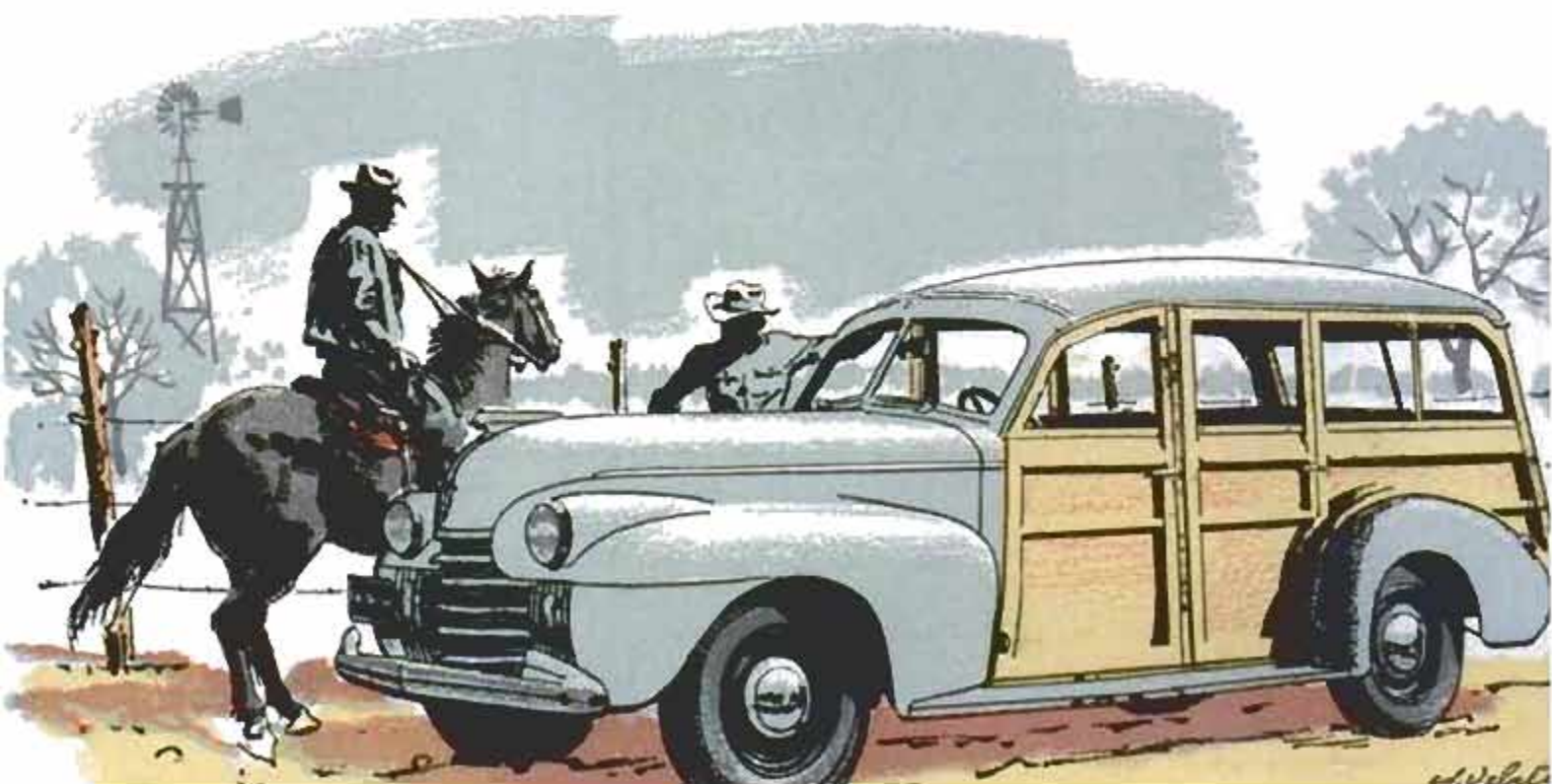

1. Follow instructions on the other side

Back

Gps511back-001B

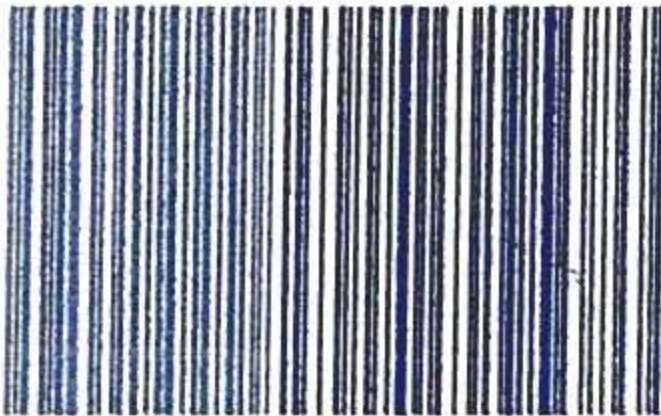

Inverted Back

1. Follow instructions on the other side

Folded edge of the page



Inverted Foldout slip-sheet

1. Open the foldout page
2. Insert this sheet with
 1. Front side touching the free page
 2. Arrow pointing to the fold
3. Slice the folded edge
4. Close the page and slip-sheet



Foldout slip-sheet

1. Open the foldout page
2. Insert this sheet with

1. Front side touching the free page
2. Arrow pointing to the fold

3. Slice the folded edge

4. Close the page and slip-sheet

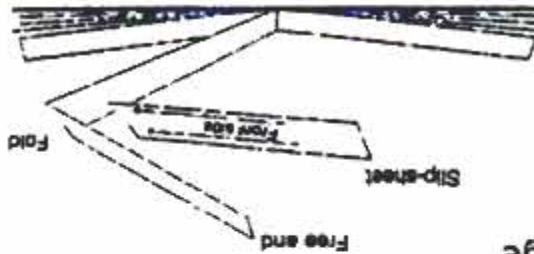



1924 Chrysler

With a high-speed, high-compression engine, with its four-wheel hydraulic brakes, small wheels and large tires, the first Chrysler was a pace setter for the industry both in style and in substance

1928 Ford Model A

After the Model T came the Model A. No financial success, the car was simple, reliable and rugged. It was basic automobile design at its best. Shatterproof windshield glass was a real safety first

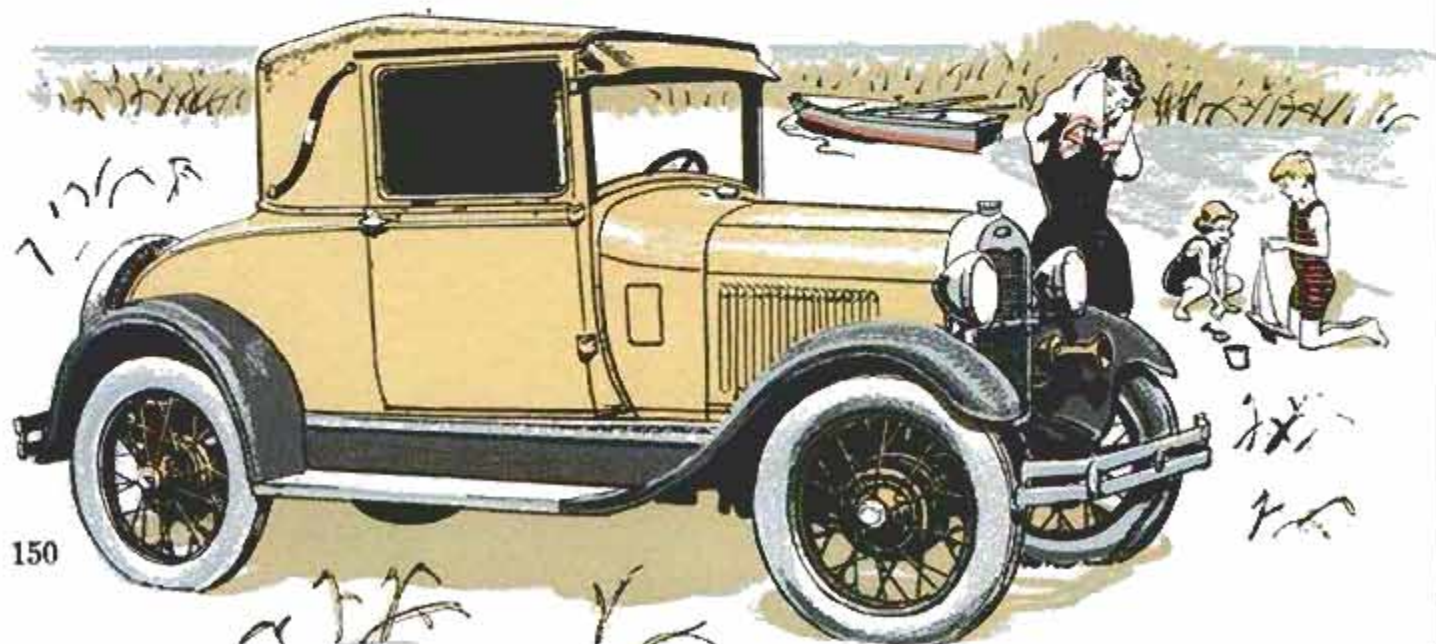

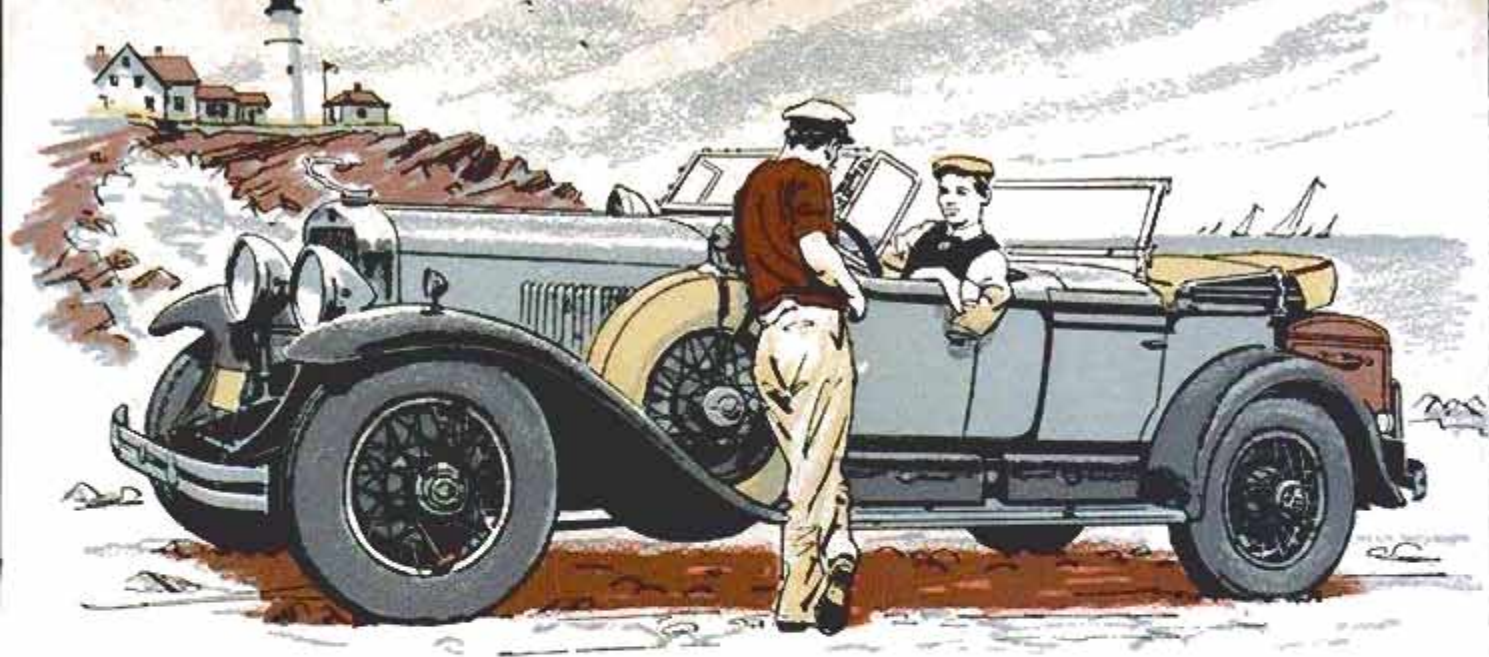

1929 Cadillac

Continuing to make driving easier, the 1929 Cadillac brought out its synchromesh transmission. No longer could you identify the novice driver by the grinding noises as he shifted the gears

1932 Ford V8

Bold, indeed, was the step Ford took when it introduced the powerful V8 engine into the low-price field, an engine so far advanced that it was built without major change for 22 years

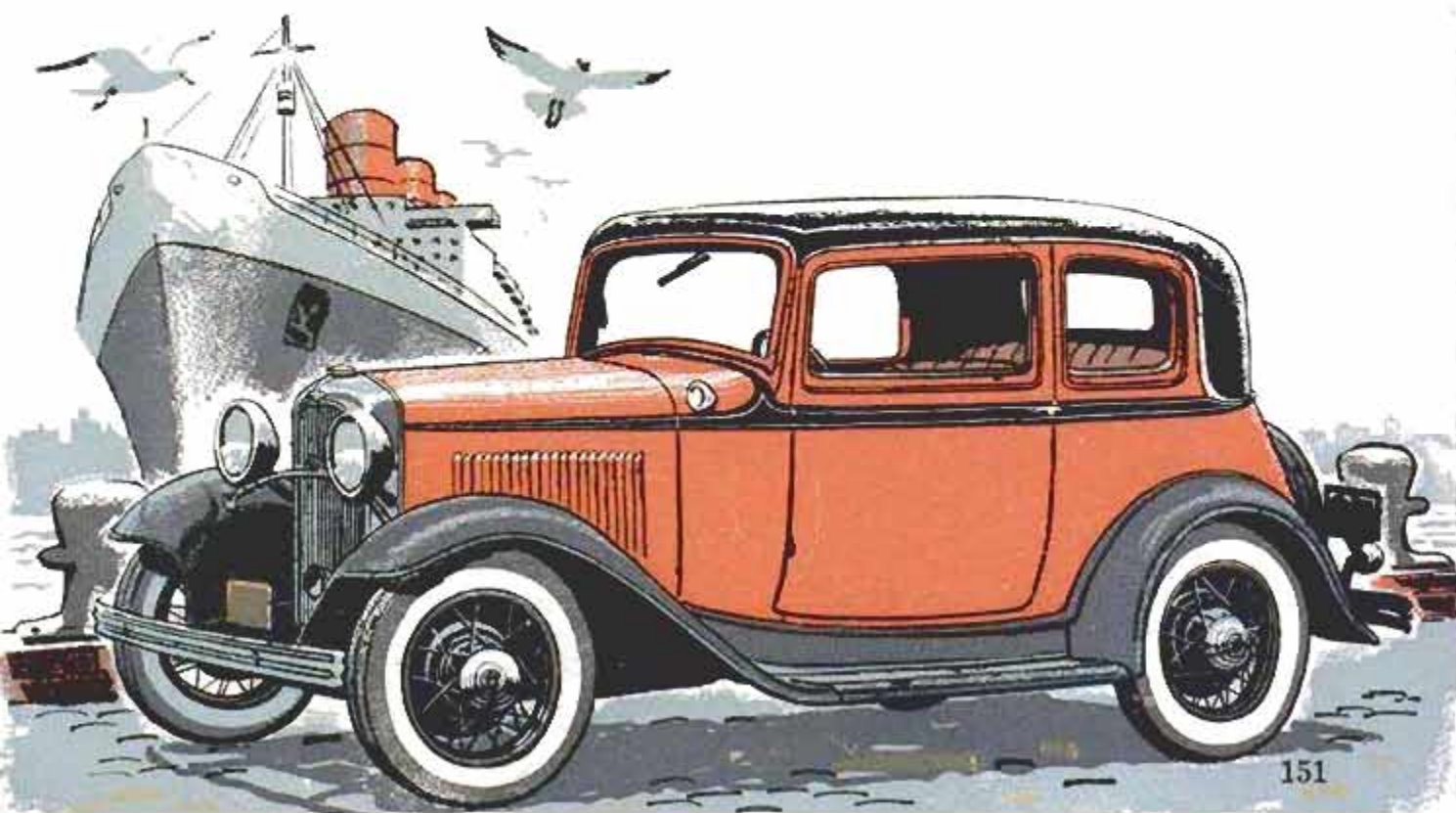

Here Are the Experts

WHO HELPED PM SELECT THE SIGNIFICANT SIXTEEN

Popular Mechanics wishes to thank the following experts on American automotive history for their help in selecting the Significant Sixteen:

Christy Borth

DETROIT, MICHIGAN.
Special assistant to the
Managing Director
Automobile Manufacturers
Association

Henry Austin Clark, Jr.

Long Island Automotive Museum
SOUTHAMPTON, NEW YORK.
An outstanding authority on
old cars

Walter O. MacIvain

MANCHESTER, CONNECTICUT.
Editor of *The Bulb Horn*,
official publication of the
Veteran Motor Car Club of America

Smith Hempstone Oliver

LAKE WORTH, FLORIDA.
Former Associate Curator,
Head of Section of Land
Transportation,
Smithsonian Institution

David J. Wilkie

DETROIT, MICHIGAN.
Automotive Editor of the
Associated Press since 1939
and veteran observer of the
automotive industry

How Would You Have Picked Them?

To narrow down the list of great automobiles that have been built in the United States to the Significant Sixteen is an arbitrary job. Some cars are omitted that, some experts will feel, should have been included. So that you will know which cars came closest to being included, we are printing the list of cars in the final elimination round. From this list of 33 cars, the Significant Sixteen were selected.

How would you have picked them?

An Honor Roll of Great Cars

1896 Duryea	1909 Simplex	1925 Hudson
1897 Stanley Steamer	1911 Mercer	1928 Ford Model A
1898 Columbia Mark VIII	1912 Cadillac	1929 Chrysler
1902 Oldsmobile	1915 Cadillac V8	1929 Cadillac
1904 Sturtevant Automatic	1915 Packard	1932 Ford V8
1905 Franklin	1916 Hudson Super 6	1933 Chevrolet (Turret Top)
1905 Marmon	1924 Packard	1934 Chrysler Airflow
1905 Pierce-Arrow	1921 Essex Coach	1936 Lincoln Zephyr
1908 Cadillac	1921 Duesenberg	1940 Oldsmobile
1909 Ford Model T	1922 Rickenbacker	1940 Bantam Jeep
	1923 Oakland	1947 Studebaker
	1924 Chrysler	

REPRINTS OF THE SIGNIFICANT SIXTEEN

Reprints of these 16 paintings printed on one side only and suitable for framing are available (as long as the supply lasts) for 25 cents in coin to cover costs. Address requests to

Bureau of Information,
Popular Mechanics, 200 East Ontario St., Chicago 11, Ill.

THE 1958 CARS

DETROIT LISTENING POST

By Art Railton

ARE WE JUST going over the hump? Could be. This may be the year of the Big Switch. There's something different in the air.

True, there hasn't been any stampede yet, but there's more sales emphasis on economy than in many years.

George Romney, president of American Motors, and Crown Prince of the Compact-Car Dynasty, recently predicted that 350,000 imported cars will be sold in 1958. If true, that will cause pencil sharpening in Detroit.

In 1950, there were only 16,336 foreign cars sold here (most of them sports cars). In that year 6,326,000 American cars were sold.

In 1958, Romney predicts that there will be 350,000 foreign cars sold (21 times as many) and, he says, only 5,800,000 American cars (500,000 fewer than in 1950).

When American-car sales sag and import sales skyrocket, something's going to be

done. That you can bet your money on.

Rambler's new American represents the first time in memory that a company has reincarnated a discontinued car (the smaller Rambler of 1955). This is the equivalent of heresy in the automobile business. "Americans will never go backward" has been the Detroit slogan for years.

But Romney feels certain that now is the time to test that slogan. He plans to build 20,000 of these small cars in 1958. The sales will not, AM feels, cut into Rambler sales, but will be all-new business. Rambler, incidentally, virtually alone in the industry continues to sell in sharply increased volume.

Mercury is considering a revival of its Medalist. Another indication of the Big Switch. This low-price line was dropped to make room for the Edsel between Ford and Mercury. But Mercury sales apparently are soft enough to cause talk of reviving the price leader.

Oldsmobile reduced horsepower and increased economy of its 1958 Eighty-Eight model (only slightly, to be sure, but an indication of the trends of the year).

Ford is pushing its lowest-price model in

(Continued to page 284)

PRODUCTION OF PASSENGER CARS DURING 1957

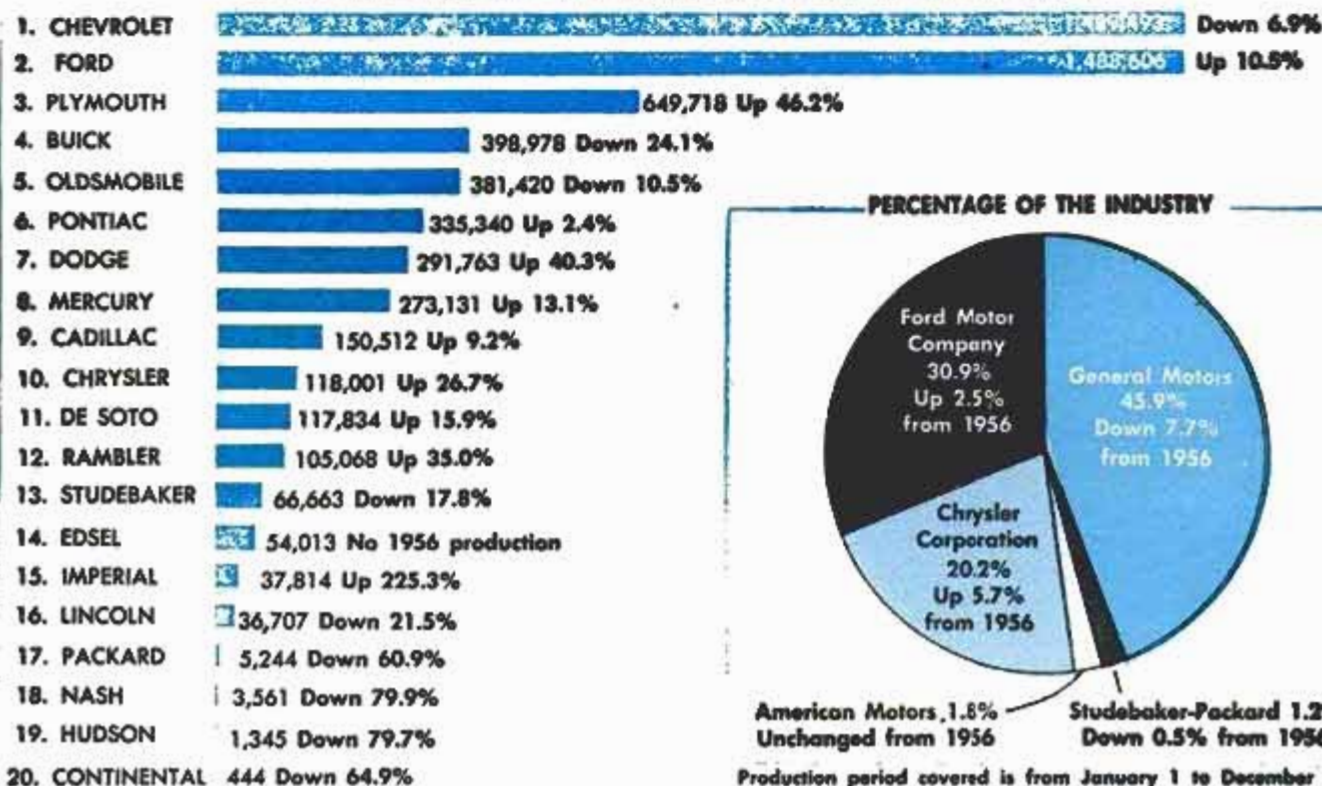

TOTAL FOR INDUSTRY: 6,005,655 passenger cars—Up 5.3% from 1956

PERCENTAGE OF THE INDUSTRY

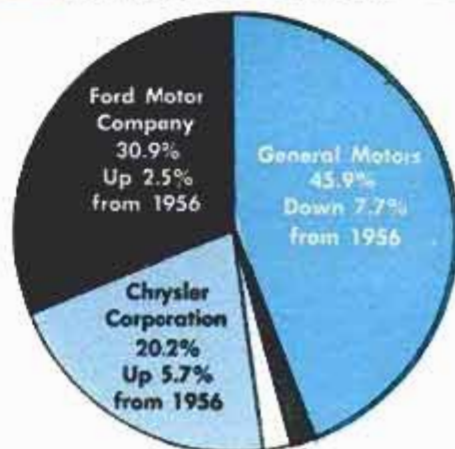

Production period covered is from January 1 to December 31, 1957. Total production for 1957 is expected to be about 6,100,000 cars. Estimates by courtesy of Automotive News

HOW WELL DO YOU KNOW THE '58 CARS?

STYLISTS TRY to make cars attractive—and tempting, too. But they also must provide easy identification so each car on the street becomes an advertisement. Usually this identification is worked into the front or rear. It's more visible there.

How many of these identification devices do you recognize? Name over 15 and you're expert, 8 to 15 you're average, 0 to 7 you're below average and need to study the following pages.

For photos of the cars
turn the page:



1



2



3



4



5



6



7



8



9



10



11



12



13



14



15



16



17



18



19

To find out how many you identified correctly turn to page 160.



From \$2587 to \$3116



AMERICAN

From \$1700 to \$1800
(approx.)

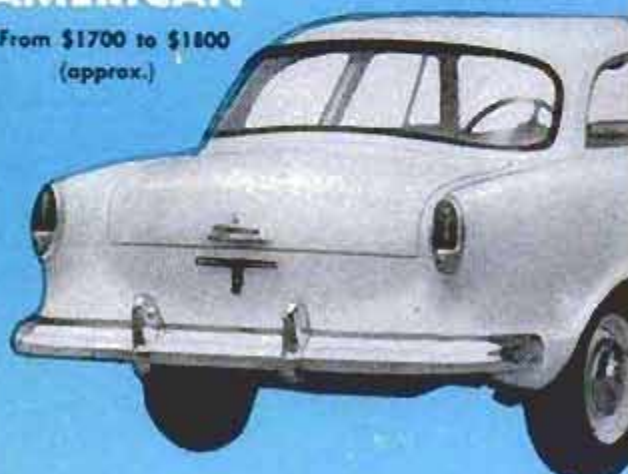

BUICK

From \$2636 to \$5125



CADILLAC

From \$4784 to \$13,074





CHEVROLET

From \$2013 to \$2841

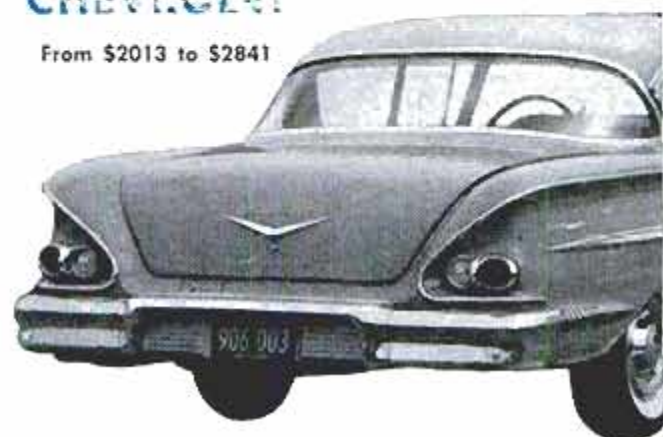

CHRYSLER

From \$3129 to \$5083

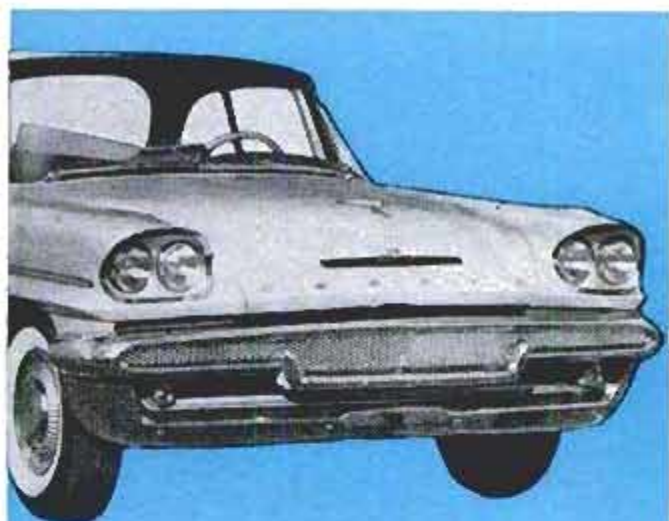

DE SOTO

From \$2819 to \$4369



DODGE

From \$2449 to \$3354





EDSEL

From \$2519 to \$3801



FORD

From \$1977 to \$3173



IMPERIAL

From \$4839 to \$5969



LINCOLN

From \$4803 to \$6283





Oldsmobile
From \$2652 to \$4118



OLDSMOBILE
From \$2772 to \$4300



PACKARD
From \$3214 to \$3995

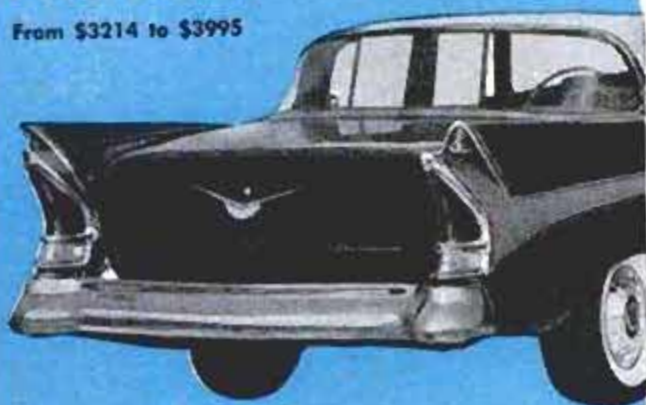

Packard
From \$2028 to \$3067



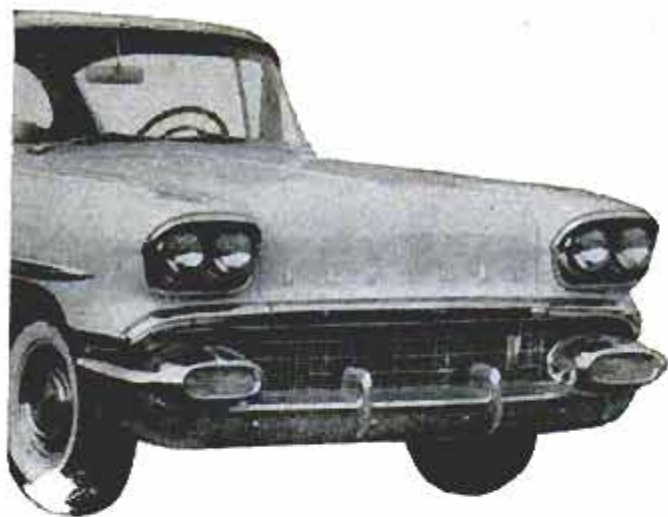

PONTIAC

From \$2573 to \$3586

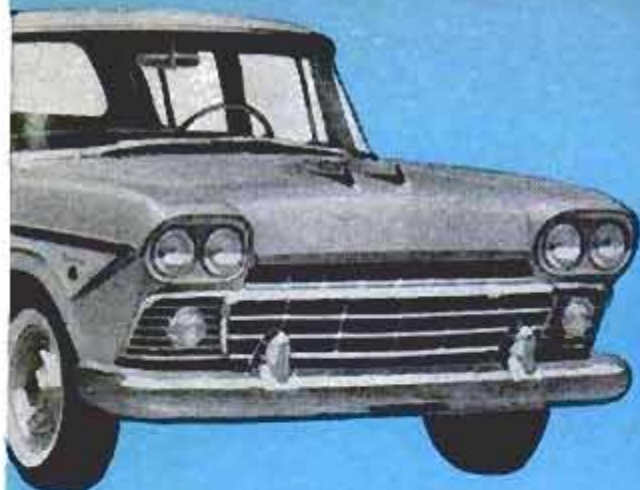

RAMBLER

From \$2047 to \$2751



STUDEBAKER

From \$1795 to \$3282

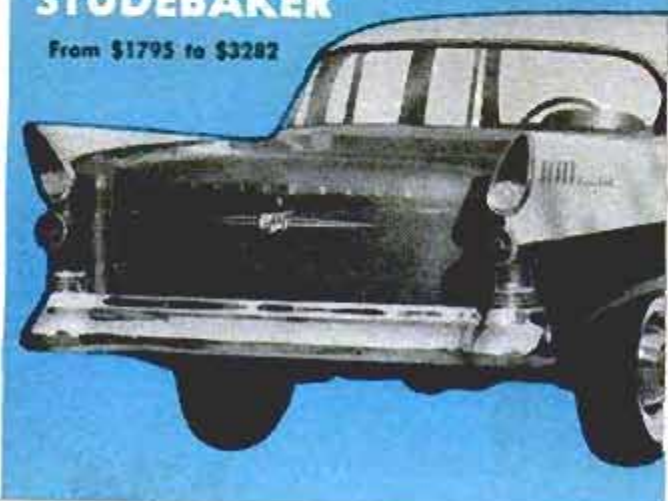

Recognition-Test Answers

If you haven't taken the test, turn back to page 155 before looking at the answers



1. OLDSMOBILE



2. MERCURY



3. PACKARD



4. BUICK



5. DODGE



6. LINCOLN



7. IMPERIAL



8. DE SOTO



9. PLYMOUTH



10. CHRYSLER



11. AMERICAN



12. STUDEBAKER



13. RAMBLER



14. CADILLAC



15. EDSSEL



16. FORD



17. PONTIAC



18. AMBASSADOR



19. CHEVROLET

porty Type—These Are for You

About two feet longer (it is 205.4 inches over-all), the new Thunderbird is a four-seater. Its V8 engine puts out 300 horsepower. Displacement is 352 inches, compression 10.2 to 1. For more about the car and specifications, see page 178. Here is the new hardtop model. Not announced yet, but rumored to be coming out early in the spring is a soft-top convertible body style



THUNDERBIRD

Few changes have been made in the new Chrysler 300D, except in horsepower. This model develops 380 horsepower in the standard engine, 390 with optional fuel injection. Displacement is 392 cubic inches in the hemispheric-head V8. It continues to be a fast, heavy road car that will cover miles quickly and willingly. Highly tuned, it is no car for inching along in city traffic



CHRYSLER 300-D

Still the only American entry in the sports-car category, the new Corvette remains a cozy two-seater. Weighing just 2800 pounds (thanks to lightweight plastic), it is an uncontradictable bomb when powered by a 290-horsepower V8 and four-speed transmission (both optional). Inside are changes also: Instrument panel has all dials where driver can read them, for example



CORVETTE

PACKARD HAWK

Not stampeded by the industry's big switch to four of a kind, Packard retains single headlights in its Hawk series. Also retained is the classic nonwrap windshield. Again this year, horsepower is 275 and displacement 289 cubic inches. Standard is the supercharger that cuts in on demand to ram pressurized air through the two-barrel carburetor for power surges



THE IMPORTS:



◊ FIAT from Italy

It comes in three sizes: A "big" 92-inch-wheelbase sedan (left); a smaller 600, featuring the roomy Multipla design; and an even smaller 500. Prices from \$1000 to \$2500

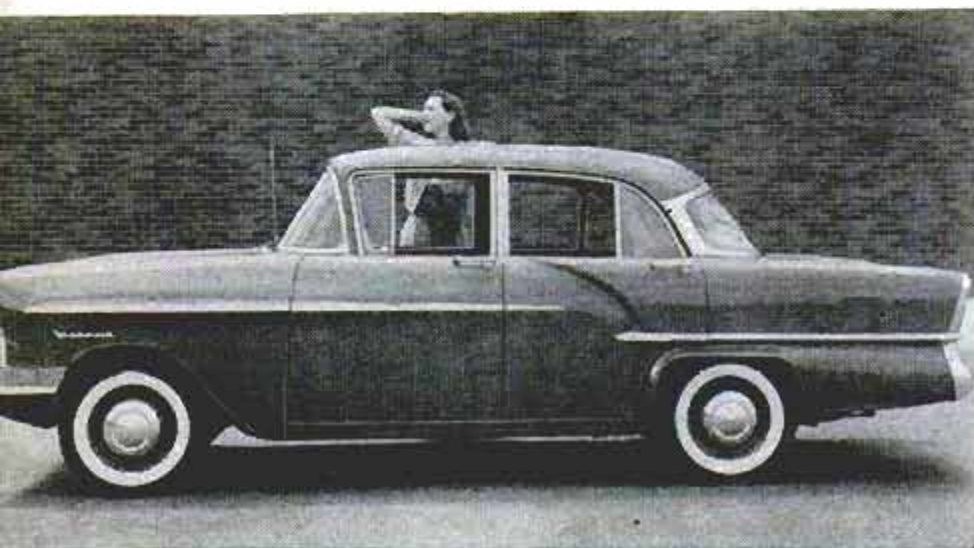

◊ VAUXHALL from England

General Motors now admits that a few in America will buy small cars. To satisfy them, it imports this trim sedan and sells it through Pontiac dealers. Price is \$1850

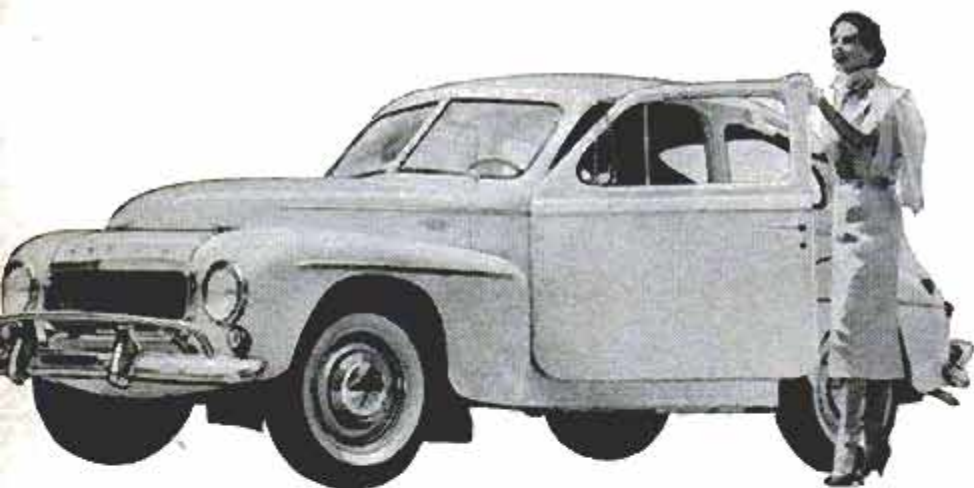

◊ VOLVO from Sweden

Favorite with performance lovers, the Volvo is a comparatively high-power family car. Fast and solid, it corners like a racer. Comes as a two-door only. Price is \$2200



◊ MERCEDES-BENZ 190SL from Germany

Like a micrometer, the 190SL is a joy to handle. Despite its modest engine (four cylinders), it's alert, responsive under a good driver. Expensive, though. Price is \$5200

VOLKSWAGEN from Germany



Not beautiful like the VW Ghia shown here, the standard VW sedan outsells all other imports because of reliability. Air-cooled, rear-engined, it's truly a workhorse. Prices: \$1545 up to \$2450



FORD from England



Styled in America, made in England, British Fords come in several sizes. This one is a big Consul four-door. All look more American than most imports. Prices: \$1539 to \$2900



RENAULT from France



Pleasant to drive and economical to own, the Renault Dauphine is a roomy (for its size, that is) four-door sedan. It has a water-cooled rear engine and a reasonable trunk space under the hood. Price: \$1645



METROPOLITAN from England



Part of the American Motors family, this car is a British-American hybrid. Actually just a two-seater, it is smaller than other cars on these pages. Peppy. Price is \$1567



(Continued on next page)



◇ OPEL from Germany

GM also sells its German Opel over here through Buick dealers. This wagon has a six-foot-long cargo space. Sedan model is also available. Price: About \$2000



◇ AUSTIN from England

Although this A95 station wagon is not available yet over here, Austin has two smaller sedans that are. Both are good economy cars. Price is \$1545 to \$2100

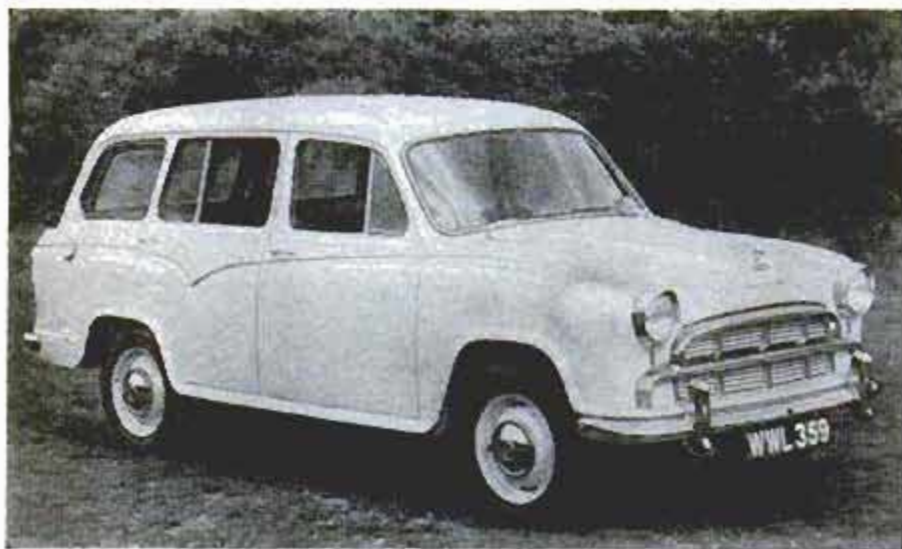

◇ MORRIS from England

Another neat wagon is the Morris Oxford Traveller, too new to be available here yet. Other Morris cars include the excellent Morris 1000. Prices: From \$1629 to \$1900

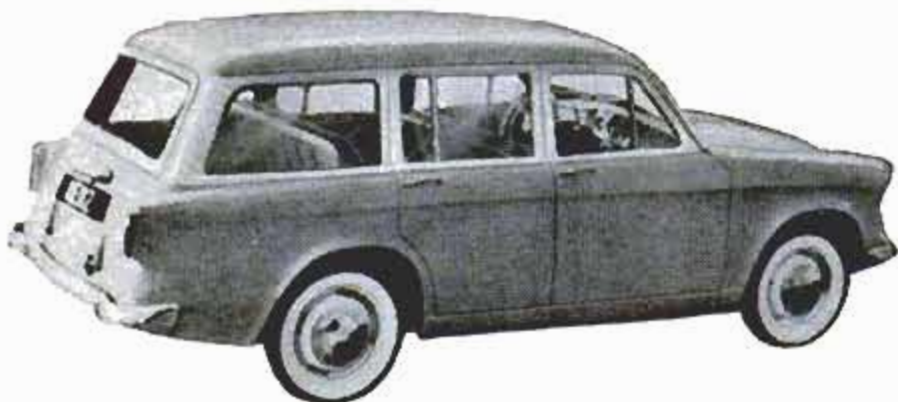

◇ HILLMAN from England

Also new and now being sold here is the four-door Hillman wagon. Other models are sedans, a sleek convertible, an austerity wagon. Prices: \$1535 to \$2299

1958 SPECIFICATIONS

CONTINUED ON NEXT PAGE

	Lowest-price 4-door Model	Lowest-price Heater	Automatic Transmission	Power Steering	Lowest-price Radio	Shipping Weight	Wheelbase	Over-all Length	Displacement	Horsepower	Compression Ratio	Bore and Stroke
AMERICAN Two-door Six	\$1789	\$72	\$179	None	\$60	2495	100.0	178.3	195.6	90	8.0	3.13x4.25
STUDEBAKER Scotsman Six	\$1874	Standard	None	None	\$61	2735	116.5	202.4	185.6	101	7.8	3.00x4.38
Champion Six	\$2253	\$71	\$203	\$74	\$61	2810	116.5	202.4	185.6	101	7.8	3.00x4.38
Commander V8	\$2378	\$71	\$203	\$74	\$61	3155	116.5	202.4	259.2	180	8.3	3.56x3.25
President V8	\$2639	\$71	\$203	\$74	\$61	3325	120.5	206.4	289.0	225	8.3	3.56x3.63
RAMBLER Deluxe Six	\$2047	\$76	\$200	\$80	\$82	2947	108.0	191.2	195.6	127	8.7	3.13x4.25
Rebel Custom V8	\$2457	\$76	\$200	\$85	\$82	3300	108.0	191.2	250.0	215	8.7	3.50x3.25
FORD Custom 300 Six	\$2119	\$46	\$180	\$69	\$70	3258	116.0	202.0	223.0	145	8.6	3.62x3.60
Fairlane V8	\$2409	\$46	\$180	\$69	\$70	3508	118.0	207.0	292.0	205	9.1	3.75x3.30
Fairlane 500 V8	\$2562	\$46	\$180	\$69	\$70	3523	118.0	207.0	332.0	240	9.5	4.00x3.30
								optional →	352.0	300	10.2	4.00x3.50
CHEVROLET Delray Six	\$2155	\$49	\$188	\$70	\$61	3439	117.5	209.1	235.5	145	8.25	3.56x3.94
Biscayne V8	\$2397	\$49	\$188	\$70	\$61	3450	117.5	209.1	283.0	185	8.5	3.88x3.00
Bel Air V8	\$2547	\$49	\$188	\$70	\$61	3470	117.5	209.1	283.0	185	8.5	3.88x3.00
								optional →	348.0	250	9.5	4.13x3.25
PLYMOUTH Plaza Six	\$2169	\$69	\$180	\$77	\$73	3255	118.0	206.0	230.0	132	8.0	3.25x4.63
Savoy V8	\$2413	\$69	\$180	\$77	\$73	3400	118.0	206.0	318.0	225	9.0	3.91x3.31
Belvedere V8	\$2548	\$69	\$180	\$77	\$73	3430	118.0	206.0	318.0	225	9.0	3.91x3.31
								optional →	350.0	305	10.0	4.06x3.38
DODGE Coronet Six	\$2530	\$84	\$180	None	\$87	3410	122.0	213.8	230.0	138	8.0	3.25x4.63
Coronet V8	\$2637	\$84	\$180	\$92	\$87	3555	122.0	213.8	325.0	252	9.0	3.69x3.80
Royal V8	\$2797	\$84	\$220	\$92	\$87	3570	122.0	213.8	325.0	252	9.0	3.69x3.80
Custom Royal V8	\$3030	\$84	\$220	\$92	\$87	3640	122.0	213.8	350.0	295	10.0	4.06x3.38
								optional →	361.0	305	10.0	4.12x3.38
AMBASSADOR Super V8	\$2587	\$83	\$230	\$90	\$99	3456	117.0	200.2	327.0	270	9.7	4.00x3.25
Custom V8	\$2732	\$83	\$230	\$90	\$99	3462	117.0	200.2	327.0	270	9.7	4.00x3.25
EDSEL Ranger V8	\$2592	\$87	\$231	\$85	\$80	3805	118.0	213.2	361.0	303	10.5	4.05x3.50
Pacer V8	\$2735	\$87	\$231	\$85	\$80	3826	118.0	213.2	361.0	303	10.5	4.05x3.50
Corsair V8	\$3425	\$87	Standard	\$85	\$80	4235	124.1	218.9	410.0	345	10.5	4.20x3.70
Citation V8	\$3615	\$87	Standard	\$85	\$80	4230	124.1	218.9	410.0	345	10.5	4.20x3.70
MERCURY Monterey V8	\$2721	\$94	\$226	\$108	\$102	4277	122.0	213.2	383.0	312	10.5	4.30x3.30
Montclair V8	\$3236	\$94	Standard	\$108	\$102	4329	122.0	213.2	383.0	330	10.5	4.30x3.30
Park Lane V8	\$3944	\$94	Standard	Standard	\$102	4418	125.0	220.2	430.0	360	10.5	4.30x3.70
PONTIAC Chieftain V8	\$2638	\$96	\$231	\$108	\$102	3735	122.0	210.5	370.0	240	8.6	4.06x3.56
Super Chief V8	\$2834	\$96	\$231	\$108	\$102	3770	124.0	215.5	370.0	240	8.6	4.06x3.56
Star Chief V8	\$3071	\$96	\$231	\$108	\$102	3825	124.0	215.5	370.0	255	8.6	4.06x3.56
BUICK Special V8	\$2700	\$102	\$220	\$108	\$102	4115	122.0	211.8	364.0	210	8.0	4.13x3.40
Century V8	\$3316	\$102	Standard	\$108	\$102	4241	122.0	211.8	364.0	300	10.0	4.13x3.40
Super V8	\$3789	\$102	Standard	Standard	\$102	4500	127.5	219.1	364.0	300	10.0	4.13x3.40
Roadmaster V8	\$4667	\$102	Standard	Standard	\$102	4646	127.5	219.1	364.0	300	10.0	4.13x3.40
Limited V8	\$5112	\$102	Standard	Standard	\$102	4700	127.5	227.1	364.0	300	10.0	4.13x3.40
DE SOTO Firesweep V8	\$2819	\$89	\$180	\$106	\$94	3660	122.0	216.5	350.0	280	10.0	4.06x3.38
Firedome V8	\$3085	\$89	\$220	\$106	\$94	3965	126.0	218.6	361.0	295	10.0	4.12x3.38
Fireflite V8	\$3583	\$89	Standard	\$106	\$94	3990	126.0	218.6	361.0	305	10.0	4.12x3.38
OLDSMOBILE Series 88 V8	\$2837	\$97	\$231	\$108	\$102	3985	122.5	208.2	371.0	265	10.0	4.00x3.69
Super 88 V8	\$3112	\$97	\$231	\$108	\$102	4008	122.5	208.2	371.0	305	10.0	4.00x3.69
Series 98 V8	\$3824	\$97	Standard	Standard	\$102	4316	126.5	216.7	371.0	305	10.0	4.00x3.69
CHRYSLER Windsor V8	\$3129	\$93	\$220	\$108	\$100	3895	122.0	218.1	354.0	290	10.0	3.94x3.83
Saratoga V8	\$3818	\$93	Standard	Standard	\$100	4120	126.0	220.2	354.0	310	10.0	3.94x3.83
New Yorker V8	\$4295	\$93	Standard	Standard	\$100	4195	126.0	220.2	392.0	345	10.0	4.00x3.90
PACKARD Sedan V8	\$3214	\$71	Standard	\$69	\$80	3575	120.5	213.2	289.0	225	8.3	3.56x3.63
CADILLAC Series 62	\$4891	\$129	Standard	Standard	\$164	4675	129.5	216.8	365.0	310	10.25	4.00x3.63
Sixty Special	\$6232	\$129	Standard	Standard	\$164	4930	133.0	225.3	365.0	310	10.25	4.00x3.63
Series 75	\$8460	\$129	Standard	Standard	\$164	5360	149.8	237.1	365.0	310	10.25	4.00x3.63
IMPERIAL Imperial	\$4945	\$141	Standard	Standard	\$176	4590	129.0	225.8	392.0	345	10.0	4.00x3.90
Crown	\$5632	\$141	Standard	Standard	\$176	4755	129.0	225.8	392.0	345	10.0	4.00x3.90
LeBaron	\$5969	\$141	Standard	Standard	\$176	4780	129.0	225.8	392.0	345	10.0	4.00x3.90
LINCOLN Capri	\$4951	\$142	Standard	Standard	\$183	4754	131.0	229.0	430.0	375	10.5	4.30x3.70
Premiere	\$5565	\$142	Standard	Standard	\$183	4802	131.0	229.0	430.0	375	10.5	4.30x3.70
Continental	\$6072	\$142	Standard	Standard	\$183	4888	131.0	229.0	430.0	375	10.5	4.30x3.70

* estimated

	HEADROOM		SEAT HEIGHT		LEGROOM		SHOULDER ROOM		HIPROOM		TURN-CIRCLE DIAMETER
	Front	Rear	Front	Rear	Front	Rear	Front	Rear	Front	Rear	
AMERICAN	34.2	33.0	10.8	13.2	44.0	37.5	51.5	49.8	58.0	45.3	36.0 ft.
STUDEBAKER											
All except President V8	36.0	35.0	12.6	12.3	43.0	39.0	55.5	54.5	59.5	59.0	39.0 ft.
President V8	36.0	35.0	12.4	11.8	43.0	41.0	55.5	54.5	59.5	59.0	41.5 ft.
RAMBLER (all series)	36.0	35.0	10.4	14.2	43.0	40.0	57.7	57.6	59.8	60.1	37.3 ft.
FORD											
Custom 300 Six	39.9	37.9	10.7	14.4	45.1	44.7	57.6	57.0	60.3	60.3	40.1 ft.
All Fairlane models	38.9	37.7	10.7	14.0	45.1	42.7	57.3	57.0	60.0	60.1	41.6 ft.
CHEVROLET (all series)	35.0	34.2	10.8	13.0	44.6	42.7	56.4	56.2	62.1	63.1	37.7 ft.
PLYMOUTH (all series)	35.7	34.2	10.8	12.0	45.5	41.5	60.5	60.4	63.0	62.7	42.3 ft.
DODGE (all series)	35.7	34.5	10.8	12.0	45.5	42.5	60.5	60.4	63.0	62.7	43.6 ft.
AMBASSADOR V8	36.0	35.0	10.4	14.2	43.0	40.0	57.7	57.6	59.8	60.1	39.8 ft.
EDSEL											
Ranger	33.9	33.6	10.7	14.0	43.1	40.7	57.3	57.0	60.0	60.1	41.7 ft.
Pacer	33.2	33.6	10.6	14.0	43.1	40.7	57.3	57.0	60.0	60.1	41.7 ft.
Corsair and Citation	33.9	32.8	10.6	14.5	44.2	43.4	59.7	59.7	63.5	63.5	43.2 ft.
MERCURY											
Park Lane	34.0	32.8	10.6	14.5	44.1	43.4	60.2	60.2	61.3	62.9	44.6 ft.
All others	33.9	33.2	10.6	14.5	44.1	43.4	60.2	60.2	61.3	62.9	43.7 ft.
PONTIAC											
Chieftain V8	35.0	34.3	10.4	13.0	44.7	41.6	56.4	56.2	62.0	63.1	41.7 ft.
Super Chief and Star Chief V8	35.0	34.3	10.2	12.8	44.5	41.4	56.4	56.2	62.0	63.1	42.1 ft.
BUICK											
Special V8	34.9	33.5	10.9	12.0	43.0	41.7	56.9	55.7	62.6	62.1	43.2 ft.
Century V8	34.9	33.5	10.8	11.9	43.0	41.6	56.9	55.7	62.6	62.1	43.2 ft.
Super V8	36.4	35.1	10.9	11.0	43.5	44.5	58.5	56.8	65.7	65.0	44.5 ft.
Roadmaster V8	35.8	34.5	11.2	11.7	43.2	44.1	58.5	56.8	65.5	64.8	44.5 ft.
Limited V8	35.8	34.5	11.2	11.7	43.2	44.1	58.5	56.8	65.5	64.8	44.5 ft.
DE SOTO (all series)	35.7	34.5	10.8	12.0	45.5	43.0	60.5	60.4	63.0	62.7	*
OLDSMOBILE											
Series 88 V8	35.1	33.5	11.2	11.8	44.0	41.2	56.9	55.7	62.5	62.1	42.0 ft.
Super 88 V8	34.6	33.5	11.2	11.6	43.8	41.2	56.9	55.7	62.5	62.1	42.0 ft.
Series 98 V8	34.6	33.1	11.2	11.9	43.8	41.6	56.9	55.7	62.5	62.1	43.0 ft.
CHRYSLER (all series)	35.7	34.5	10.8	12.0	45.5	43.0	60.5	60.4	63.0	62.7	†
PACKARD (all series)	36.0	35.0	12.4	11.8	43.0	41.0	55.5	54.5	59.5	59.0	41.5 ft.
CADILLAC											
Series 62	35.0	34.9	13.5	12.7	45.0	45.2	59.0	57.0	65.2	65.0	43.4 ft.
Sixty Special	33.9	34.8	13.9	12.7	45.0	45.3	59.0	57.0	65.0	65.0	45.0 ft.
Series 75	36.6	35.7	12.8	13.6	43.6	N.A.	59.0	56.8	65.5	57.9	51.7 ft.
IMPERIAL	35.4	34.2	‡	12.5	46.0	45.0	64.0	62.0	61.0	60.2	48.1 ft.
LINCOLN											
Capri and Premiere	35.0	33.8	11.5	14.5	44.4	46.6	63.1	63.0	61.0	65.5	44.4 ft.
Continental	35.0	34.1	11.5	14.5	44.4	42.9	63.1	67.0	61.0	65.1	44.4 ft.

* Firesweep—46.5 ft., all others 49.3 ft.

† Windsor—43.6 ft., all others 46.9 ft.

‡ Crown and LeBaron—9.8, all others 10.3

NOTES ON SPECIFICATIONS

N.A.—Data not available at press time.

NONE: No such option available on the car.

STANDARD: This item comes on the car at no added cost.

All specifications, except where otherwise noted, are for four-door models. For those cars which do not offer four-door models with centerposts, the specifications are for the equivalent four-door hardtops.

All dimensions are in inches, unless otherwise stated.

Car prices are the suggested advertised-delivered prices. These include federal excise taxes and suggested dealer handling—delivery charges. Not included are such variables as freight from the factory to your city, optional equipment, state and local taxes.

Accessory prices are, as stated, for the lowest-price item available as factory-installed equipment. These prices include federal excise taxes, but not state and local taxes.

All horsepower ratings are for standard-equipment models only, except as noted. This is the horsepower you get for the price listed in the first column. In the case of Buick, for example, almost all Specials are sold with automatic transmissions and have 250 horsepower. But the horsepower on the standard-equipped Special that you can buy for \$2700, as stated, is only 210, as the table shows. To get the 250-horsepower engine you must buy the automatic transmission at extra cost.

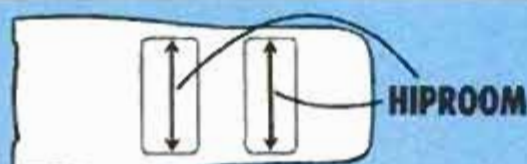

HIPROOM



LEGROOM

HEADROOM

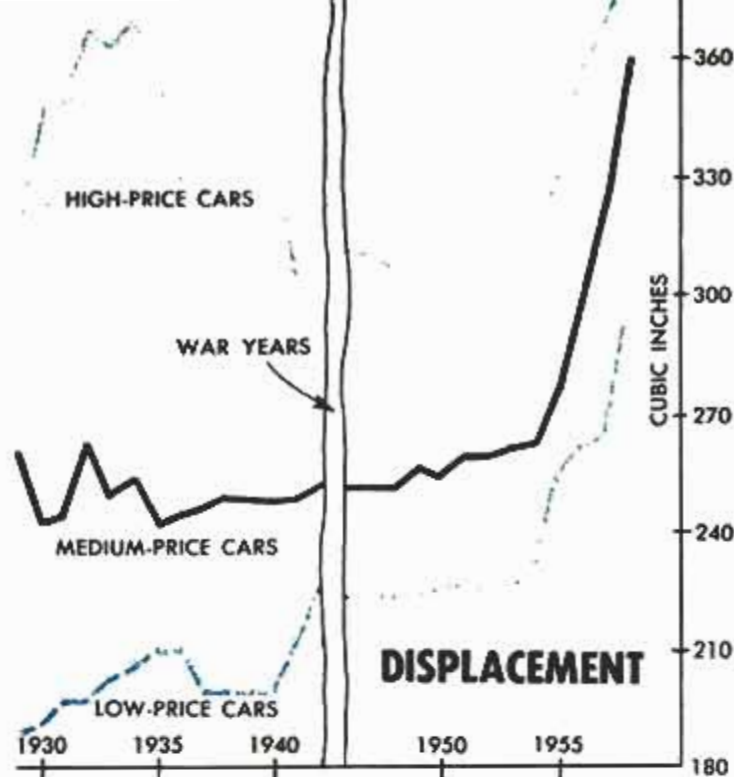

Left, engine displacements are skyrocketing, especially in low-price cars. This is one reason why gas economy is so low in city driving. High-price cars are moving back to their prewar peaks

Bottom, the chart is proof of the horsepower race. The three curves show how engine horsepower has been soaring in the past years

This Year's Crop of Engines

By David Critchlow

NOWHERE ELSE in the world has the V8 become so refined as in America. It has evolved into a classic pattern.

This refinement resulted from the skyrocketing popularity of the V8 in the low-price cars. Engineers had to come up with an efficient engine suitable for volume production at reasonable cost.

Today, assembly lines of different companies produce cars powered by remarkably similar V8 engines, no

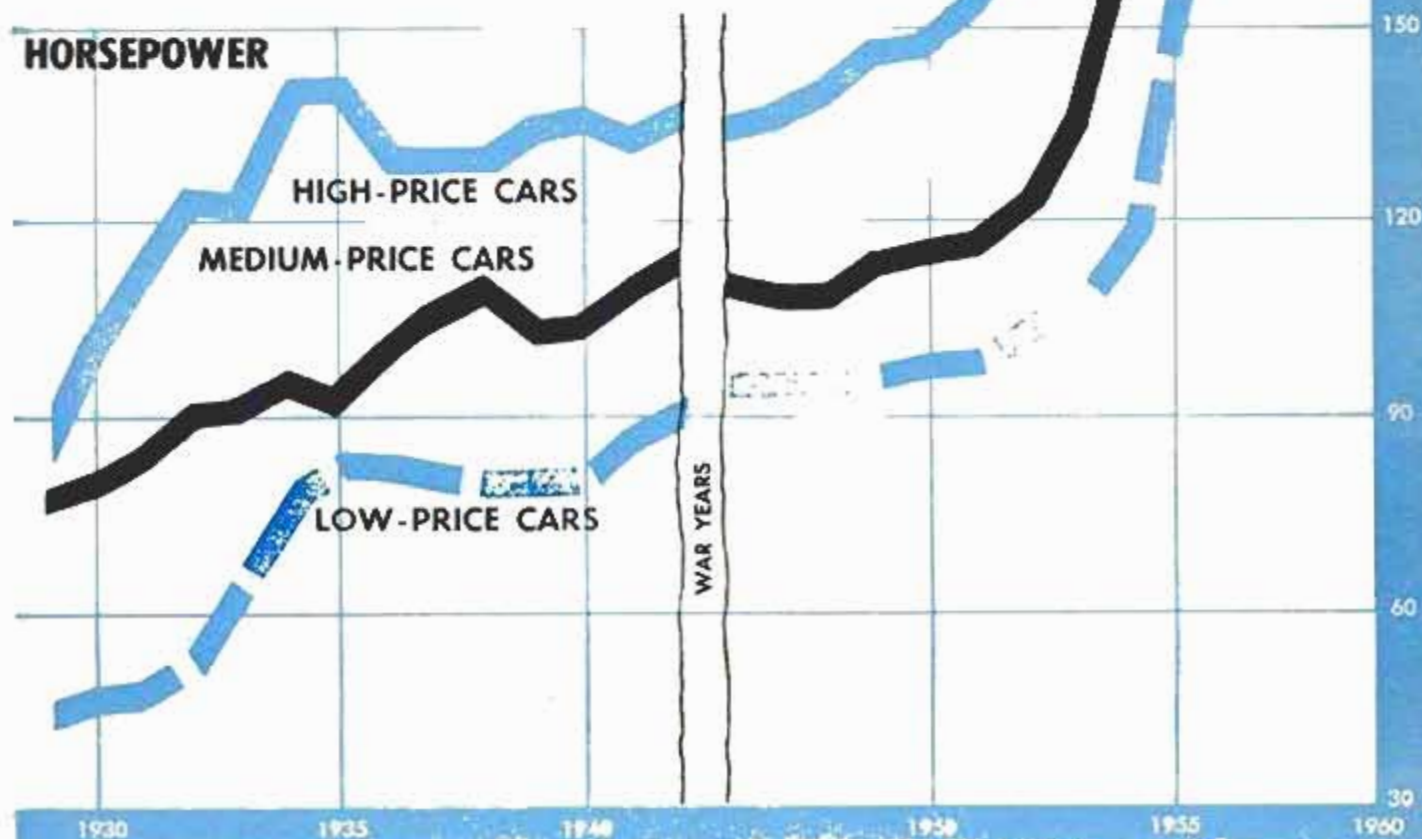

360
330
300
270
240
210
180
150
120
90
60
30

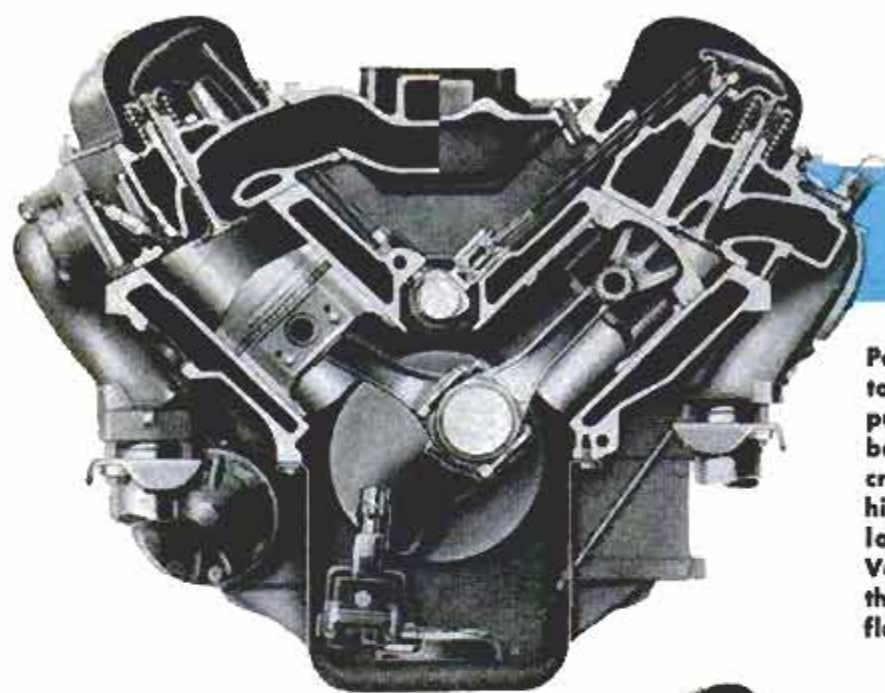

CHEVROLET

Peaking the piston dome and angling the top of the block 16 degrees, Chevrolet puts its fully machined combustion chamber inside the block. This is said to create more turbulence and to produce a higher volumetric efficiency. Spark-plug location gives short flame travel. Valves are located out in the open on the flat face of the head to allow free flow of gas, insuring good breathing

MERCURY

Ford Motor Company offers two all-new engines for 1958. Here is the Mercury version. It is larger than the Ford-Edsel design. Like Chevrolet, it has its fully machined combustion chamber in the block. The intake manifold is water-jacketed to eliminate the need for an exhaust heat-control valve. The deep skirt provides rigidity. Hot spots are eliminated by the alternate location of the exhaust valves

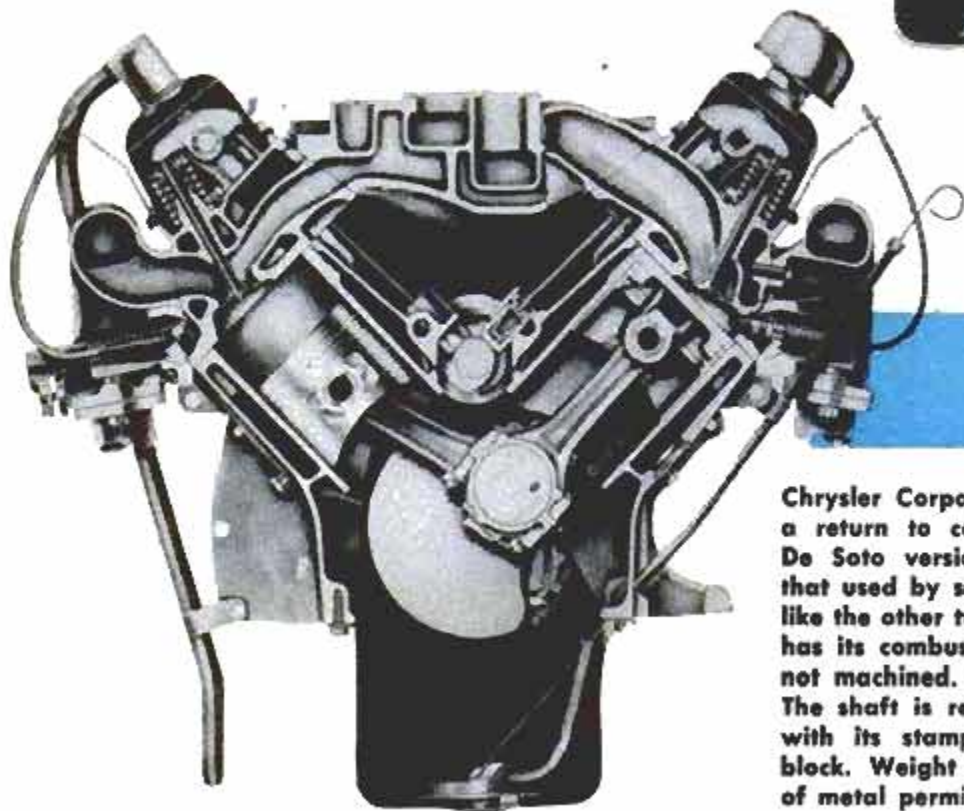
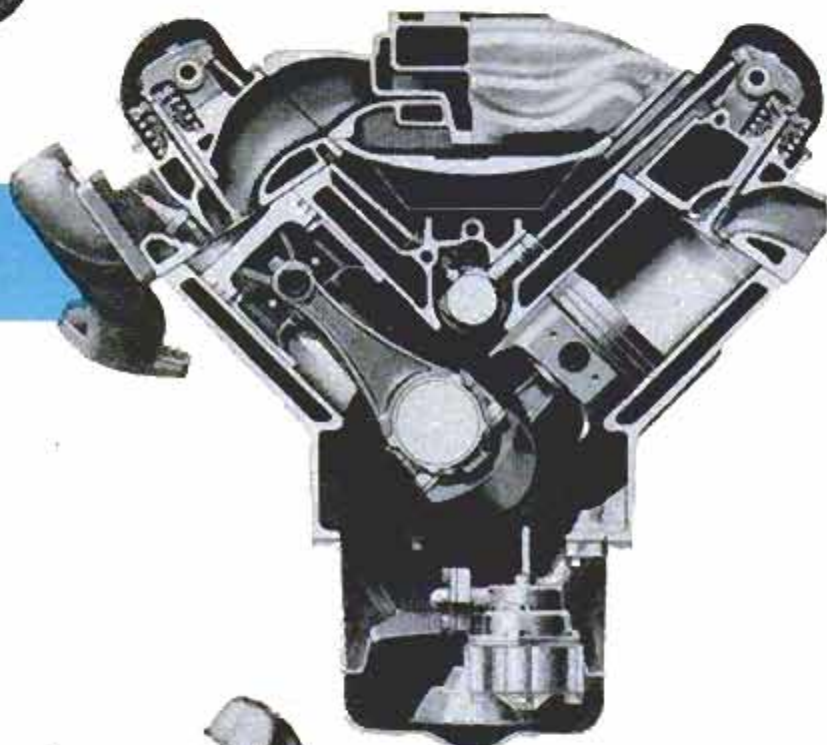

DE SOTO

Chrysler Corporation's new engine for 1958 is a return to conventional design. Here is the De Soto version, differing only in size from that used by some Dodges and Plymouths. Unlike the other two engines on the page, this one has its combustion chamber in the head. It is not machined. Stamped rocker arms are used. The shaft is retained (Chevrolet uses no shaft with its stamped arms). It has a deep-skirt block. Weight is kept low. The smaller mass of metal permits the engine to warm up faster

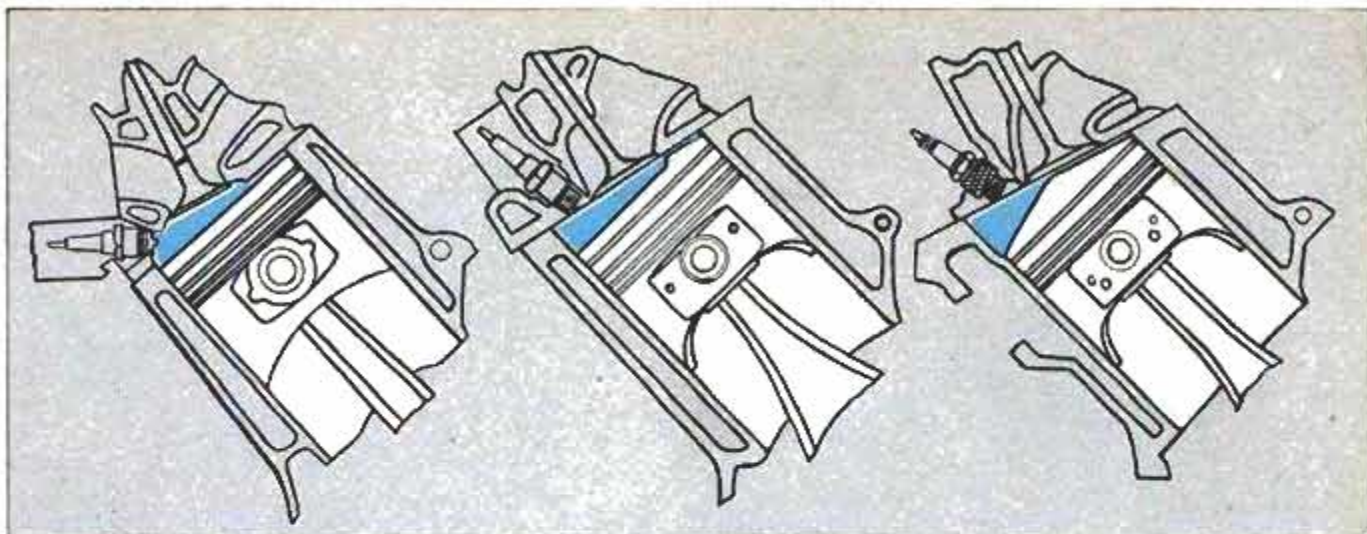

Left to right, De Soto, Mercury and Chevrolet combustion chambers, three solutions to the problem of shape

surprise since the aims of all are similar: Good performance, low cost, suitability for full or semiautomated tooling.

The standard American V8 is a large-displacement, short-stroke engine with overhead valves and a high compression ratio. Its crankshaft has five main bearings and it turns in a cast-iron block beneath two banks of four cylinders arranged in a 90-degree vee. Power output is high and torque characteristics provide exceptional performance at low and medium speeds in heavy vehicles equipped with automatic transmissions.

Similar though these engines are, there are numerous details that demonstrate original and ingenious solutions to design problems. The highly efficient (but costly) hemispheric combustion chamber Chrysler brought out six years ago is one example. Another is the Chevrolet-Pontiac stamped rocker-arm design which first appeared three years ago to startle the industry by pointing the way to a significant cost reduction in eliminating the expense of a rocker-arm shaft.

For 1958, each of the Big Three has a new V8. These engines are built in a variety

of sizes, but it is convenient to group them by parent company rather than by car make or displacement size. Except for General Motors, all makers extend the basic engine into more than one line of cars. In this way, at a reasonable investment in tooling, the companies can offer a wide range of engine sizes to each brand, opening the market to a wide variety of buyers.

Let's look at the three major companies and their new V8 engines for 1958.

FORD MOTOR COMPANY

Ford engineers developed two entirely new groups of V8 engines for 1958. Size is the principal distinction. One has a medium displacement, the other an extremely large displacement.

The smaller of the two (used in Ford, some Edsels and Ford trucks) comes in three displacements: 332, 352 and 361 cubic inches.

The first two (332 and 352) have a common bore of 4 inches; strokes are 3.3 inches and 3.5 inches respectively. These two V8s are used in the 1958 Ford cars, rated at 265

(Continued to page 290)

Left to right, De Soto, Ford, Chevrolet heads. Arrows point to spark-plug holes. De Soto's combustion chamber is not machined; Ford's is fully machined; Chevy's is not in the head at all, being in the block

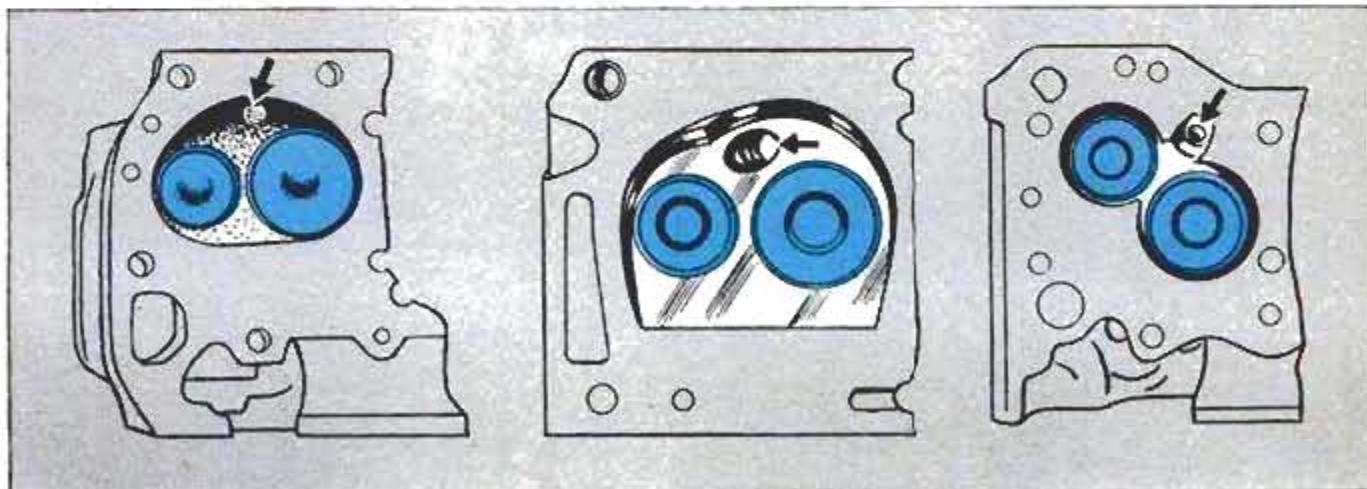

A 1½-CAR FAMILY

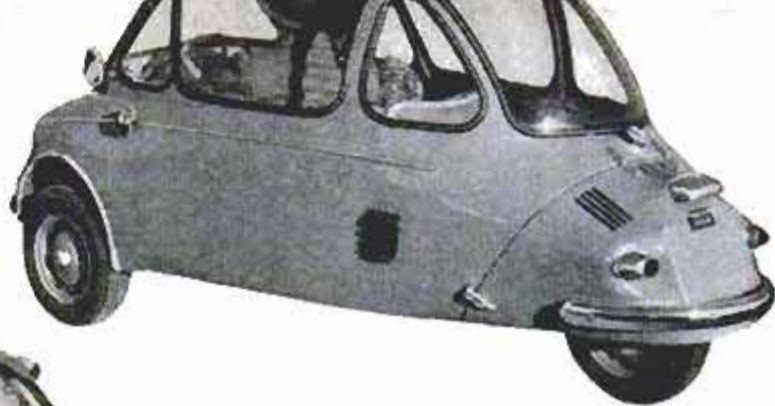

A USE TEST OF BUBBLE CARS

HEINKEL

Weighing 535 pounds, the Heinkel has three wheels, an air-cooled one-cylinder engine in the rear. Visibility is unlimited. The four-stroke engine has a 10.4-cubic-inch displacement and takes about a quart of oil for an oil change

It's harder to get out of the Heinkel because the wheel does not swing out with the door. But the Heinkel has enough room behind the seat for two children or for carrying large bundles



HALF A LOAF is better than none—we all know that. But what about half a car? Is it better than none? Or perhaps in some cases better than a whole car?

Bubble cars, like the Isetta and the Heinkel, may be the answer to the problem of the American suburban housewife. Perhaps the 1½-car family is a practical solution in a car-dependent society in which the husband needs a car to drive to work and the wife needs one to get to town.

To put bubble cars to a use test, *Popular Mechanics* made available two of them (Heinkel and Isetta) to four typical suburban housewives for a week at a time. These women, all with small children, were told to use the cars as if they were their own. And they did.

They finished the test with mixed feelings.

All agreed that the cars (and perhaps any car so small) have serious limitations. These limitations are, unfortunately, tied in with their advantages. It is the smallness of these bubble cars which makes them desirable, yet at the same time makes them of limited usefulness.



Left, the Isetta 300 test car. It has four wheels, a one-cylinder air-cooled engine. Weight is 770 pounds. Displacement is 18 cubic inches and oil capacity 3.6 pints

Below, the Isetta 600, a new and enlarged version not yet available in this country. It has a rear seat with a side door and it should answer most of the complaints of the housewives who tested the two cars for PM

ISETTA



For example, high on the best-liked list is ease of parking, a product of small size. These cars are driven head-on into parallel parking space. No backing is required. In jammed traffic lanes, backing against the current into a small parking space can be nervewracking. If done clumsily, this can be embarrassing. The bubble car ends this worry.

Economy is a very big plus feature, of course. In the test, during which all mileage was stop-and-go city-traffic driving, the Isetta averaged 42 miles per gallon, the Heinkel averaged 52 miles per gallon.

But gasoline mileage is not the only economy. Both cars have one-cylinder air-cooled engines. This is about as simple as a car can get and it virtually eliminates all expense-creating complications.

It is doubtful if the out-of-pocket cost of operating either of these cars would cut seriously into any household's budget, although

(Continued to page 296)

You open the Isetta's door with the steering wheel, which swings forward so you exit more easily. Even so, entry and exit are awkward, especially in a tight skirt



STYLISTS, the men who create the shapes that eventually become your automobile, are basically artists. It is their job to give a practical device like the motorcar a look of beauty that is pleasing.

In their work (which, incidentally, is

always behind locked doors because they work on the day after tomorrow), they use a language of their own.

Here, thanks to the styling departments of Chrysler Corporation and the Ford Motor Company, is some of the stylists' lingo.

A

Ace. An exceptional design.

A-post. Pillar connecting roof to body at windshield. Also known as A-pillar



Applique. Something added to the basic form: chrome moldings, crests, trim

B

Backlight. Rear window

B-post. Pillar connecting roof to body at rear of front door. Also known as B-pillar

BBC. Bumper to back of cab

Bead. Indentation running along or across sheet metal. Also known as ripple

Beehive. Backup light located in center of disk. Also known as bull's-eye

Beltline. Break between lower body and upper structure.



Bezel. Rim surrounding and supporting the headlight.

Biscuit. Shape formed on many door panels and seats.

Blind quarter. Windowless area at rear of greenhouse.

Blisters. Bumps over wheels for clearance

Blurps. Bumps of any kind.

Body roll. Convex sheet-metal form

Bomb. Projectilelike object used as a bumper guard. Also known as Dagmar



Buck. Wooden framework that supports clay model.

Bulbous. Fat section. Well-rounded.

Cant. Angle of departure or angle of lowest point behind rear wheel. Angle of approach or angle of lowest point of bumper

Catwalks. Area between fenders and hood, also known as valley

Clean. Absence of moldings.

Cluster. Grouping of instruments on dashboard

C-post. Rear pillar connecting roof and body. Also known as C-pillar

Crazy. Nice.

Creaseline. Leading edge of hood. Also known as wing section, windsplit or prow

CV. Controlled ventilation. Small vent windows front and rear

D

Dagmar. Rounded sphere on bumper guard. Also known as bomb

DLO. Daylight opening

Deck lid. Metal covering for trunk and spare tire

Doghouse. Rectangle housing gas-filler cap



Drip molding. Chrome strip above doors

Drip line. Forward edge of rear quarter of roof

E

Egg crate. Grille characterized by horizontal blades supported by vertical struts

Eyebrow. Forward extension of front-fender crown over headlight. Also known as shroud hood, shade visor



Fast back. Greenhouse flows into rear deck with no break in surface

Fence. Representing the section above the belt and below the window

Fillet. Radius between two intersecting surfaces.

Fins. Upper sections of quarter panels, also known as blades.

Fleet. Fast-looking, indicative of motion.

Flipper. Door-lock cover

Fireplace. Grille opening, also known as mouth

Frying pan. Circular ending of jet tube.

Garnish molding. Painted sheet-metal strip just below side windows on interior of car.

Gasarooney. Terrific, overpowering, weird

Goo-goo. Overdone.

Gorky. Looks awkward, out of shape.

Gorped-up. Overdone, too many embellishments.

Greenhouse. Upper structure, passenger compartment.



Gutty. Powerful appearance, has race-car look

Hairy. Has too powerful an appearance, overdone.

Hardware. Metal parts of door interior

Header. Top of windshield, inside or out.

Highlight. Light reflection on body surface

Hot. Advanced design.

Ipsipipsi. Correct proportions. Right on the nose.

Ivory towers. Styling studios.

Jazzy. Flashy

Jet tube. Cylindrical form extending through quarter panel.



Jounce. Clearance for up-and-down movement of wheel

L

Lowlight. Secondary light, such as ground reflection on body.

Louver. Air intake.

M

Mouth. Grille Opening. Also known as fireplace.

N

Notchback. Greenhouse flows into rear deck with a break

O

OD. Outside diameter, as of a tire.

Overhang, front or rear. Distance from wheel center to front or rear extremity of car.

Pizazz. Give it everything.

Pork chop. Section joining end of dashboard and door panel, so called because of its shape.



Prendelo. Automatic transmission quadrant, suggested by the letters P - R - N - Dr - Lo.

Q

Quarter panel. Sheet metal between the doors and each of the four corners of the body.

Rocker panel. Bottom edge of body below doors between front and rear wheel-houses.

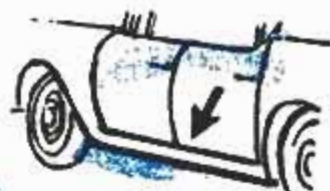

S

Sassy. Has appearance of high performance.

Scallop. Concave indentation in sheet metal.

Sings. Meaning it glitters.

Spaghetti. Too many moldings, overdone.

Spooky. Embodying futuristic styling concepts.

Squealy. A rendering or drawing making broad use of black.

Stacks. Tail pipes.

Stinkle. Glitter or shine.

Sweep spear. Molding running along the body.

Sweeten. Make refinements in a design.

Taut. Sprightly

Telephone pole. Molded upright form directly below taillight.

Thrust. Feeling of direction.

Tumblehome.

Amount of lean towards the center or degree of slant from the vertical of the upper portion of body.



Tuned in. Well qualified, knows what he's doing.

Turn-under. Turning under of lower body sections

V

Valley. Low area between fender and hood. Same as catwalk

W

Wheelhouse. Opening for wheel.

Windlace. Stripping attached to door openings to prevent wind noises



What's Best a... for Your Car?

By Dale Kelly, SAE, Registered Professional Engineer

HIGH COMPRESSION — what does it mean? Unlike some loudly shouted phrases, high compression is worthwhile.

In fact, increased compressions are probably the most important single improvement in automobile engines during the past 50 years. A given amount of gasoline does almost twice as much work at a compression ratio of 10 to 1 as at 3 to 1.

With the poor gasolines of years ago, any attempt to raise compression resulted in abnormal, uncontrolled combustion causing what was then called "spark knock" (now known as detonation).

Probably no harm is done by a momen-

tary trace of knock during acceleration, but continued severe knocking can ruin an engine in a few hours.

As gasolines have been progressively improved in knock resistance (both by improved refining and by the addition of tetraethyl lead), the limitations on compression ratios have been raised.

Twenty-five years ago, the best premium gasoline had a Research octane number (the measure of knock resistance) of about 74. Today, regular gasoline has an average octane number of 91, premium is about 99 and the superpremium fuels are about 102.

But, as you can see from the map on page 175, gasoline in the central Atlantic states averages five octane numbers higher than gasoline in the Rocky Mountains. Oil companies do this deliberately, partly because an engine is less likely to knock in the lower atmospheric pressure at high altitudes.

For years, most oil companies have marketed two grades of gasoline—regular and premium. Originally, premium differed from regular primarily in that it contained tetraethyl lead (a half teaspoonful of which in a gallon of gasoline gives a tremendous improvement in knock resistance). For this reason, premium gas was commonly called Ethyl gasoline. Today nearly all regular gasolines are leaded just about as much as premium gasoline.

Back in 1956, the highest standard compression ratio in the new cars jumped to 10

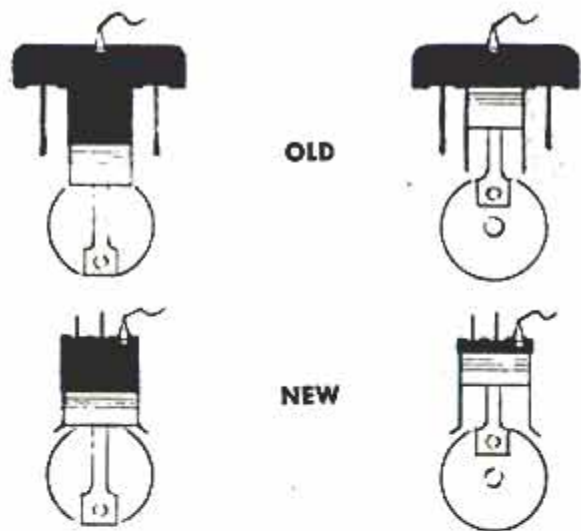

Years ago, ratio between cylinder volumes with the piston at bottom and top of stroke was only 3 to 1. New V8 engines are more efficient with 10 to 1 ratio

Below, here is how knock looks in slow motion. The flame "explodes" in the last two frames, causing knock

General Motors Research photos



Below, high-octane gas burns slowly without knocking. Movies of a combustion chamber show even burning



to 1. The compression spread between these new cars and the old cars was too great to be accommodated by the two existing grades of gasoline. So several companies brought out super-premium, a fuel useful primarily in those few late-model cars with very high compression ratios. (One company, Sun Oil Company, has developed a mixing pump which dispenses as many as six grades of gasoline from one hose.)

So today, when you drive into a service station, you have to decide which of these several grades you should buy. There is an important difference in price per gallon. Is there a major difference in what you get?

Actually, there is a big spread between the highest octane number your engine can use effectively and the lowest on which it can run reasonably well, if (and this is important) the ignition is timed to match the particular grade of gas being used.

In other words, you have a choice. Your engine may be adjusted to run satisfactorily on any two and sometimes all three of them. Your choice depends on how much you, as a buyer, are willing to spend for the extra acceleration your car may be able to give on the more expensive gasoline.

This extra amount of acceleration depends on your engine's compression ratio and, to a lesser extent, on the number of miles it has been accumulating carbon and other deposits.

Timing the engine for regular gas instead of premium may decrease or it may increase gasoline mileage. But usually there is no important change either way. However, mileage per dollar will almost always be better on regular gasoline.

All cars now have a vacuum-advance to give, at light load, the additional spark advance necessary for best gasoline mileage. If an ignition system is engineered for regular and the owner advances the spark to obtain the small improvement in acceleration that may be possible with premium, he could get too much advance at light load. This will reduce his gasoline mileage. The 1958 Plymouth reported on in last month's *PM* is an example of this. In this case, he will pay more and get fewer miles per gallon.

Just because it costs more does not necessarily mean that premium gasoline is better. The semiannual survey by the Bureau of Mines shows that, except for the lower octane number, regular gasoline is substantially equal in quality to premium. Therefore, there is no reason for using premium gasoline except for antiknock.

Much of the improved performance of today's gasoline, regular and premium alike, is due to additives other than tetraethyl lead. Almost all gasoline today contain a

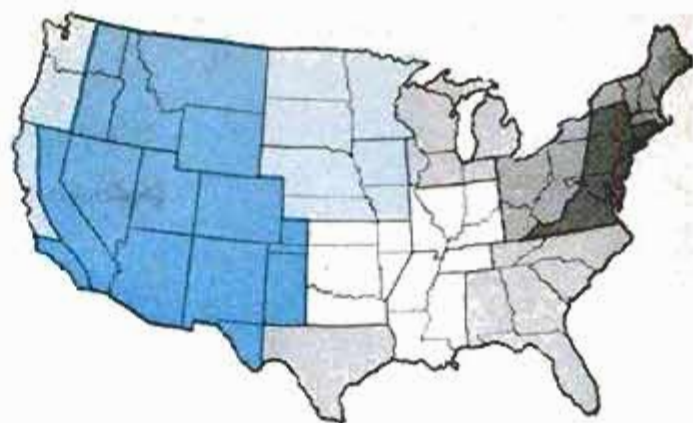

OCTANE RATINGS BY SECTIONS OF THE COUNTRY

Areas in white sell gasolines with average octane rating. Other sections sell gasoline of one or more octain points above or below the national average

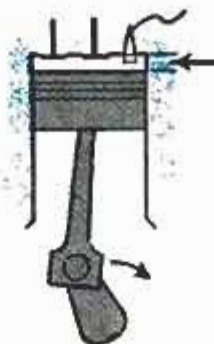

Left, "retarded" spark occurs when the piston has almost completed its upstroke. The engine will run on low-octane gas with a possible loss of power and economy

Right, "advanced" spark occurs well before top of stroke. This takes full advantage of high-octane fuel. Engine would knock on regular

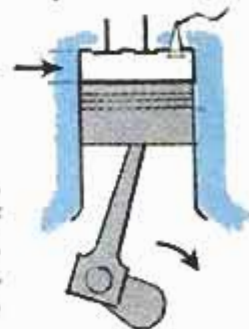

phosphorus compound, such as TCP (tri-cresyl-phosphate) to retard the formation of deposits in the combustion chambers.

Today's engines are so large that they operate most of the time at a small fraction of full power. Part-throttle operation subjects the engine to more accumulation of deposits. Unless additives such as TCP are used, spark plugs are apt to be short-circuited by these deposits and white-hot particles in the combustion chambers are likely to ignite the fuel mixture prematurely (which also causes detonation).

Other additives used in some of today's gasoline prevent the formation of gum in storage, gum that would later collect in carburetors and inlet manifolds. Additives also remove such accumulations if they occur. They also prevent corrosion of tanks and fuel systems (and of the oil companies' pipelines and tanks). Additives discourage carburetor icing, which is troublesome when the temperature is at freezing or a few degrees above with high humidity.

As far as octane requirements are concerned, cars fall into three categories. At

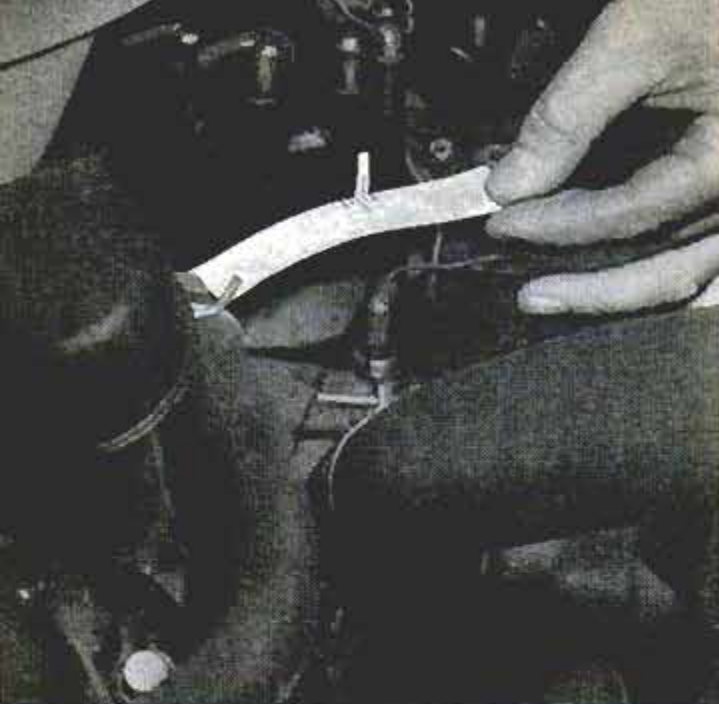

one extreme, certain late models with high compression ratios will run on regular only with an appreciable loss in acceleration. At the other extreme, most older cars with low compression ratios will run as well on regular as on premium. For these two groups the choice is easy to make.

In the middle, however, are many cars for which the choice is not so simple. These cars will accelerate better on premium, but it is difficult to say how much better without running a test. It is difficult to tell whether an owner can detect the improved performance and, even when he can detect it, whether he will consider it worth the extra cost of premium.

For these cars in the middle, the best solution is a simple road test by the owner to show how far the spark can be advanced without knock on each grade and how far it must be advanced for good accelerating.

If you have a reasonably new car, the first thing you do is make a scale (older cars usually have a marked scale attached to the distributor) so you can advance or retard the spark a precise amount conveniently. You make such a scale from a piece of cardboard or wood. It should be long enough so that one end butts against some immobile, well-defined part of the engine while the other end extends past the side of the distributor.

Stick an adhesive-tape patch on the side of the distributor cap and mark a reference line in it. Lay the scale against the immobile part so it runs alongside the reference point and mark it accordingly. Then on each side of this center mark which shows the spark setting as it is now, place additional marks at $\frac{1}{8}$ and $\frac{1}{16}$ -inch intervals. With this scale you will be able to advance or retard the spark precisely.

Find a stretch of road about $\frac{1}{4}$ to $\frac{1}{2}$ mile long on which your car can be driven wide open for 10 second or longer without exceeding safe and legal speeds. The course should be wide, straight and lightly traveled. If possible, it should have a gradual uphill grade.

Select a stationary marker, such as a certain telephone pole or road sign, for your starting line and another such marker as the finish line at about the point your car will be at after 10 or 15 seconds' acceleration.

Make up a chart on a pad like those shown on page 177. Put a few gallons of regular gasoline in the tank. (If you have been using premium, the tank should be almost empty when the regular is added. Then run the engine until the regular gasoline has had time to work through into the carburetor.)

If your car has an automatic transmis-

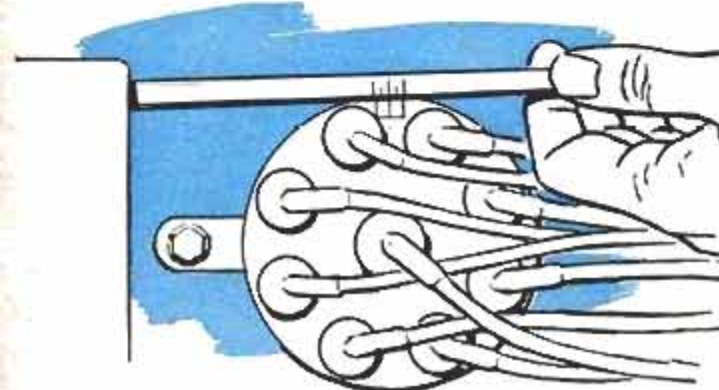

You can retune your engine for the test with this homemade cardboard or wood scale that you match up against a bit of tape stuck to the distributor cap

Below, the author adjusts a variable-compression test engine used to measure the octane rating of gasolines

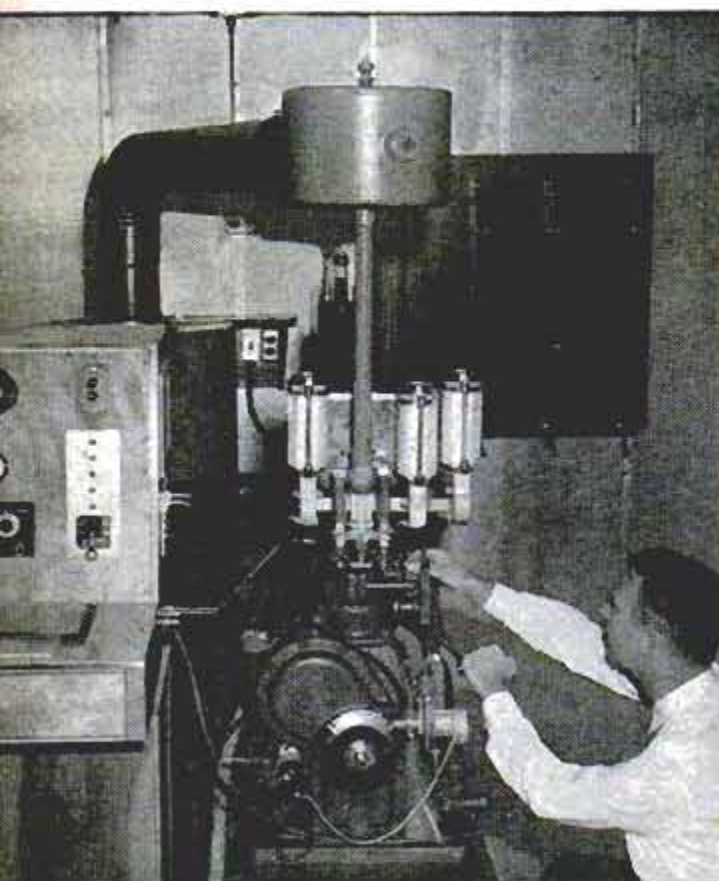



PICK STRAIGHT COURSE WITHOUT TRAFFIC HAZARDS

STARTING MARKER

You will find out which grade of gasoline is best for your car by simple tests on a course like this one

sion, stop beside the first marker and accelerate until you pass the finish line. If you have a handshift transmission, approach the starting line in high gear at exactly 20 miles per hour and floor the accelerator just as you pass the marker, keeping it floored until you pass the finish line.

Read the speedometer carefully as you cross the finish line. Write this figure on the chart. Also note on the chart the amount of engine knock, if any, during the run, describing it as trace, light, medium or heavy. It may be wise in the first test, at least, to make several runs to get an average to allow for minor errors.

Now advance the spark $\frac{1}{8}$ inch (being careful to retighten the lock screw) and repeat the test. Turning the distributor in the direction the rotor spins retards the spark, the opposite way advances it. Then advance it again to the $\frac{1}{8}$ -inch marker and repeat. If necessary, advance the spark farther to find the point beyond which

there is no appreciable increase in acceleration or the point at which the engine knocks. In no event should you advance the spark beyond this point.

If the engine knocks at its original setting, turn the distributor the opposite direction to retard the spark $\frac{1}{16}$ inch and run the test. If it still knocks, retard another $\frac{1}{16}$ inch and repeat. Do this until you have retarded the spark enough so the engine does not knock on regular.

If the spark cannot be advanced to the maximum power point without knocking on regular, you now can fill the gas tank (it should be nearly empty by this time) with premium and drive around until the extra-cost fuel is in the carburetor.

Return to the course and test the car with premium at the distributor settings which, because of knock, could not be used with regular.

When you have finished, your note pad

(Continued to page 298)

Typical test data on a late-model high-compression car. On regular gas, it has to have spark set for acceleration loss of 2 to 4 miles per hour. This would probably be unacceptable to most drivers. It would probably go fewer miles per gallon on regular gasoline. With the spark advanced slightly, the car accelerates best and runs on premium gasoline without knocking

Spark setting	$\frac{1}{8}$ " Ret.	$\frac{1}{16}$ " Ret.	As found	$\frac{1}{16}$ " Adv.	$\frac{1}{8}$ " Adv.
Speed at end of acceleration run-m.p.h.	51	53	54	55	55
Knock {	on regular	None	Trace	Light	Did not try
	on premium	None	None	None	Trace

Typical test data on an older, low-compression car. Here the use of a premium gas would be money thrown away. With the spark set "as found" it develops maximum acceleration without knocking. If owner bought most expensive gas for this car and advanced the spark he would get less acceleration

Spark setting	$\frac{1}{8}$ " Ret.	$\frac{1}{16}$ " Ret.	As found	$\frac{1}{16}$ " Adv.	$\frac{1}{8}$ " Adv.
Speed at end of acceleration run-m.p.h.	50	51	52	52	51
Knock {	Reg.	None	None	Trace	Light
	Prem.	Did not try	Did not try	None	None

The T's A BIG BIRD NOW

To paraphrase a popular song: The grille is gone. It's now part of the big bumper. Sculptured metal is used instead of trim



THERE WILL be plenty of screaming over the new Thunderbird. Some will scream with delight about the roominess of the low-slung four-seater, about its big trunk space for vacation trips. Others will scream that Ford has destroyed their baby, the "cute" little T-Bird of yesterday.

Much larger than the original model (in fact, it is longer than some 1958 Ford sedans), the 1958 Thunderbird resembles the late-departed Continental Mark II.

Perhaps Ford is hoping to combine these two markets to create one that is big enough to be profitable. This may be an important factor in the design change.

The Thunderbird is now more closely related to the Lincoln than to the Ford. It is

produced at the same plant as the Lincoln. Actually, the unfinished bodies are built by the Budd Company and shipped to the Lincoln assembly plant for addition of running gear and interiors.

Unit construction is used throughout (as in the Lincoln), providing an all-welded, rattlefree package.

Four separate seats of the bucket type are used and the cushion contouring holds riders securely during fast cornering.

Standard is the 300-horsepower Ford V8 engine. Overdrive is optional with the three-speed handshift transmission. Dual-range automatic transmission is optional.

The hardtop is not interchangeable with the softtop — it's a permanent roof.

Luggage space is almost 50 percent larger in the new Thunderbird. The four round taillights have concentric backup lights

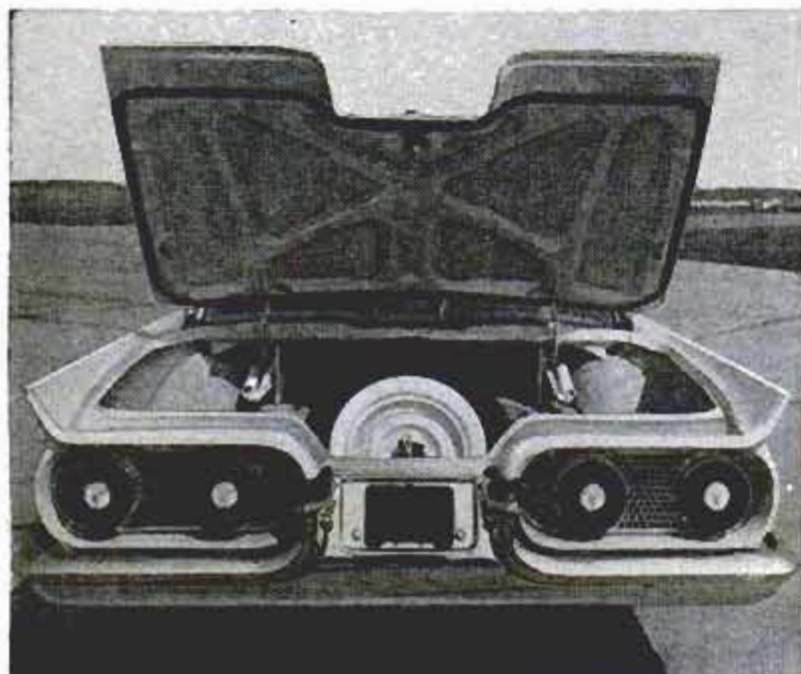

1958 SPECIFICATIONS

(1957 specs in parentheses)

Wheelbase	113.0 (102.0)
Over-all length	205.4 (181.4)
Over-all width	77.0 (72.8)
Over-all height	52.5 (51.6)
Rear-axle ratio	3.7 (3.56)
Bore and stroke	4.00 x 3.50
Displacement	352 (312 and 292)
Horsepower	300 (292 and 312)
Compression	10.2 (9.1 and 9.7)
Shipping weight	3708 (3299)
Headroom, front	34.5 (33.6)
rear	33.3 (none)
Seat height, front.....	11.0 (7.0)
rear	13.1 (none)
Legroom, front	43.4 (44.9)
rear	38.1 (none)
Luggage capacity.....	20.5 cu. ft. (14.0)
Turn-circle diameter	39.3 (35.0)
Wheel turns, lock-to-lock	4.1 (3.5)
Steering ratio	25 to 1 (23 to 1)



You can take along company now that the car has a back seat. All seats are higher, more comfortable

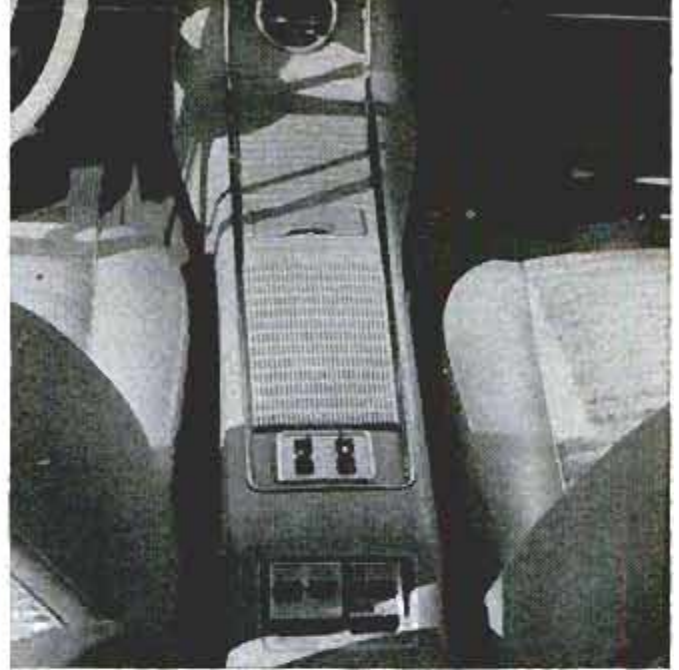

Right through the center runs this console on which are various controls. It's no car for young lovers

Not announced yet, but expected later is a soft-top convertible.

Suspension is by coil springs all around with air bags as optional.

Ford continues to describe it as a personal car, although the word prestige has been added. However, those who have driven prototype models feel that some of its personal character has been lost.

Being bigger and heavier, it has become more unwieldy, something that contradicts the personal tag. On first acquaintance, at least, it is not a car you feel intimate with.

The new Thunderbird is a fine car by its own standards, but it is not the pert, old "Bird." ★ ★ ★

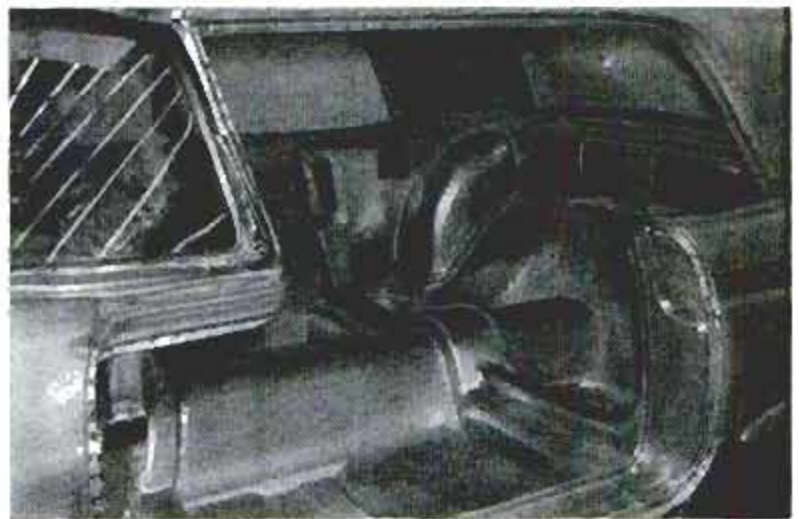

All-welded unit construction is used. Here you see the big driveshaft hump that makes the central console necessary

With its squared-off roof line and blind rear quarters, the new body is reminiscent of the Mark II Continental



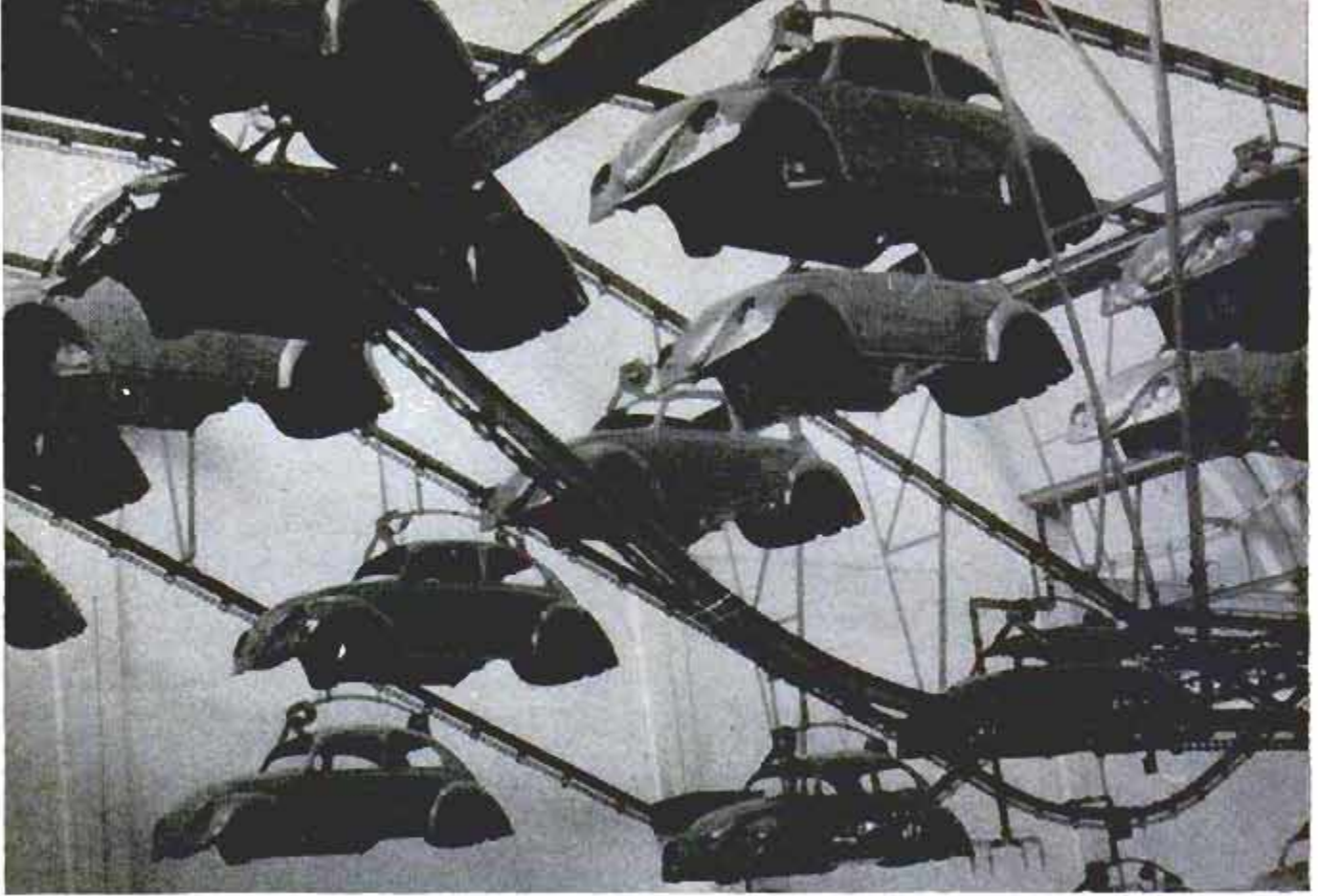

Like ornaments on a Christmas tree, VW bodies inch along toward the five final assembly lines at Wolfsburg

By *Arthur R. Railton*

You might expect this many trunk lids to last weeks, but it's just enough for a day's production of VWs





The author, second from left, watches a worker operate a power wrench on one of the three VW engine lines

RARELY HAS what at first glance seemed like so little, accomplished so much.

That, in a sentence, is the Volkswagen story.

Defying most of the rules, a maverick all the way, the Volkswagen has become the world's first international car—a machine "at home" in 100 countries with customers in most of them waiting months for delivery.

An empire is being created. Millions and millions of dollars are involved. Hundreds of thousands of persons are affected. In fact, some believe the economy of Western Germany (and perhaps of Western Europe and the Free World) is wedded to this enterprise.

Yet the whole structure rests on an elemental, almost-too-simple machine designed and developed 20 years ago. It is a machine so unpretentious that the American auto industry laughed when it first began to sell in this country and even today some still laugh



Dr. Nordhoff: "The 4,000,000th VW will still look the same"

More than 2000 VWs a day stream down this conveyor belt off the five final assembly lines at Wolfsburg

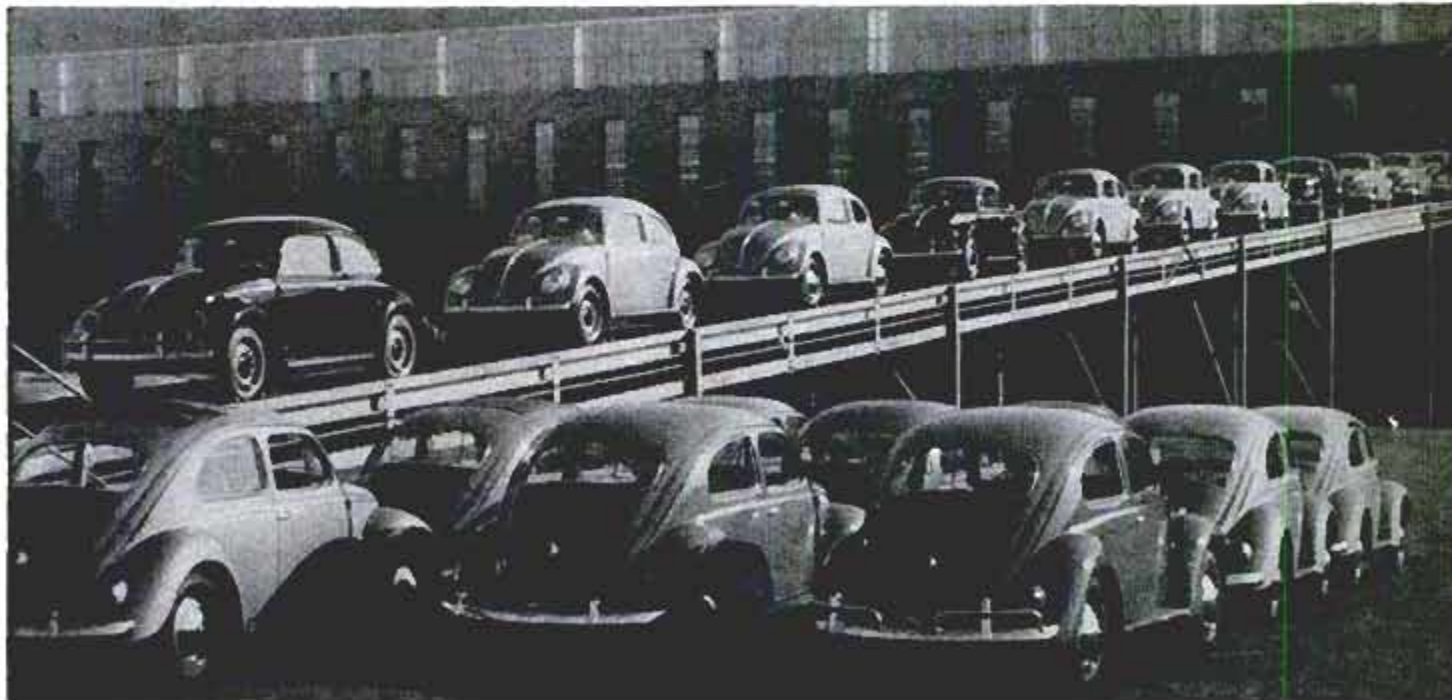

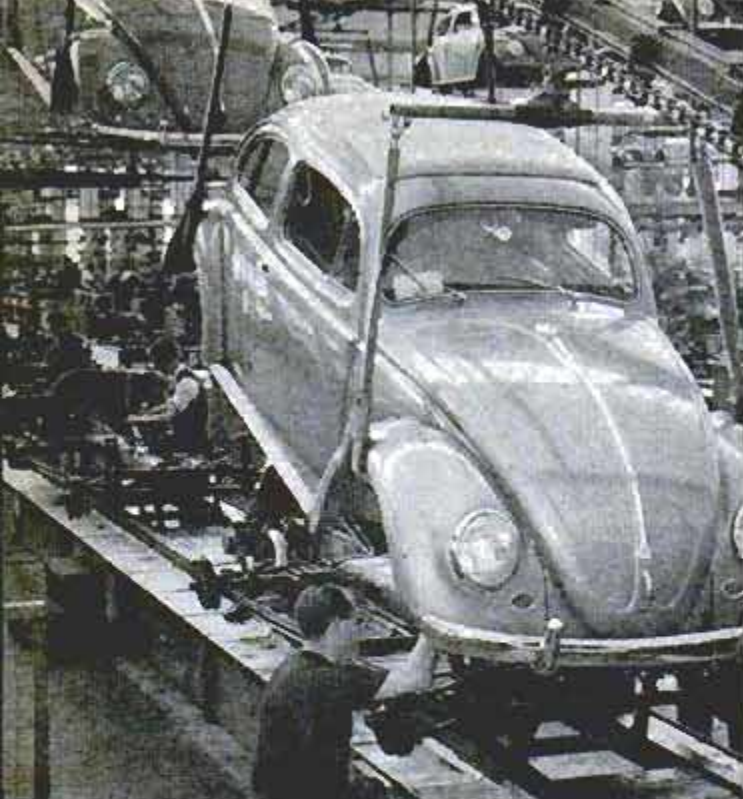

Body drop on one of the lines. Production is simplified by having just one body: Two-door sedans

Fresh off the assembly line, VWs are hauled on long double-deck trains to Hamburg for shipment overseas

(although their numbers are decreasing).

Yet it sells in greater numbers each year with no evidence of slackening.

How long can this continue? Success like the VW's is easy to take, but is it easy to hold?

Millions Without Change

Millions of VW engines have been built without major change in the past 20 years—a longer period of production than the Ford Model-T engine (VW officials are keenly aware of the parallel and ask uneasily "Will it happen to us?").

Yet this 20-year-old engine supports the empire. Will it support it for another 20 years?

The writer went to Wolfsburg, Germany, the city of Volkswagen, to study the VW miracle. I wanted to learn what makes this car, which looks so ordinary, so successful. I wanted some guesses about its future.

I wanted to find out if success will spoil Volkswagen.

One hazard of success is that you tend to stick with the formula—you resist change. By standing still (as Ford did with the Model T) you let the world rush past.

Will Volkswagen make this mistake?

Dr. Heinz Nordhoff, top man at Volkswagen, told this reporter that "the only decision I am really proud of is that I have refused to change Porsche's design. It's hard to remain the same. You can always sell cars by being new. But we chose a different course."

There is plenty of pressure on Nordhoff

to change. There always has been—even in the beginning before Nordhoff took over.

Right after the war, when VW was first resuming production, the so-called experts demanded changes. You can't sell that car without changing it, they said.

In the first place, they warned, it is associated with Hitler. Nobody is going to buy a car so closely linked to Hitler and the Nazis.

"It Needs a New Name"

In the second place, it has a name that the rest of Europe won't buy: Volkswagen. That's too German, too soon after the war. You must give it a new name to show it's the new Germany.

And anyway, these experts continued, the design is wrong. It has a rear engine and a rear engine will never sell. It has an air-cooled engine and the Franklin Company long ago discovered that air-cooling won't sell. It's too noisy. And those headlights in the fenders! Pierce Arrow went broke with that design.

These were the arguments for change back in 1946 and 1947.

But at the start (this was before Nordhoff took over), the car couldn't be changed. It either had to be built as it was or not built at all. There was no money, no material, no machinery for changes.

But there were many workers in Wolfsburg, most of them refugees. They were happy to work, mostly to have something to do, to feel some security in an uncertain, demoralized war-torn country. They had

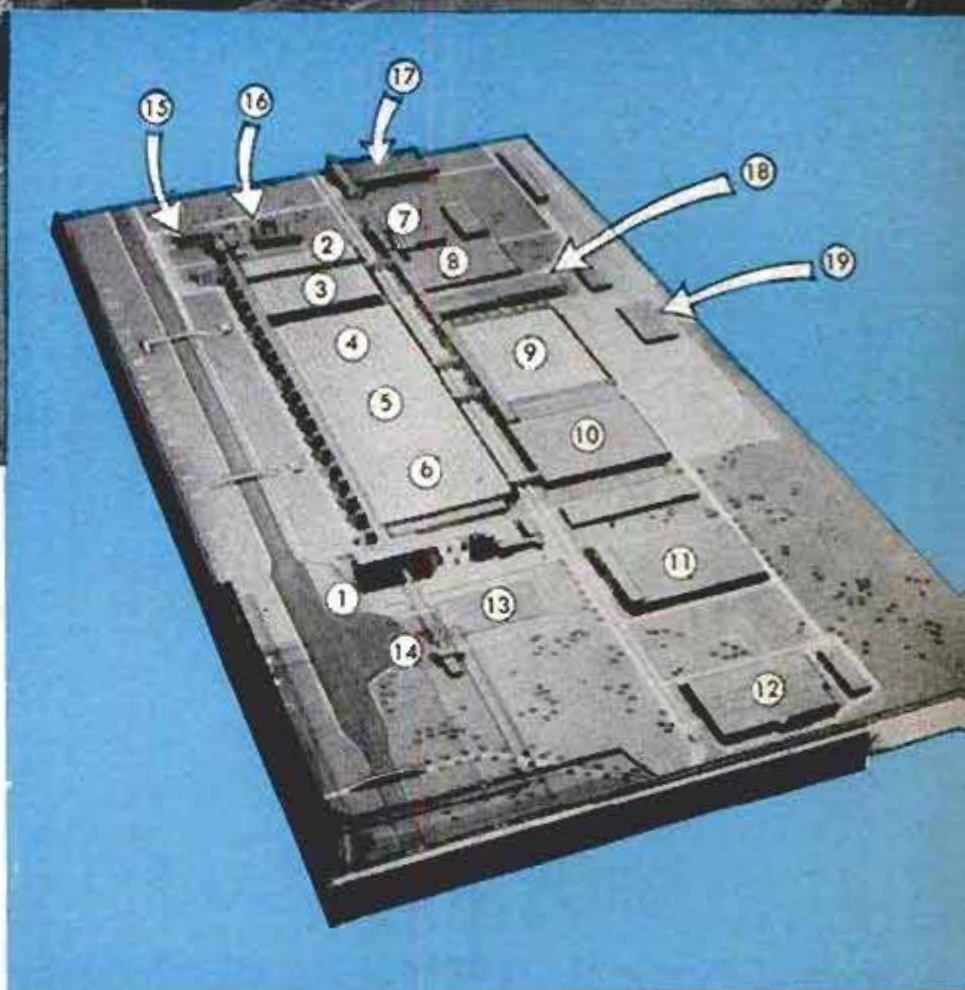
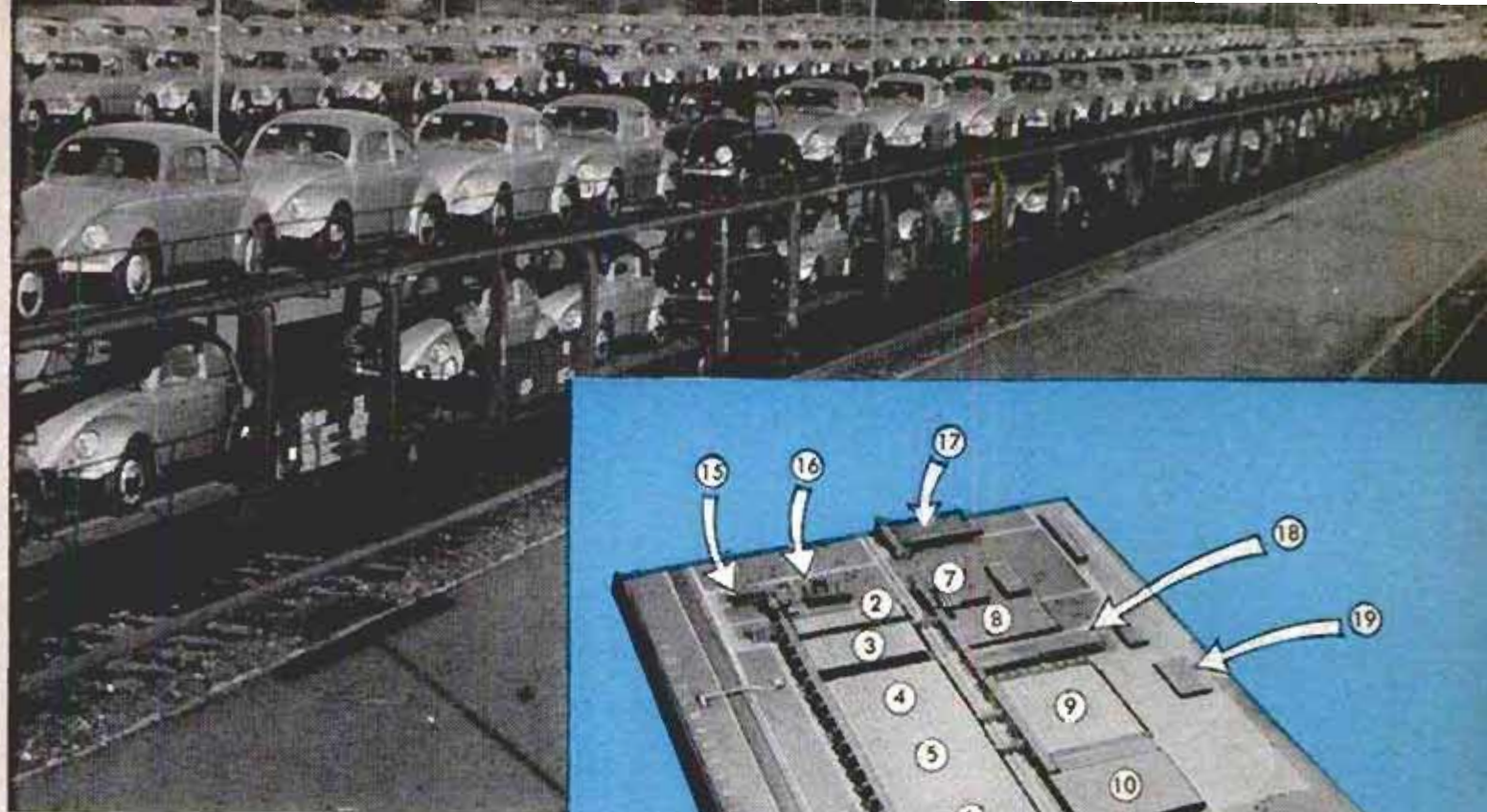

1. Power plant; 2. New stamping mill; 3. Old stamping mill; 4. Body assembly in white; 5. Frame, chrome, upholstery; 6. Engine-transmissions; 7. Research and Development; 8. Knocked-down-car shipping; 9. Final assembly and painting; 10. Wheel shop; 11. New engine-transmission plant; 12. Foundry; 13. Harbor for Midland Canal; 14. Conveyor belt to boilers; 15. New office building; 16. Service department; 17. Spare-parts warehouse; 18. Shipping office; 19. Train loading. Originally, the plant included only 1, 3, 4, 5, 6, 7, 12, 18

At Osnabrück, the Karmann Company takes VW chassis and builds sleek Ghias and Volkswagen convertibles

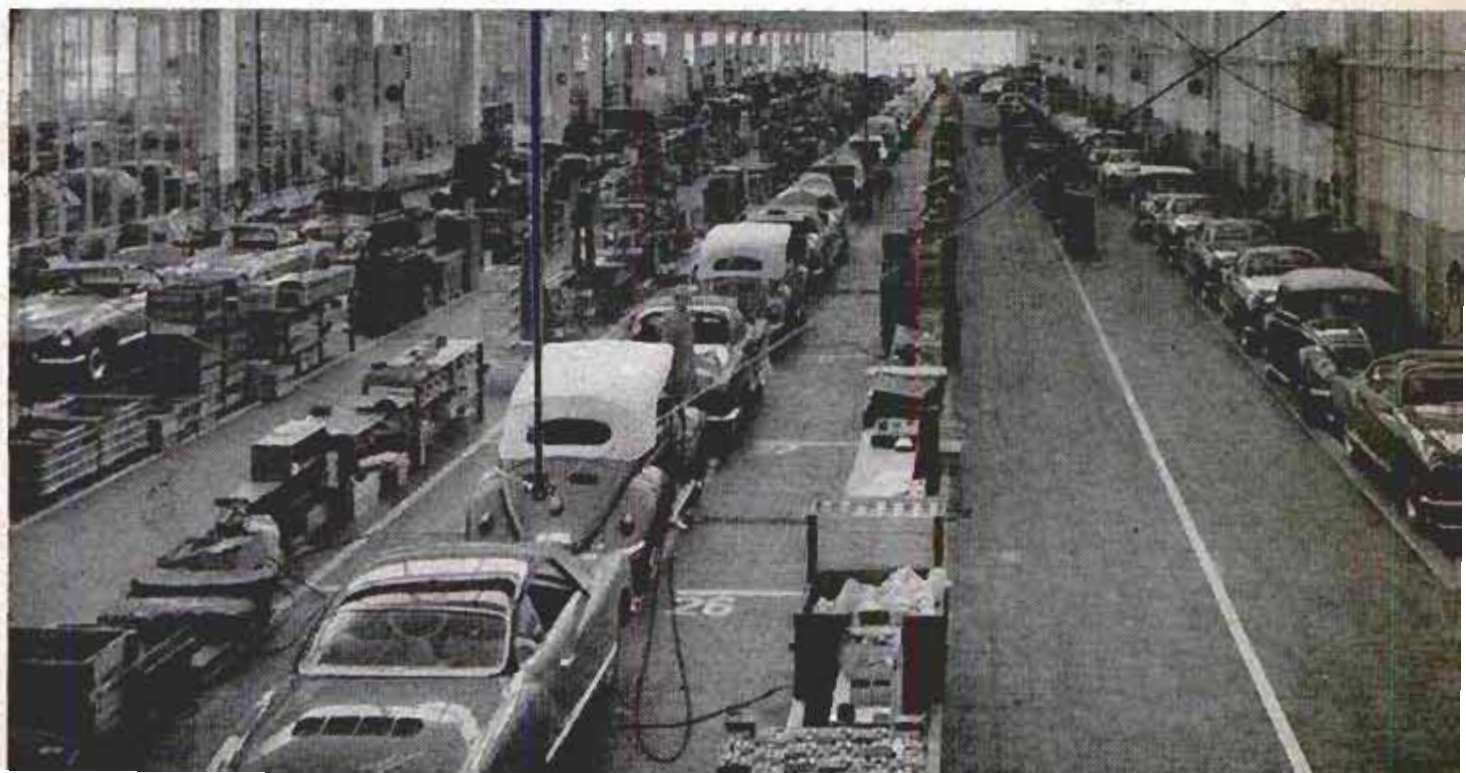



Air view of original plant after bombed areas (blue lines) were repaired. It's much larger today, see page 183

barracks in which to live, electricity from the factory's power plant to light their homes and potatoes to eat—but not much more at first.

Most of the cars they built were taken over by the Allied military authorities. Nobody in Germany could buy cars anyway. And the car wouldn't sell elsewhere because of its reputation and design—at least, so the British occupation forces thought.

Dutch Importer Turns the Tide

The first real break came when a Dutch importer visited Wolfsburg and said he could sell 10,000 of the cars if he could get them to Holland. That man was Ben Pon (still the VW distributor in Holland—a

rich man today). Some VW veterans say he's the man to whom they owe everything. He proved the car would sell outside Germany. The great success story had begun.

But will this success story continue? You don't stay ahead by standing still. Nordhoff knows that. And, contrary to what most people think, Volkswagen has not stood still.

Changes Have Been Minor

Not one part of the VW is the same as the original version, Nordhoff told me. Most changes have been minor. But there have been big changes (by VW standards at least): Synchronesh transmission; completely redesigned oil cooler (the result of

(Continued to page 254)

Built for speeds up to 100 miles per hour, this one-mile engineering test track seems to be rarely used

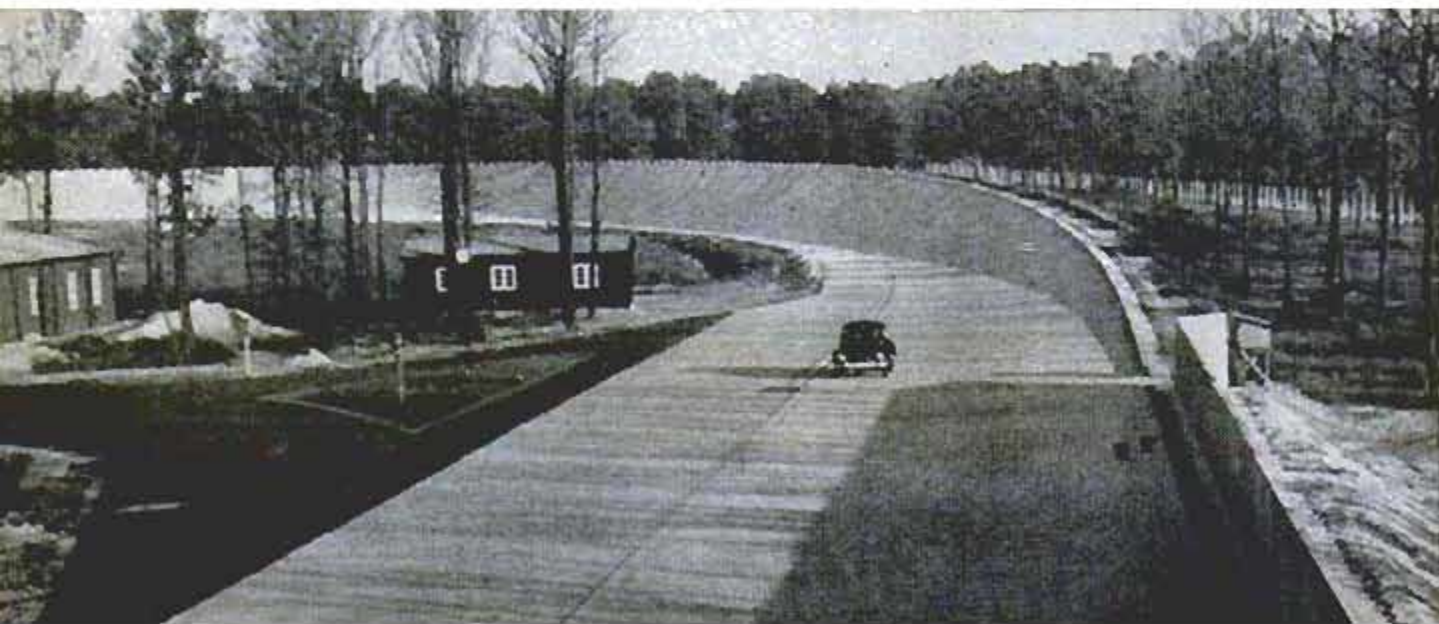

HERMAN ESARGUE
EXPERT RADIATOR SERVICE
BROOKFIELD, ILL.



How a Professional Recores an Auto Radiator

By Henry J. Kandl

1130 ROBINHODD LANE
LAGRANGE PARK, ILL.

IF YOU HAVE EVER had to replace the radiator of your car because it had been damaged or was badly plugged and caused overheating, your mechanic probably recommended that the radiator be recored. This repair is just as effective as a com-

pletely new radiator, but is considerably less expensive. You were pleased at being able to save money, but have you ever wondered just what recoring is? The step-by-step photos on these pages show how a professional replaces a core. ★ ★ ★

This radiator has been damaged by the engine fan and crankshaft pulley during front-end collision

First step in disassembly of damaged radiator is to unsolder upper ends of side brackets from upper tank

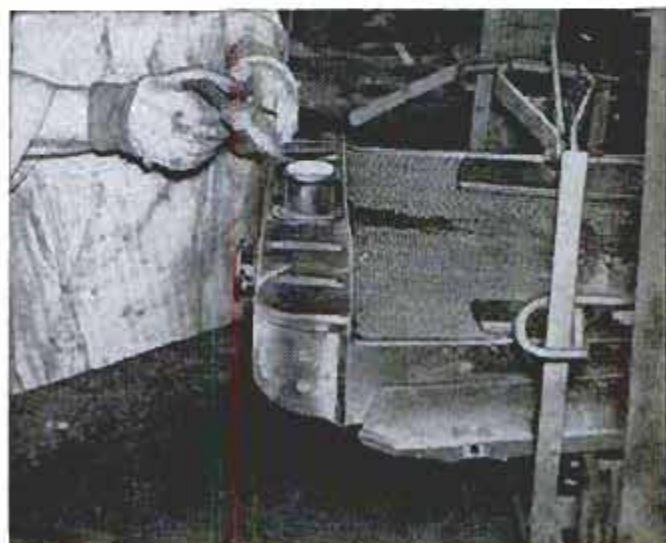

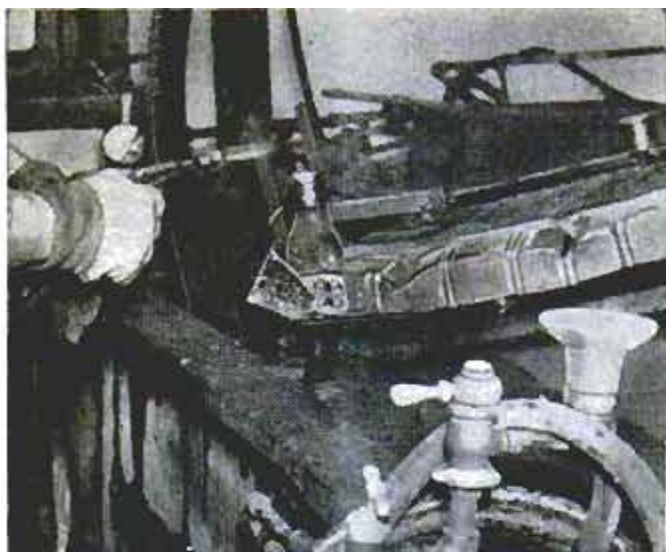

Lower ends of side brackets that hold radiator in car are removed from bottom tank. Note that tank also has been damaged in collision and needs repair

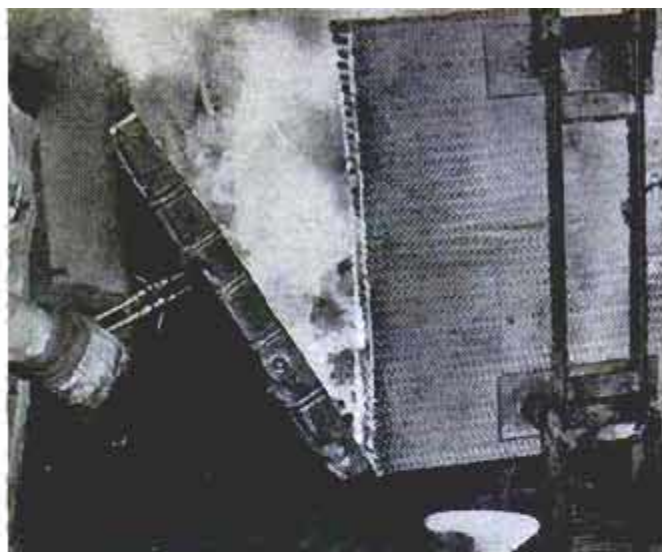

After side brackets are removed, the bottom tank is unsoldered. After it is removed from old core, tank is repaired easily and reshaped to fit new core

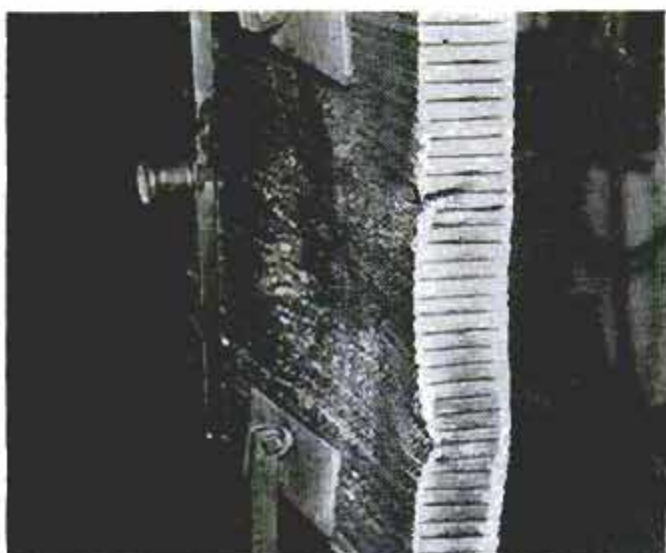

View of lower end of radiator core shows extent of damage. Deep cuts on end of core extend into water tubes, which appear to be long, thin slits in core

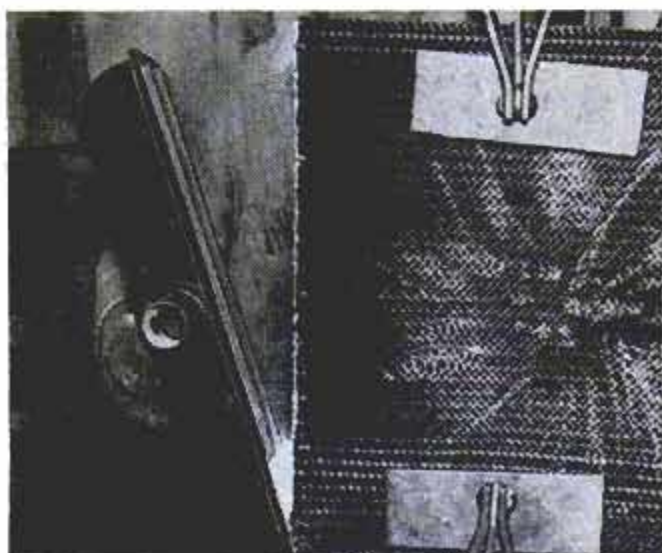

Last step in disassembly of damaged radiator is removal of upper tank. Air-acetylene torch is used for all operations, as it has lower temperature flame

Edges of upper and lower tanks are wire-brushed to remove rust, dirt and scale to assure complete tinning in preparation for soldering them to new core

Edges of new core now are cleaned with a wire brush to remove any residue that may have been formed during manufacture, to assure watertight soldering

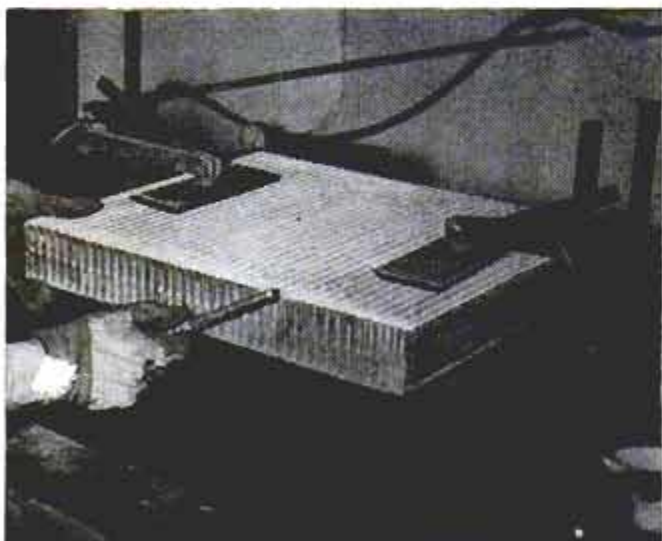

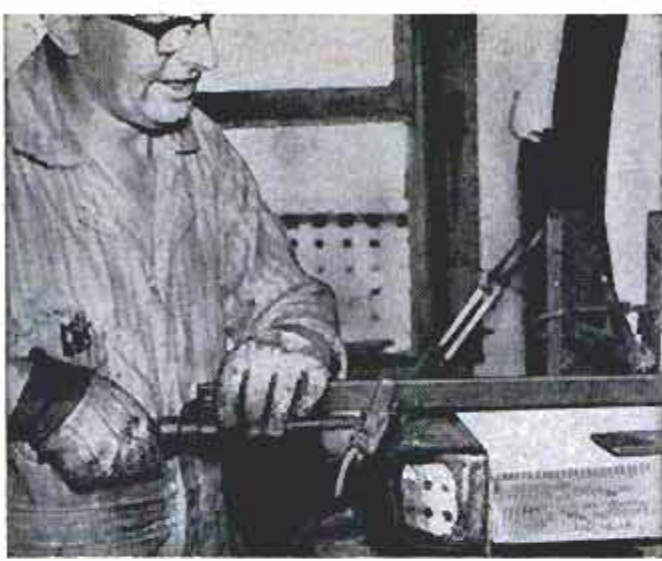

Upper tank now is clamped to new core and soldered in place. Lower tank is attached in the same manner. Special jig keeps core in proper working position



Bottom tank is already soldered in place. Here upper tank is receiving final touches. Skill is required for soldering, as radiator metal is extremely thin

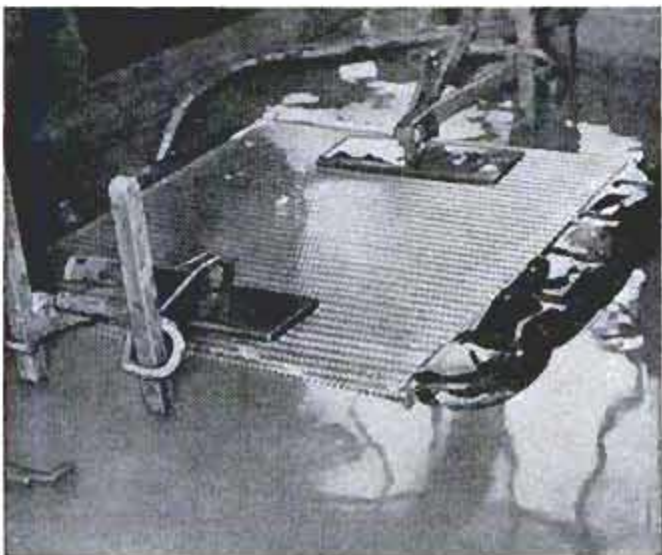

Core-and-tank assembly now is tested under air pressure in water tank. Test is made both before and after side brackets are attached to assembly



Side brackets are set in place and ends are soldered to upper and lower tanks of radiator. This is the final step in reassembling reconditioned radiator

Strictly for the sake of appearance, a coat of special black paint is sprayed on finished job. Paint is of a type that does not insulate against heat

Here is recond radiator, shining in its new paint. It looks like a brand-new radiator, will operate just as efficiently as original radiator on the car

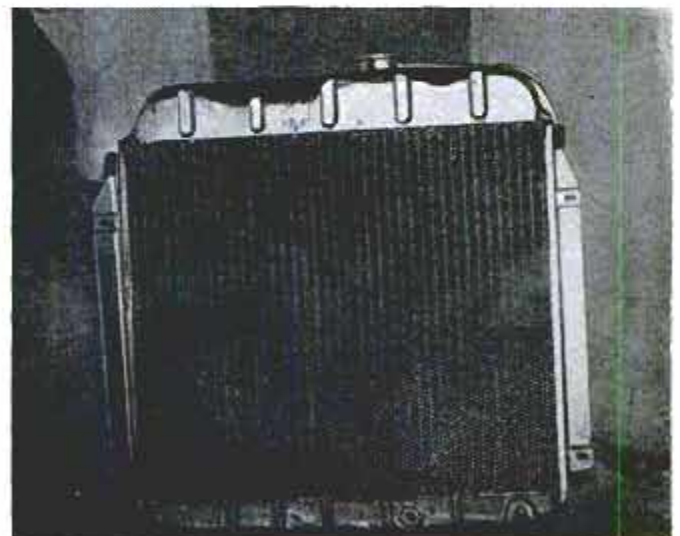

"Roll Off" Map Holder Mounts on Car Instrument Panel

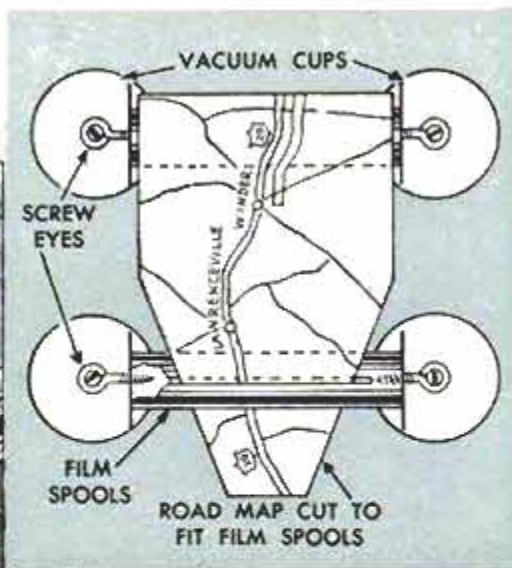

Four vacuum cups, of the type fitted with a screw, are mounted on top of the instrument panel to hold four screw eyes that provide "axles" for two film spools as shown in the detail. Cut a strip from a road map to include your route, making the strip just wide enough to fit on the spools. Taper the ends of the map strip so that it can easily be threaded onto the spools. The threads on the screw eyes, binding against the inside of the spools,

will prevent the latter from rolling too freely when the map is being unwound.—Bruce D. Stewart, Winder, Ga.

There will be no need for fumbling with a folded road map while driving if you make this convenient "roll off" map holder.

Causes and Cures for Cool-Weather Engine Stalling

During late fall and early spring, when the weather is cool and humidity high, many motorists are troubled by having their car engines die every time speed is dropped to idle. After a few miles of driving, when the engine is thoroughly warmed, the problem disappears. "Carburetor icing" is the term generally used to describe the condition that causes the trouble. When gasoline is sprayed into the carburetor throat it tends to vaporize, and in so doing requires heat. It absorbs heat from whatever is around it, in this case the carburetor. The temperature of the metal is reduced to the freezing point, and air, drawn in with the gasoline, contains a large percentage of water vapor on a humid day. The water vapor condenses

and freezes on the cold metal, and can build up a sufficient volume of ice to restrict the carburetor throat. When the car is driven at moderate speed, the throttle plate is open far enough so that gasoline and air can be drawn into the manifold. However, when the throttle plate is closed to the idle position, the opening is so small that the ice completely restricts it. Some gasolines now have additives that prevent icing conditions. However, if you have this problem with your car, there are a couple of things that can be done. One is to set the idle adjustment for a slightly faster idle during the weather periods in which icing occurs. A second method is to shift to neutral when stopping, with left foot on the brake, right foot on the gas pedal.

Tractor-Trailer Fleet Equipped With Two-Voltage Lighting

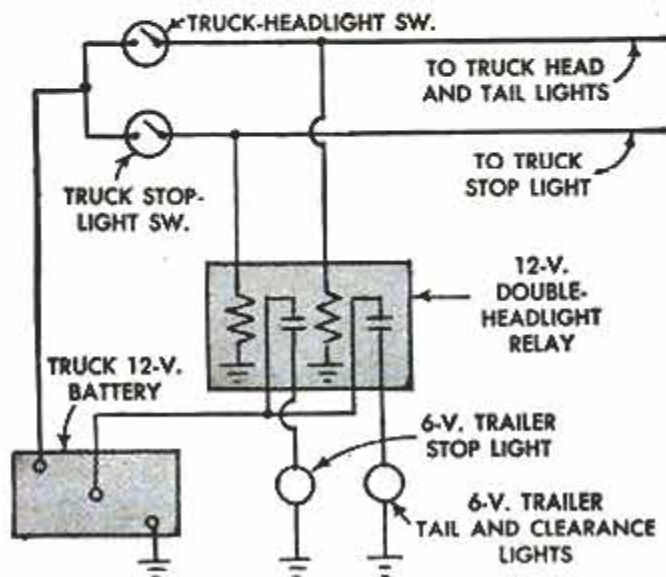

When one truck-fleet owner purchased a number of new tractors that had 12-volt lighting systems, he was faced with the problem of using them with trailers equipped with 6-volt lights. Also, because some of the older tractors still had 6-volt systems, it was impractical to convert the trailers to 12 volts. His solution was to have a battery post soldered to the center post of each 12-volt battery, and a lead run from this post through a circuit, including a headlight relay, as shown in the detail. Another method of achieving this result would be to hook up a resistor to a separate wiring system, which would reduce battery current from 12 to 6 volts.

Albert W. McDermid, Sacramento, Calif.

Do-It-Yourself Auto-Body Repair

Photos courtesy
Taylor and Art Plastics, Inc.

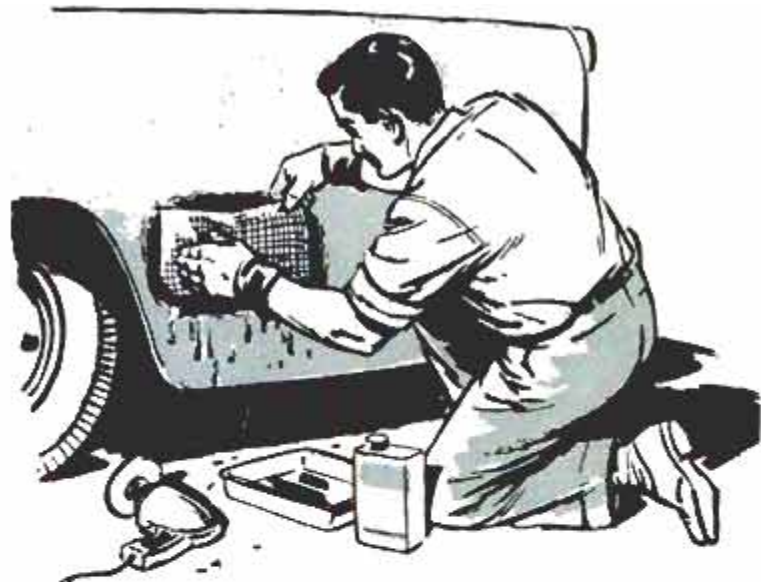

LIKE MANY ANOTHER skill, automobile-body repairing now has become a job that can be handled easily by the handy man. Glass-fiber materials and epoxy resins have made this possible. Most glass-fiber products, such as auto bodies and awnings, consist of glass fiber and polyester resins. This latter resin produces a strong, lightweight material, but does not adhere to other substances. Epoxy resin adheres tenaciously to metals and other materials. When buying a repair kit for auto-body work, be sure it contains epoxy resin. Because no heat is required when making repairs with glass fiber,

warping and distortion of the sheet metal do not occur. Also, since no acids or fluxes are required, as when lead is used to make a sheet-metal repair on a car body, glass-fiber does not present a painting problem. If fluxes and acids are not completely removed or neutralized, they will

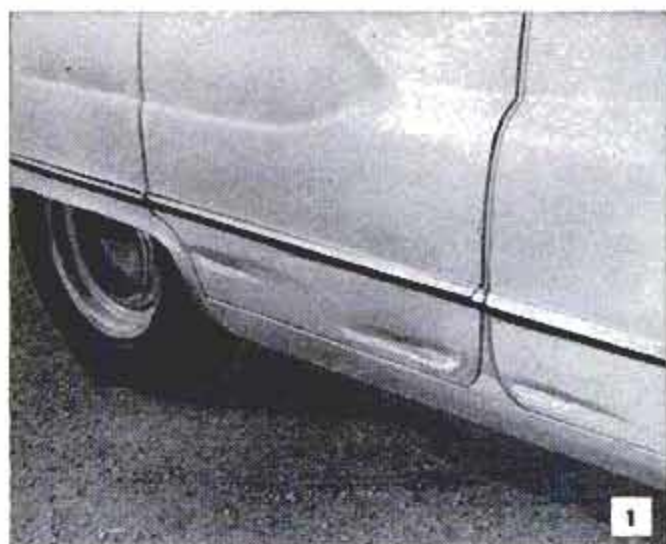

This type of damage, not extensive, but unsightly and value-reducing, is repaired easily by the handy motorist with kit containing glass fiber and resin

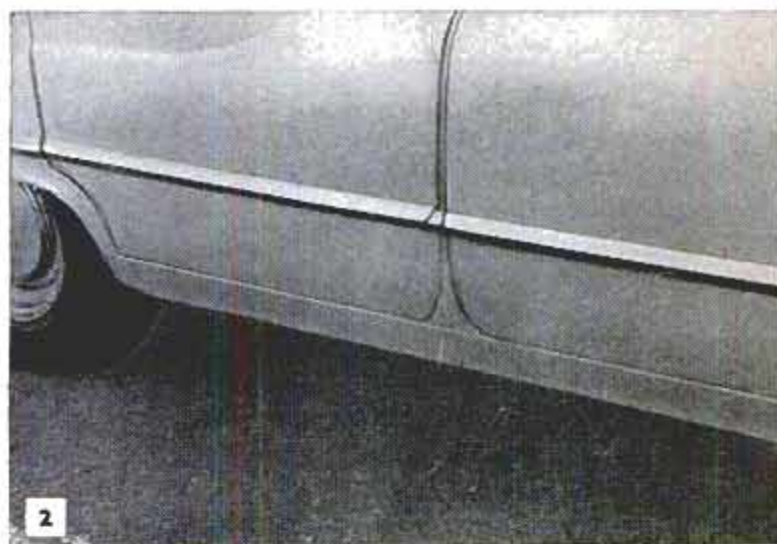

Repair with glass fiber restores original appearance to car body. Repair is as permanent as one made with metal, has added advantage of being rustproof

Because excess resin will run onto paint and damage it, paper towels are taped to body around area to be repaired, so they absorb resin, protect the paint

After glass-fiber cloth has set and been sanded, small pits and imperfections are filled with glass-fiber "putty," applied with regular putty knife

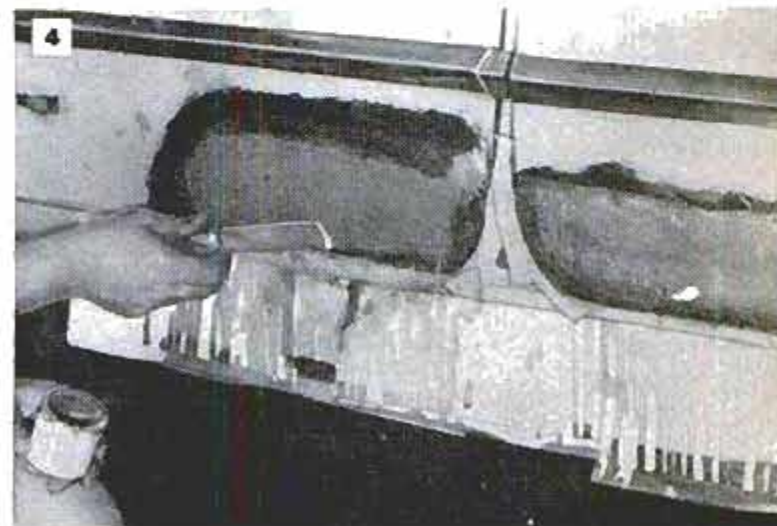
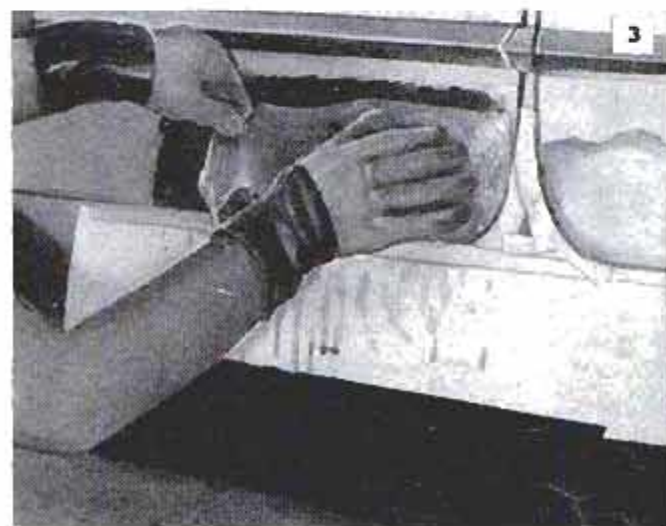



Heat lamps are used to warm metal before glass-fiber patch is applied and, as here, to speed drying of patch after it has been applied to body metal

Disk sander is used first to prepare surface for repair, then to smooth glass-fiber patch after it is applied. Use coarse or medium-grit sanding disks

react with the paint and cause it to peel off down to bare metal.

Whether damage to an auto body is due to something denting the sheet metal, as in Fig. 1, or is due to rust, Fig. 7, it can be repaired to like-new condition as shown in Figs. 2 and 9. The first step in making a glass-fiber repair is to sand down the damaged area, Figs. 6 and 7, removing the paint several inches beyond the actual damage.

Next, wipe the sanded metal with a solvent to remove all traces of oil and wax. If there are holes torn or rusted through the metal, tap the edges inward. Now, drill a series of small holes just outside the perimeter of the damage. Resin will be forced through these holes and help anchor the glass-fiber patch to the sheet metal. To assure maximum adhesion of the glass-fiber material, the damaged area of the car body should be warmed by using heat lamps. Pieces of glass-fiber cloth now are cut to fit over the damaged areas. The resin and hardening chemical now are mixed together in a shallow pan in the proportions given by the manufacturer. Rubber gloves must be worn when dipping the glass-fiber cloth in the resin and applying it to the sheet metal, Figs. 3 and 8. Heat lamps are used again, this time to speed drying. When dry, the glass-fiber patches are sanded down to the contour of the body. If any air bubbles or low spots appear, glass-fiber "putty," a mixture of chopped glass fibers and resin, is spread on the patch, Fig. 4. After the putty has set firmly it is sanded flush, the area is cleaned and a prime coat of paint is sprayed on the repair. As shown in Figs. 3, 4 and 5, paper towels should be attached to the sheet metal around the damaged area to prevent the resin from harming the paint. ★ ★ ★



Rusted-out areas of body sheet metal are repaired as easily as dents. If holes are quite large, wadded newspapers are used to support patch until it sets

When applying glass-fiber cloth that has been dipped in epoxy resin, rubber gloves are worn to protect hands. Cloth is pressed smooth to remove air bubbles

Trunk lid has been restored to like-new condition without need for welding or use of lead. Repair is strong, light, rustproof and as permanent as metal



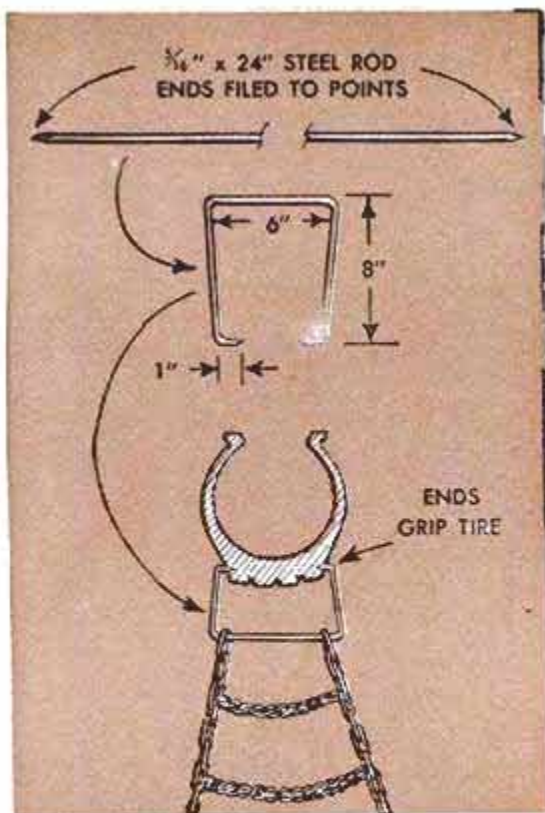

U-Shaped "Clamps" Simplify Installing Tire Chains

Because installing tire chains is necessary only when the weather is at its worst, the job never can be considered pleasant. Also, due to the slight clearance between the wheels and fenders on some late-model cars, it is necessary to raise each side of the car with a bumper jack to permit fitting a chain on the wheel on that side. However, with the aid of two U-shaped "clamps," bent from $\frac{1}{16}$ -in. steel rod as indicated in the detail, the need for jacking is eliminated and the job of installing the chains is made easy. The ends of the arms of the U-shaped clamps are ground to points and bent inward, as shown, to

provide a gripping action on the edges of the tire treads. In use, the clamps are "threaded" through the end links of the tire chains and are clamped to the tire treads. The chains then are stretched out behind each wheel and the car is backed slowly until the clamps come around close to the opposite ends of the chains. Someone standing beside the car can signal the driver when to stop. Or, as illustrated, a block of wood placed at the end of each chain will contact the wheels and let the driver know that he has backed far enough. The clamps and blocks then are removed.

Andy Vena, Philadelphia, Pa.

Improving Windshield-Defroster Efficiency for Driver

On many cars, the defroster clears the passenger side of the windshield before it does the driver's side, where it actually is needed first. Generally, this is due to the fact that the defroster hose is shorter on the passenger side. On new cars, the difference in clearing time is only a matter of moments. However, on older cars, where the heater and defroster fans work with reduced efficiency, this time difference is noticeable and potentially hazardous. To

remedy this situation, remove the hose from the passenger side of the defroster-fan housing, and stretch a 1-in.-wide strip of tape across the outlet. This usually will balance the air flow so that the driver's side of the windshield will clear first. In some cases it may be necessary to reduce or increase the width of the tape strip in order to produce the desired defrosting effect on either side of the windshield.

Donald G. Daus, Indianapolis, Ind.

Turn Signal Indicates Emergency

With the indicator set for a left-turn, the directional lights on your car can be used as emergency caution lights when changing a tire or making other repairs at the side of a road at night.

Oil Prevents Frozen Trunk Lid

You can prevent the lid of your car trunk from being frozen shut this year by wiping the rubber gasket with a heavy coating of olive oil. The oil, which helps seal out water, will not harm the rubber gasket.

Guard Rails Protect Children in Rear of Station Wagon

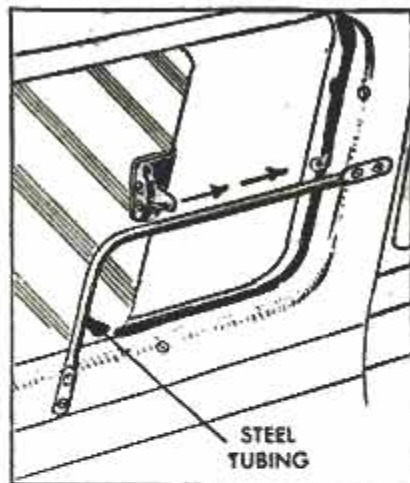

Restless youngsters riding in the back of a station wagon sometimes are tempted to slide open the windows and lean out to view the passing scenery. You can protect against this potentially hazardous situation by fitting guard rails, bent from steel tubing, inside the windows as shown. They are attached with sheet-metal screws.

Auxiliary Ignition Battery for Cold-Weather Starting

For every degree drop in temperature, an automobile storage battery loses some of its efficiency, and down around zero degrees F. the usable energy in even a fully charged battery may be only 60 percent of normal. This often is the reason that the starter sometimes seems barely able to turn over the engine on a bitter-cold day. And because cold oil in the engine causes increased resistance to the engine turning, the starter motor must consume more electrical energy than usual. The result is that little or no electricity is left to be sent through the coil, distributor and to the spark plugs. The engine simply will not start. However, with the aid of a 6-volt lantern battery—two in series for a 12-volt ignition system—plus a single-pole, double-throw, momentary-contact switch and a few feet of 16-ga. stranded copper wire, you can hook up a sure-starting auxiliary-battery system that will start your engine during even extremely cold weather. The

lantern batteries are held on the fire wall in a clamp bent from sheet metal and attached with sheet-metal screws. Note which pole of the car battery is grounded and ground the corresponding poles of the lantern batteries. Next, remove the coil end of the wire leading from the ignition switch to the coil and connect a wire in its place to run to the momentary-contact switch that is located on the instrument panel. Connect the wire from the coil to the common pole of the switch. Now, connect the wire from the ignition switch to the normally closed pole of the switch. A length of wire then is run from the lantern batteries to the momentary-contact pole of the switch. For starting the engine, push the switch to the momentary-contact side and use the starter in the usual way. Current from the lantern batteries goes through the coil and distributor and fires the plugs. When the engine starts, release the switch so ignition returns to normal.

Improved Timing Light Aids Home Auto Mechanic

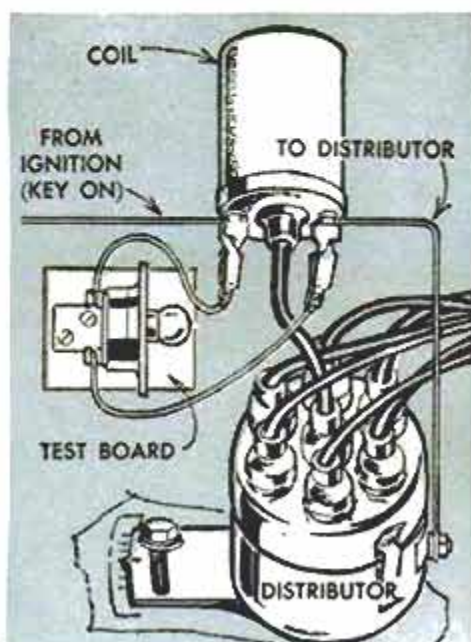

Here is a timing light for the home mechanic. A 6 or 12-volt bulb, such as from a taillight, is fitted in a socket mounted on a wooden base. A wire on each contact of the socket has a battery clip at the end. One clip is snapped on each low-voltage terminal of the coil and the engine rotated until the timing mark aligns with the arrow. With the ignition on, rotate the distributor until the light just goes out, which indicates that the points are opening to produce a spark.



A PLACE FOR EVERYTHING

FOLD-AWAY SEWING CENTER

By W. G. Waggoner

FEW HOMES CAN SPARE a separate room for sewing. More are apt to have 12 in. of wall space which is all the depth this fold-away sewing center requires. When closed, it looks like just another wall storage cabinet, but when open, it reveals a most complete and compact sewing workshop that is sure to please any family seamstress. Here in one floor-to-ceiling cabinet are stored all the essentials that go to make sewing really convenient. Featuring drop leaves which let down to provide a padded cutting and pinning table and a legless sewing-machine stand, the cabinet has a separate compartment for a dress form, shelves for dress material and patterns, thread racks and three button trays.

Where you can install it is an individual problem. Perhaps the most practical locations are in a bedroom, if large enough, or

in a corner of a basement recreation room. Figs. 4 and 6 show how the basic cabinet goes together. The depth is determined by the height of the sewing machine since it swings in over the button trays. Plywood is used for the ends, bottom and partitions, as well as the overhead storage doors. Shelves and bottom are set in dadoes in the upright members and then the front edges are faced with 2 x 4s. Strips across the back at top and bottom serve as anchor cleats for screwing the cabinet to the wall. Three standard flush-type doors, two measuring 24 x 80 in. and one 36 x 80 in., are used for the drop leaves and for the door for the dress-form compartment. The 36-in. door provides the cutting table, while one of the others is cut in three pieces to make the sewing-machine table and the doors above and below it, Fig. 2. Note how



Racks and pull-out trays located over sewing machine keep thread, buttons and needles within easy reach

the rear edge of the table rests against a 2 x 4 stop when open, and how it is built up to double thickness with strips of wood and hardboard, Fig. 1, to suit the sewing machine. The surface of this, as well as the cutting table, is padded and covered.

Fig. 5 shows the method employed to counterbalance the cutting table. Here flat-type window-sash balances are mounted on wooden blocks and attached to a U-shaped assembly to which the rear edge of the door is hinged. Drawer rollers fitted to the edges of the assembly make it roll easily in a track formed with cleats. Stop rods sliding in screw eyes engage holes in the top of the track to lock the table at the proper height. A single leg folds flush and supports the outboard end. ★ ★ ★

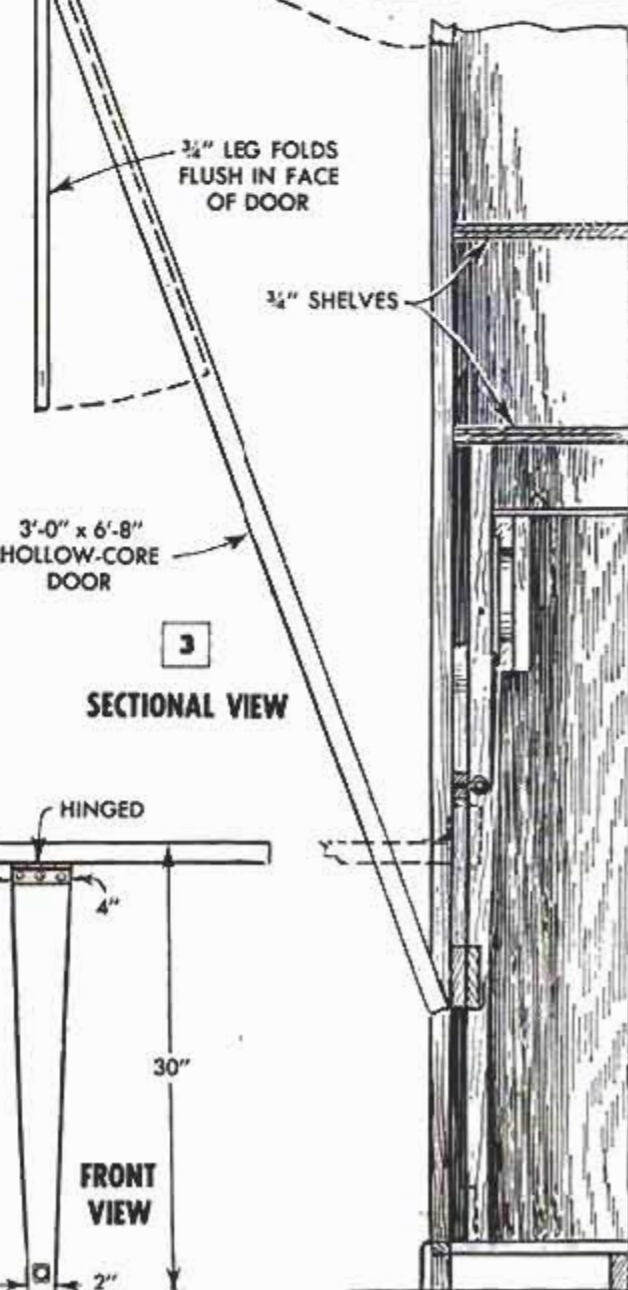
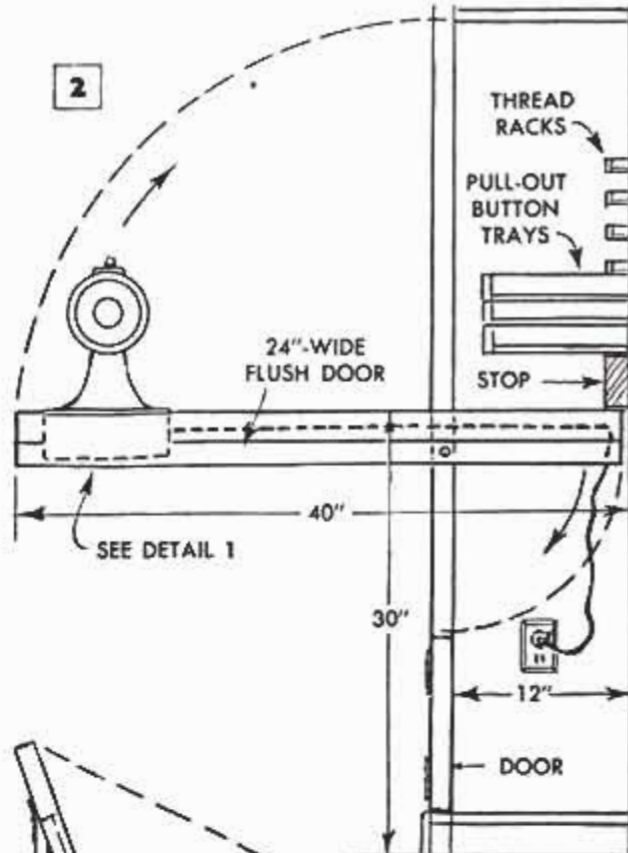
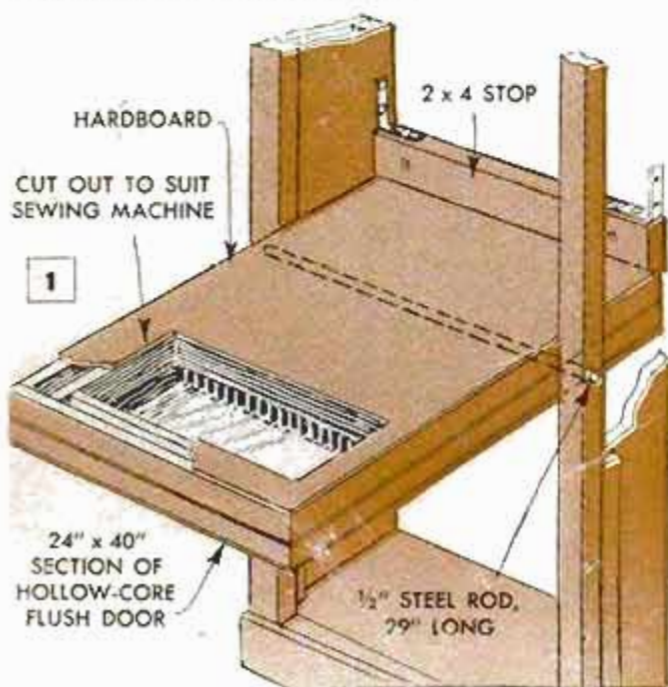

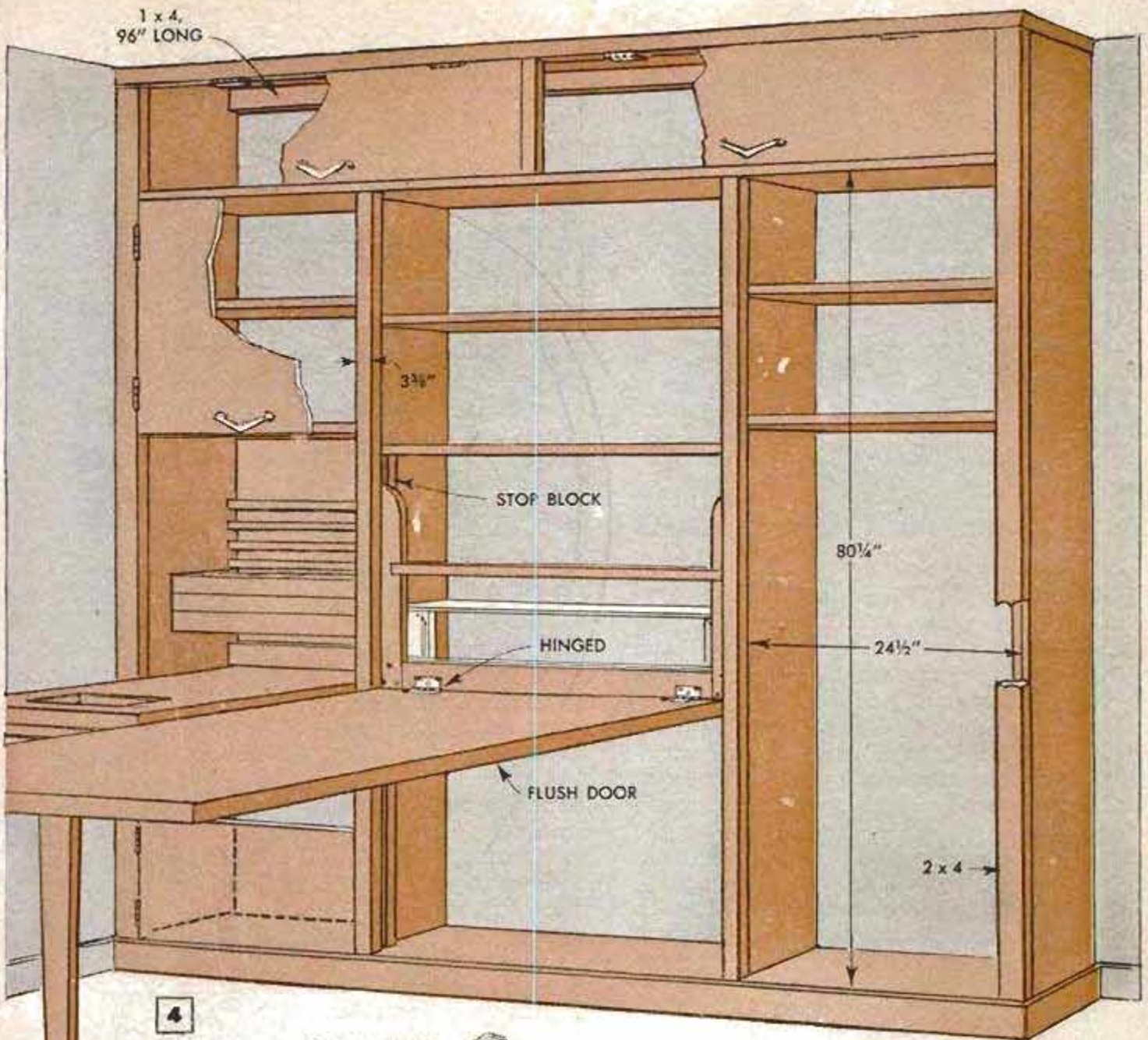

4

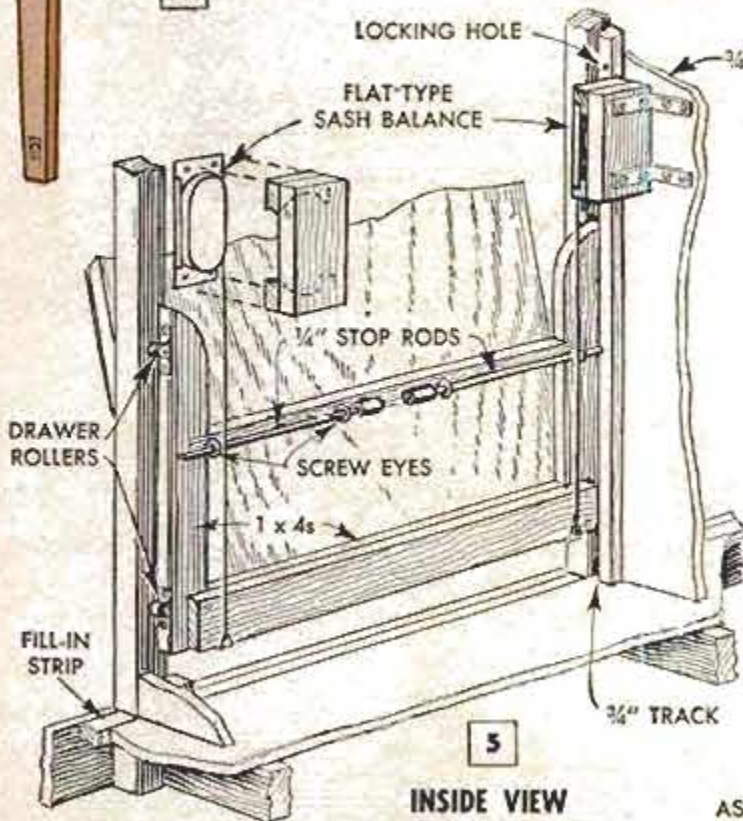

5

INSIDE VIEW

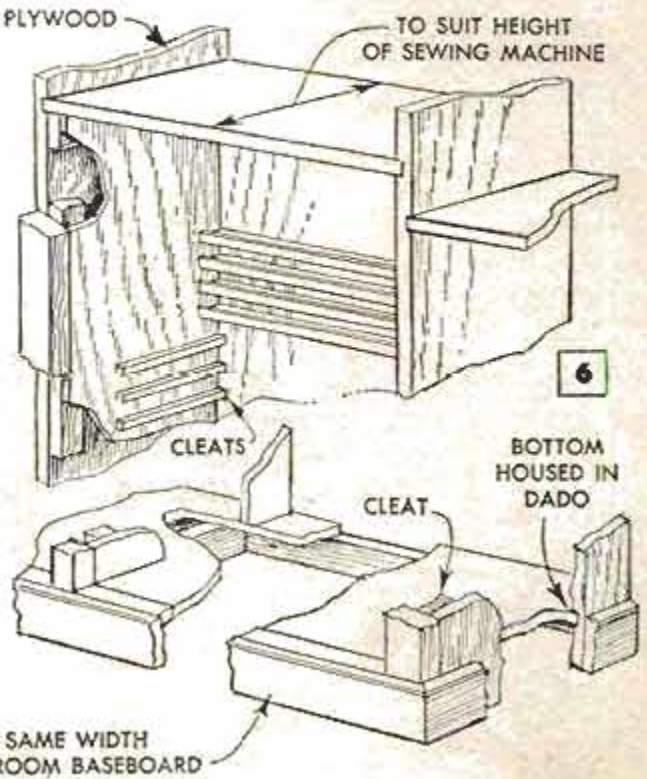

6

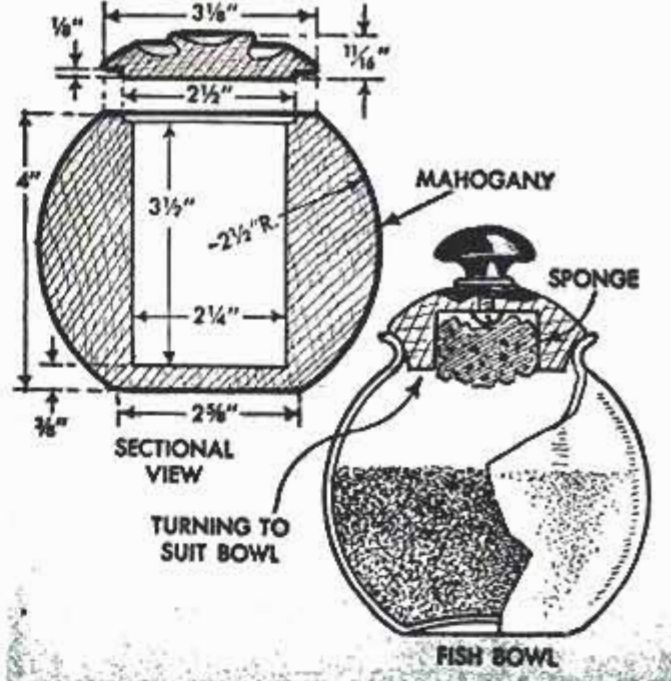

Two Simple Lathe Projects for the Smoker

If you have a wood-turning lathe, and smoke either a pipe or cigarettes, one of these two projects will let you combine hobby and habit. The "cannon ball" cigarette box will hold a full pack of king-size cigarettes; the capacity of the fish-bowl humidor depends on the size of the bowl used which, in turn, is determined by the amount of tobacco a smoker keeps on hand. Hardwood, such as Philippine mahogany, is suggested for the cannon ball, although any hardwood can be used. Softwoods with interesting grains also would make an attractive sphere. A block consisting of alternate laminations of dark and light woods, when turned, will present a strik-

ingly attractive pattern. If you have a friend who is a bowler, drill a couple of finger holes in the sphere, finish it with an ebony stain, and present it to him as a useful as well as ornamental memento of his hobby. Fish bowls come in a variety of shapes and sizes. Rose bowls, usually of lighter-weight glass, also could be used as humidors. A wooden lid is turned to fit the mouth of the bowl, then a recess is bored in the underside to accommodate a sponge that is moistened to keep the tobacco fresh. The knob on the lid can be a wooden turning, or a metal one in chrome or antique brass finish.

Hi Sibley, Nuevo, Calif.

Wall Rack for Roll-Film Adapter

When not in use, a roll-film adapter for a camera may be kept safe from accidental damage by storing it on two wooden clothespins screwed to the darkroom wall. Mount the pins upside down in a vertical position and just far enough apart to take the adapter.—John J. Rea, Urbana, Ill.

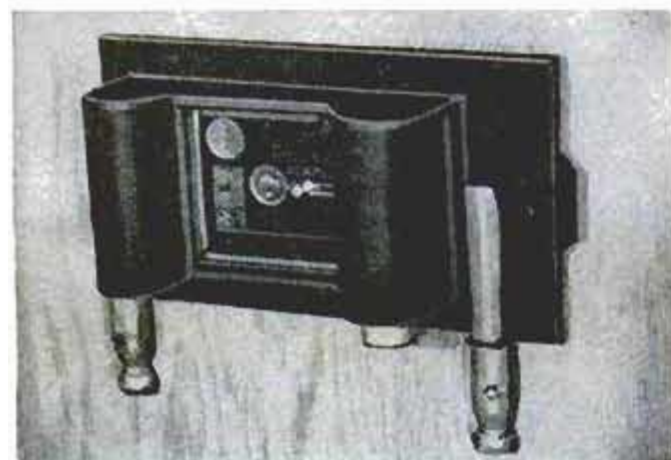

Square Held in Sawhorse Leg

On jobs where a try square is used frequently, such as when installing siding, the tool can be kept conveniently at hand by placing it in a slot cut in one leg of a wooden sawhorse. If a sawhorse has metal legs, attach a U-shaped metal bracket to one leg to accommodate the square.

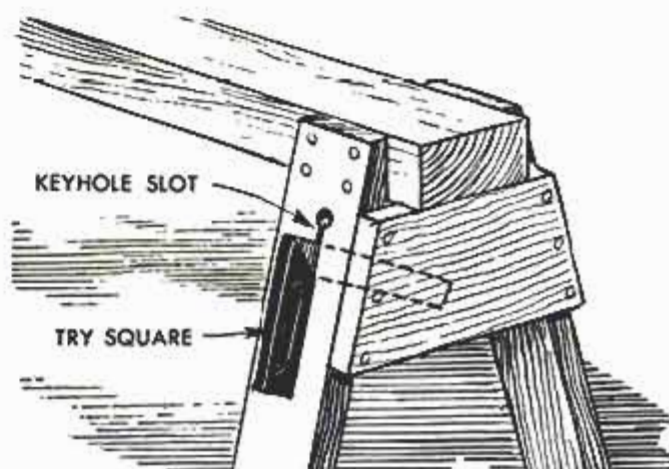



alls of ‘

CONSTRUCTED of “extruded” snow cylinders, “Fort Freezer” will withstand a heavy seige of snowball fighting. Spraying the fort with water on a cold night will give it resistance to thaw so it will last through several above-freezing days. First, mark off the outlines of the fort, then form a row

of snow cylinders along the lines, using the “extrusion machine” detailed below. Walls can be made any desired height, snow being packed between the cylinders as “mortar.” When the Fort Freezer warriors venture forth to storm another fort, hardboard shields will provide protection.

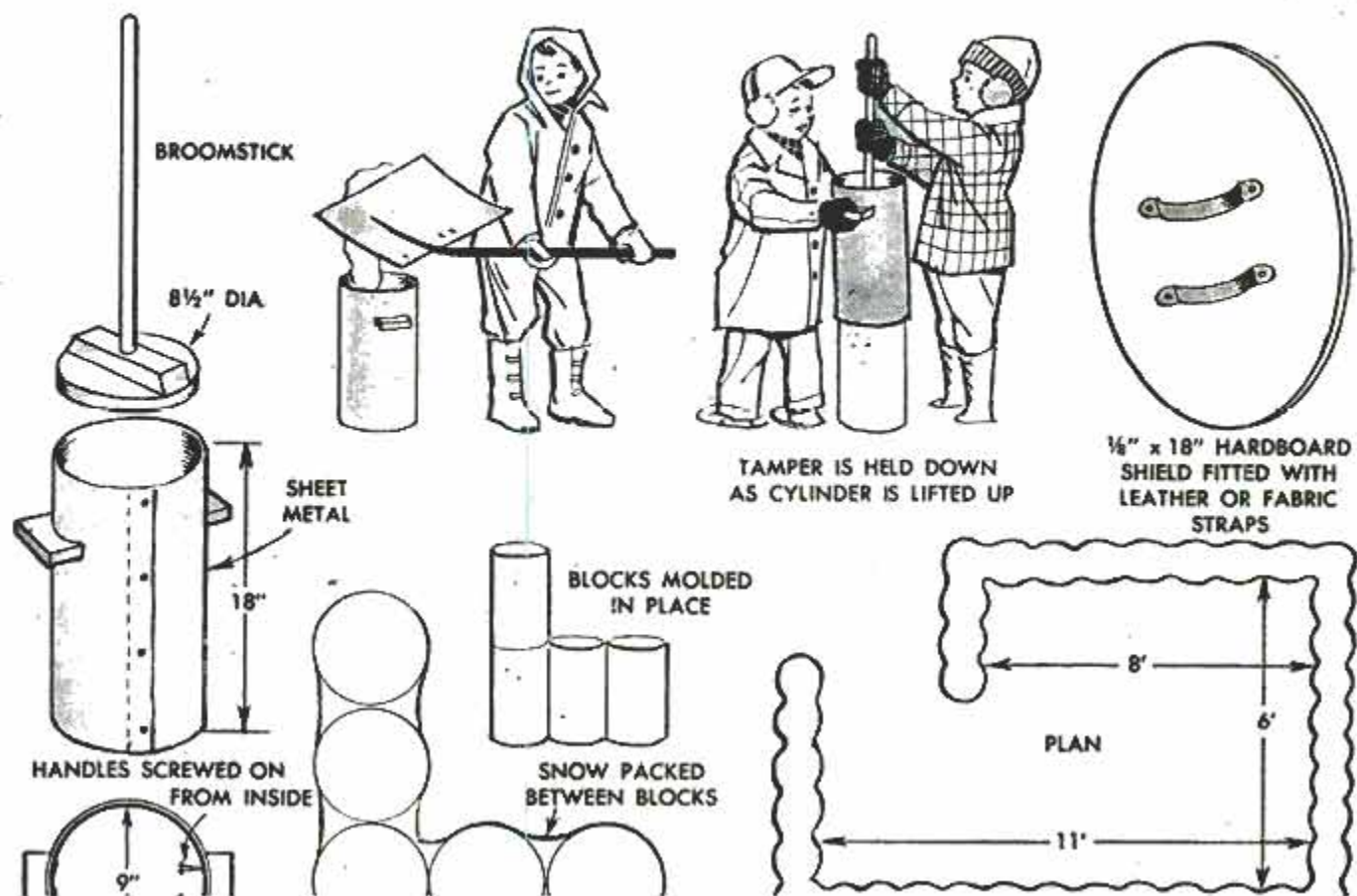



SHOP UNDER BASEMENT STAIR

You Will Be Proud Of These Power Tools

THEY ARE MADE BY DELTA and each unit has been designed and built to meet the diversified needs of the home shop and the school shop. To meet satisfactorily the requirements of these two applications the tools must be rugged. A 9-in. circular saw must be capable of handling a cut up to the full capacity of a 9-in. blade. The lathe must stay put, wherever it's placed, whether you're turning down a large square for a table leg, or recessing stock on the faceplate for a decorative wooden bowl. These operations call for heavy cuts and that means strength and stability where it's needed. Yet each unit must be light enough to be easily portable, so that you can move it about to the point where it is to be used, or push it back against the wall out of the way. At the same time, the unit must be attractive. Not pretty, but pleasing to look at, especially in the home workshop.

While many experienced craftsmen prefer to work with individual power tools, they will tell you there are advantages in

owning a combination unit, especially if the available shop space is limited, say, to the area under the basement stairway as in the photo above, or to the end of the garage as pictured on the opposite page. With these tools you have a choice of combination or of individual units. As an example, note the saw-jointer unit above. This comes also as a separate saw and jointer, each machine on an individual stand. Or you can buy the combined units as pictured above. Add the folding drill press, disk sander and saber saw (also available but not pictured), and you have very nearly a complete shop. All these machines are driven from one motor—the drill press, saber saw and sander being driven from a V-pulley, which is easily and quickly attached to the circular-saw arbor.

If your home-shop space is limited to the garage, the photo on the opposite page shows what can be done with attractive shop built-ins and a radial saw and dust collector. It's really a one-machine shop, but the radial saw is not a one-operation

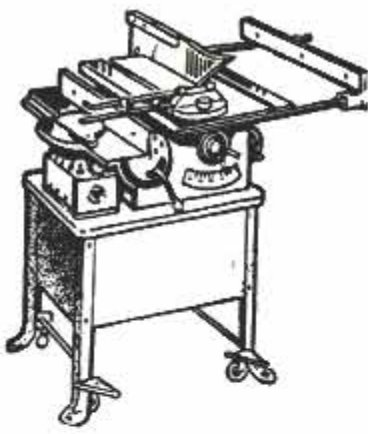

COMBINATION
SAW-JOINTER
UNIT

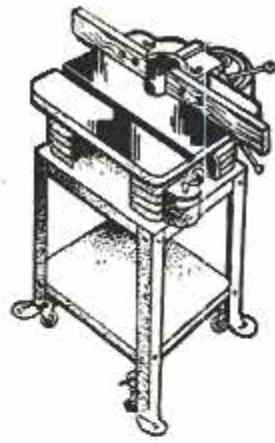

VERTICAL-
SPINDLE
SHAPER



11-IN.
DRILL PRESS



VACUUM
DUST
COLLECTOR

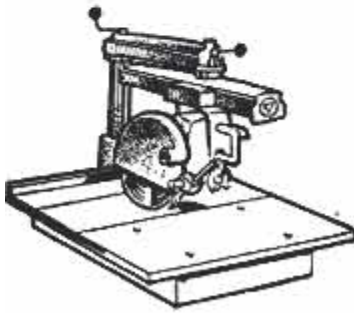

9-IN.
RADIAL
SAW

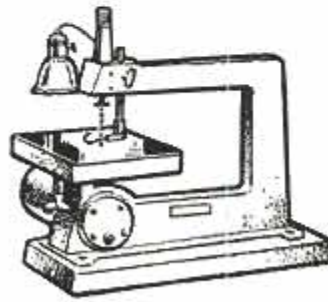

16-IN.
JIGSAW

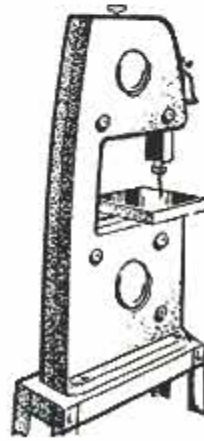

10-IN.
BANDSAW

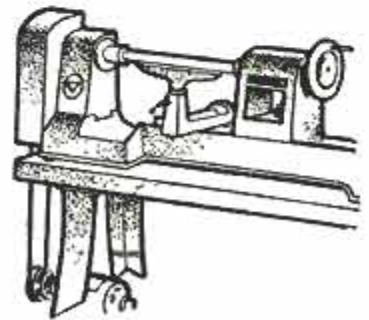

12-IN.
LATHE

SHOP IN THE GARAGE

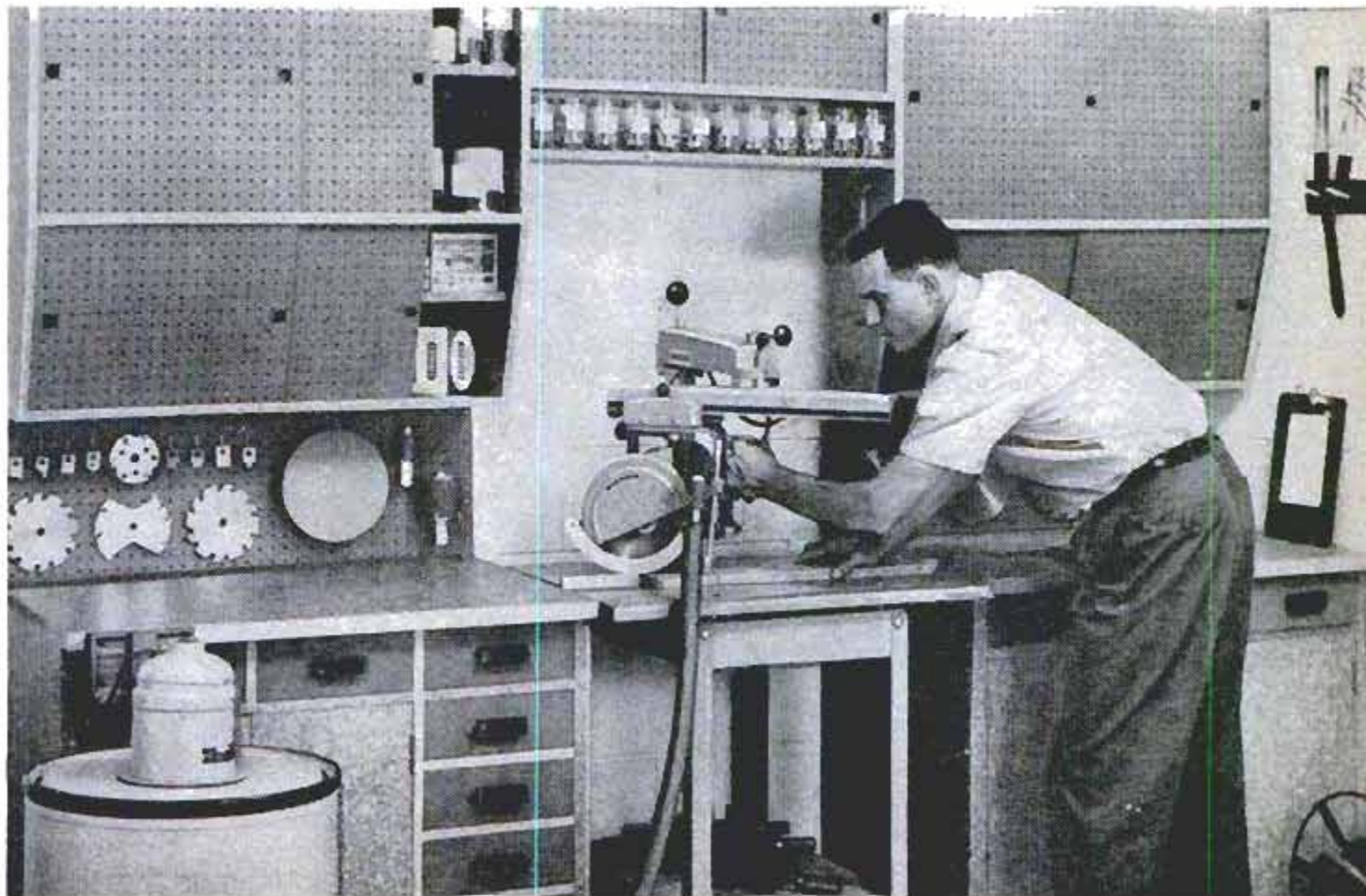

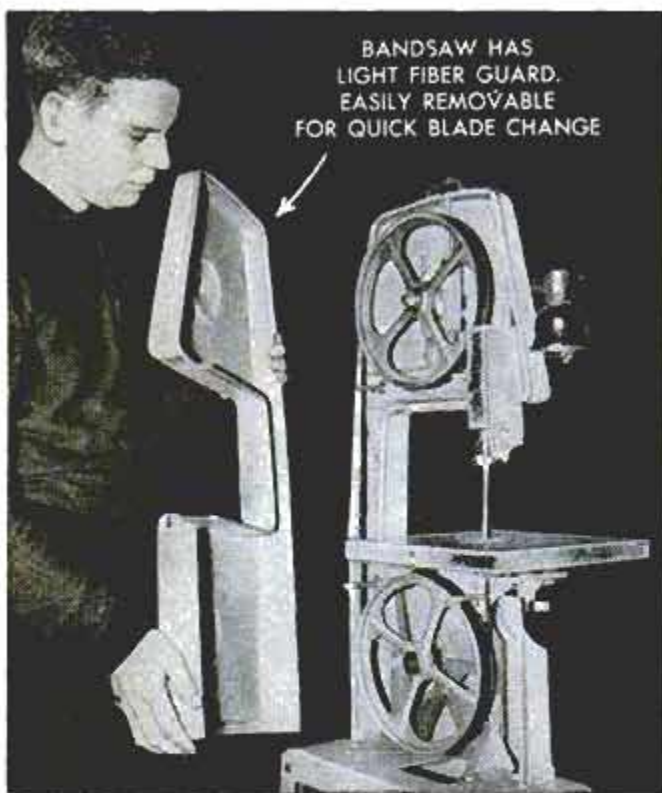

BANDSAW HAS
LIGHT FIBER GUARD.
EASILY REMOVABLE
FOR QUICK BLADE CHANGE

machine. It's a fast, accurate rip and cross-cut saw; it will cut grooves, dadoes, compound angles, bevels and, with accessories available, it becomes a router, drill, shaper, sander and grinder. Special retractable-caster sets are available for nearly all of the individual power-tool stands pictured. The caster sets are operated by a foot treadle and raise or lower the entire machine as desired. When the casters are in the down position the unit is raised clear of the floor and can be rolled easily to the desired position. Retracting the casters by a simple movement of the treadles lowers the stand to the floor. The combination unit (also the individual machines of which this unit is made up), the shaper, drill press, radial saw, jigsaw and bandsaw are available with steel stands to which the caster sets can be fitted. The dust collector is fitted with a special set of three casters which are regular equipment.

Now note some of the special features of the new machines. First of all, guards are

SPECIAL FEATURES OF DELTA MACHINES WHICH

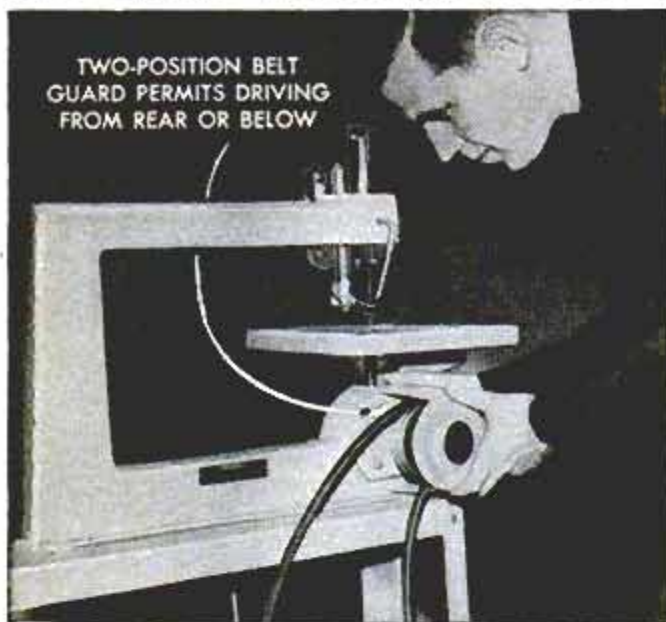

TWO-POSITION BELT
GUARD PERMITS DRIVING
FROM REAR OR BELOW

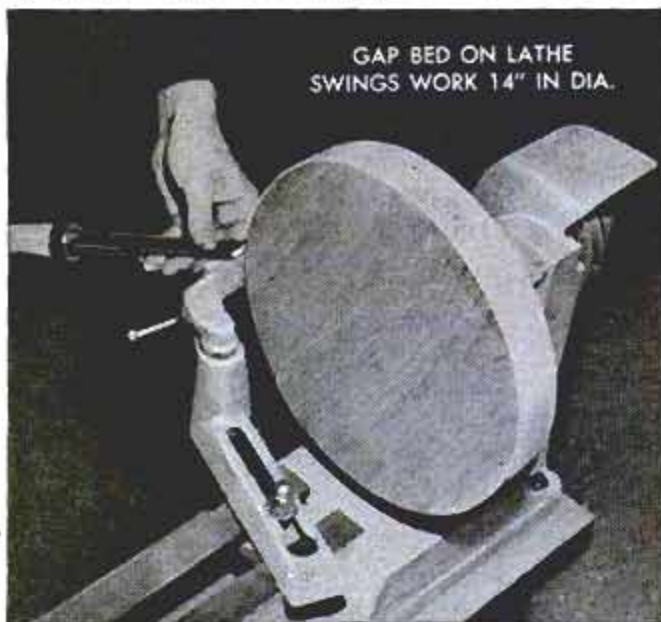

GAP BED ON LATHE
SWINGS WORK 14" IN DIA.



WRENCH CAN BE
INSERTED FROM FRONT
OR BACK OF TAILSTOCK

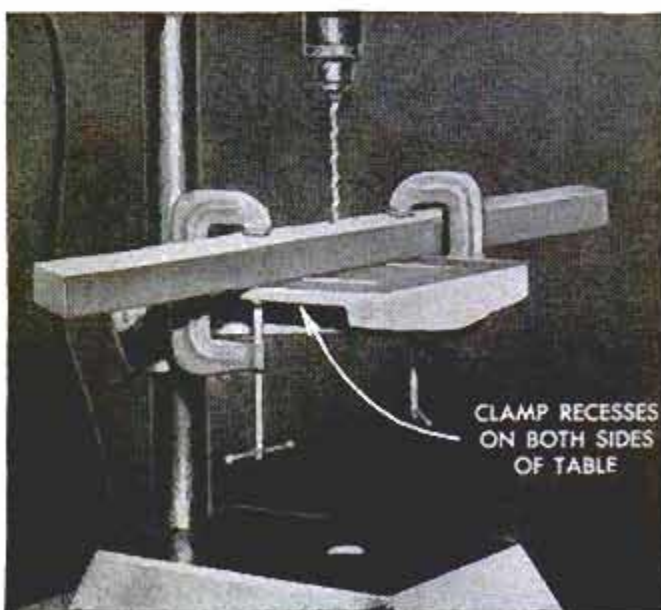

CLAMP RECESSES
ON BOTH SIDES
OF TABLE

fitted at all points where moving parts might cause injury in a moment of inattention on the part of the operator. A good example is the manner of guarding the radial-saw blade. The guard covers the top half of the blade and also the cutting edge as shown in the photo on page 199. The bandsaw is fitted with a special light-fiber guard which covers wheels and blade as in the photo at the top left on the opposite page. The lathe, jigsaw and drill press have belt guards designed to prevent fingers from being caught between the belt and pulley. The shaper can be fitted with a special ring guard to prevent any possibility of hand injury when running a molding cut on curved work. An accessory lamp is available for the bandsaw, jigsaw and drill press as work on these machines usually requires concentrated light.

Notes on the photos below and on the opposite page point out several new features of the 12-in. lathe. It swings work 12 in. in diameter over the bed, but the gap

in the bed adjacent to the headstock permits you to turn disks 14 in. in diameter. Note also the open tailstock which permits inserting the wrench from either side. The tool-rest clamp will not fall between the bed ways should you find it necessary to remove the tool-rest arm. There's an indexing pin and plate built into the headstock as in the upper right-hand photo below.

Note especially that the belt guard on the jigsaw, center left-hand photo on the opposite page, can be placed in two positions for driving with a V-belt from the rear of the machine or from below. This feature permits mounting the machine either on a bench or stand and still make use of the protective features of the guard. The drill-press table is recessed on both sides so that you can place C-clamps as in the lower right-hand photo, opposite page. The unit also takes interchangeable spindles which are available. The dust collector holds 3 bu. of dust and chips. ★ ★ ★

PROMOTE SAFETY, EFFICIENCY AND VERSATILITY

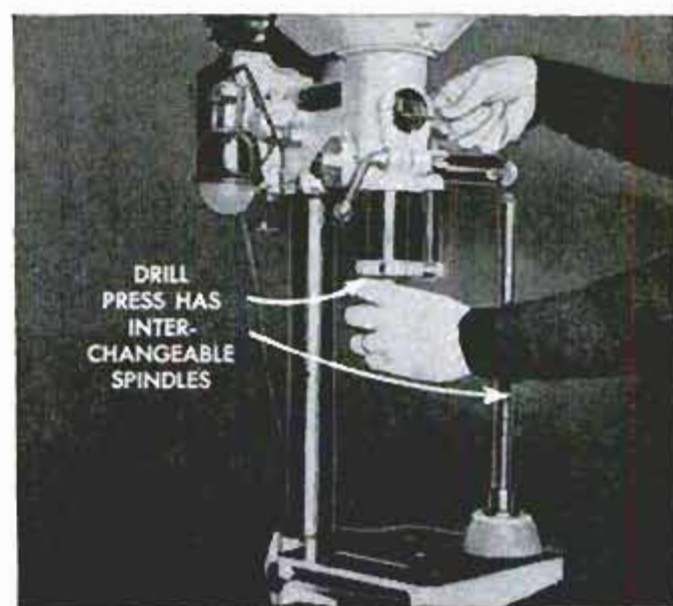
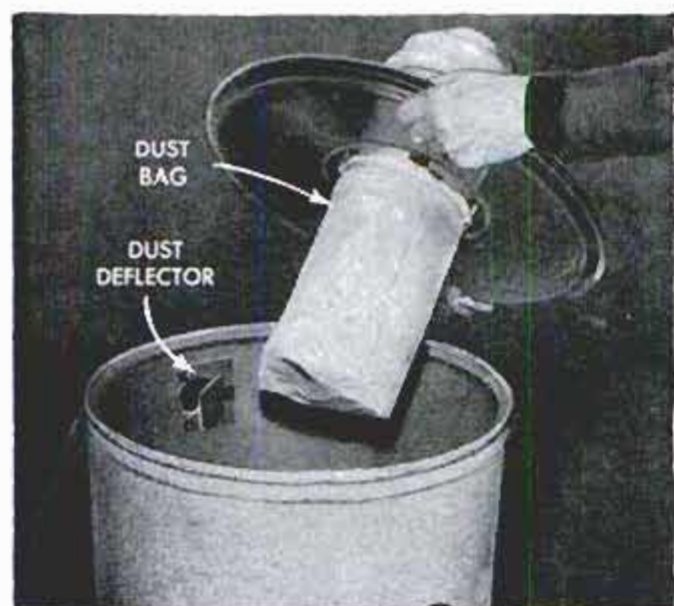
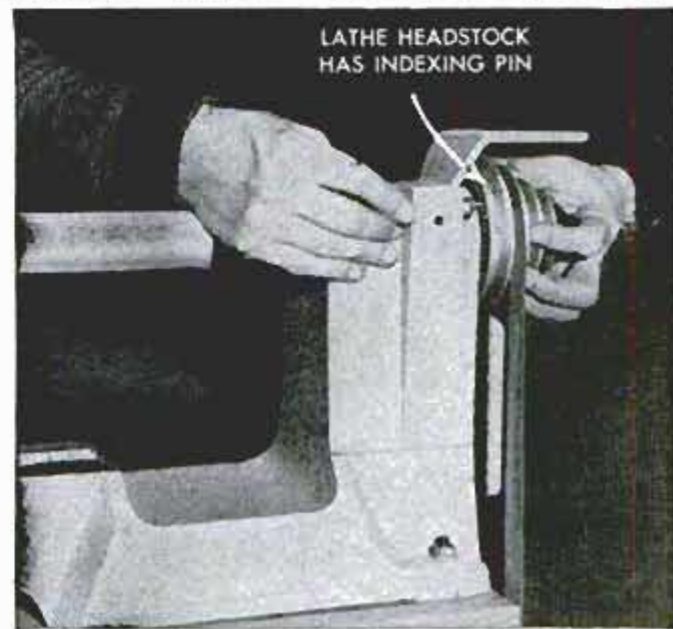

Improved Vacuum-Cleaner Attachment Permits Cleaning Inside Typewriter



To clean inside the confined spaces of a typewriter, tape a rubber tube to the radiator-cleaning attachment of a vacuum cleaner. The tube should be about 10 in. long, with an inside diameter of about $\frac{1}{4}$ in. After fitting the end of the tube into the attachment, seal the connection with tape. Vacuum cleaning a typewriter is preferable to blowing out the dirt, as air pressure is likely to drive dirt particles between moving parts.

Temporary Gas-Leak Repair

For a temporary repair on a leaking gas line, wipe the spot clean and dry and apply nail polish. The dried polish will seal a minor leak for a few hours, but a permanent repair should be made as soon as possible.

☐ Cardboard that is used in most laundered shirts provides a good guard to protect the floor when painting baseboards. Just hold the cardboard against the baseboard and slide it along on the floor as you paint.

☐ If a spray gun produces a distorted spray, probably the nozzle is partially clogged. Use a clean solvent to wash the nozzle. Never use a metal instrument to clean the nozzle orifice.

Bandage Repair Salvages Model

Plastic models too badly damaged to be repaired with just cement can be salvaged by reinforcing the damaged area with gauze bandage. Assemble the broken pieces and cement them in the usual way and allow the cement to set. Then apply gauze over the area and saturate it with cement.



"Rack" Supports Ferrotypes Tins

When drying a number of small prints, one photo enthusiast fits two ferrotypes tins in a wire "rack" made by soldering together two lengths of wire bent as indicated. The bowed tins provide a self-supporting unit that can be placed anywhere on a work surface while prints are drying.

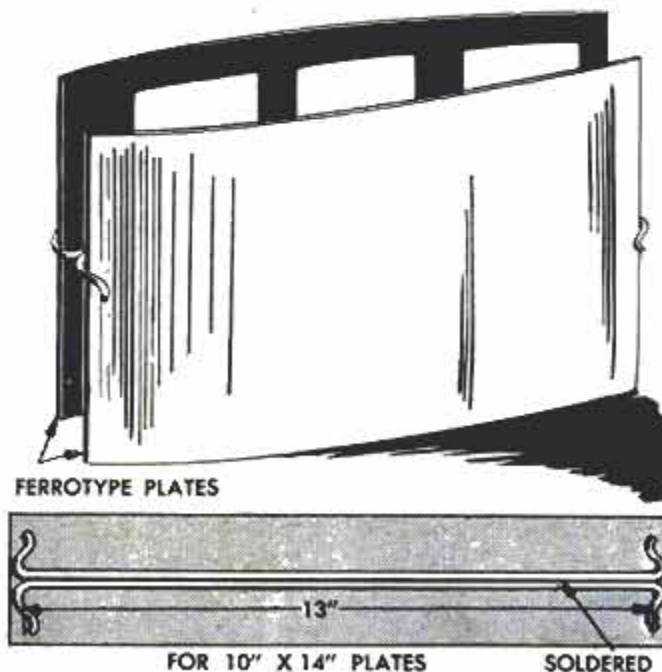

HOW TO WORK WITH HARDBOARD

HARDBOARD may not be new to you. You, perhaps, have already used it for drawer bottoms, bypassing cabinet doors, as an underlayment for a tile floor or to surface the top of your workbench.

In the material itself, there are a dozen advantages to be considered in using this manmade product. The do-it-yourselfer who works with it for the first time will find its hard, smooth surface ideal for painting. The material is all good since there are no knots or other surface imperfections to bother with. Being without grain, it has equal surface strength in all directions which means it cannot check or split like wood. It offers good and permanent resistance to moisture and can be formed into bends and curves. Best of all, it can be worked almost as easily as wood with hand and power tools, although its hard surface dulls cutting edges more quickly. It can be surface-nailed, screwed, glued and clamped like wood.

Hardboard comes $\frac{1}{8}$, $\frac{3}{16}$ and $\frac{1}{4}$ in. thick and in standard or tempered panels. If you want it for outdoor use, or for indoor use where high-humidity conditions prevail, you ask for tempered since it is harder and is treated to withstand moisture. If you want it for indoor use, you ask for standard. Popular sheet size is 4 x 8 ft., although smaller panels of standard size can be had.

WHAT IS HARDBOARD?

Basically, hardboard is reconstructed wood. It is manufactured by separating wood fibers, leaving each surrounded by its natural adhesive agent, and rearranging them in a "felted" or matted form under heat and pressure. The hardboard panel resulting from the process is a dense, grainless board which has great strength, durability and adaptability.

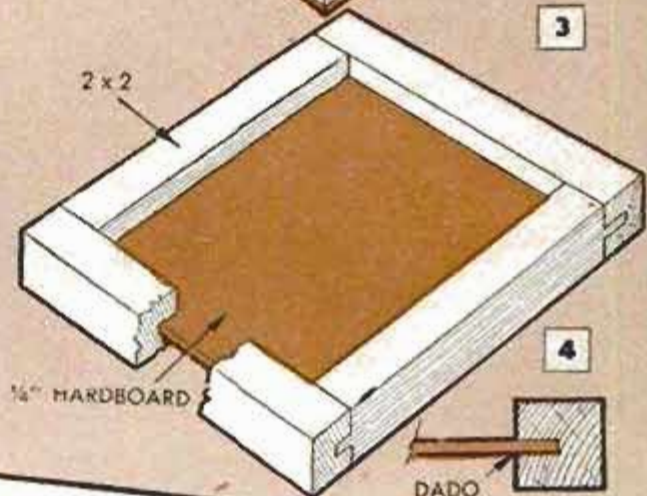
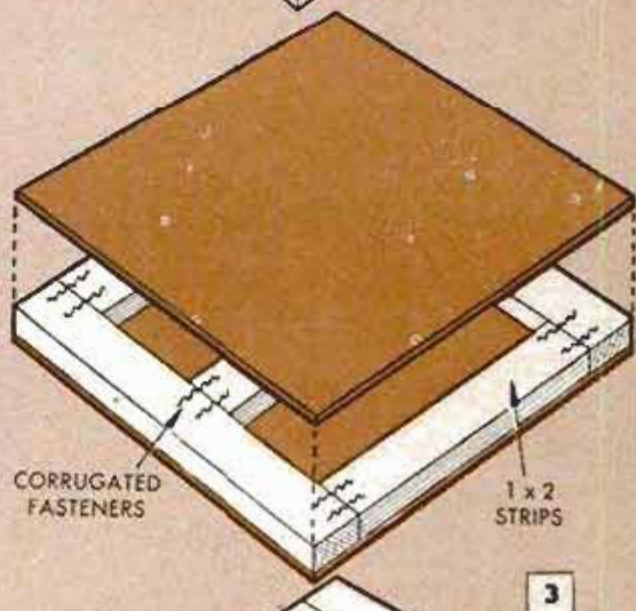
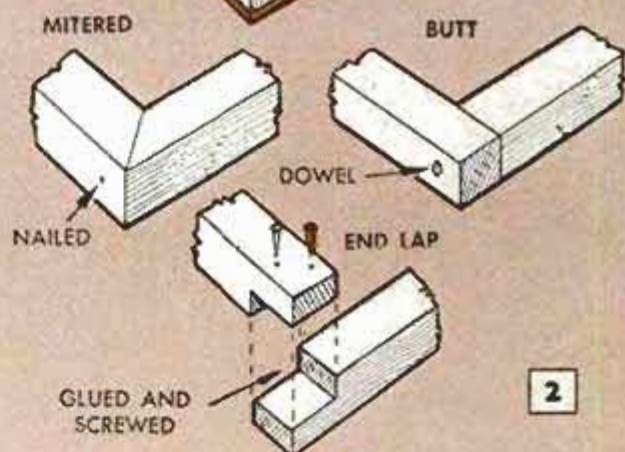
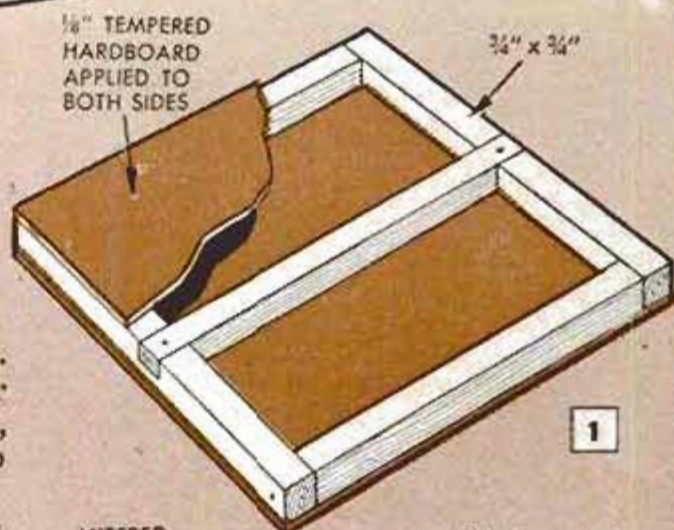

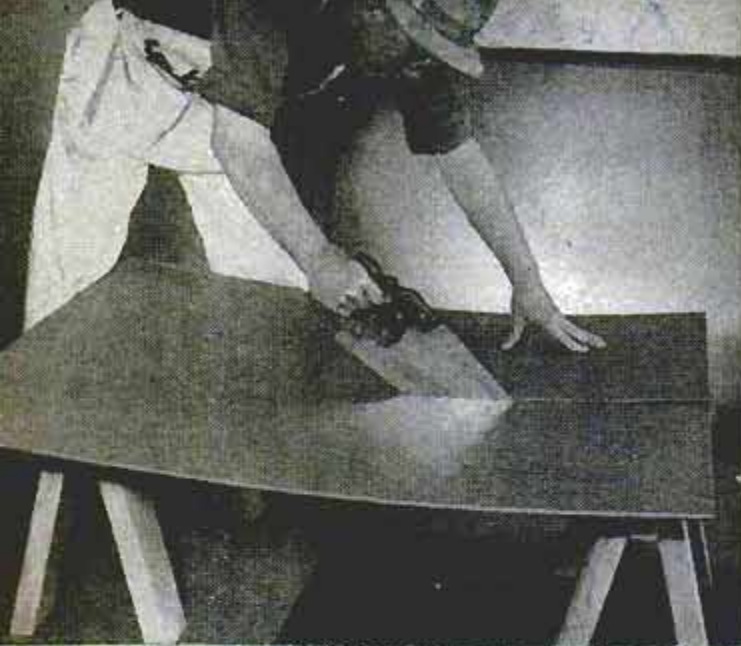

To achieve "balanced construction" when making hollow panels, you must remember this: Hardboard of the same thickness must be used on both sides of the panel. If $\frac{1}{8}$ -in. tempered board is used on one side and $\frac{1}{4}$ -in. standard on the other, the pull will be unequal and the panel will have a tendency to warp. Likewise, when wood veneer is applied to a hardboard core, veneer of the same thickness must be added to both sides to minimize warping.

Figs. 1, 3, 4 and 9 show four different ways to construct hardboard panels. With the exception of the panel shown in Fig. 4, both hardboard facings are applied to a perimeter framework of wood strips which are cross-braced for additional rigidity when the panel is more than 12 in. wide. One cross brace is sufficient for panels up to 24 in. wide. Wider panels should be cross-braced at 12-in. intervals, or at equal intervals if the width is less than a multiple of 12. If the panel measures 2 x 4 ft., one cross brace, running parallel with the 4-ft. perimeter strips, is sufficient. Crisscross bracing is not necessary. In all panels of balanced construction it is best to provide vent slots so the panel can "breathe." These are shallow saw kerfs made in the perimeter strips on two sides of the panel where they will not be noticed. Fig 2 shows three ways of joining the $\frac{3}{4}$ -in.-sq. perimeter strips. Cross braces are either half-lapped or butted. Where wider perimeter strips are used, such as 1 x 2s, the strips can be joined with corrugated fasteners as shown in Fig. 3. The hardboard facing may be attached to the wood strips with nails or screws, nails and glue, or glue alone when clamps are available. Nails and screws can be countersunk and covered with wood putty. Glue is preferred to other type fasteners, particularly if the panel is to be machined later for fit.

The lightweight panels, made as shown in Fig. 1 are recommended for swinging and bypassing cabinet doors, for the walls of built-in storage cabinets and as shelves for bookcases and closets. When a more substantial panel is required, heavier perimeter strips are recommended, Fig. 3.

Fig. 4 shows how a panel can be made

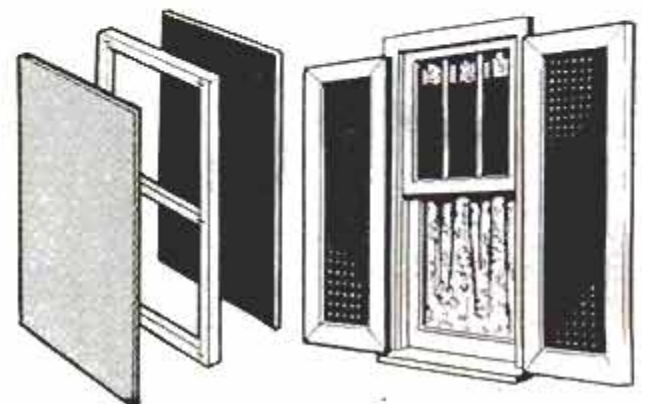
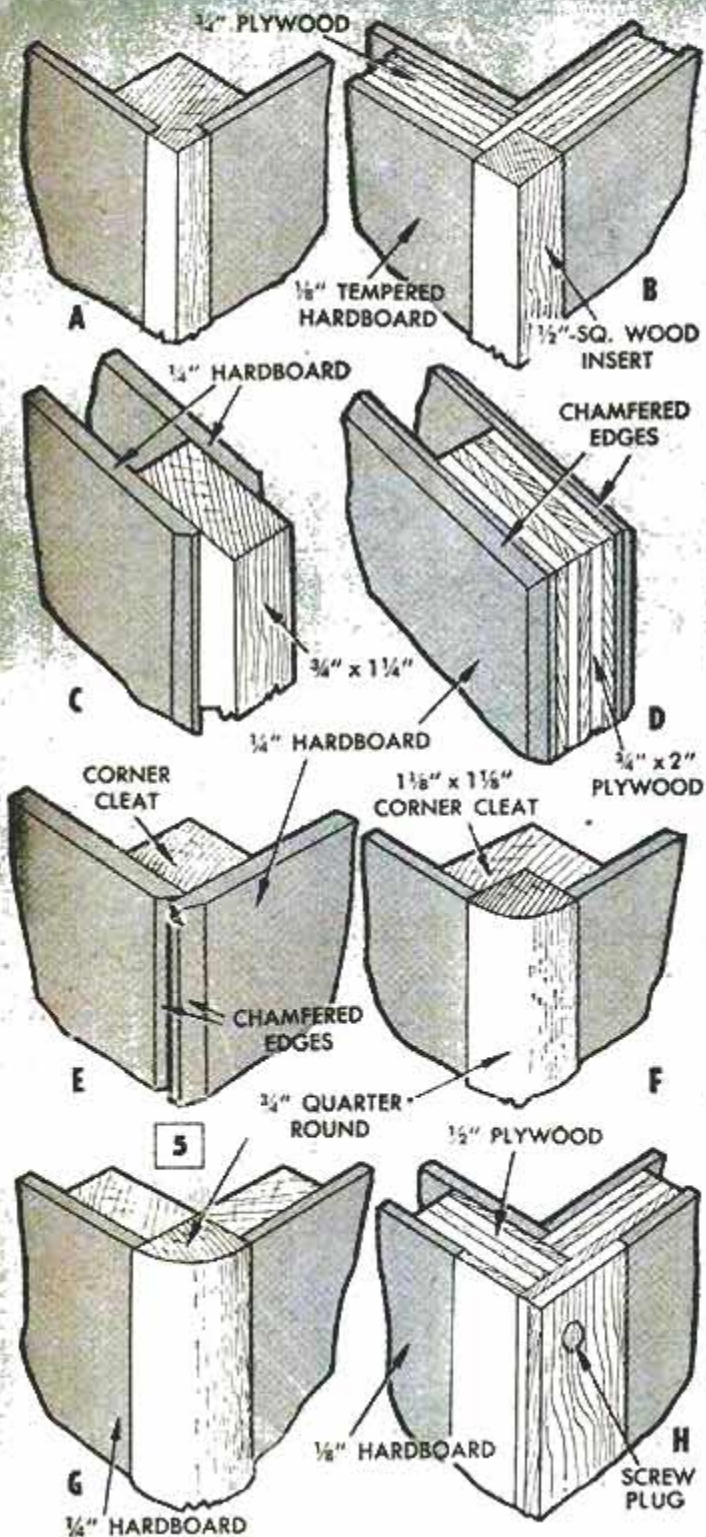

HARDBOARD BOOKCASE

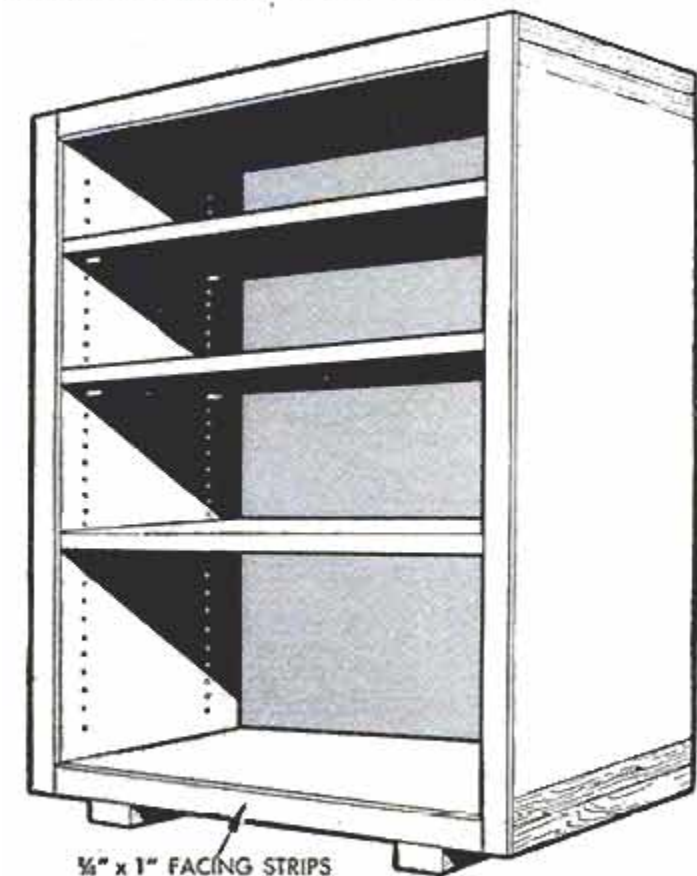

1/4" x 1" FACING STRIPS

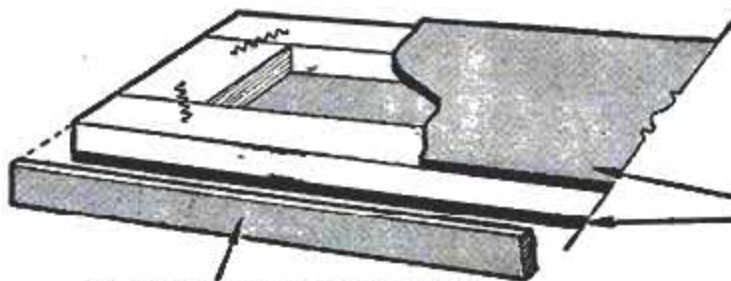

1/4" x 3/8" FACING STRIP ON SHELVES

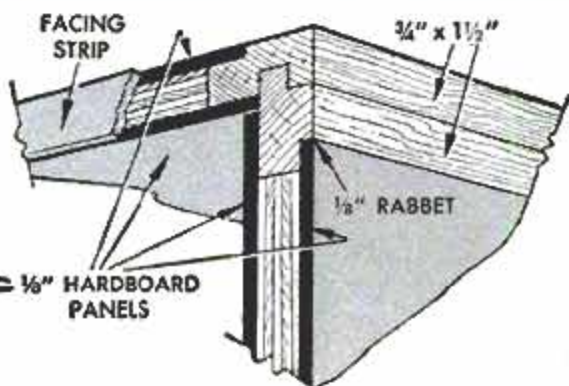

FACING STRIP

3/4" x 1 1/2"

1/2" RABBET

1/4" HARDBOARD PANELS

from a single sheet of 1/4-in. hardboard. Here the wooden frame members are grooved, or dadoed, to fit over the edges of the hardboard. It is standard practice to cut the insert a scant smaller than the depth of the grooves to provide clearance should the hardboard expand. Cross bracing is not necessary unless the hardboard spans an area of more than 16 in. Cross bracing, when necessary, consists of battens equal in thickness to the lip of the perimeter strips which are applied to both

sides of the hardboard, 16 in. apart. The same sunken-panel effect can be achieved in another way which eliminates grooving. This is done by gluing 1/2 x 1-in. or 3/4 x 1-in. wood strips to both sides of the hardboard at the edges.

Fig. 6 shows how laminated-hardboard panels can be built up by bonding together two or three layers of 1/4-in. material, using either contact cement or regular glue. Such panels, which are relatively warp-free, are ideal for cabinet doors, both hinged and sliding types, counter tops and bread and meat carving boards. If such doors are to be hinged, a lip can be formed by running a rabbet around the edges and then chamfering the corner as shown in the detail. This can be done either with a bench saw or a jointer. In the case of a two-layer door, the rabbet can be formed by simply cutting the bottom piece 1/2 in. smaller all around than the top one. If glue is used instead of contact cement, the work should be clamped to assure a good bond. If hardboard is used which is smooth

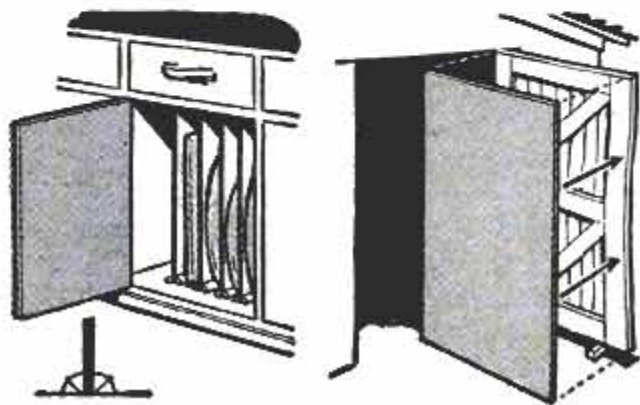

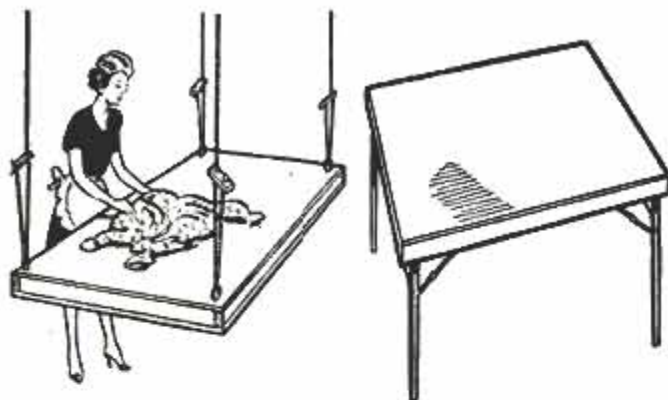
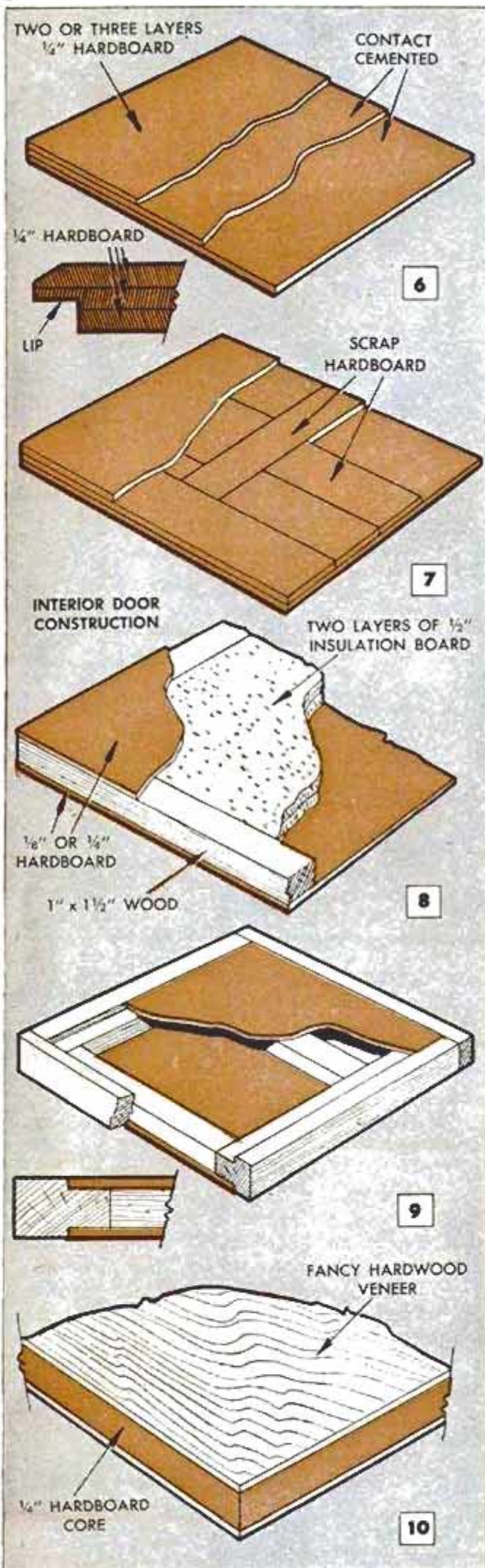

on one side only, the rough, "screened" side should first be sanded somewhat to assure a better bond.

Fig. 7 shows how hardboard scraps can be utilized in laminated panels. Here the core, or center layer, is made up piecemeal from random-size scraps which are assembled and glued to one face piece and then the opposite facing is added. Scrap pieces of hardwood of uniform thickness can be used for the core.

Fig. 8 shows how flush-type interior doors can be made of hardboard. Here the center is filled with layers of 1/2-in. insulation board to produce a door that has both thermal and sound-deadening values. The side perimeter strips are ripped about 2 in. wide from 1-in. stock, the bottom one 3 in. wide. A cross brace at least 4 in. wide to accept a lock is located in the frame at doorknob height. Corrugated-metal fasteners can be used at the corners of the wooden frame but the cross brace should just be glued. Spots of glue are applied here and there on the back of the hardboard panels to bond them to the insulation-board core. This type of door is most easily assembled by gluing the frame to one sheet of hardboard, installing the sections of insulation board and finally attaching the second hardboard panel.

Hardboard also may be used as the core of fine-wood panels, Fig. 10. For example, when a press is available, mahogany veneer can be applied to both sides of 1/4-in. hardboard. Such panels are sturdier and more warp-free than natural-wood panels of the same thickness.

Fig. 5 shows eight methods of making corner joints. You'll notice here that strips of plywood can be used as well as solid wood. Details C and D show two ways that panels can be assembled where both surfaces are exposed. All of these methods afford protection to the edges which are subject to chipping. Details F and G show how common quarter-round molding can be used to both conceal the hardboard edges and provide a neat rounded corner. Chamfering is another good way to overcome chipping of the exposed edges and at the same time take away the plain square

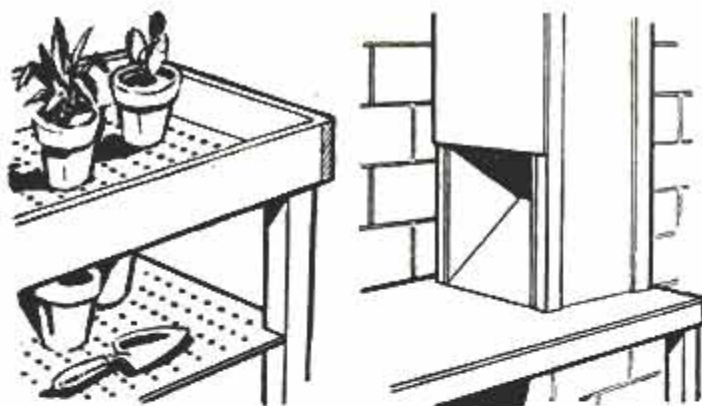

edge. Details C and E show two examples.

Hardboard leftovers can be put to good use in making drawers. Fig. 11 shows how the sides and backs can be built-up by applying $\frac{1}{8}$ -in. hardboard to scrap-wood frames and then grooving to receive the hardboard bottom. A solid-wood core is used for the drawer front and faced both sides with hardboard. Figs. 12 and 13 show how facing strips of $\frac{1}{8}$ or $\frac{1}{4}$ -in. wood can be used to cap the exposed edges of hollow built-up panels so that when painted they give the appearance of solid-wood construction. Note the corner joint.

Where it is desired to glue shelves or partitions in dados in hollow, hardboard panels, cross bracing is installed at the proper points, Fig. 14, so that the grooves can be made to receive them. As a rule, you'll find in joining two panels together at a corner, Fig. 15, that a more accurate job can be done if the edge members are cut first. Trying to do this after the panels are assembled can be an awkward job and lead to an ill-fitting joint. ★ ★ ★

HARDBOARD STORAGE RACK

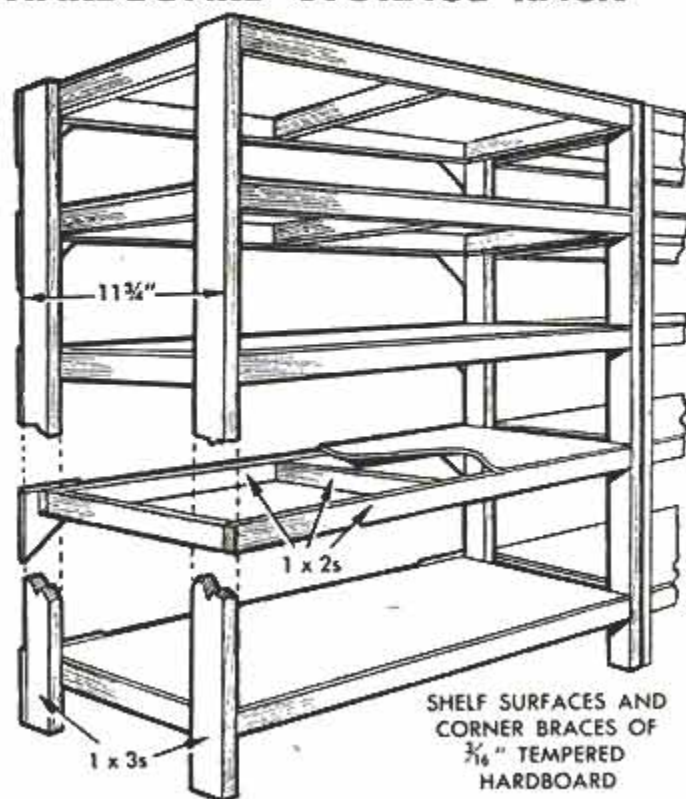

SHELF SURFACES AND CORNER BRACES OF $\frac{3}{16}$ " TEMPERED HARDBOARD

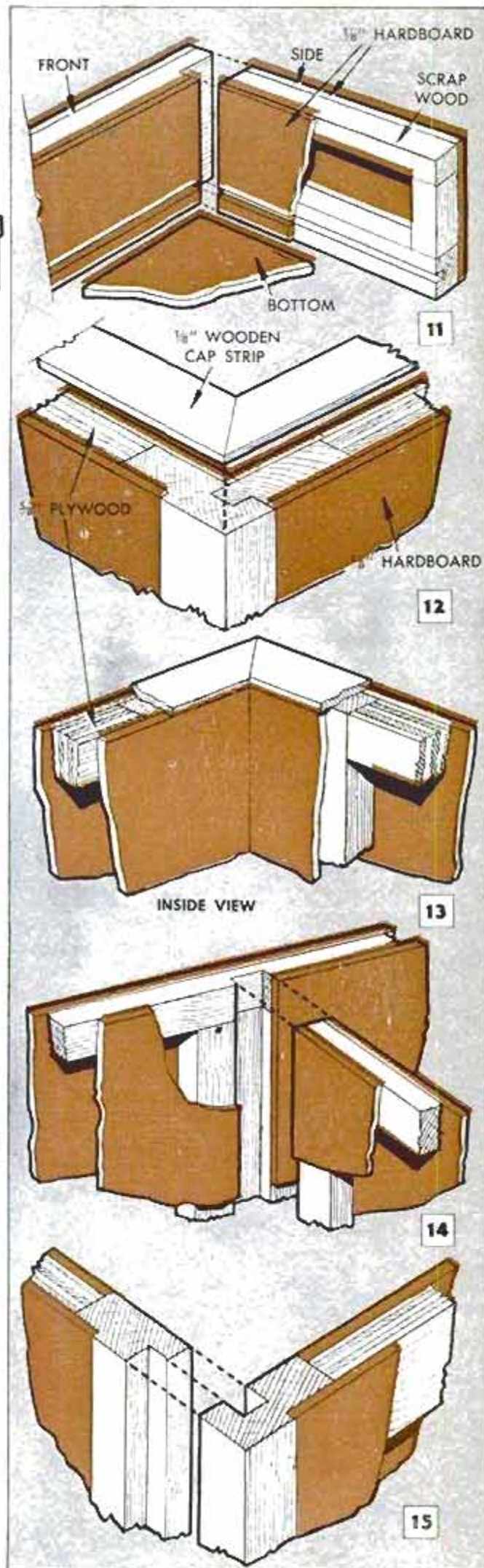

How to Mend a Sink Stopper

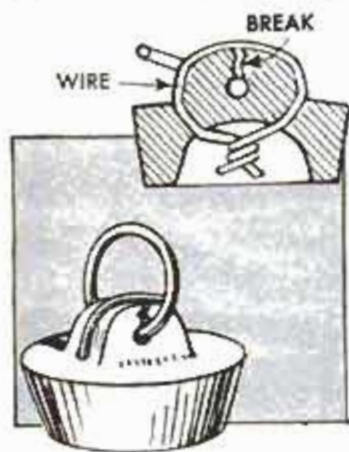

When the ring pulls out of that sink stopper you can make an emergency repair with a loop of wire as in the sectional view. Punch two holes through the stopper, force the ends of the wire through and twist tightly on the underside.

Hinged Blocks Hold Sandpaper

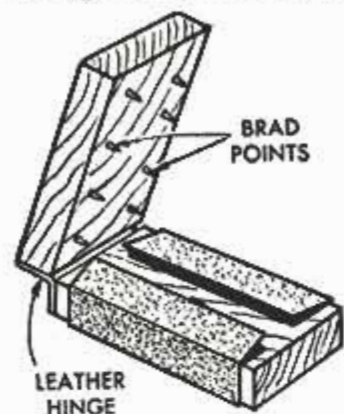

Here's a handy sanding block you can make in a few minutes. Hinge two blocks with leather and drive brads through the upper block so that the points project $\frac{1}{8}$ in. to hold the sandpaper securely.

Rubber Band Holds Pail Handle



Often it's handy to hold the handle, or bail, of a paint pail upright. A rubber band snapped around the handle will do the trick nicely. It holds the bail upright where it's easily grasped and at the same time it serves as a brush rest or wiper.

"Teardrop" Drawer Pulls

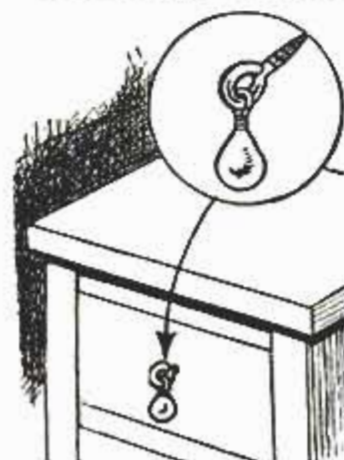

Casting sinkers of the type that are teardrop-shaped can be made into attractive and durable drawer pulls for a shop cabinet. Just open a small screw eye, attach the sinker and then turn the screw eye into the drawer front.

DRYING OVEN FOR

By Walter E. Burton

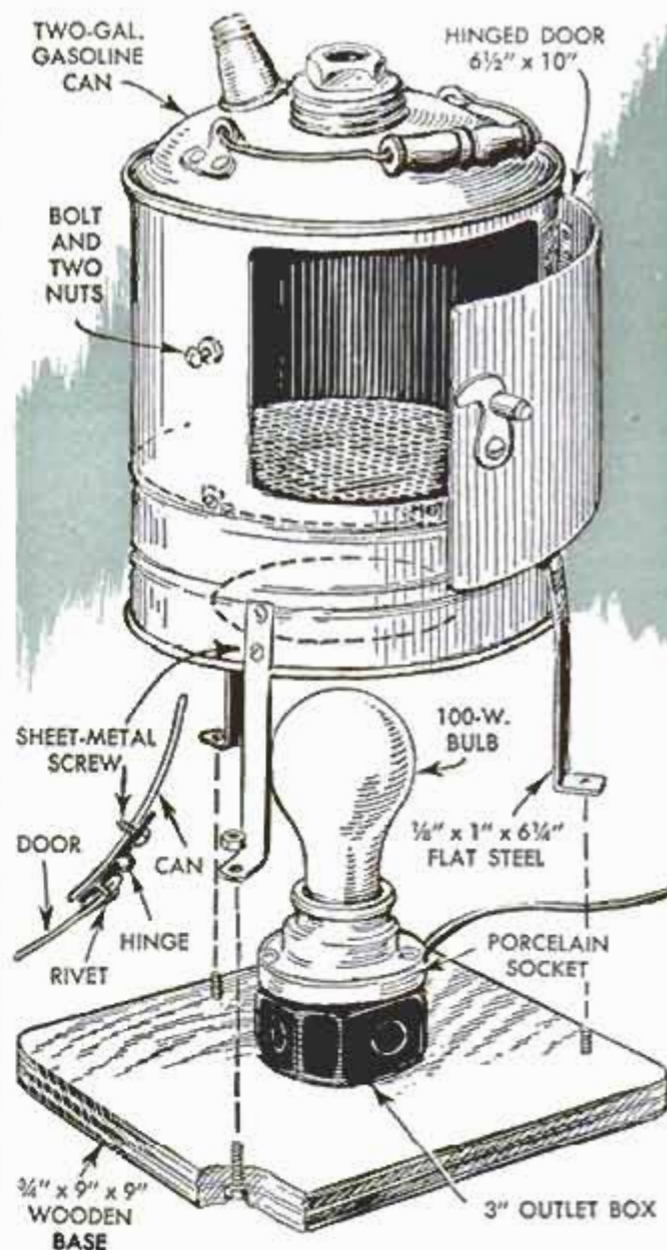

Legs of flat steel are attached with sheet-metal screws. Note the 2 3/4-in. opening in bottom of can



HOBBYWORK

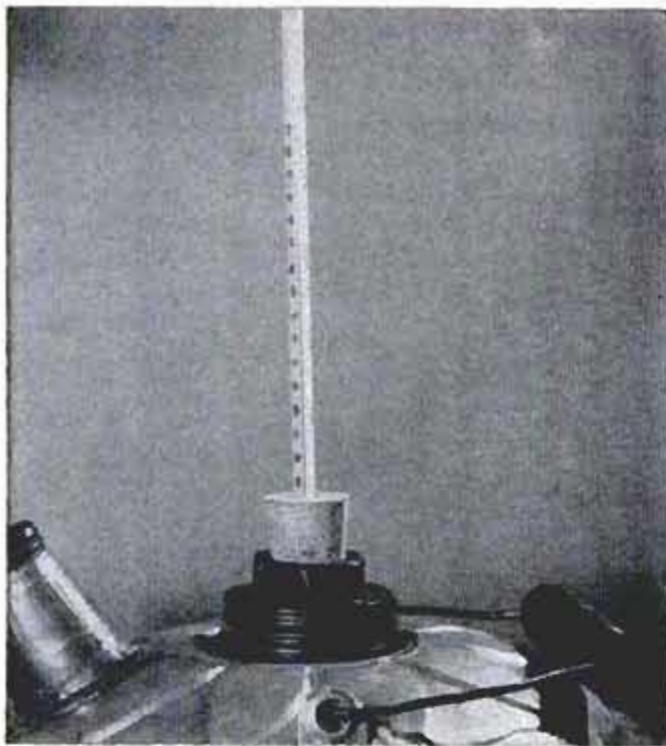

Temperature of the oven can be checked by inserting thermometer in cork and sticking in filler hole

DOZENS OF USES will be found for a drying oven in the workshop and hobby room. Not only will it prove handy during humid weather in speeding the drying of spray enamels, but its gentle warm-air circulation will hasten the drying of plaster casts, clay models, cemented bric-a-brac and small glued objects. Air entering through an opening in the bottom of the can is heated by a 100-watt lamp, rises and escapes through the uncapped spout and filler openings. With a 100-watt bulb, the oven maintains a temperature between 140 and 160 deg. F. Of course, less heat

Bottom from food can is hooked to hardware-cloth shelf to provide heat deflector and drip cup over lamp

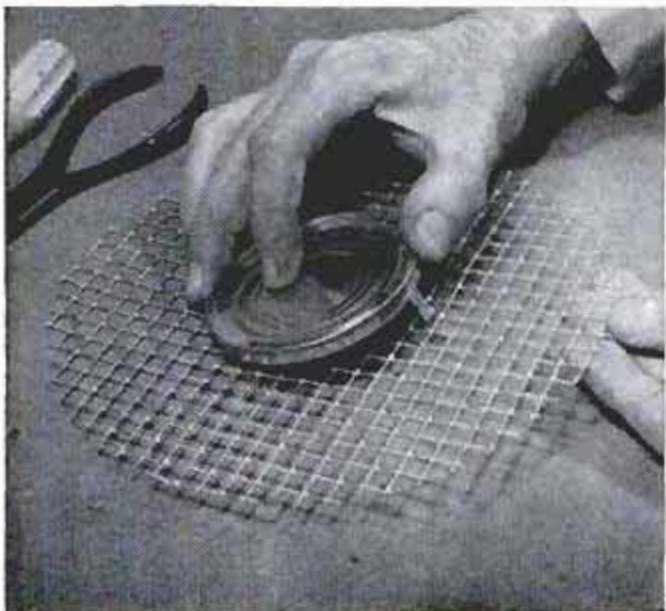

can be had by using a smaller watt lamp.

As you can see, it is made primarily from a two-gal. gasoline or oil can which is provided with a hinged door, a hardware-cloth shelf and legs to support it over the lamp. A deflector cut from the bottom of a tin can is hung $\frac{1}{4}$ in. below the shelf and directly over the bulb to avoid a hot spot and to catch drips. The shelf rests on sheet-metal screws which are turned in through the side of the can a little below the door opening. When using the oven to dry lacquer or other finishes containing highly volatile solvents, leave the oven door open the first few moments to permit the solvent fumes to escape. Of course, there should be adequate room ventilation, too. ★ ★ ★

Heat from 100-watt lamp bulb provides warm circulating air to speed drying of this cemented doll head



Sheet-Metal Easels for Displaying Wallpaper Rolls

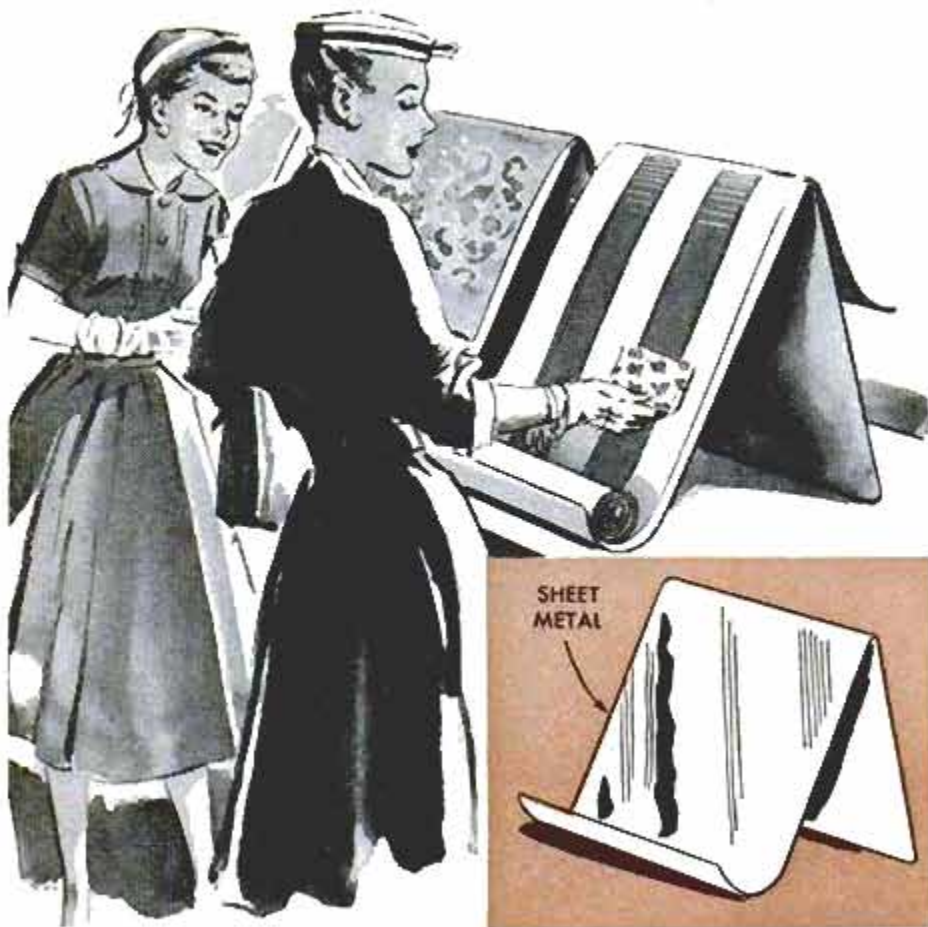

Showing wallpaper patterns from rolls for customer viewing is easily and conveniently accomplished by one store owner who uses easels made from lengths of sheet metal to display selected rolls as shown in the illustration. After a customer selects preferred patterns from sample books, the appropriate rolls are removed from stock and placed on the easels for better examination, especially where large patterns are concerned. To make an easel, simply shape a curved trough at one end of a length of heavy-gauge sheet aluminum or steel and make a right-angle bend in it as shown. Since it is easy to make an easel of this type, you can turn out as many as are needed in a hurry.

Household Glue Made From Starch

For a handy household glue try the following formula: To one cup of granulated laundry starch add enough water to produce a liquid of whipping-cream consistency. Then, bring the mixture to a boil and allow it to cool.

Putty Used as Pipe-Joint Seal

If pipe-joint compound is unavailable the next time you repair a water-pipe line, try using linseed-oil putty. When applied to the threads of a joint the same as compound, the putty provides an effective seal. Eugene E. Snell, Lynn, Mass.

Hardboard Window Cornice

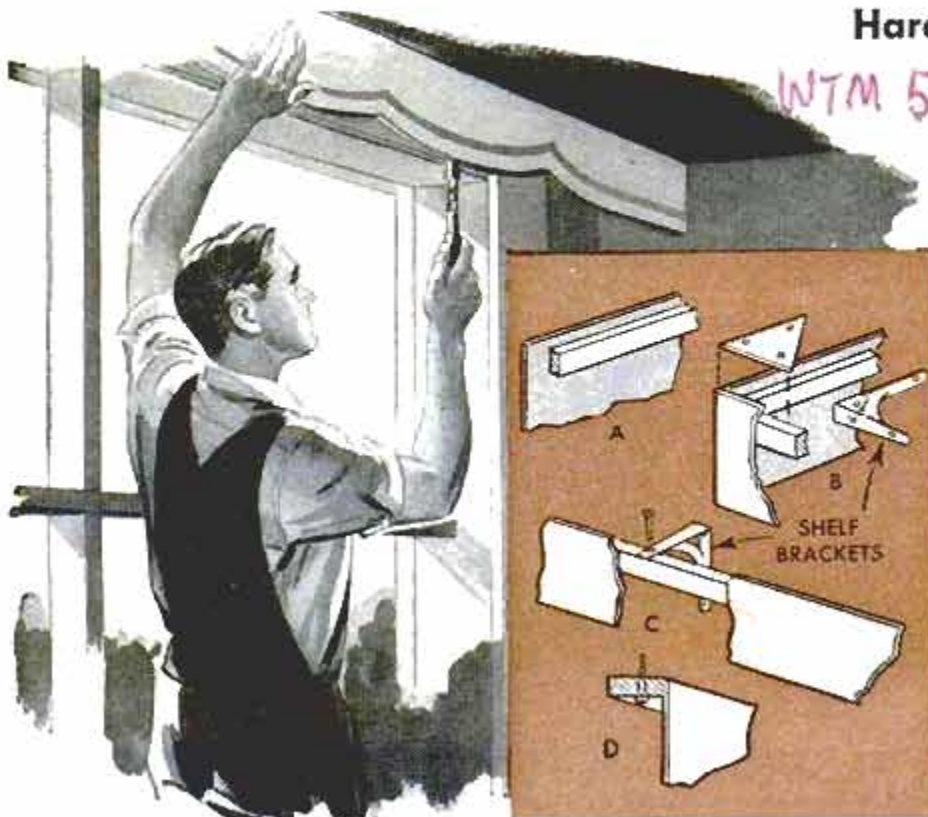

WTM 59 Here is an attractive window cornice that you can make out of inexpensive materials consisting of a hardboard facing nailed on a frame of furring-strip stock. If the cornice is to be attached to the window frame, the hardboard is nailed to 1 x 2s and mounted on the frame by means of shelf brackets as in details A, B and C. For a cornice that is attached to the ceiling, the facing material is nailed to a 1 x 3 and screwed to ceiling joists as in detail D. A scallop design can be cut on the cornice as shown, or it can be left plain and painted as desired.

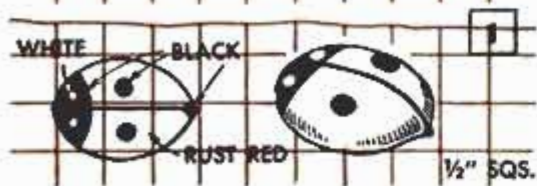
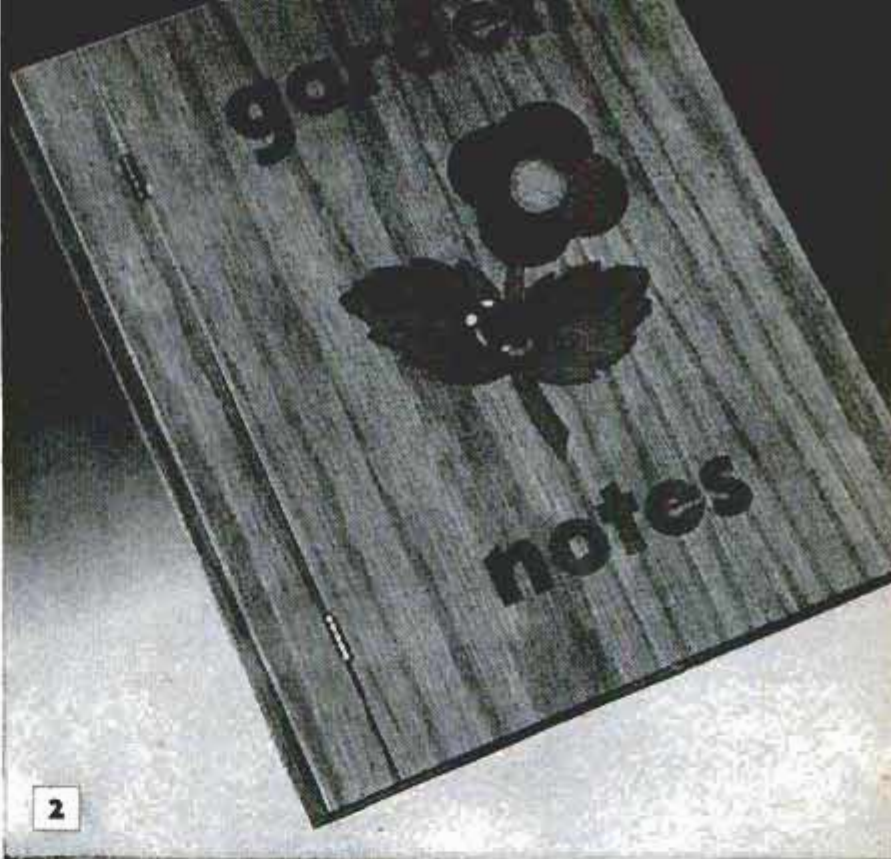
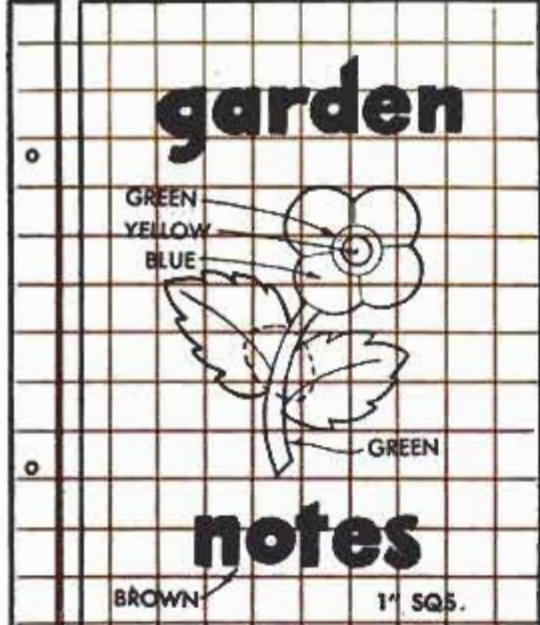

ONE FOR YOUR SCRAPBOOK

By Bess A. Lee

WIM 59

GOOD BOOKS deserve good covers and this is especially true when it comes to scrapbooks which can become dog-eared in no time at all if not provided with stiff, durable covers. Such covers need not be plain pieces of wood. As these examples show, they can be dolled up with novel overlays depicting the particular subject.

The covers themselves are simple enough, being nothing more than three pieces of 1/4-in. plywood. One piece provides the back and the others the front which is hinged together with tiny brass hinges. Front and back covers are then tied together with a leather thong which also holds the paper filler. The overlay designs can be cut from 1/8-in. plywood, sheet plastic or flexible veneer tape which comes in rolls like ribbon and can be easily cut with a knife or single-edge razor blade. Art stores sell ready-cut letters, but if you have a jigsaw, you can cut these out yourself, Fig. 4. Some of the small letters can be burned in the wood if you have a wood-burning tool. A coat or two of shellac makes a good finish for the covers. Boiled linseed oil applied with a cloth will give a less glossy finish.

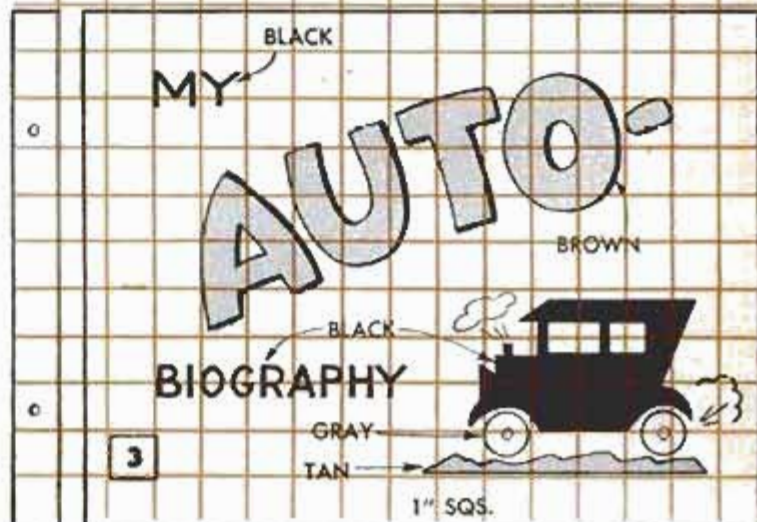
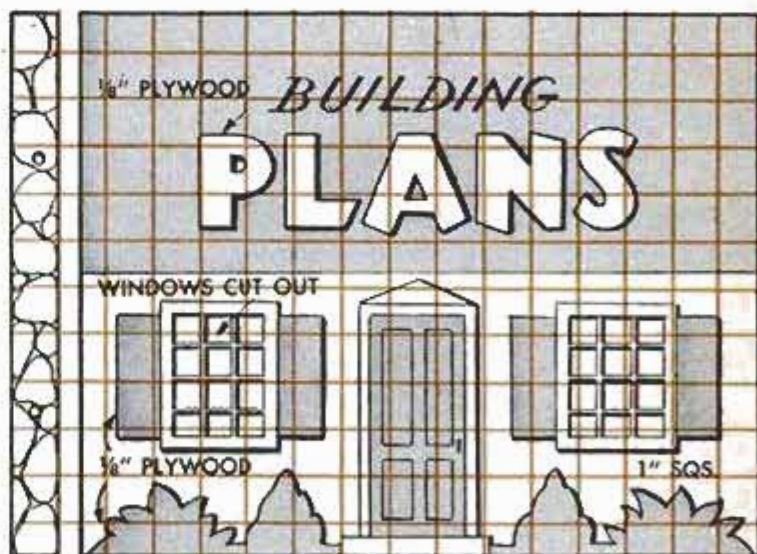

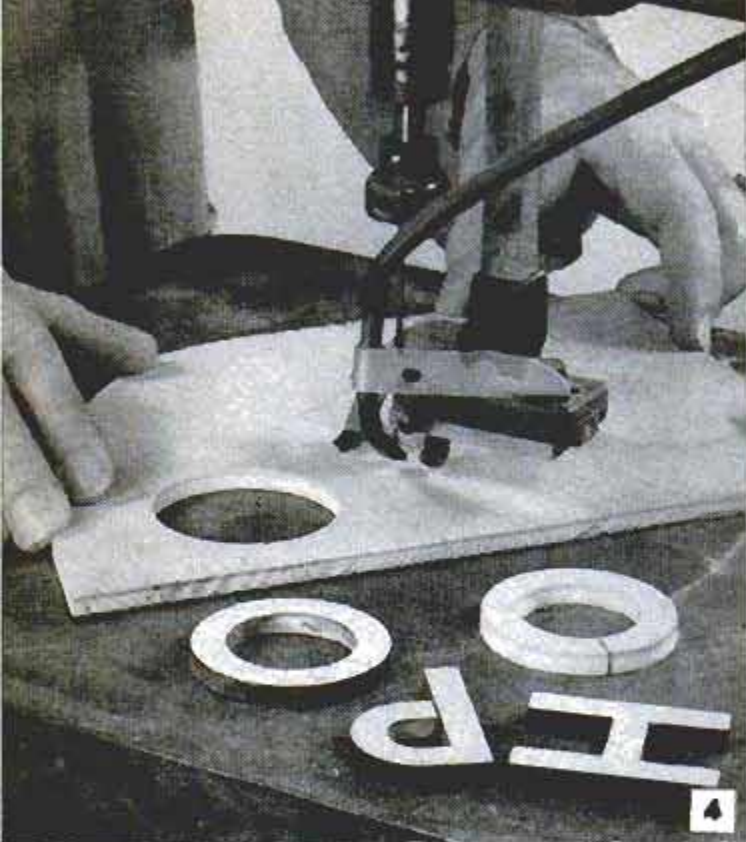

In duplicating any of the covers, you first have to enlarge the patterns by ruling off on paper an equal number of squares of the size indicated. The Garden Notes cover, Figs. 1 and 2, features a flower complete with a ladybug. Here each section of the leaves and flower is cut out separately from thin veneer. Birch is good for this since color stains or water colors, applied after gluing, will let the grain show through. The carved ladybug is simply glued in place on top of the flower.

An appropriate cover for a scrapbook for new home ideas, plans and clippings is shown below Fig. 2. Representing the front of a house, it makes a book large enough to hold pages from even the larger mag-



azines. The shutters, shrubs and doorstep are jigsawed separately from thin plywood, while the rest of the house design is simply painted on. The word "plans," which is also jigsawed, should be left natural or finished light to contrast against a dark roof. The part to which the cover is hinged is made to look like a stone fireplace by painting it gray or terra cotta and then outlining the stones in black.

The cover shown in Fig. 3 is designed for a vacation motor-trip scrapbook. Letters of the word "auto," as well as the antique car and bumpy road, are jigsawed and glued on. The rest of the design is merely painted on. A few strokes of white paint indicate steam and exhaust from the car.

Designed as a cover for a diary, the one shown in Fig. 5 makes use of a sun and

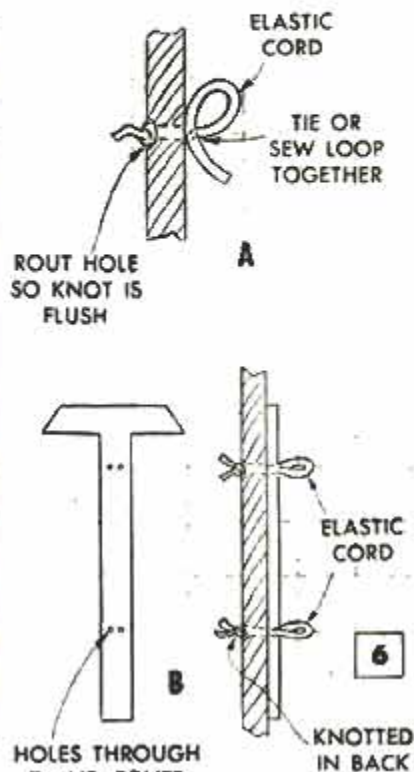
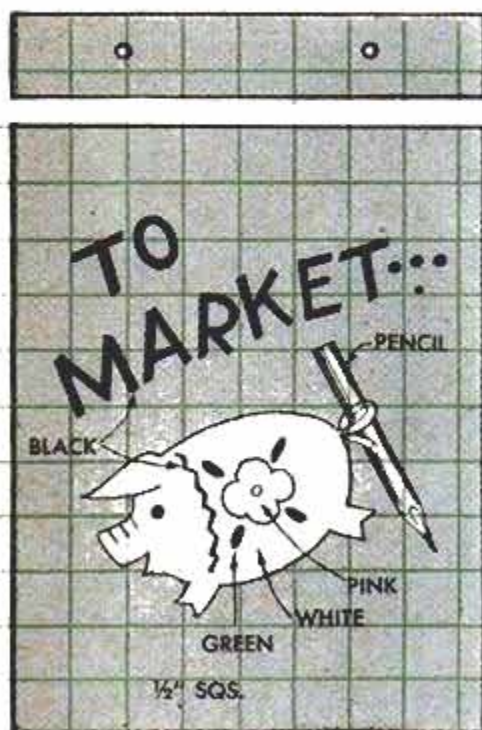

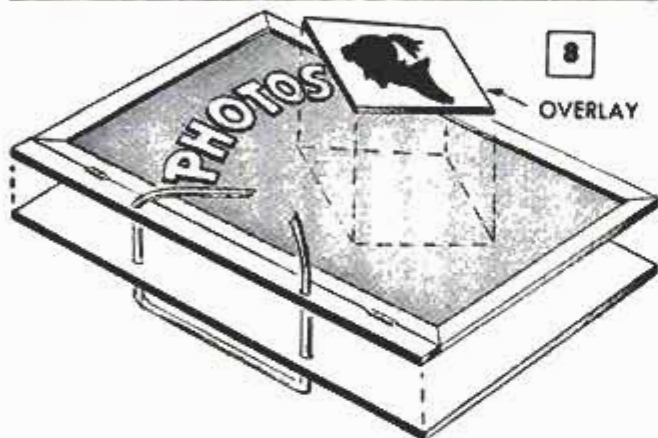
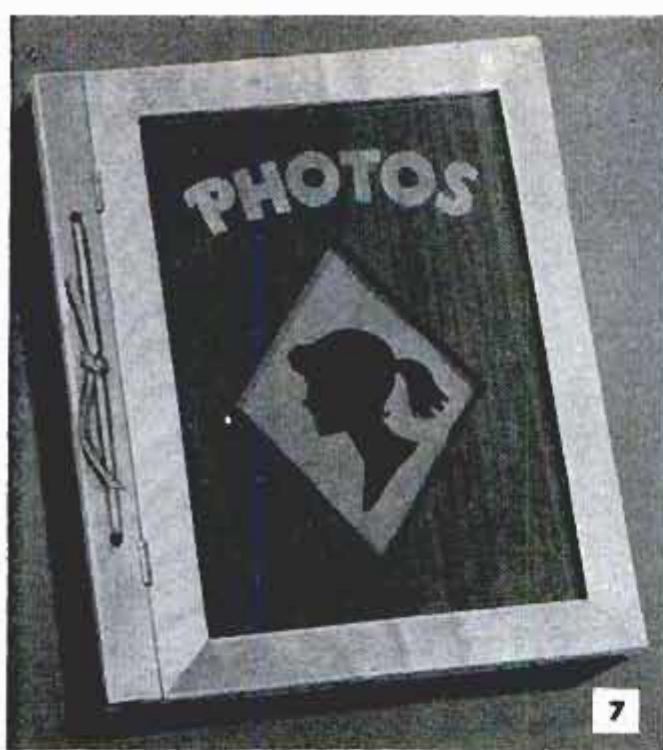

moon cutout to carry out the title, Days to Remember. A school notebook or pad of paper punched at the top to match the holes in the coverpiece makes a good filler since it can be kept as a pad when filled and removed from the scrapbook.

Elastic cord inserted through holes in the covers and looped and knotted on the back keeps a pencil handy in the two covers shown in Fig. 6. A bright thumbtack is used in one to simulate the chrome hub cap on the auto wheel. The large T and L letters are sawed out and glued on. The rest of the lettering of both covers, as well as the birds and pig, is painted on.

The photo-scrapbook cover, Fig. 7, is made to look like a framed picture. Starting with a dark-plywood back, in which a diamond is cut, a light-colored frame is glued to the surface around the edges and mitered at the corners. An insert of light wood is fitted in the diamond opening and a silhouette pasted in the center. A variation of this is shown in Fig. 8 in which the diamond is an overlay which is merely glued in place. The letters of the word "photos" should be jigsawed from 1/4-in. plywood and glued on to stand out in relief. ★ ★ ★

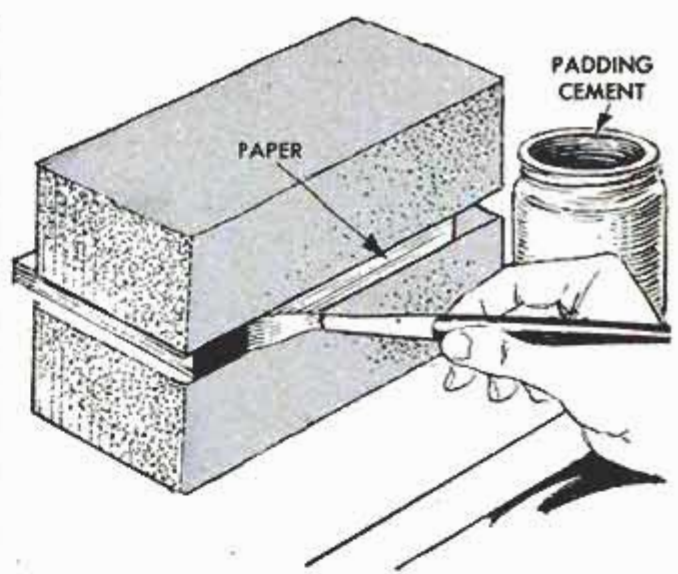

Simple Way to Make Scratch-Pads

Discarded letterheads and other printed matter can be converted to scratch-pads by purchasing a little padding cement from a printer. This is the adhesive used for binding the edges of such pads. After cutting the paper to size, stand all the original edges together and place the stack between heavy weights, such as a couple of bricks. This will keep the edges aligned while coating with the padding cement.

Ink Bottles Won't Tip

Three bottles of drawing ink are less apt to tip than one when they are bound together with a strip of masking tape. You'll find them less awkward to handle, too, when kept in groups of three. Be sure to draw the tape tightly.



☛ Sew little magnets into the corner of a pot holder and it will always be at hand as it can then be attached to the stove.

STAY-LEVEL

By G. E. Hendrickson

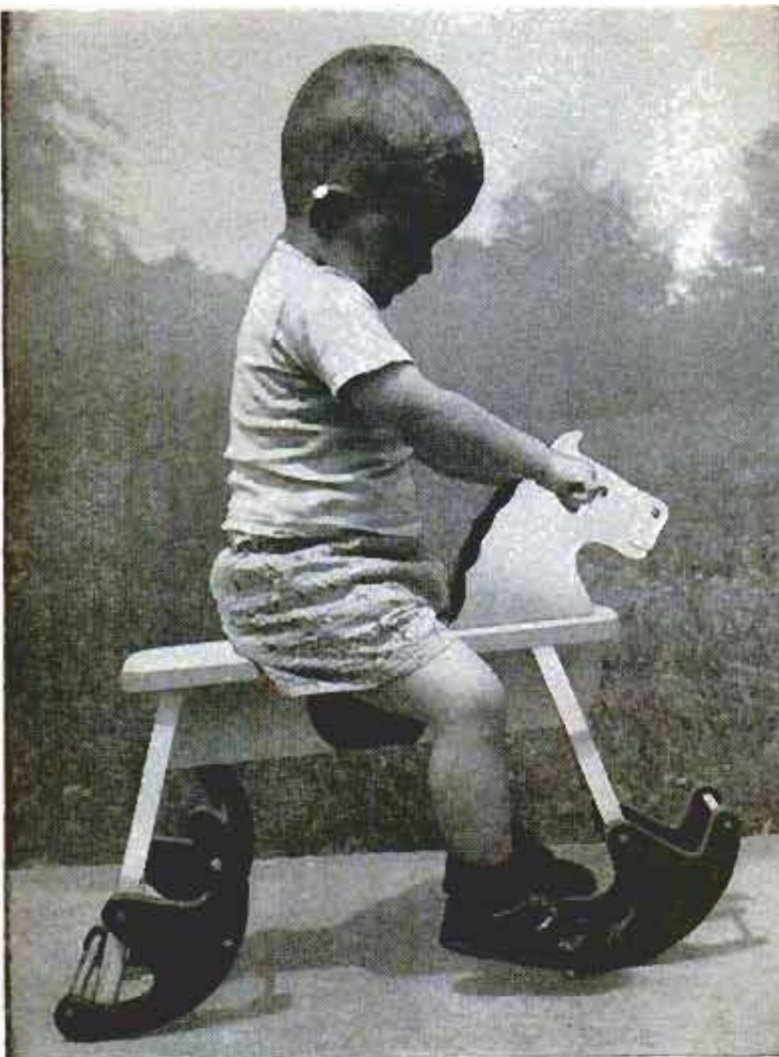

EVEN THE YOUNGEST rider is in no danger of having this rocking horse throw him. The reason is that the two sets of rockers are so positioned that the body of the horse remains level at full gallop. Note how they are pivoted in much the same manner as a porch glider. All parts for the horse, including the rockers, can be cut from $\frac{3}{4}$ -in. plywood, following the squared patterns on the facing page. Axles and rocker stops are lengths of $\frac{3}{8}$ -in. dowel. The stops are an added feature that limits the length of swing of the rockers, and also prevents the rockers from being inverted when the horse is dragged about by its youthful owners. On the front set of rockers, the rear stop is allowed to project about 3 in. outside each rocker to provide footrests for the rider, and also as a means of "driving" the horse. ★ ★ ★

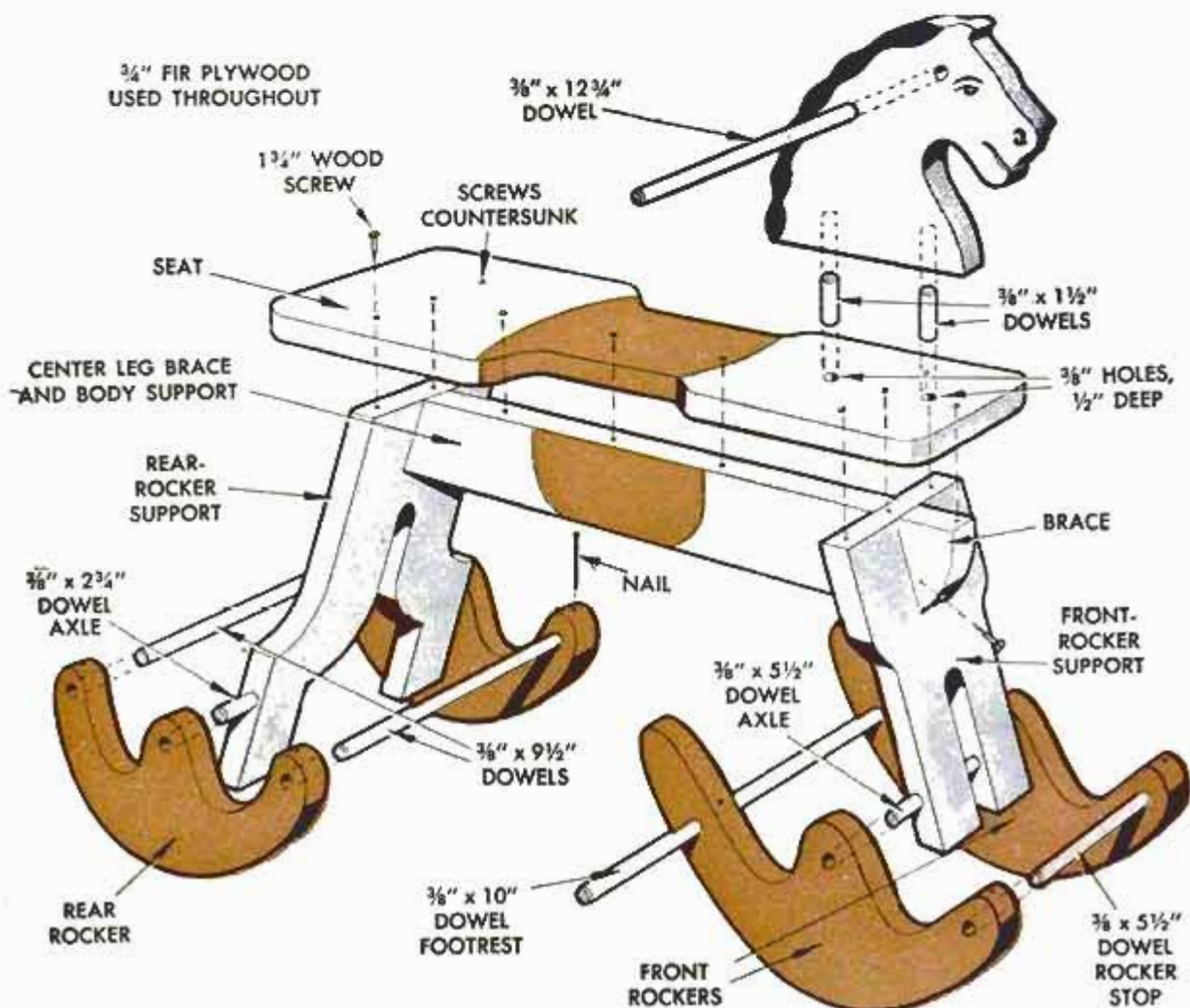

ROCKING HORSE

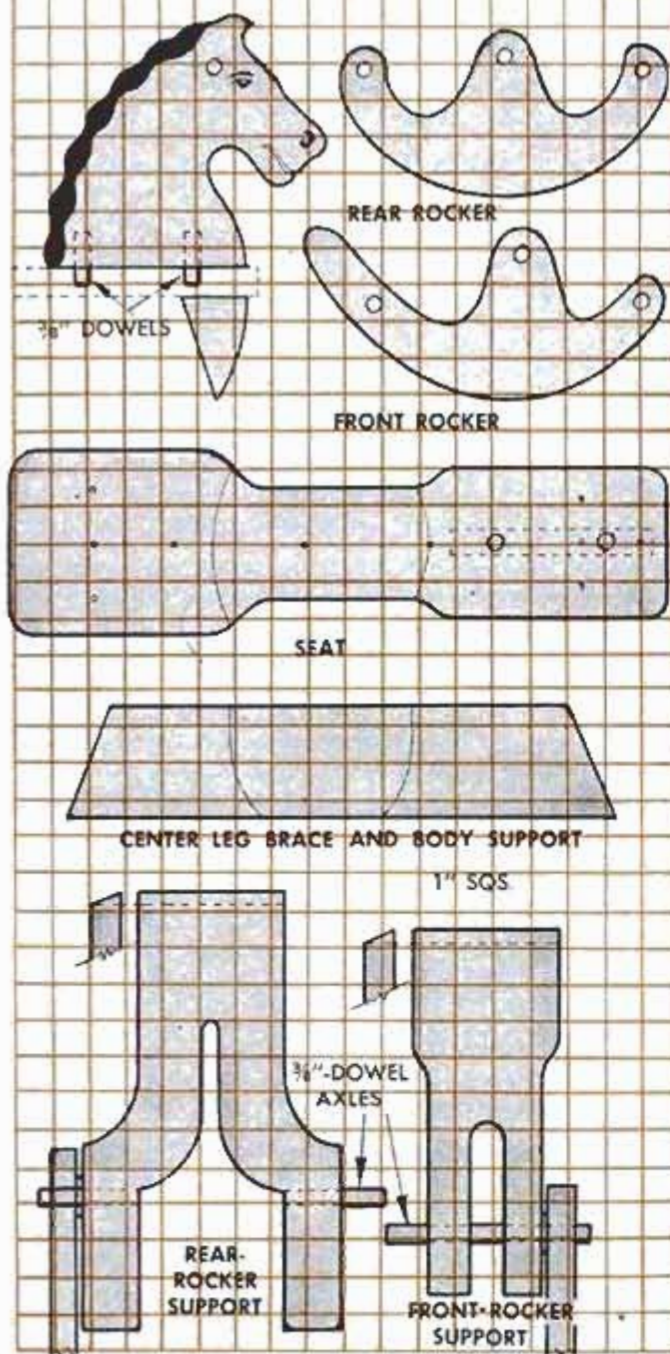

FEBRUARY 1958

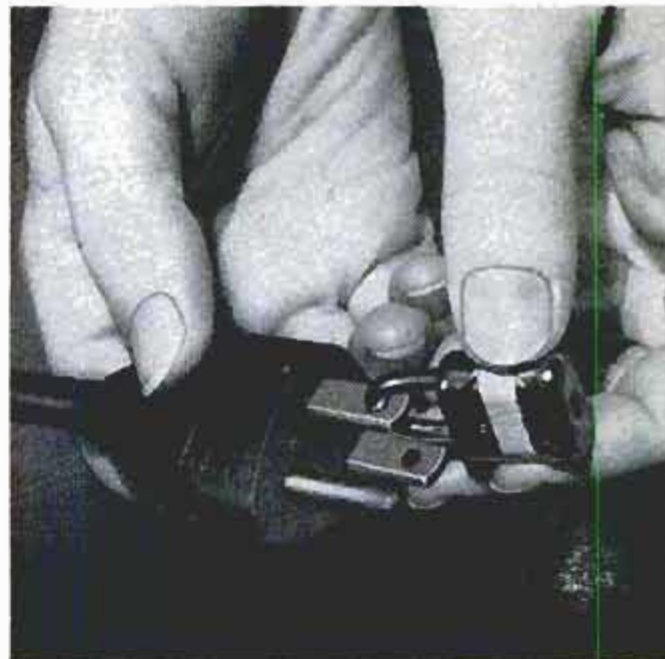

Power-Tool Cord Padlocked

To prevent children or unauthorized persons from using power tools left out on your workbench, slip a small padlock through the hole in one of the plug prongs as indicated. It will prevent the plug from being inserted in a receptacle.

"Noiseproofing" Leather Seats

When annoying creaks develop in the leather seats of an automobile they can be eliminated by rubbing saddle soap between the seat cushions and side panels, and between the cushions and seat backs. Also, rub soap on adjacent edges of the pivoting backs of the front seats of two-door cars.

Watering Tank Used as Cage

Placed on its side and fitted with doors covered with hardware cloth, this steel watering tank is used as a utility shelter on one farm. Poultry, small pigs and pets are kept in it. The doorframes are tubing and steel angle.

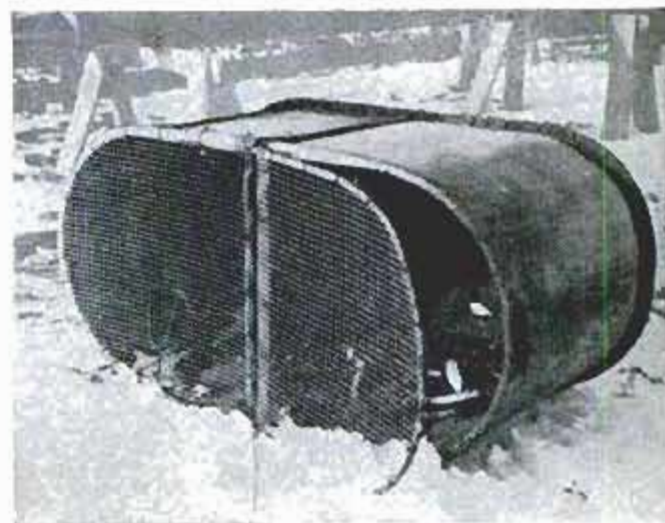

215

Hobby Cabinet Provides Both Storage and Work Surface

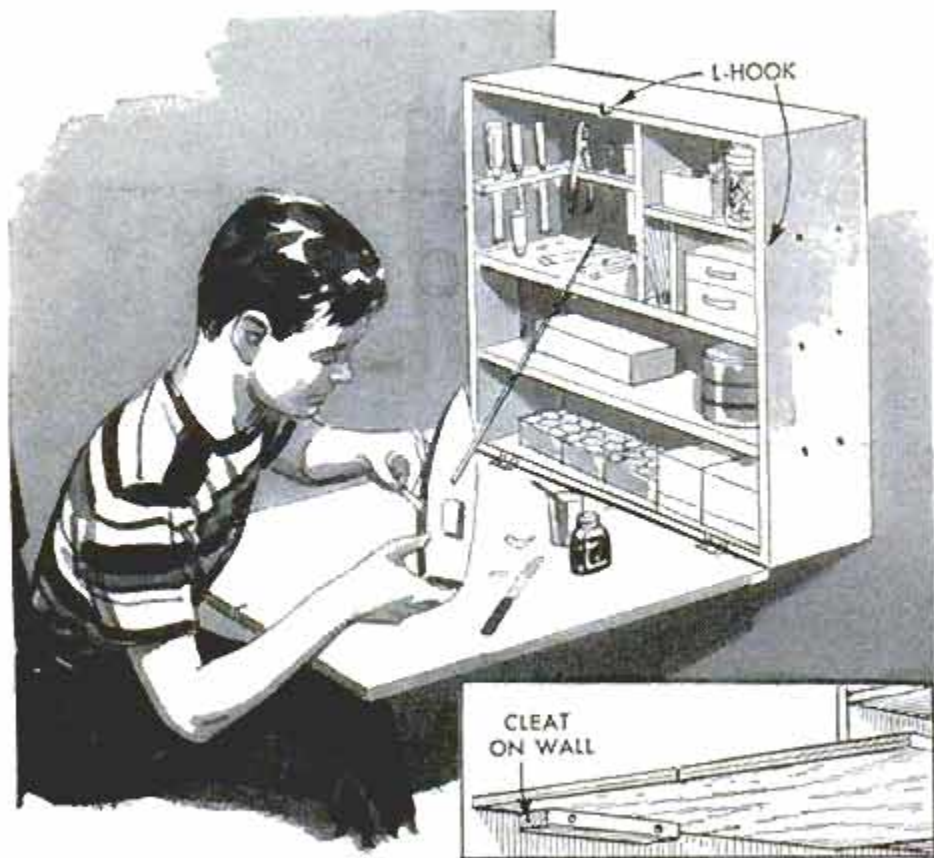

Fastened to the wall in a corner of a room, this small wall cabinet serves both as a storage place for hobby supplies and as a workbench. Depending on the hobby concerned, the cabinet can have two or three shelves, and whatever vertical partitions prove necessary. The door, which can be $\frac{3}{8}$ or $\frac{1}{2}$ -in. plywood, is hinged to the bottom shelf. When the door is dropped to a horizontal position to be used as a workbench, it rests on a cleat attached to the adjacent wall. If the cabinet is located on a wall not adjacent to another, chains or brackets can be used to support it. For a latch, a L-hook is used at side or top, fitting a notch in the door.

Layout Blue Container

Instead of using a large pot or bottle of layout blue when doing a small job, clean out an empty nail-polish bottle and fill it with the blue. The polish bottle is small and handy, and contains its own brush in the screw cap.

Tape-Spool Reel Stores Line

Instead of having a chalk line a tangled mess when you want to use it, wind it on a reel made from an adhesive-tape spool. A small knob screwed to the flange of the spool permits quick winding, and your forefinger is used as the "axle" of the reel.



Tape Protects File-Card Edges

Small file cards (3 x 5 in.) that become frayed and torn around the edges from frequent handling may be protected by binding the edges with cellulose tape. The narrow tape strips will not interfere with any notations made on the cards.

Ring-Binder Photo "Album"

Small, easily handled photo "albums" can be made by taping a strip of cardboard to one edge of each photo as indicated, and punching holes in the cardboard. Notebook rings then are used to make a ring binder for the photos. This idea is especially good for pictures in a sequence, such as those taken on a vacation trip. Details A and B show two methods of applying the tape.

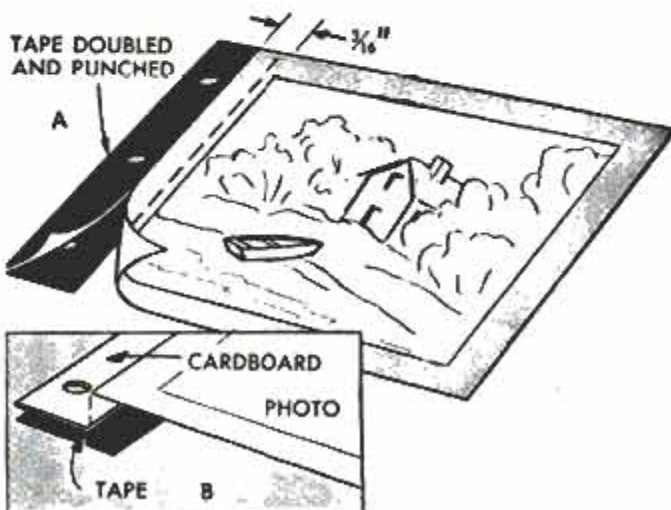



First Aid For Your Trophies

SINCE MOUNTED FISH and birds, as well as animal heads, collect dust just as does household furniture, they, too, need an annual spring-cleaning. So that your favorite trophies look their best, here are taxidermist-approved methods that will enable you to restore safely their original lifelike appearance.

For proper cleaning of mounted fish, dust all surfaces with a soft cloth, wiping with the lay of the scales. Then, touch up faded parts with oil colors as in Fig. 1, and apply a coat of clear lacquer. Soft bread makes a good "dusting cloth" for cleaning feathers on mounted birds, Fig. 3. Cleaning fluid may be used for removing grime, but do not use soap and water. The best way of removing dust from fur is to vacuum it



with a small unit, working with the "grain" of the hair as in Fig. 2. For horns, wipe off the dust and then wash them with mild soapsuds, being careful not to wet the fur. Then, dry the horns and polish them with liquid floor wax, Fig. 4.

Eyelashes are made to glisten when coated with clear shellac as in Fig. 5. White corn meal is best for cleaning a bearskin rug. After vacuuming the pelt, pure corn meal is hand-rubbed into the fur and then removed by vigorously beating the pelt on a clothesline, using a carpetbeater.

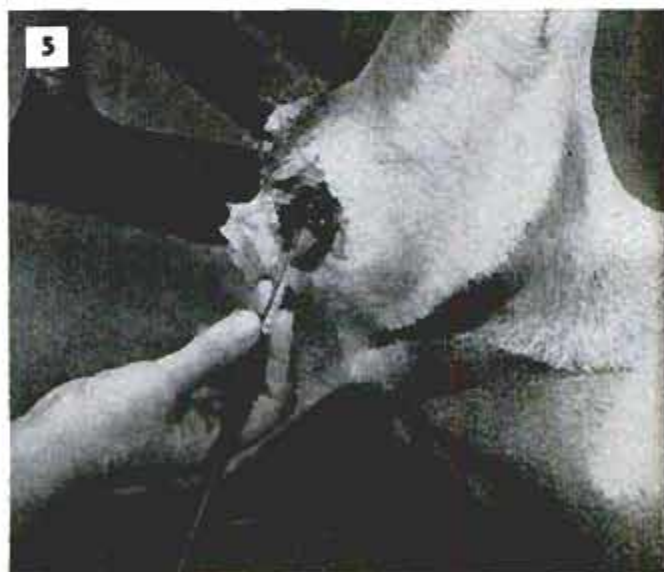

CARDBOARD STEREO VIEWER

By Allan Carpenter

THE NEXT TIME you entertain a group of friends with stereo slides, it won't be necessary for each person to wait until the viewer is passed to him. All that you need do to eliminate this inconvenience, is make several cardboard viewers like the one shown in the drawings so that at least one viewer is provided for every two people present.

To make a viewer, first outline the various parts in full size on medium-weight cardboard. Draw dotted lines for folds as indicated in each of the drawings. Then, cut the parts from the cardboard stock and make the indicated cutouts in the slide carrier and focus component, detail A, and in the lens housing, detail B. After gluing a strip of household wax paper over two of the square cutouts as shown in detail A, the slide carrier and focus component is folded as indicated by the dotted lines. Cellulose tape is used for joining the edges that form corners. The free end of the slide carrier is then folded inward and glued to the bottom as shown. A cardboard tab for pulling the carrier when focusing a slide, is taped to the bottom at the front to complete this component.

Before folding and taping the edges of the lens housing, the lenses are centered on the $\frac{3}{4}$ -in.-dia. holes and taped in place as indicated in detail B. The diameters of the lenses used is not important except that the lenses be of the same size and focal length for any one viewer and have a diameter of less than $1\frac{1}{2}$ in. but greater than



Cut Sheet Metal With Hacksaw

When no suitable tin snips is available, use a hacksaw to cut sheet metal. To do this, reverse the blade so that the teeth point toward the handle and clamp the sheet to be cut to a bench top as shown. Then, mark the sheet for cutting, draw a second parallel line 1 in. from the first and saw alternately along both lines, rolling the metal as the cutting proceeds.

S. Clark, East Bradenton, Fla.

Picture Framing the Easy Way

Proper positioning of a picture in a frame is assured if first the glass is removed and the picture is placed under it for trimming. Pictures that are smaller than the glass but larger than the opening in the frame, are positioned on the glass as desired and secured with cellulose tape.

Handy Darkroom Safe for Enlarging Paper Has Self-Closing Door

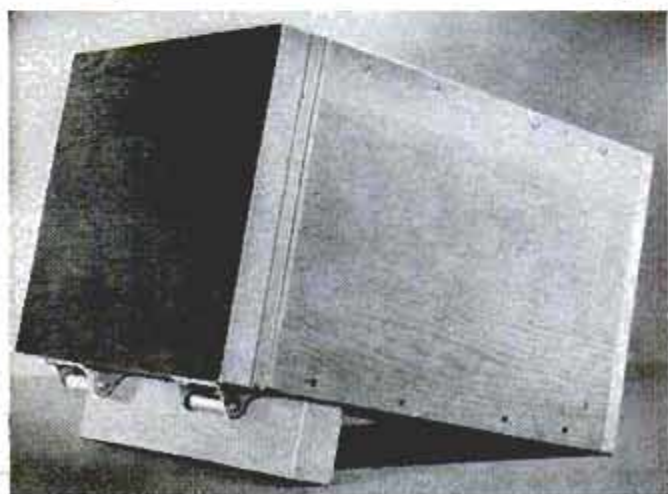

This light-tight paper safe was made by one amateur photographer for storing enlarging and print paper. Plywood strips glued in $\frac{1}{4}$ -in. rabbets cut in the inside edges of the door and open end of the box overlap when the cover is closed. All corners of the box are rabbeted to prevent light leaks. The door is mounted on spring-loaded hinges that automatically close it when released. A block of wood supports the front end of the safe so that it is on a slight incline to prevent paper from falling to the floor if other sheets should cling to the one being withdrawn.

B. Brownold, Cedarhurst, N. Y.

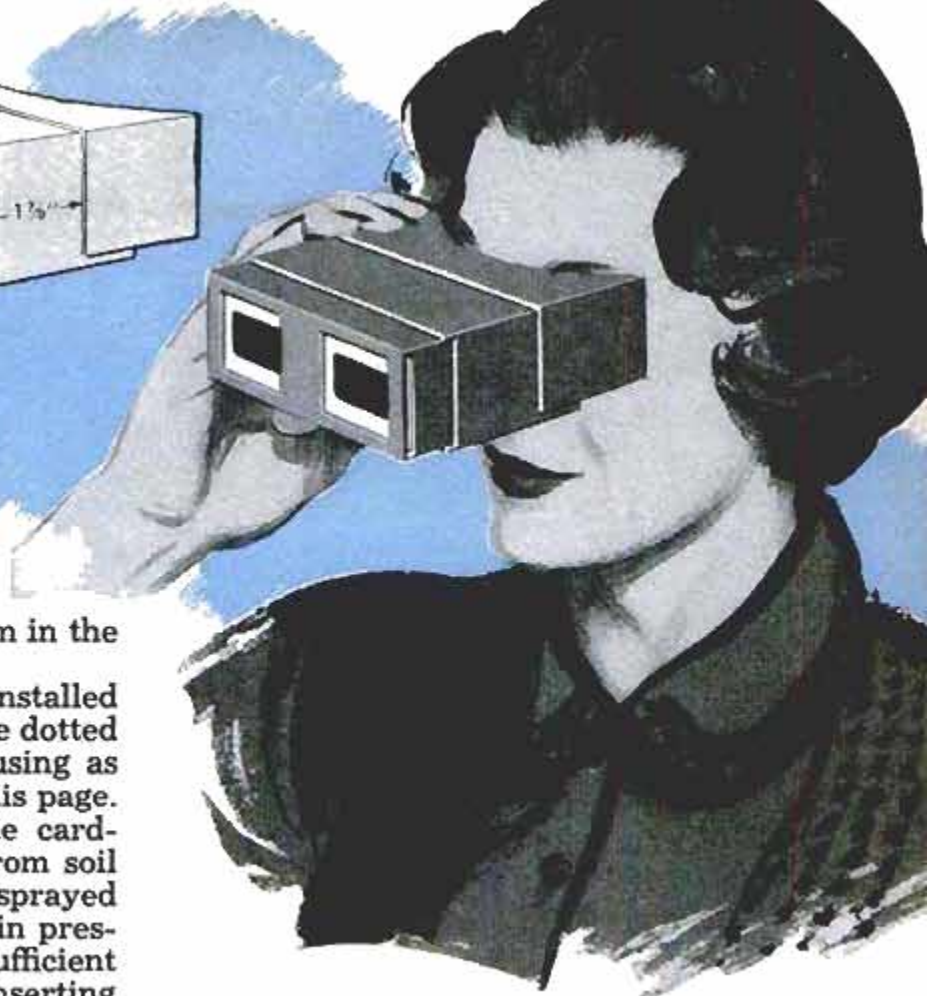
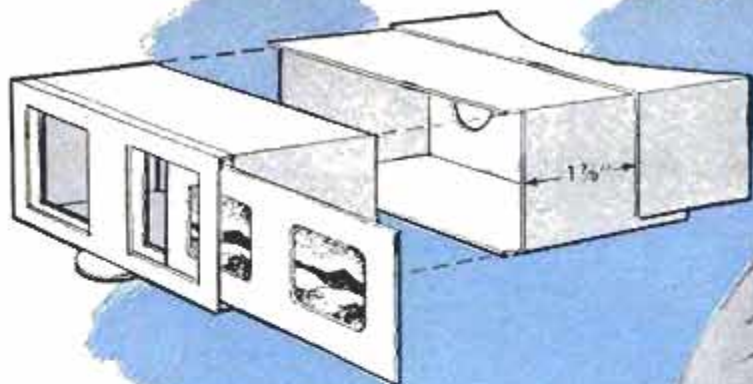

$\frac{7}{8}$ in. for proper positioning of them in the space allotted.

The light shield, detail C, is installed simply by folding the ends along the dotted lines and gluing it to the lens housing as shown in the detail at the top of this page. To improve the appearance of the cardboard viewers and protect them from soil and wear, all outer surfaces are sprayed with paint of the type that is sold in pressurized cans. Be sure to allow sufficient time for the paint to dry before inserting the slide carrier into the lens housing. ★ ★ ★

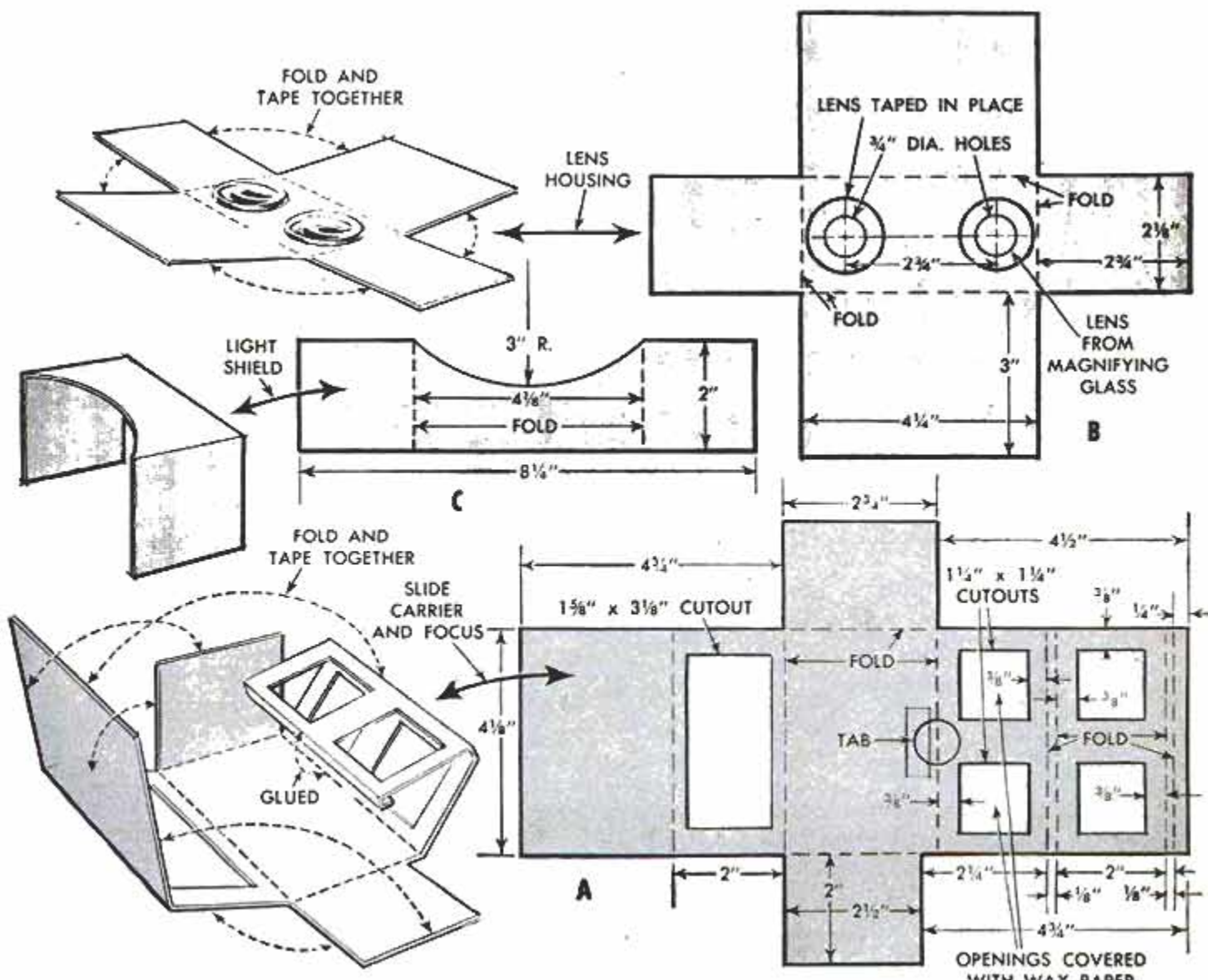



Rocks Gripped by Tire Chain

Using a car or truck to pull a large rock from the ground and drag it away takes the hard work out of the job, but produces the problem of how to wrap a chain on the rock so that it does not slip. Tire chains are ideal for this; the cross links and side chains form loops that grip projections on the rock.—R. P. Dunlop, B. C., Can.

Driving Screws in Plaster Wall

Wood screws driven into a plaster wall have little holding power, and usually chip the surface and pull free. To improve holding power, first drill a hole in the plaster and pack it with steel wool. Then drive the screw into the steel wool.

"Taped" Waterproof Labels



Waterproof labels for jars, cans and other objects are easy to make when the desired information is typed or written on a clean sheet of paper and stripped off with transparent tape. The tape then is applied to a smooth surface of the object receiving the label.

Use a soft-lead pencil, or strike the keys hard if a typewriter is used to write the label. In the latter case, the use of a new ribbon is recommended.

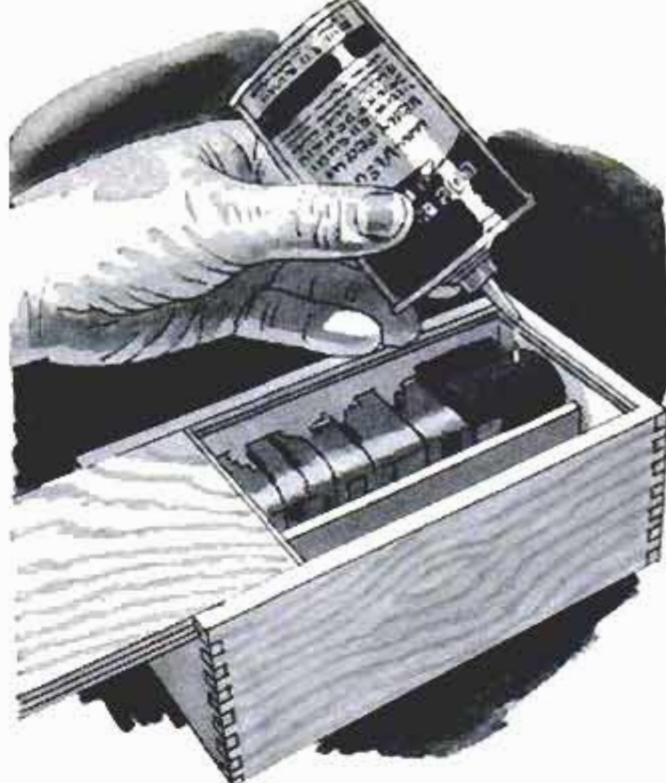

Oiled Felt Rustproofs Cutters

In damp locations expensive shaper cutters may rust even though stored in a wooden box. Keep the cutters rust-free by storing a piece of rolled felt in the box, and soaking it with a good quality gun oil. Fumes from the slowly evaporating oil will condense on the cutters and keep away damage-causing moisture.

Cleaning Small Brass Articles

Small brass articles that have become tarnished can be cleaned by immersing them in a solution consisting of: ammonia, $\frac{1}{2}$ cup; detergent, $\frac{1}{2}$ cup, and water, 2 qt. After the brass has soaked for an hour, remove and polish it with fine steel wool.

Magnets Aid in Paint-Dipping

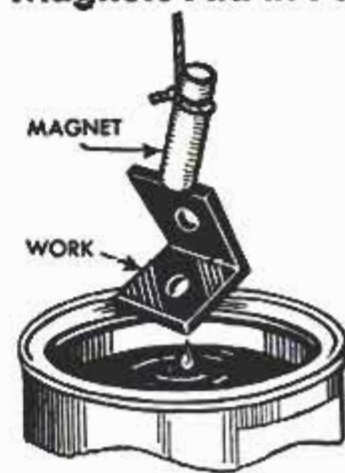

Iron or steel parts can be dipped in paint with a minimum of contact by the supporting device if small magnets are used as indicated. Dipped parts can be kept on the magnets until the paint dries. A touch-up with paint may be required on the small

areas contacted by the magnets, and the magnets themselves should be scraped free of paint each time they are used to prevent an undue accumulation.



Motorized Wheelbarrow Converts to Sprayer

By Ronald L. James

HERE IS A WHEELBARROW that will enable you to move heavy loads over rough terrain or soft ground with almost no effort. When the removable tray is unbolted and a water pump and spray tank installed on the platforms provided for them, the unit can be used for spraying insecticide on fruit trees, shrubs and home-garden crops.

A 1-hp. air-cooled engine from an old lawn mower provides ample power to move the loaded unit at about 2 m.p.h. over any surface. When the V-belt from engine to gearbox is disconnected and the power is used to run the water pump by means of another V-belt-and-pulley assembly, about 150 lb. of pressure is available with the high-pressure geared pump shown for spraying. A high-speed engine and reduction gear are necessary for this dual-purpose unit to turn the pump at high speed and drive the wheelbarrow at slow speed.

The frame of the wheelbarrow is torch-welded from $\frac{3}{4}$ -in. black steel pipe and $\frac{1}{8} \times 1\frac{1}{4}$ -in. angle iron as shown in Figs. 1, 5, 7 and 8. Lugs welded to the right side of the angle-iron section of the frame, as in Fig. 5, provide a means of bolting the gearbox in the required position. The gearbox used for the unit shown is a war-surplus J-H No. 1045 having an 85 to 1



When wheelbarrow tray is removed and spray assembly installed in its place, idler control automatically relieves tension on V-belt running from engine to gearbox which places latter in "neutral" position



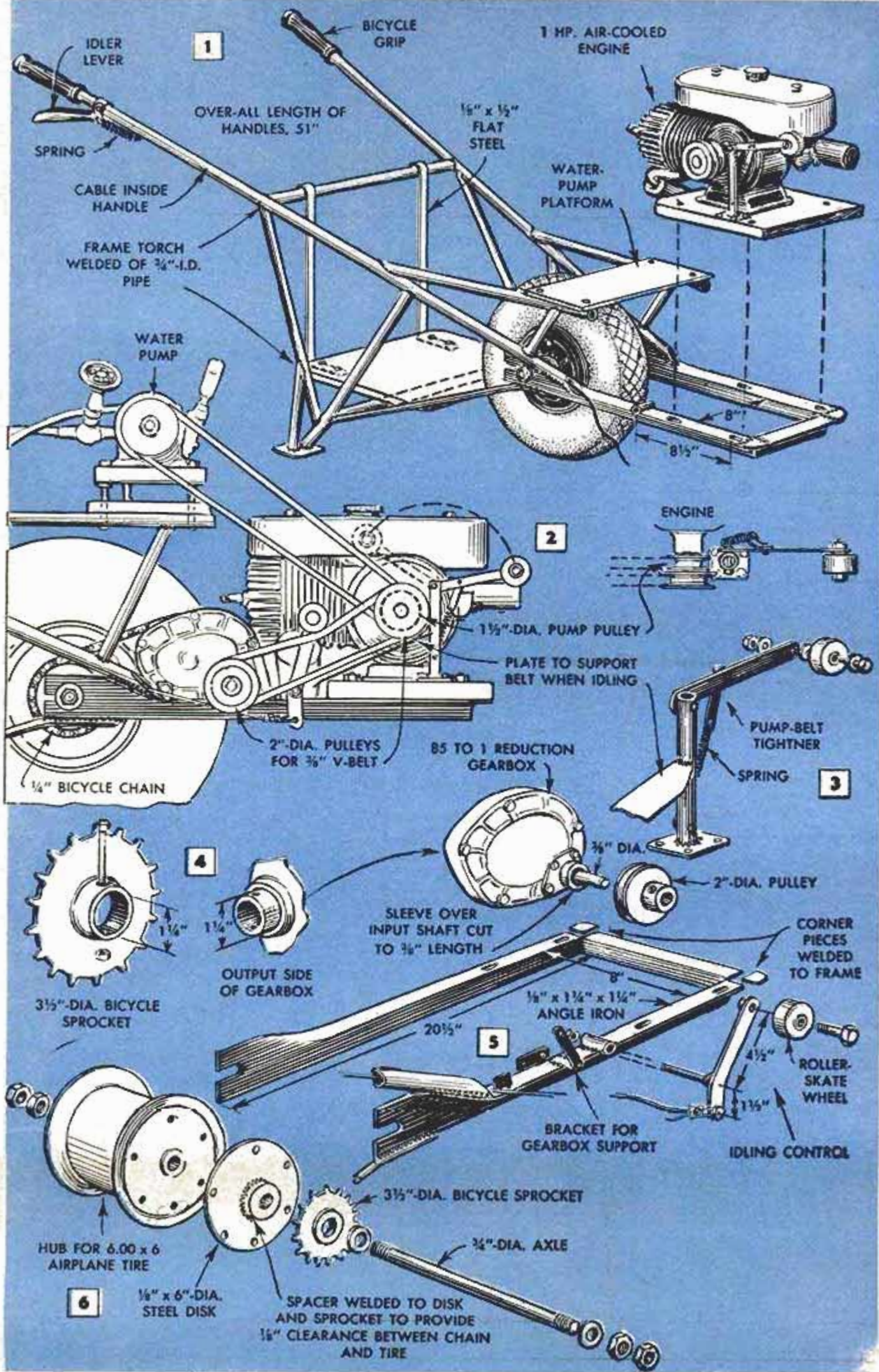

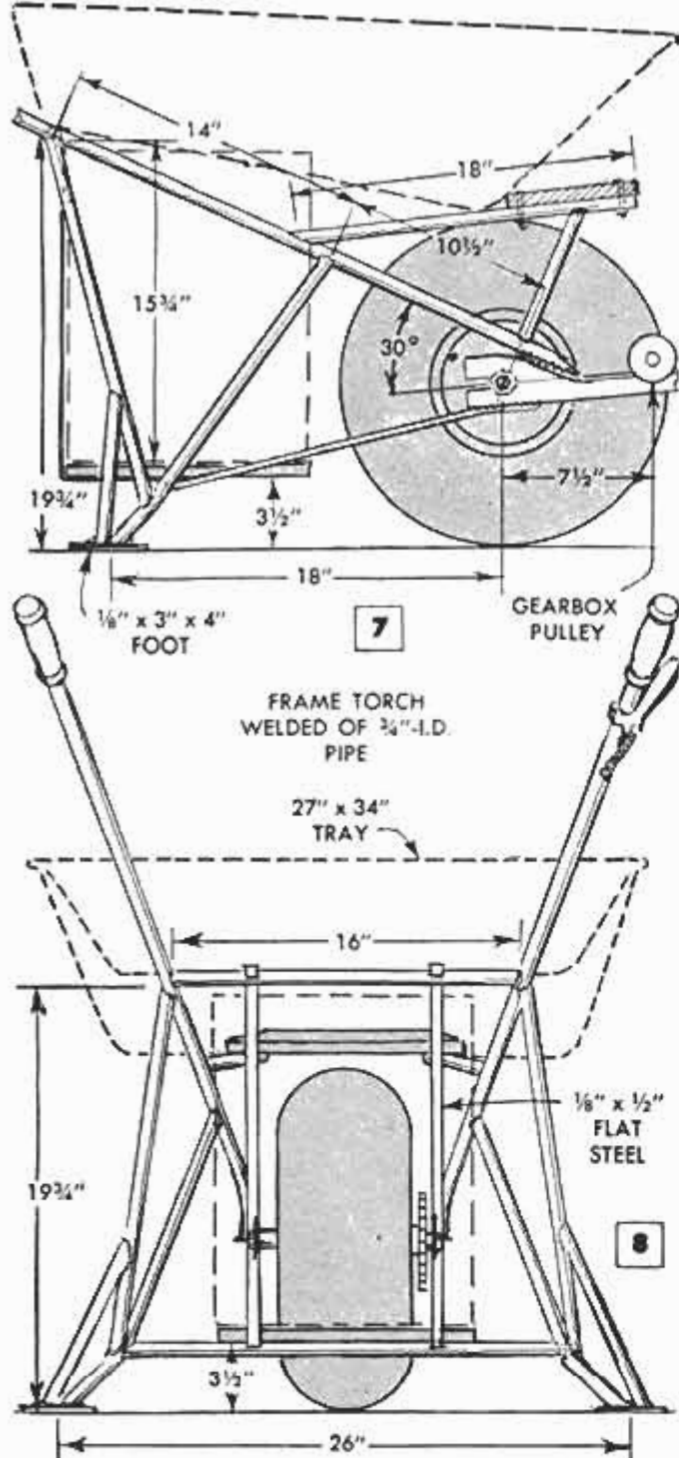

reduction. To permit mounting a 2-in.-dia. pulley for the drive belt on the $\frac{3}{8}$ -in.-dia. input shaft, the sleeve on the latter is cut to a length of $\frac{3}{8}$ in.

The sprockets are 3½-in.-dia. bicycle sprockets, one of which is mounted on the 1¼-in.-dia. output shaft on the gearbox and the other on the wheel hub as shown in

Figs. 4 and 6. The output sprocket has a 1¼-in. inside-dia. sleeve welded to one side of it. Holes drilled through the sprocket and output-shaft sleeves accept a $\frac{1}{4}$ x 1½-in. carriage bolt for easy connecting or removing of the sprocket.

The tire is a discarded airplane tire mounted on a war-surplus wheel or hub. If unobtainable, the hub also can be made by cutting the necessary parts from hardwood plywood and assembling them with waterproof glue.

The sprocket for the wheel is spot-welded to a steel spacer that is then welded to a $\frac{1}{8}$ x 6-in. steel disk. After slipping the wheel on the hub, this assembly is bolted to the hub as in Fig. 6. The purpose of the spacer is to provide $\frac{1}{8}$ -in. clearance between the drive chain and sidewall of the tire. If a narrower tire or a wheel with a wider hub is used, it may not be necessary to provide a spacer.

Tension on the drive chain can be adjusted by loosening the outer nuts on the wheel axle and sliding the latter forward or backward in the slots provided for it as required. Lateral adjustment of the wheel is made by turning the inner nuts on the axle in the direction that the wheel is to be moved, in the same manner as the wheels on a bicycle are adjusted to prevent them from rubbing against the frame members.

The idling control, Fig. 5, is simply a belt tightener which applies pressure to the V-belt running from engine to gearbox when the idler lever is pressed against the handle, Figs. 1 and 2. When the lever is held in this position, power is supplied to the drive wheel through the gearbox. When the lever is released, a small spring attached to it relieves tension on the cable connecting the lever to the control so that the gears are automatically placed in "neutral." This improvised clutch is necessary for starting the engine, stopping briefly to unload or load the wheelbarrow, or when pushing the unit with the engine turned off. Also, it serves as a safety precaution. A plate that is welded to the pump-belt tightener supports the idler belt when it is inoperative to reduce drag on the drive-shaft pulley, Figs. 2 and 3. ★ ★ ★

Moistureproof Paper-Tape Roll

Gummed paper tape of the type used in roll dispensers can be prevented from sticking at the edges if both sides of the roll are given a thin coat of rubber cement or paraffin. This prevents moisture from penetrating the exposed sides of the roll. The coatings offer only slight resistance when a strip of tape is removed.

Polish Renews Weathered Rubber

Black liquid shoe polish, applied on a weathered windshield gasket, fills the tiny cracks in the exposed rubber and coats it with a thin film of wax for protection against further oxidation. This treatment also can be used to freshen the appearance of rubber floor mats, accelerator and brake-pedal covers and other rubber items.

Party Game Tests Eye and Hand Coordination



Introduce this interesting device at your next party and let your guests challenge each other as to who has the better coordination between hands and eyes. A small metal eye must be guided over a metal rod without touching it, the eye being just twice the diameter of the rod. The eye is bent on the end of a wire "wand" that is covered with rubber tubing to insulate it. A flexible wire is soldered to the end of the wand and run through a flashlight bulb, a dry cell and a switch to the horizontal rod over which the eye is passed. With this circuit, the bulb will light whenever the eye contacts the rod, which is bolted to a bracket that is screwed to a plywood base. If a doorbell or buzzer is used instead of a bulb, three dry cells will be required instead of just one.—E. R. Haan, Evanston, Ill.

Shockproof Grip for Star Drill

To provide a firm, shock-resistant grip on a star drill, cut a hole through a solid rubber ball and force the drill through it. Hammer shocks are absorbed by the ball so hand fatigue is reduced considerably.

Glue Helps Hang Heavy Doors

When hanging a heavy door in a soft-wood frame, prevent the hinge screws from pulling loose quickly by first drilling a pilot hole and filling it with glue. Then drive the screw into the glue-filled hole.

Emergency Shirt-Collar Stays

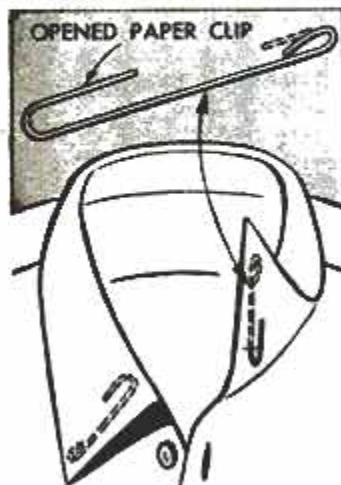

When collar stays have been mislaid, satisfactory substitutes can be improvised from ordinary paper clips. Each clip is rebent so there is a closed loop in one end, and an open loop in the other. The loops are bent at right angles to each other.

Piston Ring Is "Storage Rack"



Fitted over a nail in the workshop wall, a piston ring provides an ideal holder for large nuts and washers. Spring tension keeps the ends closed to permit the parts to be slipped around for easy selection. Twisting the ring ends slightly permits quick removal of the items.

☞ To clean a slender vase, fasten a piece of old sponge on a stick and push it down into the vase.

☞ Use an empty spray-deodorant bottle to rinse the leaves of delicate house plants and to give them extra moisture.

On the MARKET

for Do-It-Yourselfers

1. PROTECTIVE COATING is compounded for application to smooth metal surfaces where only perfect adhesion will prevent chipping or peeling. It comes in three colors: White, light gray and red; can be sprayed, brushed or rolled on. Can be applied to galvanized gutters and downspouts without any aging or preparation of surface other than cleaning

Master Bronze Co., Inc., 538-548 W. State St.,
Calumet City, Ill.

2. GRAINED FINISH comes in blond, maple tone, blond mahogany and walnut. Base, intermediate and finish coats can be applied over the original finish on old pieces of furniture. Works equally well on new projects. Second application is the graining coat and is worked with the graining tool 2 to 3 min. after application. Comes with full instructions

North Star Paint & Varnish Co., 612 Vandalia St.,
St. Paul 14, Minn.

3. POCKET-SIZE SOIL TESTER gives a reasonably accurate check on safe foundation loads for different types of soils. Useful to contractors and homeowners for checking soil conditions before laying driveways, patios and slab floors. Calibrated for direct readings in tons per sq. ft. Pointed plunger of instrument is forced into soil to give the desired reading

Soiltest, Inc., 4711 W. North Ave., Chicago 39

4. DECORATIVE acoustical tile absorb up to 20 times more sound than common ceiling materials, can be installed by any home handyman. Tile are 12 x 12 in. and come with a special joint that conceals nails or staples used in fastening to furring strips. Fine for soundproofing first and second-floor ceilings in homes and apartments, also basement rumpus rooms

The Celotex Corp., 120 S. LaSalle St., Chicago

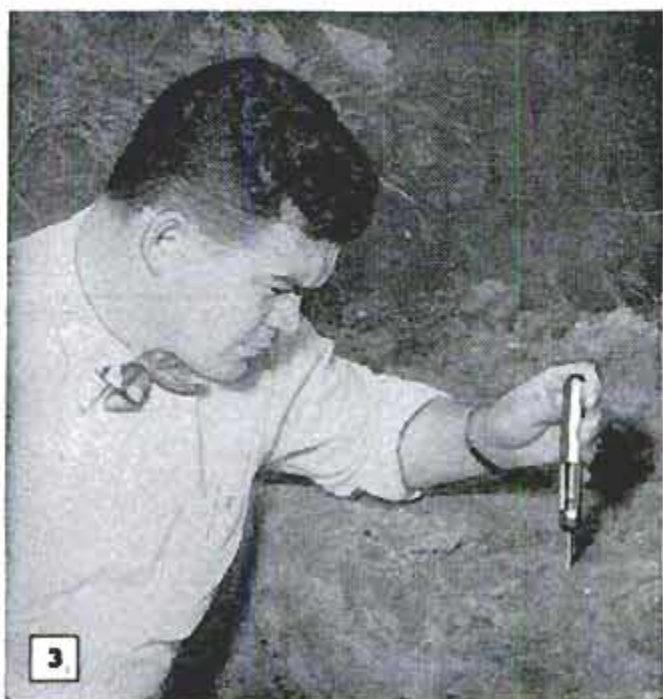

Brace for Clothes Pole Adds Storage Space in Closet



Heavily laden clothes-closet poles that sag can be leveled by means of a plywood brace that adds storage space as well. The brace consists of a sheet of plywood, cut to form a partition as indicated. A notch is cut in the upper end to receive the pole. Tie and shoe racks, as well as hooks for smaller articles can be attached to the plywood.—L. W. Smith, Portland, Ore.

Aluminum-Foil Screw Anchors

Masonry-screw anchors may be improvised from ordinary household aluminum foil. First, roll the foil into a tight cylinder and tap it into the drilled hole. Next, drive an ice pick or small-diameter punch into the end of the foil to form a shallow starting hole for the screw. Finally, drive the screw into the foil.

Screw-Eye Cabinet Latch



Where appearance is not a prime factor, as in workshop cabinets, simple latches can be improvised from screw eyes. One is driven into the cabinet frame and aligned with a slot cut in the edge of the door. Rotating the screw eye to a vertical position, latches the door, and moving it to the horizontal position permits the door to be opened. On metal cabinets, a small pad eye can be used in the same manner.

On metal cabinets, a small pad eye can be used in the same manner.

Scoop Measures Dry Chemicals

Ideal for use in the darkroom for measuring out small quantities of dry chemicals is a miniature plastic scoop with graduated marks. Scoops of this type may be purchased at cosmetic counters and in the household section of department stores.

Drawing-Board Surface Renewed

If your drawing board has become pitted with thumbtack holes, here is one method of renewing the surface. Dip round wooden toothpicks in glue and force them into the tack holes. When the glue has set, break off the toothpicks and sand flush with the surface of the board. An over-all sanding will remove minor irregularities in the wood as well as smooth the picks.

Dust Plugs for Rifle Barrels

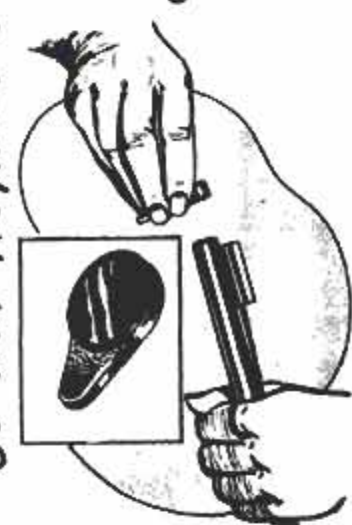

Rifles that are stored with the muzzle upward in a vertical rack can be protected against dust by sealing the muzzle with a rubber lens cap. Fitted with a tab for easy removal, the caps are available in a variety of sizes at most photo-supply shops. Another method of protecting a rifle is to use

an adjustable cap of the type used to reseal opened bottles of beverages. Some of the latter type can be reshaped for this use.



STANDARD SHEET OF ABRASIVE

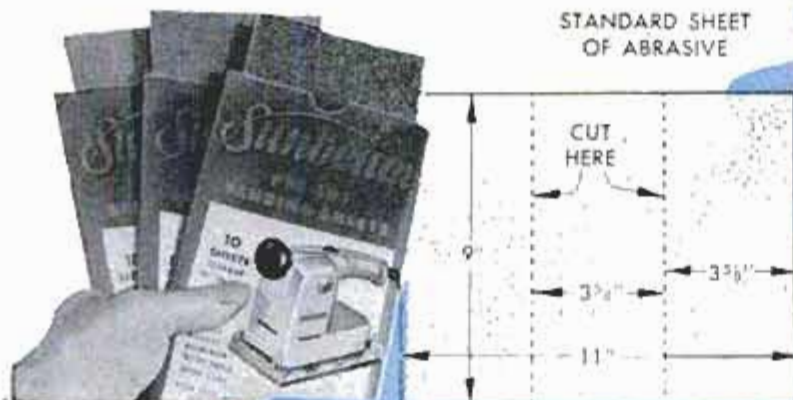

1

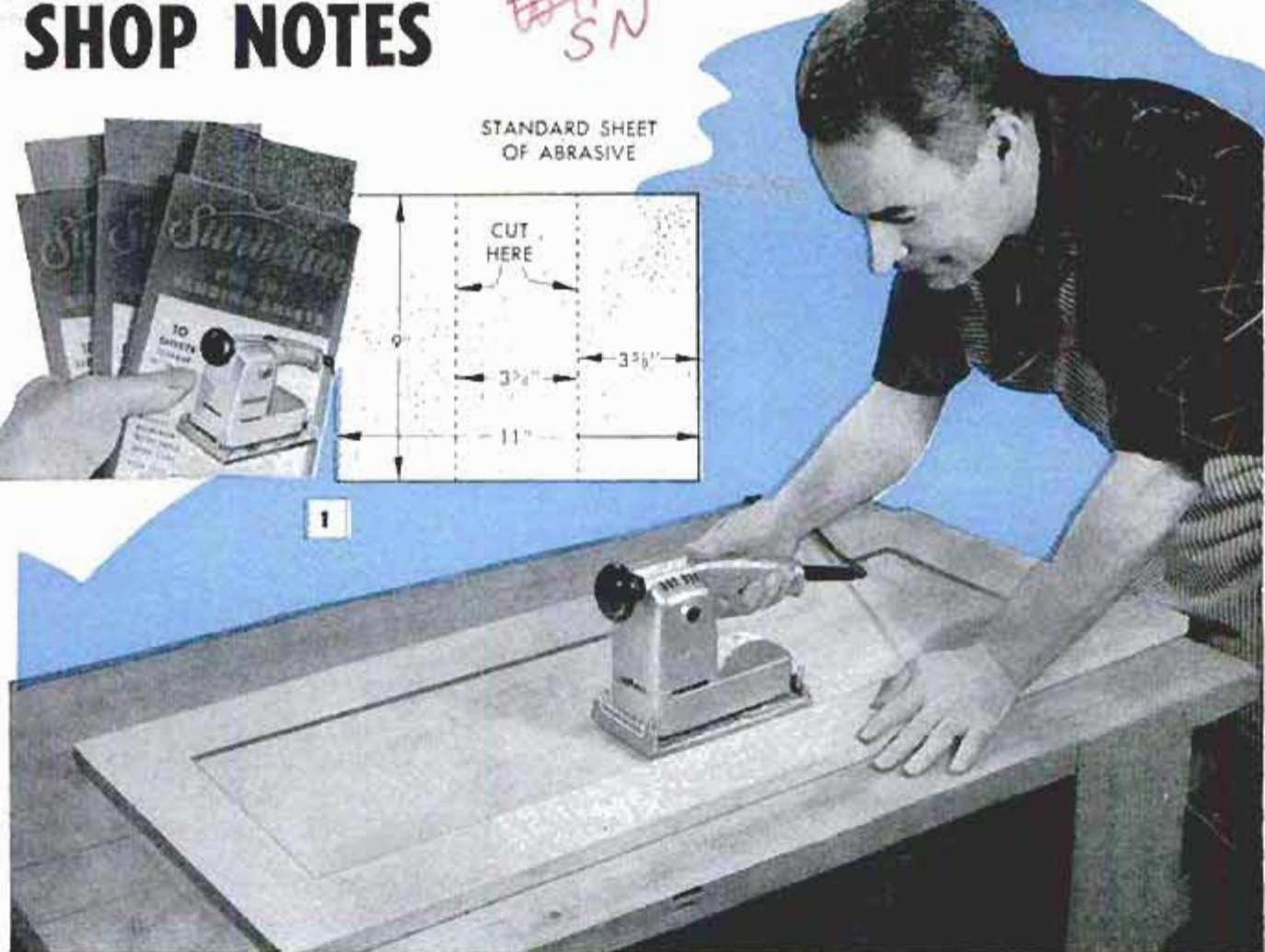

Finish That Shop Project With a PAD SANDER

By Sam Brown

YOUR PAD SANDER is a sanding block, a speedy polisher and a rubbing pad, all in one motor-driven unit. Like other portable power tools, it's designed to be held with one or both hands when in operation. On nearly all types the pad, or shoe, is driven at a fairly high speed in an orbital, or circular, motion. The length of the stroke averages about $\frac{3}{16}$ in. However, some machines are available which feature a straight stroke, rather than a curved, or orbital, stroke. Pad sanders having a straight stroke of the pad permit the use of somewhat coarser abrasives than do the orbital types. All these machines are fitted with conventional motors having rotating armatures. Another type of pad sander uses a magnetic-coil drive and operates at very high speed.

All pad sanders are finishing sanders and do their best work with comparatively fine abrasives, 2/0 to 6/0 grades on both hardwood and softwood. Most pad sanders come with a pad taking a sheet of abrasive

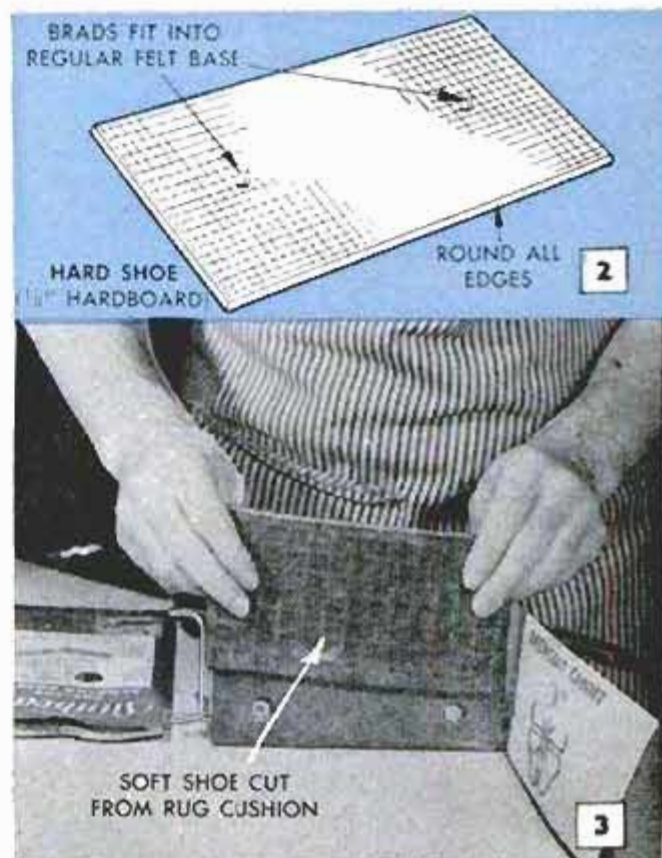



Above, pad sander works just as effectively on a vertical surface as on horizontal table top. Below, while not all-inclusive, the table lists and describes abrasives suited to pad sanders

ABRASIVE PAPER GRADES			
GRIT	EQUIV. "O" SERIES	GENERAL DESCRIPTION	REMARKS
600	—	SUPER-FINE	USED FOR WET SANDING PRODUCES HIGH SATIN FINISH
500	—		
400	10/0		
360	—		
320	9/0		
280	8/0	VERY FINE	USED FOR DRY SANDING ALL FINISHING UNDERCOATS. THESE GRADES WILL NOT SHOW SANDING MARKS
240	7/0		
220	6/0*		
180	5/0	FINE	FOR FINAL SANDING OF BARE WOOD. GOOD FOR SMOOTHING OLD PAINT
150	4/0*		
120	3/0	MEDIUM	USE FOR GENERAL WOOD SANDING. GOOD FOR FIRST SMOOTHING OF OLD PAINT, PLASTER PATCHES
100	2/0*		
80	1/0		
60	1½*	COARSE	USE No. 1½ FOR ROUGH-WOOD SANDING. No. 1 IS COARSEST PAPER WHICH CAN BE USED TO ADVANTAGE WITH PAD SANDER.
50	1		
40	1½		
36	2	VERY COARSE	ALL TOO COARSE FOR PAD SANDERS. THESE GRADES REQUIRE HEAVY MACHINES AND HIGH SPEED TO CUT WELL
30	2½		
24	3		

*Grades generally supplied as Very Fine, Fine, Medium and Coarse

measuring $3\frac{5}{8} \times 9$ in. which means you can cut three strips to fit the pad from a standard 9 x 11-in. sheet of abrasive, Fig. 1. Special packs containing 6 to 10 ready-cut sheets also are available. Either way, you have a wide range of abrasive grades readily available. The table, Fig. 5, lists and describes applications of abrasive grades suitable for use on pad sanders when working either metal or wood. The sander pad usually comes with a felt facing about $\frac{3}{16}$ in. thick. This gives about the right flexibility for all average work, but for some types of sanding on bare wood a hard shoe is desirable. This is especially true when sanding fir and similar woods having a pronounced grain of alternating hard and soft-grain structure. A hard shoe made as in Fig. 2 will give the abrasive the necessary rigid backing.

On the other hand, a softer shoe is an advantage when smoothing an old finish with a fine abrasive. A rectangular section cut from a discarded rug pad, or cushion, is just the thing. Cut and fit as in Fig. 3, making sure that the auxiliary pad is exactly the same size as the original. Lacking a section of rug pad, a piece of sponge rubber usually will serve the purpose.

One special feature you'll notice right away when using a pad sander is that you can work right up to a vertical surface or into a corner. And you'll see that it does equally good work on both horizontal and vertical surfaces, Fig. 4. Its use saves a lot of time when smoothing plasterboard joints and



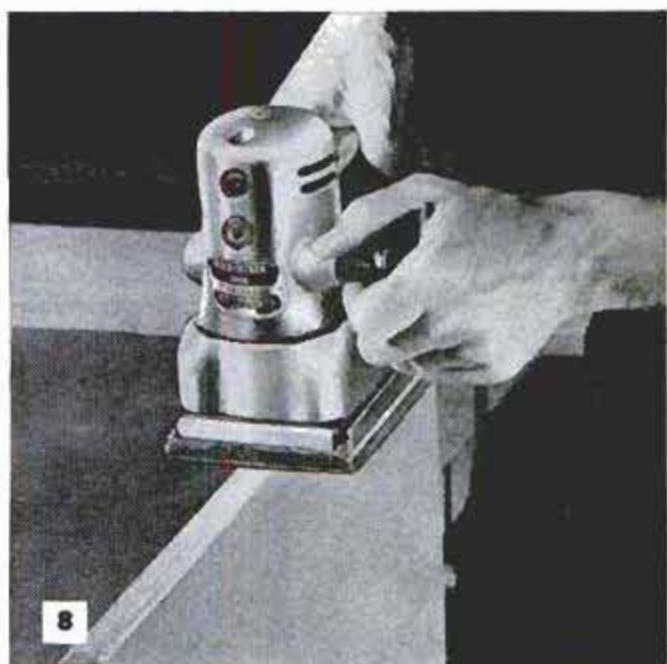
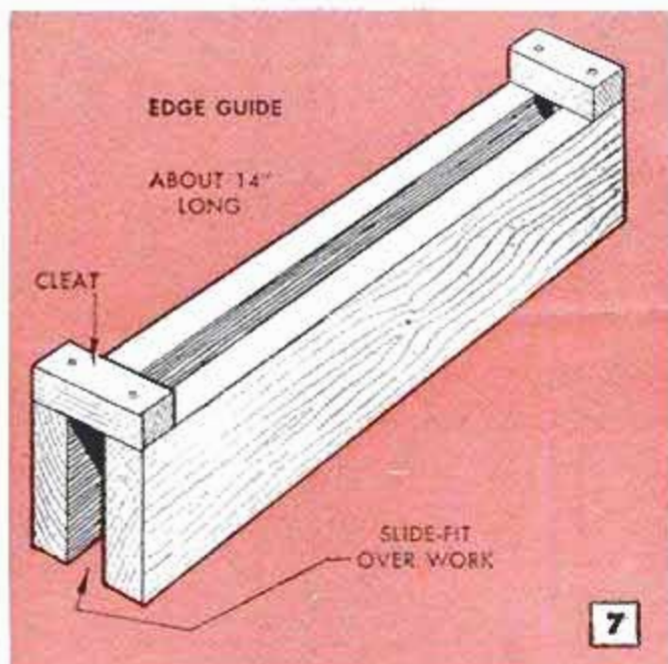

cleaning up old woodworking that is to be re-finished. Don't attempt to sand off an old finish with a pad sander. It just isn't designed for the job. Remove the old finish with a paint and varnish remover, clean the surface and allow to dry. Then use a medium to fine-grade abrasive on the pad sander and you'll end up with a fine finish-sanding job.

There's one thing to make sure of before you begin sanding or when you replace the worn sheet of abrasive. Be sure that the abrasive sheet is drawn taut with the locking device, Fig. 6. If it is slack, even slightly, it will not travel with the pad and sanding efficiency will be greatly reduced. Some locking devices, or paper locks, are operated with a screwdriver as in Fig. 6. Others are lever-operated. All types are designed to hold the ends of the abrasive sheet securely across the full width and to keep the sheet under the correct tension.

All pad sanders are equipped with a handle, or knob, for two-handed operation.

This is for the purpose of guiding the machine rather than applying pressure. The knob is, of course, necessary when working on a vertical surface as in Fig. 4. On all regular work on a flat, horizontal surface the weight of the machine is sufficient to make the abrasive "bite" uniformly on hardwood or softwood. Pressure in excess of the weight of the machine may cause the abrasive to leave semicircular scratches, or marks, on the surface of the work, especially when using the coarser grades. Another two-handed job with the pad sander is smoothing the edge of plywood, Fig. 8. This can be done with reasonable accuracy freehand as pictured, but if you must have a job that compares with jointer accuracy, then take time to make the edge guide detailed in Fig. 7. Use the same kind of wood for both lengthwise members so that the cutting action will be at approximately the same rate. This will tend to hold the sander square with the edge of the work and you'll get a clean job with sharp corners. In this





job as in all others, keep the sander moving. A straight stroke, back and forth just as you do in hand sanding, works very well. The pad will cut equally well in both directions.

When sanding resinous woods and when finish-sanding old paint or varnish in preparation for polishing, the abrasive will tend to clog, become coated with resin or paint pigment. When this happens, apply a few drops of turpentine to the abrasive and then hold a steel-bristle brush on the pad while the sander is running. This treatment generally will remove the coating quite effectively.

Your pad sander really shines when it comes to fine sanding of finishing coats in either clear finishing materials or pigment finishes, such as colored lacquers and enamels. This can be done either by the wet or dry process. Sanding of the top coat depends on the type of finish and the degree of gloss desired. A simplification of these processes is use of a ready-mixed

rubbing compound which is applied to the surface and then rubbed down with a pad of coarse burlap or a piece of pile carpeting attached to the sander pad in place of the abrasive. However, the ultimate in fine furniture finishing is wet sanding with a waterproof silicon-carbide abrasive paper attached to the sander pad. The advantage of wet sanding, Fig. 11, is that it builds a perfectly level surface. In order to sand down to a level surface you'll need at least three finishing coats, one sealer and two top coats, as otherwise there is always the possibility of cutting through the finish to the bare wood. Use a 500-grit paper.

Many lubricants are used for wet sanding but clean, soft water with a little soap added is quite satisfactory. The best way to add the soap is to apply it to the pad as in Fig. 13. When applying a new sheet of abrasive to the sander pad when wet sanding, always dip in water first as in Fig. 12, before clamping in place on the sander pad. *Caution:* When sanding apply the

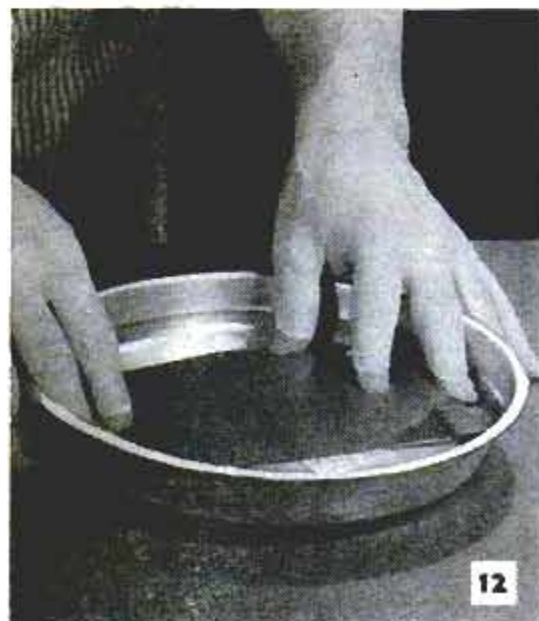

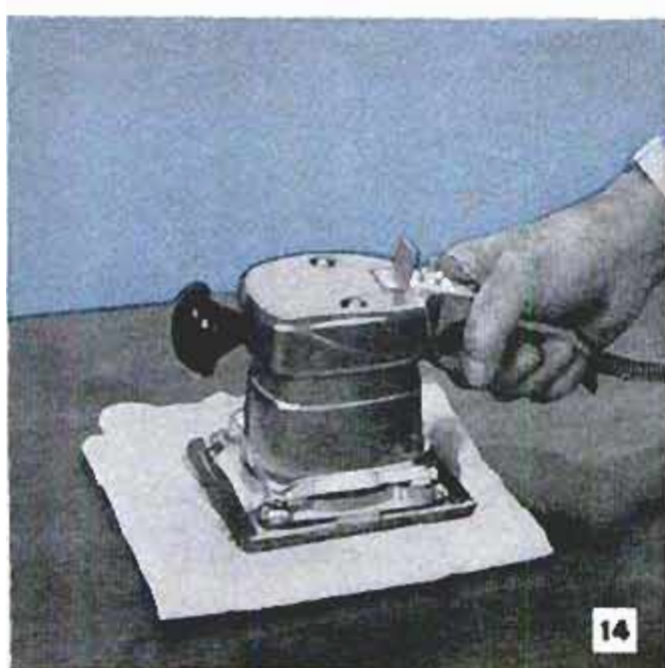

water to the surface with a sponge, being careful not to get the surface sloppily wet. Wipe off any excess water. Never dip the sander pad in the water. Take extra precautions to prevent water, even a small drop, from reaching the motor. Do not use a magnetic-type sander for wet finishing.

If you finish with wax, polish with a cloth pad as in Fig. 14. Just fold the cloth several times and place the sander at the center of the cloth pad.

One more application of the pad sander is sharpening chisels and plane irons, Fig. 10. You'll be pleased at the excellent job it does. ★ ★ ★

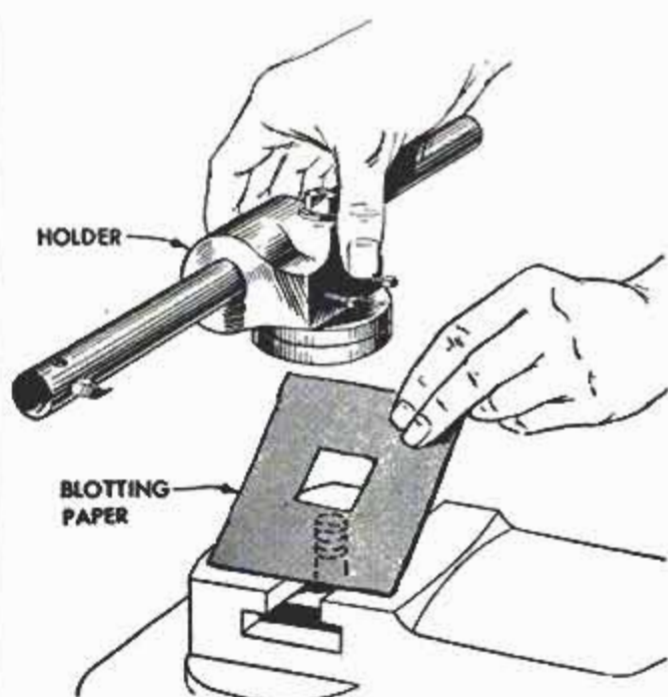

Prevent Chatter in Deep Bore

When deep-boring in roughcastings it generally is necessary to take a fairly deep cut on the first pass in order to get under the scale. This often causes chatter marks near the end of the bore due to the overhang of the cutting tool. Usually this tendency can be offset by placing a soft pad of blotting paper, several thicknesses of wrapping paper or leather under the boring-bar holder. Varying the tension on the T-bolt and reducing the feed also may help to eliminate the trouble.

Milling Squares of Varying Size on End of Round Work

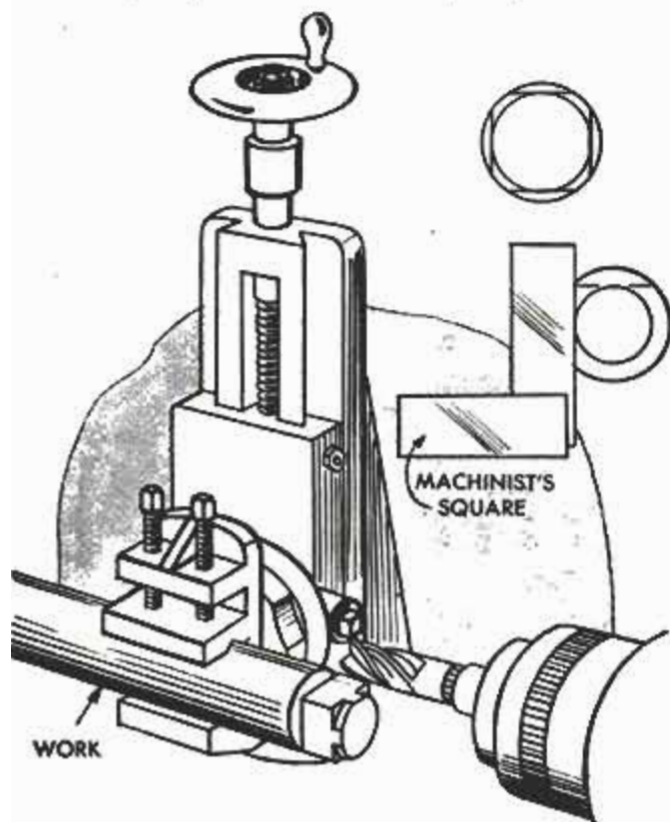

Milling squares of varying size on the ends of round workpieces can be accomplished at a fairly fast rate by this method. The first step is to chuck the shaft and turn a shoulder $\frac{1}{16}$ in. wide, running the cut in until the diameter equals the desired size of the square. Then chuck a milling cutter in the collet chuck and set up the work in the lathe milling attachment. Run the first cut in several passes and check to be sure of the setting. The final cut should just touch the top of the round turned on the end of the shaft, or cut into it slightly if a slight allowance has been made and the measurement is not too critical. Next, loosen the milling-attachment clamp and give the work a quarter turn so that the milled face bears against a machinist's square placed vertically on the lathe ways. Tighten the clamp and recheck the setting before running the second cut. Proceed in the same manner when running the third and fourth cuts. On work of small to medium diameter all cuts except the first usually can be run in one pass.

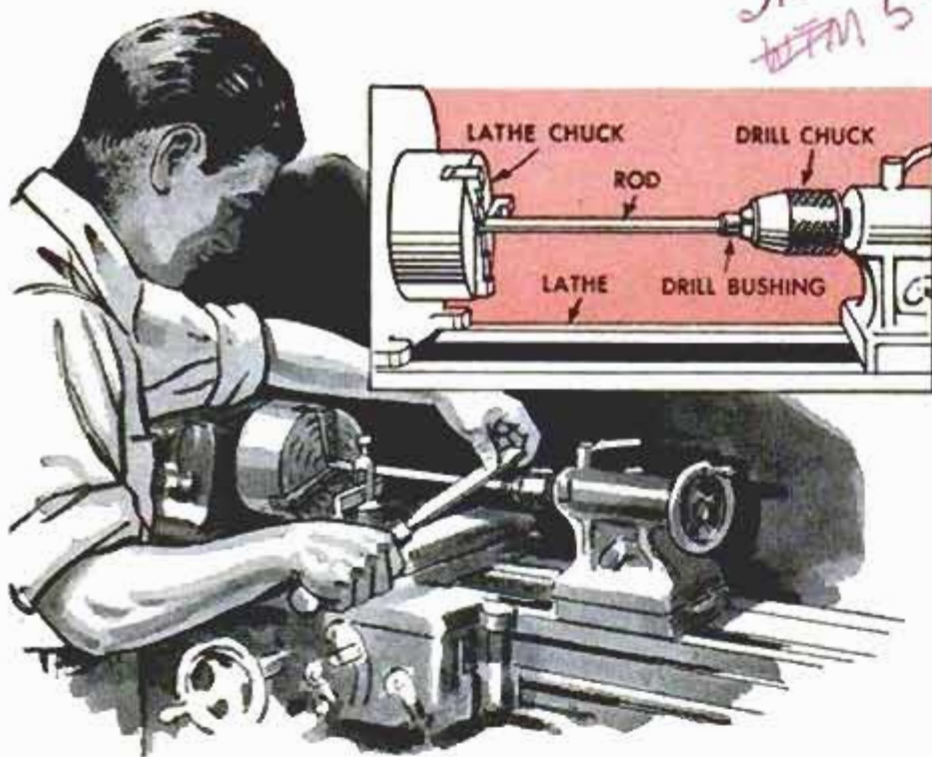

Bushing Is Bearing When Filing in Lathe

When filing work of small diameter between centers in the lathe, the pressure of filing may cause deflection. This tends to enlarge the center hole in the outer end of the work. To offset this tendency, the outer end of the work can be carried in a drill bushing (or any standard bushing) held in the tailstock. When necessary, turn the end of the work to an easy, running fit in the bushing. Lubricate occasionally with a drop or two of light oil.—Frank LaSarcina, New York City.

Simple Jig Makes Spiral Dowels Accurately on Your Bandsaw

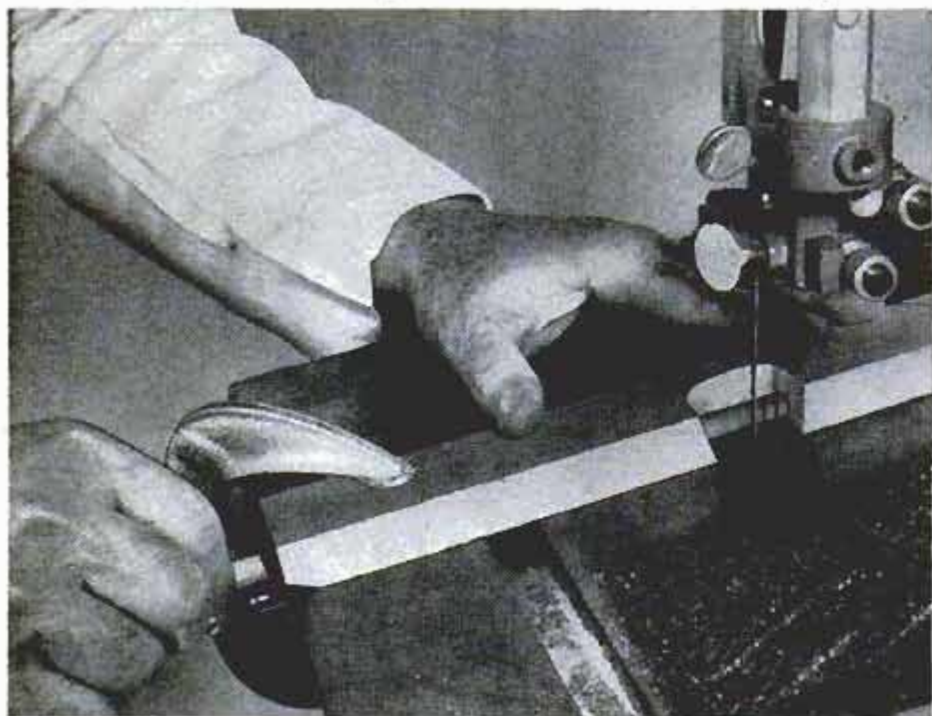

Spiral dowels of the type used by cabinet-makers are easily made on your bandsaw with this special jig. Groove a length of 1 x 2-in. stock to take the dowel in an easy, sliding fit. Then cut the strip to a length only slightly less than the width of the machine table. Tilt the table to about 10 deg. and cut a notch at the center of the jig. Set the jig so that the blade will cut into the dowel about $\frac{1}{16}$ in. and clamp in place as pictured. Insert the dowel in the groove, bring it up to the blade and feed slowly.

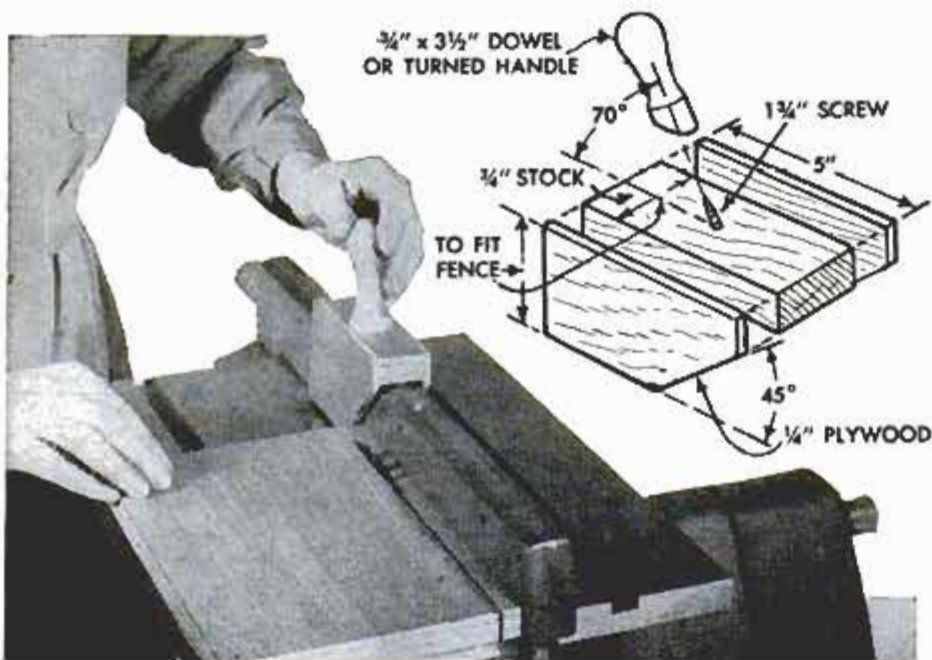

Push Stick for Saw

Here's a push stick that does a better job of keeping your fingers a safe distance from the blade on a tricky ripping cut. As you will note from the photo, it rides the ripping fence and not only holds the work down but carries it safely past the blade. Parts that fit over the fence are cut from plywood; handle is turned from solid stock.—Tom Riley, Atherton, Calif.

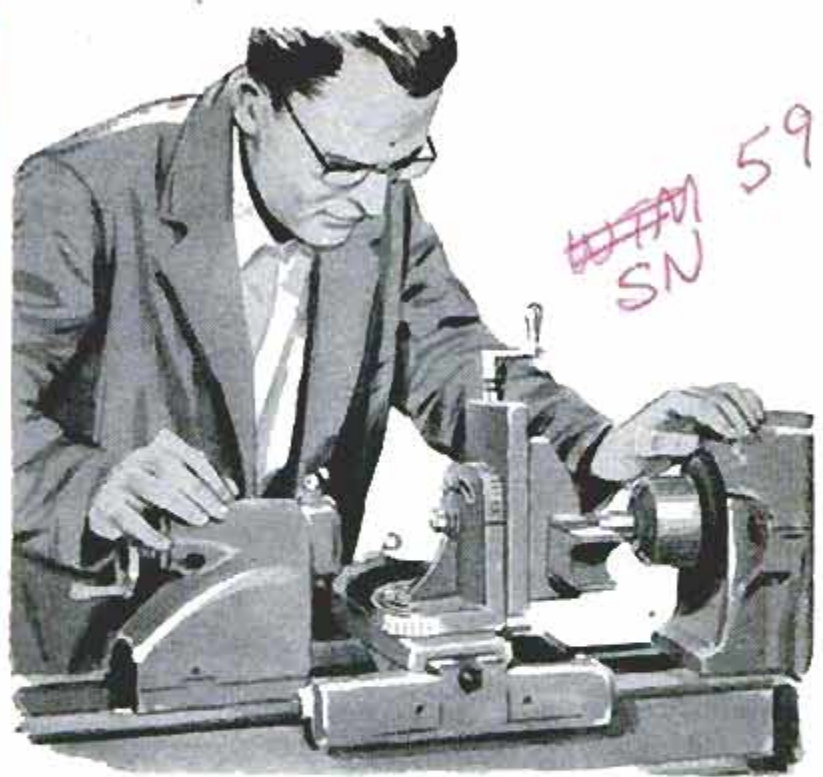
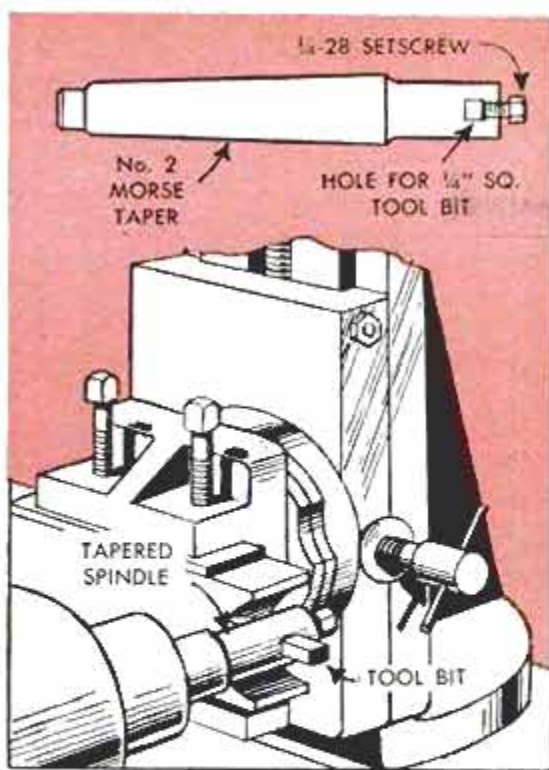

Fly Cutter Handles Those Special Milling Jobs

Some jobs that come into the shop require improvised setups on either the lathe or milling machine. Where the parts are small and preformed or semifinished and only a finishing operation is required, it often is possible to make an efficient setup on the lathe using the milling attachment. The detail shows a typical job of this type. A simple holder for a fly cutter was machined from the shank of a discarded drill bit having a No. 2 Morse taper. The broken drill was cut off, leaving about 1 in. of the straight portion of the shank projecting. This was drilled transversely and the hole squared to take a 1/4-in. tool bit, the latter

held in place with a setscrew turning into a tapped hole in the end of the shank, or spindle. This arrangement permits the tool to be adjusted to cut the required radius. Care should be taken in squaring the hole for the tool bit to obtain a close sliding fit, as otherwise the bit may tend to loosen under the setscrew when making an interrupted cut, such as that shown in the detail. Square the hole with a broach, or file carefully by hand to size. When fly-cutting on duplicate parts to the same radius, improvise a stop which will assure successive pieces being placed in the same position.—C. W. Woodson, Chicago.

Accessories Kept in Order

Power-tool accessories are always within easy reach when stored on a rack like that pictured. Select dowels that will fit easily into the spindle holes. Cut off short lengths and fit into holes drilled in a narrow shelf. Attach to wall or tool panel.

R. J. DeCristoforo, Los Altos, Calif.

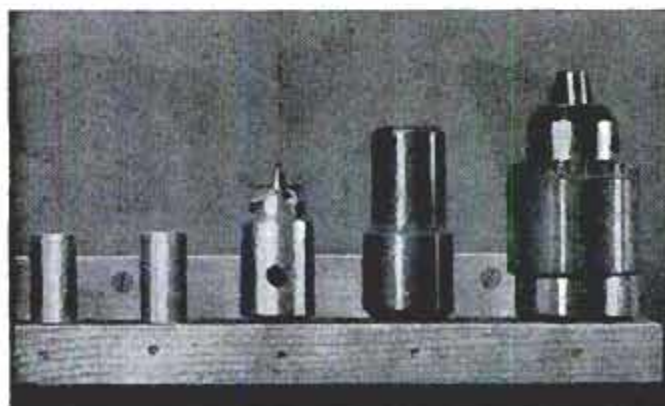

Indicator Shows Tool Position

An indicator, or gauge, which shows the position of a threading tool in an internal bore is helpful on duplicate work. It consists of a length of flat steel bent to an S-shape and carried in the toolholder. Pencil-mark the desired depth of the thread on the outside surface of the work.

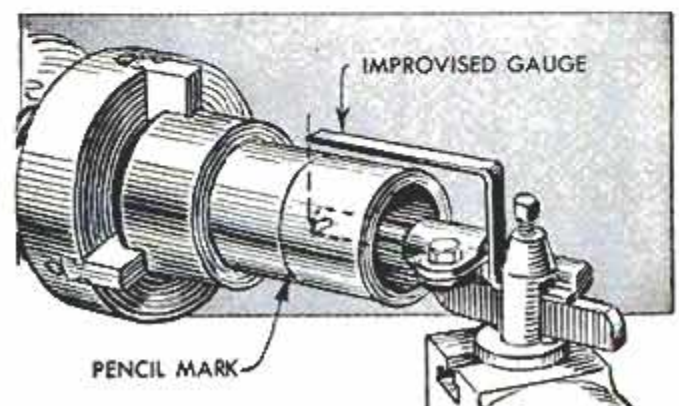

HAND TAPS ARE PRECISION TOOLS

By C. W. Woodson

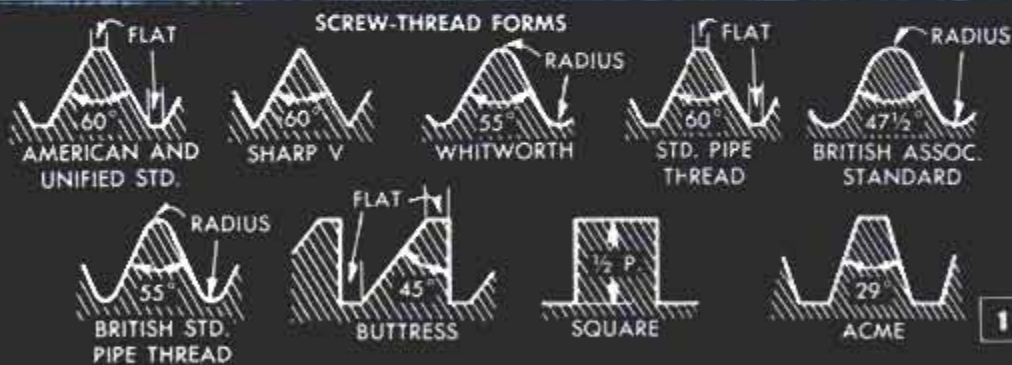
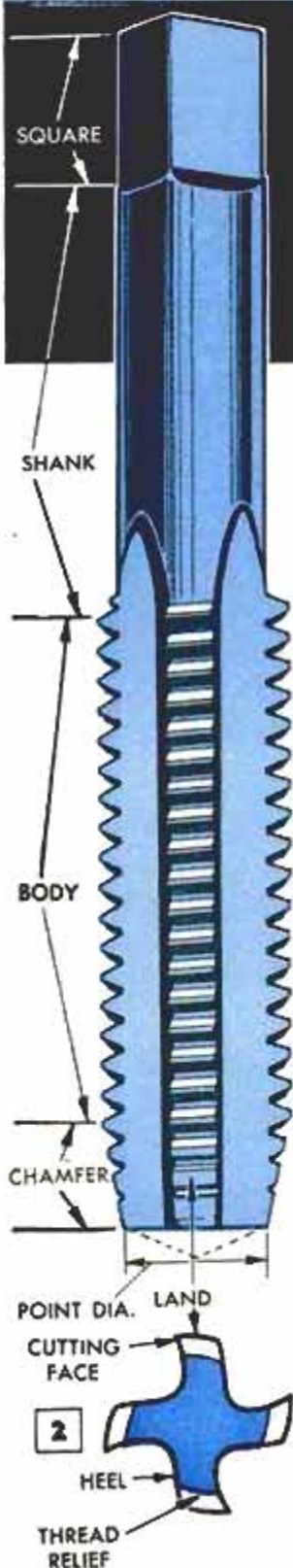

NO ONE REALLY KNOWS when a tap was first used to cut an internal thread in a hole drilled in metal, but it is certain that taps have been in use for centuries. Probably the initial development of the tap began with the first attempt to join metal to metal in an assembly consisting of several parts, one or more of which had to be removable and replaceable without damage. Such an assembly would call for the use of screw threads and screw fasteners much like those in use at the present time.

Modern hand taps have been developed to high standards of precision and long-wear life. Generating of threads on the fluted body of a tap is done by grinding rather than cutting, a process which holds the shape and contour of the thread within very close limits. The general shape and proportions of a common hand tap of the taper type is shown in Fig. 2. The body of the tap is generally taken to mean that portion of the fluted section on which the full threads are cut. The chamfered portion at the lower end of the body is that section on which the threads are chamfered, or tapered, down to the root diameter. The upper end of the round shank is always squared to take a tap wrench or other type of driver. The taper tap is generally used for tapping open, or through, holes, that is, holes which are drilled entirely through the stock. The plug tap, Fig. 3, is identical in general measurements except that the chamfered portion at the end of the body is shorter, only about 3 to 5 threads being chamfered. The bottom, or bottoming, tap is chamfered at an angle of about 10 deg., Fig. 3, the chamfer involving only 1 or 1½ threads. In handwork the taper tap is perhaps the most commonly used as it is easier to start accurately by hand methods and cuts more freely in such harder metals as can be hand-tapped. When tapping deep, blind holes by hand, Fig. 4, it is a fairly common practice to use the taper, plug and bottom taps in the same hole, beginning with the taper tap, making a second cut with the plug tap and finishing with the bottom tap. Although it takes more time, this procedure prevents wedging and possible tap breakage.

General characteristics of the American National Thread are detailed in Fig. 5. The letter P indicates the pitch, letter A the thread angle, letter F the width of the flats at the root and crest, and letter

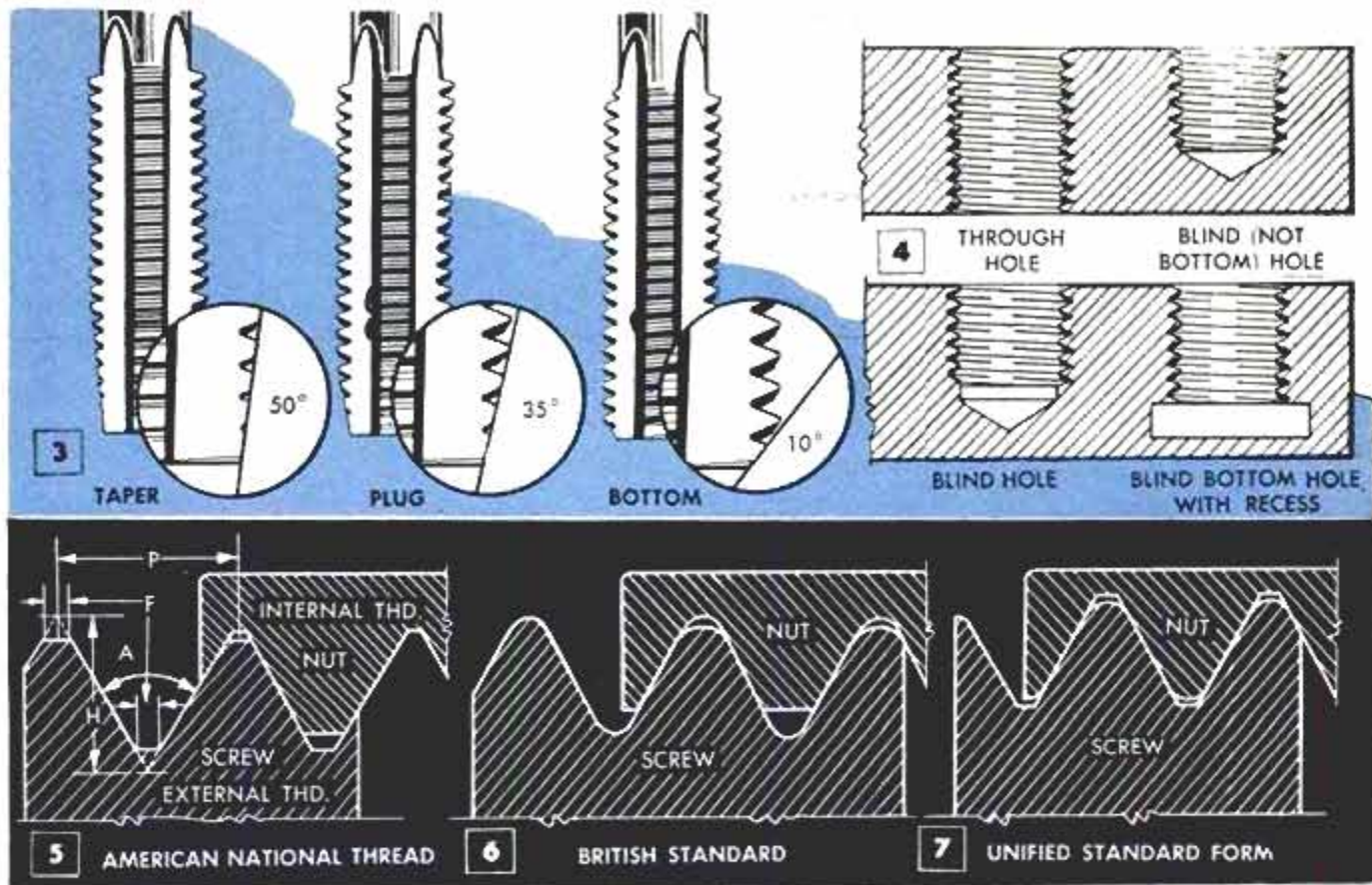

H the depth. In this instance, the latter indicates full depth of the sharp-V thread. Ordinarily it would indicate the depth as measured between the flats at the root and crest. Now compare the American with the British Standard and the Unified Standard Form, Figs. 6 and 7 and also Fig. 1. Recent international agreements between the two countries have resulted in establishing new manufacturing limits which permit nearly all sizes of the two types of threads to interchange as in the Unified Standard Form, Fig. 7.

In Fig. 8, details A, B, C and D have been somewhat exaggerated in an effort to show some characteristics of taps which are rather difficult to visualize. Pitch diameter is an example. It's defined as an imaginary cylinder, the lines indicating its surface passing through the threads at a point midway between the root and crest, detail A, Fig. 8. Pitch usually is defined as the distance from a given point on one thread to a corresponding point on the adjacent thread, the measurement being taken parallel to the axis, detail B, Fig. 8. Lead generally is taken to mean the axial advance of a thread in one complete turn of a single-thread screw. On a single-thread screw, lead and pitch are the same, detail B, Fig. 8. However, on a double-thread screw the lead is twice the pitch, detail C, Fig. 8. All common taps have a back taper, usually running from a point just above the chamfer. Any measurements taken for the purpose of checking wear should be made at the point indicated in detail D, Fig. 8.

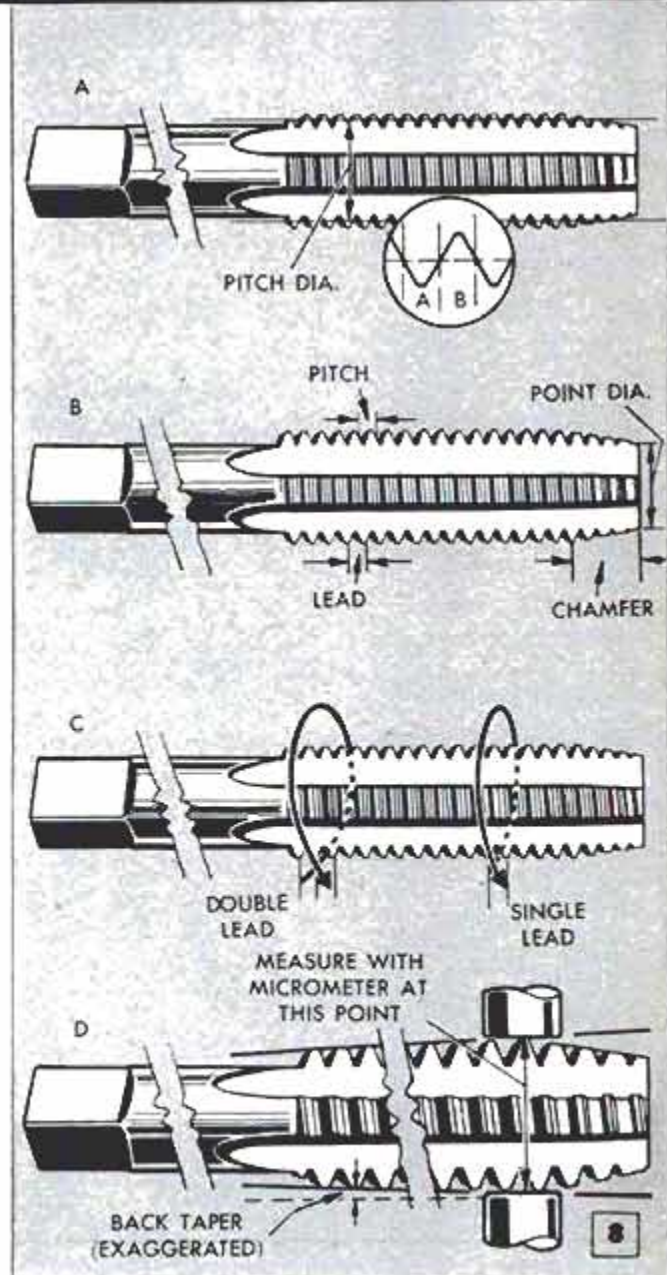

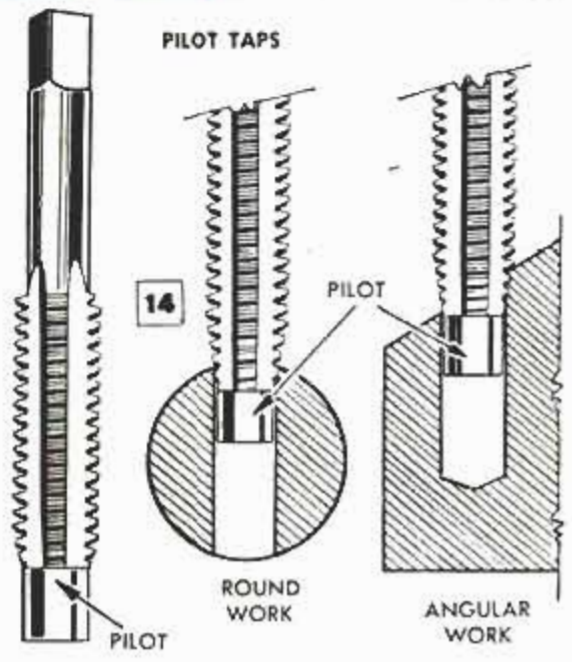
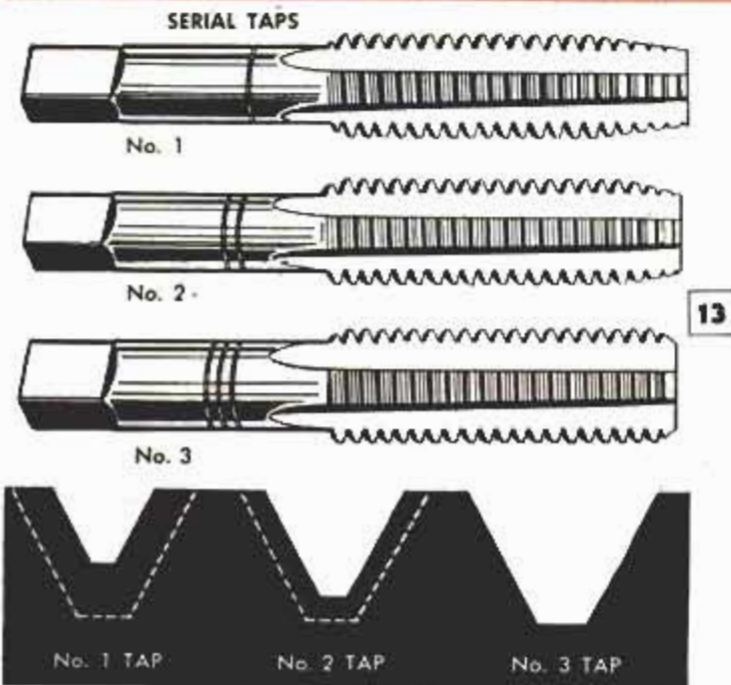
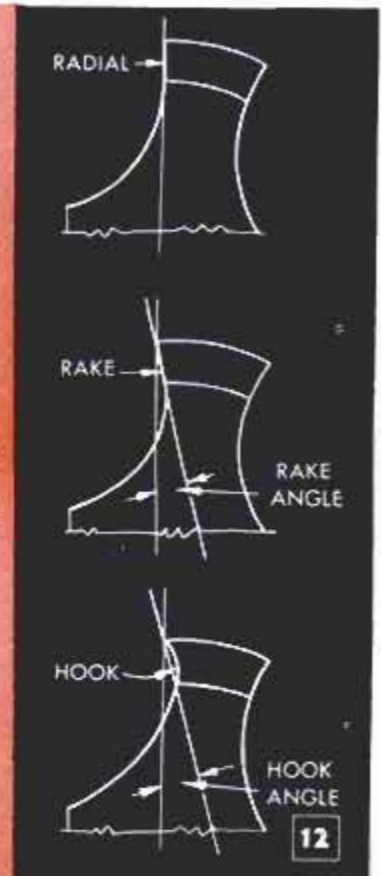
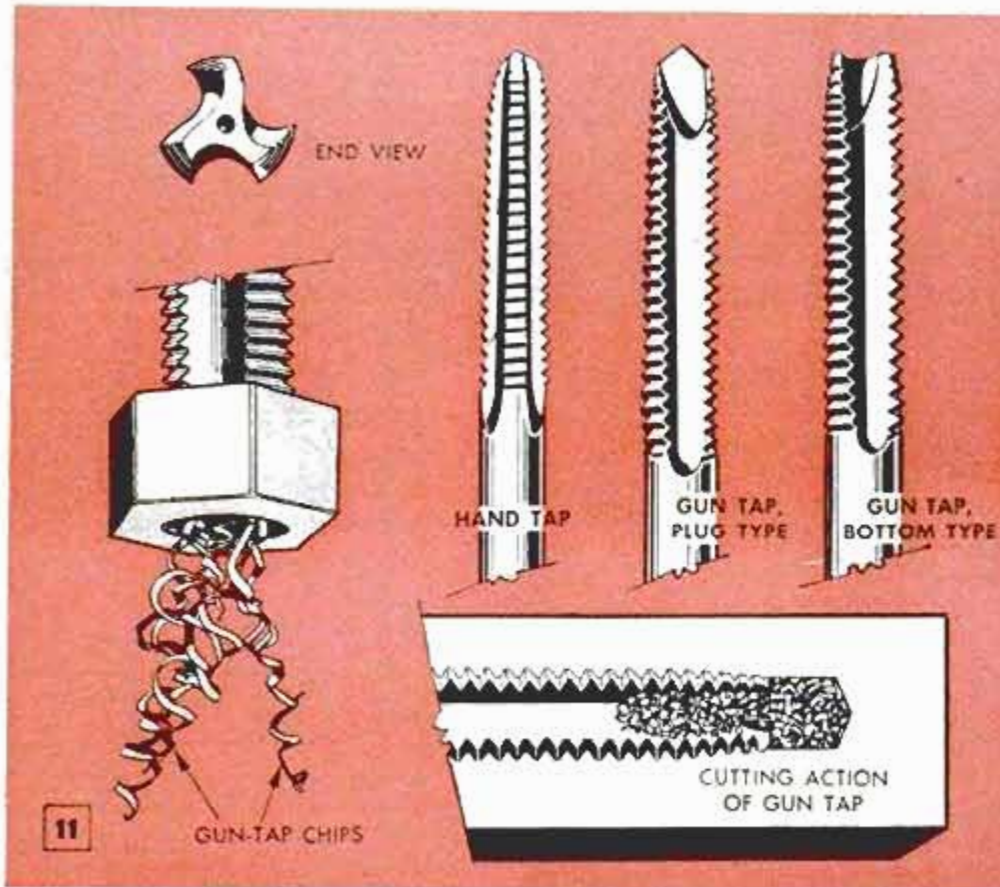
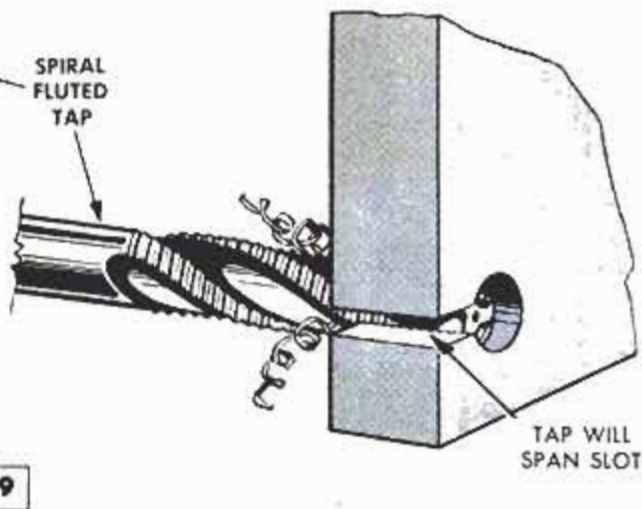
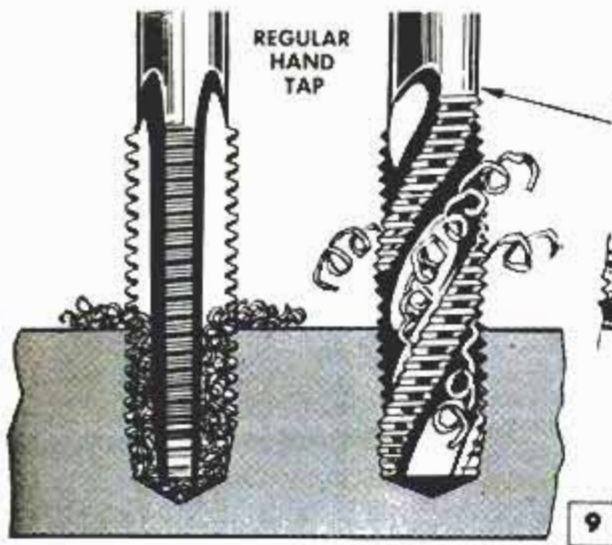

Figs. 9 and 19 compare the standard tap with a spiral-fluted tap designed for special purposes. The spiral-fluted tap will span a slot or bridge a keyway which is run into the hole as in Fig. 10. It has been specially designed to work in such hard-to-tap metals as aluminum, copper alloys, magnesium and in certain die-cast parts. The spiral flutes lift chips in much the same manner as the flutes of a twist drill, tending to clear the hole and to prevent jamming and breakage.

The gun tap, Fig. 11, is designed only for machine tapping and differs from the conventional hand tap in that it has a two-stage, or two-section, flute which cuts with a shearing action. This forces the chips to pass out of the hole ahead of the tap, rather than lifting them in the opposite direction as does the spiral tap. The flutes are shallower and narrower than those in the standard tap. This gives a greater cross-sectional area in any given size and results in greater strength and resistance to breakage.

Machining characteristics of the metal to be tapped determine tap selection for the job. As an example, brass and certain fibers call for a negative rake or a radial face like that in the top view, Fig. 12. Hard brass, bronze, malleable iron and cast steel generally tap best with a rake angle such as that in the center detail, Fig. 12. Die-cast aluminum, cast iron, magnesium and machinery steels are usually worked with a tap having a hook angle like that in the lower view, Fig. 12. These views detail only what is considered average practice. They are not all-inclusive, of course.

Serial taps come in sets of three, Fig. 13. The first, or No. 1, tap starts the thread. No. 2 tap cuts to about three fourths of full depth while the No. 3 tap finishes the thread to full depth. Pilot taps are designed for tapping round work transversely or starting a thread angularly, Fig. 14.

Fig. 15 shows a standard pipe tap and thread and a variation known as the self-sealing thread. Note the hand-tight and wrench-tight positions. Pipe taps are made in both the straight and tapered types. Interrupted-thread pipe taps, Fig. 17, detail A, are often used in place of the conventional tap, detail B, in machine tapping of pipe fittings. The interrupted thread gives somewhat greater chip clearance, produces a cleaner thread in fittings. In Fig. 16 comparisons are drawn between the 100, 75 and 50-percent thread. As noted, the 100-percent thread is rarely used. ★ ★ ★

☞ Empty window-spray bottles are good dispensers for turpentine or other solvent to spray your hands to remove paint.

REGULAR PIPE TAP

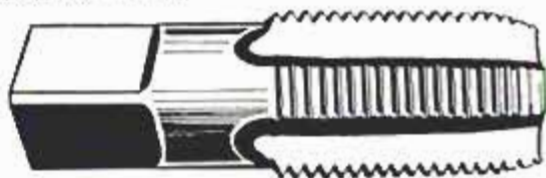

15

REGULAR PIPE THD.

DRY-SEAL THD.

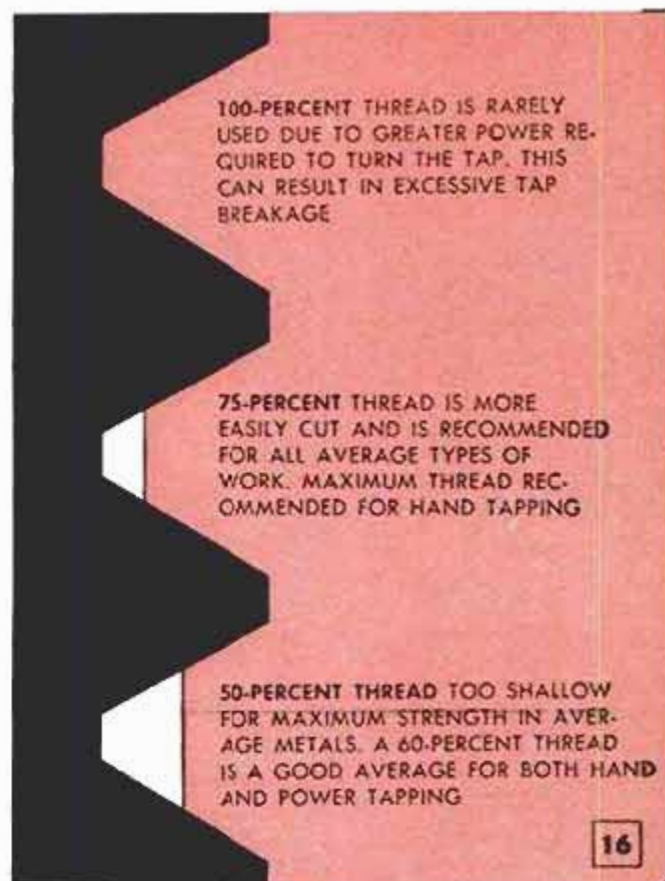
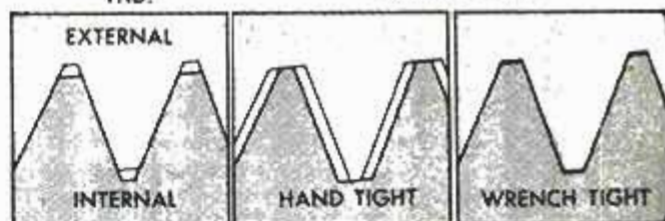

16

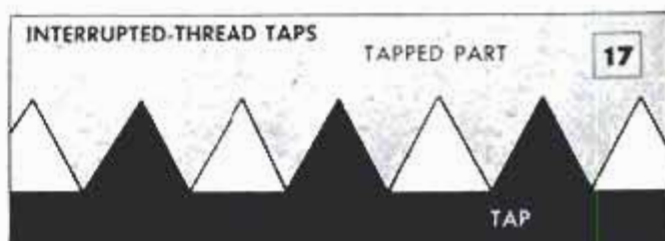
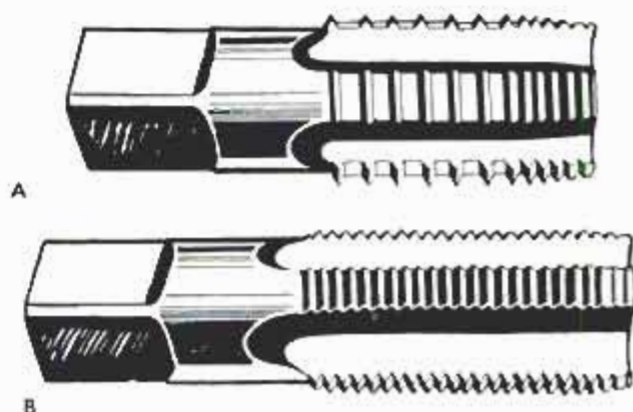

17

Hoist Uses Washing-Machine Motor, Gearbox

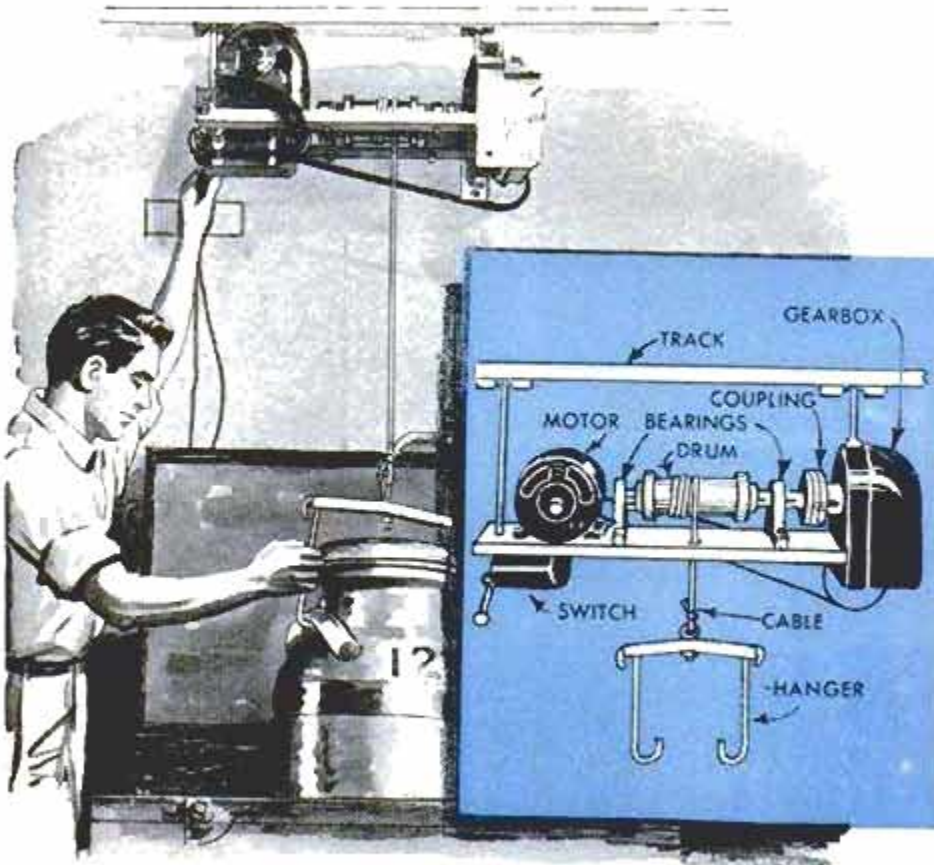

To reduce any stress on the gearbox, a flexible coupling is used between it and the cable drum. A flexible coupling can be improvised by cutting a V-belt pulley in half along the center of the V-groove, then reassembling it with nuts and bolts, rubber washers being installed between the pulley halves. If a lathe is not available, the cable drum can be made by welding large washers to the ends of a length of steel pipe. The washers should prevent cable from sliding off the ends. It also may be necessary to weld still smaller washers to the large ones to reduce the hole to a size small enough to receive the drum shaft. It then is welded solidly to the

Although originally designed for lifting loaded milk cans from a cooler to a truck, this traveling hoist will prove handy wherever loads of a similar weight must be handled. A gearbox and electric motor from a washing machine are mounted on an angle-steel frame as shown in the detail.

drum ends. A switch is mounted on the angle frame below the motor, and the wire used to connect the motor to an outlet is long enough to allow the hoist to travel the full length of the overhead track. Trolley assemblies and track were purchased new. Hobart Brothers Co., Troy, Ohio.

Timesaving Jig for End-Drilling Round Work in Quantity

SN 59

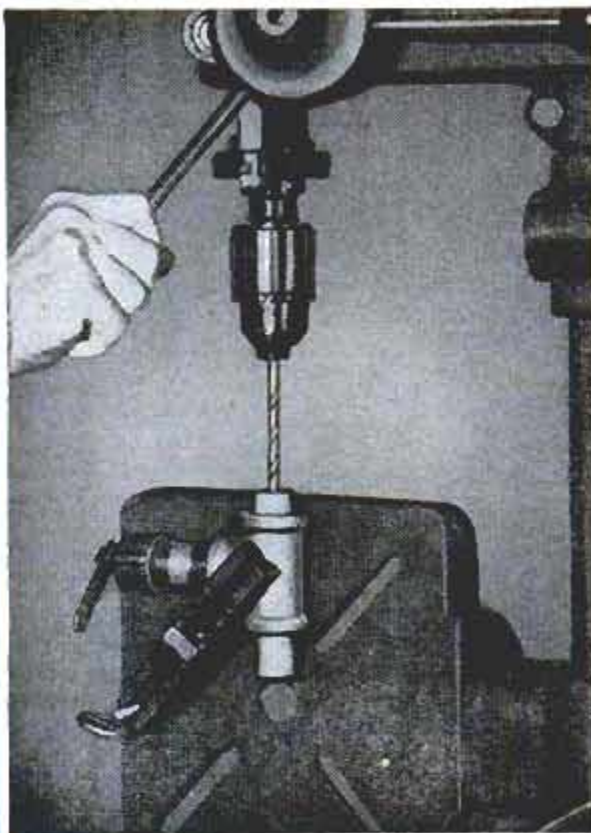
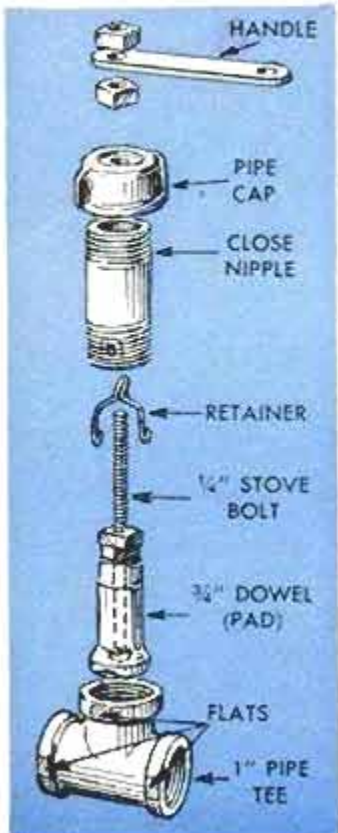

One craftsman improvised this simple jig to speed up the job of end-drilling a number of short lengths cut from $\frac{3}{4}$ -in. dowel stock. It consists of a 1-in. pipe tee, a short nipple, a pipe cap and a clamping assembly which fits inside the nipple and cap. The clamp pad is formed by shouldering a $\frac{3}{4}$ -in. dowel in the wood lathe and drilling it lengthwise to take a $\frac{1}{4}$ -in. stovebolt. The bolt head is countersunk flush and the pipe cap is drilled and tapped to take the threaded end of the bolt. When assembled, the unit is positioned and clamped to the drill-press table with a strap clamp. — Hugh Botts, New York City.

4 HANDY SHOP HINTS

Locating holes with toolmaker's buttons can be speeded up by using the special sleeve pictured in the photo at the right. The sleeve, B, is centered, turned, knurled and bored to a smooth, wringing fit over the button, A. Then the center finder, or wiggler, is brought up to the work, its center point engaging the center hole in the end of the sleeve. Although very close settings can be made with the center finder alone, a dial indicator should be used for the final setting when greater precision is required. The left-hand photo below pictures a useful support for a cutoff tool which will reduce chatter to the minimum in deep cuts. As will be noted, the support travels with the carriage. The upright is a length of tool steel of a thickness slightly less than the cutoff tool. This is welded to a base of $\frac{1}{4}$ -in. stock. Another handy kink to know about when it is necessary to drill a pattern of holes in flat stock is supporting the work on steel balls as in the center photo below. The balls hold the work in perfect alignment, yet permit it to be shifted easily. By drilling and tapping a hole in the tailstock base and turning in a capscrew to engage the carriage lock screw you can improvise a power feed for large taper-shank drills. Note the setup in the lower right-hand photo. The tailstock lock screw is loosened just enough to permit the tailstock to move with the carriage.

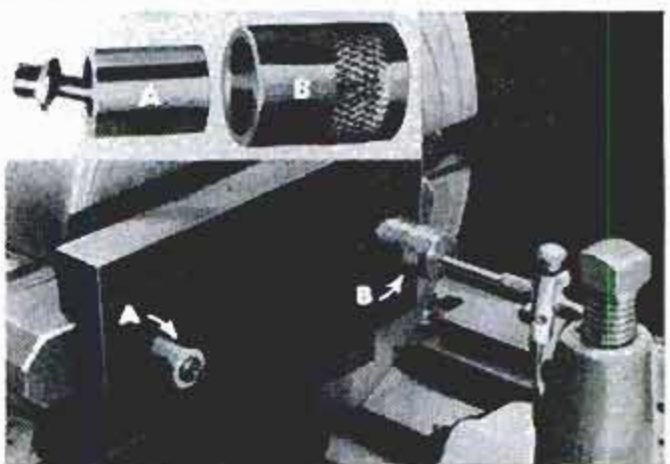
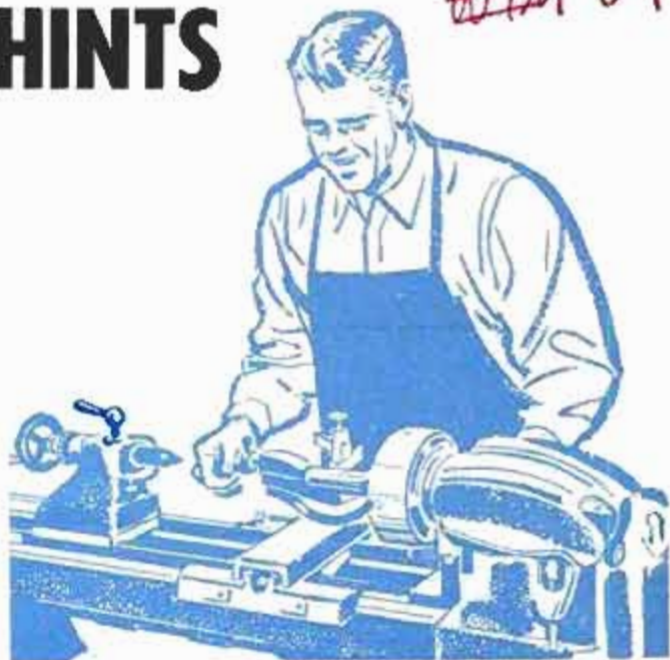

A special sleeve and center finder speed up the job of locating holes with toolmaker's buttons

A vertical support under the cut-off tool will eliminate tool vibration and chatter in deep cuts

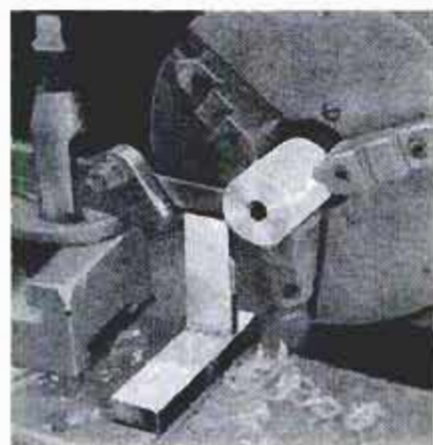

When drilling pattern of holes in flat stock support work on steel balls to permit easy shifting

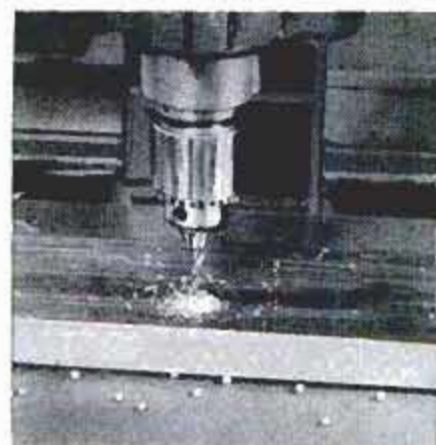

In this setup tailstock is powered. Capscrew in tailstock base engages the carriage lock screw



Use Pipe Cleaner to Open Drain Holes in Bottom of Car Door

It's always a good idea to check the drain holes in the bottom of car doors occasionally to make sure that none of them is clogged. This is best done while the car is on the hoist, as you can readily see the bottom of the opened door to make a close examination. An ordinary pipe cleaner

looped back on itself is just the thing to clean debris out of the holes. While you're at it make sure the weather stripping is firmly in place. Otherwise it may seal the holes when the door is closed. If it's covering the holes, use a sheet-metal screw to hold the weather stripping away from them.



Hand Tap Used to Make Edge-Knurling Wheel

A concave knurl, or edge-knurling wheel, is easily made in the lathe, using an ordinary hand tap as a cutter. First, the knurl blank is turned to the diameter desired and the concave cut to the same radius as that of the tap. It is then center-drilled and mounted on a special holder as pictured. This must be made to fit the lathe tool post, of course. Then chuck the fine-thread tap with the outboard end supported in the tailstock center. Mount the blank and holder in the tool post and set the lathe for back-geared drive at its lowest speed. As the blank is fed against the rotating tap the lead on the thread of the tap will rotate the blank. After the teeth of the knurl have been cut to the desired depth, harden the wheel and draw the temper to give a good cutting edge.

Spring Prevents Drill Breakage

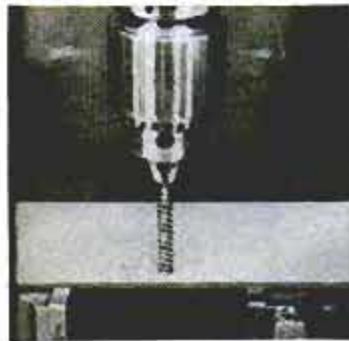

In drilling small-diameter holes through material less than $\frac{1}{4}$ in. thick, you may experience trouble with frequent drill breakage. This tendency usually can be overcome by slipping a fairly

stiff compression spring over the drill bit before lowering it to the work. The spring should be cut to a length which equals the projection of the drill bit beyond the chuck. Inner diameter of the spring coils should be only slightly greater than that of the drill.—H. J. Gerber, Stillwater, Okla.

Portable Feed Rack

A portable feed rack which takes ground feeds or supplements and roughage, such as hay or corn fodder, can save a lot of time in morning and evening feeding schedules. Here's one built on the farm trailer. A pipe framework supports the rack.

Martin Duffy, Livingston, Ill.



Stop on Bottoming Tap

On certain types of work it may be necessary to cut a thread in a blind hole to a measured depth. To do this simply run two hex nuts onto the tap and tighten at the desired distance above the end of the tap. When you near the final depth, back the tap to clear it before finishing the cut.

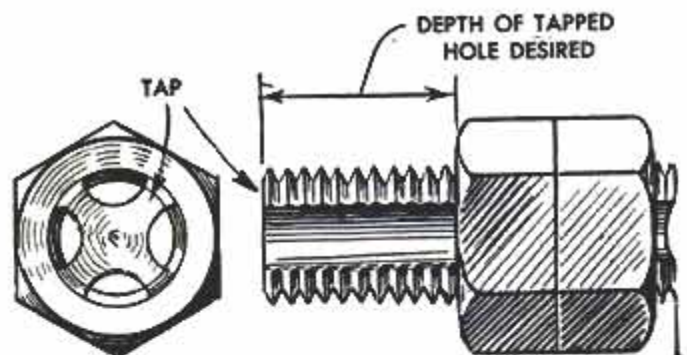

Drilling Cotter-Pin Holes

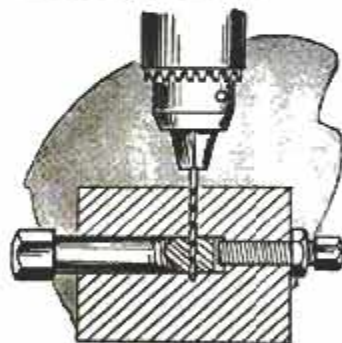

Drilling holes for cotter pins is an easy trick if you use the simple jig detailed. Counterbore a square of cold-rolled steel, the large diameter of the counterbore taking the screw or shaft in an easy fit. Then tap the small-diameter hole to take a setscrew and locknut. Now locate and drill the transverse hole in the block, the hole centering through the large diameter of the counterbore. The setscrew and locknut provide the necessary adjustment in positioning the work.

SHOPPING FOR TOOLS

1. ENGINE STAND of universal type enables serviceman to tilt engine to almost any position desired. Locks firmly in place. Takes any air-cooled reel or rotary-mower engine, also garden-tractor engines of average size, either horizontal or vertical type

The Pate-Root-Heath Co., Plymouth, Ohio

2. LAYOUT FLUID for machinists, tool and diemakers, dries almost instantly and gives a sharply contrasting scribed line that relieves eyestrain and promotes fine accuracy. Comes in bright purple for use on finished surfaces and in layout white for cast iron

Dayton Rogers Mfg. Co., Minneapolis 7, Minn.

3. PARTS CLEANER comes in a pressurized can, is nonflammable and noncorrosive and can be sprayed on painted and lacquered surfaces. Handy for cleaning oil-burner parts, auto engines and parts, removing oil stains from concrete floors, machine tools

Edward Milton, 4703 25th St., Mount Rainier, Md.

4. HAND-OPERATED SPINNER for cleaning paintbrushes and paint-roller covers works in a manner similar to a push drill. Just attach brush or roller cover to special clips, or jaws, lower into cleaning solution and press handle. Takes brushes up to 6 in.

Kruger Products, Fenkell P. O. Box 5582, Detroit 38, Mich.

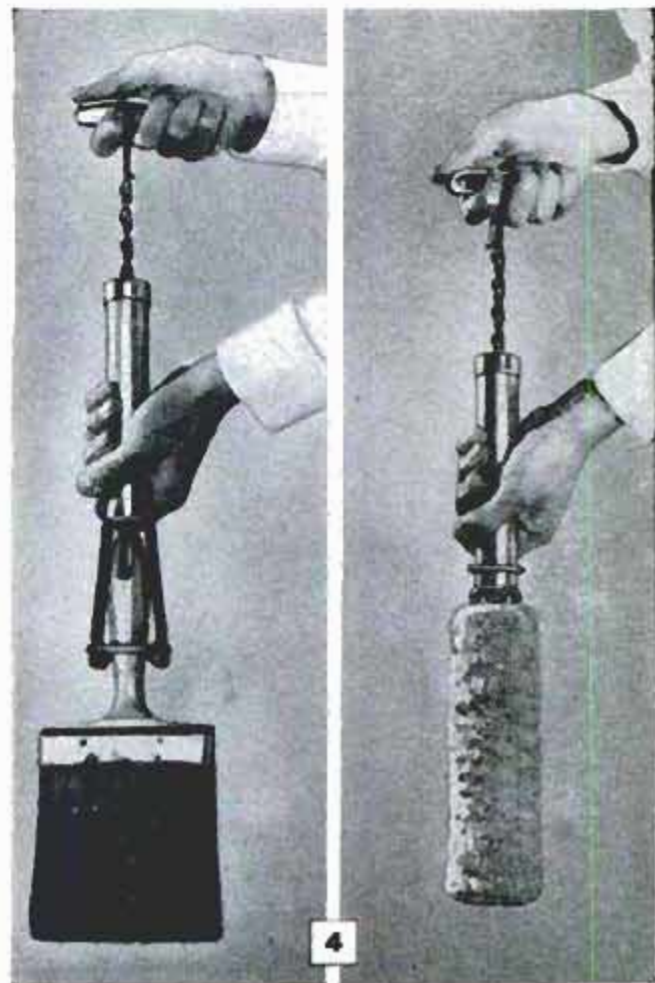

SHOPPING FOR TOOLS

Continued from preceding page



5. LIGHTWEIGHT MASONRY DRILL is diamond-faced and water-cooled for high-speed work, up to 3 in. per minute in solid concrete. Drive is by electric motor through a flexible shaft. Drills holes from 3/16 to 2 in. in diameter. Water tank is regular equipment
Powder Tool Fasteners, Inc., 5349 W. Madison St., Chicago

6. SPECIAL HAMMER comes with detachable accessories, making it both a hammer and a handled metal punch for center-punching in layout, or piercing sheet metals for self-threading screws or nails. Especially useful for punching holes for nails in metal roofing

Nelson & Timmons Tool Co., 6102 Orinoco Ave., Indianapolis 27, Ind.

7. MULTIPURPOSE MACHINE VISE is designed to grip work of almost any shape: Flat, round, angular or irregular. Locks with camming action, not conventional screw and movable jaw. Open frame permits through-drilling. Jaws open 2 1/2 in. Weighs 14 lb.

The Custanite Corp., Larchmont, N. Y.

8. COMBINATION TOOL is designed to serve as level, square and modified T-bevel all in one unit only 10 in. long. Sliding blade can be locked at 90 and 45-deg. positions to serve as a square or bevel. Can be used as a horizontal or plumb level as pictured

Mackinburg-Duncan Co., Box 1197, Oklahoma City, Okla.

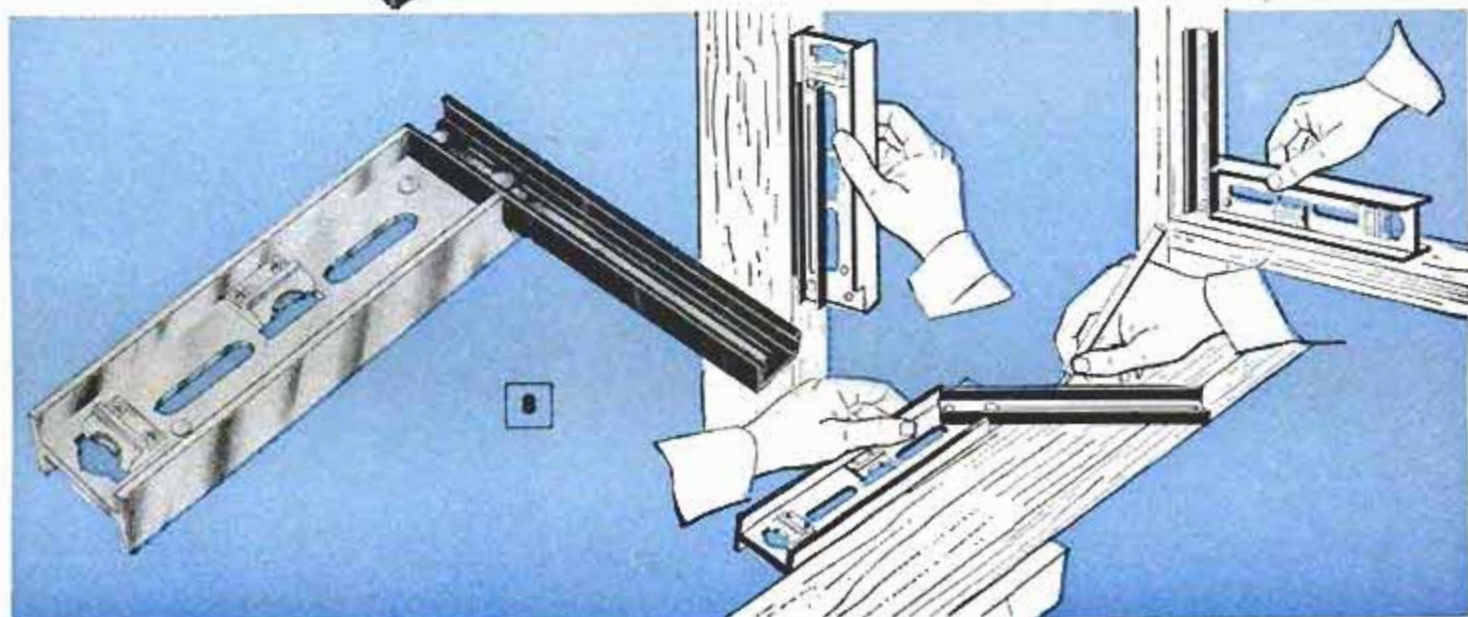
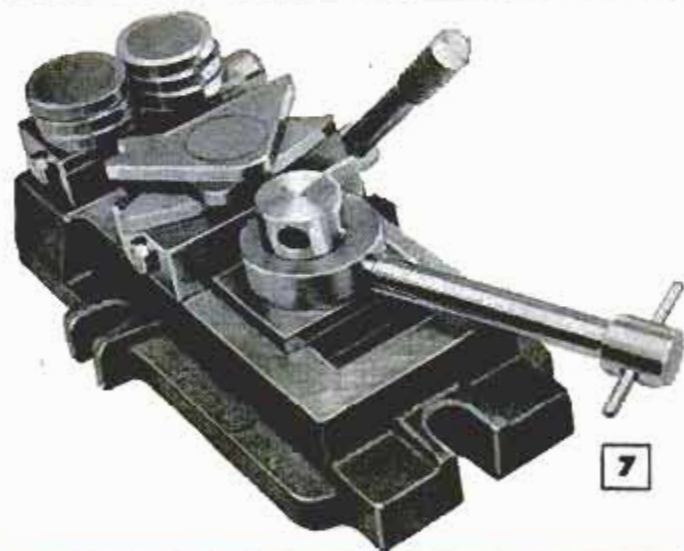

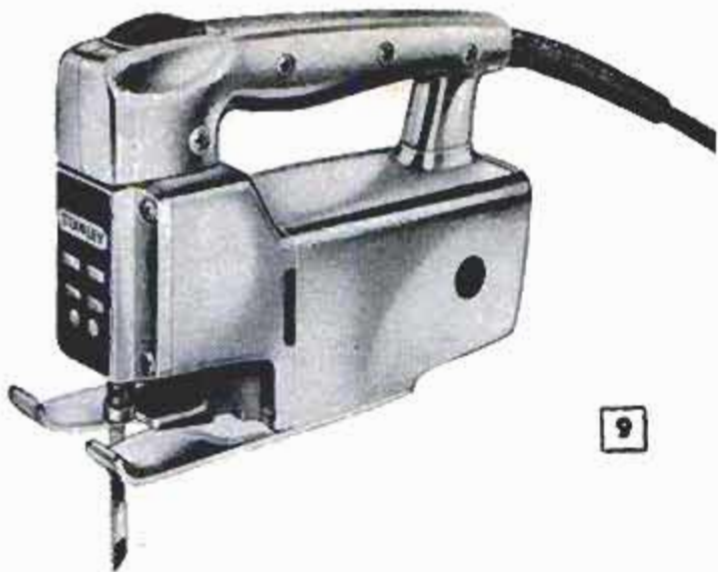

9

9. PORTABLE SABER SAW has a vibration-dampening mechanism which reduces vibration to a minimum. A feature is the sliding base which enables user to cut to a wall by using shear blade

Stanley Electric Tools, Div. of Stanley Works,
111 Elm St., New Britain, Conn.

10. PORTABLE SCAFFOLD folds up so that it can be carried like a stepladder. Mounted on casters it is especially useful for inside work. Highest level of scaffold board is 55 in. from the floor

Roll-A-Fold Scaffold Co., 3536 Stoneway, Seattle 3, Wash.



10

11. NOVEL PAINT ROLLER is designed to coat curved surfaces in one stroke. Just the thing for painting long runs of pipe, utility poles, downspouts. Two sizes for large, medium, small pipe

EZ Paintr Corp., Milwaukee, Wis.

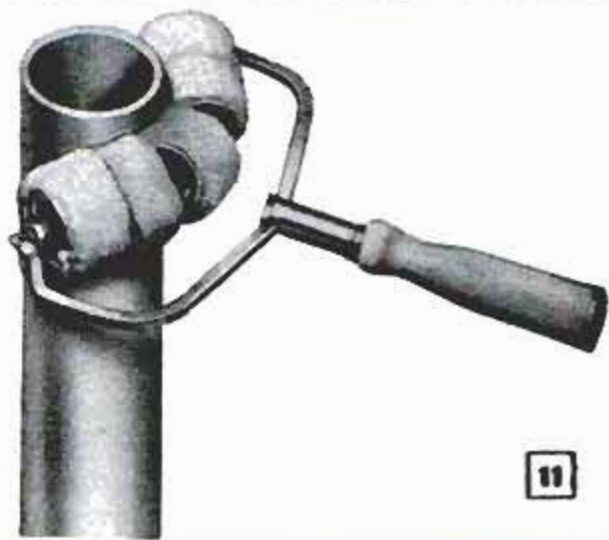

11

12-13. THREAD INSERTS are precision-formed thread liners made from stainless-steel wire. They eliminate welding, plugging or going to oversize screws in an attempt to repair stripped threads. To make the repair, Fig. 12, hole is drilled to remove damaged thread. Then it is retapped with a special tap supplied with the kit, Fig. 13. Finally insert is installed with the aid of special tool

Heli-Coil Corp., Danbury, Conn.

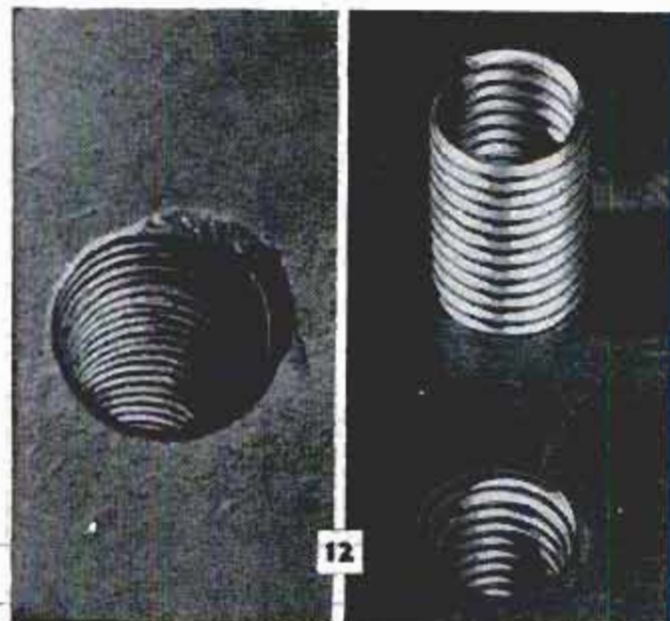

12



13

V-Block Serves as Center-Punch Guide on Simple Layout



When center-punching metal it's an advantage to use a guide that holds the punch perpendicular with the surface of the work as it is struck with the hammer. An ordinary V-block serves this purpose very well. Simply stand it on end, place the punch in the vee and move into position with the center point of the punch directly over the layout mark. A light blow of the hammer will indent the work sufficiently for all practical purposes. Of course, the punch must be correctly ground at the proper angle and with the point, or tip, located precisely in the center.

Frank L. Rush, Columbus, Ohio.

Floor Mat Catches Dust

When you sand small parts with a sanding block, place the pieces on a rubber floor mat. The mat cushions the workpiece, provides a nonslip surface and equally important, it catches the dust.

John Comstock, Wellsboro, Pa.

☐ A nut will serve as an emergency gauge when selecting a small tap drill. Locate a nut of a size that will turn onto the screw to be used. Then select a drill bit slightly larger than the inside diameter of the nut.

☐ When a stock and die are not at hand for rethreading a pipe, bolt or other fitting on which the threads have been damaged, the thread usually can be filed or ground down so that the part is again usable.

Do-It-Yourself MATERIALS GUIDE for the Homeowner and Handyman

Cross Indexed for Easy Use

If you've ever walked into a hardware store without knowing exactly what you need (and walked out without being sure of what you'd bought), you'll want a copy of this new guide that lists *all* the specifications for *all* Do-It-Yourself materials. With this book, you'll know exactly what to look for, and how to save money when you buy.

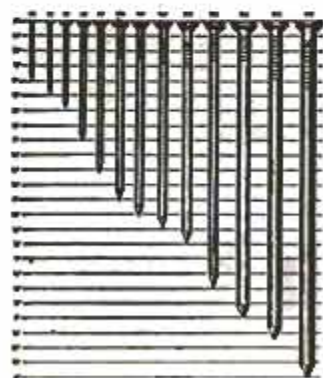

Need to know how long a 50d (penny) nail is? In the Do-It-Yourself Materials Guide, charts like the one at the left ($4\frac{1}{2}$ times larger in the book) will show you it's $5\frac{3}{8}$ inches.

The chart at the right, of common wood-screw sizes and gauges, is typical of the dozens of illustrations (all much larger) in the book. Now you'll know how to choose and where to use building and hobby materials.

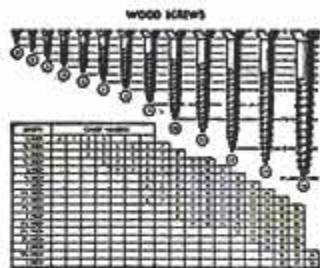

A Key to Buying and Using:

Adhesives	Fuses	Plumbing
Bolts	Glass	Plywood
Bricks	Hinges	Roofing
Conduit	Locks	Siding
Doors	Millwork	Tile
Glass fiber	Paint	Wiring

... Plus 31 other basic products. For only \$2.95 you can get this 160-page guide that will *save you time and money every time you buy supplies*. So send your order today to:

POPULAR MECHANICS PRESS, 200 East Ontario Street, Chicago 11, Illinois



Servicing Engine Ignition Systems Electronically

By Ed Brinker and Bjorn Heyning

THE IGNITION SYSTEM could very well be described as the heart of the modern gasoline engine. It produces the spark that ignites the gas which drives pistons that rotate the crankshaft which, ultimately, makes the wheels go 'round. And chances are that if your automobile, boat or airplane engine misses or otherwise fails to act just right, some component in the ignition system is at fault.

Locating ignition troubles with commonly used gauges and meters is often a time-consuming and frustrating process involving a part-by-part check of all components. This process can be greatly simplified with the electronic ignition analyzer—better known as the oscilloscope.

The oscilloscope is primarily an instrument which converts rapidly varying electrical voltages into a visual "trace" which then appears on a TV-like screen. It is ideally suited for pinpointing troubles in the ignition system whose entire operation depends upon rapidly varying voltages and currents. Because the oscilloscope clearly portrays the sequence of events occurring during the entire ignition cycle, it reveals at a glance many of the faults which could otherwise be located only after tedious step-by-step test procedures.

¹Manufactured by the Heath Co., Benton Harbor, Mich.

The oscilloscope has been used for some time as a laboratory instrument for engine analysis. In the past three or four years, some professional units have become available commercially. The relatively high cost of these, however, has prevented them from coming into general use. Now, such a unit can be purchased in kit form¹ at a price which is within reach of any mechanic or hobbyist.

Assembly of the ignition-analyzer kit requires no electronic experience. The instructions supplied with each unit are so thorough that anyone who can handle a soldering iron and follow simple directions can complete the job in a couple of spare evenings. But, in order to use the instrument to maximum advantage, the technician should be familiar with the electrical operation of the ignition system, so that he can properly interpret the pattern that appears on the oscilloscope screen.

Basic Electrical Theory

Fig. 2 shows a simple electrical circuit consisting of a battery, a coil and a switch. Below the diagram is a graph of the voltage that would appear across the switch at any instant of the cycle to be discussed.

When, at time A in the graph, the switch is suddenly closed, current from the battery begins to flow through the coil. This

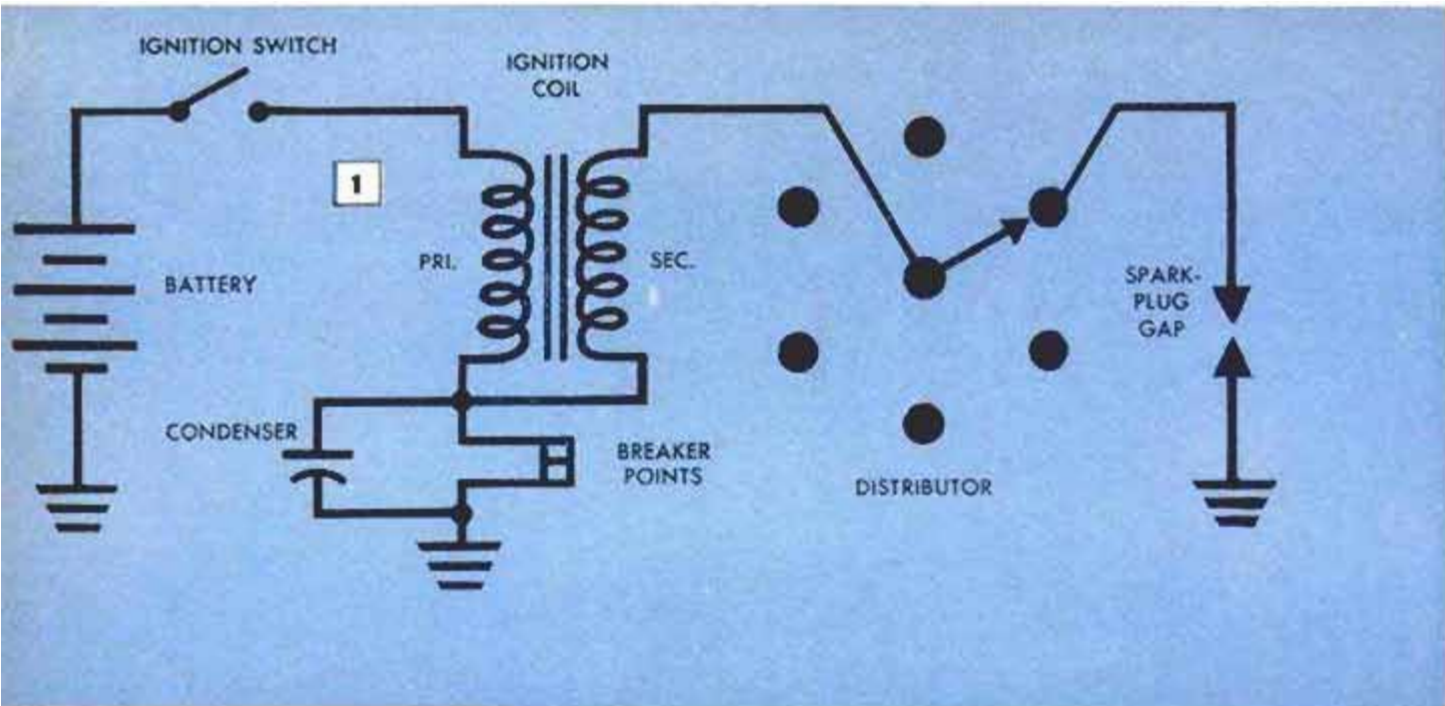

same current also flows through the switch, but since the closed switch represents a short circuit, the voltage across the switch contacts will be zero. Not so in the coil, however. As current begins to flow, a magnetic field is developed about the coil. This magnetic field starts at the center of the coil and spreads outward in all directions. In so doing, it induces a countervoltage in the coil which tends to oppose the flow of battery current. The battery, of course, quickly overcomes this opposing voltage and, in a fraction of a second, the maximum amount of current, limited only by the resistance of the wiring, will flow in the circuit. At the same time, a strong magnetic field will envelop the coil.

At time B in the graph, the switch is opened and current in the circuit is cut off immediately. When this occurs, the magnetic field about the coil abruptly collapses and induces into the coil a voltage which tries to help the battery push current through the now-open switch. Because the magnetic field collapses almost instantaneously, the induced voltage is very high (up

to several hundred volts) and this voltage appears across the switch contacts. If it were possible to open the switch instantaneously, even this high induced voltage could not force a continued current flow through the open circuit. It would gradually disappear until, at point C, only the battery voltage would remain across the open switch contacts.

In practice, the opening of contacts is a gradual rather than an instantaneous action. The high induced voltage, therefore, is actually successful in maintaining a current flow across the slowly widening gap. This appears in the form of an electrical arc which can quickly ruin the switch contacts. To prevent this arc, a condenser is connected across the switch contacts as shown in the diagram of Fig. 3.

The addition of the condenser has a pronounced effect on the voltage across the switch contacts. During time A-B, the voltage is still zero and, when the switch is opened, the collapsing magnetic field again induces a high voltage in the coil. But now, rather than jumping across an open circuit,

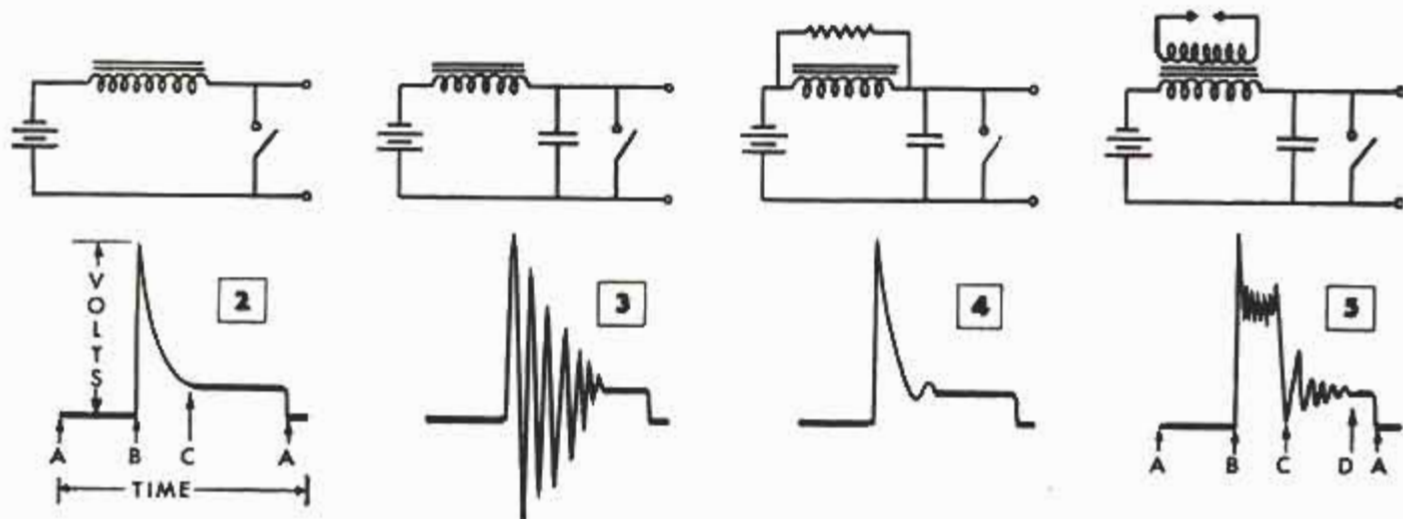

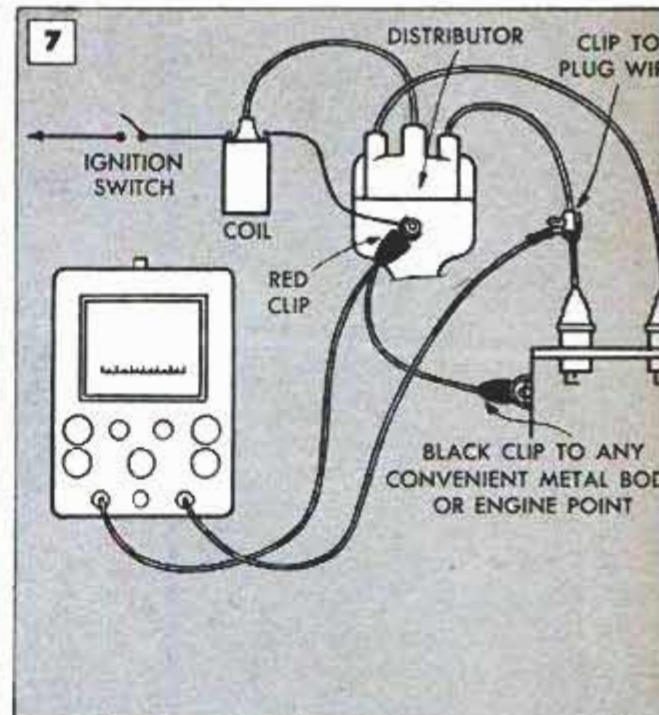
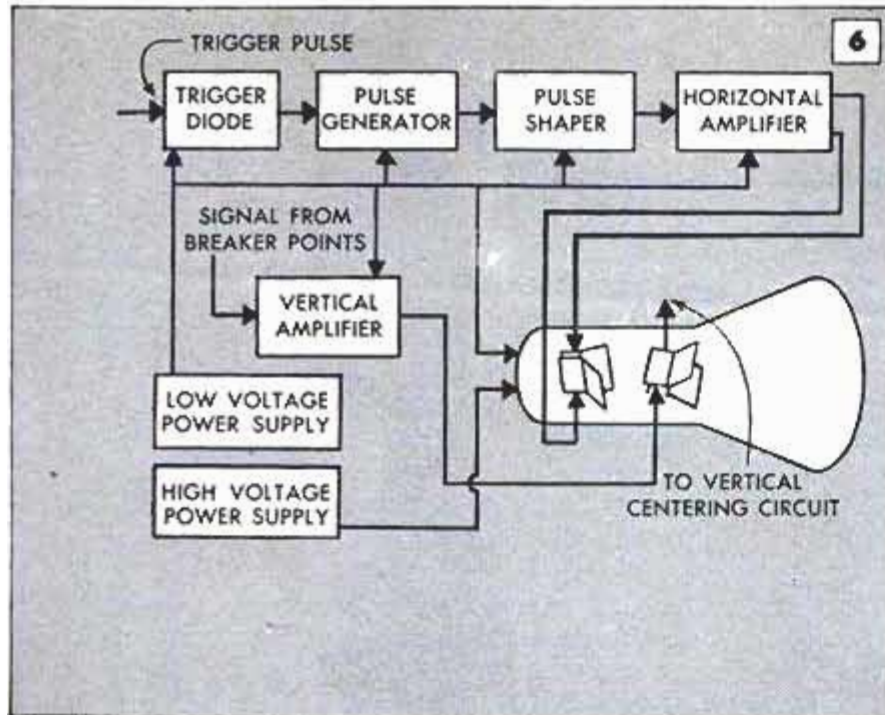

the current produced by the induced voltage rushes into the condenser. As a result, the condenser immediately charges to the full value of the induced voltage.

Of course, the condenser cannot remain in a charged state and, as soon as the magnetic field has completely collapsed, the charged condenser will discharge by sending a current through the coil in the opposite direction. This current builds up a new magnetic field about the coil. Once the condenser is discharged, this new field collapses and produces a continued current flow. The condenser, therefore, charges up in the opposite direction.

This is a continuing and repetitive process. The energy produced in the coil by the original magnetic field alternates back and forth between coil and condenser until, finally, it is completely dissipated by the resistance of the circuit. Accordingly, the voltage across the condenser and the switch contacts builds up first in one direction and then the other, as shown in the voltage graph of Fig. 3.

Fig. 4 shows what happens when a resistor is connected across the coil. Here, much of the current produced by the collapse of the initial magnetic field flows through the resistor, and very little remains to charge the condenser. As a result, the number and amplitude of the oscillations is small and the voltage graph is very similar to that of Fig. 2.

In Fig. 5, a secondary winding and a small air gap have been added to the coil of Fig. 3. The coil, therefore, becomes a transformer and, as with all transformers, any voltage built up in the primary by the expanding and collapsing magnetic field also appears in the secondary. But, because the secondary winding has a much larger

number of turns, the voltage in the secondary is correspondingly higher. Unless and until a current flows in the secondary, however, the secondary voltage does not affect the primary circuit.

The voltage graph of Fig. 5 indicates that during time A-B the voltage across the switch is zero, as in the previous examples. When, at time B, the switch is opened, the collapsing magnetic field charges the capacitor to a high voltage peak and, at the same time, induces a voltage of several thousand volts into the secondary transformer winding. When this occurs, the air in the spark gap is ionized and a spark appears across the gap terminals. We now have a current flow in the secondary winding which definitely affects the action in the primary circuit.

At the instant the spark is struck, the current in the secondary sets up a magnetic field of its own which induces a voltage back into the primary. The polarity of this voltage is such that it tries to keep current flowing into the condenser at a time when the condenser itself is trying to discharge. As a result of these two opposing forces, all action in the primary circuit stops for the duration of the spark. The condenser voltage remains fixed at the value it had attained when the spark began, except for some low amplitude oscillations reflected back from the secondary.

At point C, much of the energy in the circuit has been expended in the spark, which now can no longer sustain itself. As the spark is extinguished, secondary current stops and the condenser will resume its discharge. The remainder of the energy is then used up in primary oscillations, time C-D, as though the secondary winding were not present.

In comparing the circuit of Fig. 5 with the simplified diagram of a typical ignition system, Fig. 1, it is evident that the two circuits are identical. In the latter, the switch has been replaced with breaker points and the secondary transformer winding is connected to the gap (spark plugs) through a distributor which directs the spark to each of the plugs in the required sequence. It might be assumed, therefore, that the voltage across the condenser in the ignition system is identical to that just described. This assumption is confirmed by actual tests made with the oscilloscope.

Oscilloscope Operation and Use

Figs. 6 and 7 show a simplified block diagram of the Heath ignition analyzer and the manner in which this instrument is connected to the engine. One test lead from the analyzer is clipped to a spark-plug wire. Each time the plug fires, a triggering pulse is obtained which is applied through a trigger diode to a pulse generator. For every trigger pulse the generator produces a rectangular voltage pulse which is then "formed" by a pulse shaper, amplified, and applied to the horizontal deflection plates of a cathode-ray tube. As a

result, a bright horizontal line appears on the face of the tube. At the same time, another set of test leads is connected across the breaker points and a voltage appearing there is applied to the vertical deflection plates through the vertical amplifier. The combined action of the horizontal and vertical deflection voltages produces a pattern on the screen which is an exact replica of the voltages across the breaker points at any instant during the entire ignition cycle.²

The complete pattern of a smoothly running four-cylinder engine is shown in Fig. 8. Each pulse represents the firing of one cylinder in the regular engine firing order, beginning with the plug to which the trigger lead is connected. Any major defect in the ignition system becomes immediately apparent by viewing the entire ignition cycle. Fig. 9, for example, shows that No. 4 spark plug is not firing. Note the similarity between this pattern and that of Fig. 3.

A shorted plug, No. 2 in Fig. 10, shows up as a short, wide pulse in comparison with the others. This pulse is the result of the spark developed across the relatively narrow gap between the distributor rotor and the distributor-cap contact.

One vital feature of the analyzer is its

(Continued to page 266)

²See "Why Buy an Oscilloscope?"
Popular Mechanics, Oct. 1956

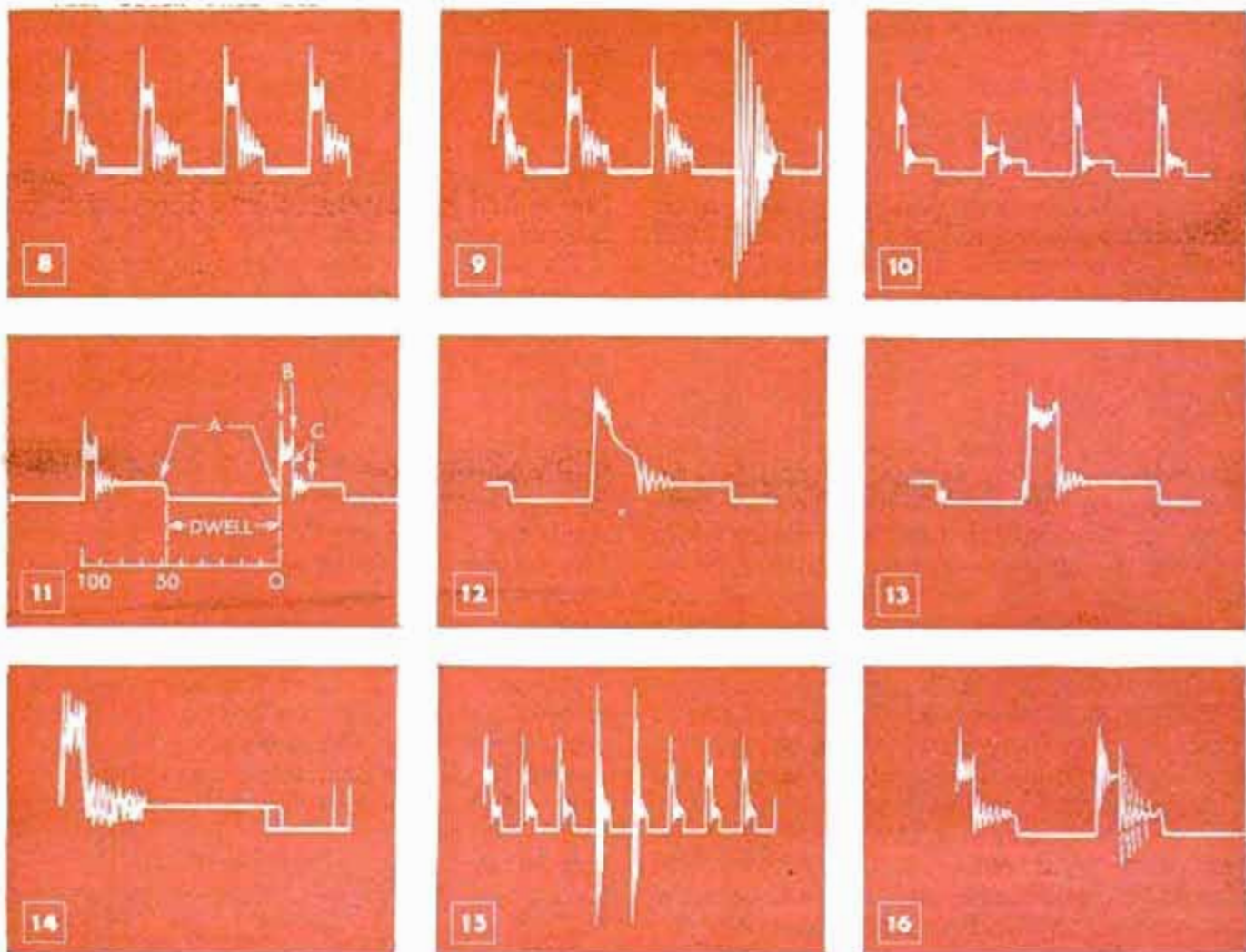

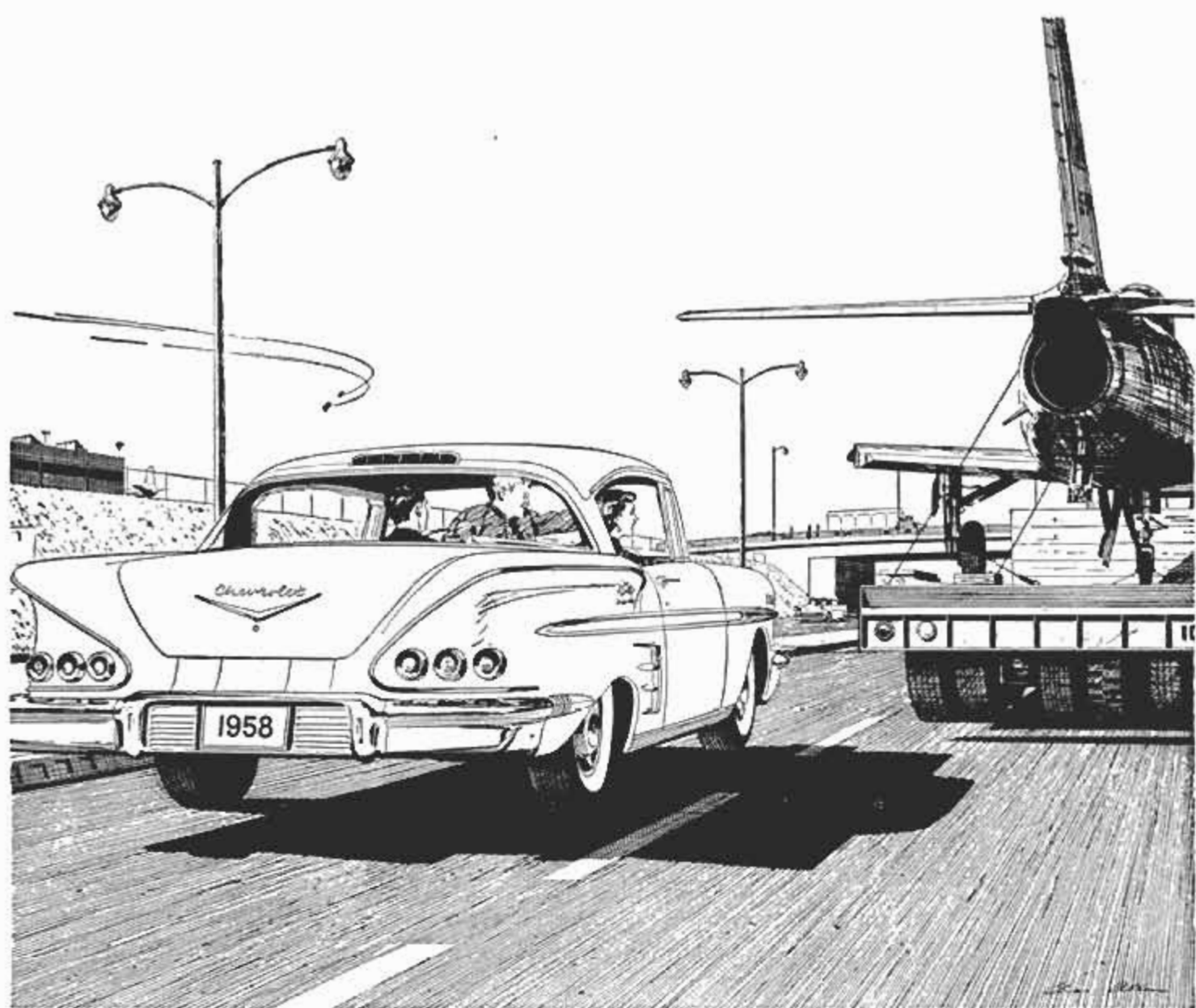

Smoothest sprint on four wheels!

TURBOGLIDE + TURBO-THRUST!

Like peaches and cream, some things seem just made to go together. On the road, the combination that really fits like a glove is Chevy's Turboglide* transmission and the radical new Turbo-Thrust V8*.

Look at the specs and you'll see why. Turbo-Thrust has a whopping 348 cubic inches of displacement—and that means oceans of torque, particularly at low- and mid-range speeds. Tie this to Turboglide's triple-turbine torque converter and you'll think you've got the municipal power plant under the hood!

Turboglide never shifts — there are no "ranges" or gear "steps." And so take-off is just one solid whispering sweep of power; cruising is as hushed and effortless as the serene drift of summer clouds.

The actual elation this superb combination provides is impossible to describe. When you experience it yourself, you'll know one of the great moments of motoring. Why don't you let your Chevrolet dealer set up that great moment for you—this week?... Chevrolet Division of General Motors, Detroit 2, Michigan. *Optional at extra cost.



For a tight grip
in tight places...

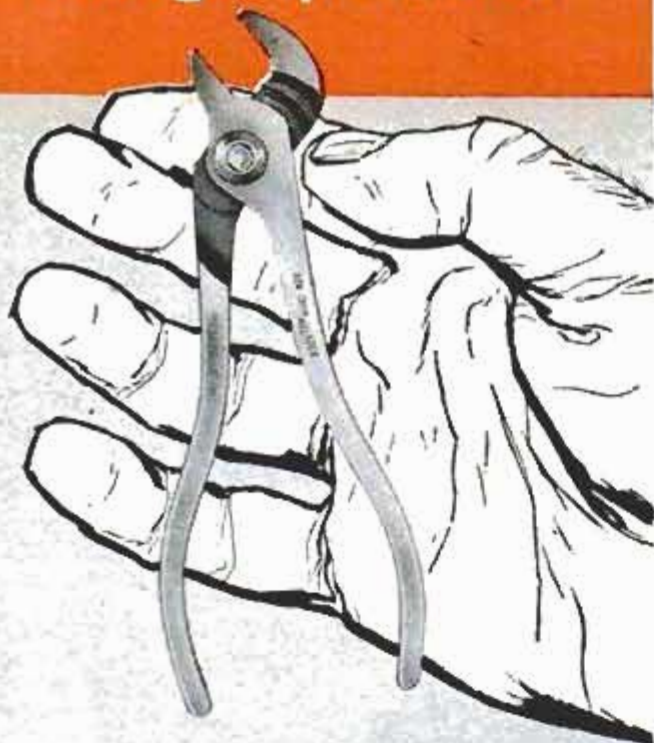

The "Mighty Midget"

CHANNEL LOCK

No. 424

This "mighty midget" is a natural for a tight grip on small work in hard-to-get-at places. Only 4-1/2" long... drop forged from high grade steel. Four exclusive Channellock precision grooved jaw adjustments... capacity to 1/2". Skilled mechanics say it's one of the handiest pliers in their kits. You'll say so, too!

CHAMPION DEPARTMENT TOOL COMPANY • MEADVILLE, PA.

ASK YOUR TOOL SUPPLIER
FOR A CHANNELLOCK No. 424



Be sure it's a genuine CHANNELLOCK
Look for the trademark on the handle

Clinic for Homemakers



As a service to our readers in solving the hundreds of problems pertaining to a home—inside or out—the editors of *Popular Mechanics* invite you to present your problems to The Clinic Editor for help and advice. Address your questions to The Clinic Editor, *Popular Mechanics Magazine*, 200 East Ontario Street, Chicago 11, Ill.



Sashes Rattle

Q—My home is an older type and when the wind blows from the west several of the window sashes rattle, especially the lower sashes. They seem to be loose in the frames and can be moved back and forth and also from side to side. There must be some way to tighten these sashes without using wedges or tape. How do I go about it?

—G. H., Kans.

A—You can correct this tendency by relocating the stops or by weather stripping. Of course, relocating the stops is perhaps the simplest and least expensive, but we would be inclined to recommend that you consider weather stripping, as this would not only stop the annoying rattle but would prevent the entrance of cold air as well. If you choose to relocate the stops, simply pry them off the frames and re nail so that their edges engage the sash frames sufficiently tight to prevent any movement. This procedure will, of course, stop rattling but may make the sashes rather difficult to open during the warmer months. This is the main reason we would recommend that you consider the installation of weather stripping.



Refinishing Breakfast Set

Q—I have a maple breakfast set of an older type which originally was finished in the natural color. Now it needs refinishing badly, the top of the table especially. It is marred and there are several rather deep scratches. I want to refinish the entire set in the same color as the original, as the graining of the wood is quite attractive. How should I go about it?—O. E., Va.

A—If you are sure that all units of the set are of maple and are not of maple and birch or some other stock such as gumwood, then it is likely that when the old finish is removed the wood will be fairly uniform in color. If, on the other hand, it contains other woods finished as maple (a fairly common practice) then the refinishing job may be somewhat more involved. In any case, it will be necessary to remove the old finish to the bare wood and apply a complete new finish. Reworking an old finish in poor condition rarely produces satisfactory results. After removing all the old finish with

(Continued to page 252)

OLDSmobility



**The new way to travel that takes
you out of the ordinary into the Rocket Age!**



... and engineered for excellence throughout!

Oldsmobile for 1958 is engineered to be both rugged and right! For its new Rocket Engine is writing this year's big economy news . . . with multiple engineering advances that boost efficient action to a brand-new high! Just try it and see how new camshaft design . . . new manifold design . . . 10-to-1 compression ratio . . . all combine to make the '58 Rocket the road's most talked about performer!

Even comfort's calibrated to the *n*th degree in Oldsmobile . . . with exclusive New-Matic Ride*! For here is *true* air suspension. Four air cushions of tough rubber-nylon give you a variable rate ride, smooth and level whatever the road

or load! It's a "closed system", too, meaning dependable performance with minimum upkeep.

And wait'll you see the brilliantly engineered accessories . . . like Oldsmobile's all-transistor Trans-Portable Radio*. It's actually *two* radios in one. With its own speaker and 160-hour batteries, the Trans-Portable plays inside or outside the car.

Wherever you go, you go with extra value in an Olds . . . with such features as Safety Plate Glass all around! Clearly the '58 Olds is a car in a class by itself! But judge for yourself . . . as your own test driver . . . in a Rocket road test soon!

*Optional at extra cost.

OLDSMOBILE DIVISION OF GENERAL MOTORS CORPORATION

Remodeling?



Building Furniture?



Sharpening Tools?



Nicholson



makes the file
you need

Available at hardware and building supply dealers.

FREE TO HOME CRAFTSMEN: "File Philosophy." Big new edition; dozens of illustrations show you how to use and care for your files. Send for your free copy soon.



NICHOLSON FILE COMPANY
Providence 1, R.I.



(In Canada: Nicholson File Company of Canada Ltd., Port Hope, Ontario)

NICHOLSON FILES
A FILE FOR EVERY PURPOSE

a remover the next step is a thorough job of sanding. Removal of the finish and sanding may reveal some sapwood which will show as lighter streaks adjoining wood of the normal heartwood color. Whether or not these lighter areas (generally found only in the table top) are objectionable is a point you will have to decide for yourself. Of course, the lighter wood can be stained to give an over-all uniformity of color. However, sap streaks are sometimes an attractive variation. After sanding, apply a sealer and sand this lightly after it dries. Some refinishers use fine steel, 000 or 0000 grade, rather than fine sandpaper for smoothing finishing coats. Follow the sealer with two coats of water-white lacquer. This can be applied with a brush (use a brushing grade) but you will get a somewhat smoother and more professional job by applying with a spray gun. Usually you can rent a gun from your local paint dealer. When spraying, it's always advisable to do it outdoors. Where it must be done inside during cold weather, be sure to provide adequate ventilation to dissipate the fumes and do the spraying away from any open flame, such as pilot lights.

Refinishing Wall Registers

Q—The wall registers in my home are old style, the type which are installed just at the floor level. The exposed metal grille needs cleaning and refinishing. I would prefer not to paint the parts, but would like to refinish them as near the original color as possible. Can one do this, and what is the procedure?

— O.E., Mass.



A—If the grille has not been varnished then cleaning should be rather simple. If they have been varnished, take off the old finish with a varnish and paint remover. Then go over all the surfaces with very fine steel wool, 000 or finer, using just sufficient pressure to remove any grime and all traces of the paint remover, if this was used. Wipe clean with a cloth dipped in solvent such as alcohol or lacquer thinner. Then finish with a coat of clear metal lacquer applied with spray gun or a fine-bristle brush. When applying metal lacquer with the brush lay it on with one-way strokes. Do not brush back over that which has been applied.

Moisture In Attic

Q—My home was built about 5 years ago and has a low-pitched roof. The rooms are all on one floor and both the attic and walls are insulated. The foundation is poured concrete and there is a basement under part of the house. There is a small louver in each gable. However, I notice that in the colder months the rafters and also the roof boards down near the eaves are damp, that is, there are beads of moisture on the surface. Once I noticed small particles of ice on the floored portion of the attic. What can I do to correct this condition?

— C. N., Mo.

A—Lack of adequate ventilation of the attic is the most probable cause of the condition you describe. It is likely that the louvers in the gables are too small to admit sufficient air to maintain circulation. The louvers also may be partially closed by leaves, cobwebs and dust. This can reduce the free area as much as 10 to 20 percent. If the cornices are of the boxed (closed) type then it may help to cut openings in the cornices to admit fresh, dry air which will tend to promote more adequate circulation. These openings should be screened to prevent entrance of insects. Also, you should check the free area of the louvers and compare with the total area of the attic floor. It's a common rule to provide 12 to 15 sq. in. of free louver area for each 10 sq. ft. of attic floor space. The present louvers in the gables might be supplemented by the installation of several roof louvers, or ventilators. Such louvers can be obtained from your local lumber or building-supply dealer with instructions for mounting.

*These men chose
their schooling—
so can you!*



Pvt. Robert K. R. Smith
Washington, D.C.
Graduate Woodrow Wilson
High School

"I took the exact
Radar course I
wanted, thanks to the
Army's technical

training program for high school graduates. Now I'm working in electronics. You can pick an Army course that fits your interests, too—and only the Army guarantees you the training you want before you enlist. So if you want to be sure you get what you want, you ought to see your Army Recruiter and find out about this terrific program."

Pvt. Max LeBlanc
Lake Charles, Louisiana
Graduate, LeGrange Senior
High School



"I had heard that the Army would let me pick the training course I wanted, but I was surprised to find they offered over a hundred different courses—and every one is guaranteed for you *before* you enlist. I chose Drafting and got really valuable training. You can find an Army course that will suit you, too. I'd suggest you see your Army Recruiter, because only the Army gives you your choice of technical training."

Seniors—get all the details on how high school graduates can choose their technical training before enlistment from 127 modern courses. Mail this coupon for your free booklet today. Or for immediate counseling visit your local Army Recruiter. He's listed in the phone book and will give you all the facts—at no obligation!

THE ADJUTANT GENERAL PM-2-58
Department of the Army
Washington 25, D. C.
Attn: AGSN

*Please send me the free Army booklet telling
how high school graduates can choose their
technical training before enlistment in Modern
Army Green.*

Name.....
Address.....
City..... State.....
Date of Graduation.....

*Now!
America's
Best-Looking
Uniform!*

**Only in
MODERN
ARMY
GREEN**

**can you
choose
your
Scientific
Course**



**Get Choice, not Chance,
in
MODERN ARMY GREEN**



The Wynners!

NUMBER ONE!

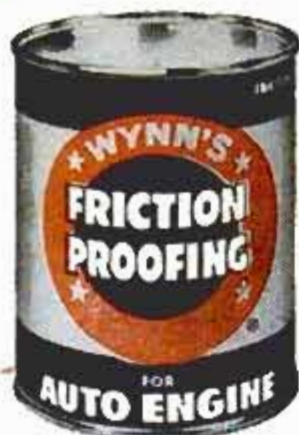

The readers of Popular Mechanics Magazine made Wynn's Friction Proofing their Wynner when they voted it the number one additive on the market.

NUMBER ONE!



This sleek Streamliner became a Wynner when it set a new American Speed record of 270.473 miles per hour at Bonneville. To get the very best performance possible, and to avoid trouble, every moving part of the Streamliner was treated with Wynn's Friction Proofing.

Make your car a Wynner - your service station, garage and new car dealer has Friction Proofing* products especially designed for radiator, upper cylinder, engine and transmission. Get the finest - the can with the red and black bull's eye - and discover for yourself that the proof of Wynn's Friction Proofing is in the performance.

Also available in Canada and everywhere in the free world.

*Friction Proofing is Wynn's Trade Mark for its exclusive metal conditioner which reduces friction between moving metals by chemically smoothing and sealing the surfaces. Manufactured by Wynn Oil Company, 1151 West Fifth Street, Azusa, California, U. S. A.

Will Success Spoil Volkswagen?

(Continued from page 184)

occasional failures under intense heat); rear window enlarged several times; hydraulic brakes with increased lining area. Changes are constantly being made and will continue to be made. (Don't be surprised to see a Volkswagen with no clutch pedal one of these years - an automatic clutch is certainly on the way.)

Biggest changes are in production standards and materials. When Nordhoff took over, cylinder walls were good for about 10,000 miles. Today, he says, they will go 100,000 miles without reboring. VW officials estimate the useful life of a VW at about 125,000 miles.

At the VW Research and Development building, I saw engines tested by running them under full load at wide-open throttle for 100 continuous hours. It's a standard test of production engines. When torn down, they show no appreciable wear.

The Secret of Success

This amazing durability, Nordhoff feels, is the secret of the car's success. It's utterly reliable under all conditions. Sold in 100 countries, it has to be. Dust conditions in the Sahara, extreme cold in northern Sweden, destructive humidity in the jungles, long, hard pulls in the mountains of Switzerland - all these conditions force Volkswagen to improve its product.

"We have chosen the hard course, but the only one we can afford to take," Nordhoff explains. "We are striving for perfection, to make our cars run forever, if possible. The normal course would be to change, to attract customers by new styling, new engines, bigger cars. We will not do that. We have built 2,000,000 Volkswagens. When the 4,000,000th VW is built, it will look the same."

Absorbed With Today's Car

Everything I saw at Wolfsburg reinforced this statement. Perhaps this complete absorption with today's product is VW's weakness.

Nowhere did I see anybody worrying about the day after tomorrow. There was no evidence of long-range research.

I asked Nordhoff if there is anyone in his organization who can match the foresight of Dr. Porsche, the original designer of the car.

"It is impossible to say," was his reply, "that we have a man of the same caliber as Dr. Porsche. But we do have a group of young engineers concerned with the distant future and they have an almost

(Continued to page 282)

* Three wonderful reasons
for **MORE LIGHT**
...**AIMED RIGHT!**



Your family deserves all the safety you can provide . . . deserves the extra safety of new Guide T-3 Headlamps.

With Guide you see farther down the road because this new, industry-approved sealed-beam headlamp, introduced just two years ago, has stepped-up power plus a new light pattern which throws more light on the right—where you need it most.

But, most important of all, these new Guide T-3 Headlamps can be perfectly aimed in minutes—in broad daylight!

Three "Guide Points" on the face of each T-3 lens are ground to tolerances within one ten thousandth of an inch. This precision, and the simplicity of the T-3 aiming method, assure you of **MORE LIGHT—AIMED RIGHT . . .** more safety for both you and your family.

If the headlamps in your car are two years old or more, have them replaced with new Guide T-3s now. And have your headlights aimed at least twice a year.

AC  THE ELECTRONICS DIVISION OF GENERAL MOTORS

Guide



T-3

SAFETY-AIM HEADLAMPS

Buy in pairs where you see



Watch Walt Disney Studios' ZORRO every week on ABC-TV

**MECHANICS,
MACHINISTS, CRAFTSMEN**

you need a

Starrett

No. 445 Series

**MICROMETER
DEPTH GAGE**

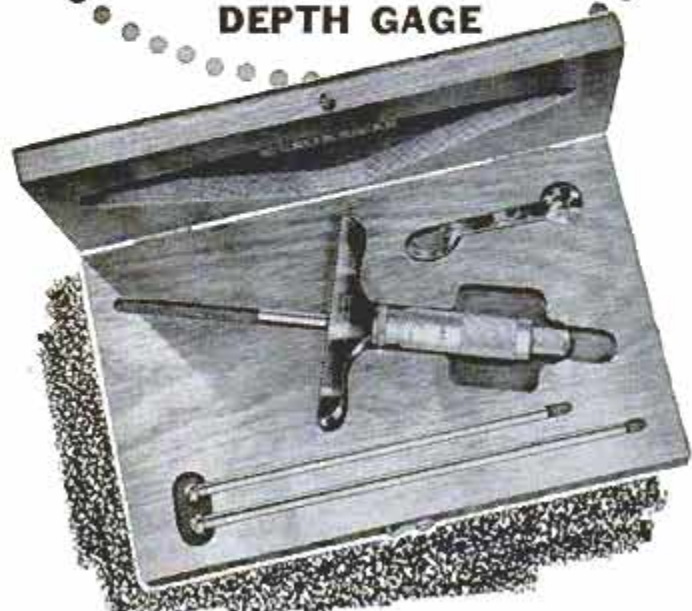

CHECK THESE PRECISION FEATURES

- No-Glare, Rust-Resistant Satin Chrome Finish on Thimble and Sleeve
- Quick-Reading Graduations — Every Thousandth Numbered
- Precision Ground Screw
- Hardened, Ground and Lapped Base and Rods
- Convenient Lock Nut — Holds Reading at Any Setting
- Individual Rod Length Adjustment

Available with 3, 4, 5 or 6-inch base in three size ranges; 0 to 3 inches with 3 rods; 0 to 6 inches with 6 rods; 0 to 9 inches with 9 rods. Also available: No. 440 — 3", 6" or 9" with 2½" base; No. 449 — 3", 6" with 2½" or 4" base and non-rotating blade rods.

BIG NEW CATALOG—FREE

Describes and illustrates over 3000 Starrett Tools. Send the coupon.



STARRETT TOOLS are carried by leading Industrial Supply Distributors and Hardware Tool Stores.

THE L. S. STARRETT COMPANY

Dept. AP, Athol, Mass., U. S. A.

Please send my free copy of the big new Starrett Catalog No. 27.

Name.....

Occupation.....

Address.....

City.....Zone...State.....

**The Weird Things They Do
With Heat!**

(Continued from page 104)

previous method. The flames burn so hotly that not a speck of carbon is left. Yet the cloth itself isn't scorched.

If that sounds like hot precision, Hess can show you even more startling examples. In a vertical furnace, for instance, two huge webs of Kraft paper zip at high speed through a radiant inferno. The intense heat laminates the paper in a continuous operation without searing a fiber.

The same general technique, applied to printing presses, makes it possible for you to get your modern news magazines on time. Before the heat engineers went to work, quality printing on a large-circulation magazine was considered impossible due to the drying time required by inks used on glossy paper. Working with ink-makers and press builders, Hess's men developed gas-fired drying burners that throw more than 2000 degrees of heat at a printed paper web as it flies through the rotary press. Despite the intense heat, the speed of the paper is such that although the ink becomes bone-dry on its flight past the flames, the paper is unaffected. Instead of tediously producing 250 smudgy black-and-white 16-page sections per minute, as they once did, today's rotary presses can turn out 1500 in four or five colors!

Precision Cooking

This kind of precision cooking is due largely to recent developments in radiant, or reflected, heat. Thousands of degrees can be directed on something instantly at full temperature and just as suddenly cut to nothing. Reason: When the flame is killed, there's no heat for the reflector to collect and reflect.

"It's interesting," points out Carl Mann, Selas' drying-division manager, "that this form of energy, probably the first used by primitive man, should have been the latest to give up its secrets to man's research. Primitive man, of course, knew only that when morning came he could crawl out of a damp cave and warm himself in the welcome rays of the sun." The sun's warmth is a perfect example of radiant heat.

In a radiant gas burner the flame's heat is collected and reflected by an incandescent ceramic cup in much the same way light is collected and focused outward from a flash bulb nestled in a polished reflector. The electromagnetic rays of radiant heat that do the job, explains Mann, travel with the speed of light. So, response to control is

(Continued to page 258)

"Sweetest Music This Side of Heaven"



Guy Lombardo drives **MERCURY'S** New Mark 78

"'Sweetest Music This Side of Heaven' has long been associated with my Royal Canadians, but after driving the new Mark 78, I'd say Mercury could claim it for outboards — on every score."

The secret of the sweet, smooth music of this 70 horsepower engine is in its exclusive six-in-line design, proved by experience to be far superior to any other for high horsepower outboards.

Here is the world's supreme expression of outboard dependability and safety. It's the powerful answer to the public's request for better power for bigger, safer, more comfortable boats. The Mark 78 has more exciting new features than ever offered on any outboard — plus the famous compact Mercury look and colorful styling.

Mercury offers the most that's new for '58 — more *all new* engines, more models, more safety features. See your Mercury dealer soon or write for **FREE** catalog.

Guy Lombardo also is famous as a power boating champion. He won the Henry Ford Memorial Trophy, Detroit's Gold Cup Race and set two world records winning the International Gold Cup Regatta.

MERCURY OUTBOARDS
Dependability with a Punch!

© 1958
Kiekhaefer Corporation
Fond du Lac, Wisconsin



just as fast as the time it takes to cut in, or cut out, the source of incandescence. On radiant-heat burners it's done in less time than it takes you to blink, either by turning the whole battery of burners away and focusing the heat rays elsewhere, or by moving the work away. "The shorter the distance between burner and workpiece, the more effective the heat transfer," explains Mann.

"Heat," Fred Hess will tell you, "is really just oxidation in a body of matter—a chemical reaction. We simply control the degree of oxidation. In one case—like baking a loaf of bread—you want to distribute the heat throughout the material; in another—such as blowing a hole for electrodes in a radio tube—you aim the heat to get the job done."

By arranging burners in rows, circles, clusters, columns and other formations, Selas engineers can put intense heat exactly where they want it. For a tractor company that needed the teeth hardened on its bogey wheels without hardening the rest of the wheel and making it brittle, the furnace became a circle of burners, blasting only the rim gears under white heat.

For United States Army Ordnance, the furnace is a series of tunnels totaling a mile in length, lined with burners so white with

heat that their dazzling glare will blind you if you look at them without glasses for any time. Through this Hades move 12½-ton, cast-steel tank hulls, heat-hardened to toughness matched only by wrought armor plate. Thousands of radiant burners, aiming their penetrating heat in predetermined patterns on the massive hulks, do the baking job.

Some "ovens" get to be pretty complex. "Glass fiber was originally made by steam," relates Hess. "It came out brittle and was useful in only a few industrial applications. We were asked to do something about it some years ago, and our engineers finally came up with the jet-flame principle that makes today's fine, flexible threads. We concentrated the heat into jet-speed flames. The heat melts the glass and the jet energy disperses it. The roaring hot exhaust gases are used to carry the threads away where they can be gathered up. Out of these threads, today, come your fireproof draperies, refrigerator insulation and glass-wool products."

Problems like this are always being thrown at Hess's heat experts. When Detroit automobile designers drew the first wrap-around windshield on a proposed new model, everyone agreed it was great. But nobody knew how the multiple curves

(Continued to page 260)

new
HARLEY-DAVIDSON



SPORTSTER

H MODEL

Hot—Husky—Handsome
handles like the
thoroughbred it is!

New bolt from the blue! . . .
Harley-Davidson's Sportster H means
extra smooth and action-packed power.

Get 12% more brake hp. with 9 to 1
compression ratio — a cyclonic
combination of special high dome
pistons, larger intake ports and valves,
and racing type tappets.

Visit your Harley-Davidson dealer
and test ride a Sportster H.

Inquire about his liberal trade-in and convenient terms.

HARLEY-DAVIDSON MOTOR CO.
Department P • MILWAUKEE 1, WISCONSIN

ROCKWELL-BUILT

DELTA "900" RADIAL SAW

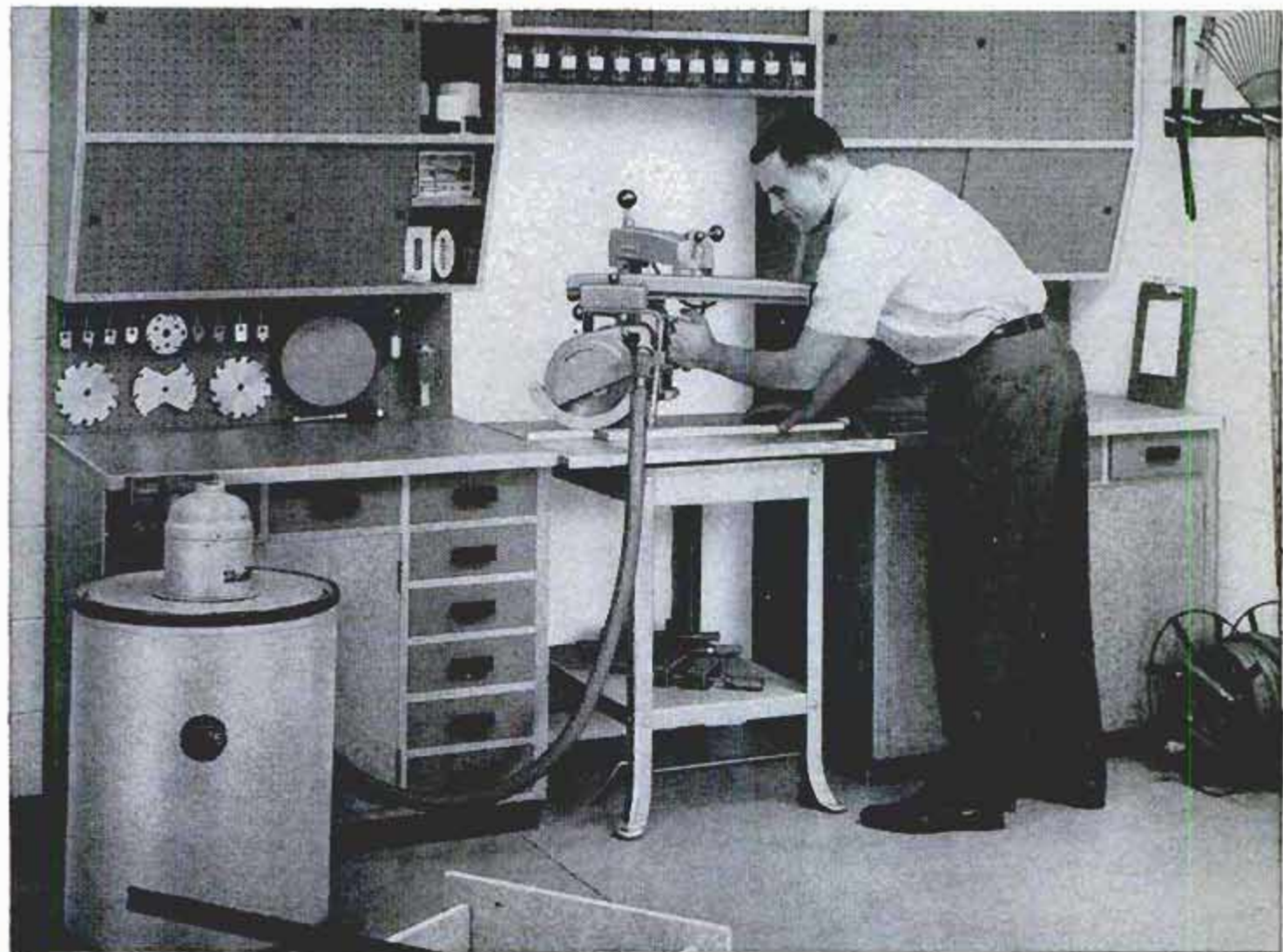

most powerful radial saw built for home workshops

Rugged as it is good looking, the New Advanced Design "900" Radial Saw is powered by a *full* $\frac{3}{4}$ hp motor. And it's so versatile that actually it's a complete, *all-purpose* workshop! You can rip, cross-cut, drill, sand, shape and do many other jobs fast and accurately. Also shown above is the New Advanced Design Delta Dust Collector. Use it with *any* power tool to keep your shop free of sawdust—even to spray paint. It's powerful enough to pick up a 1" steel ball.

IT'S SO EASY TO OWN THE BEST!

Because Delta makes the world's most *complete* line of combination, all-purpose and individual power tools, you can choose tools exactly right for *you*. And you'll have the "newest look" in the world's finest power tools.

BUILD THIS ALL-PURPOSE SHOP

Delta experts designed the compact workshop shown above so that you can build it in your

garage or basement. Easy-to-follow plans and the New Delta Reference Guide are yours—for just 10¢—send your remittance with your name and address to Rockwell Manufacturing Co., Delta Power Tool Division, 502B N. Lexington Ave., Pittsburgh 8, Pa.

Do it now—then see *all* the New Advanced Design Delta Tools at your Delta Dealer. (He's listed under "TOOLS" in the Yellow Pages.) Or at leading Department, Hardware, and Building Supply Stores.

DELTA POWER TOOLS

another fine product by

ROCKWELL



MAKE MINE KLEINS



Your skill—the quality of work you do—is controlled in no small measure by the quality of the tools you use.

That's why electricians and good workmen everywhere insist on Klein Pliers—standard of quality by which others are judged "since 1857."

In the complete Klein line you will find pliers exactly suited for every job you do. See your hardware store or Klein distributor for the Klein Pliers you need.



Your hardware store has Kleins in stock or can get them for you quickly. Look for this new display board. It shows the most popular items in the Klein line.

Mathias KLEIN & Sons
Established 1857 Chicago, Ill., U.S.A.
7200 McCORMICK ROAD • CHICAGO 45, ILLINOIS

could possibly be made cheaply and efficiently within the close tolerances needed for mass production. The problem fell in Selas' lap. Hess's men came up with a simple tunnel in which rows of radiant-heat burners line the roof. Flat-glass windshields, precut to proper pattern, enter the tunnel on moving racks. By the time they've reached the other end, radiant heat has softened them just enough so they droop into the bottoms of the racks like strips of soft clay slumping into a curved bowl. The rack bottoms are shaped to the exact mold of the desired wrap-around form, and the softened glass follows every curve.

The plastics people have a few things to thank these industrial cooks for, too. When polyethylene film first came out, packagers wouldn't use it because it was impossible to put printing on the surface. Selas engineers discovered that if the film could be heated to 825 degrees, a chemical change occurred that made the plastic substance ink-receptive. Unfortunately, at 450 degrees polyethylene film is utterly destroyed. Undaunted, the heat wizards fed the film around a chilled drum that kept the bottom of the sheet cold. On the way around, it passed under a single row of radiant burners that threw fierce heat at it for the fraction of a second it took the drum to rotate past it. In that instant the top .0004 inch of the film got a dose of heat equal to 825 degrees; the bottom stayed cool due to the chilly drum and brief heat exposure. Today, packagers print anything they want on that surface.

For the cosmetic industry and insecticide makers, the heat engineers found a way they could use cheap glass containers for their products. For years these people had shied away from putting high or even low-pressure fluids in bottles due to the danger of explosive breakage. By using close-tolerance radiant heat to preheat the glass, molding a plastic covering over it, conditioning the plastic surface for printing, and quick-drying the printing, Hess's cooks did the job. Now glass bottles are used for all kinds of bug killer, toilet water, shaving cream and the like under pressure, with spray caps. If dropped and broken, the plastic envelope contains them. This, Hess proudly points out, is one of the finest examples of heat used as a multiphase processing tool.

Extremely high temperatures often cause substances to do strange things, which the experts can put to good use. If you heat metals high enough, for instance, they'll vaporize like steam. Make this happen in a sealed chamber, and that metallic

(Continued to page 262)

PROVED AND APPROVED

“Around the World”

WITH **FORD**

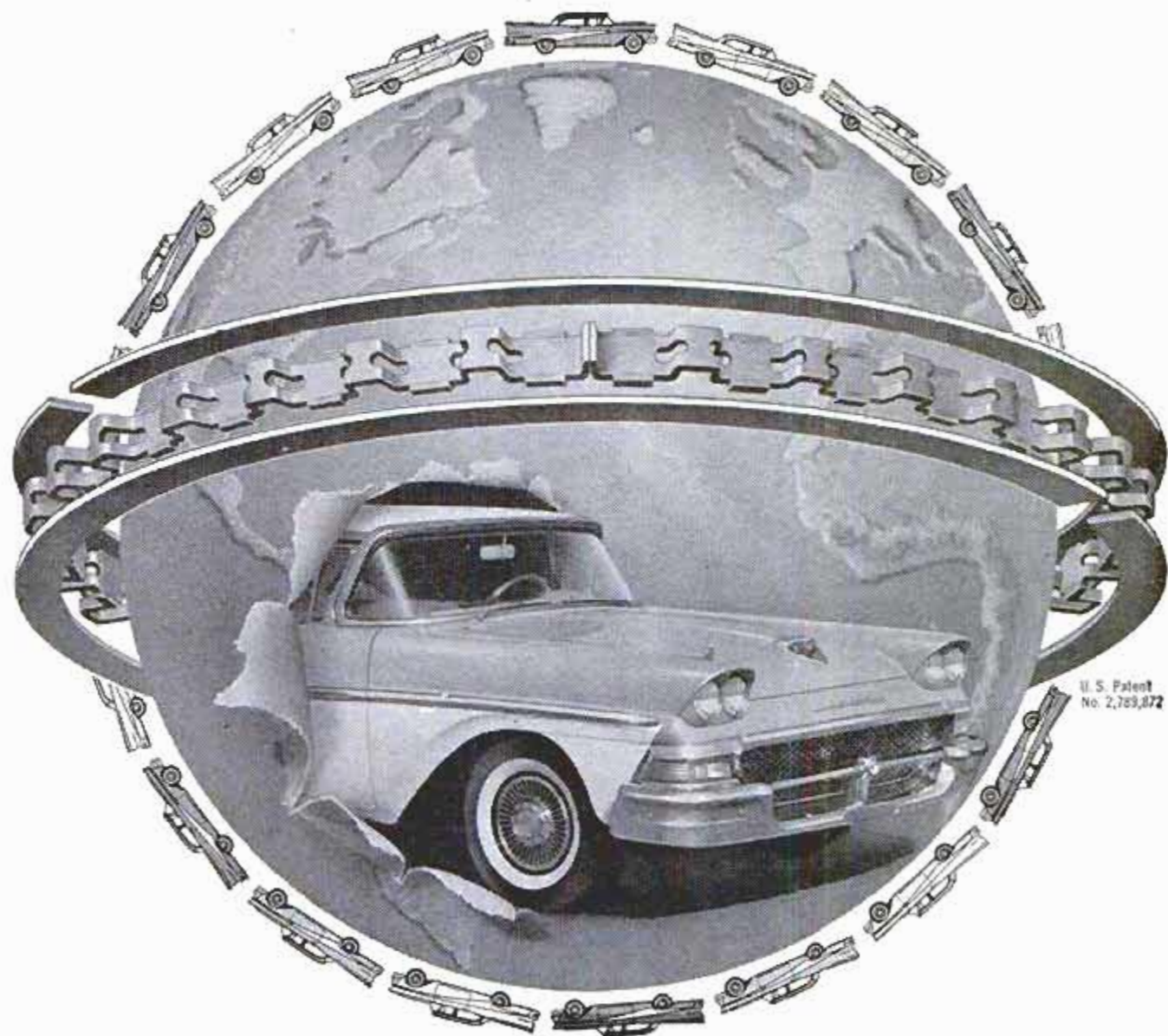

THE **Sealed Power**

STAINLESS STEEL OIL RING

FEBRUARY 1958

261

It's Tops...



for quick clean cuts . . .

RIDGID

Heavy-Duty Pipe Cutter

Powerfully built—guaranteed not to warp or break, always tracks perfectly . . . Famous RIDGID thin-blade or heavy-duty cutter wheels of tool steel roll easily, cleanly through any pipe. Special wheels for stainless steel, cast iron. Every cutter factory-tested. For your work or home, it's most for your money—buy it at your Hardware Store!

Genuine
RIDGID
The World's Most
Popular Pipe Wrench



The Ridge Tool Company, Elyria, Ohio, U. S. A.

vapor will condense on any articles you put in the chamber, giving them a shiny, metallic surface. That's how the silver and gold threads in auto seat covers, draperies and gowns are made. Put a piece of glass in the chamber and a mirror comes out. If the metallic deposit is thin enough, it's a two-purpose mirror: A person on one side can see through it, while a person on the other side sees a reflection.

Fierce heat applied to fine metal or ceramic powders under proper conditions can be made to fuse such particles into a solid mass without melting them. This is called sintering. Solid chunks of metal or ceramic with special characteristics can be made this way out of powders that have extremely high melting points, without having to heat the material to anything like its melting point.

Study of such curiosities accounts for the fact that Selas now sells holes to people. Holes are worth plenty to hospitals, cancer laboratories and even the U.S. Air Force. George Jordan is the man at Selas those job it is to find new uses for holes, and sell them. One big customer is Jackson Cancer Laboratory in Bar Harbor, Me., where cancer cultures are grown and shipped to other laboratories all over the world. The food on which these tissues grow best is a broth made from part of a nine-day-old chicken egg. The broth must be absolutely pure—uncontaminated by any bacteria from the air or the egg itself.

To guarantee such purity, cancer technicians must filter out unwanted bacteria, and that takes *some* filter. But Selas' heat experts discovered a way to cook them up by the dozen. In special ovens they developed a remarkable porous ceramic with 30 million holes to the square inch. The pores are so minute that, although molecules of pure broth can pass through, bacteria cannot.

The white cylindrical filters look like porcelain fillers for Thermos bottles. Hess likes to pick one up and tell you to touch it with the tip of your tongue. If you do, you'll find the moisture sucked away with the pull of a strong vacuum. "Capillary attraction," laughs Hess. "Don't put the surface of your tongue against it or you'll never get it off!" He's right, too. The capillary tug of those 30 million invisible holes has more "cling" than a suction cup.

Today similar filters are used to produce sterile water for hospitals. And you'll find them in floating radar devices used by the Air Force. The filters permit the half-submerged units to "breathe," but at the same time make them absolutely watertight.

These are just a few of the things that heat is making for us today. ★ ★ ★



New "dream walls" offer the warmth of wood...without the work!



Misty Walnut PANELS

How often have you dreamed of the richness, the warmth of wood-grain walls? Only to find they were beyond your budget...too tricky to install...or too much work to keep up.

No more! These new *Misty Walnut* panels bring you all the rich beauty of wood—and without the high cost, either!

Your wall panels go up in handy four-foot widths...no tedious matching or fitting. Attractive vertical grooves set off the grain, give your wall a custom-paneled look. Joints are concealed...no nails mar the surface.

Once up, your work is done. No sanding or filling. A coat of good paste wax enhances the beauty of *Misty Walnut*...no chore to keep clean.

Sound like a dream? It is...a dream come true...and it's at your lumber dealer's now. *Misty Walnut* by Masonite!

©Masonite Corporation—manufacturer of quality panel products



Masonite Corporation
Dept. PM-2, Box 777, Chicago 90, Ill.

Yes, I'd like more information on the new *Misty Walnut* panels; also "Hints to the Handyman," showing me how to work with Masonite® products.

Name.....

Address.....

City.....State.....

Zone.....County.....

the right glue
for every job you do

ELMER'S® GLUE-ALL!

and other
Elmer Glues



TROUBLESOME WOOD HATCHWAY?



REPLACE IT!

With a modern Bilco Basement Door.
All-steel, weathertight, spring-operated.
Do it yourself in just 3 to 4 hours.

Bilco

AMERICA'S FINEST
BASEMENT DOOR

Write today for
FREE illustrated
replacement folder.

THE BILCO CO., Dept. 123
NEW HAVEN 5, CONN.

Please send me complete information.

NAME
ADDRESS
CITY STATE

Is Population Outgrowing The World?

(Continued from page 143)

economist whose name went into the dictionaries for his gloomy doctrine that the world's population was increasing at a rate which, if unchecked by famines, pestilence and wars, would eventually outstrip the earth's ability to supply food.

Modern students are not so alarming. D. H. Killeffer, chemical engineer and writer, said at a luncheon given in his honor by the American Chemical Society that "We must quell the fear of 'Malthusians' who cringe before a rising curve of population. They forget that Malthus lived before the Industrial Revolution. We must show them how productivity now consistently grows faster than consumption, and not in a changing reverse ratio."

A Cambridge University zoologist, also differing with Malthus, avers that the high fecundity rate of the food-scarce nations—such as those of the Far East today—will eventually be counterbalanced by decreasing fecundity when medical science lowers the mortality rate in crowded areas.

Robert C. Cook, director of the Population Reference Bureau at Washington, D. C., says the family of man is growing at a rate of about 1.5 percent annually.

"If such a rate seems trivial," says Cook, "remember that it accounts for the phenomenal 40 million yearly increase. This rate will double a population in about 55 years." Twenty years ago the annual increase was about 25 million persons.

Talk of mushrooming populations, and the average person thinks first of the Far East—India, China, Japan. Not so: By nations, China does have the largest population—close to 600,000,000; India has 377,000,000, the U.S.S.R. 214,000,000, the United States nearly 180,000,000. But Latin America has the highest growth rate and includes several nations whose people are multiplying at a rate higher than 3 percent yearly. Although one in every four babies born in the world these days is Chinese, the Asiatic growth rate is much lower than that of Latin America.

And there are some spots on the earth where human reproduction has declined.

Japan, in recent years, has experienced the most rapid drop in birth rate ever recorded in any land: From 34.3 births per thousand population in 1947 to 19.4 in 1955.

Nearer home, Puerto Rico's birth rate has declined from 42.2 per thousand in 1947 to 34.8 in 1955.

The birth rate for the United States in 1955 was higher than Japan's: 24.6 per thousand. ★ ★ ★

Matches any \$395 saw you can buy!

\$10 DOWN
\$239
CASH

Kromedge Blade for 3-to-5 times longer wear

Extra large, easy-to-level warp-resistant table

Heavy Duty Motor Develops 2 HP

Uses standard accessories with exclusive double-end motor shaft

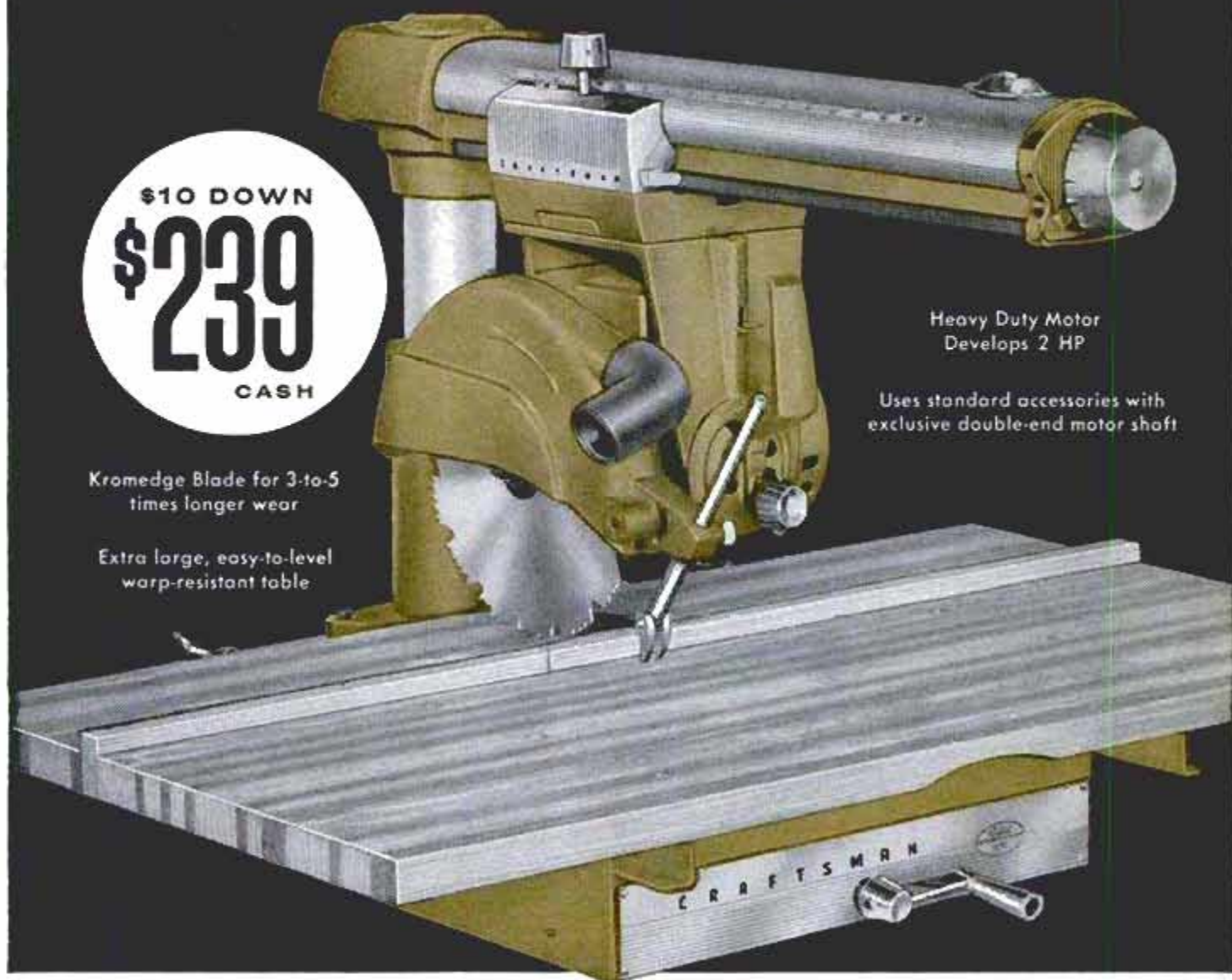

Sears All new Craftsman Accra-Arm 10" Radial Saw

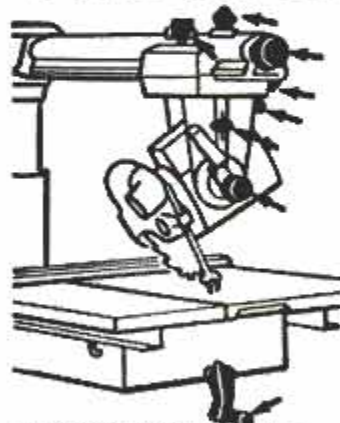

ALL CONTROLS in front for safe, easy access; color-coded for quick identification.

See it demonstrated at Sears! You can cross-cut, rip, dado, miter, compound miter, drill, shape, sand, buff and do dozens of other operations with this most versatile of tools. Here's a precision built, professional dream shop designed to fit small space . . . with maximum accuracy and features unduplicated even at \$395. Only \$10 down, about \$2.90 a week in convenient monthly payments on Sears Easy Payment Plan.

See the Accra-Arm Saw and all other Craftsman Power Tools at Sears Retail Stores . . . or order from Sears Catalog in your home or at Sears Catalog Sales Offices.

© 1958, SEARS, ROEBUCK AND CO.

SEARS
ROEBUCK AND CO.

SATISFACTION GUARANTEED OR YOUR MONEY BACK

FEBRUARY 1958

NEW Atlas 12" LATHES

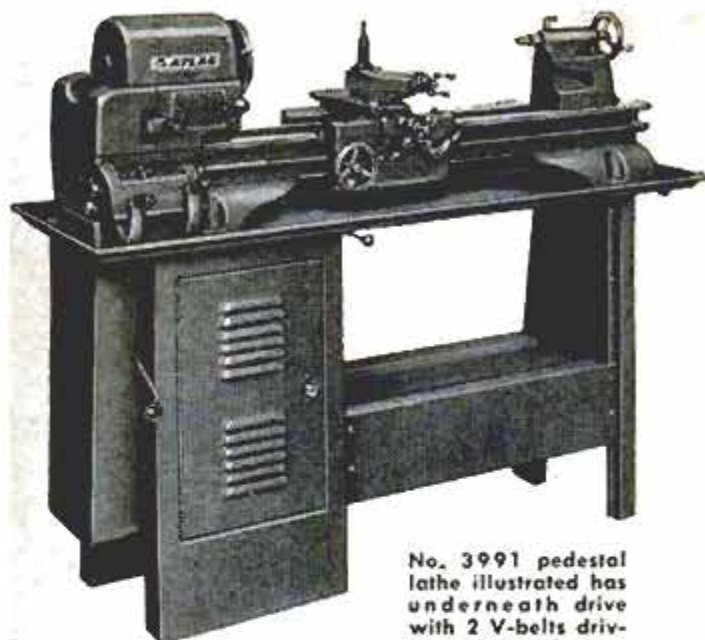

No. 3991 pedestal lathe illustrated has underneath drive with 2 V-belts driving the spindle.

The new *Atlas* 12" lathes are available in bench models with standard change gears or quick-change gears, and in two underneath drive models with pedestal base as illustrated.

Completely new inside and outside—from the ground up—with greater capacity, performance and value than have ever before been available in lathes at or near their low price.

They have big capacity—12 $\frac{1}{4}$ " swing over bed, 12" swing over saddle wings, 8" over cross slide, up to 36" between centers. And they're ruggedly built throughout to handle bigger jobs, and a wider variety of work with dependable precision.

And the new Atlas back-geared lathes have these important features as standard equipment: Timken tapered roller bearings, 16 spindle speeds, reversible power cross feed and longitudinal feed, wide thread cutting range, V-belt drive. Yet they cost you no more than smaller, less efficient machines.

You'll want to know all about these great new lathes. Write for free literature today.



The famous Atlas precision spindle—an exclusive that assures lifetime accuracy.



New, heavier bed has ground ways—a rigid precision foundation.

Servicing Engine Ignition Systems—Via Electronics

(Continued from page 248)

ability to spread out the pattern so that the various pulses may be seen individually. This permits closer inspection and shows up troubles which may not be visible in the over-all pattern. In Fig. 11, the trace is expanded to permit dwell-angle measurements. A graduated base line is supplied with the analyzer for this purpose. This illustration also shows the portions of the trace depicting specific circuit troubles. In the portion bracketed by A, for example, the breaker points are closed and the voltage should be zero. Defective points or improper spring tension would produce irregularities in this base line, as indicated in Fig. 13, which denotes bouncing points at the time of closing and opening. Improper breaker-point spacing can be determined from the dwell-time measurements.

Part B of the trace shows up troubles in the secondary circuit. A fouled plug will produce the pattern of Fig. 12, while conditions for open and shorted plugs have been discussed earlier. Note the similarity between Figs. 12 and 4. The sloping portion of the pulse is indicative of excessive resistance but, since the oscillations after the spark is extinguished appear to be normal, this resistance is present only during the time that current flows in the secondary winding. This is usually due to a defective plug or faulty plug wiring.

Part C of the trace is associated with the decaying energy in the primary circuit and shows such troubles as condenser defects and excessive primary resistance.

If the trigger lead of the analyzer is clipped to the wire between the coil and distributor cap, the oscilloscope sweep is initiated each time a spark is produced in any of the gaps. The resulting pattern shows all pulses superimposed and permits a quick and easy comparison. The pattern in Fig. 14, for example, shows excessive distributor-shaft wobble, as determined by the fact that the breaker points close at irregular intervals.

Another important advantage of the analyzer is its ability to check an engine under actual operating conditions. (This requires a separate d.c.-to-a.c. converter.) This procedure often reveals engine troubles which escape normal shop tests.

Some Specific Examples

The versatility of the analyzer can best be demonstrated with a few examples.

A motorist complained of an occasional engine miss, particularly on rough roads,

(Continued to page 268)

ATLAS PRESS COMPANY

2-24 N. PITCHER STREET • KALAMAZOO, MICHIGAN

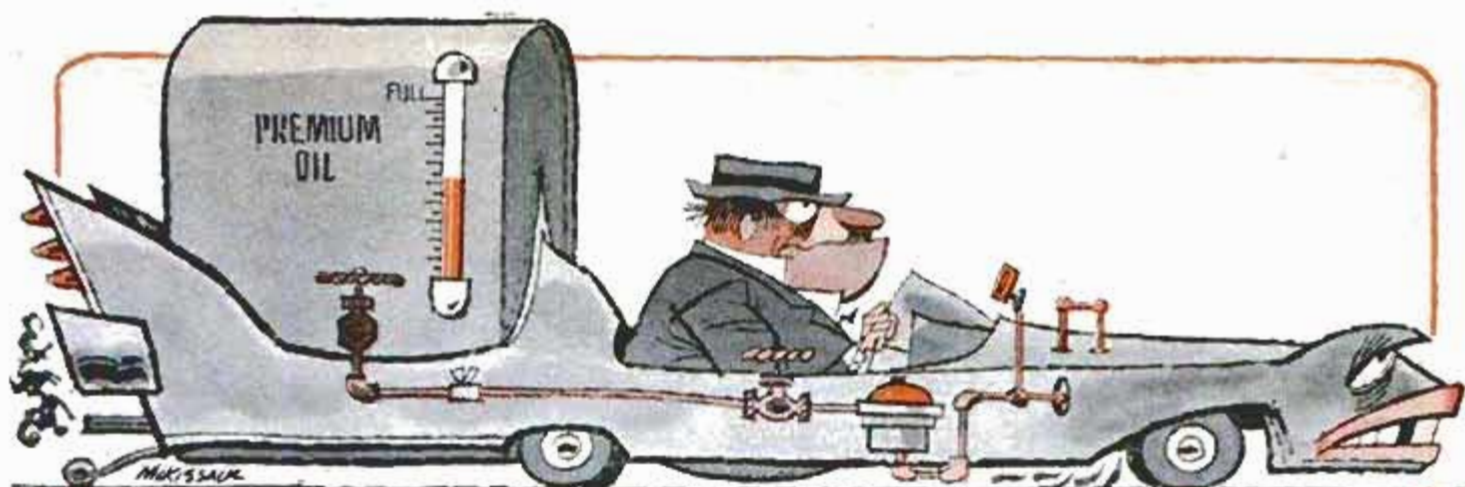

Using too much oil?... call for HASTINGS

Excessive use of oil is your first sign of worn-out piston rings. And worn-out piston rings mean power drop-off—costly wastage of gas and oil—expensive repairs later on.

See your motor specialist the minute oil-pumping warns you there's trouble ahead. When he recommends new piston rings, ask for Hastings. They're engineered exclusively

for replacement service... to stop oil-pumping, save gasoline, restore lost performance.

Get new car performance from your present car—with Hastings. Truly your best investment for thousands of extra miles of trouble-free driving. Hastings Manufacturing Co., Hastings, Mich. Piston Rings, Casite, Wear Reducer, Oil Filters, Spark Plugs

**TOUGH ON OIL-PUMPING
GENTLE ON CYLINDER WALLS**
U. S. PATENT NOS. 2614899, 2712971



HASTINGS PISTON RINGS

PRI **ROAD TO RICHES**

You can be the next uranium millionaire! Government guarantees huge bonus! PRI Instruments from \$29.95. See your local dealer today! FREE CATALOG!

Write PRI, 4223 PM W. Jefferson
Los Angeles 16, California

DEALERS WANTED

**FOR GARDEN FUN... AND
Just Easy Tilling**

USE A LOW-COST

ARIENS JET ROTARY TILLER

Free-swinging depth bar!

S-L-O-W tine speed; all-around visibility.

Easiest-handling tiller you've seen! 8" to 20" tillage width makes seedbed preparation and cultivation fun instead of a chore! Briggs & Stratton 2 1/4 h.p. engine has recoil starter; muffler. Fingertip controls; free-swinging depth bar. Timken bearings throughout. Write for free literature. Dealer inquiries invited!

Ariens / 161 Calumet Street
BRILLION, WISCONSIN

Parker COUNTERSINK BITS
No. 4 for WOOD SCREWS

For all electric drills, drill presses and hand drills

Drills and Countersinks
3 depths for flush or recessed screws
— in 1 operation —
4 bits for the 8 most popular screw sizes

Drill and Countersink Holes for Wood Screws in ONE Operation!

Automatic stop adjusts to 3 depths

TO ADJUST STOP
Press spring and slide the stop to one of the three positions on the bit shaft. Stop bits automatically.

4 Bits —
24 Combinations **\$1.70**
per set

Manufacturers of World-Famous Trojan Saw Blades and Frames

Buy the **Parker** Line

PARKER MANUFACTURING CO.
WORCESTER 1, MASS., U. S. A.

Just in time for Fix-up Time!

25% MORE POWER at a NEW LOW PRICE!



The Black & Decker U-3 1/4" Deluxe Utility Drill has always been famous for power. Now its B&D-built motor gives you 25% more power . . . to handle all kinds of rough drilling jobs in steel, wood, masonry or any other material. Still the same ease of handling . . . to let you work for long stretches without tiring. Still the same toughness . . . to give you many years of honest service. And all at a new low price! Ask your electric tool dealer about the B&D U-3 1/4" Deluxe Utility Drill. Or write: THE BLACK & DECKER MFG. CO., Dept. M028, Towson 4, Md. (In Canada: P.O. Box 278, Brockville, Ont.)

USE THE NEW U-3 POWER FOR ANY OF 24 B&D ATTACHMENTS

Running an attachment puts added strain on a motor. The motor of the new B&D U-3 Drill is powered to carry this extra sustained load because it is built by B&D with power to spare. Get more from your attachments with the U-3. And remember—with B&D Attachments engineered to work as a team with B&D Drills, you have 24 tools:



Saw	Floor Polisher	Masonry Drill	Orbital Sander
Jig Saw	Hedge Trimmer	Drill Press	Furniture Polisher
Wood Auger	Screw Driver	Countersink	Disc Sanding Table
Hole Saw	Car Polisher	Metal Buffer	Abrasive Shapers
Grinder	Paint Mixer	Bench Drill	Wire Cup Brush
Roto-Hone	Twist Drill	Disc Sander	Wire Wheel Brush



Look under "Tools-Electric"



Black & Decker®

World's Largest Maker of Electric Tools

even though new plugs, points, distributor cap and wiring had recently been installed. Routine shop tests showed nothing wrong, so the car was given a road test with the ignition analyzer connected to the engine and powered by a small converter. The owner drove the car while the mechanic watched the analyzer. The traces on the screen were perfectly normal until the driver turned onto a gravel road which had given him the worst trouble. At the first bounce, the pattern revealed that two of the cylinders were not being fired, see Fig. 15. As the car was stopped, with the engine idling, the pattern returned to normal.

A visual inspection revealed that the plug wires entered a metal cover over the spark plugs. Removal of the cover showed nothing amiss. Back at the garage, however, a closer inspection showed that the rubber block that keeps the four plug wires from being cut by the cover had been placed too low. Installation of the cover would tilt the block, pulling the plug-wire clips off Nos. 4 and 8 plugs. The rubber spark-plug insulators would keep the clips close enough for idling and running, but the rough road jolted the clips farther away and prevented firing. Moving the rubber grommets to their proper positions corrected the difficulty. A simple fault—yet one that would have been hard to find had not the analyzer provided the tip-off.

Another case involved a 1955 Buick which had been giving a service garage a lot of trouble. The engine was missing so badly that it had to be shifted to low range to get it under way from a stop light. In the shop, it was found that the engine idled smoothly but missed seriously during acceleration. It had all the earmarks of valve trouble but a compression test showed less than 10 lb. difference between cylinders. With the engine running in gear and the brakes on, the plugs were shorted out one by one. The only plug which showed no noticeable change was No. 8 which was promptly replaced. But the trouble was still there.

Now, the ignition analyzer was connected and the pattern was closely observed. It was seen that the trace was normal for all cylinders except for No. 6 in the firing order. The latter changed its shape (see Fig. 16) whenever the engine misfired. Spark plug, wire and distributor were again checked and found to be all right. Now the cylinder head was removed and careful inspection revealed that the exhaust valve was slightly bent. It would seat all right while idling, but under load it would cause the engine to miss. The mechanic found the trouble, but the analyzer showed him where to look. ★ ★ ★



10:05 A.M. The test begins. The B&D Saw will be tested on 2" lumber, making a variety of cuts.



4:00 A.M. It's 18 hours since the test began. Over 4000 ft. of lumber cut so far.



8:30 A.M. Over 22 hours and a third crew of men is on. 13 blades have been used.



Test runs through the night. After 24 hours, saw was still going strong. It was then put on laboratory testing machine to continue test* for 6 more days and nights.

*United States Testing Company, Inc., Report No. 37135, Nov. 27, 1957.

7-DAY SAW TORTURE TEST PROVES BLACK & DECKER TOO TOUGH TO BEAT!

Hour after hour, day and night—for one week, a Black & Decker Saw was tested continuously by the United States Testing Company, Inc., Hoboken, N. J. This saw received more wear and tear than most saws ever get in a *lifetime of use*.

And the saw stood up! After seven grueling days and nights, every part of the saw was found to be in perfect condition. Here is proof of Black & Decker quality... why we say Black & Decker Saws are tough enough for any job! THE BLACK & DECKER MFG. Co., Dept. M028, Towson 4, Md.

Black & Decker®

World's Largest Maker of Electric Tools



Find Your B&D Dealer in the 'Yellow Pages'

Look under "Tools-Electric"

NEW LOW PRICES
IN TIME FOR
SAW'TIME '58
SEE YOUR DEALER NOW

TOO TOUGH TO BEAT BECAUSE OF THESE FEATURES:



- Easier Handling
- More Power
- Proved Ruggedness
- Better Visibility

WHEREVER YOU DRIVE...

**THIS
IS A
GOOD
SIGN**



**CARTER
CARBURETOR
SERVICE**

Wherever your automotive travels take you, you're never far from authorized Carter fuel system service. More than 25,000 Carter trained servicemen throughout the United States are authorized to display this sign. You can depend on them to give your car the same skillful, conscientious carburetor, fuel pump and fuel filter service you get from your Carter serviceman at home.

CARTER CARBURETOR
DIVISION OF **QCF** INDUSTRIES
INCORPORATED
ST. LOUIS 7, MISSOURI

Why Burglars Can't Win

(Continued from page 137)

has ever been broken into by burglars.

Electronic alarms frequently pay off in unexpected ways. In Chicago two burglars tried to bypass an ADT alarm system by cutting a hole through the ceiling of a clothing store. A piece of plaster fell on part of the alarm circuit and flashed a central-station signal. The yeggs were still working on the roof when surprised by police. In Birmingham, Ala., a thief threw his body against a door to force it open. A defective lock gave way and the hoodlum hurled himself onto the floor with such force that he was knocked out. He was still unconscious when ADT guards and police arrived to investigate the cause of the alarm.

Yeggs Chop Hole in Wall

A trick of some professional burglars is to bypass wired windows and doors by forcing a hole in a wall with a hydraulic jack. When yeggs tried this caper at a hosiery mill in Chicago, they fled empty-handed. The building was protected by an ultrasonic device and the sound-wave pattern was upset by the movement of bricks tumbling before the hydraulic jack.

ADT guards also perform feats beyond the routine call of duty to help capture thieves who have tripped alarms. In Houston an ADT guard answering an alarm at a tobacco company heard footsteps on the roof of the building. The guard shinnied up a tree and edged out on a limb. The limb snapped but the guard grabbed at the edge of the roof and made a successful landing. He caught the young burglar and held him until firemen could raise a ladder to the roof top.

ADT engineers have established research laboratories in New York City and neighboring New Jersey to test new and improved alarm systems. They are concerned about a superblowtorch developed at Temple University. The "Temple Torch" can generate heat up to 9000 degrees F.—hot enough to melt a steel and concrete bank vault. ADT believes the Phonetalarm will detect an attack by the supertorch.

Drills and Bits Disappear

Of more immediate concern is another high-powered tool which apparently has fallen into the hands of criminals. It is a 600-pound electric drill used to cut holes in walls for air-conditioning units. With diamond-tipped drills, it can slice an eight-inch hole through a foot of concrete in three minutes. One of the machines, along

(Continued to page 272)



How easy-to-work Western Pines help you put a wall to work

The workable Western Pines make it fun to tackle this winter project—and turn out a thoroughly professional job.

Because these woods are so straight-grained, clean-cutting, they can be fashioned easily to fit your cabinet and fold-away desk plans.

Wax to a natural glow. Paint or stain to suit yourself. The Western Pines hold either treatment, give you a beautiful finish.

See your lumber dealer for an estimate.



FREE! "FRIENDLY HOME IDEAS"

85 photographs, many in color, feature traditional and contemporary ideas for building, decorating and remodeling with cheerful Western Pines. Write for your FREE copy to WESTERN PINE ASSOCIATION, Dept. 215-N, Yeon Bldg., Portland 4, Oregon.

Western Pine Association



member mills manufacture these woods to high standards of seasoning, grading and measurement

Idaho White Pine • Ponderosa Pine • Sugar Pine
White Fir • Incense Cedar • Douglas Fir • Larch
Red Cedar • Lodgepole Pine • Engelmann Spruce

TODAY'S WESTERN PINE TREE FARMING GUARANTEES LUMBER TOMORROW

BUY DIRECT
• SAVE ON •
TILLERS • TRACTORS

Full line of attachments for
mowing, gardening, farming
2-3-4 H.P. TILLERS 12"-16" CUT.

FREE CATALOG
& PRICE LIST

5-6-7-9 H.P.
2 wheel &



4 wheel tractors

RED-E TRACTOR CO.

2 FOURTH STREET
RICHFIELD, WISCONSIN

Do it now with

DAPTM



Use DAP 33 Glazing Compound for setting glass in metal or wood sash—to replace old putty around windows. DAP works fast and easy. Brilliant white or gray. At hardware, paint or building supply dealers. Ask for free do-it-yourself booklet.

DICKS-ARMSTRONG-PONTIUS, Inc.
General Offices: Dayton, Ohio

NEW, IMPROVED CALCULATOR FOR WOODWORKERS only 25c

Instantly gives information on lumber, nails, concrete mixes, painting materials, etc. Convenient, simple to read. Just set dial for nail specifications, to convert linear to board feet, find bit sizes for screws, compare characteristics of woods. 6" diameter heavily varnished greenboard. Send 25c, no stamps, please to Greenlee Tool Co., 2102 Columbia Avenue, Rockford, Illinois.



EASIER
FASTER
BETTER!



KESTER SOLDER

FREE: "Soldering Simplified"
16-page booklet—Send for
your copy today.

For General Soldering

KESTER SOLDER COMPANY

4251 Wrightwood Avenue • Chicago 39, Illinois, U.S.A.

Built to Last

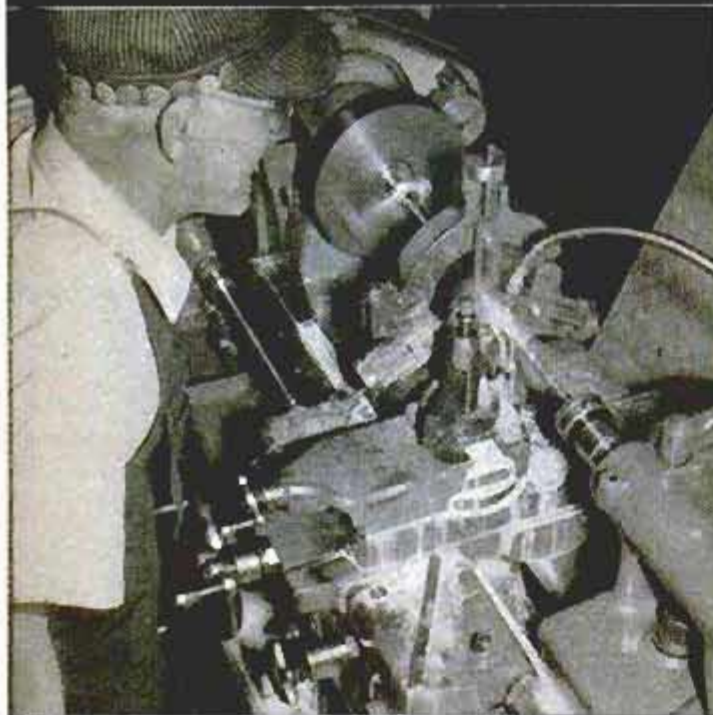

South Bend 13" and 14½" Lathes

Years mean nothing to these precision lathes, as they go on and on turning out accurate work at low cost with . . .

- Microfinished bearings with no metal-to-metal contact.
- Belt drive to spindle for vibration-free operation—no gear marks.
- Precision-cut gears and ground shafts for smooth power feeds.
- Rugged, rigid construction that will stand up under hard usage.
- Exacting workmanship by skilled craftsmen.

SPECIFICATIONS	13"	14½"
Swing over cross slide.....	7¾"	8¾"
Maximum collet capacity.....	1½"	1½"
Spindle speed range.....	20-940	15-875
Shipping weight, 7' bed.....	1760 lbs.	2089 lbs.
Base price.....	\$1675	\$2074

Write for FREE 80-page catalog.

SOUTH BEND LATHE

South Bend 22, Indiana

Builders of Lathes, Milling Machines, Shapers, Drill Presses, Pedestal Grinders



Up to 24 months to pay.

with 180 diamond bits, vanished from a Chicago store several months ago and law-enforcement officials are frankly worried.

Alarms Aid the Watchman

Electronic alarms have not entirely replaced the night watchman, but they have made his job safer. By turning a key in each of a series of transmitting stations, the watchman signals the central station that "all is well." If the signals are not received on schedule, an ADT guard is dispatched to investigate. In the ADT files are numerous cases of watchmen injured, stricken by sudden illness or attacked by criminals but rescued within a few minutes because their signals were not received. In Oklahoma City a watchman was trapped in an elevator between floors and rescued by ADT guards when signals from the transmitting stations were interrupted.

Because of the possibility that hoodlums might force a watchman at gunpoint to continue his tour of transmitting stations, the devices can be rigged to send an alarm signal to the central station without the knowledge of the intruders.

Watchmen have been replaced by alarm systems in some big warehouses and industrial plants. One large soap-company warehouse for example, is completely guarded by electronic alarm systems. The warehouse even has alarm devices to insure that the temperature of detergents doesn't drop below 40 degrees and that a room filled with toothpaste is never cooler than 50 degrees. Other alarms can alert central stations if there's as little as one inch of water on a floor, if the temperature of chemical-processing vats is too high or too low, or if a gate valve in a water-supply system is closed. ADT maintains over 60,000 shutoff-valve alarms throughout the country.

What about the cost of such protection? One firm reports it saves two dollars on insurance premiums for every dollar spent on electronic alarm systems. Another company claims it reduced its plant-protection costs by \$70,000 a year by replacing part of its watchmen with electronic guards. And a food-processing firm says it saves \$32,000 a year in pilferage losses since it had "invisible watchmen" installed at back doors and windows.

Part of the success of modern alarm systems is due to the psychological effect they have on the underworld. Burglars know their chances of cracking the electronic alarm systems are pretty slim. The record shows that for every \$1000 a burglar tries to take from ADT-protected property, he gets only 10 cents. ★ ★ ★

ACCEPT NO IMITATIONS — BE SURE IT'S A

KING O'LAWN
18" Homeowner
Model Shown
\$149.50

F.O.B. South Gate
California

Total weight of
power mower
115 lbs.



Dual Automotive
Clutch Control

Mows within 3/8"
of wall, tree, etc.

All chain drive

This mower will
give your lawn that
golf-green carpet look.

That Forward Throw
All cuttings are
delivered forward.

KING O'LAWN,

1958 Model Briggs Stratton
lightweight 4-cycle
engines used.

KING O'LAWN
Junior model
power edger
trimmer shown.

For edging and
trimming along
sidewalks, curbsings
and flower beds.

\$79.50

F.O.B. South Gate
California

Total weight of
power edger
49 lbs.

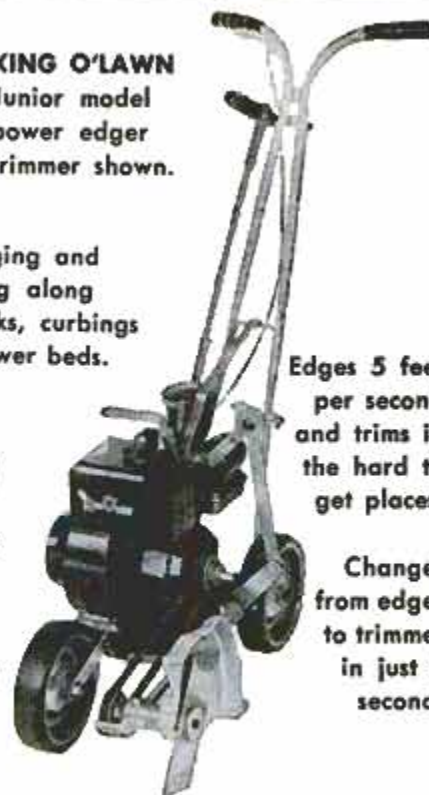

Edges 5 feet
per second
and trims in
the hard to
get places.

Changes
from edger
to trimmer
in just 3
seconds

4 Models of Power Mowers and 4 Models of Power Edgers from which to choose.
Over 2000 Dealers to serve you. A few choice dealer territories are still available. Please write

KING O'LAWN Inc.

P.O. BOX 1068 TWEEDY STATION
SOUTH GATE, CALIFORNIA

ONE-MAN SAWMILL LOW \$50.00 AS... DOWN

Take BELSAW Portable Sawmill right to the trees—turn out valuable lumber for home and farm—sell to local yards—make up to \$50 a day custom sawing for neighbors. BELSAW lasts a lifetime. No crew needed. Power with tractor or auto engine. Beginners get excellent results. Send today for FREE BOOK.

BELSAW MACHINERY CO
3458 Field Bldg. Kansas City 11, Missouri

NEW! FOR FINISHING WOOD EDGES



WELDWOOD FLEXIBLE WOOD TRIM

Real wood veneer, paper-backed, in handy rolls, for edging plywood, lumber. Many decorative uses. Apply with Contact Cement, or Presto-Set Glue. Oak, birch, African mahogany, walnut, fir, Sonora.® At your lumber dealer's. **SAVE!** Get 89¢ sample roll, 8' x 1", specify wood. Send this ad with 50¢ to: United States Plywood Corp., Dept. PM2, 55 W. 44th St., N. Y. 36, N. Y.

HOW TO PROTECT YOUR INCOME!

Earn Extra Money With A Rapid

**SHEAR SHARPENER
AND
KNIFE SERRATOR**



Easy to operate—professional-type sharpener does a perfect job in just 2 minutes on all types scissors and shears, including pinking shears. Knife guide puts proper edge on any blade. Knife serrating attachment puts saw-tooth edge on hard or soft steel blades. Quick profits from homes, dressmakers, barbers, restaurants, hotels, butchers, etc. No experience needed. Big opportunities with this precision ball bearing machine. Has 1/2 h.p. motor. A money-making investment—write for FREE FOLDER PM-2.

BEAVER MFG. CO P.O. BOX 434, 800 So. Isis Ave.
Inglewood, Calif.



Wash off old paint with water!

Amazing how easy it is to use this miracle new WASH-AWAY Paint Remover. Just brush it on . . . wait a few minutes . . . wash off with water — your surface is clean, ready to refinish. Ideal for removing old finish from delicate antiques. Fine for outside use . . . siding, shutters, porches, boats. No scraping! Nonflammable!

AT SHERWIN-WILLIAMS DEALERS EVERYWHERE!

listed in yellow pages of phone directories

Free!

ALLIED'S 1958

ELECTRONIC SUPPLY CATALOG

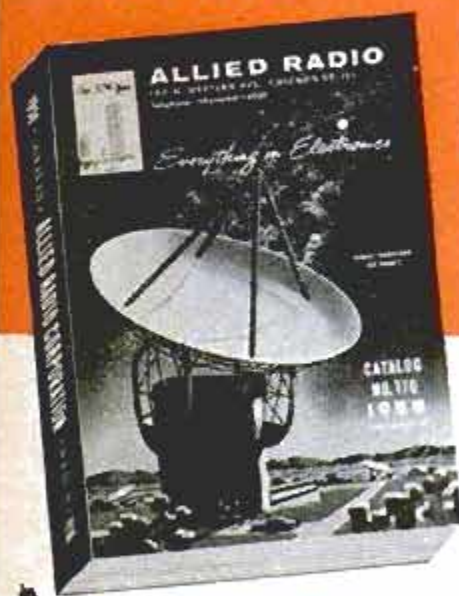

404
value-packed
pages

Send
for it!

SAVE on
everything in
electronics

EASY TERMS
AVAILABLE

WORLD'S LARGEST STOCKS

Here's everything in Electronics for Experimenters, Builders, Amateurs, Servicemen, Engineers and Hi-Fi Hobbyists:

- Amazing Build-Your-Own KNIGHT-KITS
- Hi-Fi Music Systems & Components
- Recorders & Phono Equipment
- TV Tubes, Antennas, Accessories
- Public Address Systems
- Amateur Station Equipment
- Latest Test Instruments
- Industrial Electronic Supplies
- Parts, Tubes, Transistors, Tools and Books

SAVE on everything in Electronics—get fast, dependable service—send today for your FREE 1958 ALLIED Catalog.

Everything in Electronics
From One Reliable Source

our 37th year

FREE

ALLIED RADIO

ALLIED RADIO CORP., Dept. 110-B8
100 N. Western Ave., Chicago 80, Ill.

Rush FREE 1958 ALLIED 404-Page Catalog

Name _____

Address _____

City _____ Zone _____ State _____

Atomic Revolution in the Shipyards

(Continued from page 102)

Once in their planes, pilots will be whipped into the air at 30-second intervals on four radically new catapults that actually shoot the planes away with exploding gases—like shells from a cannon. Known as ICCP (Internal Combustion Catapult Powerplant), these mighty engines consist of "combustor cylinders" two feet in diameter and 13 feet long. Fuel, fed into the rear end under pressure, along with compressed air, is exploded by igniters. As the burning mixture roars down the cylinder, water is injected, cooling the mechanism and flashing to steam. This expanding mass roars into the catapult tubes to ram a piston down the long cylinder with tremendous force, capable of flinging the heaviest carrier jets into the air at full flying speed.

Adm. Morgan pointed out that some of the biggest advantages of the new ships are so obvious they are often overlooked. Conventional carriers, for instance, can conduct air operations for only a limited number of days before more aviation fuel is needed. The CVA(N) will be able to operate its aircraft for a considerably longer period, since space formerly used for ship fuel now will be utilized for additional aircraft fuel. Even more important is the fact that this monster ship can cruise at top speed indefinitely! On a conventional ship fuel consumption increases at the cube of the speed. Twelve hours of high-speed run would nearly exhaust the supply of most surface ships. An atomic engine has no such problem. What this will do for fleet operations staggers the imagination. Actually, one prototype nuclear engine for a new Navy ship ran full speed for 1600 hours nonstop, still didn't need refueling.

While the Navy lines up its sights for the atomic era, commercial-fleet owners are watching some fast-moving developments in the offices of the U. S. Maritime Administration, the AEC, the reactor plant of Babcock & Wilcox Company outside Lynchburg, Va., and on the drafting tables of George G. Sharp, naval architects, in New York. This is the team, under Clarence G. Morse, chairman of the Federal Maritime Board and Maritime Administrator of the U. S. Department of Commerce, that is hatching the world's first atom-powered cargo-passenger liner.

Though general design of the ship is already known, nobody wants to say emphatically that details will stay put. However, the Maritime Administration's project director for the ship, Richard P. Godwin, and his project officer, Kemper Sullivan,

(Continued to page 276)

GRAVELY

More for your Money!

CULTIVATE GROWING CROPS



POWER CULTIVATE YOUR GARDEN



PERFECT SEEDBED WITH ROTARY PLOW



MOW LAWN AREAS



MOW TALL GRASS, WEEDS, CROPS



BLOW SNOW AWAY



MOVE SNOW, DIRT



HAUL HALF-TON LOADS



WRITE TODAY

GRAVELY MAKES TOUGH JOBS EASY!

Gravely does jobs other tractors won't . . . because Gravely has that *extra* power you need for the toughest lawn, garden, field and farm tasks. Does a better job everywhere, even on *steep slopes!*

With a choice of 30 attachments, you do every chore with a performance-proved tool that does it *better, faster, easier!* Because Gravely's *all muscle*—its direct engine drive puts the power where it counts— at the *working tool*. That means performance *Plus!*

More For Your Money!

Yes, you get more power, more performance, more for your money when you get Gravely. The cutaway view on the right shows you its clean, compact, power-engineered design — the reason for Gravely's remarkable performance.

Never before, in a small tractor, such remarkable *versatility*, such built-in *power*. Whatever the job, whatever the season, Gravely turns in a *real* job with unbelievable *ease and speed* . . . All-Gear Drive, Power Reverse, Balanced-Weight Handling, Push-Button Starter optional.

- ALL-GEAR DRIVE
- POWER REVERSE
- Power Attachments Securely Mounted by Only 4 Bolts

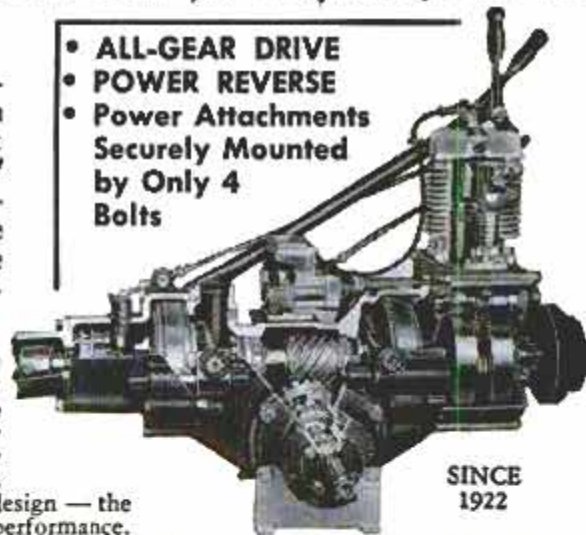

SINCE 1922

New 24-page "Power vs Drudgery" Booklet shows how Gravely can solve *your* upkeep and gardening problems *better, faster, easier*. Mail coupon today!

EASY PAY PLAN

GRAVELY TRACTORS, INC.
BOX 263, DUNBAR, W. VA.

Please send me "Power vs. Drudgery" Booklet and dealer's name.

Name _____
Address _____
City _____ Zone _____ State _____

FIELD-TESTED SINCE 1922

70¢ makes a hard job easy

 A few quick strokes with this 70-cent Red Devil Scrapper File makes dull scrapers razor-sharp. You'll be astonished at the difference. If you really hate work, buy our replacement scraper blades instead — 15¢ to 45¢.

 You sand the wood instead of your hand with this comfortable Red Devil Sandpaper Holder that lets you bear down hard. 50¢, or a dime more with sponge rubber backing pad.

 Poor patching of plaster often results from inadequate scrape-out of cracks. So the expert uses a special Red Devil Crack Scraper. For 50¢, you can afford to do likewise.

 Glass cutting is easier than you think with a Red Devil Glass Cutter and a few tips in the booklet offered below. We make 15 kinds for professionals but the 50-cent No. 024 serves most amateurs nicely. Look for the red, white, and blue package.

It's always best to buy where Red Devil Tools are sold, for wider choice, top quality, correct "how-to" advice.

Free booklet,
"How To Cut Glass."
Address Dep't. B-2

4570



Red Devil Tools.

Union, N. J., U. S. A.

World's largest manufacturer of painters' and glaziers' tools.

SAVE MONEY ON YOUR COMPRESSED AIR

buy this complete
SMITH 45-P air compressor

Right for spray painters, plumbers, contractors, monument shops, tire changing trucks, maintenance shops, quarries, utilities, many other users. Delivers 45 plus cu. ft. per minute; pressure up to 150 PSI. Powered by Wisconsin 4-cyl. air-cooled engine; uses less than 1 gal. gasoline an hour! Most compact, biggest-value compressor for its capacity anywhere! Other models to 230 cfm.



write for
FREE
brochure

GORDON SMITH & COMPANY, Inc.

411 College Street, Bowling Green, Ky.

already know just about what kind of hardware will slide down the ways two years from now.

Sporting the rakish lines of a sleek yacht, the atom liner will have a highly streamlined superstructure, topped by a teardrop-shaped dome on the bridge — a dramatic configuration made possible by elimination of stacks and uptakes. Except for this bubblelike cap on her dramatic superstructure and her unique power source, the atomic merchantman will be modest as ships go. Only 588 feet long, 78 feet a-beam and with a cruising speed of about 21 miles per hour, she's in a class slightly ahead of the Mariners. Seven holds will carry 9000 tons of cargo, and she'll accommodate some 60 passengers in well-appointed staterooms. Atomic voyagers will promenade around spacious shelter decks, on open weather decks that boast swimming pool and game courts. Forward, on the promenade deck, they will luxuriate in a big main lounge, a dancing salon, game and writing rooms. Ship's movies and television will provide entertainment.

For the first year or so, the liner will be a "laboratory ship." Her passenger list will comprise nuclear scientists, maritime architects and engineers—all of them listening, with instruments, to the ship's every purr like stethoscope-toting physicians hovering over a medical curiosity.

Passengers will be able to peer through glass walls into the engine room and the enclosed, air-conditioned central-control station. They'll see engineers man the panels of dials and switches that operate, by remote control, the reactor rods, valves and auxiliaries of the ship's propulsion system. The furnace whose atomic fires these men unleash will develop about 22,000 shaft horsepower.

"It is the same type plant that powers the *Nautilus*," Sullivan explains, "— a pressurized water reactor, used to produce steam which powers a turbine. Actually, it is a ship with a conventional steam power plant, but using a nuclear furnace instead of an oil burner."

That furnace makes all the difference, however. First, it's pretty radioactive. To take care of that problem, the designers at George Sharp's have put it and all its primary plumbing into a steel capsule that sits in a concrete nest deep in the ship's hull, forward of the wheelhouse. Measuring 50 feet long and 35 feet in diameter, this gigantic "egg" has a vertical cylinder jutting from its top to accommodate the reactor's long control rods. Inside this containment vessel sits the reactor's core, encased in its own thickly shielded cylindrical

(Continued to page 278)

ELECTRIC MOTORS — POWER KITS MAKE THOUGHT-PROVOKING GIFTS



Choose from 4 tiny motors— $1\frac{1}{2}$ to 12 volts—all today's biggest values. Also available—all types of drives for toy and hobby, research and industrial devices.

- *No. 8-100 Hi-Drive Motor, 3-6V. \$2.50
 - No. 8-100 Same for 12V. \$3.00
 - No. 3-100 Tiny Atom Motor, $1\frac{1}{2}$ -3V. \$2.00
 - For 6 V. \$2.50 For 12 V. \$3.00
 - *No. 3113N Tiny Atom motor assembly kit with many acc. \$3.50
 - *No. 14 Adjustable shaft supports kit. \$3.00
 - *No. 77 Set of 7 large pulleys. \$3.00
 - No. 1300 Small accessories kit \$1.00
 - No. 3700 Large accessories kit. \$3.00
 - *No. 700 Super-Power kit with motor and all accessories. \$10.00
 - No. 3000 Vari-speed gear unit. \$4.00
 - No. 1049 Gear train with Hi-Drive motor No. 8-100. \$5.95
 - Same with No. 9-100 Motor. \$6.45
 - * Item illustrated. Ask for FREE Cat.
- All motors have ALNICO magnets

Remit with order and we pay postage in U.S.A. No C.O.D. Add 3% Sales Tax for delivery in Ohio. Write Dept. PM.

For quick delivery see your local dealer — or order direct

WILSON'S OF CLEVELAND

425 Lakeside Ave., N.W. • Cleveland 13, Ohio

10" TILT/ARBOR SAW BUILD-IT-YOURSELF from GIL-BILT KITS-PLANS



Sturdy wood, steel, and aluminum construction. NEW DEPARTURE ball bearings. Capacity and performance of floor saws selling for \$150.00 and up. Plans, all metal parts in kit with 10" comb. blade \$25.90, less blade \$22.95. P.O.B. St. Louis. Detail PLANS-PATTERNS only \$1.00 postpaid.

Build-it-yourself 12" and 18" Bandsaws, 6" Belt Sander, Shaper. Simplified plans, build easily with hand tools only. Advertised and sold for 11 years, over 33,000 units in use. Money back guarantee. FREE CATALOG.

GILLIOM POWER TOOLS, Dept. 80-B, Lambert Field, St. Louis 21, Mo.

Print Your Own



Cards, Stationery, Advertising, Circulars, labels, photo and movie titles, church work, tags, etc. Save money. Sold direct from factory only. Raised printing like engraving, too.

Own a Printing Business

Print for Others. Good Profit. Have home shop. Junior press \$15; Senior \$29 up. We supply everything. Easy rules. Pays for self in short time. Write for free catalog of outfits and all details. KELSEY PRESSES, C-37 Meriden, Conn.

EXPLORE FOR TREASURE!



Find gold, silver, coins, jewelry, battle relics! M-SCOPE Treasure-Metal Locators. Used World-wide. Guaranteed Proven Performance. Transistors. Fiberglass cases, lightweight. Also Geiger, Scintillation Counters, Mineralights. FREE Detailed Catalog. Easy Terms. FISHER RESEARCH LAB., INC., Dept. PM-2, Palo Alto, Calif.

GENUINE ALNICO MAGNETS

AMAZING, PERMANENT, NON-ELECTRIC, HIGHLY PRACTICAL. Conduct interesting experiments. Hundreds of uses. Retrieve valuable steel items such as guns, tackle from fresh or salt water; tools from tanks & drains. GUARANTEED. Try any magnet one week. Money back if you are not well-pleased.

- No. M-710 (Wt. 53 oz.) Has pull of 225 lbs. on steel block. \$16.50
- No. M-625 (Wt. 70 oz.) Has pull of 125 lbs. on steel block. \$9.50
- No. M-575 (Wt. 18 oz.) Has pull of 75 lbs. on steel block. \$6.50
- No. M-500 (Wt. 13 oz.) Has pull of 50 lbs. on steel block. \$4.50
- No. M-300 Kit of Flat Bars 5 Pairs (10 Magnets). \$3.00
- No. M-250 Kit of Round Rods 5 Pairs (10 Magnets). \$2.50
- No. M-47 Hot Pad Magnets. 10 for \$1.00. \$0 for \$4.87
- No. M-35 Hobbyist assortment of 8 small magnets. \$1.50

Send M.O. or check. We pay postage. Sorry no C.O.D.'s.

MIAMI MAGNET COMPANY, 3240 N.W. 27th Ave., Miami 42, Fla.

FREE PLAN

Tells How to Start
Your Own Business

FILING SAWS

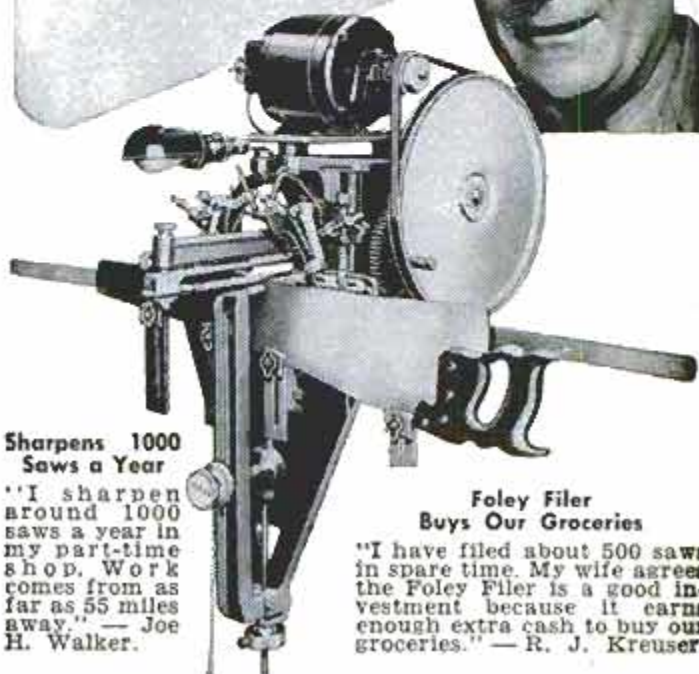

Sharpens 1000
Saws a Year

"I sharpen around 1000 saws a year in my part-time shop. Work comes from as far as 55 miles away." — Joe H. Walker.

Foley Filer
Buys Our Groceries

"I have filed about 500 saws in spare time. My wife agrees the Foley Filer is a good investment because it earns enough extra cash to buy our groceries." — R. J. Kreuser.

FOLEY FILED SAWS BRING NEW CUSTOMERS

Here is a steady repeat CASH business that pays up to \$3 to \$5 an hour, and you can start in your own basement or garage in your spare time. Every saw you sharpen with the machine accuracy of the Foley Saw Filer is an ad that brings more customers. J. C. Deibert wrote us: "Since I got my Foley Filer five years ago, I have averaged $4\frac{1}{4}$ saws each day over all this time." Howard Kuhns says "We operate 2 Foley Filers, and our business averages about 500 saws per month. The count last year was 5,798 saws."

You can file all hand saws, also band and crosscut circular saws on the Foley Saw Filer. The adjustments are simple—there is no eyestrain—and you can start right away to turn out perfect cutting saws. "The first saw I sharpened with my Foley Saw Filer came out 100%. I think it is a marvel of perfection."—writes Clarence E. Parsons.

"MONEY MAKING FACTS" explains how you can get business from hardware stores, home owners, farmers, carpenters, schools, mills, factories, etc. Just think—with a modest investment, no overhead, no stock of goods to carry, you can start right in on a cash business that will help pay the rent, buy groceries, or a new car. Get the facts—send coupon today for this practical, money-making plan. No salesman will call.



Send for FREE BOOK

FOLEY MFG. CO., 216-B Foley Bldg.,
Minneapolis 18, Minn.

Send me free book "MONEY MAKING FACTS"

Name _____

Address _____

**Bore 35 standard holes
with just one tool**

**New IRWIN
Expansive Bit**

lets you dial your size

Just turn the dial and you're set to go with this new Irwin Expansive bit. No hunting for the size you need. Fits all hand bit braces. Clean, fast, accurate boring action from $\frac{3}{8}$ " to 3"—35 standard hole sizes in all!

And what a really fine precision tool to own. It's drop-forged from special bit steel, heat treated full length, machined for accuracy and sharpness, highly polished, too. Two cutters supplied with each bit. Model No. 21 with $\frac{5}{8}$ " to 1 $\frac{3}{4}$ " boring range also available. Ideal for home handyman, professional woodworker, or farm. See your independent hardware dealer soon.



**No. 22
Micro
Dial
only
\$3.80**
 *$\frac{3}{8}$ " to 3"
boring
range*

IRWIN

Wilmington, Ohio

the original solid
center auger bit
●
screw drivers
screw driver bits

**NEW AND EASIER FOR
EVERYONE TO USE**

FOR THE MAN WHO
WANTS THE BEST

TURNER
Propane Gas
TORCH

FOR:

- Soldering
- Removing Paint
- Laying Tile
- Sweating Copper Tubing
- Thawing Pipes
- Removing Putty



The instant lighting torch that burns in any position. No pumping—no priming—for refueling just unscrew the disposable tank, discard, and replace with a new full tank available everywhere. Complete with fuel. **\$5.95**

Other TURNER Propane GAS APPLIANCES include ONE and TWO BURNER CAMP STOVES and CAMP LIGHT

FREE Folder on TURNER PROpane GAS APPLIANCES. WRITE TODAY!

TURNER BRASS WORKS
SYCAMORE, ILLINOIS

container. While the ship is under way, constantly whirring high-vacuum fans will exhaust air from the voids around the containment vessel, carrying heat losses and any possible stray radiation leakage out a ducting system through the "house" top.

Probably most of these super precautions will never be necessary, however. "If a man sat for a year in the hold right in front of the reactor," says Godwin, "he'd collect about as much radiation as he would from the luminous dial on his wristwatch."

Like any atomic furnace, this one will gradually create burned-out waste that slows down the nuclear reaction and must be removed. This highly radioactive sludge will be stored in the shielded capsule and removed in port every 50 days or so.

Actually, the big containment capsule is so strong and well-shielded that, if the reactor inside ruptured completely, the outer vessel would contain the whole atomic catastrophe—radiation and all. Dick Godwin and Kemper Sullivan have no patience with gloomy predictions of men who envision oceans made radioactive by atomic shipwrecks.

The containment vessel for the reactor on the new atomic liner is well inside the hull, so a colliding bow would have to shear plenty of steel even to reach it. The big capsule has supports designed to hold it in place even with the ship standing on her beam ends. Besides all this, on the side walls of her thick nest is a "crash pad" made up of layers of three-inch redwood planking interspersed with steel plate to absorb the shock of direct impact. "Even if the sinking caused the primary system to rupture," says Bob Jack, project engineer, "a self-closing flood valve would permit sea water to enter the capsule until pressure was equalized. Then it would close to prevent any further release of fission products. Everything would be trapped in the capsule at the bottom of the sea."

Barring drastic collisions there's almost no way for loose neutrons to escape their prison on the A-liner. Once every three years of normal operation, however, the atomic furnace will need refueling. Though methods and equipment for this delicate job may change right up until the first burned-out slugs are replaced, Godwin provides a pretty clear operational picture.

At a special dockside facility, he explains, men will remove the deck hatch over the capsule's long neck. Carefully, the lead and polyethylene lid covering the control rods will be removed. Prior to this, air from within the capsule area is blown out a vent atop the mast. A bell-shaped housing is lowered by overhead equipment and bolted

(Continued to page 280)

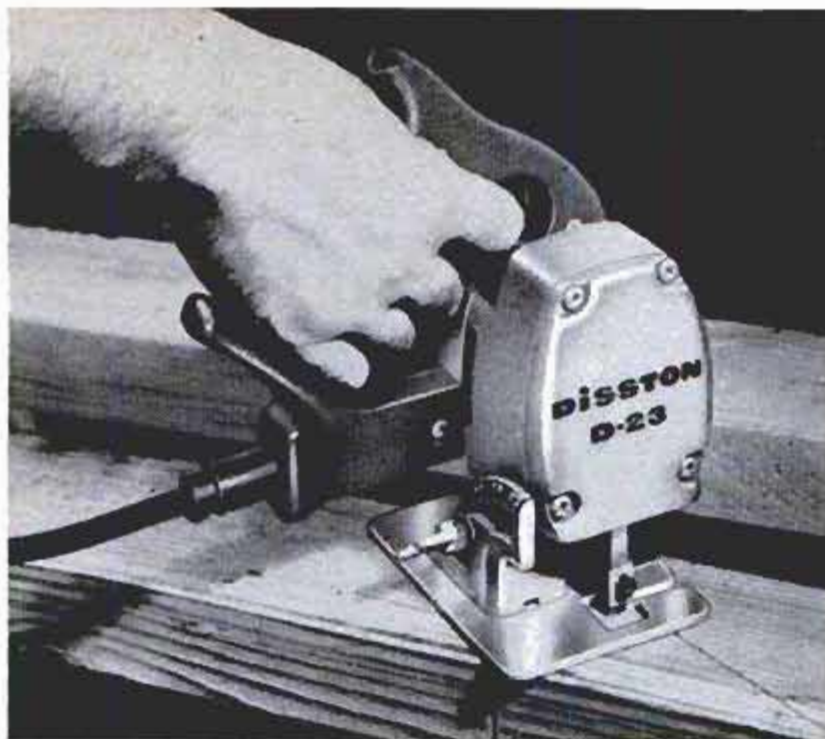

Plunge cuts without a drilled hole!



Cuts through hardwood 2 x 4's at 45° angle!



Cuts intricate figures in all materials!



Detachable electric cords come in lengths up to 100 ft.!

NOW! THE WORLD'S MOST USABLE POWER SAW!

The revolutionary **DISSTON D-23** Electric Handsaw!

This brand-new multi-purpose power saw answers the crying need of home workshop owners everywhere. It gives you—in a single professional tool—a whole shopful of power saws. Weighing only 4½ pounds, it does more cutting jobs than any other saw of its kind. Rips, crosscuts, mitres, bevels, scrolls. Does heavy workhorse cutting or fancy figures with equal ease and precision.

The Disston D-23 Electric Handsaw cuts every common home workshop material. It cuts wood, plywood, plastics, rubber tile, linoleum tile, asphalt tile, laminated paper and cloth, nylon and Plexiglass. It cuts ¼" steel plate, ½" aluminum plate, angle iron, copper, bronze and brass. It cuts pipe, tubing and sheets.

Features unmatched by other saws have been engineered into the Disston D-23 Electric Handsaw to make it the world's finest—as well as the world's most usable power saw. First, it gives you more cutting power than any other saw because it has the highest output horsepower. A 3-amp motor drives it at 3800 strokes per minute. Second, it cuts faster than any other saw because of remarkable ORBITE

action. The blade slices through material on the upstroke, but backs away on the downstroke. This also reduces fraying, need for sanding, and blade wear. Third, the new Disston D-23 Electric Handsaw cuts more accurately and lasts longer. It is the only reciprocating saw with all needle and ball bearings—9 needle and 3 ball bearings. Check these features against any saw now on the market.

Your most economical buy in power saws. Think of the 1,000-odd uses you have—right now—for this power-packed lightweight! In home repairs and improvements you'll be able to make. In do-it-yourself projects. Think of the times you've wished for just one additional saw for a particular job at hand. Think of the times you've said to yourself that one day you'll have all the saws you need. You can have them all right now in this built-to-last, most usable power saw ever made. With four blades, rip fence and 10-foot detachable cord, the revolutionary Disston D-23 Electric Handsaw sells for just \$98.50.

FREE! "Must" reading for every man interested in fine tools—Disston Workshop Manual No. 1. Read it before you buy any saw!

H. K. PORTER COMPANY, INC.

DISSTON DIVISION

514 Tacony, Philadelphia 35, Pa.

**FREE!
MAIL THIS
COUPON TODAY!**



Gentlemen: Please send me a free copy of your Disston Workshop Manual No. 1, describing the remarkable Disston D-23 Electric Handsaw. I realize there is no obligation on my part.

Name _____
Address _____
City _____ Zone _____ State _____



Make toys and dolls like new with
TUFF-BOND
QUIK-SET ADHESIVE

Just what you need for quick, easy repairing of toys, dolls, plastic clocks, radios, book ends, etc. Strong, flexible and waterproof. At better dealers everywhere. *Goodloe E. Moore, Incorporated, Danville 12, Illinois.*

STICKS ALMOST ANYTHING TO ANYTHING

Fast cutting
Top quality



SWEDISH WOOD CHISELS

Woodworking projects have that little extra professional touch when Gensco Swedish Wood Chisels are used. They're tops: hand ground, razor sharp blades, Tenite II handles are unbreakable and fire resistant . . . won't pull loose, sizes from 1/4" to 2".

Buy these accurate cutting, easier to use Gensco Wood Chisels at all leading hardware stores today. Available in sets of 4, 6 or 11 chisels in vinyl coated canvas rolls.



Set 300-4

1/4", 1/2", 3/4" and 1"



Bushman ALL-PURPOSE 21" Bow Saw



GENSCO TOOLS

A DIVISION OF

GENERAL STEEL WAREHOUSE CO., INC.

1832 N. Kostner Ave., Chicago 39, Illinois

down to replace the lid. Working remote-control tools via cables from a gantry inside the bell dome, the head is removed from the reactor vessel, burned-out fuel elements are lifted into a lead coffin which is then hauled up into the bell. The bell housing can then be unbolted, and the whole thing, coffin and all, lifted away by crane to a containment vehicle which moves it off to a storage pool for cooling.

Nobody expects the A-liner to operate economically. She is basically an \$18,000,000 test bed. But it is significant that on a voyage of 13,000 or more miles, she can carry 900 tons of cargo in space which, on a conventional ship of similar capacity, would be required for fuel.

Already, Maritime engineers are mulling over plans for tankers and bulk cargo ships. Due to the long voyages and high speeds demanded of tankers, economists estimate that an atomic supertanker would operate at costs only 14 percent more than conventional tankers.

Back in a section of the Maritime offices known as the "dreams and schemes department," Col. C. R. Denison already is busy developing ideas for the new breed of A-ship that he feels confident is on the way. Most impressive is a submarine supertanker concept. "It's about 600 feet long," explains Denison, "with an airfoil-shaped superstructure housing crew and control spaces. Besides supplying stability, the odd-looking superstructure would separate ship's personnel from the reactor area—which, of course, would be totally under water in the hull of the ship." In Col. Denison's version of this whale-shaped craft, the reactors would power hydrojet propulsion equipment—"Operating," says the colonel, "on the same basic principle as those little tin putt-putt alcohol boats we sailed in the bathtub as kids. Only these would be king size, and each engine would contain dozens of tubes to provide steady thrust."

Meanwhile, new atomic engines are being developed to propel larger ships at greater speed. Industry plans are in the works for a reactor using gas instead of water as the coolant. The gas, heating and expanding as it circulates through the atomic pile, swings through a single closed loop and spins a turbine en route. Heat exchangers, steam generators and extra plumbing are eliminated, resulting in smaller and lighter power plants with far greater efficiency and economy. "It is a step toward an American nuclear-powered merchant fleet competitive with any kind of fleet in the world," according to William Hepburn, one of the men responsible for the development. ★ ★ ★

easier, faster, more fun...



Projects for your home
made with
REYNOLDS
DO-IT-YOURSELF
ALUMINUM

These are just a few projects you can make for your home with Reynolds Do-It-Yourself Aluminum—there are hundreds more. They're easy—they're fun—and ordinary woodworking tools are all you need. These free project sheets, and many more, are at your nearby hardware or lumber dealer. Or, fill out the coupon for the Project Sheets you want and Reynolds will mail them to you.



BACK PORCH SHELF

Handy for the milkman and for you. Keeps deliveries dry in bad weather—holds packages while you unlock door. Easy to make.



MODERN CORNER TABLE

A modern corner table for your living room that combines the charm of wood and the elegance of aluminum. A project that's beautiful, functional—one you'll be proud to show. Request—PROJECT SHEET NO. 27

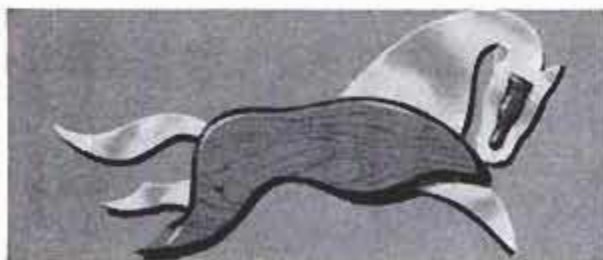

DECORATOR PLAQUE

A handsome stallion of aluminum and polished hardwood that you, and your friends, will admire for years. On—PROJECT SHEET NO. 30



**LOOK FOR THIS RACK
AT YOUR DEALER'S.**

You'll find—Sheet • Tube • Bar • Rod Fasteners • Screen and Storm Sash Sections—it's Reynolds Do-It-Yourself Aluminum headquarters.

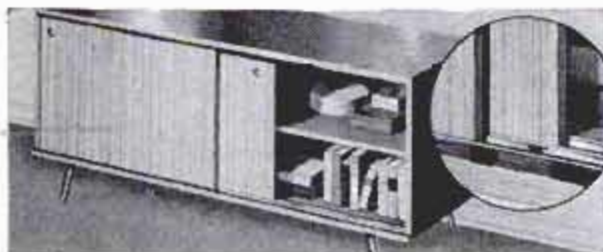

SLIDING DOOR TRACK SETS

Now, the toughest part of cabinet making is eliminated with new aluminum Sliding Door Track Sets. Use in all cabinet work where you plan sliding doors—plywood, masonite, glass—fit perfectly—glide easily—in 1/8" or 1/4" double channels.

Watch Reynolds All-Family Television Program, "DISNEYLAND," ABC-TV.

REYNOLDS DO-IT-YOURSELF ALUMINUM
2494 South Third Street, Louisville 1, Kentucky

Send me Project Sheets for:

- Modern Corner Table (Project Sheet No. 27)
 Decorator Plaque (Project Sheet No. 30)

Name _____

Address _____

City _____ State _____

New! WOOD BLEACH



a **Dexall** short cut to natural wood beauty!

- Easy way to modernize old-style wood finishes
- Just apply . . . sponge off . . . color's gone!
- Will not harm finest woods

At Paint and Hardware Stores Everywhere

DESHLER PRODUCTS INC. • Deshler, Ohio

SAVE STRAIN
SAVE SKIN

WITH
Bridgeport
NEOPRENE

CUSHION
GRIP

SCREWDRIVERS

50%
GREATER TURNING
POWER

16 sizes and
styles—Regular
and Phillips.
\$1.00 and \$2.70
At your hardware
store.

- SUPER COMFORTABLE
 - NON-SLIP GRIP
 - UNBREAKABLE HANDLE
 - FULLY GUARANTEED
 - ALLOY STEEL BLADE
- Resilient Neoprene CUSHION GRIP lets you turn screws tighter with less work—and you don't hurt your hands. Tested and approved by Mechanics

PATENT APPLIED FOR

completely free hand to do what they feel necessary.

"However, I still see quite a while ahead in which to develop the possibilities still in the present design.

"My real problem is to keep the spirit and the productivity of the engineers at a high level despite the fact that their work is almost entirely destined to be put aside, not to be translated into reality at this time."

Here is the real problem—the one that could cause success to spoil Volkswagen.

How can any company hold the truly talented engineer if his work never materializes? How long would the best stylist stay with a company that tossed all his designs into the wastebaskets? You can't keep true talent by letting it spend a year selecting six colors for next year's cars.

Unused Test Track

Behind the VW plant there is a clean new test track. Its high-speed oval is 1.8 kilometers long, just a little over a mile. It is built to handle speeds of over 100 miles per hour. It is a year old, yet is almost as white and clean as when it was built.

There is little or no activity at the track. There were no cars on it except ours during our tour.

I asked if they tested competitive cars. Rarely, was the answer. They didn't have to, seemed to be their feeling.

It could be that VW is the best car built, but it is unhealthy for its engineers to feel that way. A test track that sits idle is perhaps an indication of how success might spoil Volkswagen.

Is there American pressure to change the car? Won't the special demands of this lucrative market force some changes, perhaps spoil it?

Car Shows Feminine Influence

Already some condescensions have been made. The new dashboard has a useless strip of chrome running along it, something Dr. Porsche would probably have ripped off with his own hands. The accelerator pedal has been redesigned to satisfy women drivers. The upholstery now is flashier as well as being two-toned.

All are minor changes, but they could forecast bigger changes that might destroy the Porsche design.

VW is in the position of being condemned if it does, condemned if it doesn't.

It must change to survive, some say, but it might be spoiled by changes. The answer, of course, is to change only to improve—this requires great skill.

"If we make any big change, though,"

THE BRIDGEPORT HARDWARE MFG. CORP., BRIDGEPORT 5, CONN., U. S. A.

said one official, "it will not be a result of pressure from America, but from right here in Germany. Many VW owners in Germany are weary of the same shape, the same car. VWs are as common as lamp-posts. Owners want something different, something distinctive. Here's where the pressure is intense."

The certainty that many have had that the car will never change seems less positive these days. There is a vacancy at the top job in Research and Development—the department that plans for tomorrow. The former chief was relieved, it is rumored, because he was too much against change. Nordhoff is looking for a new Dr. Porsche—for a new genius who is 20 years ahead of his time. He hasn't found him yet. He must find him if the car is to prosper forever.

Walking along the final assembly line at the big Wolfsburg plant (where production is over 2000 cars a day), I noticed a collection of pin-up pictures on a wall.

What girls were in the pictures? No girls at all. The pin-ups were full-color advertisements of the latest American cars. These are pin-ups for VW workers—big, flashy American cars.

But the man at the top feels differently. He knows he would destroy his product if he tried to compete with America's cars.

"We will not get bigger, nor fancier," Nordhoff explains. "We must simply get better."

All changes are up to him. He will think long and hard before approving anything drastic. Nordhoff has guided the company well. Today, he heads a worldwide empire. He intends to keep it that way. ★ ★ ★

Solid-Propellant Rockets Won't Drop Burned Booster

Two-stage rockets now being built as anti-aircraft missiles will not drop the first stage after it has burned out. In the past the burned-out booster stage was jettisoned to reduce weight. But the process also required complicated separation instruments and a joint between the stages. More efficient solid fuels will reduce the over-all size and weight of the missile and overcome the dead-weight problem of carrying the booster for the remainder of the flight.

Brighter Fluorescent Lamp

With a mixture of rare gases, Westinghouse has developed a standard-sized fluorescent lamp that produces 2½ times more light and yet lasts as long as existing lamps.

FOR GLASS-SMOOTH PAINTING!

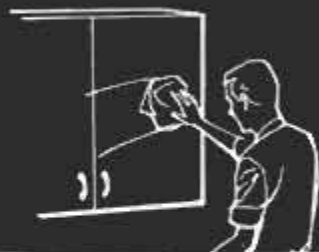

Dexall Tack-Rag

For Finest Enameling and Varnishing

Simply wipe the Dexall Tack-Rag over sanded surface before enameling or varnishing. It picks up every trace of dirt, dust and sanding particles... assures a professional-looking job!

At Paint and Hardware Stores Everywhere

DESHLER PRODUCTS INC. • Deshler, Ohio

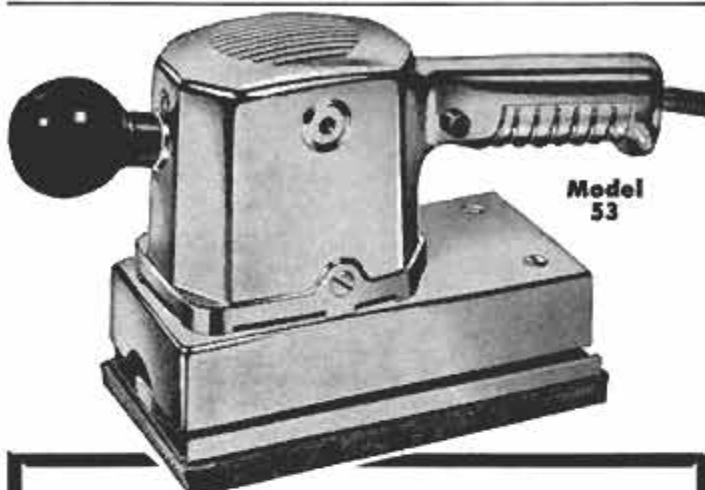

The Secret of Scratch-free Sanding!

Ask any expert—the secret of a perfect finish is to sand with the wood grain! That's what the old-time craftsman did when he sanded by hand. And so do you, when you use a Dremel Straight-Line Action Sander—except that a powerful motor does all the work.

With Dremel Straight-Line Action, you leave no cross-grain scratches or orbital swirl marks to mar the finish of your project.

Dremel sanders are compact, lightweight, and easy to grip and handle. Don't be fooled by "look-alikes" or "looks" alone. Ask your dealer for a demonstration. Then compare their price, performance, and ease of handling. You're sure to pick a Dremel—and you'll be glad you did.

See Your Power Tool Dealer Today

Dremel Straight-Line-Action Power Sanders
3 popular models — \$14.85 to \$37.50

FREE Power Tool Catalog on the Complete Dremel Line. Write today!

Quality Power Tools Since 1934

DREMEL MFG. CO.

DEPT. 1188

RACINE, WIS.



Lenk

HANDIEST LIGHT EVER MADE!

For Campers . . . Sportsmen
. . . Emergencies!

Tru-Lite LP LANTERN

WITH REPLACEABLE FUEL CONTAINER

SAFE INSTANT LIGHTING

Just open
valve and light
with match

BRIGHT WHITE LIGHT

Brighter than
100 watt bulb

ECONOMICAL LONG BURNING

Fuel container
lasts over
10 hours

ALWAYS READY

For Any
Emergency



ONLY
\$6.98
POSTPAID

COMPLETE WITH
KING SIZE FUEL
CONTAINER

A must for:

**CAMPERS • ROADSIDE FLARES
BARNs • BOATS • NIGHT FISHING •
POWER FAILURES**
USE CONVENIENT COUPON

**BUY NOW DIRECT
FROM FACTORY**

Lenk Manufacturing Co., Franklin, Kentucky

Please send me _____ Lenk LP Lantern complete
with King Size replaceable fuel container @ \$6.98.

Also send _____ King Size spare fuel containers
@ 98c each. My check (or money order) for \$ _____
is enclosed. (No C.O.D.'s Please)

NAME _____

STREET _____

CITY _____

STATE _____

Lenk Manufacturing Co., Franklin, Kentucky

The 1958 Cars

(Continued from page 154)

its current advertisements, despite the fact that it dropped its low-price Custom series at the start of the model year.

These are all signs of a change. Two years ago (or even one year ago) you would have been laughed out of the Detroit Athletic Club if you had been so bold as to suggest that these things would happen. But they have happened and they are a symptom.

So 1958 may go on record as the start of the Big Switch, the year the industry discovered it could sell cars by doing something to reduce costs of owning a car.

It is also the year in which General Motors decided to become an importer and sell its small European cars in the American market. Another indication of the changing mood.

What else will 1958 be remembered for? Here are some candidates for the Hall of Fame:

The changeover to four headlights, of course; the industry's (except Chrysler and Studebaker-Packard) adoption of some form of air suspension; the rash of greatly enlarged V8 engines which may be the last such change to be made (although each year the turbine seems further away, not closer).

These larger engines may appear to contradict the change mentioned above but they don't really. These new designs were started years ago and are only now being born. Designing a car is like rolling a ball down a bowling alley. After you let go, there are often changes you would like to make in the course of the ball, but it's too late then. The designer lets go years before you see the car. After the design is "locked in," conditions may change and he may wish he had done something different, but it's too late, the ball is going down the alley.

This lead-time handicap may also explain why the bigger, more-powerful trend continues in most cars. The average 1958 car is 213.3 inches long, 1.4 inches longer than the average in 1957. The average 1958 car weighs 3922 pounds, which is 104 pounds more than the average 1957 car. The average horsepower is up from 234.6 in 1957 to 257.0 in 1958, and displacement is up from 306.5 cubic inches in 1957 to 310.3 inches in 1958.

Incidentally, did you notice that the 1958 Chevrolet is longer than the 1958 Oldsmobile Eighty-Eight and Super Eighty-Eight? You can't tell what's what these days.

There are some deaths to report also, deaths which have been recorded quietly

(Continued to page 286)

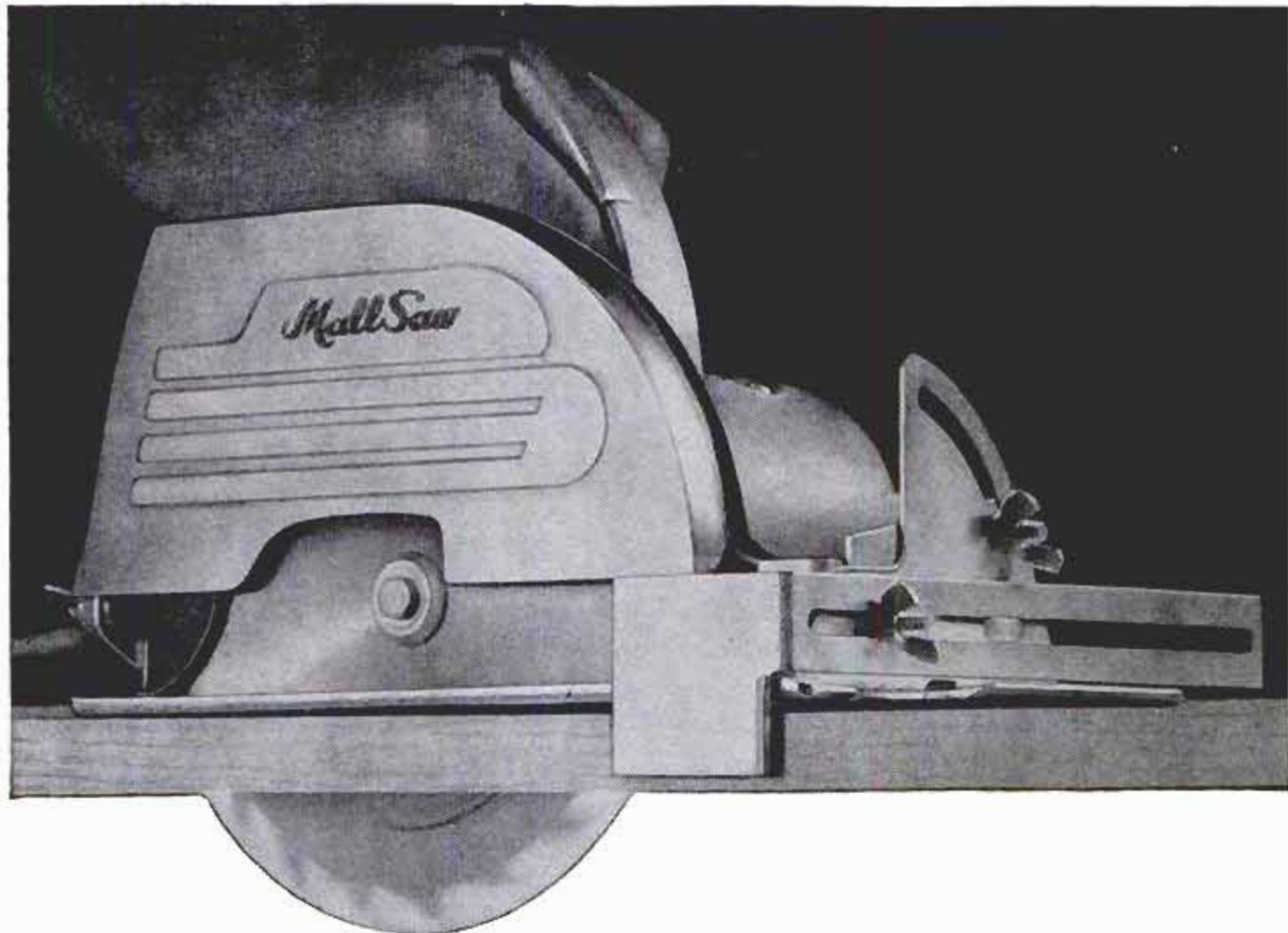

POWER

Remington 7-inch circular saw gives you an extra deep cut with power to spare!

Ideal for home workshop or maintenance. Model 71 has depth capacity of full 2 $\frac{3}{4}$ " at 90°; will cut through 2" lumber at 45°; speed: 5000 rpm. Powerful 25-60 cycle motor rated at 8.4 amps. Telescoping blade guard; one nut adjusting depth and bevel shoe; ball and self-lubricating bearings; weight: 8 $\frac{3}{4}$ lbs. 10-ft. cord, plug and ground; blade and wrench included. Ask your dealer to show you this powerful saw—it's your biggest saw value!

Remington
Mall®

MALL TOOL COMPANY
Division of Remington Arms Company, Inc., Bridgeport 2, Conn.
In Canada: Mall Tool, Ltd., 36 Queen Elizabeth Blvd., Toronto, Ont.

*Specifications and recommended list prices subject to change without notice. Prices slightly higher in Canada.

TWO MORE POWERFUL REMINGTON TOOLS



Sturdy 1/4" drill.
Model 149B, complete, \$28.50*



Rugged belt sander.
Model 31, complete, \$89.95*

Mail this coupon today!

FREE 16-PAGE CATALOG shows every type of Remington electric tool by Mall. Tells what each will do—gives prices and specifications. No cost, no obligation. Just send in this coupon.

MALL TOOL COMPANY
Division of Remington Arms Company, Inc.
Bridgeport 2, Connecticut

Please send me **FREE ILLUSTRATED CATALOG**



PM-2

NAME _____
ADDRESS _____
CITY _____ ZONE _____ STATE _____



In engine reconditioning

FEDERAL-MOGUL *means* FINE PERFORMANCE!

Any engine will perform better when reconditioning includes Federal-Mogul bearings. They are *engineered* for the job. If the crankshaft has to be turned down, there are Federal-Mogul bearings in the correct under-size to fit it. Federal-Mogul reborable bearings can be align bored. For heavy-duty jobs, Federal-Mogul sintered copper-alloys are the answer. That's why mechanics **PRE-FER** Federal-Mogul bearings . . . they are designed to restore fine performance. Ask *your mechanic!*

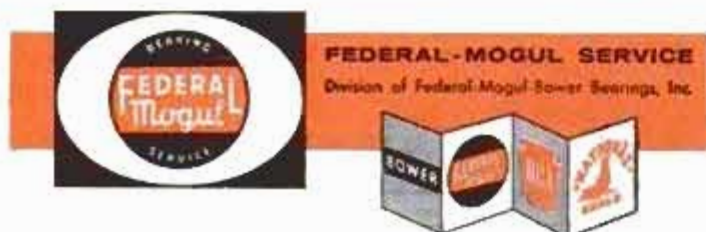

without fanfare. And, it seems, without much sorrow either.

First, there is the death of Hudson and Nash, two great names in history. The public stopped buying these cars some time ago, but tradition and hope kept them coming out each year (and losing money for their makers). Finally, reality caught up with tradition and the cars were dropped.

Now American Motors builds two Ramblers on one shell: The regular-size Rambler and a stretched-out version called the Ambassador.

Second, there was the silent burial of the most expensive monument to yesterday ever devised: The Continental Mark II. Ford Motor Company's campaign to carry on the car's identity with its 1958 Continental Mark III is understandable, but hardly believable. The Mark II was significant because of its virtually custom-made character. The extreme care with which it was made was its hallmark. It was a car for the person who could afford the finest and was willing to pay a premium for elegant distinctiveness.

The 1958 Continental Mark III is a twin to the Lincoln. It is as much a Lincoln as the Buick Limited is a Buick. When you buy the Mark III you don't get near-custom manufacture, you get another Lincoln (which, it must be added, is a fine car). But the Mark II, the loudly acclaimed revival of the prewar classic, is dead. That's the plain fact.

But, to strike a happier note, there has been a birth in the Ford family, too. The Edsel has been brought out for the world to see and, it is hoped, to buy. Thus far, the Edsel has been seen by many, bought by few. Perhaps this will change, but it is no secret that at the moment sales are disappointing. Should Mercury bring out its low-price Medalist again, there may be even more difficulty selling the Edsel.

Ford did unseat Chevrolet as the top car in sales for the model year and Plymouth did the same with Buick for third place. These are significant achievements.

There is significance in the way Buick and Oldsmobile were restyled for 1958. The 1958 Oldsmobile is a complete reversal of its customary clean, uncluttered character. Buick is even flashier than it used to be. Together these are the two most bedecked cars on the road. Such adornment is usually reserved for urgent situations.

But the move is apparently paying off in sales. According to Ward's Automotive Reports, General Motors boosted its sales from 44.5 percent of the industry for the first 10 months of 1957 to 53.7 percent in

(Continued to page 288)

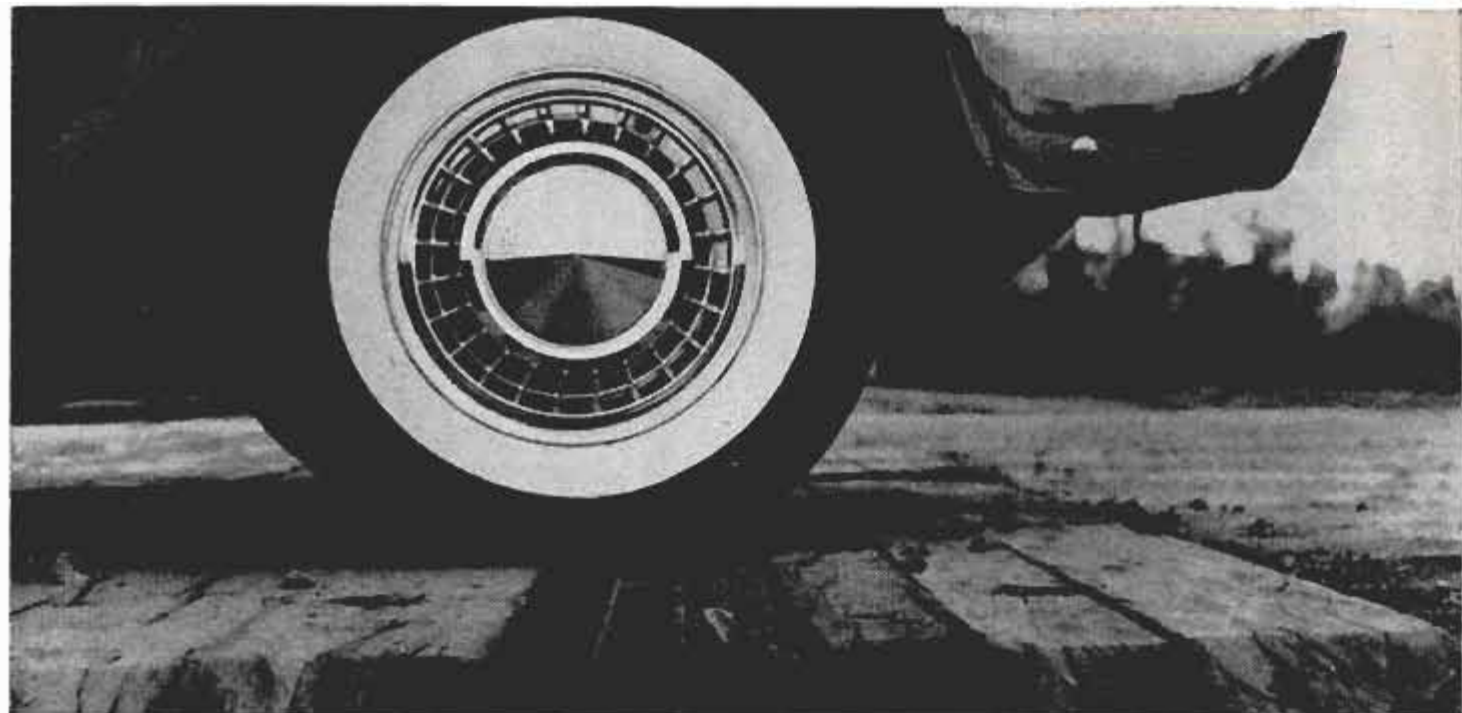

TORSION-AIRE

• WHAT IT IS • WHAT IT DOES • WHY IT IS BEST FOR YOU

Last year Chrysler Corporation proved that America was ready for something new in the way of ride and handling. And Torsion-Aire has given people just what they wanted!

Torsion-Aire is Chrysler Corporation's name for its rubber-isolated, ball-joint, anti-dip, torsion bar system of suspension. And it's unique among American cars. Its design comes from a fresh start, a clean drawing board. It is based on the belief that piecemeal modifications—and design compromises to accommodate optional suspension elements—are no match for a fully integrated, balanced system designed as a *whole*, with the *whole* car in mind.

As a result, it's *the most advanced suspension system yet developed*. No other gives you *all* these important advantages:

- Torsion-Aire is built right into the car. It's not "added on" or "extra". The Torsion-Aire system of suspension was designed for the

car . . . and the car was designed for it.

- Torsion-Aire is a complete system. It is designed "in depth" to eliminate your three biggest handling problems. No more starting squat. No more sway on turns. No more braking nose-dive.

- Torsion-Aire is standard equipment on *all Chrysler Corporation Cars*—and at no extra cost. Suspension isn't an accessory you can take or do without. It's as basic to the car as wheels.

- Torsion-Aire is a proven system. Unlike untried systems, Torsion-Aire has been proved by billions of passenger car miles—by more than a million satisfied owners.

Want more proof of Torsion-Aire superiority? Take the Torsion-Aire road test. You don't have to seek out special conditions. With a bump in almost any block—and a corner at the end of it—you can prove this new kind of ride to yourself in the first quarter mile!

CHRYSLER CORPORATION  **THE FORWARD LOOK**
PLYMOUTH • DODGE • DE SOTO • CHRYSLER • IMPERIAL

LUBRIPLATE LUBRICANTS



Make Cars Run Better... Last Longer!

LUBRIPLATE H.D.S. MOTOR OIL is made especially for today's high speed, high compression engines, both gasoline and diesel. Fully detergent, requiring no additional additives.

LUBRIPLATE AUTO-LUBE "A" is the perfect all-purpose automotive grease type lubricant. Use it for every grease application.

Your car deserves the best. . . .
Use **LUBRIPLATE**—You'll see the difference immediately!

If your service man does not have LUBRIPLATE Lubricants, ask him to write us.

OTHER LUBRIPLATE PRODUCTS

LUBRIPLATE 2-C MOTOR OIL
for outboards

LUBRIPLATE OUTBOARD GREASES
for underwater gears

LUBRIPLATE IN HANDY TUBES
for sports and household uses

LUBRIPLATE INDUSTRIAL LUBRICANTS
for every application

LUBRIPLATE DIVISION, Fiske Brothers Refining Co.
Newark 5, N. J., Toledo 5, Ohio.

CRAFTSMAN'S
wood and woodworking
MATERIALS



132 PAGES
Many in
full color

packed with rare, fancy & imported woods... veneers, plywoods, patterns, tools, ornaments, hardware... everything for the woodworker.

Get This NEW Catalog of **WOOD & WOODWORKING EQUIPMENT**

WORLD'S LARGEST SELECTION OF FINEST DOMESTIC AND IMPORTED WOODS... MOULDINGS, HARDWARE, TOOLS,—ALL AT LOW MONEY SAVING PRICES!

Your complete wood buying guide and project book. Craftsman is your best, most complete source of finest kiln-dried domestic and rare imported woods, beautiful wood inlays, colorful bandings, matched plywoods, embossed mouldings, carved ornaments, newest woodworking tools, "hard to find" cabinet hardware and fittings... more than 1,500 items! Packed with newest scroll saw patterns, project ideas & money making plans. Enclose 25c (refunded with first order) to help pay mailing, handling cost. Write now! **Craftsman Wood Service Co., Dept. A-2 2729 S. Mary Street - Chicago 8, Ill.**

December (of course, much of this boost is credited to the all-new Chevrolet).

Once again, the public proves that it will buy flash when given the opportunity, despite the fact that it (the public) always says it wants economy and less chrome!

If this sounds mixed up after the earlier discussion of economy cars, it is only because the public is mixed up. This fact is what makes the experts in Detroit mixed up, too. But do not confuse economy with austerity—that perhaps, is where the confusion lies.

It is hard to assess Studebaker-Packard this year. About the kindest thing to be said is that this company will face tough sledding ahead.

That, then, is the way the industry looks to one observer as the year 1958 begins. It is not the most promising picture, but the industry will survive (at least the major part of it; there may be a minor casualty). Perhaps next year at this time, the new cars will again be longer, heavier and more powerful, but it appears less likely than in previous years. It is this reporter's guess that we're now going over the hump and from here on the tendency will be the other way.

In view of the slow sales of most 1958 cars, it is obvious that something is not being done right. The industry, up until now, has refused to admit it could be wrong about its theory that cars must always be bigger and more powerful. It is possible that 1958 will be the year for a major change of philosophy. The steadily increasing sales of foreign economy cars may be the convincing evidence the industry needs. This foreign car "fad," as Detroit likes to call it, refuses to die out.

Also of serious concern to the industry (perhaps of more concern even than the steadily increasing foreign-car sales) is the fear that Congress will pass some limiting laws on horsepower and speed potentials of new cars.

You may hear plenty of screaming if this comes up for debate. But it may be that this is just what the industry wants. It will permit them to change their course sharply without having to admit they have been wrong! ★ ★ ★

Colored Storm Sash Made of Rigid Plastic

Self-storing, trackless storm windows are now manufactured from rigid vinyl plastic. Corner miter joints of the window frames are reinforced with molded-resin inserts. Screening is glass fiber. Storm doors also are available in colored plastic.

from

SKIL

amazing Tungsten Carbide
WORKSHOP TOOL DISCOVERY



CROSS-CUTS OR RIPS



FACE SANDS



MAKES IRREGULAR SHAPES



PLOUGHS, NOTCHES, GROOVES



MAKES DECORATIVE CUTS

New... Safe... 5-in-1 Tool! PERMA-GRIT WHEEL

SAWS, DADOES, SHAPES, SANDS, PLOUGHS

This amazing abrasive wheel is the safest and most useful accessory ever designed for table and radial saw use. It's actually 5 tools in 1! Saws, sands, shapes, dadoes and ploughs. And you never change the blade. With tungsten carbide grit permanently bonded on edge and sides, it's the slickest cutting blade ever developed. Cuts and sands wood or composition material in one operation! Even cuts laminated sheets without "pull outs." Coarse grit (36) bonded to edge and one side; other side has medium grit (80). And with no teeth to snag or drag, the Perma-Grit Wheel is safe. No kick-back... will not throw wood. One 8" Perma-Grit Wheel with 5/8" arbor. Five tools in one, only \$12.95.



PERMA-GRIT HAND SANDER—Outlasts hundreds of sandpaper sheets. A complete kit includes 1 Hand Sander, 1 Medium-Grit Sheet and 1 Fine-Grit Sheet only \$3.45.



PERMA-GRIT FILE—Full 14" blade size has coarse grit on one side and medium grit on other side. Unlike other rasps, the Perma-Grit File resists loading. Only \$2.25.

SKIL Corporation, Dept. PDC-28
5033 N. Elston Ave., Chicago 30, Ill.
In Canada: 3601 Dundas St. West, Toronto 9, Ont.

Gentlemen:
Please send me complete information on Perma-Grit products.

Name _____

Street _____

City _____ Zone _____ State _____

This Year's Crop of Engines

(Continued from page 169)

and 300 horsepower, both having four-barrel carburetion. A detuned two-barrel version (240 horsepower) of the smaller engine (332) powers some other Ford V8 models. In addition, a slightly bored-out version of the larger (352) engine is used in the Edsel Ranger and Pacer. This version (4.05-inch bore) has a 361-cubic-inch displacement and 303 horsepower.

All three of these engines (really three versions of the same engine) are conventional in design, in keeping with Ford's reputation for conservative V8 engineering. Featured are fully machined combustion chambers, until recently confined to high-price cars because of high manufacturing costs.

Full machining accurately controls the volume of each chamber and, even more important, gives surfaces a smooth finish which resists the buildup of deposits. This problem of combustion-chamber deposits becomes very critical as compressions are raised.

Moderately high compression ratios (9.5, 10.2 and 10.5 to 1) are used on these three engines.

Also of interest here is a keystone-shaped intake manifold that eliminates the customary stamped upper cover over the tappet chamber. The manifold nestles in the vee formed by the cylinder banks and adds rigidity to the whole engine.

The second group of new Ford engines is much larger in displacement. It is used in Mercury, some Edsels and all Lincolns. There are three engines in this group also.

First, there is the 383-cubic-inch Mercury Monterey-Montclair engine; second, the 410-cubic-inch Edsel Corsair-Citation engine; third, the 430-cubic-inch Lincoln and Mercury Park Lane engine.

The same 4.3-inch bore is used in the largest and smallest models but with different strokes (3.7 inches and 3.3 inches). The middle-size engine is slightly underbored to 4.2 inches and has the longer 3.7-inch stroke. Thus, three engines are accomplished by juggling two bore diameters and two stroke lengths.

This second group of Ford engines features a cylindrical wedge-shaped combustion chamber entirely in the block. Ford engineered this by inclining the top faces of each cylinder bank 10 degrees from the usual perpendicular to the bore's center line. This provides a fully machined 10.5-to-1-ratio combustion chamber of an elliptical shape that permits advantageous location of valves and spark plugs.

(Continued to page 292)



FREE

Giant New 260 Page
**AUTOMOTIVE
CATALOG!**

**SAVE
UP TO
50%**

on all parts
for your
**CAR
HOT ROD
CUSTOM CAR
STATION
WAGON
TRUCK**
— all models

Over 85,000 Items in Stock!

Newest 1958 Accessories!

Get your FREE copy now... everything you need for your car, truck, custom styled car or hot rod. Save up to 50% buying-by-mail from Whitney! Thousands of hard-to-find items for cars from 1920 to 1958. See newest Hollywood accessories not offered in stores; high speed and power parts, custom styling equipment... all at lowest prices! Guaranteed satisfaction or money back. Our 20th year.

RUSH COUPON! Please send 25c to help pay catalog mailing and handling costs. We will credit 25c on your first order for \$5.00 or more.

J. C. Whitney & Co., 1917-P2 Archer Ave., Chicago 16, Ill.

MAIL THIS COUPON - NOW!

J. C. WHITNEY & COMPANY,
1917-P2 Archer Avenue, Chicago 16, Illinois

Rush giant 1958 catalog of auto parts and accessories at sale prices. I enclose 25c to cover part of mailing and handling cost, which will be credited to me on my first \$5.00-or-more order. OFFER GOOD IN U.S.A. ONLY.

NAME.....

ADDRESS.....

CITY..... STATE.....

"ARCO JIG-SAW" cuts any shape, any material!

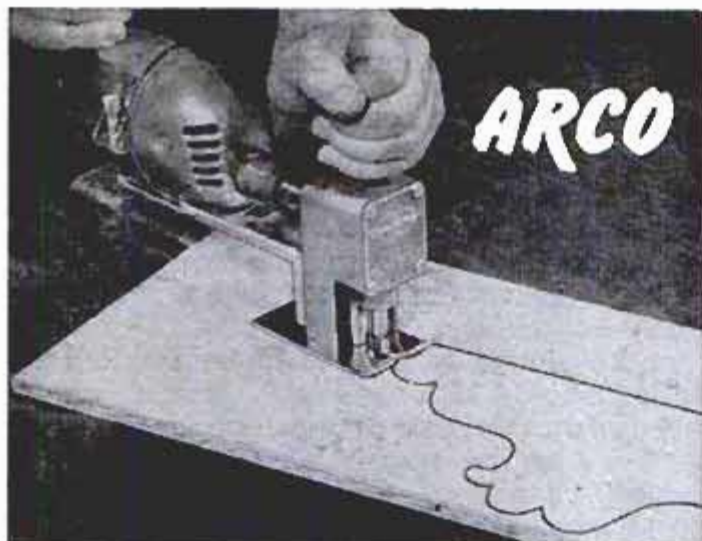

Cuts Perfect Circles with Exclusive Circle-Cutter



Makes Straight & Parallel Cuts with Exclusive Rip-Gage.

"Arco Jig-Saw," guaranteed to fit every 1/4" drill, cuts any pattern in woods, plastics, metals—even cuts 2x4's! Has same capacity and outperforms the most expensive saws because of ARCO'S exclusive adjustable Circle-Cutter (up to 20" diam.) and Rip Gage. Cuts its own starting hole. "Air-Jet" blows away saw-dust. With blade..... **\$10.95**
 6 Extra Assorted Blades for wood, plastics, metals..... **\$1.95**
 At Your Dealer or order direct on our Unconditional 20-day Money Back Guarantee. Send check, M.O. (ppd) C.O.D. plus post.

ARROW METAL PRODUCTS CO.

DEPT. PM-2, 421 WEST 203 STREET, NEW YORK 34, N. Y.

Stock up — with *Southern*



Save time, trouble and money—stock up your "Home Projects Dept." with Southern Screws... Have 'em when you want 'em in the size you want! Buy Southern—tops in quality because USA-Made! Buy 'em by the name, buy 'em by the box—and save!... At leading hardware and building supply stores everywhere.

Wood Screws • Tapping Screws • Machine Screws
 Stove Bolts • Hanger Bolts • Dowel Screws

NEW SURPLUS

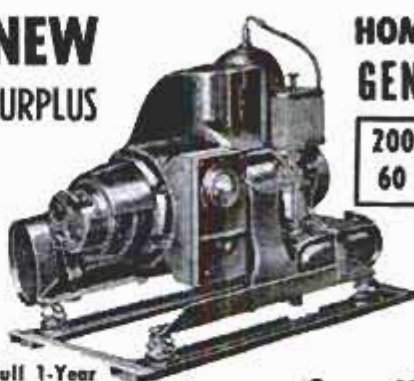

HOMELITE "Carryable" GENERATING PLANT

2000 WATT 60 CYCLE, **\$189.00**

Single Phase, A.C. 115 Volt

PORTABLE!

Fits easily in car trunk

Gov't. cost \$500.00

Save Hundreds of \$ \$ \$

Full 1-Year Guarantee

PAYS FOR ITSELF! Saves time, labor and money. Provides on-the-spot power for CONSTRUCTION, etc. where none is available or expensive to run in. **LARGE ENOUGH** for Flood-lights; Saws; Pumps; and many more labor-saving, heavy-duty machines. Ideal as a stand-by emergency power plant to duplicate house current. Plenty of power for lights, refrigerator, deep freeze, oil burner, radio, etc. Specifications below **CAN'T BE MATCHED** anywhere at this price!

GENERATOR 2000-2200 Watts, 115 Volts, 17.3 Amps., 60 cycle, single phase, AC. Overload capacity well above its rated output. Excellent automatic voltage regulation plus Field Rheostat for even closer adjustment. Built-in Volt Meter.

ENGINE Famous Homelite single cylinder engine. Air cooled; two cycle, Easy rope start. Dust and rain-proof ignition system. Built-in automatic governor. Foolproof pressure vapor lubrication system. Adjustable jet-type carburetor.

This Precision power plant has ball and needle bearings throughout and costs only 80¢ an hour to operate. Satisfaction Guaranteed.

Weights 117 lbs. Overall dimensions: 24" long x 17" wide x 17" high
SUPPLY LIMITED! IMMEDIATE DELIVERY! ORDER FROM AD
 FREE Catalog of War Surplus — Wholesale Equipment
ROBERTS ELECTRIC CO., Dept. PM-755, 849 W. Grand, Chicago 22, Ill.



PAGE FOR TILLING PLOWING MOWING

FULL LINE
2 to 6 HP with complete gear drive and reverse.

Free Catalog
LOW PRICES
EASY TERMS
Over 30 Years Experience

FULLY GUARANTEED!
Over 60 attachments available!

PAGE 1904-A S. 81st STREET MILWAUKEE, WIS.



Exclusive Double-Bearing HEAVY-DUTY PUMPS

IRRIGATE • DRAIN • CIRCULATE • SPRAY
 Up to 7,500 GPH. 3,000 GPH from 25' well. Use 1/4 to 1 HP motor. 1 1/4" inlet; 1" outlet. Stainless shaft.
TYPE X—2 oilless bronze bearings. **\$10.95**
 Won't rust.....
TYPE XB—Ball bearing model..... **\$12.95**
 Postpaid if cash with order. Rush your order today
MONEY BACK GUARANTEE
 Centrifugal and Gear Pumps in All Sizes
LABAWCO PUMPS, Belle Mead 2, N. J.

HOW TO SHARPEN

Tools, skates, garden implements, scissors

Handy 32-page illustrated booklet tells you all about it. Ask for it at your dealer's when you buy a NORTON abrasive sharpening stone. Or send 10¢ to
BEHR-MANNING CO., TROY, N.Y.



WELD IT YOURSELF IN A JIFFY!

Weld, Cut, Braze, Solder; Iron, Steel, Brass, Bronze, Aluminum and other metals safely and easily. Make your wrought iron furniture, porch railings, fences, knick-knacks and other metal specialties. With this fine equipment anyone can do professional-like work with little practice. Tool and equipment breakdowns are annoying and costly. Don't let them bother you. The Dynamic will pay for itself quickly in both time and money and is designed to operate from any properly wired 110 volt AC line.

Order your Dynamic Industrial type transformer Arc Welder for Workshop or Industrial use today. Order from this ad.
 Literature on larger equipment available on request.

DYNAMIC WELDER COMPANY, 1808 S. Federal Street, Dept. D2-B, Chicago 16, Illinois

EASY PAY PLAN

Low down-payment. Pay as you weld. Money back guarantee. Send for details. Complete outfit.
Only \$38.50
 F.O.B. Factory

"Build Your Own" gas drive portable **ARC WELDER**

SAVE \$200 to \$300

A surprisingly low investment puts you in the profitable welding trade. Couple a top performing Hobart generator with a good used auto engine and you're in business with a portable arc welder that lets you weld anywhere, any time.

Earn MORE!

Hundreds of opportunities exist in the welding field. Let's you go after the profitable outside jobs. Get started today and cash in!



"Husky Boy" air-cooled arc welder

Welds anywhere. Easily mounts on truck or trailer for getting to those profitable emergency repair jobs. Light, rugged, compact and air-cooled. Fine for fabrication purposes and tough enough for continuous operation on light or medium production work.

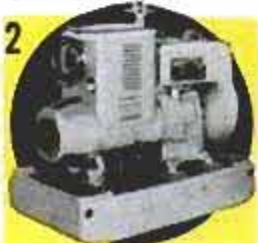

AC welder—AC power

200 amp. combination that you can connect to your own power source. Lets you operate where no power lines are available. Furnishes current for welding and power for running tools, lights, motors, etc. Build your own combination welder and power unit with a good used auto engine.



utility AC shop type welder

Welding Lessons 200 pages fully illustrated Self-teaching \$1.00 Superior performance, economical operation and general serviceability make this a popular model for small shops, implement shops, auto service shops, plumbing and heating contractors, farm welding, etc. Has same features as the big industrial models.



HOBART BROTHERS COMPANY
Box M-28, Troy, Ohio. Ph. FE 2-1223

HOBART BROS. CO., Box M-28, Troy, Ohio

without obligation, send me complete information on:

1. "Build Your Own" 2. "HUSKY BOY" Air-Cooled
 3. A.C. Welder—AC Power 4. Shop Type AC Welder

Name _____

Address _____

City _____ State _____

The step-down dome of the piston determines the quench and squish area as well as establishing turbulence characteristics. The new intake manifold design, as explained above, is used here also.

CHRYSLER CORPORATION

Chrysler engineers have, in the past, produced some advanced V8-engine designs that matched the stylists' current Forward Look in daring and ingenuity. However, the 1958 Chrysler "B" engine marks a return to conventionality.

As mentioned earlier, Chrysler startled the industry in 1951 by mass-producing an unorthodox (by passenger-car standards at least) V8 engine with hemispherical combustion chambers, previously in widespread use only in race cars and aircraft. This design provides excellent volumetric efficiency, but requires a complex valve train with two-rocker-arm shafts for each bank. As a result, it is heavy and expensive.

In 1955 Chrysler engineers introduced a new design for its lower-price lines. This engine had a polyspherical head with a much simpler valve mechanism. Because it has a single rocker-arm shaft, this design is lighter and less expensive. But its performance (compared with the conventional wedge chamber) is not enough better to justify the added cost.

So with the new 1958 engines Chrysler makes the full circle, returning to conventional design and reasonable manufacturing costs.

Chrysler's new engine family has two displacements: 350 and 361 cubic inches.

The smaller size has a bore and stroke of 4.06 and 3.38 inches, the larger size has a 4.12 bore and the same 3.38-inch bore.

A rather bewildering array of carburetor, camshaft and compression-ratio options provides a wide range of rated power outputs.

Although conventional, the new Chrysler engine incorporates features found in the most advanced competitive power plants. It is compact, has no excess weight and is thoughtfully laid out for excellent service accessibility.

Its intake manifold, similar in concept to the Ford design, has a separate sheet-metal cover which acts as the intake-manifold gasket. This is a simple and inexpensive solution to a rather difficult problem of design.

The Bendix electronic fuel-injection system (introduced by American Motors in 1957) is available as an extra-cost option. This system uses electric impulses to open and close solenoid-actuated cylinders for metering fuel.

(Continued to page 294)

Make Thrilling Models With Monogram Hobby Kits!

Authentic, All-Plastic Miniatures of Famous Aircraft,
Ships, Autos, Missiles and Military Vehicles.

Easy to Make and Fun for the Entire Family.



SA-16B Albatross



Snark Guided Missile



U. S. Air Force Snark Guided Missile, with Tractor and Launcher — Cessna 180 Sport Plane.

You Too, Can Be Proud of Your Handiwork! Finest Detail Molded in Every Part!

Once a kid's pastime. Now terrific dad and boy projects and fun for the entire family. Make an authentic, true-to-scale model yourself with a Monogram all-plastic hobby kit. What do you like—airplanes, autos, ships, army vehicles—or maybe the new Snark guided missile? You get them all in Monogram kits—the most authentic, superbly detailed miniatures—scaled from official blueprints. And they cost so little.

All of the easy-to-assemble parts are molded to exact shape in official colors. Authentic colorful decal markings and decorations and illustrated plans included. Every kit includes accessories. Many have working, operating parts. All have two to six sculptured personnel figures in action poses for group realism. Make a model with a Monogram hobby kit today and show off your own handiwork.

Now 54 Authentic Models for Your Fullest Enjoyment

Try one or more of
this selection.



AIRCRAFT

Super G Constellation 98¢
Albatross ARS Rescuer
Plane \$1.49
Piper Tri-Pacer 98¢
Cessna 180 With Floats 98¢
Ford Tri-Motor 98¢
T-28B Navy Trainer 98¢
T-28A Air Force Trainer 98¢
B-66 Twin Jet Bomber 98¢
DC-3 Airliner 98¢
PBX Catalina 98¢

B-25 Mitchell Bomber 98¢
B-26 Invader Bomber 98¢
C-47 Skytrain 98¢

MILITARY VEHICLES

U.S. Army Jeep and Gun 98¢
U.S. Army Truck \$1.49
U.S. Army Half Track \$1.49
U.S. Army Weasel 98¢

SHIPS, BOATS

Dipsy Doodle Speedboat 98¢
Sea Breeze Star Yacht 89¢

Wanderlust Sloop \$1.49
Water Devil Power
Runabout \$2.49

AUTOMOBILES

Cadillac Convertible \$2.49
Indianapolis Racer 98¢
Ford Hot Rod 98¢
Midget Racer 98¢

MISSILES

Snark Guided Missile 98¢

89¢ to
\$2.49
—
38 Kits at
\$1 or less



Monogram

Hobby Kits FOR FAMILY-FUN

At Dealers Everywhere

Monogram Hobby Kits are sold by thousands of dealers across the nation—hobby shops, toy, department and other stores, even in your own neighborhood. Be sure you get a Monogram Kit. Look for the colorful pictorial box with the big "M." Monogram Models, Inc., Chicago 32, Ill.

GET YOUR COPY



**FORTY PAGES,
PROFUSELY
ILLUSTRATED.
JUST OFF
THE PRESS.**

A new, revised and expanded edition of a practical booklet that amateur and professional mechanics and industrial arts teachers by the tens of thousands have used and endorsed. Illustrates scores of ways for doing it better and easier with thirty different hand tools. Tips on proper care and maintenance of tools along with other useful information for the mechanic and hobbyist. The coupon will bring your copy by return mail.

**SEND A DIME OR GET YOUR COPY
FREE WITH THE PURCHASE OF
ANY CRESCENT TOOL.**

Ask Your Hardware Dealer.



To Crescent Tool Co., Jamestown, N. Y.

Enclosed find 10¢ for my copy of
"HOW TO USE HAND TOOLS."

Name
Address

These new Chrysler Corporation engines are used in all De Sotos, some Dodges and some Plymouths.

GENERAL MOTORS

Except for Chevrolet, all General Motors divisions are standing pat in 1958 with their existing engines. There have been improvements and refinements, notably the Pontiac adaptation of in-block combustion chambers to their 1957 designs. However, except for Chevrolet, the basic GM engines remain unchanged.

But at Chevrolet the story is different. Here is a brand-new 348-cubic-inch engine bristling with new design features. With it, Chevy maintains its reputation for combining high performance with lightness and ruggedness in its engines. This new design outshines the 283-cubic-inch V8 of 1957 in every department.

Although displacement is increased sharply (348 compared to 283), the new V8 is about the same height, less than two inches longer and wider, and only a little over 100 pounds heavier than the smaller design.

The cast-iron block is conventional. However, the top faces of the block are cut at an angle of 16 degrees to provide a fully machined in-block combustion chamber similar to the one described in the Edsel-Mercury-Lincoln line. Chevrolet is the first low-price car to have this feature, which is certain to become universal.

The stamped rocker arms (pedestal-mounted) are continued. However, an exceptionally high rocker-arm ratio of 1.75 to 1 is used.

The new engine is available in a 250-horsepower version with a single 4-barrel carburetor or a 280-horsepower version with three 2-barrel carburetors.

There's lots of life left in the piston engine. It's hard to imagine another design getting more power for less money than the original, almost-primitive piston inside a cylinder—a piston that goes up and down to make wheels go around. ★ ★ ★

1958's NEW ENGINES

Ford's FET engine:

332 cubic inch—Ford Fairlane 500
352 cubic inch—optional on Fords
361 cubic inch—Edsel Ranger-Pacer

Ford's MEL engine:

383 cubic inch—Mercury Monterey-Montclair
410 cubic inch—Edsel Corsair-Citation
430 cubic inch—Lincoln and Mercury Park Lane

Chrysler's "B" engine:

350 cubic inch—optional on Plymouth and Dodge; standard on De Soto Firesweep
361 cubic inch—De Soto Fire dome—Firelite

Chevrolet's new engine:

348 cubic inch—optional all models

ORDER DIRECT FROM AD

SURPLUS AT FRACTION OF GOV'T COST

TOP VALUE SPECIALS

SHOP BY MAIL AND SAVE AT GROBAN'S

SATISFACTION GUARANTEED

QUICK HEAT STEWART-WARNER PORTABLE HEATERS
DELIVERS 100,000 B.T.U.!

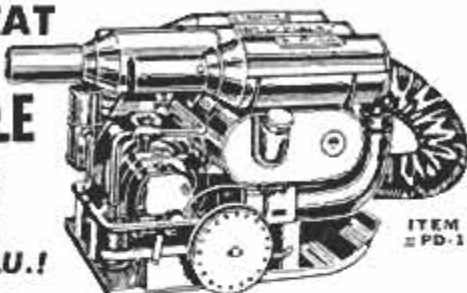

- FOR HEATING:
- Buildings, barns, workshops, basements
 - Pre-heating engines and equipment
 - Thawing fuel lines, pipes
 - Drying Grain, Plaster

Delivers 100,000 B.T.U. The cheapest, most convenient portable heater on the market! Mounted on sled for use on ice or snow—also has retractable wheels for easy one man handling.

Consists of 1½ H.P. air-cooled Lauson gasoline engine driving super-charger and turbine type blower. Heat delivered through 3 long flexible ducts, regulated by damper controls. **NO FLAME — NO FUMES.** Heater and engine burn regular gasoline. 10 gallon capacity fuel tank. Thousands in use by Air Force, on farms, by contractors, industry.

FULLY GUARANTEED — REBUILT BY U. S. AIR FORCE
READY TO RUN — EASY TO OPERATE

Net Weight 200 lbs. Shipping Weight 300 lbs.
Dimensions: 48" L x 30" W x 30" H
Government acquisition cost \$500.00

SPECIAL SALE PRICE **119.50** F.O.B. CHICAGO or SEATTLE (Your Choice)

GENERAL ELECTRIC HIGH PRESSURE AIR COMPRESSORS

Output — 1000-1500 Lbs. per Sq. In. • For filling aqua-lung tanks • For air brush work • Filling accumulator and air-oil shock struts • Cleaning and testing spark plugs • Hundreds of other uses.

Built by General Electric to exacting U. S. Air Force standards. This two cylinder, two stage air compressor rated 1000 P.S.I. output, may be modified to deliver 1500 P.S.I. Driven by 27 volt D.C. electric motor. As released from U.S.A.F. in used, serviceable condition. (Covered by our 30-day guarantee.) 14" L x 9½" H. Shpg. Wt. 15 Lbs. U. S. Gov't

ITEM #461

High pressure air receiver tank for G.E. compressor. Shpg. Wt. 2 Lbs.

15.00 F.O.B. Chicago
4.00



A \$15.00 Value 37-Piece **METAL STAMPING SET**
STAMPS NAMES, NUMBERS, ON WOOD OR METAL

ITEM #390-B — FULL ALPHABET, A-Z, NUMBERS 1-9, "6", AND PERIOD. PRECISION HAND TRIMMED, deep cut, hardened TOOL STEEL STAMPS—IN FITTED EASY ACCESS CARTON. Made to rigid U. S. Army specifications.



Only \$5.50 per Set
2 FOR 10.00 PPD.

½ H.P. ELECTRIC MOTOR 12-24 VOLTS D.C.



ITEM #465—Ideal to power fans, blowers, pumps, gear boxes, etc. on trucks, cars, marine equipment, golf buggies—operating on 12 or 24 volts. Built at great expense for the Signal Corps. by Air Associates, this ball bearing motor is rated—½ H.P.—3800 R.P.M.—20 Amp.—27.5 Volts. Will deliver ¼ H.P.—1900 R.P.M.—with 12 volt input. Standard ¾" shaft—4 bolt mounting flange. Dimensions: 6½" x 4" x 4". Shipping Weight 10 lbs.

COST U. S. GOV'T. \$78.00 A SPECIAL AT ONLY **8.95** F.O.B. Chicago

BRAND NEW! U. S. NAVY COST \$92.00

SELF-PRIMING — BRONZE 1" GEAR PUMP



FOR — • Sprinkling • Basement Draining • Fuel Transfer • Insecticide Spraying

BUILT TO EXACTING U. S. NAVY STANDARDS

FEATURES: • Ball bearing construction • NEOPRENE Pump Gears • Monel Shaft—1" Dia., 2" long • Sealed steel idler gears.

OUTPUT: 20 Gal. per Min. 100 lbs. per Sq. In. at 1500 R.P.M.—8 Gal. per Min. at 550 R.P.M. • Standard Base Mounting—¾" bolt holes • Grease cup included.

• 1" Pipe Thread Ports. • Dim. 11" L. x 5" H. x 4¼" W. Shpg. Wt. 16 lbs. **26.50** EA. Limited Quantity Order Direct 2 for 50.00 F.O.B. Chicago

FREE! NEW 1958 CATALOG 60 VALUE-PACKED PAGES of unsurpassed War Surplus and newly manufactured Equipment. Bargains for farm, home, factory, workshop. Write letter today.

Send Payment Or Purchase Order Today For Phone Orders Call WEBSTER 9-3793

GROBAN SUPPLY CO. DEPT. PM-2
GROBAN BUILDING

1139 S. WABASH AVE. CHICAGO 5, ILL.

America's Finest Cultivator at anywhere near its small price!



only **109.50** complete



Now you can no longer afford to do hard spade and hoe work. This powerful (2½ h.p.) self-propelled tiller-cultivator makes gardening a pleasure! Has a beautiful self-propelled 22" twin-spindle rotary mower attachment you can hook on in seconds—for just \$44.50; and the Safe-Speed Edger for only \$27.50. Write today for free folder and nearest dealer's name.

ROTO-HOE, Dept. P-19, Newbury, Ohio

MECHANIC'S FAVORITE!



Here's the number one choice—



It's the Huot Model 100 DeLuxe Chest—custom designed for mechanics who want the finest protection plus maximum accessibility for fine tools. Eleven drawers—seven of them cork-lined for protection. Three heavy-duty drawers for large tools—1 extra deep drawer for power tools. Single latch locks entire cabinet. Two-tone oil-resistant finish. Free bulletin describes 12 tool chests.

HUOT MFG. CO.

555 No. Wheeler Street, St. Paul 4, Minnesota



DON'T THROW IT AWAY — FIX IT WITH
Plastic Steel® 80% STEEL

AS EASY TO USE AS MODELING CLAY. Hardens in two hours — holds permanently. Can be filed, sanded and painted. PLASTIC STEEL bonds iron, steel, brass, aluminum, wood, concrete, etc., to itself or each other.

LEAKING RADIATOR? — PLASTIC STEEL mends radiators, pipes, tanks and appliances in minutes. No special tools needed. Requires no heat or pressure — will harden under water.

CAR REPAIRS — Save money on auto repairs with PLASTIC STEEL. Fix torn fenders, cracked engine blocks, leaking gas tanks.

PLASTIC STEEL has a million uses around the home, garage or farm. 3 convenient home kits — 98c, \$1.89 and \$3.95 AT LEADING HARDWARE STORES.

DEVCON CORPORATION
 175 ENDICOTT STREET, DANVERS, MASS.



Grooved Vertical Siding

PANELS 4' x 8' TO 4' x 12' WITH GROOVE-LAP JOINTS

Homasote GVS gives you a beautiful linen-like surface, without visible joints. Every 8" there are deep, 3/8"-wide grooves running lengthwise. The foolproof, weather-tight joint and the large panels make application fast and professional.

With GVS you also get the "hidden values"—weatherability, durability, superior insulation. Homasote has been used for years on top-quality exteriors. It holds paint better than wood — and can even be left unpainted until convenient.

The Homasote Handbook has the facts and figures

and the know-how on any phase of building or remodeling. See your lumber dealer—or use coupon below for data on Homasote Products of interest to you.

EASI-BILD® PATTERNS help you build toys, furniture, tool sheds, cabinets, garages, and structures of many kinds — with professional ease. Not blueprints, but illustrated, quick-reading plans. See them at your lumber dealer's; for example, look at Pattern #89, Lean-To Storage Shed—50¢.

*T. M. Reg. Easi-Bild Pattern Company

HOMASOTE COMPANY, Trenton 3, N. J.

Send me literature checked. I enclose 10¢ for handling.

Exterior Finishes Textured Homasote
 Homasote (72-page) Handbook Underlayments

Name
 Address
 City Zone State B-3

IN CANADA: TORONTO, ONT.—P.O. Box 35, Station K—MONTREAL, P.Q.—P.O. Box 20, Station H

A 1½-Car Family

(Continued from page 171)

initial cost is high (too high, the women say, being slightly more than \$1000).

The main reason for buying one of these cars rather than a lower-price old second-hand car would be the virtual absence of upkeep. There is no antifreeze to buy, only one spark plug to replace, no complicated parts to act up (the Heinkel doesn't even have a choke—you simply kick the gas pedal a few times to pump gas into the cold engine). Once the hurdles of initial cost and annual insurance are cleared, the car could be operated under the miscellaneous portion of an average food budget (probably for about 75 cents a week).

Serious Limitations

But, the women agree, there are serious limitations to the bubble cars.

The front-opening door is a clever solution to a tough engineering problem, but it is hardly a convenience. You have to lift yourself out with the strength of your arms. The Isetta has the better arrangement. Its steering column is jointed and it swings outward as the door is pushed open. The wheel becomes a huge door handle. The Heinkel wheel stays put and the driver has to slide around it to get out, pulling and pushing himself up with his arms. Heavy and older people are virtually prisoners in the cars until they learn how to exit. In no case, can you get in or out gracefully.

Inconvenient for Shopping

Another shortcoming is the location of the parcel-carrying space. In the Isetta particularly there is no place to put large sacks of groceries if more than one person is in the car. If you put several sacks of groceries on the parcel shelf behind the seat and then make a sudden stop, you are likely to end up with cans and bottles all over. The Heinkel does have space behind the seat so sacks can be put on the floor, but it is awkward to get at. It is apparent that when the cars were designed this grocery-toting activity was not considered.

If the housewife takes two or three children with her, the problem is magnified many times. One of the women who shops at the supermarket once a week was unable to pack all her groceries in either car when she had her three children along—obviously a serious limitation.

Driving the cars is something that takes a little time to master. Steering is extremely fast and there is no wasted wheel turning. You point the car where you want to go and it turns in a hurry. Shifting is

with the left hand and at first it was difficult but soon skill was acquired. Both cars require frequent shifting. The Heinkel was considerably easier to shift than the Isetta, principally because of the design of the shift quadrant.

No Complaints on Ride

Riding qualities are poor by big-car standards, but none of the women complained of being uncomfortable. For an around-town car, this was considered unimportant. Noise levels are high in both.

One serious drawback to the Heinkel is the fact that short persons can't reach the pedals without using a thick cushion behind them. Closing the door on the Heinkel was also difficult for the short driver.

All four women agreed that the car would be better as the car for their husbands to drive to work (all husbands had comparatively short drives to their places of business). Both the Heinkel and Isetta are an ideal solution for the businessman who drives a few miles a day to his office or store or for the commuter who drives to a station.

All agreed that the awkwardness of getting in and out with large packages, of lifting babies in and out, of getting themselves in and out several times during a short trip to several stores, more than offsets the advantages of the small size.

Fits in Garage

An important advantage mentioned by one tester is the fact that the tiny car can be tucked alongside the large family car in the average garage. In effect, this makes a two-car garage out of a 1½-car building.

In summary, the four feminine test drivers felt that the bubble cars did not answer all the problems. It did not do all the things they felt an "errand" car should. However, with a small amount of redesigning, especially in the ease of entry and exit and the location of luggage space, perhaps it could be made to do the job and, as they all admit, a super-economical car could be the answer to a housewife's prayer. ★ ★ ★

B-52 Tail Gunners Get TV Sky Scanners

Tail gunners in jet B-52s will be moved forward near the rest of the crew in the near future and sight their .50-caliber guns by closed-circuit television. Two cameras will continually scan the sky for enemy planes. Electronic controls already on the B-52s track the target and tell the gunner when to squeeze the trigger. The purpose of the TV scanners is to relocate the gunner in a "more favorable environment."

LITTLE SHAVER

\$1.25



Ideal for the handyman or modelmaker
— heavy duty cast iron construction



SARGENT WORKSHOP TOOLS

DIVIDERS

Extremely accurate,
free & tension ad-
justments
Carded 6" \$1.60
8" \$1.85

SQUARES

Gen'l purpose, raf-
ter & essex board
measure, Steel &
Duralumin
From \$.90

PLANES

Professional quality
planes at moderate
prices—jack, smooth
& block
Smooth from \$5.90
Block from \$1.95



At your local hardware dealer
—write for descriptive folder.

S A R G E N T
HAND TOOL DIVISION • NEW HAVEN 9, CONNECTICUT

YOUR TIME IS IMPORTANT!

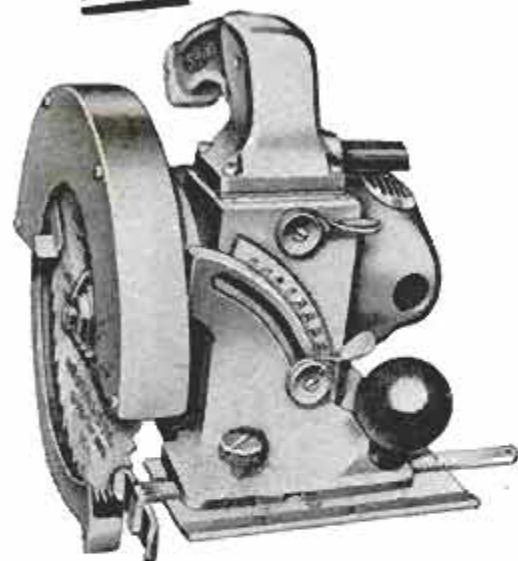

Time is money. And that's the sound dollars and cents reason for owning this modern, powerful, Sioux Electric Saw.

Home projects take shape in a hurry—like the new recreation room, the new garage, the extra bedroom.

Your Sioux Saw hurries things along, and pays for itself in a hurry too!



Look for SIoux in the yellow pages under "Electric Tools"

Write for Free Catalog



ALBERTSON & CO., INC. SIOUX CITY, IOWA, U.S.A.

Get out and GO!

**Cushman®
EAGLE**

*is for
you!*



Distinctively designed for flashing beauty; ruggedly built for a smooth, soaring ride, safety and service. Powered by the famous Cushman Husky 4-cycle engine. Up to 50 miles per hour, up to 100 miles per gallon. Ride it anywhere, everywhere.

Dealer inquiries invited

Ask your dealer for a **FREE DEMONSTRATION** or Write for new **FREE Booklet** today

CUSHMAN MOTOR WORKS, INC.

A subsidiary of Outboard Marine Corporation
968 NO. 21st • LINCOLN, NEBRASKA

Which Grade of Gas is Best?

(Continued from page 177)

should look something like one of those on page 177. The top pad shows typical test results on a late model, high-compression car. Its ignition can be advanced with premium gas far enough to improve acceleration on the test run about three miles per hour over regular gas. Many motorists may consider this worth the extra cost.

In such a car, premium might give more miles per gallon, but probably fewer miles per dollar. Premium will be more expensive to use, but will give better performance—enough better to warrant the cost.

With its ignition $\frac{1}{8}$ -inch advanced, this car develops maximum acceleration and runs on premium gas without knocking. There would be absolutely no benefit in using any higher octane number, such as in the new superpremium fuels. You would be wasting money because all the super fuel would do is allow added spark advance which, the table shows, will not improve performance.

The lower pad shows results such as might be obtained from a low-compression engine. Here, obviously, buying premium gasoline would be throwing money away.

Running on regular gasoline with the spark as it was originally, the car develops maximum acceleration and probably gives maximum gasoline mileage. If the owner bought premium or superpremium gas and advanced the spark as far as possible, he would actually lose power and acceleration as well as money.

Your individual tests will tell you what grade of gasoline you need and how timing should be set.

However, when you get a new set of distributor points, the setting may have to be changed. But with some advance planning you won't have to rerun the tests. After you complete the tests outlined above and set the timing as you want it for the gas you want to use, have a mechanic read the marks on the crankshaft pulley at the front of the engine with a stroboscopic timing light. Write down this timing setting as a permanent record. Then whenever you have new points installed, tell the mechanic to set the timing at these same marks. (Of course, when your car gets older, you may have to move up a grade or retard the spark as carbon accumulates.)

If you don't have a permanent record of the setting, mechanics will reset the timing the way the car manufacturer recommends without bothering to check your car by a test. This may be quicker, but it is not likely to produce the best timing for you, your car or your pocketbook. ★ ★ ★

"How to handle your car to get better gas mileage"



"Save gas right from the start. Depress accelerator halfway before starting. Let your engine idle at least 30 seconds before moving. Stay under 30 mph until engine warms up."

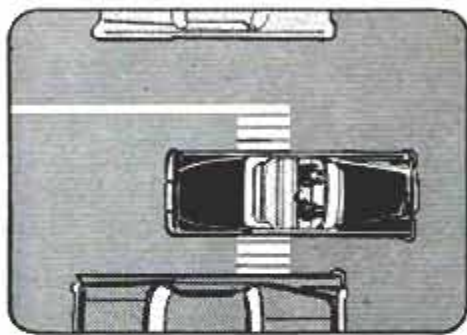

"Don't race away from stops. Accelerating hard in low gears wastes gas, and it's not worth the wear on your engine. Take it from me, you'll get there faster by taking it easy."

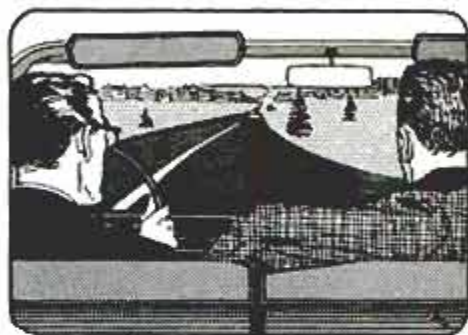

"A pro always drives with a steady foot. Uneven acceleration—slowing, then speeding up—burns far more fuel than cruising at a steady pace. And it's far safer, more relaxing."



"Keep well back of the car ahead. You can maintain steady, thrifty speeds, avoid sudden stops and gas-consuming starts. And you'll avoid situations that result in accidents."



"Take a tip from a pro. Keep your car at peak efficiency. If you drive in traffic, it's a good idea to have your carburetor and other vital engine parts checked every 8,000 miles or so."



"Remember, your carburetor is the heart of your performance. Periodic checks and adjustments by a factory-trained mechanic can save you money in improved gas mileage."

Better gas mileage is usually in your hands. Check your own driving habits. Then, have a Rochester Carburetor specialist diagnose your engine for peak performance. He's factory-trained in the precision maintenance of your carburetor. And he'll help you get top efficiency . . . and extra miles from every gallon of gas. *Rochester Products Division of General Motors, Rochester, New York.*

Maurice Abel top professional driver, points out how your gas consumption goes up sharply with every increase you make in driving speed.

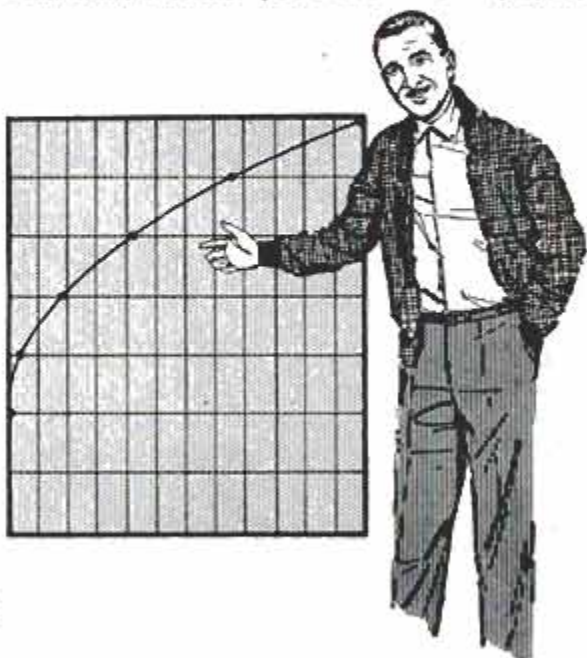

ROCHESTER CARBURETORS

Specified as original equipment on more new cars than any other carburetor



NEW BELSAW MULTI-DUTY POWER TOOL

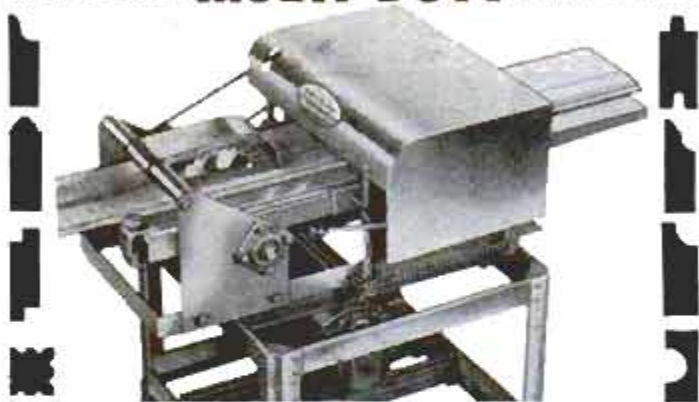

Now you can use this ONE power-feed shop to turn rough lumber into high-value moldings, trim, flooring, furniture ... ALL popular patterns.

RIP... PLANE... MOLD...

separately or all at once by power-feed... with a one horsepower motor. Use 3 to 5 HP for high speed commercial output.

FULLY SAFE - GUARDED, anti-kickback design.

Low Cost... You can own this money-making power tool for only \$30.00 down payment.

Write TODAY for free Catalog

BELSAW POWER TOOLS • 908 Field Bldg., Kansas City 11, Mo.

EVERYTHING FOR THE WOODWORKER AND HIS WORKSHOP

SHIPPED THE SAME DAY
THE CONSTANTINE WAY!

World's oldest and largest supplier of rare and fancy imported and domestic fine woods, tools and hobby materials at lowest prices. This new book is full of bargains in cabinet woods, lumber, plywood, veneers, inlays, handings, carved wood trim, mouldings, upholstery supplies, tools, unusual hard-to-get cabinet hardware wood finishing and how-to-do-it articles, plans, patterns, wood identification panel. Loaded with natural color. Newest, finest book offered. Send 50¢ today (refunded on 1st order) for this manual and get "Chips and Chats," a Constantine publication FREE for one year.

NEW SHIP SAME DAY SERVICE*

Don't hold up a project—no delay or wait for any item. New plant and facilities assure your order shipped the day received. No extra cost the Constantine way. Send today! **ALBERT CONSTANTINE AND SON, INC., 2056H Eastchester Road, New York 61, N. Y.**



MAIL COUPON TODAY!

• Albert Constantine and Son, Inc.
• 2056H Eastchester Rd., New York 61, N. Y.
• Enclosed 50¢ (refunded on 1st order). Send Catalog and FREE "Chips and Chats."

• Name _____
• Address _____
• City _____ State _____

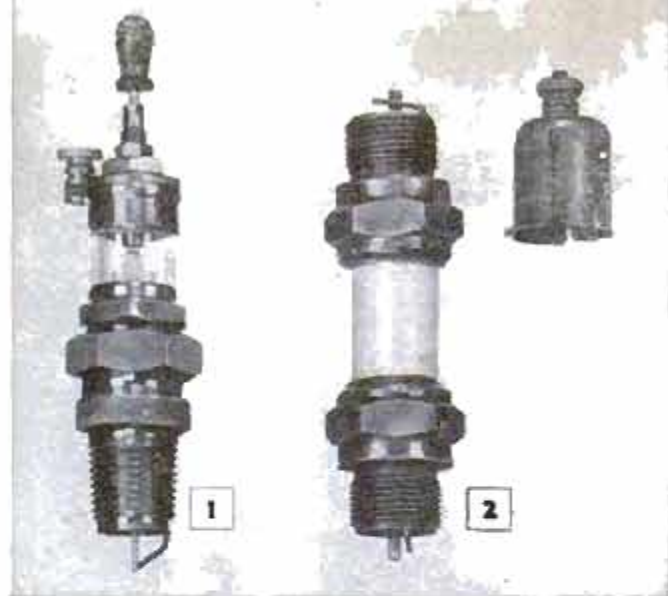

Evolution of Spark Plug Features Fans and Windows

Ideas for better spark plugs have fired the imagination of inventors since the days of the first horseless carriages. Literally thousands of versions of the spark plug have resulted, a few of which were real "Rube Goldbergs." One plug, produced before World War I, Fig. 1, had an auxiliary gap which could be opened by an insulated handle at the top. It also had a window so you could see whether the jump gap was open or closed. Another bargain of its day, Fig. 2, was a plug which could be turned upside down if one end failed. For early do-it-yourself motorists, a plug, Fig. 3, was built with a device to unfasten the inner-core assembly if it fouled. Another idea, Fig. 4, was a fan-flame design with an electrode that rotated like a propeller. An invention, Fig. 5, for self-priming plugs of 40 years ago ended the flame problem for owners who forgot to close the priming valves before spinning the crank. The plug automatically shorted if the valve was open.

Photos courtesy Champion Spark Plug Co.

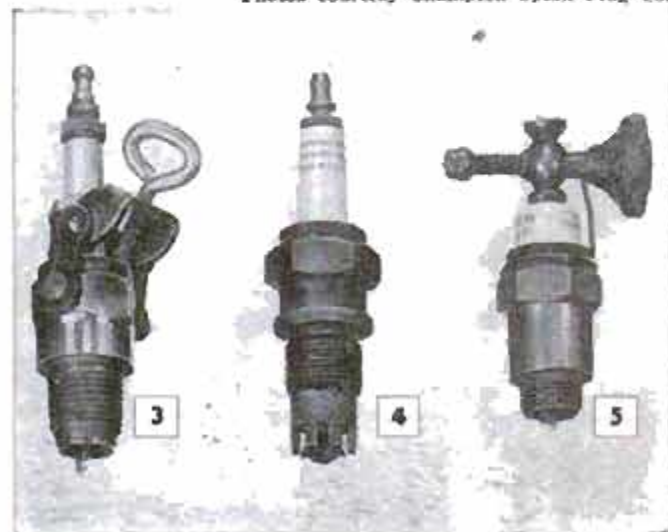

BUILD YOUR OWN ARC WELDER, LIGHT PLANT OR BATTERY CHARGER \$37.50
 Kit incl. 1 Navy NEA-5 Gen. combination AC-DC type. AC 115 V. DC 24 V., 200-300 Amps. 2 complete generators in 1, yet no larger than reg. gen. Ideal for home, shop and farm lighting plants. Delivers 1200 Watts AC, DC side for charging batteries, welding and operating war surplus motors. Also in kit: 2 Voltage Regs., AC & DC, Reverse Current Relay, 30' new welding cable, Rheostat, Electrode Holder, Toggle Switch, Welder's Shield, Wiring Diagram for kit. Wt. under 100 lbs. Approx. GOVT. COST \$650. Kit—\$37.50 Navy NEA-5 Gen. as above, purchased separately, \$23.50.

ARC WELDER KIT—\$26.00 Build your own complete make-up package incl. 1 Aircraft DC Gen. 200 Amps. 24 V.; Rheostat, Toggle Switch, 30' new welding cable, Electrode Holder, Welder's Shield, Voltage Reg. Simple instruction wiring diagram. Wt. under 100 lbs. Approx. GOVT. COST \$475. Like new, perfect. All units guaranteed pre-tested. \$26.

R1 GENERATOR KIT Jack & Heintz or GE. Rated 300 Amps. 24-32 V. With same items as above. Approx. GOVT. COST \$600. Complete 60 lb. kit—\$38.

FAMOUS NAVY MK14 AIR COMPRESSOR
 Great for paint, tree and termite spraying, air brushing, filling tires, etc. Dual and remote control elec. receptacles. 115V 60 cycle AC 1/3 H.P. Westinghouse Motor. Direct drive. Draws 10" of vacuum. Water- and Explosion-proof. Built-in air filter, adjustable pressure setting up to 47 lbs. Built-in pressure gauge. Self-contained switch. Mounting brackets. Wt. 66 lbs. gross. Approx. GOVT. COST \$585. Like NEW. Only \$19.95. With steel hand cart (rubber wheels) specially constructed for mounting this unit, 15' rubber air hose, 6' extension cord with plug & fittings. Wt. 76 lbs. Complete \$26.90.

6' BEAM COMPASS Fits in your vest pocket. Draws ellipses, spirals, arches and circles up to 12". Contains stretch-proof linen line on aluminum encased reel. NEW. Complete with 3 special push-pins—\$3.00 ppd.

ADJUSTABLE QUADRANGLE Replaces many triangles. Full quadrant 0° to 90°, calibrated to every 30 min. of arc, thus a reading or setting to 15 min. is easily obtained. Set arm to any degree of triangle. Roof Pitch Scale, Percentage Slope Scale, Sine Scale. Every edge a drawing edge. NEW. \$7.50 ppd.

Q.E.D. FLAT BEVEL SCALES
 8 scales on 1 side. Standard size scale 13 1/2" long x 1 1/2" with 100' reading on 1/8" and 50' on 1/4" scale (need not be turned over to find desired scale) graduated in 1/8, 1/4, 3/8, 1/2, 1, 1 1/2 and 3 inches to the foot. \$2.75 ppd. Pocket size scale is 7 1/2" long x 1 1/2" with 52' reading on 1/8" and 26' on 1/4" scale. All edges parallel. Can be used as a straight edge. In leather sheath—NEW—\$2.00 ppd.

HEAVY-DUTY RHEOSTAT Ideal for regulating voltage on electric welders. Rated 5.75 Ohms, 100 Watts with double windings & dual female 25 amp., 125 V. receptacles. 7" hi x 3 1/4" D. Shpg. wt. 2 1/2 lbs. Approx. GOVT. COST \$25. Brand New. \$2.25 ppd.

REVERSIBLE RATCHET WRENCH
 Hi torque. Delivers tremendous leverage. 4' handle with reversible ratchet, 4 hexagon nut sockets, 2 3/8", 2 9/16" & 3 1/8". Mfd. by Lowell. Approx. GOVT. COST \$215 per set. Wt. 50 lbs. NEW. Only \$9.95 per set.

ELECTRIC PUMP WITH CONTROL UNIT
 Runs on 12 or 24 V. Centrifugal type. Pumps 500 GPH. Complete with on and off switch rheostat, 2 speeds (hi & lo). Mfd. by Ingersoll-Rand. Shpg. Wt. 7 lbs. Approx. GOVT. COST \$195. NEW. \$8.95.

BENDIX AIRCRAFT COMPASS For boats, trucks, cars. Pioneer Instrument Co., div. Bendix. Mark VIII. Increments of 1°; 360°. Major graduations every 5°. Magnetic. Can be lighted with 6, 12 or 24 volt standard bulb. Flush panel mounting. Floating card. Tested in our own inst. lab. Approx. GOVT. COST \$250. Perfect. \$10.95 ppd.

ASTRO COMPASS MARK II Used by USAF & commercial airlines. Makes pelorus & azimuth circle for air or marine navigators. Great for astronomers. Incl. carrying case. Tested for accuracy in our own lab. Approx. GOVT. COST \$400. Now \$10.95.

BENDIX GEROTOR PUMP & MOTOR
 Use wherever fluid pumping required. Excellent for hydraulic installations. Has 3/4" pipe connections, built-in relief valve adjustable up to 1500 lbs. Max. cap. 6 GPM. 1 1/2 H.P., 24 V. motor. Use on 12 to 36 V. Approx. GOVT. COST \$350. NEW. \$10.95.

140-1 REDUCTION GEAR For beaching boats, winches, hoists. Ideal for motor in golf or boys electric car. Built-in (removable) DC motor & clutch. Hi torque, lo speed. Runs on 6-12 or 24 V. Wt. 65 lbs. gross. Approx. GOVT. COST \$300. Like NEW. \$12.00. *225-1 REDUCTION GEAR, as above—\$13.50.

EXPLOSIVE RIVET & BLOW TORCH KIT
 Contains 300 assorted Dupont Explosive Rivets, 1 set of 9 fractional drills, 1 Butane Blow Torch with extra cartridge—everything needed for blind riveting. Torch can also be used for precision soldering, brazing, etc. 3500° pinpoint flame. Approx. GOVT. COST on rivets alone. \$90. Complete kit \$5.95 ppd.

DUPONT EXPLOSIVE RIVETS Essential wherever blind riveting required. 1/8", 5/32", 3/16". Round & flat heads. Approx. GOVT. COST 32c ea. 1,000 assorted for only \$5.00 ppd.

CHRONOMETRIC TACHOMETER Built to U.S. Navy & Air Force specs. Standard brand. For counting revolutions per min. for any rotating shaft. Can be used on speeds up to 3000 RPM. Accuracy to 1/10 of 1%. Complete with male & female tips & shock-proof case. GOVT. COST \$87.50. NEW. Only \$19.95 ppd.

PROPELLER BAROMETER A precision weather instrument mounted in center of genuine rock maple radio drone "prop". Perfect for den, trophy room, boy's room. Smooth, highly varnished propeller, 30" tip to tip, cost govt. approx. \$57... now, with barometer inserted, only \$9.95 ppd. Propeller separately (can be used to operate ice sleds, etc.). NEW. \$4.95 ppd.

SPECIAL ON \$4770 NAVY AIR-COOLED POWER UNITS Tremendous power package. Can be used as a portable or stationary unit. Makes terrific welder. 30D-1A Lawrence. 24V. 2 Cylinder opposed 4 cycle 10 1/2 H.P. Complete with various generators. Net wt. 180 lbs. Gross wt. 250 lbs. Like NEW. With 140 Amp, 24 V. Gen. — \$125. With 200 Amp. Gen. — \$137.50. With AC-DC NEA5, DC side 24 V., 200 Amps.; AC side 10.5 Amps. 800 cycle — \$142.50. 300 Amp. Gen. — \$142.50.

MICROMETERS Black crackle finish frame. Easy-to-read graduations in .001. N.W. 0-1" cap. \$2.69 ppd. 1-2" cap. \$3.76 ppd.

NEW! TERRIFIC! 1958 CATALOG! Thousands of bargains in war surplus & other items. Hundreds of pictures. Send 25c for your copy today! Ppd. prices in USA only. Other prices FOB Culver City, Calif. Send cash, check or money order. 50% deposit on COD.

AIRBORNE SALES CO., INC. DEPT. PM 258
 8501 Stellar Drive, Culver City, Calif.

EARN GOOD MONEY—Spare or Full Time IN A BUSINESS OF YOUR OWN...

SMALL INVESTMENT — NO EXPERIENCE NEEDED
 Thousands of men are making big money in their own business. You too, can have a fine income with an assured future in spare or full time with the Universal lawn mower grinder. Investigate our success plan now, it includes everything you need plus facts on how others have earned over \$3,600 in one season, working part time. Act now! Mail coupon today!

ROGERS
 MANUFACTURING CO.
 Lindsey, Ohio

ROGERS MFG. CO., Dept. M28, Lindsey, Ohio
 Gentlemen: Rush me FREE details on easy inexpensive way to get into my own business.

Name _____
 Address _____
 City _____ State _____

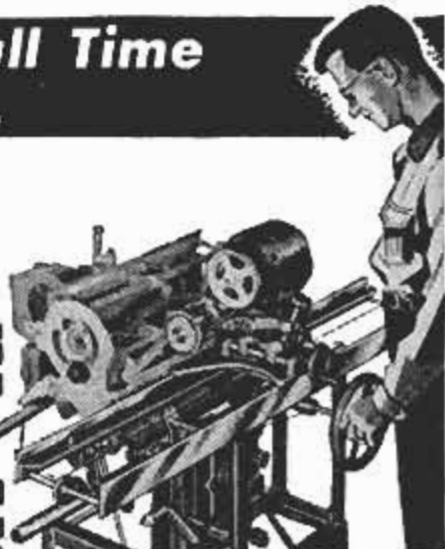



FOUND!

 the keys to your repair problems!

THE ORIGINAL DURO PLASTIC ALUMINUM

Hundreds of uses for this amazing metal in putty form. It's mixed, ready to use. Seals, solders, repairs. Applied cold, hardens into metal. Be sure you ask for DURO. **\$1.00**
LARGE 5-1/2 oz. tube only

DURO PLASTIC RUBBER

Amazing NEW latex rubber in putty form. Chemically vulcanizes, molds to any shape. Waterproofs, rustproofs, insulates, repairs, caulks. Repairs ANYTHING made of rubber. **\$1.00**
LARGE 4 fl. oz. tube



\$1.29 in Canada. Available from all better hardware, auto accessory, variety and paint stores. For further information write THE WOODHILL CHEMICAL MFG. CO. 1391 E. 34th St., Cleveland 14, Ohio

BIG VALUE!

Red flashing fresnel top — Brilliant Spotlite

\$5.25
Less Battery

AT LAST! Quality lantern heads at economy prices... for use with new double-pack 6V lantern batteries. Four models... Delta Electric Company, Marion, Ind.

Delta POWER-HEAD ELECTRIC LANTERNS

BEAT HIGH BUILDING COSTS

Build a Liberty Home yourself... or direct its construction



It's Easy to Save Thousands of Dollars

You save from \$2000 to \$5000 depending on the home you buy and the amount of work you do yourself. You save on material, contracting, labor costs; middleman's, architect's fees.

46 MODERN DESIGNS • Spacious 2, 3, 4 bedroom plans, 1, 1 1/2 baths. Brick, siding or shake exteriors. Build with basement or utility room.

YOU GET finest quality pre-cut framing, finish lumber; nails, hardware, paint, windows, doors, roofing, siding, etc., complete plans.

ONLY 10% DOWN FINANCES MATERIALS

Send 50c for colorful, illustrated, 56-page catalog

LIBERTY HOMES

Lewis Manufacturing Co. • 1282 Lafayette Ave. • Bay City, Mich. Enclosed is 50c for your big Liberty Homes Catalog

NAME _____

STREET or R.F.D. _____

CITY _____

STATE _____



"FIRE UP"

YOUR ENGINE AT ALL SPEEDS WITH AUTO-LITE SPARK PLUGS WITH

POWER TIP

LOOK FOR THE PROTRUDING TIP!

WORKBENCH PARTNERS

POPULAR MECHANICS for helpful "how-to" information and YOUR DEALER for quality products that do the job best. He stocks and displays nationally advertised products—products advertised in POPULAR MECHANICS

PM TAG of INTEGRITY

\$250,000 IN ORDERS FROM SMALL CLASSIFIED AD

Yes, you read the above statement correctly. Unbelievable? Of course—BUT IT'S TRUE. I'll gladly send you positive proof. Yes, the actual letter to prove the above statement. Write, F. W. Johnson, Class. Adv. Mgr., Popular Mechanics Magazine, Room 601, 200 E. Ontario, Chicago 11, Ill.

DRILL STAND & SHARPENER



Fits all portable drills; converts drill to bench grinder. Sharpens round shank drills from 3/32" to 1/2" diameter. Grinds 4 different drill point angles. Recessed guides eliminate use of protractor or fussy set-up work. Stand, \$6.95. Sharpener, \$2.95. Complete set includes stand, sharpener, wheelguard, clamp for drill, grinding wheel, arbor... **\$8.95** PPD.

SAW SHARPENING IS EASY



Super Filer No. 11 joints and sharpens hand and circular saws 6" to 10" with all teeth correct in height, depth, pitch, bevel. When file hits steel roller, teeth are finished. Saw runs true with no side pull. Includes 8" file. **\$9.95** PPD.

"TRU-CIRCLE"

saw set automatically sets teeth at 10° or more. **\$2.95** PPD.



SUPER SAW FILER No. 6



DOWEL CENTERS

Centers inscribe exact location for opposite holes. Pairs for 1/4", 3/8", 1/2" holes. **\$1.00** PPD.

Automatically controls depth, angle, pitch for all saws. Precision made and calibrated. Use in any vise or clamp. Includes 8" file. **\$6.50** PPD.

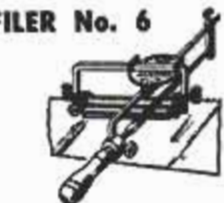

SEND FOR FREE CATALOG

MONEY BACK GUARANTEE
A. D. McBURNEY, 5908 Hollywood Blvd., Hollywood 28, Cal., Dept. A-28

POPULAR MECHANICS

BUILD WELDER OR LIGHT PLANT

Instruc. incl. TYPES AMPS VOLTS PRICE
G1 160-250 amps, 30V, New \$17.50 used \$12.95
G.E. 200 Amps 30 V New \$18.50 Used \$14.50
R-1 J. & Heints, G.E. or Ford 300 Amp. \$24.50

V-BELT PULLEY KIT. Fits R-1, P-1, G-1 & AC-DC generators; has 2 ball bearing blocks with high speed bearings, three groove V-pulley. Dr. shaft 8" long & flex coupling \$17.50

AC-DC WELDER KIT #511 G. E. GENERATOR

Makes A.C. light plant & D.C. Welder and Battery charger. Rated 1250 Watts, 115V. A.C. & 200 Amps. 30V D.C. including 1 Volt. regulator, 1 reverse c. relay, 1 D.C. Voltmeter, 1 electrode holder, 1 toggle switch, 1 Helmet, 1 rheostat and instructions \$38.50. AC-DC generator if bought separate \$24.50.

Kit as above with R-1 J. & Heints or G.E. 300 amp. gen. \$38.50. Kit with 160-250 amps. gen. \$29.50. S. Kit with New G.E. 200 amp. Gen. \$34.50.

New Reactor Coil Arc Stabilizer heavy duty for R-1, P-1, G-1, or AC-DC generators. Wound with #4 copper wire. Approx. 7" x 5" x 4" & mounting bracket. Wt. 11 lbs. #RC700 \$10.95 F.O.B. K.C. Mo.

General SALVAGE CO. SALE

WATER PUMP WITH MOTOR 1/2 H.P. D.C. runs on 6 or 12 V. D.C. Adj. press. 1" ports, 200 GPH \$12.95, 400 GPH \$14.95, 900 G.P.H. 1/4 H.P. 3/4" ports \$17.50

SAVE ON SURPLUS MOTORS
24V. DC & run on 6 & 12 volts H.P. Shaft
Delco 8 oz. in. 120 3/16x5/16" \$3.95 2/\$7.00
**Delco 1/2 8.4 amp 5/16x1" \$5.35 2/\$10.90
**Delco 1/5 6.5 amp 7/32x2" \$5.50 2/\$9.95
Bendix 1/4 8 amp 5/16x1" 4000 RPM \$5.50
*Gear Red. mtr. 2711 or 511 1 1/2 HP 3800 RPM \$4.65
Pescos 3 H.P. 2300 RPM 9/16x3/4" \$8.50 2/\$15.50
**Reversible, with two speeds (20% postage)

NEW HYDRAULIC POWER KIT Your complete hydraulic system consists of Pescos gear driven pump, 380 G.P.H. 1000 P.S.I. with 3/4 HP. DC motor 2300 R.P.M., relief valve, unloading valve, filter, Bendix 5" accumulator, reservoir, gauge 2000 P.S.I., hose and fittings. Complete Kit \$42.50. Same Kit minus motor. Complete \$37.50.
New 4 way o. center hyd. c. valve for 1 to 4 D.A. cylinders with adj relief & adj. metering. 3/8" ports, 2000 P.S.I. #821 \$14.50.

NEW HYDRAULIC CYLINDERS

Air or Oil	Bore	Stroke	Shaft	D. Action	Price
#11	1 1/4"	6"	5/8"		\$7.50
#512	2 1/8"	4"	3/4"		\$8.50
#24	3 1/8"	2 3/4"	1 1/4"		\$32.50
#511	3 1/2"	2 1/4"	1 1/4"		\$22.50
#111	3"	2 1/4"	1-3/16"		\$29.95

NEW HYDRAULIC SYSTEM KIT

#400 K. Heavy duty Power Driven. Rated 14,000 lbs. lift. Consists of 2 D.A. hyd. cylinders, 3" bore x 2 1/2" stroke, each rated 7000 lbs. with 1000 P.S.I., 1 four way hyd. control valve with built in relief #821, 1 Vickers hyd. pump, 400 G.P.H., 1500 P.S.I., 3750 RPM, 1 hyd. 2 gal. reservoir, 1 Purolator hyd. filter, 1 gauge 0-2000 P.S.I. all hose, & fittings. Value \$184.10, save \$90.00. Kit price \$94.10. Kit with two #511 cyl. \$79.95.

HYDRAULIC PUMP BARGAINS 1500 P.S.I.
MFG. TYPE R.P.M. G.P.H. Price
Pescos Gear 1500 198 \$12.95
Pescos Gear 4300 360 \$14.50
7 *Pescos Gear .447 cu. in. 270 \$15.50
*Stratopower .450 cu. in. 3750 400 \$17.50
Vickers .410 cu. in. 375 G.P.H. \$17.50
WEAVER hand pump with relief \$12.95

GENERAL SALVAGE CO. CHECK OR M.O. 2922 E. 27 St., Dept. 92, Kansas City 27, Mo.

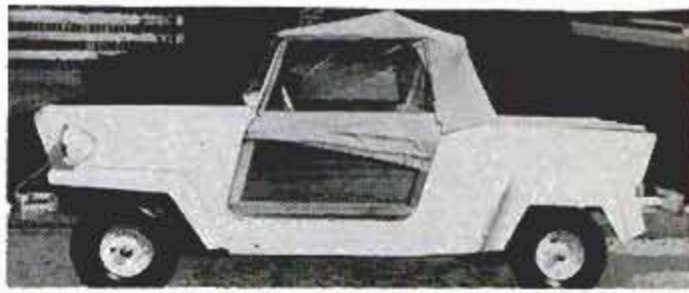

KING MIDGET ALL NEW. First model change in six years. New bodies, new chassis, new engine. Four wheel hydraulic brakes. Still World's Lowest Priced Car. Drive it for 75c per week. Rider Agents Wanted. Earn your own car. Get the facts. Send 25c for 32 page picture book with complete details, dealers price, etc., if there is no dealer near you.

MIDGET MOTORS CORPORATION, Athens 1, Ohio

SELF-STARTER



NO MORE LABOR

The Simmons Automatic Starter, a tool used with an ordinary electric drill, quickly and effortlessly starts all types of combustion engines—lawn mowers, outboard motors, cultivators, chain saws, pumps, generators, etc. For use with 1/4" or 1/2" drills. Does not become part of the engine, but can be used to start any and all types. As revolutionary as the automobile self-starter.

ORDER TODAY. Price: \$17.50 parcel post prepaid. If not satisfactory will accept return in 30 days, money refunded. Mail check or money order stating size across flats or square of nut on fly wheel shaft, as shown. (Special dealers' discount)

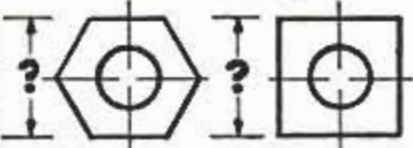

SIMMONS STARTER CORPORATION P. O. Box 1985 Albany, New York

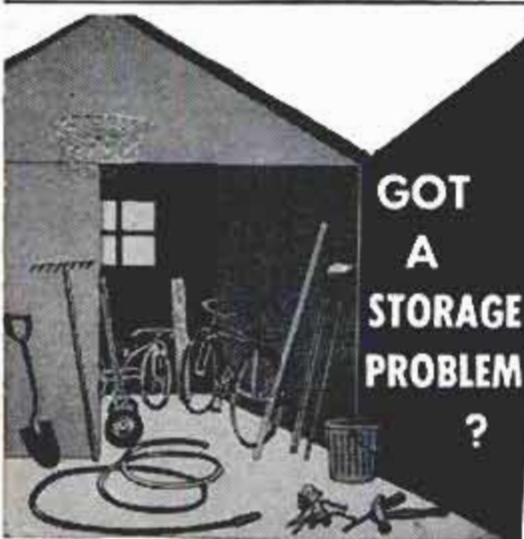

GOT A STORAGE PROBLEM?



Then you need **TURNBUCKLES** Perforated Board fixtures to end space-wasting clutter and to keep everything neatly in place until needed. **TURNBUCKLES** do-it-yourself fixtures come in a wide variety of shapes and sizes... fit easily into any wall-hung perforated board... and hold everything from clothing and kitchen utensils to hand tools and garden equipment. Send for your free copy of space-saving suggestions for home, farm and workshop.



TURNBUCKLES, Inc.
BOX 333, MICHIGAN CITY, INDIANA

NAME _____
ADDRESS _____
CITY _____ STATE _____

The PERFECT FINISH for natural wood

Seals, Primes, Finishes
dries in 30 minutes

Can be
ROLLED ON



Perfect for home and workshop. A finer, easy to use wood finish for paneling, furniture, cabinets, floors . . . all interior wood projects. Now you can apply a 2 or 3 coat finish the same day. There's nothing like Deft for a perfect finish, simply done. Nothing else to use...no thinning. And you can save more time by using a roller on large areas. Brush or spray.

Write for the many uses of Deft.

Be GOOD to your WOOD . . . deft-finish it

Wherever paints are sold

DESMOND BROS., 1826 W. 54th St., Los Angeles 62, Calif.

with sockets, QUALITY counts

P&C SOCKETS

Last longer, let you work faster, easier

Hot Forged
Special
Analysis
Steel

Chamfered
Openings Slip
On easily

Extra Strong,
Heat Treated
Thin Walls

Heavy Chrome
Plate Resists
Rust, Stays Clean

Backed by
Famous P&C
Guarantee
of Quality

Precision
Machined for
Accurate Fit



When you need sockets, buy good ones . . . P&C. Buy from the colorful P&C Merchandisers, 12,000 stores. Send 10c for tool catalog.

P&C TOOL COMPANY

Box 5926, Portland 22, Oregon

Warehouse: Schiller Park, Ill.

Subsidiary of Pendleton Tool Industries, Inc.

NEW! amazing metal mender

1001
USES



Magic

PLASTIC ALUMINUM



**REAL METAL
in PASTE form!**

Repairs all Metal • Easy to Use • No Heat or Tools Needed • Dries Metal-Hard in 3 Hours • Waterproof, Gasolineproof & Heatproof up to 600° • Can be Drilled, Filed, Tapped, Threaded when Dry • Solders, Seals, Repairs • Saves Time and Money • For Home, Industry, Autos, Boats, Plumbing

Magic Plastic Aluminum is the most amazing repair product since the invention of the nail! It is real metal in paste form and has most of the properties of metal. Easy to use by anyone—no tools or heat needed.

At all Hardware, Paint, Department and Auto Supply Stores, \$1.00 — or send \$1.00 direct to: Dept. M-2

MAGIC IRON CEMENT CO. 5400 Bower Avenue
Cleveland 27, Ohio



German Tape Player Has Auto-Dash Controls

You can have music wherever your car goes with a tape player developed by a German firm for use in automobiles. It's operated through controls on the dash and will play up to four hours of continuous music, or nearly 90 selections. A deluxe model has a transistor amplifier.

SURPLUS SALE

WAR SURPLUS
EXCESS INVENTORY
BANKRUPT STOCK

AIR COMPRESSOR BARGAINS

For painting, cleaning, tires, control termites. Assemble your own outfit. Lowest prices in U.S.
• DeLuxe Kit. Compressor, tank, gauge, regulator, paint gun, fittings. How to build instructions. List \$52. SALE \$39.49 FOB.
• Compressor 1-cyl. \$19.95; 2-cyl. \$49.95; Govt. Air Tank, \$8.79; Regulators, \$3.95; Pop Off \$1.95; Pres. Gauge \$1.89. Finest paint gun \$11.95. Auto switch \$4.75. All prepaid.

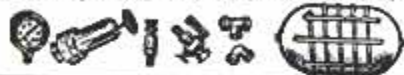

DIAL TELEPHONE

• Modern hi-efficiency attractive dial phone. Use for extension to main line on private system. Use several for complete private system, etc. Complete with ringer, dial, etc. Work on any system. Govt. cost \$25.50. SALE\$9.95 Ppd.

STORAGE BATTERY WINCH

• Powerful fully reversible, ball-bearing gear reduction winch, 1000-2000 lb. pull. Use on 6 or 12-v battery. Holds 40' of 1/4" cable. For trucks, docks, boats. Govt. cost \$280. \$46.75 FOB



WELDING GENERATOR

Finest ball bearing 300-amp. 30-v air corps generator. Makes excellent welder, power plant, fast charge battery-charger, etc.
• Full instructions. Many applications. A real buy. Govt. cost \$300. SALE\$23.95 FOB



HUNDREDS SURPLUS BARGAINS

• Amazing surplus buys, thousands of valuable items. Mechanical - electrical - sporting goods - electronics. Get our free illustrated catalog.

GOLF ELECTRIC CAR MOTOR

• Use golf or boys electric car. Geared 100 to 1. Run 6 or 12 volts. Easily reversible. Full instr. Wt. 34 lbs. Govt. cost \$250... FOB \$19.46



POWER PLANTS & GENERATORS

• Marvelous buys in new condition Govt. and factory surplus plants and generators. Write for catalog.
• 2500-w 115-v 60-c \$239.50
• 3000-w 115-v 60-c \$299.50
• 5000-w 115-v 60-c \$497.50
3 KW 115-v DC Generator \$49.50



SPECIAL OF THE MONTH!

HAND HYDRAULIC SYSTEM

• War surplus brand new expensive Blackhawk hand hydraulic twin piston pump. Pressure to 5000 lb. 294 cubic in. displacement.
• Wonderful for wagon unloaders, shop press, lift trucks, etc. Wt. 35 lbs. Govt. cost over \$100. SALE\$23.95 FOB



HYDRAULIC SPEED REDUCER

• Variable hydraulic speed reducer. Any speed from 0 to 750 rpm by simply throwing a lever. Handle up to 1 1/2 h.p. Use for midget cars, shop band saws, etc. Instant reverse. Govt. cost \$400. SPECIAL\$47.81 FOB



SURPLUS WATER HOSE

• Marvelous buy new 20-ft. lengths, 1 1/4" diam. (inside) with threaded pipe nipples. Stand pressure to 75 lbs. Wt. 12 lbs. List \$16.50. SALE\$7.69 Ppd.



ORDER FROM AD or write for catalog.

BURDEN SALES COMPANY
804 West "O" St., LINCOLN, NEBRASKA

Wash or scrape OLD PAINT OFF

Low Cost

HEAVY-BODIED KLEAN-STRIP

Non-inflammable paint remover

Fast • Clean • Safe

The Klean-Strip Co., Inc. • P. O. Box 10084 • Memphis, Tenn.



Jiffy SAWHORSE BRACKETS

NO NAILS NO SCREWS NO BOLTS

Now a sawhorse in a jiffy! Just use Jiffy Brackets and 2x4s. Sold by hdw. and bldg. supply stores everywhere, or order direct. \$1.95 A pair. *Higher W. Coast*

GRAND HAVEN STAMPED PRODUCTS CO.
Grand Haven, Mich.



TWO GREATEST RIFLE BARGAINS EVER OFFERED!

GUNSMITH TO YOU \$19.95

POWERIZED, ACCURIZED
7.5 MM (.30 CAL.)
BIG GAME SPORTER

Starting with a beautiful surplus Swiss army rifle in absolute excellent condition, our own gunsmith machines and precision crown barrel to 22" sporter length, remounts scope in sights, alters the hard mountain (red) walnut stock to sporter contours, rebeds barreled action perfectly, checks headspace, trigger pull (guar. light, crisp). Please return this gun for full refund if it is not perfect in every respect. Bore is perfect. A sporter for all big game. 12-shot bolt action repeater. Ammo: target, 48 rds., \$5; softnose hunting, 24 rds., \$3.89.

MANNLICHER CARCANO CARBINE \$12.95

6-SHOT BOLT ACTION

Here is the hardhitting, extremely accurate and powerful Carcano carbine, all milled parts. Built with famous Mannlicher action. Bore guaranteed good. Compact, fast handling, deadly on big game. 7.35 MM SOFTNOSE SPORTING AMMO, 20 rds., \$2.85. Target ammo, 54 rds., \$3.40.

TO ORDER ON FREE TRIAL! Send check, cash or money order. For C.O.D. send 1/2 or more. All items F.O.B. Los Angeles. Exp. charges collect. Calif. res. add 4% state tax. Test, shoot, return in 10 days for full refund if not ideal. Many and every respect.

THE ELLNER COMPANY

Dept. 82, 1206 Maple Avenue, Los Angeles 15, Calif.

READY CUT HOMES DO-IT-YOURSELF \$SAVE! \$\$\$

BUY DIRECT FROM MILL & SAVE ON LABOR COSTS

You can assemble any of the 57 designs from easy-to-follow plans. Every piece marked, easily identified, ready to erect. You don't have to measure or cut. It's all done economically by precision production machinery (not prefabricated). Save high skilled labor costs and material wastes. Save contractor's profits and overhead. Complete with all hardware, paint, nails, roofing, glass, etc. Sterling Homes are modern designed for comfort and convenience. Plans sold separately.

FIVE EASY PAYMENT PLANS INCLUDING MONTHLY PAYMENT

ORDER TODAY - SAVE UP TO 40%

PRICED FROM
\$2150.00 AND UP

Send 25c

Color Catalog including Floor Plans



INTERNATIONAL MILL & TIMBER CO., BAY CITY, MICH. DEPT. PM28

**The NEW
Plus + Hammer You Want**

Estwing

**"3 in One"
UNBREAKABLE
Hammer**

Forged One-Piece head-handle
Strongest Construction Known

Everlasting Cushion Grip
Lasts for Life of Head

Whip that Gives Smooth, Effective Drive
Marks You As a Master Craftsman

16 oz. head
\$5³⁵

At Leading Hardware Dealers
ESTWING MFG. CO., Dept. PM-2, Rockford, Illinois
Inventors and World's only Specialists in Unbreakable Hammers

FREEZER TIP NO. 43



Seal in freshness and flavor of pies and baked goods with "SCOTCH" Brand Freezer Tape. Fruit pies are better when frozen unbaked. Cream pies: bake as usual but freeze without meringue. Moisture-resistant "SCOTCH" Freezer Tape sticks in freezing cold to saran and other films, to foil or paper. Tape is a label, too . . . you can write on it! Get "SCOTCH" Brand in handy cutter-edge carton—in thrifty 35¢ or 98¢ rolls.

**Don't run short . . .
BETTER BUY TWO!**

Made by
Minnesota Mining & Mfg. Co.
St. Paul 6, Minn.
© 3M Co., 1958



Protect your home against
power interruptions
with an . . .

**ONAN Emergency
ELECTRIC PLANT**

Provides dependable stand-by electricity for heating system, pumps, freezer, lights, appliances. Keeps home safe, livable. Automatic start and stop. Find out how little it costs!

Write for Folder!

D. W. ONAN & SONS, INC.
3572A University Ave., S.E. • Minneapolis 14, Minnesota

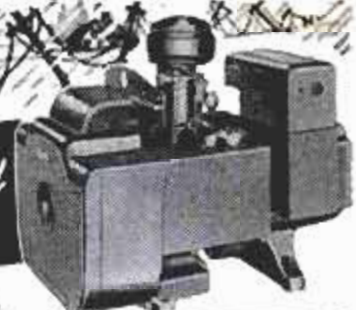

A SIZE FOR EVERY NEED
500 to 75,000 watts.
Compact, quiet-running.
Gasoline-powered
Priced from \$319.00



WHAT...

3398



QUALITY STEEL...

Good saw steel should be hard enough to hold its cutting edge and yet malleable enough to be flexible. Only saw manufacturers who operate their own mines and steel mills can give you the uniform controlled steel consistency necessary in every saw blade. Sandvik Swedish Charcoal Steel Hand Saws feature this high quality hand saw steel. This is only one of Sandvik's many exclusive advantages. Before you buy any hand saw, ask your dealer to show you a Sandvik.



Write today for the new 16 page booklet . . . "Things You Should Know About Hand Saws". It's free - Dept. PM



Sandvik STEEL, INC.

Saw & Tool Division

1702 NEVINS ROAD, FAIR LAWN, N. J.
IN CANADA: P.O. Drawer 1330, Station "O", Montreal 9

POPULAR MECHANICS

4-WHEEL DRIVE OWNERS

21 MODELS INCLUDING JEEPS

NEW AXLE POSITIONER

... Instant, positive engagement

FRONT DRIVE WITH
FREE-LOCK HUBS

LOW OPERATING COSTS

All parts stop ONLY WHEELS MOVE

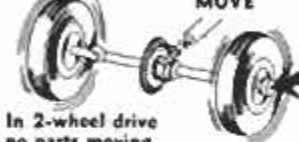

In 2-wheel drive
no parts moving

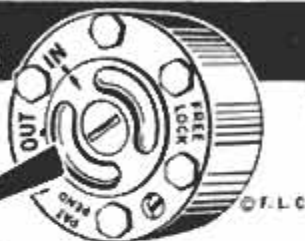

NO Rocking to Engage Hubs

Engaging hub is instant and positive with the new Axle Positioner. First time available in any hub **Unconditionally guaranteed for 1 year!**

See your dealer or write for **FREE literature.**

FREE-LOCK CORPORATION

6301 N. Federal Blvd.

Denver 21, Colorado

WELD **BRAZE**
SOLDER **CUT**



4WAY
ONLY
\$14.75
f.o.b. factory

WELDER
Complete with
Twin Carbon Arc
Torch and ac-
cessories... to
handle all metal-
craft work.

Acclaimed by thousands of Homeowners, Mechanics and Hobbyists as the welder of 1001 uses. Easily operated from properly wired 110 volt AC or DC line. The ideal gift with a life-long use... Order today on 10 day money back guarantee.

FOUR-WAY WELDER CO., Dept. F2-B
1810 S. Federal St. • Chicago 16, Ill.

YOUR CHOICE

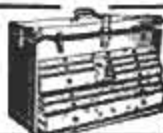

Gerstner Chests are built in many styles and sizes. Choose yours from our Free Catalog.
GERSTNER TOOL CHESTS
458 Columbia St., Dayton 7, Ohio

Ride while you work!

Plow, cultivate, mow, rake, harrow, till, plant, bulldoze, plow snow, spray, saw, maintain beautiful lawns... 8.4 hp All-gear drive. 8-W 4-speed trans., clutch, diff 770 lbs. Low cost. Ready to run. Quick-change implements. 100% satisfaction guaranteed.

Write for **FREE CATALOG**
COUNTRY SQUIRE TRACTOR CO.
P.O. Box 107-K-2
Muskego, Wis.



COUNTRY SQUIRE
TRACTOR

MODERN

IMPROVED LAWN MOWER SHARPENER AND BED KNIFE GRINDER

Sharpen any mower in 10 to 20 minutes. Hand—Power—Reel or Rotary. Modern is actually two machines in one, a Precision Bed Knife Sharpener and a Precision Reel Sharpener. Extra Bed Knife Grinder is Absolutely Unnecessary. New Mower Support makes it possible to sharpen reel without removing bed knife. The fastest precision lawn mower sharpener on the market. Costs Less. Compare Modern's Many Exclusive Features Before Buying. Send for Free Brochure No. 10 SN



MODERN MANUFACTURING CO.

160 North Fair Oaks Ave., Pasadena, California

LOOK! All New - All Precision - All Deluxe

SUPERSHOP MODEL X

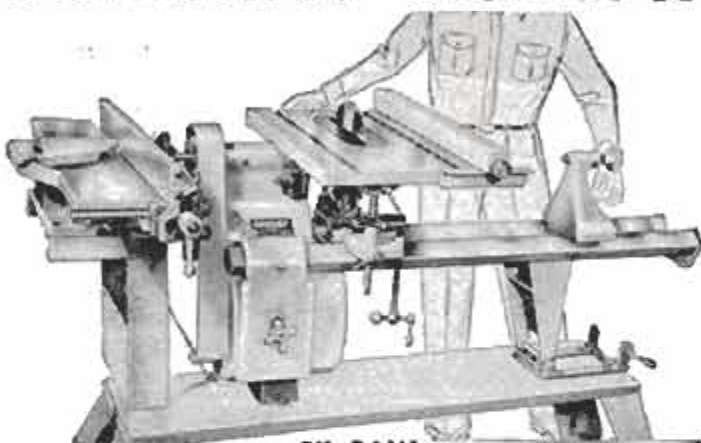

8" SAW

WE PAY ALL FREIGHT FOR YOUR FREE HOME TRIAL

ONLY \$139.50 EASY PAY PLAN

Never before have you seen so much deluxe, precision-built power tool workshop at any price! Designed for the man who wants the best. Massive cast and precision-machined headstock, self-centering inverted "V" bedways (like precision metal lathes), exclusive non-friction speed changer, extra-large cast and precision-ground saw table. 100% ball bearing, lifetime-lubricated. You save by ordering direct from factory. You are invited to test Supershop Model X in your home **FREE**. Mail coupon or postcard for **FREE** brochures, photos, details, specifications, accessory list — and amazing freight prepaid **FREE HOME TRIAL PLAN**. All free.

MAIL COUPON OR POSTCARD TODAY



Vert. Drill Press



Hor. Drill Press



8" Sander



30" Lathe



5" Grinder

POWER TOOLS, INC. 104 Yates Avenue
Beloit, Wisconsin

NAME _____

ADDRESS _____

CITY _____ STATE _____

PUT **stock** your **shop** IN YOUR SHOP!

**EASY TO
GET AT!**

With ONE HAND you can reach and get... *instantly*... exactly the size and type of screw you want. "STOCK your SHOP" is a smart, new, convenient, and economical way to buy and store screws. Try a few boxes. You'll like them!

SCREWS IN NEW CLEAR PLASTIC BOXES
FOR EASY DRIVING, ALL WOOD SCREWS ARE SPEEDIZED

An invisible lubricating film on "STOCK your SHOP" Wood Screws makes them *easy* to drive in even the hardest woods! This *free* extra feature eliminates bent and broken screws, prevents sore and aching hands. Ask for "STOCK your SHOP" the next time you buy screws.

ELCO TOOL & SCREW CORP., ROCKFORD, ILL.



**EASY TO
GET OUT!**

59¢ PER BOX



LOOK FOR THIS
SELF-SERVE
DISPLAY AT
YOUR STORE

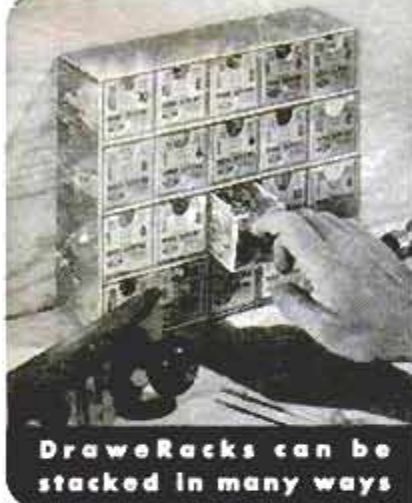

DrawerRacks can be stacked in many ways

THE 'POCKET' MACHINE SHOP

The all-purpose Plierench comes equipped with Universal gear-jaw. Tool made of chrome molly forged steel in gun metal finish. Form fit handle. Adjustable from 0" - 1 1/2". Thousand pound pressure grip for bench-vice jobs on the spot. For mechanics, home handymen, plumbers, electricians, farmers. Pipe gear-jaw or Wire gear-jaw extra at \$1.50 each. Carrier pouch free with purchase of Plierench and extra jaws. F.O.B. Chicago.

Two sizes:

7" 16 oz. (with Universal jaw) \$7.50
8 1/2" 20 oz. (with Universal jaw) \$8.50



PLIERENCH COMPANY of AMERICA
4611 N. Ravenswood Avenue, Chicago 40, Illinois Dept. P

CUT PERFECT GROOVES WITH *Warren* WASHERS ON YOUR SAW BLADE!

You Just **DIAL** the Cut Wanted

over **250,000** sets in use!



NOT ONE—NOT TWELVE—BUT 40 DIFFERENT CUTS!

Warren Washers—engineered to cut clean, accurate, parallel grooves with your present power saw. 40 micromatic adjustments—just dial the desired width. Actually strengthens blade, eliminates vibration—leave on saw for straight cuts. No burning or chewing. Over 250,000 satisfied users in 48 States and many foreign lands. Be sure to get genuine Warren Washers... they're guaranteed!

FREE! Send for free descriptive booklet. Arbor sizes 1/2", 3/8", 3/4", 1". See your dealer or write direct.

WARREN WASHERS CO.

Dept. 22, Box 98, North End Station, Detroit, Mich.

ONLY \$4.95 SET

FOLDING LEG BRACKETS



Amazing new design with automatic spring action push button control. Locks in both open and closed position. Lifetime heavy duty metal construction. Simple, foolproof. Can't stick or bind. Smooth action. Easy to attach. Only 1 3/4" x 2 1/2" x 2 1/2" in size—neat and strong. Perfect for ping-pong or any type table. Complete with all screws. Money back guarantee. SEND CHECK OR M. O.—NO C.O.D.

\$3.95 SET OF 4 POST PAID

DOO-IT STORE
1040 N. WOODWARD
ROYAL OAK, MICH.

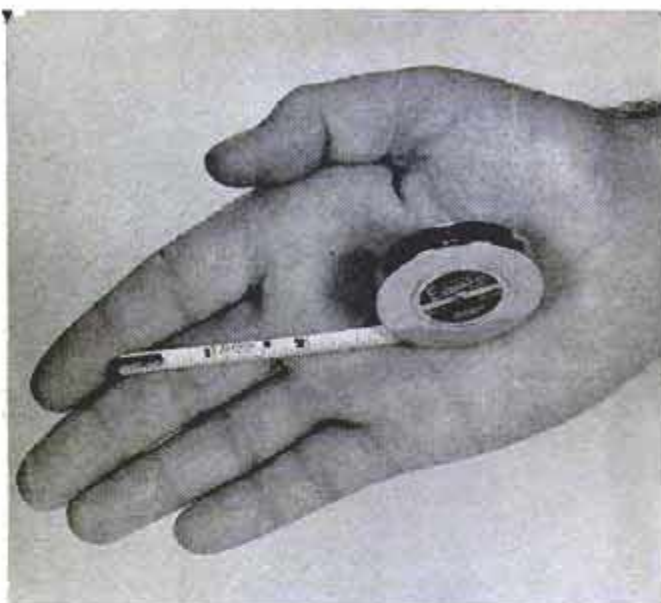

The Lufkin Rule Company, Saginaw, Mich.

Full-Length Tape Rule Is One Fourth Inch Wide

Slightly larger than a silver dollar and weighing no more than a cigarette lighter, a tape rule now on the market is only one fourth inch wide. It is made in both six and eight-foot lengths.

Ⓞ Vinyl-asbestos floor tile that is fire-retardant has been developed after years of experiments and tests.

Wear A KEY-BAK KEY-REEL

on your belt and you
WON'T LOSE YOUR KEYS!

Your keys are SAFE on a KEY-BAK Key Reel. And when your keys are safe, your home, your shop, your tools, are safe. Wear KEY-BAK on the belt. It reels back your keys; keeps them snugly at your side.

OVER A MILLION KEY-BAKS
SOLD!

Used by mechanics, truckers, police, hobbyists, custodians, and all who carry keys.

Get KEY-BAK Key Reel from your hardware or key shop.



Pocket-watch size. Highly-polished chrome

\$2.95

24" long steel chain. Strong Swedish clock spring reels in chain.

WEST OF MISSISSIPPI
Lummis Mfg. Co.
2242 E. Foothill Blvd.
Pasadena, California

EAST OF MISSISSIPPI
CTL Company
1710 W. Stewart Ave.
Wausau, Wisconsin



G E A R S

In Stock - Immediate Delivery
Gears, speed reducers, sprockets, thrust bearings, flexible couplings, pulleys, etc. A complete line is carried in our Chicago stock. Can also quote on special gears of any kind. Send in your blueprints and inquiries.

Send for Complete Catalog No. 10
CHICAGO GEAR WORKS
440-50 N. Oakley Blvd., CHICAGO 12, ILL.

BUILD
YOUR
OWN

ARC-WELDER

WE SHOW YOU HOW to build powerful D.C. Welders from surplus aircraft generator. Light or heavy work. Easy to build at low cost. Worth hundreds of dollars. PLANS 35c. SEND TODAY. Includes FREE Surplus, Welder, Electrical catalog.

LEJAY MFG. CO., 2907 EMERSON AVE. 50., MINNEAPOLIS, MINN.



BARRON Drill Press TOOLS



Broaden the usefulness of your drill press with our Rotary Planer, Surface and Drum Sanders, Router and Mortising Bits Molding Cutters . . . other essential accessories. Complete catalog and price list mailed on request.

BARRON TOOL CO. INC.
310 Architects Bldg., Detroit 1, Mich.

WRITE FOR
FREE
WORKSHOP
GUIDE

Short Cuts

with
WILHOLD*
CONTAX
CEMENT

#1. U. M. O.

SAVES
TIME

ERECT WALL PANELS
Without Nails or Clamps
Contax cement spreads easily,
bonds immediately . . . holds
permanently. Saves time.

AD NO. 1036

Paint, Hardware, Lumber, Variety Stores. Or write
WILHOLD PRODUCTS Los Angeles 31, Calif.; Chicago 44, Ill.



SAVE UP TO 50% AT PALLEY'S

3400 RPM 1/2 HP POWER SAW



RIPS - CROSSCUTS

CUTS A FINISHED 2x4 LIKE
A KNIFE THROUGH BUTTER

COMPARES TO
SAWS SELLING
UP TO \$49.50 **1998** Complete with
5-1/2" Blade

NEW A rugged, professional type, adjustable saw. Will cut any angle from 0 to 45°. Has an adjustable (0 to 6") rip fence. Safety-trigger switch on handle. Full 1/2 HP Universal AC-DC, 110-120 Volt, 60 cycle motor. Weighs only 6 1/2 lbs.

115 VOLT, 60 CYCLE SURPLUS AIR COMPRESSOR



A self-contained motor-compressor. Originally designed for Navy use. Equipped with filter for moisture-free air supply. Ideal for air gun, inflating, spraying, etc. Delivers up to 35 PSI. Motor operates on 115V, 60 cycle AC current and is rated at 1/10 HP. Turns at 1725 RPM.

Complete with built-in pressure gauge and air filter. A Surplus Bargain . . . **NOW 24.95**

AIR STORAGE TANK - Ideal for use with above compressor. Has 280 cu. in. cap. Size 6" x 14-1/2". Tested to 400 PSI. 1/4" ports. **2.95**



2 1/2x - 4x or 6x RIFLESCOPES



YOUR CHOICE! SAME PRICE!
INCLUDING MOUNT
2 1/2x - Overall lgth. 9 3/4"
25 ft. field of view at 100 yds.
4x - Overall lgth. 9 3/4"
30 ft. field of view at 100 yds.
6x - Overall lgth. 10 3/4"
18 ft. field of view at 100 yds.

NEW PAL-MASTER SCOPES

for TARGET - BENCH REST or HUNTING

Choice of 3 different powers **9.95** WITH
at the same LOW PRICE! MOUNT

COMPARE THESE QUALITY SCOPE FEATURES:

- 1 - ADJUSTMENTS Positive lateral. Direct reading Windage & Elevation Knobs
- 2 - LENSES Top quality Optical Glass - precision ground, polished, color corrected, no distortion, hard coated glass-to-air surfaces.
- 3 - EYE RELIEF 2 1/2" to 4 1/2" Safe on heavy recoil.
- 4 - RETICLE Sharp, Clear Cross-Hair
- 5 - FOCUS is Lock-Tight. Won't "shoot off."
- 6 - BARREL Rust-proof, Extra Durable Steel.
- 7 - Guaranteed to perform perfectly on ANY RIFLE.
- 8 - Made by leading American Optical firm.

MOUNT INCLUDED with SCOPE

SIDE or TOP MOUNTS available with scope to fit most rifles. When ordering specify type mount, gun model number and brand.

NEW SATELLITE SCOPE

NOW
5.95
25.00 VALUE

25 POWER x 30 MM SCOPE & TRIPOD

Nowhere but at PALLEY'S can you find a buy like this! Here's a scope, complete with a sturdy metal tripod, that you can have a lot of fun with. Use it to spot hits on the target, for stargazing, interesting views at the beach, etc. Made of aluminum and chrome plated brass. Field: 62 ft. at 1000 yds.

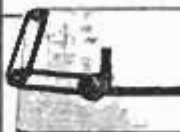

AMAZING NEW PORTABLE DRAFTING MACHINE

INCLUDES ONLY **6.95**

A professional type, scientifically engineered drawing machine. Ideal for Office, Factory, Workshop, Classroom, Artist, Home, etc. Small enough to FIT IN A BRIEFCASE. Made of black anodized aluminum with white markings. With Coos Bay Hardboard 11" x 17" drawing board. Weight 2-1/2 lbs.

SENIOR DRAWING MACHINE & BOARD - Same as above only larger - has 8" scale. Board is 3/4" x 26" x 20". Weight 3-1/2 lbs. **18.95**

DOUBLE ACTION
HYDRAULIC CYLINDER
Designed for use in series.
Ideal for use on production
line & automatic equip. 1500
PSI. 4-7/8" stroke. **3.75**

4 inch IMPORTED SLIDE RULE
Non-warping bamboo with scales on a
white nitrate face. Face scales are A,
B, C, I, C, D and K. Other side **2.95**
has S, L & T scales. In Case.

396 PAGE CATALOG

Thousands of items of all descriptions. Hand & Power Tools, Industrial & Building Materials, Micro & Telescopes, Hydraulic Equip. of all types. Send 50c TODAY for handling & mailing. Your money refunded with 1st order.

10" LOG-LOG SLIDE RULE
Professional Log-Log, Decimal Trig
Slide Rule. Non-warping top quality
bamboo - 2-color scales on white
nitrate facing. Scales are L, L, L, 1,
DF, CF, CIF, C, I, C, D, LL3 & LL2 on
one side. Other side LLO, LLL, A,
B, X, CI, C, D, S, ST & T. With **1500** dial
cursor and 16 pg. book. . . **10.95**

TO ORDER Send check, or M.O. by deposit with
C.O.D. Prices F.O.B. Los Angeles, Calif.
2263 E. VERNON AVE., DEPT. PM-2 LOS ANGELES 58, CALIF



Schupack's Amazing Tool Bargains! Save up to 100%!

Bargain Special! Deluxe Ass't. Accessories for Hand Grinders or to fit your 1/4" drill



Regular \$20 value, only **\$7.50**

Contains a wide variety of brand new mounted stones, cutters, felt polishing wheels, rotary files, grinding wheels, mandrels, drum sanders, wire brushes, bristle brushes, rubber wheels, sanding bands and many more accessories too numerous to mention. COMPLETE IN A STURDY WOODEN BOX.

12 MOUNTED WHEELS and points on 1/4" Shank **\$2.95**
36 for **\$7.50 p.p.**
For grinding on plastic, wood, soft & hard metals. Regular Value **\$8.40**. 18 Mounted points on 3/32" shank **\$2.50**; 12 mtd. wheels on 1/4" shank **\$3.60**.

No C.O.D.'s please
New Illustrated Catalog 10c
SCHUPACK SUPPLY CO. 7331 COTTAGE GROVE AVE. DEPT. PM-17 CHICAGO 19, ILL.

18 Rotary Cutters P.P. **\$5.85**

Assorted sizes cutters on 1/4" or 3/32" shank. Will fit all hand grinders. Ideal for cutting wood, metal, or plastic. **\$13.50 value.**

FLEXIBLE SHAFT—ONLY \$6.50 Post-paid

Fits all electric drills & hand power tools. 35 3/4" long. Oilite bearings. Core of specially wound, high carbon steel wire in flexible steel casing. Will accommodate tool shafts up to 1/4" dia. For lathes, electric drills, etc.

ELECTRIC HAND GRINDER
Fits in the palm of the hand and has an air-cooled motor that runs at 20,000 rpm AC or DC at 110 volts. Comes complete with both 3/32" and 1/4" inch Collets. **\$11.50 P.P. cord and shoe.**

ADAPTER CHUCK
With 2 interchangeable collets, opening from 3/32" to 1/4" on 1/4" mandrel. **\$1.50 P.P.** Price each only.

KEEP YOUR WORKSHOP TOOLS SAFE AND ORDERLY



This 7-drawer machinist's chest has a place for every tool. Extra durable heavy gauge steel. Felt lined drawers protect delicate edges... operate easily. Size: 8 1/2" x 13 1/2" x 20 1/4". \$27.95 at leading hardware stores. Slightly higher west. Other home workshop models from \$1.25 up.

WATERLOO VALVE SPRING COMPRESSOR CO.
Waterloo, Iowa

BUY GREAT NECK HAND TOOLS
... for long-lasting performance



GREAT NECK SAW MFRS., Inc.
MINEOLA, N. Y. — SEE YOUR LOCAL STORE



Loosens Rusted Bolts, nuts, screws, "frozen" parts!
LIQUID WRENCH

The super-penetrating rust solvent that quickly loosens rust and corrosion.
AT HARDWARE STORES, GARAGES SERVICE STATIONS, EVERYWHERE
RADIATOR SPECIALTY CO.
Charlotte, N. C.

IF YOU DIDN'T MARRY THE BOSS'S DAUGHTER

BE YOUR OWN BOSS!
Cash in by sharpening knives, circular saws, rotary mower blades, ice skates, sanding, buffing. Versatile, low-cost Foley 314 Grinder earns \$3 to \$5 an hour for you in spare time.
"I service saws for home owners and carpenters in my community, and all my work is guaranteed. Circular saws range from 90c for 8" blades, on up to \$3.50 each for the larger sizes. I never made a better investment."
F. J. Borowski, III
FREE PLAN tells how to boost your income this easy way. Sharpening only 3 saws a day can clear over \$1000 a year net profit. Send coupon today! No obligation. No salesman will call.



Free plan shows how to start your own spare time business

FOLEY MFG. CO., 273-B Foley Bldg., Minneapolis 18, Minn.
Send **FREE PLAN** for spare time home business with Foley 314 Grinder.
Name.....
Address.....

OUTWORKS THEM ALL

Prepares the toughest soils in one operation. All-purpose tiller-tractor tills to 12" deep — 12" to 40" wide. 3 models; 7 rotor styles including mulchers. 40 attachments include all tractor tools, mowers, snowplow. Tough chain-gear drive. Send for details.



MERRY TILLER
Northern Life Building, Box 1835, Seattle 4, Wash.

\$47,983 IN ORDERS

FROM 12 WORD AD
Read This Amazing Story
Sounds like a fairy tale—but it's TRUE. It happened to an advertiser in Popular Mechanics Classified Section. Write for this amazing story NOW. It's free. **F. W. JOHNSON, 202-CM E. Ontario St., Chicago 11, Ill.**

NEW GRIPSO TOOL KIT

Save Time, Work, Money—4 new Power Action tools do the work of dozens of tools. In handy vinyl holder.



WISE PLIERS
5 Tools in 1 — 1 ton grip gentle release. One hand adjustment.
PIPE WRENCH
Press—pull it's open. Push—it's closed. Ratchet action adjustment.
MULTI-DUTY PLIERS
Multiplies grip 10 times.
GEAR LOCK PLIERS
Patented power gear grip.
See Your Dealer or Write
H. R. BASFORD CO., 235 15th St. San Francisco 3, California

MASTER D.C. ARC WELDER

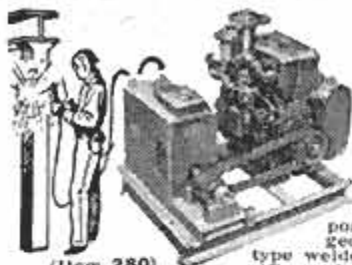

Easy To Use

(Item 280) Now a portable rugged industrial type welder with terrific performance, yet at a price hundreds of dollars less than you'd expect. Senior model made for years of trouble-free, continuous service. High capacity DC welding unit enables you to tackle any job with confidence—easily welds anything up to 2" plate using from 1/16" to 1/4" rods. Built-in stabilizer and cooling system makes arc easy to strike and hold. Dual control rheostat provides low heat soldering, brazing and welding from 30 to 300 amps. Complete with instructions, guarantee and triple V-belt or flat pulley. Easy to hook up and easy to operate.

WELDER ONLY — DUAL CONTROL MODEL. Same as above, but drive with your tractor, jeep or gas engine of 14 HP or more. (Item 38a.) Wt. 110 lbs. \$450 value **\$119.50**

WELDER ONLY—INDUSTRIAL MODEL same as above but with ceramic rotary type rheostat providing 74 different heat settings for all types of welding (Item 38b) \$500.00 value **\$139.50**

COMPLETE POWER MASTER (Illustrated above) powered by a 16 hp., air cooled Wisconsin engine. Wt. 480 lbs. (Item 280) Compare with welder costing \$1200. Factory Special **\$449.50**

WELDING KIT. Two 10 ft. leads, welding helmet, electrode holder, ground clamp. Sold only with welder at **\$10.50**

JET STEAM MASTER

Now, a super efficient portable steam generator that produces live steam at 100 lbs. pressure in 60 seconds from a cold start! Produces large volume of high pressure steam on 2 pints of fuel oil. Instantly cleans sticky grease, dirt, rust, old paint, etc. off implements and road machinery. Pays for itself in a few weeks. Sterilizes soil. Sterilizes as it cleans—milk equipment, etc. Fully automatic—oil fired with new, built-in lifetime bronze water circulating pump. Draws water from faucet or bucket, simple and safe—anyone can use. Built-in safety valve. Complete with 12 ft. of hi-pressure steam hose and new triple efficiency steam gun that automatically mixes in soap solution if desired. Wt. 250 lbs. Item 463. Special factory price **\$349.50**



MASTER AIR COMPRESSOR

COMPARE! This is the only compressor built with a NO RUST stainless steel tank. Safe up to 500 lbs. (Item 209) High pressure type, 1 1/2 C.F.M. Large volume of air for heavy duty service. For paint spraying, inflating truck & auto tires, greasing, sand blasting, etc. Piston type 2" bore compressor with built-in air filter. Master built with high strength alloys and precision bearings. Tank, 12"x24", 2100 cu. in. cap. Equipped with automatic switch that starts and stops motor to maintain desired pressure (up to 150 lbs.) and check valve, safety valve, gauge, shut-off valve, 20 ft. air hose and tire chuck. Beautifully balanced on ball bearing wheels and rubber tires. Don't take chances with used or surplus equipment. Our compressors are factory new and are guaranteed SAFE. 1/2 H.P. heavy duty model, rep. ind. motor and unloader switch. Item 209A, low factory price **\$129.50**

1 1/2 H.P. model, Cap. 3 c.f.m.—85 psi, item 209 **\$109.50**



Variable Speed Selector

Heavy duty, made by B. F. GOODRICH for industrial use. Provides instant speed changes for any drive. For machine tools, dryers, printing, conveyors, production lines, hoists—any operation requiring variable speed. Employs reliable "trouble free" planetary system. No hydraulic power losses. Infinite range, smooth operation, easy installation. 3 sizes: 1/2-1 hp. 36 lbs.; 1-2 hp. wt. 55 lbs.; 2-3 hp. wt. 105 lbs.; Reg. list \$228, \$252 and \$352. Our prices **\$79.50, \$89.50 and \$114.50**

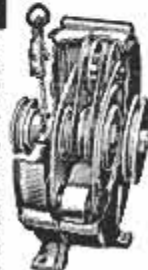

SAVE middleman profits get MASTER MECHANIC'S direct factory prices

700 WATTS PUSH BUTTON START
115 v. 60 cye. AC Powered by a rugged 2.2 HP easy starting Briggs engine. No wiring necessary; just plug in and operate. Plenty of current for any oil burner, freezer, brooder, emergency lights, etc. which require up to 700 watts. Ideal for television and radios. Complete with Voltmeter and built-in winding to charge 6 v. auto batteries. (Item 24.) Wt. 75 lbs. Easily fits in car trunk. Be prepared if storm knocks out power lines. Reg. \$275 value **\$143.50**

1200 Watt Plant (Item 45) same as item 24 but larger generator and engine with 50% greater output **\$199.50**

LIGHTWEIGHT WATER COOLED DIESEL GENERATOR PLANT
Never before available! Now offered exclusively by Master Mechanic. A low priced, lightweight, continuous duty Diesel Generator set. Powered by a super rugged, exceptionally smooth running, one cylinder Diesel engine. Operates at conservative 1750 r.p.m. and delivers full 1750-2000 watts of power. Operates on low cost fuel oil. Wt. only 240 lbs. representing a triumph of Diesel Engineering. Complete with fuel filter, oil pressure gauge, control box with duplex receptacle and voltmeter. (Item 830) Special factory price **\$399.50**

1500 WATT PLANT
115v. 60 cye. AC Push Button Start. Powered by a 3 1/2 HP. Clinton engine. Combines big output with easy portability. Provides emergency power for operating any oil burner, sump pump, freezer, television, lights, communications systems, etc. which require up to 1500 watts. (Item 22.) Wt. 110 lbs. Reg. \$475 value. Factory price **\$239.50**

1750 Watt Plant Powered by 4.5 HP Briggs engine. Electric starting & battery charging built-in. Factory price **\$279.50**

2500 WATT PLANT—Push Button Start (Item 21) 110/120 v. 60 cye. A.C. A rugged powerful plant. Reg. \$645. Spec. **\$329.50**

3500 Watt Plant Push Button Start (Item 23) 115 v. 60 cye. AC. Similar to above, but larger and 33% more capacity. Wt. 270 lbs. Reg. \$760. Factory Price **\$379.50**

DUAL VOLTAGE 110/220 for Item 21 or 23 **\$30 additional.**

BATTERY CHARGING GENERATOR Push Button Start

A husky, 750 watt plant (designed for battery charging only) that will charge 6 or 12 volt batteries in just minutes! When mounted with two 6 volt batteries it provides a terrific cold weather motor starting unit, as well as a fast charger! Charges all batteries anywhere—no in-line current needed. Ideal for service stations, garages and farms. Comes complete with ammeter and cutout. (Item 821) Wt. 120 lbs. Regularly \$295. Our special, only **\$119.50**

HEATING & VENTILATING FAN

(Item 10) Easily installed in furnace pipes. Forces even heat to all rooms. Over range removes kitchen smoke and odors. Powerful, continuous duty motor, 110-120v. AC. Mount in wall or ceiling to ventilate any area. Quiet, super-efficient fan moves huge volume of air. (400 to 600 CFM.)
8" Pipe, wt. 5 lb. **\$6.85**
9" Pipe, wt. 6 lb. **\$7.85**
10" Pipe, wt. 7 lb. **\$8.85**
12" Pipe, wt. 8 lb. **\$9.85**

GIANT METAL SHEARS

"PEXTO"
Nine inch cutting blade made of special high carbon alloy steel, perfectly aligned and ground. Easily cuts steel plate up to 12 gauge or 1/4" thick. Overall length 40". Wt. 23 lbs. (Item 156) Regular **\$14.95**
\$9.50. While they last.

PORTABLE LIGHT PLANTS

GIANT 2500 WATT PLANT
110-120 v. 60 cye. AC. Absolutely the best made — exclusive dynamicaly balanced armature; heavy windings develop up to 5000 watt overload for motor starting. Skid mounted — portable. Powered by an easy starting Briggs or Wisconsin 6 HP engine—complete with all accessories; engine easily disconnected for other uses. Big outlet box, voltmeter, no wiring necessary. Ample current for all purposes. Factory warranty. (Item 31) Wt. 210 lb. Reg. price \$585. Special at **\$299.50**

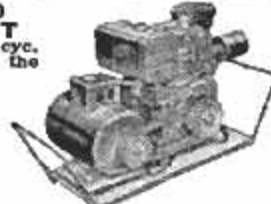

Same plant with electric self starter (Item 31a) **\$359.50**

Generator only and control box **\$169.50**

DUAL VOLTAGE 110-220 available on any of above models for \$28.00 additional.

Double Acting Hydraulic Cylinder



A powerful cylinder mfr'd. by Massey Harris which develops both a pushing and a pulling action. Will push 8,100 lbs., with a 1000 PSI pump pressure. Cylinder is 3 3/4" O.D. with 6 1/2" stroke—standard heavy duty clevises on both ends. Has standard 1/2" pipe thread openings. Can be used for tilting buckets or blades, raising or lowering implements, hydraulic presses, etc. Can also be used as an air cylinder. (Item 802) Wt. 17 lbs. Reg. \$68 value. Special **\$14.95**

OTHER DOUBLE ACTING CYLINDERS
8" stroke — 3" bore **\$34.00**
10" stroke — 3" bore **34.80**
16" stroke — 3" bore **43.00**
24" stroke — 3" bore **47.50**

We have all sizes of cylinders available.

HYDRAULIC CONTROL VALVE — 4 way open center valve with built-in adjustable relief. Controls 1 double, or 2 single acting cylinders. Equalizing feature permits easy control even under heavy loads. 3/4" pipe thread on inlet & outlet, 1/2" on cylinder outlets. Easily mounted, finger tip control. Wt. 18 lbs. (Item 822) **\$21.95**



HYDRAULIC KIT
Complete Hydraulic Kit consists of hydraulic hand pump with built-in 2 gal. reservoir and item 802 hydraulic cylinder described above. Pump has a built in relief valve and is rated at 20 tons. Kit is ideal for presses, jacks, snowblows, etc. Pump is 28" long—6" diam. with 1/2" ports. A terrific value! (Item 836), Wt. 50 lbs. **\$39.50**

Pump only (Item 836a) only **\$23.50**

HYDRAULIC HOSE COUPLERS Connect or disconnect hydraulic lines without loss of oil. 1/2" pipe threads. (Item 819) per set **\$4.95**

CABLE HOIST

2000 lb. CAPACITY. A fortunate purchase from the Air Force enables us to offer these powerful 2000 lb. electric cable hoists at a fraction of their value. Perfect for material handling, boat hoists, elevators, lifts on assembly lines, etc. Two separate 22 ft. lift cables with independent controls permit leveling the load and controlling it perfectly. Rugged ball bearing motors of geared down design 110 volts. Available for A.C. or D.C. Please specify. Makes a terrific portable hoist with our #273 D.C. light plant at **\$99.75.** Offered at less than 33% of regular cost (Hook not included). Wt. 145 lbs. A.C. Model, item 847A **\$149.50**
D.C. Model, item 847 **\$129.50**

SCREW-TYPE PRESS

A tremendously powerful press capable of exerting nine tons pressure. Pays for itself straightening bent parts, or pushing out bearings and bushings. Ideal for manufacturing and assembly operations because of precise control. Massive 1 1/2" screw permits precise control over vertical travel. Extra heavy ribbed yoke has a throat 21" high; depth capacity for working to the center of an 11" object. Includes 8" x 15 1/2" vise-type table and two pushing arbors. Wt. 150 lbs. (Item 797) Reg. **\$149.50.** Special **\$49.50**

HYDRAULIC PRESS. Nine ton capacity. See Doc. Pap. Mech's for details—or write. Complete Wt. 110 lbs. (Item 464) **\$69.50**

Send check or M.O. Prices f.o.b. Factory. 10 day Money back guarantee. SEND 10c for **BIG NEW Catalog**

YOUR MOVE, DAD!

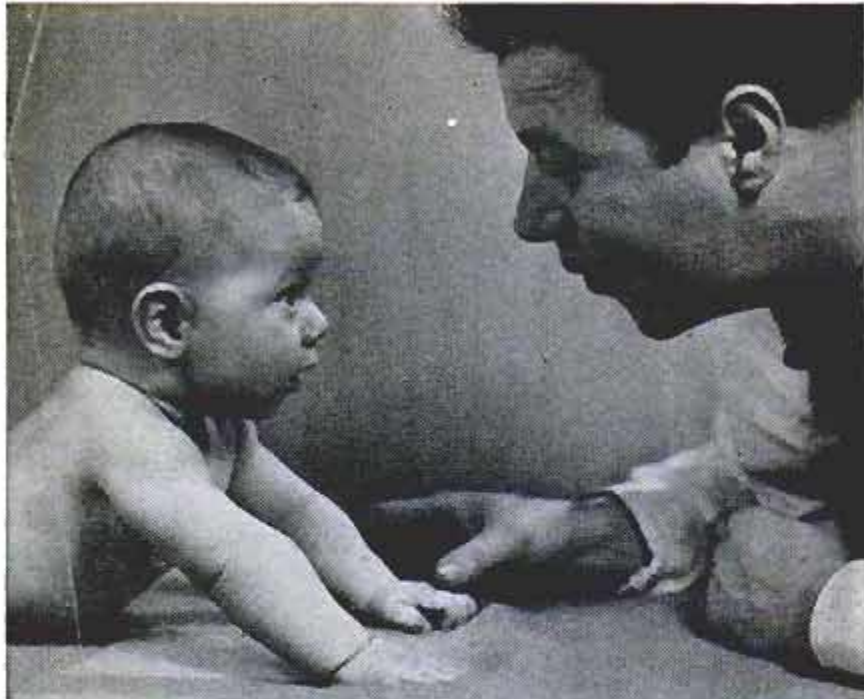

The first frantic months of fatherhood are over. You have time now to really enjoy the new baby—and time to really think ahead.

There's plenty to think about. And lots to plan for. What kind of a Dad will you be? What kind of a provider?

One thing's sure: now you've got to earn more money! About \$500 a year more, to start with. *But how?*

Try doing what some five thousand new fathers did last year. Start preparing yourself for a better job—at home, in your spare time. *Enroll with I.C.S.*

Most of these new fathers already have job promotions, fat pay boosts. One writes, "I've

jumped five years in one." Another reports, "I'm making \$125 more a month."

There's no magic in I.C.S. Just sound, practical, step-by-step training. And a *method* that makes it possible to master any subject as rapidly as your time and ability permit.

You have 257 courses to choose from. Business. Technical. Engineering. All job-related. All keyed to everyday problems. Let us send you a *free sample lesson* together with two valuable books—(1) opportunities in your field and (2) "How to Succeed." No obligation—except the new one you have as a father.

The famous I.C.S. coupon is right here. *And it's your move!*

For Real Job Security—Get an I. C. S. Diploma!

I. C. S., Scranton 15, Penna.

Accredited Member,
National Home Study Council

INTERNATIONAL CORRESPONDENCE SCHOOLS



BOX 06299B, SCRANTON 15, PENNA.

Without cost or obligation, send me "HOW to SUCCEED" and the opportunity booklet about the field BEFORE which I have marked X (plus sample lesson):

- | | | | | |
|--|--|--|---|---|
| <p>ARCHITECTURE and BUILDING CONSTRUCTION</p> <ul style="list-style-type: none"> <input type="checkbox"/> Air Conditioning <input type="checkbox"/> Architecture <input type="checkbox"/> Arch. Drawing and Designing <input type="checkbox"/> Building Contractor <input type="checkbox"/> Building Estimator <input type="checkbox"/> Carpentry and Millwork <input type="checkbox"/> Carpenter Foreman <input type="checkbox"/> Heating <input type="checkbox"/> Interior Decoration <input type="checkbox"/> Painting Contractor <input type="checkbox"/> Plumbing <input type="checkbox"/> Reading Arch. Blueprints <p>ART</p> <ul style="list-style-type: none"> <input type="checkbox"/> Commercial Art <input type="checkbox"/> Magazine & Book Illus. <input type="checkbox"/> Show Card and Sign Lettering <input type="checkbox"/> Sketching and Painting <p>AUTOMOTIVE</p> <ul style="list-style-type: none"> <input type="checkbox"/> Automobiles <input type="checkbox"/> Auto Body Rebuilding and Refinishing <input type="checkbox"/> Auto Engine Tuneup <input type="checkbox"/> Auto Technician | <p>AVIATION</p> <ul style="list-style-type: none"> <input type="checkbox"/> Aero-Engineering Technology <input type="checkbox"/> Aircraft & Engine Mechanic <p>BUSINESS</p> <ul style="list-style-type: none"> <input type="checkbox"/> Accounting <input type="checkbox"/> Advertising <input type="checkbox"/> Business Administration <input type="checkbox"/> Business Management <input type="checkbox"/> Cost Accounting <input type="checkbox"/> Creative Salesmanship <input type="checkbox"/> Managing a Small Business <input type="checkbox"/> Professional Secretary <input type="checkbox"/> Public Accounting <input type="checkbox"/> Purchasing Agent <input type="checkbox"/> Salesmanship <input type="checkbox"/> Salesmanship and Management <input type="checkbox"/> Traffic Management <p>CHEMICAL</p> <ul style="list-style-type: none"> <input type="checkbox"/> Analytical Chemistry <input type="checkbox"/> Chemical Engineering <input type="checkbox"/> Chem. Lab. Technician <input type="checkbox"/> Elements of Nuclear Energy <input type="checkbox"/> General Chemistry <input type="checkbox"/> Natural Gas Prod. and Trans. <input type="checkbox"/> Petroleum Prod. and Engr. <input type="checkbox"/> Professional Engineer (Chem) <input type="checkbox"/> Pulp and Paper Making | <p>CIVIL ENGINEERING</p> <ul style="list-style-type: none"> <input type="checkbox"/> Civil Engineering <input type="checkbox"/> Construction Engineering <input type="checkbox"/> Highway Engineering <input type="checkbox"/> Professional Engineer (Civil) <input type="checkbox"/> Reading Struc. Blueprints <input type="checkbox"/> Structural Engineering <input type="checkbox"/> Surveying and Mapping <p>DRAFTING</p> <ul style="list-style-type: none"> <input type="checkbox"/> Aircraft Drafting <input type="checkbox"/> Architectural Drafting <input type="checkbox"/> Drafting Machine Design <input type="checkbox"/> Electrical Drafting <input type="checkbox"/> Mechanical Drafting <input type="checkbox"/> Sheet Metal Drafting <input type="checkbox"/> Structural Drafting <p>ELECTRICAL</p> <ul style="list-style-type: none"> <input type="checkbox"/> Electrical Engineering <input type="checkbox"/> Elec. Engr. Technician <input type="checkbox"/> Elec. Light and Power <input type="checkbox"/> Practical Electrician <input type="checkbox"/> Practical Lineman <input type="checkbox"/> Professional Engineer (Elec) <p>HIGH SCHOOL</p> <ul style="list-style-type: none"> <input type="checkbox"/> High School Diploma | <p>(Partial list of 257 courses)</p> <ul style="list-style-type: none"> <input type="checkbox"/> Good English <input type="checkbox"/> High School Mathematics <input type="checkbox"/> Short Story Writing <p>LEADERSHIP</p> <ul style="list-style-type: none"> <input type="checkbox"/> Industrial Foremanship <input type="checkbox"/> Industrial Supervision <input type="checkbox"/> Personnel-Labor Relations <input type="checkbox"/> Supervision <p>MECHANICAL and SHOP</p> <ul style="list-style-type: none"> <input type="checkbox"/> Diesel Engines <input type="checkbox"/> Gas-Elec. Welding <input type="checkbox"/> Industrial Engineering <input type="checkbox"/> Industrial Instrumentation <input type="checkbox"/> Industrial Metallurgy <input type="checkbox"/> Industrial Safety <input type="checkbox"/> Machine Design <input type="checkbox"/> Machine Shop Practice <input type="checkbox"/> Mechanical Engineering <input type="checkbox"/> Professional Engineer (Mech) <input type="checkbox"/> Quality Control <input type="checkbox"/> Reading Shop Blueprints <input type="checkbox"/> Refrigeration and Air Conditioning <input type="checkbox"/> Tool Design <input type="checkbox"/> Tool Making <p>RADIO, TELEVISION</p> <ul style="list-style-type: none"> <input type="checkbox"/> General Electronics Tech. | <ul style="list-style-type: none"> <input type="checkbox"/> Industrial Electronics <input type="checkbox"/> Practical Radio-TV Eng'r/g <input type="checkbox"/> Practical Telephony <input type="checkbox"/> Radio-TV Servicing <p>RAILROAD</p> <ul style="list-style-type: none"> <input type="checkbox"/> Car Inspector and Air Brake <input type="checkbox"/> Diesel Electrician <input type="checkbox"/> Diesel Engr. and Fireman <input type="checkbox"/> Diesel Locomotive <p>STEAM and DIESEL POWER</p> <ul style="list-style-type: none"> <input type="checkbox"/> Combustion Engineering <input type="checkbox"/> Power Plant Engineer <input type="checkbox"/> Stationary Diesel Engr. <input type="checkbox"/> Stationary Fireman <p>TEXTILE</p> <ul style="list-style-type: none"> <input type="checkbox"/> Carding and Spinning <input type="checkbox"/> Cotton Manufacture <input type="checkbox"/> Cotton Warming and Weaving <input type="checkbox"/> Loom Fixing Technician <input type="checkbox"/> Textile Designing <input type="checkbox"/> Textile Finishing & Dyeing <input type="checkbox"/> Throwing <input type="checkbox"/> Warping and Weaving <input type="checkbox"/> Worsted Manufacturing |
|--|--|--|---|---|

Name _____ Age _____ Home Address _____
 City _____ Zone _____ State _____ Working Hours _____ A.M. to P.M. _____
 Occupation _____

Canadian residents send coupon to International Correspondence Schools, Canadian, Ltd., Montreal, Canada. . . . Special tuition rates to members of the U. S. Armed Forces.

BRAND NEW EDITION OF THE WORLD FAMOUS

ENCYCLOPAEDIA BRITANNICA

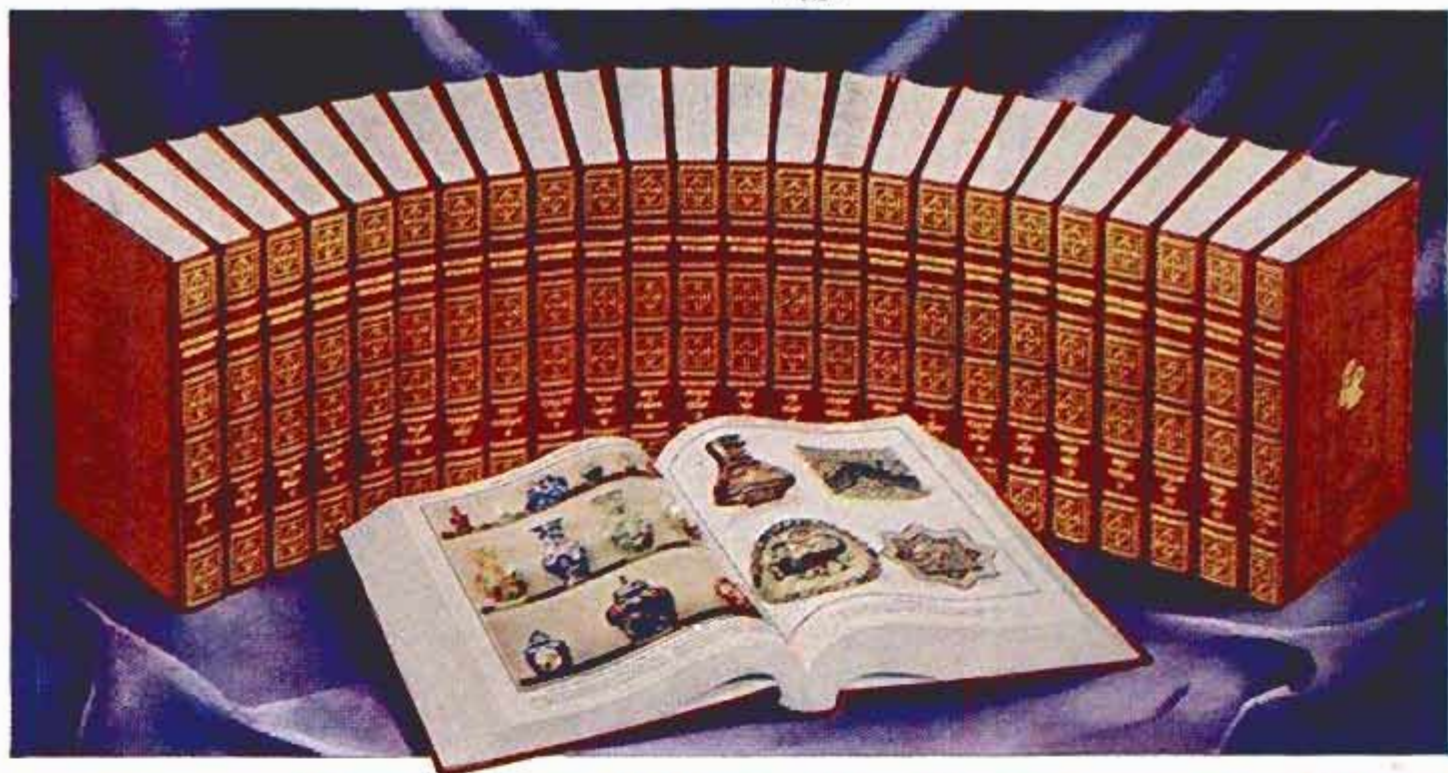

On Easy...Book a Month Payment Plan

All 24 Volumes Delivered Immediately—You Pay Later on Easy-to-Own Purchase Plan

Yes, the latest edition of Britannica—the greatest treasure of knowledge ever published—is now being offered on a remarkable plan that puts this world-renowned reference library within reach of *every* family. All 24 volumes will be placed in your home... **NOW**... you pay for it as you enjoy it... *as easy as buying a book a month!*

Thousands of Subjects of Practical Value to Your Whole Family



every kind of hobby... plus a treasure house of knowledge on *all* subjects. Useable information that can save you many dollars.

In the brand-new edition of Britannica you will find thousands of subjects that you and your family will refer to in the course of your normal day-to-day affairs. For example, you'll find special articles on household budgets, interior decorating, medicine and health, home remodeling, child care, adolescent problems, rules and regulations for all sports,

New Edition Profusely Illustrated

The new Britannica almost "televises" the information to you by means of 23,225 pictures, plus charts, maps and drawings. But it does not merely show "attractive" pictures—it is the work of 5,258 of the world's best minds. The final authority on factual knowledge; a constant inspiration that will enrich the lives of yourself and your family.

Mail Coupon NOW for FREE BOOKLET!

Self-confidence—and the confidence of others—are two rewards you can expect from Britannica's world of facts. For instance, did you know...

- Britannica provides instant and authentic information on every conceivable subject or thought.
- Britannica will enable parents to work more closely with their children at home...helping them build a more solid foundation in today's highly competitive society.
- It will build self-confidence... by helping all members of your family to understand... and talk intelligently on every subject that enters into the lives of successful men and women.



Preview Booklet Offered FREE!

Simply fill in and mail the coupon today, and we will send you... *without cost or obligation*... a copy of our beautiful new booklet which contains an exciting preview of the latest edition of Encyclopaedia Britannica. Send no money—not even for postage. It's yours, *absolutely free!*

Just as soon as we receive your coupon, we will send your illustrated free booklet, so that you can read and enjoy it at your leisure, in the privacy of your home. There is no obligation, of course. However, since this offer is necessarily limited, please mail the coupon *today* before it slips your mind.

ENCYCLOPAEDIA BRITANNICA, Dept. 52-G

425 N. Michigan Avenue, Chicago 11, Ill.

Please send me, free and without obligation, your colorful Preview Booklet which pictures and describes the latest edition of ENCYCLOPAEDIA BRITANNICA in exciting full detail. Also include complete information on how I may obtain this magnificent set, direct from the publisher, on the Book a Month Payment Plan.

Name _____ (Please Print)

Address _____

City _____ Zone _____ State _____

In Canada, write E. B. Ltd., Terminal Bldg., Toronto, Ontario

Working on "hot wires" is the job of Joe Gilbert, high voltage lineman, West Covina, Cal. He takes time for a Camel after repairing a 220,000-volt line. "Sure feels good to have a Camel," he says. "Plenty of flavor—easy to get along with."



The best tobacco makes the best smoke

The special Camel blend of costly tobaccos has never been equalled. That's why no other cigarette tastes so rich and full-flavored, smokes so mild. Today more people smoke Camels than any other cigarette of any kind. Try 'em — you'll see why.



Have a real cigarette —
have a CAMEL

R. J. Reynolds Tobacco Company,
Winston-Salem, N. C.