

# POPULAR MECHANICS

MACHINE

UNDERSTAND IT

JANUARY 1958  
35 CENTS

*Belgium's Atomium*  
— page 99

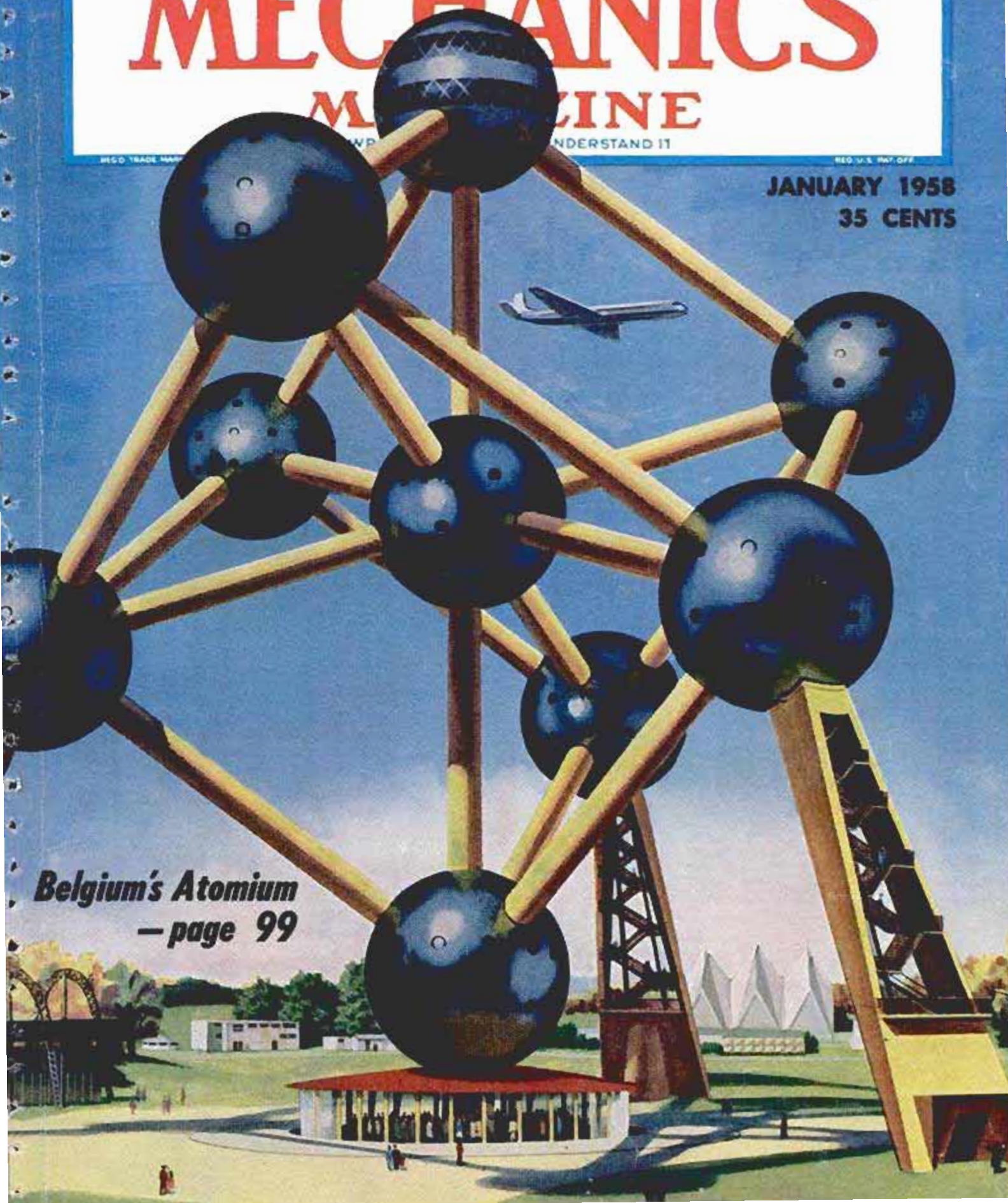



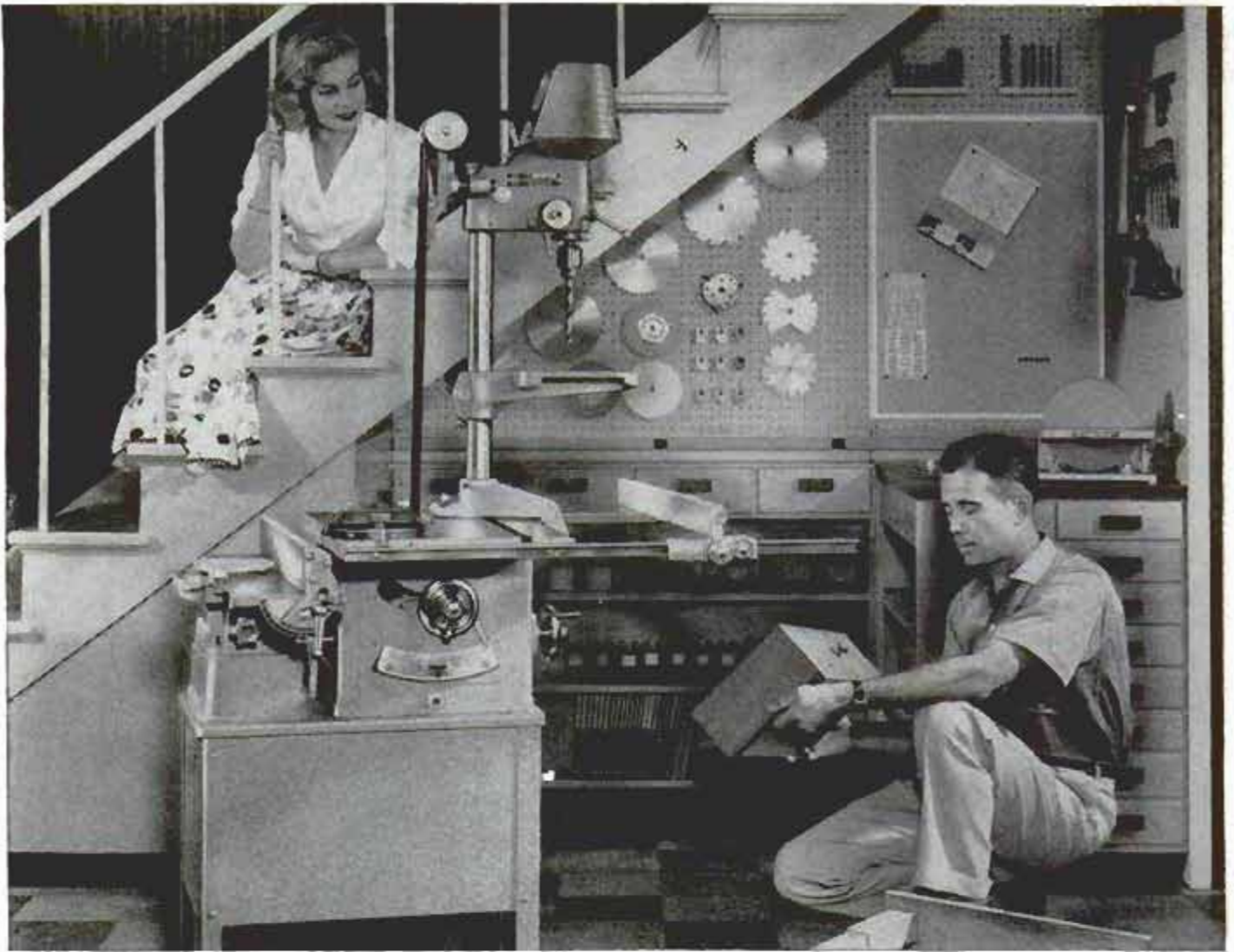

# **BIG IDEA FOR SMALL SPACE**

## ***New Advanced Design*** **DELTA'SHOP**

Combination of 4 full size tools does 95% of all workshop jobs—yet takes space only 3 feet square!

If you want a *real* shop, but don't have a lot of space, the DELTASHOP is for *you*. It's the most *practical* all-purpose combination tool built!

Here's why: In a space just 3 feet square it puts at your finger tips a powerful 9" tilting arbor circular saw, a 4" jointer, an 11" drill press, and an 8½" disk sander—all mounted on one stand and powered by one motor. And because Delta-Shop is a combination of *full size* tools (not attachments) you can buy it all at once (as little as 10% down), or the easy Tool-At-A-Time way.

### **IT'S SO EASY TO OWN THE BEST!**

Because Delta makes the world's most *complete* line of combination, all-purpose and individual power tools, you can choose tools exactly right for *you*. And you'll have the "newest look" in the world's finest power tools.

### **BUILD THIS SPACE-SAVER SHOP**

Delta experts designed this shop so that you can build it. Easy-to-follow plans and the New Delta Reference Guide are yours—**FREE**—just send a post card with your name and address to: Delta Power Tool Division, Rockwell Mfg. Co., 502A N. Lexington Ave., Pittsburgh 8, Pa.

*Do it now*—then see *all* the *New Advanced Design Delta Tools* at your *Delta Dealer*. (He's listed under "TOOLS" in the Yellow Pages.) Or at leading *Department, Hardware, and Building Supply Stores*.







The best reasons a man could possibly have for "**aimed light**" when he drives at night!



If your headlights are two years old . . . install new Guide T-3s for **MORE LIGHT—AIMED RIGHT!**



**GUIDE T-3**

FIRST headlamp designed with three "Guide Points" for quick and easy aiming by precision mechanical method.

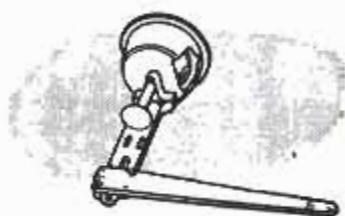

**SAFETY AIMER**

EASY adjustment without even having to turn headlamps on . . . assures perfect alignment and placement of light on the road.



**PERFECT AIM IN MINUTES**

ATTACH AIMER . . . a quick screwdriver adjustment and the job is done—in minutes—even in broad daylight.

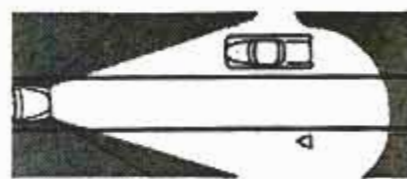

**POOR AIM**

HEADLAMPS out of adjustment . . . reduce visibility, can blind approaching drivers.

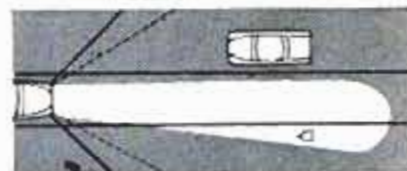

**PROPER AIM**

GUIDE T-3 headlamps can be aimed in minutes for better visibility and safety when you drive at night.

Guide **T-3**

**SAFETY-AIM HEADLAMPS**

**BUY IN PAIRS WHERE YOU SEE**



AC  THE ELECTRONICS DIVISION OF GENERAL MOTORS

Watch Walt Disney Studios ZORRO weekly on ABC-TV

JANUARY 1958

This One





Be a  
pioneer  
in the new

# AGE OF SPACE

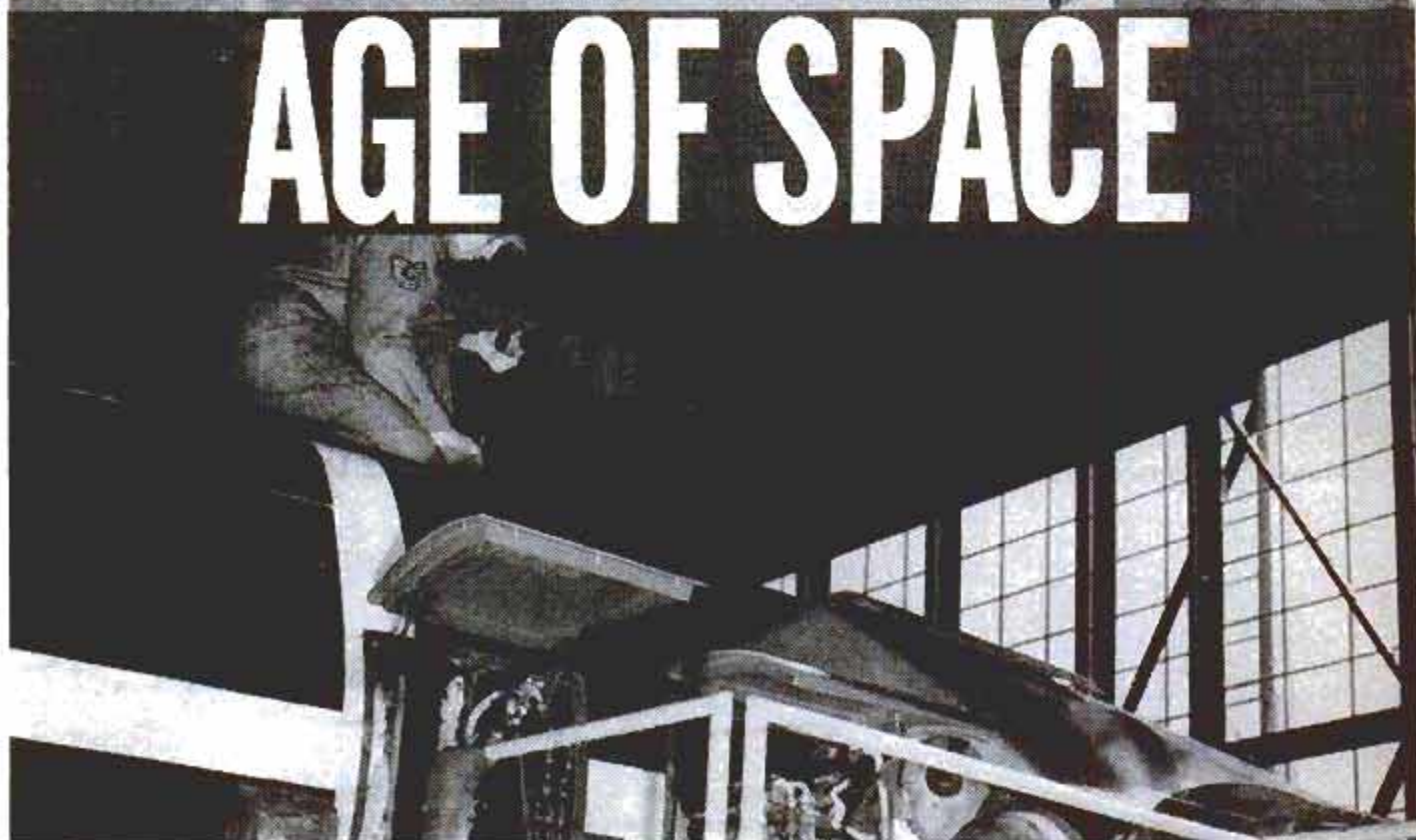

## THE FUTURE BELONGS TO THE AIRMAN

Not since Kitty Hawk have young men been offered greater challenge and promise than in today's Age of Space. It is *your* Age—an age in which the technician versed in rocket and jet propulsion, electronics, mechanics, or allied fields will play the most important role. That's why so many men today are entering the U. S. Air

Force. They know that nowhere else can they get the broad and complete range of Space Age specialty training. They know, too, that—the future belongs to the airman. Join this intelligent, forward-thinking group. Investigate your opportunities in today's Age of Space—see your Air Force Recruiter, or mail the coupon.

Go places  
faster in the  
U. S. AIR FORCE

**PASTE COUPON ON POSTCARD AND MAIL TO:**  
Airman Information, Dept. PM-4321,  
Box 7608, Washington 4, D. C.

Please send me more information on my opportunities in the U.S. Air Force. I am between the ages of 17-34 and reside in U.S.A. or possessions.

NAME \_\_\_\_\_

ADDRESS \_\_\_\_\_

CITY \_\_\_\_\_ ZONE \_\_\_\_\_ STATE \_\_\_\_\_



# Popular Mechanics Magazine

Registered in U. S. Patent Office and Canada

H. H. WINDSOR, Founder

H. H. WINDSOR, JR., Editor and Publisher

Managing Editor  
RODERICK M. GRANT

Assistant Managing Editor  
WAYNE WHITTAKER

Shop Notes and Crafts Editor  
JAMES R. WARD

Associate Editor  
CLIFFORD B. HICKS

Associate Editor, Automotive  
ARTHUR R. RAILTON

Associate Editor, Shop Notes and Crafts  
WAYNE C. LECKEY

Associate Editor, Shop Notes  
W. CLYDE LAMMEY

Radio-Television, Electronics Editor  
LOTHAR STERN

Assistant Editor, Crafts  
JAY W. HEDDEN

Assistant Editor, Makeup  
JOHN DALEN

Art Director  
FRANK BEATTY

Assistant Art Director  
HENRY NEHRBASS

Art Editor  
RALPH LINNENBURGER

Assistant Editors  
KENNETH ANDERSON EARL WOBECK  
ROBERT HENDRICKSON

Eastern Editor  
RICHARD F. DEMPEWOLFF  
Empire State Bldg., Room 2906, N.Y.C. 1

Western Editor  
THOMAS E. STIMSON, JR.  
Suite 1010, 3460 Wilshire Blvd.,  
Los Angeles 5, Calif.

London Manager  
DOUGLAS W. WEDDERSPOON  
Eagle House, Jermyn St.,  
London S.W. 1, England

Director, Bureau of Information  
ALLAN CARPENTER

## Advertising Offices

Chicago: 200 E. Ontario St., Whitehall 4-0100;  
New York: Empire State Bldg., 350 Fifth Ave.,  
LOngacre 5-7580; Detroit: General Motors  
Bldg., Room 5-118, TRinity 5-8711; Cleveland:  
Hanna Bldg., 1422 Euclid Ave., PRospect  
1-0456; Los Angeles: 3460 Wilshire, DUmkirk  
2-8458; San Francisco: Russ Bldg., Room  
468, 235 Montgomery St., YUKon 2-0823.

Published monthly by Popular Mechanics Company,  
200 E. Ontario St., Chicago 11, Ill. H. H. Wind-  
sor, Jr., president; Wm. Harrison Felridge, vice-  
pres.; Franklin S. Forsberg, operations vice-  
pres.; D. F. Windsor, vice-president and secretary-  
treasurer; H. H. Windsor III, vice-president; W. T.  
Windsor, vice-president; Joseph R. Buell, Jr., ad-  
vertising manager; Alan M. Deyoe, circulation  
manager. Single copy in the United States and  
Canada, 35 cents; subscription rates in the United  
States and possessions, Canada and countries of  
the Pan-American Postal Union, 1 year \$3.50; 2  
years, \$6.00; 3 years, \$8.00. To all other coun-  
tries add \$1.00 a year over United States prices  
for overseas postage. If you plan to move, notify us  
at least 30 days in advance so you will not miss  
an issue. Give both your old and new addresses.  
Entered as Second Class Matter, September 15,  
1903, at the Post Office at Chicago, Illinois, under  
Act of March 3, 1879. Entered as Second Class  
Matter at Post Office Dept., Canada. Registered  
as Second Class Matter at the Post Office at  
Mexico, D.F., Mexico, June 20, 1950.  
Copyright 1957 by Popular Mechanics Company.  
Copyright under International Copyright Union.  
Copyright in France. All rights reserved under  
Pan-American Copyright Union. Printed in the  
United States of America.

FOREIGN EDITIONS:	MECANIQUE POPULAIRE (French)	MECANICA POPULAR (Spanish)	POPULAER MEKANIK (Danish)	POPULAR MEKANIK (Swedish)	POPULARE MECHANIK (German)
-------------------	------------------------------	----------------------------	---------------------------	---------------------------	----------------------------

Volume 109

JANUARY 1958

Number 1

Address all communications to: 200 E. Ontario St., Chicago 11, Ill.

## In This Issue...

A New Landmark for Brussels . . . The Atomium	99
PM Tests the 1958 Chevrolet, Ford and Plymouth	108
I Drove Through Russia—Part II	116
TV Trickery	127
I Led the Thunderbirds	131
Forecast: A Sky Full of Satellites	138
The Army Adopts a New Rifle	146
The Battle of Donner Pass	155
White Alice Starts Talking	162
How to Build Physical Fitness	171

## For the Craftsman...

Binding Tape Is Versatile	183
"Dream" Darkroom Takes Little Space	186
Modernize With Ceramic Tile	200
Spark Plugs Hot and Cold	215
Push-Button Painting	220
Power in Your Hand	225
Using Drill-Press Vises	234

## Regular Departments...

Detroit Listening Post	126	Solving Home Problems	196
Keeping Up With the Atom	130	On the Market	223
What's New for Your Home	144	Shopping for Tools	236
Radio, TV and Electronics	179	Clinic for Homemakers	242

Turn to detailed index on page 92. Sources of additional information on items in this issue are shown on the Where-to-Buy-It List, available without charge by writing the Bureau of Information, Popular Mechanics, 200 E. Ontario St., Chicago 11, Ill.

## Next Month...

**BIGGEST SHIP** ever built, the atomic supercarrier will be driven by eight separate nuclear power plants. She's just one of a new breed of ships—merchantmen, carriers, cruisers and subs—powered by the atom. In the February issue you'll see an exciting preview of this strange fleet





Introducing for '58...

## OLDSmobility

a new way of  
going places  
in the Rocket Age!

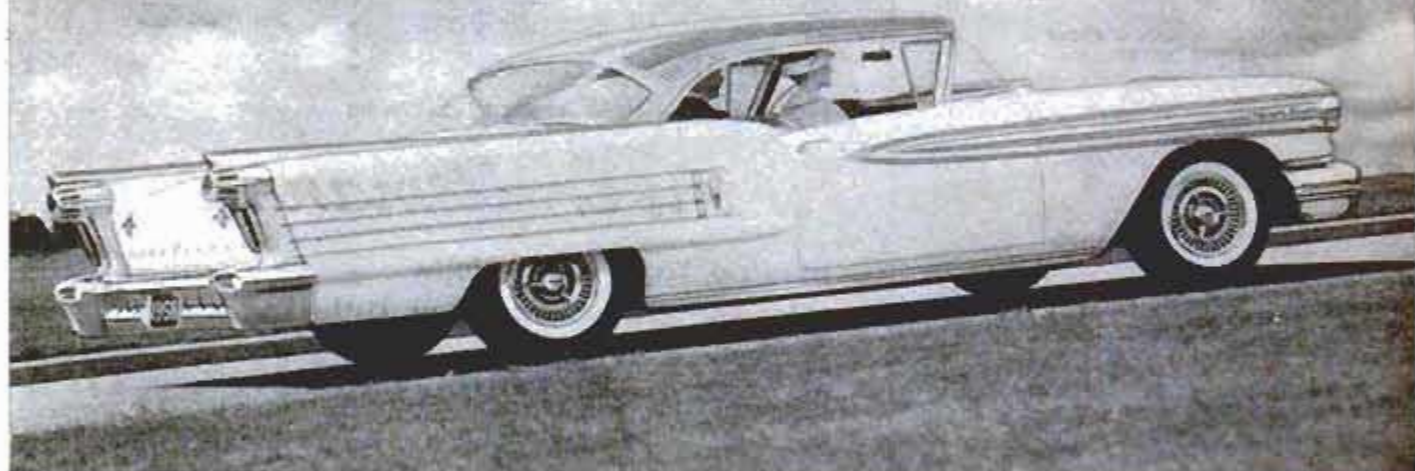

1958 OLDSMOBILE NINETY-EIGHT HOLIDAY COUPE... A CAR IN A CLASS BY ITSELF!

Meet *OLDSmobility*, as only Oldsmobile's sparkling new Ninety-Eight for '58 can express it! Those lean, low new lines tell you at once—there's no limit on Ninety-Eight luxury, no finer expression of distinguished good taste! At the wheel you'll discover a new brand of brilliance, too—the fleet, easy grace of a great performer!

For the Ninety-Eight puts you in confident command of a magnificent, *more economical* Rocket Engine . . . offers you the supreme new smoothness of New-Matic Ride\*, Oldsmobile's *true* air suspension! Only Olds brings you so much that's new for 1958!

See your Authorized Oldsmobile Quality Dealer soon!

OLDSMOBILE DIVISION, GENERAL MOTORS CORPORATION.

*\*Optional at extra cost.*

# OLDSMOBILE FOR '58

1908-1958



FORWARD FROM FIFTY... INTO THE ROCKET AGE







# How we retired in 15 years with \$300 a month

We're having a wonderful time, Betty and I. We're doing all the things we've always dreamed of doing. We enjoy our home. Summers, we pack the car and take trips. And it's all thanks to a check for \$300 that comes by mail, as regular as clockwork, every month!

Luckily for me, I was only forty when Betty began to worry about our future. "You're going to want to slow up in a few years," she'd say. And I'd laugh. Because I felt fine. "But you won't always want to work," she'd say. "Well, I still have fifteen good earning years ahead of me," I'd answer.

But one day she stopped me. She asked me how much I'd earn in the next fifteen years—not counting raises. I did some quick arithmetic, multi-

plying my salary by fifteen. It ran up into six figures! I grinned.

Betty wasn't impressed. "How much of that do you think we'll save?" she asked. I had to be honest. We were always paying off on a new car or a radio, or going places. "A thousand or two," I admitted.

"That's just our trouble," she said. "We can't seem to save. You ought to take out one of those retirement income plans right now."

So I looked into the subject and discovered the Phoenix Mutual Retirement Income Plan. It was a way I could make part of my salary *now* buy me a retirement income *later*. All I needed was to start in time. With a Phoenix Mutual Plan, I could get a check for \$300 a month for life, start-

ing in fifteen years, when I reached fifty-five. I applied immediately and qualified.

The big day came fifteen years later, when our first Phoenix Mutual monthly check for \$300 arrived in the mail. *I retired*. Now Betty and I are having the time of our lives—with no money worries.

### Send for Free Booklet

This story is typical. Assuming you qualify at a young enough age, you can plan to have an income of \$100 to \$300 a month or more—starting at age 55, 60, 65 or older. Send the coupon and receive, by mail and without charge, a booklet which tells about Phoenix Mutual Plans. Similar plans are available for women. Don't delay. Send for your copy now.

ESTABLISHED 1851

## PHOENIX MUTUAL

*Retirement Income Plan*

**GUARANTEES YOUR FUTURE**

OVER 100 YEARS OF LIFE INSURANCE PROTECTION  
FOR BUSINESS AND FAMILIES

COPYRIGHT 1957. BY PHOENIX MUTUAL LIFE INSURANCE COMPANY

PHOENIX MUTUAL LIFE INSURANCE CO.  
241 Elm Street, Hartford 15, Conn.

Please send me, without obligation, your free 28-page book showing new retirement income plans.

Plan for Men       Plan for Women

Name \_\_\_\_\_

Date of Birth \_\_\_\_\_

Business Address \_\_\_\_\_

Home Address \_\_\_\_\_



# NOW AVAILABLE! NEW WIRE STRIPPER

Proto brings you the  
latest tool designs.. first!

No need to change grip on this plier! Use thumb, turn star gauge to desired opening size, notch and strip. Handles 18 to 24 gauge without nicking or cutting. Fast, sure, professional. All New Proto tools are thoroughly job tested before quantity production. When you get them — they're right for the intended work. Complete tool catalog 10¢. Write Proto, 2209 Santa Fe, Los Angeles, Calif.



ANOTHER REASON YOU'LL  
**PREFER**  
**PROTO**  
**PROFESSIONAL**  
TOOLS

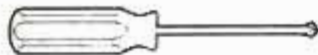

NEW! 2 1/2 Inch Blade #0  
Phillips Bit Midget Screwdriver

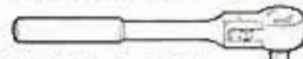

NEW! 4 1/2 Inch Midget  
Reversible Ratchet

**PROTO TOOLS**  
PROTO means Professional Tools

DIVISION OF TOOL INDUSTRIES

## ACROSS THE DESK



### To the Editor:

The photo shows my version of "The Bug" that your February and March 1957 magazines showed how to build. Mine is built on a Henry J chassis and drives like a dream, mainly due to nearly 50-50 weight

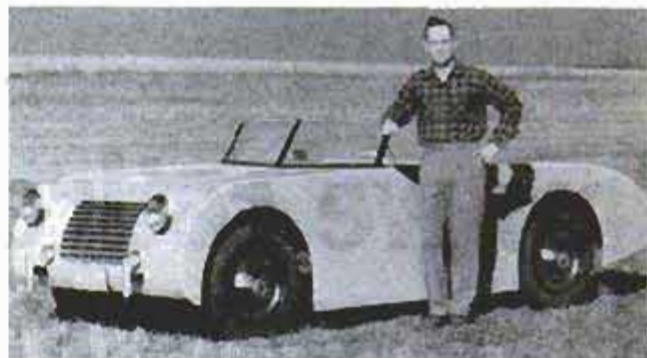

distribution and a very low center of gravity. It is 47 inches high to the top of the windshield, 164 inches long, 61 inches wide and weighs 2000 pounds. It cost \$265, not counting the original chassis. Not being a member of the "big fin" fraternity, I built it without those needless appendages.

Zane Altenburg,  
Kings, Ill.

### To the Editor:

I'm mad! It was all because our newest little son, Peter Joseph, the sixth of the tribe, and his wonderful mother were coming home from the hospital that I decided to spruce up our bedroom by doing over the floor. A quart of shellac purchased on Saturday night was carefully applied. Upon surveying my handiwork on the following morning, I was convinced that another coat was in order. Being Sunday, it was not possible to purchase another quart, so I started scouting around the cellar. Sure enough, there was a half gallon of the stuff correctly stored in a glass bottle—some two or three years ago—and the medicine chest contributed the necessary alcohol. It was lavishly applied and looked great. Several hours later I was aware of my first frustration when I came up to examine the glossy surface and found that it not only was undried, but bore a close resemblance to molasses! Five hours, six hours, ten hours later, the situation had not changed. As bedtime approached, I made my way to the bed through a sea of shellac and, as I walked with a squish-squish, had

(Continued to page 8)



# THIS FREE SAMPLE LESSON

will prove that you can become an expert

## ACCOUNTANT...AUDITOR

## OR CPA

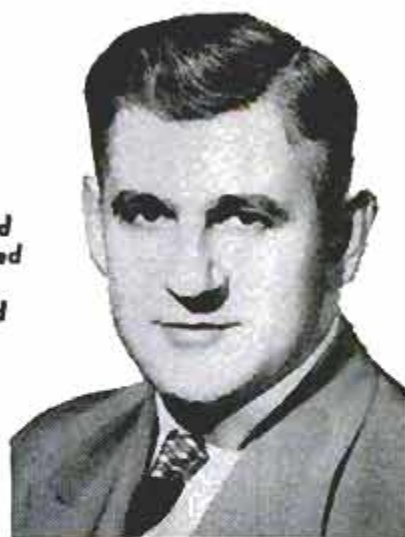

This well-paid LaSalle-trained Accountant's success could be yours.

### FREE SAMPLE LESSON

We offer you this free sample lesson so that you can prove to yourself that you CAN master Accounting—quickly, thoroughly—in spare time at home.

You will see exactly how LaSalle's famous "Problem Method" works...how you are led step-by-step through actual accounting work—learning by doing and not by study of theory alone. First you tackle easy problems, then more difficult ones—until soon you master them all. And at every step you have the close personal guidance of LaSalle's large staff of expert accountants and CPA instructors.

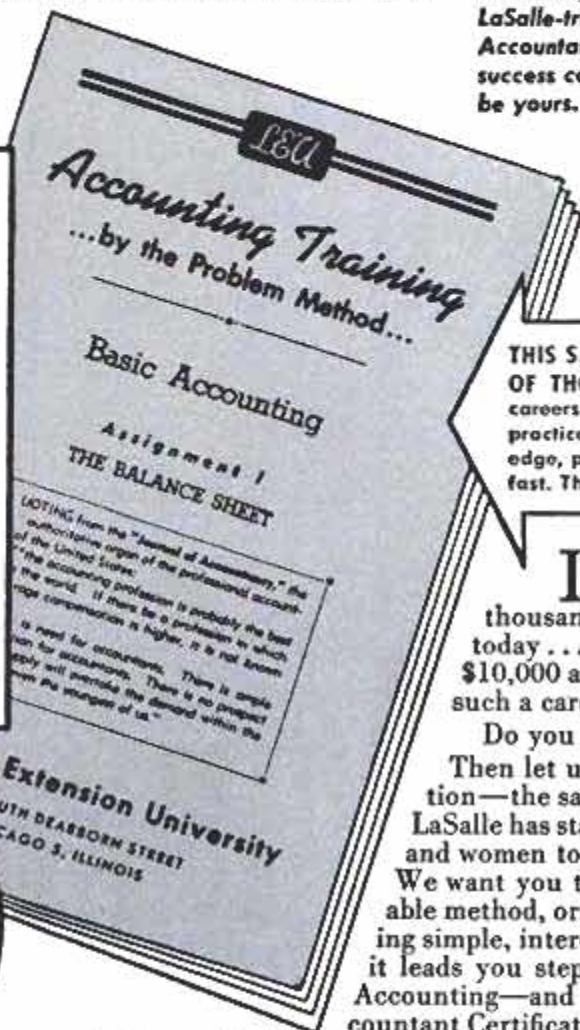

THIS SAME LESSON HAS STARTED HUNDREDS OF THOUSANDS toward well-paid accounting careers—in business, government, and public practice as CPAs. Even without previous knowledge, progress is rapid—earning power climbs fast. This sample lesson will show you why.

IF you have been envying the high incomes and good jobs enjoyed by thousands of men and women Accountants today... incomes ranging from \$5,000 to \$10,000 and more per year... why not launch such a career for yourself?

Do you doubt that you can?

Then let us send you—without cost or obligation—the same Lesson Number One with which LaSalle has started several hundred thousand men and women toward successful accounting careers. We want you to see for yourself how this remarkable method, originated by LaSalle, makes Accounting simple, interesting, practical, and certain...how it leads you step-by-step to a complete mastery of Accounting—and on up to the Certified Public Accountant Certificate if you so aspire. It doesn't matter

whether you've had previous bookkeeping experience, or whether you don't know a debit from a credit. Whether you wish to qualify as an expert accountant, advanced accountant, cost accountant, auditor, government accountant, income tax specialist, or public accountant...you'll find in LaSalle's Problem Method the exact plan to prepare you rapidly and inexpensively—in spare hours at home—without losing a day from your present job.

So right now, today...if you are an adult, employed, and earnestly ambitious for rapid advancement in one of the highest paying fields of business... send your name and address on the coupon below. We'll send you the free sample lesson—plus our illustrated book outlining today's career opportunities and how you can qualify for them. A coupon like this has started many thousands toward greater success. It can do the same for you. Mail it today!

Accredited Member, National Home Study Council

### Clip Coupon... Mail TODAY!

LaSalle Extension University... A Correspondence Institution

Dept. 164H, 417 S. Dearborn Street, Chicago 5, Illinois

YES, I want to see how LaSalle's "Problem Method" works... Send me free sample lesson—also your book, "Opportunities in Accounting"... without cost or obligation.



Name.....Age.....

Street Address.....

City, Zone & State.....

One out of every 13 of all CPAs in the U.S. has been trained by the LaSalle Problem Method

### GOOD-PAY JOBS IN MANY FIELDS

If you were an expert accountant right now, chances are you would find yourself in one of the best paid fields of business.

There are several big fields of opportunity open to men and women trained in accounting...opportunities that are wide open and highly inviting, offering maximum income and job security in good times or bad. And under LaSalle's "Problem Method" you can start earning while still learning—either in spare-time or full-time employment...or in business for yourself with no capital required.

Get the latest information by sending for our illustrated booklet, "Opportunities in Accounting"—plus free sample lesson. The coupon at right will bring both to you without cost or obligation. LaSalle Extension University, 417 S. Dearborn St., Chicago 5, Illinois.



# OPTICAL BARGAINS

## 3" ASTRONOMICAL REFLECTING TELESCOPE

(Famous Mt. Palomar type)  
See the Stars, Moon, Planets Close Up!  
60 & 120 Power — An Unusual Buy!

Assembled and Ready to Use! You'll see the Rings of Saturn, the fascinating planet Mars, huge craters on the Moon. Aluminized and overcoated 3" diameter high-speed F/10 astronomical mirror. Telescope comes equipped with a 60X eyepiece and a mounted Barlow Lens, giving you 60 & 120 power. Optical Finder Telescope, included. Sturdy, hardwood, portable tripod. Free with scope: Valuable STAR CHART and 272 page "Astronomy Book." Stock No. 85,050-M . . . . . \$29.50 f.o.b. (Shipping wt. 10 lbs.) . . . . . Barrington, N. J.



## 4 1/4" ASTRONOMICAL TELESCOPE

Mt. Palomar type! Up to 270 Power. A fine Reflector Telescope complete with real Equatorial Mount and Tripod and 6X Finder. Aluminum tube, 4 1/4" dia. mirror, rack and pinion focusing eye-piece holder, 2 eyepieces and mounted Barlow Lens for 40X, 90X, 120X and 270X. Shipping weight approx. 25 lbs. Stock No. 85,006-M . . . complete, \$74.50 f.o.b. Barrington, N. J.



## DIRECT MEASURING POCKET MICROSCOPE

— 50 POWER

Fountain pen size, makes direct measuring measurements; for checking small parts and dimensions under powerful magnification. Precision, glass etched reticle calibrated for measurements up to 1/10" by .001" divisions.



Stock No. 30,225-M . . . . . \$7.95 Pstpd.

## New! 2 in 1 Combination! Pocket-Size

### 50 Power MICROSCOPE and 10 Power TELESCOPE

Useful Telescope and Microscope combined in one amazing, precision instrument. Imported! No larger than a fountain pen. Telescope is 10 Power. Microscope magnifies 50 Times Sharp focus at any range. Handy for sports, looking at small objects, just plain snooping. Send Check or M.O. Satisfaction Guaranteed. Order Stock No. 30,059-M . . . . . \$4.50 Pstpd.



## Geophysical Year Scope

### REAL 150 POWER ASTRONOMICAL TELESCOPE ONLY \$16.95 Postpaid

Refractor type! Clear, razor-sharp viewing of stars, planets, craters on moon, etc. 32mm achromatic objective lens! First surface mirror diagonal lens! "skop" viewing. Removable eyepiece—interchangeable. 50, 75 and 150 power! Tube length 27 1/2". Special attachment clamp for vibrationless viewing. Money back guarantee. Included free: 273 page "Handbook of the Heavens", Star Chart—and 16 page Star Booklet. Stock No. 80,060-M . . . . . \$16.95 Postpaid

Larger 42mm objective model—67, 100, 200 power—same features as above, with 38" tube length—Included free: "Handbook of the Heavens", Star Chart and 16 page Star Booklet. Stock No. 80,061-M . . . . . \$19.95 Postpaid

## See The Satellites NEW, LOW PRICE SATELLITE TELESCOPE

Get ready for a terrific sky show as more Satellites are vaulted into space. See thrilling sights with our amazing Satellite Scope at unheard of low cost. Also view comets—use as a Rich-field Scope for viewing star clusters. 5 power—wide 12" field. Use of high quality war surplus optics makes possible this bargain. Stock No. 70,150-M . . . . . \$9.95 Postpaid

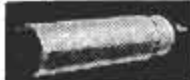

## Check, Measure, Inspect with this 6 POWER POCKET COMPARATOR

(Complete with Leather Case)

MEASURES • Angles • Radii • Circles • Linear—in both decimal inches and millimeters.

Used to check layouts, machining on tools, dies, gauges; to check threads, chamfers, wear on cutting tools, etc.

Stock No. 30,061-M . . . New Low Price . . . \$19.50 Pstpd.



## INFRARED SNIPERSCOPE TELESCOPE & PARTS

See in the dark—without being observed. War surplus Sniperscope M-2. Gov't. cost about \$1200. Instrument complete, ready to use. Includes Power Pack. Infrared light source. Will operate from 6 V auto battery. Battery or transformer available. Stock No. 85,053-M . . . . . \$150.00 f.o.b.

Save still more money! Build your own Sniperscope! We will furnish instructions—parts, including: Power Packs, 1P25A Image tubes, light units, filters, etc. For details—request FREE Bulletin A-26-H.



## WRITE FOR FREE CATALOG "H" I

Complete Line of Astronomical Telescope Parts and Assembled Telescopes. Also huge selection of lenses, prisms, war surplus optical instruments, parts and accessories. Telescopes, microscopes, satellite telescopes, binoculars, etc. Request Catalog "H" I

ORDER BY STOCK NUMBER. SEND CHECK OR MONEY ORDER. SATISFACTION GUARANTEED.  
**EDMUND SCIENTIFIC CO., BARRINGTON, N. J.**

(Continued from page 6)

the shoes taken off my feet by the gummy adhesive underfoot.

It was a hot and humid night, so all the windows were opened and several fans placed around the room. Several hours of this were to no avail, and this cure was promptly abandoned. Next, wielding a brush and several rags, a pajama-clad do-it-yourselfer was on hands and knees generously applying a coat of fresh alcohol to the rebellious floor.

For the moment, it looked as if this was it! It seemed to harden up, lose all its tackiness and the problem appeared to be solved. Five minutes after I had laid my weary bones down to rest with a great sigh of relief, a rigid finger informed me that the stickiness had returned. Two more coats of alky, and the same results. About 3 a.m., I decided that what this situation called for was heat. The windows therefore were tightly closed and two portable heaters strategically placed on opposite sides of the room. I almost died with the ovenlike atmosphere, but endured it with the hope that springs eternal. A couple of hours of this and I felt like a roast (well done), but the gooey old floor was still the same, if not worse.

There was nothing to do but inform my wife, when she was dressing the little fellow for his homecoming, of my all-night battle with the floor, and the net results. Her reaction was magnificent! "With people being murdered and wandering homeless all over the world," said she, "we won't let a thing like this disturb us." The crib, bassinet and other paraphernalia were transferred to the living room, together with a folding bed. For the next week or so, this was our "workshop" with our new baby while we tried to solve the problem of the errant floor.

An "expert" was called in. He estimated a cost of \$25 to remove the offending shellac. It was then that I hit upon the idea of putting down a new floor and covering it with rubber tile. Then came a couple of days of measuring, sawing and nailing hardboard. (Be sure to put the rough side up, nail every six inches, the man said, but nobody told me to use "untempered" board, did they?) Then came the laying of the rubber tile. It's easy, the man said—just use this trowel and scrape it along the floor. The black stuff was generously applied and the tiles laid carefully, as per instruction, from the center out. (But nobody told me only a light film of mastic was all that was necessary, did they?) The mastic—it was everywhere. Splotches appeared on wallpaper, in the hallway, on

(Continued to page 10)





# What's your boss saying about you?

The door is usually open. Today it's closed. They're talking about you . . . about your future. You don't have to hear to know what they're saying. Because there's nobody who knows more about you and your present job than you.  
*O.K. . . . So you have "experience." Five years on the same job.*

Have you *mastered* the job . . . learned everything there is to know about it? If your answer is "yes," success is right around the corner. But if the answer is "no," then your experience doesn't amount to much. And chances are these things are true about you: you just "coast" along with things . . . you do nothing and go

home all tired out. **BEWARE!** Those are danger signals. Unless you take a fresh look at things, you'll be doing the same job at the same salary for the next five years. And the next five.

### What you can do about your future

If you want to succeed . . . make more money, earn the respect of your family and community . . . you have to take the bull by the horns. Success doesn't just come along. You have to meet it halfway. So act **NOW** and make your experience mean something. Add I. C. S. *training* to your record and start going places. Do it at home, in your spare time, for a few cents a day.

*Does it work?* These facts answer that. A recent survey shows that in a single 120-day period, 1973 I. C. S. students were promoted to better jobs. If you had acted a year ago, one of them could have been you. So mail the coupon below today.

### Pick your favorite subject

257 I. C. S. courses to choose from. 203 expert I. C. S. instructors to give you personal help. No time or expense going to and from classes. No interference with business and social life.

### Your first step

Sit down *right now* and fill out the coupon below. Check your favorite subject. I. C. S. will send you **FREE** and without obligation of any sort, three books. One, "How to Succeed," tells you how to start climbing to the top. Second book outlines the opportunities in the field of your choice. Also, a free sample lesson in basic mathematics.



For Real Job Security—Get an I. C. S. Diploma! I. C. S., Scranton 15, Penna.

Accredited Member, National Home Study Council

## INTERNATIONAL CORRESPONDENCE SCHOOLS



BOX 45299A, SCRANTON 15, PENNA.

(Partial list of 257 courses)

- Without cost or obligation, send me "HOW TO SUCCEED" and the opportunity booklet about the field BEFORE which I have marked X (plus sample lesson):
- |  |  |  |  |   |
|--|--|--|--|---|
| <p><b>ARCHITECTURE and BUILDING CONSTRUCTION</b></p> <ul style="list-style-type: none"> <li><input type="checkbox"/> Air Conditioning</li> <li><input type="checkbox"/> Architecture</li> <li><input type="checkbox"/> Arch. Drawing and Designing</li> <li><input type="checkbox"/> Building Contractor</li> <li><input type="checkbox"/> Building Estimator</li> <li><input type="checkbox"/> Carpentry and Millwork</li> <li><input type="checkbox"/> Carpenter Foreman</li> <li><input type="checkbox"/> Heating</li> <li><input type="checkbox"/> Interior Decoration</li> <li><input type="checkbox"/> Painting Contractor</li> <li><input type="checkbox"/> Plumbing</li> <li><input type="checkbox"/> Reading Arch. Blueprints</li> </ul> <p><b>ART</b></p> <ul style="list-style-type: none"> <li><input type="checkbox"/> Commercial Art</li> <li><input type="checkbox"/> Magazine &amp; Book illus.</li> <li><input type="checkbox"/> Show Card and Sign Lettering</li> <li><input type="checkbox"/> Sketching and Painting</li> </ul> <p><b>AUTOMOTIVE</b></p> <ul style="list-style-type: none"> <li><input type="checkbox"/> Automobiles</li> <li><input type="checkbox"/> Auto Body Rebuilding and Refinishing</li> <li><input type="checkbox"/> Auto Engine Tuneup</li> <li><input type="checkbox"/> Auto Technician</li> </ul> | <p><b>AVIATION</b></p> <ul style="list-style-type: none"> <li><input type="checkbox"/> Aero-Engineering Technology</li> <li><input type="checkbox"/> Aircraft &amp; Engine Mechanic</li> </ul> <p><b>BUSINESS</b></p> <ul style="list-style-type: none"> <li><input type="checkbox"/> Accounting</li> <li><input type="checkbox"/> Advertising</li> <li><input type="checkbox"/> Business Administration</li> <li><input type="checkbox"/> Business Management</li> <li><input type="checkbox"/> Cost Accounting</li> <li><input type="checkbox"/> Creative Salesmanship</li> <li><input type="checkbox"/> Managing a Small Business</li> <li><input type="checkbox"/> Professional Secretary</li> <li><input type="checkbox"/> Public Accounting</li> <li><input type="checkbox"/> Purchasing Agent</li> <li><input type="checkbox"/> Salesmanship</li> <li><input type="checkbox"/> Salesmanship and Management</li> <li><input type="checkbox"/> Traffic Management</li> </ul> <p><b>CHEMICAL</b></p> <ul style="list-style-type: none"> <li><input type="checkbox"/> Analytical Chemistry</li> <li><input type="checkbox"/> Chemical Engineering</li> <li><input type="checkbox"/> Chem. Lab. Technician</li> <li><input type="checkbox"/> Elements of Nuclear Energy</li> <li><input type="checkbox"/> General Chemistry</li> <li><input type="checkbox"/> Natural Gas Prod. and Trans.</li> <li><input type="checkbox"/> Petroleum Prod. and Engr.</li> <li><input type="checkbox"/> Professional Engineer (Chem)</li> <li><input type="checkbox"/> Pulp and Paper Making</li> </ul> | <p><b>CIVIL ENGINEERING</b></p> <ul style="list-style-type: none"> <li><input type="checkbox"/> Civil Engineering</li> <li><input type="checkbox"/> Construction Engineering</li> <li><input type="checkbox"/> Highway Engineering</li> <li><input type="checkbox"/> Professional Engineer (Civil)</li> <li><input type="checkbox"/> Reading Struc. Blueprints</li> <li><input type="checkbox"/> Structural Engineering</li> <li><input type="checkbox"/> Surveying and Mapping</li> </ul> <p><b>DRAFTING</b></p> <ul style="list-style-type: none"> <li><input type="checkbox"/> Aircraft Drafting</li> <li><input type="checkbox"/> Architectural Drafting</li> <li><input type="checkbox"/> Drafting Machine Design</li> <li><input type="checkbox"/> Electrical Drafting</li> <li><input type="checkbox"/> Mechanical Drafting</li> <li><input type="checkbox"/> Sheet Metal Drafting</li> <li><input type="checkbox"/> Structural Drafting</li> </ul> <p><b>ELECTRICAL</b></p> <ul style="list-style-type: none"> <li><input type="checkbox"/> Electrical Engineering</li> <li><input type="checkbox"/> Elec. Engr. Technician</li> <li><input type="checkbox"/> Elec. Light and Power</li> <li><input type="checkbox"/> Practical Electrician</li> <li><input type="checkbox"/> Practical Lineman</li> <li><input type="checkbox"/> Professional Engineer (Elec)</li> </ul> <p><b>HIGH SCHOOL</b></p> <ul style="list-style-type: none"> <li><input type="checkbox"/> High School Diploma</li> </ul> | <ul style="list-style-type: none"> <li><input type="checkbox"/> Good English</li> <li><input type="checkbox"/> High School Mathematics</li> <li><input type="checkbox"/> Short Story Writing</li> </ul> <p><b>LEADERSHIP</b></p> <ul style="list-style-type: none"> <li><input type="checkbox"/> Industrial Foremanship</li> <li><input type="checkbox"/> Industrial Supervision</li> <li><input type="checkbox"/> Personnel-Labor Relations</li> <li><input type="checkbox"/> Supervision</li> </ul> <p><b>MECHANICAL and SHOP</b></p> <ul style="list-style-type: none"> <li><input type="checkbox"/> Diesel Engines</li> <li><input type="checkbox"/> Gas-Elec. Welding</li> <li><input type="checkbox"/> Industrial Engineering</li> <li><input type="checkbox"/> Industrial Instrumentation</li> <li><input type="checkbox"/> Industrial Metallurgy</li> <li><input type="checkbox"/> Industrial Safety</li> <li><input type="checkbox"/> Machine Design</li> <li><input type="checkbox"/> Machine Shop Practice</li> <li><input type="checkbox"/> Mechanical Engineering</li> <li><input type="checkbox"/> Professional Engineer (Mech)</li> <li><input type="checkbox"/> Quality Control</li> <li><input type="checkbox"/> Reading Shop Blueprints</li> <li><input type="checkbox"/> Refrigeration and Air Conditioning</li> <li><input type="checkbox"/> Tool Design</li> <li><input type="checkbox"/> Tool Making</li> </ul> <p><b>RADIO, TELEVISION</b></p> <ul style="list-style-type: none"> <li><input type="checkbox"/> General Electronics Tech.</li> </ul> | <ul style="list-style-type: none"> <li><input type="checkbox"/> Industrial Electronics</li> <li><input type="checkbox"/> Practical Radio-TV Eng'g</li> <li><input type="checkbox"/> Practical Telephony</li> <li><input type="checkbox"/> Radio-TV Servicing</li> </ul> <p><b>RAILROAD</b></p> <ul style="list-style-type: none"> <li><input type="checkbox"/> Car Inspector and Air Brake</li> <li><input type="checkbox"/> Diesel Electrician</li> <li><input type="checkbox"/> Diesel Engr. and Fireman</li> <li><input type="checkbox"/> Diesel Locomotive</li> </ul> <p><b>STEAM and DIESEL POWER</b></p> <ul style="list-style-type: none"> <li><input type="checkbox"/> Combustion Engineering</li> <li><input type="checkbox"/> Power Plant Engineer</li> <li><input type="checkbox"/> Stationary Diesel Engr.</li> <li><input type="checkbox"/> Stationary Fireman</li> </ul> <p><b>TEXTILE</b></p> <ul style="list-style-type: none"> <li><input type="checkbox"/> Carding and Spinning</li> <li><input type="checkbox"/> Cotton Manufacture</li> <li><input type="checkbox"/> Cotton Warping and Weaving</li> <li><input type="checkbox"/> Loom Fixing Technician</li> <li><input type="checkbox"/> Textile Designing</li> <li><input type="checkbox"/> Textile Finishing &amp; Dyeing</li> <li><input type="checkbox"/> Throwing</li> <li><input type="checkbox"/> Warping and Weaving</li> <li><input type="checkbox"/> Worsted Manufacturing</li> </ul> |
|--|--|--|--|---|

Name \_\_\_\_\_ Age \_\_\_\_\_ Home Address \_\_\_\_\_  
 City \_\_\_\_\_ Zone \_\_\_\_\_ State \_\_\_\_\_ Working Hours \_\_\_\_\_ A.M. to P.M. \_\_\_\_\_  
 Occupation \_\_\_\_\_

Canadian residents send coupon to International Correspondence Schools, Canadian, Ltd., Montreal, Canada. . . . Special tuition rates to members of the U. S. Armed Forces.



# Make BIG MONEY! Amazing New subzero **INSULATED** Jackets and Shoes!

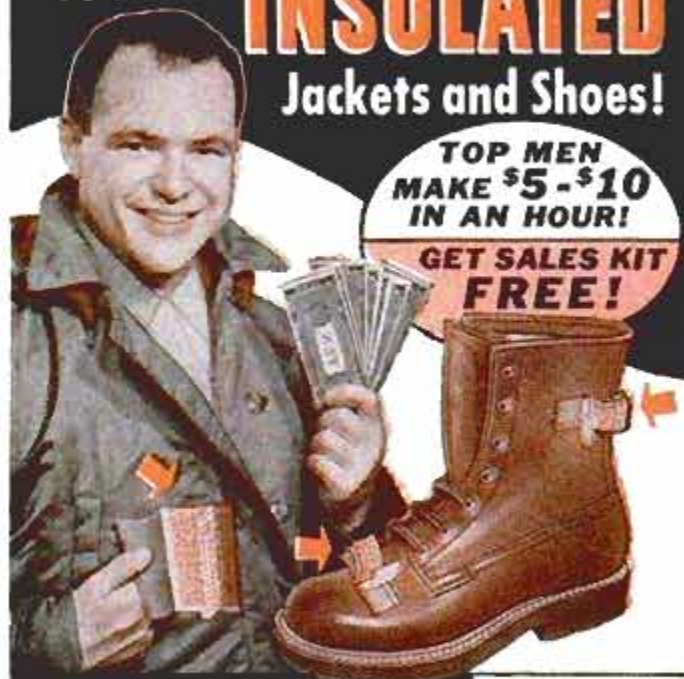

**TOP MEN  
MAKE \$5-\$10  
IN AN HOUR!**

**GET SALES KIT  
FREE!**

**Same Type Subzero Insulation  
as in U.S. Army Coldbar Suit!  
QUICK CASH IN SPARE TIME!**



**HOLDS YOU AFLOAT  
INDEFINITELY!**

Now! Start a highly profitable business without investing a cent! Act quick, be **FIRST** in town to take orders for sensational new Mason **INSULATED** Jackets and Shoes... results of a remarkable scientific discovery: a new miracle insulation with thousands of vinyl air cells that provide perfect "dead air space" insulation! ● **Keeps you WARM** even at Arctic temperatures! ● **DRY** in downpours (can't absorb water)! ● **Protected from strong WINDS!** It's the same type miracle insulation used in famous U.S. Army Coldbar Suit! Because Mason products are not sold in stores, folks must buy from YOU!

Take orders for just 2 Insulated Shoe & Jacket combinations a day in spare time and you'll earn \$90 Extra Income in one week!

**"Miracle" Features Make Money for You FAST!**

Your friends, fellow workers, truck drivers, gas station, construction men — hundreds right around home will fill your pockets with cash! Lightweight jacket covered with water-repellent Nylon, has detachable hood. Both boots, shoes are rugged leather, feature Air Cushion innersoles, Neoprene Cush-N-Crepe outsoles. With this miracle combination, walk out in cold, wet, snowy or windy weather and stay warm and dry! **ADDED FEATURE!** Men wearing, Insulated Jacket & Shoes plus Mason's Insulated **Pants** can float in water indefinitely! Outdoorsmen will buy all **THREE** from you!

### **190 OTHER Money-makers!**

You'll have 190 **OTHER** fast-selling shoes, jackets to help you build a big, repeat-order business! **EVERYBODY** needs shoes, jackets. Nationally advertised Mason products sell **fast**. You offer 170 styles for men, women: dress, sport, work shoes, boots, 28 jacket styles. **You actually feature more shoes in a greater range of sizes, widths than any store in your town!**

To start this exciting business **right away**, rush coupon NOW. You'll receive **FREE** a powerful Jacket & Shoe Sales Kit including Air Cushion demonstrator. How-to-make-Big-Money Booklet, **everything** else you need to start making **BIG CASH PROFITS** the very first hour!

**MASON SHOE MFG. CO., Dept. A-135, Chippewa Falls, Wis.**

## **Send for FREE Outfit!**

Mr. Ned Mason, Dept. A-135  
Mason Shoe Mfg. Co., Chippewa Falls, Wis.  
Yes! I want to be **FIRST** to take orders and make **QUICK CASH** in spare time with Mason's amazing new Insulated Jackets & Shoes! Rush my powerful **FREE** Sales Kit!

NAME.....  
ADDRESS.....  
TOWN..... STATE.....

the towels in the bathroom, our clothes, baby's things. After many hours, the last tile was placed and it looked beautiful.

Ah! A happy ending! But no! The next day the black mastic began oozing up through every crack. Rub, rub, rub with the steel wool, and abrasive and clear water, hours on end. And up it came behind me, more, more and more. Walking on the floor left mastic on the feet and, lo and behold, the squish, crackle, squish was still with us. In attempting to move our four-poster bed for the cleanup job, a corner was ripped from its moorings and the end of the bed fell to the floor. The bed was disassembled and, two hours and \$10 later, it was as good as new.

To make a long story short, friends, drop around sometime to see my new wall-to-wall carpeting (which I am having installed next week by an "expert").

Walter F. Loehfelm,  
Brooklyn 10, N. Y.

*Two things he did wrong:*

1. Shellac that's three years old should never be used.
2. Rubbing alcohol is excellent for the back, but is not a substitute for denatured alcohol when it comes to a thinner for shellac.—Ed.

### **Looking for a Free Movie?**

Our Shop editors were treated to an interesting 15-minute sound film recently



and we're passing the news on to clubs, schools and other groups interested in home workshops. The color film, *You Can't*

(Continued to page 16)





**A HIGHLY  
RESPECTED TRADE—  
START SOON TO  
EARN EXTRA MONEY  
IN SPARE TIME**

# Learn at Home IN YOUR SPARE TIME to Fix Electrical Appliances

To build a better future, get into a field where there's much important work and the security that comes from knowing a good trade. Servicing electrical appliances offers that OPPORTUNITY. Every wired home has an average of 8 electrical appliances. Up to 10 million new appliances are sold every year and owners pay well to keep them in repair. That's making a fast-growing need for trained men.

job. You can train at home in your spare time for only \$2.50 down and \$5.00 a month. A small price to pay for increased earnings, a more secure future. Paste coupon below on a 2c postal or mail in envelope for free book and sample lesson. Address **National Radio Institute, Dept. AAB, Washington 16, D.C.**

**Start Soon to Earn \$3, \$4, \$5, an Hour Extra in Your Spare Time**

Start soon to fix electric toasters, clocks, fans, vacuum cleaners and other appliances for neighbors and friends. Work in your basement, garage or spare room. Pick up \$3 to \$5 an Hour *extra that way*. It's easy to increase your earning power—to pay for this training many times over with your spare time earnings.

**2c TO MAIL THIS  
COUPON MAY START  
YOU TO SUCCESS  
LESSON AND BOOK  
FREE**



**Learn and Earn with Multi-Use Tester Built with Parts We Send**

This course includes the parts to build a portable, sturdy Appliance Tester that helps you locate electrical defects quickly and easily. You use it to learn and do actual electrical appliance repair jobs. If you want better pay learn this good trade. No need to give up your present

**NATIONAL RADIO INSTITUTE, Dept. AAB, Washington 16, D. C.**

Please send me Electric Appliance Training lesson and book free. (No salesman will call.)

Name ..... Age .....

Address .....

City ..... Zone ..... State .....

**ACCREDITED MEMBER NATIONAL HOME STUDY COUNCIL**



# Selling Stock At Sacrifice!

## NEVER BEFORE SUCH LOW PRICES!

Clearing out \$210,000 worth of stock at sacrifice prices. All new, first-quality merchandise. This is our famous January clearance—which means **LOWEST PRICES YET!** Stock up now. First come, first served. Your money back if you're not satisfied. Rush coupon below for **PROMPT** service. THORESEN, Inc., Dept. 6-A, 585 Water Street, New York 2, N. Y.

## Price Slashed! BEAUTIFUL NEW ZEPHIR ONE OF THE WORLD'S

## THINNEST TIMEPIECES

REGULAR PRICE! 7.98

**5.99**  
PLUS TAX

- ★ Looks Like \$75.00 Watch
- ★ 14 Karat Gold Color
- ★ Raised Gilt Hands and Numerals
- ★ New 1958 Model from Switzerland



Even at this low price you get famous Thoresen Unlimited Guarantee of free service, free annual oiling, free adjustments for lifetime of firm!

Here's the most fabulous watch value in America. Famous Zephyr ultra-thin watch—25,000 recently sold at \$7.98—reduced again to only \$5.99 plus tax for **QUICK SELL-OUT!** This is the new 1958 model, perfect in every detail; described by customers in words like these: "A rare jewel!"... "My friend thought I paid at least \$50.00 for it!"... "Keeps accurate time!" 14 karat gold color. Raised gilt hands and numerals. Precision Swiss import. Beautiful leather strap. This is a **TEMPORARY** price reduction to win new customers. (Price subject to change without notice). Don't lose out on this sensational value. NO. 210 5.99 plus 60c Federal tax. **TOTAL: 6.59** Special Save \$3 on Deluxe Model with 14 Karat Gold color expansion band. Thousands sold at \$10.99—yours for 7.99 tax-paid. NO. 210D.

## POCKET WATCH



ONLY  
**2.98**

No fancy diamond dial or wafer thin case; no alligator or golden band, no plush velvet gift box—and no fancy price tag either! Only \$2.98 buys this rugged, old-fashioned railroad-type watch. If you want an old-timer that evokes interest—and keeps good time—buy this old "choo choo" watch. Guaranteed. NO. 251... 2.98

## SWISS ARMY Type 10-in-1 Knife

50,000 Sold  
at \$3.98

**1.98**

Big! 9 inches long when open. 10 practical tools in one. Saw. File. Cork screw. Small Knife. Can Opener. Awl. Screwdriver. Utility Knife. Bottle Opener. Scissors. All easy to open & close. No jamming. No slipping. Replaces multitude of tools & gadgets can't find when needed. Rugged Korium steel. No. 18... Now 1.98



## 1958 Powerhouse Giant



from West  
GERMANY  
Still Only  
**4.98**

New faster focus. New swirling p.v. ot. New modern design. New case & straps. Best yet from West Germany. Every lens made by GRINDING. Get clearer, sharper, close-up views day or night. Our costs have risen 17%—yet new 1958 Powerhouse still only 4.98. Biggest binocular value in U.S.A. NO. 66. Case & straps included. 4.98

## WATER & SHOCK

Resistant Watch

**7.77**

50,000 sold at higher prices—now only 7.77. Water and shock resistant. Built-in shock protector. Anti-magnetic. Stainless Steel Back. Sweep second hand. Luminous dial. Runs under water. Even if we charged TWICE the price, we couldn't give you a more accurate watch. Famous Thoresen Unlimited Guarantee of free service, oiling, adjustments for lifetime of this firm. No. 263 7.77 plus 78c Federal tax. **TOTAL: 8.55** Special Deluxe Model with metal expansion band. Reg. \$11—only \$10 tax paid. No. 263D.



**RUNS UNDER WATER!**

## SOLINGEN Stainless Steel Steak Knives

New  
Low  
Price **25c**

Fantastic value. Adv. in "House Beautiful," "The American Home" etc. One million sold at prices of 33c to \$2.00 each. Now slashed to only 25c in lots of 4. New, first-quality. Gold & Ivory hue handles. Brush-taking design. Stainless steel. Serrated edges never need sharpening. 10-year replacement guarantee. No. 694 4 for \$1, 8 for 1.98



## Black Forest Hunting Knife

Reduced Again!

**88c**

plus 12c for Sheath

Another price slash on the world's most popular hunting knife. 100,000 sold at \$3.98. Thoresen cut price on replica to \$1.25. Now we cut price to only 88c plus 12c for sheath. Rugged Korium steel. Nearly 10 inches long. You'll marvel at sculptured style of handle. A real champion. No. 76... \$1 complete



## "This Insulated Vest Feels Warmer than 10 Sweaters!"\*

DuPont Dacron Fiberfill  
Gives Warmth without Weight!

SAVE \$6.00. New hunting vest with 3-ply insulation. Same vest featured in "Sports Afield" magazine recently at \$13.95—our price 7.95. Featherweight yet gives same protection as 10 sweaters—writes one customer.

Adv. at  
**\$13.95**  
**7.95**

Extra-large zipper that can't freeze. Two huge roomy pockets with inside elastic shell loops. Washable. Dries fast. Keeps shape. Long-fibered insulation by DuPont. Dustproof. Mothproof. Non-Allergic. Full purchase price refunded if you don't agree it's worth nearly TWICE the price. Red or Brown. Extra small (32-34); Small (36-38); Medium (40-42); Large (44-46); Extra Large (48-50). **FREE 10-day trial.** No. 53... 7.95



\*writes one customer

## MAIL COUPON! MONEY BACK GUARANTEE

THORESEN, Inc., Dept. 6-A  
585 Water Street, New York 2, N. Y.

Rush items below. My money back if I'm not satisfied.

NO.	QUANTITY	ARTICLE	PRICE

State Size & Color where necessary.  
MINIMUM ORDER \$2.98

- Check, money order or cash enclosed. Send prepaid  
 Send COD Plus Postal fees

PRINT NAME \_\_\_\_\_

ADDRESS \_\_\_\_\_

TOWN OR \_\_\_\_\_

CITY \_\_\_\_\_ STATE \_\_\_\_\_

Canadians: 439 King St. West, Toronto 2B, Ont.



# INVENTORS

**L**earn how to protect your invention. The U. S. Patent Laws provide that any new and useful art, machine, article of manufacture, or composition of matter, or any new and useful improvement thereof, may be patented if the act of invention is involved. Therefore, every inventor with a valuable invention should take advantage of the Patent Laws and proceed for patent protection in order to safeguard his rights.

A patent gives the inventor the exclusive right to prevent others from making, using, or selling the invention claimed in the patent for a period of seventeen years.

The Patent Laws were enacted for the benefit of the inventor to give him protection for the features of his invention which are patentable. These features must be properly and concisely set forth and claimed in a formal application for patent, in order to comply with the requirements of the Patent Laws. For that reason, unless the inventor is familiar with patent matters, he should engage a competent registered patent attorney or agent to represent him. We are registered to practice before the U. S. Patent Office and are prepared to serve you in the handling of your patent matters.

A specially prepared booklet entitled "Patent Guide for the Inventor", containing detailed information with respect to patent protection and procedure, together with a "Record of Invention" form will be promptly forwarded to you without obligation upon request.

---

## CLARENCE A. O'BRIEN & HARVEY JACOBSON

*Registered Patent Attorneys*

81-A DISTRICT NATIONAL BUILDING

WASHINGTON 5, D. C.



# LET 10 EXPERTS HELP YOU START A FABULOUS "MAIL ORDER BUSINESS"



10 Mail Order authorities who will help you every month to start an exciting Mail Order Business and to make MONEY — from your own home if you wish! At a cost of 50c per month!

It would cost you at least \$10,000 to hire these Mail Order men to show you every facet of Mail Order! Now—for just 50c a month—you can have the full benefit of their counsel and advice. Some of these authorities charge as much as \$100.00 for a single letter—yet you can get the benefit of their knowledge, their experience, their ideas EVERY MONTH for 50c! Now—for the FIRST TIME you have a chance to start a Mail Order Business—and make it pay—through the help of a sensational NEW Publication—one of the most EXTRAORDINARY, the most unusual EVER PUBLISHED! Exclusively for the MAIL ORDER BUSINESS.

## The most comprehensive Mail Trade Journal in the World!

That's what you'll say when you see this big 32 to 48 page publication, bursting from cover to cover with illus. features, ideas, news, features, depts., all about one thing—the MAIL ORDER BUSINESS. We're willing to return your money if you don't agree that it is the most comprehensive M.O. Magazine in the world.

### READ THE MAGAZINE THE BIG EXECUTIVES READ!

These Mail Order Executives KNOW the value of a good publication. They know the NECESSITY of such a magazine. YOU TOO, NEED "Mail Order Business" whether you are already in the business, just getting into it or merely thinking about going into Mail Order.

### LIKE NO OTHER MAIL ORDER PUBLICATION!

"Mail Order Business" is like NO other M.O. publication in existence today! It's available ONLY by mail! It is available on a money back guarantee. Please don't confuse this magazine with any other mail order publication.

### IDEAS, IDEAS, AND MORE IDEAS!

Someone said an idea may be worth a million. "Mail Order Business" is chockful of ideas, new ones, old ones, unusual ideas on all aspects of this business. Ideas on what to sell, how to sell it! You need just one idea to justify a subscription.

### "M.O.B. WILL TEACH YOU MAIL ORDER!"

No OTHER SOURCE can give you the HELP, ADVICE, and INSPIRATION as well and as effectively as a good magazine like "Mail Order Business" can. WE GUARANTEE a year's careful study of this magazine will give you a good working knowledge of how the Mail Order Business operates! IT'S LOW IN PRICE, TOO! Good Mail Order courses cost up to \$50.00. A subscription to M.O.B. is just \$6.00 per year!

**This Big 8 1/2" x 11" Magazine crammed full with these features every month!**

- News Stories
- Illus. Features
- Questions & Answers
- New Products
- Foreign Products
- Direct Mail
- Legal Dept.
- Sources of Supply
- Business Barometer
- New Ideas
- Adv. Clinic
- Type, Ink & Paper
- M.O. 50 Years Ago
- Free Sales Aids
- Post Office Bulletins
- Mail Order Plans
- Mail Order Lists

#### A COMPLETE NEW MAIL ORDER COURSE!

Now being published a chapter a month—By a foremost Mail Order counselor. Never before published anywhere! Don't miss a single chapter of this TREMENDOUS course! Available to you for the price of a subscription. Cost us over \$1000!

#### WHAT'S LEGAL?

An attorney with 25 years M.O. legal experience runs this special department every month. Tells you what is legal and what is not legal in mail order. Answers subscriber's legal questions about Mail Order. Think... how much would such a service ordinarily cost you?

#### NEW PRODUCTS

Dozens and dozens of selected products with Mail Order potential. Helps you to answer the question "What shall I Sell?" Tells you the price and the manufacturer. Every month a new selection. Any one of these can turn out to be a bombshell seller!

#### MATERIAL PUBLISHED EQUIVALENT TO SEVERAL BOOKS OR COURSES

"Mail Order Business" gives you over a year's period the equivalent in material to at least several books or mail order courses. And remember M.O.B. is publishing a new mail order course that cost the publisher over \$1000 to obtain!

#### ROVING PHOTO REPORTER

"Mail Order Business" roving photo reporter each month visits a big mail order concern and gives a photo story of what goes on behind the scenes! SEE how big M.O. firms function!

Have THOUSANDS of Dollars worth of help behind you—at a cost of just PEANUTS!

If you want to succeed in Mail Order—if you REALLY want to get into this fabulous business you will need every bit of the help, the inspiration, and ideas of "Mail Order Business."

#### FOREIGN PRODUCTS

Lists glamorous new products from all over the world for M.O. selling. Gives addresses where to get them. Also valuable information on how to import these items for tremendous profits! Sample Accessory Kits that sell for \$50.00—cost you \$7.00. Secure and scores of products that can spell BIG PROFITS for you.

#### WHERE TO BUY IT

Need to locate the source of supply for a new item? Let "Sources of Supply" help you locate it! Available to subscribers only.

## FANTASTIC FORTUNES POSSIBLE IN MAIL ORDER!

W.R. of California started a business in his living room. Now he has 12 workers turning out \$100,000 worth of merchandise a year. D.M. of N.J. started with a coat hanger—now does 3 million a year. E.R. of Mass. decided to try selling squabs by mail. In 26 days, he made \$3,800 on one deal! C.B. of Conn. made \$100,000 during the first year of mail order operation. Dozens of other actual success stories in existence that will surprise you.

## A COMPLETE READY TO OPERATE MAIL ORDER BUSINESS PLAN FULLY DESCRIBED FOR YOU!

Think of it! A ready to operate M.O. Business complete in every detail—step by step—what to sell—how to start—how and where to buy goods—already written ads and where to place them fully described in one issue! Each plan easily worth \$100.00! A M.O.B. Exclusive! NEVER BEFORE PRESENTED ANYWHERE! Several of these valuable business plans—each different—will be offered from time to time. YOUR COST? Just the price of a single subscription!

"... By far the biggest and finest Mail Order Publication ever published! Worth its weight in gold."—D.P., N. Y.

**THIS IS WHAT ONE SUBSCRIBER SAID WHEN HE GOT HIS FIRST ISSUE!**

Don't take our word for it! See for yourself. Other complimentary letters coming in every day.

## Just \$6.00 FOR A FULL YEAR'S SUBSCRIPTION

Hardly more than 12c a week! (\$3.50 for 6 months). Remember! Special "Question and Answer" departments are yours to use as a subscriber. Don't dare miss an issue! It may be the very one with the idea, the information that can logically make you a fortune.

Mail Order Business, Box 591-AS, Lynn, Mass.  
Here's my \$6.00 for 12 issues (\$3.50 for 6 issues) of M.O.B. Rush 1st issue and remaining issues every month.

Name \_\_\_\_\_  
Address \_\_\_\_\_  
City \_\_\_\_\_ State \_\_\_\_\_  
Remember! Your money back if 1st issue isn't MORE than we said it was.

Your money back in full if you don't get at least \$100 worth of ideas and information from your first issue!  
YOU be the judge of the first issue. Look it over and decide for yourself if it isn't MORE than we said it to be. If not, we'll gladly return your money in FULL without a quibble, too. What have you to lose?

**MAIL ORDER BUSINESS** BOX 591-AS, LYNN, MASS.



GET FULL FACTS  
**FREE!**

Prepare for a  
**Profitable, Exciting Future**

as an **Electronics Technician!**

**No Previous Technical Experience Required!**

Opportunities were never greater for the man who wants to get someplace and be somebody than they are today in the fast-expanding, profitable field of Electronics.

Let us tell you without cost or obligation how you may prepare for a real career in one or more branches of Electronics, either in our well-equipped Chicago or Toronto laboratories—or at home without interfering with your present job. Send coupon for **FREE** facts today!

**AN EXCELLENT OPPORTUNITY FOR MEN 17-55!**

Even if you haven't an advanced education, find out how you may prepare in your spare time at home, to enter the **BIG OPPORTUNITY** field of Electronics. Mail coupon **TODAY!**

**Sample Booklet FREE!**

We'll give you a free copy of an interesting booklet, "Electronics and YOU." See for yourself how you may take advantage of the opportunities in this growing field.



**NO ADVANCED EDUCATION NEEDED!**

Prepare now for Electronic job opportunities in —

- |                |                |
|----------------|----------------|
| Radar          | Remote Control |
| Guided Missile | Systems        |
| Control        | Automation     |
| Computers      | Electronics    |
| Radio          | Industrial     |
| Television     | Electronics    |
| Broadcasting   | Your Own       |
| Communications | Service Shop   |

**Free Employment Service**

DeVry Tech's Placement Department is in contact with some of the best-known employers in the Electronics field. The service is free to all graduates — and DeVry Tech's record in helping to place men has been outstanding.

**Draft Age?**

We have valuable information for every man of draft age; so if you are subject to military service, be sure to check the coupon.

Accredited Member of National Home Study Council



"One of North America's Foremost Electronics Training Centers"

**DeVRY TECHNICAL INSTITUTE**

CHICAGO 41, ILLINOIS

Formerly DeFOREST'S TRAINING, INC.



**MAIL COUPON TODAY!**

DeVRY TECHNICAL INSTITUTE  
4141 Belmont Ave., Chicago 41, Ill., Dept. PM-1-0

Please give me your **FREE** booklet, "Electronics and YOU," and tell me how I may prepare to enter one or more branches of Electronics as listed above.

Name \_\_\_\_\_ Age \_\_\_\_\_

PLEASE PRINT

Street \_\_\_\_\_ Apt. \_\_\_\_\_

City \_\_\_\_\_ Zone \_\_\_\_\_ State \_\_\_\_\_

Check here if subject to Military Training.

DeVry Tech's Canadian Training Center is located at  
626 Roselawn Avenue, Toronto 12, Ontario

2032



(Continued from page 10)

Put a Price on It, was produced by Supreme Products Corporation as a service to the power-tool industry and maybe, gentlemen, it will convince your wife you can profitably and pleasurably invest in a better workshop at home. The movie is available without charge by writing Supreme Products Corporation, 380 Madison Ave., New York City 17.

**To the Editor:**

I must say that your article ("They Find Water on the Desert," PM, August 1957) on the induced-polarization method has had a very large response with us. We have received inquiries from a great number of engineers, as well as lay people, about this kind of work. I have told some of our people who are inclined to seek out "high-brow" journals as a publication medium, that if they really want to reach their peers, they should publish in *Popular Mechanics*.

E. J. Workman, President,  
New Mexico Institute of  
Mining and Technology,  
Socorro, N. Mex.

**Beg Your Pardon**

On page 112 of our October 1957 issue, we referred to a "steam-heated runway" built by the American Hydrotherm Corp.

Instead of steam, the pipes under the runway are heated by "circulating high temperature liquid heat transfer media," according to the company.

☆☆☆

Recognize our December cover painting of the USS *Carronade*? Here Thomas E. Stimson, Jr., PM Western Editor at Los Angeles, presents the original of the painting to Vice Admiral Carl F. Espe, Commander, Amphibious Force, U.S. Pacific Fleet, at his headquarters at Coronado, Calif.



## New greaseless way to keep your hair neat all day...and prevent dryness



GET IN THE SWIM WITH A GREASELESS HAIR TONIC... New Vitalis keeps hair in place and prevents dryness with V-7, the *greaseless* grooming discovery. You never have an over-slick, plastered down look. Try it. You'll like it.

\*He's soon to appear in the *Batjac-Panama* production, "China Doll."



Vitalis makes Olympic champ Bob Mathias' hair look great in the movies, too.\*

**New VITALIS® Hair Tonic with V-7.**

ANOTHER FINE PRODUCT OF BRISTOL-MYERS



# Learn TELEVISION-RADIO

*Servicing or Communications*

## by Practicing at Home in Spare Time

WITHOUT EXTRA CHARGE you get special NRI kits developed to give actual practice with TV-Radio equipment. You build, test, experiment with receiver or broadcasting circuits. All equipment yours to keep.



**NRI Has Trained Thousands for Successful Careers in TV-Radio**

### Have the High Pay, Prestige, Good Future of a Skilled TV-Radio Technician

People look up to and depend on the Technician, more than ever before. His opportunities are great and are increasing. Become a TV-Radio Technician. At home, and in your spare time, you can learn to do this interesting, satisfying work—qualify for important pay.

A steady stream of new Electronic products is increasing the job and promotion opportunities for Television-Radio Technicians. Right now, a solid, proven field of opportunity for good pay is servicing the tens of millions of Television and Radio sets now in use. The hundreds of TV and Radio stations on the air offer interesting jobs for Operators and Technicians.



**Studio Engineer KATV**  
"Now Studio Engineer at KATV. Before enrolling, I was held back by sixth grade education."  
**BILLY SANCHEZ**, Pine Bluff, Arkansas.

**All the Work He Can Do**  
"Since finishing NRI Course I have repaired 2,000 TV and Radio sets a year. NRI proved a good foundation."  
**H. R. GORDON**, Milledgeville, Georgia.

**Has Good Part Time Business**  
"Quite early in my training I started servicing sets. Now have completely equipped shop. All equipment is paid for."  
**E. A. BREDA**, Tacoma, Wash.

**The Tested Way To Better Pay See Other Side**

**CUT OUT AND MAIL CARD NOW**

### More Money Soon—Make \$10 to \$15 a Week Extra Fixing Sets in Spare Time

NRI students find it easy to start fixing sets for friends a few months after enrolling, pick up \$10, \$15 and more a week extra spending money. Many who start in spare time soon build full time TV-Radio businesses.

### Act Now—See What NRI Can Do for You



NRI has devoted 40 years to developing simplified, practical training methods. You train at home, learn-by-doing. **NATIONAL RADIO INSTITUTE, Dept. 8AA, Washington 16, D. C.**

## SAMPLE LESSON AND CATALOG BOTH FREE

**NO STAMP NEEDED!  
WE PAY POSTAGE**

This card entitles you to Actual Lesson on Servicing, shows how you learn Television-Radio at home. You'll also receive 64-Page Catalog.

**NATIONAL RADIO INSTITUTE, Dept. 8AA  
Washington 16, D. C.**

Please mail me the FREE sample lesson and 64-Page Catalog. (No Salesman will call.)

Name..... Age.....  
Address.....  
City..... Zone..... State.....  
**ACCREDITED MEMBER, NATIONAL HOME STUDY COUNCIL**





Technical KNOW-HOW - Can Give You Most Interesting, Important Work  
**LEARN-BY-DOING** with Kits NRI Sends at No Extra Charge



### YOU BUILD AC-DC Superhet Receiver

NRI Servicing Course includes all needed parts. By introducing defects you get actual servicing experience practicing with this modern receiver. Learn-by-doing.

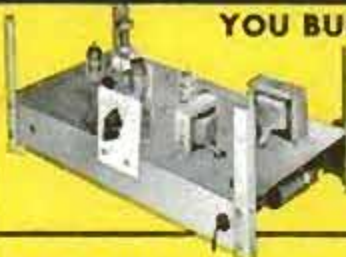

### YOU BUILD Signal Generator

You build this Signal Generator. Learn how to compensate high frequency amplifiers, practice aligning typical I.F. amplifiers in receiver circuits. Make tests, conduct experiments.

### YOU BUILD Broadcasting Transmitter

As part of NRI Communications Course you build this low power Transmitter, learn commercial broadcasting operators' methods, procedures. Train for your FCC Commercial Operator's License.



### YOU BUILD Vacuum Tube Voltmeter

Use it to earn extra cash fixing neighbors' sets; bring to life theory you learn from NRI's easy-to-understand texts.



# For Higher Pay, Better Jobs Be a Television-Radio Technician



### Servicing Needs More Trained Men

Portable TV, Hi-Fi, Transistors, Color TV are making new demands for trained Technicians. Good opportunities for spare time earnings or a business of your own. Enjoy prestige.



J. E. Smith, Founder

### Train at Home the NRI Way Famous for Over 40 Years

NRI is America's oldest and largest home study Television-Radio school. The more than 40 years' experience training men, the outstanding reputation and record of this school—benefits you many ways. Successful graduates are everywhere, in small towns, big cities. You train in your own home, keep your present job while learning. Let us send you an actual lesson, judge for yourself how easy it is to learn.

### Broadcasting Offers Satisfying Careers

4000 TV and Radio stations offer interesting positions. Govt. Radio, Police, Two-Way Communications are growing fields. Trained TV-Radio Operators have a bright future.



### No Experience Necessary — NRI Sends Many Kits for Practical Experience

You don't have to know anything about electricity or Radio to understand and succeed with NRI Courses. Clearly written, illustrated NRI lessons teach Radio-TV-Electronic principles. You get NRI kits for practical experience. All equipment is yours to keep. Mailing the postage-free card may be one of the most important acts of your life. Do it now. Reasonable tuition, low monthly payments available. National Radio Institute, Dept. 8AA, Wash. 16, D.C.

### NRI Graduates Do Important Work



#### NRI Course Easy to Understand

"Opened my own shop before receiving diploma. I am independent in my own business." D. P. CRESSEY, Stockton, California.

#### Works on Color TV

"NRI changed my whole life. If I had not taken the course, probably would still be a fireman, struggling along." J. F. McLINE, New York.

See Other Side for More Information to Better Pay

## BUSINESS REPLY CARD

No Postage Stamp Necessary if Mailed in the United States

POSTAGE WILL BE PAID BY

NATIONAL RADIO INSTITUTE

Washington 16, D. C.

**SAMPLE LESSON**  
**64-page CATALOG**  
**both FREE**



# INVENTORS

If you believe that you have an invention, you should find out how to protect it. The first step is to have a search made of the prior pertinent U. S. patents. If a report on this search indicates that the invention appears patentable you can apply for a patent, and the specifications and claims should be prepared.

The firm of McMorrow, Berman & Davidson, with offices in Washington, D. C., is qualified to take the necessary steps for you. We can make a preliminary search on your invention, advise you whether we think it can be patented, and prepare your application for patent.

Unless you are fully familiar with the U. S. Patent Laws, we recommend that you engage the services of a Registered Patent Attorney to protect your interests. The patent laws are *your* laws. A patent gives you the right to prevent others from making, using or selling the invention claimed in your patent for a period of 17 years.

Use these patent laws for your protection. Investigate whether your invention can be patented. If you have what you believe to be an invention, we suggest that you have this firm make a search for you:

*Send for a copy of our Patent Booklet entitled "How To Protect Your Invention," containing information about patent protection and patent procedure. Along with this we will also send you an "Invention Record" form, for your use in writing down and sketching details of your invention. We will mail them promptly. No obligation. They are yours for the asking.*

**McMORROW, BERMAN & DAVIDSON**

*Registered Patent Attorneys*

**PATENTS**



**COPYRIGHTS**



**PATENTS**

**135-R VICTOR BUILDING, WASHINGTON 1, D. C.**



# MEN PAST 40

**Afflicted With Getting Up Nights,  
Pains in Back, Hips, Legs,  
Nervousness, Tiredness.**

If you are a victim of the above symptoms, the trouble may be due to Glandular Dysfunction. A constitutional Disease for which it is futile for sufferers to try to treat themselves at home. Medicines that give temporary relief will not remove the cause of your trouble.

Most men, if treatment is taken before malignancy has developed, can be successfully **NON-SURGICALLY** treated for Glandular Dysfunction. If the condition is aggravated by lack of treatment, surgery may be the only chance.

## NON-SURGICAL TREATMENTS

The **NON-SURGICAL** treatments afforded at the Excelsior Institute are the result of 20 years research by scientific Technologists and Competent Doctors.

The War brought many new techniques and drugs. These added to the research already accomplished has produced a new type of treatment that is proving of great benefit to man as he advances in years.

The Excelsior Institute is devoted particularly to the treatment of diseases of men of advancing years. Men from all walks of life and from over 3,000 cities and towns have been successfully treated. They found soothing and comforting relief and a new health in life.

### EXAMINATION AT LOW COST

On your arrival here, our Doctors who are experienced specialists, make a complete examination. Your condition is frankly explained to you with the cost of treatment you need. Your decision is then made. Treatments are so mild that hospitalization is not necessary — a big saving in expense.

**RECTAL-COLON** Troubles are often associated with Glandular Dysfunction. We can treat these for you at the same time.

# FREE ILLUSTRATED BOOK

The Excelsior Institute has published a New **FREE** Book that deals with Diseases peculiar to men. It could prove of utmost importance to your future life.

Write today. No obligation.



**Excelsior Institute  
Dept. B-975  
Excelsior Springs, Mo.**

Gentlemen: Kindly send me at once your New **FREE** Book on Diseases peculiar to men. I am.....years old.

Name.....  
Address.....  
City.....State.....

C-10

## Beauty by Colorcrete Can Earn High Incomes



Beautifying buildings by Colorcrete is a business opportunity awaiting men of modest capital everywhere. Owners of homes, stores, motels, schools — almost any type of construction — are looking for means to give lifetime eye-appeal to drab or dirty concrete, stucco and similar masonry surfaces. Colorcretors can do such jobs, in little time and at little cost, and pocket generous profits. Colorcrete is a cementitious material, applied by air pressure. Tough, tenacious, enduring; 30 colors. Investigate this low-investment enterprise by writing for the Opportunity Book.

**COLORCRETE INDUSTRIES, INC.**  
570 Ottawa Ave., Holland, Mich.

## COLORCRETE

Now! **TEST YOUR OWN  
TV & RADIO TUBES**  
ALL OF THEM—EVEN PICTURE TUBE



for filament breaks

Nearly half of TV service calls are due to defective filaments. Tester shows if filaments are good. Insert tube in tester. Light shows if tube is burned out. Easy, safe. One service call saved pays for tester. Metal cases, AC or DC. Checks fuses, appliances, etc. Only \$3.95 ppd. or C.O.D. plus charges. Deluxe Model \$4.95. Instructions. Guaranteed. **GEIGER ENGINEERING CORP., Dept. AB-105**  
3735 West Lawrence Avenue, Chicago 25, Ill.

## earn as TAX EXPERT

**\$15  
HOUR**

Our students earn as much as \$3,000 in 3 short months preparing income tax returns in spare time. Also operate lucrative year-round Business Tax Service. Dignified home-office business. Experience unnecessary. We train you; help you start. State approved home training program. Write today for free prospectus.  
**UNION INSTITUTE, 68 Hudson, Hoboken 20G, N. J.**

## SCIENTIFIC CRIME DETECTION

IT'S EASY TO LEARN



Let us teach you in your own home. Learn Fingerprinting, Firearms Identification, Police Photography, Criminal Investigation Methods thoroughly, quickly, at small cost. Over 800 Bureaus of Identification in the U. S. employ I. A. S. students or graduates. Write today, stating age.

**INSTITUTE OF APPLIED SCIENCE, 1920 Sunnyside Ave., Dept. 1351**  
(A Correspondence School Since 1916) Chicago 40, Ill.

## Make Big MONEY

Complete Order-Writing Outfit **FREE!**



**Famous STARK Varieties  
Sell Fast to Vast Market for  
HOME ORCHARDS & LANDSCAPING**

Everywhere home owners want backyard fruit orchards and landscaping. Make money taking orders for world-known U.S. Patented **STARK FRUIT TREES**: Apples, Pears, Plums, Peaches, Cherries, Berries, etc. Also famous **Ornamentals**: Roses, Shrubs, etc. Plus amazing **DWARF FRUIT TREES**: plant 9 in 20-ft. space. Early yields of bushels of luscious, full sized fruit. **BIG COLORPHOTO DEMONSTRATION KIT FREE!** Write to:

**STARK BRO'S** Dept. 5518  
LOUISIANA, MISSOURI



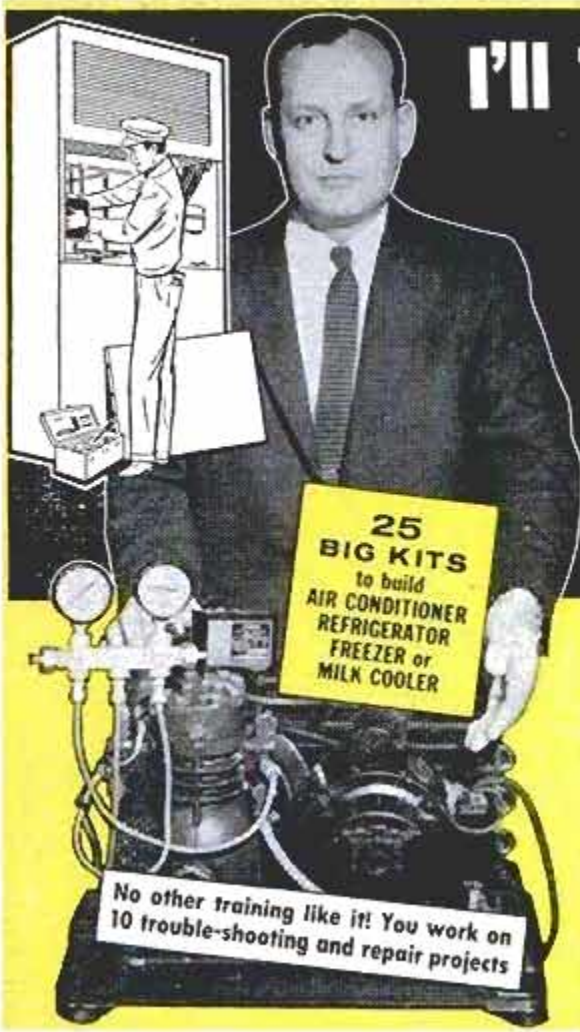

# I'll Train You at Home for A BUSINESS OF YOUR OWN —OR A BETTER JOB

—R. C. Anderson, President of CTI

## MORE OPPORTUNITIES—LESS COMPETITION IN AIR CONDITIONING AND REFRIGERATION

You've read about the amazing growth of the air conditioning and refrigeration industry. It's one of America's largest opportunity fields because over 150 million units are in use. Last year, 3 million refrigerators, 2 million air conditioners, and a million freezers were sold. All this adds up to a big demand for trained technicians who can install, repair and service. They make good money, work steady, enjoy security. Many open their own shops—become independent.

You can get ready for one of the top-pay jobs in just a few months. CTI will train you at home in spare time. You'll train with real kits, get practical experience as you go along. Be sure to mail coupon below for the full story on how you can succeed in this old, established, but growing industry!

No other training like it! You work on 10 trouble-shooting and repair projects

Only CTI sends you 25 training kits! At no extra cost, you get all parts and tools to assemble a heavy-duty, commercial-type, 1/4 h.p. high-side (illustrated above). You work on 23 shop-type programs, do 10 trouble-shooting and repair projects—all in your own home!



### You Get Experience as You Train with Kits

You practice as you train, thanks to CTI Shop-Method Home Training. CTI trains you in months, not years—eliminates a long period of low-pay apprenticeship. At left are photos of but two of the 25 big kits you get—along with easy-to-understand, illustrated lessons.

### YOUR BIG OPPORTUNITY TO OPEN A SHOP!

Students often build up a list of customers which includes not just homes, but office buildings, shops, food stores and industrial plants. They contract to do servicing on a fee basis, or simply answer calls. The Air Conditioning and Refrigeration field offers plenty of opportunity for independence. Own a shop—Be the boss! Mail coupon today!



### Many Students Earn Extra Money as They Train

Many students, soon after they start training, do repairing in spare time. They work with local dealers evenings and week-ends. Others go "on their own." They earn extra cash, get added experience. Some land full-time jobs while students, and quite a number open shops. All this is possible because CTI training is so practical.

### FIRST GET THE FACTS—THEN DECIDE

The Air Conditioning and Refrigeration industry is growing so rapidly that 20,000 newly-trained mechanics are needed each year. You owe it to yourself to investigate your opportunities. You can have all the facts—FREE—by just filling out and mailing coupon. But be sure to act today!

**COMMERCIAL TRADES INSTITUTE**  
1400 Greenleaf Avenue • Chicago 26, Illinois

**MAIL TODAY FOR FREE BOOK AND SAMPLE LESSON**

### COMMERCIAL TRADES INSTITUTE

1400 GREENLEAF AVENUE DEPT. R-437  
CHICAGO 26, ILLINOIS

Tell me how I can qualify for a better job or a business of my own. Send booklet, Success in Air Conditioning & Refrigeration, and Lesson Sample. Both FREE.

Name \_\_\_\_\_ Age \_\_\_\_\_

Address \_\_\_\_\_

City \_\_\_\_\_ Zone \_\_\_\_\_ State \_\_\_\_\_





# DRAFTSMEN



**CASH BIG  
PAY CHECKS!**

Train Now for  
more success,  
greater security

**LEARN AT HOME IN SPARE TIME**  
(or at college in Chicago)

Check the want ads in any newspaper—SEE the big-pay opportunities open to you as a draftsman. What's more, you can learn this well-paid, prestige profession at home—quickly, easily! No special talent needed. Get complete, step-by-step Chicago Tech lessons in the mail, spend a few pleasant hours studying each week. In a short time you'll be a well-trained draftsman, ready to take your pick of many good jobs. Act now!



**Free Information—Mail Coupon Today!**

Get **FREE TRIAL LESSON** plus information about C.T.C. practical training. Learn what successful Chicago Tech graduates say about high pay and opportunities in drafting. No charge, or obligation.

## CHICAGO TECHNICAL COLLEGE

A-216 Tech Bldg., 2000 So. Michigan Ave.  
Chicago 16, Illinois

Mail me **FREE** lesson with facts about big opportunities in **DRAFTING**.

Name \_\_\_\_\_ Age \_\_\_\_\_  
Address \_\_\_\_\_  
City \_\_\_\_\_ Zone \_\_\_\_\_ State \_\_\_\_\_

**EVERYTHING YOU NEED TO  
ENJOY STAMP COLLECTING for 25¢**



### LARGE ALBUM & STAMP COLLECTION, Hinges & Midget Encyclopedia

1) **LARGE ILLUSTRATED ALBUM.** Spaces for thousands of stamps from all over the world. (Pack of hinges too.) A happy home for your stamps for many years to come.

2) **VALUABLE STAMP COLLECTION.** MONACO—Grace Kelly Wedding Stamp-of-the-Year. KOREA, many more. 107 all different.

3) **MIDGET ENCYCLOPEDIA — STAMP DICTIONARY — STAMP IDENTIFIER.**

ALL 3 ITEMS REGULAR \$1.15 VALUE FOR **JUST 25¢** TO INTRODUCE OUR BARGAIN APPROVALS. **MONEY BACK GUARANTEE.** SEND 25¢ TODAY. ASK FOR LOT FO-28

**ZENITH CO.** 81 Willoughby St., Brooklyn 1, N. Y.



**INSURED TIRE SERVICE**  
**POPULAR BRANDS**

**FREE** INSURANCE POLICY given with each used tire sold. We guarantee the amount of service you pay for.

**YOU CAN'T LOSE!!**

NOWHERE CAN SUCH QUALITY BE FOUND AT SUCH LOW PRICE!

**GOODYEAR SUBURBANITE TYPE SNOW TIRES**  
New Tire Guarantee—Factory Rebuilt  
**BEST WINTER TRACTION OF ALL!**

670x15 \$9.95 710x15 650x16 650x15 \$10.90  
600x16 760x15 800-820x15

Super Quality — Rugged Performance — 6 Months Insured Service			
600x16 \$3.65 670x15 3.85 670x15 4.25 700x15 4.25 700x15 4.25	650x16 \$3.95 700x15 4.05 710x15 4.35 820x15 4.45	760x15 \$4.45 700x16 54.45 760x16 54.45	820x15 \$4.75 850x15 4.95 850x17 4.65
Supreme Quality — Nothing Finer — 12 Months Insured Service			
600x16 \$5.25 475x15 5.45 700x16 5.45 700x16 5.45	600x16 (6) 6.75 640x15 4.95 750x16 (8) 15.95 750x20 (8) 15.50	650x16 5.75 670x15 5.35 700x17 11.95 750x20 (10) 17.50	650x16 (6) 7.25 710x15 5.45 750x17 16.45 825x20 21.50
700x16 6.35 760x15 5.95 750x15 10.95 900x20 19.95	750x16 (6) 8.45 800x15 6.35 30x5 11.25 1000x20 20.45	850x16 4.95 820x15 6.35 600x20 10.95 1100x20 21.25	850x17 4.75 850x18 5.35 650x20 11.75 1000x22 21.95
850x15 5.25 670x16 5.15 32x6 (8) 11.95 1100x22 22.75	700x15 5.35 700x16 (6) 10.25 32x6 (10) 12.75 1100x24 25.95		

Whitewalls \$1.00 extra.

**MIDLAND TIRE SALES**  
Speedy shipments on Mail Orders. P.O.B. Chicago. Insurance policy sent with each order. Deduct 10% on orders for 2 or more used tires. Send **CHECK** or **MONEY ORDER**—No COD's.  
3701 S. Normal, Dept. PM-66, Chicago 9, Ill.

**WORLD'S LOWEST PRICED  
ADDING MACHINE**

Counts up to 999,999,999  
**IDEAL FOR BUSINESS AND PERSONAL USE—GUARANTEED ACCURATE.** Not a toy. Operates with only a finger flick. Adds, subtracts, multiplies, divides. Counts up to one billion. Pays for itself over and over. Ideal Gift—for Business, Income Tax and School use. **MONEY BACK GUARANTEE.** Send name and address. Pay postman only \$2.95 plus postage. Beautiful rich-looking Leathertec Case included at no extra cost. Money back in 10 days if not delighted. **AGENTS WANTED.**

**CALCULATOR MACHINE COMPANY**  
P.O. Box 126, Dept. J-81, Huntingdon Valley, Penna.

Best Pocket Size **FREE TRIAL \$2.95**  
\$3.04 IN PENNA. INCLUDING 3% TAX

## CABINET MAKING

**LOW COST HOME TRAINING COURSE FOR BEGINNERS & ADVANCED CRAFTSMEN**

Make money. Learn skills and secrets of fine woodworking and tool use. Professionally prepared shop method training tells and shows how. Covers everything. Easy to master.

**INTERSTATE TRAINING SERVICE**  
DEPT. F3, PORTLAND 13, OREGON

## COMBINATION All-Purpose JIG SAW

**BVI BUILT-IN MOTOR! POWER TAKEOFF FOR DRILLING, SANDING, POLISHING!** only \$29.95

Saws wood, plastics, metal to center of 24" circle. Converts to miter saw. Built-in power takeoff. Converts quickly to drill, sander, polisher, etc. A complete home workshop. At your dealer. Send postcard for free catalogue.  
**Burgess Vibrocrafters, Inc., Dept. A-140**  
Grayslake, Ill.

## Make Your Own SINKERS! FISHERMEN JIGS! SOUIDS! CASTING AND SPINNING LURES!

SEND FOR **FREE CATALOGUE TODAY!**  
It's fun, it's easy with Sweet's **ALUMINUM MOLDS**  
Molds for fresh and salt water fishermen. Handled and hinged for easy, fast operation. Over 100 types, 500 sizes. Write for free catalogue.





# It's Like Having Auto Factory Experts Right Beside You...

SHOWING YOU

## HOW TO FIX ANY PART OF ANY CAR!

NOW—Whether You're a Beginner  
or an Expert Mechanic—You Can  
"Breeze Through" ANY Auto Repair Job—  
QUICKLY — EASILY — RIGHT!

SUPPOSE you had an automobile factory engineer standing right beside you... guiding your hands through every step of even the toughest car repair jobs! Think how you'd "whiz through" every job! No wonder, then, that 2,500,000 MOTOR'S Auto Manuals have been sold. No wonder so many thousands of beginners and expert mechanics alike are already using MOTOR'S brand-new AUTO REPAIR MANUAL. It shows you, in step-by-step words and pictures, factory-approved repair procedures for fixing ANY part of ANY car, 1949 through 1957!

No guesswork! MOTOR'S Manual "starts from scratch" — leads you through entire job with easy directions. You CAN'T go wrong!

1000 BIG PAGES —  
OVER 2900 PICTURES

NEW, REVISED, ENLARGED Edition covers everything you need to know about all models of 23 car makes—including ALL 1957 CARS. Over ONE THOUSAND giant pages, 2,900 "This-is-How" pictures. Over 291 "Quick-Check" charts — more than 23,436 essential repair specifications. Over 225,000 service and repair facts. Plus a big new Trouble-Shooting section!

Even a green beginner mechanic can do a good job with this giant manual before him. And if you're a top-notch mechanic, you'll find short-cuts that will amaze you. No wonder this guide is used by the U. S. Army and Navy! No wonder hundreds of thousands of men call it the "Auto Repair Man's Bible"!

Engineers from every automobile plant in America worked out these time-saving procedures for their own motor car line. Now the editors of MOTOR have gathered together this wealth of "know-how" from over 160 Official Shop Manuals and "boiled it down" into crystal-clear terms in one handy indexed book!

### EVERYTHING YOU NEED TO KNOW

Includes ALL Automatic Transmissions, Power Steering, Power Brakes, latest Carburetors, Engines, Fuel Pumps, Starting Motors, 12-Volt Systems, Generators, Voltage Regulators, Distributors, Axles, etc. Factory Specifications and Adjustment Tables. Tune-up Charts, Tables of Measurements and Clearances, Overhauling and Replacement Facts — and MUCH MORE.

### Brand New! Covers All These Makes

Buick	Jeep
Cadillac	Lincoln
Chevrolet	Mercury
Chrysler	Nash
Crisler	Oldsmobile
Continental	Packard
De Soto	Plymouth
Dodge	Pontiac
Ford	Rambler
Hudson	Studebaker
Imperial	Thunderbird
Willis	



# MOTOR'S AUTO REPAIR MANUAL

CARBURETOR

GENERATOR

FUEL PUMP

STEERING GEAR

BRAKES

DISTRIBUTOR

AUTOMATIC  
TRANSMISSIONS

STARTING MOTORS

STARTER SWITCHES

AIR CONDITIONERS

IGNITION

MUCH MUCH MORE!

TRY  
BOOK **FREE**  
FOR A WHOLE WEEK

### TRY THIS BOOK 7 DAYS FREE!

Just mail coupon. (Attach it to postcard, if you wish.) When postman brings book, pay nothing. First, make it show you what it's got! Unless you agree this is the greatest time- and work-saver you've ever seen — return book in 7 days, pay nothing. Mail coupon to MOTOR Book Dept., Desk 1A, 250 West 55th St., New York 19, N. Y.

MAIL COUPON NOW FOR 7-DAY FREE TRIAL  
(Attach to Postcard if More Convenient)

### MOTOR BOOK DEPT.

Desk 1A, 250 W. 55th St., New York 19, N. Y.

Rush to me at once (check box opposite book you want):

MOTOR'S New AUTO REPAIR MANUAL. If O.K., I will remit \$2 in 7 days, \$2 monthly for 2 months and a final payment of 95c (plus 35c delivery charges) one month after that. Otherwise I will return the book postpaid in 7 days. (Foreign price, remit \$9 cash with order.)

MOTOR'S New TRUCK REPAIR MANUAL. If O.K., I will remit \$2 in 7 days, and \$2 monthly for 3 months, plus 35c delivery charges with final payment. Otherwise I will return book postpaid in 7 days. (Foreign price, remit \$10 cash with order.)

Print Name..... Age.....

Address.....

City..... State.....

Check box and save 35c shipping charge by enclosing WITH coupon in envelope entire payment of \$6.95 for Auto Manual (or \$8 for Truck Manual). Same 7-day return-refund privilege applies.

### Same FREE Offer On MOTOR'S Brand-New Truck Repair Manual

Covers every job on every popular make gasoline and Diesel truck made from 1949 thru 1957. Over 2000 pictures. 865 big pages. FREE 7-Day trial. Check proper box in coupon.





Some make more, some less: T. THORN reports:

**\$690** gross in single  
**MONTH**  
IN MY OWN BUSINESS!

**Start  
YOUR OWN  
Business!**



● Here's YOUR chance to start a money-making, year-'round business of your own and make the success you've dreamed about. R. O. Donnelly took in \$40 in seven hours. O. W. Ware landed a \$750 hotel job. R. Traynor grossed over \$450.00 in five days. Homes, hotels, offices, clubs, offer you big profit possibilities. Auto upholstery also.

**NO SHOP OR OFFICE NECESSARY.** You clean furniture on customers' premises. No hauling. No high rents. Supplies inexpensive; operate from your home. What you take in is mostly profit.

● If you want to be your own boss—free from layoffs, strikes and bosses, we will help you to start and succeed. Don't delay... read the facts, then decide for yourself.

**MAIL COUPON TODAY FOR FREE BOOK**

VON SCHRADER MFG. CO.  
110 "D" PL., Racine, Wisconsin

Without obligation rush your **FREE** booklet about how I can start my own permanent, profitable electric Upholstery Cleaning business.

Name \_\_\_\_\_

Address \_\_\_\_\_

City \_\_\_\_\_ Zone \_\_\_\_\_ State \_\_\_\_\_

**WHOLESALE Electric Guitars - Parts - Factory to You**

Solid-body Spanish, amplifiers, four neck guitars, double-necks, single-necks, triple necks, solid-body mandolin, pickup mikes, non-electric instruments, etc. 1958 Models wholesale. **FREE CATALOG.** Free home study course with instruments. Parts & plans available to build your own.

**CARVIN CO.,** Box 287, PM-1, Covina, Calif.

**MAKE STRIPES with  
new PAINT PEN**

**Straight, curved, single or double**  
With any color paint, stripe furniture, bikes, autos, model planes, toys, linoleum, wall-board. Clean, crisp decorative lines. Can't clog or smear. Also use with glue, tempera, textile paint or underglaze... on wood, glass plastic, ceramics, metals, fabrics and paper. Ask your dealer or order direct.

**DEALERS** Master paint stripping tool in display carton. Write for discounts.  
**HOBBY** "Professional" results every time. Simple, easy to use.  
**MFRS** Ask about heavy duty industrial stripping tools.  
**DOUBLE STRIPE MODEL \$3.25**  
**5 COMBINATIONS.**

**WENDELL MFG. CO.** 4234 LINCOLN AVE., Dept. 336 CHICAGO 18, ILLINOIS

Single 1/16" stripe model **\$1.25**

Other single \$1.75 stripe models ea.  
1/64", 1/32", 3/64", 5/64", 3/32" & 1/8"

Complete Kit **\$5.00** (all 7 tips)

Extra tips 90c ea.

Extra 1/4" tip... \$1.20

**Shrinks Hemorrhoids  
New Way Without Surgery**

Science Finds Healing Substance That Relieves Pain—Shrinks Hemorrhoids

For the first time science has found a new healing substance with the astonishing ability to shrink hemorrhoids and to relieve pain—without surgery.

In case after case, while gently relieving pain, actual reduction (shrinkage) took place.

Most amazing of all—results were so thorough that sufferers made astonishing statements like "Piles have ceased to be a problem!"

The secret is a new healing substance (Bio-Dyne\*)—discovery of a world-famous research institute.

This substance is now available in suppository or ointment form under the name Preparation H.\* Ask for it at all drug counters—money back guarantee. \*Reg. U. S. Pat. Off.



**"I Made \$14,839 in 1 Year  
SERVICING RADIATORS!"**

Are you earning under \$8,000 a year? Hundreds now making \$10,000-\$12,000-\$15,000 a year servicing auto truck tractor radiators the Inland way. Easy to learn. Inland, largest radiator equipment mfr., offers complete package—equipment, merchandising, "Pays-for-itself" financing, free training. \$305 down for equipment starts you. Profitable dept. for garage or service station. Write to

**INLAND MFG. CO.,** Dept. PM-1, 1108 Jackson St., Omaha 2, Nebr.



**SEND FOR THIS FREE!**

Make money. Know how to break and train horses. Write today for this book **FREE**, together with special offer of a course in Animal Breeding. If you are interested in Galting and Riding the saddle horse, check here ( ) Do it today—now.

**BEERY SCHOOL OF HORSEMANSHIP**  
Dept. 1101 Pleasant Hill, Ohio



**HIGH SCHOOL DIPLOMA**

Earn a High School Diploma at home! Prepare for better job, more pay. Study in spare time. No classes. Materials furnished. Certified teachers. Valuable diploma awarded.

Write Today for Complete Information  
**SOUTHERN STATES ACADEMY**  
Box 5344-A Sta. E Atlanta, Georgia

**REAL ESTATE  
BE A BROKER**

**PAYS BIG! SEND FOR FREE, BIG, ILLUSTRATED CATALOG NOW!** Graduates report making substantial incomes. Start and run your own business quickly. Men, women of all ages, learn easily. Course covers Sales, Property Management, Appraising, Loans, Mortgages, and related subjects. **STUDY AT HOME** or in classrooms in leading cities. Diplomas awarded. Write **TODAY** for free book! No obligation.

Approved for World War II and Korean Veterans  
**WEAVER SCHOOL OF REAL ESTATE (Est. 1936)**  
2020 Grand Avenue Kansas City, Mo.

**FOR BIG MEN ONLY!**



**SIZES 10 to 16 WIDTHS AAA to EEE**

We specialize in **LARGE SIZES ONLY**—sizes 10 to 16; widths AAA to EEE. Dress, sport, casual and work shoes; golf shoes; insulated boots; socks; slippers; rubbers; overshoes; shoe trees. Also sport shirts in your exact, extra-long sleeve length. Enjoy perfect fit in your hard-to-find size at amazingly low cost. Satisfaction Guaranteed. Sold by mail only. Write for **FREE Style Book TODAY!**

**SEND FOR FREE CATALOG**

**KING-SIZE, INC.,** 515 Brockton, Mass.



# **INVENTORS--PATENTS**

*I*f you consider your invention valuable — if you have invented any new and useful art, machine, manufacture or composition of matter or improvement thereof — take these necessary preliminary steps promptly to protect it by applying for a United States patent.

Sketch and describe your invention.  
(For convenience in starting action on your invention, use "Evidence of Invention" form offered below.)

Sign, date and have this invention disclosure witnessed by two people capable of understanding your invention.

Have us make a preliminary search among U. S. patents already granted for similar types of invention.

We then prepare a report for you on the probable patentability of your invention and recommend your further course of action.

This firm is registered to practice before the U. S. Patent Office. We are available to assist you in the preparation and prosecution of your application for patent.

**We shall be glad to send you promptly and without obligation, an instructive booklet—"Patent Protection for Inventors"—and our convenient "Evidence of Invention" form.**

**VICTOR J.**  
**EVANS & Co.** *Merlin M. Evans*

REGISTERED PATENT ATTORNEY

430-A MERLIN BUILDING

WASHINGTON 6, D. C.



## CARPENTERS AND BUILDERS GUIDES



**PRACTICAL STOREHOUSE OF MODERN CONSTRUCTION INFORMATION** (4 vol. set) for carpenters and all woodworkers. Explains in easy language and by profuse illustration principles, advances, short cuts, trade secrets, all based on the **NEWEST** information.

Vol. 1 - Tools, steel square, saw filing, joinery, furniture, etc.; Vol. 2 - Builders' mathematics, drawing plans, specifications, estimates, etc.; Vol. 3 - House and roof framing, laying out, foundations, etc.; Vol. 4 - Doors, windows, stair building, millwork, painting, etc. 4 vols. 2904 Pages. 2700 Illustrations. Whole set only \$5.

CIRCLE NO. 8 IN COUPON



## TV TELLS HOW TO ANSWER RADIO T.V. QUESTIONS

**RADIO SERVICE LIBRARY**

HERE IS LATEST INFORMATION IN THE FIELD OF RADIO AND TELEVISION REPAIRS AND SERVICING AND TROUBLESHOOTING.

**TWO COMPLETE VOLUMES - 1568 Pages - 1085 Illustrations and Diagrams, 1001 Important Facts and Figures on Modern T.V. Radio, Electronic Devices, INCLUDES TRANSISTORS & Transistors Circuits, Rectifiers, Record Changers, P.A. Systems, Phonograph Pick-ups, F.M., Auto Radio, Short Wave.**

Basic principles, Construction, Installation, Operation, Repairs, Trouble Shooting, How to get Sharp, Clear T.V. Pictures, English Axioms, How to Test, Explains COLOR SYSTEMS, Methods of Conversion, Terms, etc. Includes Ultra High Frequency. Quick ready reference of use as a home study course. Only \$8 for BOTH volumes.

CIRCLE NO. 3 IN COUPON

## MATHEMATICS MADE EASY

A COMPLETE HOME STUDY COURSE - Starting with the first principles of arithmetic, advancing step by step through the various stages of mathematics, including the rules and calculations for mechanical and electrical problems. New EASY correct methods. Includes plans and good geometry, trigonometry, algebra, calculus, etc. Practical tests, reference tables and data. How to use slide rule. 752 Pages. 550 Illustrations. Priced at only \$3.

CIRCLE NO. 11 IN COUPON

## WELDERS GUIDE

Covers Electric, Oxy-acetylene, Thermit, Inconel welding for sheet metal, spot and pipe welds, pressure vessels and aluminum, copper, brass, bronze and other metals. Airplane work, surface hardening, hard facing, cutting, grinding, etc. 608 Pages. Fully Illustrated. Only \$3.

CIRCLE NO. 10 IN COUPON

## REFRIGERATION & AIR CONDITIONING

**FOUR BOOKS IN ONE -** basic principles, servicing, operation, repair of 1. Household Refrigeration. 2. Special Refrigeration Units. 3. Commercial & Industrial Refrigeration. 4. Air Conditioning Systems. A GOLD MINE of essential information. Completely up-to-date. 1360 Pages. Fully Illustrated and Indexed. Priced at only \$5.

CIRCLE NO. 14 IN COUPON

## NEW MACHINISTS AND TOOLMAKERS HANDBOOK

**MODERN MACHINE SHOP PRACTICE - 5 PRACTICAL BOOKS IN ONE.** New from cover to cover. Tells how to set up and operate lathes, screw and milling machines, shapers, drill presses and all other machine tools. A COMPLETE INSTRUCTOR AND REFERENCE BOOK. 1728 Pages. Fully Illustrated. Priced at only \$6.

CIRCLE NO. 4 IN COUPON

## HOME APPLIANCES

**HOW TO FIX** Refrigerators Washers Dryers Vacuums Toasters Ironers Ranges Freezers

Many other **GAS AND ELECTRIC APPLIANCES**

Nandy Reference for Electric & Gas Servicemen, Mechanics, Dealers and Homeowners. Explains clearly and simply how to locate trouble, how to test, reassemble and connect. Wiring diagrams, 1000 Facts. Easy to read. Answers All your questions. 854 Pages. Illustrated. Only \$9.

CIRCLE NO. 2 IN COUPON

**PRACTICAL ELECTRICITY** - A COMPLETE HANDBOOK - Quiet, simplified, ready reference. Complete instruction and practical information on the rules and laws of electricity - Maintenance of Machinery - A.C. and D.C. Motors - Armatures - Wiring Diagrams - House Lighting - Power Wiring - Meters - Batteries - Transformers - etc. Simple to understand. 1520 Pages. 2600 Illustrations. Priced at \$5.

CIRCLE NO. 12 IN COUPON

## OIL BURNERS

New, complete, explaining in detail both domestic and industrial oil burners. Includes electrical hook-ups and wiring diagrams. Fully covering the theory, construction, installation, operation, testing, servicing and repair of all equipment. Indexed for ready reference. Over 416 Pages. 320 Illustrations and Diagrams.

Only \$2-CIRCLE NO. 28 IN COUPON

## 7-DAY FREE EXAMINATION

**SEND NO MONEY -** Pay the postman nothing! We are glad to send you any of the Audel Guides for FREE examination in your home. We take all the risks and leave the decisions to YOU. There is no obligation if you decide to keep the books you may pay for them under our astounding easy-pay plan of only \$2 a month.

## HERE IS ALL YOU DO

IT'S EASY TO ORDER: In the No-Bills Mail Order Coupon just draw a circle around the number of Audel Guides you want us to send for FREE EXAMINATION. We will send them to you at once to help you build a brighter future by increasing your SKILL. If for any reason at all you are not COMPLETELY satisfied, return the books, and that will end the matter!

## ADDITIONAL IMPORTANT TITLES

- Audel Guides are the best in their fields, written in clear simple fashion, lavishly illustrated. Circle numbers wanted in the MAIL ORDER COUPON at right. All sent for FREE EXAMINATION.
- |  |        |
|--|--------|
| No. 1 AUTOMOBILE MECHANICS GUIDE, 1672 Pages           | \$6.00 |
| No. 3 TRUCK & TRACTOR GUIDE, 1274 Pages                | 3.00   |
| No. 6 PLUMBERS & STEAMFITTERS GUIDES, 4 Book Set       | 8.00   |
| No. 7 PAINTING & DECORATING MANUAL, 664 Pages          | 2.00   |
| No. 9 DIESEL ENGINE MANUAL, 640 Pages                  | 2.00   |
| No. 13 WIRING DIAGRAMS, 204 Pages                      | 2.00   |
| No. 15 ELECTRIC LIBRARY, 7000 Pages, 10 Book Set       | 30.00  |
| No. 23 BLUE PRINT READING, 448 Pages                   | 2.00   |
| No. 27 MASONRY & BUILDERS GUIDES, 4 Book Set           | 8.00   |
| No. 28 ELECTRIC MOTOR GUIDE, 1896 Pages                | 5.00   |
| No. 29 SHEET METAL PATTERN LAYOUTS, 1152 Pages         | 7.50   |
| No. 30 SHEET METAL WORKERS HANDBOOK, 464 Pages         | 2.00   |
| No. 31 MECHANICAL DRAWING GUIDE, 192 Pages             | 2.00   |
| No. 32 MECHANICAL DRAWING & DESIGN, 480 Pages          | 3.00   |
| No. 33 ELECTRONIC DEVICES, 304 Pages                   | 2.00   |
| No. 34 ELECTRICIANS EXAMINATIONS, 272 Pages            | 2.00   |
| No. 35 ELECTRIC POWER CALCULATIONS, 480 Pages          | 2.00   |
| No. 36 ELECTRIC DICTIONARY, 9000 Terms                 | 3.00   |
| No. 37 POWER PLANT ENGINEERS GUIDE, 1568 Pages         | 3.00   |
| No. 38 ENGINEERS AND FIREMANS EXAMS, 344 Pages         | 2.00   |
| No. 39 OPERATING ENGINEERS LIBRARY, 3 Book Set         | 12.00  |
| No. 40 PUMPS, HYDRAULICS & AIR COMPRESSORS, 1760 Pages | 6.00   |
| No. 41 HOUSE HEATING GUIDE, 1008 Pages                 | 2.00   |

## MAIL THIS COUPON TODAY!

THEO. AUDEL & CO. - Self Improvement Publishers Since 1879 P1  
49 W. 23rd Street, New York 10, N. Y.

Please mail me for 7 days' FREE EXAMINATION the books I have circled at right. I agree to mail \$2 in 7 days on each book or set ordered, and to further mail \$2 a month on each book or set ordered until I have paid the purchase price, plus shipping costs. If I am not completely satisfied with my Audel Guides I may return them.

NAME \_\_\_\_\_

ADDRESS \_\_\_\_\_

OCCUPATION \_\_\_\_\_

EMPLOYED BY \_\_\_\_\_

1 2 3 4 5 6 7 8 9 10 11 12 13 14 15 25 26

27 28 29 30 31 32 33 34 35 36 37 38 39 40 41

**SAVE SHIPPING COSTS!** Check here if you enclose complete payment with order. We pay postage charges. You have same return privilege.

## Sensational Tomato Customers Report 2 BUSHELS To a Vine



Grow the world's most amazing Tomato right in your own garden and get a bushel or more of delicious, ripe tomatoes from a vine.

## BURGESS CLIMBING TRIP-L-CROP

**TOMATO** Vine grows 10 to 18 feet and outyields all other known varieties. Huge, meaty, solid fruit, wonderful flavor. Some weigh as much as 2 pounds. Excellent for slicing and canning.

**TRIAL PACKET 10c**  
Postpaid. Order Today  
**3 Packets for 25c**

LOOK FOR THE 10c BONUS COUPON ON EACH PACKET.

FREE Catalog with valuable information about "BLIZZARD BELT" Seeds, Bulbs and Plants for the "BEST GARDEN IN TOWN."

**BURGESS SEED & PLANT CO.**  
117-B, Galesburg, Mich.

## What Does Your English Say About You?

Every time you speak or write, you show what you are. Poor English can harm you more than you realize. A command of effective English helps you socially and in business. You can improve your English through Sherwin Cody's famous patented invention. If you are ever embarrassed by mistakes in grammar, spelling, pronunciation or punctuation, send for Mr. Cody's free book, "How You Can Master Good English in 15 Minutes a Day." No obligation. No salesman will call. Address: Sherwin Cody Course in English, 581 Central Drive, Port Washington, N. Y.

## MONEY in WORMS

Big money made raising crickets, hybrid red wigglers and 12 inch African fishworms—Sell by mail!—We teach you how to raise and where to sell. Free literature. Start now for big season beginning next spring.

**CARTER WORM RANCH, PLAINS, GEORGIA**

## LAW FREE BOOK THE LAW TRAINED MAN

Write today for a FREE copy of illustrated law book, "THE LAW-TRAINED MAN," which shows how to earn the professional Bachelor of Laws (LL.B.) degree through home study of the famous Blackstone Law Course. All necessary books and lessons provided. Moderate cost; convenient monthly terms. Write for FREE law training book today.

**Blackstone School of Law, 307 N. Michigan Ave.**  
Dept. 51, Chicago 1, Illinois

Founded 1890



## TROPICAL FISH

Sell for up to \$75 A PAIR

**BREED EASY-TO-SELL TROPICALS AT HOME—IN FULL OR SPARE TIME**

Imagine—up to \$75 per pair paid for beautiful, exotic fish. Big demand constantly from hobbyists, stores, business offices, interior decorators, others. Earn up to \$7.50 an hour in interesting, easy, home business.

**NO BIG INVESTMENT—NO COMPETITION**

We supply complete instruction plus everything to get you started. Operate in living room, garage, anywhere, full or part time. No "big business" competition to worry about.

Rush name, address for free illustrated booklet, business plan, premium offer. Limited supply—act now!

**FREE!**  
VIEWER-PROJECTOR & FULL COLOR SLIDE  
WORTH \$4.95

**TROPICAL FISH BREEDERS OF AMERICA**  
15121 S. Broadway, Dept. D-1  
Los Angeles 61, California



Get into

# TELEVISION RADIO-ELECTRONICS



**LEARN ALL 8 PHASES  
BY SHOP METHOD**

1. Television . . . Including Color TV
2. Radio . . . AM, FM
3. Industrial Electronics
4. Communications

**OF THE INDUSTRY  
HOME TRAINING**

5. Sound Recording & Hi-Fidelity
6. Automation
7. FCC License Preparation
8. Radar & Micro Waves

Let National Schools of Los Angeles, a Practical Resident Technical School for over 50 years, train you at home by Shop-Method for unlimited opportunities in All phases of TV, Electronics, Radio.

**You get 19 big kits  
of equipment!**

**GOOD JOBS . . . MORE MONEY  
SECURITY . . . ALL CAN BE YOURS**

YOU are needed in the great modern Television-Electronics industry. Trained technicians are in growing demand, at excellent pay, in sales and service, manufacturing, broadcasting, telecasting, communications, research, and many other important branches of the field. National Schools Master Shop-Method Training, with newly added lessons and equipment prepares you in your spare time right in your own home for these fascinating opportunities. **OUR OUTSTANDING METHOD IS PROVED BY THE SUCCESS OF GRADUATES ALL OVER THE WORLD!**

**YOUR TRAINING IS ALL INCLUSIVE**

We prepare you for a long list of job opportunities. Thousands of TV and Radio receivers are being sold every day—more than ever before. And, now, Color TV is here. Applications of Electronics in industry—**AUTOMATION**—are growing in tremendous strides. The whole field is alive—opening up new, important jobs rapidly. National Schools complete training program qualifies you in all phases of the industry.

**YOU EARN WHILE YOU LEARN**

Many students pay for their entire training—and more—with spare time earning. We'll show you how you can, too! Early in your course you receive material that shows you how to earn extra money servicing TV and Radio receivers, appliances, etc., for friends and acquaintances.

**YOU GET EVERYTHING YOU NEED**

Clear, profusely illustrated lessons, shop-tested manuals, modern circuit diagrams, practical job projects—all the valuable equipment shown above—many other materials and services—consultation privilege with our qualified staff, and Graduate Employment Service. **EVERYTHING YOU NEED** for outstanding success in Electronics.

**INDUSTRY NEEDS YOU. NATIONAL SCHOOLS  
WILL TRAIN YOU. SEND FOR FACTS TODAY  
NO OBLIGATION.**

**YOU LEARN BY SHOP METHOD** . . . you do servicing, circuit analysis, and do over 100 down-to-earth experiments. You build a Superhet Receiver and a modern TV Receiver, from the ground up, including a new, big screen picture tube. You also receive a professional, factory-made **MULTI-TESTER**. All of this standard equipment is yours to keep . . . at just one low tuition.

**RESIDENT TRAINING AT LOS ANGELES**

If you wish to take your training in our Resident School at Los Angeles, the world's TV capital, start NOW in our big, modern Shops, Labs and Radio-TV Studios. Here you work with latest Electronic equipment—professionally installed—finest, most complete facilities offered by any school. Expert, friendly instructors. Personal attention. Graduate Employment Service. Help in finding home near school—and part time job while you learn. Check box in coupon for full information.

Approved for  
GI Training



**NATIONAL SCHOOLS**

LOS ANGELES 37, CALIF

**FREE!  
VALUABLE BOOK  
& SAMPLE LESSON  
—Just Send  
Coupon!**



**NATIONAL SCHOOLS**

TECHNICAL TRADE TRAINING SINCE 1905  
LOS ANGELES 37, CALIFORNIA

**GET FAST SERVICE—MAIL NOW TO  
NATIONAL SCHOOLS, DEPT. RB-18  
4000 S. Figueroa St., Los Angeles 37, Calif.**

Rush free TV-Radio "Opportunity" Book and sample lesson. No salesman will call.

NAME \_\_\_\_\_ AGE \_\_\_\_\_

ADDRESS \_\_\_\_\_

CITY \_\_\_\_\_ ZONE \_\_\_\_\_ STATE \_\_\_\_\_

Check if interested ONLY in Resident School training at Los Angeles.

VETERANS: Give date of Discharge \_\_\_\_\_





**YOU**  
can  
acquire

**LAW NIGHTS AT HOME!**  
**LL. B. DEGREE**

LaSalle's famous Law Library—used as reference in many Law libraries and Law offices—has enabled thousands to master Law surprisingly fast, in spare hours at home, for business and professional advancement.

These 14 remarkable volumes, compiled by leading professors and lawyers, cover the whole basic field of Law in condensed, orderly, simplified manner.

You advance rapidly with this great library, plus special lectures furnished. We guide you step-by-step with personalized Problem Method of instruction . . . you learn by doing—handling legal problems—not by memorizing rules.

Send for two FREE booklets, "Law Training for Leadership," and "Evidence," answering questions about Law and its value to you, and telling how LaSalle Law graduates are winning rapid advancement in business and public life. Mail coupon below. No obligation.

**LA SALLE EXTENSION UNIVERSITY**  
**A Correspondence Institution**

417 S. Dearborn St. Dept. 164L Chicago 5, Ill.

Send me your two FREE booklets described above, without obligation.

Name.....Age.....  
Street.....  
City, Zone & State.....

**EARN \$100**  
**A WEEK AND UP**

**BE AN AUTO-DIESEL**  
**MECHANIC — EARN**  
**WHILE YOU LEARN**

Many of our graduates earn \$100 a week and up. You learn fast in our school and shops because you learn with tools on real equipment. Experienced instructors explain WHY and show you HOW, then you DO IT YOURSELF. One of the best equipped technical schools in the United States. Thirty-nine years' experience training men. Successful graduates in 48 states and many foreign countries. Approved for veterans. Day and evening classes. Free bulletin—write today.

**NASHVILLE AUTO-DIESEL COLLEGE**  
226 7th Ave. N., Dept. 86, Nashville, Tenn.

**WANTED**

**Commercial Artists**  
**Letterers — Designers**

COMMERCIAL artists WANTED by advertising agencies, publishers, newspapers, dept. stores, to fill HIGH-PAYING JOBS! 95 MILLION DOLLARS being spent for commercial art every year. Now YOU can prepare to enter this profitable field—become your own boss and command BIG FEES. You can learn Commercial Art, lettering, designing, cartooning, TV—right at home, in spare time. Easy. SHOW-HOW LESSONS. INEXPENSIVE. Send for FREE book, "Art For Pleasure And Profit." Describes our method. Lists opportunities. Tells how you can get ahead FAST in Commercial Art. Write NOW to: Washington School of Art, Studio 141, Port Washington, N. Y. Cut this out as reminder.

**GROW HERBS FOR US!**  
**AT HOME — IN YOUR SPARE TIME**

Help fill our huge demand — used in expensive medicines. Easy to grow indoors or out — multiply rapidly. Year around Profitability! You grow 'em — we buy 'em! We supply everything you need. Amazing facts and revealing plan is yours free for the asking. Be one of the first to profit — rush name and address to: NATIONAL HERB EXCHANGE: Dept. A-1 Gardena, Calif.

**FREE EXCITING DETAILS Write!**

**ARTHRITIS — RHEUMATISM**  
**VITAL FACTS EXPLAINED**

**FREE DESCRIPTIVE BOOK**

How crippling deformities may be avoided. This amazing FREE BOOK explains why ordinary methods give only temporary relief — if that. Describes a drugless method of treatment successfully applied in thousands of cases. Write for this 36-page FREE BOOK today. No obligation. BALL CLINIC, DEPT. 756, EXCELSIOR SPRINGS, MO.

**Exclusive Double-Bearing HEAVY-DUTY PUMPS**

IRRIGATE • DRAIN • CIRCULATE • SPRAY  
Up to 7,500 GPH. 3,000 GPH from 25" well. Use 1/4 to 1 HP motor. 1 1/4" inlet; 1" outlet. Stainless shaft.

TYPE X—2 oilless bronze bearings. **\$10.95**  
Won't rust.

TYPE XB—Ball bearing model. **\$12.95**  
Postpaid if cash with order. Rush your order today

**MONEY BACK GUARANTEE**  
Centrifugal and Gear Pumps in All Sizes  
**LABAWCO PUMPS, Belle Mead 2, N. J.**

**LEARN PLASTICS**



**COMPLETE LOW COST SHOP METHOD**  
**HOME TRAINING NOW AVAILABLE**

Get in on Big Money opportunities in Plastic molding, casting, forming, carving, etc. Earn as you learn with Interstate's professionally prepared course. All plastic materials furnished.

**WRITE FOR**  
**FREE**  
**BOOKLET**

**INTERSTATE TRAINING SERVICE**  
DEPT. C-3, PORTLAND 13, OREGON

**BOAT KITS** BUY DIRECT... SAVE 2/3!  
NO DEALERS - FREE FREIGHT



SAVE... on the Finest Quality Boat Kits. Lowest Prices, Mahogany Decks, Frames, Prams Racers, Cruisers, Runabouts. Over 40 Models of simple to construct boats and frame kits. SEND 10¢ FOR NEW COLOR CATALOG... Boats, Paints, Hardware, trailers, fiberglass etc. Over 2000 items for your boat.

**BUY ON EASY**  
**CREDIT TERMS**

**Boat Plans-Patterns-Frame Kits**

**Craig Craft**  
Tonawanda, N. Y.

Build over 50 modern boats from large scale plans, available with FULL-SIZE patterns, new PRE-FAST frame kits! All types: prams to cruisers, 6 to 25 ft. Best buy for Amateurs! SEND 10¢ for CATALOG.



# AMAZING MUSIC DISCOVERY

## Has You Playing Real Music The Very First Time You Try!

**Thousands Now Play Who  
Never Thought They Could  
— Requires No Teacher — No  
Boring Practice of Scales  
and Exercises . . .**

**QUICK, EASY, INEXPENSIVE!**

**I**F you are one of the many thousands who have always wanted to play music, yet hesitate to learn because "it takes too long," or "it costs too much"—here's wonderful news! Now, with this modern home-study method, you can actually play your favorite instrument *the very first time you try*—and you can go on to master that instrument in a much shorter time than you'd ever imagine possible!

### NO "SPECIAL TALENT" REQUIRED

No previous training needed — no "special talent" required. Right from the start, this amazing music discovery will have you playing *real melodies* instead of practicing tedious scales and exercises. Earliest lessons consist of delightful songs, hymns, waltzes, etc. Clear, simple directions and large, show-how pictures teach you exactly what to do, so you can't go wrong . . . even if you don't know a single note of music now! Soon you'll be playing **ALL** your favorite songs and compositions *by note!*

### NO BORING SCALES OR EXERCISES

Over 900,000 people the world over have taken up this easy-as-A-B-C way to learn music. It's all so clearly explained, so easy to understand that even children "catch on" quickly. Yes, **ANYONE** can learn to play piano, violin, accordion, guitar or any other instrument. No inconvenient lesson periods—no expensive hourly tuition. You learn in spare time of your own choosing. *You become your own music teacher . . .* and progress as rapidly or as leisurely as you wish. And lessons are only a few cents each, including valuable sheet music you'll keep always! The whole family can learn for the price of one.

### STOP CHEATING YOURSELF OF THESE JOYS

Why not let this U. S. School of Music method bring the many pleasures of music into **YOUR** life? Popularity! New friends. Gay parties. Good times. More self-confidence and poise. Extra money from playing or teaching. Possibly even a brilliant musical career. Best of all, the deep *personal satisfaction* of being able to create your own music—provide your own entertainment!

**WHICH MUSICAL INSTRUMENT DO YOU WANT TO PLAY?**



**PIANO** "I hope others will discover how easily and cheaply you can learn with this wonderful method."—Mrs. J. C. Rogers, Roanoke Rapids, N. C.



**GUITAR** "It's been fun. Hasn't cost anywhere near as much as a private teacher. Now invited to affairs, dances."—HOWARD HOPKINS, E. Syracuse, N. Y.



**ACCORDION** "I got my start with a U. S. School of Music Course. How easy it is to play this 'teach yourself' way!"—LAWRENCE WELK, Famous Orchestra Leader



**VIOLIN** "I have played for dances, and am now studying Heifetz's 'Hora Stoepta' and a couple of concertos."—IVAN W. BAYLEY, Lisco, Nebr.

**... OR ANY OF THESE OTHER INSTRUMENTS:**

<input type="checkbox"/> Saxophone	<input type="checkbox"/> Tenor Banjo	<input type="checkbox"/> Flute
<input type="checkbox"/> Trumpet, Cornet	<input type="checkbox"/> Ukulele	<input type="checkbox"/> Steel Guitar
<input type="checkbox"/> Pipe, Hammond, Reed Organ	<input type="checkbox"/> Clarinet	<input type="checkbox"/> Piccolo
<input type="checkbox"/> Trombone		

**900,000 STUDENTS  
60 Successful Years**

### SEND FOR FREE BOOK

Let us **SHOW** you why our way to learn music is so **EASY**—and so much **FUN!** See for yourself why our method has been so successful for 60 years. Clip and mail coupon for our valuable 36-page **FREE BOOK**. No obligation, no salesman will call on you. It can mean *so very much* to you for the rest of your entire life — if you will mail the coupon at right **TODAY!** U. S. School of Music, Studio 301, Port Washington, N. Y. (Special Reduced Prices on Instruments.)



**U. S. SCHOOL OF MUSIC**  
Studio 301, Port Washington, N. Y.

I am interested in learning to play, particularly the instrument checked below. Please send me your free illustrated booklet, "How to Learn Music at Home." **NO SALESMAN IS TO CALL UPON ME.**

- |  |   |   |
|--|---|---|
| <input type="checkbox"/> Piano           | <input type="checkbox"/> Pipe, Hammond, | <input type="checkbox"/> Piccolo                  |
| <input type="checkbox"/> Guitar          | <input type="checkbox"/> Reed Organ     | <input type="checkbox"/> Modern Elementary        |
| <input type="checkbox"/> Steel Guitar    | <input type="checkbox"/> Tenor Banjo    | <input type="checkbox"/> Harmony                  |
| <input type="checkbox"/> Violin          | <input type="checkbox"/> Ukulele        | <input type="checkbox"/> Mandolin                 |
| <input type="checkbox"/> Piano Accordion | <input type="checkbox"/> Clarinet       | <input type="checkbox"/> Practical Finger Control |
| <input type="checkbox"/> Saxophone       | <input type="checkbox"/> Trombone       |   |
| <input type="checkbox"/> Trumpet, Cornet | <input type="checkbox"/> Flute          |   |

Do you have the instrument? \_\_\_\_\_

Mr. \_\_\_\_\_  
Mrs. \_\_\_\_\_  
Miss \_\_\_\_\_  
(Please Print Carefully)

Address \_\_\_\_\_

City \_\_\_\_\_ State \_\_\_\_\_  
(Insert Zone Number, if Any)

If under 18, check here for Booklet A



## EARN EXTRA MONEY IN YOUR SPARE TIME... AT HOME

New Plastic-Fiberglass Process  
opens up excellent opportunities

IF you've got some spare time and could use extra cash, here is a new handbook you want to read. "How to Earn Extra Money" is just off the press. It shows you what others have done, how they got started, what they make. Tells about how one man earned \$1800.00 net profit in 6 weeks in his home shop, and how you can do the same.

**What is The Castolite Process?** It's a new way of casting, molding and laminating which industry is using for hundreds of applications. The whole thing is amazingly simple. When you mix a catalyst with the liquid plastic it sets hard within 30 minutes at room temperature.

**No Equipment is Required** because you don't need any heat and pressure, just hand and small power tools. The process is made to order for the smaller

operator with a garage or basement shop. Big business won't compete with him because items like this can't be mass produced. **Illustrated Directions Show You How** to cast colorful tiles and mosaics for table tops and wall panels. How to embed real flowers, brilliant fall leaves, butterflies, sea shells, coins, photos. How to mold fiberglass boats, and how to "glass" wooden boats, tanks, pools. It's downright uncanny all the things you can make with the same basic materials.

The **CASTOLITER** Series of manuals is full of ideas that you can adapt to your own personal requirements and circumstances. Thirty of the most popular projects are illustrated with over 150 photographs and a lot of sketches. Nothing like it has ever been published before.

### How to Get Started

Before you invest in materials we want you to know the whole story. Send 25c for "How to Earn Extra Money." Better still, order the complete **CASTOLITER** Project Series for \$1.00 and receive the handbook describing your money-making opportunities free. Write to: Commercial Craft Division, Dept. A-1.

**THE CASTOLITE COMPANY**  
Woodstock, Illinois



# FREE!

TO SECURE NAMES FOR OUR MAILING LIST

## Treasure Chest OF PRIZED STAMPS

FROM  
PIRATE STRONGHOLDS



IMAGINE! You receive FREE this whole "treasure chest" of valuable stamps from countries and islands famous in history as PIRATE hideouts! Your imagination will be carried back to the days of Jean La Fitte, Blackbeard, Captain Kidd, by these colorful stamps from the Bahamas, Barbados, Haiti, Trinidad, Liberia, Madagascar, St. Pierre and Miquelon . . . etc. You may want to sell them to envious friends. Or start a priceless "pirate country" stamp collection. **ALSO FREE** - Stamp Collector's MAP OF THE PIRATE WORLD and helpful, informative "How to Collect Stamps." Other interesting offers included for your inspection. Mail this ad now (with your name and address and 10c to help cover handling, mailing) to:

**LITTLETON STAMP COMPANY,**  
Dept. PM-1, Littleton, N. H.



## SHORTHAND IN 6 WEEKS

Write 120 words per minute  
Age no obstacle—LOWEST COST

Famous **SPEEDWRITING** shorthand. No symbols; no machines; uses ABC's. Easiest to learn and use. Fast preparation for a better position. Nationally used in leading offices and Civil Service. 120 words per minute—50% FASTER than Civil Service requirements. Over 350,000 taught by mail or through classroom instruction. The very low cost will surprise you. Typing available. 35th Year. Schools in over 400 cities in U.S., Canada, Cuba, and Hawaii.

Write For Free Booklet To: School of

DID YOU SEE  
READER'S DIGEST  
ARTICLE ON

**Speedwriting**  
Dept. 1501-B, 55 W. 42 St., N.Y. 36

## Learn ACCOUNTING Business Administration

Bookkeeping, secretarial and allied subjects at home in your spare time or attend nationally approved resident school. Write for FREE Success Book giving complete details on courses, plans, rates and employment opportunities. G.I. approved. Write Dept. A.

**Hills BUSINESS UNIVERSITY AND  
EXTENSION SCHOOL**  
629 W. MAIN ST. OKLAHOMA CITY 2, OKLAHOMA

## Rubber Stamp Press Outfits Stamp Making Supplies



A profitable home or sideline business mfg. rubber stamps. Stamp Press and all supplies. FREE catalog, advice, instruction. Permanent and profitable business. WRITE TO-DAY! Full details!

**CUSTOM MANUFACTURING**  
601-A NO. JEFFERSON, SPRINGFIELD, MO.



## "How to Make Money with Simple Cartoons"



A book everyone who likes to draw should have. It is free; no obligation. Simply address

FREE  
BOOK

**CARTOONISTS' EXCHANGE**  
Dept. 91-D Pleasant Hill, Ohio

## HYDRAULIC JACK REPAIRS

Earn While You Learn at Home



Millions of jacks in gas & auto-service stations, truckers, body-shops, riggers, factories, farms need servicing. We show you HOW - easy step by step directions—what tools to use. **EARN UP TO \$5** an hour. In spare time, in your own basement or garage. Start your own business NOW. Write for folder **PM-1** & free bonus offer.

Institute of Hydraulic Jack Repair

P.O. Box 50, Bloomfield, N. J.

## TELEPHONES and ALL SUPPLIES

Room to room, house to garage, private telephone service. **HANDSET CRADLE TELEPHONES** (2) Complete outfit with 100' wire, 2 dry cells, instructions. \$14.95

**WORM HARVESTER** - Dan Mac Magneto—gathers fish-worms by electricity. Complete with instructions. \$6.50

FREE illustrated bulletin "AA-111"

**TELEPHONE REPAIR & SUPPLY CO.**  
Dept. AA-111 1760 Lunt Ave., Chicago 26, Ill.



POPULAR MECHANICS



**NEW WAY TO  
TRAIN AT HOME  
FOR A  
BIG PAY CAREER  
AS A TOP NOTCH  
AUTO MECHANIC  
PROVE IT ABSOLUTELY FREE!**

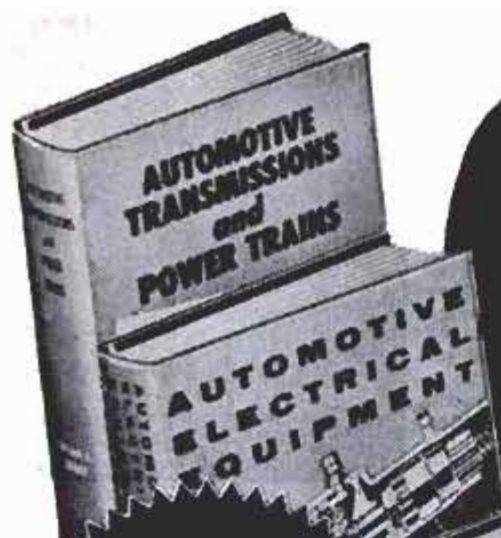

**SEND NO MONEY!**

Mail coupon below to examine these Complete Library and Home Course volumes on Auto Mechanics 10 days FREE!

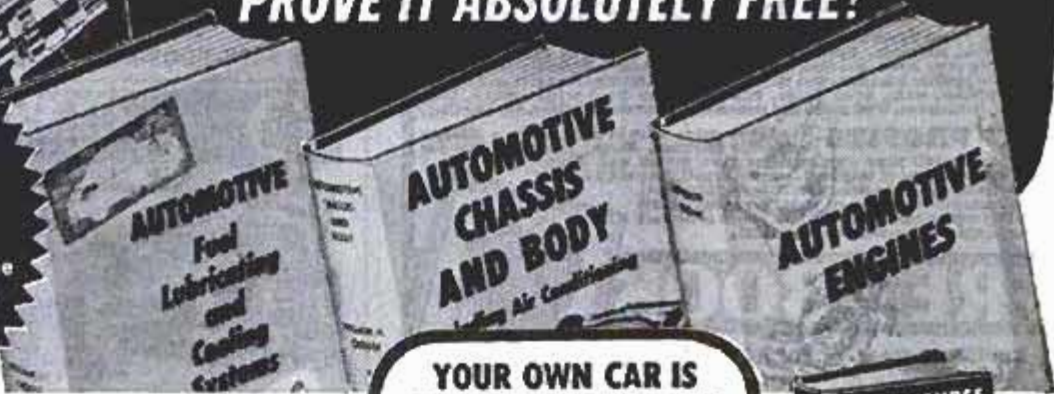

**2,745 PAGES — Nearly 2,000 Illustrations —  
Dozens of Charts. The Complete Information  
You Need To Be A Qualified Auto Mechanic!**

Start at once training this HOME SHOP way for the highest mechanics' wages in history! No matter what you are doing now, you can learn at home quickly, surely—qualify for steady work, security and rapid advancement. You can make CASH money while training—and plan to open your own shop, be your own boss! Right now 30,000 mechanics are desperately needed. Get in on this booming field and prepare for a CAREER as a specialist!

**PROVE This Amazing Training ON THE JOB!**

That's right! TEST the giant 6-volume McGraw-Hill Complete Auto Repair and Servicing Library which includes the Home Course Outline. We want to send you this made-to-auto-industry-specifications training so that you can see this Set in front of you—sample it—use it on a job—understand why ONLY a

master Set of many volumes can give you the complete facts for repairing and servicing any part in any car!

**No Longer Any GUESSWORK!**

We want you to prove how the step-by-step instructions and "every-angle" photographs, drawings and diagrams make the most complex repair easy—quick—right the first time! See how you can tune engines, overhaul carburetors, service transmissions in all cars from 1926 right up to the present day with full confidence. See how each volume is like a specialist—ready to train and guide you to meet each car need—including servicing all of the modern innovations. Make the secrets of experts your own; see how you will be in control of every situation, as if you had an engineer standing by your side to guide your entire training!

**The MASTER LIBRARY Of Automobile Mechanics**

The McGraw-Hill Library is the work of William H. Crouse, noted author of practical auto repair books and at one time a Director of Field Service Education for a division of General Motors. He takes nothing for granted, leaves no point uncovered. He has planned the Library for the man who wants to master auto mechanics—not just "tinker" at it... who wants to know the why as well as how. BASIC reasons for all work are explained in clear

**YOUR OWN CAR IS YOUR TRAINING LAB!**

The most natural place to learn auto mechanics is in your own garage! With this 6-volume Library by your side, you work on neighbors' cars, too... make cash money in spare time!



**ADDITIONAL FREE - HOME COURSE OUTLINE**

A proven plan for making auto mechanics a lifetime CAREER! Tells how to get started and how to get ahead. An absolute must for the ambitious man who wants more than just a "job." Prepared by Wm. H. Crouse. OUTLINE is yours FREE!

terms. Your knowledge is checked every few pages with exciting Self-Quizzes. You learn when to repair, how to service and the why of every job you'll ever do. Everything has been tested with thousands of beginners and engineers.

**MAIL THE COUPON—WITHOUT MONEY—TODAY**

Yes, we want you to use this giant 6-volume Library for 10 days and then make up your mind! Mail the coupon; when books arrive use them to guide you to the most complex repair you can think of. Make them prove what we say. Then—in 10 days either return them and that will end the matter, or remit \$4.75 and \$5.00 each month thereafter until \$29.75 is paid... an actual saving of \$9.30 on the regular list price of \$39.05. Don't miss out on this opportunity. Mail the coupon now!

**FREE EXAMINATION COUPON SAVES YOU \$9.30**

McGraw-Hill Book Co., Dept. PM-1  
327 West 41st St., New York 36, N. Y.

Send me for 10-day FREE trial the McGraw-Hill 6-vol. Complete Auto Repair and Servicing Library including Home Course Outline "How To Get Ahead in the Automotive Business." In 10 days I will remit \$4.75 and \$5.00 a month until \$29.75 is paid—a \$9.30 saving on list price of \$39.05. Otherwise, I will return books postpaid.

- Check below to examine free for 10 days individual Crouse books from the Library
- Engines—\$7.00
  - Fuel, Lub. & Cooling Systems—\$6.35
  - Transmissions—\$8.35
  - Chassis & Body—\$8.35
  - Automotive Electrical Equipment—\$7.00

For any single book I keep I will send \$3.00 plus delivery cost in 10 days. Balance of regular price one month later.

Name .....  
Address .....  
(Please Print)

City..... Zone..... State.....  
For price and terms outside the U. S., write McGraw-Hill Int'l., New York, N. Y. PM-1

**STEP-BY-STEP INSTRUCTIONS TELL AND SHOW YOU HOW TO**

- OVERHAUL any engine
- SERVICE, MAINTAIN any unit
- CHECK and DIAGNOSE any engine trouble
- TRACE troubles in lines
- CORRECT excess engine wear conditions
- INSTALL any new part or unit
- ADJUST all moving parts, etc.

**THOUSANDS OF FACTS!**

**TESTED AND PROVED BY THOUSANDS OF TRAINEES**



# Learn to MOUNT Birds and Animals

**To All Men & Boys!**  
Here is FUN and PROFIT!

**Send Coupon for Free Book**

Tells all about Taxidermy, and how you can learn at home to mount life-like Birds, Animals, Game-Heads, Fish. Save your valuable trophies. Decorate your home and den. Learn genuine Chrome Tanning for harness and sole leather buckskin and fine furs. Mount Common specimens, squirrels, rabbits, owls, even frogs. Into marvelous craft-work groups, both useful, humorous. Wild game not necessary. Marvellous hobby. Fascinating.

**BIG PROFITS** Turn your spare time to cash. Have a sideline profitable business. Mount game trophies for sportmen; sell your own mounts; save money and **Make Money** with expert tanning. Learn by mail from old reliable school with 400,000 graduates. **Investigate Now.** Send coupon or letter or post card **Right Now** for this marvelous **FREE BOOK.** There is no cost or obligation. Please state your **AGE.**

## FREE BOOK

Northwestern School of Taxidermy,  
2501 Elwood Bldg., Omaha, Neb.

Gentlemen—Please send me your FREE 48-page booklet explaining Taxidermy. (Please print plainly, and state age. Use postal card if more convenient.)

Name \_\_\_\_\_ Age \_\_\_\_\_

Address \_\_\_\_\_



## WARN HUBS on your

Patented



# Jeep

**STOP FRONT  
DRIVE WEAR**  
in 2-Wheel Drive!



Over 100,000 now in use!

That is real proof of their many advantages and rugged dependability. Warn Hubs on 4-wheel drives make steering easier, increase power, speed in high; add life to gears, tires, because the front drive stands still in 2-wheel drive—there is no drag! Use free-wheeling 2 w.d. or tractive 4 w.d. as needed, automatically,

as you shift, with Warn Lock-O-matics, through fingertip controls with Warn Locking Hubs. Factory approved. Iron-clad guarantee. Models for all 4 w.ds. to 1½ tons. See your dealer now! Write for free literature.

**WARN MFG. CO.**

Riverton Box 6064-A1  
Seattle 88, Wash.

**MAKE MORE \$ IN  
SPARE TIME HOURS!**

Use "IDEAL"  
Lawnmower Sharpener

New attachment makes Model 300 "Ideal" a perfect reel and rotary blade grinder—also sharpens shears, other tools! Ideal's exclusive "hook" grinding method insures quick, easy results every time. Compare all facts and you'll buy "Ideal"—leading mower sharpener for 55 years. Make more money—write for free catalog.

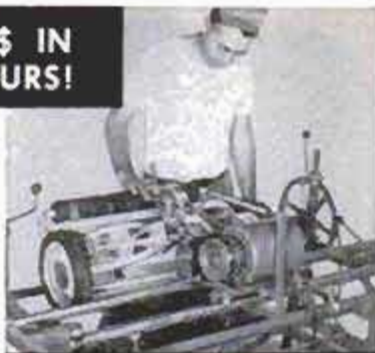

**Sharpens All Mowers**

• REEL TYPE • HAND  
• ROTARY • POWER

The FATE-ROOT-HEATH Co., Dept. PM-1, Plymouth, Ohio

## on any object ELECTROPLATE

ANY OBJECT IN HOME, SHOP, GARAGE. NOW with our NEW ELECTROCHEMICAL Outfit. You can easily do your own plating. Not a paint. But a hard durable metal plate, equal to commercial plating. Get your own plating kit with instructions on plating metal and non-metal objects as Tools, Auto Parts, Silverware, Jewelry, Baby Shoes and 1001 other articles with Chrome, Nickel, Copper, Gold, etc. **SEND NO MONEY.** Everything sent C.O.D. for the low price of ONLY \$5.95 or send \$5.95 now and receive it postpaid. Money back in 7 days if not satisfied. **M. Z. SALES CO., Dept. G-17, 113 West 42nd St., New York 36, N. Y.**



**MAKE \$\$\$\$**

BUILD THIS  
DUPLEX.  
MAKE MONEY  
OR MORE

Save Money — Floor Layout  
and Complete Costs \$1.00  
Order Floor Layout No. 1

AMERICAN  
HOUSECRAFT  
CONSTRUCTION  
TRADE MARK

Send to **American Housecraft Construction Co.**  
2241 VERMONT, INDEPENDENCE, MISSOURI

## JEEP OWNERS

RE-POWER NOW WITH A V-8 ENGINE — Use

**FORD • CHEVROLET • MERCURY**  
in 2 or 4 Whl-Dr. Jeeps, Jeepsters, Sta-Wgn, Trucks, H. J. and Kaiser cars. Conversion Kits \$43.25 to \$59.85. If you want fast action tell us which engine you wish to use, give us year, Model (2 or 4 Whl-Dr) of your vehicle. Send Min. \$15.00 Dep. and we will ship correct kit, Bal. COD. Send full amt. for Propaid shipment. Wire, phone or write for free details. Also Kits for FORD 6 engine.

**HOOSIER MACHINE PRODUCTS CO.**

312 S.E. 6th St. Phone CR 6-3442 Pendleton, Oregon, U.S.A.

## FIX OUTBOARD MOTORS POWERMOWERS, AND ALL SMALL 2 & 4-CYCLE GASOLINE ENGINES

Repair your own equipment or **MAKE EXTRA MONEY** in this growing field. Fully illustrated, easy-to-understand, Home Study Course. Write for **FREE** information.

**LINCOLN TECHNICAL INSTITUTE**  
SUITE 1-E, 472 MARKET STREET, NEWARK 3, N. J.

## RUPTURED

**BE FREE FROM TRUSS SLAVERY**

Now there is a new modern Non-Surgical treatment designed to permanently correct rupture. These Non-Surgical treatments are so certain, that a Lifetime Certificate of Assurance is given.

Write today for our New **FREE** Book that gives facts that may save you painful and expensive surgery, and tells how non-surgically you may again work, live, play and love and enjoy life in the manner you desire. There is no obligation. **Excelsior Hernia Clinic, Dept. 8305, Excelsior Spgs., Mo.**



LEARN

# ELECTRICITY AND Industrial Electronics

ON REAL EQUIPMENT  
IN THE GREAT SHOPS  
OF **COYNE**



**LARGEST, OLDEST AND BEST EQUIPPED  
SCHOOL OF ITS KIND IN U.S.**

This five story Chicago building is occupied entirely by Coyne. Five big floors of Classrooms and Massive Equipment. Thousands of successful men have trained at Coyne during past 68 years. There is no substitute for Coyne's wealth of experience.



Home of  
Coyne Electrical School

## Young men and Older men prepare for OPPORTUNITIES IN ELECTRICITY-ELECTRONICS

Whether 17 or up to 45 years of age, don't be satisfied with a "no future job." Train the Coyne way for a better job in *Electricity-Electronics*—a field that offers a world of opportunities now and in the years ahead. In industry—in the home—Electricity and Electronics are playing a vastly greater role than ever before. New developments and fabulous growth are creating increasing job opportunities.

### YOU TRAIN IN CHICAGO

Learn the easier practical way in shops of Coyne in Chicago. Shop work plus technical training. No advanced education or previous experience needed. Lifetime Employment Service to Coyne Graduates. Frequent starting dates.

#### START NOW—PAY LATER

New liberalized credit terms and Finance Plans. Part-time employment service to students. Help in making housing arrangements.

#### VETERANS OR NON-VETERANS

Coyne training is offered to Veterans and Non-Veterans alike. We'll send Bulletin giving full information. Send coupon for details.

*Training in Refrigeration and Electric Appliances can be included.*



1. You are told the how and why of each job.



2. You're shown how to do it by trained instructors.



3. You do the jobs yourself on finest equipment.

B. W. COOKE JR., Pres. **COYNE** FOUNDED 1899  
**ELECTRICAL SCHOOL**

A Technical Trade Institute Operated Not For Profit  
500 S. Paulina Street, Chicago, Dept. 18-3E  
ELECTRICITY • RADIO • TELEVISION • REFRIGERATION • ELECTRONICS

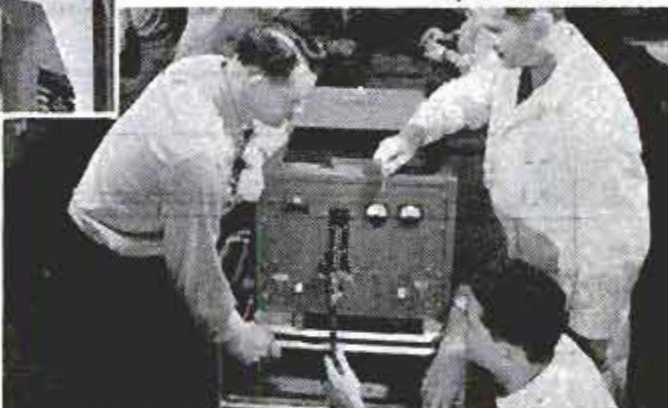

**INDUSTRIAL ELECTRONICS**—one of the more recent applications of Industrial Electronics to manufacturing processes—promises to create additional demands for trained Electrical-Electronics men such as we have never seen.

### Mail coupon for big free book!

48 Page Illustrated Book, "Guide to Careers" gives you all the facts, answers your questions about Electricity-Electronics and describes all training offered.

All information will come by return mail. No obligation and no salesman will call, so send coupon now!



Coyne Electrical School, Dept. 18-3E  
500 S. Paulina St., Chicago 12, Ill.

Send **BIG FREE BOOK** about Electricity-Electronics and details of all training you offer.

Name

Address

City  State

(I understand no Salesman will call.)



# Free! AIRMAIL COLLECTION



Get this spectacular collection of all-different, genuine Airmails from strange, far-away countries in Asia, Africa, Europe, the exotic Orient! World's largest airmail, scarce \$27 stamp, old Zeppelin, many, many others. A truly remarkable collection containing stamps worth up to 40¢ each at catalog prices! PLUS Bargain Catalog and other unusual offers. Send 10¢ for mailing costs. ACT NOW!

JAMESTOWN STAMP CO. Dept. F18PM, Jamestown, N. Y.

RUSH my Free Airmail Collection and other offers. I enclose 10¢ for mailing costs.

Name \_\_\_\_\_  
 Address \_\_\_\_\_  
 City & State \_\_\_\_\_



## There's money to be made IN THE ORNAMENTAL CONCRETE BUSINESS

There's money—Big Money—for YOU in the amazingly low cost, easy do-it-yourself production of Ornamental Concrete.

CMC durable, light-weight, easy-to-operate Aluminum Molds bring you beautiful copy-righted designs with proven national sales success.

Get the full story. Send today for your copy of the big, fully illustrated manual, "How To Turn Concrete Into Gold." Here is the complete Ornamental Concrete story. Clear, "from start-to-finish" instructions. Catalog of over 200 Specialty Molds. Valuable production and sales tips. Authoritative inside analysis of Ornamental Concrete business. Order today.

Send \$2.00  
 for your copy



**CMC**  
 CONCRETE  
 MACHINERY  
 COMPANY, INC.  
 DEPT. PM  
 HICKORY,  
 NORTH CAROLINA

# \$1 BRINGS YOU \$18

Discover Flok-Kraft and Earn \$5555 AT HOME

Earn up to \$15.00 per hour spare time. Amazing new Velvet-fiber spray instantly makes any object—Lamps, Radio & TV Cabinets, Figurines, Signs, Auto dash boards, toys, furniture, draperies—anything worth expensive \$8888 Prices—like magic, you can spray anything with this beautiful new suede-like finish that feels like rich Velvet.

EARN UP TO \$300.00 PER WEEK SPARE TIME

Imagine, materials cost only 3¢ per square foot. (Average TV or radio cabinet can be beautifully sprayed with this startling new 3-dimensional Velvet finish in 15 minutes at a cost of only 34¢ in materials. Your charge for this job is at least \$10.00.)

REPRESENTATIVES IN YOUR AREA URGENTLY NEEDED

Own your own business. Work at home in your spare time. Help fill the huge growing demand for this amazing new beautiful Velvet-fiber finish. Orders come from stores, offices, homes, architects, auto dealers,—everywhere. Possible \$20,000,000.00 worth of jobs to be done. Investigate today—be first in your area! Actual samples in 16 Radiant Colors, Booklet of 50 Home Business Opportunities and Confidential Details all sent free! Write: Coast Industries, Los Angeles 61, Calif., Dept. B-1.

## Secrets of VENTRILOQUISM Now Revealed!



Easy to learn in 60 to 90 days with our Home Study Course. RESULTS GUARANTEED. Make Money! Be Popular! Have Fun! Big Opportunity! Radio, Television, Stage Appearances! For FREE Information regarding price and terms WRITE. You must state your age. Dummy Catalog 25¢. MAHER HOME COURSE OF VENTRILOQUISM Box 36, Studio E, PM-1, Kensington Station Detroit 24, Michigan

### 250 POWER . . . .



Complete Telescope Lens Kit only \$3.49 postpaid  
 Conquer Space. Explore the Universe, Planets, Moon Craters, New Stars, etc. Complete Lens Kit consists of 80 inch focal length ground and polished objective lens, eyepiece lenses for 50 POWER, 100 POWER, 150 POWER, 200 POWER, 250 POWER, and all necessary lens fittings. Easy to make from simple step by step instructions. (Tripod and mount not included.) Money back guarantee.

BUSSE SALES CO., Hartford, Conn., Dept. PM 65

## SEND ME



every month so I am sure to see each new issue. Here's

- \$3.50 for 1 year
- \$8.00 for 3 years

name \_\_\_\_\_

address \_\_\_\_\_

city \_\_\_\_\_ zone \_\_\_\_\_ state \_\_\_\_\_

Hand this order to your newsdealer or send it to  
**POPULAR MECHANICS**  
 200 East Ontario St. Chicago 11, Ill.



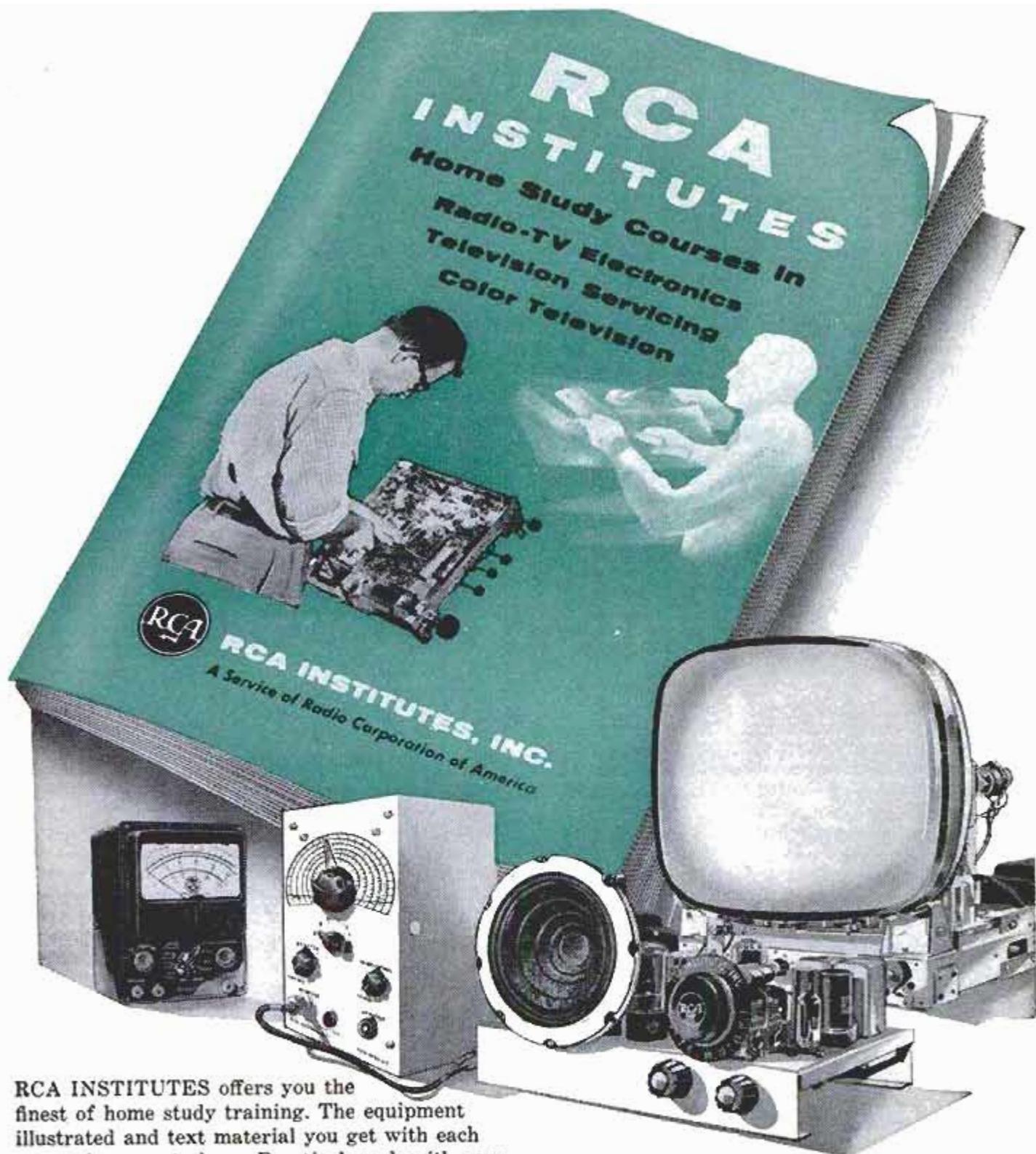

RCA INSTITUTES offers you the finest of home study training. The equipment illustrated and text material you get with each course is yours to keep. Practical work with very first lesson. Courses for the beginner and the advanced student. Pay-as-you-learn. You need pay for only one study group at a time.

**Send for this  
FREE Book Now** 

[ RESIDENT SCHOOL courses in New York City offer comprehensive training in Television and Electronics. Day and evening classes start four times each year. Detailed information on request. ]

**RCA INSTITUTES, Inc.** Home Study Dept. PM-18  
350 West Fourth Street, New York 14, N. Y.

Without obligation, send me FREE 52 page CATALOG on Home Study Courses in Radio, Television and Color TV. No salesman will call.

Name..... please print

Address.....

City..... Zone..... State.....

Korean Vets! Enter discharge date.....

In Canada — RCA Victor Co., Ltd.  
5001 Cote de Liesse Rd., Montreal 9, Que.

To save time, paste coupon on postcard.





Draftsmen with more, enjoy pleasant working conditions. Get into DRAFTING and Blue-Printing, the starting point of all production. Trained Draftsmen are needed everywhere. Machines can never replace the draftsman.

### LEARN AT HOME IN SPARE TIME

Revolutionary new method teaches you quickly the hows and whys of Mechanical, Structural, Machine, Architectural, etc. Drafting. You are sent professional drafting instruments, drafting equipment, portable drafting table, etc., at no extra cost. You learn by making actual drawings.

**BIG MONEY... ADVANCEMENT OPPORTUNITIES** offered trained draftsmen. Drafting is light, pleasant work, paying big salaries. Is a stepping stone to top managerial jobs. The draftsman plans the World of Tomorrow. That is why drafting is such interesting work.

### OWN YOUR OWN DRAFTING FIRM

The investment requirement is small, the earning possibilities great. Many draftsmen eventually branch out into manufacturing the products they created. Learn of the opportunities in Drafting.

## MAIL THIS COUPON TODAY!

**CHRISTY TRADES SCHOOL, Dept. DB-3803**  
4804 N. Kedzie Ave., Chicago 25

Mail at once your big FREE book on Drafting and Blue-Printing. Tell me how your Home Training and Professional Drafting Instruments, Portable Drafting Table, Drafting Equipment, etc. can be had on a **PAY AS YOU LEARN** plan.

NAME \_\_\_\_\_ Age \_\_\_\_\_

ADDRESS \_\_\_\_\_ CITY \_\_\_\_\_ STATE \_\_\_\_\_

## CONCRETE BLOCK HOME PLANS

### \$2500 RANCH HOME



Build your own 25' x 48' Ranch Home complete for \$2500. Forced air heating system available \$295. Contains Liv. Room, kit., three bedrooms, bath, utility room, fireplace, carport, or garage. Blueprints, instructions, and material list \$3.00 pd. Money back guarantee. Other plans - \$1900 DUPLEX, \$1150 GARAGE APARTMENT, \$950 CABIN. FREE FOLDER.

MEMBER ARKANSAS HOME BUILDERS ASSOC.

BAILEY BUILDERS, 7608 Harmon Drive, Little Rock, Ark.



## MECHANICAL DENTISTRY

To make Crowns, Plates, Bridgework, etc., for Dentists. Easy practical way to learn mechanical dentistry at home in spare time. FULL EQUIPMENT OF TOOLS AND MATERIALS INCLUDED WITH COURSE. Low tuition. Easy terms. Write for FREE BOOK about this money making profession that is not affected by machine age.

McGARRIE SCHOOL OF MECHANICAL DENTISTRY  
207 N. Broad St., Dept. 72, Philadelphia 7, Pa.

## SAVE 1/2 - 2/3 THE PRICE OF FACTORY-BUILT BOATS

**BOAT  
KIT  
CATALOG  
Free!**

Write:

Runabouts, cruisers, convertibles, fishing; 43 models, 8 through 18 ft. Freight paid. \$39.25 up. Assembled and finished by inexperienced owners. Luger boats equal factory-built in speed, handling, style, beauty; yet save you 1/2 to 2/3. Owners say: "Fastest boat on river." "Pleasure to assemble." "Everyone admires my Luger." Thousands in use. Send for big, free boat kit catalog; also lists fiberglass, hardware, accessories, trailers, paint. Write for catalog today.



**LUGER INDUSTRIES, INC.** DEPT. B-1 3404 Lyndale S. Minneapolis 8, Minn.

# INVENTORS

PROTECT YOUR INVENTION BY A U. S. PATENT. SEND FOR FREE "INVENTION RECORD" FORM AND "PATENT INFORMATION EVERY INVENTOR SHOULD HAVE."

**CARL MILLER**

REGISTERED PATENT ATTORNEY

WOOLWORTH BLDG., 36th FLOOR, 18A  
NEW YORK CITY



# INVENTORS

U. S. Patents protect your inventions. Our free book of "Instructions on Patent Procedure for Inventors," also "Certificate of Invention" form sent without obligation.

**C. A. SNOW & CO.**

REGISTERED PATENT ATTORNEYS  
428 SNOW BUILDING WASHINGTON 1, D. C.

# INVENTORS

Send for PATENT INFORMATION Book and INVENTOR'S RECORD without obligation

**GUSTAVE MILLER**  
18-PM WARNER BUILDING  
WASHINGTON 4, D.C.

REGISTERED PATENT ATTORNEY

ASSOCIATE EXAMINER  
U.S. PAT. OFF. 1922-1929

Patent Attorney & Advisor  
U. S. NAVY DEPT. 1930-1947  
PATENT LAWYER

# INVENTORS

Whether an invention is patentable can be substantially determined by a search of the U. S. Patent records. Without obligation, write for information explaining the steps you should take to secure a patent.

**JOHN N. RANDOLPH**

Registered Patent Attorney

201 Columbian Building, Washington 1, D. C.

## SPARE-TIME MONEymaking OPPORTUNITIES

READ OUR CLASSIFIED ADS

HUNDREDS OF BARGAINS

AMAZING OFFERS

# INVENTIONS WANTED

If you want to market, or sell, your invention for cash or royalties. Write for our Free Booklet. Send no drawings. We also welcome hearing from firms, or private capital, wishing to review inventions in any field. We will be glad to send notice of our clients' inventions.

**GLOBAL MARKETING SERVICE**

2420 77th Ave.

Dept. PD

Oakland 5, Calif.

# INVENTORS

I shall be pleased to furnish you, upon request, with full information relative to patent procedure—without any obligation on your part.

**PATRICK D. BEAVERS**

Registered Patent Attorney

934 Columbian Building Washington 1, D. C.



# Just Pick the Kind of Body YOU Want

CHECK IN THE COUPON BELOW!

...and I'LL SHOW YOU How EASILY You Can Have It...



*Charles Atlas*  
"World's Most Perfectly Developed Man."



**TROPHY GIVEN AWAY**  
Win this handsome Trophy, over 1 1/2 ft. high!

## Almost Overnight

WHAT kind of body do YOU want? One with the kind of power-packed shoulders that make girls go "Ga-Ga" on the beach? Or sledge-hammer biceps that will make the toughest bully respect you! Or strong-as-steel stomach muscles; a slim waist? Just tell me WHERE you want it—and I'll add **SOLID INCHES** of muscle, **FAST!** I don't care how old or how young you are—or what your present physical condition may be. Just check the "dream build" you've always wanted—right in the coupon below. Then just give me 15 minutes a day of your spare time—in the privacy of your own room—and I'll give you exactly what you ask for: **RESULTS** you can see, feel, and measure with a tape!

### WHAT'S MY SECRET?

"DYNAMIC TENSION"—that's my secret! It's the **NATURAL** method that I myself developed to change my body from the miserable skinny-chested weakling I was at 17 to my present "World's Most Perfectly Developed" body. Thousands have become marvelous physical specimens my way. I want YOU to be next!

No gadgets, no contraptions. You simply use the **DORMANT** muscle-power in your own God-given body. Before you know it, you're a **NEW MAN**—full of red-blooded get-up-and-go—healthy and handsome!

**FREE** My Valuable Illustrated 32-Page Book. NOT \$1.00 — NOT 10c — but FREE!

Send for my famous book showing how "Dynamic Tension" makes you a new man. 32 pages packed with photographs and valuable advice. See what my method has done for thousands, what it can do for YOU.

This book is a real prize. Just glancing through it may mean the turning point in your whole life! Rush coupon to me personally: **CHARLES ATLAS, Dept. 81, 115 East 23rd St., New York 10, N. Y.**



### Why Be Half a Man?

... when it's so easy to become a real **HE-MAN** my natural way. Most fellows spend all of their lives feeling only **HALF ALIVE**. But you don't have to put up with that. Give yourself honest answers to these important questions. **ARE YOU:**

- Skinny and Run Down?
- Overweight and Short of Breath?
- Always Tired?
- Nervous?
- Shy and Lacking in Confidence?
- Slow at Sports?
- Do You Want to Gain or Lose Weight?
- Are you ashamed of your **HALF-MAN** build?

I tell you what you can do about these **HALF-ALIVE** symptoms in my valuable **FREE** Book. Pick the kind of body you want—right in the coupon below. Mail it to me personally and I'll rush you my free Book at once!

### Here's The Kind of Men I Build:

Meet Hector Romero, a recent winner of one of my Atlas Trophies for the most improvement in just 3 months.



Charles Atlas thrilled millions of TV viewers with his handsome build and dynamic personality when he recently appeared as a guest on two TV shows, "Masquerade Party," and "I've Got A Secret."

### JUST LOOK AT THE RESULTS I GET!



"When I started your course I weighed only 141. Now weigh 170." —T. K., N. Y.



"Have put 3 1/2" on chest (normal). 2 1/2" expanded." —F. S., N. Y.

**CHARLES ATLAS, Dept. 81, 115 East 23rd St., New York 10, N. Y.**

*Dear Charles Atlas: Here's the kind of Body I Want:*

(Check as many as you like)

- More Weight—Solid in The Right Places
- Broader Chest and Shoulders
- More Powerful Arms and Grip
- Slimmer Waist and Hips
- More Powerful Leg Muscles
- Better Sleep, More Energy

Send me absolutely **FREE** a copy of your famous book showing how "Dynamic Tension" can make me a new man—32 pages, crammed with photographs, answers to vital health questions, and valuable advice. I understand this book is mine to keep and sending for it does not obligate me in any way.

Name \_\_\_\_\_ Age \_\_\_\_\_  
(Please Print Plainly)  
Address \_\_\_\_\_  
City \_\_\_\_\_ State \_\_\_\_\_  
 If under 14 years of age check here for Booklet A.



# YOU MAKE 'EM WE SELL 'EM!



Let me show you how to build a big pay business of your own without canvassing, without house-to-house selling!

I'll show you a simple easy way to make dozens of "Made-to-Order" cases for musicians, salesmen, hunters, manufacturers, fishermen, gun collectors, phonographs and 1001 other portables. I'll supply instructions, tools, materials — everything you need. My plan is absolutely safe! You risk nothing! Keep your present job and work sparetime until you decide to devote full time to this big pay work that is so fascinating. Set up your shop wherever you have

## MY NATIONWIDE SALES ORGANIZATION WANTS TO WORK FOR YOU!

a few spare feet. With my plan anyone can have his own business without a big investment and without previous experience, and remember you don't have to worry about sales because my National Sales Staff sells for you.

I am very satisfied to make a small profit because I can count on big volume on the supplies I sell to Casecrafters, yet home workers make a big profit because the finished cases sell for up to ten times the cost of materials. Write for full, FREE, details today.

**ABARSI CASECRAFT** 807 SUNSET BOULEVARD Dept. AA Los Angeles, Calif.



**JACK STEARNS** made \$450.00 on his first order for cases. **SO CAN YOU!** POSITIVE PROOF SENT TO YOU FREE!!!



## WANT MORE MONEY? GET INTO PHOTOGRAPHY

You can become a skilled photographer by training at home in your spare time. With the NYI Home Study Course, backed by our 50 years experience, you'll learn quickly and easily with our famous Learn-by-Doing Method. You get personal, helpful criticism, advice and loads of ideas from our teaching staff — who are as close to you as your mailbox. Do what hundreds of others are doing — Earn While You Learn! Opportunities are tremendous in Advertising, Portraits, News, Fashion, Commercial, Industrial, Color Photography, Weddings, etc.

No previous experience necessary. Enroll anytime. Big FREE Illustrated Book gives you all the facts and it's yours for the asking. Resident Training (Personal Attendance) is also available in our New York Studios. Approved for Veterans.

**NEW YORK INSTITUTE OF PHOTOGRAPHY**  
Dept. 49, 10 West 33 Street, New York 1, New York

## FREE - U.S. STAMPS

U. S. 1943 Bi-Colored Flag of Occupied Nations (as illustrated) Airmails, Commemoratives, Regular Issues, included in this collection of 25 selected, all different, genuine U.S. stamps. PLUS VALUABLE U. S. \$5.00 STAMP. Everything for 10c to cover mailing expenses. Approvals included. Act at once.

WILLETT CO., P.O. Box 338, Dept. 707, Yorktown Heights, N.Y.



## "MINIATURE MACHINE SHOP"

No Bigger Than A Typewriter, Outperforms Machines Many Times Its Size!

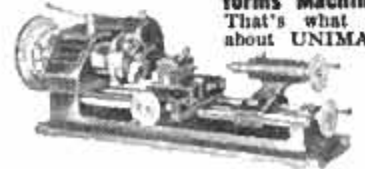

That's what a popular publication says in their 3 page feature story in the May issue. If you want a reprint of this story plus complete information about this amazing 10 in 1 combination precision tool write to:

AMERICAN EDELSTAAL, INC., UNIMAT DIV., Dept. 318, 350 B'way., N.Y. 13

## NEVER AT THIS LOW PRICE! GENUINE 135-POWER ACHROMATIC TELESCOPE

with Achromatic Lens and 4-POWER FINDER attached. **ONLY \$18.95 PREPAID**



- EXTRA BONUS GIFTS:**
- 273 page book, "Handbook of the Heavens"
  - Magic Star Finder Dial
  - 220X & 400X Eyepiece lenses

**5 Magnifications 18X-35X-65X-85X-135X**  
Brings the Moon, Planets, Stars, Satellites, People 135 times Closer, Clearer, Sharper

Never before has an ACHROMATIC 135X telescope with range finder and tripod sold for anywhere near this amazing low price! Now you can not only explore the heavens and bring the moon, planets, stars, satellites 135 times closer, but you can observe all distant objects, people, ships too, because all pictures are erect, not upside down as in all astronomical telescopes. The kind of needle-sharp color-free viewing only a genuine achromatic lens can bring you. Ready for immediate use. 5 precision lenses bring you viewing at 18X-35X-65X-85X-135X. Tubes extend to 43" made of bakelite, finished in camera bellows black, trimmed with gleaming brass. 4 power finder scope (30mm Lens) mounted on main tube is feature usually found on more expensive telescopes — brings difficult objects on target before observing with main scope. For extra stability 5 ft. hardwood folding tripod is equipped with heavy cast iron head fitted with Criterion's famous 360 degree all aluminum mount that locks instantly in any position. Obtainable only from Criterion Co. shipped prepaid. 4 famous gifts — 273 page book "Handbook of the Heavens," Magic star finder dial that aids in locating stars ANYWHERE at ANYTIME of the year. 220X & 400X eyepiece lenses included free for experiments. You must be completely satisfied with this super offer or your money back in full. Shipped Complete, nothing else to buy at amazingly low price of \$18.95. Without tripod \$14.95. Send Cash, Check, or Money Order today  
Dept. PMA20, CRITERION CO., 331 Church St., Hartford, Conn.

## LEARN AT HOME IN SPARE HOURS BE A LOCKSMITH

Learn fascinating, profitable trade from experts in spare time at home! Age or physical handicap no disadvantage. Year around, steady income. Full or part time. Practical, illustrated lessons. Make money even while learning! All materials and special tools supplied. Free Booklet.



INSTITUTE OF LOCKSMITHING, Dept. P-98  
150 PARK AVENUE E. RUTHERFORD, N.J.  
Lic. by N.J. State Board of Ed. Approved for Vets

## EXCLUSIVE! PRE-ASSEMBLED KITS! FREE CATALOG... SEND TODAY!



New! Pre-assembled kits save up to 2/3 assembly time. Send for Free Catalog Now! Cruisers, Runabouts, 12 NEW Models 12-18'. Supermart selection of Fiberglass & Accessories.

## BOAT KITS INC.

1415 W. 92nd St., Dept. B-1 Bloomington 20, Minn.



## MEN! MAKE \$4.00 AN HOUR After Work — Easy!

Show Wonderful PARAGON Shoes Work with friendly people. Free Selling Kit — up to \$4.00 cash commission per sale. Full or spare time. Over 153 styles. Big Cash Bonus. Easy selling helps, Magic Cushion. No investment. WRITE for Free Catalog.

**PARAGON SHOE CO.**  
79 Sudbury St., Dept. 20  
Boston 14, Mass.



# New Rubber Stamp Business Pays Beginners <sup>UP</sup> <sup>TO</sup> \$9.20 an hr.

**Start at home in spare  
time with this little  
table top machine**

The multi-million dollar Rubber Stamp Business—once controlled by a few big companies—is now being taken over by small home operators—one in each community throughout the U.S. Men and women who have this inexpensive machine can turn out huge quantities of Rubber Stamps with special wording that buyers once were forced to order from big cities. Material costing only 27¢ makes a stamp that sells for \$1.80. The machine that does the work is simple and easy to operate and it turns out as many as six Rubber Stamps at a time each with different wording such as names, addresses, notices, stock numbers, prices and other "copy" needed by offices, factories and individuals. Working full capacity, it can earn as much as \$9.20 an hour for the operator! Now you can get into the big-pay business yourself, with your own home as headquarters. You don't need any experience. We supply everything, including complete instructions and eight ways to get business coming in fast. Start making up to \$9.20 an hour from the very beginning. Cash in on the profitable Rubber Stamp Business in your community right away.

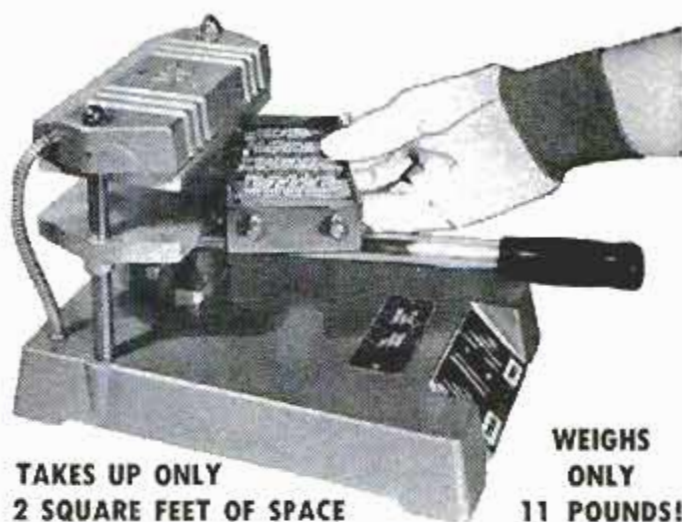

**TAKES UP ONLY  
2 SQUARE FEET OF SPACE**

**WEIGHS  
ONLY  
11 POUNDS!**

Read the complete and fascinating Rubber Stamp story in a big 110-page Book recently published by the Warner Electric Company. The book is profusely illustrated with more than 100 pictures and photographs. *And you can read it for a full two weeks without risking a penny of your own money.*

## Here's what the new WARNER PLAN Tells You about Making Money with RUBBER STAMPS

### CHAPTERS

1. HOW TO have fun now and at the same time provide for a secure and prosperous future.
2. HOW TO check the advantages of operating a Rubber Stamp Business in your own community.
3. HOW TO acquire a general knowledge of the business based on a brief history of the Rubber Stamp.
4. HOW TO visualize the scope of the Rubber Stamp market.
5. HOW TO make a Rubber Stamp (general outline).
6. HOW TO assess the value of Warner Equipment.
7. HOW TO get acquainted with the "Tools of your Trade."
8. HOW TO make a Rubber Stamp (Specific procedure).
9. HOW TO mount a vulcanized Rubber Stamp.
10. HOW TO make "Special" Rubber Stamps.
11. HOW TO cut plastic Matrix Board for the chase.
12. HOW TO get the right price for the Rubber Stamps you make.
13. HOW TO price your complete Rubber Stamp Line.
14. HOW TO figure costs so you will be sure of a substantial profit on all the work you turn out.
15. HOW TO set up your workshop.
16. HOW TO get the most out of Warner's "Eight Tested Sources for Getting Business."
17. HOW TO operate at peak efficiency when YOU ARE YOUR OWN BOSS.
18. HOW TO get started on a cash outlay so small that you can get back your entire investment inside of two weeks.

## NEW WARNER SUCCESS PLAN

**Tells How to Build — Step by Step — to  
big profits and Personal Independence  
READ THIS PLAN FOR 2 WEEKS  
ENTIRELY AT MY RISK.**



110 Pages  
More Than 100  
Pictures

Now Ready to Mail  
Tell Me Where To  
Send Your Copy  
**USE COUPON**

In this amazing Plan you will find exact and detailed instructions for starting a Home Business in spare time—without giving up your present job and without risking the loss of a single pay check. The Warner Plan shows you—with pictures, photographs and drawings—just how to make Rubber Stamps just as good as those turned out by the big companies. It shows how to get orders without canvassing or house-to-house selling. It shows you how to expand, how to get others to work for you and how to be SURE of at least twice the money you made on your present job for a life of personal independence.

But don't make any decision now. Read the Plan first—entirely at my risk. Then—after you have made a careful investigation—after you have talked things over with your family—only then do you decide what you want to do.

The thing to do now is to get full details which I will send you FREE. No salesman will call to urge you to buy anything. Mail coupon today—or just send me a postcard—and I will see that complete information goes out to you by return mail—postage paid.

### RUBBER STAMP DIVISION

1512 Jarvis Ave., Dept. R-2-A, Chicago 26, Illinois

**RUBBER STAMP DIVISION  
1512 Jarvis Avenue, Dept. R-2-A  
Chicago 26, Illinois**

**SEND NO  
MONEY**

Please rush full particulars about the little machine that can get me started in the profitable Rubber Stamp Business at home in spare time. Everything you send me is FREE. No salesman will call.

Name \_\_\_\_\_

Address \_\_\_\_\_

City \_\_\_\_\_ Zone \_\_\_\_\_ State \_\_\_\_\_



# Shows you how to become your own Expert Carpenter IN A JIFFY!

**Make your own repairs, additions, and SAVE YOURSELF MONEY**

If you can drive a nail, these step-by-step how-to-do-it books will show you even how to build a house! Completely covers all those practical details of construction (with more than 500 detailed drawings and photos) that you could only learn through years of experience.

Starts with use of tools, including the steel square, how to read blue prints, selection of right woods—goes right up through intricate joints, corner construction, use of the level-transit. Includes foundations, frame-work, roofing, even builder's hardware. All in words and pictures easy to understand and follow.

**SEND NO MONEY.** Mail the Coupon and we'll send both volumes of "Fundamentals of Carpentry" for 5 days FREE EXAMINATION. Pay nothing now. Pay nothing to postman. Just mail coupon.

**American Technical Society, Dept. AY1**  
848 E. 58th St., Chicago 37, Ill.



**SENT ON FREE TRIAL**  
886 PAGES  
552 PICTURES  
**\$8.90** COMPLETE  
IF YOU KEEP IT

**AMERICAN TECHNICAL SOCIETY, Dept. AY1**  
848 E. 58th St., Chicago 37, Ill.

Please send me "Fundamentals of Carpentry" for 5 DAYS FREE EXAMINATION. If I decide to keep the books, I will send \$8.90 for both volumes, plus shipping costs. Otherwise I will return the books and owe you nothing.

Name \_\_\_\_\_  
Address \_\_\_\_\_  
City \_\_\_\_\_ Zone \_\_\_\_\_ State \_\_\_\_\_  
 If you prefer to enclose \$8.90 with coupon, check here and we pay all shipping costs. Money refunded if not delighted.

## DRAW ANY PERSON IN ONE MINUTE

Anyone Can Draw With This Amazing New Invention—Instantly! The "Magic Art Reproducer"



**NO LESSONS! NO TALENT!**  
You Can Draw Your Family, Friends, Anything From REAL LIFE—Like An Artist Even if You CAN'T DRAW A Straight Line!

Also Excellent for Every Other Type of Drawing!

- Human Figures • Outdoor Scenes, landscapes, buildings
- Still life, vases, bowls of fruit, lamps, furniture, all objects • Copy photos, other pictures, portraits, etc.
- Copy blueprints, designs, decorations, etc., for woodwork, machine, for needlework, crocheting, knitting • Copy all cartoons.

Complete for only **\$1.98**

**FREE** with order

A.B.C. Guidance of Figure Drawing  
This valuable illustrated guide contains simple guidance on drawing human figures. Includes techniques, shading, proportions, etc., to use with your "Magic Art Reproducer" for added touches to your drawings.

**SEND NO MONEY!**  
Free 10-Day Trial!

Just send name and address. Pay postman on delivery \$1.98 plus postage. Or send only \$1.98 with order and we pay postage. 10 Day Trial must satisfy or money will be refunded.

**NORTON PRODUCTS, Dept. 193, 298 Broadway, N. Y. C.**

Yes, anyone from 5 to 80 can draw or sketch or paint anything now... the very first time you use the "Magic Art Reproducer" like a professional artist — no matter how "hopeless" you think you are! Anything you want to draw is automatically seen on any sheet of paper instantly! Then easily and quickly follow the lines of the "picture image" with your pencil... and you have an accurate original drawing that anyone would think an artist had done. Also makes drawing larger or smaller as you wish. Anyone can use it on any desk, table, board, etc.—indoors or outdoors! No other lessons or practice or talent needed!

Have fun! Be popular! Everyone will ask you to draw them. You'll be in demand! After a short time, you may find you can draw well without the "Magic Art Reproducer" because you have developed a "knack" and feeling artists have—which may lead to a good paying art career.

24 YEARS IN BUSINESS AT THE SAME ADDRESS.



Our entire stock of very slightly worn EXTRA MILEAGE TOP GRADE Tires. (Written Insurance Guarantee). SEND AD

**EVERYBODY 10% off ON EVERY TIRE**  
MAY DEDUCT

Free—Tube With Each Passenger Tire

**FREE** If you buy 2 or more Passenger 4-ply tires, WE GIVE ONE tire FREE on each order. Does not include W.W. or Truck Tires, or Snow Tires. Write for other sizes.

12 MOS. WRITTEN GUARANTEE. WHITE WALLS \$1.00 EX.	700-15	4.92	700-16	5.12	700-17	5.32	700-18	5.52	700-19	5.72	700-20	5.92	700-21	6.12	700-22	6.32	700-23	6.52	700-24	6.72	700-25	6.92	700-26	7.12	700-27	7.32	700-28	7.52	700-29	7.72	700-30	7.92	700-31	8.12	700-32	8.32	700-33	8.52	700-34	8.72	700-35	8.92	700-36	9.12	700-37	9.32	700-38	9.52	700-39	9.72	700-40	9.92	700-41	10.12	700-42	10.32	700-43	10.52	700-44	10.72	700-45	10.92	700-46	11.12	700-47	11.32	700-48	11.52	700-49	11.72	700-50	11.92	700-51	12.12	700-52	12.32	700-53	12.52	700-54	12.72	700-55	12.92	700-56	13.12	700-57	13.32	700-58	13.52	700-59	13.72	700-60	13.92	700-61	14.12	700-62	14.32	700-63	14.52	700-64	14.72	700-65	14.92	700-66	15.12	700-67	15.32	700-68	15.52	700-69	15.72	700-70	15.92	700-71	16.12	700-72	16.32	700-73	16.52	700-74	16.72	700-75	16.92	700-76	17.12	700-77	17.32	700-78	17.52	700-79	17.72	700-80	17.92	700-81	18.12	700-82	18.32	700-83	18.52	700-84	18.72	700-85	18.92	700-86	19.12	700-87	19.32	700-88	19.52	700-89	19.72	700-90	19.92
---	--------	------	--------	------	--------	------	--------	------	--------	------	--------	------	--------	------	--------	------	--------	------	--------	------	--------	------	--------	------	--------	------	--------	------	--------	------	--------	------	--------	------	--------	------	--------	------	--------	------	--------	------	--------	------	--------	------	--------	------	--------	------	--------	------	--------	-------	--------	-------	--------	-------	--------	-------	--------	-------	--------	-------	--------	-------	--------	-------	--------	-------	--------	-------	--------	-------	--------	-------	--------	-------	--------	-------	--------	-------	--------	-------	--------	-------	--------	-------	--------	-------	--------	-------	--------	-------	--------	-------	--------	-------	--------	-------	--------	-------	--------	-------	--------	-------	--------	-------	--------	-------	--------	-------	--------	-------	--------	-------	--------	-------	--------	-------	--------	-------	--------	-------	--------	-------	--------	-------	--------	-------	--------	-------	--------	-------	--------	-------	--------	-------	--------	-------	--------	-------	--------	-------	--------	-------	--------	-------	--------	-------	--------	-------

"EXTRA SPECIAL" TOP QUALITY all size 4-ply pass. FREE TIRE with 2 or more of these also.—W.W. \$1.00 Extra Factory Tested Tube given — **GIANT TIRE SALE. \$8.72 EA.**

**SNOW TIRES \$8.72 AND \$6.22 ANY SIZE**  
BLACK WALL PASS.  
DEEP HEAVY TREAD FOR ROUGH WINTER WEAR.  
Thousands of tires shipped all over the U.S.A. All tires shipped F.O.B. Phila. Send Check or M.O. with this ad. Dept. 2. No C.O.D.  
**STANDARD 834 N. Broad St., Philadelphia 30, Pa.**

## GROW MINIATURE TREES FREE! SEEDS & PLAN



New Fascinating HOBBY or HOME-BUSINESS OPPORTUNITY!  
Learn little-known techniques for growing living "Ming" Trees only inches high. Beautiful Elm, Cherry, Orange, Cypress, Peach, etc., that BLOSSOM AND BEAR TINY TASTY FRUIT. Help fill demand for these sensational dwarfed Trees. FREE SEEDS (8 kinds) and Illustrated Plan, write:

MINIATURE TREE NURSERIES, Dept. K-1, (Home-Growers Division) Gardena, Calif.

## TASOPE PHOTO-ENGRAVING PLANTS



Material Cost Of This Cut 34c Selling Price \$1.00 And Up

Establish your own profitable PHOTO-ENGRAVING business. Make cuts for newspapers, printers, and advertisers. Make etched name plates, plaques etc. Instructions furnished, no experience necessary. Sold direct from factory since 1931. First five hundred cuts sold locally or by mail will pay for plant and pay you well for your time. Write for FREE catalog.

TASOPE, DEPT. PM-1, AURORA, MO.

## STUDY TO BE A DOCTOR of Psychology or Metaphysics

Obtain a Pa.D., Ms.D., or Ph.D. Be a Teacher, Lecturer or Accredited Practitioner. Teach others how to achieve Health, Happiness and Contentment. Chartered by State. Correspondence Courses only. Write for FREE book telling how.

**THE NEOTARIAN FELLOWSHIP**  
Desk 8, Pickwick Building Kansas City 6, Missouri

## BUY IT WHOLESALE!

**SAVE 30-80%** FOR SELF OR RESELL FOR BIG PROFITS! NAME BRAND APPLIANCES, TOOLS, WATCHES, CAMERAS, PHONOS, SEWING MACHINES, JEWELRY, HOUSEWARES, SPORTING GOODS, TYPEWRITERS, ETC.

GET OUR BIG WHOLESALE CATALOG OF OVER 2,000 PROFIT MAKING ITEMS! POSTCARD BRINGS DETAILS FREE! MAIL TODAY!

**Consolidated DISTRIBUTORS**  
CLIFTON 1, N. J.

## MAKE BIG MONEY—ALL PROFIT—AT HOME

### INVISIBLE MENDING

**Pays up to \$10 in an Hour!**  
Make moth holes, cigarette burns, tears, rips, disappear from all fabrics. Little-known craft pays extra spare-time profits at home. Write today for exciting details FREE!  
**FABRICON, 6238 Broadway**  
DEPT. 321, CHICAGO 40, ILLINOIS

## Learn BAKING At Home

Baking is one of America's high industries in wages. Nearly depression-proof. Thorough basic home course lays sound foundation. If you have aptitude, write for FREE BOOKLET, "Opportunities in Commercial Baking."  
National Baking School, 635 Diversy Pkwy., Dept. 1351, Chicago 14, Illinois





# A NEWSPAPER STORY GAVE ME A BRIGHT NEW FUTURE

—and it can do the same for you

I'd been on the same job for 8 long years. A whole string of younger men were passing me by.

And it seemed that life itself was passing me by.

Then, one day I marched into the boss's office and asked him, "Why am I stuck in my job? What's wrong with me? I've worked hard for this outfit."

"Charlie," he said, "you're doing a good job . . . but you need training to step into a supervisor's job. Experience alone isn't enough."

I was steamed. But he was right . . . my education was pretty skimpy. Still, what chance did I have for special training at this stage of the game?

That night I went home feeling whipped, wondering if we'd ever have the money to give the kids the advantages we'd hope to give them.

That same night an article in the *Dispatch* caught my eye. It said that learning power actually increases until you're past middle age. It said that correspondence schools reported that older students often have a better grasp of their studies than college-age people.

That article gave me the idea. The next day I mailed an I.C.S. coupon. It was the smartest thing I ever did. Today, after only 18 months as an I.C.S. student, I'm a supervisor.

I'm not a guy who believes in miracles, but if you want to help yourself, I.C.S. can give you the educational advantages you may have missed. For someone in my position with a wife, kids and a job, I.C.S. is a sure-fire way to break out of the rut.

Mail the coupon like I did and find out for yourself.

For Real Job Security—Get an I. C. S. Diploma!

I. C. S., Scranton 15, Penna.

Accredited Member,  
National Home Study Council

## INTERNATIONAL CORRESPONDENCE SCHOOLS



BOX 50299A, SCRANTON 15, PENNA.

(Partial list of 257 courses)

Without cost or obligation, send me "HOW to SUCCEED" and the opportunity booklet about the field BEFORE which I have marked X (plus sample lesson):

- |  |  |  |  |  |
|--|--|--|--|--|
| <p><b>ARCHITECTURE and BUILDING CONSTRUCTION</b></p> <input type="checkbox"/> Air Conditioning<br><input type="checkbox"/> Architecture<br><input type="checkbox"/> Arch. Drawing and Designing<br><input type="checkbox"/> Building Contractor<br><input type="checkbox"/> Building Estimator<br><input type="checkbox"/> Carpentry and Millwork<br><input type="checkbox"/> Carpenter Foreman<br><input type="checkbox"/> Heating<br><input type="checkbox"/> Interior Decoration<br><input type="checkbox"/> Painting Contractor<br><input type="checkbox"/> Plumbing<br><input type="checkbox"/> Reading Arch. Blueprints <p><b>ART</b></p> <input type="checkbox"/> Commercial Art<br><input type="checkbox"/> Magazine & Book Illus.<br><input type="checkbox"/> Show Card and Sign Lettering<br><input type="checkbox"/> Sketching and Painting <p><b>AUTOMOTIVE</b></p> <input type="checkbox"/> Automobiles<br><input type="checkbox"/> Auto Body Rebuilding and Refinishing<br><input type="checkbox"/> Auto Engine Tuneup<br><input type="checkbox"/> Auto Technician | <p><b>AVIATION</b></p> <input type="checkbox"/> Aero-Engineering Technology<br><input type="checkbox"/> Aircraft & Engine Mechanic <p><b>BUSINESS</b></p> <input type="checkbox"/> Accounting<br><input type="checkbox"/> Advertising<br><input type="checkbox"/> Business Administration<br><input type="checkbox"/> Business Management<br><input type="checkbox"/> Cost Accounting<br><input type="checkbox"/> Creative Salesmanship<br><input type="checkbox"/> Managing a Small Business<br><input type="checkbox"/> Professional Secretary<br><input type="checkbox"/> Public Accounting<br><input type="checkbox"/> Purchasing Agent<br><input type="checkbox"/> Salesmanship<br><input type="checkbox"/> Salesmanship and Management<br><input type="checkbox"/> Traffic Management <p><b>CHEMICAL</b></p> <input type="checkbox"/> Analytical Chemistry<br><input type="checkbox"/> Chemical Engineering<br><input type="checkbox"/> Chem. Lab. Technician<br><input type="checkbox"/> Elements of Nuclear Energy<br><input type="checkbox"/> General Chemistry<br><input type="checkbox"/> Natural Gas Prod. and Trans.<br><input type="checkbox"/> Petroleum Prod. and Engr.<br><input type="checkbox"/> Professional Engineer (Chem)<br><input type="checkbox"/> Pulp and Paper Making | <p><b>CIVIL ENGINEERING</b></p> <input type="checkbox"/> Civil Engineering<br><input type="checkbox"/> Construction Engineering<br><input type="checkbox"/> Highway Engineering<br><input type="checkbox"/> Professional Engineer (Civil)<br><input type="checkbox"/> Reading Struc. Blueprints<br><input type="checkbox"/> Structural Engineering<br><input type="checkbox"/> Surveying and Mapping <p><b>DRAFTING</b></p> <input type="checkbox"/> Aircraft Drafting<br><input type="checkbox"/> Architectural Drafting<br><input type="checkbox"/> Drafting Machine Design<br><input type="checkbox"/> Electrical Drafting<br><input type="checkbox"/> Mechanical Drafting<br><input type="checkbox"/> Sheet Metal Drafting<br><input type="checkbox"/> Structural Drafting <p><b>ELECTRICAL</b></p> <input type="checkbox"/> Electrical Engineering<br><input type="checkbox"/> Elec. Engr. Technician<br><input type="checkbox"/> Elec. Light and Power<br><input type="checkbox"/> Practical Electrician<br><input type="checkbox"/> Practical Lineman<br><input type="checkbox"/> Professional Engineer (Elec) <p><b>HIGH SCHOOL</b></p> <input type="checkbox"/> High School Diploma | <p><input type="checkbox"/> Good English<br/> <input type="checkbox"/> High School Mathematics<br/> <input type="checkbox"/> Short Story Writing</p> <p><b>LEADERSHIP</b></p> <input type="checkbox"/> Industrial Foremanship<br><input type="checkbox"/> Industrial Supervision<br><input type="checkbox"/> Personnel-Labor Relations<br><input type="checkbox"/> Supervision <p><b>MECHANICAL and SHOP</b></p> <input type="checkbox"/> Diesel Engines<br><input type="checkbox"/> Gas-Elec. Welding<br><input type="checkbox"/> Industrial Engineering<br><input type="checkbox"/> Industrial Instrumentation<br><input type="checkbox"/> Industrial Metallurgy<br><input type="checkbox"/> Industrial Safety<br><input type="checkbox"/> Machine Design<br><input type="checkbox"/> Machine Shop Practice<br><input type="checkbox"/> Mechanical Engineering<br><input type="checkbox"/> Professional Engineer (Mech)<br><input type="checkbox"/> Quality Control<br><input type="checkbox"/> Reading Shop Blueprints<br><input type="checkbox"/> Refrigeration and Air Conditioning<br><input type="checkbox"/> Tool Design <input type="checkbox"/> Tool Making <p><b>RADIO, TELEVISION</b></p> <input type="checkbox"/> General Electronics Tech. | <p><input type="checkbox"/> Industrial Electronics<br/> <input type="checkbox"/> Practical Radio-TV Eng'g<br/> <input type="checkbox"/> Practical Telephony<br/> <input type="checkbox"/> Radio-TV Servicing</p> <p><b>RAILROAD</b></p> <input type="checkbox"/> Car Inspector and Air Brake<br><input type="checkbox"/> Diesel Electrician<br><input type="checkbox"/> Diesel Engr. and Fireman<br><input type="checkbox"/> Diesel Locomotive <p><b>STEAM and DIESEL POWER</b></p> <input type="checkbox"/> Combustion Engineering<br><input type="checkbox"/> Power Plant Engineer<br><input type="checkbox"/> Stationary Diesel Engr.<br><input type="checkbox"/> Stationary Fireman <p><b>TEXTILE</b></p> <input type="checkbox"/> Carding and Spinning<br><input type="checkbox"/> Cotton Manufacture<br><input type="checkbox"/> Cotton Warping and Weaving<br><input type="checkbox"/> Loom Fixing Technician<br><input type="checkbox"/> Textile Designing<br><input type="checkbox"/> Textile Finishing & Dyeing<br><input type="checkbox"/> Throwing<br><input type="checkbox"/> Warping and Weaving<br><input type="checkbox"/> Worsted Manufacturing |
|--|--|--|--|--|

Name \_\_\_\_\_ Age \_\_\_\_\_ Home Address \_\_\_\_\_  
 City \_\_\_\_\_ Zone \_\_\_\_\_ State \_\_\_\_\_ Working Hours \_\_\_\_\_ A.M. to P.M. \_\_\_\_\_  
 Occupation \_\_\_\_\_

Canadian residents send coupon to International Correspondence Schools, Canadian, Ltd., Montreal, Canada. . . . Special tuition rates to members of the U. S. Armed Forces.



# You Can Be A CLAIM INVESTIGATOR

We'll Train YOU for a LIFE OF EXCITEMENT • BIG PAY • SECURITY in the fast growing billion-dollar Claim Adjustment Field.



## INVESTIGATE



AUTO ACCIDENTS



WINDSTORM LOSSES



BURGLARIES

## EVERY COMMUNITY NEEDS ADJUSTERS

Every second of every day accidents and losses happen—and trained claim adjusters are needed to investigate and to distribute billions of dollars.

Yes, thousands of insurance companies, airlines, railroad companies, steamship lines, and Government Offices must continually use Claim Investigators and Adjusters. Trained Claim Agents are always in demand. Many earn over \$750 a month.

Here is your opportunity. At home in spare time you can learn this fascinating work—easily, quickly.

In taking our Adjuster Training Course you are given the necessary knowledge either to enter your own business or to work with one of the large companies.

Mail This Coupon NOW for FREE Book

UNIVERSAL SCHOOLS, Dept. 8APM  
University Park, Box 8202, Dallas 5, Texas

Please rush me your free book on Claim Investigation. This does not obligate me and no salesman will call.

Name \_\_\_\_\_ Age \_\_\_\_\_

Address \_\_\_\_\_

City \_\_\_\_\_ Zone \_\_\_\_\_ State \_\_\_\_\_



Offer Your Motorist - Friends  
**GUARANTEED Improvement**  
in **MOTOR COMPRESSION**  
...PEP...and **ECONOMY...**

and MAKE UP TO **\$1,500.00 IN A MONTH!**

No matter how old your friend's cars are, unconditionally guarantee them astonishing increases in compression, gas mileage and oil saving. even let them judge for themselves! Amazing new product backs you up 100%. hands you opportunity to make big money.

Build Big-Profit REPEAT Business Spare Time With

New, Improved **MOTOR OVERHAUL**  
Bigger, Better

Folks try MOTOR OVERHAUL and re-order from you time and again. Fleet operators buy large quantities on daring "You-Be-The-Judge" Guarantee. Sensational Independent Laboratory Report proves that only moments after MOTOR OVERHAUL is added to engine oil, compression increases up to 58%, gas mileage up to 54%, oil-saving up to 900%. New larger size, still only \$2.98; make up to \$1.78 profit on each one. Now with oil-stabilizer Formula X-303 for faster cold-weather starts, cool engine in summer!

**FREE! Tear Out This Ad NOW...**

and rush it with your name, address for complete money-making plans, actual copy of sensational Lab Road Test Report, daring Guarantee . . . all FREE, no obligation.

**POPE CHEMICAL CO.,** 224 W. Huron, Dept. C-3, Chicago 10, Ill.

# MR. FARMER

Does This Look Familiar?

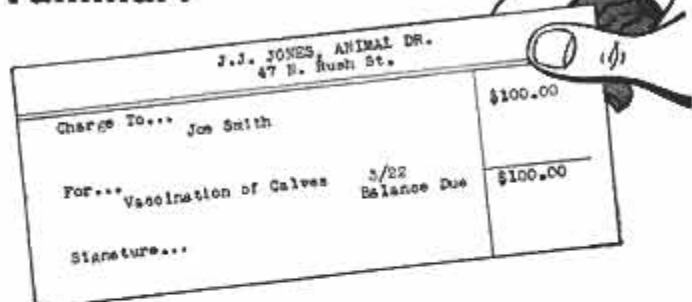

Are you paying doctor bills for sick farm animals that YOU might take care of YOURSELF? If so, you should have the

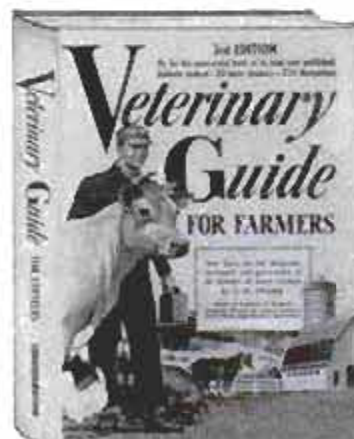

## VETERINARY GUIDE For Farmers

**NEW, ENLARGED  
3rd EDITION  
BIGGER! BETTER!  
EVEN MORE USEFUL!**

384 Pages • Illustrated  
**\$3.95**

Information  
You Can Use Every Day

Covers Cattle, Horses,  
Swine, Sheep, Poultry

It pays you to know what diseases can strike your herd; what must be done for stricken animals; how the healthy ones in the herd can be protected; how the outbreaks can be prevented in the future. This is only part of the information you get in the Veterinary Guide for Farmers. Only **\$3.95.**

**Easily Worth Many, Many Times Its Cost**

By preventing the loss of only one animal this book can easily be worth a hundred times its cost. Today's high market value of farm animals, together with the high cost of feeding and raising them, makes losses extremely expensive. Stop losses, step up your profits with the Veterinary Guide For Farmers.

**OFFICIALLY ADOPTED IN 26 STATES**

Endorsed by Vo-Ag teachers and other leaders. Adopted by "Veterans on the Farm" training classes in 26 states. It has sold more than 250,000 copies. This new edition of the "Vet Guide"—first in seven years—is more inclusive, up-to-date, even more valuable.

**Send No Money! Mail Coupon Today!**

POPULAR MECHANICS PRESS, Dept. 158  
200 E. Ontario, Chicago 11, Illinois

Rush me a copy of the Veterinary Guide for Farmers immediately. At the end of seven days I will either remit \$3.95 in full payment, or return the book to you in good order and owe nothing.

Name \_\_\_\_\_

Address \_\_\_\_\_

City \_\_\_\_\_ State \_\_\_\_\_

Check here if you enclose \$3.95.  
Same return and refund privilege.



Superior's New Model 70 UTILITY TESTER®

# FOR REPAIRING ALL ELECTRICAL APPLIANCES MOTORS·AUTOMOBILES·TV TUBES



As an electrical trouble shooter the Model 70:

- Will test Toasters, Irons, Broilers, Heating Pads, Clocks, Fans, Vacuum Cleaners, Refrigerators, Lamps, Fluorescents, Switches, Thermostats, etc.
- Will test all TV tubes for open filaments, inter-element shorts, burned out tubes, etc.
- Measures A.C. and D.C. Voltages, A.C. and D.C. Current, Resistances, Leakage, etc.
- Will measure current consumption while the appliance under test is in operation.
- Incorporates a sensitive direct-reading resistance range which will measure all resistances commonly used in electrical appliances, motors, etc.
- Leakage detecting circuit will indicate continuity from zero ohms to 5 megohms (5,000,000 ohms).

As an Automotive Tester the Model 70 will test:

- Both 6 Volt and 12 Volt Storage Batteries • Generators • Starters • Distributors • Ignition Coils • Regulators • Relays • Circuit Breakers • Cigarette Lighters • Stop Lights • Condensers • Directional Signal Systems • All Lamps and Bulbs • Fuses • Heating Systems • Horns • Also will locate poor grounds, breaks in wiring, poor connections, etc.

**IT'S SO EASY!!**



With tester's cord in outlet, current consumption of appliance is read direct on meter when line cord is connected to receptacle on panel. This typical iron takes 7 amperes (Good).



Small electric fan motor indicates 90 ohms (normal resistance).



Control circuits of most furnaces use 24 volts obtained from step-down transformer. Here's how to check room thermostat to see if wires to it are live.



Manual supplied with Model 70 shows meter needle moves to right when test leads are connected to pins 3 and 4 of this 6AU6 tube. Procedure for testing all tubes used in TV are detailed in manual.

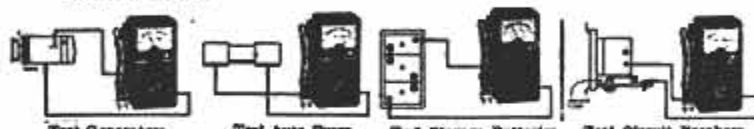

Test Generators

Test Auto Fuses

Test Storage Batteries

Test Circuit Breakers

**READ THIS!**

**READ THIS!**

**READ THIS!**

You don't pay for the Model 70 until AFTER you have examined it in the privacy of your home! Model 70 is

## SHIPPED ON APPROVAL NO MONEY WITH ORDER - NO C.O.D.

Try it for 10 days before you buy. If completely satisfied then send \$3.85 and pay balance at rate of \$4.00 per month for 3 months—No Interest or Finance Charges Added! If not completely satisfied, return to us, no explanation necessary.



**INCLUDED FREE!!**

This 64-page book—practically a condensed course in electricity. Learn by doing.

Just read the following partial list of contents:

- What is electricity? • Simplified version of Ohms Law • What is wattage? • Simplified wattage charts • How to measure voltage, current, resistance and leakage • How to test all electrical appliances and motors using a simplified trouble-shooting technique.
- How to test all TV tubes; also simple procedure for determining which specific tube (or tubes) is causing the trouble.
- How to trace trouble in the electrical circuits and parts in automobiles and trucks.

Model 70 comes complete with above book and test leads. Only ...

**15<sup>85</sup>**

MOSS ELECTRONIC DIST. CO.

Dept. D-421 3849 Tenth Ave., New York 34, N. Y.

Please rush me one Model 70. If satisfactory I agree to pay \$3.85 within 10 days and balance at rate of \$4 per month until total price of \$15.85 plus postage is paid. If not satisfactory, I may return for cancellation of account.

Name \_\_\_\_\_

Address \_\_\_\_\_

City \_\_\_\_\_ Zone \_\_\_\_\_ State \_\_\_\_\_



LEARN

# Television

RADIO-COLOR-TV  
In the great shops of COYNE



Great opportunity for a good job or your own business in one of America's fastest growing industries! New stations... new sets by the millions... Color TV... all means greater opportunities.

**Veterans and Non-Veterans**—Get practical shop work plus technical training in TELEVISION—RADIO at Coyne in Chicago—old established school—training background nearly 60 years.

Learn on real equipment—no advanced education or previous experience needed. Lifetime employment service to graduates.

**Finance Plan**—New liberalized credit terms. Enroll now, pay most of tuition later. Part time employment help to students.

**BIG FREE BOOK** Mail coupon. No obligation. No salesman will call. Act NOW.

**COYNE** CHARTERED NOT FOR PROFIT  
ESTABLISHED 1899  
500 S. Paulina, Chicago, Dept. 18-3R

**COYNE Electrical School**  
500 S. Paulina St., Chicago 12, Ill., Dept. 18-3R

Send FREE BOOK and details of your training in TV-RADIO

Name \_\_\_\_\_

Address \_\_\_\_\_

City \_\_\_\_\_ State \_\_\_\_\_

# BUY BELOW WHOLESALE



## Start Your Own HOME-IMPORT Business

Make big profits on thousands of exotic imports. No experience or investment in products needed. Famous world trader guides men and women—shows how to pocket profits in advance, how to start full or spare time home mail order business.

Open cash orders, take out the money, deduct your profits, then have the imports shipped direct from abroad. NO STOCKS TO CARRY on new plan, no face to face selling. Or handle volume orders for wholesalers, gift or department stores, etc. Export opportunities also.

### FREE SAMPLES—CONTACTS ABROAD

Following our plan you receive free, 8 imports—and membership in International Traders which provides you with monthly bulletins revealing foreign products with names and addresses of overseas suppliers.

### HUGE UNCROWDED OPPORTUNITY

Each year more imports are offered in U. S. and snapped up by mail order and store buyers alike. And the word "imported" is like magic to the millions who want new, rare, romantic and unusual gifts at big savings. And there seems to be no end to this demand. Others using our plan are now importing at low foreign costs products that sell here at handsome profits. Why not you?

GET FULL DETAILS and list of 157 imports showing amazing low foreign prices—**ALL FREE!** There's no obligation whatever. No salesman will call on you.

Air mail reaches us over night. Write today.

**THE MELLINGER CO.**  
1717 Westwood Blvd., Dept. P251  
LOS ANGELES 24, CALIF.

EXAMPLES OF  
LOW PRICES  
ABROAD

# Finish HIGH SCHOOL

AT HOME

Complete 4 Years in 12 Months

diploma

Learn More! Earn More!

Enter College, professional or technical schools.

Advance Socially. Live a

Happier, Fuller Life. Individual Courses or complete schedule.

WRITE FOR SCHOOL BULLETIN, Dept. PM-18

**ACADEMY FOR ADULTS** 30 W. Washington  
Chicago 2, Illinois



## "TI-NEE" BATTERYLESS TUBELESS LIFETIME RADIO



"TI-NEE" RADIO IS GUARANTEED TO WORK FOR YOUR LIFETIME! USES NO TUBES, BATTERIES OR ELECTRICAL PLUG-INS. Never runs down! SMALLER THAN A PACK OF CIGARETTES! RECEIVES LOCAL RADIO STATIONS MOST ANYTIME, ANYWHERE WITHOUT EXTRA ANTENNA. Uses semi-conductor crystal diode Hi-Q Tuner. Beautiful black gold plastic cabinet. Built-in Speakerphone.

SEND ONLY \$2.00 (bill, ck, mo and pay)

Postman \$4.99 COD on arrival or send \$8.99 for postpaid delivery. SENT COMPLETE READY TO LISTEN—NOTHING EXTRA TO BUY. EVEN! Extra long distance Aerial kit included free to receive stations up to 1,000 miles away. Available only from: MIDWAY COMPANY, Dept. GPM-1, Kearney, Nebraska

## PLANS · PATTERNS · FRAME PACS

World's Largest Selection. Over 200 new plans, Full Size patterns, frame pacs. Designed for the amateur. Prows, racers, cruisers, utilities, inboards, outboards, in wood, plywood, steel. New longitudinal stressed models with revolutionary bulkhead construction. Light, super strong.

Send 35c for 120 pg. PLAN CATALOG

Catalog plus Boat Building Handbook.....\$1.00

SPECIAL OFFER... Plan Catalog... plus Hardware and Accessories catalog.....\$1.00

CUSTOM-CRAFT-BUFFALO 7 NEW YORK



### SPECIAL!

- 120 PAGE PLAN CATALOG PLUS
- 200 PAGE "BOAT BUILDING FOR THE AMATEUR" COVERS
- BOAT BUILDING
- FIBER-GLASSING
- OUTFITTING, ETC.

Only \$2.50

## \$1,000,000.00 CASH IN CONFEDERATE MONEY \$2.98

Be a deep south millionaire! Have money to burn! We'll send you exactly one million bucks in honest-to-goodness authentic reproductions of genuine Confederate money and bonus bills—and all you pay is \$2.98! You can do everything with this money but spend it. Amaze and amuse your cotton-pickin' friends. Win bar bets by the barrel! Light your cigars and cigarettes with \$10.00 bills! Live it up! It's a million dollars worth of laughs and fun—all for only \$2.98.

You get one million bucks in \$10's, \$20's, \$50's, \$100's etc. denominations—enough to keep your friends laughing and happy for months—This offer is limited. Only \$4 million dollars to a customer. Our supply of this loot is limited—so rush your order.

One Million dollars only \$2.98. Four Million Dollars only \$10.00. If not delighted keep \$100,000 for your trouble and return the rest of the money for a full and prompt refund. Send to: BEST VALUES CO., Dept. M-215, 403 Market St., Newark, N.J.

Do a Real Professional-Like Job Yourself and SAVE

## HOW to PAINT

With Brush and Spray

Covers All Painting Methods and Materials

You can do professional-like painting and finishing jobs yourself and save about two-thirds of the cost. Sam Brown, noted craft authority, makes it so easy for you in his book, HOW TO PAINT WITH BRUSH AND SPRAY. Order your copy now and enjoy this tremendous saving. It covers exterior painting, wall and interior decorating, furniture finishing, concrete painting—every type of painting with brush, spray gun, roller and other methods. Tells what finish is best; what materials to use, etc. No previous experience needed. Fully illustrated. Order by mail. Only \$2.50. Money back if not pleased.

POPULAR MECHANICS PRESS, Dept. PM158  
200 E. ONTARIO ST., CHICAGO 11, ILL.





# DO YOU REALLY WANT SUCCESS IN BUSINESS— —AND WILL YOU PAY THE PRICE?

Success and security come to the man who has "trained ability." Specialized ability commands promotion. Business is glad to pay—and pay well for real "know-how."

So—if you are the man who wants success in business, we urge you to immediately take stock of yourself. If an opening should occur, either in the company who now employs you or with another company—a job which would be a definite promotion with more money—could you fill it?

If so, you are fortunate. If not, you had better do something about it, or be satisfied to stay at your present salary level.

## PREPARE FOR A HIGH-PAY POSITION

Fortunately, there is something you can do about it—if you will pay the price of investing leisure hours. You can, in your spare time at home, quickly, economically, and thoroughly, without interference with your present work, prepare yourself for a brighter future—more money and a better job.

For nearly 50 years LaSalle has been helping ambitious men and women help themselves. During that time we have enrolled more than 1,380,000 students—helping them on their way to more money—a better job.

We believe we can help you too. The coupon is for your convenience. We suggest that you check the career of your choice and mail the coupon today. By return mail, and without obligation, we will send you full information on that field—the opportunities, and what you must know to be successful.



It's true—there's always room at the top for the trained man.

Don't delay. MAIL THE COUPON NOW.



MEMBER, NATIONAL HOME STUDY COUNCIL

## SEND FOR FREE BOOK

- Accounting
- Law: LL.B. Degree
- Traffic and Transportation
- Business Management
- Stenotype (Machine Shorthand)
- Stenographic-Secretarial
- CPA Training
- Salesmanship

### LaSalle Extension University

— A Correspondence Institution —  
Dept. 164R, 417 S. Dearborn St., Chicago 5, Ill.

Please send me your FREE illustrated booklet describing the course of training I have checked.

Name.....Age.....

Address.....

City, Zone, State.....



# ENGINEERING



Photo of Heald  
Electrical Laboratory  
Approved for Veterans

Heald College Ranks **FIRST**  
West of the Mississippi  
in "Who's Who" in America

Send for **FREE** Information  
**Heald Engineering College**  
Est. 1862

Van Ness at Post, Dept. P.M.  
San Francisco, California  
Enroll Now for New Term

Thousands of  
Engineers Needed  
for Hard Pressed  
Industry  
**BACHELOR OF  
SCIENCE DEGREE,  
27 MONTHS**

**Degree Courses:**

- Electronic Engineering
- Electrical Engineering
- Highway Engineering
- Mechanical Engineering
- Structural Engineering
- Civil Engineering
- Architecture

**Diploma Courses:**

- TELEVISION  Color TV
- Tool & Die Design
- Architectural Drafting
- Mechanical Drafting
- Structural Drafting
- Surveying
- Estimating
- Master Electrician

Approved for Veterans

NAME \_\_\_\_\_  
STREET \_\_\_\_\_  
CITY \_\_\_\_\_  
STATE \_\_\_\_\_

**FREE!**  
NEW ISSUE  
**QUEEN ELIZABETH  
STAMPS**  
and illustrated  
booklet



Rush coupon today! Exciting, generous NEW offer of beautiful, hard-to-get stamps — some not even cataloged yet. These NEW Elizabeth II stamps have never been given before, now yours FREE. From world's newest country, Ghana; Pitcairn Islands, Kenya, Cook Islands, Ascension, many others. All genuine, all different, mint and used — so new you'll add them all to your collection. Other offers for inspection plus free "Stamp Collector's Guide". Offer limited. RUSH name, 10c for postage, handling to GARCELON STAMP CO., Dept. 1PMQ Calais, Maine.

GARCELON STAMP CO., Dept. 1PMQ  
Calais, Maine. Rush FREE NEW Elizabeth Stamps, Collector's Guide, other offers. Enclosed 10c for postage, handling. (PLEASE PRINT)



## New! 1958 Low-cost Starcraft Boats

Sixteen stylish new models  
in aluminum and fiberglass  
with extra features, low price!

For fishing, for fun. Fifteen-year guarantee on aluminum models. Send for free catalog today!

## STARCRAFT BOATS

Department Q-1, Goshen, Indiana

## 2 WAY PORTABLE RADIO SET

**SENDS — RECEIVES UP TO 10 MILES AS SHOWN**  
with built-in antenna or hundreds of miles with outside antennal  
Works on 80 and 40 meter (Novice) amateur radio bands—also Air-  
craft and overseas broadcast (3 to 8 mci). PORTABLE SELF-CON-  
TAINED POWERED WITH STANDARD PORTABLE RADIO BATTER-  
TERIES. NO AC PLUG-INS NEEDED! Take it with you everywhere  
you go—on trips, vacations, camping—Keep in contact with home,  
friends. Has 5 watt crystal controlled transmitter—Sensitive Re-  
generative Receiver. Send-Receive switch. Wt.  
only 3 lbs. Size, only 6"x4"x4". TESTED —  
PROVEN—SIMPLIFIED—PRACTICAL—Full infor-  
mation given on quick easy to get license.  
**SEND ONLY \$3.00** (bill, ok, mo) and pay post-  
man \$11.95 COD postage on  
arrival or send \$14.95 for postpaid delivery.  
Complete kit includes all parts, tube, coil,  
plastic cabinet, easy instructions. (Set of bat-  
teries \$2.95; crystal \$1.25.) COMPLETELY  
WIRED AND TESTED POSTPAID \$19.95. A  
regular \$49.95 value—Order now before price  
goes up. GUARANTEED—AVAILABLE ONLY FROM:  
WESTERN RADIO DEPT. BNM-1 KEARNEY, NEBR.

## Are Those Crusts and Scales PSORIASIS?



If they are, use Siroil. For 25 years psoriasis sufferers have learned that Siroil tends to remove those unsightly crusts and scales. If lesions recur, light applications of Siroil help control them. Siroil won't stain clothing or bed linens. Offered on 2-weeks-satisfaction-or-money-refunded basis.

Write for **NEW FREE BOOKLET**  
written by REGISTERED PHYSICIAN

NEW BOOKLET  
answers 30  
most-asked questions  
about psoriasis.



**AT ALL DRUG STORES**

**SIROIL LABORATORIES, INC.**  
Dept. PM-10 Santa Monica, Calif.  
Please send me your new **FREE** booklet on PSORIASIS.

NAME \_\_\_\_\_  
ADDRESS \_\_\_\_\_  
CITY \_\_\_\_\_ STATE \_\_\_\_\_



# "I call it a bad day if I don't make \$25 before noon"

(This chair alone brought \$4.50 with twenty-five minutes work and 32¢ in cleaning materials.)

"Just a few months ago I made the big move. I gave up my job and started spending all my time in the little business I had been running on the side. It wasn't an easy decision, but, now I'm tickled to death I made it. Not just because I'm my own boss or because I have an excellent chance of making over \$10,000 this year. It goes deeper than that.

"You see, this idea has caught on like wildfire in my town. Not a day goes by without my phone ringing with women calling for appointments. The beauty of it is that once a woman becomes my customer, she calls back year after year. Not only that, she tells her friends, too, and they call me. Before I know it I'm swamped with work. (And at \$7.50 an hour net profit it doesn't take long before my bank account is really mushrooming.)

"Funny thing, but back last year, before I started, I never realized the money there was in this business waiting for someone to come along and collect it. Just think: every house in town has furniture and most have rugs or carpeting. I concentrate on just the better homes and have more work than I can handle. You know why? Because women are fussy about their furnishings. Can't stand to see them dirty. That's why they call me over every year.

"The average job is worth \$25.00 to me and takes a little over 2 hours. Out of this, after paying for materials, advertising and other expenses I net about \$15.00 clear profit. This means I need just 3 jobs a day to clear \$11,250.00 in a year. Frankly, since this will be my first full-time year I'll be glad to hit the \$10,000 mark. But after that this business should grow larger each year until I have to hire men to help me handle the business.

## Personally Trained by Another Dealer

"Believe me there's nothing magic about it. I didn't know a thing about cleaning and mothproofing before I became a Duraclean dealer. But after my application was accepted I was trained right here in town by a successful dealer from another city. I was astonished by the short time it took me to become an expert. Actually, much of the credit must go to the Duraclean process, which is so safe it has earned the Parents' Magazine Seal.

"The portable machine you see is just one of the electrical machines I use. It manufactures a light aerated foam with a peculiar action chemists call 'peptizing'. It means that instead of being scrubbed deep into the fabric, dirt is gently ABSORBED by the foam, leaving the fabric clean all the way down. Women can't believe their eyes when they see how it works. Colors appear bright again, and rug pile unmat and rises like new. I don't have to soak rugs or upholstery to get them clean, which ends the problem of shrinkage, and means the furnishings can be used again the very same day. This alone has brought me a lot of customers.

"As a Duraclean dealer I make money with four other services, too: **Duraproof** . . . which makes furnishings immune to moth and carpet beetle damage (it's backed by a six year warranty). **Durashield**, a brand new dirt-delaying treatment. It coats fabrics with an invisible film that keeps dirt out. **Duraguard**, another new service, flameproofs draperies, upholstery and carpets to reduce charring

by  
**Harold  
Holmes**



and the tendency of fires to flame up. And **Spotcraft**, which consists of special chemical products for removing stubborn spots and stains. On jobs where I perform all five services, I multiply profits!

"One of the nicest things about being a Duraclean dealer is that I get continuous help from Duraclean Headquarters. My services are nationally advertised in famous magazines like *McCall's*, *House Beautiful* and many others. I also get a complete advertising kit prepared by experts. (There's even a musical commercial!) I get a monthly magazine full of methods to build business and I can meet with other dealers at Duraclean conventions. I'm also backed by insurance. In fact there are over 25 regular services I get under their unique System.

## No Shop Needed

"Maybe you too would like to break away from your job and make a fresh start in a business of your own. Do you need a shop? Certainly not. I operate from home. Need a lot of money to start? Not at all. Duraclean finances reliable men, after a moderate down payment, and furnishes enough supplies to return your TOTAL investment.

"You get everything you need: equipment, supplies, advertising matter, personal training, and regular help from Headquarters. To get all the details, fill out the coupon. There's no obligation and you can *decide for yourself*. I'll say one thing: if you DO become a Duraclean dealer, you'll be glad the rest of your life that you took time today to write."

**Irl H. Marshall, Jr., International Headquarters**  
Desk 8-161, 839 Waukegan Avenue, Deerfield, Ill.

IRL H. MARSHALL, Jr., International Headquarters  
Desk 8-161, 839 Waukegan Avenue, Deerfield, Ill.

I'm interested in owning my own business. Please send illustrated booklets and full details FREE outlining the Duraclean Dealership Program and territory arrangement.

Name \_\_\_\_\_  
Please print

Address \_\_\_\_\_

City \_\_\_\_\_ State \_\_\_\_\_



# NOW The Short Cut to Learning You've Been Waiting for



## Learn "By Ear" with the DORMIPHONE

The Scientific Discovery

That Works for You . . .

Awake and Asleep

Now, at last, science gives you an easy shortcut to learning. With this amazing new tool, you "start" to learn while awake—then the university-tested Dormiphone takes over, continues the learning process for you while you go off to sleep.

Do you want to learn a language—memorize a speech or an array of important facts, figures, formulas—Correct your speech—Break bad habits? The Dormiphone SAVES YOU TIME—EFFORT. So simple to use, children benefit—so helpful and practical it is used by educators, psychologists, people of all ages, occupations all over the world.

### Break Down Barriers to Learning

Find out HOW the Dormiphone works FOR YOU—how it can help you learn anything in less time, without intensive self-application. Write for FREE Book, "A New Dimension in Learning," or call for FREE DEMONSTRATION—Get the Scientific Evidence Today.

MODERNOPHONE, INC. Circle 7-0830  
236-018 Radio City, New York 20, N. Y.

Gentlemen: Please send me your FREE Booklet, I am interested in learning more about the DORMIPHONE and what it can do for me. No obligation—no salesman will call.  
 If under 18, check here for Special Booklet A.

NAME \_\_\_\_\_

ADDRESS \_\_\_\_\_

CITY \_\_\_\_\_ ZONE \_\_\_\_\_ STATE \_\_\_\_\_

My main interest in the Dormiphone is for:

- |  |   |
|--|---|
| <input type="checkbox"/> Learning a Language | <input type="checkbox"/> Speech Improvement     |
| <input type="checkbox"/> Memorization        | <input type="checkbox"/> Sleep Inducement       |
| <input type="checkbox"/> Habit Correction    | <input type="checkbox"/> School or College Work |



### Brand New! Latest Modell Heavy Duty!

3 1/2 Amp 1/2" SKIL DRILL

"Breezes Thru" BIG Drilling Jobs

Reg. \$44.95—OUR PRICE \$30.95  
plus \$1.00 pp. & hdq.

Designed for professional craftsmen who want a longer-life, trouble-free, heavy duty drill that will go through the toughest of woods and metals! The Skil 1/2" drill is big and powerful yet lightweight and easy to handle. Has a power-packed motor for drilling up to 1 1/2" on steel; one inch in hardwoods. Used with holesaws for cutting up to 3" diameter holes. Low spindle speed provides the high torque to handle tough drilling jobs in heavy metal and lumber. Detachable handle gives extra control. Features switch with "ON" button, spring loaded for automatic shot-off—button for sustained drilling; powerful 3.5 amp Universal AC-DC motor to 60 cycles, geared chuck and key; lightweight housing; 115 Volt; 500 RPM; 12 1/2" long, weighs 7 1/2 lbs; UL approved.

### SAVE \$13 on Sensational 6 1/2" SKILSAW

20% MORE POWER, 20% LESS WEIGHT

Brand New! Reg. \$49.95—OUR PRICE \$35.95

Here's a saw that takes the gaff of heavy work with the greatest of ease. It's lightweight, easy to handle—feels comfortable in your hand! Full one horsepower motor never gets hot, even when cutting through 2" lumber at 45 degree bevel. Features 6 1/2" blade; rugged die-cast aluminum housing; sturdy, all-steel foot for accurate cuts; friction clutch protects motor against overloading—excessive wear to gears and bearings; blade guard; safety retracting handle; Universal AC-DC motor to 60 cycles; 115 Volt; 5800 RPM; weighs 9 1/2 lbs.

Send Check or M.O. C.O.D. fee extra. MONEY BACK GUARANTEE

SCOTT-MITCHELL HOUSE, Inc. DEPT. F-1, 611 BROADWAY  
NEW YORK 12, N. Y.

## Learn PHOTOGRAPHY at Home

Splendid opportunities. Prepare in spare time. Practical basic training. Long-established school. Send for free book, "Opportunities in Photography." No obligation.  
American School of Photography, 835 Diversy Parkway, Dept. 1351, Chicago 14, Ill.



## Canvas Dog Tents For Hunting Trips

Now your dog can have his own tent when you take him along on hunting trips or outings. The portable doghouse is made of weatherproofed canvas on a frame of rust-resistant steel rods. It's 21 inches wide, 27 inches long and 21 inches high, but it folds into a package two inches thick when not in use.

## Spray of Special Solution Finds Tubeless-Tire Leaks

One quart of a special solution, when mixed with water, makes enough spray to find hidden leaks in 1000 tubeless tires. The spray is applied to the tire and rim. Air seepage from the smallest hole will cause the film of solution to bubble.

Ken-Tool Mfg. Co., Akron, Ohio



Fastest freight train in the world, says the Trans-Australian Railway, is its daily freight covering 1108 miles in 27 hours.



# HERE'S A READY-MADE FUTURE FOR YOU

MILLIONS OF HOMES IN U.S.  
HAVE 6-12 SMALL APPLIANCES  
YEAR--MILLIONS MORE SOLD EVERY  
YEAR--MILLIONS NEED REPAIR NOW  
WITH THE NEED INCREASING  
DAILY!

## Start Your own Business IN

# ELECTRICAL APPLIANCE REPAIRING

### EARN WHILE YOU LEARN

"Only had your course a few short weeks and have already made \$800.00."

J.D.S., St. Louis, Mo.

"I work day times at the shipyard and after 4:00 P.M. I operate from my cellar and garage. I average \$10.00 to \$15.00 clear every day."

W. H. Brookline, Mass.

"Make \$15.00 Saturdays and more. Am only able to operate in my spare time. It is just what a mechanically minded man needs." G.O.F., Thomasville, Ga.

### 3 EASY STEPS

We send you the "CHRISTY" Electronic Kit. A multi-purpose trouble tracer. Indicates current consumption, shorts, breaks, etc.

We teach you Electrical Appliance Repairing with cross indexed Illustrated Manuals. The Easy-to-Remember-Way.

We show you How to Get Business and Keep Business Coming to you.

WE GIVE  
YOU THIS  
ELECTRONIC  
KIT TROUBLE  
FINDER

### IN YOUR OWN KITCHEN, BASEMENT OR GARAGE

Learn at home in your spare time this fascinating, big paying profession.

If you are mechanically inclined, can hold and use tools, we can give you the training and time saving kits that will enable you to . . . Command More Money At Work . . . A Better Paying Job Elsewhere . . . Or A Business Of Your Own! New Shop Method Home Training teaches you both the technical and practical side of Electricity by having you work with your hands Building, Testing, Repairing. All instruction manuals are written in easy-to-understand language, chock full of hundreds of detailed photos and drawings. We show you how to quickly locate the trouble, how to fix it and what to charge. ALSO, how to do House Wiring, Welding, Nickel Plating, Sharpen Lawn Mowers, Skates, etc. and how to build power tools you need from spare parts.

### \$5.00 TO \$6.00 AN HOUR

Often charged for making ordinary repairs. We show you how to repair refrigerators, vacuum cleaners, washing machines, motors, irons, etc.

CHRISTY TRADES SCHOOL, Dept. D-6603  
4804 N. KEDZIE AVE. CHICAGO 25

## SEND FOR FREE BOOK!

CHRISTY TRADES SCHOOL, Dept. D-6603  
4804 N. Kedzie Ave., Chicago 25, Ill.

Please send me FREE Illustrated Book on Electrical Appliance Repairing and Special form for Paying Later from Earnings.

NAME \_\_\_\_\_ AGE \_\_\_\_\_

ADDRESS \_\_\_\_\_

CITY \_\_\_\_\_ ZONE \_\_\_\_\_ STATE \_\_\_\_\_



not everyone does as well, but E. O. Lockin, who started a business of his own, reports...

for 12 months I've averaged  
**\$800 PER MONTH**  
**INCOME** —  
most of it clear profit for me!

Many men have discovered how to be independent, to be free of bosses and layoffs. L. A. Eagles grossed more than \$200 his first week. Others report gross up to \$12,000 per year. How much you make depends largely on you. You need no special skill, no large investment.

**No shop necessary.** Our ELECTRIC RUG WASHER cleans rugs, carpets right on floor... helps to show their natural color, beauty. So efficient and safe, used by largest hotels and railroads.

You take no risk. Machines fully guaranteed. Write for full information including how to make big profits in **YOUR OWN BUSINESS.**



MAIL COUPON TODAY FOR FREE BOOK

VON SCHRADER MFG. CO., 110 "R" PL., Racine, Wis.

Without obligation, send your **FREE** booklet containing information about your ELECTRIC RUG WASHER and how I can start *my own* permanent, profitable business.

Name \_\_\_\_\_

Address \_\_\_\_\_

City \_\_\_\_\_ Zone \_\_\_\_\_ State \_\_\_\_\_



**For Many Uses!**

**Metal Turning Lathe**

Only **\$49.95**

F.O.B. Lansing, Ill.

15 1/4" bed with 4 1/2" swing.  
7" between centers.

Satisfaction Guaranteed.

**FREE FOLDER**  
Write for it today!

Rosemoor Manufacturing Co.  
Box 147J, Lansing, Ill.



**HIGH WAGES!**

Make big pay in the construction industry as an operator of Bulldozers, Draglines, Back Hoes, Scrapers and Motor Graders. Learn these skills NOW! Machines of major manufacturers are used in our training program. Contractors need operators of earthmoving machines and pay high wages to our graduates. Don't be satisfied with just a job... learn a career!

Write **TODAY** for **FREE** School Catalog,  
no obligation, to either address

**National School  
of Heavy Equipment  
Operation**

P.O. Box 8243, Dept. D-19  
Charlotte, N. C.

**Western National School  
of Heavy Equipment  
Operation**

P.O. Box 527, Dept. D-19  
Weiser, Idaho



Aeroquip Corporation, 990 S. Fair Oaks Ave., Pasadena, Calif.



## Rope-Locking Mechanism Ends "Knotty" Problems

For campers and boaters who can't tell a square knot from a bowline, there is a simple rope-locking device that eliminates problems of tying and untying. The device locks the tension automatically at whatever pull is exerted, without backlash or slackening. The load is released by pressing on a cam. It can be used for such jobs as tying down airplanes as well as tents, awnings and cargoes.

## Metal Fibers Made Into Paper

Made of minute metal fibers, a form of paper has been developed that will conduct heat and electricity. Although it looks like metal foil, the material is built-up in the same way ordinary paper is made from wood pulp. The metal paper has been made of steel, stainless steel, copper and aluminum. It has magnetic properties and a resistance to extreme temperatures. The metal fibers can be used alone or in combination with other fibers such as glass, synthetics or ordinary paper.

## More Proof There Is Life on Mars

Recent spectroscopic studies of Mars indicate there is living matter on the planet absorbing the same wavelengths of radiant energy as some forms of plant life on earth.



**WAR SURPLUS BARGAINS**

**WAR SURPLUS BARGAINS**

**\$500,000.00 INVENTORY for QUICK LIQUIDATION**

Surplus items—hundreds of them for home, shop, factory, farm and outdoor use. New items, used items, reconditioned items—all at tremendous savings—all priced for quick sale.

**Page After Page of Values**

This big catalog shows page after page of amazing money saving values. Write for your copy today. Send 10c to cover postage, mailing, etc. Write today! **SEND TODAY FOR YOUR COPY**

**10c**

**STARK'S** 212 W. Madison St.  
Dept. PM-581  
CHICAGO 6, ILL.

## MORE OUTBOARD POWER



With new propellers that are adapted to hull, engine and load! Save gas, reduce vibrations, give extra propeller "bite"—speed for ski towing. Exclusive HUB-GARD, many other features. Consult PROP SELECTOR at authorized dealers for your correct

**COLUMBIAN CUSTOMIZED PROPELLER,**  
or write COLUMBIAN BRONZE CORP., Freeport, N. Y.

## Learn LANDSCAPE GARDENING

A thorough, interesting home study course for those who wish to become a Landscaper, Garden Consultant, Contractor or Designer for profit or pleasure. Write today for FREE Booklet.

Dept. M-18 11826 San Vicente Blvd. Los Angeles 49, Calif.

## SEWS LEATHER

**AND TOUGH TEXTILES LIKE A MACHINE**

With SPEEDY STITCHER Automatic Sewing Awl, anyone can quickly and skillfully sew or repair anything made of LEATHER, CANVAS, NYLON, PLASTIC, or other heavy materials. Sews firm, even lockstitches like a machine. Gets into hard-to-reach places. Specially made for heavy duty sewing on LUGGAGE, FOOTWEAR, BAGS, AWNINGS, SAILS, SADDLERY, UPHOLSTERY, OVERALLS, AUTO-TOPS, SPORTS GEAR, and other tough sewing jobs. Here's the handiest tool you'll ever own. Will save you many times its small cost. Comes ready for instant use . . . complete with bobbin of waxed thread and 3 different types of diamond-pointed needles. Easy-to-follow directions will make you an expert in minutes. Extra needles and waxed-thread always available. Save money, send \$1.98 for post-paid delivery. If C.O.D., \$1.98 plus postage. MONEY BACK GUARANTEE.

**SPORTSMAN'S POST**  
366 Madison Ave., Dept. A-81, New York 17



1.98 ONLY

## High School at Home

### MANY FINISH IN 2 YEARS

No classes. No time wasted going to and from school. Progress as fast as your time and abilities permit. Standard H.S. texts supplied. Thousands enroll each year in this 61-year-old school. Send for FREE descriptive booklet.

**AMERICAN SCHOOL, Dept. H145**  
Drexel at 58th St., Chicago 37, Ill.

Without obligation, please send FREE descriptive booklet.

Name \_\_\_\_\_  
Address \_\_\_\_\_  
City \_\_\_\_\_



Train AT HOME for a GOOD JOB in

## AUTO MECHANICS

A better job with more pay will mean *better living* for you. It can mean a fine home, a new car, nice vacations, and good educations for the kids. If you would like to earn up to \$125 a week and more—and be able to afford better living, *train yourself* in Auto Mechanics. You can do it with CTI showing you how—and you can learn at home in spare time!

**GOOD JOBS ARE WAITING EVERYWHERE** because there are over 60 million cars and trucks on the road—7 million new ones each year. One-third are in the heavy-repair classification. Skilled mechanics are needed to keep these cars operating. You can be one of them—make big money, enjoy lifetime security—even open a shop!

**EARN AS YOU LEARN** just as many CTI students do. They make up to \$15 a week and more in spare time. Some start their own shops by graduation time. CTI Shop-Method Home training, based on resident school practice, makes every step easy.

**DIESEL MECHANICS OR BODY-FENDER TRAINING** is also yours at no extra cost. A wonderful chance to give yourself a well-rounded education. Only CTI gives you this extra choice! Get the facts: Mail coupon.



### YOU PRACTICE WITH THIS TUNE-UP KIT

Kit includes a Compression Tester, a Vacuum Gauge and Fuel Pump Tester, an Ignition Timing Light, and a portable steel case. These professional instruments help you locate engine troubles, let you get useful practice. You keep this kit!

### MECHANIC'S TOOLS TOO

You'll use these tools to get real experience. They'll increase your interest, stamp you as a "pro." You'll earn spare time cash with them. No extra cost for tools—you keep them.



**MAIL COUPON TODAY!**

## MAIL TODAY FOR 2 FREE BOOKS

**COMMERCIAL TRADES INSTITUTE**  
1400 Greenleaf Ave., Chicago 26  
Dept. A-719

Send your new Auto Mechanics book and Sample Lesson. BOTH FREE.

Name \_\_\_\_\_ Age \_\_\_\_\_

Address \_\_\_\_\_

City \_\_\_\_\_ Zone \_\_\_\_\_ State \_\_\_\_\_





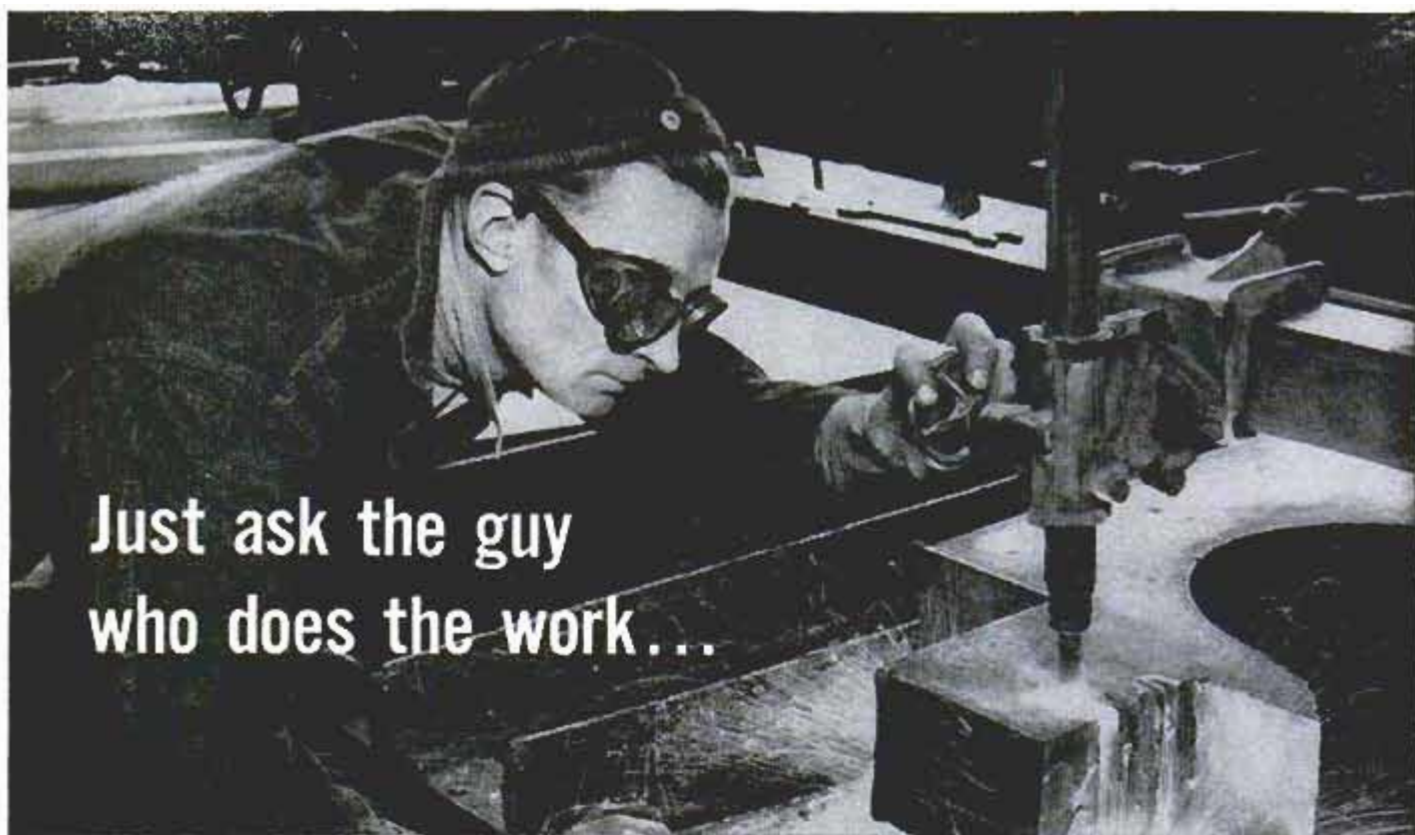

Just ask the guy  
who does the work...

Niagara Falls Machinist says:

"I'm right there! I see how much research, skill and plain hard work goes into today's top products...

**I'm always satisfied most with  
a BRAND that's made a NAME for itself!"**



"I MADE IT"

**MANUFACTURER:** "I'm satisfied it's the most modern, the best of its kind on the market. That's the only way to win satisfied customers—with a top quality product. And, that's the way to keep them, too!"



"I SOLD IT"

**DEALER:** "I know my customer is really satisfied. That's the way with well-known brands. They offer the latest improvements and widest choice. Name brands certainly save everybody a lot of headaches."



"I BOUGHT IT"

**CUSTOMER:** "I'm satisfied it's the best for my money. I'd be lost without brand names to guide me. My wife and I can even order by phone without taking any risk. We know we're getting what we want."

**THE BRANDS YOU SEE ADVERTISED IN THIS MAGAZINE ARE NAMES YOU CAN TRUST!**

They stand firmly behind every product and claim they make.

BRAND NAMES FOUNDATION, INC. • 437 FIFTH AVENUE, NEW YORK 16, N. Y.



## SPEED REDUCER CLUTCH COMBINATION TRANSMISSION

GOVT. COST  
\$262.00  
SPECIAL  
SALE!  
**\$4950**  
PRE-PAID



BRAND NEW  
SURPLUS

Speed Reducer  
alone worth  
triple this  
low price!

- Reduces speed at a 3-to-1 Ratio. These units hard to get at any price!
  - 2 Independent Outlet shafts, each separately controlled by its adjustable clutch
  - Rated up to 3.6 HP (electric), or 7.5 HP (gas engine)
  - Ball and Taper Roller Bearings throughout (smooth, quiet)
  - Input shaft 1-3/16" diameter, Output shaft 1 1/8" diameter
  - Weight 108 lbs.—Dimensions approx. 17 1/2" long x 8" wide x 8" high
- This SPEED REDUCER-CLUTCH COMBINATION can be utilized when low speeds are required . . . for starting heavy loads . . . or, for engaging and disengaging machine operation without stopping input drive. Supply limited!

ORDER DIRECT FROM THIS AD! WE PAY SHIPPING!  
FREE Catalog of Hydraulics, Generators, Surplus

ROBERTS ELECTRIC CO., Dept. PM-749, 849 W. Grand, Chicago 22, Ill.

## NEW MAGIC RADIO WALKIE TALKIE!

**YOUR OWN POCKET SIZE RADIO STATION!**  
BROADCASTS TO ANY HOME OR CAR RADIO WITHOUT WIRES OR HOOKUPS! Wt. only 5 oz. Size, 1 1/2 x 2 1/4 x 4 1/2". Bulk-in telescoping antenna. Powerful Transistor-sensitive microphone, frequency setter, break-in switch! Runs for weeks on self-contained flashlight batteries. Durable plastic case. With this Radio Talkie you CAN TALK TO YOUR FRIENDS UP TO A BLOCK OR MORE AWAY! Talk up to 1 mile or more between two automobiles. INSTANT OPERATION! Just push button to talk! No license needed. Uses inductive field magnetic radiation. Useful and real fun in a million ways! **GUARANTEED TO WORK. 1 YEAR SERVICE GUARANTEE.**

SEND ONLY \$3.00. (cash, ck, mo) and pay postman \$9.98 COD postage or send \$12.99 for prepaid delivery. COMPLETE READY TO OPERATE with instructions and hundreds of ways and tricks for broadcasts thru any radio you desire. Price may go up soon, so get your NEW POWERFUL RADIO WALKIE TALKIE NOW. Available only from:  
**WESTERN RADIO, Dept. RPM-1, KEARNEY, NEBR.**

Works in seconds!

**LIQUID WRENCH**

The super-penetrating rust solvent that quickly loosens rust and corrosion.

AT HARDWARE STORES, GARAGES SERVICE STATIONS, EVERYWHERE  
**RADIATOR SPECIALTY CO.**  
Charlotte, N. C.

3 oz. CAN  
**35c**

**New Isotronic Training Method**  
**LEARN TV REPAIR**  
**IN ONE SHORT WEEK!**

Now, after 5 year's research—a streamlined training system that *obsoletes all others!* In just 7 days you may earn \$150 weekly, without paying up to \$250 for training, studying long months! Developed by electronic scientists in cooperation with major TV mfr's., the new Isotronic method is the most practical ever devised! For conclusive proof, write for details and FREE SAMPLE LESSON. Use it on your own set or a friend's—repair it—convince yourself you can make big money immediately in your own TV business! Hurry—Free Lesson supply limited. Write:  
**Electronic Engineering Co., Dept. B-171**  
1038 So. La Brea, Los Angeles 19, Calif.



**MEN! Make up to**  
**\$1,000.00**  
**IN A MONTH!**

## without "SELLING"

Sensational Demand for Low-Priced Fire Alarm PLUS Sure-Fire "No-Selling" Plan Offers Ambitious Men Huge Profit Opportunities

## AMAZING NEW INVENTION



Even beginners who never sold anything in their lives are cleaning up unbelievable profits with the first practical effective, low priced Fire Alarm ever invented . . . needed, wanted in homes, factories, offices, stores, on farms, for boats, everywhere. Professional salesmen are making biggest profits in years! Later in this ad I'll tell you about the plan that's producing orders for 1 to 12 Fire Alarms per sale from 8 out of 10 prospects . . . without selling. Here are the facts about the Fire Alarm. It hangs on the wall like a picture—no wiring, no installation. It's always on guard . . . It "smells" a fire before danger point. When temperature rises, Fire Alarm goes off automatically howls loud warning that can be heard 1/5 mile wakes up soundest sleeper, give precious time to put out fire, call fire department, or escape. And it sells for only \$4.95 with profit up to \$2.70 on each one.



### Nearest Thing to AUTOMATION SELLING

With our field-tested plan customers sell themselves. No cold canvassing. No hard selling. It's the nearest thing to 'Automation Selling.' Imagine a sales plan even a child can use successfully because the sales tools we give you (and which you leave with your prospects) do all your selling even while you sleep! No room here to give you all the details but if you want big money fast rush the coupon now.

**Make This Lighted-Match Demonstration**

Sensitive! Lighted match triggers Alarms in 3 seconds.

**Free Sales Kit**

Send no money. Just rush coupon below for all the exciting moneymaking facts, complete Illustrated Sales Kit, everything you need to make money your first day. Learn how selling only 20 Fire Alarms a day pays

**Made \$26.52 in 3 Hours!**

"Received first shipment about noon. Worked 3 hours and made \$26.52 profit. It's a terrific seller!"  
—Stanley

you \$1,080.00 profit in a month. No competition anywhere. Get in on the ground floor now. Rush this coupon.

## MERLITE INDUSTRIES, Inc.

(ALARM DIVISION)  
114 E. 32nd St., Dept. S-15E New York 16, N. Y.

**ALVIN WESLEY, Sales Manager**  
Merlite Industries, Inc. (Alarm Division)  
114 E. 32nd St., Dept. S-15E, New York 16, N. Y.

Rush FREE SALES KIT and full details about your "No-Selling" plan which gives me opportunity to make up to \$1,000.00 in a month without cold canvassing and hard selling—automatically. I am not obligated.

Name \_\_\_\_\_

Address \_\_\_\_\_

City \_\_\_\_\_ Zone \_\_\_\_\_ State \_\_\_\_\_

In Canada: Mopa Co. Ltd., 371 Dowd St., Montreal 1, P.Q.



## "HOW I DOUBLED MY INCOME In Less Than A Year, As A CUSTOM UPHOLSTERER"



**Alvin Lederkramer, Former Low Salaried  
Auto Mechanic — Now Earning Big Pay**

"When I enrolled for UTS training I was an auto mechanic earning a meager salary. While training I earned good spare-time money. After graduation, I got a job in upholstery with better pay than ever before. Now, less than one year later, I've doubled my income. Soon, I'll get into my own business. The future looks bright, thanks to UTS."

**WHAT DO YOU WANT? Your Own Profitable Business—A Steady Job — Substantial Sparetime Earnings — A More Secure Future! They're all Waiting for YOU in the Big-Opportunity Field of Custom Furniture Upholstery.**

The big nationwide housing boom has created a great demand for trained upholsterers. Prepare for this well-paid trade — easily, quickly. You can earn as you learn to make good money all year 'round at home, in your own shop, or in a well-paid job. The practical N. Y. State-approved UTS Course teaches you professional custom furniture upholstery, reupholstery, slip-covers, furniture finishing, window cornice, cushion, and drapery making. Course includes—FREE—All tools, complete frames and materials.

**FREE ILLUSTRATED BOOK — FREE SAMPLE LESSON!** Our FREE book, "YOUR NEW WAY TO A SUCCESSFUL CAREER" with FREE Sample Lesson shows you how. **WRITE TODAY!** Training in N.Y. School also available. **Upholstery Trades School, Dept. GA-305, 721 B'way, N.Y. 3**  
**MAIL COUPON TODAY**

**MATERIALS FREE  
WITH COURSE  
YOU MAKE**

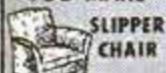

SLIPPER  
CHAIR



CLUB  
CHAIR

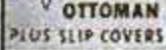

OTTOMAN  
PLUS SLIP COVERS

**Yours to keep  
or sell**

**APPROVED  
FOR VETERANS**

**UPHOLSTERY TRADES SCHOOL, Dept. GA-305  
721 Broadway, New York 3, N. Y.**

Please send me FREE book with FREE Sample Lesson. No obligation—no salesman will call.  
 Home Study  In N. Y. School Training

Name \_\_\_\_\_ (Please print plainly)

Address \_\_\_\_\_

City \_\_\_\_\_ Zone \_\_\_\_\_ State \_\_\_\_\_

Check if Korean Veteran

## EASY WAY TO LEARN DRAFTING

**Short Cut Method  
Teaches You at Home!**

Cash in on industry's critical shortage of draftsmen. This simple step-by-step method of learning allows you to develop your basic skill and progress as fast as your ability. Clearly explained, practical problems with each step pictured. Includes: Making a layout drawing, how to letter a drawing, dimensioning a drawing, making a working drawing, learning about assembly, cut-away, exploded view, and pattern drawings, how to plan a home, how to draw graphs and charts. 243 pages. 406 illustrations. \$3.80.

**Only \$3.80  
IF YOU KEEP IT**

**EXAMINE FREE BEFORE YOU BUY**

We will send you DRAFTING postpaid on 5-day FREE examination. Read it at home without obligation. After 5 days either return and owe nothing or pay bill for \$3.80 plus delivery charges.

**NOTE: FREEHAND SKETCHING for draftsmen also available for just \$1.65 more. Profusely illustrated.**

**AMERICAN TECHNICAL SOCIETY, Dept. AN1  
848 East 58th Street - - Chicago 37, Illinois**

**American Technical Society, Dept. AN1  
848 E. 58th St., Chicago 37, Illinois**

Please send me for FREE EXAMINATION the books marked below. I will either return them in 5 days without obligation or pay the amount shown plus shipping charges.

DRAFTING .. \$3.80  FREEHAND SKETCHING .. \$1.65

MY NAME \_\_\_\_\_

ADDRESS \_\_\_\_\_

CITY \_\_\_\_\_ Zone \_\_\_\_\_ STATE \_\_\_\_\_

Check here if you wish to save shipping charges by enclosing the full amount with this order. Same 5-day money back guarantee.

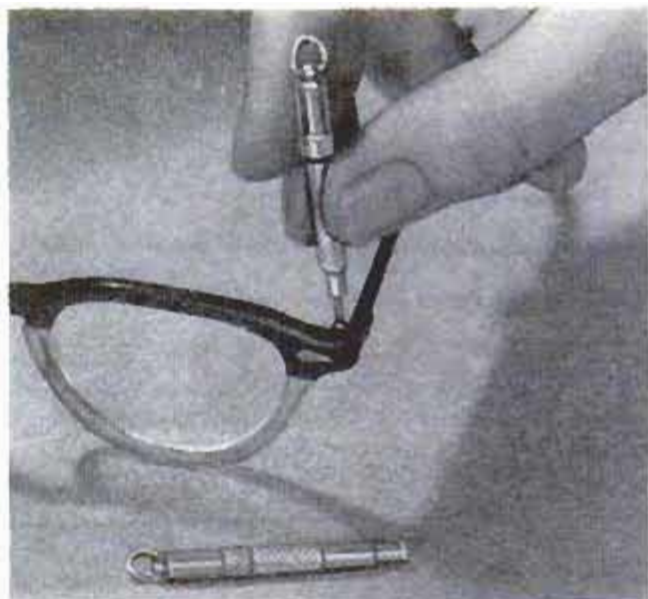

Moody Machine Products, 42 Dudley St., Providence 5, R. I.

## Telescoping Screwdriver Cover Makes It Safe in Pocket

With covered point, a midget screwdriver is safe to carry in pocket or case. The little tool is made in two parts, the screwdriver itself and the safety cover that telescopes back to reveal the point. A carrying ring is attached to the top.

## Sticks of Food for Space Fliers

Space foods are being developed for high-altitude aircraft crews in the form of sticks. Frozen and dehydrated, the food will be in containers resembling lipstick tubes and will include liquid meat and dairy products. The food sticks will replace tablets now in use.

## Mesh Sun Visor Cuts Glare But Lets Air Through

Aluminum mesh is used in a new automobile sun visor. It reduces glare but does not cast a deep shadow. The holes provide a low resistance to air flow, and the visor is lightweight, strong and rustproof.





**HEATING PROBLEMS SOLVED INSTANTLY**



**FORCED HEAT**

**VENTILAIRE  
HEATER  
BLOWER**

Instant heat when and where you want it. For room, office, store, workshop, garage, etc. Many industrial and professional warming, pre-heating, drying uses. Gives over 400% greater performance than average fan heater, yet costs no more to use. 5" blower wheel moves air 350 C.F.M.—150° heat at outlet. Safety screen guards over openings. 1200 watts. Chrome bracket. REG. LIST PRICE \$59.50

**\$24.95**

Mount or stand anywhere to blow in desired direction. Sturdy steel housing, neat enamel finish. Self-contained unit. Assembled, ready to plug into AC-110 volt. No installation. No interference with present heating system. Powerful, continuous duty enclosed motor. Cord-plug-switch. 8" x 9" x 5" — wt. 6 lbs.

**SEND CHECK OR M.O. PLUS 90c P.P.—SEND FOR BARGAIN SHEET "M" ON FANS, BLOWERS, COMPRESSORS, MOTORS, ELECTRIC TRADING CO., P.M. 10-313 CANAL ST., NEW YORK 13, N. Y.**

**AMAZING NEW "LIFETIME" RADIO**



GUARANTEED TO WORK FOR YOUR LIFETIME! USES NO TUBES, BATTERIES OR ELECTRICAL PLUG-INS. Never runs down! SMALLER THAN A PACK OF CIGARETTES! RECEIVES LOCAL RADIO STATIONS MOST ANY TIME ANYWHERE WITHOUT EXTRA ANTENNA. Uses perma-crystal diode Hi-Q Tuner — Built-in SPEAKER-PHONE. Beautiful black gold plastic case.

Send only \$2.00 (bill, ck, mo.) and pay postman \$4.99 COD on arrival or send \$6.99 for post-EXTRA TO BUY EVER! (Extra long distance airtel kit included free to receive stations up to 1,000 miles away!) Available only from:

**MIDWAY COMPANY DEPT. WPM-1 KEARNEY, NEBR.**

**BRONZE FOUNDRY**



**Schools • Home Workshops • Inventors**

Make your own castings of aluminum, copper, bronze, silver. Foundry sets are available in three sizes including 2400 Deg. F. blast Furnaces. \$26.50; \$33.50; and \$46.00 f.a.b. Marysville or Lakewood. Free Circular.

**KANSAS CITY SPECIALTIES CO. (Dept. P-1) Box 6022, Marysville, Kans. or Box 7543, Lakewood, Colo.**

**BUILD FINE GRANDFATHER CLOCK NOW**

The simple sensible SPEEDE Red-i-Kut way as thousands have—FOR YOURSELF OR SELL AT A GOOD PROFIT. SAVE HUNDREDS OF DOLLARS. SHOP TESTED PLANS "SPIRIT OF THE CENTURY" Narrow waist 83" tall or stately straight side "SPIRIT OF AMERICA." EASY-to-FOLLOW photopack PLANS & LIFE SIZE PATTERNS tell all—plus MOVEMENT BROCHURE \$1.40 up. of heavy brass weight (Kuempel original) Westminster tube BELL chime movements, gorgeous bronze-silver MOVING MOON dial, 3/4" solid-mahogany Jiffy Joint-Kwik-Bilt case kits. Send \$1.00 today—Both plans RUSH \$1.50 as folks have for over forty years.

Kuempel Chime Clock Works, #13 Kuempel Bldg., Minneapolis 16, Minn.

**KEEP YOUR... EYE ON BENJAMIN for HIGH H.C. COMP**

**AIR GUNS & CO<sub>2</sub> GAS GUNS—Top Quality at LOWEST PRICES!**



**BENJAMIN SUPER**  
Single Shot CO<sub>2</sub> Carbine Gas Rifle (BB) with Reg. Stock **\$14.95**  
Deluxe (BB) Model with Custom Stock (Shown) \$17.95

All Models Benjamin CO<sub>2</sub> Carbine Gas Rifles and Benjamin CO<sub>2</sub> Rocket Gas Pistols Use Standard Size CO<sub>2</sub> (Soda) Cartridges (available everywhere). 2-Stage Hi-10 Jet Power—High for Small Game—Low for Target—Up to 50 Shots from Each Cartridge. No Pumping—Safe—Accurate—Economical—Non-Toxic—12 Models—BB or 177 or 22.

Benjamin Air Rifles and Benjamin Air Pistols are Recognized All Over the World for Finest Workmanship and Highest Quality at Lowest Prices. Adjustable Power with Amazing Optimum Force. Fully Guaranteed—Safe—Accurate—Economical. Easy to Use Anywhere—12 Models for Target and Small Game 22 or 177 or BB from \$18.50.

**FREE!** Catalog All Models Benjamin Air Guns & CO<sub>2</sub> Guns & Special Knives Offer!

**BENJAMIN AIR RIFLE CO., MAIL TODAY!**  
896 MARION ST., ST. LOUIS 4, MO., U.S.A.

Name \_\_\_\_\_  
Address \_\_\_\_\_  
City \_\_\_\_\_ State \_\_\_\_\_

**SAM HANKS, 1957 "INDY 500" winner says:**

**"I'd like a NATIONAL SCHOOLS trained mechanic on my crew... any employer would!"**



Sam Hanks holds American Closed Course record (182.5 M.P.H.); also many state and national racing titles. At Indianapolis he was 2nd last year, 3rd in '52 and '53.

**MASTER ALL ENGINES AT HOME IN YOUR SPARE TIME NATIONAL SCHOOLS AUTO MECHANICS & DIESEL COURSE**

**INCLUDING FUEL INJECTION**

**YOU GET AND KEEP ALL THIS EQUIPMENT**

<p>Complete set of professional tools and All-Metal Tool Box. Same top-quality equipment used by expert mechanics everywhere. Use them, display them proudly.</p>	<p>"Motor Analyzing Set" contains Standard Engine Vacuum Fuel Pump Tester, Remote Starter Switch, Modern Timing Light Standard Compression Tester. Plus compact carrying case &amp; instructions.</p>	<p>Top-quality Socket Wrench with Fittings. Real professional tools you'll use during your lifetime career in repairing all types of engines, from foreign cars to big diesel jobs.</p>
---	---	---

"I've worked alongside National Schools-trained mechanics," reports Sam Hanks. "They're tops, because they get all-around training, and they know how to repair fast and right the first time. No wonder National Schools graduates command top pay."

Earn as you learn men! We'll show you how. Streamlined lessons, diagrams, manuals, latest equipment, practical methods prepare you for hundreds of jobs in scores of industries. Free Placement Assistance.

Approved for GI Training

**FREE! VALUABLE BOOK & SAMPLE LESSON JUST SEND COUPON**

Resident Training at Los Angeles  
If you wish to take your Auto-Diesel training in our famous Resident School at Los Angeles, check special box in coupon for full information.

**NATIONAL SCHOOLS**  
Los Angeles 37, California

**NATIONAL SCHOOLS**  
TECHNICAL TRADE TRAINING SINCE 1905  
LOS ANGELES 37, CALIFORNIA

**MAIL NOW**  
NATIONAL SCHOOLS, Dept. DB-18

4000 S. FIGUEROA ST.  
LOS ANGELES 37, CALIF.

Send for FREE Auto-Diesel Opportunity Book and Sample Lesson.

NAME \_\_\_\_\_ AGE \_\_\_\_\_  
ADDRESS \_\_\_\_\_  
CITY \_\_\_\_\_ ZONE \_\_\_\_\_ STATE \_\_\_\_\_

Check if interested ONLY in Resident School Training at Los Angeles

VETERANS: Give date of discharge \_\_\_\_\_





## SKILLS *for* AMERICA

# SCIENCE and INDUSTRY MOBILIZE FOR THE FUTURE—What Part Will You Play In This Technical Age?

Much has been said about the economic health of our nation and the period of singular prosperity we are living in today. It's true that at no other time has it been possible for so many of us to enjoy the fruits of our own labor to the extent that we do today. Our standard of living is a credit to the determination and energy with which we live and work, and the strength of our nation is the proof of it.

This is the situation of the present. What of the future? International developments in science and technology exhibited recently indicate that the future is moving toward us much faster than we have realized. Our country and its industries are moving to meet this challenge by mobilizing for research and development our best business, scientific and military minds to assure our leadership in science and technology. But at the same time it is imperative that each of us as responsible citizens consider very carefully what contribution we as individuals can and are willing to make in helping America maintain its role of leadership.

The same advanced technology which has built our prosperity and the power of America has in turn created a serious shortage of skilled technical brainpower. This comes at a time when we are shoulders deep in a technical age that feeds upon technical brainpower. Large scale programs of industrial development, research, invention, increased production, defense requirements, new products—all have increased our consumption of technically trained and skilled personnel to the point where our available supply is no longer sufficient to meet the demands.

The skilled manpower shortage is a problem that has been dramatized very graphically through the press, radio and television by leaders of both business and government. However, it's one thing to read about the shortage and admit it to be true; it's more vitally important that we do something about it! Readers of Popular Mechanics who have technical or mechanical aptitudes can take positive action to help alleviate the shortage and make a contribution to the security and future development of America and its technology. Many of our readers are already engaged in scientific, technical or skilled fields of work. Others could, with adequate training,

prepare for any one of the hundreds of important skilled occupations that are needed.

Perhaps your abilities or interests lean toward mechanical or technical fields. If so, why not develop them by training for one of the skills America needs now and from all evidence will continue to need throughout your lifetime. The opportunities ahead of you hold exciting prospects and challenge!

**Industrial manpower needs and employment will continue to grow in the scientific professions, technician, and skilled craftsman occupations.** For instance, competent sources estimate that by 1980 we will have about 1,700,000 engineers and scientists in our working population—but by that time we will actually need close to 3,000,000! Thus there will be by 1980 an even greater shortage than exists today, unless more people go into scientific and engineering professions. The opportunity is obvious! This field of work is now the fastest growing occupational group and will continue to be.

**Even more rapid growth in employment is expected in technical and related occupations.** Between 1940 and 1950 alone, the number of technicians employed in this country increased by 132%! In related technical occupations such as radio operators, the increase was 160%; surveyors, 90%; draftsmen, 68%. The growth in employment of technicians is being stimulated by the continuing shortage of competent engineers and scientists, and the critical need to release this professional personnel from routine duties so they can devote more time to creative thinking, research and development. From 5 to 7 technicians are needed for each engineer employed, but we are far short of the necessary supply. Due to the increasingly complicated nature of present day technology and the emphasis placed on research and development, the shortage of technicians will continue to grow, unless more people enter this interesting field of work. Employment and advancement opportunities are particularly promising for you here!

**There will also be an upward trend in the employment of skilled craftsmen** brought about by increased production, more automated methods of manufacturing, and a general increase in business activity including construction. Presently, craftsmen and foremen repre-



sent about 1 out of 8 employed workers, a higher proportion than at any other period during the past half-century. The ability of our country to produce, build, and operate the complex machinery of industry depends on the skilled worker. Their skills transform the ideas of the scientists and the plans of the engineers into goods and services.

*The skilled trades provide excellent opportunities for all those planning future careers.* Industry is experiencing shortages in certain vital skilled occupations right now. Mechanics and repairmen are needed in unprecedented numbers to install and maintain new automatic machinery and electronic equipment in factories and large business establishments. Sales and service companies need skilled help to install and service the electrical and mechanical equipment of the modern household, including the 62,000,000 automobiles in use today.

In the skilled trades a man has a wide selection of jobs depending on his interests, ability and training. Furthermore, he has the excellent opportunity of becoming self-employed in one of the machining or metal-working trades, mechanics or repairman services, or as an independent contractor or builder.

Another skilled occupation in utmost demand now is the tool and die maker, a very exacting trade requiring high levels of skill. Nearly every manufacturing operation involves the tool and die maker who must construct the jigs, fixtures and accessories that hold the work being machined and the dies that are used in stamping, pressing and forging.

**Future prospects are especially favorable for carpenters, bricklayers, cement and concrete masons.** Employment growth in these trades will continue to expand to handle our highway programs, plant expansion, and the millions of new homes that must be built to house our growing population.

**Semi-skilled occupations such as machine operators over the next ten years will offer steady employment,** but without the growth opportunities of the more highly skilled trades. Automated manufacturing and broader application of machine power production will gradually replace the need for semi-skilled workers. The same eventuality will befall the unskilled worker to an even greater degree. Men now engaged in semi and unskilled work should acquire more training and experience to prepare for the changes in skill requirements which will be brought on by automation.

*America needs the support of every citizen with mechanical or technical ability, and its industries are urgently calling for men gifted with these abilities. America's future progress and safety in the onrush of world scientific achievement depends entirely on the contribution each one of us makes to the advancement of our own science and technology.*

Have you considered that possibly you could play an active role in helping to shape our future? Look carefully at your interests, your own abilities. Are you mechanically inclined? Do you enjoy working with tools to see wood or metal take shape under your own skillful guidance? Perhaps you are interested

in experimenting with engines, electronics, or chemistry in your spare time. Do you like to work out technical or mathematical problems? If you have any one of these or similar mechanical or technical interests, *it's entirely possible that you have within you potentials which if developed through education and training could lead to a very worthwhile career in a scientific, technical or skilled field!*

Measure your aptitudes and interests in relation to the hundreds of skilled occupations our nation is calling on its citizens to supply. Find out what training or education is required to become experienced in the career of your choice. *Take action now!* Training takes time, and industry wants trained men. Only through education and training can you thoroughly acquire a skill, and only through further education can you continue to advance in your field.

Today school administrators, engineers, scientists are urging people to continue their education. They say: If you are in high school now, by all means stay there until you graduate. If it's possible, continue on through college. If you are even slightly inclined toward technical subjects, by all means take science or engineering courses in an engineering school or one of the fine technical institutes. And anyone can improve his skills through trade, vocational schools or good correspondence courses.

**Educational requirements are rising in a great number of skilled occupations.** It's a well known fact today that the more education a person has, the higher his income is likely to be, the better his chances are for advancement, and the better equipped he will be to assume responsibility.

You will need all the training you can get to be successful in our modern technology. That's why we urge you to start preparing now for the skill of your choice. Study the occupation thoroughly. Find out what type of work is involved, what your duties would be, what training you will need to be the best in your field. Check working conditions, earnings and employment outlook in the occupation you've selected. Popular Mechanics will gladly help you do this by means of our newly published career guidance booklet, "SKILLS for AMERICA". Write for a free copy of this booklet to Dept. SFA-18, Popular Mechanics Magazine, 200 E. Ontario St., Chicago 11, Ill.

The next and most important step in planning your career is to get the best training possible. Select courses with care. Choose the engineering or technical institute, trade or vocational school that is right for you. This issue of Popular Mechanics can help you. Within our advertising pages are some of the finest technical and trade schools in the land. They will be glad to serve you—to help you plan your career and select the best program of study. Write to them. Ask their advice. Then start your training at once.

You can make a personal contribution to the future progress and security of your country and enrich your life with the satisfaction of achievement if you are willing to. Won't you do your part to help develop skills for America?



# Electric Home Recorder



## Make Your Own Records at Home!

Test your voice. Talk, Sing, Play. Immediate playback. Fun at home. Practical for office & school. Send records to friends. Make records from radio or TV. Play back favorites years later.

Even conceal mike in another room! Makes 33, 45 or 78 rpm records (any speed). Set includes: Recording Unit (arm & electro-magnetic cutting stylus) which operates on any turntable, electric Studio Microphone, cutting needles & blank records. No wiring.

Ready to use. Independent of phone circuit. Guaranteed. **\$14.95**  
Complete Set Postpaid Only (Package of 5 Blank Discs \$1.98)

# USED ELECTRIC GENERATOR

Cost Over \$20.00 New; While They Last, \$3.95

Generates Up to 75 Volts. Use to generate electricity, to ring bells, light up lights, as a medical battery, deliver terrific electric shock as joke, many electrical experiments, classroom uses, etc. Cost over \$20 new. Used but excellent operating condition. Hand crank or gear wheel drive. Made by leading electrical companies. Each has 3 or 4 five-inch 1-lb. bar magnets (alone worth more than total cost), generating armature, wire leads, gear crank, ready for use. Originally used in crank phones. Complete unit weighs over 5 lbs. Postpaid \$3.95.



**JOHNSON SMITH COMPANY, Dept. 624, Detroit 7, Mich.**

# New! TINY POCKET SIZE RADIO

\$2.98



Listen at work, play, in bed. Fits shirt pocket. No tubes. No batteries. No electric plug-ins. No expense. Plays day & night forever. New self-powered diode rectifier replaces tubes. No building. Use short aerial for local stations. Complete broadcast band. Red plastic case only 3 x 3 1/4 x 1 1/2 inches. Lifetime guarantee. Radio (without phone) \$2.98. Hearing Aid Phone (plugs in ear, flesh-colored, almost invisible) \$1.98. Regular phone \$1.25.

**JOHNSON SMITH & COMPANY Dept. 624 Detroit 7, Mich.**

# BIG MONEY FOR YOU IN ARC WELDING

This picture guide makes learning easy

Here is a quick, easy way to start a new career and earn big money in electric arc welding. Welders are in great demand! Jobs available everywhere! Pays up to \$200 a week. This up-to-the-minute handbook tells you everything you need to know. 275 how-to-do-it pictures. Step-by-step instruction from blueprint reading to hidden arc, submerged arc, heliarc, and other recent developments. Used by tech. schools in courses costing hundreds of dollars.

## EVERYTHING YOU MUST KNOW

Includes: Arc welding machines. Accessories needed. 17 practical lessons in techniques. Welding metals and alloys. New electrodes. Hard facing. Pipe welding. Machinery and Structural welding. Methods of testing. Latest metal arc processes. 282 pgs. with index. \$4 complete. **AMERICAN TECHNICAL SOCIETY, Dept. A01 848 E. 58th Street - Chicago 37, Illinois**



Only \$4.00

IF YOU KEEP IT

FREE EXAMINATION

You need send no money. Fill in name and address and get **ELECTRIC ARC WELDING** for 5 days **FREE EXAMINATION**. Pay nothing now, pay nothing to postman on delivery.

**AMERICAN TECHNICAL SOCIETY, Dept. A01**

**848 E. 58th Street, Chicago 37, Illinois**

**JUST MAIL THIS**

Please send me **ELECTRIC ARC WELDING** for 5-day **FREE EXAMINATION**. If I decide to keep the book I will send you \$4 plus shipping costs within 5 days.  (\$4.90 with study guide, Check box if study guide is desired.) Otherwise, I will return and owe you nothing.

MY NAME \_\_\_\_\_

ADDRESS \_\_\_\_\_

CITY \_\_\_\_\_ Zone \_\_\_\_\_ STATE \_\_\_\_\_

Check here if you prefer to enclose full amount now. We then pay all shipping charges. Money refunded if not satisfied.



# 100X Area Magnifying Projector

— Enlarges Pictures, Printing, & Objects! — Full Color!

**NEW!** Electric Magna-Vue Optical Instrument projects & enlarges clippings, pictures, sketches, objects in full natural color, correctly & readable. Project on wall, screen or table. **MAGNIFIES 100 AREAS.** Enlarges any material up to 3 1/4 x 4 in. to 32 x 40 in. For home, school, class, business, shop use. Also make signs, sketches easy from any copy. Enamelled steel, 10 7/8 in. high. Quality 2" focusing lens. Operates on standard 110 volt current. Money back guarantee. Price Postpaid..... **\$4.98**

**JOHNSON SMITH CO., Dept. 624, Detroit 7, Mich.**

# 12-Foot BULL WHIP



**HARD HITTING! LOUD CRACKING!** Experts knock ashes off cigarettes. Yank people off feet. Used by trainers, ranchmen. Loud cracker like shot-gun blast. 4-ply hand plaited all leather. With loop handle.

6-ft. \$1.98. 8-ft. \$2.69. 10-ft. \$3.29. 12-ft. \$5.45.

**Johnson Smith Company, Dept. 624, Detroit 7, Mich.**

# Tiny Earphone and Microphone

Almost invisible. Listen to radio, TV. Phone in private. Secretly "Pick Up" sounds in other rooms. Flesh colored, hearing-aid style phone. Plugs in ear. Wear walking, in bed, working. Also used as microphone. Crystal element. High sensitivity. Use with any radio, TV, phone, amplifier, etc. Regularly \$7.50. New Imported Model Only..... **\$1.98**

**JOHNSON SMITH CO., Dept. 624, Detroit 7, Mich.**



# Catalog of 3100 Novelties 10c

Send 10c for amazing catalog of novelties, live animals, scientific supplies, hobbies, funmakers, planes & boats, looms, magic tricks, joke articles, unusual seeds, gadget timersavers, cameras, optical goods, projectors, movies, lucky jewelry, religious novelties, disguises, musical instruments, stamps, coins, puzzles, fortune tellers, radios, auto & bike accessories, telescopes, magnifiers, compasses, banks, smokers' gadgets, artists' supplies, printing sets, engines, motors, shockers, knives, billfolds, guns, rifles, sports, books, games, plants, etc. Send 10c (3 for 25c—get for friends!). **JOHNSON SMITH & CO. Dept. 624 Detroit 7, Michigan**

## NEW DETOUR SCALES

made of finest grade stainless steel. Satin finish—precision graduations in 32nds of an inch. Use same as a straight edge rule—measure straight thru an obstruction. A must for every tool kit. Send for literature—Agents wanted.

**SET OF THREE (4, 5 and 6") \$9.00** POSTAGE PAID

SEND CHECK, MONEY ORDER OR C.O.D.  
**EDGAR E. WISHAW INDUSTRIES**  
4315 Galeys Lane Racine, Wisconsin

## ENGINES — BRAND NEW

in original factory cartons. **CLINTON D700 2 HP** cast iron **HEAVY DUTY** long life with flyball governor & rope starter. Retail value \$55.00

**ONLY \$29.85** Hurry — this is a limited offer. No C.O.D.'s, Cash, or Checks.

Send Postal Money Orders only to:  
**C. W. MOTT, Box 28, Brookfield, Ill.**  
Engines will be shipped freight collect. No returns

## MODERN IMPROVED LAWN MOWER SHARPENER AND BED KNIFE GRINDER

Sharpen any mower in 10 to 20 minutes. Hand—Power—Reel or Rotary. Modern is actually two machines in one: a Precision Bed Knife Sharpener and a Precision Reel Sharpener. Extra Bed Knife Grinder is Absolutely Unnecessary. New Mower Support makes it possible to sharpen reel without removing bed knife. The fastest precision lawn mower sharpener on the market. Costs Less. Compare Modern's Many Exclusive Features Before Buying. Send for Free Brochure No. 10 SN

**MODERN MANUFACTURING CO.**  
160 North Fair Oaks Ave., Pasadena, California



## AUTOMATIC

MAKES NEW PROFITS

## RETOOTHER

for HAND SAWS

Cuts new teeth in 30 seconds - any size # to 16 points. Old teeth fall off as chips. Easy to operate. A perfect job.

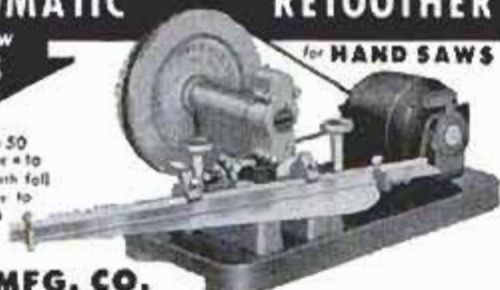

**BURR MFG. CO.**

8933-J VENICE BLVD. LOS ANGELES 34, CALIFORNIA

## GREATEST NEW DEVELOPMENT IN AUTOMOTIVE SAFETY!

TRACTION-MASTERS simply installed on your car assure a smooth, level ride - safe, short stops - faster starts! No dip - no dive - no sway! Improved traction in snow, ice or mud. Tremendous savings on tire, spring, shock and gear life! Blowout protection!

**MONEY-BACK GUARANTEE!**

Write Dept. PM-1 for FREE BROCHURE  
JOBBER INQUIRIES INVITED

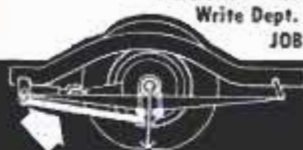

**Traction-Master Co.**

2917 W. OLYMPIC BLVD.  
LOS ANGELES 6, CALIF.



Clark Equipment Co., Battle Creek, Mich.

## Truck Takes to Water, Snow or Sand

Able to go places and do things heretofore impossible, a rough-terrain fork truck has been built for the U. S. Army Quartermaster Corps. It is designed to remove military supplies from landing craft during combat. Also, it will handle heavy materials across snow and in areas inaccessible to conventional equipment. The truck will operate in five feet of water, drive sideways, reach out for its load, pull itself out of holes and travel 25 miles per hour either in reverse or forward.

JANUARY 1958

## EARN WHILE YOU LEARN

# RADIO-TELEVISION

my new, faster way!



Frank L. Sprayberry  
Educational Director

Let me prove to you . . . without cost or obligation . . . that I can prepare you to be a Radio-Television Serviceman in 10 Months or Less

Let the true facts speak for themselves! That's why I want you to have my big new catalog and an actual sample lesson of Sprayberry Training—both FREE! READ—then make up your own mind! Train at home in spare hours for the best jobs and the biggest pay in Radio-Television. Easy payment terms suited to your budget. I will help you earn extra money doing radio service jobs while you learn!

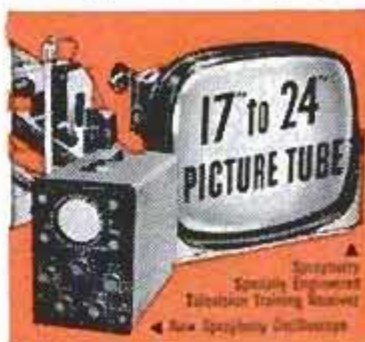

## Get Practical Experience with 25 Kits of Radio-TV Parts

Practical experience counts most. In addition to modern lessons, you train with actual parts and equipment. Build the famous Sprayberry Training Television Set, Multi-Range Tester, 2-Band Radio, other Test Equipment—all yours to keep. Get latest training

on Color TV, Transistors, Hi-Fi and UHF Conversions . . . included to make your training more valuable.

You owe it to yourself to get all the facts . . . Mail coupon for catalog and sample lesson—FREE

See for yourself . . . in actual pictures and descriptions . . . why Sprayberry Radio-Television Training offers more. Backed by almost 25 years of training experience. Three training plans to suit your exact needs. Rush coupon today for big new catalog and sample lesson. No obligation; no salesman will call.

**SPRAYBERRY ACADEMY OF RADIO-TV**  
1512 Jarvis Ave., Dept. 10-C, Chicago 26, Ill.

TWO  
BIG  
FREE  
BOOKS

HOW TO READ ABOUT IT  
**Radio-Television**

TRAINING PLAN



Mail Coupon Today!

SPRAYBERRY ACADEMY OF RADIO-TELEVISION  
1512 Jarvis Ave., Dept. 10-C, Chicago 26, Ill.

Please rush catalog on your ALL-NEW Radio-Television Training Plans. I understand this does not obligate me and that no salesman will call. Include Sample Lesson FREE.

Name \_\_\_\_\_ Age \_\_\_\_\_

Address \_\_\_\_\_

City \_\_\_\_\_ Zone \_\_\_\_\_ State \_\_\_\_\_



X-9

As a Cavitec manufacturer you can supply all the units to build all the walls of the "Cavalier" for



National  
Average

**\$96213\***

Blueprints  
available  
\$15.00  
per set



Superfine masonry at sensationally low price explains why the local manufacturing of Cavitec has such great potentials as a community enterprise. Local processing of local materials effects vast economies . . . enables low prices to builders yet upward of 100% mark-up on basic costs. Hundreds of choice franchise-protected territories open. 5 years to pay for machine. "Cavalier", shown above, indicates the kind of price-appeal which helps sell Cavitec for every type of residential, commercial and industrial construction. Write at once for "Opportunity, Unlimited" and tentative reservation of territory.

16" long  
2 1/4" high  
8" and 4" thick  
•  
Modular dimensions  
Large voids for insulation qualities  
•  
Range of 14 shades and tones  
•  
Striated or plain face



W. E. DUNN MFG. CO.  
409 W. 24th St., Holland, Mich.



Let me show you

HOW TO SPEAK AND WRITE  
LIKE A COLLEGE GRADUATE

I have helped thousands of men and women who have not had college training in English to become effective speakers, writers, and conversationalists. With my new C. I. METHOD, you can stop making mistakes, build up your vocabulary, speed up your reading, develop writing skill, learn the "secrets" of conversation. You don't have to go back to school. Takes only 15 minutes a day at home. Costs little. 32-page booklet mailed FREE upon request. Send me a card or letter TODAY!

Don Bolander, Career Institute

Dept. 1051 25 East Jackson Chicago 4, Illinois

ENGINEERING DEGREE IN  
27 MONTHS

B. S. DEGREE IN

Aeronautical, Chemical, Civil, Electrical, Mechanical and Electronic Engineering (inc. Radio and TV)

Also B.S. DEGREE in 36 mo. in Mathematics, Chemistry, Physics (inc. Nuclear Physics). Engineering Science prep. courses. Thorough, practical program. Individualized instruction emphasized. Government approved for G.I.'s.

Keeping pace with progress in science and engineering

Spacious campus, 20 bldgs.; dorms, gym, Playing field. Modern, well-equipped labs including new physics lab and wind tunnel. Low tuition. New terms start quarterly. Enter March, June, September or December. Big demand for graduates. Students from 48 states and 40 foreign countries. Many earn a major part of their college expenses in this large industrial center. Send coupon for free catalog and full information. Enroll now!

INDIANA TECHNICAL COLLEGE

518 E. Washington Boulevard, Fort Wayne 2, Indiana

Please send me free information on 27 MO. B.S. DEGREES in:

Aeronautical  Chemical  Civil  Electrical   
Mechanical  Electronics

on 36 MONTH B.S. DEGREES in:

Mathematics  Chemistry  Physics

Name \_\_\_\_\_

Address \_\_\_\_\_

STEP UP PERFORMANCE  
OF YOUR OUTBOARD



Send card for OUTBOARDER'S BIBLE — our 1958 catalog. It's FREE. Contains much valuable information on how to get MORE SPEED, or more THRUST for WATER SKIING from motors of 7 1/2 to 60 HP; better performance and load carrying capacity from any motor old or new. Easily understood recommendations enable you to choose a propeller virtually custom-built for your motor-boat-load combination — inexpensive, more rugged and damage-proof than the original. Send card, Michigan Wheel Co., Dept. PM-1, Grand Rapids 3, Mich.

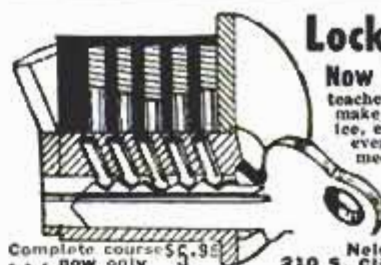

Locksmithing AND KEY MAKING

Now Made Easy! Practical up-to-date course

teaches you how to pick locks, de-code, make master keys, repair, install, service, etc. New self-instruction lessons for every handyman, homeowner, carpenter, mechanic, service station operator, fix-it shop, hardware dealer, gunsmith. 55 easy illustrated lessons. Full price only \$5.95 postpaid; or C.O.D. plus postage. Satisfaction or refund guaranteed.

Complete course \$5.95  
... now only \$3.95  
Nelson-Hall Co., Dept. AS-2  
210 S. Clinton St. Chicago 6, Ill.

LEARN WHILE ASLEEP!



Exciting details free!

Sleep-Learning Research Association  
P.O. Box 610-A Omaha, Nebraska

YES! SEND

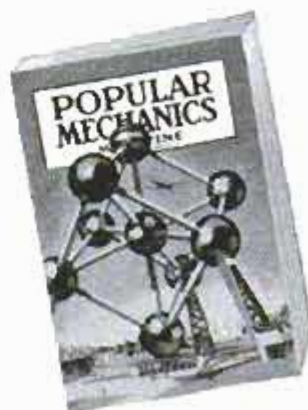

directly  
to my door  
every month

I am enclosing

\$3.50 for 1 year  
 \$8.00 for 3 years

name \_\_\_\_\_

address \_\_\_\_\_

city \_\_\_\_\_ zone \_\_\_\_\_ state \_\_\_\_\_

Hand this order to your newsdealer or send it to

POPULAR MECHANICS  
200 East Ontario St. Chicago 11, Ill.



# LEARN MEAT CUTTING AT NATIONAL

Pay After Graduation



The steady dependable trade of Meat Cutting taught easily in 8 short weeks. YOU LEARN BY DOING under actual meat market conditions in big modern school at Toledo.

For beginners or men with experience. Get a profitable store of your own. Remember, PEOPLE MUST EAT! Big pay jobs. Free employment help. Thousands of successful graduates.

Buying, cutting, percentage, pricing, advertising, selling, etc. A complete retail meat education. National School established 35 years. Get National training NOW. Pay your tuition in easy weekly

payments after you graduate. Send coupon for FREE 52 page school catalog — TODAY. G.I. approved.

**National School of Meat Cutting, Inc., Dept. 50-Z, Toledo 4, Ohio**

Send me your FREE school catalog on National Training at Toledo in Meat Cutting, Meat Merchandising and Self Service Meats. No obligation. No salesman will call.

Name \_\_\_\_\_ Age \_\_\_\_\_

Address \_\_\_\_\_

City \_\_\_\_\_ State \_\_\_\_\_

Approved for training Korean Veterans

## 75 POWER TELESCOPE 25X-45X-75X \$3.98

New 3 in one telescopes, 3 variable 25X-45X-75X magnification, Brass bound, 25 power for ultra bright images 45 & 75 power for long range. Guaranteed to bring distant stars, moons, objects, sports 75 times closer.



Most powerful scope sold anywhere near this amazing low price. American made, 3 sections. Opens 36" closes 1 ft. contains 4 ground & polished lenses. Can also be used as powerful compound microscope. Directions included. Mass production enables us to offer telescope complete at \$3.98 postpaid. Money back guarantee. Get yours now.

CRITERION CO., 331 Church St., Hartford, Conn., Dept. PMB53

### make your own Gems 36.50

The Gem Maker comes complete with all necessary equipment, including a super-charged diamond blade for sawing, and all the wheels for grinding, shaping and polishing; also complete instructions. The complete equipment as shown, less motor and belt for only \$36.50. f.o.b., Burlington, Wisconsin. Write today for information and literature.

**B&I MANUFACTURING CO.**  
Dept. P, Burlington, Wis.

## MEN WANTED

Earn \$100 Per Week and up

**AUTO DIESEL MECHANICS**

Master a trade with a future — learn Auto-Diesel mechanics in our shops. You learn with tools on real equipment. Earn while you learn. Many of our graduates earn \$100 per week and up. No previous experience necessary. Day and night courses. Approved for veterans. Write for free bulletin.

**NASHVILLE AUTO-DIESEL COLLEGE**

226 7th Ave., N., Dept. 75

Nashville 3, Tenn.



## BUILD and FLY Bensen HELICOPTER

Glider type 'copter—easy to build, simple to fly. Can also be mounted on floats or boat. No pilot's license required. Order 3-view drawings, specs and photo for \$1. Motor powered Gyro-Copter drawings \$2.

Ask about detailed plans and construction kits.

**BENSEN AIRCRAFT CORP., Dept. PM-18**  
P. O. Box 2725, Raleigh, N. C.

Name \_\_\_\_\_  
Address \_\_\_\_\_

## NEW! HMS BOUNTY MODEL KIT!

Famed mutiny ship. Every detail accurate — cannon, launch, rigging. Precision plastic parts, cement, plans. 14 3/8". \$2.98. For catalog, send 10c to Dept. P1, 4223 Glencoe, Venice, Cal.

wherever hobby kits are sold



\$2.98

# YOU, TOO, CAN BE A WIZARD at FIGURES

**MAIL COUPON for New Book that Makes Mathematics EASY READ 5 DAYS FREE!**

Had trouble with MATHEMATICS, like so many other people? You probably were taught incorrectly. Try this new step-by-step method, with easy-to-understand examples right in your own home in spare time. Makes learning MATH a snap. It's all due to proper presentation, and you'll now find it not only easier, but actually fascinating. To get ahead on any job, you need to know your mathematics. It's a social asset, too. Why not try this method and see?

**SEND NO MONEY.** Just mail the coupon, and we'll send you "Practical Mathematics" for 5 days FREE EXAMINATION. Pay nothing now. Pay nothing to postman. Just mail coupon.

**AMERICAN TECHNICAL SOCIETY, Dept. AE-1**  
848 E. 58th St., Chicago 37, Ill.

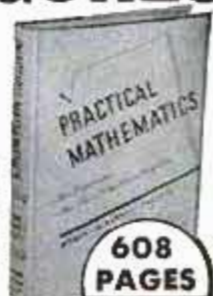

Only \$3.95

**IF YOU KEEP IT**  
Contents includes:  
Basic arithmetic simplified. How to solve problems with fractions quickly. Short cuts to figuring weights and measures. Methods for figuring areas and volume. How to use Logarithms and figure square root.

**AMERICAN TECHNICAL SOCIETY, Dept. AE-1 JUST MAIL THIS**  
848 E. 58th St., Chicago 37, Ill.

Please send me "Practical Mathematics" for 5 days FREE EXAMINATION. If I decide to keep the Book, I will send you \$3.95 within 5 days, plus shipping costs. Otherwise I will return it and owe you nothing.

NAME \_\_\_\_\_

ADDRESS \_\_\_\_\_

CITY \_\_\_\_\_ ZONE \_\_\_\_\_ STATE \_\_\_\_\_

If you prefer to enclose \$3.95 with coupon, check here, and we pay all shipping costs. Money refunded if not delighted.



# SAVE \$ ON U\$ GOV'T \$URPLUS\$

Our publication "Government Surplus Sales" lists hundreds of items for sale by the U. S. Government at tremendous savings, as low as 1c on a \$1.00.

These are samples of the savings that are being made:

LIFE BOAT .... \$12.00	GRINDER ..... \$4.69	SHAPER ..... \$15.00	DUMP TRUCK..... \$76.77
TRACTOR ..... \$75.00	TYPEWRITER .... \$7.51	FREEZER ..... \$50.00	SPRAY PAINTER..... \$15.25
	MOTOR ..... \$4.00		

Hundreds others listed in our bulletin "Government Surplus Sales" and may be purchased direct from U. S. Government. Hunting, Fishing, Camping, Sporting Equipment, Photographic Equipment and Supplies, Radio and Electronic Equipment, Amphibious Trucks, Jeeps, Boats, Motors, Binoculars, Plumbing, Electrical Equip., Cars, Power Tools, Machinery, Chemicals, Furniture, Office Equipment, Supplies, Scrap, Etc.

How may you receive our bulletin "Government Surplus Sales?" By sending \$1.00 to  
**GOVERNMENT SURPLUS SALES, P. O. Box 169, Department 8-5, East Hartford 8, Conn.**



## I'LL GUARANTEE YOU RIPPLING MUSCLES

IN 6 WEEKS OR MONEY BACK  
 You can have tremendous power, look bigger, have more confidence this tested way. Revolutionary new "Body Mold" courses builds your body in a way no other method can match. Get course FREE with order. Lowest factory price.  
**DAN LURIE BARBELLS**  
 50 lb. set \$ 8.98 • 100 lb. set \$14.98  
 150 lb. set \$21.98 • 200 lb. set \$27.98  
 EXTRA 1/2 lb. — 1 lb. per lb. 50% rush, balance C.O.D. FOR PLANT  
**DAN LURIE BARBELL CO.**  
 Dept. 859-A, Bklyn 12, N.Y.

FREE! SEND FOR NEW SPORTS & HEALTH CATALOG

YOUR NEIGHBORHOOD NEEDS AN ELECTRICAL APPLIANCE



# TROUBLE SHOOTER

Men needed to repair and service all kinds of Electrical Appliances—  
 AUTOMATIC WASHERS - DRYERS  
 IRONS - VACUUMS - TOASTERS  
 REFRIGERATORS - FANS - HOME  
 FREEZERS - AIR CONDITIONERS  
 —home and industrial motors, etc.,  
 also home and industrial wiring.

**Big, Year-'Round Profits!**  
 HELP US FILL HUGE DEMAND

MODERN BIG PROFIT ONE-MAN BUSINESS YOURS AT HOME — SPARE OR FULL TIME.

No previous experience needed. New, visual "Shop-Practice" method quickly shows you how. Hundreds of plain-as-day "How to" photos and drawings make it easy. A corner of garage, porch, attic, or basement is all the space needed. No costly leases — no big overhead. We show you how to make business come to you.

**BIG MONEY, SECURE FUTURE—INDEPENDENCE.**

F. V. in N. Y. says, "I made \$800 in 3 months while studying." T. E. H. in W. Va. says, "Made \$14 a day while learning."

**EVERYTHING FURNISHED—including BIG TOOL KIT**  
 Instructions are complete and include a Tool Kit and Appliance Tester. Everything furnished to help you build your own big-profit business at home. Our new 30-day income plan shows you how to start making money almost at once. Send no money—just your name and address on coupon below. I will rush you FREE complete success plan with full details. Do it NOW—BE FIRST!

**PACIFIC TRAINING SCHOOL, Dept. P-581**  
 11029 So. Vermont Ave., Los Angeles 44, Calif.

**PACIFIC TRAINING SCHOOL, Dept. P-581**  
 11029 So. Vermont Ave., Los Angeles 44, Calif.

Gentlemen: Rush me the postpaid your FREE plan for success in the Appliance Repair Business and the Free Book Entitled "The Appliance Repair Business and You" and remember I am under no obligation.

Name \_\_\_\_\_  
 Address \_\_\_\_\_  
 City \_\_\_\_\_ Zone \_\_\_\_\_ State \_\_\_\_\_

Enjoy the Fascinating Story of the Horseless Carriage in



## Popular Mechanics AUTO ALBUM



The most intriguing book about the automobile ever printed. It's thrilling, fascinating and informative. From the very first gasoline-propelled buggy to the cars of today and the atomic auto of the future. The first cars — the men who made them — the scrambled start and the development of the fabulous auto industry—the story of auto racing—the growth of the Nation's highways. 166 thrilling action pictures—old-time cars—racing cars—early auto advertising—automotive oddities. Roll call of names of more than 2000 autos made in the U.S. included. Ideal gift book. Cloth bound. only \$3.00 by mail. Money back if not pleased.

**POPULAR MECHANICS PRESS, Dept. PM-158**  
 200 East Ontario Street Chicago 11, Illinois

## Do YOU Know Your WOODS?

Take this 20-second quiz!



1. What wood is used chiefly for piano, organ and accordion keys? It is white and bears red berries around Christmas time.
2. What wood has a bark that can be used as a drink? It is used for fence posts and the building of small boats.
3. What wood is used in the making of axes, hammers, skis, mallets and for smoking meat?
4. What tree is given its name because of the long needles it bears?

See answers below.\*

Now have at your fingertips answers to these questions and much other vital information on your wood-working projects with Popular Mechanics new book—**"HANDBOOK of AMERICAN WOODS"**

This big 264-page guide describes and pictures all the commercial domestic species. It helps you select the proper woods for different projects and shows what substitutes may be used to achieve unusual effects. It can save you many hours of work and money for it contains detailed descriptions of the properties, grain, figure, color, workability and common uses of 48 softwood and 118 different hardwoods. You learn of the more interesting and outstanding characteristics of the tree, its natural growth range, a complete list of its common names and the official State trees. Written in PM's easy-to-understand style and well illustrated (over 70 actual photographs) **Handbook of American Woods** is a valuable addition to the library of any home craftsman or wood hobbyist. Send for your copy today. Money back if not pleased. Mail coupon below now and get your own "Lumber Yard" of beautiful woods.

- \* 1. American Holly 2. Sassafras 3. Hickory 4. Long Leaf Pine

**POPULAR MECHANICS PRESS, Dept. 158**  
 200 E. Ontario St., Chicago 11, Ill.

RUSH my copy of **Handbook of American Woods**, in paper-bound edition for only \$2.75 in full payment.

I enclose check or money order  Send COD (U.S. only)

Name \_\_\_\_\_  
 Address \_\_\_\_\_  
 City \_\_\_\_\_ Zone \_\_\_\_\_ State \_\_\_\_\_



New PROFIT-PROVEN\* Home-Business!

"I make \$400<sup>00</sup>  
a week!"



SCREEN  
TRADE MARK REG.  
PRINT

SCREEN PRINT CO.  
Dept. 21  
15127 S. Broadway, Los Angeles 61, Calif.  
Gentlemen: Please mail me Free Revealing  
Details, samples, Opportunity Plan,  
etc.—All this is sent absolutely Free and  
sent to me by return mail. I am under no  
obligation now or ever.

NAME \_\_\_\_\_  
ADDRESS \_\_\_\_\_  
CITY \_\_\_\_\_ ZONE \_\_\_\_\_ STATE \_\_\_\_\_



**free!**  
Complete REVEALING DETAILS.  
Authentic SAMPLES. Proven  
Big-Money OPPORTUNITY  
PLAN. "HOW-TO" BOOKLET.  
Learn the secrets. Rush  
this coupon TODAY!

\*Proves MR. J. T. ANDERSON, Inglewood, Calif.  
(Notarized statement on file in  
our office and open to inspection)

Big Money?—sure it is—because Huge Profits  
are waiting to be "tapped" with this **MIRACLE  
NEW PRINTING METHOD**. Now, you may share  
the exciting secrets and build a big-paying **FULL  
OR SPARE TIME** Screen Printing Business right  
**IN YOUR OWN HOME**. Yes, we'll teach you,  
too, how to turn pennies into dollars in this  
newest, most sensational printing method ever  
invented. **WHAT IS SCREEN-PRINT?** It's an ex-  
citing new printing technique—amazingly sim-  
ple and fascinating. (It may soon revolutionize  
the entire printing industry) **NO EXPENSIVE  
EQUIPMENT**, no printing press, no "cuts," no art  
ability, no experience is necessary—yet you can  
print beautiful professional jobs on **PAPER,  
GLASS, LEATHER, CLOTH—ANYTHING!** You print  
in all colors—even new "glowing" **FLUORESCENT**

**COLORS**. It's amazing—but true! **EARN PROFITS  
IMMEDIATELY—IN YOUR OWN HOME!** Start  
in your garage, basement, kitchen, spare room  
—anywhere! It's much easier than you think.  
Then expand as this new printing industry  
grows. **300% PROFIT** on some jobs—earn up to  
\$12.50 per hr. **HELP FILL THE HUGE GROWING  
DEMAND**. No selling because every business in  
your area needs Screen-Printing. You can save  
them up to 50% on printing, too. **WE SUPPLY  
EVERYTHING YOU NEED**. Never before has such  
a profit opportunity been offered to anyone wishing  
to start a full-time or spare-time "business of his  
own." Don't Hesitate! All the **CONFIDENTIAL  
FACTS** are yours if you **MAIL COUPON TODAY**—  
before it's too late.



**READ WHAT OTHERS  
ARE SAYING—** Investigate!  
"Would not take \$1000.00 for  
secret... just what I  
have been searching for  
the world over for."  
C.S., Nev.: "Making  
75% of living ex-  
penses already in  
spare time." E.L.,  
Ontario: "Made \$80  
first week—terrific  
opportunity"—  
W.S., Iowa.  
Mail Coupon and  
Learn Secrets Too!

Print colorful ADVERTISING DISPLAYS, SIGNS, BANNERS, POSTERS, LABELS, WALLPAPER, NOVELTIES, INSTRUMENTS, ETC. ET

**FREE AMAZING NEW BOOK  
"HOW TO ANSWER ADS"**



Never before have you seen anything like this.  
Tells you in simple language the correct way to  
answer ads. Gets you quicker replies—better re-  
sults, and greater satisfaction. Will save you  
time and money and it's **ABSOLUTELY FREE**.  
No obligation whatever. Every reader of adver-  
tising should have this booklet. Send a postcard  
for your copy NOW. F. W. JOHNSON, Popular  
Mechanics Magazine, Room 600-A, 204 East  
Ontario Street, Chicago 11, Ill.

**Brilliant new real metal plate  
ELECTROPLATE**



**AUTO CHROME**  
NOW using NEW ELECTROCHEMICAL outfit  
You can easily do your own plating on  
**ANY** object. YES, THIS KIT WILL EVEN  
PLATE NON-METALS. Not a paint.  
But a hard DURABLE metal plate,  
equal to commercial plating. Kit  
comes to you COMPLETE. Con-  
tains its own power pack. Get  
your own plating kit with inst-  
on plating thousands of objects  
with **CHROME, COPPER, SIL-  
VER, GOLD**. SEND NO MONEY  
—everything sent COD for only  
\$7.98 or send \$7.98 now and  
rec. it postpaid. Money back in 7 days if not satisfied. METOMIC  
MFG. CORP., Dept. PM-2, 514 W. 25 St., New York 1, N. Y.

**Get info.. PLASTIC LAMINATING AT HOME!**



Get **ORDERS** and **CASH** from your mail-  
man—do work in **SPARE TIME** at home  
—or expand into **FULL TIME** business.  
Send coupon for Free facts about the newest  
and most fascinating of all home operated  
businesses. For the first time a simplified  
machine brings the fabulous profits of  
**Plastic Sealing and Plastic Laminating**  
within the reach of the small operator. Any-  
one can learn to operate the machine with  
a few minutes practice—then with our  
**Magic Mail Plan** can get mail orders pour-  
ing in daily with cash in every envelope.  
**No canvassing—no selling**. We even

**Make \$20 to \$30 a Day by..  
MAGIC MAIL PLAN!**

supply the circulars you mail to bring back cash and orders.  
Don't waste a minute. Rush your name. We'll send you **FREE**  
and postpaid, pictures, prices, details, and all the facts you need  
to start. Mail coupon or send name on postcard. No charge.  
Warner Electric Co., 1512 Jarvis Av., Dept. L-2-A, Chicago 26, Ill.

**Make Thousands of Beautiful Art Creations**

**COSTUME JEWELRY • CIGARETTE BOXES  
TRAYS • CANDLESTICKS • COASTERS  
LAMP BASES • BOOK ENDS...ALL IN  
SPARKLING COLORED PLASTIC**



**THIS  
MAN..**  
... is taking out of  
the machine a Plastic Sealing  
Job—ordered by mail—only  
11¢ in material cost brings  
back \$2.58 in cash by mail.  
Capacity of machine: **\$25.00  
profit per hour of operation.**

**WARNER ELECTRIC CO., 1512 Jarvis Av.  
Dept. L-2-A, Chicago 26, Ill.**

At no cost to me, please rush complete details  
postage prepaid. I am under no obligation.

Name \_\_\_\_\_  
Address \_\_\_\_\_  
City \_\_\_\_\_ Zone \_\_\_\_\_ State \_\_\_\_\_





# BOOKS for CHILDREN



**as birthday gifts . . . for the holidays . . .  
for fun and education anytime!**



### Mr. Wizard's Science Secrets

The star of the famous TV program penned this educational, entertaining book that will help in school and through a lifetime. The book is just like Don Herbert's unusual program and just as intriguing. It contains more than 150 of his experiments in word and picture. Answers thousands of "how" and "why" questions children ask on the human body, gravity, flight, heat and radiation, electricity, etc. It's facts with fun—so interesting children never tire of learning. They turn wine into water, make mothballs dance, cause water from a faucet to bend mysteriously, other breath-taking tricks. . . . **\$3.00**



### Golf for Boys and Girls

"Start right" . . . says Chick Evans, golfer's greatest amateur stylist, and with this handsomely illustrated book he teaches young readers the fun, fundamentals and rules of golf. Gives Chick's own "golden rules," selected from more than 30,000 notes he has made during a half-century of play as boy, youth and man, and first double crown winner in history (capturing the national amateur and open championships in the same year). It will quickly introduce your boy or girl to this exciting game, or help improve their skill. . . . **\$3.50**



### Build-It-Yourself Book for Boys

Every active boy enjoys creating things with his hands. Give your or a friend's "Tom Sawyer" this book and watch his face light up! It contains 56 toys, games, gadgets, electrical and mechanical devices that any boy can make: a tree house, sidewalk auto, a microscope that really works, airplane and boat models, water skis, surfboard, bobsled, boomerangs, hunting knife, rafts, scooters, kites, log cabins, radios, weather instruments, taxidermy projects, telegraph set, telephone and many others. Easy-to-follow instructions and 469 how-to-do-it pictures will encourage and inspire him. . . . **\$2.50**



### "There's Adventure in" Career Books for Boys 11-17

Introducing a unique new series of career books for the boy of today who needs and wants to know more about the technical, scientific world we live in . . . and his future in the world of tomorrow. Each story is told as exciting fiction through the eyes of teen-age boys, but skillfully woven throughout the stories are the even bigger, even more startling facts about the career opportunities in the title sciences. The books suggest the kind of educational preparation needed, the types of occupations that are now open and will be opening in the future. Well researched and authentic, but full of fun, facts and practical inspiration. . . . Each **\$2.50**



### Popular Mechanics JUNIOR Do-It-Yourself ENCYCLOPEDIA

A 12-volume set, complete with beautiful rack, which contains 3,072 informative pages, over 5,000 pictures, photos, and diagrams and literally thousands of subjects and projects children want to know about and do. Highly recommended by leading educators, child experts and counselors. It guides your boy and girl into worthwhile interests, fully develops their natural talents. It's easy to read, with large type, and overflowing with myriad delightful projects for the 8-to 16-year-old. Worth many times its cost in lifetime dividends for them and you. . . . **\$19.95**



### Science Milestones

This record of the march of science will fire the imagination, and inspire youngsters in their pursuit of scientific knowledge. Contains dramatic revelations of 60 important individuals whose contributions, from 400 B.C. to the present, are landmarks in the history of science. Hippocrates, Archimedes, Galileo, Newton, Franklin, Watt, Fulton, Faraday, Pasteur, Lister, Koch, Edison, Bell, the Curies, Einstein, Fleming and others. They will thrill to its triumphs and tragedies, the idealism and the persecution, the brilliant flashes of insight and patient plodding of research. Adults will too! . . . **\$5.00**



### The Boy Mechanic

For over forty years the standard handbook for the young home craftsman. The completely new sixth edition has 500-plus projects for the boy who wants to make things that work and go. It describes how to improve the performance of a bicycle or a power lawn mower, or how to get more fun out of an electric train. It tells how to build a soapbox racer, an ice boat, a dinghy—something for every place, time and season. 1100 photos and diagrams make it one of the most elaborately illustrated "What To Make" books ever printed. PM's step-by-step instructions make it one of the best. . . . **\$3.95**



### The Boy Scientist

This book won for Popular Mechanics the 1955 award of the Thomas Alva Edison Foundation as publisher of "The Best Children's Science Book." It's an outstanding introduction to the exact sciences, bursting with facts every modern boy wants to know. Written and illustrated with such clarity that even complex principles are quickly grasped by the young mind . . . astronomy, physics, chemistry, sound, electricity, atomic theory, relativity, hydraulics, space flight. A gift of this book may well start some boy on the way to becoming one of the nation's top scientists. . . . **\$3.95**

**POPULAR MECHANICS PRESS, Dept. 158, 200 E. Ontario St., Chicago 11**  
RUSH books I have checked below. If not pleased, I can return in good order within seven days for full refund.

- Remittance enclosed.  Send C.O.D.; U.S.A. only.  
 Mr. Wizard  Golf for Boys & Girls  Book for Boys  Junior Encyclopedia  
 Adventure in Chemistry  Adventure in Electronics  Adventure in Atomic Energy  
 Science Milestones  Boy Mechanic  Boy Scientist

Name \_\_\_\_\_  
 Address \_\_\_\_\_  
 City \_\_\_\_\_ Zone \_\_\_\_\_ State \_\_\_\_\_

*all from*

**POPULAR  
MECHANICS**

Satisfaction Guaranteed or Your Money Refunded

← **MAIL THIS COUPON**

POPULAR MECHANICS





## unlimited opportunity for graduate engineers

Demand for our engineering graduates exceeds supply. Important firms visit campus regularly to interview seniors. Industrial growth . . . automation . . . technical advances create career opportunities for engineers, accountants, management experts. Share rewards awaiting college men . . . higher income . . . rapid advancement. Grasp your chance for a better life now! Start any quarter in this world-famed college. Approved for veterans.

### Bachelor of Science degree in 27 months

In Mechanical, Civil, Electrical, Chemical, Aeronautical, Radio (TV-Electronics) Engineering. In 36 months a B.S. in Business Administration (General Business, Accounting, Motor Transport Management majors). Superior students may accelerate. 36-weeks course in Drafting. Intensive program: technical fundamentals stressed; comprehensive courses with more professional class hours. Small classes; personalized instruction. Enrollment limited. Preparatory courses. Beautiful campus. Well-equipped, new and modernized buildings and laboratories. Enter Mar., June, Sept., Jan.

Earnest, capable students (whose time and budget require accelerated courses and modest costs) are invited to write Jean McCarthy, Director of Admissions, for catalog and book "Your Career in Engineering and Commerce."



## TRI-STATE COLLEGE

418 College Avenue • • • Angola, Indiana

**CASH IN ON**

## WAR SURPLUS!

IMAGINE! \$100 VALUES—NOW SELLING FOR PENNIES

Hundreds of surplus items for home, farm, garage and shop . . . going for pennies on the dollar! All built to the government's higher standards. Tools, machinery, gear reducers, pumps, boats, motors; page after page of tremendous bargains.

SEE FOR YOURSELF: Send for this big catalog and see for yourself! See pages of surprising bargains. See items that cost the government thousands of dollars going for pocket change. Act now. Cash in on government surplus. Send 10c for your copy.

KARL ORT, Dent.PM1, Thomasville, Pa.



## FOLDING LEG BRACKETS



Amazing new design with automatic spring action push button control. Locks in both open and closed position. Lifetime heavy duty metal construction. Simple, foolproof. Can't stick or bind. Smooth action. Easy to attach. Only 1 3/4" x 2 1/2" x 2 1/2" in size—neat and strong. Perfect for ping-pong or any type table. Complete with all screws. Money back guarantee. SEND CHECK OR M. O.—NO C.O.D.

**DOO-IT STORE**  
1040 N. WOODWARD  
ROYAL OAK, MICH.

**\$3.95**  
SET OF 4  
POST PAID

## FREE LAFAYETTE CATALOG

JUST OFF THE PRESS!  
NEW 180 PAGE ELECTRONIC CATALOG FEATURING  
THE BEST BUYS IN THE BUSINESS

Packed with the largest selection of Electronic, Radio and T.V. Parts, and equipment, PA, Hi-Fi systems, tubes, antennas, Transistor Kits, parts and components, Test Equipment, new build your own kits, tools, books, Microscope, drafting equipment, Binoculars, Telescopes, All Radio, TV and Ham supplies—ALL AT GREAT SAVINGS —For the economy-minded servicemen, dealer, engineer and technician. **CHUCK FULL OF BUYS! SEND FOR YOUR FREE COPY TO-DAY.**



Name \_\_\_\_\_  
Address \_\_\_\_\_  
City \_\_\_\_\_ Zone \_\_\_\_\_ State \_\_\_\_\_

**Lafayette Radio** 165-08 LIBERTY AVE  
JAMAICA 33, N. Y.

## Makes \$216.00 A MONTH IN SPARE TIME!



**M. M. Rearick Says: "I AVERAGE UP TO \$216.00 A MONTH OPERATING MY BELSAW SHARP-ALL AFTER WORK AND ON SATURDAYS"**

Now you can turn your spare time into Big Cash Profits with new BELSAW SHARP-ALL. Sharpen knives, scissors, shears, snips, ice skates, mower blades, hedge trimmers, grass whips, axes, chisels, screw drivers, scrapers and saws . . . just about any household, garden and shop tool. Your own CASH business in 15 square feet of your basement or garage . . . all your prospects in your own neighborhood. No calls to make. No experience needed. No inventory. Your SHARP-ALL quickly pays for itself.

**FREE BOOK** tells how to start your own cash business.

Learn how easily you can start your own spare time business. Amazing low cost, easy-payment plan. Send coupon today for FREE BOOK.



## BELSAW SHARP-ALL CO

718 Field Building • Kansas City 11, Missouri

Send me your FREE BOOK.

Name \_\_\_\_\_  
Address \_\_\_\_\_  
City and State \_\_\_\_\_



## I'll Send You This Handsome SAMPLE CASE—FREE!



Make up to  
\$30<sup>00</sup> in a Day!

Your Own  
Tailored Suits  
Without 1¢ Cost

If you want to make more money, spare time or full time, rush the coupon below today for this big, valuable tailoring Sample Case packed with 100 beautiful, big-value suit and overcoat samples. Just show the samples and last-minute styles to friends, fellow-workers, others. Take their orders for fine made-to-measure clothes—and pocket BIG CASH PROFITS in advance. No experience, no tailoring knowledge needed—and no money needed, ever. WE SUPPLY EVERYTHING FREE... sample case, sample suitings, equipment, complete instructions. Start making money first day!

Use Spare Evenings... Weekends... Make Money... Get Suits!  
It's easy to make money taking orders in just spare time—lunch-time, evenings, weekends. When men see the fine fit, quality and value of our suits—THEY ORDER! So we make it easy for you to get your own personal suits and overcoats without paying even one penny. Don't wait! Rush coupon with your name, address, and age for FREE Sample Case.

**PROGRESS TAILORING COMPANY**  
Dept. T-216, 500 South Throop Street, Chicago 7, Ill.

**PROGRESS TAILORING CO., Dept. T-216**  
500 S. Throop St., Chicago 7, Ill.

Please rush ABSOLUTELY FREE the valuable Sample Case with suit fabrics and style display. Include instructions, money-making plans and details for getting my own suits without paying one cent.

Name.....Age.....

Address.....

City.....State.....

## Every Mason Wants



Masonic books for Blue Lodge Chapter, Commandery, Scottish Rite and Shrine. Our Rituals Are Used the World Over. Send for free catalog for Masons, Odd Fellows, Knights of Pythias, Knights of Columbus, etc.

**EZRA A. COOK PUBLICATIONS, INC.**

P.O. Box 796 37A Chicago 90, Ill.

You can make money in

# WATCH REPAIR

Learn at home the low cost Sweazey Way

Watch repairing pays up to \$6 an hour, part time watch makers report on survey. Unique and modern Sweazey home study System starts you making repairs right away on Swiss and American watches. Professionally prepared training. No previous experience needed. Special tools provided for practice. Tuition only \$5 a month. Free sample lesson and opportunity book give all facts. Write today. No obligation.

**CHICAGO SCHOOL OF WATCHMAKING**

2330 N. Milwaukee Ave., Dept. 118, Chicago 47, Illinois

**FREE BOOK and SAMPLE LESSON**

CHICAGO SCHOOL OF WATCHMAKING  
2330 N. Milwaukee Ave., Dept. 118, Chicago 47, Illinois  
Please rush FREE BOOK and Sample Home Study Lesson.

Name.....Age.....

Address.....

City.....Zone.....State.....

## "How to Go into Business for YOURSELF"

If you know a trade or occupation—why not go into business for yourself? Why not make the profits others are now making?

IT'S EASY TO START A NEW BUSINESS. It's easier than you think—once you learn the 9 easy steps of building a new business of your own. National Business Consultants has shown over 5000 others how to be successful—let us show YOU too. We guide you every step of the way with sound, proved simple business practices. **EXPAND YOUR OWN BUSINESS.** Learn our tested, profit-making methods for business success. If you already own a business, let N.B.C. guide you too. You'll be amazed. **SEND FOR FREE BOOKLET TODAY!** "How to Start a Business" is jam-packed with revealing information. In easy-to-understand language it explains how to start and make any kind of business profitable. Free for the asking! Sent to you in confidential plain envelope. *Just write:*  
**NATIONAL BUSINESS CONSULTANTS, Office P-1, Los Angeles 61, Calif.**



**BOTH FREE!**

Rush Name on  
Postcard Today!



**FIX home & car APPLIANCES YOURSELF**

**NEW! EICO® REDI-TESTER**  
KIT \$12.95 Factory-wired \$15.95

All-in-one MULTI-RANGE ac/dc voltmeter, ammeter, ohmmeter, wattmeter, leakage checker. Locates defects in irons, fans, refrigerators, mixers, air-conditioning, TV & radio tubes and parts, batteries, generators, etc. Easy instruction Book has introduction to electricity & procedures for common repair jobs. Examine EICO's complete line of 50 professional Instruments & Kits - Write for FREE Catalog PPM-1

Electronic Instrument Co., Inc., 33 00 Northern Blvd., L.I.C. 1, N.Y.

## ENGINEERING DEGREE IN 27 MONTHS

B.S. Degree, Aero., Chem., Civil, Elec. Mech. & Electronic Engineering (inc. Radio, TV), 36 mo. B.S. degree in Math., Chem., Physics. Prep courses. Demand for grads. Spacious campus. 20 bldgs.; dorms, auditorium, gym. Low rate. Earn board. G.I. approved. Enter March, June, Sept., Dec. Catalog.

1618 E. Washington Blvd.  
Fort Wayne 2, Indiana  
Keeping pace with progress

## INDIANA TECHNICAL COLLEGE



USED BY U. S. ARMED FORCES  
**MACHINE TOOL RECONDITIONING**  
& THE ART OF HAND SCRAPING (3rd printing)

SEND FOR FREE FOLDER DESCRIBING  
ILLUSTRATED BOOK

MACHINE TOOL PUBLICATIONS, 382 Holly Ave., Saint Paul 2, Minn.

## Join THE MARCH OF DIMES

They need  
**YOU!**





# FREE!

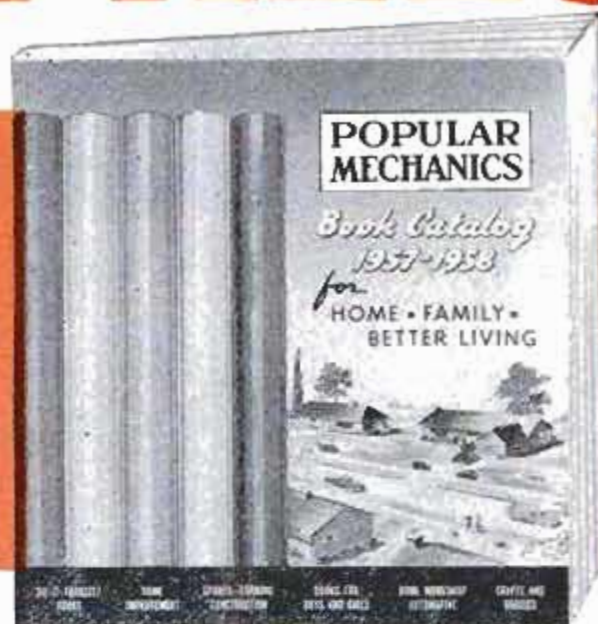

## POPULAR MECHANICS NEW BOOK CATALOG

**Pictures and Describes 95  
Different Books and Booklets—  
MANY OF THEM JUST OFF THE PRESS!**

Books for every need, every purpose to help you save time and money on

- home improvement and maintenance
- new homes and garages
- automobile repair and purchase
- tool purchases, use, upkeep
- workshop planning and projects
- hi-fi, television, radio, other equipment
- crafts and hobbies of all kinds
- farm equipment and animals

—all edited and written by practical men who know how to present their subject in the clearest manner possible, to give you the information you want, prepared in a way that will be the greatest help in the project you plan

**PLUS** Books of fun and education for Boys and Girls, Sport Books, Books of activities and enjoyment for the Entire Family — and many, many more!

28 large pages, beautifully illustrated and printed in two-colors, fully indexed by subject and title for fast, easy reference.

\* Catalog is free of charge. However, please enclose 10c to cover forwarding costs.

**MAIL  
COUPON  
TODAY**

Popular Mechanics Press, Dept. 158, 200 E. Ontario St., Chicago 11, Ill.  
RUSH big new Book Catalog. I enclose 10c in coin to cover all handling, addressing and postage charges.

Name \_\_\_\_\_  
Address \_\_\_\_\_  
City \_\_\_\_\_ Zone \_\_\_\_\_ State \_\_\_\_\_

JANUARY 1958

## 94.6% OF BAILEY GRADUATES ARE EMPLOYED AT TOP PAY IN THE FIELDS WHICH THEY WERE TRAINED!



### DIESEL-AUTO MECHANICS DESPERATELY NEEDED!

We have a far greater demand for our students than we can fill!

We can show you an actual waiting list of leading companies throughout the world who have tried Bailey graduates — found them outstanding, and are coming back for more!

Bailey Graduates are Successful . . . **RECEIVE BIG PAY — HAVE SECURE FUTURE!**

The Famous Bailey Course prepares you for BOTH Diesel and Gasoline Mechanics.

This is a must—due to the advent of using Diesel principles, such as 'Fuel Injection' on passenger cars . . . use of gasoline engines for starting Diesel engines, etc. You learn all this at Bailey in the amount of time ordinarily required to learn just one of these subjects, **ALL FOR THE PRICE OF ONE.**

Don't be satisfied with a 'futureless', one-type job — learn how you can make big money now!

Write today for Free Booklet that takes you on a step-by-step camera tour through our spacious, modern shops — See Bailey students in action as they Learn-by-doing with the Famous Bailey Method of training!

We provide you with housing and part time jobs while in school, plus nation-wide placement service for graduates.

## BAILEY Technical SCHOOLS

1634 S. GRAND

ST. LOUIS 4, MO.

### MAIL TODAY!

Please mail immediately this free booklet without obligation.

**FREE BOOKLET**



Name \_\_\_\_\_  
Address \_\_\_\_\_  
City \_\_\_\_\_ State \_\_\_\_\_  
APPROVED FOR VETERAN . . . NON-VETERAN



**POPULAR MECHANICS PRESS, Dept. 158**

**200 E. Ontario Street, Chicago 11, Illinois**

Gentlemen: Please send copies of book nos.:

1 2 3 4 5 6 7 8 9 10 11 12 13 14  
15 16 17 18 19 20 21 22 23 24 25 26  
27 28 (circle numbers desired)

Remittance enclosed

Send C.O.D. (\$2.00 or more) I enclose \$\_\_\_\_\_

Name \_\_\_\_\_

Address \_\_\_\_\_

City \_\_\_\_\_ Zone \_\_\_\_\_ State \_\_\_\_\_

**FILL-IN and  
MAIL THIS  
← COUPON!**

**SAVE MONEY *with these* NEW DO-IT-YOURSELF BOOKS**



- 1. HOW TO PAINT INSIDE AND OUT:** Step-by-step instructions. Easy to follow illus.
- 2. HOW TO LAY LINOLEUM AND TILE:** How to get the best from your labors. Diagrams.
- 3. HOW TO REMODEL YOUR BASEMENT AND ATTIC:** Planning ideas, hints, instructions. Illus.
- 4. HOW TO TAKE CARE OF YOUR LAWN:** Detailed guide to a perfect lawn and healthy shrubs.
- 5. HOUSE WIRING AND ELECTRICAL REPAIRS:** Ideas and instructions for the homemaker. Diagrams.
- 6. SMALL BOATS YOU CAN BUILD:** Plywood dinghy, 15-ft. sailing knockabout, 8-ft. duckboat, etc.
- 7. PLUMBING REPAIRS MADE SIMPLE:** Fix faucet noises, water hammer, clogged pipes yourself.
- 8. FENCES, GATES, TRELLISES AND WALKS:** Variety of fences, etc., with instructions, diagrams.
- 9. BUILT-IN FURNITURE FOR YOUR HOME:** Wall cabinet, wardrobe, linen closet, crib, etc.
- 10. BUILD YOUR OWN BARBECUE:** Stone and brick fireplaces, grills, barbecue pits, etc.
- 11. LAWN AND GARDEN PROJECTS:** Picnic furniture, folding chairs, garden pool, etc.
- 12. THREE LOW-COST HOMES YOU CAN BUILD YOURSELF:** Build your own home—save half the cost.
- 13. 125 SIMPLE HOME REPAIRS:** Stop faucet leaks, replace sash cords, cut glass, etc.
- 14. SIMPLE TELEVISION REPAIRS:** Only a screwdriver, pliers and soldering iron necessary.

- 15. MODERNIZE YOUR KITCHEN:** Planning for convenience and economy. Ideas, diagrams.
- 16. 30 ONE-EVENING PROJECTS:** Decorative, easy-to-make chairs, lamps, tables, shelves, etc., for the home.
- 17. HOW TO WINTERIZE YOUR HOME:** Prepare for bad weather. Make storm windows, repair roofs, etc.
- 18. HOW TO SET UP YOUR HOME WORKSHOP:** Detailed layout plans for basement conversion. Diagrams.
- 19. LANDSCAPING YOUR HOME AT LOW COST:** How to plan and plant beautiful home surroundings.
- 20. CONCRETE CONSTRUCTION AROUND THE HOME:** How to make steps, walks, driveways, fireplaces, etc.
- 21. REFINISHING FURNITURE, FLOORS AND WOODWORK:** What you need and how to do the job properly.
- 22. HOW TO USE POWER TOOLS IN YOUR HOME WORKSHOP:** Basic and advanced operations, ideas, tips.
- 23. HOW TO CURE YOUR LEAKY BASEMENT:** Causes of, and how to stop, dampness and water seepage.
- 24. MONEY-SAVING HOUSEHOLD FORMULAS:** Safe, efficient polishes, cosmetics, etc., you can make.
- 25. UPHOLSTERING AT HOME:** Using foam rubber, upholster chairs, benches, etc., at a big saving.
- 26. HOW TO GET THE MOST OUT OF YOUR CIRCULAR SAW:** How to build and use this tool for best results.
- 27. HOW TO MODERNIZE HARDWOOD FLOORS:** Step-by-step instructions and diagrams for renovation.
- 28. HOW TO MODERNIZE WALLS AND CEILINGS:** Ideas for wall and ceiling treatments and how to carry them out.

**ONLY  
25¢ EACH**

**PLEASE NOTE**

Minimum Order Five (5) Books

**5 for  
\$1.00**



# TRAIN AT HOME

in Your Spare Time  
or in the Great  
Allied School

The  
**ALLIED**  
Way for  
Best Pay



Mr. Harry Lebeson, President  
Allied Institute  
of Technology



Drafting—All Branches

Tool & Machine Design  
(Bachelor Degree TE)

Tool Engineering  
(Bachelor Degree ME)

Mech. Engineering

Master Machinist

Tool & Die Making

Auto Mechanics

Air Conditioning

Refrigeration

Prepare for the best jobs in your spare time at home. With ALLIED'S practical Home Study program you can progress so rapidly that big new opportunities will soon be open to you. ALLIED'S Home Training methods are the finest ever designed for they are based on the successful programs developed in the ALLIED School for more than a quarter of a century.

Your Home Training entitles you to two weeks of training at the great Allied shops at no additional tuition cost, should you desire it. You get many advantages and additional services when you enroll for ALLIED training.

## More Jobs Than Graduates

As an Allied trained man you can go up fast—to higher and still higher pay or you can build your success in a business of your own. Due to great industrial expansion industry has been clamoring for Allied trained men to fill important jobs. Shortages of Draftsmen, Designers, Tool Engineers, Machinists, Air Conditioning, Refrigeration and Heating Technicians, and Auto Mechanics are so widespread you can pick a high paying field and look forward to Achievement and Security. You can begin your training in short courses at Home or at Allied Institute, and continue progressively toward an Engineering Degree in 31 months.

Allied is approved by industry, National Home Study Council, Department of Education, Office of Public Instruction, State of Illinois, U. S. Department of Justice. BE AN ALLIED TRAINED MAN—GET THE FACTS—MAIL COUPON TODAY.

## Mail Coupon for Free Sample Lesson

### ALLIED INSTITUTE of TECHNOLOGY, DIV.

ALLIED SCHOOL OF MECHANICAL TRADES  
1338-42 South Michigan Avenue, Dept. PM-18, Chicago 5, Illinois

Gentlemen:

Mail me FREE BOOKS explaining ALLIED'S courses of instruction and FREE SAMPLE lesson. Vets write date of discharge.

I am interested in the training I have checked below:  Resident  Home Study

- |   |  |   |
|---|--|---|
| <input type="checkbox"/> DRAFTING—All Branches                    | <input type="checkbox"/> MECH. ENGINEERING<br>Bachelor Degree (ME) | <input type="checkbox"/> AUTO MECHANICS   |
| <input type="checkbox"/> TOOL & MACHINE DESIGN                    | <input type="checkbox"/> MASTER MACHINIST                          | <input type="checkbox"/> AIR CONDITIONING |
| <input type="checkbox"/> TOOL ENGINEERING<br>Bachelor Degree (TE) | <input type="checkbox"/> TOOL & DIE MAKING                         | <input type="checkbox"/> REFRIGERATION    |

NAME \_\_\_\_\_

ADDRESS \_\_\_\_\_

CITY \_\_\_\_\_ COUNTY \_\_\_\_\_ STATE \_\_\_\_\_



**FREE BOOKS**

tell how YOU can become an ALLIED TRAINED MAN. Write TODAY!

ALLIED INSTITUTE OF TECHNOLOGY, DIV.  
ALLIED School of Mechanical Trades  
1338-42 South Michigan Avenue  
Dept. PM-18, Chicago 5, Illinois



**EARN  
BIG  
PAY**

**COURSES OPEN  
IN SHOP METHOD  
TRADES  
TRAINING**

THE TRAINED MAN GETS THE BREAKS  
PRACTICAL & HOME STUDY COURSES

- WELDING • ELECTRONICS
- DRAFTING • REFRIGERATION
- AUTO MECHANICS • DIESEL
- AIR CONDITIONING • RADIO
- TELEVISION • PHOTOGRAPHY
- COMMERCIAL ART

DIPLOMAS  
AWARDED  
GRADUATES



PLACEMENT  
SERVICE  
MAINTAINED  
TO ASSIST  
GRADUATES

For Full Details without obligation write to our information office: Department AW, 3330 University Ave. S.E., Minneapolis, Minn.

IN CANADA:

English—935 Weston Road, Toronto 9, Ontario  
French—65 Jean Talon St., W. Montreal, Quebec

OPERATING FOR A QUARTER CENTURY  
COAST TO COAST



**MOTOR  
DRIVEN**

R.L.I. of  
New York City re-  
ports: "MY GENERAL  
BLOCK MACHINE  
PAID FOR ITSELF  
IN FIRST 2 WEEKS!"  
Hundreds now in  
use the world over!  
Write for FREE details today!

**EXTRA**

Amazing illustrated  
book gives floor plans for 6 sensational concrete block bunga-  
lows. Tells how to lay blocks, lay out building lines, mix  
concrete, build steps, porch and concrete floors all at great  
savings. Written by experts. Can save many times the cost of  
the machine! Get it now! No strings attached. Send \$1.

BOOK SENT FREE IF YOU BUY MACHINE.  
\$1 REFUNDED IF YOU BUY LATER.

**GENERAL ENGINES CO.**

DEPT. M-18, ROUTE 130, THOROFARE, N. J.



**FORD OWNERS**  
*save  
money!*



Make Your Ford Run Better . . . Last Longer  
. . . and Save Hundreds of Dollars with PM's  
Completely New **MANUAL FOR FORD OWNERS!**

Get this book, written especially for you, without one penny of risk and get more out of your car. Mail coupon for **MANUAL FOR FORD OWNERS** today. When the book comes, skip through the pages and see how your investment in one of America's most popular automobiles can be even a better investment than you thought. If you don't agree, send the book back and you'll get your money back.

**A Popular Mechanics  
Book Written Just for You**

Not a re-hash of service manuals. A complete new Popular Mechanics book written for the Ford owner by an outstanding automotive authority with the full cooperation of Ford engineers and service directors. It will save you money on repairs and service; make your Ford last longer; give you safe, economical and trouble-free motoring. And this is true whether you take your Ford to a regular service station or service it at home.

**Prevents Trouble. Cuts  
Down on Repair Bills**

Nothing like this manual anywhere. It covers all phases of operation, service and maintenance. It has entire chapters on the individual parts of your Ford—battery, ignition, starter, generator, regulator, lighting, fuel system, engine, lubrication, gasoline qualities, cooling systems, transmission, differential, rear axle, brakes, wheel alignment, tire care, body maintenance, trouble shooting on the road, etc. It covers your Ford, new and older models, step by step—bumper to bumper—showing you how parts operate; what can go wrong; how repairs and adjustments should be made and how to avoid all types of trouble.

**Money Back If  
Not Satisfied**

Mail the coupon today. Send only \$3.50 or you can pay postman. Money-back guarantee protects you.

**Official, Authoritative,  
Practical Information**

Written by C. E. Paeker, formerly service school instructor and auto show lecturer for automobile manufacturers, Member Society of Automotive Engineers, Special Services Editor of Automobile Digest, contributor to leading magazines, author of some of the biggest selling books on Automotive subjects.

**All New!**

Covers All Models  
1950 to 1958



**368 Pages. Hundreds of How-  
To-Do-It Illustrations and  
Diagrams**

The entire book follows Popular Mechanics famous easy-to-read and easy-to-understand style. While primarily intended for the Ford owner, to help him get more out of his car at lower cost, it can be worth its weight in gold to the auto mechanic and service station operator who works, not only on Fords, but on all other makes as well, to which the information in the book can be easily applied.

*Order on this Coupon*

POPULAR MECHANICS PRESS, Dept. 158  
200 E. Ontario St., Chicago 11, Ill.

Send Manual for Ford Owners at once. If not satisfactory I will return it within 7 days and you will refund full purchase price.

Remittance for \$3.50 enclosed.  Send C.O.D.

Name \_\_\_\_\_

Address \_\_\_\_\_

City \_\_\_\_\_ State \_\_\_\_\_

POPULAR MECHANICS



**WORLD'S  
BEST  
WANT-AD  
MEDIUM**

# CLASSIFIED ADVERTISEMENTS



Advertisements in this section \$1.25 per word, each insertion, minimum 10 words, payable in advance.

To be inserted under proper classification, copy must be in our office the

20th of the second month preceding date of issue

F. W. Johnson, Manager, Classified Advertising

Popular Mechanics Magazine, 200 East Ontario Street, Chicago 11, Illinois

## YOU'LL PROFIT

By reading and answering the classified ads in this section. Hundreds of opportunities for you to make and save money

### AUTOMOBILES, MIDGET CARS

**MIDGET** Sport car with reverse. Low price. Powermij, 940 North 23rd St., Omaha 2, Nebraska.

**SECRETS** Now available on power, acceleration and performance. Dynamometer proven. Information in detail. Send \$1.00 to Palmint Eng. s.a.e., P.O. Box 126, So. San Gabriel, California. Money back guarantee.

**MAGAZINE** About antique automobiles. Send for free sample copy. Franson's Motor News, Box 17128, San Diego 17, California.

**AUTOMOBILES**, Brand new 1958, most any make. 15% discount. Literature 25¢. Dyer Automobile Co., Detroit 39, Mich.

**WHOLESALE** Costs of any American make car and equipment \$1.00 each make. Briggs, Box 52, Hempstead, N. Y.

**BULLDOZER**—Boy's gas or electric drive. Realistic—Plans and photographs \$3.00. J. Bickford, 25 Pershing Dr., Plainville, Conn.

1958 **SUPERIGNITIONER**: Starting, pep, mileage \$4.50. Kaisers, barbells, art, raritypers, I.B.M.'s. EG, Elmsford, N. Y.

**HUNDREDS** Of automobile catalogs—Old, new and foreign; dealer books; glossy photographs; shop manuals; free motor magazines listed by non-profit club. Write to get on free mailing list. Auto Maniacs, Stockbridge, Mich.

### AUTO SUPPLIES AND EQUIPMENT

**FORD T and A parts?** Try best source old model parts, all makes. Wisneski, Milwaukee 7, Wis.

**POWERSCAN**—Power controlled, car rear view mirror, eliminates the blind spot. Free circulars. Gim Industries, 3420 PM Trimble Ave., Cincinnati 7, Ohio.

**CUT** Oil consumption in your car-truck. Build-yourself instruction \$1.50. Sexton Company, Box 81, Allen, Kentucky.

**RECONDITIONED** Spark plugs 32¢ each postpaid. Satisfaction guaranteed. State make, model of car. Ace Supply Co., P. O. Box 572, Martinsville, Va.

**FREE** Giant 1958 parts catalog. Thousands scarce accessories stores don't have. Gadgets, custom equipment. Send 25¢ postage (refundable). Newhouse Automotive Industries, 5805-PM-1 Beverly, Los Angeles 22, Calif.

**AUTO** Accessory and parts catalog. 1958 edition—All new! 229 pages. Save up to 50%. 75,000 items, including Hollywood accessories, hi-speed equipment, rebuilt engines, all parts and accessories for all cars and trucks! Hard-to-get parts! Send 25¢ (refundable). J. C. Whitney, 1919 PM-1 Archer, Chicago 16, Ill.

**FOUR** Capsules repairs leaking radiators. One dollar prepaid. Chemical Products, 128 Kent St., Brooklyn 22, New York.

**HEADLIGHT** Glare! Stop it when night driving with our Glare-Bars. DuPont Distributors, Box 695, New York 1, N. Y.

**HYDRAULIC** Jack repair kits. Repair your own. Send 25¢ to cover cost of price list. Jack Parts Co., 2000 South Claiborne Ave., New Orleans 13, La.

**WILLYS** Jeep tops—Convertible tops. Free catalogue. Mor-Nan, 500 Rantoul St., Beverly, Mass.

**CHROME** Plating. Do-it-yourself complete kit for automobile chromeware. \$2.98 postpaid anywhere. Guaranteed. Fairmont Chemical Company, East Syracuse, New York.

**RING-Valve** job while driving. \$6.00. Literature. Motaloy, Grantham, Penna.

**NEW** And used parts at savings. Complete guaranteed parts service for all models cars and trucks, 1924 and later. Largest in the West. Jeep and army parts specialists. Newest type shifting hubs for all jeep and all military and latest production front end drive vehicles. \$27.50 and up. Write, Pioneer Auto and Truck Parts Co., 734 W. 13th Avenue, Denver 17, Colo.

**DO-IT-YOURSELF** booklets. 24 different booklets each covering an interesting subject. Free catalog. Popular Mechanics Press, 631 N. St. Clair St., Chicago 11.

**FLASH!** Start your car instantly in cold weather. Guarantee 12 volt on 6 volt battery. For starting purpose only. \$1.00 blueprint instruction. K. S. Service, 142, Bryant, Calif.

**SAVE** Money on Jeep and army truck parts. Large inventory. Catalogs for Jeep or G.M.C. owners. American Auto Parts Co., 1830 Locust, Kansas City, Mo.

**FREE!** New catalog. Speed, power, mileage increasing equipment. Discounts! Almqvist Engineering, Milford PM5, Penna.

**AUTOMOTIVE** Books. Free catalog. Popular Mechanics Press, 631 N. St. Clair St., Chicago 11.

### AUTO TRAILERS

**TRAILERS**. Pickup coach blueprints. Literature 10¢. Comstock Trailers, Parsons, Kansas.

**TRAILER** Manual. Over 200 pages 250 pictures. Tells how to buy, tow, travel, build, live-in, repair. \$1.98. Trail-R-Club of America, Dept. PM 18, Box 1376, Beverly Hills, Calif.

**BUILD** Expanding eight foot trailer. Accommodates five. Literature 10¢. Framar Company, Wilmington, Mass.

**TRAILER** Building manual \$1.00. Booklet 30¢. Kamcraft, Box 1153, Milwaukee 1, Wis.

### MOTORCYCLES, BICYCLES, MOTORSCOOTERS AND SUPPLIES

**RECONDITIONED** Motorcycles and motors. Chromium accessories. Complete stock Indian parts. Expert rebuilding. Fast service. Indian Motorcycle Sales, Kansas City 27, Missouri.

**HARLEY** - Davidsons—Used bargains. New, used parts, accessories for all models. Bulletin, catalog 25¢. Knuth's (Factory Dealer), 1753 Muskego, Milwaukee, Wis.

**RACING** Power cams for Cushman, Whizzer, Mustang, Hiawatha, Continental. Send your cam and \$10. Weber Cams, Box 33175, Los Angeles 33, Calif.

**MIDGET** Car \$10, quarter midget \$55, Doodlebug motorscooter \$20, less engines. Engines \$2.50 up. Whizzer \$15. Servicycle \$35. (Mailorder only.) Send 25¢ (35¢ for first class mailing) for new directory-catalogue number 81, listing these and hundreds of other bargains in new and used motorscooters, midget cars, home-builders parts, plans, etc. Midget Motors Directory, Athens, Ohio.

**NSU** Scooters and motorcycles. BMW motorcycles, 2 to 35 h.p., shaftdrive and chaindrive. Butler & Smith, P.O.B. 45, New York City 24.

**MIDGET** Auto \$25.00; 1954 Whizzer \$20.00; Cushman motorscooter \$25.00; motorcycle \$10.00. Rush 25¢ (35¢ first class mail) for new catalog #962 listing amazing bargains in motors, midget cars, motorcycles, motorbikes, construction plans. Associated, Box 534, Toledo, Ohio.

**SAVE 20%** On genuine H.D. parts. Used parts for Harley, Indian, Cushman, Whizzer, Servicycles. Used outboard parts. Est. 32 yrs. Bill's Cycle Shop, 1005 S. State, Syracuse 3, N. Y.

### AVIATION

**AVIATION** Surplus bargain catalogue. One dime. Box 22PM3, Thomasville, Penna.

**HELICOPTER**—Heliport book, interesting, educational \$1. Become your community's heliport authority, profitable, fascinating. Stuart Tufford, 8518 N. Lyndale, Minneapolis 12, Minnesota.

**ACTION** Airplane photographs. Beautiful colors. 14"x17". Decorate rooms. Six assorted. Send \$1.00. Jarvis, Box 126, Bostonia, California.

**BUY** Surplus aircraft; accessories; engines; instruments; electronics. Direct from U. S. government. List and procedure \$1.00. Aviation Surplus Center, Dept. 50, Eters, Penna.

**GOVERNMENT** Sells—Surplus aircrafts; fuselages; assemblies; accessories; engines; instruments; electronics; misc. Buy direct now from U. S. government. Depot list and procedure \$1.00. Brody, Box 8-PMA, Sunnyside 4, New York.

**PARACHUTES**, \$1.00 Each. Government surplus. Yours will be sent postpaid. Send \$1.00 immediately to Jarvis, Box 126, Bostonia, California.

**SMALL** Helicopters theory and guide manual. Drawings. Construction data. \$2.00. Sandhill Aircraft, Box 336, Atkinson, Nebraska.

**PROPELLERS**, Plans, supplies for airboats and snowplanes. Latest designs, prompt delivery. Catalog 25¢. Banks-Maxwell, Box 3301E, Ft. Worth 5, Texas.



## BATTERIES, GENERATORS

EDISON Nickel storage batteries. Any voltage, any amperage. Unconditionally guaranteed. Power plants, generators, motors. Literature. Hawley Smith Co., Croton Falls 1, N. Y.

## ELECTRICAL SUPPLIES

ELECTRIC Pencil: Engraves all metals \$2.00. Beyer Mfg., 10511-H Springfield, Chicago 43.

LAMPS—Parts catalog containing wiring instructions, 25¢. Gyro Lamps, 3438P N.W. 54 Street, Miami, Fla.

INSTRUCTIONS Preventing electrocution from T.V., radios, appliances. Also testing fuses, wiring, \$1.00 Duckworth, 1102 E. Limberlost Drive, Tucson, Arizona.

MAGNETIZER—Magnetizes screwdrivers, etc., only \$1.00 postpaid. Kubiak, Huntingdon Valley, Penna.

LAMP. Electrical parts, wholesale. Thousands of items for repairing, converting. Catalog 25¢. Brown Lamp, Box 305, Clayton 5, Mo.

## WELDING, SOLDERING, PLATING

ELECTRIC Welders New, heavy-duty, 180 amp. Free trial. Dealerships open. 20 year warranty. 8159 South Pleasant, Department A1, Minneapolis 20, Minn.

WELDERS. 110/220. \$39.50. Morris, 1070 Inner Drive, Schenectady 3, New York.

A.C. Welders, 4 sizes, lowest prices. Free literature. Holgeron's Service, Canton, Kansas.

ACETYLENE Welding outfits, new \$54.50. arcwelders \$56.50. Eagle Welding, Dept. P.M., 5085 Broadway, Chicago 40, Ill.

BUILD-Your-Own welder or welder and power combination. Low cost unit connected to used engine lets you weld anywhere. Free booklet tells how. Get into profitable welding business. Write Hobart-weld, Box M-182, Troy, Ohio.

BUY Welding supplies direct from manufacturer. Cable, welding rods, helmets, etc. Portable arc-welders and kits at tremendous savings. Free factory catalog! LeJag Mfg. Co., 2927 Emerson Ave. So., Minneapolis, Minn.

WELD. Solder, cut, braze.  $\frac{1}{8}$ " welder complete \$7.95. Flame-torch \$3.95. Postage 50¢. 75 ampere transformer welder  $\frac{1}{2}$ " \$24.95 complete. F.o.b. Essay Mfg. Co., Quincy 69, Mass.

## MACHINERY, TOOLS, SUPPLIES

METAL Drawers with index handles. Request literature. Johnson Metal Products, Chalmers, Indiana.

McCULLOCH Chain saw parts for all model saws  $\frac{1}{2}$  price. Used but guaranteed okay. Barnett Equipment Co., So. Glens Falls, N. Y.

POWER Tools, not toys. Discounts. Factory catalogs. World Tool Supply, Box 4404, Joyfield Station, Detroit 28, Mich.

OIL Drum cement mixer assembly kit. Circular. Nu-Way-Do Co., Newaygo, Mich.

SURPLUS Socket wrenches, half-price. Davis, 3606-A Lakeland, Shreveport, La.

DAWN Gage revolutionizes round stock centering for turning or drilling. \$2.96 postpaid. Details free. Dawn Crafts, 215 Commonwealth, Buffalo 18, N. Y.

INDICATORS, Federal #C71 Dial +/- .0005 only \$12.50, postage paid. Special aircraft tools. Genex, P.O.B. 665, Sun Valley, Calif.

\$38.25 POSTPAID. Lathe model engineers. English. Science Now Company, Catskill, New York.

## ENGINES, MOTORS, DYNAMOS

$\frac{1}{2}$  HORSEPOWER Electric motors, a.c. 110, used, good \$5.00 each, f.o.b. Plant Machinery Corp., Richmond & Norris Sts., Philadelphia 25, Penna.

REWIND Motors yourself. Complete instructions \$1.00. Lewis Mfg., Howell, Michigan.

WINDING Data. 375 motors, single and three phase, \$1.10. Data Company, Box 7631, Kansas City 28, Mo.

MOTORS To power turntables, model boats, tiny bench mandrels, and toys. A  $1\frac{1}{2}$  to 3 volt d.c., 5000 to 9200 r.p.m.,  $1\frac{1}{2}$ "x $1\frac{1}{2}$ "x $1\frac{1}{2}$ " h. motor for \$2.00. Also a variable gear kit for speeds 30 to 460 r.p.m. including motor at \$4.00. Garwood, Box 9237, Fort Worth 7, Texas.

GAS Engines: Foreclosure sale:  $1\frac{1}{2}$  to 9 h.p. Brand new, factory fresh, latest models. Briggs Stratton, Clinton, Lauson. Positively below wholesale prices or your money back \$23.50 and up (freight paid). Details free. Northern, 172-M Merrimac Street, Boston 14, Mass.

ELECTRIC Repairmen. Send for catalog ohmmeters, winding equipment. Motor Industries, Quincy, Illinois.

## BOATS, OUTBOARD MOTORS

DECALS—International code signal, 2" square, authentic colors, complete alphabet. Personalize your boat, trailer, car, home. 15¢ each. Free catalogue. Lighthouse Box 145-B, Plymouth, Mass.

BOAT Plans—Full size patterns, frame kits. Modern inboards and outboards for amateur builders. Complete new catalog 50¢ or specify requirements. Glen Designs, 9152 Rosecrans, Bellflower, California.

FIBERGLASS Polyester bonding kit. Strong, durable, light. Illinois Blow Pipe, 3800 Halfday Road, Deerfield, Ill.

FREE Catalog! Boat kits, trailers, fiberglass, marine hardware. Luger Industries, Dept. M-1, 3404 Lyndale South, Minneapolis, Minnesota.

SAVE Money. New, used outboard motor parts. Send wants. Stamp appreciated. Outboard Motor Mart, 229-M State, Boston 9, Mass.

MARINE Conversions for Ford and Jeep engines. Catalog 25¢. Lehman Manufacturing Company, 972D Broad Street, Newark 2, New Jersey.

FULL Size, cut-to-shape boat patterns, blueprints, 7 $\frac{1}{2}$ -36 feet. Big new 88 pg. illustrated "Build a Boat" catalog of naval architect-designed cruisers, runabouts, skiffs, outboard boats, sailing, racing, houseboats, 50¢. "How to Build a Boat" booklet, \$2.50. Hardware and equipment catalog, \$2.00. Cleveland Boat Blueprint Co., Dept. A-66, Box 1651, Cleveland, Ohio.

FORDS and Jeeps 100% marine engines with famous Convo-Kits. Deluxe catalogue 25¢ coin. Oscomotors, 3637B Lawrence, Philadelphia 40, Penna.

NEW, Used, rebuilt marine motors. Marine conversions, fittings. Free catalog. Stokes Marine Supply, Dept. 24, Coldwater, Michigan.

FIBERGLASS Permanent boat waterproofing. Special 25% discount. Complete kits, \$9.45 up. Guaranteed materials. Easy application. Full instructions. Free literature. Ajax Plastics, Dept. PM, P.O. Box 1323, Fort Worth, Texas.

14', 65 H.P.-Lycoming-powered pusher-type air boat. Starter, windshield, wheel, \$595.00. Includes trailer. Ray Carr, 744 Southgate Ave., Daly City, Calif.

FOR Airboat or snow sled. Franklin 4 cyl. 108 h.p. New condition. Warwick Engineering Co., Box 387, Warwick, R. I.

PROPELLERS, Plans, supplies for airboats, snowplanes. Catalog 25¢. Banks-Maxwell, Box 3301F, Ft. Worth 5, Texas.

FIBERGLASS Your boat! Wholesale prices. Send for information, sample. Aqua Glas, Box 99, Altadena, Calif.

DELUXE, Fiberglass, lapstrake dinghies, 2.5 h.p. outboards, \$205.00! 260 powerboat plans, catalog 50¢. Marinecraft, Box 161-M, Brighton, Mass.

BUILD Small boats. Booklet 25¢. Catalog free. Popular Mechanics Press, 633 N. St. Clair St., Chicago 11.

## ATHLETIC EQUIPMENT, BODY BUILDING COURSES

BE Taller! Coach's genuine "Inch-At-A-Time" System, \$1. "Strong Man Foods" \$1. Satisfaction guaranteed. Marty Snyder, Box 195-EZ, Union City, New Jersey.

BARBELLS, Dumbbells. Courses. Free catalogue. Good Barbell Co., Siloam Springs, Arkansas.

OUTSTANDING Physical development! Any age. New guaranteed discovery uses only a rope! Strength, health, muscles. Gain-reduce. Free details. Roperise, 4834-A Art, San Diego 15, California.

## SPORTING GOODS, GUNS, FISHING TACKLE, ARCHERY, TRAPPING

LUOERS! Mausers! Colts! P-38s! Kentuckies! Weatherbys! Antique-modern guns, guncessories! Super bargain catalog only 50¢. Agramonte's, Yonkers 2G, N. Y.

AUTHENTIC Primitive weapon reproductions! Spears, crossbows, edged weapons, etc. Colorful, deadly, decorative. Catalogue 10¢. Primitive Weapons, Pevely, Missouri.

RIFLES, Shotguns, pistols, scopes, ammunition. Dealers prices. Berkshire Gun Rack, Six Lakes, Michigan.

BIG Money raising crickets and 12 inch African fishworms. Free literature. Carter Ranch, Plains, Georgia.

5000 BARGAINS, Firearms, binoculars, war relics. Catalog 50¢. Smith Firearms, Runnemede, N. J.

FREE Sporting goods catalogs! Save 70%. Econ-O-Mart, Whippany 2, New Jersey.

JAP Rifle altering to 30-06, \$6.00. Jap-shells, \$3.95. Catalog 5¢. T. P. Shop, West Branch 11, Mich.

BUILD Barbecue. Complete plans. Booklet 25¢. Free catalog. Popular Mechanics Press, 633 N. St. Clair St., Chicago 11.

HOW To catch fish with small. Secret recipes, formulas, methods, 25¢. Johnston's, 312 Lake Avenue, Ithaca, New York.

FREE—Below wholesale fishing catalog. Fishing Tackle Mart, Dept. 51, Box 6737, Chicago, Ill.

FREE Catalog. Newest items. Bargains. Gadgets, beads, spinners, lure parts, sinker molds. Finnyports MD, Toledo 6, Ohio.

WORLD'S Finest gun "bore" cleaner. (Govt. surplus.) Sample 2¢ can, 25¢ postpaid. Bennett's Surplus, 1262 Campau, Flint 4, Michigan.

SAMPLE: 25¢ Copy of "The Archers' Magazine." Send 10¢. 1200 Walnut Street, Philadelphia 7, Pennsylvania.

## TAXIDERMY

TAXIDERMY Instructions complete in four volumes. \$5.00. "Amateur Tanning" \$1.50. Grantz, 322 N. 15th, Allentown, Penna.

## EARTHWORMS

FREE Folder, "How to Make \$3,000 Yearly. Sparetime, Backyard, Raising Earthworms!" Oakhaven 56, Cedar Hill, Texas.

CALIFORNIA Meal worms. Ice bait supreme. Keeps weeks. 200-\$1.00, 1000-\$3.50 postpaid. Dealers and distributors inquire. Crest Bait Distributors, 3328 Madison Avenue, Indianapolis 77, Indiana.

RAISE Domesticated earthworms. Instructions free. Frank H. Barnhart, 209 Lamont, San Antonio, Tex.

FREE Literature—Amazing profits raising giant fishworms and crickets. Carter Redworms, Plains, Georgia.

EARTHWORM Raising, marketing, feeding. Booklet \$1.00 postpaid. Free, soilless method. R. Goocher, Box 883, Menlo Park, Calif.

## BINOCULARS, TELESCOPES, MICROSCOPES, MAGNIFIERS

REFLECTING Telescope, 60X, completely assembled \$29.75. Guaranteed observatory clearness. Free information. Skyscope, 475 Fifth Avenue, New York City 17.

REFLECTOR Telescope kits \$7.25 (3") to \$175 (12"). Mirrors, cells, focusing mounts, tripods, eye systems. Anything, everything in telescopes. Free catalog Also ready to use telescopes from \$25. Esco Products, Oakridge, N. J.

WAR Surplus bargains: Millions of lenses, instruments, telescopes, binoculars, components and complete line of astronomical telescope items. World's greatest optical market-place! Send only \$1.00 for beginner's 10-lens kit and big instruction booklet Stock 2-CH. Write for catalog "CH," free! Edmund Scientific Co., Barrington, New Jersey.

BUILD Astronomical telescope. 35 page illustrated book. \$1.00 postpaid. Oil Coast Industries, El Campo, Texas.

MICROSCOPE Catalog free. Research Scientific Supplies, 138 West 23rd Street, New York 11, N. Y.



**BUILD** Your own reflector telescope. Complete kit: Mirrors, eyepieces, tripod, all other accessories. Request free illustrated literature. Criterion Manufacturing, Dept. DPM37, Hartford, Conn.

**REFRACTOR** And reflector telescopes. Also mirrors, lenses, tripods, etc., for making your own telescope. Free illustrated catalog. Suffolk Science, Mattituck, N. Y.

**MICROSCOPE** Slides. Anatomical. Free list. Bay, 409 Roosevelt, San Francisco 14, California.

**DYNASCOPE**—Sensational new reflector telescope. Send for details. Criterion Co., Dept. DP40, Hartford, Conn.

**ONLY 25¢!** Powerful imported vest pocket telescope. Magnifies many times! Order today! Southland Products, Lincolnton, North Carolina.

**BINOCULARS**, Telescopes, microscope terrific values \$3.98 up. Request free money-saving catalog. Criterion, Dept. P62, Hartford, Conn.

**SATELLITE** Spotter. Aluminum telescope, 6X, \$2.95. Importer, 3218 SE122, Portland, Oregon.

**MIDWINTER** Sale, amazing prices precision binoculars. Folder "Binocular Selecting," catalog free. Prentiss Importers, Mercury Bldg., West Los Angeles 25, Calif.

### PLANTS, SEEDS, BULBS, NURSERY AND GARDEN SUPPLIES

**WE** Sell on the installment plan. Best varieties peach and apple trees, low as 20¢; grapevines 8¢; shrubs 13¢; evergreens 20¢; berries and plants. Catalog free. Benton County Nursery, Box 561, Rogers, Arkansas.

**RAISE** Your shrubs, trees from seed. Free planting guide, price list. Woodlot Seed Co., Norway 9, Michigan.

**WORLD'S** Greatest cash crop. Free information. Write Ginseng Gardens, Asheville, N. C.

### PETS—DOGS, BIRDS, RABBITS, HAMSTERS, ETC.

**WE** Pay \$3.50 lb. dried. Grow mushrooms, cellar, shed and outdoors. Spare, full time, year round. We have 25,000 customers. Free book. Washington Mushroom Ind., Dept. 171, 2954 Admiral Way, Seattle, Wash.

**BEAUTIFUL** Pure white pedigreed police puppies. Ansonia Kennels, McHenry, N. Dak.

**HAMSTERS**—Young Golden, pairs \$2.50; breeders \$3.50. Engle's Hamstery, 2609 South 11 $\frac{1}{2}$  St., Terre Haute, Ind.

**RAISE** Rabbits successfully by knowing facts. 48 page illustrated book describing 25 breeds. Housing, feeding, breeding, marketing, etc. Plus bulletin, 25 cents. American Rabbit Association, 36 Arba Building, Pittsburgh, Penna.

**MAKE** Money raising chinchillas, mink, nutria, rabbits, cavies for us. Free catalog. Keeney Brothers, New Freedom 2, Penna.

**STRAIGHT** Cooners! World's oldest kennel. Combination hounds, rabbit, fox, beagles, deerhounds, bird dogs. Puppies of all breeds. Prices reasonable. Trial. Free catalogue. Raccoon Mountain Kennels, Box 464, Boaz, Alabama.

**SPORTSMEN**: World's largest kennels offers 500 bird dogs, straight cooners, combination hounds, beagle hounds, rabbit hounds, small squirrel dogs, fox and deer hounds. Catalogue free. Smokey Mountain Kennels, Cleveland, Tennessee.

**ANGORA**, Chinchilla, New Zealand rabbits. Particulars free. Grinsteads, Edwardsville, Illinois.

**RAISE** Rabbits. Make money. We furnish breeding stock. Pay us later with young rabbits you raise. Send \$2.00 for details, also market information, book on rabbits, subscription Rabbit Magazine. Johnsons, Box 683, Kansas City, Missouri.

**HAMSTERS**—Young Golden pairs, \$2.29; breeders, \$3.29. Free literature. Syram Hamstery, 1042 First East, Oskaloosa, Iowa.

**DESCENDED** Skunks, monkeys, hawks, reptiles. Illustrated catalogue, 25¢. Trails End Zoo, St. Stephen, S. C.

**WHY** Ordinary trade? Receive squab prices. Thousands wanted daily. Write Ledford Farm, Box 685P, Gaffney, S. C., for free secret-revealing book.

**RACCOONS**, Minks. Bred females. Baby skunks. Catalog, 25¢. Shady Fur Farm, Springfield, Minnesota.

**RAISE** Rabbits or mink on \$500 month plan. Free details. White's Rabbitry, Delaware, Ohio.

**HAMSTERS**—Ideal pets. \$2.95 pair. Free booklet. Jer-Fre's Hamstery, 2425 Hoyt, Muskegon Heights 13, Michigan.

**WHITE** German Shepherd puppies. Theatrical dog tricks. Knoff, Nashotah, Wisconsin.

**HAMSTERS**—Golden: Young, \$3.00 pair, breeders, \$4.00 pair. New mutation, \$5.00 pair. Adirondack Hamstery, Prospect 10-A, New York.

### FUR BEARING ANIMALS

**BRED** Females, mink-nutria. Finest quality. Reasonable prices. Voight Farms, Atlanta 2, Texas.

**MINK** Raising information free. Complete. Lake Superior Mink Farm, Superior, Eel, Wisconsin.

**RAISE** Mink: Free booklet, pen plans, inside secrets, feed, care. Mink are money makers. Investigate today. Lawrence Molgard, Brigham City 12, Utah.

**1000 BRED** Mink — Booklet, plans 25¢. Lake Ontario Ranch, Gravel Road, Webster, N. Y.

### FARMS, FARM LANDS, REAL ESTATE

**FREE** Strout catalog! Farms, homes, businesses, resorts, retirement properties. Over 2900 values in 34 states. 57 years' service. World's largest! Write Strout Realty, 7-MP So. Dearborn, Chicago 3, Ill.

**HOMESITES** \$15 Monthly—California's finest garden section. Morro Bay's scenic shores. Wonderful fishing, boating. Fertile soil, softest water, temperate climate, congenial community. Free literature. Richard Otto, Department M, San Luis Obispo, California.

**\$5.00 MONTHLY** Buys 40 acres productive land. Near town. Price \$250.00. Free list. Box 425-P, Carthage, Mo.

**FLORIDA**. Nice homesites, \$345 at \$10 monthly. Folder free. Howard Vernor, DeLand, Florida.

**FLORIDA** Homesites, new lakeside development. Moderate prices, monthly payments. Pine hunting, fishing. Adjoins Ocala National Forest. Literature. Grace Parker, Paisley, Florida.

**FLORIDA** Homes with income. Low taxes. Box 848, Eustis, Florida.

**CANADIAN** Tax sale lands for three dollars an acre and up. Small monthly payments. Farms, timber, hunting and fishing camps, minerals. Limited number of properties. Write at once for free catalogue. Tax Sale Service, Room 105, 120 Bloor St., W., Toronto 5, Canada.

**FLORIDA** — 2 $\frac{1}{2}$  Acres; \$15 down, \$15 monthly; full price, \$695. High elevation, near Gulf of Mexico. Suitable farming, citrus, poultry. Free information. Florida Sunshine Coast Development Co., Brooksville, Florida, Dept. PM-1.

**CALIFORNIA** Investment bonanza, 40 to 640 acre tracts state land, \$5 acre minimum. 10¢ brings brochure. Pioneer Ranches, 7419-PM Beverly, Los Angeles 36, California.

**FARMS** \$195. \$10 Monthly. Descriptions free. Write: Armstrongs, Shook, Mo.

**FLORIDA'S** Finest trailer sites beautifully wooded, 80 by 100 feet. Payable \$20 cash and \$20 monthly. Famous Panama City gulf resort area. Excellent hunting, fishing, all sports. Also lovely wooded homesites low prices, easy terms. Booklet free. Wendell Wood, Fountain, Florida.

**TEXAS** Cabin sites, 5 clear mammoth lakes. Finest fishing, hunting. Good roads, electricity. Developing fast. Private boat dock, fishing pier, barbecue pits, tables, and picnic grounds free to lot owners. Ideal for retirement or recreation. Near 3 thriving towns. Everything you could wish for. Two (2) adjoining lots total cost for both only \$145.00, \$10.00 down, \$10.00 month. Write for maps, photos, etc. Dept. GS-8, Box 50, Kingsland, Texas.

**OPPORTUNITIES!** Government land. U. S., Alaska, Canada. Sledge Surveys, Macon, Mississippi.

**SCENIC** Mountain homesides near state park, lake, \$295 at \$5 monthly. Free literature. Evelyn Pratt, Box 6331, Greensboro, N. C.

**BIG** Acreage, small price. 336 Tennessee acres for only \$5,500! Ideal livestock and tree farm. Large year-round spring creek. 75 acres tillable, 250 wooded, 35 now in pasture, acre orchard. Older-type 5-room home, 2 fireplaces—See picture in catalog. Two barns, 3 poultry houses, smokehouse, good well house, tenant house. On school bus, r.f.d. routes, handy to store. Quick buyer gets hay baler, mowing machine, miscellaneous tools for only \$5,500, \$1,000 down. Immediate possession! Free winter catalog, bargains coast to coast! United Farm Agency, 1304-PM Consumers Bldg., Chicago 4, Ill.

**SUMMER** Cabin sites, inside Glacier Park. Level, trees, accessible. 50x98, excellent title, \$200. \$10 down, \$10 monthly. Free folder. Charles Green, Coram, Mont.

**FLORIDA** Trailer homesites. Water system. \$495.00. \$10.00 monthly. Lake privileges. Box 2005, Deland, Florida.

**WANTED** — Brotherhood group to rent 120 houses. Pictures, map. Perrys, Brier Hill, Penna.

### PROFITABLE OCCUPATIONS

**INVESTIGATE** Accidents—Earn \$750 to \$1,000 month. Thousands of airlines, insurance companies, steamship lines urgently need claim investigators. We train you home spare time. Placement counsel and help. Free book, now! No obligation. Universal Schools, T-1, Box 8202, Dallas 5, Texas.

**\$10,800 PROFITS!** Your own mailorder business! No risk! Treasury, 709 Webster, New Rochelle L-58, N. Y.

**ANNOUNCING** Home study course in commercial baking. Practical basic training. Good field for those with aptitude. Free booklet, "Opportunities in the Baking Industry." National Baking School, 835 Diversey Pkwy., Dept. 3431, Chicago 14.

**MAGAZINE** Subscription—Largest commissions. Bonus. Qualified Agency, 451DA Kingston, Brooklyn 25, N. Y.

**WELDERS** Make money. Learn quick at our modern school. Enroll today. Write or visit Galion Welding, Galion, Ohio.

**HOME** Mailorder beginner's manual, sources, methods, opportunities, 25¢. Carnahan Bros., 9610 Acacia, Fontana, Calif.

**FREE** Information, mail order business. Write Box 8382, Albuquerque, New Mexico.

**RECEIVE** Samples, job, money earning opportunities. Informative literature, \$1.00. Duals, 4821 Homerlee, East Chicago, Indiana.

**\$60.00 WEEKLY**, Sparetime — Easy! Home Venetian blind laundry. Free book. Burt, 2434ES, Wichita 13, Kansas.

**FREE** Book "990 Successful, Little-Known Businesses." Work home. Plymouth, 1610-43 Street, Brooklyn 4, N. Y.

**MUSHROOMS** Quicker, easier, cheaper. Newest facts free. Luxur, 641 South 19th, Newark 3, N. J.

**MONEY** Plans! Secret Journal, Grandpa, two daughters made \$2,500 first month! Work home. Publiccos, Oceanside, Calif.

**WE** Pay \$3.50 lb. dried. Grow mushrooms. Cellar, shed and outdoors. Spare, full time, year round. We have over 25,000 customers. Free book. Washington Mushroom Ind., Dept. 99, 2954 Admiral Way, Seattle, Wash.

**SAVE** Money! Buy wholesale! Free catalog general merchandise. Norris, 487-M Broadway, New York City.

**SPARETIME** Repeat profits taking magazine subscriptions. Special offers. Cassell Agency, Boynton Beach, Florida.

**FREE** Folio "\$5,000-\$45,000; Unlimited Vacations." No merchandise. Unknown! Work home, sparetime! Haylings, Carlsbad, Calif.

**BE** The Popular Mechanics representative in your neighborhood and earn big profits in your spare time. Write Popular Mechanics Magazine, Room 305M, 200 E. Ontario St., Chicago 11.

**BIG** Money raising fishworms and crickets. Free literature. Carter Wormery, Plains, Georgia.

**BAKE** New greaseless doughnuts in kitchen. Sell stores. Free recipes. Michael Ray, 3605 South 15th, Minneapolis 7, Minn.

**FREE** Book "505 Odd, Successful Businesses." Work home. Pacific, Oceanside, Calif.



**RAISE Pheasants on \$100 week plan.** Little capital and space can make you independent. Free details. Great Central System, Columbus 1, Kansas.

**MAKE Flexible molds.** Cast plaques, figurines. Free sample. Tooker, 1045-M Fairview, Hamilton, Ohio.

**VENDING Machines—No selling.** Operate a route of coin machines and earn amazing profits. 32-page catalog free. Parkway Machine Corporation, Dept. 25, 715 Ensor Street, Baltimore 2, Maryland.

**AUCTIONEERING—Home study course.** Diploma granted. Auction School, Ft. Smith, Ark.

**BUY Wholesale!** Over 10,000 nationally advertised products. Appliances, cameras, sporting goods, housewares, watches, typewriters, tools, clothing, etc. Send post-card today. Buy-Rite, Box 258, Hawthorne 3, New Jersey.

**LEARN The high paying newspaper trade at home.** For details write Thomas Smith, P. O. Box A-3987, Sarasota, Fla.

**AMERICA'S Largest wholesale supply.** Buy, sell. Amazing profits. New free plan. Associated Wholesalers, Box 52-DX, Burlington, Iowa.

**BIG Profits in welding.** Easy to learn. Low cost training in completely equipped non-profit school. GI approved. Write for free booklet. Hobart Trade School, Box M-183, Troy, Ohio.

**EARN \$240.00 A month at home,** spare time doing only two \$5.00 invisible mending jobs a day. Big money paid for service that makes cuts, tears disappear from fabrics. Steady demand. Details free. Fabricon, 6236 Broadway, Chicago 40, Ill.

**\$1000.00 MONTHLY For 27 years!** Astounding mailorder plan! Free facts. Dixieland Publishers, Asheboro 64, N. C.

**WHOLESALE!** Clothing, appliances, jewelry, furniture, etc. United Wholesalers, 1265 C. Broadway, New York 1, N. Y.

**START Mail order discount business at home** selling gifts, appliances, books, housewares, watches, jewelry, cookware, tableware, dinnerware, cutlery, etc., at discounts to 75%! Invest nothing in stock. We ship orders under your name. Self-selling catalogs printed with your name, names of mailorder buyers supplied. Catalog, details free. Topval Corp., Lindenhurst 817, N. Y.

**FOOD Supplements booming!** Sell super-potent "Supervite." Vitamin Specialties, 5522 1/2 Hollywood, Los Angeles 28.

### BOOKS, PERIODICALS, PICTURES, POSTCARDS

**OUT-Of-Print books at lowest prices!** You name it, we find it! Fast service. No obligation. International Bookfinders, Box 3003-PM, Beverly Hills, Calif.

**NATIONAL Geographic Magazines, 1888-1956.** Periodical Service, Box 465-PM, Wilmington, Delaware.

**"HOME Improvement Guide."** New, amazing 192 page volume. Packed with ideas, plans for remodeling, decorating, landscaping, built-in projects, \$2.50 pre-paid. Popular Mechanics Press, 200-HG East Ontario St., Chicago 11.

**RARE Magazines, catalog 10¢.** Nationwide Exchange, Box 1375-P, San Antonio 6, Texas.

**BOOKFINDERS!** All subjects. Send wants! Jaher Book Service, 183 Hazelwood Drive, Westbury, N. Y.

**FREE: Exciting catalog packed with books covering most everything.** Think of it—From cover to cover you will find described and illustrated hundreds of books telling how to fix and how to build almost anything. How to remodel your home; do your own decorating, plumbing, electrical work. Simplified books covering concrete work, carpentry, painting, furniture making and refinishing. How to build your own boat, home workshop tools. Best books on photography, welding, hobbies, homecraft. How to make a home freezer. Send for your free copy now. Popular Mechanics Press, 200-BC East Ontario St., Chicago 11, Ill.

**FREE: Catalog!** Hundreds of subjects! Treasure-Site Book Company, 279 South Alden, Philadelphia 39.

**JOHN Friend, bookfinder, can get the books you want.** Free search service. Box 2570PM, Long Beach 1, California.

**BOOKHUNTERS!** Scarce, miscellaneous books. Atlantic Book Service, Cedar Street, Charlestown 29, Mass.

**DISPOSAL Sale:** New-used books. List sample free. Persil, 438 New York Ave., Brooklyn 25, N. Y.

**BRITISH Book bargains—Any subject.** Catalog free. Transbooks, Box 1-PMS, Wantagh, N. Y.

**DO-It-Yourself books:** Free list. Stanford Simon, Box 931, Lake Arthur, La.

**UNUSUAL Books.** Free literature. Write: Monti, 219 Tinton, Eatontown, N. J.

**SPECIAL 30¢—32 Page booklet, "Your Aquarium"** for 15¢. Innes Publ. Co., 12th and Cherry Sts., Philadelphia 7, Penna.

**RACING Homing Pigeon Magazine** (11 issues yr.). Articles on breeding, training, club news. Yearly subscription \$3.50. Sample copy free. American Racing Pigeon News, 2421 Old Arch Road (PM), Norristown, Penna.

### GAMES, TOYS, NOVELTIES

**TOY Soldiers, pirates, or cowboys \$1.25 per hundred.** Three hundred \$3.20. Doyle, 5849 Burns Street, Forest Hills 75, New York City.

### MAGIC TRICKS, PUZZLES, JOKER NOVELTIES

**20 LICENSES And permits, assorted.** \$1.00. Ace, Box 142, Camden 1, New Jersey.

**VANISHING Cards with magic catalog.** 25¢. Box 391, Jackson Heights, New York.

**3100 NOVELTIES, Jokes, tricks, gadgets, funmakers, hobbies.** Big catalog 10¢. Johnson-Smith, D-424, Detroit 7.

**VENTRILOQUISM, easiest method.** Details free. Smith, 2125 N. Bigelow, Peoria, Ill.

**VENTRILLO, Professional voice-throwing instrument and catalog 25¢.** Box 971-PM, Philadelphia 5.

**WORLD'S Finest professional magic.** Joker novelties. Giant illustrated catalog 10¢. Top Hat, Evanston 12, Illinois.

**BE A magician! Large professional catalog of latest tricks.** 35¢. Ireland, C-109 North Dearborn, Chicago 2, Illinois.

**PROFESSIONAL Catalog, 175 pages, 25¢.** Williams, 900 Plymouth, Ellwood City, Penna.

**DOLLAR Magic set free with catalog 25¢.** 4462-PM Germantown, Philadelphia.

**WHOLESALE! Thirty 10¢ trick novelties \$1.00!** Profits! 1746-W Market, Philadelphia 3.

**SENSATIONAL Magician's wand 25¢.** Vanishes handkerchief! Catalog included. Box 1352-PM, Philadelphia 5.

**SMOKEBOMBS 25¢, 7 For \$1.00.** Terrific! 4463-PM Greene, Philadelphia 44.

**ONLY 10¢ Brings you magic's greatest value.** Douglas famous catalog, 500 tricks. Tricks for amateur and professional, for pocket, parlor, club, stage, with balls, coins, cards, cigarettes, silks, apparatus. Fastest service to magicians everywhere for over 30 years. Amaze your friends, send 10¢ today. Douglas Magicland, Dept. 10, Dallas, Texas.

### COINS, TOKENS, CURRENCY

**RAREST Carson City mint dollar 1885.** Uncirculated, \$3.00. Illustrated coin catalogue 25¢. Shultz, Salt Lake City 10, Utah.

**21 DIFFERENT Indianhead cents \$2.00.** Bargain lists free. Sayers, 1000 Unaka, Johnson City, Tennessee.

**1958 GIANT U.S. coin catalogue 25¢.** Ace, 314 S. Clark, Chicago 4.

**WHOLESALE Coins for dealers, investors.** Lists 10¢. Al Johnson, Box 35, Colorado Springs, Colo.

**44 DIFFERENT Uncirculated coins.** \$1.00. Oddehon, Box 482, St. Louis, Mo.

**SAN Francisco mint closed! Made only cents and dimes in 1955.** In short supply and great demand. One each, brilliant uncirculated, for 25¢. Free coin lists with order. Bryson Stamp & Coin Company, 612 White, Toledo 5, Ohio.

**BARGAINS, U.S. coins: 1893 Columbian world's fair half dollar, \$1.00.** Ten different Indian pennies, 75¢. Two-cent piece, and 3-cent piece, \$1.00. Gold 1/4 eagle, \$9.00. Gold 1/2 eagle, \$12.50. Beautiful coin bracelet, \$1.00. Many coins available. What do you need? Rare Coin Company, 31 North Clark, Chicago 2.

**LARGEST Coin magazine, 180 pages, 35¢.** Scrapbook, 7320-J Milwaukee, Chicago 31.

**COINS From Formosa, Vatican, etc., plus foreign banknote, 10¢ with coin approvals.** Littleton Coin Co., Littleton 81, New Hampshire.

**LINCOLN Cents 1910-S, 1913-S, 1921-S, 1923-S, 1924-S, all for \$2.** Gasser's, Box 34615, Los Angeles 34, California.

**GET Profit and pleasure in collecting old coins.** Send 10¢ for 56-page illustrated coin catalog. You'll be delighted with it. Send for it now. B. Max Mehl, 370 Mehl Building, Fort Worth, Texas. Largest rare coin establishment in U. S. Established 40 years.

**OLD United States gold coins bought.** John J. Pirpo, 120 Santa Ana Ave., San Francisco 27, Calif.

**COMPLETE United States coin bargain lists, Indianhead cent, 10¢.** Economy Sales, 156-A Dean, Mansfield, Mass.

**NUMISMATIC Magazine samples 25¢.** Subscription \$2. Stamps accepted. Flying Eagle, 229-M South 11th, Newark 7, New Jersey.

**START Your own coin collection.** Information, price lists, 10 different dates, Lincoln cents prior 1921, \$1.00. Louis Bell, Masonic Building, Decatur, Alabama.

**WANTED—1822 \$5.00 Gold pay \$10,000.00.** 1913 liberty head nickel \$4,000.00. 1894-S dime \$2,000.00. 1876-C.C. 20¢ piece \$1,000.00. 1901-S quarter \$60.00-\$500.00. 1922 50¢, \$6.00-\$80.00. 1885 trade dollar \$1,000.00. Uncirculated dollars 1804-1839, 1893-S, 1895-P, 1903-O \$100.00-\$5,000.00. Certain dates Lincoln cents before 1932, \$100.00; flying eagle cents, \$500.00; Indian cents, \$140.00; dimes before 1943, \$300.00; quarters before 1924, \$1,000.00; half dollars before 1905, \$1,000.00; halfcents, \$500.00; 2¢ pieces, \$100.00; 3¢ pieces, \$130.00; half-dimes, \$500.00. Hundreds of others worth \$10.00-\$1,000.00. Canadian coins: 1921 5¢ silver, \$100.00. 1889 dimes, \$50.00. 1875 quarters, \$75.00. 1921 50¢, \$500.00. Wanted—Large cents, gold coins, paper money, etc. Know their true value. Our large illustrated guarantee buying-selling catalogue, send \$1.00. Purchase catalogue giving complete alcoin information before sending coins. Catalogue dollar refunded on \$20.00 sale. Thousands of persons have sold us coins. Worthycoin Corporation Incorporated 1938. Leaders Numismatic Quotations, K-440-C, Boston 8, Mass.

**CASH For Indian cents.** Frank Dimambro, 527 Niagara, Utica, N. Y.

**OLD Money wanted.** Will pay fifty dollars for nickel of 1913 with liberty head (no buffalo). We pay cash premiums for all rare coins. Send 5¢ for large coin folder. May mean much profit to you. Numismatic Co., Dept. 20, Fort Worth, Texas.

**LINCOLN Cents, buffalo nickels, Canadian large cents.** Bargain list 10¢. Hughes, 21 Ottawa, Grand Rapids, Michigan.

**MEXICAN Silver dollar (peso) \$1.00.** Kossan Service, 142, Friant, Calif.

**LARGE Cent \$1, bargain list included.** Delmaco, Box 1123, Wilmington 99, Del.

**SOUTH American banknote and lists—10¢.** Dwight Musser, Dunbar, West Virginia.

**FREE! Every serious collector wants our free circular.** Write: Emporium, Wenona, Illinois.

**BRILLIANT, Uncirculated Mexican silver peso, 35¢.** Free bargain list. Spranz, Box 168, Alamo, Texas.

**SILVER Dollars: Uncirculated, 1879p through 1891p, 1897p \$2.00 each, 1893cc \$15.00.** Retail lists 10¢. Holden's, Garwin, Iowa.

**PRIVATE Collector wants buy Lincoln cents, fine, better.** Rolls, sets, singles. Send description, price. Wright Titus, 2017 Cedar Springs, Dallas, Texas.

**COIN Bargain lists "Canadian Bulletin"** 10¢. Marles, Box 833, Calgary, Canada.

**COIN Albums and accessories.** Send dime for new 24-page illustrated catalog. Coin Care Corp., 1627 West Anahelm, Long Beach 13, Calif.

**FORTUNE And a hobby, too.** "Coin Collecting for Profit," \$1.00. Refundable. Lists and uncirculated coin, 10¢. Elliott, 235 Juniper, Coraopolis, Penna.

**20 DIFFERENT Early Lincoln cents, \$1.00.** Approvals. Buza, Stevens Point, Wis.

**INDIAN Cent plus Bargain Lists 10¢.** Hutchinson's, Box 4747, Philadelphia 34, Penna.



32 PAGE Deluxe U.S. illustrated coin list 25¢. Stoney, 192 Washington, Boston 8, Mass.

PAYING \$4.00 A hundred for Indian head pennies. Fred Carpenter, Mantl, Utah.

GROW Money at home! Proof sets of coins grow rapidly in value! In 1936 a proof set cost \$1.81. Today, it is worth over \$400.00! Each set contains 5 beautiful coins: 1¢, 5¢, 10¢, 25¢, 50¢; hand-struck by the mint especially for collectors. Proof sets are treasures as investments and make wonderful gifts. Get yours now: 1957 set only \$3.00; 1956—\$4.00; 1955—\$6.50; 1954—\$7.50; 1953—\$13.00; 1952—\$24.00; 1951—\$33.00; 1950—\$53.00. Complete set 1950-1957 inclusive—\$135.00. 10-day money-back guarantee. Send your want lists for other coins. Postal Products Company, Jos. Gordon ANA 11036, Fast Mail Order—5614-MC California Street, San Francisco 21, California.

U. S. Coins command high prices. U. S. coins, including many found in your change, command high prices. "The Handbook of U. S. Coins" 1958 edition illustrates, describes and lists the prices paid by reputable dealers for every coin ever minted by U. S. 126 pages of fascinating and valuable information. Only \$1.00 postpaid. Empire State Coin & Stamp Co., Empire State Building, Suite 337, New York City. We buy coins.

FOREIGN Coin, banknote and large illustrated coin list for 3¢ postage. Bargains: Indian head cent, 10¢; wooden nickel, 10¢; Chinese dollar, 53¢. Approvals included with every order. Tatham Coin Company, Springfield 30, Massachusetts.

ADVANCE Orders taken now on 1958 proof sets. Get yours early! One set, \$2.50; 10 sets, \$24.00; 25, \$59.00; 50, \$115.00; 100, \$223.00. Postpaid. Money-back guarantee of satisfaction. Many other proof sets and coins in stock. Send your want lists. We buy coins also. Dan's—Dan Morafka ANA, 432-P 23rd Ave., San Francisco 21, California.

U. S. Large cent and two cent piece and coin list only \$1.00. Pounds, North Wales, Penna.

GIGANTIC 82-Page bargain catalogue \$1.00 (deductible on \$10.00 order). Large dollar bill (new) \$7.50, \$5 gold \$11.95 (paying highest prices all gold coins, any quantity). Guidebook \$1.75; Premium handbook \$1.00. Currency catalogue \$1.00. Fast service. Beebe's, 4514 North 30th, Omaha 11, Nebraska.

ONE Million dollars Confederate money in \$10's, \$20's, \$50's, \$100's etc. only \$2.98. Limit four million for only \$10.00. Best Values Company, Dept. M-216, 401 Market Street, Newark, New Jersey.

### STAMP COLLECTING

DEALERS—Wholesale list. Postage 3¢. Frank, 5031 Queensberry, Baltimore 15, Maryland.

PRE 1894—United States, three copies free to approval applicants. Collier, Chamblee, Ga.

312 MIXED U. S. only 10¢ to Gold Nugget approval applicants. Nothing like them. Kessel's, Box 6116, Tucson, Arizona.

AUSTRALIA—Fifty different exciting commemoratives, animals, kings, queens. This valuable Australian collection only 10¢ with approvals. Viking, Great Neck 8, New York.

307 DIFFERENT Stamps 25¢, including India, China, Vatican, Russia, British Colonies, Japan, Africa, Scandinavia, Pakistan, Newfoundland, Australia, exceptionals, unusuals. Only with approvals. Lincoln Stamp Company, St. Catherine's 218, Ontario.

TERRIFIC Stamp bargain! Israel, Iceland, Vatican assortment—Plus exotic triangle set. Also fabulous British Colonial accumulation. Plus large stamp book. All four offers free. Send 10¢ to cover postage. Empire Stamp Corp., Dept. PM, Toronto, Canada.

STAMP Finder, world map and encyclopedia of stamp issuing countries only 5¢. Approvals. Goliath Company, Bethlehem K1, New Hampshire.

25 QUALITY British Empire pictorials, 25¢. Approvals. Abbott, Andover, Conn.

ROMANIA, 180 Different complete commemorative, semipostal, airmail sets, Scott over \$50, for only \$13.25. Unusual Stamp Service, Box 1116, Palos Verdes Estates, Calif. (Members APS, SPA, ASDA.)

FREE—Airmails, commemoratives, pictorials, Approvals. H. P. Wischart, Frankfort, Ohio.

200 DIFFERENT Argentina \$1.00. Doc Shoenfelt, 259 Belmont, Mansfield, Ohio.

FREE United States commemorative list. H & S, 45 Bromfield, Boston, Mass.

320 DIFFERENT 25¢. Includes everything: Worldwide collection, pictorials, airmails, sets, Vatican, Israel, Philippines, Bolivia, Albania (Roosevelt), Indonesia (Famous American), topicals, bird, flower, fish, others. Everything 25¢ to those requesting approvals. Century Stamps, Box 7-M, New York 71, New York.

100 STAMPS 10¢ With bargain approvals. Hazard, 520 S. Paddock, Pontiac, Michigan.

"VALU-Packed" American stamp catalog, 10¢! Sullivan, Pioneer Building, St. Paul 1, Minn.

77 DIFFERENT U. S.—25¢. Approvals. Utecht, 1134D North Keeler, Chicago 51.

FIRST U. N. set. Among world's prettiest. Only 10¢. Approvals. Welles, Box 1246-R, New York City 8.

100 DIFFERENT China 10¢ with approvals. Plymouth, Dept. A-9, Bell, Calif.

7 CANAL Zone 10¢. Approvals. Merkel Stamps, 30 Grandview, South Hadley Falls, Mass.

TEN Israel, free! Popular-priced, attractive approvals accompany. Nymed, Box 503, Biloxi, Mississippi.

SUPERIOR Worldwide mission mixture. Amazing variety! Half pound \$1.60 postpaid. Bay Nielsen, 4545B Harvard, Montreal 28, Canada.

U. S. Stamps. Giant bargain catalog—10¢. Raymax, 35-VZ Maidenlane, New York City 38.

EXTRAORDINARY Antaxotic set free with approvals. (Postage appreciated.) Variety Stamps, Box 98-B, Newton Highlands 61, Mass.

300 DIFFERENT Given free with approvals. Particulars. Windsor Stamps, 8834 Cornell Ave., Chicago 17.

FREE, Surprise assortment, 50 different world wide. With attractive approvals, popular prices. Banner, Box 65-M, Park Forest, Illinois.

GIANT Approvals, thousands different, 1¢ and 2¢ each. Wahl's Stamp Exchange, 7008P Farragut, Chicago 31, Ill.

60 DIFFERENT U. S., included 30 commemoratives 25¢. No approvals. Seidenberg, Appleton, Wisconsin.

25 SWITZERLAND, 3¢ With approvals. L. Salsman, 1729 Milvia, Berkeley, Calif.

WONDERFUL Offer. 7 complete mint sets only 10¢ with approvals. Reich (M26), 1033 Lawrence, Chicago 40.

UNITED Nations. Five different 10¢. Approvals. Anderson, 1112 Harrison, San Francisco 3, Calif.

800 WELL Mixed U. S. 25¢. Monjar, 1750 Fairmount, Cincinnati 14, Ohio.

10 DIFFERENT Israel 10¢ with approvals. Wheeler, Winona Lake, Indiana.

1958 U. S. Price list. 25¢. Lee's, Box 796, Rockford, Illinois.

1000 DIFFERENT, \$1.00 With approvals. Louis Golden, 6721 Eastwood, Philadelphia 49, Pennsylvania.

FREE Monaco holy year issue with approvals. Stamps, Diamond, Pennsylvania.

FREE! Amazing list! Alphabetical! Two feet long! Stampmart, Hartford 1, Conn.

FREE 200 different good stamps with low priced approval. Joseph Reiner, 6428 Morningside Drive, Kansas City, Mo.

\$5.00 COOLIDGE, Only 15¢. Write for details. U. S. stamps exclusively. Futurama, Box 7282, Miami (Ludiam), Florida.

MINIATURE Collection Queen Elizabeth sets! Dominica, Virgins, Barbados, Gibraltar, Tristan, Malta. 21 mint bicolors, 25¢. Approvals. Gannon Stamps, Box 931, Canton 1, Ohio.

PENNY Approvals! Regardless catalogue! Kloster, 4154—52nd St., San Diego 5, Calif.

14,000 DIFFERENT! Amazing new plan builds your collection systematically, country by country. Only 50¢ weekly. Free details. L. G. Ware, Stepney 75, Conn.

FREE 50 Worldwide introducing inexpensive approvals. University Stamps, P.O. Box 95, Tamiami Station, Miami 44, Florida.

INTRODUCING Our better United States approvals, we offer 15 United States stamps including Columbian, Pan-Pacific, famous American, airm, others; only 10¢. Ocean Stamps, Box 64-PM, Brooklyn 29, New York.

UNITED States price list, 116 pages, price 25¢. Mark Hanna, 335 Fifth Ave., Pittsburgh 22, Penna.

U. S. Mint flag set, complete, \$1.00. Free list. Brooks, 2323 Avenue X, Brooklyn 35, New York.

SPACEPHOBIA? Our 1¢-2¢ approvals cure quickly. BKJ, Astor, Boston 23, Mass.

FREE! 100 British Empire, 10¢ handling. Approvals included. Kensington Stamps, Buffalo 15, N. Y.

"ABE Lincoln" giant diamond, rainbow colored flag set, Israel, South Korea, 50 others different only 10¢. Approvals. Champlain, Isle La Motte, Vermont.

FREE United States illustrated catalog. Bailey, 45 Bromfield, Boston, Mass.

U. S. approvals. Low prices. Eagle Stamps, Romine Ave., Pittsburgh 26, Penna.

ECONOMICAL 1/2¢-3¢ Approvals, 33,000 varieties. Dresel, Box 128-N, West Englewood, New Jersey.

TWO \$5.00 U.S. stamps plus 20 different, 10¢ with U.S. approvals. Irwin, Box 1105, Brooklyn 30, N. Y.

FREE! 107 British Colony stamps. All different, from Britain's farflung colonial empire. Catalog value \$2.50. Free stamp magazine, approvals. Send 10¢ for handling. Act now! Niagara Stamp Co., St. Catherine's 71, Ontario.

UNITED States commemorative collection containing 33 different—10¢. Approvals. White, 516-A Avenue L, Brooklyn 30, New York.

SELL Your surplus good grade stamps. Write, describing fully what you have. Vanroy Shirk, Lebanon, Pennsylvania.

50 DIFFERENT Argentine 10¢. Approvals. Reuter, 611 W. 40th Pl., Los Angeles 37.

AMAZING Offer! 200 United States stamps—including commemoratives, airmails, high denominations to \$1.00. Only 10¢ to approval applicants! Illustrated bargain lists free. Mystic Stamp Co., Dept. 80, Camden, New York.

100 STAMPS, 10¢ With approvals. Smith, 508A Brooks, College Station, Texas.

OLD Scarce U.S. seconds on approvals. Slight imperfections, lowest prices. Hernefield, Clintonhill Sta., Newark 8, N. J.

100 OLD United States between 1861 and 1935, \$1.00. Roush Stamps, 51 Chestnut, Mansfield, Ohio.

UNITED States approvals. Select copies, used—mint. Kingsbury, Fairfax, Vermont.

ICELAND 10 Different beautiful stamps for only 10 cents to applicants for our good old fashioned approvals. Old Colony Stamp Co., Dept. A, Milford, Connecticut.

1-2¢ EACH! Thousands of exciting worldwide stamps. Free examination. Cole, Box 223-A, Buffalo 21, N. Y.

225 STAMPS For only 10¢! This mammoth value includes airmails, pictorials; stamps from strange countries cataloging up to 25¢ each! Also approvals. Mystic Stamp Company, Camden 80, New York.

100 DIFFERENT Austria, 10¢. Approvals. Aronson, Box F, Newton Centre 59, Mass.

WEIRD Diamond shape coffee stamps. Lovely flower triangle! First American big commemorative. Greenland, 4dol dancer, etc. Free with approvals. Capital Stamp Co., Ferrysburg 2, Mich.

25 DIFFERENT Commemoratives 1893 up 10¢. U. S. approvals. K&B, Box 70, Brooklyn 23, N. Y.

MINT U. S. at face! Older commemoratives only in 25¢ packet. Limit one with request for mint U.S. approvals. Western, Box 1689P, Salinas, California.

500 DIFFERENT Stamps only 50¢ with approvals. Littleton Stamp Company, Littleton T1, New Hampshire.

135 DIFFERENT U.S. commemoratives \$1.00, 50-25¢. Request approvals. Harold Hobbs, 18 East 196th Street, New York 68, N. Y.

200 WORLDWIDE 10¢ To approval applicants. Collins', P.O. Box 125, Shell Beach, Calif.



CANADA, 100 Different 35¢ with bargain approvals. K. S. Holmes, London, Canada.

QUALITY Approvals at 2¢ each. Hadrian, 22 East 29th, New York City 16.

FREE! Over 100 different, \$2.50 value, including Israel, British Colonies, U. S., First U. N., Siberia; triangles, animals, sports. Approvals, illustrated catalogue accompany. Send 10¢ for mailing. Gatewood, Box 346, Winston-Salem, N. C.

FREE Sample! Interesting, informative, illustrated. National Stamp News, Anderson, South Carolina.

TRADE: Send 1-500 different. Receive others. 25¢. Wright, Church III, Troy, New York.

U. S. Duck stamp 25¢ with approvals. Jester Stamp Co., Milford, Delaware.

FREE! Surprise packet! Approvals at wholesale discounts. Conklin, Osage, Iowa.

ITALY—100 Different 10¢ with approvals. DeRespinis, G.P.O. Box 771A, New York 1, N. Y.

TRIANGLES—25 Different 50¢. Big list free. Universal, Box 6, Kenosha 5, Wis.

FREE. 20 Different air mails with approvals. Tower, Box 342, Shenandoah, Va., Miami, Fla.

GREATEST Assortment old U. S., famous Americans, flags, presidents, commemoratives, approvals plus surprise packet, 10¢ handling. Metropolitan Stamps, Box 312YE, Jackson Heights, N. Y.

WOW! 110 All different Germany 10¢ Zeppelins, semi-postals, airmails, high values, etc. Giant catalog, bargain lists included with beautiful approvals. Jamestown Stamp, Dept. A18PM, Jamestown, N. Y.

RUSSIA, 25 Exciting gems or 2 Hawaii 5¢ with approvals. Belmont Stamps, Washington 15, D. C.

ISRAEL, 10 Different free. Approvals. Chippewa, Box 65M, Doylestown, Ohio.

FREE! 15 Different Manchukuo, plus world's only octagonal stamp, plus Abyssinia Red Cross set; with approvals. C. H. Cleveland, Jr., 806 North Humphrey Ave., Oak Park, Illinois.

100 DIFFERENT, 10¢ To approval applicants. Cochran, 1814 West Corona, Phoenix, Ariz.

WORLD Wide stamp approval bargains for adults. Ehde, Amiret, Minnesota.

FREE, Singapore, Borneo, Sarawak, Nyasaland pictorials. 5¢ handling. Approvals, Murrays, 1020 Rademacher, Detroit 9, Michigan.

FREE! Five bicolored triangles; super approvals. Satellite Stamps, Box 7248 (Ludlum), Miami 55, Florida.

FIFTY British Colonies, 3¢ postage. Approvals, Bellet, Mapledale, Hazel Park, Mich.

FIFTY Different United States. Obsolete and current. 10¢. Ed Keller, Library, Penna.

FREE! 15 Mint French Colonies; interesting approvals accompany. Tropicana, Box 624-M, Oakland Park, Fla.

BE Surprised! Free gift with first approvals. Western, Box 1689F, Salinas, California.

FREE! Money-saving U. S. list. No approvals accompany. Chassy, Box 42-PMX, Babylon, N. Y.

SPAIN 100 Different 10¢ to approval applicants. Morell, 203 Fenimore St., Brooklyn 25, N. Y.

FREE! Giant bargain catalog—New edition listing thousands of bargains including U. S. and B. N. A. stamps, packets, mixtures, albums, accessories and supplies; sent with beautiful approvals. Jamestown Stamp, Dept. E18PM, Jamestown, N. Y.

FREE Pope and Olympic triangles, Indonesia, Greenland 31 different to serious approval applicants. Fine sets and singles with liberal graduating discounts. Something for everyone. Postage prepaid. Iroquois Stamp Co., Box 849, Lake Forest, Illinois.

BRITISH Colonies, 100 different 10¢, also free albums, catalogs for purchasing approvals. Coast, P. O. 2187A, Santa Ana, California.

115 BRITISH Empire 25¢ with better grade approvals. Mokwa, 2855 W. Byron, Chicago 18, Ill.

HAITI, Thailand, Saar, Victoria, Pitcairns, Ghana, Monaco, plus 50 all different free with interesting approvals. Stamp Imports, Peterborough, Ontario.

FREE! Eight sided stamp, triangle, diamond, midget, mammoth, to approval buyers. Downey, Box 70-A, Bell, Calif.

1250 STAMPS \$1.00. World wide. Good variety, off paper. Many pictorials and commemoratives. No approvals follow. Harrison's Stamps, 1435 1st Ave., Oakland 6, Calif.

PARAGUAY Heroes. Mint set fourteen, ten cents. Approvals. John Schuster, 301 Sandpiper, Playa Del Rey, California.

HUNGARY, Gigantic bicolored "dog triangles"—Free! Approvals. William Deems, 226 Race, Ravenswood, West Virginia.

FREE Stamp wallet, perforation gauge sent to new approval customers. Robert J. Clark, Box 728-P, Evanston, Ill.

U. S. Commemoratives; 145 different \$1; 210 different \$2. Moseley, 6 Hanley Downs, St. Louis 17, Missouri.

FREE! "Surprise mystery packet." Approvals. Steele, Box 451-R, Long Beach, California.

PICTORIALS, The world's most beautiful and prized postage stamps. 75 different. 10¢. Approvals. Adults. Farmer, 6919 Camrose, Los Angeles 28.

APPROVAL Applicants get beautiful stamp packet. Hilltop, Box 696, Haverstown, Penna.

BRITISH Empire 100 different. Only 10¢. Approvals. Woodworth, 764 Otis, Spartanburg, S. C.

FREE Beginners' packet! Penny approvals. Moffatt's, 740 Milton, Rock Hill, South Carolina.

100 FOREIGN. 20 U. S. commemoratives, 10¢. Approvals. Weckerling, 1304F Choquette, Austin 5, Texas.

6 OZ. Mixed U. S. old, new 25¢. Lists. Weatherby, Medina, Ohio.

APPROVALS, References. Collection Builders Stamp Co., Box 93, Passaic, N. J.

100 STAMPS, 100 Countries, \$1.00. Imports. 2309 Clement, San Francisco 21, California.

100 DIFFERENT Stamps, 10¢ with approvals. Finney, Box 89, El Monte, Calif.

U. N., U. S. free with approval purchases. Stamp Farm, Oxford, Wis.

BARGAIN! Monthly lists. Philatelic accumulation. \$2.85 value 20¢. Approvals. Bristol, Canton Center, Conn.

DELUXE U. S. illustrated list free. Stone, 192 Washington, Boston 8, Mass.

EXCHANGE. Send 100-200 different stamps with 15¢. Receive different. Patterson, Lancaster 10, New York.

500 U. S. Stamps 25¢; 300 foreign 25¢. Carlton's 10243 Silverten, Tujunga, Calif.

NEXT Ten 3¢ P.D. artcraft covers \$1.00. Aufderheide, Box 224, Trenton 8, N. J.

GIANT Diamond, midget triangle, timer, 26 others, 3¢. Approvals. Carpenter, P.O. Box 310, Claremont, Calif.

40,000 VARIETIES Available on approvals. 1/4¢ upwards. Keigwin, Box 933B, Daytona, Florida.

500 FINE Mixed U. S. 15¢. Wright, 201M Mealey, Hagerstown, Maryland.

EXCITING Strange countries packet. Free with approvals; Saxon, Orange, California.

TEN Alaska wartime censored covers plus rare Alaska dog team cover and copy of Alaska magazine, only \$1.00. Arctic Cachet Company, Box 81, Ketchikan, Alaska.

12,000 PENNY Approvals waiting for you. Many from exotic countries, pictorials, airmails, new issues. Tilbury, Box 862, Newark 1, N. J.

BIG Grab pack 25¢. Approvals. Klondike, 682 Jefferson, Elgin, Illinois.

JAPAN: One hundred different pictorials. Animals, birds, flowers. Everything sent for twenty cents with oriental approvals. Boger, Box 152, North Wales, Penna.

STAMP Collecting outfit, includes packet worldwide stamps, package hinges, water-mark detector, millimeter gauge. Everything 10¢ with approvals. Lorain Brown, Marion, Michigan.

JAPAN Scarce #609 cat. \$1.50, with approvals 20¢. Ben Ezra, 3530 Paulding Ave., New York 69, N. Y.

ALBANIAN-Roosevelt set free. Approvals. W-B Stamps, Wilkes-Barre, Penna.

KENYA—Queen set to 1/-. Free with approvals. Lee Hoover, Box 3594, Portland 8, Oregon.

CAMBODIA, Laos, Viet Nam, included in my approvals. W. Hamilton, 4772 Milwaukee Ave., Chicago 30, Ill.

FREE 137 British Colonies all different with approvals. Act now. Send 10¢ for handling. Veteran Stamp Company, 169 Kensington Ave. N., Hamilton, Ont., Canada.

FREE List of selected packets. Gift with order. Katen, 3709 Ralph Road, Silver Spring, Maryland.

PENNY Approvals. Thousands. Bargains for pennies. Gifts with purchases. Penny Stamps, Orange 1, California.

FREE! Fine mint complete King George coronation and peace set. 10¢ handling. Unsurpassed British approvals. Krehbiel, 176 W. 87th, New York 24, N. Y.

FREE: Mauritania, Nyassaland, Comorro Hyderabad, Swaziland Armenia with bargain approvals. Box 342, Tamiami, Miami 44, Florida.

FREE 100 Different stamps. Adult approval applicants. Norge, Ho-Ho-Kus, N. J.

EARTH Satellite stamp free. Attractive approvals. Stamp Center, P.O. Box 76, Brooklyn 26, N. Y.

### ANTIQUES, RELICS, INDIAN GOODS, CURIOS

ARROWHEAD Making kit, complete instructions, \$2.00. Master lost art easy! Chief Blackhawk, Box 564-N, Kennewick, Washington.

4 SELECTED Arrowheads \$1.00. Smith, 841 N. Tacoma, Indianapolis 1, Indiana.

INDIANCRAFT, 40 Page illustrated catalog 15¢. Grey Owl, 4518 1/2 Seventh, Brooklyn 20, N. Y.

ILLINOIS: Gesundheit—For sale: several hundred Revolutionary, Civil War, Indian muskets, rifles, carbines, swords, bayonets, powder-horns, bullet molds, holsters, canteens, Kentucky rifles, frontiers, duelling pistols. Stagecoach-guns, 50,000 collectors cartridges. Many Confederate items. 10,000 coins, Confederate money, 100,000 Indian relics, arrowheads, spearheads, tomahawks, bannerstones, discoids. Mounted birds, squirrels, deerheads, steer-horns, violin wood, agates, fossils, minerals. Gold dollars. Illustrated catalog 35¢. Heicke Mansion, Wrenona, Illinois.

4 ARROWHEADS \$1.00. Spearhead \$1.00. Strand beads \$1.00. Paul Summers, Canyon, Texas.

SCALPING Knife, spearhead, thunderbird \$4.00. Catalog free. Arrowhead, Glenwood, Arkansas.

ANCIENT Grooved stone tomahawk \$3.00. Indian relic list free. Lear's, Glenwood, Arkansas.

### PRECIOUS STONES, MINERALS

SAPPHIRE, Topaz, tourmaline, garnet, peridot. Five uncut gem specimens, \$1.00. Ten polished gems, baroque shaped, \$1.00. Free bargain list jewelry, gems, Profitable, easy "do-it-yourself" projects. O'Brien's, 1116M Wilcox, Hollywood 38, Calif.

CUT Gems, make jewelry—For profit or fun. 100 page magazine tells how: where to get supplies. Sample 25¢ or request free literature. Lapidary Journal, Del Mar 2, Calif.

EARTH Science, the rockhounds national magazine. Subscription \$2.00. Sample 35¢. Box 1357-PM, Chicago 90, Ill.

AGATES, Gems, machines. Free list. Northwest Gems, 2819 North Warner, Tacoma 7, Washington.

LARGEST Gem and mineral magazine tells how to have profitable fun with rocks, gems, jewelry. Monthly, \$3.00 year. Sample 25¢. Gems & Minerals, Dept. A1, Mentone, California.

18 COLORFUL And basic U. S. mineral specimens attractively boxed with descriptive folder \$1.00 prepaid. Included free dinosaur bone pocket piece. Rock Haven Mineral Co., Dept. A, Whitefield, N. H.

MAPS And handbooks for rock hounds, treasure hunters, prospectors. Catalog, 25¢ (refunded). Simpson Publishing Company, W. 19-27th, Spokane 41, Wash.

FREE Examination offer. Thirty uncut gem specimens. Collectors, students, cutters write for details. Or send \$3.50. No foreign orders. Reed's 4930B, Palo Alto S.E., Albuquerque, New Mexico.



**FIND** Strategic rare minerals. You may be overlooking some worth a fortune: uranium, vanadium, tungsten, columbium, tantalum, bismuth, nickel, cobalt, chromium, titanium, molybdenum, manganese, platinum, etc. Learn how to find and identify them. Send for free copy "Overlooked Fortunes." Duke's Research Laboratory, Box 666, Dept. O, Hot Springs, New Mexico.

**MINERAL** Specimens for collectors. All varieties, world wide localities. Choice quality, lowest prices. List free. Plummer's, 4720 Point Loma Ave., San Diego 7, California.

**GENUINE** Natural dark green crystals for polishing gems. Samples \$3.00. Harold L. Wilson, Route 1, Eatonville, Wash.

**ROCKHOUSES**, Jewelry hobbyists. 10 specimens Black Hills rose quartz, \$1.00. Aylesworths, Box 1868, Rapid City, So. Dak.

### HOBBIES AND COLLECTIONS

**PROPAGANDA** Leaflets W. W. II; sample 35¢; Nazi medals, badges, sample 50¢; embroidered swastika and catalog 25¢. Insignia Club, Box 71, Rockaway Park A-94, N. Y.

**COLLECTORS** Matchbook covers, 100 different unused, \$1.00. Catalog 25¢. Album \$3.00. Charles Edelman, 1311-C East 84, Cleveland 3, Ohio.

**INVENTING** Can be an interesting and profitable hobby. Write for complete particulars. Institute of American Inventors, Dept. 40-E, 635-F St., N.W., Washington 4, D. C.

**ARMY-Navy-Marines—A.F.**, one regulation military belt with brass buckle plus 25 assorted medals, badges, campaign ribbons, battle stars, patches, ratings etc. All for \$1.00. Supreme Military, Dept. PM, 48 West 27 St., New York City.

**MILITARY** Miniatures. Civil War. Custer's Cavalry, American Revolution and U. S. Marines. Illustrated catalog 35¢. Bussler Miniatures, Dept. Z, 40 Howe St., Quincy 69, Mass.

**WANTED**—Cigarette, tobacco cards. Write Charles Bray, East Bangor, Penna.

**NAZI** Insignia, 12 different \$1.00. Medals, patches, armbands, flags, daggers. Illustrated lists, 15¢. Hobbyland, 1207 1st St., W., Calgary, Canada.

### CAMERAS, PHOTO SUPPLIES

**PHOTOGRAPHY** For pleasure or profit. Learn at home. Practical basic training. Long established school. Free booklet. American School of Photography, 835 Diversey Parkway, Dept. 3441, Chicago 14.

**LEICA**, Contax, Nikon, Minox, Exakta. All leading brands. Trade, buy, sell. Free catalog. Write Mr. Gallagher, Wall St. Camera Exchange, 80 Wall St., New York 5, N. Y.

**FREE!** Free! Send for your new 52 page photographic bargain book. Over 5,000 new and used items at huge savings. For your free bargain book, write to Dept. 111, Central Camera Co., Chicago 4, Ill.

**GET** Our prices first! Free! New bargain catalog. Imperial, Dept. PM1, 34 Park Row, New York City 38.

**KODAK**, Bell-Howell, discounts to 40%. Photo equipment, appliances, free catalog. Mailers Mart, Box 135-MP4 3 Peiham, New York.

**BEST** Discount (up to 50%) camera supplies. Leading brands. Send 25¢ to cover cost of catalog. Refund on receipt of first order. Mel-Jo Camera Co., Box 91-C, Cooper Station, New York 3, N. Y.

### PHOTO FINISHING

**COLOR** Processing—High quality, fast service and low prices. Kodachrome developing 85¢; prints 27¢. Kodachrome: 35mm. processing, 20 exposures: \$1.45; 36 exposures, \$2.25. Send for complete price list and free mailers. Photo-Mail, Box 216M, Madison Square Station, New York City 10.

**KODACHROME** Processing—8mm roll or 35mm 20 exp., \$1.25. Prompt service. Write for mailer and prices. Color Pix, Dept. P, CPO Box 30, Kingston, N. Y.

**FREE!** Color snapshot folder. Offers, lists, mailers. Houghton's, Erving, Mass.

**12 EXPOSURE** Rolls, 39¢. Jumbo prints. Guaranteed work, one day service. Lincoln Studios, Dept. K, Box 13, Lincoln, Nebraska.

**PARTICULAR?** 8 Jumbos—40¢, 12—50¢. Special: 35 mm., 36 exposures \$1.25. Introductory offer. Flash Foto, Box 36M, Brooklyn 4, N. Y.

**8-HOUR** Service on deluxe jumbo prints. 8-exposure roll developed and 8 jumbo prints 40c, 12 exposure 55c, 16 exposure 70c; 35mm. 20 exposure 75c, 36 exposure \$1.25. Jumbo deckledge reprints 4c each. Contact prints made if specified. Bay Photo Service, P.O. Box 210, Oakland, California.

**SUPERIOR** Quality. Prompt service. 8 jumbos in album 40¢. 16 contacts 50¢. Jumbo reprints 5¢. Satisfaction guaranteed. Also complete color film finishing service. Write for free circulars and mailers. Fast-X-Photo, Box A, Jersey City, N. J.

**YOUR** Photos reduced to postage stamp size. Genuine glossy photos gummed backs. Use on letters, greeting cards, business cards, etc. Send any size print, 48 hour service 100 for \$1.00. Stampfoto, Triboro Sta., New York City 35.

**POSTCARD!** Your b.&w. publicity photograph, snapshot printed on enamel stock, 500, \$9.95, 1,000, \$14.95. Samples free! Kardko, 603 West Central, Toledo 10, Ohio.

### MOTION PICTURES AND SOUND EQUIPMENT

**ALASKA** Wildlife Kodachrome movies and slides. Free catalog. Mac's Foto, 315-14th, Anchorage, Alaska.

**RECORDERS**, Hi-Fi. Free catalogue. Carstan, 215 E. 88 St., New York City 28.

**5,000** 8-16MM. Movie films. Free catalogues. International, Greenvale, N. Y.

**FREE!** Blackhawk's big new 1958 sale catalog new and used 16mm., 8mm. movies; 2" x 2" color slides; used 16mm. sound projectors! Biggest stock in U.S.A.! Cameras, accessories, supplies, too! Blackhawk Films, Davenport 14, Iowa.

**MOVIE** Camera film: 8mm. roll \$1.50, 16mm. 100' \$3.00. Free processing. Better Films, 742 New Lots, Brooklyn, N. Y.

**8-16MM.** Films. Free catalogue, with sample film 10¢. Garden, 690 Howard Avenue, Brooklyn, N. Y.

**SAVE 50%!** Guaranteed-fresh color, b.&w. movie film! 8mm., 16mm. Free catalog! Eso-R, 47th Holly, Kansas City 12, Missouri.

**NEW** 1958 Bargain discount 8 mm catalogue also 16 mm sound. Write National Cinema, 71 Dey Street, New York City. Specify 8 or 16 mm.

**16MM** Film sale. Rentals \$3.95. Sound Films, Box 262, Chicopee, Mass.

**FREE!** Big new catalog of 8mm and 16mm movies. Imperial, Dept. PM2, 34 Park Row, New York City 38.

**FREE** Catalog. Save dollars. Fresh 8mm., 16mm. b&w and color film. Home processing equipment. Superior Bulk Film Company, 448 No. Wells, Chicago 10.

### MUSIC AND MUSICAL INSTRUMENTS

**CLARINETS** And trumpets from factory. Save 50%. Free information. Libro's Music Center, 591 Chapel St., New Haven, Conn.

**RECORDS**, Hi-Fi. Big discounts. Noelson, Box 211, Wall Street, New York City 5.

**WRITE** Songs. Big money and reputation. Write for information. J. Gordon Pub. Co., 4700 South California Avenue, Chicago.

**SONGS** Into dollars. Share \$29 million dollars yearly for new songwriters, song-poets. Songs composed, published, promoted by famous firm. Information, appraisal free. Send to Nordyke Publishing, 6000 Sunset, Hollywood 28PM, California.

**SWISS** Musical movements (best) \$2.50. Electrical movements \$5.50. Spielman, 131 West 42nd, New York City 36.

**SONGS** And poems wanted. U. S. Music Studios, Box 222A, Belmont, Mass.

**BECOME** A famous, highly paid, "western-folk" radio-recording star! For complete instructions rush \$1.00 to Country Music Enterprises, Lethbridge, Alberta, Canada.

**SONG** Poems wanted. Five Star Music Masters, 630 Beacon Building, Boston.

**1958 ACCORDIONS**—Direct from importer. Save 50% and more! Free trial. Lifetime guarantee. Trades accepted. Free catalog. Write Accordion Manufacturers Outlet, Dept. 18-R, 2003 Chicago, Chicago 22.

**SONGPOEMS** And lyrics wanted. Mail to: TinPan Alley, Inc., 1650 Broadway, New York 19, N. Y.

**POEMS** Wanted for new songs. Send poems. Free examination. Immediate consideration. Songcrafters, 2724 Arcade Station, Nashville, Tenn.

**POEMS** Wanted for new songs. Send poems. Immediate consideration. Crown Music Company, 49-C West 32 Street, New York City.

**ELECTRIC** Guitars, amplifiers, wholesale. Free catalog. Carvin P.M.M. Covina, California.

**ACCORDIONS**, Wholesale to everyone. Save up to 60%. All national known brands. Free catalogue. Del Principe, 29 South Cicero, Chicago 44.

**POEMS**, Songs wanted! Publishing, recording. Bengol, 93 Jefferson, Chelsea 50, Massachusetts.

**SONG** Request guarantees royalties. Instructions two dollars. Howard Olenik, Mt Morris, Mich.

**PLAY** Guitar, any instrument. Guaranteed shortcut courses 60% off. Free catalog. Staff School 10-A, Bradley Beach, New Jersey.

**SACRED** Music composed. Song printed. Reginald Belcher, Box 354, Morristown, New Jersey.

**DISCOUNTS**—Instruments, accessories, national brands. Tempo Music, 37 Cutler, New London, Connecticut.

**VIOLINMAKERS**, Repairers. Fine tone wood, and all violin supplies. Send for free wholesale new price list. International Saks, 414-MPM E. Baltimore St., Baltimore 2, Maryland.

**ACCORDIONS** Wholesale—10 day trial. Free catalog. American Accordion Center, 5329-PM-1, Belmont, Chicago.

### RADIO, TELEVISION AND ELECTRONICS

**TUBES-TV**, radio, transmitting, special purpose types. Bought, sold, exchanged. Send details to F. M. Gensler, W2LNI, 512 Broadway, New York 12, N. Y.

**TRANSISTOR** Kits, parts. Free information. Transit, Box E2, Alden Manor, N. Y.

**CRYSTAL** Radio kit \$1.00, preassembled \$1.25, phone \$1.75; catalogue. Clearco Crystal Company, 2966 North 4th, Milwaukee 12, Wisconsin.

**GOVERNMENT** Surplus. Radios, parabolic reflectors. Amazing picture list 10¢. Meshna, Malden 48, Mass.

**TAPE** Recorders, hi fi components, tapes. Unusual values. Free catalog. Dressner, 69-02M 174 St., Flushing 65, N. Y.

**"20 DX** Crystal Set Plans" handbook—30¢. Laboratories, 328-C Fuller, Redwood City, California.

**CRYSTAL** Radio experimenters write to Hulet, 305 Hope, Lakewood, N. J.

**FREE!** Giant bargain catalog. Transistor, "Sun" radios, kits, portables, audio, electronics, photographic, optics, tools, household. Write Lektron, 131M Everett Ave., Chelsea, Mass.

### BUSINESS OPPORTUNITIES

**FREE** "Franchise Profit Letter," describes nationwide opportunities. Exclusive distributorships, dealerships, agency operations. Write today. National Franchise Reports, 333 North Michigan, Chicago 1.

**EXCLUSIVE** Distributorship available in most areas for world-famous cadmium battery guaranteed to outlast your car. Tremendous profit opportunity. Investment for merchandise only. Free franchise. Cadmium Battery, Corporation Dept. 102, El Segundo, California.

**TO \$100.00** Weekly. Sparetime, home operated mailorder business. Successful beginner's plan. Everything supplied. Lynn, 10420-M National, Los Angeles 34.

**READ** "Mailorder Laws and Regulations" and "Mailorder Rules for Beginners". Learn about necessary licenses, different taxes, legal requirements, etc. Both books, \$2.00. Tasker, 1603 Peach Street, Alexandria, Virginia.

**BIGGEST** Money makers in the field: Acme saw and lawnmower sharpeners. Free literature. Max Mfg. Co., 138 Stockton Ave., San Jose 28, Calif.

**OPERATE** Profitable mail order business. Write Universal, 105 N. Seymour, Fond Du Lac, Wisconsin.



MAKE \$25.00 Or more daily. For more information send \$1.00 to James Montano, 1601 Young St., Santa Fe, N. Mex.

\$60.00 WEEKLY. Sparetime - Easy! Home Venetian blind laundry. Free book. Burt, 2434EP, Wichita 13, Kansas.

LEARN Real estate by listening to records. Lee Institute, Brookline 46, Mass.

FREE Folder - "137 Successful Home Businesses." Service, Box 636PM, Newport News, Virginia.

CAMERA Owners! Earn \$50.00 week-ends! Instructions \$1.00, information free! Kline, 935-PM North Austin, Chicago 51, Illinois.

SELL Books by mail. Details free. Berryman, 153 Victoria, Northlake, Ill.

COLOUGLAZED Concrete pottery made without molds. Patented method. Cemetery products, novelties, tiles. Basement leak-sealing. Money-making projects. Booklet, details free. Men only. National Potteries Company, Grand Rapids, Minnesota.

SELL Merlin electronic garage door operators. Make from \$50 to \$75 on every sale. Operate from your home. M. J. Fitzgerald Co., 2815 West Vilet Street, Milwaukee 8, Wisconsin.

PLASTERCRAFT Molds and supplies. Follet Studios, Box 362, Moorhead, Minn.

VALUABLE Distributorship throughout United States. With exceptional high rate of earnings. A business established over 20 years with 200,000 users. Investment \$8,500-\$12,500. Box 1457, 1501 Broadway, New York.

PIANO Tuning learned quickly at home. Tremendous field! Musical knowledge unnecessary. Information free. Empire School of Piano Tuning, Champaign, Ill. (Founded 1935).

MUSHROOMS Quicker, easier, cheaper. Newest facts free. Luxur, 641 South 19th, Newark 3, N. J.

THEY Hand him \$100! Free packet Secret Journal. 919 secrets-plans! Work home. Publicae, Oceanside, Calif.

BUY Direct from factories—Appliances, cameras, watches! Free details! Cam Company, 6810PM-20th Ave., Brooklyn 4, N.Y.

MIMEOGRAPHING Services pay sensational local profits. Exciting secret plans exposed! Write: Mozelle Mime Shop, Bonham 7, Texas.

SELL Books by mail. 400% profit. Royal, Box 368-X, Cleveland 27, Ohio.

\$34.70 TWO Hours. Manufacturing. No selling. Carlayne Castings, 1803 Fremont, Rapid City, South Dakota.

BRUSH Plating outfits for plating articles in the home and shop. No tanks necessary, silvering mirrors, spare or full time. Free particulars. Gunmetal Co., Ave. H, Decatur, Illinois.

BUY Wholesale! Over 10,000 nationally advertised products. Appliances, cameras, sporting goods, housewares, watches, typewriters, tools, clothing, etc. Send postcard today. Buy-Rite, Box 258, Hawthorne 1, New Jersey.

WANT To make big money at home? \$10.00 profit in an hour possible with invisible mending. Make tears, holes, disappear from clothing, fabrics. Steady year-round demand from cleaners, laundries, homes. Details free. Fabricon, 6234 Broadway, Chicago 40, Illinois.

WHOLESALE—Thousands nationally advertised products. Buy, sell. Amazing profits. New, free plan. Associated Wholesalers, 1016-D Starr, Burlington, Iowa.

OPERATE Mailorder folio business! Free details. Ballard's, 425 East Catherine, Louisville 3, Ky.

MAKE Flexible molds. Cast plaques, figurines. Free sample. Tooker, 1045-R Fairview, Hamilton, Ohio.

NATURAL Molding rubber, extra thick. Free sample. W. Wooley, 1016-A Donald, Peoria, Illinois.

BIG Money raising fishworms and crickets. Free literature. Carter Farms, Plains, Georgia.

VENDING Machines—No selling. Operate a route of coin machines and earn amazing profits. 32-page catalog free. Parkway Machine Corporation, Dept. 26, 715 Ensor Street, Baltimore 2, Maryland.

\$70 WEEKLY—Home, spare time. Simplified mail bookkeeping. Immediate income—easy! Auditax, 34757A, Los Angeles 34.

START Home business making statuary, plaques, novelties, garden furniture, artificial marble flooring, liquid marble. Make your own flexible molds. Amazing profits. Only \$1.98. Free literature. Popular Mechanics Press, 631 No. St. Clair St., Chicago 11.

WANT More business? Here's an amazing opportunity to increase your sales. Talk to thousands of interested readers of "Mechanica Popular." Our Spanish Edition covers the Latin American countries like a blanket. They're real mailorder buyers. Classified rate 75¢ per word. Try an ad in our next issue. Classified Advertising Department, Popular Mechanics Magazine, 200 East Ontario Street, Chicago 11, Ill. cago 11.

MINK Raising information free. Complete. Lake Superior Mink Farm. Superior, EEL, Wisconsin.

COPUBLISH Mail Sale Advertiser, leading mail order paper. Details, latest copy, dime. Vanroy Shirk, Lebanon, Penna.

LEARN Photo-negative portrait retouching. Men, women. \$5 hour possible spare or full time at home. Easy, glamorous. Work for photographers by mail order. Full details sent free. Duval, 100 So. Vermont, Los Angeles 4.

YOUR Own name brand business. No investment; no inventory. Part time or full time. Sell famous brands of appliances, housewares, silverware, radios, vacuum cleaners, lamps, tools, clocks, watches, jewelry, etc., etc. over 1000 items. Join thousands of successful independent dealers. Send for free catalog and dealer price list. H. B. Davis Corp., Dept. 11, 145 W. 15 St., New York City.

11,000 NEW Prospects daily. Baby record books, shoes, albums. Sell mailorder. Use our literature. Write: No-Co-Ro, Capitola, California.

BAKE New greaseless doughnuts in kitchen. Sell stores. Free recipes. M. Ray, 3605 South 15th, Minneapolis 7, Minnesota.

FIX Typewriters. Inexpensive home course teaches factory secrets. Free booklet. Athey, Tarentum, Penna.

MONEY For you! Big profits! Cast plaster figurines, bookends, plaques at home with XL rubber molds. No experience needed! Write for illustrated, 40-page catalog, only 25¢! Plastic Arts Studios, 3403 So. Madison Street, Department 5, Muncie, Indiana.

PLATE Baby shoes, jewelry, gifts, bronze and colored pearl. Free booklet. Platex, 11029 South Vermont, Los Angeles 44.

FREE Catalog. Contains hundreds of businesses, farms and income properties throughout U.S., Canada. Specify type and location desired. Deal direct with owners. U. I. Buyers Digest, 1608 Hillhurst, Dept. PM-3, Los Angeles 27, Calif.

LIQUID Rubber. Make flexible molds. Free sample. Chaney, 1907-A East Road, Jacksonville 11, Florida.

START Home mimeographing business. Pays amazing profits. Literature free. Housel, Lanoka Harbor, N. J.

BOOKKEEPERS, Accountants. Operate a bookkeeping service. Part or full time. Amazing simplified system. Wonderful money-making opportunities. Complete information free. National Bookkeeping Publishing Co., Suite 307, 3435 Broadway, Kansas City 11, Mo.

WE Pay \$3.50 lb. dried. Grow mushrooms. Cellar, shed and outdoors. Spare, full time, year round. We have 25,000 customers. Free book. Washington Mushroom Ind., Dept. 172, 2954 Admiral Way, Seattle, Wash.

\$250 WEEK Cleaning venetian blinds. Patented machinery. Free literature. Robinson, 7213B, Indianapolis 1, Indiana.

FREE Book "505 Odd, Successful Businesses." Work home. Pacific, Oceanside, Calif.

I Want to send you proof of the wonderful pulling power of Popular Mechanics classified pages. What's your proposition? Write me today. Include literature if possible. F. W. Johnson, Manager Classified Advertising, Popular Mechanics Magazine, 200 E. Ontario St., Chicago 11, Ill.

INTERNATIONAL Mailorder business. Complete setup service—Not just instructions. Hermes, 152 West 42, New York City 36.

PLASTERCRAFT Molds, liquid rubber, plasters, flocks, candle supplies. Catalog and manual free. Blue Rapids Supply, Blue Rapids, Kansas.

MARY-Mac agency—motorized vibrator. Cushions, chairs, tables, belts. Mary-Mac Factory, 1012 Powhattan, Dallas, Texas.

FREE Folio "\$5,000-\$45,000, Unlimited Vacations." No merchandise. Unknown! Work home, sparetime! Haylings, Carlsbad, Calif.

FREE Folder. "How to Make \$3,000 Yearly. Sparetime, Backyard, Raising Earthworms!" Oakhaven 38, Cedar Hill, Texas.

MAKE \$46 From square foot plywood; jigsaw necessary. Free details. Woodart, Bridgewater, Mass.

\$5,000 YEARLY, Spare time at home. Nothing to buy. No local selling. Dignified. Guaranteed. Home Harvest, Rt. 3, Box 3491-A, Albuquerque, New Mexico.

DRIVE-In restaurants make big money! Investigate—Read Drive-In Magazine. \$3.00 subscription shows how. Box 312, Pratt, Kansas.

MAKE Extra money. Cash commissions. Everybody buys easy-to-sell advertising book matches. Union label. All sizes. Cuts for all businesses. Powerhouse selling kit free. Steady repeat business. No experience necessary. Superior Match Co., Dept. MX-158, 7528 S. Greenwood, Chicago 19.

LET Me sell your products nationally. I'll send you free information on how to establish sparetime-full time Cascraft business. You build! We sell! Everything supplied. Abarsi, 807-SG Sunset, Los Angeles 12, Calif.

GROW A living miniature forest or orchard (only inches high), that bears tasty tiny fruit at home. Learn amazing dwarfing secrets! Sensational fascinating hobby, profitable home-business opportunity. Free details! Miniature Nurseries, Dept. JY, Gardena, California.

"50 New Home-Business Ideas" booklet, sample free. Spray exotic velvet-suede on anything. Plockcraft-JY, Los Angeles 61.

\$250.00 WEEK Spare time profit possible. Earn at home with new fascinating printing method. \$5 starts you. Send no money now. Free confidential facts and valuable samples. Screen-Print, JY, Los Angeles 61.

BREED Rare tropical fish at home. Earn big money! Learn secrets! Help fill huge demand. Amazing opportunity! Free plan. Tropical Fish Breeders, Los Angeles 61, Calif.

HOME-Import mail order business—Import profitable items below wholesale. Experience and product investment unnecessary. Full, spare time. Famous world trader guides you. Free list "157 Imports," details. Mellinger, P701, Los Angeles 24.

GROW Expensive herbs for us! Big profits home-business of your own. Year around profitability! We supply everything necessary! Send for free amazing facts and revealing plan. National Herb Exchange, Box JY, Gardena, California.

NEW Dollar dishwasher. Latest home convenience. Lightning dollar seller. Makes dishes gleam. Samples sent on trial. Kristee 115, Akron, Ohio.

MINIATURE Golf plans \$1.00. Lil-Putt, Box 294, Rock Island, Illinois.

START Your own self-service tube checker route full-part time. Must have \$1000 cash. Write Test'Ur Own, Box 163, Sta. F, Milwaukee 9, Wis.

GROW Orchids at home. Profitable, fascinating. Successful home grower explains special light, temperature and humidity conditions orchids need. Free! Full details. Orchids, 100 S. Vermont, Los Angeles 4.

2000 AGENTS Wanted throughout U. S. for unusual patented product. Push-button spray can. Combats moisture, rust. Exceptional opportunity. Billion dollar market. Retail \$2.95. Send \$2 for 12-oz. sample and dealer literature. Bergmann Enterprises, 215 N. Flores, San Antonio, Texas.

START Your own business on credit. Your own boss. 1527 dealers sold \$5,000 to \$32,000 in 1956. We supply stocks, equipment on credit. 200 home necessities. Sales experience unnecessary. Pleasant profitable business backed by world-wide industry. Write Rawleigh's, Dept. A-U-PPM, Freeport, Ill.

EARN \$10,000 Yearly raising Angora rabbit wool for us. Information 25¢ coin. American Angora Company, Malta 12, Montana.

IMPORTING. Modern dropship method. Details free. The Hazen Company, 6601M—8th Avenue N. St. Petersburg 10, Florida.

NEW Household product. Wonderful repeater. Amazing merchandising plan. Keystone Specialties, Box 274A, Scottsdale, Penna.



**LIQUID Marble**—Building compositions! "Compofloor." Mold pottery, statuary. Tilex walls, ceilings. Particulars free. Marbleizing Service, Edwardsville, Illinois.

**DOLLARS** In every mail. Profitable mail order operates in your home, farm, or office. Send for free details. Webb Imports, 8729 1/2 Warvale, Rivera, Calif.

**\$100.00 WEEKLY** Spare room. Raise redworms soilless way. Odorless. Charlie Morgan, Box 116E, Bushnell, Florida.

**"HOW To Start a Business"** booklet sent free! If you know any trade, go into business for yourself! Learn the 9 easy steps to follow. We've guided 5,000 others to success. Revealing free booklet yours for the asking! Write! National Business Consultants, Office JY, Los Angeles 61, Calif.

**FREE Polio.** Work at home. Sparetime! Send stamp. Jackson, Box 37215-PM, Los Angeles 37, Calif.

**250 MARKETS** For your photographs \$1.00. Guaranteed. Feather, Greenville, Penna.

**FINANCING.** Our booklet, "Venture Financing," explains modern methods of financing small business. Send \$1.00 to Business Publications, 526 1st Ave. North, Seattle 9, Washington.

**STAY Home!** Get cash orders in your mail. Big profits. We supply everything—Fill your orders. Write: E. E. Allen Mail Service, 2038 Hazel, Detroit, Michigan.

**MAIL Order** advertising agency executive reveals sensational no-risk advertising and merchandise methods. Start in office or home; minimum capital; positive profits. Free details: Impact! 3407 Prospect Avenue, Dept. 11-1, Cleveland 15, Ohio.

**ABUNDAVITA** Means better living, bigger bank balances! Campo, 391-A Grand, Long Beach 14, California.

**MAKE \$3 To \$5** hour sharpening saws, lawnmowers sparetime at home. Free book. Victor B. Foley Co., Columbia Heights, Minn.

**MAKE** Strange plastic building material of waste, easily. Water, fire, wear and termite resistant. Bays Laboratory, Oklahoma City, 9.

**BIG Garden tractors** \$109.00. Sells for \$242.00 retail Universal Mfg. Co., 324 West Tenth, Indianapolis 2, Indiana.

**TYPIST** Operate profitable mail-order business. Stamp brings details. General Sales, 336 Roosevelt St., Creve Coeur, Ill.

**YOUR Photo** on stamps. No investment—No stock. Big profits. Free samples. Miniature Photostamps, Box 44-M, New York City 67.

**BUY Wholesale!** Name brand products. Free catalog! United Wholesalers, 1265-F Broadway, New York 1, N. Y.

**WE Establish** you in your own mail order discount business. Sell appliances, gifts, books, housewares, watches, jewelry, cookware, tableware, dinner, cutlery, etc., at discount to 75%. No stock needed. We ship orders under your name. Self-selling catalogs printed with your name, advertising postcards, circulars, names of mail order buyers supplied. Catalog, details free. Topval Corp., Lindenhurst 918, N. Y.

**BECOME** Factory distributor of aluminum windows, doors, jalousies, awnings, etc. Sell wholesale and retail. Small investment. Starlight Mfg. Co., R. D. #1, Box 605, Lakewood, N. J.

**BIG Money** in mailorder. Merrill Hindland, Box 182AP, Hatfield, Penna.

**SELLING** By mail fascinating. Profitable. Free information. Alfano, 19 Pine, Closter, New Jersey.

**EARN \$50 To \$60** daily repairing typewriters, write New England Training Service, Carmel 2, Maine.

**MAKE** New perfume creations. Highly profitable, clean, dignified, easy. Write Dharma Perfume Company, 234 South Michigan, FM7, Chicago 4, Illinois.

**OPERATE** Profitable mailorder business! Write: Thomas Bond, 1637H West Vernon, Phoenix, Arizona.

**TAKE-Out** foods. Your own business using successful proven methods. Write for details. Alamo Take-Out Foods, Inc., 1832 Tyler, Hollywood, Florida.

**"MAIL-A-Way"** books. Profits galore. Free details. Script System, Box 4076, St. Petersburg, Florida.

**RUBACREAM!** Concentrated latex cream! Makes molds quicker! Thicker! Instructive literature free! Castcraft Studios, 508-PM Marion St., Brooklyn 33, N. Y.

**OPERATE** Mail-order printing brokerage. Details free. Advisory Service, Hartsdale, N. Y.

**EARN \$10,000** Yearly—Only two sales daily. World's best seller, the Holy Bible. Illustrated Protestant or Catholic. Margareta's, P.O. Box 92, Hazleton 7, Penna.

**WANTED:** Home producers, to be subcontractors. Cast plastic products for manufacturers in our clearing house service. Thousands of easily made items required. Cash in at home, without previous experience. Plastic Service Associates, Dept. 1-PM, East Boston 28, Massachusetts.

**QUICK Profits**, with no capital! Take orders for magazines your neighbors like. Want. Make cash on the spot! We show how with free kit. Get yours now. Write McGregor Magazine Agency, Dept. 310, Mount Morris, Ill.

**EVERYBODY** Likes candy. Make professionally home. (Our 47th year.) Ragsdale Candies, B107, East Orange, New Jersey.

**WE Love** our mailman—He leaves over \$1000.00 monthly in our rural mailbox. My college professor husband drafted a scientific home mailorder method. We bought a Texas ranch, live as we always wanted. Now we sell the Ranch Mailorder Method. Operates anywhere. Inquire: Eveningshade Ranch, Boerne, Texas.

**BUILD** Fascinating hobby-business engraving plastics! Profits to \$5 hour! Sample, details 25¢. Engraved aluminum door emblems \$1.00. Desco Distr's., 5262-J Van Nuys, Van Nuys, California.

**BUY** At wholesale prices! Resell at big profits. Brand name merchandise—Appliances, cookware, housewares, watches, jewelry, rings, dry goods, clothing, luggage, tools, sporting goods, toys, gifts, etc. Free 1958 color catalog. Write today. Merit Home Products, Dept. PM-1, 107 Manhattan Ave., Brooklyn 6, New York.

**CANDIED** Popcorn and potato chip equipment. Eakins, Box 933-A8, Springfield, Ohio.

**MONEY** Wants you. Turn 12 spare hours weekly into extra cash. Free details. Woodward, 1221 Edgewood, Havertown (3D), Penna.

**CASH** From sawdust, tin-cans, newspapers. Over 200 uses. Instructions \$1.00. Charles Company, 12-KAB, Norwood, Ohio.

**ASSEMBLE** Crazy-Mazies. Supply dept. stores, gift shops, etc. with new art sensation. Send \$2.00 for kit and details. Crazy-Mazies, P.O. Box #2046, Dayton 29, Ohio.

**SEND \$1.00** For book "You Too Can Read Handwriting." Handwriting Psychologist, Moorpark, California.

**BE** Appointed state notary public now. Write, Stationers, Boerne, Texas.

**LEARN** Landscaping—The growing, use, maintenance and profit in ornamentals. Start in a small way, work into a profitable business. We show you how. Earn your diploma studying at home. Write for free booklet National Landscape Institute, Dept. M-18-C, 11826 San Vicente Blvd., Los Angeles 49, Calif.

**READ** The truth about mail order business from beginners standpoint. 10,000 word idea booklet, "How to Build Your Own Mail Order Business" 50¢ coin or m.o. Refunded if not satisfied. Robert K. Brown, Box 72, North Tonawanda, New York.

**START** Paying home mailorder business. Write Publications, 2961-M Grand River, Detroit 1.

**INTERNATIONAL** Mail order items: Only Globetrotter's datasheet gives you both foreign suppliers names plus risk free selling methods. Send one dollar (cash, check, moneyorder) to Globetrotter, 1951 Richmond, Houston 6, Texas.

**CASH** From sawdust, newspapers, tin-cans, glass! 135 methods \$1.00. Guaranteed! ABC Publications, Box 849-SP, San Francisco 1, California.

**CASH** From bottle caps! Methods 50¢. Specimens included. \$1.00. Metro, Box 151-K, Oak Park, Illinois.

**LEARN** Flower arrangement and floristry. Start your own business, full or part time. Many good paying positions open. Earn while learning. Send for free book. National Landscape Institute, Studio M-18-C, 11826 San Vicente Blvd., Los Angeles 49, California.

**"MAIL Order Business"** magazine. Most comprehensive mail trade journal in the world! 3 sample issues \$1. Refunded if unsatisfactory. Box 591, CP, Lynn, Mass.

## MONEYMAKING OPPORTUNITIES

**WIN** Contest prizes. Contests—Helps. Contests, 25 Earl, Red Bank, N. J.

**SEA-Gro:** Revolutionary soil, feed additive. Nothing like it. Big profits. Repeat business. Sea-Gro, Paramount, Calif.

**WEAVE** Rugs. Make big profits. No experience necessary! Free catalog, sample card, and low prices on carpet warp, rug filler, looms, parts, inexpensive beam counter. If you have loom, give make, weaving width please. OR. Rug Company, Dept. 1851, Lima, Ohio.

**START** Big-pay business at home in spare time. No experience needed to operate little table-top machine for bronzing baby shoes. Make \$5.46 profit on every pair. Full particulars free. Send postcard to Mason, 1512 Jarvis, Room CM2A, Chicago 26, Ill.

**TAPE** Recording—Fabulous new business! \$500.00 monthly spare time! Entire country wide-open. Free facts. Dixieland Publishers, Asheboro 2A, N. C.

**137 BUSINESS** Plans collection. For home or outside, sparetime possible. Little or no capital, big profits potential, practical, diversified. Mandy and Tous, 216 West Jackson Boulevard, Chicago 6.

**KNOW** How pays! 600 secret, successful plans, tips, sources, hows. Stanley, 258 N. Freeman, Inglewood 3, California.

**FABULOUS** German synthetic gems! White. Brilliant. Hard! Titania's replacement. \$2.00 carat. MexTex, 721PM, El Paso, Texas.

**MAKE** Money writing short paragraphs! No tedious study. I tell you what to write, where and how to sell; and supply list of editors buying from beginners. Many small checks add up quickly. Write to sell, right away. Send for free facts. Benson Barrett, Dept. C-27-N, 7464 Clark, Chicago 26.

**EARN** Cash at once, sending us easy orders for magazines your friends, neighbors want. Instant profits! We show how. For free kit, everything you need, write McGregor Magazine Agency, Dept. 320, Mount Morris, Ill.

**MAKE** Big easy profits making costume jewelry at home in spare time! Quick, easy to make; easier to sell! Details free! Don-Bar, 3511 W. Armitage, Dept. A-192, Chicago 47, Ill.

**IMPORT!** Make big profits. Details. Warner, Box 6, Fort Scott, Kansas.

**HOTTEST** Mail order plan ever! Sell photos, films, art novelties. Huge proven profits! Free details! Profits Unlimited, Dept. 1E, 15015 Ventura Blvd., Sherman Oaks, California.

**KILL** Pests for profit! \$1300.00 monthly proved! Rid homes, farms, business of termites, rodents, pests. New shortcut methods! Learn everything two weeks! Free success plan. APCOA, Dept. 1E, 15015 Ventura Blvd., Sherman Oaks, Calif.

**MAKE** Money, mailing sample business cards. Vosacek Printing, 4444 Ute, San Diego 17, Calif.

**START** Home mail order business. I made enough money to retire. Now own \$18,000 home, Cadillac car, have money in bank. Amazing facts free. Norris Cole, 217 49th Street West, Bradenton, Florida.

**LEARN** Directing money-raising campaigns for churches, hospitals, institutions. Earned \$3065 in six weeks on my first campaign on \$50 investment. Unlimited field. Course backed by 35 years experience. William Henry Arbogast, 229 East Mason Avenue, Alexandria, Virginia.

**YOUR** Name on giant mailing list. Hundreds of opportunity offers. Send 25¢ and state offers or mds. desired. Direct Mail Service Co., Box 581, Bakersfield, Calif.

**5000** BIG Mails—Only! \$1.00. Heyer, 36-11 Raven, Levittown 32, New York.

**OLD** Neckties worth \$3 to \$5 made into Windsor knots. A most fascinating and profitable hobby or business. Information and instruction free. Windsor, 438 N. Roosevelt, Wichita 8, Kansas.

**MEN—Women!** Start money-making plastic laminating business at home in spare time. Material that costs 11¢ brings back \$2.58. No canvassing or selling but mail orders bring in \$20 a day. Write for full particulars free. Rush name on postcard to Warner, Room CL2A, 1512 Jarvis, Chicago 26, Ill.



**AMAZING** Successes through franchises! Become exclusive franchise holder your territory. Information rushed. National Franchise Reports, 333 North Michigan, Chicago 1.

**HOW** To gain quick promotion—More money; right where you work. Foolproof. Details free. Ern-Mar Company, Clermont, Florida.

**1000 MONEYMAKING Opportunities!** Free details. George Lucas, Bellevue 1, Washington.

**\$60.00 WEEKLY**, Sparetime—Easy! Home Venetian blind laundry. Free book. Burt, 2434ER, Wichita 13, Kansas.

**ESTABLISH** Your own business. Simplified instruction qualifies you to prepare income tax forms for others. No experience. Unlimited income. Full time or part time. Full details free. International Tax Institute, 524—26th Avenue, San Francisco 21.

**EARN** Sparetime money by mail. Details free. Elvet Bloomfield, Box 24, Station A, St. Joseph, Mo.

**\$15,000 PROFIT** In one year possible, on \$5.00 cash and just 3 hours attention weekly! Experience unnecessary! Pabulous but true! Proof, complete detailed plan, only \$1.00. Satisfaction or refund! Columbia Enterprises, 8203-P, Grubb Road, Silver Spring, Maryland.

**"HOME Business Digest"** has money-making opportunities galore. Sample 25¢. Donovan, 79-PM Greenbelt, Levittown, New York.

**ATTENTION** Typewriter owners. Make handsome profits. Write today. Groves Company, 682, Hastings 8, Nebraska.

**DO** It yourself. What? Repair TV, build furniture, make barbecue, plumbing repairs, build boats, do house wiring, remodel home, lay tile, modernize kitchen, repair home, and scores of other things you can do yourself. Books covering each subject, only 25¢. Send for descriptive list. It's free. Popular Mechanics Press, 200-LB East Ontario St., Chicago 11, Ill.

**BUY Wholesale!** 30-80% discounts! Appliances, gifts, typewriters, tools, watches, sporting goods, jewelry, cameras, housewares, etc. Consolidated Distributors, Clifton 28, New Jersey.

**FREE** Folio "\$5,000-\$45,000. Unlimited Vacations." No merchandise. Unknown! Work home, sparetime! Haylings, Carlsbad, Calif.

**READ** Progressive Mailtrade, the magazine that tells how to make money by mail. Dime brings sample and special offer. Progressive Mailtrade, Box 357, Sheboygan, Wisconsin.

**BIG** Money raising, fishworms and crickets. Free literature. Carter Hatchery, Plains, Georgia.

**EARN** Money evenings copying and duplicating comic cartoons for advertisers. Adservice, Argyle 1, Wisconsin.

**SELL** Titania gems. Far more brilliant than diamonds. Catalog 10¢. Diamondite, 2420-M 77th, Oakland 5, California.

**VENDING** Machines—No selling. Operate a route of coin machines and earn amazing profits. 32-page catalog free. Parkway Machine Corporation, Dept. 27, 715 Ensor Street, Baltimore 2, Maryland.

**FREE** Book "505 Odd, Successful Businesses." Work home. Pacific, Oceanside, Calif.

**DOLLARS** Every day! It's magical—You keep all the dollars. Setup free. Otto Miller, Box 588-W, Oshkosh, Wis.

**JOIN** The prosperity parade with a mail order bookshop in your own home. Valuable information free. Practical Publications, 3974-P Milwaukee, Chicago 41, Ill.

**WE** Pay \$3.50 lb. dried. Grow mushrooms, Cellar, shed and outdoors. Spare, full time, year round. We have 25,000 customers. Free book. Washington Mushroom Ind., Dept. 173, 2954 Admiral Way, Seattle, Wash.

**BUY Wholesale!** Save 66-2/3%! 100,000 name brand appliances, housewares, clothing, furniture, tools, sporting goods—Everything! Free catalogs! National Buyers Service, Box 3338EB, San Francisco, Calif.

**AGED** Homemaker nets \$100 weekly! Free packet Secret Journal. 919 secrets-plans! Work home. Publicas, Oceanside, Calif.

**MUSHROOMS** Quicker, easier, cheaper. Newest facts free. Luxur, 641 South 19th, Newark 3, N. J.

#### EXPORT — IMPORT

**DO** Anything with music! Free details. Universal Imports, Box 667, Round Lake, Illinois.

**FREE** Information—How to start an importing business from your home. Direct Mail Service Co., Box 581, Bakersfield, Calif.

#### FORMULAS, PLANS, ETC.

**FORMULAS;** All kinds, latest, best. Literature free. Kemixal, Park Ridge, Ill.

**PRACTICAL** Formulas. Lists free. Cummings, Chemist, Gordon Ave., Syracuse 4, N. Y.

**LATE**, Modern manufacturing formulas. List free. Moon Chemical, Martville, New York.

**COSMETICS**, Perfumes, manufacturing formulas. Folder free. Fiedler, Box 21, Jamaica Plain 30, Mass.

**FORMULAS** For latest money-making discoveries. New! Good! Valuable literature free! Miller, Chemist, 1517-D, Tampa, Florida.

#### PLASTICS

**LEARN** Plastics at home. Complete kit—\$5.98. Dime brings sample plastic, three experiments, full details! Plastic Projects, Box 5, Detroit 24, Michigan.

**LAMINATORS** "Job" out your larger work. We now laminate up to 20" x 24". Send for new price list. Lieco, Box 66, College Pt. 56, N. Y.

**NEW** Liquid casting plastic, clear, colors. Embed real flowers, coins, photos. New Manual shows fine things you can make at home and sell at big profit. Send 25¢. Castolite, Dept. A-101, Woodstock, Illinois.

**PLASTIC** casting and mold supplies. Catalog includes instruction in mold construction, casting, Manufacturing methods. Liquid glass, steel, rubber. Send 25¢. GEL, Box 261, Union, N. J.

**PLEXIGLAS**, Square foot cost. 1/16", \$1.20; 1/8", \$1.52; 3/16", \$1.86; 1/4", \$2.21; 3/8", \$3.23; 1/2", \$4.36. Colors add 10¢. Send 15¢ for postage. Aristocrat Plastics, 23 Sussex Avenue, Newark, N. J.

**LEARN** Plastics fabrication for spare time income. Low cost home training now available. Write for free booklet. Interstate Training Service, Dept. D-3, Portland 13, Ore.

**LAMINATING** Supplies. Free price list. Solomonson, 46 Cornhill, Boston 8, Mass.

**BOXES**, Plastic. Free list. Althor, 170 Bay 23 Street, Brooklyn, N.Y.

**PLEXIGLAS**, Acetate, vinylite, polyester, fiberglass, epoxy, styrofoam, mold materials. 28 page instructive, informative wholesale-retail catalog. 25¢. Gem-O-Lite, 5527 Cahuenga Blvd., North Hollywood, California.

#### CHEMISTRY

**SPECTROSCOPE** For quick analysis \$3.00. Kuttingson, 26278 Arastradero, Los Altos, Calif.

**CHEMISTRY**—Science magazines. Literature free. Lankton, Box 5128-C7, Lansing 6, Michigan.

**CHEMICALS** In small quantities. Chemistry and apparatus sets. 26th year. Catalog 25¢. John H. Winn Co., Inc., 124M West 23 Street, New York 11, N. Y.

**"SCIENTIFIC** Oddities." Free sample copy. Franks, 3121 South Racine, Chicago 8.

**CHEMICALS**, Glassware. Catalog 25¢. Laboratory Sales, Box 161-A Brighton, Mass.

**AMAZING** New Book of Science. Experiments, formulas, and catalogue of laboratory supplies. Only 25¢. National Scientific Co., Dept. PM-1, 500 West Road, Lombard, Illinois.

**CHEMICALS** And apparatus for industrial, analytical, and private laboratories. Catalog 25¢. Dept. M-50, Biological Supply Co., 1176 Mt. Hope Ave., Rochester 20, N. Y.

**EXPERIMENTERS:** Bargains catalog, 25¢ (refundable). Hagenow Laboratories, 2414 Clarck, Manitowoc, Wisconsin.

**ILLUSTRATED** Catalog: Chemistry, mineralogy, biology 25¢. Tracey Laboratories, Evanston, Illinois.

#### AGENTS WANTED

**AMAZING** New liquid. Discovery mends, repairs fabrics of all kinds in 60 seconds. Astounding demonstration. Everyone buys. Free sample offer. Write No-Sew, Dept. PM1, 330 South Wells, Chicago 6.

**BIG** Profit selling ties (\$2.00 value) \$6.50 dozen. Free catalog. Empire Cravats, 656-PM Broadway, New York City 12.

**GENUINE** Alligators, stuffed and preserved. No sales resistance. Write for free catalog. Sample assortment, \$3.95. Pan-Coast, 30 N.E. 17th St., Miami, Fla.

**CASH** Commissions at once, taking orders for magazines every family wants! No experience needed. For free money-making kit, with everything you need, write McGregor Magazine Agency, Dept. 300, Mount Morris, Ill.

**MAKE** Money selling hosiery by mail at home, spare time. Amazing sheer nylon stockings (not sold in stores) guaranteed 8 months. Receive dollar bills and keep them! We deliver and collect balance. Self-selling circulars, mail order buyers' names supplied. Details free. Dept. 13, Kendex, 108 Lawrence St., Brooklyn 1, N. Y.

**MAKE** \$75 To \$500 spare time showing friends, neighbors newest of the new, sensational, exclusive modern-design, studio-style all occasion greeting cards for birthdays, anniversaries, get-well, friendship, etc. Everybody orders. You keep 50¢ of every \$1.00. Send no money. Rush name for 2 beautiful assortments on approval. Wallace Brown, 11 E. 26th St., Dept. A-242, New York City 10.

**AMAZING** Greeting card money-maker—Make \$75.00 on 100 deluxe \$1.25 assortments. Newest 21 for \$1 tall cards, gift novelties, 133 fast sellers. Gift bonuses besides biggest profits. Experience unnecessary. Stationery samples free, others on approval. \$1.25 gift for prompt action. Creative Cards, 4401 Cermak, Dept. 514-H, Chicago 23.

**HANDLE** Native handicrafts. Samples, details free. Smith, 98, Dematagoda Place, Colombo 9, Ceylon.

**FOG-Stop** windshield cloth. Instantly removes blurry mist, frost, sleet, snow. Stops windshield fogging. Samples sent on trial. Kristee 74, Akron, Ohio.

**FREE** Sample! Beautiful leather pictures. Sylviak, Apartado 9036, Mexico 1, D. F.

**AGENTS**—300% Profit selling genuine gold window letters; stores and offices. Free samples. Metallic Sign Letter Co., 1217-D West Newport, Chicago.

**YOUR** Ad in this space will get some good agents for you. Yes, I'll prove it. Write for Folder "A" right now. P. W. Johnson, Classified Advertising Manager, Popular Mechanics Magazine, 200 E. Ontario St., Chicago 11, Ill.

**GOLD** Or silver letters, numbers. Windows, doors, trucks. 1" to 6". 500% profits. Free samples. Atlas-T, 544 West 79th, Chicago 20.

**PRINTING**, Advertising salesmen—Excellent moneymaking sideline selling decalcomania name plates, small quantities. Automobile initials, sign letters. Free samples. Ralco, XL, Boston 19, Mass.

**YOUR** Own business—Used suits \$1.50, overcoats 65¢, mackinaws 35¢, shoes 12½¢, ladies coats 30¢, dresses 15¢. Enormous profits. Catalog free. Nathan Portnoy Associates, 605-AA West 12th Place, Chicago 7.

**EASY** Handwork makes fast-selling useful articles. Sample free. Sunmade Company, Brockton 84, Massachusetts.

**GET** "Handiboy" moistener to lick trading stamps, etc. Sells on sight, carry one in your pocket. It will pay your expenses. Sample 50¢. You make 100% profit! A. C. Hummel Co., Mfrs., Cincinnati 13, Ohio.

**\$500.00 EXTRA** In spare time! Show friends Sunshine's outstanding nationally advertised 24 card "everyday" ensemble (tall, petite, and square cards). Sells for only \$1.00, worth much more, cannot be purchased in stores. Luxurious cards sell on sight. Special fund raising plan for churches, clubs, etc. Write for details and samples on approval! Sunshine Art Studios, Inc., 13 Warwick, Springfield 1, Mass.; (West of Rockies, write Pasadena 1, Calif.).



**MEN-Women agents:** Sensational new moneymakers — Beautifully hand-painted, plastic personalized photo enlargements, compacts, rings, bracelets, lockets, etc. Simply take orders, pocket 40% commission. We deliver and collect. Sales outfit free. Novelco, 3343 North Ave., Chicago 47.

**DAMASCENE Earrings!** Exotic oriental-ism. Huge profit. Ohga, PM 103, Sigakenkusatu, Japan.

**NEW Self-watering flower pot.** Write for free literature. T. H. Greenwood Company, North Hills, Penna.

**SEEKING New products?** Get my outfit 47 money-making specialties. Latest conveniences for home, car. Send no money. Just your name. Kristee 75, Akron, Ohio.

**I'LL Send you free stocking sample** newest advancement in hosiery since discovery of nylon. Patented full-length; stays up without supporters, amazingly comfortable. Nationally advertised price \$1.95. Make money fast introducing to friends at \$1.00 pair. American Mills, Dept. 637, Indianapolis, Indiana.

**\$1,000.00 A Month** for making dramatic 3-second demonstration of amazing, light-weight Presto fire extinguisher. New chemical used by airforce snuffs out fires instantly. Only \$4.95. Terrific commissions. Millions want it. Free kit. Merlite, 114 E. 32nd, Dept. P-66E, New York City 16.

**\$78.00 WEEKLY**, Plus cash bonus, from one fast, easy sale, a day, selling low-priced cookware. Write for amazing details! Swanson Housewares, Box 848-B, Station A, St. Petersburg 1, Florida.

**ENGLISH Chamois.** Franchises available salesmen calling service station, janitors. Regular reorders. Chamtana, Hudson Falls, N. Y.

**\$25 DAY, Easy.** New fire extinguisher. Retail \$2.95. Profit \$2.00. Free sales kit. Edconco, 155 East 44th Street, Dept. P-1, New York 17, New York.

**EARN Big money** full or part-time. Quickie Spray shines all leather instantly without buffing, brushing. Be first! Rush refundable \$1.00 for demonstrator, selling kit. Franchises available. James R. Barnett Co., Dept. PM-18, Wellesley Hills 81, Mass.

**GOLDMINE** Of 600 money makers. Free copy. Specialty Salesman Magazine, Desk 5B, 307 North Michigan, Chicago 1, Ill.

**AMAZING "Spray-shoe shine."** 3 second demonstration sells 8 out of 10 prospects. \$2 seller. Make \$1.40 profit each sale. Send name and address for free details or \$1 for giant sample. Trend, 58 W. 15th, New York City 11.

**\$30 DAILY Easy** selling world's finest bibles. Star-Brite, Box 1165, Lakeland Fla.

**PLASTIC Cigarette roller.** Big profits. Sample \$1. Mac Products, 1249 Massillon Rd., Akron, Ohio.

**TERRIFIC Profits** with compression seal. Whirlwind seller. Free literature. Hofer, Menno, South Dakota.

**WORLD'S Fastest** electric paint remover. Yerkminster, 110 West 49th, New York City 18.

**DOWLRITE®.** Pocket adding machine \$2.98. Use while shopping. Sample \$2.00 (refundable.) Dowlrite, Box 754, Atlanta 1, Georgia.

**REFLECTING Road signs.** Sell like wild fire. Prospects everywhere. Wonderful profits. Details free. AA Sign Service, 2914 West 43rd St., Chicago 32, Ill.

**SELL The famous "Gam"** 4-in-1 and 6-in-1 combination tools and really make money. Details. Box 1546M, Lancaster, Penna.

### BUY IT WHOLESALE

**USED** And new watches \$2 up. Free list. Southern Watches, 5-PM So. Wabash, Chicago 3.

**BUY Wholesale!** Discounts to 80%! Gifts, appliances, housewares, tools, watches, etc. Midwest, 1MP-156, Pontiac, Illinois.

**ELECTRIC Guitars, amplifiers.** wholesale. Free catalog. Carvin FMW, Covina, Calif.

**JOIN Catalog club.** Send \$1.00 (refundable) for 8 wholesale catalogs. Stark, Box 9897, Houston 15, Texas.

**BUY Wholesale!** Thousands nationally advertised products! Send postcard! Southland Products, Lincolnton, N. C.

**BUY Wholesale!** Over 10,000 nationally advertised products. Appliances, cameras, sporting goods, housewares, watches, typewriters, tools, clothing, etc. Send postcard today. Buy-Rite, Box 258, Hawthorne 4, New Jersey.

**BIG Multicolor wholesale catalog!** Housewares, appliances, clothing, silverware, cookware, luggage, binoculars, radios, phonographs, cameras, recorders, projectors, typewriters, shavers, sporting goods, toys, tools, sewing machines, watches, jewelry. Name brands. Huge discounts. Postcard: Selbyco, Decatur 152, Illinois.

**ADDING Machines,** new, subtract, guaranteed. \$35. Context, 1637 Delmonte, Seaside, Calif.

**BUY Wholesale!** Appliances, jewelry, clothing, tools, etc. Free catalogs! United Wholesalers, 1265-M Broadway, New York City 1.

**FREE Wholesale catalog.** Gifts, appliances, books, housewares, watches, jewelry, cookware, tableware, dinnerware, cutlery, etc. Discounts to 80%. Topval Corp., Lindenhurst 824, N. Y.

**SAVE Up to 15%** on silverware, gifts, appliances, dinnerware, cookware, cutlery, jewelry, watches. Send 25¢ for catalog. William Springer, Ocoee, Florida.

**MEDICINE Cabinets,** mirrors, shower cabinets, bathroom accessories, etc. Complete catalog free. Hot deal for agents. Kenron Products, 4928 Milwaukee, Chicago 11.

**WHOLESALE Genuine diamond rings,** jewelry. Distributors, Box 106J, Hudson, New York.

**AUCTION-By-Mail.** Lower than wholesale. Information 25¢. Bidders Service Bureau, Box 522, Niagara Falls, N. Y.

**BULOVA, Benrus, Gruen, Elgin watches,** ladies and men's, \$13.50 boxed. 17 jewels. Sample \$14.50. Earrings, \$3.00 dozen. Chain Store Novelty Co., 19 W. 34th St., New York 1, N. Y.

### SALESMEN—DISTRIBUTORS

**INCREASE Present income.** Build growing sideline, fulltime business. No investment. Farmers, agents, dealers. Take orders for Campbell's Gro-Green Liquid Fertilizer Concentrates. Free sample, sales kit. Campbell Co., Rochelle 332, Illinois.

**IF You're interested** in making money in selling, see the hundreds of exceptional opportunities in Salesmen's Opportunity Magazine. Send name for your copy, absolutely free. Tell us what you're selling now. Opportunity, 848 N. Dearborn, Dept. 17, Chicago 10, Illinois.

**MAKE Extra money.** Cash commissions. Everybody buys easy-to-sell advertising book matches. Union label. All sizes. Cuts for all businesses. Powerhouse selling kit free. Steady repeat business. No experience necessary. Superior Match Co., Dept. M-158, 7528 S. Greenwood, Chicago 19.

**ANYONE Can sell famous Hoover uniforms** for beauty shops, waitresses, nurses, doctors, others. All popular miracle fabrics—Nylon, dacron. Exclusive styles, top quality. Big cash income now, real future. Equipment free. Hoover, Dept. A-100, New York 11, N. Y.

**WILL You wear new suits and topcoats** without one penny cost and agree to show them to friends? You can make up to \$30.00 in a day even in spare time, without canvassing. Progress Tailoring Co., 500 South Throop St., Dept. T-326, Chicago 7, Illinois.

**AD Matches!** Sell amazing designs—10, 20, 30, 40 and 240-light book matches. Bigger spot cash commissions; every business a prospect. Low prices for high quality. Repeats. Start without experience; men, women; full, part time. Buy nothing! Sales kit furnished. Match Corp., Dept. PM-97, Chicago 32, Illinois.

**\$1,000.00 A Month** for making dramatic 3-second demonstration of amazing light-weight Presto Fire Extinguisher. New chemical used by airforce snuffs out fires instantly. Only \$4.95. Terrific commissions. Millions want it. Free kit. Merlite, 114 E. 32nd, Dept. P-66E, New York City 16.

**MONEY Back** low priced trading stamp plan pays you bigger spot cash profits with steady year 'round income from re-order commissions. Every grocery, gas station, drug store, etc., are quick buyers. Free pocket sales kit. Worth, P-1, 1925 South Michigan Avenue, Chicago 16, Ill.

**MAKE Money.** Sell sensational dwarf trees, bear giant-size apples, peaches, pears. Ornamental. Also Stark-Burbank standard trees, roses, shrubs, vines, etc. Outfit free. Stark, Desk 30718, Louisiana, Mo.

**YOUR Own \$10,000 business.** Just 3 sales a day! No investment, carry no stock. We train. Be salesman for universally wanted product not sold in stores! Rush card for details. Box 2651, Dept. 1213, Charlotte, N. C.

**CALENDARS,** Advertising novelties, matches. All styles, including religious, varnished, 12 sheet, girls. Hundreds of advertising novelties, book matches, etc. Fleming Calendar Co., Sales Division, 6539 Cottage Grove, Chicago 37, Ill.

**BIG Moneymaking opportunity.** Exclusive line uniforms, jackets, pants, shirts, coveralls, sportswear. Advertising embroidered. Every business prospect. Get selling outfit free! Master Co., Dept. N-3, Ligonier, Ind.

**GET New shirt outfit free.** Make \$90.00 weekly on 5 average orders a day. Famous quality made-to-measure dress and sport shirts at \$3.95 up sell fast to all men. No experience needed. Full or part time. Write: Packard Shirt Co., Dept. 609, Terre Haute, Ind.

**SIMPLE Demonstration** of our new invention amazes business and professional men. Write to Frank Brown, Jr., Dept. P-1, Box 97, Milan, Missouri.

**MAKE Big money** selling the Security hand pressure dry chemical fire extinguisher. First time offered for direct sales. Write today for free information. No obligation. Hudson Mfg. Co., Sheridan 3, Michigan.

**SALESMEN:** A radically new patented mouse-trap. A child can set it. Most territories open. Write Patented Products Co., 214 E. 41 St., New York City.

**SENSATIONAL Values** big profits. Sell 100 guaranteed blue surgical steel razor blades \$1.25. Guaranteed electric razor or ladies' hairremover \$4.95. 50% profit. Rapid sellers through stores, groups, m.o., full, part time. Send cash for samples, selling helps. Almaco, P.O. Box 15, Milamberg, Ohio.

**CALLING Boys 12 years or older.** Earn easy \$1 to \$5 weekly in just a few hours of your spare time. Join 30,000 happy, successful boys selling "Grit"—Cash in on repeat sales 52 weeks in the year. You need not be experienced. "Grit" actually sells itself. It's America's favorite family newspaper in 875,000 homes. Sell for 10¢; make 4¢ profit. Earn steady money; win prizes; get valuable business training. For your first papers and selling helps write today. Grit, Dept. Mech., Williamsport, Penna.

**NEON Window signs—custom made.** 100% profit to salesmen. Merchants save 50%. Write Neon Tube Co., 1758 S. Cleve. Ave., Canton, Ohio.

### EMPLOYMENT INFORMATION

**BOOMING Venezuela—Only hours** from the States. New data regarding jobs, opportunities, conditions, etc. Salaries to \$1650 monthly U. S. tax exempt. Bonuses, living allowances extra. First-hand information direct \$2.00 (\$2.35 air mailed) checks or money orders only. Paul B. Smith, Apartado 172, Maracaibo, Salina, Venezuela.

**JOBS On merchant ships.** Big pay. Box 4092, Jacksonville, Florida.

**JOBS Overseas!** Janecck Development Co., 1090 Hub Station, New York 55, N. Y.

**FREE Information:** Earn high pay. All trades. Foreign and U.S.A. job opportunities. Travel paid. Applications, write Dept. 61J, National Employment Information, 1020 Broad, Newark, N. J.

**COPYRIGHTED Reports** on best paying jobs with travel, adventure, promotions. Construction, aviation, shipping, laborers, clerical, trades, supervisory, factory, unusual opportunities. Many types of work. Skilled and unskilled. Foreign and state-side openings for men and women. Only \$2.00 (\$2.25 airmail), including registration-advisory service. Satisfaction guaranteed. Included absolutely free: Special reports on Alaska, Spanish airbase construction. South American opportunities and husband-wife foreign jobs. Research Services, Suite 514-PMY Meramec Building, St. Louis 5, Missouri.



**GOOD Jobs** available in Washington. Information free. Henderson, 170 Temple Village, Alexandria, Virginia.

**TRUCK Drivers**, laborers helpers, craftsmen over \$1000 monthly for northern bases. For information South America, Spain, Europe, Alaska, etc. Foreign job listing \$1.00. Universal, 1110 Commerce Building, St. Paul, Minn.

**JOBS, Opportunities**, Los Angeles classified \$1.00. Personal Service, Box 321, North Hollywood, California.

**AMERICAN Overseas jobs**. High pay, men, women. Transportation paid. Free information. Transworld, Dept. M, 200 West 34th St., New York City 1.

**FLORIDA Jobs** pay big. Special copyrighted analysis airmailed \$2.00. Free contacts. Sun-Glo Service, Perry 4, Florida.

**MIAMI Beach**, Miami, Hialeah. Hundreds of jobs. Classified want ads \$1. Questions answered per order. Chamar Service, Box 594, Hialeah, Fla.

**GET That better job!** The Job Seeker's Manual tells how. \$1 postpaid. Satisfaction guaranteed. Job Search Services, Box 241-P, Pleasantville, N. Y.

**FOREIGN**, Alaskan, U.S.A. Jobs! To \$1,500.00 monthly! Million Americans employed overseas. Copyrighted reports. Who to contact for highest paying jobs! Laborers, trades, drivers, office, engineers, many others. 52 Countries—Booming West, Latin America, Spain, Europe, all continents. Registration, advisory service. Application forms. Unconditional money-back guarantee! \$2.00. (Airmailed \$2.25) (C.O.D.'s accepted) International Reporter, St. Louis 1-PE, Missouri.

**COMING To California?** 15 page booklet: Jobs, housing, opportunities. \$1.00. Chesley, 3977 1/2 Texas Street, San Diego 4, California.

**FLORIDA—Job listings**, housing, food \$1.00. Baughman's, 2221 Corliss, Orlando, Florida.

**SOUTHERN California employment lists**. Los Angeles, San Diego, \$1.00 each. "Be Prepared to Move." Nonskilled lists included. Calemployment, 844 Oaklawn, Chula Vista 1, Calif.

**WHAT? \$12,000 A year in wages?** That is what I make. So can you. \$2.00 brings you the facts. F. Dasher, 4716 Walther Ave., Baltimore 14, Md.

### SPECIAL SERVICES

**TRANS-World** import mail order club supplies new sources, markets for many products. Free details. Nunnally Exporters, San Angelo, Texas.

**WASHINGTON** Research and information. Any subject. 249 libraries, 25 million volumes. Also federal government matters. Powers, Box 7397, Washington 4.

**INFORMATION** On anything. Ferguson Research Specialists, 116-14 141 St., South Ozone Park 36, N. Y.

### EDUCATIONAL AND INSTRUCTION

**LEARN** Gunsmithing at nationally recognized gunsmithing school. Master instructors, latest equipment, modern shops, classrooms. Day-night classes start weekly. V.A. approved P.L. 16, 550, 894. Write for brochure on gunsmithing, outboard motor repair, sporting goods repair, mechanical drawing, architectural drafting. Colorado School of Trades, 1545 Hoyt, Denver 15, Colorado.

**PIANO** Tuning pays. Big money in spare time. Learn at home in 30 days. No musical knowledge necessary. Phonograph, records, tools and instructions furnished. Personal instructions available. Free catalog. Capital Piano Tuning School, 3160 S.W. 16th Court, Fort Lauderdale, Fla.

**ENGINEERING** Degrees earned through home study. Residence courses also available. Pacific International University, (operating as a College of Engineering only at present), 5719-B Santa Monica Boulevard, Hollywood 38, California.

**LEARN** Bricklaying—Earn \$8000.00 year. New 3D color projection simplifies instruction. Amazing. Handicraft Div. B6, Box 74 Attalla, Ala.

**BE** An investigator. Write for free details. State age. National Detective Academy, 535 East 4th Street, Box 1082, Scottsdale, Arizona.

**LEARN** Mail order publishing. Free details. Rainone Printer, Middle Village 79, New York.

**HIGH School** diploma at home. Licensed teachers—Approved materials. Southern States Academy, Box 5344-MX, Station E, Atlanta, Georgia.

**WE** Pay \$3.50 lb. dried. Grow mushroom. Cellar, shed and outdoors. Spare, full time, year round. We have 25,000 customers. Free book. Washington Mushroom Ind., Dept. 174, 2954 Admiral Way, Seattle, Wash.

**EARN** Degree. Free bulletin. Home-study only. Midwestern Bible School, 1060 Broadripple, Indianapolis.

**BOOKKEEPERS!** Increase your earnings! Operate your own simplified "Dollar-A-Week" bookkeeping and tax service. Full or spare time. Details free. No obligation. Ellis, Box 300, Cedar Grove, North Carolina.

**BE** A real estate broker. Study at home. Send for free catalogue. Midwest School of Real Estate, 68 North Chicago Street, Joliet, Illinois.

**TIMESTUDY**—Your key to positive personal profits. Associated Techniques, Box 235, Hollidaysburg, Penna.

**EARN** College degrees, correspondence. Metropolitan University, Box 86, Glendale 5, California.

**LEARN** Appliance service and repair. Motors, washers, refrigeration, cleaners, everything. Free booklet. Armstrong, 11027-A South Vermont, Los Angeles 44.

**STUDY** For Doctor's degree of psychology, metaphysics and divinity. Correspondence courses only. College of Divine Metaphysics, Dept. P-M, 2811 North Illinois, Indianapolis 8, Indiana.

**BE** A real estate broker. Study at home. Write for free book today. GI approved. Weaver School of Real Estate, 2018P Grand, Kansas City, Missouri.

**USED** Correspondence courses and books sold and rented. Money back guarantee. Catalog free. (Courses bought.) Lee Mountain, Pisgah, Alabama.

**EARN** While you learn. Auto and diesel mechanics master this top paying trade. Many graduates earn \$100 a week and up. Approved for Korean veterans. For free information write Dept. No. 256, Nashville Auto-Diesel College, Nashville 3, Tenn.

**LEARN** While asleep! Details free. Research Association, Box 610-MC, Omaha, Nebraska.

**WANT** A diesel job? New opportunities to increase income. Higher pay. More money. We can help you qualify. Tools. Shop method home training. Write today! Diesel, Tractor, Heavy Equipment Division. Interstate Training Service, Dept. B-3, Portland 13, Oregon.

**INVESTIGATOR** Training. Phillips Secret Service System, 1917-B North Kenneth, Chicago 39.

**USED** Correspondence courses and educational books bought, sold, rented. Free catalog. Educational Exchange, Menlo, Georgia.

**PIANO** Tuning pays. Learned easily at home. GI approved. 59th year. Free booklet. Niles Bryant School, Dept. P, 3731 Stockton, Sacramento 20, Calif.

**SECRET** Investigation. Experience unnecessary. Investigators particulars free. George Wagner, M125 West 86th, New York 24.

**LEARN** Civil and criminal investigation at home. Earn steady good pay. Institute Applied Science, 1920 Sunnyside, Dept. 161, Chicago 40, Ill.

**COMPLETE** Your high school at home in spare time with 61-year-old school. Texts furnished. No classes. Diploma. Information booklet free. American School, Dept. H145, Drexel at 58th, Chicago 37, Illinois.

**BLUEPRINT** Reading—Train at home. Learn to read blueprints with confidence in 10 easy lessons. Write today Belton School, 1059-V North Lawndale, Chicago 51.

**MEN** Wanted, age 19 to 45, to train as draftsmen designers at home in spare time. Big pay opportunities. Write for free brochure. American Technical Society, 850 E. 58th St., Dept. PM-581, Chicago 37, Illinois.

**SHORTHAND** In four days. Learn at home. \$2.98 ppd. Take notes three times faster. Fineline Company, 303-PM Fifth Avenue, New York 16, N. Y. Free literature available.

**MONEY, Happiness**. Free inceptor for success. NISL, Box 610, Long Beach, Calif.

**LEARN** By ear with Dormiphone. While you slumber, amazing new scientific invention works for you. Revolutionary Dormiphonic tools give you a shortcut to learning languages, correct speech; memorizing facts, figures; ideal for self-improvement; relaxation, habit training. Saves time, effort. So simple, children benefit. Used by educators, psychologists. Write today for fascinating free book. No obligation. Modernophone, Inc., 320-018 Mezz. Radio City, New York City 20.

**FINISH** High School at home, spare time. No classes. Diploma awarded. Write for free catalog. Wayne School, Catalog HF-82, 2527 Sheffield, Chicago 14.

**DRAFTING**, Design, blueprint reading. Good paying. Easy to learn at home. Minimum age 17. Write Utilities Engineering Institute, Dept. TC-10, 2525 Sheffield, Chicago 14.

**THE Art of Job Getting**. An original treatise. May mean much to you! Only \$1.00 postpaid. Educators Placement Service, 1026 N.W. 22 St., Gainesville, Fla.

**WELDERS** Earn big money. Easy to learn arc-gas-automatic welding. New equipment, low cost training in non-profit school. GI approved. Free booklet. Hobart Welding School, Box M-181, Troy, Ohio.

**WATCH**-Making, jewelry home study courses. Greatest deal! Watchmaking Institute, Culver City, California.

**HANDWRITING** Analysis now accepted in college, business, industry. Our men, women who use grapho analysis spare, full time earning more money, getting prestige, success, happiness. Uncrowded, fascinating field for intelligent men, women anxious to get ahead. We need more members. Investigate this growing field where you give a real service to your fellow man. Opportunities unlimited. Free sample lesson and information to all over 21. Write today! IGAS, 3307 National Station, Dept. 1012, Springfield, Missouri.

**BECOME** Doctor in Psychology in two years: A special study that modern life exacts to-day for employees, merchants, industrialists, professional men, teachers and others. Learn it by airmail direct. Remit \$2.00 by money order, so that we may send you details of that course and examinations. Write Universidad Latino Americana, P.O. Box 1970, Havana, Cuba.

**SING**. Speak, with power, personality. Self-training records. Amazing details. Canfield, 2018-A 5th Ave., South, Minneapolis 4, Minn.

**DANCE!** Free "automatic instructor" proves you can! Homestudies, 4388 Bedford, Brooklyn.

**WANT** U.S. gov't job? Many open now, \$224-\$377, plus big yearly increases. Men-women, 18-55. Experience often unnecessary. Prepare now! Training until appointed. Free booklet shows jobs, salaries, sample coaching. Write: Franklin Institute, Dept. R-24, Rochester, N. Y.

**EARN** Degree from college abroad, taking test. No travelling. Numerous fields. Aureab, Central Valley, New York.

**ENGINEERING**, Home study. Midwest Engineering School, 10923 Hillcrest, Hickman Mills 34, Missouri.

**FREE** "Amazing Subconscious": Six steps to success. Box 847 (H-1), Ocean Park, Calif.

**LEARN** Mineralogy at home. Geologists show you how. 60 specimen collection included. Free catalogue. Mineral Science Institute, Desk 2, 159 E. Ontario, Chicago 11.

**LEARN** Physical therapy, massage at home. Free information. Mac Vane School, Fort Payne, Alabama.

**PHYSICAL** Therapy and massage. Home training. Practice privately or work with doctors and hospitals. Free catalogue. National Institute, Desk 4, 159 E. Ontario, Chicago, Ill.

### PLAYS, STORIES, MANUSCRIPTS

**WANT** Your book published? Learn how we publish, advertise, promote, distribute. Many successes. Free booklet PM. Vantage, 120 West 31, New York City. Midwest office: 220 S. Michigan Ave., Chicago, Ill.

**WANTED:** Book manuscripts, all subjects considered. Greenwich Book Pub., Atten Mr. Zealand, 489 Fifth Ave., New York City.



MAKE Money writing features. Amazing book tells how. Free literature. Ben Arid, Hermosa Beach, Calif.

### CARTOONING, COMMERCIAL ART, SHOWCARD & SIGN PAINTING, TATTOOING

LEARN Sign painting at home. Free talent test. Ben Kerns, Box 812-PM, Greenville, S.C.

YOU can entertain with chalk talks. Catalog 10¢. Balda The Cartoonist, Oshkosh, Wis.

CARTOON Your way to success! Internationally known instructor, Raye Burns, will personally teach you to create original, salable cartoons at home. Course of 26 lessons only \$2.85. Write for free details. Raye Burns School, Box 3583-P, Cleveland 18, Ohio.

LEARN Sign painting with fascinating system. Straley, 410 S. Western, Springfield, Ohio.

"HOW To Make Money With Simple Cartoons"—A book everyone who likes to draw should have. It is free; no obligation. Simply address Cartoonists' Exchange, Dept. 91-C, Pleasant Hill, Ohio.

LEARN Profitable, fascinating tattooing. Free illustrated information. Zeis, 728-C, Rockford, Illinois.

SIGN Painting—Lessons by mail. Books on lettering, gold leaf, show cards, pictorial. Write: Sign Instruction, 4304 Virginia, Kansas City 10, Missouri.

PAINT Signs—Master die cut, outline letter patterns. Complete assortment 1½" to 12" high, prepaid \$2.00. Eyerly, 583, Newton, Iowa.

### ADVERTISING AGENCIES, LETTER WRITERS, FOR ADVERTISERS

ADVERTISE: 24 Words. 100 Canadian newspapers \$5.50. Lists free. Advertising Bureau, 10511-C Springfield, Chicago 43.

ADVERTISING. Result-getting ads prepared, placed newspapers, magazines, radio, anywhere! Lowest rates. Catalogue free. Baker Advertising Agency, 189 W. Madison, Chicago 2.

MAILING Lists most any classification \$5.00 1000. Your circulars mailed with ours \$4.00 1000. Write for our literature. Dixie Mailers, King, N. C.

WANT More business? Here's an amazing opportunity to increase your sales. Talk to thousands of interested readers of "Mechanics Popular." Our Spanish Edition covers the Latin American countries like a blanket. They're real mailorder buyers. Classified rate 75¢ per word. Try an ad in our next issue. Classified Advertising Department, Popular Mechanics Magazine, 200 East Ontario Street, Chicago 11, Ill.

ADVERTISING Ratebook leading newspapers, magazines, free. Chicago Advertising Agency, Chicago 4.

FREE! 1958 Advertisers Rate and Data Directory. 52 pages! E. H. Brown Advertising Agency, 20 N. Wacker, Chicago 6.

ADVERTISE In Opportunity Ads. Sample copy 25¢. Post. 1425-P West 32nd, Indianapolis 23, Indiana.

### RUBBER STAMPS AND OFFICE SUPPLIES

AIRMAILED Pocket stamp \$1.00. Free emblem catalog. Kraft, Box 2, Los Angeles 53, California.

STOCK Rubber stamps wholesale. Mahair, 8911 North Orleans, Tampa 4, Fla.

DELUXE Pocket stamp. 3 lines \$1.00, prepaid. 8 hour service. Quality Rubber Stamps, 114 Hollywood Blvd., Biloxi, Miss.

QUALITY Rubber stamps! 3 lines \$1.00. Signature stamp \$3.50. Prompt service. Money-back guarantee. Campfield, 14 Beaufort Circle, Springfield 4, Mass.

RUBBER Stamps of quality, 17¢ up. Illustrations free. You can profit. Manhattan Business Supply, 536A Fifth Avenue, New York 36, N. Y.

8 HOUR Service. Postpaid 1st class. 3 lines \$1.00. Guaranteed. Bassler, Ludlow, Mass.

### TYPEWRITERS, DUPLICATORS, OFFICE DEVICES

ADDING Machines, subtract, new, guaranteed. \$35. Regina, 1637 Delmonte, Seaside, Calif.

RECONDITIONED Typewriters, duplicating, printing devices. \$25.00 up. Supplies. Appliances. DixieGraph, King, N. C.

### PRINTING, MULTIGRAPHING, MIMEOGRAPHING, GUMMED LABELS

1000 EMBOSSED Business cards \$3.50. Samples. Hickman Company, Coalgate, Oklahoma.

1500 PERSONALIZED 5/8"x1 1/4" Labels \$1.00. Your 3 line name and address printed with blue ink on fine quality white gummed paper. Money back guarantee. Hamilton-Ward, Dept. 10B, Westfield, Mass.

ADS Running under this heading sell printing. Ask me for proof. I'll gladly send you amazing facts. Ask for Folder "P." F. W. Johnson, 200 E. Ontario St., Chicago 11, Ill.

CIRCULARS, Booklets, letterheads, envelopes, Estimates, anything! Lonelml Printers, Paulding, Ohio.

TOP Quality printing, mimeographing. Free literature. Currier, PM, New Lebanon Center, N. Y.

MIMEOGRAPHING—Letters, pricelists, formulas, instructions. Lowest prices. Lem's Letter Shop, 5710 Stanton, Detroit 8.

BETTER Grade printing. Reasonable. Estimates, Hamel-Printer, 210 5th Avenue, Suite 1104, New York City 10, N. Y.

BUSINESS Cards. Printing. Reasonable. Free catalog. Edmondson, Box 4865-P, Atlanta 2, Georgia.

LADIES' Gentlemen's stationery, 100 sheets, 100 envelopes \$1.98. Starlight, 170-05 Baisley Boulevard, Jamaica 34, New York.

MIMEOGRAPHING, Offset printing, letter heads, business cards. Mary's, 1126 10th St., Des Moines 14, Iowa.

10,000 ATTRACTIVE 2 Color circulars \$20. Testimonials, news items, ads reproduced for sales campaigns. Samples, Fame, 291 Ellis, San Francisco 2, Calif.

GENUINE Engraved letterheads \$18.00 per 1000. Samples. Midwestern, Huntington, Indiana.

PRINTING—Expert craftsmanship. Free samples. Walp, Box 4308P, Mobile, Ala.

OFFSET Printing at mimeograph prices. Write Perkins Printing Service, Fremont, Nebraska.

FREE Catalog, postpaid printing. D M Press, Sebastopol, California.

PRINTING—Photo-offset, letterpress, mimeographing. Samples free. Litho, Madison, Tenn.

250 8 1/2 x 11 LETTERHEADS And 250 6 3/4 envelopes \$4.90 postpaid. Grunzig Press, Avenel, N. J.

BUSINESS, Personal printing—Labels, rubber stamps, accessories. Illustrated catalog, free! Brose, 196-A, Clerk, Jersey City 5, N. J.

YOUR Name and address printed on gummed labels. 500—3 lines \$1.00. 15¢ each extra line. 1/2 x 1 1/2. Print clearly. No c.o.d.'s. Addison Mail Order, PMA-1, 1840 Addison, Chicago 13.

LABELS? What sort? Free samples. S. Eddy, 7 Greenacres Ave., West Hartford 7, Conn.

1,000 BUSINESS Cards. Raised letters, \$3.50. Samples. Pioneer, Island Park 2, New York.

LETTER Heads and envelopes. Send samples for quotations. F & F, 104 James Ave., East McKeesport, Penna.

OFFSET Printing—\$6.75, 1000, 8 1/2 x 11. 24 hour service. National Letter, 251 West 42 St., New York City 36.

FAST, Guaranteed accurate, complete printing service. Catalog—3¢ stamp. Box 1062, Albany, Georgia.

SPECIAL 50% Discount. Write Randolph Press, Box 3406-C, Detroit 3, Mich.

### PRINTING OUTFITS AND SUPPLIES

MAKE Your own self-molding rubber stamps and printing cuts. Plexirubber, Argyle 1, Wisconsin.

DO Your own printing. Save money. Simple rules. We supply everything. Print for others; good profit. Raised printing like engraving too. Have home shop. Details free. Kelsey Presses, V-11, Meriden, Connecticut.

PRINTING Presses, type, supplies, lists 3¢. Turnbaugh Service, Mechanicsburg, Penna.

### PATENT ATTORNEYS

C. A. Snow & Co.—M427, Snow Building, Washington 1, D. C. Registered Patent Attorneys. Write for information.

PATENTS. "Proof of Invention" free. E. E. Vrooman, Registered Patent Attorney, 507 McKim Building, Washington 5, D. C.

"INVENTOR'S Guide" and "Record of Invention" free on request. Frank P. Ledermann, Registered Patent Attorney, 154 Nassau Street, New York City.

INVENTORS: Without obligation, write for information explaining the steps you should take to secure a patent. John Randolph, Registered Patent Attorney, 203 Columbian Bldg., Washington 1, D. C.

INVENTION Record form free and "Patent Information Every Inventor Should Have." Carl Miller, Registered Patent Attorney, Woolworth Building, New York.

CANADA—Ramsay Company Registered, 273 Bank Street, Ottawa, Canada.

INVENTORS—Take these preliminary steps toward patent protection. Sketch and describe your invention. Sign, date and have this disclosure witnessed by two people who understand your invention. Have us make a preliminary search among U.S. patents already granted for similar types of invention. We report on the probable patentability of your invention and recommend your further course of action. Write for our instructive booklet, "Patent Protection for Inventors" and convenient "Evidence of Invention" disclosure form. Victor J. Evans & Co., 431-A Merlin Building, Washington 6, D. C.

INVENTORS: Learn how to protect your invention. Unless the inventor is familiar with patent matters, he should engage a competent registered patent attorney or agent to represent him. We are registered to practice before the U. S. patent office and prepared to serve you in handling your patent matters. "Patent Guide for the Inventor" containing detailed information concerning patent protection and procedure with "Record of Invention" form will be forwarded to you upon request—without obligation. Clarence A. O'Brien & Harvey Jacobson, Registered Patent Attorneys, 81B-A District National Building, Washington, D. C.

INVENTORS—If you believe you have an invention, you should find out how to protect it. The firm of McMorro, Berman & Davidson with offices in Washington, D. C., is qualified to take the necessary steps for you. Send for copy of our Patent Booklet "How to Protect Your Invention." We will also send you an "Invention Record" form. No obligation. They are yours for the asking. McMorro, Berman & Davidson, Registered Patent Attorneys, 134-C Victor Building, Washington 1, D. C.

### FOR INVENTORS

INVENTORS—This firm is registered to practice before the United States Patent Office and available to assist you in the preparation and prosecution of your patent application. "Patent Protection for Inventors" booklet containing detailed information and steps to take toward patent protection sent promptly upon request. No obligation. Victor J. Evans & Co., 432-A Merlin Building, Washington 6, D. C.

INVENTORS: Learn how to protect your invention. Unless the inventor is familiar with patent matters, he should engage a competent registered patent attorney or agent to represent him. We are registered to practice before the U. S. Patent Office and prepared to serve you in handling your patent matters. "Patent Guide for the Inventor" containing detailed information concerning patent protection and procedure with "Record of Invention" form will be forwarded to you upon request—without obligation. Clarence A. O'Brien & Harvey Jacobson, Registered Patent Attorneys, 81A-A District National Building, Washington, D. C.

INVENTORS—Send for free Patent Information book and Inventor's Record. Registered Patent Attorney, Associate Examiner, Patent Office 1922-29, Patent Attorney & Advisor, Navy Department 1930-47. Gustave Miller 18A Warner Building, Washington 4, D. C.

INVENTORS: We analyze commercial possibilities of your patent. Send \$10.00 and copy of your patent papers. Arizona Patent Research, Inc., P.O. Box 2468, Phoenix, Arizona.



**INVENTORS**—If you believe you have an invention, you should find out how to protect it. The firm of McMorrow, Berman & Davidson with offices in Washington, D. C., is qualified to take the necessary steps for you. Send for copy of our Patent Booklet "How to Protect Your Invention." We will also send you an "Invention Record" form. No obligation. They are yours for the asking. McMorrow, Berman & Davidson, Registered Patent Attorneys, 134-B Victor Building, Washington 1, D. C.

**IDEAS** Developed and patent drawings. Write Apostolescu Co., 55 West 42 Street, New York 36, N. Y.

**200 WANTED** Inventions and how to invent them! Information free. MCB, 1221P West Minnehaha Pkwy., Minneapolis, Minn.

**INVENTIONS WANTED**—27 years experience promoting patented, patent pending inventions. National Service Bureau, 3130 Meramec, St. Louis 18, Mo.

**WHY** Let your ideas remain idle simply because you lack equipment and facilities to complete development? Our technical staff and fully equipped electrical, electronic, electro-chemical, physics, and mechanical laboratory now offers inventors service to perfect, analyze, or test your ideas. For information write Connecticut Research Company, Box 168, Old Lyme, Conn.

**INVENTIONS** And ideas designed for your profit and patented for your best protection at low definite fees. Thirty years experience in developing and patenting inventions in U.S. and foreign countries. Patent searches with valuable report \$15.00. Joseph O'Brien, 132 Nassau Street, New York 38, N. Y.

**PATENT** Searches \$5.00. 48-hour airmail service. Invention protection forms free. Write Patent Engineering Service, 711 14th Street N. W., Washington 5, D. C.

**INVENTORS:** Test the commercial value of your patented or unpatented inventions, quickly and inexpensively. Write for free information. Institute of American Inventors, Dept. 40-B, 635-F St., N.W., Washington 4, D. C.

**INVENTORS,** Don't sell your invention patented or unpatented until you receive our offer. Write Cowgill, Box 298, Marion, Ohio.

**INVENTION** Record form free and "Patent Information Every Inventor Should Have." Carl Miller, Registered Patent Attorney, Woolworth Building, New York.

**PATENT** Searches \$5.00. 48-hour service. Free invention protection forms. Write Raymond L. Smith, Patent Searcher, 620 Sheraton Building, Washington 5, D. C.

**INVENTORS:** Information on patent procedure furnished on request, without obligation. John Randolph, Registered Patent Attorney, 202 Columbian Building, Washington 1, D. C.

**PATENT** Searches, including copies of nearest patents, \$6.00. Reports airmailed within 48 hours. More than 100 registered patent attorneys use my service. For free invention protection forms, write Miss Ann Hastings, P.O. Box 176, Washington 4, D. C.

**INVENTIONS** Wanted now by my manufacturer-clients. Patented, unpatented. Write Gilbert Adams, Patent Broker, 80-S Wall Street, Financial District, New York City.

#### INVENTIONS WANTED

**INVENTIONS** Wanted now by my manufacturer-clients. Patented, unpatented. Write Gilbert Adams, Patent Broker, 80-S Wall Street, Financial District, New York City.

**INVENTORS:** Hundreds of manufacturers have requested our assistance in locating marketable new products. Complete information free. Institute of American Inventors, Dept. 40-D, 635-F St., N.W., Washington 4, D. C.

**CASH** Buyers for inventions. Write National Inventors Institute, Box 7007, Cleveland 28, Ohio.

**INVENTORS,** Don't sell your invention patented or unpatented until you receive our offer. Write Cowgill, Box 298, Marion, Ohio.

**SUPERIOR** Promotions. Patented: unpatented inventions. Information booklet, free. Superior, 338-344 North Rodeo, Beverly Hills, Calif.

**WANTED**—Marketable products, mechanical, electrical or electronic for manufacture. Patent, unpatented. Buy outright or license. Complete manufacturing and distribution facilities. Write direct, Victor Research Laboratories, Box 763, Woodlyn, Penna.

**INVENTIONS** Wanted: Patented, patent pending. 27 years experience promoting inventions. National Service Bureau, 3120 Meramec, St. Louis 18, Mo.

**INVENTIONS** Wanted. Patented; unpatented. Tremendous manufacturers lists. Global Marketing Service, 2420 77th, Oakland 5, California.

**INVENTIONS** Needed immediately for manufacturers. For additional information write Kessler Corporation, 51-IW, Fremont, Ohio.

**THE** United States annual pictorial catalogue of new inventions for the year (1958-1959) is being compiled. To show your invention in America's largest invention catalogue write publishers; A. J. Murphy & Associates, 681 Market Street, San Francisco 5, California.

**INVENTIONS** Wanted: Patented, unpatented. All types desired by our clients. Immediate information by airmail. Inventors Marketing Service, P.O. Box 17, Dept. M, Gonzales, Texas.

**ARE** You interested in offers from reliable manufacturers for your invention? Patented, unpatented. Harvey Engineers, Cambridge, Maryland.

**INVENTIONS** That can be made from aluminum. Southern Products, 2014 Northeast 18th Street, Ft. Lauderdale, Florida.

#### PATENTS FOR SALE

**ALUMINUM** Combination walking stick luggage carrier. 22 ounces. U.S. patent approved. Holloway, 1318 Greene Avenue, Montreal 6, Canada.

#### MANUFACTURING

**MODELS**—Small lot manufacturing. Metals, plastics, etc. Milburn, Burlington, Kentucky.

**DRAFTING,** Blueprints of your ideas. Holland Drafting Service, Marion, Mich.

#### MODELS. MODEL SUPPLIES

**SHIP** Models. Most complete line in New England. Kits, fittings, plans, books, tools, engines, motors. 1958 illustrated catalog 35¢. James Bliss & Co., Inc., Dept. SM, 342 Atlantic Ave., Boston 10, Mass.

**SHIP** Model kits and fittings including clippers, trawler, fishermen, frigates, privateer, radio control tug, etc. Send 25¢ for 1957 catalog. Model Shipways, Box 85, Bogota, N. J.

**BALSA** Wood and model aircraft. 40-page catalog 25¢. Sig Co., Montezuma, Iowa.

**SHIP** And yacht model fittings; blueprints. Send 35¢ for illustrated catalog listing hundreds of items. A. J. Fisher, 1002-1 Etowah Ave., Royal Oak, Mich.

**CATALOGS:** 84 Page ships fittings 50¢ with refundable coupon, trains 50¢, collectors soldiers 25¢, radio control 15¢, vehicles, guns 20¢, airplanes 20¢, general hobby 15¢, leathercraft 10¢. Polks, 314M Fifth Ave., New York City 1.

**LIVE** Steam and park locomotive catalog 25¢. Friends Steam Models, Topsfield, Mass.

**BUILD** Miniature passenger hauling live steam locomotive, with file and drillpress. We do machine work, you bolt it together. Catalog 50¢. Little Engines, Lomita, Calif.

**MODELS,** Hobbies, supplies. 270 page catalog \$1.00. Refunded upon \$5.00 in orders. Joyner's, 221 N. Limestone, Lexington, Ky.

**LIONEL** Trains—Appliances. Big discounts. Bulletin free. Catalog 25¢. Mack Bros., 2043P Chicago Ave., Chicago 22.

#### HOME CRAFTSMEN

**FREE.** New big illustrated catalog, leathercraft, metalcraft, woodcraft kits and supplies. Complete stock, top values, latest ideas. Write today. J. C. Larson Co., Dept. 7727, 820 S. Tripp, Chicago 24.

**OVER** 900 Woodworking projects. Books and patterns. Free catalog. Craftsman, 115-C Worth Street, New York City 13.

**LEATHERCRAFT.** Send 10¢ for new 76-page catalog of tools, supplies, kits, including metalcrafts, enameling, ceramics, all other crafts. Complete stock. Reasonable. Since 1910. Sax Bros., Dept. PM-1, 1111 N. 3rd, Milwaukee, Wis.

**FREE** Catalog. 2150 artist-drawn patterns, designs. Craftplans, 1322-A Wabash, Chicago 5.

**129 FULL-Size** artist drawn jigsaw patterns. \$1.00. Craftplans, 1322-A Wabash, Chicago 5.

**SHOP** On wheels. Inexpensive wheel kit. Free catalog. Ripplinger's, 1926 Gravois, St. Louis 4, Mo.

**PATTERNS** Flying ducks, man sawing wood. Dutch maid churning butter, and 30 lawn ornaments, only \$1.00. Lincolns Studio, Columbia, Conn.

**AMERICA'S** Most complete home craft supply company. Send 10¢ for big colored catalog. Giles & Kendall Co., Huntsville, Alabama.

**LEARN** Art metalcraft and jewelry making. Complete, inexpensive, home training course now available. Special tools and materials furnished. Write for free booklet. Interstate Training Service, Dept. L-3, Portland 13, Oregon.

**KNOCKDOWN** Cedar chests and lumber. Free price list. Bedford Lumber Company, Shelbyville, Tennessee.

**WOODWORKING** And cabinetmaking course for beginning and advanced home craftsmen. Only complete low-cost home training program available. Write for free booklet. Interstate Training Service, Dept. G-3, Portland 13, Ore.

**ALL** Crafts, supplies. Large free catalog. National Handicraft, 199 William Street, New York City 38.

**STYLECRAFT** "Pretraced" leather kits. Handbags, billfolds, filigree belts. Patterns on leather. Just carve, assemble and lace. "Pre-carved" kits also available. Send 25¢ for catalog, free folder. Refunded first order. Apache Leather Company, 2804 E. Washington St., Phoenix, Arizona.

**LEATHERCRAFT,** Imported and domestic leather, tools, kits, complete catalog, 25¢ refundable. Midas, Box 1255, Dept. J7, Huntington Park, California.

**FREE** Seashells catalog. Instruction book 35¢. Secor's, Bradenton, Florida W.

**16 LAWN** Chairs, 22 tables, benches, trellises. Plans and necessary patterns \$1.00. Mastercraft, 13M, 7041 Olcott, Chicago 31, Illinois.

**101 PATTERNS** Of smart gifts, novelties, shelves, action windmills. Plus "Make Money Jig Sawing." \$1.00. Mastercraft, 15M, 7041 Olcott, Chicago 31, Illinois.

**NEW.** Steel drawer pulls. Index type. Dozen \$1 p.p. Johnson Metal Products, Chalmers 1, Indiana.

**LEATHERCRAFT,** Copper enameling, mosaic tile, metal tooling, many more crafts. Complete illustrated catalog free. Kit Kraft, 281, Studio City, Calif.

**BUILD** Your own well-driller, approximate cost \$35, plus ¾ horsepower electric or gas motor. Drills ¼ inch hole 100 feet deep or more through any formation. For blueprints and instructions. Send \$8.00 to: Roy Vulgamore, R.R. #7, Chillicothe, Ohio.

**89 JIG** Saw patterns. Beautiful shelves, ornaments, novelties. Plus "How, Where to Sell." \$1.00. Mastercraft, 14M, 7041 Olcott, Chicago 31, Illinois.

**BEAUTIFUL,** Seasoned walnut and cherry. Squares, blocks and dimensional lumber. Prices competitive. Price list free. Midland Lumber Co., P.O. Box 124, St. Joseph, Missouri.

**A** New tool that points center. Use center locator for laying out mortise and tenon, half lap and slip joints, dowel work, and plowing specified groove widths in center of various material widths. Order yours today. \$1.00 prepaid. Gard Tool Company, Box 233, Springfield, Illinois.

**BUY** Picture frames from us in mitered pieces, you do gluing and nailing yourself. Save big money on frames, also get free delivery. Chesapeake Picture Frame Co., Box 533, Baltimore 3, Maryland.

**FREE** "Do-it-yourself" leathercraft catalog. Tandy Leather Company, Box 791 F25, Fort Worth, Texas.

#### DO IT YOURSELF

**GRANDFATHER** Clock movements, barometers, blueprints, kits. Wholesale catalog 25¢. Mason-Sullivan, Noroton, Conn.



**AWNINGS.** Build your own. Fiberglass, aluminum. Write for literature. Lustergero, Inc., Wickliffe, Ohio.

**MAKE** Your own aluminum windows. Information. Gould's Hardware, Woodstock, Ontario, Canada.

**BUILD** Rotary tiller and mower combined or separate. Kits and parts. Mass production low prices. 2½ and 3 h.p. engines \$35.00 and \$38.00. Circulars free. Shaw Du-All (PM), Galesburg, Kansas.

**MAKE** Paint stick to metal with "Metal Treat." \$1.00 bottle makes one gallon. At leading hardware and paint stores or prepaid from Klean-Strip Co., P.O. Box 10083-B, Memphis, Tenn.

**18 FULL-Size** patterns. Save money with easy-to-use, professionally designed full-size patterns. Make money selling beautiful, useful furniture. Make modern step and cocktail tables; metal lamps; cupola; 12-foot outdoor. All patterns test-built; sold with money-back guarantee. Get your free list of these convenient, economical patterns today. Popular Mechanics Press, 200-HH E. Ontario Street, Chicago 11, Ill.

#### **WATCHES, OLD GOLD, JEWELRY**

**FREE.** Illustrated catalog. Jewelry, parts, supplies. Poisson's, Box 52, Medford 55, Massachusetts.

**RHINESTONES,** Pearls, costume jewelry supplies. Catalog 10¢. Rhinestone kit including catalog, \$1.00. J & M Novelties, Dept. CA-3, Box 173, Broadview, Illinois.

**WATCHMAKERS' Tools,** materials, supplies, watches. Catalog. Gales, Box 1000, Chicago 90, Illinois.

**COSTUME** Jewelry supplies, settings, rhinestones, etc. 88 page illustrated catalog. 25¢. Milady, Box 1328, G.P.O., New York City.

**WATCH** And clock repairing books. Free catalog. North American, 2320-AA, Milwaukee, Chicago 47, Illinois.

#### **RAZORS, BLADES, SHARPENING**

**FREE** Sample blade, imported from Germany. Revolutionary accomplishment. First time in U.S.A. Paul M. Weil, 601 West 144 St., New York City 31.

#### **FOR THE HOME**

**FREE.** Discount catalog! Save on gifts, housewares, books, jewelry. Postage prepaid. Carpet Enterprises, 232 Normandy Rd., Massapequa, N. Y.

**HEAT** Your home, business for almost nothing. Folio with drawings free with purchase of "Rainbow Fire Color." Transforms your fireplace into rainbow colors. Longer lasting economy. Box \$2.00 including folio p.p. 2 boxes \$3.50. Limited offer. Ottaquechee Products Company, Quechee, Vermont.

**FOAM** Rubber furniture cushions. Factory seconds. 50% discount. Free catalog. Perma-Foam, 390-C Nye Avenue, Irvington, N. J.

"**HOME** Improvement Guide." New, amazing 192 page volume. Packed with ideas, plans for remodeling, decorating, landscaping, built-in projects. \$2.50 prepaid. Popular Mechanics Press, 200-HG East Ontario St., Chicago 11.

**FIRE** Alarm (dependable) \$4.95. Howard Sawyer, 5813 Benton Heights, Baltimore 6, Md.

#### **OF INTEREST TO WOMEN**

**WE** Pay \$3.50 lb. dried. Grow mushrooms. Cellar, shed and outdoors. Spare, full time, year round. We have 25,000 customers. Free book. Washington Mushroom Ind., Dept. 176, 2954 Admiral Way, Seattle, Wash.

**SELL** Fine fabrics. Get yours wholesale. Box 863, Norwalk, Conn.

**STAMPED** Linens for embroidery or painting. Buy direct from manufacturer and save. Send for free catalog. Merribee, 16 West 19th St., Dept. 628, New York 11, N. Y.

"**8 MISTAKES** Parents Make." Every parent should have this new book about child training. It is free; no obligation. Simply address Parents Association, Dept. 671, Pleasant Hill, Ohio.

**GOOD** Pay, making scented flowers sparetime. Free sample. Floralart, Sharon 25, Penna.

**WANTED** At once, woman with car. Would you like to earn \$35 or more a week in your spare time, calling on housewives in your vicinity, with Rawleigh products? Write Rawleigh's, Dept. A-790-PPM, Freeport, Ill.

**WANT** To make big money at home? \$10.00 profit in an hour possible with invisible mending. Make tears, holes, disappear from clothing, fabrics. Steady year-round demand from cleaners, laundries, homes. Details free. Fabricon, 6270 Broadway, Chicago 40, Illinois.

**MONEY** In famous Florida-Capri jewelry. Send 25¢ for sample pair earrings and wholesale catalog. Shellcrafters, 5626 N. Skyway, St. Petersburg, Fla.

**\$25 A Day** easy with 60% profit. Friends and neighbors will thank you for demonstrating new beauty tips and most glamorous ways to use famous Studio Girl Hollywood Cosmetics. Information I send you quickly qualifies you as a beauty adviser so you can make up to \$25 or more a day to start—Or \$5.00 an hour for spare time. If you write me today I will include actual samples for which you pay nothing, now or ever. Send name, letter or postcard, to me personally. Harry Taylor, President, Studio Girl Cosmetics, Dept. 1281K, Glendale, Calif.

**E-Z Ups** for your toaster will toast small pieces, cake, muffins, etc. One dollar. Jeanne Shop, 504 Richey, West Collingswood 6, N. J.

#### **PERSONAL**

**MECHANICS,** Engineers, operators. Get your trade identification card. G. A. Hunter, 769 E. Hastings, Vancouver, Can.

**LOVELAND** Remails to someone dear 25¢. Konrad, Box 144-R3, Loveland, Ohio.

**BIBLE** Questions answered. Stamped envelope. Bylon, 17167 Bentler, Detroit 19, Michigan

"**HOW** Can I find out?" You can! Information confidentially developed. Any matter, person, problem. Worldwide. Officially licensed. Established 1922. William Herman, 170 Broadway, New York City.

**PAY** Your bills now. Borrow \$100 to \$600 cash by mail. Easy, quick, private. Repay in small monthly installments over 20 months. Your payments may run ½ less than now; have money left over to spend. Loan order blank mailed free in plain envelope. Advise amount needed. State Finance Co., 323 Securities Bldg., Dept. A-227, Omaha 2, Nebr.

**BORROW** Money by mail. \$100 to \$600 from postal finance. Employed men, women easily obtain \$100 to \$600 fast, entirely by mail. Repay in small monthly payments. Friends, relatives, employer, tradespeople will not know you are applying for loan. Advise occupation, amount wanted. Postal Finance Company, 200 Keeline Bldg., Dept. 658A, Omaha, Nebr.

**LOANS** By mail. Borrow \$50 to \$500. Employed men and women over 25, eligible. Confidential, no co-signers, no inquiries of employers or friends. Up to 2 years to repay, monthly payments. Supervised by State of Nebraska. Loan application sent free in plain envelope. Give occupation. American Loan Plan, City National Bank, Dept. PM-1, Omaha, Nebraska.

**PHILIPPINE** Information \$1.00, clippings 25¢, remailing 50¢. O'Villasis, Canlaon, Quezon City, Philippines.

**IMPROVE** Your position! Message "A" free. Peoples Publishing Service, Box 416, McLean, Virginia.

#### **REMAILING SERVICE**

**SEATTLE** Remails — 25¢. Forwarding \$3.00 monthly. Dorman, P.O. Box 42, University Station, Seattle 5, Washington.

**MIAMI** Remails 25¢, month \$3.00. Ed. Polaski, Box 272, Miami 47, Fla.

**REMAILS.** 25¢ Each way, \$3.00 monthly. Hale, Box 1, Glenmont, N. Y.

**REMAILING** Miami, Miami Beach, 25¢. Scenic postcards. R. Shay, 103 Marion, Hollywood, Florida.

**MIAMI** Beach remails 25¢. Zurga, 1455 Meridian, Miami Beach 39, Florida.

**HOLLYWOOD.** Three remails \$1.00. Personal Service, Box 321, North Hollywood, California.

**COLUMBUS** Mailing, receiving-forwarding address for rent. Details free. William McLaughlin, 800 Stewart, Columbus 6, Ohio.

**FLORIDA** Remailing letters 25¢, all year around. Pronto, P.O. Box 118, Miami Beach, Fla.

**MAIL** Received-forwarded. \$3 month. Hedgpeth, Box 830, Alhambra 23, Calif.

**NATION'S** (And world's) capital remails. 25¢. Powers, Box 7397, Washington 4.

**ALOHA!** Six colored hula girl postcards—\$1.00. Remaild free. Souvenir gifts available. Surprise your friends. Now! Today! Write: Jim Fobel, 4503-HG Aukai Avenue, Honolulu.

**CONFIDENTIAL** Mail service. \$3.00 month. Remails, 25¢. Kent, Box 4606, San Francisco.

**LETTERS** Remaild 25¢. J. Love, 1419 E. 83d, Los Angeles 1, California.

**SWITZERLAND** Air remails 50¢. Rare stamps. Voney, 28 Sameriter Str., Zurich, Switzerland.

#### **TREASURE FINDERS**

**FREE** Literature—Light weight, guaranteed metal detectors, Geiger counters and mineralights. Kits and assembled models. Electronic Applications. Dept. M, Box 8, Arlington 10, Virginia.

**GOLD,** Silver metal detectors. Geiger counters for uranium. Violites. Sensational new fully guaranteed models. None finer. Information free. Detectron Corp., 5528 Vineland Ave., North Hollywood, Calif.

**TREASURE.** Metal-mineral detectors, M-scope. Used worldwide for treasure hunting. Geiger, scintillation counters, mineralights. From \$14.75. Guaranteed. Time payment plan. Free treasure, uranium information. Free catalog. Fisher Research Lab., Inc., Dept. C-1, Palo Alto, Calif.

**FIND** Buried treasure, gold and silver, with Goldak's sensational 3½ lb. "find-it" locator, only \$64.50. Write for free literature on complete line of mineral, metal locators; Geiger and scintillation counters. Goldak, 1541 W. Glenoaks Blvd., Glendale, Calif.

**GEIGER** Counters. Tremendous savings. Closing out at \$29.95 (was \$119.50!) and up. Genuine RCA. Original factory sealed cartons. New, complete. Catalog "GC" free. Write Barry Electronics Corp., 512 Broadway, New York 12, N. Y.

#### **FOR SALE—MISCELLANEOUS**

**HEARING** Aid batteries, wholesale. Free list. Habs, Box 51, York, Penna.

#### **WANTED—MISCELLANEOUS**

**WOULD** Like work at home sparetime. Wisner, 10 S. Robinson, Baltimore 24, Md.

**WANTED.** Manufacturers interested in developing an electronic system of automation. Box 502, Huntington Park, Calif.

**QUICKSILVER,** Platinum, silver, gold. Ores analyzed. Wholesale Terminal, Norwood, Mass.

**SCRAP** Mercury (quicksilver) containers supplied — Tantalum, tungsten, silver, platinum. Metallurgical Products Company, Established 1909, 35th & Moore Sts., Philadelphia 45, Penna.

#### **MISCELLANEOUS**

**OUTDOOR** Toilets, cesspools, septic tanks cleaned, deodorized with amazing new product. Safe, harmless, easy to use. 150,000 customers your guarantee of satisfaction. Money-back guarantee. Postcard brings free trial offer. Burson Laboratories, Dept. D-21, 951 Willard Ct., Chicago 22, Ill.

**BARGAIN!** Copy of Alaska magazine, map, checkako certificate with your name inscribed; deed to Good Enough mine and Alaska pocket guide. All for \$1.00. The Alaska Sportsman, Ketchikan, Alaska.



RARE Alaska dog-team covers with post-masters' signature 50¢ each. Arctic Cachet Company, Ketchikan, Alaska.

JAPAN: Buy direct. 24 page catalogue. Kimono, jewelries, gifts, novelties, etc., makers' list, business informations. Send \$1.00 money order. Clarence Yamagata, 202 Naka 7 Bldg., Marunouchi, Tokyo.

LEGITIMATE Big mail 25¢. John Butterworth, 489 Henry, Detroit 1, Mich.

OPPORTUNITY To sell your handicraft. Send samples to promoter. Pinkbeiner, 1621 N. Frederic St., Burbank 1, Calif.

HAIRCUT As you like it. Booklet 25¢. Mastrolia, 32-22HB 89th, Jackson Heights 69, New York.

RECEIVE Free moneymaking offers galore. Baker, Box 108-P Sugarland, Tex.

SLOGANEERS. Exclusively created originally designed slogans produce results. Write Sloganeers, 232 - 5th Ave. No., St. Petersburg 1, Florida.

10 ALL Different mail order magazines plus our 4 page list of unique, imported, fast-selling items. All for 25¢. Emerson Trading Co., Pompton Plains 39, N. J.

DISCOUNT Dialer. Durable pocket size bakelite vinyl computer. Fantastic. \$1.00. Edco Products, Box 186, Dept. A, Norfolk 1, Va., No c.o.d.

\$20.00 WORTH Of Pocket combs—\$3.00. Other good buys. Burke Associates, Manchester, Mass.

MASONIC Publications. Restricted to Masons-candidates. Request complete list. Gerard's, Box 604-P, New Orleans, La.

WHOLESALE! Clothing, appliances, jewelry, furniture, etc. United Wholesalers, 1265 G. Broadway, New York 1, N. Y.

RECEIVE—Sample magazines, mails, offers everywhere. Get listed. 25¢. Rorick, Box 86P, Cincinnati 26, Ohio.

SELL! Buy! Trade! Anything. Read, Trading Post Magazine, 10¢. Thorne's, 525 Dewey, Jackson 30, Michigan.

100 HOLLOW Ground single or double edge \$1.00. Ladies electric shaver \$4.95. Mexican feather pictures. Sample quarter. Bender Supply, Box 87, Rosenberg, Texas.

SEND Me up to six of your old ties, with one dollar, and I will return same number, different, cleaned and pressed. Tie-Man, P.O. Box 41, Crawfordsville, Oregon.

STUPENDOUS Mental power. Adults. Details—3¢. Wisdom, 846 Sunnyside, Chicago 40.

TROUBLE Lamp invention. Focus light where needed, instantly! Circular free. Hook Mfg., New Holland, So. Dak.

REPLICA Authentic Hawaiian war canoe, 5" long. All parts pre-cut, ready to sand and assemble, \$1.00. R. Sauer, 45-016 Likeke Place, Kaneohe, Hawaii.

MEN—Women: Want to feel younger? Customer yet to request refund. Be amazed. Mailed in plain wrapper. Send \$7.50 for month requirement. Vita-Prestige, Box 1268, Huntington Park, California.

GERMAN Cuckoo clock \$2.00. Gray Company, Box 948, Vallejo, Calif.

RECEIVE MAIL opportunities, magazines, samples, 25¢. Jones, 8448 Kavanagh Rd., Baltimore 22, Maryland.

I want to send you proof of the wonderful pulling power of Popular Mechanics classified pages. What's your proposition? Write me today. Include literature if possible. F. W. Johnson, Manager Classified Advertising, Popular Mechanics Magazine, 200 E. Ontario St., Chicago 11, Ill.

LEARN While asleep! Details free. Research Association, Box 610-MC, Omaha, Nebraska.

YOUR Name wanted. We'll send 1000 publishers, mailers, wholesalers your name, on our list one year 25¢. Dixie Mailers, King, N. C.

BOOKS On antiques and their prices. Free circular! P. Warman Publishers, Uniontown, Penna.

WE Pay \$3.50 lb. dried. Grow mushrooms. Cellar, shed and outdoors. Spare, full time, year round. We have 25,000 customers. Free book. Washington Mushroom Ind., Dept. 175, 2954 Admiral Way, Seattle, Wash.

BUY Wholesale! Over 10,000 nationally advertised products. Appliances, cameras, sporting goods, housewares, watches, typewriters, tools, clothing, etc. Send postcard today. Buy-Rite, Box 258, Hawthorne 2, New Jersey.

CIGARETTES—Make 20 for 9¢. Facts free. Moberly, Box 810, Owensboro, Kentucky.

CESSPOOLS. Septic tanks, clogged drains. How they function and how to keep them working. Free literature. Chemical Cesspool & Drain Cleaning Co., Boston 34, Mass.

WANT More business? Here's an amazing opportunity to increase your sales. Talk to thousands of interested readers of "Mecanica Popular." Our Spanish Edition covers the Latin American countries like a blanket. They're real mailorder buyers. Classified rate 75¢ per word. Try an ad in our next issue. Classified Advertising Department, Popular Mechanics Magazine, 200 East Ontario Street, Chicago 11, Ill.

70 BIBLE Lessons 25¢. Bulletin, Box 87, Cathedral Station, New York 25, N. Y.

WRITE For free catalog. New government surplus—GI self-instruction books. Value over \$7 each. Mathematics, history, foreign languages, accounting, farming, auto-mechanics, establishing new business, etc. \$1.00 each postpaid. Choose from over 60 courses. Sual Co., Dept. B, Elsinore, California.

RECEIVE Big mails, sample magazines, offers. Get listed 25¢. Ed. Polaski, Box 372, Miami 47, Fla.

SADDLES, Boots, western wear, leather supplies. Free catalog. Silver Spur, Box 1785-N1, Ft. Worth, Texas.

SMALL Businessmen. Why go broke? Small Business Advisory Bureau, Box 425, Minneapolis 1, Minnesota.



The 6-Transistor  
Portable That Plays  
Anywhere!

build  
your own  radio  
and SAVE

No other portable gives you so many important features at such a low price. You get a 4" x 6" speaker for "big-set" tone—500 to 1000 hour battery life—unbreakable molded plastic cabinet in Holiday Gray—efficient, all-transistor circuit—and easy, step-by-step assembly instructions and pictorial diagrams. Have fun building and using this fine set. Shpg. Wt. 4 lbs.

HEATHKIT TRANSISTOR  
PORTABLE RADIO KIT  
MODEL XR-1 **\$34.95**  
(with cabinet, less batteries)

FREE HEATHKIT CATALOG AVAILABLE

Pioneer in  
"do-it-yourself"  
electronics

Describes many more "do-it-yourself" kits for hobby—hi-fi—ham radio—and experimenting. Get your copy now for complete selection of fun projects that save you money.



**HEATH COMPANY**  
BENTON HARBOR 17, MICHIGAN A SUBSIDIARY OF DAYSTROM, INC.  
Please send FREE Heathkit Catalog

NAME \_\_\_\_\_  
ADDRESS \_\_\_\_\_  
CITY & STATE \_\_\_\_\_



**BARBELLS**  
140-Pound, CHROME DELUXE Barbell-Dumbbell set only \$18.80.  
This is our feature set and is the finest ever manufactured.  
Training with adjustable weight is the BEST way to keep fit; the ONLY way to develop great strength and a perfect body. As the oldest and best equipped barbell company, BUR gives value and prices no one can equal.

100  
POUND  
SET  
\$11.80

Extra  
Plates Only  
10c Pound

SEND FOR FREE CATALOG.  
**BUR BARBELL CO.**  
Lyndhurst 9, New Jersey

More than 1,300,000 families read POPULAR MECHANICS every month for valuable suggestions and product information. It is your assurance of quality workmanship with quality products



**NEW FOR HOMECRAFTSMEN**  
**DIAMOND\*FLEX**  
**BAND SAW BLADE**

- "Diamond-hard" points (they scratch glass)
- Last up to 5 times longer
- Cuts aluminum, brass, masonite, etc.
- Skip tooth style

Up to 66" — \$1.84	79" — 83" — \$2.27
67" — 72" — 2.09	84" — 93 1/2" — 2.56
73" — 78" — 2.15	3/16", 1/4", 3/8" widths

Blades shipped post paid. Ask for our FREE circular showing complete craft shop supplies.

**Cary Merchandise Distributing Co.**  
P. O. Box 229 \_\_\_\_\_ Cary, Illinois





**PLEASE  
SEND ME**



for the  
time checked.  
I am enclosing . . .

- 1 year \$3.50  
 2 years \$6.00

name \_\_\_\_\_

address \_\_\_\_\_

city \_\_\_\_\_ zone \_\_\_\_\_ state \_\_\_\_\_

Hand this order to your newsdealer or send it to  
**POPULAR MECHANICS**  
200 East Ontario St. Chicago 11, Ill.

Your choice of school is highly important to your career in



**INDUSTRIAL  
ELECTRONICS**



**RADIO-  
TELEVISION**



**ELECTRONICS  
COMMUNICATIONS**

Become an  
**ELECTRICAL ENGINEER**  
or an  
**ENGINEERING TECHNICIAN**  
at

**MSOE in Milwaukee**

Choose from courses in:  
**ELECTRICAL ENGINEERING**  
Bachelor of Science degree in 36 months.  
Communications or Electrical  
Power option.

**ENGINEERING TECHNOLOGY**  
Assoc. in Applied Science degree—in 18  
months.  
Electronics Communications  
Electrical Power, or Computers

MSOE—located in Milwaukee, one of America's largest industrial centers—is a national leader in electronics instruction—with complete facilities, including the latest laboratory equipment, visual aid theater, amateur radio transmitter—offers 93 subjects in electrical engineering, electronics, radio, television, electrical power, and electricity.

Advisory committee of leading industrialists. Courses approved for veterans. Over 50,000 former students. Excellent placement record.

Previous educational, practical, and military experience evaluated for advanced credit.



**TERMS OPEN SEPTEMBER, JANUARY,  
MARCH, JULY**

Write today!  
Choose wisely—your  
future depends on it.

**MILWAUKEE  
SCHOOL OF ENGINEERING**

Dept. PM-158, 1025 N. Milwaukee St.  
Milwaukee 1, Wisconsin

Send FREE career booklets. (Please print)

I am interested in \_\_\_\_\_ (Name of course)

Name \_\_\_\_\_ Age \_\_\_\_\_

Address \_\_\_\_\_

City \_\_\_\_\_ Zone \_\_\_\_\_ State \_\_\_\_\_

Eligible for veteran's educational benefits? Yes \_\_\_\_\_ No \_\_\_\_\_



**WATCH FOR THIS EMBLEM**



*... to enter the*  
**\$125,000**  
**CONTEST**

sponsored by the  
**HOME IMPROVEMENT**  
**COUNCIL**

**GRAND PRIZE**

**\$25,000**

**SECOND PRIZE**

**\$10,000**

**THIRD PRIZE**

**\$3,000**

**1,000 OTHER AWARDS**  
**TOTALING \$87,000**

The dealer who displays this symbol is a quality retailer co-operating in promoting better living through home improvement. He will provide you with your complete contest guide, and he stands ready to help you plan any projects that the contest might bring to your mind.

**POPULAR**  
**MECHANICS**  
MAGAZINE

POPULAR MECHANICS Magazine has been a prime mover in the Home Improvement Council. We believe strongly in its aims, and urge you to consult the dealer displaying this emblem when planning your home improvement project.



**FREE WHOLESALE CATALOG** *get up to 50% off*

**MAKE MONEY!! SAVE MONEY!!**  
Buy Tools, Hardware, appliances, photo equipment, sporting goods, power tools, paints and thousands of other nationally advertised products at **WHOLESALE COST TO YOU.**

**"SEND FOR FREE 1958 WHOLESALE CATALOG TODAY"**  
**SILVO HARDWARE COMPANY**  
Dept. PM-1, P. O. Box 266, Philadelphia 5, Pa.

**LEARN PEST CONTROL FOR PROFIT!**  
**UP TO \$1000.00 MONTHLY PROVED!**



Rid homes, farms, businesses, etc., of termites, rodents, all pests! Nation-wide demand for qualified exterminators! Start your own business or join established firm. Job openings announced everywhere! Work full or part time for big money. Learn everything in 2 weeks. No educational requirements - amazingly easy! For Free Success Plan write, APCOA, Dept. 6B, 15015 Ventura Boulevard, Sherman Oaks, Calif.

**NEW RAISED DECK CRUISER KIT \$475** **FREE 1958 CATALOG**  
frt. inc.



One of five low price Taft cruisers. Write for catalog showing complete line. **18 Ft. Model**

**TAFT MARINE WOODCRAFT**  
Dept. PM-158, 636-39th Ave. N.E., Minneapolis, Minn.

**BUILD A VIBRATOR** and **RELAX FOR HEALTH!**

Build a vibrator for your favorite lounge chair. An easy "do-it-yourself" project. At a total cost of less than \$10.00, your present lounge chair can be made equal to vibrating chairs costing up to \$150.00. Let us show you how. We send you complete instructions for **ONLY \$1.00.**

**SOONERLAND INDUSTRIES**  
P. O. Box 6102, Oklahoma City, Oklahoma

**ELECTRONICS MADE EASY**

**BUILD YOUR OWN HI-FI SET!**  
**MAKE A TRANSISTOR RADIO!**

**THIS PM BOOK SHOWS YOU HOW to make almost any electronic device**

192 pages of step-by-step instructions even the electronics beginner can follow. Tells all about:

- High Fidelity—what it is
- Specifications of component parts
- What to look for in equipment
- Simplified transistor experiments
- Radio-Television—How it works
- How to do radio servicing
- What is a schematic diagram
- All about electrons and protons in simple language
- How a vacuum tube works
- What are resistors and capacitors
- How to select Hi-Fi equipment
- How to wire and solder
- Short wave reception
- Home recording procedure
- Use of hand tools
- Types of antennas

Now, as a career or hobby, step into the amazing field of electronics without any previous knowledge or experience whatever. **Electronics Made Easy** trains you by doing . . . actually shows you how to build and operate many of the newest and most useful electronic devices at amazingly low cost. If you'd like a Hi-Fi set for your home, a transistor radio no bigger than your hand, a sensitive intercom, a wireless record player—you can build these and dozens of other projects, even if you've never fixed a door bell or lamp before. This book explains in simple language exactly how radio tubes work, how signals are transmitted and received, how to convert old radios into useful equipment, how to read diagrams . . . and many other interesting and informative ideas. Contains plans for dozens of valuable electronics and radio units, with picture and schematic diagrams so clear even the beginner can do perfect work. This book can start you on a highly profitable career—in another five years there will be a shortage of more than 500,000 electronics technicians in this country. Or it can introduce you to one of the most fascinating hobbies of today. Order now, under **\$2.95** post-paid money-back guarantee. Only . . .

**Popular Mechanics Press, Dept. 158**  
200 E. ONTARIO ST., CHICAGO 11, ILL.

You buy better when you buy brands advertised in **POPULAR MECHANICS** **PM TAG of INTEGRITY**

# DIESEL MECHANICS IN DEMAND

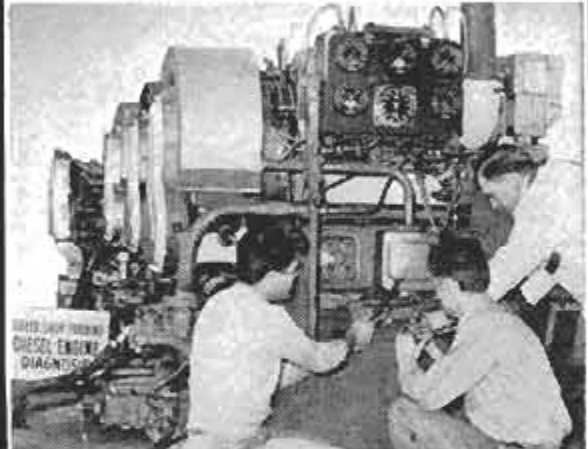

Learn to earn big pay in DIESEL in our large, modern equipped Chicago school and shop. No previous experience or training necessary. We help you find living quarters and part time job while in school. Complete, practical courses taught in the following trades, under the supervision of experienced, expert technicians.

**— CHOOSE YOUR TRADE —**

CHECK HERE	WEEKS
<input type="checkbox"/> DIESEL MECHANICS	20
<input type="checkbox"/> AUTO MECHANICS	20
<input type="checkbox"/> BODY & FENDER	17
<input type="checkbox"/> GAS-ARC WELDING	4-12
<input type="checkbox"/> REFRIGERATION	14
<input type="checkbox"/> AIR CONDITIONING	9
<input type="checkbox"/> MACHINIST TRADE	30
<input type="checkbox"/> ADVANCED MACHINIST	33
(includes tool & die)	
<input type="checkbox"/> PIANO TUNING & REPAIR	36

FREE JOB PLACEMENT SERVICE DURING AND AFTER TRAINING

## ENGINEERING COURSES

These courses teach practical and technical phases and lead to a degree. They are designed to prepare men for supervisory positions in Diesel-Automotive and Refrigeration-Air Conditioning fields. Students with high school education, or equivalent, will be accepted.

<input type="checkbox"/> DIESEL AUTOMOTIVE ENGINEERING	27 months
<input type="checkbox"/> REFRIGERATION & AIR COND. ENGINEERING	18 months
All Above Courses Approved for CIVILIANS	<input type="checkbox"/> OR GI'S
<input type="checkbox"/> WELDING ENGINEERING	18 months

## EARTH MOVING EQUIPMENT OPERATORS TRAINING

Latest, most modern road building and construction equipment on 600 acre training area. Learn grading, terracing, land clearing, etc., on crawler tractors, front end loaders, pay loaders, cranes, etc. 200 hour 5 week course or special week end courses.

Start your career with Greer by checking your interest above and mail coupon for complete information at no obligation.

NAME \_\_\_\_\_ AGE \_\_\_\_\_  
STREET \_\_\_\_\_  
TOWN \_\_\_\_\_ ZONE \_\_\_\_\_ STATE \_\_\_\_\_

Established 1902  
**GREER SHOP TRAINING**  
Box A, 2236 S. Michigan Ave.  
Chicago 16, Illinois



# OUR BUSY INVENTORS



**BATTERY VEST** was invented by Hermann H. Bly of Wanamassa, N. J., to extend the life of dry-cell batteries in regions of extreme cold. Ordinary radio batteries last only two hours at temperatures colder than 65 degrees below zero Fahrenheit. Vest, worn under parka, allows body heat to warm dry cells, extending life to 20 hours



**PLASTIC-FOAM GENERATOR** could be used to salvage a sunken ship without first making the ship airtight, according to its inventor, Barclay M. Ivanek of Grand Rapids, Mich. Liquid thermo-plastic foam would congeal into hard, buoyant bubbles when pumped into water. Continued pumping would raise the ship

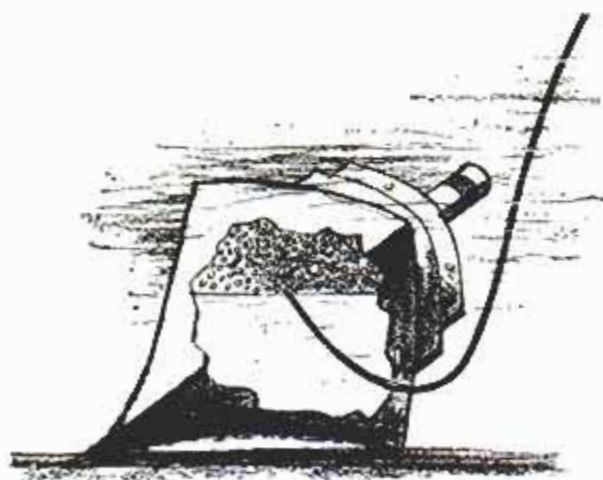

**TOOTHPASTE DISPENSER** suggested by Mrs. E. L. Enochs of Modesto, Calif., could be attached to the bathroom wall by a metal or plastic holder. Pushing a plunger on the top of the glass or plastic container would dispense the desired amount of paste on the toothbrush. The dispenser would eliminate the problems of removing and replacing tube caps and unsightly twisted tubes in the medicine cabinet





**TOOL CASE** with pivoted end members was patented by Vittorio Rocchetti of Rovereto, Italy. End members with tool-receiving holes swing upward on pivots in side walls of box

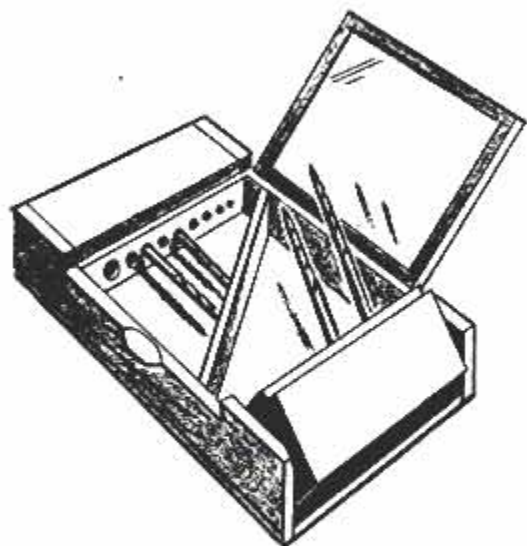

**TILTING GLASSES** of special value to machinists, dentists and others who do precision work, swing out of the line of vision by turning a small knob on the frame. The inventor, Louis Zanetti of Coral Gables, Fla., suggests that tilting frames could be adapted for dark lenses to be worn at the beach or for drivers who need them intermittently on trips

**BOAT STABILIZER** was invented by Walter S. Gaskovitz of Chicago, Ill. The outrigger is an inflatable tube held by its own expansion in rings. It is attached to the boat by clamps

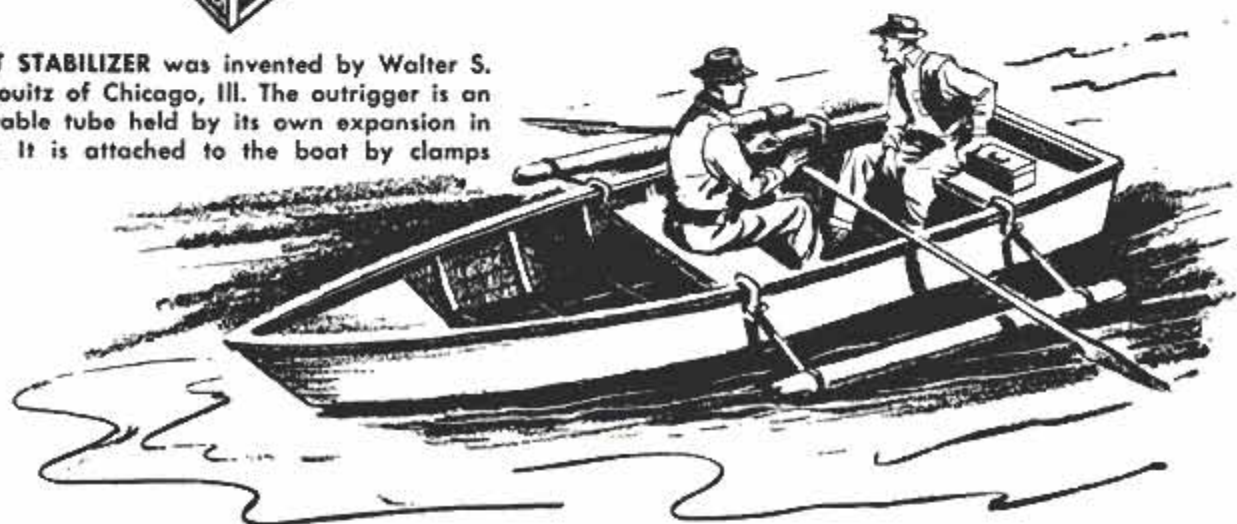

**TOASTER-GRILL** invented by W. S. Taylor of Arlington, Va., could be used as a conventional toaster or turned on its side and used as a sandwich grill. Folding out both sides converts the appliance into a skillet

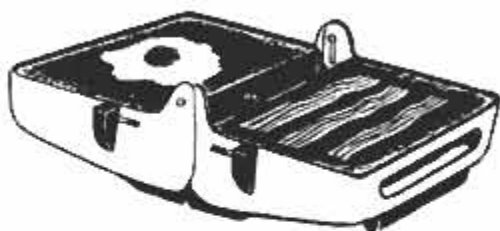

**BOBBING DECOY** patented by Riley D. Argo of Ridgely, Tenn., has decoys mounted on shaft moved by submerged rocker arm

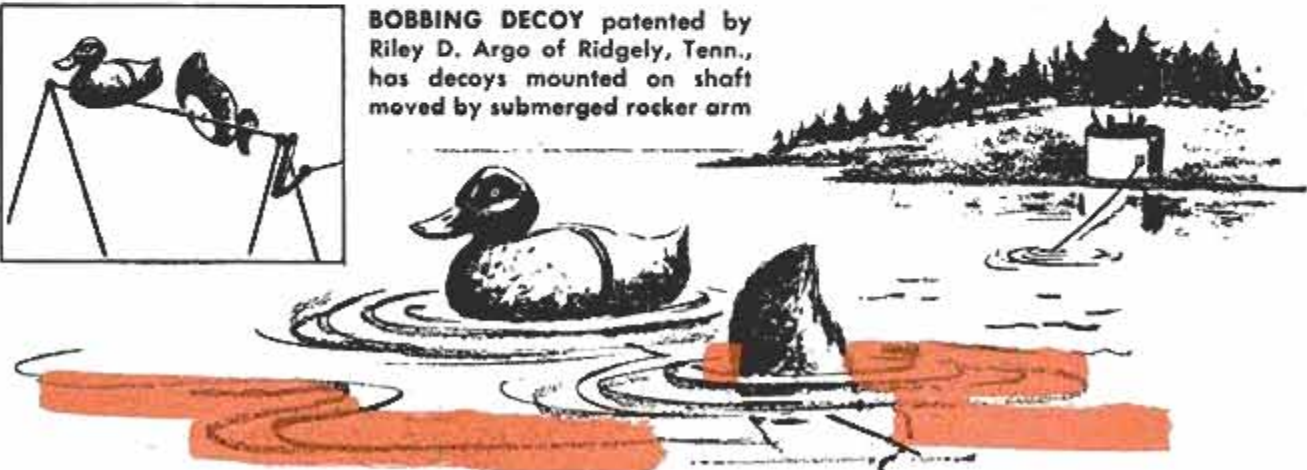



SAVE 1/2 ON ACCORDIONS • SAVE 1/2 ON ACCORDIONS

**BUY DIRECT and SAVE UP TO 1/2 ON ITALIAN ACCORDIONS EASY TERMS**



**AMAZING NO RISK OFFER...**  
Now you can afford a world famous Accordion of finest tone and breathtaking beauty! Low wholesale prices save you half and more.

**5 DAYS FREE TRIAL**

**ACT NOW! FREE—**  
• Music Stand  
• Home Study Course  
• Deluxe Case  
• Certified Guarantee

**COLOR CATALOG FREE**  
Mail Coupon

**MONEY BACK GUARANTEE**  
Buy direct from world's largest dealer. Save 50% or more. 30 newest models to choose from. Extra bonus gifts if you buy now. Satisfaction guaranteed or money back. Trade-ins accepted. Low down payment; pay little as \$10.00 a month. Try before you buy on FIVE DAY TRIAL. Rush coupon now for FREE color catalog and wholesale price list. Write TODAY. **Accordion Manufacturers and Wholesalers Outlet, Dept. R18, 2003 W. Chicago Ave., Chicago 22, Ill.**

**Accordion Manufacturers & Wholesalers Outlet**  
2003 W. Chicago Ave., Dept. R18, Chicago 22, Ill.  
Send FREE Color Catalog and price list.

NAME \_\_\_\_\_  
ADDRESS \_\_\_\_\_  
CITY \_\_\_\_\_ STATE \_\_\_\_\_

**SURPLUS ARMY JACKETS**

Tremendous value, excellent condition! Improved G.I. drawstring waist; 9-oz. water-repellent Mountain Cloth, poplin-lined; bellows pockets. For all outdoor wear, Olive Drab, State size: S-M-L. Rush check or M.O. today! Money back guarantee.

**ONLY \$2.88 plus 25c postage**  
Ask for big FREE surplus catalog

**MARKO SURPLUS Dept. PW-1, 540 S. State St., Chicago 5, Ill.**

**LET FIREMAN FIRE EXTINGUISHERS PROTECT YOUR CAR, SHOP, YOUR FAMILY, TOO!**

**Fire Kills Over 4,000 Children Yearly!**

You can guard your family and property against this needless tragedy with a FIREMAN FIRE EXTINGUISHER. FIREMAN FIRE EXTINGUISHERS are small enough to fit the hand, powerful enough to do the job of larger, bulkier extinguishers. They contain war-burn, CBM, are tested to put out oil, grease, gasoline—even electrical—and all other types of fires in seconds. Your name, automobile, shop, boat, trailer, dress, office, cabin, need more than fire insurance—they need fire protection. High-pressure container sprays fire-killing spray up to 11 feet. Container REFILLABLE. FIREMAN FIRE EXTINGUISHERS are guaranteed for performance, can be easily mounted for ready use, retail for as low as \$4.95.

Ask your hardware or auto-supply dealer for a FIREMAN FIRE EXTINGUISHER TODAY—or write direct.

**AGENTS WANTED!**

Big pay for full or part time agents. Good territories still open—no experience necessary, no age limit. Write for FREE SALES KIT.

**INTERSTATE PRECISION PRODUCTS**  
706-J E Vermont, Anaheim, California

**WHERE-TO-BUY-IT INDEX**

**AUTOMOTIVE**

Detroit Listening Post.....126  
Baby car goes anywhere on low-pressure tires (Atwood Vacuum Machine Co., Rockford, Ill.).....143  
School bus has elevator for handicapped pupils.....143

**AVIATION**

Army helicopter bristles with rockets and machine guns for test.....106  
Research helicopter for Army has four small rotors.....107  
Jet-plane model makes bomb run.....154

**BOATS**

Outboard boats go "around the world in 34 1/2 days" (Kiekhaefer Corp., Fond du Lac, Wis.).....105  
Three-cylinder outboard develops 60 horsepower (Scott-Atwater Mfg. Co., 2901 E. Hennepin Ave., Minneapolis 13, Minn.).....106  
Fishing dory climbs out of water—it's amphibious.....115

**FARMING**

Tractor takes slick surfaces with 24 by 24-inch tires (Atwood Vacuum Machine Co., Rockford, Ill.).....152  
Tractor hoppers spot borer poison (Niagara Chemical Div., Food Machinery and Chemical Corp., Middleport, N. Y.).....154  
Haymaking is one-man operation with automatic equipment (John Deere Co., Moline, Ill.).....160

**MISCELLANEOUS**

Thin tube foretells wall TV and sky view for air pilot (Kaiser Aircraft and Electronics Corp., 1924 Broadway, Oakland 12, Calif.; Douglas Aircraft Co., Inc., El Segundo Div., Santa Monica, Calif.; Allen B. Dumont Laboratories, Inc., 450 Bloomfield Ave., Clifton, N. J.; Bell Helicopter Corp., P. O. Box 482, Fort Worth, Tex.).....104  
Interchangeable engine fits model plane, boat or car (Wen-Mac Corp., 11511 Tennessee Ave., Los Angeles 64, Calif.).....105  
Liquid insulation foams into place (Bakelite Co., 269 Madison Ave., New York City 16).....107  
Tractor "battering ram" demolishes concrete (Emaco Concrete Cutting Co., 2751 E. 11th St., Los Angeles, Calif.).....115  
Huge "swamp buggy" powered by airplane engines.....122  
Shutterless camera makes wide-angle pictures (Perkins-Elmer Corp., Norwalk, Conn.).....122  
"Chemical" bomber for SAC.....123  
Flying Swiss ski lift puts tourists on glacier top.....123  
Exhaust flare of rocket salvo lights up sky.....137  
Round pool table teaches coordination.....137  
Turn on the windows—it's getting dark.....137  
Circular hospital eliminates dead-end corridors.....151  
Adhesive will bond plastic to rubber and metal (Bell Telephone Laboratories, 463 West St., New York City).....152  
Air-tube suit makes floating easy as falling off a log.....152  
Students' teaching machine repeats questions missed.....152  
This pipeline delivers fuel by remote control.....153  
Model U. S. capitol built with pearls.....154  
Plywood will serve as church in Korea.....160  
Giant heat-treating furnace bakes guided-missile parts.....166  
Ramjets on copter blades fight frost in California.....166  
One man trains 32 horses with exerciser.....167  
Snooper TV camera probes pipelines.....167  
Steam engine built from auto parts.....167  
Cabana home . . . and one for the road.....168  
Plastic sailfish rivals nature (Joe Williams, Florida Game-fish Co., Miami, Fla.).....170  
Pocket-size slide rule has plastic-coated scales (Arthur F. Smith Co., 311 Alexander St., Rochester 4, N. Y.).....170  
Sling totes any rifle (J-K Co., P. O. Box 1173, Sacramento, Calif.).....170  
Egg assembly line separates yolks from whites (Seymour Foods, Inc., 609 Quincy St., Topeka, Kans.).....177  
Four hundred tons of church go for ride.....178  
Portable wash basin for campers.....254  
Slide "popping" eliminated by automatic projector (Bausch and Lomb Optical Co., Rochester, N. Y.).....256

**SCIENCE**

Canned milk holds flavor for months.....106  
Solar-heat collector used for drying grain.....115  
Keeping up With the Atom.....130  
A prediction in 1910—nears reality in '58.....142  
Pitch and roll machine tests submarine equipment.....143  
Carbon filters cut smog symptoms.....264  
Doctors operate on "cold" brain.....270

**WHAT'S NEW FOR YOUR HOME?**

Burglar alarm doubles as fire alarm.....144  
Disappearing clothesline.....144  
Temperature alarm.....144  
Vacuum-cleaner tool caddy.....144  
Automatic vegetable peeler.....145  
Clothes sprinkler.....145  
Shaver-cord reel.....145  
Silver-storage drawer.....145  
Swivel magnifying mirror.....145

**Radio-Television, Electronics**

Build your own Tel-Amp.....179

**Craftsman and Shop Notes Index**

**HOUSE AND HOME**

Drapery extensions "enlarge" windows.....194  
Appliance data stored in "picture cabinet".....195  
(Continued to page 94)



# BUILD YOUR OWN

Walks · Driveway · Outdoor Fireplace, etc.



At very little cost, you can lay foundations, sidewalks and driveways, build steps, outdoor fireplaces, sandboxes, tennis courts, pools — all concrete work. And it's easy to do! Just follow this PM book that tells and shows all: how to make the right mixture, plan and apply. Contains 50 professional short cuts, hundreds of pictures. Only \$2.50 postpaid. Money back if not pleased. Order today!

**POPULAR MECHANICS PRESS**  
Dept. 158, 200 E. Ontario  
Chicago 11, Illinois

The terrific high costs of even little concrete jobs are mostly for labor. Now save all the labor costs with . . .

**FREE Details write today**

## MAIL ORDER Opportunity!

**START FROM HOME... SPARE TIME**

We want a limited number of intelligent men and women to work at home on an exclusive mail order business proposition. No selling — we furnish everything including literature, names, addresses, stock and ship items for you. All you do is mail for us and receive money coming to your own mail box. write: **MAIL ORDER DISTRIBUTORS (Franchise Division)**

15201 South Broadway  Dept. A-1, Los Angeles 61, Calif.

**\$2.95 OR 2 FOR \$5.00!**

**TESTED AND GUARANTEED**

Write for free list on all types of telephones. Shipments F.O.B. Simpson, Pa.

**TELEPHONE ENGINEERING CO., Dept. 188, Simpson, Pa.**



## ADD THOUSANDS OF \$\$ TO THE VALUE OF YOUR HOME!

Now PM Book tells and shows how to handle power tools like an expert—and make valuable property improvements

A thorough knowledge of power tools and how to use them will enable you to perform hundreds of major and small projects around your home at tremendous savings, and increase its value significantly. Now, with the aid of "Getting Started with Power Tools," it's easy, fun, safe to do more home remodeling and repair jobs, make beautiful furniture, toys and boats, or execute other more ambitious projects you have wanted to do, but never could. This remarkable book, in 160 pages of easy-to-understand text and scores of illustrations, shows you all about the interesting and profitable avocation of working with power tools. Special attention is given to the type of learning problems encountered by the novice. Each major type of power tool is illustrated with captions showing all its parts. But this book is written for the skilled craftsman as well. It tells what you should look for in planning a power tool shop, and how to lay it out for greatest efficiency. It stresses safety procedures that will benefit even the experienced workman. Various attachments are shown that will give one tool many uses, thus saving on the total investment. Never before has a book on power tools been written for the home craftsman that provides as much basic information for the novice, and as many down-to-earth work hints for the expert, as "Getting Started with Power Tools." Order your copy today, with a money-back guarantee if not pleased. Send your check or money order to the address below in the amount of only. . . . . **\$2.50**

**POPULAR MECHANICS PRESS**  
Dept. 158, 200 East Ontario St.,  
Chicago 11, Illinois

**CONTENTS**

- Ch. 1 — Selecting power tools
- Ch. 2 — Installing power tools
- Ch. 3 — Portable power tools
- Ch. 4 — Operating the circular saw
- Ch. 5 — Dado-head techniques
- Ch. 6 — Drill-press operations
- Ch. 7 — Operating the bandsaw
- Ch. 8 — How to use the jigsaw
- Ch. 9 — Working with the wood lathe
- Ch. 10 — Wood-shaper techniques
- Ch. 11 — Fundamentals of the jointer

# 8" TILT ARBOR SAW

## 1957 MODEL—BELOW COST!

**BLADE TILTS—TABLE REMAINS LEVEL**

Heavy duty all cast iron and steel construction. Precision ground cast iron table. Price includes massive cast iron mitre gauge and patented motor drive that fits any motor. Cross cuts, rips, bevels, mitres, dadoes, cuts compound angles — everything expected of saws costing four times as much. Depth of cut adjustable; 0" to 2 1/4" — table always level. Send check or M.O. \$1.00 deposits on C.O.D.'s.

**SPECIAL BARGAIN** — This saw is our 1957 model. Each saw is brand new — sent to you in factory sealed cartons. Sold and guaranteed direct from the factory to you at a fantastic bargain.

**FREE 10 DAY TRIAL — MONEY BACK GUARANTEE**

Try this famous saw 10 days. If you are not satisfied that it does the work of any tilt arbor saw, regardless of price, return for immediate money back refund.

*Sent Express Collect*

*We reserve right to refund money if stock is exhausted*

**AMERICAN MACHINE & TOOL CO.**  
ROYERSFORD 25, PA.



Less Blade  
**NOW \$9.95**  
Was \$24.95

## PREPARE FOR BETTER JOB, BIGGER PAY IN SPARE TIME AT HOME

Today, choose the job you want—and prepare for it in time you might otherwise waste. Or if you are already in the work you like best, start training now for quicker promotion and increased pay. During the past 61 years **AMERICAN SCHOOL** has helped ambitious people to reach higher goals. Check subject that interests you and mail coupon for full information.

**AMERICAN SCHOOL, Dept. G145, Drexel at 58th, Chicago 37, Ill.**

Without obligation, please send **FREE** and postpaid, full particulars about the subject checked below.

Accounting	Contracting	Mechanical Engineering
Apprenticeship Courses	Diesel Technician	Mechanical Technology
Architecture & Building	Drafting—Building Trades	Metalworking Courses
Automotive Technician	Drafting—Machine Trades	Plumbing—Practical
Better Foremanship	Electrical Engineering	Private Secretary
Blueprint Reading	Electricity—Practical	Retail Merchandising
Bookkeeping	Electronics—Industrial	Salesmanship—Outside
Business Management	<b>HIGH SCHOOL COURSES</b>	Sheet Metal Work
Civil Engineering	Machinists	Tool Making

NAME \_\_\_\_\_

HOME ADDRESS \_\_\_\_\_

CITY \_\_\_\_\_

OCCUPATION \_\_\_\_\_

AGE \_\_\_\_\_

STATE \_\_\_\_\_

**MAIL COUPON NOW**



## New "PULL-GEAR" SPEED-REDUCING PULLEY



**Provides Correct Speed and Power to Drill Up to 1 1/2" with 1/2 H.P. Motor**

Amazing new internally geared speed reducer doubles drill press capacity. Greater power, greater efficiency, greater productivity. Provides the correct speed and power for larger drilling, reaming, tapping and boring on light presses. Easily installed in five minutes. Adaptable to all type machines. Spindle speed range approx. 45 to 3000 RPM. Made in 3 motor shaft sizes: 1/2" — 5/8" — 3/4". Write for literature.

WRITE FOR LITERATURE

### THE PULL-GEAR CO.

25427 Mound Road  
Center Line, Mich.

DEALERS:

Chicago, Ill. — Chicago Supply & Tool Co.  
Cleveland, Ohio — Reynolds Machinery Co.  
Los Angeles, Calif. — Almquist Brothers  
New York City — Rudolf Bass

## Made \$2,600 LAST SEASON



with  
**FOLEY  
LAWN MOWER  
SHARPENER**

### 99c Profit On Each Dollar!

It costs less than 1c per mower for electricity and material. The Foley sharpens all blades and cutter bar together just like lawn mower manufacturers do it. Start in spare time in basement or garage. The Foley handles up to 3 or 4 mowers per hour—prices run \$1.50 to \$3.00 for hand mowers—\$5.00 to \$8.00 for power mowers.

**FREE — VALUABLE ILLUSTRATED BOOK** shows how to sharpen all leading makes of power mowers. Foley prices are low—easy payment plan lets you pay for machine with profits. **FREE PLAN** tells how to start. Send coupon today—no salesman will call.

"Last year we sharpened and repaired about 1000 lawn mowers for a net profit of \$2,600," says E. G. "Years ago... I bought a Foley Lawn Mower Sharpener," writes W.T.J., "the best investment I ever made. I have made a good living for my wife and myself and have put money in the bank besides."



SEND FOR FREE BOOK

FOLEY MFG. CO., 107-8 Foley Bldg., Minneapolis 18, Minn.  
Send FREE BOOK and FREE PLAN on Foley Lawn Mower Sharpening business.

Name \_\_\_\_\_

Address \_\_\_\_\_

Spice cabinets add charm to room.....	204
Replacing ceramic tile on wall or floor.....	207
Installing inside-wall vent fan.....	212
Ornate cast-iron brackets are support for novelty shelf.....	214

### HOUSEHOLD HINTS

Cleaning bone knife handles.....	189
Solving Home Problems—	
Avoid splintering of chair or table leg when shortening it.....	196
Easy to make liquid soap.....	196
Extra compartment spaces in drawer.....	196
Measuring linoleum.....	196
Shoehorn used as trowel for small plants.....	196
Sorting garments in a clothes closet.....	196
Easily located coaster.....	197
How to keep a small child from pulling lamp from table.....	197
Keep garments from slipping off hangers.....	197
Make a spool-and-bobbin rack.....	197
To remove a tight-fitting ring.....	197
White, opaque jars make decorative containers.....	197
Kitchen memo pad.....	206
Decorative receptacle for lunch bags.....	214

### MISCELLANEOUS

Aluminum-foil favor cups.....	189
Combination mailbox-signpost.....	189
Enameled nameplates.....	190
Card makes pinless badges.....	191
Reflector is mailbox flag.....	191
Repairing torn book pages.....	191
ABC of stains.....	192
Coiled extension cords don't become tangled when stored.....	194
Arrow on platen tells typist when end of paper is reached.....	198
Olive oil removes paper.....	198
Spring reduces trap losses.....	198
Draw freehand curves.....	203
"No spill" birdseed dispenser.....	203
Special leash holds small dog on car seat.....	203
Supercage for parakeet assembled from wooden dowels.....	207
Personalized headboards.....	208
Eliminate water-tap thump.....	214
Quick ball-point pen repair.....	214
Fishing float on address tags prevents pulling out.....	218
Improved carrying handle from rubber hose.....	218
Better typewriter performance.....	224
3 voltages from one battery.....	231
This surfacer combines three machines in one.....	234
Lever-operated gate latch saves stooping.....	238
Multiple V-belt drive for farm feed grinder.....	238

### ON THE MARKET

Electric plug projects 5/16 in. from wall.....	223
Hardwood dowels in diameters under 1/4 in.....	223
Natural reeds woven together form matting.....	223
Nonflammable paint remover.....	223

### PHOTOGRAPHY

Flashlight slide viewer.....	191
Glass strip is dodging tool.....	195
Flashlight is camera aid.....	198
Plastic juice containers speed film processing.....	199
"Preview" 35-mm. negatives.....	203
Faster photochemical mixing.....	207
Talcum powder will remove fingerprints from negatives.....	210
Low-cost film editor.....	211
Light seals for Graflarger.....	224

### SHOPPING FOR TOOLS

Bench-saw table.....	236
Insert-type roller die.....	236
Manually powered fastening tool.....	236
Miter calculator.....	236
Plumber's pliers.....	236
Shop lamp can be moved to any point.....	236
Three-way lock washer has barbs.....	236
Tiny jet pump is self-priming.....	236

### WORKSHOP HINTS

Better turning of softwood.....	189
"Dry cutting" sheet rubber.....	189
Tool for freeing sash.....	189
Identifying receptacle plates.....	194
Undercut hole holds wood filler.....	194
Tool for removing light bulbs.....	198
Miniature shop "bellows".....	207
Marking locations on cylinder.....	210
Notched block is "vise".....	210
Testing level for accuracy.....	210
Wood rasp improvised from taped hacksaw blades.....	210
Cementing wood-chisel handles.....	224
Drop-dispensing "oil can".....	224
Guide aids knife sharpening.....	224
Bandsaw makes jigsaw blades.....	230
V-block from lengths of hose.....	230
Holder keeps tools handy.....	234
Turning true-radius fillets.....	234
Saw blades stored in albums.....	238
Simulated polished finish on turned cast iron.....	238

**NOTICE**—It is the intention of this magazine to provide its readers with information regarding the latest developments in the mechanical arts. Except where otherwise indicated, this magazine has no information as to any unexpired patents in respect of the developments reported herein. In the event that commercial use is to be made of any of the developments reported herein, it is suggested that legal counsel be consulted to avoid liability for patent infringement. It is not the purpose of this magazine to encourage patent infringement but, as indicated, it is the intention of this magazine to report on the latest developments in the mechanical arts.



THE MARK  
OF QUALITY

**ALUMA**  
Craft



## Speedy... Stable... Safe

There's a good, secure feeling and a sense of deep pride in owning a boat bearing the name Aluma Craft. For Aluma Craft has come to mean sound beautiful design... excellent performance, fine precision construction. Aluma Craft means year after year of carefree, trouble-free, prideful, comfortable, thrilling safe fun afloat. No annual overhaul, no upkeep. Super-strong and light, available in many models and pleasing color combinations, just name the size, the features you want... Aluma Craft has the model for you. Easy terms... Easy payments. Send for free, colorful "Boat Show" catalog showing beautiful new models.



## ALUMA CRAFT BOAT COMPANY

1519 Central Avenue N.E., Minneapolis 13, Minnesota

## NEW! Completely UP-TO-DATE!

### Manual for PLYMOUTH OWNERS



**COVERS ALL MODELS 1941 to 1957. Gives you more from your Plymouth for less. So accurate mechanics can use it... so simple a woman can understand it**

Now fix it yourself and save money on Plymouth repairs. With this Popular Mechanics book you prevent trouble... enjoy care-free driving... increase trade-in value... get sparkling performance... and avoid major repairs by fixing minor troubles before they get serious. Not just a re-hash of service manuals, but a completely updated version of the famous 1950 PM book written by automotive expert Ed Packer, with the assistance of the Chrysler Corporation. Covers latest Plymouth features: power brakes, torque bar suspension, automatic transmission, tubeless tires, air conditioning, etc. Motor specifications are given for all models 1941-57. Contains 272 pages, more than 350 photos, diagrams, tables, charts, breakdown drawings, plus clear, non-technical directions that make all repairs as simple as ABC. Shows you how to diagnose troubles by feel, sound, sight, smell and performance.



### MONEY BACK IF IT DOESN'T SAVE MORE THAN IT COSTS!

One minor repair will save the cost ten times over. Read it. Then you decide. If you don't see that you'll save more than the cost, send it back for refund. **SEND NO MONEY.** Send postcard. Ask for PLYMOUTH Manual. Postman will deliver C.O.D. for \$3.50 plus postage. Or, save postage by sending \$3.50 with order. Save its cost on your next repair. Send today.

**POPULAR MECHANICS PRESS, Dept. 158**  
200 E. Ontario St. Chicago 11, Illinois

## STOP FAN DRAG!

### with the NEW **FAN-O-MATIC** MODEL 200 Automatic FAN RELEASE

Makes fan a free-wheeling unit  
at speeds over 35 MPH\*

### INCREASES

- Available Horsepower up to 20 M.P.H. at cruising speeds.
- Gas Mileage up to 3 miles per gallon... by actual road tests.
- Acceleration up to 10%... in official tests conducted at Indianapolis Speedway by U. S. Auto Club.

### REDUCES

- Engine Noise, Vibration for smoother, quieter riding.

Simple to install. Adaptable to most cars  
Installation instructions with every unit

\*Easily adjustable to higher or lower speeds



AVAILABLE at Auto Dealers, Garages, Service Stations  
Manufactured and Guaranteed by  
**Radiator Specialty Co., Charlotte, N. C.**  
In Canada: Radiator Specialty Co., Ltd., Toronto





see the amazing new  
EASY-TO-BUILD ELECTRONIC

**ALLIED knight-kits**

in **ALLIED'S 1958**  
**ELECTRONIC SUPPLY CATALOG**

**FREE!**

**BUILD YOUR OWN!  
SAVE MONEY—HAVE FUN**



**HI-FI KITS**



**HOBBY KITS**



**INSTRUMENT KITS**



**HAM KITS**

**404** value-packed pages

**SAVE on Everything in Electronics**

**WORLD'S LARGEST STOCKS**

Everything for Experimenters, Builders, Amateurs, Servicemen, Engineers and Hi-Fi Hobbyists. Get more for your money in Hi-Fi systems and components; build-your-own KNIGHT-KITS; recorders and phono equipment; TV tubes, antennas, accessories; Amateur station equipment; test instruments; industrial electronic equipment—plus the world's largest stocks of parts, tubes, transistors, tools and books. Send today for your **FREE 1958 ALLIED Catalog!**

Everything in Electronics From One Reliable Source  
our 37th year **EASY TERMS AVAILABLE**

**ALLIED RADIO**

send for  
**FREE**  
Catalog

**ALLIED RADIO CORP., Dept. 105-A8  
100 N. Western Ave., Chicago 80, Ill.**

Rush **FREE 1958 ALLIED 404-Page Catalog**

Name \_\_\_\_\_

Address \_\_\_\_\_

City \_\_\_\_\_ Zone \_\_\_\_\_ State \_\_\_\_\_



Donaldson Co., 2520 Larpenleur St., St. Paul 8, Minn.

### Airtight Can Holds Brushes in Oil

Paintbrushes are kept clean and preserved in a gallon can with an airtight plastic cover. They are suspended by clips and immersed in a formula of pine oils.

### Oxygen Test Helps Prospectors Find Ore

Measuring the amount of oxygen isotopes in rock surrounding valuable mineral deposits may be a future aid to prospecting. Millions of years ago when the earth was being formed intense heat accompanied the formation of ore deposits, causing chemical changes in the rocks around them. Now, scientists of California Institute of Technology are using a special mass spectrometer to locate gold, lead and zinc by an analysis of oxygen in neighboring rock formations. The system is the equivalent of having a geochemical thermometer capable of taking temperatures that existed about 250 million years ago.

### Big Lignite Field Found in India

One of the world's largest fields of lignite has been discovered in southern India. It extends over 100 square miles in a thick layer about 180 feet beneath the ground. Geologists estimate the field contains 2000 million tons of lignite, with easily workable deposits of 200 million tons in a 5½-square-mile area.



**Pre-tested** against all saws on the market—  
**here's the world's finest, most versatile saw!**

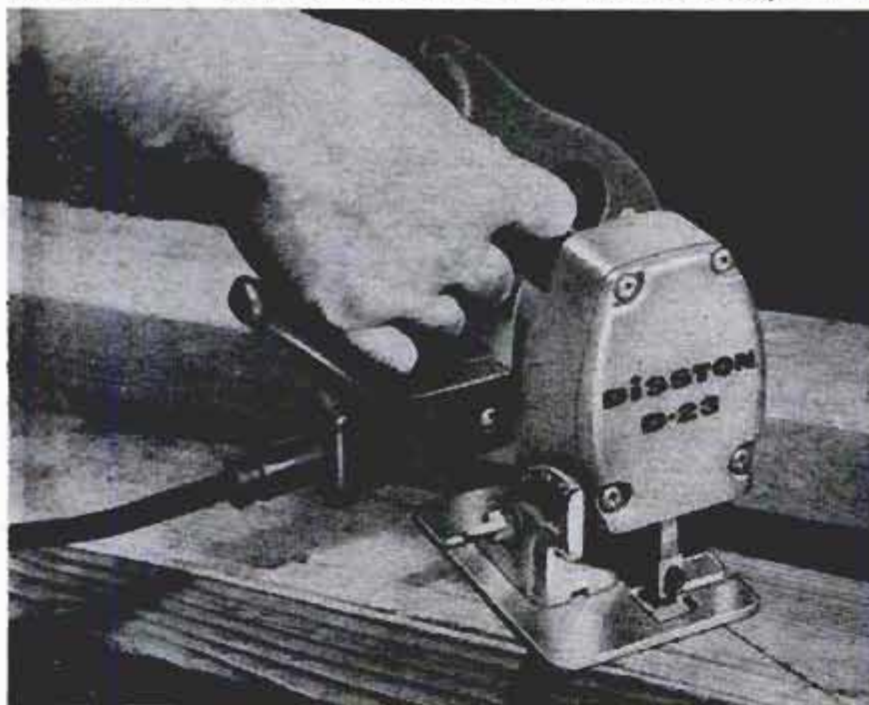

Plunge cuts without drilled hole



Cuts thru 2 x 4's at 45 degree angle



Cuts intricate figures in all materials



Detachable cords. Various lengths

*Zips through 2x4's ... cuts 1/4" steel plate ... cuts 1/2" aluminum*

**NEW! DISSTON D-23 ELECTRIC HAND SAW**  
**lets you handle 1000 workshop jobs just "like a professional"**

**3800 "ORBITE ACTION" Strokes Per Minute**

Blade swings into work on cutting stroke—backs off on down-stroke. Accelerates cutting, reduces fraying and need for sanding... saves spoilage, reduces blade wear. Slices through work up to 50% faster!

**Highest output horsepower**

Delivers more actual cutting power than any saw of its type. It's the only reciprocating saw with all ball and needle bearings—9 needle and 3 ball bearings—for smooth, beautifully accurate cutting and longer life!

**Cuts all these materials**

Wood, plywood, plastics, rubber tile, linoleum tile, asphalt tile, laminated paper and cloth, nylon and Plexiglas. Cuts steel (up to 1/4"), aluminum, angle iron, copper, bronze and brass. Cuts pipe, tubing, and sheets.

It's fast, versatile, only 4 1/2 lbs., and built the way Disston makes saws—to last a lifetime! From its power-packed 3 amp motor to its 12 special-purpose blades and quick blade-change features, the Disston D-23 Electric is designed to give you *the world's finest saw!*

If you take pride in your workmanship, if you appreciate fine tools, you'll want to know all about this truly great electric hand saw for home and professional use. Fully guaranteed. \$98.50 with four blades, rip fence and eight foot cord.

**H. K. PORTER COMPANY, INC.**

**DISSTON DIVISION**

To get free booklet—mail coupon today!



H. K. PORTER COMPANY, INC., Henry Disston Division  
 51, Tacony, Philadelphia 35, Pa.

Gentlemen:

Please send me (without obligation) a free copy of your Disston Workshop Manual No. 1 describing the remarkable D-23 Electric Hand Saw.

NAME .....

ADDRESS .....

CITY ..... ZONE ..... STATE .....





Police cars have to start in a flash—and go like the wind.  
Nearly *twice* as many use Champions as any other plug!

Q. Why are nearly twice as many police cars in the U.S.A. powered by Champion spark plugs?

A. Champions give full-firing power. Put new Champions in your car every 10,000 miles. You'll get an *immediate* boost in horsepower...and save gasoline, too!



*World's favorite spark plug on land, on sea, and in the air*

**CHAMPION**



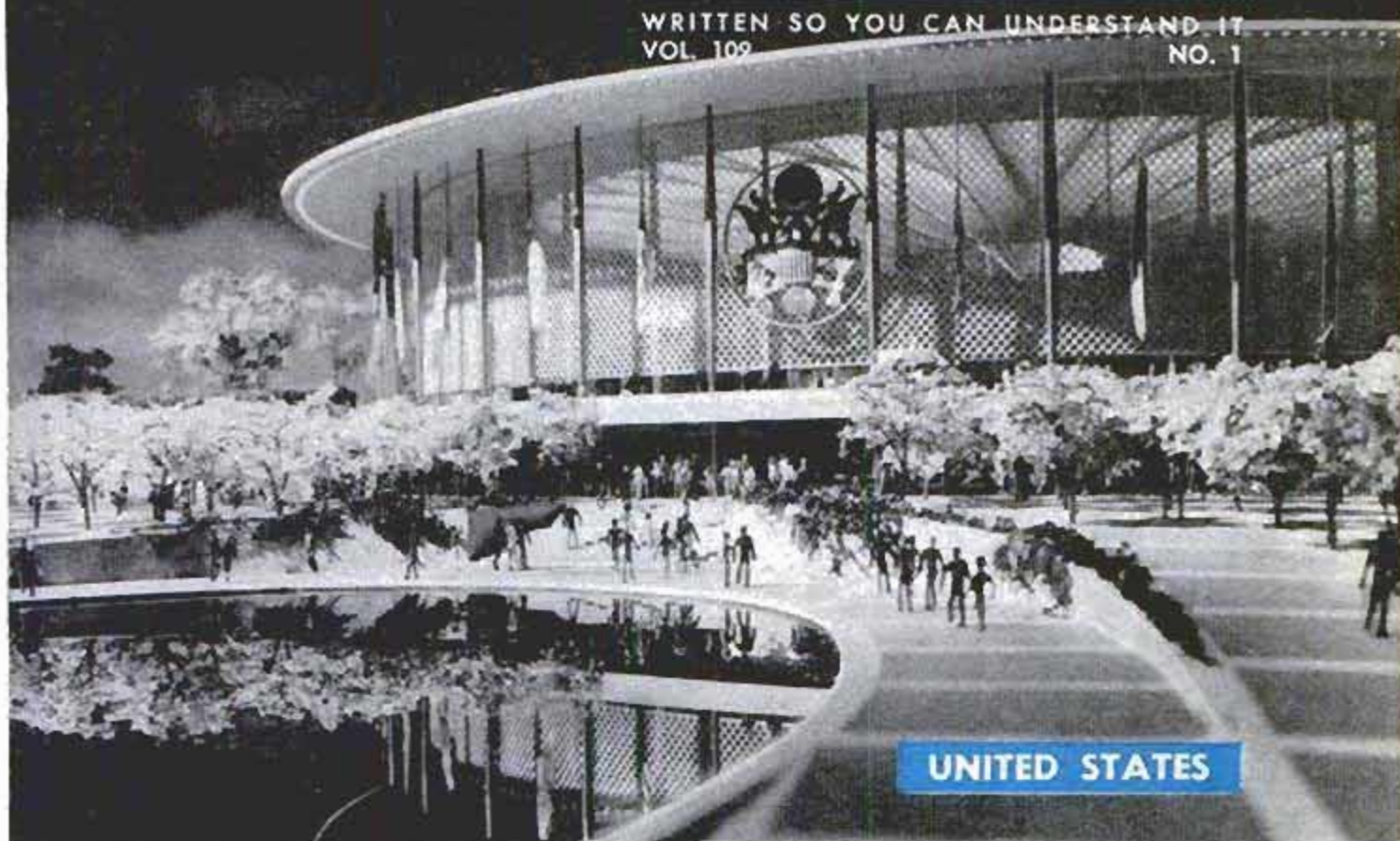

"Crystal and gold palace" is what the Belgians call the U.S. pavilion at the 1958 world's fair in Brussels



## A NEW LANDMARK FOR BRUSSELS...

# THE ATOMIUM

By G. H. Davis

SINCE THE DAYS of the Great Exhibition in London in 1851, every large world's fair has had some spectacular piece of architecture as a central attraction. The 1851 exhibition had its Crystal Palace, the 1889 exhibition in Paris produced the Eiffel Tower, the 1939 fair in New York had the Trylon and Perisphere, and now the Brussels Universal and International Exhibition of 1958 will have its Atomium—probably the strangest structure of them all.

This oddity, to symbolize the atom age, will be 334 feet high and represents a metal

crystal enlarged about 200 billion times. It was originally designed to be 460 feet high but this plan had to be abandoned because of the danger to aircraft.

The nine spheres of the Atomium will be connected to each other by large tubes containing Escalators or stairways to reach the spheres. To make the tubes less noticeable, they will be covered with a paint camouflage while the spheres of highly polished aluminum will shine brightly. It is proposed to have flashing lights around each sphere to represent the orbits of



# The Atomium

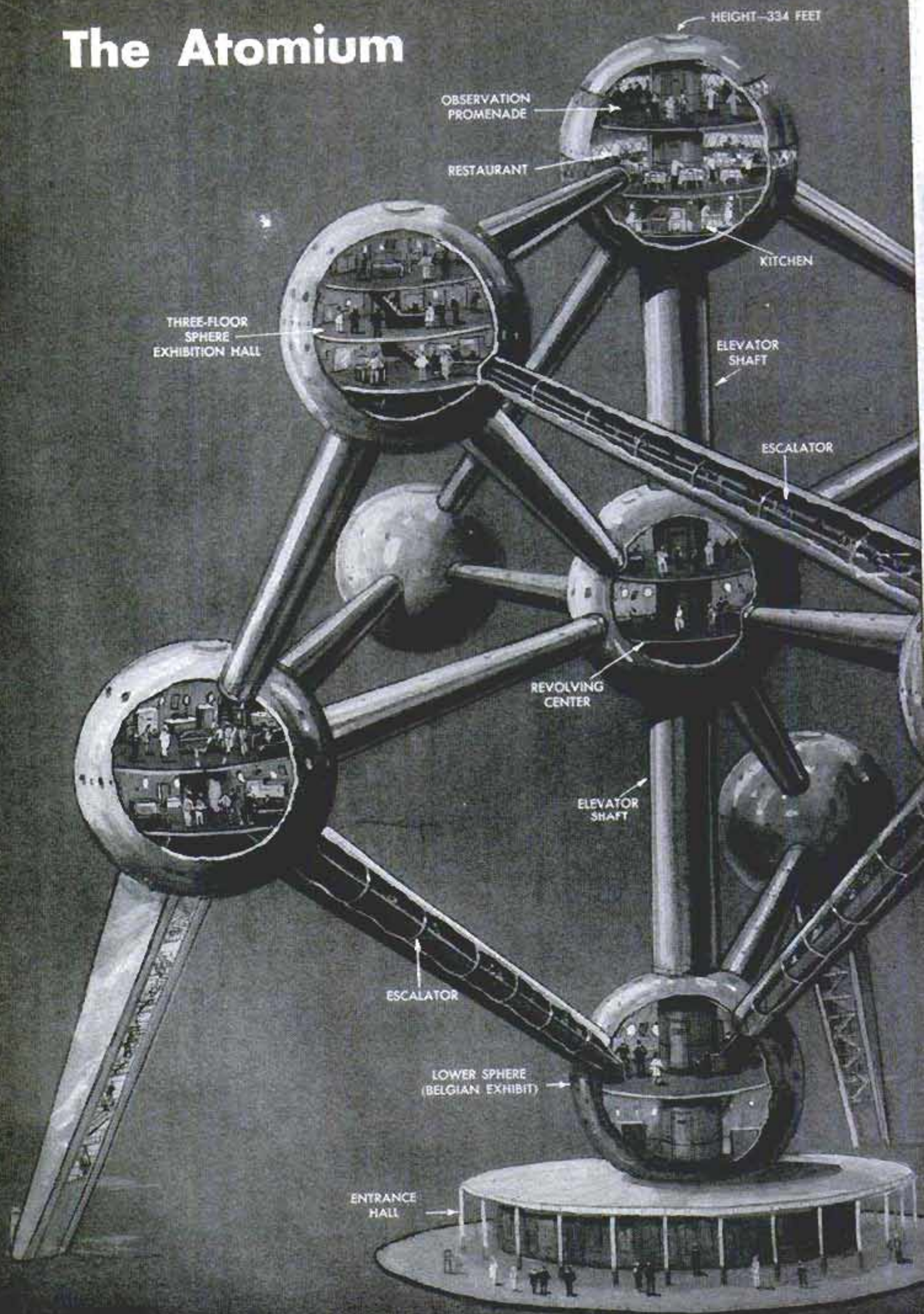



SECTION OF THREE-FLOOR SPHERE

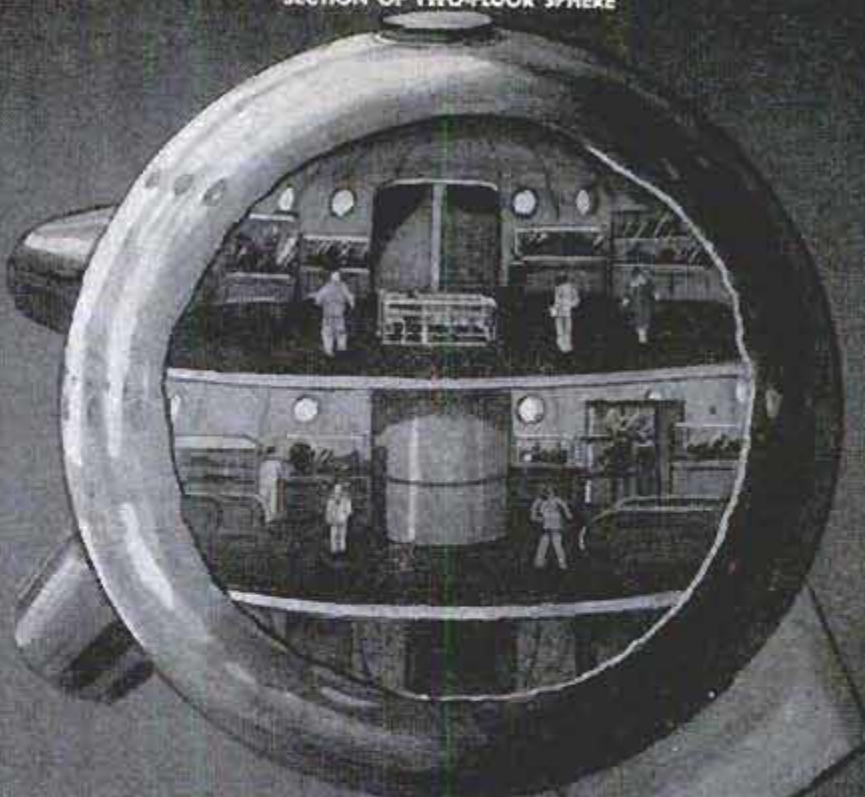

STAIRWAYS  
INSIDE SHAFT

CAFE OR  
EXHIBITION  
HALLS

CUTAWAY OF THREE-FLOOR SPHERE  
SHOWS MAIN RIBS,  
INNER STAIRS, ESCALATOR TERMINALS,  
PORTHOLES

DIAMETER OF SPHERES—59 FEET

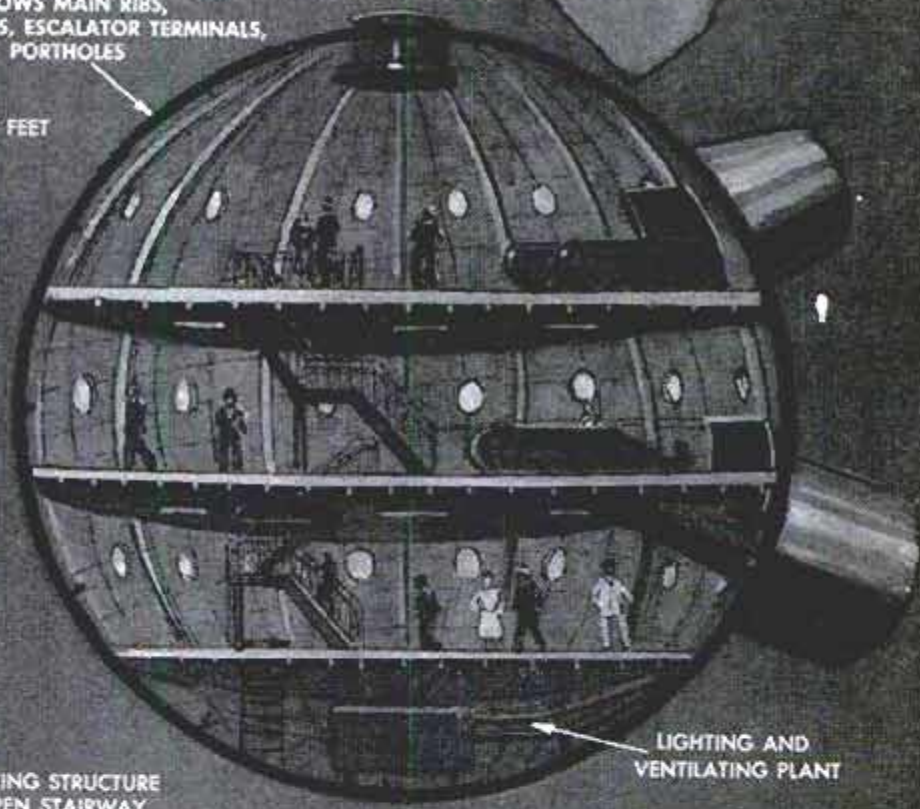

LIGHTING AND  
VENTILATING PLANT

SUPPORTING STRUCTURE  
HAS OPEN STAIRWAY

INTERIOR OF MAIN ENTRANCE HALL







## SWITZERLAND

Swiss pavilion is put together like a honeycomb with a lake in center to plug "the playground of Europe"

electrons around the atom nucleus. Each sphere will be 59 feet in diameter, some being provided with two floors and others with three. Inside the majority of the spheres will be exhibitions available to the public.

Up the central shaft will run an elevator capable of carrying about 20 persons per trip. This elevator will carry people to the topmost sphere where they will find a first-class restaurant and a magnificent view. From here they will be able to see not only the entire fair grounds but the beautiful wooded country around Brussels, the Royal Palace of Laeken and, in the far distance, the field of Waterloo.

The Atomium will have a complete system of ventilation as the interior of the spheres would otherwise get very hot on summer days. Each sphere will be electrically lighted and there will be glass-fiber portholes to let in daylight.

Both the United States and Russia have

French designers went all-out modern with exhibition hall made of steel and prefab concrete panels



## FRANCE

reserved spheres in which they will show atomic energy for peace in many phases. Great Britain, France, Italy and many other countries will be exhibiting in other spheres, while the base sphere will be used for a Belgian exhibit.

Many engineering problems have had to be overcome in the designing and building of the Atomium, particularly the main foundation at the base of the central shaft. At one time rumors were circulated that there had been a serious cave-in, but the engineers on the spot assured me that this was untrue and that the foundations were fully capable of supporting nearly double the weight of the finished structure and a big crowd in the spheres. Certainly, the shaft stood solid and straight to the sky when I viewed it, though it only had its lowest sphere in position at the time.

### Will Resist Gale Winds

The designers also had to guard against wind pressures which may be considerable on such an unconventional structure. Again I was assured that wind-tunnel tests have proved conclusively that the finished building will be well able to withstand gale-force winds of 112 miles per hour, far greater than any ever experienced in the area. At night the Atomium spheres will provide a glittering and beautiful spectacle with the gigantic globes sparkling with a vast number of points of light.

Of all the foreign exhibits that will be temporarily planted on Belgian soil during this world's fair, the largest area will be occupied by the United States with a pavilion and adjacent grounds covering 29,700 square yards. The great circular pavilion will be the largest free-span circular building in the world. The pavilion is 340



feet in diameter and 90 feet high and has an adjacent theater that will seat about 1000 persons.

This "crystal and gold palace," as the pavilion has been described, will be constructed chiefly of plastic and steel and topped with a plastic suspended roof resembling a bicycle wheel. The roof will be attached only to a rim connected with an inner metallic ring by steel cables in tension. The ceiling, also suspended, will be of metal mesh permitting light to flood the pavilion.

The outer ring of this huge "bicycle wheel" will rest upon two concentric rows of gilded steel columns. The walls will be hung between the columns and made of cellular-plastic "honeycomb," sealed with an undulating plastic cover. Present plans also suggest there will be hanging gardens around the building.

### Classic Simplicity

The second floor will present an uninterrupted space about 60 feet wide overlooking the interior garden on one side and directly connected with exterior gardens and a balcony. The classic simplicity of the pavilion will be enhanced by The Great Seal of the United States, of enormous dimensions, placed over the main entrance. A colorful note will be the flags of all the states flying from the building.

The pavilion is circular to conform with the shape of the site and was designed by Edward D. Stone of New York.

The United States pavilion has been called dignified and impressive, possibly because it does not follow the "weird and wonderful" modernistic designs of several of the other countries. The exhibit is costing approximately \$15,000,000.

The Swiss section of the exhibition will take the form of a group of pavilions joined like the cells of a beehive. A small lake in the center of the pavilions reminds visitors of the lakes and other vacation features of Switzerland. Inside the Swiss buildings will be more reminders of the rugged grandeur of a land that has been called "the playground of Europe." The exhibits will also include products of Swiss industry

(Continued to page 252)



VATICAN

For the first time in history, the Vatican is taking part in a world's fair with this church of unique triangular design. The timber framework is 190 feet high and can be dismantled



SOVIET RUSSIA

Russian building of steel, aluminum and concrete, has Victorian solidity. The structure is built around a gigantic statue of Lenin

Canadian pavilion will house industrial as well as agricultural products, also big movie theater and coffeshouse



CANADA





Here's how 21-inch TV set may look in near future. Model is held by its inventor, William Ross Aiken



Used in airplane cockpit, picture of area in which pilot is flying appears on TV tube in front of him

## Thin Tube Foretells Wall TV and Sky View for Air Pilot

BECAUSE OF NEW TECHNIQUES in the field of electronics, airplane instrument panels and home television sets may soon have something in common—a rectangular picture tube less than three inches thick. The thin cathode-ray tube was invented by William Ross Aiken and developed in the Kaiser Aircraft and Electronics Corporation laboratories. Military uses for the new TV tube were developed for the Douglas Aircraft Company. For the aircraft pilot,

Another model of the thin-tube TV set is mounted in a piece of modern furniture. It also could be installed in any wall



the thin TV tube will serve as an electronic windshield, showing an artificial picture of the terrain and sky conditions about him. For the TV viewer at home, the new picture tube may result in new designs for sets, with screens mounted in any wall or hung like picture frames. The picture tube, only  $2\frac{5}{8}$  inches thick, is made of two rectangular pieces of plate glass with about an inch of space between them. The edges are sealed with powdered-glass solder to hold the vacuum. The surface of the thin tube is the equivalent of a 21-inch conventional screen. In the thin tube, the electron beam is injected at the bottom of one side. Deflection plates along the bottom edge bend the beam upward between the front and back glass walls. The inside of the front wall is coated with a new transparent phosphor which is said to improve the contrast. The thin TV tube also is reported to have sharper focusing properties. A new method of printing electrode elements on the inside surfaces of the glass eliminates the need for assembled metal parts. Printed circuits are used in the tube controls. The thin tube will replace many of the instruments needed for blind flying of an airplane and can be operated by a small electronic computer. A similar control system was developed by Allen B. Dumont Laboratories, Inc., for Bell Helicopter Corp.





## Outboard Boats Go "Around the World in 34½ Days"

Two boats powered by outboard motors recently completed a trip "around the world in 34½ days." The 25,000-mile run was made around a closed course on a lake in Florida in a test of the endurance of modern outboard motors. The boats, five-place runabouts with stock 60-horsepower Mercury motors, made continuous night-and-day runs and were refueled and driv-

ers changed while under way. The average speed of the lead boat was 30.2 miles per hour and gas consumption averaged 7.9 miles per gallon. Calculations show that each engine crankshaft made 225 million revolutions and each ignition system produced 1350 million sparks. The 25,000-mile distance is estimated to be the equivalent of 10 years of normal use.

## Interchangeable Engine Fits Model Plane, Boat or Car

Young model enthusiasts now can obtain a boat, an airplane and a racing car all powered by the same engine. A kit contains the three models with one engine which can be switched from model to model depending upon whether the youngster wants to operate on land, sea or in the air. The tethered racing car will attain speeds

of 40 miles per hour, and the boat, which has controls for straightaway or circular racing, makes 20 knots. The engine is the new recoilable type, started by pulling on a finger loop, much as an outboard motor is started by a rope pull. The kit includes a starting battery and cables, fuel and a control line for the plane model.





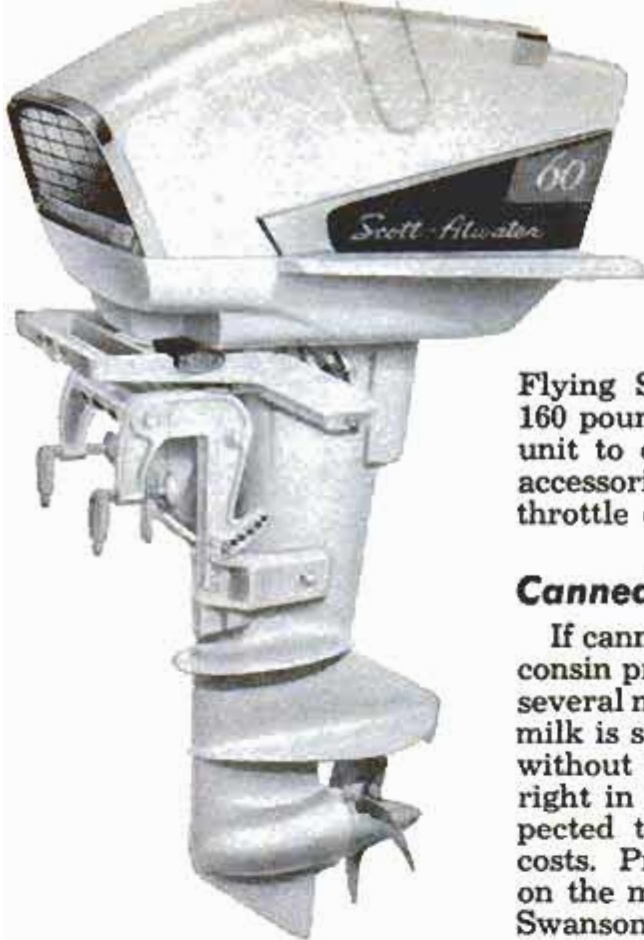

## Three-Cylinder Outboard Develops 60 Horsepower

Something new in outboard motors this year is a three-cylinder, 60-horsepower model. Though three-cylinder, in-line models have been available in Europe for some time, this is the first modern production model in this country. Called the Flying Scott, the Scott-Atwater motor weighs only 160 pounds. One innovation is a slightly offset lower unit to counteract the propeller's torque. Two new accessories are available, a single-lever shift and throttle control, and a powered tilt mechanism.

## Canned Milk Holds Fresh Flavor for Months

If canning tests announced by the University of Wisconsin prove successful, it will be possible to purchase several months' supply of canned milk at one time. The milk is said to retain its freshness for months with or without refrigeration. Concentrated and sterilized right in dairy plants, the new canning system is expected to broaden markets and reduce distribution costs. Processing equipment to do the job is already on the market, according to H. E. Calbert and A. M. Swanson, who had charge of the research project.

## Army Helicopter Bristles With Rockets and Machine Guns for Test

Undergoing tests for the Army at Fort Benning, Ga., is a heavily armed H-34 Choctaw helicopter. The armament fittings, specially installed by Sikorsky Aircraft, in-

clude forty 2.75 rockets, two 5-inch anti-tank and antisubmarine rockets, two 20-millimeter cannon, three .50-caliber and six .30-caliber machine guns.







U. S. Army photo

## Research Helicopter Has Four Small Rotors

Instead of one or two big rotors, a novel helicopter under test by the Army has four small ones. Called the Quadrotor, the helicopter has two sets of spars to support the

four rotors. Tests are under way to determine possible costs and operational advantages. Convertawing, Inc., has been awarded an Army contract to continue research.

### Liquid Insulation Foams Into Place

Insulation may be "foamed" into place in your next home. Bakelite chemists are producing fast-setting foams which fill narrow cavities, simulating the space between studs in a wall, to a uniform density. Two liquid ingredients are mixed and poured immediately into the cavity. The mixture foams up and hardens into a cellular structure within 60 seconds. Because the liquid is converted into a foam of 200 times greater volume, the new insulating technique is expected to save shipping as well as labor costs. The insulating value of the phenolic foam compares favorably with the values of current insulating materials. Although the foam can be applied at the building site, it is expected to be particularly applicable to prefabricated buildings.

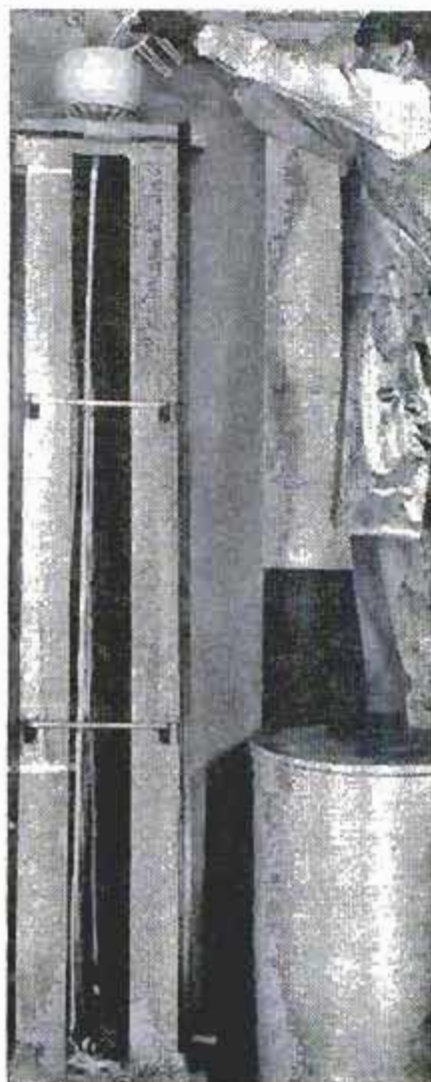



# AN ENGINEER'S ANALYSIS

By Dale Kelly, SAE  
Registered Professional Engineer

# 1958 CHEVROLET

**MODEL TESTED:** 1958 Bel Air four-door sedan with new 348-cubic-inch V8 engine, four-barrel carburetor, dual exhausts, Powerglide transmission. Rear-axle ratio: 3.36 to 1. Wheelbase: 117.5 inches. Tires: 7.50 by 14. Weight: 3753 pounds with gas tank half full (55 percent on front wheels, 45 percent on rear). Mileage on car at time of test: 350 miles. Barometer: 29.12 inches. Temperature: 81 degrees F. Payload: 200 pounds.

## ACCELERATION TIME FROM STANDING START (in seconds)



Ignition timed for:	0 to 20	0 to 40	0 to 60	0 to 80	¼ mile
Regular gasoline.....	2.7	5.4	10.2	18.2	17.8
Premium gasoline.....	2.4	4.9	9.1	16.2	17.0
Super-premium gasoline.....	No improvement shown				

(All tests in Drive range. Gasoline had the following octane ratings by Research method: Regular 90; Premium 97; Super-premium 105.)

## FUEL ECONOMY (miles per gallon)



Ignition timed for:	Steady 30 m.p.h.	Steady 50 m.p.h.	Steady 70 m.p.h.	Traffic Route
Regular gasoline.....	17.2	15.0	12.2	10.2
Premium gasoline.....	19.1	15.4	13.5	9.65

(In traffic test car makes 10 full stops per mile and is driven fast enough to average 15 miles per hour.)

Estimated average

**ANNUAL GASOLINE BILL: \$230 for 10,000 miles**

(Based on exclusive use of premium gas at 33 cents a gallon.)

## SPEEDOMETER ERROR (miles per hour)



Speedometer reading .....	20	30	40	50	60	70	80
True speed .....	20	30	40	49	58	67	76

## ODOMETER ERROR (miles traveled)

Odometer registered 103.5 miles for actual distance of 100 miles.



## DRIVER'S VISION

Driver could see part of road 15.5 feet in front of car, full width of road 18.0 feet in front of car.



## GROUND CLEARANCE (unloaded car)

Worst dip that could be crossed.....23-ft. radius  
Worst hump that could be crossed...14-ft. radius  
Deepest rut that could be negotiated.....6.5 in.  
Curb clearance for door opening.....14 in.

## MISCELLANEOUS

### STEERING

Steering-wheel turns for 100-ft. circle...0.85 turn  
Curb-to-curb turn-circle diameter.....38.5 feet  
Wall-to-wall turn-circle diameter.....41.5 feet  
Steering-wheel turns, lock-to-lock.....5.3 turns

### TRUNK CAPACITY

16 cartons (one cubic foot each)

### CENTER OF GRAVITY

22.2 inches

### WATER RESISTANCE

Splash-pan test: No leaks, no ignition trouble  
High-pressure test: Doors leaked badly

## OBSERVATIONS

Chevrolet has new X-frame and turn-circle diameter is very short (three feet less than in 1957). Center of gravity an inch lower than 1957. Foot-operated park brake easier to set than previous hand brake. It easily held car on a 14-percent grade.

Two of the four small lights in front grille are dummies.

High-temperature (180-degree) cooling-system thermostat is standard. Hotter water means more heat from car heater and should increase engine life. Owners who use alcohol-type antifreeze will have to replace thermostat with cooler version.

Gasoline tank filled satisfactorily. First 2½ gallons put into an empty tank did not register on the gauge.



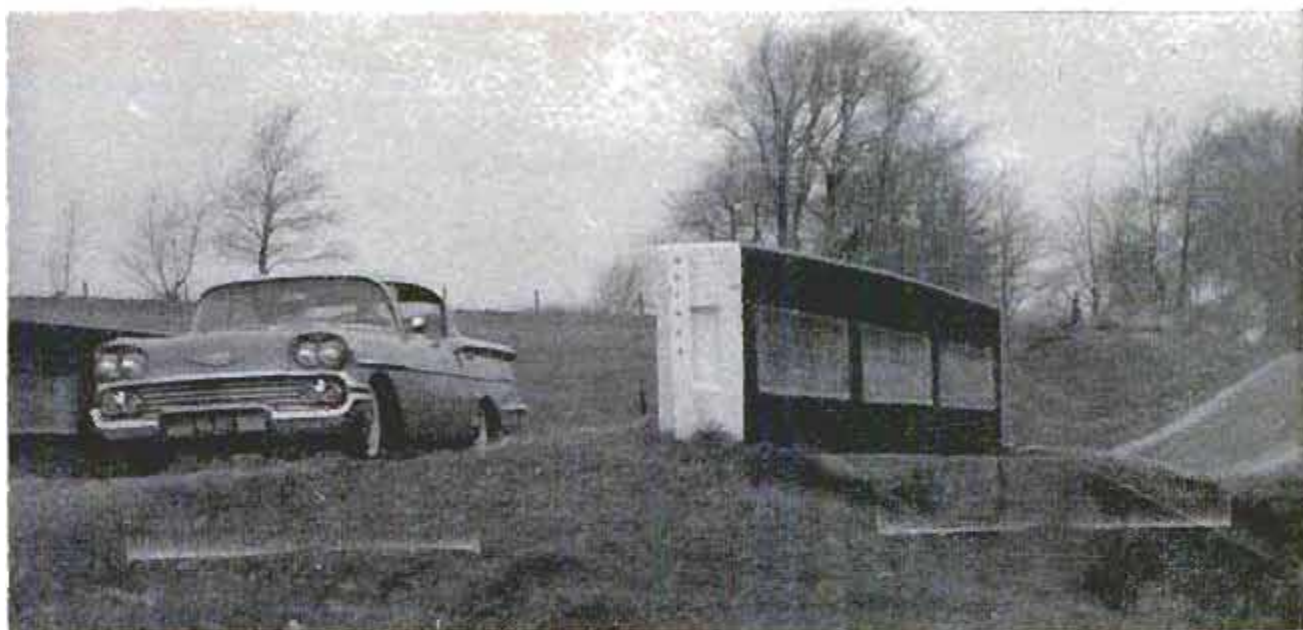

On undulating roads, Chevy's air suspension provides a firm, pleasant ride without nauseating oscillation

## PM Tests the 1958 Chevrolet, Ford, Plymouth

By Arthur R. Railton

**A**RE THEY LIKE three peas in a pod? Are they equally good in all respects? Or are there enough differences so that only one (the Chevrolet, the Ford or the Plymouth) is the car for you?

PM is trying to help you answer these questions. Dale Kelly's engineering analysis in this issue gives scientific data on which to base your choice. This article tries to help by giving carefully considered judgments of each car's important features.

In subsequent issues, the owners themselves will tell you their experiences in the PM Owners Report series.

Certainly there are areas where the cars are so similar that it's hard to separate them. Riding quality is such an area.

PM gave a blindfold test to four men (none had been in a 1958 car previously). The test covered a short ride over a smooth city street and then later a longer ride over a rough road with sharp dips taken at higher-than-normal speeds.

The riders were asked to list the three cars in order of riding quality.

What happened? The front-seat rider in each case rated Ford best, Plymouth second best and Chevrolet third best.

The three rear-seat riders (and it's fair to add that rear-seat ride is apt to be less comfortable than front-seat ride) gave a clear victory to Chevrolet on the rough road, and a tie for Chevrolet and Plymouth on the smooth road. Both times, the three rear-seat riders ranked Ford lowest.

The test Chevrolet was equipped with air suspension (an extra-cost option).

Neither the Ford nor Plymouth had air bags. With the air ride, Chevrolet got top billing in the rough ride, but on the boulevard it did not seem to make enough difference to beat out Plymouth.

The four test riders agreed that differences among the three cars are minor indeed. None was outstandingly better or outstandingly worse in ride than the others.

If you sit in each of the cars in rapid succession you will notice a difference in seating position and comfort. Ford and Chevrolet have the most comfortable driving position. You sit upright and seem to assume a better control position than you do in the Plymouth. Plymouth's front seat is low and its vertical cushion tilts backward at an angle that is tiring in traffic situations when an alert driver tends to lean forward. Passengers, however, may prefer the Plymouth's relaxed seat posture.

Another comfort factor is leg position, especially for the driver—he cannot shift his legs around the way passengers can. Chevrolet and Ford rate about equal, with a slight margin for Chevrolet. The driver's leg position on the Plymouth is less comfortable because of the very low front seat. There is no support for the thigh of the gas-pedal leg unless the seat is moved to its extreme back position. Left-foot brakemen may find Plymouth less convenient because the most comfortable position for the left leg requires the foot to be far away from the excellently shaped brake pedal.

The distance between the dimmer switch and the brake pedal on the Plymouth is



## AN ENGINEER'S ANALYSIS

By Dale Kelly, SAE

Registered Professional Engineer

# 1958 FORD

**MODEL TESTED:** 1958 Ford Fairlane 500 four-door sedan with 352-cubic-inch V8 engine, four-barrel carburetor, dual exhausts, Cruis-O-Matic transmission, power brakes, power steering and power seat. Rear-axle ratio: 2.69 to 1. Wheelbase: 118 inches. Tires: 8.00 by 14. Weight: 3874 pounds with gas tank half full (57 percent on front wheels, 43 percent on rear). Mileage on car at time of test: 447 miles. Barometer: 29.17 inches. Temperature: 68 degrees F. Payload: 200 pounds.

### ACCELERATION TIME FROM STANDING START (in seconds)



Ignition timed for:	0 to 20	0 to 40	0 to 60	0 to 80	1/4 mile
Regular gasoline.....	2.9	6.4	11.2	20.1	18.4
Premium gasoline.....	2.8	5.9	10.2	18.7	17.8
Super-Premium gasoline.....	No significant improvement				

(All tests in D<sub>1</sub> range. Gasoline had the following octane ratings by Research method: Regular 90; Premium 97, Super-premium 105.)

### FUEL ECONOMY (miles per gallon)



Ignition timed for:	Steady 30 m.p.h.	Steady 50 m.p.h.	Steady 70 m.p.h.	Traffic Route
Regular gasoline.....	17.0	14.5	12.6	9.1
Premium gasoline.....	17.0	13.5	12.4	8.9

(In traffic test, car makes 10 full stops per mile and is driven fast enough to average 15 miles per hour.)

Estimated average

**ANNUAL GASOLINE BILL: \$256 for 10,000 miles**

(Based on exclusive use of premium gas at 33 cents a gallon.)

### SPEEDOMETER ERROR (miles per hour)



Speedometer reading.....	20	30	40	50	60	70	80
True speed.....	19	28	37	46	56	65	75

### ODOMETER ERROR (miles traveled)

Odometer registered 102 miles for actual distance of 100 miles.



### DRIVER'S VISION

Driver could see part of road 16 feet in front of car, full width of road 24 feet in front of car.



### GROUND CLEARANCE (unloaded car)

Worst dip that could be crossed.....25-ft. radius  
 Worst hump that could be crossed...19-ft. radius  
 Deepest rut that could be negotiated.....7.25 in.  
 Curb clearance for door opening.....12 in.

### MISCELLANEOUS

#### STEERING

Steering-wheel turns for 100-ft. circle...0.90 turns  
 Curb-to-curb turn-circle diameter.....41.5 feet  
 Wall-to-wall turn-circle diameter.....44.0 feet  
 Steering-wheel turns, lock-to-lock.....4.5 turns

#### TRUNK CAPACITY

13 cartons (one cubic foot each)

#### CENTER OF GRAVITY

21.9 inches

#### WATER RESISTANCE

Splash-pan test: Insignificant leaks. No ignition trouble.  
 High-pressure test: Slight door leaks.

### OBSERVATIONS

In general, an entirely satisfactory car. Front-seat headroom, trunk capacity and curb clearance under the doors could stand improvement. Ford has combined a big engine displacement with an economy-ratio rear axle.

The new Cruis-O-Matic is a three-speed transmission practically identical with Fordomatic except for controls. With control in normal drive (D<sub>1</sub>) position, it starts in First regardless of accelerator-pedal position. For safer starting in snow or ice, the control can be shifted to D<sub>2</sub> position which starts it in Second. With accelerator pedal against the floorboard, the test car shifted from First to Second at 50 miles per hour,

from Second to Third at 80 miles per hour. With a light pedal pressure, it shifted at 12 miles per hour and 32 miles per hour. A thoughtless driver could drive the car indefinitely in Second at 30 miles per hour. At any speed under 70 you can downshift into Second by flooring the pedal to give extra power for passing. Below 35 miles per hour, it downshifts into First.

Gasoline tank filled satisfactorily. First 1 1/2 gallons put into an empty tank did not register on the gauge.

Power brakes had enough reserve vacuum to make four stops after the engine was turned off.





**Ford has lots of power and its automatic transmission combines positive action with extreme smoothness**

great and when both are being used frequently, as they could be in some situations, the left foot has to move around constantly.

Ford's rear floor has two deep stepdowns that are too small to accommodate all six feet of three rear-seat passengers (or even four feet of two riders for long periods). Some have to ride with one foot up on a hill, the other foot down in the valley.

Chevrolet also has two stepdowns in the rear, but they are much more roomy. However, there is a high tunnel that requires an uncomfortably wide leg spread by the center rear-seat passenger (much wider than on the other two cars).

Plymouth has no stepdown and therefore has the lowest tunnel and the most comfortable leg position for the center rear-seat rider, but the center seat cushion is thinly padded. The brace for the stub center post of the four-door hardtop cuts into rear-seat legroom of the Plymouth more than in the others.

To the driver, Ford seems to be bigger than the others and, consequently, it is less easily wheeled around in traffic. There is a lot to the state of mind in driving in traffic and the bigger the car "feels," the less easy it is to maneuver.

Although it feels bigger, Ford is actually two inches shorter than Chevrolet and only an inch longer than Plymouth.

Despite being biggest, Chevrolet feels smallest of the three. Many things combine to create this sensation. The steering-wheel position is such that you feel to be in complete control—it has a little of the sports-car feel to it. The upright front seat provides better vision and emphasizes the feeling of mastery. Plymouth's low front seat somewhat offsets its outstanding han-

dling qualities and the driver feels he has less control than with the Chevrolet.

The Chevrolet is more maneuverable in fact, than the others. It turns around in a 37.4-foot circle. Ford's circle is four feet larger, Plymouth's almost five feet larger.

Plymouth's excellent (and fast) power steering makes up in large part for its reduced maneuverability. The driver feels he can put it (and the Chevrolet also) in a smaller space than he can put the Ford. If the front of the Plymouth came to a sharp point (heaven forbid), the driver feels he could run it into the eye of a needle, that's how precise the steering is.

Fast cornering is a pleasure in the Plymouth, which is a joy to take over winding roads. Ford is poorest in this respect.

Chevrolet's dashboard is most convenient by a narrow margin. Instruments are well shaped and easily read, day or night. Plymouth's instrument layout is equally good, but the rest of the dash is less desirable. Ford's speedometer is excellent in the daytime, but at night the numbers are not easy to read. Ford, however, has the best lighting of knobs and controls. There are no secrets on the Ford dash, every knob is clearly labeled and lighted.

Neither Ford nor Chevrolet has windshield reflections at night, but Plymouth does have one annoying reflection across the top of the curved glass.

Mounted far to the right, the Chevrolet clock is of no use at all to the driver. This is the only poor feature of the dashboard. Plymouth sensibly installs its clock in the instrument panel right in front of the driver and Ford's is about halfway over, visible but not easily so.

To reach into the Plymouth glove compartment, the driver has to leave his place



# AN ENGINEER'S ANALYSIS

By Dale Kelly, SAE  
Registered Professional Engineer

# 1958 PLYMOUTH

**MODEL TESTED:** 1958 Belvedere four-door sedan with 318-cubic-inch V8 engine, two-barrel carburetor, single exhaust, TorqueFlite transmission, power brakes, power steering, power seat and windows. Rear-axle ratio: 3.18 to 1. Wheelbase: 118 inches. Tires: 7.50 by 14. Weight: 3832 pounds with gas tank half full (55 percent on front wheels, 45 percent on rear). Mileage on car at time of test: 750 miles. Barometer: 29.3 inches. Temperature: 64 degrees F. Payload: 200 pounds.

## ACCELERATION TIME FROM STANDING START (in seconds)



Ignition timed for:	0 to 20	0 to 40	0 to 60	0 to 80	¼ mile
Regular gasoline .....	1.9	6.4	12.3	24.0	18.85
Premium gasoline .....	2.0	6.0	12.1	24.0	18.7
Super-premium gasoline.....	No improvement shown				

(All tests in Drive range. Gasoline had following octane ratings; by Research method: Regular 90; Premium 97; Super-premium 105.)

## FUEL ECONOMY (miles per gallon)



Ignition timed for:	Steady 30 m.p.h.	Steady 50 m.p.h.	Steady 70 m.p.h.	Traffic Route
Regular gasoline .....	20.8	17.4	12.8	10.8
Premium gasoline .....	20.0	16.0	13.4	10.8

(In traffic test car makes 10 full stops per mile and is driven fast enough to average 15 miles per hour.)

Estimated average

**ANNUAL GASOLINE BILL: \$207 for 10,000 miles**

(Based on assumption that premium gas at 33 cents a gallon and regular gas at 30.5 cents a gallon will both be used.)

## SPEEDOMETER ERROR



Speedometer reading .....	20	30	40	50	60	70	80
True speed .....	20	29	38	47	55	64	72

## ODOMETER ERROR

Odometer registered 105 miles for actual distance of 100 miles

## DRIVER'S VISION

Driver could see part of road 19 feet in front of car, full width of road 25 feet in front of car.



## GROUND CLEARANCE (unloaded car)

Worst dip that could be crossed.....29-ft. radius  
Worst hump that could be crossed .....19.5-ft. radius  
Deepest rut that could be negotiated.....7 in.  
Curb clearance for door opening.....13 in.

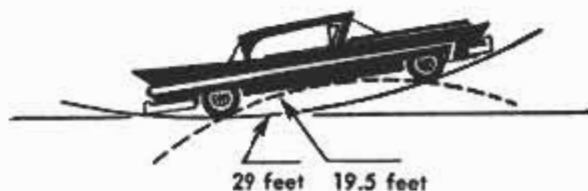

## MISCELLANEOUS

### STEERING

Steering-wheel turn for 100-ft. circle...0.70 turn  
Curb-to-curb turn-circle diameter.....42.0 feet  
Wall-to-wall turn-circle diameter.....45.0 feet  
Steering-wheel turns, lock-to-lock.....3.6 turns

### TRUNK CAPACITY

18 cartons (one cubic foot each)

### CENTER OF GRAVITY

23.0 inches

### WATER RESISTANCE

Splash-pan test: No leaks, no ignition trouble  
High-pressure test: Slight door leaks

## OBSERVATIONS

Distortion in windshield corners a little worse than most.

Transmission was the three-speed TorqueFlite, Chrysler Corporation's newest model. With light accelerator pressure, it shifted from first to second at 12 miles per hour, to third at 18. With wide-open throttle, it shifted at 25 and 50. When pushed past the detent to the floorboard, it

shifted at 35 and 70.

Park brake held easily on 14-percent grade. Brake reserve tank permitted two or three applications with engine dead.

Gasoline tank filled satisfactorily. First 2 gallons in empty tank did not register on the gauge.

Power steering excellent, requiring little winding.





**Fast cornering is a treat in a Plymouth. It takes curves like this one almost as flat as a sports car does**

behind the wheel and slide over to the right. Both Chevrolet and Ford have glove compartments where they can be reached from the driver's seat.

Both control knobs on the Plymouth radio are on the driver's side of the dial, making it unnecessary to reach across the dash to tune in a station. This is an improvement that others could use.

Windshield wipers are good on all three cars. Ford's leaves the largest unwiped area in the center—a triangle about five inches wide at its narrowest point. The other two have wipers that leave less than two inches unwiped. Ford's vacuum wipers are fastest and have a desirable infinitely adjustable speed range, the other two have dual-speed electric wipers. Electric wipers have the advantage of constant speed, the disadvantage of limited speed adjustment.

Chevrolet's rear-view mirror arrangement is best, Plymouth's poorest. Ford and Plymouth mount outside rear-view mirrors on the front fenders ahead of the windshield. They must be viewed through the distorted curve in the wrap-around glass. The mirrors on these two are useless in rain or snow because that part of the windshield is not wiped.

Chevrolet's rear mirror is mounted on the door, just to the left of the steering wheel, and provides excellent rear vision under all conditions.

All three test cars had small body noises, a normal situation in a new car. Ford's was a minor rattle in the trunk area, Chevy's was around the steering column and dash, Plymouth's was in the left front door. Except for these infrequent noises, all are extremely quiet, pleasant cars to travel in. It's difficult to believe that any car at any price could offer very much more than

these three in comfortable high-speed traveling over good roads.

Automatic transmissions on all are excellent although Plymouth's does have some jerkiness, especially at full throttle. Chevrolet's is smoothest, Ford's the most positive. Plymouth's seems to require the most engine windup on acceleration. In fact, Plymouth was the least responsive of the three test cars. However, since all have more response than the driver has any use or need for, this is an academic point.

Four headlights are standard on all and they provide excellent illumination down the road on high beam. But most of the time high beam cannot be used because of approaching traffic.

The back seat of the Plymouth is the most awkward to enter and leave. Chevrolet's is easiest.

Heaters on all work well. All give heat within a mile or so from a cold start on a moderate morning. No extreme cold days were experienced so no complete test could be made. Heater controls are simplest on Plymouth and Chevrolet, more complex and stiffer on the Ford.

Exterior styling is for you to judge. Each to his own taste. However, it is unfortunate that each of the cars mounts a potentially deadly decoration on its front fenders.

Chevrolet's are most dangerous, being knife-edge wind splits that would slice into the flesh on impact. Plymouth's are similar and only slightly less sharp. Ford's are round but perhaps equally dangerous.

In summary, the ideal car would be one that had the roominess and maneuverability of the Chevrolet, the exceptional road sense and handling ease of the Plymouth, with the power and automatic transmission of the Ford.

★ ★ ★



COMING IN FEBRUARY

# *PM's Big Annual Auto Section*

You'll want to read and discuss the experts' choice of

## *AMERICA'S MOST SIGNIFICANT CARS THROUGH THE YEARS*

You'll want to clip and frame the eight-page color section devoted to these sixteen outstanding automobiles



### YOU'LL FIND:

Details and specs on all 1958 cars  
Pictures and data on popular foreign cars  
Industry production data and trends



### YOU'LL GET ANSWERS TO:

Is half a car better than none?  
Which gasoline is best for your car?  
Will success spoil Volkswagen?

**NEXT MONTH—JOIN CARWISE PEOPLE COAST TO COAST  
WHO READ PM'S FAMED ANNUAL AUTOMOTIVE SECTION**



## Tractor "Battering Ram" Demolishes Concrete

Tearing up miles of solid-concrete retaining wall is easy with a tractor-mounted compressed-air "battering ram." Jackhammers are difficult to handle horizontally, but this rig is operated easily by one man. Air is supplied by a 300-cubic-foot portable compressor. The device, boasting a three-foot-long stroke, was built by a California concrete-wrecking firm working on the widening of Cahuenga Pass in Hollywood.



## Solar-Heat Collector Used for Drying Grain

Agricultural engineers at Michigan State University are experimenting with methods of using solar-heat devices on the farm. One outfit is a scale-model heat collector made of sheet metal painted with black asphalt and covered with a sheet of glass. Air heated by the collector is blown into a bin where it dries grain. Engineers figure a collector with 1000 square feet of surface can heat air as warm as a furnace burning two gallons of fuel per hour.

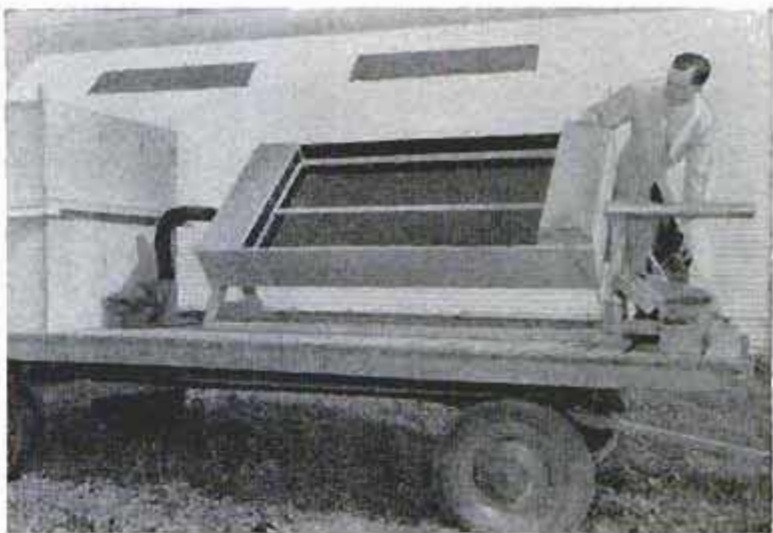

## Fishing Dory Climbs Out of Water—It's Amphibious

Taking a cue from wartime amphibious craft, Harvey Smith of Pacific City, Ore., has converted his surf dory into an eight-knot boat and a 15-miles-per-hour land vehicle. It is powered by a 95-horsepower inboard engine. The rear-axle assembly of an automobile is mounted above the en-

gine with a chain drive to the two wheels. One clutch engages the wheels, another the propeller. The stern steering wheel under the rudder is from an old airplane. An offset in the boat's stern had to be extended 30 inches to accommodate the equipment. One man can operate it.

Engine drives rear axle through a chain and sprocket, which powers chain-driven wheels outside the boat





*Kept...  
P/M Highlights*



Parked on Red Square, Victor drew sight-seers. In background are towers of nine churches that form St. Basil's Cathedral

# I DROVE THROUGH RUSSIA

By David Scott

## PART II

**WE HAD BEEN** two days in Russia, two days of driving down a broad, virtually empty highway. After a stopover at Smolensk we headed once more for our goal, that city of paradoxes, Moscow. In the back seat, as always, was Vladimir, the 22-year-old interpreter assigned to us by Intourist, the Soviet travel agency.

Mid-afternoon of this third day brings a change of scenery. About 30 miles from Moscow we start seeing clusters of houses. Most of

Traffic moves fast on the broad avenues of central Moscow. Dotted center strips are a refuge for pedestrians







**Moscow paradox: Century-old houses sprouting TV antennas stand in shadow of massive new apartments**

them are wooden shanties, but every one sprouts a TV antenna. Occasionally we pass a factory. At the city outskirts, huge apartment houses stand amid a forest of building cranes. Then the traffic really starts—few cars, but an endless stream of green trucks, like an army on the move.

New impressions tumble in. The road is being sprinkled by water tankers, then swept by mechanical brushes to clean up the muddy tracks deposited by trucks from adjacent building sites. Vladimir tells us you can be fined for driving a dirty car in Moscow. It's also an offense to blow your horn or drop a cigarette butt in the street.

Our first stop on this broad belt of concrete is for a bewildering set of four traffic lights. Normally you can turn right on red, but a left-turn is allowed only on a double green light. Overhead hangs a row of circular signs indicating lanes, prohibited vehicles, permitted turns and other regulations. The usual system for left-turns on main avenues is to proceed straight across

an intersection to the U-turn sign halfway up the block, then swing around into the oncoming traffic and cut across to be in position for the next right-turn.

In the center of the city there's a running battle between cars and pedestrians, although the Muscovite walker (usually runner) stranded in midstream has enough sense to stand dead still as the traffic rushes past him. It's a rat race to the uninitiated, but the militiamen (Russian for cops) seem unconcerned. Immaculately garbed in military-type uniforms, they often control traffic merely with a jerk of the head or repeated whistle blasts. Experiencing this continuous war of man vs. machine, we recalled the laconic advice of the English-language guide to motorists in the U.S.S.R.: "When necessary, the car should be stopped in time to avoid an accident."

At the vast permanent Agricultural and Industrial Exhibition in Moscow we had a close look at the cars the Russian can buy. Most popular is the four-seater Moskvitch,





Editor of a Russian science magazine is regular reader of *Popular Mechanics*. His job is to indoctrinate youth in science

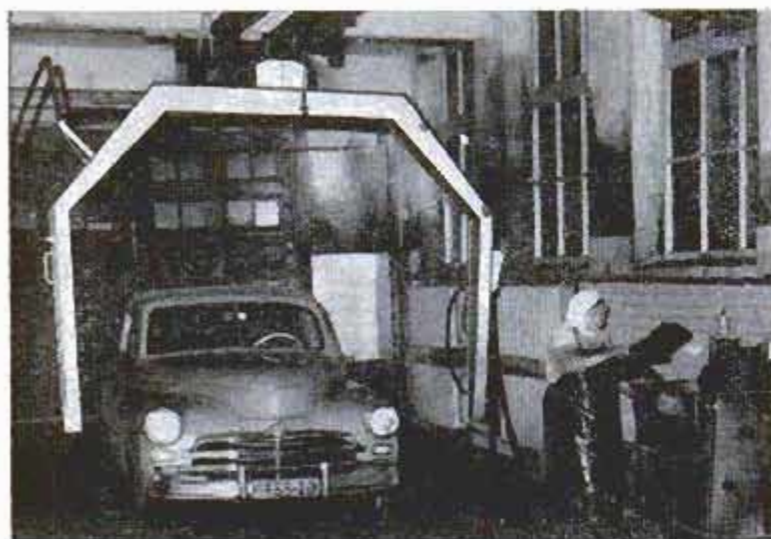

It's illegal to drive a dirty car along Moscow streets, but a complete car wash by this sturdy woman costs only 50 cents

Factory for Moskvitch automobiles has an automated line which turns out an average of 185 cars a day



similar in appearance to more than one British model and costing the ruble equivalent of \$1500. This represents more than one year's average wages and must be paid in cash—there's no consumer credit. Outwardly the car is conventional, with integral body-chassis, a 35-horsepower L-head engine and three-speed manual transmission. Radio and heater are standard.

Beneath the surface the Moskvitch bristles with features that reflect the arduous Soviet driving conditions and weather. For example, the engine has two separate oil filters and a radiator shutter. A towing hook is fitted in case you get bogged down, and the seats fold flat to form a double bed for when you're stranded miles from nowhere. The toolkit would equip a small garage, including no fewer than 20 different wrenches.

We also had a look at the larger Volga that sells for \$3000. It is powered by one of Russia's first overhead-valve gas engines—a four-cylinder unit rated at 70 horsepower. Initially it was to have an automatic transmission, but this gave so much trouble that the idea was shelved. It is a pleasantly styled machine—a compromise between American and European designs.

A visit to the Moskvitch plant gave us a glimpse of how the Soviets make cars. Daily output





In a near-disaster in Poland, woman cyclist shown at right was struck by author's car, shattering windshield



Russians eagerly replaced windshield with plastic. Then, when replacement pane arrived, they installed it free

there is 185, amounting to half the country's total annual production of 110,000 units. Machinery is modern by European standards, with a considerable number of automatic transfer lines for the engine block and cylinder head, manifold, transmission housing and other large components. Automation is applied widely to special-purpose machines for making smaller parts such as pistons and universal joints.

Russia's production figure for trucks is more impressive, since the country's trans-

port system relies heavily on fleets of rugged machines. Almost all these trucks are heavy-duty jobs with pay-load ratings from 2½ to 40 tons, and current output is some 370,000 a year. Although this is only about half of America's production in the same load category, it is over three times the combined output of Britain, West Germany and France.

At the ZIL plant in Moscow we saw one four-tonner or a heavier six-by-six version rolling off the assembly lines every 2½ minutes. Over 20 automatic lines are used

Russian Moskvitch, costing \$1500, is rugged car designed for bad roads, has towing hook, two oil filters

Volga sedan, larger car with better styling, sells for \$3000—more than two years' wages for most Russians







Russian factories have fine equipment. This is an automatic transfer line for machining cylinder blocks at Moskvitch plant



Here's the author at work in hotel overlooking Kremlin, St. Basil's Cathedral. Cost was \$11.25 a day with meals and interpreter

Apartment houses go up in a hurry on outskirts of Moscow. Road is being widened into a six-lane highway



for machining engine and transmission parts, and production is keyed to a high pitch. In addition to trucks, the factory turns out 11 coaches a day, with 1500 bicycles and 30 refrigerators as sidelines. I was struck by the number of women workers (nearly a third of the 40,000 employees), and especially by the way they held every type of man's job.

I had a unique chance at both these factories to sample personally the Russians' technical proficiency and zeal, since the Victor reached Moscow somewhat bruised after an accident. Near-disaster had struck us in the middle of Poland—a country where travelers to Russia must reckon with peasants asleep at the reins of horse-drawn carts, small children teetering about on man-sized bicycles, animals grazing along the roadway and other hazards.

This time it was a woman on a bicycle who cut across my path just as I was about to overtake her. Despite frantic horn blasts and shrieking tires she never once looked around. Braking furiously and swinging far to the left in a flanking movement, I hit her. She rolled over the hood, snapped the radio antenna, smashed the windshield and bounced forward in a series of somersaults on the road. By some miracle she was not killed—not even any bones broken.

Shaken, but glad to have escaped so lightly, we had driven on slowly to Warsaw with the wind buffeting our faces. A Warsaw





Parked outside his hotel, the author's GM-built Victor always attracted a group of car-hungry Russians

garage had fastened a flat piece of plastic in place to serve as a windshield, but the wrap-around corners remained exposed to the elements. At the end of 800 drafty miles it was heartening to find in Moscow a cable from the Vauxhall factory in England (which had loaned me the car) announcing that a new piece of glass was on the way.

Before it arrived we visited the ZIL factory where the chief engineer insisted that his experimental shop improve the repair, despite my protests that a replacement windshield was coming by air. At the end of the day the Victor was returned to us looking almost like new. Corner sections of plastic had been shaped and bent in the

(Continued to page 268)



There are no billboards along Russian roads, but plenty of propoganda posters extolling Communism

Painted lanes guide traffic through empty acres of a square in central Moscow. The Kremlin is at right







## Huge "Swamp Buggy" Powered by Airplane Engines

Like a giant swamp buggy, the U. S. Navy ship YAG 37 is powered by "fans." They are T-34 turboprop airplane engines, two fore and two aft on gun mounts. The engines drive the ship up to eight knots and, since the gun mounts will turn in

a complete circle, she can go in any direction—even sideways. The engines are the former Liberty ship's only source of power, her propellers and all steam equipment having been removed. The Navy has not divulged the purpose of the experiment.



## Shutterless Camera Makes Wide-Angle Pictures

Panoramic photographs like an aerial view of Long Island (at left) are made by a new lightweight camera that has no shutter. The image is recorded on the film as it moves over a slit in the camera. The 53-pound unit is only slightly wider than the 70-millimeter film it uses. A rotating glass prism provides a horizon-to-horizon sweep as it scans across, rather than along, the flight path of an airplane carrying it. Besides its military uses, the tracking camera will be valuable for studies of unexplored areas, timber reserves or highway routes.







## Flying Swiss Ski Lift Puts Tourists on Glacier Top

One of the highest airfields in the world is a landing strip recently completed 9000 feet above sea level, on the edge of Switzerland's Diablerets Glacier. The airport was built primarily for tourists who want to be

able to land near the mountain peak and ski down the glacier bank. There is a telephone link with the top station on Mount Pillon to provide both skiers and pilots with the latest weather conditions.

## "Chemical" Bomber for SAC

By Murray Q. Smith

With missiles now coming into their own in the armed forces, what is the future of the Strategic Air Command? Will it give way to a missile force? The answer is no. Present long-range ballistic missiles are not geared to make last-minute flight-path changes if an enemy target is moved. For such missions the Strategic Air Command will use a manned aircraft that looks very much like a missile. Designated the WS-110 (Weapon System 110), the aircraft will not burn conventional jet-plane fuel but instead will use what are termed the "exotic" fuels, special chemicals that oxidize at fantastically high temperatures and with amazing rapidity. The plane will resemble the X-10 test vehicle built by North American Aircraft recently to test aerodynamic configuration and controls systems for the Navaho intercontinental winged-missile test program. The WS-110 "chemical" bomber will be long, sleek and needle-nosed with two little elevator tabs at the nose. The main delta wing will be near the tail. Six chemical-fuel engines will provide enough thrust to carry it to alti-

tudes of over 100,000 feet at speeds three times that of sound. The WS-110 will be built almost completely of steel and titanium. And the titanium and stainless-steel skin will be stretched and stressed like a tight drum. Another reason the Air Force still needs manned bombers is the factor of reliability. If one small part of an electronic control weapon goes wrong, the whole equipment malfunctions. A pilot, on the other hand, can make compensations to suit particular situations. Lt. Gen. Clarence S. Irvine, Air Force Chief of Materiel, probably will select the main contractor for the WS-110 as an over-all management head and specify that smaller subcontractors be used to provide chemical-bomber components. The powerful exotic-fuel engines will be built by General Electric. There are only three large aircraft companies now in position to build chemical bombers—Convair, Boeing and North American. The WS-110 will be used as a replacement for the present SAC mainstay, the Boeing B-52. It will outfly any manned aircraft the Air Force now has, including the B-58.



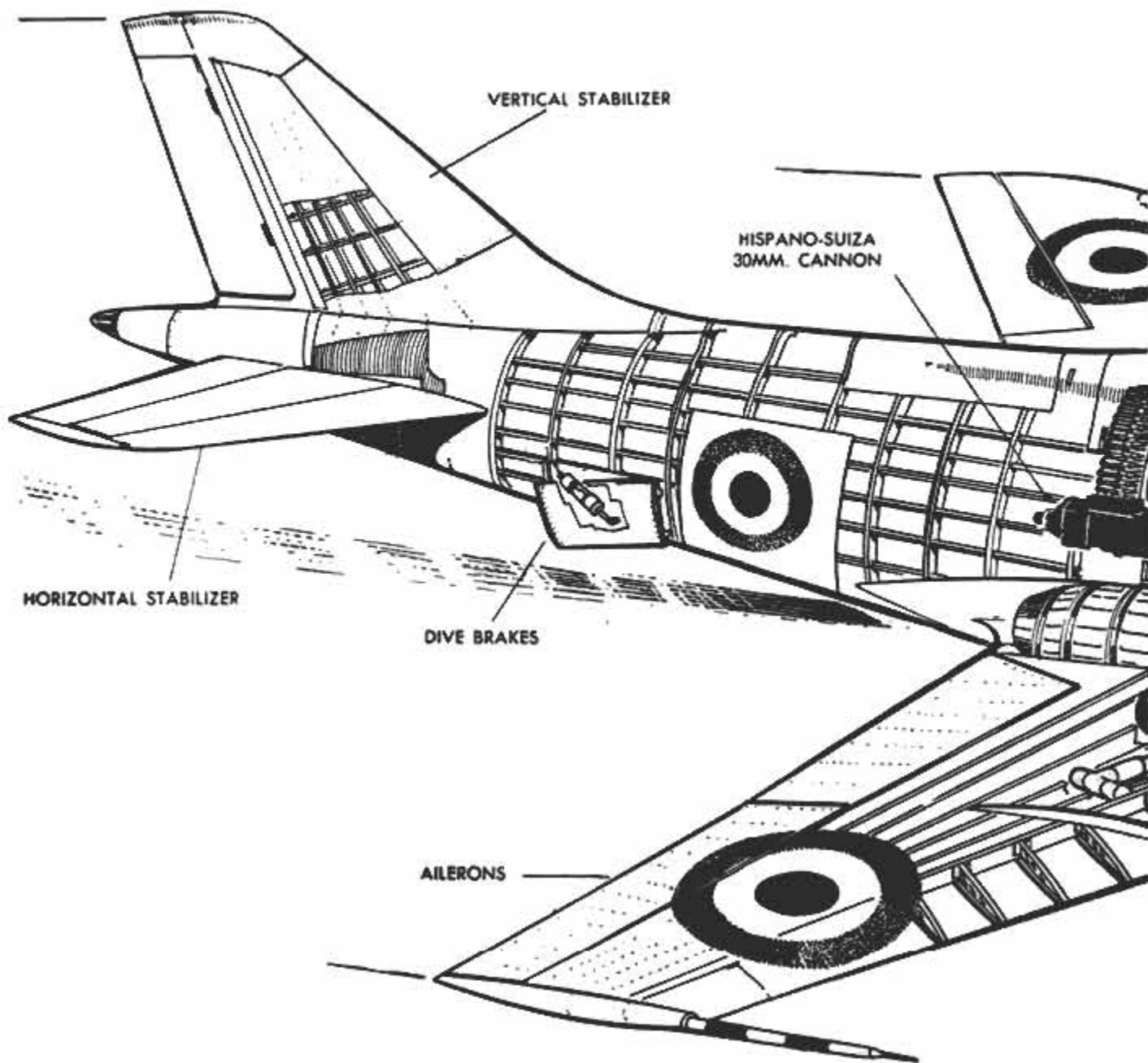

**WITHOUT FANFARE**, another small, lethal interceptor, built to suit NATO requirements, has shuddered through the sound barrier in dives to become Italy's first supersonic daytime fighter.

The new mighty midget is the Sagittario 2. Tipping the scales at 7276 pounds "soaking wet" makes this plane less than half the weight of U. S. aircraft with the same speed potential. It is cheap and easy to produce. The "banshee wail" of its Rolls-Royce Derwent jet engine sends it rocketing at speeds up to Mach 1.2 in a flashy display of maneuverability provided by a one-piece wing of transsonic Italian design, with dramatic 45-degree sweepback.

Primarily, the job of the Sagittario 2 will be as an assault aircraft or pure interceptor. The plane is curious in many respects. Contrary to all the other single-engined military jet aircraft flying today, its engine is forward instead of behind the pilot. This

"wrinkle" cuts down the weight associated with conventional air-intake ducts and long exhaust pipes.

The centrifugal-compressor section of the engine is bulbous, almost filling the forward fuselage. Its small-diameter jet pipe is kinked under the pilot's cockpit and exhausts its jet stream beneath the mid-fuselage.

Flow of air to the jet engine is via a ram intake in the nose, through to the engine-bay plenum chamber where the double-sided impeller draws its supply.

Armament consists of two Hispano-Suiza 30-millimeter cannon, one on each side of the fuselage. The plane may also carry a choice of two 500-pound bombs, two 715-pound napalm tanks, two 500-pound guns or 12 three-inch rockets.

The 3638 pounds of engine thrust permit the Sagittario to climb to 40,000-foot altitude in 10 minutes. Its level-flight speed is



# Italy's First Supersonic Fighter— The Sagittario

By Ruth J. Turner  
and Thomas Turner

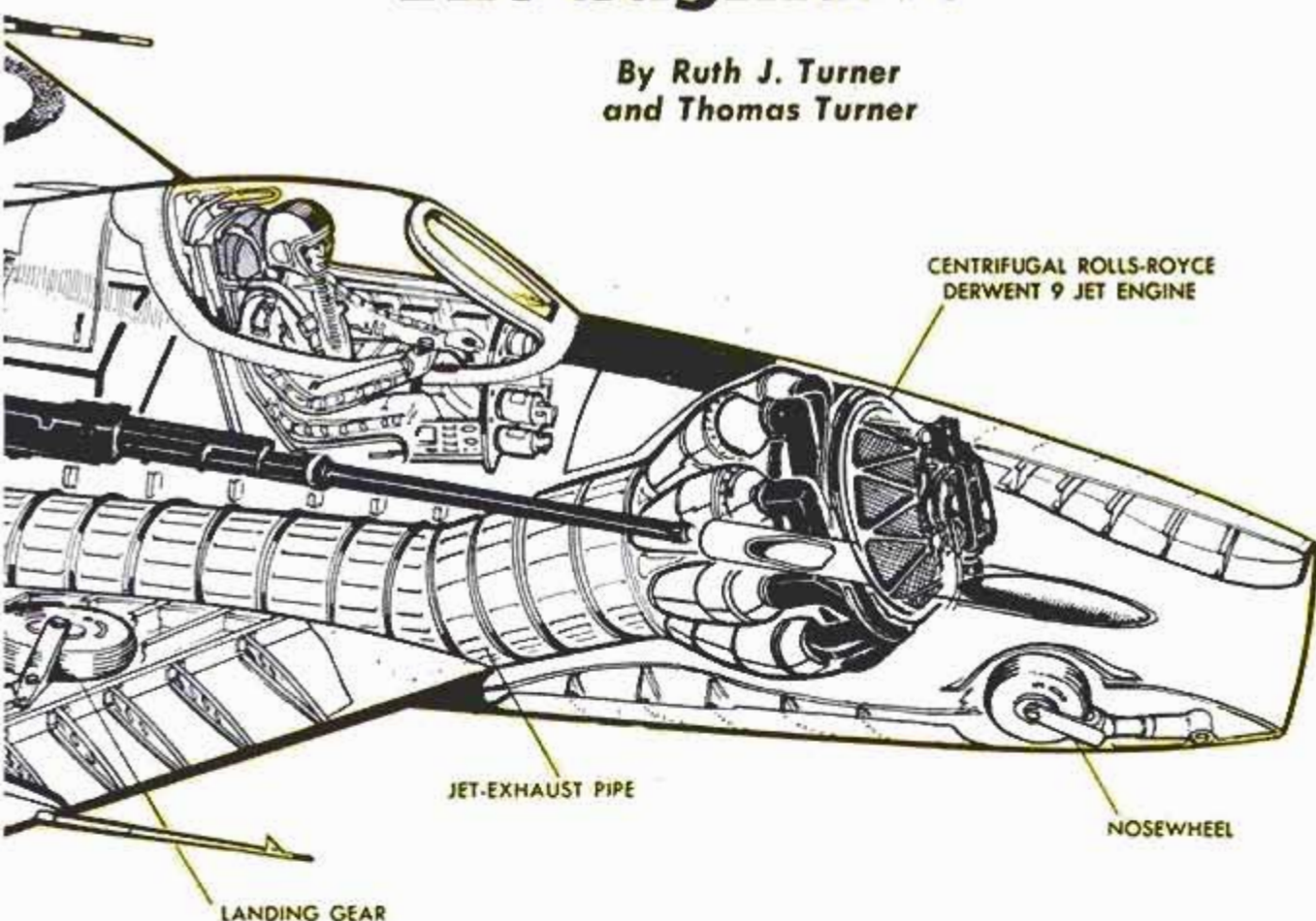

Sagittario 2, shown in take-off and flight aspects  
dives at Mach 1.2, flies level at 567 miles per hour

567 miles per hour. And in a nose dive the Mach potential of 20 percent above the speed of sound is reached. Power-to-weight ratio associated with this lightweight fighter enables it to take off and land in restricted areas, a necessary advantage in these days of nuclear vulnerability associated with large airfields and runways.

The Sagittario's pilot sits far back from the nose entry and is provided with an upward-ejection seat and back-type parachute. The windshield side panels and canopy are integrated into a single unit, providing larger vision area than the conventional cockpit transparencies. Increase in vision is due to elimination of windshield side members. On many present-day interceptors these constitute a blind spot.

Other characteristics of the aircraft are: Wingspan, 24.6 feet; length, 31.27 feet; wing loading, 46.49 pounds per square foot; and empty weight, 5071 pounds. ★ ★ ★

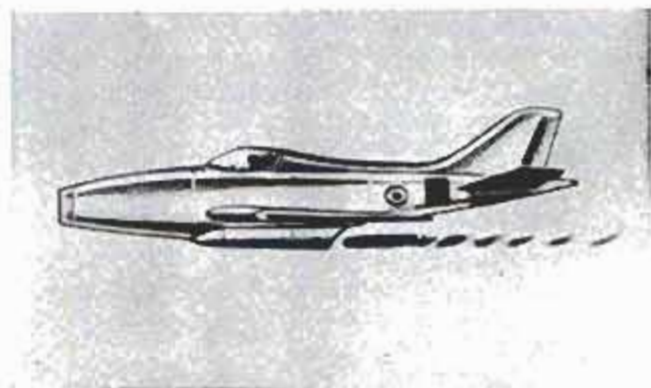
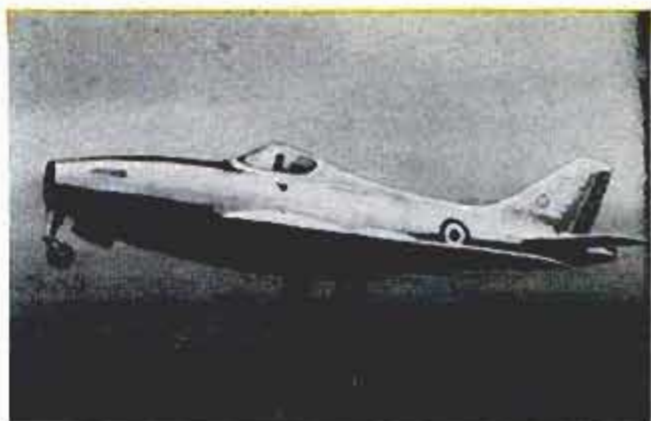





## LISTENING POST

By Art Railton

**T**HE HOLE AT the bottom gets bigger.

Again this year the upgrading of models and prices continues, leaving a wider price range for the imports to prosper in.

A new price line has been crossed. There is no Ford, Chevrolet or Plymouth today that sells for under \$2000. Even the plainest, simplest, lowest-powered version of these cars has a base price of over \$2000.

One year ago the bottom price line was about \$1900, two years ago about \$1800, three years ago about \$1600.

Chevrolet's Impala (added this year) is a luxury car by any standard. Ford, winner of the 1957 sales sweepstakes, dropped its low-priced Customline.

But there are two mavericks in the crowd. Like mavericks generally, they are not being taken seriously by the rest of the industry. One is Studebaker with its \$1800 Scotsman. The other (and it is coming out in January) will be the American Motors' American. This low-priced series will jump into that vast emptiness between \$1600 and \$2000. Exactly where it will land is unknown right now, but it will probably come in below the Scotsman.

### New But Old

This American is a slightly (and very slightly, it is) modified version of the 1955 Rambler two-door sedan. On a 100-inch wheelbase, it comes in two versions—plain and fancy. Obviously those are not the names American Motors will use. They will call them something like Deluxe and Superdeluxe—nothing is "plain" in this business.

The engine will be the same L-head six used previously with slightly higher compression. It develops 90 horsepower, same as before. The increased compression could mean better gas mileage.

Over-all, it is 15 feet long, about a foot or so shorter than present Ramblers.

It looks now as though the Studebaker-Packard affiliation with the tiny Goggomobil is off. It would have been good for the S-P dealers. Such a novelty would

have created lots of floor traffic, something everybody needs these days and especially Studebaker-Packard dealers.

The real trouble with S-P is the extreme spread of its models. It has more series, more different designs than many of the big companies. It's hard to see how there can be any profit with such a diversification of production.

### Air for Torsionaire?

Neither Chrysler nor American Motors has air suspension at this writing, but if rumors are correct (and rumors *are* correct sometimes) things may be different shortly.

Chrysler denies any interest in air, but the rumor persists that it will offer optional air bags on the rear wheels late in the 1958-model run or perhaps not until the 1959 cars come out. This system will not replace the leaf springs, but will augment them. It will provide a means of leveling the rear end for constant height regardless of load. By this combination of torsion bars in front, air in the rear, the expression "Torsionaire ride" will have real meaning. Up until then, the only air in Torsionaire is in the tires.

American Motors, too, is expected to offer an air-bag option before the winter's over. Its design is such that the bags can be mounted inside the rear coil springs, requiring little retooling. A compressor maintains pressure to keep the car level.

Other rumors from Detroit are that Chrysler is getting close to a central hydraulic system and may have it in time for 1959. It may need a big splash in 1959 to keep its third-year body shell selling until "suddenly-it's-1960" comes around.

Part of the system may be hydraulically powered brakes instead of the vacuum-powered in use today. It may also be possible to increase braking action by using the torque converter's pumping action to slow down the car. If you can make a car go by pumping oil, you can slow it down the same way. When you apply the brakes you would operate a valve to force the converter to work against itself, slowing down the car.

Much the same system operates today when you put the transmission in Low to hold you back in descending a hill. If the control is hooked up with the brake pedal, there would be less work for the brake bands to do. And, it is generally agreed that the brakes in all cars have not kept pace with the horsepower and speed.

Cadillac has just about reached the end of the power road with its engine so, the story is, next year may bring out a new and bigger V8, possibly with an all-aluminum block, the first in the industry, a claim Cadillac often can make. ★ ★ ★



*When a man-size spider walks a giant web, when scissors draw the villain's blood or a lobster spits in the waiter's eye, put it down to*

## **TV TRICKERY**

*By Jack B. Kemmerer*

**S**EATED AT A SIDEWALK TABLE in a Paris cafe, a customer watched in fascination a huge, freshly cooked lobster placed in front of him by the waiter. Each time he reached for the lobster the huge shellfish swiftly moved its large claws protectingly over its head. Reaching for a hammer, the would-be diner attempted to hit the lobster but each time the claws parried the blow. The man finally called the waiter to see what he could do with the reluctant lobster. As the waiter bent over to inspect the lobster and its strange actions more closely a stream of water hit him in the eye.

Actually the customer and the waiter weren't too surprised. They had rehearsed this particular scene numerous times before it was used on one of Ed Sullivan's TV shows. The belligerent lobster had been ordered from the special-effects

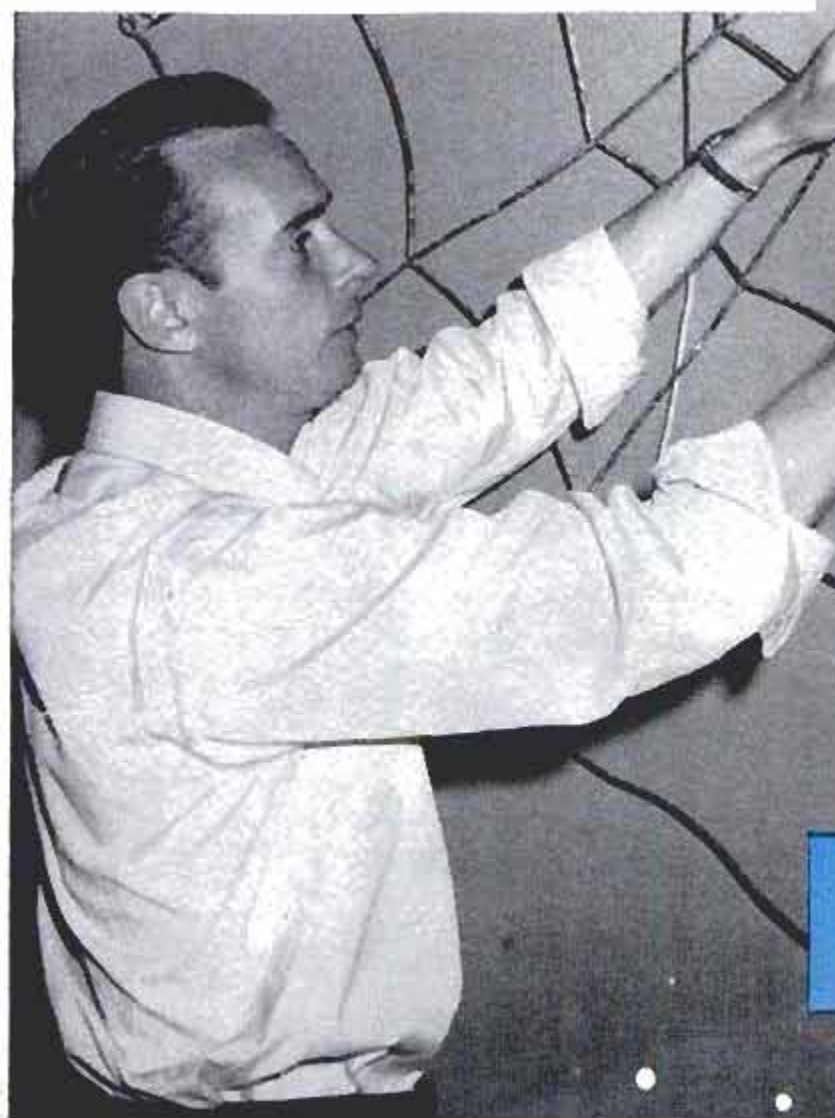

Special-effects man for a television studio makes adjustment on huge spider that moves across web during show





Special-effects man checks the prop lobster and finds it works perfectly. Man hidden by tablecloth operates lobster

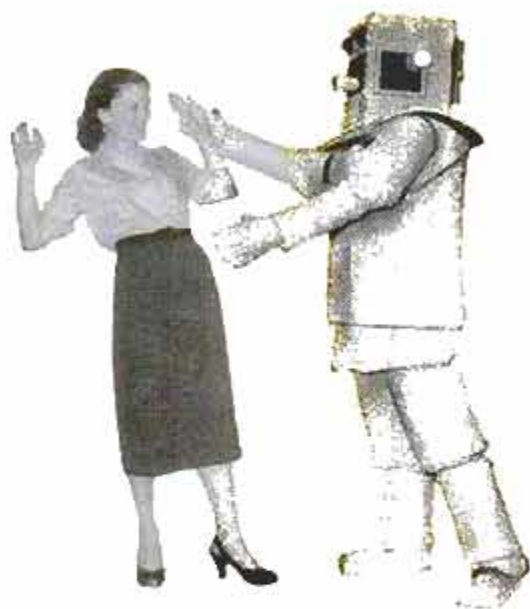

Robots on live-TV shows have a man inside; mechanical robots sometimes go haywire

department to do just that and it had carried out its orders to perfection.

Constructing such a lobster wasn't too difficult a job for the special-effects gang of Columbia Broadcasting System, for they specialize in building trick sight props and their TV department in Hollywood is the largest of its kind in the country. Robert Waugh, Hollywood head of special effects for CBS, has had to produce such unusual props as spiders that crawl across webs, dragons that emit smoke and fire, cross-bows that shoot tomatoes, barrels that spurt "beer" through a bullet hole, numerous false snakes, phony oil wells and anything else gag writers dream up for their clients.

On most ideas, ample time is allowed for

building a prop but occasionally the writers or directors dream up a new gag on the very eve of the show. "That happened to us once," Waugh said, "when Red Skelton's director came in with an idea to use a huge diamond ring—about nine inches tall and at least that in diameter. Yet the ring still had to be light enough in weight so that Red's guest star, Carol Channing, could wear it on her finger."

To do this, the special-effects team designed the ring, grabbed a chunk of balsa wood and went to work. About six hours later, the "million-carat diamond" ring was ready.

"That was an easy one," Waugh grinned. "A sight prop we made for Playhouse 90 was a lot harder. They wanted a pair of

It looks like bullet-punctured keg but close-up shows how soapy water is pumped through prepared hole





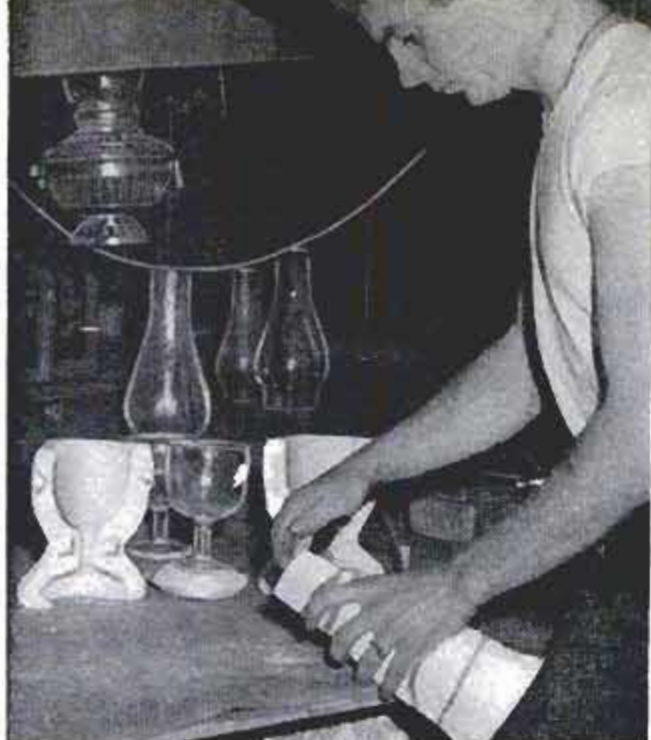

Special-effects "glass factory" makes realistic prop "glass" by molding resin which shatters safely

shears that would 'bleed' on cue." The shears were made from wood and painted to look exactly like any ordinary pair of shears. A plastic tip was attached to the end of the blade with a tube running from the plastic tip up through the blade to the locknut that holds the shears together. Here a small rubber ball was inserted and filled with make-believe blood. In the TV show, the actress would pick up the shears to stab the villain but he would force the shears against her cheek, cutting a long bleeding gash. Actually, the actress squeezed the bulb in the shears and the "blood" appeared to flow from her cheek.

Special-effects men often are asked to make "breakaways" of different kinds. One

How to make a "million-carat diamond" ring. Huge gem is shaped from big hollow block of balsa wood

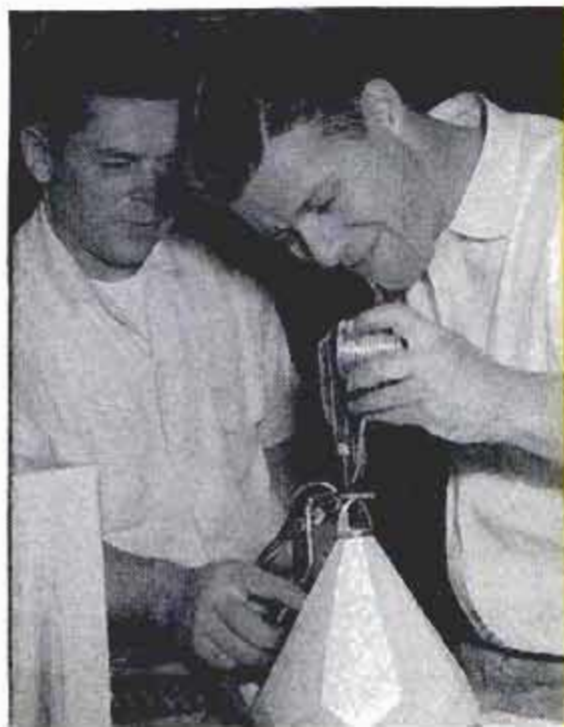

Fake blood oozes from plastic tip of wooden shears when rubber bulb is squeezed during TV fight scene

most frequently used is glass. But the "glass" used in TV bottles and windowpanes actually is a resin called PS-2. A plaster mold is made of the object and the resin is melted and poured into the mold. Temperature is important because if the resin is too cool it won't pour properly and if it's too hot it acquires a yellow color and doesn't photograph properly. The molded resin shatters like glass, but without the danger of cutting the TV performers.

★ ★ ★







# Keeping up with the ATOM

**THAT SILVER EGG** looming against the sky at right is the dome of the first West German reactor station. Located at Garching, near Munich, the station recently received a shipment of uranium bars—its source of power—from the United States. The reactor, resplendent in its silver dome, was built for use by the atomic-research department of Munich Technical University.

☆☆☆

**SPEAKING OF REACTORS**, Dr. Paul F. Gast of the General Electric Company's Hanford Laboratories has estimated that a major reactor disaster could kill about 50 persons, seriously injure as many as 1000 and cause up to several hundred million dollars in damage to land. Dr. Gast emphasizes that these are theoretical estimates and could be either over or under by a factor of three.

In a major accident to a reactor, the chief hazard is not from the explosion itself, but from the radioactive materials scattered by the explosion. Most fission products would be contained within the reactor building, but a small fraction would escape and would sift slowly to earth as fallout. These could cause death to anyone within 10 to 50 miles downwind from the reactor.

As a counterbalance to these rather pessimistic observations, Dr. Gast reports that



the chances of such an uncontrolled explosion are believed to be "vanishingly small."

☆☆☆

**HERE'S A DRAMATIC** example of what the atomic age has produced in the way of useful radioactive products. Recently the most powerful radiation source ever shipped for the use of private industry left Oak Ridge, Tenn. It was bound for the Linden, N. J., laboratories of the Esso Research and Engineering Company, where it will be used in research on the application of atomic energy to the oil industry. The shipment consisted of about 15,000 curies of radioactive cobalt. In radioactivity, this is equivalent to about 33 pounds of pure radium. This is more than seven times the world's supply of refined radium!

☆☆☆

**ATOMIC NOTES:** A packaged nuclear power plant produced in England is said to be competitive anywhere in the world where a firm pays \$19.60 a ton or more for coal. . . . The AEC has suspended development work on the food irradiation reactor for the Army. . . . The Veterans Administration is using radioactive tracers to find the cause of mental illness and the action of tranquilizing drugs.

☆☆☆

**THE GENERAL ELECTRIC** biologist at left is piping a dose of highly active radiocesium into an experimental pond. Biologists are studying the effects of this isotope on the fish and insect life of a typical pond.







Top-notch USAF aerobatic team has thrilled millions of spectators with their breath-taking maneuvers

# *I Led the Thunderbirds*

By Maj. Jacksel M. Broughton

UNITED STATES AIR FORCE

**B**ILL POGUE, a black speck seven miles away in the sky, mushroomed to life size in just about 15 seconds as we approached and passed each other, wing tip to wing tip, at a closing speed of more than 1400 miles per hour. Twenty-five feet below us, the wingmen of our foursome were doing the same—at right angles to our track. Everyone was on time. In this maneuver, called the “bomb burst,” our tight diamond formation climbs 10,000 feet straight-up, then each plane breaks out and away in a wide rolling loop. Diving for the ground at some 700 miles per hour from the four points of the compass, we all intersect over the same point simultaneously (if we’re on the ball), stacking ourselves a few feet apart to avoid the possibility of colliding.

This particular crossover was made about 800 feet in front of a swarming crowd at Daytona Beach, Fla. As Bill’s F-100 flashed by, I suddenly realized this

was the last time I’d hunt the sky for three specks, in order to time our split-second pass so we’d cross just in front of the crowd. This was my last show with the “T-birds.” For 2½ years I was the leader of this unique group. Taken together, they are the world’s first supersonic aerobatic

Author Broughton, who led the “T-birds” 2½ years, is also a West Pointer and veteran of Korean fighting







This Thunderbird team includes, from left: Sam Johnson, solo pilot; Doug Brenner, right wingman; Robby Robinson, leader; Bart Bartley, left wingman, and Bill Pogue, "slot" man

team, and probably the hottest team of precision-information pilots going. Individually, each is a great guy, a devoted officer and a top pilot—with combat ribbons and bravery decorations to prove it.

The Thunderbirds were organized as the United States Air Force's official aerobatic team in May 1953. Their job was to show the public how a first-line supersonic jet fighter becomes the most destructive weapon imaginable in the hands of today's highly skilled, team-trained Air Force pilots. Since its activation, the team, which is constantly changing as older members rotate to new assignments and new pilots replace them, has dazzled more than 10 million spectators in some 280 demonstrations involving 425,000 miles of travel across both Americas.

When I joined the Thunderbirds in October 1954, the boys were flying Republic F-84G Thunderjets—straight-winged, maneuverable but subsonic planes with fuel pods on the wing tips. A year later, Republic sweptback our wings with the faster, more powerful Thunderstreak. But it wasn't until June 1956 that we got the North American F-100C Super Sabres that the team flies today. The single-place fighter, distinguished by the rakish 45-degree sweepback of its low wings and tail surfaces, has been clocked at 822.135 miles per hour—straight and level. A clamshell canopy gives the pilot 360-degree visibility and allows for pressurization at altitudes up to the plane's 50,000-foot ceiling. Besides ejection seat, each plane carries a drag chute for safe stops on short or icy runways. Ordinarily, this formidable fighting craft mounts four 20-millimeter cannon, but for the team's work, these have been removed. Our "armament" is a smoke tank containing 20 gallons of engine oil that feeds out into the exhaust stream to produce spectacular trails of white smoke, tracking maneuvers across the sky.

On the road, the "Birds" travel with seven Super

Trailing smoke to show flight paths, 700-mile-per-hour T-birds break away in "bomb burst," their most spectacular maneuver





In diamond-formation five-G pull-out, planes traveling faster than sound buzz crowd gathered along beach



Team's new commander, Major Robinson, is at right with Major Broughton, in front of F-100 Super Sabre lead plane



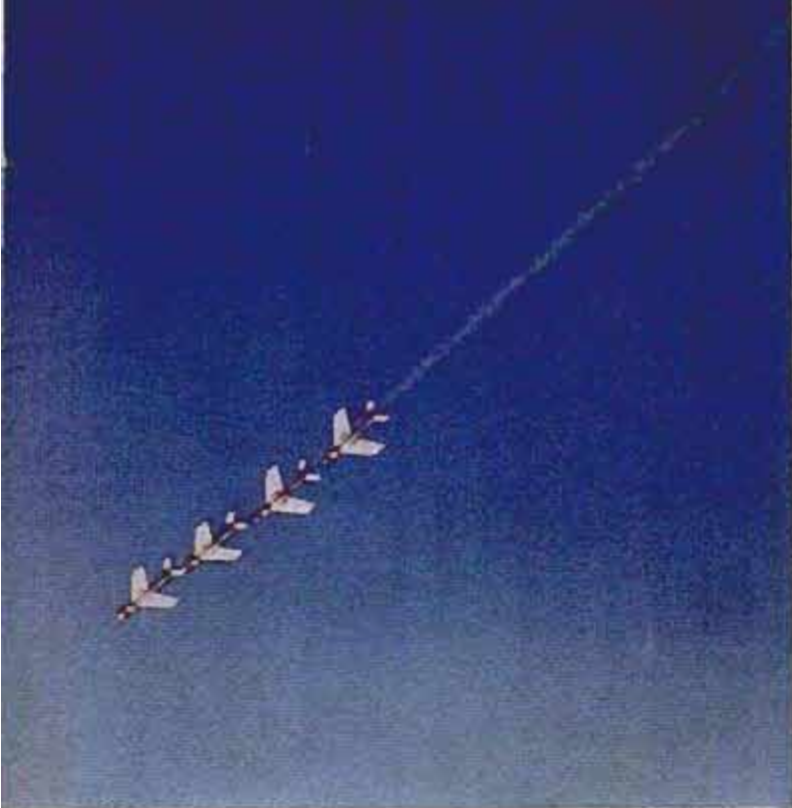

"Thunderbirds . . . now!" is the formation battle cry of the precision fliers, as they play follow-the-leader. Sometimes they are only a few feet apart. Below, the beginning of a "four-leaf-clover" maneuver



Sabres painted a dazzling red, white and blue pattern. Along with the team goes a two-place T-33 Shooting Star observer plane, and two C-119 Packets carrying the parts and crew to maintain the planes. In all, some 40 men make up the Thunderbird unit. Each is hand-picked. About 25 go on a trip, and of these only five are pilots who fly in the show. Four of them, flying Sabres in a tight diamond formation at speeds up to 750 miles per hour—wing tips overlapping with five-foot vertical separation—perform loops, corkscrew rolls, vertical turns and other precision maneuvers shown on these pages.

So close are the separation tolerances in this formation flying, that the "slot" man, bringing up the rear of the diamond, has to have the leading edge of his tailfin washed down after each show to remove the carbon from the lead plane's jet exhaust. Yet, if he ever allowed that 3000-degree blast to drop a few feet and engulf his canopy during those loops and rolls, it would melt the canopy—and him. Actually, the slot man follows his 700-miles-per-hour teammates far closer than any sane auto driver would tail another car at 20 miles per hour on a highway.

Between formation maneuvers during the shows, a solo pilot roars past the crowd at 750 miles per hour, producing a sonic boom as he goes. He does four-point and eight-point barrel rolls, with hesitations like the sweep hand on a stop watch. He makes a pass upside-down. On his last run, he rockets in at nearly sonic speed, pulls into a vertical climb, and bores into the sky rolling as he goes until he vanishes.

All this takes precision timing and coordination of the highest caliber. Every Thunderbird must be so familiar with every detail of every maneuver that he can anticipate another man's action before the fellow thinks of it. We like the fellow who was overheard informing his friend at one of our shows: "One man flies one plane, and his electronic stuff flies all them other planes." Equally complimentary was the "doubting Thomas" who wanted to know where all the wires were that held the planes together.

The real answer, of course, is that it's done by men who know their business. Last February when I got my orders to move on, the team consisted of myself, leading the diamond; Lt. (now Capt.) D. D. "Doug" Brenner as right wing; Lt. (now Capt.) R. D. "Bob" Anderson as left wing; and Lt. W. R. "Bill" Pogue in the slot position. Capt. J. M. "Bart" Bartley was our solo man.

Probably the best way to describe the problems and techniques involved in fly-



Thunderbird aerobic maneuvers, right, require split-second timing. Each man must anticipate the others' actions before they are made, or —disaster

ing high-precision formation aerobatics, is to go through some of the highlights in a typical Thunderbird show like the one at Daytona.

Before any show, we "Monday-morning quarterback" the last show. Each man points out his partners' errors, then has to listen to his own. New ideas to forestall errors and improve precision on tough turns are hacked over. Local wind and weather are carefully studied. Wind can mean a lot in timing for the bomb burst, for instance, where every man is going in a different direction but must arrive back at a given point with everyone else. Every man is thoroughly briefed on obstacles over the course. In Caracas, Venezuela, the bomb burst had to be executed beside a sheer 7000-foot mountain. It required plenty of judgment for the man who looped over and roared down in a dive only a few hundred feet above the slope all the way. Even flat Daytona Beach had a tower nearby that was higher than our 100-foot flight path. Every T-bird had that tower's precise location pegged in his brain. Another hazard at Daytona was sea gulls. One gull in a jet intake could mean the end of a Thunderbird. Bart solved that one. On his first pass, before our arrival, he roared down the beach skimming the sand, lighting and relighting his afterburner and sounding like a mortar battalion. The crowd thought it was a thriller for them. Actually, he was scaring away the birds. The system worked—no sea gulls stayed around the area that day.

While Bart did this, we made a customary inspection of our planes and ran through a 10 to 15-minute warm-up. Our "mech" crew, headed up by M/Sgt. Ray Mather, is tops. No show has ever been canceled.

Flying diamond formation at about 20 feet, our "entrance" is usually made from behind the crowd to surprise them. At Daytona this pass took us seaward. Capt. Bill Scott, our narrator, was busy down on the beach, as usual, directing the crowd's attention elsewhere via PA system to build the surprise even more.

Out over the water our routine began with a "change-over whifferdill"—a group roll performed while the boys shift up into trail formation. They watch for my nose to rise. Usually I'll give them a blast on the intercom radio: "Nose coming up. Bob, you call the shift." Bob Anderson, second man in file, watches the rim of my intake lift over the horizon. "Thunderbirds, now!" he says, creeping up under my left wing,



VERTICAL 360° TURN



"WHIFFERDILL"



'BOMB BURST"



SINGLE "CLOVERLEAF"



"CORKSCREW" ROLL





Taking off wing tip to wing tip, "Birds" practice constantly; despite dangers have had no serious accidents

while Doug roars up under the right, Bill guns into the slot and we all go over on our backs. Once more around and we're flying trail straight and level. Radio chatter goes on between team members constantly throughout the show—sometimes to coordinate a crucial maneuver, sometimes just so we all know we're still there. I may call a row of orders just to set the stage so no one has any doubts about who does what, or when.

For instance, as we prepare to swoop into a "cloverleaf"—a plain inside loop with slight roll to left or right at the vertical point to give us a 90-degree change in direction—I may call all the shots even though everyone knows what to do with

his eyes shut. It would sound like this: "This will be a cloverleaf to the left . . . I'll call the smoke, break and roll . . . Thunderbirds, smoke on now! . . . break—now! . . . and rolling!"

At other times, precision depends on one of the men behind me who may have to start a maneuver by speeding up, dropping back or shifting position before the rest of us can budge. Then the ball is thrown to the key man in the maneuver.

What the Thunderbirds call a whifferdill, for example, is a vertical U-turn in which the formation climbs steeply, rolls to the left, swoops in a high arch upside down and levels off right side up going in the

(Continued to page 244)

Team rolls in a "whifferdill." Slot plane's tailfin is washed after flight to remove exhaust of lead jet







## Exhaust Flare of Rocket Salvo Lights Up Sky

Full blast of exhaust from the 24-rocket salvo of a Convair F-102A Delta Dagger makes the all-weather jet interceptor appear to be afire. The 2.75-inch folding-fin rockets leave their tubes in the missile-bay doors two at a time in 12 rapid pulses. Heat-resistant enamel protects the aircraft

from rocket-blast corrosion and the fiery burst is so momentary that only a thin film of dust will remain on the F-102A. A half dozen of the supersonic missiles can be seen streaking past the nose of the plane. A high-speed-sequence camera froze the rockets in their flight.

## Turn on the Windows— It's Getting Dark

Homes of the future may have windows that provide light at night as well as during the day. Westinghouse scientists are experimenting with a transparent phosphor placed between two sheets of glass and having an electrical conducting charge. This allows the window to be used in the customary manner, but at night electricity is turned on and the transparent phosphors emit light. The process, called electroluminescence, also can be applied to glass ceilings, coffee-table tops, murals and in various architectural designs.



## Round Pool Table Teaches Coordination

U. S. Navy pilots are using a round pool table not only for amusement, but also to help the training of their coordination. It was designed by Capt. James A. Niforopilos of San Francisco, Calif. Playing the game requires directional coordination similar to flying an airplane. Seven balls are used, and the five pockets are 72 degrees apart.





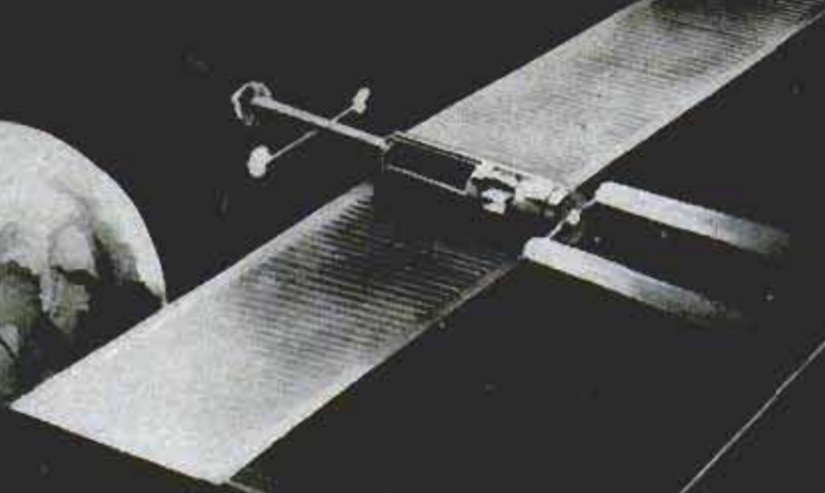

TRAIL OF ROCKET  
WITH SPUTNIK

ION-PROPELLED  
SPACE VEHICLE



BALLOON-LAUNCHED  
FARSIDE ROCKET  
SOARS 4000 MILES

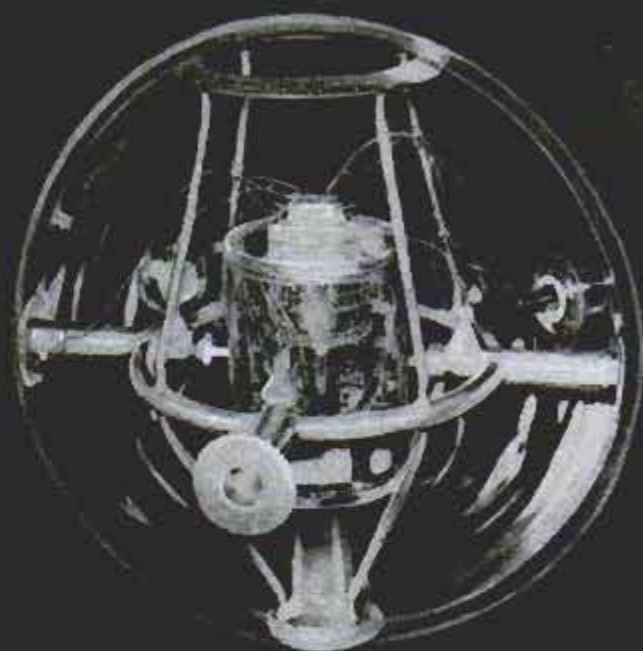

U. S. SATELLITE



FARSIDE ROCKET



MANNED SATELLITE  
(U. S. DESIGN)

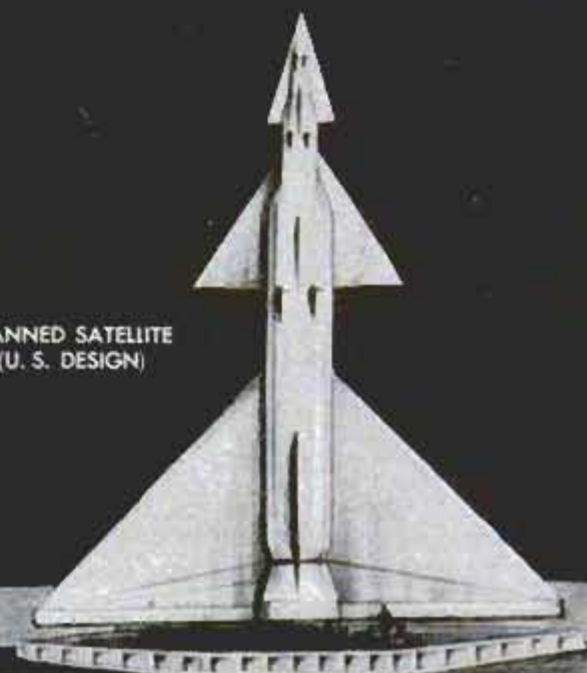





*Forecast:*

# A SKY FULL OF SATELLITES

Based on a drawing from Convair (Astronautics) Division of General Dynamics Corporation

By Richard F. Dempewolff

**M**AN'S GREAT DREAM of stepping off his island in the universe to explore the spangled reaches of space took a giant step toward realization on October 4, 1957. That date marks the exclamation point in history when a 184-pound moon, boosted by a mighty rocket smashing skyward from an airfield on the Caspian Sea, was programmed into an 18,000-mile-per-hour orbit around the earth.

Roaring unmanned space vehicles already capable of reaching up to splash visible blots of potassium or metallic sodium across the real moon's face 239,000 miles away, and manmade baby satellites plaintively beeping back messages about temperature, cosmic rays, the intensity of meteorite showers and other unknown conditions "out there," are advance scouts for man's own expeditions into the void. But the day Earth's first space "Viking," clad in a still-to-be-designed "Buck Rogers" pressure suit, steps to the surface of another world from a still-to-be-designed spaceship capable of weathering still-to-be-discovered storms and hazards of outer space, is many moons (and many rockets) away.

Some of those moons and rockets, however, are already in the hardware stage and about to be fired into orbit. Parts of others—more elaborate space platforms with TV cameras aboard—are under test in laboratories where they are being sub-

jected to conditions of outer space to make sure they'll stand up when subjected to the real thing. Still more advanced space stations and vehicles are on the drawing boards—proven in theory, but waiting for word from the "advance scouts" before money and manpower are thrown into their actual construction. During the next few months and years, according to experts involved in both the United States and the Russian space programs, we soon will witness a sky full of satellites, all orbiting around our globe like Jupiter's moons.

At Vanguard headquarters in Washington's Naval Research Laboratory, nearly half a hundred glittering satellites are already built. Most are being used for test in huge vacuum chambers simulating conditions of outer space. Many of the weird-looking spheres are covered with metal cups, beneath which heat or cold can be applied to any portion of the satellite's skin, just as it will be in the burning sun and polar frigidities beyond the atmosphere. Of all this hardware, four baby spheres weighing 4½ pounds and carrying only a tiny transmitter powered by solar batteries, may be orbiting by the time you read this. Four larger ones, measuring 21 inches in diameter and weighing 21½ pounds, are scheduled for launching in March. Meanwhile the Russians have been launching heavier satellites. Their Sputnik II, sent aloft early in November, was



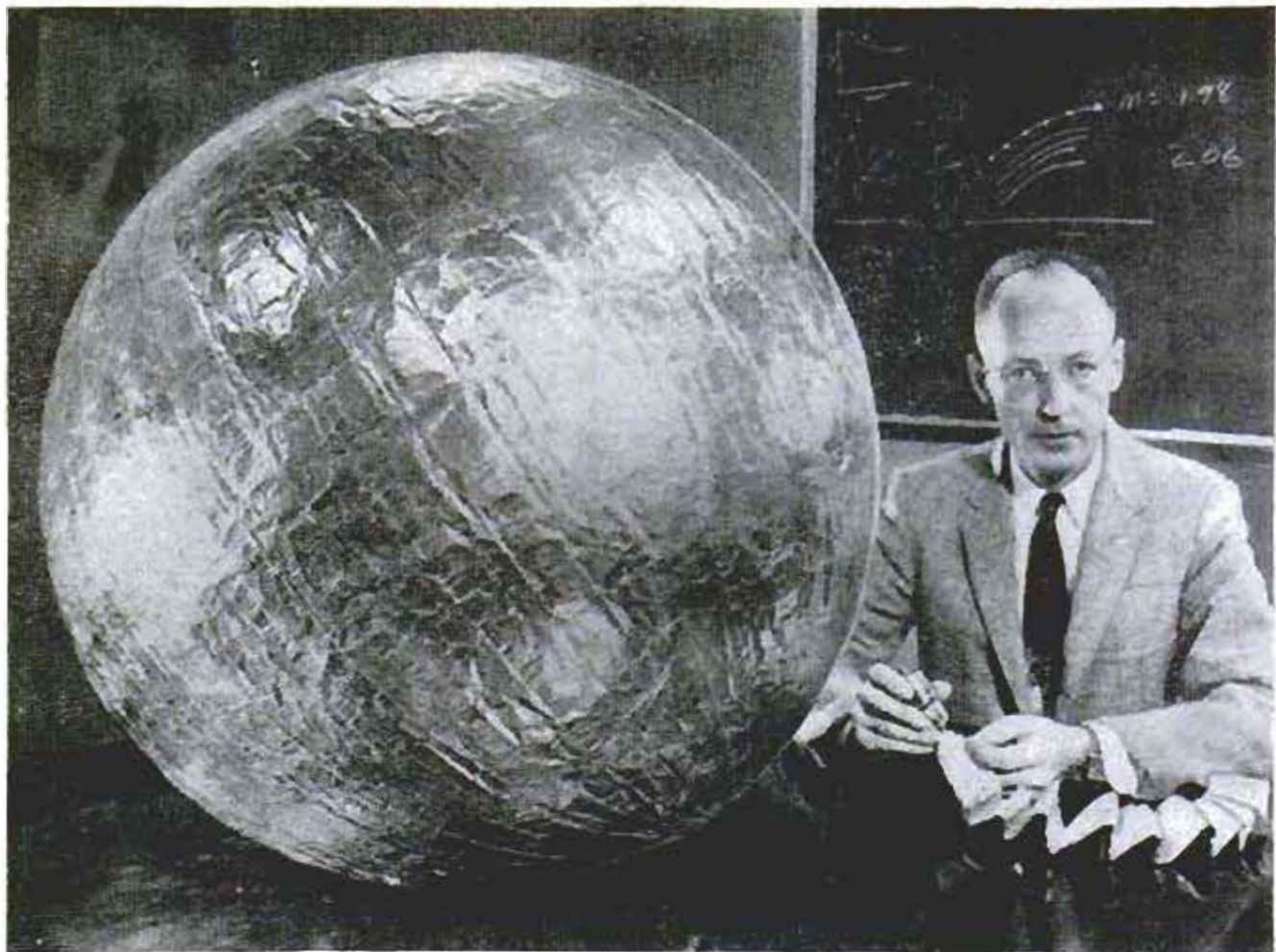

Inflatable baby satellite is covered with aluminum foil. Scientist holds deflated ball and inflating cartridge

reported to weigh 1120 pounds with maximum altitude of 1056 miles. This satellite carried the first living creature, a dog, into outer space.

In the labs along the Naval Research Laboratory's off-limits corridors, you can

Giant satellite-tracking camera is so accurate it can photograph a golf ball 60,000 feet in the air

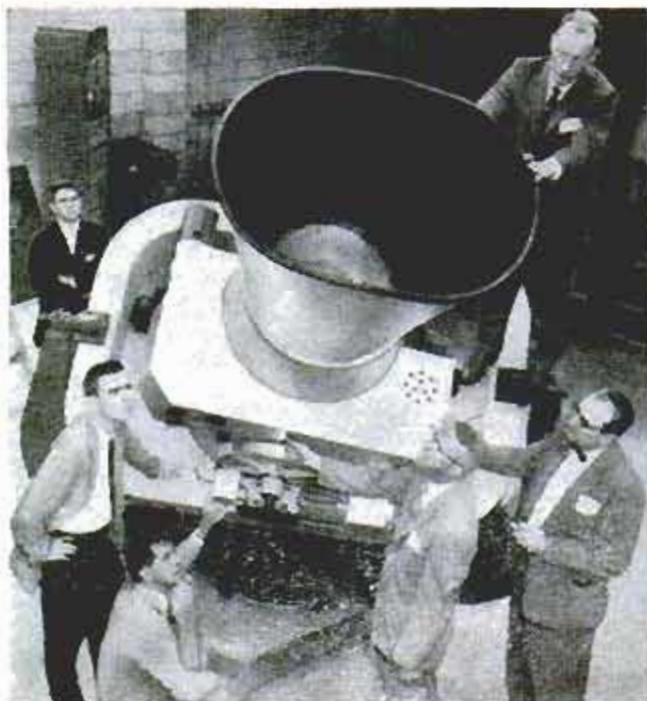

see technicians at work on 10-pound plastic-encased instrument cores for the U. S. spheres. The cylindrical package, a masterpiece of miniaturization, looks like a stack of plump pancakes. "Unlike Russia's first sputnik which, as far as we know, contained only a transmitter," says Dr. John P. Hagen, Vanguard director, "ours has instruments to perform many jobs." Some of the things our orbiting satellites will do: An ionization chamber in the sphere's shell will pick up and record amounts and types of radiation from the sun; sensitive skin instruments will count particles of meteoric dust colliding with the sphere as it whisks along; a strip "thermistor," stuck on the satellite's magnesium hide like a Band-Aid, will record the outdoor temperatures of space; baby microphones will pick up and count sounds of collisions with larger meteorites—a hazard of space that may make it prohibitive for men to travel there; cosmic-ray counters will tally particle bombardments, and shoot each strike to an amplifier for boosting. A tiny electronic brain, regulated by solar power, will store all the data from these instruments, correlate it, send it to a coder and then out over the sphere's minitrack transmitter for broadcast to earth. "The signal," says a Vanguard technician, "is much more





*21000 Brookpark, Cleveland, Ohio*

Courtesy of Lewis Flight Propulsion Laboratory, National Advisory Committee for Aeronautics

Ion-propulsion model is operated in near-vacuum chamber to simulate conditions to be found in outer space

musical than that of Sputnik I—a series of high, low, long and short tones almost like a melody.”

Though the United States Air Force refuses to deny or admit it, an elaborate space-platform program called Project Pied Piper (also known as Big Brother because of its watchdog implication) is reported well under way. A globe-circling reconnaissance satellite, orbiting at an altitude between 300 and 1000 miles, Pied Piper would carry TV cameras and transmitters, and radar or infrared scanning systems which could sweep all corners of the earth once every 24 hours, monitor global events such as weather, atom-bomb tests, undue massing of ship or aircraft fleets, and so on. Taken with telephoto lenses, pictures would carry detail as sharp and clear as an aerial photo taken at 5000 feet. Target date for an unmanned version of Big Brother is estimated about 1960; manned version, about 1965. Some of the tough problems that still need solving: Electronic coding of picture data so it can be transmitted to earthlings, some kind of motorized gimbal mount to keep the camera pointed at earth while the satellite spins its way through

(Continued to page 262)

U.S. satellite launcher, three-stage Vanguard rocket, gets a static test of first-stage rocket at Florida missile center

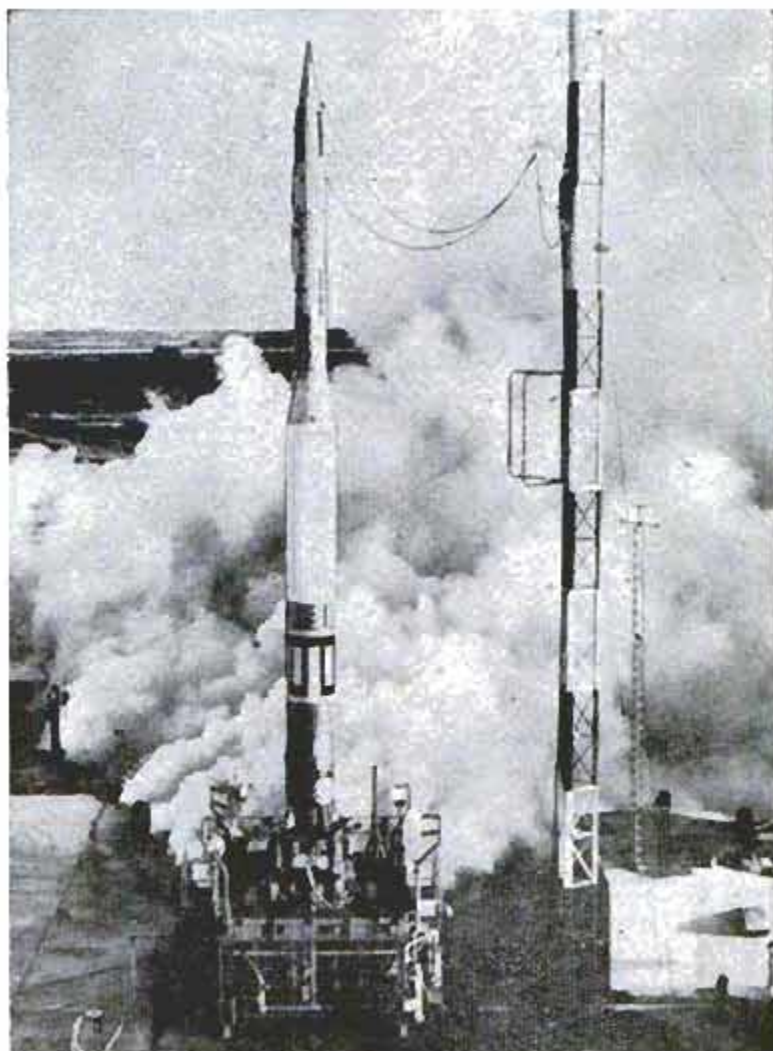



## A Prediction in 1910—

SOMETIMES the most outlandish prophecies come true. Away back in 1910, *Popular Mechanics* printed the prediction of "a Michigan inventor" that the telephone would one day convert a conversation from one language to another by "some mysterious mechanism yet to be designed."

Cagily, the editor of that day called it a "very distant likelihood."

The item, as published in our issue of February 1910, is reproduced in the opposite column. It came to us from Arthur D. Preston, a contributor. He remembered it the other day when he read of the 1958 actuality—an electronic machine that will interpret four foreign languages and automatically print the translation in English. Writing us from Preston Cottages, Laguna Beach, Fla., Preston recalled the item of nearly 50 years ago and said "it would be interesting to read it and compare with" the electronic device of today.



## AN INTERPRETING TELEPHONE

The reader must not be led to think by the above head that any such wonderful device has yet been invented, or

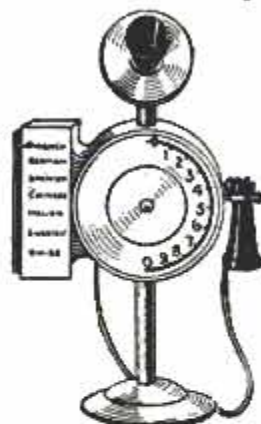

that there is anything but a very distant likelihood of such a device in the future. Yet, every great invention has appeared impossible to the many and difficult to most before its arrival, and very simple afterwards.

The interpreting telephone, however, is nothing more or less than the prophecy of a Michigan inventor, who believes the time will come when a person at one end of the line can speak one language and that any language can be heard at the other end. That is, any language the telephone is provided with. The drawing shows the Michigan man's idea of how it is to be accomplished. Attached to the side of an ordinary telephone receiver is a box in which the different languages are stored. If the man answering the phone is Chinese, he will move the indicator opposite the Chinese language, and then some mysterious mechanism yet to be designed will receive the English words coming over the wire and convert them into Chinese.

## Nears Reality In '58

The man who made the dream come true is Peter Toma, 32-year-old Hungarian physics teacher at a California technical school. He uses a Datatron electronic computer to do the job of interpreting Russian, French, German and Spanish — automatically typing out English translations. Toma, who fled Communist Hungary in 1945 and speaks eight languages, primed his electronic linguist by first transmitting to its magnetic memory drum condensed dictionaries in the four languages. These were punched on paper tape in numerical computer code along with translating instructions. The computer converts the code into alphabetic characters and types out a page of English translation.



## Pitch and Roll Machine Tests Submarine Equipment

Now you can get seasick without going to sea. A machine that simulates the pitch and roll of a ship has been developed to test power-plant instruments for the atomic submarine *Triton*. The machine, dubbed "Rough Rider," also reproduces the effect of a rolling sea on the pressure and liquid level in the radioactive coolant loop of the *Triton's* atomic power plant.

## Baby Car Goes Anywhere On Low-Pressure Tires

Excelling in off-highway use, as on golf courses or construction projects, a tiny personal car has supersoft tires of only seven pounds air pressure. Its three wheels are fitted with Terra-Tires to carry it through snow, ice, mud or sand without bogging down. Power comes from either an 8½-horsepower gasoline engine or a powerful electric motor run by a set of storage batteries.

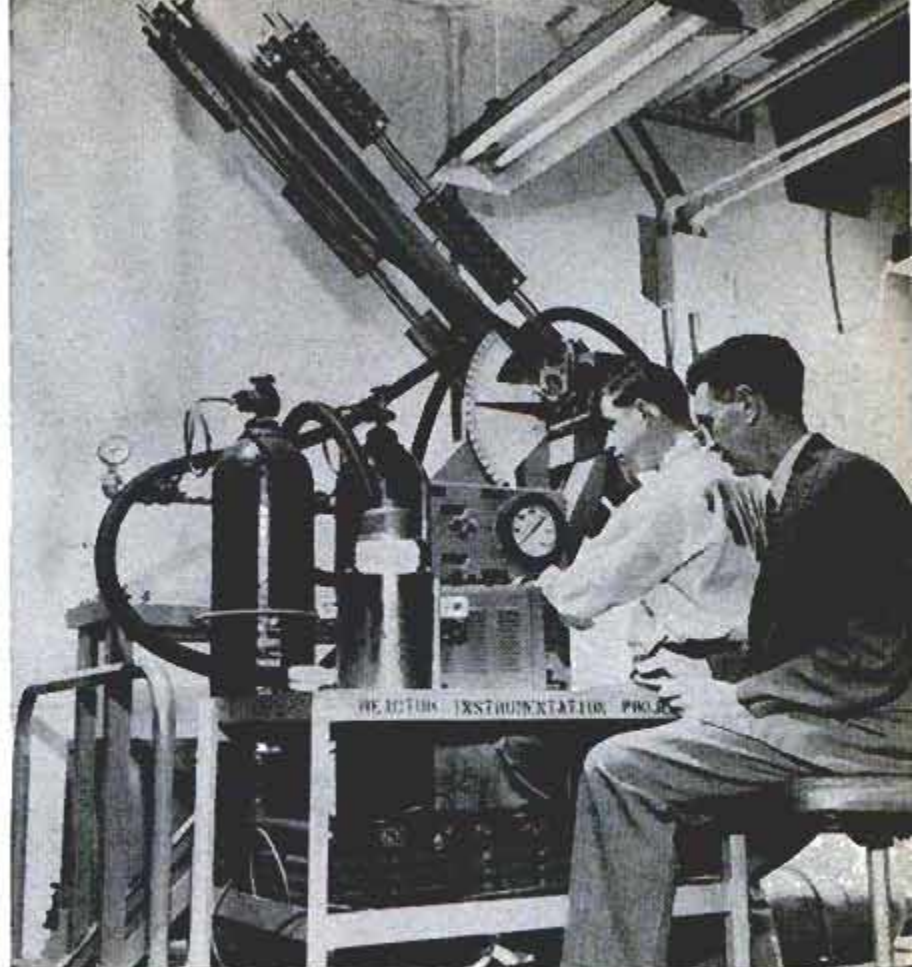

## School Bus Has Elevator For Handicapped Pupils

Powered by a large battery which is independent of the engine, an elevator helps the driver put handicapped children aboard a school bus in San Lorenzo, Calif. The elevator is enclosed within the bus and affords special protection for the children's feet while their wheel chairs are raised or lowered. The \$14,000 bus also has floor anchors to hold the chairs while the bus is moving, and safety belts for the children. The novel bus travels about 112 miles per day.

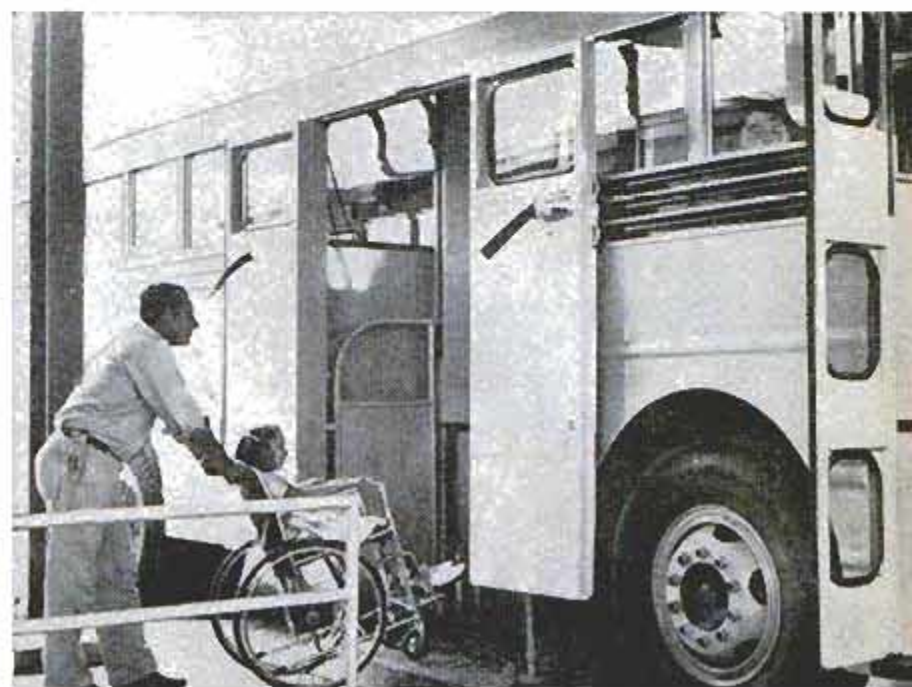



# WHAT'S NEW FOR Your Home



- 1 VACUUM-CLEANER TOOL CADDY** keeps attachments within easy reach because they move with the cleaner. The cleaner has large wheels which give the appliance mobility and easy ascent on stairs. Opening a door at front of cleaner automatically detaches disposable dust bag. Unit weighs only 17 pounds

Westinghouse Electric Corp., 240 Fourth St., Mansfield, Ohio

- 2 DISAPPEARING CLOTHESLINE** can be used in outdoor or indoor drying area without disrupting table-tennis or patio schedules. When not in use, unit can be closed so that only the aluminum casing is seen on the wall. Models of two sizes hold either four 25-foot or five 30-foot lengths of plastic line

McClintock Mfg. Co., 802 W. Whittier Blvd., Whittier, Calif.

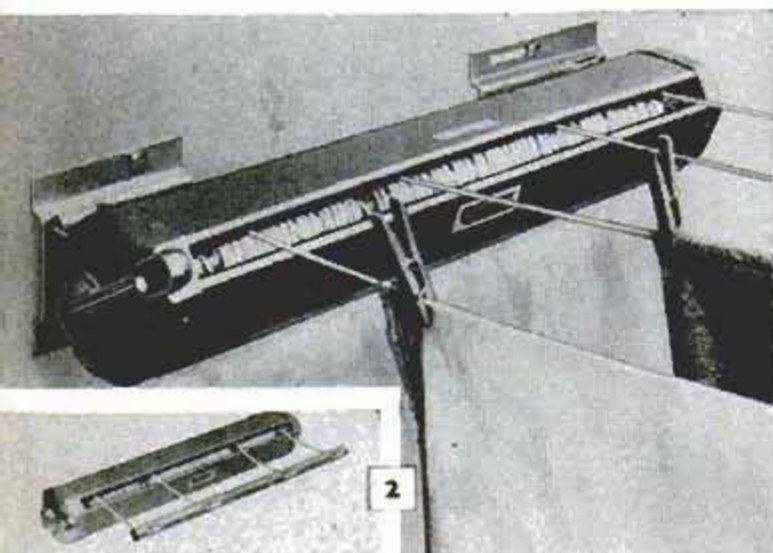

- 3 TEMPERATURE ALARM** saves burned fingers and scorched tongues by ringing a bell when the baby bottle, soup or sauce is as warm as you want it. The device operates like a bimetal thermostat which responds to heat faster on one side than the other. The stainless-steel base can be cleaned in hot water

Ding-Go, Div. Wells Mfg. Co., Comptche, Calif.

- 4 BURGLAR ALARM** that doubles as a fire alarm not only sounds off with a piercing shriek but throws a light beam. In the event of fire, the spotlight also serves as a safety light. The battery-powered master unit is about the size of a shoe box and it can be installed by anyone who can handle a screwdriver

Growler Alarm Corp., 30 W. 36th St., New York City 18

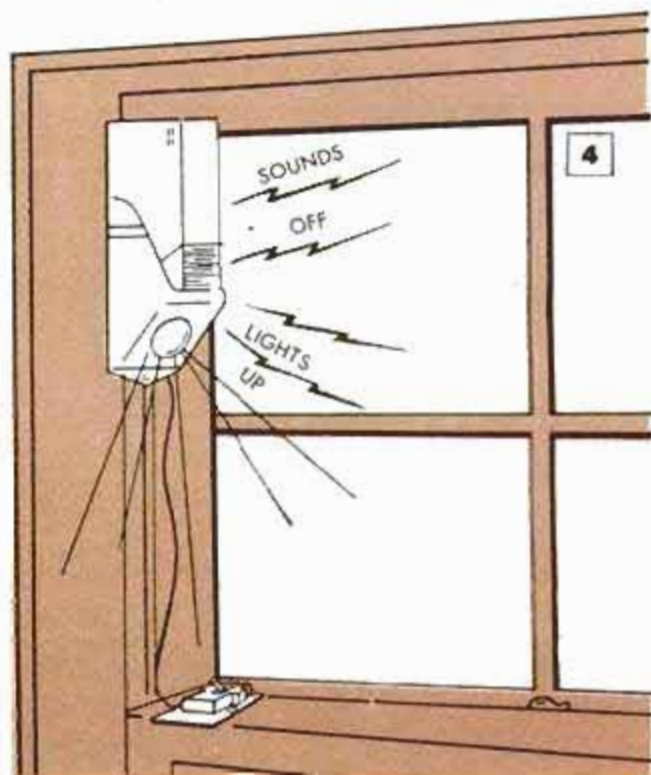





- 5 SHAVER-CORD REEL** holds five feet of cord but only amount you need is extended. When you're finished shaving, the entire length automatically retracts into the plastic caddy. Cord reel works with all electric shavers and in any standard socket. It can be left in outlet
- E. Joseph Cossmann & Co., 7015 Sunset Blvd., Hollywood 28, Calif.



- 6 CLOTHES SPRINKLER**, built into iron, eliminates the need to presprinkle clothes. Press a button on top of the iron handle and a fine spray of warm water is released onto stubborn wrinkles or pressed-in creases. The combination steam and dry iron has special deionizing unit for use with hard water
- General Electric Co., 1285 Boston Ave., Bridgeport, Conn.

- 7 SILVER-STORAGE DRAWER** is made from any cabinet drawer with the help of a kit consisting of a base pad 17½ by 20 inches, one long riser divider and a short one. When silver is stored in the converted drawer it is covered with a cloth which is treated to prevent tarnishing. The unit holds 140 pieces
- International Silver Co., 169 Colony St., Meriden, Conn.

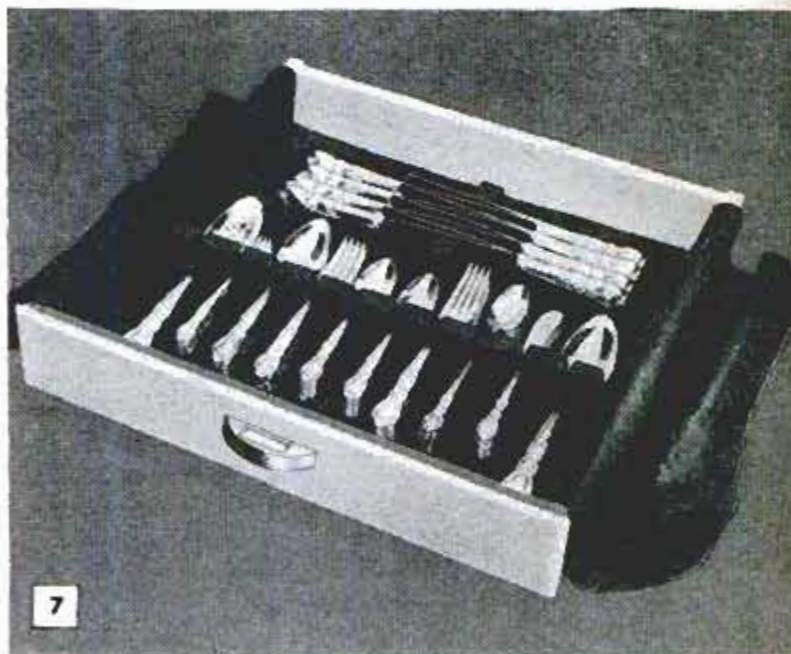

- 8 AUTOMATIC VEGETABLE PEELER** works on water pressure. With this device you can peel potatoes or scrape carrots or cucumbers without the problem of disposing of peelings. You simply slip the rubber hose on faucet and turn on water. A chrome-plated scraper fine-cuts peelings which are washed away
- Elton, Inc., 225 W. Erie St., Chicago 10

- 9 SWIVEL MAGNIFYING MIRROR** has a rubber suction-cup base which holds it securely to bathroom wall, a window pane, dressing table or any smooth surface. It can be carried in glove compartment of the car so members of the fair sex can check their make-up without changing position of rear-view mirror
- Knickerbocker Rubber Co., 6101 S. May St., Chicago 21





## THE NEW WEAPONS SYSTEM



M15

M14

M60

Rifles are alike, except M15 has heavier barrel, bipod. M60 can be hand-fired or on two types of mounts



Army's sleek and rugged M14 is lightweight, fires both full and semiautomatic

These weapons are familiar to veterans of three wars. The machine guns and BAR date back to World War I

## OLD WEAPONS BEING REPLACED



BAR

M3 SUBMACHINE GUN

CARBINE

M1

LIGHT  
MACHINE GUNS

HEAVY  
MACHINE GUN



**It's Good-By to the Garand and BAR.  
Despite Guided Missiles and Sputniks—**

# **THE ARMY ADOPTS A NEW RIFLE**

**By William D. Perkins**

**M**ILLIONS OF AMERICAN MEN carried it billions of miles all over the world, had to care for it like a baby, loved and hated it, slept with it, fought and saved their lives with it, won two wars with it. But soon it will be a relic of the past.

For the U. S. Army is retiring its famed "best friend" of the infantryman—the M1 Garand rifle. Also three other longtime favorites of ex-GIs from Normandy to Korea — the BAR (Browning automatic rifle), the M2 carbine and the M3 submachine gun.

Taking their place is a pair of sleek and versatile new rifles. In an age of Sputniks, hydrogen bombs and ICBMs, the Army still is intent on improving the foot-soldier's basic weapon.

By 1960 the infantryman will either carry the Army's newly adopted M14 rifle (a

lighter modification of the M1) or the same rifle with a heavier barrel and a bipod, the M15.

The editors of *Popular Mechanics* wanted to know the details of the new rifles, how they compare with the weapons they are replacing and, most important of all, how they "feel" to the nonmilitary man who would have to enter or re-enter the service in the event of another all-out war.

So the author, a combat infantryman of World War II, visited the Army's Aberdeen Proving Ground in Maryland, talked to a number of experts, fired both the old and the new weapons, and spent a footsore day walking through the maze of the Pentagon in Washington, D. C., gathering additional information.

The most significant advantage of the new weapons system is that one basic

M14 is one inch longer due to flash suppressor, weighs less even with 12 more rounds and magazine, is said to be more reliable, accurate







BAR

Author found M14 fired the same as M1 except for additional firepower, M15 was uncontrollable on automatic



BELGIAN FN

Controversial Belgian FN rifle, adopted by other NATO powers, lost out in U.S. competition with M14-15



M60

Army's 23-pound all-purpose machine gun, shown with bipod, rounded out streamlining of infantry weapons



New weapons fire NATO cartridge at right; M1, left

#### THE ARMY'S OLD AND NEW RIFLES

	M1	M14	BAR	M15
WEIGHT, WEAPON ALONE*	9.3	8.2	20	13.1
LOADED*	10.57	10.16	22	14.15
LENGTH*	43.6	44.4	47.81	44.14
NUMBER OF PARTS	88	102	150	114
FIELD-STRIPPING TIME, IN SECONDS	30	40	80	50
ASSEMBLY	60	40	140	100
MAXIMUM RATE OF FIRE, ROUNDS PER MINUTE	16 to 32	16 to 32 and 700	300 to 350 and 600	16 to 32 and 700

\* Weight and length in pounds and inches, and tenths of pounds and inches



combat firearm, with two types of barrels, is replacing four. This will greatly simplify the Army's all-important problems of mass manufacturing, large-scale training, costs, maintenance and supply.

The important change in the weapons system itself is that the M14-15 can be adjusted to both full and semiautomatic fire using 20-cartridge magazines. The M1 with its eight-round clip and the carbine with a 10-round magazine were converted to both forms of fire at the end of World War II; only the carbine was standardized.

The new rifle will fire 700 rounds per minute automatically. Like the M1, it is .30-caliber, gas-operated and will fire 16 to 32 rounds per minute semiautomatically, depending on the capabilities of the individual rifleman. The BAR with its 20-round magazine fires 300 to 350 rounds per minute on its slow rate-of-fire adjustment, and 600 rounds on fast fire. The M14-15 is not adjustable to a slower rate of fire, and is changed from semiautomatic to automatic fire by turning a lever located on the upper right-hand side of the receiver.

#### Ammunition Is Standardized

Standardization of ammunition is another advantage of the Army's modernized weapons system. The M14-15 uses a new 7.62-millimeter cartridge that is interchangeable with the weapons of our North Atlantic Treaty Organization (NATO) allied countries. The 7.62 is the European metric equivalent of .30 caliber. The NATO cartridge is one half inch shorter and has the same velocity as the round used in the M1 and BAR. But 160 rounds weigh a pound less. The cartridge also is fired in the Army's new machine gun, the 23-pound M60, which will replace the three types of machine guns in use since 1919.

Weight was another vital factor in the selection of the M14-15. The M14 unloaded weighs a pound less than the M1. Loaded, although with 12 more rounds and a magazine, it still weighs less than the M1. With the heavy barrel, bipod and hinged butt plate to hold it down on the shoulder, the M15 loaded weighs eight pounds less than the BAR.

A valuable improvement in the barrels of the M14-15 is a slotted flash suppressor

that almost does away with the light of ignited muzzle gases in nighttime firing. Although the M14 itself is shorter than the M1, due to a smaller receiver using the NATO cartridge, with the addition of a flash suppressor it is an inch longer. The M15 is almost four inches shorter than the BAR.

A surprising feature of some limited-production-run models of the M14 is the absence of a bayonet stud, indicating the possibility that the Army has at last decided hand-to-hand fighting is a thing of the past. At this time Army officials have not standardized other attachments, such as a grenade launcher, for the M14.

The M14-15 has more individual parts than the M1, but less than the BAR. However, the M14-15 action parts are fewer and simpler in design. Essential field-stripping is a little slower with the M14 compared to the M1, but field-stripped assembly is faster and both are faster with the M15 than with the BAR.

There is little metallurgical improvement in the M14-15 barrels, so they will not be longer-lasting. Their maximum range of 3500 yards and effective range of 500 yards are the same as the M1 and BAR.

Accuracy has been improved with the new weapons system compared to the old, according to Army officials, although the combat-simulation and field-test reports by the Continental Army Command are classified "secret" and details are not available.

The M14-15 is reported to be more reliable under extreme combat conditions than the other weapons. The new rifles passed all tests with flying colors. Both in



Grimace on face of "lefty" soldier firing M14 automatically indicates force of its 700-round-per-minute capacity. Note absence of bayonet stud





the laboratory and in the field their endurance was superior. They are said to be more rugged in taking a beating under all adverse conditions. But again, the details are classified. All the Army officials would say is that the M14-15 performed "as good or better" than the other weapons.

When the M14-15 has fired 10 or more rounds, it may be reloaded without changing magazines by inserting a "charger" in the receiver. Otherwise, additional characteristics of the rifles, such as sights, stock and bolt action, are similar to the M1.

At Aberdeen, I fired the combat weapons of the basic infantry unit — the M1 and BAR of the past and present, and the M14-15 of the future.

It was a familiar feeling once again to handle the M1, for the first time in 12 years. It fired with the same old jolt, acrid smell of burned powder and back-breaking, arm-bending methods of doing it "by the book."

Firing the M1 must be like riding a bicycle — once learned, it's not forgotten. With a zeroed-in M1 at 100 yards, I fired a small target pattern inside the bull's-eye and two hits just outside it. This included both slow fire and fast-as-possible firing.

The M14 on semiautomatic fire handled exactly the same as the M1. My target pattern was a little larger, but this included more and faster "snap" shots to see if the additional available firepower could be used effectively. Apparently it can. The M14 "hefted" a little better than the M1, indicating it has better balance.

With the BAR I had a fair pattern in and around the bull's-eye on both slow and fast fire. And, it's still the same old BAR with its tendency to malfunction.

The heavy-barrel M15 on automatic fire, however, was an entirely different matter.

To me, it was uncontrollable. It climbed fast at one o'clock. Trying to hold it down made it fire into the ground in front of the target. Only the first and second shots hit in and above the bull's-eye. I missed the target 10 out of 20 times. Short bursts weren't effective either, because the fastest snap of the trigger gets off four or five rounds.

You really have your hands full trying to hold on target a bucking, sight-blurring lightweight rifle throwing lead at a rate of over 11 rounds per second.

An expert rifleman did better, though. He is a member of the Aberdeen Ordnance engineering staff, and firing rifles is his job. His average target pattern was at nine o'clock with one in the bull's-eye, 18 scattered in the next two rings and one miss.

Other expert riflemen told me they thought the M14-15 is "totally ineffective as an automatic weapon." They pointed out the old theory that for every pound you decrease the weight of an automatic weapon and for every round you increase its firepower, you decrease its accuracy proportionately.

"What we really need," said another expert, "is an automatic rifle with the dependability and the ruggedness of the M14-15, but with the slow-fire feature of the BAR."

"What you can't see you can't hit," remarked another expert, "and one thing's sure—you can't see what you're shooting at with the M14-15 on automatic."

They said firing the rifle from the hip is almost impossible, and trying to fire it from the shoulder standing is downright dangerous. The rifle was so "hot" that, lacking familiarity, I did not fire it in these positions.

(Continued to page 266)





All patients have outside rooms in 66-bed circular unit. Nurses' area and utility rooms are in the center

## Circular Hospital Eliminates Dead-End Corridors

**NURSES WILL SAVE** one step in every three while attending patients in the new circular Valley Presbyterian Hospital in Van Nuys, Calif. The round floor plan is designed to eliminate dead-end corridors, provide each room with some sun each day and to save 37 percent of the steps that nurses have to make in conventional hospitals. Patients' rooms are on the outside perimeter of the building and the nurses' work area is in the center of each floor. Each room is to have a television set on the wall in front of the bed, with bedside push-button controls and a speaker available to each patient. Each patient can control his share of the window area, from bright sunlight to darkness.

Floor plan shows interior design of circular hospital

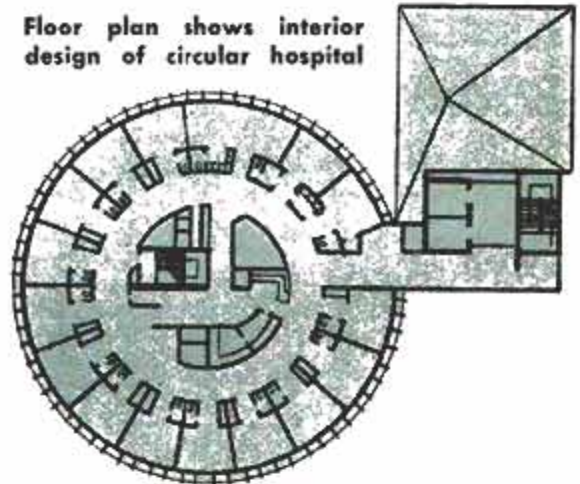

Rectangular structure at right will contain operating rooms, X-ray rooms, laboratory and pharmacy areas







### Adhesive Will Bond Plastic To Rubber and Metal

So strong is a new adhesive that for the first time polyethylene plastic can be successfully bonded to rubber, brass or brass-plated metals. The adhesive has a bond strength of about 1000 pounds per square inch, thus requiring 2000 pounds to pull apart a two-inch-diameter "sandwich" of polyethylene, rubber and brass.

### Tractor Takes Slick Surfaces With 24 by 24-Inch Tires

Designed for traction on mud, sand, snow or wet surfaces is a new 2800-pound tractor equipped with tires that are 24 inches wide and 24 inches in diameter. Air pressure is five pounds for front tires, seven for rear tires. Front wheels are unpowered, have individual suspension. Rear wheels are powered through a locking differential.



### Air-Tube Suit Makes Floating Easy as Falling Off a Log

Demonstrations of a new safety suit have proved that timberworkers can survive an accidental plunge into a stream or pond. The logger floats like a log because of air tubes inside his specially designed waterproof jacket and trousers. Two large air tubes keep the legs on the surface. The tubes are attached with slide fasteners.

### Students' Teaching Machine Repeats Questions Missed

High-school and college students can test themselves with a machine that repeats questions about lessons as often as needed to produce correct answers. When the student has a right answer, he advances a lever which reduces the number of times the particular question will recur. Questions are printed on a disk which revolves.





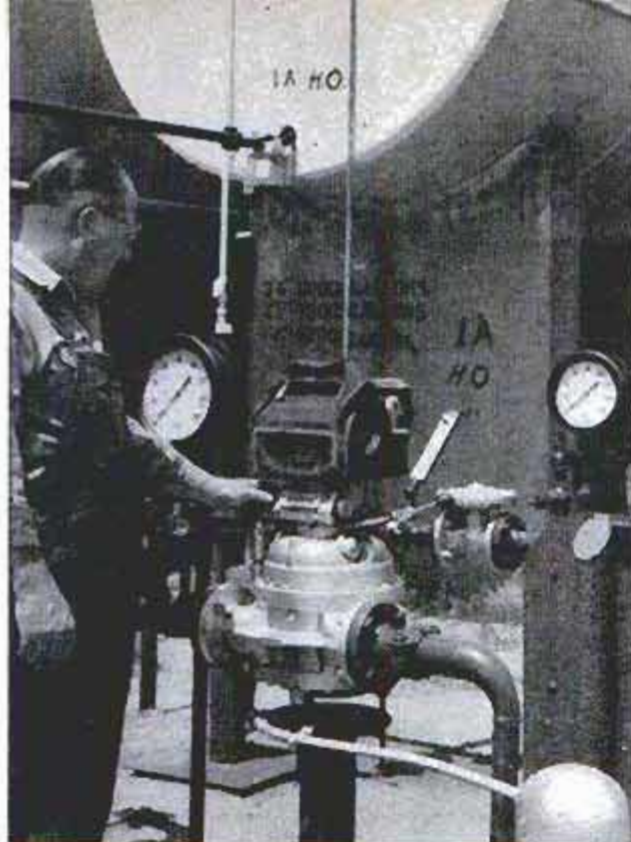

Plant agent at Colon, Mich., sets meter for number of gallons of fuel to be sent from Whiting, Ind.



Plant agent telephones dispatcher in Whiting. Line also connects to automatic equipment beside agent

## This Pipeline Delivers Fuel by Remote Control

RISING COSTS of gasoline and fuel oil are causing oil companies to seek less-expensive patterns of operation. The Standard Oil Company of Indiana has already effected substantial savings by using automation and unattended pipeline facilities. Further economies are now expected with remote-controlled delivery of fuels from pipelines to bulk plants which supply the retailer.

To gather experimental data, Standard's bulk plant at Colon, Mich., has been equipped with automatic devices which permit unattended delivery of fuel from pipeline to storage tank. This is accomplished by the pipeline dispatcher at Whiting, Ind., who telephones a series of code signals which activate automatic plant equipment in Colon.

The plant agent in Colon has little to do after gauging his tanks for the amount of fuel to be delivered. He telephones this information to the pipeline dispatcher, who determines how much fuel is available. When the order is approved, the plant agent aligns the proper tank valves, sets the delivery quantity on a meter, then inserts a ticket in a printer to

make a record of the amount of gasoline or fuel oil that has been delivered.

The dispatcher in Whiting can tell by the amount of fuel in the pipeline when the fuel oil has arrived at Colon. He then telephones a series of code signals that put a purge pump in operation and open a solenoid-piloted valve to begin delivery of the fuel. Another telephone signal starts a flashtester which automatically stops the flow of heating oil if even a trace of gasoline is detected.

Map below shows location of Colon, selected for automation test because it is near mid-point of Whiting-River Rouge pipeline

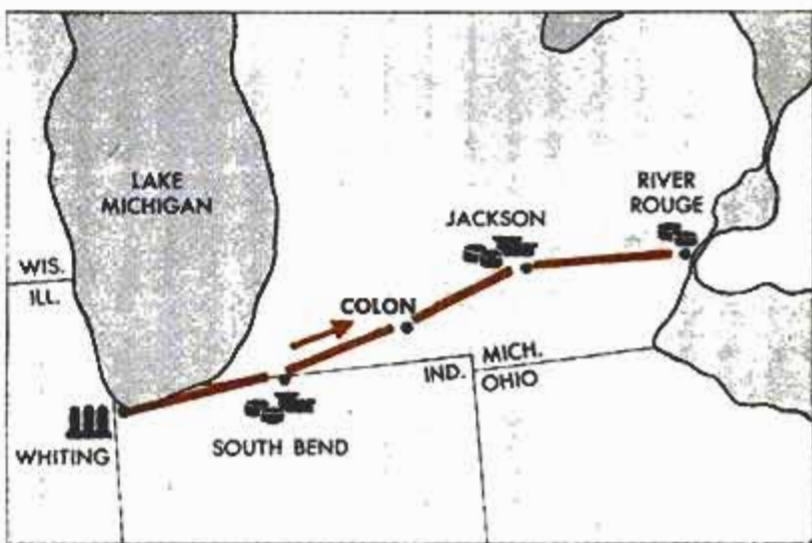



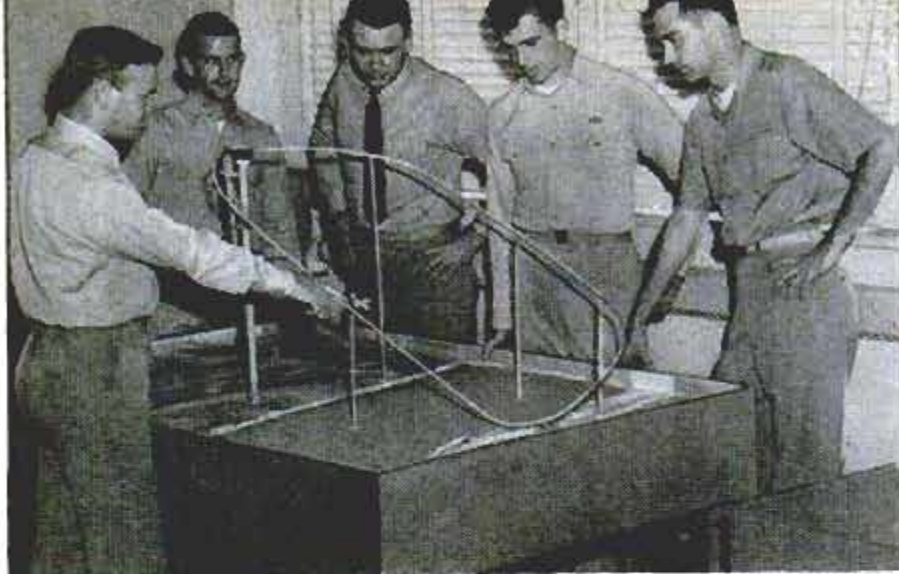

## Jet-Plane Model Makes Bomb Run

How to make a dive-bombing run with a jet aircraft is demonstrated with a miniature plane mounted on a tubing track at the Naval Air Station at Pensacola, Fla. Electrically operated, a set of gears make the plane increase speed on the bomb run, decrease speed on the pull-out, and turn and bank.



## Model U. S. Capitol Built With Pearls

Approximately 200,000 cultured pearls were used to construct a model of the U. S. Capitol. The scale model, valued at \$250,000, was made in Japan. It was shipped to the United States where it will be exhibited during a three-year tour.

☐ Deepest producing oil well in the world, bringing oil up from 21,465 feet below the surface, has been brought in at Plaquemines Parish, La.



## Tractor Hoppers Spot Borer Poison

Better control of corn borers is claimed for a granular applicator which drops dry DDT directly into the leaf whorls where the first brood of borers do most of their damage. Since the spreaders below the chemical hoppers spot the DDT where it's needed most, the applicator reportedly is more economical than spraying devices, which apply the insecticide over wide areas where it's not needed. The tractor mounting frame permits adjustment of the applicator to the height of the corn, with a maximum of approximately six feet of ground clearance. The agitator is chain-driven.





Tiny white square on state map represents area in relief map

# The Battle of Donner Pass

By Thomas E. Stimson, Jr.

PHOTOS: CALIFORNIA DIVISION OF HIGHWAYS; HAL ROTH

**L**ADY, THE ROAD IS CLOSED because there's a bad blizzard about two miles ahead. What? Yes, I know it's a nice morning and there isn't a cloud in the sky. But up at Horseshoe there's a 70-mile wind. It's blowing 100 miles per hour in the gusts. Snow is driving across the road so thick

you just can't see where you are going."

All during the preceding night when the snow was coming down better than a foot per hour the highway crews had battled to keep the road open. The three most critical miles across Donner Summit were cleaned off every 10 minutes. Armond

Rotary plow opening road after it had been buried by a heavy storm. Overhanging snow must be removed







Looking along U. S. 40 as it winds through snow-covered Sierra Nevada Mountains toward Donner Summit

Motorists are required to use tire chains on slick pavement. Wind gusts sometimes start cars skidding



Close, foreman at Donner, had kept three pieces of equipment on this stretch of road all night long. First was a grader with a blade that pushed the fresh snow toward the side of the road. A mile behind was a plow, and another mile to the rear was a big rotary that scooped up the collected snow and hurled it far from the roadside.

Close used eight additional plows and rotaries on the other 14 miles of his section. East beyond Donner Lake, west toward Yuba Gap, other crews had kept their sections open. Traffic was light and not a car spun out, not one big highway truck and trailer jackknifed into a snowbank to tie up the road.

The storm ended at daybreak and then



the howling gale swooped down, whipping up the fresh snow and driving it across the road in blinding clouds. Traffic was halted for an hour; later, vehicles equipped with chains were allowed to creep across the summit. The wind was still strong and the chains were a precaution against gusts that otherwise might skate a car sideways across the pavement.

Donner Summit, 7135 feet above sea level, is the highest point attained by U. S. 40 on its way across the Sierra Nevada mountains in California. This transcontinental highway is the main route to San Francisco from the east, the road that the California Division of Highways strives to keep open all winter long. Commercial travelers, military traffic, the big over-the-road merchandise trucks, all depend on U. S. 40.

Half-a-dozen roads cross the mountains, to be sure, but most of them are higher or longer or too narrow and steep for some of the traffic. No attempt is made to keep all of them plowed open. Any time the snow crews lose their battle on Highway 40 there's often only one practical detour to the coast, via southern California 300 miles to the south.

Twenty feet of snow falls on Donner Summit during a mild winter, and the average is closer to 40 feet. The record is the 65 feet that fell six years ago. That was the heartbreak winter in which the snow fighters lost the road and didn't get it open again for 28 long days. Equipment broke down, men wore themselves out, and tremendous slides of earth and rock fell across portions of the road that are cut into the cliffs on the east side of the pass.

One storm followed after another so rapidly that winter that the crews never had



Driver of a rotary snowplow patiently guides his machine at two miles per hour through roadside drifts

a chance to clean up after one snowfall and prepare for the next. Ordinary working shifts of eight hours were stretched out to 12 hours plus. Trees fell across the road and were buried in the snow and had to be cut out with saws and axes. One rotary plow "went blind" when its windshield wipers broke and snow banked up against the glass. The driver managed to keep going by following the directions that were radioed to him by another snow fighter in a pickup truck right behind him.

Another rotary went out of action for a

**When a truck jackknifes across the highway, everything stops. The flagman patiently tries to keep order**







Rotary plows working in parallel paths to open highway after a storm produce strange wafers of packed snow

time when a boulder crashed down on its hood, smashing the windshield and doing other damage. A third developed a faulty fuel pump at the peak of one storm. In the midst of all this, a streamlined passenger train became snowbound near Yuba Gap. A rescue train with a snowplow in front was buried under a snowslide en route to the streamliner and couldn't be moved. Not until the highway crews cut a path through 10-foot drifts were the 200 passengers on the train rescued.

By the time that winter was over, highway plows and rotaries from as far as 500

miles away had been diverted to the High Sierra section and put to work.

Fighting the winter snows is actually an all-year task. During the summer months all the snow-removal equipment is sent down to the Sacramento shops for complete overhaul and repairs, and meanwhile the crews repair winter damage to the road itself. Usually there are miles of pavement to be resurfaced. Frost bumps that are caused by water getting under the pavement and then freezing are cut out and repaved, culverts and gutters are cleaned of gravel and debris. Food, gasoline and

With short-wave radio, road information can be relayed, equipment ordered, drivers, mechanics shifted

When rotary auger picks up a stone or board, shear pin snaps and crewman has to get out and replace it





other supplies are trucked to the maintenance stations. Radio equipment on each truck and plow is checked over.

Beginning in October the thousands of orange-colored snowstakes are planted along the edges of the highway. These 12 and 14-foot-tall markers will guide the drivers of the snow-removal equipment and keep them from driving off a cliff at times when visibility is down to a matter of just a few feet.

By November, the Donner snow camp, closed in the summer, is occupied. The 40-man crew eats and sleeps on the second floor, the first floor is a heated garage in which the snow vehicles are stored and where emergency repairs can be made.

Highway 40 uses the same route over the Sierra that Fremont's party pioneered in 1844 and that later became the main trail for the gold seekers of '49. Donner Summit and Donner Lake to its east are named for the ill-fated Donner party that was trapped by an eight-foot snowfall in the early days while trying to cross the mountains.

During the gold-rush days a wagon road was completed over the summit and more recently the road was widened and paved to accommodate the growing number of automobiles. Not until 30 years ago was any attempt made to keep the road open all through the winter.

Today the highway is a good mountain road but it's far from adequate for the enormous amount of traffic that uses it. Up

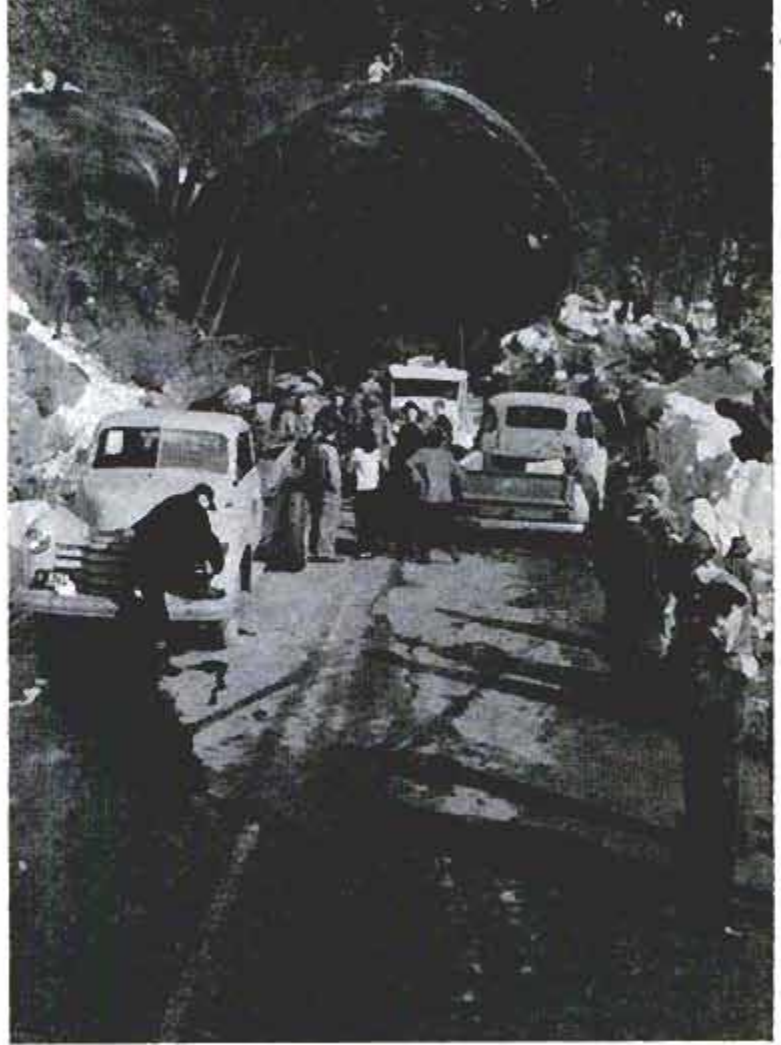

Boulder loosened by thawing snow blocks U. S. 50, a highway used as alternate route when blizzards rage in Donner Pass

at Donner, Armond Close has seen seven miles of cars lined up on a Saturday morning, trying to get into the parking areas around the ski resorts. That's an exception, of course, and yet traffic causes more tie-ups on the road than anything else.

Chains are mandatory for all traffic

(Continued to page 248)

Tow rigs designed especially for mountain highways are needed when big semitrailers get stuck in the snow

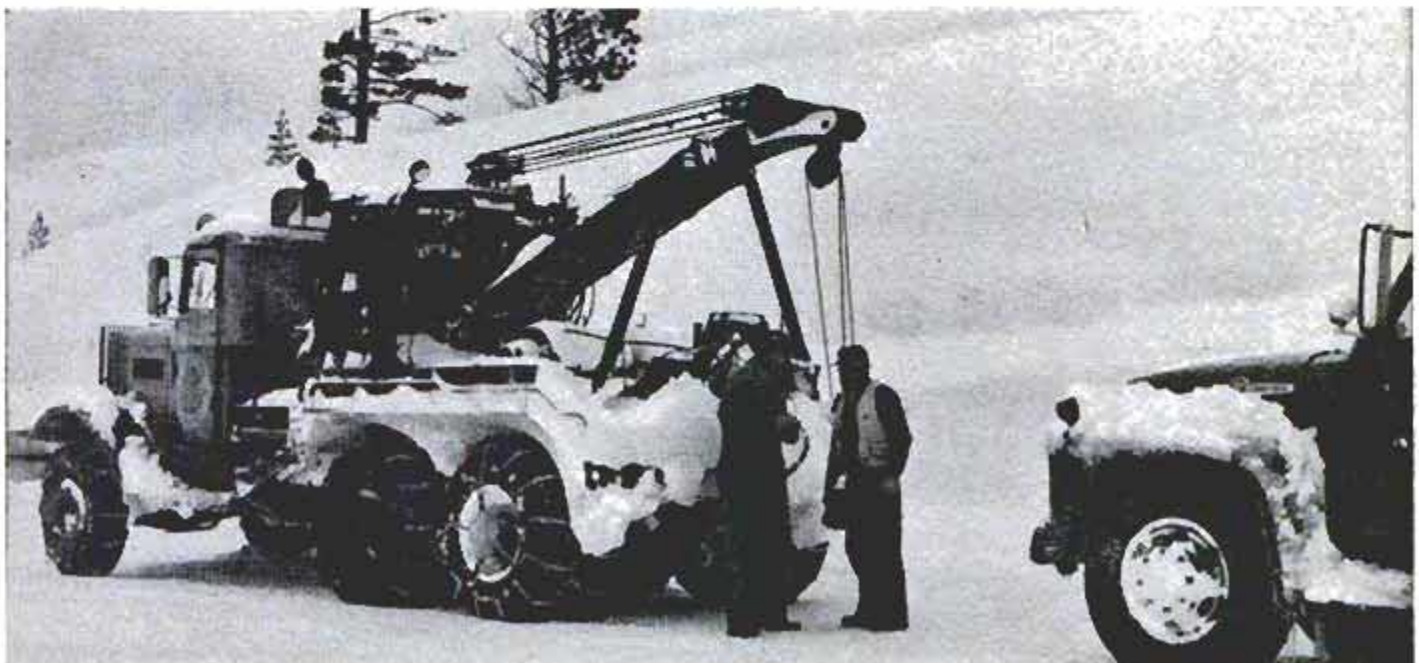





## Plywood Dome Will Serve as Church in Korea



All the building materials for the igloo-shaped sanctuary in the photograph above could be carried in a large pickup truck. The 39-foot hemisphere, built from 134 sheets of  $\frac{1}{4}$ -inch exterior-grade plywood, will be used as a church at Naju, South Korea. Using the geodesic-dome design of architect Buckminster Fuller, the building gets its strength from the geometric pattern of the 4 by  $6\frac{1}{2}$ -foot sheets of plywood on 2 by 2-inch ribbing. It was erected in 16 hours, left, with much of the work done by small boys. The building weighs 3500 pounds.

## Haymaking Is One-Man Operation With Automatic Equipment

Into the high-sided wagon, below, goes a bale of hay, tossed out of a twine-tie baler by a newly developed ejector attachment. The attachment eliminates the need for bale pickup men or men on the wag-

on. When the load is delivered to the barn, it can be dumped into an automatic elevator and conveyor system that will distribute the bales in the loft. The half-size bales do not have to be stacked.





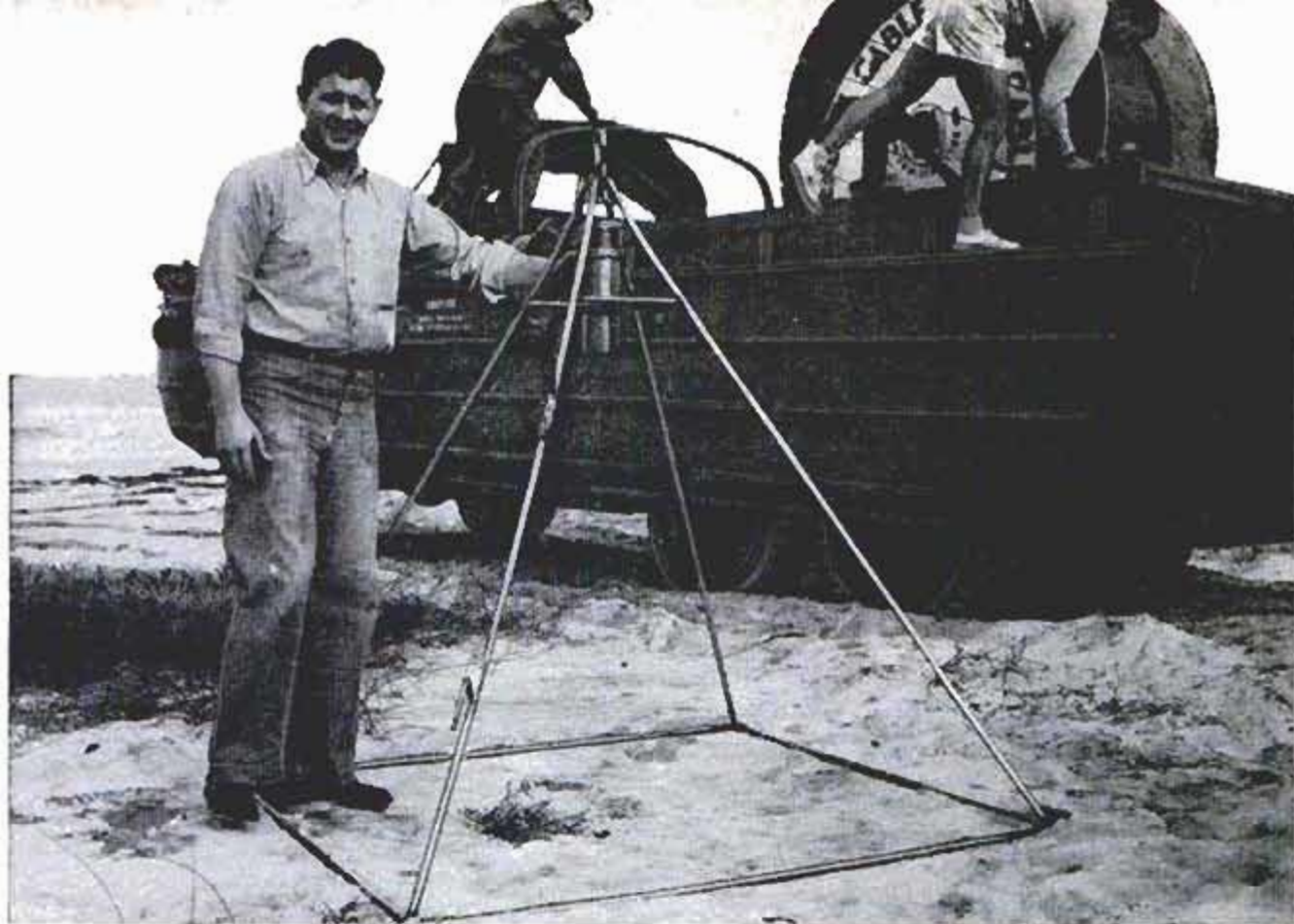

## How the Navy Measures an Ocean Wave

INSTALLED BENEATH the Pacific Ocean, west of Monterey Peninsula, is an instrument that keeps a written report for the U. S. Navy on the size of ocean waves. The device, called a Shore Wave Recorder, consists of a brass cylinder about a foot long and four inches in diameter. As waves on the surface, some 40 feet above, rise and fall, they cause the water pressure to increase and drop. These variations in pressure activate a rubber bellows in the low-

er chamber of the instrument. The motion of the bellows activates a potentiometer in the middle chamber and produces a varying electrical current. The electrical impulses are transmitted through a cable to a recording instrument on shore which makes a continuous ink trace. The "slow leak" device between the chambers of the pressure head, shown in the diagram, compensates for slow changes in water level which might complicate the record.

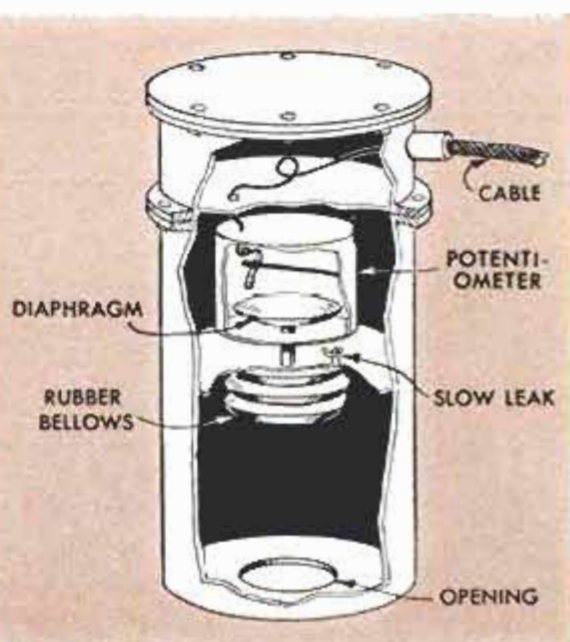
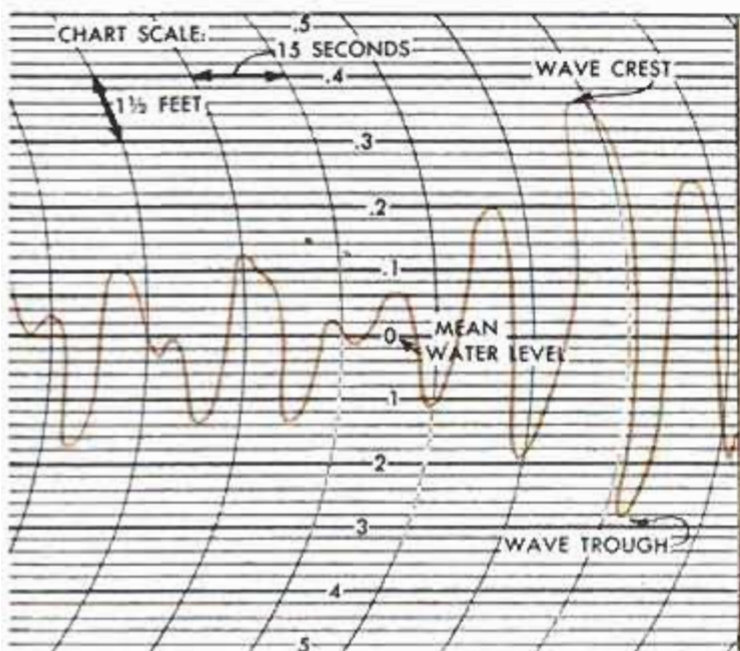



# White Alice Starts Talking

By Thomas E. Stimson, Jr.

**L**OOKING LIKE MONSTROUS kinds of vegetation from another planet, some strange manmade objects are sprouting from the tundra in the frozen North.

Some of the weird shapes resemble giant loudspeakers standing on tall steel legs. Some look like huge outdoor movie screens. Still others are toothpicklike towers with grotesque metal "foliage" on their tops.

In addition there are big domes that sometimes are mounted on stilts and that sometimes emerge from the tops of "trains," the long, low, scientifically designed structures inside of which men can live comfortably during sub-zero Arctic winters.

Some of the objects go by the name of White Alice, others are known as DEW Line.

DEW (Distant Early Warning) Line is the chain of radar stations that the United States and Canada have built across the

top of the continent, from Point Barrow to Baffin Island. DEW Line would give the first warning of any hostile bombers en route across the top of the world to North America. The big domes that characterize the main DEW Line stations are radomes, protective canopies inside of which the long-range search equipment is operated.

White Alice is the code name for a new and revolutionary radio system just being completed in Alaska. It hurdles mountain ranges, goes around the curvature of the earth and links remote Alaskan outposts together for the first time. At Anchorage, it ties in with the existing long-distance telephone facilities to the United States.

White Alice isn't affected by auroras or other atmospheric phenomena that can tie up ordinary radio communication in the North for hours or days at a time. Its circuits carry up to 132 voice channels and it spans

New Alaskan radio system uses "tropo-scatters," foreground, that deflect and receive beams off troposphere

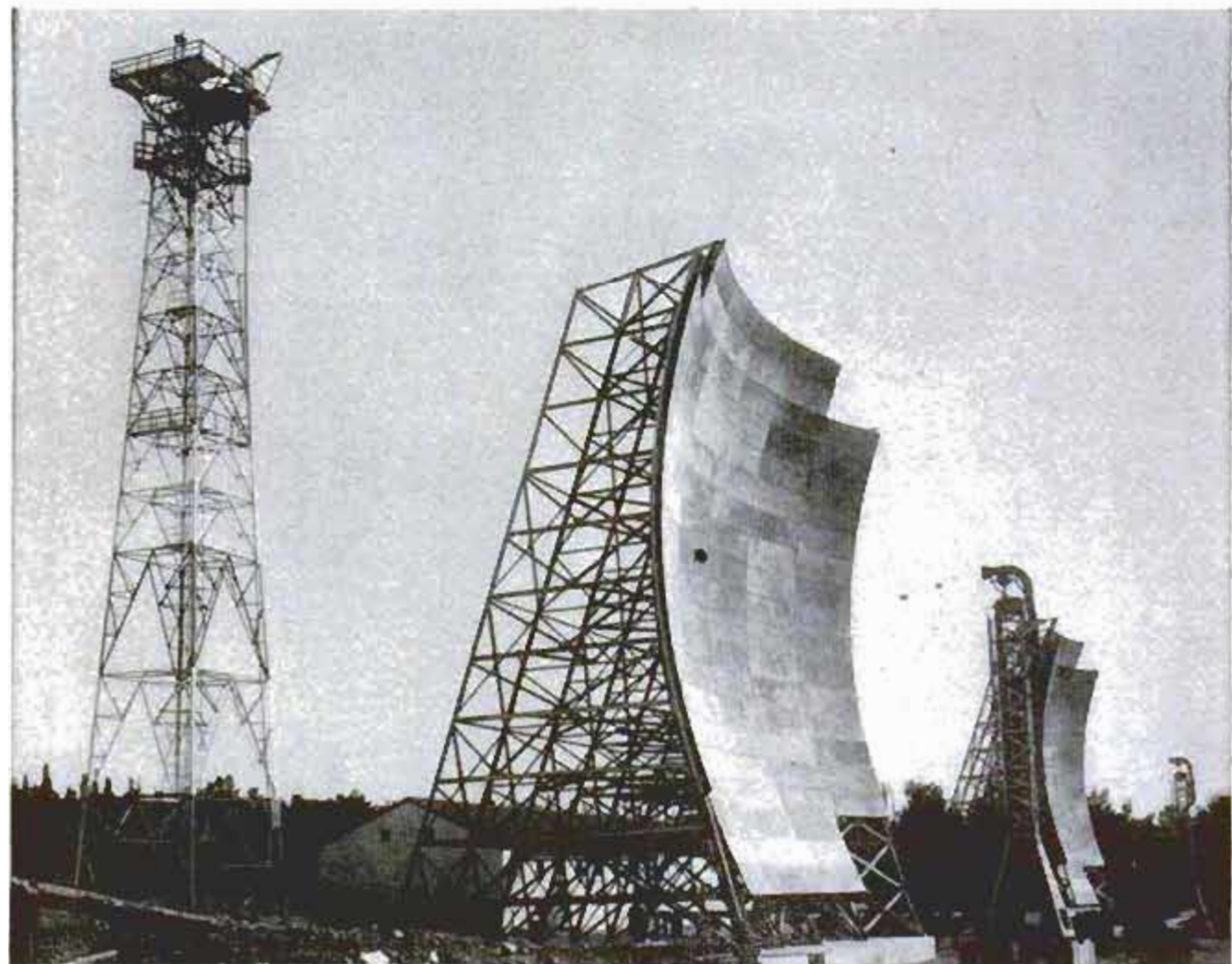





F-89 pilot "scrambles," as White Alice provides communication between Air Force bases and early warning stations

distances of several hundred miles at a jump, as compared to the approximately 40-mile range of standard microwave radio.

The engineers call it "tropo-scatter" or, more technically, "forward-propagation tropospheric scatter." It uses what was once thought to be a freak condition: The occasional bouncing of a TV program into a shadow area, the occasional long-distance hop of a line-of-sight UHF transmission.

Some such radio reflections come from dust and moisture particles in the atmosphere, even from variations in air density several miles up. Scientists of the Bell Telephone Laboratories and Western Electric Company found they could put this phenomenon to work and tried it first on an experimental basis between Florida and Cuba, and later for the military.

White Alice is the first large telephone network to use tropo-scatter. Its 33 stations in Alaska cover 3100 route miles and are being completed at a cost of \$100,000,000. It is for use by the public as well as by the Air Force and other government agencies.

Communication engineers expect a big future for the tropo-scatter system. They say it can bring reliable long-distance phone service to remote areas that are now impractical to reach. By hopping from island to island they think high-fidelity tropo-scatter can circle the whole earth. New improvements



Spotted are most of the 33 Alice stations, covering 3100 miles. Certain details are omitted for security reasons





This is a White Alice station main radar-search antenna, without its usual protective dome of plastic

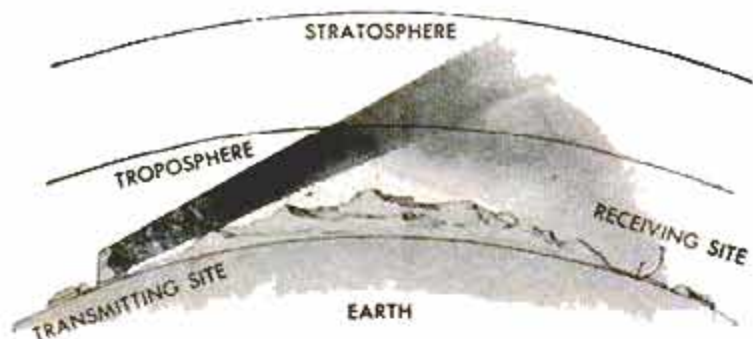

One ten-trillionth "bounced" signal may be received hundreds of miles away, and yet it is sufficient

White Alice stations would continue operating if generators failed, using 12-volt storage batteries



now being worked on will allow 600 voice channels, plus one color-TV circuit and one black-and-white TV circuit to be carried on one beam. Engineers expect that with these improvements, continent-to-continent television broadcasts will be possible on an everyday basis. Tropo-scatter is frequency-modulated, single side-band, ultra-high-frequency.

The objects on the Alaskan landscape that resemble huge loudspeakers are the medium-range antennas of the White Alice system. The curved steel 60-foot "drive-in movie screens" likewise are antennas, used for the longest jumps.

A feed-horn mounted on a tower sprays its energy against the parabolic surface of the screen, and the screen focuses the power into a narrow beam that shoots far across the horizon. In effect the curved antenna is a big radio "searchlight."

Far beyond the horizon, tiny amounts of the energy are deflected or scattered downward by the dust and inequalities of the troposphere. A screen-type receiving antenna picks up some of the deflected energy, concentrates it and conducts it to powerful amplifiers. The incoming energy may only be one ten-trillionth of the transmitted signal, but this minute amount is enough to be amplified and retransmitted without distortion.

A big-screen antenna not only must be built with great accuracy, it must be designed to withstand tremendous wind forces. The White Alice screens are able to take 120-knot winds without deflection. Each screen weighs 100 tons and is anchored to a reinforced-concrete foundation weighing 300 tons and extending 20 feet below the surface of the ground. In areas where ice and snow are severe, the antennas have their own de-icers; the rear structure that supports the screen is enclosed and warm air circulates inside.

For its shortest line-of-sight jumps and in populated areas, White Alice uses microwave relays instead of tropo-scatter.

White Alice was built on a "crash" basis, in approximately two years, because of the need for reliable communication by the aircraft control and warning stations that guard Alaska's west coast. DEW Line, farther north, is not served by White Alice. Instead, it uses a somewhat different scatter system that bounces its waves off the ionosphere rather than the troposphere.

The advantage of ionospheric scatter is that distances of up to 1200 miles can be spanned without relays. But it has limited channel capacity and is troubled by meteors. The ionized trails of meteors are very good reflectors of radio waves, hence signal strength goes up and down depending on the number of meteors that are



plunging through the upper atmosphere. Neither tropo-scatter nor ionospheric-scatter communication can be jammed by other transmitters.

DEW Line is 3000 miles long and is built entirely within the Arctic Circle, with some stations within 1200 miles of the North Pole. It consists of more than 50 radar sites, some of which are main stations using long-range rotating antennas, with auxiliary "gap filler" stations between to complete the coverage.

Its radar equipment can detect and track low-flying aircraft, as well as planes at high altitudes. It is fitted with the best available "antijamming" circuitry to help it locate aircraft even when its signals are deliberately being jammed. DEW Line uses automatic alarms that alert its operators whenever a bomber-sized aircraft is detected.

The construction of this electronic fence in a period of 32 months is one of the great engineering feats of the century. The total cost was \$600,000,000. Much of the work was done in secret, all of it in a calculated hurry. Western Electric and the Bell System were the prime contractors.

Not only was it necessary to transport and install the huge yet delicate radar systems themselves, all sorts of auxiliary structures were required. Living quarters, supply warehouses, fuel tanks, towers, airfields, hangars, even roads had to be built at the sites.

The Arctic summer lasts no more than a couple of months, and only for a few weeks are the Arctic shores relatively free of ice. Fleets of supply ships from Halifax and Seattle dashed north during the ice-free periods to deliver 200,000 tons of cargo on beaches across the top of the continent, areas for which no navigation charts exist.

During the other months of the year additional equipment, food, petroleum and other necessities were flown north by airplane or were carried by overland sleds drawn by tractors. Cargo aircraft alone made 58,000 flights and delivered 140,400 tons of equipment. At the peak of construction more than 7500 men were busy in the North.

(Continued to page 260)

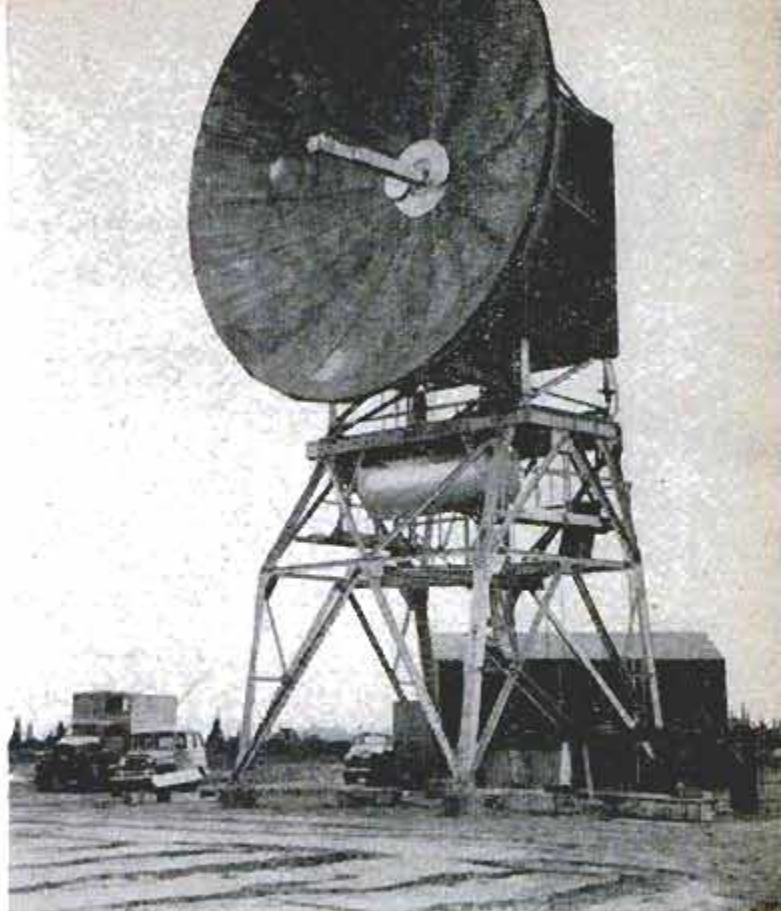

Another type of equipment used is a dish-like radio antenna that concentrates transmission beams. White Alice was built on a "crash" basis in two years

Typical DEW Line station, with plastic dome protecting search and radio equipment. Crews live in "train" of buildings with most of the comforts of home

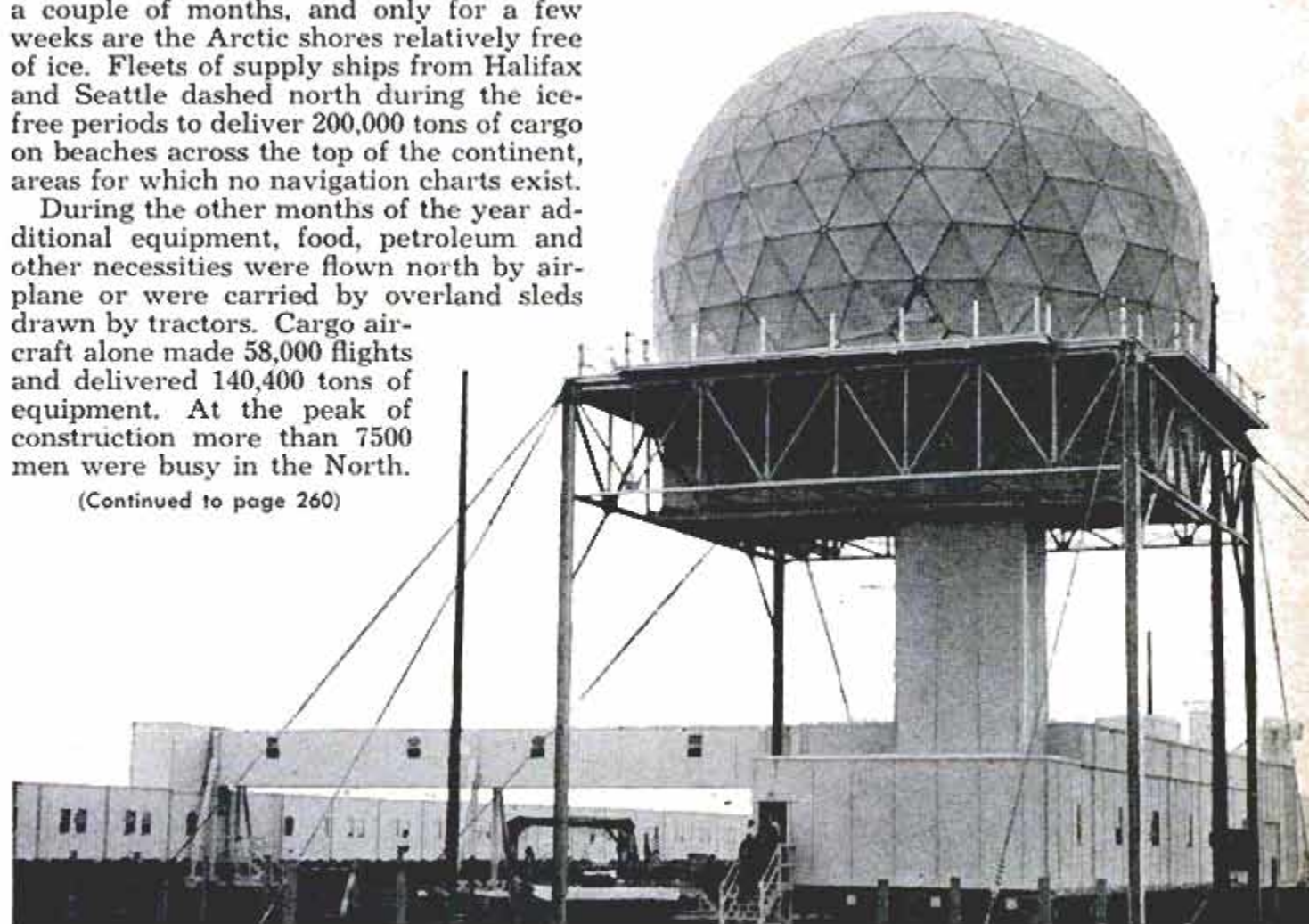



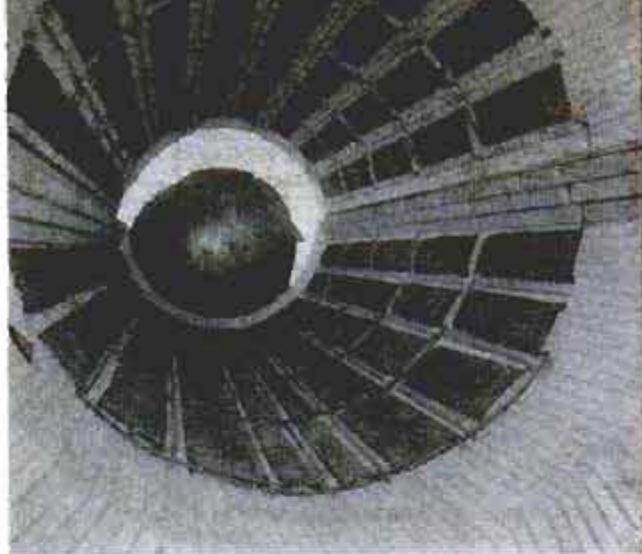
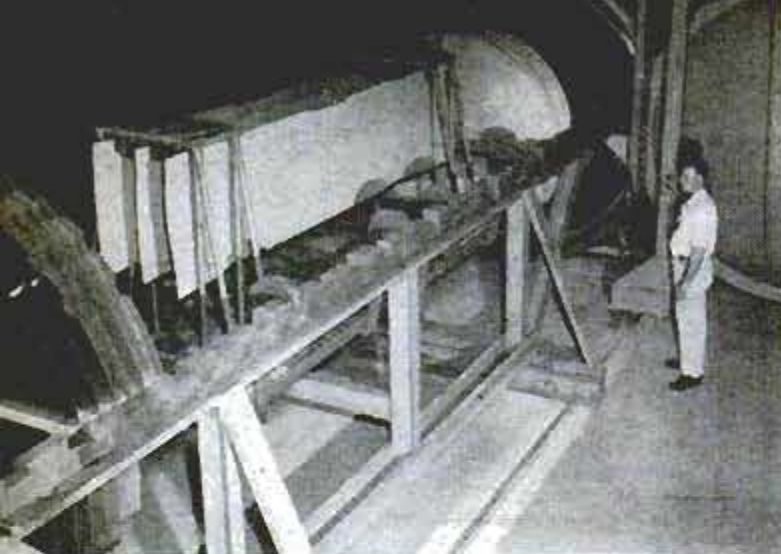

Titanium parts for supersonic guided missiles are rolled on rails, left, into giant electric furnace at right

## Giant Heat-Treating Furnace Bakes Guided-Missile Parts

Temperatures up to 2100 degrees F. are produced in a vacuum furnace built to process titanium parts for guided missiles. The 1400-cubic-foot furnace uses enough electric power to light a town of 1500 popula-

tion. The high temperature and vacuum remove hydrogen impurities which would cause titanium to become brittle and crack under stress. Previously, titanium sheets had to be cut down to fit smaller furnaces.



## Ramjets on Copter Blades Fight Frost in California

Simple ramjet motors mounted on the tips of helicopter rotor blades are being tested in California as "frost control" machines. When the helicopter hovers 35 to 40 feet over an orchard, lower left, heat produced by the motors has proved sufficient to raise the orchard temperature as much as four degrees. The experiments so far have been limited to 15 minutes apiece because the ramjet motors consume two gallons of gasoline per minute and the aircraft's tank holds only 30 gallons. The helicopters also are being tested for spraying or dusting crops. The photograph below shows the spectacular effect of the ramjets belching yellow flame when they are started. During normal operation, only a circle of blue light is produced by the whirling pods. The ramjet helicopter is started by engaging a small gasoline engine to the rotor drive shaft.





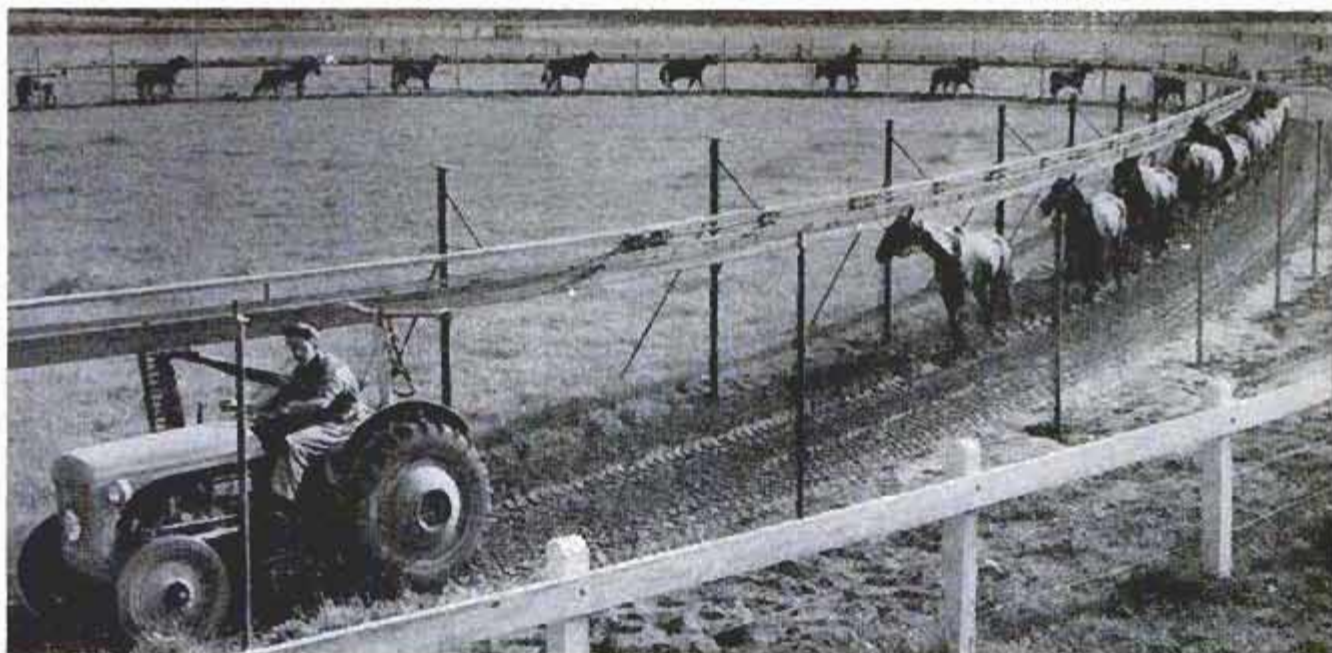

## One Man Trains 32 Horses With Exerciser

Training and exercising 70 horses every day without help was the problem solved by a riding master in the Netherlands. Facing a shortage of trainers, he built a hitch conveyor to help do the job. The

hitches are on wheels and move on double rails. The horses are tied to the hitches which are connected by rods and pulled by tractor. Up to 32 horses at a time can be exercised by one man.

## Steam Engine Built From Auto Parts

Joseph Mohr of Marathon, Wis., built a 2½-horsepower steam-engine locomobile from salvaged auto parts. With a boiler jacket made of oil drums, he can get up 120 pounds of steam in 20 minutes and travel 10 miles per hour. The fuel is wood, and extra water is carried on the rear platform. The driving cylinder on top of the boiler is connected to an automotive transmission by a chain drive and pinion gear. This permits the usual forward speeds and reverse to maneuver the vehicle.

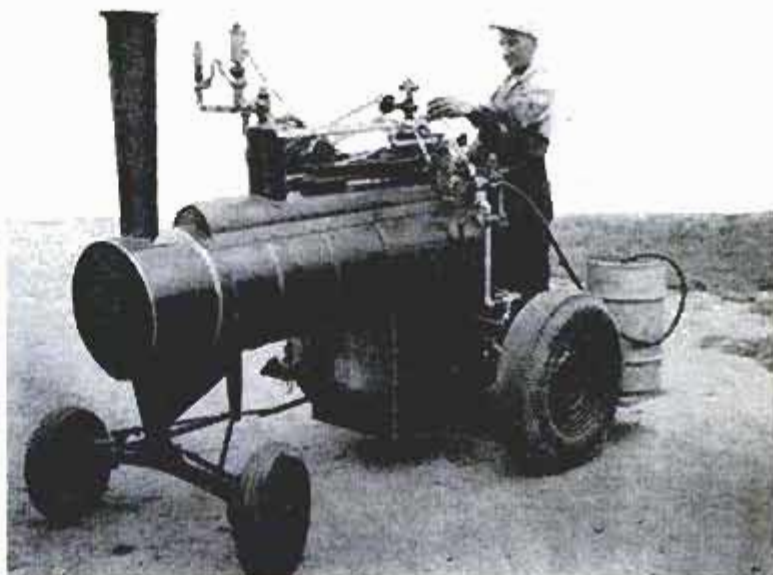

## Snooper TV Camera Probes Pipelines

German engineers have developed a small television camera to examine the inside of oil pipelines. Guiding wheels suspend the camera inside the pipe. Light from four bulbs enables the camera to "see" in a complete circle through a revolving mirror mounted at an angle in front of the lens. On the receiving end, special TV screens have been developed with sufficient clarity to see any defects on the inside walls.





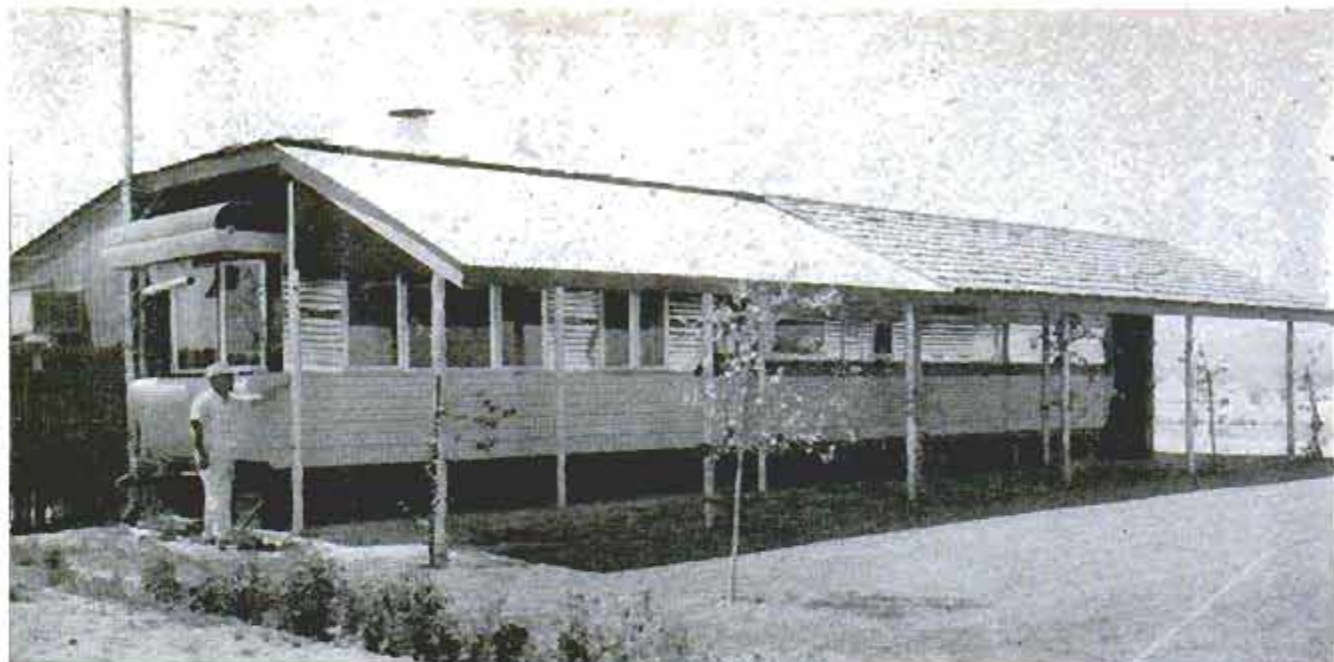

The Mullens of Phoenix, Ariz., built their house around their big trailer with removable connecting doors

## CABANA HOME . . . *and one for the road*

**Y**EAR-ROUND MOBILITY was the goal of the C. Thad Mullens of Phoenix, Ariz., when they planned their semimobile home which provides both mobility and a place where they can hang their hats between trips.

To achieve this dual purpose, the Mullens bought a trailer and a three-quarter-acre site about 15 miles out of Phoenix. Then Mullen built a cabana

around the trailer for a permanent home. By simply removing 16 screws from the inside doors and removing the wall on one side, Mullen can haul his trailer out and be on his way.

Unlike most trailerites, Mullen demanded a cabana with such adjoining luxuries as a large back yard and a floodlighted pool. The cabana has connecting doors to the trailer which give the feeling of a

Immovable side of house boasts this hooded fireplace. Steps back of fireplace lead to trailer part of home

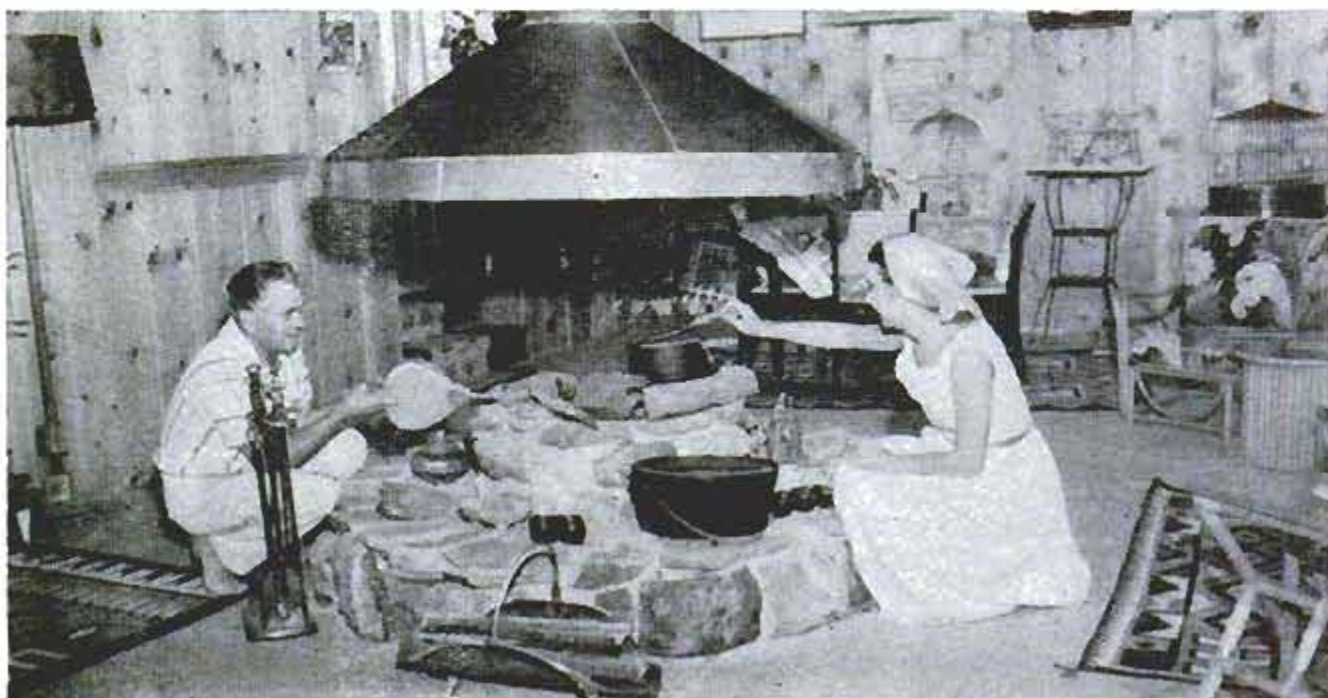



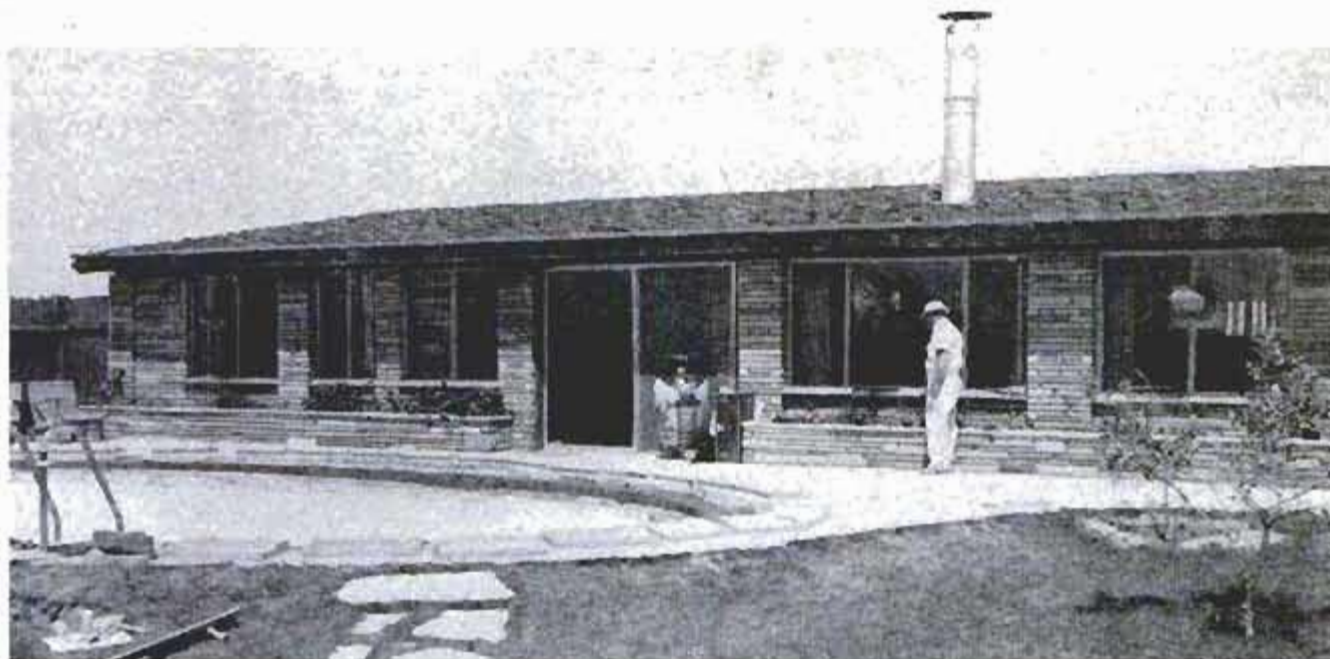

Front of the home looks almost conventional with stone siding and cedar-shake roof. Patio extends to pool

single unit. The 50-foot-long, 18-foot-wide home has sides of red-wood while the front wall is sandstone. Twelve steel columns support the slanting roof.

The trailer is separated from the cabana proper by about four inches. Connecting frames were inserted in this gap along with glass-fiber insulation.

The 36 by 18-foot living room has knotty-pine walls and built-in storage cabinets with sliding doors. The den, or office, is 14 by 14 feet and is also finished in knotty pine.

The Mullens take great pride in their hooded fireplace located in the center of the living room. Made of native Arizona rock, the fireplace has a five-foot base and a firebox that is 2½ feet in diameter. It is 36 inches from the base to the copper hood. The smokestack is 18 inches in diameter. Mullen has placed concrete in the base of the galvanized-iron baffle, which he claims keeps the baffle cooler.

He estimates the cost of the cabana at about \$10,000. To keep the place comfortably cool, he uses a two-ton refrigeration unit in each of the two sections. With fewer refinements, Mullen thinks the home could be built for much less. The Mullens say their six-room home gives them the feeling of solid roots—yet retains the mobility of a trailer. ★ ★ ★

Above at right, Mullen points to the removable wall where tow car can be backed up. Right, steps lead up into trailer rooms

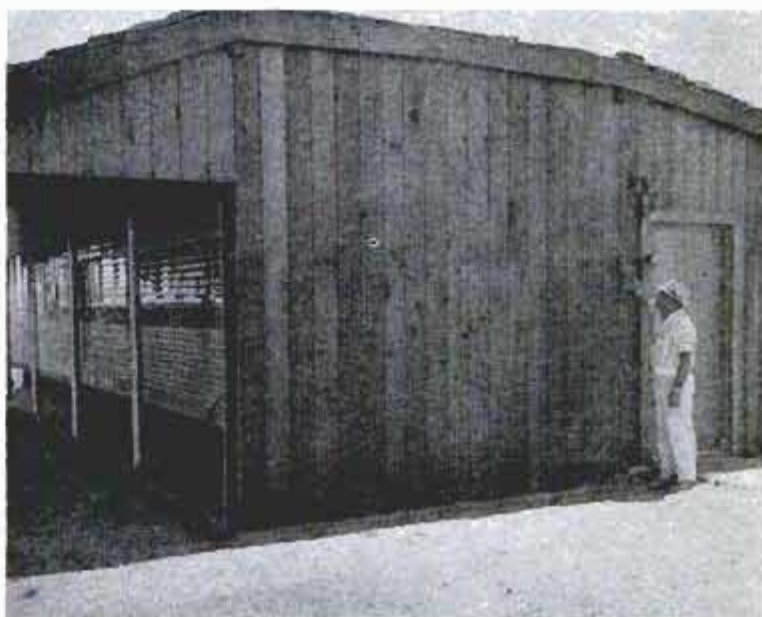





### Sling Totes Any Rifle

Hands and arms are free with a new sling that fits any make or model shoulder weapon. Not a permanent attachment to the gun, an adjustable strap holds it at the butt and at the muzzle with a protective cover. It can be quickly attached and removed from the gun.

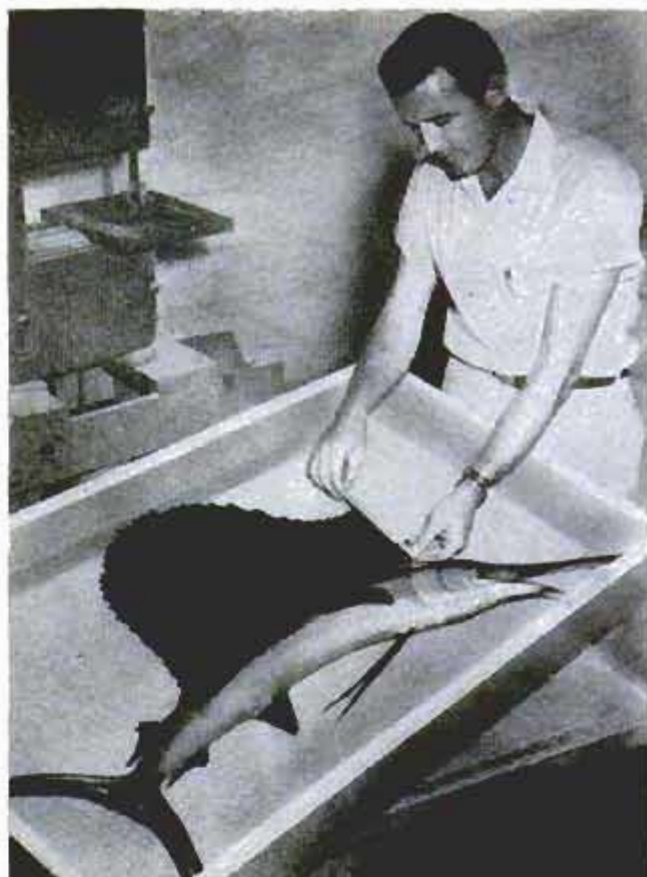

### Plastic Sailfish Rivals Nature

Manufacturing lifelike small sailfish is a hobby-turned-business of Jim Williams of Miami, Fla. The four-foot reproductions are molded in a special plastic material to the exact specifications of a real fish, and each of the replicas is hand-painted in realistic colors.



### Pocket-Size Slide Rule Has Plastic-Coated Scales

Engineers and others using slide rules can carry a new six-inch model in their pocket. It has the graduations and five-place readability of a 66-inch instrument. Plastic-coated spiral scales are enclosed in a metal case and cannot lose their accuracy due to warping. The rule operates in three simple movements, and is used to solve all types of mathematical problems.





**YOU CAN'T BECOME** physically fit overnight, nor can you do it without hard physical effort. But if you have no serious physical defects, you can develop enough strength and stamina to sail through a normal day's work with buoyancy and alertness—and still have enough reserve energy to enjoy leisure and to meet unexpected emergencies. And that, by definition, is physical fitness.

But you won't accomplish much in a single burst of violent activity. Several businessmen in Oregon learned this the hard way a few months ago. A brisk, vigorous workout, they decided, would clear the cobwebs from their minds and the kinks from their joints. So one evening they gathered at a school gymnasium and plunged headlong into a rough-and-tumble basketball game.

For days afterward, these men hobbled through their work nursing stiff joints, sore muscles, backaches and body bruises. Never before had the business world in Oregon harbored such a grim collection of "cripples!"

And no wonder! Too many sedentary adults approach exercise with the same kind of reckless abandon—and with the same unfortunate results. These men had been inactive for years. They simply were not in condition for the rugged



Jumping jack is typical calisthenic necessary in slowly increasing exercise level

# How to Build Physical Fitness

By *Dr. H. Harrison Clarke*

RESEARCH PROFESSOR, SCHOOL OF HEALTH AND PHYSICAL EDUCATION, UNIVERSITY OF OREGON

As told to *Ken Metzler*

Twist stick, wrestling stick from opponent, and other competitive games require top physical conditioning

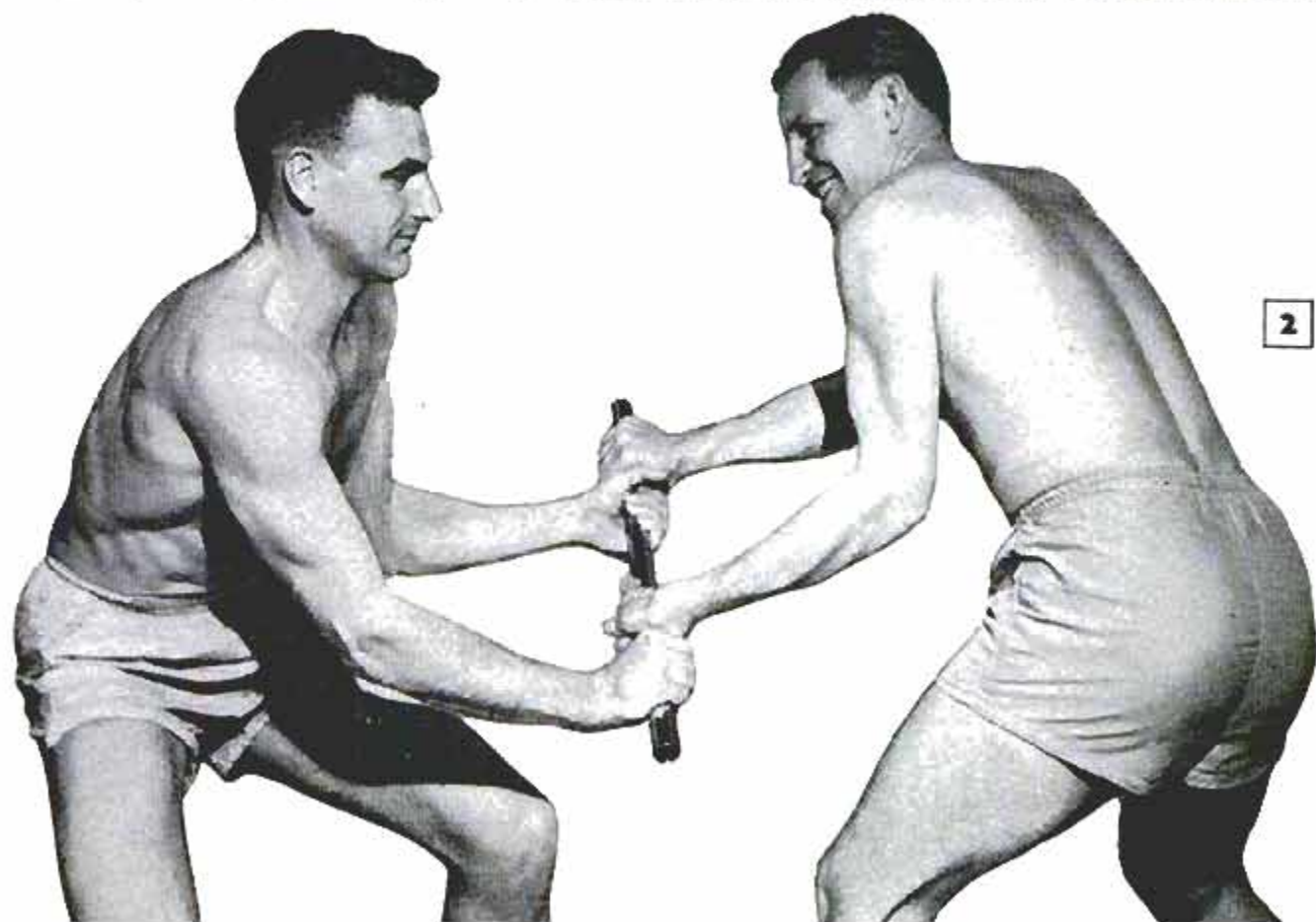



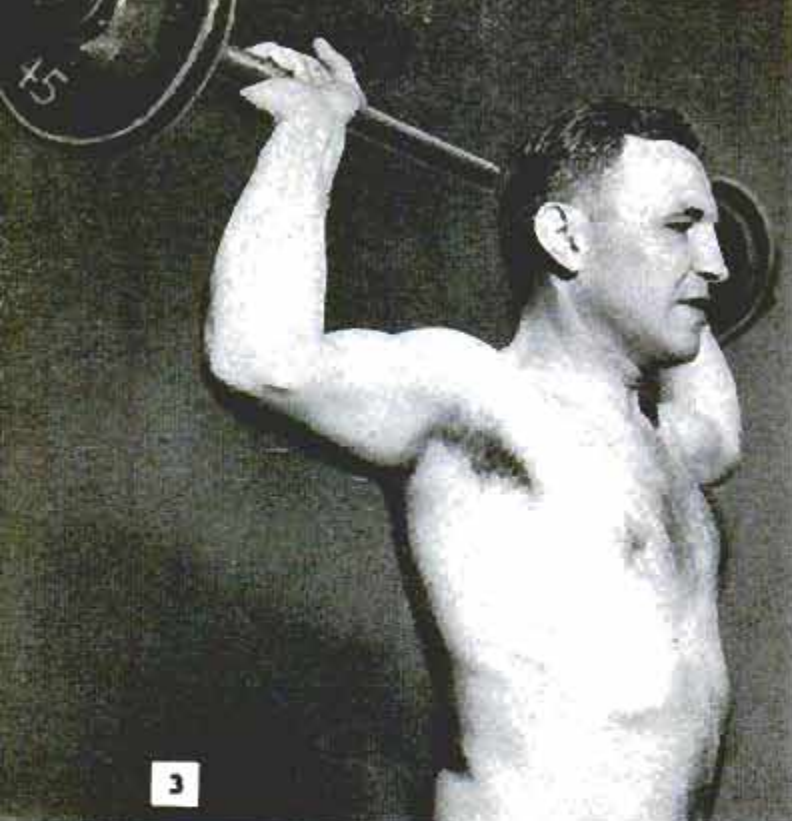

Overhead press involves raising bar bell from back of shoulders to full extent of arms. Exercises must be strenuous, although within limits of strength

physical exertion of basketball. Had they systematically developed an adequate level of physical fitness first, they never would have suffered the painful aftermath. And they probably would still be playing basketball and other games, instead of dismissing exercise as something just for youngsters.

They would have felt and looked better, too. Physical fitness is closely related to



Modified chinup with doorway bar. When 20 of these can be accomplished without undue exertion, bar should be moved up to arm's length for full chinups



Forearm curl calls for standing with feet apart, holding weight straight out and raising it to chest by forearm action, without moving upper arms or body

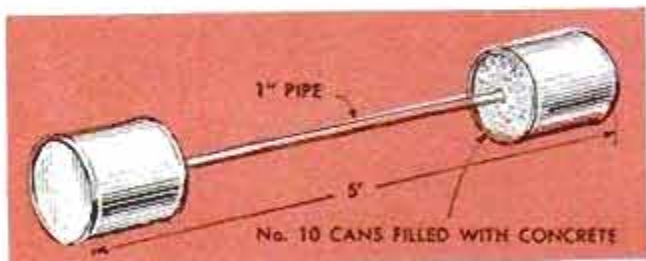

Above, bar bells are easy, inexpensive to make. Size of cans, amount of cement determine weight. Left, in side bends, place bar bell over shoulders, bend from side to side, keeping knees rigid, feet flat



## EXERCISE CHART

BODY AREA	CALISTHENICS	WEIGHT EXERCISES
Warmup	"JUMPING JACK," FIG. 1	
Arm and Shoulder EXTENSION FLEXION	PUSHUPS CHINUPS, FIG. 4	OVERHEAD PRESS, FIG. 3 CURLS, FIG. 5
Trunk LATERAL ABDOMINAL  BACK  FLEXIBILITY	SIDE BENDS SITUPS LEG LIFTS, FIG. 7 "SWAN," FIG. 8 "BOWSTRING," FIG. 9 FORWARD BENDS TRUNK STRETCHER, FIG. 10	SIDE BENDS WITH WEIGHTS, FIG. 6 SITUPS WITH WEIGHT ON CHEST  FORWARD BENDS WITH WEIGHTS
Legs	DEEP KNEE BENDS	KNEE BENDS WITH WEIGHTS, FIG. 11
Agility	LEG CHANGER, FIG. 12 SQUAT-THRUST, FIG. 13	
<b>COMBATIVE EXERCISES</b> HAND WRESTLE, FIG. 14 PULL ACROSS LINE, FIG. 15 "TWIST STICK," FIG. 2 "ROOSTER FIGHT," FIG. 16		In the weight exercises listed here, follow the "progression" principle. Select a weight that will allow you to do the exercise 10 times. Gradually increase to 20 repetitions, then start over at 10 with a heavier weight.

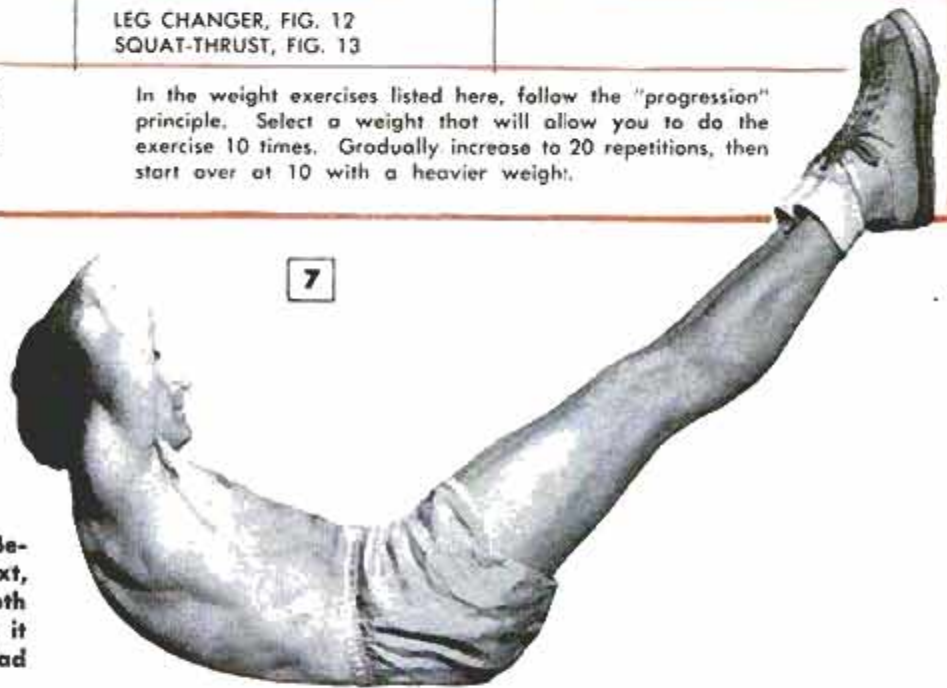

Leg lifts should be gradual. Begin by raising legs only. Next, with arms extended, raise both legs and shoulders. Then try it with hands clasped behind head

general health and well-being. Many studies have shown that fitness, mental ability and social adjustment go hand-in-hand. Before you can work effectively with people, you must be physically fit.

Vigorous and sustained physical activity tones up flabby muscles and enhances strength, poise, coordination and vitality. In building physical fitness, however, you must adhere to three basic principles.

First is "exercise tolerance." Your physical activity must be well within the limits of your strength and endurance. It is unnecessary—and undesirable—to strain to your uppermost limit to build fitness. Keep your activity at a reasonable—though strenuous—pace.

Second is the "overload" concept. This term means simply that the muscles should be worked harder than they usually perform in a normal day's activities—but always within the tolerance limits.

The final principle is "progression." You

must not only maintain a regular schedule of exercise, but you must progressively increase its severity to keep up with your growing strength and endurance.

The situp exercise is a good illustration of the progression principle. (In situps you lie on your back, raise your trunk off the floor and as far forward as possible.) With your arms extended in front of you, do 10 situps a day for three days. Increase them to 11 for several days, then gradually to 20. Then start again at 10, but with your hands clasped behind your neck to make the exercise more difficult. Finally, try holding a 10-pound weight on your chest or doing situps from an inclined board (head lower than feet).

Three further concepts should govern any program for physical-fitness development. First, determine through an appropriate test whether you measure up to a reasonably adequate standard of physical development. Second, if you are not up to





Swan exercise with hands behind back; force them up and back, raise legs and chest. Force elbows in



Bowstring should be slowly increased to 20 times. Grasp feet, pull with arms, raise chest off floor

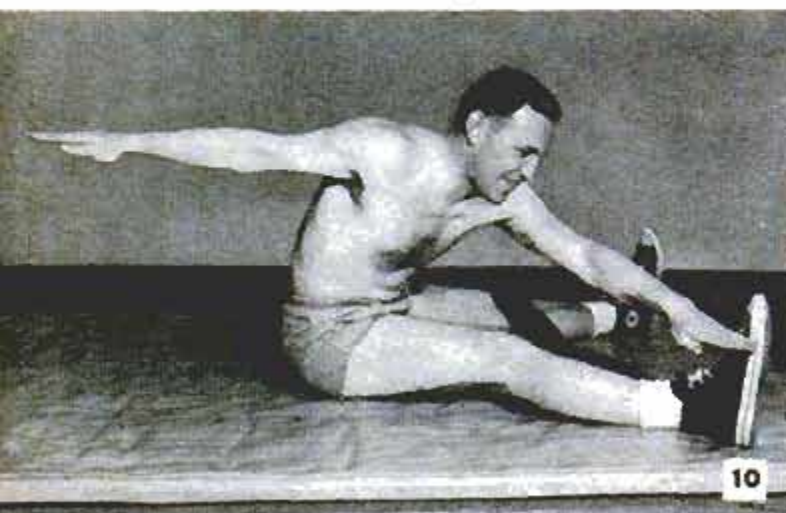

Trunk stretcher is effective all-around exercise. Secret is to stretch hand to and beyond opposite foot



Do knee bends with weight after first practicing without it. Stand and squat until upper legs are parallel to floor

par, find out why. And then start to work on corrective measures.

If you are considerably below par, you may know it already, for the symptoms are readily apparent. You come home from work day after day too fatigued for anything but the easy chair. Perhaps your back aches. You're breathless after climbing a couple of flights of stairs. You have trouble getting things done and chances are you have "fatigue posture"—protruding abdomen, slumped shoulders and a sway (hollow) back.

Just how fit should you be? The Navy, in its "Standard Physical Fitness Test," figures that the average sailor should be able to do a squat-thrust, Fig. 13, 28 times in 60 seconds. He should also do 36 situps (hands behind neck), 27 pushups and 9 chinups. You're doing fair if you can do 20 squat-thrusts in a minute, 24 situps, 15 pushups and five chinups. (To avoid sore muscles, it's wise to practice these exercises a few weeks before going all-out in this test.) Older men should also aim for these goals.

The causes of poor fitness vary widely with each person. Often it is a combination of factors with, as you might suspect, lack of exercise at the top of the list. Other causes may be poor nutrition, illnesses, overweight tendencies, emotional disturbances and faulty health habits, such as not getting enough sleep.

Before delving into a program of fitness development, it's a good idea to see your physician. He can identify and treat any defects or organic disturbances that may be draining away your strength. In a few cases, he may advise only moderate exercise until certain conditions are cleared up. A person with a heart ailment should, of course, follow his doctor's advice.

Individuals also differ greatly in their need for specific types of physical activity. For this reason, physical educators who work with substrength individuals like to prescribe exercise much the same as a physician prescribes treatment. Some people, for instance, should devote more effort



12

Leg changer is running without going anywhere. Rapidly alternate feet for a minute

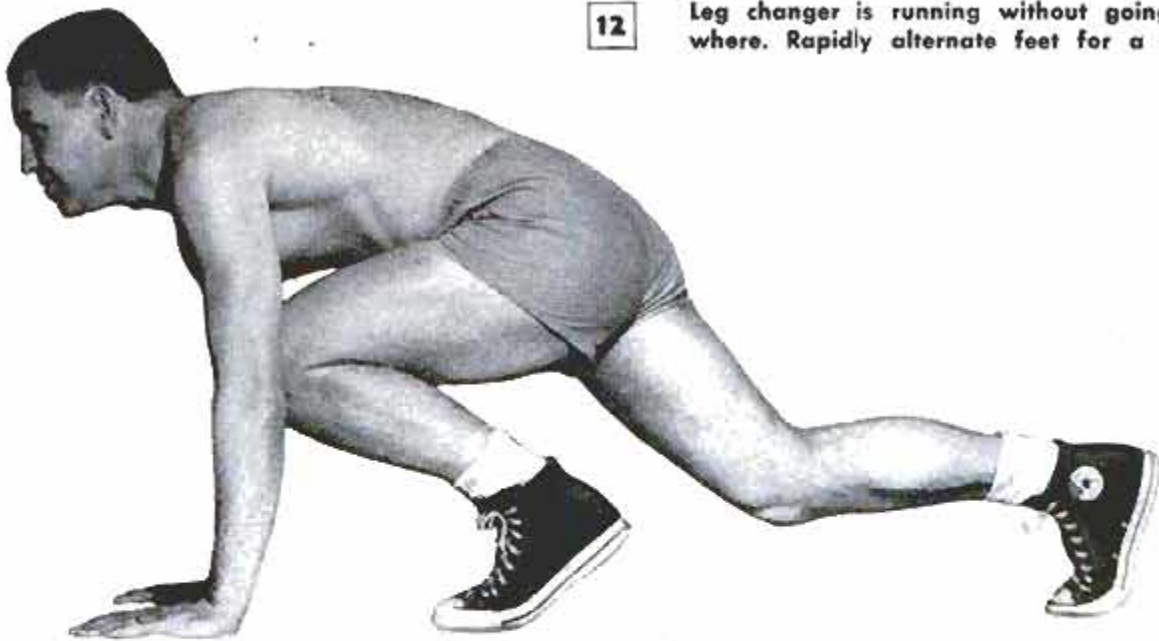

to develop their arm and shoulder muscles. College and military-fitness tests have shown an appalling lack of strength in these muscles.

Thus no single set of exercises is appropriate for everyone. But those listed in the accompanying chart are basic and designed to cover the major muscle groups and to provide for agility and flexibility.

Some would argue with the need for flexibility. But in a study of 5000 cases of low back pain, Dr. Hans Kraus, a New York physician, found a strong relationship between their pains and the ability to pass six simple strength and flexibility tests. Most failures were in the flexibility test (bending over, knees rigid, and touching the floor). When these people developed

themselves enough to pass the tests, their backaches usually disappeared.

In choosing exercises to fit your own needs, select those which offer the greatest resistance to the muscles, but are within your tolerance limits. Resistance can be applied by parts of the body (calisthenics), by inanimate objects (weight lifting) and by other individuals (combatives). At first, it is best to stick to calisthenics and weight lifting. Combatives are fun and beneficial, but the competitive element may lead you to overstrain if not in good condition.

You can expect slight muscle soreness after your first exercises, but it will disappear quickly after the muscles develop to handle the new stresses placed on them.

A regular exercise schedule of three

13

Squat-thrust starts from standing position. Then squat, thrust legs back and reverse the procedure. Repeat rapidly for one minute

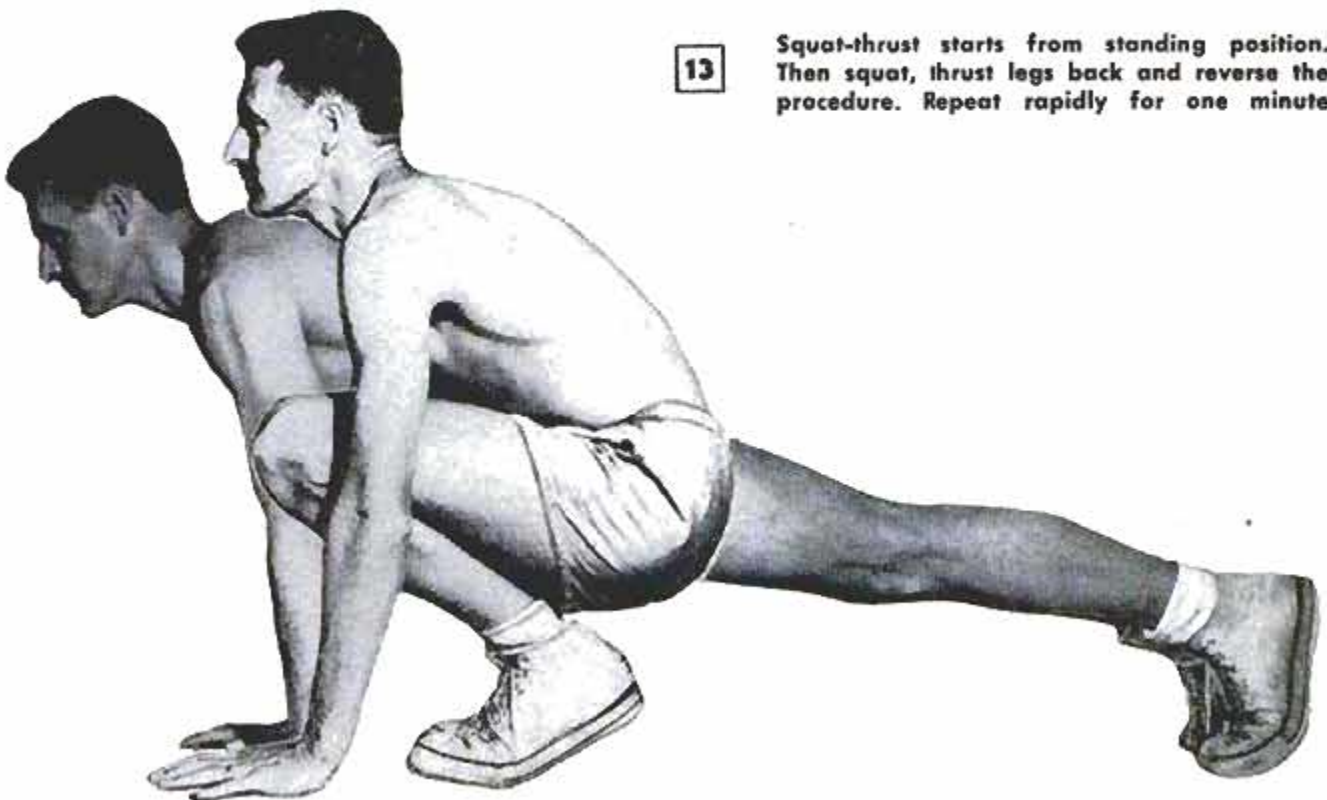



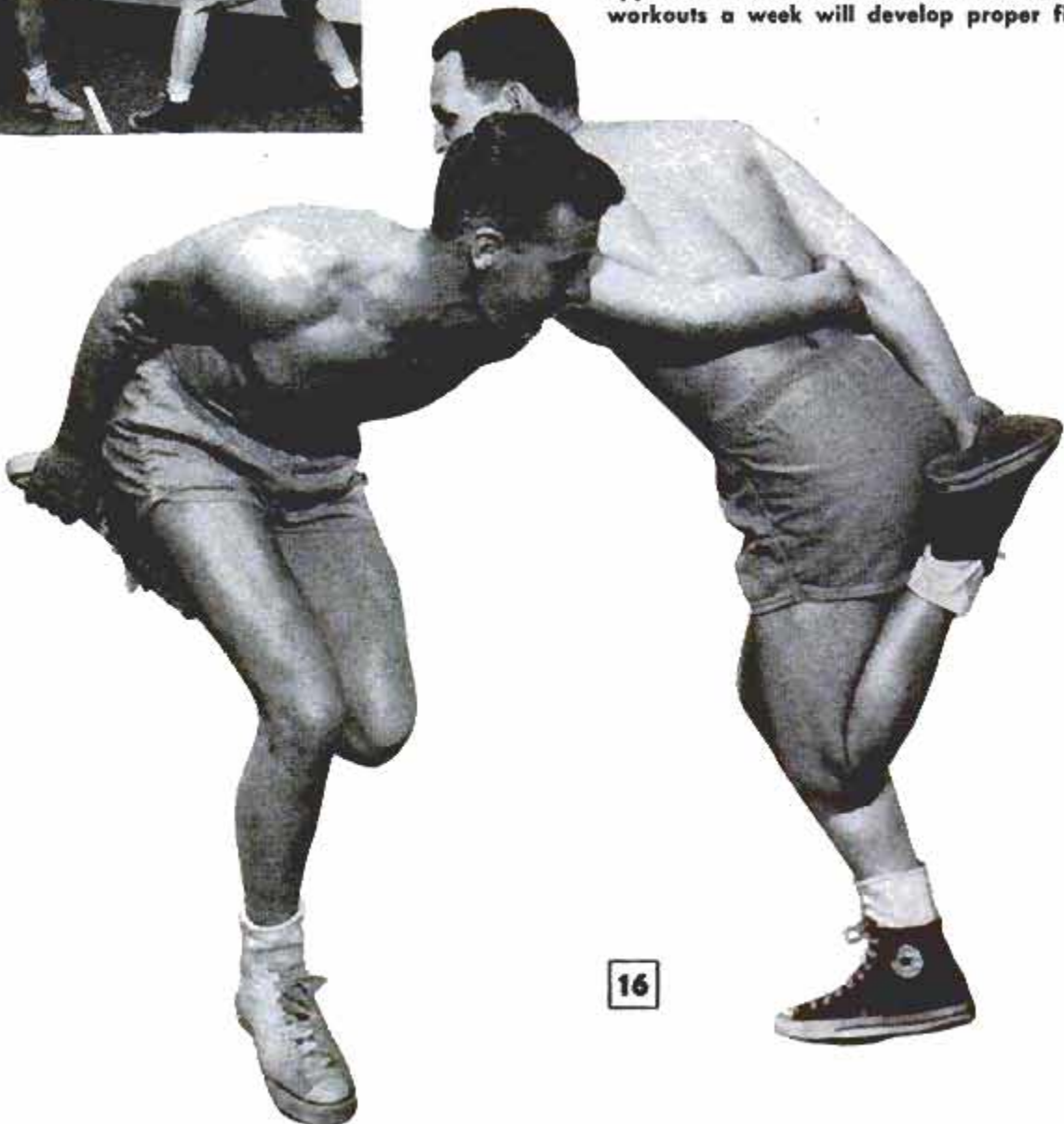

half-hour periods a week is sufficient to develop good physical condition, so long as you stay with it and progressively increase the load. Even after you have developed a good level of fitness, you must maintain an exercise schedule.

These exercises build up muscle fibers, develop previously unused fibers, enlarge the muscles and open up better circulation to supply energy-producing oxygen.

But in addition to muscular strength, you should work on "circulatory respiratory" endurance—the ability to keep going for long periods. The best exercises for this are recreational activities: Hiking, running, bicycling, swimming, skiing and others. Vigorous sports like tennis, soccer, basketball and handball are valuable—when you're in condition.

These exercises develop the heart and lungs much the same as calisthenics build up individual muscle groups. In sedentary adults, much of the lung capacity is never used. Exercise enlarges the lung capacity to feed more oxygen into the blood stream. It also increases the number of blood cells and their

(Continued to page 256)

Hand wrestling, Fig. 14, pull across line, Fig. 15, and rooster fight, Fig. 16, are combative exercises, with purpose of making opponent lose his balance. Three half-hour workouts a week will develop proper fitness



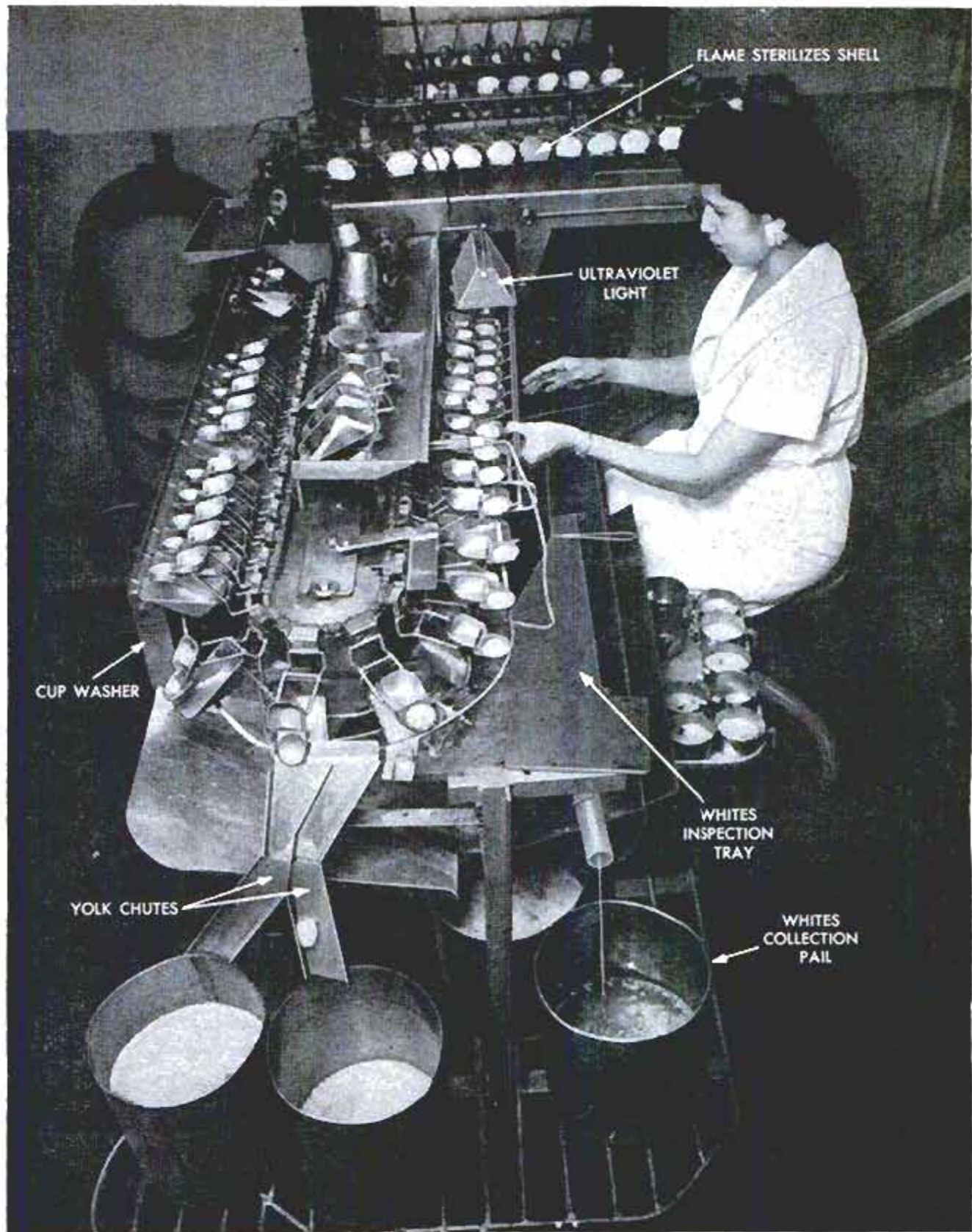

## Egg Assembly Line Separates Yolks From Whites

AMONG THINGS MACHINES CAN DO better than people are breaking eggs and separating the yolks from the whites. One machine also washes and sterilizes the shells before they are broken. The contents are dropped into separating cups and the empty shells are carried away on a conveyor. The cups carry the whites and yolks

under an ultraviolet light which makes certain bacteria appear fluorescent. The machine operator removes inedible eggs or broken yolks. Whites flow over a shallow inspection tray and into a collection pail. Yolks are separated electronically for light or dark color above a divided chute. Cups are washed before receiving another egg.



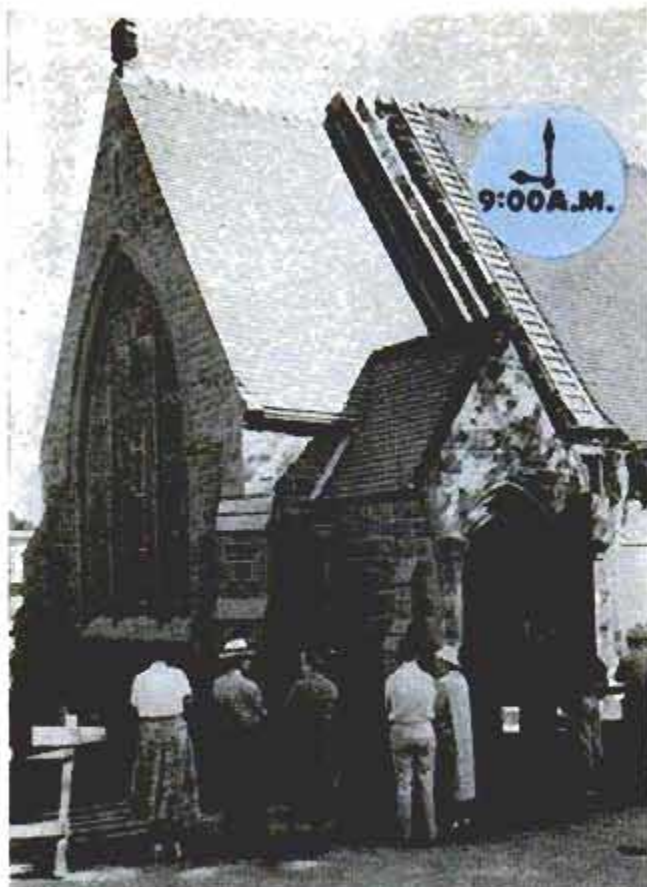

At 9 a.m., gap appears between main church structure and front section being pushed by hydraulic jacks

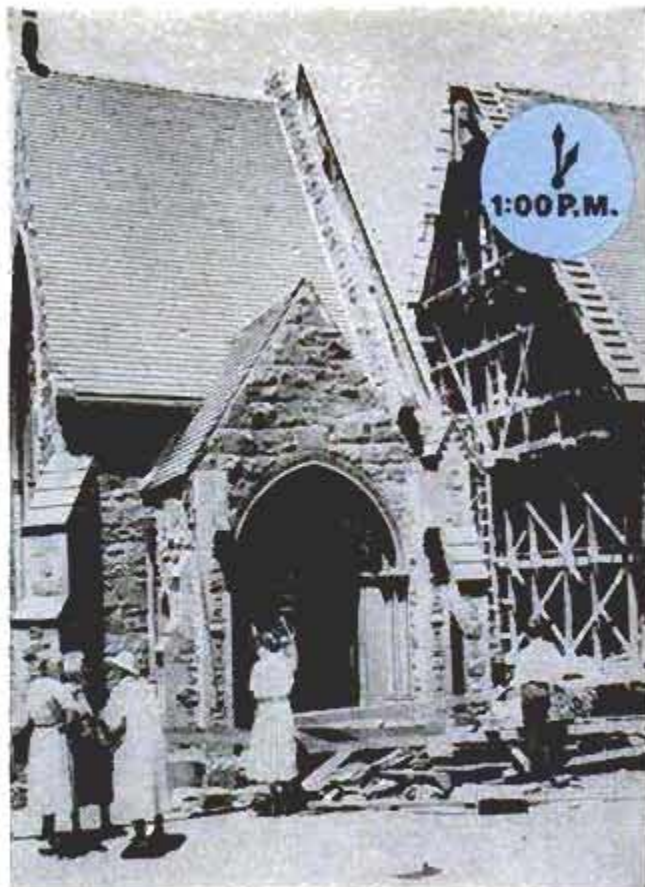

Four hours later, massive chunk of building has moved about 20 feet at rate of an inch per minute

## Four Hundred Tons of Church Go for Ride

Church section rides on I-beams as workman checks thrust of hydraulic jacks. Jacks had to be coordinated to push evenly

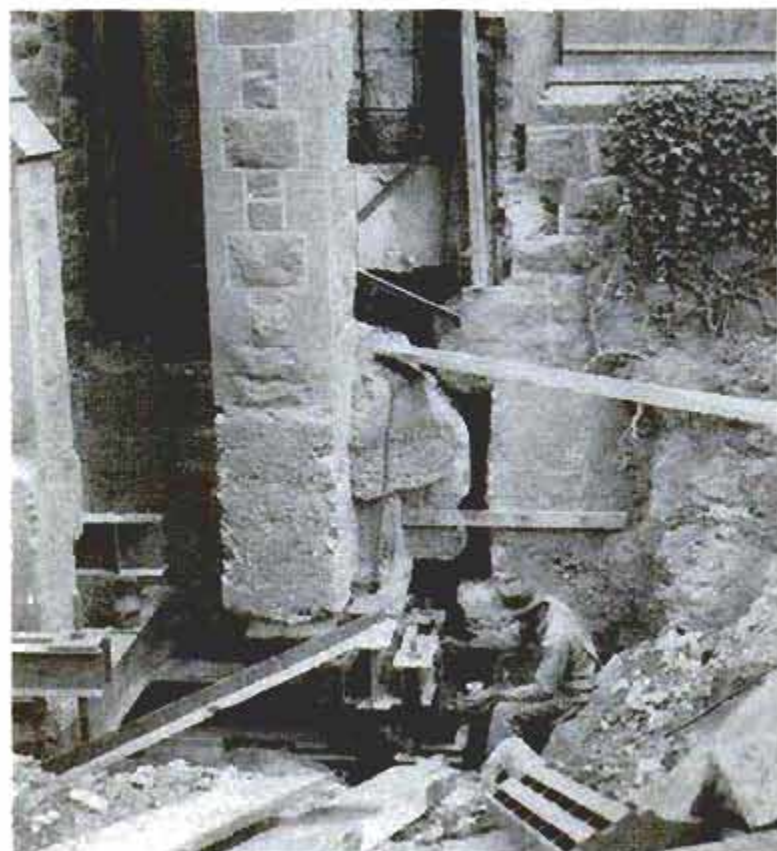

RATED AS ONE of the most difficult projects attempted by building movers, the 400-ton front section of the Episcopal Church of St. Matthew, in San Mateo, Calif., was rolled 30 feet without a hitch. Moving the four-story-high section of the 91-year-old church was particularly risky because it contained a stained-glass window valued at \$80,000. Purpose of the move was to add length to the structure so the seating capacity could be increased. It was estimated that moving the front section 30 feet from the main structure, and building the addition in the space between, would cost \$50,000 less than razing and rebuilding part of the church. The moving operation was so closely planned that a sinkage allowance of one inch was made to line up the floor which will be laid between the two sections. The front section was rolled on heavy I-beam tracks supported by cement-filled caissons sunk more than 25 feet in the earth.



# Radio TELEVISION Electronics

X 15 A



*For Family or Business Telephone Conferences—*

## Build Your Own TEL-AMP

*By Lou Dell*

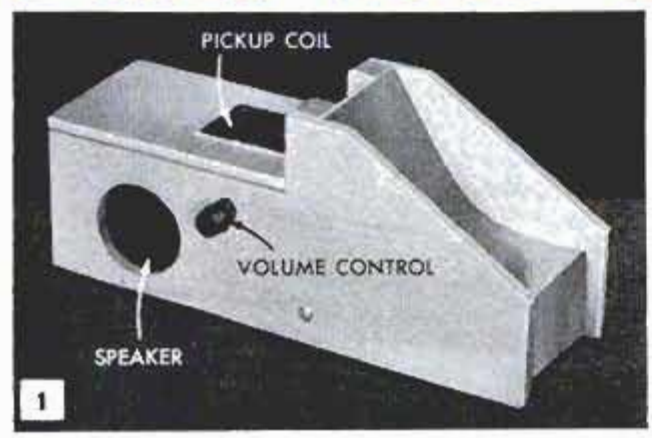

THERE IS NO DOUBT that the "private listening" feature of the telephone serves a very useful and important function, but there are times when it is just a plain nuisance. When you call home from the office, for example, or perhaps from some out-of-town location, it would certainly be convenient to talk to the whole family at the same time rather than carry on a number of separate and repetitive conversations. Here's a telephone accessory



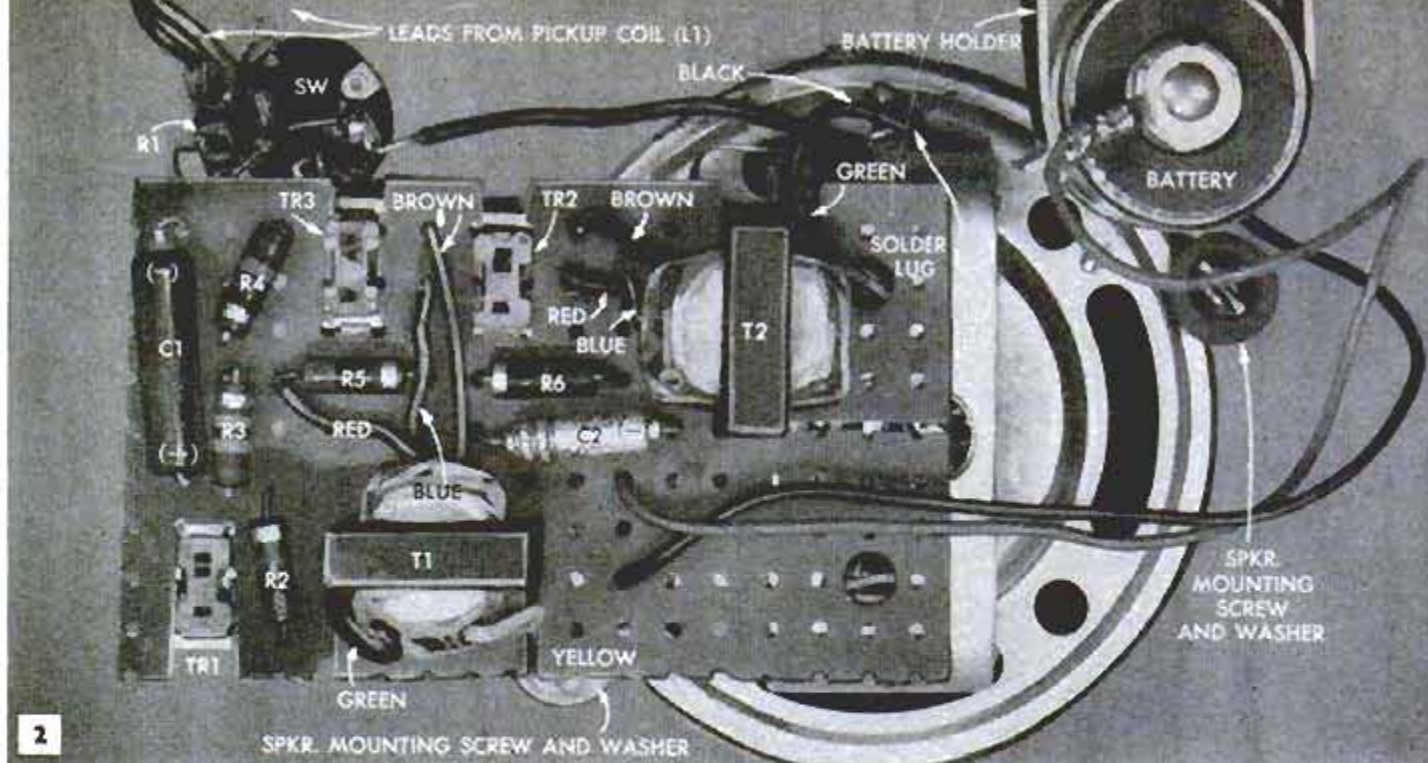

you can build yourself which will permit you to do just that. It won't get you in trouble with the phone company, either, because it requires no electrical connection to the telephone. When the phone rings, merely lift the receiver off the hook, place it on the Tel-Amp, and with the flick of a switch the caller on the other end of the line is "brought into the room" to participate in any group conversation.

This, of course, is not the only convenience offered by the handy little Tel-Amp. When your arm gets tired, or your neck begins to ache from prolonged use of the conventional shoulder rest, you can just set the receiver on the Tel-Amp and carry on your conversation in the normal manner. At the same time, your hands are free

to take notes, or thumb through files, and you can even take a walk across the room with never an interruption.

### How It Works

A photograph of the completed Tel-Amp is shown in Fig. 1. Principally, it consists of a magnetic pickup, a transistorized amplifier for increasing the volume of incoming speech to a loudspeaker level, and an aluminum reflector which gathers the energy from oncoming sound waves and directs it towards the microphone part of the telephone handset.

The amplifier is a rather simple affair (see schematic diagram in Fig. 7), consisting of three transistors and the necessary associated small parts. It draws very little

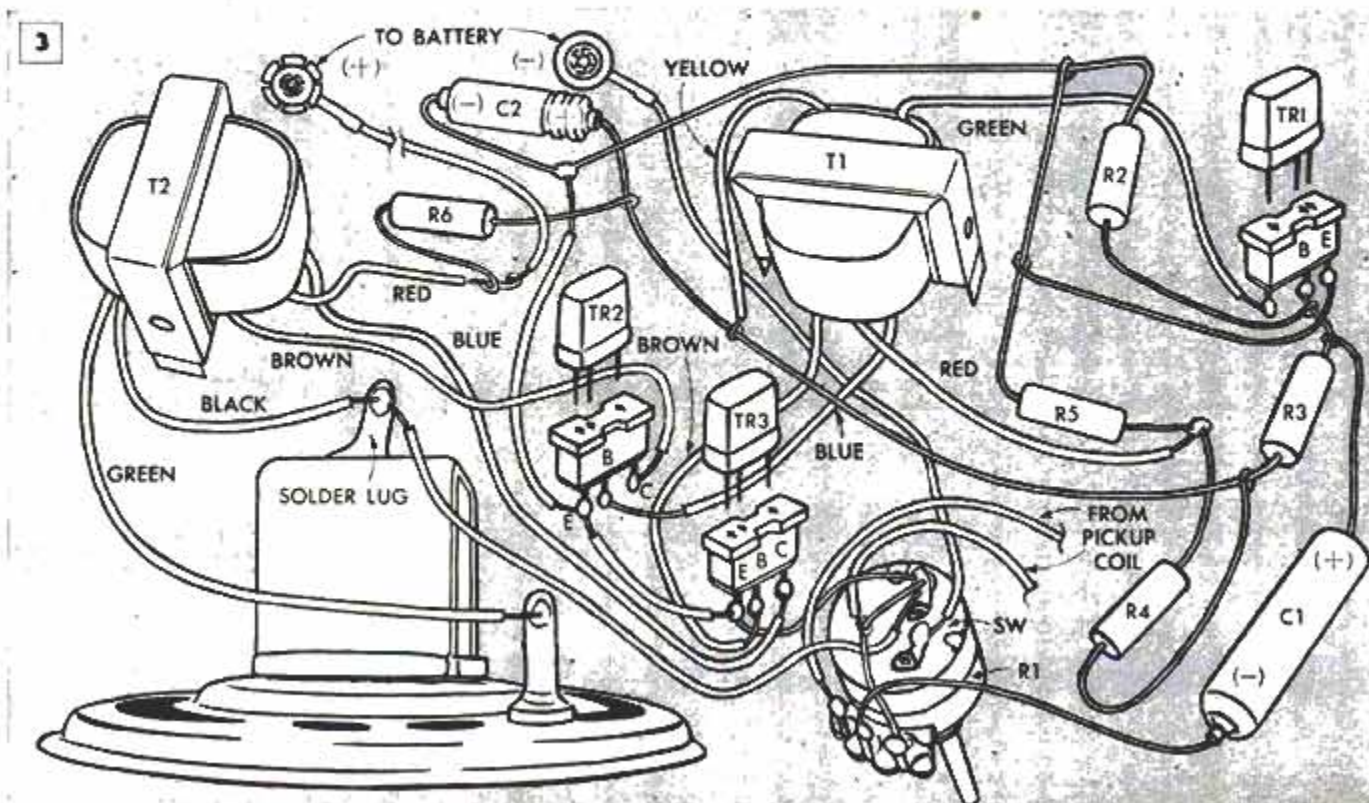



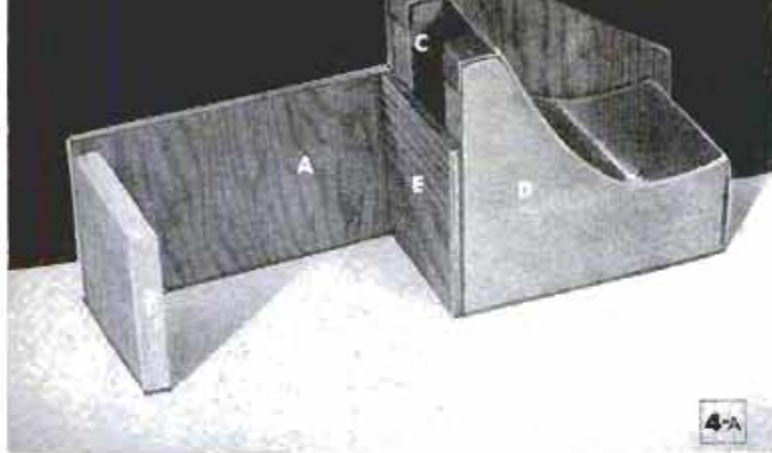

4-A

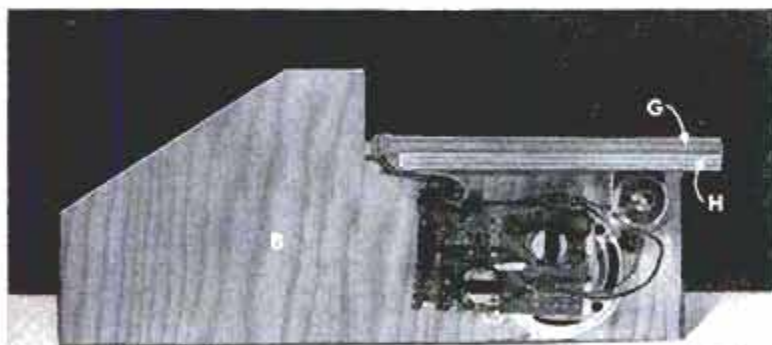

4-B

current and the single 9-volt battery, which furnishes all the operating power, will last almost as long as it would on the dealer's shelf, providing that you remember to turn the unit off after a call has been completed.

In use, the receiving portion of the telephone handset is placed on or near the magnetic pickup coil, L1. When the person on the other end of the line speaks, an electric current flows through a set of coils located in the earpiece. This current sets up an alternating magnetic field around the coils which varies in strength and frequency in exact accordance with the cur-

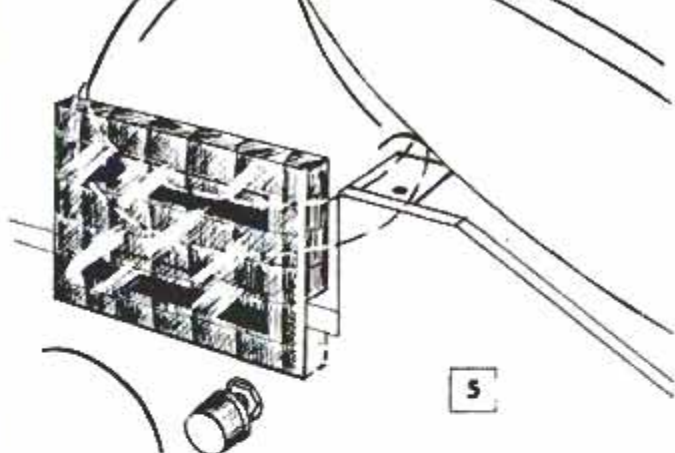

5

rent. This varying magnetic field induces a voltage in the pickup coil which corresponds to the original signal current.

In the amplifier, the feeble voltages induced in the pickup are amplified by transistor TR1 and transformer-coupled to the push-pull-connected output transistors TR2 and TR3. These provide sufficient power to drive the loudspeaker to ordinary room-volume levels. All parts used in the amplifier are standard and readily available from most radio-parts distributors.

### Construction

The magnetic pickup is made from a salvaged output transformer. Satisfactory performance could probably be obtained with one of the commercially available telephone pickups, but it is far more satisfying, and less expensive, to wind your own. Any old radio transformer, or any inexpensive replacement-type unit will do the job.

The three parts of the transformer—the E-shaped laminated core, the coil bobbin and the frame—are disassembled as shown in Fig. 8-A, and the core is split into two equally thick portions. (The thin laminations are held together only with wax, and can easily be split with a pocketknife or

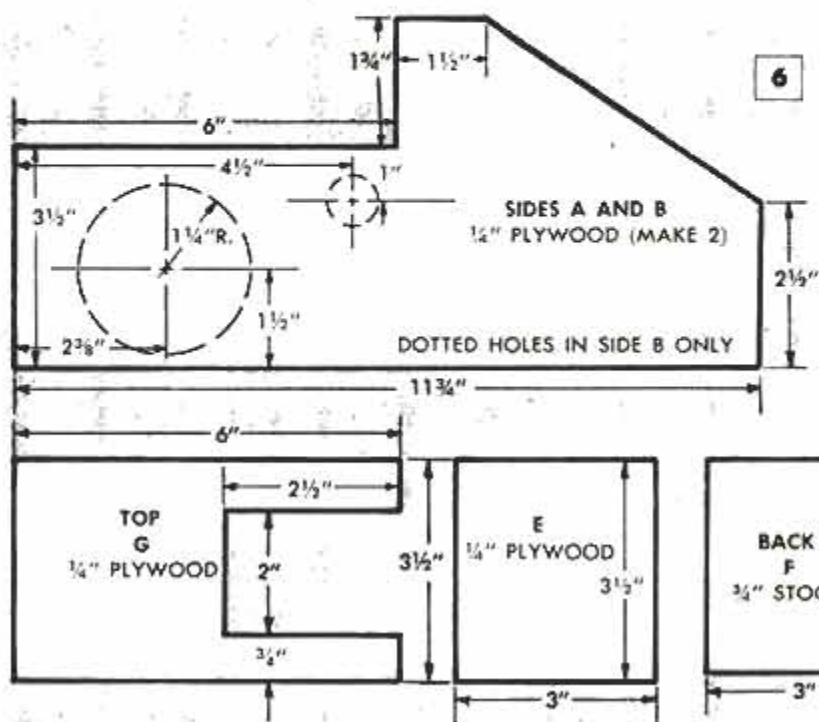

6

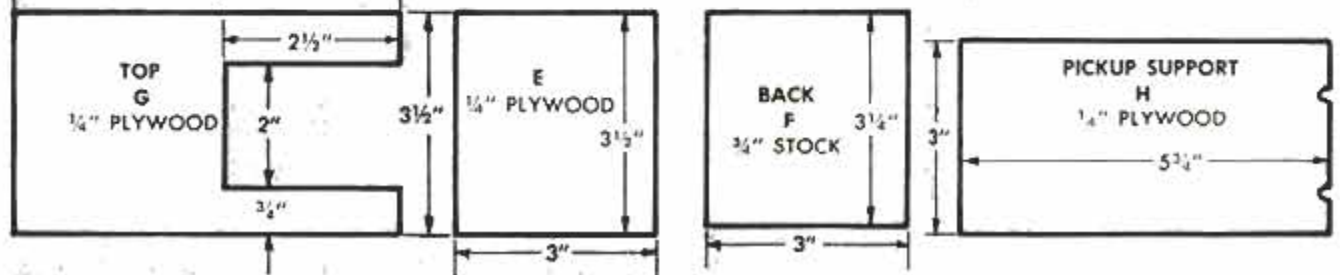
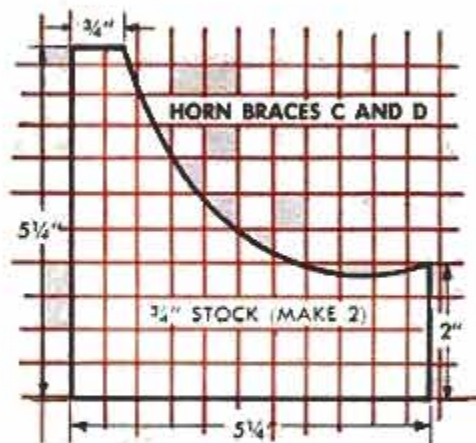



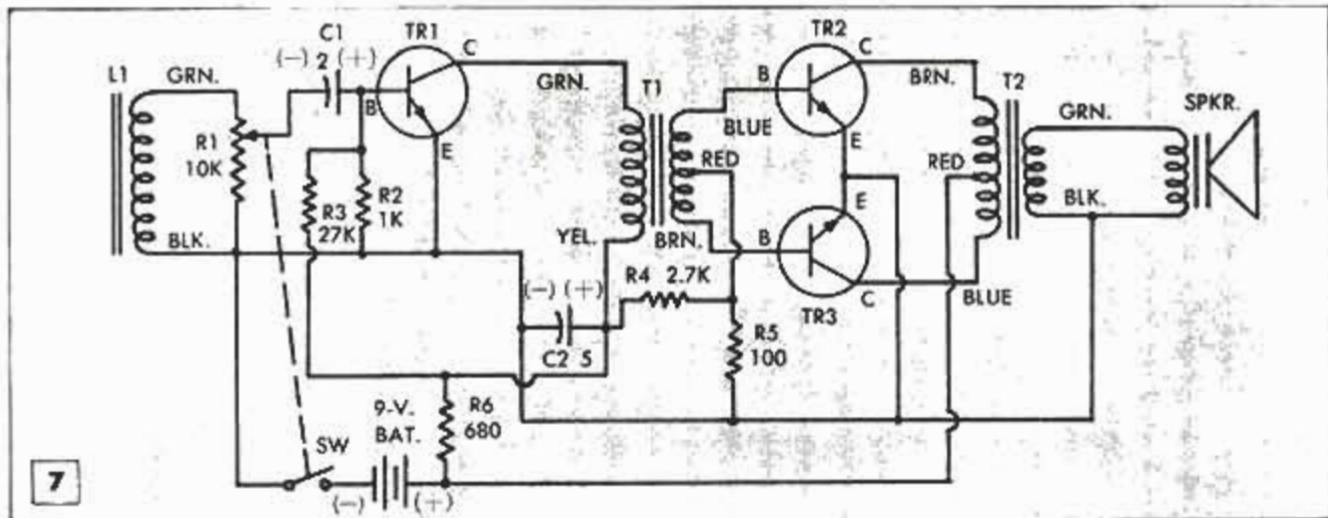

similar instrument.) Then the two portions of the core are butted together end-to-end, Fig. 8-B, and tightly wrapped with several layers of cellulose tape. The tape must cover all edges in order to insulate the coil, which will be wound around the circumference, from the core.

Now comes the most tedious, though not necessarily difficult, part of the job—winding the coil. Tear the outer paper cover from the transformer bobbin and remove and discard the primary transformer winding which is made of relatively heavy wire. This exposes the fine-wire secondary which is used for winding the pickup. The hookup wire soldered to the ends of the fine-wire leads should be torn off to simplify coil winding, even though these will have to be resoldered later.

Tape two or three inches of the fine wire to the flat side of the core and wind the remainder of the wire around the core circumference as shown in Fig. 8-C. This is not as difficult as it looks because the wire is wax-impregnated and will stay in place pretty well. If some strands do tend to slide off the edge, they can be secured with a little cellulose tape.

After all the wire from the bobbin has been transferred to the core (you may be surprised at the large amount) wrap the entire coil tightly with cellulose tape to

#### LIST OF MATERIALS

TR1, TR2, TR3=Sylvania 2N35, NPN transistors.  
 R1=10,000-ohm potentiometer, audio taper, with s.p.s.t. on-off switch.  
 R2=1000-ohm, ½-watt carbon resistor.  
 R3=27,000-ohm, ½-watt carbon resistor.  
 R4=2700-ohm, ½-watt carbon resistor.  
 R5=100-ohm, ½-watt carbon resistor.  
 R6=680-ohm, ½-watt carbon resistor.  
 C1=2-mfd. miniature electrolytic capacitor.  
 C2=5-mfd. miniature electrolytic capacitor.  
 T1=5000:7500 CT-ohm transistor driver transformer, Thordarson TR2 or equiv.  
 T2=825CT:3.4-ohm transistor output transformer, Thordarson TR29 or equiv.  
 L1=Magnetic pickup coil (see text).  
 Speaker=2¼-in. FM loudspeaker, RCA-type 222S1.  
 Battery=9-volt transistor battery with matching snap-on connectors.  
 Miscellaneous: Perforated Bakelite board (see text), battery holder, transistor sockets with mounting clips (3), knob for volume control, thin aluminum (see text), solder lug, assorted wood and machine screws and metal washers, hookup wire, rosin-core solder, material for cabinet (see Fig. 6).

prevent its eventual unraveling. Scrape the enamel insulation from the ends of the fine wire with steel wool and resolder the two hookup leads to the ends.

**Wiring the Amplifier.** If you've ever done any radio wiring, you'll have no trouble with this amplifier. A perforated Bakelite board, 3⅜ x 1⅞ x ⅛ inch, serves as a chassis for mounting the small parts. Fig. 2 shows the parts layout on top of the board. Note that the transformers and transistor

(Continued to page 258)

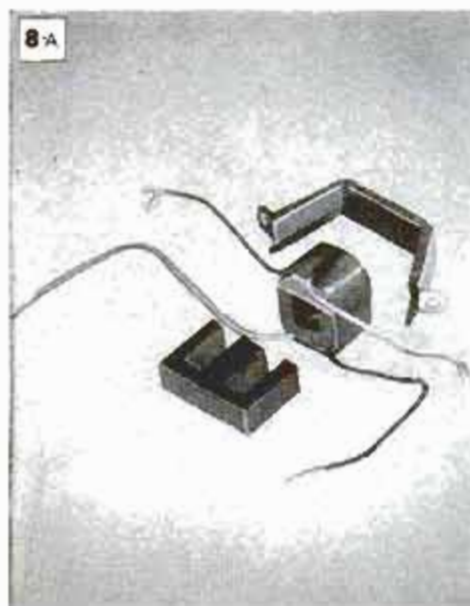



# BINDING TAPE

## *is Versatile*

By Walter E. Burton



**A**DHESIVE-COATED cloth tape is sold for use as a binding for the cut ends of carpets and rugs and for patching torn fabric, but there are numerous other uses for the material around the home and shop as illustrated in this article. Applied with a warm or hot iron, depending upon the product, the tape can be made to adhere quickly to various fabrics. Some types are coated with a special adhesive that will stick to metal, wooden and glass surfaces. Be sure to check the manufacturer's directions before purchasing tape, since not all products are suitable for all applications.

Cloth tape is sold in a variety of colors, making it useful for a number of decorative purposes, and for replacing letters and emblems missing from pennants and other items. Some types of cloth tape are excellent for making lightweight hinges and latches that must be attached to surfaces into which nails or screws could not be conveniently driven. Other applications may occur once you are aware of the ease with which the product can be handled and its durability when used to perform jobs normally reserved for metals, plastics and other materials of high-tensile strength.

Here is how most types of adhesive-coated cloth tape should be applied. First, make sure that the surfaces to which it is applied are free of dust and all emulsion-forming materials, such as grease and oils. The manufacturer's directions should be carefully followed, especially instructions concerning the temperature of the iron or other heated metal tool used to bond the adhesive properly. When specific instructions are lacking, tests can be made to determine the best temperature and other important factors or conditions necessary for proper bonding of the material.

When tape is bonded to new wood, as in making small cloth hinges and latches,

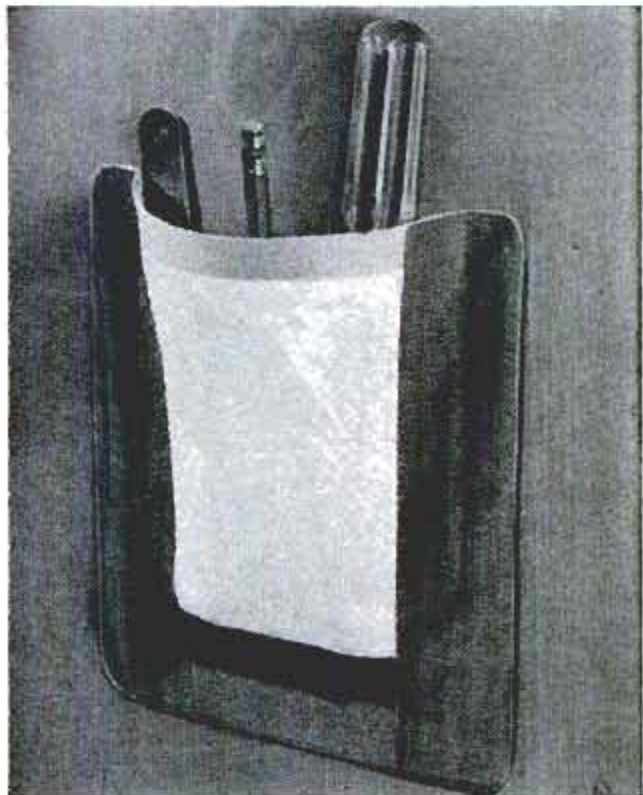
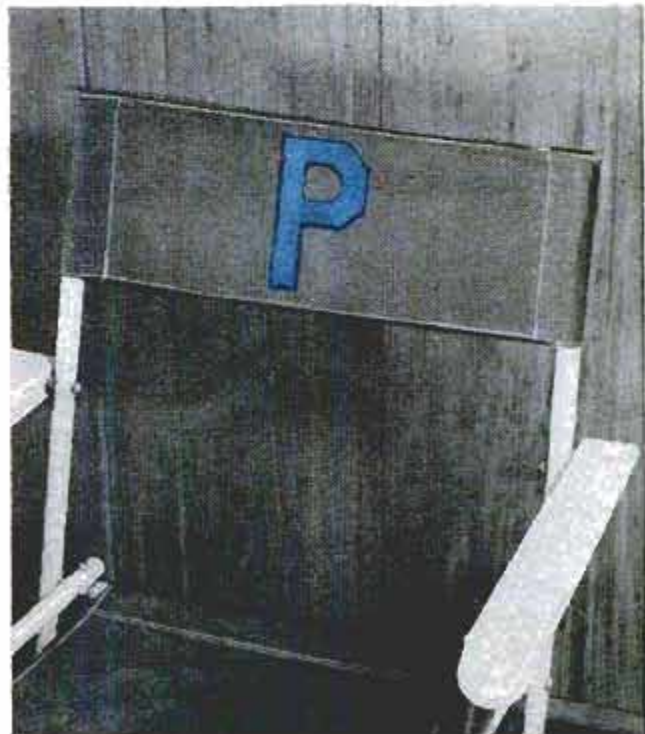

Fig. 1, handy cloth pocket is ironed on inside of tent wall with 1½-in.-wide tape at bottom and sides. Fig. 2 below, decorative monogram applied on canvas back of deck chair is made of colored tape strips





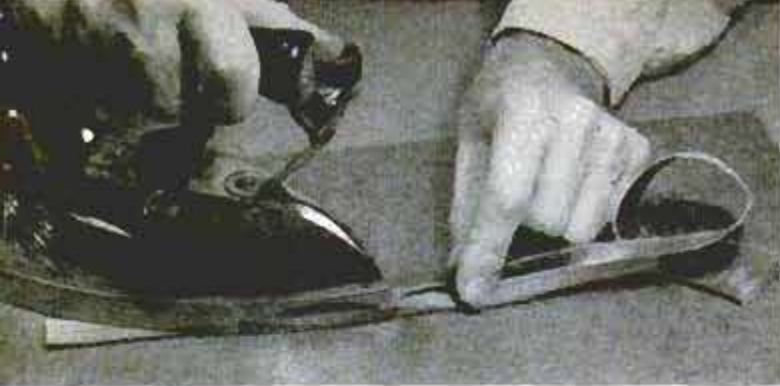

Fig. 3, strap for camera case is made by ironing tape that has the sides folded in on adhesive



Fig. 4, damaged front edge of small shelf is concealed by covering it with tape of blending color

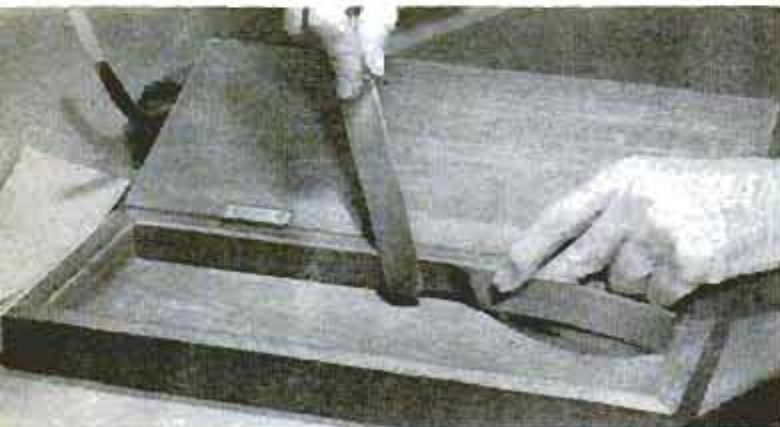

Fig. 5, narrow-width rug tape is used for lining sides of jewelry box, wide width is used on bottom

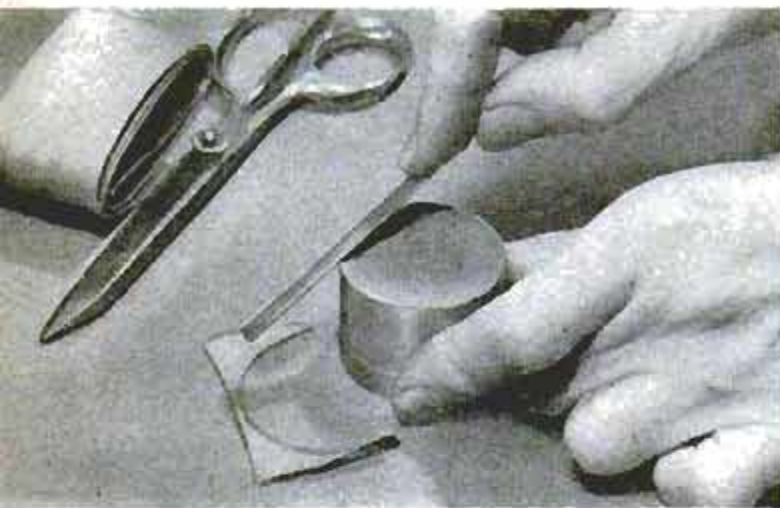

Fig. 6, when tape is used to provide scuffproof base on metal object, trim tape edges with emery board

Fig. 7, used as "piano hinge," tape is ironed on lid and box as indicated in hinge-methods detail



Figs. 7 and 8 and accompanying details, care should be taken to avoid damaging or discoloring the tape upon applying the finish. Since adhesion is of primary importance in this particular application, be sure to provide a completely dustfree, smooth surface to secure a good bond.

One of the most useful widths of carpet-binding and similar cloth tapes that must be applied with a heated iron is the 1½-in. width, obtainable at the notion counters of most department stores. Rug bindings also are available in 2¼, 3¾, and 5¾-in. widths, with the latter two widths especially suitable for covering large areas, such as lining a small box, Fig. 5.

When cutting tape into narrow strips and odd shapes, a pair of sharp scissors or a sharp knife and straightedge should be used. When installing tape on an object with no surface irregularities and ample workspace, a conventional electric pressing iron can be used to apply pressure and the required heat as shown in Fig. 7. Various other devices and tools may be used for applying heat to the tape, such as the blade of a dinner knife as in Fig. 5. For special jobs, variously shaped pieces of cast iron, steel and other metals may be adapted for use and heated in the flame of a torch or gas stove. A pair of clamp-type pliers can be used for holding these improvised "irons" when heating and using them for this purpose.

Until you learn to judge the proper degree of heat to be used for bonding the adhesive on the tape, it is wise to place a sheet of paper between the iron and tape. This simple precaution prevents the hot iron from scorching the tape. Since an electrically heated iron affords a greater measure of temperature control, with its adjust-

#### HINGE METHODS

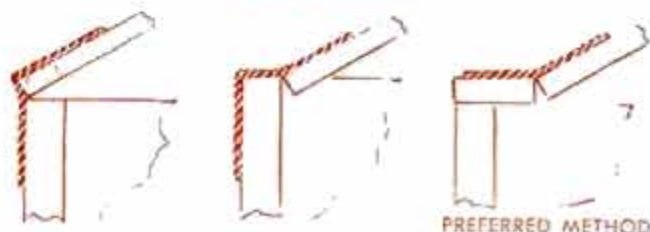



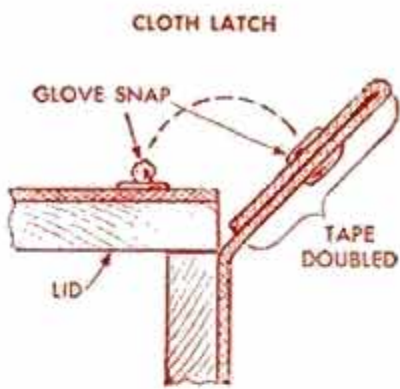

Fig. 8, above, cloth latch for lightweight box is made by installing parts of snap fastener on tape tabs that are ironed on lid and box. Tab on box is doubled, as shown in detail, for greater strength

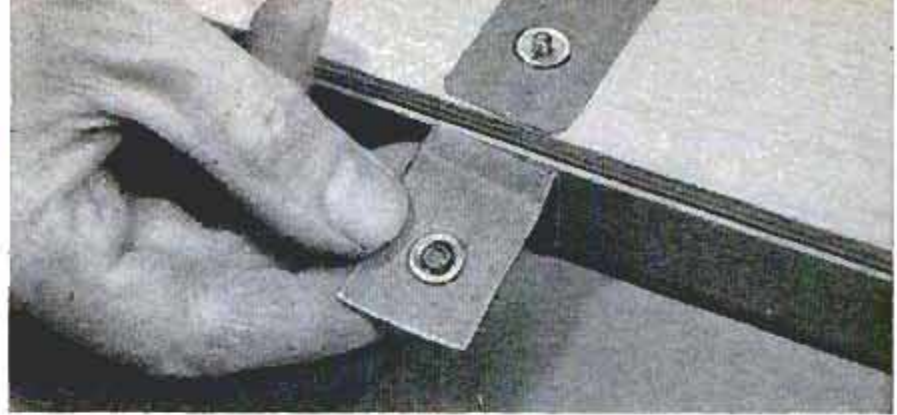
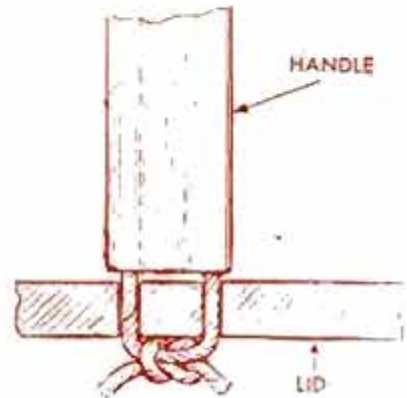
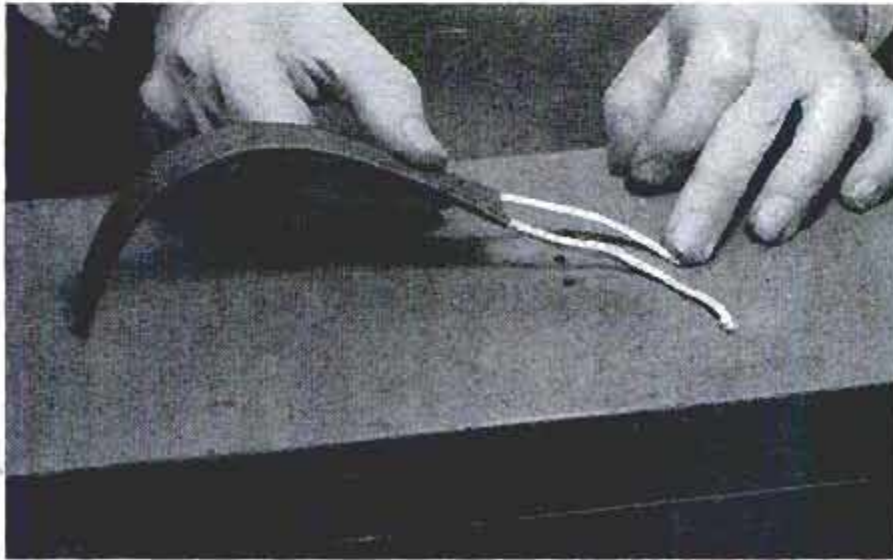

Fig. 9, photo and detail below, strong cords sealed in tape folds are inserted in holes in box lid and knotted. Cords are sealed in tape folded as in Fig. 3, by using heated rod to apply pressure and heat



able thermostat and polished work surface, this appliance should be used for applying tape whenever possible. If a protective sheet of paper cannot be used on work as explained above, you can avoid scorching

the tape by testing the heated iron on a small piece of the tape or a piece of cloth of similar thickness. When metal fasteners are attached to tape, it should be doubled for greater strength, Fig. 9. ★ ★ ★

## Rural Mailbox Swings on Arm

This pivoting mount for a rural mailbox is ideal for country roads. When concealed by snowdrifts, a passing snowplow will not damage or dislodge it as would be the case with a conventional post mounting adjacent to the road. Instead, the pivoting mailbox moves with the force of the plow and swings into position once the plow has passed. To make the mount, simply set a post on the bank of the roadway so that it leans slightly toward the road and is located about 8 ft. from it. Then, form a large U-shape from  $\frac{3}{4}$ -in. pipe, mount one end on the post as shown, and bolt the mailbox to the other end.

Remember that a surface to be painted must be clean or the paint may chip off. Also remember that a varnished or shellacked surface must be roughened with steel wool or sandpaper before painting.

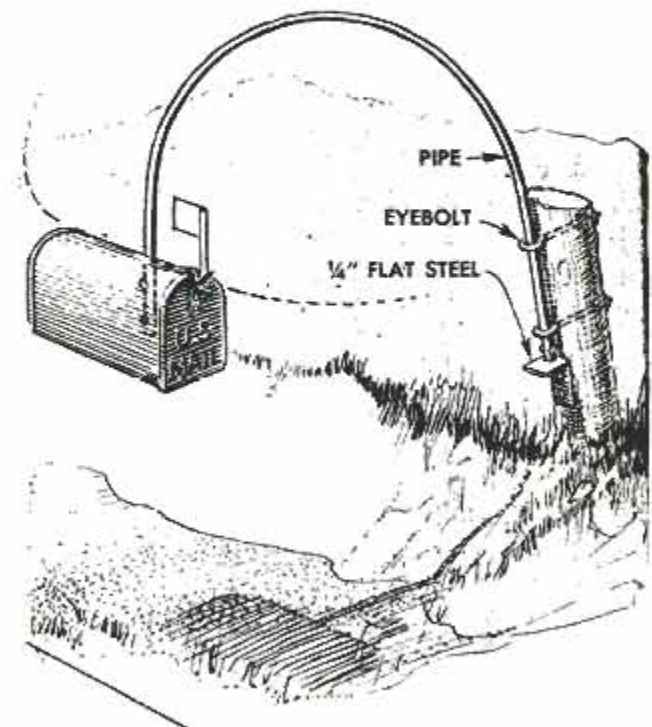





Paper cutter is located in recessed cabinet at right end of sink. Ferrotypes storage racks are below sink

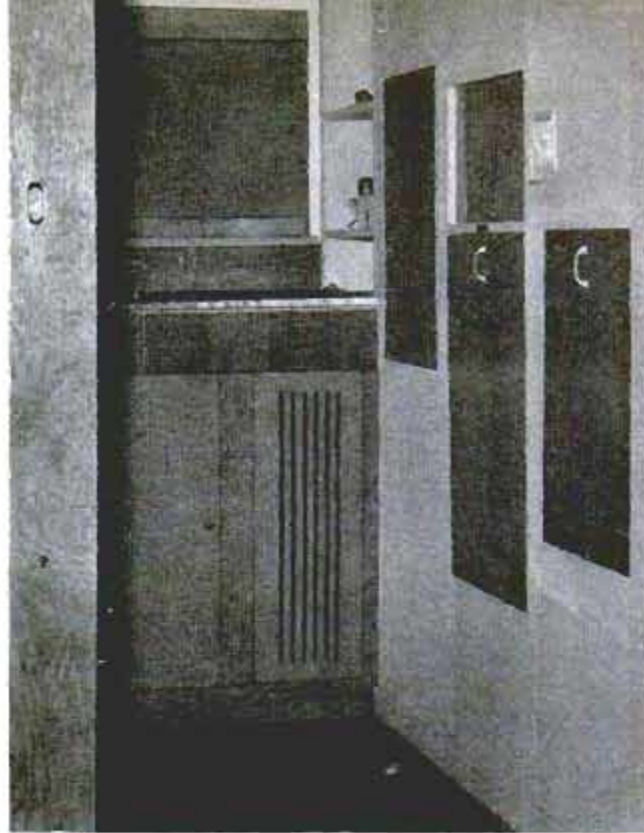

View of the right side of the darkroom through the sliding door shows neat appearance of flush cabinets

## "Dream" Darkroom Takes Little Space

PhotoKinks 58 + WTM 59

By William G. Waggoner

1614 CARAMAY WAY, SACRAMENTO, CALIF.

AFTER YEARS of using makeshift darkrooms in kitchens or bathrooms, I finally built a "dream" darkroom, in which were incorporated ideas worked out during the many frustrating hours spent with my improvised setups. A portion of a garage, an area measuring 8 x 10 ft., was used for the darkrooms, although any small area could be remodeled in a similar manner. Because nothing projects from the walls except the enlarger, a minimum amount

Typewriter was included in equipment in original darkroom, stationery is stored in cabinet above it

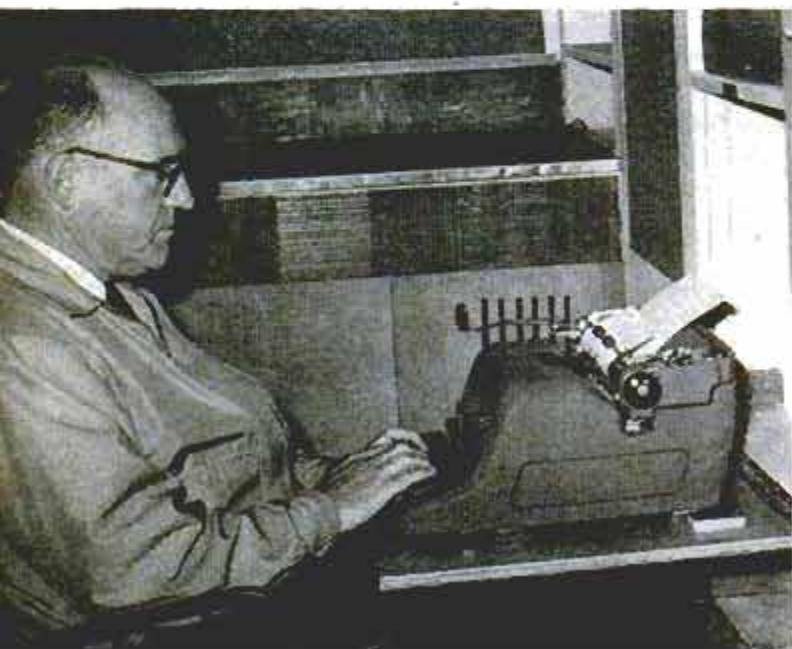

of floor space is required for the dark room.

First step in construction is to build false walls 10 in. out from the original back and side walls. In this 10-in. space are located all the cabinets for storing equipment and supplies. Dimensions for all cabinets must be determined before the false-wall framing is erected, as the wall studs must be spaced to accommodate the widths of the various cabinets. All cabinets are built as indicated in the lower left-hand detail on the facing page, each one being simply a box assembled with glue and screws and screwed to the wall studs. The front edges of each cabinet project beyond the face of the studs the thickness of the material to be used as a wall covering. When the covering is applied, the cabinets will be flush with the surface. Dimensions shown on the cabinet in the detail are for one make of standard typewriter. Each cabinet must be dimensioned to accommodate the material or piece of equipment it is to contain. Note in the detail that the desk lid of the cabinet, cut from  $\frac{5}{8}$  or  $\frac{3}{4}$ -in. plywood, is fitted with a piano-type hinge that is screwed to a cross piece attached just inside the front edges of the cabinet. The distance from the hinge center to the bottom of the cabinet is the same as the



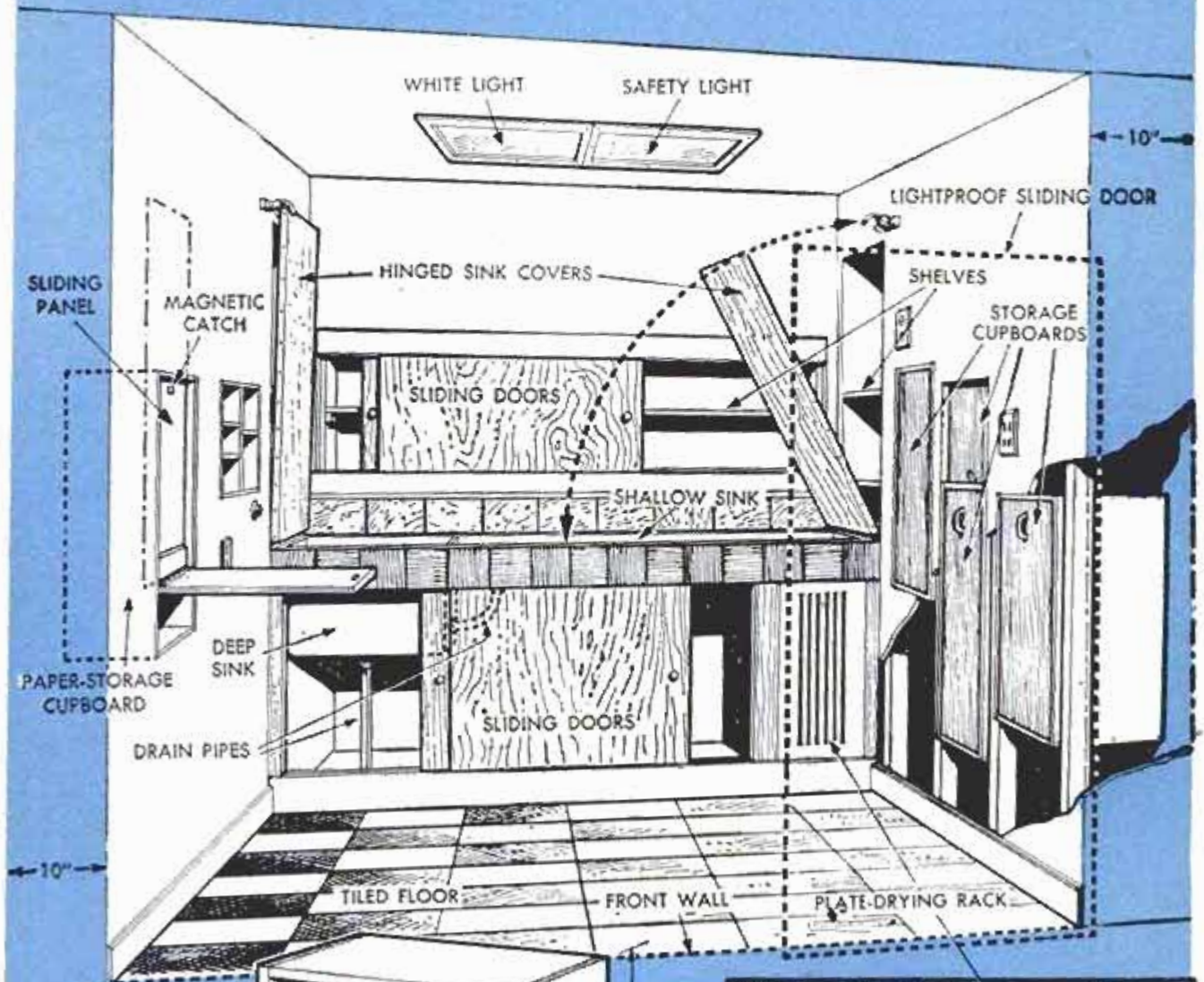
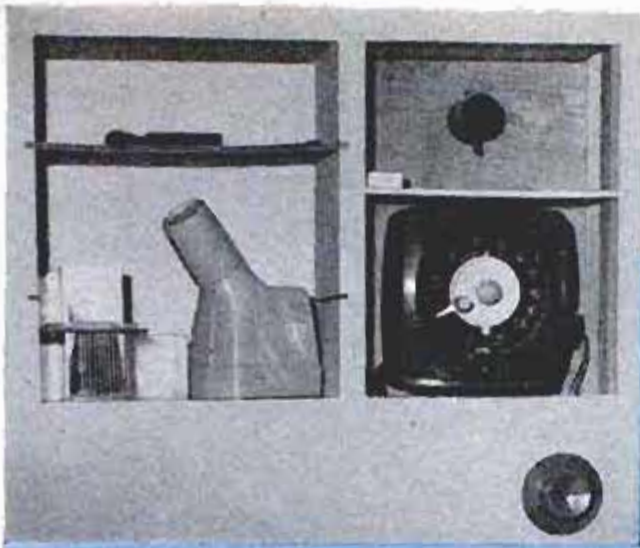

TYPICAL STRUCTURE OF STORAGE CUPBOARDS

LID PIVOTS DOWN, FORMING OWN SUPPORT

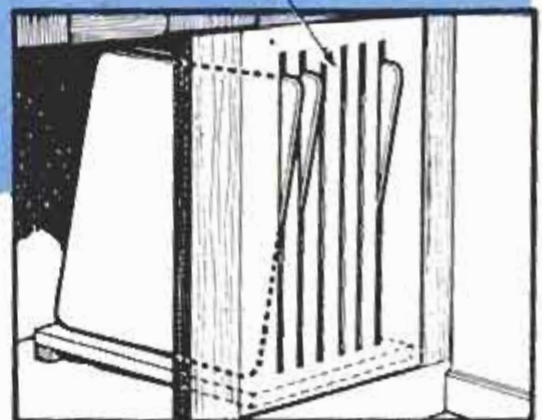
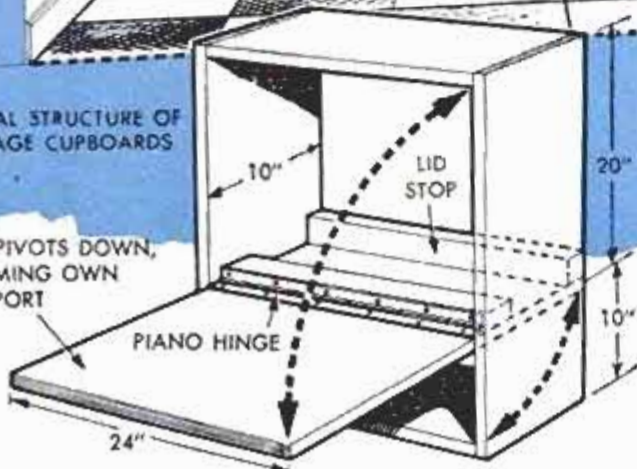



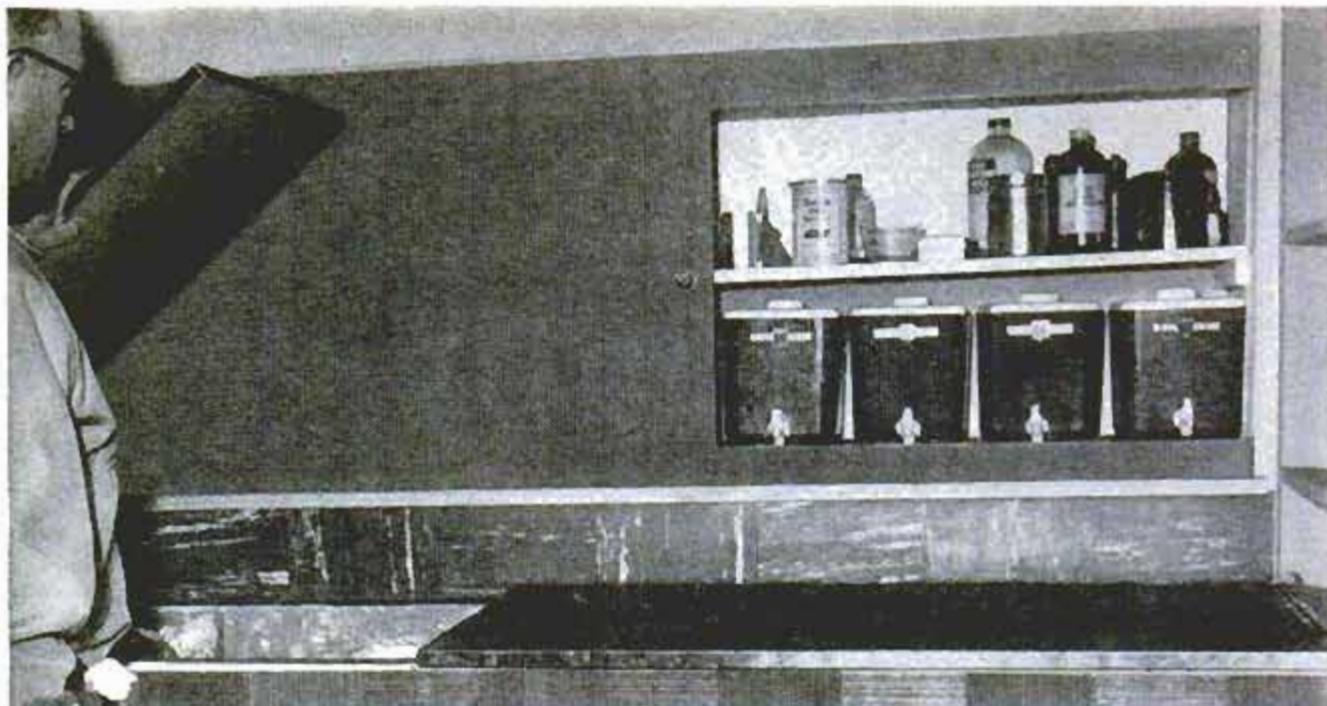

Hinged covers drop down to make sink a worktable. Cabinets are back of sink, shelves are at each end

distance from the front edge of the cabinet to the inside surface of the cabinet back. Thus, when the door pivots on the hinge, the lower end of the door rests against the underside of a stop at the back of the cabinet. With this setup, the cabinet lid is self-supporting, requiring no external braces or legs to keep it in a horizontal position. When equipment is fastened to the inside surface of the doors, as is the typewriter in the lower left-hand photo, page 186, weight of the equipment will keep the door in the closed position without need of any sort of latch. The paper-storage cabinet, upper right-hand photo, page 187, differs from the other cabinets by having an inner, light-tight door. It slides in grooves cut in the sides of the cabinet and through a slot cut in the top. Because no equipment is attached to the door, a magnetic latch is used to hold it closed.

### Spacesaving Features

Another spacesaving feature of the darkroom is a combination sink-worktable. Two hinged covers of  $\frac{3}{4}$ -in. plywood, covered with linoleum or plastic laminate, form the worktable that swings up out of the way when the sink is used. Screen-door closers are used to hold them against the walls. The sink was custom-made at a sheet-metal shop, and is painted with liquid rubber on the inside. It has a deep and a shallow basin. The deep basin has a perforated pipe coiled in the bottom through which water is run, causing tiny jets of water to keep the tank water agitated for thorough print washing. Depth of the water in both basins is controlled by standpipes that consist of lengths of plastic tubing

cemented in holes cut in sink stoppers. Water flowing in the shallow basin serves as a water-temperature control for the developer, stop bath and fixer chemicals that are in floating trays. Water from the shallow basin drains into the deep basin.

Cabinets under the sink have sliding doors that run on T-shaped tracks. Track of this type is available at most building-supply and some hardware stores. At one end of the sink cabinet is a storage rack for ferrotype plates, as indicated in the lower right-hand detail on page 187. Above the sink at the back and ends are shelves and cabinets for storage of equipment and supplies, as shown in the photo at the top of this page. Here again, the 10-in. space is used to good advantage. Sliding doors also are used on the cabinets back of the sink, open shelves are located at each end. Near the center of the left-hand wall of the darkroom is a shelf on which the enlarger is located. To its right are recessed shelves on which is kept material used with it. A timer is wired into an outlet box at the back of one shelf, which eliminates the need for any exterior wiring. The only cord showing is the one from the enlarger. A white light and a safelight are installed in boxes built flush with the ceiling. The door of the darkroom is a sheet of plywood that is suspended on nylon rollers from an overhead track. A cornice over the track, a recess at one side and at the bottom of the door, plus a felt strip along the other side, makes it light-tight. No recess is required for the full door, as it slides along the wall inside the darkroom. A hinged door also could be used, made light-tight and opening outward. ★ ★ ★



## Combination Mailbox-Signpost

This combination mailbox-signpost located on the highway adjacent to a farm road clearly indicates the name of the owner as well as the name of the farm.

A. M. Wettach, Mt. Pleasant, Iowa

## Better Turning of Softwood



Next time you turn a piece of softwood in a lathe, first apply some sodium silicate or water glass around the dead-center hole of the turning. It will impregnate the wood and harden upon drying to provide a smooth bearing surface. Keep the dead center oiled.

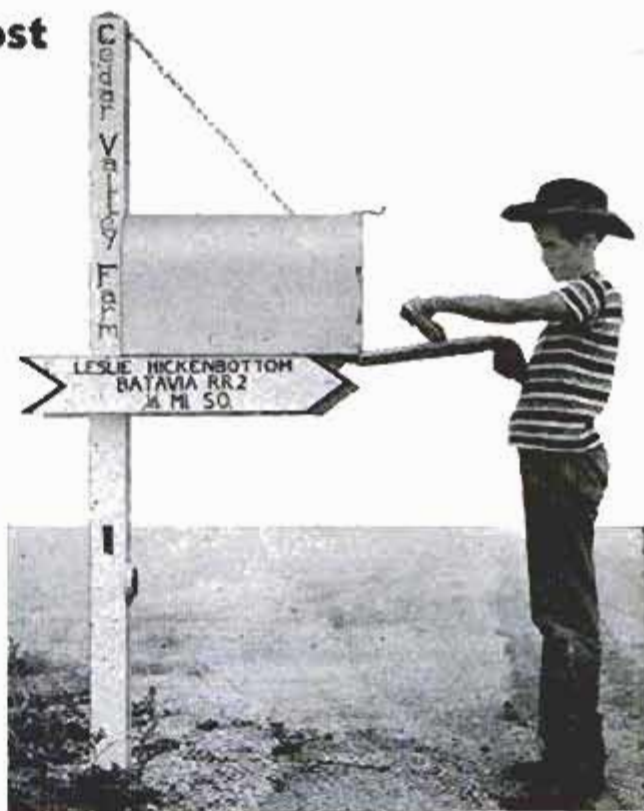

## "Dry Cutting" Sheet Rubber

Instead of dipping scissors in water to aid in cutting sheet rubber, place a piece of acetate film on both sides of the rubber along the line of the cut. The acetate prevents the rubber from creeping and assures a clean cut. The acetate film from a package of cigarettes is large enough for most small jobs.

## Tool for Freeing Sash

Jammed double-hung sash are freed quickly with this simple tool. It consists of a 10-in. length of 1½-in.-sq. stock, on the end of which is screwed a Z-shaped length of ½-in. flat steel. The end of the flat is filed to a knife-edge. A short length of dowel, used as a fulcrum, is stored in a hole bored in the end of the tool.

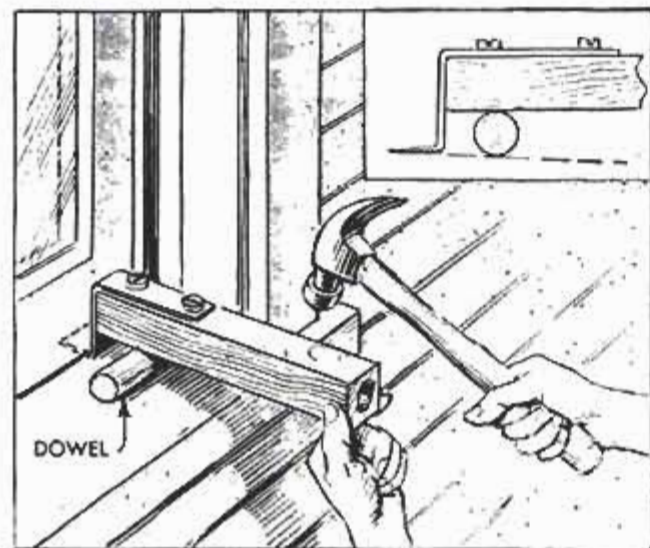

## Cleaning Bone Knife Handles

White bone handles on knives and other kitchen utensils can be cleaned of stains and given a "like new" appearance by rubbing them with a flannel cloth that has been dipped in peroxide. For deeply embedded stains, soak the bone for a few minutes in a solution of water and household bleach. Rinse and then wipe dry.

## Aluminum-Foil Favor Cups

Unique little favor cups for a party can be made from aluminum foil, using two water tumblers or individual gelatin molds as "dies." Shape the foil over one tumbler, press the second down over the first, and the cup is formed. Trim the edge and add a pipe-cleaner handle as on the finished cup in the photo.





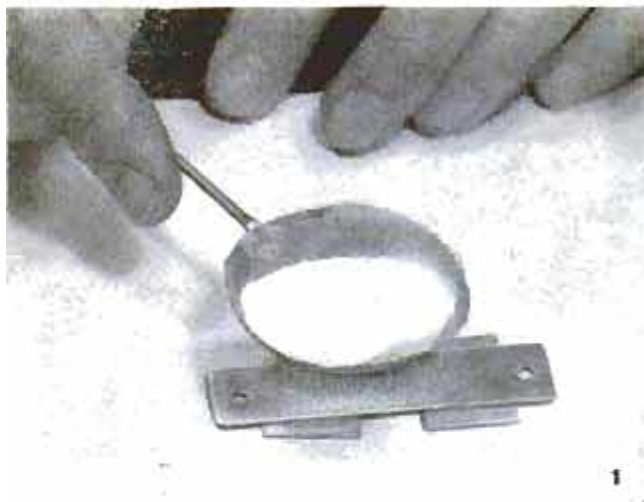

To make sign weatherproof, both sides are enameled. Back is sprinkled with enamel powder and fired first

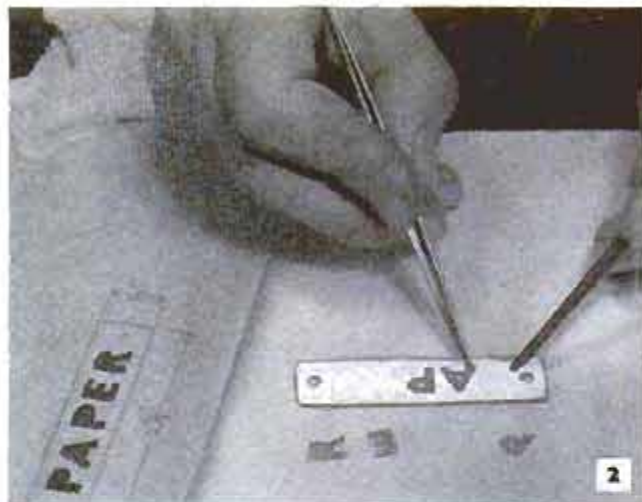

After front is fired, cutout letters are spaced on sign and powder is sprinkled over letters and sign

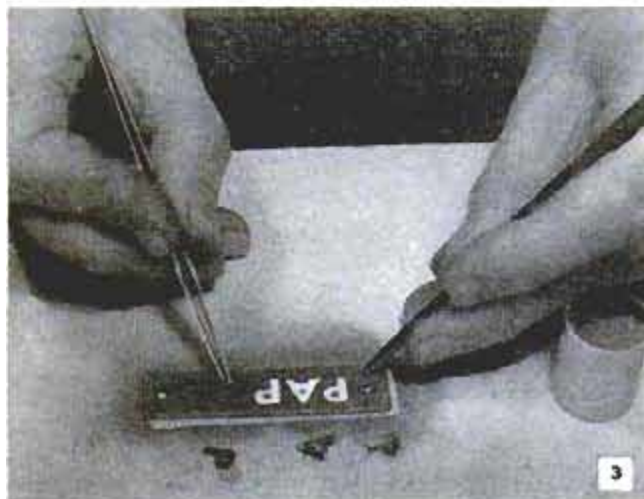

Tweezers are used to lift letters to which tab is attached, thus removing powder from letter spaces



Finally, firing hardens last coat of enamel of contrasting color and attractive sign is ready for use

## Enameled

WTM 59

## NAMEPLATES

MANY PEOPLE whose hobby is enameling ornamental objects, such as ash trays, pins and brooches, overlook more prosaic but equally useful items like nameplates and signs. The fired enamel is fadeproof and highly resistant to weathering and wear, which makes it an ideal material for signs to be used in outdoor locations. Described in this article is a sign with the word "paper" enameled on it, to be used over the door of a built-in receptacle on an enclosed porch. It will no doubt suggest other signs of similar type for other uses. One such application would be a sign over the milk door, which is a feature of some homes as a precaution against delivered milk being frozen in winter weather or providing neighborhood cats with breakfast. An address and nameplate near the front door would be well done in enameled letters and numbers.

Both sides of the signplates are to be enameled, so apply the enameling powder to the back, Fig. 1, and fire it in a kiln. The plate may be slightly curved when removed from the kiln, but will straighten when enamel is applied to the front. On the front side of the sign now apply and fire a layer of enamel of the color the letters are to be. Letters for the sign are made by drawing, or by tracing them from a newspaper or book. Cut the letters from fairly stiff paper, then attach a tab of cellulose tape to each one. Place the letters on the enameled background, Fig. 2, then sprinkle enamel powder of contrasting color over the sign and letters. Next, using tweezers, lift the letters by the tabs, Fig. 3. Remove any powder that falls in the letter spaces. Finally, fire the piece and your sign is completed, as in Fig. 4, ready for many years of service.



## Card Makes Pinless Badges

Ribbon badges worn by officials and delegates to conventions and similar meetings need not be pinned to shirts or coats if they are stapled to pieces of cardboard cut to fit the pocket. Besides permitting the badges to be removed quickly, the cardboard eliminates pinholes in garments.

## Eraser Used as Scouring Pad

A typewriter eraser with wedge-shaped ends can be used with or without scouring powder to remove small burned spots on metal pans, and to clean between the tines of forks. The nonabrasive end of the eraser can be used on enamelware pans and on dishes.

## Flashlight Slide Viewer

Color transparencies can be viewed with the aid of a flashlight if a bracket is provided to hold a magnifying glass over the light as shown. Cut the bracket from sheet metal and secure it to the flashlight with a rubber band. The rim of the magnifying glass is supported by the bracket, while the handle rests on your hand. If the light beam is uneven, cover the flashlight lens with tissue paper for a diffuser.



## Reflector Is Mailbox Flag

The usual red-painted flags on rural mailboxes are difficult to see in poor light, whether in the raised or lowered position. To assure easier visibility, as well as eliminate the need for frequent repainting of the flag, one farmer attached a large bicycle reflector in its place. The flag was cut off and the arm was drilled to accommodate a bolt which was used to attach the reflector. An added advantage of the reflector is that it gives warning of the mailbox location to passing cars and thereby reduces possible damage.

JANUARY 1958



## Repairing Torn Book Pages

Thinned library paste and white tissue paper are ideal for mending tears in book pages. First, place wax paper under the tear and spread the torn edges with paste. Brush paste on an area around the tear and press on a piece of the tissue. Pat the paper dry, wipe off excess paste and sprinkle on talcum. Repeat the operation on the opposite side of the page. For replacing the corners of pages that have been broken off, use cigarette paper. Cut a triangle of the paper slightly larger than necessary and paste it on the corner. Turn the page over and paste a similar triangle on the opposite side. Then trim the triangles.

Emma A. Musculus, Manistee, Mich.

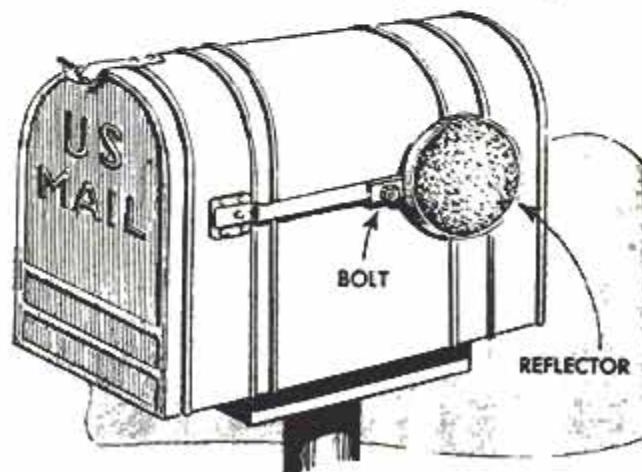
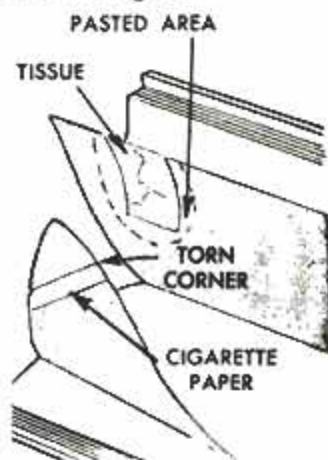

191





Chloroform applied with cotton balls cleans grease-spots on delicate fabrics without leaving rings

# ABC

## OF STAINS



**M**ANY STAINS that are considered difficult or impossible to remove, simply require application of the correct cleaning agent for removal of the discoloration. If the stain is removed within a short time, cleaning is made much easier since most liquids that stain readily set or dry with time. The cleaning hints shown on these pages will aid you in removing stains from various materials. ★ ★ ★

Stains on felt hat, if not caused by perspiration, usually are only on surface. Such stains are best removed by rubbing them gently with fine sandpaper



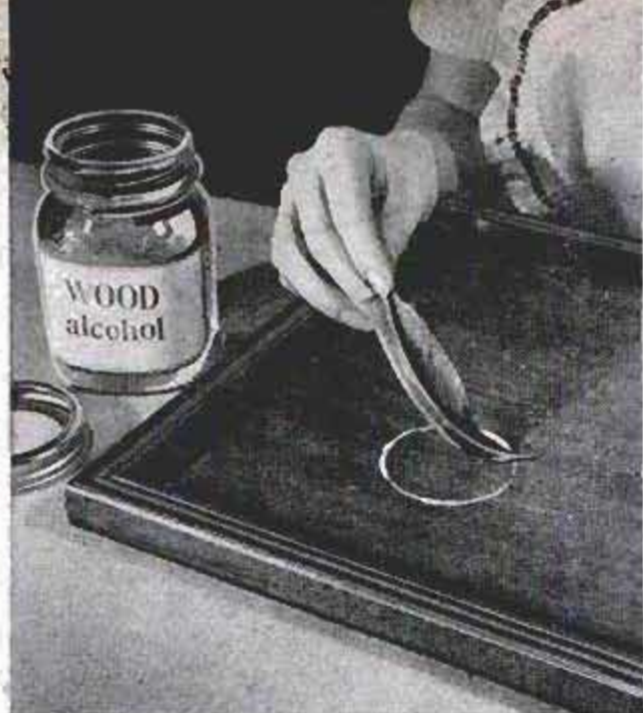

Ring on varnished surface is made less apparent by brushing it with a feather dipped in wood alcohol



Remove inkstains by sponging with oxalic acid, then wiping with cotton balls saturated with ammonia

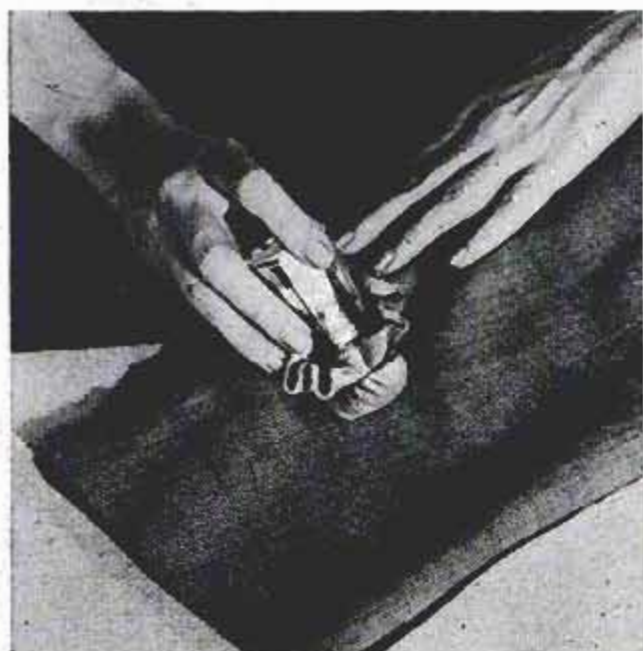

Above, spot remover made from salt shaker has cap filled with cotton, covered with cloth. Shaker is filled with solvent. Below, wood surface too stained for repair is covered with cloth print and shellacked



Above, sponge paintspots with turpentine, allow to soak. Repeat until softened paint can be removed. Below, nap on suede leather is restored by buffing shiny spots with emery board from manicure kit

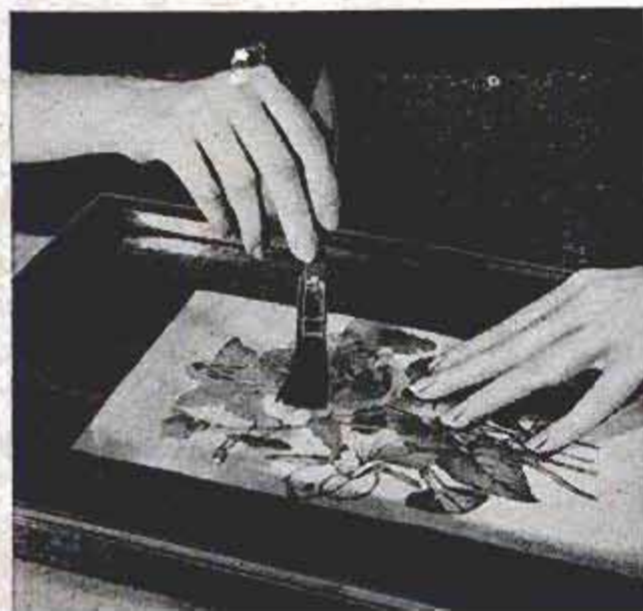



## Coiled Extension Cords Don't Become Tangled When Stored

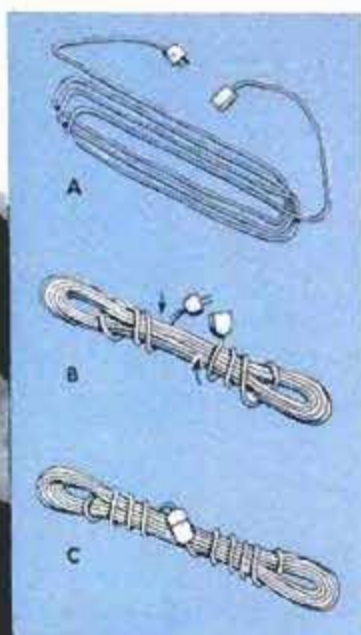

To prevent extension cords from becoming tangled when stored, one homeowner coils them as shown. To do this, coil each cord on your arm so that about 15 in. of cord at each end is left uncoiled, detail A. Then, bring each end through the coil loop nearest to it and tightly wrap them around the coil. One end is wrapped in a clockwise direction and the other in the opposite direction but with the turns of each directed toward the center of the coil, detail B. After the plugs are joined together, detail C, the coil cannot unwind.

## Undercut Hole Holds Wood Filler

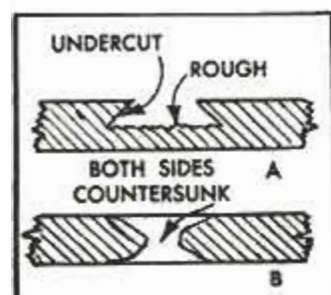

When filling a hole in plywood or wood, the filler is more likely to remain intact if the hole is undercut and prepared as shown in detail A of the drawing. If the hole should extend through the material, both sides of it should be countersunk as in detail B.

C. A. Phillips, Corning, N. Y.

extend through the material, both sides of it should be countersunk as in detail B.

## Identifying Receptacle Plates

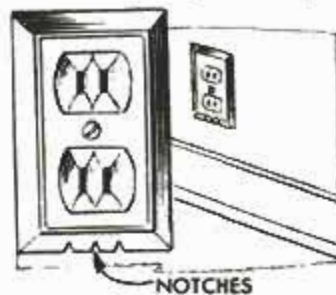

For easy identification of the circuit to which an electrical circuit is connected, one home craftsman files a certain number of notches in each wall plate as shown in the

drawing. The number of notches in each case corresponds to the circuit number to which the receptacle is connected.

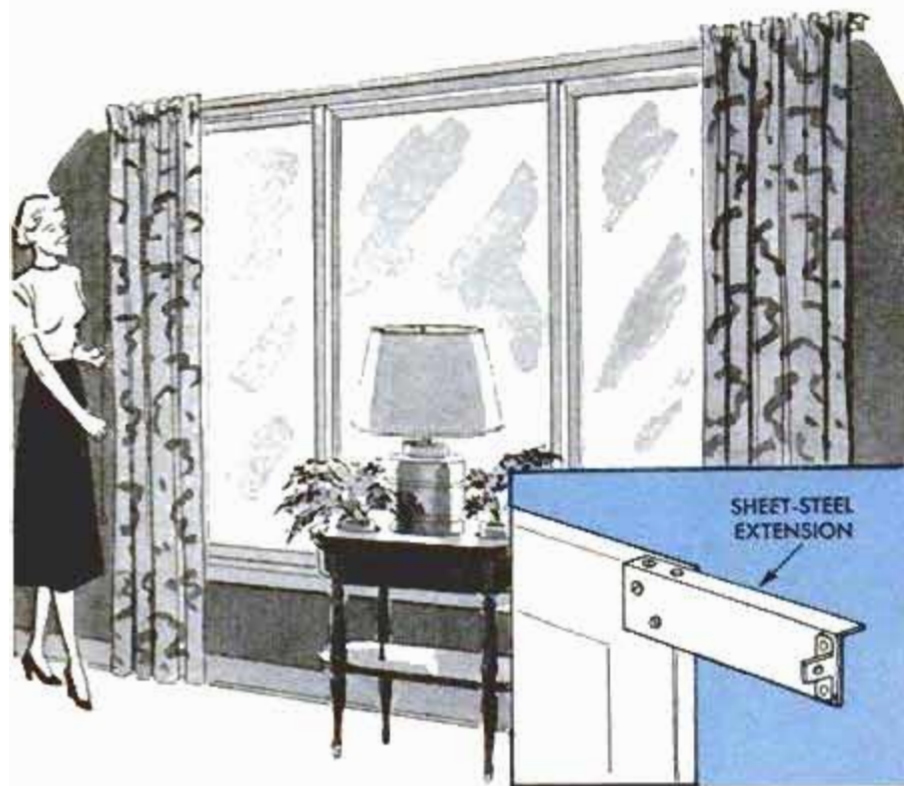

## Drapery Extensions "Enlarge" Windows

Windows appear larger and admit more light when the drapery hardware is mounted on extensions made of sheet steel as shown. This permits the draperies to be pulled open so that nearly all of the window is open to view. The extensions are formed from 16-ga. sheet steel and screwed to the window frame, one on each side to extend about 6 in. from the frame as shown in the detail. The old drapery brackets are removed from the window casing and bolted to the ends of the extensions.



# Appliance Data Stored In "Picture Cabinet"

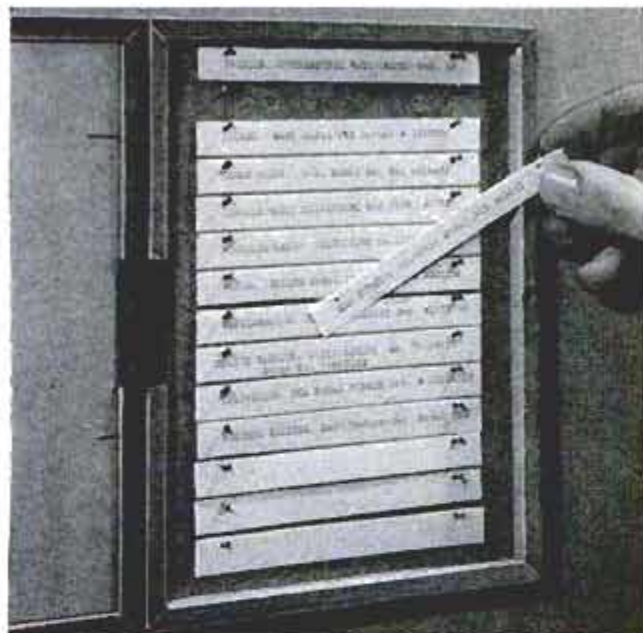
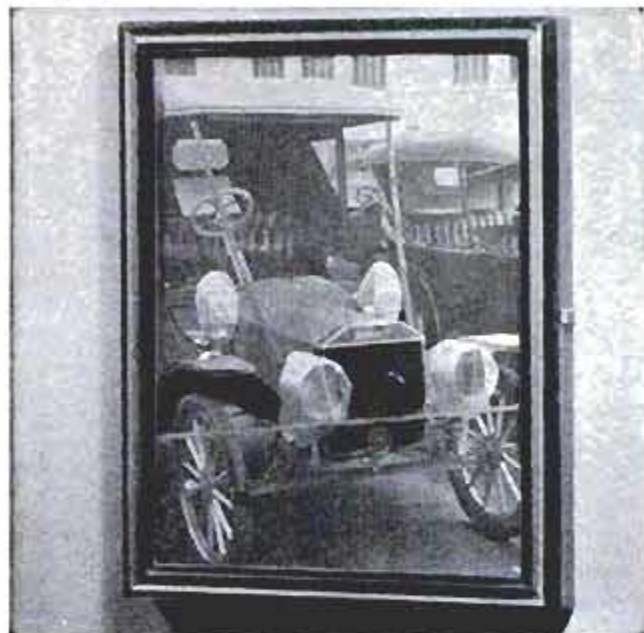

Above, appliance-data cabinet appears to be ordinary picture. However, picture frame is door of shallow cabinet that contains cards with important data on home appliances typed on them, upper right

Model and serial numbers of household appliances are kept conveniently at hand by one homeowner, by recording this data on small cards and filing them in the camouflaged cabinet shown in the photos above. The cabinet is a shallow wall box with a hinged picture frame attached to function as a door. Since the over-all thickness of the frame and cabinet is less than 1 in., the unit looks like an ordinary picture. To make the cabinet, obtain a small picture frame with outside measurements of about 6 x 8 in. Then, make a shallow cabinet the same size as the picture frame as shown in the drawing and detail. For the sides of the cabinet,  $\frac{3}{16}$  x  $\frac{9}{16}$ -in. pine, oak, walnut or other suitable wood can be used and  $\frac{1}{8}$ -in.-thick plywood or hardboard can be used for the back. The picture frame swings on a 2 x  $\frac{3}{4}$ -in. butt hinge mortised into the frame and cabinet as shown. For an inconspicuous means of keeping the door closed, a length of spring brass is bent to form a friction-type catch and screwed to the frame as in the detail.

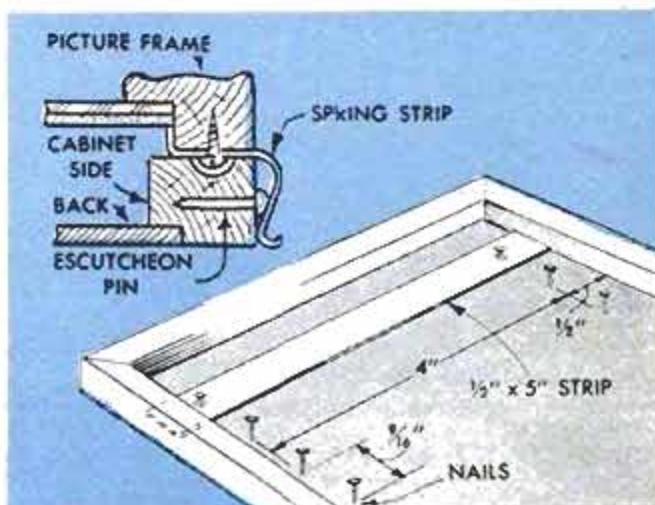

An escutcheon pin, driven into the side of the cabinet frame as shown, holds the catch when the door is closed. The data cards or strips are cut from 3 x 5-in. file cards and holes are punched near the ends of each so that they can be hung on nails as shown in the drawing. The nails should be slanted upward to keep the cards in place. When an appliance is replaced by a new one, a new card is made up and placed on the nails over the old one so that a complete service record is maintained. Finish cabinet to match the picture frame.

## Glass Strip Is Dodging Tool

The next time you make a print that requires dodging (underexposing selected areas of a print), try using a strip of glass with the desired shape of the mask painted on it as shown. Use any water-soluble paint for this purpose so that the mask can be removed and a different mask applied for each subsequent use. A strip of clear plastic can be used instead of glass.

Richard Hanscom, Elmhurst, Ill.







**SORTING GARMENTS** in a clothes closet is easy if you use a wooden bar pivoted to a shelf as indicated above



**UNROLLING A PIECE OF LINOLEUM** to measure it is unnecessary if it is pulled out to spiral one end as above. This exposes the turns of rolled linoleum so that a tape can be used for measuring it

**WHEN WORKING WITH PLANTS** in small pots, try using a shoehorn as a trowel. You will find it ideal for this purpose. In some cases, it may be necessary to bend the horn slightly for the job



# Solving HOME PROBLEMS

**IF YOU NEED SOMEPLACE** to hide valuables, look at the back of some of the drawers in your home. If space permits, a wooden pocket may be glued to the back of a drawer to provide a secret hiding place

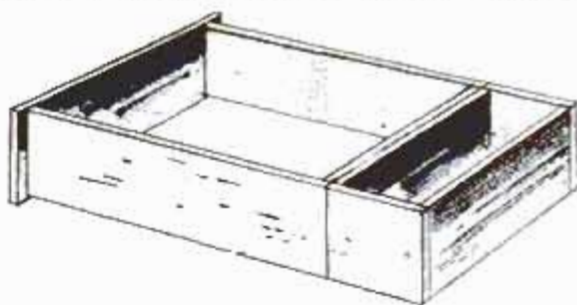

**SPLINTERING** of a chair or table leg when shortening it will be avoided if masking tape is used as shown below. Wind the tape on the leg so that one edge is flush with the cutting line on the leg

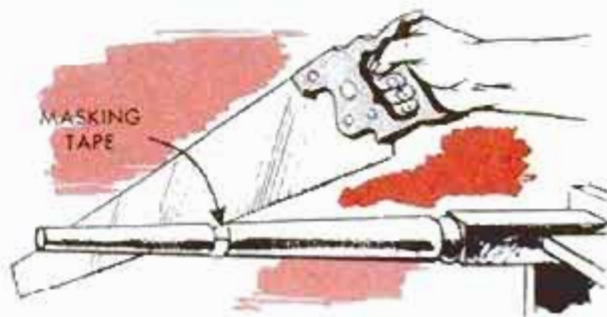

**LIQUID SOAP** is easy to make by breaking up cake soap and dissolving it in a water-filled canning jar as shown below. This is a good way to utilize small pieces of cake soap that are often discarded





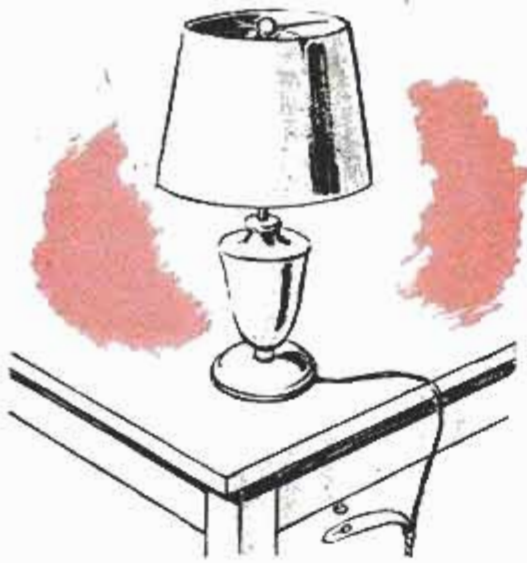

**A SMALL CHILD** can't pull a lamp from a table if the cord is attached to the table as above. Just cut a keyhole in a leather strap and tape it to the cord



**WHITE, OPAQUE JARS** that contained shampoo, cosmetic creams or similar substances may be used as decorative containers on a dressing table, or in the bathroom or kitchen. Clean the jars and then decorate the covers with enamel and decals

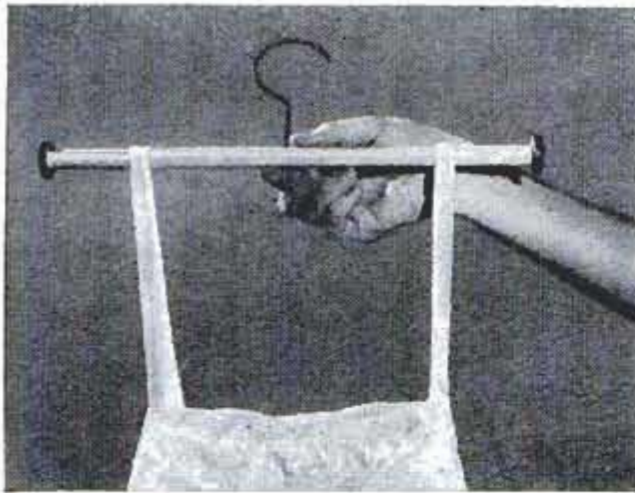

**GARMENTS HUNG BY SHOULDER STRAPS** will not slip off this hanger, which is merely a length of  $\frac{1}{2}$  or  $\frac{3}{4}$ -in. dowel fitted with a wire hook. Wooden disks of slightly larger diameter are screwed to the ends



**DO YOU HAVE DIFFICULTY** using a coaster in a dimly illuminated room while watching TV? Try ordinary paper plates. They provide table protection, and are easily located without distracting attention

**IF USUAL METHODS** have failed to remove a tight-fitting ring, use aluminum foil. Wrap it snugly around your finger and over the knuckle; slide the ring over it



**WITH A  $\frac{3}{4}$ -IN. WOODEN BLOCK** and a few 16d nails you can make this spool-and-bobbin rack in a few minutes. Drive the nails through the block and file off the points. It is a good idea to drill pilot holes for the nails to avoid splitting the wood

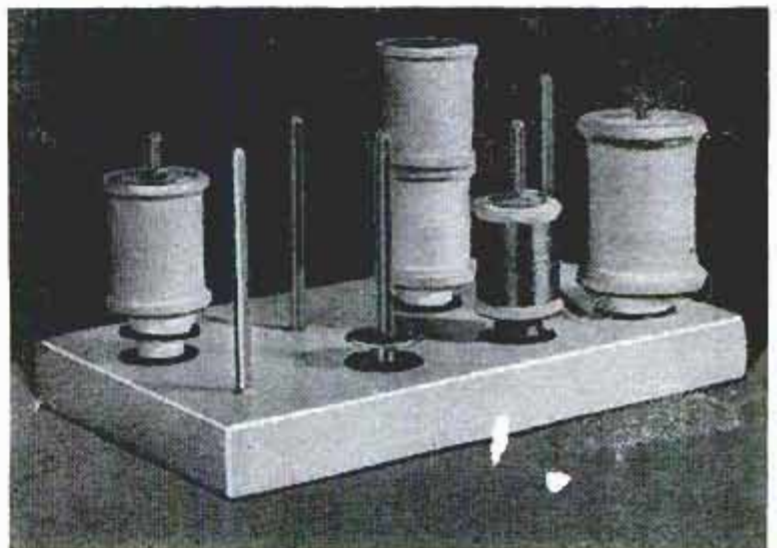



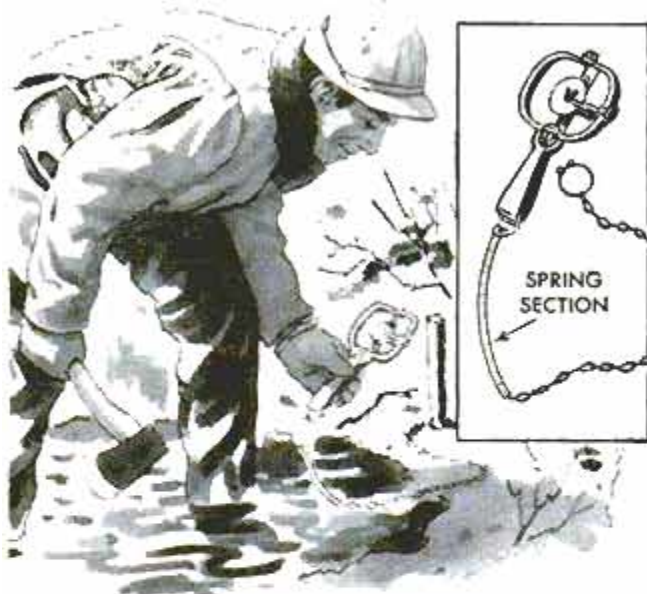

### Spring Reduces Trap Losses

To prevent animals from jerking free of chained-down traps, one trapper fits a length of screen-door spring between each trap and chain. Pulling on the trap then causes the spring to extend and act as a "shock absorber," so an animal cannot brace against the trap and pull itself free.

H. W. Swope, Danville, Pa.

### Tool for Removing Light Bulbs

Removing and replacing out-of-reach light bulbs is no problem with a tool made from the bulb clamp cut from a lamp shade. It is attached to the end of a dowel or broomstick and wrapped with a few turns of friction tape. Bend the clamp so it squeezes firmly on a bulb to both rotate and hold it.

### Arrow on Platen Tells Typist When End of Paper Is Reached

To determine when you are near the lower end of the paper in a typewriter, try the following method: First, paint a thin white line straight across the roller. After the paint dries, insert a sheet of standard typewriter paper and align the upper edge with the line. Then, mark the front edge of the paper at the bottom where you normally type the last line. Run the paper through the platen until the mark appears

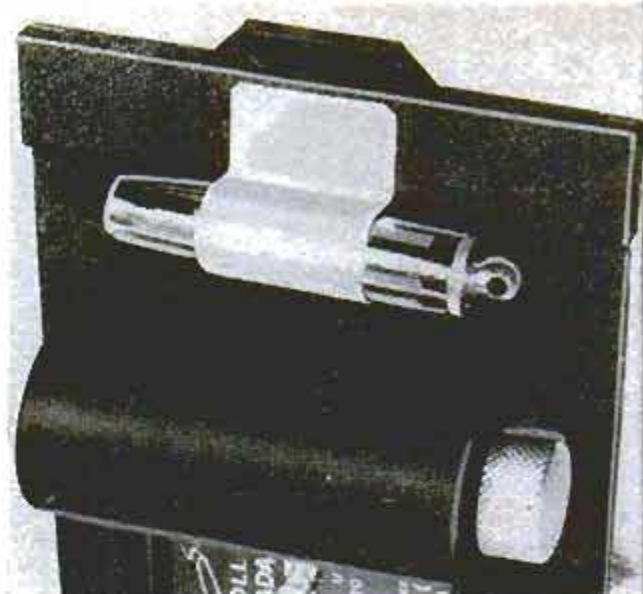

### Flashlight Is Camera Aid

Attached to the side of a camera, a penlight will prove handy for focusing and aiming when taking shots in dim light. The bracket for the light is bent from a piece of light sheet metal, then soldered or screwed to the camera case and painted to match the camera.

John J. Rea, Urbana, Ill.

### Olive Oil Removes Paper

Paper that has become stuck to a polished wood surface can be removed without damage to the finish by using olive oil. Place a few drops of the oil onto the paper and wait until the paper absorbs it. This will loosen the paper, after which it can be peeled off. The excess oil now can be wiped up with a soft cloth.

on the roller and paint an arrow on the platen pointing to it. To use the markings, align a sheet of paper as mentioned above, start typing and when you observe that the sheet is nearly completed and the arrow appears as shown in the photo, you have space for one more line. You'll find that the arrow makes two revolutions per sheet of typing paper.

Robert L. Hay, Rochester, N. Y.





# Plastic Juice Containers Speed Film Processing

By Karl Mickelson



Above, plastic juice containers permit accurate developing of three reels of film at one time. Below, paper bags protect solutions from light damage when stored in same containers as used for developing

WHEN USING a rapid developer (1 min.) for processing roll film, plastic juice containers such as the ones shown, permit instant transfer of film from developer to short-stop solution. This reduces the chance of overdeveloping negatives, as when a daylight-type tank is used, with the attendant lapse of time necessary to pour the developer from the tank and refill it with the short stop.

Also, multiple reels of film can be processed at one time by bending a tee on one end of a 20-in. length of stainless-steel wire and stacking the reels on it as shown in the photo above. Besides being a timesaver, this idea is useful for making a comparison check between different rolls of film developed for the same length of time. Solutions need not be removed from the plastic containers for storage after each time of use as when a daylight developing tank is used. Simply replace the airtight lids and slip a paper bag over each of them as shown, to prevent light damage.

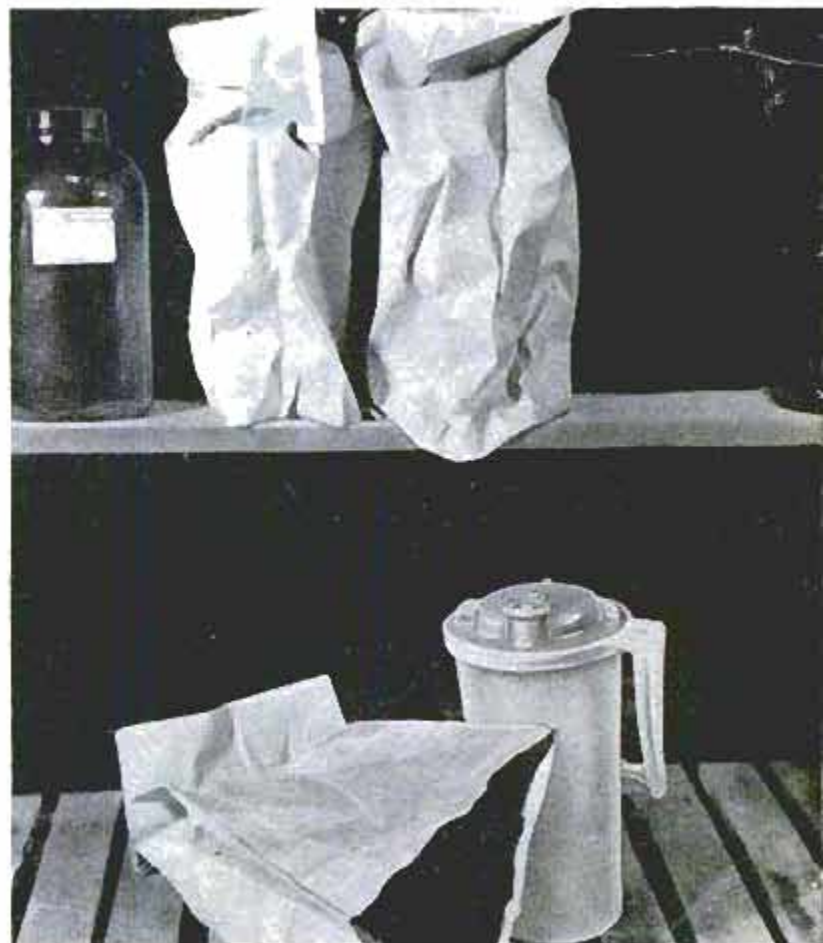





AFTER

BEFORE



Above, before and after photos show dramatic difference resulting from application of ceramic tile

Below, wallboard and plywood are nailed to fireplace, walls and floor to provide surfaces for tile

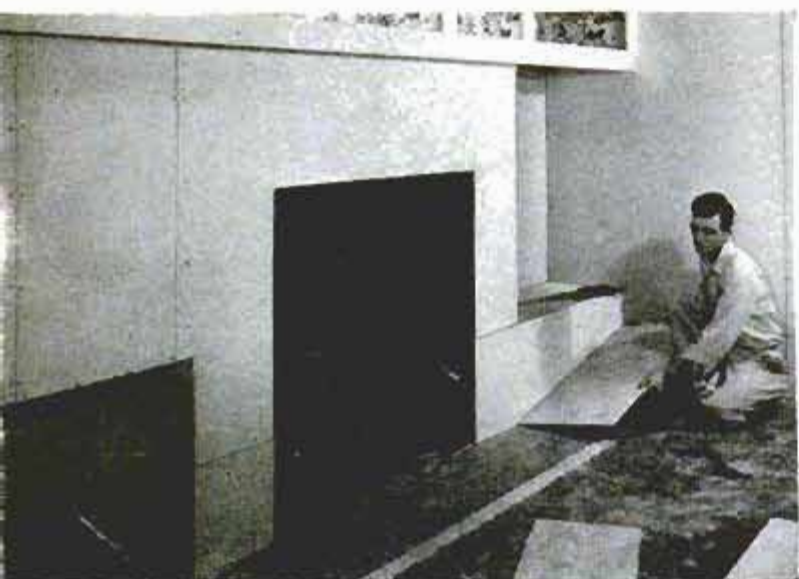

## X 160 WTM 59 Modernize

INSTEAD OF CONSIDERING an old-fashioned brick fireplace a problem when remodeling and modernizing a home, make it an eye-catching center of attraction with the aid of ceramic tile. Available in more than 200 colors, and a wide variety of shapes, sizes, textures and patterns, one or more types of tile can be chosen to match or contrast with any decor, whether it be modern or period.

Necessary alterations to permit the installation of tile consist of providing smooth surfaces on which it can be attached with adhesives, lower left-hand photo. Adjacent to the fireplace opening, fireproof asbestos wallboard or gypsum wallboard is cemented and nailed to the brick with masonry nails. Away from the opening, wallboard and plywood nailed over wood framing are used for surfacing materials. All joints in the surfacing materials should be taped, plastered and sanded smooth. If the hearth directly in front of the fireplace is brick, it is covered with a coating of mortar so it is flush with the plywood used to cover the floor on either side, upper left-hand photo, opposite page. During the remodeling, overhead storage cabinets can be installed, and space provided for storing firewood. On the fireplace shown, unglazed mosaic tiles were used on the vertical surfaces, larger-sized glazed tiles were used on the horizontal surfaces. Glazed tiles require soaking overnight, mosaics do not.





Mortar over brick hearth brings it flush with plywood nailed to floor on both sides of fireplace



Toothed spreader is used to spread adhesive smoothly and evenly over surfacing material for attaching tile

## With Ceramic Tile

since they absorb little water. Adhesive is troweled on the surfacing material, the tiles are installed and time allowed for the adhesive to set. Next, grout is applied and the excess removed with a squeegee. The tiles are wiped with a damp cloth, then finally polished with a dry cloth. To assure thorough curing, the grout should be kept moistened for the first eight hours. For cutting either glazed or unglazed tile, a regular cutter does the best job. However, glazed tiles can be scored with a glass

Mosaic tiles come in 1 x 2-ft. sections, pasted on a sheet of paper, which permits faster application

cutter on the face, then tapped on the back side to crack them. Unglazed tiles are "cut" by breaking with pliers or pincers. Cut edges are smoothed with a dry oil-stone. Photographs on these pages show a step-by-step installation of tile on a typical fireplace. Dimensions and locations of storage areas and seats will vary with each individual fireplace and choice of decor. But in all cases, the finished product will be beautiful, and requires only occasional cleaning with a damp cloth. ★ ★ ★

After adhesive has set for about 1 hr., paper on mosaic tiles is moistened, peeled off as shown







Glazed tiles are used to cover floor and hearth, as well as walls of firewood-storage space. These tiles require overnight soaking before they are installed



Glazed tiles can be cut by scoring on face with ordinary glass cutter, using another tile as straightedge. Score should be parallel with ribs on tile back

Below, tapping scored tile on back fractures it on score line. Regular tile cutters are available, make the job easier and assure that fewer tiles are wasted

Below, grout is forced into joints, using either hands or a sponge. Grout should be consistency of heavy cream to assure complete filling of joints



Below, after grout is applied, excess is removed by using rubber squeegee. Action of squeegee also tends to compact grout more firmly into the joints

Below, damp sponge is used for final cleanup, after grout has set firmly. Powder film left after moisture dries is polished away with soft, dry cloth

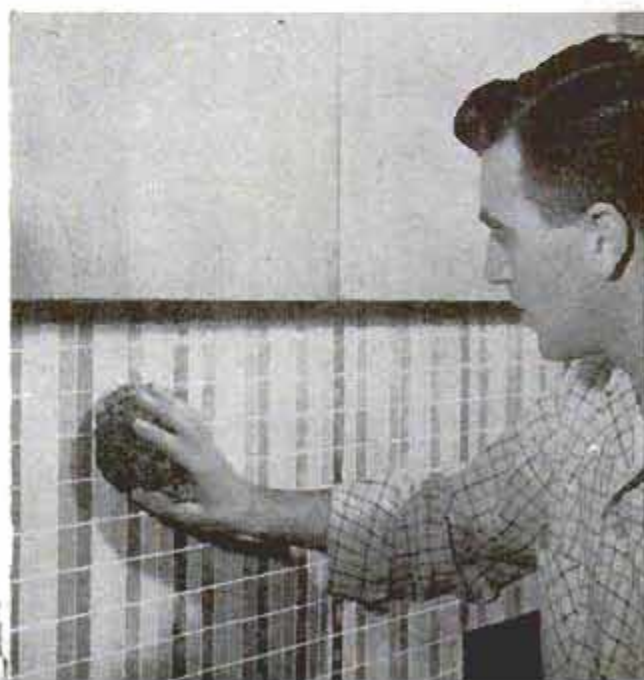



# Special Leash Holds Small Dog on Car Seat

To prevent injury to a small dog that rides on the front seat of the car, one dog owner secures the dog's leash to a sponge-rubber ball that is wedged between the back and seat cushions as shown. A short leash is used for this purpose so that the dog cannot slide off the seat at a sudden stop. Restricting the dog's movements in this manner also saves the instrument panel from claw scratches.

## "No Spill" Birdseed Dispenser

For a handy container for filling seed or gravel cups, one bird fancier removes the top from a table-salt container of the type that is fitted with a metal pouring spout and fills it with the desired material. After the top is replaced on the dispenser, masking tape is used to reseal it. All traces of salt must be removed from the container before using it for this purpose. — Mrs. Joyce R. Pelella, Highland Falls, N. Y.

## Draw Freehand Curves

With a little practice, curves of large radii can be drawn freehand using a pen or pencil and a bearing for an axis as shown in the photo. To do this, simply place a small roller bearing under your wrist or forearm, depending upon the radius of arc desired. Then, hold a pencil between the thumb and index finger and rotate the entire arm to draw the arc desired.

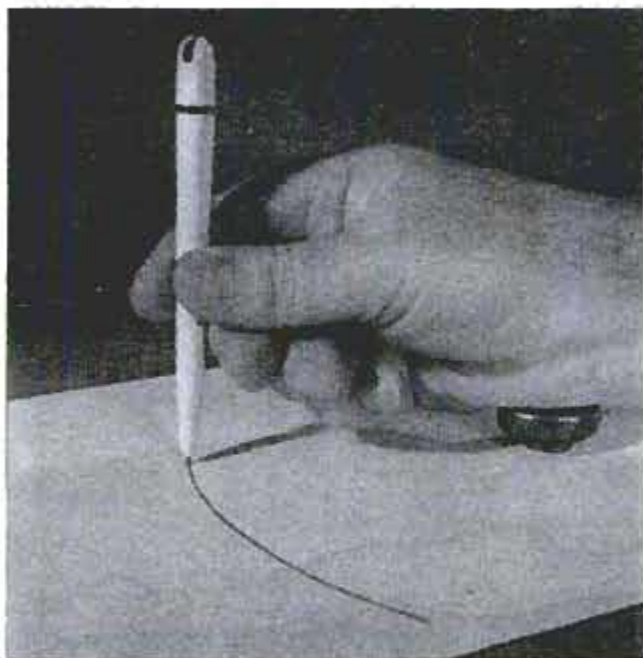

☞ You can help your children keep their rock and shell collection neatly stored, yet within reach when they want it, by providing them with empty egg cartons for storing the items.



## "Preview" 35-mm. Negatives

A small slide viewer of the type shown provides an excellent means of examining 35-mm. and other small negatives in roll form when selecting frames from which enlargements or prints are to be made. For easier feeding of negatives through a plastic viewer, enlarge the slot at the bottom to provide proper clearance.

H. Leeper, Canton, Ohio.



☞ When purchasing a paintbrush, keep in mind that the bristles of the best brushes have long tapered tips and split ends. The bristles are of different lengths and are formed to a full head.



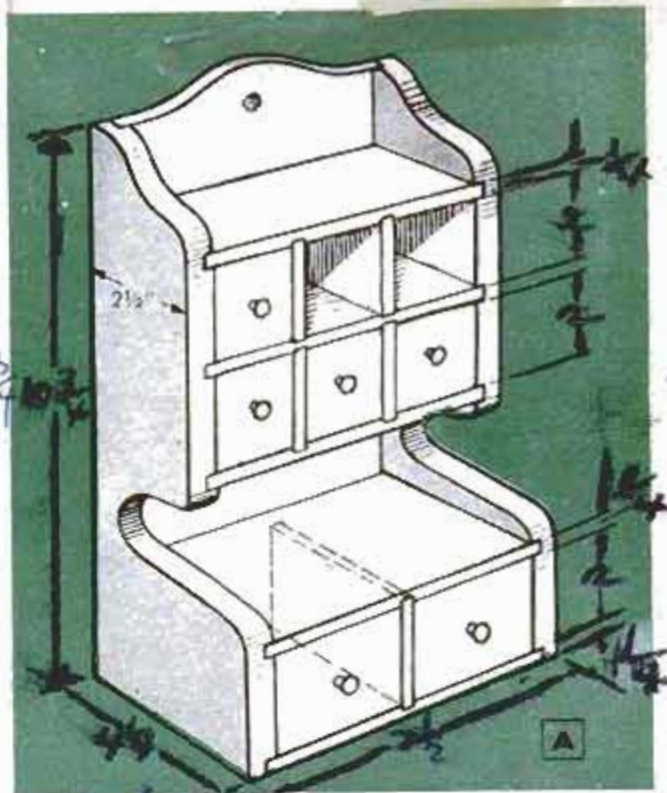

Quaint and charming as grandmother's kitchen, this spice cabinet still goes well with modern decor

# Spice Cabinets Add Charm to Room

By Don C. Skillman

ALTHOUGH MODERN packaged spices have made spice cabinets somewhat obsolete, the charm of these little pieces of furniture has increased over the years. If your home decor is colonial or Early American, the designs of typical spice cabinets, as represented by the three details, A, B, C, are especially appropriate. But even in a modern decor the cabinets make fine conversation pieces, as well as being good showpieces for knickknacks and storage space for small odds and ends.

Patterns for two of the cabinets are made

by enlarging the squared drawings, the third cabinet has no curves except for the circular keyholed projection at the upper end of the cabinet back. All joints in the cabinets are glued and nailed with small brads. Use care when cutting the small pieces for the drawers. For greater safety on a circular saw, rip a length of stock to the right width, then "slice" off pieces of the right lengths for the drawer sides and backs. Use the same method for the drawer fronts, cutting rabbets on a length of stock, then cutting it up. ★ ★ ★

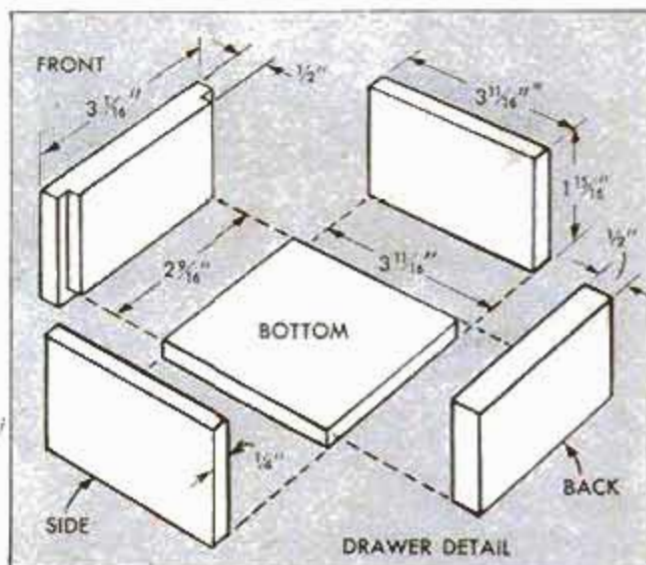
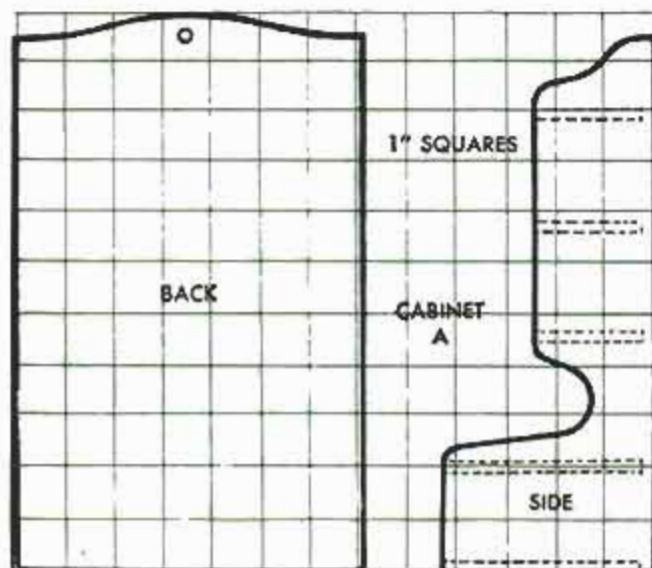



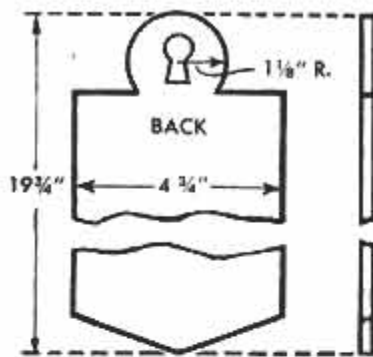
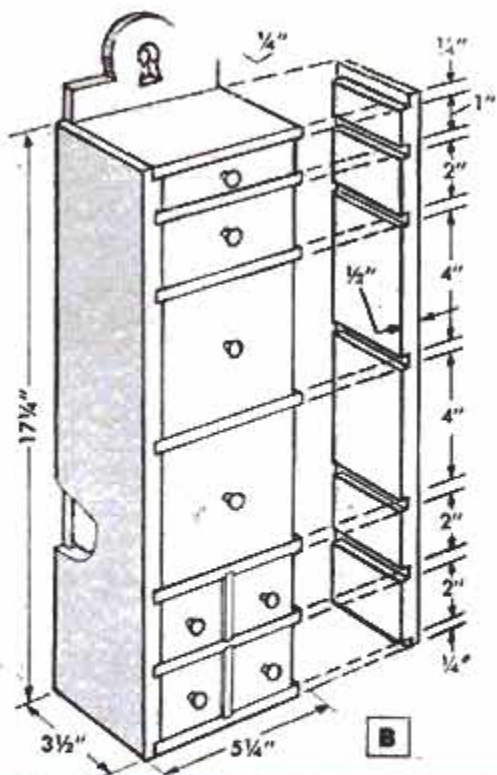

Depending on whether your selected wall space is vertical or horizontal, one of the two cabinets on this page will meet your requirements. Horizontal cabinet has more space for knickknacks on its top; vertical cabinet has more drawer storage space. Either cabinet is an attractive and practical decoration

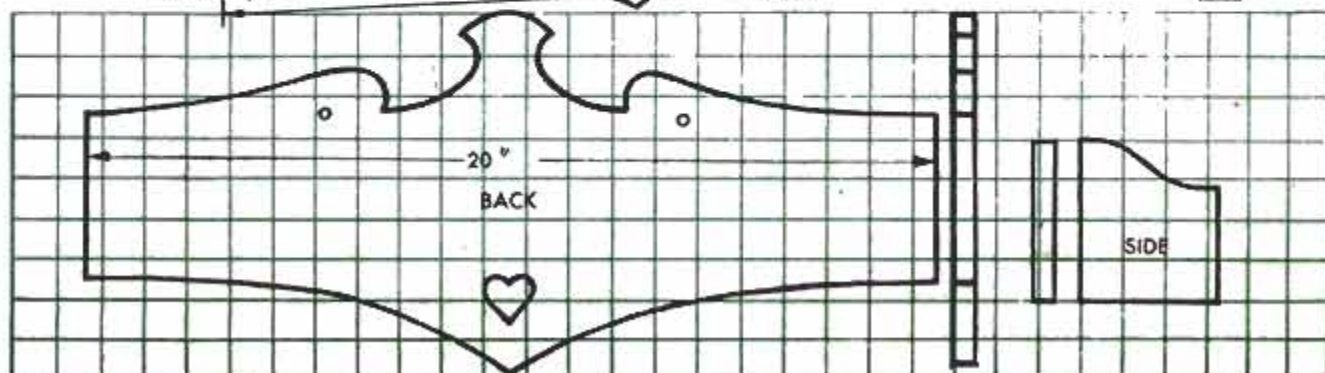
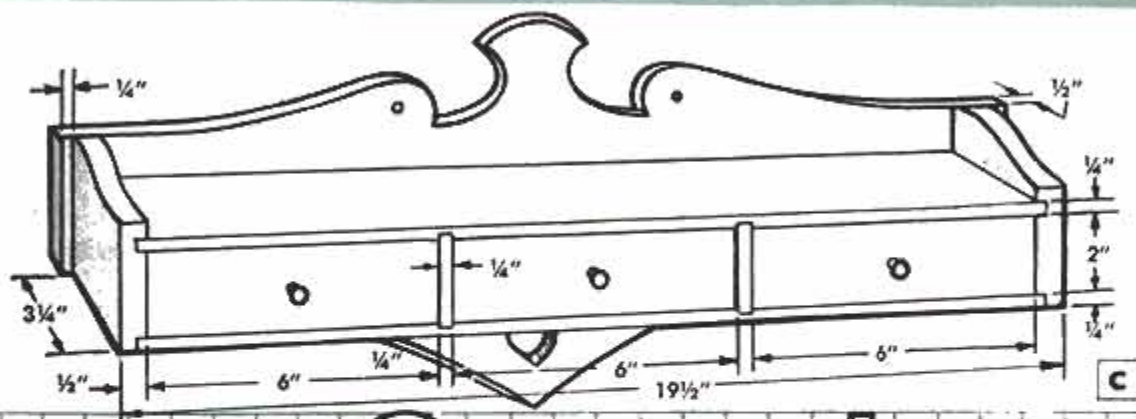
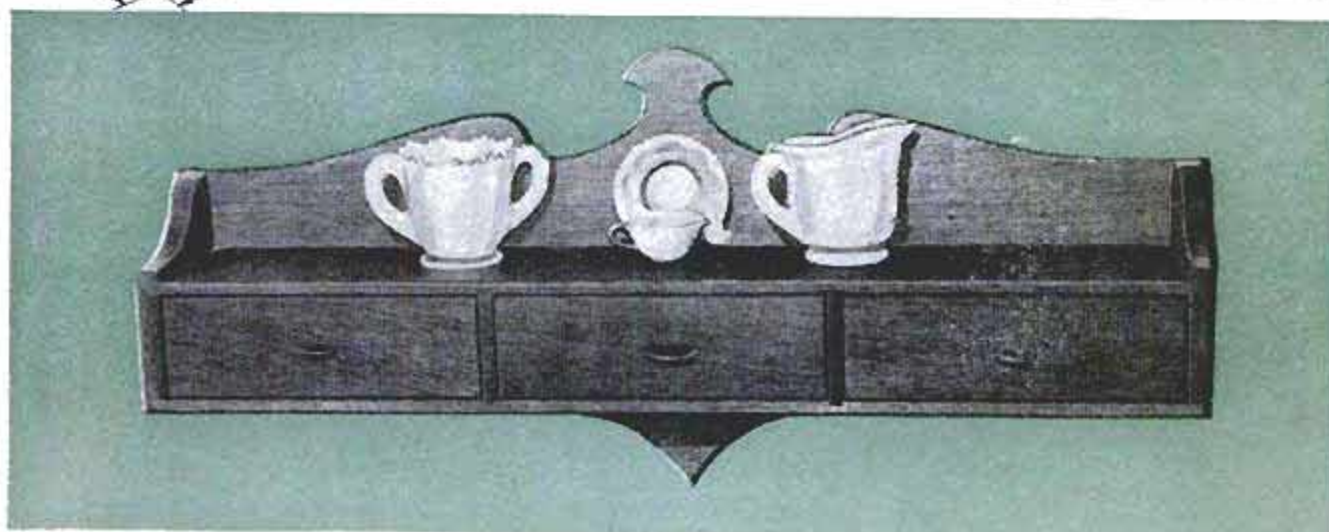



# KITCHEN MEMO PAD

By Bertram Brownold



Below, aluminum cutout is sandwiched between two blocks of wood, drilled for bolts and then clamped

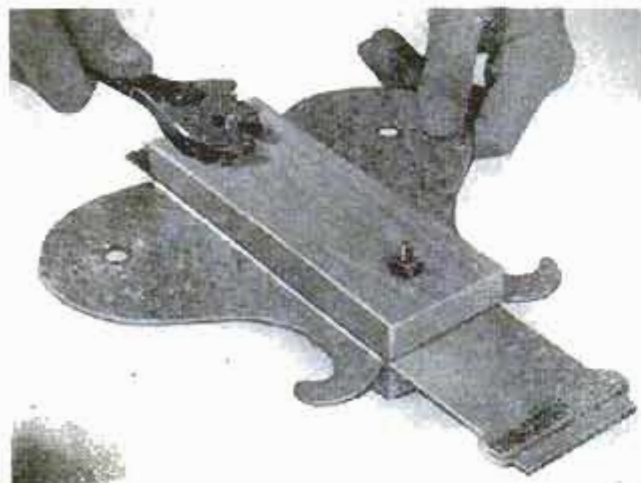

HUNTING FOR SLIPS of paper to jot down grocery lists, family notes and other reminders is a thing of the past for the lucky housewife whose husband makes this roll-type memo pad. A 3000-in. roll of adding-machine tape, which rotates on a shaft mounted between two arms of the holder, provides a goodly supply of note paper. Make a full-size pattern from the squared drawing and trace it on a 9 x 12-in. sheet of soft aluminum. Note that both sides of the wing portions of the cutout are given a hammered finish after the aluminum is cut out and before the sides are bent at right angles. A ball-peen hammer is used to produce the hammered dimple finish. Two blocks of wood clamped to the center portion of the cutout by drilling two holes in the aluminum for bolts, permit sharp bends to be made. A brass rod threaded at the ends for cap nuts, serves as a shaft for the roll of tape and makes it easy to refill the holder with a new roll of tape. A strip of flat aluminum is riveted to the holder at the bottom for tearing off the paper. Two small washers under the strip and over the rivets will permit the paper to pass underneath. The upturned scrolls on the sides of the holder form a rack for a pencil. A hanging hole is provided at the top of the holder for attaching it with a screw.

Below, sharp bends in sides of holder are made by hammering metal against wooden clamping blocks

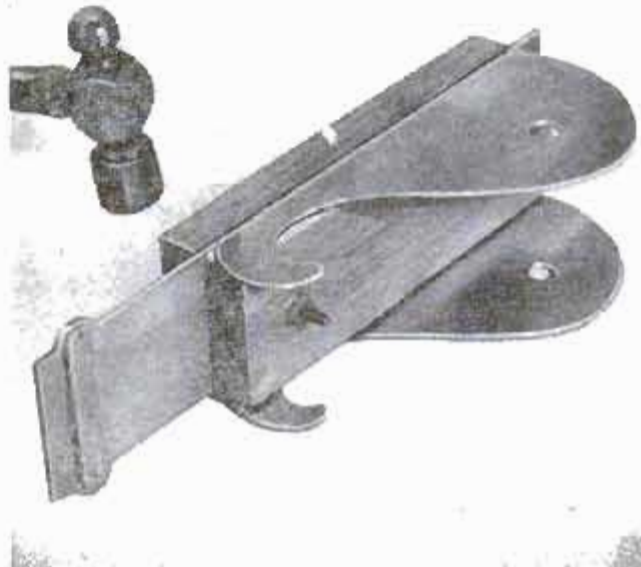
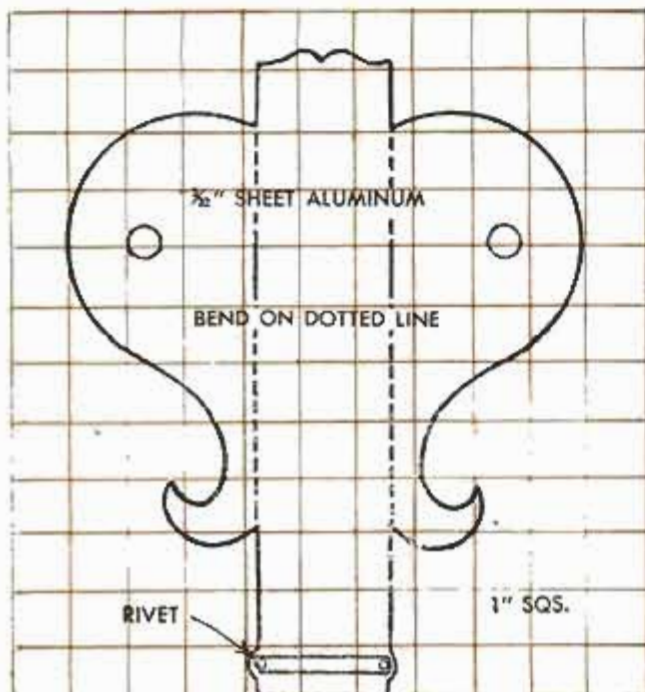



### Supercage for Parakeet Assembled From Wooden Dowels

Here is a king-size cage that will let a parakeet or canary flutter about in grand style. It is made primarily from 86 standard 1/4 x 36-in. dowels. Two dowel-fitted end frames are made of 1 x 2s ripped down the middle. Blind holes are drilled 3/4 in. on centers on adjacent faces of the members to receive the dowels. Drilled strips of lattice stock support the dowels at the center of the cage and form a doorway 7 1/2 in. square. The combination door and ladder pivots on a dowel and the slight spring to the dowels

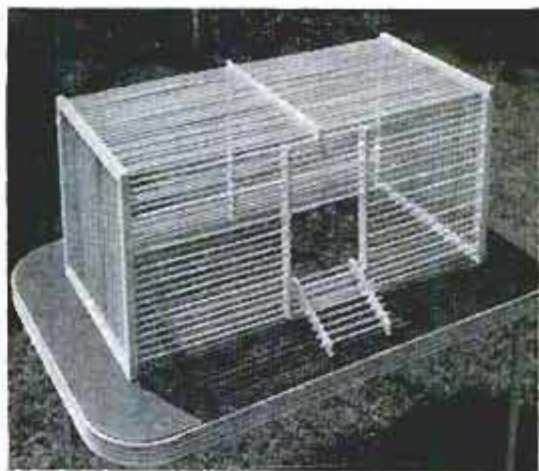
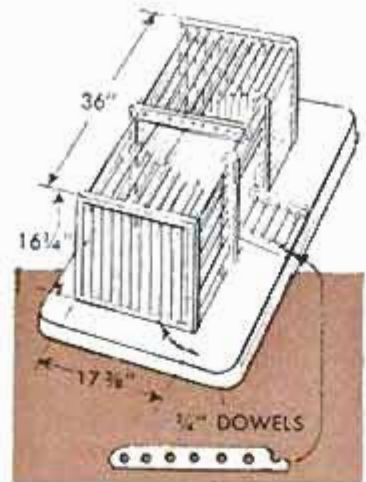

holds it shut. The swing-down door makes it easy for a bird to re-enter the cage when permitted to fly about the house.

### Miniature Shop "Bellows"

Consisting of a soda straw stuck in a hollow rubber ball, this miniature "bellows" is ideal for blowing dust and dirt from difficult-to-reach locations. Blowing such debris with your mouth always invites the risk of having foreign particles blown into your eyes and causing trouble.

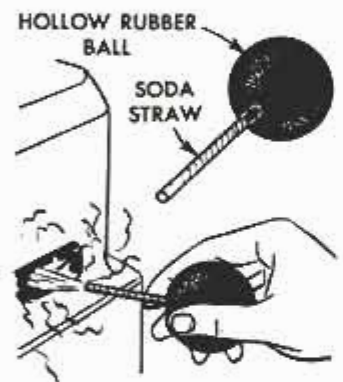

### Faster Photochemical Mixing

For more rapid mixing of photochemicals, use a "piston" rather than a stirring rod. The piston is a plastic disk, drilled and forced onto the end of a plastic penholder. The metal insert in the end of the penholder is removed. When the piston is plunged up and down in the liquid, it creates rapid circulation.

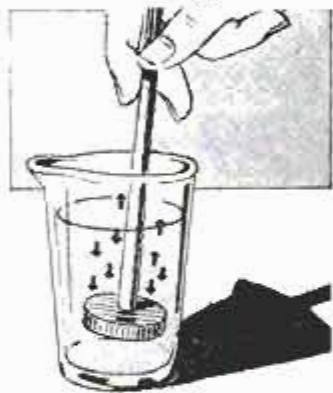

### Replacing Ceramic Tile On Wall or Floor

No special skill is involved in replacing a cracked ceramic tile on a bathroom floor or wall. First, cut a groove in the mortar joint completely around the tile to be removed, using a metal-cutting keyhole saw, detail A. Then chip away the broken tile with a hammer and chisel, starting from the center of the tile, detail B. Avoid hitting or prying on adjacent tiles to prevent damaging them. If the new tile is to be reset in adhesive, it is not necessary to chisel out the old mortar bed. However, this will be necessary if the tile is to be reset in a new portland-cement bed. In most cases, the surface should be completely dry when adhesive is used. For mortar, the old cement must be moistened before applying the new.

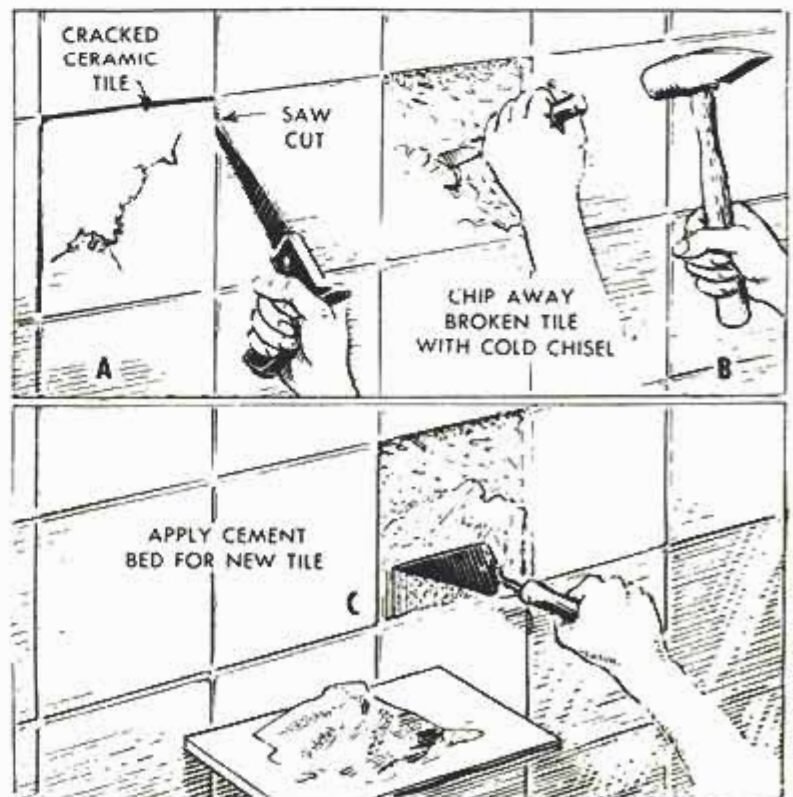



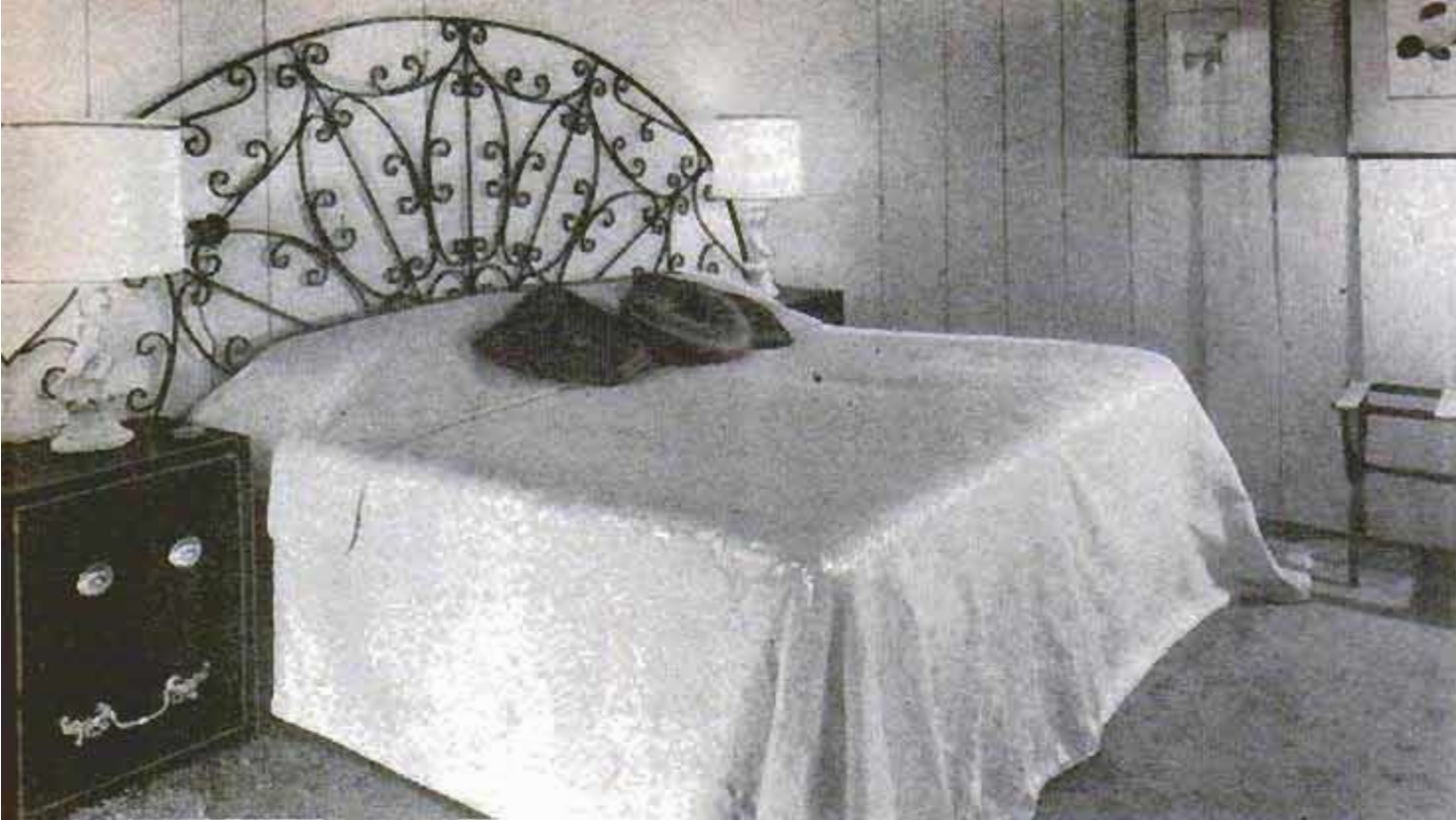

Black wrought iron, suggestive of New Orleans and Deep South plantations is used for this headboard

## WTM 59 Personalized Headboards

**D**OWN THROUGH THE CENTURIES, headboards have had a fascination for mankind, reflecting his station in life, his wealth and his superstitions. Kings used a full wall, draped with silks and satins to show their royalty. Hand-carved, jewel-encrusted headboards proved that a man had the wealth to afford such luxuries. And the four-poster with its draperies provided the sleepers with privacy and kept

Colonial is the motif here, maple the wood used in this headboard that has a touch of Early American

out the "dangerous" night air. Even today, headboards can show a facet of a person's personality. Driftwood is for dreamers of a wide expanse of sea and sun-drenched beaches. Frilly materials and soft colors reflect the femininity of the owner. A headboard with lights, bookcase and radio shows a person with a practical mind. On these two pages are shown headboards as individual as the owners. ★ ★ ★

Modern and functional is this headboard, combined with a double dresser to provide an L-shaped unit

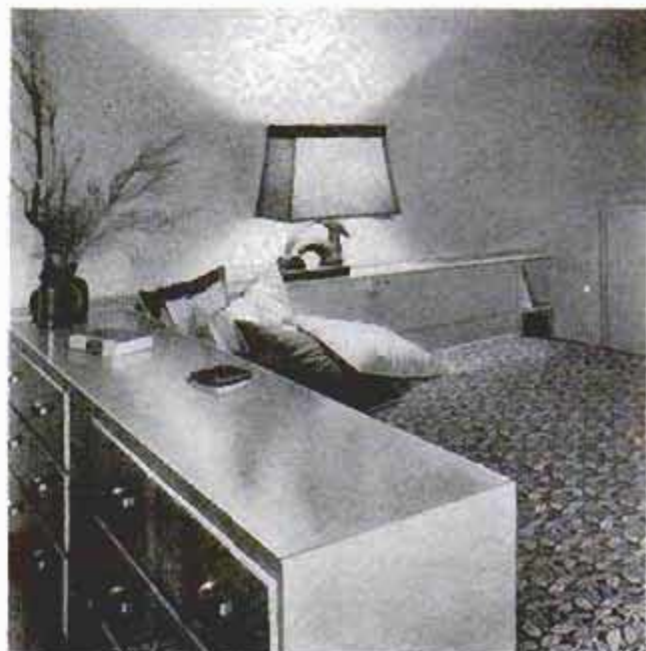





Closet and storage space are combined in this wall-sized headboard that includes windows in its design



Framed in alcove, padded white headboard has its feminine look enhanced by pull-back white draperies



Early American is the design, maple the wood, used in this headboard that complements the room's decor



Tailored draperies hung from cornice change this fairly conventional bedstead to interesting headboard

Both headboard and matching picture frame are made of sea-polished driftwood in "skipper's" room

Rustic, but modern in natural finish, this headboard has a scrollwork frame over vertical planks





## Wood Rasp Improvised From Taped Hacksaw Blades

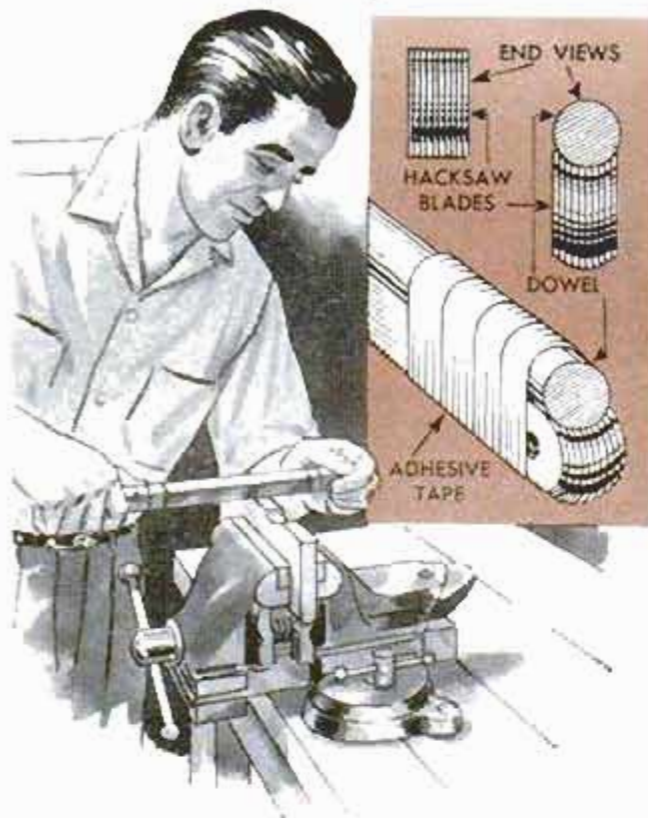

Several hacksaw blades taped together at the ends make an efficient, improvised wood rasp. If the alternate blades are reversed so the teeth point in opposite directions, the rasp will cut in both directions. For a flat rasp, simply tape the blades together. If a "half round" rasp is needed, tape the blades to a dowel as indicated. "Handles" are formed on the rasps by the tape. Make the tape wrappings long enough to provide a comfortable grip.

Frank Shore, New York City.

### Testing Level for Accuracy

If you have a doubt as to the accuracy of a level, here is a quick method of testing it. Tape a sheet of paper to a vertical surface and mark on it along one edge of the level when the bubble is positioned between the marks to indicate it is truly horizontal. Now reverse the instrument end-for-end and mark along the same edge again. If the marks are parallel, the level is true, if not it must be adjusted.

### Marking Locations on Cylinder

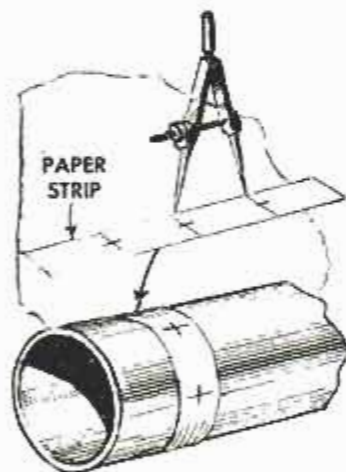

Marking the locations of a number of holes to be drilled equidistant on the circumference of a cylinder is done quickly with a strip of paper and a compass. Measure the circumference, using a strip of paper. Then, unroll the paper and step off the proper number of holes with

a compass. Finally, rewind the paper strip on the cylinder and mark off the holes.

### Notched Block Is "Vise"



Finish-filing or rounding the ends of small diameter rods, dowels or pins when they are hand-held is extremely difficult because the object or small part shifts under file pressure. To overcome this problem, use a block of wood with a notch cut in one end and clamped in a vise

as indicated. The object to be filed then is held firmly in the notch and will not shift.

### Talcum Powder Will Remove Fingerprints From Negatives



The slightest trace of a fingerprint on a negative can ruin an otherwise flawless print. Where regular film cleaners will not completely remove a stubborn fingerprint, I have found that talcum powder dusted lightly on the negative and rubbed with a bit of cotton will do the trick. This method also works equally well for removing waterspots from negatives. In each case, the important thing to remember is always to work with the film placed on a clean, smooth surface and, of course, to do the polishing on the emulsion side of the film.

Eugene M. Hanson, Los Angeles, Calif.



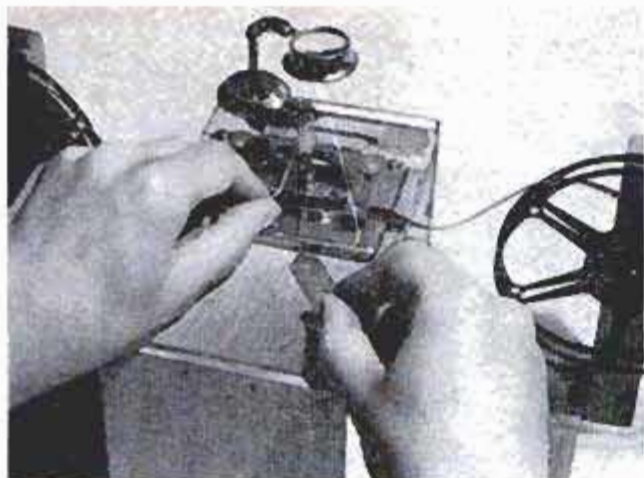

Main component of editor is film splicer that permits cutting and splicing of film as it is edited

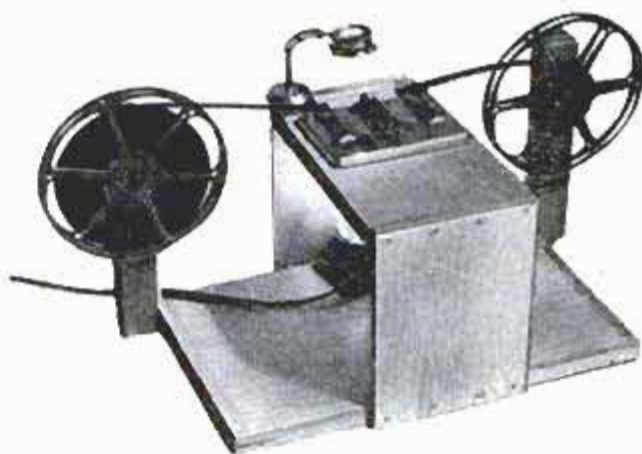

With reels pushed forward on spindles, film then is fitted in slide over light and examined with glass

## Low-Cost Film Editor

By Russ Whitaker

IF THERE IS ANY SECRET to making home movies really entertaining and interesting, it is proper editing. When several different subjects are on the same reel—a child at play, people at a party, then an auto race—viewers quickly lose interest because they cannot concentrate on one subject for any length of time. And blank spots in a film are of interest to no one. If cost has kept you from owning an editor, here is an inexpensive unit that can be assembled for the price of a low-cost film splicer, an extra film reel and some odds and ends from the workshop. No dimensions are given as they will vary with the components used. Also, while the unit shown was built to edit 8-mm. film, only slight modifications are required to permit it to be used for 16-mm. film. A surface-mounted porcelain socket is screwed to the plywood base to hold a 10-watt frosted lamp that shines up through a  $\frac{3}{8}$ -in.-dia. hole in the top surface of the editor ( $\frac{3}{4}$  in. for 16-mm. film). The film splicer is screwed to the surface just behind the light opening as shown. Two strips of wood, one with a rabbet on its lower edge, as in the detail, are positioned so that film pulled between them passes over the light. The overhang of the rabbet should not extend past the sprocket perforations in the film. The rabbet helps to hold the film down on the editor, and also shields the sprocket holes so that light does not shine through them. As shown in the detail, two rabbeted strips are suggested when 16-mm. film is edited. However, one strip must be movable to permit the film to be lifted out for cutting and splicing. This movable strip can be held by two screws on which wing nuts are turned for easy loosening. Slots

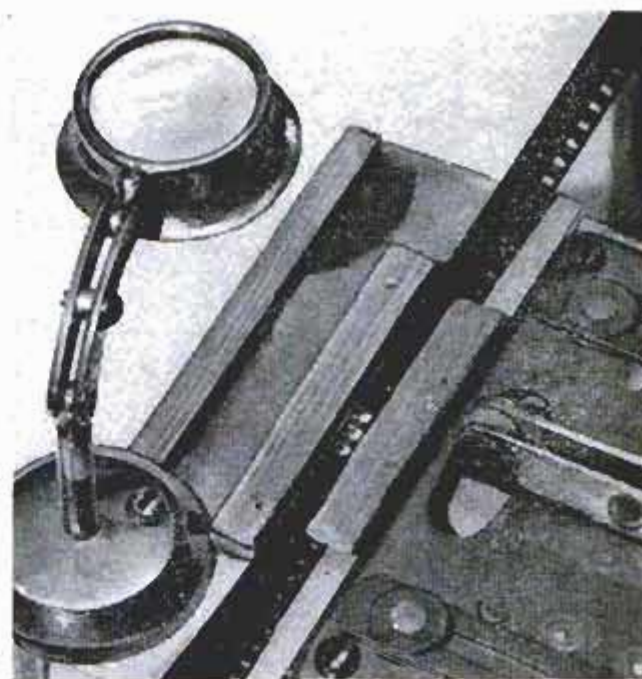

Above, film in slide with light shining through it. Below, two types of slides for two sizes of film

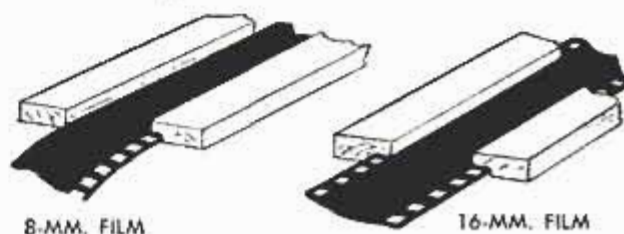

in the editor, under the strip, will allow it to be moved back for removal of the film, then repositioned and held in place when the film is pulled through it. All surfaces of the hold-down strips that contact the film should be sanded smooth so the film will not be scratched. For easier examination of the film, mount an adjustable magnifying glass over the light opening as indicated. The two brackets for holding the reels are fitted with 2-in. machine screws on which the reels can slide back and forth as the film is pulled from the hold-down strips and moved to the splicer.



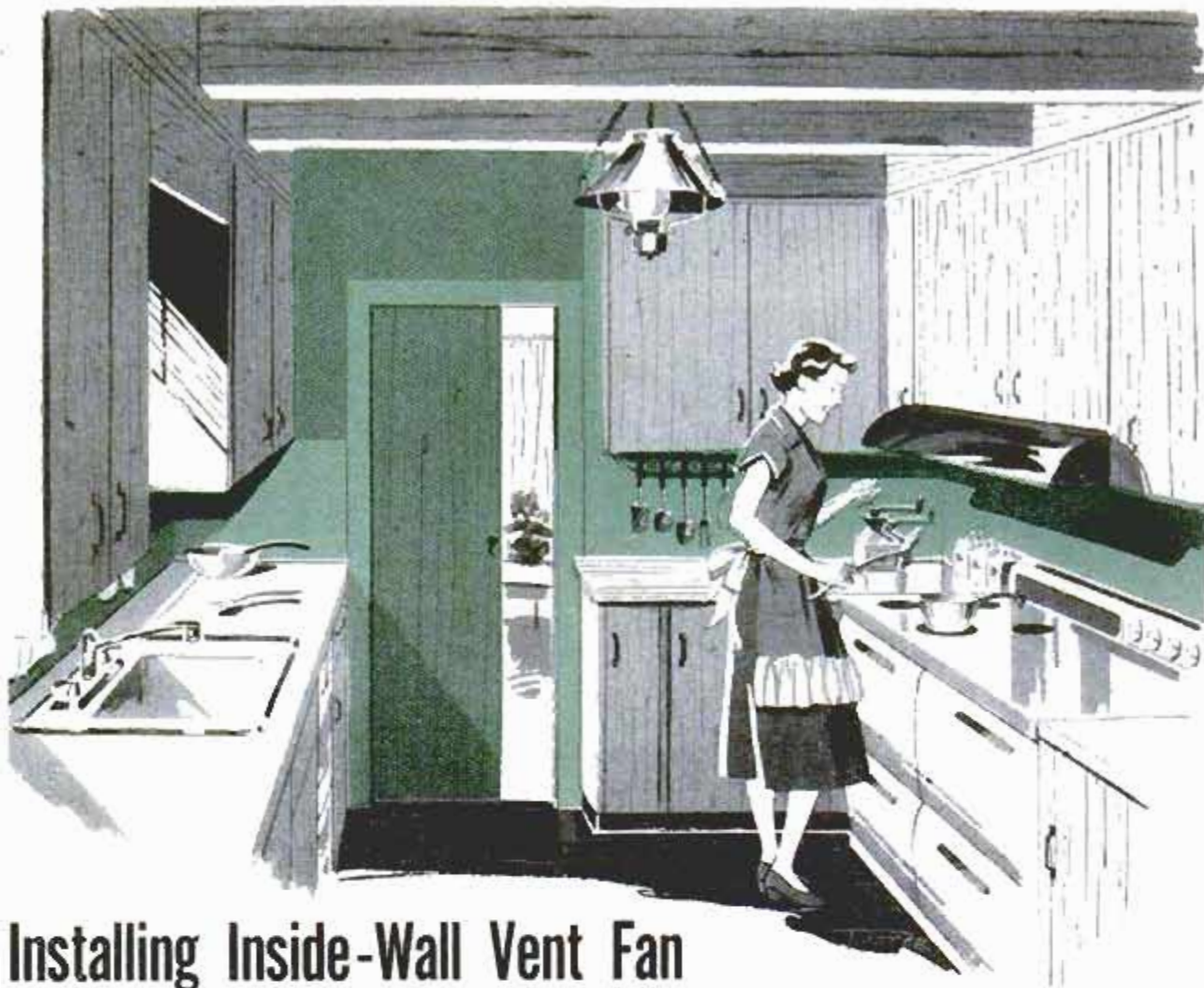

## Installing Inside-Wall Vent Fan

**W**HEN a kitchen range is located on the inside wall of a two-story house, installing a vent fan might seem to be a problem if there is no way of running ducts up between the wall studs. Actually the installation is fairly simple, and also can add

First step in installation is to make cutouts in cabinet shelves for duct. Soffit also is opened

to the appearance of the kitchen. The ducting is routed up through wall cabinets over the range, then through a false ceiling beam to the outside wall. Photographs on this and the facing page give a step-by-step description of a typical installation. ★ ★ ★

Next step, as shown below, is to attach vent hood, complete with fan and motor, to bottom of cabinet

Photos courtesy Western Pine Association

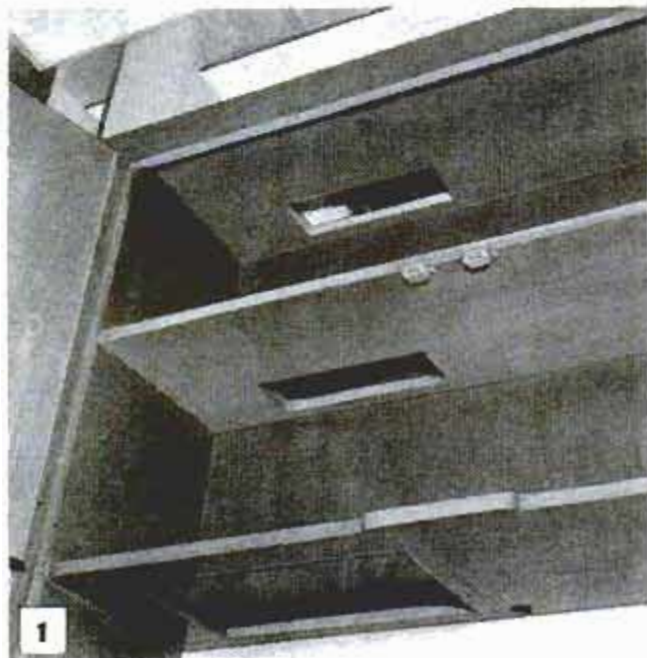





After hood is attached and ductwork run up through cabinet, right-angle elbow is installed in soffit space to route ducting horizontally across ceiling



Installation is now complete up to ceiling. Horizontal lengths of ducting now are fitted and run to opening that has been cut through outside wall

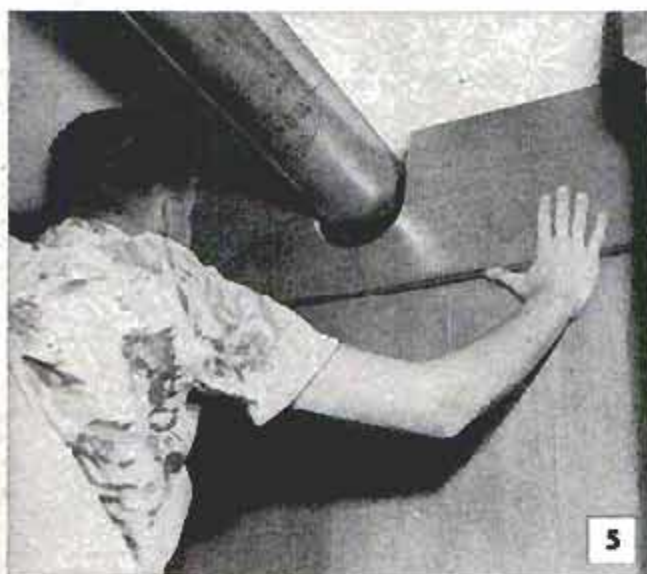

After ductwork across ceiling has been fitted and run to outside-wall opening, soffit face is cut out to accommodate ducting, then is replaced on soffit



Centered over the horizontal duct, a length of 1-in. stock is nailed to the ceiling to provide a means of supporting the "beam" to be fitted around the duct

Three sides of box that form simulated beam now are nailed around duct. Lower corners of box are mitered so assembled box will appear as solid wooden beam

Before horizontal run of ducting is installed, hole is cut through outside wall. End of duct then is protected by weatherproof louver or other device





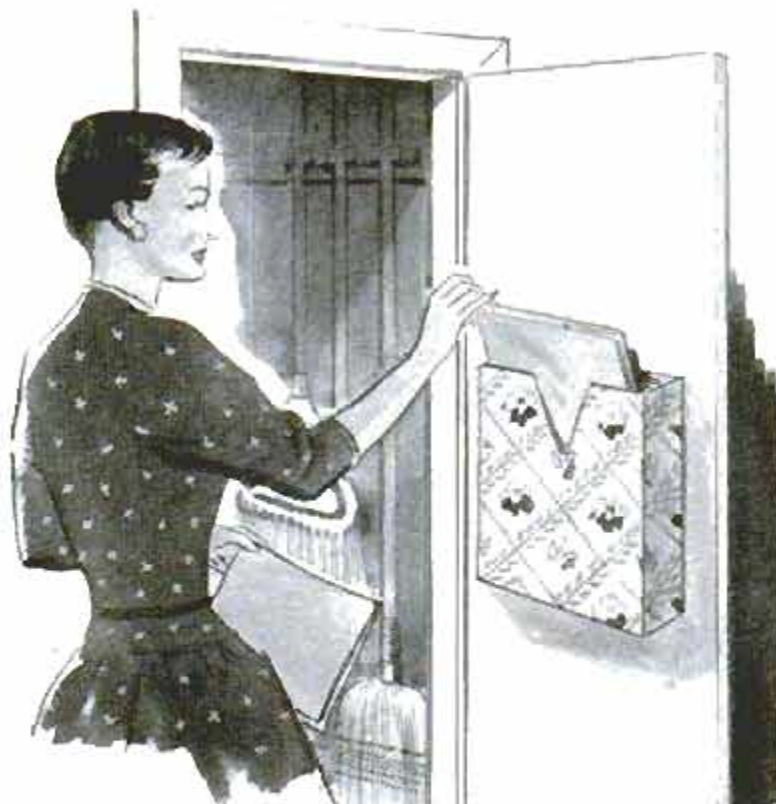

## Decorative Receptacle For Lunch Bags

This attractively decorated receptacle, made from a clothing box, is handy for storing grocery bags for later use as lunch bags and other purposes. Attached to the inner side of a broom-closet door, the container remains out of sight yet within easy reach. To make the receptacle, first remove one end of the upper and lower halves of a box of suitable size and cut a V-slot in the front as shown. Then, reinforce all corners with mending tape and cover the exposed sides of the box with gift-wrapping paper. Thumbtacks hold the paper-bag receptacle on the door. It may also be mounted on a pantry wall or other location with clear cellulose tape.—R. M. Woodbury, Natick, Mass.

## Quick Ball-Point Pen Repair

If the retracting mechanism in your ball-point pen fails to extend and retract the point when desired, try this quick repair. Simply remove the ink cartridge and spring and stretch the latter about  $\frac{1}{2}$  in. to provide greater tension on the release mechanism and reassemble the pen. Take care not to break the spring.

John W. Nestler, Tampa, Fla.

## Eliminate Water-Tap Thump

That thump you hear each time a water tap is closed abruptly might be caused by the displacement of air by water in the standpipes of the system. Usually this can be corrected, or at least minimized, by draining the system with all taps open and the main valve closed. Then, close taps and open the main valve.

Burton H. Kleinman, Highland Park, Ill.

## Ornate Cast-Iron Brackets Are Support for Novelty Shelf



Here is an ornate novelty shelf that any one can make in a few minutes. Three cast-iron brackets brazed together at right angles to each other support the shelf top as shown in the photos. For the top, two cut-outs of  $\frac{3}{8}$ -in. plywood are glued together and screwed to the bracket assembly by means of metal clips clamped over the legs of the brackets. To provide a "molded" edge, the bottom cutout is made slightly smaller than the top one. Two brass cornerplates screwed to the underside of the shelf at the back attach the shelf to the wall as shown.—Otto Merker, Chicago.

WITM  
59



SN  
M 59



## Spark Plugs Hot and Cold

By Morton J. Schultz

**YOUR AUTOMOBILE ENGINE** will produce maximum performance and economy only when the spark plugs meet a number of conditions. First, they must be the correct plugs for that particular engine. That is, they must be of the right heat range. Then, they must be clean, properly gapped and in good condition. Service stations, garages and auto-supply stores have charts showing the correct type of plug for any engine. The only reason for using a plug of a colder or hotter heat range than that specified is if your driving is done under certain conditions.

The terms "hot" and "cold" spark plugs may seem somewhat confusing, when it is considered that an automobile engine generally is quite hot when it is operating.

Actually, the term refers to the ability of the insulated tip of a spark plug to dissipate heat rapidly or slowly. The difference in the two types of plugs is illustrated in the left-hand detail, Fig. 1. When a spark plug is considered hot, the insulated tip around the electrode is long and the heat must travel farther from the tip of the plug to reach the engine coolant. When a plug is cold, the tip is short and heat reaches the coolant quickly. The right-hand detail in Fig. 1 shows how spark plugs range in type from very cold to extremely hot. Also note that in no case does the insulated tip project below the end of the threaded portion of the spark plug. When a spark plug is screwed into the head of an engine it becomes, in effect, a part of the combustion

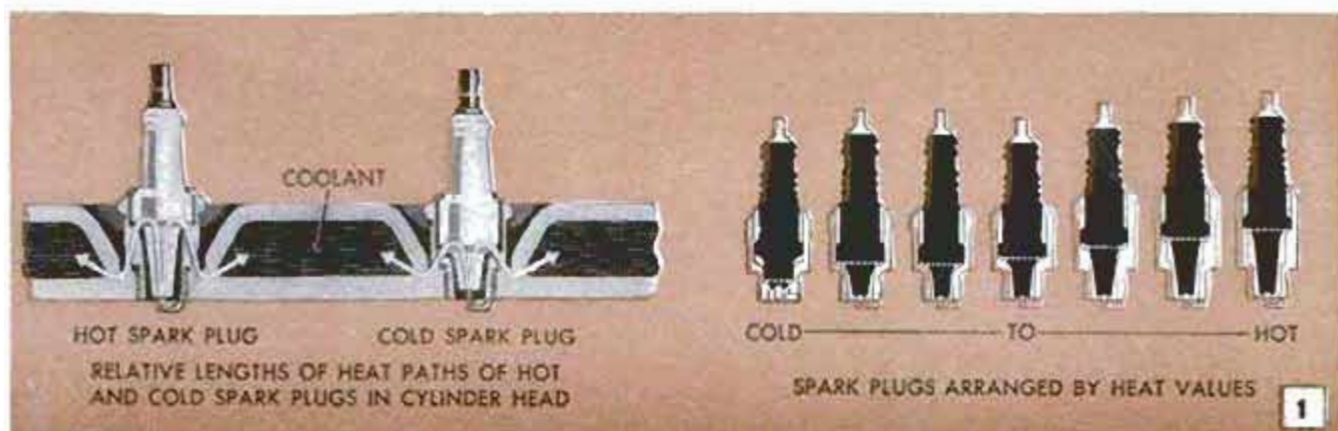





**2** When removing wires from spark plugs, grasp connectors to prevent loosening connectors from wires



**3** Use proper spark-plug wrench to avoid damaging plug removed, as well as porcelains of adjacent plugs



**4** After plugs have been loosened, clean dirt from around plugs, so that it does not fall into cylinders



**5** To check on condition of each cylinder, fit plugs into drilled block, numbered to match engine cylinders

chamber. Should it project into the chamber, it would immediately become glowing hot and would burn away in a short time. This is the reason that spark-plug gaskets must always be used. Without a gasket, a plug will extend too far into the combustion chamber and cause a change in the spark characteristics designed into the combustion chamber.

When combustion-chamber temperatures are relatively low, the longer lasting heat of hot spark plugs assures complete combustion. Thus, hotter plugs should be used when a car is consistently driven at low speeds around town, if much stop-and-start driving is done, or if the car is operated in abnormally cold areas. Examination of the spark plugs after a few thousand miles of driving will tell you if you need hotter plugs. Details A, B and C in Fig. 7 show three conditions that can result from plugs that are too cold. Detail A is an extreme example, showing what happens when a car is driven only on short trips where the engine never reaches operating temperature. This condition also will occur when worn piston rings allow an

excess amount of oil to be forced into the combustion chambers. Hotter spark plugs will help prevent fouling due to this latter condition, but the only genuine cure is to have new rings installed in the engine. Details B and C in Fig. 7 are various degrees of the same problem encountered with much slow driving, and where a hotter plug would be an aid to more efficient operation.

The opposite conditions and problems occur when a normal plug is too cold for the type of driving done. If a car is driven almost constantly at high speeds, pre-ignition may occur. This condition is caused when the spark-plug tip remains hot enough to cause the fuel-air mixture entering a cylinder to ignite before the plug fires. Sometimes incorrectly called "spark knock," pre-ignition can seriously damage an engine if allowed to continue for any length of time. (True spark knock occurs when a distributor is adjusted for too much advance, and ignition occurs before a piston reaches top dead center. The reaction and results, however, are similar to those of pre-ignition.) Colder plugs are



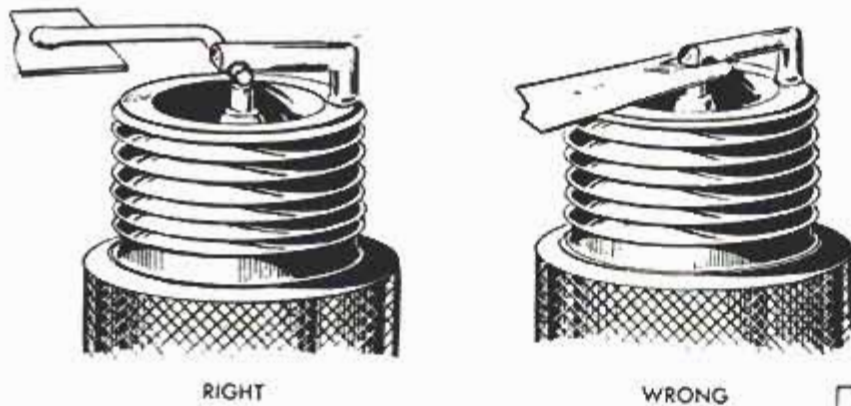

6

Exaggerated drawing shows reason that round feeler gauge is more accurate than a flat one when adjusting gap of used spark plugs

indicated in cases of preignition. If examination of the spark plugs in your engine discloses the tips to be white, blistered or burned, as indicated in details D, E and F in Fig. 7, the plugs should be replaced with a set with a colder heat range. The need for colder plugs also occurs when a car is driven mostly in abnormally hot areas, or when much hill or mountain driving is done. Under these latter conditions any automobile engine will operate at higher temperatures, and preignition occurs readily.

In all conditions where a colder or hotter plug seems indicated, use a plug only one range colder or hotter to avoid going to extremes. If there is any doubt as to whether a colder or hotter plug is required, take your car to an experienced mechanic. He can tell quickly what type of plug is needed.

If you clean and regap the spark plugs yourself, there are several precautions to be observed when removing and installing them. Figs. 2 through 5 show the steps in removing the plugs. To remove the wires, grasp the connector when possible rather than the wire, to assure that the wire is not loosened in the connector, Fig. 2. Use a spark-plug wrench or deep socket, Fig. 3, to loosen the plugs. Do not use an open-end or box-end wrench or pliers to remove a plug. The porcelain of the plug being

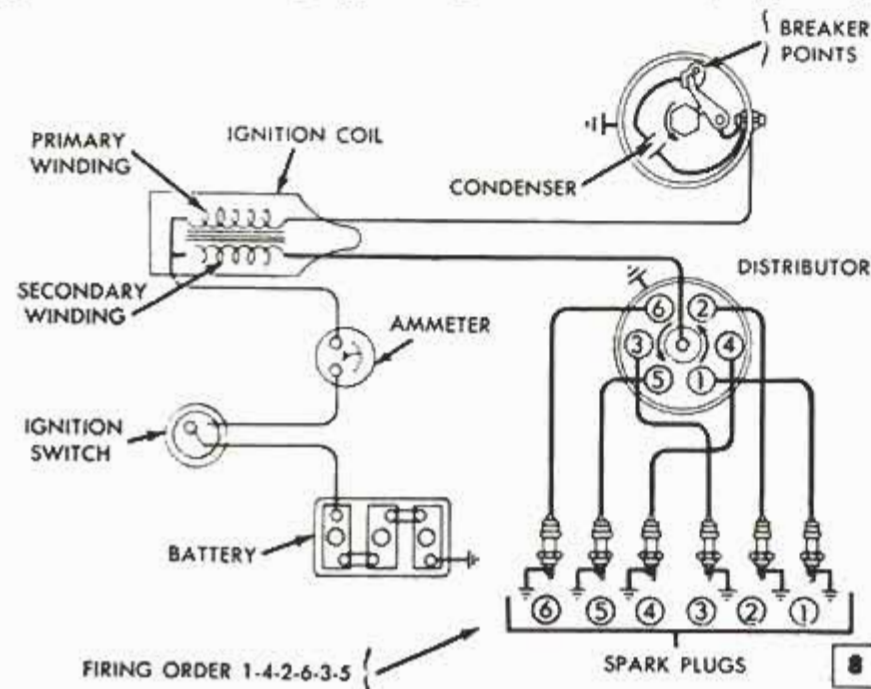

8

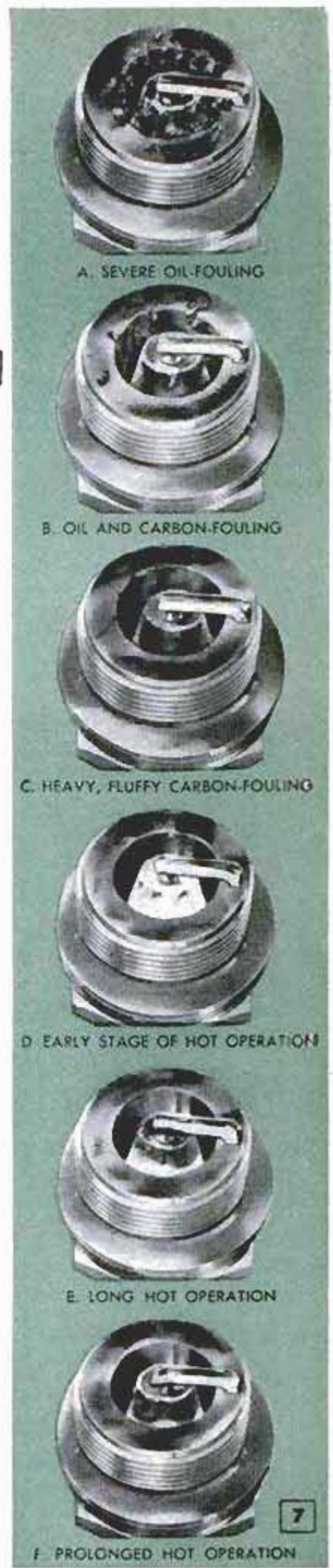

7



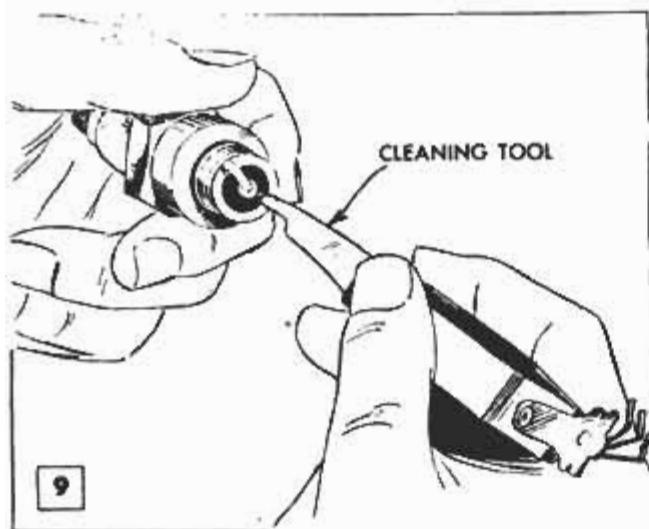

removed, or the porcelain of an adjacent plug, may be damaged. When the plugs are loosened, use compressed air, if available, to blow loose dirt from the spark-plug depressions in the engine head. If no air is available, use a cloth or a dry paintbrush to clean the depression. Then remove the plugs and fit them in a block of wood drilled to receive them. Number the plugs to correspond with the cylinders from which they were removed. Examination of the plugs then can tell you which of the cylinders is pumping oil, or otherwise malfunctioning. If a plug from one cylinder seems to be missing, although it appears to be all right, and then is switched to another cylinder where it continues to miss, you know it is the plug rather than the cylinder that is at fault. A malfunctioning spark plug must be replaced.

When a feeler gauge is used to regap plugs, Fig. 6, a round gauge is best. As shown in exaggeration in the left-hand detail, the ground contact burns away in

the area of the spark in a somewhat semi-circular fashion. When a flat gauge is used, it contacts the flat, unburned surface of the ground electrode, and the actual gap then is too wide. This precaution refers to plugs that have been in use. New plugs can be set with a flat gauge. When plugs are removed from an engine, they should be placed in a container of gasoline or other solvent to remove any oily film on the porcelain body, and wiped dry. The film on the porcelain may absorb moisture and cause a plug to short out. Any oil on the lower end of the plug also will be removed. Sandblasting machines will clean the insulated tip of a plug, but a cleaning tool, such as shown in Fig. 9, also should be used to dig out any carbon or compacted oil. In some cases, sand grains from the sandblaster will become embedded in the compacted oil in a plug, and later drop into the cylinder when the plug is reinstalled in the engine. The sand can cause scoring of the cylinder walls and damage to the valve seats and faces, and possibly to the main and connecting-rod bearings.

When new plugs are installed in an engine, or the old ones are cleaned and regapped, new gaskets should be used. Also, new distributor points should be installed. As shown in the diagram of a representative ignition system in Fig. 8, the spark plugs are at the end of the system, and any ignition component not operating properly will affect plug operation. Distributor points that are burned and pitted will cause spark plugs to misfire. When new points are installed, you can be sure that any plug that misfires is malfunctioning in itself, or because of some trouble in the cylinder. ★ ★ ★

### Improved Carrying Handle From Rubber Hose

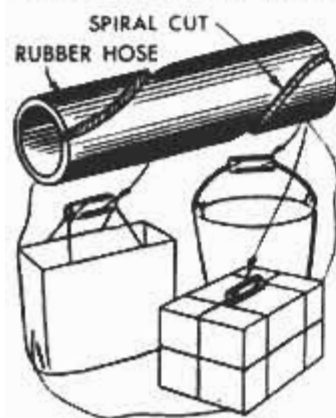

Lengths of rubber hose, temporarily slipped over the handles of pails, shopping bags and cord-wrapped packages to afford a more comfortable grip, will stay in place more easily if they are cut spirally. Grips so cut do not

tend to slip off cords or bails during use, and thus defeat their purpose, like those that are cut straight across. For a permanent grip, wrap the hose with a few turns of tape.

### Fishing Float on Address Tags Prevents Pulling Out



If you use a two-tag address method for mailing laundry, one tag being enclosed in the case, and the other exposed to show the address, a cork fishing float can be used as an aid to assure prompt delivery. The connecting twine or wire between the tags is inserted through a hole in the float. The cork prevents the inside tag from being accidentally pulled out of the case and lost.



# Layout Template For Scalloped Trim

MAKING SCALLOPED trim for valances and kitchen cabinets is easy for W. G. Tilsher of South San Gabriel, Calif., who uses a template as in Fig. 2, to scribe the desired design on stock that is to be scalloped. The same template is used for all three designs or styles shown in Fig. 1. Templates with larger or smaller radii may be used to create a variety of distinctive scallop designs.

Templates are cut from  $\frac{1}{8}$ -in. plywood as indicated in Fig. 2. The first step, before scribing any design on stock to be scalloped, is to divide the length of it by the radius of the template used to obtain the number of equal spaces into which the piece is divisible, as D, D1, etc., Fig. 3. The remainder, if any, is divided by two for dimension A, which centers the scallop pattern on the stock. Should the remainder be greater than 3 in., subtract from the divisor or add to it an amount not to exceed 1 in. After center lines 1, 2, 3, etc. are drawn on the stock, style No. 1, the template is placed on the center lines, one at a time, and the arcs that form the scallops are scribed as indicated. The 45-deg. angles that form the points between the arcs are drawn with a combination square as in Fig. 2. A line drawn parallel to the edge of the stock determines the size of the points.

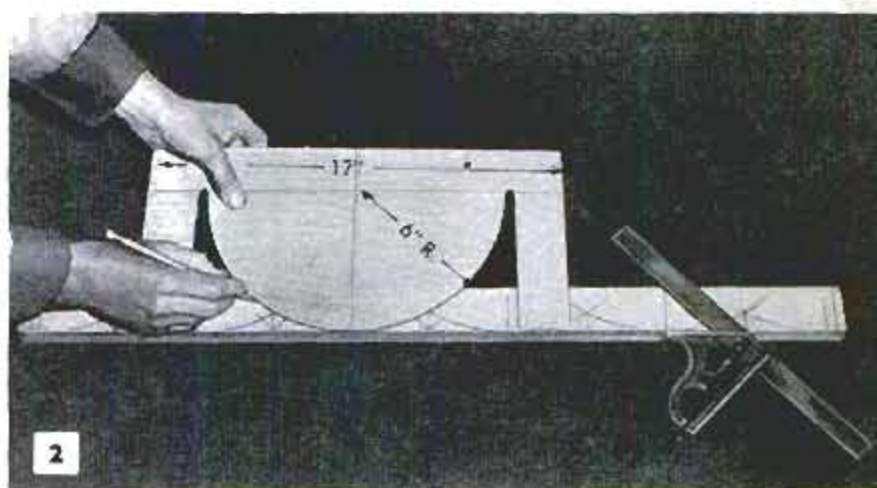
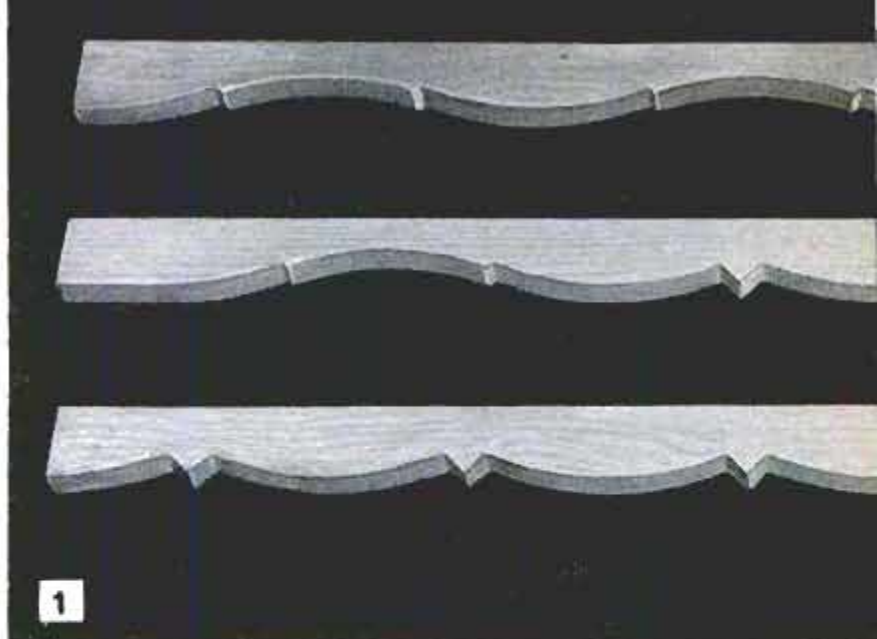

The procedure for outlining the scallop, style No. 2, is the same as for the first one, except that the template is reversed for the second arc. Line H determines the positioning of the inverted arc and line H1 positions surface S relative to adjacent surfaces of arcs. Surface S and the point of style No. 1 can be any size desired.

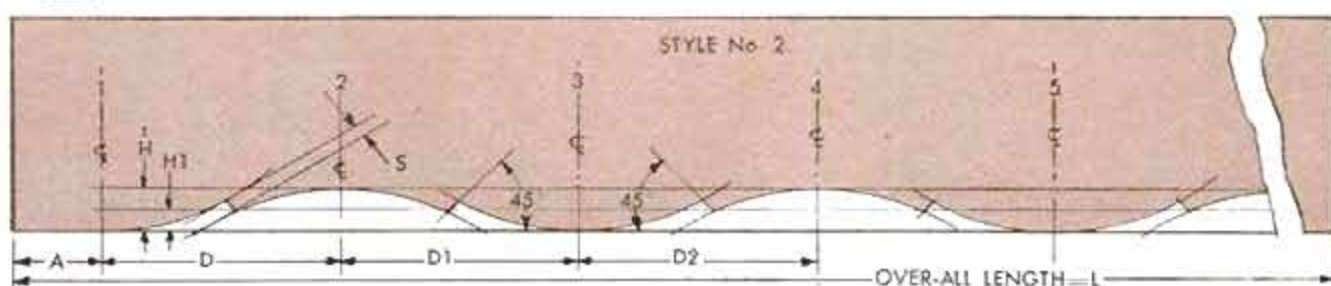
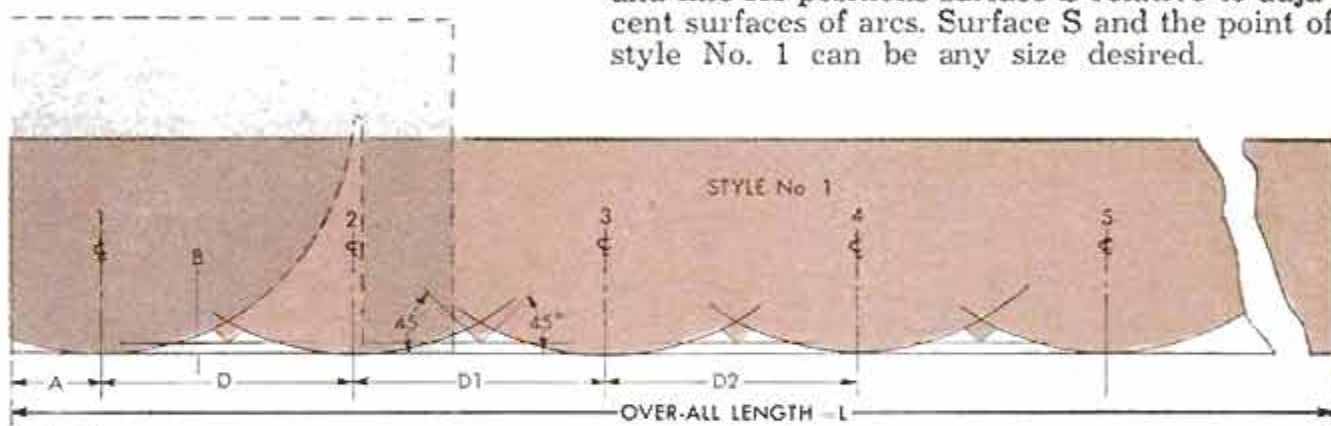



# PUSH-BUTTON



IF YOU LIKE push-button magic, you'll enjoy doing touch-up and small painting jobs with pressurized spray paint. Lacquer and enamel paints are made in a variety of colors, finishes and brands and sold in handy 12 and 16-oz. cans, Fig. 1. Also available, are clear and opaque plastics, lacquers and varnishes that are ideal for spraying photographs, drawings, flowers, electrical circuits and other objects with a protective film to guard against moisture and dust damage. Any child can paint with the cans, and, with a little practice, you can turn out first-class professional work.

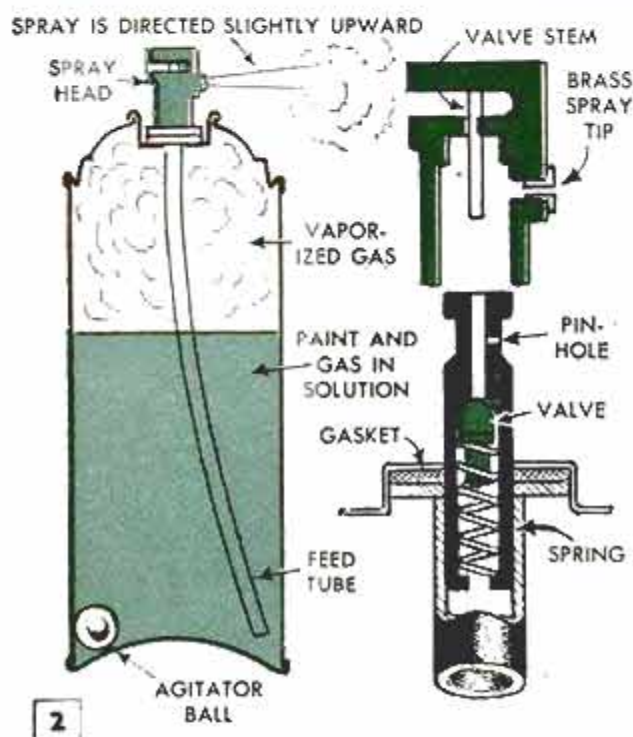

This is how most types of spray cans work: The main body of each can is pressurized with a liquid gas, usually Freon or Genetron. The gas vaporizes and develops a pressure of about 30 lb. per sq. in., forcing the liquid up the feed tube, ready to be released at the touch of your finger. The liquid gas in solution with the paint contributes to atomization by giving the paint particles a kind of explosive action, producing a fine mistlike spray. The gas itself is harmless, vaporizing instantly on exposure to air. Fig. 2 shows a typical valve and spray head, although there are numerous variations. The spray head itself can be removed for cleaning.

The table, Fig. 3, gives data on some of the various products available. The clear acrylic solution contains no pigment and

3 TYPE OF PAINT	GENERAL USE	WORK DISTANCE	DRYING TIME	APPLICATION AND REMARKS
CLEAR ACRYLIC	CLEAR PROTECTIVE FILM FOR ALL METALS. ALSO GOOD FOR DRAWINGS, MAPS	10 TO 16 IN.	5 TO 10 MIN.	One coat covers. Have work well-lighted so that you can see the transparent coating. Spray a full wet coat. Work should be 70° F. or warmer to prevent clouding. Wipe polished metal with cleaner before spraying
METALLIC	FOR ANY SURFACE WHERE A GOLD, COPPER, ALUMINUM OR CHROME FINISH IS DESIRED	10 TO 14 IN.	10 MIN. TO 1 HR.	Usually covers in one coat. Paint must be sprayed wet to avoid chalking (rubbing off when dry). Some brands and a few types will chalk slightly even though applied correctly and are suitable only for work that is not to be handled
LACQUER ENAMEL	FOR TOUCH-UP OR COMPLETE FINISH. WIDE VARIETY OF COLORS, BLACK AND WHITE	8 TO 12 IN.	15 MIN.	Dries fast. Low pigment content usually requires two or three coats which can be applied in rapid succession. Most products formulated with nonlifting solvents which are safe over any previous finish including varnish
PAINT ENAMEL	GENERAL PURPOSE PAINT, TOUGH AND DURABLE FOR INSIDE OR OUTSIDE WORK, ALL COLORS	12 TO 18 IN.	1 HR. TO 4 HRS.	Cheapest of the various products. Usually requires two coats, the first coat being a light coat followed by a second, heavier coat in about 10 min. Paint remains tacky a long time and tends to clog spray tip

AVERAGE COST ABOUT \$2 PER 16-OZ. CAN (ABOUT 1/2 PINT LIQUID)



# PAINING

needs no mixing; all others contain a pigment that settles out of solution and requires agitation to mix it properly. The metallics have the most hiding power and will cover most surfaces with one coat. Also, this paint is available in blue, green and red. Metallics should be sprayed wet, since a dry, dusty spray (overspray) of itself causes chalking.

The lacquer products are slightly more expensive than others but have the advantage of fast drying. The least expensive of the various products and also the poorest by virtue of very slow drying, are the paint enamels. However, if you can be patient, the resulting finish is tough and durable. The pigment content of general-purpose paints is very low and will not cover in one coat. The correct procedure for applying these products is to spray a fine coat at 15 to 18 in. from work. Allow 10 min. for this to dry and then apply a second, heavier coat at about 12 in. from the work.

Spray concentration for various working distances is shown in Figs. 5 and 6. The minimum working distance is 8 in., since this space is needed to let the gas escape from the paint which otherwise would erupt, causing pinholes.

As far as spraying technique is concerned, the main idea is to get the paint on—you'll learn by practice. For most work, the spray should be constantly trig-

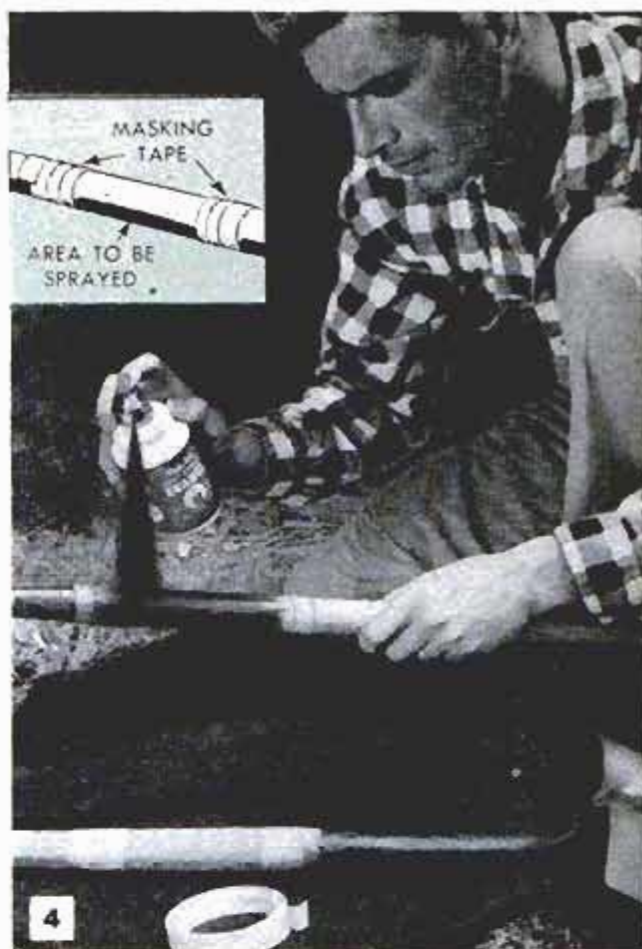

Color bands sprayed on tool handles preserve wood, remind forgetful neighbor to return borrowed tools

gered so that you start and end the spray stroke off the work, Fig. 7. Edges should be sprayed with an oblique stroke, Fig. 10, that covers part of the adjoining surface. You then minimize overspray by starting

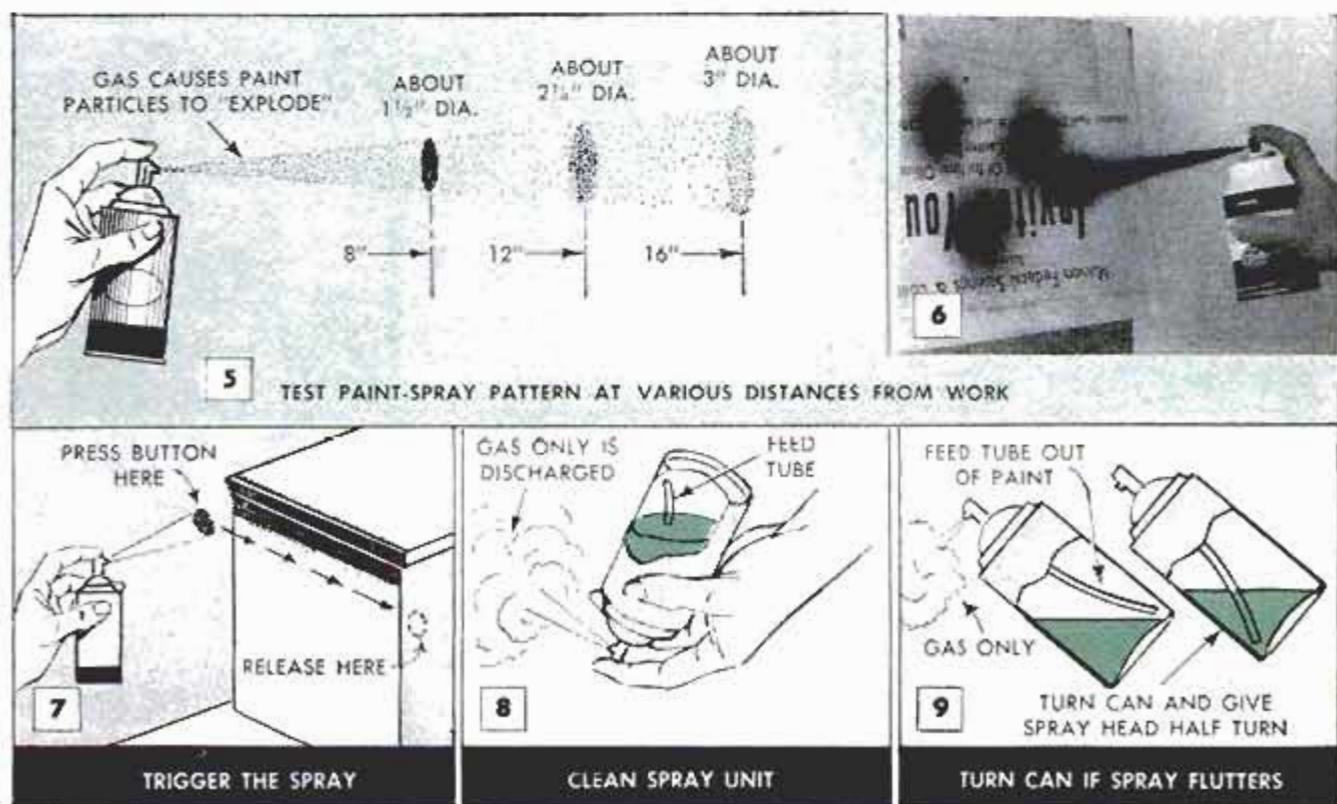



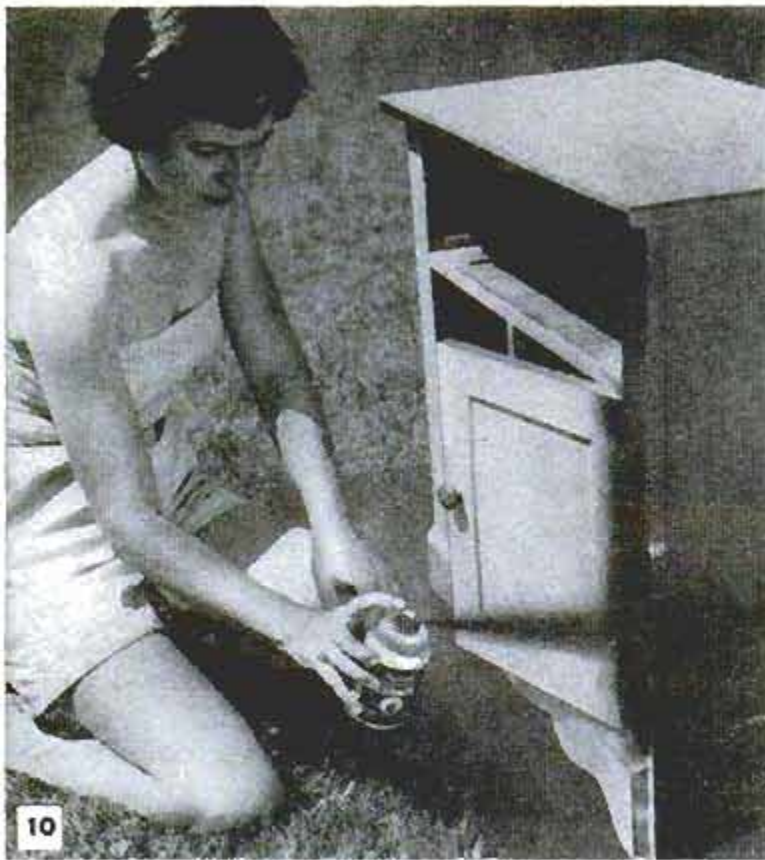

10 Edges are sprayed with oblique stroke that covers part of adjoining surface to reduce overspray when painting flat surface

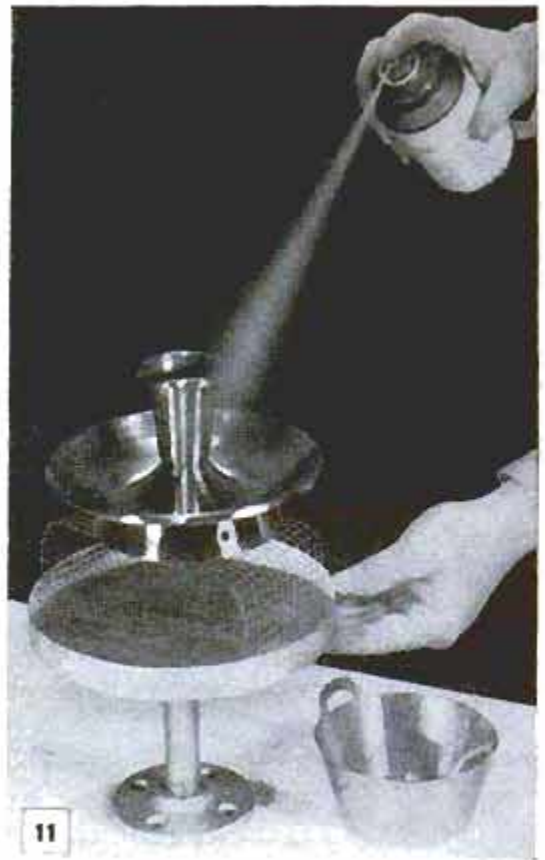

11 Mesh of hardware-cloth support prevents overspray from being deflected onto work

and stopping spray strokes just inside the edges when doing the flat surface. All flat surfaces should be sprayed by starting at the near edge, letting the overspray drift forward on work not yet coated as in Figs. 12 and 13.

### Avert Clogging of Tip

After every job, invert the can and depress the button three or four times until you hear the hissing sound of gas only being discharged, Fig. 8. Add to this the simple precaution of wiping the spray tip and you will seldom be bothered with clogging. If the spray tip appears to be clogged, remove the spray head and push a fine wire through the spray hole. If the can has a valve, such as the one shown in Fig. 2, also clean the small hole in the valve body. Spray heads can be switched from can to

can, if they are of the same design. A clogged inner valve can be freed by removing the spray head and placing a drop or two of paint thinner in the valve body.

Don't neglect work preparation. The temperature of the paint should be between 60 and 90 deg. F. If it is too cold, the can of paint can be placed in a pan of warm water and heated to the required temperature. The recommended room temperature and atmospheric conditions are the same for this work as apply to other types of painting. If you paint outdoors, use a cover to keep paint off the surrounding area, Fig. 10. An ideal support for small jobs is hardware cloth, Fig. 11, because its open surface allows overspray to escape without settling on the work. When only a part of a surface is to be painted, the adjacent surfaces are masked, Fig. 4. ★ ★ ★

Figs. 12 and 13, flat surfaces are painted by starting at near end, allowing overspray to drift forward on work not yet coated. Fig. 14, cold paint is warmed by placing can in a pan of 90 to 100-deg. water



12

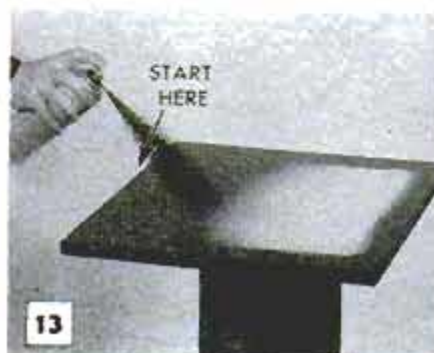

13



14





1

# On the MARKET

for Do-It-Yourselfers

**1. NATURAL REEDS** are woven tightly together with strands of nonrusting steel wire to form a matting which comes in rolls 6 ft. wide and 18 ft. long. Widely accepted by decorators and architects for both interior and exterior use for patio covers, shades, room dividers and fences  
 Rattanraft, 312 W. Fifth St., Los Angeles 13, Calif.

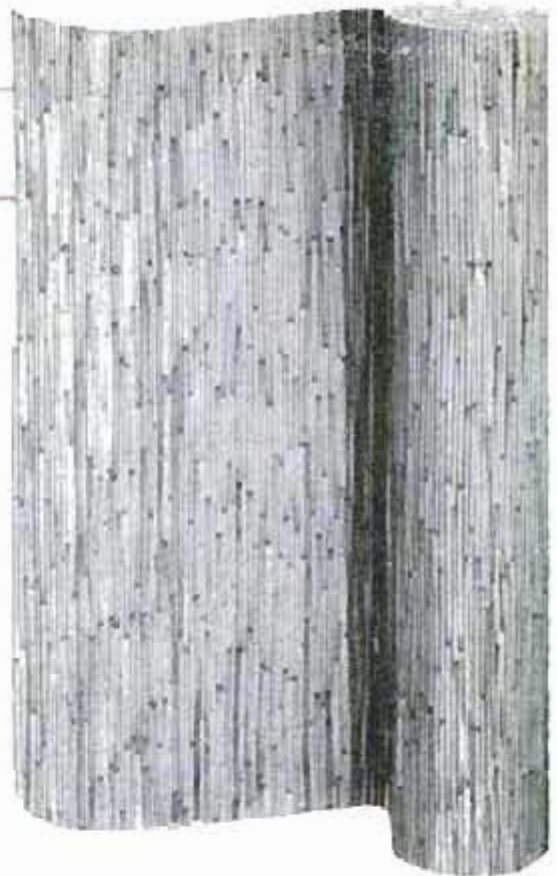

**2. HARDWOOD DOWELS** in diameters under 1/4 in. have been made available in a hobby package containing 365 dowels ranging in size from 1/16 to 7/32 in. inclusive. Also available in packages of 40 and 100 pieces. All sizes are 36 in. long. Just the thing for making detail parts  
 Cleveland Dowel Pin Co., 12703 Triskott Rd., Cleveland 11, Ohio

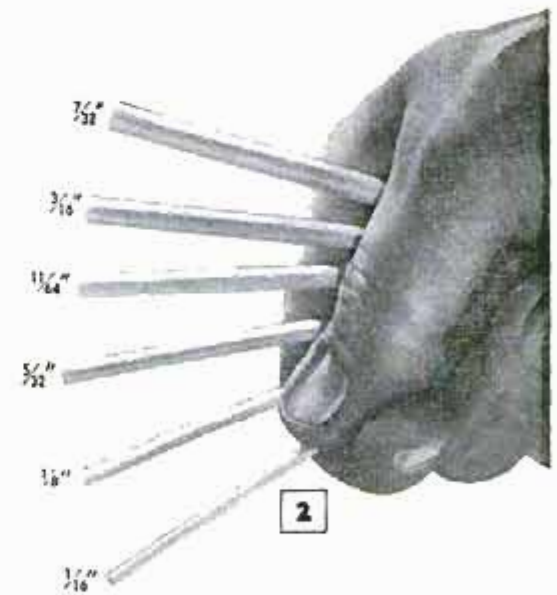

2

**3. NONFLAMMABLE PAINT REMOVER** softens almost any common finishing material, including latex-base paints. It is based on an emulsifying formula which means that both remover and softened finish can be washed off with water. Remover is fast acting and requires no neutralizer  
 The Kleen Strip Co., Inc., P. O. Box 10085, Memphis 6, Tenn.

**4. ELECTRIC PLUG** projects only 5/16 in. from the cover plate of the wall receptacle. Cord hangs nearly flush with wall, rather than curving outward and down. Comes in two decorator colors, brown and ivory. Details A to D, inclusive, show recommended procedure in wiring plug  
 Ball & Socket Mfg. Co., Cheshire, Conn.



3

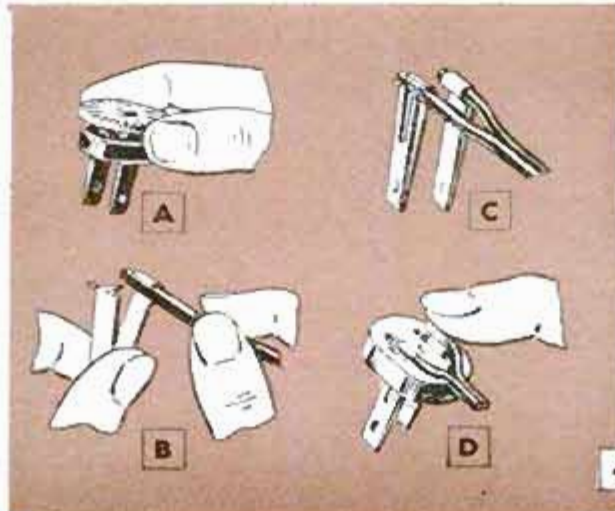

4





## Guide Aids Knife Sharpening



Maintaining a constant angle between an oilstone and the blade of a pocketknife when sharpening it is no problem when an "angle guide" is used. The guide consists of a paper clip slipped over the back edge of the blade. Hold both blade and clip against the stone when honing the blade and the angle will remain constant.

## Light Seals for Graflarger

If there is too much of a light leak between the negative carrier and slide when a Graflarger is used on the back of a Speed Graphic camera, the risk of fogging sensitive paper can be reduced by installing light seals along the edges. The seals are strips of plush cut from the light trap of a film-pack container as indicated.

Harrison Neustadt, New York City.



## Better Typewriter Performance

After a period of time the platen, or rubber roller, on a typewriter becomes hard and pitted from the constant hammering of the keys. To assure more legible typing, soften the surface of the platen by wiping it with a cloth dipped in acetone. Do not let the acetone touch a painted surface as it will damage the paint.

## Drop-Dispensing "Oil Can"

When the maintenance directions for a small motor call for a specific number of drops of oil at definite periods of time, use a medicine dropper as an "oil can." The medicine dropper will permit you to apply precisely the number of drops required.

Sam Fenn, Skokie, Ill.

## Cementing Wood-Chisel Handles

Wooden handles that loosen easily from the sockets of wood chisels can be kept firmly in place by using adhesive of the type used to cement sandpaper disks to a disk sander. Warm either the chisel handle or adhesive before applying.





# SHOP NOTES

## POWER IN YOUR HAND

*Portable jigsaws will cut almost any common material, in any position*

By Sam Brown

WITH ONLY a few exceptions a portable jigsaw will handle any job you can do on a conventional jigsaw or even a small band-saw. You carry the saw to the work, not the work to the saw. This means you can cut round, square or rectangular openings in panels too large to be conveniently worked on a stationary jigsaw. A cut can be started at any point on a board or plywood panel without running in from the edge or even drilling a starting hole. Just place the saw with the blade inside the line, in the waste. Start the motor and lower it slowly into the wood. It will cut through  $\frac{3}{4}$ -in. stock in a few seconds. And, of course, the portable jigsaws will rip, crosscut and run any curved cut down to about a 1-in. radius. This limitation in making curved cuts is due to the heavy-gauge saber blade used in the portable units. In addition to making the regular cuts in wood, portable jigsaws will cut soft metals, Fig. 1, sheet steel, plastics, rubber and fabrics. A special knife-edged blade is used when cutting the latter two materials. A small table is available from several manufacturers of portable jigsaws which is so designed that the portable unit can be inverted and clamped or screwed to the underside of the table to make an efficient stationary saber saw.

When laying out work which is to be cut with the portable jigsaw, the radius limitations of the blade should be kept in mind. When the job calls for an opening made to a given size with straight, smooth edges, then it is best to drill  $\frac{3}{8}$ -in. holes in the corners of the pattern

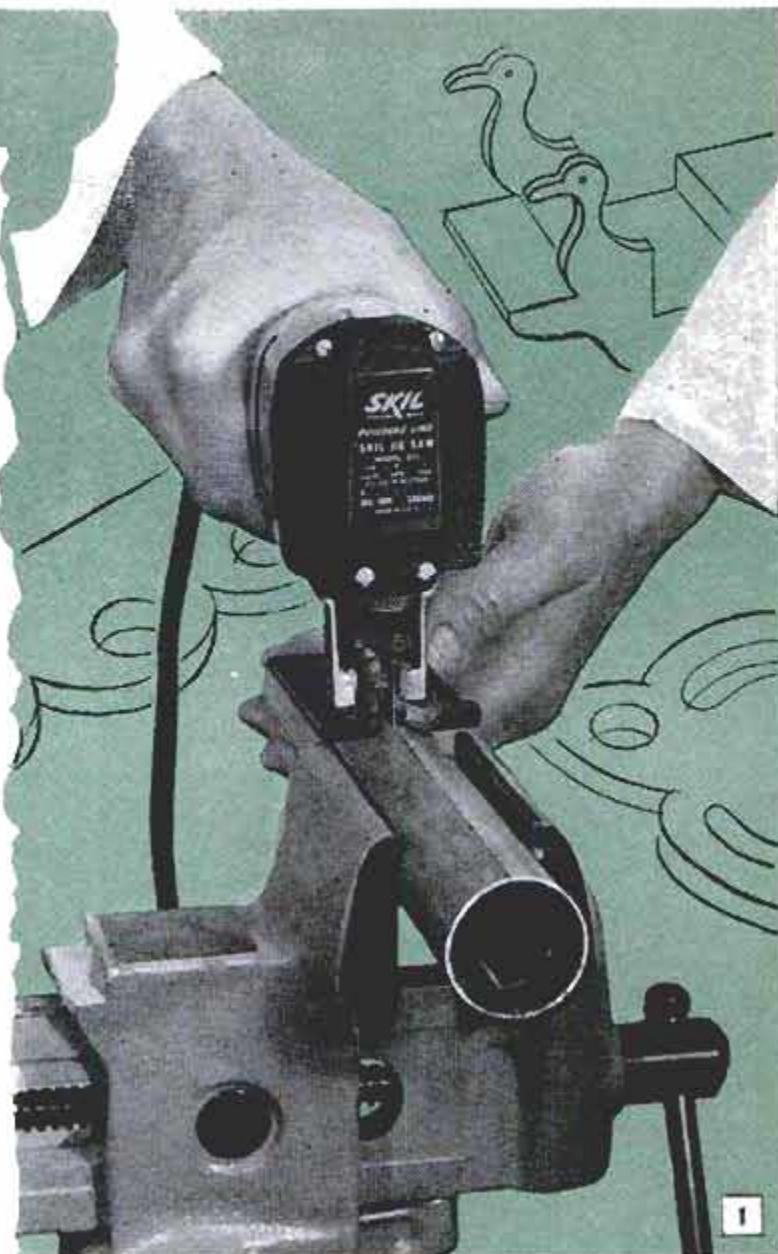

When slotting tubing in the manner pictured above it may be necessary to cut the blade to obtain sufficient clearance. Below, details cover four important points in sawing technique

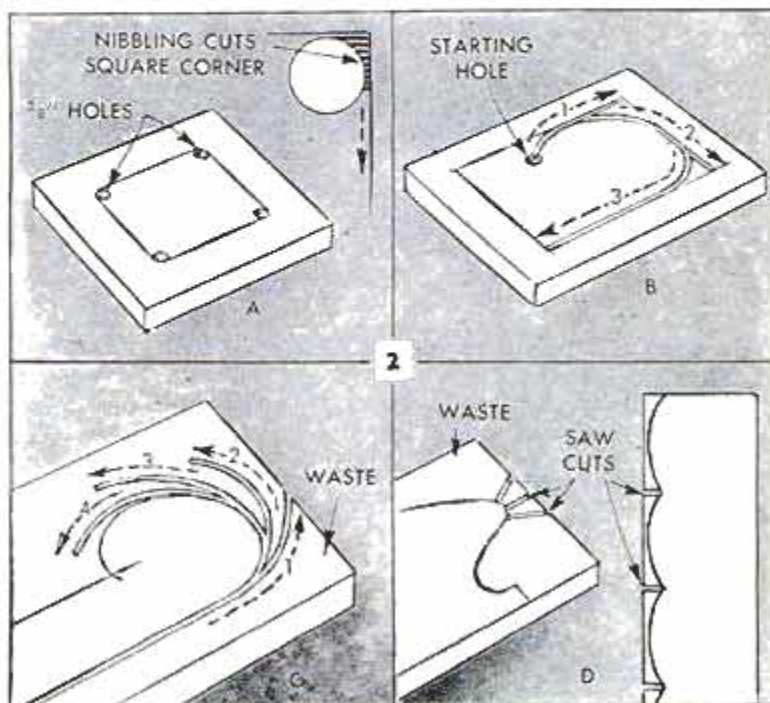



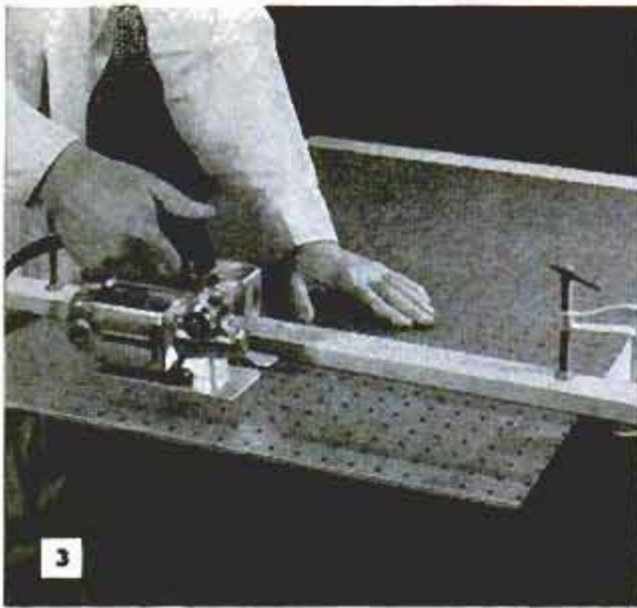

Straight cuts should be made with the soleplate of saw bearing against a straightedge. In this way you assure accuracy equal to that of a circular saw

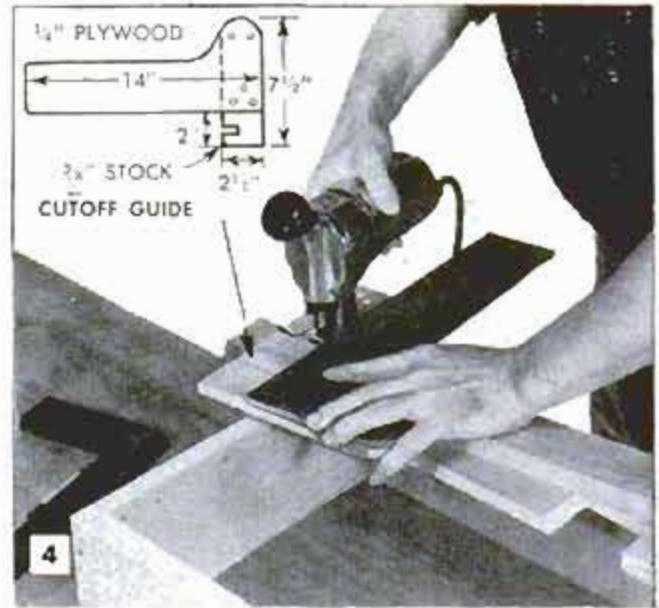

When you require an accurate cut across grain, use cutoff guide. Guide is held against the edge of stock in the same way as you would hold a T-square

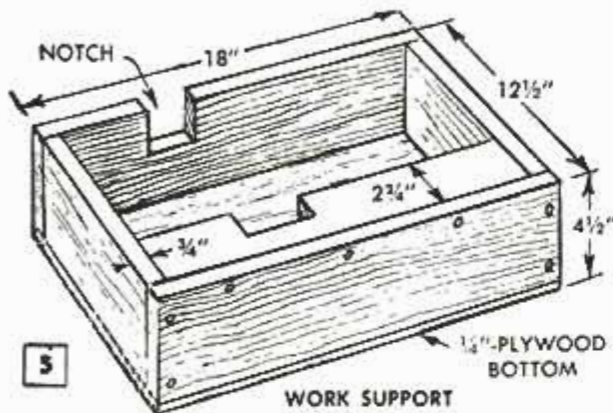

When the job calls for cutting and ripping a number of small pieces you'll save time by making a work support on which stock can be placed and held firmly

Some types of portable jigsaws are provided with a ripping guide either as an accessory or regular equipment. It enables you to rip stock to exact width

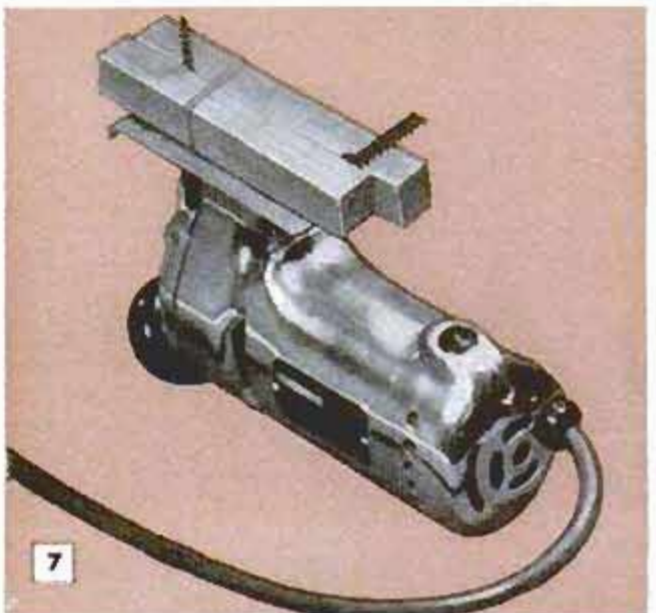
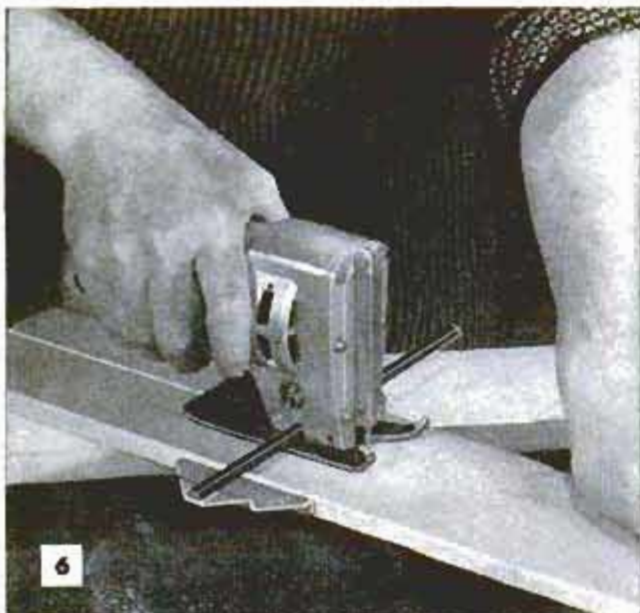

layout for insertion of the blade, Fig. 2, detail A. After cutting out the waste, the corners are squared up by nibbling cuts. Another method requiring the drilling of only one starting hole is shown in Fig. 2, detail B. Here successive cuts are run to the corners of the layout from a starting hole drilled in the waste. The method will produce an opening through the stock with square corners, provided, of course, the work is done with care. Two methods of handling comparatively short-radius cuts are shown in Fig. 2, details C and D. A third method which saves time is shown at the right in detail D. When cutting scallops, run cuts in from the edge of the stock to the pattern lines at the points shown. This preliminary step will permit running

On straight cuts it's important to have the blade aligned with the edge of the soleplate. This is done with two strips of wood, a blade and a rubber band



curved cuts continuously in one direction.

When you require a straight ripping cut through wood or a composition material, such as hardboard, clamp a straightedge to the work as in Fig. 3. Determine the width to be cut off, measure the distance from the edge of the soleplate on the jigsaw to the blade and set the straightedge accordingly. For cutting off, or crosscutting, make the guide detailed in Fig. 4. Some portable jigsaws are supplied with a ripping-fence accessory, Fig. 6.

Due to the projection of the blade below the stock when the jigsaw is in operation, it's handy to have a work support when jigsawing small pieces of stock. One design which has a wide range of applications is detailed in Fig. 5. It's simply a sturdy box made to the dimensions indicated, or larger if desired, and having one side notched. An insert having a second notch of the same size is nailed inside the box as indicated, the notches being aligned. In use, the box, or support, is placed on the bench and the work located so that the waste overhangs the edge as in Fig. 4. Or, if you are ripping a short piece, turn the box around, center the work over the notch in the side of the box and into the notch in the insert, without danger of cutting into the bench top or the support.

When the saw is guided in either ripping or crosscutting, it is essential that the blade be aligned with the edge of the soleplate. Fig. 7 shows a way to do this quite accurately by placing a square strip of wood on each side of the blade, clamping

Concave scallops are cut freehand or with a jig pivoting on a pin driven into a second strip of stock. Strip is notched to provide starting slot for blade

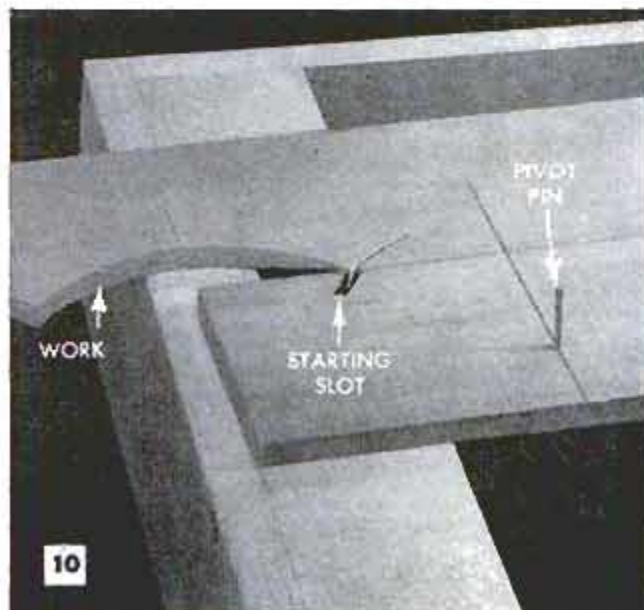

JANUARY 1958



SEE DETAIL A, FIG. 9

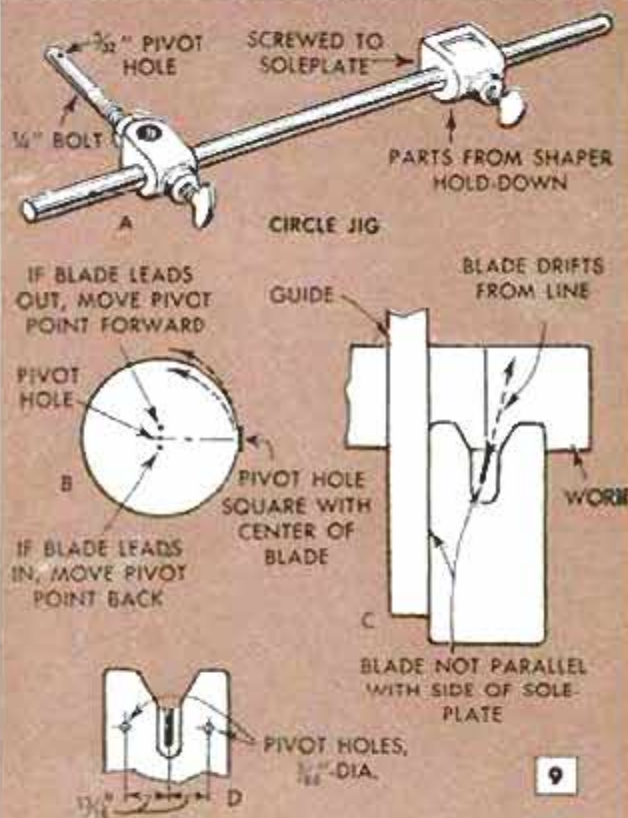

9



SEE DETAIL D, FIG. 9



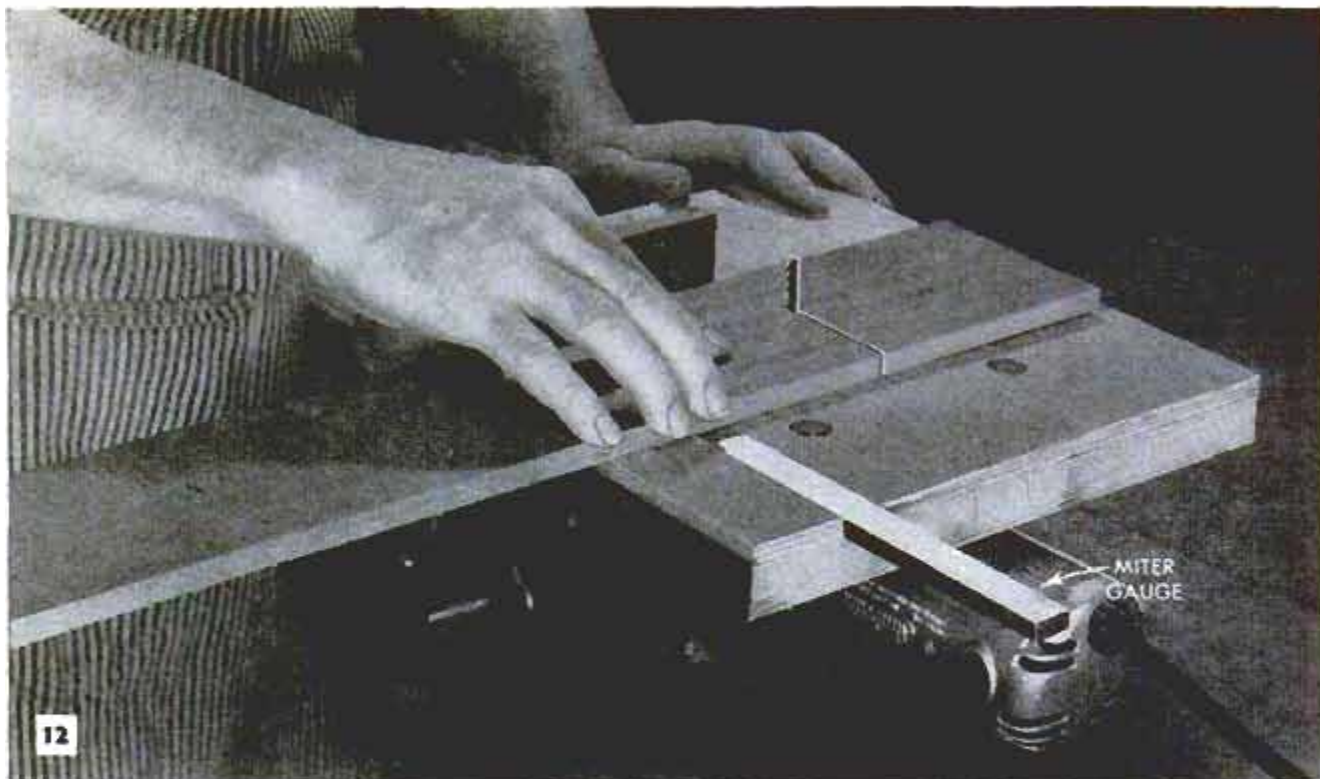

Some manufacturers of portable jigsaws provide an accessory table which converts the portable unit into a stationary saber saw. Or, you can improvise the table pictured above by following details in Fig. 17

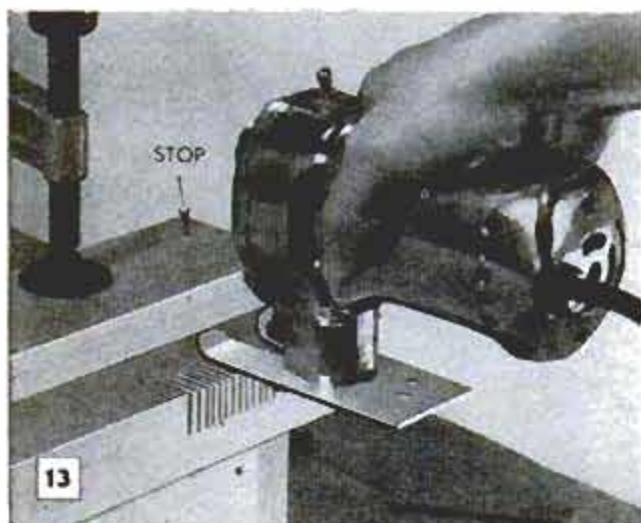

Above, square recessing from edge of stock is easy. Cut blade to a length that will give the depth required, clamp a stop to work and make adjacent cuts. Below, making a pocket cut with jigsaw

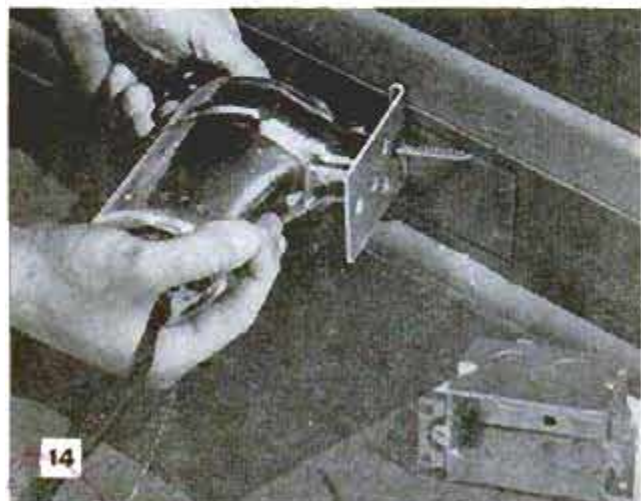

the strips together with a rubber band. A second blade is inserted between the strips as pictured to serve as a spacer. Release the blade-clamping screws in the plunger and move the strips right or left until the edge of one aligns with the edge of the soleplate. Then tighten the clamping screws, making sure that the blade does not shift as the screws are tightened. Note detail C, Fig. 9, which shows how the blade tends to drift from a guided cut if it is out of line with the soleplate.

Circle cutting is a common operation with the portable jigsaw and in order to do the job accurately it is necessary to improvise a swiveling jig. Fig. 9, detail A, shows such a jig assembled from parts of a small shaper hold-down. Fig. 8 shows this improvised jig in use. In setting up such a jig for circle cutting it may be necessary to change the location of the pivot as in detail B, Fig. 9. Cutting scallops also can be done with a circle jig using the setup shown in Fig. 10, and the work support detailed in Fig. 5. Another problem involving the cutting of short-radius scallops is pictured in Fig. 11 and detailed in D, Fig. 9. Here the saw pivots on a pin (a small brad will do) on a  $1\frac{3}{16}$ -in. radius. This is permissible as the blade is only made to cut a quarter circle. Two small holes are drilled in the soleplate as in detail D, Fig. 9, and the saw is placed against the stock with the pin entering one of the holes. After the first cut is made to the pattern line, the saw is lifted off the pin and turned in the opposite direction, the pin entering the second hole. A second



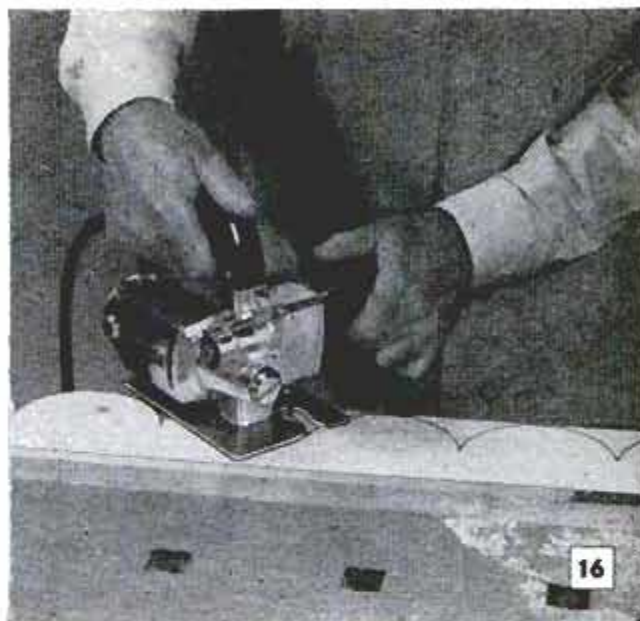
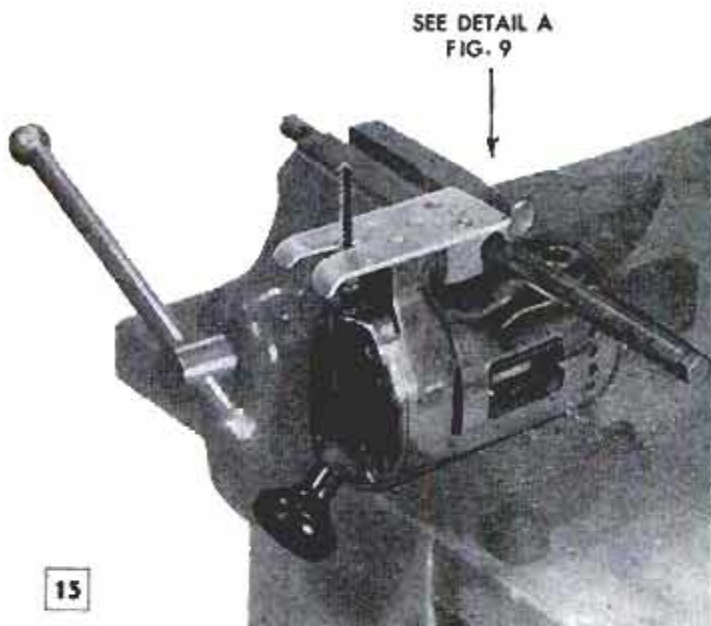

cut finishes the semicircle. Larger scallops can be run freehand as in Fig. 16.

By making a plywood table, as in Fig. 17, you can convert almost any type of portable jigsaw into a table saw, or saber saw. The table detailed in Fig. 17 is shown in use in Fig. 12. Of course, in order to adapt the table to various makes of saws you will have to make some variations from the type detailed in Fig. 17. For saber sawing small pieces you can do very well with the setup shown in Fig. 15, using two of the three parts of the shaper hold-down, detail A, Fig. 9. One lug of the hold-down is screwed to the soleplate and the rod is locked in the vise. The soleplate of the saw serves as a table.

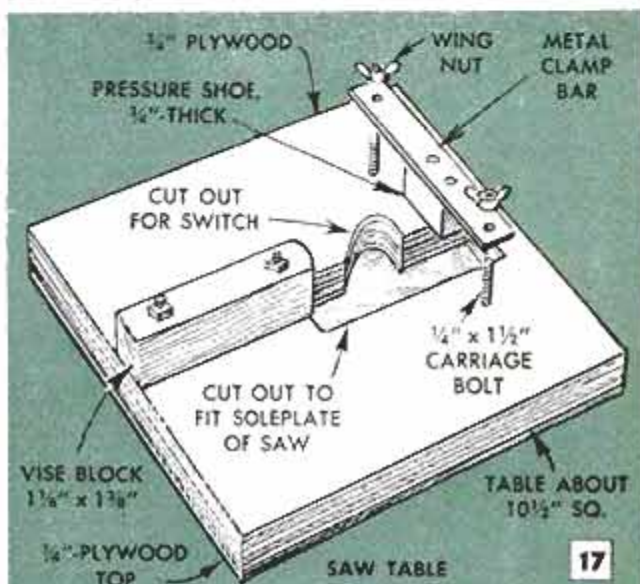

Recesses can be run in from the edge of a board simply by cutting the blade off to give the depth of cut required. Ordinarily, the blade projects about 2 in. below the soleplate at the end of the downstroke. Cut off the blade to give a 1-in. or 3/4-in. projection and it will cut a recess, or even a blind mortise, 1 in. or 3/4 in. deep. The setup for this job is made as in Fig. 13, clamping a stop to the work as indicated. Make adjacent cuts and remove the waste with a sharp chisel. One of the most novel of portable jigsaw operations is pocket cutting, Fig. 14. Make the layout with scribed lines on the work, then tilt the saw as pictured, start the motor and swing the blade into the work. It will cut through in seconds. A similar job is blind mortising, but in this case the blade must be cut off to give the required mortise depth. The table, Fig. 18, outlines a general classification of average work done with portable jigsaws and the blades best suited to the job. Entries under "blade" in the table refer to the various blades pictured in Fig. 19. The assortment of six blades does not include the knife-edged blade. ★ ★ ★

18	WORK	BLADE
	GENERAL SAWING IN WOOD	BLADE A, 6 OR 7 TEETH PER INCH. 5/16" WIDE
	SCROLL CUTS	BLADE A. ALSO B, 8 TEETH PER INCH. 1/4" WIDE FOR INTRICATE CUTS
	FOR SMOOTHEST CUT	BLADE C, 10 TEETH, 3/16" WIDE. ALSO D, 14 TEETH, 1/4" WIDE
	THIN METALS, PLASTICS	HIGH-SPEED BLADES E AND F. WITH 14 TO 24 TEETH PER INCH

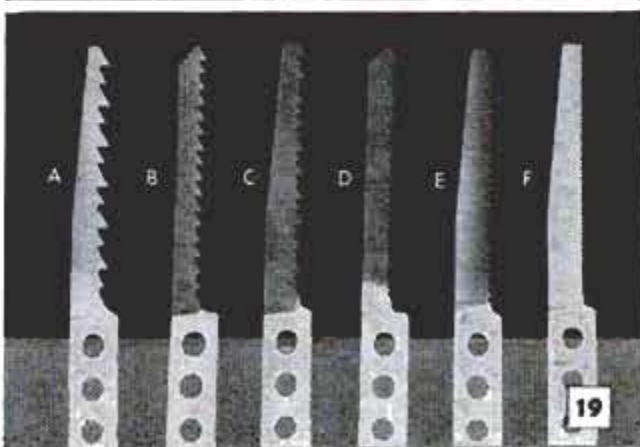



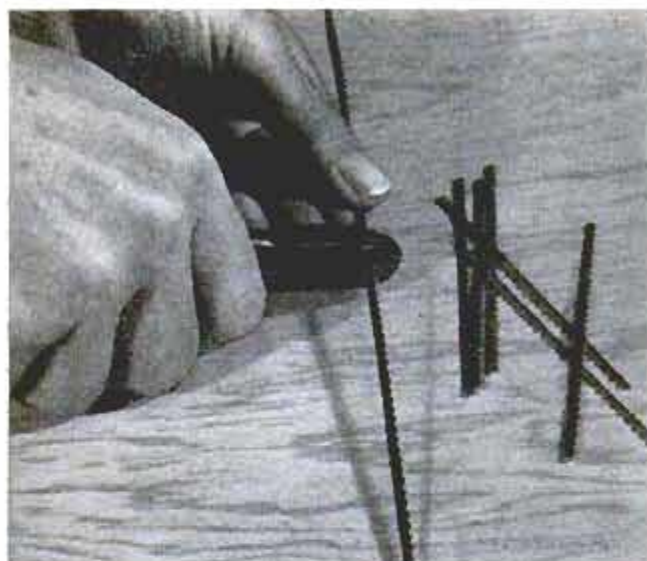

### Bandsaw Makes Jigsaw Blades

Don't throw away the bandsaw blade that breaks before it has served its full period of usefulness, especially a narrow one  $\frac{3}{8}$  in. or less in width. It will make excellent jigsaw blades when cut to the proper lengths. The set of the teeth is just right for jigsawing and they are shaped for fast, clean cutting on either curved or straight work. The narrow blades are easily cut with nippers. Grind ends square.

R. J. DeCristoforo, Los Altos, Calif.

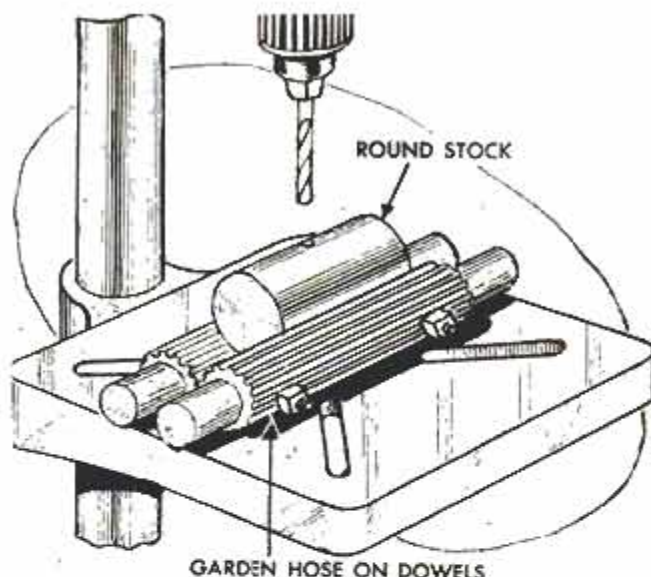

### V-Block From Lengths of Hose

When you have only an occasional piece of round work to drill, the purchase of a V-block is hardly justified. Where the work does not require extreme accuracy you can improvise a substitute quickly and easily. Just cut two 5-in. lengths of garden hose, press a length of  $\frac{3}{8}$ -in. dowel through each piece and bolt the two together. A V-block made this way won't slip, and also prevents the work from turning with the drill.

G. B. Hendrickson, Argyle, Wis.

## PM Books for Boys and Girls to help them know about Science

**MR. WIZARD'S SCIENCE SECRETS**, by Don Herbert. The star of the famous TV program seen coast-to-coast weekly on more than 60 stations has written this educational and entertaining book that will help in school and through a whole lifetime. The book is just like his unusual program and just as intriguing. It contains more than 150 of his television experiments, in word and picture. Answers thousands of "how" and "why" questions children ask on the human body, gravity, flight, heat and radiation, electricity, etc. It's facts with fun—so fascinating and interesting children never tire of learning.

264 pages. \$3.00.

**THE BOY SCIENTIST**, by John Lewellen. An up-to-the-minute introduction to the exact sciences, bursting with facts every modern boy wants to know. Written and illustrated with such clarity that even complex principles are quickly grasped by the young mind. This book won for Popular Mechanics Company the 1955 award of the Thomas Alva Edison Foundation as publisher of "The Best Children's Science Book." A truly outstanding work.

264 pages. \$3.95

**SCIENCE MILESTONES**, from the *Science Digest* series. A record of the march of science which will fire the imagination, and inspire youngsters in their pursuit of scientific knowledge. Contains dramatic revelations of 60 important individuals whose contributions, from 400 B.C. to the present, are landmarks in the history of science. This book is as fascinating as fiction, as factual and revealing as a laboratory report. Beautifully illustrated and printed.

312 pages. \$5.00

The books above are ideal as birthday gifts, Christmas presents or for general reading for the scientific-minded youngster. Each is authoritative, clearly presented and illustrated, quality printed and bound, as you would expect from the publishers of Popular Mechanics Magazine. You and your children must be pleased or your money back. Send check or money order today for the books of your choice to—

**Popular Mechanics Press, Dept. 158**  
200 E. ONTARIO STREET • CHICAGO 11, ILLINOIS







## 3 VOLTAGES From One Battery

HERE'S THE WAY one auto serviceman altered a conventional 12-volt battery to supply 6, 8 and 12-volt current when required for starting stalled cars. In cold weather the 8-volt hookup will start a car readily when its 6-volt battery is low. Photo A shows the hookup of the ground strap and cable for taking off 6-volt current. Photo B shows the hookup for 8-volt current and photo C pictures the battery in the normal hookup. To make provision for taking off 6 and 8-volt current, two terminal posts are added. Clean the ends of the 3rd and 4th-cell connectors and roughen the cleaned surface slightly so that new lead will bond to the old when poured. Then melt lead and pour the two additional posts in a negative-post mold. Care must be taken to locate the posts so that there is ample clearance. Also, it is advisable to make sure that the clamps fit the posts.

Of course, the battery is also capable of supplying 12-volt current for the later model cars with 12-volt systems. Ordinarily the battery is charged as a 12-volt unit, but if current is drawn heavily from the 6-volt hookup, it can be recharged as a 6-volt unit by hooking the charger to the positive post and the 3rd-cell negative post.

Ken Hadenfeldt, Storm Lake, Iowa.

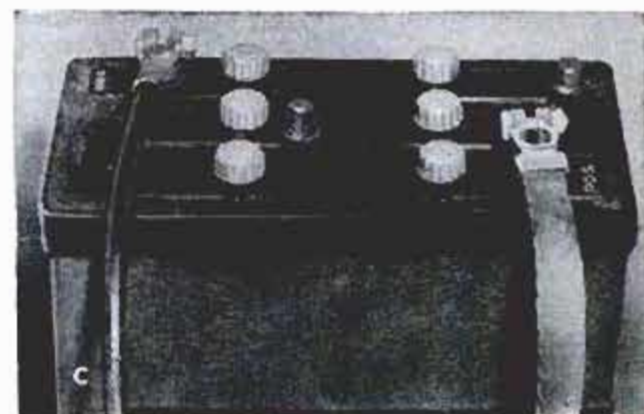
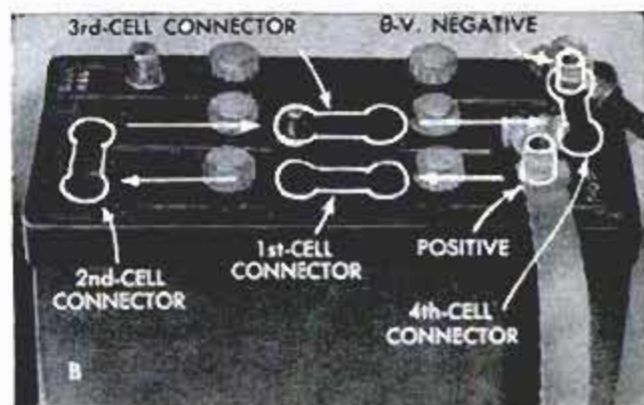
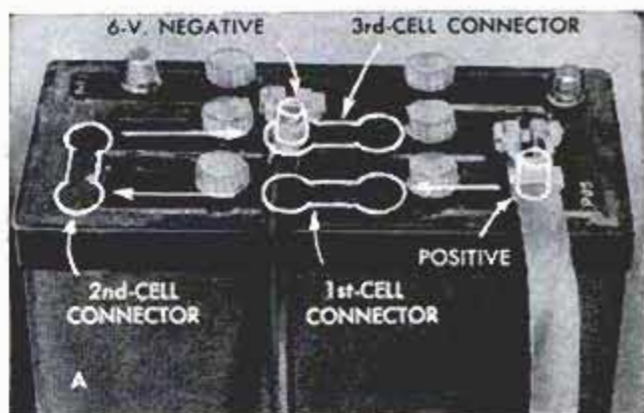



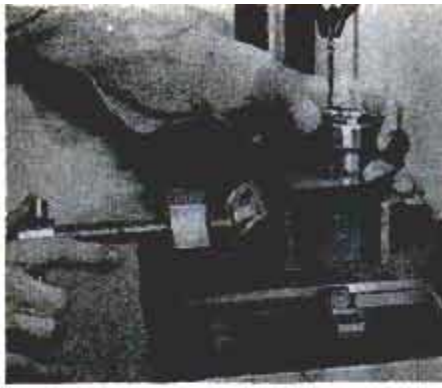

**V-BLOCK** clamped in vise, above, holds round work of larger diameter than  $\frac{1}{2}$  in. Use of V-block assures greater accuracy than would be possible with shallow vees milled in vise jaws. Note that in this setup the vise is held in position with strap clamps which engage grooves milled in sides of vise

**SURFACE GRINDING**, right, is done with a high degree of accuracy by placing the work on a parallel bar and clamping in a drill-press vise. In this instance, the vise is fitted in slides bolted to the drill-press table. This setup permits movement of work under abrasive, thus eliminating the grind marks

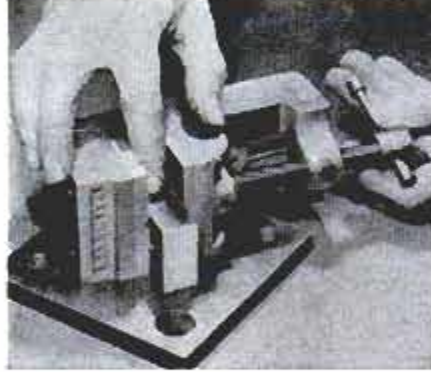
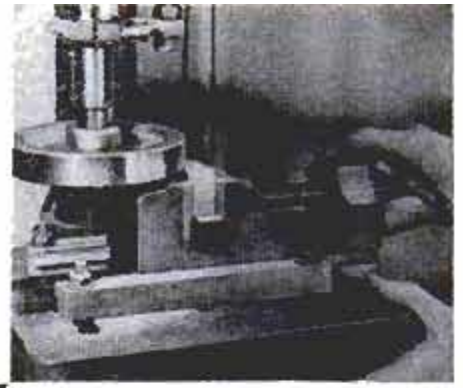

**POSITION WORK** having perpendicular surfaces, left, by placing the vise on its side on a surface plate or the drill-press table. Place the work in position and tighten the clamp screw. Procedure assures that work is aligned with sides and bottom of vise. Work can be drilled in position shown if desired

# YOUR DRILL-PRESS VISE HAS

By *Walter E. Burton*

**A DRILL-PRESS VISE** is something more than a simple device for holding parts in position. It's milled flat on the bottom, usually the end and the sides, also the top of both the fixed and movable jaws. The faces of the jaws are milled square with the flats on the base and top. In addition, vees usually are milled in the fixed jaw and on some uni's grooves are milled along both sides of the frame, making it possible to mount the vise in metal slides, or hold it in a fixed position with strap clamps. Some models of drill-press vises also are mounted on special bases having a pivot and sliding clamp arms which per-

mit tilting the vise for angular work. Thus in addition to serving as a vise for holding parts, the unit fills in as a positioning jig or a fixture for work on round, square, rectangular, hexagonal and octagonal work, also work of irregular shape. Photos above, below and on the opposite page show operations on the drill-press table which are typical of the wide range of usefulness of the tool. The flats permit it to be placed in any of the positions shown with assurance that it will produce accurate work, provided certain precautions are taken when placing it in position on the machine. Be sure table is clear of chips. ★ ★ ★

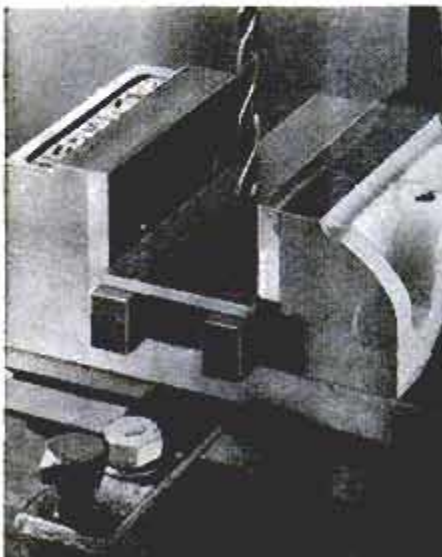

**ACCURATE DRILLING** of metal less than  $\frac{1}{4}$  in. thick, left, can be done by placing the work on ground-steel parallels and then tightening the vise jaws lightly. This precaution eliminates possibility of work springing under pressure of drilling

**WISE** also can be used on end as shown at the right. End of fixed jaw is milled perpendicular to bottom, permitting edge-slotting of the aluminum ring with a router bit. Vise and ring are moved as a unit and forced lightly against rotating bit

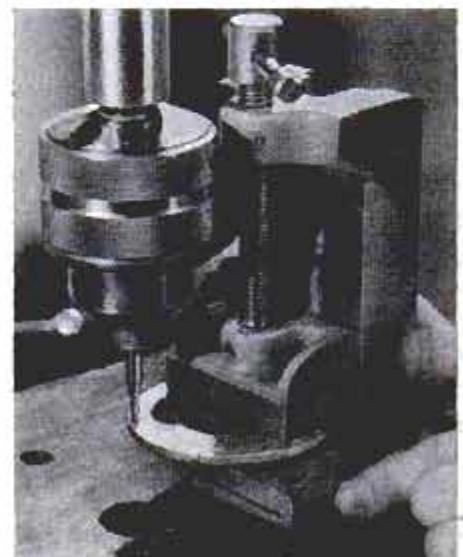

*WFA  
SN 59*



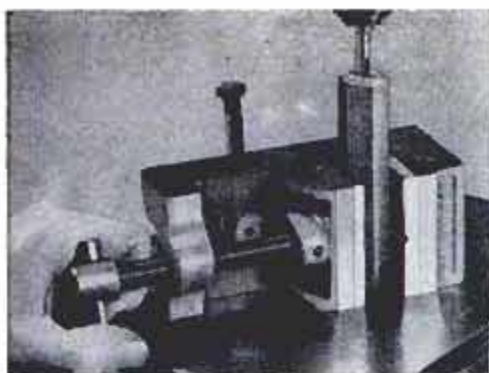

**DRILL VISE** can be used in almost any convenient position on the drill-press table with the jaws in the normal position, on the right or left side, or on end. In the photo above, the vise is being used on its side to hold a short length of hex stock for center-drilling end. Note stop behind vise. This is simply a bolt attached to drill-press table with two nuts to prevent the vise from turning.

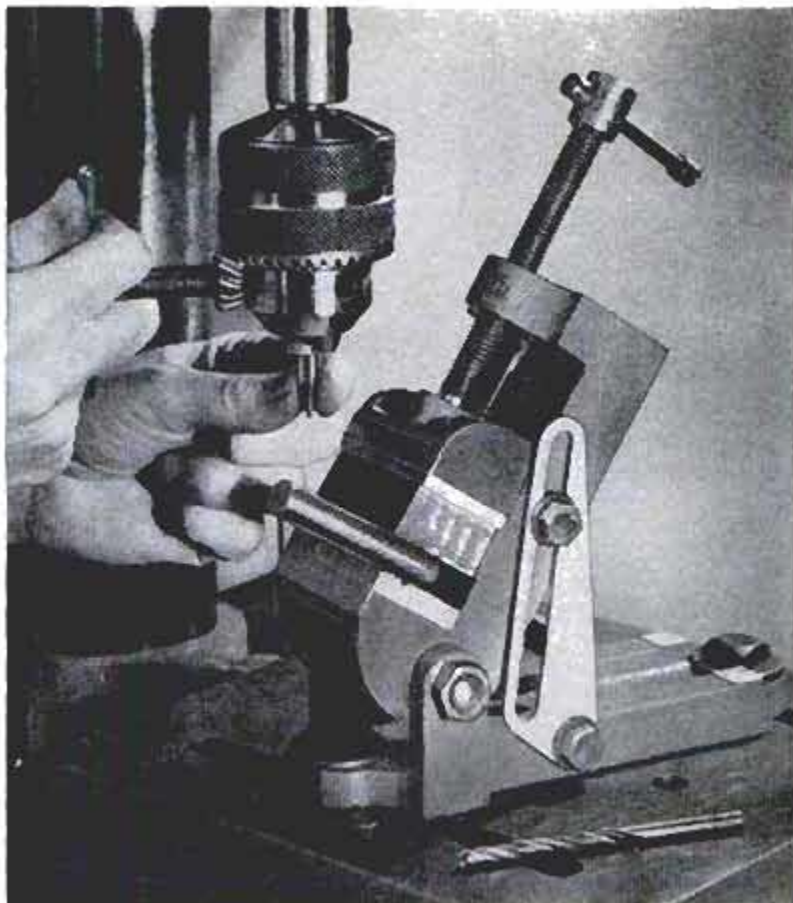

## MANY USES

**CENTERING** a transverse hole through round stock can be done by making a drill guide from stock of same diameter as that to be drilled. Then both pieces are clamped in vise as in photo at the right, centering the guide automatically. Note that vise is held in position with a strap clamp which prevents its shifting.

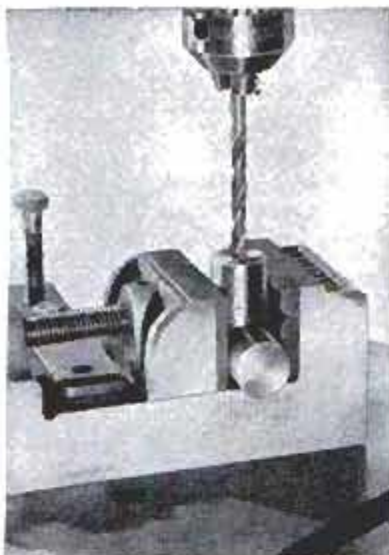

**ANGLE DRILL VISE**, above, comes with special base and slotted brackets that permit vise to be set at any practical working angle. Can be locked rigidly in desired position. Unit also is handy on the bench for holding small parts.

**ANGLE DRILLING**, below, can be done with essentially the same setup as that pictured at the right. End of the drill guide is tapered to the work angle, detail B. When the two parts are clamped in the vise, drill bit will enter the work without drifting. Work must be centered under drill and vise clamped to table.

**TAPERED WORK**, such as the Morse tapered shank pictured below, can be held in regular drill vise by using a round and a length of flat steel as backing. Work having a steeper angle, or taper, can be held in a similar manner, see detail A.

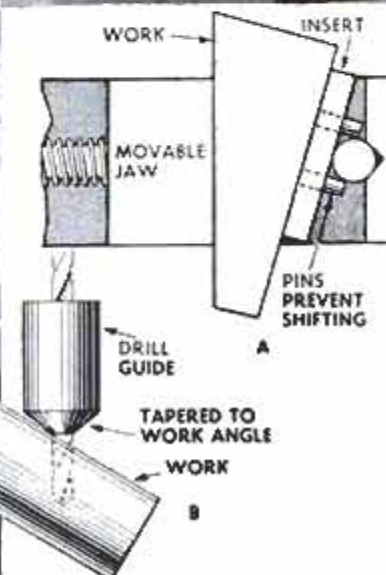



# This Surfacer

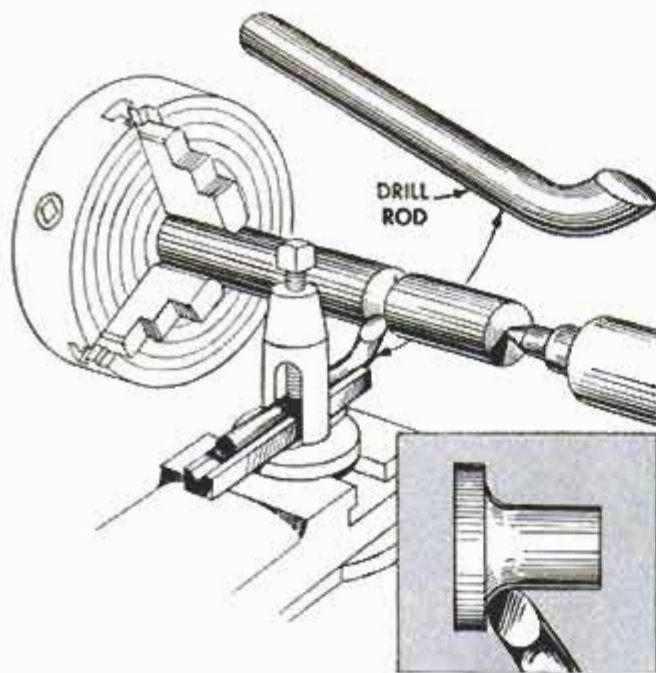

## Turning True-Radius Fillets

Turning true-radius fillets and grooves on duplicate work can be speeded up with a turning tool made especially for the purpose. By using drill rod for the tool, a size can be selected to give the radius desired. Heat one end to a bright red and bend to 45 deg. Then grind roughly to about a 5-deg. rake angle. Then harden and draw the temper to give a good cutting edge. Finish-grind and hone to remove all marks of the coarse grinding. Mill or file a half-round holder to support the tool. Grind a flat on the straight section of the tool to form a seat for the tool-post screw.

C. W. Woodson, Chicago.

## Holder Keeps Tools Handy

By taking time to make this durable holder you'll eliminate many a lengthy search for misplaced tools. It's made from heavy sheet metal and can be screwed to the bench top or to the top of the tool panel. Drill a row of holes near each edge to take the tool shanks, sweat solder a strip to one edge as shown and bend over a piece of pipe.—Luke Williams, Columbus, Ohio.

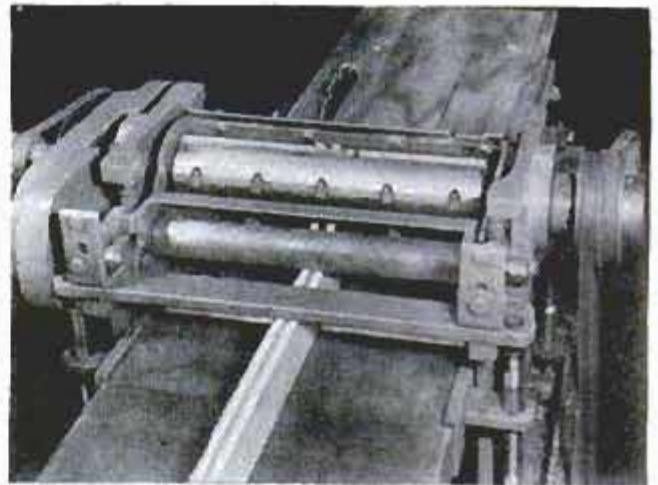
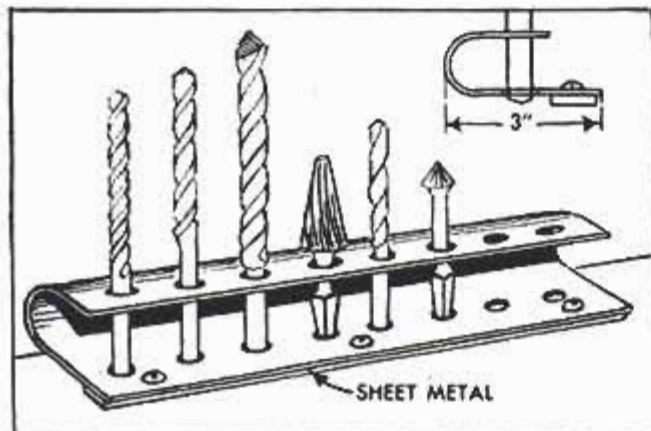

Cutterhead is pictured with guards removed and molding cutters fitted for cutting tongue on edge of stock. Matching tongue-and-groove cutters are used

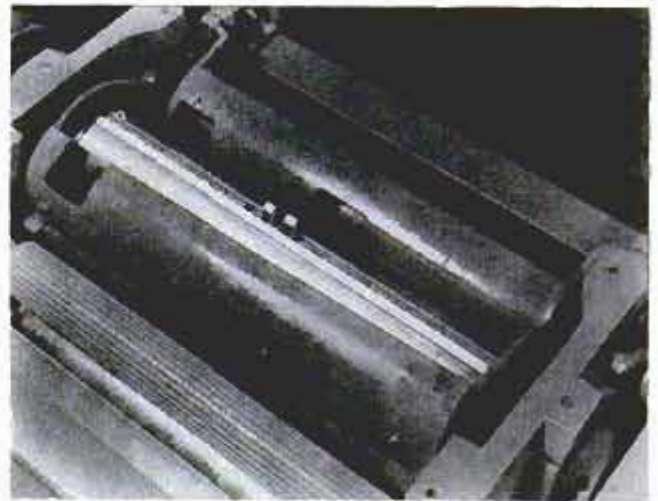

Tongue cutter is in position at center of head. Also can be placed at end of cutterhead. Note clearance openings. A variety of cutter shapes are available

Ripsaw is driven from cutterhead shaft. Can be shifted right or left to rip stock to desired width. Stock is hand-fed to saw, power-fed through the surfer

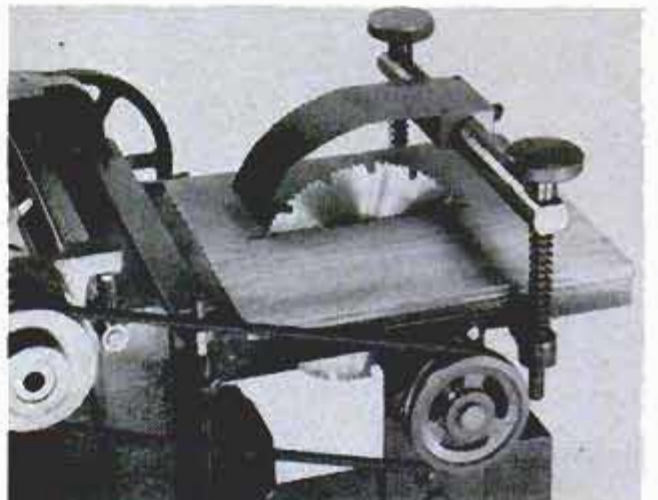



ETA 57

# Combines Three Machines in One

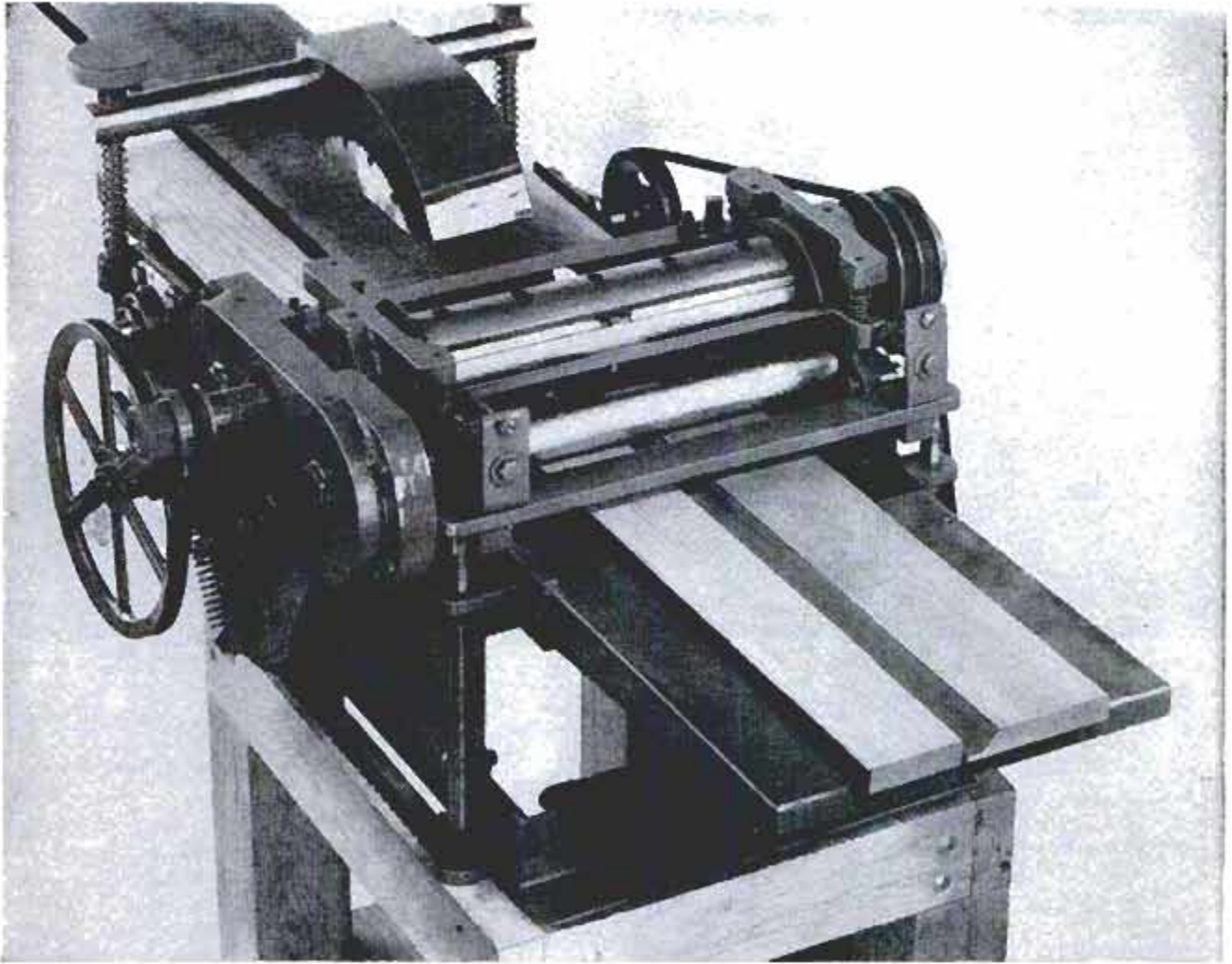

Here machine is set up to perform three operations, ripping to width, surfacing to thickness and molding one edge of stock. Takes material 12¼ in. wide and up to 4 in. thick under cutterhead. Guards have been removed

**I**T'S A SURFACER, rip saw and shaper, all in one. This new machine by Belsaw rips the board to width, surfaces it smooth on one side and cuts a molding on the edge. Note the setup in the photo above and you'll see how all three operations are finished in just one pass of the stock. As the first operation, the rip saw cuts the board to width. The cutterhead carries both surfacing and molding cutters and performs the two remaining operations of surfacing and molding simultaneously.

Photos on the opposite page show how cutters are mounted in the head. In the setup in the upper photo, opposite page, the machine is adjusted to form a tongue on the edge of the stock. Only the molding cutters are used in this operation. Remove the saw blade and molding cutters and you have a single surfacer, or planer, as these machines are sometimes referred to in the shop. Or, raise the cutterhead to give clearance underneath, replace the blade, clamp a guide fence to the infeed table and you have an efficient rip saw. ★ ★ ★

With guards in place and mounted on a special steel stand, machine becomes the compact, efficient unit pictured below. Motor is mounted in steel stand

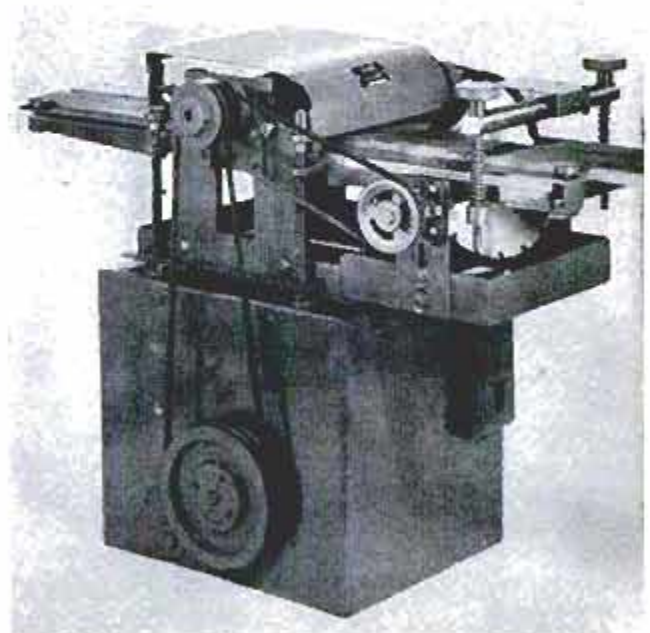



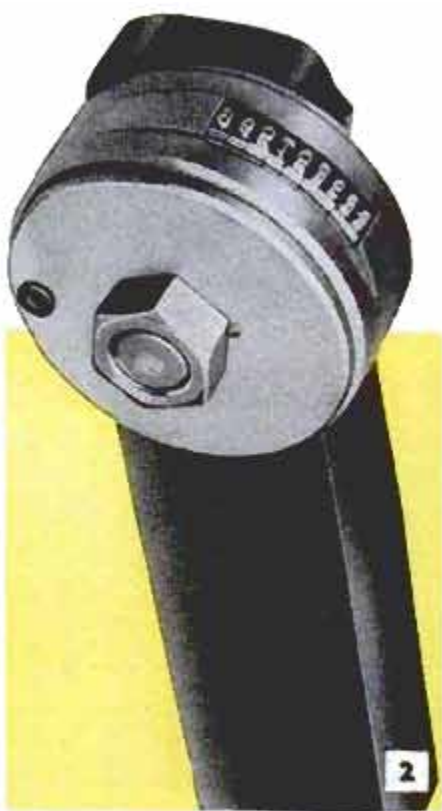
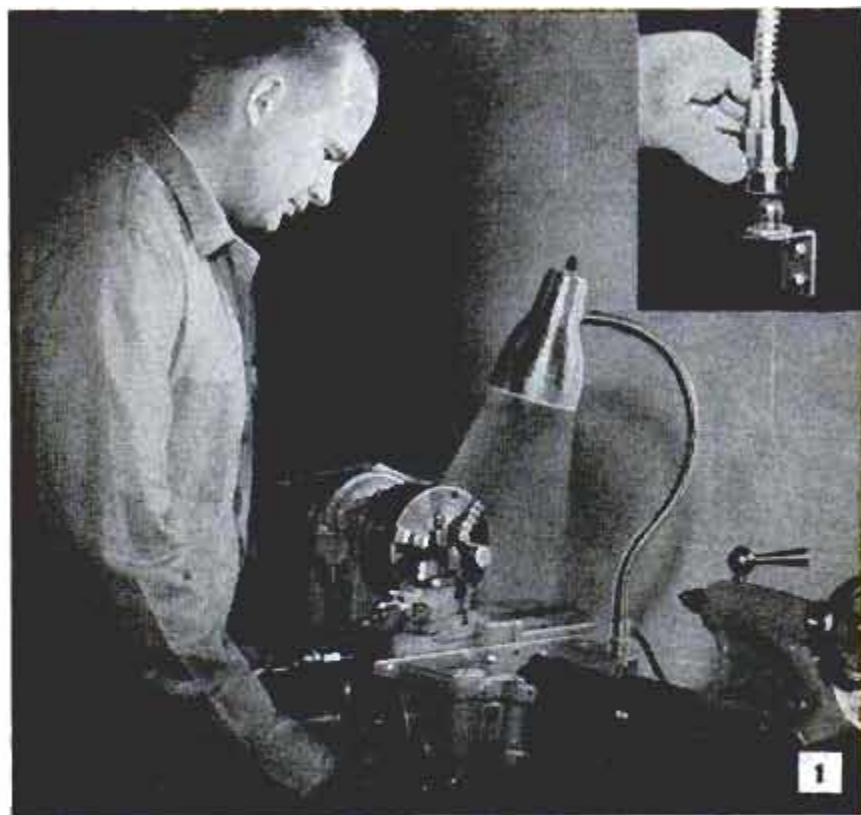

# SHOPPING FOR TOOLS

**1. SHOP LAMP** can be moved to any point where light must be concentrated. Comes with special mounting brackets which are installed at bench, on machines or any other point where light is required. Available with 18 and 24-in. flexible arms and "cool" shades. Inset above pictures special mounting bracket which can be screwed to wall, machine or bench

Moffatt Products, Inc., 4824 Triton Dr., Minneapolis 22, Minn.

**3. MANUALLY POWERED FASTENING TOOL** utilizes a hammer blow to drive a fastener through steel up to  $\frac{1}{4}$  in. thick. Seats a variety of fasteners in any kind of building materials. Special hand guard and leveling plate protect user from injury. Plate is detachable, making it possible for fasteners to be placed in corners and other hard-to-reach places

Ramset Fasteners, Inc., 12117 Berea Rd., Cleveland 11, Ohio

**5. TINY JET PUMP IS SELF-PRIMING**, handles 450 gal. per hr. Compact size requires the minimum of space for installation. Mounted on a suitable base with electric motor or gas engine, the unit is easily portable. Suitable for filling overhead tanks, draining flooded basements or for small sprinkling or irrigating systems. Comes complete, ready to install

Jacuzzi Bros., Richmond, Calif.

**7. BENCH-SAW TABLE** is designed for man whose requirements do not warrant the outlay for a larger and heavier unit. Steel table has ground and polished working surface measuring 12 x 13 in. Blade rips and crosscuts stock 2 in. thick. Double locking fence and conventional miter gauge are regular equipment. Arbor tilts 45 deg.; raises and lowers

Roeca Products, Inc., 2916-4th Ave., S., Minneapolis, Minn.

**2. INSERT-TYPE ROLLER DIE** for lathes and screw machines features a spring return which returns marking unit to starting position after part has been marked. Can be supplied with one or more lines of lettering or any number of characters, with a part of lettering permanent, or with all letters interchangeable. Special symbols also can be supplied

M. E. Cunningham Co., 1025 Chateau St., Pittsburgh 33, Pa.

**4. PLUMBER'S PLIERS** come with soft-jaw inserts for work on plated plumbing fixtures and decorative nuts and screws of various types. Jaw openings are adjustable from  $\frac{1}{4}$  to  $2\frac{1}{2}$  in. by sixteenths. Jaw liners, or inserts, can be supplied in brass or nylon, the latter material being recommended for work on chrome-plated fittings. Either type is attached with screws

P & C Tool Co., P. O. Box 5926, Portland 22, Ore.

**6. THREE-WAY LOCK WASHER HAS BARBS**, or teeth, on both faces to engage the nut and metal on which it is seated. This feature gives a vertical, rotary and horizontal locking effect that will withstand excessive vibration without loosening. Barbs are hardened to enable them to embed in all but the hardest metals. Available in various common sizes

Hi-Standard Stamping & Mfg. Co., 18228 James Couzens, Detroit 35, Mich.

**8. MITER CALCULATOR** gives the correct compound-angle settings at a glance. Saves both time and wasted stock when cutting various forms of the so-called hopper joint. To use, you determine work angle and align scale with predetermined work angle. Correct settings for saw-blade tilt and miter-gauge angle appear in windows on the right and left sides of scale

Miterite, 1459 Patio Dr., Campbell, Calif.



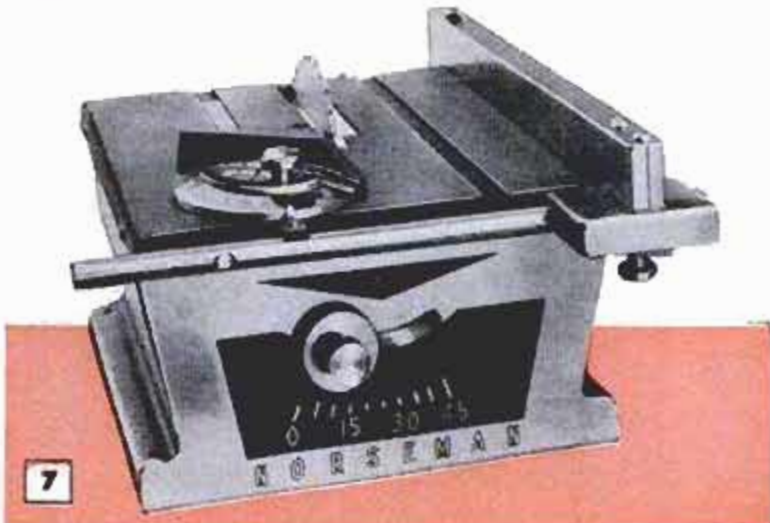
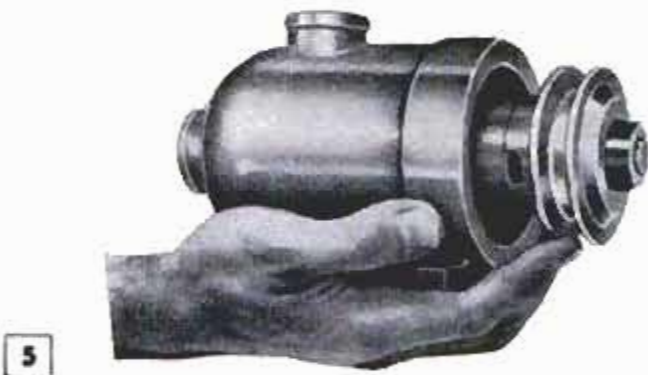
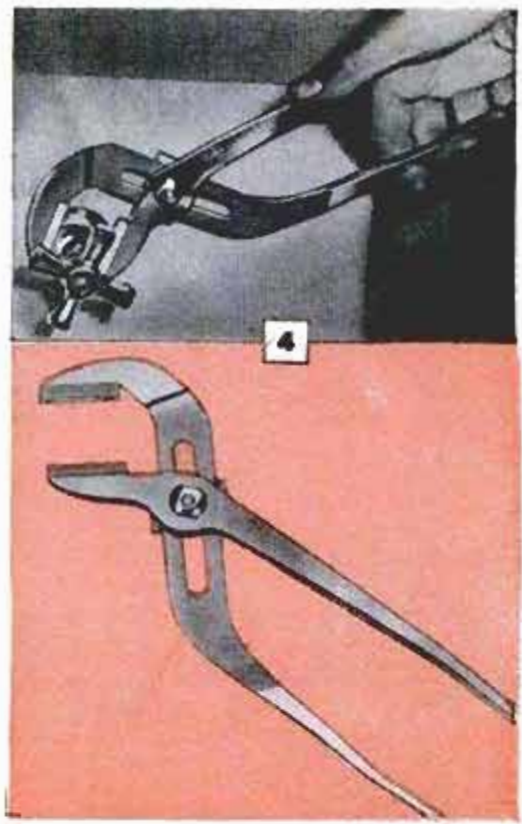
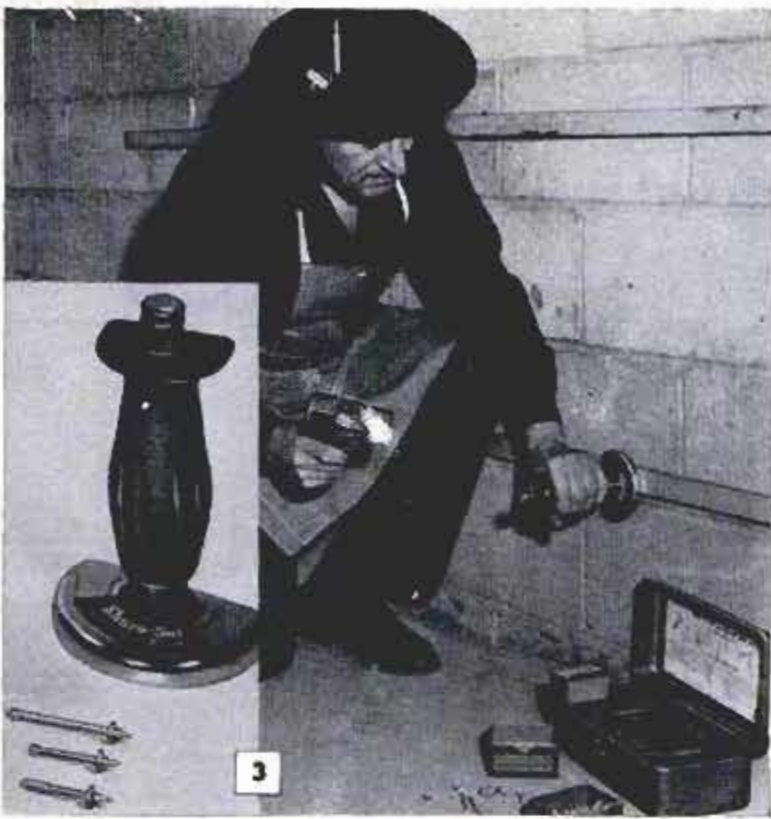



# Lever-Operated Gate Latch Saves Stooping

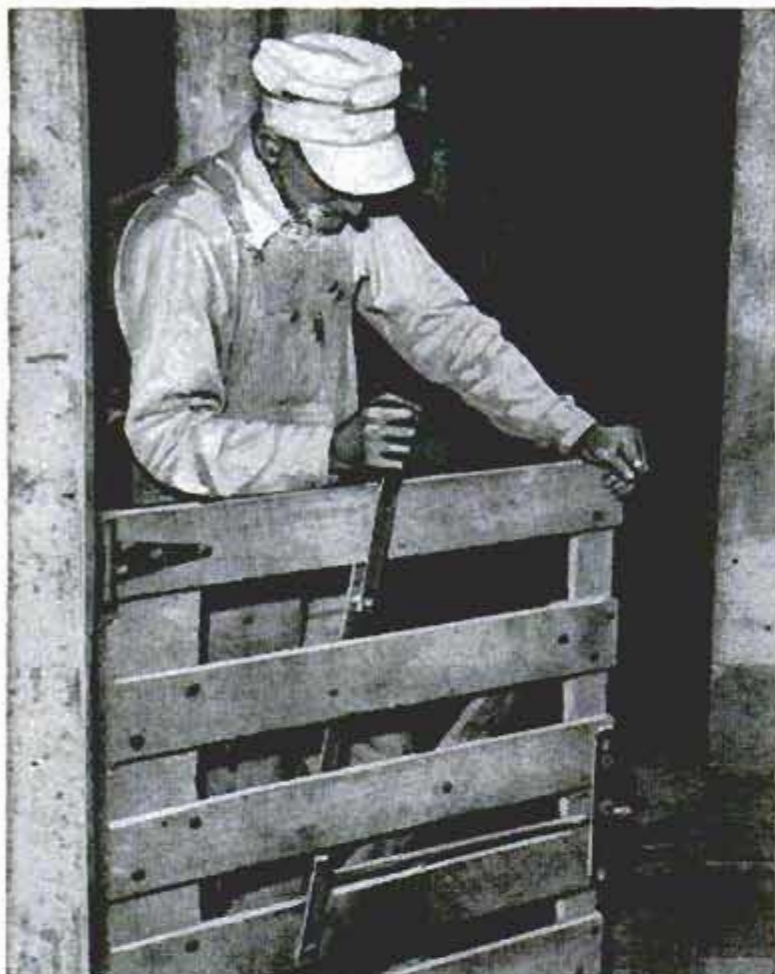

Pivoted to a lever that extends above the gate, this heavy bolt latch is operated from either side of the gate. The lever is bent just above its pivot point to the opposite side of the gate, then extends above the gate. The upper end of the lever is bent double and bolted to itself so that it completely encircles the top rail of the gate. The slide bolt for the latch is a length of steel rod pivoted to the lever at the point where it passes through the gate. A length of flat steel bolted to adjacent cross members of the gate serves as a retainer.

## Saw Blades Stored in Album

Circular-saw blades can be safely stored in an ordinary record album. You'll always know where they are and they'll keep in perfect condition over long periods of time if you take certain precautions. Coat the blade on both sides with a light oil and place between two sheets of heavy oiled paper. Fold the corners of the paper over and seal with tape.

## Simulated Polished Finish On Turned Cast Iron

Occasionally it is desirable to finish cast iron to a high polish after turning in the metal lathe. There's an easy way to do this by simulating the polished finish, using a file as the "polisher." Grind the end of the file square across and to a bevel of 3 to 5 deg. Hone to a sharp edge. Then turn the toolholder approximately parallel with the lathe axis, set the top edge at center and use as a tool rest for the file. Take very light cuts to avoid scoring.

Frank L. Rush, Columbus, Ohio.



## Multiple V-Belt Drive For Farm Feed Grinder

To eliminate trouble caused by slippage of a flat-belt drive from tractor to hammer mill, one farmer replaced the flat pulley on the grinder with a multiple V-pulley. Then he mounted an 18-in. flat pulley on an angle-steel bracket as pictured, the pulley shaft extending beyond the pillow-block bearings far enough to engage the power take-off shaft direct from the tractor. Then matched V-belts are placed side by side to form the efficient drive shown.

John Fitzpatrick, New London, Iowa.

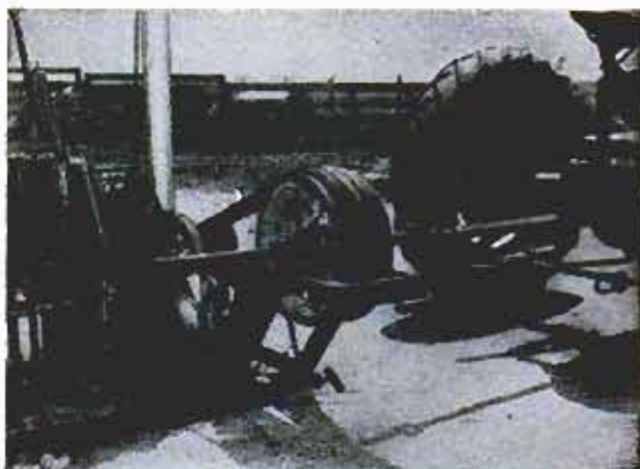





## Why Magna?

—Because MAGNA's new, complete family of superior power tools incorporates the first significant design contributions in over a quarter-century!

**HERE'S WHY THE MAGNA 11-IN. BAND SAW** gives you more than any other band saw: • *New Ease of Operation* with exclusive Automatic Blade Tracking (quick, safe blade changing!) Single-knob for one-hand adjustment of blade guide height! • *Increased Capacity* — blade offsets to cut any length stock, up to 6" thick! • *Integral Precision* — exclusive Cross-Slot table for precision re-sawing! • *Rugged Durability* — one-piece pressure-cast frame! Basic Band Saw only \$79.95, delivered! Mail coupon today for full specifications in *free* Magna-Line catalog.

**Own the MAGNA 11-in. Band Saw for as little as \$1.54 a week!**



MAGNA-LINE tools for home and industry include (l to r): 9" Saw, 9" Saw-Jointer, 18" Jigsaw, 4" Jointer, 6" Belt Sander, Compressor-Sprayer, 30" Lathe, 12½" Drill Press. (Also the new MAGNA Thrifty-Three: 8" T/A Saw, 12½" Jigsaw, 4" Belt Sander).



MAGNA POWER TOOL CORPORATION  
World's largest independent  
producers of power tools

MAGNA POWER TOOL CORPORATION  
Dept. 703-M, Menlo Park, California, OR  
Dept. 703-M, Box 2808, Fort Wayne, Indiana

Please send me your free, illustrated MAGNA-LINE catalog:

Name \_\_\_\_\_

Address \_\_\_\_\_

City \_\_\_\_\_ Zone \_\_\_\_\_ State \_\_\_\_\_

© T. M. REG.



# New Kodak 300 Projector

yet shows your slides bigger,



Here's a color-slide projector so lightweight you can carry it like a portable radio... so compact, you can store it on a bookshelf. Best of all, it lets you enjoy thrilling big-screen projection even in a small room. At a distance of 10 feet, for example, your favorite 35mm color slide will fill a 40-inch-wide screen.

You really have to see and handle the new Kodak 300 Projector to appreciate its remarkable versatility. Try the focusing and elevating mechanism... the smooth glide of the new Kodak Readymatic Slide Changer. And when you project your

favorite color slide, notice that the rock-steady picture you get is brilliantly illuminated *clear to the corners!*

Your Kodak dealer will be glad to show you the new lamp-condenser system and superb 4-inch, *f/3.5* lens that produce these superior screen results. Ask him, too, about the Kodak 300 Projector's ultra-quiet cooling system... built-in cord storage space. Complete with self-cover.

Kodak 300 Projector with Readymatic Slide Changer (holds up to 36 slides in cardboard mounts), \$64.50... or as little as \$6.45 down.

Kodak 300 Projector with 36-slide self-storing Magazine Changer, \$74.50... as little as \$7.45 down.

*Prices are list, include Federal Tax, and are subject to change without notice.*

## The only projector with the completely new



**SO LIGHT, SO COMPACT,** so easy to carry! Has self-cover, measures only 5 x 11 inches square, weighs only 9 pounds.



**FOCUSING AND ELEVATION** adjustments are fast... precise... with all essential control knobs at your finger tips.

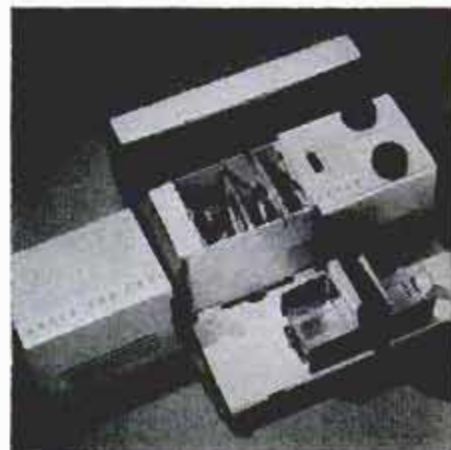

**QUICK, E-A-S-Y ACCESS** to the lamp and condenser compartment—storage space for your lamp cord is built right in.

**EASTMAN KODAK COMPANY,**



**is ultra-portable**  
*brighter!*



## Kodak **READYMATIC SLIDE CHANGER**



**PROJECTS 35MM, BANTAM, or the new, big 1½ x 1½ slides. Also (with an adaptor) single frames of your stereo slides.**

**Rochester 4, N.Y.**

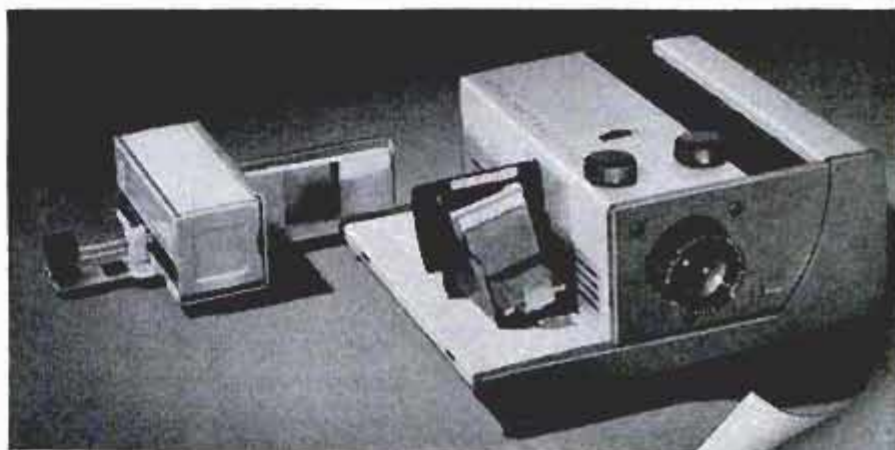

**CHOICE OF EXCLUSIVE new Kodak Ready-matic Slide Changer which accepts up to 36 slides per loading, or self-storing, magazine-type slide changer.**

**Kodak**  
TRADE-MARK



# Engines don't age...

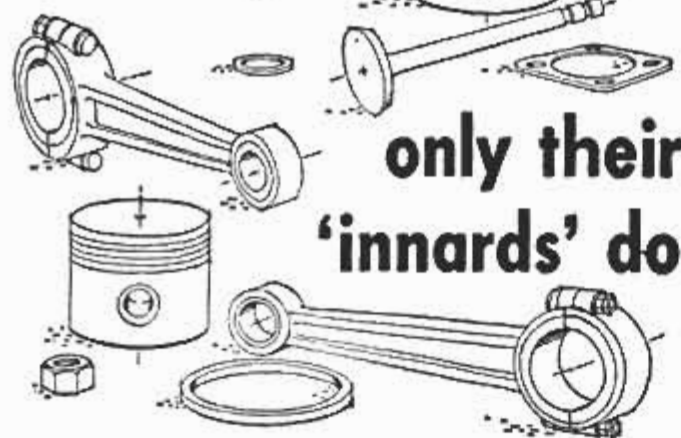

## only their 'innards' do

You can restore new car power,  
save oil immediately with

## Sealed Power KromeX Piston Ring Sets

Sealed Power's KromeX Piston Ring Set with the new stainless steel oil ring (U.S. Patent 2,789,872) controls oil and saves you money immediately. Even under high vacuum conditions there is no smoking when you install this ring set.

This unique oil ring is being used as original equipment in the two makes of cars which out-sell all others. Judged by either your pocket-book or car's performance, Sealed Power's KromeX Ring Set with the stainless steel oil ring is your best buy.



### FROM US TO YOU

An illustrated manual on engine care—free, yours for the asking. "Care and Feeding of Engines" is highly informative, could save you a lot of maintenance expense. For your free copy, write Sealed Power, Dept. G-1, Muskegon, Michigan.

# Sealed Power

## PISTON RINGS

BEST IN NEW CARS! • BEST IN OLD CARS!

# Clinic for Homemakers

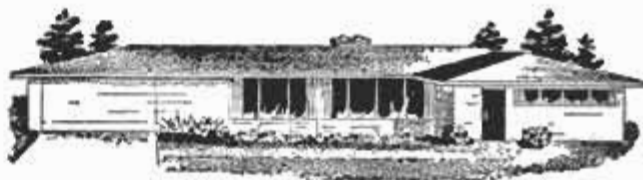

As a service to our readers in solving the hundreds of problems pertaining to a home—inside or out—the editors of *Popular Mechanics* invite you to present your problems to The Clinic Editor for help and advice. Address your questions to The Clinic Editor, *Popular Mechanics Magazine*, 200 East Ontario Street, Chicago 11, Ill.

### Stained Exterior Door Turns White



**Q**—Two doors in my home are stained a light-oak color and then varnished two coats. This was done a year ago. Lately during the cold weather I have noticed grayish-white spots on the finish, irregular in shape but covering a sq. ft. or less in area. There are several of these on each door. The spots are on the inside, not the outside. What is this, and how can I restore the finish—R.H., Mich.

**A**—We assume, of course, you are referring to outside doors. It is not possible to say with certainty what has caused the grayish-white spots you describe, but we would be inclined to say it is due to moisture condensation. In cold weather the temperature at the surface of the door on the room side is much lower than that of the air in the room. This causes the moisture in the air to condense on the colder surface. Ordinary varnish or shellac would eventually be affected by this condition. However, there is one other possibility that should be considered. If the doors are unprotected, that is, by an awning or porch roof, water may seep through the joints where the rails join the stiles and work through the wood, or the joint, to a point under the varnish film. This also can cause the defect you describe. Of course, the remedy depends on the cause. If the discoloration is due to condensation, then we would suggest that you remove the old finish from the inside of the doors, restain if desired, and apply an outside clear finish which is especially compounded to withstand weathering. If it can be determined that the discoloration is due to seepage of water through the joints, then, of course, the openings at the joints must be sealed with a calking compound or putty.

### Removing Old Paint From Plaster

**Q**—I want to remove several layers of old paint from a small plastered area, about 20 sq. ft. Is there anything faster than an ordinary paint and varnish remover? If so, what?—H. M., Pa.

**A**—There are perhaps faster solvents but we couldn't recommend them for the purpose you have outlined. A paint and varnish remover is the safest and in the end, we believe, the surest. You should use the paste type of remover which will stick to a wall or ceiling. Take time to apply it uniformly with a wide puttyknife or a spreader of the type used to apply tile cement. Give the remover plenty of time to work. A small amount of clear lacquer of the spray grade will tend to speed the action of the remover somewhat. Add about one-eighth pint to a quart of remover.



# GRAVELY

## More for your Money!

Now!  
30 Tools



CULTIVATE GROWING CROPS

POWER CULTIVATE YOUR GARDEN



MOW GRASS OR WEEDS MULCH LEAVES



MOW LAWN AREAS



MOW TALL GRASS, WEEDS, CROPS



BLOW SNOW AWAY



MOVE SNOW, DIRT



HAUL HALF-TON LOADS



## GRAVELY MAKES TOUGH JOBS EASY!

Gravelly does jobs other tractors won't . . . because Gravelly has that *extra* power you need for the toughest lawn, garden, field and farm tasks. Does a better job everywhere, even on *steep slopes!*

With a choice of 30 attachments, you do every chore with a performance-proved tool that does it *better, faster, easier!* Because Gravelly's *all muscle*—its direct engine drive puts the power where it counts— at the *working tool*. That means performance *Plus!*

### More For Your Money!

Yes, you get more power, more performance, more for your money when you get Gravelly. The cutaway view on the right shows you its clean, compact, power-engineered design — the reason for Gravelly's remarkable performance.

Never before, in a small tractor, such remarkable *versatility*, such built-in *power*. Whatever the job, whatever the season, Gravelly turns in a *real* job with unbelievable *ease and speed* . . . All-Gear Drive, Power Reverse, Balanced-Weight Handling, Push-Button Starter optional.

- ALL-GEAR DRIVE
- POWER REVERSE
- Power Attachments Securely Mounted by Only 4 Bolts

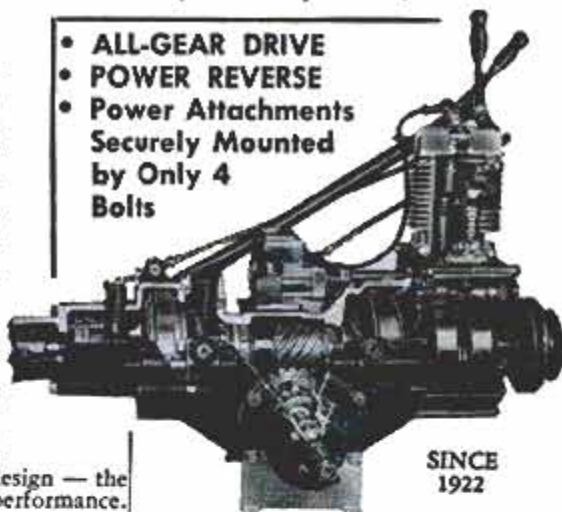

SINCE 1922

New 24-page "Power vs Drudgery" Booklet shows how Gravelly can solve *your* upkeep and gardening problems *better, faster, easier*. Mail coupon today!

EASY PAY PLAN

**GRAVELY TRACTORS, INC.**  
BOX 163, DUNBAR, W. VA.

Please send me "Power vs. Drudgery" Booklet and dealer's name.

Name \_\_\_\_\_  
Address \_\_\_\_\_  
City \_\_\_\_\_ Zone \_\_\_\_\_ State \_\_\_\_\_

WRITE TODAY

FIELD-TESTED SINCE 1922



## I Led the Thunderbirds

(Continued from page 136)

opposite direction. It's a simple, graceful way of turning around. But it's tough when we use it to change from diamond to trail formation. The slot man must back off first so the wingmen can slip back behind me in proper order, so Bill Pogue is the lad on whom the maneuver depends. If you listened in on our frequency during this one, you'd hear something like this going on upstairs: "Thunderbirds, come up to AB (afterburner) range . . . ABs now! . . . this'll be a change-over whifferdill . . . Bill Pogue, you call the change. . . ."

With four roaring afterburners going, the diamond rolls into the arch as Bill takes over: "Roger . . . Thunderbirds, now!" Pogue eases throttle, Doug's right wing lifts as he slides back on Bill's nose, Bob's left wing rises as he slides in behind me. In two seconds we're pulling out of the whifferdill single file at 700 miles per hour, streaming long columns of smoke.

### Sounds Like Card Players

And so it goes. One fellow who did hear us on his radio during a show said we sounded like a bunch of guys sitting around playing cards. Actually we could probably fly the show without talking—and nearly did one day at Maxwell Field. Ed "Lucky" Palmgren, then my slot man, broke his throttle cable during our vertical climb into the bomb burst. I heard him tell me as he rolled out of formation and dove for the strip. Then I discovered I couldn't call a signal. My transmitter was dead. Lucky landed safely, and the three of us went on with the show. At first the wingmen flew by watching me—then they took over and called the turns between them. Nobody knew the difference.

Anticipating the leader's every move is the real secret of tight-formation aerobatics, and the T-birds are crackerjacks at it. One of the trickiest pieces of timing is, of course, the crossover following the bomb burst. Each man, looping and rolling in an opposite direction from his opposing partner at the 10,000-foot-altitude breakaway, must spot all three of the other planes as he begins to flatten out. Then, the four pilots, approaching each other from the four points of the compass at sonic speed, must gauge distance, timing and altitude to arrive at the same point at the same time—allowing just enough difference in elevation to avoid the most colossal head-on crash imaginable. The boys are so hot on this, from endless practice, that their tolerances become infinitely small. At one show

over Bolling Field, former wingmen Burt Spalding and Bill Creech gave the customers a real thrill. Zooming down from four miles high, Spalding flattened out only four feet above ground, roaring south at crossover point; Creech shot past him going north at three feet of altitude. Every photographer in sight was flat on his stomach as they crossed.

On most maneuvers the wingmen work hardest. In order to put a formation through rolls and turns as though the four ships were a single unit, these pilots must continually play the throttle and follow the movement of the leader's wing tips—maintaining constant position beneath them. "We're working and pulling the stick against nose-down trim like mad the whole time," Bob Anderson will tell you. "I work under a constant four-to-five G pull throughout the show." This is the reason newcomers to the team spend two weeks massaging sore arm muscles.

### Stand on Wing Tips

You get the idea when you visualize the wingman's position in something like the 360-degree vertical turn, when the entire diamond stands on its wing tips, roaring in a tight circle at nearly the speed of sound. Bob explains it this way: "On the roll-out, the outside wingman is like the guy at the end of a string of skaters cracking the whip. Afterburner exploding, I swing wider and faster than anyone else to stay in position. I'm pulling more than five Gs. If my hand slipped off the stick it would weigh so much I couldn't lift it."

### G-Suit Offsets Gravity

Every T-bird has a pressurized G-suit to offset the pulling strains of gravity, but few of us care for the added encumbrance, and they're seldom worn. They also add one more thing that can foul up. In the middle of a maneuver one day, the intake valve on mine let go. The suit blew up like a balloon, squeezing me like the coils of a boa constrictor. I grabbed the hose, yanked it loose and deflated it before it throttled me. I finished the show without it.

With all hazards and split-second precision required in formation aerobatics, it would be remarkable if the Thunderbirds didn't have an incident to remember.

Bill Pogue won't forget the day when his entire electrical system went out during a show, leaving him without anything—including landing-gear power. He dropped away, shot a flame-out pattern and landed hot. On top of everything else, his drag chute failed. Fortunately he made the runway, which was a long one, and skidded

(Continued to page 246)





**You can buy a new car with the money this coupon can save you!**

Send 25¢ today  
for 72-page  
catalog in color  
**THE ALADDIN CO.**  
BAY CITY, MICH.

NAME \_\_\_\_\_  
STREET \_\_\_\_\_  
CITY \_\_\_\_\_  
ZONE \_\_\_\_\_ STATE \_\_\_\_\_

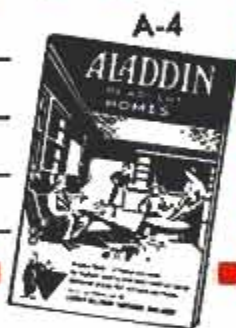

# ALADDIN READI-CUT HOMES

**ARE ENGINEERED TO SAVE YOU THOUSANDS OF DOLLARS!**

LOOK AT THE FACTS: Aladdin sells thousands of houses. Because of the huge quantity of lumber used the average builder cannot match Aladdin's prices. And you save on labor. Instead of paying

carpenters \$20 a day or more you can easily build, or help build, an Aladdin home yourself. Thousands have done it. Please keep one thing in mind: *When you build an Aladdin Home you get the finest quality lumber and materials — shipped to you Freight Paid.* There's a wide choice of modern designs by Aladdin's architects and your finished Aladdin Home will stand comparison with homes priced far above what you pay. That's why thousands of families who must save are buying Aladdin Homes today. *One thing more: Aladdin Homes are in all 48 States — you can see one near you before you buy.* But first send the coupon above for Aladdin's new 1958 Catalog. It will open your eyes to savings you never thought possible! Mail it today!



Noted for **HIGHEST QUALITY** and **BEST CONSTRUCTION**



At **DELIVERED PRICES** that will **SAVE YOU MONEY**



**110 MODERN FLOOR PLANS**  
5 to 8 Rooms — RANCH, COLONIAL, CAPE COD, 2-STORY  
NOT PREFABRICATED • ALL MATERIALS READI-CUT

from  
**\$3,000**  
We pay  
the freight



# EASY CASTS

QUICK AS A FLASH



... with  
**PUSH-BUTTON  
Magic!**

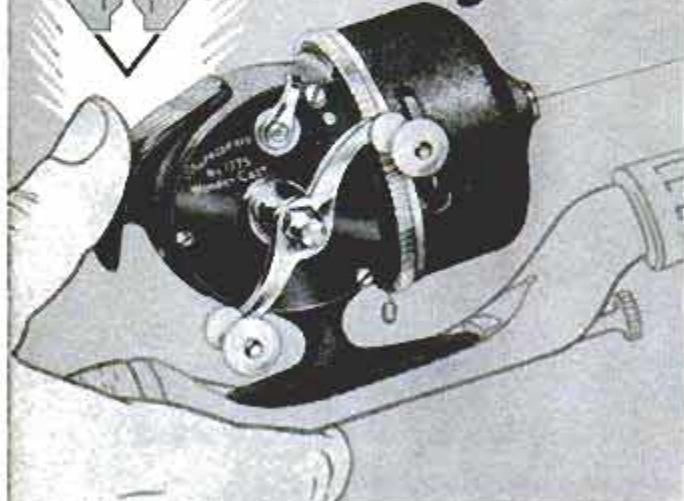

## Shakespeare PUSH-BUTTON WONDERCAST

Just a push of the button... a s-w-i-s-h of the rod... presto! You're push-button fishing! All the good attributes of bait casting plus the benefits of fixed-spool spinning are combined for backlash-free, "magic" casts of live bait, light or heavy lures. Ask your dealer about its advanced design, trouble-free performance, and rugged construction. Sparkling duo-tone black finish, non-reverse crank; outer cone turns for quick drag changes. Easy to handle bait casting crank. All outstanding features to help everyone catch more fish—*have more fun!* No. 1775 (filled with 125 yds. 6 lb. monofilament)..... \$19.95

**"FISHIN' FUN"  
FOR EVERYONE**



**FREE! 5 COLORFUL NEW FISHING BOOKLETS AND CALENDAR** Latest in fishing ideas and equipment. Write for these 5 brand new booklets on salt water, bait casting, spinning, fly and push-button fishing.



**SHAKESPEARE COMPANY**  
Dept. PM-1, Kalamazoo, Michigan

Please send me absolutely free your 5 new fishing booklets and calendar.

Name \_\_\_\_\_

Address \_\_\_\_\_

City \_\_\_\_\_ State \_\_\_\_\_

to a halt just a few feet from the end. "Hairiest" of all was the day when Lucky Palmgren flamed out at 5000 feet during practice near Maxwell Air Force Base in Alabama. He dove for the nearest open patch—a tiny cornfield—while we all watched, knowing the field was too small. It was. But Lucky didn't get his nickname for nothing. He rocketed in, skimmed over one set of telephone wires, ducked under another, ran out of cornfield still going 100 miles per hour, roared across a railroad, sheared off his landing gear on a road embankment, over which he bounded, bashed through a fence leaving his tail assembly behind, knocked off a wing at the butt on a phone pole, thumped to a stop, climbed out, and flew a show the next day.

### No Serious Mishaps

An interesting fact, of which every Thunderbird is proud, is that no serious mishaps have ever occurred due to pilot goofs. At our home base, Nellis in Nevada, the team practices twice a day, going through routines repeatedly until each maneuver is letter perfect. At briefings, the slightest errors are ruthlessly hashed over. T-birds know how to take criticism, or they'd never become Thunderbirds. Most of it is good-natured, anyway. On his first show, Doug Brenner turned the wrong way on the bomb-burst breakaway and came in ten seconds late on the crossover. He picked up the tab on all T-bird entertainment for several days as a result. Bart found himself confronted with a little pile of entertainment chits, too, until he licked the habit of scraping his tail skid on sharp take-offs. The system works better than fines. Thunderbirds like expensive entertainment when a teammate is paying.

If you see the Thunderbirds perform this year, not all the boys mentioned in this article will be up there. Maj. J. A. "Robby" Robinson will be in the lead plane calling the shots. Doug Brenner will still be manning that right wing. Bob Anderson, now a captain, has been moved along to other assignments after nearly two years of top Thunderbirding, but Bart Bartley, our old solo man, is up there holding down the left wing in his place. Bill Pogue is still in the slot catching jet exhaust on his tailfin, and Capt. S. R. "Sam" Johnson has moved in to take over Bart's former solo job. Capt. Bob McIntosh is spare pilot and engineering officer, eager and ready to move up to the solo position when the next team member completes his tour and moves on.

But nobody, not even a former Thunderbird, will be able to tell the difference. All these lads are as hot as they come in a jet pilot's saddle. ★ ★ ★



# SKIER'S SPECIAL!

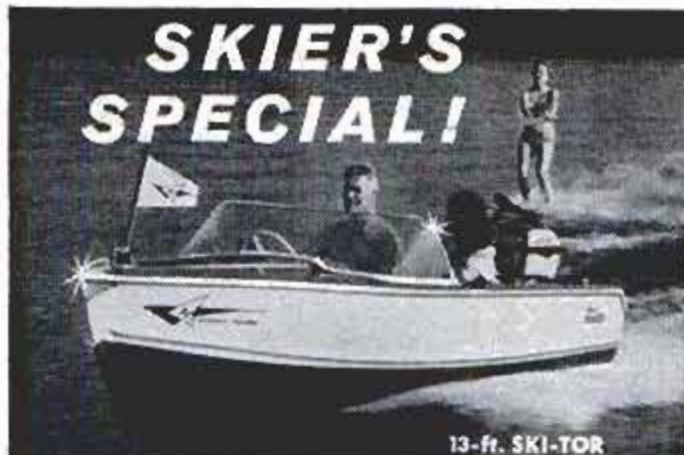

13-ft. SKI-TOR

New all-around ski and sports boat. Husky—63" beam, 55" transom, 40 hp rated. Speed, stability, maneuverability. See your dealer. Ask about the new **GUARANTEE**—or write us for details and free catalog.

ARKANSAS TRAVELER BOATS  
2006 E. 14th St., Little Rock, Arkansas



## Ride while you work!

Plow, cultivate, mow, rake, harrow, till, plant, bulldoze, plow snow, spray, saw, maintain beautiful lawns. 8-4 hp. All-gear drive. B-W 4 speed trans. clutch, diff. 770 lbs. Low cost. Ready to run. Quick-change implements. 100% satisfaction guaranteed.

Write for FREE CATALOG  
COUNTRY SQUIRE TRACTOR CO.  
P.O. Box 107-K-1  
Muskego, Wis.

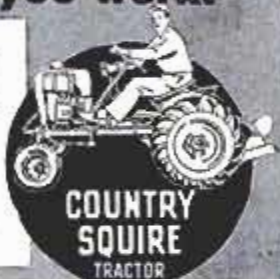

## 10" TILT/ARBOR SAW BUILD-IT-YOURSELF from GIL-BILT KITS-PLANS

Sturdy wood, steel, and aluminum construction, NEW DEPARTURE ball bearings. Capacity and performance of floor saws selling for \$150.00 and up. Plans, all metal parts in kit with 10" comb. blade \$25.99, less blade \$22.95. F.O.B. St. Louis. Detail PLANS-PATTERNS only \$1.00 postpaid.

Build-it-yourself 12" and 18" Bandsaws, 6" Belt Sander, Shaper. Simplified plans, build easily with hand tools only. Advertised and sold for 11 years, over 33,000 units in use. Money back guarantee. FREE CATALOG.

GILLIOM POWER TOOLS, Dept. 80-A, Lambert Field, St. Louis 21, Mo.



YOU SHOULD EQUIP  
YOUR TRAILER WITH

## BULL DOG

- AXLE ASSEMBLIES
- JACKS • COUPLERS

Straight or drop axles in single or tandem—capacity up to 10,000 lbs.—any width. Also Torq-Less Axles for all types of trailers.

**JACKS**—Bull Dog Jacks make hitching and parking a one-man job.

**COUPLERS**—Bull Dog Couplers hitch or unhitch to trailer in a moment.

Write today for FREE Descriptive folder 13A.



HAMMER BLOW TOOL COMPANY

WAUSAU, WISCONSIN

JANUARY 1958

## New Starrett Tools

for

**CARPENTERS**

**BUILDERS**

**HOME CRAFTSMEN**



Lightweight Aluminum

## AUTOMATIC CENTERING PUNCH

**No. 819** centers screw-starting holes for hinges, latches, other hardware. Press down and it strikes. No hammer needed. Features lightweight sure-grip aluminum handle, self-centering locating sleeve, adjustable striking force, hardened steel point.

**No. 92**

## 9-INCH DIVIDER

Holds standard long pencil or steel point. Has long legs for wide range, fine adjustment for accurate setting. Heavy duty construction — legs won't wander on rough work.



**No. 11-HC**

## COMBINATION SQUARE

The indispensable multi-purpose tool. Tempered steel blade has accurate machine divided graduations. Square head has patented reversible lock bolt, built-in spirit level and scriber. Also available with center head. Sizes from 4" to 24".



**Big New Catalog — FREE.** Describes and illustrates over 3000 Starrett Tools. Send the coupon.

STARRETT TOOLS are carried by leading Industrial Supply Distributors and Hardware Tool Stores.



THE L. S. STARRETT COMPANY  
Dept. AP, Athol, Mass., U.S.A.

Please send my free copy of the big new Starrett Catalog No. 27.

Name.....

Occupation.....

Address.....

City.....Zone.....State.....



## The Battle of Donner Pass

(Continued from page 159)

during storms and afterward until snow that the plows didn't scrape off is thawed with salt and is pushed off the pavement. Some drivers protest about the rule on chains, but this is a wet snow that is much more slippery than the dry powder of the Rockies and the Midwest.

Every winter a permanent chain-control gate is established on the east side of the mountains near Donner Lake; on the west side of the mountains a truck is parked by the roadside to serve as a chain-control point. The truck moves uphill when chains are required only across the summit; then is driven downhill again below the snow line when a fresh storm moves in.

### Radio Summons Help

When a big truck slides into a snow-bank in spite of its tire chains, traffic is slowed down or may be halted completely while a radio message is relayed to the nearest commercial garage for a wrecking truck. In the Donner area these calls go to Truckee, 12 miles to the east, where the Thornton garage maintains two big wrecking rigs especially designed for mountain-highway work. Originally the wreckers were military tank retrievers. Now they are fitted with 25-ton winches and are short-coupled so they can back and turn on narrow roads.

Some of the trucking companies have

Front-drive mechanism of grader is fixed at repair shop highway department set up at Donner Summit

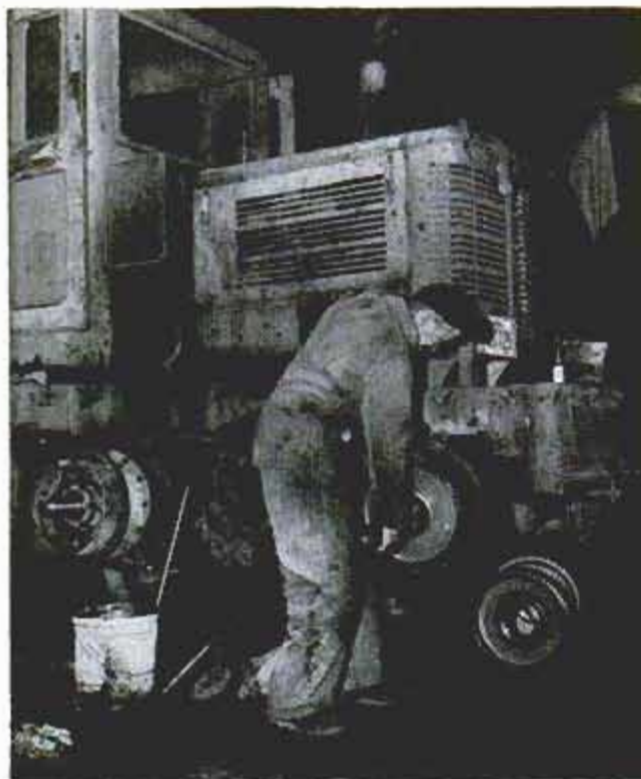

Cab of this rotary snowplow has reinforced steel plate over cab to protect driver from rockslides

taken a tip from railroads that use a helper engine for boosting a heavy train up steep grades. Instead of taking a chance on a truck spinning out in the snow, the companies employ Thornton to tow their trucks and trailers or big tankers up the steepest grades all the way to the summit.

### Open Highways Are Vital

Modern commerce and modern tourists are so dependent on highway transportation that the California Division of Highways makes a daily radio roundup of highway conditions in California and adjoining states, then teletypewrites these reports to newspapers, radio stations and automobile clubs.

On a typical winter morning the daily report may include such information as "U. S. 40, chains required over Donner Summit for eastbound traffic; U. S. 50, chains required 12 miles east of Placerville; U. S. 99, road icy at Dunsmuir, carry chains; U. S. 199, one-way traffic north of Patrick's Creek due to slide; Carson Pass, Ebbetts Pass, Tioga Pass, roads closed on account of snow."

This road information is also available by phoning any of the branch offices of the division of highways. At night and on week ends an automatic phone-answering device in each of the offices repeats the information when the office phone number is dialed.

(Continued to page 250)



## GOT A LOCK PROBLEM?

To make locks work easier and last longer, add a few drops of LOCK-EASE to any lock mechanism. LOCK-EASE — a graphited fluid flushes out dirt — leaves a long-wearing protective film to seal out rain, snow, salt, ice and dust that cause locks to stick, rust and wear out. LOCK-EASE prevents keys from sticking... locks from freezing. Use LOCK-EASE on car locks, garage locks, padlocks and all door locks in and out of the home. For best results, "LOCK-EASE" locks regularly! 4-oz. "Drop or Stream" can only 49c, everywhere.



### LOCK-EASE®

Graphited  
**LOCK  
FLUID**



American Grease Stick Co.  
Muskegon, Michigan

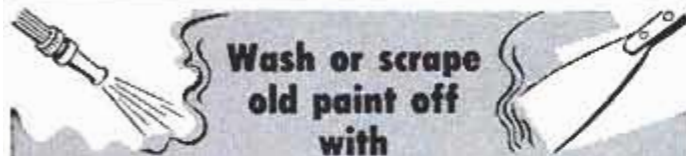

Wash or scrape  
old paint off  
with

## HEAVY-BODIED KLEAN-STRIP

## DINSMORE Compasses

Beautiful, precision made. Designed and styled for modern cars. Dinsmore compasses save you time and money by showing you the right way — the short cuts. An ideal gift for every one who drives.

ONLY COMPASS  
APPROVED BY  
AUTO MAKERS!

WRITE FOR COMPASS HISTORY FOLDER

DINSMORE INSTRUMENT CO., 1802-21 Kelso St., Flint 2, Mich.



TRAVELITE 1953  
ILLUSTRATED  
GUIDEWAY 1955  
(NOW ALL PARTS)  
SEE YOUR DEALER

## SAVE MONEY on LUMBER

with the LOW-COST  
**BELSAW PLANER**

### Convert Rough and Random Size Lumber into Cabinet Finished Stock

Now anyone can make perfect cabinet finished stock from low-cost rough lumber... any size up to 12 1/4 inches wide and 6 inches thick. Turn out high grade finished material at a fraction of the cost you pay lumber yards. Big 42-inch-long bed makes it easy to plane heavy, wide and long pieces... BELSAW self-feeds at 14 to 34 feet per minute.

USE THIS ONE LOW-COST MACHINE for Planing, Jointing, Sawing, Milling, Tongue and Groove.

You can easily make flooring, siding and many other popular patterns with your Belsaw. Your Belsaw quickly pays for itself with savings on raw materials and profits on finished stock... a highly profitable machine for custom work. Compare Belsaw with any 12-inch planer on the market... Belsaw gives you more essential features—yet costs you \$50 to \$125 less than others.

Send Today for Free Literature on the Belsaw Multi-Duty Planer.

BELSAW MACHINERY CO 2058 Field Bldg. Kansas City 11, Mo.



## IT'S MAGIC!

### Turn your Black & Decker Electric Drill into...

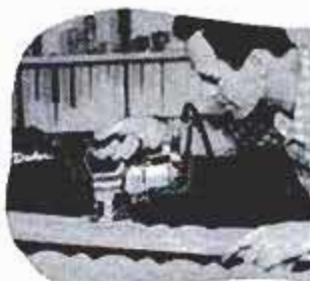

a Jig Saw  
for just \$19<sup>95</sup>

B&D Jig Saw Attachment is perfect for straight, curved or irregular cuts in lumber, plastics, metal, other sheet material.

or a Screwdriver for \$10<sup>45</sup>



or a Sander  
for only \$16<sup>95</sup>

B&D Orbital Sanding Attachment gives professional satin-smooth finish. Does an hour's sanding in five minutes.

or a Hedge Trimmer  
for \$19<sup>95</sup>



or a Saw  
for just \$14<sup>95</sup>

B&D Saw Attachment—world's safest—has all adjustment features of professional saws. Cutting depth of 1 1/2".

or do many other jobs,  
thanks to the magic of

**Black & Decker**  
attachments...

...engineered to give you  
top performance with all  
B&D 1/4" Utility Drills.

Insist on  
B&D's U-3  
1/4" Drill.  
Packs more power  
to do more jobs.



## Black & Decker

World's Largest Maker of  
Electric Tools



Look under "Tools-Electric"



## NEW OAK FLOORING LAYS LIKE TILE over concrete, wood or old tile floor



## Bruce Laminated Oak Block

Modernize your home by installing this beautiful hardwood floor over your old floors. Or use low-cost Bruce Laminated Blocks to create new living space in attic, basement or addition.

**Easy to lay** — Just apply adhesive (Bruce Everbond Coldstik) and lay blocks. Tongues and grooves assure tight fit. No nailing . . . and no sanding or finishing either, because Bruce Laminated Blocks are completely prefinished at the factory. Your new floor is ready to be used and admired as soon as you lay it.

**Moisture-resistant** — Blocks are 9" square and only 1/2" thick. The three oak plies are laminated under heat and pressure with waterproof glue to prevent expansion and contraction. Ask your lumber dealer for a cost estimate. Mail coupon for color literature on Bruce Laminated Blocks.

### SEND FOR COLOR FOLDER

E. L. Bruce Co.  
Box 397-N, Memphis 1, Tenn.

Send complete information on Bruce Laminated Oak Block Floors.

Name \_\_\_\_\_

Address \_\_\_\_\_



**Bruce LAMINATED Oak Block Floors**

By the world's largest hardwood flooring maker

All the roads over the rugged Sierra Nevada range are being steadily improved and within a few years you'll be able to breeze across the mountains on a divided four-lane expressway. U. S. 40 measures 211 miles from the Nevada state line to its terminus in San Francisco, and 139 miles of this distance are already of freeway status or are being improved to four wide lanes. The Donner section of the freeway will be one of the last built, and present plans are to route it somewhat north of the present summit to avoid the cliffs and provide easier grades. Even so, the 10 miles of relocation will cost \$1,000,000 per mile. The present road will be retained as a route to the existing ski resorts.

### Melt the Snow Off?

For a time the highway engineers hoped they could eliminate the need of constant snow removal during winter storms after the new freeway is built. They had visions of keeping the pavement hot so that snow would melt as soon as it fell and then flow off the edges of the road. But the idea wasn't practicable. Aside from the enormous cost of steam plants and steam lines, there were other obstacles.

Present plans are to build a big new snow camp at a sheltered point on the new expressway, large enough to house 100 men. It will require that many snow fighters, and twice as much equipment as at present.

When the expressway is completed you'll be able to cross the Sierra at 60 miles per hour in the summer, though during the snow season you may still have to put on your chains and hold your speed down to 25 miles per hour. Even at that, you'll be breezing across one of the highest and most rugged mountain ranges in the country, in the middle of the winter, in comfort and safety. ★ ★ ★

### Glycerin Added to Water Reduces Cooking Time

Three-minute eggs can be prepared in 1½ minutes and the cooking time for other foods greatly reduced by adding harmless glycerin to water. This was discovered by a 14-year-old Maryland science student, Brenda Gail Kanegis. When glycerin, which is highly soluble, is added to water at the weight ratio of 60-percent glycerin and 40-percent water, a 10-degree C. rise in boiling temperature is obtained. The technique also could replace fats and oils in the frying of many foods, according to Miss Kanegis' research, which has been recognized by the American Chemical Society.



# GIVE YOURSELF A RAISE in '58

## Make \$20 to \$30 a Week Extra Income in Spare Time

Here comes 1958—are you going to get ahead faster next year? How—ask the boss for a raise? That doesn't always work. Here's an idea—be your own boss in spare time and give yourself a raise. \$20 to \$30 a week extra money is easily possible with the machine and the plan offered in this ad.

## Earn up to \$3 or \$5 an Hour with FOLEY SAW FILER

Here is a steady repeat CASH business you can start in your own basement or garage and make up to \$3 or \$5 an hour in your spare time. You can file all hand saws, also band and crosscut circular saws on the Foley Saw Filer. The adjustments are simple—there is no eye-strain—and you can start right away to turn out perfect cutting saws.

"My spare time saw filing business has made me \$952 these first ten months."

—R. T. CHAPMAN

"I made \$756 last year filing saws, and it sure comes in handy. I do this work in my spare time."

—JAMES B. WILLIAMS

"Last year's profit amounted to \$3,000. Not so bad for a one-man outfit."

—CHARLES C. HOUGH

"I have done 4 or 5 thousand saws in my spare time in the 4½ years since I got the outfit, and they are all coming back with repeat orders."

—LEN CREGO

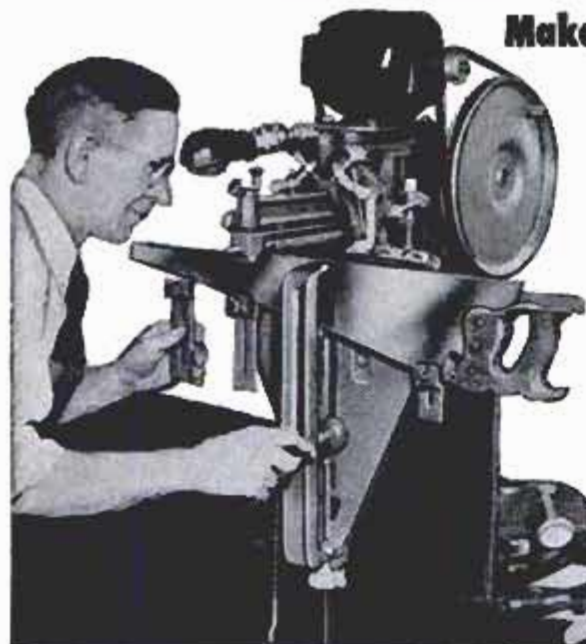

## Send Today For FREE BOOK "MONEY MAKING FACTS"

"MONEY MAKING FACTS" explains how you can get business from hardware stores, homeowners, farmers, carpenters, schools, mills, factories, etc. Get the facts—send coupon today for this practical, money-making plan. No salesman will call.

**FOLEY MFG. CO.** 116-8 Foley Bldg., Minneapolis 18, Minn.

Send me free book "MONEY MAKING FACTS"

Name \_\_\_\_\_

Address \_\_\_\_\_

## NEW, IMPROVED CALCULATOR FOR WOODWORKERS only 25c

Instantly gives information on lumber, nails, concrete mixes, painting materials, etc. Convenient, simple to read. Just set dial for nail specifications, to convert linear to board feet, find bit sizes for screws, compare characteristics of woods. 6" diameter heavily varnished cardboard. Send 25c, no stamps, please to Greenlee Tool Co., 2101 Columbia Avenue, Rockford, Illinois.



## U-MAK-IT BOAT KITS



30 years of boat kit pioneering. 30 models. Prams, Rowboats, Outboards, Cabin Cruisers and Skiffs.

### SEND FOR ILLUS. CATALOG

Showing all models from 8' to 23'. Const. details, paints, access., etc. All you need to build your own.

MAIL 35c (coin) for Postage & Handling.

## NEW LAPSTRAKE SKIFF KITS

Now added to our great line of kits, new easy to assemble Lapstrake Skiffs.



**U-MAK-IT** products

DELAND, FLORIDA — DEPT. 12

## HANG FIXTURES SECURELY

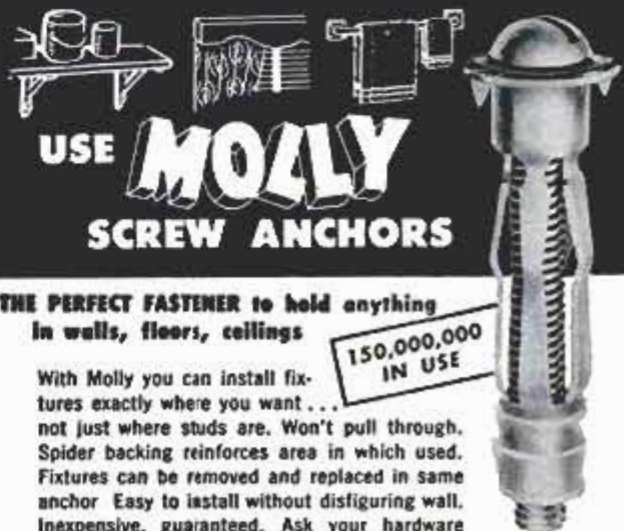

# USE MOLLY SCREW ANCHORS

THE PERFECT FASTENER to hold anything in walls, floors, ceilings

With Molly you can install fixtures exactly where you want... not just where studs are. Won't pull through. Spider backing reinforces area in which used. Fixtures can be removed and replaced in same anchor. Easy to install without disfiguring wall. Inexpensive, guaranteed. Ask your hardware dealer for genuine Molly... the name is stamped on the cap.

150,000,000 IN USE

SEND \$1.00 FOR SAMPLE BOX OF 12



200 N. 5th ST. • READING, PA.

Enclosed is \$1.00 for which please send me a sample box of 12 Mollys postpaid.

NAME \_\_\_\_\_

ADDRESS \_\_\_\_\_

CITY \_\_\_\_\_

ZONE \_\_\_\_\_ STATE \_\_\_\_\_



You'll agree-  
it's the  
**HANDIEST  
PLIER  
OF THEM  
ALL**

**CHAN NEL LOCK**  
No. 420

You'll like the all 'round usefulness of the Channellock No. 420 . . . its terrific gripping power . . . its quick, non-slip adjustability up to 1-3/4" size. And you'll find it easy to use in hard-to-get-at places because of its compact design. Mechanics everywhere say no other plier does so many jobs so well. You'll say so, too!

**CHAMPION DEARMENT  
TOOL COMPANY  
MEADVILLE, PENNSYLVANIA**



**ASK YOUR  
TOOL SUPPLIER  
FOR  
CHANNELLOCK  
PLIERS**

**Be sure its a genuine CHANNELLOCK  
Look for the trademark on the handle**

## A New Landmark for Brussels . . . The Atomium

(Continued from page 103)

(especially watchmaking) and the wonders of its civil engineering in building enormous dams and tunnels high in the mountains. Considerable space will be devoted to agriculture and also the culture and history of the country.

The French building, of somewhat bizarre design, will be made of metal and prefabricated concrete panels. It is designed to give an impression of columns and wires and tends toward the modern trend in French architecture. The chief architect is M. Guillaume Gillet.

The interior of the French pavilion will hold exhibits of engineering, handicrafts and agriculture as well as cultural displays. Special space will be devoted to Paris and a typical high-class French restaurant.

Canada's exhibit will be housed in an almost square pavilion that will contain a movie theater, a large restaurant, cocktail lounges and a coffeehouse. Sixty Canadian students will be in attendance to explain to visitors all the numerous exhibits, both agricultural and industrial. Canada, long regarded as an agricultural country, will put special emphasis on its rapid industrial development and great mineral wealth.

Just across the way from the United States section of the exhibition will be the square glass-roofed U.S.S.R. building. This massive concrete, steel and aluminum structure will surround a gigantic statue of Lenin. The pillared entrance to the pavilion will have wide steps and above it a large hammer and sickle.

When I viewed the partly constructed Russian building it gave me the impression of rather unimaginative solidity compared with the lighter touch introduced by many of the other nations. It seems to typify the heavy decorative type of architecture of the Victorian era which is so characteristic of the present architecture of many of the large buildings in Moscow.

The Russians, with their usual reticence, have not announced much detail of what their building will contain, but it has been stated unofficially that many items will be exhibited that have not previously been released for exhibition or shown to the Western World. There will be tremendous emphasis on Russian progress in civil engineering, atomic energy (this will also be shown in one of the spheres of the Atomium) and the arts and sciences. It is probable that some material will be included on the Russian satellite.

(Continued to page 254)



## ENGINES "Sing"!

WITH **MILESMASTER**<sup>®</sup>



**FUEL  
PRESSURE  
REGULATOR**

For smooth running, quick starting, better mileage . . . install a genuine MILESMASTER. Prevents flooding. Only \$6.95  
**MILESMASTER, INC., Dept. K, Exeland, Wisconsin**



### YOUR BEST RESOLUTION FOR 1958:

Never To Make A Wrong Turn  
Or Lose Directions Driving

You'll Make It, Too, With A

### HULL AUTO COMPASS

For 25 Years, America's Favorite  
Motoring and Boating Guide

\$6.95 and  
\$5.50

At your dealer's or  
write for literature

**HULL MFG. CO., P. O. BOX 246-D-1, WARREN, OHIO**

### ONE-MAN SAWMILL LOW \$50<sup>00</sup> DOWN AS . . .

**FREE BOOK**

Take BELSAW Portable Sawmill right to the trees—turn out valuable lumber for home and farm—sell to local yards—make up to \$50 a day custom sawing for neighbors. BELSAW lasts a lifetime. No crew needed. Power with tractor or auto engine. Beginners get excellent results. Send today for FREE BOOK.

**BELSAW MACHINERY CO**  
P.O. 3458 Field Bldg. Kansas City 11, Missouri

for the man  
who wants the  
**BEST**

### TURNER<sup>®</sup> Propane TORCH

- Solder
- Remove paint and putty
- Lay tile
- Light charcoal
- Thaw pipes

Only  
**\$5.95**

### MULTI-TORCH CHEST

Includes 1 Turner Torch, 1 heavy duty burner, 1 chisel point soldering tip, 1 flame spreader. All in heavy steel chest.



\$13.85 value only **\$9.99**

TURNER Propane Gas  
CAMP LIGHT  
**\$12.95**



TURNER PROPANE  
GAS STOVE  
**\$24.95**



At hardware, automotive and sporting goods stores

**TURNER BRASS WORKS**  
Sycamore, Illinois

**Beat High Building Costs . . .**

## Build a Beautiful Liberty Home yourself ...or direct its construction! SAVE THOUSANDS OF DOLLARS



### 46 MODERN DESIGNS

The 3 bedroom Woodlawn

Spacious, rambling homes of all types including split levels. Some with attached garages. 2, 3 and 4 bedroom plans, 1 and 1½ baths. Large living areas, family rooms and kitchens. Build with basement or utility room. Brick, siding or shake exteriors available. Designs for wide or narrow lots.

### HERE'S WHAT YOU GET

Liberty Homes are ready-cut homes . . . a complete package of ready to assemble materials including all framing lumber, finish lumber, trim, nails, hardware, paints, windows, doors, roofing, siding, etc., including complete plans for easy construction.

### FINANCING IS EASY

Liberty Homes are approved by Banks and Savings & Loan Associations throughout the country . . . acceptable for FHA or VA financing. Liberty's own 5-year Payment Plan is also available, requiring only 10% DOWN to finance Liberty materials.

Your savings on a Liberty Home can amount from \$2000.00 to \$5000.00 depending on the home you buy and the amount of work you do yourself. That's because you save many ways: *You save on material costs. You save on contracting costs. You save on labor costs. You save all material waste. You save all middle-man's profit. You save all architect's fees.*

### IRON-CLAD GUARANTEE

Liberty Homes guarantee, in writing, to supply highest quality materials in sufficient quantity to complete your Liberty Home.

**MATERIALS SHIPPED FREIGHT PREPAID**

Send 50c for big, colorful 56-page catalog.



### LIBERTY HOMES

Lewis Manufacturing Co. • 1281 Lafayette Ave. • Bay City, Michigan  
Enclosed is 50c for your big Liberty Homes Catalog.

NAME \_\_\_\_\_

STREET or RFD \_\_\_\_\_

CITY \_\_\_\_\_

STATE \_\_\_\_\_



**IT'S EASY  
TO BLOND  
FINISH  
OLD OR NEW  
SURFACES  
WITH...**



**Nine Lustrous Wood Tone  
FINISHES**

## DISTRIBUTORS

### New England States

Polar Co., Inc.  
Lewiston, Me.  
The Garrison House  
Brockton, Mass.

### South Atlantic States

Lauderdale Paint, Inc.  
Fort Lauderdale, Fla.  
Lyon's Paint Mart  
Sarasota, Fla.  
Hugh Reilly Co.  
Washington, D.C.

### Middle Atlantic States

J. Leven & Co.  
Irvington, N.J.  
A. Flohr Co., Inc.  
Bronx, N. Y.  
Sol Schwartz & Sons  
Brooklyn, N. Y.  
The Glidden Co.  
Buffalo, N. Y.

Pearl City Paint & Glass Co., Inc.  
Jamestown, N. Y.

Norman & Sons  
Queens Village  
Long Island, N. Y.

The Glidden Co.  
Rochester, N. Y.

Chas. B. Padden & Sons  
Erie, Pa.

### East North Central States

Dependon Products Co.  
Chicago, Ill.

Hooker Paint & Glass  
Chicago, Ill.

Hooker Paint & Glass  
Decatur, Ill.

Hooker Paint & Glass  
Peoria, Ill.

Rock Island Paint Co.  
Rock Island, Ill.

Barker-Lubin Co.  
Springfield, Ill.

The Glidden Co.  
Waukegan, Ill.

The Behrens Co.  
Anderson, Ind.

The Glidden Co.  
Fort Wayne, Ind.

The Glidden Co.  
Hammond, Ind.

The Glidden Co.  
Indianapolis, Ind.

Hooker Paint & Glass  
Muncie, Ind.

Reefer Sales & Service  
Detroit, Mich.

Sharp Brothers  
Detroit, Mich.

The Glidden Co.  
Grand Rapids, Mich.

The Glidden Co.  
Akron, Ohio

Avenue Paint Co.  
Canton, Ohio

Yenkin Majestic Paint Corp.  
Columbus, Ohio

Poepelmeier's  
Dayton, Ohio

The Glidden Co.  
E. Cleveland, Ohio

The Glidden Co.  
Lakewood, Ohio

Davis & Rodgers  
Toledo, Ohio

Bert Steinkellner Paint Co.  
Milwaukee, Wis.

E. J. Gehrke & Sons  
Oshkosh, Wis.

### West North Central States

The Glidden Co.  
Des Moines, Ia.

Martin Wallpaper & Paint  
Dubuque, Ia.

Hooker Paint & Glass  
Sioux City, Ia.

P & J Paint Co.  
Duluth, Minn.

Fred G. Anderson  
Minneapolis, Minn.

Gardner Hardware Co.  
Minneapolis, Minn.

Swanson's  
St. Paul, Minn.

### South Central States

Bridges-Smith & Co.  
Louisville, Ky.

Superior Paint Co.  
Lafayette, La.

Mountain States  
Hostetter Paint Co.  
Tucson, Ariz.

Ewing's Paint & Wallpaper  
Denver, Colo.

### Pacific States

Hughes Paint Co.  
Los Angeles, Calif.

*Also distributed in Canada*

**NORTH STAR Paint and Varnish Co.**  
St. Paul 14, Minnesota

Another structure that will no doubt become one of the outstanding features of the Brussels fair is the large footbridge which traverses the foreign section of the exhibition. It is divided into two walks with a central open space which is 39 feet wide. The bridge will be 49 feet high and 1312 feet long.

### Widespread Building Program

In addition to organizing the fair, industrious Belgians are feverishly constructing new highways, bridges and railroads to handle the traffic. They are also encouraging international exhibitions in Brussels which cannot be accommodated at the fair. Coincident with the world's fair but separate from it will be the annual International Inventors' Exhibition, opening on June 6 for a month. Its president, Paul Quintin, recently toured the United States inviting American inventors to submit their entries and said he expects some 1000 inventions to be accepted for exhibit and for sale or license to manufacturers attending the show.

One thing is certain—all roads in Europe this year will lead to the great world's fair in Brussels. ★ ★ ★



**Portable  
Wash  
Basin**

**for  
Campers**



Designed for camping trips, as well as for physicians, is a portable wash basin, complete with water, soap and towel. One side of the case has a reservoir with a capacity of approximately 10 quarts of water.



ORDER DIRECT FROM AD

SURPLUS AT FRACTION OF GOV'T COST

TOP VALUE SPECIALS

SHOP BY MAIL AND SAVE AT GROBAN'S

SATISFACTION GUARANTEED

BRAND NEW

## WALKER 5-TON HYDRAULIC LIFT KIT

ITEM #KW-116



FOR — • SNOW PLOWS • TO DUMP FARM WAGONS • ADJUST DEPTH OF PLOWS • HYDRAULIC PRESS • HYDRAULIC JACK.

THE COMPLETE KIT CONSISTS OF: 1—Walker Hydraulic Hand Pump—Rated 1500 lbs. per sq. inch with 2 gal. hydraulic reservoir • Release valve • Filler plug and air vent

• 28" steel handle. Fine for hydraulic presses; snow plows, jacks. Dimensions: 6" Diameter, 29" long with 3/4" pipe thread port. Pump Assembly Item #P449. . . . . 23.50

1—6 Ft. length double wire braid rubber covered hydraulic hose—tested to 20,000 lbs. Item #27B4. . . . . 3.95

1—Hydraulic Cylinder, 3" bore, 6" stroke. Husky 3/4" solid steel shaft. Will lift 10,000 lbs. using 1500 lbs. of pump pressure. Clevis mountings that take 3/4" diameter pins. May be used for single or double action service. Overall length 17 1/4"—retracted. Item #C419. . . . . 12.50

1-Gallon hydraulic fluid furnished free with each kit. Plus all necessary hydraulic fittings. Total ship. wt.—60 lbs.

COMPLETE KIT PRICE . . . . . 38.95 F.O.B. CHICAGO

(ALL OF ABOVE INCLUDED)

PORTABLE

## 1000 WATT A.C. LIGHT PLANT

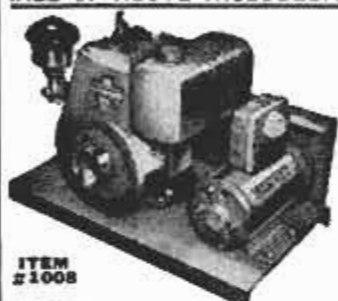

Electricity For Your Comfort

COMPACT — Fits in the trunk of your car FAST STARTING

ENGINE: CLINTON 3.6 H.P. Manual Start  
GENERATOR: Ball bearing construction 1000 Watts, 115 Volts A.C. 60 cycles.

SAME AS HOUSEHOLD CURRENT

SIZE: 20 1/2" x 12" x 16" Shipping Weight 100 lbs. boxed

PRICE: Save \$110.00 from \$259.50 list price. Now! F.O.B. Chicago . . . . . 149.50

## GROBAN FOUR-WAY OPEN CENTER HYDRAULIC CONTROL VALVE

ITEM #126—Four-way open center control valve, with built-in adjustable relief valve factory set at 1000 P.S.I. Spring loaded neutral position. For use with one double acting cylinder. In neutral position cylinder is locked and pump unloaded. Can be used as single unit or mounted in series. Has 3/4" pipe thread inlet and outlet. 1/2" pipe thread cylinder ports. Finger grip handle. Ship. wt. 10 1/2 lbs.

AN OUTSTANDING BUY! F.O.B. Chicago . . . . . 23.50

## SELF-PRIMING ALL BRONZE & MONEL GEAR PUMP

ITEM #383—USE FOR:  
• Sprinkling • Irrigation • Insecticide Spraying • Sump Pump • Fuel Transfer • Home Water Systems • Dewatering • Salt Water, Chemical, Acid Pumping



FEATURES • Needle Bearing Construction • 1 1/2" Pipe Thread Inlet, 1 1/4" Hose Outlet • Standard 3/4" Keyed Shaft • All Bronze Body & gears, Monel Shaft • Equipped with Drain Cocks, Grease Cup, Internal Drive Gears for long, trouble free service. • Four mounting feet.

CAPACITY: From 10 to 80 Gal. Per Min. At Speeds from 550 to 2400 R.P.M. Using from 3/4" to 20 H.P. For Pressures to 250 lbs. Ship. Wt. 58 lbs. U. S. Navy Cost \$168.00. F.O.B. Chicago. . . . . 39.50 Two for 75.00

MULTI-PURPOSE

## HYDRAULIC PUMP OR MOTOR

ITEM #55



Silent, high efficiency, Helical Gear Type Ball Bearing, Hydraulic Pump or Motor. Rated 8 Gal. Per Min. At 1500 R.P.M.—Delivers 1000 P.S.I. Using 8 H.P.—Reversible Rotation—3/4" Pipe Thread Inlet and Outlet Ports—1/4" Drain Port—3/4" shaft with keyway and flat for either direct or pulley drive. Dimensions—5 3/4" high, 7 1/4" long, 5 1/2" wide. Shipping weight 18 lbs. F.O.B. Chicago. . . . . 52.50

## FOR WELDING, BATTERY CHARGING, ELECTRO-PLATING GENERAL ELECTRIC D.C. GENERATOR

ITEM #G-476 — 400 amps., 30 volts D.C., using up to 20 H.P. 3700/7200 R. P. M. Rotation counter-clockwise. 3/4" spline shaft. Dimensions: 18 1/2" long x 7 1/4" deep. Shipping weight 75 lbs.



47.50 F.O.B. Chicago

SHAFT DRIVE-COUPLING from 3/4" spline to 3/4" standard. . . . . 3.95

## FREE! NEW 1958 CATALOG

60 VALUE-PACKED PAGES of unsurpassed War Surplus and newly manufactured Equipment. Bargains for farm, home, factory, workshop. Write letter today.

Send Payment Or Purchase Order Today For Phone Orders Call Webster 9-3793

GROBAN SUPPLY CO. DEPT. PM-1  
GROBAN BUILDING  
1139 S. WABASH AVE. CHICAGO 5, ILL.

NEW 1958 CATALOG

200 MODELS—SAVE 2/3

## BOAT KITS

EASY TO BUILD—Designed for the amateur. Over 200

Models. Plans to Cruisers, 8 to 21 ft. Formed hulls Semi and Custom finished. Save 50%... Now NEW Sea Ray Molded FIBERGLAS BOAT KITS. Truly professional results. NO upkeep. SAVE 2/3 assembly time. 12 to 16 ft. Utilities and Runabouts. SEND 35c for 64 page Boat Kit & 24 page Sea Ray Catalogs. SEND \$1.00 for both plus "Boating Handbook". Dealers inquire for franchise.

BOAT PLANS & PATTERNS  
Frame-Pac Kits

World's largest selection: over 200 plans, full-size patterns, frame-pac kits! Designed strictly for amateurs! All types: prams, kayaks, racers, runabouts, catamarans, houseboats, cruisers • Inboard-outboard 6-40' wood-plywood-steel! Send 35c for PLAN CATALOG Catalog PLUS "Boatbuilding Handbook" \$1.00

WRITE NOW! CUSTOM CRAFT, BUFFALO 7L, N.Y.



The Modern PLASTIC for lasting Home Repairs

PERMANENTLY mends cracks or holes in wood, tile, stone or plaster. Sticks and stays put—Does not chip, shrink or fall out. Easy to use. Economical. Mold it, chisel it, polish or paint it. The big 4-lb. can is obtainable from your lumber, paint or hardware dealer at \$1.25; or will be shipped direct postpaid (in U. S.) for \$1.50. Complete satisfaction guaranteed or your money refunded.

DONALD DURHAM CO.  
Box 804-T Des Moines, Iowa



Free!

# ALLIED'S 1958

## ELECTRONIC SUPPLY CATALOG

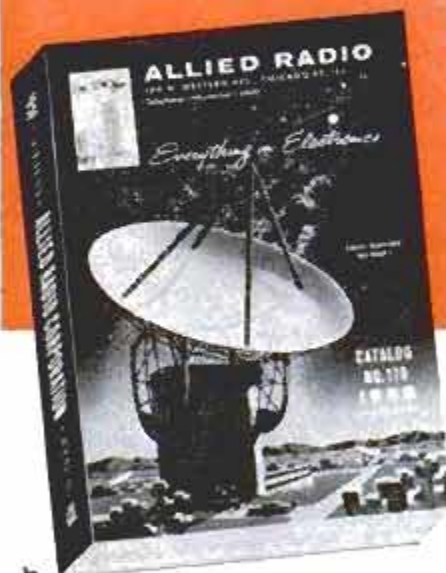

**404**  
value-packed  
pages

**Send  
for it!**

**SAVE on  
everything in  
electronics**

EASY TERMS  
AVAILABLE

### WORLD'S LARGEST STOCKS

Here's everything in Electronics for Experimenters, Builders, Amateurs, Servicemen, Engineers and Hi-Fi Hobbyists:

- Amazing Build-Your-Own KNIGHT-KITS
- Hi-Fi Music Systems & Components
- Recorders & Phono Equipment
- TV Tubes, Antennas, Accessories
- Public Address Systems
- Amateur Station Equipment
- Latest Test Instruments
- Industrial Electronic Supplies
- Parts, Tubes, Transistors, Tools and Books

SAVE on everything in Electronics—get fast, dependable service—send today for your FREE 1958 ALLIED Catalog.

Everything in Electronics  
From One Reliable Source

send for  
**FREE**  
Catalog

our 37th year

## ALLIED RADIO

ALLIED RADIO CORP., Dept. 106-A8  
100 N. Western Ave., Chicago 80, Ill.

Rush FREE 1958 ALLIED 404-Page Catalog

Name \_\_\_\_\_

Address \_\_\_\_\_

City \_\_\_\_\_ Zone \_\_\_\_\_ State \_\_\_\_\_

## How to Build Physical Fitness

(Continued from page 176)

capacity to carry oxygen. The heart is stronger from exercise and thus able to pump more blood with each stroke.

Dr. Paul D. White, Boston's famed heart specialist, is as avid a hiking, bicycling and climbing enthusiast as you'll find. "It's the luxury—not the stress and strain—that is stopping the hearts in this country," says this 70-year-old physician.

President Eisenhower exercises an hour each day—doctor's orders. So did the last three occupants of the White House, Presidents Hoover, Roosevelt and Truman.

Many others have found ways to keep physically active. In Oregon, a 45-year-old surgeon runs the mile nearly every day of the week. Countless persons elect to walk as much as two or three miles to and from work each day. A 70-year-old man who bands eagles as a hobby (a task that requires climbing tall trees) figures that he is not ready to go to work until he can chin himself 15 times.

These men have realized the benefits of hard exercise in an era in which mechanization has taken over many of the functions that muscle-power once handled. We'd never want to return to the horse and buggy, but our increased leisure and softer living demand greater responsibility in keeping physically fit. ★ ★ ★

## Slide "Popping" Eliminated By Automatic Projector

Described as a fully automatic slide projector, this model is designed to eliminate the need for refocusing. Once the first slide has been focused on the screen, no further adjustment is necessary for successive slides. A time-cycling device on the control panel can be set to show each slide for any period between 4 and 60 seconds. Each slide is then advanced automatically. The projector will handle all 2 by 2 slides mounted in cardboard, plastic, metal or glass, or intermixed in the same tray.



POPULAR MECHANICS



Protect your home against  
power interruptions  
with an...

## ONAN Emergency ELECTRIC PLANT

Provides dependable stand-by electricity for heating system, pumps, freezer, lights, appliances. Keeps home safe, livable. Automatic start and stop. Find out how little it costs!

Write for Folder!

**D. W. ONAN & SONS, INC.**  
3263 University Ave., S.E. • Minneapolis 14, Minnesota

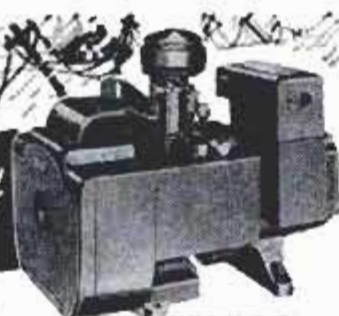

**A SIZE FOR EVERY NEED**  
500 to 75,000 watts.  
Compact, quiet-running.  
Gasoline-powered  
Priced from \$319.00

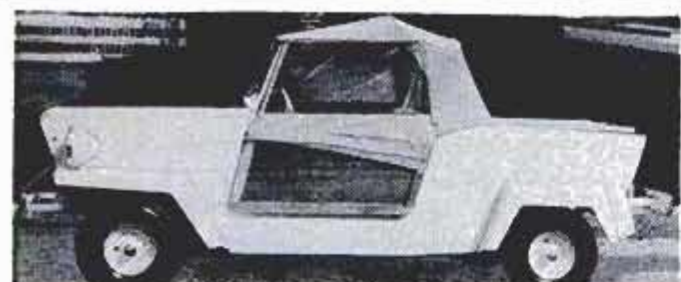

**KING MIDGET** ALL NEW. First model change in six years. New bodies, new chassis, new engine. Four wheel hydraulic brakes. Still World's Lowest Priced Car. Drive it for 75c per week. Rider Agents Wanted. Earn your own car. Get the facts. Send 25c for 32 page picture book with complete details, dealers price, etc., if there is no dealer near you.

**MIDGET MOTORS CORPORATION, Athens 1, Ohio**

# STAR

## HACK SAW BLADES with New "Handy-Pak" convenience

Now precision-made STAR Blades are mounted on special "Handy-Pak" cards. Makes storing and handling easier and safer. Cards also give helpful working tips... show the best blade for each job.

### STAR "LEVER-LOCK" FRAMES



- Patented "Lever-Lock" positions and tensions blade automatically.
- Handle molded for comfort.
- High-strength tempered steel back, perfectly balanced.

AT ALL LEADING HARDWARE STORES

For fact-filled booklet on metal cutting, send 10¢ in coin. ☎ 4606

**CLEMSON BROS., INC.** MIDDLETOWN, N. Y., U.S.A.

## Be Your Own Boss in the Profitable Excavating Business!

### EARN UP TO \$1,000 AND MORE PER MONTH

Wherever you live, you'll find plenty of profitable work the whole year 'round for this versatile outfit... not just a "trencher" but an all-purpose excavating machine! Custom operators everywhere are making big money with Sherman Power Diggers. ONE BOUGHT A FARM WITH JUST THREE YEARS' PROFITS! Work for builders, contractors, utilities, and municipalities on such jobs as septic tanks and drainfields, sewer lines, fuel tank installations, foundations and footings, gas and water lines, field tilling and many others. The Sherman Power Digger mounted on a Ford Tractor travels quickly from job to job, digs at a fraction of the cost of manual labor. It's simple to operate, easy to maintain, built to last.

Send now for information about the easy-to-get jobs for your Sherman Power Digger. Let us tell you—without obligation—how you can go into business for yourself with an investment of less than \$5000. Or make a small down payment and pay the balance from earnings.

**SHERMAN PRODUCTS, Inc.**  
Dept. 1736 Royal Oak, Michigan



Send Now for FREE LITERATURE!

Sherman Products, Inc.  
Dept. 1736 — Royal Oak, Michigan

Send me information on how I can get into the excavation business on my own.

NAME \_\_\_\_\_

ADDRESS \_\_\_\_\_

CITY \_\_\_\_\_ STATE \_\_\_\_\_



## Build Your Own Tel-Amp

(Continued from page 182)

sockets are mounted in slots which have been cut in the board with a hacksaw or coping saw. This eliminates the need for complicated cutouts.

When all parts are mounted, fasten the board to the rear of the speaker frame. The speaker recommended in the parts list has two tapped holes in the frame specifically for this purpose. Place a long solder lug on the top mounting screw, between the board and the speaker.

Final wiring is shown in the pictorial diagram of Fig. 3. Pay close attention to the polarity (+ and -) of the electrolytic capacitors, the color coding of the transformer leads and the pin spacing of the transistor sockets. Carefully route the wires on the bottom of the board to prevent short circuits between any two bare wires. Use spaghetti (varnished insulating tubing) wherever necessary. Be sure to solder all junctions, but apply only enough heat to make a good solder connection. Excessive heat may damage the fragile parts.

The volume control, R1, and the pickup coil should be connected to the amplifier with pieces of hookup wire long enough to permit their ultimate placement in the proper position in the case. This applies also to the battery leads.

**Preliminary Tests.** After the wiring has been completed and the transistors have been inserted in the sockets, the performance of the amplifier should be checked. Because the ultimate position of the pickup depends upon the orientation of the coils in the telephone handset, the tests should be conducted with the particular phone for which it is intended.

As a test, call up a friend, or perhaps a number which gives continuous time or weather information and, with the Tel-Amp volume control turned to maximum, place the receiver end of the handset on the pickup coil. If a howl is heard through the speaker, turn the volume down until the howl disappears. Now, change the position of the handset with respect to the coil to determine the required position for maximum volume. Don't be alarmed if maximum volume, before an annoying howl appears, is somewhat limited. This will be greatly improved when the amplifier is installed in the cabinet.

During tests on the original model, it was found that the latest handsets gave best performance with the earpiece placed directly against the flat portion of the pickup. With other types, best results were obtained with the pickup in an upright

position against the side of the receiver.

**A Little Woodwork.** Figs. 4-A and 4-B show the two preassembled sections of the case used in the original model. Detailed plans for the individual parts are given in Fig. 6. (This case was designed so that the earpiece will rest directly on top of the coil as shown in the title illustration. If preliminary tests show that your phone works best with the coil in an upright position, the design of the case must be modified slightly to permit vertical coil mounting, see Fig. 5.)

The cutout in the cabinet top, part G, should provide a snug fit for the pickup coil. If the dimensions of your coil are not  $2 \times 2\frac{1}{2}$  in. this cutout must be changed accordingly.

Assemble pieces A, C, E, D and F in that order, as in Fig. 4-A, using a good wood glue and finishing nails. Then, cut a thin piece of do-it-yourself aluminum (available from hardware stores) to the required size and nail it to the horn braces, parts C and D, following the contour of these pieces.

Now, construct the subassembly of Fig. 4-B, using parts G, H and B. Mount the battery holder, the volume control and the speaker-amplifier assembly as illustrated in Fig. 2. Note that the speaker is rim-mounted to side B with a couple of wood screws and metal washers. Press the pickup coil into the cutout of part G and fit its connecting leads into the two small notches of part H, so that the leads will not interfere with the final assembly.

Final assembly consists of fastening together the two subassemblies of Figs. 4-A and 4-B. Use wood screws rather than nails to permit easy disassembly in the event of possible trouble. If all wood pieces have been cut to the correct size, a tight-fitting final assembly will result. The entire unit, reflector and all, may be given a coat of paint to match the surroundings.

### Possible Modifications

Transistorized and battery-operated, the Tel-Amp requires no connection to the a.c. line and is ready for instant use the moment the switch is turned on. However, the unit should be turned off at the end of a conversation to prevent undue battery wear. This minor inconvenience could be eliminated by replacing the on-off switch, SW, with a separate, leaf-spring-type, snap-action switch. This unit can be positioned so that the weight of the handset, when placed in position, will close the switch and apply power to the amplifier. When the handset is removed, the switch would open automatically and disconnect the battery from the circuit. ★ ★ ★



# NEW *Atlas* 12" LATHES

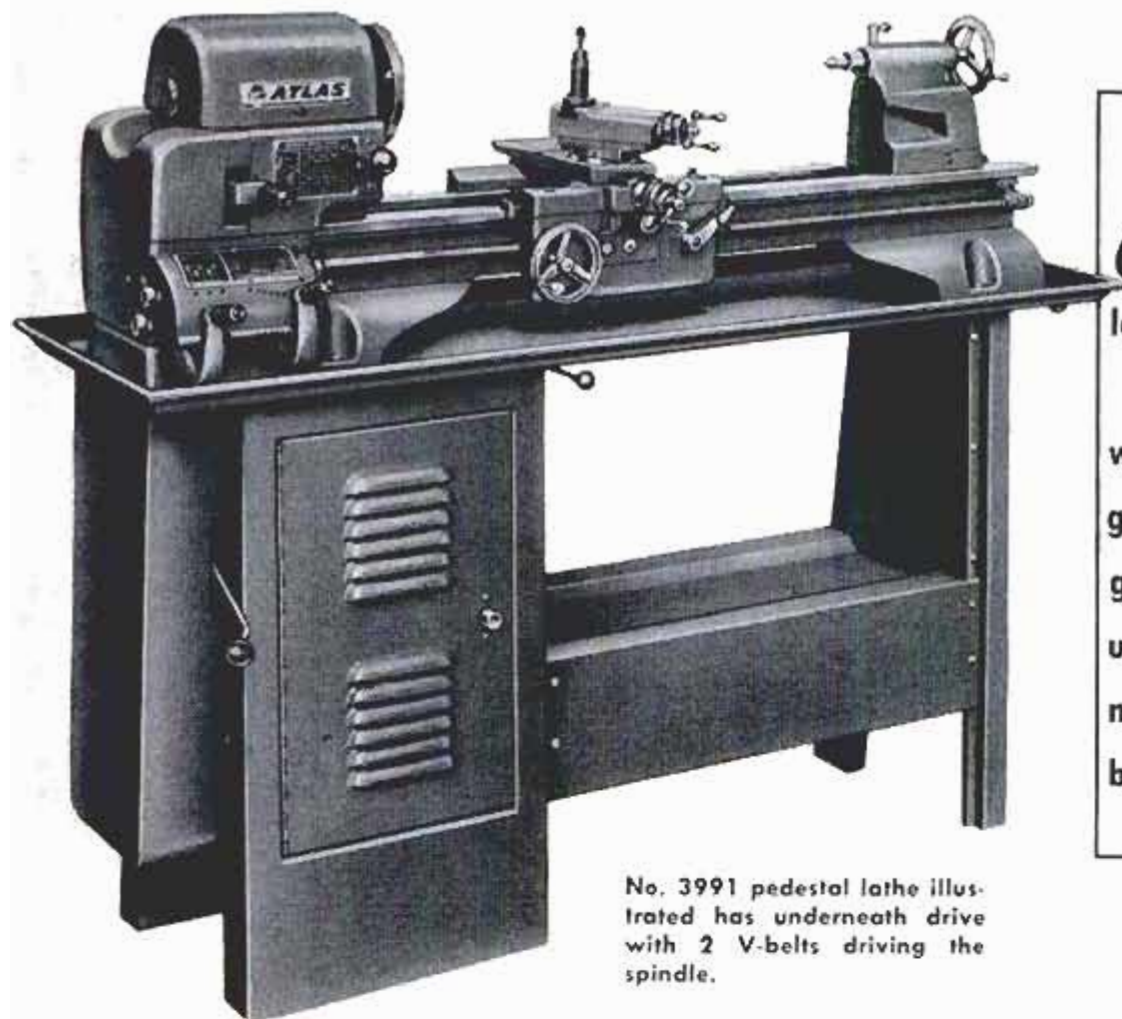

No. 3991 pedestal lathe illustrated has underneath drive with 2 V-belts driving the spindle.

The new *Atlas* 12" lathes are available in bench models with standard change gears or quick-change gears, and in two underneath drive models with pedestal base as illustrated.

Completely new inside and outside — from the ground up — with greater capacity, performance and value than have ever before been available in lathes at or near their low price.

They have big capacity — 12 $\frac{1}{4}$ " swing over bed, 12" swing over saddle wings, 8" over cross slide, up to 36" between centers. And they're ruggedly built throughout to handle bigger jobs, and a wider variety of work with dependable precision.

And the new Atlas back-geared lathes have these important features as standard equipment: Timken tapered roller bearings, 16 spindle speeds, reversible power cross feed and longitudinal feed, wide thread cutting range, V-belt drive. Yet they cost you no more than smaller, less efficient machines.

You'll want to know all about these great new lathes. Write for free literature today.



The famous Atlas precision spindle—an exclusive that assures lifetime accuracy.



New, heavier bed has ground ways—a rigid precision foundation.



## ATLAS PRESS COMPANY

1-24 N. PITCHER STREET • KALAMAZOO, MICHIGAN



## White Alice Starts Talking

(Continued from page 165)

DEW Line operates in conjunction with the Mid-Canada and Pine Tree radar screens to its south and with the coastal and offshore-radar alert systems on both sides of the continent. Its long-range radio-communication system feeds information directly to CONAD (Continental Air Defense) in Colorado Springs, to the Strategic Air Command and to the newly formed ADCANUS (Air Defense, Canada-United States).

Ultimately it will supply information not only to human military commanders, but to a huge electronic thinking machine as well. Known as SAGE (Semi-Automatic Ground Environment), this robot computer will correlate all available information about an oncoming enemy force with the characteristics of the defending weapons, then tell the defending commanders what to do. Modern weapons are so complex and are of so many different types that the human mind can't always make split-second decisions that would use all weapons to the best advantage. SAGE, remembering everything it is told, will make the decisions.

DEW Line is being operated for the Air Force by 600 technicians of Federal Elec-

tric Corporation. The radar crews are literally insulated from the Arctic climate by the heated trains in which they live and work. Named for their long shape, this type of building was chosen both for ease of fabrication and because any accidental fire could be most easily isolated and extinguished. Inside the buildings, the men enjoy virtually all the comforts of home.

A few years ago, only a well-organized expedition could do much traveling above the Arctic Circle. The country had been explored only superficially and the best maps were far from accurate. White Alice crews, for instance, found that some mountains were actually 10 miles from their map locations and sometimes 1000 feet taller than indicated.

Today the North is becoming well-mapped and even well-populated. Even the most remote areas have airstrips and communication facilities. Travel is so easy that tourists from Fairbanks think little of flying by chartered plane to watch the Eskimo dances at Point Barrow. Petroleum and numerous minerals have been found in the North, even though exploration is still incomplete.

DEW Line is strictly a military project but, at the same time, DEW Line and White Alice are playing a vital part in opening up the Far North. ★ ★ ★

# Just as much fun as they look!

The Flashing **Cushman**

and the ALL-NEW **Cushman**

## EAGLE ROAD KING

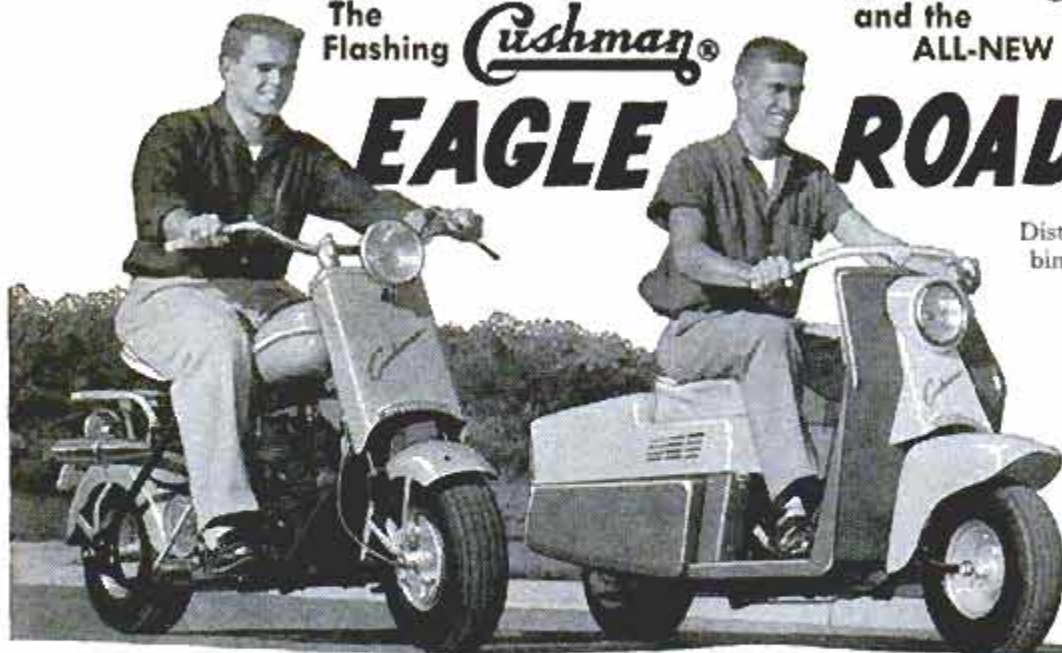

Distinctive, modern design combined with rugged construction for safety, service, and a smooth, soaring ride make Cushman the choice for a world of fun and excitement. Powered by the famous Cushman Husky 4-cycle engine. Up to 50 miles per hour, up to 100 miles per gallon. Ride a Cushman. You'll agree they're just as much fun as they look!

CUSHMAN MOTOR WORKS, INC.

967 No. 21st St LINCOLN, NEBRASKA

Please send FREE booklet  EAGLE  ROAD KING

NAME \_\_\_\_\_

ADDRESS \_\_\_\_\_

CITY \_\_\_\_\_ STATE \_\_\_\_\_

Ask your dealer for a FREE DEMONSTRATION  
or write for new FREE booklet today  
SOLD AND SERVICED NATIONALLY  
Replacement parts immediately available

Dealer inquiries invited

**CUSHMAN MOTOR WORKS, INC.**  
A SUBSIDIARY OF OUTBOARD MARINE CORPORATION  
LINCOLN, NEBRASKA



## What Do 3 Out of 4 Doctors Recommend to Relieve Pain?

A survey shows 3 out of 4 doctors recommend the famous ingredients of Anacin Tablets to relieve pain of headache, neuritis and neuralgia. Here's why Anacin® gives you better total effect in relieving pain than aspirin or any buffered aspirin:

- ➔ **ACTS INSTANTLY:** Anacin goes to work instantly. Brings fast relief to source of your pain.
- ➔ **MORE EFFECTIVE:** Anacin is like a doctor's prescription. That is, Anacin contains not one but a combination of effective, medically proven ingredients.
- ➔ **SAFER:** Anacin simply can not upset your stomach.
- ➔ **LESSENS TENSION:** Anacin also reduces nervous tension, leaves you relaxed, feeling fine after pain goes. Buy Anacin today.

## MONEY for MEN ALL DATA FREE

THE PLASTEX Industry needs manufacturers on small scale and for big production of Lamp and Clock Stands, Art Goods and Novelties in Plastex and Marble imitation. Experience unnecessary. Use material makes regular 10¢ store sellers. Rubber moulds furnished for speed production. Small investment brings good returns. We are now placing big Chain Store Orders with manufacturers. Ambitious men have chance for real prosperity. Our Free booklet will interest and benefit you.

**PLASTEX INDUSTRIES, Dept. A**  
3400 Third Ave. New York 56, N. Y.

## GEARS

**In Stock - Immediate Delivery**  
Gears, speed reducers, sprockets, thrust bearings, flexible couplings, pulleys, etc. A complete line is carried in our Chicago stock. Can also quote on special gears of any kind. Send in your blueprints and inquiries.

Send for Complete Catalog No. 10  
**CHICAGO GEAR WORKS**  
440-50 N. Oakley Blvd., CHICAGO 12, ILL.

## Find HIDDEN TREASURES

GOLD, SILVER, PRECIOUS METALS with the Famous Model 27 Metal Detector. Lightweight, ultra-sensitive, low cost. None finer. Also GEIGER COUNTERS for uranium and the VIOLITE for tungsten. INFORMATION FREE

THE *Detectron* CORP.  
5528 Vineland Ave., No. Hollywood, Calif.



## Short Cuts with WILHOLD WHITE GLUE

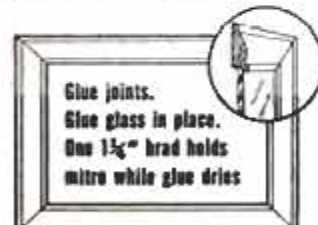

Glue joints.  
Glue glass in place.  
Use 1 1/4" brad holds  
mitre while glue dries

**MAKE PICTURE FRAMES**  
without dowels or splines

You'll like it better. Simplifies woodworking. Sets quick, dries clear,

holds permanently. Illustrated, one of many Wilhold shortcuts. FREE BOOKLET.

Paint, Hardware, Lumber, Variety Stores. Or write **WILHOLD PRODUCTS** Los Angeles 31, Calif.; Chicago 44, Ill.

## arc welding Pays Big MONEY!

**Cash In**  
on the big demand  
for arc welding

200 Ampere  
"HUSKY BOY"



AC Transformer  
Shop Type Welder



AC Welder  
AC Power  
Combination

Every day more and more opportunities for big profits arise in arc welding. Why not cash in, especially when it's so easy to do—with a low cost, high efficiency Hobart welder. Any one of these easy-to-use models puts you in business immediately.

200 amp. "HUSKY BOY" welds anywhere. Light, rugged, compact—easily mounts on your tractor or trailer to go to those emergency repair jobs. Portable mountings also available.

AC TRANSFORMER is a popular model for small shops, auto service shops, plumbing and heating contractors, farm welding, etc. Economical to operate, yet has big industrial model features.

AC WELDER/AC POWER 200 amp. combination furnishes current for welding and power for running tools, lights, etc. Simply connect it to your own power source or to portable gas engine. WELDING LESSONS BOOK, 200 pages, fully illustrated. Self teaching, \$1.00

**HOBART BROS. CO., BOX M-18, TROY, OHIO, FE 2-1223**  
"One of the world's largest builders of arc welding equipment"

## "BUILD-YOUR-OWN" GAS DRIVE WELDER



Save \$200 to \$300 using this Hobart DC Welding Generator that gives you the opportunity to build your own efficient portable gasoline driven arc welder, at low cost.

These generators come equipped with all the features that are standard with Hobart factory-built engine driven models. Write for free booklet—"How To Build Your Own Arc Welder."

Some typical home-built welders



HOBART BROTHERS CO., Box M-18, TROY, OHIO, U.S.A.  
Please rush me complete information on:

- "Husky Boy"  AC Welder/AC Power  
 AC Transformer  Build-Your-Own  
 Send Welding Lessons Book, I enclose \$1.00.  
 Booklet—"How To Build Your Own Arc Welder"

Name \_\_\_\_\_

Address \_\_\_\_\_

City \_\_\_\_\_ State \_\_\_\_\_



## A Sky Full of Satellites

(Continued from page 141)

space, a rocket powerful enough to get the big satellite up there.

What keeps a satellite in the sky anyway? Why does our four-stage Farside rocket fall back after penetrating 4000 miles into space, while a sputnik can get a mere 170 miles up and stay put? The secret lies in speed and direction. Farside goes straight up until gravity stops it. Earth's gravitational field extends infinitely. Dr. Fred Whipple, director of Harvard's Smithsonian Astrophysical Observatory, explains it simply, graphically: "The sputniks were steered to a flat course at 18,000 miles per hour. They keep trying to shoot off at a tangent to the earth with exactly the same force that gravity is tugging them downward. Hence, they orbit around and around the globe, forever falling earthward but never getting there." Put any object above earth's atmosphere, traveling horizontally at a speed great enough to offset gravity (18,000 miles per hour at 600 miles; less speed at higher altitudes), and presto! — you have a satellite.

### Easier to Hit Moon

Shooting a powerful rocket straight up to slap the moon's face is headline material, but takes less tricky rocketry than precisely steering a satellite into orbit. Our Navy's project Farside, a four-stage complex of rockets with one stage nested inside the other, is lifted 20 miles by a helium-filled polyethylene balloon. There, above most of earth's atmosphere, the rocket takes off—right through the balloon—to soar thousands of miles, collecting data and radioing it back to earth via 3½-pound transmitters in each stage's nose cone. The name Farside, according to the project's liaison officer, Comdr. Tom Wilcox, has nothing to do with the other side of the moon and never did. "It was thought up by a secretary in my office, and everyone liked it, that's all," he says. A few alterations to Farside's assembly, according to American rocket expert Willy Ley, are all that's necessary to give it an escape velocity of 25,000 miles per hour and make it a moon rocket. The job of converting Sputnik I for moon-target practice is even simpler, since a 30-pound reduction in weight and slight increase in final speed would do the job.

But to send a satellite into orbit is something else. Our 21½-pound sphere needs a three-stage rocket with 27,000 pounds of thrust to get up there, and must be fired eastward to take advantage of the earth's spin. Russia's Sputnik I, if her rocketry

resembles ours, had to have a massive, multistage vehicle weighing 150 tons and capable of a 300,000-pound shove to throw the 184-pound sphere into orbit. Intricate self-contained guidance systems of gyroscopes, pendulums and computers steer the big rocket, and program it into a course parallel to the earth's surface. Delicate plumbing and instruments, sandwiched between the rocket's glowing 4000-degree skin (from friction with air) and tanks of liquefied gas at 350 degrees below zero, must still function perfectly or the launching is a bust. "The trouble with liquid fuels," grumbles a noted rocket engineer, "is you've got to tote along both fuels and oxidizer—a touchy combination." The advantage is the ability to control the flow of fuel, changing thrust to keep the rocket going in the right direction. Solid propellants, though easier to handle, burn erratically. Farside rocket components, using solid fuel in a new form, however, have restored hope for solid propellants in future rocketry.

### Future Propulsion Fantastic

Some of tomorrow's rocket-propulsion systems may be truly fantastic. In laboratories of the National Advisory Committee for Aeronautics, scientists are poring over ion engines that they predict will propel and control future satellites in their orbits. In these tiny motors, charged bits of atoms formed in an electrical discharge are accelerated by a magnetic field, producing a high-speed jet-stream of ions at temperatures up to 20,000 degrees F. NACA engineers see the day when that little jet will be used, in the vacuum of outer space where air-breathing engines can't operate, to move a satellite from its orbit and send it on a course to other worlds.

An atomic rocket, already designed by the Atomic Energy Commission, carries a supply of liquid-hydrogen propellant that explodes into voluminous mass as it circulates through a uranium furnace in the nose.

All these items are, actually, a prelude to the day when man himself steps off into the void beyond the atmosphere — a day that, until last October 4, was considered a pure fantasy coddled by a few fanatics. Today, it is frighteningly close to reality. Prof. Kirill Stanyukovich, who is a leading Russian rocket expert, has casually predicted manned flight to the moon in three years; to Mars in 13 years. Willy Ley more conservatively sees a manned spaceship six years away, a big manned space station in a dozen years, and a manned moonship assembled at the station a few years later.

(Continued to page 264)



**DON'T THROW IT AWAY**

**FIX IT WITH**

**Plastic Steel** <sup>80% STEEL</sup>

as easy to use  
as modeling clay!



**PLUMBING TROUBLES?**

Be your own plumber. Fix leaking pipes and valves in minutes with **PLASTIC STEEL**. No special tools needed. Bonds metal or porcelain to itself or each other. Hardens in two hours. Can be filed, sanded and painted.



**AUTO REPAIRS**—Repair cracked blocks, torn fenders, leaking gas tanks, etc. Save time and money.

**FURNITURE AND APPLIANCES**—Do 1001 permanent repair jobs around the house. Fix wooden or wooden furniture, appliances, etc.

**3 CONVENIENT HOME KITS**

\$.98, \$1.89 and \$3.95 sizes at leading hardware stores.

**WRITE FOR FREE BOOKLET**

**DEVCON CORPORATION**

175 Endicott St., Danvers, Mass.

**BETTER BUILT**



Gerstner Chests last longer and serve better. Free Catalog to Machinists and Toolmakers.  
**GERSTNER TOOL CHESTS**  
458 Columbia St., Dayton 7, Ohio

**WELD BRAZE  
SOLDER CUT**



**4WAY**  
ONLY  
**\$14.75**  
f.o.b. factory

**WELDER**  
Complete with  
Twin Carbon Arc  
Torch and ac-  
cessories... to  
handle all metal-  
craft work.

Acclaimed by thousands of Homeowners, Mechanics and Hobbyists as the welder of 1001 uses. Easily operated from properly wired 110 volt AC or DC line. The ideal gift with a life-long use... Order today on 10 day money back guarantee.

**FOUR-WAY WELDER CO., Dept. F2-A**  
1810 S. Federal St. • Chicago 16, Ill.

**CRAFTSMAN'S**  
wood and woodworking  
**MATERIALS**



**132 PAGES**  
Many in  
full color

packed with rare, fancy & imported woods... veneers, plywoods, patterns, tools, ornaments, hardware... everything for the woodworker.

Get This **NEW** Catalog of  
**WOOD & WOODWORKING**  
EQUIPMENT

**WORLD'S LARGEST SELECTION OF FINEST DOMESTIC AND IMPORTED WOODS... MOULDINGS, HARDWARE, TOOLS... ALL AT LOW MONEY SAVING PRICES!**

Your complete wood buying guide and project book. Craftsman is your best, most complete source of finest kiln-dried domestic and rare imported woods, beautiful wood inlays, colorful bandings, matched plywoods, embossed mouldings, carved ornaments, newest woodworking tools, "hard to find" cabinet hardware and fittings... more than 1,500 items! Packed with newest scroll saw patterns, project ideas & money making plans. Enclose 25c (refunded with first order) to help pay mailing, handling cost. Write now! **Craftsman Wood Service Co., Dept. A-1**  
2729 S. Mary Street • Chicago 8, Ill.

**?? SHOP QUIZ ??**

**Question 1** \_\_\_\_\_

What's the **EASIEST** way to drive wood screws?

**Question 2** \_\_\_\_\_

What's the **EASIEST** way to remove wood screws?

**Question 3** \_\_\_\_\_

What's the **EASIEST** way to run nuts or bolts on or off?

**Question 4** \_\_\_\_\_

What's the **EASIEST** way to use heavy-duty cutting tools like hole saws, masonry and auger bits?

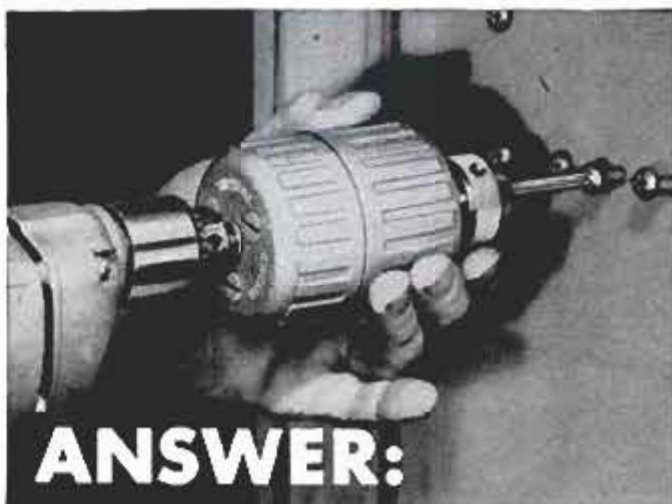

**ANSWER:**

WITH YOUR ELECTRIC DRILL AND A

*Supreme* **Versamatic**

Reversible speed reduction attachment that fits every power drill. Increases power 7 times. Reverses with one simple twist. A must for every drill owner. **\$14.95**  
AT LEADING TOOL COUNTERS

By the makers of **SUPREME BRAND CHUCKS**

**SUPREME PRODUCTS CORPORATION**

2222 S. Calumet, Chicago 16, Illinois

A Division of A+S-R Products Corporation



The Goodyear Corporation has released plans for a three-man satellite designed to orbit at a maximum altitude of 500 miles. This satellite would be launched by a three-stage ferry rocket developed by the company and called Meteor Junior.

One of the biggest problems of space travel is getting people back safely. Their vehicles, traveling at 18,000 to 20,000 miles per hour, would melt down to a glowing lump of tubing if they plunged into the atmosphere at such speeds. Dr. Wernher von Braun, chief of development at the Army's guided-missile center in Huntsville, Ala., has suggested a winged-glider arrangement that would enable the vehicle to orbit through the atmosphere, slowing gently and finally landing like any aircraft. Actually, the first men to fly into space probably will get there not in satellites, but in craft similar to our present ramjet and rocket-driven high-altitude research planes. In fact, it's a good bet North American Aviation's test pilot Scott Crossfield will be the world's first space pilot this year, if he flies the nearly completed X-15 rocket plane to its design potential of 4500 miles per hour at 100 miles altitude. While Crossfield won't get into orbit, he will be a mere 70 miles from sputnik's track at perigee (point of orbit nearest to the earth) and higher than any human has ever been. Flights like this will pave the way for tomorrow's spaceship pilots.

#### Space Stations Seen

Most fascinating of all satellite prospects for the near future are the manned space stations, due within a dozen years according to experts. Such a massive satellite, capable of housing a crew of 50 to 75 men, might be a huge cylinder with a vast disk of solar batteries at one end or, as Ley and von Braun have visualized it, a doughnut-shaped affair in which men work and live in corridor-type rooms filled with instruments. The station, Ley says, would orbit at an altitude of about 1000 miles.

First, according to von Braun, space-ships carrying half a dozen men at a time will enter the orbit. Other rockets from earth will ferry structural parts, prefabricated sections and nylon bags full of small equipment up to them each day. All these things, dumped out into the orbit on arrival will actually be individual satellites larruping around the earth like the sputnik's final-stage rockets. Lashed together to keep them from kiting all over the universe, they will comprise a loose stockpile from which the builders can construct their home in the sky. Men in space, wearing pressure suits, will propel themselves in any direction by tiny rocket motors.

Once the big satellite is finished and a crew installed, assembly of moonships and outer-planet ships will be accomplished the same way. Advantage of launching space-ships from such an island in space is great. Fantastic speeds can be achieved, Ley points out, since a rocket in space accelerates continuously at phenomenal rates as long as its fuel holds out. Using earth as a launching pad, most of the fuel is burned pushing the massive vehicle through the atmosphere.

#### No Friction in Space

Since friction is no problem in space, interplanetary spaceships need no streamlining. They will, according to Ley and von Braun, consist mostly of one huge spherical or cylindrical fuel tank. Small rocket motors and living quarters will be tied to the tank by metal girders. Spidery legs will provide something to land on. Taking off from the space station, they will move through the solar system like monstrous insects at six-figure speeds.

The men, says Willy Ley, will probably stay out only six weeks or so before returning to earth. Most of their work will be done aboard the space station, which probably will be man's most valuable space tool for years to come. Most of us will be around to see it in operation. But in the next few years, dozens of unmanned platforms will provide plenty of interesting surprises. Some of these satellites will be sent aloft soon to study aurora, to forecast weather, to learn the mysteries of radiation in the upper layers and to photograph the surface of other planets in the clear unfuzzy light of outer space. Dr. Hagen wants to see a telescope-observatory satellite circling the earth every three hours at an altitude of 2500 miles. There probably will be a microwave-relay satellite, operating on solar batteries, to bounce TV signals to anyplace in the world.

If everyone who should know is right, we will see a sky full of satellites in short order. ★ ★ ★

---

#### Carbon Filters Cut Smog Symptoms

Irritation resulting from smog may be reduced by activated-carbon filters in air-conditioning systems, according to engineers at the University of California at Los Angeles. Activated-carbon filters were tested in offices of a downtown Los Angeles building without the knowledge of the workers. The workers complained less of eye, throat and nose irritation on days when the carbon filters were used to purify the air.



**WAR SURPLUS BARGAINS SAVE UP TO 90%**

**FAMOUS NAVY MK14 AIR COMPRESSOR**

Great for paint and tree spraying, air brushing, filling tires, etc. Dual and remote control electrical receptacles. 115V 60 cycle AC 1/3 H.P. Westinghouse Motor. Direct drive. Draws 10" of vacuum. Water- and Explosion-proof. Built-in air filter, adjustable pressure setting up to 45 lbs. Built-in pressure gauge. Self-contained switch. Mounting brackets. Wt. 66 lbs. gross. Approx. GOVT. COST \$585. Like NEW. Only \$19.95.



**EXPLOSIVE RIVET & BLOW TORCH KIT**

Contains 300 assorted Dupont Explosive Rivets, 1 set of 3 fractional drills, 1 Butane Blow Torch with extra cartridge—everything needed for blind riveting. Torch can also be used for precision soldering, brazing, etc. 3500° pinpoint flame. Approx. GOVT. COST on rivets alone, \$90. Complete kit \$8.95 ppd.

**DUPONT EXPLOSIVE RIVETS**

Essential wherever blind riveting required. 1/8", 5/32", 3/16". Round & flat heads. Approx. GOVT. COST 32c ea. 1,000 assorted for only \$5.00 ppd.



**BUILD YOUR OWN ARC WELDER, LIGHT PLANT OR BATTERY CHARGER \$39.75**

Kit incl. 1 Navy NEA-5 Gen. combination AC-DC type. AC 115 V. DC 24 V., 200-300 Amps. 2 complete generators in 1, yet no larger than reg. gen. Ideal for home, shop and farm lighting plants. Delivers 1200 Watts AC. DC side for charging batteries, welding and operating war surplus motors. Also in kit: 2 Voltage Regs., AC & DC. Reverse Current Relay, 30' new welding cable, Rheostat, Electrode Holder, Toggle Switch, Welder's Shield, Wiring Diagram for kit. Wt. under 100 lbs. Approx. GOVT. COST \$650. Kit—\$39.75. Navy NEA-5 Gen. as above, purchased separately, \$27.50.

**P2 GENERATOR KIT \$29.95**

Build your own complete make-up package incl. 1 Gen., 24 V., 200-250 Amps; Rheostat, Toggle Switch, Welder's Shield, 30' new welding cable. Voltage Reg. Electrode Holder, Wiring diagram for hookup as welder. Wt. under 100 lbs. Approx. GOVT. COST \$550. NEW, \$29.95. P2 GEN. as above, purchased separately — \$24.95.

**R1 GENERATOR KIT**

Jack & Heints or GE. Rated 300 Amps. 24-32 V. With same items as above. Approx. GOVT. COST \$800. Complete 80 lb. kit — \$39.95.

**M1 GENERATOR**

Great for trucks, boats, battery charging & other DC equipment. 50 Amps. 24-32 V. 2000-4000 RPM. Wt. 45 lbs. Approx. GOVT. COST \$200. NEW, Only \$19.50.

**CHRONOMETRIC TACHOMETER**

Built to U.S. Navy & Air Force specs. Standard brand. For counting revolutions per min. for any rotating shaft. Can be used on speeds up to 3000 RPM. Accuracy to 1/10 of 1%. Complete with male & female tips & shock-proof case. GOVT. COST \$87.50. NEW, Only \$21.95 ppd.

**COMPLETE 2-WAY TELEPHONE SYSTEM**

For that extra phone in the home, shop, farm, etc. Kit consists of 2 Western Electric telephone hand sets, 300 ft. wire, 1 dry charge lifetime storage battery. (Ready for instant use by adding regular tap water.) Simple Clear phone conversations for miles. Wt. 20 lbs. Approx GOVT. COST \$75. NOW \$9.95.

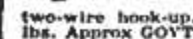

**HOMELITE PORTABLE POWER PLANT**

Ideal for welding, battery charging, emergency lights for cabins, camps, aircraft, trailers or wherever power needed. Easy rope pull starting. Fully equipped, ready to start. 2000 W., 32 V., 5 H.P. Like NEW. Tested. Shock-mounted. Deluxe type. Net wt. 115 lbs. Gross wt. cased 200 lbs. Approx. GOVT. COST \$700. Now — \$65.00. 2500 W. — \$75.

**BENDIX GEROTOR PUMP & MOTOR**

Use wherever fluid pumping required. Excellent for hydraulic installations. Has 3/4" pipe connections, built-in relief valve adjustable up to 1500 lbs. Max. cap. 6 GPM. 1 1/2 H.P., 24 V. motor. Use on 12 to 36 V. Approx. GOVT. COST \$350. NEW, \$10.95.



**140-1 REDUCTION GEAR**

For beaching boats, winches, hoists. Ideal for motor in golf or boys electric car. Built-in (removable) DC motor & clutch. Hi torque, lo speed. Runs on 6-12 or 24 V. Wt. 65 lbs. gross. Approx. GOVT. COST \$300. Like NEW, \$12.00. \*225-1 REDUCTION GEAR, as above — \$13.50.



**HEAVY-DUTY RHEOSTAT**

Ideal for regulating voltage on electric welders. Rated 5.75 Ohms. 100 Watts with double windings & dual female 25 amp, 125 V. receptacles. 7" hi x 3 1/4" x 1 3/4" D. Shpg. wt. 2 1/2 lbs. Approx. GOVT. COST \$25. Brand New. \$1.95. 2 for \$3.50.

**B-16 KOLLSMAN AIRCRAFT COMPASS**

Ideal for boats, cars, etc. Grad. in 5° increments. Liquid-filled. Lighted. Poly-plane compensator. Panel mounting. 3 1/2" dia. face; 4 1/2" deep. Checked & tested in our own lab. Approx. GOVT. COST \$150. Like NEW, \$12.95 ppd.

**ASTRO COMPASS MARK II**

Used by USAF & commercial airlines. Makes pelorus & azimuth circle for air or marine navigators. Great for astronomers. Incl. carrying case. Tested for accuracy in our own lab. Approx. GOVT. COST \$400. Now \$10.95.

**HEAVY-DUTY ELECTRIC MOTOR**

Compact unit that fits in small places. 2 1/4 HP. 24-32 V. DC. Spline shaft. Pnd mounting. Fan cooled. RPM up to 4000. Famous brand. Wt. 20 lbs. Approx. GOVT. COST \$250. NEW, \$9.50.



**MICROMETERS**

Black crackle finish frame. Easy-to-read graduations in .001. NEW. 0-1" cap. \$2.69 ppd. 1-2" cap. \$3.79 ppd.

**DRILL BARGAIN COUNTER**

New Large Size Carbon U.S. Navy Surplus Production Drills. National Brands.

No. 3 Taper		No. 4 Taper	
1 1/32"	\$4.50	1 5/16"	\$7.95
1 1/16"	\$4.60	1 11/16"	\$8.15
1 3/32"	\$4.80	1 13/32"	\$8.50
1 1/8"	\$4.90	1 7/16"	\$8.75
1 5/32"	\$5.00	1 15/32"	\$9.25
1 3/16"	\$5.50	1 19/32"	\$9.95
1 7/32"	\$6.00	1 21/32"	\$10.50
1 1/4"	\$6.25	1 25/32"	\$11.00
1 9/32"	\$7.50	1 13/16"	\$12.95
		1 27/32"	\$13.25
		1 7/8"	\$14.00

All Prices Prepaid

**NEW! TERRIFIC! 1958 CATALOG!**

Thousands of bargains in war surplus & other items. Hundreds of pictures. Send 25c for your copy today! Ppd. prices in USA only. Other prices FOB Culver City, Calif. Send cash, check or money order. 50% deposit on COD.

**AIRBORNE SALES CO., INC. DEPT. PM158**

8501 Stellar Drive, Culver City, Calif

**SPARE-TIME MONEYMAKING OPPORTUNITIES—READ OUR CLASSIFIED ADS HUNDREDS OF BARGAINS AMAZING OFFERS**

**CUT-TO-FIT HOMES CUT BUILDING COSTS**

**ORDER NOW**

**SAVE UP TO 1/3**



Build your own home and save the builders' profit—plus savings in lumber and labor with Sterling Ready-Cut-Homes. Anyone can assemble with simple, easy to follow plans furnished. Every house complete with all lumber, roofing, nails, glass, hardware, paint, doors and windows marked ready to erect. Freight paid. Complete building plans ready for filing at low cost. Sold separately if desired. Write today!

**PRICED FROM \$2150 up**

Five Easy Payment Plans

Send 25c for NEW COLOR CATALOG

**INTERNATIONAL MILL AND TIMBER CO. DEPT. PM-18 BAY CITY, MICHIGAN**



# DREMEL MOTO-TOOL

Handiest tool you'll ever own. Its high speed (27,000 RPM) is ideal for precision grinding, polishing, carving, drilling, engraving, de-burring, sharpening, etc. Eliminates time-consuming hand work. Weighs only 13 oz.—handles easily as a pencil. Does fine detail work with pin point accuracy. Widely used by tool and die makers, model builders, craftsmen, technicians, since 1936.



MOTO-TOOL MODEL NO. 2  
(Shown above) ..\$19.95  
MODEL NO. 1 ..\$12.85

MOTO-TOOL KIT NO. 2 (as shown)  
Incl. Model No. 2 Moto-Tool, 23 accessories (high speed cutters, grinder, polishers, etc.)  
in a sturdy steel case ..\$27.50

MOTO-TOOL KIT NO. 1 ..\$21.50  
SEE YOUR DEALER or write for FREE catalog on the complete Dremel line of power tools.

QUALITY POWER TOOLS SINCE 1934  
DREMEL MFG. CO., Dept. 127A, Racine, Wis.

## The Army Adopts A New Rifle

(Continued from page 150)

Army officials, however, say the purpose of the M14-15 on automatic fire is to deliver area fire, as with a shotgun, rather than point fire at an individual target. It will be used to pin down the enemy during an advance, for close-in fighting, harassing fire, in assaults and other combat situations calling for heavy, concentrated firepower.

For these uses, the experts agree it is an effective weapon. How much accuracy a soldier can achieve with it will depend on the length and type of his training, and such physical characteristics as strength and coordination. The Army doesn't even know the answers to some of these problems, because it hasn't mass-trained soldiers with the rifles.

Strange as it may seem, in wagon-before-the-horse fashion, the Army developed and adopted the NATO cartridge before it did the M14-15 and the M60 machine gun. Several rifles were proposed as a standardized NATO weapons system to use the cartridge, but the field narrowed down to the M14-15 and the Belgian FN rifle, named after its manufacturer, Fabrique National d'Armes de Guerre.

The British, Canadian and Belgian armies adopted the FN rifle. So did a non-NATO country, Australia. However, the U. S. Army was dubious.

Initially, the FN rifle did not pass several U. S. Army tests. But after modifications, both the M14-15 and the FN rifles were declared suitable for Army acceptance.

The Army picked the M14-15, saying in an official announcement that it was because of the lighter weight difference and because the M14-15 "is considered better suited for American transition to both mass production and training."

Certainly the M14-15 is a better, more dependable all-purpose weapons system than the one it is replacing. The criticism against its full-automatic feature is offset by the fact that it can be fired semiautomatic, too.

The only problems will be ammunition supply and the most effective tactical use of the weapon in combat. With the new lightweight cartridges, the individual soldier will be able to carry more ammunition. But with an automatic rifle in his hands, it will be human nature for him to want to use it that way most of the time. How will the individual soldier be able to carry, and be supplied with enough ammunition to keep up with heavy use? It will call for the strictest discipline in the combat firing of the weapon on the part of the individual soldier and his unit leaders. ★ ★ ★

## MAKE YOUR OWN

NEW! SAFE, RUGGED  
ALUMINUM ALLOY TANKS

UNLIMITED USES FOR LAND  
or WATER SPORTS — PLEASURE

These rugged aluminum alloy tanks are light, safe, extremely buoyant and can easily be adapted to hundreds of uses. They are non-corrosive and require no upkeep. You can make rafts for swimming, power craft for river and lake fun. They can be used for liquid storage and supply tanks. The possibilities are unlimited and you can have more fun than you ever imagined.



### SPECIFICATIONS

Tough aluminum alloy. 110 gal. capacity. Wt. 60 lbs. Lgth. 11½ ft. Dia. Max. 18". Crates 60" x 42" x 23". Support 700 lbs. each. Cad. plated steel brackets welded to tank for assembly.

\$45 each FOB Montgomery, Alabama.

WRITE TODAY for more information on structural aluminum available for construction purposes. Be the first in your area to have a pontoon craft. Ask about plans.

NO C.O.D.'s. SEND CHECK or MONEY ORDER to

RAFT  
CATAMARAN  
FLOATING DOCK  
PONTOON CRUISER  
HOUSE BOAT  
UTILITY TANK



ENGEL & ASSOCIATES

P. O. BOX 408 • ADRIAN, MICHIGAN



# NEW YEAR'S RIFLE SALE!

\$19.95 OR LESS



## MANNLICHER CARCANO CARBINE

Late model Mannlicher Carcano carbines: caliber 7.35mm barrel, 6 shot magazine, bolt action, very good condition. An inexpensive rifle for the hunter, \$12.95. Special select grade as new \$17.95. Military issue ammunition on clips, 54 rounds, \$3.40. Softnose ammunition for hunting, \$2.85 per 20.

**\$12.95**



## REMINGTON 7mm RIFLE

Genuine original Remington high power single shot rolling block rifle, Model 1902; 30" nitro-proof, hi-carbon steel barrels, caliber 7mm Mauser. Fair condition but in serviceable shooting order, \$9.95. Military ammunition, \$7.50 per 100 rds.

**\$9.95**



## JUST IN: GERMAN ARMY RIFLES

The famous German MAUSER MODEL 88 - 5-shot bolt action rifle, cal. 8mm. Calibrated sights, boreas guar. N.R.A. Good. Full walnut stocks, a fine hunting weapon as it is or may be easily converted to a sporter. Fine German workmanship, of course. We have a few Model 88's selected for good exteriors which we are selling for \$18.95. Ammunition special \$7.50 per 100 rds.

**\$9.95**



## "Big 11" Mauser Rifle

**GOOD TO VERY GOOD ORIGINAL PAPER PATCH AMMO AVAILABLE IN QUANTITY!**

If you want a sporting thrill, try hunting the way they did 75 years ago. This is a collector's item and an unbelievable import find, together with plenty of ammo. Model 71/84 Mauser repeating rifle, 7-shot bolt action 31" barrel. A must for your collection, but be sure to take it out hunting. Guar. good. Choice walnut stocks. AMMO SPECIAL: 11MM Mauser (for Model 71/84), 100 rds., \$7.50.

**\$14.95**



## SCHMIDT-RUBIN RIFLE

Swiss Army service rifle, Model 89; the famous Schmidt-Rubin caliber .33 (7.5mm) Swiss, 30" barrel, extremely fast and smooth, straight pull bolt action mechanism, all machined parts, finest quality Swiss workmanship throughout, made with the precision of a watch, the finest manually operated rifle ever designed, bores like new, \$14.95. Military ammunition on 6 shot stripper clips, 48 rounds, \$5. Soft nose ammunition for hunting, \$3.25 per 20 rounds. Swiss Model 89 bayonet with scabbard for above, \$3.95. Saw-tooth Engineer's bayonet with sheath, \$4.95. Sling, muzzle cover and cleaning kit \$1.50 (with rifle order only).

**\$14.95**



## OUR GUNSMITH'S SPECIAL SPORTER

Swiss Mountaineer Sporting carbine. This is the famous rifle as above modified for hunting use with 22" barrel, stock shortened and refinished, fitted with sling swivel, making a fine 7 1/2 lb. super accurate hunting rifle. Boreas are like new

**\$19.95**



## 3 HISTORIC RIFLES \$24.95



ITALIAN CARCANO G.S. (Ethiopian campaign)

EARLY RUSSIAN (Czarist and early Red army)

Mannlicher-Berthier (French S. African Berber uprising)

**INDIVIDUAL GUNS, \$9.95 EA.**

All Three for \$24.95 A WALL FULL OF GUNS FOR THE PRICE OF ONE!

These are all obsolete collector's items, all mechanically complete to the last detail. We do not recommend firing them due to their age, and the fact that our gunsmiths have not checked them due to low cost. They are strictly for your den.

TO ORDER: Enclose check, cash or M.O. 1/2 dep. for C.O.D. Shipped RR Ex. collect. FOB Pasadena, Calif. res. add 6% state tax. 10-day money back guarantee

## THE ELLNER COMPANY

Dept. 67, 1206 Maple Avenue, Los Angeles 15, California

## POWER HACKSAW \$59.85



LESS MOTOR F.O.B. Benton Harbor

\* Rugged cast iron construction. Wt. 56 lbs., bronze bearings. Draw cut. Auto. return lift. Auto. shut-off. Vise swivels 45°. Cap. 4"x4".

Dept. PM, P.O. Box 116 BENTON HARBOR, MICHIGAN

Send for full details and name of nearest dealer.

## EXCEL MACHINE TOOLS



**DRAINS** cellars, cisterns, wash tubs; **\$7.95**  
**IRRIGATES - CIRCULATES - SPRAYS**

Up to 3,000 GPH; 450 GPH 80" high; or 1800 GPH from 25' well Use 1/6 to 3/4 HP motor. Coupling included free. 1" inlet; 3/4" outlet. Stainless steel shaft. Won't rust or clog. Type P - \$7.95.

CELLAR DRAINER KITS (less motor)  
"Low Boy" - 15" high, 1500 GPH..... \$12.95  
"High Boy" - 32" high, 3,000 GPH..... \$15.95  
Postpaid if cash with order. MONEY BACK GUARANTEE  
LABAWCO PUMPS, Belle Mead 7A, N. J.



## SAW SHARPENING IS EASY

Super Filer No. 11 joints and sharpens hand and circular saws 6" to 10" with all teeth correct in height, depth, pitch, bevel. When file hits steel roller, teeth are finished. Saw runs true with no side pull. Includes 8" file.

**\$9.95** PPD.

"TRU-CIRCLE" saw set automatically sets teeth at 10° or more. **\$2.95** PPD.



## SUPER SAW FILER No. 6

Automatically controls depth, angle, pitch for all saws. Precision made and calibrated. Use in any vise or clamp. Includes \$6.50 file. **\$6.50** PPD.



## DOWEL CENTERS

Centers inscribe exact location for opposite holes. Pairs for 1/4", 3/8", 1/2" holes. **\$1.00** PPD.

MONEY BACK GUARANTEE-CATALOG FREE

A. D. McBURNEY, 5908 Hollywood Blvd., Hollywood 28, Cal., Dept. A-18

JANUARY 1958

## Brand New! Portable Light Plants

WITH PUSH BUTTON STARTER. 115 V AC (& 12 V DC) Always available.

Be prepared with reliable emergency power, designed for use with radio gear, etc. Only unit at these low factory prices fully shielded and filtered for radio, and individually checked by scope. Not surplus, but



brand new 4-cycle, easy starting, cast iron cylinder engines, fiber glass insulated generators, and control boxes with voltmeter and controls. No wiring necessary, just plug in and operate. Conservatively rated. Just the generator for CD, Field Day, Camping and Boats. Complete line. Fully guaranteed.

700 watt (A712) Shpg. wt. 77 lbs..... **\$143.50**  
1000 watt (A1012) Shpg. wt. 90 lbs..... **\$195.50**  
2500 watt (A2512) Shpg. wt. 225 lbs..... **\$325.50**

Sizes to 3500 watts. Dual voltage models, automatic controls, etc., available. Write:

**GENERAL ELECTRONIC SERVICE**  
P.O. Box 9, Dept. PM-1, Burlington, W.



# ACCEPT NO IMITATIONS

BE SURE IT'S A  
**KING O'LAWN**

The Edger-Trimmer with  
"That Forward Throw."

**\$79.50** F.O.B. South Gate  
California

1958 Model Briggs Stratton  
light weight 4 cycle engine.  
Total weight of Power  
Edger — 49 lbs.

## KING O'LAWN

Junior model  
power edger  
trimmer shown.

4 models of  
power edgers  
and 4 models  
of power mowers  
from which to choose

Over 2000 dealers to serve you. A few choice  
dealer territories are still available. Please write

**KING O'LAWN Inc.** P.O. Box 1068 Tweedy Sta.  
South Gate, California



Edges 5 feet  
per second  
and trims in  
the hard to  
get places.

Changes  
from edger  
to trimmer  
in just 3  
seconds



Russian schoolgirls try out a new sidecar bicycle,  
one of the exhibits at the Polytechnical Museum

## I Drove Through Russia

(Continued from page 121)

complex form for a perfect fit. A new head-  
light unit was installed and the whip an-  
tenna brazed on. Touch-up paint covering  
body scratches exactly matched the un-  
usual shade of red. As a bonus, the car  
was washed and greased. After collecting  
the new windshield from the airport we  
hopefully took it with us to the Moskvitch  
plant—but there was no need to ask, they  
offered to put it in.

These small examples of technical enter-  
prise link up with the success of projects  
such as the earth satellite in this formerly  
backward country. On different scales,  
both represented a challenge to Russians  
who from childhood had been steeped in  
science as the key to their future.

This was dramatized for me in Moscow's  
Polytechnical Museum, where 20,000 ex-  
amples of working models of modern ma-  
chinery and equipment are crammed into  
50 halls and sections: gas turbines, blast  
furnaces, hydroelectric power stations and  
electronic computers. When I went there  
it was filled with conducted groups of  
school children, and it was an eye opener to  
see 10-year-old girls in pigtailed intently  
studying a steel-rolling mill or complicated  
machine tools.

I had another glimpse of this scientific fer-  
vor when I visited the offices of *Tekhnika  
Molodezhi* (*Technology for the Young*).  
Backed by state funds, this monthly has a  
half-million circulation—limited only by  
paper supplies. It presents advanced de-  
velopments, such as in nuclear physics or  
high-speed metal-cutting with ceramic  
tools, in simple terms and with humorous

(Continued to page 270)

**MEASURES UP!**  
ONLY  
**\$2.39**  
(10 FT.)  
the *Evans*  
**KING-SIZE  
TAPE**  
IT STANDS UP STRAIGHT  
6-8-10-12 FOOT LENGTHS

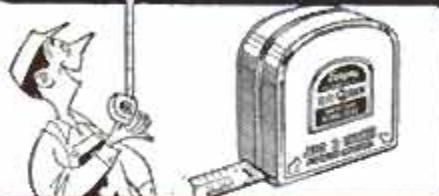

Long upright measuring jobs are easy with  
Evans King Size. Blade is a full 3/4" wide...  
33% wider than ordinary tapes. Stands  
straight up or lays down flat—won't bend  
or buckle. Easier to read, too. Free belt clip,  
Tenite utility case. Sliding end hook—for  
100% accurate inside-outside measuring.

**Exclusive! NO FIGURING!**

feet & inches? Read here →   
inches? Read here → 

Get *Evans* Regular White-Tapes  
only 98¢ 50 Ft. only \$4.98  
Tenite utility case • All *Evans* quality  
6-8-10-12-50-100 foot lengths  
Hardware dealer—Today!

**W. W. RULE CO.**  
Montreal, Que.



# SURPLUS SALE

WAR SURPLUS  
EXCESS INVENTORY  
BANKRUPT STOCK

## STORAGE BATTERY WINCH

• Powerful fully reversible, ball-bearing gear reduction winch. 1000-2000 lb. pull. Use on 6 or 12-v battery. Holds 40' of 1/4" cable. For trucks, docks, boats. Govt. cost \$280. **SALE \$46.75 FOB**



## ARMY BLOWER-DRYER-HEATER

• Marvellous new condition engine driven high-capacity (100,000 BTU) heater-blower. Burns gasoline—tremendous output heated air. • Wonderful for drying farm grains, heating warehouses, contractors, etc. • starting froze-up equipment, etc. Complete with long flexible heat ducts. Size 30"x48"x34". Wt. 198 lbs. Govt. cost \$525. **SALE \$92.70 FOB**

## HYDRAULIC SPEED REDUCER

• Variable hydraulic speed reducer. Any speed from 0 to 750 rpm by simply throwing a lever. Handle up to 1 1/2 h.p. Use for midget cars, shop band saws, etc. Instant reverse. Govt. cost \$400. **SPECIAL \$47.81 FOB**

## AIR COMPRESSOR BARGAINS

For painting, cleaning, tires, control termites. Assemble your own outfit. Lowest prices in U.S. • DeLuxe Kit. Compressor, tank, gauge, regulator, paint gun, fittings. How to build instructions. List \$52. **SALE \$39.49 FOB**. • Compressor 1-cyl. \$19.95; 2-cyl. \$49.95; Govt. Air Tank, \$8.79; Regulators, \$3.95; Pop Off \$1.95; Gauge \$1.89. Finest paint gun \$11.95. Auto switch \$4.75. All prepaid.



## DIAL TELEPHONE

• Modern hi-efficiency attractive dial phone. Use for extension to main line on private system. Use several for complete private system, etc. Complete with ringer, dial, etc. Work on any system. Govt. cost \$25.50. **SALE \$9.95 Ppd.**



## AIR FORCE BOATS

• Amazing yellow rubberized air boats. Finest expensive design. Carry 1 or 2 men. Folds into compact pkg. Easily inflated. Very safe. Marvellous fishing or river floater trips. With sail mast. Govt. cost over \$100. **SALE \$27.95 Ppd.** • Large 20-man inflatable boats. Govt. cost \$495. **SALE \$59.50 FOB**



## HYDRAULIC SURPLUS BARGAINS

• Save to 80%. Build loaders, lifts, etc. • Super special cylinder. 1 1/2" bore x 4" stroke. (Precision) Govt. cost \$75. **SALE \$3.89 Ppd.** • 100s other hydraulic pumps, cylinders, hose, etc.

## GOLF ELECTRIC CAR MOTOR

• Use golf or boys electric car. Geared 100 to 1. Run 6 or 12 volts. Easily reversible. Full instr. Wt. 34 lbs. Govt. cost \$250. **SALE \$19.46**

## FISH and WORM SHOCKER

• Hand operated AC generator signal unit. Voltages up to 110. Ideal for signal bells, fish worm getter, experiments, many other uses. Cost over \$11.00. **SALE \$3.49 Ppd.**

## ELECTRIC PUMP

• Runs on 12 volt battery. Centrifugal type. Many uses. Fine boat pump, fish ponds, etc. Govt. cost \$64. **Ppd. \$9.95**

## ARMY PHONE & TEST UNIT

• Consists of field phone and meter test unit. Talk, ring or test. Talks 20 miles. Useful for testing etec. appliances, motors, etc. Cost \$121. **Sale \$24.95 Ppd.**

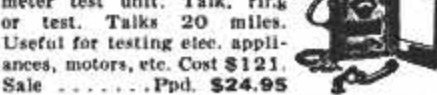

## SPECIAL OF THE MO.



## ELECTRIC BARBECUE MOTOR-SPIT

(Only 300 units available.) • Electrify your outdoor or indoor fireplace, grill, etc. Food out of this world with this gear reduction (2 RPM) 110-v AC motor-driven roasting-broiling spit. • Motor, 26" steel spit, meat spear holders, etc. Full instructions. Unit made from expensive Govt. surplus motor. Orig. cost \$19.50. **SALE \$8.91 Ppd.**

## POWER PLANTS & GENERATORS

• Marvellous buys in new condition Govt. and factory surplus plants and generators. Write for catalog. • 2500-w 115-v 60-c **\$239.50** • 3000-w 115-v 60-c **\$299.50** • 5000-w 115-v 60-c **\$497.50** • 28,000-w 115-v 230-60-c **\$1495.00** • 3 KW 115-v DC Generator **\$49.50**

## GEAR SPEED REDUCER

• Ratio 20 to 1. Finest precision quiet gears. Ball bearing. Use with AD frac. h.p. motors for speeds down to 20 RPM. Dozens uses—window displays, timing, band saws, etc. Heavy cast Al. case. Govt. cost \$47.50. **SALE \$9.81 Ppd.**

## IRRIGATION PUMPS

2 1/2" size, 16,500 gph • New bronze b-bearing centrifugal 280 gal. per min. 65 ft. head. Intake 2 1/2". With 6" pulley. Wonderful unit. Govt. cost \$98. **SALE \$49.50 FOB** • Same pump in 1 1/2" size 140 gal. 70 ft. head. Govt. cost \$62. **SALE \$24.61 Ppd.**

ORDER FROM AD or write for catalog.

**BURDEN SALES COMPANY**  
303 West "O" St., LINCOLN, NEBRASKA

## PAGE FOR TILLING PLOWING MOWING

**FULL LINE** 2 to 6 HP with complete gear drive and reverse.  
**Free Catalog** LOW PRICES EASY TERMS Over 30 Years Experience  
**FULLY GUARANTEED!** Over 60 attachments available!

**PAGE** 1904-A S. 81st STREET MILWAUKEE, WIS.

## Print Your Own

Cards, Stationery, Advertising, Circulars, labels, photo and movie titles, church work, tags, etc. Save money. Sold direct from factory only. Raised printing like engraving, too. **Own a Printing Business**

Print for Others. Good Profit. Have home shop. Junior press \$15; Senior \$29 up. We supply everything. Easy rules. Pays for self in short time. Write for free catalog of outfits and all details. **KELSEY PRESSES, C-37 Meriden, Conn.**



## GET YOUR COPY

Just off the press! Forty pages of useful information for professional and amateur mechanics. Profusely illustrated. Worth dollars — mailed postpaid for a dime — anywhere in U. S. A.

**CRESCENT TOOL CO., Jamestown, N. Y.**



## Modernize with Marlite for years of wear, just minutes of care!

Give any room in your home a bright, new look with beautiful Marlite. This easy-to-install paneling in sheets, planks or blocks goes up fast over old walls or new with simple carpenter tools. And Marlite melamine plastic finish resists dirt, grease, stains, moisture. It cleans with a damp cloth; stays like new for years. See your building materials dealer for Marlite in distinctive "Companion Colors," marble patterns, wood finishes—or write for free decorating ideas book. Marlite Division of Masonite Corporation, Dept. 142, Dover, Ohio.

**Marlite**



plastic-finished paneling

ANOTHER QUALITY PRODUCT OF MASONITE® RESEARCH



THINK

# REFERRED

by Leading  
Appliance Manufacturers  
NOW AVAILABLE TO YOU!

EMERSON ELECTRIC



## MOTORS

First choice of manufacturers for 67 years!  
Now you can choose from 21 different designs from 1/4 to 1 H.P. Write for free catalog No. M-159. The Emerson Electric Mfg. Co., St. Louis 21, Mo.

EMERSON-ELECTRIC

of St. Louis . . . Since 1890



### Repair... in a jiffy!



**TUFF-BOND  
QUIK-SET  
ADHESIVE**



The No. 1 waterproof neoprene adhesive for replacing rubber stripping around auto windshields and doors, refrigerator doors, and for caulking around trailer windows. At better dealers everywhere. Goodloe E. Moore, Incorporated, Danville 14, Illinois.

STICKS ALMOST ANYTHING TO ANYTHING



Russian policeman directs traffic from center circle. Another in tower in background operates signals

cartoons. A few years ago science fiction was shunned as "unrealistic," but now there is a special "Fantastic Editor" concerned with stories about rocketships and interplanetary travel.

The last thing we saw on the Moscow sky line as we drove westward was the tower above the 32-story "Palace of Science"—claimed to be the tallest building in Europe. This is the new university, conceived on a massive scale with 150 lecture halls and 1000 laboratories to take care of 17,000 students. But the paradoxes of Russia re-emerged with the first sight of the wooden shacks and broken-down trucks.

Politics aside, this country with nearly three times the area of America appears to have the pioneering spirit of the Midwest 100 years ago, along with a massive appetite for 20th-century technology. ★ ★ ★

### Doctors Operate on "Cold" Brain

Cold blood is being used by research physicians to perform heretofore impossible brain operations. Experimenting on dogs, the doctors found a way to recirculate oxygen-supplied chilled blood until a brain is lowered from the normal 100 degrees F. to 50 degrees. At this point a brain no longer needs blood and oxygen. So the doctors operate on a virtually bloodless brain to correct such conditions as faulty brain arteries, now considered inoperable, or even pump in a chemical solution to stop or slow the growth of a tumor. The experiments are being conducted at Duke University Medical Center.

☐ About 440,000 million gallons of water per day are used in the U. S.—an increase of 34 percent between 1950 and 1955.



# NEW GRIPSO Do-it-Yourself TOOL KIT

## SAVE TIME - WORK - MONEY

Four new and different Power Action tools that actually do the work of dozens of separate tools. Complete in handy heavy-duty vinyl holder that will hang on workshop wall or fold for easy carrying. Ready when you need them.

See Your Nearest Dealer or Write

H. R. BASFORD CO.

235 - 15th Street, San Francisco 3, Calif.



**GRIPSO VISE PLIERS**  
Hand vise, pliers, clamp, nut wrench, pipe wrench. One ton grip releases gently with touch on trigger. No bruised knuckles.

**GRIPSO-MATIC PIPE WRENCH**  
Strongest pipe wrench made. Lightweight, streamlined, works on hard to get at places. No screw to turn—works faster and easier.

**GRIPSO MULTI-DUTY PLIERS**  
3 Piece design, multiplies grip 10 times. 4-position slip-joint gives wider range parallel jaws with non-slip grip.

**GRIPSO GEAR-LOCK PLIERS**  
First new plier improvement in years with Power-Gear grip for all shapes and sizes to 1 1/2". Slimmer—streamlined wide adjustment.

## OUTWORKS THEM ALL

Prepares the toughest soils in one operation. All-purpose tiller-tractor tills to 12" deep - 12" to 40" wide. 3 models; 7 rotor styles including mulchers. 40 attachments include all tractor tools, mowers, snow plow. Tough chain-gear drive. Send for details.



## MERRY TILLER

Northern Life Building, Box 1835, Seattle 4, Wash.

## TWO WAYS TO BUY BETTER

Your dealer knows the right products for your needs—quality products that are nationally advertised. POPULAR MECHANICS brings you a monthly roundup of valuable "how to" information and product advertising. Read POPULAR MECHANICS every month—then talk to your dealer.



**\$3 to \$5 an hour**  
**IN SPARE TIME**

### WITH NEW FOLEY PRECISION GRINDER

Make \$3 to \$5 an hour in your own spare time business. Low cost machine sharpens circular saws, rotary mower blades, ice skates, does sanding, polishing, buffing. Easy to operate—no experience needed. Send coupon today for Free circular. No salesman will call.

FOLEY MFG. COMPANY  
173-8 Foley Bldg.  
Minneapolis 18, Minn.

Send Free Circular on Foley Precision Grinder.

Name \_\_\_\_\_

Address \_\_\_\_\_

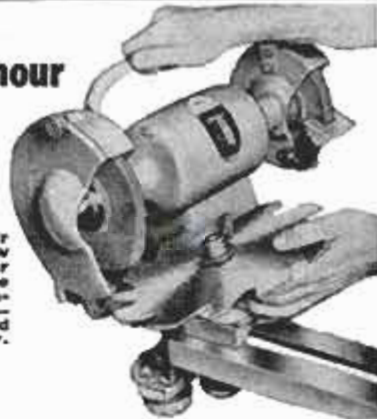

## 115 VOLT, 60 CYCLE SURPLUS AIR COMPRESSOR



A self-contained motor-compressor. Originally designed for Navy use. Equipped with filter for moisture-free air supply. Ideal for air gun, inflating, spraying, etc. Delivers up to 35 PSI. Motor operates on 115V, 60 cycle AC current and is rated at 1/10 HP. Turns at 1725 RPM.

Complete with built-in pressure gauge and air filter. A Surplus Bargain . . . **Now 27.95**

AIR STORAGE TANK - Ideal for use with above compressor. Has 280 cu. in. cap. Size 6" x 14-1/2". Tested to 400 PSI. 1/4" ports. **2.95**

## 3400 RPM 1/2 HP POWER SAW

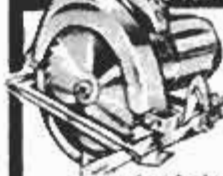

**RIPS - CROSSCUTS**  
**CUTS A FINISHED 2x4 LIKE A KNIFE THROUGH BUTTER**

COMPARES TO SAWS SELLING UP TO \$49.50 **19.98** Complete with 5-1/2" Blade

A rugged, professional type, adjustable saw. Will cut any angle from 0 to 45°. Has an adjustable (8 to 6") rip fence. Safety-trigger switch on handle. Full 1/2 HP Universal AC-DC, 110-120 Volt, 60 cycle motor. Weighs only 6 1/2 lbs.



**DOUBLE ACTION HYDRAULIC CYLINDER**  
Designed for use in series. Ideal for use on production line & automatic equip. 1500 PSI, 4-7/8" stroke. **3.75**

### 396 PAGE CATALOG

Thousands of items of all descriptions. Hand & Power Tools, Industrial & Building Materials, Micro & Telescope, Hydraulic Equip. of all types. Send 50¢ TODAY for handling & mailing. Your money refunded with 1st order.



### SATELLITE SCOPE

**25 POWER NEW 30 MM**

**Only 5.95**

PIGSKIN CASE \$2.00 EXTRA VALUE Made of aluminum and chrome plated brass in white, black or black crackle finish (please specify). Has field of 62 ft. at 1000 yards. Many uses. FREE! Catalog section full of other optical bargains. Order Mailer X-58 See Microscopes, Telescopes, etc.

**Palley's**

TO ORDER: Send check, or M.O. 1/2 deposit with C.O.D.'s. Prices P.O.F., Los Angeles, Calif.  
1253 E. Vernon Avenue, Dept. PM-1 Los Angeles 58, California



# EVERYTHING FOR THE WOODWORKER AND HIS WORKSHOP

SHIPPED THE  
SAME DAY

THE  
CONSTANTINE  
WAY! \*



World's oldest and largest supplier of rare and fancy imported and domestic fine woods, tools and hobby materials at lowest prices. This new book is full of bargains in cabinet woods, lumber, plywood, veneers, inlays, bandings, carved wood trim, mouldings, upholstery supplies, tools, unusual hard-to-get cabinet hardware wood finishing and how-to-do-it articles, plans, patterns, wood identification panel. Loaded with natural color. Newest, finest book offered. Send 50¢ today (refunded on 1st order) for this manual and get "Chips and Chats," a Constantine publication FREE for one year.

### NEW SHIP SAME DAY SERVICE \*

Don't hold up a project—no delay or wait for any item. New plant and facilities assure your order shipped the day received. No extra cost the Constantine way. Send today! ALBERT CONSTANTINE AND SON, INC., 2050 Eastchester Road, New York 61, N. Y.

## MAIL COUPON TODAY!

• Albert Constantine and Son, Inc.  
• 2056G Eastchester Rd., New York 61, N. Y.  
• Enclosed 50¢ (refunded on 1st order). Send Catalog and FREE "Chips and Chats."

• Name \_\_\_\_\_  
• Address \_\_\_\_\_  
• City \_\_\_\_\_ State \_\_\_\_\_

## HELPFUL BOOKS

Send post card asking for FREE catalog  
Popular Mechanics Press, 200 E. Ontario, Dept. 601, Chicago 11

# MAKE YOUR OWN BOLTS, BRACES, HANGERS!



now available  
**GALVANIZED!**

## REDI-BOLT® THREADED STEEL RODS

Save repair and construction time. Just cut to length; heat and bend; add std. nuts. Seven sizes: 1/4", 5/16", 3/8", 7/16", 1/2", 5/8", and 3/4". Handy lengths of 24" and 36". Available in galvanized or blue rust-resistant finish.

Sold in Leading Hardware Stores

**REDI-BOLT, Inc.**

5330 Indianapolis Blvd., East Chicago, Indiana

# stock your shop

- SCREWS
- BOLTS
- NUTS



ELCO TOOL & SCREW CORP.

ROCKFORD, ILLINOIS

PER BOX

DraweRack  
without boxes

59¢

### EASY TO GET AT! EASY TO GET OUT!

Buy your screws in these handy, sparkling, clear-plastic drawer-boxes! Generous quantities of top-quality fasteners at 59c per box. Keep them in the ingenious, multi-purpose DraweRack storage system — ready for quick selection and instant use! At your hardware store...

ALL WOOD SCREWS ARE  
SPEEDIZED  
FOR EASY DRIVING INTO  
EVEN HARDEST WOODS

59¢



## WELD IT YOURSELF IN A JIFFY!

Weld, Cut, Braze, Solder: Iron, Steel, Brass, Bronze, Aluminum and other metals safely and easily. Make your wrought iron furniture, porch railings, fences, knick-knacks and other metal specialties. With this fine equipment anyone can do professional-like work with little practice. Tool and equipment breakdowns are annoying and costly. Don't let them bother you. The Dynamic will pay for itself quickly in both time and money and is designed to operate from any properly wired 110 volt AC line.

Order your Dynamic Industrial type transformer Arc Welder for Workshop or Industrial use today. Order from this ad.

Literature on larger equipment available on request.

DYNAMIC WELDER COMPANY, 1808 S. Federal Street, Dept. D2-A, Chicago 16, Illinois

### EASY PAY PLAN

Low down-payment.  
Pay as you weld.  
Money back guarantee.  
Send for details.  
Complete outfit.

**Only \$38.50**

F.O.B. Factory



**STOP** Rear End Scraping  
on Drive-in Curbs



**STOP** "BOTTOMING"  
on Dips, Bumps



**KEEP HEADS  
ON ROAD**



with **LaHer** CANTILEVER SPRING BOOSTERS  
for all makes, models - cars and trucks

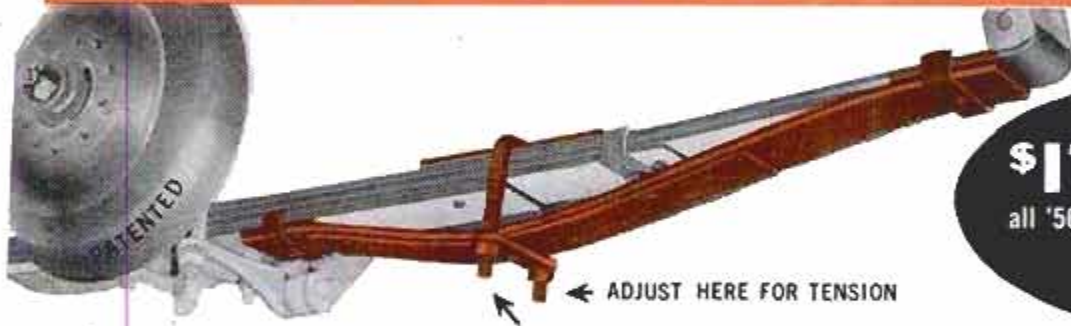

**PRICE**  
**\$17.90** \$14.90  
all '56, '57, '58  
Chrysler  
Product  
Cars. all other  
makes,  
models.

- Fastest selling Helper Spring in America - over 500,000 sold.
- Stabilizes car and reduces driving fatigue
- Increases carrying capacity up to 1000 lbs.
- Does not interfere with shock absorber operation.
- Raises car, either side or both, to any height required.
- Install in 5 minutes. Puts mirror in line.
- LAHER, America's leading spring manufacturer for 50 years.



**LAHER SPRING & TIRE CORP.**  
ST. LOUIS, 2131 Locust St. • OAKLAND, 2615 Magnolia St. • PITTS-  
BURGH, 5515 Penn Ave. • MEMPHIS, 300 Madison Ave. • LOS  
ANGELES, 807 E. 8th St. • FORT WORTH, 910 Florence St. • SAN  
FRANCISCO, 98 - 12th St. • SALT LAKE CITY, 541 So. State  
St. • SEATTLE, 714 E. Pike St. • PORTLAND, N.W. 15th & Davis  
St. • SPOKANE, 1319 W. Second Ave. • SACRAMENTO, 1217 - 16th St.

JOBBER AND DISTRIBUTORS WRITE NOW ABOUT OPEN TERRITORIES

**SEE YOUR NEAREST AUTO SUPPLY OR SERVICE DEALER TODAY!**  
If he cannot supply you, send check or money order to  
address nearest you, giving us your make, model and  
year of car. Check above for price to fit your make and  
model, and we will ship direct, postage paid on money  
back 15 day trial guarantee.

### Hassock With Extra Cushions Converts to Chair or Pallet



Madsen Chair Co., Cleburne, Tex.

Among the versatile furniture items now available is a hassock that converts to a chair, a pallet or a station-wagon bed. Two throw cushions are stored inside the hassock. The back of the unit can be detached and used as another throw cushion or it will swing upward on a hinge to serve as a chair back. The hassock and cushions are covered with plastic or soil-

resistant fabrics. There's a handle in the back for carrying the unit.

### Shooting Stars Formed "Recently"

Meteorites falling on earth possibly came from a gigantic collision of planets or asteroids comparatively recently in the scale of celestial time, according to a newly developed theory. Scientists say the parent planets or asteroids were formed at about the time of the earth's formation, 4½ billion years ago. However, studies of meteorites falling on the United States indicate they probably were traveling in space for only 240 to 280 million years.

### Coating Reduces Frost

Defrosting a refrigerator may be easier in the future because of a tasteless, odorless and nontoxic chemical coating recently invented to retard frost accumulation on cold surfaces.

### Drug May Counteract Convulsions

British scientists may have found a new drug that will allow Navy frogmen to stay underwater for long periods without suffering convulsions caused by oxygen poisoning, although the material has been tested only on animals.



Save up to 100%!

**SPECIAL—100 PIECES for ELECTRIC GRINDERS**  
Grinding Wheels, Cut-off Wheels, Sanding Discs, Mounted Stones, Honing Stones, Rotary Cutting Burrs, Mandrels and other items... **\$1 P.P.**

**12 MOUNTED WHEELS** and points on 1/4" Shank. **\$2.95**  
\$7.50 p.p.  
For grinding on plastic, wood, soft & hard metals, Regular Value \$8.40, 18 Mounted points on 3/32" shank \$2.50; 12 mtd. wheels on 1/4" shank \$3.60.

**18 Rotary Cutters** P.P. **\$5.85**  
Assorted sizes cutters on 1/4" or 3/32" shank. Will fit all hand grinders. Ideal for cutting wood, metal or plastic. Brand new.

**ADAPTER CHUCK**  
With 2 interchangeable collets, opening from 3/32" to 0, on 1/4" mandrel. **\$1.50 P.P.**  
Price each only.....

Post-paid value **\$4.50**  
Fits all electric drills & hand power tools. 35 3/4" long. Oilite bearings. Core of specially wound, high carbon steel wire in flexible steel casing. Will accommodate tool shafts up to 3/8" dia. For lathes, electric drills, etc.

**FLEXIBLE SHAFT—ONLY**  
Post-paid **\$6.50**  
Fits all electric drills & hand power tools. 35 3/4" long. Oilite bearings. Core of specially wound, high carbon steel wire in flexible steel casing. Will accommodate tool shafts up to 3/8" dia. For lathes, electric drills, etc.

**ELECTRIC HAND GRINDER**  
Fits in the palm of the hand and has an air-cooled motor that runs at 20,000 rpm AC or DC at 110 volts. Comes complete with both 3/32 and 1/4 inch Collets. **\$11.50 P.P.**

No C.O.D.'s please  
New Illustrated Catalog 10c

SCHUPACK SUPPLY CO. 7331 COLTIDGE GROVE AVE. DEPT. PM-16 CHICAGO 12, ILL.

**BUY GREAT NECK HAND TOOLS**  
... for long-lasting performance



**Precision Balanced NAIL HAMMER**

One-piece, forged steel, rubber-cushioned, no-slip grip

**GREAT NECK SAW MFRS., Inc.**  
MINEOLA, N. Y. — SEE YOUR LOCAL STORE

**ROAD TO RICHES**

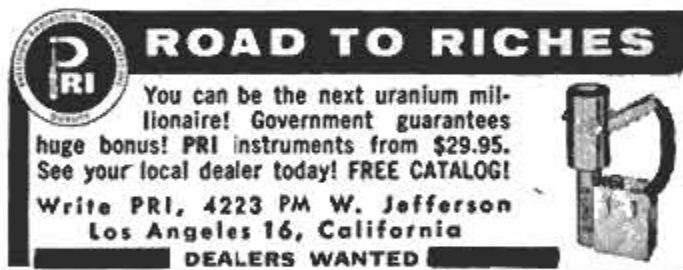

You can be the next uranium millionaire! Government guarantees huge bonus! PRI instruments from \$29.95. See your local dealer today! **FREE CATALOG!**

Write PRI, 4223 PM W. Jefferson Los Angeles 16, California

**DEALERS WANTED**

Do it yourself ...



**with McKINNEY Forged Iron Cabinet Hardware**

For den, kitchen, family room or living room. Easy to install. Dull Black, Swedish Iron or Olde Copper finishes. At your local Hardware or Building Supply dealer.

McKinney Mfg. Co., 1715 Liverpool St., Pittsburgh 33, Pa.  
Please send illustrated Forged Iron Cabinet Hardware Literature

Name \_\_\_\_\_  
Address \_\_\_\_\_  
City \_\_\_\_\_ Zone \_\_\_\_\_ State \_\_\_\_\_

**FREE! NEW PORTABLE TOOL REFERENCE GUIDE**

Hundreds of time and money-saving ideas for hobbyists, builders, professional wood-workers. New folder #205 includes 60 pictures of latest tools with complete specifications on how they work and what they do. Write for your free copy now!

**PORTER-CABLE MACHINE COMPANY**  
8141 Marcellus St., Syracuse 4, N. Y.

**FREE AMAZING NEW BOOK "HOW TO ANSWER ADS"**

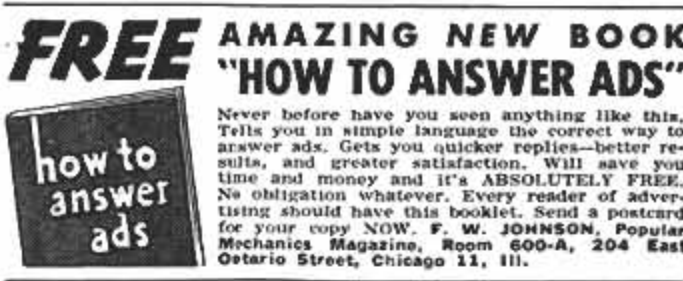

Never before have you seen anything like this. Tells you in simple language the correct way to answer ads. Gets you quicker replies—better results, and greater satisfaction. Will save you time and money and it's **ABSOLUTELY FREE**. No obligation whatever. Every reader of advertising should have this booklet. Send a postcard for your copy NOW. **F. W. JOHNSON, Popular Mechanics Magazine, Room 600-A, 204 East Ontario Street, Chicago 11, Ill.**

**MOTORIZED SLED PUSHER**



Exciting new thrills in winter sport. Speeds up to 40 m.p.h. or more on ice and snow. No propeller—no danger. Use your own sled. Fun for many. Also excellent for ice fishermen, and commercial use. 1 1/2 h.p. air cooled motor can be used on any size sled. Easily built within a week—start yours now for fun this winter. Send \$2.00 check or money order (no C.O.D.s) for complete Do It Yourself plans and material list.

**MOTOR SLED COMPANY**  
354 Argyle Rd., Rocky River 16, Ohio

**EARN GOOD MONEY—Spare or Full Time IN A BUSINESS OF YOUR OWN...**

**SMALL INVESTMENT — NO EXPERIENCE NEEDED**

Thousands of men are making big money in their own business. You too, can have a fine income with an assured future in spare or full time with the Universal lawn mower grinder. Investigate our success plan now, it includes everything you need plus facts on how others have earned over \$3,600 in one season, working part time. Act now! Mail coupon today!

**ROGERS**  
MANUFACTURING CO.  
Lindsey, Ohio

ROGERS MFG. CO., Dept. M18, Lindsey, Ohio  
Gentlemen: Rush me FREE details on easy inexpensive way to get into my own business.

Name \_\_\_\_\_  
Address \_\_\_\_\_  
City \_\_\_\_\_ State \_\_\_\_\_





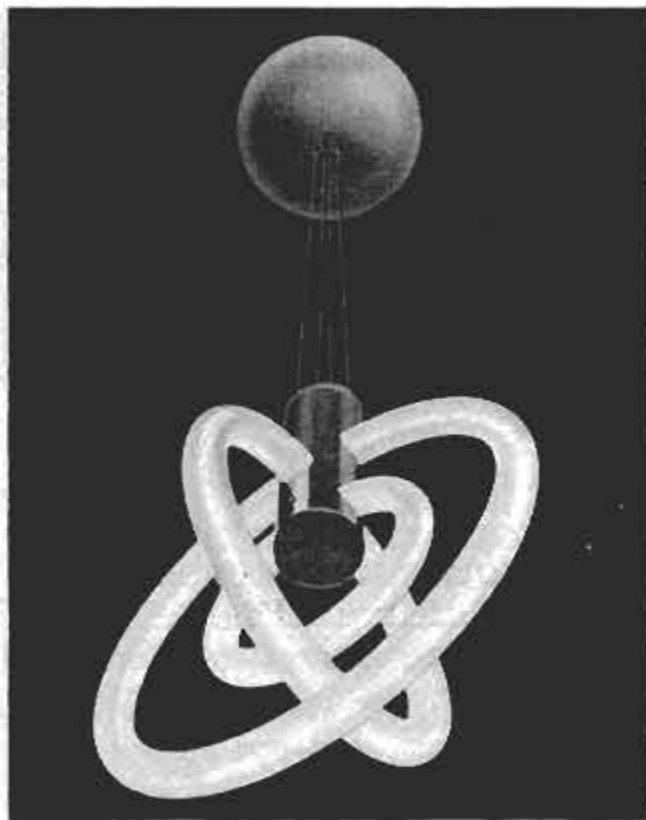

### Futuristic Light Fixture Uses Fluorescent Rings

Resembling satellite orbits, three circular fluorescent tubes are part of the modern design of a chandelier manufactured in West Germany. The light fixture was designed to provide illumination over a wide area of rooms with high ceilings.

### Five-Ounce Jet-Engine Model Develops Four-Pound Thrust

Speed records for model jet planes may be shattered by a tiny turbojet engine designed by an Air Force officer. Weighing only five ounces, the model jet engine develops four pounds of thrust. Lt. George R. Smith spent 3½ years designing and building the first working model. Each turbine blade was bent to the proper angle by hand and the corresponding blades in the inner chamber of the compressor were carved from solid aluminum. The engine operates silently.



## LOOK! All New - All Precision - All Deluxe SUPERSHOP MODEL X

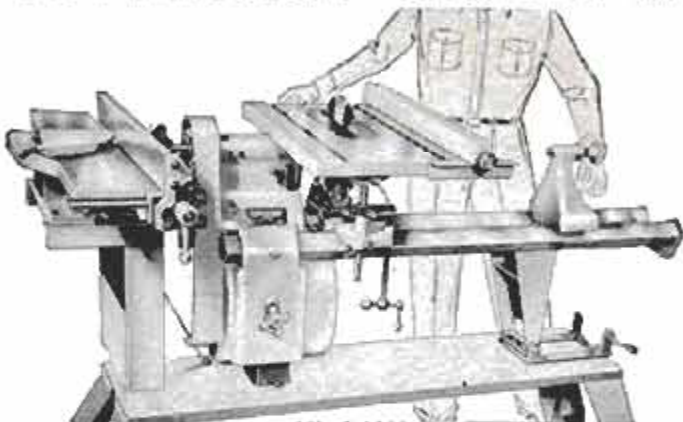

8" SAW

**WE PAY ALL  
FREIGHT FOR  
YOUR FREE  
HOME TRIAL**

**ONLY  
\$139.50  
EASY  
PAY  
PLAN**



Vert. Drill Press



Hor. Drill Press



8" Sander



30" Lathe



5" Grinder

Never before have you seen so much deluxe, precision-built power tool workshop at any price! Designed for the man who wants the best. Massive cast and precision-machined headstock, self-centering inverted "V" bedways (like precision metal lathes), exclusive non-friction speed changer, extra-large cast and precision-ground saw table. 100% ball bearing, lifetime-lubricated. You save by ordering direct from factory. You are invited to test Supershop Model X in your home FREE. Mail coupon or postcard for FREE brochures, photos, details, specifications, accessory list — and amazing freight prepaid FREE HOME TRIAL PLAN. All free.

**MAIL COUPON OR  
POSTCARD TODAY**

**POWER TOOLS, INC.** 103 Yates Avenue  
Beloit, Wisconsin

NAME \_\_\_\_\_  
ADDRESS \_\_\_\_\_  
CITY \_\_\_\_\_ STATE \_\_\_\_\_



# "ARCO-SAW" does more than a \$100 portable saw!



ZIPS THRU 2" BOARD IN ONE EASY CUT!



CUTS ANY GROOVE.  
AN "ARCO" EXCLUSIVE!



CUTS ANY ANGLE!

Build anything from a bookcase to a bungalow with this rugged portable saw. Fits any 1/4" drill. Rips & crosscuts up to 2" board. Exclusive "Dado-Arbor" adjusts for cutting grooves up to 1/2" wide x 1" deep in ONE CUT! Not even a \$100 portable saw has a dado cutter. Has Depth-Bevel-Rip Gages. Safety-yoke permits 1-hand operation. Incl. 5" blade. . . . . **\$12.95**

At Your Dealer or order direct on our Unconditional 20-day Money Back Guarantee. Send check, M.O. (ppd.) C.O.D. plus post.

**ARROW METAL PRODUCTS CO.**

Dept. PM-1 • 421 West 203 St. • New York 34, N.Y.

## GENUINE ALNICO MAGNETS

AMAZING, PERMANENT, NON-ELECTRIC, HIGHLY PRACTICAL. Conduct interesting experiments. Hundreds of uses. Retrieve valuable steel items such as guns, tackle from fresh or salt water; tools from tanks & drains. **GUARANTEED.** Try any magnet one week. Money back if you are not well-pleased.

- No. M-710 (Wt. 53 oz.) Has pull of 225 lbs. on steel block... **\$16.50**
- No. M-625 (Wt. 70 oz.) Has pull of 125 lbs. on steel block... **\$9.50**
- No. M-575 (Wt. 18 oz.) Has pull of 75 lbs. on steel block... **\$6.50**
- No. M-500 (Wt. 13 oz.) Has pull of 50 lbs. on steel block... **\$4.50**
- No. M-300 Kit of Flat Bars 5 Pairs (10 Magnets)... **\$3.00**
- No. M-250 Kit of Round Rods 5 Pairs (10 Magnets)... **\$2.50**
- No. M-47 Hot Pad Magnets, 10 for \$1.00... **50¢ for \$4.87**
- No. M-35 Hobbyist assortment of 8 small magnets... **\$1.50**

Send M.O. or check. We pay postage. Sorry no C.O.D.'s.  
MIAMI MAGNET COMPANY, 3240 N.W. 27th Ave., Miami 42, Fla.

## CUT PERFECT GROOVES WITH *Warren* WASHERS ON YOUR SAW BLADE!

You Just DIAL  
the Cut Wanted

over 250,000  
sets in use!

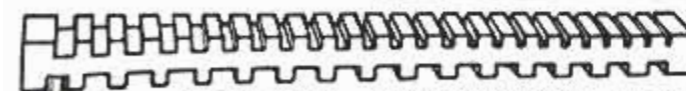

NOT ONE—NOT TWELVE—BUT  
40 DIFFERENT CUTS!

Warren Washers—engineered to cut clean, accurate, parallel grooves with your present power saw. 40 micromatic adjustments—just dial the desired width. Actually strengthens blade, eliminates vibration—leave on saw for straight cuts. No burning or chewing. Over 250,000 satisfied users in 48 States and many foreign lands. Be sure to get genuine Warren Washers . . . they're guaranteed!

**FREE!** Send for free descriptive booklet. Arbor sizes 1/2", 3/8", 3/4", 1". See your dealer or write direct.

**WARREN WASHERS CO.**

Dept. 21, Box 98, North End Station, Detroit, Mich.

ONLY  
**\$4.95**  
SET

**STOP WASTING MONEY**  
on worn-out piston rings

Get **HASTINGS**  
STEEL-VENT

### NEW! FOR FINISHING WOOD EDGES



#### WELDWOOD FLEXIBLE WOOD TRIM

Real wood veneer, paper-backed, in handy rolls, for edging plywood, lumber. Many decorative uses. Apply with Contact Cement, or Presto-Set Glue. Oak, birch, African mahogany, walnut, fir, Sonora.® At your lumber dealer's.

**SAVE!** Get 89¢ sample roll, 8' x 1", specify wood. Send this ad with 50¢ to: United States Plywood Corp., Dept. PM1, 55 W. 44th St., N.Y. 36, N.Y.

### BARRON Drill Press TOOLS



Broaden the usefulness of your drill press with our Rotary Planer, Surface and Drum Sanders, Router and Mortising Bits Molding Cutters . . . other essential accessories. Complete catalog and price list mailed on request.

**BARRON TOOL CO. INC.**  
310 Architects Bldg., Detroit 1, Mich.

WRITE  
FOR  
FREE  
WORKSHOP  
GUIDE



*Southern*  
SCREWS AND BOLTS  
CAN MAKE A

**BIG DIFFERENCE**  
in the permanence and quality of  
your workshop projects.

QUALITY MAKES THE DIFFERENCE

BUY *Southern*

BUY 'EM BY THE NAME . . .

BUY 'EM BY THE BOX  
AND SAVE!



Ask for them at your hardware or building supply store



## LESS THAN WHOLESALE

### 1500 WATT PLANT

115v. 60 cyc. AC Push Button Start. Powered by a 3 1/2 HP. Clinton engine. Combines big output with easy portability. Provides emergency power for operating any oil burner, sump pump, freezer, television, lights, communications systems, etc. which require up to 1500 watts. (Item 22) Wt. 110 lbs. Reg. \$475 value. Factory price...

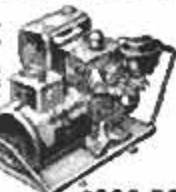

**\$239.50**

**1750 Watt Plant** Powered by 4.5 Briggs engine. Electric starting & battery charging built-in! Factory price...

**\$279.50**

**2500 WATT PLANT**—Push Button Start (Item 21) 110/120 v. 60 cyc. A.C. A rugged powerful plant. Reg. \$645. Spec.

**\$329.50**

**3500 Watt Plant Push Button Start** (Item 23) 115 v. 60 cyc. AC. Similar to above, but larger and 33% more capacity. Wt. 270 lbs. Reg. \$760. Factory Price...

**\$379.50**

**DUAL VOLTAGE** 110/220 for Item 21 or 23 —\$30 additional.

We make every type and size of light plants —Write, giving us your requirements!

### BATTERY CHARGING GENERATOR

#### Push Button Start

A husky, 750 watt plant (designed for battery charging only) that will charge 6 or 12 volt batteries in just minutes! When mounted with two 6 volt batteries it provides a terrific cold weather motor starting unit, as well as a fast charger! Charges all batteries anywhere — no in-line current needed. Ideal for service stations, garages and farms. Comes complete with ammeter and cutout. (Item 821) Wt. 120 lbs. Regularly \$295. Our special, only...



**\$119.50**

### 9 TON HYDRAULIC PRESS

A tremendously powerful hydraulic press, capable of exerting 18,000 lbs. pressure. Pays for itself many times over—straightening bent connecting rods, king pins, crank shafts, axles, link pins and bars — or pushing out frozen bearings and bushings. Developed pressure under precise control and visible at all times on accurate gauge. Complete with both large and small anvils and jigs to straighten any kind of curve or bend. (Item 464) Wt. 110 lb. Actual list price \$365. Our special close-out price...



**\$69.50**

**SCREW TYPE PRESS.** Nine ton capacity. See Sept. Pop. Mech's. ad for details—or write. Complete, Wt. 150 lbs. (Item 797)...

**\$49.50**

### Double Acting Hydraulic Cylinder

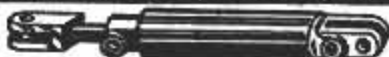

A powerful cylinder mfr'd. by Massey Harris which develops both a pushing and a pulling action. Will push 8,100 lbs., with a 1000 PSI pump pressure. Cylinder is 3 3/4" O.D. with 6 1/2" stroke—standard heavy duty clevises on both ends. Has standard 1 1/2" pipe thread openings. Can be used for tilting buckets or blades, raising or lowering implements, hydraulic presses, etc. Can also be used as an air cylinder. (Item 802) Wt. 17 lbs. Reg. \$68 value. Special...

**\$14.95**

### OTHER DOUBLE ACTING CYLINDERS

8" stroke — 3" bore..... 534.00  
10" stroke — 3" bore..... 34.80  
16" stroke — 3" bore..... 43.00  
24" stroke — 3" bore..... 47.50

We have all sizes of cylinders available.

**HYDRAULIC CONTROL VALVE** — 4 way open center valve with built-in adjustable relief. Controls 1 double, or 2 single acting cylinders. Equalizing feature permits easy control even under heavy loads. 3/4" pipe thread on inlet & outlet. — 1 1/2" on cylinder outlets. Easily mounted, finger tip control. Wt. 16 lbs. (Item 822).....

**\$21.95**

### HYDRAULIC KIT



**BUY**  
at dealer prices

direct from  
**MASTER MECHANIC'S**  
factory

**EXCLUSIVE! NEW!**

### LIGHTWEIGHT WATER COOLED DIESEL GENERATOR PLANT

Never before available! Now offered exclusively by Master Mechanic. A low priced, lightweight, continuous duty Diesel generator set. Powered by a super rugged, exceptionally smooth running, one cylinder Diesel engine. Operates at conservative 1750 r.p.m. and delivers full 1750-2000 watts of power. Operates on low cost fuel oil. Wt. only 240 lbs. representing a triumph of Diesel Engineering. Complete with fuel filter, oil pressure gauge, control box with duplex receptacle and voltmeter. (Item 830) Special factory price.....

**\$399.50**

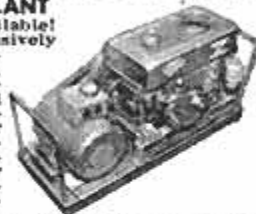

### JET STEAM MASTER

Now, a super efficient portable steam generator that produces live steam at 100 lbs. pressure in 60 seconds from a cold start! Produces large volume of high pressure steam on 2 pints of fuel oil. Instantly cleans sticky grease, dirt, rust, old paint, etc. off implements and road machinery. Pays for itself in a few weeks. Sterilizes soil. Sterilizes as it cleans—milk equipment, etc. Fully automatic—oil fired with new, built-in lifetime bronze water circulating pump. Draws water from faucet or bucket. Simple and safe—anyone can use it! built-in safety valve. Complete with 12 ft. of hi-pressure steam hose and new triple efficiency steam gun that automatically mixes in soap solution if desired. Wt. 250 lbs. Item 463. Special factory price.....

**\$349.50**



### HEATING & VENTILATING FAN

(Item 10) Easily installed in furnace pipes. Forces even heat to all rooms. Over range removes kitchen smoke and odors. Powerful, continuous duty motor, 110-120v. AC. Mount in wall or ceiling to ventilate any area. Quiet, super-efficient fan moves huge volume of air. (400 to 600 CFM.)  
8" Pipe, wt. 5 lb..... \$6.85  
9" Pipe, wt. 6 lb..... \$7.85  
10" Pipe, wt. 7 lb..... \$8.85  
12" Pipe, wt. 8 lb..... \$9.85



### "RIGID" PIPE STRAP WRENCH

The harder you pull, the tighter it grips. Rig 12" handle and 1 1/2"x24" heavy web strap—will last a lifetime! Wt. 3 lbs. (Item 383) Reg. \$3.95. Our special...  
Super 15" model—larger for more leverage and bigger fittings. (Item 383A).....

**\$1.95**

**\$2.95**



### JET FLOW BLOWER

Tremendous air movement (1800 CFM) and quiet operation make this double inlet 10" turbine blower unobtainable for heating, cooling, drying and air conditioning. Ideal for attic or barn ventilation, converting gravity heating to forced air; spray booth extraction. Operates with any 110v.



## PORTABLE LIGHT PLANTS

(Item 24)

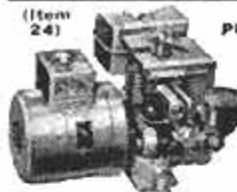

### 700 WATTS PUSH BUTTON START

115 v. 60 cyc. AC Powered by a rugged 2.2 HP easy starting Briggs engine. No wiring necessary! Just plug in and operate. Plenty of current for any oil burner, freezer, brooder, emergency lights, etc. which require up to 700 watts. Ideal for television and radio. Complete with Voltmeter and built-in winding to charge 6 v. auto batteries. (Item 24) Wt. 75 lbs. Easily fits in car trunk. (If prepared if storm knocks out power lines. Reg. \$275 value).....

**\$143.50**

**1200 Watt Plant** (Item 45) same as Item 24 but larger generator and engine with 50% greater output.....

**\$199.50**

### CABLE HOIST

**2000 lb. CAPACITY.** A fortunate purchase from the Air Force enables us to offer these powerful 2000 lb. electric cable hoists at a fraction of their value. Perfect for material handling, boat hoists, elevators, lifts on assembly lines, etc. Two separate 22 ft. lift cables with independent controls permit leveling the load and controlling it perfectly. Rugged ball bearing motors of geared down design 110 volts. Available for A.C. or D.C. Please specify. Makes a terrific portable hoist with our 275 D.C. light plant at \$99.75. Offered at less than 33% of regular cost! Hook not included. Wt. 145 lbs. A.C. Model, Item 847A.....  
D.C. Model, Item 847.....

**\$149.50**

**\$129.50**

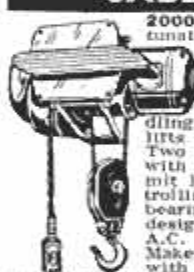

### FAUCET WATER HEATER

Instant hot water from any faucet for just pennies—sounds unbelievable—but it's true! You just slip MASTER MECHANIC'S new Faucet Water Heater over any water faucet, plug it in a wall outlet and you've got steaming hot running water instantly for dishes, shaving, washing baby's bottle, etc. Simple and safe—operates on ordinary 110v. house current—costs only 2 1/2 cents per hour for hot water. Ideal for homes, barns, cabins, trailers, etc. Easily regulated from lukewarm to full hot. Fully guaranteed! (Item 408) Wt. 2 lbs. Factory price F.O.B. Burlington, only.....

**\$4.95**

### GIANT METAL SHEARS

"PEXTO"  
Nine inch cutting blade made of special high carbon alloy steel, perfectly aligned and ground. Easily cuts steel plate up to 12 gauge or 1/4" thick. Overall length 40". Wt. 23 lbs. (Item 156) Regular \$40.50. While they last.....

**\$14.95**

### MASTER D.C. ARC WELDER

Easy To Use  
Now! a portable rugged, industrial type welder with terrific performance, yet at a price hundreds of dollars less than you'd expect. Senior model made for years of trouble-free, continuous service. High capacity DC welding unit enables you to tackle any job with confidence—easy to use.



(Item 280)



Why SOUTH BEND 9" and 10K Lathes?

# FAST They're built for ACCURATE WORK

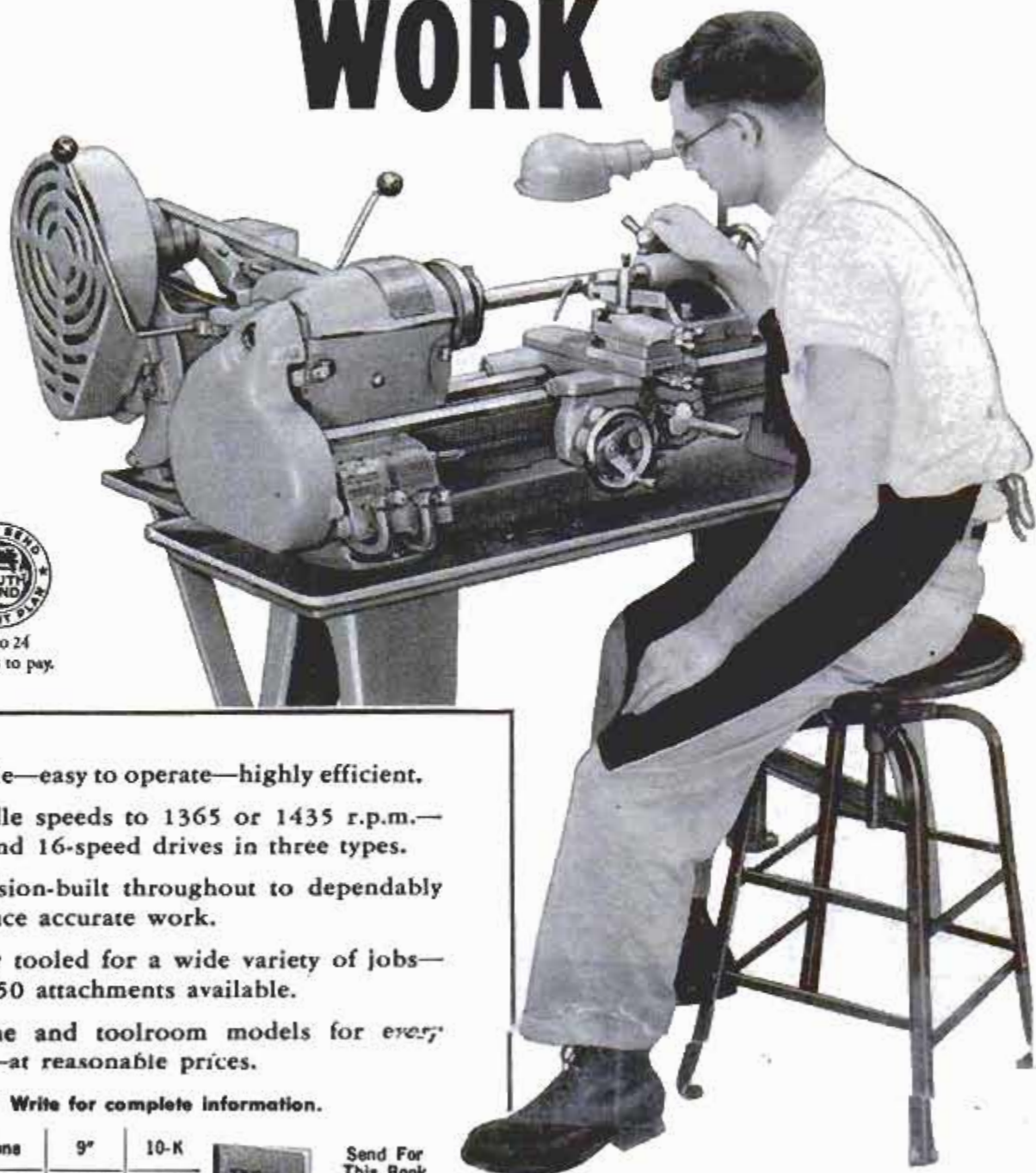

Up to 24  
months to pay.

- Simple—easy to operate—highly efficient.
- Spindle speeds to 1365 or 1435 r.p.m.—12- and 16-speed drives in three types.
- Precision-built throughout to dependably produce accurate work.
- Easily tooled for a wide variety of jobs—over 50 attachments available.
- Engine and toolroom models for every need—at reasonable prices.

Write for complete information.

Specifications	9"	10-K
Swing over bed	9 $\frac{3}{4}$ "	10 $\frac{1}{8}$ "
Between centers	16"-34"	16"-34"
Collet capacity	$\frac{1}{2}$ "	$\frac{3}{8}$ "
Base price, from	\$280	\$388



Send For  
This Book  
"How to Run  
a Lathe"—128  
pages of help-  
ful instruc-  
tions. 50¢  
postpaid.

## SOUTH BEND LATHE

South Bend 22, Indiana

Builders of Lathes, Milling Machines,  
Shapers, Drill Presses, Pedestal Grinders



# Making as High as \$1,000 A Month

A message to all men who are looking for a way to make more money faster, with one of America's greatest inventions wanted by millions

Folks Are Amazed when you Tell Them This New Kind of Protection Costs Only

**\$4.95**



**Here's Your Opportunity to Get into the BIG MONEY CLASS FASTER with Sensational PRESTO FIRE EXTINGUISHER. Over 3,000,000 sold for Homes, Offices, Autos, Service Stations, Stores, Farms, Boats**

Wouldn't you like to be making as much as \$1,000 in a month? Of course not everybody makes such profits starting out, but look at these profit reports: A Florida salesman earned \$600 in 1 month. An Ohio man earned \$2100 in 2 months. A New

York salesman earned \$1500 in one month. A New Hampshire man added the Presto as a sideline and picked up an extra \$1800 in 20 months. Men everywhere, even in off hours, are rolling up amazing profits. How about you?

## WHAT'S THE SECRET?

PRESTO contains an amazing new chemical—"Chlorobromomethane" or "C.B." The Germans developed "C.B." as a secret defense against fire during the war. After the war, a famous American firm, The Dow Chemical Company, acquired the formula from the U. S. Government and began manufacturing it here. Then we (Merlite Industries) designed a handy, yet amazingly effective, fire extinguisher to contain and release this new wonder-chemical. In comparing the effectiveness of "C.B." in fighting fires, The Dow Chemical Company's report states, "It has been proved that 'C.B.' is about 1.5 to 6 times as effective as other common extinguishing agents on an equal weight basis." This means that Presto can be made light and handy so even a woman or child can use. No pumping, no heavy tank. Just twist the knob, and flames disappear!

## WHY LARGE PROFITS ARE EASY

Everyone is terrified by FIRE! Every year fires kill more than 11,000 persons, destroy over SEVEN BILLION DOLLARS of property. Millions of people have been waiting for this sure, simple, inexpensive safeguard. Most people who see the dramatic, five-second demonstration want one or more, at the low price of \$4.95. You make as much as \$2.70 on every one. Get started in this rich new field now. Don't put it off. Every day you hesitate may cost you \$10, \$15, or even \$50 you could otherwise be making. Get the facts FREE. Simply mail postcard in this ad—no stamp needed. But do it now!

### Only Presto Has ALL These Features

-  Ends Fire as Fast as 2 Seconds
-  Chemical Contents 1.5 to 6 times More Effective than Others
-  Weighs Less Than 3 Lb.
-  Easily Held in One Hand—Even by a Child
-  Needs No Inspection or Re-Charging—Does Not Corrode or Deteriorate
-  Costs Only \$4.95—Yet Outperforms Bulky Extinguishers Costing Several Times as Much
-  Automatic Pressure—No Pumping
-  Guaranteed for 20 Years—Certificate is Packed With Every Presto

## Big Money Like This Even in Spare Time



**Charles Kama Reports \$1,000 in One Month**  
"I think I've succeeded pretty well. I'm making more than \$1,000 a month, and I haven't touched bottom yet."  
Charles Kama, Texas

**William F. Wydallis Reports \$15.20 an Hour**

"For every hour I devoted to the Presto, I find I have earned an average of \$15.20 an hour."



William F. Wydallis, Ohio



**Walter Gable Reports \$75 to \$80 a Week**

"My selling time has averaged less than a day or two a week. These part time sales have brought me as much as \$75 to \$80 a week."

Walter Gable, Md.

**FREE** Full Details of this Truly Amazing Money-Making Opportunity  
**JUST MAIL CARD BELOW**

**IMPORTANT!** Be sure to print your name and address in space on card below. Then simply cut out this card along dotted lines and drop in the mail box. No stamp necessary. We'll rush all facts to you at once, free and without obligation.

**PRINT YOUR NAME and ADDRESS HERE**

**BE SURE TO PRINT YOUR NAME AND ADDRESS ON SPACES BELOW**

Dept. X-15E

MERLITE INDUSTRIES, INC.

114 EAST 32ND STREET

NEW YORK 16, N. Y.

3c — POSTAGE WILL BE PAID BY —

**BUSINESS REPLY CARD**  
NO POSTAGE STAMP NECESSARY IF MAILED IN THE UNITED STATES

FROM \_\_\_\_\_  
NAME \_\_\_\_\_  
ADDRESS \_\_\_\_\_  
CITY \_\_\_\_\_ STATE \_\_\_\_\_

FIRST CLASS  
PERMIT  
NO. 52914  
NEW YORK, N. Y.

**MERLITE INDUSTRIES, INC.** DEPT. X-15E  
114 E. 32nd ST. NEW YORK, N. Y.





IN TOWN TRAFFIC . . . some spark plugs, designed for high speeds, become fouled and cause misfiring and loss of power.



ON THE HIGHWAY . . . some spark plugs, designed for low speeds, invite destructive pre-ignition or misfire causing power loss. Why gamble when . . .

## Auto-Lite Spark Plugs with **POWER TIP** "Fire Up" your engine\* at all speeds!



If you drive both at town-traffic and at highway speeds, here's why you should use Power Tip . . . the first spark plug ignition-engineered for today's engines and today's driving

At low speeds, the projecting Power Tip is in the thick of combustion where it gets hot quicker and stays hot to burn fouling deposits away *clean*. At higher speeds, the projecting tip is in the path of the incoming air-fuel mixture where it operates cooler to effectively *check* power-robbing pre-ignition. Ask your garage or service station to install Auto-Lite Spark Plugs . . . the *only* spark plugs with Power Tip . . . and start enjoying top performance and economy from your car at *all speeds*.

\*Power Tip, with or without Resistor, is ignition-engineered for overhead-valve V-8 engines and for most overhead-valve 6-cylinder engines in all these cars—Buick, Cadillac, Chevrolet, Chrysler, De Soto, Dodge, Plymouth, Ford, Hudson, Imperial, Lincoln, Mercury, Nash, Oldsmobile, Packard, Pontiac, Rambler, Studebaker.

YOU CAN SEE  
THE BIG NEW  
DIFFERENCE IN  
SPARK PLUGS!



Ordinary Tip    Power Tip

Power Tip protrudes farther into the combustion chamber for better ignition. Fuel burns more evenly and completely to give top performance and economy at all speeds.

# AUTO-LITE® SPARK PLUGS WITH **POWER TIP**

Auto-Lite makes a complete line of spark plugs, including Standard, Resistor, Small-Engine, Transport, Aircraft, and Diesel-Starting.