

DEC. 1957

MORE OF THE '58 NEW CARS

35 CENTS

# POPULAR MECHANICS

## MAGAZINE

WRITTEN SO YOU CAN UNDERSTAND IT

REG. TRADE MARK GREAT BRITAIN No. 40436

REG. U.S. PAT. OFF.

The Navy's Bobtailed Fireball  
—Page 121



**TUBELESS TIRES—**

*What Drivers Think of Them*

How to Measure Physical Fitness

*For the Craftsman*

**BUILD YOUR OWN TELESCOPE**

Copyrighted material

*Remell Brown*



# Wonderful Start!



**Lesson number one: a new set of ACs  
can save three times their cost in gasoline**

**First solo!** Great day for any driver . . . and it's a great day when a new set of AC Hot Tip Spark Plugs goes into your car. Here's why: the long, thin, recessed "Hot Tip" insulator heats faster to burn away carbon, oil and combustion deposits. This exclusive AC anti-fouling action assures efficient fuel combustion—saves as much as one gallon of gasoline in ten. In an average year's driving this would pay for a new set of AC Hot Tip Spark Plugs three times over.

ACs are factory equipment on more new cars than any other make. Install new ACs every 10,000 miles!



AC  THE ELECTRONICS DIVISION OF GENERAL MOTORS

**ACTION**  
starts with



**HOT TIP  
SPARK PLUGS**

Watch Walt Disney Studios' ZORRO  
every week on ABC-TV



# OLDSmobility



EXCITING "ROCKET AGE" STYLE THAT REFLECTS YOUR OWN GOOD TASTE!



OLDSMOBILE'S SUPER 88 FOR '58...GEARED FOR SUPER PERFORMANCE!

A 1958 Oldsmobile is waiting for you . . . a car that's in a class by itself! A new Rocket Engine car . . . a magnificent performer in the famous Rocket tradition, and offering the *greatest improvement in fuel economy* in Oldsmobile history. Beneath the exciting distinction of line and color . . . beyond the renowned power plant . . . are new expressions of Oldsmobile's style and engineering leadership. For example, New-Matic Ride\* (Oldsmobile's *true* air suspension) is the greatest advance in riding comfort since air was first put in tires! And this is only the beginning. In every way, this is *your* car for this mobile era! OLDSMOBILE DIVISION, GENERAL MOTORS CORP.

\*Optional at extra cost.

This One



7PD7-BEU-XC2F

## OLDSMOBILE



1908-1958

FORWARD FROM FIFTY...INTO THE ROCKET AGE



SEE YOUR NEAREST AUTHORIZED OLDSMOBILE QUALITY DEALER

DECEMBER 1957

1

Copyrighted material



# FORMER SERVICEMEN

with  
technical  
skills



YOU CAN BE AN IMPORTANT MAN WITH A  
GUARANTEED FUTURE...IN THE U.S. AIR FORCE

More than just a technician, the Air Force specialist is a man of responsibility and importance. He is the one the Air Force *depends on* to maintain and operate its increasingly complex equipment. But with this responsibility, he also knows a great sense of pride—and a guaranteed future, both professionally and economically. As a technician, you, too, can have this satisfaction and assurance—in the U.S. Air Force. See your Air Force Recruiter, or mail the coupon.

THE FUTURE BELONGS TO THE AIRMAN

Today and  
Tomorrow  
you're better off  
in the  
U.S. AIR FORCE

**PASTE ON POST CARD AND MAIL TO:**

Prior Service Information, Dept. PM-3321  
Box 7608, Washington 4, D. C.

Please send me more information on the Air Force Prior Service Program.

Name \_\_\_\_\_

Address \_\_\_\_\_ Age \_\_\_\_\_

City \_\_\_\_\_ Zone \_\_\_\_\_ State \_\_\_\_\_



# Popular Mechanics Magazine

Registered in U. S. Patent Office and Canada

H. H. WINDSOR, Founder

H. H. WINDSOR, JR., Editor and Publisher

Managing Editor  
RODERICK M. GRANT

Assistant Managing Editor  
WAYNE WHITTAKER

Shop Notes and Crafts Editor  
JAMES R. WARD

Associate Editor  
CLIFFORD B. HICKS

Associate Editor, Automotives  
ARTHUR R. RAILTON

Associate Editor, Shop Notes and Crafts  
WAYNE C. LECKEY

Associate Editor, Shop Notes  
W. CLYDE LAMMEY

Associate Editor  
WILLIAM D. PERKINS

Radio-Television, Electronics Editor  
LOTHAR STERN

Assistant Editor, Crafts  
JAY W. HEDDEN

Assistant Editor, Makeup  
JOHN DALEN

Art Director  
FRANK BEATTY

Assistant Art Director  
HENRY NEHRBASS

Art Editor  
RALPH LINNENBURGER

Assistant Editors  
KENNETH ANDERSON EARL WOBECK  
ROBERT HENDRICKSON

Eastern Editor  
RICHARD P. DEMPWOLFF  
Empire State Bldg., Room 2008, N.Y.C. 1

Western Editor  
THOMAS E. STIMSON, JR.  
Suite 1010, 3460 Wilshire Blvd.,  
Los Angeles 5, Calif.

London Manager  
DOUGLAS W. WEDDERSPON  
Eagle House, Jermyn St.,  
London S.W. 1, England

Director, Bureau of Information  
ALLAN CARPENTER

## Advertising Offices

Chicago: 300 E. Ontario St., Whitehall 4-0100;  
New York: Empire State Bldg., 350 Fifth Ave.,  
LONGacre 5-7580; Detroit: General Motors  
Bldg., Room 5-118, TRINITY 5-8711; Cleveland:  
Hanna Bldg., 1422 Euclid Ave., PRospect  
1-0458; Los Angeles: 3460 Wilshire, DUmkirk  
2-8458; San Francisco: Russ Bldg., Room  
468, 235 Montgomery St., YUKON 2-0823.

Published monthly by Popular Mechanics Company,  
200 E. Ontario St., Chicago 11, Ill. H. H. Wind-  
sor, Jr., president; Wm. Harrison Fetridge, exec.  
vice-pres.; Franklin S. Forsberg, operations vice-  
pres.; D. F. Windsor, vice-president and secretary-  
treasurer; H. H. Windsor III, vice-president; W. T.  
Windsor, vice-president; Joseph H. Busch, Jr., ad-  
vertising manager; Alan M. Deyoe, circulation  
manager. Single copy in the United States and  
Canada, 35 cents; subscription rates in the United  
States and possessions, Canada and countries of  
the Pan-American Postal Union, 1 year \$3.50; 2  
years, \$6.00; 3 years, \$8.00. In all other coun-  
tries add \$1.00 a year over United States prices  
for overseas postage. If you plan to move, notify us  
at least 30 days in advance so you will not miss  
an issue. Give both your old and new addresses.  
Entered as Second Class Matter, September 15,  
1903, at the Post Office at Chicago, Illinois, under  
Act of March 3, 1879. Entered as Second Class  
Matter at Post Office Dept., Canada. Registered  
as Second Class Matter at the Post Office at  
Mexico, D.F., Mexico, June 20, 1950.  
Copyright 1957 by Popular Mechanics Company,  
Copyright under International Copyright Union,  
Copyright in France. All rights reserved under  
Pan-American Copyright Union. Printed in the  
United States of America.

FOREIGN EDITIONS: MECANIQUE POPULAIRE (French) MECANICA POPULAR (Spanish) POPULAER MEKANIK (Danish) POPULAR MEKANIK (Swedish) POPULARE MECHANIK (German)

Volume 108

DECEMBER 1957

Number 6

Address all communications to: 200 E. Ontario St., Chicago 11, Ill.

## In This Issue...

I Drove Through Russia	-	-	-	-	81
What Makes a Driver Tired?	-	-	-	-	88
More New Cars for 1958	-	-	-	-	90
Report From a Roving Editor	-	-	-	-	96
Honeywell's House of Magic	-	-	-	-	100
Artist With a Lathe	-	-	-	-	109
<b>IN FULL COLOR —</b>					
Rainbows From Bouncing Atoms	-	-	-	-	113
<b>THE COVER STORY —</b>					
The Navy's Bobtailed Fireball	-	-	-	-	121
A Floridan Swims Upstairs	-	-	-	-	126
Photo Tips for Philatelists	-	-	-	-	134
The Owners Report on Tubeless Tires	-	-	-	-	140
How to Measure Physical Fitness	-	-	-	-	145
Shutterbug Shopping Center	-	-	-	-	156

## For the Craftsman...

Dust-Free Record Cabinet	-	-	-	-	165
Planting Boxes for Your Indoor Garden	-	-	-	-	182
Reflecting Telescope	-	-	-	-	188
Decorations for Your Xmas Tree	-	-	-	-	202

## Regular Departments...

Detroit Listening Post—A Report From Europe	-	-	-	-	106
What's New for Your Home	-	-	-	-	150
Radio, TV and Electronics	-	-	-	-	161
Solving Home Problems	-	-	-	-	178
On the Market for Do-It-Yourselfers	-	-	-	-	195
Christmas Shopping for Tools	-	-	-	-	208
Clinic for Homemakers	-	-	-	-	224

Turn to detailed index on page 74. Sources of additional information on items in this issue are shown on the Where-to-Buy-It List, available without charge by writing the Bureau of Information, Popular Mechanics, 200 E. Ontario St., Chicago 11, Ill.

## Next Month...

**BOLD ARCHITECTURE** will dominate the 1958 International Exhibition at Brussels. One of the startling structures, a symbol of the atom age, will be the Atomium—a 334-foot high model of an iron crystal. In the January issue you'll see a dramatic preview of the 1958 World's Fair

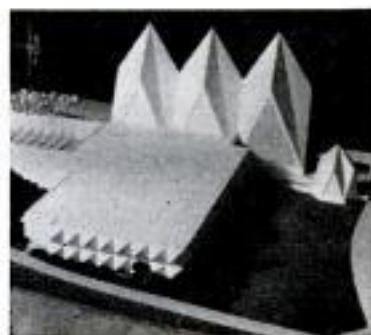



# The car that uses more aircraft principles than any other land-bound vehicle yet built

When you look at that Dynastar Grille — those dual Vista-Vision Headlights—you know you're observing a completely restyled Buick.

And when you drive it, you very soon understand why it was named the B-58 Buick, after the most advanced airplane yet designed.

For this car uses more principles straight from the world of aviation than any automobile in history.

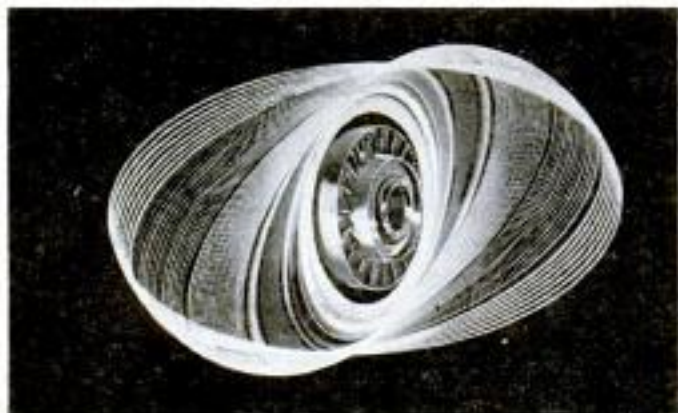

It happened that many engineering ideas that were years in development all came together in one year. And they're all here in this 1958 Buick.

Read about some of these features in this brief article. Then see your Buick dealer for a very convincing demonstration of what these features do for your driving.

**1. Flight Pitch Dynaflow® Has First True, Infinitely Variable Stator** — As you raise or lower your foot on the gas pedal, you automatically change the angle of the blades in this stator. You literally switch the pitch a million ways, just like today's airplane propeller. Oil, pouring through these vanes against the pump

at 180 m.p.h., is redirected to suit every driving situation. You can have maximum power ratio for starting, hills, emergencies. You can have maximum economy ratio for effortless cruising. You're always in perfect pitch.

## **2. B-12000 Engine Develops Thrust of 12,000 Pounds Behind Each Piston Stroke—**

This is the most modern, the most efficient engine it is possible to build for today's fuels. Vertical-valved for compactness, this great power plant exerts a 10 to 1 compression—releases a thrust of 6 tons at each piston's power stroke. Combined with Flight Pitch Dynaflow, that results in superbly smooth and instantaneous

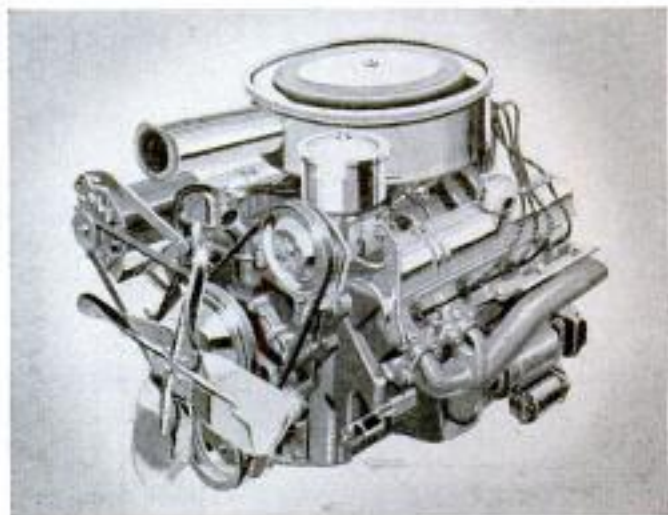

response — a sense of control utterly different from any other car of similar size and weight. Here is the first big car that's light on its feet.

**3. Air-Cooled Aluminum Brakes\* Run Cooler, Make More Quick Stops Without "Fade"**—Aluminum absorbs and dissipates heat quickly — so Buick engineers built the front





When better automobiles are built Buick will build them

brake drums of aluminum. On each drum, they designed 45 fins, which hurl cooling air inside the brake. Still not content, they made all brake linings wider and thicker. The result: Straighter, surer, smoother braking — especially on downgrades. Longer lining-life, even in worst traffic areas.

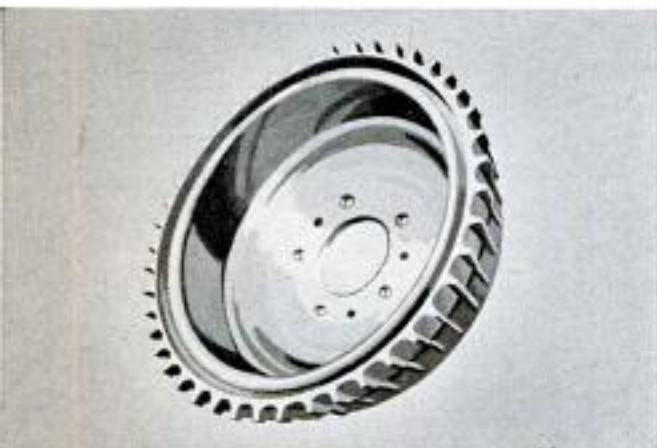

**4. Miracle Ride plus Buick Air-Poise Suspension\* Is Automatically Self-Levelizing** — Buick's new ride begins with these traditional basics: X-member frame; full-length torque tube, soft coil springs at all four wheels. These, together with new ride improvements such as longer stabilizers and outrigger shock absorbers, produce a thrilling new experience that well



deserves the name, "The Miracle Ride." This same basic Buick ride engineering was made to order for air suspension — makes Buick's new Air-Poise Suspension the world's finest. Four columns of compressed air (in place of the four coil springs) give you an infinitely variable spring rate — same smoothness, same "come-back," same ideal height regardless of road or passenger weight or placement. No other ride approaches it.

BUICK Division of GENERAL MOTORS

*\*Flight Pitch Dynaflow standard on Limited and Roadmaster 75, optional at extra cost on other Series. Aluminum Brakes standard on all Series except Special. Air-Poise Suspension optional at extra cost on all Series.*

*It Looks and Feels Like*  *Flight on Wheels*

# The Air Born B-58 Buick

See TALES OF WELLS FARGO, Monday Nights, NBC-TV and THE PATRICE MUNSEL SHOW, Friday Nights, ABC-TV

DECEMBER 1957

5



# OWN a Nationally Advertised Business

World Wide



We'll show you how to earn **\$8,750 clear PROFIT** the first year on just 2 jobs a day . . . personally train you, furnish all equipment.

- NO SHOP NEEDED
- START IN SPARETIME IF NOW EMPLOYED
- YOU OFFER 3 SERVICES

Even if employed, enjoy the prestige and financial independence of your OWN business. We offer a lifetime opportunity to reliable men. You will be trained in your town by a Duraclean dealer, who will reveal the Duraclean System and plans for building business. He helps you get quickly established. Just 2 average jobs a day earns **\$8,750 NET profit** the first year. Employ others, MULTIPLY profits. Business grows from recommendations, repeat orders. Under our guidance you become an expert in the care of rugs and upholstery. Easy to to learn. We furnish everything.

## YOU CAN START FROM YOUR HOME

These are full-time dealerships, but you can start part-time from home. All work done with portable equipment in homes, offices, hotels, institutions. We work with you 12 months of the year, provide 25 regular services to help you build business: National Advertising in McCalls, House & Garden, dozen others, Insurance, Complete Local Ad Kit, Publicity Program gets free newspaper stories, Monthly Magazine, Conventions. Many others.

### THREE ways to make money

1. **DURACLEAN**: Famous ABSORPTION process for cleaning rugs, carpets, upholstery. Recommended by leading stores and manufacturers. NO scrubbing, soaking, shrinking. Aerated foam safely removes dirt, grease. Dries so fast, customers use furnishings in few hours!  
 2. **DURASHIELD**: Soil-retarding treatment that KEEPS furnishings clean MONTHS longer. So new you may be first in town to offer this type service.  
 3. **DURAPROOF**: Protects against damage by moths, carpet beetles. Only such treatment backed by an International 8-year Warranty!

### Send for FREE Booklet!

A moderate payment establishes your business—pay balance from sales. We furnish electric machines, complete sales material, enough supplies to return TOTAL investment. Our FREE booklet explains urgently needed services, large profit, easy terms, PROTECTED territory. Send coupon today.

DURACLEAN CO., 7-16D Duraclean Bldg., Deerfield, Ill.

## "OWN a Business" Coupon

Duraclean Co., 7-16D Duraclean Bldg., Deerfield, Ill.

Please rush free booklet and letter giving full details of how I may OWN a growing, lifetime business.

Name \_\_\_\_\_

Address \_\_\_\_\_

City \_\_\_\_\_

State \_\_\_\_\_

## ACROSS THE DESK



### Model Motorcycle

Our German correspondent, Hans F. Kutschbach, has sent along this photograph of Gunther Gad of Nuremberg with the



tiny motorcycle he built. It is a model of the Zuendapp KS 601. Gad is an apprentice in the Zuendapp shop and it took him several months to build the model.

### To the Editor:

The article, "Science Showman," in the October 1957 issue, page 136, indicates that you cannot sail a boat by blowing air from a fan attached to the boat into the sail. Unless this is a demonstration of air turbulence it isn't a very good demonstration, since it is possible to sail a boat in this fashion if the sail is set so that it doesn't reflect the air particles back into the air coming toward the sail. As a matter of fact, one type of braking action on jet planes uses this principle to produce a force opposite to the motion of the plane. Reflector sails or panels are inserted into the jet blast to direct the blast somewhat forward, which slows the plane down.

William P. Lawson,  
Boswell, Ind.

### To the Editor:

Would you please send us all the information on the plans of "The Traditional House" in the October 1957 PM?

(Continued to page 10)



# WHAT HAPPENS WHEN A MAN DECIDES TO DO SOMETHING ABOUT HIS FUTURE!

The proven rule of "learn more to earn more" took M.E.F. (name on request) from a position of truck driver to that of an accounting executive in sixteen months. Listen to what M.E.F. says:

"I was driving a truck—working long hours and not making much money. I had a burning desire to better myself in life, and decided to enroll with LaSalle. I went along driving my truck days and studying nights and got my first break after completing 35 assignments. I took a cost accounting position. Within one month after starting full-time, I received my first raise, thereafter followed more. One of the greatest thrills of my life came just nineteen months after I started with LaSalle. When our firm opened up a branch office, I was assigned to take charge of the Accounting Department and my salary has doubled."

M.E.F. took a proved road to success—and his letter is typical of the thousands we have in our files from men and women in all walks of life.

## YOU DESERVE SUCCESS

There is no reason why you can't win success through LaSalle's Accounting Training. Today the demand for good accountants far exceeds the supply. This spells real opportunity to the man who is prepared.

You need no special talents to become a success in Accounting. You do not even need a preliminary knowledge of bookkeeping. All you need is the will to work—to achieve success perhaps years sooner.

Under the LaSalle Problem Method you can acquire a thorough knowledge of Accounting—you can master its fundamental principles—become expert in the practical application of those principles. You learn by doing—without losing any time from your present work. You train directly under the supervision of a competent staff of Certified Public Accountants and accounting experts.



## TWO FREE BOOKS

We offer you a FREE SAMPLE LESSON so that you can *prove to yourself* that you can master Accounting—quickly, thoroughly—in spare time at home. You'll see exactly how LaSalle's famous "problem method" works . . . how you are led step-by-step through actual accounting work—learning by doing and not by study of theory alone. Along with the sample lesson you will receive FREE the valuable book, "Opportunities in Accounting." It explains how we train you from the ground up—or from where you are now—according to your individual needs.

Send the coupon RIGHT NOW. Don't lay it aside and say you'll do it later. It can be the means of your SUCCESS—perhaps larger success than you have ever dreamed. At least it's worth considering.

ACCREDITED MEMBER, NATIONAL HOME STUDY COUNCIL

  
**SEND FOR FREE BOOK**



**LaSalle Extension University**  
— A Correspondence Institution —  
Dept. 1264H, 417 S. Dearborn St., Chicago 5, Ill.

Please send me, free of all cost or obligation, a sample lesson in Accounting . . . also, your latest illustrated book, "Opportunities in Accounting."

Name . . . . . Age . . . . .  
Address . . . . .  
City, Zone, State . . . . .



# SKIPPED ME AGAIN!



POOR BURT! HE MISSED OUT ON THAT PROMOTION AGAIN!

I WAS DETERMINED TO MAKE GOOD IN MY JOB...BUT DETERMINATION, I FOUND, WAS NOT ENOUGH!

I HAD PLENTY OF EXPERIENCE. AND THE BOSS SEEMED TO LIKE ME. I LACKED JUST ONE THING—**TRAINING!**



SORRY, BURT! I KNOW YOU'VE WORKED HERE LONGER. BUT TED HAS THE SPECIAL TRAINING WE NEED. YOUR CHANCE WILL COME ...SOMEDAY!

**I.C.S.** IS THE OLDEST AND LARGEST CORRESPONDENCE SCHOOL IN THE WORLD. 257 COURSES. PERSONALIZED INSTRUCTION, CAREER GUIDANCE, EASY-PAY PLAN. DIPLOMA TO GRADUATES.

SIX MONTHS LATER... I.C.S. SENT MY BOSS REGULAR REPORTS OF MY PROGRESS. THEN ONE MORNING...

BURT, I'VE JUST MADE YOU THE ASSISTANT MANAGER OF YOUR DIVISION...AT \$15 MORE A WEEK. AND THE WAY YOU'RE GOING NOW, THIS IS JUST THE BEGINNING.



GOSH! THANKS MR. TAYLOR!

I GOT IT, HONEY! I GOT THE PROMOTION! OUR MONEY WORRIES ARE OVER! TODAY'S OUR LUCKY DAY!

TODAY AND THE DAY YOU MAILED THAT I.C.S. COUPON!



WHY NOT MAKE THIS YOUR LUCKY DAY? LET I.C.S. PUT YOU ON THE ROAD TO MORE PAY, RAPID ADVANCEMENT, REAL JOB SECURITY. HERE'S THE FAMOUS COUPON. MAIL IT NOW!



I WAS TIRED OF WAITING FOR "SOMEDAY."  
I MADE UP MY MIND TO ACT! I'D GET THE  
TRAINING I NEEDED...SOMEHOW!  
JANE HAD A SUGGESTION...

I CAN'T QUIT MY  
JOB AND GO BACK TO  
SCHOOL! AND I SURE  
DON'T WANT THAT  
NIGHT CLASS  
ROUTINE IN  
THE CITY!

WHY NOT STUDY  
AT HOME?...THE  
WAY DAD DID...  
WITH I.C.S.



JANE SHOWED ME AN I.C.S.  
ADVERTISEMENT IN POPULAR  
MECHANICS. THERE WAS THE  
FAMOUS COUPON.AND THERE WAS  
EXACTLY THE COURSE I WANTED..

SAY, THEY'LL SEND ME  
A CAREER KIT FREE...  
THREE BIG SUCCESS  
BOOKS.

DAD SAYS  
HE NEVER  
WOULD  
HAVE BEEN  
MANAGER IF IT  
WEREN'T  
FOR I.C.S.



# FREE!

I. C. S. CAREER KIT CONSISTING OF...

- 1 "HOW TO SUCCEED"  
32-PAGE GOLD MINE
- 2 CAREER CATALOG...  
OPPORTUNITIES IN YOUR  
FIELD.
- 3 SAMPLE LESSON (MATH)  
SHOWS I.C.S. METHOD.

For Real Job Security—Get an I. C. S. Diploma! I. C. S., Scranton 15, Penna.

Accredited Member,  
National Home Study Council

## INTERNATIONAL CORRESPONDENCE SCHOOLS



BOX 90953M, SCRANTON 15, PENNA.

(Partial list of 257 courses)

Without cost or obligation, send me "HOW TO SUCCEED" and the opportunity booklet about the field BEFORE which I have marked X (plus sample lesson):

- |  |  |  |  |   |
|--|--|--|--|---|
| <p><b>ARCHITECTURE and BUILDING CONSTRUCTION</b></p> <ul style="list-style-type: none"> <li><input type="checkbox"/> Air Conditioning</li> <li><input type="checkbox"/> Architecture</li> <li><input type="checkbox"/> Arch. Drawing and Designing</li> <li><input type="checkbox"/> Building Contractor</li> <li><input type="checkbox"/> Building Estimator</li> <li><input type="checkbox"/> Carpentry and Millwork</li> <li><input type="checkbox"/> Carpenter Foreman</li> <li><input type="checkbox"/> Heating</li> <li><input type="checkbox"/> Interior Decoration</li> <li><input type="checkbox"/> Painting Contractor</li> <li><input type="checkbox"/> Plumbing</li> <li><input type="checkbox"/> Reading Arch. Blueprints</li> </ul> <p><b>ART</b></p> <ul style="list-style-type: none"> <li><input type="checkbox"/> Commercial Art</li> <li><input type="checkbox"/> Magazine &amp; Book illus.</li> <li><input type="checkbox"/> Show Card and Sign Lettering</li> <li><input type="checkbox"/> Sketching and Painting</li> </ul> <p><b>AUTOMOTIVE</b></p> <ul style="list-style-type: none"> <li><input type="checkbox"/> Automobiles</li> <li><input type="checkbox"/> Auto Body Rebuilding and Refinishing</li> <li><input type="checkbox"/> Auto Engine Tuneup</li> <li><input type="checkbox"/> Auto Technician</li> </ul> | <p><b>AVIATION</b></p> <ul style="list-style-type: none"> <li><input type="checkbox"/> Aero-Engineering Technology</li> <li><input type="checkbox"/> Aircraft &amp; Engine Mechanic</li> </ul> <p><b>BUSINESS</b></p> <ul style="list-style-type: none"> <li><input type="checkbox"/> Accounting</li> <li><input type="checkbox"/> Advertising</li> <li><input type="checkbox"/> Business Administration</li> <li><input type="checkbox"/> Business Management</li> <li><input type="checkbox"/> Cost Accounting</li> <li><input type="checkbox"/> Creative Salesmanship</li> <li><input type="checkbox"/> Managing a Small Business</li> <li><input type="checkbox"/> Professional Secretary</li> <li><input type="checkbox"/> Public Accounting</li> <li><input type="checkbox"/> Purchasing Agent</li> <li><input type="checkbox"/> Salesmanship</li> <li><input type="checkbox"/> Salesmanship and Management</li> <li><input type="checkbox"/> Traffic Management</li> </ul> <p><b>CHEMICAL</b></p> <ul style="list-style-type: none"> <li><input type="checkbox"/> Analytical Chemistry</li> <li><input type="checkbox"/> Chemical Engineering</li> <li><input type="checkbox"/> Chem. Lab. Technician</li> <li><input type="checkbox"/> Elements of Nuclear Energy</li> <li><input type="checkbox"/> General Chemistry</li> <li><input type="checkbox"/> Natural Gas Prod. and Trans.</li> <li><input type="checkbox"/> Petroleum Prod. and Engr.</li> <li><input type="checkbox"/> Professional Engineer (Chem)</li> <li><input type="checkbox"/> Pulp and Paper Making</li> </ul> | <p><b>CIVIL ENGINEERING</b></p> <ul style="list-style-type: none"> <li><input type="checkbox"/> Civil Engineering</li> <li><input type="checkbox"/> Construction Engineering</li> <li><input type="checkbox"/> Highway Engineering</li> <li><input type="checkbox"/> Professional Engineer (Civil)</li> <li><input type="checkbox"/> Reading Struc. Blueprints</li> <li><input type="checkbox"/> Structural Engineering</li> <li><input type="checkbox"/> Surveying and Mapping</li> </ul> <p><b>DRAFTING</b></p> <ul style="list-style-type: none"> <li><input type="checkbox"/> Aircraft Drafting</li> <li><input type="checkbox"/> Architectural Drafting</li> <li><input type="checkbox"/> Drafting Machine Design</li> <li><input type="checkbox"/> Electrical Drafting</li> <li><input type="checkbox"/> Mechanical Drafting</li> <li><input type="checkbox"/> Sheet Metal Drafting</li> <li><input type="checkbox"/> Structural Drafting</li> </ul> <p><b>ELECTRICAL</b></p> <ul style="list-style-type: none"> <li><input type="checkbox"/> Electrical Engineering</li> <li><input type="checkbox"/> Elec. Engr. Technician</li> <li><input type="checkbox"/> Elec. Light and Power</li> <li><input type="checkbox"/> Practical Electrician</li> <li><input type="checkbox"/> Practical Lineman</li> <li><input type="checkbox"/> Professional Engineer (Elec)</li> </ul> <p><b>HIGH SCHOOL</b></p> <ul style="list-style-type: none"> <li><input type="checkbox"/> High School Diploma</li> </ul> | <ul style="list-style-type: none"> <li><input type="checkbox"/> Good English</li> <li><input type="checkbox"/> High School Mathematics</li> <li><input type="checkbox"/> Short Story Writing</li> </ul> <p><b>LEADERSHIP</b></p> <ul style="list-style-type: none"> <li><input type="checkbox"/> Industrial Foremanship</li> <li><input type="checkbox"/> Industrial Supervision</li> <li><input type="checkbox"/> Personnel-Labor Relations</li> <li><input type="checkbox"/> Supervision</li> </ul> <p><b>MECHANICAL and SHOP</b></p> <ul style="list-style-type: none"> <li><input type="checkbox"/> Diesel Engines</li> <li><input type="checkbox"/> Gas-Elec. Welding</li> <li><input type="checkbox"/> Industrial Engineering</li> <li><input type="checkbox"/> Industrial Instrumentation</li> <li><input type="checkbox"/> Industrial Metallurgy</li> <li><input type="checkbox"/> Industrial Safety</li> <li><input type="checkbox"/> Machine Design</li> <li><input type="checkbox"/> Machine Shop Practice</li> <li><input type="checkbox"/> Mechanical Engineering</li> <li><input type="checkbox"/> Professional Engineer (Mech)</li> <li><input type="checkbox"/> Quality Control</li> <li><input type="checkbox"/> Reading Shop Blueprints</li> <li><input type="checkbox"/> Refrigeration and Air Conditioning</li> <li><input type="checkbox"/> Tool Design</li> <li><input type="checkbox"/> Tool Making</li> </ul> <p><b>RADIO, TELEVISION</b></p> <ul style="list-style-type: none"> <li><input type="checkbox"/> General Electronics Tech.</li> </ul> | <ul style="list-style-type: none"> <li><input type="checkbox"/> Industrial Electronics</li> <li><input type="checkbox"/> Practical Radio-TV Eng'g</li> <li><input type="checkbox"/> Practical Telephony</li> <li><input type="checkbox"/> Radio-TV Servicing</li> </ul> <p><b>RAILROAD</b></p> <ul style="list-style-type: none"> <li><input type="checkbox"/> Car Inspector and Air Brake</li> <li><input type="checkbox"/> Diesel Electrician</li> <li><input type="checkbox"/> Diesel Engr. and Fireman</li> <li><input type="checkbox"/> Diesel Locomotive</li> </ul> <p><b>STEAM and DIESEL POWER</b></p> <ul style="list-style-type: none"> <li><input type="checkbox"/> Combustion Engineering</li> <li><input type="checkbox"/> Power Plant Engineer</li> <li><input type="checkbox"/> Stationary Diesel Engr.</li> <li><input type="checkbox"/> Stationary Fireman</li> </ul> <p><b>TEXTILE</b></p> <ul style="list-style-type: none"> <li><input type="checkbox"/> Carding and Spinning</li> <li><input type="checkbox"/> Cotton Manufacture</li> <li><input type="checkbox"/> Cotton Warping and Weaving</li> <li><input type="checkbox"/> Loom Fixing Technician</li> <li><input type="checkbox"/> Textile Designing</li> <li><input type="checkbox"/> Textile Finishing &amp; Dyeing</li> <li><input type="checkbox"/> Throwing</li> <li><input type="checkbox"/> Warping and Weaving</li> <li><input type="checkbox"/> Worsted Manufacturing</li> </ul> |
|--|--|--|--|---|

Name \_\_\_\_\_ Age \_\_\_\_\_ Home Address \_\_\_\_\_

City \_\_\_\_\_ Zone \_\_\_\_\_ State \_\_\_\_\_ Working Hours \_\_\_\_\_ A.M. to P.M. \_\_\_\_\_

Occupation \_\_\_\_\_ Canadian residents send coupon to International Correspondence Schools, Canadian, Ltd., Montreal, Canada. . . . Special tuition rates to members of the U. S. Armed Forces.



EXCELLENT  
XMAS GIFTS

## OPTICAL BARGAINS

### 3" ASTRONOMICAL REFLECTING TELESCOPE

(Famous Mt. Palomar type)

See the Stars, Moon, Planets Close Up!  
60 & 120 Power — An Unusual Buy!

Assembled and Ready to Use! You'll see the Rings of Saturn, the fascinating planet Mars, huge craters on the Moon. Aluminized and overcoated 3" diameter high-speed 1/10 astronomical mirror. Telescope comes equipped with a 60X eyepiece and a mounted Barlow Lens, giving you 60 & 120 power. Optical Finder Telescope, included. Sturdy, hardwood, portable tripod. Free with scope: Valuable STAR CHART and 272 page "Astronomy Book." Stock No. 85,080-H . . . \$29.50 f.o.b. (Shipping wt. 10 lbs.) Barrington, N. J.



### 4 1/4" ASTRONOMICAL TELESCOPE

Mt. Palomar type! Up to 270 Power. A fine Reflector Telescope complete with real Equatorial Mount and Tripod and 6X Finder. Aluminum tube, 4 1/4" dia. mirror, rack and pinion focusing eye-piece holder, 2 eyepieces and mounted Barlow Lens for 40X, 90X, 120X and 270X. Shipping weight approx. 25 lbs. Stock No. 85,006-H . . . complete, \$74.50 f.o.b. Barrington, N. J.



### NEW! STATIC ELECTRICITY GENERATOR

See a thrilling spark display as you set off a miniature bolt of lightning. Absolutely safe and harmless. Stands 14" high. Turn the handle and two 9" plastic discs rotate in opposite directions. Metal collector brushes pick up the static electricity, store it in the Leyden jar type condenser until discharged by the jumping spark. Countless tricks and experiments. 24 page instruction booklet included. Stock No. 76,070-H . . . \$10.95 Postpaid



### New! 2 in 1 Combination! Pocket-Size

### 50 Power MICROSCOPE and 10 Power TELESCOPE

Useful Telescope and Microscope combined in one amazing, precision instrument. Imported! No larger than a fountain pen. Telescope is 10 Power. Microscope magnifies 50 Times. Sharp focus at any range. Handy for sports, looking at small objects, just plain snooping. Send Check or M.O. Satisfaction Guaranteed. Order Stock No. 30,059-H . . . \$4.50 Pstpd.



### MOUNTED BARLOW LENS

Double and triple your Telescope's power with a Barlow Lens. Ours is mounted in chrome-plated, brass tubing with variable spacers — just slide this mounted negative lens into your 1 1/4" I.D. eyepiece holder, and use your regular eyepieces in it. Fully guaranteed to please you. Stock No. 30,200-H . . . \$8.00 ppd.



### 6X FINDER TELESCOPE

Has crosshairs for exact locating. You focus by sliding objective mount in and out. Base fits any diameter tube—an important advantage. Has 3 centering screws for aligning with main telescope. 20-mm. diam. objective. Weighs less than 1/2 pound. Stock No. 50,121-H . . . \$8.00 ppd.



Check, Measure, Inspect with this

### 6 POWER POCKET COMPARATOR

(Complete with Leather Case)

MEASURES • Angles • Radii • Circles • Linear—in both decimal inches and millimeters.

Used to check layouts, machining on tools, dies, gauges; to check threads, chamfers, wear on cutting tools, etc.

Stock No. 30,061-H . . . New Low Price . . . \$19.50 Pstpd.



### INFRARED SNIPERSCOPE TELESCOPE & PARTS

See in the dark—without being observed. War surplus Sniperscope M-2. Gov't. cost about \$1200. Instrument complete, ready to use. Includes Power Pack, infrared light source. Will operate from 6 V auto battery. Battery or transformer available. Stock No. 85,053-H . . . \$150.00 f.o.b.

Save still more money! Build your own Sniperscope! We will furnish instructions—parts, including: Power Packs, 1P25A image tubes, light units, filters, etc. For details — request FREE Bulletin A-26-H.



**SIMPLE LENS KITS!** Fun for adults! Fun for children! Kits include plainly written, illustrated booklet showing how you can build lots of optical items.

Stock No. 2-H—10 lenses . . . \$ 1.00 Postpaid  
Stock No. 5-H—45 lenses . . . \$ 5.00 Postpaid  
Stock No. 10-H—80 lenses . . . \$10.00 Postpaid

### WRITE FOR FREE CATALOG "H"!

Complete Line of Astronomical Telescope Parts and Assembled Telescopes. Also huge selection of lenses, prisms, war surplus optical instruments, parts and accessories. Telescopes, microscopes, satellite telescopes, binoculars, etc. Request Catalog "H"!

ORDER BY STOCK NUMBER — SEND CHECK OR MONEY ORDER. SATISFACTION GUARANTEED!  
**EDMUND SCIENTIFIC CO., BARRINGTON, N. J.**

(Continued from page 6)

Which of these two plans has the greatest call? My husband and I have a little bet on. I say Traditional. Thank you.

Mrs. Calvin Nicol,  
Brooklyn 33, N. Y.

During the first 15 days after publication, we have received 215 letters on the Traditional House and 201 on the Modern. We will probably receive thousands of additional letters, so you can see it is too early to claim a victory over your husband. Watch this column for results.—Ed.

### To the Editor:

I have been buying your magazine for the past four or five years and I always wait for the next issue with great interest,



as I believe it is always better than the last. I would like to send you a picture of my SS United States. I made it all out of Icelandic material and, of course, from your Popular Mechanics plans.

Gudni Hermansen,  
Herjolfsgotu 7,  
Vestmannaeyar, Iceland.

### To the Editor:

The article, "The Saga of the DC-3," August 1957 issue, was great. Let's have more like it. It's interesting to know the little-known facts about a truly great plane.

Joe Galvin,  
Melvindale, Mich.

### To the Editor:

In your issue dated August 1957, I noticed a picture of a caddy cart with a club selector fitted to it.

If the manufacturers are interested in an additional refinement, I would suggest fitting a measuring device to the cart: A dial would be set, while standing on the tee, at the distance in yards of the hole—then, as the player walked down the fairway after striking his drive, the meter would reduce

(Continued to page 12)





# I WILL TRAIN YOU AT HOME FOR GOOD PAY JOBS IN TELEVISION-RADIO

J. E. SMITH, Founder, N. R. I.

**America's Fast Growing Industry Offers You Good Pay—Bright Future—Security**

## NRI TRAINED THESE MEN

 "Started to repair sets six months after enrolling. Earned \$12 to \$15 a week in spare time."—**ADAM KRAULIK, JR.**, Sunnyside, Pennsylvania.

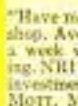
 "Have my own Radio-TV shop. Average about \$100 a week without advertising. NRI training my best investment."—**LARRY P. MOTT**, Miami, Fla.

 "Am doing Radio and Television Servicing full time. Now have my own shop. I owe my success to N.R.I."—**CURTIS STATH**, Ft. Madison, Iowa.

 "Am with WCOB. NRI course can't be beat. No trouble passing 1st class Radio-phone license exam."—**JESSE W. PARKER**, Meridian, Mississippi.

 "By the time I graduated I had paid for my course, a car and testing equipment. Can service toughest jobs."—**E. J. STRICKER**, New Boston, Ohio.

 "Before finishing the NRI course I was employed as Studio-Engineer at KMMJ. I am now announcing."—**BILL DIEZELLE**, Grand Island, Nebraska.

People look up to and depend on the Technician, more than ever before. His opportunities are great, and are increasing. Become a Technician. At home, and in your spare time, you can learn to do this interesting, satisfying work—qualify for important pay; develop confidence and skills you need to get jobs in this vast industry.

**Start Soon to Make \$10, \$15 a Week Extra Fixing Sets**

NRI students find it easy to start fixing sets for friends a few months after enrolling. Use the Tester built with parts NRI furnishes, to locate TV-Radio receiver troubles. Many who start in spare time, soon build full time TV-Radio businesses. Invest in training yourself—it pays big profits soon.

### NRI Training Is Up-to-Date

NRI is America's oldest and largest home study Television-Radio school. More than 40 years' experience training men for success benefits you many ways. NRI methods are tested, proved. Successful graduates are everywhere, in small towns, big cities.

## You Learn by Practicing with Parts NRI Sends



Clearly written, well illustrated NRI lessons teach Television-Radio-Electronic principles. Also, *without extra charge*, you get NRI kits developed especially to give actual practice with TV-Radio equipment. You build, test, experiment with actual Television-Radio receiver or broadcasting circuits; build, use, testing equipment. All equipment is yours to keep. No experience necessary; many successful NRI graduates did not finish high school. NRI has developed simplified, practical training methods. Ambitious men can get ahead fast. Mail coupon for Actual Lesson and 64-page Catalog FREE. See how you train at home to be a Technician, to get ahead.

**The Tested Way To Better Pay!**

**2 FREE BOOKS SHOW HOW MAIL COUPON**



**Technical Know-How Brings Better Pay**—A stream of new electronic products is increasing job and promotion opportunities for Television-Radio Technicians. Transistor Radios, Color TV, Hi-Fi were unknown a few years ago. Guided missiles, automation, etc. would not be possible without this miracle science—Electronics.



The hundreds of TV and Radio stations on the air offer interesting jobs for Operators and Technicians.

A solid, proven field of opportunity is servicing the millions of Television and Radio sets now in use.

### TV-Radio Needs Men of Action—Mail Coupon

You don't have to know anything about electricity or Radio to understand and succeed with NRI courses. You train in your own home—keep your present job while learning. Mailing the coupon can be one of the most important acts of your life. Do it now. Reasonable tuition, on low monthly payments available. Let us send you an actual lesson. Judge for yourself how easy it is to learn. A 64-page catalog gives details of opportunities and training. Address: **NATIONAL RADIO INSTITUTE, Dept. 7NA, Washington 16, D. C.**

### Good for Both—FREE

**NATIONAL RADIO INSTITUTE, Dept. 7NA, Washington 16, D. C.**

Mail me Sample Lesson and 64-page Book, FREE. (No salesman will call. Please write plainly.)

Name.....Age.....

Address.....

City.....Zone.....State.....

ACCREDITED MEMBER NATIONAL HOME STUDY COUNCIL







Better  
Results...

WHEN YOU USE THE  
**PACEMAKER GRAPHIC®**  
**SYSTEM OF PHOTOGRAPHY**

The Pacemaker Graphic 45 provides the advanced amateur with a complete system of photography that has been proved best by press and professional photographers the world over. Three types of focusing, three types of viewfinding, three types of flash synchronization and three types of shutter release give you a wide choice of techniques to solve any picture-taking problem. Fitted with Graflok Back, you can use any of the film receptacles shown below for sheet, roll or even Polaroid's professional "picture-in-a-minute" film! Your Graflex dealer (listed in the yellow pages of your phone book) will gladly give you a demonstration. Pacemaker Graphic 45 with Graflok Back, Graphic Rangefinder, 135mm. Optar f/4.7 lens and Graflex fully synchronized shutter as little as—\$18.90 a month!



**GRAFMATIC® FILM HOLDER**  
Actually a sheet film magazine. Holds 6 sheets. Changing is lightning fast, smooth and fool-proof. Little thicker than a 2-sheet holder.



**GRAFLEX® ROLL HOLDER**  
Adapts Graphic for use of low cost, daylight loading roll film. Gives you the utmost in film economy.



**GRAPHIC®  
POLAROID  
BACK**

This special back permits use of the new professional Polaroid film for "picture-in-a-minute" photography.



**RITEWAY® FILM HOLDERS**  
The ultimate in film receptacles. Accurate film positioning always. Unconditional two year guarantee.

For further information see your dealer or write Dept. PM-127, Graflex, Inc., Rochester 3, N. Y. Prices include federal tax where applicable and are subject to change without notice. Prices slightly higher in Canada.

**GRAFLEX®**  
A SUBSIDIARY OF 

(Continued from page 10)

the distance by the number of yards walked. When the player reached his ball, he could read the dial and be able to calculate how far remained to play and select his club accordingly.

W. A. Illsley,  
Provincial Secondary School,  
Okene, via Owo,  
Northern Nigeria.

**To the Editor:**



No longer silent is this 70-year-old wooden Indian that graced the cigar stores of yesteryear. Fitted with a two-way intercommunication system, the venerable chieftain can strike up a conversation with passers-by, as for example the day he startled a girl by chiding her for having her picture snapped with her arm about him.

The voluble redskin stands in front of a tobacco shop in St. Thomas, Ont., Can., and is rolled inside every night.

Henry Miller,  
Winnipeg 5, Man., Can.

**To the Editor:**

Herman Eck of Wykoff, Minn., has probably owned and driven the same car longer than any other man in the United States, according to Edward T. Ragsdale, general manager of Buick and vice-president of General Motors. Just to prove it, Eck threw a party a short time ago for the car, marking the 40th anniversary of the purchase of a 1917 Buick. Friends of Eck wrote Ragsdale about it and he sent Eck a miniature of a 1957 Buick and congratulated him on "driving the same car longer than any other person." Eck has driven his car about 144,000 miles and has never been cited for a traffic violation. He had one minor accident in 1921 when a man on horseback ran into him. Eck said he always had serviced his own car and takes pride in keeping it in top running condition. "I bought the car for \$750," he explained. "I said it would last me a lifetime, but people just laughed at me. But I think I can make it last for another ten years or so."

Sorry, no further details from Buick's public relations department about that man on horseback.—Ed.





# INVENTORS

**L**earn how to protect your invention. The U. S. Patent Laws provide that any new and useful art, machine, article of manufacture, or composition of matter, or any new and useful improvement thereof, may be patented if the act of invention is involved. Therefore, every inventor with a valuable invention should take advantage of the Patent Laws and proceed for patent protection in order to safeguard his rights.

A patent gives the inventor the exclusive right to prevent others from making, using, or selling the invention claimed in the patent for a period of seventeen years.

The Patent Laws were enacted for the benefit of the inventor to give him protection for the features of his invention which are patentable. These features must be properly and concisely set forth and claimed in a formal application for patent, in order to comply with the requirements of the Patent Laws. For that reason, unless the inventor is familiar with patent matters, he should engage a competent registered patent attorney or agent to represent him. We are registered to practice before the U. S. Patent Office and are prepared to serve you in the handling of your patent matters.

A specially prepared booklet entitled "Patent Guide for the Inventor", containing detailed information with respect to patent protection and procedure, together with a "Record of Invention" form will be promptly forwarded to you without obligation upon request.

**CLARENCE A. O'BRIEN & HARVEY JACOBSON**

*Registered Patent Attorneys*

**71-M DISTRICT NATIONAL BUILDING**

**WASHINGTON 5, D. C.**



# Art Talent Test FREE!

Find out if you have the talent for a career in commercial art. Take this simple Art Talent Test at home. It was devised by professional artists at our school as a test of natural talent. We will advise you, free and without obligation, whether your talent is worth training. We're the world's largest home study art school. For over 40 years, we've been preparing talented beginners for successful careers in art.



WRITE FOR YOUR  
FREE COPY TODAY!

**ART INSTRUCTION, INC., STUDIO 12137**  
500 South 4th Street • Minneapolis 15, Minnesota

Please send me your Talent Test, without cost or obligation.  
(PLEASE PRINT)

Name \_\_\_\_\_ AGE \_\_\_\_\_ Phone \_\_\_\_\_  
Address \_\_\_\_\_ City \_\_\_\_\_ Zone \_\_\_\_\_  
State \_\_\_\_\_ County \_\_\_\_\_ Occupation \_\_\_\_\_



## PLAY RIGHT AWAY ANY INSTRUMENT —even if you don't know a single note now!

**N**OW it's EASY to learn ANY instrument. No boring exercises. Even if you don't know a single note now, we'll have you playing delightful pieces RIGHT AWAY—right from your FIRST lesson! And properly, BY NOTE. Simple as A-B-C. Make amazing progress. No special "talent" needed. Learn at home in spare time, without a teacher. Low cost! Soon you can play any piece you wish. 900,000 students including TV Star Lawrence Welk. (59th successful year.)

### FREE 36-PAGE ILLUSTRATED BOOK

—Just send this ad, with your name and address filled in below to: U. S. School of Music, Studio A3012, Port Washington, N. Y. (No obligation; no salesman will call.)



Name \_\_\_\_\_  
Address \_\_\_\_\_

**Learn ACCOUNTING**  
Business Administration  
Bookkeeping, secretarial and allied subjects at home in your spare time or attend nationally approved resident school. Write for FREE Success Book giving complete details on courses, plans, rates and employment opportunities. G.I. approved. Write Dept. A.

**Hills BUSINESS UNIVERSITY AND EXTENSION SCHOOL**  
619 W. MAIN ST. OKLAHOMA CITY 2, OKLAHOMA



## 119 JIG SAW PATTERNS

FULL-SIZE . . . trace on wood and saw out. Clever, ORIGINAL designs, things you can make to SELL. Wall shelves, lawn signs, planters, book ends, others. **\$1** postpaid

**BURGESS VIBROCRRAFTERS, INC.**

Rush \$1 today. DEPT. C-31, Grayslake, Illinois

SAVE 1/2 - 2/3 THE PRICE OF FACTORY-BUILT BOATS

## BOAT KIT CATALOG Free!

Runabouts, cruisers, convertibles, fishing; 43 models, 8 through 18 ft. Freight paid. \$39.25 up. Assembled and finished by experienced owners. Luger boats equal factory-built in speed, handling, style, beauty; yet save you 1/2 to 2/3. Owners say: "Fastest boat on river." . . . "Pleasure to assemble." . . . "Everyone admires my Luger." Thousands in use. Send for big, free boat kit catalog; also lists fiberglass, hardware, accessories, trailers, paint. Write for catalog today.



Write:

**LUGER INDUSTRIES, INC.** DEPT. B12 3404 Lyndale S. Minneapolis 8, Minn.



# Here's the **BEST DEAL YET.** for the man who needs a **BETTER JOB - MORE MONEY**

If you're just "breaking even"... if you're "in the hole" every month... if your wife wants to look for work—you need more money, a better job! You can have a good job with top pay and security in the old, established, but fast-growing Air Conditioning and Refrigeration industry. This field needs 20,000 newly-trained mechanics every year. It needs ambitious men to open service shops. *It needs you!* Don't say you're no mechanic! We know that. We also know we can train you at home to become a skilled mechanic. CTI has a real good deal for you. Just fill in and mail coupon and we'll rush full details.

R. C. ANDERSON  
President  
CTI

**NOW YOU CAN LEARN  
AIR CONDITIONING  
AND REFRIGERATION  
by practicing at home  
with real equipment!**

## YOU GET "FIELD EXPERIENCE" AS YOU TRAIN

You train at home in spare time. CTI sends you 23 big kits of parts and tools. You assemble a commercial-type, heavy-duty, 1/4 h.p. refrigeration high-side (illustrated at right.) Then you build an air conditioner, refrigerator, freezer or milk cooler. All equipment included with training! No extra cost.



## You Get Kits Like These

At left is photo of tools included in just one kit. You get other tools, tubing, much equipment. Kits are sent on a planned schedule so that you learn in easy stages. You learn fast, too!



In another kit (right) you get motor, fan, pulley, service tools. Kits develop skill, let you get experience, eliminate years of low-pay apprenticeship.

## YOUR BIG CHANCE TO OPEN A SERVICE SHOP

Want to be independent—be your own boss? The air conditioning and refrigeration field is one of the best. It's big, uncrowded, packed with opportunity. Start small and grow big. Many students do service work on a monthly fee basis—do repairing for shops, food stores, meat markets, etc. Others answer home calls. In time, they build up a customer list, open a shop. You could, too!



**FIRST GET THE FACTS—THEN DECIDE**



## Add to Your Income by Earning Cash as You Train

CTI training is practical, just like working on actual jobs. Like other students, you'll want to do repair work for profit soon after starting. Many students pay their tuition this way, add to their incomes, even get started in a business. Get the facts about this. *Mail coupon.*

COMMERCIAL TRADES INSTITUTE • 1400 Greenleaf Ave. • Chicago 26, Illinois

## MAIL COUPON TODAY FOR 2 FREE BOOKS

**COMMERCIAL TRADES INSTITUTE**  
1400 GREENLEAF AVENUE DEPT. R-428  
CHICAGO 26, ILLINOIS

Rush me your booklet, *Success in Air Conditioning & Refrigeration*, and Sample lesson. Both FREE.

Name \_\_\_\_\_ Age \_\_\_\_\_

Address \_\_\_\_\_

City \_\_\_\_\_ Zone \_\_\_\_\_ State \_\_\_\_\_



"TRAINING YOU CAN TRUST"



# Make More Money Soon Fixing Electric Appliances



**Actual Lesson  
FREE** Fast Growing  
Field Offers  
Good Pay, Security  
Interesting Work

## Learn at Home in Spare Time

Earn more money. Enjoy doing important, interesting work. Learn Electrical Appliance Servicing. This is a field of increasing opportunity. Today there is an average of 8 appliances in every wired home. More than eighty million additional appliances, valued at about 8 billion dollars sold in one year. Find out more about this great, growing field. Find out how NRI can train you, at home and in spare time to be an Appliance Service Technician. See how you can start soon to make extra money servicing appliances.

## Add to Your Income Soon After Enrollment Opportunities Increasing for Service Technicians

NRI Training is practical, thorough. You get easy-to-understand lessons, and NRI supplies parts to build professional type Multi-Use Tester. Use it to get practical experience. Soon, you can add to your income by servicing appliances. Build a profitable *sideline* for your spare time—qualify for a good job—develop a business and be your own boss. As an Appliance Service Technician, your opportunities are broad—your services wanted, gladly paid for, highly regarded in your community.

Appliances are necessary to comfortable, convenient living. Owners pay well to keep them in repair. The field is amazingly big. In addition to major appliances such as electric ranges, air conditioners, refrigerators, there are over 40,000,000 electric irons, 5,000,000 electric blankets, 15,000,000 coffee makers, plus more millions of vacuum cleaners, fans, toasters, mixers, etc.



## Learn and Earn with Tester Diploma when You Finish

Locate appliance troubles easily with Portable Appliance Tester you build. You use it to learn and do actual electric appliance repair jobs. For only \$2.50 with enrollment and \$5 per month, get training including Tester—a small price to pay for increased earnings. Mail coupon for Sample Lesson and Book—your first step toward more interesting work, bigger earnings. **NATIONAL RADIO INSTITUTE, Dept. AN7, Washington 16, D. C.**

**TESTING APPLIANCES FOR  
ELECTRICAL TROUBLES**

NATIONAL RADIO  
INSTITUTE  
WASHINGTON, D. C.

Over 40 Years  
Experience  
Backs Up  
NRI Training

How to Learn  
**SERVICING  
ELECTRICAL  
APPLIANCES**

**Find Out What  
Appliance Repair  
Offers You**

## Mail Coupon FOR LESSON AND BOOK FREE

**National Radio Institute**  
Dept. AN7, Washington 16, D. C.

Please send me Electric Appliance Servicing Lesson and Book FREE. (I understand no salesman will call.)

Name \_\_\_\_\_ Age \_\_\_\_\_

Address \_\_\_\_\_

City \_\_\_\_\_ Zone \_\_\_\_\_ State \_\_\_\_\_

ACCREDITED MEMBER, NATIONAL HOME STUDY COUNCIL



# INVENTORS

If you believe that you have an invention, you should find out how to protect it. The first step is to have a search made of the prior pertinent U. S. patents. If a report on this search indicates that the invention appears patentable you can apply for a patent, and the specifications and claims should be prepared.

The firm of McMorrow, Berman & Davidson, with offices in Washington, D. C., is qualified to take the necessary steps for you. We can make a preliminary search on your invention, advise you whether we think it can be patented, and prepare your application for patent.

Unless you are fully familiar with the U. S. Patent Laws, we recommend that you engage the services of a Registered Patent Attorney to protect your interests. The patent laws are *your* laws. A patent gives you the right to prevent others from making, using or selling the invention claimed in your patent for a period of 17 years.

Use these patent laws for your protection. Investigate whether your invention can be patented. If you have what you believe to be an invention, we suggest that you have this firm make a search for you.

*Send for a copy of our Patent Booklet entitled "How To Protect Your Invention," containing information about patent protection and patent procedure. Along with this we will also send you an "Invention Record" form, for your use in writing down and sketching details of your invention. We will mail them promptly. No obligation. They are yours for the asking.*

## McMORROW, BERMAN & DAVIDSON

Registered Patent Attorneys

PATENTS • COPYRIGHTS • PATENTS

135-P VICTOR BUILDING, WASHINGTON 1, D. C.



# LET CAR EXPERTS GUIDE YOUR HANDS THROUGH ANY AUTO REPAIR



**QUICKLY--  
EASILY--RIGHT!**

**FREE  
7-DAY  
TRIAL**

**MOTOR'S  
AUTO  
REPAIR  
MANUAL**

**Brand New--Covers  
All These Makes**

- |             |             |
|-------------|-------------|
| Wulch       | Jeep        |
| Cadillac    | Lincoln     |
| Chevrolet   | Mercury     |
| Chrysler    | Nash        |
| Clipper     | Oldsmobile  |
| Continental | Packard     |
| De Soto     | Plymouth    |
| Dodge       | Pontiac     |
| Ford        | Rambler     |
| Hudson      | Studebaker  |
| Imperial    | Thunderbird |
| Willlys     |             |

**Same FREE Offer  
On MOTOR'S Brand-New  
Truck Repair Manual**

Covers EVERY job on EVERY popular make gasoline and Diesel truck made from 1949 thru 1957. For FREE 7-Day Trial, check the proper box in coupon.



SUPPOSE you had an automobile factory engineer standing right beside you . . . guiding your hands through every step of even the toughest car repair job! Think how you'd "wink through" every job! No wonder, then, 2,000,000 MOTOR'S Auto Manuals have been sold. No wonder so many thousands of beginners and expert mechanics alike are already using MOTOR'S brand-new AUTO REPAIR MANUAL. It shows you, in step-by-step words and pictures, factory-approved repair procedures for fixing ANY part of ANY car, 1949 through 1957!

No guesswork! MOTOR'S Manual "starts from scratch" — leads you through entire job with easy step-by-step directions, clear "how-to" pictures. Tells WHERE to start, what TOOLS to use, how to remove, repair and replace parts. You CAN'T go wrong.

**1000 Big ILLUSTRATED Pages**  
NEW, REVISED, ENLARGED edition contains the "meat" from over 100 OFFICIAL shop manuals—simplified for YOU in over 1,000 big pages—22,436 essential repair specifications. More than 2,900 "this-is-how" pictures. 225,000 service and repair facts. Leads beginners every step of the way. Time-saving factory repair procedures for experts. Used by U. S. Army and Navy.

**Try Book FREE 7 Days**

Just mail coupon. (Attach it to postcard if you wish.) Make **MANUAL PROVE** what it's got. Unless you agree this is the greatest time and work saver ever—return book in 7 days, pay nothing. Mail coupon to: MOTOR Book Dept., Desk 112, 250 W. 55th St., New York 19, N. Y.

**MAIL COUPON NOW FOR 7-DAY FREE TRIAL  
(Attach to Postcard if More Convenient)**

**MOTOR BOOK DEPT.**  
Desk 112, 250 W. 55th St., New York 19, N. Y.

Rush to me at once (check box opposite book you want):

MOTOR'S New AUTO REPAIR MANUAL. If O.K., I will remit \$2 in 7 days, \$2 monthly for 2 months and a final payment of \$6 (plus 35¢ delivery charges) one month after that. Otherwise I will return the book postpaid in 7 days. (Foreign price, remit \$9 in cash with order.)

MOTOR'S New TRUCK REPAIR MANUAL. If O.K., I will remit \$2 in 7 days, and \$2 monthly for 2 months, plus 35¢ delivery charges with final payment. Otherwise I will return books postpaid in 7 days. (Foreign price, remit \$10 cash with order.)

Print Name..... Age.....

Address.....

City..... State.....

Check box and save 35¢ delivery charge by enclosing WITH coupon in envelope entire payment of \$6.56 for Auto Manual (or \$8 for Truck Manual.) Same return-refund privilege.

**INSURED TIRE SERVICE**  
**POPULAR BRANDS**

SPECIAL! Deduct 10% on orders for 7 or more used tires.

**FREE** INSURANCE POLICY given with each used tire sold. We guarantee the amount of service you pay for.  
**NOWHERE CAN SUCH QUALITY BE FOUND AT SUCH LOW PRICE!**

**YOU CAN'T LOSE!!**

**GOODYEAR SUBURBANITE TYPE SNOW TIRES**  
New Tire Guarantee—Factory Rebuilt  
**BEST WINTER TRACTION OF ALL!**

670x15	\$9.95	710x15	650x15	650x15	\$10.90
600x16		760x15	800-820x15		

Super Quality — Rugged Performance — 6 Months Insured Service

600x16	\$3.85	670x15	\$3.95	700x16	\$4.45	780x16	\$4.75
680x15	3.85	670x16	4.05	710x15	4.35	820x15	4.25
690x16	4.25	700x16	3.95	760x15	4.45	850x17	4.68

Supreme Quality — Nothing Finer — 12 Months Insured Service

600x16	\$5.25	475x19	\$5.45	700x16	\$10.45	700x20	\$12.50
600x16	6.75	640x15	4.95	750x16	15.95	750x20	15.50
650x16	5.75	670x15	5.35	700x17	11.95	750x20	17.50
650x16	7.25	710x15	5.45	750x17	16.45	825x20	21.50
700x16	6.35	760x15	5.95	750x18	16.95	900x20	19.95
750x16	8.45	800x15	6.35	30x5	11.25	1000x20	20.45
850x16	4.95	820x15	6.35	600x20	10.95	1100x20	21.25
850x17	4.75	850x15	5.35	650x20	11.75	1000x22	21.95
650x15	5.25	670x16	5.15	32x6	11.95	1100x22	22.75
700x15	8.35	700x16	10.25	32x6	12.75	1100x24	25.95

Whitewalls \$1.00 extra.

**MIDLAND** Speedy shipments on Mail Orders, F.O.B. Chicago. Insurance policy sent with each order. Deduct 10% on orders for 2 or more used tires. Send CHECK or MONEY ORDER—No COD's.

**TIRE SALES** 3701 S. Normal, Dept. PM-65, Chicago 9, Ill.

## High School Course at Home Many Finish in 2 Years

If you did not or cannot finish high school, here is your opportunity. Study in spare time at home. Go as rapidly as your time and abilities permit. Course equivalent to residential school—prepares for college exams. Standard texts supplied. Credit for subjects already completed. Single subjects if desired. Diploma awarded. Be a High School graduate. Start studies now. Free Bulletin. Write today.

**AMERICAN SCHOOL, Dept. H945**  
Drexel at 58th, Chicago 37, Illinois

## TELEPHONES and ALL SUPPLIES

Room to room, house to garage, private telephone service. **HANSET CRADLE TELEPHONES** (2) Complete outfit with 100' wire, 2 dry cells, instructions. \$14.95  
**WORM HARVESTER** — Dan Mac Magneto—gathers fishworms by electricity. Complete with instructions. \$6.50  
*Illustrated bulletin "AA-18" 10c*



**TELEPHONE REPAIR & SUPPLY CO.**  
Dept. AA-110 1760 Lunt Ave., Chicago 26, Ill.



## Troubled with GETTING UP NIGHTS, Pains in BACK, HIPS, LEGS, Tiredness

If you have these symptoms then your troubles may be traced to Glandular Dysfunction . . . a constitutional disease. Medicines that give temporary relief will not remove the cause of your trouble. Neglect of Glandular Dysfunction often leads to premature old age and sometimes incurable malignancy.

The past few years men from over 3,000 communities have been successfully treated here at the Excelsior Institute. They have found soothing relief and a new outlook in the future of life.

The Excelsior Institute, devoted to the treatment of diseases peculiar to older men by NON-SURGICAL methods has a NEW FREE BOOK that tells how Glandular Dysfunction may be corrected by proven NON-SURGICAL treatments. This book may prove of utmost importance in your life. Write today. There is no obligation. Excelsior Institute, Dept. 8929, Excelsior Springs, Mo.

POPULAR MECHANICS



**DeVry Tech** CAN PREPARE YOU IN SPARE TIME AT HOME...

for a Profitable Future in

# Electronics

as used in

## Guided Missiles

ETC.



**No Previous Technical Experience  
or Advanced Education Needed!**

If you think you need a "pull," advanced education or previous technical experience to prepare for a profitable career in the fast-growing, big opportunity field of Electronics—you're mistaken. The most important thing is a sincere desire to be somebody and to get somewhere.

During the past 26 years we have successfully trained farmers, store clerks, factory hands and men of practically every calling from 17 to 55. If these men can do it in their spare time, why can't you?

Regardless of your experience, we urge you to fill in coupon below for full FREE facts about our modern training that follows the same basic method used in our Chicago and Toronto Laboratories. It will cost you nothing for information that may prove to be the turning point in your career. Act now! Send coupon TODAY!

An **INDEX** to a Better Job,  
a Brighter Future

Communications • Radar • Television

Micro-Waves • Radio • Computers • Indus-

trial Electronics • Automation Electronics

"One of North America's Foremost Electronics Training Centers"



Accredited Member  
of National  
Home Study Council

**DEVRY TECHNICAL INSTITUTE**

CHICAGO 41, ILLINOIS

FORMERLY

DIFOREST'S TRAINING, INC.



### Draft Age?

We have valuable information for every man of draft age; so if you are subject to military service, be sure to check the coupon.

### Live-Wire Employment Service

DeVry Tech's Placement Department is in contact with some of the best-known employers in the Electronics field.

The service is free to all graduates—and DeVry Tech's record in helping to place men has been outstanding.

### FREE BOOKLET!

We'll give you a free copy of an interesting booklet, "Electronics and YOU."

See for yourself how you may take advantage of the opportunities in this fast-growing field.



### MAIL COUPON TODAY!

DeVry Technical Institute

4141 Belmont Ave., Chicago 41, Ill., Dept. PM-12-N

Please give me your FREE booklet, "Electronics and YOU," and tell me how I may prepare to enter one or more branches of Electronics as listed above.

Name \_\_\_\_\_ Age \_\_\_\_\_

Please Print

Street \_\_\_\_\_ Apt. \_\_\_\_\_

City \_\_\_\_\_ Zone \_\_\_\_\_ State \_\_\_\_\_

Check here if subject to military training.

DeVry Tech's Canadian Training Center is located at 626 Roselawn Avenue, Toronto 12, Ontario



# Inventors

If you consider your invention valuable, take these necessary preliminary steps promptly to protect it by applying for a United States patent.

Sketch and describe your invention. (For convenience in starting action on your invention, use "Evidence of Invention" form offered below.)

Sign, date and have this invention disclosure witnessed by two people capable of understanding your invention.

Have us make a preliminary search among U. S. patents already granted for similar types of invention.

We then prepare a report for you on the probable patentability of your invention and recommend your further course of action.

This firm is registered to practice before the U. S. Patent Office. We are available to assist you in the preparation and prosecution of your application for patent.

We shall be glad to send you promptly and without obligation, an instructive booklet—"Patent Protection for Inventors"—and our convenient "Evidence of Invention" form.

**VICTOR J. EVANS & Co.** *Merlin M. Evans*  
REGISTERED PATENT ATTORNEY  
330-P MERLIN BUILDING, WASHINGTON 6, D. C.

## Shrinks Hemorrhoids New Way Without Surgery

Science Finds Healing Substance That Relieves Pain—Shrinks Hemorrhoids

For the first time science has found a new healing substance with the astonishing ability to shrink hemorrhoids and to relieve pain—without surgery.

In case after case, while gently relieving pain, actual reduction (shrinkage) took place.

Most amazing of all—results were so thorough that sufferers made astonishing statements like "Piles have ceased to be a problem!"

The secret is a new healing substance (Bio-Dyne\*)—discovery of a world-famous research institute.

This substance is now available in suppository or ointment form under the name Preparation H.\* Ask for it at all drug counters—money back guarantee. \*Reg. U. S. Pat. Off.



### MAKE BEGINNERS BIG PROFITS

Many men and women making big money on imports by mail order from home. No investment in merchandise or ads. We tell you where to get low cost products from abroad and supply list of magazines that run no-cost ads. Write for Free details. MELLINGER CO. Dept. G25C, 1717 Westwood, Los Angeles 24, Calif.

## Secrets of VENTRILOQUISM Now Revealed!



Easy to learn in 60 to 90 days with our Home Study Course. RESULTS GUARANTEED. Make Money! Be Popular! Have Fun! Big Opportunity! Radio, Television, Stage Appearances! Fee FREE! Information regarding price and terms WRITE. You must state your age. Dummy Catalog 25c. MAHER HOME COURSE OF VENTRILOQUISM Box 36, Studio E, PM-32, Kensington Station Detroit 24, Michigan

## REAL ESTATE BE A BROKER

PAYS BIG! SEND FOR FREE, BIG, ILLUSTRATED CATALOG NOW! Graduates report making substantial incomes. Start and run your own business quickly. Men, women of all ages, learn easily. Course covers Sales, Property Management, Appraising, Loans, Mortgages, and related subjects. STUDY AT HOME or in classrooms in leading cities. Diploma awarded. Write TODAY for free book! No obligation. Approved for World War II and Korean Veterans.

WEAVER SCHOOL OF REAL ESTATE (Est. 1936)  
2020R Grand Avenue Kansas City, Mo.

FREE  
BOOK  
TELLS  
HOW

## MAKE STRIPES with new PAINT PEN

**Straight, curved, single or double**  
With any color paint, stripe furniture, bikes, autos, model planes, toys, linoleum, wall-board. Clean, crisp decorative lines. Can't clog or smear. Also use with glue, tempers, textile paint or underglaze... on wood, glass plastic, ceramics, metals, fabrics and paper. Ask your dealer or order direct.

<b>DEALERS</b> Master paint striping tool in display carton. Write for discounts. Order now.	<b>HOBBY</b> "Professional" results every time. Simple, easy to use.	<b>MFRS</b> Ask about heavy duty industrial striping tools.
---	---	--

**DOUBLE STRIPE MODEL \$3.25**  
5 COMBINATIONS. . . .

Single 1/16" stripe model \$1.25

Other single \$1.75 stripe models  
1/64", 1/32", 3/64", 5/64", 3/32" & 1/8"

Complete Kit \$5.00 (all 7 tips)

Extra tips 90c ea.

Extra 1/4" tip...\$1.20

**WENDELL MFG. CO.** 4234 LINCOLN AVE., Dept. 335  
CHICAGO 18, ILLINOIS

POPULAR MECHANICS



**GREATEST  
ADVANCE IN  
SHOP-METHOD  
HOME TRAINING**

# EARN MORE MONEY...GET INTO TELEVISION ELECTRONICS-RADIO

**Learn ALL 8 PHASES in ONE MODERN HOME-STUDY COURSE**  
At Home - In Spare Time

## YOU GET ALL THIS NEWEST PRACTICAL EQUIPMENT

- Parts to build a modern TV set, including all tubes plus a large screen Picture Tube
- Parts to build a powerful Superhet Receiver, standard broadcast and short wave
- Parts to conduct many experiments and build Continuity Checker, RF Oscillator, TV Circuits, Audio Oscillator, TRF Receiver, Signal Generator
- A Valuable Professional Multitester



**19 BIG KITS  
YOURS TO KEEP**

## YOUR NATIONAL SCHOOLS TELERAMA COURSE COVERS ALL 8 PHASES

- |                                    |                                |
|------------------------------------|--------------------------------|
| 1. TELEVISION, INCLUDING COLOR TV  | 5. PREPARATION FOR FCC LICENSE |
| 2. RADIO, FM AND AM                | 6. AUTOMATION                  |
| 3. INDUSTRIAL ELECTRONICS          | 7. RADAR AND MICRO WAVES       |
| 4. SOUND RECORDING AND HI FIDELITY | 8. COMMUNICATIONS              |

## YOU ARE NEEDED IN THE TELEVISION-ELECTRONICS-RADIO INDUSTRY!

You can build a secure future for yourself if you get into Electronics NOW! Today's shortage of trained technicians creates tremendous opportunities. National Schools Shop-Method trained technicians are in constant and growing demand for high-pay jobs in Broadcasting and Communications, Electronic Research, Servicing and Repair, and many other branches.

Let National Schools, a Resident Technical School for over 50 years train you for today's unlimited opportunities in electronics! Our Shop Method trains you to be a MASTER-TECHNICIAN. Completely up to date, developed by experienced instructors and engineers, your Telerama Course will teach you all phases of the industry quickly, clearly and correctly. You can master the most modern projects, such as Color TV, printed circuits - even prepare for FCC License without taking a special

course. You can handle sales, servicing, manufacturing, or make good money in your own business. SEND FOR FACTS TODAY!

**EARN AS YOU LEARN.** Many of our students earn their entire tuition and more in Spare Time jobs we show them how to do while learning.

**YOU GET EVERYTHING YOU NEED** - Clear, profusely illustrated lessons, shop-tested manuals, modern circuit diagrams, practical job projects - all the valuable equipment shown above

- many other materials and services - consultation privilege with our qualified staff, and Graduate Employment Service. **EVERYTHING YOU NEED** for outstanding success in Electronics.

## RESIDENT TRAINING AT LOS ANGELES

If you wish to take your training in our Resident School at Los Angeles, the world's TV capital, start NOW in our big, modern Shops, Labs and Radio-TV Studios. Here you work with latest Electronic equipment - professionally installed - finest, most complete facilities offered by any school. Expert, friendly instructors. Personal attention. Graduate Employment Service. Help in finding home near school - and part time job while you learn. Check box in coupon for full information.



**FREE!**

Fully illustrated "Career" Book in TV-Radio-Electronics. PLUS actual sample lesson - yours at no cost, no obligation. CLIP COUPON NOW... MAIL IT TODAY!

APPROVED FOR G.I. TRAINING

# NATIONAL SCHOOLS

4000 S. FIGUEROA ST., LOS ANGELES 37, CALIF.



## NATIONAL SCHOOLS

TECHNICAL TRADE TRAINING SINCE 1905  
LOS ANGELES 37, CALIFORNIA

GET FAST SERVICE - MAIL NOW TO

**NATIONAL SCHOOLS, Dept. RB-127**  
4000 S. FIGUEROA ST., LOS ANGELES 37, CALIF.  
Rush free TV-Radio "Opportunity" Book and sample lesson. No salesman will call.

NAME \_\_\_\_\_ AGE \_\_\_\_\_  
ADDRESS \_\_\_\_\_  
CITY \_\_\_\_\_ ZONE \_\_\_\_\_ STATE \_\_\_\_\_

Check if interested ONLY in Resident School Training at Los Angeles.  
VETERANS: Give date of Discharge \_\_\_\_\_



# DRAFTSMEN



**CASH BIG  
PAY CHECKS!**

Train Now for  
more success,  
greater security

**LEARN AT HOME IN SPARE TIME**  
(or at college in Chicago)

Check the want ads in any newspaper—SEE the big-pay opportunities open to you as a draftsman. What's more, you can learn this well-paid, prestige profession at home — quickly, easily! No special talent needed. Get complete, step-by-step Chicago Tech lessons in the mail, spend a few pleasant hours studying each week. In a short time you'll be a well-trained draftsman, ready to take your pick of many good jobs. Act now!



**Free Information—Mail Coupon Today!**

Get **FREE TRIAL LESSON** plus information about C.T.C. practical training. Learn what successful Chicago Tech graduates say about high pay and opportunities in drafting. No charge, or obligation.

## CHICAGO TECHNICAL COLLEGE

5-215 Tech Bldg., 2000 So. Michigan Ave.  
Chicago 16, Illinois

Mail me **FREE** lesson with facts about big opportunities in **DRAFTING**.

Name \_\_\_\_\_ Age \_\_\_\_\_

Address \_\_\_\_\_

City \_\_\_\_\_ Zone \_\_\_\_\_ State \_\_\_\_\_

## Catalog of 3100 Novelties 10c

Send 10c for amazing catalog of novelties, live animals, scientific supplies, hobbies, funmakers, planes & boats, toys, magic tricks, joke articles, unusual seeds, gadget timersavers, cameras, optical goods, projector movies, lucky jewelry, religious novelties, disguised musical instruments, stamps, coins, puzzles, fortune tellers, radios, auto & bike accessories, telescopes, magnifiers, com passes, banks, smokers' gadgets, artists' supplies, printing sets, eye glasses, motors, shockers, knives, billfolds, guns, rifles, sports, books, games, plants, etc. Send 10c (3 for 25c—get for friends!).  
**JOHNSON SMITH & CO.** Dept. 435 Detroit 7, Michigan

## NEW SIMPLEX MODEL 400 LAWNMOWER SHARPENER

### Many Exclusive Features

The **NEW SIMPLEX** is the fastest, most accurate straight-line lawnmower grader ever built... gives you all these advantages:

- Grinds all mowers—real type, rotary, hand or power, any size.
- No dis-assembly needed, get and all remain in engine, support bar retainer.
- Grinding head feeds both horizontally and vertically, turns 90° for bed knives.
- Fast, positive adjustments, 4-point support on steel base with leveling screw.
- Rugged, long life construction and many other features.

Get the facts on the new **SIMPLEX 400** before you buy any sharpener.

Send for free brochure today



Small investment  
returns  
big profits!

**The Fate-Root-Mouth Company**  
Dept. PM-12 • Plymouth, Ohio

24 YEARS IN BUSINESS AT THE SAME ADDRESS.



Our entire stock of very slightly worn **EXTRA MILEAGE TOP GRADE TIRES**, (Written Insurance Guarantee). **SEND AD**

**EVERYBODY MAY DEDUCT 10% off ON EVERY TIRE**

Free—Tube With Each Passenger Tire

**FREE** If you buy 2 or more Passenger 4-ply tires, WE GIVE ONE tire **FREE**, on each order. Does not include W.W. or Truck Tires, or Snow Tires. Write for other sizes.

12 NOS. WRITTEN GUARANTEE, WHITE WALLS \$1.00 EX.	
600-16	\$5.32 475-15 \$4.82 700-15(6) \$7.82 700-20
600-16(6)	5.32 640-15 4.32 750-16(8) 10.72 750-20(10) 15.72
650-16	5.72 670-15 5.52 700-17 9.82 825-20 18.92
650-16(6)	6.62 710-15 5.52 750-17 10.32 825-20 18.92
750-16(6)	7.52 760-15 5.82 825-15 12.92 900-20 17.92
550-17	3.72 800-15 5.92 600-20 9.02 1000-20 17.92
650-15	5.52 820-15 5.92 650-20 9.82 1100-20 19.92
700-15	4.92 700-16(6) 7.32 750-15 10.72 1100-22 18.92

"EXTRA SPECIAL" TOP QUALITY all size 4-ply pass. **FREE TIRE** with 2 or more of these also.—W.W. \$1.00 EA. **\$8.72**  
Extra Factory Tested Tube given — **GIANT TIRE SALE.**

**SNOW TIRES \$8.72 AND \$6.22 ANY SIZE**  
BLACK WALL PASS.  
DEEP HEAVY TREAD FOR ROUGH WINTER WEAR.  
Thousands of tires shipped all over the U.S.A. All tires shipped F.O.B. Phila. Send Check or M.O. with this ad, Dept. 2, No C.O.D.  
**STANDARD 834 N. Broad St., Philadelphia 30, Pa.**



## SHEET METAL MACHINES

Brakes form angles, locks, pans, etc. Quick eccentric clamp. All steel construction.

15"—16 gauge steel	\$28.00
36"—22 gauge steel	\$37.00
48"—24 gauge steel	\$52.00
Floor stand	\$ 8.00
15"—24 gauge Folder	\$16.50
36" Pan and box brake	\$50.00
1/4 x 3 Adjustable Bender	\$11.50
16 gauge 7" Bench Shear 3 adj. gauge	\$16.50
36"—20 gauge Curve Former	\$11.50

ORDER DIRECT OR SEND FOR FREE CATALOG

**YKKE MFG. CO., P-4158 Jason St., Denver 11, Colo.**

## BECOME AN EXPERT IN

## TRAFFIC and TRANSPORTATION

Traffic men earn \$4,000 to \$10,000 and up. Thousands of firms need experts on rates, tariffs, regulations. We train you **thoroughly** in spare time at home for executive traffic jobs. Personal training under traffic authorities. Write for free book "Traffic and Transportation."

**LASALLE Extension University, 417 So. Dearborn St.**  
A Correspondence Institution Dept. 1264-T, Chicago 5, Ill.



## Print Your Own

Cards, Stationery, Advertising, Circulars, labels, photo and movie titles, church work, tags, etc. Save money. Sold direct from factory only. Raised printing like engraving, too.

### Own a Printing Business

Print for Others, Good Profit. Have home shop. Junior press \$15; Senior \$29 up. We supply everything. Easy rules. Pays for self in short time. Write for free catalog of outfits and all details.  
**KELSEY PRESSES, C-37 Meriden, Conn.**

## MEN WANTED

Earn \$100 Per Week and up

**AUTO DIESEL MECHANICS**

Master a trade with a future—learn Auto-Diesel mechanics in our shops. You learn with tools on real equipment. Earn while you learn. Many of our graduates earn \$100 per week and up. No previous experience necessary. Day and night courses. Approved for veterans. Write for free bulletin.

**NASHVILLE AUTO-DIESEL COLLEGE**

226 7th Ave., N., Dept. 73

Nashville 3, Tenn.

## Helps You Overcome FALSE TEETH Looseness and Worry

No longer be annoyed or feel ill-at-ease because of loose, wobbly false teeth. **FASTEETH**, an improved alkaline (non-acid) powder, sprinkled on your plates holds them firmer so they feel more comfortable. Avoid embarrassment caused by loose plates. Get **FASTEETH** at any drug counter.

POPULAR MECHANICS



TRAIN FOR OPPORTUNITY FIELD OF

# ELECTRONICS

ON REAL EQUIPMENT  
IN THE GREAT SHOPS  
OF **COYNE**



**LARGEST, OLDEST AND BEST EQUIPPED  
SCHOOL OF ITS KIND IN U.S.**

This five story Chicago building is occupied entirely by Coyne. Five big floors of Classrooms and over a quarter of a million dollars worth of Equipment. Thousands of successful men have trained at Coyne. There is no substitute for Coyne's wealth of experience.



## OPPORTUNITIES IN ELECTRICITY-ELECTRONICS

Train the Coyne way for a better job in *Electricity-Electronics*—a field that offers a world of opportunities now and in the years ahead. In industry—in the home—Electricity and Electronics are playing a vastly greater role than ever before. New developments and rapid growth are creating increasing job opportunities. Automation Electronics—one of the more recent applications of Industrial Electronics to manufacturing processes—promises to create additional demands for trained Electrical-Electronics men such as we have never seen. Electrical Training can be taken separately or combined with Television-Radio. Send coupon for more information.

*Training in Refrigeration and Electric Appliances can be included.*

**YOU TRAIN IN CHICAGO**—Learn the easier practical way in shops of Coyne in Chicago. Shop work plus technical training. No advanced education or previous experience needed. Lifetime Employment Service to Coyne Graduates.

### START NOW—PAY LATER

New liberalized credit terms and Finance Plans. Part-time employment service to students. Help in making housing arrangements.

### VETERANS OR NON-VETERANS

Coyne training is offered to Veterans and Non-Veterans alike. We'll send Bulletin giving full information. Send coupon for details.



1. You are told the how and why of each job.



2. You're shown how to do it by trained instructors.



3. You do the jobs yourself on finest equipment.

B. W. COYNE JR., President

**COYNE** FOUNDED 1899  
ELECTRICAL SCHOOL

A Technical Trade Institute Operated Not For Profit

500 S. Paulina Street, Chicago, Dept. 97-72H

ELECTRICITY • RADIO • TELEVISION • REFRIGERATION • ELECTRONICS



## TELEVISION — RADIO ELECTRONICS

Great opportunity for a good job or your own business in one of America's fastest growing branches of Electronics! New stations by the hundreds . . . new sets by the millions . . . and now Color TV . . . all means greater opportunities in Sales and Service. Separate courses in Radio-Television or in combination with Electricity-Electronics available. Coupon brings details.

### Mail coupon for big free book!

48 Page Illustrated Book, "Guide to Careers" gives you all the facts. Whether you prefer Electricity-Television-Radio or Combined Electronics Training this book describes all training offered.

Information comes by mail. No obligation and no salesman will call.



Coyne Electrical School, Dept. 97-72H  
500 S. Paulina St., Chicago 12, Ill.

Send **BIG FREE BOOK** and details of all training you offer. However, I am especially interested in

- Electricity-Electronics     Television-Radio  
 Combined Electronics Training

Name \_\_\_\_\_

Address \_\_\_\_\_

City \_\_\_\_\_ State \_\_\_\_\_

(I understand no Salesman will call.)



# Check the Kind of Body You Want



Charles Atlas

... and I'll Show You How EASILY You Can Have It!

Just tell me, in coupon below, the kind of body you want—and I'll give it to you SO FAST your friends will be amazed! "Dynamic Tension," my easy, 15-minute-a-day method, will make your chest and shoulders bulge... arms and legs surge with power... your whole body feel "alive!"

**FREE BOOK** Learn how I became "World's Most Perfectly Developed Man"—Mail coupon! **CHARLES ATLAS**, Dept. 8M, 115 East 23 Street, New York City 10, N. Y.

**CHARLES ATLAS, Dept. 8M, 115 East 23rd St., New York 10, N. Y.**

Dear Charles Atlas: Here's the Kind of Body I want! (Check as many as you like)

- |  |  |
|--|--|
| <input type="checkbox"/> More Weight—Solid—in The Right Places | <input type="checkbox"/> Powerful Arms, Legs, Grip |
| <input type="checkbox"/> Broader Chest, Shoulders              | <input type="checkbox"/> Slimmer Waist, Hips       |
|  | <input type="checkbox"/> Better Sleep, More Energy |

Send me absolutely FREE a copy of your famous book showing how "Dynamic Tension" can make me a new man—32 pages, crammed with photographs, answers to vital questions, and valuable advice. No obligation.

NAME \_\_\_\_\_ AGE \_\_\_\_\_  
(please print or write plainly)  
ADDRESS \_\_\_\_\_  
CITY \_\_\_\_\_ STATE \_\_\_\_\_



## WARN HUBS



© 1957 WARN

OVER 100,000 WARN HUBS NOW IN USE ON 4-WHEEL DRIVES Models for all 4 w.ds. to 1 1/2 tons

idle the front drive in 2-wheel drive... stop drag... reduce wear.

Warn Hubs mean big savings in gear, engine, tire wear, gas, plus new pep, performance, power, handling ease. And now, with Warn Lock-O-matics, you have economical, drag-free 2-w.d. or tractive 4-w.d. automatically, as you shift! Ask your dealer for Warn Lock-O-matic or Locking Hubs today!

**WARN MFG. CO.** RIVERTON BOX 8064-A12 SEATTLE 88, WASH.

# YOU CAN MAKE AS MUCH AS \$20,000 A YEAR WITH YOUR OWN BUSINESS!

Here's your opportunity to make big money on a small investment! Open your own RICHARDSON Roadside Stand, backed by our proven formula and franchise plan. Our 35 years of experience in merchandising root beer at stands, parks, fountains and two world fairs is passed on to you. Let us show you—without obligation—how you can go into business for yourself with a minimum investment and join the successful franchised RICHARDSON Roadside Stand operators earning up to \$20,000 and more a year! A RICHARDSON franchise permits you to build a modern, nationally advertised RICHARDSON patented stand. Here's your chance to set up a nice business that's easy to operate, simple to maintain, designed to give you big seasonal profits or income all year 'round. Write for further information, now!

**RICHARDSON Corp.** Box 790 Dept. P. M.—1 Rochester 3, New York



## Rubber Stamp Press Outfits Stamp Making Supplies

A profitable home or sideline business mfg. rubber stamps. Stamp Press and all supplies. FREE catalog, advice, instruction. Permanent and profitable business. WRITE TODAY! Full details!



**CUSTOM MANUFACTURING**  
601-A NO. JEFFERSON, SPRINGFIELD, MO.

## MONEY in WORMS

Big money made raising crickets, hybrid red wigglers and 12 inch African fishworms—sell by mail—We teach you how to raise and where to sell. Free literature. Start now for big season beginning next spring. **CARTER WORM RANCH, PLAINS, GEORGIA**

## CABINET MAKING



### LOW COST HOME TRAINING COURSE FOR BEGINNERS & ADVANCED CRAFTSMEN

Make money. Learn skills and secrets of fine woodworking and tool use. Professionally prepared shop method training tells and shows how. Covers everything. Easy to master.

Write for Free Booklet **INTERSTATE TRAINING SERVICE** DEPT. F3, PORTLAND 13, OREGON

## JEEP OWNERS

RE-POWER NOW WITH A V-8 ENGINE — Use **FORD • CHEVROLET • MERCURY** in 2 or 4 Whl-Dr. Jeeps, Jeeps, Jeeps, Sta-Wgn, Trucks, H. J. and Kaiser cars. Conversion Kits \$43.25 to \$59.85. If you want fast action tell us which engine you wish to use, give us year, Model (2 or 4 Whl-Dr) of your vehicle. Send Min. \$15.00 Dep. and we will ship correct kit. Bal. COD. Send full amt. for Prepaid shipment. Wire, phone or write for free details. Also Kits for FORD 6 cpg. **HOOSIER MACHINE PRODUCTS CO.** 312 S.E. 6th St. Phone 676 Pendleton, Oregon, U.S.A.

## 75 POWER TELESCOPE 25X-45X-75X \$3.98

New 3 in one telescopes, 3 variable 25X-45X-75X magnification. Brass mount, 25 power for ultra bright images 45 & 75 power for long range. Guaranteed to bring distant stars, moons, objects, sports 75 times closer.

Most powerful scope sold anywhere near this amazing low price. American made, 5 sections. Opens 36" closes 1 ft. contains 4 ground & polished lenses. Can also be used as powerful compound microscope. Directions included. Mass production enables us to offer telescope complete at \$3.98 postpaid. Money back guarantee. Get yours now. **CRITERION CO., 331 Church St., Hartford, Conn., Dept. PM52**



POPULAR MECHANICS



**RCA** offers you the  
 finest training  
 at home in  
**Radio-TV**  
 electronics,  
**TV servicing,**  
**Color TV**

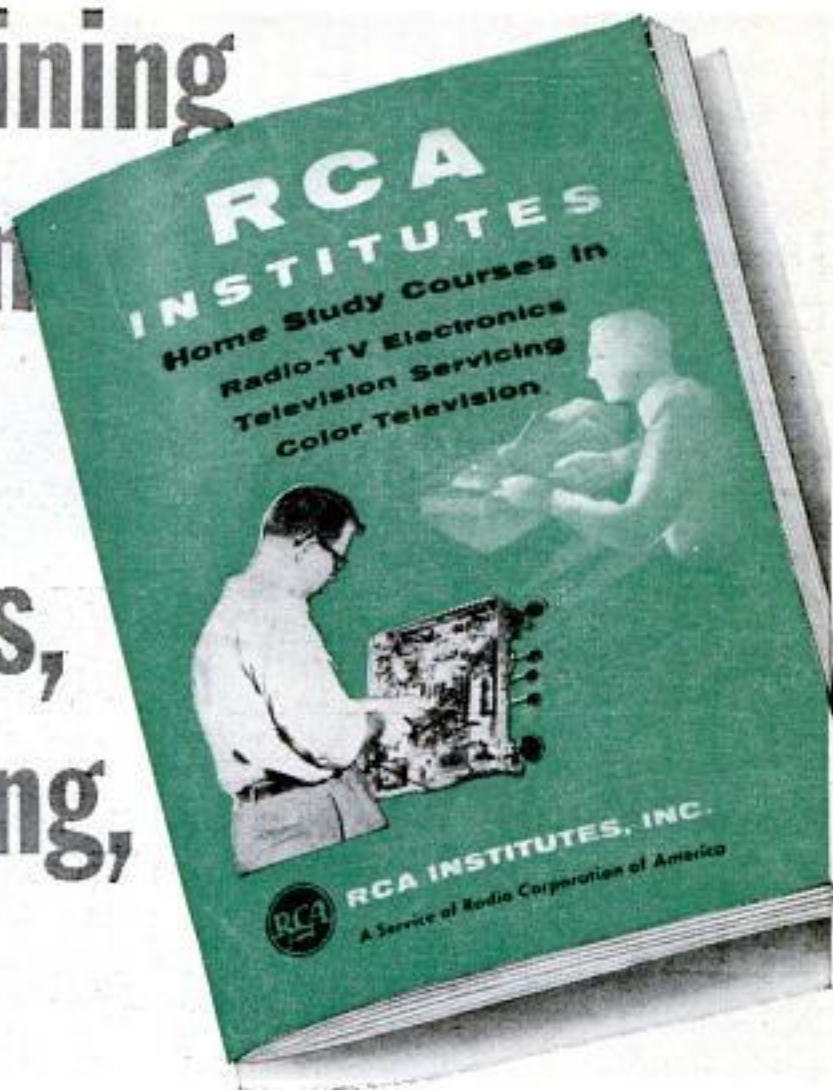

**SEND FOR THIS FREE  
 BOOK NOW!**



**RCA INSTITUTES, INC.**  
 A SERVICE OF RADIO CORPORATION OF AMERICA  
 350 WEST FOURTH STREET, NEW YORK 14, N.Y.

In Canada—RCA Victor Company, Ltd.,  
 5001 Cote de Liesse Rd., Montreal 9, Que.

Pay-as-you-learn. You need pay for only one study group at a time. Practical work with very first lesson. All text material and equipment is yours to keep. Courses for the beginner and advanced student.

RCA Institutes, Inc., Home Study Dept. PM-127  
 350 West Fourth Street, New York 14, N. Y.  
 Without obligation, send me FREE 52 page CATALOG on Home Study Courses in Radio, Television and Color TV. No Salesman will call.

Name.....  
 Please Print

Address.....

City..... Zone..... State.....

KOREAN VETS! Enter discharge date.....

To save time, paste coupon on postcard



# Learn to MOUNT Birds and Animals



**To All Men & Boys!**

Here is **FUN** and **PROFIT!**

**Send Coupon for Free Book**

Tells all about **Taxidermy**, and how you can learn at home to mount life-like **Birds, Animals, Game-Heads, Fish**. Save your valuable trophies. Decorate your home and den. Learn genuine **Chrome Tanning** for harness and sole leather buckskin and fine furs. Mount **Common** specimens, squirrels, rabbits, owls, even frogs, into marvelous craft-work groups, both useful, humorous. Wild game not necessary. Marvellous hobby. Fascinating.

**BIG PROFITS** Turn your spare time to cash. Have a sideline apartment; sell your own mounts; save money and **Make Money** with expert tanning. Learn by mail from old reliable school with 400,000 graduates. **Investigate Now.** Send coupon or letter or post card **Right Now** for this marvelous **FREE BOOK**. There is no cost or obligation. Please state your **AGE**.

## FREE BOOK



Northwestern School of Taxidermy,  
2512 Elwood Bldg., Omaha, Neb.

Gentlemen:—Please send me your **FREE** 48-page booklet explaining Taxidermy. (Please print plainly, and state age. Use postal card if more convenient.)

Name \_\_\_\_\_ Age \_\_\_\_\_

Address \_\_\_\_\_

## Make \$500 an Hour CASH PROFIT THE DAY YOU START!



**START YOUR OWN BUSINESS AT HOME... SHARPEN HOUSEHOLD, GARDEN AND SHOP TOOLS IN SPARE TIME**

Now you can turn spare time into Big Cash Profits with new Belsaw Sharp-All. Sharpen knives, scissors, shears, snips, ice skates, mower blades, hedge trimmers, grass whips, axes, chisels, screw drivers, scrapers and saws... just about any household, garden and shop tool. Your own CASH business with no inventory. No calls to make. No experience needed.

Learn how easily you can start your own spare time business. Amazing low cost easy-payment plan. Send postcard for **FREE BOOK**.

**BELSAW SHARP-ALL CO**  
718 Field Bldg. • Kansas City 11, Missouri



## TREMENDOUS OPPORTUNITIES AIRCRAFT JOBS TOP PAY! GOOD FUTURE!

Start your career in aviation NOW! Rapidly expanding aircraft industry needs hundreds of trained, fully-qualified technicians. **AERO MECHANICS SCHOOL** recognized by leading airlines. C.A.A. license upon completion of courses. Government-approved Classes start monthly, include jet engines. No previous experience or training needed. Get in on the ground floor of the "air age" Can lead to Flight Engineer jobs at \$850.00 per month. Training invaluable to those entering military service. Approved for Veterans, Write:

### AERO MECHANICS SCHOOL

Dept. PM-1, Municipal Airport, Kansas City, Mo.

**Mr. "N" Made \$9,700 Last Year By Selling Just 20 KEEP/SAFEs a Month!**



Like Mr. "N" you can profit with **KEEP/SAFE**—the fine personal safe that undersells all others. Only safe sold direct. 85% of homes, farms and small businesses are prospects. \$30 to \$71 profit per sale, plus bonuses up to \$12 a sale. Choice territory, chance to become district agent. **FREE DEMONSTRATOR!** Get details, giving address including county.

**JOHN D. BRUSH & CO., INC.**  
575 West Ave. Rochester 11, N. Y.

## "How to Make Money with Simple Cartoons"



A book everyone who likes to draw should have. It is free; no obligation. Simply address **FREE BOOK**

**CARTOONISTS' EXCHANGE**  
Dept. 912-D Pleasant Hill, Ohio

**Exclusive Double-Bearing HEAVY-DUTY PUMPS**  
IRRIGATE • DRAIN • CIRCULATE • SPRAY  
Up to 7,500 GPH. 3,000 GPH from 28" well. Use 1/4 to 1 HP motor, 1 1/4" inlet; 1" outlet. Stainless shaft. TYPE X—2 oilless bronze bearings. **\$10.95**  
Won't rust.....  
TYPE XB—Ball bearing model.....**\$12.95**  
Postpaid if cash with order. Rush your order today  
**MONEY BACK GUARANTEE**  
Centrifugal and Gear Pumps in All Sizes  
**LABAWCO PUMPS, Belle Mead 2, N. J.**

## TORSO-HEALTH CLUB MEMBERS

gain supremely **ENERGETIC BODIES**. My **FAMOUS COURSE** teach **REJUVENATION** & figure control. **Feel YOUNG & GAY!** Give age, height & weight. Mail \$2. Results or refund.  
**ANTONE MATYSEK, 940 Wilton Drive, Baltimore 27, Md.**

## LAW FREE BOOK THE LAW TRAINED MAN

Write today for a **FREE** copy of illustrated law book, **"THE LAW-TRAINED MAN,"** which shows how to earn the professional Bachelor of Laws (L.L.B.) degree through home study of the famous Blackstone Law Course. All necessary books and lessons provided. Moderate cost; convenient monthly terms. Write for **FREE** law training book today.

**Blackstone School of Law, 307 N. Michigan Ave.**  
Founded 1890 Dept. 59, Chicago 1, Illinois

**WORLD'S LOWEST PRICED  
ADDING MACHINE** Vest Pocket Size  
FREE TRIAL  
**\$2.95**  
COUNTS UP TO 999,999,999  
**IDEAL FOR BUSINESS AND PERSONAL USE—GUARANTEED ACCURATE.** Not a toy. Operates with only a finger flick. Adds, subtracts, multiplies, divides. Counts up to one billion. Pays for itself over and over. **Ideal Gift—for Business, Income Tax and School use.**  
**MONEY BACK GUARANTEE.** Send name and address. Pay postman only \$2.95 plus postage. Beautiful rich-looking leatherette case included at no extra cost. Money back in 10 days if not delighted. **AGENTS WANTED.**  
**CALCULATOR MACHINE COMPANY**  
P.O. Box 126, Dept. 2-57, Huntingdon Valley, Penna.



POPULAR MECHANICS

Copyrighted material



# AUDELS GUIDES FOR MECHANICS & ENGINEERS

## HOME APPLIANCES

HOW TO REFRIGERATORS Dryers Vacuum Washers Ironers Freezers Toasters Ranges

Many other GAS and ELECTRIC APPLIANCES

Handy Reference for Electric & Gas Servicemen, Mechanics, Dealers and Homeowners. Explains clearly and simply how to locate troubles, how to test, reassemble and cable-wire. Wiring diagrams, 1000 Facts. Easy to read. Answers ALL your questions. 264 Pages, Illustrated. Only \$6. CIRCLE NO. 2 IN COUPON

## REFRIGERATION & AIR CONDITIONING

FOUR BOOKS IN ONE - basic principles, servicing, operation, repair of 1. Household Refrigeration, 2. Special Refrigeration Units, 3. Commercial & Industrial Refrigeration, 4. Air Conditioning Systems. A GOLD MINE of essential information. Completely up-to-date. 1390 Pages. Fully illustrated and indexed. Priced at only \$9. CIRCLE NO. 14 IN COUPON

## NEW MACHINISTS AND TOOLMAKERS HANDBOOK

MODERN MACHINE SHOP PRACTICE - 5 PRACTICAL BOOKS IN ONE. New from cover to cover. Tells how to set up and operate lathes, screw and milling machines, shapers, drill presses and all other machine tools. A COMPLETE INSTRUCTOR AND REFERENCE BOOK. 1726 Pages. Fully illustrated. Priced at only \$6. CIRCLE NO. 13 IN COUPON

## CARPENTERS AND BUILDERS GUIDES

PRACTICAL STOREHOUSE OF MODERN CONSTRUCTION INFORMATION (4 vol. set) for carpenters and all woodworkers. Explains in easy language and by profuse illustration principles, advances, short cuts, trade secrets, all based on the NEWEST information. Vol. 1 - Tools, steel square, saw filing, joinery, furniture, etc. Vol. 2 - Builders' mathematics, drawing plans, specifications, estimates, etc. Vol. 3 - House and roof framing, laying out, foundations, etc. Vol. 4 - Doors, windows, stair building, millwork, painting, etc. 4 vols. 1904 Pages. 3700 Illustrations. Whole set only \$8. CIRCLE NO. 9 IN COUPON

**PRACTICAL ELECTRICITY** A COMPLETE HANDBOOK - Quick, simple, direct ready reference. Complete instruction and practical information on the rules and laws of electricity - Maintenance of Machinery - A.C. and D.C. Motors - Armatures - Wiring Diagrams - House Lighting - Power Wiring - Meters - Batteries - Transformers - etc. Simple to understand. 1520 Pages. 2600 Illustrations. Priced at \$5. CIRCLE NO. 4 IN COUPON

## ADDITIONAL IMPORTANT TITLES

Audel Guides are the best in their fields, written in clear simple fashion, lavishly illustrated. Circle numbers wanted in the MAIL-ORDER COUPON at right. All sent for FREE EXAMINATION.

No. 1	AUTOMOBILE MECHANICS GUIDE, 1492 Pages	\$4.00
No. 2	TRUCK & TRACTOR GUIDE, 1376 Pages	5.00
No. 3	PLUMBERS & STEAMFITTERS GUIDES, 4 Book Set	8.00
No. 4	PAINTING & DECORATING MANUAL, 464 Pages	2.00
No. 5	DIESEL ENGINE MANUAL, 640 Pages	3.00
No. 6	WIRING DIAGRAMS, 304 Pages	2.00
No. 13	ELECTRIC LIBRARY, 7900 Pages, 10 Book Set	26.00
No. 25	BLUE PRINT READING, 445 Pages	2.00
No. 26	MASONRY & BUILDERS GUIDES, 4 Book Set	8.00
No. 27	ELECTRIC MOTOR GUIDE, 1056 Pages	3.00
No. 28	OIL BURNER GUIDE, 416 Pages	2.00
No. 29	SHEET METAL PATTERN LAYOUTS, 1132 Pages	7.50
No. 30	SHEET METAL WORKERS HANDBOOK, 448 Pages	2.00
No. 31	MECHANICAL DRAWING, 192 Pages	2.00
No. 32	MECHANICAL DRAWING & DESIGN, 480 Pages	3.00
No. 33	ELECTRONIC DEVICES, 304 Pages	3.00
No. 34	ELECTRICIANS EXAMINATIONS, 372 Pages	2.00
No. 35	ELECTRIC POWER CALCULATIONS, 480 Pages	2.00
No. 36	ELECTRIC DICTIONARY, 9000 Terms	2.00
No. 37	POWER PLANT ENGINEERS GUIDE, 1548 Pages	5.00
No. 38	ENGINEERING AND DRAWING, 344 Pages	2.00
No. 39	OPERATING ENGINEERS LIBRARY, 3 Book Set	12.00
No. 40	PUMPS, HYDRAULICS & AIR COMPRESSORS, 1740 Pages	6.00
No. 41	HOUSE HEATING GUIDE, 1008 Pages	3.00

## TV TELLS HOW TO ANSWER RADIO RADIO T.V. QUESTIONS SERVICE LIBRARY

HERE IS LATEST INFORMATION IN A READY FORM FOR RADIO AND TELEVISION REPAIRMEN, SUBSCRIBERS AND STUDENTS. TWO COMPLETE VOLUMES - 1508 Pages - 3200 Illustrations and Diagrams, 1000 Important Facts and Figures on Modern T.V., Radio, Electronic Devices, INCLUDES TRANSISTORS & Transistor Circuits, Rectifiers, Record Changers, P.A. Systems, Phonograph Pick-ups, F.M., Auto Radio, Short Wave.

Basic principles, Construction, Installation, Operation, Repair, Trouble Shooting, HOW TO GET SHOW, OVER T.V. Pictures, Install Aerials, How to Test, Explains COLOR SYSTEMS, Methods of Conversion, Tests, etc. Includes Ultra High Frequency, Quick ready reference or use as a home study course. Only \$8 for BOTH volumes. CIRCLE NO. 3 IN COUPON

## OIL BURNERS

New, complete, explaining in detail both domestic and industrial oil burners. Includes electrical hook-ups and wiring diagrams. Fully covering the theory, construction, installation, operation, testing, servicing and repair of all equipment. Indexed for ready reference. Over 450 Pages. 320 Illustrations and Diagrams. Only \$2. CIRCLE NO. 28 IN COUPON

## MATHEMATICS MADE EASY

A COMPLETE HOME STUDY COURSE - Starting with the first principles of arithmetic, advancing step by step through the various stages of mathematics, including the rules and calculations for mechanical and electrical problems. New EASY correct methods. Includes plane and solid geometry, trigonometry, algebra, calculus, etc. Practical tests, reference tables and data. How to use slide rule. 752 Pages. 500 Illustrations. Priced at only \$2. CIRCLE NO. 11 IN COUPON

## WELDERS GUIDE

Covers Electric, Gas-acetylene, Thermit, Gasmetal welding for sheet metal, spot and pipe welds, pressure vessels and aluminum, copper, brass, bronze and other metals. Air-plane work, surface hardening, hard facing, cutting, brazing, etc. 608 Pages. Fully illustrated. Only \$3. CIRCLE NO. 10 IN COUPON

## 7-DAY FREE EXAMINATION

SEND NO MONEY - Pay the postman nothing! We are glad to send you any of the Audel Guides for absolutely FREE examination in your own home. We take all the risks and leave all the decisions up to YOU. There is no obligation if you decide to keep the books of your choice you may pay for them under our outstanding easy plan of only \$2 a month.

## HERE IS ALL YOU DO

IT'S EASY TO ORDER: In the No-Risk Mail Order Coupon at the right just draw a circle around the number of Audel Guides you want us to send you for FREE EXAMINATION. We will send them to you at once to help you build a brighter future by increasing your skill. If for any reason at all you are not COMPLETELY satisfied, return the books to us, and that will end the matter. NO STRINGS OR CATCHES TO THIS OFFER.

SAVE 1/2 ON ACCORDIONS • SAVE 1/2 ON ACCORDIONS • SAVE 1/2 ON ACCORDIONS

# BUY DIRECT and SAVE UP TO 1/2 on ITALIAN ACCORDIONS EASY TERMS



AMAZING NO RISK OFFER... Now you can afford a world famous Accordion of finest tone and breathtaking beauty! Low wholesale prices save you half and more.

**5 DAYS FREE TRIAL**

## ACT NOW! FREE-

- Music Stand
- Home Study Course
- Deluxe Case
- Certified Guarantee

**COLOR CATALOG FREE**  
Mail Coupon

## MONEY BACK GUARANTEE

Buy direct from world's largest dealer. Save 50% or more. 30 newest models to choose from. Extra bonus gifts if you buy now. Satisfaction guaranteed or money back. Trade-ins accepted. Low down payment; pay little as \$10.00 a month. Try before you buy on FIVE DAY TRIAL. Rush coupon now for FREE color catalog and wholesale price list. Write TODAY. Accordion Manufacturers and Wholesalers Outlet, Dept. R127 2003 W. Chicago Ave., Chicago 22, Ill.

Accordion Manufacturers & Wholesalers Outlet  
2003 W. Chicago Ave., Dept. R127, Chicago 22, Ill.  
Send FREE Color Catalog and price list.

NAME \_\_\_\_\_  
ADDRESS \_\_\_\_\_  
CITY \_\_\_\_\_ STATE \_\_\_\_\_

# RUPTURED

## BE FREE FROM TRUSS SLAVERY

Now there is a new modern Non-Surgical treatment designed to permanently correct rupture. These Non-Surgical treatments are so certain, that a Lifetime Certificate of Assurance is given.

Write today for our New FREE Book that gives facts that may save you painful and expensive surgery, and tells how non-surgically you may again work, live, play and love and enjoy life in the manner you desire. There is no obligation. Excelsior Hernia Clinic, Dept. 8305, Excelsior Spgs., Mo.

## MAIL THIS NO-RISK COUPON TODAY!

THEO. AUDEL & CO. - Self Improvement Publishers Since 1879 P12 1 2 3 4  
49 W. 32nd Street, New York 10, N.Y.

Please mail me for 7 days' FREE EXAMINATION the books I have circled at right. I agree to mail \$2 in 7 days on each book or set ordered, and to further mail \$2 a month on each book or set ordered until I have paid the purchase price, plus shipping costs. If I am not completely satisfied with my Audel Guides I may return them.

NAME \_\_\_\_\_ 5 6 7 8  
ADDRESS \_\_\_\_\_ 9 10 11 12  
OCCUPATION \_\_\_\_\_ 13 14 15 16  
EMPLOYED BY \_\_\_\_\_ 17 18 19 20  
21 22 23 24  
25 26 27 28 29  
30 31 32 33  
34 35 36 37  
38 39 40 41

SAVE SHIPPING COSTS! Check here if you enclose complete payment with order. We pay postage charges. You have some return privilege.



not everyone does as well, but E. O. Lockin, who started a business of his own, reports...

for 12 months I've averaged  
**\$800 PER MONTH**  
**INCOME** —  
 most of it clear profit for me!

• Mr. Lockin expresses his grateful thanks for the opportunity to make a decent living on his own. Many men have discovered how to be independent, to be free of bosses and layoffs. L. A. Eagles grossed more than \$200 his first week. R. E. Traynor says, "I made \$62 gross in one day." Others report gross up to \$12,000 per year.

How much you make depends largely on you. You need no special skill, no large investment. Can start part time until you have full time.

**No shop necessary**

Our **Electric Rug Washer** cleans rugs, carpets right on floor... helps to show their natural color and beauty. So efficient and safe, used by largest hotels and railroads:

You take no risk. Machines fully guaranteed. Mail coupon today for complete information including how to start making big profits in your own business.

**VON SCHRADER MFG. CO.**  
 RACINE, WISCONSIN

You, too, can start your own business. No special skill, no large investment required. Mail coupon today for interesting FREE book.

**VON SCHRADER MFG. CO.,**  
 W10 "R" Pl., Racine, Wisconsin

Send at once (no obligation) your FREE booklet containing information about your **Electric Rug Washer** and how I can start my own permanent, profitable business.

Name.....  
 Address.....  
 City.....Zone.....State.....



**DRAFTING is**  
 the way to *Big Income*  
**OPPORTUNITIES!**

Learn at home in your spare time. Become a professional Draftsman. Enjoy good pay, respected position in an ever growing field. CHRISTY TRAINING is easy and clear. You learn by making actual drawings, planning production, see things develop. You learn the interesting, easy-to-remember way by doing.

**PAY AS YOU LEARN PLAN**

CTS will send you 50 illustrated drafting manuals, set of professional drafting instruments, equipment and supplies plus a portable drafting table... everything you need! Send name for **FREE BOOK** and **PAY LATER FORM**. CHRISTY TRADES SCHOOL, 4804 N. Kedzie, Dept. DB-3703, Chicago 25.

**Now! TEST YOUR OWN TV & RADIO TUBES**  
 ALL OF THEM—EVEN PICTURE TUBE



Nearly half of TV service calls are due to defective filaments. Tester shows if filaments are good. Insert tube in tester. Light shows if tube is burned out. Easy, safe. One service call saved pays for tester. Metal case. AC or DC. Checks fuses, appliances, etc. Only \$3.95 ppd. or C.O.D. plus charges. De-Luxe Model \$4.95. Instructions. Guaranteed. **GEIGER ENGINEERING CORP., Dept. AB-104** 3738 West Lawrence Avenue, Chicago 25, Ill.

**FIX OUTBOARD MOTORS**

**POWERMOWERS, AND ALL SMALL 2 & 4-CYCLE GASOLINE ENGINES**

Repair your own equipment or **MAKE EXTRA MONEY** in this growing field. Fully illustrated, easy-to-understand. Home Study Course. Write for **FREE** information.

**LINCOLN TECHNICAL INSTITUTE**  
 SUITE 12-E, 472 MARKET STREET, NEWARK 5, N. J.

**FREE! 1958 PHOTO GUIDE**

36 pages crammed with newest "how-to" info; lists every type of camera, movie camera, projector, enlarger, accessory. All at low discount prices, easy time payments, generous trade-ins.

**SEND POSTCARD NOW! GRAND CENTRAL CAMERA**  
 1 East 43 Street, New York, N. Y. DEPT. 30

**TELEPHONE HAND SETS**

Western Electric and Federal Telephone Co.  
**THE SAME AS ON YOUR OWN TELEPHONE**  
**\$2.00 ea. ppd. MONEY BACK GUARANTEE**  
 M.E.C.O., INC. • 14315 Bessemer St. • Van Nuys, Calif.

**How to Build Your Own GARAGE**

Save as Much as 50% of Usual Construction Costs

Get Popular Mechanics' brand new book **How to Build Your Own Garage** by Wayne Leckey, Assistant Shop Notes Editor, and find out how you can build your own garage at savings of 50% of usual cost. Leckey tells in famous step-by-step instructions and shows in big, clear photos, drawings and diagrams how to perform every building operation from laying the concrete to installing the final trim. There are 25 designs. Brick, frame, and concrete block fully covered. Send \$3.50 for your copy. 7-day money back guarantee.

POPULAR MECHANICS PRESS, 200 E. Ontario, Chicago 11, Ill.

We Buy in Carloads, So We Sell for Less! (Not Recaps)

**GOODRICH, U. S. General, Firestone & others, worn slightly. I replace FAST any defective tire, Frt. Excl.**

**12 MONTH GUARANTEE**  
 School Busses, Hospitals & Churches use our **EXTRA MILEAGE TOP GRADE TIRES**. Written Golden Rule Guarantee sent.

**EVERYBODY MAY DEDUCT 20%** Free Tube with every Pass. Tire

**ALSO ALL SIZE NEW & USED TRACTOR FARM TIRES**

**FREE** If you buy 2 or more Passenger 4-Ply tires, we give ONE tire FREE on each order. Does not include Truck, Snow or White Wall tires.

600-16	\$5.65	640-15	\$5.42	700-15(6)	\$8.62	750-20	\$12.62
600-16(6)	6.52	670-15	5.42	700-17	10.70	825-20	19.22
650-16	5.85	710-15	5.42	750-17	11.02	900-20	19.22
650-16(6)	7.12	760-15	5.72	750-16	9.52	1000-20	19.22
700-16	6.42	800-15	6.22	650-20	10.52	1100-20	19.72
750-14	10.52	820-15	6.22	700-20	11.32	900-16 Mil.	17.52

**GENUINE STANDARD BRAND** Released by **\$9.65 NEW TIRE**  
**FACTORY ADJUSTED TIRES** Co. adjusters any car **GUAR.**

**GOODYEAR SUBURBANITE \$8.80 18 Mo.** Blat Name famous in  
 AND OTHER **GUAR.** tires 42 yrs.  
**SNOW TIRES W.W. \$1 ex.** any size

**MARVIN BLATT** 6th & Spring Garden Philadelphia, Pa. Send ck. or M.O. FOB. Phila. I personally select your tires as if my future depended on it.



## You Can Be a Local Manufacturer of CAVITEX

## SUPERFINE MASONRY

Local production explains why Cavitex can offer so much in quality for so little money, yet is so generous in profit potentials. It's a case of streamlined manufacturing—processing local materials for local building—cutting out the high costs of freight and distribution.

Cavitex creates new standards of beauty—in size, proportion and color. "Puts emphasis on the horizontal." Cored-out design for lighter weight and greater insulation values. Available in 8-inch and 4-inch.

Hundreds of territories are available to men looking for a local manufacturing enterprise. Franchise privileges. Responsible operators can obtain basic equipment on attractive rental terms. The Cavitex industry is sponsored by a million-dollar company backgrounded by fifty years of experience and reputation. Write or wire at once for "Opportunity, Unlimited" and tentative reservation of territory.



W. E. DUNN MFG. CO.  
409 W. 24 St., Holland, Mich.

X-6

## MAKE UP TO \$20 A DAY WITH



MONEY  
MAKING  
SALES PLAN FREE

tailor, dressmaker—everybody uses scissors and all need sharpening two to four times a year. Don't let some one else beat you to this opportunity. Write immediately to

SERR-EDGE MACHINE CO., 9731 Lorain Ave., Cleveland, Ohio

### VIBRO-TOOL

**BVI** Favorite Tool Kit For Hobbyists!  
Complete with 10 Attachments!

only \$14.95

Easiest-to-use tool ever invented for engraving jewelry, etching copper and steel, decorating metal, glass, tooling leather. Built-in motor delivers 7200 strokes a minute. Comes in steel chest with 10 all-purpose accessories. At your dealer. Send for free catalogue.

Burgess Vibrocrafters, Inc., Dept. A-107  
Grayslake, Ill.



## BE THE STRONGEST MAN IN YOUR COMMUNITY



### Let Me Show You How!

"I was thin, underweight and almost died of Bright's Disease in my youth. My parents' prayers and my determination brought me through and led to my discovery of four great body building secrets. These will give you giant strength in easy steps."

### BIG BOOK FREE—WRITE TODAY

"Learn how vigor, health, fine physique, the admiration of friends can be yours. Follow the simple instructions of my course—a few minutes a day and you can build your body as I have built mine." Satisfaction guaranteed. Act NOW!

PAUL ANDERSON, the world's strongest man. **PAUL ANDERSON** Dept. PW12  
Tecon, Ga.

DECEMBER 1957

## SAM HANKS, 1957 "INDY 500" winner says: "I'd like a NATIONAL SCHOOLS trained mechanic on my crew ... any employer would!"

Sam Hanks holds American Closed Course record (182.5 M.P.H.); also many state and national racing titles. At Indianapolis he was 2nd last year, 3rd in '52 and '53.



## MASTER ALL ENGINES AT HOME IN YOUR SPARE TIME NATIONAL SCHOOLS AUTO MECHANICS & DIESEL COURSE INCLUDING FUEL INJECTION

### YOU GET AND KEEP ALL THIS EQUIPMENT



Complete set of professional tools and All-Metal Tool Box. Same top-quality equipment used by expert mechanics everywhere. Use them, display them proudly.

"Motor Analyzing Set" contains Standard Engine Vacuum Fuel Pump Tester, Remote Starter Switch, Modern Timing Light, Standard Compression Tester. Plus compact carrying case & instructions.

Top-quality Socket Wrench with Fittings. Real professional tools you'll use during your lifetime career in repairing all types of engines, from foreign cars to big diesel jobs.

"I've worked alongside National Schools-trained mechanics," reports Sam Hanks. "They're tops, because they get all-around training, and they know how to repair fast and right the first time. No wonder National Schools graduates command top pay."

Earn as you learn men! We'll show you how. Streamlined lessons, diagrams, manuals, latest equipment, practical methods prepare you for hundreds of jobs in scores of industries. Free Placement Assistance.

Approved for GI Training

**FREE!**  
VALUABLE BOOK  
& SAMPLE LESSON  
JUST SEND COUPON



Resident Training at Los Angeles  
If you wish to take your Auto-Diesel training in our famous Resident School at Los Angeles, check special box in coupon for full information.

**NATIONAL SCHOOLS**  
Los Angeles 37, California

## NATIONAL SCHOOLS

TECHNICAL TRADE TRAINING SINCE 1905  
LOS ANGELES 37, CALIFORNIA

MAIL NOW  
NATIONAL SCHOOLS, Dept. DB-127

4000 S. FIGUEROA ST.  
LOS ANGELES 37, CALIF.

Send for FREE Auto-Diesel Opportunity Book and Sample Lesson.

NAME \_\_\_\_\_ AGE \_\_\_\_\_

ADDRESS \_\_\_\_\_

CITY \_\_\_\_\_ ZONE \_\_\_\_\_ STATE \_\_\_\_\_

Check if interested ONLY in Resident School Training at Los Angeles

VETERANS: Give date of discharge \_\_\_\_\_

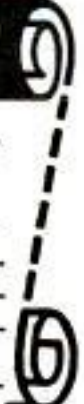

29



## I'll Send You This Handsome SAMPLE CASE—FREE!



Make up to  
\$30<sup>00</sup> in a Day!

Your Own  
Tailored Suits  
Without 1¢ Cost

If you want to make more money, spare time or full time, rush the coupon below today for this big, valuable tailoring Sample Case packed with 100 beautiful, big-value suit and overcoat samples. Just show the samples and last-minute styles to friends, fellow-workers, others. Take their orders for fine made-to-measure clothes—and pocket BIG CASH PROFITS in advance. No experience, no tailoring knowledge needed—and no money needed, ever. WE SUPPLY EVERYTHING FREE... sample case, sample suitings, equipment, complete instructions. Start making money first day!

Use Spare Evenings... Weekends... Make Money... Get Suits!

It's easy to make money taking orders in just spare time—lunch-time, evenings, weekends. When men see the fine fit, quality and value of our suits—THEY ORDER! So we make it easy for you to get your own personal suits and overcoats without paying even one penny. Don't wait! Rush coupon with your name, address, and age for FREE Sample Case.

**W. Z. GIBSON, INC., Dept. S-516**  
500 South Throop Street, Chicago 7, Illinois

**W. Z. GIBSON, INC., Dept. S-516**

500 S. Throop St., Chicago 7, Ill.  
Please rush ABSOLUTELY FREE the valuable Sample Case with suit fabrics and style display. Include instructions, money-making plans and details for getting my own suits without paying one cent.

Name.....Age.....

Address.....

City.....State.....

## NEVER AT THIS LOW PRICE! GENUINE 135-POWER ACHROMATIC TELESCOPE

with Achromatic Lens and  
4-POWER FINDER attached

ONLY  
\$18<sup>95</sup>  
PREPAID

### EXTRA BONUS GIFTS:

- 273 page book, "Handbook of the Heavens"
- Magic Star Finder Dial
- 220X & 400X Eyepiece lenses

**5 Magnifications 18X—35X—65X—85X—135X**  
Brings the Moon, Planets, Stars, Satellites, People  
135 times Closer, Clearer, Sharper

Never before has an ACHROMATIC 135X telescope with range finder and tripod sold for anywhere near this amazing low price! Now you can not only explore the heavens and bring the moon, planets, stars, satellites 135 times closer, but you can observe all distant objects, people, ships too, because all pictures are erect, not upside down as in all astronomical telescopes. The kind of needle-sharp color-free viewing only a genuine achromatic lens can bring you. Ready for immediate use. 5 precision lenses bring you viewing at 18X—35X—65X—85X—135X. Tubes extend to 43" made of bakelite, finished in camera bellows black, trimmed with gleaming brass. 4 power finder scope (30mm Lens) mounted on main tube is feature usually found on more expensive telescopes—brings difficult objects on target before observing with main scope. For extra stability 5 ft. hardwood folding tripod is equipped with heavy cast iron head fitted with Criterion's famous 360 degree all aluminum mount that locks instantly in any position. Obtainable only from Criterion Co. shipped prepaid. 4 famous gifts—273 page book "Handbook of the Heavens." Magic star finder dial that aids in locating stars ANYWHERE at ANYTIME of the year. 220X & 400X eyepiece lenses included free for experiments. You must be completely satisfied with this super offer or your money back in full. Shipped Complete, nothing else to buy at amazingly low price of \$18.95. Without tripod \$14.95. Send Cash, Check, or Money Order today

Dept. PMA19, CRITERION CO., 331 Church St., Hartford, Conn.

## REPAIR ANY WATCH



... Swiss or American

No previous experience needed to learn modern watch repair. An enjoyable hobby or profitable career. Unique Sweazey System starts you making repairs right away. Develops your skill step by step. Teaches you modern shop methods... professional short cuts... mistakes to avoid. Learn by personal attendance or spare time home study. Free sample lesson. No obligation. Write today!

FREE  
SAMPLE  
LESSON

**CHICAGO SCHOOL OF WATCHMAKING**  
2330 N. Milwaukee, Dept. 1127, Chicago 47, Illinois

## LEARN UPHOLSTERY

EARN  
MORE  
MONEY

YOU'RE IN BUSINESS RIGHT OFF—Practical course, complete upholsterer's tools, materials, frames, all you need to earn while you learn AT HOME. N. Y. State-approved professional training in upholstery, slip covers, etc. Big Opportunity Field. Send for FREE Illust. Catalog. FREE Sample Lesson. Write Today. Approved for Vets.

Upholstery Trades School, Dept. FX-312, 721 Broadway, New York 3, N.Y.

## TASOPE PHOTO-ENGRAVING PLANTS



Establish your own profitable PHOTO-ENGRAVING business. Make cuts for newspapers, printers, and advertisers. Make etched name plates, plaques etc. Instructions furnished, no experience necessary. Sold direct from factory since 1931. First five hundred cuts sold locally or by mail will pay for plant and pay you well for your time. Write for FREE catalog.

Material Cost  
Of This Cut 34¢  
Selling Price  
\$1.00 And Up

TASOPE, DEPT. PM-12, AURORA, MO.

## SEND ME



every month so I am sure to  
see each new issue. Here's

- \$3.50 for 1 year  
 \$8.00 for 3 years

name

address

city

zone

state

Hand this order to your newsdealer or send it to  
**POPULAR MECHANICS**  
200 East Ontario St. Chicago 11, Ill.





**Mannlicher**  
**CARCANO**  
**CARBINE** \$12.95

**6-SHOT BOLT ACTION HUNTERS!**

Here is the hard-hitting, extremely accurate and powerful Carcano carbine, elite small arm of the Italian Army, all milled parts. Built with famous Mannlicher action. Bore guaranteed good. Barley-corn front sight, adjustable rear. Excellent saddle weapon. Compact, fast handling, deadly on big game. 7.55 MM SOFTNOSE SPORTING AMMO, 20 rds., \$2.80. Military ammo, 54 rds., \$3.40. TO ORDER! Send check, cash or N.O. 1/2 deposit for C.O.D. Shipped FOB Pasadena, Calif. res. add 4% state tax. 10-day money back guarantee.

**GOLDEN STATE ARMS CORP.**  
188 W. Green Street, Pasadena 248, Calif.

## Free Book on Arthritis And Rheumatism

**HOW TO AVOID CRIPPLING DEFORMITIES**  
Explains why drugs and medicine give only temporary relief and fail to remove the causes; tells all about a specialized non-surgical, non-medical treatment which has proven successful since 1919. Write for this 36-page FREE BOOK today.

**BALL CLINIC Dept. 756 Excelsior Springs, Mo.**

**Be A FLORIST** Thousands of money making opportunities full or part time. Many start business in own home. Flower arrangement included to enable you to make professional corsages, sprays, etc. Professional material supplied with Home Study Training. Write for FREE Book.

**NATIONAL LANDSCAPE INSTITUTE**  
Studio M-127 11826 San Vicente Blvd. Los Angeles 49, Calif.

**on any object ELECTROPLATE**  
ANY OBJECT IN HOME SHOP GARAGE.

NOW with our NEW ELECTROCHEMICAL outfit. You can easily do your own plating. Not a paint. But a hard durable metal plate, equal to commercial plating. Get your own plating kit with instructions on plating metal and non-metal objects as Tools, Auto Parts, Silverware, Jewelry, Baby Shoes and 1001 other articles with Chrome, Nickel, Copper, Gold, etc. SEND NO MONEY. Everything sent C.O.D. for the low price of ONLY \$5.95 or send \$5.95 now and receive it postpaid. Money back in 7 days if not satisfied. M. Z. SALES CO., Dept. G-16, 118 West 42nd St., New York 36, N. Y.



**EARN BIG PAY**

**COURSES OPEN IN SHOP METHOD TRADES TRAINING**

THE TRAINED MAN GETS THE BREAKS  
PRACTICAL & HOME STUDY COURSES

**CHECK YOUR COURSE HERE AND MAIL**

WELDING  AIR CONDITIONING  
 AUTO MECHANICS  DIESEL  
 TELEVISION & ELECTRONICS  
 RADIO  PHOTOGRAPHY  
 REFRIGERATION  DRAFTING  
 COMMERCIAL ART

**Chicago Vocational Training Corporation**

DIPLOMAS AWARDED GRADUATES

PLACEMENT SERVICE MAINTAINED TO ASSIST GRADUATES

For Full Details without obligation write to our information office: Department AW, 3330 University Ave. S.E., Minneapolis, Minn.

IN CANADA:  
English—935 Weston Road, Toronto 9, Ontario  
French—65 Jean Talon St., W Montreal, Quebec.

**OPERATING FOR A QUARTER CENTURY COAST TO COAST**

**SHORTHAND IN 6 WEEKS**

Famous SPEEDWRITING shorthand. 120 words per minute. No symbols; no machines; uses ABC's. Easiest to learn, write and transcribe. Low cost. For business and Civil Service. Over 350,000 graduates. Typing available. 35th Year. Schools in over 400 cities. Write for FREE booklet to:

**Speedwriting**  
Dept. 1512-7  
55 W. 42 St., N. Y. 36, N. Y.

# INVESTIGATE ACCIDENTS

Train quickly in your own home for repeat income in the exciting, secure Claim Investigation and Claim Adjusting field. Our students and graduates are already earning \$4, \$5, \$6 an hour extra SPARE TIME — and up to \$10,000 a year Full Time. You need NO prior experience or higher education. Your age does NOT matter.

## HERE IS YOUR CHANCE FOR ACTION AND REAL JOB SECURITY

As a trained Claim Investigator you will (1) INVESTIGATE FACTS and (2) DISTRIBUTE MONEY as the representative of wealthy organizations.

No other business offers you greater opportunities for success and security. Here's why: The huge, rapidly expanding Claim Investigation and Adjusting Profession right now distributes more money than any other service industry. And it's growing fast. Over 200 MILLION ACCIDENTS must be investigated this year for Insurance Companies, Airlines, Railroads, Steamship Lines, and Government Offices.

**MAIL NOW for FREE BOOK** →

SEND TODAY for Big, FREE, Illustrated Catalog. Learn the exciting facts about Universal Schools' low cost training. No obligation. No salesman will call. GI APPROVED.



**UNIVERSAL SCHOOLS**  
6801 Hillcrest Ave.  
Dept. PM-12, Dallas 5, Texas

Please rush me your FREE book on Claim Investigation. This does not obligate me and no salesman will call.

Name \_\_\_\_\_ Age \_\_\_\_\_

Address \_\_\_\_\_

City \_\_\_\_\_ Zone \_\_\_\_\_ State \_\_\_\_\_

Approved by Government for Korean Veterans



# UNIMAT



## MINIATURE MACHINE SHOP

"No bigger than a typewriter, outperforms machines many times its size." That's what a popular publication says about UNIMAT in a 3 page feature story. UNIMAT is the precision tool that craftsmen, inventors and hobbyists dream about. You just can't beat it for machining small parts from steel, brass, aluminum, wood and plastic. You'll want a free reprint of this story plus complete information about this amazing 10 in 1 workshop. Write today to:

AMERICAN EDELSTAAL, INC. • UNIMAT DIVISION  
Dept. 312 • 350 Broadway • New York 13, N.Y.

## "I'M MAKING MORE THAN \$1000 a Month Haven't Touched Bottom Yet!"



C. KAMA

—reports Charles Kama, Texas, one of many who are "cleaning up" with orders for PRESTO. Science's New Midget Miracle Fire Extinguisher. So can YOU!



Amazing new kind of fire extinguisher. Tiny "Presto" does job of bulky extinguishers that cost 4 times as much, are 8 times as heavy. Ends fires fast as 2 seconds. Never corrodes.

Guaranteed for 20 years! Over 2 million sold! Sells for only \$4.95.

Show it to civil defense workers, owners of homes, cars, boats, farms, etc., and to stores for resale—make good income. H. J. Kerr reports \$20 a day. Wm. Wydallis \$15.20 an hour. FREE Sales Kit. No obligation.

MERLITE INDUSTRIES, Dept. P-15D  
PRESTO DIV., 114 E. 32 St., New York 16, N.Y.  
Canada: Mopa Co., Ltd., 371 Dowd St., Montreal 1, P.Q.

**WAR SURPLUS BARGAINS**

**WAR SURPLUS BARGAINS**

**\$500,000.00 INVENTORY for QUICK LIQUIDATION**

Surplus items—hundreds of them for home, shop, factory, farm and outdoor use. New items, used items, reconditioned items—all at tremendous savings—all priced for quick sale.

**Page After Page of Values**

This big catalog shows page after page of amazing money saving values. Write for your copy today. Send 10c to cover postage, mailing, etc. Write today! **SEND TODAY FOR YOUR COPY**

10c

**STARK'S** 212 W. Madison St.  
Dept. PM-5712  
CHICAGO 6, ILL.

**Free! SCARCE TRIANGLE COLLECTION**

Get this big valuable collection of triangle stamps... brought to you from the wilds of Africa, Europe, exotic Latin America, etc. All genuine, all different: scarce airmails, commemoratives, giant & midget stamps. EXTRA! Bargain Catalog, "Collectors Manual" and other exciting offers. Send 10c for mailing costs. Supplies limited, ACT NOW!

**Jamestown Stamp Co., Dept. H12PM, Jamestown, N. Y.**

**TY DAN, THE MUSCLE MAN SAYS**

**I'LL GUARANTEE YOU RIPPING MUSCLES**

IN 6 WEEKS OR MONEY BACK

You can have tremendous power, look bigger, have more confidence this tested way. Revolutionary new "Body Mold" course builds your body in a way no other method can match. Get course FREE with order. Lowest factory price.

**DAN LURIE BARBELLS**

50 lb. set \$ 4.95 • 100 lb. set \$14.95  
150 lb. set \$21.95 • 200 lb. set \$27.95  
Extra 10% — 1% per lb. 50% cash, balance C.O.D. FOR PLEASANT

**DAN LURIE BARBELL CO.**  
52M12 Bristol St., Dept. 759N, Bklyn 12, N.Y.

**FREE! SEND FOR NEW SPORTS & HEALTH CATALOG**

**WHOLESALE Electric Guitars - Parts - Factory to You**

Solid-body Spanish, amplifiers, four neck guitars, double-necks, single-necks, triple-necks, solid-body mandolin, pickup mikes, non-electric instruments, etc. 1958 Models wholesale. FREE CATALOG. Free home study course with instruments. Parts & plans available to build your own.

**CARVIN CO., Box 287, PM-12, Covina, Calif.**

**\$2.95 OR 2 FOR \$5.00!**

**TESTED AND GUARANTEED**

Write for free list on all types of telephones. Shipments F.O.B. Simpson, Pa.

**TELEPHONE ENGINEERING CO., Dept. 1287, Simpson, Pa.**

**HOW TO BREAK and TRAIN HORSES**

**SEND FOR THIS FREE!**

Make money. Know how to break and train horses. Write today for this book FREE, together with special offer of a course in Animal Breeding. If you are interested in Galting and Ridding the saddle horse, check here ( ) Do it today—now.

**BEERY SCHOOL OF HORSEMANSHIP**  
Dept. 11012 Pleasant Hill, Ohio

**ONE MILLION DOLLARS CASH IN CONFEDERATE MONEY**

**Yours only \$2.98**

Be a deep south millionaire! Have money to burn! We'll send you exactly one million bucks in honest-to-goodness Confederate money—and all you pay is \$2.98! You can do everything with this money but spend it. Amaze and amuse your cotton-pickin' friends. Win bar bets by the barrel! Light your cigars and cigarettes with \$10.00 bills! Live it up! It's a million dollars worth of laughs and fun—all for only \$2.98.

You get one million bucks in \$10's, \$20's, \$50's, \$100's etc. denominations—enough to keep your friends laughing and happy for months—This offer is limited. Only \$4 million dollars to a customer. Our supply of this loot is limited—so rush your order.

One Million dollars only \$2.98. Four Million Dollars only \$10.00. It was delighted keep \$100,000 for your trouble and return the rest of the money for a full and prompt refund. Send to —BEST VALUES CO., Dept. M-151, 403 Market St., Newark, N.J.



**FOR QUICK STARTING . . .  
SMOOTH ACCELERATION  
NO STALLING — BETTER MILEAGE**

INSTALL A **MILESMASTER**®

**FUEL PRESSURE REGULATOR**



Let Milesmaster help you enjoy better, more economical motoring. Sold everywhere . . . only \$6.95.

**Money Back Guarantee**

Dept. K

**MILESMASTER, INC.** Exeland, Wisconsin



**Train at Home for  
a Top-Pay Job in AUTO  
MECHANICS**

Skill adds many extra dollars to your pay check. This is especially true in the auto field, where 100,000 mechanics are needed. Average pay in some areas is \$3 per hour. It's easy to train at home in spare time for a secure job with a bright future, in America's No. 1 industry. *Mail coupon for full details. No cost nor obligation.*

**Get Experience Using Tune-Up Kit & Tools**



CTI sends you a Tune-Up Kit, the kind that skilled mechanics use to locate engine troubles. You receive a compression Tester; Vacuum Gauge & Fuel Pump Tester; Ignition Timing Light; portable steel case. You also get mechanic's tools, including socket set. You acquire experience using kits.

**DIESEL MECHANICS OR BODY-FENDER REBUILDING** is yours at no extra cost. Only CTI offers this extra choice. You get fully-rounded training in all phases of mechanics.

**Many Students Earn Money as They Train**

by taking part-time jobs in local shops or fixing cars "on their own." Many make enough to pay all tuition and buy extra equipment. Some open shops, become independent.

**Get Facts Now—Decide Later MAIL TODAY**

Your future is worth looking into. Get facts on job and business opportunities. Mail coupon today—Commercial Trades Institute, Chicago 26, Ill.

**FREE  
BOOKLETS**

**COMMERCIAL TRADES INSTITUTE**

1400 GREENLEAF AVENUE

CHICAGO 26, ILLINOIS

DEPT. A-687

Send booklet, *Big Money in Auto Mechanics*, and *Sample Lesson*. Both are FREE.

Name \_\_\_\_\_ Age \_\_\_\_\_

Address \_\_\_\_\_

City \_\_\_\_\_ Zone \_\_\_\_\_ State \_\_\_\_\_

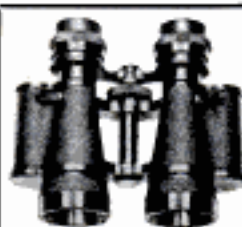

**7 x 35  
FIELD GLASS  
\$14.95!**

INTRODUCTORY SALE. For the FIRST time due to mass volume buying—a 7x35 center focus UNITED Field Glass is being offered for only \$14.95! Don't confuse with cheap toy glasses. Handsome. Sturdy. Precision made. Metal fittings throughout. Whisper weight 13 oz! 4 3/4" high! Carry Famous UNITED "Seal of Quality" trademark and sold on 30 DAY MONEY BACK FREE TRIAL GUARANTEE! Made in Japan. Fine leather case, straps included. Cash orders post-paid. C.O.D.'s require \$2.00 deposit. Add 10% Federal Tax. UNITED BINOCULAR CO., 8043 S. Western Ave., Dept. FRP-1908, Chicago 20.

**PLANS · PATTERNS · FRAME PACS**

World's Largest Selection. Over 200 new plans, Full Size patterns, frame pacs. Designed for the amateur. Frigs, racers, cruisers, utilities, inboards, outboards, in wood, plywood, steel. New longitudinal stressed models with revolutionary bulkhead construction. Light, super strong. **Send 35c for 120 pg. PLAN CATALOG** Catalog plus Boat Building Handbook.....\$1.00 **SPECIAL OFFER. . . .** Plan Catalog . . . plus Hardware and Accessories catalog.....\$1.00



**SPECIAL!**  
• 120 PAGE PLAN CATALOG PLUS  
• 200 PAGE "BOAT BUILDING FOR THE AMATEUR" COVERS BOAT BUILDING FIBER-GLASSING OUTFITTING, ETC.  
**Only \$2.50**

CUSTOM-CRAFT-BUFFALO 7 NEW YORK

**LAW...**

**STUDY AT HOME** Legally trained men win higher positions and bigger success in business and public life. Greater opportunities now than ever before.

**More Ability: More Prestige: More Money** We guide you step by step. You can train at home during spare time. Degree of L.L.B. We furnish all text material, including 14-volume Law Library. Low cost, easy terms. Get our valuable "Law Training for Leadership" and "Evidence" books FREE. Send NOW.

LASALLE EXTENSION UNIVERSITY, 417 South Dearborn Street  
A Correspondence Institution Dept. 2264L Chicago 5, Ill.

**COMPLETE YOUR HOME WORKSHOP**

WITH A . . . **RELIABLE  
BENCH  
FURNACE**

MODEL SHOWN

**\$52.50  
PP**

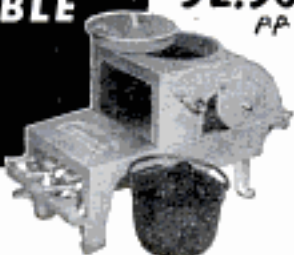

The home hobbyist will find the side door perfect for heating long bars, soldering irons, drills etc. The Reliable Bench Furnace also is equipped with a removable pot for melting all soft metals and alloys.

**FREE!**

Specifications and literature on complete line.

**WRITE TODAY!  
RELIABLE**

**MACHINE & MFG. CO., INC.**  
420 H Ave. N.W. Cedar Rapids, Ia.



**"TOOK IN \$217  
FIRST 10 DAYS"**

Some make more, some less

**We help you to start Your  
Own All-Year Business!**

**Make Big Money!** With our easily operated, highly efficient wall washer, Chas. Stelle took in \$217 gross in first ten days. E. L. Goss took in more than \$10,000 in one year. E. C. Taber wrote, "I made \$400 gross in two weeks." And no wonder—this machine washes walls 6 times faster and better than by hand. **Your Money-making Opportunity. Enjoy independence—freedom from bosses, layoffs. Customers everywhere—homes, offices, schools, etc. Expenses low, profits high. No shop necessary; operate from home. Can start spare time until your full time is available.**

**Lose no time. Get all facts without obligation**

**FREE BOOK! MAIL COUPON TODAY!**

- **VON SCHRADER MFG. CO.**
- **W10 "W" Pl., Racine, Wisconsin**
- **Send at once (no obligation) your FREE booklet containing information about your WALL WASHING MACHINE and how I can start my own permanent, profitable business.**
- **Name \_\_\_\_\_**
- **Address \_\_\_\_\_**
- **City \_\_\_\_\_ Zone \_\_\_\_\_ State \_\_\_\_\_**



**NEW MAGIC RADIO WALKIE TALKIE!**

**YOUR OWN POCKET SIZE RADIO STATION!**

BROADCASTS TO ANY HOME OR CAR RADIO WITHOUT WIRES OR HOOKUPS! Wt. only 5 oz. Size, 1 1/2" x 3 1/2". Built-in telescoping antenna. Powerful transistor-sensitive microphone, frequency setter, break-in switch! Runs for weeks on self-contained flashlight batteries. Durable plastic case. With this Radio Talkie you CAN TALK TO YOUR FRIENDS UP TO A BLOCK OR MORE AWAY! Talk up to 1 mile or more between two automobiles. INSTANT OPERATION! Just push button to talk! No license needed. Uses invisible fluid magnetic radiation. Useful and real fun in a million ways! **GUARANTEED TO WORK. 1 YEAR SERVICE GUARANTEE.**

**SEND ONLY \$2.00.** (cash, ck., mo) and pay postman \$9.98 (COD) postage or send \$11.98 for prepaid delivery. COMPLETE READY TO OPERATE with instructions and hundreds of ways and tricks for broadcasts thru any radio you desire. Price may go up soon, so get your NEW POWERFUL RADIO WALKIE TALKIE NOW. Available only from **WESTERN RADIO, Dept. RPM-12, KEARNEY, NEBR.**



**4-WHEEL DRIVE OWNERS**

21 MODELS INCLUDING JEEPS

**NEW AXLE POSITIONER**

... Instant, positive engagement

**FRONT DRIVE WITH  
FREE-LOCK HUBS**

**LOW OPERATING COSTS**

All parts stop ONLY WHEELS MOVE

In 2-wheel drive no parts moving



**NO Rocking to Engage Hubs**

Engaging hub is instant and positive with the new Axle Positioner. First time available in any hub **Unconditionally guaranteed for 1 year!**

See your dealer or write for **FREE literature.**

**FREE-LOCK CORPORATION**

6301 N. Federal Blvd. Denver 21, Colorado

**FORD OWNERS**

*save money!*



**Make Your Ford Run Better . . . Last Longer . . . and Save Hundreds of Dollars with PM's Completely New MANUAL FOR FORD OWNERS!**

Get this book, written especially for you, without one penny of risk and get more out of your car. Mail coupon for **MANUAL FOR FORD OWNERS** today. When the book comes, skip through the pages and see how your investment in one of America's most popular automobiles can be even a better investment than you thought. If you don't agree, send the book back and you'll get your money back.

**A Popular Mechanics Book Written Just for You**

Not a re-hash of service manuals. A complete new Popular Mechanics book written for the Ford owner by an outstanding automotive authority with the full cooperation of Ford engineers and service directors. It will save you money on repairs and service; make your Ford last longer; give you safe, economical and trouble-free motoring. And this is true whether you take your Ford to a regular service station or service it at home.

**Prevents Trouble. Cuts Down on Repair Bills**

Nothing like this manual anywhere. It covers all phases of operation, service and maintenance. It has entire chapters on the individual parts of your Ford—battery, ignition, starter, generator, regulator, lighting, fuel system, engine, lubrication, gasoline qualities, cooling systems, transmission, differential, rear axle, brakes, wheel alignment, tire care, body maintenance, trouble shooting on the road, etc. It covers your Ford, new and older models, step by step—bumper to bumper—showing you how parts operate; what can go wrong; how repairs and adjustments should be made and how to avoid all types of trouble.

**Money Back If Not Satisfied**

Mail the coupon today. Send only \$3.50 or you can pay postman. Money back guarantee protects you.

**Official, Authoritative, Practical Information**

Written by C. E. Packer, formerly service school instructor and auto show lecturer for automobile manufacturers. Member Society of Automotive Engineers, Special Services Editor of Automobile Digest, contributor to leading magazines, author of some of the biggest selling books on Automotive subjects.

*All New!*

**Covers All Models 1950 to 1958**



**368 Pages. Hundreds of How-To-Do-It Illustrations and Diagrams**

The entire book follows Popular Mechanics famous easy-to-read and easy-to-understand style. While primarily intended for the Ford owner, to help him get more out of his car at lower cost, it can be worth its weight in gold to the auto mechanic and service station operator who works, not only on Fords, but on all other makes as well, to which the information in the book can be easily applied.

*Order on this Coupon*

**POPULAR MECHANICS PRESS, Dept. 1257  
200 E. Ontario St., Chicago 11, Ill.**

Send Manual for Ford Owners at once. If not satisfactory I will return it within 7 days and you will refund full purchase price.

Remittance for \$3.50 enclosed.  Send C.O.D.

Name \_\_\_\_\_

Address \_\_\_\_\_

City \_\_\_\_\_ State \_\_\_\_\_

**POPULAR MECHANICS**

Copyrighted material



# EARN \$100 A WEEK AND UP

## BE AN AUTO-DIESEL MECHANIC — EARN WHILE YOU LEARN

Many of our graduates earn \$100 a week and up. You learn fast in our school and shops because you learn with tools on real equipment. Experienced instructors explain WHY and show you HOW, then you DO IT YOURSELF. One of the best equipped technical schools in the United States. Thirty-nine years' experience training men. Successful graduates in 48 states and many foreign countries. Approved for veterans. Day and evening classes. Free bulletin—write today.  
**NASHVILLE AUTO-DIESEL COLLEGE**  
226 7th Ave. N., Dept. 86, Nashville, Tenn.

## Finish HIGH SCHOOL AT HOME

Complete 4 Yrs. in 12 Months

Learn More! Earn More! Enter professional or technical schools. Advance Socially. Live a Happier, Fuller Life. Individual Courses or complete schedule. WRITE FOR SCHOOL BULLETIN.

### ACADEMY FOR ADULTS

30 W. Washington, Dept. PM-127, Chicago, Ill.

## LOOK WHAT 1c WILL BUY!

### 100 Blue Steel Blades for 1c ea.

100 Genuine BLUE surgical steel double-edge blades for 1c each. Not a close-out! New, first-quality, guaranteed to fit your razor perfectly. Guaranteed to give same close shaves as brands costing 20 for 98c—or money back. Thousands sold. Send one dollar for prompt free delivery. THORESEN, Inc., Dept. 6-N-131, 595 WATER STREET, NEW YORK 2, N. Y.

## Learn LANDSCAPE GARDENING

A thorough, interesting home study course for those who wish to become a Landscaper, Garden Consultant, Contractor or Designer for profit or pleasure. Write today for FREE Booklet.

NATIONAL LANDSCAPE INSTITUTE  
Dept. M-127 11826 San Vicente Blvd. Los Angeles 49, Calif.

## BUY IT WHOLESALE!

SAVE  
30-80%

FOR SELF OR RESELL FOR BIG PROFITS! NAME BRAND APPLIANCES, TOOLS, WATCHES, CAMERAS, PHONOS, SEWING MACHINES, JEWELRY, HOUSEWARES, SPORTING GOODS, TYPEWRITERS, ETC.

GET OUR BIG WHOLESALE CATALOG OF OVER 2,000 PROFIT MAKING ITEMS! POSTCARD BRINGS DETAILS FREE! MAIL TODAY!

Consolidated DISTRIBUTORS  
CLIFTON 1, N. J.

## STOP THE COLD! DUCK-IT Only



Real comfort in cold climates for sportsmen. Excellent camouflage for stalking ducks, deer, etc. Keeps face, neck, and ears warm during long exposure. Warm over face or under chin. Heavy, durable yet soft and flexible. Fits all head sizes. 100% wool. Send \$1.98 to  
**WOOLWEAR COMPANY**  
Box 12 N San Gabriel, Calif.

# I WILL TRAIN YOU FOR RADIO-TELEVISION

ON MY EXCLUSIVE  
NO-OBLIGATION  
NO-RISK TRAINING PLAN



Frank L. Sprayberry,  
Educational  
Director

Let me prove to you . . . without cost or obligation . . . that I can prepare you to be a Radio-Television Serviceman in 10 Months or Less

Let the true facts speak for themselves! That's why I want you to have my big new catalog and an actual sample lesson of Sprayberry Training . . . both FREE! Read, then make up your own mind! Train on my exclusive NO OBLIGATION PLAN . . . which means you DO NOT sign any kind of time payment contract. You pay for and accept your training as fast or as slowly as you wish. Prepare now for big paying jobs in Radio-TV or your own business. I will help you earn while you learn . . . in spare hours at home.



## Get Practical Experience with 25 Kits of Radio-TV Parts

Practical experience counts most. In addition to modern lessons, you train with actual parts and equipment. Build the famous Sprayberry Training Television Set, Multi-Range Tester, 2-Band Radio, other Test Equipment—all yours to keep. Get latest training

on Color TV, Transistors, Hi-Fi and UHF Conversions . . . included to make your training more valuable.

You owe it to yourself to get all the facts . . . Mail coupon for catalog and sample lesson — FREE

See for yourself . . . in actual pictures and descriptions . . . why Sprayberry Radio-Television Training offers more. Backed by almost 25 years of training experience. Three training plans to suit your exact needs. Rush coupon today for big new catalog and sample lesson. No obligation; no salesman will call.

## SPRAYBERRY ACADEMY OF RADIO-TV

Dept. 10-W, 1512 Jarvis Ave., Chicago 26, Illinois

TWO  
BIG  
FREE  
BOOKS

## Mail Coupon Today!



SPRAYBERRY ACADEMY OF RADIO-TELEVISION  
Dept. 10-W, 1512 Jarvis Ave.,  
Chicago 26, Illinois

Please rush catalog on your ALL-NEW Radio-Television Training Plans. I understand this does not obligate me and that no salesman will call. Include Sample Lesson FREE.

Name \_\_\_\_\_ Age \_\_\_\_\_

Address \_\_\_\_\_

City \_\_\_\_\_ Zone \_\_\_\_\_ State \_\_\_\_\_





**MEN! Make up to  
\$1,000 IN A  
MONTH!**

**without "SELLING"**

**Sensational Demand for Low-Priced Fire Alarm PLUS Sure-Fire "No-Selling" Plan Offers Ambitious Men Huge Profit Opportunities**



Even beginners cleaning up unbelievable profits with first practical, effective, low priced Fire Alarm. Needed in homes, factories, offices, stores, on farms, etc. Merlite Fire Alarm hangs on wall like a picture... no wiring, no installation. It's always on guard, "smells" fire before danger point. When temperature rises, Fire Alarm goes off automatically, howls loud warning that can be heard 1/5 mile, wakes up soundest sleeper, gives precious time to put out fire, call fire department, or escape. Sells for only \$4.95, with profit up to \$2.70 on each one.

**Nearest Thing to Automation Selling**

With our field-tested plan customers sell themselves. No cold canvassing; no hard selling. It's the nearest thing to "Automation Selling." Even a child can use plan successfully with powerful sales tools we give you (which you leave with prospects). This plan makes money for you even while you sleep! No room here to give you full details, but write for amazing facts.

**FREE SALES KIT**

Send no money. Just rush your name and address for all the exciting money-making facts, complete Illustrated Sales Kit, everything you need to make money first day. Learn how selling only 20 Fire Alarms a day brings you \$1,080.00 a month. No competition. Rush your name and address today.

**Dramatic  
LIGHTED-MATCH  
DEMONSTRATION**

Sensitive!  
Lighted match  
triggers Alarm  
in 3 seconds!

**MERLITE INDUSTRIES, INC. (Alarm Div.)**

114 E. 32nd St., Dept. S-15D New York 16, N. Y.  
IN CANADA: Mopa Co., Ltd., 371 Dowd St., Montreal 1, P. Q.

**BELT SANDER**



**MAKES ALL SANDING JOBS EASIER!  
BUILT-IN FAN-COOLED MOTOR!**

only  
**\$24<sup>95</sup>**

Makes rough and fine-finish jobs go quicker, easier. Positive chain drive. Change sanding belts in less than 10 seconds. Rugged cast aluminum housing for light weight. At your dealer. Send postcard for free catalogue.



Burgess Vibrocrafters, Inc., Dept. A-108, Grayslake, Ill.

**GENUINE  
360 POWER  
3" REFLECTING  
TELESCOPE**

**COMPLETE WITH  
50X, 120X, 150X, 360X  
magnifications, 4X finder scope,  
folding tripod, plus "Handbook  
of Heavens" & Magic Star Finder**



Only  
**\$26<sup>95</sup>**

Never before a precision reflecting telescope sold with all these features, for anywhere near this low price. Professional observations guaranteed with this powerful astronomical telescope. Equipped with special WIDE-ANGLE lens for observing satellites, stars, nebulae, comets, Saturn's rings, Jupiter, Mars, Moon's detail, other celestial phenomena with observatory clearness, amazing closeups guaranteed on all objects. Will "split" close double stars. Acclaimed by experts. Optically & scientifically correct, for serious astronomical work. Comes completely assembled ready to use. Eyepieces give full range of powers, 50X, 120X, 150X, 360X. 3 inch f12.5 mirror aluminized & overcoated, guaranteed to resolve to Dawes limit. Special ventilated aluminum mirror housing for use in all climates. 3 foot hardwood folding tripod. Equatorial, alt-azimuth mount. Aluminum head compensates for earth's rotation & permits automatic tracking of astronomical objects. 36" Bakelite phenolic tube. 4X finder scope sights target fast. Completely portable; scope instantly removable from tripod for easy storage & carrying to remote areas. Also included with this amazing precision instrument, 270 page book "Handbook of the Heavens," Magic Star Finder. Satisfaction completely guaranteed or money refunded. Sent complete, nothing else to buy at the amazing low price of only \$26.95. Send cash, check, or money order. Shipped by express F.O.B. Shipping weight 10 lbs. Dept. DPM 2, OPTIK INSTRUMENTS CO., 509 Fifth Ave., N. Y. 17, N.Y.

**INVENTORS**

**PROTECT YOUR INVENTION BY A  
U. S. PATENT. SEND FOR FREE  
"INVENTION RECORD" FORM AND  
"PATENT INFORMATION  
EVERY INVENTOR SHOULD HAVE."**

**CARL MILLER  
REGISTERED PATENT ATTORNEY  
WOOLWORTH BLDG., 36th FLOOR, 127A  
NEW YORK CITY**



**INVENTORS**

U. S. Patents protect your inventions. Our free book of "Instructions on Patent Procedure for Inventors," also "Certificate of Invention" form sent without obligation.

**C. A. SNOW & CO.  
REGISTERED PATENT ATTORNEYS  
428 SNOW BUILDING WASHINGTON 1, D. C.**

**INVENTORS**

Whether an invention is patentable can be substantially determined by a search of the U. S. Patent records. Without obligation, write for information explaining the steps you should take to secure a patent.

**JOHN W. RANDOLPH  
Registered Patent Attorney  
201 Columbian Building, Washington 1, D. C.**

**INVENTORS**

Send for **REGISTERED PATENT  
PATENT INFORMATION ATTORNEY**  
Book and **ASSOCIATE EXAMINER**  
**INVENTOR'S RECORD** U.S. PAT. OFF. 1922-1929  
without obligation  
**GUSTAVE MILLER** Patent Attorney & Advisor  
127-PM WARNER BUILDING U. S. NAVY DEPT. 1930-1947  
WASHINGTON 4, D. C. **PATENT LAWYER**

**INVENTORS**

I shall be pleased to furnish you, upon request, with full information relative to patent procedure—without any obligation on your part.

**PATRICK D. BEAVERS  
Registered Patent Attorney  
934 Columbian Building Washington 1, D. C.**

**Christmas LAWN CUTOUTS**



Give a cheerful greeting to passersby! These jolly cutouts are easy to make, fun to display, children love them! Just cut to pattern 3/4-in. exterior plywood or hardboard, prime, draw in features and clothing detail from pattern, paint in gay colors. That's all there is to it!

**Order These FULL-SIZE PATTERNS!**

Plan #121. Jolly Santa. Always a favorite..... **50c**  
Plan #122. Sleigh & Reindeer (for lawn or roof)..... **\$1.00**

**POPULAR MECHANICS PRESS**

Dept. 1257, 200 East Ontario Street, Chicago 11, Illinois  
RUSH  Plan #121  Plan #122. I enclose.  
Name \_\_\_\_\_  
Address \_\_\_\_\_  
City \_\_\_\_\_ Zone \_\_\_\_\_ State \_\_\_\_\_



## NEW MINIATURE PRE-CUT MODEL HOME KIT



The "Wilshire" — \$4.95  
postpaid

**A & B MODEL BUILDERS, INC.**  
1905-A West 45th Kansas City, Kansas

Amazing authentic detail— $\frac{1}{4}$  in. scale. Ideal gift. Easy to assemble — materials are also available for designing your own home. Send for actual miniature window, door, siding, shingles and catalog showing other pre-cut models—25c.

## Locksmithing AND KEY MAKING

**Now Made Easy!** Practical up-to-date course teaches you how to pick locks, de-code, make master keys, repair, install, service, etc. New self-instruction lessons for every handyman, homeowner, carpenter, mechanic, service station operator, fix-it shop, hardware dealer, gunsmith. 63 easy illustrated lessons. Full price only \$4.95 postpaid or C.O.D. plus postage. Satisfaction or refund guaranteed.

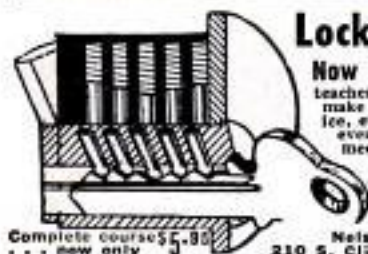

Complete course \$5.80  
... new only

Nelson-Hall Co., Dept. MT-2  
210 S. Clinton St. Chicago 6, Ill.

## A POSTCARD CAN PUT YOU IN A FINE BUSINESS!

**Rush Card TODAY for FREE OUTFIT!**

Get into highly profitable, repeat-order shoe business! Sell new line of Air-Cushion comfort shoes to friends, neighbors, folks at work! Over 210 dress, sport, work, safety shoe styles for men, women. Never sold by stores. Just 2 easy orders a day—in spare time—bring you \$217 extra income a month! No investment. Rush name and address TODAY for FREE SELLING OUTFIT!

MASON SHOE, Dept. 945, Chippewa Falls, Wis.



## HIGH SCHOOL DIPLOMA

Earn a High School Diploma at home! Prepare for better job, more pay. Study in spare time. No classes. Materials furnished. Certified teachers. Valuable diploma awarded.

Write Today for Complete Information  
**SOUTHERN STATES ACADEMY**  
Box 5344-A 514 E Atlanta, Georgia



## SURPLUS SALE

**\$49.50** NEW TOOL POST GRINDERS  
REGULAR PRICE \$125.00

1-6 H.P. MOTOR

Less Grinding Wheel  
TAKES WHEELS UP TO 1 $\frac{1}{2}$ " x 4"  
EXTRA QUILL EXTERNAL OR  
INTERNAL \$19.50

MONEY BACK GUARANTEE  
EDWARD J. NOLAN, PULASKI, NEW YORK



## GREATEST NEW DEVELOPMENT IN AUTOMOTIVE SAFETY!

TRACTION-MASTERS simply installed on your car assure a smooth, level ride—safe, short steps—faster starts! No dip—no dice—no sway! Improved traction in snow, ice or mud. Tremendous savings on tire, spring, shock and gear life! Blowout protection!

**MONEY-BACK GUARANTEE!**

Write Dept. PM17 for FREE BROCHURE  
JOBBER INQUIRIES INVITED



**Traction-Master Co.**  
2917 W. OLYMPIC BLVD.  
LOS ANGELES 6, CALIF.

# DIESEL MECHANICS IN DEMAND

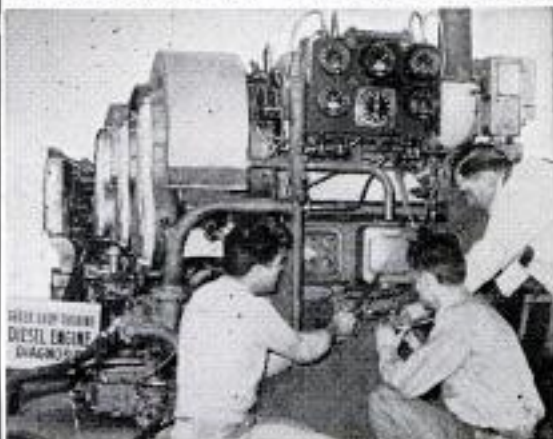

Learn to earn big pay in DIESEL in our large, modern equipped Chicago school and shop. No previous experience or training necessary. We help you find living quarters and part time job while in school. Complete, practical courses taught in the following trades, under the supervision of experienced, expert technicians.

APPROVED FOR CIVILIANS  OR GI'S

— CHOOSE YOUR TRADE —

CHECK HERE	WEEKS
<input type="checkbox"/> DIESEL MECHANICS	20
<input type="checkbox"/> AUTO MECHANICS	20
<input type="checkbox"/> BODY & FENDER	17
<input type="checkbox"/> GAS-ARC WELDING	4 - 12
<input type="checkbox"/> REFRIGERATION	14
<input type="checkbox"/> AIR CONDITIONING	9
<input type="checkbox"/> MACHINIST TRADE	30
<input type="checkbox"/> ADVANCED MACHINIST	33
(includes tool & die)	
<input type="checkbox"/> PIANO TUNING & REPAIR	36

FREE JOB PLACEMENT SERVICE  
DURING AND AFTER TRAINING

## ENGINEERING COURSES

These courses teach practical and technical phases and lead to a degree. They are designed to prepare men for supervisory positions in Diesel-Automotive and Refrigeration-Air Conditioning fields. Students with high school education, or equivalent, will be accepted.

<input type="checkbox"/> DIESEL AUTOMOTIVE ENGINEERING	27 months
<input type="checkbox"/> REFRIGERATION & AIR COND. ENGINEERING	18 months
<input type="checkbox"/> WELDING ENGINEERING	18 months

## EARTH MOVING EQUIPMENT OPERATORS TRAINING

Latest, most modern road building and construction equipment on 900 acre training area. Learn grading, terracing, land clearing, etc., on crawler tractors, front end loaders, pay loaders, cranes, etc. 200 hour 5 week course or special week end courses.

Start your career with Greer by checking your interest above and mail coupon for complete information at no obligation.

NAME \_\_\_\_\_ AGE \_\_\_\_\_

STREET \_\_\_\_\_

TOWN \_\_\_\_\_ ZONE \_\_\_\_\_ STATE \_\_\_\_\_

Established 1902

## GREER SHOP TRAINING

Box L, 2236 S. Michigan Ave.  
Chicago 16, Illinois



**Just Released!**

**NEW**

# ARMY MINE DETECTOR

**Thousands of Uses**

**Model SCR625A.** A portable device for detecting metallic and nonmetallic objects. Find buried pipe lines, cables, wires, hidden jewelry, coins, sewer tile, etc.

This unit comes complete with spare tubes, batteries, resonators, and instructions manual — all in wooden chest 8 $\frac{1}{4}$ " height x 28 $\frac{1}{4}$ " length x 15" depth. Weight in operation is only 15 pounds. Uses standard batteries.

Shipping weight appr. 85 lbs.  
F.O.B. N. Y.  
No C.O.D.'s.  
Send order to:

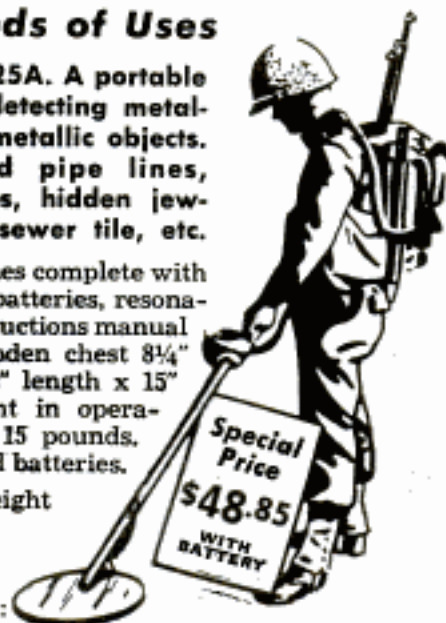

**COLUMBO TRADING CO., INC.**

395 Canal St., Dept. PM, New York 13, N. Y.

**AUTOMATIC**

MAKES NEW PROFITS

**RETOOTHER**

for HAND SAWS

Cuts new teeth in 50 seconds — any size #1 to 16 pitch. Old teeth fall off in 10 min. Easy to operate. A perfect job.

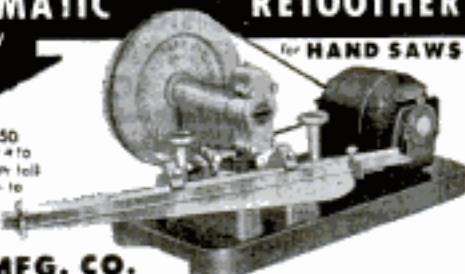

**BURR MFG. CO.**

8933-D VENICE BLVD. LOS ANGELES 34, CALIFORNIA

## NOW The Short Cut to Learning You've Been Waiting for



LEARN "BY EAR" WITH THE **DORMIPHONE**

A Scientific Discovery that Works for You . . . Awake and Asleep

Now, at last, an easy shortcut to learning. With this amazing new tool, you "start" to learn while awake—then the Dormiphone takes over while you go off to sleep. Do you want to learn a language—memorize a speech, facts, figures, formulae—correct your speech—break bad habits? The Dormiphone SAVES YOUR TIME—EFFORT. Simple—helpful—practical. Used by educators, psychologists, people of all ages, occupations.

Find out HOW the Dormiphone works. Write for FREE Book—Get the Scientific Evidence NOW.

**MODERNOPHONE, INC., 236-127 Radio City, New York 20, N. Y.**  
Gentlemen: Please send me your FREE Book.

NAME \_\_\_\_\_

ADDRESS \_\_\_\_\_

CITY \_\_\_\_\_ ZONE \_\_\_\_\_ STATE \_\_\_\_\_

My main interest in Dormiphones is for:

- |  |   |
|--|---|
| <input type="checkbox"/> Learning a Language | <input type="checkbox"/> Speech Improvement     |
| <input type="checkbox"/> Memorization        | <input type="checkbox"/> Sleep Inducement       |
| <input type="checkbox"/> Habit Correction    | <input type="checkbox"/> School or College Work |

## AMAZING NEW "LIFETIME" RADIO



GUARANTEED TO WORK FOR YOUR LIFETIME! USES NO TUBES, BATTERIES OR ELECTRICAL PLUG-INS. NEVER TURNS DOWN! SMALLER THAN A PACK OF CIGARETTES! RECEIVES LOCAL RADIO STATIONS MOST ANYTIME ANYWHERE WITHOUT EXTRA ANTENNA. Uses perma-crystal diode Hi-Q Tuner — Built-in SPEAKERPHONE. Beautiful Black gold plastic case.

Send only \$2.00 (bill, ck, mo.) and pay postman \$4.00

paid delivery. SENT COMPLETE READY TO LISTEN—NOTHING EXTRA TO BUY EVER! (Extra long distance aerial kit included free to receive stations up to 1,000 miles away!) Available only from: MIDWAY COMPANY DEPT. WPM-12 KEARNEY, NEBR.

## BARBELLS

100 POUND SET \$11.80

Extra Plates Only 10c Pound

140-Pound, CHROME DELUXE Barbell-Dumbbell set only \$18.80.

This is our feature set and is the finest ever manufactured.

Training with adjustable weight is the BEST way to keep fit; the ONLY way to develop great strength and a perfect body. As the oldest and best equipped barbell company, BUR gives value and prices no one can equal.

SEND FOR FREE CATALOG.

**BUR BARBELL CO.**

Lyndhurst 9, New Jersey



## A HOBBY BUILDER'S ANVIL

2" high, 4 $\frac{1}{2}$ " long with 6 assorted tools. \$2.00 postpaid in U.S.A.

**BOB HODGSON**

Box 398

Dover R. D. 2, Pa.

## STUDY TO BE A DOCTOR

of Psychology or Metaphysics

Obtain a Ps.D., Ma.D., or Ph.D. Be a Teacher, Lecturer or Accredited Practitioner. Teach others how to achieve Health, Happiness and Contentment. Chartered by State. Correspondence Courses only. Write for FREE book telling how.

**THE NEOTARIAN FELLOWSHIP**

Desk 8, Pickwick Building

Kansas City 6, Missouri

## YES! SEND



directly to my door every month

I am enclosing

- \$3.50 for 1 year  
 \$8.00 for 3 years

name \_\_\_\_\_

address \_\_\_\_\_

city \_\_\_\_\_

zone \_\_\_\_\_

state \_\_\_\_\_

Hand this order to your newsdealer or send it to

**POPULAR MECHANICS**  
200 East Ontario St. Chicago 11, Ill.









## ***School Is "Lab" for Heating Engineers***

ON THE EASTERN OUTSKIRTS of Des Moines, Iowa, is a \$50,000 two-room school building where children make a contribution to science while studying the traditional "three Rs." With no special effort on their part, the pupils serve as subjects for heating and ventilating engineers who are seeking better ways to build the much needed classrooms of the near future. The engineers believed the best place to test new types of heating and air-conditioning equipment would be in a real school building with dozens of active children reading and writing or singing and playing as they would in any other school. The research school building, called a "living laboratory," was designed by R. C. Ovresat of the architectural firm of Perkins and Will, for Lennox Industries, Inc. Research workers moved their instruments into the classrooms and thermocouples were located throughout the building to measure any slight variation in temperature. With children participating, the engineers study such things as temperature changes that occur when a number of students are opening and closing doors on a chilly morning

or the effect of body heat in a classroom previously heated to the optimum temperature. Information gained from the research is expected to save taxpayers at least \$1000 per classroom in the construction of future school buildings.

Research engineer takes readings registered by the thermocouples located in strategic parts of school



POPULAR MECHANICS



# How are YOU getting to the top?

Are you job-climbing the hard way? Struggling to get ahead. Gaining ground slowly. Always in danger of slipping back.

Or are you getting an up-to-date lift? Riding a method that's sure and sound. Forging ahead of others. Rising to responsible positions by virtue of real ability.

Neither way is easy. Both require time, effort, real determination. But the I.C.S. method is faster because it's powered by *success*. Enrolling with I.C.S. is like being given a hand by the top men in your field.

Behind the 257 I.C.S. Courses, you find recognized authorities, personalized instruction, simplified texts, individual guidance—all you need to prepare for advancement.

Sound good? Then take a moment right now to get all the facts. Mark and mail the coupon below. At no cost and without obligation, you get complete details including three books: (1) Opportunity Handbook for the field of your choice, (2) 36-page pocket guide, "How to Succeed," (3) sample lesson (Math) demonstrating the I.C.S. method. With these, you can plan intelligently how best to get to the top.



For Real Job Security—Get an I. C. S. Diploma! I. C. S., Scranton 15, Penna. Accredited Member, National Home Study Council

## INTERNATIONAL CORRESPONDENCE SCHOOLS



BOX 46953M, SCRANTON 15, PENNA.

(Partial list of 257 courses)

- Without cost or obligation, send me "HOW TO SUCCEED" and the opportunity booklet about the field BEFORE which I have marked X (plus sample lesson):
- |  |  |  |  |   |
|--|--|--|--|---|
| <p><b>ARCHITECTURE and BUILDING CONSTRUCTION</b></p> <ul style="list-style-type: none"> <li><input type="checkbox"/> Air Conditioning</li> <li><input type="checkbox"/> Architecture</li> <li><input type="checkbox"/> Arch. Drawing and Designing</li> <li><input type="checkbox"/> Building Contractor</li> <li><input type="checkbox"/> Building Estimator</li> <li><input type="checkbox"/> Carpentry and Millwork</li> <li><input type="checkbox"/> Carpenter Foreman</li> <li><input type="checkbox"/> Heating</li> <li><input type="checkbox"/> Interior Decoration</li> <li><input type="checkbox"/> Painting Contractor</li> <li><input type="checkbox"/> Plumbing</li> <li><input type="checkbox"/> Reading Arch. Blueprints</li> </ul> <p><b>ART</b></p> <ul style="list-style-type: none"> <li><input type="checkbox"/> Commercial Art</li> <li><input type="checkbox"/> Magazine &amp; Book Illus.</li> <li><input type="checkbox"/> Show Card and Sign Lettering</li> <li><input type="checkbox"/> Sketching and Painting</li> </ul> <p><b>AUTOMOTIVE</b></p> <ul style="list-style-type: none"> <li><input type="checkbox"/> Automobiles</li> <li><input type="checkbox"/> Auto Body Rebuilding and Refinishing</li> <li><input type="checkbox"/> Auto Engine Tuneup</li> <li><input type="checkbox"/> Auto Technician</li> </ul> | <p><b>AVIATION</b></p> <ul style="list-style-type: none"> <li><input type="checkbox"/> Aero-Engineering Technology</li> <li><input type="checkbox"/> Aircraft &amp; Engine Mechanic</li> </ul> <p><b>BUSINESS</b></p> <ul style="list-style-type: none"> <li><input type="checkbox"/> Accounting</li> <li><input type="checkbox"/> Advertising</li> <li><input type="checkbox"/> Business Administration</li> <li><input type="checkbox"/> Business Management</li> <li><input type="checkbox"/> Cost Accounting</li> <li><input type="checkbox"/> Creative Salesmanship</li> <li><input type="checkbox"/> Managing a Small Business</li> <li><input type="checkbox"/> Professional Secretary</li> <li><input type="checkbox"/> Public Accounting</li> <li><input type="checkbox"/> Purchasing Agent</li> <li><input type="checkbox"/> Salesmanship</li> <li><input type="checkbox"/> Salesmanship and Management</li> <li><input type="checkbox"/> Traffic Management</li> </ul> <p><b>CHEMICAL</b></p> <ul style="list-style-type: none"> <li><input type="checkbox"/> Analytical Chemistry</li> <li><input type="checkbox"/> Chemical Engineering</li> <li><input type="checkbox"/> Chem. Lab. Technician</li> <li><input type="checkbox"/> Elements of Nuclear Energy</li> <li><input type="checkbox"/> General Chemistry</li> <li><input type="checkbox"/> Natural Gas Prod. and Trans.</li> <li><input type="checkbox"/> Petroleum Prod. and Engr.</li> <li><input type="checkbox"/> Professional Engineer (Chem)</li> <li><input type="checkbox"/> Pulp and Paper Making</li> </ul> | <p><b>CIVIL ENGINEERING</b></p> <ul style="list-style-type: none"> <li><input type="checkbox"/> Civil Engineering</li> <li><input type="checkbox"/> Construction Engineering</li> <li><input type="checkbox"/> Highway Engineering</li> <li><input type="checkbox"/> Professional Engineer (Civil)</li> <li><input type="checkbox"/> Reading Struc. Blueprints</li> <li><input type="checkbox"/> Structural Engineering</li> <li><input type="checkbox"/> Surveying and Mapping</li> </ul> <p><b>DRAFTING</b></p> <ul style="list-style-type: none"> <li><input type="checkbox"/> Aircraft Drafting</li> <li><input type="checkbox"/> Architectural Drafting</li> <li><input type="checkbox"/> Drafting Machine Design</li> <li><input type="checkbox"/> Electrical Drafting</li> <li><input type="checkbox"/> Mechanical Drafting</li> <li><input type="checkbox"/> Sheet Metal Drafting</li> <li><input type="checkbox"/> Structural Drafting</li> </ul> <p><b>ELECTRICAL</b></p> <ul style="list-style-type: none"> <li><input type="checkbox"/> Electrical Engineering</li> <li><input type="checkbox"/> Elec. Engr. Technician</li> <li><input type="checkbox"/> Elec. Light and Power</li> <li><input type="checkbox"/> Practical Electrician</li> <li><input type="checkbox"/> Practical Lineman</li> <li><input type="checkbox"/> Professional Engineer (Elec)</li> </ul> <p><b>HIGH SCHOOL</b></p> <ul style="list-style-type: none"> <li><input type="checkbox"/> High School Diploma</li> </ul> | <ul style="list-style-type: none"> <li><input type="checkbox"/> Good English</li> <li><input type="checkbox"/> High School Mathematics</li> <li><input type="checkbox"/> Short Story Writing</li> </ul> <p><b>LEADERSHIP</b></p> <ul style="list-style-type: none"> <li><input type="checkbox"/> Industrial Foremanship</li> <li><input type="checkbox"/> Industrial Supervision</li> <li><input type="checkbox"/> Personnel-Labor Relations</li> <li><input type="checkbox"/> Supervision</li> </ul> <p><b>MECHANICAL and SHOP</b></p> <ul style="list-style-type: none"> <li><input type="checkbox"/> Diesel Engines</li> <li><input type="checkbox"/> Gas-Elec. Welding</li> <li><input type="checkbox"/> Industrial Engineering</li> <li><input type="checkbox"/> Industrial Instrumentation</li> <li><input type="checkbox"/> Industrial Metallurgy</li> <li><input type="checkbox"/> Industrial Safety</li> <li><input type="checkbox"/> Machine Design</li> <li><input type="checkbox"/> Machine Shop Practice</li> <li><input type="checkbox"/> Mechanical Engineering</li> <li><input type="checkbox"/> Professional Engineer (Mech)</li> <li><input type="checkbox"/> Quality Control</li> <li><input type="checkbox"/> Reading Shop Blueprints</li> <li><input type="checkbox"/> Refrigeration and Air Conditioning</li> <li><input type="checkbox"/> Tool Design</li> <li><input type="checkbox"/> Tool Making</li> </ul> <p><b>RADIO, TELEVISION</b></p> <ul style="list-style-type: none"> <li><input type="checkbox"/> General Electronics Tech.</li> </ul> | <ul style="list-style-type: none"> <li><input type="checkbox"/> Industrial Electronics</li> <li><input type="checkbox"/> Practical Radio-TV Eng'g</li> <li><input type="checkbox"/> Practical Telephony</li> <li><input type="checkbox"/> Radio-TV Servicing</li> </ul> <p><b>RAILROAD</b></p> <ul style="list-style-type: none"> <li><input type="checkbox"/> Car Inspector and Air Brake</li> <li><input type="checkbox"/> Diesel Electrician</li> <li><input type="checkbox"/> Diesel Engr. and Fireman</li> <li><input type="checkbox"/> Diesel Locomotive</li> </ul> <p><b>STEAM and DIESEL POWER</b></p> <ul style="list-style-type: none"> <li><input type="checkbox"/> Combustion Engineering</li> <li><input type="checkbox"/> Power Plant Engineer</li> <li><input type="checkbox"/> Stationary Diesel Engr.</li> <li><input type="checkbox"/> Stationary Fireman</li> </ul> <p><b>TEXTILE</b></p> <ul style="list-style-type: none"> <li><input type="checkbox"/> Carding and Spinning</li> <li><input type="checkbox"/> Cotton Manufacture</li> <li><input type="checkbox"/> Cotton Warping and Weaving</li> <li><input type="checkbox"/> Loom Fixing Technician</li> <li><input type="checkbox"/> Textile Designing</li> <li><input type="checkbox"/> Textile Finishing &amp; Dyeing</li> <li><input type="checkbox"/> Throwing</li> <li><input type="checkbox"/> Warping and Weaving</li> <li><input type="checkbox"/> Worsted Manufacturing</li> </ul> |
|--|--|--|--|---|

Name \_\_\_\_\_ Age \_\_\_\_\_ Home Address \_\_\_\_\_  
 City \_\_\_\_\_ Zone \_\_\_\_\_ State \_\_\_\_\_ Working Hours \_\_\_\_\_ A.M. to P.M. \_\_\_\_\_  
 Occupation \_\_\_\_\_

Canadian residents send coupon to International Correspondence Schools, Canadian, Ltd., Montreal, Canada. . . . Special tuition rates to members of the U. S. Armed Forces.



# ... TURN CONCRETE INTO GOLD!



**MOTOR DRIVEN**

R.L.T. of New York City reports: "MY GENERAL BLOCK MACHINE PAID FOR ITSELF IN FIRST 2 WEEKS!" Hundreds now in use the world over! Write for FREE details today!

## MAKE UP TO \$75 A DAY IN YOUR OWN BUSINESS

If you want to have your own business — to start a business on your own — here's your big opportunity! New high speed, low cost General block machine produces up to 1,000 concrete blocks a day. Sell all you make to builders, supply houses, and others for homes, factories, buildings, garages. Cash in on the building boom! You can make profits of 100% to 150% — up to \$75 a day! General block machine equipped with 1/2 h.p. electric motor — or can be supplied with gasoline engine — works anywhere, in life space, indoors or out. Operates from ordinary house light socket. Simple, foolproof 3 step operation — so easy a child can do it. Makes superior 3 core blocks any size from 4" to 12". Also makes chimney, saff, corner and other types. Blocks meet any building code anywhere in the country. Materials — sand, water, cement, available anywhere. Simple illustrated operating instructions and mixing formulae for cement and Cinder blocks supplied with each machine. Write for FREE folder with full information.

### EXTRA

Amazing illustrated book gives floor plans for 6 sensational concrete block bungalows. Tells how to lay blocks, lay out building lines, mix concrete, build steps, porch and concrete floors all at great savings. Written by experts. Can save many times the cost of the machine! Get it now! No strings attached. Send \$1.

BOOK SENT FREE IF YOU BUY MACHINE.  
\$1 REFUNDED IF YOU BUY LATER.



## GENERAL ENGINES CO.

DEPT. M-127, ROUTE 130, THOROFARE, N. J.

## Kits for Christmas! GENIAC COMPUTER KIT

You can construct over 50 different circuits and 40 different machines that compute, reason, solve puzzles and demonstrate a wide variety of basic computer circuits with the GENIAC electric brain construction kit. Thousands of schools, colleges, industrial firms and private individuals have bought GENIACS since we first brought them on the market.

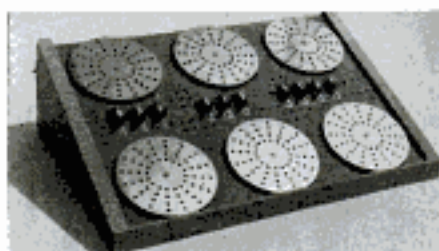

GENIAC set up to do a problem in space ship engineering

We have recently added a circuit for composing music, which gives us special pleasure because it was designed by a 16 year old boy who learned about computers from his GENIAC. Dozens of other youngsters have created their own designs for computing circuits, used GENIACS in their school projects and established a solid foundation of information on computers with GENIACS.

Each kit comes complete with Beginners Manual, Study Guide, instructions for building all the machines and circuits, rack (exclusive with our GENIAC), parts tray, and our complete question answering service. When you buy a GENIAC you are buying a first course in computer operation.

Each kit comes with a one week money back guarantee if you are not satisfied.

Price of Kit complete with parts tray, rack, all components, manuals and texts \$19.95 (postpaid in U. S., add 80c west of Mississippi). (\$2.00 outside United States.)

SCIENCE KITS, Dept. PM-127, Oliver Garfield Company  
126 Lexington Avenue New York 16, N. Y.

**WHAM-O** \$1.50 40-18 FULL

KILLS LIKE A RIFLE — KILLS RABBITS, SQUIRRELS  
Powerful, silent, accurate  
For hunting, target, routing pests.

Sportsman's choice  
sold over 1 million  
over!

NEW! Superior quality pure gum rubber  
215 heavy extra steel bolts set

HUNTING SLINGSHOT

Heavy duty 7" ash stock.  
40 heavy steel balls, extra rubber.  
Largest, adapter for shooting arrows.

GUARANTEED: Professional model of Nat'l Slingshot Assn. All dealers, or write  
WAMO MFG. CO., Box K15 San Gabriel, Calif.  
FREE catalog on crossbows, knives, games, pistols, etc.

## ENGINEERING DEGREE IN 27 MONTHS

## INDIANA TECHNICAL COLLEGE

B.S. Degree, Aero., Chem., Civil, Elec., Mech. & Electronic Engineering (inc. Radio, TV), 30 mos. B.S. degree in Math., Chem., Physics. Prep courses. Demand for grads. Spacious campus. 20 bldgs.; dorms, auditorium, gym. Low rate. Earn board. G.I. approved. Enter Dec., March, June, Sept. Catalog. 1612 E. Washington Blvd. Fort Wayne 2, Indiana  
Keeping pace with progress

**FREE WHOLESALE CATALOG**

get up to 50% off

MAKE MONEY!! SAVE MONEY!!  
Buy Tools, Hardware, appliances, photo equipment, sporting goods, power tools, paints and thousands of other nationally advertised products at WHOLESALE COST TO YOU.

"SEND FOR FREE 1957 WHOLESALE CATALOG TODAY"

**SILVO HARDWARE COMPANY**  
Dept. PM-12, P. O. Box 266, Philadelphia 5, Pa.

## NEW! Completely UP-TO-DATE!

## Manual for PLYMOUTH OWNERS



COVERS ALL MODELS 1941 to 1957. Gives you more from your Plymouth for less. So accurate mechanics can use it . . . so simple a woman can understand it

Now fix it yourself and save money on Plymouth repairs. With this Popular Mechanics book you prevent trouble . . . enjoy care-free driving . . . increase trade-in value . . . get sparkling performance . . . and avoid major repairs by fixing minor troubles before they get serious. Not just a re-hash of service manuals, but a completely updated version of the famous 1950 PM book written by automotive expert Ed Packer, with the assistance of the Chrysler Corporation. Covers latest Plymouth features: power brakes, torque bar suspension, automatic transmission, tubeless tires, air conditioning, etc. Motor specifications are given for all models 1941-57. Contains 272 pages, more than 350 photos, diagrams, tables, charts, breakdown drawings, plus clear, non-technical directions that make all repairs as simple as ABC. Shows you how to diagnose troubles by feel, sound, sight, smell and performance.



### MONEY BACK IF IT DOESN'T SAVE MORE THAN IT COSTS!

One minor repair will save the cost ten times over. Read it. Then you decide. If you don't see that you'll save more than the cost, send it back for refund. SEND NO MONEY. Send postcard. Ask for PLYMOUTH Manual. Postman will deliver C.O.D. for \$3.50 plus postage. Or, save postage by sending \$3.50 with order. Save its cost on your next repair. Send today.

POPULAR MECHANICS PRESS, Dept. 1257  
200 E. Ontario St. Chicago 11, Illinois



# LEARN MEAT CUTTING AT NATIONAL

Pay After Graduation



The steady dependable trade of Meat Cutting taught easily in 8 short weeks. YOU LEARN BY DOING under actual meat market conditions in big modern school at Toledo.

For beginners or men with experience. Get a profitable store of your own. Remember, PEOPLE MUST EAT! Big pay jobs. Free employment help. Thousands of successful graduates.

Buying, cutting, percentage, pricing, advertising, selling, etc. A complete retail meat education. National School established 35 years. Get National training NOW. Pay your tuition in easy weekly

payments after you graduate. Send coupon for FREE 52 page school catalog — TODAY. G.I. approved.

**National School of Meat Cutting, Inc., Dept. 50-Y, Toledo 4, Ohio**

Send me your FREE school catalog on National Training at Toledo in Meat Cutting, Meat Merchandising and Self Service Meats. No obligation. No salesman will call.

Name \_\_\_\_\_ Age \_\_\_\_\_

Address \_\_\_\_\_

City \_\_\_\_\_ State \_\_\_\_\_

Approved for training Korean Veterans



## Wanted MOTEL-RESORT MANAGERS

Men, women. Qualify for hundreds of fascinating, leisurely well-paid executive positions now open with luxurious Motel-Resorts coast-to-coast. Pick your own location, climate! Join our thousands successful graduates up to 75 years young. Employment assistance! Experience unnecessary. Learn at home, spare time. Apartment and hotel opportunities, too.

FREE! "Resort-Motel Opportunities" booklet. Write-Dept. N14F, MOTEL MANAGERS TRAINING SCHOOL, 612 S. Serrano, Los Angeles 5.

## IT'S EASY...

### MAKE MONEY IN PHOTOGRAPHY

Good pay and fascinating work await you in photography! Start making money quickly in sparetime—step into your own studio or exciting career job. LEARN-BY-DOING method trains you at home! Write TODAY for FREE catalog. Also Resident Training. Co-ed. 48th Year. Approved for Veterans.

**NEW YORK INSTITUTE OF PHOTOGRAPHY**  
Dept. 49, 10 West 33 Street, New York 1, New York  
48th YEAR

## LEARN WHILE ASLEEP!



Exciting details free!

Sleep-Learning Research Association  
P.O. Box 610-A Omaha, Nebraska

## TWO WAYS TO BUY BETTER

Your dealer knows the right products for your needs—quality products that are nationally advertised. POPULAR MECHANICS brings you a monthly roundup of valuable "how to" information and product advertising. Read POPULAR MECHANICS every month—then talk to your dealer.



DECEMBER 1957

## PREPARE FOR THE BEST JOBS IN INDUSTRY

**STUDY AT HOME**  
in your spare time or at ALLIED INSTITUTE

- Drafting—ALL BRANCHES
- Tool & Die Designing
- Machine Designing
- Tool Engineering
- Mech. Engineering
- Machinist—Tool & Die
- Air Conditioning Heat & Refrigeration

### MORE JOBS THAN GRADUATES

You can begin your training in Short Courses and continue progressively toward an Engineering Degree in 31 months. Allied is approved by Industry, National Home Study Council, Dept. of Education, Office of Public Instruction, State of Illinois, U. S. Dept. of Justice.

SEND FOR **FREE BOOKS**

ALLIED SCHOOL, 1338 S. Michigan Ave., Chicago 5, Ill.

ALLIED SCHOOL OF MECHANICAL TRADES  
1338-42 South Michigan Ave., Dept. PM-127, Chicago 5, Ill.

Send me without obligation information on your courses:

- |  |   |
|--|---|
| <input type="checkbox"/> DRAFTING—ALL BRANCHES                   | <input type="checkbox"/> TOOL ENGINEERING     |
| <input type="checkbox"/> TOOL & DIE DESIGNING                    | <input type="checkbox"/> MECH. ENGINEERING    |
| <input type="checkbox"/> MACHINE DESIGNING                       | <input type="checkbox"/> MACHINIST—TOOL & DIE |
| <input type="checkbox"/> AIR CONDITIONING — HEAT & REFRIGERATION |   |
| <input type="checkbox"/> HOME STUDY                              | <input type="checkbox"/> RESIDENT             |
| <input type="checkbox"/> VETERAN                                 | <input type="checkbox"/> NON VETERAN          |

NAME \_\_\_\_\_

ADDRESS \_\_\_\_\_

CITY \_\_\_\_\_ COUNTY \_\_\_\_\_ STATE \_\_\_\_\_



# ENGINEERING DEGREE IN 27 MONTHS

## B. S. DEGREE IN

**Aeronautical, Chemical, Civil, Electrical, Mechanical and Electronic Engineering (inc. Radio and TV)**

Also B.S. DEGREE in 36 mo. in Mathematics, Chemistry, Physics (inc. Nuclear Physics), Engineering Science prep. courses. Thorough, practical program. Individualized instruction emphasized. Government approved for G.I.'s.

### Keeping pace with progress in science and engineering

Spacious campus, 20 bldgs.; dorms, gym. Playing field. Modern, well-equipped labs including new physics lab and wind tunnel. Low tuition. New terms start quarterly. Enter December, March, June or September. Big demand for graduates. Students from 48 states and 40 foreign countries. Many earn a major part of their college expenses in this large industrial center. Send coupon for free catalog and full information. Enroll now!

## INDIANA TECHNICAL COLLEGE

5127 E. Washington Boulevard, Fort Wayne 2, Indiana

Please send me free information on 27 MO. B.S. DEGREES in:

Aeronautical  Chemical  Civil  Electrical   
Mechanical  Electronics

on 36 MONTH B.S. DEGREES in:

Mathematics  Chemistry  Physics

Name \_\_\_\_\_

Address \_\_\_\_\_

## AMAZING NEW PERSONAL POCKET RADIO



**LISTEN IN PRIVATE WHILE YOU WALK!**  
SMALLER AND LIGHTER THAN ANY TRANSISTOR "POCKET RADIO" yet, only 3 1/2 lb. Size 1"x2 3/4"x4 1/4" complete. Black Gold Brakzeror plastic case. POSITIVELY NO HOOKUPS OR WIRES NEEDED! BUILT IN 1000 MILE ANTENNA! Soap in flashlight batteries lasts for months. "Glow in the Dark!" Easy to use top controls (while walking, riding, etc.). Has special tiny, soft plastic almost invisible ear-plug—LETS YOU ALONE LISTEN ANYTIME. ANYWHERE without anyone else knowing you are hearing radio music, sports, news, weather, etc. GUARANTEED TO WORK ANYWHERE RADIO CAN BE USED. ONE YEAR SERVICE GUARANTEE.

**SEND ONLY \$5.00** (rk. mo) and pay postman \$14.95 plus postage on delivery or send \$19.95 for postpaid delivery. A REAL \$39.95 VALUE! AVAILABLE NOW ONLY FROM US AT HALF PRICE

WHILE OUR SUPPLY LASTS. American made! You can always get repairs if ever needed. NOT AN UNSWORKABLE INCOMPLETE KIT OF PARTS OR PLANTING. A REAL MIDGET PERSONAL POCKET SIZE RADIO. Get yours now—Listen when you want without bothering others. Price will go up soon so rush your order now for YOUR TINY TONE POCKET PERSONAL RADIO. Available only from:  
**WESTERN RADIO** Dept. APM-12 **KEARNEY, NEBR.**



## HIGH WAGES!

Make big pay in the construction industry as an operator of Bulldozers, Draglines, Back Hoes, Scrapers and Motor Graders. Learn these skills NOW! Machines of major manufacturers are used in our training program. Contractors need operators of earthmoving machines and pay high wages to our graduates. Don't be satisfied with just a job . . . learn a career!

Write TODAY for FREE School Catalog, no obligation, to either address

**National School of Heavy Equipment Operation**

P.O. Box 8243, Dept. D-18  
Charlotte, N. C.

**Western National School of Heavy Equipment Operation**

P.O. Box 527, Dept. D-18  
Weiser, Idaho



Students in industrial-arts courses started their project by staking out the site for the house

## High School Students

WORKING ABOUT THREE HOURS a day, 84 boys enrolled in the industrial-arts courses at Hagerstown (Maryland) High School built a seven-room brick house as part of their regular instruction program. How well the boys did is shown by the fact that the house was sold for \$21,000. Also, 60 of the students were offered jobs in the building trades. The project had the backing of trade unions and contractors alike. In fact, representatives of both groups served on the advisory committee. The house, including the breezeway and garage, measures 67 by 34 feet. It contains a living room, dining room, kitchen, three bedrooms and a bath. Basic plans for the house were drawn by Standard Homes, Washington, D. C., although the boys added the breezeway, garage and a few other touches themselves. Plumbing and plastering are not included among the building courses offered at the school so these jobs were performed by adult workmen. Excavating for the foundation involved equipment not available at the school and it, also, was done by a private contractor. Everything else, from staking out the site to applying the shingles on the roof, was done by students under the guidance of their teachers. By the time the house was completed the boys enrolled in carpentry, bricklaying, sheet-metal and electrical-wiring courses had received valuable on-the-job training. The house was completed in two school terms.



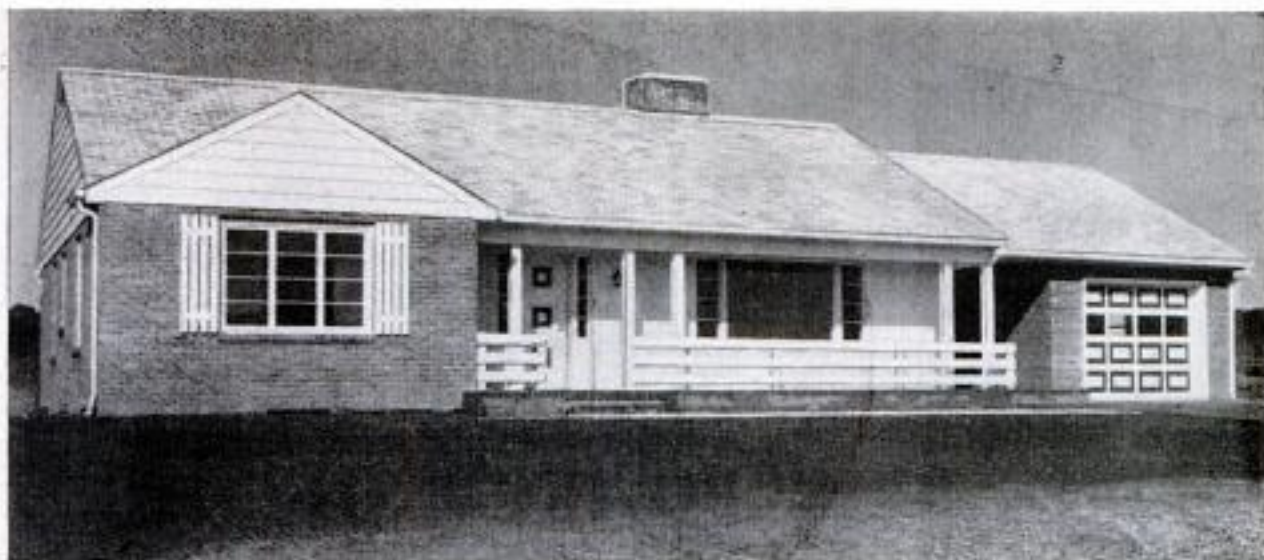

The boys added the garage and breezeway to the original house plan. The seven-room home sold for \$21,000

## Build a House

Boys in electrical-wiring class acquired plenty of practical experience on project



Besides on-the-job training in bricklaying, masonry-class pupils were taught the proper way to lay concrete foundation

Carpentry students used electric power saws. Trade unions and contractors helped supervise the educational project





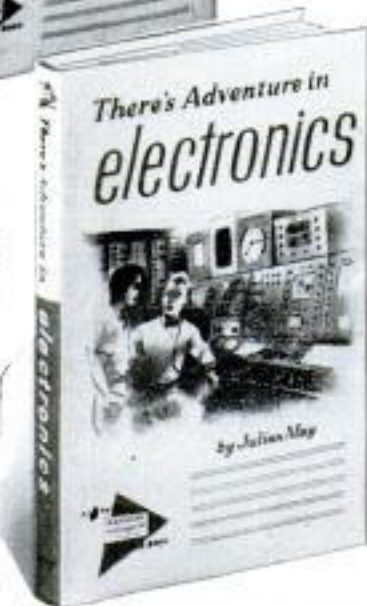
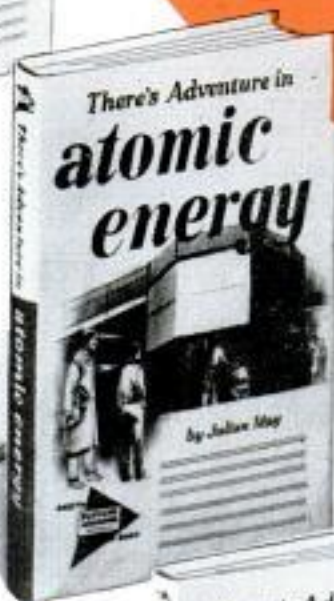
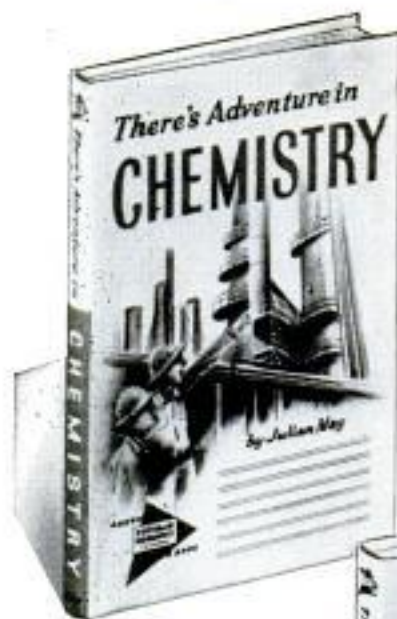

**THE IDEAL**  
*Christmas Gift*  
**FOR THE BOYS IN**  
**YOUR LIFE WHO HAVE A**  
**GROWING INTEREST IN**  
*Science*

**3 New Exciting**  
**Fascinating**  
**CAREER-BUILDING**  
**ADVENTURE BOOKS**

**There's Adventure In**  
**CHEMISTRY**

The mysteries of Chemistry unfold through the adventures of typical American boys. Thrilling fiction, yet scientifically sound. Provides understanding of career opportunities and requirements in Chemistry. Illustrated. 175 Pages .....\$2.50

**There's Adventure In**  
**ATOMIC ENERGY**

The Atomic Age is here and youth is reaching for simple, understandable information. Here it is, in exciting fiction form, yet factually correct. Explains the career possibilities, whets the boy's desire to go farther. Illustrated. 175 Pages .....\$2.50

**There's Adventure In**  
**ELECTRONICS**

With all the thrills of adventure stories, the facts about Electronics are given in story form, not only to educate, but also to help the boy judge Electronics as his life's work. Illustrated. 175 Pages .....\$2.50

Thrilling adventures in Chemistry, Atomic Energy and Electronics. Told in fascinating fiction style, yet factually accurate, with experiments boys can make. Career aptitude tests are included. Thoughtful gifts for boys age 11 to 17. They'll be grateful!

*Buy Them Wherever Books Are Sold . . . or Order Direct from*

**POPULAR MECHANICS PRESS**

200 East Ontario Street, Dept. M-12 Chicago 11, Illinois

Popular Mechanics Press, Dept. M-12  
 200 E. Ontario St., Chicago 11, Ill.  
 Please send the following "There's Adventure" books prepaid. I enclose \$2.50 for each book ordered.

CHEMISTRY     ATOMIC ENERGY     ELECTRONICS

Name \_\_\_\_\_

Address \_\_\_\_\_

City \_\_\_\_\_ Zone \_\_\_\_\_ State \_\_\_\_\_



# SAVE \$ ON US GOV'T SURPLUS\$

Our publication "Government Surplus Sales" lists hundreds of items for sale by the U. S. Government at tremendous savings, as low as 1c on a \$1.00.

These are samples of the savings that are being made:

LIFE BOAT .....\$12.00	GRINDER .....\$4.69	SHAPER .....\$15.00	DUMP TRUCK.....\$76.77
TRACTOR .....\$75.00	TYPEWRITER ....\$7.51	FREEZER .....\$50.00	SPRAY PAINTER.....\$15.25
	MOTOR .....\$4.00		

Hundreds others listed in our bulletin "Government Surplus Sales" and may be purchased direct from U. S. Government. Hunting, Fishing, Camping, Sporting Equipment, Photographic Equipment and Supplies, Radio and Electronic Equipment, Amphibious Trucks, Jeeps, Boats, Motors, Binoculars, Plumbing, Electrical Equip., Cars, Power Tools, Machinery, Chemicals, Furniture, Office Equipment, Supplies, Scrap, Etc.

How may you receive our bulletin "Government Surplus Sales?" By sending \$1.00 to

**GOVERNMENT SURPLUS SALES, P. O. Box 169, Department 8-5, East Hartford 8, Conn.**

## Pocket-Size SKATE SHARPENER



A few strokes now and then keeps skates in trim and you out front.

POSTPAID, EACH **\$1.00**

OR 3 FOR **\$2.85**

S & W INDUSTRIES, Box 237, Cardston, Alta.

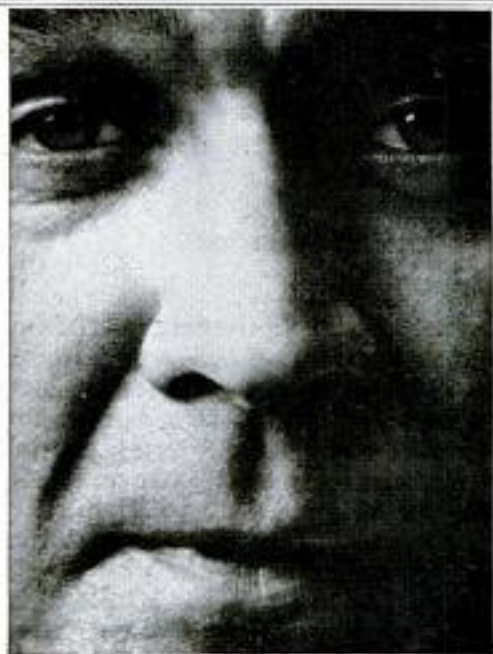

## Are your chances against cancer any better today?

The answer's yes . . . IF! Formerly, we could cure one out of every 4 cancer patients. Today, it's one out of 3. So why the big IF? Because the odds against cancer depend on you. Only you can give us the money we need to keep research going full speed. Remember, time is *everything* with cancer. Send a check *now* to "Cancer", care of your local Post Office.

**American Cancer Society**

DECEMBER 1957

New Isotronic Training Method

## LEARN TV REPAIR IN ONE SHORT WEEK!

Now, after 5 year's research—a streamlined training system that *obsoletes all others!* In just 7 days you may earn \$150 weekly, without paying up to \$250 for training, studying long months! Developed by electronic scientists in cooperation with major TV mfr's., the new Isotronic method is the most *practical* ever devised! For conclusive proof, write for details and FREE SAMPLE LESSON. Use it on your own set or a friend's — repair it — convince yourself you can make *big money immediately* in your own TV business! Hurry — Free Lesson supply limited. Write: Electronic Engineering Co., Dept. A-17C 1038 So. La Brea, Los Angeles 19, Calif.

## PREPARE FOR BETTER JOB, BIGGER PAY IN SPARE TIME AT HOME

Today, choose the job you want—and prepare for it in time you might otherwise waste. Or if you are already in the work you like best, start training now for quicker promotion and increased pay. During the past 60 years AMERICAN SCHOOL has helped ambitious people to reach higher goals. Check subject that interests you and mail coupon for full information.

AMERICAN SCHOOL, Dept. G945, Drexel at 58th, Chicago 37, Ill.  
Without obligation, please send FREE and postpaid, full particulars about the subject checked below.

<input type="checkbox"/> Accounting	<input type="checkbox"/> Contracting	<input type="checkbox"/> Mechanical Engineering
<input type="checkbox"/> Apprenticeship Courses	<input type="checkbox"/> Diesel Technician	<input type="checkbox"/> Mechanical Technology
<input type="checkbox"/> Architecture & Building	<input type="checkbox"/> Drafting—Building Trades	<input type="checkbox"/> Metalworking Courses
<input type="checkbox"/> Automotive Technician	<input type="checkbox"/> Drafting—Machine Trades	<input type="checkbox"/> Plumbing—Practical
<input type="checkbox"/> Better Foremanship	<input type="checkbox"/> Electrical Engineering	<input type="checkbox"/> Private Secretary
<input type="checkbox"/> Blueprint Reading	<input type="checkbox"/> Electricity—Practical	<input type="checkbox"/> Retail Merchandising
<input type="checkbox"/> Bookkeeping	<input type="checkbox"/> Electronics—Industrial	<input type="checkbox"/> Salesmanship—Outside
<input type="checkbox"/> Business Management	<input type="checkbox"/> HIGH SCHOOL COURSES	<input type="checkbox"/> Sheet Metal Work
<input type="checkbox"/> Civil Engineering	<input type="checkbox"/> Machinists	<input type="checkbox"/> Test Making

NAME \_\_\_\_\_ OCCUPATION \_\_\_\_\_ AGE \_\_\_\_\_  
HOME ADDRESS \_\_\_\_\_ STATE \_\_\_\_\_  
CITY \_\_\_\_\_

Consent: Write American School, Dept. G945, 6083 Sherbrooke St. W, Montreal

MAIL COUPON NOW





The 6-Transistor  
Portable That Plays  
Anywhere!



build  
your own **HEATHKIT** radio  
and **SAVE**



**HEATHKIT TRANSISTOR  
PORTABLE RADIO KIT**

MODEL XR-1 **\$34.95**

(with cabinet, less batteries)

**FREE HEATHKIT CATALOG AVAILABLE**

Pioneer in  
"do-it-yourself"  
electronics

Describes many more  
"do-it-yourself" kits for  
hobby—hi-fi—ham radio—  
and experimenting. Get  
your copy now for complete  
selection of fun projects  
that save you money.



**HEATH COMPANY**

BENTON HARBOR 17, MICHIGAN A SUBSIDIARY OF DAYSTROM, INC.  
Please send FREE Heathkit Catalog

NAME \_\_\_\_\_

ADDRESS \_\_\_\_\_

CITY & STATE \_\_\_\_\_

**FREE PLAN**  
tells how to start your own business  
**FILING SAWS**

Here is a steady repeat CASH business you can start in your own basement or garage in your spare time and make up to \$3 or \$5 an hour. You can file hand, band and cross-cut circular saws on the Foley Saw Filer. No eyestrain—no experience needed. "The first saw I sharpened with my Foley Filer came out 100%,"—writes Clarence E. Parsons.



Every saw you sharpen with the Foley Saw Filer brings you more customers. "I rented a two-car garage and have all the work I can do"—Charles H. Smith.

**FREE BOOK**

Shows How to Start  
Foley Price Guide gives  
saw sharpening charges.  
Send coupon today. No  
salesman will call.

FOLEY  
SHARPENING  
PRICE  
GUIDE

MONEY  
MAKING  
FACTS

**SEND COUPON FOR FREE BOOKS**

FOLEY MFG. CO., 1243-7 Foley Bldg.  
Minneapolis 18, Minn.

Send me free book "Money Making Facts" and Foley  
Price Guide of saw sharpening charges.

Name \_\_\_\_\_

Address \_\_\_\_\_



Reliable Laboratories, Inc., 3238 Fenkell Ave., Detroit 38, Mich.

### Pipe Gives Water-Cooled Smoke

Using the idea of the Oriental hookah, an American-made pipe has a plastic bowl at the bottom to cool and filter tobacco smoke through water. A small white disk made of cellulose material near the top of the plastic bowl also serves as a filter. A little metal shut-off valve at the front of the pipe prevents the reverse flow of liquid from the filter bowl. The pipe can be taken apart for cleaning.

### Lightweight Helicopter Doubles as Car

Rush-hour traffic bothering you? Maybe this is the answer. The 200-pound helicopter that doubles as a car has a 40-horsepower air-cooled engine that burns standard automobile gasoline. A small propeller behind the driver's seat pushes it along the highway at speeds up to 30 miles per hour. A stallproof, free-spinning rotor carries the vehicle through the sky at a top speed of 80 miles per hour. The rotor blades do not turn when the machine is used as a car. The copter sells for approximately \$2000 without the engine.





# Get into.. PLASTIC LAMINATING AT HOME!



**THIS MAN...**  
... is taking out of the machine a Plastic Sealing Job—ordered by mail—only 1 lb in material cost brings back \$2.58 in cash by mail. Capacity of machine: **\$25.00 profit per hour of operation.**

Get **ORDERS** and **CASH** from your mailman—do work in **SPARE TIME** at home—or expand into **FULL TIME** business. Send coupon for Free facts about the newest and most fascinating of all home operated businesses. For the first time a simplified machine brings the fabulous profits of **Plastic Sealing and Plastic Laminating** within the reach of the small operator. Anyone can learn to operate the machine with a few minutes practice—then with our **Magic Mail Plan** can get mail orders pouring in daily with cash in every envelope. **No canvassing—no selling.** We even

**Make \$20 to \$30 a Day by.. MAGIC MAIL PLAN!**

supply the circulars you mail to bring back cash and orders. Don't waste a minute. Rush your name. We'll send you **FREE** and postpaid, pictures, prices, details, and all the facts you need to start. Mail coupon or send name on postcard. No charge. Warner Electric Co., 1512 Jarvis Av., Dept. L-2 P, Chicago 26, Ill.

**Make Thousands of Beautiful Art Creations**  
**COSTUME JEWELRY • CIGARETTE BOXES**  
**TRAYS • CANDLESTICKS • COASTERS**  
**LAMP BASES • BOOK ENDS...ALL IN**  
**SPARKLING COLORED PLASTIC**



**WARNER ELECTRIC CO., 1512 Jarvis Av.**  
Dept. L-2-P, Chicago 26, Ill.  
At no cost to me, please rush complete details postage prepaid. I am under no obligation.

Name \_\_\_\_\_  
Address \_\_\_\_\_  
City \_\_\_\_\_ Zone \_\_\_\_\_ State \_\_\_\_\_

## SCIENTIFIC CRIME DETECTION



**IT'S EASY TO LEARN**  
Let us teach you in your own home. Learn Finger Printing, Firearms Identification, Police Photography, Criminal Investigation Methods thoroughly, quickly, at small cost. Over 800 Bureaus of Identification in the U. S. employ I. A. S. students or graduates. Write today, stating age.

**INSTITUTE OF APPLIED SCIENCE, 1920 Sunnyside Ave., Dept. 1359**  
(A Correspondence School Since 1916) Chicago 40, Ill.

**250 POWER.....**  
**Complete Telescope Lens Kit** only **\$3.49** postpaid

Conquer Space, Explore the Universe, Planets, Moon Craters, New Stars, etc. Complete Lens Kit consists of 80 inch focal length ground and polished objective lens, eyepiece lenses for 50 POWER, 100 POWER, 150 POWER, 200 POWER, 250 POWER, and all necessary lens fittings. Easy to make from simple step by step instructions. (Tripod and mount not included.) Money back guarantee.

**BUSSE SALES CO., Hartford, Conn., Dept. PM 64**

## RUPTURED?

Something different. Light. Cool. No leg straps. No elastic. No pressure on hips or spine. Inexpensive. Worn by Mechanics, Farmers, Doctors, etc., everywhere. Guaranteed. Write

**HAND-LOCK PRODUCTS EST. 1893 DEPT. PM, PRESTON, ONT., CAN.**

**"I Made \$14,839 in 1 Year SERVICING RADIATORS!"**

Are you earning under \$4,000 a year? Hundreds now making \$10,000-\$12,000-\$15,000 a year servicing auto-truck-tractor radiators the inland way. Easy to learn. Inland, largest radiator equipment mfr., offers complete package—equipment, merchandising, "Pays-for-Itself" financing, free training, \$300 down for equipment starts you. Profitable dept. for garage or service station. Write to **INLAND MFG. CO., Dept. PM-12, 1108 Jackson St., Omaha 2, Nebr.**

## 2 WAY PORTABLE RADIO SET

**SENDS—RECEIVES UP TO 10 MILES AS SHOWN**  
with built-in antenna or hundreds of miles with outside antenna. Works on 80 and 40 meter (Novice) amateur radio-bands—also Aircraft and overseas broadcast (3 to 8 incl. PORTABLE SELF-CONTAINED POWERED WITH STANDARD PORTABLE RADIO BATTERIES. NO AC PLUG-INS NEEDED! Take it with you everywhere you go—on trips, vacations, camping—keep in contact with home, friends. Has 5 watt crystal controlled transmitter—Sensitive Regenerative Receiver. Send-Receive switch. WL, only 3 lbs. Size, only 6"x4"x4". TESTED—PROVEN—SIMPLIFIED—PRACTICAL—Full information given on quick easy to get license. **SEND ONLY \$3.00** (bill, ck, m.o. and pay post-arrival or send \$14.95 for postpaid delivery. Complete kit includes all parts, tube, coils, plated cabinet, easy instructions. (Set of batteries \$2.95; crystal \$1.25.) COMPLETELY WIRED AND TESTED POSTPAID \$19.95. A regular \$49.95 value—Order now before price goes up. **GUARANTEED—AVAILABLE ONLY FROM:**

**WESTERN RADIO DEPT. BNR-12 KEARNEY, NEBR.**

## college graduates get ahead faster!

You see it in your own city. They have higher incomes... advance more rapidly. Grasp your chance for a better life. Industrial growth... automation... technical advances create career opportunities for engineers, accountants, management experts. Share rewards awaiting college men. Important firms visit campus regularly to employ Tri-State College graduates. Start any quarter in this world-famed college. Approved for veterans.

### Bachelor of Science degree in 27 months

In Mechanical, Civil, Electrical, Chemical, Aeronautical, Radio (TV-Electronics) Engineering. In 26 months a B.S. in Business Administration (General Business, Accounting, Motor Transport Management majors). Superior students may accelerate. 36-weeks course in Drafting. Intensive program: technical fundamentals stressed; comprehensive courses with more professional class hours. *Small classes; personalized instruction.* Enrollment limited to 1800. Preparatory courses. *Beautiful campus.* Well-equipped, new and modernized buildings and laboratories. Enter Jan., Mar., June, Sept. Earnest, capable students (whose time and budget require accelerated courses and modest costs) are invited to write **Jeann McCarthy, Director of Admissions,** for catalog and book "Your Career in Engineering and Commerce."

**TRI-STATE COLLEGE**  
4127 College Avenue • • • Angola, Indiana

**KEEP YOUR... EYE ON BENJAMIN** "First in POWER and ACCURACY"  
**for HIGH H.C. COMP**  
**AIR GUNS & CO. GAS GUNS—Top Quality at LOWEST PRICES!**

**BB or 177 or 22**  
**BENJAMIN SUPER**  
CO<sub>2</sub> Gas Carbine with Reg. Stock as low as **\$14.95**  
Deluxe Model with Custom Stock (Shown) as Low as \$17.95

Benjamin Air Rifles and Benjamin Air Pistols are Recognized All Over the World for Finest Workmanship and Highest Quality at Lowest Prices. Adjustable Power with Amazing Optimum Force. Fully Guaranteed—Safe—Accurate—Economical. Easy to Use anywhere—12 Models for Target and Small Game BB or 177 or 22. All Models Benjamin CO<sub>2</sub> Carbine Gas Rifles and Benjamin CO<sub>2</sub> Rocket Gas Pistols Use Standard Size CO<sub>2</sub> Cartridges (available everywhere). 2-Stage W-L Jet Power—High for Small Game—Low for Target—Up to 50 Shots from each Cartridge. No Pumping—Safe—Accurate—Economical—Non Toxic—12 Models BB or 177 or 22.

**FREE!** Catalog All Models Benjamin Air Guns & CO<sub>2</sub> Guns & Supplies. Also, Money-Saving Offer on Hunting & Fishing Accessories.

Send Free Catalog and Special Offer!  
**BENJAMIN AIR RIFLE CO., 896 MARION ST., ST. LOUIS 4, MO., U.S.A.**  
Name \_\_\_\_\_  
Address \_\_\_\_\_  
City \_\_\_\_\_ State \_\_\_\_\_





## THE UNLADYLIKE BEHAVIOR OF MARIA MITCHELL

In a quiet house in Lynn, Massachusetts, in 1889, an old woman lay waiting for death. "Well," she said in amused wonder, "if this is dying, there is nothing very unpleasant about it." And the book closed for one of the most remarkable of the many remarkable women America has produced.

Her story began on a night very long ago when, as a Quaker girl in Nantucket, Maria Mitchell discovered a comet—and got a gold medal worth 20 ducats from the Danish King.

Overnight she became a celebrity. But many people, wedded to the popular notion of woman as a "household ornament," regarded Maria as an unwelcome phenomenon and her discovery as only an accident.

That was because they didn't know Maria Mitchell. At 12 she could regulate a ship's chronometer; at 17 she understood Bowditch's "Practical Navigator" and was studying science in self-taught French, German and Latin. In time she would become the first woman member of the American Academy of Arts and

Sciences, the first woman astronomy professor—in Matthew Vassar's Female College—and a member forever of New York University's Hall of Fame.

Moreover, all her adult life she was to work with growing success in the crusade to make American women free.

No one these days would question the rewards of Maria Mitchell's crusade. Women today enrich every level of public life. And, in family life, they guard financial security two times out of three. One reason, probably, why their families have more than \$40,000,000,000 saved—in guaranteed-safe United States Savings Bonds.

Women know there is no *safer* way to save. Trust them. Through Payroll Savings or at your bank, start *your* Bond program, too. Today. **Now Savings Bonds are better than ever!** Every Series E Bond purchased since February 1, 1957, pays 3¼% interest when held to maturity. It earns higher interest in the early years than ever before, and matures in only 8 years and 11 months. Hold your *old* E Bonds, too. They earn more as they get older.

PART OF EVERY AMERICAN'S SAVINGS BELONGS IN U.S. SAVINGS BONDS

*The U. S. Government does not pay for this advertisement. It is donated by this publication in cooperation with the Advertising Council and the Magazine Publishers of America.*





# MR. FARMER

Does This Look Familiar?

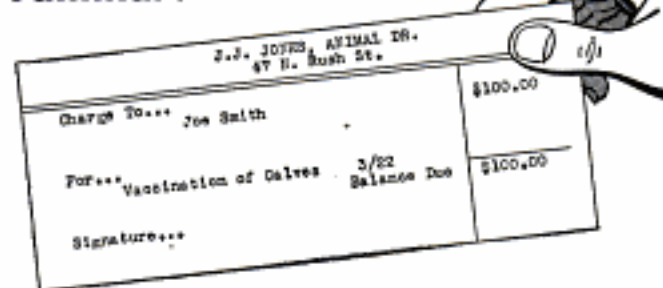

Are you paying doctor bills for sick farm animals that YOU might take care of YOURSELF? If so, you should have the

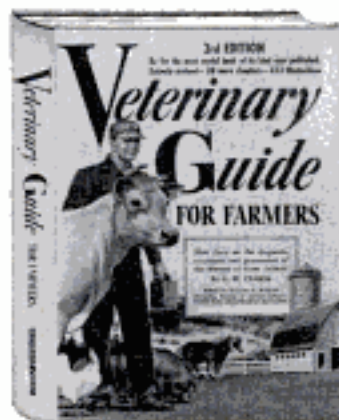

## VETERINARY GUIDE For Farmers

**NEW, ENLARGED  
3rd EDITION  
BIGGER! BETTER!  
EVEN MORE USEFUL!**

384 Pages • Illustrated  
**\$3.95**  
Information  
You Can Use Every Day

Covers Cattle, Horses,  
Swine, Sheep, Poultry

It pays you to know what diseases can strike your herd; what must be done for stricken animals; how the healthy ones in the herd can be protected; how the outbreaks can be prevented in the future. This is only part of the information you get in the Veterinary Guide for Farmers. Only \$3.95.

**Easily Worth Many, Many Times Its Cost**

By preventing the loss of only one animal this book can easily be worth a hundred times its cost. Today's high market value of farm animals, together with the high cost of feeding and raising them, makes losses extremely expensive. Stop losses, step up your profits with the Veterinary Guide for Farmers.

**OFFICIALLY ADOPTED IN 26 STATES**

Endorsed by Vo-Ag teachers and other leaders. Adopted by "Veterans on the Farm" training classes in 26 states. It has sold more than 250,000 copies. This new edition of the "Vet Guide"—first in seven years—is more inclusive, up-to-date, even more valuable.

**Send No Money! Mail Coupon Today!**

POPULAR MECHANICS PRESS, Dept. 1257  
200 E. Ontario, Chicago 11, Illinois

Rush me a copy of the Veterinary Guide for Farmers immediately. At the end of seven days I will either remit \$3.95 in full payment, or return the book to you in good order and owe nothing.

Name \_\_\_\_\_

Address \_\_\_\_\_

City \_\_\_\_\_ State \_\_\_\_\_

Check here if you enclose \$3.95.  
Same return and refund privilege.

Now you can know many of the things the veterinarian knows. You'll learn how to recognize the symptoms of diseases dangerous to your farm animals, and how to treat them yourself. The Veterinary Guide For Farmers is all you need. Completely revised, it's the most useful book of its kind. It tells you what the causes of diseases are and how you can prevent them. New 12-page diagnosis chart helps you identify the disease immediately.

**Simplified • Non-Technical  
Thoroughly Practical**

Written by G. W. Stamm, Edited by Dallas S. Burch, former executive, Bureau of Animal Industry. Presented in the most simple, non-technical terms, its 384 pages are packed with how-to-do-it instructions, pictures, charts, etc., needed on every farm.

# ENGINEERING



Photo of Heald  
Electrical Laboratory  
Approved for Veterans

Heald College Ranks **FIRST**  
West of the Mississippi  
in "Who's Who" in America

Send for **FREE** Information  
Heald Engineering College

Est. 1863  
Van Ness at Post, Dept. P.M.  
San Francisco, California

Enroll Now for New Term

Thousands of  
Engineers Needed  
for Hard Pressed  
Industry

**BACHELOR OF  
SCIENCE DEGREE,  
27 MONTHS**

Degree Courses:

- Electronic Engineering
- Electrical Engineering
- Highway Engineering
- Mechanical Engineering
- Structural Engineering
- Civil Engineering
- Architecture

Diploma Courses:

- TELEVISION  Color TV
- Tool & Die Design
- Architectural Drafting
- Mechanical Drafting
- Structural Drafting
- Surveying
- Estimating
- Master Electrician

Approved for Veterans

NAME \_\_\_\_\_  
STREET \_\_\_\_\_  
CITY \_\_\_\_\_  
STATE \_\_\_\_\_

## HYDRAULIC JACK REPAIRS



**Earn While You Learn at Home**

Millions of jacks in gas & auto-service stations, truckers, body-shops, riggers, factories, farms need servicing. We show you **HOW**—easy step by step directions—what tools to use. **EARN UP TO \$5 an hour**, in spare time, in your own basement or garage. Start your own business **NOW**. Write for folder #PM12 & free bonus offer.

Institute of Hydraulic Jack Repair

P.O. Box 50, Bloomfield, N. J.

**YOU CAN MAKE \$85 PER WEEK  
IN YOUR SPARE TIME** WITH THIS EASY,  
PROVEN SALES PLAN



Full time agents make over \$1,000 per month—earnings start with first call. Every home, office, car, boat, trailer and farm is your customer when you sell the

**FIREMAN**

**FIRE EXTINGUISHER  
NO EXPERIENCE NEEDED!  
NO AGE LIMIT!**

The extra money you need can now be yours with the most exciting product you've ever seen. Fireman fire extinguishers contain a war proven chemical that amazes customers. The demonstration does all the selling for you. We show you how. Others are making **BIG MONKEY** with this success proven product—so can you. Let us start you on the road to high income, your own business. Send the coupon now for full details.

High Pressure  
Super  
Fireman  
Fire  
Extinguisher  
Contains  
CBM.

**SEND  
FREE  
SALES  
KIT**

INTERSTATE PRECISION PRODUCTS CORP.  
706 E. Vermont, Anaheim, California

SEND FREE SALES KIT  
 Enclosed is \$11.95 (check or M.O.) for four top selling extinguishers with **MONEY BACK GUARANTEE** if I return extinguishers within 30 days.

NAME \_\_\_\_\_  
STREET \_\_\_\_\_  
CITY \_\_\_\_\_ ZONE \_\_\_\_\_ STATE \_\_\_\_\_



# SKILLS for AMERICA THE ENGINEERING TECHNICIAN

CAREER SERIES ONE

American industry is dynamically on the move today. It is thought by many that we are on the threshold of a new era of technological progress in which the influence of science and the application of engineering principles will measurably affect production methods.

Industry continues to look for more highly skilled personnel, and emphasis is increasingly placed on the training and background experience the individual has to offer. Employment opportunities and advancement are self-provided if the individual strives for the proper training and is willing to work hard and accept responsibility.

Industry is looking for the kind of men who will become leaders in our advancing technology—men who will offer creative thinking, skilled hands and technically trained minds. If you would accept this role of leadership, prepare now by taking advantage of the educational opportunities at your disposal. Examine the facilities provided by the Technical, Trade and Vocational Schools who are training today the technicians, engineers and skilled craftsmen for tomorrow's industry.



"90% of the men on my staff have a technical education. I insist on it. We must have men with technical training or we won't progress. In my case, I feel the training I took through a technical institute contributed directly to my success. It's given me responsibility I wouldn't have otherwise. And that goes for any man eager for advancement—get a technical education first." *Hugo E. Free, Welding Superintendent, The Oilgear Co.*

## THE ENGINEERING TECHNICIAN

By Karl O. Werwath

Chairman, Working Group on Supporting Technical Personnel of the President's Committee on Scientists and Engineers

Perhaps the fastest growing area of higher education in the United States is the technical institute type, which prepares engineering technicians to meet the increasing number of occupational responsibilities in our technological economy.

This growing need for specialized technical manpower is in two directions: the depth of technical know-how and the greater number of trained people required. We frequently refer to the shortage of technical personnel as a "shortage of engineers". Actually, this is only a part of the problem, since the numerous new semi-professional occupations, coupled with the alarmingly small number of qualified engineering technicians to fill them, is even a more serious matter.

The modern industrial nation requires about 200 new four-year engineering graduates per million population per year. At the present, this would mean approximately 35,000 graduate engineers each year. We are graduating considerably less than that number. These engineers are part of an engineering team which should include five engineering technicians for each graduate engineer, in addition to the required skilled craftsmen. In our national educational pattern this relationship is almost the opposite, with less than one-fifth the needed number of engineering technicians now graduating from technical institute type courses. To attain the proper proportions and thus retain our position in a growing technological economy, we in the United States must develop talent to produce annually a greater number of engineers and up to ten times the number of qualified technicians.

But who is this engineering technician? What does he do and what is his preparation for his work? He is broadly defined as one who is engaged in certain vital, fundamental technical functions of product development, production, distribution, installation, operation and maintenance. While the engineer plans,

"Advancement? An adequate technical education is vital to advancement. The training I received in a school of engineering has helped me coordinate the dozens of technical activities in broadcasting, and has led directly to my position of responsibility." *Norbert J. Richard, Engineering Supervisor, Station WISN, Milwaukee, Wis.*



"The man with insight into technical problems because of his training will be promoted by his employer. My position and salary have progressed due to my technical education." *William P. Gainer, Television Engineer, Station WISN-TV, Milwaukee, Wis.*



"The man with a technical education gets first consideration over all others when we interview. This is a policy in our company. We look for men with imagination, a sense for the practical, and the kind of training that enables them to grasp technical problems and solve them. My business partner and I are both graduates of a technical institute. This training has helped us develop our own business. Naturally we believe in its value to others." *Omer M. Larson, Secretary-Treasurer, Federal Store Equipment Co., Inc.*





the technician makes and does; while the engineer creates, the technician applies. The technician is often the liaison between the professional man and the craftsman.

There are now over 100 accredited or approved courses in ten major fields in which technicians have become prominent and in which technician employment opportunities have demanded course development. These fields include aeronautical design, maintenance and production; air conditioning, heating and refrigeration; architecture and building construction; civil technology; electronics and radio-television; electrical power and control; instrumentation and watchmaking; metal fabrication and tool design; photographic; and steam, diesel and automotive technology.

Courses are from one to three years in length but generally require two academic years of full-time study. High school graduation or equivalent is needed for admission and most courses have specific additional matriculation stipulations. These programs are briefer and more technical in content than are professional curriculums. They include a heavy schedule of specialized technical subjects and are balanced with a program of related studies in mathematics, physical sciences, and engineering drawing. English, economics, human relations round out most schedules. Such technical institute courses are offered by privately endowed, public and proprietary institutions in many of the metropolitan areas of the nation and generally lead to a degree of Associate in Applied Science with a major in a technical specialty.

The pattern of successfully established programs have two basic, distinguishing factors. First, a technical institute curriculum is planned around the technical specialties and a neatly integrated combination of supporting subjects, both geared to dynamic industrial requirements. It is a specific form of higher education and is not a combination of skill training courses with some aspects of broader education. Second, the course also takes into account that the engineering technician, in executing his work, is a part of management. His education, of necessity then, also includes such training as is required of a leader in a free-enterprise technological environment.

The opportunities in this field open a broad choice of careers for hundreds of thousands of Americans who can also make a real contribution in advancing the interests of a strong, healthy economy and in strengthening the national defense.

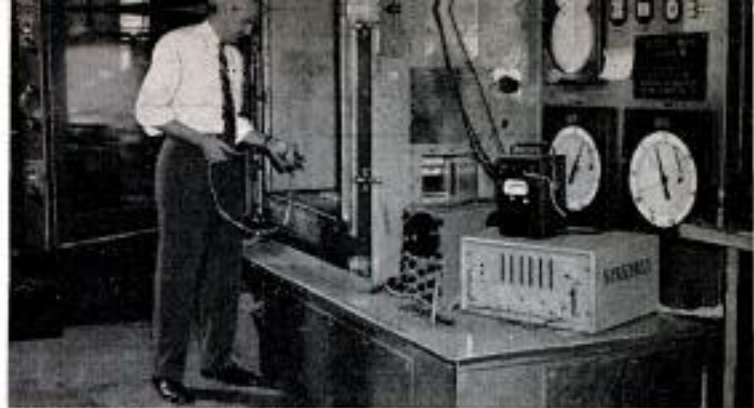

AC Spark Plug, Div. G.M. Corp. Laboratory Technician tests detailed part using Stratosphere Chamber to simulate conditions of humidity, temperature and altitude.



General Electric Co., X-ray Dept. Training customer service representatives is an important capacity of the Engineering Technician Specialist in industry; here explaining function of the components of cancer X-ray machine.



Allen-Bradley Co. Electronic Technician employs his skill to assemble complicated equipment, make tests and inspections of finished units; here he checks assembly and operation against line diagram.

Customer Engineers analyze performance of electronic data processing machine using highly sensitive electronic testing instruments.

IBM 705 Installation, A. O. Smith Corp.



## SKILLS for AMERICA

DECEMBER 1957

53



**94.6% OF BAILEY GRADUATES ARE EMPLOYED AT TOP PAY IN THE FIELDS WHICH THEY WERE TRAINED!**



**DIESEL-AUTO MECHANICS DESPERATELY NEEDED!**

We have a far greater demand for our students than we can fill! We can show you an actual waiting list of leading companies throughout the world who have tried Bailey graduates — found them outstanding, and are coming back for more! **Bailey Graduates are Successful . . . RECEIVE BIG PAY — HAVE SECURE FUTURE!**

The Famous Bailey Course prepares you for BOTH Diesel and Gasoline Mechanics. This is a must—due to the advent of using Diesel principles, such as 'Fuel Injection' on passenger cars . . . use of gasoline engines for starting Diesel engines, etc. You learn all this at Bailey in the amount of time ordinarily required to learn just one of these subjects, **ALL FOR THE PRICE OF ONE.** Don't be satisfied with a 'futureless', one-type job — learn how you can make big money now! Write today for Free Booklet that takes you on a step-by-step camera tour through our spacious, modern shops — See Bailey students in action as they Learn-by-doing with the Famous Bailey Method of training! We provide you with housing and part time jobs while in school, plus nation-wide placement service for graduates.

**BAILEY Technical SCHOOLS**  
1634 S. GRAND ST. LOUIS 4, MO.

**MAIL TODAY!**

Please mail immediately this free booklet without obligation.

**FREE BOOKLET**



Name.....  
Address.....  
City..... State.....  
**APPROVED FOR VETERAN . . . NON-VETERAN**

**OUR BEST VALUE OF THE YEAR!  
2 1/2 AMP. RUGGED POWER  
1/4" THOR SPEEDRILL**



**Geared Chuck & Key—AC-DC 2400 RPM**  
If your work calls for a "rugged" drill with POWER to SPARE, insist on a 2 1/2 Amp. job . . . and make sure it's THOR! No finer drill made! Solid steel, heat-treated helical gears; thrust taken on hardened steel ball and plate; gears permanently packed and sealed in LIFETIME grease! Switch, trigger and lock assembly simplifies locking and release trigger. You'll be wise to buy 2 at this price. Supplies limited!

**BRAND NEW!**  
**\$14.95**  
plus 50c pp. & hdg.

**Prices SLASHED 50% on Famous ROCKWELL CARBIDE TIPPED CIRCULAR SAW BLADES**

There's no finer name in saw blades than Rockwell! Now you can buy these blades, in original factory packages, at only half the regular price! Will fit most radial and portable saws. Carbide tip and perfect balance is your assurance of perfect cutting through all varieties of wood and wood laminates plus aluminum, magnesium, formica, flexboard, plastics, gypsum board, tank, plywoods, rubber, floorboard, jurite, bakelite, tileboard, masonite and similar materials.

- |                                      |                                   |
|--------------------------------------|-----------------------------------|
| 6" blade with 10 teeth . . . \$ 6.50 | 8" blade with 8 teeth . . . 6.50  |
| 7" blade with 8 teeth . . . 6.50     | 8" blade with 16 teeth . . . 8.50 |
| 7" blade with 14 teeth . . . 7.50    | 10" blade with 18 teeth 12.50     |

All prices plus 50c ea. for pp. & hdg.  
In 1/2" and 5/8" round and 1/2" and 13/16" square bores to fit Skil, Thor, Mall and Cummins saws. Please specify when ordering.  
Send Check or M.O. C.O.D. fee extra. **MONEY BACK GUARANTEE**

**SCOTT-MITCHELL HOUSE, Inc.** DEPT. M-510, 611 BROADWAY, NEW YORK 12, N. Y.

**"TI-NEE" BATTERYLESS TUBELESS LIFETIME RADIO**



"TI-NEE" RADIO IS GUARANTEED TO WORK FOR YOUR LIFETIME! USES NO TUBES, BATTERIES OR ELECTRICAL PLUG-INS. Never runs down! SMALLER THAN A PACK OF CIGARETTES! RECEIVES LOCAL RADIO STATIONS MOST ANYTIME, ANYWHERE WITHOUT EXTRA ANTENNA. Uses semi-conductor crystal diode Hi-Q Tuner. Beautiful black gold plastic cabinet. Built-in Speakerphone.

**SEND ONLY \$2.00** bill, e.k. mo. and pay

postman \$4.99 COD on arrival or send \$6.99 for postpaid delivery.  
SENT COMPLETE READY TO LISTEN—NOTHING EXTRA TO BUY EVER! Extra long distance Aerial kit included free to receive stations up to 1,000 miles away. Available only from:  
**MIDWAY COMPANY, Dept. GPM-12, Kearney, Nebraska**

**Be an industrial designer**

Combine your design abilities with technical aptitudes in Industrial Design training at Art Center School in California. Work under practicing professionals for upper level jobs as automotive stylists, product and package designers. Design offices, stores, motels, showrooms, shopping centers. Constant demand for graduates. Recent placements with Ford, G.M., Kaiser Aluminum, G.E., Raymond Loewy and other leading design studios. 700 students. Co-ed. Accredited. B.P.A. Degree. Four-year course can be completed in 2 yrs. 8 mos. by year-round training. New terms Feb., June, Sept. Enroll early. Write Mr. Mead for new catalog. 5353 West 3rd St., Los Angeles 5, California.

**ART CENTER SCHOOL**

**LEARN LOCKSMITHING**

Learn fascinating, profitable trade from experts in spare time at home! Age or physical handicap no disadvantage. Year around, steady income. Full or part time. Practical, illustrated lessons. Make money even while learning! All materials and special tools supplied. Free Booklet, **INSTITUTE OF LOCKSMITHING, Dept. P-97**  
150 PARK AVENUE E. RUTHERFORD, N. J.  
Lic. by N. J. State Board of Ed. Approved for Vets

**NYLON GOLD SUIT**  
**WHOLESALE \$23 398** post paid



These brand new below-zero suits cost the government \$23.00. Double layer nylon gives unbelievable protection from the cold. Micro tight knit seals body warmth in and locks cold weather out. Light weight - designed for U.S. Jet Pilots. Wear under your jacket for real body comfort. Check these features:  
Double layer of water repellent nylon. Elasticized ankles to seal warmth in. Heavy duty zippers last a lifetime. Flex action knees for free movement.  
This amazing bargain won't last at this price of \$3.98 — Order Now! Specify Large, Medium or Small. Wool Hood for Head \$1.98 Jacket \$2.98 (as shown)

**ORDER BY MAIL**

Send to **S & R RESEARCH, Box H 82, San Gabriel, Calif.**



WORLD'S  
BEST  
WANT-AD  
MEDIUM

# CLASSIFIED ADVERTISEMENTS



Advertisements in this section \$1.25 per word, each insertion, minimum 10 words, payable in advance.

To be inserted under proper classification, copy must be in our office by

20th of the second month preceding date of issue

F. W. Johnson, Manager, Classified Advertising

Popular Mechanics Magazine, 200 East Ontario Street, Chicago 11, Illinois

## YOU'LL PROFIT

By reading and answering the classified ads in this section. Hundreds of opportunities for you to make and save money

### AUTOMOBILES, MIDGET CARS

110 MPH With motorcycle engine racing car! (Formula III) plans and instructions. \$5.00. Dane Racing Cars, 13015 Lorne, North Hollywood 11, Calif.

SPORT Car with reverse. Low price. Details free. Powermij, 940 North 23rd St., Omaha 2, Nebraska.

BOYS' Power-driven auto. Build your own. Plans 35 cents. Sypher Co., Sta. P., Toledo, Ohio.

SUPERIGNITIONITER: Starting, pep, mileage, \$4.50. Kaisers, Varitypers, IBM's, mimeographs, courses, barbells. EG, Elmsford, N. Y.

NEW 1958 Automobiles—To 25% off. Meder, 550 Fifth Avenue, New York City 36.

HUNDREDS Of automobile catalogs—Old, new and foreign; dealer books; glossy photographs; shop manuals; free motor magazines listed by non-profit club. Write to get on free mailing list. Auto Maniacs, Stockbridge, Mich.

### AUTO SUPPLIES AND EQUIPMENT

POWERSCAN—Power operated car rear vision mirror, eliminates the blind spot in driving. Free circulars. Gilm Industries, 3420 Trimble Ave., Cincinnati 7, Ohio.

NOLITE Dome light switch control. Patented. Two for \$1, on approval. Deactivator, Anderson, S. C.

SPARK-O-Matic power plugs. More power plus more miles per gallon. Life guarantee. Salesmen wanted. R. J. Catherman, Windsor, Mass.

RING-Valve job while driving. \$6.00. Literature. Motaloy, Grantham, Penna.

FREE Giant 1958 parts catalog. Thousands scarce accessories stores don't have. Gadgets, custom equipment. Send 25¢ postage (refundable). Newhouse Automotive Industries, 5806-PM Beverly, Los Angeles 22, Calif.

NEW And used parts at savings. Complete guaranteed parts service for all models cars and trucks, 1924 and later. Largest in the West. Jeep and army parts specialists. Newest type shifting hubs for all jeep and all military and latest production front end drive vehicles. \$27.50 and up. Write. Pioneer Auto and Truck Parts Co., 734 W. 13th Avenue, Denver 17, Colo.

WILLYS Jeep tops—Convertible tops. Free catalogue. Mor-Nan, Box 123, Boston 14, Mass.

DO-It-Yourself booklets. 24 different booklets each covering an interesting subject. Free catalog. Popular Mechanics Press, 631 N. St. Clair St., Chicago 11.

FLASH! Start your car instantly in cold weather. Guarantee 12 volt on 6 volt battery. For starting purpose only. \$1.00 blueprint instruction. K. S. Service, 142, Friant, Calif.

STOP Chrome rust from salts. 50¢ postpaid. Wax Products Co., Escanaba, Mich.

AUTO Accessory and parts catalog. 1957 edition, all new! 228 pages. Save up to 50%. 75,000 items, including Hollywood accessories, hi-speed equipment, rebuilt engines, all parts and accessories for all cars and trucks! Hard-to-get parts! Send 25¢, refundable. J. C. Whitney, 1919 PM Archer, Chicago 16, Ill.

SAVE Money on Jeep and army truck parts. Large inventory. Catalogs for Jeep or G.M.C. owners. American Auto Parts Co., 1830 Locust, Kansas City, Mo.

FREE! New catalog. Speed, power, mileage increasing equipment. Discounts! Almquist Engineering, Milford PM5, Penna.

AUTOMOTIVE Books. Free catalog. Popular Mechanics Press, 631 N. St. Clair St., Chicago 11.

### AUTO TRAILERS

BUILD Expanding eight foot trailer. Accommodates five. Literature 10¢. Fra-Mar Company, Wilmington, Mass.

CABIN Trailer kits. Pleasure or business. Write Burlington Manufacturing Company, Burlington, Iowa.

BLUEPRINTS Trailers, Pickup coaches. Trailer supplies. Literature 10¢. Comstock Trailers, Parsons, Kansas.

TRAILER Building manual \$1.00. Booklet 30¢. Kamcraft, Box 1153, Milwaukee 1, Wis.

### MOTORCYCLES, BICYCLES, MOTORSCOOTERS AND SUPPLIES

NSU Scooters and motorcycles, BMW motorcycles, 2 to 35 h.p., shaftdrive and chaindrive. Butler & Smith, P.O.B. 45, New York City 24.

1953 CUSHMAN \$15. Midget car \$25. Micromidget \$63. less motors. Motors \$3 up. Evinrude outboard \$10. Whizzer \$7.50. (Mailorder only). Send 25¢ (35¢ for first class mailing) for new 32-page Directory-Catalogue Number Eighty listing these and hundreds of other bargains in new and used motorscooters, midget cars, home-builders parts, plans, etc. Midget Motors Directory, Athens, Ohio.

RECONDITIONED Motorcycles and motors. Chromium accessories. Complete stock Indian parts. Expert rebuilding. Fast service. Indian Motorcycle Sales, Kansas City 27, Missouri.

HARLEY - Davidsons—Used bargains. New, used parts, accessories for all models. Bulletin, catalog 25¢. Knuth's (Factory Dealer), 1753 Muskego, Milwaukee, Wis.

BANKRUPT Motorcycle bargains at giveaway prices. Catalog bulletin 25¢. Bunico, 146-BK, Covington, Virginia.

### AVIATION

SMALL Helicopters theory and guide manual. Drawings. Construction data. \$2.00. Sandhill Aircraft, Box 398, Atkinson, Nebraska.

PROPELLERS, Plans, supplies for airboats and snowplanes. Latest designs, prompt delivery. Catalog 25¢. Banks-Maxwell, Box 3301E, Ft. Worth 5, Texas.

ACTUAL Flight training possible on low income. Send \$2.00 for written detailed method plus informative booklet. ATS, Box 715 Hialeah, Florida.

AVIATION Surplus bargain catalogue. One dime. Box 23PM10, Thomasville, Penna.

BUY Surplus aircrafts; fuselages; assemblies; aircraft engines; helicopters; instruments; electronics; radiotelephones; misc. Buy direct now from U. S. Government. Depot list and procedure \$1.00. Brody, Box 8-PM, Sunnyside 4, New York City.

BUILD Your own plane! Complete plans, instructions \$1.00. Flying course included. ABC Publications, Box 849-AP, San Francisco 1, California.

SPORTPLANE Building manual illustrated \$1.00. Circulars 20¢. Kamcraft, Box 1153, Milwaukee 1, Wis.

HUNDREDS Aviation surplus items! Priced catalog, 10¢. Aero Parts, 8102 Lockheed, Houston, Texas.

### BATTERIES, GENERATORS

EDISON Nickel storage batteries. Any voltage, any amperage. Unconditionally guaranteed. Power plants, generators, motors. Literature. Hawley Smith Co., Croton Falls 1, N. Y.

### ELECTRICAL SUPPLIES

INSTRUCTIONS Preventing electrocution from T.V., radios, appliances. Also testing fuses, wiring. \$1.00 Duckworth, 1102 E. Limberlost Drive, Tucson, Arizona.

MAGNETIZER—Magnetizes screwdrivers, etc., only \$1.00 postpaid. Kubiak, Huntingdon Valley, Penna.

LAMP. Electrical parts, wholesale. Thousands of items for repairing, converting. Catalog 25¢. Brown Lamp, Box 305, Clayton 5, Mo.

ELECTRIC Pencil: Engraves all metals \$2.00. Beyer Mfg., 10311-H Springfield, Chicago 43.

MONEY, Happiness. Free inceptor for success. NISL, Box 610, Long Beach, Calif.

PHYSICAL Therapy and massage. Home training practice. Privately or work with doctors and hospitals. Free catalogue. National Institute, Desk 4, 159 E. Ontario, Chicago, Ill.

LAMPS—Parts catalog containing wiring instructions. 25¢. Gyro Lamps, 3438P N.W. 54 Street, Miami, Fla.



## WELDING, SOLDERING, PLATING

**NEW** All-in-one oxyacetylene outfit welds sheet, plate; cuts heavy steel; heats; brazes. Uses interchangeable tips. Portable, easy to operate. Complete with instructions, \$84.50. Gas cylinders on special money-saving plan. Write for free information: Dept. M, Linde Company, 30 East 42nd Street, New York 17, New York.

**BUILD-Your-Own** welder or welder and power combination. Low cost unit connected to used engine lets you weld anywhere. Free booklet tells how. Get into profitable welding business. Write Hobart-weld, Box M-1272, Troy, Ohio.

**ELECTRIC** Welders New, heavy-duty, 180 amp. Free trial. Dealerships open. 20 year warranty. 1519 South Pleasant, Department A1, Minneapolis 20, Minn.

**BUILD** Fast selling welded hand trucks (merchandise, beverage, appliance, etc.). We supply production models (sample "utility" \$9.95). Information. Wilson Steel Products, Childersburg, Alabama.

**WELDERS**, 110/220, \$39.50. Morris, 1070 Inner Drive, Schenectady 3, New York.

**A.C. Welders**, 4 sizes, lowest prices. Free literature. Holger's Service, Canton, Kansas.

**ACETYLENE** Welding outfits, new \$54.50, new welders \$56.50. Eagle Welding, Dept. P.M., 3085 Broadway, Chicago 40, Ill.

## MACHINERY, TOOLS, SUPPLIES

**PAYSWELL** Sprayer, compressor type, 50 lbs pressure, time payments, trades, free information, Selco Corp. 224 W. 7 St., St. Paul 2 Minn.

**METAL** Drawers with index handles. Request literature. Johnson Metal Products, Chalmers, Indiana.

**DAWN** Gage quickly centers round stock for turning or drilling. \$2.95 postpaid. Details free. Dawn Crafts, 215 Commonwealth, Buffalo 16, N. Y.

**McCULLOCH** Chain saw parts for all model saws 1/2 price. Used but guaranteed okay. Barnett Equipment Co., So. Glens Falls, N. Y.

**BID** Your price on surplus tools, etc. Lower than wholesale. Subscription \$3.00 year. Information 25¢. Bidders Service, Box 522, Niagara Falls, N. Y.

**INDICATORS**, Federal #C71 dial—.0005 only \$12.50, postage paid. Special aircraft tools. Genex, P.O.B. 665, Sun Valley, Calif.

**POWER** Tools, not toys. Discounts. Factory catalogs. World Tool Supply, Box 4404, Joyfield Station, Detroit 28, Mich.

**OIL** Drum cement mixer assembly kit. Circular. Nu-Way-Do Co., Newaygo, Mich.

## ENGINES, MOTORS, DYNAMOS

**DIESEL** Injector parts wanted, GM51-71-110. Bares, 7120 Carnegie, Cleveland 3, Ohio.

**GAS** Engines: Poreclosure sale: 1 1/2 to 9 h.p. Brand new, factory fresh, latest models. Briggs Stratton, Clinton, Lauson. Positively below wholesale prices or your money back. \$23.50 and up (freight paid). Details free. Northern, 172-M Merrimac Street, Boston 14, Mass.

**ELECTRIC** Repairmen. Send for catalog ohmmeters, winding equipment. Motor Industries, Quincy, Illinois.

**1/2 HORSEPOWER** Electric motors, a.c. 110, used, good \$5.00 each. f.o.b. Plant Machinery Corp., Richmond & Norris Sts., Philadelphia 25, Penna.

**REWIND** Motors yourself. Complete instructions \$1.00. Lewis Mfg., Howell, Michigan.

**WINDING** Data. 275 motors, single and three phase, \$1.10. Data Company, Box 7631, Kansas City 28, Mo.

## BOATS, OUTBOARD MOTORS

**SAVE** Money. New, used outboard motor parts. Send wants. Stamp appreciated. Outboard Motor Mart, 229-M State, Boston 9, Mass.

**FREE** Catalog! Boat kits, trailers, fiberglass, marine hardware. Luger Industries, Dept. 12, 3404 Lyndale South, Minneapolis, Minnesota.

**MARINE** Conversions for Ford and Jeep engines. Catalog 25¢. Lehman Manufacturing Company, 972D Broad Street, Newark 2, New Jersey.

**FULL** Size, cut-to-shape boat patterns, blueprints, 7 1/2-38 feet. Big new 88 pg. illustrated "Build a Boat" catalog of naval architect-designed cruisers, runabouts, skiffs, outboard boats, sailing, racing, houseboats, 50¢. "How to Build a Boat" booklet, \$2.50. Hardware and equipment catalog, \$2.00. Cleveland Boat Blueprint Co., Dept. A-66, Box 1651, Cleveland, Ohio.

**CATALOGUE** Free—Boating flags, gifts, gadgets. Lighthouse, Box 145-B, Plymouth, Mass.

**MARINE** Conversion, Willys to Cadillac, engines, kits and parts. Catalogue and conversion hints free. Barr Marine, 2706 Castor Avenue, Philadelphia 34, Penna.

**FORDS** And Jeeps 100% marine engines with famous Convo-Kits. Deluxe catalogue 25¢ coin. Oscomotors, 3627B Lawrence, Philadelphia 40, Penna.

**BOAT** Plans. Full size patterns. Frame kits. Modern inboards and outboards for amateur builders. Complete new catalog 50¢ or specify requirements. Glen Designs, Box 548, Compton, Calif.

**NEW**, Used, rebuilt marine motors. Marine conversions, fittings. Free catalog. Stokes Marine Supply, Dept. 24, Coldwater, Michigan.

**FIBERGLAS** Permanent boat waterproofing. Special 25% discount. Complete kits, \$9.45 up. Guaranteed materials. Easy application. Full instructions. Free literature. Ajax Plastics, Dept. PM, P.O. Box 1323, Fort Worth, Texas.

**BUILD** Small boats. Booklet 25¢. Catalog free. Popular Mechanics Press, 633 N. St. Clair St., Chicago 11.

**260 POWERBOAT** Plans, patterns, catalog 50¢. Marinecraft, Box 161-M, Brighton, Mass.

**FIBERGLASS** Your boat! Complete kits including color resin. Low as \$8.50. Aquaglas, Box 99, Altadena, Calif.

## ATHLETIC EQUIPMENT, BODY BUILDING COURSES

**BARBELLS**, Dumbbells. Courses. Free catalogue. Good Barbell Co., Siloam Springs, Arkansas.

**BASKETBALL** Players, coaches—Increase shooting average up to 75%. Learn home. \$1.00. Satisfaction guaranteed. Basketball, Box 208, Kilgore, Texas.

**OUTSTANDING** Physical development! Any age. New guaranteed discovery uses only a rope! Strength, health, muscles. Gain-reduce. Free details. Roperise, 4634-A Art, San Diego 15, California.

**BE** Taller! Coach's genuine "Inch-At-A-Time" System, \$1. "Strongman Foods," \$1. Satisfaction guaranteed. Marty Snyder, Box 195-MW, Union City, New Jersey.

**JUDO**, 125 Pages, 186 illustrating photographs, \$1.00. Marshall Mail Merchandising, Dept. 2A, Payne Road, Bethel, Connecticut.

**BE** Taller! Amazing guaranteed instructions \$1.00. ABC, Box 849-TP, San Francisco 1, California.

## SPORTING GOODS, GUNS, FISHING TACKLE, ARCHERY, TRAPPING

**FREE** Below wholesale fishing catalog. Fishing Tackle Mart, Dept. 512, Box 6737, Chicago 80, Ill.

**FREE** 152 Page fishing catalog. Includes latest "do it yourself" kits. Netcraft Company, Dept. B12, Toledo 15, Ohio.

**LUGERS!** Mausers! Colts! P-38s! Kentucks! Weatherbys! Antique-modern guns, accessories! Super bargain catalog only 50¢. Agramonte's, Yonkers 2G, N. Y.

**LAZY-IKE** "Rod-Rac" holds fishing rod of all sizes at any point on shaft. Mounts on wall, holds three rods, \$1.98. Kautsky Lazy Ike Co., Ft. Dodge 31, Iowa.

**AUTHENTIC** Primitive weapon reproductions! Spears, crossbows, edged weapons, etc. Colorful, deadly, decorative. Catalogue 10¢. Primitive Weapons, Pevely, Missouri.

**RIFLES**, Shotguns, pistols, scopes, ammunition. Dealers prices. Berkshire Gun Rack, Six Lakes, Michigan.

**BIG** Money raising crickets and 12 inch African fishworms. Free literature. Carter Ranch, Plains, Georgia.

**5000 BARGAINS**, Firearms, binoculars, war relics. Catalog 50¢. Smith Firearms, Runnemed, N. J.

**FREE** Sporting goods catalogs! Save 70%. Econ-O-Mart, Whippany 2, New Jersey.

**MOLDS** For fisherman's sinkers, jigs, squids, casting and spinning lures. Free catalog. Sweet's Molds, Tonawanda 1, New York.

**JAP** Rifle altering to 30-06, \$6.00. Japshells, \$3.95. Catalog 5¢. T. P. Shop, West Branch 11, Mich.

**BUILD** Barbecue. Complete plans. Booklet 25¢. Free catalog. Popular Mechanics Press, 633 N. St. Clair St., Chicago 11.

## EARTHWORMS

**EARTHWORM** Raising booklet \$1.00 postpaid. Free, soilless method. R. Goocher, Box 883, Menlo Park, California.

**RAISE** Earth worms. Profitable, easy instructions 25¢. Lair's Hatchery, Box 84, Virden, Illinois.

**FREE** Folder, "How to Make \$3,000 Yearly. Sparetime, Backyard, Raising Earthworms!" Oakhaven 56, Cedar Hill, Texas.

**CALIFORNIA** Meal worms. Ice bait supreme. Keeps weeks, 200-\$1.00, 1000-\$3.50 postpaid. Dealers and distributors inquire. Crest Bait Distributors, 3328 Madison Avenue, Indianapolis 27, Indiana.

**RAISE** Domesticated earthworms. Instructions free. Frank H. Barnhart, 209 Lamont, San Antonio, Tex.

**FREE** Literature—Amazing profits raising giant fishworms and crickets. Carter Redworms, Plains, Georgia.

## BINOCULARS, TELESCOPES, MICROSCOPES, MAGNIFIERS

**BUILD** Your own reflector telescope. Complete kit: mirrors, eyepieces, tripod, all other accessories. Request free illustrated literature. Criterion Manufacturing, Dept. DPM 36, Hartford, Conn.

**BUILD** Astronomical telescope. 35 page illustrated book. \$1.00 postpaid. Oil Coast Industries, El Campo, Texas.

**AMAZING** Prices precision binoculars. Folder, "Binocular Selecting," catalog free. Dealers also write. Prentiss Importers, Mercury Bldg., West Los Angeles 25, Calif.

**MICROSCOPE** Catalog free. Research Scientific Supplies, 126 West 23rd Street, New York 11, N. Y.

**REFRACTOR** And reflector telescopes. Also mirrors, lenses, tripods, etc., for making your own telescope. Free illustrated catalog. Suffolk Science, Mattituck, N. Y.

**DYNASCOPE**—Sensational new reflector telescope. Send for details. Criterion Co., Dept. DP39, Hartford, Conn.

**REFLECTING** Telescope, 60X, completely assembled \$29.75. Guaranteed observatory clearness. Free information. Skyscope, 475 Fifth Avenue, New York City 17.

**REFLECTOR** Telescope kits \$7.25 (3") to \$175 (12"). Mirrors, cells, focusing mounts, tripods, eye systems. Anything, everything in telescopes. Free catalog. Also ready to use telescopes from \$25. Ecco Products, Oakridge, N. J.

**WAR** Surplus bargains: Millions of lenses, instruments, telescopes, binoculars, components and complete line of astronomical telescope items. World's greatest optical market-place! Send only \$1.00 for beginner's 10-lens kit and big instruction booklet Stock 2-CH. Write for catalog "CH," free! Edmund Scientific Co., Barrington, New Jersey.

**POCKET** Microscope! 50X—See nature's wonders, 2500 times magnification. \$1.00 postpaid. DuPont Distributors, 2153 Amsterdam Avenue, New York 32, N. Y.

**BINOCULARS**, Telescopes, microscope, terrific values \$3.98 up. Request free money-saving catalog. Criterion, Dept. P61, Hartford, Conn.

**SEE** Satellite. Famous Swift binoculars. Powerful, 6 x 30 C. F. Precision ground. Rubycoted lenses, prisms. Deluxe leather case free. Lifetime service guarantee. Only \$29.50, tax included, postpaid. Martin & Martin, Dept. PM, 1187 Canyon Heights Drive, Niles, Calif.

## PLANTS, SEEDS, BULBS, NURSERY AND GARDEN SUPPLIES

**WORLD'S** Greatest cash crop. Free information. Write Ginseng Gardens, Asheville, N. C.



## PETS—DOGS, BIRDS, RABBITS, HAMSTERS, ETC.

**HAMSTERS**, Young Golden, \$2.50 pair. Breeders \$3.50 pair. Engle's Hamstery, 2608 So. 11<sup>1</sup>/<sub>2</sub>, Terre Haute, Ind.

**LIVE Nutria** \$15.00 each. Complete animal, reptile list 25¢. Snake Farm, Laplace, Louisiana.

**HAMSTERS**—Golden: young, \$3.00 pair. Fully developed \$4.00 pair. Adirondack Hamstery, Prospect 10-N, N. Y.

**HAMSTERS**—Young Golden pairs, \$2.89, breeders, \$3.89. Free literature. Syrian-American Hamstery, Oskaloosa, Iowa.

**ALLIGATOR**—Live baby, harmless. Send \$5 p.p.d. to Alley Farm, P. O. Box 303, Miami Shores, Fla.

**WHITE German Shepherd puppies**. Theatrical dog tricks. Knoff, Nashotah, Wisconsin.

**WE Pay \$3.50 lb. dried**. Grow mushrooms, cellar, shed and outdoors. Spare full time, year round. We have 25,000 customers. Free book. Washington Mushroom Ind., Dept. 171, 2954 Admiral Way, Seattle, Wash.

**BEAUTIFUL Pure white pedigreed police puppies**. Ansonia Kennels, McHenry, N. Dak.

**RAISE Rabbits** successfully by knowing facts. 48 page illustrated book describing 25 breeds. Housing, feeding, breeding, marketing, etc. Plus bulletin. 25 cents. American Rabbit Association, 36 Arba Building, Pittsburgh, Penna.

**MAKE Money** raising chinchillas, mink, nutria, rabbits, cavia for us. Free catalog. Keeney Brothers, New Freedom 2, Penna.

**HAMSTERS**—Young Golden pairs, \$2.95, breeders \$3.95. Free booklet. Jer-Fre's Hamstery, 2425 Hoyt, Muskegon Heights 13, Mich.

**RAISE Rabbits** on \$500 month plan. Plenty markets. Free details. White's Rabbitry, Delaware, Ohio.

**STRAIGHT Cooners!** World's oldest kennel. Combination hounds, rabbit, fox, beagle, deerhounds, bird dogs. Puppies of all breeds. Prices reasonable. Trial. Free catalogue. Raccoon Mountain Kennels, Box 464, Boaz, Alabama.

**SPORTSMEN!** World's largest kennels offers 500 bird dogs, straight cooners, combination hounds, beagle hounds, rabbit hounds, small squirrel dogs, fox and deer hounds. Catalogue free. Smokey Mountain Kennels, Cleveland, Tennessee.

**ST. Bernard puppies**. Loving lasting gifts. Slegend, Waukeg, Iowa. Ph. 7502.

## FUR BEARING ANIMALS

**1000 BRED Mink**—Booklet, plans 25¢. Lake Ontario Ranch, Gravel Road, Webster, N. Y.

**AMAZING Profits** producing fur. Free information. Twentieth year. Votght Farms, Atlanta 2, Texas.

**MINK Raising** information free. Complete. Lake Superior Mink Farm, Superior, EEL, Wisconsin.

**RAISE Mink!** Free booklet, pen plans, inside secrets, feed, care. Mink are money makers. Investigate today. Lawrence Mould, Brigham City 12, Utah.

## FARMS, FARM LANDS, REAL ESTATE

**FREE Strout catalog!** Farms, homes, businesses, resorts, retirement properties. Over 2900 values in 34 states. 57 years' service. World's largest! Write Strout Realty, 7-MP So. Dearborn, Chicago 3, Ill.

**HOMESITES \$15 Monthly**—California's finest garden section. Morro Bay's scenic shores. Wonderful fishing, boating. Fertile soil, softest water, temperate climate, congenial community. Free literature. Richard Otto, Department M, San Luis Obispo, California.

**OPPORTUNITIES!** Government land. U. S., Alaska, Canada. Sledge Surveys, Macon 1, Mississippi.

**CALIFORNIA State government land**, 40 to 640 acre tracts. \$5 acre minimum. 10¢ brings information on available locations, maps of 500,000 acres. Pioneer Ranches, 7419-PM Beverly Blvd., Los Angeles 28, California.

**\$5.00 MONTHLY Buys 40 acres** productive land. Near town. Price \$250.00. Free list, Box 425-F, Carthage, Mo.

**FLORIDA**, Nice homesites, \$345 at \$10 monthly. Folder free. Howard Vernor, DeLand, Florida.

**FLORIDA Homesites**, new lakeside development. Moderate prices, monthly payments. Fine hunting, fishing. Adjoins Ocala National Forest. Literature. Grace Parker, Paisley, Florida.

**TEXAS Cabin sites**, 5 clear mammoth lakes. Finest fishing, hunting. Good roads, electricity. Developing fast. Private boat dock, fishing pier, barbecue pits, tables, and picnic grounds free to lot owners. Ideal for retirement or recreation. Near 3 thriving towns. Everything you could wish for. Two (2) adjoining lots total cost for both only \$145.00, \$10.00 down, \$10.00 month. Write for maps, photos, etc. Dept. GS-1, P. O. Box 50, Kingsland, Texas.

**FLORIDA Homes** with income. Low taxes. Box 848, Eustis, Florida.

## PROFITABLE OCCUPATIONS

**WELDERS** Make money. Learn quick at our modern school. Enroll today. Write or visit Gallon Welding, Gallon, Ohio.

**INVESTIGATE Accidents**—Earn \$750 to \$1,000 month. Thousands of airlines, insurance companies, steamship lines urgently need claim investigators. We train you home spare time. Placement counsel and help. Free book, now! No obligation. Universal Schools, T-12, Box 8202, Dallas 5, Texas.

**BIG Profits** in welding. Easy to learn. Low cost training in completely equipped non-profit school. GI approved. Write for free booklet. Hobart Trade School, Box M-1273, Troy, Ohio.

**HOME Mailorder** beginner's manual, sources, methods, opportunities, 25¢. Carnahan Bros., 9610 Acacia, Fontana, Calif.

**FREE Information**, mail order business. Write Box 8382, Albuquerque, New Mexico.

**MAGAZINE Subscriptions**—Largest commissions. Bonus. Qualified Agency, 451CA Kingston, Brooklyn 25, N. Y.

**CHARACTER Analysis**, free brochure. Lucas System, 3419 Sunset, Los Angeles 26, California.

**RECEIVE Samples**, job, money earning opportunities. Informative literature, \$1.00. Druels, 4821 Homerlee, East Chicago, Indiana.

**\$60.00 WEEKLY**, Sparetime — Easy! Home Venetian blind laundry. Free book. Burt, 2434ES, Wichita 13, Kansas.

**\$100.00 WEEKLY** Spare time with a tape recorder! Fabulous new business. Entire country wide open! Record weddings, parties, sports events, stereophonic sound, sound-on-sound multiple recordings. Make radio commercials, sound effects. Have fun and make big money in the glamorous business of tape recording. Money-making facts free! Dixieland Publishers, Asheboro 2, N. C.

**FREE Book "990 Successful, Little-Known Businesses"**. Work home. Plymouth, 1610-43 Street, Brooklyn 4, N. Y.

**MUSHROOMS** Quicker, easier, cheaper. Newest facts free. Luxur, 641 South 19th, Newark 3, N. J.

**MONEY Plans!** Secret Journal. Grandpa, two daughters made \$2,500 first month! Work home. Publiccos, Oceanside, Calif.

**OPERATE Profitable home mail-order business**. Details free. Fox, 12022 Pine, Norwalk, Calif.

**WE Pay \$3.50 lb. dried**. Grow mushrooms. Cellar, shed and outdoors. Spare, full time, year round. We have over 25,000 customers. Free book. Washington Mushroom Ind., Dept. 99, 2954 Admiral Way, Seattle, Wash.

**SAVE Money!** Buy wholesale! Free catalog general merchandise. Norris, 487-M Broadway, New York City.

**SPARETIME** Repeat profits taking magazine subscriptions. Special offers. Cassell Agency, Boynton Beach, Florida.

**FREE Folio "\$5,000-\$45,000: Unlimited Vacations"**. No merchandise. Unknown! Work home, sparetime! Haylings, Carlsbad, Calif.

**BE The Popular Mechanics** representative in your neighborhood and earn big profits in your spare time. Write Popular Mechanics Magazine, Room 305M, 200 E. Ontario St., Chicago 11.

**BIG Money** raising fishworms and crickets. Free literature. Carter Wormery, Plains, Georgia.

**BAKE New greaseless doughnuts** in kitchen. Sell stores. Free recipes. Michael Ray, 3605 South 15th, Minneapolis 7, Minn.

**RAISE Pheasants** on \$100 week plan. Little capital and space can make you independent. Free details. Great Central System, Columbus 1, Kansas.

**FREE Book "505 Odd, Successful Businesses"**. Work home. Pacific, Oceanside, Calif.

**MAKE Flexible molds**. Cast plaques, figurines. Free sample. Tooker, 1045-M Fairview, Hamilton, Ohio.

**VENDING Machines**—No selling. Operate a route of coin machines and earn amazing profits. 32-page catalog free. Parkway Machine Corporation, Dept. 25, 715 Ensor Street, Baltimore 2, Maryland.

**AUCTIONEERING**—Home study course. Diploma granted. Auction School, Ft. Smith, Ark.

**BUY Wholesale!** Over 10,000 nationally advertised products. Appliances, cameras, sporting goods, housewares, watches, typewriters, tools, clothing, etc. Send postcard today. Buy-Rite, Box 258, Hawthorne 3, New Jersey.

**WANT To make big money** at home? \$10.00 profit in an hour possible with invisible mending. Make tears, holes, disappear from clothing, fabrics. Steady year-round demand from cleaners, laundries, homes. Details free. Fabricon, 6236 Broadway, Chicago 40, Illinois.

**LEARN The high paying newspaper trade** at home. For details write Thomas Smith, P. O. Box A-3987, Sarasota, Fla.

**AMERICA'S Largest wholesale supply**. Buy, sell. Amazing profits. New free plan. Associated Wholesalers, Box 52-DX, Burlington, Iowa.

## BOOKS, PERIODICALS, PICTURES, POSTCARDS

**CATALOGUE** Free, old books, Wall Enterprise, 4069 Grover, Boise, Idaho.

**BRITISH Book bargains**—Any subject. Catalog free. Transbooks, Box 1-PMR, Wantagh, N. Y.

**2 STREET Scene cards**, 25¢. C. Fox, Box 332, Cannon Falls, Minnesota.

**JOIN Organization** for older folks. Strive for better benefits. Five issues of magazine, 50¢. Age Outlook, 1015 W. Liberty St., Rome, N. Y.

**FREE: Catalog!** Hundreds of subjects! Treasure-Site Book Company, 279 South Alden, Philadelphia 29.

**JOHN Friend**, bookfinder, can get the books you want. Free search service. Box 2570PM, Long Beach 1, California.

**BOOKHUNTERS!** Scarce, miscellaneous books. Atlantic Book Service, Cedar Street, Charlestown 29, Mass.

**OUT-Of-Print books** at lowest prices! You name it, we find it! Fast service. No obligation. International Bookfinders, Box 3003-PM, Beverly Hills, Calif.

**NATIONAL Geographic Magazines, 1888-1956**. Periodical Service, Box 465-PM, Wilmington, Delaware.

**"HOME Improvement Guide"**. New, amazing 192 page volume. Packed with ideas, plans for remodeling, decorating, landscaping, built-in projects. \$2.50 prepaid. Popular Mechanics Press, 200-RO East Ontario St., Chicago 11.

**RARE Magazines**, catalog 10¢. Nationwide Exchange, Box 1373-P, San Antonio 6, Texas.

**BOOKFINDERS!** All subjects. Send wants! Jaher Book Service, 183 Hazelwood Drive, Westbury, N. Y.

**FREE: Exciting catalog** packed with books covering most everything. Think of it—From cover to cover you will find described and illustrated hundreds of books telling how to fix and how to build almost anything. How to remodel your home; do your own decorating, plumbing, electrical work. Simplified books covering concrete work, carpentry, painting, furniture making and refinishing. How to build your own boat, home workshop tools. Best books on photography, welding, hobbies, homecraft. How to make a home freezer. Send for your free copy now. Popular Mechanics Press, 200-RO East Ontario St., Chicago 11, Ill.

## GAMES, TOYS, NOVELTIES

**PEGLESS Cribbage board**. No pegs. No holes. Just slide the pointers. A beautiful gift item. \$2.95 prepaid. Curtis Products Co., No Woodstock, N. H.



**PRECISION** Pigmy cigarette lighter. Penny size authentic miniature construction similar Ronson, etc. Cute stylish practical. Order several for gifts, etc. \$2.95. Satisfaction guaranteed. Pigmy Co., 1503 Beecher St. S.W., Atlanta 10, Ga.

### MAGIC TRICKS, PUZZLES, JOKER NOVELTIES

**ONLY 10¢** Brings you magic's greatest value. Douglas famous catalog, 500 tricks. Tricks for amateur and professional, for pocket, parlor, club, stage, with balls, coins, cards, cigarettes, silks, apparatus. Fastest service to magicians everywhere for over 30 years. Amaze your friends, send 10¢ today. Douglas Magicland, Dept. 10, Dallas, Texas.

**STINKBOMBS**, Disgustingly potent! 12-11. Kits, 1452-F Drake, San Pablo 10, California.

**MAGICIAN'S** Headquarters! Catalog 25¢. Hocus Pocus, 317 North State, Jackson, Mississippi.

**MAGIC** Trick book, vanishing cards, illustrated catalog, 25¢. Ward, 60 E. 43d, New York City 17.

**20 LICENSES** And permits, assorted, \$1.00. Ace, Box 142, Camden 1, New Jersey.

**MYSTIFY** Friends, 40 card tricks, no props or sleight-of-hand. \$1.00. Soderlund, 8078 Ardmore, Cleveland, Ohio.

**FREE** Illustrated catalog. Magic. Hoodini escapes, jokes. Be popular. Make money. Sell tricks. Entertain. Great opportunities. Big illustrated catalog free. Great Heaney, Oshkosh, Wisconsin.

**3100 NOVELTIES**, Jokes, tricks, gadgets, funmakers, hobbies. Big catalog 10¢. Johnson-Smith, D-424, Detroit 7.

**VENTRILLOQUISM**, easiest method. Details free. Smith, 2125 N. Bigelow, Peoria, Ill.

**VENTRILLO**, Professional voice-throwing instrument and catalog 25¢. Box 971-PM, Philadelphia 5.

**WORLD'S** Finest professional magic. Joker novelties. Giant illustrated catalog 10¢. Top Hat, Evanston 12, Illinois.

**BE** A magician! Large professional catalog of latest tricks. 35¢. Ireland, C-109 North Dearborn, Chicago 2, Illinois.

**PROFESSIONAL** Catalog, 175 pages. 25¢. Williams, 900 Plymouth, Ellwood City, Penna.

**DOLLAR** Magic set free with catalog 25¢. 4462-PM Germantown, Philadelphia.

**OO** Ventriloquist, all secrets told. Make money, surprise friends, have fun. Send 35¢ for catalogue of dummies, dialogues, etc. Limited supply. Gosagh, 203 E. Kickapoo, Hartford City, Indiana.

**WHOLESALE!** Thirty 10¢ trick novelties \$1.00! Profits! 1746-W Market, Philadelphia 3.

**SENSATIONAL** Magician's wand 25¢. Vanishes handkerchief! Catalog included. Box 1352-PM, Philadelphia 5.

**COMPLETELY** Illustrated professional amateur magic catalog 25¢. Stowell, Woodstock, New York.

**SMOKEBOMBS** 25¢. 7 For \$1.00. Terrific! 4463-PM Greene, Philadelphia 44.

### COINS, TOKENS, CURRENCY

**6 GENUINE** Coins, 6 different generations. British royal family. George III to Elizabeth II, 1760 to 1957, \$1.00. International Coin Company, 157A Rupert, Winnipeg, Canada.

**RAREST** Carson City mint dollar 1885. Uncirculated, \$3.00. Illustrated coin catalogue 25¢. Shultz, Salt Lake City 10, Utah.

**21 DIFFERENT** Indianhead cents \$2.00. Bargain lists free. Sayers, 1000 Unaka, Johnson City, Tennessee.

**MEXICO** Mint set, \$1.00 postpaid. Five different brilliant, uncirculated, interesting, centavos coins. Davis, Box 1305, Pecos, Texas.

**1955 MINT** Set P-D-S, 11 pieces, brilliant select uncirculated \$2.95. 1956 proof set \$3.90. 1957, \$2.80—Mint sealed. Thomas Lavin, 6751 Paschall Ave., Philadelphia 42, Penna.

**GREECE**, Bolivia, Portugal, Chile—All for 10¢. Brown, Box 547, Madison, S. D.

**CANADIAN** Uncirculated cent, nickel and dime plus "Canadian bulletin" 25¢. Marles, Box 823, Calgary, Canada.

**1958 GIANT** U.S. coin catalogue 25¢. Ace, 314 S. Clark, Chicago 4.

**WILL** Buy completed sets Lincoln cents, Mercury dimes, very good to uncirculated rolls of 50 any date or mint prior 1935. Write giving description and price. Private Collector, 2017 Cedar Springs, Dallas 1, Texas.

**OLD** Money wanted. Will pay \$100.00 for 1894 dime, 8 mint. \$50.00 for 1913 Liberty head nickel (not buffalo). Big premiums paid for all rare coins. Send 5¢ for large coin folder. May mean much profit to you. Numismatic Co., Dept. 20, Fort Worth, Texas.

**CATALOGS** For U. S. coins: Handbook \$1.00, guidebook \$1.75, standard catalog \$6.00, modern foreign coins \$4.00. Ray's Coin Shop, 79 E. Van Buren, Chicago 5, Ill.

**OLD** Coin bracelet, 15 real coins from Canada, India, Pakistan, etc. Mounted on gold plated chain. Big coin catalog free. Jerry's, Box 38, Shouns, Tenn.

**LINCOLN**, Indian cents, all dates, 1922D cent and complete pricelist 50¢. Penny Mart, PL-8, Box 629, Chicago 90.

**CONFEDERATE** Currency, bought, sold, 1958 coin handbook, 126 pages, \$1.00; uncirculated 1950-D nickel \$1.50; uncirculated 50¢ commemorative \$1.00. Cook Coins, Jackson 5, Mississippi.

**ONE** Million dollars Confederate money in \$10's, \$20's, \$50's, \$100's etc. only \$2.98. Limit four million for only \$10.00. Best Values Company, Dept. M-150, 401 Market Street, Newark, New Jersey.

**OLD** Large dollar bills \$3. Bash, Box 516, Champaign, Illinois.

**BARGAINS**—\$5 Gold \$11.95; \$10 gold \$22.95; \$20 gold \$43.95. Beautiful complete uncirculated sets (in deluxe holders)—Argentina, Camerons, Cambodia, Laos, Libya, Paraguay, Peru, Siam, Tahiti, Viet Nam, each \$1.45. 82-page gigantic bargain catalogue \$1.00 (free with \$10 orders). Guidebook \$1.75. Fast service. Bebee's, 4514 North 30th, Omaha 11, Nebraska.

**HONDURAS**, Austria, Finland, Switzerland's coins, all 10¢. Jolie, Roslyn Heights, N. Y.

**BOOK** By R. S. Yeoman—Handbook of U. S. coins, prices paid by dealers, \$1.00 postpaid. Send stamped envelope with list of your coins for free appraisal. Gordon Coin & Supply, Gordon Bldg., 3872 Mt. Diablo Blvd., Lafayette, California.

**50,000 COINS**, Medals, Confederate bills. Lists free. Collectors magazine 25¢. Nagy, 8PM South 18th St., Philadelphia 3, Penna.

**INDIAN** Cents, 10 different \$1.00. 20 different, folder, \$2.50 postpaid. Starter collections. Prager, 470 27th Avenue, San Francisco, California.

**CATALOG** \$1. Handbook of United States coins. Bound 126 pages. Illustrated, priced. Katen, 1444 Primrose Road, N.W., Washington 12, D. C.

**WHOLESALE** Coins for dealers, investors. Lists 10¢. Al. Johnson, Box 35, Colorado Springs, Colo.

**BOOK** Collecting coins 75¢ cash. Joseph Coffin, 1182 Broadway, New York 1, N. Y.

**44 DIFFERENT** Uncirculated coins, \$1.00. Oddehon, Box 482, St. Louis, Mo.

**LARGEST** Coin magazine, 180 pages, 35¢. Scrapbook, 7320-J Milwaukee, Chicago 31.

**SAN FRANCISCO** mint closed! Made only cents and dimes in 1955. In short supply and great demand. One each, brilliant uncirculated, for 25¢. Free coin lists with order. Bryson Stamp & Coin Company, 612 White, Toledo 5, Ohio.

**12 DIFFERENT** Indian cents, coin list, \$1.00. Pounds, North Wales, Penna.

**BARGAINS**, U.S. coins: 1893 Columbian world's fair half dollar, \$1.00. Ten different Indian pennies, 75¢. Two-cent piece, and 3-cent piece, \$1.00. Gold 1/4 eagle, \$9.00. Gold 1/2 eagle, \$12.50. Beautiful coin bracelet, \$1.00. Many coins available. What do you need? Rare Coin Company, 31 North Clark, Chicago 2.

**COINS** From Formosa, Vatican, etc., plus foreign banknote, 10¢ with coin approvals. Littleton Coin Co., Littleton 81, New Hampshire.

**U.S. Coins** on approval. Reasonable. Hutchinson, Box 4747, Philadelphia 34, Pennsylvania.

**LINCOLN** Cents 1910-8, 1913-8, 1921-8, 1923-8, 1924-8, all for \$2. Gasser's, Box 34615, Los Angeles 34, California.

**GET** Profit and pleasure in collecting old coins. Send 10¢ for 56-page illustrated coin catalog. You'll be delighted with it. Send for it now. B. Max Mehl, 370 Mehl Building, Fort Worth, Texas. Largest rare coin establishment in U. S. Established 40 years.

**COIN** Collectors magazine samples 25¢. Subscription \$2. Stamps accepted. Eaglet, 229 South 11th St., Newark 7, N. J.

**OLD** United States gold coins bought. John J. Firpo, 120 Santa Ana Ave., San Francisco 27, Calif.

**COMPLETE** United States coin bargain lists. Indianhead cent, 10¢. Economy Sales, 156-A Dean, Mansfield, Mass.

### STAMP COLLECTING

**125 DIFF.** Pictorials from 65 countries, cat. value \$8.00, \$1.00 including Monaco 209-11 nudes. No approvals. Bardwell, 98 Legion, Maywood, Ill.

**FREE**, United States, commemoratives, flags, famous Americans, dime handling, Murrays, 1020 Rademacher, Detroit 9, Michigan.

**100 DIFFERENT** China 10¢ with approvals. Plymouth, Dept. A-9, Bell, Calif.

**CANADA**, 35 Beautiful pictorial stamps for \$1.00. St. Francis Clinic, 41 Furby St., Winnipeg 1, Canada.

**7 CANAL** Zone 10¢. Approvals. Merkel Stamps, 30 Grandview, South Hadley Falls, Mass.

**TEN** Israel, free! Popular-priced, attractive approvals accompany. Nymedi, Box 503, Biloxi, Mississippi.

**SUPERIOR** Worldwide mission mixture. Amazing variety! Half pound \$1.60 postpaid. Bay Nielsen, 4545B Harvard, Montreal 28, Canada.

**U.S. Stamps**, Giant bargain catalog—10¢. Raymax, 35-VZ Maidenlane, New York City 38.

**FREE!** "Mystery packet," with approvals. Steele, Box 451-P, Long Beach, Calif.

**MYSTERIOUS** Orient! Free packet with our exciting, colorful, inexpensive approvals. Tropicana, Box 624M, Oakland Park, Florida.

**PENNY** Approval stamps. Robert A. Arthur, 920 Third, Seattle 4, Wash.

**EXTRAORDINARY** Antarctic set free with approvals. (Postage appreciated.) Variety Stamps, Box 98-B, Newton Highlands 61, Mass.

**300 DIFFERENT** Given free with approvals. Particulars. Windsor Stamps, 8834 Cornell Ave., Chicago 17.

**FRENCH** Large pictorials 5¢ Approvals. Fabian, Box 10556, Tampa 9, Florida.

**FREE**, Surprise assortment, 50 different world wide. With attractive approvals, popular prices. Banner, Box 65-M, Park Forest, Illinois.

**GIANT** Approvals, thousands different, 1¢ and 2¢ each. Wahl's Stamp Exchange, 7088P Farragut, Chicago 31, Ill.

**GIANT** Stamp zoo free! Snakes, leopards, rhinoceros, zebu, koalabear and other fierce jungle beasts. Approvals. Send 10¢ for handling. Free stamp magazine. Lincoln Stamp Co., St. Catharine's 118, Ontario.

**FANTASTIC!** 100 Mint, used United States commemoratives, etc. Plus mint plate block. Only \$1.00. Strait's, 1017 Wilmington Blvd., Wilmington, Calif.

**FREE** Nude collection. Stamps picturing nudes free. Approvals. Stampmaster, 2432 Fernwood, San Jose 26, California.

**25 DIFFERENT** Queen Elizabeth stamps 10¢ to applicants requesting worldwide approvals. Broad, Box 866, Lexington, Ky.

**60 DIFFERENT** U. S., included 30 commemoratives 25¢. No approvals. Seidenberg, Appleton, Wisconsin.

**INTERESTING** Approvals, mailed with United Nations stamps. BH Stamp Exchange, Box 64, New York City 34, N. Y.

**FREE**, San Marino, Mozambique, Czechoslovakia, Australia, Argentina. Approvals. May, Box 886-T, Coral Gables 34, Florida.

**50 DIFF.** Large pictorials only 25¢ to approval applicants. Bill Shoemaker, R.D. #1, New Oxford, Penna.

**U. S. Price** list, mint singles, blocks, plate blocks. Walter Kotowski, 19265 Eureka, Detroit 34, Mich.

**SWAP** Better duplicates. Beginners, intermediate, advanced. 913 59th, Richmond 24, Virginia.



WOW! 135 All different Germany 10¢. Zeppelins, semi-postals, airmails, high values. Big bargain lists and approvals included. Jamestown Stamp, Dept. A-12PMC, Jamestown, N. Y.

1000'S Stamps free with purchases. Details! Stamp Farm, Oxford, Wis.

25 SWITZERLAND 3¢ With approvals. L. Salsman, 1729 Milvia, Berkeley, Calif.

100 FOREIGN, 20 U. S. commemoratives, 10¢. Approvals. Weckerling, 1304C Choquette, Austin 5, Texas.

IRAQ, Iran, Syria, Lebanon, Egypt, Israel, free! Excellent approvals. Pannorana, Box 229, Miami 2, Florida.

111 DIFFERENT Commemoratives \$1.00. Approvals. Miller, 234 Treehaven, Buffalo, New York.

ISRAEL, Se-tenant triangles, souvenir sheet, free, approvals. Knott, 434 East 76th, New York City 21.

TWELVE Different souvenir sheets, \$2.00. Ward Brothers, 69 Harvey Street, Cambridge 40, Mass.

25 DIFFERENT Newfoundland 25¢ with approvals. Woodside, Brockville, Ontario, Canada.

WONDERFUL Offer. 7 complete mint sets only 10¢ with approvals. Reich (M26), 1033 Lawrence, Chicago 40.

125 DIFFERENT United States — \$1.00 approvals. Utechts, 1143J North Keeler, Chicago 51.

UNITED Nations. Five different 10¢. Approvals. Anderson, 1112 Harrison, San Francisco 3, Calif.

GIGANTIC Collection free. Includes triangles, early United States, animals, commemoratives, British Colonies, high value pictorials, etc. Complete collection plus big illustrated magazine all free. Send 5¢ for postage. Gray Stamp Company, Dept. PM, Toronto, Canada.

LIBERIA. Beautiful set of four native flowers, priced at 60¢ in standard catalog, only 10¢. Approvals. Gollath Company, Bethlehem Pl, New Hampshire.

COLLECTION Monaco stamps featuring wedding of Princess Grace Kelly; also Presidents Eisenhower, Lincoln, Washington, Roosevelt and others. Only 10¢ to introduce approvals. Littleton Stamp Co., Littleton B1, New Hampshire.

FREE! Giant catalog offering thousands of bargains. Sent with beautiful approvals. Jamestown Stamp Co., Dept. E12PMC, Jamestown, N. Y.

FREE! Free! Round the world packet to approval applicants. Steverson, 131 Dryden Dr., Meriden, Conn.

600 WELL Mixed U. S. 25¢. Monjar, 1750 Fairmount, Cincinnati 14, Ohio.

EKOTIC Packet 50 Orient stamps free! Exciting, inexpensive approvals. Holiday, Box 773, Miami 35, Florida.

MYSTERY Bag stamp collection, 10¢ with U. S. and foreign approvals. Hill Company, P.O. Box 51, Defiance, Ohio.

UNITED States. Fine mint airmails. #C7, #C8, #C9, #C10. Only \$1.15. Approvals accompany. Whiton Paine, Westport 11, Connecticut.

510 DIFFERENT 50¢; 1025, \$1.00. Approvals. Klondike, 682 Jefferson Elgin, Ill.

HUNGARY, Gigantic bicolored "dog triangles"—Free! Approvals. William Deems, Ravenswood, West Virginia.

1 AND 2 Cent approvals in envelopes. R. Schnobelen, Columbiana, Ohio.

FREE: Xmas packet, Nativity. With Bargain approvals. Box 342, Tamiami, Miami 44, Florida.

SCARCE South African animals, set complete thru 10 shillings, \$1.00. Seeves, 41 Herschel, Lynn, Mass.

OLDEST Man in the world—Complete set, postage and airmail, plus "Christmas" stamps complete, all 10¢ with approvals. Mark International, 4628 N. Hollywood, Milwaukee 11, Wis.

BARGAIN Lists free. U. S.-foreign, Moseley, 6 Hanley Downs, St. Louis 17, Missouri.

SEVENTY Old U. S., Famous Americans, flags, presidents, commemoratives with approvals plus surprise packet for 10¢ handling. Metropolitan Stamps, Box 312VG, Jackson Heights, N. Y.

FREE! Coronations, triangles, sports, animals, Monaco Pipe given approval applicants. Exotic, Box 482-M, Coral Gables 34, Florida.

FREE 60 Different foreign. Request approvals. Stanley Zajac, 159 Emerson Ave., Toronto, Canada.

10 DIFFERENT Israel 10¢ with approvals. Wheeler, Winona Lake, Indiana

SURPRISING Collection, unused, free introducing approvals. Philatelic Rodeo, Pennington, New Jersey.

NEWFOUNDLAND, 15 Different free after dollar purchase from approvals. Day Stamp Co., Box 102, Moncton, N. B., Can.

50 DIFFERENT South America 10¢ with colorful approvals. Superior Stamps, Box 53-A, Cathedral Station, New York 25, N. Y.

1958 U. S. Price list. 25¢. Lee's, Box 786, Rockford, Illinois.

BULGARIA; Fifty different exciting pictorials. Animals, trucks, flowers. This valuable collection, only 15 cents with approvals. Boger, Box 152, North Wales, Penna.

LUXEMBOURG, 25 Different 5¢, approvals. Neal, 5950 Tower, Riverside, California.

100 DIFFERENT Used U. S. commemoratives 65¢. Cash with order. Schwartz, Box 9, New York 68, N. Y.

1000 DIFFERENT, \$1.00 With approvals. Louis Golden, 6721 Eastwood, Philadelphia 49, Pennsylvania.

BEAUTIFUL Topical packet 25¢. Unbeatable approvals. E. McConnell, Fredonia, New York.

SEND Two times for the best U. S. catalogue you have ever received. New-Way Stamp, Lawrence, Mass.

FREE Monaco holy year issue with approvals. Stamps, Diamond, Pennsylvania.

FREE Fifty different with approvals. H. P. Wisehart, Frankfort, Ohio.

600 MIXED U. S. Old-new 25¢. Lists. Weatherby, Medina, Ohio.

FREE! Amazing list! Alphabetical! Two feet long! Stampmart, Hartford 1, Conn.

FREE 200 different good stamps with low priced approval. Joseph Reiner, 6428 Morningside Drive, Kansas City, Mo.

\$5.00 COOLIDGE, Only 15¢. Write for details. U. S. stamps exclusively. Futurama, Box 7282, Miami (Ludlum), Florida.

MINIATURE Collection Queen Elizabeth sets! Dominica, Virgins, Barbados, Gibraltar, Tristan, Malta. 21 mint bicolors, 25¢. Approvals. Gannon Stamps, Box 931, Canton 1, Ohio.

PENNY Approvals! Regardless catalogue! Kloster, 4164—52nd St., San Diego 5, Calif.

14,000 DIFFERENT! Amazing new plan builds your collection systematically, country by country. Only 50¢ weekly. Free details. L. G. Ware, Stepney 75, Conn.

INTRODUCING Our better United States approvals, we offer 15 United States stamps including Columbian, Pan-Pacific, famous American, airm, others; only 10¢. Ocean Stamps, Box 64-PM, Brooklyn 29, New York.

SPECIAL: United Nations Set, 10¢ with approvals. Noble, Owego 1, New York.

1000 DIFFERENT Worldwide stamps, only \$1.00. Universal, Box 6, Kenosha 5, Wisconsin.

UNITED States price list, 116 pages, price 25¢. Mark Hanna, 335 Fifth Ave., Pittsburgh 22, Penna.

U. S.—25 Different commemoratives 10¢ approvals. Wilber, Box 332, R. D. 7, Schenectady 2, New York.

U. S. commemoratives, beautiful colonials, airmails, topicals, 3¢ with approvals listing. Bristol, Canton Center, Conn.

1000 STAMPS \$1.00. Good variety, off paper. World wide. Many pictorials. No approvals follow. Satisfaction guaranteed. Whalen, 1435—1st Ave., Oakland 6, Calif.

FREE! Gold Coast! Monaco triangles! Madagascar! Approvals. Keating, 2520-P Boulevard, Jersey City, New Jersey.

FREE 50 Worldwide introducing inexpensive approvals. University Stamps, P.O. Box 95, Tamiami Station, Miami 44, Florida.

U. S. Mint flag set, complete, \$1.00. Free list. Brooks, 2323 Avenue X, Brooklyn 35, New York.

BRITISH Africa colonials. Used, to shilling value. 50 different \$1.00. Real fine assortment. Harrison's Stamps, 1435 First Ave., Oakland 6, California.

FREE! Illustrated prize catalog of stamps, albums, mixtures, packets. Adventurer, Buckland, Connecticut.

SPACEOPHOBIA? Our 1¢-2¢ approvals cure quickly. BKJ, Astor, Boston 23, Mass.

FREE! 100 British Empire. 10¢ handling. Approvals included. Kensington Stamps, Buffalo 15, N. Y.

KOREA, 25 Different catalog value \$7.00. yours for only \$2.00. Coast, P.O. 2187K, Santa Ana, California.

WANTED—Stamp collections, accumulations. Murray Gold, 62-95p Saunders, Rego Park 74, N. Y.

"ABE Lincoln" giant diamond, rainbow colored flag set, Israel, South Korea, 50 others different only 10¢. Approvals. Champlain, Isle La Motte, Vermont.

PENNY Approvals that satisfy. Robert Meed, P.O. Box 62, Brooklyn 29, N. Y.

WORLDWIDE, 50 All different, absolutely free just to introduce our incomparable approvals. Kent Stamp Company, G.P.O. Box 87, Brooklyn, N. Y.

WORLD'S Smallest and strangest stamps only 10¢ with approvals. Finney, Box 89, El Monte, Calif.

FREE United States illustrated catalog. Bailey, 45 Bromfield, Boston, Mass.

U. S. approvals. Low prices. Eagle Stamps, Romine Ave., Pittsburgh 26, Penna.

ECONOMICAL 1/4¢-3¢ Approvals, 33,000 varieties. Dressel, Box 128-N, West Englewood, New Jersey.

TWO \$5.00 U.S. stamps plus 20 different, 10¢ with U.S. approvals. Irwin, Box 1105, Brooklyn 30, N. Y.

FREE! 107 British Colony stamps. All different, from Britain's farflung colonial empire. Catalog value \$2.50. Free stamp magazine, approvals. Send 10¢ for handling. Act now! Niagara Stamp Co., St. Catherine's 71, Ontario.

UNITED States commemorative collection containing 33 different—10¢. Approvals. White, 516-A Avenue L, Brooklyn 30, New York.

SELL Your surplus good grade stamps. Write, describing fully what you have. Vanroy Shirk, Lebanon, Pennsylvania.

50 DIFFERENT Argentine 10¢. Approvals. Reuter, 611 W. 40th Pl., Los Angeles 37.

AMAZING Offer! 200 United States stamps — including commemoratives, airmails, high denominations to \$1.00. Only 10¢ to approval applicants! Illustrated bargain lists free. Mystic Stamp Co., Dept. 80, Camden, New York.

U. S. Classics. Over 50 yrs. old. 15 selected old-timers. Missing in biggest collections. All 15 at less than 1¢ each. 10¢ with approvals. Jaro, Box 246-T, New York City 8.

100 STAMPS, 10¢ With approvals. Smith, 508A Brooks, College Station, Texas.

OLD Scarce U.S. seconds on approvals. Slight imperfections, lowest prices. Herfield, Clintonhill Sta., Newark 8, N. J.

100 OLD United States between 1861 and 1935, \$1.00. Roush Stamps, 51 Chestnut, Mansfield, Ohio.

UNITED States approvals. Select copies, used—mint. Kingsbury, Fairfax, Vermont.

ICELAND 10 Different beautiful stamps for only 10 cents to applicants for our good old fashioned approvals. Old Colony Stamp Co., Dept. A, Milford, Connecticut.

1-2¢ EACH! Thousands of exciting worldwide stamps. Free examination. Cole, Box 223-A, Buffalo 21, N. Y.

225 STAMPS For only 10¢! This mammoth value includes airmails, pictorials; stamps from strange countries cataloging up to 25¢ each! Also approvals. Mystic Stamp Company, Camden 80, New York.

100 DIFFERENT Austria. 10¢. Approvals. Aronson, Box F, Newton Centre 59, Mass.

WEIRD Diamond shape coffee stamps. Lovely flower triangle! First American big commemorative. Greenland, idol dancer, etc. Free with approvals. Capital Stamp Co., Ferrysburg 2, Mich.

25 DIFFERENT Commemoratives 1893 up 10¢. U. S. approvals. K&B, Box 70, Brooklyn 23, N. Y.

MINT U. S. at face! Older commemoratives only in 25¢ packet. Limit one with request for mint U.S. approvals. Western, Box 1689P, Salinas, California.



500 DIFFERENT Stamps only 50¢ with approvals. Littleton Stamp Company, Littleton Tl. New Hampshire.

ONE Hundred stamps plus beautiful pictorial mint set only 10¢. Approvals. Robdal Stamp Department, Riverside, Connecticut.

135 DIFFERENT U.S. commemoratives \$1.00. 50-25¢. Request approvals. Harold Holub, 18 East 198th Street, New York 68, N. Y.

200 WORLDWIDE 10¢ To approval applicants. Collins', P.O. Box 125, Shell Beach, Calif.

FOREIGN Stamps, 1¢ to 5¢ approvals. Barr, 467 Oneida, Pittsburgh 11, Penna.

FREE! 50 Different Portuguese; colorful, inexpensive approvals. Elkhart, Box 33, Elkhart, Indiana.

CANADA, 100 Different 35¢ with bargain approvals. K. S. Holmes, London, Canada.

QUALITY Approvals at 2¢ each. Hadrian, 22 East 29th, New York City 18.

FREE! Over 100 different, \$2.50 value, including Israel, British Colonies, U. S., First U. N., Siberia; triangles, animals, sports. Approvals, illustrated catalogue accompany. Send 10¢ for mailing. Gatewood, Box 348, Winston-Salem, N. C.

1958 U. S. Illustrated catalogue free. Stone, 192 Washington, Boston 8, Mass.

FREE Sample! Interesting, informative, illustrated. National Stamp News, Anderson, South Carolina.

### ANTIQUES, RELICS, INDIAN GOODS, CURIOS

SCALPING Knife, spearhead, thunderbird \$4.00. Catalog free. Arrowhead, Glenwood, Arkansas.

ANCIENT Grooved stone tomahawk \$3.00. Indian relic list free. Lear's, Glenwood, Arkansas.

4 PERFECT Arrowheads \$1.00. Smith, 841 N. Tacoma, Indianapolis 1, Indiana.

COLORFUL Indian design beaded belts. Genuine leather. Three-quarter inch width \$1.95, one inch width \$3.95, lengths 20" to 44". State width and length. Excellent gifts. Cheshire Specialties Co., 40 Pine Terrace, Cheshire, Connecticut.

ILLINOIS: Gesundheit—For sale: several hundred Revolutionary, Civil War, Indian muskets, rifles, carbines, swords, bayonets, powder-horns, bullet molds, holsters, canteens, Kentucky rifles, frontiers, duelling pistols, Stagecoach guns, 50,000 collectors cartridges. Many Confederate items, 10,000 coins, Confederate money, 100,000 Indian relics, arrowheads, spearheads, tomahawks, bannerstones, discoids, mounted birds, squirrels, deerheads, steer-horns. Violin wood, agates, fossils, minerals. Gold dollars. Illustrated catalog 35¢. Heicke Armory, Wenona, Illinois.

INDIAN Relics, baskets, weapons. Lists 10¢. Rush, 34, Belvidere, N. J.

ARROWHEAD Making kit, complete instructions, \$2.00. Master lost art easy! Chief Blackhawk, Box 564-N, Kennewick, Washington.

### PRECIOUS STONES, MINERALS

FAIRYSTONES, Genuine, from old Virginia. Only spot on earth found. Only stone worn by many presidents. Stone and beautiful legend \$1.00. Stonehenge, 1809 Brantley, Winston-Salem, N. C.

SAPPHIRE, Topaz, tourmaline, garnet, peridot. Five uncut gem specimens, \$1.00. Ten polished gems, baroque shaped, \$1.00. Free bargain list jewelry, gems. Profitable, easy "do-it-yourself" projects. O'Brien's, 1118M Wilcox, Hollywood 38, Calif.

DIAMONDS: Discounted, registered, written guarantee. Example: Genuine flawless Marshall diamond, 1/4 carat mounted. Your price: \$77.00 plus tax. Write, House of Marshall, 11 Lawrence St., Lyons 3, New York.

LARGEST Gem and mineral magazine tells how to have profitable fun with rocks, gems, jewelry. Monthly, \$3.00 year. Sample 25¢. Gems & Minerals, Dept. A10, Mentone, California.

FIFTEEN Genuine gemstones mounted in attractive case including history of gemstones \$3.00. Individual gemstones 50¢. Major Industries, Box 147, Morris-town, N. J.

CUT Gems, make jewelry—For profit or fun. 100 page magazine tells how; where to get supplies. Sample 25¢ or request free literature. Lapidary Journal, Del Mar 2, Calif.

EARTH Science, the rockhounds national magazine. Subscription \$2.00. Sample 35¢. Box 1357-PM, Chicago 90, Ill.

AGATES, Gems, machines. Free list. Northwest Gems, 2819 North Warner, Tacoma 7, Washington.

### HOBBIES AND COLLECTIONS

ARMY-Navy-Marines—A.F., one regulation military belt with brass buckle plus 25 assorted medals, badges, campaign ribbons, battle stars, patches, ratings etc. All for \$1.00. Supreme Military, Dept. PM, 48 West 27 St., New York City.

MILITARY Miniatures. Civil War. Custer's Cavalry, American Revolution and U. S. Marines. Illustrated catalog 35¢. Bussler Miniatures, Dept. Z, 40 Howe St., Quincy 69, Mass.

COLLECT Handcuffs, legions. Unique, exciting hobby. 25¢ brings list, illustrated article. Patterson Smith, IFL, 269 Shepard, E. Orange, N. J.

MINIATURE Soldiers. Over 700 different sets to choose from. Catalog 10¢. Willard Snyder, 1809 Ranstead St., Philadelphia 3, Penna.

HOBBIES, Models, supplies. 270 page catalog \$1.00. Refunded upon \$5.00 in orders. Joyner's, 221 N. Limestone, Lexington, Ky.

GORGEOUS Shells and marine life from Seven Seas, \$2.00, \$5.00, \$10.00 assortments. Satisfaction guaranteed, cash with order postage extra. Jeans, 42 Evergreen Road, North Fort Myers, Florida.

NEW, 15 Different match covers 10¢ Box 202, Rochester 1, N. Y.

PROPAGANDA Leaflets W. W. II; sample 25¢; Nazi medals, badges, sample 50¢; embroidered swastika and catalog 25¢. Insignia Club, Box 71, Rockaway Park A-94, N. Y.

NAZI Medals listings 10¢. Kingstone, 920 Third, (338) Seattle 4, Washington.

COLLECTORS Matchbook covers. 100 different unused, \$1.00. Catalog 25¢. Album \$3.00. Charles Edelman, 1311-C East 84, Cleveland 3, Ohio.

NAZI Insignia, 12 different \$1.00. Medals, patches, armbands, flags, daggers. Illustrated lists. 15 cents. Hobbyland, 1207 1st St., W., Calgary, Canada.

INVENTING Can be an interesting and profitable hobby. Write for complete particulars. Institute of American Inventors, Dept. 40-E, 635-F St., N.W., Washington 4, D. C.

### CAMERAS, PHOTO SUPPLIES

FREE! Free! Send for your new 52 page photographic bargain book. Over 5,000 new and used items at huge savings. For your free bargain book, write to Dept. 1112, Central Camera Co., Chicago 4, Ill.

KODAK, Bell-Howell, discounts to 40% Photo equipment, appliances, free catalog. Mailers Mart, Box 135-MP 3 Pelham, New York.

COMPLETE, Quality Beseler "Dream Darkroom" kit contains everything necessary to set up modern darkroom in your home. Free booklet, "Fun in the Darkroom," tells how your whole family can enjoy pleasures of darkroom photography, earn sparetime money too. Write Charles Beseler Co., 206M South 18th Street, East Orange, New Jersey.

PHOTOGRAPHY For pleasure or profit. Learn at home. Practical basic training. Long established school. Free booklet. American School of Photography, 835 Diversey Parkway, Dept. 3442, Chicago 14.

PRINT 100 Pictures on cloth, etc., \$1.00. Young, Box 655P, Waterloo, Iowa.

### PHOTO FINISHING

COLOR Processing—High quality, fast service and low prices. Kodachrome developing \$34; prints 27¢. Kodachrome: 35mm. processing, 20 exposures; \$1.45; 35 exposures, \$2.25. Send for complete price list and free mailers. Photo-Mall, Box 216M, Madison Square Station, New York City 10.

3 DAY Service on beautiful personalized Christmas cards from your photo or negative. Write for free sample and information. Lincoln Studios, Dept. K, Box 13, Lincoln, Nebr.

QUALITY Kodak finishing, 8 exposure roll 40¢; 12 exposure 60¢; 16 exposure 70¢. Reprints 5¢. Fast service. Guaranteed quality. 40 years continuous operation. Be a satisfied customer. We do color. Send for mailers. Mail Order Photo Service, Box 397, Watertown, Wisconsin.

AMAZING Photos made invisible, can be developed again, etc. Many commercial possibilities. Airmail \$10 bill (or equivalent currency) for process and samples. International Inventors, Box 871, Copenhagen (O), Denmark.

25 WALLET Size silk finish photos from any picture, \$1.00 with this ad. Original returned unharmed. Studio, Box 701, Springfield, Missouri.

MAKE Better enlargements; BlendOray screens. Any enlarger, no retouching, \$1.00. Nichols Photo, Bristol, Penna.

KODACHROME Processing—8mm roll or 35mm 20 exp., \$1.25. Prompt service. Write for mailer and prices. Color Pix, Dept. P, CPO Box 30, Kingston, N. Y.

FREE! Color snapshot folder. Offers, lists, mailers. Houghton's, Erving, Mass.

12 EXPOSURE Rolls, 35¢, jumbo prints. Guaranteed work, one day service, Lincoln Studios, Dept. K, Box 13, Lincoln, Nebraska.

8-HOUR Service on deluxe jumbo prints. 8-exposure roll developed and 8 jumbo prints 40¢, 12 exposure 55¢, 16 exposure 70¢; 35mm, 20 exposure 75¢, 36 exposure \$1.25. Jumbo deckle edge reprints 4¢ each. Contact prints made if specified. Bay Photo Service, P.O. Box 210, Oakland, California.

ENLARGEMENTS, Heavyweight seven 5x7's or four 8x10's \$1.00. Jack Koons, Huntington Mills, Luzerne County, Penna.

KODACOLOR Prints 25¢. Save over \$1.00 on full roll developed and printed. 8 exposure rolls \$2.25, 12 exposures \$3.45. All color Laboratories, Box 24, Dept. 81, St. Louis, Mo.

PARTICULAR? 8 Jumbos—40¢ 12—50¢. Special; 35 mm., 36 exposures \$1.25. Introductory offer. Flash Foto, Box 38M, Brooklyn 4, N. Y.

### MOTION PICTURES AND SOUND EQUIPMENT

NEW 1958 Bargain discount 8 mm catalogue also 16 mm sound. Write National Cinema, 71 Dey Street, New York City. Specify 7 or 16 mm.

16MM Film sale. Rentals \$3.95. Sound Films, Box 262, Chicopee, Mass.

16MM, Movies, 35 mm, slides, sold and rented. Huntoon Rentals, Bellows Falls, Vermont.

ALASKA Wildlife Kodachrome movies and slides. Free catalog. Mac's Foto, 315—14th, Anchorage, Alaska.

RECORDERS, Hi-Fi. Free catalogue. Carstan, 215 E. 88 St., New York City 28.

5,000 8-16MM. Movie films. Free catalogues. International, Greenvale, N. Y.

FREE! Blackhawk's big new 1958 sale catalog new and used 16mm., 8mm. movies; 2" x 2" color slides; used 16mm. sound projectors! Biggest stock in U.S.A.! Cameras, accessories, supplies, too! Blackhawk Films, Davenport 14, Iowa.

MOVIE Camera film: 8mm. roll \$1.50, 16mm. 100' \$3.00. Free processing. Better Films, 742 New Lots, Brooklyn, N. Y.

8-16MM. Films. Free catalogue, with sample film 10¢. Garden, 690 Howard Avenue, Brooklyn, N. Y.

SAVE 50%! Guaranteed-fresh color, b.&w. movie film! 8mm., 16mm. Free catalog! Eco-R, 47th Holly, Kansas City 12, Missouri.

8MM Movies 50 ft. \$1.00. Special offer—Animals, cartoons, travel, comedies. Send \$1.00. Movieland Films Inc., 16121M Sherman Way, Van Nuys, California.

### MUSIC AND MUSICAL INSTRUMENTS

RECORDS, Hi-Fi. Big discounts. Noelson, Box 211, Wall Street, New York City 5.

WRITE Songs. Big money and reputation. Write for information. J. Gordon Pub. Co., 4700 South California Avenue, Chicago.

SONGS Into dollars. Share \$29 million dollars yearly for new songwriters, song-poets. Songs composed, published, promoted by famous firm. Information, appraisal free. Send to Nerdyke Publishing, 6000 Sunset, Hollywood 28PM, California.



**SONGPOEMS** And lyrics wanted. Mail to: TinPan Alley, Inc., 1650 Broadway, New York 19, N. Y.

**POEMS** Wanted for new songs. Send poems. Free examination. Immediate consideration. Songcrafters, 2724 Arcade Station, Nashville, Tenn.

**POEMS** Wanted for new songs. Send poems. Immediate consideration. Crown Music Company, 49-C West 32 Street, New York City.

**ELECTRIC** Guitars, amplifiers, wholesale. Free catalog. Carvin P.M.M. Covina, California.

**SWISS** Musical movements, \$1.90. Helax, 218 West 72nd Street, New York City 23.

**ACCORDIONS**, Wholesale to everyone. Save up to 60%. All national known brands. Free catalogue. Del Principe, 29 South Cicero, Chicago 44.

**POEMS**, Songs wanted! Publishing, recording. Bengal, 93 Jefferson, Chelsea 50, Massachusetts.

**SONG** Request guarantees royalties. Instructions two dollars. Howard Olenik, Mt. Morris, Mich.

**SWISS** Musical movements. (Best.) \$2.50. Spelman, 131 West 42nd, New York City 36.

**SONGWRITERS**: Melodies furnished 50-50 basis. Records, protection. National Songwriter's Guild, 16H Ocean Shore Drive, Ormond Beach, Florida.

**ACCORDIONS** - Direct from importer. Save 50% and more! Free trial. Lifetime guarantee. Trades accepted. Free catalog. Write Accordion Manufacturers Outlet, Dept. 127-R, 2003 Chicago, Chicago 22.

**VIOLIN** Makers supplies. Free catalog. 309 W. Fourth, Los Angeles 13.

**ACCORDIONS** Wholesale—10 day trial. Free catalog. American Accordion Center, 5329-PM-12, Belmont, Chicago.

**CLARINETS** And trumpets from factory. Save 50%. Free information. Libro's Music Center, 591 Chapel St., New Haven, Conn.

### RADIO, TELEVISION AND ELECTRONICS

**CRYSTAL** Radio experimenters write to Hulet, 305 Hope, Lakewood, N. J.

**FREE!** Giant bargain catalog. Transistor, "Sun" radios, kits, portables, audio, electronics, photographic, optics, tools, household. Write Lektron, 131M Everett Ave., Chelsea, Mass.

**CRYSTAL** Radio kit \$1.00, preassembled \$1.25, phone \$1.75; catalogue. Clearco Crystal Company, 2966 North 4th, Milwaukee 13, Wisconsin.

**GOVERNMENT** Surplus. Radios, parabolic reflectors. Amazing picture list 10¢. Meshna, Malden 48, Mass.

**TAPE** Recorders, hi fi components, tapes. Unusual values. Free catalog. Dressner, 69-02M 174 St., Flushing 65, N. Y.

"20 DX Crystal Set Plans" handbook—30¢. Laboratories, 328-C Fuller, Redwood City, California.

**TRANSISTOR** Kits, parts. Free information. Transit, Box 15-F7, Alden Manor, N. Y.

### BUSINESS OPPORTUNITIES

**UNIQUELY** Different! Profitable mail-order opportunities galore! Powerful advertising copy! Revealing information! Craft, 2494 So. 10th, Fresno 25, Calif.

**TO \$100.00** Weekly. Sparetime, home operated mailorder business. Successful beginner's plan. Everything supplied. Lynn, 10420-N National, Los Angeles 34.

**OPERATE** Mail-order printing brokerage. Details free. Advisory Service, Hartsdale, N. Y.

**MAKE** Money taking orders on leading name brand tools. No inventory to carry. \$1,000,000.00 stock to draw on. Profits up to 50%. Send \$1.00 for giant wholesale catalog. \$1.00. Refunded first purchase. U. S. Supply, Dept. CL-2, 149 Church Street, New York, New York.

**FREE** "Franchise Profit Letter," describes nationwide opportunities. Exclusive distributorships, dealerships, agency operations. Write today. National Franchise Reports, 333 North Michigan, Chicago 1.

**SHINE** Cars without polish. New invention. Lightning seller. Cars gleam like mirror. Samples sent on trial. Kristee 114, Akron, Ohio.

**EXCLUSIVE** Distributorship available in most areas for world-famous cadmium battery guaranteed to outlast your car. Tremendous profit opportunity. Investment for merchandise only. Free franchise. Cadmium Battery, Corporation Dept. 102, El Segundo, California.

**SELL** By mail. Experts give tested methods. Alfano, 19 Pine, Closter, New Jersey.

**CASH** Income collecting local information. No selling. Free details. Dorco, Box 494, Muncie, Ind.

**MAKE** Strong, sawdust, or earthen boards. Build attractive, fireproof houses. 800% profit. Exclusive territory. Bays Laboratory, Oklahoma City 9.

**LET** Me sell your products nationally. I'll send you free information on how to establish sparetime-full time Casecraft business. You build! We sell! Everything supplied. Abars, 807-SE Sunset, Los Angeles 12, Calif.

**OPERATE** Profitable home business, by mail. B. Mann, Woodcliff Lake, New Jersey.

**FOOL** Proof! The amazing method that makes all fortunes. Write: Ideal Industries, 1430-W Monroe, Chicago 7, Ill.

**MAKE** Big money selling merchandise by mail! Possibly a fortune. We supply catalogs, customers names. Fill your orders. Money making details free! Harvey Sales, 5713 Euclid, Cleveland 3, Ohio.

**CASH** From sawdust, seventy methods. Tin-cans, thirty methods. Newspapers, eighteen methods. Instructions 50¢ each. All three \$1.00. Charles Company, 12-XAR, Norwood, Ohio.

**WANTED:** Home producers, to be subcontractors. Cast plastic products for manufacturers in our clearing house service. Thousands of easily made items required. Cash in at home, without previous experience. Plastic Service Associates, Dept. 12-PM, East Boston 28, Massachusetts.

**BECOME** Tax consultant. Graduates earn to \$3,000 every tax season preparing returns evenings. State approved. Union Institute, Hoboken 2F, N. J.

**OPERATE** Profitable mail order business. Write Walter Service, 4159A East 112th, Cleveland 5, Ohio.

**GROW** Expensive herbs for us! Big profits home-business of your own. Year around profitability! We supply everything necessary! Send for free amazing facts and revealing plan. National Herb Exchange, Dept. DR, Gardena, Calif.

"**HOW** To Start a Business" booklet sent free! If you know any trade, go into business for yourself! Learn the 9 easy steps to follow. We've guided 5,000 others to success. Revealing free booklet yours for the asking! Write! National Business Consultants, Office DR, Los Angeles 61, Calif.

**GROW** A living miniature forest or orchard (only inches high), that bears tasty tiny fruit at home. Learn amazing dwarfing secrets! Sensational fascinating hobby, profitable home-business opportunity. Free details! Miniature Nurseries, Dept. DR, Gardena, California.

**BUY** At wholesale prices! Resell at big profits. Brand name merchandise—Appliances, cookware, housewares, watches, jewelry, rings, dry goods, clothing, luggage, tools, sporting goods, toys, gifts, etc. Free 1958 color catalog. Write today. Merit Home Products, Dept. PM-12, 107 Manhattan Ave., Brooklyn 6, New York.

**HOME-Import** mail order business—Import profitable items below wholesale. Experience and product investment unnecessary. Full, spare time. Famous world trader guides you. Free list "157 Imports," details. Mellinger, G70C, Los Angeles 24.

**START** Your own business on credit. Your own boss. 1527 dealers sold \$5,000 to \$32,000 in 1956. We supply stocks, equipment on credit. 200 home necessities. Sales experience unnecessary. Pleasant profitable business backed by world-wide industry. Write Rawleigh's, Dept. L-U-PPM, Freeport, Ill.

"**50** NEW Home-Business Ideas" booklet, sample free. Spray exotic velvet-suede on anything. Flockcraft-DR, Los Angeles 61.

**FREE** Lesson. Repair your TV set, or friends. Amazing new Isotronic system trains you to handle any TV service job in one short week! Start your own business. Save up to \$200 on schooling. Write: Electronic Engineering, Dept. AC-17C, 1038 S. LaBrea, Los Angeles 19, Calif.

**MAIL** Order advertising agency executive reveals sensational no-risk advertising and merchandise methods. Start in office or home; minimum capital; positive profits. Free details! Impact! 3407 Prospect Avenue, Dept. 11-12, Cleveland 13, Ohio.

**MAKE** Money! Sharpen carbide tools and drills. "Do it yourself" in your basement or garage with new patented "Coolie-Grinderlap." Easy to use Re-Lod-Able, Re-Set-Able diamond wheel included. Fine diamond finish gets business. Build steady route, pick up and deliver. Cash business of your own. Machine used by largest companies. Plugs into any light circuit, weight 100 lbs., cheap to operate. Write for free instruction books, prices and territory. DTCO., Box 33, South Haven, Mich.

**HOT** Air heat, your area, sell neighbors, stores, wholesale, retail, sample, \$1.00, unsatisfied, money back. Alvin Richards, 240 S. Exchange, St. Paul 2 Minn.

**LEARN** Flower arrangement and floristry. Start your own business, part or full time. Many good paying positions open. Earn while learning. Send for free book. National Landscape Institute, Studio M-127-C, 11826 San Vicente Blvd., Los Angeles 49, Calif.

**READ** "Mailorder Laws and Regulations" and "Mailorder Rules for Beginners". Learn about necessary licenses, different taxes, legal requirements, etc. Both books, \$2.00. Tasker, 1603 Peach Street, Alexandria, Virginia.

**BIGGEST** Money makers in the field; Acme saw and lawnmower sharpeners. Free literature. Max Mfg. Co., 133 Stockton Ave., San Jose 26, Calif.

**MANUFACTURER** Plastic fishing lures, 95% finished, direct from our moulds. Send \$5.00. You are in business with stock. Returnable. Quaker City Manufacturing Company, 3514-24 N. Lawrence St., Philadelphia 40, Penna.

**OPERATE** Profitable mail order business. Write Universal, 166 N. Seymour, Fond Du Lac, Wisconsin.

**OPERATE** Mailorder printing brokerage. Details free. Advisory Service, Hartsdale, New York.

**MAKE** Extra money. Cash commissions. Everybody buys easy-to-sell advertising book matches. Union label. All sizes. Cuts for all businesses. Powerhouse selling kit free. Steady repeat business. No experience necessary. Superior Match Co., Dept. MX-1257, 7528 S. Greenwood, Chicago 19.

**MONEY** Wants you. Tells 97 ways to "Make A Million." Others have. Why can't you? Free details. Woodward, 1221 Edgewood, Havertown, (3B), Penna.

**MAKE** \$25.00 Or more daily. For more information send \$1.00 to James Montano, 1601 Young St., Santa Fe, N. Mex.

**\$250.00** WEEK Spare time profit possible. Earn at home with new fascinating printing method. \$5 starts you. Send no money now. Free confidential facts and valuable samples. Screen-Print, DR, Los Angeles 61.

**FREE** Listings of unique opportunities. Unlimited profits. Fortune Enterprises, Addison, Illinois.

**100** NYLON Hose rejects \$2.00. Allsheer Mills, 21831 Cloverlawn, Oak Park, Mich.

**TYPIST** Operate profitable mailorder business. Stamp brings details. General Sales, Creve Coeur, Ill.

**EASY** Christmas cash. Your own name on hand-painted tie. Wear yours, receive quick sales. Ideal personalized gift. \$3.50. You keep \$1.25. Starting sample only \$2.00. Get your name sample today. Consumers Counsel, 17811-P Detroit Avenue, Cleveland 7, Ohio.

**100% PROFIT** Mailing needed automotive product. Laircraft, Box J-5008, Detroit 35, Michigan.

**\$69.00** WEEKLY, Sparetime - Easy! Home Venetian blind laundry. Free book. Burt, 2434EP, Wichita 13, Kansas.

**MAKE** Money sharpening saws, lawnmowers sparetime with Foley machines. Cash business, customers repeat. Free book shows how to start. Victor A. Foley Co., Columbia Heights, Minn.

"**TURN** Rags Into Riches." Methods \$1.00. Metro, Box 151-J, Oak Park, Illinois.

**LEARN** Mailorder selling. Pays big! Free Colliers' reprint! Elliott, 252-A Gainsboro, Toronto 8, Canada.



LEARN Real estate by listening to records. Lee Institute, Brookline 46, Mass.

FREE Folder — "137 Successful Home Businesses." Service, Box 636PM, Newport News, Virginia.

BUY Wholesale! Appliances, tools, watches, auto accessories, etc. Huge discounts. United Wholesalers, 1265-F Broadway, New York 1, N. Y.

READ The truth about mail order business from beginner's standpoint. 10,000 word idea booklet "How to Build Your Own Mail Order Business" 50¢ postpaid. Promptly refunded if not satisfied. Robert K. Brown, Box 72, North Tonawanda, New York.

CAMERA Owners! Earn \$50.00 week-ends! Instructions \$1.00, information free! Kline, 935-PM North Austin, Chicago 51, Illinois.

SELL African wood carvings, busts, figures, heads, etc. Huge profits. Details free or \$1.00 with sample carving. Kempe, Box 4098, San Diego 4, California.

LEARN The termite business. Free information. Hamlin Institute, Hamlin, W. Va.

SELL Books by mail. Details free. Berryman, 153 Victoria, Northlake, Ill.

COLORGLAZED Concrete pottery made without molds. Patented method. Cemetery products, novelties, tiles. Basement leak-sealing. Money-making projects. Booklet, details free. Men only. National Potteries Company, Grand Rapids, Minnesota.

SELL Merlin electronic garage door operators. Make from \$50 to \$75 on every sale. Operate from your home. M. J. Fitzgerald Co., 2815 West Vliet Street, Milwaukee 8, Wisconsin.

LEARN Sewing machine repairing. To \$125.00 weekly. Sparetime. Supplies. Add to present business. Write today! Taylor Service, Box 2128, San Bernardino, Calif.

YOU Can make money at home in spare time taking magazine renewal subscriptions. No capital or experience necessary. All supplies furnished. Write today! McGregor Magazine Agency, Dept. 110, Mount Morris, Illinois.

PLASTERCRAFT Molds and supplies. Pollet Studios, Box 362, Moorhead, Minn.

VALUABLE Distributorship throughout United States. With exceptional high rate of earnings. A business established over 20 years with 200,000 users. Investment \$8,500-\$12,500. Box 1457, 1501 Broadway, New York.

PIANO Tuning learned quickly at home. Tremendous field! Musical knowledge unnecessary. Information free. Empire School of Piano Tuning, Champaign, Ill. (Founded 1935).

MUSHROOMS Quicker, easier, cheaper. Newest facts free. Luxur, 641 South 19th, Newark 3, N. J.

THEY Hand him \$100! Free packet Secret Journal. 919 secrets-plans! Work home. Publicae, Oceanside, Calif.

HOW To grow orchids at home. Profitable, fascinating. Successful home grower shows you how he does it. Free, full details. Orchidland, 100 S. Vermont, Los Angeles 4.

POPCORN And potato chip equipment. Ekins, Box 933 A7, Springfield, Ohio.

BUY Direct from factories—Appliances, cameras, watches! Free details! Cam Company, 6810PM-20th Ave., Brooklyn 4, N. Y.

MIMEOGRAPHING Services pay sensational local profits. Exciting secret plans exposed! Write: Moxelle Mimeo Shop, Bonham 7, Texas.

SELL Books by mail. 400% profit. Royal, Box 368-X, Cleveland 27, Ohio.

REBUILD Batteries; repair dolls; make rubber stamps. "75 ideas" free. Universal, Box 1076-A, Peoria, Ill.

\$34.70 TWO Hours. Manufacturing. No selling. Carlayne Castings, 1803 Fremont, Rapid City, South Dakota.

BRUSH Plating outfits for plating articles in the home and shop. No tanks necessary, silvering mirrors, spare or full time. Free particulars. Gunmetal Co., Ave. H, Decatur, Illinois.

BUY Wholesale! Over 10,000 nationally advertised products. Appliances, cameras, sporting goods, housewares, watches, typewriters, tools, clothing, etc. Send postcard today. Buy-Rite, Box 258, Hawthorne 1, New Jersey.

WANT To make big money at home? \$10.00 profit in an hour possible with invisible mending. Make tears, holes, disappear from clothing, fabrics. Steady year-round demand from cleaners, laundries, homes. Details free. Fabricon, 6234 Broadway, Chicago 40, Illinois.

WHOLESALE—Thousands nationally advertised products. Buy, sell. Amazing profits. New, free plan. Associated Wholesalers, 1016-D Starr, Burlington, Iowa.

OPERATE Mailorder folio business! Free details. Ballard's, 425 East Catherine, Louisville 3, Ky.

MAKE Flexible molds. Cast plaques, figurines. Free sample. Tooker, 1045-R Fairview, Hamilton, Ohio.

NATURAL Molding rubber, extra thick. Free sample. W. Wooley, 1016-A Donald, Peoria, Illinois.

BIG Money raising fishworms and crickets. Free literature. Carter Farms, Plains, Georgia.

START Home business making statuary, plaques, novelties, garden furniture, artificial marble flooring, liquid marble. Make your own flexible molds. Amazing profits. Only \$1.58. Free literature. Popular Mechanics Press, 631 No. St. Clair St., Chicago 11.

WANT More business? Here's an amazing opportunity to increase your sales. Talk to thousands of interested readers of "Mechanics Popular." Our Spanish Edition covers the Latin American countries like a blanket. They're real mailorder buyers. Classified rate 75¢ per word. Try an ad in our next issue. Classified Advertising Department, Popular Mechanics Magazine, 200 East Ontario Street, Chicago 11, Ill.

VENDING Machines—No selling. Operate a route of coin machines and earn amazing profits. 32-page catalog free. Parkway Machine Corporation, Dept. 28, 715 Ensor Street, Baltimore 2, Maryland.

\$70 WEEKLY—Home, spare time. Simplified mail bookkeeping. Immediate income—easy! Auditax, 34757A, Los Angeles 34.

BREED Rare tropical fish at home. Earn big money! Learn secrets! Help fill huge demand. Amazing opportunity! Free plan. Tropical Fish Breeders, Los Angeles 81, Calif.

MINK Raising information free. Complete. Lake Superior Mink Farm. Superior, EEL, Wisconsin.

COPUBLISH Mail Sale Advertiser, leading mail order paper. Details, latest copy, dime. Vanroy Shirk, Lebanon, Penna.

LEARN Photo-negative portrait retouching. Men, women. \$5 hour possible spare or full time at home. Easy, glamorous. Work for photographers by mail order. Pull details sent free. Duval, 100 So. Vermont, Los Angeles 4.

YOUR Own name brand business. No investment; no inventory. Part time or full time. Sell famous brands of appliances, housewares, silverware, radios, vacuum cleaners, lamps, tools, clocks, watches, jewelry, etc., etc., over 1000 items. Join thousands of successful independent dealers. Send for free catalog and dealer price list. H. B. Davis Corp., Dept. 11, 145 W. 15 St., New York City.

11,000 NEW Prospects daily. Baby record books, shoes, albums. Sell mailorder. Use our literature. Write: No-Co-Ro, Capitola, California.

BAKE New greaseless doughnuts in kitchen. Sell stores. Free recipes. M. Ray, 3605 South 15th, Minneapolis 7, Minnesota.

FIX Typewriters. Inexpensive home course teaches factory secrets. Free booklet. Athey, Tarentum, Penna.

MONEY For you! Big profits! Cast plaster figurines, bookends, plaques at home with XL rubber molds. No experience needed! Write for illustrated, 40-page catalog, only 25¢! Plastic Arts Studios, 3403 So. Madison Street, Department 3, Muncie, Indiana.

PLATE Baby shoes, jewelry, gifts, bronze and colored pearl. Free booklet. Platex, 11029 South Vermont, Los Angeles 44.

FREE Catalog. Contains hundreds of businesses, farms and income properties throughout U.S., Canada. Specify type and location desired. Deal direct with owners. U. I. Buyers Digest, 1608 Hillhurst, Dept. PM-3, Los Angeles 27, Calif.

LIQUID Rubber. Make flexible molds. Free sample. Chaney, 1907-A East Road, Jacksonville 11, Florida.

START Home mimeographing business. Pays amazing profits. Literature free. Housel, Lanoka Harbor, N. J.

BOOKKEEPERS, Accountants. Operate a bookkeeping service. Part or full time. Amazing simplified system. Wonderful money-making opportunities. Complete information free. National Bookkeeping Publishing Co., Suite 307, 3435 Broadway, Kansas City 11, Mo.

WE Pay \$3.50 lb. dried. Grow mushrooms. Cellar, shed and outdoors. Spare, full time, year round. We have 25,000 customers. Free book. Washington Mushroom Ind., Dept. 172, 2964 Admiral Way, Seattle, Wash.

\$250 WEEK Cleaning venetian blinds. Patented machinery. Free literature. Robinson, 7213B, Indianapolis 1, Indiana.

FREE Book "505 Odd, Successful Businesses." Work home. Pacific, Oceanside, Calif.

INTERNATIONAL Mailorder business. Complete setup service—Not just instructions. Hermes, 152 West 42, New York City 36.

PLASTERCRAFT Molds, liquid rubber, plasters, flocks, candle supplies. Catalog and manual free. Blue Rapids Supply, Blue Rapids, Kansas.

I Want to send you proof of the wonderful pulling power of Popular Mechanics classified pages. What's your proposition? Write me today. Include literature if possible. F. W. Johnson, Manager Classified Advertising, Popular Mechanics Magazine, 200 E. Ontario St., Chicago 11, Ill.

FREE Folio "\$5,000-\$45,000. Unlimited Vacations." No merchandise. Unknown! Work home, sparetime! Haylings, Carlsbad, Calif.

MARY-Mac agency—motorized vibrator. Cushions, chairs, tables, belts. Mary-Mac Factory, 1013 Powhattan, Dallas, Texas.

FREE Folder. "How to Make \$3,000 Yearly. Sparetime, Backyard, Raising Earthworms!" Oakhaven 38, Cedar Hill, Texas.

MAKE \$46 From square foot plywood; jig saw necessary. Free details. Woodart, Bridgewater, Mass.

\$3,000 YEARLY. Spare time at home. Nothing to buy. No local selling. Dignified. Guaranteed. Home Harvest, Rt. 3, Box 3491-A, Albuquerque, New Mexico.

FREE—Profitable spare time home business plans. Box 51-PMA, Des Plaines, Ill.

#### MONEYMAKING OPPORTUNITIES

BIG Money listing accounts for our collection service. No selling. No investment. Professional Protective Service, 216 West Jackson Blvd., Chicago 5.

GET On government surplus sales mailing lists. Bid direct. Lists and procedure \$1.00. E. Harkin, Box 381, Lawndale, California.

TERMITE Control brings big income and lifelong security. Professional methods bring income within 2 weeks; Free details. Meritrol, 231 17th St., Bakersfield, Calif.

AMAZING Successes through franchises! Become exclusive franchise holder your territory. Information rushed. National Franchise Reports, 333 North Michigan, Chicago 1.

UNUSUAL Christmas profitunity. Organizations; individuals. Rewarding. Bonus Enterprises, Mahattan 2, Kans.

FREE \$3.00 Merchandise certificate. Send \$1.00 now for your catalog. Texas size discounts. Also part-time money-making opportunities. Specialties Unlimited, 2409C East Lancaster, Fort Worth, Texas.

EARN \$5.00 Hour sharpening tools. Free circular. Malone, 3370-N53, Milwaukee 16, Wisconsin.

MAILORDER Home work opportunities 10¢. Palm, Box 1221, Baton Rouge 6, La.

HOME-Operated mail order business, selling business cards. Vosacek Printing, 4444A Ute, San Diego 17, Calif.

"FLOCKON" New, profitable, fascinating way to beautify anything—Christmas trees, decorations, automobiles, signs, toys, everything. For business or pleasure. \$15.00 hourly earnings. Your satisfaction guaranteed. Send for material and complete instructions. Special introductory offer \$3.00. United Flockon Company, 820 Taunton Avenue, Seekonk, Massachusetts.

MAKE \$5,000 Yearly sparetime raising mink, chinchillas, nutria, etc. Free booklet reveals proved plans. Write Furs, 588 Mt. Pleasant Road, Toronto 1, Canada.



**OPERATE.** Profitable mail order business, everything furnished. Universal Trades, Box 5516, Chicago 80, Illinois.

**\$35-\$200 WEEKLY** Plating baby shoes, making costume jewelry, novelties, etc. Details free. Jo-Ca Electroplater, 7840-D Northwest Sixth Court, Miami 50, Florida.

**1000 MONEYMAKING Opportunities!** Free details. George Lucas, Bellevue 1, Washington.

**\$5000 ANNUALLY** Possible for you in mail order. Free details. Ransse, Box 1719-A, Richmond 14, Virginia.

**PREPARE** Income tax returns at home spare time. \$5.00-\$10.00 per hour. Simplified instructions. It's a honey. Particulars free. Reynard, Box 1295-F, Peoria, Illinois.

**\$200 WEEKLY** Possible, operating high-way equipment. Learn how. Free details. Jendix, Box 197L, Monroe, Wis.

**\$35-\$100 WEEKLY** In spare time! Ten proven ways only \$1. Homework, 4505 Harriet So., Minneapolis 9, Minn.

**NET \$50,000 A year** at home. Plans free. Fortune Enterprises, Addison, Illinois.

**EARN Extra money!** Machine, supplies, \$4.98. First few orders bring back investment. No risk. Details free. Warner Sales & Mfg., Box 1136, San Francisco.

**IN 1952** I was unemployed, had little money. Today I am retired. Will help anyone get started absolutely free. Norris Cole, 217 49th Street West, Bradenton, Florida.

**NATIONAL Cooperative** moneymaking mailing service organization. Details 10¢. Bayou Enterprises, 119 North Sterling, Lafayette, La.

**\$60.00 WEEKLY, Sparetime** — Easy! Home Venetian blind laundry. Free book. Burt, 2434ER, Wichita 13, Kansas.

**HOTTEST Mail order plan ever!** Sell photos, films, art novelties. Huge proven profits! Free details! AMPRO, Dept. 1D, 429 South Western, Los Angeles 5, Calif.

**KILL Pests for profit!** \$1200.00 monthly proved! Rid homes, farms, business of termites, rodents, pests. New shortcut methods! Learn everything two weeks! Free success plan. APCOA, Dept. 1D, 429 South Western, Los Angeles 5, Calif.

**EARN Sparetime dollars.** Work home. \$50.00 weekly possible. Industries, 526 S. Western, Chicago 12.

**ESTABLISH Your own business.** Simplified instruction qualifies you to prepare income tax forms for others. No experience. Unlimited income. Full time or part time. Full details free. International Tax Institute, 524-26th Avenue, San Francisco 21.

**START Fire extinguisher service.** Big paying home business. Mix chemicals yourself. Free details. Longworth, 6018 Stringer, Fruitport, Mich.

**EARN Sparetime money** by mail. Details free. Elvet Bloomfield, Box 24, Station A, St. Joseph, Mo.

**WIN Contest money.** General Contest Bulletin gives hundreds of tips. Lists current contests, rules. Sample magazine 25¢. General Contests, 1609 1/2 East 5th, Duluth, Minnesota.

**"INSIDE Story of Mail Order."** New book. Information free. Young, Box 655P, Waterloo, Iowa.

**\$15,000 PROFIT** In one year possible, on \$5.00 cash and just 3 hours attention weekly! Experience unnecessary! Fabulous but true! Proof, complete detailed plan, only \$1.00. Satisfaction or refund! Columbia Enterprises, 8203-P, Grubb Road, Silver Spring, Maryland.

**"HOME Business Digest"** has money-making opportunities galore. Sample 25¢. Donovan, 79-PM Greenbelt, Levittown, New York.

**ATTENTION Typewriter owners.** Make handsome profits. Write today. Groves Company, 682, Hastings 8, Nebraska.

**DO It yourself.** What? Repair TV, build furniture, make barbecue, plumbing repairs, build boats, do house wiring, remodel home, lay tile, modernize kitchen, repair home, and scores of other things you can do yourself. Books covering each subject, only 25¢. Send for descriptive list. It's free. Popular Mechanics Press, 300-LB East Ontario St., Chicago 11, Ill.

**BUY Wholesale!** 30-80% discounts! Appliances, gifts, typewriters, tools, watches, sporting goods, jewelry, cameras, housewares, etc. Consolidated Distributors, Clifton 28, New Jersey.

**FREE Folio "\$5,000-\$45,000.** Unlimited vacations." No merchandise. Unknown! Work home, sparetime! Haylings, Carlsbad, Calif.

**READ Progressive Mailtrade,** the magazine that tells how to make money by mail. Dime brings sample and special offer. Progressive Mailtrade, Box 357, Sheboygan, Wisconsin.

**BIG Money raising, fishworms and crickets.** Free literature. Carter Hatchery, Plains, Georgia.

**EARN Money evenings** copying and duplicating comic cartoons for advertisers. Adservice, Argyle 1, Wisconsin.

**SELL Titania gems.** Far more brilliant than diamonds. Catalog 10¢. Diamondite, 2420-M 77th, Oakland 5, California.

**VENDING Machines—No selling.** Operate a route of coin machines and earn amazing profits. 32-page catalog free. Parkway Machine Corporation, Dept. 27, 715 Ensor Street, Baltimore 2, Maryland.

**FREE Book "505 Odd, Successful Businesses."** Work home. Pacific, Oceanside, Calif.

**DOLLARS Every day!** It's magical! You keep all the dollars. Setup free. Otto Miller, Box 588-W, Oshkosh, Wis.

**JOIN The prosperity parade** with a mail order bookshop in your own home. Valuable information free. Practical Publications, 3974-F Milwaukee, Chicago 41, Ill.

**WE Pay \$3.50 lb. dried.** Grow mushrooms. Cellar, shed and outdoors. Spare, full time, year round. We have 25,000 customers. Free book. Washington Mushroom Ind., Dept. 173, 2954 Admiral Way, Seattle, Wash.

**BUY Wholesale!** Save 66-2/3%! 100,000 name brand appliances, housewares, clothing, furniture, tools, sporting goods—Everything! Free catalogs! National Buyers Service, Box 3338EB, San Francisco, Calif.

**SELL Hawaiian perfume.** Receive beautiful Hawaiian gifts free. Write for circulars. Waiteko, 207 Kilauea Ave., Hilo, Hawaii.

**MEN And women wanted** to start home business in spare time with little table-top rubber stamp machine. Easy to earn up to \$8.80 an hour without previous experience. Full particulars free by mail. Send postcard to Roberts, 1512 Jarvis, Room CR-2-L, Chicago 26, Ill.

**MUSHROOMS Quicker, easier, cheaper.** Newest facts free. Luxur, 641 South 19th, Newark 3, N. J.

**AGED Homemaker nets \$100 weekly!** Free packet Secret Journal. 919 secrets-plans! Work home. Publicas, Oceanside, Calif.

**EARN \$50.00 Daily** making mats, shoes and mud guards from old tires. S and S Patents Inc., 1307 North Clark St., Chicago 10, Ill.

**MEN-Women! Start money-making plastic laminating business** at home in spare time. Material that costs 11¢ brings back \$2.58. No canvassing or selling but mail orders bring in \$20 a day. Write for full particulars free. Rush name on postcard to Warner, Room CL3-L, 1512 Jarvis, Chicago 26, Ill.

**SELL Books by mail.** Directory tells wholesale sources. Send \$1.00. Clemons, Box 187-B, Sunnyvale, California.

**START Big-pay business** at home in spare time. No experience needed to operate little table-top machine for bronzing baby shoes. Make \$5.46 profit on every pair. Full particulars free. Send postcard to Mason, 1512 Jarvis, Room CM-2-L, Chicago 26, Ill.

**MAKE Money writing short paragraphs!** No tedious study. I tell you what to write, where and how to sell; and supply list of editors buying from beginners. Many small checks add up quickly. Write to sell, right away. Send for free facts. Benson Barrett, Dept. C-27-K, 7464 Clark, Chicago 26.

**MAKE Money** at home, \$2,000-\$5,000 unlimited. Details free. Fox, 12022 Pine, Norwalk, Calif.

#### EXPORT — IMPORT

**DO Anything with music!** Free details. Universal Imports, Box 667, Round Lake, Illinois.

#### FORMULAS, PLANS, ETC.

**FREE, Large formula catalog.** Analysis reasonable. Western Chemical, Salem, Oregon.

**FORMULAS For latest money-making discoveries.** New! Good! Valuable literature free! Miller, Chemist, 1517-D, Tampa, Florida.

**ICE-Less ice.** Formula 20¢. Turcotte, C.P. 142, St-Sauveur, Quebec, Canada.

**FORMULAS; All kinds, latest, best.** Literature free. Kemikal, Park Ridge, Ill.

**PRACTICAL Formulas.** Lists free. Cummings, Chemist, Gordon Ave., Syracuse 4, N. Y.

**LATE, Modern manufacturing formulas.** List free. Moon Chemical, Martville, New York.

**COSMETICS, Perfumes, latest manufacturing formulas.** Folder free. Pieder, Box 21, Jamaica Plain 30, Mass.

#### PLASTICS

**NEW Liquid casting plastic, clear, colors.** Embed real flowers, coins, photos. New manual shows fine things you can make at home and sell at big profit. Send 25¢. Castolite, Dept. P-101, Woodstock, Illinois.

**LEARN Plastics at home.** Complete kit — \$5.98. Dime brings sample plastic, three experiments, full details! Plastic Projects, Box 5, Detroit 24, Michigan.

**60 CASTING Materials — 1,000 ideas.** Catalog 25¢. Gel, Box 261, Union, N. J.

**PLEXIGLAS, Square foot cost.** 1/16", \$1.20; 1/8", \$1.52; 3/16", \$1.86; 1/4", \$2.21; 3/8", \$3.23; 1/2", \$4.36. Colors add 10%. Send 15¢ for postage. Artisticrat Plastics, 23 Sussex Avenue, Newark, N. J.

**LEARN Plastics fabrication** for spare time income. Low cost home training now available. Write for free booklet. Interstate Training Service, Dept. D-3, Portland 13, Ore.

**LAMINATING Supplies.** Free price list. Solomonson, 48 Cornhill, Boston 8, Mass.

**BOXES, Plastic.** Free list. Althor, 170 Bay 23 Street, Brooklyn, N.Y.

**PLEXIGLAS, Acetate, vinylite, polyester, fiberglass, epoxy, styrofoam, mold materials.** 28 page instructive, informative wholesale-retail catalog. 25¢. Gem-O-Lite, 5527 Cabuenga Blvd., North Hollywood, California.

#### CHEMISTRY

**CHEMICALS, Highest quality, in small quantities;** chemistry sets, apparatus and laboratory supplies. 25th year. Catalog 25¢. John H. Winn Co., Inc., 124M West 23 Street, New York 11, N. Y.

**CHEMICALS And apparatus** for industrial, analytical, and private laboratories. Catalog 25¢. Dept. M-50, Biological Supply Co., 1176 Mt. Hope Ave., Rochester 20, N. Y.

**EXPERIMENTERS; Bargains catalog,** 25¢ (refundable). Hagenow Laboratories, 2414 Clark, Manitowoc, Wisconsin.

**60 PAGE Booklets!** "Beginners Chemistry," "Chemistry," "Physics," "Relativity," "Light," "Astronomy," "Electricity," "Radio," "Useful Tables," "Scientific Oddities." 10¢ each. Franks, 3121 South Racine, Chicago 8.

**CHEMISTRY-Science magazines, Literature free.** Lancton, Box 5126-C6, Lansing 6, Michigan.

**CHEMICALS, Equipment catalog 25¢.** Laboratory Sales, Box 161-A, Brighton, Mass.

**ILLUSTRATED Catalog: Chemistry, mineralogy, biology 25¢.** Tracey Laboratories, Evanston, Illinois.

**AMAZING New Book of Science, Experiments, formulas, and catalogue** of laboratory supplies. Only 25¢. National Scientific Co., Dept. PM-12, 500 West Road, Lombard, Illinois.

**SPECTROSCOPE For quick analysis** \$5.00. Kuttington, 26278 Arastradero, Los Altos, Calif.

#### AGENTS WANTED

**FREE Sample! Beautiful feather pictures.** Sylviak, Apartado 9036, Mexico 1, D. F.

**FREE Sample, Money making formulas.** Kolumite, Box 572, Dayton 1, Ohio.

**BEAUTIFUL Feather pictures!** Free details, sample 20¢ stamps. Apartado 1668, Mexico 1, D. F.



**AGENTS — 300% Profit** selling genuine gold window letters; stores and offices. Free samples. Metallic Sign Letter Co., 1217-D West Newport, Chicago.

**YOUR Ad** in this space will get some good agents for you. Yes, I'll prove it. Write for Folder "A" right now. P. W. Johnson, Classified Advertising Manager, Popular Mechanics Magazine, 200 E. Ontario St., Chicago 11, Ill.

**GOLD Or silver letters, numbers.** Windows, doors, trucks, 1" to 6". 500% profits. Free samples. Atlas-T, 544 West 99th, Chicago 20.

**PRINTING, Advertising salesmen—**Excellent moneymaking sideline selling decalcomania name plates, small quantities. Automobile initials, sign letters. Free samples. Balco, XL, Boston 19, Mass.

**YOUR Own business—**Used suits \$1.50, overcoats 65c, mackinaws 35c, shoes 12½c, ladies coats 30c, dresses 15c. Enormous profits. Catalog free. Nathan Portnoy Associates, 605-AA West 13th Place, Chicago 7.

**REAL Diamond rings.** Nationally advertised. Sell direct. Make big middleman's profit. No investment. Experience unnecessary. Free catalog, details. Gleam-light, 107B North Columbus, Mount Vernon, N. Y.

**FOG-Stop windshield cloth.** Instantly removes blurry mist, frost, sleet, snow. Stops windshield fogging. Samples sent on trial. Kristee 70, Akron, Ohio.

**EASY Handwork** makes fast-selling useful articles. Sample free. Sunmade Company, Brockton 64, Massachusetts.

**1200% PROFIT** On \$1.50 item! Darcel, 17 Jefferson, Providence 8, R. I.

**DAMASCENE Earrings!** Exotic orientalism. Huge profit. Ohga, PM 102, Sigakenkusatu, Japan.

**SELL Hawaiian gift items.** Maier Products, 1120 Koko Hd., Honolulu.

**SIXTY Fast-selling** name brand watches, cookware, cutlery, etc. To 84% wholesale discount. Catalog free! Jones, B.P.M. 1, 164 Sumpter St., Brooklyn 33, New York.

**60% PROFIT** On cosmetics — Famous nationally advertised Hollywood cosmetics pay 60%. Make \$25 day up. Hire others. For free samples, details, write Studio Girl, Glendale, Calif. Dept. 12712G.

**MUSIC Greeting cards.** Dorby Music Cards, Box 354, Morristown, New Jersey.

**EARN \$1,112.40** Monthly selling sensational new invention which makes open windows burglar-proof. 5 second demonstration sells every home owner. Write Kirien Products, Dept. P12, 2201 Grand, Kansas City, Missouri.

**EARN \$10,000** Yearly—Only two sales daily. World's best seller, the Holy Bible. Illustrated Protestant or Catholic. Margareta's P.O. Box 92, Hazelton 7, Penna.

**STRANGE Dry window cleaner.** Sells like wild. Replaces messy rags, liquids. Simply glide over glass. Samples sent on trial. Kristee, 73, Akron, Ohio.

**\$200 WEEKLY** Selling Charm, scientific foot powder. Sample, details 50¢. Pilgrim, Box 31, Latonia, Ky.

#### BUY IT WHOLESALE

**BIG Multicolor** wholesale catalog! Housewares, appliances, clothing, silverware, cookware, luggage, binoculars, radios, phonographs, cameras, recorders, projectors, typewriters, shavers, sporting goods, toys, tools, sewing machines, watches, jewelry. Name brands. Huge discounts. Postcard: Selbyco, Decatur 163, Illinois.

**JOIN Catalog** club. Send \$1.00 (refundable) for 8 wholesale catalogs. Stark, Box 9897, Houston 15, Texas.

**BUY Wholesale** appliances, houseware, watches, catalog \$1 (refundable). Holby, 48A, W.H.P., Goldsboro, N. C.

**1958—1954 AUTOMOBILES** To 40% off! Jakiel, 2944 Western, Chicago 47n.

**BUY Wholesale!** Appliances, tools, watches, auto accessories, etc. Huge discounts. United Wholesalers, 1265-M Bdw., New York 1, N. Y.

**WHOLESALE Catalog!** Diamond rings, jewelry. Distributors, Box 106G, Hudson, New York.

**USED** And new watches \$2 up. Free list. Southern Watches, 5-PM So. Wabaah, Chicago 3.

**BUY Wholesale!** Discounts to 80%! Gifts, appliances, housewares, tools, watches, etc. Midwest, IMP-156, Pontiac, Illinois.

**BARGAINS, Joblots, closeouts.** 2000 items. Tremendous savings, clothing, toys, gifts, jewelry, television, etc. 25¢ brings wholesale catalog. \$1.00 merchandise certificate included free. Reliable Jobbing, 311-B North Desplaines, Chicago.

**SAVE TO 75%** on household items, 25¢, refundable. William Springer, Ocoee, Florida.

**ELECTRIC** Guitars, amplifiers. Wholesale. Free catalog. Carvin PMW, Covina, Calif.

**BUY Wholesale!** Over 10,000 nationally advertised products. Appliances, cameras, sporting goods, housewares, watches, typewriters, tools, clothing, etc. Send postcard today. Buy-Rite, Box 258, Hawthorne 4, New Jersey.

**BUY Wholesale!** Nationally known brands. Catalog \$1. (Refundable). D'Auria Sales, Box 356-PM, Jackson, Michigan.

#### SALESMEN—DISTRIBUTORS

**AD Matches!** Sell amazing designs—10, 20, 30, 40 and 240-light book matches. Bigger spot cash commissions; every business a prospect. Low prices for high quality. Repeats. Start without experience; men, women; full, part time. Buy nothing! Sales kit furnished. Match Corp., Dept. PM-98, Chicago 32, Illinois.

**NEW Exclusive** money maker. Amazing aluminum wall lamps, movable from room to room. Sure sale in home, institutions, and offices. No competition. Free catalog Maypole Clamp Co., Inc., 727 Delaware Ave., Youngstown, Ohio.

**INCREASE** Present income. Build growing sideline, fulltime business. No investment. Farmers, agents, dealers. Take orders for Campbell's Gro-Green Liquid Fertilizer Concentrates. Free sample, sales kit. Campbell Co., Rochelle 332, Illinois.

**MONEY** Back low priced trading stamp plan pays you bigger spot cash profits with steady year 'round income from reorder commissions. Every grocery, gas station, drug store, etc., are quick buyers. Free pocket sales kit. Worth, P-12, 1825 South Michigan Avenue, Chicago 16, Ill.

**SALESMEN.** Radically new patented mouse-trap. A child can set it. Most territories open. Write, Patented Products, 214 E. 41, New York City.

**BIG Cash** commissions! Complete line 230 shoe styles, also jackets. Postcard brings you free kit! Mason, Chippewa Falls 15, Wisconsin.

**AGGRESSIVE** Representatives wanted. Leading line fiberglass boats. Peninsular Fiberglass Products, Hialeah, Florida.

**WILL** You wear new suits and topcoats without one penny cost and agree to show them to friends? You can make up to \$30.00 in a day even in spare time, without canvassing. Stone-Field, 532 South Throop Street, Dept. S-928, Chicago 7, Illinois.

**REPRESENT** A complete line of quality paint products used by owners of homes, factories, public buildings. Establish yourself in a profitable lifetime business, get full credit for repeat orders. Rated firms sold open account; get your commission checks weekly! No investment, no deliveries, no collecting. Experience in our line unnecessary but you must be willing to make calls. Full or part time. Our firm established over 20 years, top rating in D & B. Line is available only through established representatives on direct factory basis. Write today in confidence if interested. J. H. Coggin, Sales Manager, P. O. Box 325, Evansville, Indiana.

**MAKE Money.** Sell sensational dwarf trees, bear giant-size apples, peaches, pears. Ornamental. Also Stark-Burbank standard trees, roses, shrubs, vines, etc. Outfit free. Stark, Desk 30768, Louisiana, Mo.

**MAKE Extra** money. Cash commissions. Everybody buys easy-to-sell advertising book matches. Union label. All sizes. Cuts for all businesses. Powerhouse selling kit free. Steady repeat business. No experience necessary. Superior Match Co., Dept. M-1257, 7528 S. Greenwood, Chicago 19.

**OFFICE** Furniture, mimeographs and office supplies. Tremendous profits. Send \$1.00 for big illustrated catalogs and dealer discount sheet. None free. Marx Stationery Corp., 1017 Filbert, Philadelphia 7, Penna.

**EXCELLENT Opportunity** for profits right now selling finest line of advertising specialties and calendars. Sales unlimited. Sell to retailers and manufacturers at high commission. For full or part time salesmen. Reply Kedoo Products, Box 169, Morristown, New York.

**ENGLISH Chamol** importer needs additional distributors. Nunnally Exporters, San Angelo, Texas.

**DIRECT** Factory distributor for well known, United States government approved, automotive product. Exclusive sales rights. Excellent repeats. Salesmanager, 6319 Wilson Avenue, St. Louis 10, Missouri.

**INCREASE** Your income—Sell advertising ball point pens and advertising specialties. Directory factory connection. Write today. Wilkinson-Akers, Inc., 725 Kansas Ave., Kansas City, Kans.

**\$10 AN Hour** spare time. Every woman needs an ironing board cover. None can resist the only cover guaranteed 2 years. Reversible, copper fabric one side, aluminum other. Free sample. Award Products, 1444 Eric Lane, East Meadow, N. Y.

**IF** You're interested in making money in selling, see the hundreds of exceptional opportunities in Salesmen's Opportunity Magazine. Send name for your copy, absolutely free. Tell us what you're selling now. Opportunity, 848 N. Dearborn, Dept. 17, Chicago 10, Illinois.

#### EMPLOYMENT INFORMATION

**FOREIGN, Alaskan, U.S.A. jobs!** To \$1,500.00 monthly! Million Americans employed overseas. Copyrighted reports. Who to contact for highest paying jobs! Laborers, trades, drivers, office, engineers, many others. 32 countries—New Niagara project, booming West, Latin America, Spain, Europe, all continents. Registration advisory service. Application forms. Unconditional money-back guarantee! \$2.00 (airmailed \$2.25). C.O.D.'s accepted. International Reporter, St. Louis 1, PC, Mo.

**FLORIDA'S** Booming. Statewide opportunity analysis, job plan, contact list airmailed \$2.00. Sun-Glo Service Bureau, Perry 3, Florida.

**COMING** To California? Choice listings; jobs, housing, business opportunities, in San Francisco, Los Angeles, San Diego. 15 page booklet plus free gift. \$1.00. Chesley, 3077½ Texas Street, San Diego 4, California.

**JOB Consultant** expert on Miami Beach, Miami, Fort Lauderdale, Palm Beach area. Don't gamble. Know the facts before you leave. Latest information regarding jobs, salaries, construction, rentals, food prices, etc. Personal questions answered. Classifieds included. Air mail \$2.00. C.O.D. accepted. Job Consultant, Box 425, Oakland Park, Fla.

**BOOMING** Venezuela—Only hours from the States. New data regarding jobs, opportunities, conditions, etc. Salaries to \$1650 monthly U. S. tax exempt. Bonuses, living allowances extra. First-hand information direct \$2.00 (\$2.35 air mailed) checks or money orders only. Paul B. Smith, Apartado 172, Maracaibo, Salina, Venezuela.

**JOBS Galore**—Big pay in fabulous, booming Southern California. Classifieds \$1. Box 1261B, Sherman Oaks, California.

**COPYRIGHTED** Reports on best paying jobs with travel, adventure, promotions. Construction, aviation, shipping, laborers, clerical, trades, supervisory, factory, unusual opportunities. Many types of work. Skilled and unskilled. Foreign and state-side openings for men and women. Only \$2.00 (\$2.25 airmail), including registration-advisory service. Satisfaction guaranteed. Included absolutely free: Special reports on Alaska, Spanish airbase construction. South American opportunities and husband-wife foreign jobs. Research Services, Suite 514-PMX Meramec Building, St. Louis 5, Missouri.

**ALASKA, Overseas, U. S., Calif. jobs.** Thousands needed! Transportation paid. To \$400 weekly. All trades. Men, women. Send \$2.00 for applications, current contacts and job information. International, Box 16, San Diego 12, Calif.

**NEW** England job and business opportunities galore, \$2.00. \$2.25 airmail. Abercrombie, Box 629, Holyoke, Mass.

**JOBS** On merchant ships. Big pay. Box 4092, Jacksonville, Florida.

**JOBS Overseas!** Janeczek Development Co., 1090 Hub Station, New York 55, N. Y.



**WANT Work in Washington?** Particulars free. Henderson, 170 Temple Village, Alexandria, Virginia.

**FREE Information:** Earn high pay. All trades. Foreign and U.S.A. job opportunities. Travel paid. Applications, write Dept. 61J, National Employment Information, 1020 Broad, Newark, N. J.

### SPECIAL SERVICES

**INFORMATION** On anything. Ferguson Research Specialists, 116-14 141 St., South Ozone Park 36, N. Y.

**INCREASE** Your sales in Latin America. Deal with technical translators. We'll print your catalog, bulletin, etc. Pinos, P.O. Box 6485, Los Angeles 55, Calif.

**INCOME** Tax assistance! Refunds available! Grifco, 613 Latham, Wynnewood, Pennsylvania.

**PERSONAL** Typing in 24 hours. \$2.50 plus 20 cents handling and mailing. Course, Box 12, Rowena, Texas.

### EDUCATIONAL AND INSTRUCTION

**LEARN** "By ear" with Dormiphone. While you slumber, the amazing new scientific invention works for you. Revolutionary Dormiphonic tools give you a shortcut to learning languages, correct speech; memorizing facts, figures; relaxation, habit training. Saves time, effort. So simple, children benefit. Used by educators, psychologists. Write today for fascinating free book. No obligation. Modernophone, Inc., 320-127 Mezz., Radio City, New York City 20.

**MEN** Wanted age 18 to 45 to train as builders, estimators and contractors at home in spare time. Big pay opportunities. Write for free brochure. American Technical Society, 850 E. 58th St., Dept. PM-1257, Chicago 37, Illinois.

**LEARN** Gunsmithing at nationally recognized gunsmithing school. Master instructors, latest equipment, modern shops, classrooms. Day-night classes start weekly. V.A. approved P.L. 18, 550, 894. Write for brochure on gunsmithing, outboard motor repair, sporting goods repair, mechanical drawing, architectural drafting. Colorado School of Trades, 1545 Hoyt, Denver 15, Colorado.

**PIANO** Tuning pays. Big money in spare time. Learn at home in 30 days. No musical knowledge necessary. Phonograph, records, tools and instructions furnished. Personal instructions available. Free catalog. Capital Piano Tuning School, 3160 S.W. 16th Court, Fort Lauderdale, Fla.

**ENGINEERING** Degrees earned through home study. Residence courses also available. Pacific International University, (operating as a College of Engineering only at present), 5719-B Santa Monica Boulevard, Hollywood 38, California.

**FINISH** High School at home, spare time. No classes. Diploma awarded. Write for free catalog. Wayne School, Catalog HF-81, 2527 Sheffield, Chicago 14.

**BLUEPRINT** Reading—Train at home. Learn to read blueprints with confidence in 10 easy lessons. Write today Belton School, 1059-U North Lawndale, Chicago 51.

**WELDERS** Earn big money. Easy to learn arc, gas, automatic welding. New equipment, low cost training in non-profit school. GI approved. Free booklet. Hobart Welding School, Box M-1271, Troy, Ohio.

**LEARN** Bricklaying—Earn \$8000.00 year. New 3D color projection simplifies instruction. Amazing. Handicraft Div. B6, Box 74, Attalla, Ala.

**BOOKS.** Free general catalog, 100 pages. Text, vocational, educational, instructional subjects. Millions of volumes, new and used. Bargain prices. Books bought. Est. 1902. Long's College Book Co., Dept. PM, Columbus 1, Ohio.

**SING.** Speak, with power, personality. Self-training records. Amazing details. Canfield, 2018-A 5th Ave., South, Minneapolis 4, Minn.

**DRAFTING.** Design, blueprint reading. Good paying. Easy to learn at home. Minimum age 17. Write Utilities Engineering Institute, Dept. TC-9, 2525 Sheffield, Chicago 14.

**LEARN** Civil and criminal investigation at home. Earn steady good pay. Institute Applied Science, 1920 Sunnyside, Dept. 169, Chicago 40, Ill.

**AUCTIONEERING** Home study. Sample chant free. Nelson Auction College, Renville, Minnesota.

**COMPLETE** Your high school at home in spare time with 60-year-old school. Texts furnished. No classes. Diploma. Information booklet free. American School, Dept. X945, Drexel at 38th, Chicago 37, Illinois.

**MASTER** Watchmaking at home. Free sample lesson. Chicago School, 2328-YN Milwaukee, Chicago 47.

**MEMORY** Education; more mental power; lesson one free. Memorology Studio, 2918-M Sunnyside, Chicago 25, Illinois.

**LEARN** To sing at home with the Key to Singing Success by Edward Novis, teacher of Dick Powell, Kenny Baker, Donald Novis. Send one dollar, Studio 7B, 12311 Hartsook, North Hollywood, California. For private singing lessons call Poplar 2-7237 in Hollywood.

**BE** An investigator. Write for free details. State age. National Detective Academy, 535 East 4th Street, Box 1082, Scottsdale, Arizona.

**HIGH** School, civil service, business, college, correspondence courses. Earn diploma, degrees. Aureav, Central Valley, N. Y.

**LEARN** Mail order publishing. Free details. Rainone Printer, Middle Village 79, New York.

**HANDWRITING** Analysis now accepted in college, business, industry. Our men, women who use grapho analysis spare, full time earning more money, getting prestige, success, happiness. Uncrowded, fascinating field for intelligent men, women anxious to get ahead. We need more members. Investigate this growing field where you give a real service to your fellow man. Opportunities unlimited. Free sample lesson and information to all over 21. Write today! IGAS, 2307 National Station, Dept. 1013, Springfield, Missouri.

**HIGH** School diploma at home. Licensed teachers—Approved materials. Southern States Academy, Box 5344-MX, Station E, Atlanta, Georgia.

**EARN** Degree. Free bulletin. Home-study only. Midwestern Bible School, 1060 Broadripple, Indianapolis.

**WE** Pay \$3.50 lb. dried. Grow mushrooms. Cellar, shed and outdoors. Spare, full time, year round. We have 25,000 customers. Free book. Washington Mushroom Ind., Dept. 174, 2954 Admiral Way, Seattle, Wash.

**SWEDISH** Massage, learn at home. Diploma. Dr. Swanson School Swedish Massage, Illinois licensed vocational school, 3809 Alta Vista Terrace, Chicago, Ill.

**BE** A real estate broker. Study at home. Send for free catalogue. Midwest School of Real Estate, 68 North Chicago Street, Joliet, Illinois.

**TIMESTUDY**—Your key to positive personal profits. Associated Techniques, Box 235, Hollidaysburg, Penna.

**EARN** College degrees, correspondence. Metropolitan University, Box 86, Glendale 5, California.

**LEARN** Appliance service and repair. Motors, washers, refrigeration, cleaners, everything. Free booklet. Armstrong, 11027-A South Vermont, Los Angeles 44.

**STUDY** For Doctor's degree of psychology, metaphysics and divinity. Correspondence courses only. College of Divine Metaphysics, Dept. P-M, 2811 North Illinois, Indianapolis 8, Indiana.

**BE** A real estate broker. Study at home. Write for free book today. GI approved. Weaver School of Real Estate, 2018P Grand, Kansas City, Missouri.

**USED** Correspondence courses and books sold and rented. Money back guarantee. Catalog free. (Courses bought.) Lee Mountain, Pisgah, Alabama.

**EARN** While you learn. Auto and diesel mechanics master this top paying trade. Many graduates earn \$100 a week and up. Approved for Korean veterans. For free information write Dept. No. 256, Nashville Auto-Diesel College, Nashville 3, Tenn.

**HELP** Yourself to abundant living. Our courses have aided students to richer fuller lives. Learn secret of contentment, happiness. Earn degrees Ps.D., MsD. Write for free book. College of Universal Truth Correspondence School, 23-C E. Jackson, Chicago.

**BOOKKEEPERS!** Increase your earnings! Operate your own simplified "Dollar-A-Week" bookkeeping and tax service. Full or spare time. Details free. No obligation. Ellis, Box 200, Cedar Grove, North Carolina.

**LEARN** While asleep! Details free. Research Association, Box 610-MC, Omaha, Nebraska.

**WANT** A diesel job? New opportunities to increase income. Higher pay. More money. We can help you qualify. Tools. Shop method home training. Write today! Diesel, Tractor, Heavy Equipment Division, Interstate Training Service, Dept. B-3, Portland 13, Oregon.

**INVESTIGATOR** Training. Phillips Secret Service System, 1917-B North Kenneth, Chicago 39.

**USED** Correspondence courses and educational books bought, sold, rented. Free catalog. Educational Exchange, Menlo, Georgia.

**PIANO** Tuning pays. Learned easily at home. GI approved. 59th year. Free booklet. Miles Bryant School, Dept. P, 3731 Stockton, Sacramento 20, Calif.

**SECRET** Investigation. Experience unnecessary. Investigators particulars free. George Wagner, M125 West 86th, New York 24.

### PLAYS, STORIES, MANUSCRIPTS

**"HOW** And Where to Sell Manuscripts." Send \$1.00 to Editor, Box 262P, Hollywood, California.

**WANT** Your book published? Learn how we publish, advertise, promote, distribute. Many successes. Free booklet PM. Vantage, 120 West 31, New York City. Midwest office: 220 S. Michigan Ave., Chicago, Ill.

**WANTED:** Book manuscripts, all subjects considered. Greenwich Book Pub., Atten. Mr. Zealand, 489 Fifth Ave., New York City.

### CARTOONING, COMMERCIAL ART, SHOWCARD & SIGN PAINTING, TATTOOING

**"HOW** To Make Money With Simple Cartoons"—A book everyone who likes to draw should have. It is free; no obligation. Simply address Cartoonists' Exchange, Dept. 912-C, Pleasant Hill, Ohio.

**BASIC** Art training at home. New plan. Free booklet. Students' Art Club, Kennebunkport, Maine.

**TATTOOING** Supplies. Free catalog. Spaulding & Rogers, Court St., Jacksonville, No. Carolina.

**LETTER** Patterns. Many sizes and styles. Free catalog. Berge Co., Gonvick, Minnesota.

**ASK** For free facts about our famous cartooning course. Cartoons-of-the-Month, Roslyn, New York.

**LEARN** Sign painting at home. Free talent test. Ben Kerns, Box 812-PM, Greenville, S.C.

**TATTOOING** Outfits, licensed course. Brochures 25¢. Zels, 728 Leslie, Rockford, Illinois.

**LEARN** Sign painting with fascinating system. Straley, 410 S. Western, Springfield, Ohio.

**YOU** Can entertain with chalk talks. Catalog 10¢. Balda The Cartoonist, Oshkosh, Wis.

**CARTOON** Your way to success! Internationally known instructor, Raye Burns, will personally teach you to create original, salable cartoons at home. Course of 26 lessons only \$2.85. Write for free details. Raye Burns School, Box 3583-P, Cleveland 18, Ohio.

### ADVERTISING AGENCIES, LETTER WRITERS, FOR ADVERTISERS

**BEFORE** Advertising—Get instructive Ad-Guide and newspaper-magazine rate-book, free. Chicago Advertising Agency, Chicago 4.

**EXCLUSIVE!** 10,000 1957 Gift buyers' names on gummed labels, \$15 per 1000. First time offered. Sara-Kay Imports, Tallahassee, Florida.

**ADVERTISE:** 24 Words. 100 Canadian newspapers \$5.50. Lists free. Advertising Bureau, 10511-C Springfield, Chicago 43.

**ADVERTISING.** Result-getting ads prepared, placed newspapers, magazines, radio, anywhere! Lowest rates. Catalogue free. Baker Advertising Agency, 129 W. Madison, Chicago 2.



MAILING Lists most any classification \$3.00 1000. Your circulars mailed with ours \$4.00 1000. Write for our literature. Dixie Mailers, King, N. C.

WANT More business? Here's an amazing opportunity to increase your sales. Talk to thousands of interested readers of "Mechanics Popular." Our Spanish Edition covers the Latin American countries like a blanket. They're real mailorder buyers. Classified rate 75¢ per word. Try an ad in our next issue. Classified Advertising Department, Popular Mechanics Magazine, 200 East Ontario Street, Chicago 11, Ill.

#### RUBBER STAMPS AND OFFICE SUPPLIES

THREE Lines—\$1.00. Signature \$3.95. Helms Stamp Company, Bristol, Tenn.

8 HOUR Service, 3 lines \$1.00. Guaranteed. Bazzler, Ludlow, Mass.

RUBBER Stamps. All kinds. Literature free. Capital Stamp Works, Box 187, Lincoln, Nebraska.

QUALITY Rubber stamps! Distinctive lettering. 3 lines \$1.00. Prompt service. Money-back guarantee. Campfield, 14 Beaufort Circle, Springfield 4, Mass.

#### TYPEWRITERS, DUPLICATORS, OFFICE DEVICES

RECONDITIONED Typewriters, duplicating, printing devices, \$25.00 up. Supplies. Appliances. Dixie Graph, King, N. C.

DISTRIBUTOR Sale! Sensational new portable typewriter. Low price! Details free. Clifford Sales, 172 Greenwich St., New York 7, N. Y.

#### PRINTING, MULTIGRAPHING, MIMEOGRAPHING, GUMMED LABELS

1000 BUSINESS Cards. Raised letters. \$3.50. Samples. Pioneer, Island Park 42, New York.

125 LETTERHEADS, 8 1/2 x 11. One color, \$1.50. 2 colors, \$2.00. Academy Press, Enterprise, Kansas.

1000 BUSINESS Cards \$2.99 postpaid. Samples. Crescent Art, 2416 LaHarpe, New Orleans 18.

BUSINESS Printing. Top quality. Bottom prices. A. Hanson, Malvern, Penna.

1000 EMBOSSED Business cards \$3.50. Samples. Hickman Company, Coalgate, Oklahoma.

GUARANTEED Printing that pleases. Lower priced. Farrell, PM, Liberty, New York.

YOUR Name and address printed on gummed labels. 500—3 lines \$1.00. 15¢ each extra line. 1/2 x 1 1/4. Print clearly. No c.o.d.'s. Addison Mail Order, PM-12, 1840 Addison, Chicago 13.

1,000 NAME. Address stickers. \$1.00. Century, 2618 Illinois, Topeka, Kansas.

MAIL Dealers, salesmen, brokers wholesale letterhead deal. Murl, Box 748, Dayton 1, Ohio.

NEED Labels, decals. Free samples. S. Eddy, 7 Greenacres Ave., West Hartford 7, Connecticut.

1500 PERSONALIZED 3/8 x 1 1/4 Labels \$1.00. Your 3 line name and address printed with blue ink on fine quality white gummed paper. Money back guarantee. Hamilton-Ward, Dept. 10B, Westfield, Mass.

OFFSET Printing—\$6.50 1000 8 1/2 x 11, 24 hour service. National Letter, 251 W. 42 St., New York City 36.

EXCELLENT Printing. Reasonable. Samples. Mondello Press, Sycamore St., Belmont 79, Mass.

ADS Running under this heading sell printing. Ask me for proof. I'll gladly send you amazing facts. Ask for Folder "P." F. W. Johnson, 200 E. Ontario St., Chicago 11, Ill.

TESTIMONIALS. News items, ads reproduced in quantities. Fame, 291 Ellis, San Francisco 2, Calif.

10,000 ATTRACTIVE 2 Color circulars \$20. Stickers, cards. Samples. Fame, 291 Ellis, San Francisco 2, Calif.

CIRCULARS, Booklets, letterheads, envelopes. Estimates, anything! Lonelms Printers, Paulding, Ohio.

BUSINESS Printing. Samples, prices free. Howprint, 723-G Eunice, Webster Groves 19, Missouri.

TOP Quality printing, mimeographing. Free literature. Currier, PM, New Lebanon Center, N. Y.

MIMEOGRAPHING—Letters, pricelists, formulas, instructions. Lowest prices. Lem's Letter Shop, 5710 Stanton, Detroit 8.

BUSINESS Printing, rubber stamps. Free catalog. Broce, 196 Clerk Street, Jersey City 5, N. J.

BETTER Grade printing. Reasonable. Estimates. Hamel-Printer, 210 5th Avenue, Suite 1104, New York City 10, N. Y.

#### PRINTING OUTFITS AND SUPPLIES

PRESSES, Type cabinets, supplies. List for stamp. Lincoln Press Company, 220K Hartwell, Fall River, Mass.

MAKE Your own self-molding rubber stamps and printing cuts. Plexirubber, Argyle 1, Wisconsin.

DO Your own printing. Save money. Simple rules. We supply everything. Print for others; good profit. Raised printing like engraving too. Have home shop. Details free. Kelsey Presses, V-11, Meriden, Connecticut.

PRINTING Presses, type, supplies, lists 3¢. Turnbaugh Service, Mechanicsburg, Penna.

#### PATENT ATTORNEYS

INVENTORS—Take these preliminary steps toward patent protection. Sketch and describe your invention. Sign, date and have this disclosure witnessed by two people who understand your invention. Have us make a preliminary search among U.S. patents already granted for similar types of invention. We report on the probable patentability of your invention and recommend your further course of action. Write for our instructive booklet, "Patent Protection for Inventors" and convenient "Evidence of Invention" disclosure form. Victor J. Evans & Co., 331-P Merlino Building, Washington 6, D. C.

INVENTORS—If you believe you have an invention, you should find out how to protect it. The firm of McMorro, Berman & Davidson with offices in Washington, D. C., is qualified to take the necessary steps for you. Send for copy of our patent booklet "How to Protect Your Invention." We will also send you an "Invention Record" form. No obligation. They are yours for the asking. McMorro, Berman & Davidson, Registered Patent Attorneys, 134-A Victor Building, Washington 1, D. C.

INVENTORS: When you are satisfied that you have invented something of value, write me, without obligation, for information as to what steps you should take to secure a patent. Write Patrick D. Beavers, Registered Patent Atty., 935 Columbian Bldg., Washington 1, D. C.

REGISTERED Patent attorney offers services. Sanders, 6430 Evans, Chicago 37, Illinois.

C. A. Snow & Co.—M427, Snow Building, Washington 1, D. C. Registered Patent Attorneys. Write for information.

PATENTS. "Proof of Invention" free. E. E. Vrooman, Registered Patent Attorney, 507 McKim Building, Washington 5, D. C.

"INVENTOR'S Guide" and "Record of Invention" free on request. Frank P. Ledermann, Registered Patent Attorney, 154 Nassau Street, New York City.

INVENTORS: Without obligation, write for information explaining the steps you should take to secure a patent. John Randolph, Registered Patent Attorney, 203 Columbian Bldg., Washington 1, D. C.

INVENTORS: Learn how to protect your invention. Unless the inventor is familiar with patent matters, he should engage a competent registered patent attorney or agent to represent him. We are registered to practice before the U. S. patent office and prepared to serve you in handling your patent matters. "Patent Guide for the Inventor" containing detailed information concerning patent protection and procedure with "Record of Invention" form will be forwarded to you upon request—without obligation. Clarence A. O'Brien & Harvey Jacobson, Registered Patent Attorneys, 71B-K District National Building, Washington, D. C.

INVENTION Record form free and "Patent Information Every Inventor Should Have." Carl Miller, Registered Patent Attorney, Woolworth Building, New York.

#### FOR INVENTORS

WHY Let your ideas remain idle simply because you lack equipment and facilities to complete development? Our technical staff and fully equipped electrical, electronic, electro-chemical, physics, and mechanical laboratory now offers inventors service to perfect, analyze, or test your ideas. For information write Connecticut Research Company, Box 168, Old Lyme, Conn.

INVENTIONS And ideas designed for your profit and patented for your best protection at low definite fees. Thirty years experience in developing and patenting inventions in U.S. and foreign countries. Patent searches with valuable report \$15.00. Joseph O'Brien, 132 Nassau Street, New York 38, N. Y.

PATENT Searches \$5.00. 48-hour airmail service. Invention protection forms free. Write Patent Engineering Service, 711 14th Street N. W., Washington 5, D. C.

INVENTORS: Learn how to protect your invention. Unless the inventor is familiar with patent matters, he should engage a competent registered patent attorney or agent to represent him. We are registered to practice before the U. S. patent office and prepared to serve you in handling your patent matters. "Patent Guide for the Inventor" containing detailed information concerning patent protection and procedure with "Record of Invention" form will be forwarded to you upon request—without obligation. Clarence A. O'Brien & Harvey Jacobson, Registered Patent Attorneys, 71A-K District National Building, Washington, D. C.

INVENTORS: Test the commercial value of your patented or unpatented inventions, quickly and inexpensively. Write for free information. Institute of American Inventors, Dept. 40-B, 635-F St., N.W., Washington 4, D. C.

INVENTORS. Don't sell your invention patented or unpatented until you receive our offer. Write Cowgill, Box 298, Marion, Ohio.

INVENTION Record form free and "Patent Information Every Inventor Should Have." Carl Miller, Registered Patent Attorney, Woolworth Building, New York.

PATENT Searches \$5.00. 48-hour service. Free invention protection forms. Write Raymond L. Smith, Patent Searcher, 629 Sheraton Building, Washington 5, D. C.

SEARCHES—Put your patent searches in the hands of a registered patent attorney or agent, as he qualifies to give a worthwhile patentability report. Record of invention form upon request and information on patent protection. Patrick D. Beavers, Registered Patent Attorney, 936 Columbian Bldg., Washington 1, D. C.

INVENTORS: Information on patent procedure furnished on request, without obligation. John Randolph, Registered Patent Attorney, 203 Columbian Building, Washington 1, D. C.

PATENT Searches, including copies of nearest patents, \$5.00. Reports airmailed within 48 hours. More than 100 registered patent attorneys use my service. For free invention protection forms, write Miss Ann Hastings, P.O. Box 176, Washington 4, D. C.

BEST Market for selling your invention is "Gadgets Patents Invention News" readers. Inventors' Service, 107 W. Van Buren, Chicago 5, Illinois.

INVENTIONS Wanted now by my manufacturer-clients. Patented, unpatented. Write Gilbert Adams, Patent Broker, 80-S Wall Street, Financial District, New York City.

INVENTORS—If you believe you have an invention, you should find out how to protect it. The firm of McMorro, Berman & Davidson with offices in Washington, D. C., is qualified to take the necessary steps for you. Send for copy of our patent booklet "How to Protect Your Invention." We will also send you an "Invention Record" form. No obligation. They are yours for the asking. McMorro, Berman & Davidson, Registered Patent Attorneys, 1349 Victor Building, Washington 1, D. C.

INVENTORS! Have you good patentable ideas? Write Mr. Metzler, 11 West 42nd, New York City.



**INVENTORS**—This firm is registered to practice before the United States Patent Office and available to assist you in the preparation and prosecution of your patent application. "Patent Protection for Inventors" booklet containing detailed information and steps to take toward patent protection sent promptly upon request. No obligation. Victor J. Evans & Co., 332-P Merila Building, Washington 6, D. C.

**INVENTORS**—Send for free Patent Information book and Inventor's Record. Registered Patent Attorney, Associate Examiner, Patent Office 1923-29, Patent Attorney & Advisor, Navy Department 1930-47. Gustave Miller 127A Warner Building, Washington 4, D. C.

#### INVENTIONS WANTED

**INVENTIONS** That can be made from aluminum. Southern Products, 2914 Northeast 18th Street, Ft. Lauderdale, Florida.

**INVENTORS**—Do you want to sell or license your invention on cash or royalty basis? Write Kessler Corporation, 512-1W, Fremont, Ohio.

**INVENTIONS** Wanted now by my manufacturer-clients. Patented, unpatented. Write Gilbert Adams, Patent Broker, 80-8 Wall Street, Financial District, New York City.

**PATENTED**—Unpatented. Bought, sold, promoted. No advance charges. Inventions Sales Co., Williamson Bldg., Cleveland 14, Ohio.

**\$5000 FOR INVENTIONS**, ideas, anykind. Research membership \$8.00 year, or send \$2.00 cash for legal forms to Research, 210 5th Ave., New York City 10.

**INVENTORS**: Hundreds of manufacturers have requested our assistance in locating marketable new products. Complete information free. Institute of American Inventors, Dept. 40-D, 635-F St. N.W., Washington 4, D. C.

**CASH BUYERS** for inventions. Write National Inventors Institute, Box 7007, Cleveland 28, Ohio.

**INVENTORS**, Don't sell your invention patented or unpatented until you receive our offer. Write Cowgill, Box 298, Marion, Ohio.

**INVENTIONS** Wanted. Patented or patent pending. 26 years experience promoting inventions. National Service Bureau, 3120 Meramec, St. Louis 18, Mo.

**SUPERIOR** Promotions. Patented; unpatented inventions. Information booklet, free. Superior, 338-344 North Rodeo, Beverly Hills, Calif.

**INVENTIONS** Wanted. Patented; unpatented. Tremendous manufacturers lists. Global Marketing Service, 3420 77th, Oakland 5, California.

**ATTENTION** Inventors. We extend our invitation to exhibit your invention at the largest International Inventors Exhibition being held during the 1958 World's Fair at Brussels, Belgium. Non-profit world-wide market facilities. Contact Otto Witt, Official American Correspondent, Box 1481, Milwaukee 1, Wis.

#### PATENTS FOR SALE

**PLASTICS** Molding. Copyrighted item for sale on royalty basis. Inquire. Gabor Racy, 179 George St., New Haven, Conn.

**RATCHET** Wrench, offset ratchet screw-driver. Williams, 3154 Marr Rd., Columbus, Indiana.

#### MANUFACTURING

**WIRE** Forming stamping tools, dies. Send your print, part or sketch. B. L. Tool & Die, B. Lindberg, Prop., 413-26th St., Union City, N. J.

**DESIGNING**, Tools, dies, models, manufacturing. Pro Devco, Box 983, Cincinnati 1, Ohio.

**MODELS**—Small lot manufacturing. Metals, plastics, etc. Milburn, Burlington, Kentucky.

#### MODELS, MODEL SUPPLIES

**GEARS** And model supplies for the inventors. Send 10¢ for catalog. Pierce Model Works, Tinley Park, Illinois.

**WORKING** Steam engines, boilers, tractors, fittings. Catalog \$1.00. Tiny Power, Corvallis, Oregon.

**SHIP** Models and yacht supplies complete. Large 68 page catalogue 50¢. Bill Wild's, 510 East 11 St., New York City 9.

**SHIP** Models. Most complete line in New England. Kits, fittings, plans, books, tools, engines, motors. 1958 illustrated catalog 35¢. James Bliss & Co., Inc., Dept. 8M, 342 Atlantic Ave., Boston 10, Mass.

**SHIP** Model kits and fittings including clippers, trawler, fishermen, frigates, privateer, radio control tug, etc. Send 25¢ for 1957 catalog. Model Shipways, Box 85, Bogota, N. J.

**Balsa** Wood and model aircraft. 40-page catalog 25¢. Sig Co., Montezuma, Iowa.

**SHIP** And yacht model fittings; blueprints. Send 35¢ for illustrated catalog listing hundreds of items. A. J. Fisher, 1002-1 Etowah Ave., Royal Oak, Mich.

#### HOME CRAFTSMEN

**FREE** Catalog. 2150 artist-drawn patterns, designs, Craftplans, 1322-A Wabash, Chicago 5.

**LEATHERCRAFT**, Copper enameling, mosaic tile, metal tooling, many more crafts. Complete illustrated catalog 10¢. Kit Kraft, 2212, Studio City, Calif.

**101 PATTERNS** Of smart gifts, novelties, shelves, action windmills. Plus "Make Money Jig Sawing." \$1.00. Mastercraft, 125M, 7941 Olcott, Chicago 31, Ill.

"**OLD Whittler**" read-cut figures make whittling fun! Send \$1.00 for set. The DAE Company, Box 219, Baraboo, Wis.

**129 FULL-Size** artist drawn jigsaw patterns. \$1.00. Craftplans, 1322-A Wabash, Chicago 5.

**SHOP** On wheels. Inexpensive wheel kit. Free catalog. Ripplinger's, 1926 Gravois, St. Louis 4, Mo.

**LEATHERCRAFT**. Send 10¢ for new 78-page catalog of tools, supplies, kits, including metalcrafts, enameling, ceramics, all other crafts. Complete stock. Reasonable. Since 1910. Sax Bros., Dept. PM-12, 1111 N. 3rd, Milwaukee, Wis.

**PATTERNS** Flying ducks, man sawing wood, Dutch maid churning butter, and 30 lawn ornaments, only \$1.00. Lincoln Studio, Columbia, Conn.

**OREGON** Myrtlewood A rare and beautiful wood for the lathe. Ken. Dorman, Oakland, Oregon.

**DAWN** Gage information free. See Machinery classification. Dawn Crafts, Buffalo 16.

**MEXICAN** Silver peso coins. Decorate belts, purses, bracelets. New, brilliant. Five for \$1.00. Robinson, Apartado 23548, Mexico 10, DF, Mexico.

**FREE!** Manufacturing licenses thousands priceless patented inventions! Your choice. Guaranteed "Patent Abstract Series" data, \$3.00. Bodi-Kare, 1323 Chaparral, Corpus Christi 3, Texas.

**AMERICA'S** Most complete home craft supply company. Send 10¢ for big colored catalog. Giles & Kendall Co., Huntsville, Alabama.

**LEARN** Art metalcraft and jewelry making. Complete, inexpensive, home training course now available. Special tools and materials furnished. Write for free booklet. Interstate Training Service, Dept. L-3, Portland 13, Oregon.

**FREE** "Do-it-yourself" leathercraft catalogue. Tandy Leather Company, Box 791-T22, Fort Worth, Texas.

**KNOCKDOWN** Cedar chests and lumber. Free price list. Bedford Lumber Company, Shelbyville, Tennessee.

**WOODWORKING** And cabinetmaking course for beginning and advanced home craftsmen. Only complete low-cost home training program available. Write for free booklet. Interstate Training Service, Dept. Q-3, Portland 13, Ore.

**ALL** Crafts, supplies. Large free catalogue. National Handicraft, 199 William Street, New York City 38.

**STYLECRAFT** "Pretraced" leather kits. Handbags, billfolds, filigree belts. Patterns on leather. Just carve, assemble and lace. "Pre-carved" kits also available. Send 25¢ for catalog, free folder. Refunded first order. Apache Leather Company, 2804 E. Washington St., Phoenix, Arizona.

**LEATHERCRAFT**. Imported and domestic leather, tools, kits, complete catalog. 25¢ refundable. Midas, Box 1255, Dept. J7, Huntington Park, California.

**FREE** Seashells catalog. Instruction book 35¢. Secor's, Bradenton, Florida W.

#### DO IT YOURSELF

**TERMITES?** Treat your home yourself. Free information. Hamlin Institute, Hamlin, W. Va.

**REMOVE** Rust with metal treat. \$1.00 bottle makes one gallon. At leading hardware and paint stores or prepaid from Klean-Strip Co., P.O. Box 10083-A, Memphis, Tenn.

**MAKE** A mobile. 10 easy steps, \$1.00. Mobiles, 4602 B St., S. E. Washington 19, D. C.

**REFLECTIVE** Sign letters. Bobby Robertson, 14 Brooks Drive, Austell, Georgia.

**LAY** Bricks like an expert with steel spacers. Make large U. S. maps, complete patterns for floors or walls. Sign Manufacturing Co., Four Thirty Delaware Ave., Buffalo 2, N. Y.

**18 FULL-Size** patterns. Save money with easy-to-use, professionally designed full-size patterns. Make money selling beautiful, useful furniture. Make modern step and cocktail tables; metal lamps; cupola; 12-foot outboard. All patterns test-built; sold with money-back guarantee. Get your free list of these convenient, economical patterns today. Popular Mechanics Press, 200-HH E. Ontario Street, Chicago 11, Ill.

**GRANDFATHER** Clock movements, barometers, blueprints, kits. Wholesale catalog 25¢. Mason-Sullivan, Noroton, Conn.

#### WATCHES, OLD GOLD, JEWELRY

**COSTUME** Jewelry supplies, settings, rhinestones, etc. 88 page illustrated catalog. 25¢. Milady, Box 1328, G.P.O., New York City.

**GOLD**, Silver, platinum, diamonds wanted. Cash immediately, highest prices; appraisals made. Wilmot's, 1087 Bridge, N.W., Grand Rapids 4, Mich.

**WATCH** And clock repairing books. Free catalog. North American, 2320-AN, Milwaukee, Chicago 47, Illinois.

**WATCHMAKERS'** Jewelers' supplies. Largest Encyclopaedic catalog 25¢. Bengal Wholesalers, Culver City, California.

**10 SWISS** Watches \$18.00. Catalog 20¢. Berkowitz, 1150 Castlehill, New York City 62.

**LEARN** Precision casting, gold, silver, any metal. Particulars \$1.00. Box 481, Austin, Minn.

#### RAZORS, BLADES, SHARPENING

**BLADES**. Guaranteed comfortable, smooth, not usual hard scrape. 100 double edge, display box, \$1.50, resell \$5.00. Samples. Kerr, 635-41st Street, Brooklyn 32, N. Y.

"**PERMASHAVE**" Sharpens Barberway double, single blades. Results guaranteed. \$2.00 postpaid. Michael Malecki Co., 111 Bushwick Ave., Brooklyn 6, N. Y.

**DOUBLE** Edge razor blades. Send \$1.00 for 100. Holden, 1706b N. Hollywood Way, Burbank, Calif.

#### FOR THE HOME

**FOAM** Rubber furniture cushions. Factory seconds. 50% discount. Free catalog. Perma-Foam, 390-C Nye Avenue, Irvington, N. J.

"**HOME** Improvement Guide." New, amazing 192 page volume. Packed with ideas, plans for remodeling, decorating, landscaping, built-in projects. \$2.50 prepaid. Popular Mechanics Press, 200-HQ East Ontario St., Chicago 11.

**AMAZING** New polish for your storm windows and doors. New formula. Guaranteed. Send \$1.00 for can. Cameo Chemical Products, 1342 East 7 Mile, Detroit 3, Michigan.

**FIRE** Alarm (dependable) \$4.95. Howard Sawyer, 5813 Benton Heights, Baltimore 6, Md.

#### OF INTEREST TO WOMEN

**SHOP-By-Mail**. Quality merchandise. Low prices. Free catalog. Quality House, Box 893, Kannapolis, N. C.

**60% PROFIT** On cosmetics—Famous nationally advertised Hollywood cosmetics pay 60%. Make \$25 day up. Hire others. For free samples, details, write Studio Girl, Glendale, Calif. Dept. 12712G.



**WANTED** At once, woman with car. Would you like to earn \$35 or more a week in your spare time, calling on housewives in your vicinity, with Rawleigh products? Write Rawleigh's, Dept. L-790-PPM, Freeport, Ill.

**WE Pay \$3.50 lb. dried. Grow mushrooms.** Cellar, shed and outdoors. Spare, full time, year round. We have 25,000 customers. Free book. Washington Mushroom Ind., Dept. 175, 2954 Admiral Way, Seattle, Wash.

**SELL** Fine fabrics. Get yours wholesale. Box 863, Norwalk, Conn.

#### PERSONAL

**DESK Markers.** Names engraved on copper plate against 8"x2 1/2" wooden base. Twenty letters allowed. Print, \$2.25 post paid. Burt's, 612 Center, Butler, Penna.

**MAKE** Your own will now. Free advice. Legal Lights, 916 Barry, Chicago 14, Ill.

**BORROW** Money by mail. \$100-\$600. Anywhere. Air mail service. Postal Finance, 200 Keeline Building, Department 658X, Omaha 2, Nebraska.

**MECHANICS** Engineers, operators. Get your trade identification card. G. A. Hunter, 769 E. Hastings, Vancouver, Can.

**SCIENTIFIC** Analysis. Send handwriting sample. \$1. Jean Gayden, 1205 Bayou, Tallulah, Louisiana.

**LOVELAND** Remails to someone dear 25¢. Konrad, Box 144-R3, Loveland, Ohio.

**"SECRETS** Handwriting Reveals" \$1.00. Grapho Analyst, 1516 Sinaloa, Simi, Calif.

**INFORMATION** About anything. Low rates. Research, Box 722, Riverhead, N. Y.

**CONFIDENTIAL** Receiving, forwarding service. Free information. Institute, Box 979, Houston 1, Texas.

**KNOW** Your I.Q. rating. Send \$1.00 for Crane's (20 min.) standard intelligent quotient examper. Crane, 1733 Raymond Hill Rd., So. Pasadena, Calif.

**BIBLE** Questions answered. Stamped envelope. Bylon, 17167 Bentler, Detroit 19, Michigan.

**ENJOY** Health. Free booklet. Ruth's Nutrition, 152 Kearny, PM, San Francisco, Calif.

**"HOW** Can I find out?" You can! Information confidentially developed. Any matter, person, problem. Worldwide. Officially licensed. Established 1922. William Herman, 170 Broadway, New York City.

#### REMAILING SERVICE

**BARRANQUILLA,** Colombia, South America—Christmas cards, remails and view cards. 25¢. T. P. Dann, 76-30, Carrera 51B, Barranquilla, Colombia.

**BOLIVIA** Remails 30¢, reairmails \$1 half ounce. Fred Brand, 524-28 Ave., San Francisco.

**HONOLULU**—6 Postcards \$1.00! Re-mailed free. 10 exotic gifts available. List free. Write today! Fobel, 4503-P Aukai Avenue, Honolulu.

**LETTERS** Remailed from Lakeland, Florida. 25¢. Box 2074, Lakeland, Florida.

**WASHINGTON** Remails. 25¢. Anselm, 712 Buchanan, N.E., Washington 17, D. C.

**SEATTLE** Remails—25¢. Forwarding \$3.00 monthly. Dorman, P.O. Box 42, University Station, Seattle 5, Washington.

**REMAILS** 35¢ Xmas cards 25¢. I affix Canadian air stamps. Ross Hancock, 83 Bellhaven Rd., Toronto 8, Canada.

**MIAMI** Remails 25¢, month \$3.00. Ed. Polaski, Box 272, Miami 47, Fla.

**SAN** Francisco remails. 25¢. Receiving-forwarding \$3.00 month. Kent, Box 4608.

**REMAILS,** 25¢ Each way. \$3.00 monthly. Hale, Box 1, Glenmont, N. Y.

**CHRISTMAS** Cards remailed 25¢. J. Love, 1419 E. 83, Los Angeles 1, Calif.

**LETTERS,** Christmas cards remailed, 25¢; 3 for 30¢. McKee, Box 202, North Hollywood, California.

**LETTERS** reairmailed with Colombian stamps. Two \$1.00. César de Hart, Apartado Aereo 480, Barranquilla, Colombia, South America.

**LETTERS** Remailed. 25¢. V. P. Gimbart, Box 328, St. Petersburg, Florida.

**REMAILING** Miami, Miami Beach, 25¢. Scenic postcards. R. Shay, 103 Marion, Hollywood, Florida.

**AIR** Remails. I affix stamps. Three for \$1.00. Paul S. Torres, Casilla #332, Tacna, Peru.

**NEW** York City remails 25¢. Receiving-forwarding, \$3.00 monthly. Rowe, P.O. Box 98, Kew Gardens 15, N. Y.

**COLUMBUS** Mail forwarding-receiving address for rent. Details free. William McLaughlin, 800 Stewart, Columbus 6, Ohio.

**SECRET** Mail receiving, forwarding system. \$3 month. Hedgpeh, Box 830, Alhambra 23, California.

**LETTERS** Remailed from Detroit, 25¢ each. Patrick L. Kennedy, 2111 Springle, Detroit 15, Michigan.

**FREE** New York address. Receiving, forwarding, remailing 25¢. Henry, 173-32 64th Ave., Flushing 65, N. Y.

#### TREASURE FINDERS

**INDICATOR.** Locates uranium, buried money, minerals. Price \$25.00. Dirt samples tested free for oil. Horton's Surface Oil Survey, Belle Rive, Illinois.

**TREASURE,** Metal-mineral detectors. M-scope. Used worldwide for treasure hunting. Geiger, scintillation counters, mineralights. From \$14.75. Guaranteed. Time payment plan. Free treasure, uranium information. Free catalog. Fisher Research Lab., Inc., Dept. C-1, Palo Alto, Calif.

**FIND** Buried treasure, gold and silver, with Goldak's sensational 3 1/2 lb. "find-it" locator, only \$84.50. Write for free literature on complete line of mineral, metal locators; Geiger and scintillation counters. Goldak, 1541 W. Glenoaks Blvd., Glendale, Calif.

**FREE** literature—Light weight, guaranteed metal detectors, Geiger counters and mineralights. Kits and assembled models. Electronic Applications. Dept. M, Box 8, Arlington 10, Virginia.

**GOLD,** Silver metal detectors. Geiger counters for uranium. Violites. Sensational new fully guaranteed models. None finer. Information free. Detecron Corp., 5528 Vineland Ave., North Hollywood, Calif.

#### FOR SALE—MISCELLANEOUS

**HEARING** Aid batteries, wholesale. Free list. Habs, Box 51, York, Penna.

**4 BALLPENS,** Comb, pocketsaver, \$1.00 postpaid. Refills 10¢. General, 1614 W. Calvert, Wichita 13, Kansas.

#### WANTED—MISCELLANEOUS

**QUICKSILVER,** Platinum, silver, gold. Ores analyzed. Wholesale Terminal, Norwood, Mass.

**SCRAP** Mercury (quicksilver) containers supplied—Tantalum, tungsten, silver, platinum. Metallurgical Products Company, Established 1909, 35th & Moore Sts., Philadelphia 45, Penna.

#### MISCELLANEOUS

**GLUE-IT-yourself** assortment. \$1.00 buys four different Marmora adhesives. Send your buck and your problems to Marmora, Box 429, Camden 1, N. J.

**70 BIBLE** Lessons 25¢. Bulletin, Box 87, Cathedral Station, New York 25, N. Y.

**ENGINEERING** Drawings and sketches require proper lettering. Make yours look professional using Slot-Letter guide. No guide lines necessary. Learning simple. Thousands of professional draftsmen and many schools are changing to Slot-Letter. Excellent present. \$1.50 postpaid. Dolgorukov Manufacturing Co., Dept. D., Fisher Bldg., Detroit, Mich.

**WRITE** For free catalog. New government surplus—GI self-instruction books. Value over \$7 each. Mathematics, history, foreign languages, accounting, farming, auto-mechanics, establishing new business, etc. \$1.00 each postpaid. Choose from over 60 courses. Sual Co., Dept. B, Elsinore, California.

**PHOTOCOPIES** Of any document 50¢ plus postage. Additional copies 10¢ each. Electro-Copy, 509 North Union, Chicago 10, Ill.

**RECEIVE** Big mails, sample magazines, offers. Get listed 25¢. Ed. Polaski, Box 272, Miami 47, Fla.

**SADDLES,** Boots, western wear, leather supplies. Free catalog. Silver Spur, Box 1785-N1, Ft. Worth, Texas.

**GERMAN** Cuckoo clock \$2.00. Gray Company, Box 948, Vallejo, Calif.

**HOW** To gain promotion, a pay raise; right where you work, right now! Details free. Ern-Marr Co., Clermont, Florida.

**IMPORTED** Swedish steel bullet knife. 7/16" x 4", \$1.00 postpaid. Martin, 1187 Canyon Heights Drive, Niles, California.

**RECEIVE** MAIL opportunities, magazines, samples, 25¢. Jones, 8448 Kavanagh Rd., Baltimore 22, Maryland.

**IMPROVE** Your position! Message "A" free. Peoples Publishing Service, Box 416, McLean, Virginia.

**22 VITAMINS** 100 Days' supply \$3.00. Donte Chemicals, Great Neck 17, N. Y.

**RECEIVE** Big mails. Get listed, dime. Mailoservice, P.M.M., Bronxville, N. Y.

**1001 VALUABLE** Things free. Tremendous offers. All free. Valmart, Dover 32, New Jersey.

**CELEBRATING** 50 Years in men's neckwear business. \$7.50, \$12.00 and \$15.00 dozen, all at \$3.50. Assorted large shape ties, special, gross lots \$30.00. Imported silk ties, new 1957 styles and patterns, @ \$9.00 doz. Harry Leinkram, 915 Broadway, New York City.

**GIANT** Size rat traps. 36 inches by 60 inches around. Can be used as fish baskets in private ponds. Customers claim 15 wharf rats one night, another 57 fish one night. \$3.50 each f.o.b. plant. Slocumb Supply Co., Douglas, Ga.

**GENUINE** Mounted alligator, 3 ft. long, \$5.00. Wallets, belts, of genuine alligator, rattlesnake or python skin, \$4.00 each; three for \$10.00. Also live wild pets, animals, birds, reptiles. Catalog 10¢. Ray Singleton, Rattlesnake, Fla.

**GOD** Answers prayers. Interesting folder free. Methods Research, Box 2236, Kansas City 42, Mo.

**I Want** to send you proof of the wonderful pulling power of Popular Mechanics classified pages. What's your proposition? Write me today. Include literature if possible. F. W. Johnson, Manager Classified Advertising, Popular Mechanics Magazine, 200 E. Ontario St., Chicago 11, Ill.

**DRAFTING** Machines, portable. Drafting Equipment Co., Randolph Street, Meadville, Penna.

**WORLD'S** Smallest Bible 25¢. Five, \$1.00. Fox, 12022 Pine, Norwalk, Calif.

**LEARN** While asleep! Details free. Research Association, Box 610-MC, Omaha, Nebraska.

**RECEIVE** Magazine samples, mails, catalogues, offers from everywhere. Get listed 25¢. Rorick, Cincinnati 28, Ohio.

**YOUR** Name wanted. We'll send 1000 publishers, mailers, wholesalers your name, on our list one year 25¢. Dixie Mailers, King, N. C.

**BOOKS** On antiques and their prices. Free circular! P. Warman Publishers, Uniontown, Penna.

**JAPAN:** Buy gifts direct. Dolls, kimono, records, etc., \$4 page catalogue, business information—\$1.00. Send money order. Clarence Yamagata, 202 Naka 7 Bldg., Marunouchi, Tokyo.

**WE Pay** \$3.50 lb. dried. Grow mushrooms. Cellar, shed and outdoors. Spare, full time, year round. We have 25,000 customers. Free book. Washington Mushroom Ind., Dept. 175, 2954 Admiral Way, Seattle, Wash.

**BUY Wholesale!** Over 10,000 nationally advertised products. Appliances, cameras, sporting goods, housewares, watches, typewriters, tools, clothing, etc. Send postcard today. Buy-Rite, Box 258, Hawthorne 2, New Jersey.

**CIGARETTES**—Make 20 for 9¢. Facts free. Moberly, Box 810, Owensboro, Kentucky.

**CESSPOOLS.** Septic tanks, clogged drains. How they function and how to keep them working. Free literature. Chemical Cesspool & Drain Cleaning Co., Boston 34, Mass.

**WANT** More business? Here's an amazing opportunity to increase your sales. Talk to thousands of interested readers of "Mechanica Popular." Our Spanish Edition covers the Latin American countries like a blanket. They're real mailorder buyers. Classified rate 75¢ per word. Try an ad in our next issue. Classified Advertising Department, Popular Mechanics Magazine, 200 East Ontario Street, Chicago 11, Ill.



**Gift packaged for Christmas!  
McKINNEY MAILBOXES**

Complete line of handsome, fine quality mailboxes for every type of home. The only mailboxes ready-wrapped for Christmas giving.



See your Hardware or Building Supply Dealer today!

**Find HIDDEN TREASURES**

GOLD, SILVER, PRECIOUS METALS with the Famous Model 27 Metal Detector. Lightweight, ultra-sensitive, low cost. None finer. Also GEIGER COUNTERS for uranium and the VIOLITE for tungsten. INFORMATION FREE

THE *Detectron* CORP.  
5528 Vineland Ave., No. Hollywood, Calif.



**make your own Gems** 36<sup>50</sup>

The Gem Maker comes complete with all necessary equipment, including a super-charged diamond blade for sawing, and all the wheels for grinding, shaping and polishing; also complete instructions. The complete equipment as shown, less motor and belt for only \$34.50, f.o.b., Burlington, Wisconsin. Write today for information and literature.

**B&I MANUFACTURING CO.**  
Dept. P. Burlington, Wis.

**BUY and USE  
CHRISTMAS  
SEALS**

fight TB

**Are YOU Boating—or BAILING?**

**for \$10.75**  
plus 50c for postage  
**DePERSIA  
AUTOMATIC  
BAILERS\***  
**WORK FOR  
YOU  
AUTOMATICALLY**

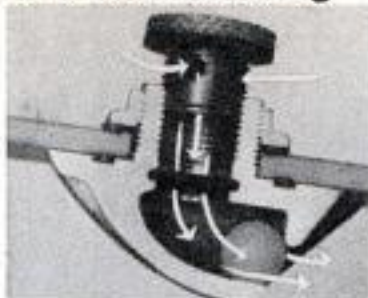

**RUNNING**

Constantly bailing your boat while in a forward motion—closes automatically when boat is stopped. Buoyant check ball does all the work for you. Attractive gold colored Safety Cap seals against possible seepage, for mooring. Aluminum sand casting. Dichromate sealed. Fits hulls up to 1 1/4 in. thickness. Can be used on rowboats and canoes as automatic drain.

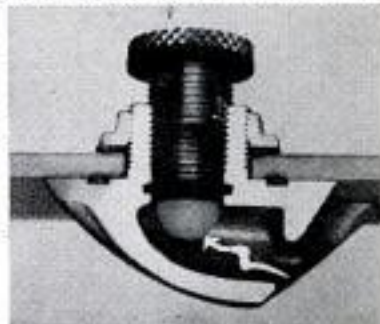

**STANDING**

**EASILY INSTALLED  
Do-It-Yourself Project.**

\*U.S. Pat. No. 2772648

Canadian Pat. No. 542 062

**DISTRIBUTORS INQUIRIES WELCOMED**

**De PERSIA AUTOMATIC BAILER, INC.**  
GRAND HAVEN, MICHIGAN

**Boost Your Power!**

**FAN-O-MATIC**  
Automatic  
**FAN RELEASE**

Automatically disengages fan at speeds over 40 mph!

At speeds over 35 MPH, standard automobile fans waste horsepower! The FAN-O-MATIC now makes your fan a free-wheeling unit, releasing wasted horsepower at speeds over 40 MPH.

- Increases Available Horsepower . . . up to 15 HP
- Increases Gas Mileage . . . up to 2 mpg.
- Increases Acceleration . . . up to 10%
- Reduces Engine Noise
- Reduces Vibration



PAT. PEND

ADAPTABLE TO ALL CARS  
SIMPLE TO INSTALL

Tested and proved on Indianapolis Speedway under supervision of U. S. Auto Club.

2150



At your Garage, Ser. Sta. or Car Dealer!  
If your dealer does not yet have it, ask him to write us for Jobber who can supply him.

**RADIATOR SPECIALTY CO.**  
CHARLOTTE, NORTH CAROLINA



Do every job easier  
and better with a  
**COLUMBIAN  
LEVEL**



No. 524-4



This 4-vial, lightweight, accurate, durable aluminum level belongs in your tool kit. It's attractive, easy to handle . . . gives accurate readings from either edge. Metallic-sealed vials, protected on both sides with extra-heavy glass lenses, are set in special "ever-last" cement. No need for adjusting.

Length . . . . . 24 in.  
No. Plumbs . . . . . 2

Weight . . . . . 2 lbs.  
No. Levels . . . . . 2

See your Dealer!

Packaged in "Certified  
Levelpack" carton.  
Write for free catalog

**\$5.90**  
delivered

**COLUMBIAN VISE & MFG. CO.**

Dept. PM 524 • Cleveland 4, Ohio

Set a Hand Saw  
in 32 seconds

**FOLEY** Power  
**SAW SETTER**



for hand and band saws

The Foley Automatic Power Setter has exclusive "twin hammer" action (one for each side of saw), operating from a single spring, insuring utmost accuracy. ONCE through turns out a perfectly set, true cutting saw. No tooth breakage, relieves eye strain. Sets all hand saws (with handles left on) and band saws from 4 to 16 points per inch.

FREE — Foley Price Guide of saw sharpening charges, also Foley Setter circular. Write today — no salesman will call.

**FOLEY MFG. CO.** 1285-7 Foley Bldg.  
Minneapolis 18, Minn.



**G E A R S**

In Stock — Immediate Delivery  
Gears, speed reducers, sprockets, thrust bearings, flexible couplings, pulleys, etc. A complete line is carried in our Chicago stock. Can also quote on special gears of any kind. Send in your blueprints and inquiries.

Send for Complete Catalog No. 10

**CHICAGO GEAR WORKS**  
440-50 N. Oakley Blvd., CHICAGO 12, ILL.



Silence PING

USE SAE 10W-30

**KENDALL**

**SUPER B MOTOR OIL**

Portable Seat for Infant Clamps to Edge of Any Table



High-frequency sound waves, already used to detect flaws in wood, may enable man to locate fungus diseases that slowly destroy good timber.

This portable baby seat clamps onto a table, saves space and provides nontipping safety. It weighs three pounds, is made of sturdy metal and canvas and folds flat for carrying. The seat is made in England.

**Playback Hearing Aid  
Slows Down Speech**

Speech sounds are not only made louder but slowed down by a sound-spacer hearing aid that helps persons listen more accurately to rapid conversation. The sound spacer actually records speech and plays it back in a slower tempo. Johns Hopkins Hearing and Speech Center, Baltimore, Md., has announced the development of the new hearing device.

**Low-Grade Gasoline Converted  
To High-Octane Fuel**

More high-octane gasoline per barrel of crude oil is promised with a new process that upgrades low-octane portions of gasoline by passing them over platinum pellets. The process, called hydroisomerization, was developed by Gulf Research and Development Company and Universal Oil Products Company.

POPULAR MECHANICS



**NEW simplified arc welding kit**  
... just plug it in!



a real, easy to use 100 amp. welder (not a toy)

For home workshop—Do your own repairs—lanks, fenders, tools, machine parts. Build metal furniture, bins, racks, etc. Low cost welder easy to operate on properly wired 110 or 220v house wiring. Hundreds of Uses—auto service, body, fender shops, plumbing and heating contractors. Comes ready to use. Send for FREE "Welder's Vest Pocket Guide"

HOBART BROS. CO.  
Box M-1274, Troy, Ohio

a product of one of the world's largest builders of arc welders



**YOUR BEST RESOLUTION FOR 1958:**  
Never To Make A Wrong Turn  
Or Lose Directions Driving  
You'll Make It, Too, With A

**HULL AUTO COMPASS**

For 25 Years, America's Favorite Motoring and Boating Guide

\$6.95 and \$5.50 At your dealer's or write for literature

HULL MFG. CO., P. O. BOX 246-D-12, WARREN, OHIO



**"FIRE UP"**

YOUR ENGINE AT ALL SPEEDS WITH AUTO-LITE SPARK PLUGS WITH

**POWER TIP**

LOOK FOR THE PROTRUDING TIP!

**BRONZE FOUNDRY**



Schools • Home Workshops • Inventors

Make your own castings of aluminum, copper, bronze, silver. Foundry sets are available in three sizes including 2400 Deg. F. blast Furnaces. \$26.50; \$33.50; and \$46.00 f.o.b. Marysville or Lakewood. Free Circular.

KANSAS CITY SPECIALTIES CO. (Dept. ) Box 6022, Marysville, Kans. P-12 / or Box 7543, Lakewood, Colo.

**FREE AMAZING NEW BOOK "HOW TO ANSWER ADS"**



Never before have you seen anything like this. Tells you in simple language the correct way to answer ads. Gets you quicker replies—better results, and greater satisfaction. Will save you time and money and it's ABSOLUTELY FREE. No obligation whatever. Every reader of advertising should have this booklet. Send a postcard for your copy NOW. F. W. JOHNSON, Popular Mechanics Magazine, Room 600-A, 204 East Ontario Street, Chicago 11, Ill.



**Glu-Bird**  
MAKES IT  
**EASIER**

- clean to use
- dries clear
- holds tight
- permanent

WILHOLD PRODUCTS Los Angeles 31, Calif., Chicago 44, Ill.

**HEAVY DUTY 12" BAND SAW** only \$34<sup>95</sup>

BUILT-IN 2-SPEED MOTOR!

SAWS WOOD, STEEL, TILE, PLASTICS! Saws straight or curved cuts to center of pieces 24" wide, any length, in wood, steel, tile, plastics, many other materials! Portable. 2-speeds for wood or metal cutting. Rugged construction. At your dealer Send postcard for free catalogue.



Burgess Vibrocrafters, Inc., Dept. A-124, Grayslake, Ill.



**Deft-finished in 3 minutes each coat...ROLLED ON.**

A 3-coat Deft-finish was applied to the desk above in less than half a day. Each coat was lightly sanded with 6/0 paper. Final coat was steel woolled to a beautiful satin-smooth finish. Roller application was used on flat areas, brush on edges.

Deft is the perfect finish for home and workshop. It's completely trouble-free, no thinning required. It dries in 30 minutes. Use Deft on all interior wood projects, cabinets, furniture, paneling, floors, etc. You'll agree that there's nothing like Deft Wood Finish. Seals, primes, finishes — nothing else to use. Apply by roller, brush or spray gun.

Wherever paints are sold. Or write for free booklet to Desmond Bros. 1826 W. 54th St., Los Angeles 62, California

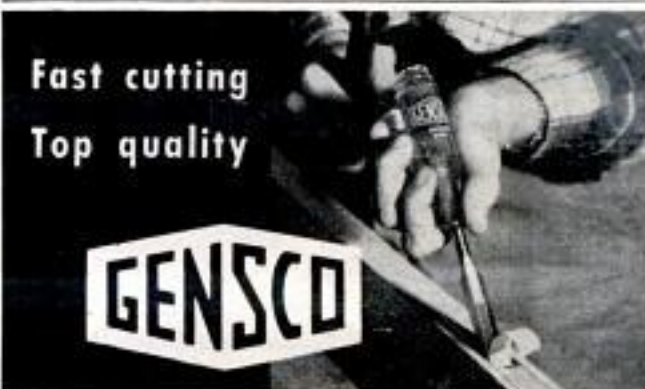

Fast cutting  
Top quality



**SWEDISH WOOD CHISELS**

Woodworking projects have that little extra professional touch when Genesco Swedish Wood Chisels are used. They're tops: hand ground, razor sharp blades, Tenite II handles are unbreakable and fire resistant... won't pull loose, sizes from 1/4" to 2".

Buy these accurate cutting, easier to use Genesco Wood Chisels at all leading hardware stores today. Available in sets of 4, 6 or 11 chisels in vinyl coated canvas rolls.



Set 300-4

1/4", 1/2", 3/4" and 1"

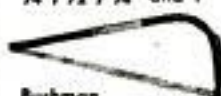

Bushman ALL-PURPOSE 21" Bow Saw

**GENESCO GENESCO TOOLS**  
A DIVISION OF

GENERAL STEEL WAREHOUSE CO., INC.  
1832 N. Kostner Ave., Chicago 39, Illinois





**The man who knows best—**  
*Your quality dealer says:*

**YOU BUY BETTER  
 WHEN YOU BUY  
 QUALITY**  
**TOOLS, EQUIPMENT  
 AND MATERIALS**

*A Sound Suggestion!*

Your dealer will most likely recommend products advertised in *Popular Mechanics*. Make it a point to read *Popular Mechanics* for helpful information and project suggestions. *Popular Mechanics* publishes more product information than any other magazine of its kind. And products advertised in *Popular Mechanics* are top-quality products

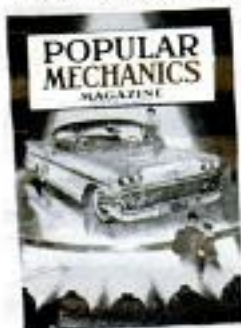

—products you will be proud to own. Ask your dealer. He reads *Popular Mechanics*, too.

Who knows better the best tools, equipment and materials for your job than the man who sells them every day—your quality dealer?

He knows that nationally-advertised products last longer and do the job better—at no greater cost. He recommends and sells them with complete confidence because they are backed by nationally-known manufacturers.

Whenever you plan home projects, make it a point to talk with your quality dealer about the tools, equipment and materials that will do the job best. Make him your project partner, and you will do the job quicker with better results. He is always happy to help you.

HOME IS WHAT YOU MAKE IT  
 —AND YOUR DEALER CAN HELP





## 115 Volt, A. C., ELECTRIC GENERATORS

60 Cycle, Single Phase, Continuous Duty



750 Watt Cost \$115.00 **\$59.50** fob  
 1000 Watt Cost \$150.00 **\$79.50** fob  
 2000 Watt Cost \$235.00 **\$115** fob

**BRAND NEW SURPLUS FULLY GUARANTEED**

Ideal as a permanent or stand-by unit for electricity IDENTICAL to house current. Perfect for farms, camps, aboard ship, oil fields, mines, etc. Easily handles lights, refrigerator, deep freeze, oil burner, radio; power for saws, floodlights, drills, pumps, etc.

All ball bearing. Operates at 3600 R.P.M. Drive with 2 HP to 3 1/2 HP or larger engine—or use power take-off. Voltage self regulating. Standard base mounting. Two outlets. Modern, compact design. Tremendous overload capacity. Operates in either direction!

**SUPPLY LIMITED! WE PAY SHIPPING! ORDER FROM AD**  
**FREE CATALOG OF OTHER SURPLUS, HYDRAULICS**

Phone TAYLOR 9-1365

**ROBERTS ELECTRIC CO., Dept. PM-733, 849 W. Grand, Chicago 22, Ill.**



**Now!  
 NEW  
 EASE IN**

## SNOW REMOVAL

With Steering Sulky and Self Starter

- Powerful Gravelly Tractor—with *push-button Starter, New Steering Sulky* and *Snowblower*—make snow removal almost child's play!
- You can blow snow—deep or light, wet or dry—wherever you want it, with fingertip maneuverability. 48" Snow Flow also available. 23 year 'round attachments... *All on Easy Pay Plan.*

Write today for FREE 24-page "Power vs Drudgery" Booklet!

**GRAVELLY TRACTORS, INC.**  
 BOX 1263 DUNBAR, W. VA.

**FIELD-TESTED SINCE 1922**

**1/4 MIDGETS**  
 The little league of family racing. \$395.00 complete. Write for free literature. Dealerships now available.

**RACE-CRAFT**  
 RACE-CRAFT MIDGET CARS  
 8474 E. Garvey Boulevard  
 South San Gabriel, Calif.

**1 Bit to DRILL · REAM · SAW** IN SHEET METAL, WOOD, ANGLE IRON, TRANSITE, BAKELITE.

Fits any 1/2" or 3/4" electric drill or drill press. Drill's own 1/2" starter hole; cuts straight, curves, or angles. Made of finest High Speed, abrasion-resistant steel. Easy to use.

**New, Low Price \$2.95** Postpaid 3 for \$8.50  
**Money-Back Guarantee**

Specify Bit for Wood, Heavy Metal, All-Purpose

**INTERNATIONAL TWIST DRILL CORP.**  
 618 Wyandotte, Kansas City, Mo.

DEALER INQUIRIES WELCOME

**For A SAFE, WARM XMAS give a MO-DE-CO BATHROOM CEILING HEATER**  
**ATTRACTIVE — INSTANT HEAT OUT OF CHILDREN'S REACH**

Approved 1000 Watts 120 V AC-DC

Completely assembled ready to hang exactly like a beautiful light fixture. Connects to standard wiring.

**EASILY INSTALLED DO-IT-YOURSELF**  
**\$22.75** Delivered, check or money order  
**HEAT UNLIMITED**  
 13915 Addison St., Sherman Oaks, Calif.

**ONE-MAN SAWMILL** LOW \$5000 AS... **50** DOWN

Take BELSAW Portable Sawmill right to the trees—turn out valuable lumber for home and farm—sell to local yards—make up to \$50 a day custom sawing for neighbors. BELSAW lasts a lifetime. No crew needed. Power with tractor or auto engine. Beginners get excellent results. Send today for **FREE BOOK.**

**BELSAW MACHINERY CO.**  
 3455 Field Bldg., Kansas City 11, Missouri



**PUT *your* stock SHOP IN YOUR SHOP!**

**EASY TO GET AT!** With ONE HAND you can reach and get... *instantly*... exactly the size and type of screw you want. "STOCK your SHOP" is a smart, new, convenient, and economical way to buy and store screws. Try a few boxes. You'll like them!

**SCREWS IN NEW CLEAR PLASTIC BOXES**

**FOR EASY DRIVING, ALL WOOD SCREWS ARE SPEEDIZED**

An invisible lubricating film on "STOCK your SHOP" Wood Screws makes them *easy* to drive in even the hardest woods! This *free* extra feature eliminates bent and broken screws, prevents sore and aching hands. Ask for "STOCK your SHOP" the next time you buy screws.

**ELCO TOOL & SCREW CORP., ROCKFORD, ILL.**

**EASY TO GET OUT!**

**59¢ PER BOX**

**LOOK FOR THIS SELF-SERVE DISPLAY AT YOUR STORE**



Drill and  
Countersink  
Holes for  
Wood Screws  
in ONE  
Operation!

4 Bits —  
24 Combinations

Manufacturers of World-Famous Trojan Saw Blades and Frames

Buy the **Parker** Line

**PARKER MANUFACTURING CO.**  
WORCESTER 1, MASS., U. S. A.



**\$1.70**  
per set

for the man  
who wants the  
**BEST**

**TURNER®**  
Propane TORCH

- Solder
- Remove paint and putty
- Lay tile
- Light charcoal
- Thaw pipes

Only  
**\$5.95**

**MULTI-TORCH CHEST**

Includes 1 Turner Torch, 1 heavy duty burner, 1 chisel point soldering tip, 1 flame spreader. All in heavy steel chest.



\$13.85 value only **\$9.99**

TURNER Propane Gas  
CAMP LIGHT  
**\$12.95**

TURNER PROPANE  
GAS STOVE  
**\$24.95**



At hardware, automotive and sporting goods stores

**TURNER BRASS WORKS**  
Sycamore, Illinois

## WHERE-TO-BUY-IT INDEX

Source of supply appears after items commercially available

### AUTOMOTIVE

What makes a driver tired?.....	88
Fangio and Behra test drive Vespas.....	99
Karmann-Ghia adds convertible model to stable of VW bodies.....	99
Korean Sibal makes debut.....	106
European Listening Post.....	132
Four-passenger Isotta has one rear door.....	153
Midget electric car built for handicapped boy.....	153

### AVIATION

MATS' flying warehouse takes to the air.....	86
Heat-beating steel for fast aircraft.....	112
Jet interceptor for U. S. Air Force flies 1500 m.p.h.....	131
Three-stage parachute saves pilot in ground-level ejection seat.....	131
Pusher-prop plane converts to car.....	153

### MISCELLANEOUS

School is "lab" for heating engineers.....	40
Laminated common lumber makes inexpensive lap siding (Oregon Forest Products Laboratory, 17th and May, Corvallis, Ore.).....	78
"Big Mac" links Michigan with Michigan.....	94
Aluminum mold cures big tires.....	112
Propeller at bow maneuvers ferry.....	112
CD kitchen serves 25,000.....	120
"Iglu" provide cool comfort in the Tropics.....	120
Five-ton roller made from culvert section.....	125
Tractor moves German farmer.....	125
Safety link on hoist prevents electric shock (E. D. Bullard Co., 2680 Bridgeway, Sausalito, Calif.).....	130
British "Bloodhound" tracks enemy by radar.....	132
Electronic brain with a "heart" helps assign Navy personnel.....	132
Electronic organ built from kit of semi-assembled parts (Electronic Organ Arts, 4878 Eagle Rock Blvd., Los Angeles 41, Calif.).....	138
Trucks tied together tote 80-ton transformer.....	138
Loaded truck trailers ride ship across ocean.....	139
"Assembly line" for tomatoes.....	143
Basketball-in-the-water gives new twist to an old game (Aqua-Ball, 420 Market St., San Francisco, Calif.).....	143
Honolulu roof top will rotate.....	144
Robot arm and hand has 25 movements (Planet Corp., 1822 Sunset Ave., Lansing 6, Mich.).....	144
One-man hay rig picks up bales and builds a stack (Harro-Bed Co., Fowler, Calif.).....	149
It takes a bug to catch a bug.....	152
They measure water in snow for hydroelectric plants.....	152
"Long-pole sled" circles at 60 m.p.h. for thrill ride.....	153
Power saw converted to drill for ice fishing.....	153

### PHOTOGRAPHY

Camera doubles as projector (Wittnauer Instruments Div., Longines-Wittnauer Watch Co., 580 Fifth Ave., New York City).....	87
Electric eye adjusts lens for automatic camera (Bell & Howell Co., 7100 McCormick Rd., Chicago 45).....	132
Camera shoots binocular's view.....	144

### SCIENCE

Bar-graph oscilloscope does job of 40 meters.....	130
Quick radioactive test for moisture or density (Nuclear-Chicago Corp., 229 W. Erie St., Chicago).....	130
Metal measuring.....	132
Thorium promises cheaper A-power.....	143
Chemists make new products from sugar and petroleum.....	264

### WHAT'S NEW FOR YOUR HOME?

Drain cover prevents basement flooding.....	150
Glass holder clips on edge of plate.....	150
Light socket for temporary lighting.....	150
Plastic door for dog.....	150
Electric sharpener.....	151
Finger-pull handle on wall plug.....	151
Floor lamp attaches to floor and ceiling.....	151
Thin stovetop.....	151
Spring holders keep ironing-board cover smooth.....	151

### Radio-Television, Electronics

Television today—	
Closed-circuit, three dimensional, color-television system (General Electric Co., Electronics Park, Syracuse, N. Y.).....	161
Packaged TV studio (Hallamore Electronics Co. Div., Slegler Corp., Anaheim, Calif.).....	161
Closed-circuit television camera (Electron Corp., 5512 Dyer, Dallas, Tex.).....	161
You can build a hi-fi AM-FM tuner (Allied Radio Corp., 100 N. Western Ave., Chicago 80).....	162
For experimenters and hobbyists—	
Direction finder (Heath Co., Benton Harbor, Mich.).....	164
ESL Dust Bug (Electro-Sonic Laboratories, Inc., 35-54 38th St., Long Island City 6, N. Y.).....	164
"Breadboarding" technique permits assembly of electronic circuits without solder (Van-Dee Products, 300 Ocean Ave., Laguna Beach, Calif.).....	164
Aerovox E-Z-Code (Aerovox Corp., 740 Belleville Ave., New Bedford, Mass.).....	164

(Continued to Page 76)

POPULAR MECHANICS

Copyrighted material



## BUY SURPLUS NOW

DIRECT FROM U.S. GOVT. DEPOTS

TREMENDOUS SAVINGS —

BUY AT FRACTION OF ARMY COSTS

FOR SALE—Boats; LST's; LCVP's; Aircrafts; Helicopters; Marine Engines; Radar; Sonar; Radiotelephones; Walkie-Talkies; Nautical Instruments; Electronics; Marine Equipment and Hardware; Misc. Also — Jeeps; Trucks; Tractors; Trailers; Amphibious Vehicles; etc.

SEND FOR: DEPOT LIST AND PROCEDURE \$1.00

BRODY, Box 8 (Dept. PM), Sunnyside 4, New York

## POWER HACKSAW \$59.85

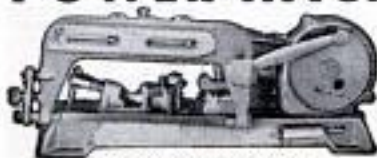

LESS MOTOR  
F.O.B. Benton Harbor

• Rugged cast iron construction. Wt. 56 lbs., bronze bearings. Draw cut. Auto. return lift. Auto. shut-off. Vise swivels 45°. Cap. 4"x4".

Dept. PM, P.O. Box 116  
BENTON HARBOR, MICHIGAN

Send for full details and name of nearest dealer.

EXCEL MACHINE TOOLS

NEW 1958 CATALOG

## BOAT KITS

200 MODELS—SAVE 2/3

EASY TO BUILD—Designed for the amateur. Over 200

Models. From to Cruisers, 8 to 21 ft. Formed hulls

Semi and Custom finished. Save 50%... Now NEW

Sea Ray Molded FIBERGLAS BOAT KITS. Truly professional results. NO upkeep. SAVE 2/3 assembly time. 12 to 16 ft. Utilities and Runabouts. SEND 35c for 64 page Boat Kit & 24 page Sea Ray Catalogs. SEND \$1.00 for both plus "Boating Handbook". Dealers inquire for franchise.

WRITE NOW! CUSTOM CRAFT, BUFFALO 7, N. Y.

## BARGAINS



WHOLESALE • Sources of 100,000 items wholesale • Rare Money-Makers opportunities • HUNDREDS of TERRIFIC offers in Toys, Books, Household goods, Jewelry, Greeting cards, etc. . . . SAMPLE BARGAINS • Famous \$16.00 Perfume at 60c • 50c boxes Everyday, Xmas cards, 7c box • \$1.00 toys, 20c • \$1.95 silk ties, 12 1/2c • Penicils, 99c gross • \$17.50 talking dolls at \$7.50! PLUS MANY, MANY OTHERS!

Lists Every Month Hundreds of Terrific Buys in—

• BANKRUPT, Closeout, Surplus Goods • New and UNUSUAL items

• WHOLESALE ITEMS • BELOW

• HUNDREDS of TERRIFIC offers in Toys, Books, Household goods, Jewelry, Greeting cards, etc. . . . SAMPLE BARGAINS • Famous \$16.00 Perfume at 60c • 50c boxes Everyday, Xmas cards, 7c box • \$1.00 toys, 20c • \$1.95 silk ties, 12 1/2c • Penicils, 99c gross • \$17.50 talking dolls at \$7.50! PLUS MANY, MANY OTHERS!

• HUNDREDS of TERRIFIC offers in Toys, Books, Household goods, Jewelry, Greeting cards, etc. . . . SAMPLE BARGAINS • Famous \$16.00 Perfume at 60c • 50c boxes Everyday, Xmas cards, 7c box • \$1.00 toys, 20c • \$1.95 silk ties, 12 1/2c • Penicils, 99c gross • \$17.50 talking dolls at \$7.50! PLUS MANY, MANY OTHERS!

• HUNDREDS of TERRIFIC offers in Toys, Books, Household goods, Jewelry, Greeting cards, etc. . . . SAMPLE BARGAINS • Famous \$16.00 Perfume at 60c • 50c boxes Everyday, Xmas cards, 7c box • \$1.00 toys, 20c • \$1.95 silk ties, 12 1/2c • Penicils, 99c gross • \$17.50 talking dolls at \$7.50! PLUS MANY, MANY OTHERS!

• HUNDREDS of TERRIFIC offers in Toys, Books, Household goods, Jewelry, Greeting cards, etc. . . . SAMPLE BARGAINS • Famous \$16.00 Perfume at 60c • 50c boxes Everyday, Xmas cards, 7c box • \$1.00 toys, 20c • \$1.95 silk ties, 12 1/2c • Penicils, 99c gross • \$17.50 talking dolls at \$7.50! PLUS MANY, MANY OTHERS!

• HUNDREDS of TERRIFIC offers in Toys, Books, Household goods, Jewelry, Greeting cards, etc. . . . SAMPLE BARGAINS • Famous \$16.00 Perfume at 60c • 50c boxes Everyday, Xmas cards, 7c box • \$1.00 toys, 20c • \$1.95 silk ties, 12 1/2c • Penicils, 99c gross • \$17.50 talking dolls at \$7.50! PLUS MANY, MANY OTHERS!

• HUNDREDS of TERRIFIC offers in Toys, Books, Household goods, Jewelry, Greeting cards, etc. . . . SAMPLE BARGAINS • Famous \$16.00 Perfume at 60c • 50c boxes Everyday, Xmas cards, 7c box • \$1.00 toys, 20c • \$1.95 silk ties, 12 1/2c • Penicils, 99c gross • \$17.50 talking dolls at \$7.50! PLUS MANY, MANY OTHERS!

• HUNDREDS of TERRIFIC offers in Toys, Books, Household goods, Jewelry, Greeting cards, etc. . . . SAMPLE BARGAINS • Famous \$16.00 Perfume at 60c • 50c boxes Everyday, Xmas cards, 7c box • \$1.00 toys, 20c • \$1.95 silk ties, 12 1/2c • Penicils, 99c gross • \$17.50 talking dolls at \$7.50! PLUS MANY, MANY OTHERS!

• HUNDREDS of TERRIFIC offers in Toys, Books, Household goods, Jewelry, Greeting cards, etc. . . . SAMPLE BARGAINS • Famous \$16.00 Perfume at 60c • 50c boxes Everyday, Xmas cards, 7c box • \$1.00 toys, 20c • \$1.95 silk ties, 12 1/2c • Penicils, 99c gross • \$17.50 talking dolls at \$7.50! PLUS MANY, MANY OTHERS!

• HUNDREDS of TERRIFIC offers in Toys, Books, Household goods, Jewelry, Greeting cards, etc. . . . SAMPLE BARGAINS • Famous \$16.00 Perfume at 60c • 50c boxes Everyday, Xmas cards, 7c box • \$1.00 toys, 20c • \$1.95 silk ties, 12 1/2c • Penicils, 99c gross • \$17.50 talking dolls at \$7.50! PLUS MANY, MANY OTHERS!

• HUNDREDS of TERRIFIC offers in Toys, Books, Household goods, Jewelry, Greeting cards, etc. . . . SAMPLE BARGAINS • Famous \$16.00 Perfume at 60c • 50c boxes Everyday, Xmas cards, 7c box • \$1.00 toys, 20c • \$1.95 silk ties, 12 1/2c • Penicils, 99c gross • \$17.50 talking dolls at \$7.50! PLUS MANY, MANY OTHERS!

• HUNDREDS of TERRIFIC offers in Toys, Books, Household goods, Jewelry, Greeting cards, etc. . . . SAMPLE BARGAINS • Famous \$16.00 Perfume at 60c • 50c boxes Everyday, Xmas cards, 7c box • \$1.00 toys, 20c • \$1.95 silk ties, 12 1/2c • Penicils, 99c gross • \$17.50 talking dolls at \$7.50! PLUS MANY, MANY OTHERS!

• HUNDREDS of TERRIFIC offers in Toys, Books, Household goods, Jewelry, Greeting cards, etc. . . . SAMPLE BARGAINS • Famous \$16.00 Perfume at 60c • 50c boxes Everyday, Xmas cards, 7c box • \$1.00 toys, 20c • \$1.95 silk ties, 12 1/2c • Penicils, 99c gross • \$17.50 talking dolls at \$7.50! PLUS MANY, MANY OTHERS!

• HUNDREDS of TERRIFIC offers in Toys, Books, Household goods, Jewelry, Greeting cards, etc. . . . SAMPLE BARGAINS • Famous \$16.00 Perfume at 60c • 50c boxes Everyday, Xmas cards, 7c box • \$1.00 toys, 20c • \$1.95 silk ties, 12 1/2c • Penicils, 99c gross • \$17.50 talking dolls at \$7.50! PLUS MANY, MANY OTHERS!

• HUNDREDS of TERRIFIC offers in Toys, Books, Household goods, Jewelry, Greeting cards, etc. . . . SAMPLE BARGAINS • Famous \$16.00 Perfume at 60c • 50c boxes Everyday, Xmas cards, 7c box • \$1.00 toys, 20c • \$1.95 silk ties, 12 1/2c • Penicils, 99c gross • \$17.50 talking dolls at \$7.50! PLUS MANY, MANY OTHERS!

• HUNDREDS of TERRIFIC offers in Toys, Books, Household goods, Jewelry, Greeting cards, etc. . . . SAMPLE BARGAINS • Famous \$16.00 Perfume at 60c • 50c boxes Everyday, Xmas cards, 7c box • \$1.00 toys, 20c • \$1.95 silk ties, 12 1/2c • Penicils, 99c gross • \$17.50 talking dolls at \$7.50! PLUS MANY, MANY OTHERS!

• HUNDREDS of TERRIFIC offers in Toys, Books, Household goods, Jewelry, Greeting cards, etc. . . . SAMPLE BARGAINS • Famous \$16.00 Perfume at 60c • 50c boxes Everyday, Xmas cards, 7c box • \$1.00 toys, 20c • \$1.95 silk ties, 12 1/2c • Penicils, 99c gross • \$17.50 talking dolls at \$7.50! PLUS MANY, MANY OTHERS!

• HUNDREDS of TERRIFIC offers in Toys, Books, Household goods, Jewelry, Greeting cards, etc. . . . SAMPLE BARGAINS • Famous \$16.00 Perfume at 60c • 50c boxes Everyday, Xmas cards, 7c box • \$1.00 toys, 20c • \$1.95 silk ties, 12 1/2c • Penicils, 99c gross • \$17.50 talking dolls at \$7.50! PLUS MANY, MANY OTHERS!

• HUNDREDS of TERRIFIC offers in Toys, Books, Household goods, Jewelry, Greeting cards, etc. . . . SAMPLE BARGAINS • Famous \$16.00 Perfume at 60c • 50c boxes Everyday, Xmas cards, 7c box • \$1.00 toys, 20c • \$1.95 silk ties, 12 1/2c • Penicils, 99c gross • \$17.50 talking dolls at \$7.50! PLUS MANY, MANY OTHERS!

• HUNDREDS of TERRIFIC offers in Toys, Books, Household goods, Jewelry, Greeting cards, etc. . . . SAMPLE BARGAINS • Famous \$16.00 Perfume at 60c • 50c boxes Everyday, Xmas cards, 7c box • \$1.00 toys, 20c • \$1.95 silk ties, 12 1/2c • Penicils, 99c gross • \$17.50 talking dolls at \$7.50! PLUS MANY, MANY OTHERS!

• HUNDREDS of TERRIFIC offers in Toys, Books, Household goods, Jewelry, Greeting cards, etc. . . . SAMPLE BARGAINS • Famous \$16.00 Perfume at 60c • 50c boxes Everyday, Xmas cards, 7c box • \$1.00 toys, 20c • \$1.95 silk ties, 12 1/2c • Penicils, 99c gross • \$17.50 talking dolls at \$7.50! PLUS MANY, MANY OTHERS!

• HUNDREDS of TERRIFIC offers in Toys, Books, Household goods, Jewelry, Greeting cards, etc. . . . SAMPLE BARGAINS • Famous \$16.00 Perfume at 60c • 50c boxes Everyday, Xmas cards, 7c box • \$1.00 toys, 20c • \$1.95 silk ties, 12 1/2c • Penicils, 99c gross • \$17.50 talking dolls at \$7.50! PLUS MANY, MANY OTHERS!

• HUNDREDS of TERRIFIC offers in Toys, Books, Household goods, Jewelry, Greeting cards, etc. . . . SAMPLE BARGAINS • Famous \$16.00 Perfume at 60c • 50c boxes Everyday, Xmas cards, 7c box • \$1.00 toys, 20c • \$1.95 silk ties, 12 1/2c • Penicils, 99c gross • \$17.50 talking dolls at \$7.50! PLUS MANY, MANY OTHERS!

• HUNDREDS of TERRIFIC offers in Toys, Books, Household goods, Jewelry, Greeting cards, etc. . . . SAMPLE BARGAINS • Famous \$16.00 Perfume at 60c • 50c boxes Everyday, Xmas cards, 7c box • \$1.00 toys, 20c • \$1.95 silk ties, 12 1/2c • Penicils, 99c gross • \$17.50 talking dolls at \$7.50! PLUS MANY, MANY OTHERS!

• HUNDREDS of TERRIFIC offers in Toys, Books, Household goods, Jewelry, Greeting cards, etc. . . . SAMPLE BARGAINS • Famous \$16.00 Perfume at 60c • 50c boxes Everyday, Xmas cards, 7c box • \$1.00 toys, 20c • \$1.95 silk ties, 12 1/2c • Penicils, 99c gross • \$17.50 talking dolls at \$7.50! PLUS MANY, MANY OTHERS!

• HUNDREDS of TERRIFIC offers in Toys, Books, Household goods, Jewelry, Greeting cards, etc. . . . SAMPLE BARGAINS • Famous \$16.00 Perfume at 60c • 50c boxes Everyday, Xmas cards, 7c box • \$1.00 toys, 20c • \$1.95 silk ties, 12 1/2c • Penicils, 99c gross • \$17.50 talking dolls at \$7.50! PLUS MANY, MANY OTHERS!

• HUNDREDS of TERRIFIC offers in Toys, Books, Household goods, Jewelry, Greeting cards, etc. . . . SAMPLE BARGAINS • Famous \$16.00 Perfume at 60c • 50c boxes Everyday, Xmas cards, 7c box • \$1.00 toys, 20c • \$1.95 silk ties, 12 1/2c • Penicils, 99c gross • \$17.50 talking dolls at \$7.50! PLUS MANY, MANY OTHERS!

• HUNDREDS of TERRIFIC offers in Toys, Books, Household goods, Jewelry, Greeting cards, etc. . . . SAMPLE BARGAINS • Famous \$16.00 Perfume at 60c • 50c boxes Everyday, Xmas cards, 7c box • \$1.00 toys, 20c • \$1.95 silk ties, 12 1/2c • Penicils, 99c gross • \$17.50 talking dolls at \$7.50! PLUS MANY, MANY OTHERS!

• HUNDREDS of TERRIFIC offers in Toys, Books, Household goods, Jewelry, Greeting cards, etc. . . . SAMPLE BARGAINS • Famous \$16.00 Perfume at 60c • 50c boxes Everyday, Xmas cards, 7c box • \$1.00 toys, 20c • \$1.95 silk ties, 12 1/2c • Penicils, 99c gross • \$17.50 talking dolls at \$7.50! PLUS MANY, MANY OTHERS!



Ability to stand up under the toughest conditions is the reason why more than 100 leading railroads use EXIDE batteries. You'll get the same rugged dependability and power aplenty when you put an EXIDE battery in your car.



WHEN IT'S AN Exide . . . YOU START

## NEW! CLIPPER SHIP MODEL KIT!

Flying Cloud, queen of clipper fleet. 21 contoured sails, rigging, long boats. Precision plastic parts, cement, plans. 14 3/4". For catalog send 10c to Dept. DM, 4223 Glencoe, Venice, Calif.

wherever  
hobby kits  
are sold



\$2.98

## \$1 BRINGS YOU \$18

Discover Flok-Kraft and Earn \$\$\$\$\$ AT HOME

Earn up to \$15.00 per hour spare time. Amazing new Velvet-fiber spray instantly makes any object (Lamps, Radio & TV Cabinets, Figurines, Signs, Auto dash boards, toys, furniture, draperies—anything!) worth expensive \$\$\$\$\$ Prices . . . like magic, you can spray anything with this beautiful new suede-like finish that feels like rich Velvet.

EARN UP TO \$300.00 PER WEEK SPARE TIME

Imagine, materials cost only 3c per square foot. (Average TV or radio cabinet can be beautifully sprayed with this startling new 3-dimensional Velvet finish in 15 minutes at a cost of only 34c in materials. Your charge for this job is at least \$10.00.)

REPRESENTATIVES IN YOUR AREA URGENTLY NEEDED

Own your own business. Work at home in your spare time. Help fill the huge growing demand for this amazing new beautiful Velvet-fiber finish. Orders come from stores, offices, homes, architects, auto dealers—everywhere. Possible \$20,000,000.00 worth of jobs to be done. Investigate today—be first in your area! Actual samples in 16 Radiant Colors. Booklet of 50 Home Business Opportunities and Confidential Details all sent free! Write: Coast Industries, Los Angeles 81, Calif., Dept. B-12.



## BECOME A . . . Machine Tool DRAFTSMAN & DESIGNER

Mail Coupon For Free Brochure

Simplified home study training program. Learn every phase of Machine Drafting and Tool Designing. Step up to a better job—big-pay. Use spare hours—no interference with present work. Diploma awarded. Low Tuition.

American Technical Society  
Dept. PM-1257, 850 E. 58th St.  
Chicago 37, Ill.

Please send me your FREE BROCHURE and full details about Machine Draftsman and Tool Designer training program.

Name .....

Address .....

City .....

State .....



Free!

ALLIED'S  
1958

ELECTRONIC SUPPLY CATALOG

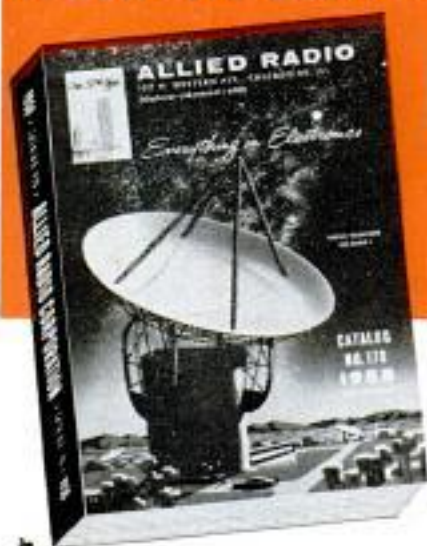

404  
value-packed  
pages

Send  
for it!

SAVE on  
everything in  
electronics

EASY TERMS  
AVAILABLE

### WORLD'S LARGEST STOCKS

Here's everything in Electronics for Experimenters, Builders, Amateurs, Servicemen, Engineers and Hi-Fi Hobbyists:

- Amazing Build-Your-Own KNIGHT-KITS
- Hi-Fi Music Systems & Components
- Recorders & Phono Equipment
- TV Tubes, Antennas, Accessories
- Public Address Systems
- Amateur Station Equipment
- Latest Test Instruments
- Industrial Electronic Supplies
- Parts, Tubes, Transistors, Tools and Books

SAVE on everything in Electronics—get fast, dependable service—send today for your FREE 1958 ALLIED Catalog.

Everything in Electronics  
From One Reliable Source

our 37th year

send for  
FREE  
Catalog

ALLIED RADIO

ALLIED RADIO CORP., Dept. 5-M7  
100 N. Western Ave., Chicago 80, Ill.

Rush FREE 1958 ALLIED 404-Page Catalog

Name \_\_\_\_\_

Address \_\_\_\_\_

City \_\_\_\_\_ Zone \_\_\_\_\_ State \_\_\_\_\_

(Continued from Page 74)

## Craftsman and Shop Notes Index

### AUTOMOTIVE

Ramps and platforms elevate car for easier access.....	187
Auxiliary frame on pickup truck supports long loads.....	197
Salt box is handy container for carrying sand in car.....	200
Cold-weather starting aid.....	207

### HOUSE AND HOME

Prevent pipes from freezing.....	167
Horse-collar house number.....	168
Weather stripping silenced.....	168
Tray on folding stand ideal for snacks.....	169
Basic dimensions for breakfast nooks.....	173
Wooden base keeps washer and drier off floor.....	181
Holiday window decoration for night or day.....	196
Modified cake pan is bird feeder.....	196
Outside Christmas displays.....	198
Giant oilcloth potsmitties are unique outside decorations.....	204

### HOUSEHOLD HINTS

Eraser is recipe-card holder.....	173
Solving Home Problems—	
Assure good flowerpot drainage.....	178
Dollies "stretched" on glass plate.....	178
Threading a needle.....	178
To free a frozen door.....	178
Washing-instruction tags stored on medicine-cabinet door.....	178
Get 100 percent use from candles.....	179
Paper clamp is "third hand".....	179
Refuse pails easily rustproofed.....	179
Roller calendar will lie flat.....	179
Trouser-hanger grip restored.....	179
Extending life of chamomise.....	200
Vari-colored candlestick melted from contrasting inlay.....	200
Baking-soda "fire extinguisher".....	204
Three methods of cleaning and refinishing old brass.....	204

### MISCELLANEOUS

Shade ink drawing with brush.....	167
Thumbtacks are drawer gliders.....	167
Gate made of salvaged items.....	168
Repair tackle with nail polish.....	169
Improvised Bunsen burner.....	172
Notch ship's margin planks.....	172
Wrap gift with paper tablecloth.....	172
Multiple neon flasher.....	174
Musical biddy.....	176
Preventing accidental erasures on tape recordings.....	176
Cedar-shingle coverage.....	180
Machine speeds perforating.....	180
Self-setting target for air-rifle shooting practice.....	180
Wedge holds movie film on reel.....	180
Tool saves milk-can lids.....	181
Pen modified with paper clip to prevent blots under ruler.....	186
Tree-ornament hangers bent from pipe cleaners.....	186
Method of enlarging drawings eliminates need of erasing.....	193
Improvised stand accommodates any size Christmas tree.....	196
Shadow-box display frame for dolls.....	197
Hobbyhorse and cart.....	201
Calculating roof areas.....	214

### ON THE MARKET

Automatic sash lock.....	195
Decorative enamel in pressurized can.....	195
Lightweight insulating material.....	195
Liquid weather strip.....	195

### PHOTOGRAPHY

Cooling photo developer.....	169
Luminous tape in darkroom.....	172
Aquarium heater keeps developer at right temperature in winter.....	174
Ground wire on darkroom brush removes static electricity.....	176
Improvised diffusing screen.....	180
Photos vignettted on enlarger with cardboard cutout.....	187
Record on bottle assures that developer is replenished.....	193
Level held on camera tripod.....	194
Protecting mailed photographs.....	194
Self-closing photo-paper box.....	194
Reels stored on dowel racks.....	200

### TOOLS

Jackknife-style scribing tool.....	172
Drill-press work support.....	205
Heavy-bodied lubricants for spinning aluminum.....	207
Shopping for Tools—	
Bench grinder.....	208
Hand screw.....	208
Orbital-sander kit.....	208
Portable router.....	208
Saw-jointer combination.....	208
Glass drill.....	209
Portable-electric-drill kit.....	209

(Continued to Page 78)

NOTICE—It is the intention of this magazine to provide its readers with information regarding the latest developments in the mechanical arts. Except where otherwise indicated, this magazine has no information as to any unexpired patents in respect of the developments reported herein. In the event that commercial use is to be made of any of the developments reported herein, it is suggested that legal counsel be consulted to avoid liability for patent infringement. It is not the purpose of this magazine to encourage patent infringement but, as indicated, it is the intention of this magazine to report on the latest developments in the mechanical arts.



**SAVE STRAIN  
SAVE SKIN**

WITH  
**Bridgeport  
NEOPRENE  
CUSHION  
GRIP**

**SCREWDRIVERS**



**50%  
GREATER TURNING  
POWER**

16 sizes and styles—Regular and Phillips.  
\$1.00 and \$2.70  
At your hardware store.

- SUPER COMFORTABLE
- NON-SLIP GRIP
- UNBREAKABLE HANDLE
- FULLY GUARANTEED
- ALLOY STEEL BLADE

Resilient Neoprene CUSHION GRIP lets you turn screws tighter with less work—and you don't hurt your hands. Tested and approved by Mechanics

THE BRIDGEPORT HARDWARE MFG. CORP., BRIDGEPORT 5, CONN., U. S. A.

**5 NEW CRUISER KITS**

Many other models. Best values in fiberglass covering kits, marine supplies.



18 ft. Offshore Cruiser

**TAFT MARINE WOODCRAFT**  
Dept. PM-1257 636 39th Ave. N.E. Minneapolis 21, Minn.

LOW AS **\$399**  
Freight included. FREE COLOR CATALOG

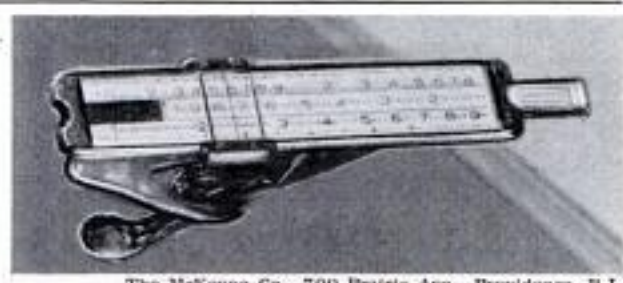

The McKenna Co., 700 Prairie Ave., Providence, R.I.

**Tie Clasp Is Replica of Slide Rule**

Novelty item designed for engineers and other technological people is a realistic slide-rule tie clasp. The replica has numbers printed on a white-acetate background covered by clear plastic. It looks like it will actually work, but it doesn't.

**Dial Once for Conference**

Telephone conferences involving a number of executives in one building may be called by dialing a single code number which rings all phones.

**FOR  
CONVENIENCE  
FOR  
POWER SANDING  
FOR  
HAND SANDING**



**BEAR  
BRAND  
SANDPAPER**

**Now..in new HANDY PACKS**



**Sanding Discs**  
with Universal Center Hole... Assorted ADALOX Paper for all standard portable sanders and drills.

**Sanding Sheets**  
in new HANDY PACKS of Assorted ADALOX Paper OPENKOTE for most oscillating sanders and hand sanding.



**At your favorite Hardware Store**

You can't mistake the Handy Packs in their bright new dress packaged in convenient on-top-of-the-counter display boxes. You never make a mistake—when you use the best, Bear Brand.



**BEHR-MANNING CO.**

TROY, N. Y. **NORTON** ASSOCIATES  
A DIVISION OF NORTON COMPANY  
Behr-Manning Products: Coated Abrasives • Pressure-Sensitive Tapes  
Sharpening Stones • Norton Products: Abrasives • Grinding Wheels  
Grinding Machines • Refractories





No Finer Gift for  
Man or Boy...

# Starrett® TOOLS

For that man or boy who loves fine tools — what better gift than accurate, dependable STARRETT tools? Handyman or mechanic, hobbyist or skilled craftsman, there's a STARRETT tool that's right for him and right for your budget, too.



Starrett No. 436  
0-1" Micrometer



Starrett No. 11  
12" Combination Square



Starrett No. 902  
Kit of Measuring Tools



Starrett No. 815  
Toolmaker's Hammer  
with Magnifying Glass



Starrett No. 1010  
Dial Indicator  
Pocket Gage



Starrett No. 425  
Pocket Slide Caliper

**3000 GIFT IDEAS.** Ask your Starrett distributor to show you these and many more gift-worthy Starrett items. Or write for the Starrett No. 27 Catalog. Use the coupon.

STARRETT TOOLS are carried by leading Industrial Supply Distributors and Hardware Tool Stores.

THE L. S. STARRETT COMPANY  
Dept. AP, Athol, Mass., U.S.A.

Please send my free copy of the big, new Starrett No. 27 Catalog describing the many Starrett Tools recommended for Christmas and Gifts the year-round.

Name.....  
Address.....  
City.....Zone.....State.....



(Continued from Page 75)

Small bolts and screws in plastic containers.....	209
12-piece set of carving tools.....	209
Utility tray for drill press.....	209
Complete belt sander.....	210
Concentric grooves in heads of hand-held tools.....	210
Contour-scraper kit.....	210
Portable arc welder.....	210
Push-pull tapping attachment.....	210
Radial saw has controls at front.....	211
Saw blade cuts sheet metal.....	211
Screwdriver has built-in wire stripper.....	211
Socket wrench has hinged handle.....	211
Stepladder locks in the open position.....	211
Clean holes in aluminum alloys require special drill bits.....	212

## WORKSHOP HINTS

Special push stick aids sawing.....	167
Miter box nailed to flange and clamped to workbench.....	168
Retaining groove in bench top keeps screws from rolling off.....	172
Tubing protects tap threads.....	173
Checking shaper-cutter profile.....	174
Screw secures chisel handle.....	181
"Drill bit" for pilot holes.....	186
Rounding glass edges.....	186
Small-parts soldering iron.....	186
Stovepipe used as small-parts wall rack.....	186
Screwdriver drives lag screws.....	187
Adjustable jig permits accurate marking of blind holes.....	193
Improvised holder confines torch flame.....	207
Pliers altered to hold wire.....	207
Restoring grip of lever wrench.....	207
Groove in center of wheel speeds grinding.....	212
Nonspill pouring spout.....	212
Pencil shading aids cope cut.....	212
Pocket-type tire gauge actuates compressor switch.....	212
Set-screw tips.....	213
Cross-feed stop for lathe.....	214
New abrasive cuts fast and clean.....	214
Chucking round work in vise.....	216
Masking tape prevents chipping of plastic when sawing.....	216
Oil carried to boring tool.....	216
Resetting lathe tailstock.....	216
Drilling angular holes accurately in dual-vise setup.....	217
Shop-made indicator centers work in four-jaw chuck.....	217
Soldering hints.....	218
Centerless work support.....	220
Damaged screwdrivers adapted to other practical uses.....	220
Drill bits stored in handle.....	220
Pressure-sensitive tape holds blocks on faceplate for turning.....	220



## Laminated Common Lumber Makes Inexpensive Lap Siding

Low-grade lumber forms the core of a new type of broad-lap siding which is less expensive than conventional siding. It is produced by grooving and fitting together common boards so they will resist warping, then covering them with two layers of veneer. An overlay laminate of resin-fiber plastic is added. The common-board core is visible only at the ends, which are usually covered in finished construction. The inset photo shows layers of veneer and plastic on the common board.



# "There's more than one way to improve your gas mileage"

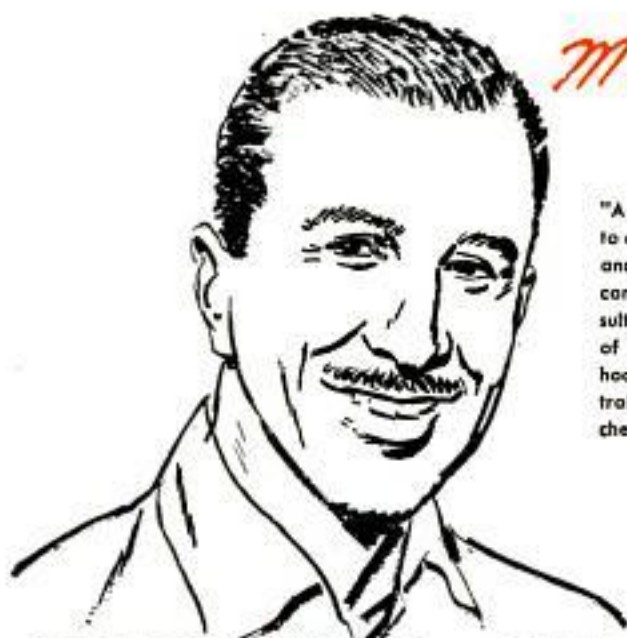

*Mauri' Ross* —experimental test driver and automotive engineer.

"A professional driver has a lot to do with getting top performance and economy from new cars he tests. But, the best results also depend on a number of intricate systems under the hood. That's why he relies on trained mechanics for needed checks and adjustments."



"Worn spark plugs could be a source of power and fuel loss. Electrodes must be clean, properly gapped and free from corrosion. New plugs at least every 10,000 miles is best."



"A pro always makes sure distributor points are clean and set at the proper distance for best performance. Arcing or cracks in the cap may develop to further decrease gas mileage."

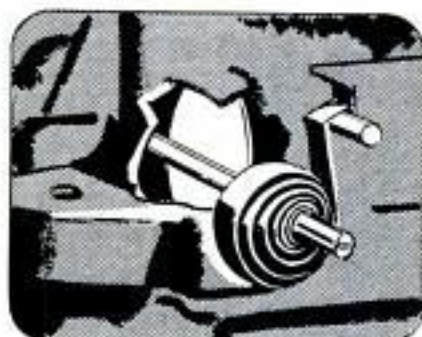

"A trained mechanic checks the manifold heat control valve for possible trouble. A valve that's stuck open delays proper vaporization, a closed valve creates a loss of power."



"The vacuum system must be examined and connections tightened. Air filters should be cleaned. Clogged filters or air leaks upset mixture ratio and cause rough idle and fuel loss."



"Your carburetor should also receive a thorough check for any signs of needed adjustment, repair or cleaning. Proper care assures precision operation and maximum fuel economy."

*Specified as original equipment on more new cars than any other carburetor.*

Make sure you're taking advantage of the many ways to improve your gas mileage. See your Rochester Carburetor Specialist. He can properly diagnose your engine and make the necessary adjustments to give you the best possible performance and economy. And he's factory-trained to keep your precision-built Rochester Carburetor in top condition to deliver maximum mileage.



ROCHESTER PRODUCTS DIVISION OF  
GENERAL MOTORS, ROCHESTER, N. Y.





# '58's real eye-opener is CHEVY!



And that's a fact. You never saw so much sharp engineering, so many advanced ideas, such stunning changes packed into one year's progress. You'll spend hours studying this one and never run out of surprises. For '58, Chevy's new from the paint on in—and that means body, suspension, chassis, engines . . . the works! Sure, they're lovely to look at. But come on down and get the real eye-opener, the inside story! . . . Chevrolet Division of General Motors, Detroit 2, Michigan.

<ul style="list-style-type: none"> <li>● LEVEL AIR RIDE—100% air springs, front and rear.*</li> </ul>	<ul style="list-style-type: none"> <li>● 3 CARBURETORS on Super Turbo-Thrust V8 . . . and 280 h.p.!*</li> </ul>	<ul style="list-style-type: none"> <li>● NEW WHEELBASE—2½ inches longer for extra room and comfort.</li> </ul>	<ul style="list-style-type: none"> <li>*Optional at extra cost.</li> <li>**Except with Overdrive.</li> </ul>
<ul style="list-style-type: none"> <li>● TURBO-THRUST V8 with combustion chambers in the block!*</li> </ul>	<ul style="list-style-type: none"> <li>● CLOSE-RATIO Synchro-Mesh transmissions on all V8's.**</li> </ul>	<ul style="list-style-type: none"> <li>● NEW BODIES—9 inches longer, up to 2½ inches lower.</li> </ul>	<ul style="list-style-type: none"> <li>● DUAL HEADLAMPS for better light pattern, longer low beam.</li> </ul>
<ul style="list-style-type: none"> <li>● NEW BODY-FRAME design has double-wall cowl for added rigidity.</li> </ul>	<ul style="list-style-type: none"> <li>● 4 COIL SPRINGS with advanced Four-Link rear suspension.</li> </ul>	<ul style="list-style-type: none"> <li>● NEW IMPALA luxury models rival the costliest cars.</li> </ul>	<ul style="list-style-type: none"> <li>● 348-CUBIC-INCH Turbo-Thrust V8's with "gable-roofed" pistons.</li> </ul>
<ul style="list-style-type: none"> <li>● NEW FRAME—has new X-design for extra lowness.</li> </ul>	<ul style="list-style-type: none"> <li>● FUEL INJECTION—top efficiency, instant acceleration.*</li> </ul>		<ul style="list-style-type: none"> <li>● TURBOGLIDE, the super-smooth, triple-turbine transmission.*</li> </ul>



# POPULAR MECHANICS

DECEMBER  
1957

WRITTEN SO YOU CAN UNDERSTAND IT  
VOL. 108 NO. 6



Author drives GM-built Vauxhall Victor past towers, palaces and churches along banks of river in Moscow

*Reprinted "PM Highlights"*

## I DROVE THROUGH RUSSIA

PART I

By David Scott

*34 A Church Crescent, Finchley, London, N.3, England*

THIS IS IT," I thought as we rolled slowly over the bridge spanning the Bug River — 1200 miles and 12 frontier posts from London, which we had left four days before. A Russian sentry at the barrier, his carbine shoulder-slung under a raincoat, eyed the GM-built Vauxhall Victor. "Wait here," he indicated.

An ambulance arrived from nowhere and

deposited a young man. "Good afternoon," he greeted us in English. "I am your interpreter from Intourist [the Soviet travel agency]. Call me Vladimir," he said, climbing into the back seat. "Follow that car." And we were off on our motor trip to Moscow.

The ambulance led the way into Brest, four miles away, whose busy railway sta-

This is the iron curtain. Gate on German autobahn serves as check point for entry into Communist territory







Russian interpreter buys tickets on glass-enclosed bus that moves through Agricultural and Industrial exhibits



Road maps are scarce in Russia, so signboards are erected at major highway junctions to show the way

tion is Russia's westernmost mainline terminal. Although taken aback by this informal penetration of the last iron curtain of all, we had more surprises to come.

Upstairs, in a large room with tasseled velvet drapes and plush armchairs reminiscent of Grandma's front parlor, a serious youth from Intourist explained that there was no customs inspection. We merely had to sign a declaration that we carried no opium, hashish or live ammunition! He waved aside our carnet (the international travel document that permits temporary importation of cars without paying duty), and presented another form on which we promised to take the car out of the country when we left.

Our passports were quickly stamped and we bought some gasoline coupons at 50

Country of paradoxes: Russia has jetliners in regular service, relies on creaking wagons for rural transport







Friendly truck driver hooked up air compressor and inflated tires when author couldn't get air at gas station

cents a gallon. We then bolted a hearty midafternoon meal at the station restaurant, and 22-year-old Vladimir, assigned to us for the duration, said "Let's go."

#### Brest Is First Stop

First stop was at Brest's fuel depot, where 25 liters of 74-octane "premium" gas were pumped into the tank. Prepared for this, we'd had the Victor fitted with a 6.8 to 1 compression head at the factory in England. Once on the road again, Vladimir gave us a small route plan with instructions printed in English.

Moscow, we saw, was 635 miles ahead, and on the way were only 14 towns and six filling stations. The vision of wide-open spaces came to life as we sped eastward.

The broad, tree-lined road sweeps through the flat countryside on the edge of the Pripet Marshes, and you can drive miles without seeing a person or house.

Roadside views are of brown fields reaching to the horizon, peat bogs and occasional signs in the strange Russian letters. The Victor purred on sweetly at a steady 60, slipping by a truck or horse-drawn wagon at long intervals. We were headed for Minsk, 210 miles from the border, our scheduled stop for the night.

#### Cut Speed for Safety

But, as darkness fell, this sparse traffic became a real hazard. The first hazy form caught in our headlights suddenly became an unlit wagon, and the scream of our tires

Everywhere Scott went, people were interested in his car. Here bus drivers and kids peer under the hood







Farmers spread their grain across the highway so the wake of passing vehicles will blow away the chaff



Russian invalids can buy this three-wheeled auto at low price. Engine at rear can be serviced from seat

woke the peasant asleep at the reins. After this near escape we cut the speed to about 45 and flicked on the piercing spotlight.

The wisdom of this precaution was demonstrated a few minutes later when we eased past several logs lying in the road. Beyond them were splintered wooden boards, and finally a dead horse—but no trace of the vehicle that had apparently plowed into the cart.

#### Road Markings Inadequate

There was no warning of a section of road under repair, and only sharp braking prevented us from sailing into a sea of mud and rocks. Signs were inadequate, and the few reflecting signs were aimed at the wrong angle to catch oncoming lights. It was no joke driving now, and we felt in-

Main roads of Minsk are stately boulevards, but author's car took a beating on cobbles of the side roads







Fleet of new Moskvitch station wagons makes a roadside stop near Smolensk while en route to customers

tense relief when the lights of Minsk finally appeared.

Dinner at the best hotel in town was ample, and Vladimir helped us choose dishes like caviar and shashlik from the Russian menu. We ordered with relish, since Intourist was footing the bill. Actually, we had each paid in advance for 13 days at the rate of \$11.25 a day. This covered the hotel, three meals and a traveling interpreter (full time, when away from his Moscow girl friend). Other expenses we paid in cash, but at a special tourist rate of exchange that gave us a ruble for 10 cents instead of the usual 25 cents. With that we could buy a bottle of beer for 35 cents and cigarettes at 10 cents a pack.

Our double room upstairs boasted more old-fashioned luxury, with heavy lace cur-

tains, furniture upholstered in rich silk brocade, a marbled desk and a huge rubber plant. In strange contrast were the exposed plumbing, cold water and stopperless sink of the dingy, mirrorless bathroom. This was one of the many paradoxes of Soviet life that we were to find at every turn in this country that has tried to telescope into 40 years what advanced Western nations have taken over 100 to accomplish.

#### Country of Paradoxes

Example: Russia leads America in hurling a manmade satellite into space, but runs the inefficient side-valve engines that power most of its vehicles on 66-octane gas. With the Tu-104 it is the only country to have jet airliners in regular service, but

(Continued to page 244)

Author stopped at roadside restaurant at Tolochin, 300 miles from Moscow. Meat and potatoes cost 30 cents







## MATS' FLYING WAREHOUSE TAKES TO THE AIR



Squat design of massive aircraft puts belly of fuselage two feet above runway. Turboprop engines develop 24,000 horsepower. Cavernous interior of C-133A fuselage is 16 feet in diameter. It will hold 16 Jeeps or, with a second deck, 400 troops



ON THE TWO-MILE RUNWAY at Wright-Patterson Air Force Base in Dayton, Ohio, four T-34 turboprops took a snarling, 24,000-pound bite at the air. Slowly, an unbelievable monster of an airplane began to move under the whip of 18-foot, three-bladed, turboelectric "fans." The plane's wingspan—179 feet 8 inches—would have overhung both sidelines of a football field by more than 10 feet. With its radome on the goal line, its 48-foot-high tail would have towered four stories above the 50-yard line. The craft's cavernous 16-foot-diameter fuselage looked like the interior of a vehicular tunnel. This was the first production model of the Military Air Transport Service's C-133A—Douglas' latest in flying giants. The designers built this flying warehouse to carry a payload of 100,000 pounds for 1000 miles—twice the capacity of the C-124 Globemaster. Through a 12-foot-high loading door under the tail, nearly any ground-force military vehicle in existence can rumble up the plane's self-contained ramp and be stowed, fully assembled. The vast interior will swallow 10 Weasels, 16 loaded Jeeps, or two 40,000-pound bulldozers. A second door near the front of the cabin permits simultaneous loading directly from a truck bed, without benefit of lifting devices. Reason for this is the C-133's unique "squat" when she's aground. The bottom of her fuselage clears the concrete by about two feet. Primarily a freighter, seats can be fitted into sockets, enabling the "133" to haul 200 troops. A second deck might boost the capacity to 400 passengers.



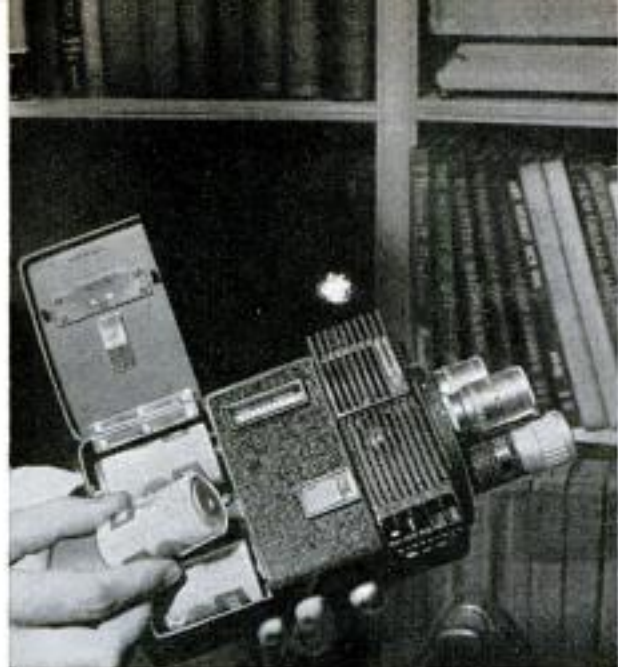

Movie camera operates on flashlight batteries. Signal light in view finder tells when power is too low



Camera has projector, wide-angle, telephoto, standard lenses. View finder shows field for each lens

## CAMERA DOUBLES AS PROJECTOR

HOME MOVIES can be projected from the camera that took them. The eight-millimeter unit can be converted from camera to projector, and vice versa, in 30 seconds. The same film gate is used for both projection and picture-taking. Pictures are taken on standard double-eight-millimeter film, which is divided during the developing process. It is projected as eight-millimeter film. As a camera, the unit requires no winding since three batteries provide power for a year of average use. A small bulb dims when the battery charge is running low, but the unit maintains a steady film speed of 16 frames per second as long as sufficient charge is available. The entire unit can be carried in a two-part case no larger than a photographer's gadget bag. Or the base section of the bag can be detached for carrying the camera alone.

Lifting feed spindle moves shutter back, letting light from small bulb glance off angled mirror and through projection lens

With side panel removed, base in place, reels attached, camera becomes projector

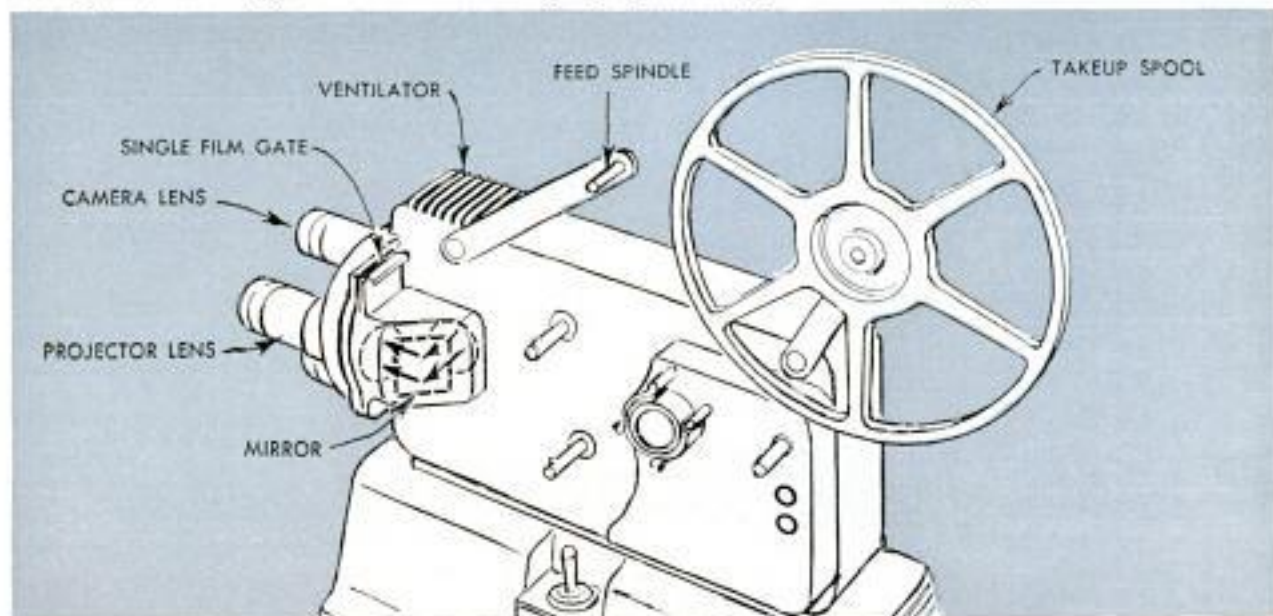





To start the long test, the cars cross the U.S.-Canada border on the bridge at Fort Kent in northern Maine



Drivers were given daily physical exams as well as psychological tests. Below, at the end of the run in Miami Beach, the drivers congratulate each other



## *De Soto looks for the answer—* **WHAT MAKES A**

**E**VERYBODY TESTS cars. De Soto Division says it's time to test people, particularly people in cars—the drivers.

After all, a car is useless without a driver. What's more important than to discover what makes a driver tired?

De Soto looked for the answer to this question in an unusual seven-day test from the northern tip of Maine to Miami Beach, Fla. This reporter went along as the official press representative.

Two cars made the 2300-mile trip. One was a completely restored, like-new 1929 De Soto roadster—De Soto's first model year. It had none of the luxuries that we now think of as necessities. The second car was a brand-new 1958 De Soto convertible, loaded with today's newest and most convenient extras. De Soto hoped to learn whether the new car with all its power assists was less tiring than the old model.

Guinea pigs for the test were two De Soto engineers, both experienced test drivers. Before the run began they were given intensive tests by a psychologist to determine their normal condition. The idea was to subject them to the stress of driving and to measure how tired they became. They alternated cars—one day in the 1929 model, the next in the 1958 model.

Along on the test was an experienced psychologist. He gave the two drivers several tests every night to measure eye-hand





Driver Cy Korompay, left, and the author stretch their legs during a gas stop on the Massachusetts turnpike

## DRIVER TIRED?

By Arthur R. Railton

coordination, reading accuracy, finger dexterity and reasoning abilities. Blood samples were taken from the drivers every night to discover any physiological effects.

I watched the drivers as they took these nightly tests. I rode with them occasionally (the rest of the time they were alone in the car so there would be no additional fatigue-affecting factors besides driving). I talked at length with the test psychologist, Dr. Joe Motto of Detroit, Mich. and with the project psychiatrist, Dr. A. S. Church, also of Detroit. I drove along behind the cars for hours to see how the drivers responded to traffic conditions.

At the end of the run I studied the report made by the two doctors and, adding that material to what I learned, came up with this account. What it says may surprise you.

First, a word about the two cars. As you would expect, the new, carefully tuned 1958 De Soto made the trip without incident. It was just a breeze for this powerful

(Continued to page 240)



Part of the fatigue test was a climb up Mount Washington in New Hampshire. The cars had no trouble at all. Driver Bill Duckett checks the 1929 engine afterward. Below, coming down from the cloud-wrapped peak provided a good test of brakes





# 1958

## A REPORT ON THE CADILLAC, FORD AND PONTIAC

By Arthur R. Railton



Atop Pontiac's rear axle is a U-shaped yoke to stop windup

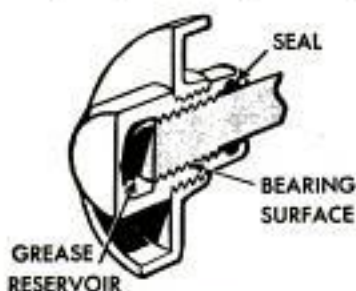

Ford moves toward the lubed-for-life car with this bearing

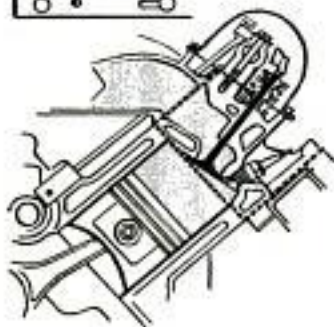

Dots outline Ford's new cylinder head that is right-angled to simplify production. Combustion chambers are machined too

A CAR THAT NEVER NEEDS a grease job? It's on the way, say Ford engineers. It could be here today, they think, but buyers might be suspicious of a car without grease fittings.

But the day will come when your car is lubed-for-life at the factory. A big step has been taken—a threaded steel bushing in the front suspension of Ford's 1958 cars. A special lubricant is sealed inside a cavity in the bearing when the unit is assembled. It never has to be greased again.

Work is needed to adopt the principle throughout the car, but engineers say it can be done and will.

Pontiac, with its all-new body, frame and engine is the real big story this month. Its new X-frame permits the body to be lowered without a sharp stepdown in the passenger compartment. It increases torsion stiffness without much added weight. A three-joint propeller shaft is used.

Coil springs are on all four wheels (making mounting of air bags simpler when ordered). To restrict rear-axle wind-up, there's a big U-shaped upper-control arm mounted atop the differential, its two arms attached to the frame. This yoke also provides lateral stability during cornering. Lower control arms take the braking and driving thrust.

Pontiac's new V8 engine has a 370-cubic-inch displacement (as recently as 1953 the biggest engine in any American car had only 331 inches). Compression is upped to 10.5 to 1 on high-performance Pontiacs. Standard compression is 8.6 to 1. Horsepowers range from 240 to 310. Fuel injection is optional on all models.

All three cars under discussion offer air suspension as optional equipment, Ford in its Fairlanes and wagons only. The Ford system differs from the General Motors design in its leveling controls: One for fast leveling, the other for slow leveling.

The fast leveling is actuated when you open a door (it is hooked into the courtesy-light door switches). The door switch operates a solenoid that opens the large orifice in the leveling valves (two in front, one in rear). Because air rushes in volume through the valve, the car levels itself in the time it takes passengers to enter or leave. As long as all doors remain closed, only the slow-leveling orifice of the valves operates. Thus air is admitted to the air bags

(Continued to page 266)

### STUDEBAKER HARDTOP

Studebaker and Packard have a new body style out this month. It's this two-door hardtop, a model that has the room of a two-door sedan, the roof of a hardtop. Previously, the only hardtop offered was the Hawk







Fender tips, front and rear, were extended to make the Coupe de Ville look several feet longer than it is



Big change is in the backward slanting tailfins. The rear roof supports are thinner to add visual length

## Cadillac

MODEL FOR MODEL, Cadillacs are not much longer this year. Added over-all length is just under an inch. But they look several feet longer. No magic here, just a visual trick that results from lengthening front fenders and hood and modifying rear-fender shape a little. But there is a new model that's longer: An extended-deck sedan that stretches its trunk an additional 8.5 inches. Air suspension is optional, coil springs on all four wheels standard. Power is up slightly, displacement is unchanged.



Four headlights, a more horizontal grille add what Cadillac calls the "broad-shouldered look" for 1958

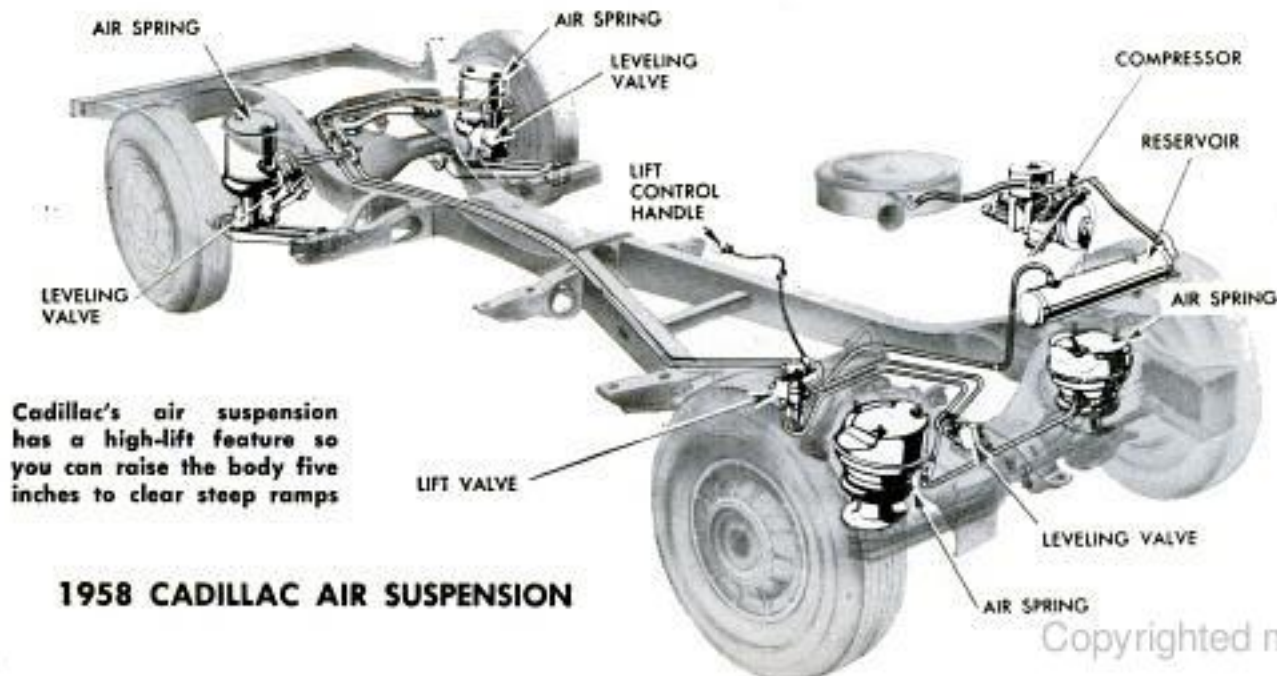

Cadillac's air suspension has a high-lift feature so you can raise the body five inches to clear steep ramps

### 1958 CADILLAC AIR SUSPENSION





New front-end styling and reworked side trim give these Fords a fresh look despite use of the 1957 shell

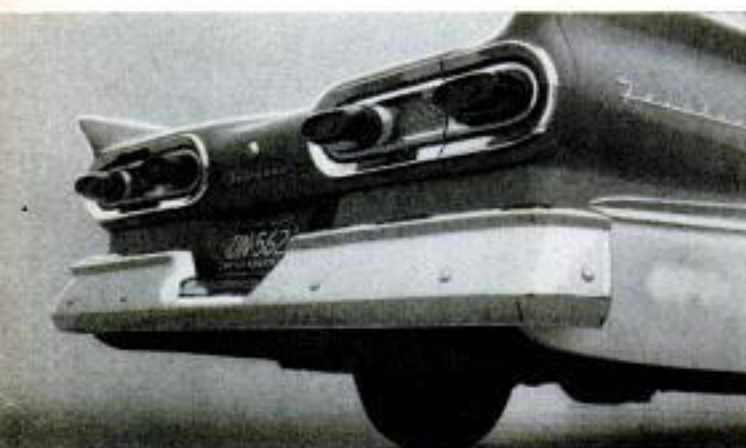

Above, Ford replaced its wagon-wheel taillights with four bold ovals. No bumper guards are used in rear

## Ford

FORD'S BIG CHANGE is under the hood, but it has freshened its 1957 body shell by major front, rear and roof changes.

Four headlights and a perforated grille give a new front look, while at the back, four oval taillights make Ford's the best-lit rear on the road. The trunk lid is deeply contoured and the roof grooved.

With lots of inches (332 and 352) and power (240 to 300 horsepower), the new V8 is designed for efficiency (see page 90). With Ford's new transmission and 2.69 rear axle, it is said to have 15 percent more economy.

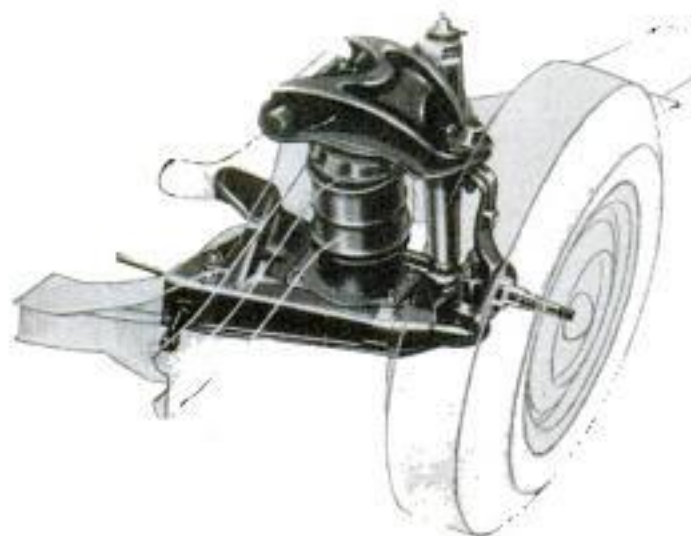

Air suspension is optional on high-price Fords. Left, front suspension. Right, cutaway of the Ford air bag

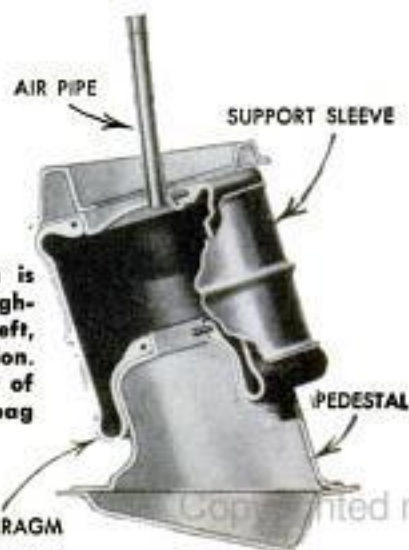

RUBBER DIAPHRAGM

Cop...nted material





Above, Star Chief four-door Safari station wagon. Below, the Bonneville sport coupe has special side trim

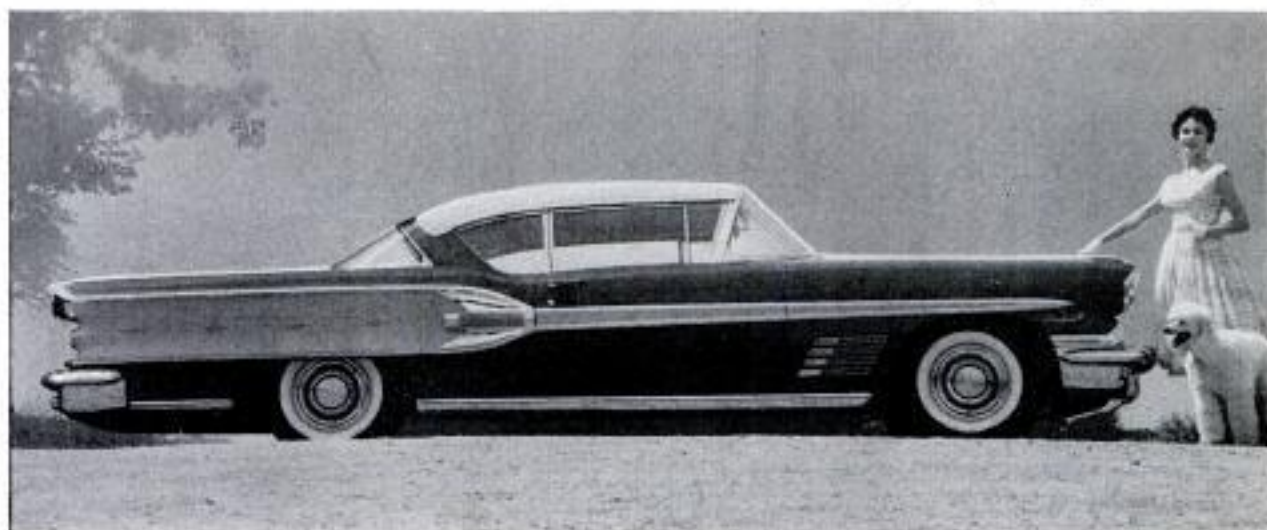

## Pontiac

**WHEELBASES** are the same, but that's about all. The new Pontiac is lower by as much as 4.5 inches, wider by 2.2 inches, longer on some models by 8.7 inches. It's big and it looks it.

Flashiest are two Bonneville models: The two-door hardtop and the convertible (another convertible is available in the low-price Chieftain series).

These Bonneville models, billed as family-size dream cars, are 1.4 inches lower than other Pontiacs and have distinctive trim on the sides, sculptured rear decks. The two-door hardtop has a simulated vent in the rear of the roof.

Air suspension is available on all Pontiacs, as is fuel injection. Horsepower ranges from 240 on the Chieftain to 310 on fuel-injected models. All have 370 cubic inches.

Optional on Bonneville convertibles are four bucket seats. A passenger-assist handrail is built into Bonneville dashboards.



Above, front suspension arms are stampings. The center white area is air-suspension unit. Below, optional bucket seats

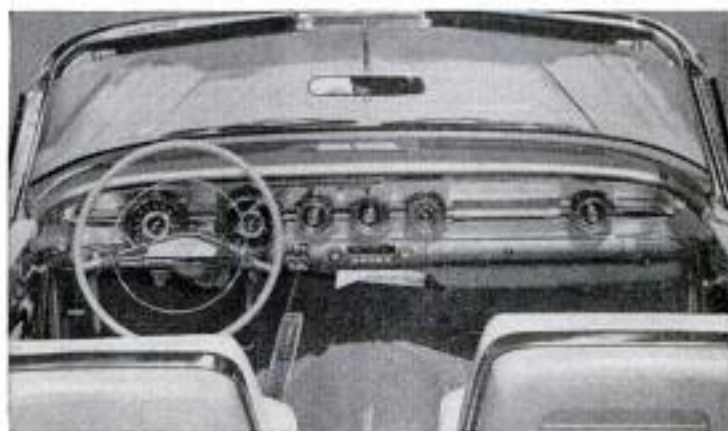





U. S. Steel photo

## "Big Mac" Links Michigan With Michigan

On November 1 the world's longest suspension bridge was opened to traffic, and motorists for the first time could drive across the Straits of Mackinac. The bridge (See *Popular Mechanics*, January 1957), under construction for 3½ years, links the

southern and northern peninsulas of Michigan. The towers of the majestic five-mile span rise more than 750 feet from bedrock. The suspended section is 8614 feet long. The "Magnificent Mackinac" has a capacity of 6000 cars per hour.

### ***Recommended Reading for Satellite Background***

- ✓ **"Our Missile Arsenal," *Popular Mechanics*, December 1956.**  
A roundup of all U. S. missiles from the smallest to the IRBM (intermediate-range ballistic missile) and the ICBM (intercontinental ballistic missile) designed for intercontinental warfare and to lift satellites beyond the earth's atmosphere.
- ✓ **"Taxi to Venus," by Thomas E. Stimson, Jr., *Popular Mechanics*, March 1957.**  
The problems of our astronautical engineers as they head into spaceship business.
- ✓ **"Stand By for Satellite Take-off," by Fred L. Whipple and J. Allen Hynek, *Smithsonian Astrophysical Observatory, Popular Mechanics*, July 1957.**  
Details on U. S. satellite, how it will cruise through space and its scientific function.
- ✓ **"Mystery Fuels for the Missile Age,"  
by Thomas E. Stimson, Jr., *Popular Mechanics*, July 1957.**
- ✓ **"Space Travel and Our Technological Revolution,"  
by Dr. Wernher von Braun, *Missiles and Rockets*, July 1957.**
- ✓ **"How You Can Spot the Satellite,"  
by Richard F. Dempewolf, *Popular Mechanics*, August 1957.**



# How Proposed U. S. Satellite Compares With Russia's

IN JULY, 1955, the United States announced its program to launch an artificial moon. Scientific attention all over the world was focused on the proposed satellite. Then, a few weeks ago, a mighty multistage rocket roared skyward from Russia, dropped its spent engines and spat out a tiny sphere. The little moon went whirling around the earth so fast that in little more than two days it could have flown to the moon and back.

How does that first Russian satellite—announced as a practice shot for more elaborate satellites to come—compare with the proposed American moon?

In size the two satellites are almost identical (the Russian is slightly larger) but there is a tremendous difference in weight. The Russian satellite weighs 184 pounds to only 21½ pounds for the proposed American satellite. The Russians launched theirs on a generally north-south orbit while the announced orbit of the U.S. satellite will be generally west to east to take advantage of the earth's rotation during launching. The first Russian satellite simply broadcast its position and possibly the temperature. The American moon is designed to transmit a wide variety of scientific information. The altitudes and rotation times probably will be roughly comparable, but this can't be determined until the U.S. satellite takes its place in the sky.

And when that U.S. satellite finally whirls off into its orbit, there may be several companions waiting to greet it on the fringes of space.

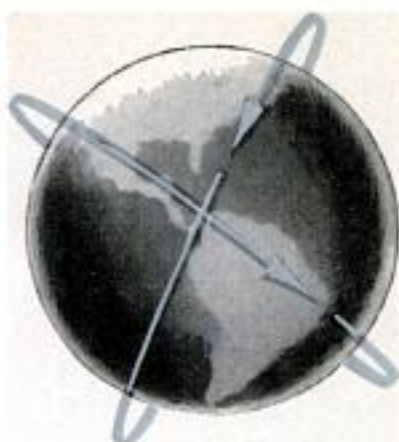

HOW DO THE SATELLITES COMPARE?

	RUSSIA'S FIRST SATELLITE	PROPOSED U. S. SATELLITE
SIZE	22.8-INCH DIAMETER	21-INCH DIAMETER
WEIGHT	184 POUNDS	21½ POUNDS
SPEED	18,000 MILES PER HOUR	18,000 MILES PER HOUR
ALTITUDE OF ORBIT	560 MILES	300 TO 800 MILES
TIME OF ONE COMPLETE ROTATION	96 MINUTES, 2 SECONDS	
ANGLE OF ORBIT	25 DEGREES TO EQUATOR IN GENERAL A NORTH-SOUTH ORBIT	35 DEGREES TO EQUATOR IN GENERAL A WEST-EAST ORBIT
EQUIPMENT	BATTERIES, RADIO TRANSMITTER, OTHER EQUIPMENT NOT ANNOUNCED. ONE SCIENTIFIC INSTRUMENT, A THERMISTOR TEMPERATURE MEASUREMENT	BATTERIES, TRANSDUCER INSTRUMENTS TO REPORT ON AEROPTIC COLLISIONS, TEMPERATURES, IONIZATION, SOLAR RADIATION, COSMIC RAYS, ULTRAVIOLET LIGHT, MAGNETIC FIELD, AND OTHERS
ROCKET USED	MULTI-STAGE ROCKET, CONSTRUCTION DESCRIBED BY VARIOUS SOURCES, 120,000 TO 300,000 POUNDS	TISSOT THREE-STAGE ROCKET, 100,000 POUNDS





"Approaching Anchorage . . . a typical fiord with mountains on each side, Portage Glacier at its end"

## Report From a Roving Editor

*For a man who prefers the old-fashioned automobile to these newfangled flying machines, Tom Stimson had quite a trip up to Point Barrow, Alaska, recently. Our Western Editor at Los Angeles made the flight to visit the DEW Line and "White Alice" radio installations. This is his firsthand report; next month he tells of the White Alice outpost he visited*

### *Dear Boss:*

Traveling to Point Barrow to cover the DEW Line story (Distant Early Warning radar) made a very unique trip and so I'll give you a detailed report. You should go yourself; you'd get the same impression that going up to this arctic outpost, sort of casually and offhand, is almost unreal.

Last Sunday 10 newspaper and magazine people left Los Angeles for McChord Air Force Base at Tacoma. Travel was in a C-47 (two-engine DC-3). We stopped in San Francisco to pick up two writers, and spent a total of six hours jogging along to Tacoma.

There we were to meet the rest of the group from the East Coast. They were in

Tom Stimson (circle) with another correspondent and Eskimo employees of DEW Line at Point Barrow, Alaska





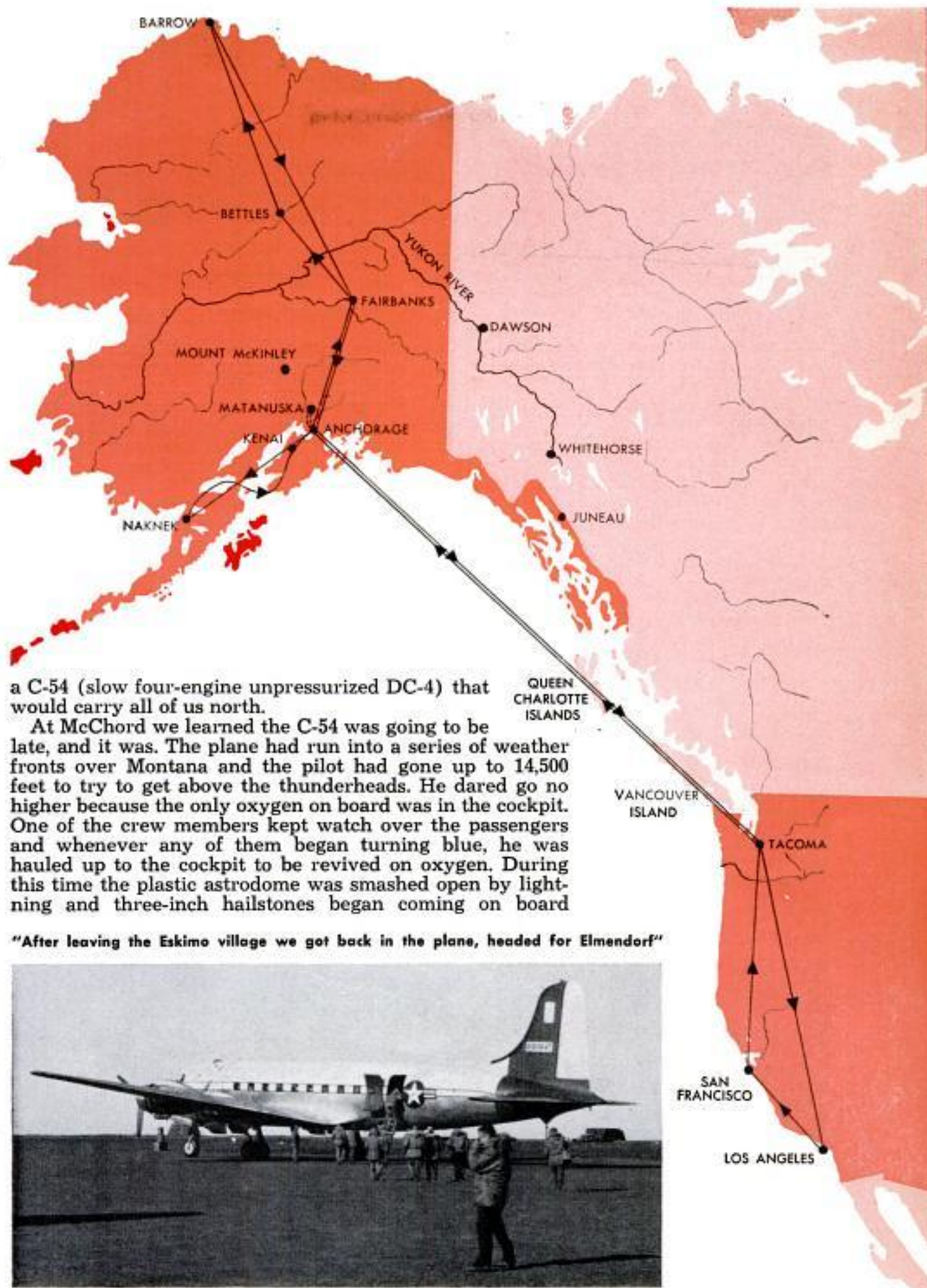

a C-54 (slow four-engine unpressurized DC-4) that would carry all of us north.

At McChord we learned the C-54 was going to be late, and it was. The plane had run into a series of weather fronts over Montana and the pilot had gone up to 14,500 feet to try to get above the thunderheads. He dared go no higher because the only oxygen on board was in the cockpit. One of the crew members kept watch over the passengers and whenever any of them began turning blue, he was hauled up to the cockpit to be revived on oxygen. During this time the plastic astrodome was smashed open by lightning and three-inch hailstones began coming on board

**"After leaving the Eskimo village we got back in the plane, headed for Elmendorf"**



DECEMBER 1957



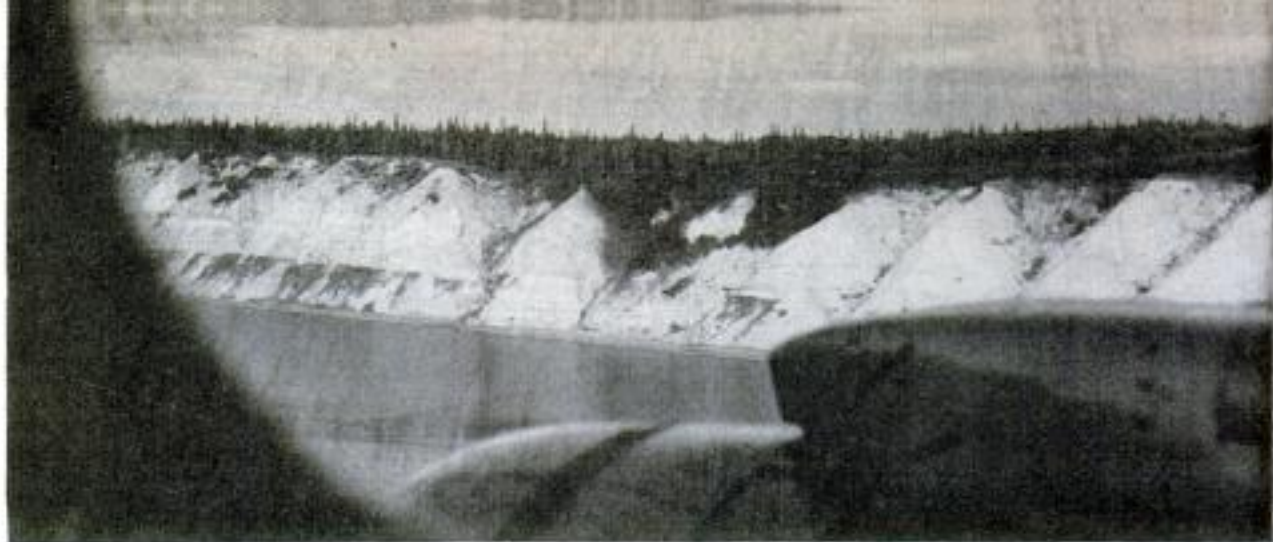

"Kenai Peninsula . . . the pilot got the plane down on the water just offshore, at an altitude of 50 feet"

through the hole. Hailstones smashed the copilot's windshield, dented the leading edges of the engine cowlings, and ripped off the upper surfaces of the elevators. I would not have enjoyed any part of this.

Sunday night the Air Force people in charge of the press tour tried via Washington to get another plane. None was available, so the maintenance group at McChord replaced the windshield, bolted a metal cover across the astrodome hatch and resurfaced the elevators. These repairs took most of the morning. We started north at lunchtime, ran the length of Vancouver Island, passed over the Queen Charlotte group, and cut across the Pacific at 9000 feet for Anchorage, flying mostly between cloud layers. At Anchorage we turned north for Fairbanks, passing within 30

miles or so of 20,220-foot Mount McKinley and getting some good views of it.

We were scheduled to stop at Ladd Air Force Base, Fairbanks, pick up parkas and sleeping bags, and continue to Point Barrow. But we'd had a late start, had been nine hours in the air, and were tired. The group decided to RON (Remain Over Night, Air Force parlance) at Ladd, and we did. It was a warm night but by regulations, I suppose, the quarters were steam-heated. We opened all windows and slept on top of the bedding. Fairbanks is pretty far north and it was dark only a few hours.

Next morning we were airborne at six, went up to 9000 feet, and headed for the radio beacon at Bettles, en route to Point Barrow. The plane crossed the winding

(Continued to page 250)

"We 'climbed' the glacier by airplane, looking down at the blue-green ice a couple of hundred feet below"





## Fangio and Behra Test Drive Vespas

Famed racing drivers Juan Manuel Fangio of Argentina, left, and Jean Behra of France examine the new Vespa cars at Roquebrune-St. Martin, France. The four-passenger Vespas were later tested by the race drivers who usually pilot the speedy Maseratis.



## Karmann-Ghia Adds Convertible Model to Stable of VW Bodies

For Volkswagen fans who also like the sleek styling of sports cars, this Karmann-Ghia convertible body is now available on a VW chassis. The design reportedly is based on a law of aeronautics. A cruising and maximum speed of 72 miles per hour is

listed for this model and road-holding ability is said to be good. The Karmann-Ghia coupe body, previously introduced, now has a velvet-lined rear luggage compartment which can be doubled in size by moving the foam-rubber rear seat forward.

## Korean Sibal Makes Debut

Similar to a low-priced American passenger car is the first automobile built in South Korea. The six-cylinder model, shown at its recent debut in Seoul, didn't just roll off an assembly line. It was constructed by the brothers Choe, a pair of mechanics who needed two years of labor to complete the sedan. Most of the work was done with hammers, blowtorches and other simple tools. The name of the car is Sibal, meaning "the start." It cost \$5600 to build.





# Honeywell's House of Magic

By John G. Hubbell

BRAIN  
OF A  
SATELLITE

4817 Emerson Ave. S.  
Minneapolis 9, Minn.  
HONEYWELL

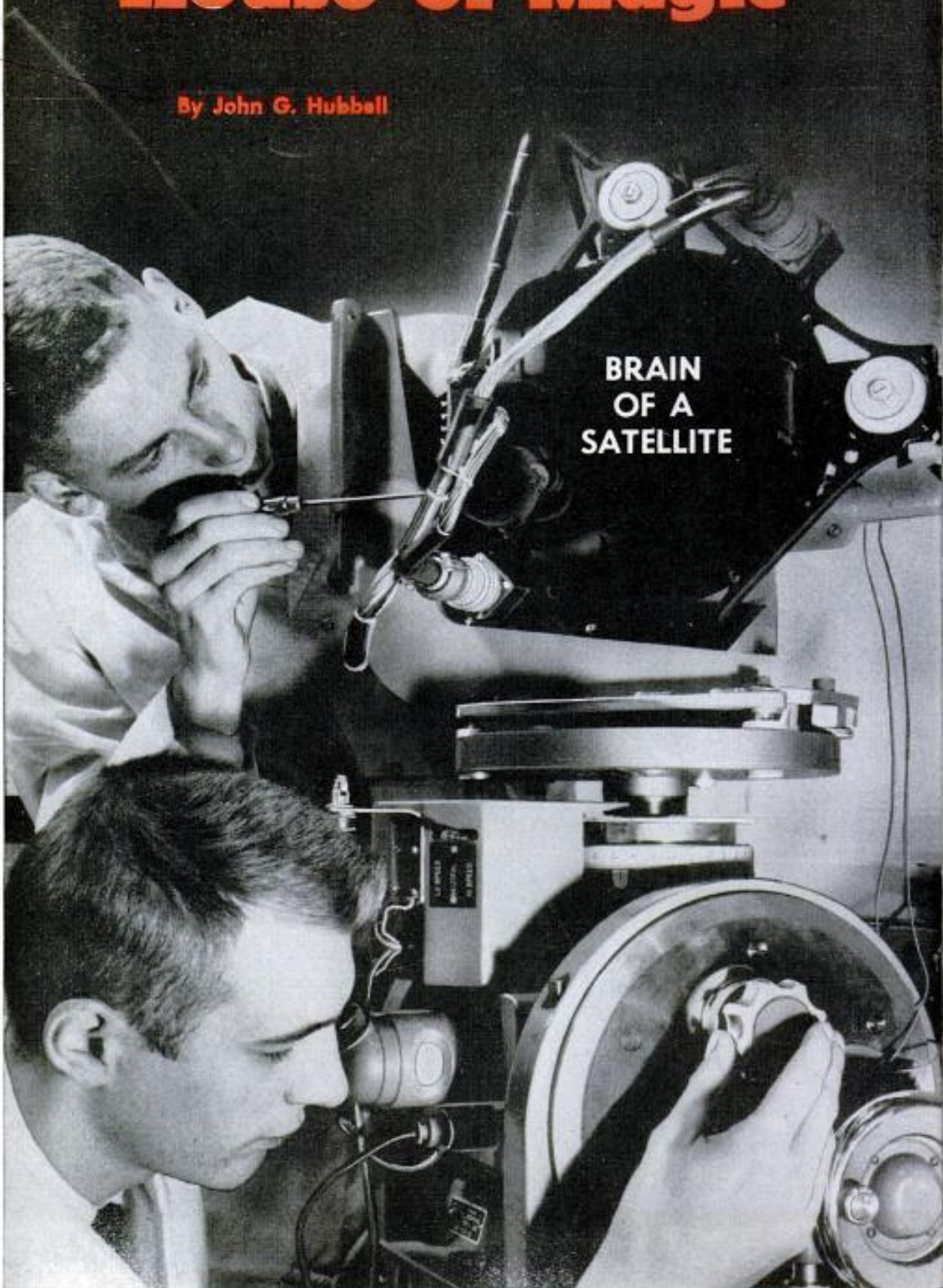



**N**OT LONG AGO, at Minneapolis-Honeywell's General Research Laboratories in Hopkins, Minn., I gave a lot of information about our house to Dr. Finn Larsen, Honeywell's Director of Research. I told him the number and approximate sizes of all the rooms, doors and windows, and the type of construction and insulation materials used throughout. To this, Dr. Larsen added some notes about our Minnesota climate, then relayed all the information to a machine five feet tall and two feet wide. In five minutes and 44 seconds, the machine had calculated precisely the amount of heat our house, an eight-room frame dwelling, would lose during the next 50 years, and handed me a heating bill for nearly \$12,000!

This electronic prophet, called the House Analog Computer, was built by a team of Honeywell research scientists who make a career of improving human comfort.

"We wanted to experiment with new ideas for heating and air-conditioning systems," says Dr. Preston McNall, who headed the project, "but it took too much time and cost too much money to wait out the weather. Often, when the right weather conditions did arrive, they prevailed too briefly. Somehow, we had to create our own authentic weather and make it stand still."

They did just that. The computer can exactly simulate any building's reactions to any climate, throughout its life span. Now Honeywell scientists are able to study at will the effects of climate on any type of house and on new home building materials, in order to develop new heating and air-conditioning control systems which may some day provide the ultimate in living comfort.

They've been doing things about the weather since a raw March night in 1883 when a young Minneapolis inventor named Alfred M. Butz became exasperated because he had to go down to the cellar to open or close the damper doors on his coal furnace every time the house grew too chilly or overly warm. He began tinkering, and within a few days he found a way to do the job automatically.

Opposite page, Honeywell was given job of devising "brain" for our satellite rocket

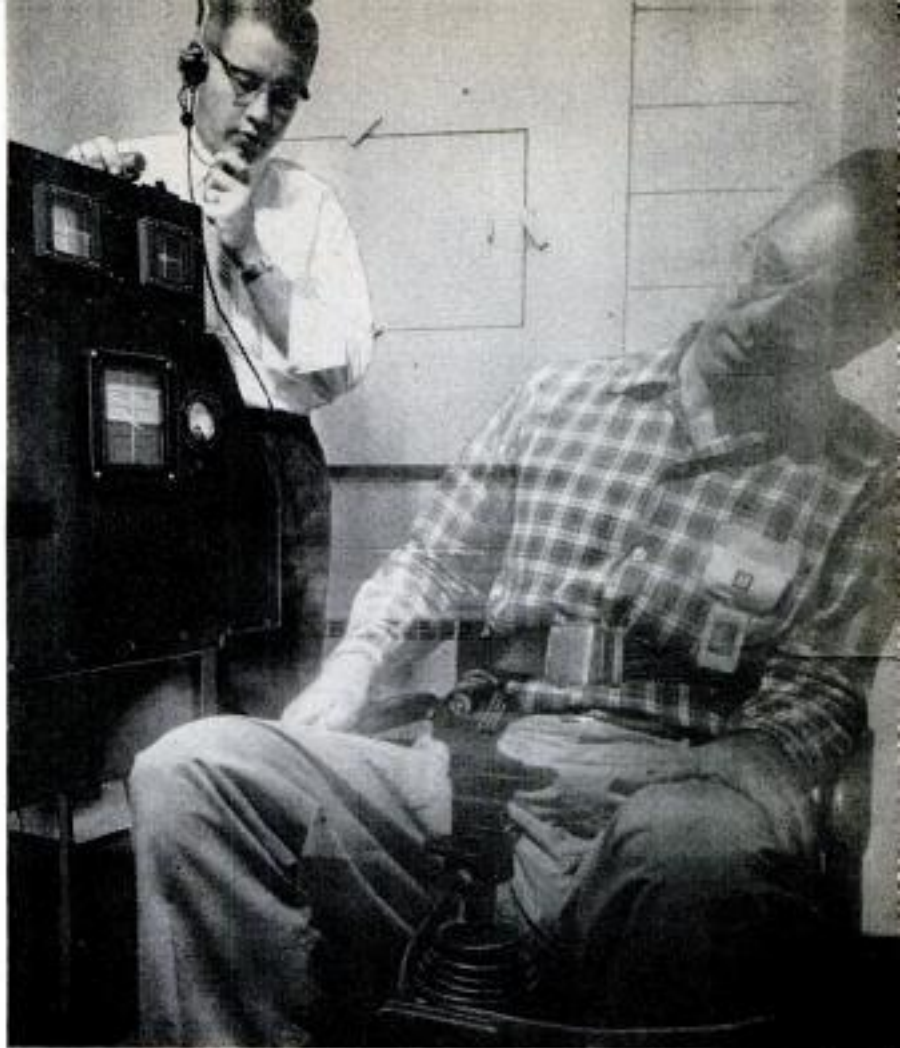

Honeywell engineer whirls pilot in rotating chair. As pilot turns, he tries to read the instruments and react as required

Building engineer pushes button and diagrams of heating system flash on screen, showing him where corrections are needed

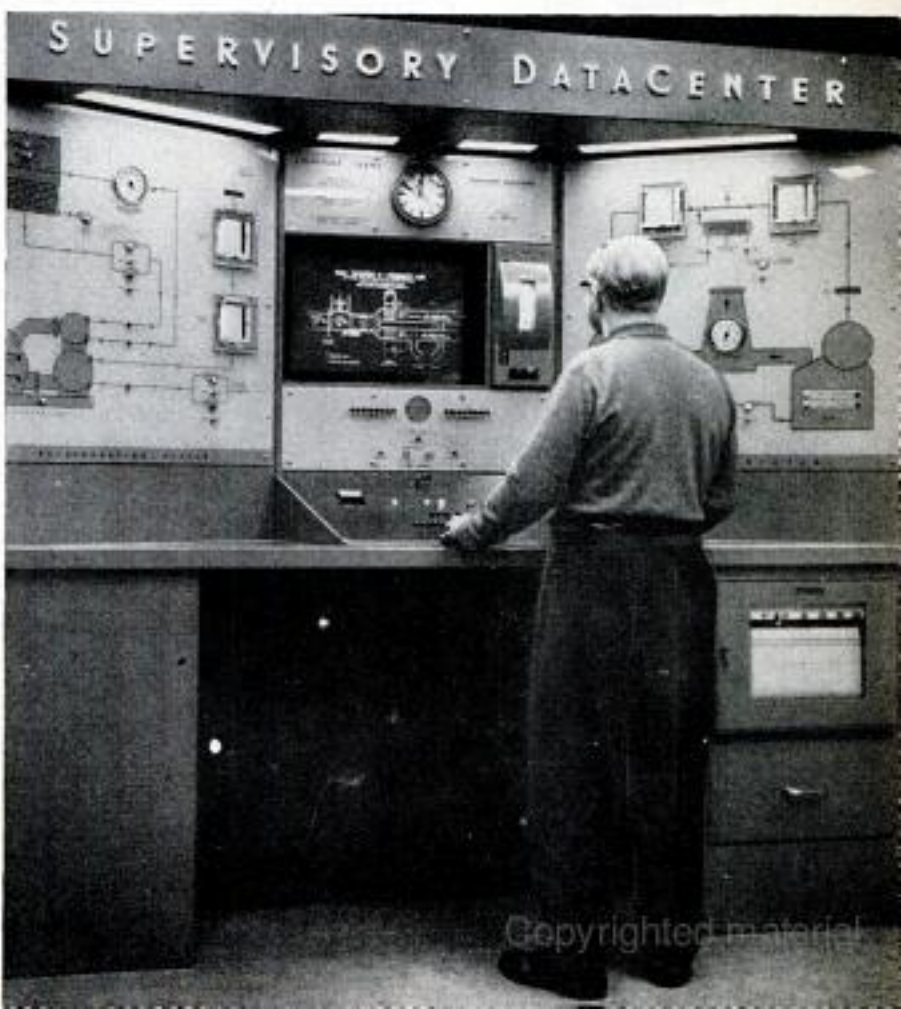



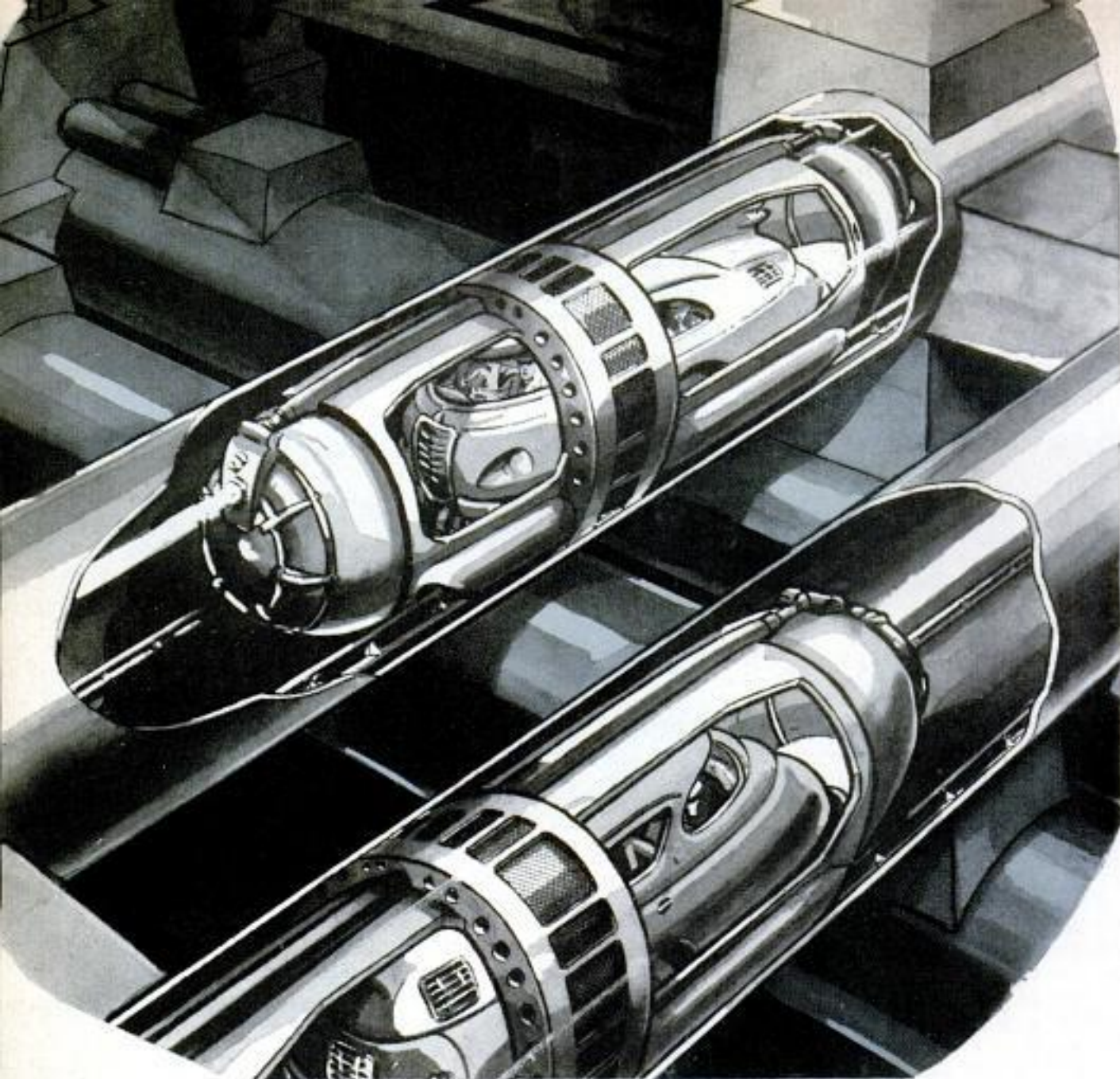

Honeywell engineer predicts that by A.D. 2000 cars will zip through network of crashproof pneumatic tubes

It was based on a simple scientific principle: Butz knew that heat makes most substances expand, cold makes them contract; and brass and rubber have widely different rates of expansion and contraction. He cemented paper-thin strips of the two materials together, fastened down one end of the brass-rubber strip, placed the other between two electrical contacts a fraction of an inch apart. Then he ran wires from the contacts to an electric motor he had attached to the furnace dampers. As his house became warm, the strip began warping toward the contact which would cause the motor to close the dampers; as the house cooled, the strip warped back to the other contact, opening the dampers to supply the house with more heat.

Today, 74 years later, the principle Butz worked with has been parlayed into a company that makes 12,740 automatic devices which reach into every facet of life, and range in price from 30 cents for a simple electrical switch to \$2,500,000 for enormously complex equipment which performs office and clerical routine completely, quickly and precisely.

For the first 40 years of its existence the firm, then known as the Minneapolis Heat Regulator Company, concentrated on making the controls which automatically regulate temperatures in tens of millions of homes throughout the world today. But following a merger in 1927 with the

This is probably the first heating regulator ever produced, putting the company in business







M-H engineers, even with help of their hands, had trouble discussing three-dimensional gyro problems



To help themselves in their work, they designed this "talking tool" which pinpoints area under discussion

leading competitor in the thermostat field, Mark C. Honeywell's Heating Specialties Company of Wabash, Ind., the newly formed Minneapolis-Honeywell began to branch out fabulously.

William R. Sweatt, who had been president of Minneapolis Heat Regulator Co., and Mark Honeywell were convinced the heating controls business was just a start. Through the depression years they hired as many good engineers as they could find and urged them to concentrate on new uses for automatic control. Soon Honeywell devices were in the processing industries, controlling temperatures, humidities, pressures and rates of flow of steam, oil, gas,

air, water and chemicals of all descriptions.

During World War II the company made 4,773,561 devices for the armed forces. When officers in the photographic laboratory at Wright Field were looking for a way to hold cameras level and steady during reconnaissance flights, Honeywell engineers devised a mount to hold the camera rigidly on target even in the roughest flight. When the position of the airplane changes even slightly, gyroscopes in the mount instantly sense it, measure the change and signal a delicate mechanism which repositions the mount so fast the camera lens doesn't have time to leave the target!

M/Sgt. Don Hamilton from the Wright

Tremendously accurate gyros are tested in this instrument. Hats and smocks help keep room free of dust

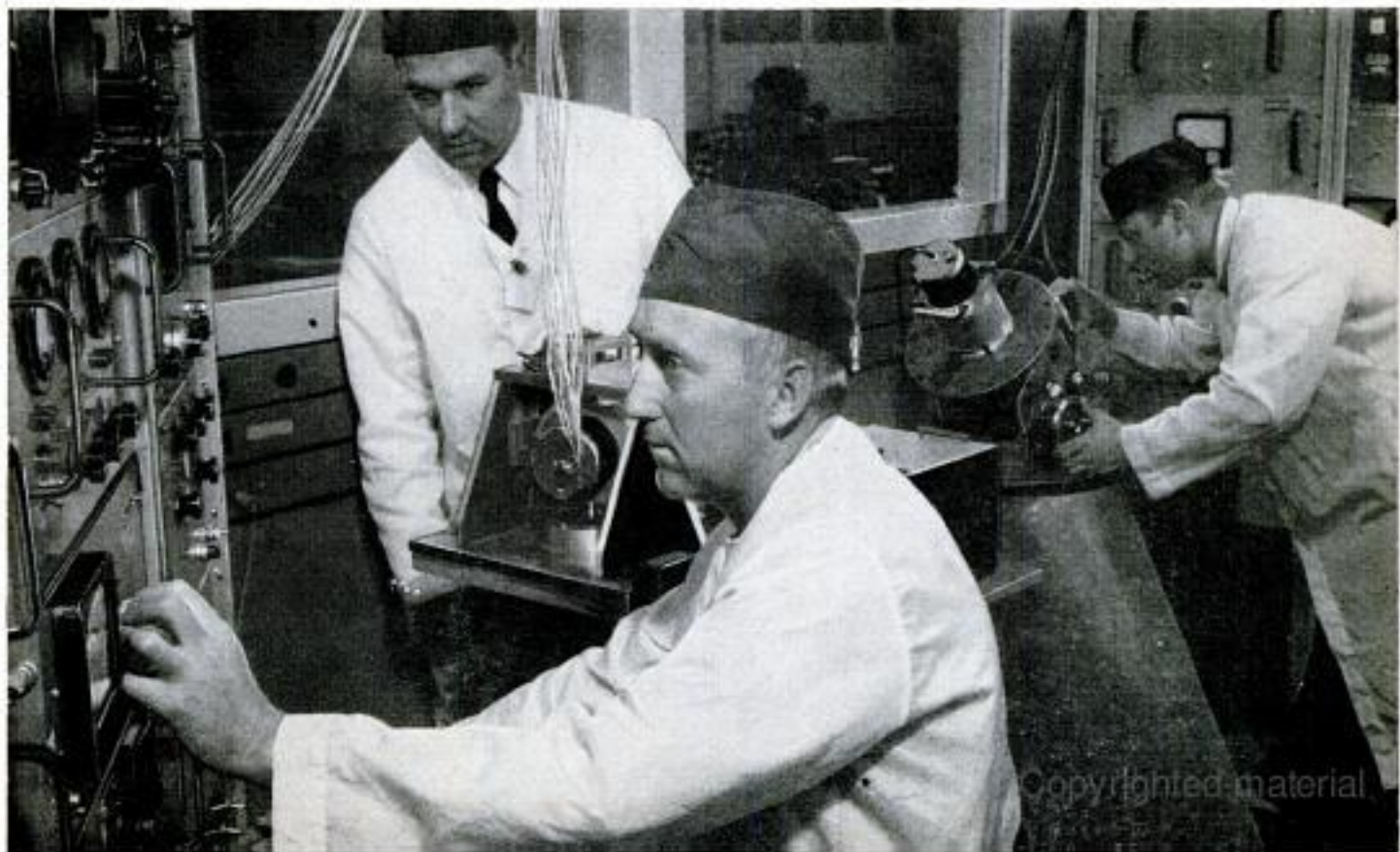





Scientists devised automatic page turner to help polio-paralyzed engineer condense scientific reports

Field armament laboratory watched, absorbed, when the electronic camera mount was first demonstrated. Then, quietly, he pledged the Honeywell men to utmost secrecy and led them to a small, dark room in the armament lab. In the middle of the room stood a table on which was the Norden bombsight. This, he explained, was the best bombsight ever developed; but it was useless unless some way could be found to hold the heavy bomber absolutely rigid during the bombing run. Human reactions to flight deviations just weren't quick enough. Could the same idea which had been used in the camera mounting device be used to control the whole airplane?

Two-story house atop M-H headquarters building is filled with 200 thermostats for heating research



Honeywell's answer, an electronic automatic pilot, has been credited with bringing great numbers of B-17s safely back to England after the manual controls had been knocked out by German flak, or the human pilots had been so badly injured they couldn't fly the planes themselves.

Today, vastly improved versions of that autopilot put the precision in the murderous punch of the Strategic Air Command's B-36s, B-47s, B-50s and the long-range, eight-jet B-52s, and give jet fighters super-human control.

A more recent development is an inertial guidance system for aircraft, which depends greatly for its accuracy on ultrasensitive gyroscopes. The pilot simply feeds information into this device indicating where he is and where he wants to go, and it takes him there through any kind of weather. It needs no outside help from radio or radar, takes no navigational fixes on the sun or stars, is entirely unaffected by the earth's magnetic fields, and can't be jammed by an enemy.

Until a few years ago bearing friction posed a major problem for gyroscope makers. The less bearing friction a gyroscope has to work against, the more sensitive it is and the more accurately it can perform. Dr. Charles Draper of the Massachusetts Institute of Technology developed a gyro rotor sealed inside a container where it floated in a highly viscous fluid. The floating action removes bearing friction, and the viscosity serves to average out disturbing effects. Draper's gyro had incalculable military and industrial potential, but several major gyroscope manufacturers said that mass-production techniques could not be geared to such perfection. Honeywell

House analog computer replaces home at left. It can "imagine" any type of house, tell heating problems

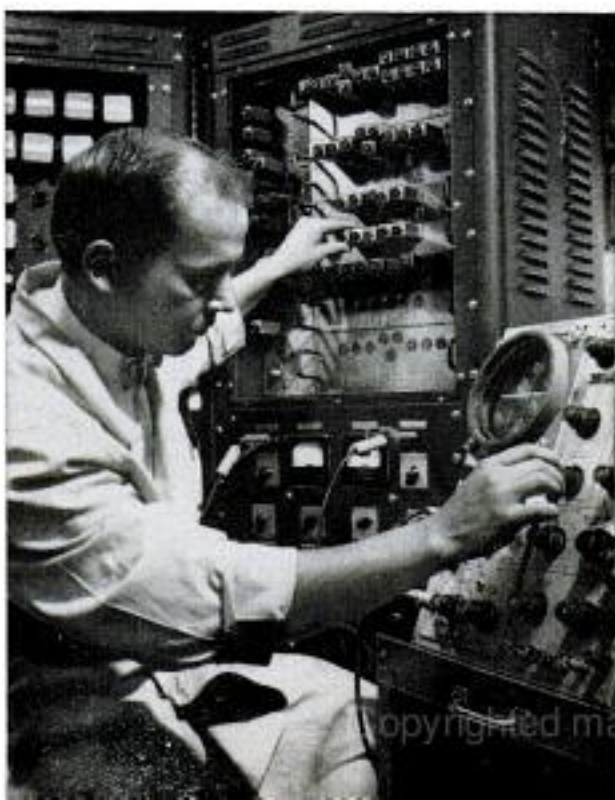



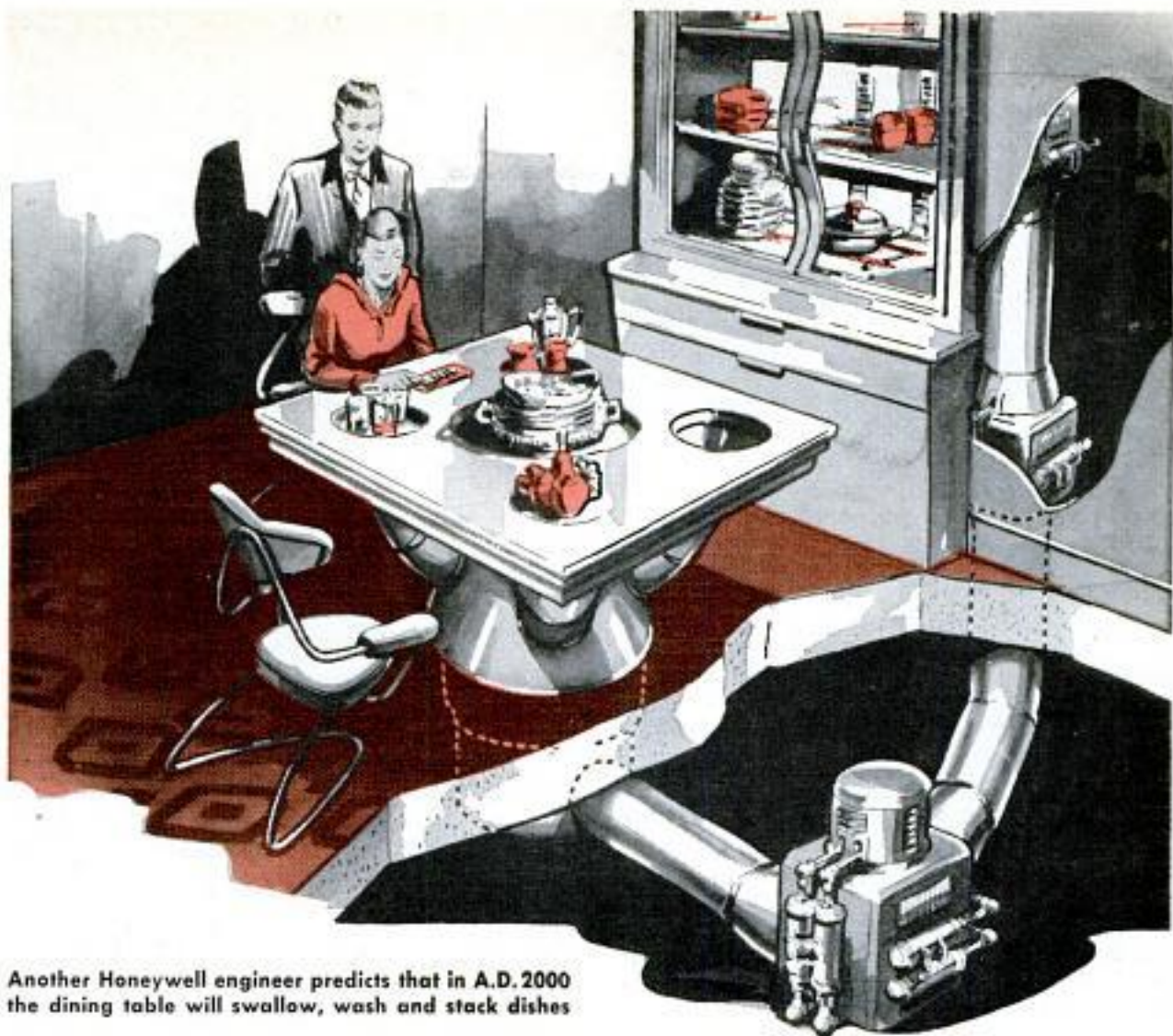

Another Honeywell engineer predicts that in A.D. 2000 the dining table will swallow, wash and stack dishes

said it *could* be done, and since then has produced more than 25,000 for U. S. and Canadian jet fighters and guided missiles.

Last year Honeywell engineers used this gyro to explode the long-standing myth that the Empire State Building sways like a reed when a strong wind blows. The gyro proved that the world's tallest building is also one of the most stable, never moving off-center more than approximately  $\frac{1}{4}$  inch! A much bigger job is scheduled. Three of these gyros will help guide the three-stage Vanguard rocket when it lifts the earth satellite to its orbit in the sky.

Another highly sensitive but extremely rugged gyro is being installed in the gun turrets of tanks, and will enable the guns to fire with deadly accuracy while moving at high speeds across rough terrain.

Meanwhile Honeywell men roam across every path of life, refusing to regard any automatic-control problem as insoluble. For example, there never had been a practical way to heat and cool New York City subway cars. A full car can carry up to 300 passengers, who generate enough excess body heat to warm a 10-room house.

But car doors open and close every few minutes, and the number of passengers continually changes. Honeywell's comfort specialists conquered this imposing challenge with two electronic thermostats, each containing a highly sensitive strand of wire  $\frac{27}{10,000}$  inch in diameter. One thermostat checks temperatures outside the car; the other monitors the interior. At each change in temperature, the wire signals an electronic system which instantly heats or cools the car as required for maximum comfort.

The first time the tuna clipper *Sun Ray*, of San Diego, went hunting with Honeywell's electronic "Sea Scanar," it made a record-breaking 293-ton catch—worth \$70,000—in six weeks. The Canadian whaler *Nahmint* caught three whales the first week it operated with the device. The Sea Scanar fires bursts of high-frequency sound waves in a complete port-to-starboard sweep around the front of the boat. Electronic echoes return to a screen and give the fisherman a panoramic view of the whole area. The sound the Scanar emits when an echo comes back identifies the

(Continued to page 256)





**WE MAY NOT** like it. Europeans may not like it, but it's happening anyhow. European cars are becoming more American. I attended two great international auto shows, one in Frankfurt (Germany), the other in Paris (France) and came away convinced.

The trend is strong. How long it will continue may depend on European prosperity. Cars, like men's suits, are becoming standardized. Nobody objects to this in suits, perhaps nobody will object to it in cars. Here is some evidence of the trend:

- Vauxhall's new Cresta has the same creased roof, three-piece rear window that Buick and Olds featured in 1957.
- The Simca Vedette has tailfins, wrapped windshield and flashy colors.
- The DKW 600 has miniature Dagmars with Cadillac-like rubber inserts on its bumpers. Headlights have slanted shrouds.
- The German Ford is bigger, has more power, an automatic transmission.
- Goggomobil has a bigger model with American-style wrap-around windshield.
- Isetta now offers a rear seat and more power with a bigger engine.
- Auto Union 1000 sports coupe with its canted tailfins looks like a Thunderbird.
- Even the Japanese Prince looks like a cross between a Ford and a GM car.

There are exceptions. Holdouts include Volkswagen (and when VW gets tailfins, the world will tremble!), the Fiat and Renault (although Renault offers a Gordini engine option for "hot" performance).

Colors are brighter. Crowds at Frankfurt admired a purple Borgward with yellow leather interior. The Tatra V8 from Czechoslovakia was purple with a vile green interior.

Meanwhile America still borrows from Europe. At Paris a Pinin Farina two-door hardtop on a 1957 Buick chassis was much admired. When a door is opened, the roof raises itself several inches so you can get

into it without knocking your hat off.

Simple, clean and chromeless, the body was unlike any Buick you've seen recently. Buick (and GM) may be going Italian. If so, the Christmas-tree styling, so long a part of Buick's character, will have to go. This fellow Farina will have none of that—one reason why he and American Motors parted. He takes styling seriously. If you don't like what he does, it's too bad. Take it or leave it, but don't tinker with it.

No official word has been released about Farina working for GM or Buick. But it could be. Buick provided the chassis, however it did not commission the design. Harlow H. Curtice, GM's president, posed for photographs in the car and he was all smiles. This may have been mere coincidence, but such coincidences are more often planned than not in the billion-dollar auto business.

### What About the Shows?

The European shows are big. At Frankfurt, vehicles fill more than a dozen buildings totaling 16 acres. Some companies, like Mercedes-Benz, Volkswagen and Ford, take over entire buildings.

One day at Frankfurt over 200,000 paid to see the show. No dancing girls, no entertainment, just cars from 34 companies.

The Paris show is held in the Grand Palais, a huge exposition hall (another section for trucks and motorcycles is held elsewhere). One Sunday crowd was so large it was impossible to get close enough to see many of the cars. Over a million persons visited the show in 11 days.

Neither show uses pretty girls to make the cars more appealing—a standard American device. At Frankfurt, two shapely girls were handing out literature for a tire company. Their presence was a break with tradition and did not please the other exhibitors.

In Paris, the only girls near the exhibits wore baggy white smocks and were kept busy dusting the cars all day long.

### Cars Are Enough

Apparently, the car is still entertainment enough in Europe. Take Citroen, for example. The 2CV was introduced in 1946 and is the ugliest thing man ever put on wheels. Yet at the Paris show, it was overrun by thousands who looked at it, climbed into it, peered under the hood. You cannot cross a Paris street without being grazed by a 2CV they are so numerous, yet it was a big hit at the show. How much attention would an 11-year-old Chevy get at the Chicago show?

Europeans seem more interested in how a car works than the average American. It

(Continued to page 264)









Above, pretty models are rare in Europe's auto shows but at Frankfurt a tire company had these two

Left, some of the big companies, like VW and Ford, had complete buildings to themselves at Frankfurt

←Continued from preceding page

American cars got little attention at Paris. Edsel, because of its newness, was the most popular design







Despite his handicap, Bill Frank operates a one-man business turning out objects of art in his workshop

## Artist With a Lathe

*He never worked with power tools until he lost his sight*

**B**ILL FRANK OF Chicago cannot see. Yet Bill Frank, working from "mental blueprints," can turn out beautiful wood projects on his lathe. Recently he turned out a real object of art—an attractive mahogany dish weighing only an ounce. The dish is only  $\frac{1}{32}$  inch thick, and he turned it to this paper thinness on a lathe after first cutting the disk on a bandsaw and drilling it for mounting on the faceplate.

Frank lost his sight in an industrial accident 10 years ago. Prior to that, he had never worked with power tools. He learned woodworking from scratch without the help of his eyes. In the past three years he has converted his senses of touch, smell and hearing into a successful one-man business. And he has a fine safety record, marred only by an occasional burned finger tip and one minor cut with a chisel.

His workshop is an eight by eight-foot cubicle in his basement apartment. There, while his guide dog Chinook watches, Frank turns out wood bowls, lamp bases,

His prize project is this mahogany dish, beautiful as fine china—so thin you can see light through it







Special circle-cutting jig has a sliding scale which permits him to set the desired diameter by touch



Turning the workpiece on the jig's pivot point, he saws out the disk, then prepares it for the lathe

trays, Lazy Susans and jewel boxes.

"I work out the design as I go along," he explains. "However, if a customer wants a particular design, I give him clay and he shapes a model. Then I duplicate it."

Frank's workshop, precisely suited to his needs, is equipped with a 10-inch bandsaw, a 15-inch drill press and an 11-inch lathe.

In selecting wood for a project, he feels its end grain, gauges its relative weight and samples its distinctive odor, which will be intensified by friction on the lathe.

"To me, zebrawood smells like a stable," Frank says. "Amaranth from British Guiana is suffocating. Walnut and pine have a bitter smell, and Costa Rican cocobola makes me sneeze. Myrtle wood has a scent like fish glue. Vermilion is another wood with a musty smell, and teak gives off an oily odor. Personally I prefer to work with fragrant Brazilian rosewood."

To demonstrate his woodworking technique, Frank places a pine slab three inches thick on the saw table. He first must cut a disk from it. To aid him in this job, he has a special circle-cutting jig presented to him by Duro Metal Products Company of Chicago.

The jig resembles an oak breadboard, and through it runs a steel channel. Sliding in the channel is a metal scale. A wire "finger" on the scale slips into notches spaced an inch apart in the channel. Thus Frank can measure the distance between the bandsaw blade and a steel pin on the scale by feeling the notches. He then impales the slab of wood on the steel pin, and knows the exact radius of the disk the saw will cut.

Flipping a switch, Frank starts the saw. Its 1/4-inch blade whines through the pine as Frank slowly rotates the slab on its metal pivot. His sensitive ear is tuned to the cutting tone of the blade, and at any given moment he has an accurate idea of

the position of the blade in its path around the disk.

Frank next places a metal bar 3/8 inch thick on the drill table, lowers the drill until it touches the bar, then locks the depth stop on the drill. Thus the drill will penetrate no farther than the preset depth.

"This leaves me enough thickness at the base of the disk to fasten it to the lathe faceplate," explains Frank.

He then uses a center finder to mark the disk, and drills the center hole to the preset depth.

He has a homemade instrument, a hardwood disk, for locating the screws for the lathe faceplate 120 degrees apart. Protruding through the disk are three finishing nails spaced to match the screw holes in the faceplate. And protruding through the center of the disk is a fourth nail. With his fingers, Frank locates the center hole used in cutting the pine disk, and guides this fourth nail into it. Then, when he presses down, the finishing nails leave impressions in the surface of the workpiece. He uses these impressions as guides for the screws in fastening the work to the faceplate.

After mounting the faceplate, he turns on the lathe, using a knee switch. This permits him to turn the lathe on or off without removing his hands from the work. He has notched the post of the tool rest so he can determine the proper working height. Blocks four inches high raise the lathe's head and tailstocks so he can make faceplate turnings up to 22 inches in diameter.

After putting on a respirator, he selects one of his carbide-tipped chisels and places it on the tool rest with his fingertips just behind the cutting edge. First he shapes the outside contour of the bowl. Then, stopping the lathe, he swings the tool rest into position for cutting the recess. His first step here is to turn a small groove about an inch from the edge.





With a drill press he drills a hole which will serve as a maximum-depth guide in his work on the lathe



Using a marking disk he made himself, he marks holes on bottom surface to register with holes on faceplate



Left, with center hole as a guide, he shapes bowl with all the skill of a sighted craftsman. He can tell his progress by touch, sound and even smell

Frank uses five grades of sandpaper to prepare the surface for finishing. The finish includes a coat of sealer, which is followed by three coats of lacquer

"Although I gauge thickness with my fingertips," Frank reports, "the groove keeps me from going astray as I rough out the interior." He also keeps his ears tuned for the characteristic hum which tells him when the bowl has been turned to the proper thickness.

Frank usually can turn out one of his handsome custom-made projects in half a day. When he's satisfied with his lathework, he smooths the surfaces with five grades of sandpaper. Then a neighbor helps him apply one coat of sealer and three coats of lacquer. As a final touch he brands his trademark, "Woods by Frank," on the bottom of his handiwork.

They are objects of art, created to please the eye by a man who has no eyes to help him. ★ ★ ★





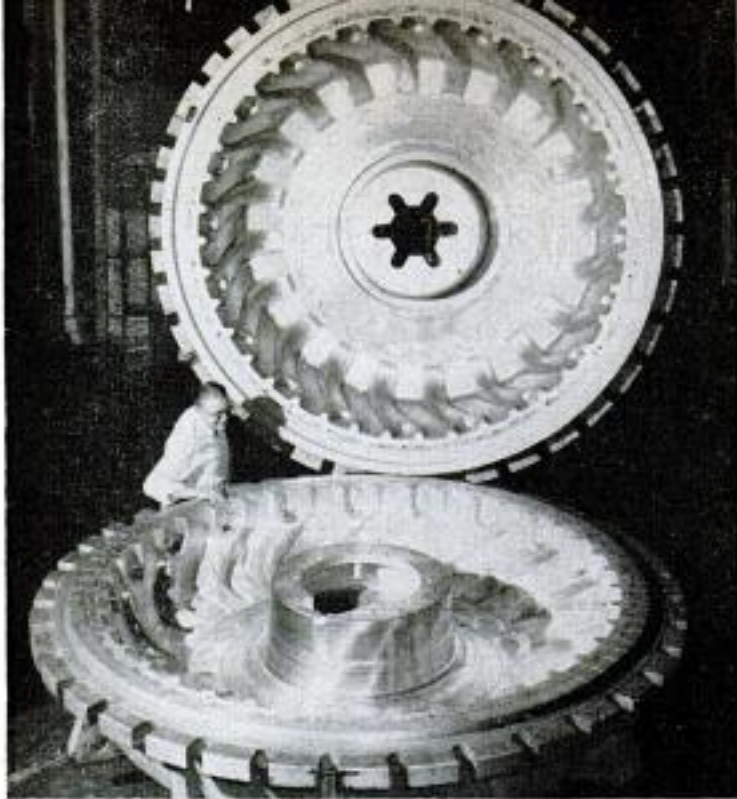

## Aluminum Mold Cures Big Tires

Weighing only a third as much as molds previously used to produce the big rubber tires for construction equipment are new aluminum casting sections. Tires that come from this mold are about 7 feet 6 inches in diameter and weigh 2500 pounds. Producing the tire mold itself was quite a feat. It required 70 separate sand sections assembled on a level concrete slab and filled with molten aluminum alloy. The aluminum mold actually will be used to cure the "green" tires after the inner tubes have been inserted. The tires are cured by heating the mold with steam to nearly 300 degrees F. for six hours while a hydraulic ram holds the sections together.



## Propeller at Bow Maneuvers Ferry

Built to handle 28 freight cars between San Francisco Bay points is the new train ferry, *Las Plumas*. Three main screws at the stern, powered by 700-horsepower diesel engines, provide a speed of 12 knots. But the ferry also has a bow propeller which operates at any angle to the keel for easy maneuverability. The vessel is refueled by rolling a tank car aboard and draining the fuel through manholes in the deck.



## Heat-Beating Steel For Fast Aircraft

Steel that will beat the heat of Mach 4—1000 degrees F. at about 2700 miles per hour—has been developed for future aircraft and missiles. It will be used as skin and in major structural parts. The stainless steel is manufactured in conventional electric furnaces and rolled on continuous strip mills. The manufacturer reports it has high strength, is easily fabricated, can be produced in volume. It also resists corrosion and is economical. The steel is made by a precipitation hardening process, a heat treatment that causes a strong bond between the minute particles of the metal, and contains 15 percent chromium and seven percent nickel.





Dazzling effect of Christmas tree under black light is achieved with various fluorescent compounds. Inset, tree under normal light

# "RAINBOWS" FROM BOUNCING ATOMS

By Richard F. Dempewolff

**L**IGHT NO HUMAN EYE CAN SEE is illuminating secrets hidden in the structure of the elements. A darkened room in an old Bayside factory, across the East River from New York's skyline,

doesn't light up when Bill Cooper flicks a switch and floods the darkness with invisible rays. But, instantly, countless excited molecules plunge the room into rainbows of blazing color.

Fluorescent paint and powders lend novelty to Christmas decorations from reindeer to "stained glass"

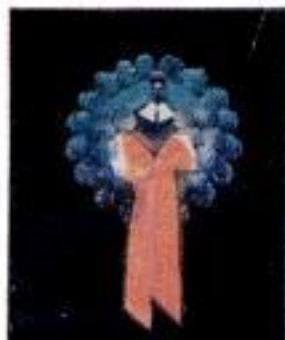



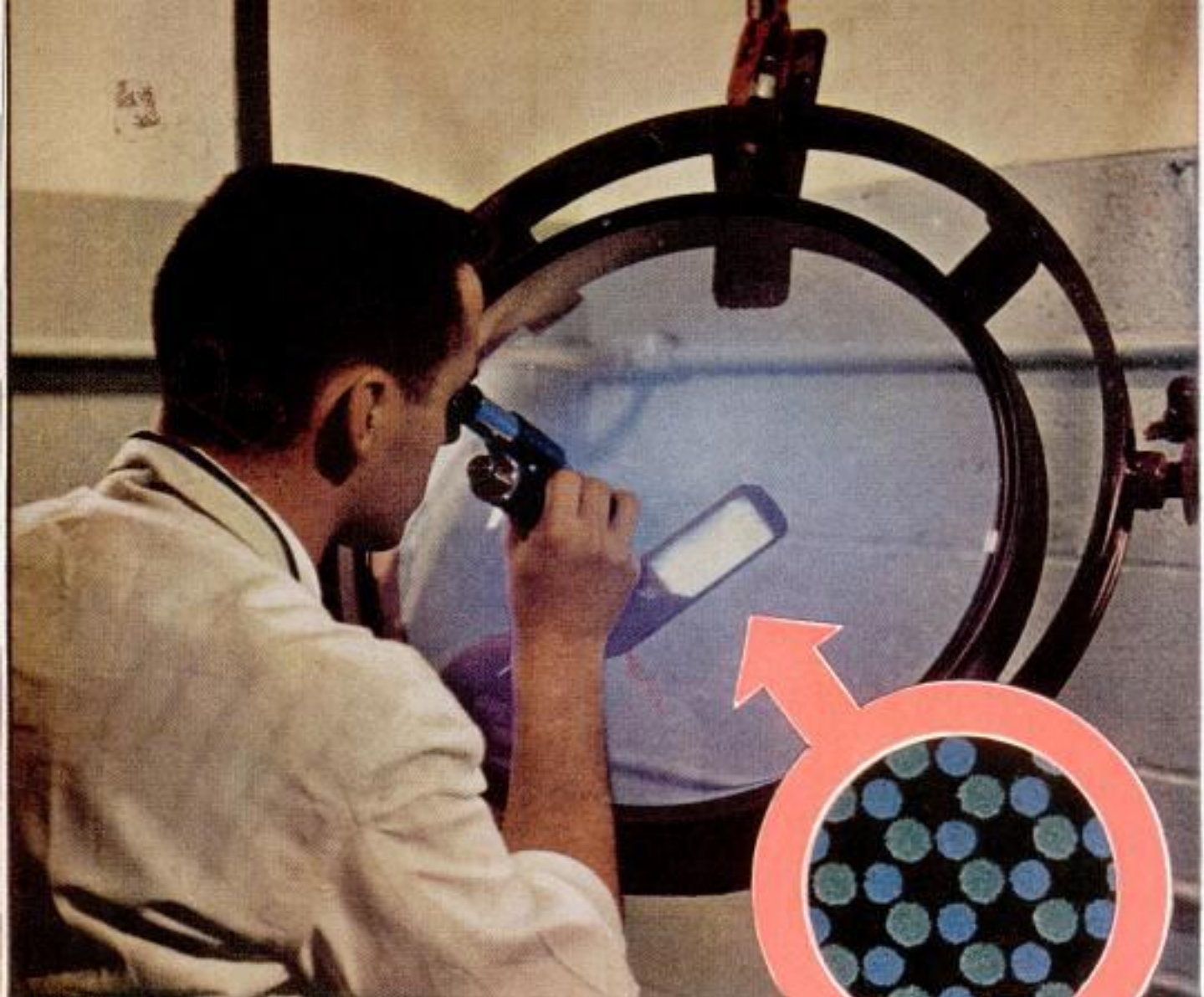

Technician at Sylvania laboratories uses black light and microscope to check blue and green phosphor dots on color TV tube

A pile of drab rocks in the corner becomes a hoard of brilliant red, green, yellow and purple gems. A seemingly blank blackboard turns into a vivid chart. Stacks of plain paper blaze fiery red and blue. Some sheets that had nothing on them are covered with luminous writing. A clutter of ordinary stamps on a table glows like tiny neon signs.

Bill Cooper, president of Black Light Eastern Corporation, uses this eerie room to amaze people — and usually succeeds. But even more amazing is the job that “short wave” light is doing all over the world. Recently, on a barren granite mountain north of Tonopah, Nev., “invisible” rays pouring from a portable lamp in the hands of a prospector struck telltale fire from nondescript gray rock, revealing one of the richest uranium strikes in the nation.

On a boat in New York Harbor, sanitation experts next spring hope to aim a similar ray at samples of water. Some, containing minute quantities of invisible dye, will glow an unearthly green and, if all

goes as planned, may finally lead investigators to sources of pollution that have been fouling the city’s beaches. Not long ago, the beam trapped a ring of check passers on the West Coast by causing a set of invisible fingerprints to glow green. It saved the life of an Air Force pilot by producing light in a smear of oil seeping from an invisible crack in the plane’s engine block.

Under invisible light, military students read complicated maps and charts in the dark. Hobbyists are building fireplaces whose rocks glow at night, and decorating homes with living colors at holiday time. Collectors are off on a new hunt — for stamps that change color and glow under the ray, and drab minerals that look like a Fourth of July display when the regular lights are out.

Ultraviolet, the invisible ray performing these jobs, is not new. Early in World War II it set airplane instruments aglow so pilots could read them in the dark. The ray was tried as a sterilizing agent, crime





When viewed under natural light, the nondescript rock above looks like what it is: willemite-calcite



Under ultraviolet, the willemite-calcite—one of the most spectacular minerals—glows in brilliant color

Uranium ore may look like this sandy-colored specimen of autunite when seen in ordinary daylight



Ultraviolet reveals concentrations of uranium ore in patches of green against bluish-purple autunite



detector and a host of other things (*Popular Mechanics*, April 1945). Recently, with the development of new lamps that are safer, more serviceable and versatile, scores of new applications are being discovered.

### Ultraviolet Is Invisible

What is ultraviolet? "First of all," explains Cooper, "it's light. It is invisible because its wavelength is shorter than the human eye can detect—just as ultrasonic

frequency in sound is beyond the capability of the human ear."

Light is measured in units called angstroms, and the full solar spectrum has 1,000,000 of them, going from cosmic rays at the low end, to infrared at the other end. All we ever see is a tiny sector of the spectrum between 3800 and 7600 angstroms on the vast scale. At 3800 angstroms, visible light is deep, vibrating violet. Below that, down to about 500, is the ultraviolet zone beyond a human's vision. Actually, this is

Bill Cooper likes to surprise visitors to his office by turning ultraviolet rays on his rock collection

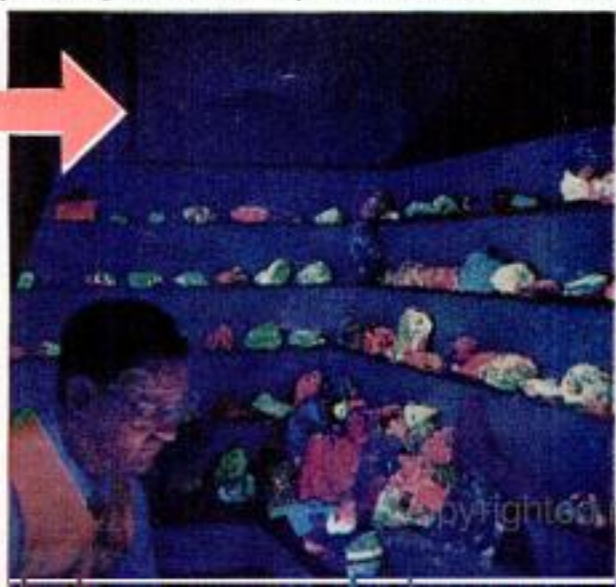
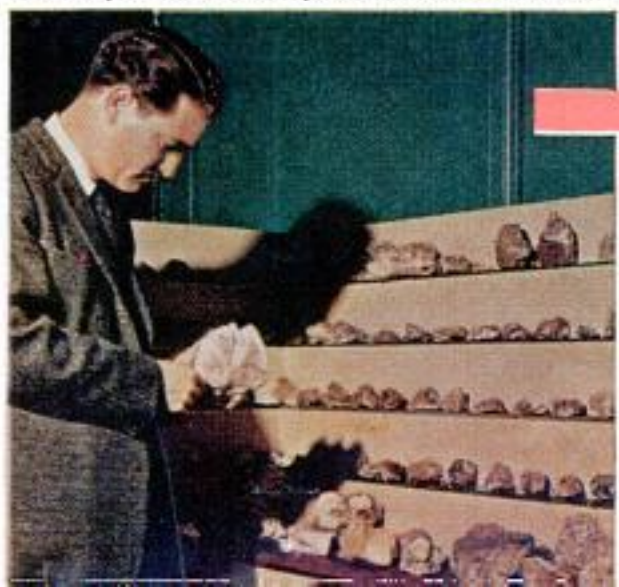





Defense plants use fluorescing pass cards for restricted areas. They glow pink (inset) under black light radiation. Sunlight has plenty of it, but only a fraction reaches the earth to give us a tan or sunburn, since it is filtered out by atmosphere. Above the ionosphere, a man would burn to a crisp under bombardment by the ultra-short-wave radiation of ultraviolet.

What modern science has done is to reproduce certain sectors of the ultraviolet spectrum with electric lamps. Usually these

This is how hands and clothing of a burglar look under black light after contact with tracer powder



are sealed glass tubes containing a gas such as argon, plus a drop of mercury. When energized with electric current, this combination will produce ultraviolet rays.

"Most people," says Cooper, "think ultraviolet and black light are the same. They're not. Black light is a name we give to 'near ultraviolet,' in the range close to visible light. This is long-wave ultraviolet, harmless to eyes and skin. It is used in homes for table displays, mineral collections, black-light kits for children, advertising and so on. Lamps giving off short-wave radiation are called mineralights because of many minerals' response to them. Mineralight radiates in the ultraviolet zones that give you a 'sunburn.' Goggles are used with them since they can damage eyes. These are the prospectors' lamps, sun-tan lamps, therapeutic and sterilizer lamps."

### 3000 Substances Fluoresce

Black light and mineralight between them cause more than 3000 known substances to fluoresce. Fluorescence occurs when the molecules in a substance absorb ultraviolet rays of certain wavelengths and react by moving around excitedly, releasing energy in the form of visible light. That light can be any color of the rainbow, depending on the substance. At home, this can provide startling displays.

POPULAR MECHANICS



Murals painted with fluorescent oils may appear like blank walls in regular light, but spring to life at night under the black rays. Nowadays fluorescent paints in all colors, for wood, ceramics, indoors or outdoors are easily acquired. Bill Cooper has a thousand suggestions. One of his friends spray-painted a piece of driftwood with fluorescent color for a lamp base. It is gray under normal light, but when the room is darkened, a hidden black light makes it glow green and it becomes a TV light.

To demonstrate the decorative scope of new materials, Cooper set up a plain Halverson Christmas tree in his office and painted it with invisible fluorescent paints, dyes, glitter dust, powders and chalks. It looked like any small white Christmas tree should look in normal light. But when the black light was turned on, coated ornaments glowed, branches glittered with diamonds, packages shimmered with ribbons of light and messages appeared on them.

#### New York's Fluorescent Aquarium

More recently, Bill set up a fluorescent aquarium in New York's Aquarium Stock Company. Invisible fluorescent red, green and blue glitter dust stained the foliage. Naturally fluorescent minerals formed the rocky background. Some sands fluoresce a yellow, and these covered the tank bottom. Invisible fluorescent paint coated the decorative objects. To top it off, a few drops of fluorescein went in the water. In normal light, such an aquarium looks like any other. But in a darkened room, a black light replacing the regular aquarium light converts it into an eerie underwater world of unbelievable color in which tropical fish move shadowlike through glowing green water.

Follow Cooper around for a day, and

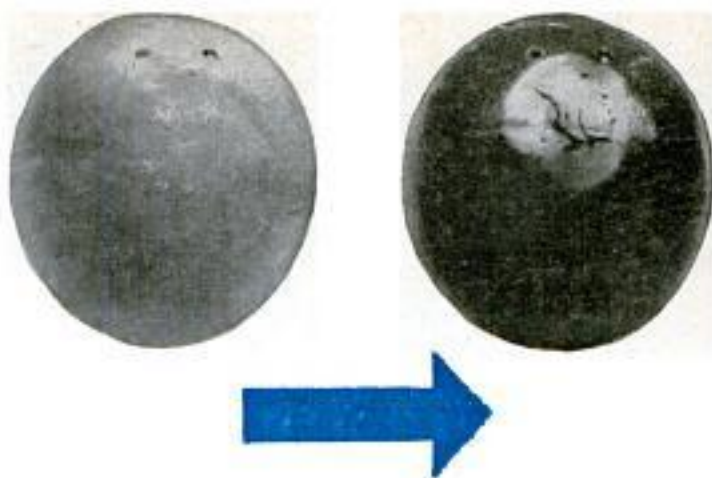

Left, orange under normal light looks healthy, but under ultraviolet, right, "invisible" green rot shows

he'll open your eyes to hundreds of items that fluoresce violently in any normal home. Petroleum jelly glows bright blue or green. So does lubricating oil. Some plastic toys and golf tees burn orange or red under the ray. Green bottle glass will often fluoresce brilliant yellow or green, due to tiny traces of uranium in it. Cheap calico may blaze up with all the colors of the rainbow. Moth balls are a vivid purple, waxes shine in many colors, and the average medicine cabinet looks like the trail of a super Fourth of July skyrocket. "Such materials are easily used in creating home-grown displays by anyone owning an inexpensive black light," Cooper points out.

Fluorescent dyes in water can produce some unique effects. Outdoor goldfish ponds, bathed in black light, become glowing fairylands when only a few drops of fluorescein are added. Out at Disneyland's Rainbow Caverns, banks of ultraviolet play across a whole series of roaring waterfalls, each fluorescing a different brilliant color

Textile worker inspects invisible patterns stamped with fluorescent ink—used as guide for stitching

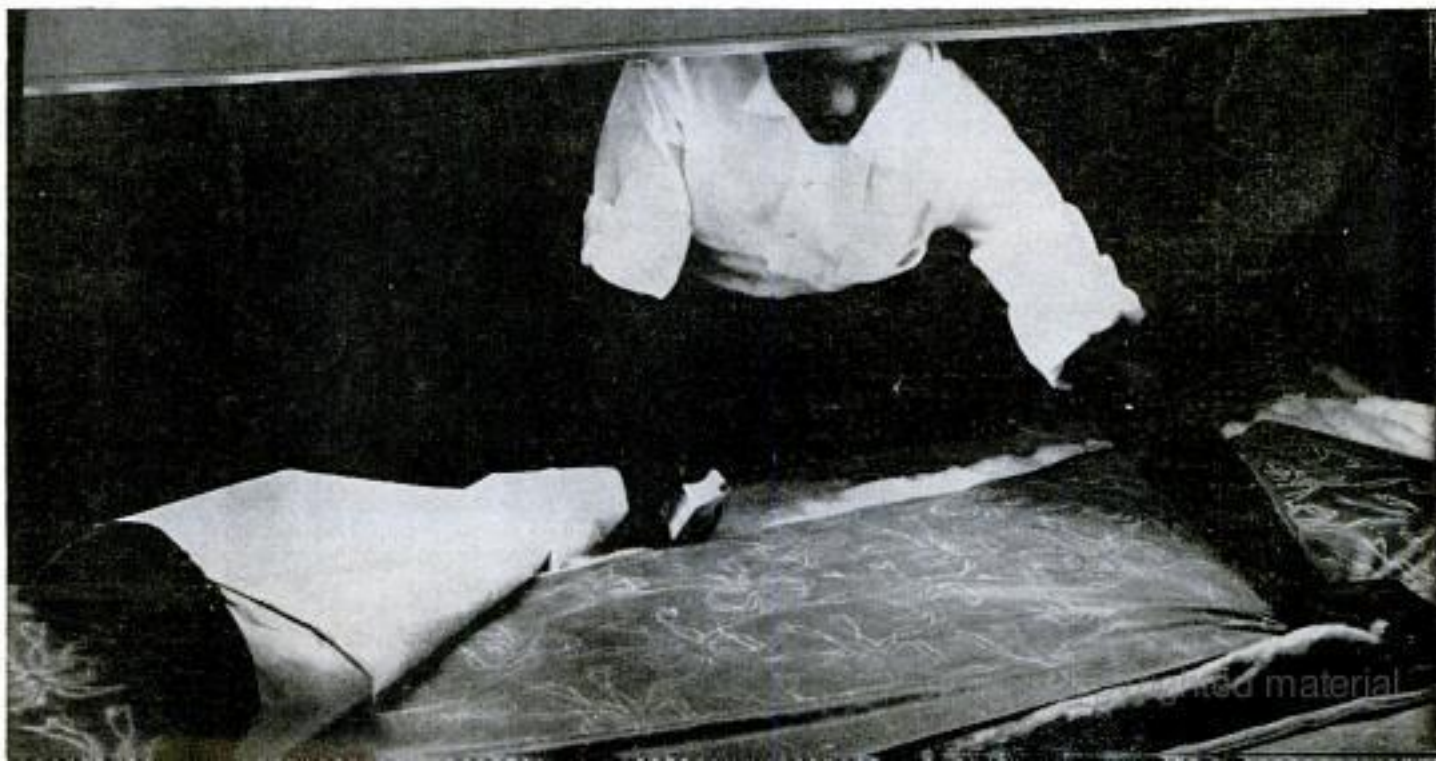



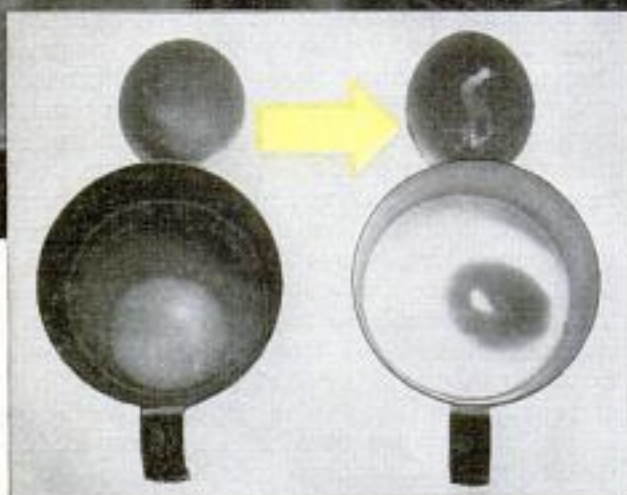
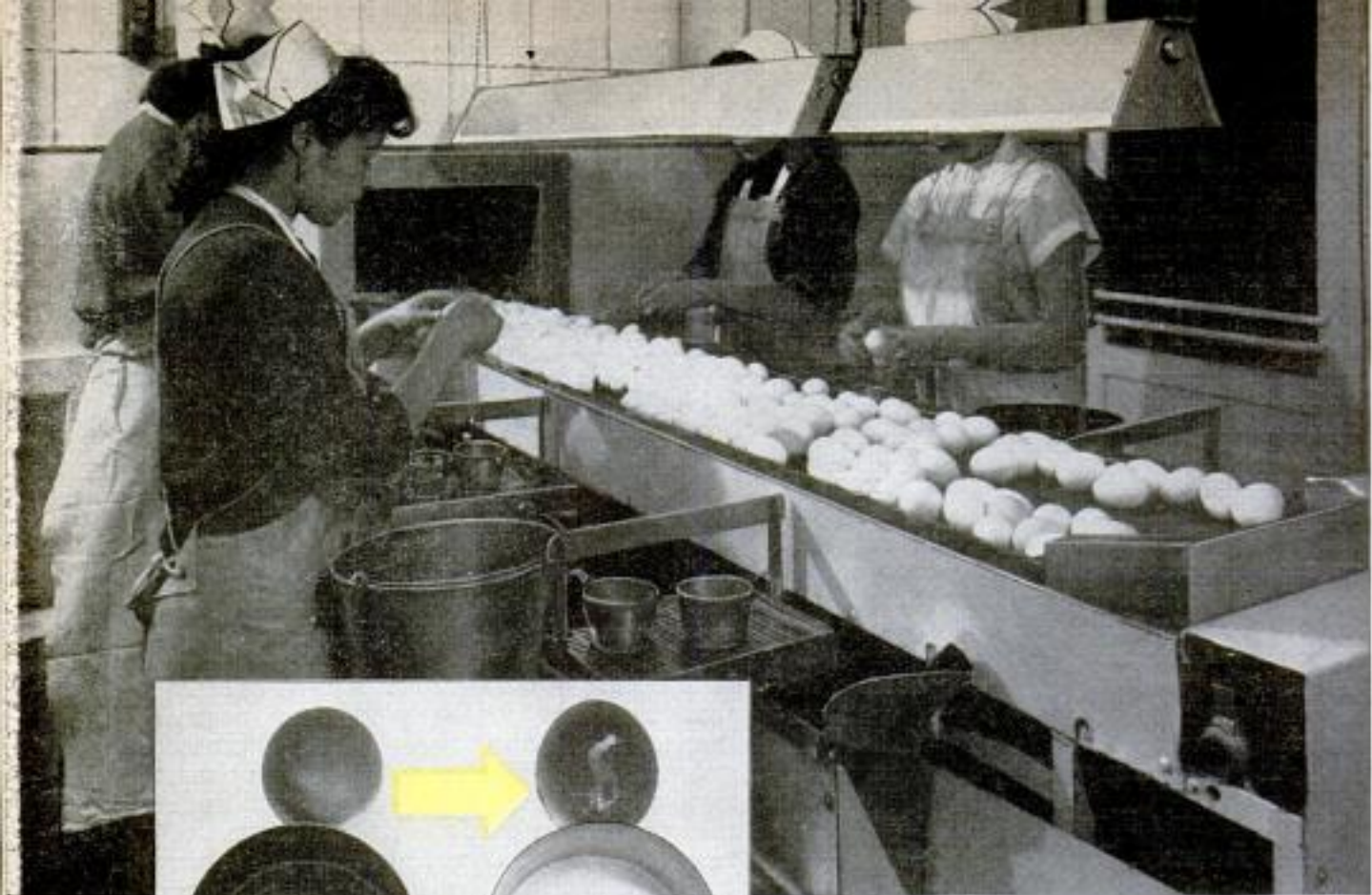

Ultraviolet lamp over egg-sorting table quickly reveals the good and the bad. Left, good egg appears clear under the lamp. The spoiled egg at right is a cloudy green color. Infection shows through shell

due to various mineral salts in solution. The effect is spectacular.

Black light has prompted a whole new field of hobbies. Fluorescent-stamp collecting is just one of them. Inks and paper used in stamps may fluoresce vividly in some issues and not others, making them considerably more valuable. One nondescript stamp in Bill Cooper's collection does a complete color reversal.

Wood carvers have found that black locust, sumac and Oregon-grape root will glow vivid shades of yellow under mineral-light if gathered during summer and fall. They use these materials for carved candlesticks, or in frames for mosaic displays of fluorescent minerals, that are hung on a wall and sprayed with ultraviolet for the benefit of startled guests. "Anyone can make such a display," Cooper reveals, "by laying a half-inch-thick frame on wrapping paper. Bits of fluorescent mineral which are collected at night with black light, are placed inside the frame. Plaster is poured over the stones, flush with the frame. When the plaster is set, turn it over, strip the paper, clean up the surface, and you've got a beautiful fluorescent mosaic."

Dr. F. L. Whiting, a New York dentist, went a step further and made a Nativity diorama using fluorescent stones for the cavelike background in which solid-gold figurines stand. An ultraviolet lamp hidden behind the boxlike frame for the display makes the entire background fluoresce. A Fifth Avenue jeweler used the piece of \$5000 craftsmanship in his show window last Christmas.

#### Many Minerals Fluoresce

Actually, hundreds of known minerals fluoresce. As a result, a new kind of rock-hound is prowling outcrops and old mine workings, hunting only stones that glow under ultraviolet lamps. Such collections, which light up in a gaudy array of spectacular color under radiation, can be interesting and valuable. Many enthusiasts keep specimens in glass bookcases, with ultraviolet lamps hidden along the sides. Some have devoted whole rooms to private "spectaculars." One enterprising collector, Walter Sutter, of Tacoma, Wash., sawed massive specimens of stone into slabs with which he built a fluorescent fireplace in his living room.



Fluorescent-rock hunting can be lucrative even for beginners. A few years ago near some abandoned mines in Franklin, N. J., where one of the greatest stock piles of fluorescent minerals in the country lies on heaps of rubble from the diggings, a mineralight rock-hound unearthed a 100-pound chunk of wollastonite that glowed a fiery orange. It sold recently for \$2500.

Most fluorescent-mineral collectors eventually get into the serious business of prospecting for valuable ores. Portable mineralight short-wave lamps are filtered to screen out nearly all stray visible light, passing only short-wave ultraviolet rays. Prowling the hills at night with these invisible beams, prospectors excite vivid color responses from rocky outcrops containing minerals like scheelite (the tungsten ore), secondary uranium ores, and ores containing production quantities of zinc, mercury and zirconium. "Since 1951," Cooper points out, "mineral light has exposed more than \$100,000,000 worth of scheelite alone by exciting its vivid blue-white fluorescence."

In the Tonopah, Nev., strike, it was a woman and her son, using mineralights, who turned up bright-yellow fluorescence in old granite outcrops—instead of the blue-white scheelite common in the area. It turned out to be autunite, a rich uranium ore. Subsequent mineralight exploration in the area turned up vein after vein of the

(Continued to page 228)



Prospector uses ultraviolet lamp to study characteristics of radioactive ore located by geiger counter

Transmission or crankcase oil leak? Mechanic, below, tests samples of oil which fluoresce differently

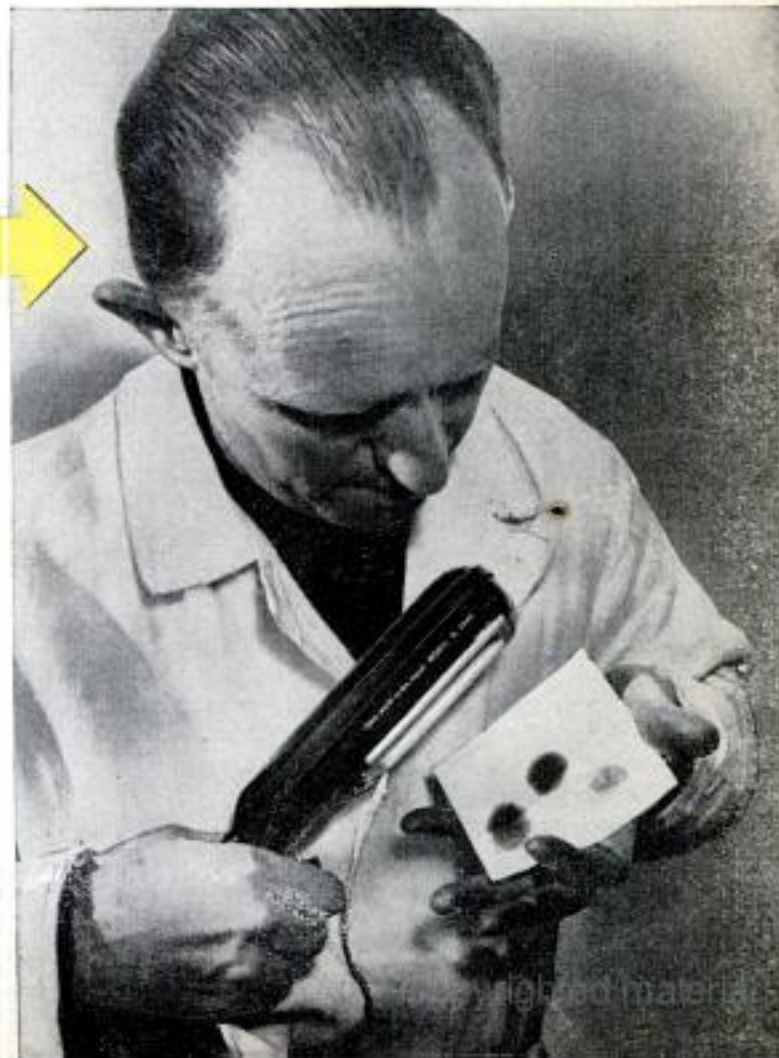





Converted from old bus at cost of \$7000, mobile kitchen is ready to handle mass feeding in emergency



Unit carries 280 gallons of LP gas, enough to operate bus, kitchen equipment and lights for 36 hours



Each cooking pot in foreground holds 500 servings

## CD Kitchen Serves 25,000

Operated by a four-man crew, the mobile kitchen of the Dade County, Fla., Civil Defense organization is geared to serve 25,000 meals a day. The meal probably would be a stew and limited to 10 ounces per person, but it would provide emergency nourishment for a community hit by a major disaster. Civil Defense officials plan a fleet of six such mass-feeding units for the Miami area. The unit in the photographs is a converted 1947 Reo bus. The frame was cut and extended 10 feet and the original gasoline engine was modified to permit the use of LP gas. All equipment operates on LP gas. The unit carries a 36-hour supply of fuel.

## "Igloos" Provide Cool Comfort in the Tropics

Igloos in the Tropics? The igloo, ideally suited to the low temperatures of the far north, now has been adapted to the high temperatures of the Tropics. Seven buildings patterned after the Eskimo's traditional abode have been built in Balboa, Canal Zone, Panama. The domes of the buildings have been painted white to reflect the sun's

rays. Roof lines extend to form visors over the windows to keep out the tropical sun and to provide protection from rain. In addition, each "igloo" is air-conditioned. The buildings are connected by covered passageways, also painted white to reflect the heat. The igloos were built for rental as business offices.

Chrysler Airtemp photo





An aerial photograph showing the USS Carronade (LST-1169) in the middle of an amphibious assault. The ship's deck is crowded with landing vehicles, including tanks and trucks, which are being pushed off the bow. Several rockets are in the air, some having just been launched from the ship's deck. The water is dark, and the shoreline is visible in the distance.

## The COVER STORY

The USS Carronade goes into action with three rockets zooming shoreward and another igniting in launcher

*By Joseph Stocker*

**I**N ANY AMPHIBIOUS ATTACK during wartime, one of the major requirements (along with sturdy foot soldiers who don't mind getting wet) is offshore fire support.

In the Pacific fighting of World War II,

this role was largely filled by destroyers and cruisers. But they couldn't get in close enough to suit the Navy—or the Army either, for that matter. With the development of rockets after the war, the Navy converted some of its LSMs (Landing Ship





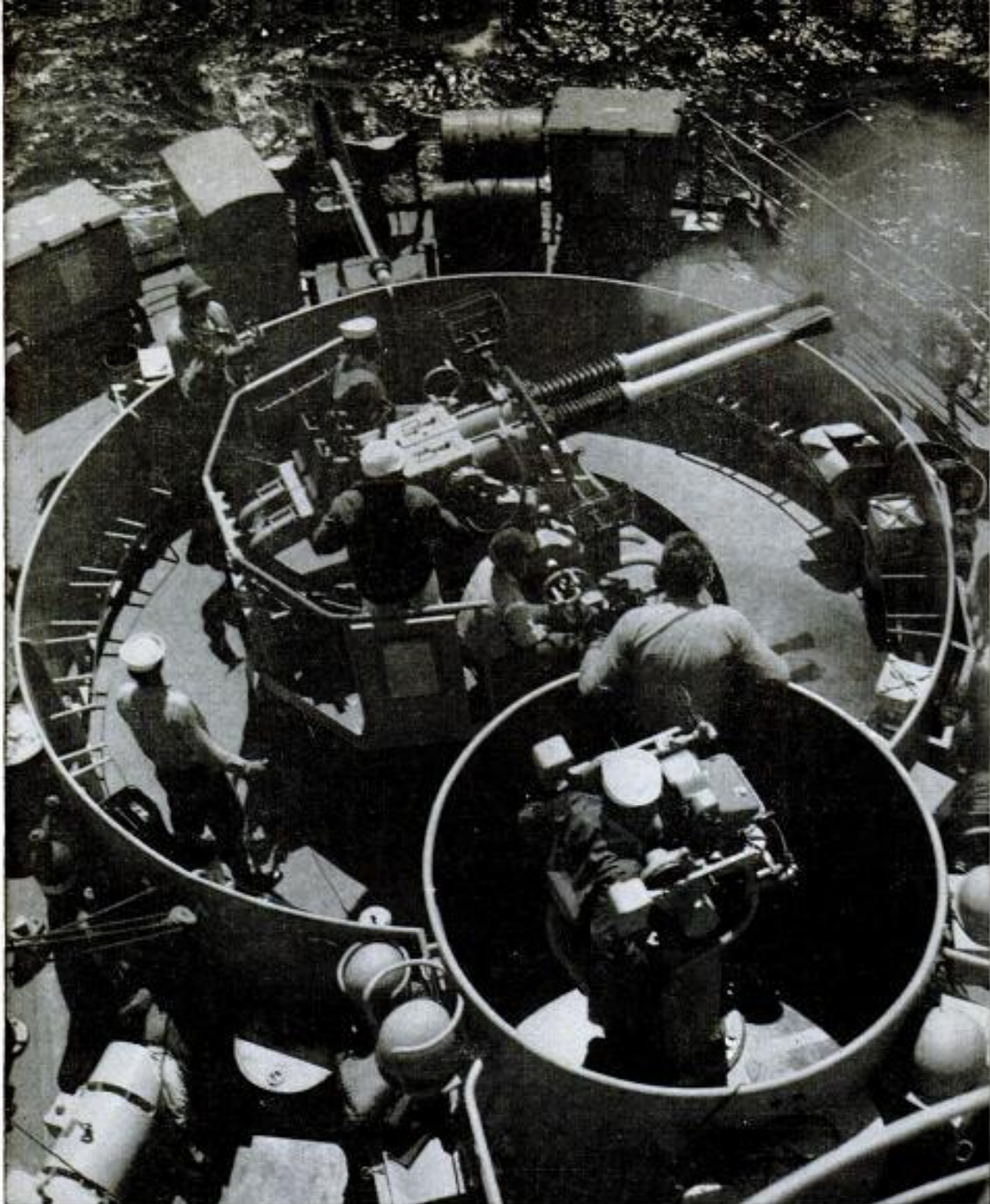

**Carronade has conventional weapons, too. Here, 40-millimeter cannons provide support and protection fire**

Medium) into rocket launchers for offshore bombardment. But the LSMRs, as they became known, didn't have the speed or maneuverability that was needed, or an adequate fire-control system.

Today, however, the Navy thinks it has the problem licked. The answer? The USS *Carronade*, a doughty and quaint-looking little bobtailed craft with speed, maneuverability and almost as much firepower as a cruiser.

The *Carronade*, first of what the Navy anticipates will be a long and distinguished line of vessels, is known technically as an "inshore fire-support ship." She derives her name from a naval gun developed in

Scotland and first used by the British against the American colonists in the Revolutionary War. She can clip off 17 knots (to the LSMR's 10 knots). She packs eight twin rocket launchers—stubby little weapons scarcely higher than a man's head. And she has controllable variable-pitch propellers which, according to the Navy, make her "nearly the most maneuverable ship afloat."

The *Carronade's* launchers are capable of firing rockets at far greater speed than the old LSMR. Her fire-control system, built around a new-type computer, makes possible a shore bombardment of unprecedented accuracy.



Electronic brain in computer room automatically regulates launchers, fires rockets by remote control, either singly or in salvos with pin-point accuracy

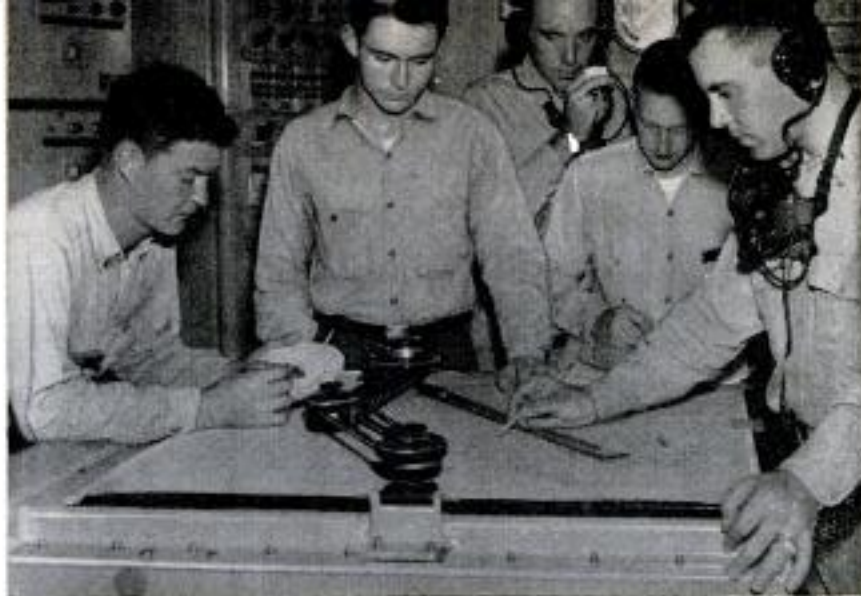

The *Carronade's* five-inch rockets pack the same punch as shells from a five-inch gun. They are spin-stabilized for accuracy and have an effective range of up to six miles. Several salvos can be fired per minute.

In action, the ship launches its rockets by remote control. No one is on deck. Down in the magazines the handlers load

two rockets into a hoist and press the compressed-air button that shoots them up into position in their launcher. In the computer room, meanwhile, an electronic brain is digesting such information as speed, course, roll of the ship, and distance and direction to the target. Then it automatically turns the launchers and points them at the correct angle. A single rocket or a

Ship's foredeck bristles with eight of these twin launchers. Five-inch rockets have a range of six miles

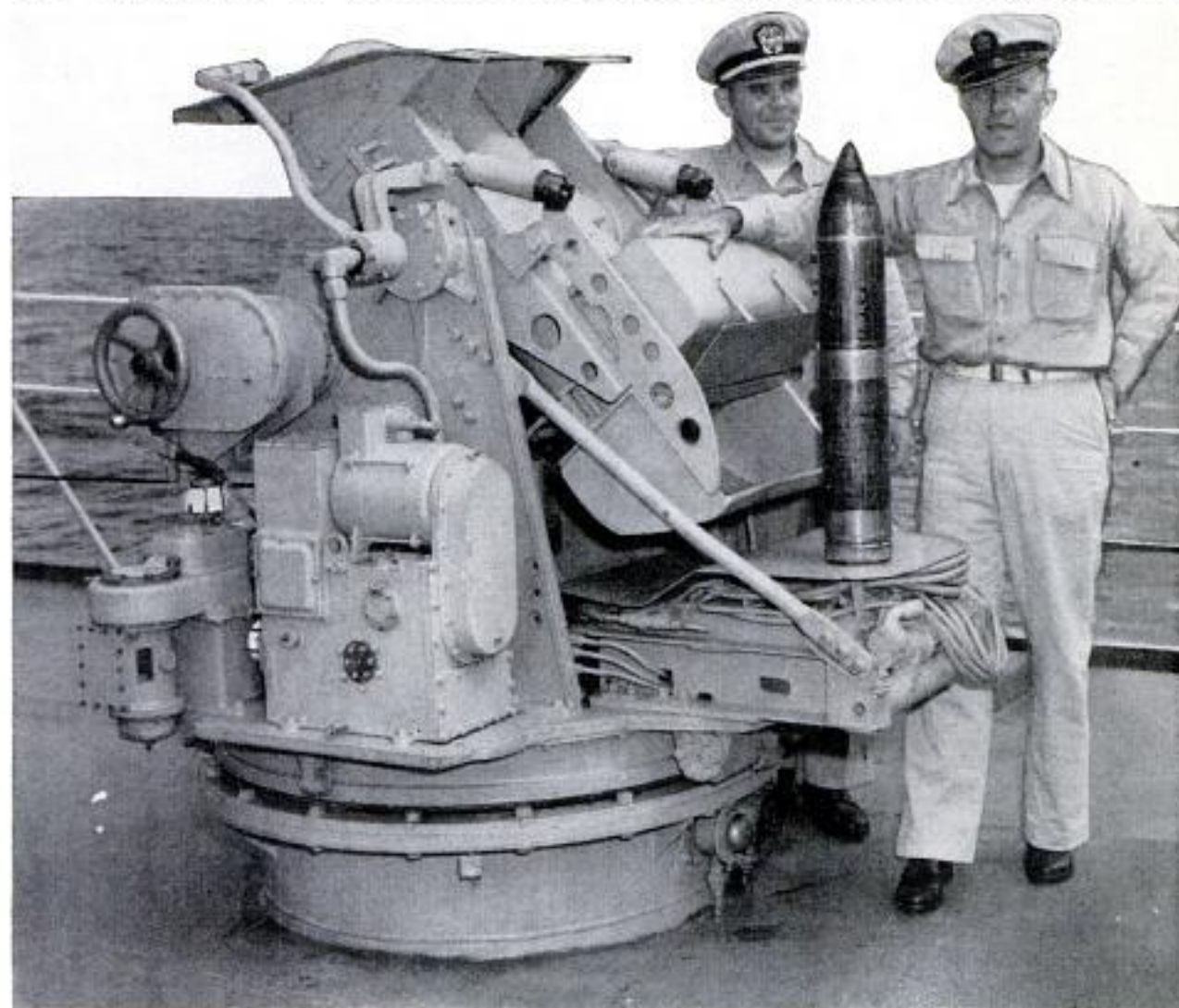



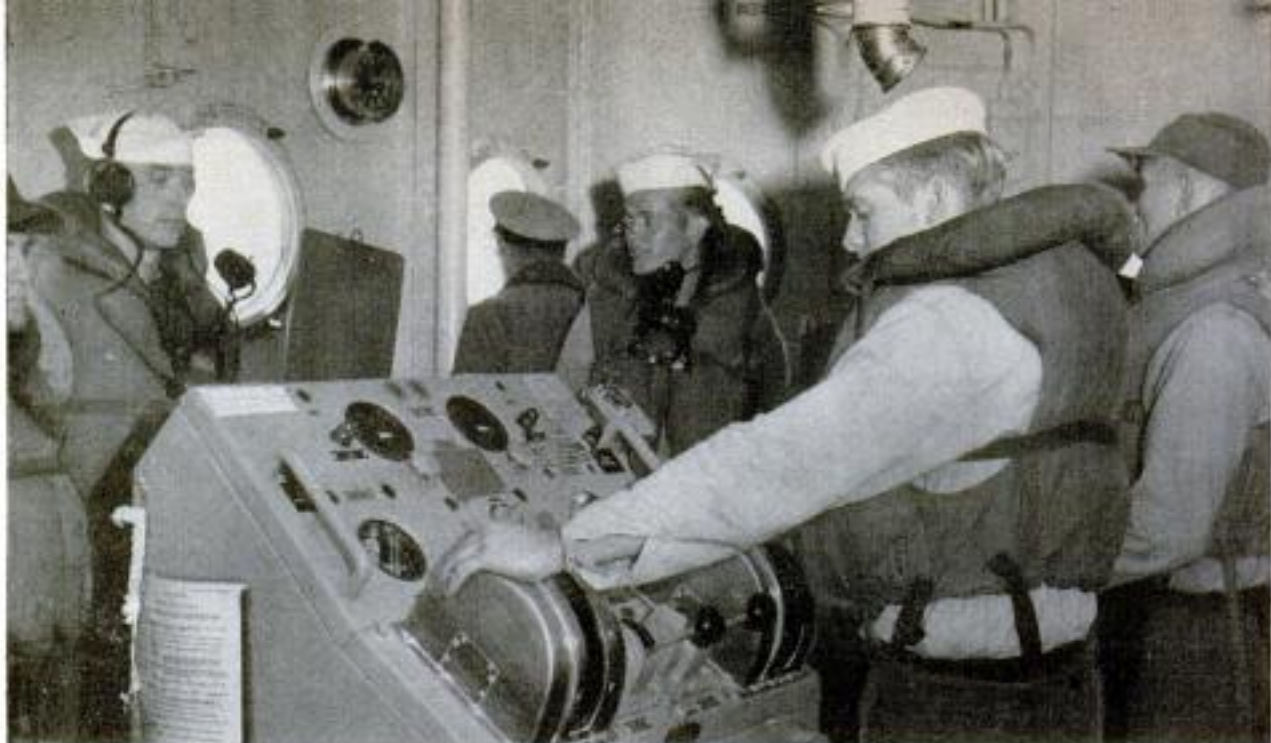

*Carronade's* nerve center is bridge. She can attain the high speed of 17 knots, is extremely maneuverable

complete salvo can be fired by pressing the proper button.

Immediately after a salvo is fired, the handlers in the magazines load more rockets into the hoists and send them on their way. Within seconds the ship is ready to fire another salvo.

Ten years ago, rockets like these were

not especially accurate. They were regarded as an area weapon. Today accuracy has been stepped up to the point that the gunnery officer on the *Carronade* is apt to be told: "Target, moving tank just below the clump of trees bearing 135 degrees!"

But the *Carronade* has still another  
(Continued to page 236)

Range finder provides data for computer. When off-duty, sailors enjoy the most luxurious ship in the Navy





## "Drive Through" Auto Ferry



Someday an airline passenger will be able to drive his automobile into the rear of a British-built plane, fly economically to his destination, and then drive away out the front of the craft.

These are the specifications of a new airplane that will carry 30 tourist coach passengers in its top deck and six automobiles below. The cars will be able to drive straight through the fuselage using doors at both ends.

The plane is being built by the British firm of Hawker Siddeley, manufacturer of the Hawker Hunter and other military aircraft. A prototype is scheduled for completion next year.

It is designed to be a medium-range, economical multipurpose airplane to provide passenger and freight service at low cost. Powered by four Rolls-Royce turboprop engines, it will have a cruising speed of 300 miles per hour at 25,000 feet altitude and a range of over 2000 miles.

An all-air-coach version would carry 80 passengers, a military type would transport 70 troops and their accessory equipment and vehicles, and an all-freight adaptation would have a pay load of more than 25,000 pounds.

Initially, the British firm plans to build 10 of the airplanes, and hopes to sell them there and in other countries.

### Five-Ton Roller Made From Culvert

Crushing the lumps of plowed soil is sometimes necessary in irrigation farming. A Colorado farmer does this with a roller he made by filling a section of 36-inch culvert with four tons of concrete. Axle and tongue add another ton of weight.



### Tractor Moves German Farmer

When a farmer in West Germany moved into a new home recently, he found the stairway was too narrow for some of his furniture. He solved the problem by loading the furniture on the fork-lift attachment of his tractor and raising it to a second-floor window.





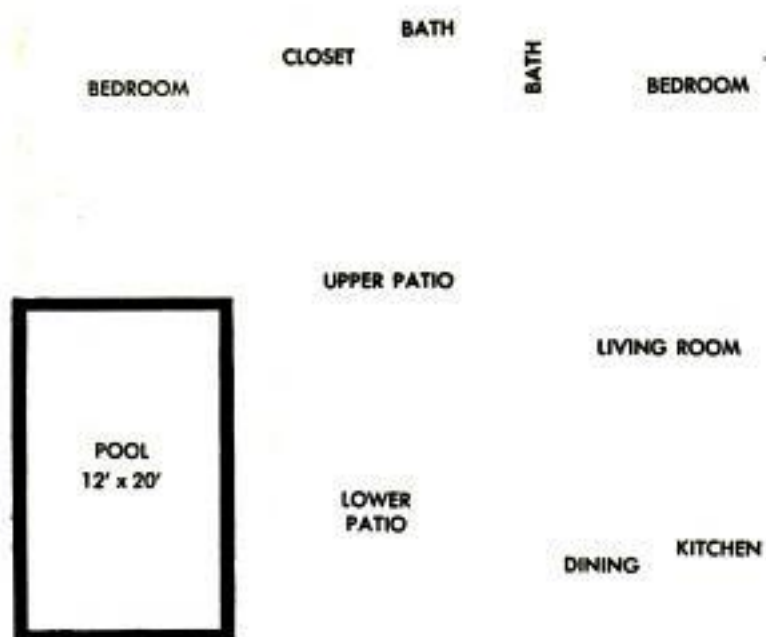
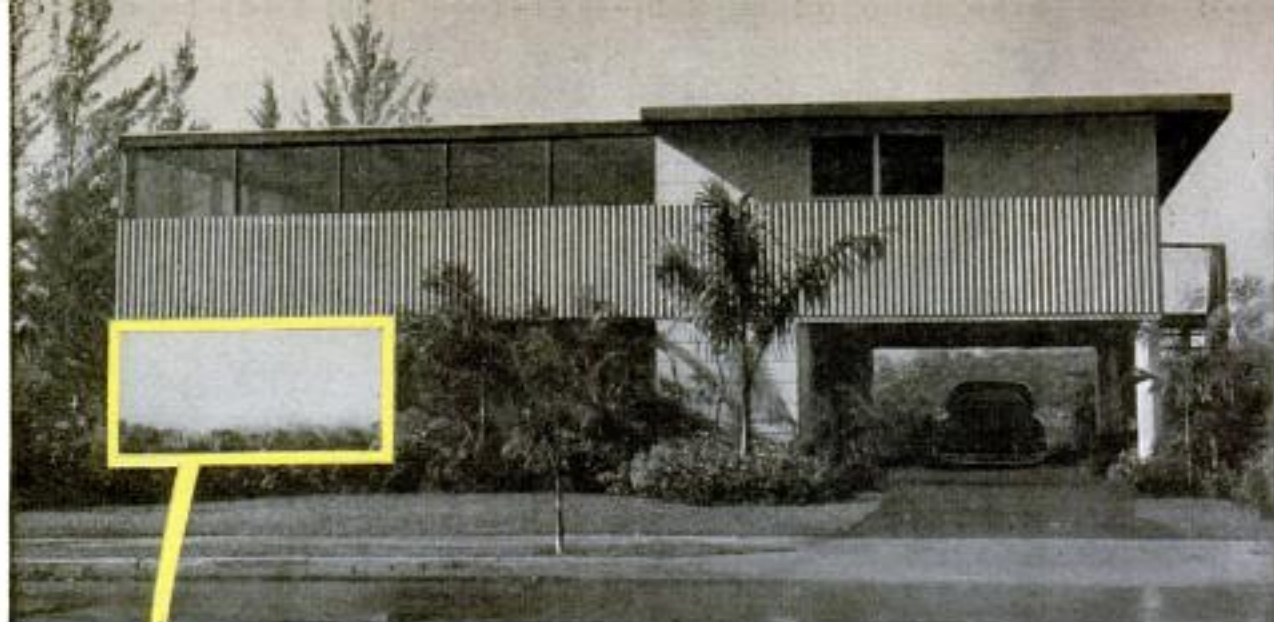

Compact house has outdoor-living areas, including the swimming pool and patios, all under the roof. The living quarters are on second floor

This view is from lounging area at end of swimming pool and looking across the upper patio into living room. Glass doors are pushed back



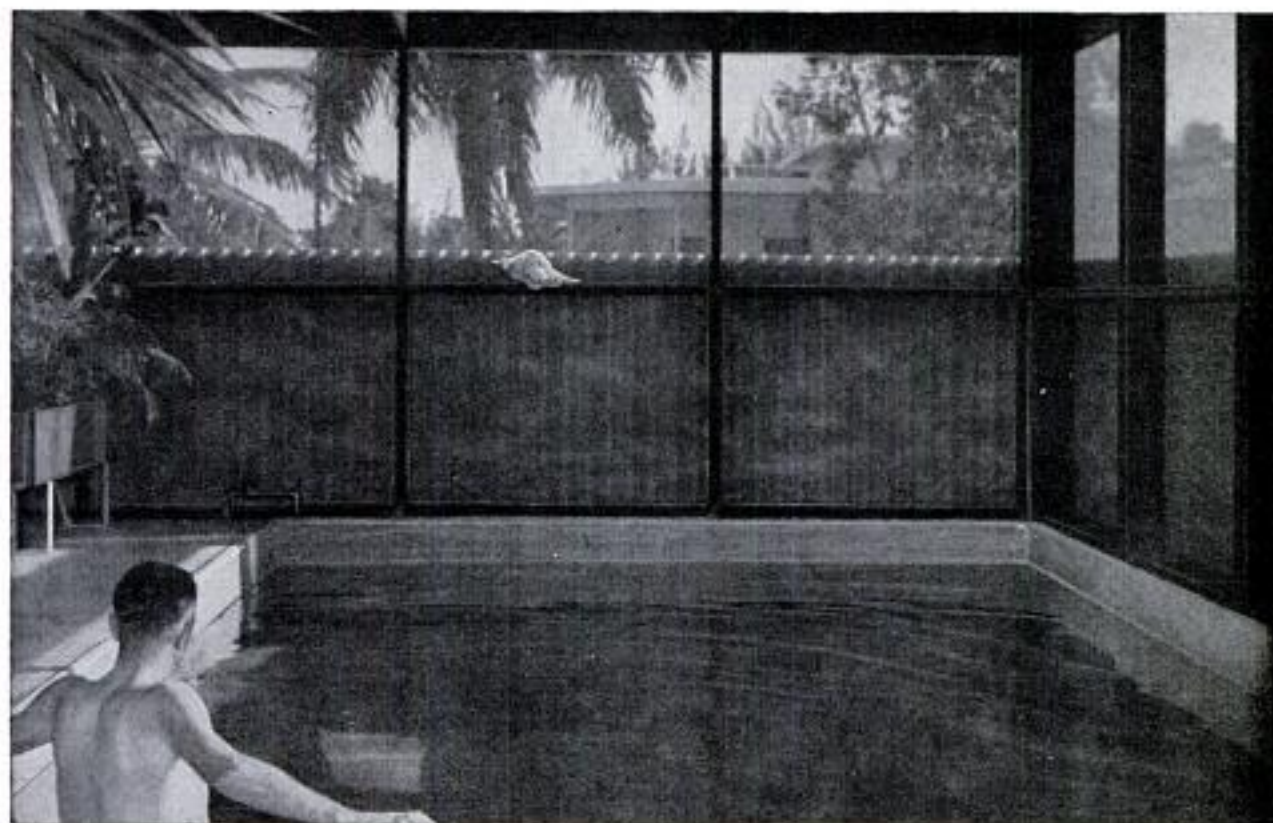

Surface of poured-concrete pool is at second-story level. Corrugated panel outside screen gives privacy

*By Edward Dickson and Max Hunn*

**T**HE OUTDOORS comes indoors in a house owned by John E. Turner of Miami, Fla., and the key to the structure's unusual design is an upstairs swimming pool.

By going to the second floor with his pool, Turner was able to assemble under one roof on a comparatively small lot a two-bedroom, two-bath home, complete with living room, dining-kitchen area, a pool and sun terrace, spacious patio, carport and utility room. He achieved complete privacy, too.

It was quite a design problem which Turner handed to his architect, Ralph A. Anderson. He wanted to build on a 70 by 80-foot lot. He wanted a good-size home, but he also wanted a swimming pool and a patio for relaxation. Because the lot is just a stone's throw from Biscayne Bay,

there was the problem of minimizing the remote but possible danger of damage from high water swept in by a hurricane.

As Anderson finally designed the house, all essential living quarters are on the second floor, with easy access to the 12 by 20-foot swimming pool and a spacious lounging terrace. On the first floor, Turner obtained his roomy patio, floored in cast stone, and has landscaped it with plants, including palms which extend upward in the house to reach above the balcony of the sun terrace on the second floor.

The home has limited yard space but, as compensation, Turner has his shrubbery growing indoors and he has a type of privacy that permits him to entertain at barbecue and swimming parties out of view of neighbors or passers-by.

The house is 47 feet wide and 41 feet





Glass-block window in wall of the swimming pool affords underwater view from the first-floor patio. Trees and shrubs carry out tropical scheme, some extending to second floor. Below, the second-floor patio provides plenty of lounging space near pool

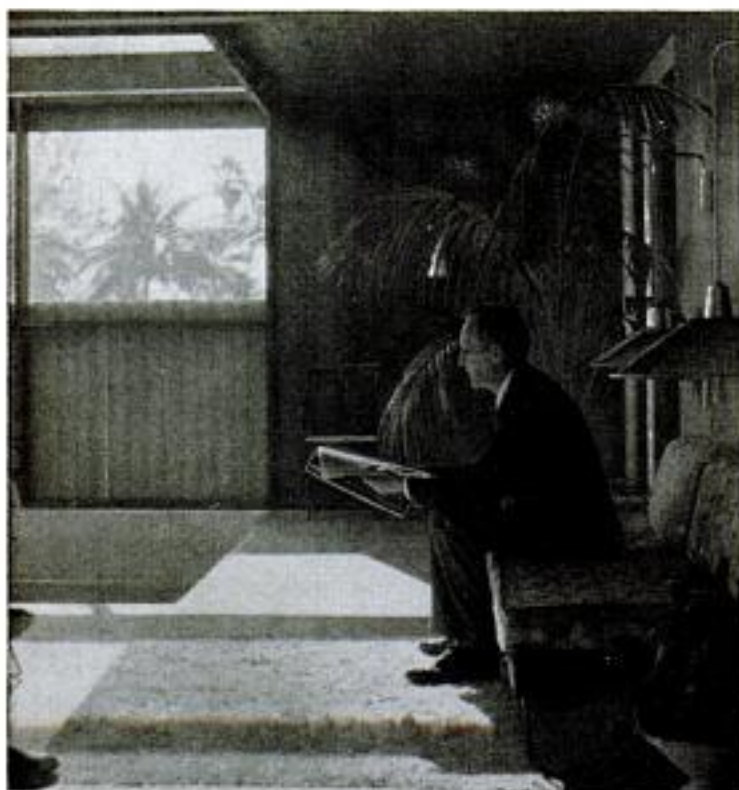

long, of concrete-block construction. Inside there are two distinct areas—the outdoors, represented by the first-floor patio and the upstairs swimming pool and terrace; and the indoors, the upstairs living quarters which can be shut off by sliding glass doors. The pool is supported by the same pilings which were required for the foundations for the entire building; the poured-concrete pool is simply set above rather than into the ground. Pumping-and-filtering equipment for the pool were installed in one corner of the downstairs patio. Screens of matchstick bamboo were hung in this corner to conceal the equipment.

### House Is Compact

By putting the pool upstairs and leaving the first floor as a patio, Anderson was able to compress into a comparatively small area the same features which would sprawl over a large lot with a one-floor structure and outdoor-living areas. At the same time, he has elevated all essential portions of the house above any high-water danger mark.

The house is entered through a door in the carport. Inside you are in a screened garden area used for "outdoor" barbecues. Just opposite the door is a glass block set into the concrete wall of the swimming pool. Through this you can look into the interior of the pool at subsurface level.

### Stairs Lead to Pool

Wooden stairs lead to the second floor. There, you turn to the left to the sun terrace and pool, or to the right to the living quarters. The terrace-pool area is screened with plastic which lets in the sun and keeps out insects.

The use of redwood, oak and fir in walls, floors and ceilings of much of the living area gives a warm contrast to the concrete used in the pool area. Sliding glass doors in the living section can shut off the "outdoors" in cool weather without affecting the view. To increase privacy, Anderson used a panel of corrugated weatherproof material as a shield at pool height around the screened area and across the front. The house cost \$26,000. ★ ★ ★



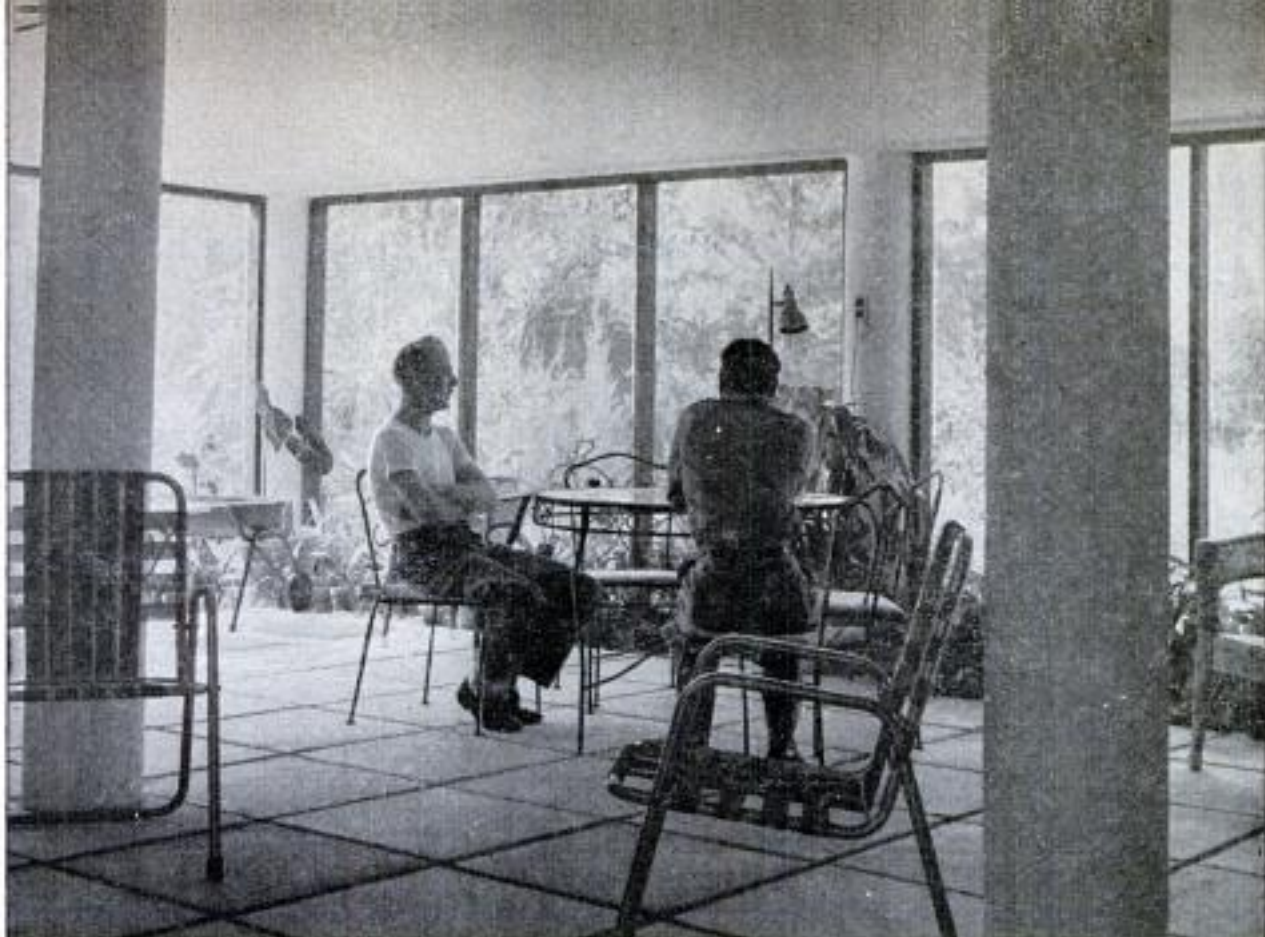

This sunny enclosure is on the first floor behind the swimming pool. Here Turner gives "outdoor" barbecues

Windows along interior wall of dining area provide view across well of lower patio to the swimming pool

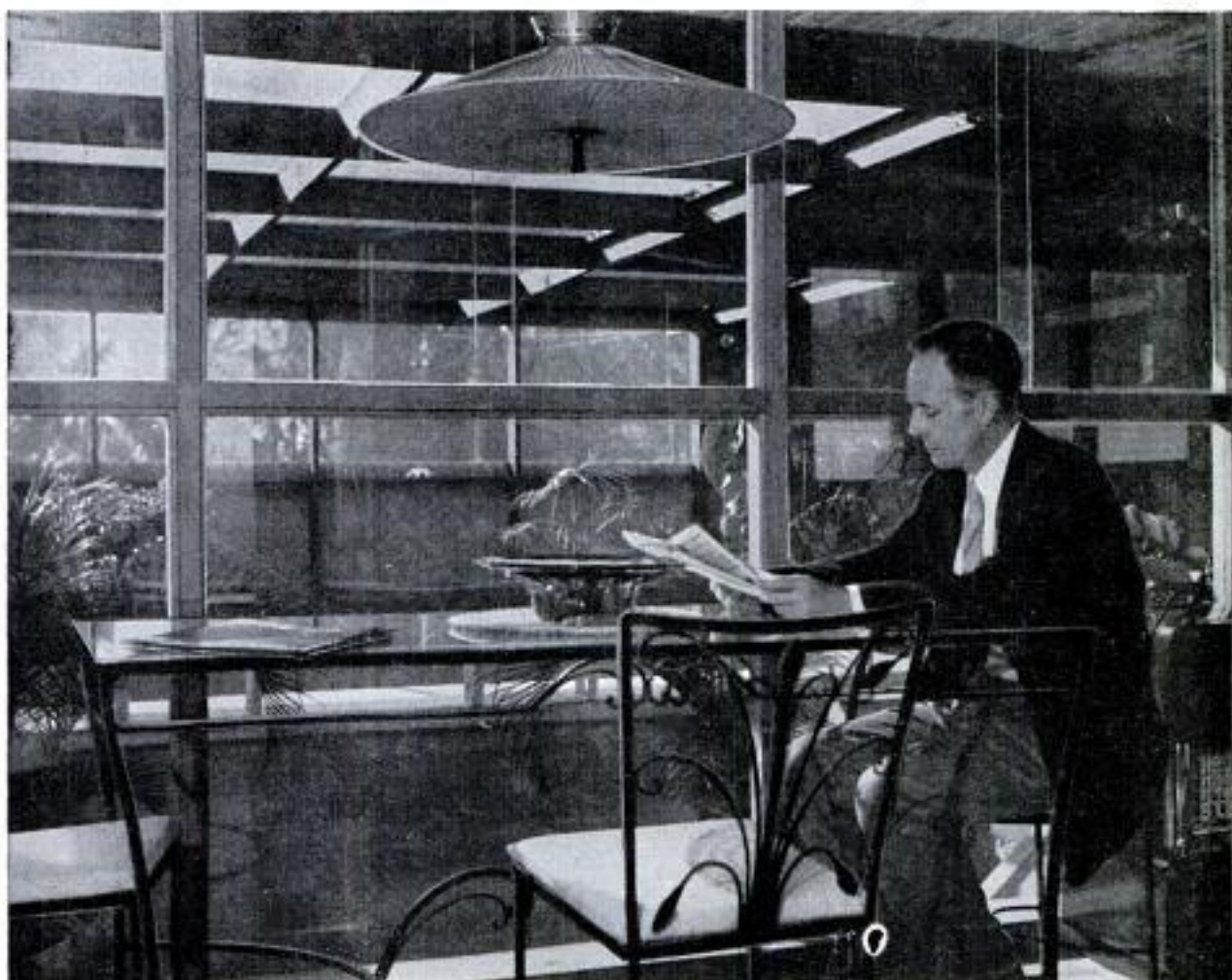



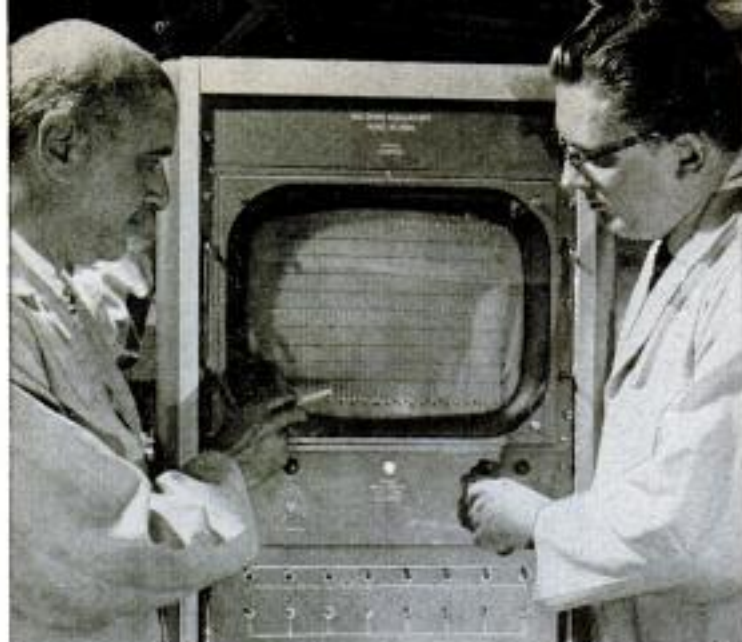

## Bar-Graph Oscilloscope Does Job of 40 Meters

Data from 40 different sources can be measured simultaneously on an electronic bar-graph oscilloscope developed by the International Telephone and Telegraph Company. The scope can be used to study strain at various points along an airplane wing or numerous heat characteristics of an object. Previously, it would have been necessary to have 40 separate meters around a laboratory to measure the data that can be projected on the electronic bar-graph.

## Safety Link on Hoist Prevents Electric Shock

Insulated by a new safety link, hook tenders are protected from electrocution if a crane's boom or cables accidentally touch a power line. The cylindrical link is made of plastic and glass fiber with steel connectors at each end. The links can support up to 25 tons and offer protection from as much as 50,000 volts of current.

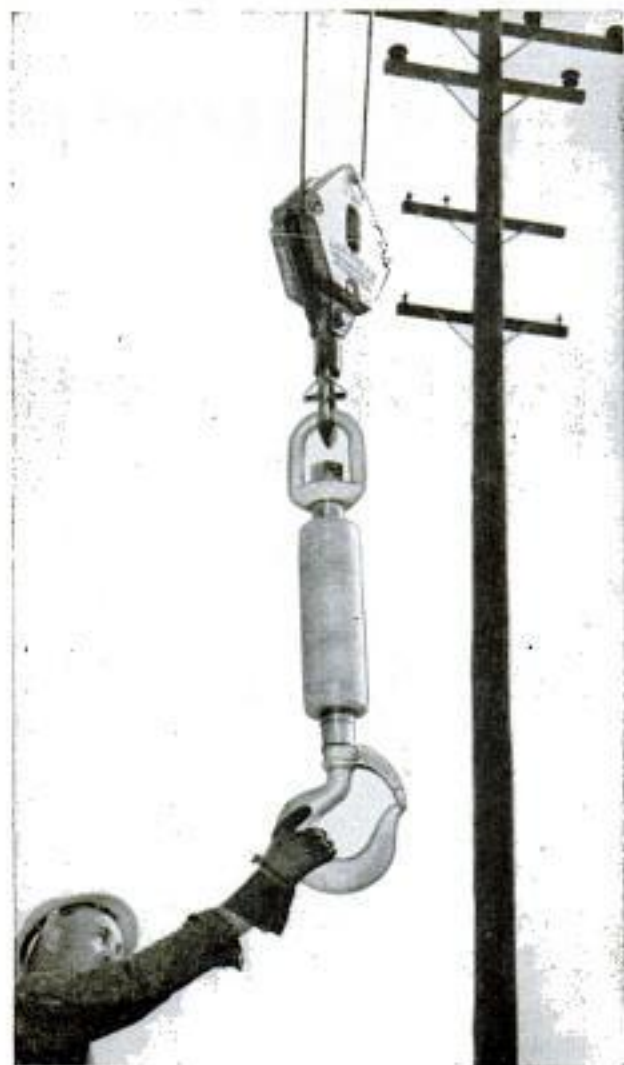

130

## Quick Radioactive Test For Moisture or Density

Operating on the principle that different amounts of moisture and density cause a varying degree of radioactivity "scatter," a new field instrument can measure moisture content or density of materials in two minutes. Moisture is measured with a radium-beryllium probe, while density is tested with a cesium-137 probe.



POPULAR MECHANICS

Copyrighted material





## Jet Interceptor for U. S. Air Force Flies 1500 M.P.H.

Newest and fastest all-weather jet interceptor in the U. S. Air Force is the F-106A. Called the Delta Dart, the plane can fly about 1500 miles per hour. It resembles the F-102A, except it is larger and the

vertical stabilizer has been squared off. Both planes are used by the Air Defense Command. The Delta Dart is equipped with the most advanced electronic fire-control system ever developed.

## Three-Stage Parachute Saves Pilot in Ground-Level Ejection Seat

For the first time in this country, a man has been ejected from an airplane at ground level and parachuted to the ground uninjured. It was a demonstration of a new ejection seat. A young flyer was ejected from a two-seat Grumman Navy jet fighter during take-off. Three stages of parachutes

opened for his descent to the ground in five seconds. Nearly two thirds of jet aircraft fatalities occur either on take-off or landing, when pilots do not have time to bail out, and 94 percent of the resulting crash landings cause fatalities. The ejection seat was designed by a British firm.

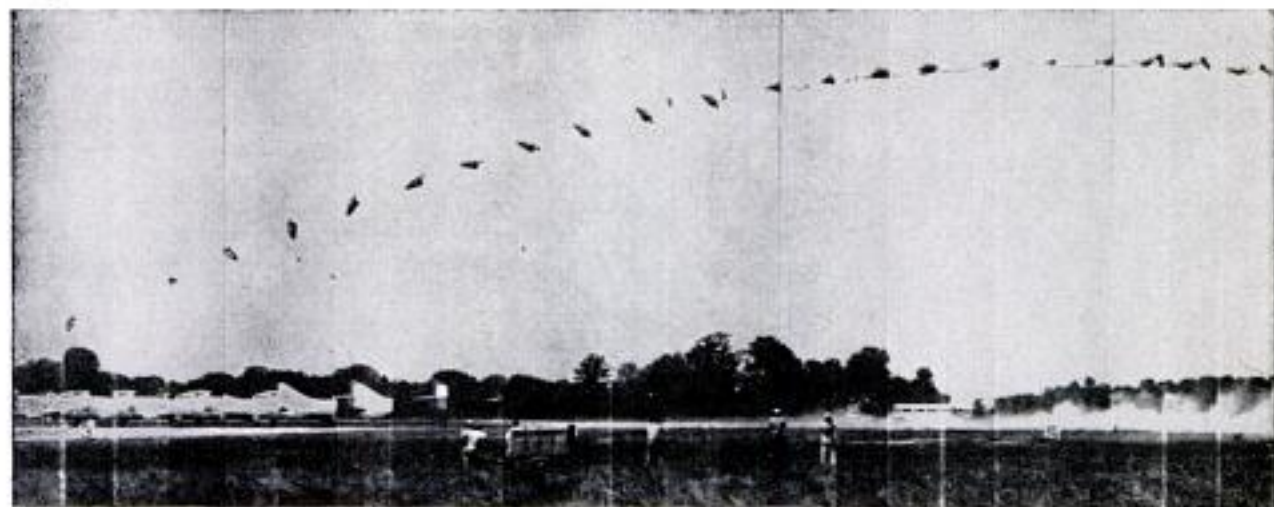





### **British "Bloodhound" Tracks Enemy by Radar**

Scheduled to replace fighter aircraft as England's first line of defense is the new surface-to-air supersonic guided missile with the appropriate nickname of "Bloodhound." Manufactured by the Bristol Aero Company, the Bloodhound has a reported speed of more than 2000 miles per hour. The missile is powered by a Thor-type ramjet engine. The British announced that the new missile will be able to track down enemy weapons by radar. The U.S. Bomarc surface-to-air missile has a reported speed of approximately 1850 miles per hour with two ramjet engines.



### **Electric Eye Adjusts Lens For Automatic Camera**

Movie makers no longer need to miss action scenes while they check the light meter and adjust the lens. A new eight-millimeter camera has a photoelectric cell which automatically adjusts the lens iris as the sunlight or artificial light changes. It can adjust the aperture from f:1.9 to f:16 in less than a second.

### **Metal Measuring**

University of Wisconsin chemists have developed a rapid method for measuring metal in solutions. This electrolytic technique is so precise it can measure one part of lead in five trillion parts of solution.



### **Four-Passenger Isetta Has One Rear Door**

Displayed in Munich, Germany, is the "large, family-sized" Isetta, a somewhat grown-up version of the Italian firm's two-seater "motorcoupe." Like the original model, the four-passenger car has the front entrance that swings up. It also has one rear door, on the right side, for entrance to the rear seats. The two-door model has a 19.5-horsepower engine mounted in the rear and reportedly gets about 40 miles per gallon of gas. The new model has a top speed of about 60 miles per hour, according to the manufacturer.



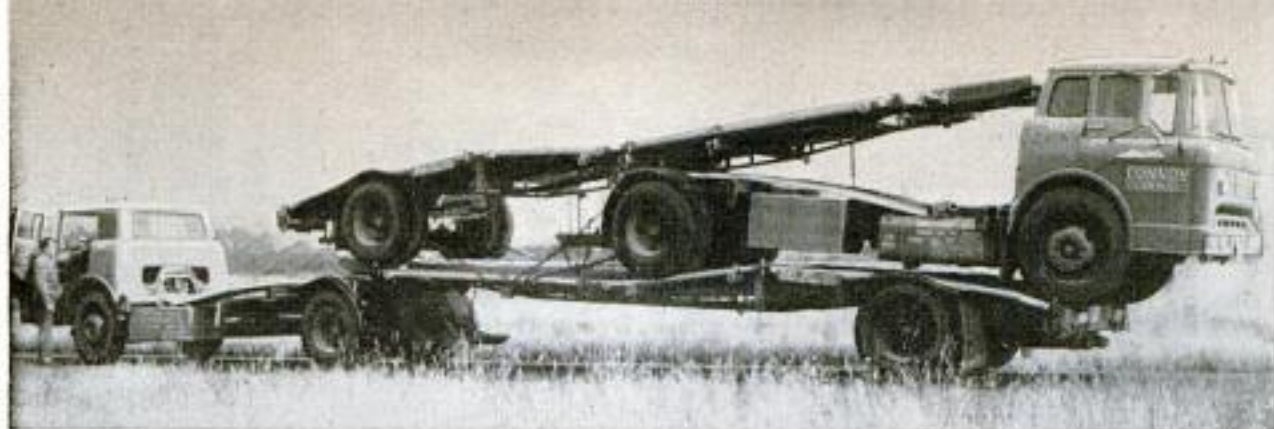

## Big Tractor-Trailer Hauls Twin on Its Back

First there was piggyback, now there's a new one—"truckyback," one complete tractor-trailer hauling another. The equipment was designed by a Portland, Ore., trucking firm to avoid "deadheading" rigs, which costs time and money. It

was made possible with the use of aluminum in fabricating the lighter, sturdier auto-hauling trailers. Total weight of the tractor and trailer is 16,000 pounds. The unit can carry a gross weight of 40,000 pounds or a duplicate of itself.

## Surprise!

Marines now are taught to use inflatable life rafts as "secret weapons" for investigating enemy-held terrain. The enemy observes what is apparently an abandoned, overturned raft. Clinging to the underside, their heads in the air trapped beneath it, are reconnaissance scouts who use the craft for cover while scouting the shore.



## Portable Electric Bomb Hoist Developed for Navy Planes

Weighing considerably less than manual bomb-hoisting gear now in use is a 47-pound portable electric hoist developed for the Navy by the Douglas Aircraft Company. The new rig will lift a 2500-pound load at a rate of 15 feet per minute. For loads up to 5000 pounds, the hoists can be

used in pairs. The electric hoist permits safe bomb lifting with  $\frac{1}{32}$ -inch accuracy. The unit requires a single electric cable connected to a deck-edge receptacle or a portable power supply. A hand crank on the cable drum operates the hoist when electric power is not available.





# PHOTO TIPS FOR PHILATELISTS

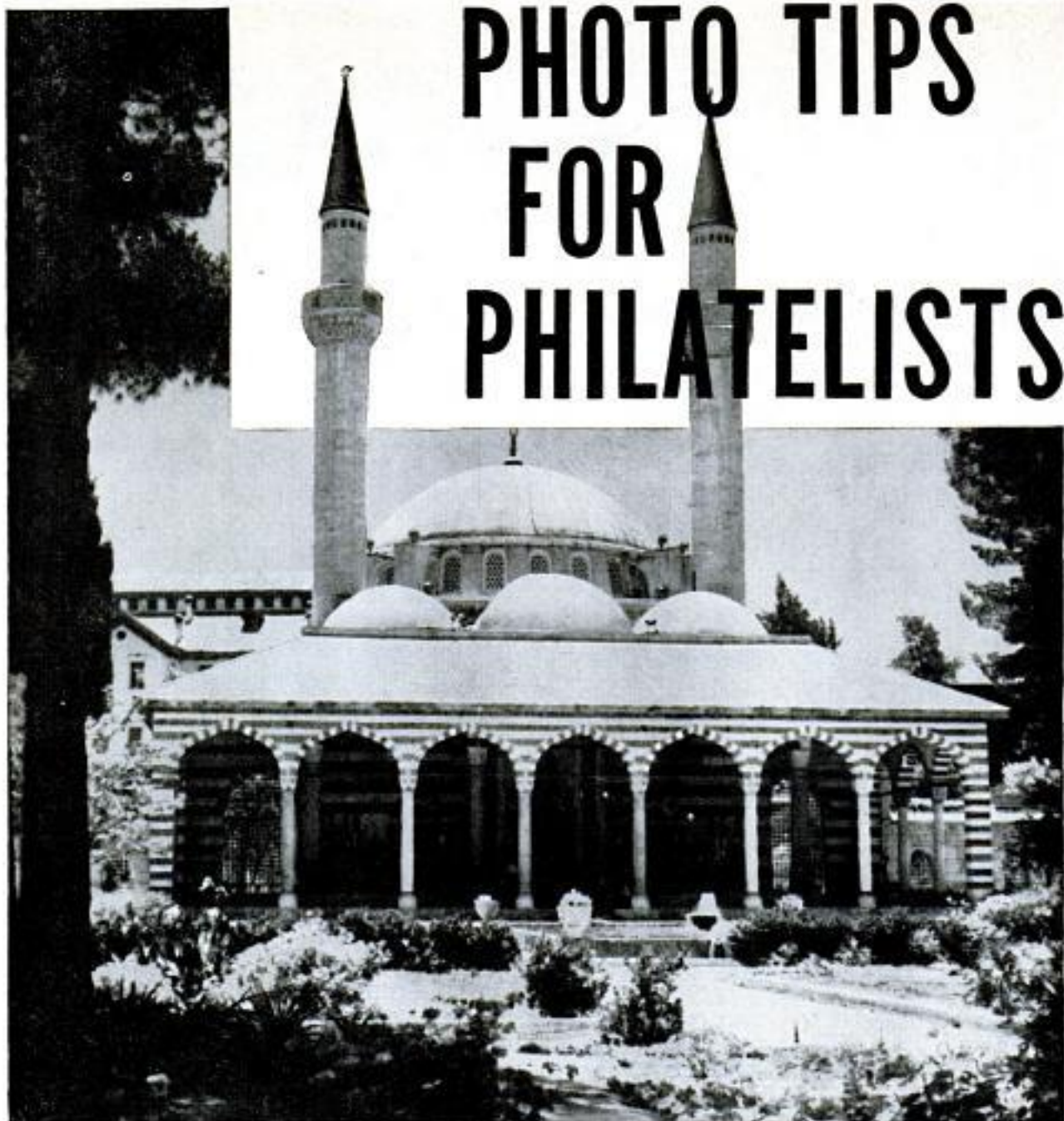

Stamp collectors who travel can give their albums an increased personal interest by taking their own photos to match the designs on their stamps

**By Ernest A. Kehr, F.R.P.S.L.**

*Stamp News Editor, New York Herald Tribune*

**T**HE STAMP COLLECTOR who owns a camera but hasn't yet used it in his philatelic pursuits, reminds me of the man who owns a basement full of power tools and uses them solely to cut kindling wood.

Photography today is just about the most valuable accessory a stamp collector can use to increase the beauty and interest of his albums, and to help him better study the items in them.

A few wealthy philatelists are engaging professional photographers for the work they want done—and are paying fancy prices for it. Some individuals are doing it themselves, but the potentials of combining photography and philately still are all but unexplored.

Virtually anybody with a camera and a rudimentary



understanding of its use can expect remarkable results with a minimum of practice.

The use of a camera will aid him immeasurably in enhancing the attractiveness of his album. The modern philatelic trend, which stresses the pictorial subject of the stamp lends itself well to photographic treatment.

Whether your camera is an inexpensive box type, or a costly apparatus with a trunk full of accessories is immaterial. Through the intelligent use of what you have, you'll soon turn your stamp album from a dull, commonplace volume into a possession that will fascinate you and any who scan its pages.

The basic aim of a stamp collection is to tell a story of the specimens in it.

Most collectors visit places or buildings which have been used as the subject of a stamp design. If he will take his camera along and shoot a picture of that scene, preferably from the same angle as is shown on the stamp, he will obtain a photograph that can be mounted on the same page as his stamp, to give it that unsurpassed personal touch of human interest.

The camera solves the greatest of cover collectors' headaches. Philatelic interest centers on both sides of a cover (envelope, wrapper or post card). Yet, unless one takes a cover from its moorings on a page each time someone wants to see the back or cuts the envelope open and mounts it flat on the page (thereby destroying its worth), he is faced with frustration.

The camera solves that difficulty. Make a same-size picture; mount it directly under the face of the cover and there never will be any further need to wonder what markings are on the reverse.

But it is really in the field of advanced philatelic study that the camera proves its true worth and adaptability and versatility.

Ordinarily a strong magnifier is sufficient for the detection of printing defects, shifted transfers, plate cracks, die differences, paper, watermarks, repairs or any of the other minutiae for which serious philatelists constantly search.

But working with a glass, which most often covers only a fraction



Use of the proper filter to absorb color of stamp enables the philatelist to study overprints, simplifying detection of fakes



Photographic filters also bring up the faint postmarks which otherwise may not be strong enough for accurate identification



Photographs, when greatly enlarged for detailed study, help the collector to distinguish between genuine and counterfeit



FIRST SPHYNX ISSUE

August 8 1867

designed by E. Hoff of Hirschberg Germany  
lithographed by V. Penisson Alexandria

TYPE IV

- A. Cleopatra's Needle is too far to left and is smaller than other types
- B. The three dots in Arabic inscription are equidistant and on same line level
- C. The second Arabic character in upper panel touches inner frame line
- D. Base of the pyramid does not touch the frame at right.

1. Aastre

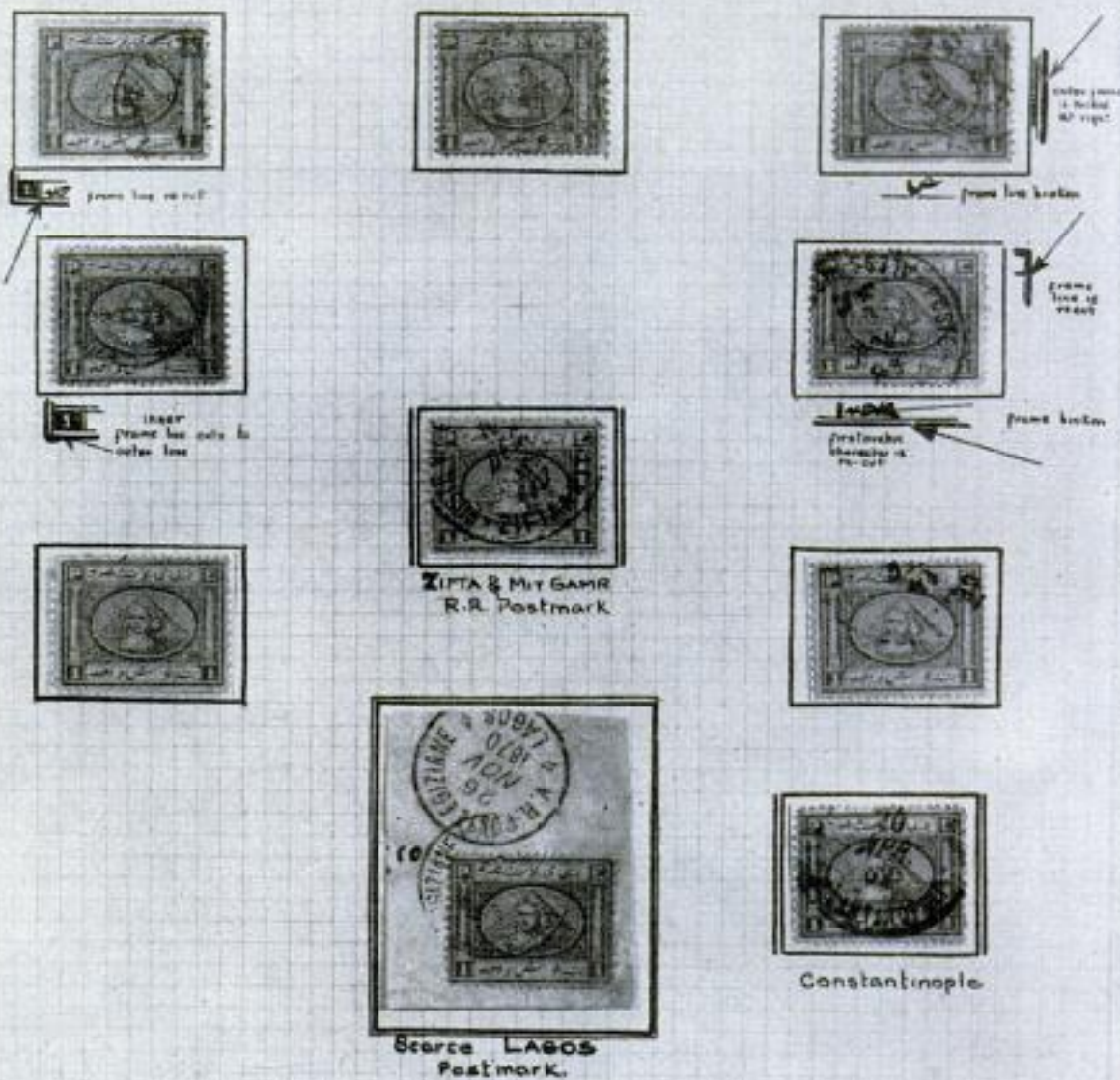

With a photographic record of each album page, the philatelist has identification in case of theft or loss

of the stamp area anyway, is a tedious, eyestraining task. Making a photograph of the stamp and then studying the enlarged print, on the other hand, eliminates this inconvenience.

For all ordinary examination, the philatelic-photographer requires only a reg-

ular picture of a stamp, block or cover, the print of which should be enlarged to either a 5 by 7 or 8 by 10-inch size.

For such work one just does a straight copy job, using a process film and shooting the stamp subject against a black background so all perforation teeth stand out



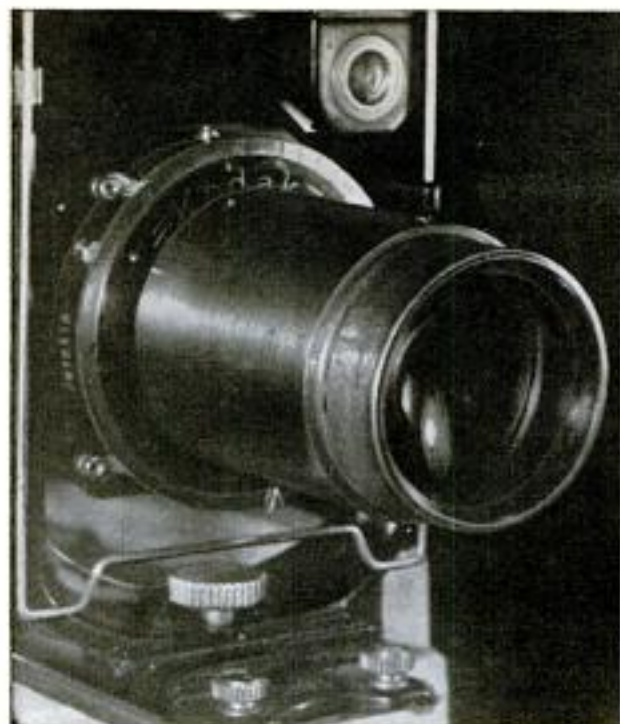

Photomicrographs can be made by adding an engraver's magnifying glass to front of normal lens

strong in contrast. For a matter of convenience I save the black-paper interleaving that comes between my cut film. I then place the stamps to be photographed on these. In focusing, I see that the sheet and the stamps on it just fill the ground glass. In this way I know that my negative images will be the same size without further measurement. I then can make a contact print and get a photographic duplicate, or enlarge to any desired size, up to 11 x 14, and even greater if necessary.

But it is the ability of negative emulsions to "see" what the naked eye cannot perceive, that makes photography a particular boon to the philatelist.

When a stamp is printed in pale rose, yellow, green, blue or brown, it is all but impossible to examine it visually without terrific eyestrain.

Emulsions, however, reproduce in sharp black and white even the tiniest details. Take the one-kreutzer stamp of Austria, issued in 1850. For over 60 years students have been studying that stamp, hunting for trivial design differences that provide clues to original printing arrangements of the clichés. In about 1940, the late Felix Brunner decided to use photography. By studying black-and-white prints of this weak yellow stamp he discovered more about the stamp in half a decade than had his predecessors in three generations.

An assortment of filters for the camera lens adds to the photographer's ability to do useful philatelic work.

Very frequently a postmark is as interesting and as important as the stamp itself

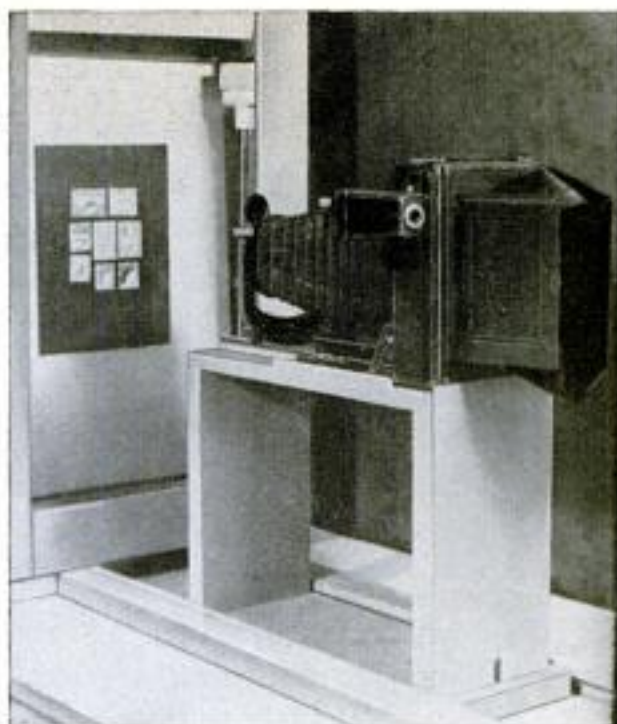

Easy to build, a simple copying rack provides the perfect alignment necessary for precise photography

yet, equally often, it is impossible to clearly read the text of the obliteration, because the color of the stamp happens to be strong and dark.

By photographing that stamp through a filter which absorbs the color of the basic stamp, the finished picture will emphasize the postmark—distinct, clear and readily legible.

The same applies to stamps with overprints. Very frequently an overprinted stamp's value is much greater if it happens to have been made from a surcharging plate that included minor varieties of type fonts. These varieties often are tiny and minute. A filter-photograph of the stamp in question clearly reveals the exact identity of the overprint.

After a little practical experience, the philatelist soon will learn minor techniques that will aid him in other ways.

Suppose he has a stamp, but cannot discover by normal methods of dipping it in carbon tet or benzine, whether it is watermarked or not. The camera will give him an infallible answer. He will place it in his copying frame between two panes of clear glass, light it from *behind*, and then use a filter of the same color as the ink used to print the stamp. If it is watermarked, the design will register on the negative; if it has none, he will see only the texture of the paper.

This same technique is used to determine the kind of paper on which a stamp is printed: Wove, laid, quadrille, batonné, etc. It may also be used to examine a

(Continued to page 238)





### Trucks Tied Together Tote 80-Ton Transformer

To move an 80-ton electric transformer along a highway, two flat-bed trucks were tied together with heavy chains. Drivers had to coordinate their speed and other factors to a split-second while men atop the transformer moved wires out of the path.



### Electronic Brain With a "Heart" Helps Assign Navy Personnel

Because the Navy's new electronic equipment for assigning personnel gives consideration to personal duty preferences, it's called the "brain with the human heart." The equipment is used to process 40,000 Pacific Fleet orders each month.

### Electronic Organ Built From Kit of Semiassembled Parts

Now you can build an electronic organ, with a pitch range duplicating many of the great pipe organs of the world, from units of semiassembled parts. The units include a preassembled keyboard, foot pedals and

electron-tube tone generators. The organ has a separate electronic oscillator for each note. An accessory percussion unit can be added to the organ for drum, bell, tambourine, whistle and other effects.

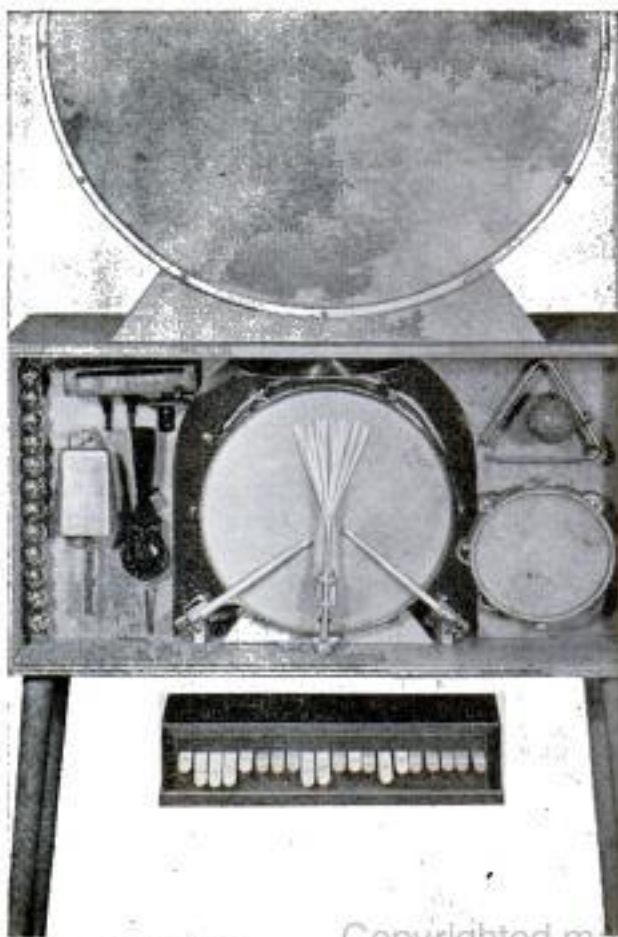



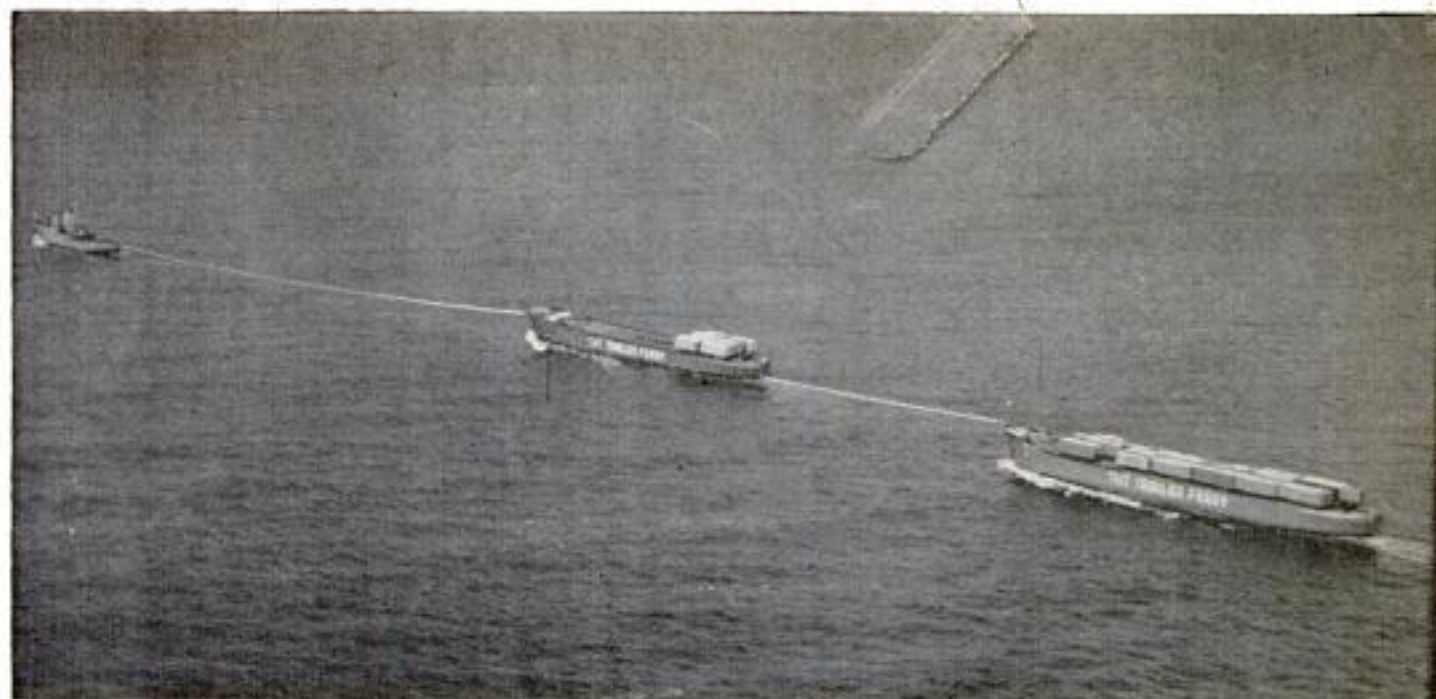

Two ferries, loaded with trailers, are towed by a single tug on a voyage between Puerto Rico and Florida

## Loaded Truck Trailers Ride Ship Across Ocean

HUGE HIGHWAY TRAILERS now are moving freight across the ocean. Trailer trucks can be loaded anywhere in the heart of America and unloaded several days later in the heart of France. Roll-on, roll-off trailer ferries make possible this new type of transoceanic transport. For some time, TMT Trailer Ferry, Inc., has been shipping trailers between coastal and Caribbean ports on converted World War II landing craft. Two such craft, loaded with trailers, are towed by a tug. However, the voyage across the ocean requires a larger vessel. The result is the *TMT Carib Queen*, modified from an uncompleted LSD (Landing Ship Dock). The 475-foot vessel is capable of carrying up to 92 trailers, 97 automobiles and 500 tons of bulk cargo. The craft has a speed in excess of 16 knots. With her ramp in place, the *Carib Queen* can be unloaded and simultaneously reloaded in a scant four hours. Ordinarily an overseas shipment goes through six or more separate handlings between the shipper and the receiver. The big advantage of the new ferrying system is that the freight is loaded only once and unloaded only once. The *Carib Queen* is expected to carry at least 30 percent more cargo than a conventional ship of the same speed and size.

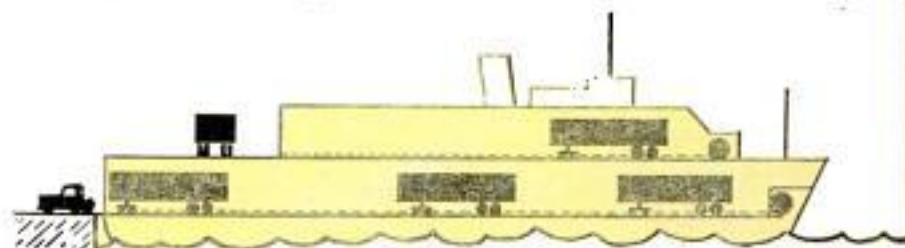

Truck moves trailer across ramp into ship. Trailer then is clamped to dolly and pulled by winch along tracks inside ship

Loaded trailer is backed into stern ramp of the vessel. Through this system, ship can be unloaded and reloaded in four hours







### **HERE'S WHAT THE OWNERS SAY:**

"Haven't had a flat in the last 40,000 miles with tubeless tires."

"My employer operates a fleet of 16 tractors and 22 trailers. This equipment is equipped entirely with tubeless tires which have fewer flats than tires with tubes previously used."

"It is my opinion that tubeless tires are the biggest mistake the tire industry ever made."



### **HERE'S WHAT THE REPAIRMEN SAY:**

"Tubeless tires require more experience and better care in servicing, but are far less hazardous."

"Tire thumping is the big headache in tubeless tires."

"You find more tires with tubes out of round or with a heavy side than tubeless."

"I very definitely feel tubeless tires can be improved by the manufacturers."



# TUBELESS TIRES: MOST OWNERS LIKE THEM

**H**AVE YOU HEARD ANY bitter complaints against tubeless tires recently? These tires became standard equipment on the '55 models, and any such basic change is bound to touch off controversy.

By now the average motorist has had considerable experience with tubeless tires. At the drop of an ounce of air pressure he may find himself involved in a long discussion on tire thump, rim leaks and the value of installing a tube inside a tubeless tire.

Just how good are tubeless tires? Are the complaints justified? Do motorists mourn the passing of the old-fashioned inner tube?

To find answers to these questions, *Popular Mechanics* sent questionnaires to hundreds of motorists all over the country—owners of '55, '56 and '57 cars. Also, because tire complaints eventually end up in the serviceman's lap (especially since tubeless tires can't be repaired by the motorist himself), similar questions were asked of tire repairmen selected at random across the country.

## Decision for Tubeless

The result is a clear-cut decision in favor of tubeless tires. Then why the talk against them? Apparently here, as in most other fields, the dissatisfied motorist is the vocal motorist, while the satisfied driver rolls along without saying much about his tubeless tires.

In any event, 71 percent of the owners prefer tubeless tires; 29 percent, tires with tubes. Furthermore, 84 percent indicated that tubeless tires give less trouble than tube tires.

In general, the repairmen are much more critical of tubeless tires than the owners themselves. These men, in stating their personal preference for their own cars, show a slight margin in favor of tubes: 50 percent prefer tires with tubes; 47 percent, tubeless; and 3 percent prefer a combination of the two—that is, tubeless tires, with tubes added.

## Two Major Likes

The owners have two definite likes in regard to tubeless tires, likes that are mentioned much more frequently than any others: The fact that most punctured tires won't go flat immediately, giving the driver time to reach a repairman, and the fact

that tubeless tires require fewer repairs.

"They retain sufficient air after a puncture to carry me to a service station."—Virginia naval officer.

"Tubeless tires don't go down immediately after small puncture."—Alabama real-estate salesman.

"Gradual deflation when punctures, better traction."—Florida superintendent.

"On my last puncture, nail was in the tire 500 miles before the tire went flat."—Florida student.

"Have had no trouble in approximately 30,000 miles of driving on tubeless tires."—Iowa tool engineer.

"No tubes, good service, less trouble."—New Mexico chemist.

"Long wear, no trouble. Perfectly satisfied."—Arizona teacher.

"Trouble-free!"—Alabama jeweler.

## Less Heat Build-up

Tire manufacturers emphasize one big advantage of the tubeless tire, but only six percent of the owners mention this point.

"A tubeless tire runs cooler in hot weather."—Colorado service-station operator.

"Cooler operation. Tires are less apt to blow out for this reason."—Idaho truck driver.

Other likes, in order of mention, include safety, soft ride, less total cost, better balance and less squealing.

"You get a softer ride on a tubeless tire."—Missouri manager.

"No weights on wheels, but car runs as though tires are in perfect balance."—Michigan medical student.

"No need to buy tubes when new tires are purchased or exchanged."—Washington adding-machine mechanic.

"They make your car ride smoother. No squeal on asphalt roads."—Washington, D. C., secretary.

"You don't have to worry about pinching the tube when you change one, or a leak caused by the tube chafing inside the tire."—Vermont railroad fireman.

"No tube to fool with."—Michigan auto assembler.

"Less trouble keeping them in balance."—Kentucky plant superintendent.

"Less noisy on the road. I like them on curves and take-off because they do less squealing."—Kentucky warehouse worker.

"The greatest handicap that tubeless



# OWNERS' EXPERIENCE WITH TUBELESS TIRES

<b>Had blowouts?</b>	
Yes .....	11%
No .....	89%
<b>Had punctures?</b>	
Yes .....	53%
No .....	47%
<b>Had slow leaks?</b>	
Yes .....	30%
No .....	70%
<b>Have tires pulled away from rim?</b>	
Yes .....	5%
No .....	95%
<b>Have tires developed thump?</b>	
Yes .....	25%
No .....	75%
<b>Which type gives most trouble?</b>	
With tubes .....	84%
Tubeless .....	16%

<b>OVER-ALL RATING</b>	
Prefer tubeless .....	71%
Prefer tires with tubes .....	29%
<b>Would patch own tires if possible?</b>	
Yes .....	23%
No .....	77%
<b>Have repairmen suggested putting tubes in tubeless tires?</b>	
Yes .....	31%
No .....	69%
<b>Do you have tubes in tubeless?</b>	
Yes .....	8%
No .....	92%
<b>Which type lasts longer?</b>	
Tubeless .....	33%
With tubes .....	10%
About the same .....	57%

<b>Which type do you prefer?</b>	
Tubeless .....	71%
With tubes .....	29%

## THE TIRE REPAIRMEN REPORT:

<b>Have suggested putting tubes in tubeless?</b>	
Yes .....	91%
No .....	9%
<b>Which type lasts longer?</b>	
Tubeless .....	14%
With tubes .....	35%
About the same .....	51%
<b>Which type do you prefer for own car?</b>	
Tubeless .....	47%
With tubes .....	50%
Tubeless with tubes .....	3%

tires must overcome is the false rumors started by old-timers and service-station attendants."—Washington, D. C., auto salesman.

"You get a better guarantee than with a tube tire!"—Michigan factory worker.

### Complaints, Too!

But the 29 percent of the owners who prefer tires with tubes are vehement in their complaints. By far the biggest complaint is the difficulty of obtaining proper service.

"Can't find a station attendant that knows how to fix them."—Washington broker.

"Can't repair and mount them without going to a garage."—Ohio engineer's assistant.

"Thumping cannot be repaired as easily. High replacement cost."—Iowa pipe-fitter.

"Some cool mornings they have a thump, but most of that soon leaves."—Georgia aircraft mechanic.

"Continual thumping of tire."—Georgia housewife.

"Had gravel go through a nylon tubeless after only 30 miles of driving. No adjustment from dealer."—Tennessee mail carrier.

"Can't keep the pressure up."—Missouri minister.

"Have thrown the tread off seven tubeless tires in the last two years."—Kansas salesman.

"Won't hold air if wheel develops dent from accident or rough handling."—Connecticut photographer.

"The manufacturer charges the same

whether he supplies a tube or saves that cost. The tubeless tire is one of many small gimmicks for skinning the consumer."—Delaware college professor.

"Cost too much money to buy and repair."—Delaware secretary.

"Biggest mistake the tire industry ever made. Cost approximately \$10 more than the others and aren't half as good."—Connecticut diemaker.

"Have been unable to get tubeless tires to hold up after recapping."—North Carolina manager.

"Too much latex in one tire, and it rolled into balls like golf balls, throwing the wheel out of balance."—Minnesota truck driver.

"Tire is lower cost to car manufacturer, yet costs the consumer the same or more than a tube tire."—Ohio salesman.

"Balance them one day and they are out the next."—Arizona welder.

"I sell tires, and 80 percent of our customers change to tubes when they buy new tires."—Missouri store manager.

"One of my tires is 'leaking rubber' around the rim, paper-thin, shredded."—South Carolina student.

"They don't seem to seal tight if the rim is rough."—Oregon lift-truck operator.

"First set developed separations between tread and cord on four of the five tires in 15,000 miles. The second set separated the same way on one tire at 4000 miles."—Nebraska engineer.

### Causes of Blowouts

Owners who reported blowouts with tubeless tires were asked to describe the

(Continued to page 242)





## "Assembly Line" For Tomatoes

Harvesting 8000 acres of tomatoes requires a mechanical monster with conveyor-belt arms reaching 165 feet on either side of the central unit. A crew of 107 men operates the machine on an 18-mile-long tomato patch near Homestead, Fla. The machine automatically grades, sizes and rejects the tomatoes as they roll into the unit from the conveyors.



## Basketball-in-the-Water Gives New Twist to an Old Game

Aqua-ball is catching on as the latest innovation in swimming-pool sports. With rules similar to basketball, the equipment can be set up in minutes and is adjustable to variations in pool edges. It includes a six-foot heavy-net backstop, waterproof enameled backboard, a steel-frame goal, rustproof frame and base, height adjuster, ball, ball-inflator pump, game rules and installation instructions.

## Thorium Promises Cheaper A-Power

Viewed as the solution to cheaper atomic power, an extraction process has been developed to make thorium serve as a substitute for uranium-235. Scientists at Battelle Memorial Institute, Columbus, Ohio, report a recovery of 99.89 percent purified thorium—good enough for reactor uses.







## Honolulu Roof Top Will Rotate

Patrons of a refreshment lounge atop a 17-story office building planned in Honolulu will be able to view most of the city without leaving their chairs. The slowly rotating lounge will make a complete revolution every hour. Windows of the building will have permanent vertical sunshades that rotate electronically with the passage of the sun. Tinted window walls of the lounge will slant outward.

*Möller Optical Works  
Hamburg, Germany*

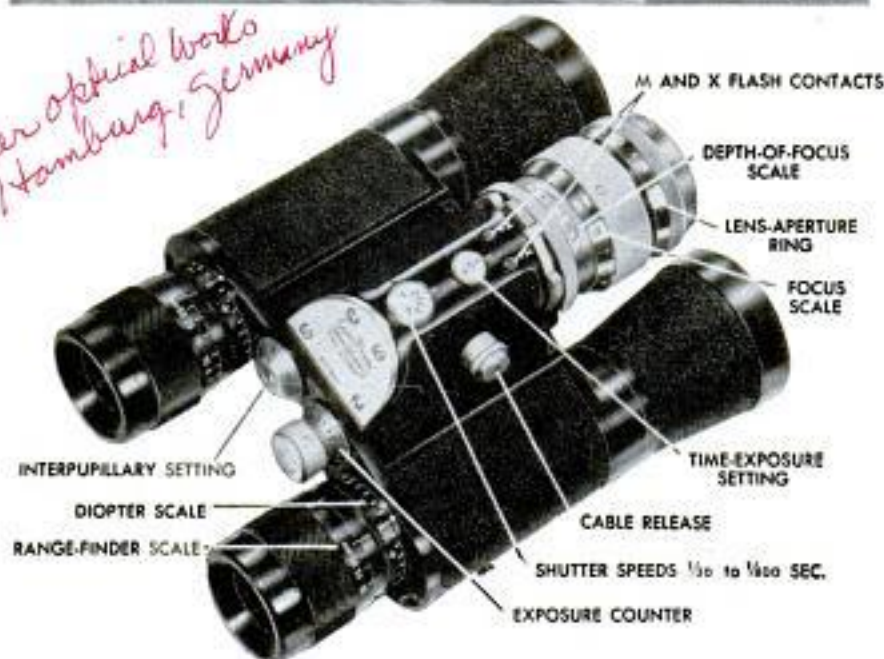

## Camera Shoots Binocular's View

Taking photographs of what's seen through a pair of binoculars is now a reality. A German manufacturer has combined a 16-millimeter still camera with telephoto lens and a 7 by 35-millimeter binocular. The camera has an f:3.5 90-millimeter lens, and its 20-exposure film is loaded and removed without threading. When the binocular's eyepieces are focused, they are the range finders for setting the camera lens.



## Robot Arm and Hand Has 25 Movements

Designed to simulate practically every motion of a human arm, wrist and hand, a new industrial robot can perform a total of 25 individual movements during any one cycle or sequence. The robot arm was built to handle hazardous operations for an automobile factory, such as taking hot castings from a die-casting machine. The arm will extend, retract, raise, lower and rotate 270 degrees. The hand will open, close and rotate 360 degrees.



**I**N THIS HIGHLY mechanized era, most people know more about their automobile engines than the "engines" that run their own bodies. Yet the study of these chemical power plants we call muscles has fascinated scientists for centuries.

More than 700 muscles provide the force for every human activity, from batting an eyelash to climbing a mountain. Combined, your muscles are rated at three horsepower. They're physically capable of lifting 1000 times their own weight. They work with such efficiency that if the human body were equipped to handle motor fuel, it could operate for 10 days on a gallon of gasoline.

Since 1699 when a Frenchman named De la Hire made the first recorded strength tests by comparing men with horses, scientists have explored the capabilities of muscles. Today, with a nation deeply concerned over the poor physical fitness of American children, their work has gained new impetus.

At the University of Oregon's physical-education laboratory, for instance, researchers are probing everything from muscle fatigue to the effects of athletics on children. This work is directed by Dr. H. Harrison Clarke, who has devoted a 30-year career to strength measurement.

Is it safe for Johnny to play football? Why do some children become top athletes while others don't? For the answers, Oregon researchers have launched an ambitious



Dr. H. Harrison Clarke, left, discusses University of Oregon physical-fitness project with school coach Theodore Schopf

## A COLLEGE LAB TELLS

# How to Measure Physical Fitness

By Ken Metzler

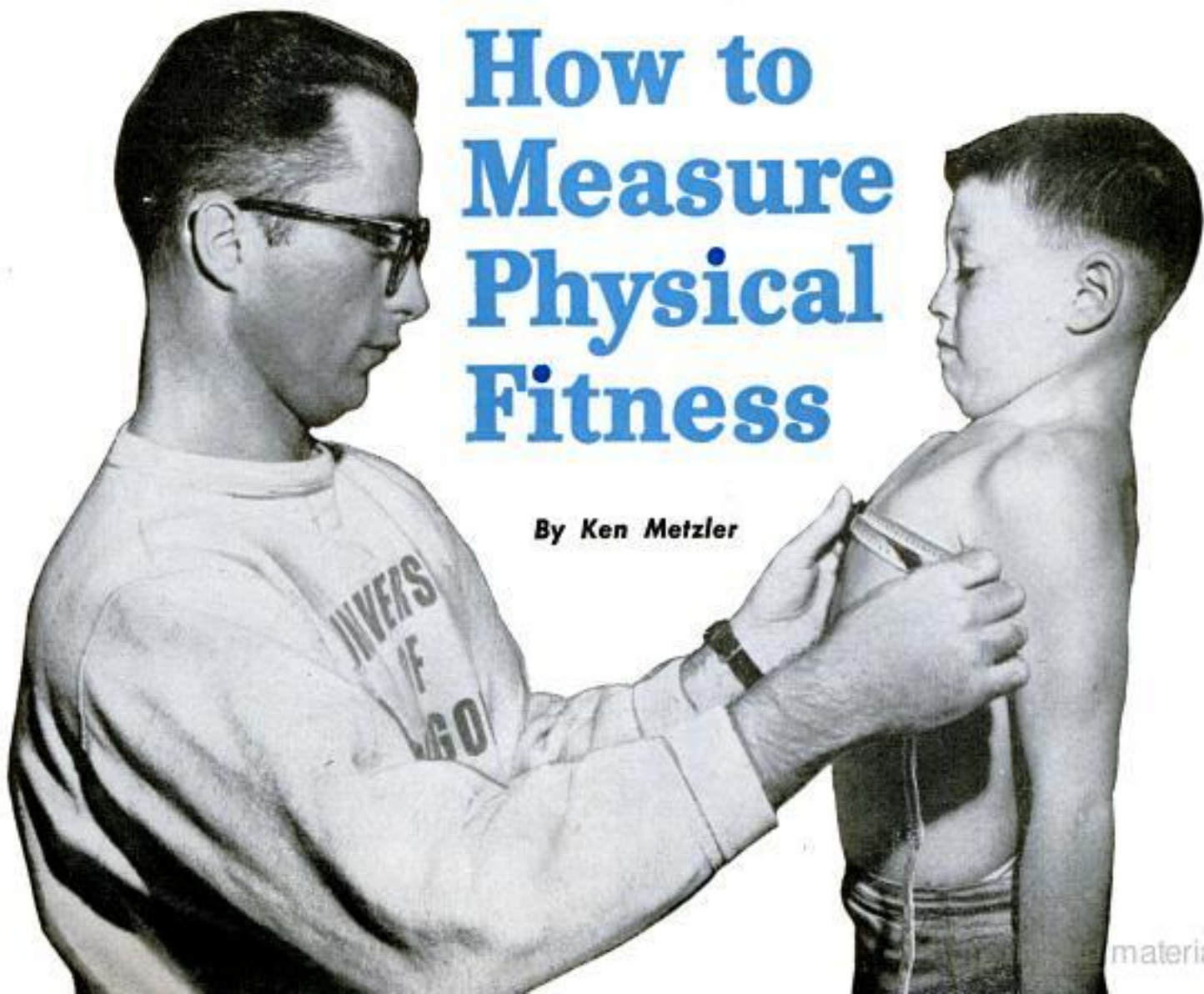





Physical capacity, above, is only part of Oregon program, organized because of report that U. S. children are inferior to European youngsters in fitness

Ergograph machine measures muscle fatigue. Such tests tell something's physically wrong, but not what. Doctor Clarke's case studies diagnose these causes



study of 560 boys aged 7 to 17. They will record their physical, social and intellectual growth through high school and college. In a few years they expect to answer many questions that have puzzled parents.

In such a study, researchers must measure the capabilities of muscle groups. They use a cable-tension strength test developed by Clarke when he was an Air Force officer in charge of reconditioning convalescents during World War II.

This test was originally designed to determine progress made in helping men to regain their strength. It measures the pounds of strain placed on a cable by persons pulling with various sets of muscles. All major muscle groups are included, even finger and thumb muscles. It's basically the same system that is used to measure stress on aircraft control cables.

When a man shrugs his shoulders, he can put as much as 500 pounds of force behind it, according to this test. The ankle plantar flexors (muscles used to stand on tiptoe) are capable of nearly 400 pounds of force in the average man. That's just on one leg. Thumb muscles can pull 30 to 40 pounds. But because of psychological limits, a person's physical strength is barely touched. It can be increased phenomenally in times of stress. Newspapers a few years ago carried an item about a man who lifted a wrecked car off an injured person. He has never been able to do it since.

Another test in common use measures

Cable-tension test, developed by Doctor Clarke, determines strength of various muscular movements. It's similar to system that tests aircraft control cables





physical fitness. The Rogers Physical Fitness Index has tests for grip strength and lifting capacity of back and leg muscles. The PFI test, as it's called, also has two muscular-endurance tests (push-ups and pull-ups) and a lung-capacity measurement. It was developed in 1925 by Dr. Frederick Rand Rogers. Sets of median scores, or "norms," have been worked out for each age-sex-weight classification. Each person thus competes against a mathematically computed score of 100—par for his classification.

But this test obviously cannot answer a vital question: What causes poor fitness? The test is like a doctor's thermometer—it can indicate something's wrong, but not what it is. With this in mind, Clarke devised a case-study method to diagnose the underlying causes. This is done through personal interviews, plus health-habit, social-adjustment and other questionnaires.

Flabby, unexercised muscles are behind poor fitness more than half the time, Clarke found. Other factors—faulty nutrition, glandular disturbances, worries, even romantic disappointments—are important, too. The PFI score of one college freshman spurted from 63 to 100 in just three months after he learned his miss-

ing soldier-brother was alive and well.

"Whenever I exercise," complained another student, "my heart beats faster. I can feel the blood rushing through my veins. It scares me." The heart always does this in exercise, he was told. When a doctor said he didn't have heart trouble, the youth was persuaded to take a PFI test. His below-par score of 69 spurred him into taking conditioning classes like nothing else could. Eventually he achieved a par score.

An analysis of hundreds of such case studies has presented a good composite picture of the typical low-fitness youth: 20 percent overweight, below normal in social adjustment, above average in scholastic potential (but doing poorly in actual schoolwork), does not participate in strenuous physical activity, smokes, doesn't get enough sleep.

The report of Dr. Hans Kraus that American children are far behind European youngsters in physical condition

Grip strength is shown by manometer, part of Rogers Index widely used by schools to tell physical-fitness level





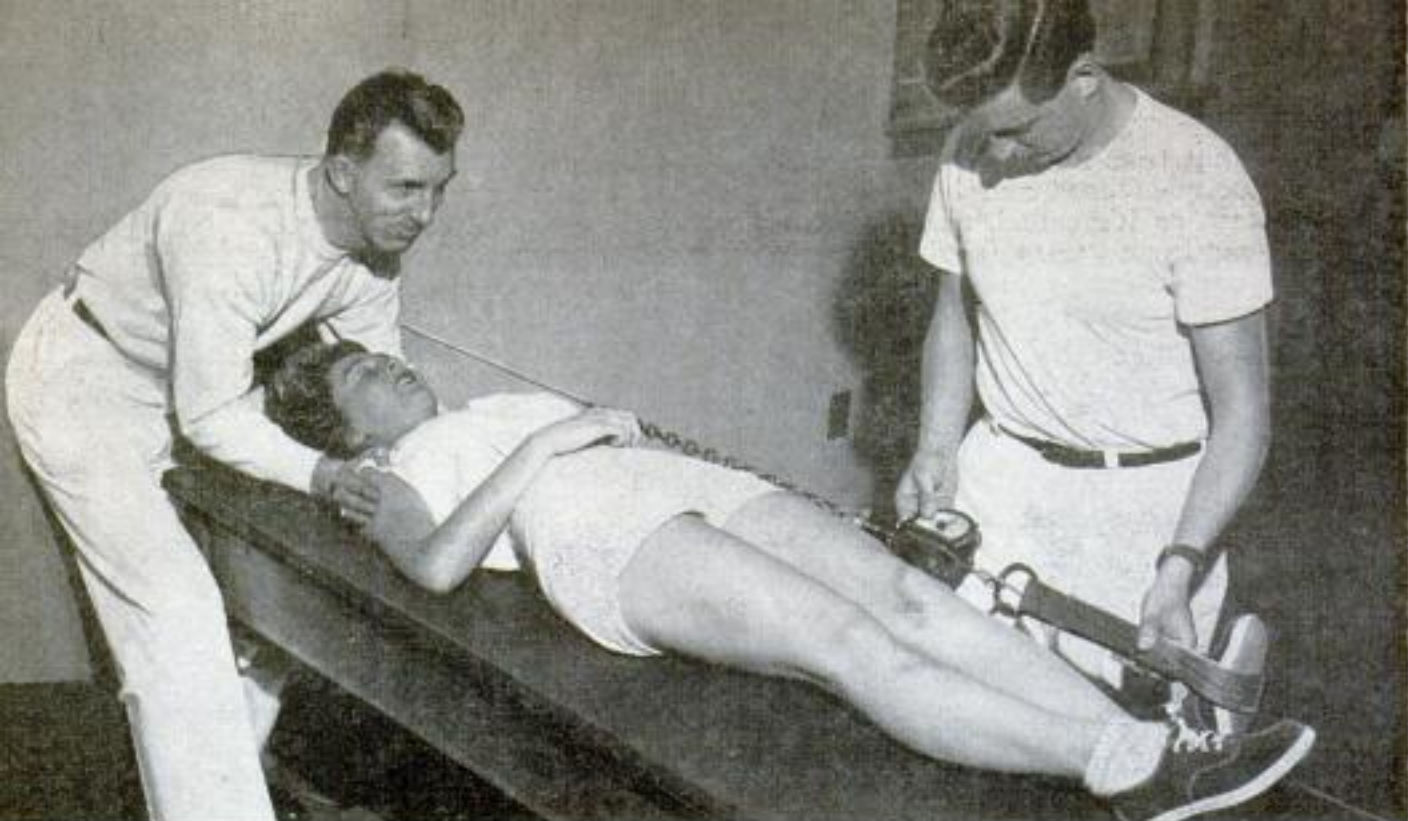

Ankle muscles are among the most powerful in the body. Tests indicate they exert nearly 400 pounds of force

## *Next Month*

prompted Oregon's physical educators to initiate a unique "physical-fitness pilot study." PFI tests were given to 2500 high-school boys and girls throughout the state. Tests disclosed that one fourth of the boys and one third of the girls were not strong enough to work and play effectively.

But this was only the beginning. High-school physical-education teachers picked out their low-scoring students for special strengthening exercises. Many youngsters exercised at home, too, for it was important to them to make 100 on the PFI test. When retested months later, most of them did.

Fitness is important to girls, too. In the words of a woman physical educator, "We tend to make such

(Continued to page 232)

**Leg-lift measures these muscles. Flabby, unexercised muscles cause poor fitness most of the time, Doctor Clarke found**

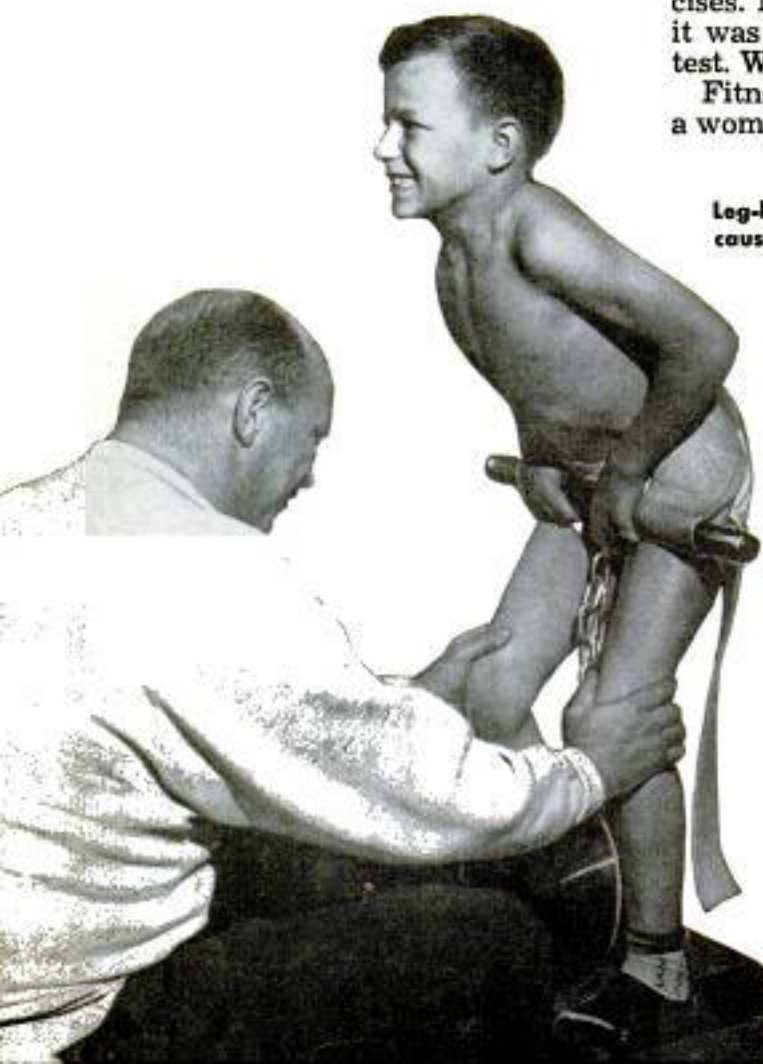

**Spirometer tells lung air capacity. Hard exercise will correct run-down condition, toughen muscles**







## One-Man Hay Rig Picks up Bales and Builds a Stack

**AUTOMATIC HANDLING** of baled hay from the pickup in the field to the stacking of bales in the storage area can now be accomplished by one man seated at the controls of the power unit. The photograph at the top of the page shows a pickup device starting to scoop a bale of hay from the field. It goes onto a lifting rack which holds either six large or eight small bales. The next picture shows what happens when the last bale of a group is moved into position by the rack. The lower bales

are pushed against a bar that triggers a hydraulic ram. The ram lifts the rack and places the bales on the hauling bed. The hauling bed holds 54 large or 64 small bales, unloads them in a single stack.

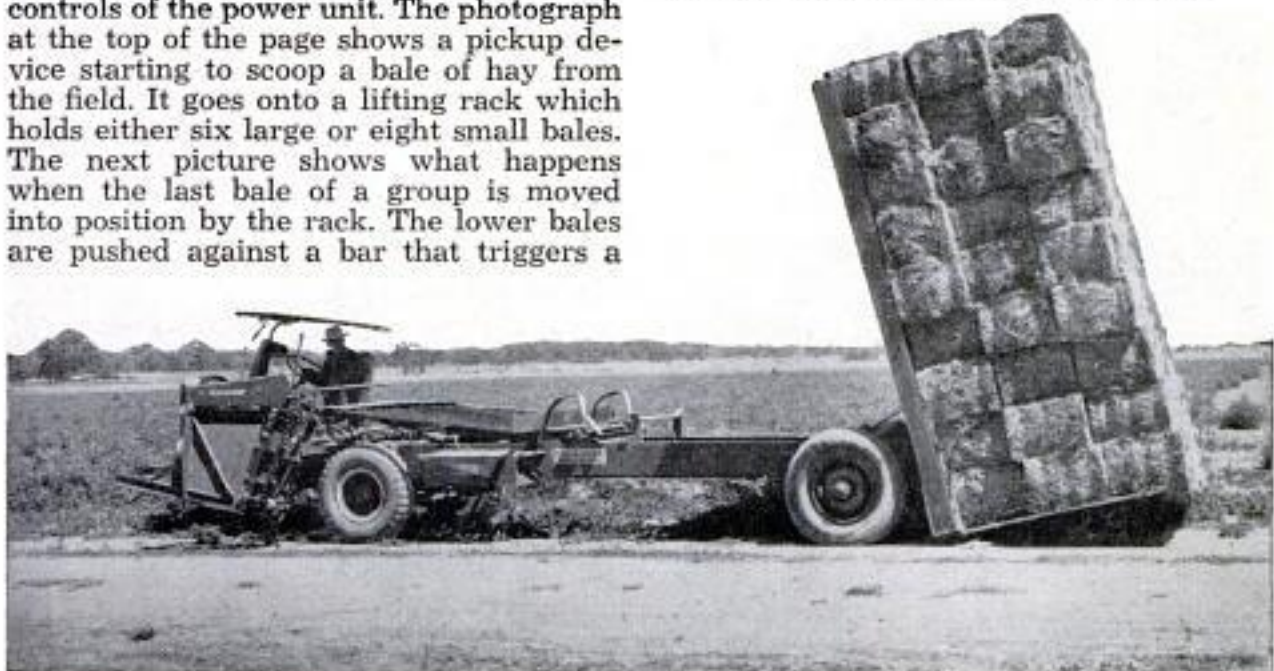





# WHAT'S NEW FOR YOU

**PLASTIC DOOR** for the family dog has ingenious overlapping vanes that automatically snap back into place to keep out insects and bad weather. The door is easy to install, and is available in different models for home, doghouse, garage or kennel. One style permits milk and other deliveries inside the house. The doorways can be opened by the gentle nudge of a puppy, or a kitten, and even old dogs can be taught this new trick with a little training

Turen, Inc., Beaver Park, Danvers, Mass.



**DRAIN COVER** prevents basement flooding due to sewer backup in heavy rainstorms. A rubber cone fits over the drain, and is held in place when its crossbar is forced down between the drain bars and turned to straddle them underneath. The device has a spring safety valve that releases excessive air and backwater pressure. It will cover drains up to five inches in diameter. Also available are similar covers for basement-toilet and shower drains

Acme Home Equipment, 3012 W. Devon Ave., Chicago 45

**GLASS HOLDER**, below left, is a coil of steel wire that clips onto the edge of a china, plastic or paper plate. It holds a glass or tumbler so it can't tip or slide off the plate. A coffee cup fits snugly inside when a folded paper napkin is inserted through the top ring. There is a slight angle to the coil so when it is attached to a plate, the glass or cup is held perfectly erect. The clip-on holders come in sets of eight, with either a brass or nickel-plated finish

Practical Products, P. O. Box 137, Martinsville, Va.



**LIGHT SOCKET** for temporary, decorative lighting fastens quickly to wiring without stripping the insulation. It is designed for use on No. 12 or 14 rubber-covered, stranded wire. The connection is made when the socket's cap is screwed on and two pins go through the insulation to contact the wires. An extra ring, molded into the cap, forces the wires into position, while four splines align them accurately. A detachable wire is provided for hanging

Pass and Seymour, Inc., Syracuse 9, N. Y.

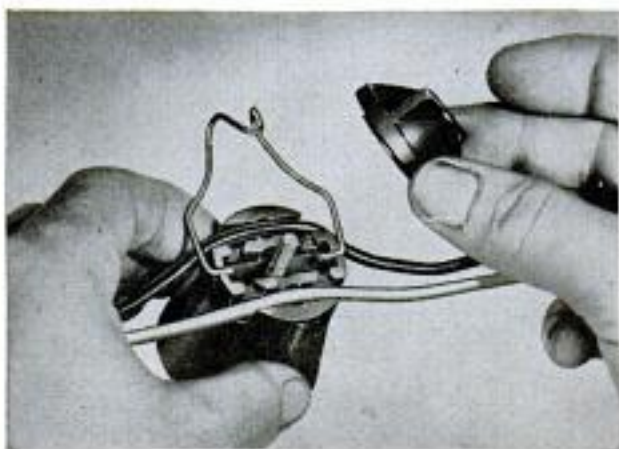





**FINGER-PULL HANDLE** on wall plug soon will be available in matching colors on lamps and electric appliances. The wire comes out the side of the plug. The handle makes it easier to pull the plug out and is safer than the old method of grasping the plug or jerking the wire. Excess wire can be stored off the floor by inserting loops through the plastic handle  
 Miller Electric Co., 120 Main St., Pawtucket, R. I.

**THIN STOVETOP**, above right, is only three inches deep and can be installed on any 30-inch base cabinet with room left for a top drawer. It fits flush and does not require a rim or gasket. The seven-speed switches of the electrical unit turn on an indicator light when a burner is on. The stovetop is available in copper-tone porcelain or stainless steel  
 Tennessee Stove Works, Chattanooga 1, Tenn.

**FLOOR LAMP** right, can be in the center of a room without a cord stretching across the floor. The "lamp pole" moves along an electrical contact strip connected to a ceiling outlet. The pole is propped between the strip and the floor, and a spring unit at the top makes contact. A push-button control operates the lights either as a group or individually  
 Steffel Co., 525 W. Superior St., Chicago 10

**SPRING HOLDERS** keep an ironing-board cover smooth and tight. Four to six are used depending on the size of the board. Wire clips at each end are kept properly spaced by metal straps, which also protect the cover and keep the rolled-under edges flat. They can be used on any type of ironing board and the coil springs maintain a consistent tension  
 Slip Seal Co., 1750 California Ave., Long Beach 13, Calif.

**ELECTRIC SHARPENER**, below, produces exceptionally smooth, keen edges on knives, tools and scissors. Blades are held against a circular oilstone that is attached to a motor. Its gentle honing action does not draw the temper of hardened steel. An angle guide positions the work for the proper edge bevel. The oilstone is reversible for extra-fine finishing  
 E. F. Britten Co., Cranford, N. J.

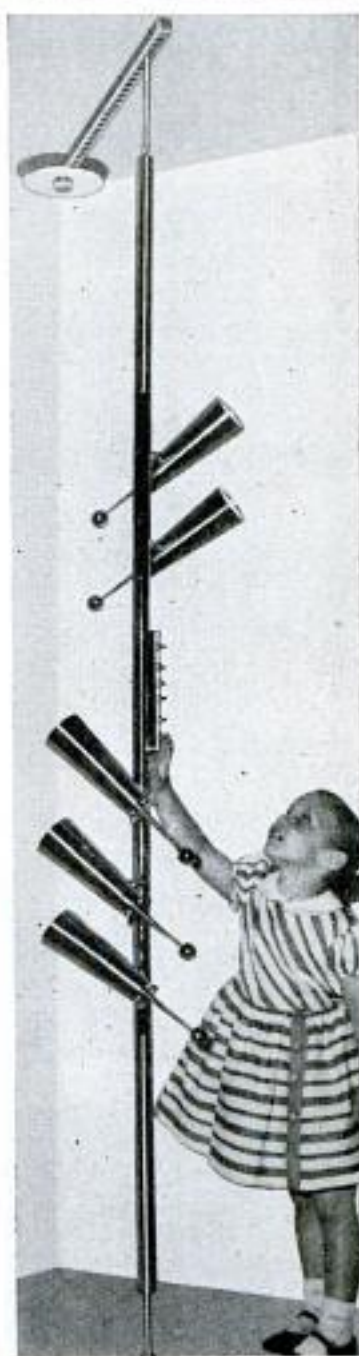
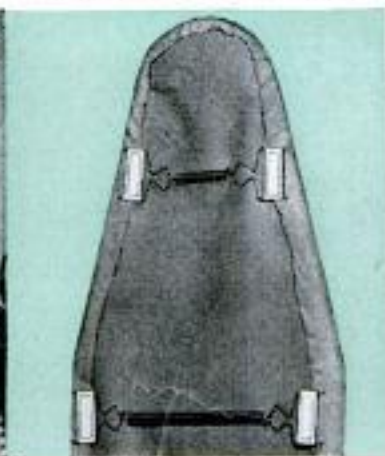





## They Measure Water in Snow for Hydroelectric Plants



Wading through snowdrifts two miles above sea level is part of the job of making electricity in southern California. That's because the runoff from the melting snow provides the water to turn the hydroelectric generators. Hydrographic teams use a helicopter to reach 18 sampling spots where they measure the water content of the snow and forecast the amount of water available for generating electricity. Last year their forecast was 99 percent accurate.



## It Takes a Bug To Catch a Bug

When you call a Miami, Fla., exterminator to rid your house of bugs, he'll drive up in the most frightening bug of all. It is a strange, popeyed insect that rolls on four wheels. The businessman added a customized body covering to his tiny Isetta car to make it look like something that lives under a flat rock. It is all in the interest of sales promotion.





## Power Saw Converted to Drill for Ice Fishing

Because he didn't like the work of chopping through the thick ice at Lake Winnebago, Wis., winter-fishing enthusiast R. Kocian decided to build his own ice drill. He fashioned an auger blade of steel and

welded it to a shaft. The shaft was attached to the gasoline engine that operates his power saw. The result, above, is a drill that will cut an eight-inch hole through two feet of ice in less than a minute.

## Midget Electric Car Built for Handicapped Boy

Six sensitive switches on a control panel operate power steering, forward and reverse gears, lights and horn of this tiny electric car. It was built for nine-year-old Sandy Clarke of South St. Paul, Minn., afflicted with a rare muscle ailment. Finger movements operate controls.



## "Long-Pole Sled" Circles at 60 M.P.H. for Thrill Ride

Here's a new winter sport enjoyed by a group of men living near Holy Name Lake, Minn. Known as the "long-pole sled," the contraption consists of a sled on the end

of a pole which is turned by the rear end of a car. A gasoline engine furnishes the power. The sled travels over the ice at speeds up to 60 miles per hour.







Removing the "lost" logs from the Texas Long Leaf millpond was termed by workmen the world's dirtiest job

## Timber Harvest in the Mud

By C. C. Springfield

**J. C. "TEX" WALKER**, operator of the Walker Brothers Lumber Mill, Huntsville, Tex., once found a lost treasure of buried timber.

He was walking along a street in Trinity, about 20 miles from Huntsville, when he met an old man—a mechanic for the Texas Long Leaf Lumber Co. of Trinity before the firm had closed for the lack of timber.

Queried on the whereabouts of timber for Walker Brothers' saws, the old-timer said: "No, I don't know where there is any really good standing timber, but I do know where there is some of the best timber in Texas, providing a man'd be willing to go to the trouble to get it."

"I'm willing to go a far piece," said Walker.

"Well, it's here," said the old man, "in the Texas Long Leaf millpond."

Walker snorted. "There wasn't a stick in sight, when I looked at the pond today."

"You didn't look deep enough," said the old man. "Me, I wouldn't have thought so

myself, if I hadn't seen a pond drained in Louisiana, maybe 50 years ago. The bottom was covered with logs—'sinkers'—hundreds of them. They snaked them out and I'll bet they got a million feet out."

"Was it rotten?" asked Walker.

"Not a piece. The water had preserved it. And they're in this pond. Too many times we old-timers over the years have seen some particularly good piece of timber pitched in the pond . . . and never seen it come out. Oh, they're there. I guarantee it."

Walker checked. He found there were logs still in the pond. He made a deal with the millowners to drain the lake and see what was there.

He began emptying the pond. By the time the 20-foot-deep lake, covering some 20 acres, had dropped a few feet, he found that the old-timer had spoken truly. He saw the ends of a few poles rearing their heads from the water. Still more could be seen as the water level dropped. A few





As they left the water, the logs generally shed their bark. Although soaked, they were not waterlogged

days later, he began snaking them out with a dragline.

At his mill, he found that they "cut like cake." Nearly all were devoid of bark; it had dropped off as the logs were loaded or pulled from the pond. Although they were solid, as yellow as candy, and cut easily, still they stank. The smell hovered over the yard and stuck to clothes when worn away from the pond. Just the same, the logs were top-quality timber. Walker also found that they dried both quicker and straighter than the timber that he usually handled.

#### Logs Were 40 Feet Long

During the three months he was grubbing them out of the pond, he uncovered logs that were 40 feet long—too long to haul on his trucks. He found monsters, too, for one 24-foot log scaled out 1200 board feet. He also discovered that this lumber would sell as fast as he could produce it. Today, he hasn't a stick on hand. It was big stuff, the kind of material that was just right for heavy construction—3 by 12 inches by 24 feet.

Pointing to a stack of drying timber, he said: "You just don't get this sort of lumber from second-growth timber. I'll bet there is not a tree in Walker County which will

give you this type of wood." Most of it was high-grade heart timber, precious wood today.

During the early part of his operations, Walker figured that after he got the logs off the top of the surface, he'd be able to dig out another layer at least 10 feet deep under the slush. He missed his bet here because those logs were packed in, sealed almost solid. Instead of getting them out, the bulldozer tore them up.

All in all, Walker reclaimed about 500,000 board feet of top logs. ★ ★ ★

J. C. Walker, who reclaimed the logs, shows some of the sawed yellow timber which "cut like cake"







# Shutterbug Shopping Center

**W**ANT TO TAKE underwater photographs, but can't afford the expensive equipment? Could you use a pocket-size flash reflector? A hand viewer with slide magazine? Here is a selection of these and other new and unique items for the photographer enthusiast. ★ ★ ★



**1. PANORAMIC 35-MILLIMETER** camera takes 355-degree photographs—almost a complete circle. Photo across the pages was taken inside an automobile, starting at left looking out the rear window and ending at right showing the other corner of the rear window. It's done with mirrors. The lens points straight up, at right angles to the scene being photographed. A mirror covers the lens at a 45-degree angle, and spins in a circle to reflect the scene. Below the lens inside the camera, another 45-degree mirror turns at the same time and flashes the lens-formed image onto the film. The film is held stationary, while the interior section of the camera turns and exposes it through a narrow slit. The camera, which was invented in Japan, can't take a full-circle photo because it loses five degrees at the point where the film enters and leaves the picture chamber

Panorax Kogaku Kogyo K.K. 106 Arai Juku 5-chome, Ohtaku, Tokyo, Japan

**2. WATERPROOF CASE** enables the owners of all but the largest still or motion-picture cameras to take underwater photographs. It is molded in one piece, and made of flexible and transparent plastic to permit operation of the camera's controls underwater. The nine by seven-inch case is sealed with a glass cover. Has been successfully used at depths of 100 ft.

W. J. Vost Rubber Corp.,  
2045 E. 12th St., Los Angeles 23, Calif.



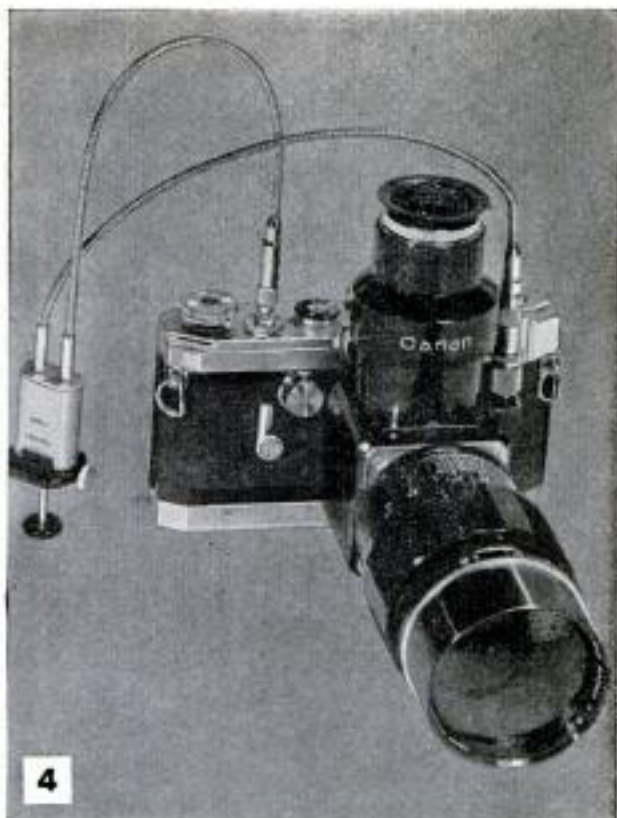

**3. EIGHTY SECONDS** of continuous filming at 16 frames per second is a feature of this motion-picture camera. It is available in single-lens and two and three-lens versions. The 16-millimeter camera has an automatic film-threading mechanism, a 100-foot film capacity, five running speeds, a constant-speed motor, and two of the models have a "zoom" view finder to show the exact field covered by the lenses

Bell & Howell Co., 7100 McCormick Rd., Chicago 45

**4. TELEPHOTO LENS** at a speed of  $f:3.5$  and a focal length of 200 millimeters is made from a newly discovered rare-earth optical glass. It has a reflex housing with double-cable release and a lever that automatically cocks the shutter, lifts the viewing mirror and exposes the film in a single operation. The lens is designed for precision performance and all elements are coated for natural color correction

Canon Camera Co., Inc., 550 Fifth Ave., New York City

**5. HAND VIEWER** with slide magazine operates automatically with a push-pull plunger. Enlarging the slides seven times, it is offered either with a battery-powered light source or by plugging it into an electrical outlet. The magazine holds 20 standard two by two-inch cardboard slides. Single slides can be viewed without the magazine. A system of double diffusion provides even image illumination

Airequip, 20 Jones St., New Rochelle, N. Y.







6

**6. CAMERA-LIGHTER** is an actual windproof lighter with a built-in eight-millimeter camera. The metal case is slightly larger than a standard pocket lighter and it weighs 3½ ounces. The camera has a view finder, an f:3.5 lens, fixed focus, shutter speed of 1/50 second, and bulb, an automatic film advance and stop. Its special daylight-loading magazine contains film for 20 exposures in black and white or color  
Silver Bells, Ltd., 600 16th St., Oakland, Calif.



7



8

**8. HOME PROJECTOR** shows regular 2¼ by 2¼-inch slides, and easily converts with an adapter to take both 35-millimeter and the new 38-millimeter super slides. It is all-metal in construction, weighs nine pounds and includes the recently developed horizontal-burning 300-watt lamp. The overlapping fan blades not only cool the lamp, but also send air between the condenser lenses and against the film  
Realist, Inc., 2051 N. 19th St., Milwaukee 5, Wis.

**9. MINIATURE FLASH** unit unfolds 11 metal blades like a fan to become a reflector only four inches in diameter. The case is made of ivory plastic, it attaches to any standard camera, uses bayonet-base bulbs and is powered by a hearing-aid-type 22½-volt battery. The blades are opened by turning a knob in one direction, while bulbs are ejected by turning the same knob in the opposite direction  
Carl Zelas, Inc., 485 Fifth Ave., New York City 17



9



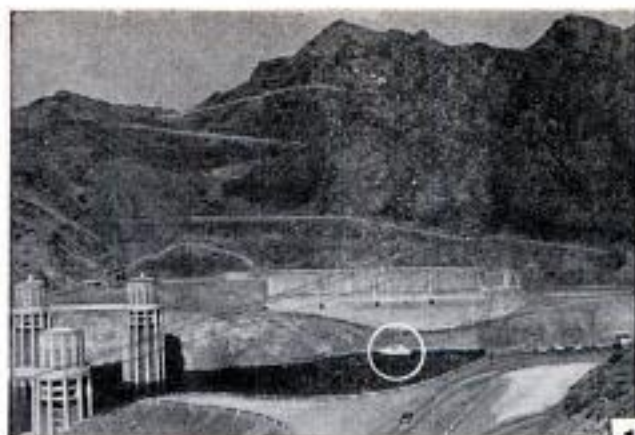

10

**10. TELEPHOTO COMBINATION** took the sharp close-up picture, upper right, from the far-distant location at left. The system includes a telescope with a wide selection of orthoscopic eyepieces. They match in perfect alignment with a platform that mounts most makes of 35-millimeter and  $2\frac{1}{4}$  by  $2\frac{1}{4}$  still cameras and 8 and 16-millimeter movie cameras. Effective focal lengths range from 750 to 2000 millimeters

D. P. Bushnell & Co., Inc.,  
316 Bushnell Building, Pasadena, Calif.



**11. TWO PHOTOGRAPHS** per second can be snapped with an attachment to the Praktina FX camera. It is a heavy-duty spring motor built to precision tolerances and simple in mechanical design to provide reliable, trouble-free operation. The device weighs 20 ounces and can be connected either before or after the film is loaded. It can be used in all types of rapid-sequence photography

Standard Camera Corp., 500 Fifth Ave., New York City



11

**12. FAST FILM** makes it possible to snap a picture and project it on a screen several minutes later. The 1000-speed panchromatic film is used in a Polaroid Land camera. The transparency is removed from the camera and placed in a solution to harden the emulsion. It is then mounted in special slides of different sizes. The process is about one third the cost of conventional slides

Polaroid Corp., Cambridge 39, Mass.



12

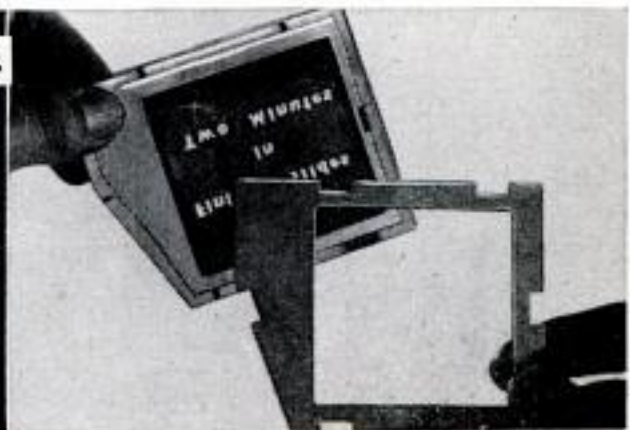





## Pusher-Prop Plane Converts to Car

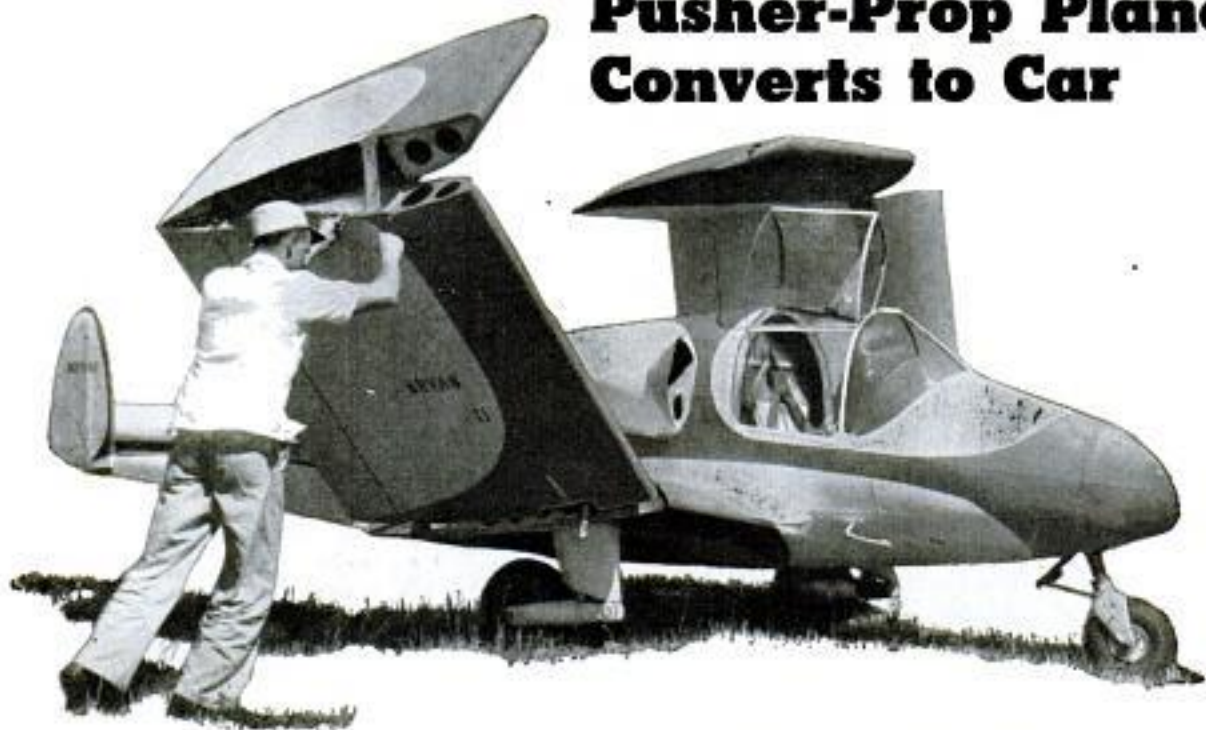

Changing this vehicle from an airplane to a car, or vice versa, takes approximately 10 minutes. The pilot, above, simply folds the wings over fuselage and attaches license plates



WITHIN 10 MINUTES after landing his auto-plane, Leland Bryan, a Highland, Mich., mechanic, can convert it to a highway vehicle. Inventor Bryan simply folds up the wings. Built at a cost of about \$1000, the "hop rod" has a top speed of 95 miles per hour in the air and 60 miles per hour on the road. It carries a car license plate (under the nose in bottom photo) for highway travel and has Civil Aeronautics Authority permission to fly within a 25-mile radius of Bryan's home. He can make longer flights by making special application to the CAA. Bryan constructed the single-seat craft from parts of a standard Ercoupe. The same pusher propeller that drives the auto-plane through the air powers it on the road.



# Radio Electronics

## Television Today



1. As an indication of things to come, General Electric Co. here demonstrates the world's first three-dimensional color-TV system, developed for remote servicing of nuclear reactors. Young lady in photo lines up toy trucks by watching televised image on special receiver through Polaroid glasses. Though currently not feasible for the living room, system can be adapted for numerous industrial applications requiring lifelike closed-circuit TV reproduction



2. One man can install and operate this TV studio which contains all equipment necessary for "live," film or remote broadcasts. Included at less than \$15,000 are film and slide projectors, audio facilities, cameras and transmitting circuitry. All items can be controlled from a single master console. Designed for closed-circuit or wireless broadcasts, system can be used industrially, or by small communities for augmenting national programs with local broadcasts

3. Keeping your eye on things is easy and relatively inexpensive with this new television camera designed for closed-circuit applications in homes, schools and industry. Camera, which requires no special lighting, can be monitored by a number of ordinary TV sets connected to it with cables. Or, a number of cameras

may be monitored by a single receiver for complete coverage of a large area. Complete camera costs less than \$500, but unit is also available in kit form at a substantial saving. Five preassembled modules included with basic components, shown below, and simplified circuitry make kit construction easy

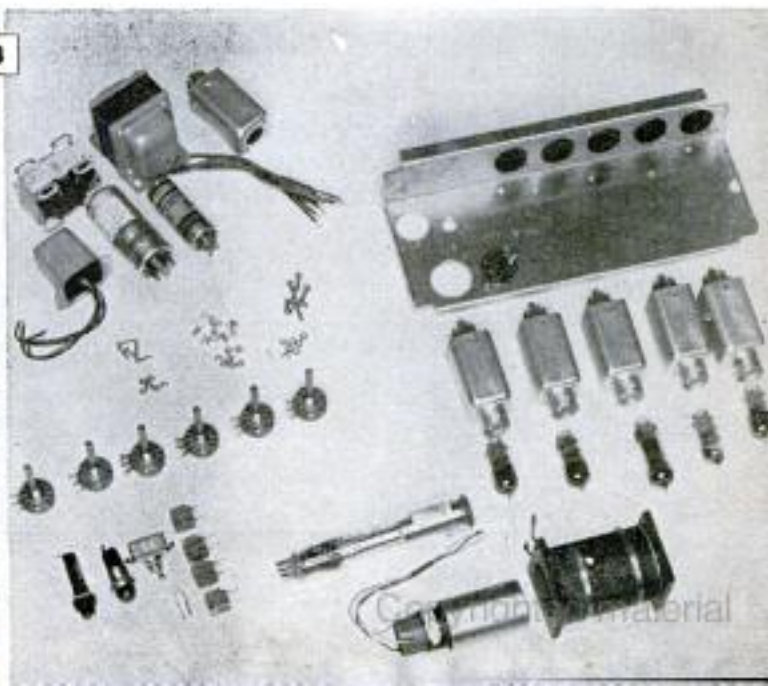



# You CAN Build a Hi-Fi FM-AM Tuner

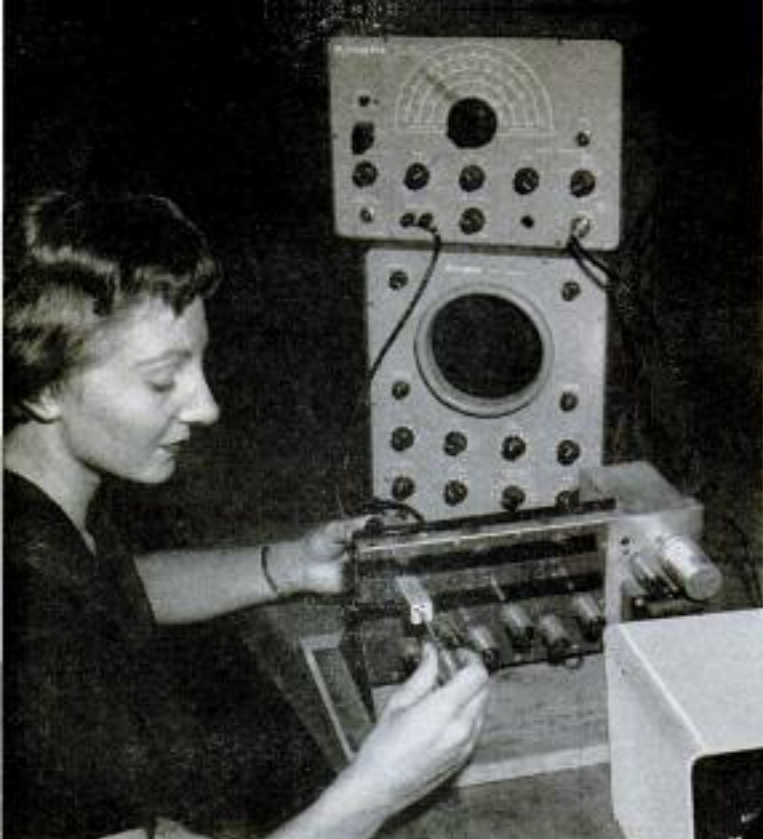

Carefully prealigned i.f. transformers and close-tolerance r.f. coils obviate need for complicated final adjustments

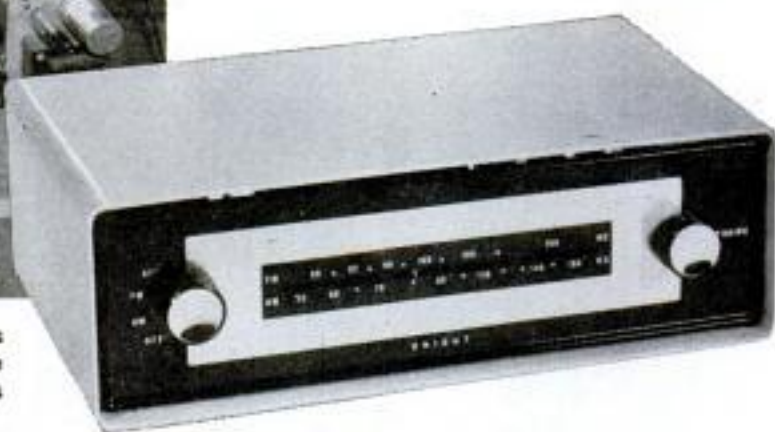

**H**I-FI KITS have been around for many years. Amplifiers and preamp kits are available literally "by the dozens," and almost any commercially built speaker enclosure can also be purchased in knocked-down form by the hobbyist who wants to save money or who takes particular pride in building his own equipment. But when it comes to hi-fi tuner kits, the choice has been severely limited. It isn't that hi-fi tuners are particularly difficult to design—the large selection of really good commercial units proves otherwise—nor that there is a lack of interest on the part of the kit builder in a high-quality radio tuner. It's just that many manufacturers have been reluctant to package a kit for a component whose ultimate performance depends as much on individual wiring and final adjustment as it does on the choice and design of the circuit. And that's why Allied Radio's new Knight FM-AM tuner kit is of special interest.

Circuitwise, this 9-tube tuner is not very different from many high-quality com-

mercially assembled units. For FM reception there's a tuned r.f. amplifier (for low noise and good image rejection), followed by a mixer and separate, drift-compensated oscillator which provides excellent stability during warm-up and under widely varying line-voltage conditions. Further insurance against oscillator drift is provided by an a.f.c. (automatic frequency control) circuit which can be disabled by the front-panel selector switch for the reception of weak or distant stations.

Two i.f. amplifiers, a ratio detector and an audio-amplifier stage follow in that order. Finally, a cathode-follower output stage permits the use of relatively long cables between the tuner and subsequent amplifier without the loss of signal quality.

On AM, there is a tuned r.f. amplifier, a converter and an i.f. amplifier. This is followed by a detector, using a separate 1N34 diode, an audio amplifier and, again, a cathode-follower output stage. The specifications for the completed tuner are given in the table.

Specifications (shown below) for perfectly aligned tuner. Due to carefully prealigned components, these specifications are approached without the complicated post-construction adjustments formerly required

SPECIFICATIONS:	FM	AM
Tuning range	88-108 mc.	540-1600 kc.
Sensitivity	2½ microvolts for 20 db quieting	3 microvolts for 10-db signal-to-noise ratio (at terminals)
Output	1 volt—with 1000-microvolt signal (I.F.) 60 db below 1 volt	1 volt with 5000-microvolt signal—60 db
Hum and noise	200 kc. at 50% down on curve	8 kc. at 50% down on curve
I.F. band width	60 db	20 db
Image rejection	20-20,000 cycles	20-8000 c.p.s. at 50% down on curve
Frequency response		



For the potential builder, however, the big feature of this kit is not the circuitry, but the ease with which the tuner can be constructed. Almost the entire tuner is built on an etched and drilled board comprising over 90 percent of the tuner wiring. The top of the board is screened to show the exact location of the various resistors, capacitors and other parts so that, with reasonable care, it is virtually impossible to make a wiring error. The little actual wiring which must be done by the builder is clearly shown in the illustrated step-by-step manual.

The printed board not only speeds up construction but it permits the use of carefully pre-aligned i.f. transformers and r.f. coils so that the need for final alignment is almost entirely eliminated. With conventionally wired sets, individual wiring methods cause such variations of stray lead inductance and capacity that precise prealignment of associated components is impossible. With printed circuits, however, only the variations in interelectrode capacities between vacuum tubes, even tubes of the same type, can upset the original alignment. But these variations are relatively small and their effects are minimized by the broad-band design of the tuner circuits. As a result, post-construction alignment is required only in extreme fringe areas where the last measure of performance must be gleaned from the tuner. The adjustments which are necessary require no test instruments or special tools.

Designed as a basic tuner, the Knight kit has only a tuning control and a function switch (Off, AM, FM without a.f.c. and FM with a.f.c.). The job of controlling tone and volume is left to the amplifier or preamp with which the tuner must be used.

Hi-fi hobbyists planning to take advantage of the many fine musical programs on the air today will welcome the addition of the Knight FM-AM tuner to the long list of hi-fi kits. Its price is low enough to be within reach of even a modest budget; its construction simple enough even for a beginner; its performance good enough to complement associated equipment of highest quality. ★ ★ ★

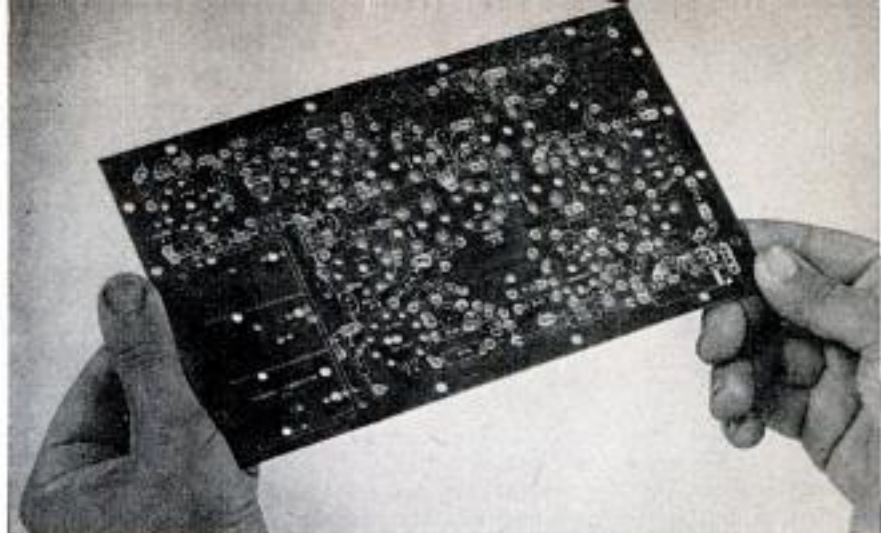

Screened printed-circuit board shows exact location of most small parts and makes child's play out of the construction of a normally complicated and critical high-fidelity component

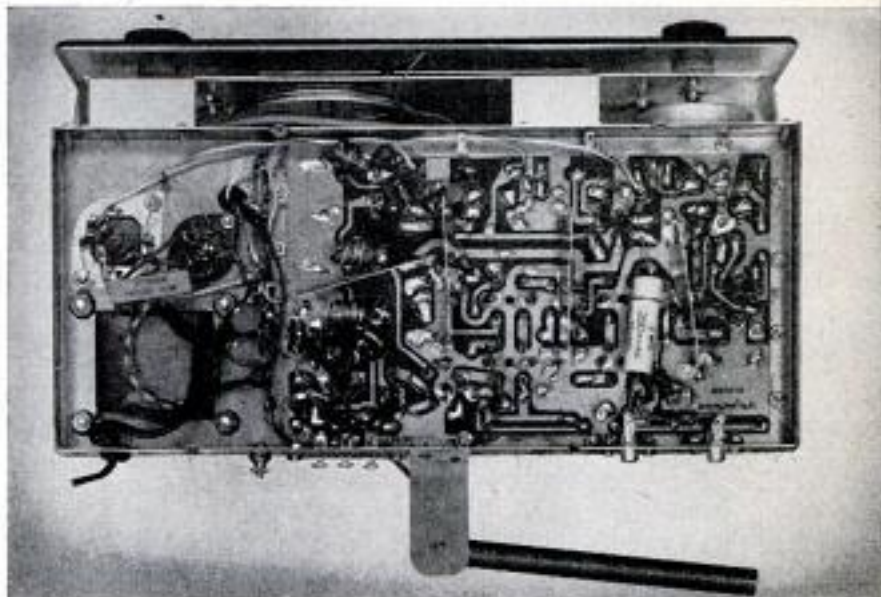

Where's all the wiring? Bottom of completed tuner chassis appears almost empty. Normal wiring is replaced with printed circuit to speed construction and minimize chances for errors. Below: Top of finished tuner chassis before installation of tubes. Adjustable AM loop antenna is mounted on back of chassis

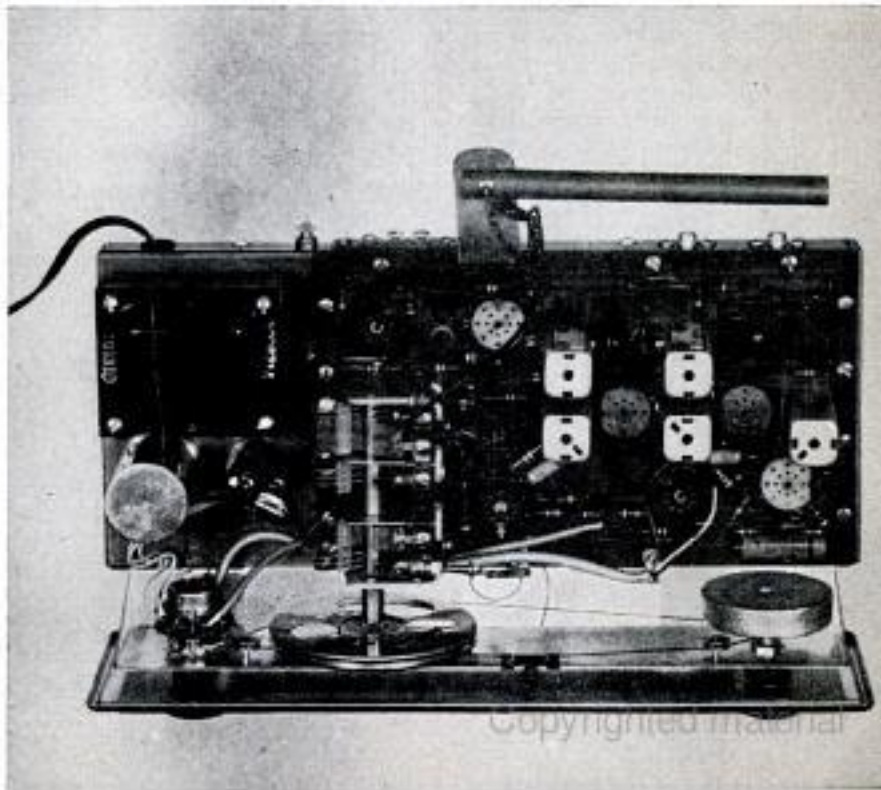



# For Experimenters and Hobbyists

The new Heath Radio Direction Finder Kit seems to be just what the doctor ordered for small-boat owners, pilots and other outdoor-sports enthusiasts who sometimes find themselves out of sight of land or familiar landmarks. It consists of (and can be used as) a sensitive portable radio with a highly directional ferrite antenna. Antenna is adjustable from front panel to obtain a rapid bearing on any station in standard-broadcast band

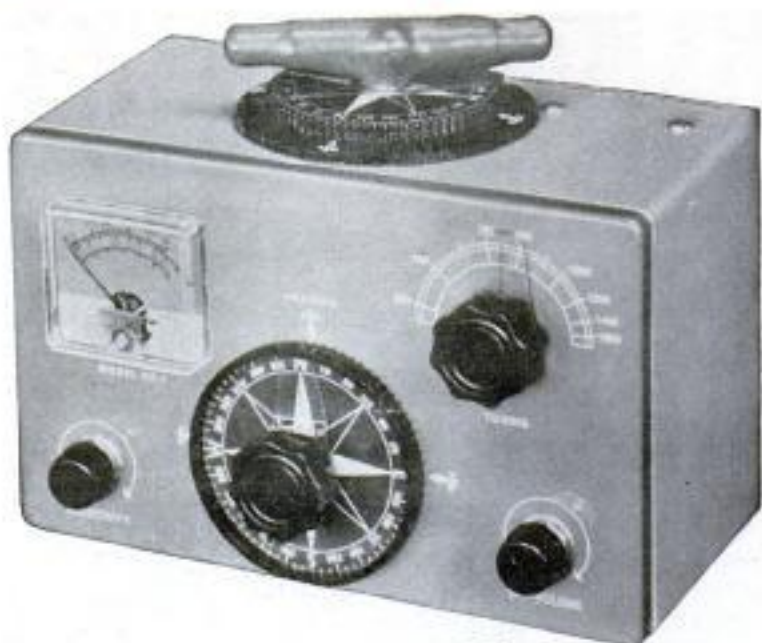

Discriminating hi-fi-ers can banish annoying "snap, crackle and pop," caused by dust and static electricity on a record surface, with the new ESL Dust Bug which attaches to any record player by means of suction-cup base. Unit loosens and collects dust and eliminates static before it can reach the reproducing stylus

A new "breadboarding" technique permits experimental assembly of electronic circuits without solder or mechanical connectors. Breadboard consists of 130 conductive cells covered with elastic material. Component leads and wires are connected by inserting them in the cells and can be removed quickly without damage to leads or loosening the contacts

Prospective "hams" can learn code the easy way with new code teacher consisting of a printed-circuit board and "electric" pencil. As pencil is drawn down each slot, the "dits" and "dahs" of the corresponding letters are reproduced by a buzzer. Board also mounts a telegraph key for code practice in the conventional manner. Built-in lamp permits visual transmission

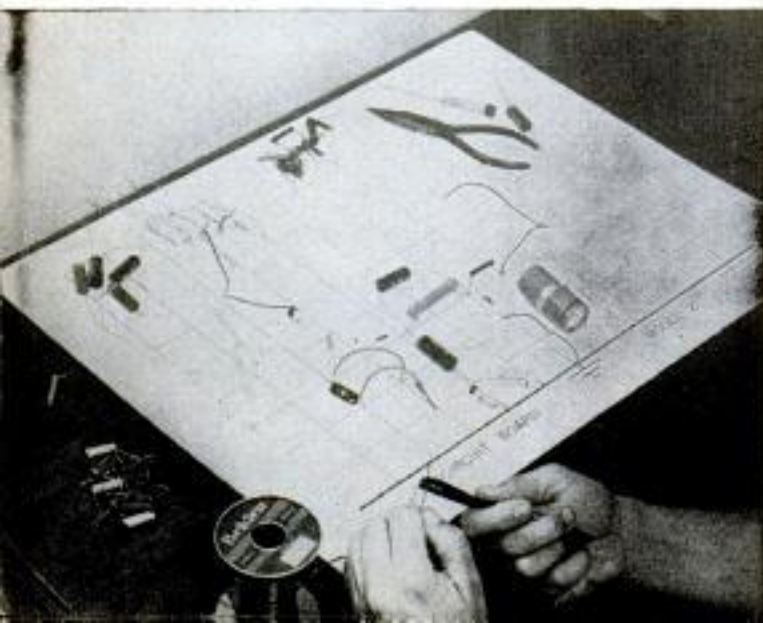







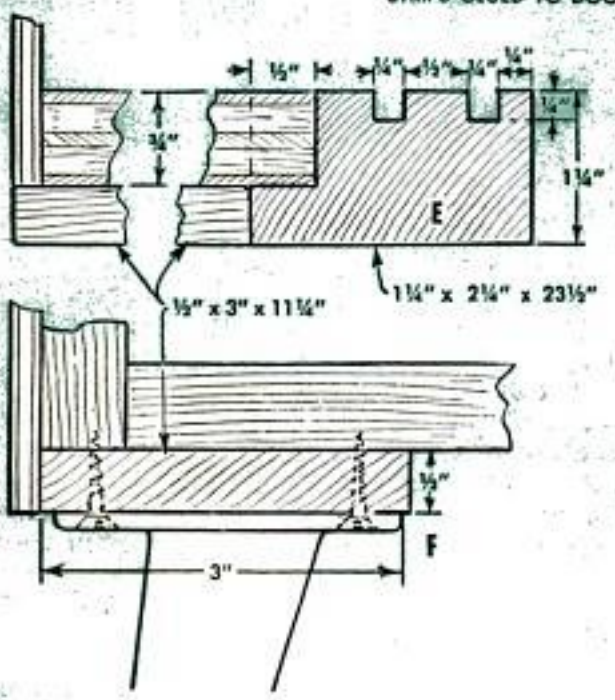
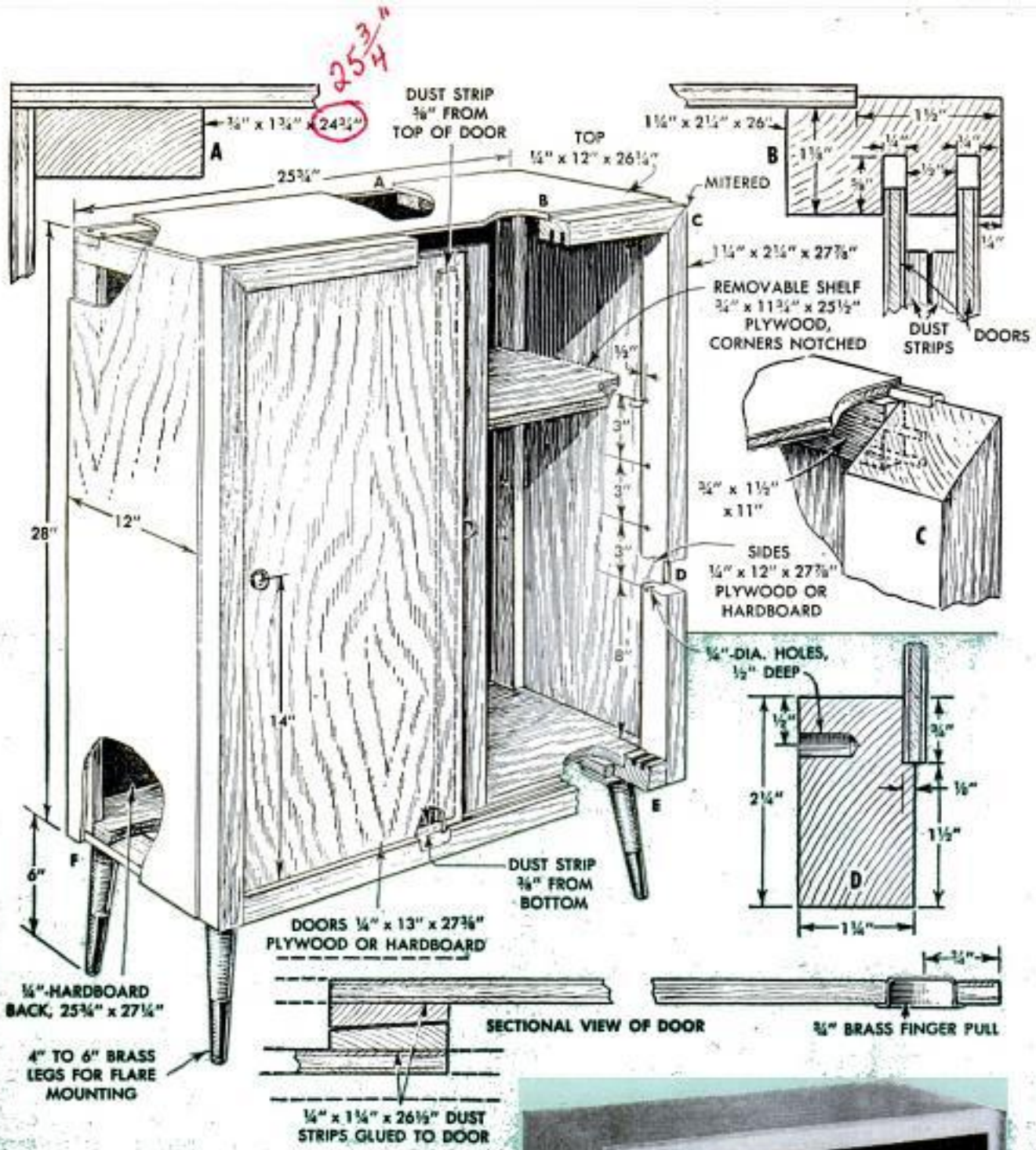



adequately strengthen those corners.

Next, the hardboard back is nailed in position, details A and E, and the two plywood sides added. After rabbeting the ends of the top panel as indicated in detail C, it is glued in place. The 1/4-in. holes drilled in the corner framing members, as shown in the drawing and detail D, accept steel shelf supports that permit adjusting the shelf. These holes should be drilled before assembling the framework at the front of the cabinet. The positions and spacing of the holes may be altered and one or more shelves used if desired.

Notice that the grooves for the sliding doors are cut 3/8 in. deeper in the upper horizontal framing member, detail B, than in the lower one, detail E. This permits installing the doors after the cabinet is completed. To do this, first insert the upper end of the inner door in its appropriate groove and then drop the door in the lower groove opposite the upper one. The same procedure is used for installing the outer door in the outer pair of grooves. Before installing the doors, brass finger pulls are fitted in them as shown, and the upper and lower edges of each door are beveled on the back side for easy sliding.

If hardboard is used for the doors, it can be painted black to contrast with an ivory-colored outer framework at the front. You may prefer to leave the entire cabinet in the natural finish of the woods used, or apply stain and varnish, especially when hardwood stock and plywood have been used for all exterior members. ★★

### Special Push Stick Aids Sawing

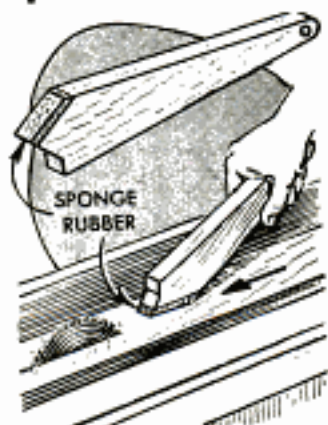

When ripping long stock on a table saw, one craftsman uses a special push stick he designed for the purpose. It's made with a length of sponge rubber cemented to an angled surface cut adjacent to one leg of the V-notch. This permits him to hold the work against the fence and safely push it into the saw. The V-notch is used in the usual manner when the end of the work reaches the edge of the saw table.

Calcimined walls should be washed thoroughly with a sponge and warm water before painting. All traces of calcimine must be completely removed in order for the paint to adhere properly.

DECEMBER 1957

### Thumbtacks Are Drawer Gliders

Heavy shop drawers can be made to slide easily by driving thumbtacks in the bottom edges of the sides as shown. For tight-fitting drawers, it may be necessary to slightly countersink the thumbtack heads to expose only the crowns of the heads.

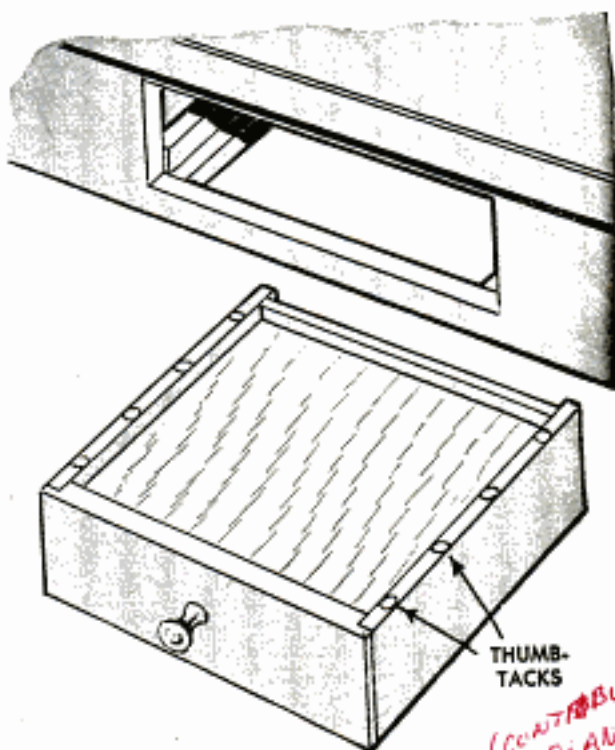

### Prevent Pipes From Freezing

You can prevent water pipes from freezing by painting the exposed pipes with a mixture of equal parts of glycerin and melted paraffin. This precaution can save you an expensive repair bill.

### Shade Ink Drawing With Brush

You can produce a variety of shading effects on ink drawings with a hand brush or piece of sponge rubber. Simply rub them over the surface of a stamp pad and apply the ink as shown in the drawing. Since the edges of sponge rubber tend to produce lines, use only the flat surface.

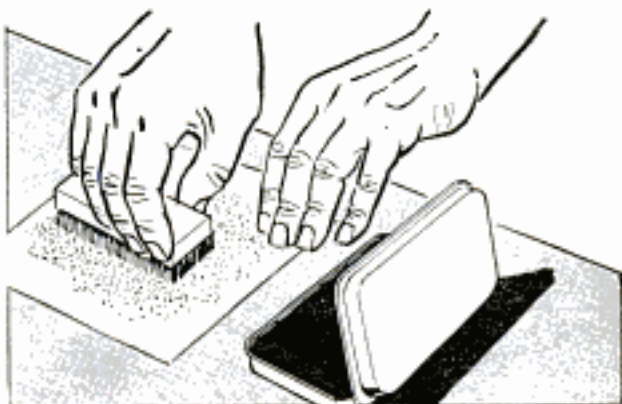



## Miter Box Nailed to Flange and Clamped to Workbench



If you have experienced difficulty in keeping a wooden miter box steady while sawing, try nailing the box to a wide piece of stock. Allow the stock to project at the front of the box so that the flange thus formed can be clamped to the workbench with a couple of C-clamps. Position the clamps so they don't interfere with sawing.

## Horse-Collar House Number

Two old workhorse collars and a lantern of the same period—the latter wired for electricity—have been combined by one homeowner to assemble this unusual name and address sign that is located in the yard.—F. Leland Elam, Sacramento, Calif.

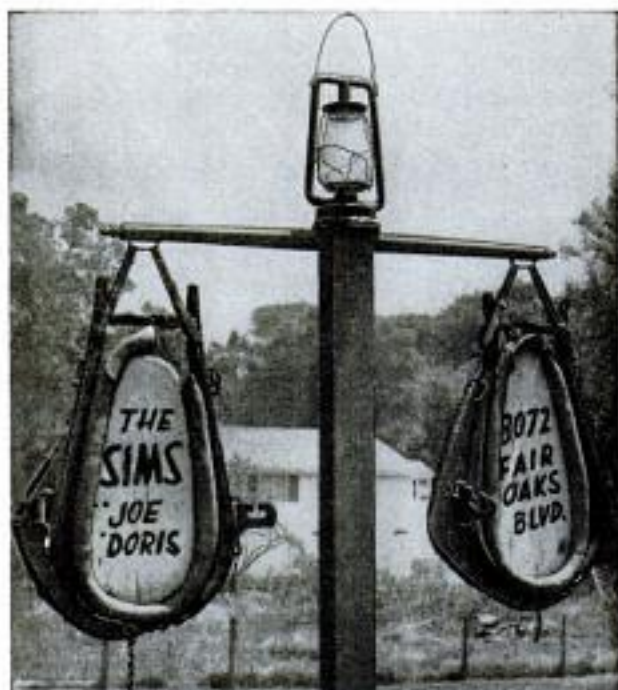

## Gate Made of Salvaged Items

Scrap odds and ends of various materials were combined to make this unusual gate. A length of pipe provides a column on which the gate hinges pivot. The hinges themselves consist of lengths of discarded wooden columns bored to accommodate the pipe column. The "mallet" effect is gained by wrapping the column sections with strips of flat steel, and nailing lengths of split dowels to the gate to appear to be handles. The chain and singletree were salvaged from an old farm wagon.



## Weather Stripping Silenced

You can stop that annoying howl of a spring-type metal weather stripping on an outside door when it is subjected to wind pressure by providing a resilient cushion under the weather stripping as shown. For the cushion, use a strip of self-adhering sponge rubber. Usually a  $\frac{1}{8}$ -in. thickness of rubber provides a satisfactory cushion without making the door too difficult to open or close.

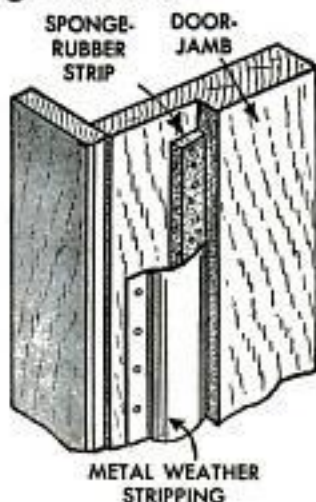



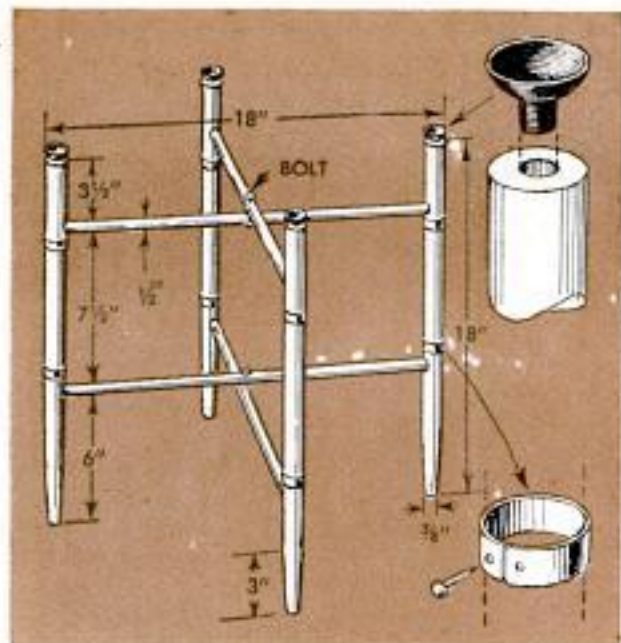

## Tray on Folding Stand Ideal for Snacks

Serving snacks to a few guests or the family is much easier for the hostess when the serving tray can be placed on a folding stand such as the one illustrated. The stand will take a tray of any shape with a radius of 9 in. or more and folds flat for compact storage. Rubber suction cups glued in holes drilled in the upper ends of the legs hold the tray securely once it is pressed in position on them, making the unit very adaptable for use as a TV table, tea table, snack table or end table as desired. If no suitable tray is available, the one shown can be made by making a full-size pattern from the squared drawing and cutting the members from 1/4-in. hardwood plywood and assembling them with glue and nails. The legs of the stand are 1-in.-dia. hardwood dowels, cut to length and drilled to accept the crossrails. The latter are cut from 1/2-in.-dia. hardwood dowels. A hole, drilled vertically through the diameter of each crossrail, accommodates a 3/16 x 1 1/4-in. stove bolt at each pivot as shown in the drawing above. Before gluing the crossrails, 1/4-in.-wide strips of polished sheet brass are wrapped around the legs at two elevations and secured with brass escutcheon pins as indicated in one of the details. The holes for the suction cups, also, are drilled at this time. The legs and crossrails are painted black to contrast with the decorative brass trim on the legs for a smart appearance.

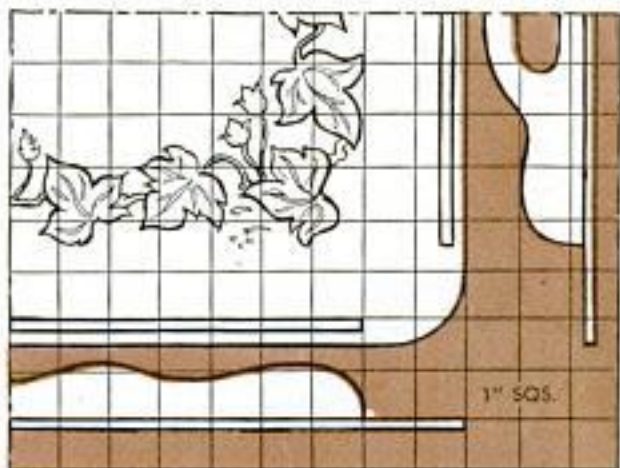
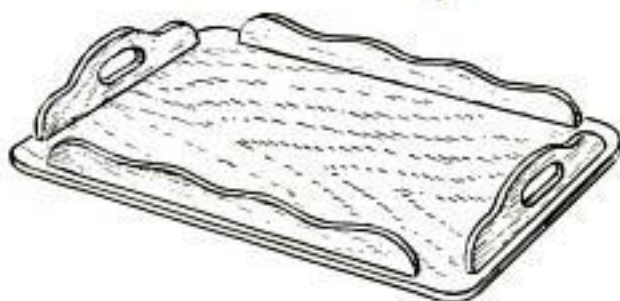

ated in one of the details. The holes for the suction cups, also, are drilled at this time. The legs and crossrails are painted black to contrast with the decorative brass trim on the legs for a smart appearance.

Bertram Brownold, Cedarhurst, N. Y.

## Cooling Photo Developer

When cooling or warming a bottle of photo developer under a faucet, try inverting a drinking glass over the open neck so that the water can flow down all sides of the bottle. This will permit the water to envelop the entire bottle without entering it.—J. Comstock, Wellsboro, Pa.

## Repair Tackle With Nail Polish

Clear fingernail polish is ideal for quick repairs to chipped plugs, loose rod windings and damaged windings on flies and other fishing tackle. Also, a drop of polish on a mosquito bite will stop the itching almost immediately.

Harry J. Miller, Sarasota, Fla.



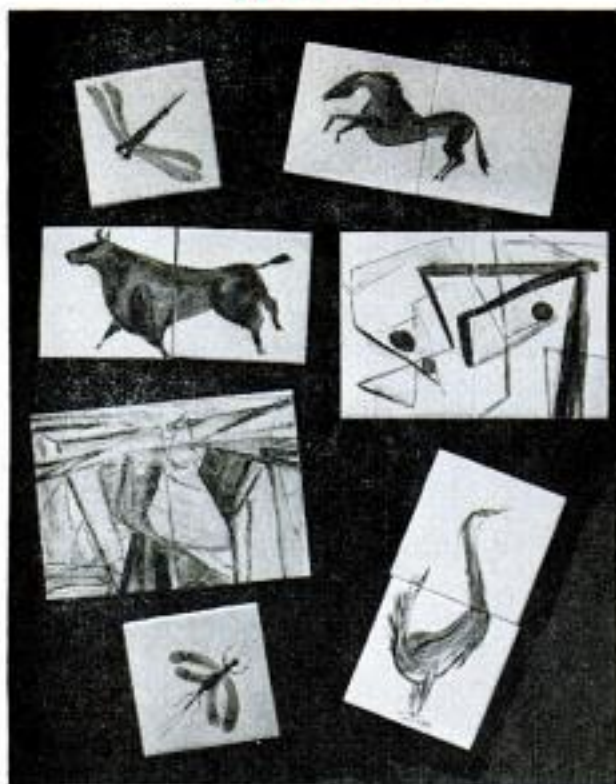

1. Figures and designs painted with color-oxide mixtures become part of tile after firing them in kiln

**I**F YOU HAVE a penchant for household furniture that is a bit unusual, here is a coffee table you will want to make. Ceramic tile, some with colorful figures painted on them, are cemented to a panel of  $\frac{3}{4}$ -in. plywood which is mounted on wrought-iron legs to produce a beautiful and serviceable coffee table with a personal touch.

2. Painting figures on tile is easy with paint made from colored oxide mixed with liquid furniture wax



# CERAMIC-TOP

By F. Leland Elam

Color combinations and arrangements of the tile are limited only by individual taste and ability and by the availability of tiles in the desired colors. The  $21\frac{1}{4}$  x 30-in. plywood top used for the table illustrated accommodates an even number of glazed tile  $4\frac{1}{4}$  in. sq., while the edges are faced evenly with 1-in. wide unglazed tile in 1 and  $2\frac{1}{16}$ -in. lengths. Other sizes of tiles can be used for the top and edges simply by cutting the plywood top to the required size. Also, designs as well as figures can be painted on the tiles selected for that purpose, Fig. 1.

Before obtaining the tile, it is a good idea to sketch several layouts, simulating the colors of available tile and drawing figures and designs and locating them for the most pleasing effect. Then, obtain the required tile and place the large ones on the plywood base according to the color plan of the selected layout. Next, remove the tiles that are to be painted. When two or more tiles serve as a background for a single figure, they must be taped together for proper alignment of the segments.

Paints for the illustrations are made up by mixing a small amount of liquid furniture polish (wax base) with a colored oxide that is appropriate for each of the required paint colors. The wax serves as a good vehicle for flowing on the colored oxides

3. Grout is worked into tile joints by moving palm of hand with circular motion over surface of table





# COFFEE TABLE

in that it dries quickly, preventing the colors from intermixing. A small brush is used to apply the paint as in Fig. 2.

After the tiles are painted, they are placed in an electric kiln for firing at a temperature of 1750 deg. F. At the moment the glaze on the tile melts, the heat is turned off and the tile is allowed to cool with the kiln door closed. When cooled, the glaze hardens again and the figure or design fuses with it in permanent colors.

The next step is to return the painted tiles to their respective places on the table and begin cementing the tiles, starting at one corner, and being careful to align the outside tiles with the edges of the table. When all large tiles are set, the small ones are cemented on the edges of the table as shown. Ceramic-tile cement is used for both types of tile.

About 8 hr. after the tiles have been cemented, the tile joints are filled with grout as in Fig. 3. For this, portland cement is dry-mixed with powdered brick-red cement chrome oxide. Then, water is added until it attains a consistency of light cream. After the grout has dried for 15 min., the excess is wiped from the tile with a damp sponge, Fig. 4. About 24 hr. are required for complete hardening of the grout, after which a 10 percent solution of

4. After grout sets, excess is removed with wet sponge, being careful not to dislodge it from joints

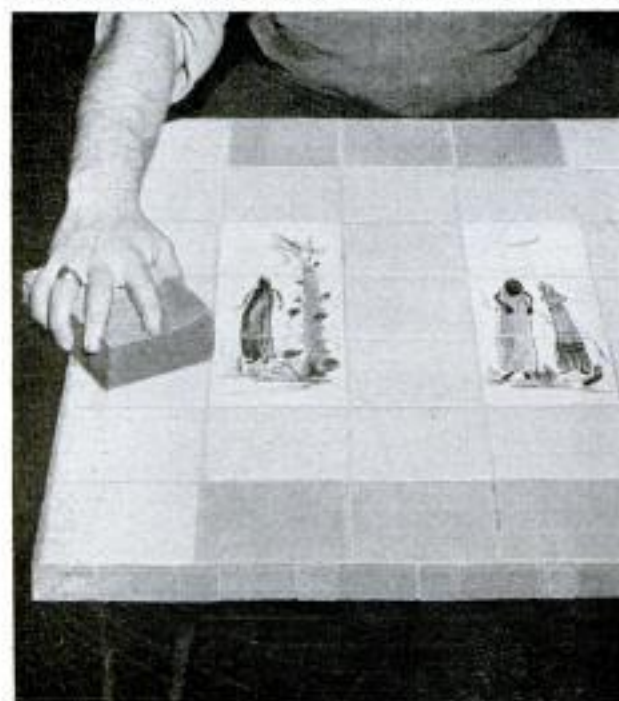

muriatic acid is applied to the entire tiled surface, Fig. 5, to dissolve any remaining grout particles. The acid is then removed by rinsing with water. Wear rubber gloves when rinsing off the acid and be careful it does not get on the clothes. ★ ★ ★

5. Muriatic-acid solution brushed on tile, dissolves hardened grout particles for removal with wet sponge







## Retaining Groove in Bench Top Keeps Screws From Rolling Off

Screws, nuts and other small parts of an assembly that are placed on a workbench can be kept from rolling off the top by cutting a  $\frac{3}{8}$ -in. groove in it near the outer edges as shown. A groove is better for this purpose than a raised border of wood or metal because the groove will not interfere with work that must be placed over the edges of the bench and it permits easy cleaning of the bench top.

## Wrap Gift With Paper Tablecloth

When you have a large package to wrap as a gift, try using a paper tablecloth of the required size for wrapping material. This makes a neater and more attractively wrapped package than is possible when several sheets of gift-wrapping paper are joined together to cover the package.

## Jackknife-Style Scribing Tool

Here is a handy scribing tool that you can carry in a trouser pocket, since the sharply pointed scriber can be closed safely in the same manner as a jack-knife blade. The tool is made by forming a loop at the end of a length of stiff wire and pointing the other end. The wire is then mounted on a hardwood handle with a deep groove cut in it.



## Improved Bunsen Burner

When you need a Bunsen-type gas burner for shop-work or for heating household repairwork, this improvised burner can be made in a few minutes. Simply form a length of soft-copper tubing as shown in the detail and drill several small holes in the upper end of the spiral to admit air. A length of rubber tubing connects the burner to an outlet.

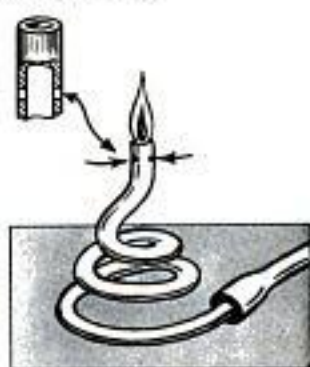

## Luminous Tape in Darkroom

Luminous paint or tape applied on the edges of darkroom shelves make film, holders and film hangers easier to locate in the dark. Select spots for the tape carefully to prevent fogging the film when loading or developing it.

Marshall Lincoln, Fort Wayne, Ind.



## Notch Ship's Margin Planks

For authentic reproduction of model ships made to scale, the ends of deck planks at the bow should be squared and let into notches in the margin planks, as shown, rather than ending them in sharp points. The squared end of each plank should equal one third of its width.

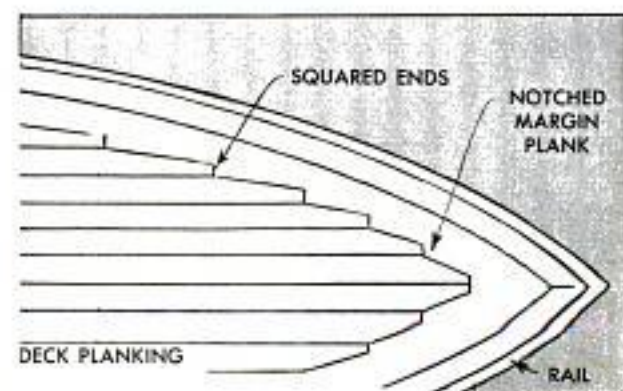



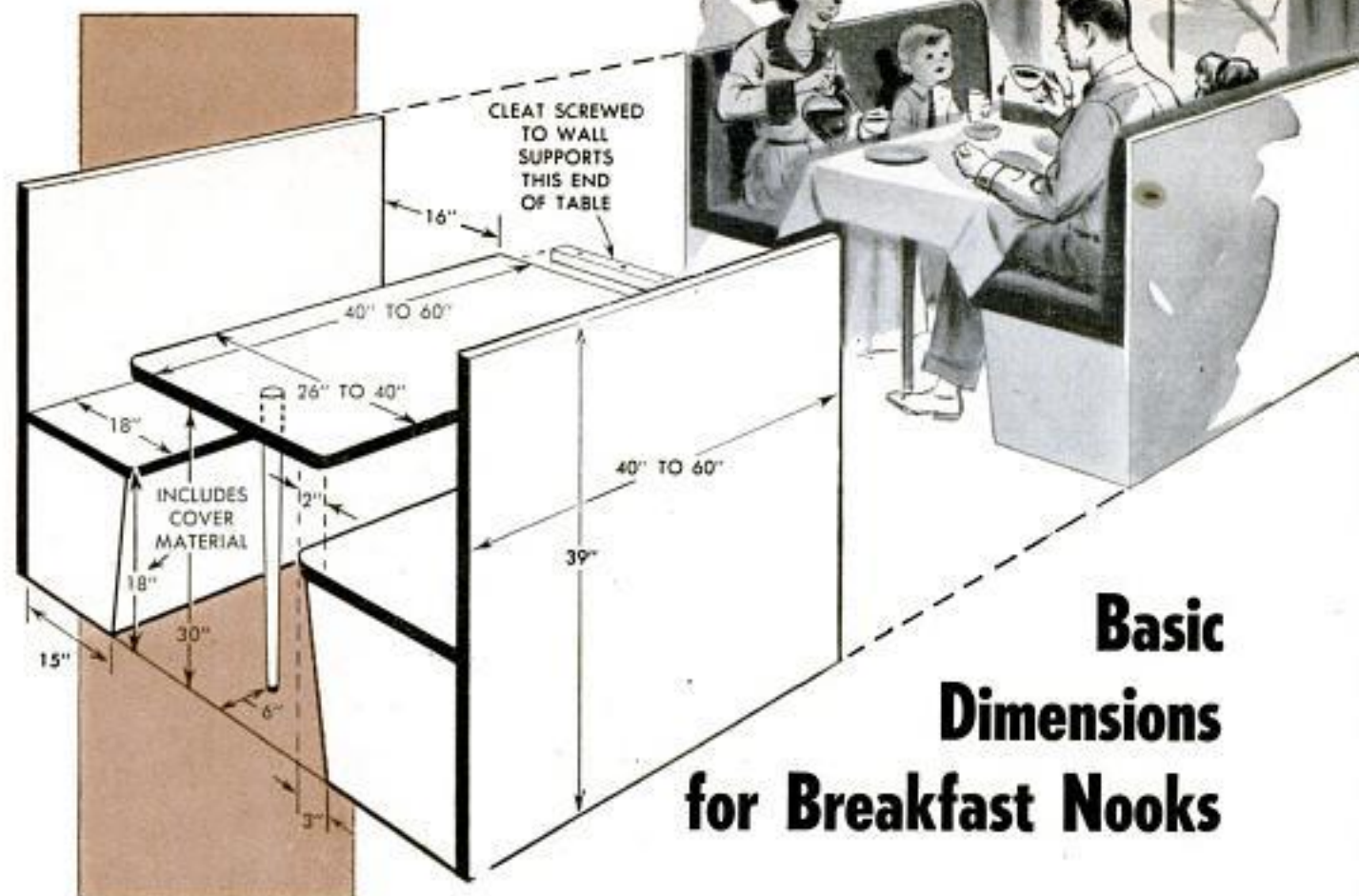

## Basic Dimensions for Breakfast Nooks

When building a breakfast nook it should be noted that dimensions and clearances have been fairly well standardized as given in the above drawing. The most common arrangement for accommodating four persons is to have two benches, one on either side of the table as shown in the illustration. In some cases a single L-shaped or U-shaped seat may be preferable. The table can be supported at the outboard end by means of single wooden or wrought-iron leg and a cleat under the opposite end for attachment to the wall. A crutch tip on the leg prevents damage to the floor covering and deadens sound when dishes contact the table surface. Exposed corners on the table and seats should

be rounded at about a 2-in. radius and are then less likely to cause painful bruises. Seats of plywood or lumber,  $\frac{3}{4}$  in. thick, are the simplest to build and the easiest to keep clean. The seats may be supported in the same manner as the table, or they may form tops of storage bins or cabinets. For increased comfort, seats should be cushioned. However, the thickness of the cushioning material must be calculated before constructing the seats so that their over-all height does not exceed 18 in. The material used for covering the cushions should have a smooth finish since a person sitting on the inside of the table must slide across the seat when entering or leaving.—E. R. Haan, Evanston, Ill.

### Eraser Is Recipe-Card Holder

For handy reference when cooking, one housewife inserts the recipe card being used between the felt plies of a blackboard eraser as shown in the detail. One eraser can accommodate several cards when used in this manner.

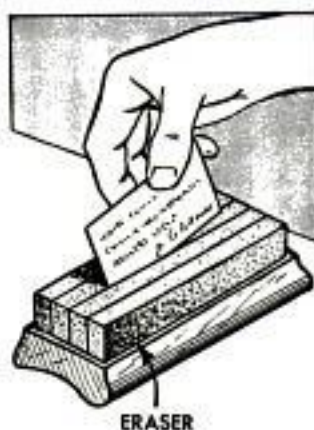

### Tubing Protects Tap Threads

Protect the threads on the taps of your tap-and-die set by cutting sheaths for them from rubber tubing as shown in the photo. The sheaths also will prevent the cutting edges of the taps from damaging other tools stored with them.





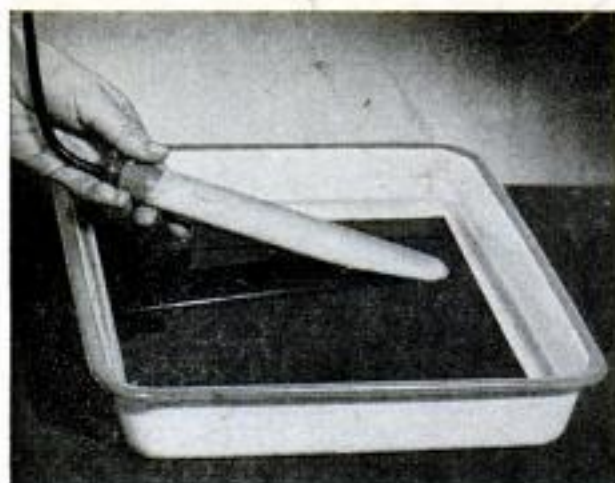

### Aquarium Heater Keeps Developer At Right Temperature in Winter

During the winter months the temperature in most basement darkrooms is below that required to maintain the developer at 68 deg. F. If the developer is too cold, it will be difficult to get full-toned prints and full-scale negatives. To avoid this difficulty, submerge an electric tropical-fish aquarium heater in the developer and set the control so that a constant temperature of about 68 deg. F. is maintained. A 25-watt heater is adequate for use in a developing tray, while a 50 or 100-watt heater would be more suitable for a deep developing tank.

### Checking Shaper-Cutter Profile

Being a reverse of the actual cut, sometimes it is difficult to tell in looking at a shaper cutter the exact profile it will cut. A quick way to make a positive pattern is to hold a piece of paper against the flat face of one blade and tear forward.

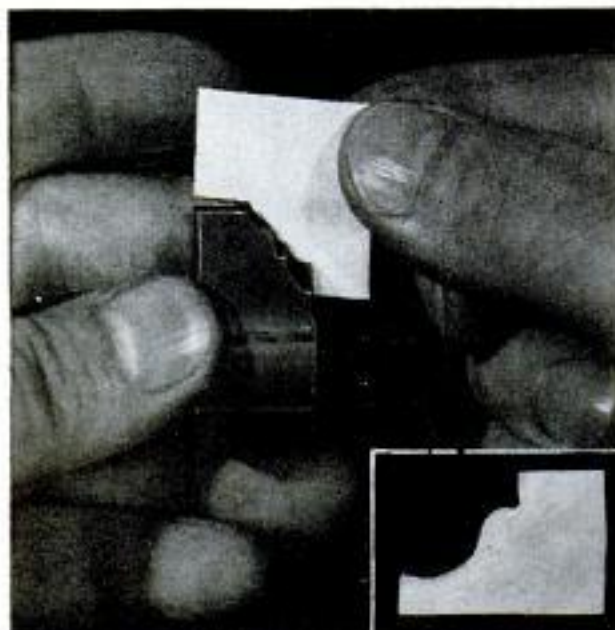

# MULTIPLE

By James A. McRoberts

*746 Carroll St., Brooklyn 15, N.Y.*

**DANCING NEON LIGHTS** will turn your Christmas tree into a conversation piece when wired to this special flasher. It controls the rate of flash of the bulbs by varying either the resistance or the capacity, or both, of a relaxation oscillator, thus making the lights blink individually and intermittently.

The basic circuit is shown in Fig. 2. A simple selenium-rectifier power supply furnishes d.c. power at about 150 volts to the lamp line. Each neon bulb has its own resistor and capacitor, R-2 and C-2, Fig. 5, which determines the flash rate of the bulb. The power supply will operate as many as 20 lamps without reducing noticeably the flash rate.

Flash rate is determined primarily by the values of R and C (resistor and capacitor) for each lamp of the circuit. The lamp size may be anywhere from  $\frac{1}{25}$  to 2 watts. The smaller lamps will give a brighter flash, with the  $\frac{1}{4}$ -watt NE-7 bulb, Fig. 4, being preferred. The bulb simply acts as a switch when the capacitor charges to its striking voltage. The lamp then partially discharges the capacitor and the cycle repeats. The size of the lamp has very little to do with the flash rate.

For a 150-volt supply, a combination of a 0.2 capacitor and a 22-meg. resistor, such as R-2 and C-2 for lamp No. 1 (L-1), yields a flash rate of about one flash per sec. With a 22 meg. and 0.1 mfd., the rate is roughly two flashes per sec. Dropping the resistor to 10 meg. and the capacitor to 0.1 mfd. gives about four flashes per sec. If the capacity is raised to 0.5 mfd. and two 22-meg. resistors are used, the rate will be one flash every five sec.

How power supply is housed in hinged plastic box. Black cord is power line, white cord is lamp feed

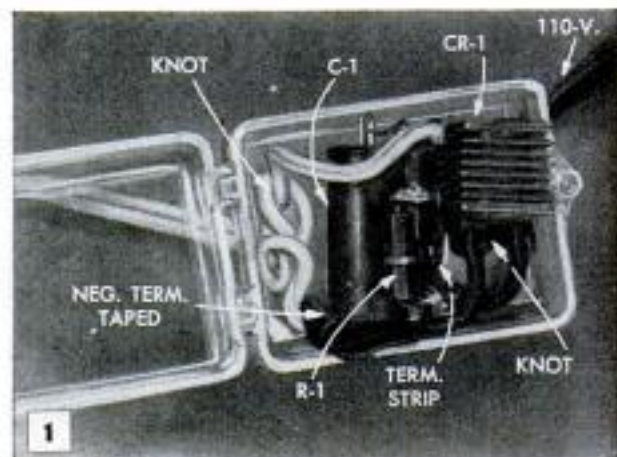



# NEON FLASHER

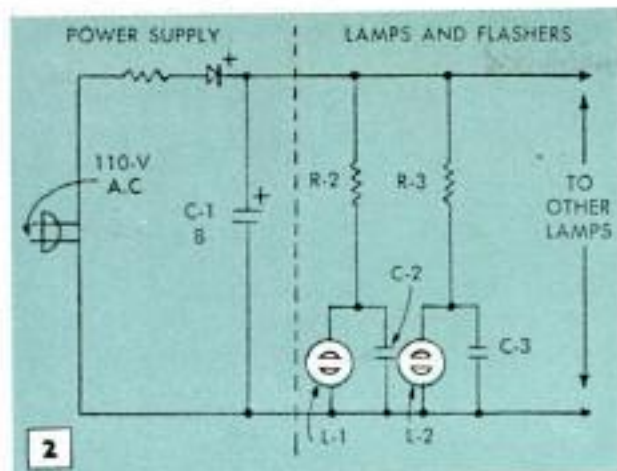

Schematic of circuit shows power supply at left. Additional lamps may be added in parallel across leads

A small plastic case is used to house the power supply which contains the selenium rectifier, surge resistor and the capacitor, Fig. 1. The terminal strip keeps the parts in place, and knots tied in the power and lamp wires prevent tension on the components. The common lead of the lines and the capacitor is simply taped after being soldered.

Fig. 5 shows the method of wiring each flash unit in the string, C-2 being a capacitor and R-2 being a resistor. The leads are soldered and taped and the completed unit looks like Fig. 3. Be careful to tape the connections well since one side of the power line is connected straight through. Also, watch that you do not break the fragile wires of the neon leads. Bulbs with bases may be used, too, such as the NE-17 in place of the NE-7. In using the 1-watt NE-30-type bulb, the wires are soldered directly to its screw base or to a socket to which the capacitor and resistor are attached. Tolerances of the resistors, capac-

Some of the various neon bulbs available. Smaller lamps give brighter flash. NE-7 type is preferred

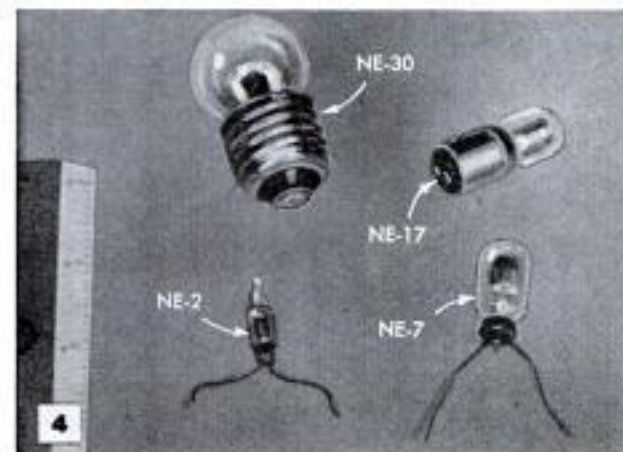

DECEMBER 1957

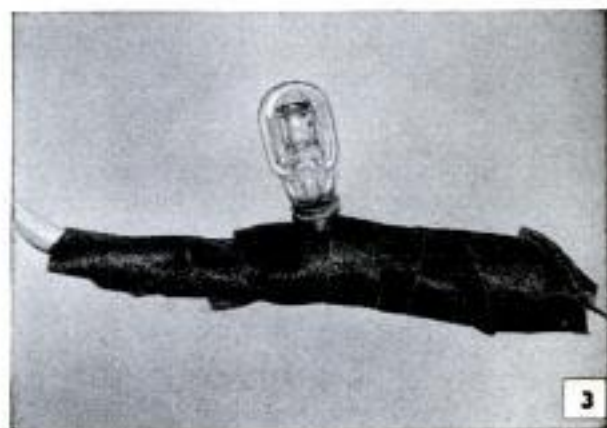

Here's what each lamp will look like in your string of lights after connections and components are taped

itors and lamps usually allow slightly different flash rates for the same nominal values. Thus, a staggered effect is provided even with the same components. ★ ★ ★

Shown untaped, this is how the components of each flash unit are wired. Space them about 18 in. apart

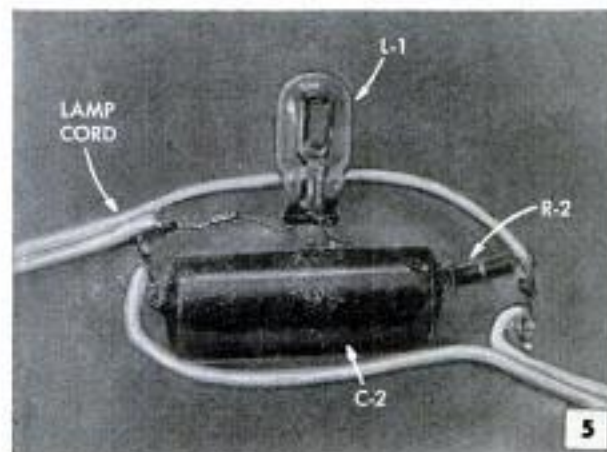





### Preventing Accidental Erasures On Tape Recordings

The sad misfortune of accidentally erasing a tape recording can be avoided in the future on some recorders by keeping a short piece of rubber tubing over the erasing button. In this way, the button cannot be depressed without first removing the tubing.—J. G. Forbes, Los Angeles, Calif.

☐ When figuring the amount of wallpaper needed for a room, make exact measurements of the walls and then deduct total area of doors and windows.

### Ground Wire on Darkroom Brush Removes Static Electricity

A paintbrush used for dusting film negatives, plateholders, etc., should be fitted with a ground to remove any static electrical charge which attracts more dust. To do this, solder one end of a length of wire to the metal ferrule of the brush and fit the other end of the wire with an alligator clamp. When the brush is used, simply clamp the wire to a convenient cold-water pipe.—Ken Murray, Colon, Mich.

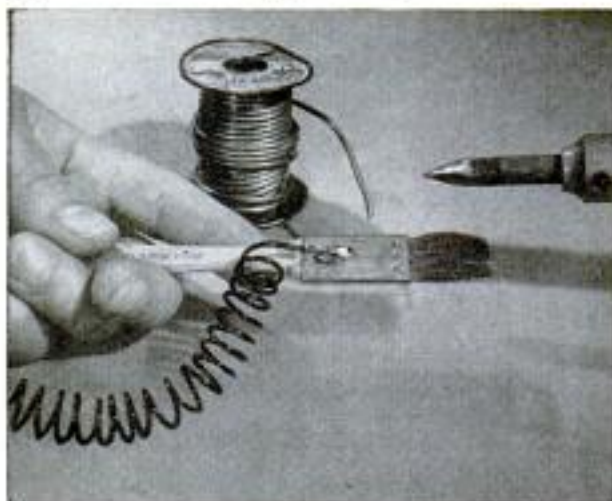

# MUSICAL

By Elma Waltner

**T**ODDLERS OF PULL-TOY AGE will be fascinated by this friendly hen that struts along, flapping her wings and "clucking" a three-note tune. The "music box," Fig. 1, is the most complicated part of the toy and will take the most time to construct. To begin, felt strips are cemented to two wooden spacer blocks that then are screwed between the plywood sides of the box, and spaced as in Fig. 4. Three strips of metal, dimensioned as in Fig. 5, now are drilled to permit using brads to hold them loosely on the blocks. Felt washers are used under the heads of the brads so the metal bars can vibrate freely when struck by the hammers. The latter are cut from  $\frac{3}{4}$ -in. stock to the approximate shape indicated in Fig. 4. The curved surfaces on which the strikers slide should be sanded smooth to assure minimum resistance. Drill  $\frac{1}{4}$ -in. blind holes in the hammers and cement ends of lengths of  $\frac{1}{4}$ -in.-dia. spring curtain rods in these holes. The other ends of the springs are cemented in holes drilled through another spacer block as indicated in the details. Screw this block between the sides of the music box so that the hammers are positioned about  $\frac{1}{8}$  in. away from the centers of the metal bars when the hammers are hanging free. Next, cut the axle 6 in. long from a  $\frac{3}{8}$ -in. dowel. Drill three  $\frac{1}{8}$ -in. holes in the axle, spacing them 120 deg. apart and locating them so that 1-in. lengths of dowel fitted in the holes will be centered on the hammers, Fig. 5. Temporarily install the wheels, rotate the axle and trim the striker dowels so they operate the hammers properly. Now, using patterns made by enlarging the squared drawing, Fig. 3, cut out the vari-

When "music box" is assembled, strikers are adjusted in length to assure the proper operation of hammers

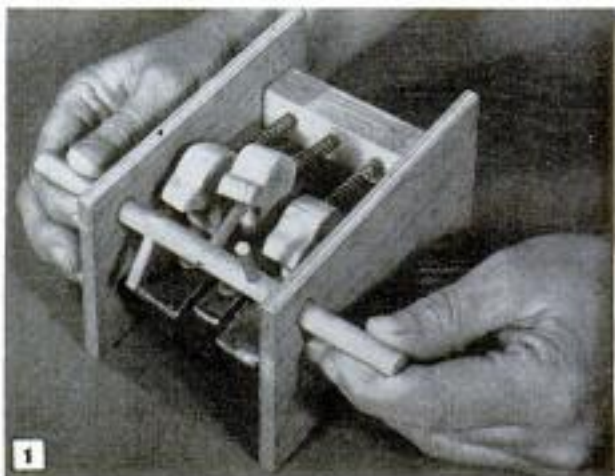



# BIDDY

ous parts of the hen's body and assemble it around the music box. Glue the rear wheels to the axle and attach the front wheels with wood screws. Wings are pivoted to the body by drilling clearance holes in the wings and driving wood screws into the body. The legs are pivoted to the wings and rear wheels by the same method. Position the pivot of one leg 180 deg. away from the other, so the wings and legs will move alternately. Drive a screw eye into the front of the toy to permit attaching a towing string, paint it in bright colors and the hen will appear as in Fig. 2, ready to be towed about. ★ ★ ★

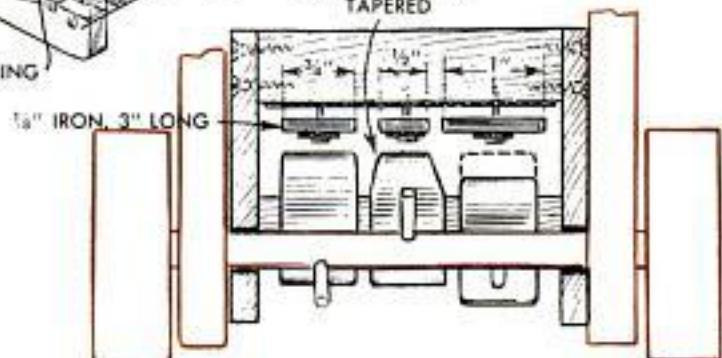
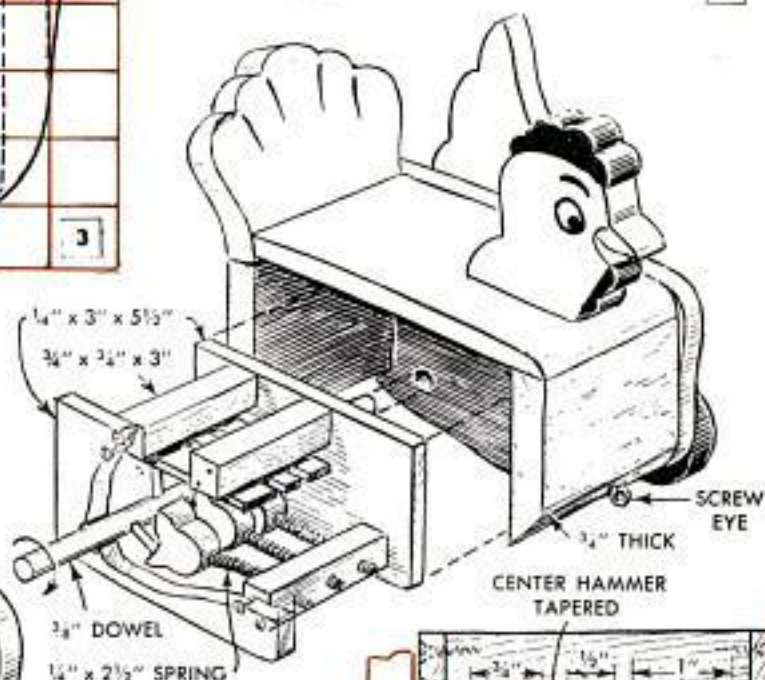
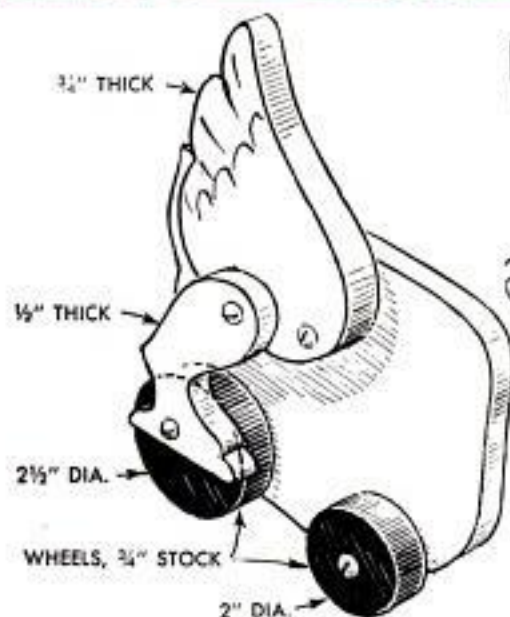
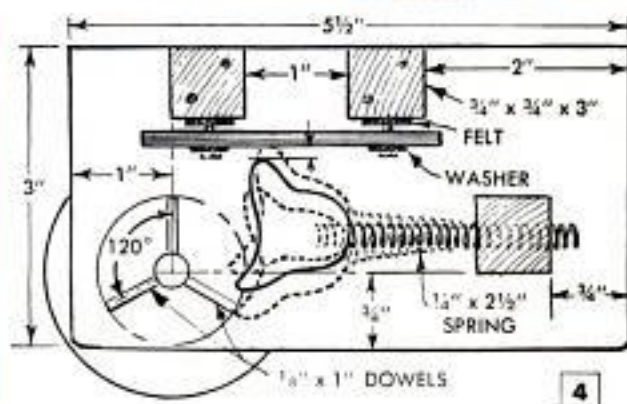
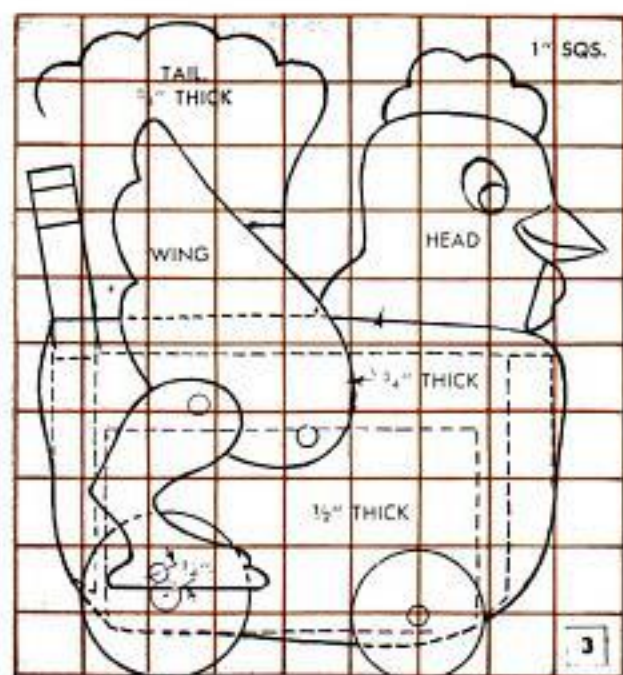





# Solving HOME PROBLEMS

**TO FREE A FROZEN DOOR**, caused by moisture running to the bottom edge of the door and freezing to the sill, apply salt water, using an oil can as applicator

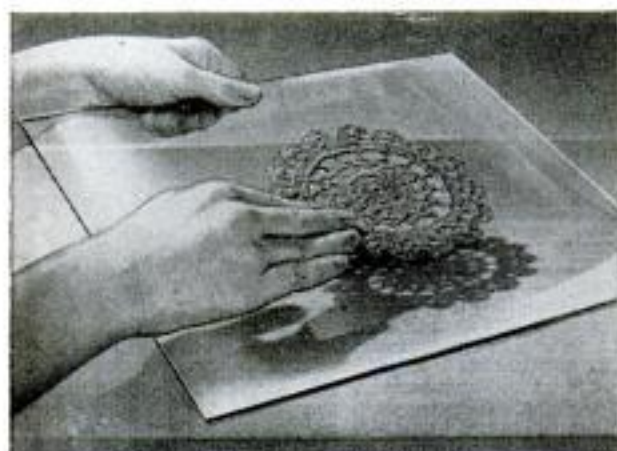

**DOILIES "STRETCHED" ON GLASS PLATE** are as neat as when pin-type stretcher is used. Dip doily in starch, spread on glass or mirror and allow to dry



**THREADING A NEEDLE IS MUCH EASIER** when the end of very heavy thread is first flattened with pliers so it passes easily through oval needle eye

**ASSURE GOOD FLOWERPOT DRAINAGE** without loss of soil by fitting bottle cap over drain hole. It holds in soil, lets water seep out under irregularities in crimped edge of cap

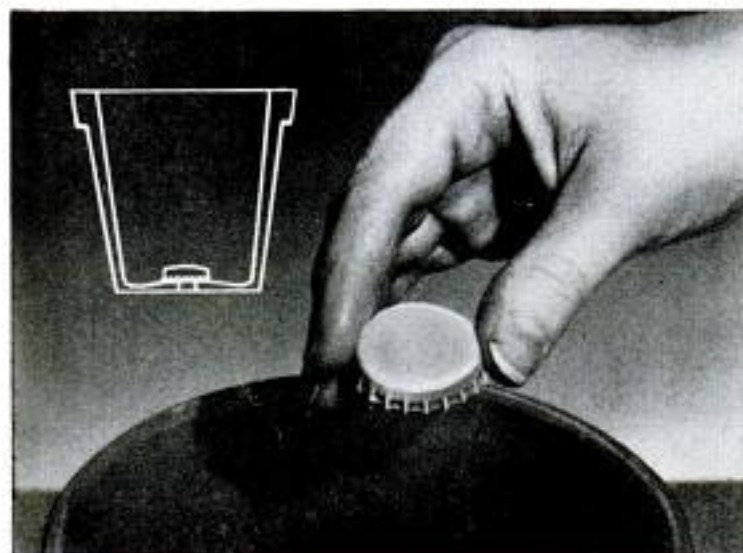

178

**WASHING-INSTRUCTION** tags in envelope on inside of medicine-cabinet door are handy when hand-washing delicate items



POPULAR MECHANICS



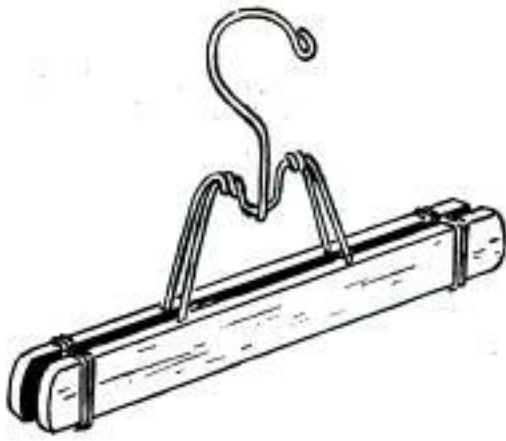

**WHEN TROUSER HANGER LOSES GRIP**, slip heavy rubber bands over ends. Added thickness and resistance of rubber compensate for loss of spring tension



**GET 100 PERCENT USE FROM CANDLES** by dropping one stub into dessert glass to provide wick, melting others and pouring wax into glass around first stub

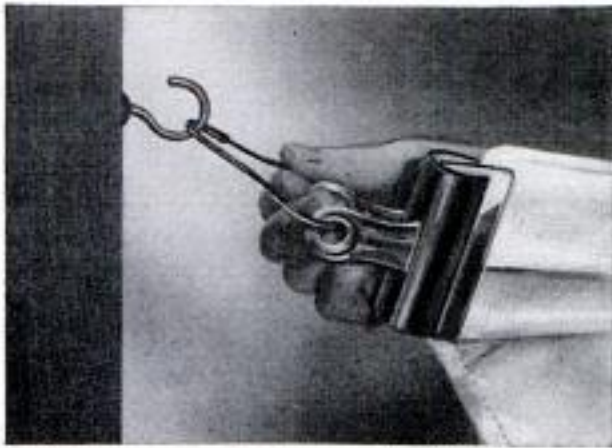

**PAPER CLAMP IS "THIRD HAND"** when folding bed sheets and other large items. Slip clamp onto shower-curtain ring, fit ring over large cup hook on wall



**KEEP SIZE MARKS IN SHOES LEGIBLE** until shoes wear out by painting over the numbers with clear nail polish when shoes are new, numbers readable

**ROLLED CALENDAR WILL LIE FLAT** if tube in which it is mailed is held over steam to moisten paper before removing



DECEMBER 1957

**REFUSE PAILS EASILY RUSTPROOFED** by polishing the inside with hard wax. Heavy coating of wax also makes the pails easier to clean by preventing food from sticking to the sides



179

Copyrighted material



## Self-Setting Target for Air-Rifle Shooting Practice

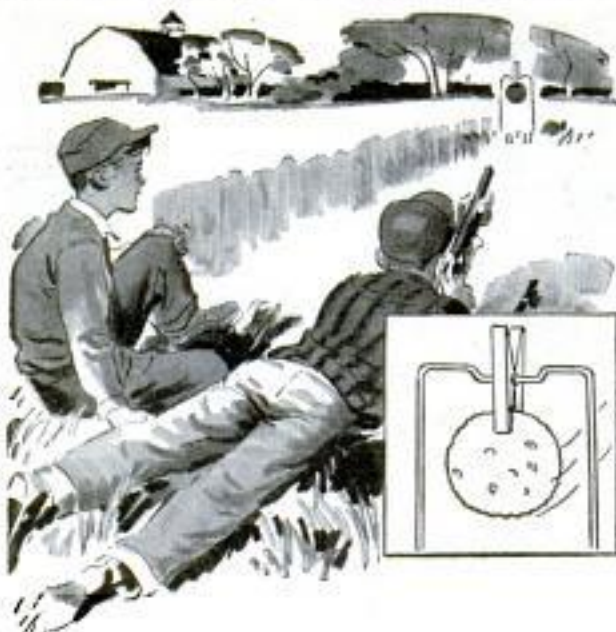

Air-rifle target practice is fun when you have a target, such as the one shown, that swings into shooting position immediately after it is struck by a pellet. To make the target assembly, a length of wire is slipped through the spring coil of a clamp-type clothespin and the wire bent as indicated. One end of a metal food can serves as a target when it is gripped by the clothespin as shown in the detail.

## Cedar-Shingle Coverage

Calculating cedar-shingle coverage is made easy for both builder and do-it-yourselfer by the rule-of-eight method which can be applied to any amount of shingles at any weather exposure. Here's how it is done: Count the layers of shingles in a bundle and multiply the amount by the number of inches of weather exposure desired. Then divide the result by the number 8 to determine the square-foot coverage per bundle. For example, a bundle usually contains 36 shingles or 18 layers at each end. Suppose the weather exposure desired is 7 in. Thirty-six multiplied by 7 is 252. This divided by 8 gives  $31\frac{1}{2}$ , or the square feet of area that a bundle will cover.

Red Cedar Shingle Bureau

## Wedge Holds Movie Film on Reel



Movie film will not unwind if a square of sponge rubber is wedged between the sides of the reel as shown. Wedges of a suitable size cut from a discarded kneeling pad are ideal stops for this purpose.

## Machine Speeds Perforating

Pricking a pattern to transfer it by the dusting method is a tedious chore when a stylus is used to perforate the paper. A faster way is to use a sewing machine. Remove the thread from the machine and adjust it for a long running stitch. Then run over the outlines of the pattern. Your pattern will be perforated in a jiffy.

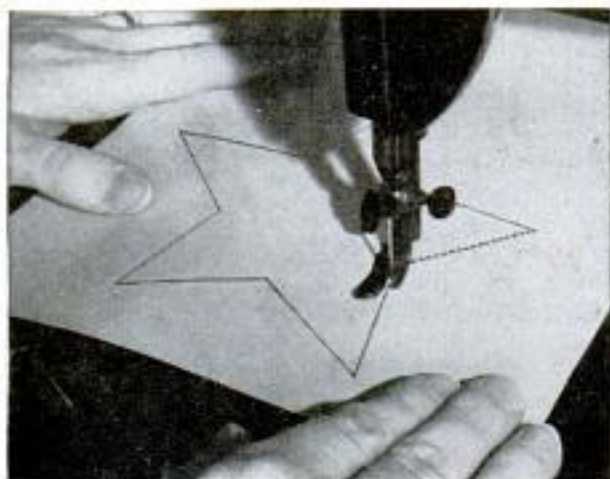

## Improved Diffusing Screen

Two alligator clips soldered together as shown in the photo provide a handy means of attaching a diffusing screen to a photo-flood reflector. The diffusing screen shown here is an embroidery hoop on which a dampened cloth is stretched. The clips used should not be so small as to hold the diffuser too close to the reflector as heat from the bulb may cause the diffuser to burn. The length of the clips can be extended easily enough by soldering them to a flat link. Spring clothespins also can be used.

John J. Rea, Urbana, Ill.

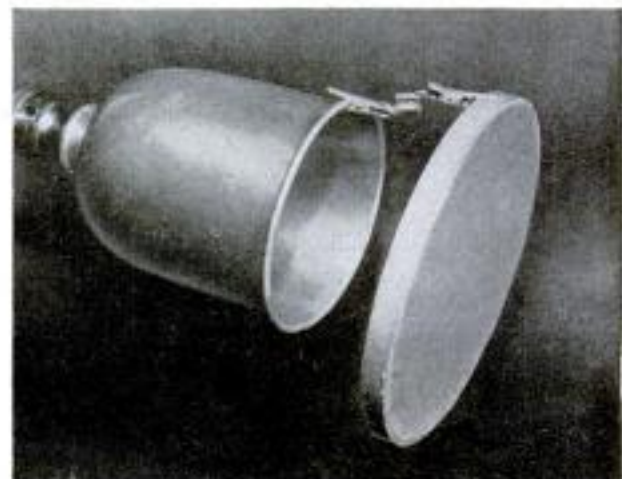



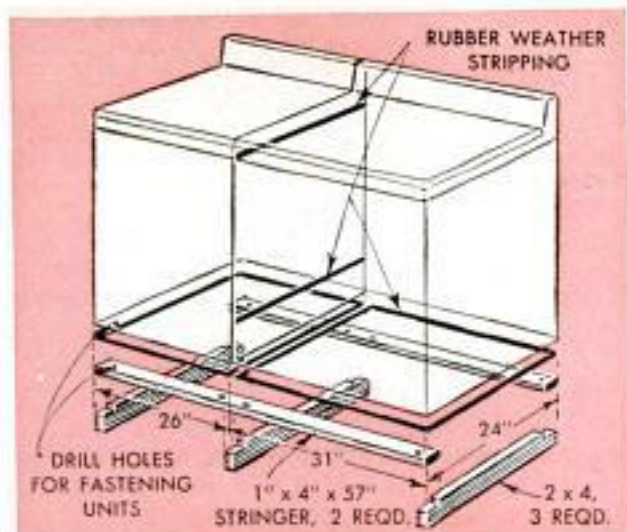

## Wooden Base Keeps Washer and Drier off Floor

Many homeowners are faced with the problem of preventing rust from damaging the bottoms of their automatic washers and driers, especially when the units are kept in the basement. Keeping the units in place when in operation and preventing dirt from collecting under them also presents a problem. All you have to do to solve these problems is mount the units on a simple wooden base made from three 24-in. lengths of 2 x 4 to which two 1 x 4-in. stringers are attached as shown in the photo and drawing. The over-all lengths of the stringers should equal the combined widths of your units plus  $\frac{1}{2}$  in. to accommodate two lengths of weather stripping placed between the units. The center 2 x 4 is located directly under the two facing sides of the units for proper support. Before assembling the base, coat all members with a wood preservative to prevent rot. Use zinc-coated nails or brass

screws to assemble it. To mount the laundry units on the base, remove the leveling screws from each machine and drill holes in the wooden frame for fastening them later as shown. Then, glue rubber weather stripping to all surfaces on the wooden base that will come in contact with the units. Also, glue two lengths of the same type of weather stripping on the side panel of one of the machines, as shown, to prevent them from rubbing each other when operating. With the units in position on the base, use the leveling screws to bolt the units to the base. Integrating both units on one base tends to absorb much of the vibration that causes "travel." Adequate clearance under the units permits sufficient ventilation to prevent condensation of moisture and provides ample space for easy cleaning under them. Also, the work level is improved at this increased height.—R. E. Clark, Aurora, Ill.

### Tool Saves Milk-Can Lids

Milk-can lids can be loosened for removal without battering them if a tool, such as the one shown, is used instead of a hammer. To make it, simply slip a length of rubber hose over a 1-ft. length of pipe.



☐ Next time you want to shine your shoes, and find that there is no polish, try a little paste floor wax. The wax has a neutral color and may be used on either dark or light shoes.

### Screw Secures Chisel Handle

To prevent the wooden handle of a chisel from working loose, one home craftsman cements the handle in the ferrule. Then, a hole is drilled in the ferrule and countersunk to accept a screw as shown in the detail.



☐ Use a cloth moistened with denatured alcohol to clean ivory piano keys, and expose them to the light during the day as darkness may cause true ivory keys to yellow with age.



# ATTRACTIVE PLANTING BOXES for Your Indoor Garden

By C. W. Woodson

**L**IVING INDOOR GREENERY can be yours the year 'round with a little careful planning. And by using these planting boxes you can change room decor, plants can be moved about to create attractive color effects. As an example, a live evergreen can serve as a room divider in summer and as a living Christmas tree during the holiday season. The secret of this changeability is the use of the planting boxes and balled specimens rather than making permanent plantings indoors. Balled evergreens in the medium and narrow pyramidal forms, also many other low-growing shrubs, can be made to thrive indoors wherever light, temperature and humidity can be closely controlled. Usually it is possible to meet these conditions in both old and new homes. During the warmer months the larger plants and shrubs can be moved outdoors and utilized as portable decorative features of the permanent outdoor-garden plantings.

To assure long life, use redwood or cy-

press for planting boxes. Coat the interior with hot asphalt, or line with sheet copper, all joints being soldered. Drain holes in the bottom of the box are protected by extending short lengths of tubing through them, and soldering to the liner.

On these two pages are shown detailed drawings of a planting box that is suitable for a living Christmas tree. Stock for the sides is 1½-in. material, the bottom is 1-in. stock. The bottom is drawn by scribing a hexagon inside a circle. The radius of the circle is 6¾ in., which is within a fraction of an inch of being equal to the side of the inscribed hexagon. A slight adjustment of a compass will produce six equal divisions on the circle, to provide six sides for a hexagon. The stars for the planting box are cut from ¾-in. stock and are attached after the box is assembled with glue and screws. This particular container may be painted in bright colors in keeping with the holiday spirit, as it is used generally for a decorated Christmas tree.

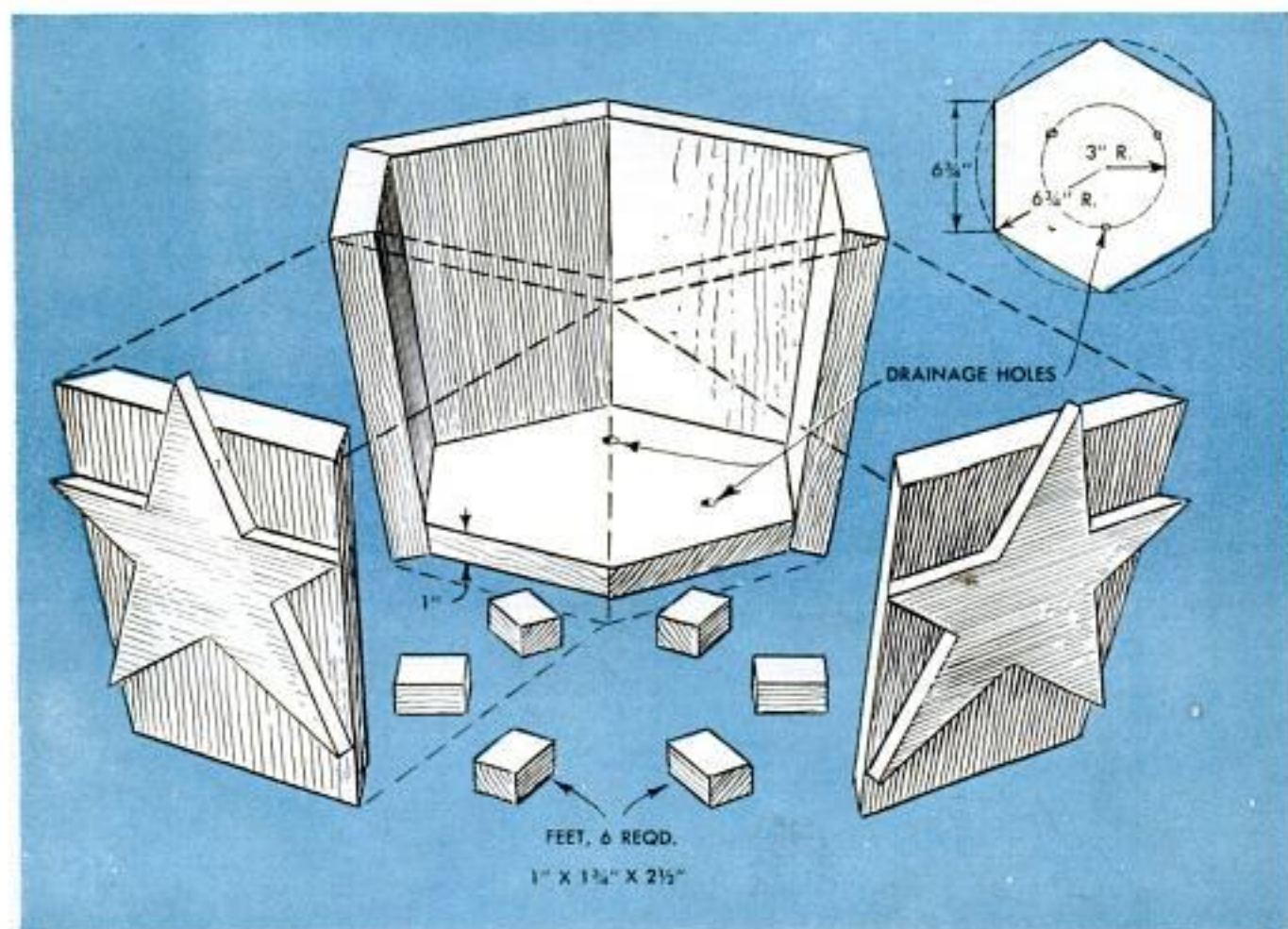





All plant boxes should be raised slightly by the addition of feet so air can circulate beneath and keep bottom dry. Also, all should have drainage holes bored in the bottom to allow excess water to escape. Pieces of broken pottery may be placed over the holes. Copper liners can be fitted to all boxes if you wish

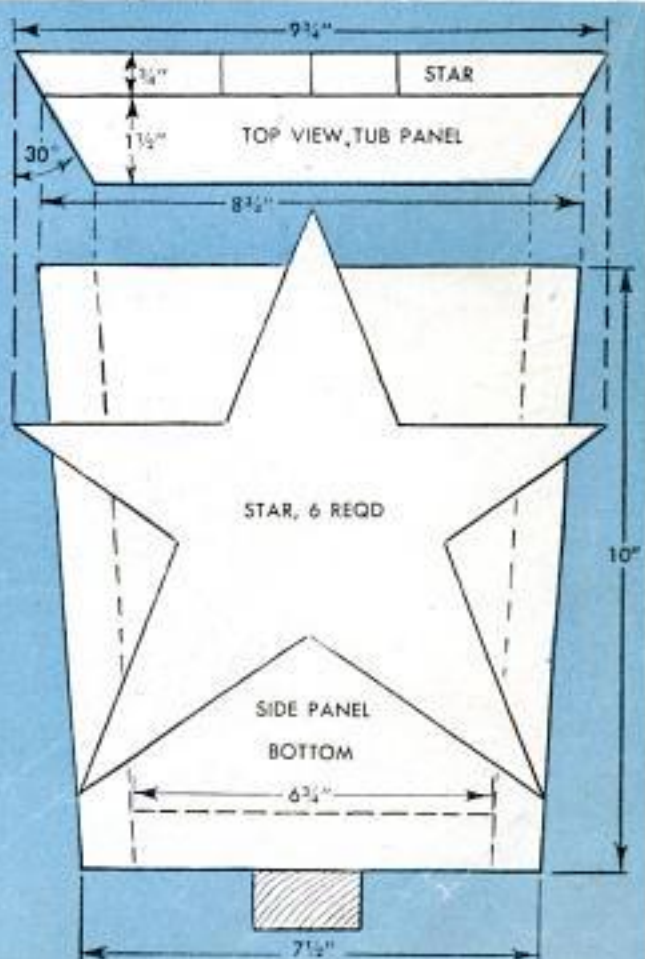
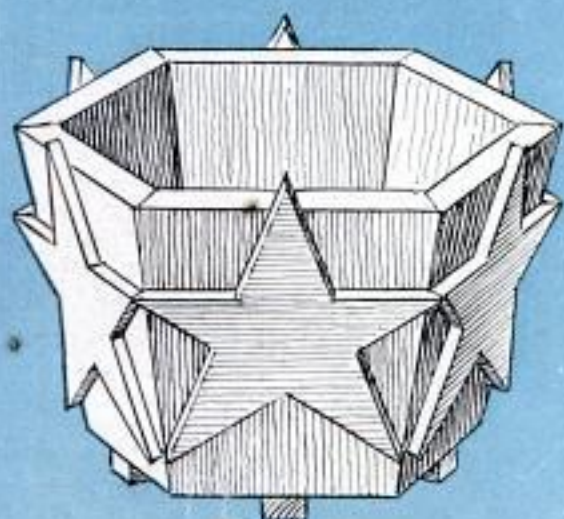



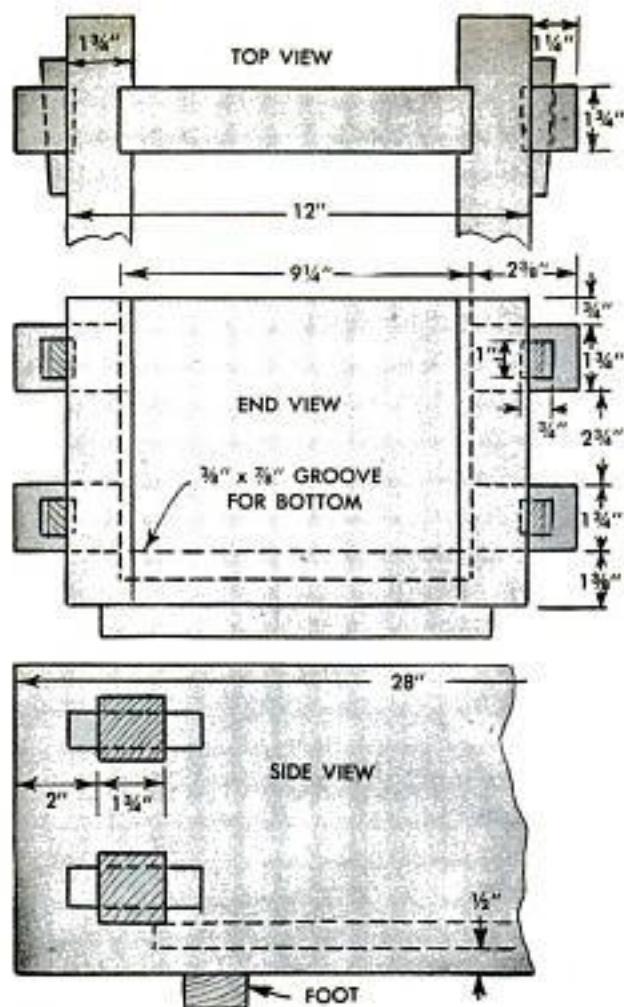

On this page are shown the details of a rectangular planting box of more modern design. Despite its modernity, no nails or screws are used in its assembly. Instead, the ancient method of using wedge-shaped pegs is employed. A mortising bit and a drill press are handy in making the cutouts in the construction of this planting box, but a careful craftsman can use a regular wood bit and a wood chisel to obtain excellent fits between the various components. The sides of this box are cut from 1 3/4-in. stock, the bottom from 7/8-in. material.

Feet for this planting box are strips of wood. Some sort of feet or spacers are needed under all planting boxes that are portable, to allow for drainage and to assure circulation of air under a box. This will prevent any moisture that collects on the outside of the box from remaining long, and causing rot or mildew. A situation that might cause water to collect on the bottom of a planting box would be an overwatering which would cause water to run out the drain holes in the bottom of the box, and collect on the bottom. Such moisture might encourage the growth of harmful bacteria or fungi, that would produce a root-destroying disease in the soil.

On page 185 is shown a square planting box that is ideal for small evergreens and ornamental shrubs. If you have ever

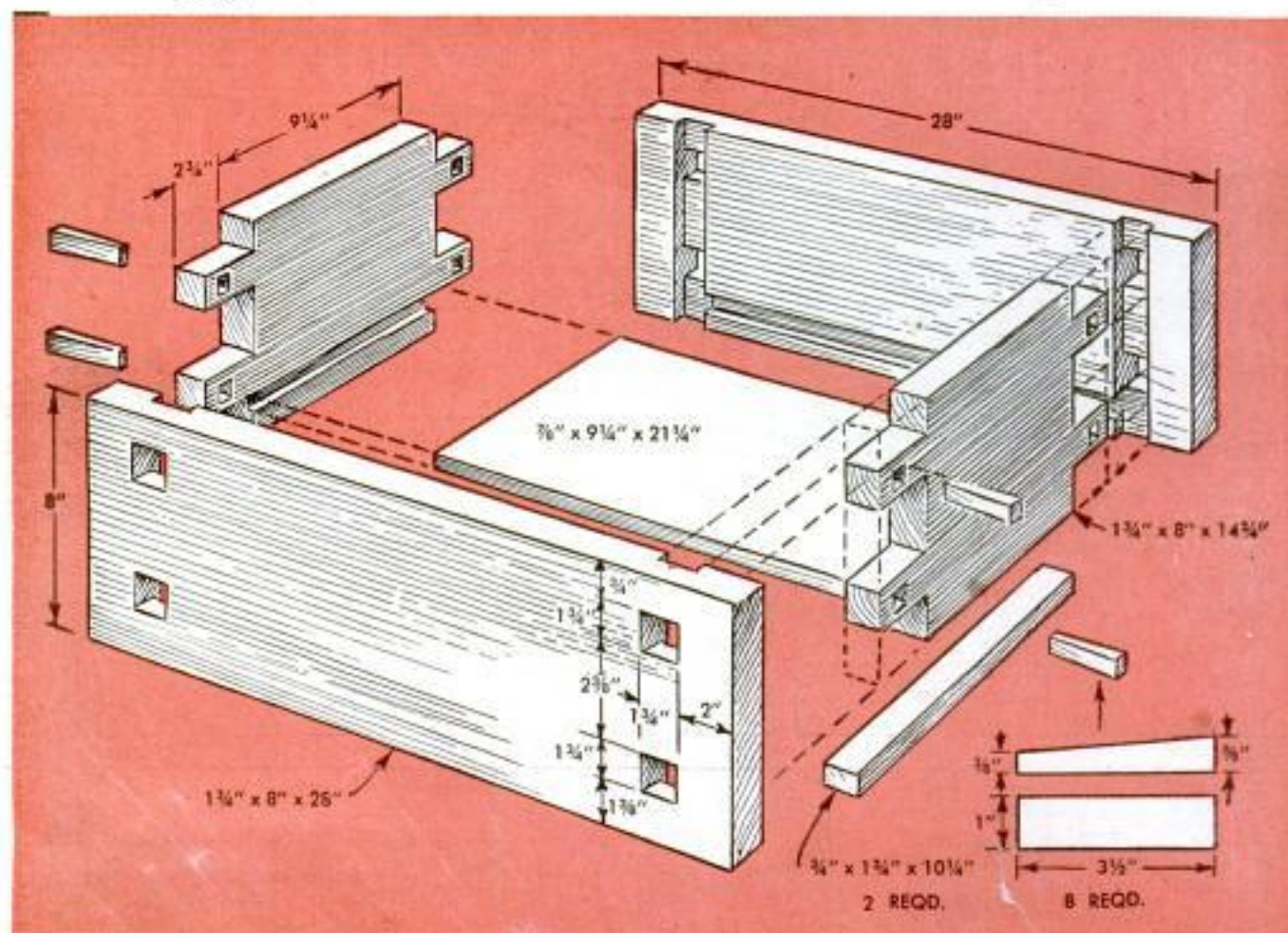



wished you could occasionally change the character or appearance of your terrace by moving the planting to different locations, this container will permit you to satisfy that whim. Some plants that die out in the fall can be kept in bloom almost all year 'round if they are moved indoors before frost occurs. Planting boxes of varying sizes built in the same proportions and design as the one on this page will permit various kinds of shrubs and plants to be moved indoors to beautify your home during the long winter months.

Miniature rosebushes that bloom all year 'round, as well as dwarf fruit trees now are available, and would fit easily into any of the several planting boxes described in this article. Also, you might have a spot in your living room that would require a planting box of a special shape to fit properly. Build it in that space and bring summertime outdoor beauty into your home. It will be easier to forget the cold and blowing snow outside with green, blossoming shrubs inside your living room.

★ ★ ★

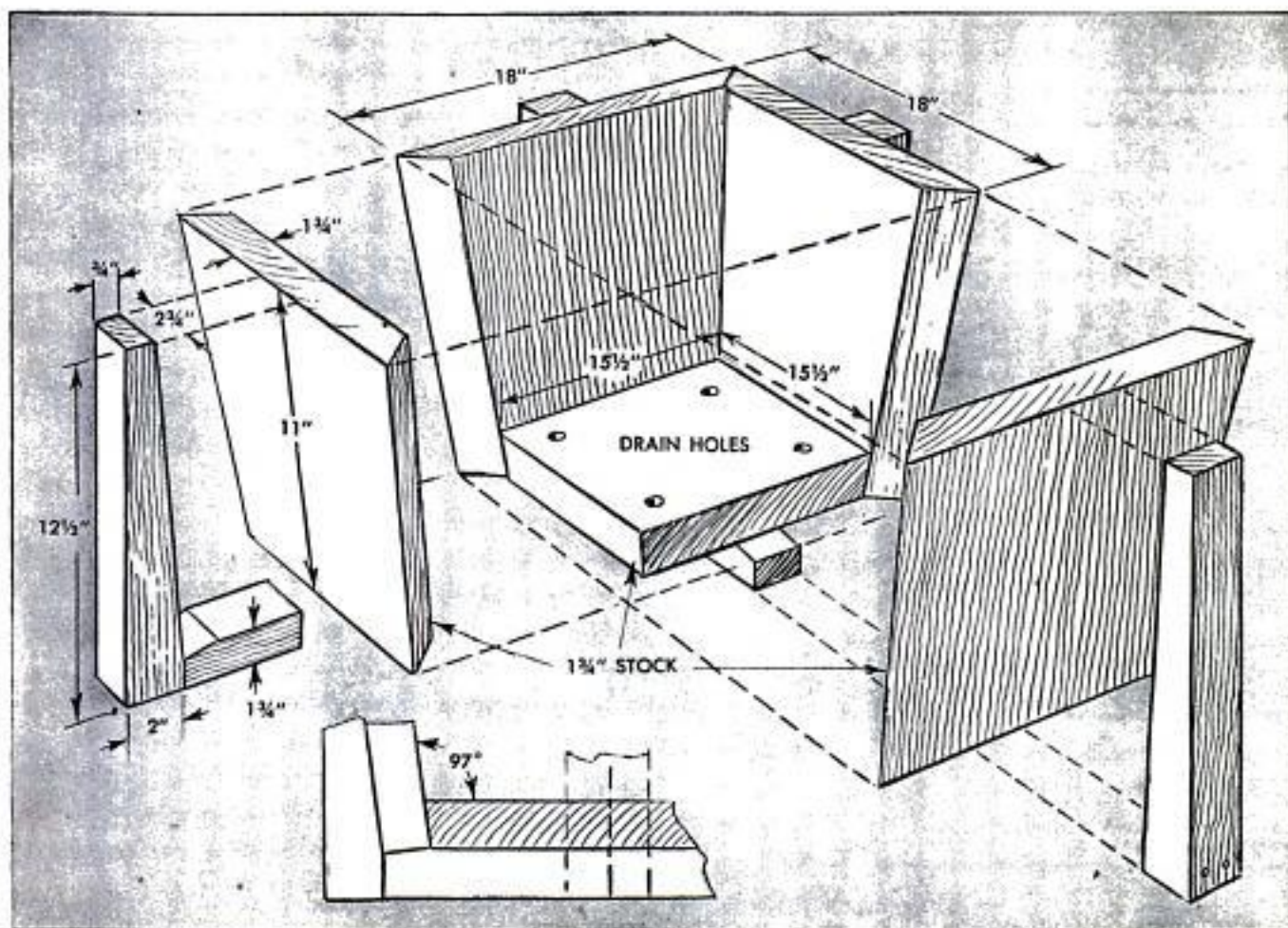



## Stovepipe Used as Small-Parts Wall Rack

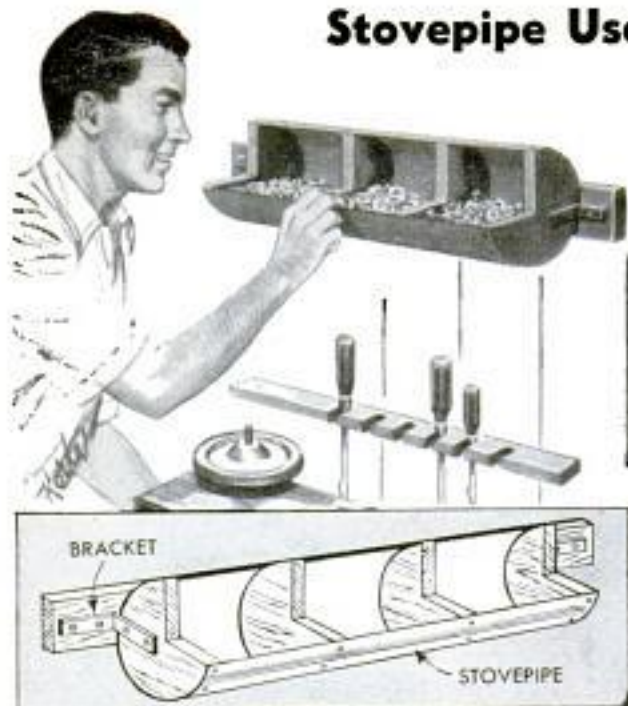

Ideal for small parts is this wall rack, consisting of a length of stovepipe divided into compartments by wooden disks from which a quarter-circle segment is cut. Circumference of the disks should be about one fourth larger than that of the pipe. For example: A 6-in. pipe has about an 18-in. circumference. The disks should be about 6½-in. dia. Any projecting metal can be bent to form a right-angle flange.

## "Drill Bit" for Pilot Holes

Accurately dimensioned pilot holes for wood screws are bored by one craftsman who uses a "drill bit" that is a wood screw of the proper size from which the head is removed. The straight shank of the screw then is chucked in a hand drill, and the holes bored.

J. A. Comstock, Wellsboro, Pa.

## Tree Ornament Hangers Bent From Pipe Cleaners

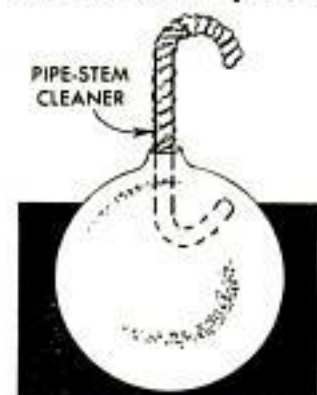

Lost hangers for Christmas-tree ornaments can be replaced with hangers bent from pipe cleaners. Bend one end of the cleaner as indicated and insert it in the ornament so it will spring open a little. Form hook at other end.

## Pen Modified With Paper Clip To Prevent Blots Under Ruler

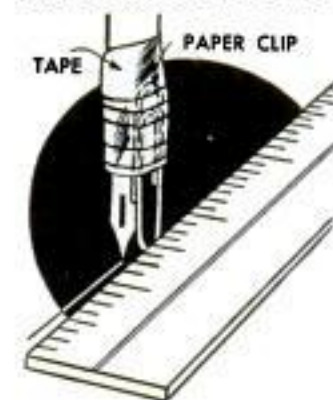

To prevent blots that are caused when ink creeps under a ruler along which a pen is drawn, tape a paper clip to the end of the pen. The clip should extend just short of the penpoint so the point contacts the paper first.

## Rounding Glass Edges

After you have cut a sheet of glass to fit on a table top or other piece of furniture, the sharp edges should be smoothed. An efficient tool that will round the top and bottom edges simultaneously can be made by wrapping a piece of sandpaper over the groove edge of a short length of tongue-and-groove flooring as shown.



## Small-Parts Soldering Iron

Ideal for soldering in restricted locations, and on small, delicate parts, such as transistors, is this soldering iron improvised from a propane-gas torch and a length of copper wire. Several turns of the wire are wrapped around the torch nozzle, then the wire is bent to pass through the flame and extend 3 or 4 in.

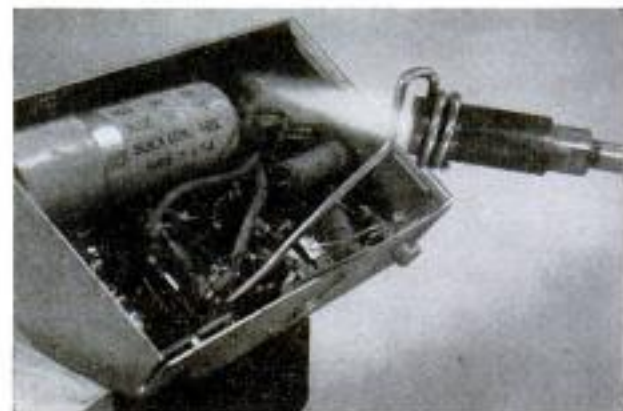



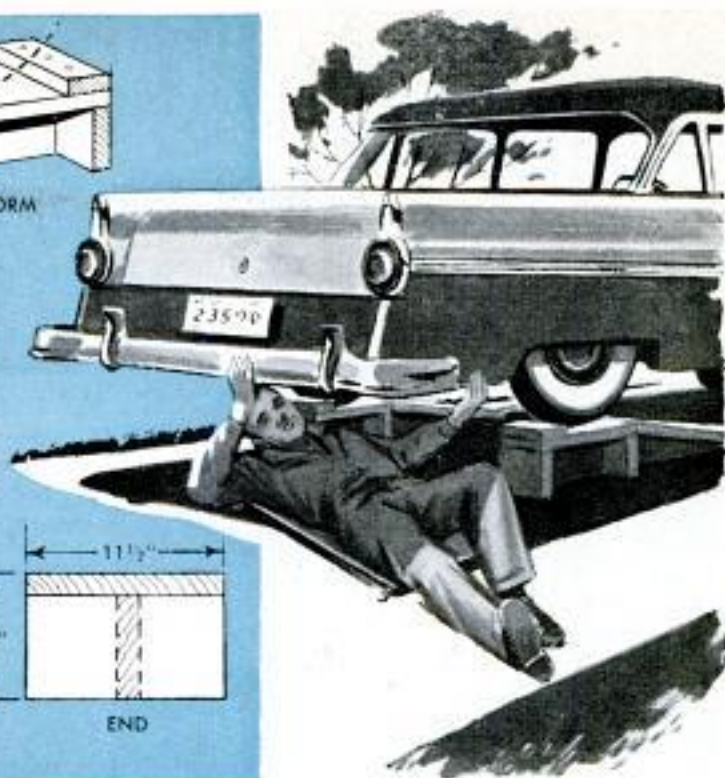
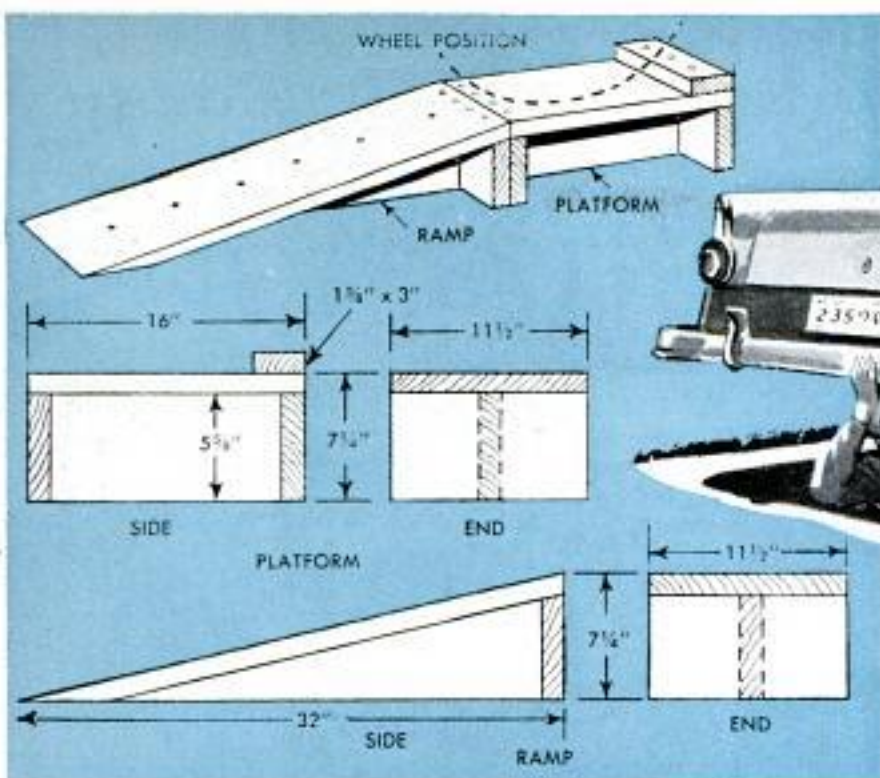

## Ramps and Platforms Elevate Car for Easier Access

Occasional jobs that require you to get under your car, such as draining the crankcase oil or installing a new muffler or tailpipe, can be performed in your garage or on a driveway if you have these strongly built wheel ramps and platforms at hand. Two sets should be sufficient, as there seldom is need for all four wheels of a car to be raised at the same time. In use, the ramps and platforms are arranged end-to-end as shown, and the car is driven or backed up the ramps onto the platforms. The ramps then can be removed until the job is completed to provide more working space under the car. Both ramps and plat-

forms are made of 2 x 12 and 2 x 6 stock. Height of the units should not be more than the 7 1/4 in., which is gained when 2-in. stock is placed on top of a 2 x 6. This height provides ample working space under the car, while keeping it steady. To assure maximum strength, use wood screws of a suitable size, rather than nails, to assemble the ramps and platforms. A cleat nailed to one end of each platform serves as a stop to prevent the car wheel from running off. For additional safety, when the car is on the platforms, fit chocks under both the front and rear of one of the wheels that is on the ground to prevent rolling.

## Photos Vignetted on Enlarger With Cardboard Cutout

To vignette a photo with an enlarger, first make a mask by tracing the projected image on a piece of cardboard, then cut it out with scissors. The width of the shaded border around the image in the photo is determined by the distance the cutout is held above the enlarger easel.

## Screwdriver Drives Lag Screws

When no socket wrench is available to fit the head of a lag screw that is to be countersunk, a screwdriver can be used instead by modifying the screwhead. Saw a slot in the head of the screw wide enough to accept the blade of a heavy screwdriver. To apply sufficient turning force, it may be necessary to use a wrench on the driver.

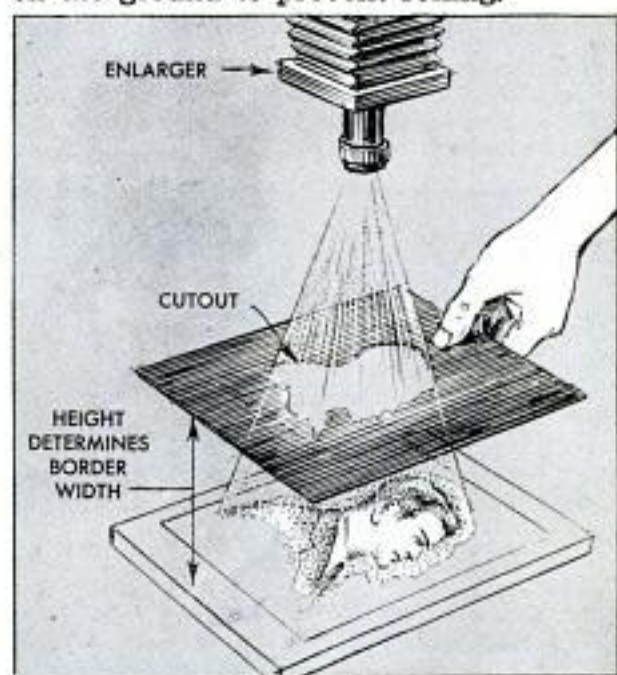



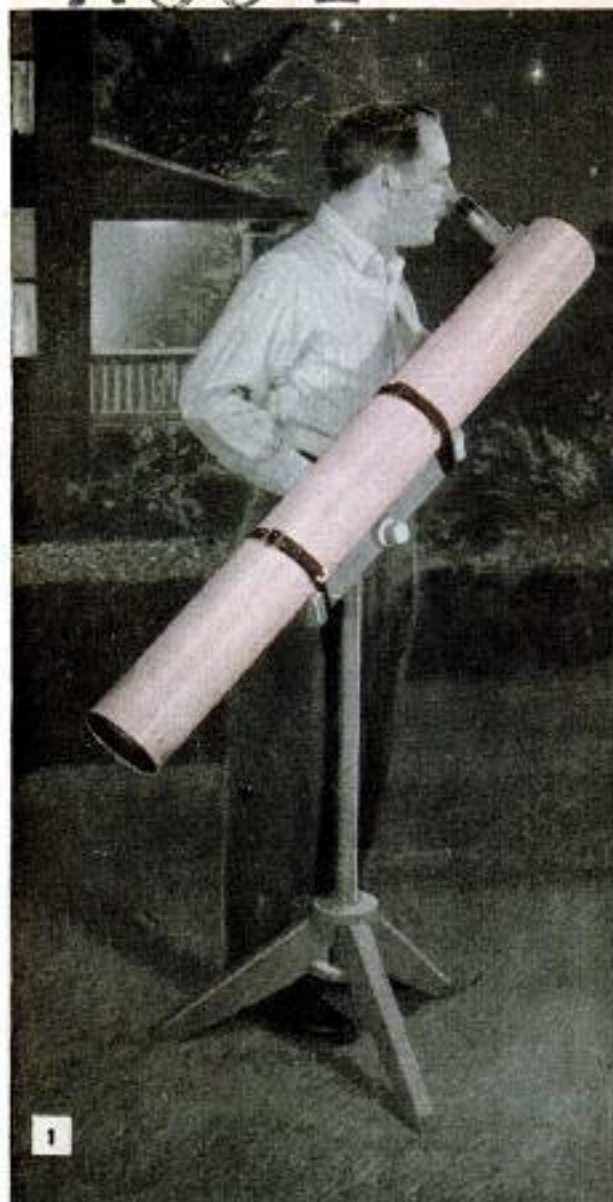

# 4 1/4" REFLECTING TELESCOPE

By Sam Brown

HERE IS a powerful reflecting telescope any amateur astronomer or would-be stargazer would be proud to own. The clarity and brilliance of astronomical and daytime views at 60 to 180 times magnification will amaze you. To build the telescope, simply purchase a 4 1/4-in.-dia. concave mirror and an eyepiece assembly with a 1/4, 1/2 or 1-in. eyepiece and assemble these components on a cardboard tube, mount and tripod as shown in the photos and drawings. Also, the eyepiece mount and eyepiece can be made as shown in Fig. 12 if you have access to the necessary power tools. When the telescope is fitted with a 1-in. eyepiece, it has a field of view of about 1 deg. which is equivalent in coverage to two moons, or 52 ft. at 1000 yd. (See Fig. 6 for more performance data.)

The principal advantages of the reflector over the refractor type of telescope with a lens objective are: (1) The reflector is much less expensive inch for inch of the objective, and (2) the reflector works by reflecting light rays instead of bending (refracting) them and consequently is not affected by color faults usually present to some degree when light passes through a glass lens.

When used with 1/4-in.-dia. eyepiece, this telescope will permit you to see stars to the 12th magnitude

Fig. 2, below, black gummed tape applied on end of cardboard tube protects the edge and gives it finished appearance. Right, after taping both ends of tube, it is covered with enamel-finish paper

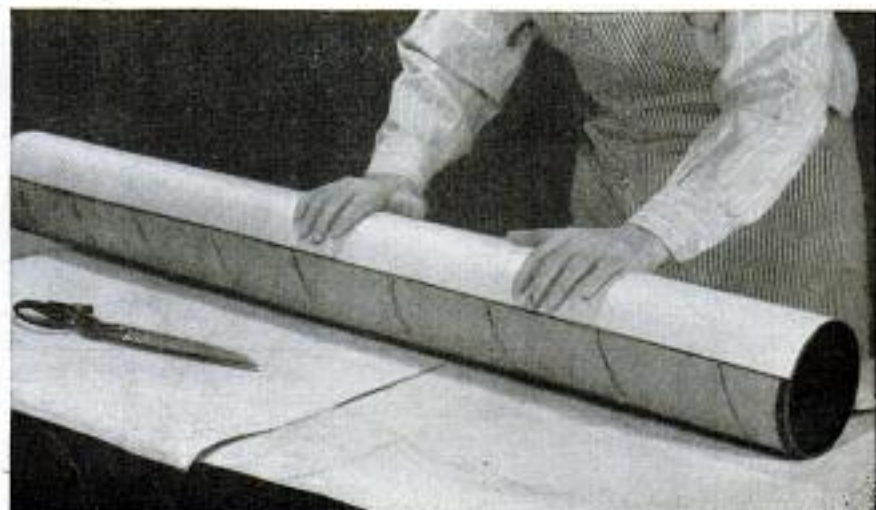



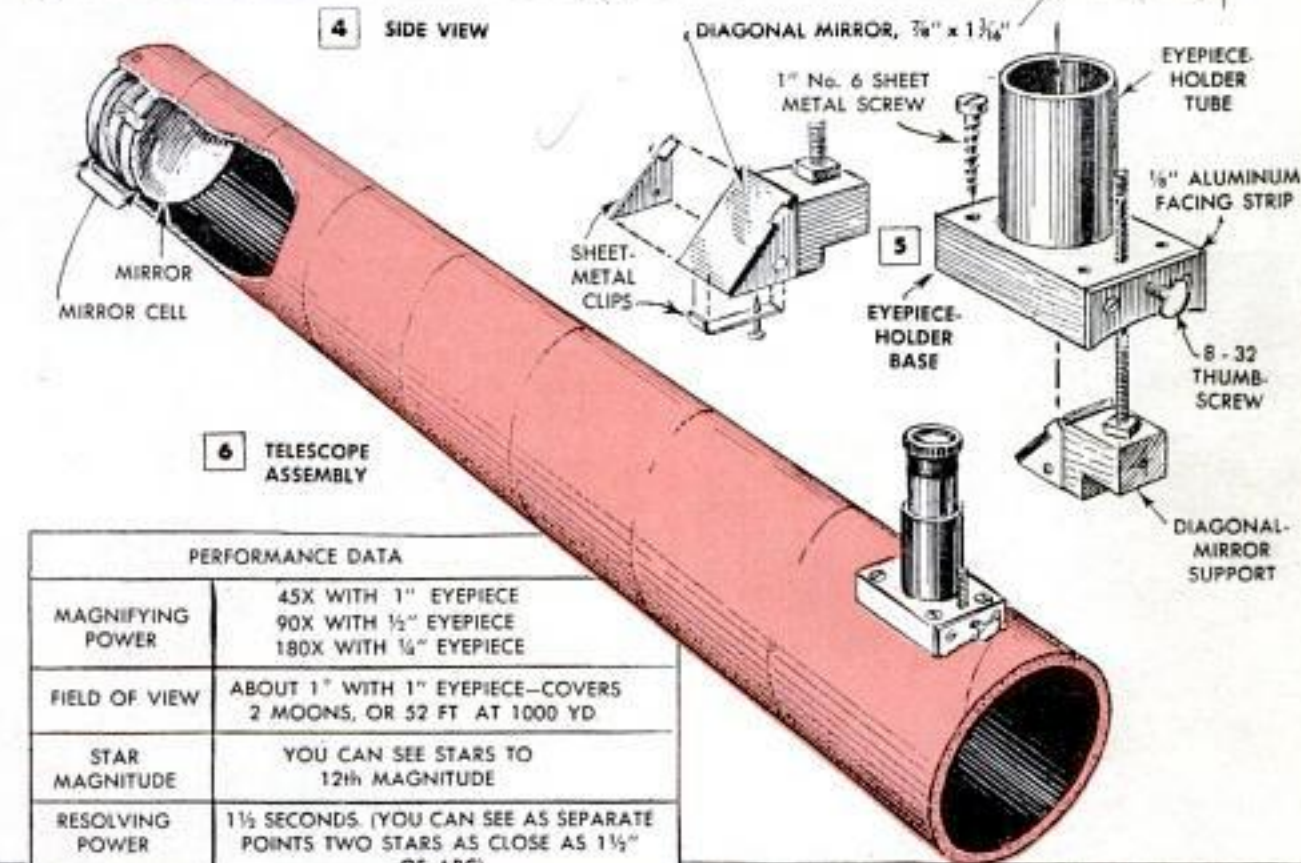
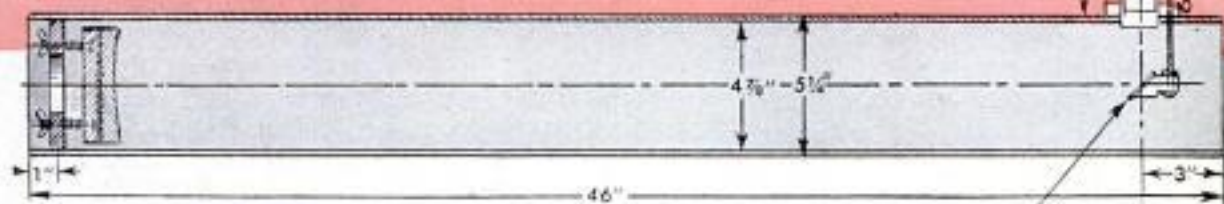
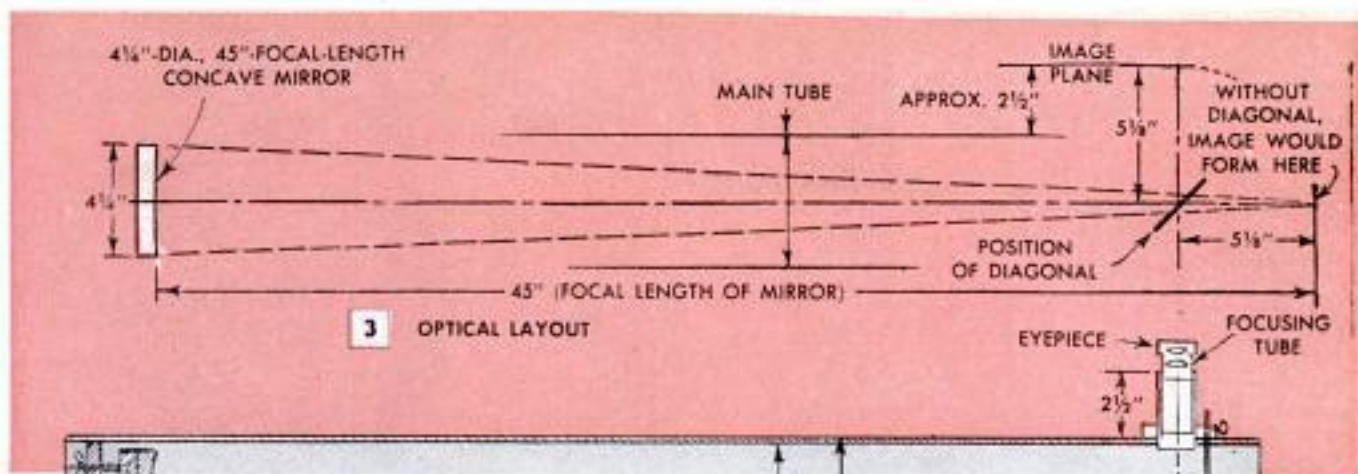

PERFORMANCE DATA	
MAGNIFYING POWER	45X WITH 1" EYEPIECE 90X WITH 1/2" EYEPIECE 180X WITH 1/4" EYEPIECE
FIELD OF VIEW	ABOUT 1° WITH 1" EYEPIECE—COVERS 2 MOONS, OR 52 FT AT 1000 YD
STAR MAGNITUDE	YOU CAN SEE STARS TO 12th MAGNITUDE
RESOLVING POWER	1 1/2 SECONDS. (YOU CAN SEE AS SEPARATE POINTS TWO STARS AS CLOSE AS 1 1/2" OF ARC)

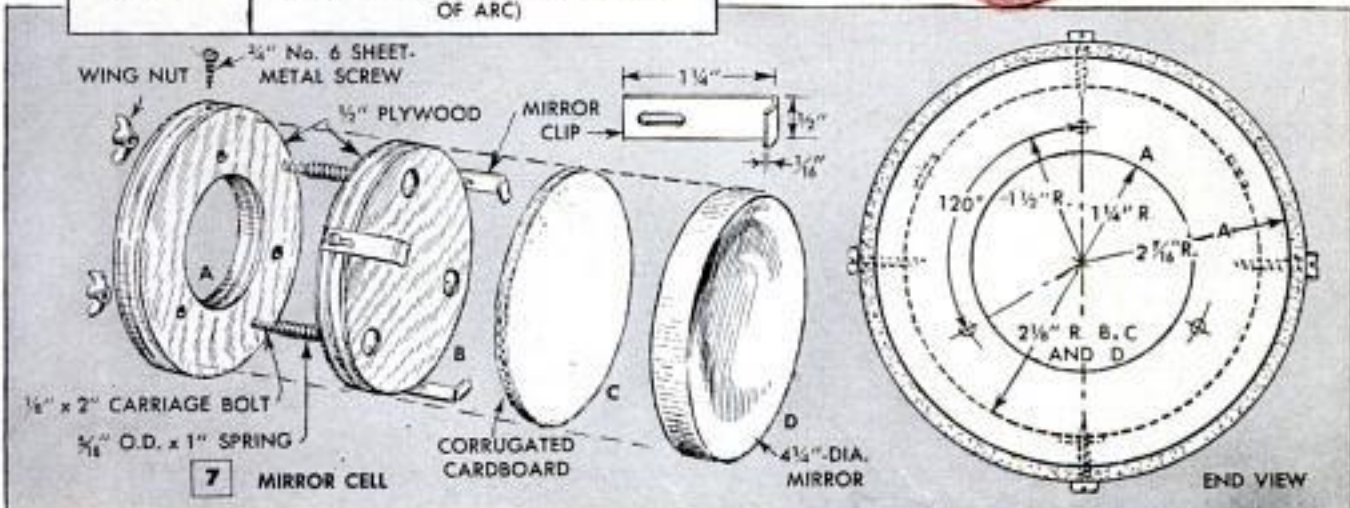



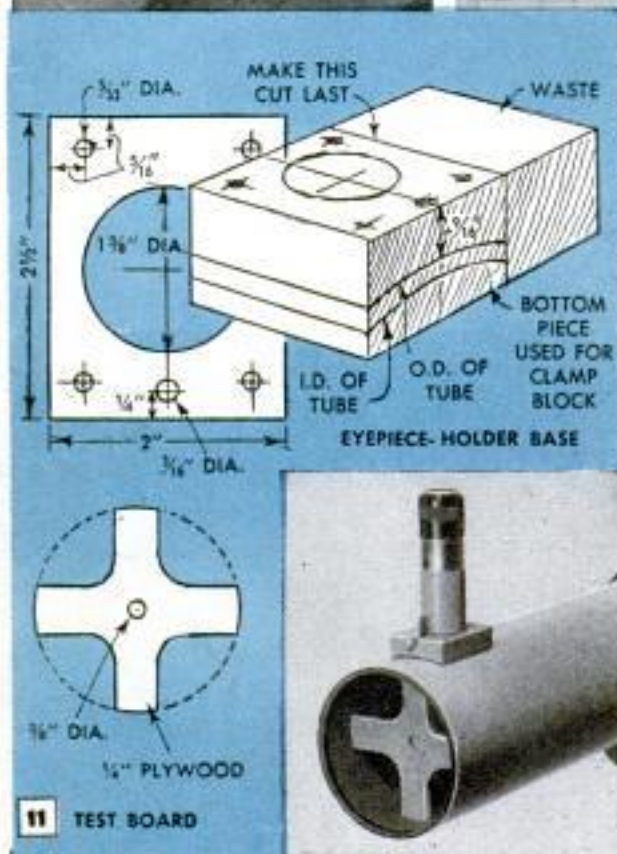
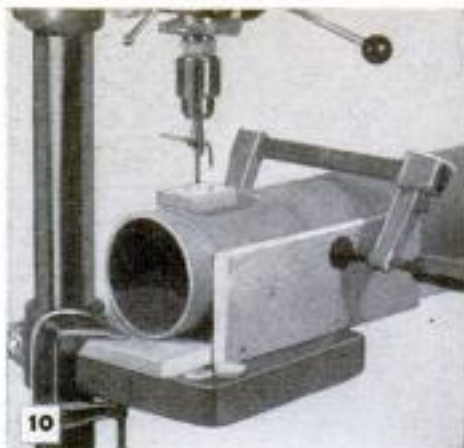
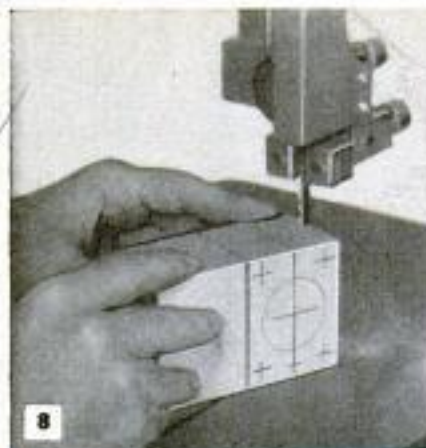

You can get a good idea of how a reflecting telescope works from Figs. 3 and 4. Light from a distant object is reflected and focused by the mirror objective. Without a diagonal mirror that is in a fixed position at 45 deg. from the axis of the concave mirror, the image would form at the forward point as in Fig. 3. The diagonal catches the concentrated light rays and deflects them to a point above and outside the tube where the image can be brought into sharp focus and viewed with any type of magnifying glass. It will be noted that the diagonal is positioned directly in the path of the incoming light. This obstruction blocks some of the light (the center of the concave mirror is "blind"), but the

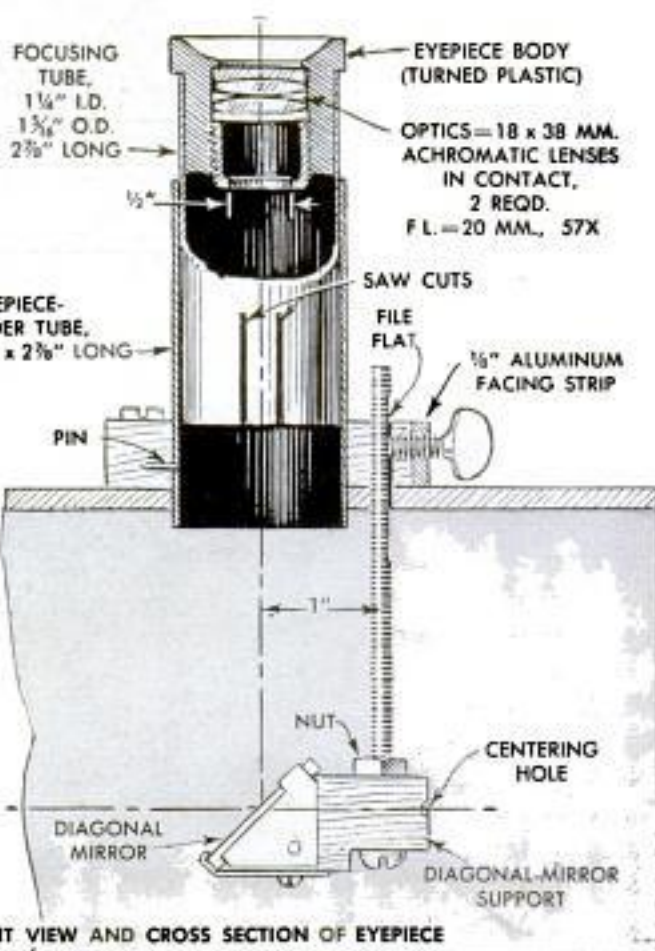
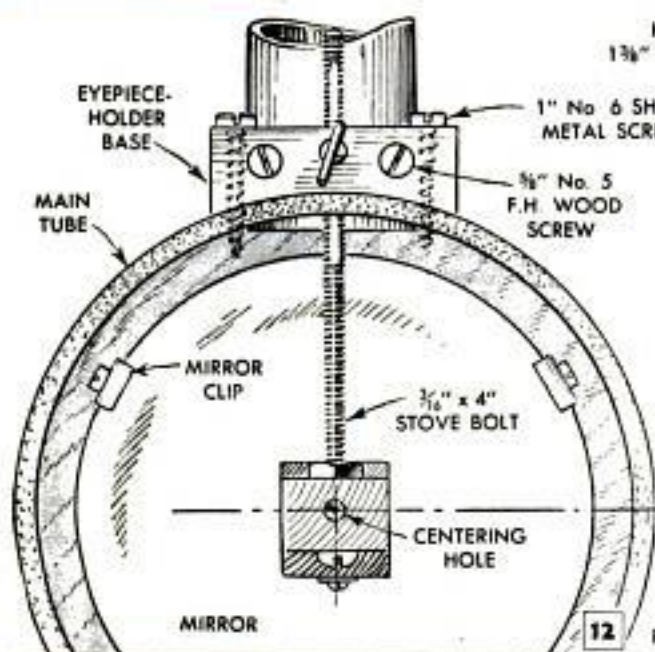



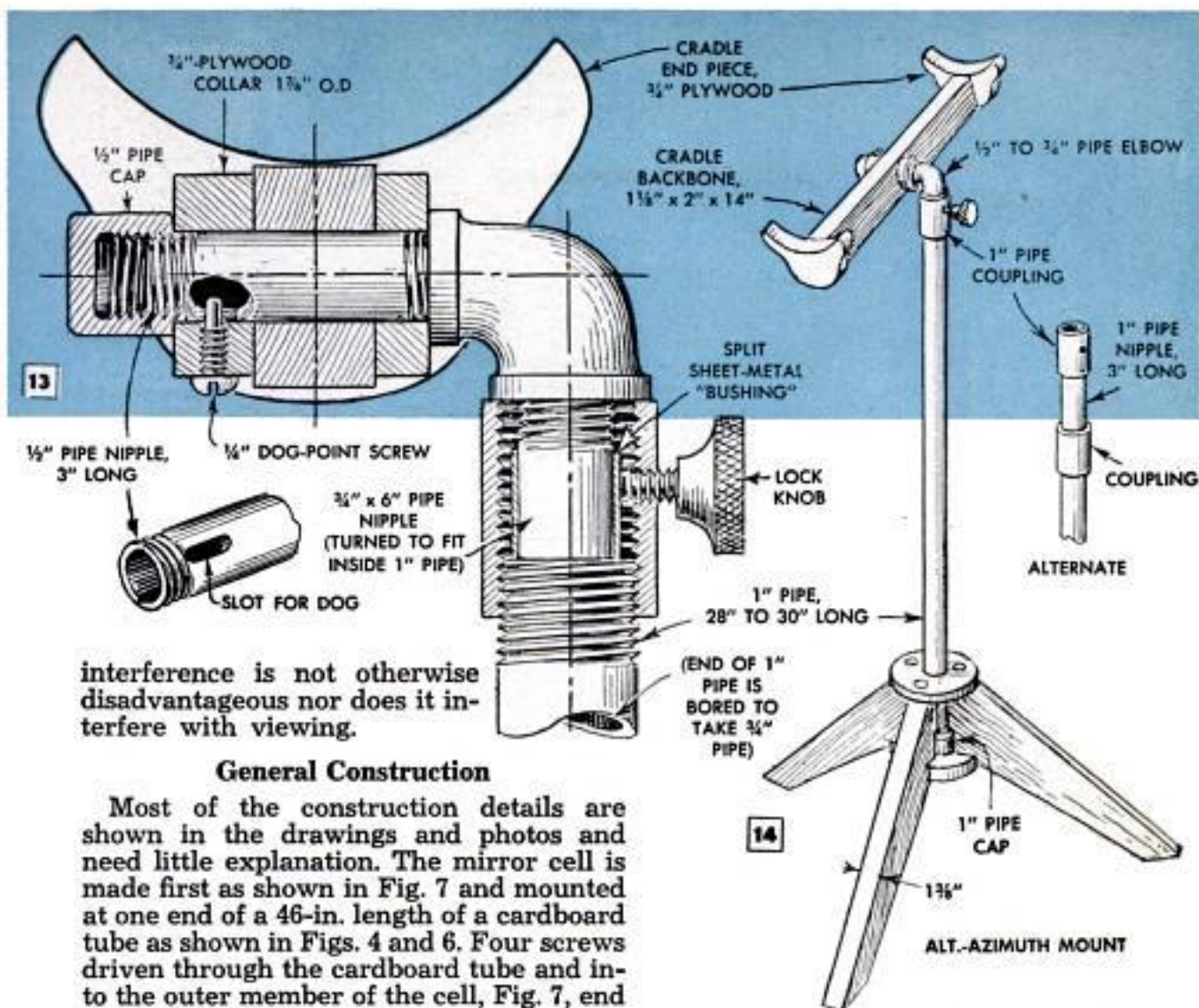

interference is not otherwise disadvantageous nor does it interfere with viewing.

### General Construction

Most of the construction details are shown in the drawings and photos and need little explanation. The mirror cell is made first as shown in Fig. 7 and mounted at one end of a 46-in. length of a cardboard tube as shown in Figs. 4 and 6. Four screws driven through the cardboard tube and into the outer member of the cell, Fig. 7, end view and detail A, hold the cell unit in a fixed position in the tube, subject to slight adjustment. The latter can be done by tightening or loosening the three wing nuts at the back of the cell. This adjustment is necessary to position the mirror so that its axis intersects exactly the center of the diagonal, Fig. 4.

The unit incorporating the eyepiece holder, diagonal support and mirror is made next. This unit can be purchased

ready for installation for about \$10 if you prefer to buy it. The base of the eyepiece holder is a bandsaw and drill-press job as shown in Figs. 8, 9, 10 and 11. The bottom piece of the cutout, Fig. 11, is used for

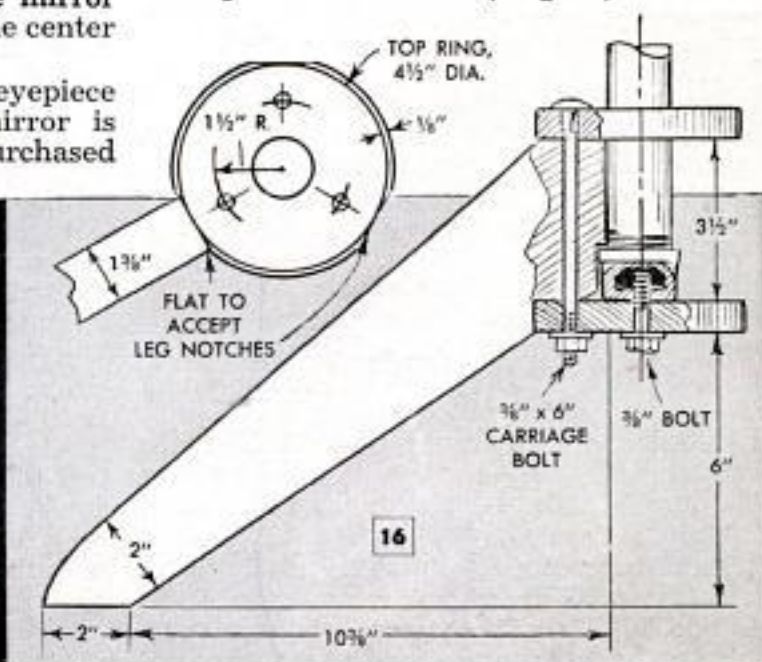
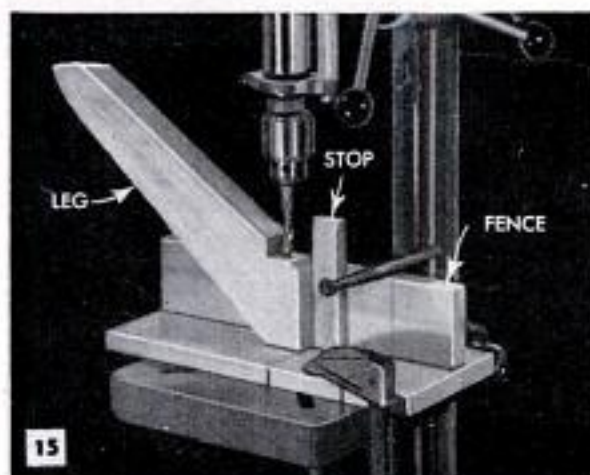



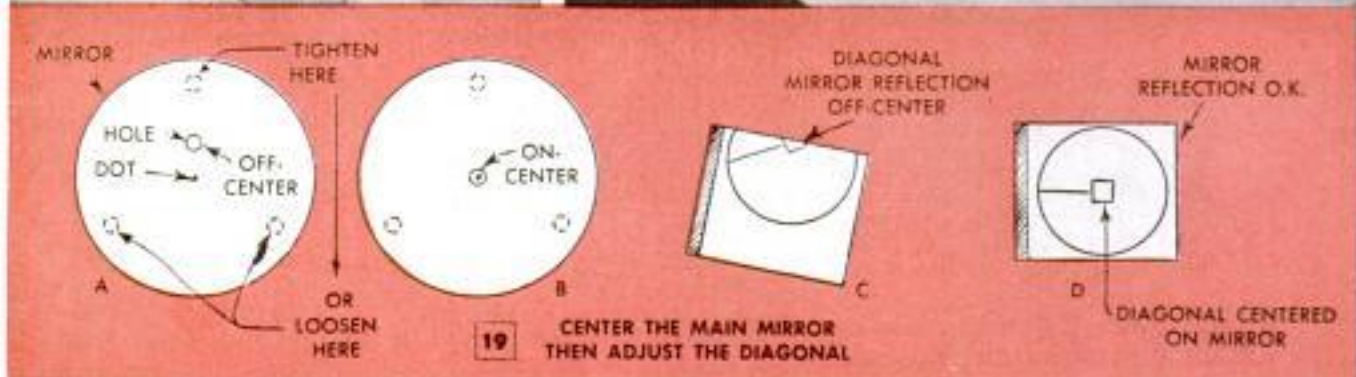

a clamping block when drilling the holes for screwing the base to the tube and then is discarded. After the base is screwed to the tube, the hole that accepts the eyepiece tube is cut with a hole cutter, Fig. 10, that cuts wood and main tube in one operation.

#### Alt.-Azimuth Mount and Tripod

The mount and tripod shown in Figs. 13, 14, 15 and 16 are rugged units with friction adjustments for any latitude, declination and ascension. The assembly includes a cradle made of wood to which the telescope is held by means of two straps. The other parts are stock pipe fittings that require some machining as indicated. The horizontal pipe shaft on which the cradle is mounted, is slotted to receive the end of a dog-point screw as shown in Fig. 13. This permits the pipe cap at the end to be screwed on the shaft to apply tension on the plywood collar on each side of the cradle without the tendency for the cap to unscrew when the cradle is tilted.

The vertical axis of the mount is a  $\frac{3}{4}$ -in. pipe nipple with the outside diameter reduced to fit inside the 1-in. pipe column, the upper end of which is reamed to provide adequate clearance, Fig. 13. The alternate assembly, Fig. 14, should be used, if a long length of pipe cannot be reamed in your lathe.

Detailed construction of the base of the tripod part of the mount is shown in Figs. 15 and 16. The pipe column of the mount is screwed into a pipe cap that is tapped to

take a  $\frac{3}{8}$ -in. bolt. The latter clamps the tripod assembly securely to the mount by means of two plywood rings as shown. Accurate drilling of the carriage-bolt holes in the legs is done with the fence setup shown in Fig. 15.

#### Collimation

Collimation is the optical term indicating alignment of optical elements. The collimation of any reflecting telescope is simplified by inking a center dot on the concave mirror, using a cardboard mask for proper positioning of the dot as in Fig. 18.

The test board, Fig. 17, is used to align the main mirror in the tube. To do this, light from a flashlight is beamed at the board and the position on the mirror of the reflected hole in relation to the inked dot is noted. What you are likely to see may be similar to the off-center positions of dot and hole as in Fig. 19, detail A. To correct this, simply tighten or loosen the wing nuts on the mirror cell until the reflected image of the hole is superimposed over the dot as in detail B.

After the concave mirror is adjusted, drop the diagonal into position so that it is in the approximate center of the tube. Then look through the eyepiece tube without the eyepiece and note if the reflected image of the concave mirror is centered on the diagonal mirror. A slight turn to the left will correct the misalignment shown in detail C, to bring both mirrors into alignment as in detail D. Now you are ready to use the telescope. ★★★



## Method of Enlarging Drawings Eliminates Need of Erasing

Here is an improvement on the usual method of copying pictures to a larger size with the aid of guiding squares drawn on the picture. With this method, neither picture nor drawing sheet is marked, thus eliminating subsequent erasing. First, prepare a "master guide" of celluloid by scratching squares on it. This guide is placed on the picture to be copied and taped to prevent it from slipping. Squares now are inked on a sheet of paper as large as the sheet on which the enlarged drawing is to be made. Place the drawing paper over the squared paper and tape both to a pane of glass set above a lamp so the squares will show through the paper clearly, and proceed with the drawing.

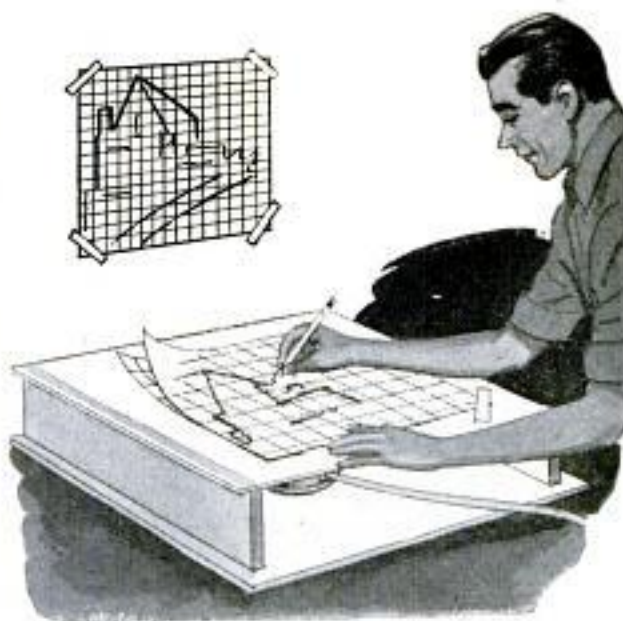

## Record on Bottle Assures That Developer Is Replenished



Replenisher must be added to frequently used photo developer to prevent it from deteriorating. To avoid forgetting about the replenisher, each time the developer is used mark the date on a label on the bottle. Later, if there is doubt as to whether or not the developer has been replenished, it is a simple matter to compare the number of rolls of film developed with the data on the bottle.

☐ Plastic berry baskets placed on shelves or in bureau drawers of a child's room help keep toys and small articles of clothing in order, and also add a touch of color to the furnishings.

## Adjustable Jig Permits Accurate Marking of Blind Holes

Aligning blind holes to be drilled for dowels in adjacent members, always a problem, becomes a simple operation when this adjustable marking jig is used. Marking points project from each side of the jig, permitting both pieces of stock to be marked simultaneously. A scale marked on the cross members of the jig permits the points to be centered on the work. Both the slotted and scaled members of the jig are strips of  $\frac{3}{16}$  x 1-in. steel flat. The scaled members are drilled together to assure that the holes are aligned accurately. A rule is used to mark the scales on these members, which are clamped side by side during this operation to assure further accuracy. One scaled member is riveted to the slotted pieces, the other is attached with carriage bolts and wing nuts so it can be moved to adjust the spacing between the holes. In use, the jig is tapped into one member, then the other is placed on top and tapped onto the marking points.

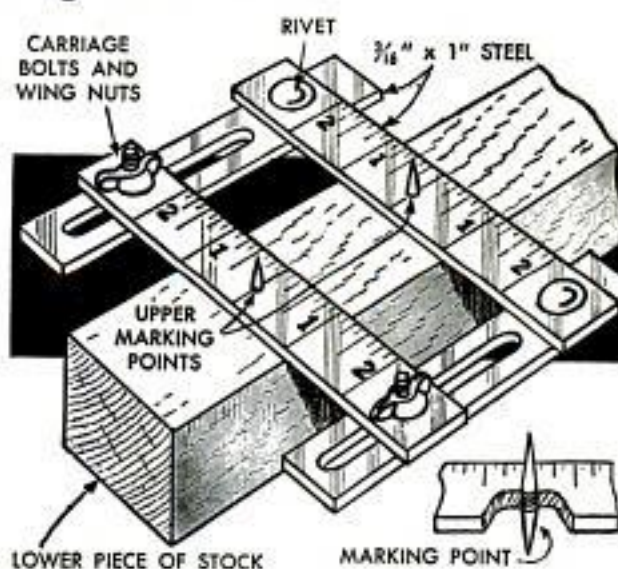

☐ If you need an overnight case, and none is available, simply remove a portable typewriter from its case and use the latter as a substitute.







# On the MARKET

for Do-It-Yourselfers

**1. DECORATIVE ENAMEL** in a pressurized can is made specially for outdoor use on wrought-iron furniture, outdoor grilles, railings and lampposts. Dries in a few minutes to a weather-resistant flat black, especially attractive on all types of ornamental iron. Use on old or new surfaces. Can contains 18 oz.

Sapotin Paints, Inc., 205 E. 42nd St., New York City 17



1

**2. LIQUID WEATHER STRIP** comes in a squeeze bottle. Weatherseals and waterproofs as it dries. Adheres permanently, but can be stripped off. Comes in black, gray, green, pink and white to match most paints. Special applicator tip on bottle is designed to apply a continuous strip of uniform width

Meridian Products Co., 366 Madison Ave., New York City 17



2

**3. AUTOMATIC SASH LOCK** is spring-actuated, locks when the sash is closed. It's regular sash-lock size and fits any standard wooden sash. Photo shows unit in closed position while details below show how striker releases latch as the sash is lowered to the closed position. Each unit is chrome-finished

Skill Sales Corp., 415 S. Kedzie Ave., Chicago 12

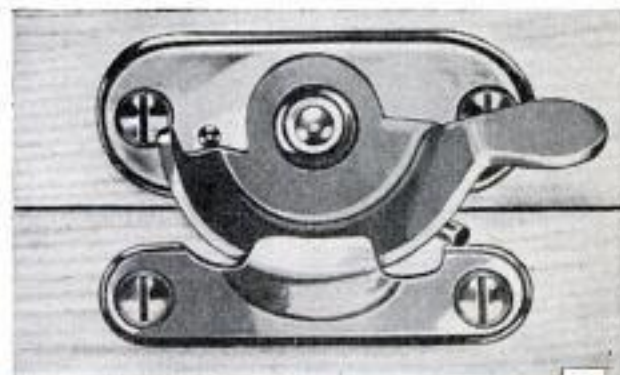

3

**4. LIGHTWEIGHT INSULATING MATERIAL** is poured directly from the bag into the hollow cores of concrete-block walls. Its use is said to cut heat loss through concrete-block walls as much as 50 percent. One 4-cu.-ft.-capacity bag contains sufficient insulating material to fill 16 standard concrete blocks

Perlite Institute, 45 W. 45th St., New York City 36



4





## Improved Stand Accommodates Any Size Christmas Tree

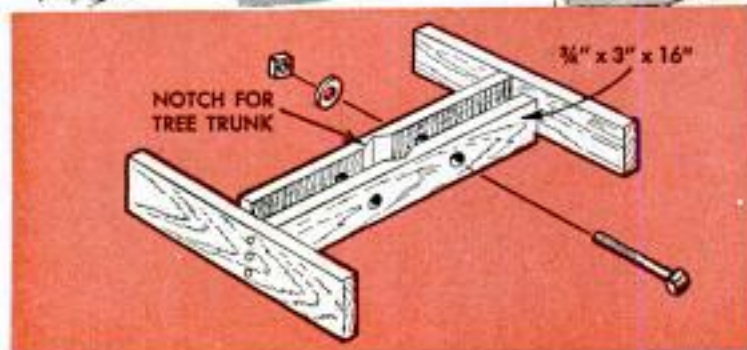

If you are putting up the tree on Christmas Eve and the stand that was all right last year now is broken, or just cannot be found, there is no need to panic if you have a couple of lengths of lumber in your workshop. The improvised stand shown in the detail can be made from stock of any size, and of dimensions that will accommodate almost any size tree. If the trunk of a tree is fairly large at the bottom, longer bolts are used in the clamping portion of the stand. If a pan of water is to be used under the tree, use wider stock for the two end pieces so that the clamping members are raised above the floor to clear the pan and let the trunk rest in the water.—A. V. Malone, Pasadena, Calif.



## Holiday Window Decoration For Night or Day

With slight modifications this holiday-decoration idea used by one homeowner can be adapted to any size window. A cutout of a simple drawing is pasted to the glass. Draperies form a background during the day, light shines through the draperies at night to silhouette the drawing. For an added effect, a Christmas-tree light in a foil star shines down on the scene.—Albert C. Speckman, Racine, Wis.



## Modified Cake Pan Is Bird Feeder

You can make a practical bird feeder in a matter of minutes by cutting slits in opposite edges of a cake tin, bending the bottom at right angles and riveting as indicated. Holes punched in the vertical portion of the feeder will permit it to be hung on projecting nails or screws. Accumulation of rainwater in the pan is prevented by the open slits which will permit it to drain away.



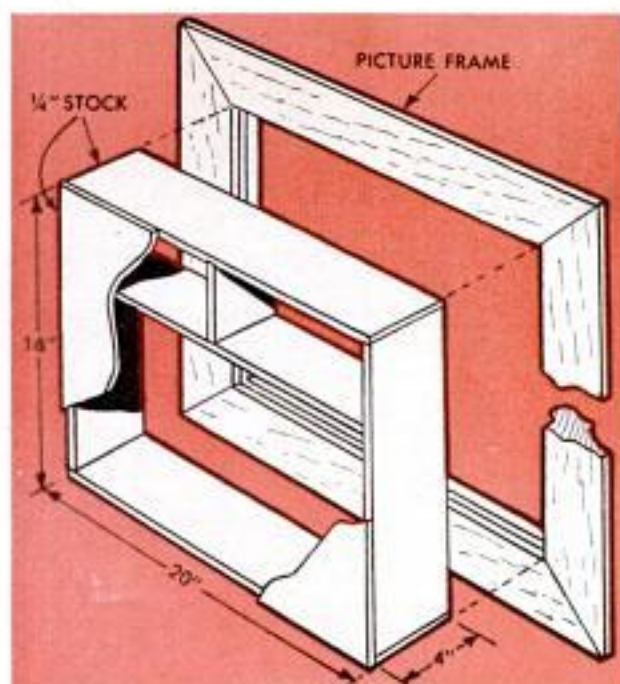

## Shadow-Box Display Frame for Dolls

If there is a young lady in your home who is proud of her doll collection, she will be delighted with this shadow-box picture frame that will permit her to display her dolls as "three-dimensional pictures." Large picture frames, such as were fashionable several decades ago, may be found in many attics, and are ideal for the frame for the shadow box. If such a frame is not available, picture-frame stock can be purchased at a lumberyard and made into a frame of any desired size. Dimensions given in the detail are those of the original picture box, which was made from a picture frame found in an attic, so the dimensions should be considered only representative. The size of the dolls to be displayed in a particular picture box will

determine the size of the frame, the number and type of partitions—whether vertical or horizontal—and the depth of the frame. Unless a doll is extremely large, the 4-in. dimension shown for the depth of the frame is sufficient. A greater depth will cause the frame to project too far from the wall on which it is hung. Top, bottom, sides and partitions of the picture box are cut from  $\frac{1}{2}$ -in. stock. The back can be  $\frac{1}{4}$ -in. plywood or hardboard. For a novel effect, use hardwood-faced plywood of a grain and color that will complement room decor. Wallpaper to match that used in the little girl's room also can be used as a background. For an illusion of depth, install a mirror at the frame back.

Mrs. Jean Lyon, Cedar Rapids, Iowa.

## Auxiliary Frame on Pickup Truck Supports Long Loads

Long, but light items, such as pipe and lumber, can be carried in the short bed of a pickup truck by adding a U-shaped frame made of  $\frac{3}{8}$  x 2-in. flat steel. It is pivoted to the inner surfaces of the truck-bed sides on  $\frac{1}{4}$ -in. steel plates as indicated. For easier loading and unloading, a roller consisting of a length of 3-in. pipe is installed near the end of the frame. To make sure that most of the weight of a load is supported on the truck bed, the frame should be pivoted so that the roller is level with, or slightly above, the truck bed when the tail gate is lowered and the frame swung to the rear. When not in use, the frame is swung forward to be out of the way. Although the roller is handy, it can be omitted if desired.

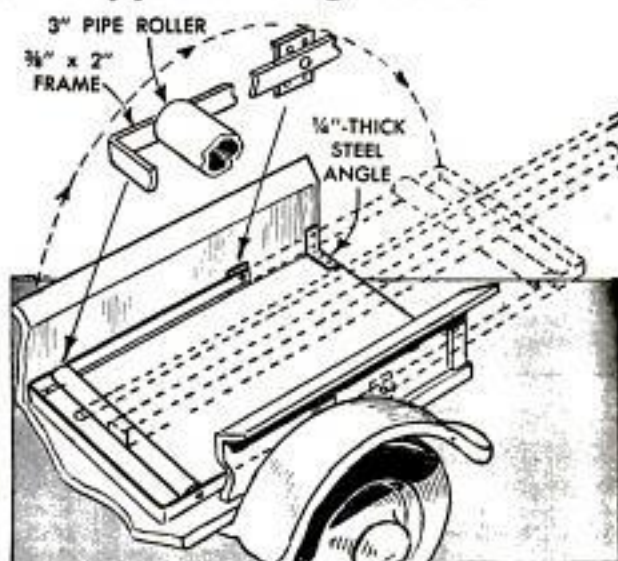





# OUTSIDE CHRISTMAS DISPLAYS

By Hi Sibley

WHETHER IT'S SANTA and his reindeer charging across the top of your roof, or a fireplace on the front lawn, flanked by red-flamed candles, an outside decoration gives your home a special holiday look. Santa, his sleigh and reindeer are jigsawed from  $\frac{1}{4}$ -in. exterior-grade plywood. At least three pairs of reindeer should be used. Santa's toys are carried in a large laundry bag filled with dummy packages and hooked to the back of the sleigh. Steel angles are used to attach the sleigh and deer to the roof. Harness can be painted on the deer, reins are lengths of white plastic clothesline which contrasts with the brown deer. Use a spotlight for night-time illumination.

Except for the mantel,  $\frac{1}{4}$ -in. exterior

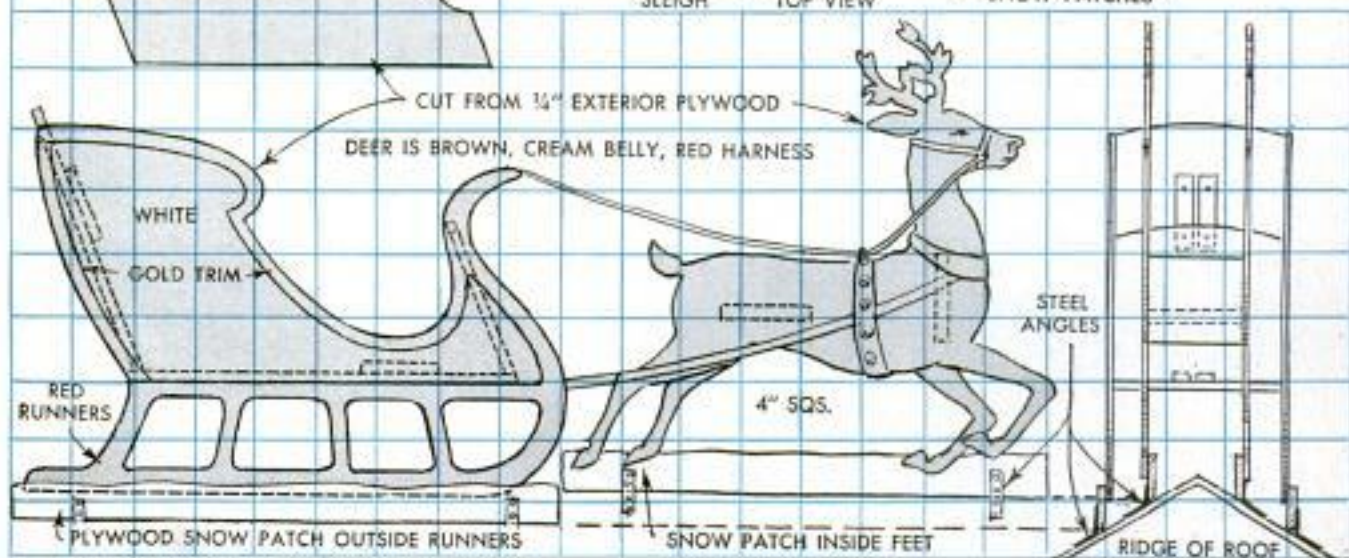
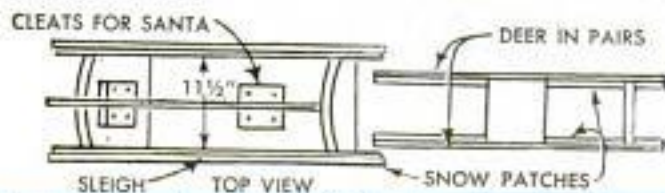





plywood also is used to make the fireplace which is built around a 1 x 2 framework. Paint the fireplace brick-red, then stripe with white lines for mortar. Paint the inside of the fireplace black. The candles are made from 24-in. lengths of 6-in. stovepipe. One length is cut in half and the sections fitted on full lengths to provide two 36-in. candles. Wooden disks at the top and bottom of each candle keep them in shape and provide a means of attaching receptacles and sockets for the bulbs. The candles are painted a bright red. ★ ★ ★

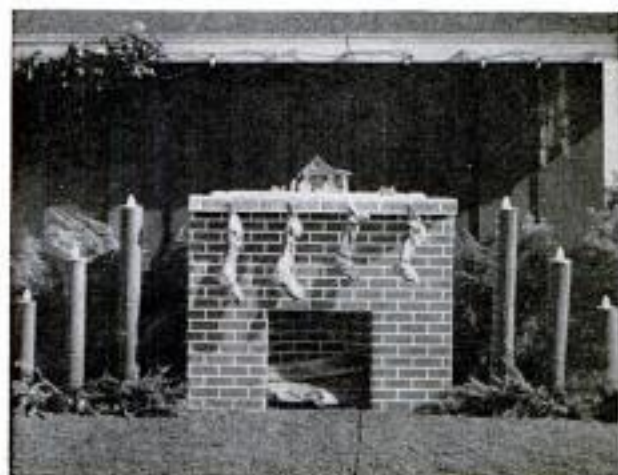
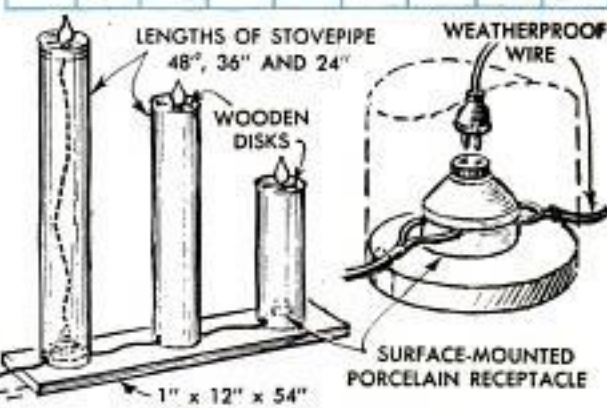
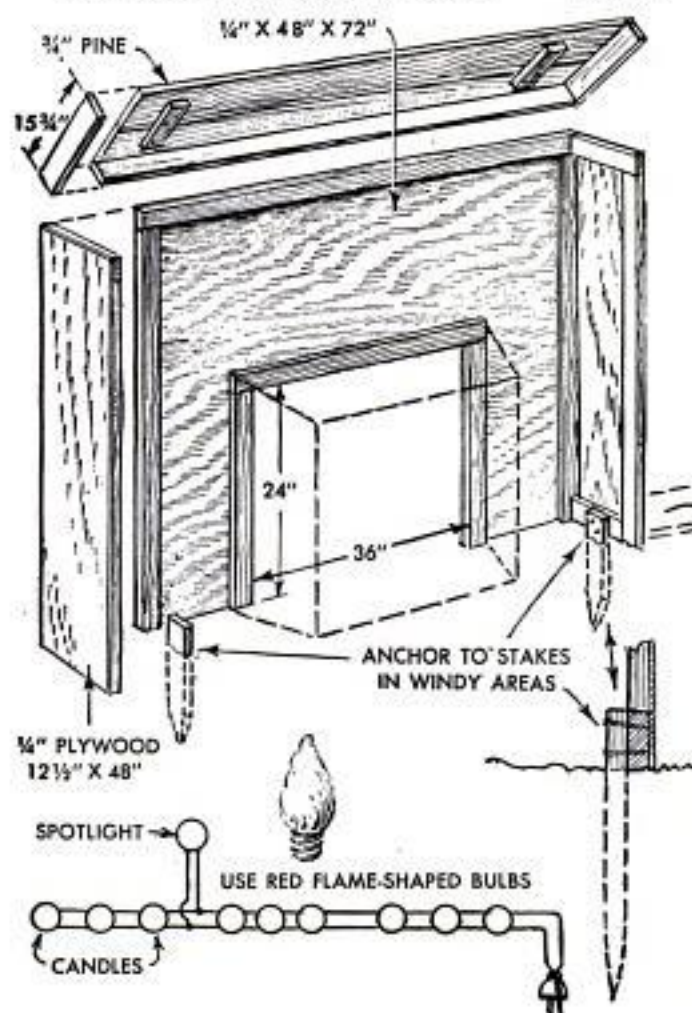
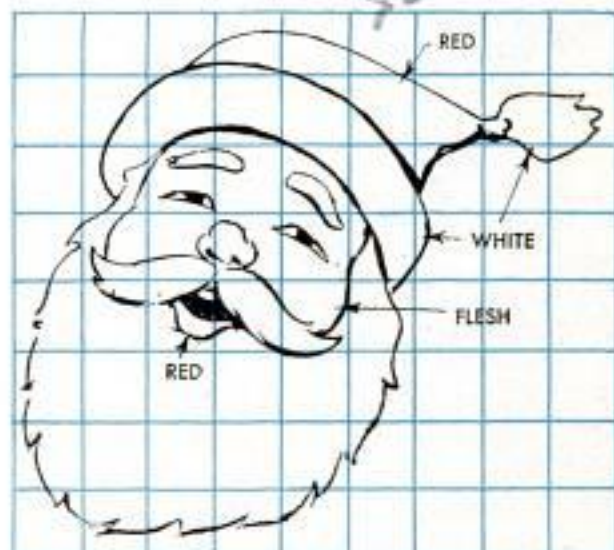



## Salt Box Is Handy Container for Carrying Sand in Car



Every motorist should carry a little sand in his car during the winter just in case he may get stuck on a slick spot next to a curb. One of the handiest ways of carrying sand without spilling is to pour some in a salt box. The pouring spout makes it easy to spread the sand where needed.

## Varicolored Candlestick Melted From Contrasting Inlay

A varicolored candle can be obtained for a table decoration by drilling two or more holes in the top of the candle and inserting small cake candles of contrasting colors. Light the wick on the large candle only and a very pleasing effect will result when the small ones melt and the colored wax flows together.

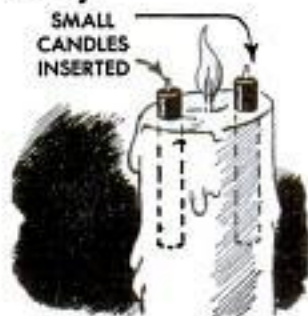

E. M. Wooden, Franklin Lakes, N. J.

Ⓐ rubber spatula is handy when mixing and pouring paint from one can to another. Besides being a good mixing paddle, it is useful for scraping out the final drop.

## Reels Stored on Dowel Racks

Developing reels can be stored neatly in the darkroom on a rack consisting of dowels inserted in blind holes drilled in a shelf. Most reels can be fitted on dowels of  $\frac{1}{4}$  or  $\frac{3}{8}$ -in. dia. Dowels should be long enough to hold three 120 reels. Drill the holes to provide a snug fit, so glue is not needed to keep the dowels in place. This permits them to be removed easily for cleaning the shelf.

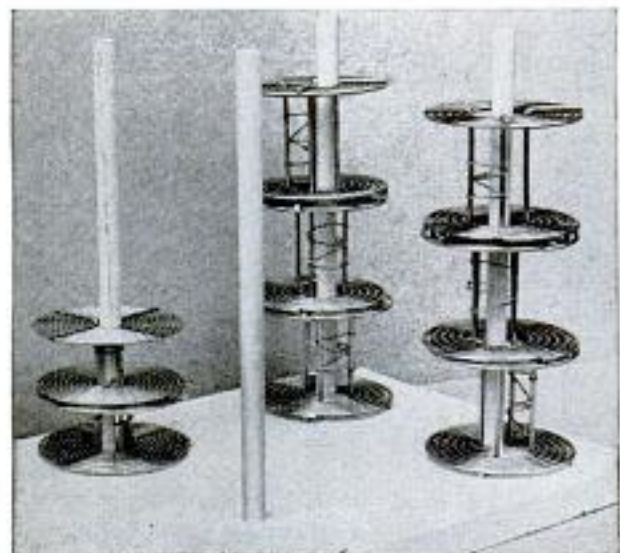

## Extending Life of Chamois

Before putting a chamois away to dry, rinse it in lukewarm water to which a small amount of acetic acid or household ammonia has been added. Use just enough acid so that the slippery feeling of the chamois disappears, and the chamois will dry soft and flexible. If the chamois is soiled, first wash it in a lukewarm soap-and-water solution, then rinse it in the water-acid mixture. Do not use hot water.







A NIFTY CHRISTMAS GIFT

**X342B**  
**AND CART**

# Hobbyhorse

HERE'S A HOBBYHORSE that will not only accommodate a young rider but permit him to carry a load as well in the attached cart. To make it, first draw a full-size pattern of the horse head and trace it on 1 $\frac{3}{8}$ -in. pine for sawing. The eyes, mouth and nose can be carved or just painted on. The eyes can be carved by drilling part way with a  $\frac{3}{4}$ -in. bit held at an angle. All sharp edges are chamfered and then a  $\frac{7}{8}$ -in. hole is bored for a dowel or broomstick neck. A screw eye with a ring attached is turned into each side of the mouth

to form a bridle bit. Old shoes will provide the leather for the ears, and a narrow belt will make the bridle. The cart is attached to the dowel with a flat-steel bracket.

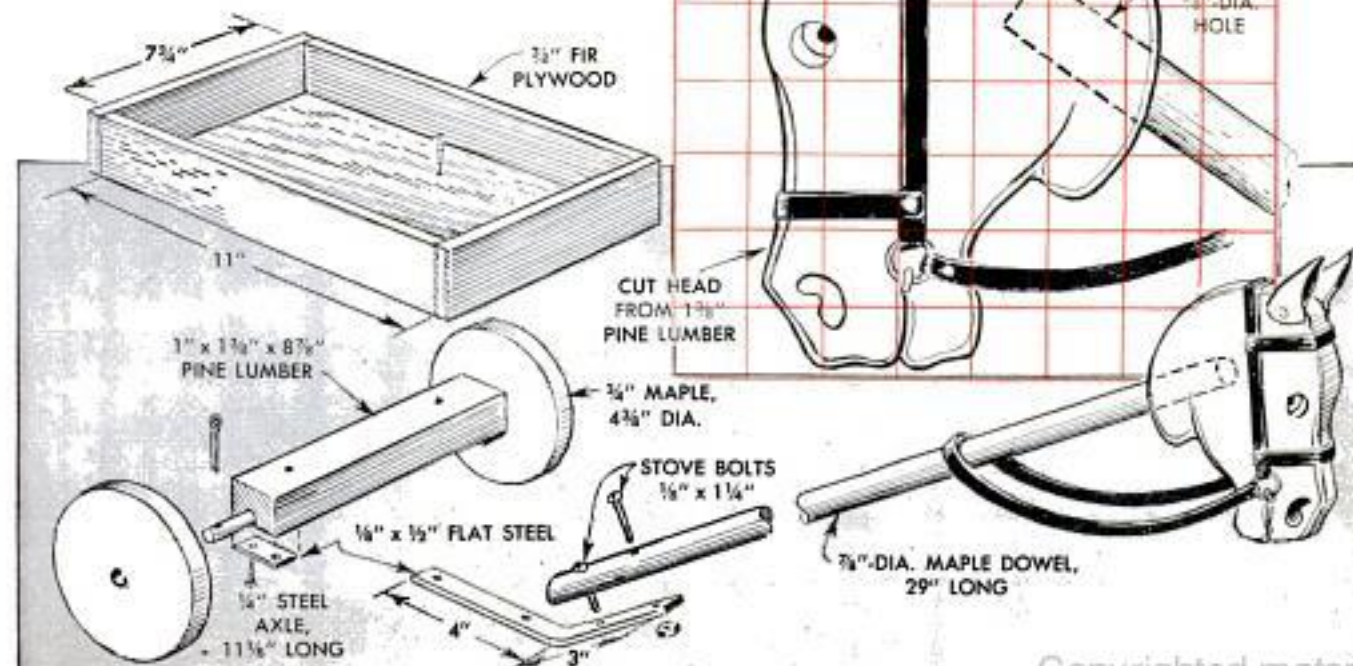





*Decorations  
for Your  
Xmas Tree*







"Glitter" sprinkled on plastic-foam ornaments will adhere well if foam first has been immersed in water

**C**HRISTMAS-TREE ornaments made of plastic foam are snow-white and crisp-looking, but they do lack the festive glitter of other types of ornaments. However, it takes only a little work to add color and sparkle to the foam. Sequins, which are available in a variety of shapes, sizes and colors can be pinned to the foam with common pins. The ends of the pins are bent over to keep the sequins in place. "Glitter," either the type on sale in art stores, or the edible type used for cake decorating, may be "cemented" to the ornaments by first dipping the foam in water, then sprinkling the glitter on it. Shake off the excess particles and let the foam dry. On the opposite page are shown a number of plastic-foam ornaments. ★ ★ ★

One ornament with sequins, and one without show the difference in appearance of decorated plastic foam



DECEMBER 1957



Above, pin holding each sequin is bent with pliers. Below, pattern of sequins is placed before pinning

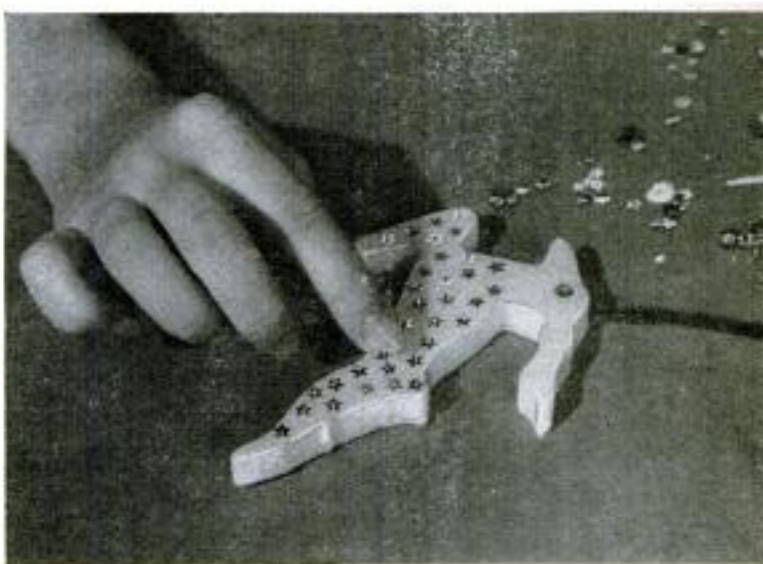

Below, no matter what the shape of a plastic-foam ornament, it can be given a new look and sparkle



203

Copyrighted material





## Giant Oilcloth Poinsettias Are Unique Outside Decoration

Vivid red poinsettias cut from oilcloth and supported on wire frames decorate the front of this motel in Whitehall, Mont. A cluster of Christmas-tree lights is placed at the center of each flower, and evergreen-covered pipes provide stems. Giant candles are made from cardboard tubes that have been painted red, then splattered white to simulate candle drippings. Outdoor receptacles hold flame-shaped bulbs.

## Baking-Soda "Fire Extinguisher"

Small fires on a kitchen range, caused when grease or oils blaze up, can be smothered quickly by throwing on a handful of baking soda. Keep a box of this "fire extinguisher" handy to the range.

## Three Methods of Cleaning and Refinishing Old Brass

Depending on the type of finish desired, bright, dull or antique, one of three methods of polishing brass is used. For a bright finish, clean the object with a good-quality metal polish, using a soft cloth and brush for carved designs. When the polish is dry, buff to a shine with a flannel cloth. For a dull finish, mix enough linseed oil with

rottenstone to make a mixture the consistency of heavy cream. Rub the object until tarnish disappears, then wipe away rottenstone mixture with a soft cloth dipped in linseed oil. For an antique finish, rub the object with furniture polish, then remove excess oil with a soft cloth. Polish with a flannel cloth.



### CONTENTS

- Ch. 1—Selecting power tools
- Ch. 2—Installing power tools
- Ch. 3—Portable power tools
- Ch. 4—Operating the circular saw
- Ch. 5—Dado-head techniques
- Ch. 6—Drill-press operations
- Ch. 7—Operating the bandsaw
- Ch. 8—How to use the jigsaw
- Ch. 9—Working with the wood lathe
- Ch. 10—Wood-shaper techniques
- Ch. 11—Fundamentals of the jointer

## ADD THOUSANDS OF DOLLARS TO THE VALUE OF YOUR HOME...

**New PM Book tells and shows how to handle power tools like an expert—and make valuable property improvements**

A thorough knowledge of power tools and how to use them will enable you to perform hundreds of major and small projects around your home at *tremendous savings*, and *increase its value* significantly. Now, with the aid of a new Popular Mechanics book, "Getting Started with Power Tools", it's easy, fun, safe . . . and with no previous experience you'll be able to do more home remodeling and repair jobs, make beautiful furniture, toys and boats, or execute many other projects you may have wanted to do, but never could.

This remarkable book, in 160 pages of easy-to-understand text and scores of illustrations, shows you all about the interesting and profitable avocation of working with power tools. Special attention is given to the type of learning problems encountered by the novice, and each major type of power tool is clearly illustrated with captions showing all of its components. But this book is written for the skilled craftsman as well. It contains many helpful hints that will save time and money. It tells what you should look for in planning a power tool shop, and how to lay it out for greatest efficiency. It stresses safety procedures that will benefit even the practiced workman. And various attachments are shown that will convert one tool to multiple duty, thus saving on the total investment. Never before has a book on power tools been written for the home craftsman that provides as much basic information for the novice, and as many down-to-earth work hints for the expert, as "Getting Started with Power Tools". Order your copy today, with a money-back guarantee if not pleased. Send your check or money order to the address below in the amount of only..... **\$2.50**

**POPULAR MECHANICS PRESS, Dept. 1257**  
200 EAST ONTARIO ST. CHICAGO 11, ILLINOIS



SN 59

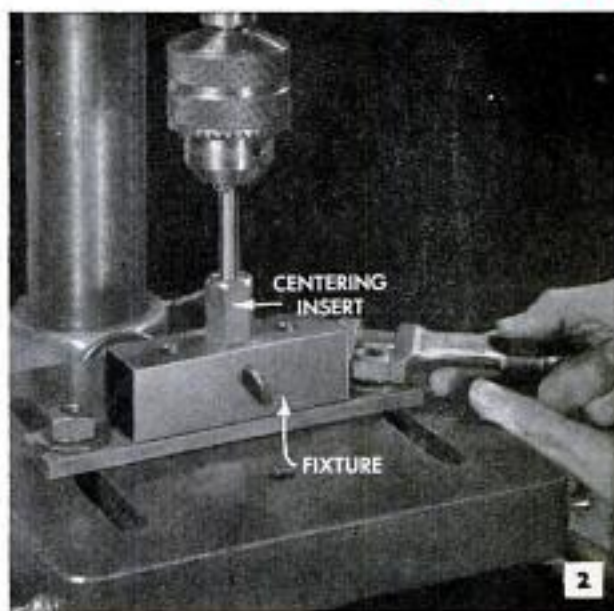

## DRILL-PRESS WORK SUPPORT *has interchangeable inserts*

By Walter E. Burton

**W**ORK-HOLDING PROBLEMS are not always solved advantageously by use of a drill-press vise. Final repetitive operations on semifinished parts, holding dissimilar parts for center drilling, blind drilling or tapping can often be done faster and with greater accuracy by using a table fixture having interchangeable work supports. These usually are made up to suit the job at hand, those detailed, A, B, C, D, Fig. 6, being intended only as suggestions. Also, a drill chuck, Fig. 1, or a small lathe scroll chuck can be used to advantage on some types of work. Such chucks must be fitted with a special shouldered spindle to fit the center hole in the fixture.

Two types of work, two work positions and two uses of the stop are shown in Figs. 4 and 5. Where fine accuracy is not involved, the stop permits the work to be held in the hand without danger of injury which sometimes occurs when the drill bit grabs suddenly and spins the work. The stop rod eliminates this hazard. The fixture, detailed in Fig. 6, and shown in Figs. 1 to 5 inclusive, consists of a 4½-in. length of 1½ x 1½-in. mild steel (tool steel also can be used) screwed to a slotted baseplate which is bolted to the drill-press table. Holes in the fixture are drilled ⅜ in. and

reamed to ½-in. dia. Of course, these holes should be drilled with a drill bit in perfect condition and with the fixture assembled and bolted on the drill-press table in the position in which it will be used. This procedure will assure accuracy.

To align the fixture, Fig. 2, a centering insert, or locator, is used. This can be made

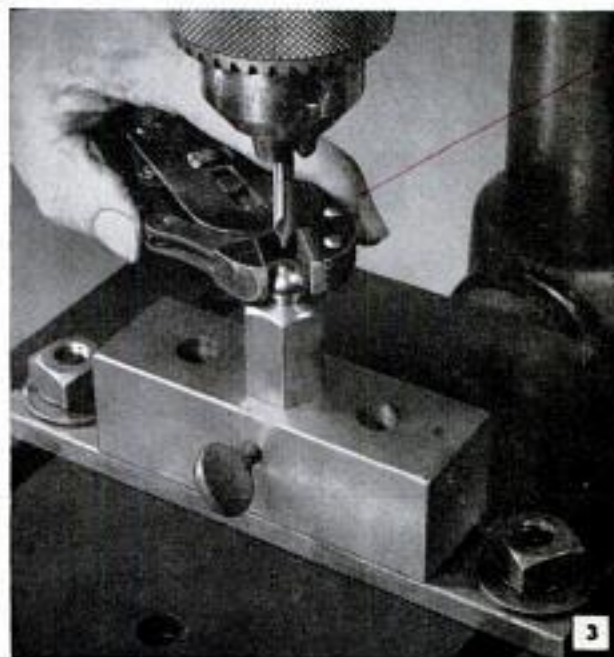

VISE-GRIP WRENCH  
BROADHEAD CARBET  
H560 E.  
71st,  
Cleveland 5,  
Ohio



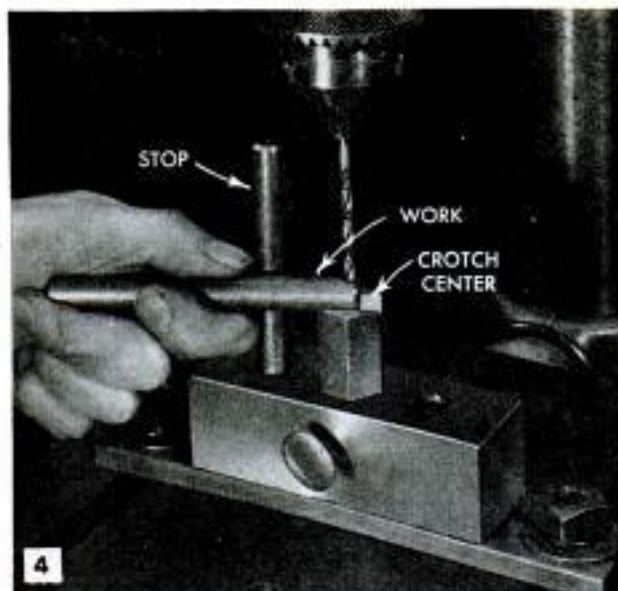

A stop prevents work from spinning with drill should latter grab unexpectedly. Inserts are held in place by thumbscrew which tightens against spindle

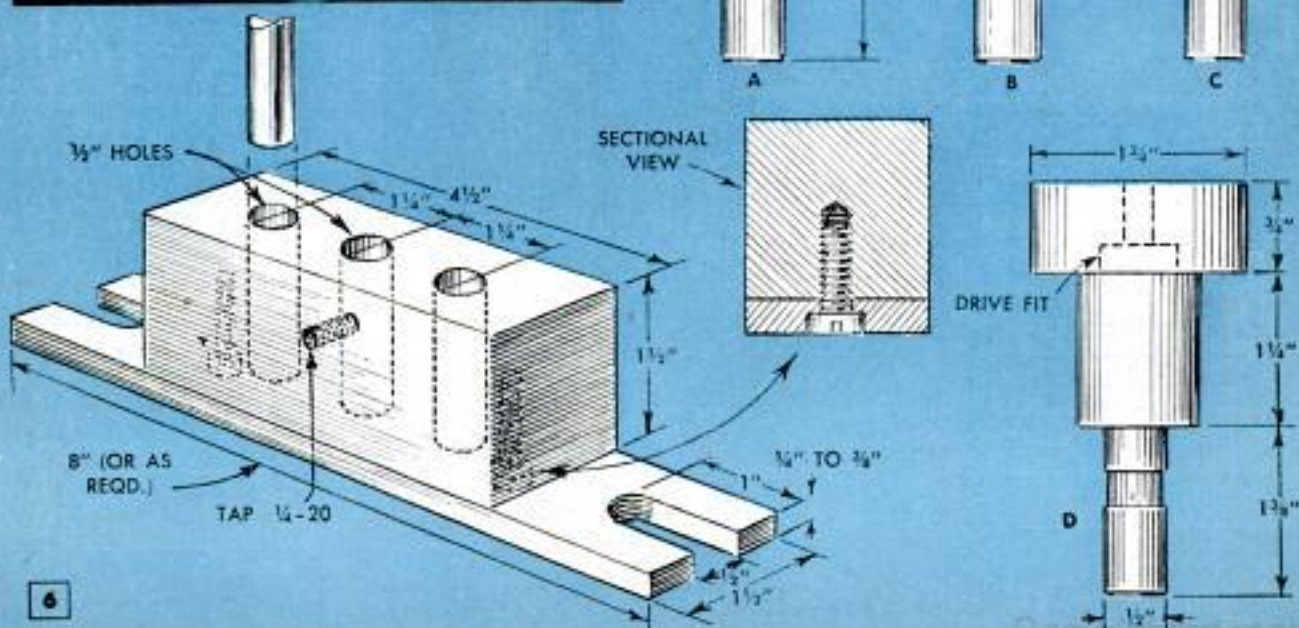
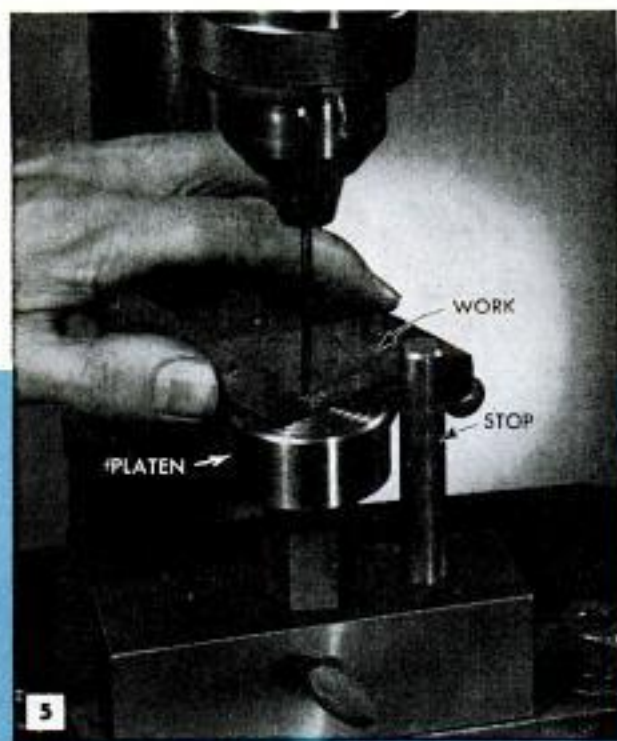

from round or hex stock as in detail B, Fig. 6. This insert also can be used as a work support. The latter is drilled  $\frac{5}{16}$  in. and reamed to  $\frac{3}{8}$  in. Use a short length of  $\frac{3}{8}$ -in. drill rod in the chuck when aligning the parts as in Fig. 2. Use  $\frac{1}{2}$ -in. drill rod for the stop, Figs. 4 and 5.

The platen, Fig. 5, can be fitted with a  $\frac{3}{8}$  or  $\frac{1}{2}$ -in. spindle for use with inserts A or B, or can be turned with a recess for use with insert D, Fig. 6. If used as in Fig. 6, detail D, the parts should be turned to a light drive fit. Spindles for all the inserts can be formed simply by turning down from the 1-in. dia., or by drilling the stock and inserting spindles made from  $\frac{1}{2}$ -in. drill rod. The  $\frac{1}{2} \times \frac{1}{4}$ -in. groove takes the point of the setscrew when the spindle is locked in position in the fixture. This prevents the slight burring, caused by tightening of the setscrew, from interfering with insertion and withdrawal of the insert. The crotch-centering insert, detail C, Fig. 6, can be made with a 45-deg. countersink for centering a ball, or with a 45-deg. (90-deg. including angle) V-groove for supporting round stock, Fig. 4. It also can be made by using round stock or hex stock as shown. The dimensions of the fixture and inserts can, of course, be varied to suit individual requirements. For ordinary work it is not necessary to harden the inserts or the block, but for repetitive jobs hardening will help to maintain accuracy. ★ ★ ★



## Improved Holder Confines Torch Flame

This holder will save you the time required to extinguish and relight the flame when welding a job that requires intermittent use of a gas torch. The holder keeps the torch in place and eliminates fire hazard. Just cut a 2-in. hole in a 5-qt. can about 5 in. from the top. Fill the can half full with water. While rearranging the work, insert the torch tip in the hole.

Stanley Clark, East Bradenton, Fla.

## Heavy-Bodied Lubricants For Spinning Aluminum

Commercially pure aluminum which has been annealed generally requires the use of a heavy-bodied lubricant to prevent scoring under heavy pressure of spinning tools. Blanks 3 to 12 in. in diameter spin easily when coated with tallow or petroleum jelly. On somewhat larger blanks ordinary beeswax provides both adequate lubrication and protection against scoring.

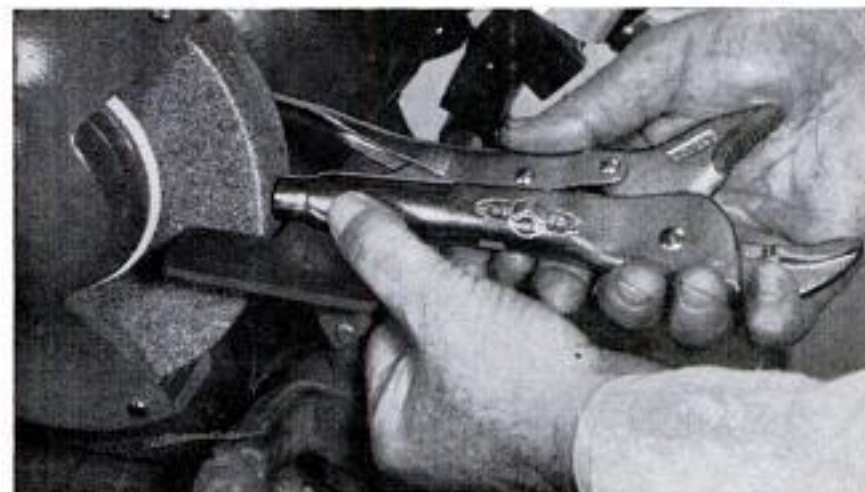

## Restoring Grip Of Lever Wrench

Lever wrenches, or clamping pliers, often wear to the point where the clamping screw will no longer adjust the jaws to grip tightly. When this occurs, remove the screw and grind off the end of the fixed handle. This will restore the original grip of the wrench jaws.—R. Moore, Wellsville, Ohio.

## Pliers Altered to Hold Wire

When the corrugations on the inner meeting faces of fence-plier handles become worn they will not grip barbed wire firmly for stretching. If the wire slips, it will be scored and may break later on. To prevent this, file a half-round groove in each handle, using a  $\frac{1}{8}$ -in. round file. The grooves should register so that they form an opening of about  $\frac{1}{8}$ -in. dia. when the handles are closed. This simple alteration permits the wire to be gripped firmly.

## Cold-Weather Starting Aid

On a severely cold morning when your car won't start it's helpful to remember this trick. Wrap a cloth several turns around the manifold just below the carburetor and soak with boiling water. This warms the manifold and vaporizes fuel for a quick start.

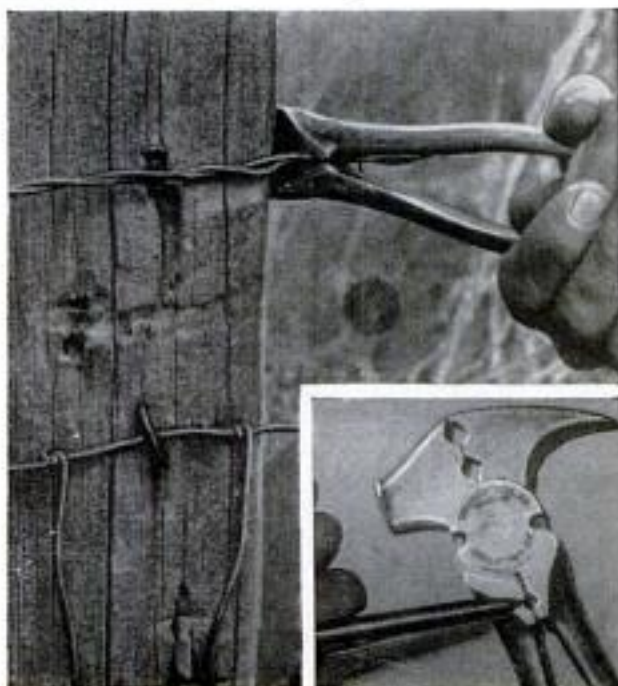



# Christmas SHOPPING



**1. PORTABLE ROUTER** is controlled by a trigger switch mounted in a specially designed "saw grip" handle which permits one-hand operation of the machine. A 1¼-hp. motor spins bits and cutters at 22,000 r.p.m. Accessories include dovetail and hinge templates, an interchangeable planing attachment and shaper table

Porter-Cable Machine Co.,  
106 Exchange St., Syracuse 6, N. Y.

**2. HAND SCREW** is made with soft-metal inserts, or pads, which prevent marring work and also make it easier to remove residual glue which may adhere to the jaws. Otherwise, hand screw is of conventional type with hardwood jaws, threaded steel spindles and wooden handles. Comes in 3 sizes, 4½, 6 and 8½-in. jaw openings

Wetzler Clamp Co.,  
43-15 11th St., Long Island City 1, N. Y.

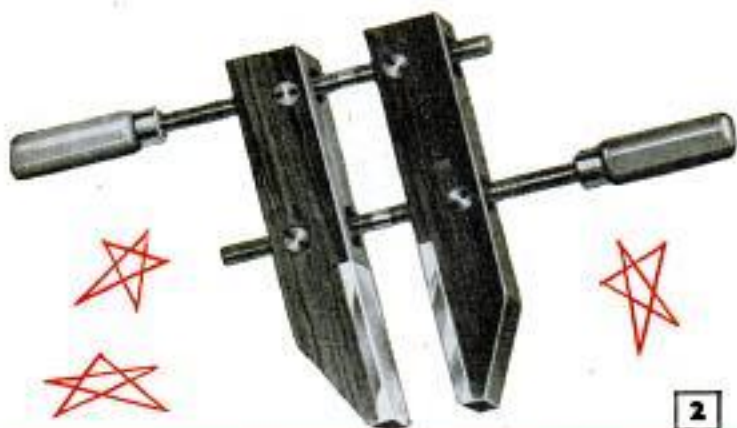

**3. SAW-JOINTER COMBINATION** has several new features. Rip fence aligns automatically and locks at both ends with a turn of the locking handle. Raising and tilting units are operated with one hand-wheel and screws are self-cleaning. Will not clog with sawdust. Miter-gauge clamp grips stock firmly, prevents creeping

Montgomery Ward, 618 W. Chicago Ave., Chicago

**4. ORBITAL-SANDER KIT** includes the sander, steel carrying case and all the necessary accessories for finish sanding, buffing and polishing. High-speed orbital motion of pad puts an extra-fine finish on both hard and soft wood without scratching or ridging surface. Brings a waxed surface to a high polish with lamb's-wool pad

Speedway Mfg. Co., Div. of Thor Power Tool Co.,  
1843 S. Laramie Ave., Cicero 50, Ill.

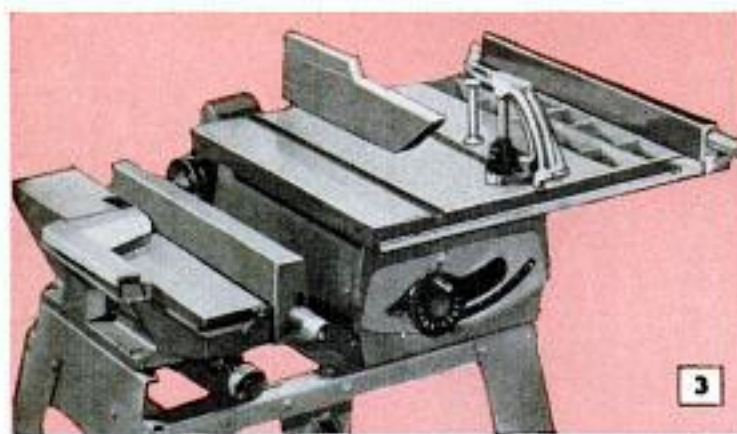

**5. BENCH GRINDER** has been designed for home-shop and light industrial applications such as sharpening hand tools, buffing and scratch-brush work. Comes equipped with 6-in. grinding wheel, 6-in. wire wheel, tool rests and wheel guards. Unit is mounted on rubber pads for quiet operation on workbench. Speed is 3450 r.p.m.

The Stanley Works, 111 Elm St., New Britain, Conn.

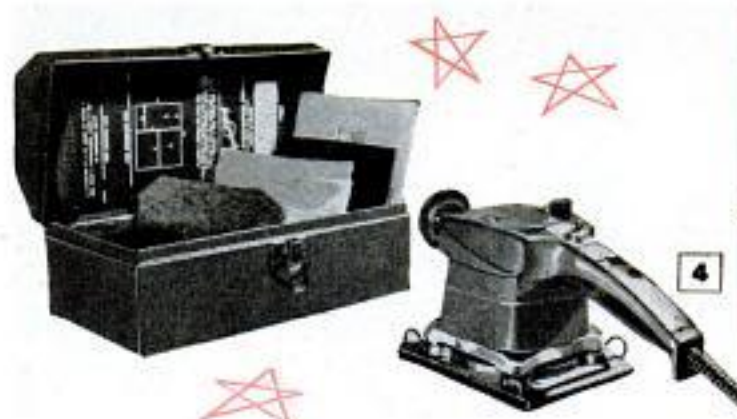



# FOR TOOLS



6

**6. GLASS DRILL** cuts clean holes in glass up to 1 in. in dia. Edges of holes are sharp, no chipping on either side of glass. Made in two types, one driven by portable drill, the other being motor-driven

*Ju-Go Glass Drilling Machines, Box-884, Journal-844-846, Jersey City 6, N. J.*

**7. PORTABLE-ELECTRIC-DRILL KIT** includes ¼-in. drill, 5 twist-drill bits, 4 wing, or spade-type, bits for wood, screwdriving attachment and a set of 5 countersinks for screws, the latter for 5 sizes of screws

*Skil Corp., 5033 N. Elston, Chicago 30*

**8. SMALL BOLTS AND SCREWS** come in special plastic containers which are designed to fit into individual compartments in a sheet-metal rack. Screws, bolts are packed one size in each plastic container

*Rockford Screw Products Co., Rockford 46, Ill.*

**9. 12-PIECE SET OF CARVING TOOLS** includes all those commonly needed for wood carving and making linoleum-block printing cuts. Over-all length of each tool is 5¼ in. Each is fitted with 4½-in. handle

*A. S. Trading Co., 60 Lexington Ave., New York City 10*

**10. UTILITY TRAY** for drill press clamps to the column to hold drills or a number of finished and unfinished parts in production work. May be positioned as pictured or reversed to clear machine table

*The Western Tool and Mfg. Co., Springfield, Ohio*

(Continued to page 210)



7



8



9

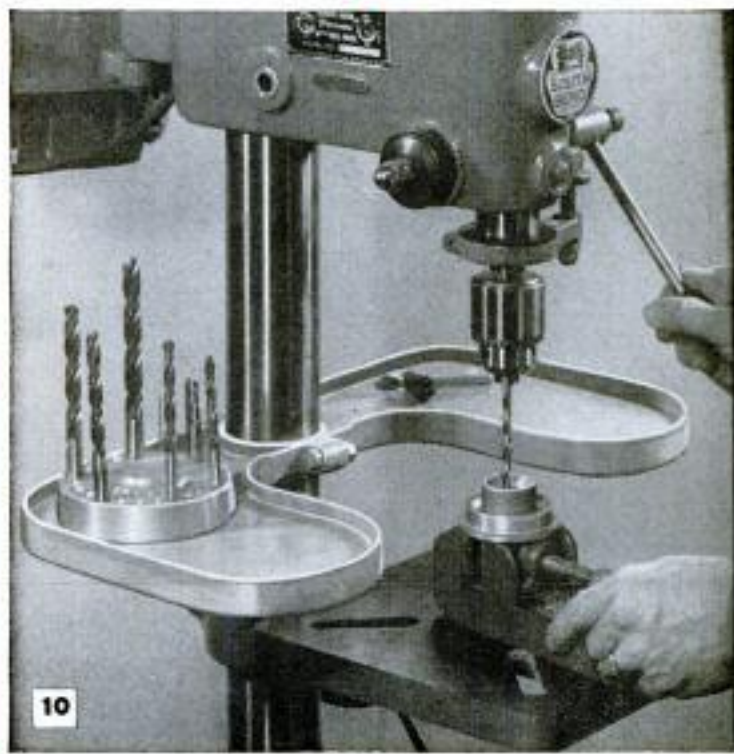

10



# Christmas SHOPPING FOR TOOLS



11

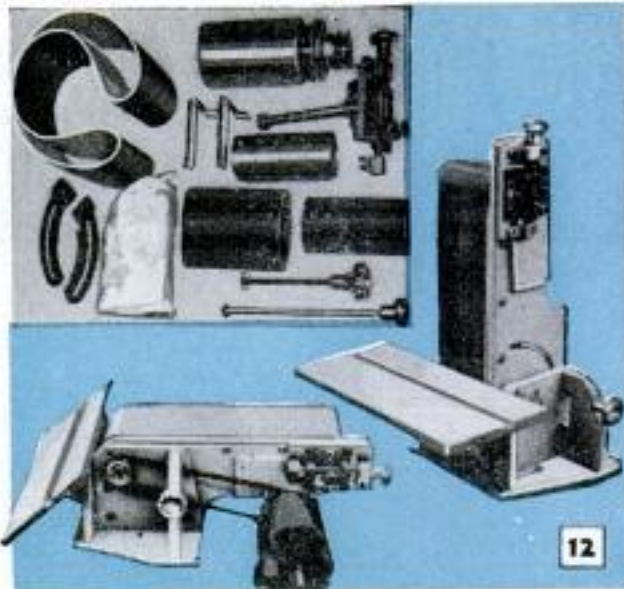

12



13



14



15



16

**11. CONTOUR-SCRAPER KIT** consists of 5 shaped blades and a special plastic handle to which the blades can be attached individually. Used to remove paint and varnish from flat and molded surfaces such as picture frames, reeded and fluted columns  
Mertolan Products Co., 186 Madison Ave., New York City

**12. COMPLETE BELT SANDER** comes in a build-it-yourself kit. All metal parts are completely machined ready for assembly. Kit comes complete with plans and full-size patterns for cutting the wooden parts which you make yourself from plywood as specified

Gilliam Power Tools,  
P.O. Box 6157, Lambert Field, St. Louis 21, Mo.

**13. CONCENTRIC GROOVES** in the upset head of such hand-held tools as cold chisels, stone chisels, star drills and calking irons add a safety factor and also improve balance. Grooves tend to prevent mushrooming of head of tool under heavy blows

Damascus Steel Products Corp., Rockford, Ill.

**14. PUSH-PULL TAPPING ATTACHMENT** designed to be driven by a portable electric drill features an unusual instant reverse which enables the operator to back out the tap by power rather than by hand. Drives any standard tap up to 5/16 in. in dia.

Scott-Mitchell House, Inc., 611 Broadway, New York City 12

**15. PORTABLE ARC WELDER** has a new-type transoidal transformer having a 90 percent power factor at rated output. Welds steel up to 1½ in., cuts ¼-in. steel plate. Operates on 115 or 230-volt a.c. Handles electrodes from 3/32 up to and including 5/32 in.

Brennen, Buell and Weber, Inc., 202 Mott St., New York City 12



**16. STEPLADDER** locks in the open position so that it cannot accidentally fold while in use. Also is fitted with a sliding bench, or shelf, and handrail unit which can be raised to a convenient working position to hold tools, paint pails, brushes and other accessories within handy reach while standing on any of the steps. Shelf locks firmly in place when raised

The Safe-T-Ladder Co., Huntville, Ohio

**17. SCREWDRIVER** has a built-in wire stripper in the handle which strips any wire up to No. 1 ga., including stranded wire. Handle is conventional shape except that it has a transverse opening through which the wire to be stripped is inserted. The U-shaped cutter which does the stripping is molded into the plastic. The screwdrivers are available in 4 sizes

Wire Stripper Tools, Inc., Glen Head, N. Y.

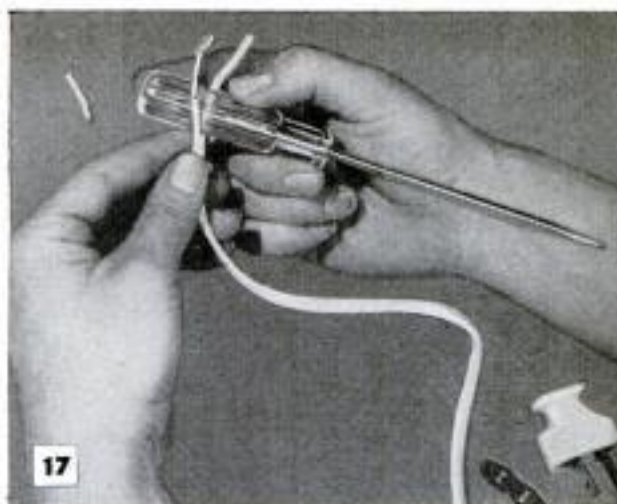

**18. RADIAL SAW** has all controls located at the front of the machine for easy accessibility, safety and convenient operation. Special motor develops over 2 hp., drives 10-in. blade. Switch is fitted with safety keylock, cannot be closed until key is inserted and turned. Warp-resistant table is built up of laminated wood and is of exceptionally large size

Sears, Roebuck and Co., 925 S. Homan Ave., Chicago 7



**19. SOCKET WRENCH** has a hinged handle which gives greater leverage and permits operation in exceptionally close quarters. When socket is engaged, pressing down slightly on the wrench head disengages handle and permits it to swing freely in either direction. Releasing wrench head allows it to engage at any point. Meets regular specifications for torque

F & C Tool Co., P.O. Box 5926, Portland 22, Ore.



**20. SAW BLADE** of unusual design cuts thin sheet metals, corrugated roofing, heating ducts, gutters and downspouts. At conventional saw speeds the blade heats the metal to the melting point, slicing its way through stock rather than sawing. Deep slots in edge of blade act as cooling vanes, or fins, preventing overheating of blade at the cutting edge

Sears, Roebuck and Co., 925 S. Homan Ave., Chicago 7

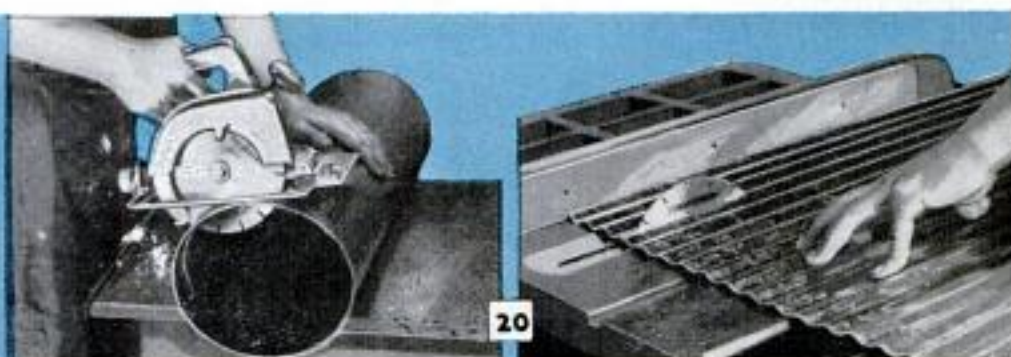
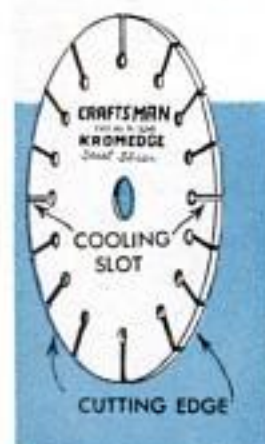





### Groove in Center of Wheel Speeds Grinding

Fine grinding wheels of small diameter often tend to glaze and heat abnormally when grinding the softer metals. This tendency generally can be minimized by cutting a shallow groove at the center of the wheel with a diamond dresser. The groove should be  $\frac{1}{2}$  in. deep, and about  $\frac{1}{8}$  in. wide. The groove reduces the area in contact with the work and dissipates heat.

Frank LaSaracina, New York City.

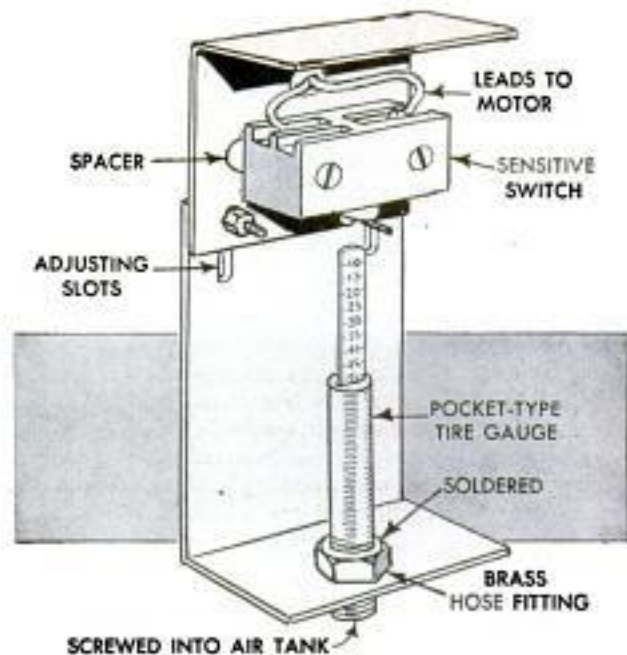

### Pocket-Type Tire Gauge Actuates Compressor Switch

Here's the pressure switch for that air compressor you're building. It consists of a sensitive switch and a pocket-type tire gauge mounted on an adjustable two-piece bracket, the latter providing pressure control over a considerable range. A short length of  $\frac{1}{8}$ -in. threaded pipe is soldered to the end of the tire gauge, passed through a hole drilled in the lower leg of the bracket and screwed into a tapped hole in the pressure tank. Adjust the bracket so that the plunger of the gauge actuates the switch when desired pressure is reached.

Thomas N. Park, Woodland Hills, Calif.

### Clean Holes in Aluminum Alloys Require Special Drill Bits

Drilling holes in aluminum alloys up to  $\frac{1}{2}$  in. in diameter calls for high-spiral drill bits and high-spindle speeds. A cutting speed of 600 r.p.m. at the periphery of the drill bit gives average good results.

Using this figure as a basis of reckoning spindle speeds, a  $\frac{1}{8}$ -in. drill would require a speed of 1800 r.p.m. while a  $\frac{1}{2}$ -in. drill would call for a speed of 4584 r.p.m.

Robert A. Ridout, Glenview, Ill.

### Pencil Shading Aids Cope Cut

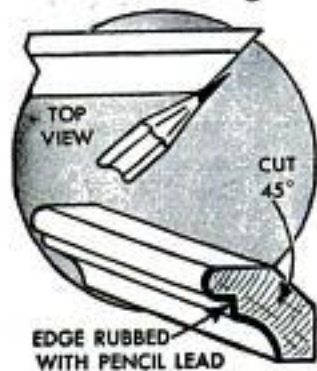

A cope cut on the second piece of molding is made easily and accurately if you first miter the stock. Then shade the molding profile with a soft-lead pencil. This gives you a clean, sharp line which is easily followed

with the coping blade. Use a narrow, fine-toothed blade.—Leonard S. Knox, Chicago.

### Nonspill Pouring Spout



Force a section of curved radiator hose over the spout of a 5-gal. fuel can and you eliminate the waste of a lot of gasoline or fuel oil. The extra length of the spout enables you to drop the end into the fuel-tank

opening before the fuel begins to pour from the spout.—E. V. Reyner, Townsend, Mont.



SN 59

# SETScrew TIPS

PARTS HELD IN PLACE with setscrews are found on all types of power equipment, both in home and industrial shops. On newer power units, setscrews usually are of the socket type of a length which will turn in flush with the surface of the part being held in place. On older equipment you often find headless slotted setscrews of the flush type and also setscrews with projecting square heads. If the latter are used on moving parts, such as pulley or gear hubs, they should be replaced with socket setscrews as a safety measure. Also, socket setscrews that project should be replaced with a screw of the correct length. See the upper left-hand detail in Fig. 2. If the screw projects, it may catch clothing and cause a serious injury.

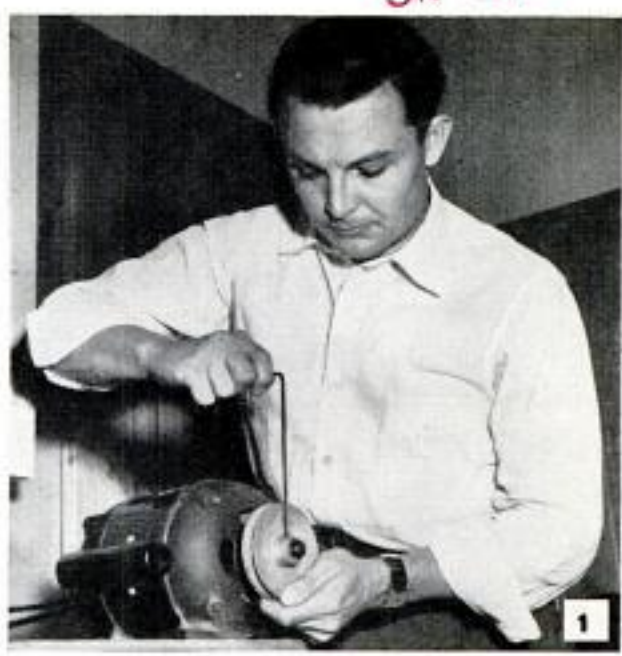

When you loosen a socket setscrew from a pulley hub, use the long leg of the socket-setscrew wrench as in Fig. 1. Be sure that the hex end of the wrench is pressed into the screw socket as far as it will go. If the screw cannot be loosened with the wrench in this position, use the short leg, but be careful not to apply too much pressure.

If you place a pulley or gear on a round shaft, file a flat on the shaft as in the upper right-hand detail, Fig. 2. Otherwise the pulley may be extremely difficult, if not impossible, to remove.

Be sure to turn the setscrew out far enough to clear before turning a pulley to remove it from a shaft, upper detail, Fig. 3. If the shaft is already scored, tap the pulley back and remove scores with a file. In an emergency you can use a file tang as a socket-setscrew wrench, upper detail, Fig. 4. A short handle of pipe or tubing, Fig. 4, makes it easier to turn the regular setscrew wrench.

Louis Martin Reitz, Bourbon, Mo.

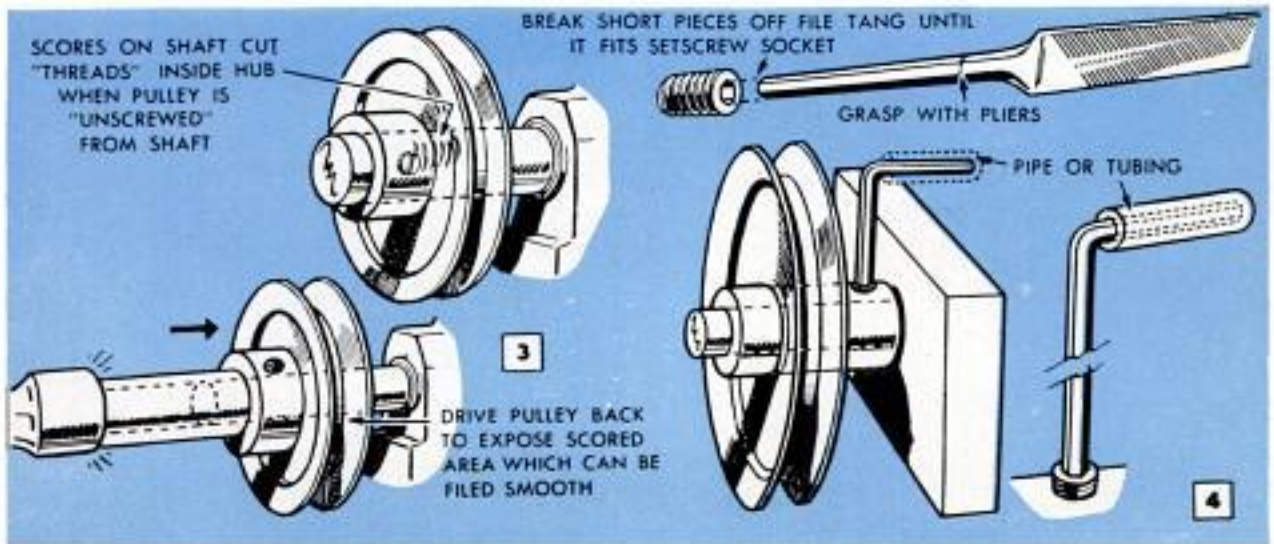
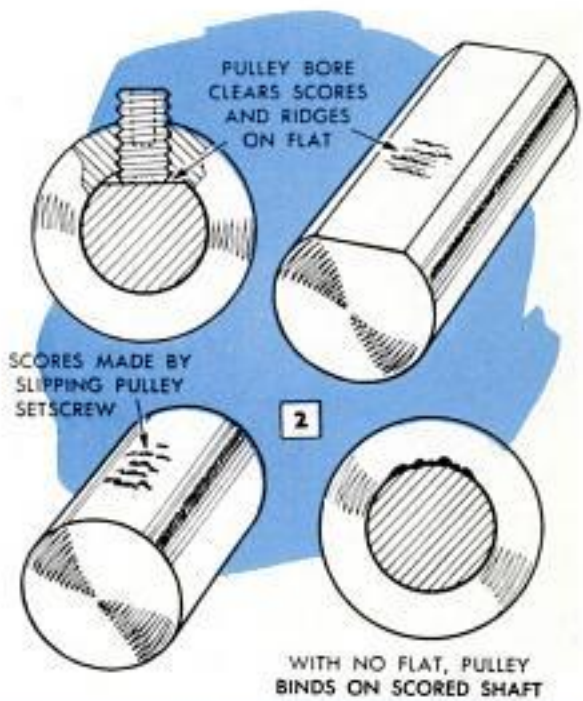



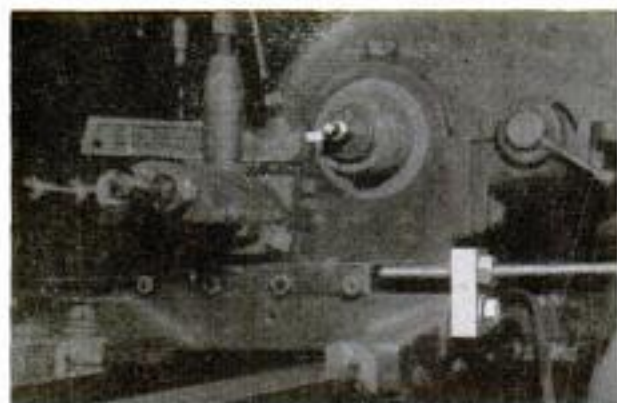

### Cross-Feed Stop for Lathe

When duplicating metal turnings, especially small parts, a cross-feed stop assures consistent accuracy and a saving in time. A  $\frac{1}{16}$ -18 threaded stop rod, a hex nut and a steel block are all the parts you need to make one suitable for the purpose. The block is drilled and tapped for the rod and also is drilled for a setscrew by means of which it is attached to the back slide of the lathe carriage as pictured. The hex nut holds the rod in the desired position. The guard usually will have to be removed from the cross-feed slide so the end of the slide can contact the rod.

Carleton A. Phillips, Corning, N. Y.

### Calculating Roof Areas

When you need to calculate shingle requirements for reroofing an ordinary gable roof without dormers, you will remember that to figure the area of a rectangle you simply multiply the dimensions of two adjacent sides. But a hip roof usually consists of two triangles and two trapezoids. Figure as in the details. Measuring the roof periphery at the eaves and then multiplying by one half the rafter length gives you the area of a conical roof.

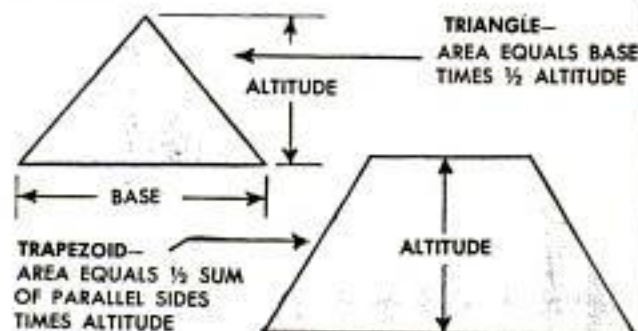

## This New Abrasive Cuts Fast and Clean

**T**HIS ABRASIVE is really new. The abrasive grains are of tungsten carbide and these are fused to steel by a process developed by Skil Corp. It's now available as a rasp for handwork, a shoe for orbital sanders and hand-sanding blocks, a sleeve for sanding drums and a grit wheel, or disk, for use on a circular saw. Photos below and on the opposite page show what it will do in the shop. Cuts wood, metal and plastic faster than any abrasive you ever used. Won't clog or burn the work. The secret of its fast-cutting properties is that the abrasive grains are not brittle—they stay needle sharp. The disk and rasp are faced with two grit sizes. With the disk you can rip and crosscut wood, rough sand and finish, remove waste to the line, run grooves and cope cuts with the speed of a dado head. ★ ★ ★

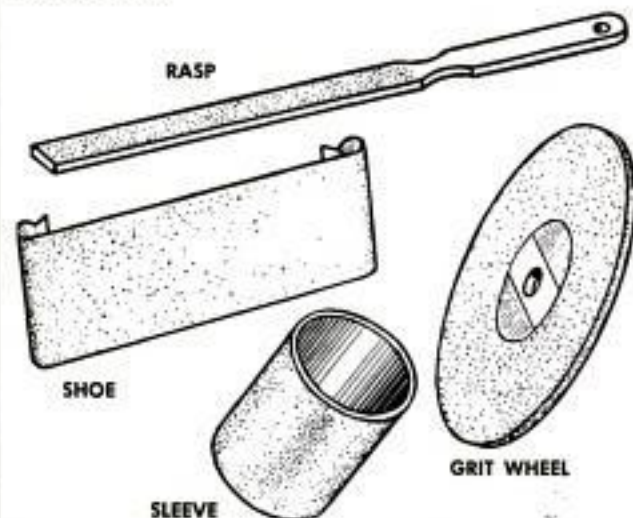

Above, new carbide abrasive is presently available in the accessories pictured. Below, an orbital sander with shoe does a real job on plasterboard joints







**It's a fast, smooth-cutting rasp for expert work on wood. Needle-sharp abrasive severs the wood fibers. Comes with two grit sizes for roughing and finishing**

**Rough shaping stock to an irregular pattern line as in spiling, can be done by making adjacent cuts and then cleaning out the waste to pattern lines**



**Disk makes grooves any width from 1/4 in. up. You'll be surprised at how fast it cuts. Disk will load somewhat in resinous wood. Clean with turpentine**



DECEMBER 1957



**A smooth ready-to-finish edge on curved work is a sure thing with this carbide-grit drum. It's free-cutting, no burning or discoloration of the wood**

**One side of the disk is faced with a coarse, open grit, the other with fine grit. Does a sharp, clean job of rounding corners without chipping or scoring**



**Disk makes cope cuts of average depth in two passes. Cuts as cleanly as a dado head or molding cutter. Feed the stock against the coarse side of the disk**



215



## Masking Tape Prevents Chipping of Plastic When Sawing

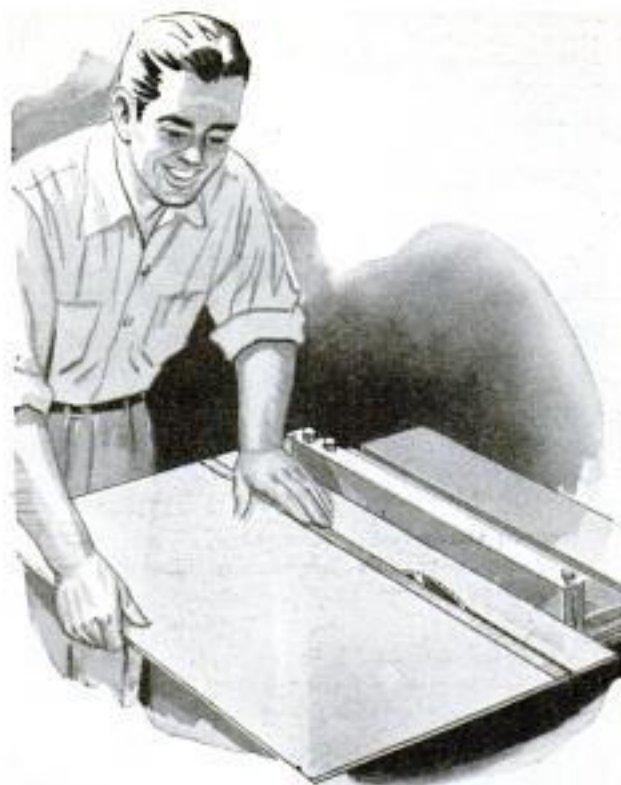

Before cutting a sheet of plastic on the circular saw, apply a length of masking tape to the top face of the sheet, the edge of the tape flush with the pattern line. The tape will prevent chipping of the cut edges. Use a crosscutting blade with a light set to the teeth.

## Chucking Round Work in Vise

Here's one way to overcome the difficulty of holding round work in a vise. Thread the end of a short length of steel round to take a screw-on-type drill chuck. File or grind two flats on the opposite end. Then set up as detailed. — Frank Shore, New York City.

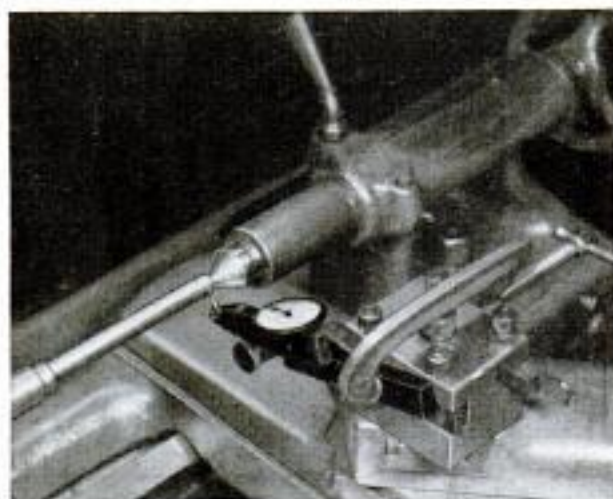
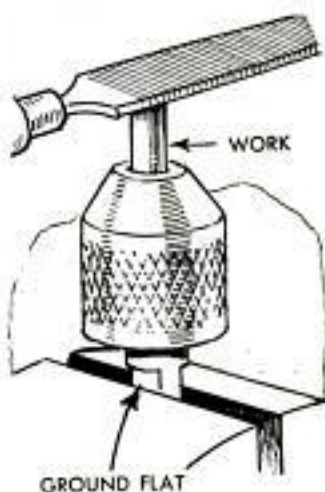

## Resetting Lathe Tailstock

After turning a taper with the tailstock offset it's a rather tedious chore to reset it for turning a straight shaft. Bring the tailstock back to the witness marks on the base, run a light cut on the work and check for taper with a dial indicator. Suppose, for example, the shaft still shows a taper of .004. Zero the indicator at the end of the shaft and move the tailstock (toward operator) until the indicator shows .002. Tighten the tailstock clamp nut and recheck the reading. If the reading holds, the centers are very closely aligned.

J. C. Magee, Schenectady, N. Y.

## Oil Carried to Boring Tool

A constant supply of coolant to the boring tool is necessary in production work. In deep bores the problem is to supply oil to the tool in a uniform flow. Large boring bars usually are sufficiently rigid to permit drilling small transverse and longitudinal blind holes in a position to form a continuous passage as detailed. One transverse hole must be drilled directly into the longitudinal hole, entering at a point directly over the cutting tool. The second hole is drilled into the longitudinal hole at right angles to the first. Then the hole system is plugged. By improvising a nozzle, a steady flow of coolant can be brought directly from the pump.

Frank L. Rush, Columbus, Ohio

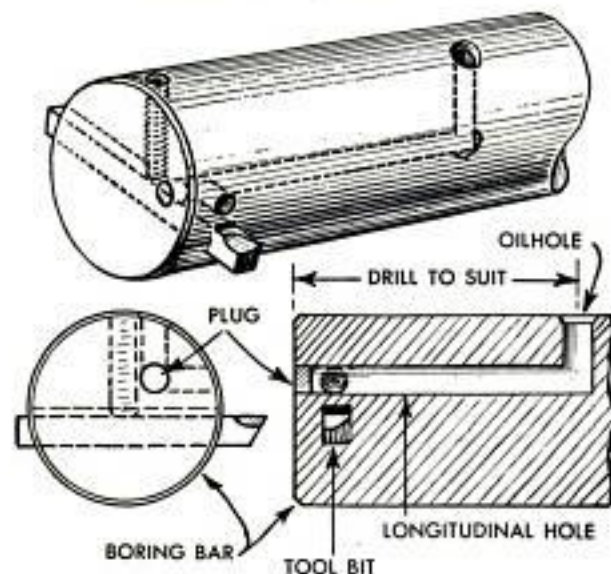



SN 59

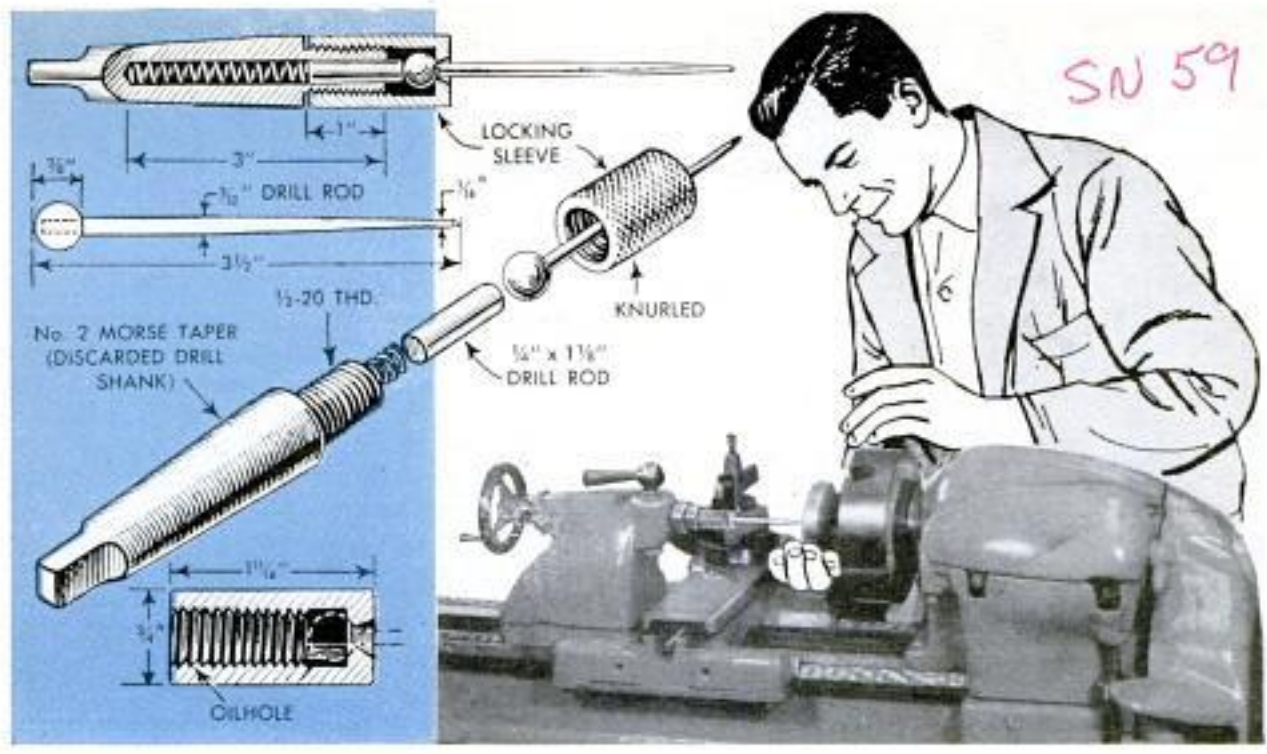

### Shop-Made Indicator Centers Work in Four-Jaw Chuck

When dial-indicator accuracy is not required, this improvised indicator, or wiggler, speeds up the rather tedious job of centering work in a four-jaw chuck. The unit is built up on a discarded drill shank having a No. 2 Morse taper. The large end of the tapered shank is squared, shouldered and threaded to take a knurled locking sleeve as shown in the sectional view. The locking sleeve seats a ball-tipped pointer against a spring-loaded plunger housed in the tapered shank. Drill the hole for the spring and plunger immediately after shouldering and threading the tapered shank without removing the latter from the lathe spindle. This procedure will as-

sure concentricity. Make sure that the plunger, which is cut from 1/4-in. drill rod, is a free fit in the hole in the shank. Run a long taper on one end of the pointer and then machine the end to a 60-deg. included angle. Shoulder the opposite end of the pointer to a force fit in a hole drilled in a 3/8-in. dia. steel ball. In use, the work is placed in the four-jaw chuck and centered as closely as possible by eye alone. Then the indicator is placed in the tailstock and the latter is run up until the pointer enters the center hole in the work. Turn the lathe by hand and adjust the chuck jaws until the pointer runs dead true.

C. W. Woodson, Chicago.

### Drilling Angular Holes Accurately in Dual-Vise Setup

Where the angle is not critical, reasonably accurate angular drilling can be done with the setup pictured. It's useful when angular drilling is called for and there's no angle vise at hand. Nearly all drill vises will serve as the second vise in the setup as the fixed jaw usually is squared on the outer face. Set the second vise with a protractor to the required angle with both vises in the position shown. Then clamp the larger vise in position on the table. Don't move the setup after the angle has been determined. Then grind the drill bit to the recommended angle and start the drill with very light pressure. In some cases it is best to put through a pilot hole first, especially if the finished hole is more than 1/4 in. in dia.

H. J. Gerber, Stillwater, Okla.

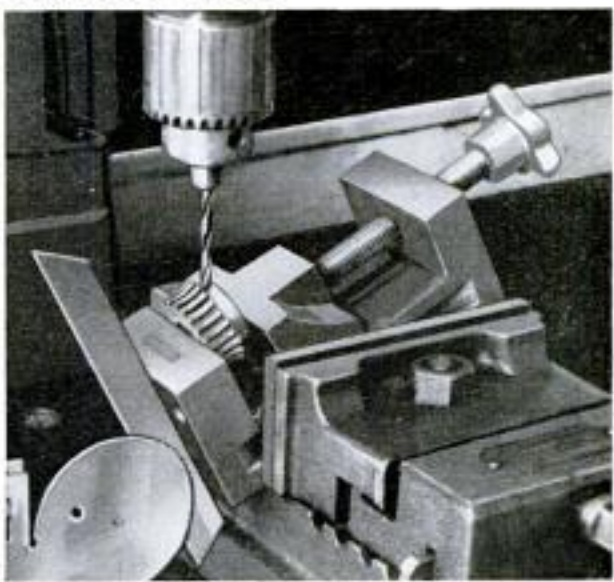



SN 59

# Soldering Hints

By Ken Murray



A NEAT AND SOUND JOB of hand soldering calls for chemically clean joining surfaces, heated uniformly to the correct temperature. From there on, the procedures are determined largely by the type of work, its size and the number of separate soldering operations necessary to complete the job. Surfaces are made chemically clean by fluxing and manual use of an abrasive to loosen grime and corrosion. Often the nature of the work will permit abrading and fluxing the surface in one operation. The iron used must be of a size to heat the work quickly to soldering temperature. The flame from a torch is adjusted to concentrate heat at the desired point. ★ ★ ★



**CLEAN AND FLUX** work in one operation. One of the main reasons for failure of a soldering job is lack of care in cleaning the joining surfaces. After cleaning, surface of metal begins to oxidize quickly. This can be prevented by combining cleaning and fluxing. Dip fine steel wool in paste flux, or saturate with liquid flux, and go over surface thoroughly



**CUT WIRE SOLDER** into three or more fine strands with tin snips before applying to delicate work involving joining of small parts. By touching one of the strands to heated work only minimum quantity of solder will flow, resulting in a neat, smooth joint. On some types of work it is helpful to cut wire solder into short pieces, each about 1/8 in. long

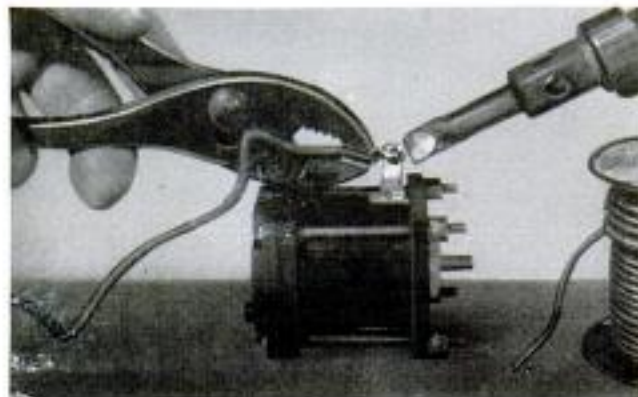

**BURNING OF INSULATION** can be prevented by gripping insulation close to bared portion of the wire with pliers. Jaws of pliers absorb heat and prevent charring. On some types of work it is possible to grip bared portion of wire just beyond the insulation. This is more effective where nature of work will permit. Avoid gripping insulation too tightly



→  
**HEAT-RADIATING STAND** lengthens life of the heating element of your soldering iron where the nature of the work requires that the iron be maintained at full heat for intermittent use. Photo pictures the stand complete and in use. Fins dissipate heat when iron is placed inside while not in use. Also eliminates fire hazard from bench-top soldering

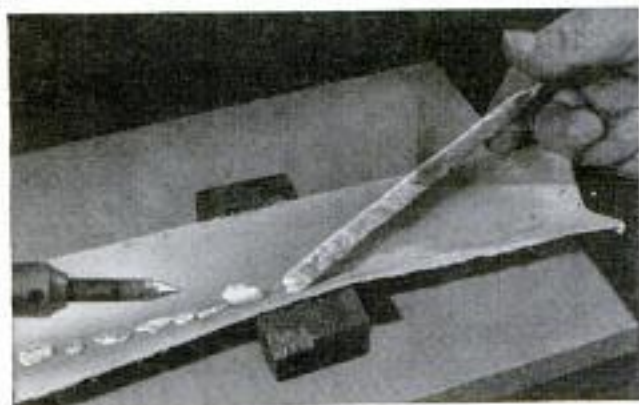
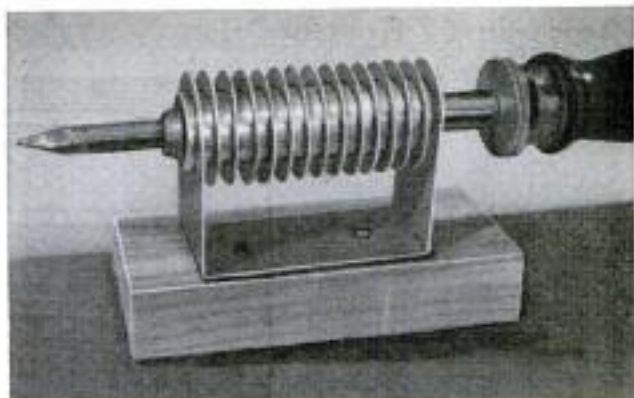

←  
**SAVE SOLDER SCRAPS** by placing pieces in a creased strip cut from sheet asbestos. Apply heat, either with a small torch or large soldering iron, until solder melts and flows in a continuous strip. If asbestos strip is creased sharply at the center solder will harden into a triangular strip which is usable as bar solder when work is coated with paste flux

→  
**RED WARNING MARK** identifies acid-core solder, so that it will not be used by mistake when soldering electrical connections. Mark spool of acid-core wire solder with a red crayon in the manner pictured, then spread the color by rubbing it lightly with thumb. This will leave a thin red film of color on each coil of solder which is easily seen

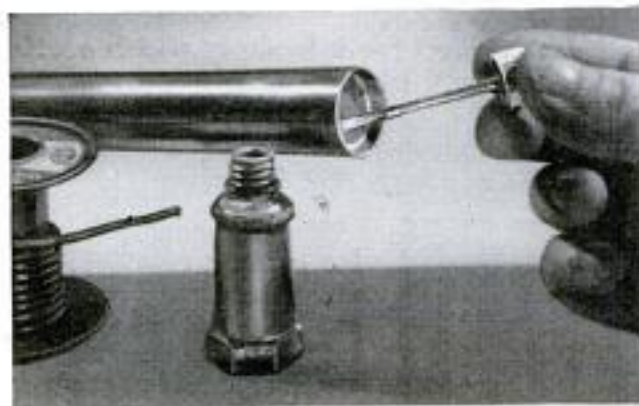
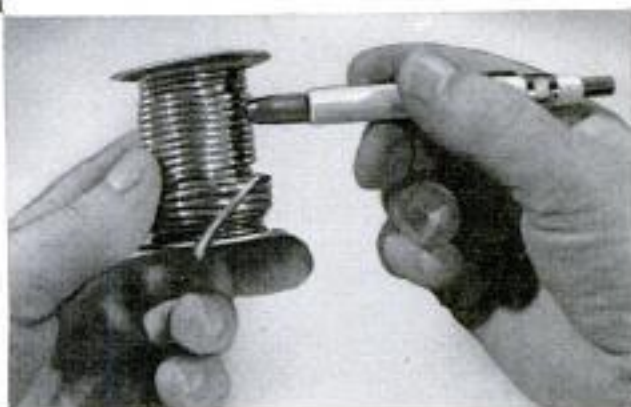

←  
**WHEN APPEARANCE OF SOLDER JOINTS** is a factor, as on certain models and in instrument work, joints are sometimes coated with aluminum paint after the solder has cooled. This prevents a slow darkening of solder due to oxidation. Pour a small quantity of the point into a fingernail polish bottle and use the applicator to apply paint to the joint

→  
**SPRING-TYPE CLOTHESPIN** makes a good clamp for holding small parts in place while soldering. Cover the jaws with two thicknesses of sheet asbestos cemented in place to prevent wood from being charred by heat from iron. Use sodium silicate (water glass) as a cement. For clamping heavier work, pads of an ordinary C-clamp are covered this way





## Damaged Screwdrivers Adapted to Other Practical Uses

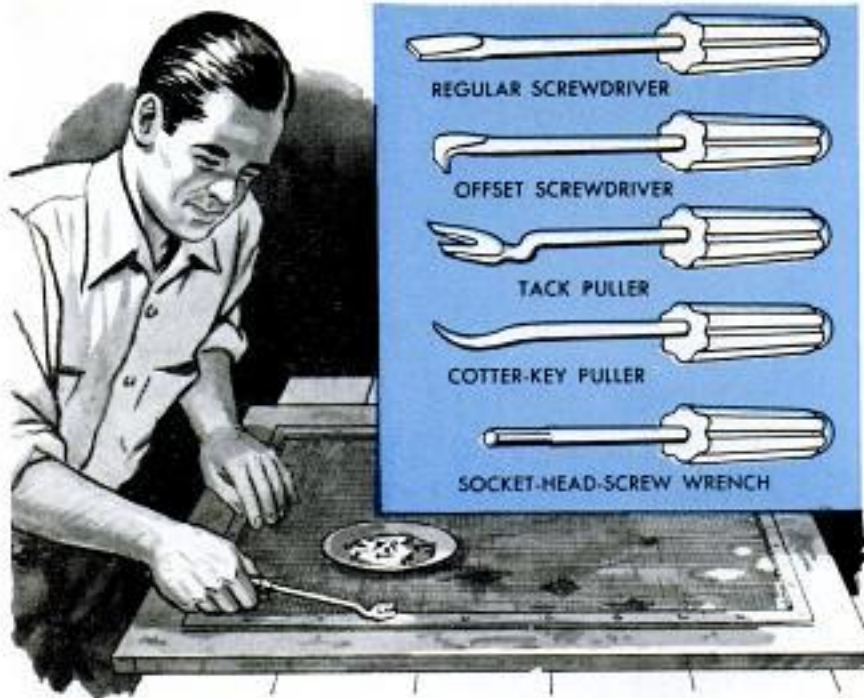

Several useful hand tools can be made by reworking discarded or damaged screwdrivers. Anneal (heat) the point and bend the blade at right angles, harden and you have a handy offset driver. Make a tack lifter in the same way, only hammer the blade out while hot to make it wider. A handy cotter-key puller can be made by a similar procedure except that you draw the blade to a point. Bend and harden. Or, cut off the blade, grind square and weld on a section of hex rod to make a socket-screw wrench.—Charles H. Willey, Concord, N. H.

### Drill Bits Stored in Handle

Ever think of storing drill bits in the top handle of your ½-in. portable electric drill? This handle is, of course, removable and usually consists of steel tubing or pipe having one end threaded. Just press a piece of tissue into the threaded end, screw in place and cap with a crutch tip.



A. Vena, Philadelphia, Pa.

### Centerless Work Support

Here's a solution to one of those special machine-shop problems, that of supporting the centerless end of a rod on which a long knurl was to be run. A live lathe center (soft) was squared off at the big end and counterbored for a bushing which carries the free end of the rod.

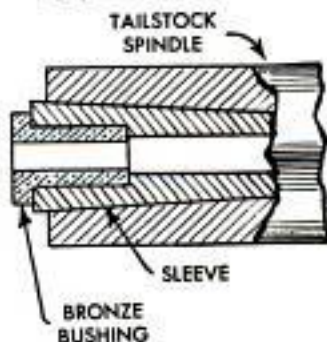

Frank L. Rush, Columbus, Ohio

### Pressure-Sensitive Tape Holds Blocks on Faceplate for Turning



Small hardwood blocks, for turning rosettes, pulls and other small parts, are easily attached to the lathe faceplate or to a wooden backing disk by means of pressure-sensitive tape. Use of the tape as a fastener instead of the center screw eliminates the need for a screw hole in the work. Several strips of the tape attached to a wooden backing disk screwed to the faceplate will hold a disk up to 2 in. in dia.—D. C. Marshall, Manhattan, Kans.



*These men chose  
before enlistment—  
so can you!*



**Pvt. Floyd E. Van Briesen**  
Brookings, South Dakota  
Graduate, School of  
Agriculture

"I picked my own Army job training, and it was guaranteed for me *before* I enlisted. I chose a fine Diesel Repair course. My instructors were really good, and the training equipment was the best you could find. Now I'm an expert in diesels. I found only the Army offers a deal like this."



**Pfc. Allen M. Voeltz**  
Bouler, Wisconsin  
Graduate, Bouler Union  
Free High school

"If you want an education, there's no plan like the one the Army offers graduates. I was surprised at how many courses are offered—practically everything. I chose the Guided Missile course I wanted—trained in an exciting new field. This guaranteed training is great. Why not find out about it?"

Seniors—get all the details on how high school graduates can choose their technical training before enlistment from 127 modern courses. Mail this coupon for your free booklet today. Or for immediate counseling visit your local Army Recruiter. He's listed in the phone book and will give you all the facts—at no obligation!

THE ADJUTANT GENERAL  
Department of the Army  
Washington 25, D.C.  
Attn: AGSN

PM-12-57

Please send me the free Army booklet telling how high school graduates can choose their technical training before enlistment in Modern Army Green.

Name.....

Address.....

City..... State.....

Date of Graduation.....

*It's Here!  
America's Newest,  
Smartest Uniform!*

Only in  
**MODERN**  
**ARMY**  
**GREEN**

can you  
choose  
your  
**Technical**  
**Training**



Get Choice, not Chance  
in  
**MODERN ARMY GREEN**





TO TAKE AND SHOW COLOR SLIDES BIG AS LIFE . . .



New Kodak Pony IV Camera features simplified exposure settings, zone focusing. Complete with camera, flashholder, case, slide viewer. Kodak Pony IV Camera Outfit, \$58.40 (Camera alone, \$39.95)



Built-in meter tells exactly how to set camera for just-right exposures! Kodak Signet 50 Camera with two-reflector flashholder, \$82.50 (Kodak Signet 30 Camera, same basic camera without meter, \$55)



Kodak Signet 40 Camera in luxury gift outfit includes case, Kodak Rotary Flashholder, battery, Kodak Filter Kit. Kodak Signet 40 De-Luxe Outfit, \$96 (Camera and Super-M 40 Flashholder, \$74)

## Christmas Gifts from Kodak

When you open a Kodak Camera Outfit first, you can save all the fun of Christmas—and years to come—in pictures

8mm MOVIES—FINEST FAMILY GIFT OF ALL . . .

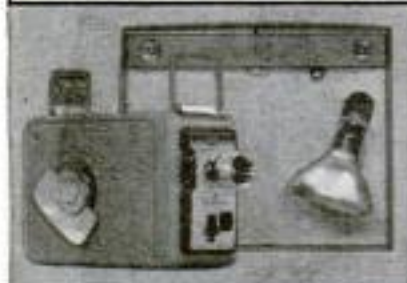

Brownie Movie Camera  $f/2.7$  takes color movies with snapshot ease. Complete with Brownie 2-Lamp Movie Light and flood lamps for indoor use. Brownie Movie Camera Kit,  $f/2.7$ , \$38.40 (Camera, \$29.95)



Complete movie outfit—Brownie Movie Camera,  $f/2.3$ ; Brownie 300 Movie Projector shows movies 3 feet wide. Brownie 300 Movie Outfit complete, \$104.70 (Camera, \$39.75. Projector, \$64.95)



Take and show movies up to 4 feet wide! Brownie Movie Camera  $f/1.9$ , case, 4-lamp light bar, Brownie 500 Movie Projector. Brownie 500 Movie Outfit complete, \$144.95 (Camera alone, \$49.75)

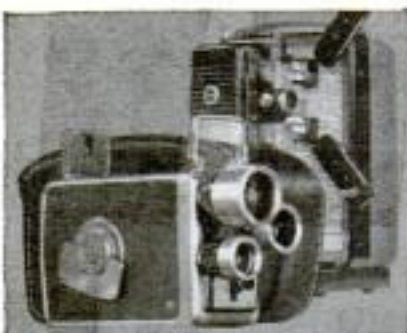

Brownie Movie Camera, Turret  $f/1.9$  takes normal, wide-angle, telephoto movies; Cine-Kodak Showtime 8 Projector shows 8mm movies extra bright. Kodak Super 8 Movie Outfit, \$214 (Camera, \$84.75)

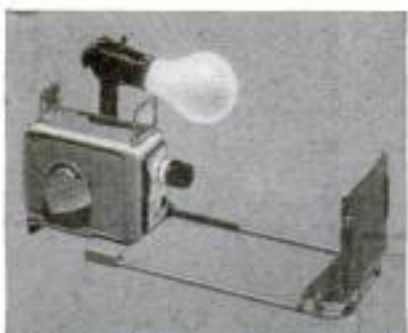

Titles and close-ups are easy with this titler for Brownie Movie Cameras. Includes camera platform, close-up lens, light bar, easel, title cards, "special effect" masks. Brownie Movie Titler Outfit, \$15.95

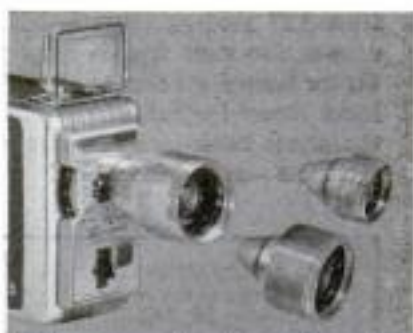

Take panoramic wide-angle or close-up telephoto views with your single-lens Brownie Movie Camera. Converters slip over regular lens. Kodak Wide-Angle and Telephoto Converters, \$18.50 each.

EASTMAN KODAK COMPANY, Rochester 4, N.Y.





Kodak Retina Camera outfits include telephoto and wide-angle lens components, case, carry-all bag. Kodak Retina IIIC Camera Outfit, \$394 (Camera, \$175). Kodak Retina IIC Outfit, \$351 (Camera, \$132)

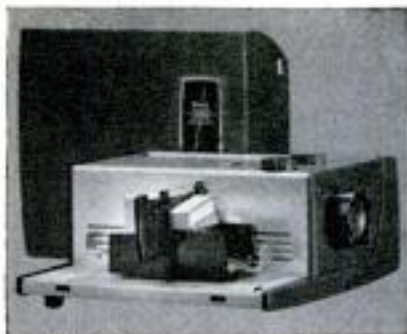

Kodak 300 Projector is ultra-portable, shows color slides big and bright. Quiet; cool; has finger-tip controls. Kodak 300 Projector with Readymatic Changer, \$64.50 (with Magazine Changer, \$74.50)



Complete color-slide outfit. Includes Kodak Pony IV Camera, Kodak 300 Projector. Kodak Pony Color-Slide Outfit, \$104.50 (Kodak Signet 40 Color-Slide Outfit with same projector, \$138.50)

**say**

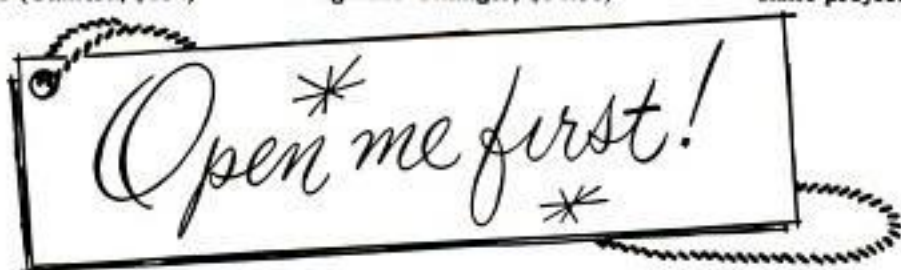

FOR 'ROUND-THE-CLOCK SNAPS IN BLACK-AND-WHITE OR COLOR...



Brownie Starflash Camera takes color slides, black-and-white and color snaps. Built-in flashholder. Complete with bulbs, batteries, film. Brownie Starflash Outfit, \$9.95 (Camera alone, \$8.95)

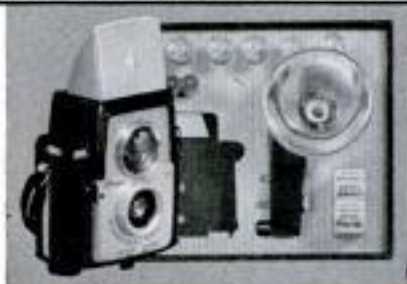

Brownie Starflex Camera "previews" your shot, takes color slides and snapshots. Complete with camera, flashholder, batteries, film. Brownie Starflex Outfit, \$16.50 (Camera alone, \$10.75)



World's most popular snapshot camera in a gift outfit complete with Brownie Hawkeye Camera, flashholder, batteries, bulbs, film. Brownie Hawkeye Flash Outfit, \$15.25 (Camera alone, \$7.95)



Preview-finder of Kodak Duaflex IV Camera shows picture *big!* Complete with camera, flashholder, batteries, bulbs, film. Kodak Duaflex IV Flash Outfit, \$25.25 (De-Luxe Flash Outfit, \$38.75)



New Kodak Rotary Flashholder permits you to shoot six flashbulbs without reloading. Two models to fit most cameras. Kodak Rotary Flashholders, from \$10.95 (Batteries not included.)



Kodak Photo-Hobby Outfits for developing negatives, printing snapshots at home. From \$10.75

**Kodak**  
TRADE MARK

*Prices are list, include Federal Tax wherever applicable, and are subject to change without notice*



## Shelling out for oil too often?

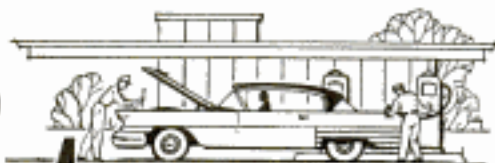

**YOU STAY OUT  
of this expensive danger  
zone when you re-ring  
with Sealed Power!**

Does your oil stick read low when you pull in for gas? Notice bluish exhaust fumes when you slow down? Miss the old pep and surge your car once had? Stop right now throwing oil money away! It's high time for you to get a Sealed Power ring job and go from drain to drain without buying oil.

### IMMEDIATE OIL SAVINGS

Sealed Power's KromeX Ring Sets are engineered to start you saving on oil bills at once. And Sealed Power's revolutionary new stainless steel oil ring will keep giving you maximum oil control with no smoking . . . will go on resisting corrosion and sludge . . . will assure top performance for *double* the ring life you expect from ordinary rings.

### FREE! BOOK ON AUTO CARE

Want to know more about proper car maintenance? This free 34-page booklet is packed with information which will make you expert at understanding and caring for your engine. Called "Care and Feeding of Engines," it's yours for the asking. The tips you'll find in it could save you hundreds of dollars. For your free copy, write Sealed Power, Dept. G-12, Muskegon, Michigan.



# Sealed Power

## PISTON RINGS

**BEST IN NEW CARS! • BEST IN OLD CARS!**

## Clinic for Homemakers



As a service to our readers in solving the hundreds of problems pertaining to a home—inside or out—the editors of *Popular Mechanics* invite you to present your problems to The Clinic Editor for help and advice. Address your questions to The Clinic Editor, *Popular Mechanics Magazine*, 200 East Ontario Street, Chicago 11, Ill.

### Fence to Drift Snow Over Garden

*Q—I'm told that a low fence erected on the side of the garden plot from which winter winds blow will cause snow to drift over the plot, which will be beneficial. Is this true? And can I build a fence near a strawberry bed?*

*M.B.—Madison, Wis.*



*A—It's true that a board or picket fence placed as you suggest will cause snow to drift over the garden plot if the plot is in the open where the prevailing winds sweep across it. The only direct benefit from the drifted snow is derived from the moisture which seeps slowly into the soil when the drift melts away in the spring. Also, under certain conditions, this additional moisture may tend to stimulate the activity of nitrifying bacteria and thus increase the available nitrates in the topsoil. The drift also will prevent the blowing of dry soil during the winter months. Drifting snow over a strawberry bed by means of a fence could, perhaps, be recommended for the same reasons, but it is advisable to mulch the bed after the ground freezes with coarse straw or other material. The mulch should be removed from the plants in the spring.*

### Stopping Floor Squeaks

*Q—I have oak floors in my living and dining rooms. The floors in both rooms squeak when walked on, not just in certain areas, but all over the floor. In many places the top floor seems to be springy but the floor boards are in good condition and all joints are tight. How can I remedy this trouble?*

*H.B., Rochester, N.Y.*



*A—You do not say whether the house is old or new, nor do you give the thickness of the flooring. If the floor has been laid a number of years, it is probable that the nails holding the bridging between the joists have loosened, permitting the floor to spring irregularly as you walk through the room. This has the effect of loosening the nails holding the top floor to the subfloor. Slight movements between the two floors produce most of the squeaks. Raise the floor slightly with screw jacks and wooden extensions placed under the joists.*

(Continued to page 226)





# Drop a hint for a NEW THOR SPEEDSHOP

*Christmas will last all year long!*

When you do your Christmas hinting, make it for something special—a new Thor SpeedShop. It's really three tools in one—a drill, a jig saw and a reciprocating sander, plus seven drill bits, four abrasive sheets, buffing bonnet and a steel carrying case. And you get it all for the Christmas special price of just \$37.50. Quality built—you bet! The basic power unit of Thor's SpeedShop is the ¼" SpeedDrill model 20 (½" in wood). This drill is super-powered with a full 2.5 amperes. Power aplenty for the custom-made accessories. The drill and the accessories were made for each other and for long productive life. Look for the bright Christmas display at your dealers. Ask to see the complete SpeedTool line. SpeedWay Manufacturing Company, division of Thor Power Tool Company, Prudential Plaza, Chicago 1, Illinois.

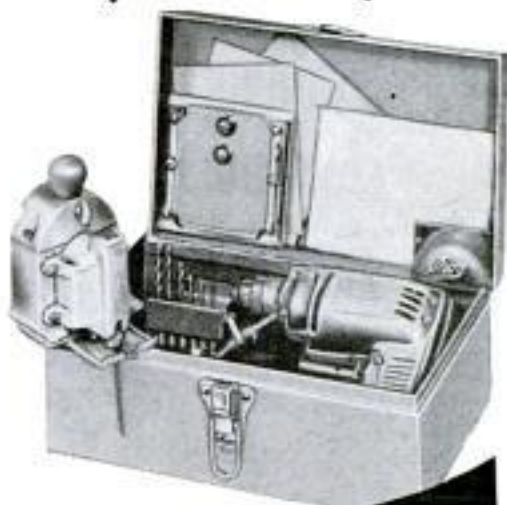

**\$37<sup>50</sup> buys 3 tools in 1**

See the dealer with the bright Thor display



Includes lambswool buffing pad, 7 drill bits, 4 abrasive sheets, steel carrying case.



**THOR POWER TOOL COMPANY  
CHICAGO**

*Branches in all principal cities*  
World's largest exclusive manufacturer  
of portable air and electric tools





**THE REACH IS RIGHT AND TIGHT**

**with KRAEUTER**

**LONG NOSE PLIERS**



#1781-7"

You can depend on reachability and cutting power with Krauter's #1781 Long Chain Nose Pliers. And your reach will be tight and sure for those hard-to-get-at jobs with the extra long milled jaws of these pliers.

Buy the right line. It's the Krauter line. Krauter tools are unreservedly guaranteed.

Send for catalog #25 illustrating complete Krauter line.

**BUY THE FINEST  
BUY KRAEUTER  
BUY AMERICAN**

MODERN AS TOMORROW

**krauter & co., inc**

FOR 100 YEARS THE FINEST IN HAND TOOLS 1860-1960 NEWARK, N. J.



(Continued from page 224)

Tighten the bridging, driving in additional nails if necessary. Then drill a line of small holes midway between each pair of floor joists, spacing the holes about 6 in. apart and taking care not to drill through the top floor. Select flat-headed screws of a size to fit these holes and of a length that will enter the floor board but will not go entirely through.



#### Garage Doors of Knotty Pine

**Q**—I would like my garage doors to be built of knotty pine in board-and-bleed construction and finished in the natural color like interior woodwork. However, my carpenter does not recommend this; he says doors of this type and finish will soon warp and be difficult to open and close. Is he right? Or is there some finish that will prevent this?

M. E., St. Paul, Minn.

**A**—We are inclined to agree with your carpenter, although it is true that natural-finished garage doors of knotty pine are now quite widely used. If sound, well-seasoned stock is obtained and if the doors can be built and the finish applied immediately to protect the wood from undue moisture absorption, then it is probable that doors of this construction would be satisfactory.

#### Open Joints in Downspouts

**Q**—What causes the joints in downspouts to open? I recently noticed that two downspouts on the north side of my house have open joints.

O. L., Ind.

**A**—Perhaps the most common cause is a partial clogging of the downspout by entrapped leaves or other trash which may build up to the point where the obstruction will collect water which freezes in cold weather. Normally the corrugations in downspout sections allow sufficient expansion to prevent opening of the seam, but if the spout is clogged, the pressure may be sufficient to open the seam. Sometimes it is possible to force the seamed edges back in place and crimp with pliers. Otherwise the section should be replaced.

#### Removing Ceiling Beams

**Q**—Our older home has a beamed ceiling in the living room. I think the trim and the ceiling beams are of oak and it has been stained a dark color which undoubtedly has darkened more with age. We have planned to remove the beams and refinish the remaining woodwork in this one room. We hesitate, however, because of the possibility of weakening the structure in some way by removal of the beams. Without breaking out some of the plaster it apparently is not possible to tell whether the beams are solid or are built up of three or more pieces. What do you think of the advisability of the procedure?—S.T., N. Y.

**A**—In older homes, especially those more than 50 years old, it is quite possible that the beams are of solid stock. However, you do not give the size of the beams or describe their appearance. Neither did you say whether the house is of masonry or frame construction. In older homes the type of construction often determines how the ends of the beams are set into the walls. If, for example, the walls are of solid masonry such as brick or stone, the ends of the beams are sometimes housed in the masonry. This would make removal of the beams somewhat difficult and perhaps not advisable. If, on the other hand, the beams are of hollow, or false, construction and are in a frame structure the chances are good that the ends are supported on a ribband nailed to the studs. If this is the case, then removal would be comparatively simple. Perhaps the best procedure would be to remove plaster at one end of one of the beams. This should reveal not only the type of beam which was used, but also how the ends are anchored in the walls.





# NEVER NEEDS NEW BATTERIES!

## NEW REMINGTON CHARGE-A-LITE

The secret of Charge-A-Lite's revolutionary new storage battery is the newly invented Nickel Cadmium storage cell. Unlike any other battery, it's non-corrosive . . . holds a charge indefinitely when not in use. Charge-A-Lite is simple, rugged. It's hermetically sealed, can't leak, recharges overnight.

To recharge, just plug into any AC socket. The compact, ivory plastic case is 4½" x 2", weighs 3.5 ounces.

Charge-A-Lite comes with spare bulb and unbreakable lens. One year warranty

on sealed unit. At better stores and Remington Shaver Service Centers, or write for name of dealer.

### Bright Idea for Christmas!



Distributed by

**Remington Rand** Electric Shaver

Division of Sperry Rand Corporation, 60 Main St., Bridgeport 2, Conn.



**new**  
**Fir Plywood**  
**8 BOAT PLANS**

only **25¢** each

PERFORMANCE TESTED  
 Fir Plywood Fleet  
 ARCHITECT DESIGNED

See your lumber dealer or use coupon below.

Large, easy-to-follow plans contain illustrated step-by-step instructions and complete bill of materials.



No. 30. 7' 9" Pram Dinghy



No. 35. 11' 3" Outboard



No. 40. 13' 4" Outboard



No. 45. 13' 9" Punt



No. 50. 15' Outboard



No. 55. 15' 11" Runabout



No. 60. 18' Day Cruiser



No. 65. 20' Cabin Cruiser

**\*Use Only Exterior Fir Plywood  
 For All Marine Construction**

(EXT-DFPA® Means 100% Waterproof Glue!)

EXT-DFPA®

EXT-DFPA®

Douglas Fir Plywood Association, Dept. 9, Tacoma, 2, Wash.

Please send plans checked below. I enclose 25c for each. (Good in U.S.A. only)

No. 30  No. 35  No. 40  No. 45  No. 50  No. 55  No. 60  No. 65

Name \_\_\_\_\_

Address \_\_\_\_\_

City \_\_\_\_\_ Zone \_\_\_\_\_ State \_\_\_\_\_

## Rainbows From Bouncing Atoms

(Continued from page 119)

valuable ore in the seams of the old granite mountain. Mineralight will activate green or greenish-yellow response in nearly all secondary uranium ores.

Some prospectors use ultraviolet to identify or pinpoint radioactive ores that they've located in general by geiger counters and scintillometers. In Pennsylvania recently, a rock-hound got a suspicious reading with his geiger counter on a cliff wall. But where to dig? He wired Cooper to fly in a mineralight, lowered it over the cliff side at night, found his fluorescent ore in an outcrop and went to work on a commercial deposit.

Prowling the wilderness in the dark adds spice to prospecting. Cooper loves to tell about a friend, hot on the trail of yellow-glowing autunite in the New Hampshire forests last summer. A rustle in the leaves brought him up short. As he fanned his invisible light in the direction of the sound, a pair of widely spaced fluorescent eyes glowed at him out of the blackness. Slowly the eyes rose to a height of seven feet. A three-inch row of blue fluorescing teeth grinned under the eyes. "That's when he realized there was a bear out there," says Bill. "You can't see past a mineralight. The bear saw only a faint violet light that hurt his eyes. He finally ambled off."

### Lamps Test Food

Because of ultraviolet's unique ability to make certain things fluoresce in certain colors, it is a supersleuth in many fields of science and industry. On the West Coast black light is detecting spoilage in citrus fruit before it happens. Oranges and grapefruit pass on belts beneath lamps which cause invisible bruise spots to fluoresce a bright purple. Dairies are handling eggs the same way. Pseudomonas, the tiny organisms in egg white that make a bad egg bad, will cause the whole egg to fluoresce a ghastly green under black light. "If you ever saw one," says Cooper, "you'd never eat another egg before checking it first."

Sanitary engineers, toting portable black lights around dairies, are able to detect invisible traces of bacteria-breeding milkstone deposits which glow blue or white in otherwise clean equipment. They are also able to trace rodents by the characteristic fluorescent trail they leave behind them, and thus the engineers discover and clean out the nests.

As a sleuth for solving actual crimes, black light has hung up quite a record in the past few years. In FBI laboratories, as

(Continued to page 230)



# Newest in the LIONEL yards

Look at these locomotives, cars and accessories. Then see them and the newest and longest freight and passenger train sets in action at your Lionel dealer.



Lionel Super "O" Track with its two realistic flat-top "T" shaped running rails and inconspicuous

third rail is authentic even to the molded ties, accurately detailed tie plates and rail spikes.



**NEW**

**No. 345 Culvert Unloading Station.** Crane travels by remote control to car, lowers magnetic lift, picks up culvert section, transports it to station, returns for more. Car included.

**No. 334 Operating Dispatching Board.** At remote control command, man moves across catwalk, changes information in the illuminated slots. Train names can be chalked in.

**No. 55 "Tie-Jector" Car.** Car moves under its own power, throwing ties along-side track. Railside trips control the action.

**No. 128 Animated Newsstand.** Fun-packed! Push remote control button and newsdealer moves to front of stand...newsboy turns and offers paper while pup (believe it or not!) chases his tail around hydrant.



**NEW**



**NEW**



**NEW**



**NEW**

**No. 746LTS Norfolk & Western Loco.** The most powerful steam loco in the Lionel line. A scale-detailed model of the N&W's 16-wheel 250-ton giant. With MAGNE-TRACTION, headlight, smoke... and whistle in the matching tender.

Free New 52-Page Catalog in Full Color. Get your copy at your Lionel dealer.

Hobbyists will want to see Lionel's new HO line as well as the "O27," "O," and Super "O" lines.

**THE LIONEL CORPORATION, 15 East 26th Street, New York 10, N. Y.**



**THE CHOICE  
OF TOP  
CRAFTSMEN**

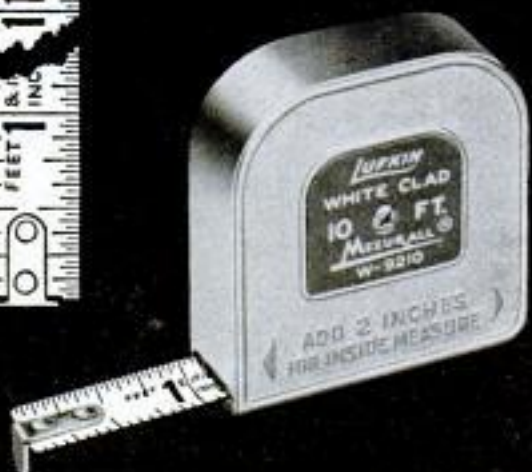

**LUFKIN WHITE CLAD**

**MEZURALL  
TAPE RULES**

467

**NEW...**

an accurate  
pocket tape  
rule that's  
really  
convenient  
to carry!



*actual size*

**LUFKIN EXECUTIVE  
THINLINE**

484

at hardware, lumber and  
tool dealers everywhere

well as homicide and detective bureaus in New York and the West Coast cities, police have found all manner of things that fluoresce, helping them to track down and identify criminals. Burn and X-ray scars glow vivid pearly white; many kinds of stains have a distinctive fluorescent color under black light. Old tattoo marks that were removed chemically leave a special fluorescence in the skin forever. Bits of dust indiscernible to human eyes often fluoresce like diamond glitter. Invisible traces of lipstick will glow fiery red under the lamp. Irradiated ink will show up, too, and many an altered will or document has trapped a villain when the original writing — which he thought was gone forever — leaped vividly from the page when sprayed with black light.

#### Detectives Use Black Light

The use of invisible tracer pastes, inks, dyes and powders that glow brightly when exposed to ultraviolet, is one of the most fascinating phases of black-light sleuthing. The paste was used to trace thieves who stole valuable copper wire used in government rural electrification installations. Fluorescent paste has also been used on firebox handles to trap people who turn in false alarms. The South Pasadena police have caught burglars who have crawled over a window sill covered with fluorescent powder. Stealing from gasoline tanks at a New Jersey tank farm was stopped when fluorescent dye was added to the tanks. Carburetors of guilty employees fluoresced under black light.

Some store owners are now protecting themselves from phony-check passers by insisting on invisible fingerprints on the check. These prints show up only under black light. If a check bounces, the culprit's fingerprints are turned over to the police.

A race track in New England protects itself from phony tickets by printing the official ones with fluorescent ink.

A bee specialist in the San Joaquin Valley uses fluorescent tracer powder at hive entrances to check the trails of his working bees through an orchard. The blossoms visited glow under black light. This helps work out artificial pollination systems for citrus orchards.

Mechanics are now using the natural fluorescence of oils to trace leaks in motors. Each type of oil fluoresces with a different intensity. Art collectors use black light to reveal "doctored" paintings, patched porcelain or fake quartz crystal. Genuine quartz crystal will pass ultraviolet short waves, but glass will not.

It takes a pretty slick fake to fool invisible light. ★ ★ ★



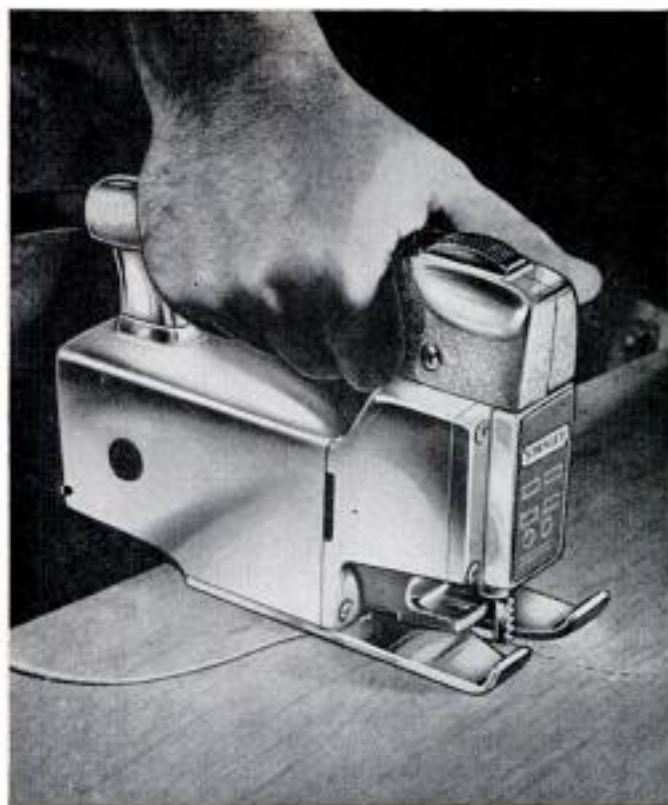

## This New Stanley Sabre Saw makes all kinds of cuts in all kinds of places

*A heavy-duty precision tool*

Introductory price . . . only **\$54<sup>50</sup>**

This portable jig saw cuts 2" lumber, plywood, plastics, sheet metal, etc. And the blades you use have 25% longer life because they have a 25%

longer stroke. It's a fast cutting, smooth-working power saw that makes all kinds of cuts in all kinds of places. Try it and see for yourself.



Cutting curves



Cutting up to a wall



Making plunge cuts

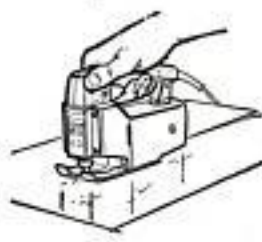

Cutting sheet metal

- 3300 strokes per minute
- Chip blower keeps cutting line clear
- Quick, easy blade change
- Stanley-built heavy-duty motor
- Anti-vibration mechanism
- Cool, comfortable, easy grip handle

**FREE RIPPING GUIDE!**

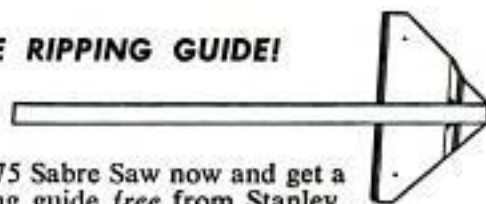

Buy your H75 Sabre Saw now and get a handy ripping guide *free* from Stanley.

Write for free Catalog 400E to Stanley Electric Tools, Division of The Stanley Works, 62D Myrtle St., New Britain, Connecticut.

**AMERICA BUILDS BETTER AND LIVES BETTER WITH STANLEY**

# STANLEY

This famous trademark distinguishes over 20,000 quality products of The Stanley Works—hand and electric tools • drapery, industrial and builders hardware • door controls • aluminum windows • stampings • springs • coatings • strip steel • steel strapping—made in 24 plants in the United States, Canada, England and Germany.



# Nicholson Tool Quiz

How many of these saw blades do you know?

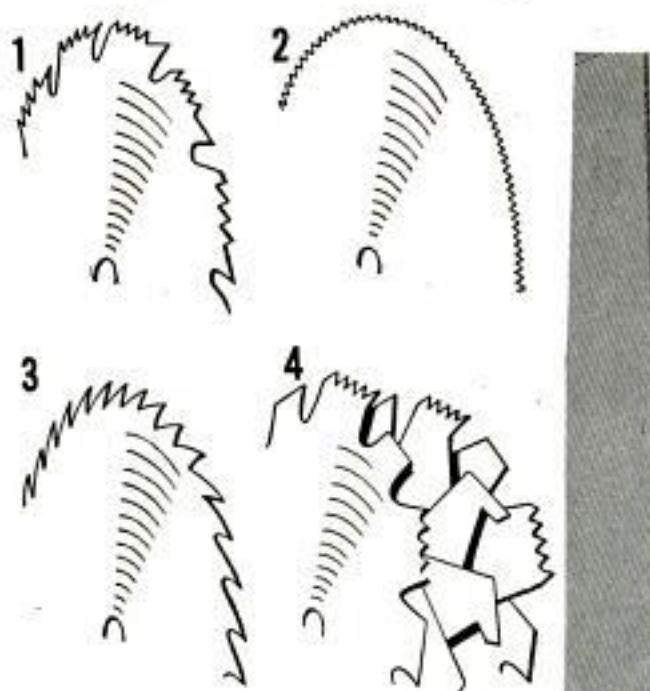

Answers: 1. Combination blade. 2. Plywood blade. 3. Rip blade. 4. Dado cutters.

The modern home craftsman can pick just the right blade for every job that comes up. And he can keep his blades in top cutting shape with Nicholson and Black Diamond files.

A dull blade causes rough lumber edges, sticks frequently, and even blows fuses. Touch up these lazy blades. Nicholson makes a file for every blade that can be sharpened in the home shop. Tell your hardware dealer the type of blade you want to cut better. He'll recommend the proper file. Remember, a sharp blade is safer and more efficient.

**FREE!** "File Philosophy," big new edition on types, use and care of files. Write for your copy soon.



**NICHOLSON FILE COMPANY**

Providence 1, R.I.



(In Canada: Nicholson File Company of Canada Ltd., Port Hope, Ontario)

## NICHOLSON FILES

**A FILE FOR EVERY PURPOSE**

## How to Measure Physical Fitness

(Continued from page 148)

dainty things of our women. But they just can't carry on with life when they're that fragile." Many Oregon high-school girls showed that they could hold their own. A pretty, 104-pound sophomore girl lifted 330 pounds on the back-lift test, 1250 pounds on the leg-lift—better than a lot of boys.

### Happy With Results

Oregon's physical educators were so happy with the results of the pilot study that they plan to make "Operation Fitness" an annual program. The study dramatically illustrated what physical educators have long tried to point out—that the best way to toughen up our kids is to improve the fitness of the sub-par youngsters. Sports programs, so often proposed as a panacea for these ills, won't accomplish this, simply because poorly conditioned youngsters lack the skill and stamina to participate.

There's nothing wrong with the muscles of most youngsters—adults, too—that hard exercise can't correct in time. It opens up thousands of previously collapsed capillaries, tiny "pipelines" that nourish the muscles. It toughens and thickens the walls of muscle fibers, increases the amount of connective tissue in the fibers and enlarges individual fibers. Previously unused fibers develop healthily as repeated demands are made of them.

### Fatigue Not in Muscles

Though muscles become worn-out after hard exercise, much of the fatigue is in the nervous system rather than the muscle itself. Hard-working muscles consume tremendous energy. This is illustrated in "energy cost" experiments—analyzing the expired air of subjects doing rigorous exercise. A treadmill study indicates the oxygen requirement of muscles increases eight times when the pace is increased from 140 to 180 steps per minute.

But muscles recover quickly. This is shown in fatigue studies directed by Clarke at the University of Oregon. In a machine called an ergograph, subjects lifted weights repeatedly with the forearm to the point of exhaustion. When measured 30 seconds later, muscles controlling this movement had lost one third of their strength. But 12 minutes later they were back to 90 percent of normal.

Muscle-fatigue studies have many applications. A few years ago a new insulated rubber boot was designed for soldiers in

(Continued to page 234)





*Announcing...*

*the third limited edition of one of the world's great motor cars*

*Fury*  
*by Plymouth*



It's definitely not made for you if you're just looking for "basic transportation"... not this jewel in Buckskin Beige and Gold... the fabulous new FURY that actually outclasses even the FURY of other years.

That's hard to do! But this gem does it! Introducing the new GOLDEN COMMANDO V-8 engine\*... 350 cubic inch, 10 to 1 compression, dual quads—a mill giving the greatest performance in Plymouth history.

*\*Optional, at low extra cost.*

With famous Torsion-Aire Ride, featuring torsion bar front suspension, this new FURY really hugs the pavement, corners flat and stops level—without nose-dive. You don't just drive a FURY... you virtually wear it!

Don't wait until a new FURY pulls alongside at a stop light to look one over... let your Plymouth dealer show you the terrific things that happen when the builders of great motor cars set out to surpass themselves—and succeed!



*Star of the Forward Look... •Fury by Plymouth*



Korea. How, the Army wondered, did this boot compare in muscle fatigue to the regular combat boot?

Clarke, then at Springfield College, Mass., sent groups of men marching over a rough 7½-mile route with different types of footwear. He measured the strength of ankle muscles before and after the marches. The Army soon had its answer: The insulated boot was twice as hard on marchers as the combat boot (5.82 percent average strength-loss as compared to 2.87 percent for the combat boot). Both were vastly superior to the low-cut shoe which caused a 7.53 percent loss.

### Army-Pack Fatigue Studied

Another study explored the muscle fatigue in carrying different types of Army packs. Groups of college students carried various kinds of 41-pound packs over 7½ miles of countryside. A new experimental pack, which distributes most of the weight around the waist, caused one-third-less muscle fatigue than the combat pack and only one half that of the rucksack. The combat pack affected marchers most in the neck muscles (11¼ percent loss of strength). The rucksack affected the neck and trunk muscles most. But the experimental pack affected no muscle groups significantly greater than the others.

### Continuing Effects

An interesting adjunct to this study probed into the conditioning effects of these marches. The 30 participating college students began with an average physical-fitness index of 104 and emerged after seven marches (52½ miles) with a PFI of 113. They increased their average Army physical-efficiency test score from 253 to 281; the Air Force fitness-test score from 56 to 59.

Through 30 years of such work, Clarke has concluded that anyone without serious organic, structural or nutritional defects can develop sufficient strength to be physically fit—to keep up with the physical demands of living with sufficient reserve for emergencies. Hard exercise is the only means. It must be in ways that offer sufficient resistance to the muscles, whether it's calisthenics, weight-lifting or "combative sports" (such as Indian wrestling).

Persons who have been inactive for long periods should work into severe exercise gradually, giving the muscles a chance to adjust to new loads. But at the same time, no one should shirk hard exercise. As a physiologist once said wryly, "If you must play tiddlywinks, do it with manhole covers!"

★ ★ ★



## Change an idle corner to a home office with low-cost Western Pines

Snug, attractive, useful—gives you a handy spot to write or 'phone or file things.

And so simple to build in. The Western Pines are straight-grained, carefully-dried, soft-textured, economical. They take any finish beautifully, look lovely just left natural and waxed.

Whatever your building or remodeling plans, check the Western Pines. Your lumber dealer will be glad to give you details.



**FREE!** "FRIENDLY HOME IDEAS"—85 photographs, many in color, feature traditional and contemporary ideas for building, decorating and remodeling using cheerful Western Pines. Write for your FREE copy to WESTERN PINE ASSOCIATION, Dept. 211-N, Yeon Bldg., Portland 4, Oregon.

## The Western Pines

<b>Idaho White Pine</b>	and these woods from the Western Pine mills
<b>Ponderosa Pine</b>	WHITE FIR • INCENSE CEDAR
<b>Sugar Pine</b>	RED CEDAR • DOUGLAS FIR
	ENGELMANN SPRUCE
	LODGEPOLE PINE • LARCH

are manufactured to high standards of seasoning, grading, measurement

TODAY'S WESTERN PINE TREE FARMING GUARANTEES LUMBER TOMORROW



Porter-Cable gives you this popular  
**professional quality saw for only \$59<sup>50</sup>**

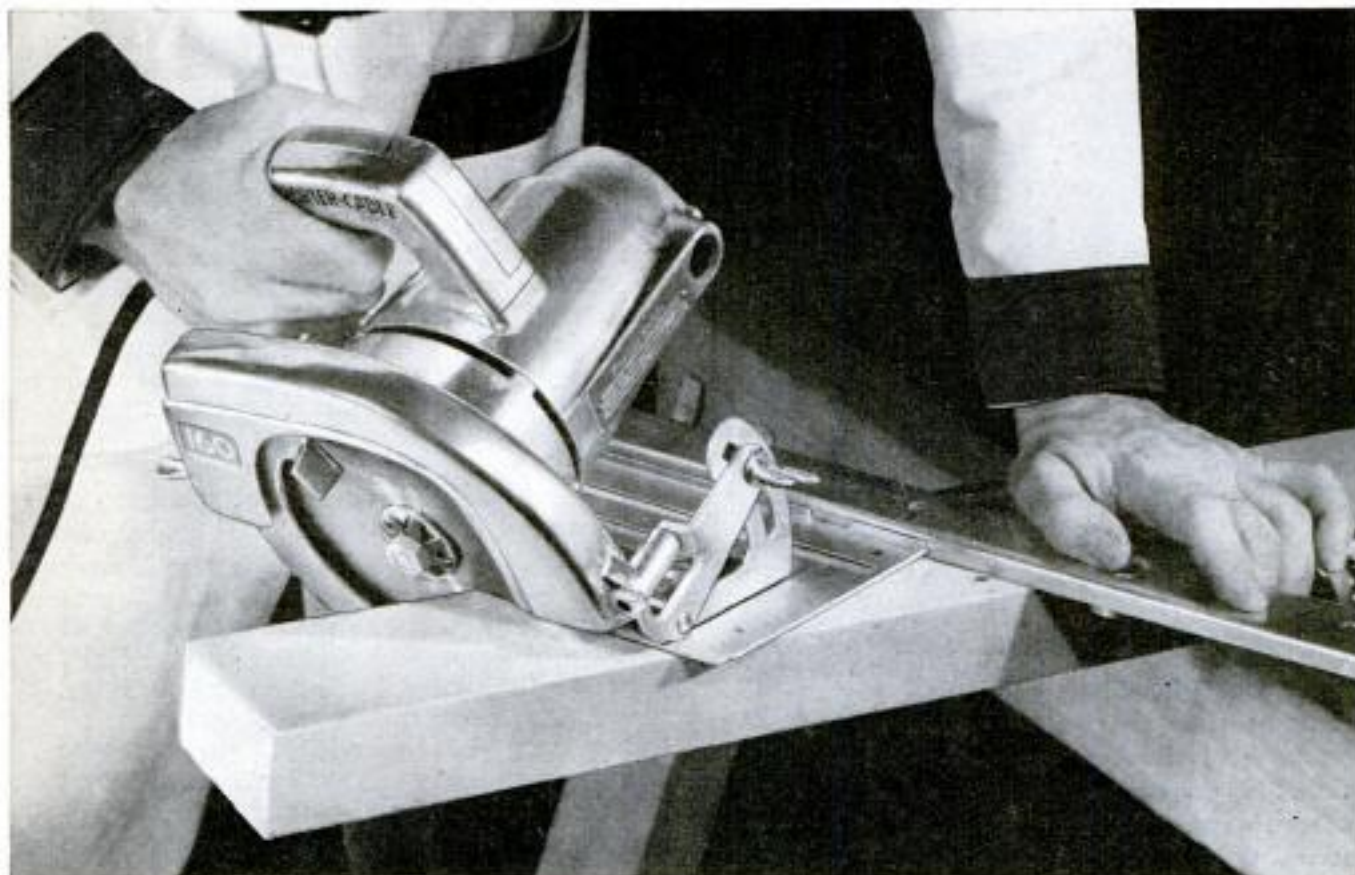

**Big saw performance!** Porter-Cable's Model 160 Saw gives you exclusive features found *only* in Porter-Cable quality Saws — at a sensational, new low price!

It makes every professional cut, including compound miters, in full 2" dressed lumber. It provides all the power, speed and cutting capacity you'll need in a saw.

Model 160 Saw is precision-built throughout for years of trouble-free service. You get the famous Porter-Cable Kick-Proof Clutch, telescoping guard, precision ball bearings and instant depth and bevel adjustments, for accuracy and ease of use.

For real saw value, you can't beat this low price anywhere. It's at your dealer's now — be sure to see and try it. Write for free literature.

Model 160 Saw, Only **\$59.50**  
In handy kit form, **\$69.50**

*Kit Includes:*  
Model 160 6½" Saw

Rip Guide for fast, accurate ripping all dressed 2" lumber up to 45°

Carrying Case . . . constructed of strong, welded steel for full protection and durability

**SEE YOUR DEALER — OR MAIL COUPON TODAY!**

- PORTER-CABLE MACHINE CO.
- 714B N. Salina St., Syracuse 8, N. Y.
- Please send complete information on Model 160 Saw, and the name of my nearest dealer.

Name \_\_\_\_\_  
Address \_\_\_\_\_  
City \_\_\_\_\_ Zone \_\_\_\_\_ State \_\_\_\_\_

**Porter-Cable**

*Quality Power Tools*

In Canada: write Porter-Cable, Ltd., Box 5019, London, Ont. Canadian prices slightly higher.



## "CRESTOGRIP" UTILITY PLIER

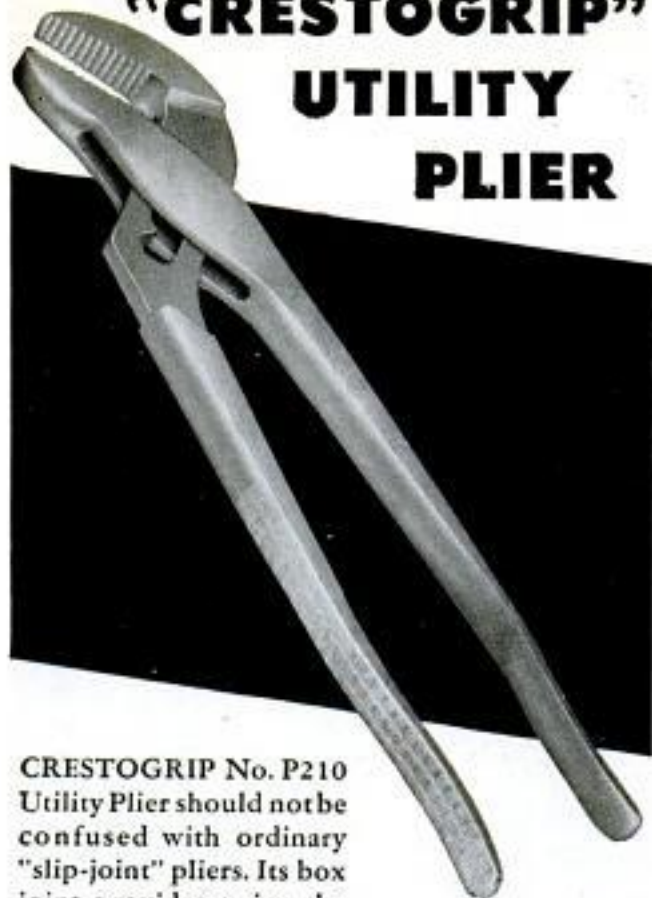

CRESTOGRIP No. P210 Utility Plier should not be confused with ordinary "slip-joint" pliers. Its box joint provides twice the strength of the conventional lap joint and eliminates sideways twist and strain. Grips flat, square, hex or round objects with powerful leverage. Adjusts to four positions up to 1½" capacity. It has no rivet projections and measures only ½" at its thickest point. Finished in rust-resistant zinc plate.

### ARTISAN'S TIE CLASP



● For the craftsman or hobbyist who is proud of his skill, a handsome gold-plated clasp designed by a leading jewelry manufacturer. A \$2.00 value... yours for 75¢, post paid. Write Crescent Tool Co., Jamestown, N. Y., Dept. M.

## CRESCENT TOOLS

*Give Wings to Work*

*Sign of the Artisan  
Symbol of Excellence*



Crescent is our trade-mark, registered in the United States and abroad, for wrenches and other tools. Sold by leading distributors and retailers everywhere and made only by

**CRESCENT TOOL COMPANY, JAMESTOWN, N. Y.**

## The Navy's Bobtailed Fireball

(Continued from page 124)

advantage that endears her to the gobs and officers who sail her. That's living quarters which are more sumptuous than anything else in the fleet.

The Navy called in Raymond Loewy, the famed industrial designer, to lay out the quarters. He turned the *Carronade* into a reasonable approximation of a floating summer resort. Bunks are separated from each other by lightweight panels. There are individual bed lights. The mess hall is outfitted with four-place tables and upholstered chairs instead of long tables and benches. The galley has electric ovens, a deep fryer, a dishwasher and garbage grinder—in short, everything a housewife (or a Navy cook) could long for. There's an all-in-one entertainment system, with a radio, phonograph, tape recorder-player and individual-volume-control speakers in every living compartment.

All in all, the *Carronade* is the Navy's luxury counterpart of the *Queen Mary*. But, more important, she's a devastating weapon. As one high-ranking Navy official put it: "When I see this fine vessel designed for the specific purpose of pulverizing enemy-held beachheads, I realize how many lives could have been saved had this kind of ship been available to us during the war." ★ ★ ★

## Infrared Rays Cook "Red Hots"

Using the heat of infrared rays, this table unit will cook six wieners in 60 seconds, according to the manufacturer. The ends of the wieners are placed in two troughs of salt water. If subjected to too much cooking, the wieners break, which turns off the electricity. A mercury switch stops the current when the lid is open.



POPULAR MECHANICS



# CHRISTMAS HINTS

from the  
**Weldwood Wizard**

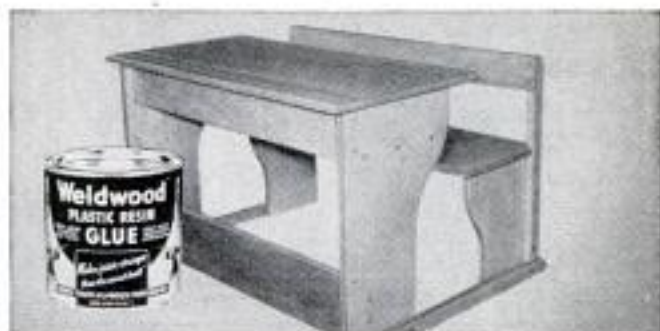

Make Christmas Gifts Like This With Weldwood Plastic Resin Glue. Build this Weldwood Plywood play-school bench with Plastic Resin Glue for strong, permanent joints. 3½-oz. cans, 35¢; 8-oz., 65¢. New 96-page Weldwood book gives 18 projects you can build. A 50¢ value—only 25¢ with coupon.



Give A Boat Kit And Weldwood Waterproof Resorcinol Glue. A kit boat built with Weldwood Waterproof Plywoods and Weldwood Waterproof Glue gives years of low-maintenance pleasure. New easy-to-mix glue makes a completely waterproof bond that's impervious to heat, cold, fungus, oils. Sizes from \$1.00.

## Weldwood® Wizards

Adhesives, Firzite®, Saffinac®, Flexible Wood-Trim®  
On Sale at  
Hardware, Paint, and Lumber Dealers\*



SEND FOR PINE PROJECTS BOOK TODAY—SAVE 25¢

United States Plywood Corporation  
Box 61, New York 46, N. Y.

PM-12-57

Please send me my copy of your 96-page book, "Projects You Can Build With Weldwood Old Craftsman Pine Plywood." I enclose 25¢.

NAME.....

STREET.....

CITY.....STATE.....



Santa Says:  
"A WONDERFUL HOBBY  
WORKSHOP GIFT"

JUST DIAL  
40 DIFFERENT  
WIDTHS ON  
ANY SAW!

WITH **Warren** DADO  
SAWING WASHERS

Cut 40 smooth, accurate, parallel grooves—any angle, with your present saw blade. Dial desired width with Micromatic adjustment. Leave on saw for straight cuts. Sizes to fit your arbor—½", ¾", 1", 1½". A perfect gift for woodworkers. See your dealer or write!

ONLY  
**\$4.95**  
PER  
SET

SEND FOR FREE BOOKLET

**WARREN WASHERS COMPANY**

DEPT. 32 • BOX 98 • NORTH END STATION • DETROIT, MICH.



**10" TILT/ARBOR SAW**  
BUILD-IT-YOURSELF  
from GIL-BILT KITS-PLANS

Sturdy wood, steel, and aluminum construction. NEW DEPARTURE ball bearings. Capacity and performance of floor saws selling for \$150.00 and up. Plans, all metal parts in kit with 10" comb. blade \$25.90, less blade \$22.95. F.O.B. St. Louis. Detail PLANS-PATTERNS only \$1.00 postpaid.

Build-it-yourself 12" and 18" Bandsaws, 8" Belt Sander, Shaper. Simplified plans, build easily with hand tools only. Advertised and sold for 10 years, over 33,000 units in use. Money back guarantee. FREE CATALOG.

GILLIOM POWER TOOLS, Dept. 80-M, Lambert Field, St. Louis 21, Mo.

## Ride while you work!

Plow, cultivate, mow, rake, harrow, till, plant, bulldoze, plow snow, spray, saw, maintain beautiful lawns. 8.4 hp. All-gear drive. B-W 4 speed trans. clutch, diff. 770 lbs. Low cost. Ready to run. Quick-change implements. 100% satisfaction guaranteed.

Write for FREE CATALOG  
COUNTRY SQUIRE TRACTOR CO.  
P.O. Box 107-K-12  
Muskego, Wis.



**COUNTRY  
SQUIRE  
TRACTOR**

Protect your home against  
power interruptions  
with an...

**ONAN** Emergency  
ELECTRIC PLANT

Provides dependable stand-by electricity for heating system, pumps, freezer, lights, appliances. Keeps home safe, livable. Automatic start and stop. Find out how little it costs!

Write for Folder!

**D. W. ONAN & SONS, INC.**  
3261 University Ave., S.E. • Minneapolis 14, Minnesota

A SIZE FOR EVERY NEED  
500 to 75,000 watts.  
Compact, quiet-running.  
Gasoline-powered.  
Priced from \$319.00

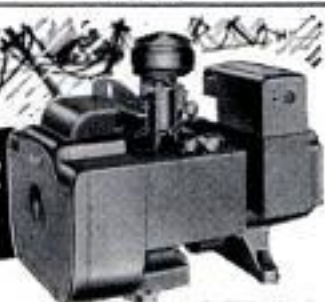



# Looking for Something?

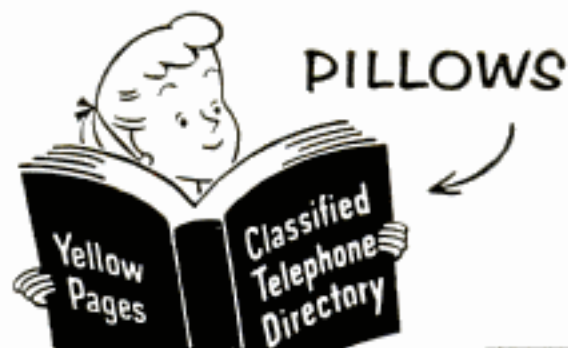

FROM COSTUMES TO PILLOWS  
*whatever you need-*



Ads displaying this emblem  
make your shopping easy.

## Photo Tips for Philatelists

(Continued from page 137)

stamp's soundness. Even the slightest tear which has been cleverly repaired will be revealed by photographing the stamp.

There isn't a more efficient accessory known to stampdom with which to rapidly detect counterfeits, than the camera and enlarger.

By making an 8 by 10 enlargement of a stamp known to be genuine, and then making one of similar size of a questionable item, the photographer-philatelist can immediately spot the tell-tale differences, no matter how small they may be.

One of the most practical and valuable uses to which the camera can be put, is that of recording a collection. By making photocopies of every page, one has a permanent reference catalogue of his treasured possessions. Should the collection ever be lost or stolen, such a reference is of inestimable value in assisting its recovery, or settling an insurance claim.

Recently a number of famous collectors have made 35-millimeter slides of their stamps for use when addressing a gathering of collectors on some specialty subject. In such talks the display of the actual stamps satisfied only a few of the audience right in front of the speaker. By using slides and projecting them on a screen, the entire audience can see.

(The current Illustrations Law of the United States Secret Service allows the photography in black and white of any stamp in existence, including United States issues. Color photographs may be taken only of foreign issues which no longer are valid for the prepayment of postage.)

There is no end to the versatility of a camera in philatelic work. Each individual gradually will develop techniques of his own, to suit and meet personal requirements. But whether he confines himself to ordinary methods or experiments with new ones of his own, he is certain to find unlimited pleasure, satisfaction and utility in the combination of his photographic and philatelic activities. ★ ★ ★

## Chemists Make New Products From Sugar and Petroleum

Two of the most abundant and inexpensive chemicals, sugars and petroleum products, can now be combined to produce a whole range of promising compounds. Dr. Carl B. Linn told the American Chemical Society that hydrogen fluoride is used as an agent to convert sugars and petroleum derivatives into detergents, germicides, pharmaceuticals and plastics materials.





Something **NEW**  
for your Christmas List!

# 5 POWER TOOLS IN ONE

## NEW Dremel Deluxe MOTO-SHOP



### COMPLETE POWER WORKSHOP IN ONE COMPACT, PORTABLE UNIT

The amazing new Dremel Moto-Shop is the most versatile multi-purpose tool ever invented. Has 1,001 home and shop uses. Basically, it's a 15" Jig Saw with a unique power take-off to which you simply connect other attachments. It then converts to a disc sander, bench grinder, buffing wheel, and a flexible-shaft machine... all powered by a ball-bearing rotary motor. And this professional-quality, portable power shop can be set up practically anywhere — basement workshop, kitchen counter, or card table. Weighs only 12 lbs. As a Jig Saw, it will cut 1 3/4" wood, 18 gauge copper, 1/16" steel — all with the same blade. Foolproof blade guard makes it absolutely safe

— even for children. Handles everything from bird-houses to full-size furniture.

The flexible-shaft is a complete machine shop in itself. Use it for sharpening, grinding, polishing, carving. Collet capacity 1/64" to 1/8".

Moto-Shop is the perfect "ALL FAMILY" workshop — safe for even mom and the children. Helps build a close father-son relationship.

**Model 57 Moto-Shop.** Includes Jig Saw with disc sander attachment only. Other attachments can be added later..... **\$33.95**

**Deluxe Model 57 Moto-Shop,** with all attachments shown ..... **\$49.95**

Price of attachments only, if purchased separately ..... **\$19.95**

#### DREMEL POWER SANDERS

... Featuring Straight-Line Action



Dremel Straight-Line Action Sanders sand with the grain of the wood. Quickly produce a velvet smooth finish, free from cross-grain scratches and orbital swirl marks. Save a lot of elbow grease, too. Three popular models to choose from —

**\$14.85 to \$37.50**

#### DREMEL MOTO-TOOL

The Pocket Size Machine Shop



Most versatile and useful tool you can own. Grinds, drills, polishes, carves, sharpens, engraves. Handles easily as a pencil. Saves time, eliminates tedious hand work. Produces 27,000 RPM. Ideal for craftsmen, hobbyists, model builders, home owners, etc. Four prices to choose from —

**\$12.85 to \$27.50**

#### DREMEL MOTO-SAW

The Famous Electric Scroll Saw



Cuts the most intricate designs like magic. Saws wood up to 3/4", also plastics, light metals, floor and wall tile. Saws to the center of a 19" circle. 7,200 cutting strokes per minute. Unique FOUR-WAY BLADE HOLDER permits cutting in any direction.

Model 203 . . . **\$6.85**

Buy your Dremel Gift at Your Nearby Power-Tool Dealer Today!



WRITE FOR FREE CATALOG

Quality Power Tools since 1934 **DREMEL MFG. CO.** Dept. 117M, Racine, Wisconsin





At Rockefeller Plaza, De Soto Chief Engineer A. E. Kimberly describes the car to a curious New Yorker

## What Makes a Driver Tired?

(Continued from page 89)

car. However, and this you may not have expected, the 1929 De Soto also rolled along for 2300 miles without skipping a beat. Except for one flat tire and momentary overheating as it crawled in second gear on hot Daytona Beach, the old car performed beautifully.

There was one side trip in the run, a diversion of about 100 miles so the cars could climb Mount Washington in New Hampshire's White Mountains—a favorite test road for all carmakers.

### Old Car Scoots

The tiny old roadster scooted up to the 6300-foot-high, cloud-shrouded peak without even breathing hard. And coming down, its short wheelbase, excellent weight-brake ratio and fast steering permitted it to skitter down the winding road faster than the 1958 model.

Incidentally, although not important to the test, gasoline mileage was measured. The old car averaged 15.5 miles per gallon over the 2300 miles, while the 1958 model averaged 14.5 miles per gallon. This gives a small advantage to the 1929 model, much smaller, however, than many would have expected.

Most people feel that the old cars were much more economical than today's big-engined, big-bodied models. Apparently they were not. The much smaller 1929 roadster with its six-cylinder engine averaged only one mile per gallon more than the big 1958 V8 De Soto.

Sure, the new car went faster and did it more easily on the highways. (It averaged 44.8 miles per hour, the old car averaged 38.7 miles per hour.) Sure, it accelerated better in town. It was more comfortable, warmer, quieter and roomier

(in fact, the 1929 roadster with its top up became downright unpleasant to one driver who confessed to a mild case of claustrophobia in it).

The new car had a radio, a cigarette lighter, a windshield washer, a power seat that could be adjusted up and down, forward and backward to change the seating position after hours of driving. It had power windows, automatic transmission with push buttons, power steering and power brakes. It had just about everything necessary to make a driver's job relaxing and free from fatigue.

The old car had none of these. It had a three-speed hand-shift transmission, vacuum windshield wipers that stopped altogether during a hard pull, nonadjustable seat, cloudy isinglass side curtains, a narrow slit of a windshield with no hint of a wrap-around, poor headlights and a hard ride. It had a solid front axle—no front-wheel independent suspension to absorb road shock. Steering was stiff but accurate.

### What Was Result?

And what happened? How did the fatigue study turn out? What did it prove?

Strangely enough, the tests failed to show that the old car made the driver any more tired than the new car. Occasionally, a driver would report that he felt more tired in the old car, but the nightly tests did not confirm it. Apparently what tires the driver most is not the physical activity. The driver of the old car did eight times as much physical work as the new-car driver. (Counters on the pedals and steering gear of each car measured the actual work done.) Yet, at the end of the day he was no more fatigued than the other driver.

Both drivers tired, but they tired the

(Continued to page 262)



When this Florida coastal storm developed, the top went up the hard way—no push-button top in '29!



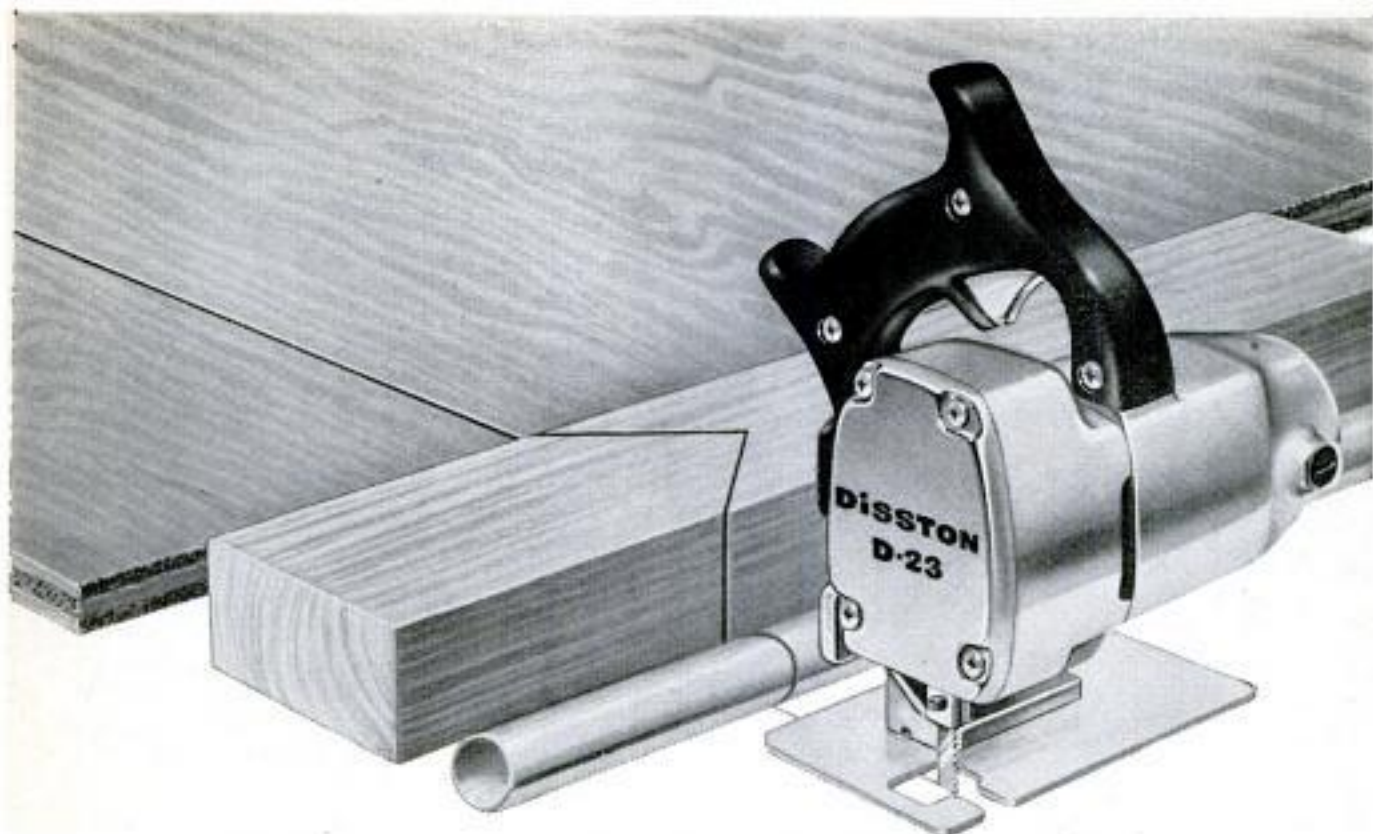

NOW, A VERSATILE, 5¼ POUND  
TOOL THAT CUTS WOOD, METAL, PLASTIC

# DISSTON

## D-23 ELECTRIC HAND SAW



**HERE'S A GREAT NEW DISSTON** tool for both professionals and hobbyists with a name famous for good saws for more than 100 years. The DISSTON D-23 has proved itself 15% to 50% faster than any competi-

tive electric saw. It has extra easy-to-change blades for cutting plywood, 2 x 4's, plank lumber, sheet metal, pipe, tubing and plastics. It saws straight lines, circles, scrolls or bevels with a true, fray-less cut. Only \$98.50

**"ORBITE" ACTION.** The blade of the DISSTON D-23 has an orbital motion (at 3,800 strokes per minute). It cuts on the upstroke, moves away from the material on the downstroke. The result is fast, professional work with minimum wear on the blade.

**FREE BOOKLET:** Write today for an illustrated booklet about many more convenient and exclusive features of the DISSTON D-23. Address: H. K. Porter Company, Inc., Henry Disston Div., 512 Tacony, Philadelphia 35, Pa.

**H. K. PORTER COMPANY, INC.**  
Henry DISSTON DIVISION





## Stop wasting money on worn-out piston rings!

You can't see the wear on your piston rings. But you can feel it—in your engine's loss of power—and in your pocketbook.

At the first sign of oil-pumping, smoking exhaust or loss of power, ask your motor specialist for a ring check-up. If your car needs new rings, you'll be money ahead on gas and oil . . . and avoid big repair bills later on by installing new Hastings Piston Rings now.

They stop oil-pumping, seal compression and provide the special lubrication worn engines need.

Don't gamble with the power and economy that are built into your engine. Restore it, keep it, enjoy it. Get new rings. And be sure they're Hastings—the only rings engineered exclusively for replacement service in your car. Truly the best money you can spend on your car.

**HASTINGS**  
Piston Rings

HASTINGS MANUFACTURING CO. • HASTINGS, MICH.  
Piston Rings, Casite, Wear Reducer,  
Oil Filters, Spark Plugs

## Tubeless Tires: Most Owners Like Them

(Continued from page 142)

circumstances. Surprisingly, in more than half the cases—54 percent—temperature was not a factor. These blowouts occurred either at night or on cool days. Speed, however, apparently was a factor. Almost half the blowouts occurred at speeds of 60 miles per hour or higher.

Tire repairmen are not as sold on tubeless tires as the owners themselves. For example, 53 percent feel that tubeless tires give motorists more trouble than tires with tubes. What kind of trouble? Seventy percent of the repairmen list slow leaks as the most frequent cause of trouble. The same percentage states that they have more complaints of tire thump with tubeless tires than with tires with tubes. And 91 percent say they have recommended, at one time or another, that the motorist install tubes in tubeless tires for reasons ranging from leaks that can't be found to peace of mind for the customer.

And significantly, almost every repairman recommends two to six pounds higher pressure for both front and rear tires than the manufacturer's recommendation.

Here are some typical comments from repairmen:

"We can balance a thump out of both tubeless and tube tires. But you find more tube tires out of round or with a heavy side."—Colorado.

"The major causes of complaint can be attributed to inadequate or careless repairs. Various tire manufacturers can contribute materially by eliminating the ridges on the liner, as these ridges have to be completely removed in the affected area before a patch can be properly applied."—Florida.

"A boot will not hold on any sizable cut."—Louisiana.

"Tube-type tires can be inspected 100 percent better for breaks and nail holes."—Indiana.

"On the whole, tubeless tires were not good enough to put on the market when they were."—Missouri.

"Lots of accidents are due to the car sliding sidewise, causing air to leave the tubeless tire."—Oklahoma.

"If for any reason a rim is cut or bent it means a new wheel."—Colorado.

"Tire leaks air through liner but comes out of tire at another spot. It is impossible to locate true leak."—Nevada.

These are the opinions of the men who know tires best—the owners themselves and the tire-repair specialists. ★ ★ ★



# Tense, Nervous Headaches Need This Relief

A survey shows 3 out of 4 doctors recommend the famous ingredients of Anacin to relieve pain. Here's why Anacin® gives better total effect in pain relief than aspirin or any buffered aspirin:

- ➔ **ACTS INSTANTLY:** Anacin goes to work instantly. Brings fast relief to source of your pain.
- ➔ **MORE EFFECTIVE:** Anacin is like a doctor's prescription. That is, Anacin contains not one, but a combination of medically proven ingredients.
- ➔ **SAFER:** Anacin simply can not upset your stomach.
- ➔ **LESSENS TENSION:** Anacin also reduces nervous tension, leaves you relaxed, feeling fine after pain goes. Buy Anacin Tablets today!

**1957 CATALOG BOAT KITS** WOOD and FIBERGLAS

EASY TO BUILD - DESIGNED for professional results by the amateur. World's largest selection of top performance, latest design, prams, skiffs, racers, runabouts, sailing boats, cruisers. 8 to 20 ft. Mahogany decks, frames. FREE FREIGHT. SEND FOR FREE CATALOG

Includes fiberglass parts, accessories

**Boat Plans-Patterns-Frame Kits**

Build over 50 modern boats from large scale plans, available with FULL-SIZE patterns, new PRE-FAB frame kits! All types: prams to cruisers, 6 to 25 ft. Best buy for Amateurs! SEND 10¢ for CATALOG.

*Craig's Craft*  
Tonawanda, N. Y.

*the finest*

**PUTTY KNIVES**

*are*

**Red Devil Tools.**

**PRI ROAD TO RICHES**

You can be the next uranium millionaire! Government guarantees huge bonus! PRI instruments from \$29.95. See your local dealer today! FREE CATALOG!

Write PRI, 4223 PM W. Jefferson  
Los Angeles 16, California

**DEALERS WANTED**

**EASIER  
FASTER  
BETTER!**

**KESTER SOLDER**

FREE: "Soldering Simplified" 16-page booklet - Send for your copy today.

**KESTER SOLDER COMPANY**  
4251 Wrightwood Avenue • Chicago 39, Illinois, U.S.A.

For General Soldering

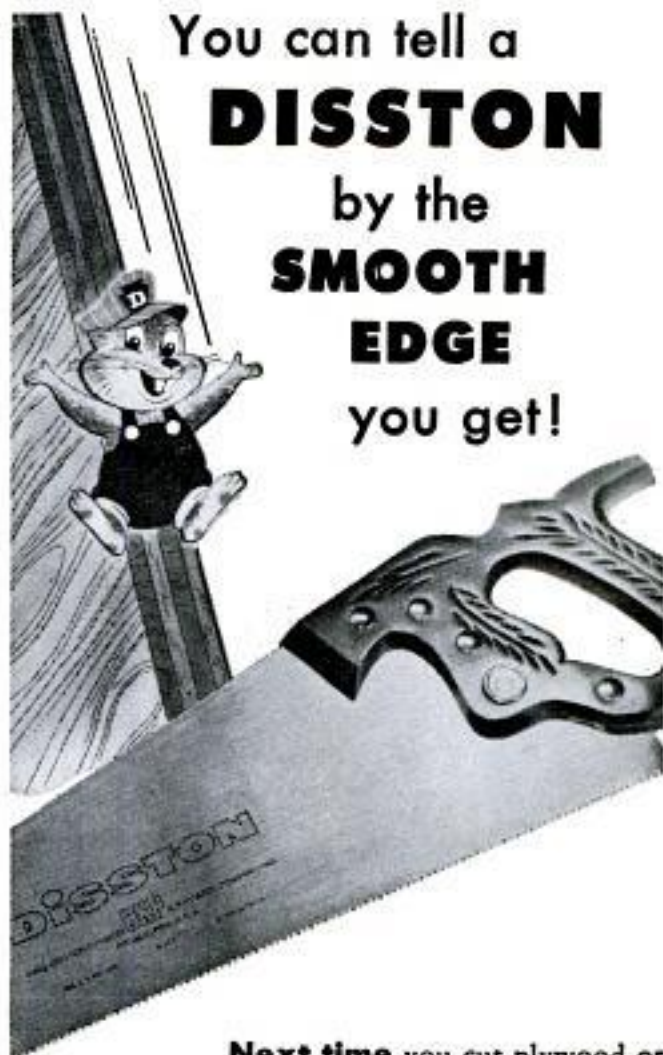

You can tell a  
**DISSTON**  
by the  
**SMOOTH  
EDGE**  
you get!

Next time you cut plywood or other well-seasoned woods, use a 10-, 11- or 12-point Disston Hand Saw. Note how easily it cuts . . . what a beautifully smooth finished edge it leaves! That's because these fine-toothed saws are specifically designed for finishing work. Made of fine tool steel, with perfectly tempered and double taper ground blade, Disston Saws give years and years of service, too.

At better hardware dealers... everywhere!



Choose a 5 1/2-point Disston Hand Saw for cutting with the grain.

Choose a 7-, 8- or 9-point Disston Hand Saw for cutting across the grain.

**FREE ILLUSTRATED BOOKLET!** 64-page Disston Saw, Tool & File Manual. Tells how to choose and use tools; how to care for them. Helpful hints on wood and metal working, and selection of materials. For your free copy write today to: *Henry Disston Division, H. K. Porter Company, Inc., Philadelphia 35, Pa.*

**H. K. PORTER COMPANY, INC.**  
Henry DISSTON DIVISION



# NOW! CUT ALMOST ANYTHING

with **WISS** "Mighty Midget" Snips! No. V-13



1. Metal
2. Vinyl Tile
3. Rubber
4. Leather
5. Fish
6. Poultry
7. Shrubs

**ONLY \$2.25!** "Mighty Midget" Solid Steel Snips fit easily into your pocket or fishing tackle box. Make straight and curved cuts. At leading hardware and tool stores. Get a pair soon!

**OTHER WISS SNIPS  
FOR HOME, FARM, AND  
PROFESSIONAL  
CRAFTSMEN**

**CIRCULAR and  
STRAIGHT CUT  
\$3.10 and  
\$4.10**



Versatile as "Mighty Midget" snips. 10" model cuts 24 gauge metal; 13" model cuts 21 gauge.

**REGULAR  
\$2.60  
to  
\$3.80**



For powerful straight cutting. Four different sized models. Good for all sheet metal work, 25-20 gauge.

**METAL MASTER  
M-3  
\$4.25\***



Tremendous power! Only 10" long. Make intricate straight or curved cuts in 18 gauge metal, with half the normal effort!

\* Slightly higher in Denver and West. Vinyl handle grips optional and extra.

**J. WISS & SONS CO., NEWARK 7, N. J.**

**WISS... always a cut above competition**



Minsk-Moscow highway is well surfaced, but side roads are muddy lanes used by horse-drawn wagons

## I Drove Through Russia

(Continued from page 85)

relies on creaking wagons for much of its rural transport. Russia's production and variety of machine tools rivals that of America, but it gave up making ballpoint pens as a bad job, and consumer goods are generally shoddy, expensive and scarce.

More contrasts were seen in Minsk the next morning. This war-devastated city of 412,000 people has been rebuilt with imposing apartment houses and office blocks lining the broad avenues. But when we drove off the main street in a two-hour hunt for a gas pump that both worked and delivered the "high test" fuel, we bounced over bone-rattling cobbles in a road booby-trapped with flooded potholes, with manhole covers sticking two inches above the surface.

### Late Start for Moscow

After a late start we dawdled along in the bright sunshine with photogenic clouds, and gave up all hope of reaching Moscow that night. The Minsk-Moscow highway stretches for 450 flat miles with scarcely a bend. It was possible to wind the Victor up to an effortless 75 miles per hour—safe, we thought, until an unexpected wavy spot tossed us against the roof. At first glance this road with no speed limit looks a natural for sports cars, but hard suspension here would be murder, and about 65 is top for steady cruising.

Driving through this vastness, so like the American great plains, we saw many places where grain was spread out across half

(Continued to page 246)



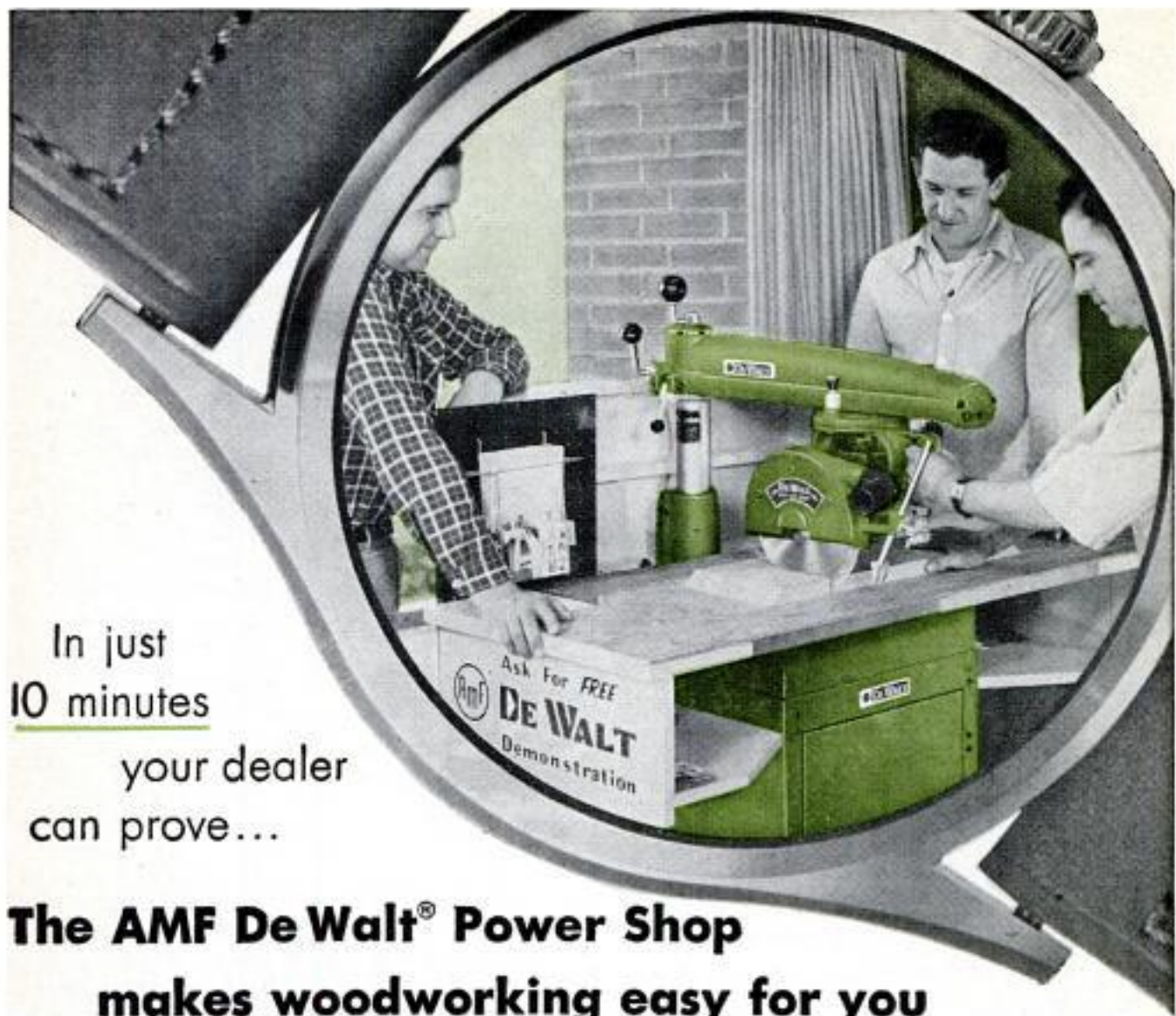

In just  
10 minutes  
your dealer  
can prove...

## The AMF DeWalt® Power Shop makes woodworking easy for you



**SEE** Safer, easier  
top-side cutting



**SEE** Direct-drive power,  
no belts, no pulleys



**SEE** DeWalt's exclusive  
safety features



**SEE** Layout marks visible  
every cut, no mistakes



**SEE** Work moves straight—  
saves 75% floor space



**SEE** DeWalt becomes 12  
professional tools in 1

See for yourself why DeWalt's original radial arm design, big capacity, and unsurpassed accuracy make it the finest, most valuable all-purpose power tool you can own.

Your dealer will quickly show you how a DeWalt saves the cost of a shop full of tools — makes all home woodworking fast, easy, safe... fun! How you can make furniture, build in cabinets, finish off the attic or basement, make home repairs... do all those things you've always wanted, *even if you've never used a power tool before!*

See your Franchised DeWalt Dealer for a Free, *convincing* demonstration today! Easi-Budget Terms — 10% down, 2 years to pay!

Owners! Send for valuable new DeWalt Woodworking Manual, just \$3.95 pp.

Send the coupon for free booklet and name of nearest DeWalt dealer.

Another **AMF** Product



DeWalt Inc., Dept. PM-712, Lancaster, Pennsylvania  
Subsidiary of AMERICAN MACHINE & FOUNDRY COMPANY

- Send FREE colorful 20-page Booklet and name of dealer.  
 I enclose \$3.95 (check or m.o.) for DeWalt woodworking manual.

Name \_\_\_\_\_

Address \_\_\_\_\_

City \_\_\_\_\_ Zone \_\_\_\_\_ State \_\_\_\_\_



# New **RIGID** Wrench Gift Package



**...a Merry Christmas  
that lasts a lifetime!**

*(Ideal for Father's Day, birthdays, etc., too)*

Every "handy-man" wants these famous **RIGID** pipe and monkey wrenches for his home repair jobs. The world's most popular with millions of users, they're just what he needs for quick repairs of leaky pipes and faucets. Extra handy for toy, bike and yard equipment, too!

Attractive green-and-gold package serves as a handy carrier for small tools. Sized for convenient drawer storage, it keeps tools safely together.

See and buy these new **RIGID** Wrench Gift Packages at your hardware dealer's today.

**The Ridge Tool Company, Elyria, Ohio, U.S.A.**



the width of the road to dry in the sun. The wake of passing traffic blows away the chaff. Sometimes even small threshing machines were parked and running on the asphalt. Trucks were used to crush flax by driving them back and forth across it.

Our companions of the road were long-distance coaches that seat 32 people in comfort, and use a 180-horsepower supercharged diesel mounted at the rear to thunder along at close to 70. Few passenger cars were seen, and the traffic consisted mostly of gas-engined four-ton trucks. These are the stalwarts of Russian transport, and carry everything from timber and cows to mountainous loads of hay and up to 30 farm workers packed in like sardines.

## **Trucks Take Beating**

They take a terrific beating from both overloading and tortuous roads, and we saw several trucks with dislocated axles rolling with a crablike movement. Once a four-tonner with recapped tires shed a large hunk of loose tread right in our path. Garages are widely spaced in Russia, and every truck driver is both trained and equipped to make major repairs on the spot. More than once we saw a roadside replacement of a broken spring or half shaft. These trucks are really run into the ground. I was told that they normally do 120,000 miles before a major overhaul, and are kept going for up to 500,000.

## **Gas Stations Are Scarce**

Truck drivers take a break at the rare gas stations along the highway, and the bright red Victor always attracted a crowd when it pulled in to refuel. They were tough, roughly dressed men, but always ready to talk and be helpful. At one place where no air was available, a gruff driver brought his truck over, attached a hose to his compressor and inflated our tires.

Their questions were always the same. "Americanski?" eyeing the Victor's panoramic windshield and tailfins. I told them it was made in England. "What's the top speed and fuel consumption?" They nodded approvingly when I gave the metric equivalent of the 75 miles per hour and 24 miles per gallon that we had done with the low-compression head and a diet of the local "liquid asbestos." Then: "What does it cost? Does it belong to you? How long would you have to work to buy one?" Finally the inevitable: "Can we look at the engine?" As a dozen heads peered under the hood, someone always crawled underneath the car to see the suspension. The usual verdict was: "A fine machine, but too low for our roads."

*(Continued next month)*





## GIVE EVERYDAY SHOOTING FUN

Suddenly the thrills and skills of shooting become part of the whole family's *everyday fun life*. Your gift of Crosman Pellguns with controlled range and power makes it possible . . . safer, accurate shooting, right in and around the home, all year long. Clean and quiet: no powder, no explosion. Powered by odorless, non-toxic CO<sub>2</sub> gas or compressed air. For gifts that really hit the mark . . . rifles, pistols, a home shooting range . . . ask your sporting goods dealer about Crosman Pellguns.

Shooting is 3 Times  
More Fun with . . .

**Crosman**

Power Without Powder® **PELLGUNS®**

Available in Canada

World's largest producer of pellet rifles and pistols

**FREE!** 32-page Gun Book. Write Crosman Arms Co., Inc., Dept. PM-12, Fairport, N. Y.



**KING MIDGET** ALL NEW. First model change in six years. New bodies, new chassis, new engine. Four wheel hydraulic brakes. Still World's Lowest Priced Car. Drive it for 75c per week. Rider Agents Wanted. Earn your own car. Get the facts. Send 25c for 32 page picture book with complete details, dealers price, etc., if there is no dealer near you.

**MIDGET MOTORS CORPORATION, Athens 1, Ohio**

## SAVE MONEY ON YOUR COMPRESSED AIR



buy this complete  
SMITH 45-P air compressor

Right for spray painters, plumbers, contractors, monument shops, tire changing trucks, maintenance shops, quarries, utilities, many other users. Delivers 45 plus cu. ft. per minute; pressure up to 150 P.S.I. Powered by Wisconsin 4-cyl. air-cooled engine; uses less than 1 gal. gasoline an hour! Most compact, biggest-value compressor for its capacity anywhere! Other models to 230 cfm.

write for  
**FREE**  
brochure

**GORDON SMITH & COMPANY, Inc.**  
411 College Street, Bowling Green, Ky.



## MONROE LOAD-LEVELERS

keep loaded cars level . . .

If you load your car with samples, equipment, etc., if you drive a station wagon or haul a trailer, if you load family and luggage into your car for weekend or vacation trips, you need:

### MONROE LOAD-LEVELERS

Automatically compensate for lightened load to give a comfortable ride when car is normally loaded.



Simple Installation  
Merely Replace Shock  
Absorbers

- STOP BOTTOMING
- STOP BUMPING ON DRIVEWAYS
- INCREASE RIDING COMFORT
- INCREASE ROAD CLEARANCE
- STOP SWAYING ON CURVES
- KEEP HEADLIGHTS ON ROAD

Mail this coupon and 10c for literature.

Dept. PM

**MONROE AUTO EQUIPMENT CO., Monroe, Michigan**

Name \_\_\_\_\_

Address \_\_\_\_\_

City \_\_\_\_\_



Do it now with

**DAP**™



Use new DAP Rope Caulk for a dozen do-it-yourself jobs around home. Weatherstrip inside windows to stop drafts and heat loss. Apply or remove in minutes. Sold in rolls by hardware, paint and building supply dealers. Ask for free do-it yourself booklet.

**DICKS-ARMSTRONG-PONTIUS, Inc.**  
General Offices: Dayton, Ohio

# HI-FI TOOLS by UTICA

Now for the Hi-Fi enthusiast, a complete set of quality hand tools designed for the assembly of Hi-Fi components.

Backed by famous full guarantee. Use UTICA, the tools the experts use.

**UTICA DROP FORGE & TOOL DIVISION**  
Kelsey-Hayes Co., Utica 4, N.Y.



46-4 — midget diagonal

819-12" long shank screwdriver



262-5½ — transverse end-cutter



654-6 — long nose with cutter



778-6½ — needle nose with stiff jaws



## "Walking" Magnetometer Weighs 12 Pounds

Oil and mineral prospecting has been made easy with a "walking" magnetometer weighing only 12 pounds. It will locate and tell information about magnetic minerals directly, and minerals of different magnetic character and oil-bearing materials indirectly. Used like a geiger counter, it can be applied anywhere man can go, including over large or small bodies of water.

## Wheelbarrow Spreads Sand

Pushing a new type of wheelbarrow spreads its load of sand automatically and evenly. An adjustable nozzle allows the sand to pour out onto a flywheel which throws the sand in all directions. A cogwheel connection causes this action. The wheelbarrow is manufactured in Germany.





ORDER DIRECT  
FROM AD

SURPLUS AT  
FRACTION OF  
GOV'T COST

TOP VALUE  
SPECIALS

SHOP BY MAIL  
AND SAVE AT  
GROBAN'S

SATISFACTION  
GUARANTEED

BRAND NEW

## WALKER 5-TON HYDRAULIC LIFT KIT

FOR — • SNOW PLOWS • TO  
DUMP FARM WAGONS • ADJUST  
DEPTH OF PLOWS • HYDRAU-  
LIC PRESS • HYDRAULIC JACK.

THE COMPLETE KIT CONSISTS  
OF: 1—Walker Hydraulic Hand  
Pump—Rated 1500 lbs. per sq. inch  
with 2 gal. hydraulic reservoir • Re-  
lease valve • Filler plug and air vent  
thread port. Pump Assembly Item #P449..... **23.50**  
1—6 Ft. length double wire braid rubber covered  
hydraulic hose—tested to 20,000 lbs. Item #27B4... **3.95**  
1—Hydraulic Cylinder, 3" bore, 6" stroke. Husky 3/4" solid steel  
shaft. Will lift 10,000 lbs. using 1500 lbs. of pump pressure.  
Clevis mountings that take 3/4" diameter pins. May be used for  
single or double action service. Overall length  
17 1/4"—retracted. Item #C419..... **12.50**  
1-Gallon hydraulic fluid furnished free with each kit.  
Plus all necessary hydraulic fittings. Total ship. wt.—40 lbs.

ITEM  
#KW-  
116

• 28" steel handle. Fine for hydraulic presses; snow plows, jacks.  
Dimensions: 6" Diameter, 29" long with 3/4" pipe  
through port. Pump Assembly Item #P449..... **23.50**  
1—6 Ft. length double wire braid rubber covered  
hydraulic hose—tested to 20,000 lbs. Item #27B4... **3.95**  
1—Hydraulic Cylinder, 3" bore, 6" stroke. Husky 3/4" solid steel  
shaft. Will lift 10,000 lbs. using 1500 lbs. of pump pressure.  
Clevis mountings that take 3/4" diameter pins. May be used for  
single or double action service. Overall length  
17 1/4"—retracted. Item #C419..... **12.50**  
1-Gallon hydraulic fluid furnished free with each kit.  
Plus all necessary hydraulic fittings. Total ship. wt.—40 lbs.

**COMPLETE KIT PRICE** **38.95** F.O.B. CHICAGO  
(ALL OF ABOVE INCLUDED).....

## 1 1/2 H.P. HYDRAULIC SPEED REDUCER

with FINGERTIP CONTROL

USE FOR: • Reamer Drives • Midget  
Cars • Feed Mills • Canning Machines  
• Conveyors • Lathes • Milling Ma-  
chines • Motor Boats • Cream Sepa-  
rators • Garden Tractors •  
Output  
Pumps

Variable output speeds from 0  
to input speed available by  
moving control handle. Locking  
handle maintains setting. Use in-  
put power of 1/4 to 1 1/2 H.P. Shafts 3/4"  
diam. Input rotation counter-clockwise  
facing shaft. Input speed 750 R.P.M.  
7 1/2" x 7 1/2" x 11 1/2". Output rotation  
reversible. Shipp. wt. 31 lbs. Complete with 2 qts. of  
oil and full instructions. F.O.B. Chicago..... **72.50**



ITEM #115

reversible. Shipp. wt. 31 lbs. Complete with 2 qts. of  
oil and full instructions. F.O.B. Chicago.....

## 1 H.P. 12 VOLT ELECTRIC MOTOR

ITEM #308 — • For electric wheel  
chairs (Pop. Mech. design—Mar. 1953).  
• For electric golf carts.  
• For self-propelled scooters, children's  
midget cars.

Rated 1 H.P.—100 amps., 5600 R.P.M.,  
12 volts, D.C.—This double shaft motor of  
ball-bearing construction may be run on 6  
volts for lower horsepower requirements—Standard 3/4" shafts,  
flange mountings.—Dimensions: 8"x4 1/2"x4 1/2". F.O.B. Chicago  
Shipp. wt. 19 lbs. A real value at..... **12.50**



**2 H. P. ELECTRIC MOTOR**  
ITEM #315—24 Volts, 80 Amps., 4000 RPM, spline shaft both ends.  
Style similar to above. Mfgd. by Hobart or Diehl. F.O.B. Chicago..... **13.00**

## BELT DRIVEN A. C. GENERATORS

Ideal for powering electric tools, oil burner,  
refrigerator, lights, or other appliances re-  
quiring up to 1000 watts of power. **1000  
WATTS, 115 Volts, 60-cycles A.C. 3600  
R.P.M.** Compact, self-regulating generator  
with V Belt pulley and double outlet receptacle.  
Rotation counterclockwise. May be driven by  
tractor or auxiliary gasoline engine. Requires  
2 1/2 HP minimum. Dimensions: 10" long x  
8" high x 6" wide. Shipping wt.  
27 lbs. F.O.B. Chicago..... **79.50**



ITEM #1010

**MODEL 700 750 WATTS** A. C. Generator F.O.B. Chicago..... **59.50**  
**MODEL 2000 2000 WATT** A. C. Generator F.O.B. Chicago.... **133.00**

## QUICK HEAT STEWART-WARNER PORTABLE HEATERS

DELIVERS  
100,000 B.T.U.!

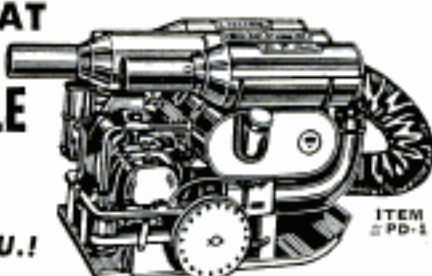

ITEM  
#PD-1

FOR HEATING:

- Buildings, barns, workshops, basements
- Pre-heating engines and equipment
- Thawing fuel lines, pipes
- Drying Grain, Plaster

Delivers 100,000 B.T.U. The cheapest, most conven-  
ient portable heater on the market! Mounted on  
sled for use on ice or snow—also has retractable  
wheels for easy one man handling.

Consists of 1 1/2 H.P. air-cooled Lauson gasoline en-  
gine driving super-charger and turbine type blow-  
er. Heat delivered through 3 long flexible ducts,  
regulated by damper controls. **NO FLAME — NO  
FUMES.** Heater and engine burn regular gaso-  
line. 10 gallon capacity fuel tank. Thousands in use  
by Air Force, on farms, by contractors, industry.

FULLY GUARANTEED — REBUILT BY U. S. AIR FORCE  
READY TO RUN — EASY TO OPERATE

Net Weight 200 lbs. Shipping Weight 300 lbs.  
Dimensions: 48" L x 30" W x 30" H  
Government acquisition cost \$500.00

SPECIAL **119.50** F.O.B. CHICAGO or  
SEATTLE (Your Choice)

## HIGGINS BRONZE CENTRIFUGAL PUMP

PUMPS ALMOST ANYTHING

Fine for: — • Irrigation • Sump  
Pumping • Sewer Drainage • 75 gal-  
lons per minute @ 2400 R. P. M.  
Higgins Type PNB, Model R, marine  
bilge pump. Open Impeller design for handling  
muddy water. Delivers 75 gallons per minute,  
30 foot head with 3/4 H.P. motor.  
Pump body and impeller are made of solid  
bronze, with alloy steel 1/2" diameter shaft,  
1 1/4" long. Rotation of the pump is clockwise. Inlet has 1 1/2"  
pipe thread. Plain 1 1/2" outlet for hose connection. Di-  
mensions 12"x7"x8". Shipping weight 23 lbs. F.O.B. Chicago..... **23.50**



ITEM  
#414

**FREE! NEW WINTER CATALOG**  
60 PAGES of unsurpassed War Surplus  
and new Equipment Bargains for farm,  
home, factory, workshop. Write today.

Send Payment Or Purchase Order Today  
For Phone Orders Call WEBSTER 9-3793

**GROBAN SUPPLY CO. DEPT.**  
**GROBAN BUILDING** PM-12

1139 S. WABASH AVE. CHICAGO 5, ILL.

Change your oil  
and filter NOW!



**NEW FRONT MOUNTED  
TRACTOR SAW**  
Clear Brush, Fell Trees WHILE YOU RIDE.  
Cuts Both Horizontal and Vertical

Operator controls Saw from Tractor  
Seat. Cuts Brush at 2 M.P.H. ...  
Trims Hedge, Fells and Bucks up to  
24-in. Trees. Tractor Power makes  
Sawing Faster and Easier.

→ Send Postcard Today for FREE FOLDER and Prices. ←  
BELSAW IMPLEMENT CO., 4108 Field Bldg., Kansas City 11, Mo.



see the amazing new  
EASY-TO-BUILD ELECTRONIC  
**ALLIED knight-kits**



in **ALLIED'S 1958**

**ELECTRONIC SUPPLY CATALOG**

**FREE!**

**BUILD YOUR OWN!  
SAVE MONEY—HAVE FUN**



**HI-FI KITS**



**HOBBY KITS**



**INSTRUMENT KITS**



**HAM KITS**

**404** value-packed pages

**SAVE on Everything in Electronics**

**WORLD'S LARGEST STOCKS**

Everything for Experimenters, Builders, Amateurs, Servicemen, Engineers and Hi-Fi Hobbyists. Get more for your money in Hi-Fi systems and components; build-your-own KNIGHT-KITS; recorders and phono equipment; TV tubes, antennas, accessories; Amateur station equipment; test instruments; industrial electronic equipment—plus the world's largest stocks of parts, tubes, transistors, tools and books. Send today for your **FREE 1958 ALLIED Catalog!**

Everything in Electronics From One Reliable Source

our 37th year

**EASY TERMS AVAILABLE**

**ALLIED RADIO**

send for  
**FREE**  
Catalog

**ALLIED RADIO CORP., Dept. 24-M7  
100 N. Western Ave., Chicago 80, Ill.**

Rush **FREE 1958 ALLIED 404-Page Catalog**

Name \_\_\_\_\_

Address \_\_\_\_\_

City \_\_\_\_\_ Zone \_\_\_\_\_ State \_\_\_\_\_

## Report From a Roving Editor

(Continued from page 98)

Yukon River in its brown hills, and over the brown, barren, arid Brooks Range. There was no snow north of Fairbanks and it turns out this whole region gets very little precipitation. As much as 120 feet of snow falls in the glacier area down south; at Point Barrow the average annual snow-fall is only seven inches.

Leaving the Brooks Range, the pilot began his letdown, for now we were over the Polar Shelf, a flat expanse not much above sea level and filled with ponds, lakes, and winding rivers that loop back and forth. Approaching Barrow we could see the ice pack five miles offshore, with strings of floes reaching out into the open water.

It was cold, windy and showering at Point Barrow and we needed the parkas.

First thing I saw at Point Barrow after getting off the plane was a sign reading "No Parking" in front of the tiny control building at the airstrip. Only 1200 miles from the Pole, and they had traffic rules.

The group toured the overheated buildings of the DEW Line radar installation, then stood through an hour-long ceremony out-of-doors where the weather was bitter. The ceremony marked the acceptance of DEW Line by the Air Force from the construction contractors.

There was then a reception in the large library room of the Arctic Institute, attended by the contractors, the Air Force officers who had flown up for the acceptance ceremony, and officers of the Navy supply ships anchored offshore. The admiral of the supply force introduced me to an artist who turned out to be Arthur Beaumont from Los Angeles, a marine painter I had known 20 years or so ago. He was making the cruise with the supply ships.

On one wall of the library was the pelt of a huge polar bear that had been shot 20 feet from the cookhouse last January. Outside, in cages, the institute has a small zoo of arctic animals that had been trapped for behaviorism studies. They included large foxes, a couple of wolverines and some young, large, brown arctic owls.

After lunch the correspondents visited the Eskimo village a few miles down the beach, using a big amphibious tractor as a taxi. The roads are gravel, raised above the tundra, but still muddy. There are a few trucks and Jeeps but most of the vehicles are tracked types suitable for mud, snow and ice. The Eskimo village is mostly tar-paper shacks and wooden houses, with muddy lanes and standing water. Some of the houses have a pole at each end of

(Continued to page 252)



Help her to "Surprise" you with

# MILLERS FALLS TOOLS

for  
Christmas



Check the tools you want most and leave this page where "Santa" will see it

### "DYNQ-MITE" POWER WORKSHOP

No. "888" POWER TOOL — 3 tools in 1:  $\frac{3}{8}$ " Drill, 6" disc Sander, and 6" Polisher. 3200 rpm, 4 amp. rating, \$44.95



#### RUGGED ATTACHMENTS LIKE THESE

turn the "888" into a complete 16-tool power workshop

No. 8811  
6" Portable Saw Attachment  
\$18.95



No. 882  
Orbital Sander Attachment  
\$17.45



No. 8818  
2" Plane Attachment  
\$22.95



NEW  
No. 1220



**PLANE-R-FILE.** Reversible handle . . . double-sided blade . . . cuts wood, plastic, even steel. Two tools in one — a plane and a file — all for only . . . \$3.49

#### HANDY ATTACHMENTS FOR $\frac{1}{4}$ " ELECTRIC DRILLS

- Buffing & Sanding attachment — 2 speeds; easy to use.  
No. 2120 . . . . . \$9.30
- Jig Saw attachment — cuts wood, metal; smooth, speedy.  
No. 2140 . . . . . \$11.95
- Orbital Sander attachment — for fine finish sanding.  
No. 2160 . . . . . \$15.95



For free folders or name of nearest dealer, write  
MILLERS FALLS CO., Dept. PM-22, Greenfield, Mass.



## MAKE YOUR OWN

**NEW! SAFE, RUGGED  
ALUMINUM ALLOY TANKS**

**UNLIMITED USES FOR LAND  
or WATER SPORTS — PLEASURE**

These rugged aluminum alloy tanks are light, safe, extremely buoyant and can easily be adapted to hundreds of uses. They are non-corrosive and require no upkeep. You can make rafts for swimming, power craft for river and lake fun. They can be used for liquid storage and supply tanks. The possibilities are unlimited and you can have more fun than you ever imagined.



### SPECIFICATIONS

Tough aluminum alloy. 110 gal. capacity. Wt. 60 lbs. Lgth. 11/5 ft. Dia. Max. 18". Crates 60" x 42" x 23". Support 700 lbs. each. Cad. plated steel brackets welded to tank for assembly.

**\$45** each FOB Montgomery, Alabama.

WRITE TODAY for more information on structural aluminum available for construction purposes. Be the first in your area to have a pontoon craft. Ask about plans.

**NO C.O.D.'s. SEND CHECK or MONEY ORDER to**

**ENGEL & ASSOCIATES**

P. O. BOX 408 • ADRIAN, MICHIGAN

**RAFT  
CATAMARAN  
FLOATING DOCK  
PONTOON CRUISER  
HOUSE BOAT  
UTILITY TANK**



the roof with a few slabs of unappetizing meat strung out on a line between, curing in the weather. The Eskimos who were visible, mostly children, wore summer parkas of cloth with fur around their faces. Winter parkas are all fur. There were some skin umiaks pulled up on the gravelly beach.

We spent a hurried 10 minutes in a store. Curio shops at Fairbanks and Anchorage are full of Eskimo-made, but nevertheless commercial, ivory bracelets, pins, earrings and so on, with prices mainly starting at \$5. The same shops are all stocked with good-looking ash trays and other dishes depicting Eskimos and dogs and Arctic scenes, all signed "Sascha B," which is the trade name of the Brastoff pottery located near my home in Santa Monica.

After leaving the Eskimo village we got back in the plane and headed for Elmendorf Air Force Base, Anchorage. The pilot's windshield was iced up for much of the trip but there was nothing for him to see anyway. We were in the clouds and could barely see the wing tips. We flew at 11,500 feet to clear any mountains on the route.

### A Visit to "White Alice"

Wednesday the plane took us to a White Alice installation at Naknek at the root of the Aleutian Peninsula. White Alice is the code name for the new tropospheric scatter type of radio communications system just being completed in Alaska. Here the "no-see-ums" were a pest; actually they are very visible indeed. We were past the black-fly and mosquito season; these were the only pests encountered.

After lunch in a super-steam-heated dining room and a tour of Naknek, the pilot took us on a little sight-seeing trip on the way back to Anchorage. Until now the C-54 had been handled like the big transport it is—flying straight and level at high altitudes. On this afternoon the pilot gave us the bush-pilot treatment, close-ups of the scenery. He stayed under the lowest level of broken clouds and cruised up valleys and then canyons to the famed Valley of 10,000 Smokes. This scenic spot has been reading *Reader's Digest* lately and no more than a dozen smokes are left. We saw none of them, even at low level.

By now there was the wide base of a big mountain in front of us, most of it lost in the clouds overhead, and with glaciers on its sides. We cruised around the shoulders of the mountain at a couple of hundred feet above the steep slopes, and hunted for mountain passes to avoid going up into the clouds. I am a very timid air passenger and along in here I was mentally helping

(Continued to page 254)

**FLETCHER**

## WHO CAN'T CUT GLASS?

HAVE YOU TRIED THE NEWLY IMPROVED  
LUBRICONE IMPINGED WHEEL?  
(an exclusive feature by FLETCHER,  
glass cutter manufacturers since 1903)

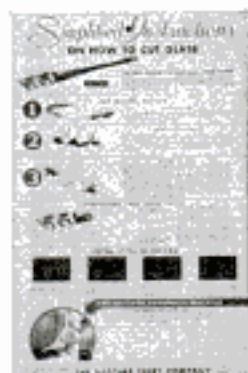

SEND FOR THIS FREE CARD. IT TELLS YOU  
"HOW TO CUT GLASS"

It explains how to cut circles, drill holes, etc.

**IT'S FREE**

THE ILLUSTRATED GLASS CUTTER CAN BE  
PURCHASED FROM YOUR LOCAL DEALER

Ask for it by name, FLETCHER

**THE FLETCHER-TERRY CO., Dept. D, Forestville, Conn.**



What a "HANDY NEW YEAR" Gift for Christmas!

NEW

**WISE-GRIP®**

WITH *EASY* RELEASE

Does more jobs than any other hand tool—EASIER than ever!

Here's that unusual gift you've been looking for—for him! A whole tool kit in one trim, easy-to-carry, easy-to-use hand tool. Is actually super-pliers, all-purpose wrench, clamp and wire-cutter. Locks on with ton grip. Unlocks with "push-button" ease. Outperforms any other single tool in the world. Choice of 7" and 10" models from only \$2.15 to \$2.95.

Made Only By

PETERSEN MFG. CO., Dept. M-12, DeWitt, Nebr.



PRESS HERE  
**Click!**

jaws spring open!

NO. 10WR  
\$2.95

AT ALL  
HARDWARE  
STORES

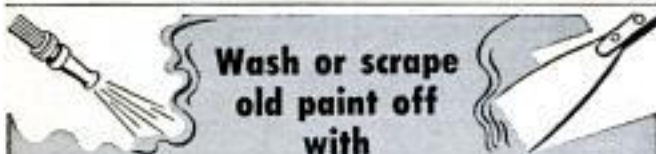

Wash or scrape  
old paint off  
with

**HEAVY-BODIED KLEAN-STRIP**

**3 WORKSHOP PLANS  
TO FIT YOUR SPACE AND BUDGET**

Build your own workshop! Get complete plans, easy-to-follow instructions and bills of material for three Delta designed shops—plus Delta's New Workshop Reference Manual. Send name and address with 25c in coin to: Delta Power Tool Division, Rockwell Mfg. Company, 502M No. Lexington Ave., Pittsburgh 8, Pa.

Professional Mechanics'  
**TOOL CHEST**

FOR YOUR  
HOME WORKSHOP



This may be the lowest cost full-sized chest in America! 4 sliding drawers in blue-gray rugged steel cabinet. 26" x 12 1/2" x 12 1/4". Keep your valuable tools safe, clean and always at your fingertips.

**\$25<sup>90</sup>** F.O.B. ST. PAUL

FREE BULLETIN

**HUOT MFG. CO.**  
555 No. Wheeler St., St. Paul 4, Minn.



**MINIATURE BATTERY POWERED VEHICLES**

\$79.50 Kit Form  
\$99.50 Assembled



Drilling, reaming and tapping required on kits

- \* **SAFE...** Dead-man's Switch—Shock-free Electrical System—3 MPH Speed.
- \* **DURABLE...** Cast-Aluminum Structure and Bronze Bearings.
- \* **POWERFUL...** Battery Powered 2 HP Motor Starts instantly.

These vehicles are ideal as Quality Toys or for light industrial use. Small enough to fit into an auto trunk, yet powerful enough to pull a 250 lb. man up a steep slope.

Powered by Size 1 Automobile Battery (\$8.95 extra)



Battery Charger \$7.95



\$69.50 Kit form  
\$89.50 Assembled

Drilling, reaming and tapping required on kits

25% Deposit required with order • Shipped Railway Express Collect

OBERHAUSEN ENGINEERING CORP. • 4009 ASHFORD RD., N.E. • ATLANTA 19, GA.

DECEMBER 1957

253



**3** New **BLACK & DECKER**  
**POWER KITS**  
ring the bell in a raft of jobs!



- Powerful B&D U-3 1/4" Drill
- Choice of three attachments engineered especially for B&D Drills



**Jig Saw-Drill Power Kit** teams B&D Jig Saw Attachment with U-3 Drill. Makes bookends, toys, repairs.



**Sander-Drill Power Kit** pairs B&D Orbital Sanding Attachment with U-3 Drill. Refinishes built-ins, furniture, antiques.



**Saw-Drill Power Kit** combines B&D Saw Attachment (world's safest) with U-3 Drill. Makes bookshelves, furniture, toys.

Black & Decker Tools are priced to fit your budget! Kits from \$39.95—Tools from \$29.95—Attachments from \$10.45. *The Black & Decker Mfg. Co., Dept. M127, Towson 4, Md. (In Canada: P.O. Box 278, Brockville, Ont.)*



The famous  
**U-3 Drill**  
in three new  
combinations



Look under "Tools-Electric"



**Black & Decker**  
World's Largest Maker of Electric Tools

the pilot at his controls. I didn't know then that there was a lot more coming.

After crossing the peninsula we flew across the strait and cruised along the low northern shore of the Kenai Peninsula. We were still sight-seeing, and currently looking for moose. This is best done at about 100 feet above the trees. No moose, so the pilot got down on the water just offshore, at an altitude of 50 feet. We were scaring the sea gulls (and me).

Approaching Anchorage, the pilot cruised up Turnagain Arm, a typical fiord, narrow, with tall mountains on each side, and with Portage Glacier at its end. We "climbed" the glacier by airplane, looking down at the blue-green ice a couple of hundred feet below, went over the top into the peaks, and almost skied down a glacier.

I was alarmed. I made my way up to the cockpit to see what it looked like from there, and we were headed for a black peak sticking out of the ice maybe two blocks ahead. Most of the crew were taking snapshots out of the side windows. They were having a big time and so was I, but not in the same way. We snaked in and out of the peaks, saw a lot more glaciers, and returned to Elmendorf mightily impressed with the plane and the pilot.

#### Party Returns South

On Thursday the C-54 and press party returned south. I decided to RON (hot dog!) at Anchorage to visit another, more typical White Alice site adjacent to Matanuska Valley. The Elmendorf people took me out there by car. The road cuts through Fort Richardson on the outskirts of Anchorage and there is a big sign at each end of the reservation reading "No Big Game Hunting on This Fort." Moose are more than plentiful; the problem is not shooting one, but hauling the 1000-pound carcass to a truck after the kill.

Friday morning I visited some of the officials of the Alaska Railroad. One of their big problems is moose. They kill 200 to 300 of them every year, running them down on curves.

Friday afternoon I returned to McChord, via MATS, in a C-118, which is a plush Douglas DC-6 with the seats facing the rear for safety. Got to McChord about midnight, took a taxi with two other people to the Seattle-Tacoma airport to sign in.

I returned south the next day by United in a DC-6 that required only 3½ hours from Sea-Tac to L.A., overflying Reno, Lake Tahoe and part of Yosemite. Recognized a lot of lakes I have fished. The trip was pretty, but not at all comparable to Alaska. Thanks for a nice trip.

Tom Stimson



# SURPLUS SALE

WAR SURPLUS  
EXCESS INVENTORY  
BANKRUPT STOCK

## MOTOR POWER HACK SAW

Outstanding motor tool bargain. Machine shop power hack saw. Cuts heaviest bar, pipe, angles, etc. fast and accurate. Automatic, simply press switch—it does the rest.  
● Holding vise will handle up to 3 1/2" stock. Uses ordinary hack saw blades. Every farm, garage and plumbing shop should have one.  
SALE . . . (Less motor) . . . \$34.95 Ppd.  
● We have limited quantity complete with 1/4 h.p. motor on base at only \$49.50 Ppd.

## DC WELDING GENERATOR

Finest ball bearing 300-amp 30-v air corp generator. Makes excellent welder, power plant, fast charge battery-charger, etc.  
● Full instructions. Many applications. A real buy. Govt. cost \$300.  
SALE . . . \$23.95 FOB



## FURNACE DUCT BLOWER

New built-in motor turbine type blower. Ideal for improving heating ability of old type furnaces. Force air thru long ducts. Equally good for air conditioning, etc.  
● Complete with 115-v 60-cp. integrally mt'd. motor. 725 cfm. Size 8"x9 1/2" outlet. Overall size 13"x11"x12". List \$40.75.  
SALE . . . \$24.95 FOB

## STORAGE BATTERY WINCH

Powerful fully reversible, ball-bearing gear reduction winch. 1000-2000 lb. pull. Use on 6 or 12-v battery. Holds 40' of 1/4" cable. For trucks, docks, boats.  
Govt. cost \$280. \$46.75 FOB



## ARMY BLOWER-DRYER-HEATER

Marvelous new condition engine driven high-capacity (100,000 BTU) heater-blower. Burns gasoline—tremendous output heated air.  
● Wonderful for drying farm grains, heating warehouses, contractors, etc., starting freeze-up equipment, etc. Complete with long flexible heat ducts. Size 30"x48"x34". Wt. 108 lbs. Govt. cost \$525.  
SALE . . . \$92.70 FOB

## HYDRAULIC SPEED REDUCER

Variable hydraulic speed reducer. Any speed from 0 to 750 rpm by simply throwing a lever. Handle up to 1 1/2 h.p. Use for midsize cars, shop hand saws, etc.  
Govt. cost \$400. SPECIAL . . . \$47.81 FOB



## GEAR REDUCTION POWER-HOUSE MOTOR

Runs on 6 or 12-v battery  
● Remarkable Govt. gear reduction motor. Extremely powerful. Fully reversible. Gear ratio 100-1. Output speed 50 rpm at 6.0 volts, 100 rpm at 12.0 volts. Unit will also run on AC through transformer.  
● Ideal for winches, factory personnel cars, boys and invalids cars, homemade lift trucks, truck tail-gate loaders, etc.  
● Gears are finest precision all ball bearing. Full instructions for use.  
Govt. cost \$365. SALE . . . \$19.72 FOB

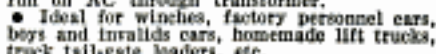

## EXPERIMENTAL RAY TUBE

Spectacular brand new Govt. fascinating educational Cathode Ray tube. Amazing experiments. Uses AC voltage. Makes ultra sensitive detector. Lissajous' experiments, etc. Brilliant green fluorescent screen. Special 905 laboratory type.  
● Booklet on Cathode Ray tube theory and experiments plus instructions for building home experimental oscilloscope with each tube. Wonderful Govt. cost \$52.50.  
SALE . . . \$4.91 Ppd. in USA.



## AIR COMPRESSOR BARGAINS

For painting, cleaning, tires, control terminals. Assemble your own outfit. Lowest prices in U.S.  
● DeLuxe Kit. Compressor, tank, gauge, regulator, paint gun, fittings. How to build instructions. List \$52. SALE \$39.49 FOB.  
● Compressor 1-cyl. \$19.95; 2-cyl. \$49.95; Govt. Air Tank, \$8.79; Regulators, \$3.95; Pop Gun \$1.95; Pres. Gauge \$1.89. Finest paint gun \$11.95. Auto switch \$4.75. All prepaid.



## OTHER OUTSTANDING SURPLUS BUYS

Many buys—power plants, hydraulic pumps and cylinders, hose, plastic pipe, electronics.  
● Step-By-Step Automatic Switch \$13.71 Ppd.  
● 560 Govt. Centrifugal 1 1/2" Pump \$4.61 Ppd.  
● Burglar-Fire Alarm System . . . \$3.95 Ppd.  
● Finest Plastic Water Pipe, per ft. . . \$2.00 Ppd.  
● Boat and Truck Hand Winch . . . \$4.95 Ppd.  
● Govt. Jungle Hammock-Tent . . . \$6.95 Ppd.  
● Hand Crank Fish-Worm Shocker . . . \$3.89 Ppd.  
● 12-v DC Bilge Pump, boats, etc. . . \$9.95 Ppd.  
● 240 Air Powered Tree Pruner, 10" \$8.99 FOB  
● 1500-w DC-AC (300 cy.) Generator 13.91 FOB  
● Magneto Oak Case Telephone . . . \$8.97 FOB  
● Step-Up Trans. 1 KW 115 to 230-v 16.35 Ppd  
● 3000-w G.E. DC 115-v Generator 49.50 FOB

## SPECIAL OF THE MONTH!

### 2500-WATT 60-C AC PLANT

#### CONTRACTOR-FARMER MODEL

FACTORY OVERSTOCK!  
39 brand new leading make portable and emergency use 115/230-v sing. ph. 60-c 2500-w plants. These are the DeLuxe model #1. Powerful rugged with Briggs model 23 engine driving an all ball bearing self-regulating generator. No extra equipment required. Will supply correct voltage from zero to full wattage output to any 2-wire or 3-wire 115/230-v system.  
● Ideal for farm or city homes when power lines fail. Extensive outages often occur during winter.  
● Excellent for camping trips, operating portable tools such as drills, saws, chain saws, etc.  
● We guarantee it a super-buy offered at less than normal dealer cost.  
List \$425. SALE . . . \$239.50 FOB.



## DIAL TELEPHONE

Modern hi-efficiency attractive dial phone. Use for extension to main line on private system. Use several for complete private system, etc. Complete with ringer, dial, etc. Govt. cost \$25.50.  
SALE . . . \$9.95 Ppd.



## HYDRAULIC EQUIPMENT BARGAINS

● Agricultural Cylinder (6 1/2" stroke) \$14.95  
● Control Valve for DA Cycle . . . \$2.95  
● Pump, 1000 lb. 12 gpm 400 rpm . . . \$5.50  
● Cylinder, 2" bore 10" stroke . . . \$17.95  
● Pressure Gauges, 1000, 1500 or 3000 lb. (Prepaid) . . . \$4.49

## CONTRACTOR—BUILDER—FARMER LEVEL

Precision quality level by leading mfg. Excellent for setting foundations, grading, farm contouring, surveying, etc. Powerful optically true telescope, finely graduated azimuth scale, sensitive level adjustment, polished oak tripod, 8 1/2 ft. 3-section rod, fine case, instructions, etc. A wonderful buy.  
SALE . . . \$42.95 Ppd.



ORDER FROM AD or write for big new WINTER CATALOG 1000s of itemat Motors, sporting goods, hand-electric tools, watches, etc. We pay freight on many items.

## BURDEN SALES COMPANY

814 West 140th St., LINCOLN, NEBRASKA

# FREE AMAZING NEW BOOK "HOW TO ANSWER ADS"



Never before have you seen anything like this. Tells you in simple language the correct way to answer ads. Gets you quicker replies—better results, and greater satisfaction. Will save you time and money and it's ABSOLUTELY FREE. No obligation whatever. Every reader of advertising should have this booklet. Send a postcard for your copy NOW. P. W. JOHNSON, Popular Mechanics Magazine, Room 600-A, 204 East Ontario Street, Chicago 11, Ill.



## Get New 132 Page Catalog of WOOD AND WOODWORKING MATERIALS

WORLD'S LARGEST SELECTION—Lowest Prices  
Your buying guide for finest kiln dried domestic and rare imported woods, inlays, bandings, matched plywood, mouldings, ornaments, etc. Biggest selection of tools and hand-to-find hardware. Packed with zero-3 saw patterns, projects, wood facts and money-making ideas. Enclose 25c (refunded on first order) to help pay mailing and handling costs. Write today to CRAFTSMAN WOOD SERVICE COMPANY 2729 S. Mary Street, Dept. A12, Chicago 8, Ill.



The Table Turns! The Blade Turns! The Blade Travels! . . . and every last motion is made beneath the working surface of the revolutionary new HORTON UNDERBENCH CUT-OFF SAW!  
You've never seen a saw like this before! Works on patented Quick-Set Turntable principle . . . provides the ultimate in speed, safety, versatility. Performs like a portable, radial and hand-saw combined. Positions instantly cuts off at any needed angle (including compounds); changes rapidly from cut-off to rip. All in a matter of seconds! Whether your goal is greater craftsmanship, efficiency, or profit . . . send at once for FREE ILLUSTRATED BROCHURE on this amazing saw! HORTON MANUFACTURING CO., INC., P.O. Box 747-P, Goldthwaite, Texas.

# MONEY MEN ALL FREE

THE PLASTEX Industry needs manufacturers on small scale and for big production of Lamp and Clock Stands, Art Goods and Novelties in Plastic and Marble imitation. Experience unnecessary. The material makes regular 10c store sellers. Rubber moulds furnished for speed production. Small investment brings good returns. We are now placing big Chain Store Orders with manufacturers. Ambitious men have chance for real prosperity. Our Free booklet will interest and benefit you.

PLASTEX INDUSTRIES, Dept. A  
3400 Third Ave. New York 16, N. Y.

## EXTRA VALUE



Value "plus" is built into every Gerstner Chest to guarantee long life and real service. Free Catalog to machinists and toolmakers.  
GERSTNER TOOL CHESTS  
457 Columbia St., Dayton 7, Ohio

## SAW SHARPENING IS EASY

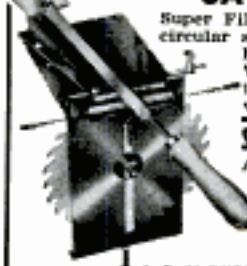

Super Filer No. 11 joints and sharpens hand and circular saws 6" to 10" with all teeth correct in height, depth, pitch, bevel. When file hits steel roller, \$9.95 PPD. teeth are finished. Saw runs true with no side pull. Includes 8" file.

## SUPER SAW FILER No. 6—\$6.50 ppd.

Automatically controls depth, angle, pitch for all saws. Precision made and calibrated. Use in any vise or clamp. Includes file.

FREE CATALOG — Dept. A-127

A. D. McBURNEY, 5908 Hollywood Blvd., Hollywood 28, Cal.



MOST APPRECIATED

*gift* FOR THE



Engineer  
Draftsman  
Architect  
Teacher  
Student

# VEMCO

## DRAWING INSTRUMENTS

Wherever mechanical drawing is used, professionals and students recognize the quality of VEMCO drawing instruments. Complete sets in beautiful California saddle leather cases, from \$18.45. Individual instruments also available, from \$2.95.



See them at leading  
blue printers, stationers,  
and drafting  
equipment dealers

DRAFTING EQUIPMENT  
OF QUALITY

V. & E. MANUFACTURING CO. PASADENA, CALIFORNIA



### *'Tugit'* GETS YOU GOING AGAIN!

When snow or mud imprisons your car, 'Tugit' gets it out fast! This powerful lever-operated hoist works smoothly at any angle. A 40 lb. pull on the handle lifts or shifts a ton! Compact 'Tugit' operates where a standard hoist would be too big. You get action when the handle end moves only 3 1/2". In placing a heavy part in a tight spot, you can move the load 3/32" at a time. A finger-tip control makes it simple to change from "up" to "down" or into "free wheeling." 'Tugit' Makes 1,000's of Jobs Easy. Get a 1 or 2-ton 'Tugit' for your tool box, car trunk or truck. Small size weighs only 16 1/2 lbs. In building a home or fence, fixing a tractor or clearing a woodlot, portable 'Tugit' saves time, trouble, expense, \$63.50 up. See your Shaw-Box Distributor or write us for Bulletin 388.

- Hauls rocks, logs
- Tightens guy wires
- Moves wreckage
- Positions parts
- Lifts boats, motors
- Shifts machinery
- Squares frames
- Spots trailers
- Hoists tanks, vats
- Pulls out posts
- Handles pipe, concrete slabs



57B-3

**MANNING, MAXWELL & MOORE, INC.**  
SHAW-BOX CRANE & HOIST DIVISION  
354 W. BROADWAY MUSKEGON, MICHIGAN



Comfortable cow! Temperature regulator is the first ever devised specifically for comfort of dairy herds

## Honeywell's House of Magic

*(Continued from page 105)*

object. The screen shows its depth, distance, course, size and speed.

The U. S. Steel Corporation complained that when temperature-measuring instruments were placed inside open-hearth furnaces, they melted in the 3000-degree F. heat. Honeywell's industrial-instrumentation engineers came up with a gadget that looks through a window into the furnace, studies the intensity of the light inside and instantly translates it into temperature.

For the harried dairyman, Honeywell has developed an electronic process which not only increases butter production by 50 percent, but also gets more butter out of less cream, makes it taste better and stay fresh longer, and at reduced cost. Similar robots keep sharp electronic reflexes at work in bakeries and bubble-gum plants, monitoring ingredients for quality, precisely timing mixing processes, measuring consistencies, and baking and cooking.

Dr. James A. Oliver, curator of reptiles at the Bronx Zoo in New York, complained that when people visited the Zoo, many of his snakes slithered behind rocks, and his alligators and crocodiles submerged in their ponds. Honeywell engineers learned from Dr. Oliver exactly which temperature each reptile preferred most. Now rattlers bask in an 80-degree temperature over radiant-heating panels in the front of their cages, cobras glide contentedly in an

*(Continued to page 258)*



**NOW CUT  
HOLES & DISCS  
IN SECONDS!**

**SLUG  
BEING  
EJECTED**



**"ARCO HOLE-SAW"  
with New Automatic "SLUG-EJECTOR"**

Fits any Electric Drill, Lathe, Drill Press, Motor

Exclusive "Slug-Ejector" pops out discs immediately—therefore works 3-times faster than other hole saws selling for twice as much. 4-shatterproof blades easily exchanged to cut 1" 1 1/2", 2" & 2 1/2" holes thru any 3/4" stock.

Safety-lock prevents blades from "jumping out." . . . **\$5.95**

No. 650 HOLE-SAW as above but with 7 blades to cut 1" 1 1/4", 1 1/2", 1 3/4", 2", 2 1/4" & 2 1/2" holes. . . . **\$7.95**

At your dealer or order direct on our 20-DAY MONEY BACK GUARANTEE. Send check, M.O. (ppd), COD + post.

**ARROW METAL PRODUCTS CO.**

Dept. PM-12, 421 West 203rd St., New York 34, N. Y.



**GENUINE ALNICO  
MAGNETS**

**AMAZING, PERMANENT, NON-ELECTRIC, HIGHLY PRACTICAL.** Conduct interesting experiments. Hundreds of uses. Retrieve valuable steel items such as guns, tackle from fresh or salt water; tools from tanks & drains. **GUARANTEED.** Try any magnet one week. Money back if you are not well-pleased.

No. M-710 (Wt. 53 oz.) Has pull of 225 lbs. on steel block. . . \$16.50  
No. M-625 (Wt. 70 oz.) Has pull of 125 lbs. on steel block. . . \$9.50  
No. M-575 (Wt. 18 oz.) Has pull of 75 lbs. on steel block. . . \$6.50  
No. M-500 (Wt. 15 oz.) Has pull of 50 lbs. on steel block. . . \$4.50  
No. M-598 24" Wall Type Tool and Knife Holder, Complete. . . \$5.95  
No. M-325 12" Wall Type Tool and Knife Holder, Complete. . . \$3.25  
No. M-300 Kit of Flat Bars 5 Pairs (10 Magnets). . . \$3.00  
No. M-250 Kit of Round Rods 5 Pairs (10 Magnets). . . \$2.50  
No. M-47 Hot Pad Magnets, 10 for \$1.00. . . \$1.00  
No. M-35 Hobbyist assortment of 8 small magnets. . . \$1.50

Send M.O. or check. We pay postage. Sorry no C.O.D.'s.  
**MIAMI MAGNET COMPANY, 3240 N.W. 27th Ave., Miami 42, Fla.**



**NEW, IMPROVED CALCULATOR  
FOR WOODWORKERS only 25c**

Instantly gives information on lumber, nails, concrete mixes, painting materials, etc. Convenient, simple to read. Just set dial for nail specifications, to convert linear to board feet, find bit sizes for screws, compare characteristics of woods. 6" diameter heavily varnished cardboard. Send 25c, no stamps, please to Greenlee Tool Co., 2112 Columbia Avenue, Rockford, Illinois.

**\$40 for 1 1/2 DAY'S SPARE TIME WORK  
GRINDING LAWMOWERS**

Yes, J. H. B. writes, "not bad for a 76 year old young fellow earning \$40 for a day and a half's work" . . . and others are making even bigger money with the Universal Model B Lawnmower Grinder. You, too can make good spare or full time profits in your own business in your garage or basement. We furnish everything you need. Write today. No cost or obligation. Dept. M-127

**ROGERS  
MANUFACTURING CO.  
LINDSEY, OHIO**



**EARN  
MORE**

with one of these "simplified"  
**arc welders**

**EASY TO USE!  
EASY TO BUY!  
EASY TO CASH IN  
ON THE BIG DEMAND  
FOR WELDING WORK!**

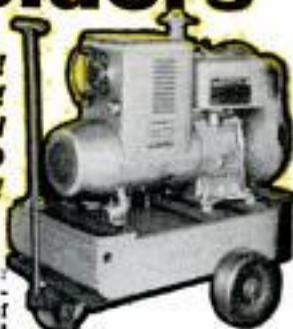

**1 "Husky Boy"**



**2 AC Transformer**



**3 "Bantam Champ"**

You can put more money in your pocket—get into your own profitable business with any one of these highly efficient low cost welders.

**"HUSKY BOY."** 200 amp. "HUSKY BOY" air cooled welds anywhere. It's light, rugged, compact—easily mounts on your tractor or trailer for traveling to emergency repair jobs. Portable mountings for shop use are available.

**AC TRANSFORMER.** 295 amp. AC Welder for operating on single phase 220 volt power. Just right for production and repair work in shops. A welder that quickly pays for itself out of extra earnings.

**"BANTAM CHAMP."** A 250 amp. motor generator arc welder specially designed to let you do profitable repair work in your own shop or production welding.

**HOBART TRADE SCHOOL.** Get the details on how you can quickly learn arc welding by actual on-the-job experience. Full or partial courses. Non-profit school, low tuition.

**LESSONS BOOK.** 200 pages fully illustrated, complete with charts and diagrams. Self teaching. \$1.00.

**HOBART BROS. CO., BOX M-127  
Phone FE 2-1223 TROY, OHIO**

"One of the world's largest builders of arc welding equipment"

**Build Your Own!**

. . . portable gas drive welder save \$200 to \$300



Simply connect this Hobart generator only to a good used auto engine. Gives you all the advantages of a factory-built welder. Ask for FREE build your own book.



**HOBART BROTHERS CO., BOX M-127, TROY, OHIO**  
Send additional information on items checked:

1. Husky Boy       4. Build Your Own  
 2. AC Transformer       5. Hobart Trade School  
 3. BANTAM CHAMP  
 Enclosed is \$1.00 for Welding Lessons Book.

Name \_\_\_\_\_  
Address \_\_\_\_\_  
City \_\_\_\_\_ State \_\_\_\_\_



# Two pumps in one!



... THE  
**CARTER**  
**POWER CENTER**  
**FUEL AND VACUUM PUMP**

This versatile CARTER combination fuel pump provides continuous vacuum for your windshield wipers—at any speed or on acceleration.

You also have the high capacity of the CARTER fuel pump and the high-efficiency of the CARTER ceramic fuel filter... all built into one compact unit. It's easy and economical to install. See your CARTER dealer, or ask your serviceman.

**CARTER CARBURETOR**  
DIVISION OF **ACF** INDUSTRIES  
INCORPORATED  
ST. LOUIS 7, MISSOURI

exposed 85-degree area, and alligators and crocodiles now find the concrete around their pools more satisfactory than the temperature of the water.

In the dry-cleaning business, the trick is to know exactly when and how much water should be added to the dry-cleaning solvent to prevent shrinkage and undue



This is the first electronic automatic pilot designed for American precision bombers in World War II

weakening of the fabric. Honeywell put a tiny, specially treated plastic square embossed with a gold-leaf sensing element in an enclosure connected to the dry-cleaner washer. The device—so sensitive to humidity that it can detect the presence of a teaspoonful of water in an average-size room—constantly measures and regulates the amount of water coming into the washer. Over 1000 dry-cleaning plants have put this system to work. The same kind of device keeps humidity in hospital surgical rooms almost at the saturation point, to help prevent sparks from static electricity from setting off explosions of anesthetic gases.

Company President Paul B. Wishart likes to keep raising the sights of his men. Recently he asked several of his key scientists to set forth in memos what they thought life would be like in A.D. 2000. Here are some of their answers—not "blue-sky stuff," I am told, but rather conservative predictions from highly regarded members of a conservative profession.

• Machines will diagnose and, in many cases, treat human illness. Since sickness usually produces chemical changes in the body before severe onset, frequent, periodic checkups by

(Continued to page 260)



## MODERN IMPROVED LAWN MOWER SHARPENER AND BED KNIFE GRINDER

Sharpen any mower in 10 to 20 minutes. Hand—Power—Reel or Rotary. Modern is actually two machines in one, a Precision Bed Knife Sharpener and a Precision Reel Sharpener. Extra Bed Knife Grinder is Absolutely Unnecessary. New Mower Support makes it possible to sharpen reel without removing bed knife. The fastest precision lawn mower sharpener on the market. Costs Less. Compare Modern's Many Exclusive Features Before Buying. Send for Free Brochure No. 10 SN



**MODERN MANUFACTURING CO.**  
160 North Fair Oaks Ave., Pasadena, California

## QUALITY FASTENERS COST NO MORE

Low-cost, high-quality Southern fasteners give your project Quality and Permanence! Buy 'em by the box—and save!

Wood Screws • Tapping Screws • Machine Screws • Drive Screws • Dowel Screws • Stove Bolts • Hanger Bolts • Carriage Bolts



**3 PASS SPORT CAR**  
Ideal 2nd Car or Sportabout.  
Fully Equipped.  
Write For Literature.

## ESHELMAN TRACTORS

LOW AS \$99

Plows-Cultivates-Saws  
Cuts-Dozer-Harrow  
Hauls-Snow Plow-  
Rolls. Eshelman Tractors, Tillers, Riding Rotary Mowers for Better Lawns and Gardens. Advertised in GOOD HOUSEKEEPING. Thousands of satisfied users. Write for Free Literature. Dept. 300, ESHELMAN, Balto. 2, Md. \$519.75



Shipping Points: BALTIMORE - CHICAGO - DENVER

## DRAINS cellars, cisterns, wash tubs; \$7.95 IRRIGATES - CIRCULATES - SPRAYS

Up to 3,000 GPH; 450 GPH 80" high; or 1800 GPH from 2 1/2" well. Use 1/2 to 3/4 HP motor. Coupling included free. 1" inlet; 3/4" outlet. Stainless steel shaft. Won't rust or clog. Type P—\$7.95. **CELLAR DRAINER KITS (less motor)**  
"Low Boy"—15" high, 1500 GPH. \$12.95  
"High Boy"—32" high, 3,000 GPH. \$15.95  
Postpaid if cash with order. **MONEY BACK GUARANTEE**  
LABAWCO PUMPS, Belle Mead 7A, N. J.



## NOW You Can DRILL, SAW, REAM, CUT ALL WITH ONE BIT!

Beaver's new improved Hi-Speed side cutting drill bit can be used on any electric drill, drill press, lathe, etc. Made from the finest American hi-speed steel. 3 1/2" long, 2" side cutting section, 1/4" diameter. Designed to cut steel, wood, plastic, aluminum, etc. **MONEY** back guaranteed. Specify types desired. All Purpose, Wood and Heavy Metal. **BUY** From Your Dealer or send check or money order today. Dealer & jobber inquiries invited. Ideal Gift. **BEAVER DRILL & TOOL CO., 3008 J McGee Trafficway, Kansas City, Mo.**



**BEAVER HI-SPEED-SAW DRILL BITS**  
**ONLY \$2.45 each 3 for \$7.00**

## RUGGED P & C PUNCHES & CHISELS make tough jobs easy...



There's no substitute for quality when it comes to punches and chisels. That's why smart men buy P&C. Hot forged from special analysis alloy steel scientifically tempered. Precision ground points and cutting edges... backed by famous P&C guarantee of quality.



Buy your tools from colorful P&C Tool Merchandisers in more than 12,000 stores coast to coast. Send 10c for catalog.

## P & C TOOL COMPANY

Box 5926, Portland 22, Oregon  
Chicago Warehouse: Schiller Park, Ill.  
Subsidiary of Pendleton Tool Industries, Inc.

## READY CUT HOMES

\$2150 AND UP DIRECT FROM MILL

**YOU SAVE** the items which help make today's building cost expensive: high labor cost, contractor's profit and overhead, insurance, architect's fees. Cut-to-Fit eliminates usual lumber and material waste, also costly mistakes. Anyone can assemble. Simple, easy-to-follow plans furnished and each part numbered. Complete with all lumber, roofing, nails, glass, hardware, paint, doors, windows. Freight paid. Low-cost building plans sold separately if desired. 57 Homes and Floor Plans.



5 EASY PAY PLANS  
COLOR CATALOG

Send 25c for *Starting Homes*

**INTERNATIONAL MILL & TIMBER CO.**  
Dept. PM-127 Bay City, Mich.



## A CHRISTMAS GIFT FOR LIFETIME ENJOYMENT WELD IT YOURSELF IN A JIFFY!

Weld, Cut, Brase, Solder! Iron, Steel, Brass, Bronze, Aluminum and other metals safely and easily. Make your wrought iron furniture, porch railings, fences, knick-knacks and other metal specialties. With this fine equipment anyone can do professional-like work with little practice. Tool and equipment breakdowns are annoying and costly. Don't let them bother you. The Dynamic will pay for itself quickly in both time and money and is designed to operate from any properly wired 110 volt AC line.

Order your Dynamic Industrial type transformer Arc Welder for Workshop or Industrial use today. Order from this ad. Literature on larger equipment available on request.

**DYNAMIC WELDER COMPANY, 1808 S. Federal Street, Dept. D2-N, Chicago 16, Illinois**

**EASY PAY PLAN**  
Low down-payment. Pay as you weld. Money back guarantee. Send for details. Complete outfit.  
**Only \$38.50**  
F.O.B. Factory



## The luckiest men in town get



### TOOLS

for Christmas!

To be sure you're lucky just call her attention to this ad. You might also point out that the whole family will benefit. Those long delayed repairs . . . suddenly, they'll be done. And that big project, the new fence, the new room, or the bookcase . . . suddenly it's done too, and everyone's so proud of you and Sioux.

**ALBERTSON & CO., INC.**  
SIOUX CITY, IOWA, U.S.A.

WRITE FOR CATALOG

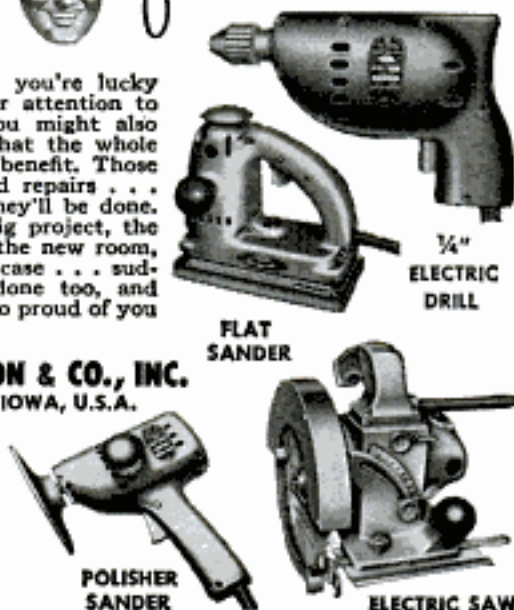

1/4" ELECTRIC DRILL

FLAT SANDER

POLISHER SANDER

ELECTRIC SAW

Make this Christmas a **SAFE** Holiday with.

# Lenk

INSTANT FIRE EXTINGUISHER



only \$1.89

- Pressurized Spray for Instant Action
- Full 16 oz. Capacity
- Wall bracket included
- Can be used many times over

Available at Hardware Counters Everywhere

**THE LENK MFG. CO.**  
FRANKLIN, KENTUCKY

these machines will make possible the prevention of most diseases.

- Our comfort environment will be so well controlled that we will be able to keep the atmosphere at the ideal level for the happiest, most energetic, productive life.

- Houses will be kept so clean by electronic dust and dirt traps that housecleaning will never be necessary. Dining-room tables will quietly swallow dishes after a meal and transfer them to a dishwasher which will clean the dishes, dispose of garbage, stack and store eating utensils until the next mealtime.

- Roads and streets will be replaced by a network of pneumatic tubes. Family vehicles will need only a small amount of mobile power, since they will only have to get from the owner's home to a nearby tube. Then they will be pneumatically powered to any desired destination. Pneumatic pockets will completely eliminate the possibility of crashes.

- Recreation will be the world's biggest industry. Football stadiums, baseball parks and race tracks will be heated or cooled for maximum spectator comfort in any climate. The work week will be about 20 hours long, but work as we now know it will no longer exist—it will be more of a social philosophy.

- Contents of the world's greatest libraries and schools will be available to anyone over special television services. From an armchair, it will be possible to call for any information by coded request.

- Ways will be found to transmit information to the brain in such a way that loss of sight and hearing will not restrict one's activities in any way. And the senses of people with normally good vision and hearing will be strengthened; for instance, it will be possible to see in total darkness.

If these possibilities stagger the imagination, consider the case of Sanford Shaleen, a young Honeywell engineer, who four years ago came out of a bout with bulbar polio completely paralyzed from his neck to his ankles. His career seemed ended until his Honeywell colleagues devised a way to put his brain, still as strong as ever, to valuable use for the company.

They arrived at his bedside with a pulpit-like stand, put a dictating machine next to it and a microphone close to his head. Then they brought in piles of engineering reports. Shaleen's job they explained, would be to read the reports and dictate short, sharp condensations into the machine.

Shaleen brightened, but said it didn't seem practical—someone would have to stay with him and turn each page as he finished reading it. The engineers placed a report on the stand and told him to get busy—pages would turn automatically when he turned his head in the desired direction!

How far will automation go? "In 10 or 15 years," says president Wishart, "industry will be using entirely different types of controls from those in use today. They will be more sophisticated. They will control whole processes, not just isolated production operations." ★ ★ ★



## General SALE

### BUILD WELDER OR LIGHT PLANT

Instruc. incl. TYPES AMPS VOLTS PRICE  
 G.E. 300 amp. 24V New \$17.50 Used \$12.95  
 R-1 J. & Heints. G.E. or Ford 300 24 \$24.50  
 G.I. 100-250 amp. 24V. New \$15.50 used \$9.95

V-BELT PULLEY KIT. Fits R-1, P-1, G-1 & AC-DC generators. Has 2 bearing blocks with high speed bearings, three groove V-pulley. Dr. shaft 8" long & flex coupling \$17.50

AC-DC WELDER KIT New G.E. #811  
 Generator. Makes A.C. Light Plant & D.C. battery charger. Rated 1250 Watts, 115V. A.C. & 300 Amps. 30V D.C. including 1 Volt. regulator, 1 reverse C. relay, 1 Solenoid idling device, 1 electrode holder, 1 toggle switch, 1 helmet, 1 rheostat and instructions \$38.50. AC-DC generator if bought separate \$24.50.  
 Kit as above with R-1 J. & Heints or G.E. 300 amp. gen. \$38.50. Kit with 100-250 amp. gen. \$26.50. S. Kit with New G.E. 200 amp. Gen. \$34.50.

New Reactor Coil Air Stabilizer heavy duty for R-1, P-1, G-1, or AC-DC generators. Wound with #4 copper wire. Approx. 7" x 5" x 4" & mounting bracket. Wt. 11 lbs. #RC700 \$10.95 P.O.B. K.C. Mo.

### WATER PUMP WITH MOTOR

1/4 H.P. 2 1/2 V.  
 D.C. runs on 6 or 12 V. D.C. Adj. press. ports, 200 GPH \$12.95, 400 GPH \$14.95. 500 G.P.H. 1/4 H.P. 2 1/2" ports \$17.50

### UTILITY TOOL KIT

Runs on 6-12-24 Volts D.C. Consists of 5 Amp. geared motor, 2 handles, 3 jaw chuck takes up to 3/4" drill, switch, flexible shaft appr. 30" L. & M. Shaft arbor \$10.95.

### NEW HYDRAULIC POWER KIT

Your complete hydraulic system. Consists of Pesco gear driven pump, 380 G.P.H. 1000 P.S.I. with 3/8" HP. DC motor 2300 R.P.M., relief valve, unloading valve, filter, Bendix 5" accumulator, reservoir & pressure gauge to 2000 P.S.I. and all necessary hose and fittings. Complete Kit \$39.50. Same Kit minus motor, Complete \$32.50.

### HYD. PUMP BARGAINS

MFG. TYPE	R.P.M.	G.P.H.	Price
Pesco Gear	1500	198	\$12.95
Pesco Gear	4300	380	\$14.50
Pesco Gear	.447 cu. in.	370	\$18.50
Strabpower	450 cu. in.	1750	\$17.50
Vickers	400 G.P.H.	518.50	875 G.P.H. \$16.50

### NEW HYDRAULIC CYLINDERS

Air or Oil	Bore	Stroke	Shaft	D. Action	Price
#11	1 1/4"	4"	3/8"	1/2"	\$6.95
#12	2 1/4"	4"	3/8"	1/2"	\$6.50
#17	4 1/4"	10 3/4"	1-3/16"	1-3/16"	\$17.50
#11	3 1/4"	2 1/4"	1 1/4"	1 1/4"	\$22.50
#111	3"	2 1/4"	1-3/16"	1-3/16"	\$28.50

### NEW HYDRAULIC SYSTEM KIT

#400 K. Heavy duty Power Driven. Rated 14,000 lbs. lift. Consists of 2 D.A. hyd. cylinders, 3" bore x 2 1/2" stroke, each rated 7000 lbs. with 1000 P.S.I., 1 four way hyd. control valve with built in relief #821, 1 Vickers hyd. pump, 400 G.P.H., 1500 P.S.I., 3750 RPM, 1 hyd. 2 gal. reservoir, 1 Purulator hyd. filter, 1 gauge 0-2000 P.S.I. all hose & fittings. Value \$184.10, save \$90.00. Kit price \$94.10. Kit with two #511 cyl. \$79.95.

New Four Way Hyd. control valve for 1 to 4 D.A. cylinder with adj. relief and adj. metering. #4" ports. #821. 2000 P.S.I. \$14.50.

New 1/4 H.P. 7500 R.P.M. D.C. 9 Amps. Electric Actuator. Adj. travel 850 lbs.; either direction; tension load 2800 lbs. 2800 lbs. \$8.95; 2 \$15.90

**GENERAL SALVAGE CO. CHECK OR M.O.**  
 2922 E. 27 St., Dept. 82, Kansas City 27, Mo.

Works in seconds!



## Loosens Rusted Bolts nuts, screws, "frozen" parts!

# LIQUID WRENCH

The super-penetrating rust solvent that quickly loosens rust and corrosion.

AT HARDWARE STORES, GARAGES SERVICE STATIONS, EVERYWHERE

**RADIATOR SPECIALTY CO.**  
Charlotte, N. C.

3 oz. CAN 30c

## Jiffy SAWHORSE BRACKETS

NO NAILS NO SCREWS NO BOLTS

Now a sawhorse in a jiffy! Just use Jiffy Brackets and 2x4s. Sold by hdw. and bldg. supply stores everywhere, or order direct. \$1.95 A pair. Higher W. Coast

**GRAND HAVEN STAMPED PRODUCTS CO.**  
Grand Haven, Mich.

## How to MAKE MONEY with Simple CARTOONS

A book everyone who likes to draw should have. It is free; no obligation. Simply address

**FREE BOOK**

**CARTOONISTS' EXCHANGE**  
Dept. 912-A Pleasant Hill, Ohio

## Sharpen ALL CIRCULAR SAWS THE QUICK-WAY

Model PG-12 Complete No extras to buy. \$19.95 Postage Paid



Sharpens joints, gums and rebaths all cross-cut, rip, standard and master combinations, miter, planer and radial saw blades to 12" diameter. Precision sharpening guaranteed by special Index Dials. New safety guide prevents tilting or gouging. Mounting block and special \$3.00 grinding wheel furnished. Fits bench, table and radial swing saws.

Thousands of satisfied users. Featured in leading publications. Order today. Send check, cash or money order. We pay postage in U.S.A. Free Booklet "How to Sharpen Circular Saws."

**QUICK-WAY SAW CO.**  
136 Tompkins Street Cortland, N.Y.

## ONLY Estwing GIVES YOU A CHOICE OF UNBREAKABLE HAMMERS

Made and Guaranteed by Estwing

INVENTORS AND ONLY SPECIALISTS IN UNBREAKABLE HAMMERS AND HATCHETS



**NEOPRENE GRIP**  
16 oz.  
Tubular Steel Handle



**LEATHER GRIP**  
16 oz.  
One-Piece Head and Handle

**AT LEADING HARDWARE DEALERS**

ESTWING MFG. CO., DEPT. PM-8, ROCKFORD, ILL.

## COMBO. BENCH-ROTARY and CHAIN SAW

### CUTS UP TO A FULL 9 INCHES

Chain Saw cuts 4x4's, 8x8's, logs, fence posts, etc. Also ideal for pruning trees, clearing brush, cutting firewood and rough hewing. When used as a rotary saw it will cut a full 2-1/8" - it will rip, mitre, notch and handle all standard cuts. The rotary saw has a 6-1/4" comb, blade, 1/2" Square arbor. The automatic clutch ends "kickback" and helps eliminate motor "burn-out". Blades can be changed in minutes. Has powerful Universal AC-DC, 115V motor. Chain saw speed 2500 ft. per/min. Power saw speed is 4700 RPM. Wt. 13 lbs

**NOW \$59.95**

with 10ft., 3-wire rubber cord.

### 10" LOG-LOG SLIDE RULE

Professional Log-Log, Decimal Trig Slide Rule. Non-warping top quality bamboo - 2-color scales on white nitrate facing. Scales are L, LL1, DF, CF, CIF, C1, C, D, LL3 & LL2 on one side. Other side LLO, LLOO, A, B, X, CI, C, D, S, ST & T. With SPECIAL cursor and 16 pg. book. 1095

### NEW PAL-MASTER SCOPES

**YOUR CHOICE OF 2 1/2" - 4 or 6X**  
 Windage & Elevation Adjustments - Optical Glass, Hard Coated Lenses - Angle Eye Relief - Cross-Hair Reticle - Lock Tight Focus - Rust-proof Steel Barrel - GUARANTEED to perform on any RIFLE. Specify type rifle and Model No. We will send proper mount.

**SCOPE & MOUNT \$9.95**

Send for 32 pg. FREE Optical Catalog section showing other scopes.

## SPEC. XMAS BARGAIN

FREE Full-Color Mallet packed with many spec. Xmas Bargains. Order mallet XM-85.

### WORLD'S MOST AMAZING CATALOG

NATIONALLY ADVERTISED MERCHANDISE - EXCITING IMPORTS - FACTORY CLOSEOUTS NEW and USED GOVT SURPLUS

From EVERYWHERE we bring you items of every description! Camping & Sports Goods, Fishing & Hunting Gear, Tees, Winter Clothing, Guns, Photo Supplies & Cameras, Binoculars, Telescopes, Hand & Power Tools, Do-It-Yourself Supplies, Building Materials, Hobby Kits.

Send 50c  
(for handling & mailing)

Your 50c will be refunded with your first order of \$1.00 or more.

TO ORDER: Send check, or M.O. 1/2 deposit with C.O.D.'s. Please P.O.B., Los Angeles, Calif.

**Palley's**  
2263 E. Vernon Avenue, Dept PM-32, Los Angeles 58, Calif.



**LOOK, MISTER!**

*No Hands*



**It's Self-Gripping**

**CHAN NEL LOCK**

**No. 410**

**HEAVY-DUTY PLIER**

How's this for gripping power? You won't know your own strength 'til you grab hold with this heavy-duty self-gripping plier. The Channellock No. 410 HEAVY-DUTY is actually a combination plier-wrench . . . and it will get into tight places you can't reach with a pipe wrench. A mighty handy, multi-purpose tool with four jaw adjustments up to 1-1/8".

ASK YOUR TOOL SUPPLIER FOR A  
CHANNELLOCK No. 410 HEAVY-DUTY PLIER

BE SURE IT'S  
A GENUINE  
CHANNELLOCK



LOOK FOR THE  
TRADEMARK  
ON THE HANDLE

**CHAMPION DeARMENT TOOL COMPANY**  
MEADVILLE, PENNSYLVANIA

same amount whether in the new car or the old car. The doctors did not attempt to pinpoint what made the drivers tired, except to hint that it may be due to the anxieties of driving. The new car, apparently as much as the old car, requires the constant attention of the driver in traffic situations. Although he may not have to work physically, he works mentally and perhaps this is why he is just as tired at the end of the day as the old-car driver.

When asked which car they preferred, the two drivers, of course, said the 1958 model. It is, as all agree, much more pleasant and comfortable to drive. It provides a warm, secure haven in which to cover the miles quickly and without anxiety. There is little reason for concern about tires, about engine failure, about not reaching the destination. And, as a result, it is more pleasant to drive. The driver feels that it is easier and less tiring, but apparently it is not, if the tests are reliable.

#### **Future Meaning**

What does all this mean to the automobile of the future? It certainly is not the final study on this subject. There will be, and should be, others. But it does provide evidence that the industry (De Soto Division, at least) senses that there is more to improving a car than merely eliminating physical effort.

As the test drivers themselves state, the only fault with the 1958 model was a tendency to monotony because so much of the work is done for them. With today's straight, stop-free toll roads and through ways, this is a problem that the industry must face. And, if De Soto is any example, the industry is beginning to face it.

More work should be done on monotony, the researchers feel. Some experts feel that monotony causes fatigue. Dr. Church of the De Soto test does not, he feels it is anxiety that tires the driver.

Perhaps there is something to be said for the old cars after all. At least, they did keep the driver occupied. He listened to the tires because he expected a flat at any moment, he listened to the engine because a rod might burn out, he listened for sounds of overheating.

Today's cars make it unnecessary to listen, to be concerned and, the test drivers feel, perhaps this is what leads to boredom and monotony. Whether monotony results in fatigue is a question yet unanswered.

In any case, the De Soto test opens a new field for study—a field that will interest all of us until that future day when we simply dial a destination on the dashboard and our car takes us there while we sleep. ★ ★ ★



## ELECTRIC MOTORS — POWER KITS MAKE EXCITING XMAS GIFTS

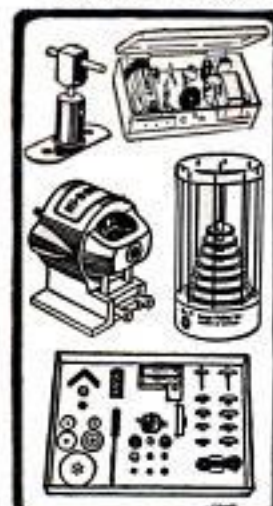

A gift of Wilson's battery-operated motors and power kits will keep the recipient happy and busy for months. Select from this list of exciting gifts for boys and hobbyists of all ages—and MAIL YOUR ORDER TODAY FOR FAST BEFORE XMAS DELIVERY.

- \*No. 8-100 Hi-Drive Motor, 3-6V. .... \$2.50
- No. 9-100 Same for 12V. .... \$3.00
- No. 3-100 Tiny Atom Motor, 1 1/2-3V. For higher voltage. .... \$2.50
- \*No. 3113N Tiny Atom motor assembly kit with many acc. .... \$3.50
- \*No. 14 Adjustable shaft supports kit. .... \$3.00
- \*No. 77 Set of 7 large pulleys, 6 shafts and 3 belts. .... \$3.00
- No. 3700 Large accessories kit. .... \$3.00
- \*No. 700 Super-Power kit with motor and all accessories. .... \$10.00
- No. 3000 Vari-speed gear unit. .... \$4.00
- No. 1049 Gear train with Hi-Drive motor No. 8-100. .... \$5.95
- Same with No. 9-100 Motor. .... \$6.45
- \*Item illustrated. Ask for FREE Cat.

All Wilson's motors have Permanent Alnico Magnets.

Remit with order and we pay postage in U.S.A. No C.O.D. Add 5% Sales Tax for delivery in Ohio. Write Dept. F2L.

For quick delivery see your local dealer — or order direct



**WILSON'S OF CLEVELAND**

425 Lakeside Ave., N.W. • Cleveland 13, Ohio

## IDEAL CHRISTMAS GIFT FOR ANY MAN

**WELD** **BRAZE**  
**SOLDER** **CUT**

Acclaimed by thousands of Homeowners, Mechanics and Hobbyists as the welder of 1001 uses. Easily operated from properly wired 110 volt. AC or DC line. The ideal gift with a life-long use....Order today on 10 day money back guarantee.

**FOUR-WAY WELDER CO., Dept. F2-N**  
1810 S. Federal St. • Chicago 16, Ill.



**4WAY**

ONLY **\$14.75**  
f.o.b. factory

**WELDER**

Complete with Twin Carbon Arc Torch and accessories... to handle all metal-craft work.

**64" FLEXIBLE SHAFT** ONLY **\$6.95**  
WOVEN WIRE CORE  
USE AS ELECTRIC DRILL

GOVT. SURPLUS — never used — limited quantity. REAL BARGAIN. Cannot be duplicated for less than \$15.00. Coupling fits 1/2" or 3/4" motor shaft (state which), spindle end fits standard chuck. Durable, heavy. Use it for grinding, polishing, buffing, drilling, etc.

Check for same only \$1.25. Send check or money order and we will ship P.P. prepaid or C.O.D. Plus Postage. Money refunded if not satisfied.

**L. C. DOWNEY CO. — Dept. M**  
8004 TRAYMORE AVE., PHILA. 18, PA.

## Automatic Saw Set...

**MAKE EXTRA PROFITS!**  
Set 400 teeth per minute on hand or band saws, 4 to 16 point, with the BeMaCo Automatic Saw Set. Fast, accurate, true hammer-anvil action sets teeth uniformly, eliminates tooth breakage. Used profitably by saw shops and manufacturers everywhere. Every machine positively guaranteed!  
Write for details—today!

**BEAVER MFG. CO.**  
PO Box 434  
800 1515 AVENUE • INGLEWOOD, CALIF.

Saw Machine Division 31-C

## LOOK! All New - All Precision - All Deluxe SUPERSHOP MODEL X

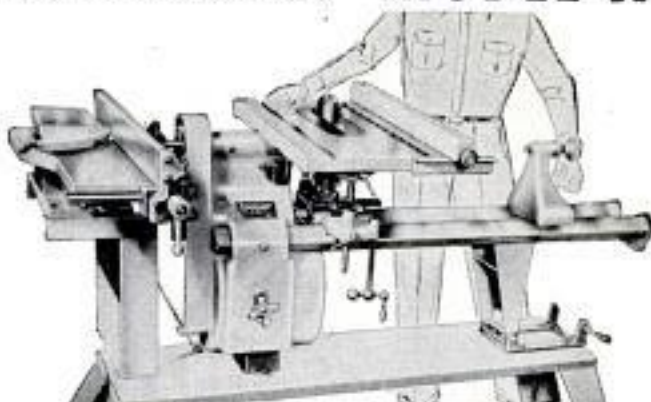

8" SAW

**WE PAY ALL  
FREIGHT FOR  
YOUR FREE  
HOME TRIAL**

**ONLY  
\$139.50  
EASY  
PAY  
PLAN**



Vert. Drill Press



Hor. Drill Press



8" Sander



30" Lathe



5" Grinder

Never before have you seen so much deluxe, precision-built power tool workshop at any price! Designed for the man who wants the best. Massive cast and precision-machined headstock, self-centering inverted "V" bedways (like precision metal lathes), exclusive non-friction speed changer, extra-large cast and precision-ground saw table. 100% ball bearing, lifetime-lubricated. You save by ordering direct from factory. You are invited to test Supershop Model X in your home FREE. Mail coupon or postcard for FREE brochures, photos, details, specifications, accessory list — and amazing freight prepaid FREE HOME TRIAL PLAN. All free.

**MAIL COUPON OR  
POSTCARD TODAY**

**POWER TOOLS, INC.** 102 Yates Avenue  
Beloit, Wisconsin

NAME \_\_\_\_\_  
ADDRESS \_\_\_\_\_  
CITY \_\_\_\_\_ STATE \_\_\_\_\_



## European Listening Post

(Continued from page 108)

may be because their cars are simple, more easily understood. They study cutaway models of engines and transmissions arduously. Even women seem interested.

At Frankfort, the tiny DKW 600 was the big hit. It is not yet in production and was displayed to test public reaction. The public reacted. Hundreds stood as if transfixed.

At Paris, the new Vespa 400 was just as big an attraction. No styling tricks here though, just a small elemental machine. The crowd was so big on Sunday you couldn't get within 50 feet of it. No design short of an atomic car would create that much interest in America.

Europe is in transition. People who now own scooters are moving up into baby cars. At Frankfort, one entire building was filled with baby cars of 600-cubic-centimeter displacement or less (about one tenth the size of the 1958 Ford V8 engine).

### American Cars

For the most part American cars were looked at only casually. The mood seemed to be more idle curiosity than true interest. There were no cutaways or operating exhibits, just cars—and the cars were kept locked. Most European cars were unlocked

and people could climb in and jiggle the steering wheel. American cars were marked "hands off please." They are off limits outside the show as well. Few Europeans can afford to buy them or to run them and those who can, soon find them inconvenient on Europe's streets.

Edsel attracted more attention than any other American production car, perhaps because it was the newest (an old Oldsmobile Rocket "dream" car was the biggest spectator attraction at Paris among American cars, but of course it is not a production model). Five Edsels were sold during the Frankfort show.

Most European comments overheard at the American exhibits referred to bigness, expensive operating and licensing costs. Frequent criticisms were heard about poor paint jobs and slipshod trim fits.

Despite such criticism, there's no doubt that European cars are going American. As one German sales manager said, "The next five years belong to the American stylists. Even such conservatives as Mercedes-Benz and BMW will have to go along. People like American styling."

Could be. The next question is: What does this do to the imported-car market here in the States where much of the business is in protest against American design? ★ ★ ★

## HANDEE<sup>®</sup> A COMPLETE WORKSHOP IN YOUR HAND



The powerful new Hi-Torque HANDEE grinds, polishes, cuts, saws, engraves, burnishes, cleans. A necessity in every workshop. Works in wood, hardened steel, non-ferrous metals, glass, ceramics. Packed with power and speed (25,000 rpm). Cool running. Fits the hand for pencil-point precision. 110 or 220-v. 25 to 60 cycles AC or DC.

with 6 accessories  
**\$23.95**

**TOOL OF 1001 USES!**  
With every type of cutting tool in metal case. **\$32.95**

Order your Handee Today!

**CHICAGO WHEEL**

& Mfg. Co. Dept. PM-12  
1101 W. Monroe Street, Chicago 7, Illinois

### BUILD FINE GRANDFATHER CLOCK NOW

The simple sensible SPEEDE Red-i-KUT way as thousands have—FOR YOURSELF OR SELL AT A GOOD PROFIT. SAVE HUNDREDS OF DOLLARS. SHOP TESTED PLANS "SPIRIT OF THE CENTURY" Narrow waist "S" tall or stately straight side "SPIRIT OF AMERICA." EASY-TO-FOLLOW photograph PLANS & LIFE SIZE PATTERNS tell all—plus MOVEMENT BROCHURE \$40 up, of heavy brass weight (Kuempel original) Westminster, tube BELL chime, movements, gorgeous bronze-silver MOVING MOON dials, 3/4" solid-mahogany case kits. SEND \$1.00 today—Both plans RUSH \$1.50 as folks have for forty years.

Kuempel Chime Clock Works, 211 Kuempel Bldg., Minneapolis 16, Minn.

### TRANSFORMER WELDER \$24.95 FOR QUINCY

Complete with everything. Ready to plug in. 110 volts AC. Draws 15-30 Amps. Produces 75 Amps, 5 heats. Welds metal from 1/16" to 1/4" using 1/16" to 3/32" standard rods. Guaranteed unconditionally. 10-day trial. \$5 deposit on C.O.D. Does everything welders costing up to \$75 do. 1/4" welder \$7.95 plus 50c for postage.

ESSAY MFG. CO., INC., Dept. 51, Quincy 69, Mass.

## "WE PAID FOR OUR HOME with a Foley Saw Filer"

FOLEY MFG. CO.  
1216-7 Foley Bldg.  
Minneapolis 18, Minn.

Send Free Book

**\*MONEY  
MAKING  
FACTS\***



Here is the true story of Leslie Patrick—as told by his wife. "I can truthfully say Mr. Patrick made a wonderful investment with his Foley Saw Filer. In 1946, we had only a Model A Pickup and all our belongings were in it. Since then, my husband has done so well with his Foley Saw Filing Machine and repair shop that we bought a house and paid for it; bought a new car and built an addition to our house; and he has got a lot of new machines in the shop. Nicest of all, it is all paid for."

**Make up to \$3 or \$5 an hour**

With the Foley Automatic Saw Filer you can sharpen hand, band, and circular saws just like new. Start in spare time, in your garage or basement. No experience needed. Build up a steady, repeat CASH business which will buy YOU a home or new car. Send coupon for FREE BOOK. No salesman will call.

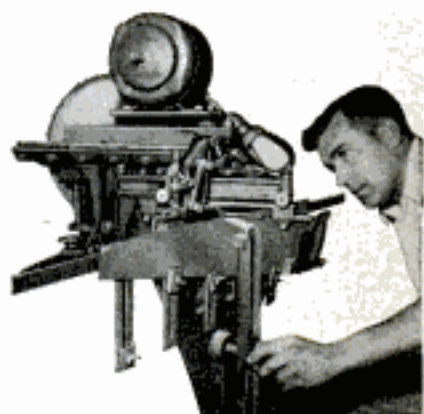

Name \_\_\_\_\_

Address \_\_\_\_\_



**WAR SURPLUS** AND OTHER **BARGAINS** **SAVE UP TO 90%**



**SPECIAL ON \$4770 NAVY AIR-COOLED POWER UNITS**

Tremendous power package. Can be used as a portable or stationary unit. Makes terrific welder.

30D-1A Lawrence, 24V, 2 Cylinder opposed 4 cycle 10 1/2 H.P. Complete with various generators. Net wt. 180 lbs. Gross wt. 250 lbs. Like NEW. With 140 Amps, 24 V. Gen. — \$125. With 200 Amp. Gen. — \$137.50. With AC-DC NEA5, DC side 24 V., 300 Amps. AC side 10.5 Amps. 800 cycle — \$142.50. 300 Amp. Gen. — \$142.50.

**140-1 REDUCTION GEAR** For beaching boats, winches, hoists. Ideal for motor in golf or boys electric car. Built-in (removable) DC motor & clutch. Hi torque, lo speed. Runs on 6-12 or 24 V. Wt. 65 lbs. gross. Approx. GOVT. COST \$300. Like NEW. \$12.00. \*225-1 REDUCTION GEAR, as above — \$13.50.



**BENDIX GEROTOR PUMP & MOTOR** Use wherever fluid pumping required. Excellent for hydraulic installations. Has 3/4" pipe connections, built-in relief valve adjustable up to 1500 lbs. Max. cap. 8 GPM. 1 1/2 H.P., 24 V. motor. Use on 12 to 36 V. Approx. GOVT. COST \$350. NEW, \$10.98.

**CHRONOMETRIC TACHOMETER** Built to U.S. Navy & Air Force specs. Standard brand. For counting revolutions per min. for any rotating shaft. Can be used on speeds up to 3000 RPM. Accuracy to 1/10 of 1%. Complete with male & female tips & shock-proof case. GOVT. COST \$87.50. NEW. Only \$21.95 ppd.



**REVERSIBLE RATCHET WRENCH** Hi torque. Delivers tremendous leverage. 4' handle with reversible ratchet. 4 hexagon nut sockets, 2 3/8", 2 9/16" & 3 1/8". Mfd. by Lowell. Approx. GOVT. COST \$215 per set. Wt. 50 lbs. NEW. Only \$10.95 per set.

**HEAVY-DUTY RHEOSTAT** Ideal for regulating voltage on electric welders. Rated 5.75 Ohms, 100 Watts with double windings & dual female 25 amp, 125 V. receptacles. 7" hi x 5 1/4" x 1 3/4" D. Shop. wt. 2 1/2 lbs. Approx. GOVT. COST \$25. Brand New. \$1.95.



**ARC WELDER KIT \$27.95** Build your own complete make-up package incl. 1 Aircraft DC Gen. 200 Amps, 24 V.; Rheostat, Toggle Switch, 30' new welding cable, Electrode Holder, Welder's Shield, Voltage Reg. Wiring diagram for hookup as welder. Wt. under 100 lbs. Approx. GOVT. COST \$475. Like new, perfect — \$27.95. DC GEN., as above, purchased sep. — \$12.50.



**BUILD YOUR OWN ARC WELDER, LIGHT PLANT OR BATTERY CHARGER \$39.95**

Kit. Incl. 1 Navy NEA-5 Gen. combination AC-DC type. AC 115 V. DC 24 V., 300-300 Amps. 2 complete generators in 1, yet no larger than reg. gen. Ideal for home, shop and farm lighting plants. Delivers 1200 Watts AC. DC side for charging batteries, welding and operating war surplus motors. Also in kit: 2 Voltage Regs., AC & DC. Reverse Current Relay, 30' new welding cable, Rheostat, Electrode Holder, Toggle Switch, Welder's Shield, Wiring Diagram for kit. Wt. under 100 lbs. Approx. GOVT. COST \$650. Kit — \$39.95. Navy NEA-5 Gen. as above, purchased separately, \$27.50.



**R1 GENERATOR KIT** Jack & Heinz or GE. Rated 300 Amps. 24-32 V. With same items as above. Approx. GOVT. COST \$500. Complete 60 lb. kit — \$39.95.

**ESA GENERATOR** Mfd. by Leece Neville. Rated at 12 V.D.C., 50 Amp. Compact power package for trucks, boats, battery charging. Fits any installation. Shpg. wt. 25 lbs. Approx. GOVT. COST \$175. NEW, \$16.50.



**MICROMETERS** Black crackle finish frame. — Easy-to-read graduations in .001. NEW. 0-1" cap. \$2.69 ppd. 1-2" cap. \$3.79 ppd.

**DUPONT EXPLOSIVE RIVETS** Essential wherever blind riveting required. 1/8", 5/32", 3/16". Round & flat heads. Approx. GOVT. COST \$50. 1,000 assorted for only \$5.00 ppd.



**BENDIX AIRCRAFT COMPASS** For boats, trucks, cars. Pioneer Instrument Co., div. Bendix. Mark VIII. Increments of 1°; 360°. Major graduations every 5°. Magnetic. Can be lighted with 6, 12 or 24 volt standard bulb. Flush panel mounting. Floating card. Tested in our own inst. lab. Approx. GOVT. COST \$250. Perfect. \$10.95 ppd.



**ASTRO COMPASS MARK II** Used by USAF & commercial airlines. Makes pelorus & azimuth circle for air or marine navigators. Great for astronomers. Incl. carrying case. Tested for accuracy in our own lab. Approx. GOVT. COST \$400. Now \$10.95.



**NEW! TERRIFIC! 1958 CATALOG!** Thousands of bargains in war surplus & other items. Hundreds of pictures. Send 25c for your copy today! Ppd. prices in USA only. Other prices FOB Culver City, Calif. Send cash, check or money order. 50% deposit on COD.

**AIRBORNE SALES CO., INC. DEPT. PM1257**  
8501 Stellar Drive, Culver City, Calif.

**BUY GREAT NECK HAND TOOLS**  
... for long-lasting performance



**Precision Balanced NAIL HAMMER**



One-piece, forged steel, rubber-cushioned, no-slip grip

**GREAT NECK SAW MFRS., Inc.**

MINEOLA, N. Y. — SEE YOUR LOCAL STORE

**SAVE MONEY on LUMBER**

with the **LOW-COST BELSAW PLANER**

Convert Rough and Random Size Lumber into Cabinet Finished Stock

Now anyone can make perfect cabinet finished stock from low-cost rough lumber... any size up to 12 1/4 inches wide and 6 inches thick. Turn out high grade finished material at a fraction of the cost you pay lumber yards. Big 42-inch-long bed makes it easy to plane heavy, wide and long pieces... BELSAW self-feeds at 14 to 34 feet per minute.

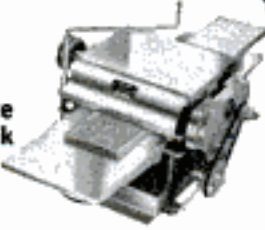

**USE THIS ONE LOW-COST MACHINE for Planing, Jointing, Sawing, Milling, Tongue and Groove.**

You can easily make flooring, siding and many other popular patterns with your Belsaw. Your Belsaw quickly pays for itself with savings on raw materials and profits on finished stock... a highly profitable machine for custom work. Compare Belsaw with any 12-inch planer on the market... Belsaw gives you more essential features—yet costs you \$50 to \$125 less than others.

Send Today for Free Literature on the Belsaw Multi-Duty Planer.

**BELSAW MACHINERY CO** 2058 Field Bldg. Kansas City 11, Mo.

**ACCEPT NO IMITATIONS**

**BE SURE IT'S A KING O'LAWN**

The Edger-Trimmer with "That Forward Throw."

**\$79.50** F.O.B. South Gate California

1958 Model Briggs Stratton light weight 4 cycle engine. Total weight of Power Edger — 49 lbs.

**KING O'LAWN** Junior model power edger trimmer shown.

4 models of power edgers and 4 models of power mowers from which to choose

Over 2000 dealers to serve you. A few choice dealer territories are still available. Please write

**KING O'LAWN Inc.** P.O. Box 1068 Tweedy Sta. South Gate, California



Edges 5 feet per second and trims in the hard to get places.

Changes from edger to trimmer in just 3 seconds



## Which Irwin bit bores holes fastest?

**Fastest cutting new Speedbor "88"** for electric drills. Bores 1" holes 2 1/2" deep in just 60 seconds. Increases the average boring range of small power drills. Sizes 1/4" to 1". Only \$.75 each.

**Fastest Boring 62T Hand Brace Type.** Only 16 turns to bore 1" holes through 1" wood. Double cutter action. Sizes 1/4" to 1 1/2". As low as \$1.

**Fastest Boring Expansive Bit Type.** Bore up to 35 standard holes with just one bit. Two sizes give 1/2" to 3" boring range. America's most versatile bit for home and farm. Only \$3.80 for largest size.

### Balanced cutting heads do the job in seconds

Every Irwin wood bit gives faster, cleaner boring in any wood — no matter the type. Spurs and cutters are precision-balanced, to give free and easy cutting action. Made to last for years. Irwin is the wood bit hardware dealers recommend.

Free Booklet tells how to use, select and take care of wood bits. Many pictures. Write Irwin, Dept. 8C, Wilmington, Ohio.

**IRWIN**

• the original solid center auger bit  
• screw drivers • screw driver bits

Wilmington, Ohio



## Lift Snow Plows . . . automatically!

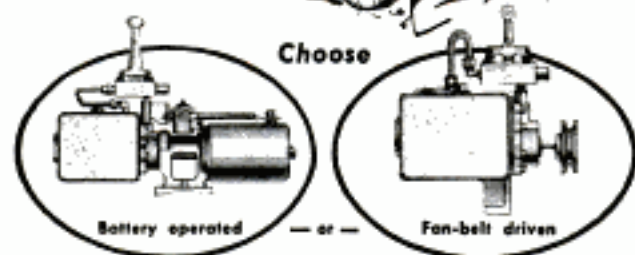

### MONARCH POWER HYDRAULIC CONTROLS

Snow removal is fast, dependable and safe with Monarch Power Hydraulic Controls. Cab-controlled for one-man instant action, the Monarch zips snow plows into operation with ease and speed. See your dealer or write for full details.

**MONARCH ROAD MACHINERY COMPANY**  
1331 MICHIGAN ST., N.E. — GRAND RAPIDS 3, MICHIGAN

266

## A Report on Three Cars

(Continued from page 90)

slowly to prevent a constant up-and-down adjustment as the car goes over bumps or rounds corners.

Pontiac and Cadillac rely solely on the slow-leveling system.

Both GM cars have a control knob so the driver can elevate the car body to full lift, enabling it to avoid rear-end drag.

Unlike the GM cars, Ford retains leaf springs in the rear when air bags are not installed. Such an arrangement makes it necessary for Ford to add a trailing-arm suspension link to absorb drive and braking thrust when air suspension is used.

Also big news at Ford is the new V8 which is designed for top efficiency in both operation and manufacture. Despite its greatly increased power and displacement (300 horsepower and 352 cubic inches) it is smaller than the engine it replaces.

It has fully machined combustion chambers that provide more accurate control of compressions among the various cylinders. This results in a smoother operating engine. The big new V8 weighs less than the 292-inch V8 and is said to use less gas.

Machined combustion chambers have shiny surfaces that make it hard for carbon to build up. The new design has no Siamese manifold porting, a frequent cause of engine hot spots. There's more room between the two heads and manifolding is simplified to make the engine breathe easier and more evenly. This aids economy as you don't overload some cylinders in order to satisfy those that are more remote.

Of major importance to the manufacturer (of less interest to the owner) is the fact that the cylinder-head design has its machined sides at right angles to each other, simplifying production-line setups. This cuts costs and assures precision fits.

There's no water jacket around the exhaust manifold on Ford's new V8 which helps thermal efficiency (the more heat you remove in the radiator, the less energy you get at the rear wheels), but also may decrease heater efficiency. It probably will take longer for the heater to warm.

Cadillac's V8 engine has been reworked. Valves are larger and the combustion chamber reshaped to increase compression to 10.25 to 1 (from 10.0 to 1). A new camshaft provides improved fuel economy and smoother idling.

Of less importance mechanically (but of much importance saleswise) is the fact that Cadillac extended its rear-end overhang about nine inches on one model to appease those who say a Cadillac should look like the longest car. ★ ★ ★

POPULAR MECHANICS

Copyrighted material



## MASTER D.C. ARC WELDER

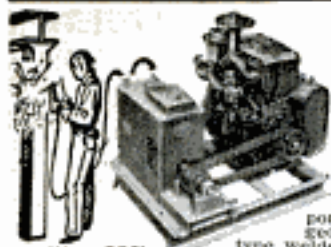

**Easy To Use**

Now! a portable rugged, industrial type welder with terrific performance, yet at a price hundreds of dollars less than you'd expect. Senior model made for years of trouble-free, continuous service. High capacity DC welding unit enables you to tackle any job with confidence—easily welds anything up to 2" plate using from 1/16" to 1/4" rods. Built-in stabilizer and cooling system makes arc easy to strike and hold. Dual control rheostat provides low heat soldering, brazing and welding from 30 to 300 amps. Complete with instructions, guarantee and triple V-belt or flat pulley. Easy to hook up and easy to operate.

**WELDER ONLY — DUAL CONTROL MODEL.** Same as above, but drive with your tractor, jeep or gas engine of 1/2 HP or more. (Item 280) Wt. 110 lbs. \$450 value. **\$119.50**

**WELDER ONLY — INDUSTRIAL MODEL** same as above but with ceramic rotary type rheostat providing 74 different heat settings for all types of welding (Item 380) \$500.00 value. **\$139.50**

**COMPLETE POWER MASTER** (illustrated above) powered by a 14.6 hp. air cooled Wisconsin engine. Wt. 480 lbs. (Item 280) Compares with welder costing \$1200. **\$449.50** Factory Special.

**WELDING KIT.** Two 10 ft. leads, welding helmet, electrode holder, ground clamp. Sold only with welder at. **\$10.50**

## HEATING & VENTILATING FAN

(Item 10) Easily installed in furnace pipes. Forces even heat to all rooms. Over range removes kitchen smoke and odors. Powerful, continuous duty motor. 110-120V. AC. Mount in wall or ceiling to ventilate any area. Quiet, super-efficient fan moves huge volume of air. (400 to 600 CFM.)

8" Pipe, wt. 5 lb. **\$6.85**  
 9" Pipe, wt. 6 lb. **\$7.85**  
 10" Pipe, wt. 7 lb. **\$8.85**  
 12" Pipe, wt. 8 lb. **\$9.85**



## JET FLOW BLOWER

Tremendous air movement (1800 CFM) and quiet operation make this double inlet 10" turbine blower unbeatable for heating, cooling, drying and air conditioning. Ideal for attic or barn ventilation, converting gravity heating to forced air; spray booth exhausts, etc. Operates with any motor. Includes variable speed motor pulley and belt. Dimensions 10" h x 18" x 16 1/2". Outlet openings 12" x 11 1/2". Wt. 45 lbs. Item 245. Reg. \$54.80. **\$29.50** Factory Special.

**HEAVY DUTY 1/2 HP motor** for above **\$17.95.**

## 52 pc. SOCKET SET

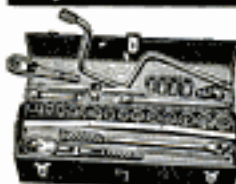

Highest quality, guaranteed non-breakable sockets made by Husky. Beautifully matched chrome thin wall alloy absolutely the best. Contains a complete set of 28 sockets in 1/4", 3/8", 1/2", 5/8", 3/4", 1", 1 1/4", 1 1/2", 1 3/4", 2", 2 1/4", 2 3/4", 3", 3 1/4", 3 3/4", 4", 4 1/4", 4 3/4", 5", 5 1/4", 5 3/4", 6", 6 1/4", 6 3/4", 7", 7 1/4", 7 3/4", 8", 8 1/4", 8 3/4", 9", 9 1/4", 9 3/4", 10", 10 1/4", 10 3/4", 11", 11 1/4", 11 3/4", 12", 12 1/4", 12 3/4", 13", 13 1/4", 13 3/4", 14", 14 1/4", 14 3/4", 15", 15 1/4", 15 3/4", 16", 16 1/4", 16 3/4", 17", 17 1/4", 17 3/4", 18", 18 1/4", 18 3/4", 19", 19 1/4", 19 3/4", 20", 20 1/4", 20 3/4", 21", 21 1/4", 21 3/4", 22", 22 1/4", 22 3/4", 23", 23 1/4", 23 3/4", 24", 24 1/4", 24 3/4", 25", 25 1/4", 25 3/4", 26", 26 1/4", 26 3/4", 27", 27 1/4", 27 3/4", 28", 28 1/4", 28 3/4".

Guaranteed against breakage. A beautiful set of tools that will handle any job in a big do-it-yourself steel box. Wt. 17 lbs. (Item 205) List price \$62.90. **\$29.95** Factory special.

## CABLE HOIST



**2000 lb. CAPACITY.** A fortunate purchase from the Air Force enables us to offer these brand new 2000 lb. electric cable hoists at a fraction of their value. Perfect for material handling, boat hoists, elevators, lift on assembly lines, etc. Two separate 22 ft. lift cables with independent controls permit leveling the load and controlling it perfectly. Rugged ball bearing motors of geared down design 110 volts. Available for A.C. or D.C. Please specify. Makes a terrific portable hoist with our #273 D.C. light plant at \$99.75. Offered at less than 33% of regular cost (Cable not included). Wt. 145 lbs. A.C. Model, item 847A. **\$149.50** D.C. Model, item 847. **\$129.50**

**SAVE** middleman profits  
 get **MASTER MECHANIC'S**  
 direct factory prices

## EXCLUSIVE! NEW!

### LIGHTWEIGHT WATER COOLED DIESEL GENERATOR PLANT

Never before available! Now offered exclusively by Master Mechanic. A low priced, lightweight, continuous duty, Diesel generator set. Powered by a super rugged, exceptionally smooth running, one cylinder Diesel engine. Operates at conservative 1750 r.p.m. and delivers full 1750-2000 watts of power. Operates on low cost fuel oil. Wt. only 240 lbs. representing a triumph of Diesel Engineering. Complete with fuel filter, oil pressure gauge, control box with duplex receptacle and voltmeter. (Item 830) Special factory price. **\$399.50**

**DIESEL ENGINE only, as above described 3.5 HP (Item 830A)** Wt. 116 lbs. **\$249.50**

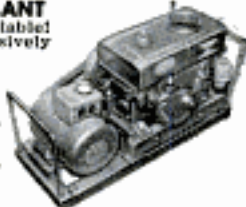

### 700 WATTS PUSH BUTTON START

115 v. 60 cye. AC. Powered by a rugged 2.2 HP easy starting Briggs engine. No wiring necessary; just plug in and operate. Plenty of current for any oil burner, freezer, brooder, emergency lights, etc. which require up to 700 watts. Ideal for television and radios. Complete with Voltmeter and built-in winding to charge 6 v. auto batteries. (Item 24.) Wt. 75 lbs. Easily fits in car trunk. Be prepared if storm knocks out power lines. Reg. \$275 value. **\$143.50**

**1200 Watt Plant (Item 45)** same as item 24 but larger generator and engine with 50% greater output. **\$199.50**

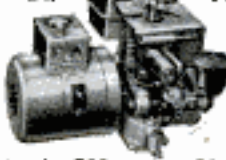

## GIANT METAL SHEARS

"PEXTO"  
 Nine inch cutting blade made of special high carbon alloy steel, perfectly aligned and ground. Easily cuts steel pipe up to 12 gauge of 1/2" thick. Overall length 40". Wt. 25 lbs. (Item 18) Regular \$49.50. While they last. **\$14.95**

## FAUCET WATER HEATER

Instant hot water from any faucet for just pennies—sounds unbelievable—but it's true! You just slip MASTEK MECHANIC'S new Faucet Water Heater over any water faucet, plug it in a wall outlet and you've got steaming hot running water instantly for dishes, shaving, washing baby's bottle, etc. Simple and safe—operates on ordinary 110V. house current—costs only 2 1/2 cents per hour for hot water. Ideal for homes, bars, cabins, trailers, etc. Easily regulated from lukewarm to full hot. Fully guaranteed! (Item 408) Wt. 2 lbs. Factory price F.O.B. Burlington, only. **\$4.95**

## JET STEAM MASTER

Now, a super efficient portable steam generator that produces live steam at 100 lbs. pressure in 60 seconds from a cold start! Produces large volume of high pressure steam on 2 pints of fuel oil. Instantly cleans sticky grease, dirt, rust, old paint, etc. off implements and road machinery. Pays for itself in a few weeks. Sterilizes soil. Sterilizes as it cleans—milk equipment, etc. Fully automatic—oil fired with new, built-in lifetime bronze water circulating pump. Draws water from faucet or bucket. Simple and safe—anyone can use it; built-in safety valve. Complete with 12 ft. of hi-pressure steam hose and new triple efficiency steam gun that automatically mixes in soap solution if desired. Wt. 250 lbs. Item 463. **\$349.50** Special factory price.



## PORTABLE LIGHT PLANTS

### 1500 WATT PLANT

115v. 60 cye. AC Push Button Start. Powered by a 3 1/2 HP. Clinton engine. Combines big output with easy portability. Provides emergency power for operating any oil burner, sump pump, freezer, television, lights, communications systems, etc. which require up to 1500 watts. (Item 22) Wt. 110 lbs. Reg. \$475 value. Factory price **\$239.50**



**1750 Watt Plant** Powered by 4.5 Hertz engine. Electric starting & battery charging built-in. Factory price **\$279.50**

**2500 WATT PLANT—Push Button Start** (Item 21) 110/120 v. 60 cye. A.C. A rugged powerful plant. Reg. \$645. Spec. **\$329.50**

**3500 Watt Plant Push Button Start** (Item 23) 115 v. 60 cye. AC. Similar to above, but larger and 33% more capacity. Wt. 270 lbs. Reg. \$780. Factory Price. **\$379.50**

**DUAL VOLTAGE 110/220** for Item 21 or 23—\$30 additional.

We make every type and size of light plants—Write, giving us your requirements!

## BATTERY CHARGING GENERATOR

**Push Button Start**  
 A husky, 750 watt plant (designed for battery charging only) that will charge 6 or 12 volt batteries in just minutes! When mounted with two 6 volt batteries it provides a terrific cold weather motor starting unit, as well as a fast charger! Charges all batteries anywhere—no biline current needed. Ideal for service stations, garages and farms. Comes complete with ammeter and cutout. (Item 821) Wt. 120 lbs. Regularly \$295. Our special, only. **\$119.50**



## Double Acting Hydraulic Cylinder

A powerful cylinder mfr'd. by Massey Harris which develops both a pushing and a pulling action. Will push 8,100 lbs., with a 1000 PSI pump pressure. Cylinder is 3 3/4" O.D. with 6 1/2" stroke—standard heavy duty clevises on both ends. Has standard 1 1/2" pipe thread openings. Can be used for tilting buckets or blades, raising or lowering implements, hydraulic presses, etc. Can also be used as an air cylinder. (Item 802) Wt. 17 lbs. Reg. \$68 value. Special **\$14.95**

**OTHER DOUBLE ACTING CYLINDERS**  
 8" stroke — 3" bore. **\$34.00**  
 10" stroke — 3" bore. **\$4.80**  
 16" stroke — 3" bore. **43.00**  
 24" stroke — 3" bore. **47.50**

We have all sizes of cylinders available.

**HYDRAULIC CONTROL VALVE** — 4 way open center valve with built-in adjustable relief. Controls 1 cylinder or 2 single acting cylinders. Equalizing feature permits easy control even under heavy loads. 3/4" pipe thread on inlet & outlet — 1/2" on cylinder outlets. Easily mounted, finger tip control. Wt. 1 lbs. (Item 822). **\$21.95**

## HYDRAULIC KIT



Complete Hydraulic Kit consists of hydraulic hand pump with built-in 2 gal. reservoir and item 802 hydraulic cylinder described above. Pump has a built in relief valve and is rated at 20 tons. Kit is ideal for presses, jacks, snow-plows, etc. Pump is 29" long—8" diam. (Item 836) Wt. 50 lbs. **\$39.50**

**Pump only (Item 836a) only. \$23.50**

**HYDRAULIC HOSE COUPLERS** Connect or disconnect hydraulic lines without loss of oil. 1/2" pipe threads. (Item 810) per set. **\$4.95**

## SCREW-TYPE PRESS

A tremendously powerful press capable of exerting nine tons of pressure. Pays for itself straightening bent parts, or pushing out bearings and bushings. Ideal for manufacturing and assembly operations because of precise control. Massive 1 1/2" screw permits precise control over vertical travel. Extra heavy ribbed yoke has a throat 2 1/2" high; depth capacity for working to the center of an 11" object. Includes 8" x 15 1/2" vise-type table and two pushing arbors. Wt. 150 lbs. (Item 797) Reg. \$149.50. Special. **\$49.50**

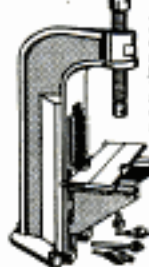

**HYDRAULIC PRESS.** Nine ton capacity. See Dec. Pop. Mech's ad for details or write. Complete Wt. 110 lbs. (Item 404) **\$69.50**

Send check or M.O. Prices f.o.b. Factory. 10 day Money back guarantee. SEND 10c for **BIG NEW CATALOG**  
**MASTER MECHANIC MFG. CO.,** DEPT. 3-21 **Burlington, Wis.**





# SOUTH BEND

## 13" Precision Lathes

**for accurate,  
low-cost machining**

These lathes are popular in the toolroom, production shop, or wherever varieties of precision parts are machined. Users prefer them for their simplicity and practically effortless handling. Job set-ups and tooling changes are made so quickly and easily that down-time is held to a minimum. A very complete line of attachments simplifies tooling. Send coupon for complete information.

### SPECIFICATIONS

**Swing**—13 $\frac{1}{8}$ " over bed and saddle wings, 8" over cross slide.

**Distances Between Centers**—28", 40", 52" maximum.

**Collet Capacity**—1" maximum (Collets interchangeable with South Bend 10"-1" Collet, 14 $\frac{1}{2}$ ", 16" and 16-24" lathes).

**Spindle Speeds**—Six to Sixteen 40 to 940 r.p.m. or 20 to 940 r.p.m. approximately.

**Power Longitudinal Feeds**—48 R.H. or L.H., .0015" to .0841".

**Power Cross-Feeds**—48, .0006" to .0315".

**Thread Cutting**—48 R.H. or L.H. pitches, 4 to 224 per inch.







### HARDENED BED WAYS

Hardened and precision ground bed ways can be supplied in lieu of regular at small extra cost—also hardened and ground cross-feed screw.



Up to 24 months to pay.

PLEASE SEND INFORMATION CHECKED:

- |   |   |   |  |   |   |   |
|---|---|---|--|---|---|---|
|  |  |  |  |  |  |  |
| <input type="checkbox"/> 9" and 10" BENCH LATHES                                    | <input type="checkbox"/> 10" to 16-24" FLOOR LATHES                                 | <input type="checkbox"/> DRILL PRESSES  | <input type="checkbox"/> $\frac{1}{2}$ " & 1" Collet TURRET LATHES                   | <input type="checkbox"/> TOOL GRINDERS  | <input type="checkbox"/> 7" BENCH SHAPERS   | <input type="checkbox"/> MILLING MACHINES   |

Name \_\_\_\_\_ Street \_\_\_\_\_  
City \_\_\_\_\_ State \_\_\_\_\_

Building Better Tools Since 1906 • SOUTH BEND LATHE • South Bend 22, Indiana



# Superior's New Model 70 UTILITY TESTER® FOR REPAIRING ALL ELECTRICAL APPLIANCES MOTORS • AUTOMOBILES • TV TUBES

*As an electrical trouble shooter the Model 70:*



- Will test Toasters, Irons, Broilers, Heating Pads, Clocks, Fans, Vacuum Cleaners, Refrigerators, Lamps, Fluorescents, Switches, Thermostats, etc.
- Will test all TV tubes for open filaments, inter-element shorts, burned out tubes, etc.
- Measures A.C. and D.C. Voltages, A.C. and D.C. Current, Resistances, Leakage, etc.
- Will measure current consumption while the appliance under test is in operation.
- Incorporates a sensitive direct-reading resistance range which will measure all resistances commonly used in electrical appliances, motors, etc.
- Leakage detecting circuit will indicate continuity from zero ohms to 5 megohms (5,000,000 ohms).

*As an Automotive Tester the Model 70 will test:*

- Both 6 Volt and 12 Volt Storage Batteries • Generators • Starters • Distributors • Ignition Coils • Regulators • Relays • Circuit Breakers • Cigarette Lighters • Stop Lights • Condensers • Directional Signal Systems • All Lamps and Bulbs • Fuses • Heating Systems • Horns • Also will locate poor grounds, breaks in wiring, poor connections, etc.

Model 70 comes complete with 64 page book written in plain easy-to-understand language. Explains laws of electricity, how to proceed with repairs of appliances and automobile circuits, how to test TV tubes, etc.

Only  
**15<sup>85</sup>**

**SHIPPED ON APPROVAL  
NO MONEY WITH ORDER — NO C. O. D.**

Try it for 10 days before you buy. If completely satisfied then send \$3.85 and pay balance at rate of \$4.00 per month for 3 months — No Interest or Finance Charges Added! If not completely satisfied, return to us, no explanation necessary.

**MOSS ELECTRONIC DIST. CO.**

Dept. D-407 3849 Tenth Ave., New York 34, N. Y.

Please rush me one Model 70. If satisfactory I agree to pay \$3.85 within 10 days and balance at rate of \$4 per month until total price of \$15.85 plus postage is paid. If not satisfactory, I may return for cancellation of account.

Name \_\_\_\_\_

Address \_\_\_\_\_

City \_\_\_\_\_

Zone \_\_\_\_\_ State \_\_\_\_\_



*Whether you give 'em  
or get 'em this Christmas*



*...there's real gift excitement in*

Watch a man's eyes sparkle when he sees these attractively gift packaged Weller Power Tools. Bet he'll want to use 'em right away. And he'd never guess they cost so little.

# Weller POWER TOOLS



*Weller*  
**Power Sander**

Model 700 **\$14<sup>95</sup>**

Sands wood smooth in a jiffy. Easy to use. Gets into corners and under low places. Fingertip "on-off" control. Assorted sandpaper and polishing cloth included.

Weller Electric Power Sanding Kit with Metal Case Model 700K **\$16<sup>95</sup>**



*Weller*  
**Sabre Saw**

Model 800 **\$19<sup>95</sup>**

Makes every kind of cut... through wood up to 1 inch thick, plastics, composition board, aluminum, etc. And it's portable... use it anywhere. Three blades included.

All Weller Power Tools and Soldering Guns are Guaranteed for 1 Year



*Weller*  
**Soldering Kit**

Model 8100K **\$7<sup>95</sup>**

Everything that's needed for quick, accurate soldering. Famous Weller Instant Heat Soldering Gun plus wire bristle cleaning brush, soldering tool and solder.

Weller Heavy Duty Soldering Kit in Metal Case Model 8250AK **\$14<sup>95</sup>**

**WELLER ELECTRIC CORPORATION • EASTON, PA.**