

NOV. 1957

THE 1958 CAR PARADE BEGINS

35 CENTS

# POPULAR MECHANICS

## MAGAZINE

WRITTEN SO YOU CAN UNDERSTAND IT

The '58  
CHEVROLET



SIX PAGES OF CHRISTMAS GIFT IDEAS  
WALT DISNEY'S MECHANICAL WONDERLAND

Do repairs and electrical work in a jiffy



with a **Weller**  
**SOLDERING KIT**

featuring the easiest-to-use  
soldering tool ever designed . . .  
the Weller Soldering Gun

**INSTANT  
HEAT  
NO WAITING**

You hold it like a pistol. Merely touch the trigger and presto . . . soldering tip heats instantly . . . dual spotlights flick on to light up your work. There's nothing else like it for quick, accurate soldering . . . even in dark and difficult places. Guaranteed for 1 year. UL approved.

**ONLY  
\$795**  
Model 8100K

**FINGERTIP  
ON-OFF CONTROL**

**HERE'S WHAT YOU GET:**

- Weller Soldering Gun—over 100 watts
- Generous Supply of Solder
- Wire Bristle Cleaning Brush
- Soldering Tool

*Cutting and Smoothing Tips available at slight extra cost*



**Weller**

**HEAVY DUTY  
SOLDERING KIT**

- Weller 250 Watt Soldering Gun
- Sturdy Metal Storage Case
- Generous Supply of Solder
- Cutting Tip • Smoothing Tip
- Tip Interchange Wrench
- 2 Instruction Booklets

Weller 250 Watt Soldering Gun alone . . . \$12.95 (Model 8250A)

WELLER ELECTRIC CORPORATION, EASTON, PA.



**ONLY  
\$1495**  
Model 8250AK



## How I retired in 15 years with \$300 a month

"Here's one Yankee who's fallen in love with the South! When I retired, I moved to the Florida West Coast. I go fishing in the inlets. It's a tropical paradise, yet it's near enough to drive into Tampa often. I'm beginning a new life—all because of the check for \$300 I get each month.

"My retiring came out of a business trip to Tampa in 1942. I was dining at a restaurant and happened to notice Don Nelson, a friend of mine from New York. I went over to wish him a wonderful vacation.

"'Vacation? Why, didn't you know we moved down here when I retired?'

"I was amazed. 'But you're too young to be retired!'

"'Nonsense!' he smiled. 'It's what I'd been planning for fifteen years.'

"Don invited me out to his home the next day. 'I sure envy you, I said. 'I know I never could save enough money.' Then Don explained that he never could have retired on what investments or savings he had. But he had a good salary and he had found a way to make part of his salary buy a retirement income. It was called the Phoenix Mutual Retirement Income Plan.

"Flying home, I noticed a Phoenix Mutual ad in a magazine. Sure enough, I could get a retirement income guaranteed for life if I started young enough. When I got home, I cut out the coupon and sent for the booklet telling all about Phoenix Mutual Plans. In a few days it came by mail. And there was exactly the plan for me. If I started right then—at

40—I'd be able to retire in only fifteen years with \$300 a month.

"I felt more and more pleased and secure as those fifteen years went by. I decided on the West Coast of Florida because I had old friends in that area. And as soon as my first check for \$300 arrived, I was off. Now that I'm settled, the real fun's just beginning."

### Send for Free Booklet

This story is typical. Assuming you start at a young enough age, you can plan to have an income of \$20 a month to \$3,600 a year or more—beginning at age 55, 60, 65 or older. Send the coupon and receive, by mail and without charge, a booklet which tells about the Phoenix Mutual Plans. Similar plans are available for women. Don't delay. Send for your copy now.

ESTABLISHED 1851

## PHOENIX MUTUAL

*Retirement Income Plan*

**GUARANTEES YOUR FUTURE**

OVER 100 YEARS OF LIFE INSURANCE PROTECTION  
FOR BUSINESS AND FAMILIES

COPYRIGHT 1957, BY PHOENIX MUTUAL LIFE INSURANCE COMPANY

PHOENIX MUTUAL LIFE INSURANCE CO.  
232 Elm Street, Hartford 15, Conn.

Please send me, without obligation, your free 28-page booklet showing new retirement income plans.

*Pr*

Name \_\_\_\_\_

Date of Birth \_\_\_\_\_

Business Address \_\_\_\_\_

Home Address \_\_\_\_\_

This One



BPDB-Z67-H8T9



## Why settle for **part-time** protection?

● **Hastings Oil Filter Cartridges keep oil clean all the time—from filter change to filter change.\* The reason is Densite.**

Densite—an amazing new type of filtering material—is made of millions of selected cotton fibres, pressure packed so oil must flow through countless tiny openings, pass many surfaces of fibres. The most microscopic abrasives cling to these fibres—and stay there!

Next filter change, ask for Hastings . . . and get *full-time* protection!

\*When replaced as normally recommended. This fact proved by tests conducted in accordance with U. S. Bureau of Standards procedure.

U. S. Pat.  
No. 2,797,811



HASTINGS MANUFACTURING COMPANY • HASTINGS, MICHIGAN  
Also makers of Piston Rings, Casite, Wear Reducer, Spark Plugs

# Popular Mechanics Magazine

Registered in U. S. Patent Office and Canada

H. H. WINDSOR, Founder

H. H. WINDSOR, JR., Editor and Publisher

FOREIGN EDITIONS:    MECANIQUE POPULAIRE (French)    MECANICA POPULAR (Spanish)    POPULÆR MEKANIK (Danish)    POPULÄR MEKANIK (Swedish)    POPULARE MECHANIK (German)

Volume 108    NOVEMBER 1957    Number 5

Address all communications to: 200 E. Ontario St., Chicago 11, Ill.

## In This Issue...

Adventure on the Stilwell Road	-	-	-	81
The New Cars for 1958	-	-	-	87
Christmas Shopping Center	-	-	-	98
San Francisco's Acre of Concrete	-	-	-	108
Cactus Valley Railroad—Apartment Style	-	-	-	113
Now Electronic Brains Are Talking	-	-	-	120
Landing Fields for Jetliners	-	-	-	124
Trouble Shooter for Carnivals	-	-	-	132
Walt Disney's Mechanical Wonderland	-	-	-	138
School for Courteous Traffic Cops	-	-	-	146
He Decorates With Weeds	-	-	-	150

## For the Craftsman...

Stacked-Drawer Bedroom Furniture	-	-	164
From the Ground up	-	-	173
More Storage Under Stairs	-	-	183
Air-Drive Motor for Ice-Fishing Sled	-	-	201
Handy Tool Dolly	-	-	207
Handy Milling Attachment	-	-	210

## Regular Departments...

Detroit Listening Post	-	-	-	107
Keeping Up With the Atom	-	-	-	122
Radio, TV and Electronics	-	-	-	160
Solving Home Problems	-	-	-	178
On the Market for Do-It-Yourselfers	-	-	-	205
How Would You Do It?	-	-	-	214
Shopping for Tools	-	-	-	218
Clinic for Homemakers	-	-	-	224

## Next Month...

AROUSÉ by reports that U. S. youths are physically inferior to Europeans, the University of Oregon's top-notch physical-education laboratory is testing muscles with ingenious machines. Don't miss "How to Measure Physical Fitness," first of a two-part article.



**Managing Editor**  
RODERICK M. GRANT

**Assistant Managing Editor**  
WAYNE WHITTAKER

**Shop Notes and Crafts Editor**  
JAMES R. WARD

**Associate Editor**  
CLIFFORD B. HICKS

**Associate Editor, Automotive**  
ARTHUR R. RAILTON

**Associate Editor, Shop Notes and Crafts**  
WAYNE C. LECKEY

**Associate Editor, Shop Notes**  
W. CLYDE LAMMEY

**Associate Editor**  
WILLIAM D. PERKINS

**Radio-Television, Electronics Editor**  
LOTHAR STERN

**Assistant Editor, Crafts**  
JAY W. HEDDEN

**Assistant Editor, Makeup**  
JOHN DALEN

**Art Director, FRANK BEATTY**

**Assistant Editors**  
KENNETH ANDERSON    EARL WOBECK  
ROBERT HENDRICKSON

**Eastern Editor**  
RICHARD F. DEMPEWOLFF  
Empire State Bldg., Room 2908, N.Y.C. 1

**Western Editor**  
THOMAS E. STIMSON, JR.  
Suite 1010, 3480 Wilshire Blvd.,  
Los Angeles 5, Calif.

**London Manager**  
DOUGLAS W. WEDDERSPOON  
Eagle House, Jermyn St.,  
London S.W. 1, England

**Director, Bureau of Information**  
ALLAN CARPENTER  
200 E. Ontario St., Chicago 11

**Advertising Offices**  
Chicago: 200 E. Ontario St., Whitehall 4-0100;  
New York: Empire State Bldg., 350 Fifth Ave.,  
LONGacre 5-7540; Detroit: General Motors  
Bldg., Room 5-118, TRINITY 5-8711; Cleveland:  
Hanna Bldg., 1422 Euclid Ave., PROSPECT  
1-0456; Los Angeles: 3460 Wilshire, DUNKIRK  
2-8458; San Francisco: Russ Bldg., Room  
468, 235 Montgomery St., YUKON 2-0823.

Sources of further information not listed in the index, starting on page 74, about articles in this issue. Irregularity are shown in the Where-to-Find-It List prepared for each issue. A copy may be obtained by readers, without charge, from Bureau of Information, Popular Mechanics, 200 East Ontario Street, Chicago 11, Illinois.

Published monthly by Popular Mechanics Company, 200 E. Ontario St., Chicago 11, Ill. H. H. Windsor, Jr., president; Wm. Harrison Petridge, exec. vice-pres.; Franklin S. Forsberg, operations vice-pres.; D. F. Windsor, vice-president and secretary-treasurer; H. H. Windsor III, vice-president; W. T. Windsor, vice-president; Joseph R. Buehl, Jr., advertising manager; Alan M. Deyoe, circulation manager. Single copy in the United States and Canada, 35 cents; subscription rates in the United States and possessions, Canada and countries of the Pan-American Postal Union, 1 year \$3.50; 2 years, \$6.00; 3 years, \$8.00. To all other countries add \$1.00 a year over United States prices for overseas postage. If you plan to move, notify us at least 30 days in advance so you will not miss an issue. Give both your old and new addresses. Entered as Second Class Matter, September 15, 1903, at the Post Office at Chicago, Illinois, under Act of March 3, 1879. Entered as Second Class Matter at Post Office Dept., Canada. Registered as Second Class Matter at the Post Office at Mexico, D.F., Mexico, June 20, 1950. Copyright 1957 by Popular Mechanics Company. Copyright under International Copyright Union, Copyright in France. All rights reserved under Pan-American Copyright Union. Printed in the United States of America.

NOVEMBER 1957

3

Copyrighted material



**Drop a hint for a**

# **NEW THOR SPEEDSHOP**

*Christmas will last all year long!*

When you do your Christmas hinting, make it for something special—a new Thor SpeedShop. It's really three tools in one—a drill, a jig saw and a reciprocating sander, plus seven drill bits, four abrasive sheets, buffing bonnet and a steel carrying case. And you get it all for the Christmas special price of just \$37.50. Quality built—you bet! The basic power unit of Thor's SpeedShop is the ¼" SpeedDrill model 20 (½" in wood). This drill is super-powered with a full 2.5 amperes. Power aplenty for the custom-made accessories. The drill and the accessories were made for each other and for long productive life. Look for the bright Christmas display at your dealers. Ask to see the complete SpeedTool line. SpeedWay Manufacturing Company, division of Thor Power Tool Company, Prudential Plaza, Chicago 1, Illinois.



**\$37<sup>50</sup> buys 3 tools in 1**

See the dealer with the bright Thor display



Includes lambswool buffing pad, 7 drill bits, 4 abrasive sheets, steel carrying case.



**THOR POWER TOOL COMPANY  
CHICAGO**

*Branches in all principal cities*  
World's largest exclusive manufacturer  
of portable air and electric tools

**POPULAR MECHANICS**

Copyrighted material

**YOUR  
SKILL**



**SOUND  
TRAINING**

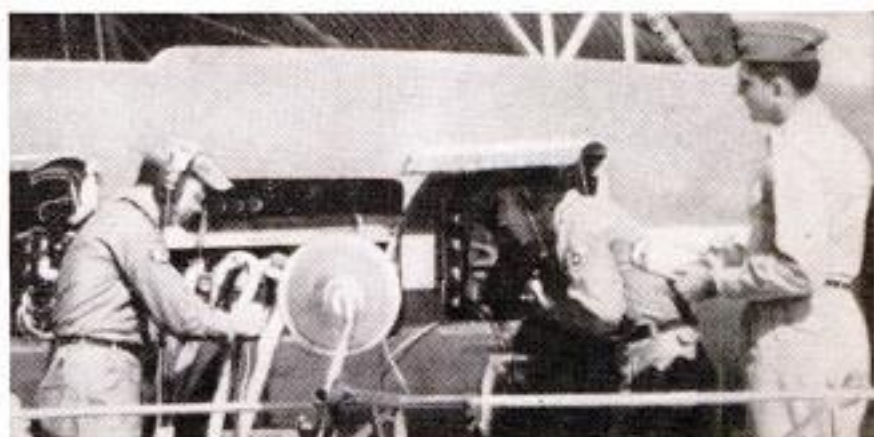

*means a real future in the new*

# **AGE OF SPACE**

go places faster in the

**U.S.  
AIR  
FORCE**

If you "like to get under the hood," you have a great future in the new Age of Space. This is the age of the technician—the man who knows rocketry, jet propulsion, electronics or another of the allied fields. As an Airman in the U. S. Air Force, you get the most complete training available in these Space Age specialties. Remember: *the future belongs to the Airman*. Talk to your Air Force Recruiter, today, or mail the attached coupon.

**PASTE COUPON ON POSTCARD AND MAIL TO:**

Airman Information, Dept. PM-2321  
Box 7608, Washington 4, D. C.

Please send me information on my opportunities in the U. S. Air Force. I am between the ages of 17-34 and reside in U.S.A. or possessions.

NAME \_\_\_\_\_

ADDRESS \_\_\_\_\_

CITY \_\_\_\_\_ ZONE \_\_\_\_\_ STATE \_\_\_\_\_

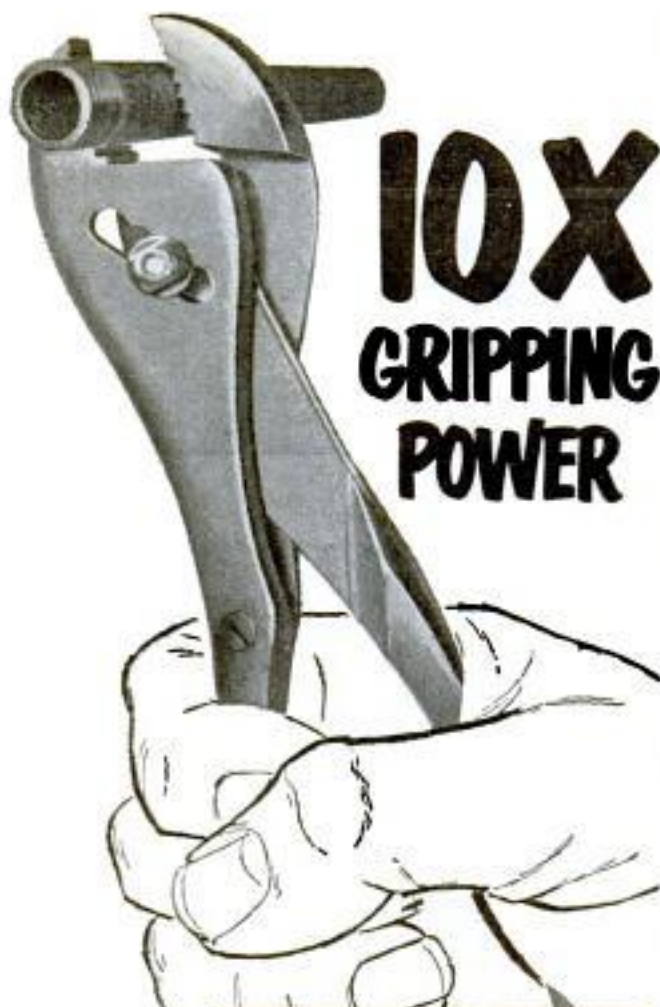

**10X  
GRIPPING  
POWER**

Proto's "Multi-Plier" increases gripping pressure ten times at jaws.

ANOTHER REASON YOU'LL  
**PREFER  
PROTO**  
PLIERS

There's no substitute for the right plier. Choose the pliers you need at your Proto dealer. Send 10¢ for 84 page catalog describing entire line to Proto Tool Company, 2200 Santa Fe Ave., Los Angeles 54, Calif.

PROTO GIVES YOU  
A BIG SELECTION

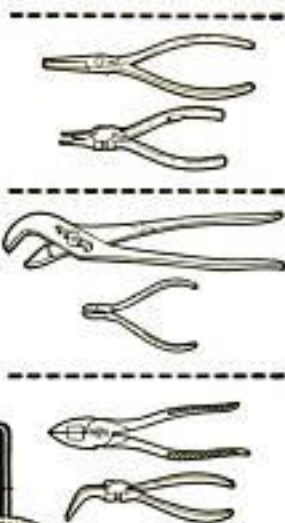

**PROTO TOOLS**  
PROTO means Professional Tools

DIVISION OF



## ACROSS THE DESK



### He Built His Own Wheel Chair

Handicapped by arthritis in the legs, back and both hands, and unable to open his right hand for the last five years, Joe Weston of Windsor, Ont., Can., built this powered wheel chair for himself—while sitting in a wheel chair. He bought a couple of wrecked motorcycles and used whatever parts he could adapt to his purpose. The rear wheel, by which the chair is



steered, was a trailer wheel; the frame is of angle iron. The sides came from an old "furnacette," the bottom from the hood of a Dodge, the armrests and rear deck are  $\frac{3}{4}$ -inch plywood. A two-horsepower, 24-volt electric motor drives the vehicle and Mr. Weston says with four six-volt car batteries he can travel five or six hours at up to 15 miles per hour. One double-pole, double-throw switch controls forward and reverse, another is hooked in series-parallel for slower speeds.

### To the Editor:

I would be obliged if you could help me obtain some information relating to ambulance vehicles and equipment in use in the United States of America. I would like, if possible, to make contact with an employee of an ambulance service in America, so that an interchange of ideas and information may be effected. I am particularly interested in the types and designs of American ambulances, and also the equipment carried in these vehicles. Of special interest to me would be the design and

(Continued to page 10)



# Satisfied with my PRESENT PAYCHECK? **NOT ME!!**

TODAY, you are probably earning enough to get by—enough to provide your family with life's necessities, and perhaps you are depositing a few extra dollars in the bank.

BUT are you content with just earning a living wage? Do you say "Someday I'll really get a break and go right on to the top." THAT'S WISHFUL THINKING!

You know that the "breaks" go to the man or woman who is prepared to take advantage of them—to the person who can fill the better job and who is worth more money. He makes the "breaks" instead of waiting for them.

## DO YOU QUESTION YOUR OWN ABILITY?

There is a field of business which has never been overcrowded—it's the ACCOUNTING FIELD. And the demand for skilled accountants—men and women who really know their business—is increasing. State and Federal legislation requires much more efficient accounting from business. Corporations are in constant need of expert counsel in matters relating to Auditing, Cost Accounting, Business Law, and Federal Income Tax. Men who prove their qualifications in this important branch of business are promoted to responsible executive positions—given an opportunity to earn real salaries. The range is \$5,000 to \$10,000 a year—even to higher income figures.

## WHY BE SATISFIED WITH YOUR PRESENT JOB?

Why accept mediocre pay when right in your own home you can acquire the necessary training to advance rapidly in the profitable, growing field of Accounting.

Under the LaSalle Problem Method you can acquire a thorough knowledge of Accounting, master its fundamental principles, become expert in the practical application of those



principles—without losing an hour from work or a dollar of pay.

Your training will be under the supervision of organization and management specialists, Attorneys and Certified Public Accountants. Preliminary knowledge of bookkeeping is not necessary. We train you from the ground up—Basic Accounting right through specialized training in Office Management, Governmental, Industrial, Commercial, or Public Accounting and CPA.

## SO RIGHT NOW—TODAY

If you are ambitious—if you are interested in a high-paying career—investigate the opportunities in this profitable field.

## FREE SAMPLE LESSON

Decide today to send for LaSalle's Accounting Lesson Number One, also FREE book, "Opportunities in Accounting." In it you will find complete information on the opportunities which are open to those qualified, and you will learn how you can prepare yourself for a better job and more money. NO OBLIGATION. MAIL THE COUPON TODAY.

ACCREDITED MEMBER, NATIONAL HOME STUDY COUNCIL

MAIL THE  
COUPON  
TODAY!

OVER 4,500 CPAs  
HAVE BEEN TRAINED  
BY THE LA SALLE  
PROBLEM METHOD

-----SEND FOR FREE BOOKS-----



**LaSalle Extension University**  
— A Correspondence Institution —  
Dept. 1164-H, 417 S. Dearborn St., Chicago 5, Ill.  
Please send me, free of all cost or obligation, Free sample lesson, and your illustrated book, "Opportunities in Accounting."

Name.....Age.....  
Address.....  
City, Zone, State.....

# BURIED ALIVE!



SIX YEARS ON THE SAME JOB WITH NEVER AN ACCIDENT... AND THEN ONE MORNING...

2 A CAVE-IN PUT ME SIX FEET UNDER FOR SIX LONG MINUTES

QUICK! GET HIM OUT OF THERE!



3 IN THE HOSPITAL, I HAD PLENTY OF TIME TO THINK

SIX YEARS I'VE BEEN BURIED ALIVE IN THAT SAME OLD JOB, JANE!

WELL, NOW'S A GOOD TIME TO DO SOMETHING ABOUT IT



4 I'D PASSED OVER DOZENS OF I.C.S. ADS IN POPULAR MECHANICS. BUT I SAW THIS ONE IN A NEW LIGHT

I.C.S. SUCCESS PLAN... SPARE-TIME TRAINING... 257 COURSES TO CHOOSE FROM... THIS COULD BE THE ANSWER... WON'T HURT TO FIND OUT



# FREE!

## I.C.S. CAREER KIT

Send coupon now...  
get all three books

INTERNATIONAL CORRESPONDENCE SCHOOLS  
BOX 21953L SCRANTON 15, PA.



HERE'S WHERE YOU COME IN! LET I. C. S. SHOW YOU THE WAY TO MORE PAY, RAPID ADVANCEMENT, REAL JOB SECURITY! MAIL THIS COUPON TODAY!

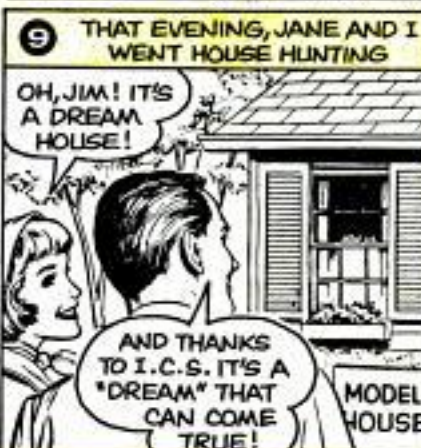

- 1 "HOW TO SUCCEED" A 32-page gold mine of ideas
- 2 CAREER CATALOG Opportunities in the field that interests you most
- 3 SAMPLE LESSON (MATH) Shows the famous step-by-step I. C. S. teaching method



For Real Job Security—Get an I. C. S. Diploma! I. C. S., Scranton 15, Penna. Accredited Member, National Home Study Council

## INTERNATIONAL CORRESPONDENCE SCHOOLS



BOX 21953L, SCRANTON 15, PENNA.

(Partial list of 257 courses)

Without cost or obligation, send me "HOW TO SUCCEED" and the opportunity booklet about the field BEFORE which I have marked X (plus sample lesson):

- |  |  |  |  |   |
|--|--|--|--|---|
| <p><b>ARCHITECTURE and BUILDING CONSTRUCTION</b></p> <ul style="list-style-type: none"> <li><input type="checkbox"/> Air Conditioning</li> <li><input type="checkbox"/> Architecture</li> <li><input type="checkbox"/> Arch. Drawing and Designing</li> <li><input type="checkbox"/> Building Contractor</li> <li><input type="checkbox"/> Building Estimator</li> <li><input type="checkbox"/> Carpentry and Millwork</li> <li><input type="checkbox"/> Carpenter Foreman</li> <li><input type="checkbox"/> Heating</li> <li><input type="checkbox"/> Interior Decoration</li> <li><input type="checkbox"/> Painting Contractor</li> <li><input type="checkbox"/> Plumbing</li> <li><input type="checkbox"/> Reading Arch. Blueprints</li> </ul> <p><b>ART</b></p> <ul style="list-style-type: none"> <li><input type="checkbox"/> Commercial Art</li> <li><input type="checkbox"/> Magazine &amp; Book Illus.</li> <li><input type="checkbox"/> Show Card and Sign Lettering</li> <li><input type="checkbox"/> Sketching and Painting</li> </ul> <p><b>AUTOMOTIVE</b></p> <ul style="list-style-type: none"> <li><input type="checkbox"/> Automobiles</li> <li><input type="checkbox"/> Auto Body Rebuilding and Refinishing</li> <li><input type="checkbox"/> Auto Engine Tuneup</li> <li><input type="checkbox"/> Auto Technician</li> </ul> | <p><b>AVIATION</b></p> <ul style="list-style-type: none"> <li><input type="checkbox"/> Aero-Engineering Technology</li> <li><input type="checkbox"/> Aircraft &amp; Engine Mechanic</li> </ul> <p><b>BUSINESS</b></p> <ul style="list-style-type: none"> <li><input type="checkbox"/> Accounting</li> <li><input type="checkbox"/> Advertising</li> <li><input type="checkbox"/> Business Administration</li> <li><input type="checkbox"/> Business Management</li> <li><input type="checkbox"/> Cost Accounting</li> <li><input type="checkbox"/> Creative Salesmanship</li> <li><input type="checkbox"/> Managing a Small Business</li> <li><input type="checkbox"/> Professional Secretary</li> <li><input type="checkbox"/> Public Accounting</li> <li><input type="checkbox"/> Purchasing Agent</li> <li><input type="checkbox"/> Salesmanship</li> <li><input type="checkbox"/> Salesmanship and Management</li> <li><input type="checkbox"/> Traffic Management</li> </ul> <p><b>CHEMICAL</b></p> <ul style="list-style-type: none"> <li><input type="checkbox"/> Analytical Chemistry</li> <li><input type="checkbox"/> Chemical Engineering</li> <li><input type="checkbox"/> Chem. Lab. Technician</li> <li><input type="checkbox"/> Elements of Nuclear Energy</li> <li><input type="checkbox"/> General Chemistry</li> <li><input type="checkbox"/> Natural Gas Prod. and Trans.</li> <li><input type="checkbox"/> Petroleum Prod. and Engr.</li> <li><input type="checkbox"/> Professional Engineer (Chem)</li> <li><input type="checkbox"/> Pulp and Paper Making</li> </ul> | <p><b>CIVIL ENGINEERING</b></p> <ul style="list-style-type: none"> <li><input type="checkbox"/> Civil Engineering</li> <li><input type="checkbox"/> Construction Engineering</li> <li><input type="checkbox"/> Highway Engineering</li> <li><input type="checkbox"/> Professional Engineer (Civil)</li> <li><input type="checkbox"/> Reading Struc. Blueprints</li> <li><input type="checkbox"/> Structural Engineering</li> <li><input type="checkbox"/> Surveying and Mapping</li> </ul> <p><b>DRAFTING</b></p> <ul style="list-style-type: none"> <li><input type="checkbox"/> Aircraft Drafting</li> <li><input type="checkbox"/> Architectural Drafting</li> <li><input type="checkbox"/> Drafting Machine Design</li> <li><input type="checkbox"/> Electrical Drafting</li> <li><input type="checkbox"/> Mechanical Drafting</li> <li><input type="checkbox"/> Sheet Metal Drafting</li> <li><input type="checkbox"/> Structural Drafting</li> </ul> <p><b>ELECTRICAL</b></p> <ul style="list-style-type: none"> <li><input type="checkbox"/> Electrical Engineering</li> <li><input type="checkbox"/> Elec. Engr. Technician</li> <li><input type="checkbox"/> Elec. Light and Power</li> <li><input type="checkbox"/> Practical Electrician</li> <li><input type="checkbox"/> Practical Lineman</li> <li><input type="checkbox"/> Professional Engineer (Elec)</li> </ul> <p><b>HIGH SCHOOL</b></p> <ul style="list-style-type: none"> <li><input type="checkbox"/> High School Diploma</li> </ul> | <ul style="list-style-type: none"> <li><input type="checkbox"/> Good English</li> <li><input type="checkbox"/> High School Mathematics</li> <li><input type="checkbox"/> Short Story Writing</li> </ul> <p><b>LEADERSHIP</b></p> <ul style="list-style-type: none"> <li><input type="checkbox"/> Industrial Foremanship</li> <li><input type="checkbox"/> Industrial Supervision</li> <li><input type="checkbox"/> Personnel-Labor Relations</li> <li><input type="checkbox"/> Supervision</li> </ul> <p><b>MECHANICAL and SHOP</b></p> <ul style="list-style-type: none"> <li><input type="checkbox"/> Diesel Engines</li> <li><input type="checkbox"/> Gas-Elec. Welding</li> <li><input type="checkbox"/> Industrial Engineering</li> <li><input type="checkbox"/> Industrial Instrumentation</li> <li><input type="checkbox"/> Industrial Metallurgy</li> <li><input type="checkbox"/> Industrial Safety</li> <li><input type="checkbox"/> Machine Design</li> <li><input type="checkbox"/> Machine Shop Practice</li> <li><input type="checkbox"/> Mechanical Engineering</li> <li><input type="checkbox"/> Professional Engineer (Mech)</li> <li><input type="checkbox"/> Quality Control</li> <li><input type="checkbox"/> Reading Shop Blueprints</li> <li><input type="checkbox"/> Refrigeration and Air Conditioning</li> <li><input type="checkbox"/> Tool Design</li> <li><input type="checkbox"/> Tool Making</li> </ul> <p><b>RADIO, TELEVISION</b></p> <ul style="list-style-type: none"> <li><input type="checkbox"/> General Electronics Tech.</li> </ul> | <ul style="list-style-type: none"> <li><input type="checkbox"/> Industrial Electronics</li> <li><input type="checkbox"/> Practical Radio-TV Eng'g</li> <li><input type="checkbox"/> Practical Telephony</li> <li><input type="checkbox"/> Radio-TV Servicing</li> </ul> <p><b>RAILROAD</b></p> <ul style="list-style-type: none"> <li><input type="checkbox"/> Car Inspector and Air Brake</li> <li><input type="checkbox"/> Diesel Electrician</li> <li><input type="checkbox"/> Diesel Engr. and Fireman</li> <li><input type="checkbox"/> Diesel Locomotive</li> </ul> <p><b>STEAM and DIESEL POWER</b></p> <ul style="list-style-type: none"> <li><input type="checkbox"/> Combustion Engineering</li> <li><input type="checkbox"/> Power Plant Engineer</li> <li><input type="checkbox"/> Stationary Diesel Engr.</li> <li><input type="checkbox"/> Stationary Fireman</li> </ul> <p><b>TEXTILE</b></p> <ul style="list-style-type: none"> <li><input type="checkbox"/> Carding and Spinning</li> <li><input type="checkbox"/> Cotton Manufacture</li> <li><input type="checkbox"/> Cotton Warping and Weaving</li> <li><input type="checkbox"/> Loom Fixing Technician</li> <li><input type="checkbox"/> Textile Designing</li> <li><input type="checkbox"/> Textile Finishing &amp; Dyeing</li> <li><input type="checkbox"/> Throwing</li> <li><input type="checkbox"/> Warping and Weaving</li> <li><input type="checkbox"/> Worsted Manufacturing</li> </ul> |
|--|--|--|--|---|

Name \_\_\_\_\_ Age \_\_\_\_\_ Home Address \_\_\_\_\_

City \_\_\_\_\_ Zone \_\_\_\_\_ State \_\_\_\_\_ Working Hours \_\_\_\_\_ A.M. to P.M. \_\_\_\_\_

Occupation \_\_\_\_\_

Canadian residents send coupons to International Correspondence Schools, Canadian, Ltd., Montreal, Canada. . . . Special tuition rates to members of the U. S. Armed Forces.

# OWN a Nationally Advertised Business

World Wide



We'll show you how to earn **\$8,750 clear PROFIT** the first year on just 2 jobs a day... personally train you, furnish all equipment.

- NO SHOP NEEDED
- START IN SPARETIME IF NOW EMPLOYED
- YOU OFFER 3 SERVICES

Even if employed, enjoy the prestige and financial independence of your OWN business. We offer a lifetime opportunity to reliable men. You will be trained in your town by a Duraclean dealer, who will reveal the Duraclean System and plans for building business. He helps you get quickly established. Just 2 average jobs a day earns \$8,750 NET profit the first year. Employ others, MULTIPLY profits. Business grows from recommendations, repeat orders. Under our guidance you become an expert in the care of rugs and upholstery. Easy to learn. We furnish everything.

## YOU CAN START FROM YOUR HOME

These are full-time dealerships, but you can start part-time from home. All work done with portable equipment in homes, offices, hotels, institutions. We work with you 12 months of the year, provide 25 regular services to help you build business: National Advertising in McCall's, House & Garden, dozen others. Insurance. Complete Local Ad Kit. Publicity Program gets free newspaper stories. Monthly Magazine. Conventions. Many others.

### THREE ways to make money

A Duraclean Dealership qualifies you to offer 3 different services: 1. **DURACLEAN**: Famous ABSORPTION process for cleaning rugs, carpets, upholstery. Recommended by leading stores and manufacturers. NO scrubbing, soaking, shrinking. Aerated foam safely removes dirt, grease. Dries so fast, customers use furnishings in few hours! 2. **DURASHIELD**: Soil-retarding treatment that KEEPS furnishings clean MONTHS longer. So new you may be first in town to offer this type service. 3. **DURAPROOF**: Protects against damage by moths, carpet beetles. Only such treatment backed by an International 6-year Warranty!

### Send for FREE Booklet!

A moderate payment establishes your business—pay balance from sales. We furnish electric machines, complete sales material, enough supplies to return TOTAL investment. Our FREE booklet explains urgently needed services, large profit, easy terms, PROTECTED territory. Send coupon today.

DURACLEAN CO., 7-16N Duraclean Bldg., Deerfield, Ill.

## "OWN a Business" Coupon

Duraclean Co., 7-16N Duraclean Bldg., Deerfield, Ill.

Please rush free booklet and letter giving full details of how I may OWN a growing, lifetime business.

Name \_\_\_\_\_

Address \_\_\_\_\_

City \_\_\_\_\_ State \_\_\_\_\_

(Continued from page 6)

construction of the ambulance stretcher, which appears, from the photographs I have seen of it, to have a retractable undercarriage to permit the handling and loading of the stretcher by one man.

In Australia, the states are divided into ambulance districts: The Latrobe Valley District being one of 16 districts in this state. This district has its headquarters at Morwell, Gippsland, the center of one of the richest deposits of brown coal in the world. We serve a population of approximately 50,000 people, and to provide an efficient service we have eight ambulances, all equipped with two-way radio. Our vehicles travel approximately 12,000 miles per month attending to some 450 calls, many of which involve traveling 200 to 500 miles. We have our own buildings and workshops, and a Committee of Management is responsible for the conduct of the service.

D. B. Matthews,  
Superintendent-Secretary,  
Latrobe Valley District Ambulance  
Service,  
McDonald and Spry Streets,  
Morwell, Victoria, Australia.

### To the Editor:

For many years I have keenly awaited each new issue of PM and I was especially interested in John Ott's observations as regards the tests in application of the shorter wavelengths of light, June 1957 issue. If I may, per medium of your splendid magazine, establish contacts with others who are making a study of ultraviolet light and its effect on plant and animal, I would be pleased to hear from them. All letters will be answered.

H. W. W. Taylor,  
R.D. 3 Papapara Road,  
Wanganui, New Zealand.

### To the Editor:

A pat on the back, please, for the editor who decided to publish the two letters on pages 6 and 8 of the August issue. They are right up my street and voice what I have been thinking and saying for many years. I used to deal with a garage in British Columbia in the 1920s which carried a notice "The man who lends the tools is out—permanently out."

Mr. Carleton Esty, who writes about Fords, may possibly remember the days when we roped the rear wheels of our Model-Ts and had to climb the mountains

(Continued to page 14)



**J. E. SMITH, Founder**  
National Radio Institute  
Over 40 Years' Experience  
In Training Ambitious Men

I Will Send You A  
**SAMPLE LESSON FREE**  
to show you how easy, practical it is to  
**Train at Home for Good**  
**Television-Radio Jobs**

**America's Fast Growing Industry Offers You Good Pay Plus a Bright Future**

People look up to and depend on the Technician, more than ever before. Offices, plants, homes everywhere—are obliged to buy his knowledge and services. His opportunities are great and are increasing. At home, and in your spare time, you can learn to do this interesting, satisfying work, qualify for important pay. No experience is needed. You train in your own home—keep your present job while learning.



**Make \$10, \$15 a Week Extra**

NRI students find it easy to start fixing sets for friends soon after enrolling. Many who start in spare time soon build profitable, full time TV-Radio businesses.



**Television's Growth is Making More Jobs, Prosperity**

Right now, a solid, proven field of opportunity for good pay is servicing the millions of Television and Radio sets now in use. Hundreds of TV and Radio stations on the air offer interesting jobs for Operators and Technicians.

**Mail Coupon—Find Out About This Tested Way to Better Pay**

You don't have to know anything about electricity or Radio to succeed with NRI courses. Mailing the coupon may be one of the important acts of your life. Do it now. Reasonable tuition, on low monthly payments available. Let us send you an actual lesson. Judge for yourself how easy it is to learn. A 64-page catalog gives details of opportunities and training. Address: NATIONAL RADIO INSTITUTE, Dept. 7MA, Washington 16, D.C.

**You Learn by Practicing with Equipment NRI Sends**

Clearly written, well-illustrated NRI lessons teach TV-Radio-Electronics principles. Also, without extra charge, you get NRI kits developed especially to give you actual practice with TV-Radio equipment. You build, test, experiment with actual Television-Radio receiver or broadcasting circuits, build, use testing equipment. All equipment is yours to keep. In your own home you gain knowledge, develop skills needed for jobs in this vast industry.

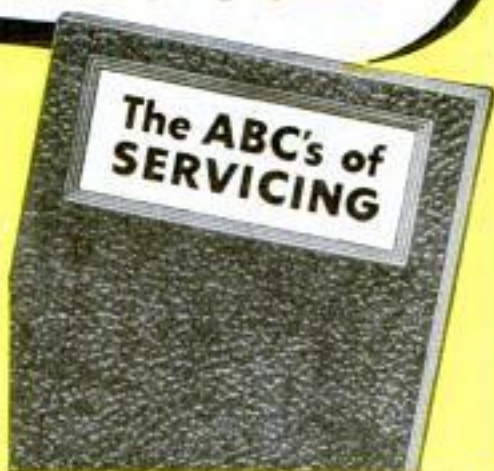

**NRI Trained These Men**



"I have my own Radio-TV business and my income has provided me with financial security. Business is great. I can't keep up with the work."—EDWARD M. DUDEK, Chicago, Ill.

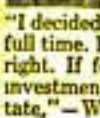

"I decided to quit my job and do TV work full time. I love my work and am doing all right. If fellows knew what a wonderful investment NRI is, they would not hesitate."—W. F. KLINE, Cincinnati, Ohio.



"Thanks to NRI, I operated a successful Radio repair shop. Then I got a job with WPAQ, later WBOB and now am an engineer for WHPE."—VAN W. WORKMAN, High Point, N. Carolina.



**MAIL COUPON FOR SAMPLE LESSON and 64-PAGE CATALOG**

**Good for Both—FREE**

NATIONAL RADIO INSTITUTE, Dept. 7MA  
Washington 16, D. C.

Mail me Sample Lesson and 64-page Book, FREE.  
(No salesman will call. Please write plainly.)

Name \_\_\_\_\_ Age \_\_\_\_\_

Address \_\_\_\_\_

City \_\_\_\_\_ Zone \_\_\_\_\_ State \_\_\_\_\_

ACCREDITED MEMBER NATIONAL HOME STUDY COUNCIL

# SMASH THRU SPACE BARRIERS!



## POWERHOUSE German Telescope!

# 4.98

- New 1958 Model!
- Now... 225 Times BIGGER AREA!

### FREE GIFT COUPON!

POWERHOUSE IMPORT DIV., Dept. 6-M-40  
585 Water Street, New York 2, N. Y.

RUSH new 1958 Powerhouse Telescope at sensational low price of only \$4.98 on 10-day some trial. My money back if I am not satisfied. Include regular \$4.98 Powerhouse German Binoculars as a FREE GIFT—mine to keep in any case!

Send COD plus postal fees.

Check, cash, money order for \$4.98 enclosed. Send everything prepaid.

PRINT NAME \_\_\_\_\_

ADDRESS \_\_\_\_\_

CITY & STATE \_\_\_\_\_

Zone \_\_\_\_\_

Mail Coupon Now for prompt delivery! POWERHOUSE IMPACT DIVISION, Dept. 6-M-40, 585 Water Street, New York 2, N. Y.

### HOW DO WE DO IT?

The answer lies in highly skilled German craftsmen who work with pride and efficiency. They are backed with the most advanced scientific machinery which helps them produce 5 to 10 times more per worker. But that's only half the story. The magic of the American dollar abroad and our vast exporting power (we import by BOATLOADS) enable us to bring you this unbelievable value—direct from supplier to you! (Never, but never do you pay for needless distribution costs and high middlemen's profits. Direct sales mean direct savings FOR YOU!)

### FREE EXAMINATION

SEND NO MONEY NOW! Deposit \$4.98 plus postal fees with your postman from the delivery point address. Examine them the better you can. Take in the incomparable beauty of the Milky Way; the unforgettable brilliance of the Big Dipper; the serene, yet revealing grandeur of the moon's peaks and craters; the solemn majesty of Jupiter and Saturn; the glory of the Pleiades. Your Powerhouse telescope is a piece of art. Whether it's 10 miles or 10,000 miles, you get sharper, better, clearer-up views you never dreamed possible!

### FREE BINOCULARS!

Seeing is believing! You must be entirely sold on the new 1958 Powerhouse before your money back. But... your German Binoculars FREE. These are our regular \$4.98 set. Thousands already sold here and in Canada. Use the binoculars for sports, hunting, races, bird watching, get views up to 2000 feet. Don't forget to include a FREE GIFT of our Doublet-Strapless Gift. Most of our Doublet-Strapless Gift is made of the finest optical glass. In any case, you can't lose in a deal like this. MAIL COUPON NOW for prompt delivery! POWERHOUSE IMPACT DIVISION, Dept. 6-M-40, 585 Water Street, New York 2, N. Y.

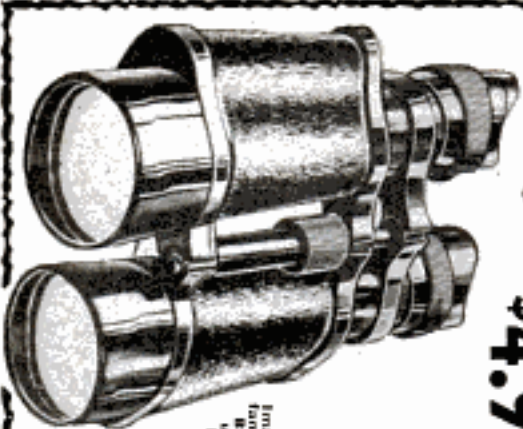

# Free! POWERHOUSE German Binoculars

Our Regular \$4.98 Seller!

Keep FREE In Any Case!

Imagine! You get the famous Powerhouse 7x35 binoculars for only \$4.98 seller. FREE when you examine the new 1958 Powerhouse Telescope. Keep binoculars as a FREE gift even if you return the telescope. This offer limited to the first 10,000 orders. Only one FREE binocular to a family! Mail coupon now.

### 5 SYNCHRONIZED LENSES!

Most low cost telescopes use 2 lenses—but this new 1958 Powerhouse uses **five FIVE** genuine synchronized Rothbar lenses—all ground and polished with meticulous precision. They are not glued, but **ANCHORED** in sturdy **STEEL RINGS!** The draw tubes are heavy duty **METAL!** Here is a quality optical instrument—the crowning achievement of the renowned 102-year-old Rothbar plant in West Germany—famed for their precision cameras, telescopes, binoculars, etc. Never before so many quality features in one moderately priced model! Genuine Objective Lenses coating with genuine magnesium fluoride! Strong metal draw tubes. Beautifully plated! Colourful eyepiece! Delicate synthesized lens system! Strainless, easy focusing! Now **225 TIMES BIGGER AREA!** What power! What range! What clarity!

### MOST PUBLICIZED TELESCOPE!

You have seen this famous Powerhouse Telescope in big national magazines, Outdoor Life, Field & Stream, Esquire, Sports Illustrated, Popular Science, Mechanics Illustrated, Popular Mechanics, Motor, VFW & ELKS Magazines to mention a few!

# INVENTORS

**L**earn how to protect your invention. The U. S. Patent Laws provide that any new and useful art, machine, article of manufacture, or composition of matter, or any new and useful improvement thereof, may be patented if the act of invention is involved. Therefore, every inventor with a valuable invention should take advantage of the Patent Laws and proceed for patent protection in order to safeguard his rights.

A patent gives the inventor the exclusive right to prevent others from making, using, or selling the invention claimed in the patent for a period of seventeen years.

The Patent Laws were enacted for the benefit of the inventor to give him protection for the features of his invention which are patentable. These features must be properly and concisely set forth and claimed in a formal application for patent, in order to comply with the requirements of the Patent Laws. For that reason, unless the inventor is familiar with patent matters, he should engage a competent registered patent attorney or agent to represent him. We are registered to practice before the U. S. Patent Office and are prepared to serve you in the handling of your patent matters.

A specially prepared booklet entitled "Patent Guide for the Inventor", containing detailed information with respect to patent protection and procedure, together with a "Record of Invention" form will be promptly forwarded to you without obligation upon request.

---

## CLARENCE A. O'BRIEN & HARVEY JACOBSON

*Registered Patent Attorneys*

71-L DISTRICT NATIONAL BUILDING

WASHINGTON 5, D. C.

**STOP**  
*Stalling...*

**CLEAN YOUR CARBURETOR**  
with **GUMOUT**  
FOR CARBURETORS

*Cleans Carburetors on-the-engine*  
removes fuel system gum, varnish and moisture

- Gasoline gum and varnish build up quickly inside the carburetor of every car. The result is stalling, high gas consumption, rough idling. That's when it's time to use GUMOUT.
- Just add GUMOUT to your gas tank. Cleans the carburetor as you drive. Or simply have your serviceman run GUMOUT directly through your carburetor.
- GUMOUT removes carburetor gum deposits quickly . . . completely.
- Buy GUMOUT at auto supply stores, or wherever automotive products are sold. There's nothing like it!

send for **FREE**  
46-page "CARBURETOR HANDBOOK"  
It's loaded with helpful information  
about your car's fuel system.

**GUMOUT DIVISION**  
Pennsylvania Refining Company  
2671 Lisbon Road, Cleveland 4, Ohio

HOW IT WORKS  
HOW TO CLEAN  
HOW TO ADJUST

(Continued from page 10)

in reverse to get gravity feed to the carburetor. Happy days, we didn't bother much then about squashy seats.

George Hornsey,  
Stoneleigh, Surrey, England.

**To the Editor:**

The enclosed photo shows my cat looking out the front window of a house I built for him. Since there are very few cat houses, I thought this photo might be of



interest to your readers. My cat is a large one; the house is built of wood, including the imitation bricks at the front end. The cat is resting on what I call the snoozing platform, which extends the full length and half the width. The lower or main floor is the chow department or dining room. The roof is shingled and the walls have three windows on the sides.

Charles Homewood,  
Los Angeles, Calif.

**To the Editor:**

Recently I was looking at one of my old issues of *PM* (May 1905) and noticed a subscription ad which stated that you could send *Popular Mechanics* to your friend for \$1 a year or at \$3 for five years. What really amazed me was that a life subscription could be obtained for only \$10. Oh, for the good old days. Nevertheless, at 10 cents or 35 cents an issue, such a fine magazine as *Popular Mechanics* will always be worth its price.

Stephen Dudley,  
Long Beach, Calif.

☐ Deep-sea telephone cable being laid 2400 miles from Point Arena, Calif., to the island of Oahu will furnish 36 circuits to supplement the 14 radio circuits now used between the mainland and Hawaii.



# Make your break NOW for a BETTER job, MORE money



## TRAIN AT HOME FOR EASY SUCCESS IN REFRIGERATION & AIR CONDITIONING

The time is ripe for you to get into the big, fast-growing Refrigeration and Air Conditioning field. The industry needs 20,000 newly-trained mechanics each year! Over 150 million units are in use today—and over 6 million new installations are being made annually. Plenty of work at top pay! Fine opportunities to open a business! Mail coupon for facts on how to break in—but fast.

R. C. ANDERSON  
President  
CTI



## You learn fast because you practice with real equipment—Get experience!

No need to attend a distant resident school—to leave your family or quit your present job! Learn quickly at home in spare time by practicing with 23 kits that CTI sends. You build a refrigerator, freezer, air conditioner or milk cooler. You do 10 trouble-shooting projects—get field-type experience.

CTI trains you in months—not years—eliminates a long period of low-pay apprenticeship. Training the CTI way is fun—not a chore. It's fascinating to prepare yourself for a fine income and security—in an uncrowded field where trained men are desperately in demand—where opportunities are great!

## A terrific opportunity to be your own boss



Thousands of CTI graduates have gone in business. The refrigeration and air conditioning industry is ideal for this purpose. You can open an appliance store, too. Coupon will bring full details.



You build a heavy-duty, commercial-type, 1/4 h.p. compressor (above). You assemble this unit in easy stages with kits that CTI sends. At left are photos of just two of the 23 kits. One shows mechanic's tools; the other depicts a motor, fan, pulley, other service tools. CTI practical training kits develop skill, provide experience, speed training!

## CTI students are making good

"I have been very busy. Had an offer to work for an appliance dealer but it looks like I'll be in business for myself before long."—Frank Fuller, Wells, N. Y. . . . "Am now working in the field. Earn \$40 more per month than before."—Frank Krotzer, Houston, Texas. . . . "I not only got a job, but today am foreman, earning \$60 a week more than before I enrolled."—E. E. Hughes, Chicago. . . . "Have my own business. Only problem is: Too much business!"—Conrad King, Cynthia, Ky. You can do as well as these men!



## MANY STUDENTS EARN MONEY DURING TRAINING

Soon after enrolling, many students do repair work in spare time. Some get part-time jobs, others make calls "on their own." Advanced students have even opened shops. With their earnings, many students pay tuition, buy additional equipment, have enough left to bank. Mail coupon for details on how to earn as you learn. No cost nor obligation.

## "TRAINING YOU CAN TRUST"

This is the home of CTI, one of the world's great home study schools. Over 40,000 graduates.

COMMERCIAL TRADES INSTITUTE  
1400 Greenleaf Avenue • Chicago 26, Illinois

MAIL TODAY FOR FREE BOOK AND SAMPLE LESSON

## COMMERCIAL TRADES INSTITUTE

1400 GREENLEAF AVENUE DEPT. R-420  
CHICAGO 26, ILLINOIS

Tell me how I can qualify for a better job or a business of my own. Send booklet, Success in Air Conditioning & Refrigeration, and Lesson Sample. Both FREE.

Name \_\_\_\_\_ Age \_\_\_\_\_

Address \_\_\_\_\_

City \_\_\_\_\_ Zone \_\_\_\_\_ State \_\_\_\_\_





**A HIGHLY  
RESPECTED TRADE—  
START SOON TO  
EARN EXTRA MONEY  
IN SPARE TIME**

# Learn at Home IN YOUR SPARE TIME to Fix Electrical Appliances

To build a better future, get into a field where there's much important work and the security that comes from knowing a good trade. Servicing electrical appliances offers that OPPORTUNITY. Every wired home has an average of 8 electrical appliances. Up to 10 million new appliances are sold every year and owners pay well to keep them in repair. That's making a fast-growing need for trained men.

**Start Soon to Earn \$3, \$4, \$5, an Hour Extra in Your Spare Time**

Start soon to fix electric toasters, clocks, fans, vacuum cleaners and other appliances for neighbors and friends. Work in your basement, garage or spare room. Pick up \$3 to \$5 an Hour *extra that way*. It's easy to increase your earning power—to pay for this training many times over with your spare time earnings.

**Learn and Earn with Multi-Use Tester Built with Parts We Send**

This course includes the parts to build a portable, sturdy Appliance Tester that helps you locate electrical defects quickly and easily. You use it to learn and do actual electrical appliance repair jobs. If you want better pay learn this good trade. No need to give up your present

job. You can train at home in your spare time for only \$2.50 down and \$5.00 a month. A small price to pay for increased earnings, a more secure future. Paste coupon below on a 2c postal or mail in envelope for free book and sample lesson. Address **National Radio Institute, Dept. AM7, Washington 16, D.C.**

**2c TO MAIL THIS  
COUPON MAY START  
YOU TO SUCCESS  
LESSON AND BOOK  
FREE**



**NATIONAL RADIO INSTITUTE, Dept. AM7, Washington 16, D. C.**  
Please send me Electric Appliance Training lesson and book free. (No salesman will call.)

Name.....Age.....  
Address.....  
City.....Zone.....State.....  
**ACCREDITED MEMBER NATIONAL HOME STUDY COUNCIL**

# INVENTORS

If you believe that you have an invention, you should find out how to protect it. The first step is to have a search made of the prior pertinent U. S. patents. If a report on this search indicates that the invention appears patentable you can apply for a patent, and the specifications and claims should be prepared.

The firm of McMorrow, Berman & Davidson, with offices in Washington, D. C., is qualified to take the necessary steps for you. We can make a preliminary search on your invention, advise you whether we think it can be patented, and prepare your application for patent.

Unless you are fully familiar with the U. S. Patent Laws, we recommend that you engage the services of a Registered Patent Attorney to protect your interests. The patent laws are *your* laws. A patent gives you the right to prevent others from making, using or selling the invention claimed in your patent for a period of 17 years.

Use these patent laws for your protection. Investigate whether your invention can be patented. If you have what you believe to be an invention, we suggest that you have this firm make a search for you:

*Send for a copy of our Patent Booklet entitled "How To Protect Your Invention," containing information about patent protection and patent procedure. Along with this we will also send you an "Invention Record" form, for your use in writing down and sketching details of your invention. We will mail them promptly. No obligation. They are yours for the asking.*

**McMORROW, BERMAN & DAVIDSON**

*Registered Patent Attorneys*

**PATENTS • COPYRIGHTS • PATENTS**

**135-M VICTOR BUILDING, WASHINGTON 1, D. C.**

## OPTICAL BARGAINS

### 3" ASTRONOMICAL REFLECTING TELESCOPE

(Famous Mt. Palomar type)

See the Stars, Moon, Planets Close Up!  
60 & 120 Power — An Unusual Buy!

Assembled and ready to use! You'll see the Rings of Saturn, the fascinating planet Mars, huge craters on the Moon. Aluminized and overcoated 3" diameter high-speed f/10 astronomical mirror. Telescope comes equipped with a 60X eyepiece and a mounted Barlow Lens, giving you 60 & 120 power. Optical Finder Telescope, included. Sturdy, hardwood, portable tripod. Free with scope: Valuable STAR CHART and 272 page "Astronomy Book." Stock No. 85,050-H . . . . . \$29.50 f.o.b. (Shipping wt. 10 lbs.) . . . . . Barrington, N. J.



### 4 1/4" ASTRONOMICAL TELESCOPE

Mt. Palomar type! Up to 270 Power. A fine Reflector Telescope complete with real Equatorial Mount and Tripod. Aluminum tube, 4 1/4" dia. mirror, rack and pinion focusing eye-piece holder, 2 eyepieces and mounted Barlow Lens for 40X, 90X, 120X and 270X. Shipping weight approx. 25 lbs. Stock No. 85,006-H . . . complete, \$74.80 f.o.b. Barrington, N. J.



### NEW! STATIC ELECTRICITY GENERATOR

See a thrilling spark display as you set off a miniature bolt of lightning. Absolutely safe and harmless. Stands 14" high. Turn the handle and two 9" plastic discs rotate in opposite directions. Metal collector brushes pick up the static electricity, store it in the Leyden jar type condenser until discharged by the jumping spark. Countless tricks and experiments. 24 page instruction booklet included. Stock No. 70,070-H . . . . . \$10.95 Postpaid



### New! 2 in 1 Combination! Pocket-Size 50 Power MICROSCOPE and 10 Power TELESCOPE

Useful Telescope and Microscope combined in one amazing, precision instrument. Imported! No larger than a fountain pen. Telescope is 10 Power. Microscope magnifies 50 Times Sharp focus at any range. Handy for sports, looking at small objects, just plain snooping. Send Check or M.O. Satisfaction Guaranteed. Order Stock No. 30,059-H . . . . . \$4.50 Pspd.



### MOUNTED BARLOW LENS

Double and triple your Telescope's power with a Barlow Lens. Ours is mounted in chrome-plated, brass tubing with variable spacers — just slide this mounted negative lens into your 1 1/4" I.D. eyepiece holder, and use your regular eyepieces in it. Fully guaranteed to please you. Stock No. 30,200-H . . . . \$8.00 ppd.



### 6X FINDER TELESCOPE

Has crosshairs for exact locating. You focus by sliding objective mount in and out. Base fits any diameter tube — an important advantage. Has 3 centering screws for aligning with main telescope. 20-mm. diam. objective. Weighs less than 1/2 pound. Stock No. 50,121-H . . . \$8.00 ppd.



### BUILD A SOLAR ENERGY FURNACE

Great Project for Geophysical Year!

A fascinating new field. Build your own Solar Furnace for experimentation — many practical uses. Easy! Inexpensive! Use your scrap wood. We furnish instructions. This sun powered furnace will generate terrific heat — 2000° to 3000°. Fuses enamel to metal. Sets paper aflame in seconds. Use our Fresnel Lens — 14 3/4" diameter . . . f.l. 14".

Stock No. 70,130-H — package of 1 . . . . . \$ 6.00 Postpd.  
Stock No. 70,131-H — package of 2 . . . . . \$11.00 Postpd.  
Stock No. 70,132-H — package of 4 . . . . . \$20.00 Postpd.



### INFRARED SNIPERSCOPE TELESCOPE & PARTS

See in the dark — without being observed. War surplus Sniperscope M-2. Gov't. cost about \$1200. Instrument complete, ready to use. Includes Power Pack. Infrared light source. Will operate from 6 V auto battery. Battery or transformer available. Stock No. 85,053-H . . . . \$150.00 f.o.b.

Save still more money! Build your own Sniperscope! We will furnish instructions — parts, including: Power Packs, 1P25A image tubes, light units, filters, etc. For details — request FREE Bulletin A-26-H.



**SIMPLE LENS KITS!** Fun for adults! Fun for children! Kits include plainly written, illustrated booklet showing how you can build lots of optical items.

Stock No. 2-H — 10 lenses . . . . . \$ 1.00 Postpaid  
Stock No. 5-H — 45 lenses . . . . . \$ 5.00 Postpaid  
Stock No. 10-H — 80 lenses . . . . . \$10.00 Postpaid

### WRITE FOR FREE CATALOG "H"!

Complete Line of Astronomical Telescope Parts and Assembled Telescopes. Also huge selection of lenses, prisms, war surplus optical instruments, parts and accessories. Telescopes, microscopes, satellite telescopes, binoculars, etc. Request Catalog "H"!

ORDER BY STOCK NUMBER (SEND CHECK OR MONEY ORDER. SATISFACTION GUARANTEED.)  
**EDMUND SCIENTIFIC CO., BARRINGTON, N. J.**

### INSURED TIRE SERVICE

## POPULAR BRANDS

**FREE** INSURANCE POLICY given with each used tire sold. We guarantee the amount of service you pay for.

**NOWHERE CAN SUCH QUALITY BE FOUND AT SUCH LOW PRICE!**

**SPECIAL!**  
Deduct 10% on orders for 2 or more used tires

**YOU CAN'T LOSE!!**

GOODYEAR SUBURBANITE TYPE SHOW TIRES			
New Tire Guarantee—Factory Rebuilt			
BEST WINTER TRACTION OF ALL!			
670x15	\$9.95	710x15 650x16 650x15	\$10.90
600x16	\$3.48	670x16	\$3.95
650x16	3.85	670x16	4.05
650x16	4.25	700x16	3.95
Supreme Quality — Rugged Performance — 6 Months Insured Service			
600x16	\$3.48	670x16	\$3.95
650x16	3.85	670x16	4.05
650x16	4.25	700x16	3.95
Supreme Quality — Nothing Finer — 12 Months Insured Service			
600x16	\$5.25	670x16	\$5.45
600x16(6)	6.75	640x16	4.95
650x16	5.75	670x16	5.35
650x16(6)	7.25	710x16	9.45
700x16	6.35	700x16	5.95
750x16(6)	8.45	800x16	6.35
550x18	4.95	820x16	6.35
550x17	4.75	880x16	5.38
690x16	5.25	670x16	5.15
700x15	5.35	700x16(6)	10.25
		10.25	32x6(10)
		Whitewall	\$1.00 extra.

## MIDLAND TIRE SALES

Speedy shipments on Mail Orders. F.O.B. Chicago. Insurance policy sent with each order. Deduct 10% on orders for 2 or more used tires. Send CHECK or MONEY ORDER.—No C.O.D.'s.

3701 S. Normal, Dept. PM-64, Chicago 9, Ill.

## SCIENTIFIC CRIME DETECTION

**IT'S EASY TO LEARN**

Let us teach you in your own home. Learn Fingerprinting, Firearms Identification, Police Photography, Criminal Investigation Methods thoroughly, quickly, at small cost. Over 800 Bureaus of Identification in the U. S. employ I.A.S. students or graduates. Write today, stating age.

**INSTITUTE OF APPLIED SCIENCE, 1920 Sunnyside Ave., Dept. 1358**  
(A Correspondence School Since 1916) Chicago 40, Ill.

## LEARN PLASTICS

**COMPLETE LOW COST SHOP METHOD HOME TRAINING NOW AVAILABLE**

Get in on Big Money opportunities in Plastic molding, casting, forming, carving, etc. Earn as you learn with Interstate's professionally prepared course. All plastic materials furnished.

**WRITE FOR FREE BOOKLET INTERSTATE TRAINING SERVICE**  
DEPT. C-3, PORTLAND 13, OREGON

## MONEY in WORMS

Big money made raising crickets, hybrid red wigglers and 12 inch African fishworms—sell by mail!—We teach you how to raise and where to sell. Free Literature. Hybrid breeder red wigglers—1000—\$4. 5000—\$17.50, postpaid. CARTER WORM RANCH, PLAINS, GEORGIA.

## Sensational FOG-STOP Windshield Cloth

Amazing Discovery! Autoists will over new FOG-STOP Windshield Cleaner. Simply glide over windshield chemically-treated Mitt—at once glass sparkles crystal clear. Hazy mist, frost, sleet, snow disappear like magic. Stops fogging. Sells like wild!

**SAMPLES FOR AGENTS** Sample offer sent immediately to all who send names at once. Hurry. Postcard will do. **SEND NO MONEY—just your name.**

**KRISTEE CO., Dept. 698. AKRON 8, OHIO**

**SKI KIT**  
**\$18.00**  
SAVE 1/2

**IDEAL CHRISTMAS GIFT**

Simply assemble and finish our new water ski kit and you have a pair of skis worth twice the price of the kit. Skis are 7 ply moulded plywood, 67 1/2" long, 7" wide, 3/16" thick. Sturdy rubber foot pieces. All parts plus instructions included — \$18.00. Order from your Michigan dealer or MICHIGAN WHEEL CO., Dept. P-11, Grand Rapids, Mich. C.O.D. orders accepted.

DeVry Tech *CAN PREPARE YOU IN SPARE TIME AT HOME...*

for a Profitable Future in

# Electronics

as used in

## Guided Missiles

ETC.



**No Previous Technical Experience  
or Advanced Education Needed!**

If you think you need a "pull," advanced education or previous technical experience to prepare for a profitable career in the fast-growing, big opportunity field of Electronics—you're mistaken. The most important thing is a sincere desire to be somebody and to get somewhere.

During the past 26 years we have successfully trained farmers, store clerks, factory hands and men of practically every calling from 17 to 55. If these men can do it in their spare time, why can't you?

Regardless of your experience, we urge you to fill in coupon below for full FREE facts about our modern training that follows the same basic method used in our Chicago and Toronto Laboratories. It will cost you nothing for information that may prove to be the turning point in your career. Act now! Send coupon TODAY!

An **INDEX** to a Better Job,  
a Brighter Future

Communications • Radar • Television

Micro-Waves • Radio • Computers • Indus-

trial Electronics • Automation Electronics

"One of North America's Foremost Electronics Training Centers"



Accredited Member  
of National  
Home Study Council

**DEVRY TECHNICAL INSTITUTE**

CHICAGO 41, ILLINOIS

FORMERLY

DEFOREST'S TRAINING, INC.



### Draft Age?

We have valuable information for every man of draft age; so if you are subject to military service, be sure to check the coupon.

### Live-Wire Employment Service

DeVry Tech's Placement Department is in contact with some of the best-known employers in the Electronics field. The service is free to all graduates—and DeVry Tech's record in helping to place men has been outstanding.

### FREE BOOKLET!

We'll give you a free copy of an interesting booklet, "Electronics and YOU." See for yourself how you may take advantage of the opportunities in this fast-growing field.



### MAIL COUPON TODAY!

#### DeVry Technical Institute

4141 Belmont Ave., Chicago 41, Ill., Dept. PM-11-N

Please give me your FREE booklet, "Electronics and YOU," and tell me how I may prepare to enter one or more branches of Electronics as listed above.

Name \_\_\_\_\_ Age \_\_\_\_\_

Please Print

Street \_\_\_\_\_ Apt. \_\_\_\_\_

City \_\_\_\_\_ Zone \_\_\_\_\_ State \_\_\_\_\_

Check here if subject to military training.

DeVry Tech's Canadian Training Center is located,  
at 626 Roselawn Avenue, Toronto 12, Ontario

©2019

Any man will enjoy new

# AIRGRATE YELLO-BOLE

**1. Smokes sweeter!**  
Imported briar bowl lined with *real honey*. Starts caking the instant you light up. Hence, no break-in.

**2. Smokes drier and healthier!** Metal grate condenses moisture, tars, nicotine. No wet heel.

**3. Smokes cooler!** Air-vented chamber draws in fresh air. Aluminum fins and shank throw off heat, cool the smoke.

Famous honey-lining!

**\$250**

Extra interchangeable bowls—\$1.25 each

"Icepak" Set—Airgrate Yello-Bole Pipe plus two extra bowls, \$5.00

Yello-Bole, New York 22

BY THE MAKERS OF KAYWOODIE PIPES

## ENGINE SLUGGISH? Get PYROIL

**DISSOLVE GUM & GOO**  
Frees valves and hydraulic lifters fast! Protects with a film of heatproof lubrication. Engines run smoother, last longer. Write for trial offer. Dept. PM-2, **GUARANTEED . . . .**



85c  
CAN  
ADD  
TO  
OIL

Nothing finer at any price  
**PYROIL** LA CROSSE, WISCONSIN  
TORONTO, CANADA



## Colorcretors are Needed Everywhere

C-9



More Colorcretors are needed to supply growing demand for the enduring, colorful beauty possible only from Colorcrete. Time-worn concrete, stucco and other old or new masonry walls are quickly transformed into clean freshness from a selection of 30 tints, tones and shades. Cementitious base—tough, tenacious, enduring. Colorcrete is applied under pneumatic air pressure by authorized Colorcretors. Machine is easy to operate and readily mobile. Opens up opportunities for men of modest capital. Broad markets with high income potentials. Write for Opportunity Book.

**COLORCRETE**

COLORCRETE INDUSTRIES, INC.  
570 Ottawa Ave., Holland, Mich.



## DRAW The First Day! NO LESSONS! NO TALENT!

New Amazing Invention—"Magic Art Reproducer." You can draw Your Family, Friends, Anything From REAL LIFE—Like An Artist Even If You CAN'T DRAW A Straight Line! Anything you want to draw is automatically seen on any sheet of paper thru the "Magic Art Reproducer." Then easily follow the lines of the "picture image" with a pencil for an original "professional looking" drawing. Also reduces or enlarges. SEND NO MONEY! Free

10 Day Trial! Pay Postman on Delivery \$1.98 plus postage. Or send only \$1.98 with order and we pay postage. Money Back Guarantee.

NORTON PRODUCTS, Dept. 142, 296 Broadway, N. Y.

## BECOME AN EXPERT IN TRAFFIC

Traffic men earn \$4,000 to \$10,000 and up. Thousands of firms need experts on rates, tariffs, regulations. We train you thereby in spare time at home for executive traffic jobs. Personal training under traffic authorities. Placement counsel and help. Write for free 46-page book "Traffic Management—the Fast Growing Profession."

LASALLE Extension University, 417 So. Dearborn St.  
A Correspondence Institution Dept. 1164T, Chicago 5, Ill.

## Secrets of VENTRILOQUISM Now Revealed!



Easy to learn in 60 to 90 days with our Home Study Course. RESULTS GUARANTEED. Make Money! Be Popular! Have Fun! Big Opportunity! Radio, Television, Stage Appearance! For FREE information regarding price and terms WRITE: You must state your age. Dummy Catalog 25c. MAHER HOME COURSE OF VENTRILOQUISM Box 30, Studio E, PM-11, Kensington Station Detroit 24, Michigan

## RUPTURED BE FREE FROM TRUSS SLAVERY

Now there is a new modern Non-Surgical treatment designed to permanently correct rupture. These Non-Surgical treatments are so certain, that a Lifetime Certificate of Assurance is given.

Write today for our New FREE Book that gives facts that may save you painful and expensive surgery, and tells how non-surgically you may again work, live, play and love and enjoy life in the manner you desire. There is no obligation. Excelsior Hernia Clinic, Dept. 8305, Excelsior Spgs., Mo.

POPULAR MECHANICS

## 1957 WINNER - INDIANAPOLIS

**SAM HANKS, famous race driver and mechanic says:**  
**"I'd like a NATIONAL SCHOOLS**  
**trained mechanic on my crew anytime!**  
**Any employer would!"**

Few racing drivers are as qualified to advise future mechanics as Sam Hanks, who builds and repairs his own racing cars. He holds the American Closed Course record (182.554 m.p.h.) and a host of state and national titles, including the National Midget Championship in '49 and the National A.A.A. crown in '53. At Indianapolis, he placed third in '52 and '53 ... last year, he was runner-up.

# MASTER ALL ENGINES IN ONE MODERN, SHOP-METHOD HOME TRAINING COURSE

# AUTO-MECHANICS & DIESEL

"NUMBER ONE COURSE IN ITS FIELD," says Sam Hanks, who predicts bright future for men who clip coupon now.

"I've worked alongside National Schools Trained mechanics," reports Sam Hanks. "They're top-notch mechanics, up on the newest advances in automotive engines — even diesel jobs and fuel injection never faze them. That kind of all-around training really *pays off* — no matter where you work. And take it from me, National Schools Trained mechanics are in big demand everywhere. They command top pay, because they learned how to repair fast and right the first time. Do I recommend National Schools Home Training in Auto Mechanics & Diesel? You bet I do."

Prove it to yourself, Men. National Schools of Los Angeles, a leader since 1905, brings its famous training shops into your home — gives you everything you need to make more money in today's big, opportunity filled Auto-Mechanics & Diesel industry.

Earn as you learn. We show you how. Easy to understand lessons, diagrams, manuals. Free Placement Assistance.

APPROVED FOR G. I. TRAINING



### RESIDENT TRAINING AT LOS ANGELES

If you wish to take your training in our Resident School at Los Angeles, start NOW in our big, modern Shops and Labs. work with the latest Auto and Diesel engines — all types — fuel injection, automatic transmissions, all power equipment — most complete facilities offered by any school. Expert, friendly instructors. Graduate Employment Service. Help in finding home near school—and part time job while you learn. Check coupon for information.

YOU GET AND KEEP ALL THIS EQUIPMENT!



Complete set of professional Tools and All-Metal Tool Box Same top-quality equipment used by expert mechanics everywhere. Use them, display them proudly.



"Motor Analyzing Set" contains Standard Engine Vacuum Fuel Pump Tester, Remote Starter Switch, Modern Timing Light, Standard Compression Tester Plus compact carrying case & instructions.



Top-quality Socket Wrench with Fittings. Real professional tools you'll use during your lifetime career in repairing, all types of engines, from foreign cars to big diesel jobs.

- COURSE COVERS**
- All engines
  - Fuel injection
  - Automatic Transmissions
  - Overhauling
  - Customizing
  - Servicing
  - Maintenance

- PREPARES YOU FOR:**
- Auto-mechanic jobs
  - Airplane mechanics
  - Farm machinery repair
  - All diesel jobs
  - Experimental Labs
  - Government work
  - Engine specialist
  - All-around mechanic

GET THE BENEFITS OF OUR 50 YEARS' EXPERIENCE!



**NATIONAL SCHOOLS**  
 LOS ANGELES 37, CALIF

**FREE!**  
 VALUABLE BOOK & SAMPLE LESSON  
 —Just Send Coupon!



**NATIONAL SCHOOLS**  
 TECHNICAL TRADE TRAINING SINCE 1905  
 LOS ANGELES 37, CALIFORNIA

MAIL NOW TO  
**NATIONAL SCHOOLS, Dept. DB-117**

4000 S. FIGUEROA ST.  
 LOS ANGELES 37, CALIF.

Send for FREE Auto-Diesel Opportunity Book and Sample Lesson.

NAME \_\_\_\_\_ AGE \_\_\_\_\_  
 ADDRESS \_\_\_\_\_  
 CITY \_\_\_\_\_ ZONE \_\_\_\_\_ STATE \_\_\_\_\_

Check if interested ONLY in Resident School training at Los Angeles.

VETERANS: Give date of Discharge \_\_\_\_\_

# HOW TO FIX ANY PART OF ANY CAR

QUICKLY--EASILY--RIGHT!

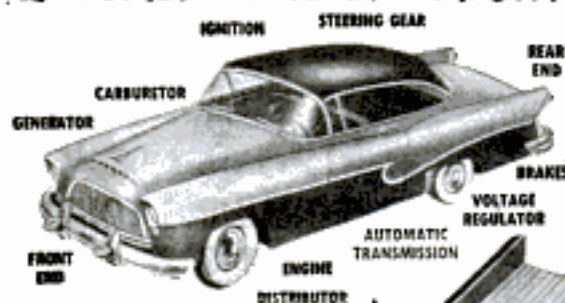

**FREE 7-DAY TRIAL**

**MOTOR'S AUTO REPAIR MANUAL**

Whether you're a beginner or an expert mechanic — now you can "breeze through" any "fix-it" job from simple carburetor adjustment to complete overhaul. Just look up job in index of MOTOR'S Brand-New Auto Repair Manual. Follow simple step-by-step directions, clear pictures. Presto—the job is done!

No guesswork! MOTOR'S MANUAL takes you from "scratch" — shows WHERE to start, WHAT tools to use. Covers EVERY job on EVERY car built from 1949 thru 1957!

Everything You Need to Know "Boiled Down" from 160 Official Shop Manuals

BIG NEW, REVISED, ENLARGED. Edition contains the "meat" from over 160 OFFICIAL shop manuals — simplified for YOU. 23,436 essential repair specifications. Over 1,000 big pages. More than 2,900 "this-is-how" pictures, 225,000 service and repair facts. Leads beginners every step of the way. Time-saving factory repair procedures for experts. Instructions and pictures so clear you CAN'T go wrong. Used by U. S. Army and Navy.

Try Book FREE 7 Days

Just mail coupon. (Attach it to postcard; if you wish.) Make Manual show you what it's got. Unless you agree this is the greatest time and work saver you've ever seen—return book in 7 days and pay nothing. Mail coupon today to: MOTOR-Book Dept., Desk 111, 250 W. 55th St., New York 19, N. Y.

Brand-New—Covers All These Makes

- |             |             |
|-------------|-------------|
| Buick       | Jeep        |
| Cadillac    | Lincoln     |
| Chevrolet   | Mercury     |
| Chrysler    | Nash        |
| Clipper     | Oldsmobile  |
| Continental | Packard     |
| De Soto     | Plymouth    |
| Dodge       | Pontiac     |
| Ford        | Rambler     |
| Hudson      | Studebaker  |
| Imperial    | Thunderbird |
|             | Willlys     |

Some FREE Offer On MOTOR'S New Truck Repair Manual

Covers EVERY job on EVERY popular make gasoline and Diesel truck made from 1949 thru 1957. FREE 7-Day Trial. Check proper box in coupon below.



MAIL COUPON NOW FOR 7-DAY FREE TRIAL (Attach to Postcard if More Convenient)

MOTOR BOOK DEPT. Desk 111, 250 W. 55th St., New York 19, N. Y. Rush to me at once (check box opposite book you want):

- MOTOR'S New AUTO REPAIR MANUAL. If O.K., I will remit \$2 in 7 days, \$2 monthly for 2 months and a final payment of 35c. (plus 35c delivery charges) one month after that. Otherwise I will return the book postpaid in 7 days. (Foreign price, remit \$9 cash with order.)
- MOTOR'S New TRUCK REPAIR MANUAL. If O.K., I will remit \$2 in 7 days, and \$2 monthly for 2 months, plus 35c delivery charges with final payment. Otherwise I will return book postpaid in 7 days. (Foreign price, remit \$20 cash with order.)

Print Name.....Age.....

Address.....

City.....State.....

Check box and save 35c delivery charge by enclosing WITH coupon in envelope entire payment of \$6.95 for Auto Manual (or \$8 for Truck Manual). Same return-refund privilege.

## INFRA-RED SNOOPERSCOPE OPTICS • LAMPS TUBES • PARTS



Former "Top-Secret" Infra-Red Viewers For Seeing in Total Darkness. Now Available For Civilian Applications!!

Army Model M-2 Snooperscopes made by BELL & HOWELL. Use RCA 1P25-A Image Tube. Priced from \$50.00 to \$125.00. Write for Descriptive Bulletin listing prices & applications, also detailed descriptions of all the Infra-Red Parts we stock.

**INFRA-RED LIGHT SOURCE.**—Lamp for M-2 Snooperscope. Input 6-volts, 3 amperes. 5/8" Glass Filter. Projects a powerful beam of invisible Infra-red radiation up to 400 feet. For I-R viewing, communication, photography. **BRAND NEW. \$6.95 Ppd. N.Y.** **POWER SUPPLY.**—M-2 Image Tube supply. For 1P25-A or CV-147 tubes. Input 4-v.d.c., 0.33 ampere. Output 4.250-v.d.c. 4 1/2"x3/8". Gov't cost \$92.00. Complete w/diagram. \$7.95 Ppd.

TERMS: Cash With Order. No COD's. Merchandise Guaranteed.

**McNEAL ELECTRIC & EQUIPMENT CO.**  
4736 Olive Street Dept. PM-11 St. Louis 8, Mo.

## MEN WANTED

Earn \$100 Per Week and up  
**AUTO DIESEL MECHANICS**

Master a trade with a future—learn Auto-Diesel mechanics in our shops. You learn with tools on real equipment. Earn while you learn. Many of our graduates earn \$100 per week and up. No previous experience necessary. Day and night courses. Approved for veterans. Write for free bulletin.

**NASHVILLE AUTO-DIESEL COLLEGE**

226 7th Ave., N., Dept. 73

Nashville 3, Tenn.



## Rubber Stamp Press Outfits Stamp Making Supplies

A profitable home or sideline business mfg. rubber stamps. Stamp Press and all supplies. FREE catalog, advice, instruction. Permanent and profitable business. WRITE TODAY! Full details!



**CUSTOM MANUFACTURING**  
601-A NO. JEFFERSON, SPRINGFIELD, MO.

## Learn ACCOUNTING Business Administration

Bookkeeping, secretarial and allied subjects at home in your spare time or attend nationally approved resident school. Write for FREE Success Book giving complete details on courses, plans, rates and employment opportunities. G.I. approved. Write Dept. A.

**Hills BUSINESS UNIVERSITY AND EXTENSION SCHOOL**  
629 W. MAIN ST. OKLAHOMA CITY 2, OKLAHOMA

## BRONZE FOUNDRY



Schools • Home Workshops • Inventors

Make your own castings of aluminum, copper, bronze, silver. Foundry sets are available in three sizes including 2400 Deg. F. blast furnaces. \$26.50; \$33.50; and \$46.00 f.o.b. Marysville or Lakewood. Free Circular.

**KANSAS CITY SPECIALTIES CO.** (Dept. ) Box 8022, Marysville, Kans. P-11 or Box 7543, Lakewood, Colo.

## DO YOU NEED MONEY?

TO PAY FOR YOUR AERONAUTICAL ENGINEERING EDUCATION AND LIVING EXPENSES while attending school in California?

NORTHROP INSTITUTE'S CO-OP Training Plan is the answer. Write for complete details. No obligation. Also get free Northrop Catalog describing TWO YEAR AERONAUTICAL ENGINEERING CURRICULUM. Remember, there is a waiting list for Northrop Institute Graduates! Approved for Veterans. Send name, address, age and veteran status.

**MAIL TO:** NORTHROP AERONAUTICAL INSTITUTE  
2205 W. Arbor Vitae Street, Inglewood 1, Calif.



Learn **PRACTICAL RADIO-TV**  
with **25 BIG KITS**

of equipment I send you while  
you train with me . . . for valuable  
shop bench experience . . .



**17" to 24"**  
**PICTURE TUBE**



The new Sprayberry Training Television receiver, built and tested in sections.

I now offer this fine modern oscilloscope.

You build this powerful 2 Band superb radio receiver.



You build the new Sprayberry Tester . . . 18-range Volt-Ohm-Milliammeter readings.

**Average cost per lesson**  
**ONLY \$3.42**  
**Including Kits and Equipment**

Prepare for a Good Paying Job—Or Your Own Business!

**"I Will Train You at Home in**  
**RADIO-TELEVISION**  
**on Liberal No Obligation Plan!"**

**New Equipment! New Lessons! Enlarged Course! The true facts are yours in my big new catalog . . . YOURS FREE . . . JUST MAIL COUPON!**



**Frank L. Sprayberry**  
Educational Director

I can train and prepare you in as little as 10 months to step into the big opportunity Radio-Television service field. Train *without* signing a binding contract . . . without obligating yourself to pay any regular monthly amounts. You train entirely at home in spare hours . . . you train as fast or as slowly as you wish. You'll have your choice of **THREE SPRAYBERRY TRAINING PLANS** . . . planned for both beginners as well as the more experienced man. Get the true facts about the finest most modern Radio-Training available today . . . just mail the coupon for my big new 56 page fact-filled catalog plus sample lesson—both **FREE**.

**Train the Practical Way—with Actual Radio-Television Equipment**

My students do better because I train both the mind and the hands. Sprayberry Training is offered in 25 individual training units, each includes a practice giving kit of parts and equipment . . . all yours to keep. You will gain priceless practical experience building the specially engineered Sprayberry Television Training Receiver, Two-Band Radio Set, Signal Generator, Audio Tester and the new Sprayberry 18 range Multi-Tester, plus other test units. You will have a complete set of Radio-TV test equipment to start your own shop. My lessons are regularly revised and every important new development is covered. My students are completely trained Radio-Television Service Technicians.

**NEWEST DEVELOPMENTS!**

Your training covers UHF, Color Television, FM, Oscilloscope Servicing, High Fidelity Sound and Transistors.

**See for Yourself . . . Make Your Own Decision . . . Mail Coupon Today!**

The coupon below brings you my big new catalog plus an actual sample Sprayberry Lesson. I invite you to read the facts . . . to see that I actually illustrate every item I include in my training. With the facts in your hands, you will be able to decide. *No salesman will call on you.* The coupon places you under no obligation. Mail it now, today, and get ready for your place in Radio-Television.

**SPRAYBERRY ACADEMY OF RADIO-TELEVISION**

1512 Jarvis Ave., Dept. 10-U, Chicago 26, Illinois

**Mail This Coupon for Free Facts and Sample Lesson**



**SPRAYBERRY ACADEMY OF RADIO-TELEVISION**  
Dept. 10-U, 1512 Jarvis Ave., Chicago 26, Ill.

Please rush all information on your **ALL-NEW** Radio-Television Training Plan. I understand this does not obligate me and that no salesman will call upon me. Include New Catalog and Sample Lesson **FREE**.

Name \_\_\_\_\_ Age \_\_\_\_\_  
Address \_\_\_\_\_  
City \_\_\_\_\_ Zone \_\_\_\_\_ State \_\_\_\_\_

# Inventors

The following are the usual preliminary steps to take toward patent protection.

You are advised first, to make a disclosure of your invention. Date, sign and have this document witnessed by two or more persons who are capable of understanding your invention. The "Evidence of Invention" form mentioned below, we offer as a convenience in making your disclosure and in starting action leading toward patent protection.

Mail your disclosure to the registered patent attorney or agent whom you select to assist you, together with a letter authorizing him to conduct a

preliminary search among previously granted U. S. patents for similar types of invention. He then prepares for you a report on the probable patentability of your invention and, if the report is favorable, recommends the further course you should take.

This firm is registered to practice before the U. S. Patent Office and is available to assist you in the preparation and prosecution of patent applications. We shall be glad to send you without obligation, the "Evidence of Invention" disclosure form mentioned above and our instructive booklet, "Patent Protection for Inventors".

VICTOR J. EVANS & Co. *Merlin M. Evans*  
REGISTERED PATENT ATTORNEY  
330-M MERLIN BUILDING, WASHINGTON 6, D. C.



AT  
LAST!

A silver spruce Christmas tree that never dies. Warren Lifetime Plastic Christmas Trees. Permanently beautiful, won't sag nor shed needles. Sturdy plastic base. Safe. Easily assembled. Con-

veniently stored in its own carton. Lasts a lifetime. Colors: Green, White, Pink.

30 inch tree ..... \$ 6.95 ..... wt. 2 lbs.  
48 inch tree ..... \$14.95 ..... wt. 4 lbs.  
72 inch tree ..... \$21.95 ..... wt. 9 lbs.

(Calif. residents please add 4% sales tax)  
C. O. D.'s pay charges plus postage

**MIRACLE CHRISTMAS  
TREE SALES CO.**

Dept. PM-7, P. O. Box 105, San Bernardino, Calif.

75 POWER TELESCOPE 25X-45X-75X \$3.98

New 3 in one telescopes, 3 variable 25X-45X-75X magnification, Brass bound, 25 power for ultra bright images, 45 & 75 power for long range. Guaranteed to bring distant stars, moons, objects, sports 7.5 times closer.

Most powerful scope sold anywhere near this amazing low price. American made, 3 sections. Opens 36" closes 1 ft.; contains 4 ground & polished lenses. Can also be used as powerful compound microscope. Directions included. Mass production enables us to offer telescope complete at \$3.98 postpaid. Money back guarantee. Get yours now.

CRITERION CO., 331 Church St., Hartford, Conn., Dept. PMB51



**Print Your Own**

Cards, stationery, circulars, etc. Save money. Print for Others. Good Profit; easy rules sent. Raised Printing like engraving, too. Junior press \$15; Senior \$29 up. Sold direct from factory only. We furnish everything. Write for free details. KELSEY PRESSES, Y-37 Meriden, Connecticut



**Troubled with GETTING UP NIGHTS, Pains in BACK, HIPS, LEGS, Tiredness**

If you have these symptoms then your troubles may be traced to Glandular Dysfunction... a constitutional disease. Medicines that give temporary relief will not remove the cause of your trouble. Neglect of Glandular Dysfunction often leads to premature old age and sometimes incurable malignancy.

The past few years men from over 3,000 communities have been successfully treated here at the Excelsior Institute. They have found soothing relief and a new outlook in the future of life.

The Excelsior Institute, devoted to the treatment of diseases peculiar to older men by NON-SURGICAL methods has a NEW FREE BOOK that tells how Glandular Dysfunction may be corrected by proven NON-SURGICAL treatments. This book may prove of utmost importance in your life. Write today. There is no obligation.

Excelsior Institute, Dept. 329, Excelsior Springs, Mo.

# WHAT ALL AUTO MECHANICS WANT TO KNOW



This Big Practical Book gives full information, with working diagrams, covering the principles, construction, ignition, service and repair of modern cars, trucks and buses.

**Diesel Engines, Hydraulic and Fluid Drives Fully Explained.**

A complete guide of 1696 Pages, with over 1500 Illustrations showing inside views of working parts, with instructions for service jobs. Completely up-to-the-minute! Priced at only \$6.

CIRCLE No. 1 IN COUPON

## HOW TO FIX HOME APPLIANCES

REFRIGERATORS TOASTERS IRONERS VACUUMS  
WASHERS DRYERS RANGES FREEZERS

Many other GAS AND ELECTRIC APPLIANCES

Handy Reference for Electric & Gas Servicers, Mechanic, Dealers and Home-owners. Explains clearly and simply how to locate troubles, how to test, reassemble and connect. Wiring diagrams. 1000 Facts. Easy to read. Answers ALL your questions. 864 Pages. Illustrated. Only \$6.

CIRCLE No. 2 IN COUPON



## TV TELLS HOW TO ANSWER RADIO RADIO TV QUESTIONS SERVICE LIBRARY

HERE IS LATEST INFORMATION IN EASY FORM FOR RADIO AND TELEVISION REPAIRMEN, SERVICEMEN AND STUDENTS

TWO COMPLETE VOLUMES—1568 Pages—1685 Illustrations and Diagrams. 1001 Important Facts and Figures on Modern T.V., Radio Transistors & Transmitters, Circuits, Rectifiers, Ranges, Chassis, P.A. Systems, Photograph Pick-up, P.M., Auto Radio, Short Wave.

Basic principles, Construction, Installation, Operation, Troubleshooting. How to get Sharp, Clear T.V. Pictures. Install and How to Test. Explains COLOR SYSTEMS, Methods of Conversion, Terminals, Includes Ultra High Frequency. Terminals, etc. Includes Ultra High Frequency. Terminals, etc. Includes Ultra High Frequency. Terminals, etc. Includes Ultra High Frequency. Terminals, etc.

CIRCLE No. 3 IN COUPON

## KNOW YOUR TRUCK

The TRUCK & TRACTOR GUIDE for Mechanics & Drivers, Foreman, Garage-men, Helpers, Owners, Trouble Shooters, Farmers, etc. Covering Gas & Diesel Motor Principles—Construction—Operation—Maintenance—Repair—Rebuild—Service of all Parts. 1174 Pages. FULLY ILLUSTRATED. Index. \$15.

CIRCLE No. 5 IN COUPON

## PLUMBERS AND STEAMFITTERS GUIDES



Practical Trade Assistant & Reference Book. Explains in plain language and by clear illustrations, diagrams, charts, graphs and pictures the principles of modern plumbing practice including Pipe Fitting and Air Conditioning. 4 Vols.—2624 Pages—3642 Diagrams & Illustrations. Only \$8 for the complete set of 4 vols.

CIRCLE No. 6 IN COUPON

## PAINTING & DECORATING MANUAL

Inside Trade Information on outside and inside work: how to mix paints, preparation of surfaces, paper, hangings, wood finishes, tools, synthetic paints, roller (with roller-hair), spray equipment, costs, estimating, etc. A COMPLETE guide to easier, better painting and decorating. 464 Pages. Fully Illustrated. Only \$2.

CIRCLE No. 7 IN COUPON

## 7-DAY FREE EXAMINATION

SEND NO MONEY—Pay the postman nothing! We are glad to send you any of the Audel Guides for absolutely FREE examination in your own home. We take all the risks and leave all the decisions up to YOU. There is no obligation! If you decide to keep the books of your choice you may pay for them under our astounding easy-pay plan of only \$2 a month.

### HERE IS ALL YOU DO

IT'S EASY TO ORDER: In the No-Risk Mail Order Coupon at the right just draw a circle around the number of Audel Guides you want to send you for FREE EXAMINATION. We will send them to you at once to help you build a brighter future by increasing your SKILL. If for any reason at all you are not COMPLETELY satisfied, return the books to us, and that will end the matter! NO STRINGS OR CATCHES TO THIS OFFER.

**THEO. AUDEL & CO.**  
49 West 23rd Street, New York 10, N.Y.  
NOVEMBER 1957

# CARPENTERS AND BUILDERS GUIDES



PRACTICAL STOREHOUSE OF MODERN CONSTRUCTION INFORMATION (4 vol. set) for carpenters and all woodworkers. Explains in easy language and by precise illustration principles, advances, short cuts, trade secrets, all based on the NEWEST information.

Vol. 1—Tools, steel square, saw fit, joinery, lumber, etc. Vol. 2—Builder's mathematics, drawing, plans, specifications, estimates, etc. Vol. 3—House and roof framing, laying out, foundations, etc. Vol. 4—Doors, windows, stair building, millwork, painting, etc. 4 vols. 1904 Pages. 1700 Illustrations. Whole set only \$5.

CIRCLE No. 8 IN COUPON

## PRACTICAL ELECTRICITY

A COMPLETE HANDBOOK—Quick, simplified, ready reference. Complete instruction and practical information on the rules and laws of electricity—Maintenance—Wiring Diagrams—House Lighting—Power Wiring—Motors—Batteries—Transformers—etc. Simple to understand. 1520 Pages. 2000 Illustrations. Priced at \$5.

CIRCLE No. 4 IN COUPON

## DIESEL

ALL THERE IS TO KNOW ABOUT MODERN DIESEL ENGINES—Basic principles, starting valves, timing, fuel pumps, fuel injection, compressor, air compressors, pistons, cylinders, lubrication, cooling systems, etc. Answers on operation, calculations. 640 Pages. Fully Illustrated. Priced \$3.

CIRCLE No. 9 IN COUPON

## WELDERS GUIDE

Covers Electric, Oxy-acetylene, Thermit, Unionsmith welding for sheet metal, spot and pipe welds, pressure vessels and aluminum, copper, brass, bronze and other metals. Argon arc, surface hardening, hard facing, cutting, brazing, etc. 608 Pages. Fully Illustrated. Only \$3.

CIRCLE No. 10 IN COUPON

## MATHEMATICS MADE EASY

A COMPLETE HOME STUDY COURSE—Starting with the first principles of arithmetic, advancing step by step through the various stages of mathematics, including the rules and calculations for mechanical and electrical problems. New EASY correct methods. Includes plane and solid geometry, trigonometry, Algebra, calculus, etc. Practical tests, reference tables and data. How to use slide rule. 752 Pages. 550 Illustrations. Priced at only \$3.

CIRCLE No. 11 IN COUPON

## NEW MACHINISTS AND TOOLMAKERS HANDBOOK

MODERN MACHINE SHOP PRACTICE—3 PRACTICAL BOOKS IN ONE. New from cover to cover. Tells how to set up and operate lathes, screw and milling machines, shapers, drill presses and all other machine tools. A COMPLETE INSTRUCTOR AND REFERENCE BOOK. 1728 Pages. Fully Illustrated. Priced at only \$6.

CIRCLE No. 12 IN COUPON

## WIRING DIAGRAMS

This book gives the practical facts on wiring of electrical apparatus. It explains clearly and SIMPLY how to wire apparatus for all fields of electricity. Each diagram is complete and self-explaining. Know your HOOR-UPS! 304 Pages. Illustrated. Only \$2.

CIRCLE No. 13 IN COUPON

## REFRIGERATION & AIR CONDITIONING

FOUR BOOKS IN ONE—Basic principles, servicing, operation, repair of: 1. Household Refrigeration. 2. Special Refrigeration Units. 3. Commercial & Industrial Refrigeration. 4. Air Conditioning Systems. A GOLD MINE of essential information. Completely up-to-date. 1350 Pages. Fully Illustrated and Indexed. Priced at only \$6.

CIRCLE No. 14 IN COUPON

# THE NEW ELECTRIC LIBRARY

A COMPLETE ENCYCLOPEDIA explaining in the simplest terms the fundamental principles, rules and applications of applied electricity.

A COMPLETE COLLEGE EDUCATION! Fully illustrated with diagrams and sketches, calculations and tables for ready reference. Questions and answers. Trial tests for practice study and review. All based on the most modern theory.

- Vol. 1—Principles and rules of electricity, magnetism, armatures, repairs. No. 15
- Vol. 2—Dynamo, DC Motors, construction, installation, maintenance, etc. No. 16
- Vol. 3—Testing instruments and tests, storage battery construction, and repairs. No. 17
- Vol. 4—Alternating current, power factor, alternators, transformers. No. 18
- Vol. 5—A.C. Motors, winding, maintenance, converters, switches, fuses, etc. No. 19
- Vol. 6—Relays, condensers, regulators, rectifiers, meters, switchboards, etc. No. 20
- Vol. 7—Wiring, house light and power, circuits, high tension, plans, code, etc. No. 21
- Vol. 8—Railways, signals, elevators, ignition, etc. No. 22
- Vol. 9—Radio, telephone, telegraph, television, motion pictures. No. 23
- Vol. 10—Refrigeration, illumination, welding, array, electrical appliances, Index. No. 24

## ALL TYPES OF BLUEPRINT READING

How to read scales, the standard symbols, detail and assembly prints, working drawings, etc. Includes hints and suggestions. THE MAN WHO CAN READ BLUEPRINTS IS IN LINE FOR A BETTER JOB. This book gives you the secret language, step by step in easy stages. 448 Pages, Very Fully Illustrated. Priced at \$3.

CIRCLE No. 35 IN COUPON

## MASONS & BUILDERS GUIDES

A PRACTICAL ILLUSTRATED 4 VOL. SET—Explaining in clear, simple language and picture illustration, principles, advances, short cuts, trade secrets, based on modern practice—Including how to figure and calculate various jobs. Vol. 1—Brick work, bricklaying, bonding, design. Vol. 2—Brick Foundations, arches, tile setting, estimating. Vol. 3—Concrete mixing, placing forms, reinforced stone. Vol. 4—Plastering, stone masonry, steel construction, blueprints. 4 Vols. 1440 Pages. 2067 Illustrations. Complete Set only \$8.

CIRCLE No. 26 IN COUPON

## ELECTRIC MOTORS

THIS GUIDE covers the construction, hook-up, control, maintenance and trouble shooting of all types of motors. Includes armature winding. Explains entire subject in great detail in simple language. Over 1000 Pages of information. 617 Diagrams. All types of motors fully illustrated and indexed for ready reference. Priced at only \$5.

CIRCLE No. 27 IN COUPON

## OIL BURNERS

New, complete, explaining in detail both domestic and industrial oil burners. Includes electrical hook-ups and wiring diagrams. Fully covering the theory, construction, installation, operation, testing, servicing and repair of all equipment. Indexed for ready reference. Over 416 Pages. 320 Illustrations and Diagrams. Only \$2.

CIRCLE No. 38 IN COUPON

## ADDITIONAL IMPORTANT TITLES

- The following Audel Guides are all the best in their fields, written in clear simple fashion, all lavishly illustrated. Circle the numbers wanted in the MAIL ORDER COUPON below. All books are sent for FREE EXAMINATION.
- No. 29 SHEET METAL PATTERNS LAYOUTS. 1152 Pages... \$7.50
  - No. 30 SHEET METAL WORKERS HANDBOOK. 488 Pages... 2.00
  - No. 31 MECHANICAL DRAWING GUIDE. 192 Pages... 2.00
  - No. 32 MECHANICAL DRAWING AND DESIGN. 490 Pages... 3.00
  - No. 33 ELECTRONIC CIRCUITS. 354 Pages... 2.00
  - No. 34 ELECTRICIANS EXAMINATIONS. 272 Pages... 2.00
  - No. 35 ELECTRIC POWER CALCULATIONS. Page 480... 3.00
  - No. 36 ELECTRIC DICTIONARY. 9000 Terms... 3.00
  - No. 37 POWER PLANT ENGINEERS GUIDE. 1568 Pages... 5.00
  - No. 38 ENGINEERS AND FIREMANS EXAMS. 248 Pages... 2.00
  - No. 39 OPERATING ENGINEERS LIBRARY. 3 Book Set... 12.00
  - No. 40 PUMPS, HYDRAULICS AND AIR COMPRESSORS. 1785 Pages... 6.00
  - No. 41 HOUSE HEATING GUIDE. 1008 Pages... 5.00

# MAIL THIS NO-RISK COUPON TODAY!

THEO. AUDEL & CO.—Self Improvement Publishers Since 1879— P11

49 W 23rd Street, New York 10, N.Y.

Please mail me for 7 days' FREE EXAMINATION the books I have circled at right.

I agree to mail \$2 in 7 days on each book or set ordered, and to further mail \$2 a month on each book or set ordered until I have paid the purchase price, plus shipping costs. If I am not completely satisfied with my Audel Guides I may return them.

NAME	7	8	9	10	11
ADDRESS	12	13	14	15	16
OCCUPATION	17	18	19	20	21
	22	23	24	25	26
	27	28	29	30	31
	32	33	34	35	36
<input type="checkbox"/> SAVE SHIPPING COSTS! Check here if you enclose complete payment with order. We pay postage charges. You have same return privilege.	37	38	39	40	41

# DRAFTSMEN



**CASH BIG  
PAY CHECKS!**

**Train Now for  
more success,  
greater security**

**LEARN AT HOME IN SPARE TIME  
(or at college in Chicago)**

Check the want ads in any newspaper—SEE the big-pay opportunities open to you as a draftsman. What's more, you can learn this well-paid, prestige profession at home — quickly, easily! No special talent needed. Get complete, step-by-step Chicago Tech lessons in the mail, spend a few pleasant hours studying each week. In a short time you'll be a well-trained draftsman, ready to take your pick of many good jobs. Act now!



**Free Information—Mail Coupon Today!**

Get **FREE TRIAL LESSON** plus information about C.T.C. practical training. Learn what successful Chicago Tech graduates say about high pay and opportunities in drafting. No charge, or obligation.

## CHICAGO TECHNICAL COLLEGE

P-215 Tech Bldg., 2000 So. Michigan Ave.  
Chicago 16, Illinois

Mail me **FREE** lesson with facts about big opportunities in **DRAFTING**.

Name \_\_\_\_\_ Age \_\_\_\_\_

Address \_\_\_\_\_

City \_\_\_\_\_ Zone \_\_\_\_\_ State \_\_\_\_\_

**EARN \$100  
A WEEK AND UP**

**BE AN AUTO-DIESEL  
MECHANIC — EARN  
WHILE YOU LEARN**

Many of our graduates earn \$100 a week and up. You learn fast in our school and shops because you learn with tools on real equipment. Experienced instructors explain WHY and show you HOW, then you DO IT YOURSELF. One of the best equipped technical schools in the United States. Thirty-nine years' experience training men. Successful graduates in 48 states and many foreign countries. Approved for veterans. Day and evening classes. Free bulletin—write today.

**NASHVILLE AUTO-DIESEL COLLEGE**  
226 7th Ave. N., Dept. 86, Nashville, Tenn.



# LEFAX TECHNICAL DATA BOOKS POCKET SIZE • LOOSE LEAF

Printed on loose leaf, 6 hole, 6 1/4"x3 3/4" bond paper, each book contains about 140 pages of technical data, condensed, accurate, essential, for engineer, technical worker, teacher, student, business man **\$1.25** each

Architecture	Surveying Tables	Machine Design	Radio
Home Heating	Highway Eng'g.	Machinist's Data	Television & FM
Illumination	General Math	Mech. of Materials	Electricity, AC
Electrician's Data	Math Tables	Pwr. Trans. Mach.	Electricity, DC
Builder's Data	Physics	Thermo. Tbls. &	AC Motors and
Lumber Data	Trig-Log Tables	Charts	Generators
Air Conditioning	Gen'l Chemistry	Phys. & Thermo-	Conversion Tabl.
Building Constr.	Chemical Tables	dynamic Data	Steel Forms
Reinf. Concrete	Analytic Chem.	Metallurgy	Welding Data
Piping Data	Mech'l Drawing	Hydraulics	Transformers,
Surveying		Metals	Relays & Meters

Write for **FREE** catalogs (2000 listings). See how helpful LEFAX can be to you. Send \$1.25 book, or \$0 for any five books to

**LEFAX PUBLISHERS, Dept. PM-117, PHILADELPHIA 7, PA.**



**SEND FOR THIS FREE!**

Make money. Know how to break and train horses. Write today for this book **FREE**, together with special offer of a course in Animal Breeding. If you are interested in Gaiting and Riding the saddle horse, check here ( ) Do it today—now.

**BEERY SCHOOL OF HORSEMANSHIP**  
Dept. 11011 Pleasant Hill, Ohio

## Official SEA, AIR & LAND PHOTOS

**SPECIAL INTRODUCTORY OFFER!**

1. 4-3 1/2 x 5 Center, Subs and Battleships
2. 4-3 1/2 x 5 World War II planes
3. 4-3 1/2 x 5 photos, world's fastest jets
4. 1-8x10 photo, Farnefall Center
5. 1-8x10 photo USN F11F-1 Tiger

Only 25c a set. Send \$1 for all 5.  
(\$2 value)

Illustr. GAT. with order. Money back guar.

**U. S. SEA & AIR PHOTOS**



DEPT. PE BOX 75084  
LOS ANGELES 5, CALIFORNIA

## STUDY TO BE A DOCTOR of Psychology or Metaphysics

Obtain a Ph.D., M.A., or Ph.D. Be a Teacher, Lecturer or Accredited Practitioner. Teach others how to achieve Health, Happiness and Contentment. Chartered by State. Correspondence Courses only. Write for **FREE** book telling how.

**THE NEOTARIAN FELLOWSHIP**  
Desk 8, Pickwick Building Kansas City 6, Missouri

## REAL ESTATE BE A BROKER

**PAYS BIG! SEND FOR FREE, BIG, ILLUSTRATED CATALOG NOW!** Graduates report making substantial incomes. Start and run your own business quickly. Men, women of all ages, learn easily. Course covers Sales, Property Management, Appraising, Loans, Mortgages, and related subjects. **STUDY AT HOME** or in classrooms in leading cities. Diploma awarded. Write **TODAY** for free book! No obligation.

Approved for World War II and Korean Veterans  
**WEAVER SCHOOL OF REAL ESTATE (Est. 1936)**  
2020R Grand Avenue Kansas City, Mo.

**NEW 1958 CATALOG**

## BOAT KITS

**200 MODELS—SAVE 2/3**

**EASY TO BUILD—Designed**

for the amateur. Over 200 Models. From Cruisers, 8 to 21 ft. Formed hulls Semi and Custom finished. Save 50%... Now **NEW** Sea Ray Molded FIBERGLAS BOAT KITS. Truly professional results. NO upkeep. **SAVE 2/3** assembly time. 12 to 16 ft. Utilities and Runabouts. **SEND 35c** for 64 page Boat Kit & 24 page Sea Ray Catalogs. **SEND \$1.00** for both plus "Boating Handbook". Dealers inquire for franchise.

## BOAT PLANS & PATTERNS

### Frame-Pac Kits

World's largest selection: over 200 plans, full-size patterns, frame-pac kits! Designed strictly for amateurs! All types: prams, kayaks, racers, runabouts, catamarans, houseboats, cruisers — inboard-outboard 6-40' wood-plywood-steel!

**Send 35c for PLAN CATALOG**  
Catalog PLUS "Boatbuilding Handbook" \$1.00  
**WRITE NOW! CUSTOM CRAFT, BUFFALO 7L, N. Y.**



# I'd like to give this to my fellow men... while I am still able to help!

I was young once, as you may be—today I am older. Not too old to enjoy the fruits of my work, but older in the sense of being wiser. And once I was poor, desperately poor. Today almost any man can stretch his income to make ends meet. Today, there are few who hunger for bread and shelter. But in my youth I knew the pinch of poverty; the emptiness of hunger; the cold stare of the creditor who would not take excuses for money. Today, all that is past. And behind my city house, my

summer home, my Cadillacs, my Winter-long vacations and my sense of independence—behind all the wealth of cash and deep inner satisfaction that I enjoy—there is one simple secret. It is this secret that I would like to impart to you. If you are satisfied with a humdrum life of service to another master, turn this page now—read no more. If you are interested in a fuller life, free from bosses, free from worries, free from fears, read further. This message may be meant for you.

By Victor B. Mason

I am printing my message in a magazine. It may come to the attention of thousands of eyes. But of all those thousands, only a few will have the vision to understand. Many may read; but of a thousand only you may have the intuition, the sensitivity, to understand that what I am writing may be intended for you—may be the tide that shapes your destiny, which, taken at the crest, carries you to levels of independence beyond the dreams of avarice.

Don't misunderstand me. There is no mysticism in this. I am not speaking of occult things; of innumerable laws of nature that will sweep you to success without effort on your part. That sort of talk is rubbish! And anyone who tries to tell you that you can think your way to riches without effort is a false friend. I am too much of a realist for that. And I hope you are.

I hope you are the kind of man—if you have read this far—who knows that anything worthwhile has to be earned! I hope you have learned that there is no reward without effort. If you have learned this, then you may be ready to take the next step in the development of your karma—you may be ready to learn and use the secret I have to impart.

## I Have All The Money I Need

In my own life I have gone beyond the need of money. I have it. I have gone beyond the need of gain. I have two businesses that pay me an income well above any amount I have need for. And, in addition, I have the satisfaction—the deep satisfaction—of knowing that I have put more than three hundred other men in businesses of their own. Since I have no need for money, the greatest satisfaction I get from life, is sharing my secret of personal independence with others—seeing them achieve the same heights of happiness that have come into my own life.

Please don't misunderstand this statement. I am not a philanthropist. I believe that charity is something that no proud man will accept. I have never seen a man who was worth his salt who would accept

something for nothing. I have never met a highly successful man whom the world respected who did not sacrifice something to gain his position. And, unless you are willing to make at least half the effort, I'm not interested in giving you a "log up" to the achievement of your goal. Frankly, I'm going to charge you something for the secret I give you. Not a lot—but enough to make me believe that you are a little above the fellows who merely "wish" for success and are not willing to sacrifice something to get it.

## A Fascinating and Peculiar Business

I have a business that is peculiar—one of my businesses. The unusual thing about it is that it is needed in every little community throughout this country. But it is a business that will never be invaded by the "big fellows". It has to be handled on a local basis. No giant octopus can ever gobble up the whole thing. No big combine is ever going to destroy it. It is essentially a "one man" business that can be operated without outside help. It is a business that is good summer and winter. It is a business that is growing each year. And, it is a business that can be started on an investment so small that it is within the reach of anyone who has a television set. But it has nothing to do with television.

This business has another peculiarity. It can be started at home in spare time. No risk to present job. No risk to present income. And no need to let anyone else know you are "on your own". It can be run as a spare time business for extra money. Or, as it grows to the point where it is paying more than your present salary, it can be expanded into a full time business—overnight. It can give you a sense of personal independence that will free you forever from the fear of lay-off, loss of job, depression, or economic reverses.

## Are You Mechanically Inclined?

While the operation of this business is partly automatic, it won't run itself. If you are to use it as a stepping stone to independence, you must be able to work with your hands, use such tools as hammer and screw driver, and enjoy getting into a pair of blue jeans and rolling up your sleeves. But two hours a day of manual work will keep your "factory" running 24 hours turn-

ing out a product that has a steady and ready sale in every community. A half dollar spent for raw materials can bring you six dollars in cash—six times a day.

In this message I'm not going to try to tell you the entire story. There is not enough space on this page. And, I am not going to ask you to spend a penny now to learn the secret. I'll send you all the information, free. If you are interested in becoming independent, in becoming your own boss, in knowing the sweet fruits of success as I know them, send me your name. That's all. Just your name. I won't ask you for a penny. I'll send you all the information about one of the most fascinating businesses you can imagine. With these facts, you will make your own investigation. You will check up on conditions in your neighborhood. You will weigh and analyze the whole proposition. Then, and then only, if you decide to take the next step, I'll allow you to invest \$15.00. And even then, if you decide that your fifteen dollars has been badly invested I'll return it to you. Don't hesitate to send your name. I have no salesmen. I will merely write you a long letter and send you complete facts about the business I have found to be so successful. After that, you make the decisions.

## Does Happiness Hang on Your Decision?

Don't put this off. It may be a coincidence that you are reading these words right now. Or, it may be a matter that is more deeply connected with your destiny than either of us can say. There is only one thing certain: If you have read this far you are interested in the kind of independence I enjoy. And if that is true, then you must take the next step. No coupon on this advertisement. If you don't think enough of your future happiness and prosperity to write your name on a postcard and mail it to me, forget the whole thing. But if you think there is a destiny that shapes men's lives, send your name now. What I send you may convince you of the truth of this proverb. And what I send you will not cost a penny, now or at any other time.

**VICTOR B. MASON**

1512 Jarvis Avenue, Suite M-2-M  
CHICAGO 26, ILLINOIS



**YOU**  
can  
acquire

**LAW NIGHTS AT HOME!**  
**LL. B. DEGREE**

LaSalle's famous Law Library—used as reference in many Law libraries and Law offices—has enabled thousands to master Law surprisingly fast, in spare hours at home, for business and professional advancement.

These 14 remarkable volumes, compiled by leading professors and lawyers, cover the whole basic field of Law in condensed, orderly, simplified manner.

You advance rapidly with this great library, plus special lectures furnished. We guide you step-by-step with personalized Problem Method of instruction . . . you learn by doing—handling legal problems—not by memorizing rules.

Send for two FREE booklets, "Law Training for Leadership," and "Evidence," answering questions about Law and its value to you, and telling how LaSalle Law graduates are winning rapid advancement in business and public life. Mail coupon below. No obligation.

**LA SALLE EXTENSION UNIVERSITY**  
**A Correspondence Institution**

417 5. Dearborn St. Dept. 1164L Chicago 5, Ill.

Send me your two FREE booklets described above, without obligation.

Name.....Age.....

Street.....

City, Zone & State.....

**ENGINEERING DEGREE IN 27 MONTHS**

**B. S. DEGREE IN**

**Aeronautical, Chemical, Civil, Electrical, Mechanical and Electronic Engineering (inc. Radio and TV)**

Also B.S. DEGREE in 36 mo. in Mathematics, Chemistry, Physics (inc. Nuclear Physics), Engineering Science prep. courses. Thorough, practical program. Individualized instruction emphasized. Government approved for G.I.'s.

**Keeping pace with progress in science and engineering**  
Spacious campus, 20 bldgs.; dorms, gym, Playing field. Modern, well-equipped labs including new physics lab and wind tunnel. Low tuition. New terms start quarterly. Enter December, March, June or September. Big demand for graduates. Students from 48 states and 40 foreign countries. Many earn a major part of their college expenses in this large industrial center. Send coupon for free catalog and full information. Enroll now!

**INDIANA TECHNICAL COLLEGE**

5117 E. Washington Boulevard, Fort Wayne 2, Indiana

Please send me free information on 27 MO. B.S. DEGREES in:

Aeronautical  Chemical  Civil  Electrical

Mechanical  Electronics

on 36 MONTH B.S. DEGREES in:

Mathematics  Chemistry  Physics

Name.....

Address.....

**Shrinks Hemorrhoids**  
**New Way Without Surgery**

**Science Finds Healing Substance That Relieves Pain—Shrinks Hemorrhoids**

For the first time science has found a new healing substance with the astonishing ability to shrink hemorrhoids and to relieve pain—without surgery.

In case after case, while gently relieving pain, actual reduction (shrinkage) took place.

Most amazing of all—results were so thorough that sufferers made astonishing statements like "Piles have ceased to be a problem!"

The secret is a new healing substance (Bio-Dyne\*)—discovery of a world-famous research institute.

This substance is now available in suppository or ointment form under the name Preparation H.\* Ask for it at all drug counters—money back guarantee. \*Reg. U. S. Pat. Off.



**WORLD'S LOWEST PRICED**  
**ADDING MACHINE**

Counts up to 999,999,999  
IDEAL FOR BUSINESS AND PERSONAL USE—GUARANTEED ACCURATE.  
Not a toy. Operates with only a finger flick. Adds, subtracts, multiplies, divides. Counts up to one billion. Pays for itself over and over. Ideal Gift—for Business, Income Tax and School Use.  
**MONEY BACK GUARANTEED.** Send name and address. Pay postman only \$2.95 plus postage. Beautiful rich-looking Leatherette Case included at no extra cost. Money back in 10 days if not delighted. AGENTS WANTED.

Vest Pocket Size  
**FREE TRIAL**  
**\$2.95**

\$3.04 IN PENNA. INCLUDING 3% TAX

**CALCULATOR MACHINE COMPANY**  
P.O. Box 126, Dept. X-57, Huntingdon Valley, Penna.

**on any object ELECTROPLATE**

ANY OBJECT IN HOME SHOP GARAGE.  
NOW with our NEW ELECTROCHEMICAL Outfit. You can easily do your own plating. Not a paint. But a hard durable metal plate, equal to commercial plating. Get your own plating kit with instructions on plating metal and non-metal objects as: Forks, Auto Parts, Silverware, Jewelry, Baby Shoes and 1001 other articles with Chrome, Nickel, Copper, Gold, etc. SEND NO MONEY. Everything sent C.O.D. for the low price of ONLY \$5.95 or send \$5.95 now and receive it postpaid. Money back in 7 days if not satisfied. W. Z. SALES CO., Dept. G-15, 111 West 42nd St., New York 36, N. Y.

**BE A CAMERA CRAFTSMAN...**

Send for FREE book!

national camera repair school-DEPT. V-11

24 YEARS IN BUSINESS AT THE SAME ADDRESS. NEARLY EVERYONE BUYS FROM STANDARD.

"We Have No Rent to Pay." That is Why We Can Sell For Less.

Our entire stock of very slightly worn EXTRA MILEAGE TOP GRADE Tires. (Written Guarantee Sent). SEND AD

**EVERYBODY 10% off ON EVERY TIRE**

**FREE** if you buy 2 or more Passenger 4-ply tires. WE GIVE ONE tire FREE, on each order. Does not include W.W. or Truck Tires, or Snow Tires. Write for other sizes.

12 MOS. WRITTEN GUARANTEE WITH EVERY TIRE					
600-16 (R) \$6.62	800-15 \$6.32	700-17 \$10.92	825-20 \$19.52		
650-16 (R) 7.32	820-15 6.32	750-17 11.32	900-20 19.52		
670-15 8.52	700-15 (R) 9.72	700-20 11.82	1000-20 20.52		
710-15 8.52	750-15 (R) 10.52	750-20 (R) 12.82	1100-20 20.52		
760-15 8.52	750-14 11.52	750-20 (10) 15.92	1000-22 21.52		

"EXTRA SPECIAL" TOP GRADE—all size 4-ply pass. tires with more TREAD for LONGER WEAR. \$8.22 TORY TESTED TUBE GIVEN—W.W. \$1.00 EXTRA. EA.

**SNOW TIRES \$8.82** ORDER ANY 4 PLY PASSENGER SIZE

12 MO. GUAR. BLACK WALL DEEP HEAVY TREAD FOR ROUGH WINTER WEAR.

Thousands of tires shipped all over the U.S.A. All tires shipped F.O.B. Phila. Send Check or M.O. with this ad Dept. 2. No C.O.D.

**STANDARD 834 N. Broad St., Philadelphia 30, Pa.**

# NOW READY! McGraw-Hill's New Train-Yourself Course

TELEVISION AND  
RADIO REPAIRING

REPAIRING  
RECORD CHANGERS

PROFITABLE RADIO  
TROUBLESHOOTING

PRACTICAL RADIO  
SERVICING

PROFITABLE  
TELEVISION  
TROUBLESHOOTING

**6 BIG VOLUMES**  
Including  
Home Course  
Outline!  
Shows how  
to Get  
Ahead Fast.

## FIX TV RADIO and RIGHT AWAY RECORD CHANGERS

—even if you've never looked inside a set before!



**BE YOUR OWN BOSS!**

**AT LAST — at Amazing LOW COST — The Most Complete TV-Radio Repair Course Ever Published. TELLS and SHOWS How to Do Every Job Quickly and Easily — Make GOOD MONEY, Full or Spare Time in the BOOMING Repair Business**

**AFTER 10 YEARS OF PREPARATION** — McGraw-Hill's new 6-Volume Course brings you everything you need to know to "cash in" on the TV-RADIO boom. Over 2,350 pages of money-making "know-how" by top factory engineers and electronic experts. **THREE** giant REPAIR MANUALS tell and show how to FIX every trouble the easy way. **TWO** huge TROUBLESHOOTERS tell exactly WHERE to begin, WHAT tools to use, HOW to "polish off" every job. Complete Home Study Volume guides you every step of the way, tells how to get ahead fast as a repairman — build up your own business, full or spare time, for **BIG PROFITS!**

### EARN While You Learn

Tested — and now used in top schools, and repair shops — Course volumes are simple enough for green beginners, amazed "pros" with new easy methods. Starts you doing simple repairs — and earning money — from very first chapter. ABC pictures and directions make tougher jobs a "snap." Before you finish you can earn many times its cost.

NO previous training needed. NO complicated formulas. **PLAIN ENGLISH**

pictures and directions cover ANY job on EVERY set — tubes, circuits, speakers, new a-c/d-c portables, Color TV, even what to charge for every job!

### BIG MONEY — Spare or Full Time

Forget lack of experience. Forget your age. Over 40 MILLION TV sets, 130 MILLION radios — and the shortage of repairmen — mean big money for you. Course makes it easy to "cash in," spare time or full, start your own business, enjoy your work and a big bank account!

### SEND NO MONEY

Try Course 10 days FREE. (We pay shipping!) If you don't agree it can get you started in a money-making repair business — return it, pay nothing. Otherwise keep it. Earn while you learn; and pay the low cost on easy terms. Mail coupon NOW. McGraw-Hill Book Co., Dept. PM-11, 327 West 41st St., New York 36, N. Y.

Examine  
Entire Course  
**FREE**  
for 10 Days!

### PARTIAL CONTENTS

- 1 Television and Radio Repairing — Testing, repairing, replacing parts, 566 pages, 700 "This-Is-How" pictures, diagrams. By John Markus, Feature Ed., Electronics Magazine.
- 2 Practical Radio Servicing — Easy-to-follow directions, diagrams, drawings — with job sheet for every repair job, 509 pages, 473 illus. By William Marcus, Alex Levy, Electronic Training Experts.
- 3 Profitable Radio Troubleshooting — WHERE to look and WHAT to do for every trouble. How to avoid costly mistakes, handle customers profitably, 330 pages, 153 "how-to" illus. By William Marcus, Alex Levy.
- 4 Profitable TV Troubleshooting — Short-cuts to SPOT and FIX every trouble — fast, for big profits. By Eugene A. Anthony, Service Consultant, General Elec. Co.
- 5 Repairing Record Changers — Step-by-step pictures and directions — how to set up service bench, etc. 278 pages, 302 A-B-C pictures. By Eugene Ecklund, Eng. DuMont Lab., Inc.
- 6 Complete Home Course Outline — Getting started in television and radio servicing. How to get the most out of your Course. How to get ahead FAST. By John Markus.

**THIS AMAZING OFFER SAVES YOU \$11.85!**

**Free** ALL THREE Valuable Repair Aids: TV, RADIO, and CIRCUIT Detect-O-Scopes (Total Retail Value \$3.00)



FREE — whether you keep the Course or not — **THREE** amazing DETECT-O-SCOPE Charts. TV and RADIO Scopes enable you to spot all tube troubles in a jiffy. CIRCUIT Scope spots all circuit troubles. Make fix-it jobs easier, faster. 16 x 21 inches. ALL THREE (worth \$3.00) yours FREE while they last on this introductory offer.

### THIS COUPON SAVES YOU \$11.85

McGraw-Hill Book Co., Dept. PM-11  
327 West 41st St., New York 36, N. Y.

Send me — postpaid — for 10 DAYS' FREE TRIAL the 6-Vol. McGraw-Hill TV, Radio and Changer Servicing Course. If okay, I'll remit only \$4.95 in 10 days; then \$5.90 monthly for 5 months. (A total savings of \$11.85 on the regular price of the Course and Detect-O-Scopes.) Otherwise, I'll return Course in 10 days; pay nothing. ALSO send FREE (to KEEP whether or not I keep the Course) the 3 TV, RADIO, and CIRCUIT DETECT-O-SCOPE CHARTS, — total value \$3.00.

Name .....

(Please Print Clearly)

Address .....

City .....

Zone No. ....

(If any) State .....

CHECK HERE if you prefer to enclose first payment of \$4.95 with coupon. Same easy pay plan; same 10-day return privilege for full refund. PM-11

**"TOOK IN \$217  
FIRST 10 DAYS"**

Some make more, some less...

**We help you to start Your  
Own All-Year Business**

**Make Big Money!** With our easily operated, highly efficient wall washer, Charles Stelle took in \$217 gross in first ten days. E. L. Goss took in more than \$10,000 in one year. E. C. Taber wrote, "I made \$400 gross in two weeks."



And no wonder... this machine washes walls 6 times faster and better than by hand.

**Your Money-making Opportunity.** We want more men to go into this profitable business for themselves and enjoy independence—freedom from bosses, layoffs. Customers everywhere—homes, offices, schools, churches, hotels, etc. How much you earn depends largely on you. What you take in is mostly profit. No need to rent shop or office; operate business from home. Can start spare time until your full time is available.

LOSE NO TIME. GET ALL FACTS WITHOUT OBLIGATION

**FREE BOOK! MAIL COUPON TODAY!**

• **VON SCHRADER MFG. CO.**  
• E10 "W" Pl., Racine, Wisconsin  
• Send at once (no obligation) your **FREE** booklet  
• containing information about your **WALL WASHING**  
• **MACHINE** and how I can start my own permanent,  
• profitable business.  
• Name \_\_\_\_\_  
• Address \_\_\_\_\_  
• City \_\_\_\_\_ Zone \_\_\_\_\_ State \_\_\_\_\_

**KEEP YOUR... EYE ON BENJAMIN**  
**for HIGH H.C. COMP**  
**AIR GUNS & CO<sub>2</sub> GAS GUNS—Top Quality at LOWEST PRICES!**



Benjamin Air Rifles and Benjamin Air Pistols are Recognized All Over the World for Finest Workmanship and Highest Quality at Lowest Prices. Adjustable Power with Amazing Optimum Force. Fully Guaranteed—Safe—Accurate—Economical. Easy to Use anywhere—12 Models for Target and Small Game BB or 177 or 22.

All Models Benjamin CO<sub>2</sub> Carbine Gas Rifles and Benjamin CO<sub>2</sub> Rocket Gas Pistols Use Standard Size CO<sub>2</sub> Cartridges (available everywhere). 2-Stage Hi-Lo Jet Power—High for Small Game—Low for Target—Up to 50 Shots from each Cartridge. No Pumping—Safe—Accurate—Economical—Non Toxic—12 Models BB or 177 or 22.

**FREE!** Catalog All Models Benjamin Air Guns & CO<sub>2</sub> Guns & Supplies. Also, Money-Saving Offer on Hunting & Fishing Accessories.

Send Free Catalog and Special Offer!  
**BENJAMIN AIR RIFLE CO., MAIL TODAY!**  
 896 MARION ST., ST. LOUIS 4, MO., U.S.A.  
 Name \_\_\_\_\_  
 Address \_\_\_\_\_  
 City \_\_\_\_\_ State \_\_\_\_\_



**66,000 CANDLEPOWER**  
World's Biggest & Most Powerful

**USES HI-VOLTAGE — LESS AMPERES**

**25 Cell Power**  
Overload "soaked up" feature gives candlepower equal to 5 old time big lights.

**15 MILE RANGE**  
On water, or forest tower, signal can be seen extreme distance. Safety lite for boats.

**SEALED BEAM IDEA**  
Factory focused bulb with both argon & nitrogen gas for brilliance and cooling.

**SOLID DIE CAST**  
Giant reflector precision die cast for perfect bulletseye.

**1958 MODEL IN GUNMETAL FINISH**  
Beautiful, like a fine rifle, revolutionary new copper plated steel barrel makes possible the use of this famous finish. Lifetime wear, the Hi-Bred is rugged and dependable.

**IDEAL XMAS GIFT — DIFFERENT**  
Every man wants this big lite. Shows up objects, provides at far distance at night. For auto travel, camping, hunting.

**Gunmetal model \$4.99 plus 35c ea postage**  
**2 Piece DeLuxe Model in chrome... \$5.99**  
 Unscrews in middle, fits glove compartment. One cell extension makes 7 cell... \$1

Batteries Reg. 6 for \$1.20, HI-BRED batteries 6 for \$1.49, Extra bulbs 5 for \$1. Order by mail — 30-day back guarantee.

**DOG SUPPLY HOUSE, DEPT. 28T**  
18440 Grand River Detroit 23, Mich.

**LEARN LOCKSMITHING**

Learn fascinating, profitable trade from experts in spare time at home! Age or physical handicap no disadvantage. Year around, steady income. Full or part time. Practical, illustrated lessons. Make money even while learning! All materials and special tools supplied. Free Booklet.

**INSTITUTE OF LOCKSMITHING, Dept. P-96**  
150 PARK AVENUE E. RUTHERFORD, N. J.

Lic. by N. J. State Board of Ed. Approved for Vets

**LAW FREE BOOK THE LAW TRAINED MAN**

Write today for a **FREE** copy of illustrated law book, "THE LAW TRAINED MAN," which shows how to earn the professional Bachelor of Laws (LL.B.) degree through home study of the famous Blackstone Law Course. All necessary books and lessons provided. Moderate cost; convenient monthly terms. Write for **FREE** law training book today.

**Blackstone School of Law, 307 N. Michigan Ave.**  
 Founded 1890 Dept. 58, Chicago 1, Illinois

**250 POWER.....**

**Complete Telescope Lens Kit** only **\$3.49** postpaid

Conquer Space, Explore the Universe, Planets, Moon Craters, New Stars, etc. Complete Lens Kit consists of 80 inch focal length ground and polished objective lens, eyepiece lenses for 50 POWER, 100 POWER, 150 POWER, 200 POWER, 250 POWER, and all necessary lens fittings. Easy to make from simple step by step instructions. (Tripod and mount not included.) Money back guarantee.

**BUSSE SALES CO., Hartford, Conn., Dept. PM 63**

**TASOPE PHOTO-ENGRAVING PLANTS**

Establish your own profitable **PHOTO-ENGRAVING** business. Make cuts for newspapers, printers, and advertisers. Make etched name plates, plaques etc. Instructions furnished, no experience necessary. Sold direct from factory since 1931. First five hundred cuts sold locally or by mail will pay for plant and pay you well for your time. Write for **FREE** catalog.

**TASOPE, DEPT. PM-11, AURORA, MO.**

**Now Many Wear FALSE TEETH With Little Worry**

Eat, talk, laugh or sneeze without fear of insecure false teeth dropping, slipping or wobbling. **PASTEETH** holds plates firmer and more comfortably. This pleasant powder has no gummy, gooney, pasty taste or feeling. Doesn't cause nausea. It's **alkaline** (non-acid). Checks "plate odor" (denture breath). Get **FASTEETH** at any drug counter.



# THESE MEN ARE GETTING PRACTICAL TRAINING IN **ELECTRICITY**

—ELECTRONICS

*On Real:*

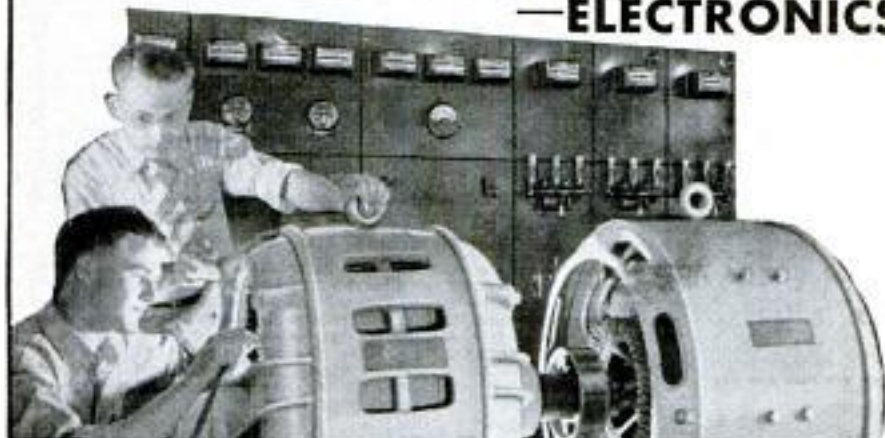

**A.C. and D.C. MOTORS  
GENERATORS  
SWITCHBOARDS  
CONTROLLERS  
WIRING JOBS  
APPLIANCES  
ELECTRONIC UNITS**

*(Shown at left—Instructor explaining operation and testing of a large Motor Generator in our A.C. Department.)*

# AND **TELEVISION-RADIO**

*On Real:*

**TELEVISION  
RECEIVING SETS  
Including Color TV  
AM and FM RADIO  
RECEIVERS including  
AUTO RADIOS  
TELEVISION TEST  
EQUIPMENT**

*(Right — Instructor helping students check the wiring and trace circuits of television receivers.)*



## Train in the great **SHOPS** of **COYNE**

**Largest, Oldest, Best Equipped School Of Its Kind In The U. S.**

Whether 17 or up to 45 years of age, prepare for your future now. Don't be satisfied with a "No Future" job. Train the Coyne way for a better job in a field that offers a world of opportunities in the years ahead.

**FINANCE PLAN** Enroll now, pay most of tuition later. Part-time employment help for students.

**WE TRAIN YOU IN CHICAGO** on real equipment. Trained instructors show you how, then you do practical jobs yourself. No previous experience or advanced education needed.

**CLIP COUPON NOW** for big new illustrated Coyne book "Guide to Careers in **ELECTRICITY** and **TELEVISION-RADIO**". No obligation; no salesman will call. Get vital facts now! *Training in Refrigeration and Electric Appliances can be Included.*



*Mail Coupon for  
Big Free Book*

Training Offered  
to **VETERANS**  
and  
**NON-VETERANS**  
Alike

**B. W. COOKE, Jr., President  
COYNE ELECTRICAL SCHOOL**  
500 S. Paulina St., Chicago 12, Ill. Dept. 87-72H  
Send **FREE** book and details of all the training you offer. This does not obligate me and no salesman will call. I am especially interested in:  
 **ELECTRICITY-ELECTRONICS**  
 **TELEVISION-RADIO**

NAME.....

ADDRESS.....

CITY.....STATE.....

**B. W. COOKE, Jr., Pres. COYNE FOUNDED 1899  
ELECTRICAL SCHOOL**

**A TECHNICAL TRADE INSTITUTE OPERATED NOT FOR PROFIT**  
500 S. PAULINA STREET, CHICAGO, Dept. 87-72H  
**ELECTRICITY ★ RADIO ★ TELEVISION ★ REFRIGERATION ★ ELECTRONICS**

NOVEMBER 1957

31

# Check the Kind of Body YOU Want

- |   |  |
|---|--|
| <input type="checkbox"/> Slimmer Waist, Hips      | <input type="checkbox"/> More Powerful Arms              |
| <input type="checkbox"/> Broader Chest, Shoulders | <input type="checkbox"/> More Powerful Legs              |
| <input type="checkbox"/> More Weight, Solid       | <input type="checkbox"/> More Energy, More Restful Sleep |



... and I'll Show You How EASILY You Can Have It!

Just tell me, in coupon below, the kind of body you want—and I'll give it to you SO FAST your friends will be amazed! "Dynamic Tension," my easy, 15-minute-a-day method, will make your chest and shoulders bulge... arms and legs surge with power... your whole body feel "alive!"

**FREE ILLUSTRATED 32-PAGE BOOK**

32 pages on how "Dynamic Tension" changed me from a 97-pound weakling into "World's Most Perfectly Developed Man"—and how it can change YOU too. Mail coupon NOW! Charles Atlas, Dept. 8-L, 115 E. 23rd St., N. Y. City 10.



CHARLES ATLAS, Dept. 8-L,  
115 East 23rd St., New York 10, N. Y.

Dear Charles Atlas—Here's the Kind of Body I Want:  
(Check as many as you like)

- |   |   |
|---|---|
| <input type="checkbox"/> Slimmer Waist, Hips      | <input type="checkbox"/> More Powerful Arms |
| <input type="checkbox"/> Broader Chest, Shoulders | <input type="checkbox"/> More Powerful Legs |
| <input type="checkbox"/> More Weight, Solid       | <input type="checkbox"/> Better Energy      |

Send me, absolutely FREE, a copy of your famous book showing how "Dynamic Tension" can make me a new man. 32 pages, crammed with photographs, answers to vital questions, and valuable advice. No obligation.

Name \_\_\_\_\_ Age \_\_\_\_\_  
Address \_\_\_\_\_  
City \_\_\_\_\_ State \_\_\_\_\_



## WARN HUBS

idle the front drive in 2-wheel drive... stop drag... reduce wear.

Warn Hubs mean big savings in gear, engine, tire wear, gas, plus new pep, performance, power, handling ease. And now, with Warn Lock-O-matics, you have economical, drag-free 2-w.d. or tractive 4-w.d. automatically, as you shift! Ask your dealer for Warn Lock-O-matic or Locking Hubs today!



© 1957 WARN

OVER 100,000  
WARN HUBS NOW  
IN USE ON  
4-WHEEL DRIVES

Models for all  
4 w.ds. to 1 1/2 tons

WARN MFG. CO. RIVERTON BOX 6064-A11  
SEATTLE 98, WASH.

SAVE 1/2 - 2/3 THE PRICE OF FACTORY-BUILT BOATS

## BOAT KIT CATALOG Free!

Runabouts, cruisers, convertibles, fishing; 43 models, 8 through 18 ft. Freight paid, \$39.25 up. Assembled and finished by experienced owners. Luger boats equal factory-built in speed, handling, style, beauty; yet save you 1/2 to 2/3. Owners say: "Fastest boat on river," "Pleasure to assemble," "Everyone admires my Luger." Thousands in use. Send for big, free boat kit catalog; also lists fiberglass, hardware, accessories, trailers, paint. Write for catalog today.



Write:

LUGER INDUSTRIES, INC. DEPT. B-11 3404 Lyndale S. Minneapolis 8, Minn.

## Be an industrial designer

Combine your design abilities with technical aptitudes in Industrial Design training at Art Center School in California. Work under practicing professionals for upper level jobs as automotive stylists, product and package designers. Design offices, stores, motels, showrooms, shopping centers. Constant demand for graduates. Recent placements with Ford, G.M., Kaiser Aluminum, G.E., Raymond Loewy and other leading design studios. 700 students. Co-ed. Accredited B.P.A. Degree. Four-year course can be completed in 2 yrs. 8 mos. by year-round training. New terms Feb., June, Sept. Enroll early. Write Mr. Mead for new catalog. 5353 West 3rd St., Los Angeles 5, California.

## ART CENTER SCHOOL

### WINDSHIELD WIPER MARK REMOVER

ELIMINATE DRIVING HAZARDS DUE TO DAMAGED WINDSHIELDS. NO NEED TO REPLACE WINDSHIELDS BECAUSE OF WIPER MARKS. THIS RARE COMPOUND USED BY CAR DEALERS FOR MANY YEARS... NOW! OFFERED TO THE PUBLIC.

SIMPLE INSTRUCTIONS INCLUDED  
1 oz. Compound enough for 3 average windshields) \$2.50  
Buffing Wheel for quicker and easier results special Buffing Wheel available to be used with electric drill \$2.50  
CHECK OR MONEY ORDER... SORRY NO C.O.D. L & M CO. BOX 57 ATLANTIC BEACH, N.Y.



## JEEP HENRY-KAISER OWNERS

RE-POWER NOW with a V-8 engine—Use FORD—CHEVROLET—MERCURY in 2 or 4 Whl-Dr. Jeeps, Jeepsers, Sta-Wag. Trucks or cars. Conversion Kits \$43.25 to \$59.85. If you want fast action tell us which engine you wish to use, give us year, Model (2 or 4 Whl-Dr) of your vehicle. Send Min. \$15.00 Dep. and we will ship correct kit, Bal. C.O.D. Send full amt. for Prepaid shipment. Wire, phone or write for free details.

HOOSIER MACHINE PRODUCTS CO.  
312 S.E. 6th St. Phone 676 Pendleton, Oregon

## FIX OUTBOARD MOTORS POWERMOWERS, AND ALL SMALL 2 & 4-CYCLE GASOLINE ENGINES

Repair your own equipment or MAKE EXTRA MONEY in this growing field. Fully illustrated, easy-to-understand, Home Study Course. Write for FREE information.

LINCOLN TECHNICAL INSTITUTE  
SUITE 11-E, 472 MARKET STREET, NEWARK 5, N. J.

## CASH IN ON WAR SURPLUS!

IMAGINE! HUNDRED DOLLAR VALUES  
—NOW SELLING FOR PENNIES!!



Hundreds of surplus items for home, farm, garage and shop... going for pennies on the dollar! All built to the government's highest standards. Tools, machinery, gear reducers, pumps, boats, motors, page after page of tremendous bargains.

SEE FOR YOURSELF!  
Send for this big catalog and see for yourself! See pages of surprising bargains. See items that cost the government thousands of dollars going for pocket change. Act now. Cash in on government surplus. Send 10c for your copy.

KARL ORT, Dept. 9M-11, THOMASVILLE, PA.

**RCA** offers you the  
 finest training  
 at home in  
**Radio-TV**  
 electronics,  
**TV servicing,**  
**Color TV**

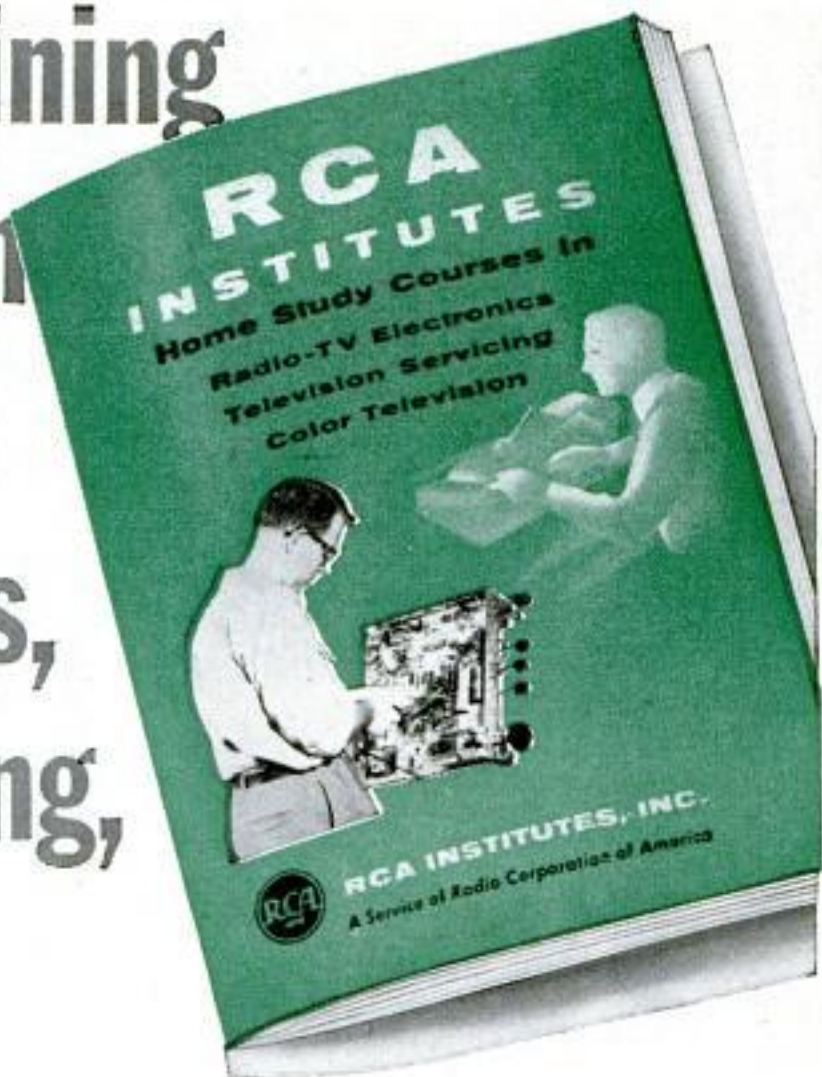

**SEND FOR THIS FREE**  
**BOOK NOW!**



**RCA INSTITUTES, INC.**  
 A SERVICE OF RADIO CORPORATION OF AMERICA  
 350 WEST FOURTH STREET, NEW YORK 14, N.Y.

In Canada—RCA Victor Company, Ltd.,  
 5001 Cote de Liesse Rd., Montreal 9, Que.

**Pay-as-you-learn. You need pay for only one study group at a time. Practical work with very first lesson. All text material and equipment is yours to keep. Courses for the beginner and advanced student.**

RCA Institutes, Inc., Home Study Dept. PM-117  
 350 West Fourth Street, New York 14, N. Y.  
 Without obligation, send me FREE 52 page CATALOG on Home Study Courses in Radio, Television and Color TV. No Salesman will call.

Name.....  
Please Print

Address.....

City..... Zone..... State.....

KOREAN VETS! Enter discharge date.....  
To save time, paste coupon on postcard

# FREE! ELIZABETH II COLONIES STAMPS and illustrated booklet



**RUSH COUPON TODAY!** Here's one of the most exciting offers ever made. Generous collection of hard-to-get, beautiful stamps from interesting, colorful British Colonies everywhere — Aden, Fiji Islands, North Borneo, Cyprus, Singapore, Bermuda, just to name a few. They're all genuine, all different — direct from the largest group of private sources in the world. What a grand addition for your collection — think how they'll grow in value. **THERE'S MORE.** We'll also send you our free, helpful **STAMP COLLECTOR'S GUIDE.** For your FREE inspection, we'll include other valuable offers. So **RUSH COUPON NOW** — add this free offer to your collection. If coupon clipped, send 10¢ for postage, handling to **GARCELON STAMP COMPANY, Dept. PM11K, Calais, Maine.**

**GARCELON STAMP CO., Dept. PM11K, Calais, Maine.**  
**RUSH Colonies stamps, Collector's Guide, other offers. Enclosed 10¢ for postage, handling. (PLEASE PRINT)**

Name.....  
 Address.....  
 City..... State.....

**You can start a \$40<sup>00</sup> a Day Business IN YOUR SPARE TIME**



## MAKE BIG CASH PROFITS IN YOUR OWN HOME SHARPENING HOUSEHOLD, GARDEN, SHOP TOOLS

Now you can turn spare time into Big Cash Profits with new Belsaw Sharp-All. Sharpen knives, scissors, shears, snips, ice skates, hedge trimmers, mower blades, grass whips, axes, chisels, screw drivers, scrapers and saws. Your own CASH business with no inventory. No calls to make. No experience needed.

Learn how easily you can start your own spare-time business. Amazing low-cost, easy payment plan. Send postcard for FREE BOOK.

**BELSAW SHARP-ALL CO**  
 718 Field Building • Kansas City 11, Missouri

**FREE BOOK**

## The Backyard PLAYBOY MOTOR SCOOTER



The newest fun for Junior. His own personal motor vehicle. Safe, quiet. Simple as a sidewalk bike. A 7-year-old can learn in minutes. The ideal birthday gift.

### FOR ADULTS, TOO!

Stows easily in plane or boat. Only 42 pounds. Ride it on the patio. A barrel of fun for your guests. The girls will simply love it. See it at your local cycle dealer's.

Folder on Request **HAP ALZINA** \$119.95 f.o.b.  
 3074 Broadway Dept. PM Oakland, Calif.  
 Dealer Inquiries Invited



## MEN - WOMEN LEARN REWEAVING MAKE MONEY AT HOME

Secrets of French Invisible Reweaving... Repair burns, tears, moth holes in Suits, Dresses... Like New. **VISUAL-WEAVER** makes it easy to learn Skil-Weave method of repair. Also learn the principles of French Reweaving. Big profit orders—spare time or full time. Send name, address today for FREE details. **SKIL-WEAVE CO., 335 W. Madison Street, Dept. 1611, Chicago 6, Ill.**



A book everyone who likes to draw should have. It is free; no obligation. Simply address **FREE BOOK**  
**CARTOONISTS' EXCHANGE**  
 Dept. 911-D Pleasant Hill, Ohio

**Now! TEST YOUR OWN TV & RADIO TUBES ALL OF THEM—EVEN PICTURE TUBE**

for filament breaks

Nearly half of TV service calls are due to defective filaments. Tester shows if filaments are good. Insert tube in tester. Light shows if tube is burned out. Easy, safe. One service call saved pays for tester. Metal case. AC or DC. Checks fuses, appliances, etc. Only \$3.95 ppd. or C.O.D. plus charges. Deluxe Model \$4.95. Instructions. Guaranteed. **GEIGER ENGINEERING CORP., Dept. AB-103 3738 West Lawrence Avenue, Chicago 26, Ill.**

**BUY IT WHOLESALE!**

FOR SELF OR RESELL FOR BIG PROFITS! NAME BRAND APPLIANCES, TOOLS, WATCHES, CAMERAS, PHONOS, SEWING MACHINES, JEWELRY, HOUSEWARES, SPORTING GOODS, TYPEWRITERS, ETC.

**SAVE 30-80%**

GET OUR BIG WHOLESALE CATALOG OF OVER 2,000 PROFIT MAKING ITEMS! POSTCARD BRINGS DETAILS FREE! MAIL TODAY!

**Consolidated DISTRIBUTORS**  
 CLIFTON 1, N. J.

## If Your Child Is a Poor Reader

See how The Sound Way To Easy Reading can help him to read and spell better in a few weeks. New home-tutoring course drills your child in phonics with records and cards. Easy to use. University tests and parents' reports show children gain up to full year's grade in reading skill in 6 weeks. Write for free illustrated folder and low price. **Bremner-Davis Phonics, Dept. P-57, Wilmette, Ill.**

POPULAR MECHANICS

## Electric Home Recorder

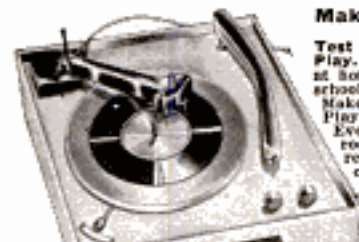

**Make Your Own Records at Home!**

Test your voice. Talk, Sing, Play. Immediate playback. Fun at home. Practical for office & school. Send records to friends. Make records from radio or TV. Play back favorites years later. Even conceal mike in another room! Makes 33, 45 or 78 rpm records (any speed). Set includes: Recording Unit

(arm & electro-magnetic cutting stylus) which operates on any portable, electric Studio Microphone, cutting needles & blank records. No wiring. Complete Set Postpaid Only. **\$14.95**

Johnson Smith Co. Dept. 599 Detroit 7, Mich.

## Catalog of 3100 Novelties 10c

Send 10c for amazing catalog of novelties, live animals, scientific supplies, hobbies, funmakers, planes & boats, looms, magic tricks, joke articles, unusual seeds, gadget time-savers, cameras, optical goods, projectors, movies, lucky jewelry, religious novelties, disguises, musical instruments, stamps, coins, puzzles, fortune tellers, radios, auto & bike accessories, telescopes, binoculars, compasses, banks, smokers' gadgets, artists' supplies, printing sets, engines, motors, shockers, knives, billfolds, guns, rifles, sports, books, games, plants, etc. Send 10c (3 for 25c—get for yourself!). **JOHNSON SMITH & CO. Dept. 599 Detroit 7, Michigan**

## TELEPHONES

and ALL SUPPLIES

Room in room, house to garage, private telephone service. **HANDSET CRADLE TELEPHONES** (2) Complete outfit with 100' wire, 2 dry cells, instructions. **\$14.95**

**WORM HARVESTER** — Dan Mac Magmelo—gathers fish-worms by electricity. Complete with instructions. **\$6.50** Illustrated bulletin "AA-18" 10c



**TELEPHONE REPAIR & SUPPLY CO. Dept. AA-19 1760 Lunt Ave., Chicago 26, Ill.**

## WE PAY \$3.50 lb.

**GROW MUSHROOMS.** Cellar, shed and outdoors. Spare or full time, year round. We have over 25,000 customers. **FREE BOOK.** Washington Mushroom Ind., Dept. 61, 2954 Admiral Way, Seattle, Wash.

## ARTHRITIS—RHEUMATISM VITAL FACTS EXPLAINED

**FREE DESCRIPTIVE BOOK**

How crippling deformities may be avoided. This amazing **FREE BOOK** explains why ordinary methods give only temporary relief—if that. Describes a drugless method of treatment successfully applied in thousands of cases. Write for this 36-page **FREE BOOK** today. No obligation. **BALL CLINIC, DEPT. 756, EXCELSIOR SPRINGS, MO.**

**—CHECK AND SEND NOW—**

## McKNIGHT'S up-to-date, easy-to-read, authentic HOW TO DO IT BOOKS

World's most popular "How to" books. Approved by vocational instructors, schools & colleges. Complete step by step details. Jam-packed with illustrations.



Send for **FREE** colorful folders describing books

Woodworking  
 Metalworking  
 Welding  
 Home Mechanics  
 Electricity  
 Crafts

**McKNIGHT & McKNIGHT Publishing Company**  
 Dept. 501, Bloomington, Ill.

NAME \_\_\_\_\_  
 ADDRESS \_\_\_\_\_  
 CITY \_\_\_\_\_ STATE \_\_\_\_\_

## Still dreaming about a good job and more pay?



**WAKE UP TO YOUR OPPORTUNITIES IN**

## Auto Mechanics

**PRACTICAL NEW WAY TO TRAIN AT HOME**

Don't rely on *luck* to make your dreams come true! Be practical and depend on *training*. As a skilled man, you can step into a good, top-pay job—enjoy security—and even open a shop.

Your best bet is to become an auto mechanic. *That's the big opportunity field today.* Over 60 million cars and trucks are on the road, and all require maintenance. At least one-third are in the heavy-repair class. There's so much work that 50,000 mechanics are needed! It's easy to learn this trade at home. Find out *how* by mailing coupon below.

**EARN MONEY IN SPARE TIME** as you train. Many students repair cars for neighbors; others get jobs in local garages; some open shops by the time they graduate. You can learn-and-earn because CTI offers practical *Shop-System* training.

**DIESEL MECHANICS OR BODY-FENDER REBUILDING** is included at no extra cost. Only CTI offers this extra choice. Get this fully-rounded mechanic's training. *Send coupon for two free books.*

**YOU PRACTICE WITH THIS TUNE-UP KIT**  
 Kit includes a Compression Tester, a Vacuum Gauge and Fuel Pump Tester, an Ignition Timing Light, and a portable steel case. These professional instruments help you locate engine troubles, let you get useful practice. You keep this kit!

**MECHANIC'S TOOLS TOO**  
 You'll use these tools to get real experience. They'll increase your interest, stamp you as a "pro." You'll earn spare time cash with them. No extra cost for tools—you keep them.

**MAIL COUPON TODAY!**

## MAIL TODAY FOR 2 FREE BOOKS

**COMMERCIAL TRADES INSTITUTE**  
 1400 Greenleaf Ave., Chicago 26  
 Dept. A-673  
 Send your new Auto Mechanics book and Sample Lesson, BOTH FREE.

Name \_\_\_\_\_ Age \_\_\_\_\_  
 Address \_\_\_\_\_  
 City \_\_\_\_\_ Zone \_\_\_\_\_ State \_\_\_\_\_



# How Much Do *you* Want to Make?

**\$15<sup>20</sup>**  
AN HOUR?



"For every hour I have devoted to PRESTO, I find that I have earned an average of \$15.20 an hour."  
William Wydallis, Ohio

**\$75 TO \$80**  
A WEEK?



Mr. Walter Gable has been selling Presto Fire Extinguishers for over 4 years. This is what he writes: "My selling time has usually averaged less than a day or two a week. These part time sales have brought me as much as \$75.00 to \$80.00 a week."  
Walter Gable, Md.

**\$1,000<sup>00</sup>** A MONTH?



"I'm making more than \$1,000 a month with PRESTO—and I haven't touched bottom yet."  
Charles Kama, Texas

**Salesmen Rave About "Sell on Sight" PRESTO Fire Extinguisher**

Wouldn't you like to make the kind of money these successful men made? Then rush name, address NOW for Sales Kit, amazing money-making plans, full story of "Miracle Midget" super-effective PRESTO Fire Extinguisher everyone needs, wants, BUYS from you at only \$4.95, while you make liberal profit on each one.

**Merlite Industries, Presto Division**

114 East 32nd St., Dept. P-15C, New York 16, N. Y.

In Canada: Mopa Co., Ltd., 371 Dowd St., Montreal 1, P. Q.



## 2 WAY PORTABLE RADIO SET

**SENDS — RECEIVES UP TO 10 MILES AS SHOWN**  
with built-in antenna or hundreds of miles with outside antenna! Works on 80 and 40 meter (Novice) amateur radio bands—also Aircraft and overseas broadcast (3 to 8 mc). PORTABLE SELF-CONTAINED POWERED WITH STANDARD PORTABLE RADIO BATTERIES. NO AC PLUG-INS NEEDED! Take it with you everywhere you go—on trips, vacations, camping—Keep in contact with home, friends. Has 5 watt crystal controlled transmitter—Sensitive Regenerative Receiver. Send-Receive switch. Wt. only 3 lbs. Size, only 6"x4"x4". TESTED—PROVEN—SIMPLIFIED—PRACTICAL—Full information given on quick easy to get license. **SEND ONLY \$3.00** (bill, ck, mo) and pay post-man \$11.95 COD postage on arrival or send \$14.95 for postpaid delivery. Complete kit includes all parts, tube, solid-plated cabinet, easy instructions. (Set of batteries \$2.95; crystal \$1.25.) COMPLETELY WIRED AND TESTED POSTPAID \$19.95. A regular \$49.95 value—Order now before price goes up. GUARANTEED—AVAILABLE ONLY FROM:  
**DEPT. DNM-11 KEARNEY, NEBR.**



WESTERN RADIO

STATEMENT REQUIRED BY THE ACT OF AUGUST 24, 1912, AS AMENDED BY THE ACTS OF MARCH 3, 1933, AND JULY 2, 1940 (Title 39, United States Code, Section 233) SHOWING THE OWNERSHIP, MANAGEMENT, AND CIRCULATION OF Popular Mechanics Magazine published monthly at Chicago, Ill., for October 1, 1957. 1. The names and addresses of the publisher, editor, managing editor, and business managers are: Publisher, Popular Mechanics Company, 200 E. Ontario St., Chicago 11, Ill.; Editor, H. H. Windsor, Jr., 200 E. Ontario St., Chicago 11, Ill.; Managing editor, R. M. Grant, 200 E. Ontario St., Chicago 11, Ill.; Exec. V.P., W. H. Petridge, 200 E. Ontario St., Chicago 11, Ill. 2. The owner is: (if owned by a corporation, its name and address must be stated and also immediately thereunder the names and addresses of stockholders owning or holding 1 percent or more of total amount of stock. If not owned by a corporation, the names and addresses of the individual owners must be given. If owned by a partnership or other unincorporated firm, its name and address, as well as that of each individual member, must be given.) Popular Mechanics Company, 200 E. Ontario St., Chicago 11, Ill.; H. H. Windsor, Jr., 200 E. Ontario St., Chicago 11, Ill.; H. H. Windsor, Jr., Trustee for H. H. Windsor III and Wm. T. Windsor, 200 E. Ontario St., Chicago 11, Ill. 3. The known bondholders, mortgagees, and other security holders owning or holding 1 percent or more of total amount of bonds, mortgages, or other securities are: (If there are none, so state.) City National Bank and Trust Company of Chicago, 208 South LaSalle St., Chicago 90, Ill. 4. Paragraphs 2 and 3 include, in cases where the stockholder or security holder appears upon the books of the company as trustee or in any other fiduciary relation, the name of the person or corporation for whom such trustee is acting; also the statements in the two paragraphs show the affiant's full knowledge and belief as to the circumstances and conditions under which stockholders and security holders who do not appear upon the books of the company as trustees, hold stock and securities in a capacity other than that of a bona fide owner. 5. The average number of copies of each issue of this publication sold or distributed, through the mails or otherwise, to paid subscribers during the 12 months preceding the date shown above was: (This information is required from daily, weekly, semi-weekly, and tri-weekly newspapers only.) Not daily publication. H. H. Windsor, Jr., Editor, Secretary and subscribed before me this 17th day of September, 1957. Harry P. Cera, Notary Public. (My commission expires March 6, 1960.)

## INVENTORS

PROTECT YOUR INVENTION BY A U. S. PATENT. SEND FOR FREE "INVENTION RECORD" FORM AND "PATENT INFORMATION EVERY INVENTOR SHOULD HAVE."

**CARL MILLER**  
REGISTERED PATENT ATTORNEY  
WOOLWORTH BLDG., 36th FLOOR, 117A  
NEW YORK CITY



## INVENTORS

U. S. Patents protect your inventions. Our free book of "Instructions on Patent Procedure for Inventors," also "Certificate of Invention" form sent without obligation.

**C. A. SNOW & CO.**  
REGISTERED PATENT ATTORNEYS  
428 SNOW BUILDING WASHINGTON 1, D. C.

## INVENTORS

Whether an invention is patentable can be substantially determined by a search of the U. S. Patent records. Without obligation, write for information explaining the steps you should take to secure a patent.

**JOHN N. RANDOLPH**  
Registered Patent Attorney  
201 Columbian Building, Washington 1, D. C.

## INVENTORS

Send for **REGISTERED PATENT PATENT INFORMATION** **ATTORNEY**  
Book and **INVENTOR'S RECORD**  
without obligation  
**GUSTAVE MILLER** Patent Attorney & Advisor  
117-PM WARNER BUILDING U. S. NAVY DEPT. 1930-1947  
WASHINGTON 4, D. C. **PATENT LAWYER**

### SPARE-TIME MONEYMAKING OPPORTUNITIES

READ OUR CLASSIFIED ADS  
HUNDREDS OF BARGAINS AMAZING OFFERS

## INVENTIONS For Sale

Our clients have excellent inventions in many fields to be manufactured and marketed on a cash, royalty or license basis. Full description of clients' inventions will be sent if you state your field of interest. **INVENTORS: WE ALSO WANT INVENTIONS OF EVERY TYPE.** Write for details.

**GLOBAL MARKETING SERVICE**  
2420 77th Avenue Dept. M5 Oakland 5, Calif.

## INVENTORS

I shall be pleased to furnish you, upon request, with full information relative to patent procedure—without any obligation on your part.

**PATRICK D. BEAVERS**  
Registered Patent Attorney  
934 Columbian Building Washington 1, D. C.

## MAKE MORE \$ IN SPARE TIME HOURS!

### Use "IDEAL"

#### Lawnmower Sharpener

New attachment makes Model 300 "Ideal" a perfect reel and rotary blade grinder—also sharpens shears, other tools! Ideal's exclusive "hook" grinding method insures quick, easy results every time. Compare all facts and you'll buy "Ideal"—leading mower sharpener for 55 years. Make more money—write for free catalog.

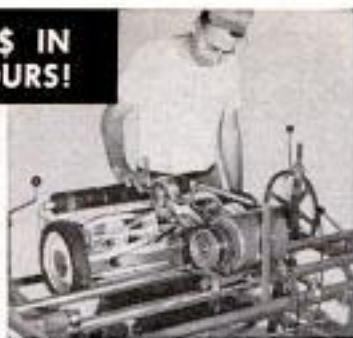

### Sharpens All Mowers

- REEL TYPE • HAND
- ROTARY • POWER

The FATE-ROOT-HEATH Co., Dept. PM-11, Plymouth, Ohio

## SALE

20 X 50 REGULARLY \$74.50  
SAVE \$44.95!

High powered, whisper-weight (27 oz.) color corrected, Achromatic binoculars. 7" high! EZ to hold, EZ to focus. Instant fingertip adjustment. **SALE PRICE FOR THIS SALE ONLY** including case and straps! Made in Japan. **USE 30 DAYS. \$29.95** If not satisfied return for refund. Add \$1 postage, handling. Add 10% Tax. UNITED BINOCULAR CO., 9043 S. Western, CIP-1808, Chicago 20. **DEALERS WANTED**



c.o.d.'s require \$2 deposit.

## Free! 75 ORIENTALS

Brought to you from the farthest ends of the earth—these exotic valuable genuine STAMPS of the Orient! 75 all-different from Borneo, Siam, China, Japan, Hong Kong, Malaya, Sarawak, Singapore.—and other exciting mysterious lands of the Far East. **EXTRA!** Free booklet, bargain lists, fascinating offers for your free examination. Send 10c for mailing costs.

JAMESTOWN STAMP CO., DEPT. C11PM JAMESTOWN, N. Y.



## HIGH SCHOOL DIPLOMA

Earn a High School Diploma at home! Prepare for better job, more pay. Study in spare time. No classes. Materials furnished. Certified teachers. Valuable diploma awarded. Write Today for Complete Information

SOUTHERN STATES ACADEMY  
Box 5344-A Sta. E Atlanta, Georgia

## IT'S EASY...

## MAKE MONEY IN PHOTOGRAPHY

Good pay and fascinating work await you in photography! Start making money quickly in sparetime—step into your own studio or exciting career job. LEARN-BY-DOING method trains you at home! Write TODAY for FREE catalog. Also Resident Training. Co-ed, 48th Year. Approved for Veterans.

NEW YORK INSTITUTE OF PHOTOGRAPHY  
Dept. 49, 10 West 33 Street, New York 1, New York  
48th YEAR

## SUBMACHINE GUNS! \$1795

ORDER BY MAIL. \$5 deposit for COD. Shipped FOB Los Angeles Calif. resid. add 4% state tax.



Collectors! The famous STEN GUN, British rapid fire sub-machine gun used by commandos, airdropped to Maquis, used in ill-fated Ro-rossel HQ raid. Cal. 9 MM Parabellum (Luger). Shipped to you complete with 32 rd. magazine; official British sling. Boreas plugged in accord with Fed. Firearms laws on machine guns. (de-activated war trophies). Gun can cock and snap. has change lever switch for full and semi-auto fire. Design of mech. basic for collectors and designers. Easy assembly for study. No license required. Detailed Sten Ordnance Manual showing all parts. \$1.00 postpaid. **EXTRA MAGAZINES, \$3.95 ea. MAG LOADERS \$1.95 ea.**

Cadmus Industries

55 Craft Bldg.  
1884 Hollywood Blvd.,  
Los Angeles 28, Calif.

Your choice of school is highly important to your career in



## INDUSTRIAL ELECTRONICS



## RADIO-TELEVISION



## ELECTRONICS COMMUNICATIONS

Become an  
**ELECTRICAL ENGINEER**  
or an  
**ENGINEERING TECHNICIAN**  
at

## MSOE in Milwaukee

Choose from courses in:

**ELECTRICAL ENGINEERING**  
Bachelor of Science degree in 36 months.  
Communications or Electrical Power option.

**ENGINEERING TECHNOLOGY**  
Assoc. in Applied Science degree—in 18 months.  
Electronics Communications  
Electrical Power, or Computers

MSOE—located in Milwaukee, one of America's largest industrial centers—is a national leader in electronics instruction—with complete facilities, including the latest laboratory equipment, visual aid theater, amateur radio transmitter—offers 93 subjects in electrical engineering, electronics, radio, television, electrical power, and electricity.

Advisory committee of leading industrialists. Courses approved for veterans. Over 50,000 former students. Excellent placement record.

Previous educational, practical, and military experience evaluated for advanced credit.



TERMS OPEN SEPTEMBER, JANUARY, MARCH, JULY

Write today!  
Choose wisely—your future depends on it.

## MILWAUKEE SCHOOL OF ENGINEERING

Dept. PM1157, 1025 N. Milwaukee St.  
Milwaukee 1, Wisconsin

Send FREE career booklets. (Please print)

I am interested in \_\_\_\_\_ (Name of course)

Name \_\_\_\_\_ Age \_\_\_\_\_

Address \_\_\_\_\_

City \_\_\_\_\_ Zone \_\_\_\_\_ State \_\_\_\_\_

Eligible for veteran's educational benefits? Yes \_\_\_\_\_ No \_\_\_\_\_

**EARN  
BIG  
PAY**

**COURSES OPEN  
IN SHOP METHOD  
TRADES  
TRAINING**

THE TRAINED MAN GETS THE BREAKS  
PRACTICAL & HOME STUDY COURSES

- CHECK YOUR COURSE HERE AND MAIL
- WELDING
  - AIR CONDITIONING
  - AUTO MECHANICS
  - DIESEL
  - TELEVISION & ELECTRONICS
  - RADIO
  - PHOTOGRAPHY
  - REFRIGERATION
  - DRAFTING
  - COMMERCIAL ART

DIPLOMAS  
AWARDED  
GRADUATES



PLACEMENT  
SERVICE  
MAINTAINED  
TO ASSIST  
GRADUATES

For Full Details without obligation write to our information office, Department AW, 3330 University Ave. S.E., Minneapolis, Minn.

IN CANADA  
English—835 Weston Road, Toronto 9, Ontario  
French—85 Jean Talon St., W Montreal, Quebec.

OPERATING FOR A QUARTER CENTURY  
COAST TO COAST

**"I'll Show You How  
to Have Giant Strength,  
Health and Success"**

Says: *Paul Anderson*

THE WORLD'S STRONGEST MAN AND  
GOLD MEDAL OLYMPIC CHAMPION.

"I built myself up from skin and bones; almost died as a youth. My parents' prayers and my own determination pulled me through and led me to discover my four great secrets of body building might.

"You, too, can have the body you want with full muscular development, robust health and right weight. Learn how you can transform your life with my course and a few minutes each day. Don't delay—Act NOW!"

MAIL COUPON TODAY!

Paul Anderson, Toccoa, Ga.

Send me FREE your illustrated book giving full details of "Easy Steps to Giant Strength."

Name \_\_\_\_\_  
(Please print)  
Address \_\_\_\_\_  
City \_\_\_\_\_ Zone \_\_\_\_\_ State \_\_\_\_\_



Dept.  
PM11

**Tells How You Can Learn to**



**FREE MOUNT BIRDS!**

Learn At Home

Men, Boys, Hunters, Fishermen, mount and save your lovely wild-game trophies. Be a Taxidermist. Mount Birds, Animals, Heads, Fish, Tan skins. YOU learn easily, quickly in spare time. Have a grand home-museum. The finest and the greatest hobby known, for sportsmen. Fun, real profits.

**FREE BOOK**

Yes, FREE, Beautiful strange, valuable BOOK, telling all about Taxidermy. Contains over 100 beautiful color-pictures. And it's yours FREE, if you rush your request. You can mount all kinds of wild-game, and common specimens too. We can positively TEACH YOU. So GRASP this opportunity, RUSH letter or postal for this amazing FREE BOOK. Don't delay. State your AGE, N. W. SCHOOL OF TAXIDERMY, 2511 Ewood Bldg., Omaha 2, Neb.

**Locksmithing AND KEY MAKING**

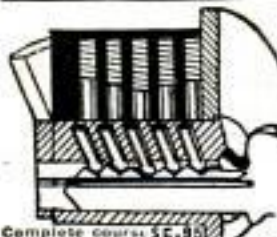

Now Made Easy! Practical up-to-date course teaches you how to pick locks, de-code, make master keys, repair, install, service, etc. New self-instruction lessons for every locksmith, homeowner, carpenter, mechanic, service station operator. It's the shop hardware dealer's gem-smith. 33 easy illustrated lessons. Full price only \$5.95 postpaid; or \$7.00, plus postage. Satisfaction or refund guaranteed.

Complete course \$5.95... now only \$3.95

Nelson-Hall Co., Dept. LT-2  
210 S. Clinton St. Chicago 6, Ill.

**GROW MINIATURE TREES**

in your home... \$5 PROFITS!



New Fascinating HOBBY or HOME-BUSINESS OPPORTUNITY! Learn little-known techniques for growing living "Ming" Trees only inches high. Beautiful Elm, Cherry, Orange, Cypress, Peach, etc., that BLOSSOM AND BEAR TINY TASTY FRUIT. Help fill demand for these sensational dwarfed Trees. PRICE ILLUSTRATED DETAILS. Write: MINIATURE TREE NURSERIES, Dept. K-11 (Home-Growers Division) Gardena, Calif.



**MECHANICAL DENTISTRY**

A profession offering unlimited opportunities. Most modern and complete course embracing every branch from Plate to Porcelain Work, which prepares you to work for Dentists or start your own business. Individual instruction—practical training in day or night school. No books—no classes. Catalog upon request. McCARRIE SCHOOL OF MECHANICAL DENTISTRY, 207 N. Broad Street Dept. 71 Philadelphia 7, Penna.

**FREE!**



Last chance for FREE SAMPLE of Ply-Craft shapes that make life-like 3-D models of Birds and Dogs. Glue and sandpaper included. No Tools Needed. Looks as if handcarved from a Solid Block. Send 25c to cover postage and handling. Or send \$1.00 for 4 models and get 4 models FREE. All different. For Children and Grown-Ups. ZENITH CORP., Dept. 93 Queens Village 29, New York

**WAR SURPLUS BARGAINS**

\$500,000.00 INVENTORY for QUICK LIQUIDATION  
Surplus items—hundreds of items for home, shop, factory, farm and outdoor use. New items, used items, reconditioned items—all at tremendous savings—all priced for quick sale.  
Page After Page of Values  
This big catalog shows page after page of amazing money saving values. Write for your copy today. Send 10c to cover postage, mailing, etc. Write today! SEND TODAY FOR YOUR COPY  
**10c**  
STARK'S 212 W. Madison St. Dept. PM-5711 CHICAGO 6, ILL.



the inside story of  
**PATENT NO. 2,442,945 \***

# ALDOR SPARK PLUGS

**THERMO-REACTOR**  
PATENTED

The ONLY FULLY AUTOMATIC spark plug in the world! Engineered especially for today's new car HI-COMPRESSION engine!

You get MORE miles per gallon, GREATER horsepower, under any and every driving condition—INSTANTLY—AUTOMATICALLY! Millions in daily use in the U.S. and in over 30 foreign countries! GUARANTEED TO OUTLAST & OUTPERFORM ANY OTHER PLUG!

Aldor's specially designed D-H\* ELECTRODE insures peak resistance to pitting and burning and assures INSTANT STARTING!

ALDOR Thermo-Reactor Spark Plugs are on sale at most better Auto Accessory Stores, Garages and Service Stations—Ask for them by name! If not available locally, send check or money order, or C.O.D. (stating year, make and model of car or type of engine) to:

**A. L. DOERING SPARK PLUG CORP.**

2 STATION PLAZA, BAYSIDE 61, N. Y.

Manufacturers of the world famous OIL FIRING Spark Plug since 1914!

The ONLY spark plug in the world with the **PATENTED AUTOMATIC "BUILT-IN-BRAIN" \***

\* The PATENTED THERMOSTATIC REACTOR DISK is an engineering marvel that gives you AUTOMATIC spark adjustment for both high and low speeds—SOMETHING NO OTHER PLUG CAN DO! Power response is faster and smoother than ever—from a standing start, easing along in traffic, or passing at cruising speeds!

VENTILATED BRASS CAP

AIR COOLED CHAMBER

2 PIECE CONSTRUCTION PREVENTS COMPRESSION LEAKS

\$150 ea.



At low speed, stop & go city driving, the Thermostatic Reactor Disk AUTOMATICALLY snaps away from the electrode causing a voltage buildup. This produces the HOT spark that burns away ALL carbon deposits and PREVENTS FOULING!



At high speed driving, the Thermostatic Reactor Disk AUTOMATICALLY snaps back to the electrode reducing voltage flow and producing the COLD plug that PREVENTS PRE-IGNITION and compression loss!

NO FOULING in stop and go city driving... NO PRE-IGNITION at high speed open road driving... AUTOMATICALLY!

A PRACTICAL AND APPRECIATED CHRISTMAS GIFT!

The Patented Thermo-Reactor is also built into the World Famous ALDOR OIL-FIRING non-fouling spark plug for older engines and worn engines using excessive amounts of oil! SELF-CLEANING, WILL NOT FOUL! Actually FIRES IN OIL!



Thermo-Reactor plugs also sold under the following trade name



**ENGINEERING DEGREE IN 27 MONTHS**

B.S. Degree, Astro., Chem., Civil, Elec., Mech. & Electronic Engineering (inc. Radio, TV), 36 mo. B.S. degree in Math., Chem., Physics. Prep courses. Demand for grads. Spurious rumors, 20 bldgs., dorms, auditorium, gym. Low rate. Earn board, G.I. approved. Enter Dec., March, June, Sept. Catalog. 1611 E. Washington Blvd. Fort Wayne 2, Indiana. Keeping pace with progress.

**INDIANA TECHNICAL COLLEGE**



... Swiss or American

Unique Sweazey System starts you making repairs right away. Develops your skill step-by-step. Teaches modern methods... professional short cuts. Learn by personal attendance or spare time home study. Free Sample Lesson. No obligation. Write today!

CHICAGO SCHOOL OF WATCHMAKING

2330 Milwaukee, Dept. 1117, Chicago 47, Ill.

## LEARN MEAT CUTTING AT NATIONAL Pay After Graduation



The steady dependable trade of Meat Cutting taught easily in 8 short weeks. YOU LEARN BY DOING under actual meat market conditions in big modern school at Toledo.

For beginners or men with experience. Get a profitable store of your own. Remember, PEOPLE MUST EAT! Big pay jobs. Free employment help. Thousands of successful graduates.

Buying, cutting, percentage, pricing, advertising, selling, etc. A complete retail meat education. National School established 35 years. Get National training NOW. Pay your tuition in easy weekly payments

after you graduate. Send coupon for FREE 52 page school catalog — TODAY. G.I. approved.

National School of Meat Cutting, Inc., Dept. 50-X, Toledo 4, Ohio

Send me your FREE school catalog on National Training at Toledo in Meat Cutting, Meat Merchandising and Self Service Meats. No obligation. No salesman will call.

Name \_\_\_\_\_ Age \_\_\_\_\_

Address \_\_\_\_\_

City \_\_\_\_\_ State \_\_\_\_\_

Approved for training Korean Veterans



During a visit to a marine-biology laboratory, students identify fish netted by a research vessel



Students themselves try a carbon-arc experiment. Learning by doing was one of the program's goals

## Delaware Students Shake Hands With Science

FOR FOUR WEEKS during the past summer, 27 tenth-grade students not only had the time of their lives, but had a top-notch introduction to science. The students participated in the Delaware Summer Science Day Camp, a unique program sponsored by the Delaware Section, American Chemical Society. The entire purpose of the program was to whet the appetites of good students who had demonstrated an interest in science.

Students could enroll in the course for a \$25 fee, with scholarships available to students who might need them. The potential scientists were so enthusiastic about the program that they wanted to extend it for an additional week.

Instead of just being told about science, the youngsters themselves participated. Furthermore, they journeyed all over

In a visit to a chemical laboratory, students discover the unique characteristics of new plastics



Delaware and parts of Pennsylvania to shake hands with some of the basic sciences. To discover the field of biology, they made overnight trips to a wildlife refuge and a marine-biology laboratory. To survey chemistry and physics they visited university and industrial laboratories.

Their introduction to astronomy included a demonstration of a planetarium and telescopes, along with a night session in which they did their own stargazing.

In other special sessions the students learned something about blood typing, genetics, anthropology, atomic energy, the use of the slide rule, stereophonic sound, science and safety, crime prevention and crime detection.

The plan worked out so well in Delaware that the American Chemical Society hopes other states will follow suit.

Potential young scientists participate in startling demonstration of stereophonic and binaural sound



# BIG REWARDS

for Industry's Most-Wanted Men



Chemical Lab  
Technician

Elec. Engineering  
Technician

Radio-TV  
Technician

Aeronautical  
Technician

General Electronics  
Technician

Industrial  
Electronics  
Technician

With the right training, you can qualify for big-pay jobs in these vital industries. Start yourself on an exciting, rewarding career and at the same time help fill a desperate need. I. C. S. can

show you how! I. C. S. spare-time training is recognized and used by leading companies throughout the U.S. and overseas. Send today for full details including three free books:

1. "How to Succeed"  
36-page guide  
to advancement.

2. Opportunity  
Handbook in  
field of your  
choice.

3. Sample lesson  
(Math) to  
demonstrate  
I. C. S. method.

For Real Job Security—Get an I. C. S. Diploma! I. C. S., Scranton 15, Penna.

Accredited Member,  
National Home Study Council

## INTERNATIONAL CORRESPONDENCE SCHOOLS



BOX 49953L, SCRANTON 15, PENNA.

(Partial list of 257 courses)

Without cost or obligation, send me "HOW to SUCCEED" and the opportunity booklet about the field BEFORE which I have marked X (plus sample lesson):

- |  |  |  |   |   |
|--|--|--|---|---|
| <p><b>ARCHITECTURE and BUILDING CONSTRUCTION</b></p> <ul style="list-style-type: none"> <li><input type="checkbox"/> Air Conditioning</li> <li><input type="checkbox"/> Architecture</li> <li><input type="checkbox"/> Arch. Drawing and Designing</li> <li><input type="checkbox"/> Building Contractor</li> <li><input type="checkbox"/> Building Estimator</li> <li><input type="checkbox"/> Carpenter and Millwork</li> <li><input type="checkbox"/> Carpenter Foreman</li> <li><input type="checkbox"/> Heating</li> <li><input type="checkbox"/> Interior Decoration</li> <li><input type="checkbox"/> Painting Contractor</li> <li><input type="checkbox"/> Plumbing</li> <li><input type="checkbox"/> Reading Arch. Blueprints</li> </ul> <p><b>ART</b></p> <ul style="list-style-type: none"> <li><input type="checkbox"/> Commercial Art</li> <li><input type="checkbox"/> Magazine &amp; Book Illus.</li> <li><input type="checkbox"/> Show Card and Sign Lettering</li> <li><input type="checkbox"/> Sketching and Painting</li> </ul> <p><b>AUTOMOTIVE</b></p> <ul style="list-style-type: none"> <li><input type="checkbox"/> Automobiles</li> <li><input type="checkbox"/> Auto Body Rebuilding and Refinishing</li> <li><input type="checkbox"/> Auto Engine Tuneup</li> <li><input type="checkbox"/> Auto Technician</li> </ul> | <p><b>AVIATION</b></p> <ul style="list-style-type: none"> <li><input type="checkbox"/> Aero-Engineering Technology</li> <li><input type="checkbox"/> Aircraft &amp; Engine Mechanic</li> </ul> <p><b>BUSINESS</b></p> <ul style="list-style-type: none"> <li><input type="checkbox"/> Accounting</li> <li><input type="checkbox"/> Advertising</li> <li><input type="checkbox"/> Business Administration</li> <li><input type="checkbox"/> Business Management</li> <li><input type="checkbox"/> Cost Accounting</li> <li><input type="checkbox"/> Creative Salesmanship</li> <li><input type="checkbox"/> Managing a Small Business</li> <li><input type="checkbox"/> Professional Secretary</li> <li><input type="checkbox"/> Public Accounting</li> <li><input type="checkbox"/> Purchasing Agent</li> <li><input type="checkbox"/> Salesmanship</li> <li><input type="checkbox"/> Salesmanship and Management</li> <li><input type="checkbox"/> Traffic Management</li> </ul> <p><b>CHEMICAL</b></p> <ul style="list-style-type: none"> <li><input type="checkbox"/> Analytical Chemistry</li> <li><input type="checkbox"/> Chemical Engineering</li> <li><input type="checkbox"/> Chem. Lab. Technician</li> <li><input type="checkbox"/> Elements of Nuclear Energy</li> <li><input type="checkbox"/> General Chemistry</li> <li><input type="checkbox"/> Natural Gas Prod. and Trans.</li> <li><input type="checkbox"/> Petroleum Prod. and Engr.</li> <li><input type="checkbox"/> Professional Engineer (Chem)</li> <li><input type="checkbox"/> Pulp and Paper Making</li> </ul> | <p><b>CIVIL ENGINEERING</b></p> <ul style="list-style-type: none"> <li><input type="checkbox"/> Civil Engineering</li> <li><input type="checkbox"/> Construction Engineering</li> <li><input type="checkbox"/> Highway Engineering</li> <li><input type="checkbox"/> Professional Engineer (Civil)</li> <li><input type="checkbox"/> Reading Struc. Blueprints</li> <li><input type="checkbox"/> Structural Engineering</li> <li><input type="checkbox"/> Surveying and Mapping</li> </ul> <p><b>DRAFTING</b></p> <ul style="list-style-type: none"> <li><input type="checkbox"/> Aircraft Drafting</li> <li><input type="checkbox"/> Architectural Drafting</li> <li><input type="checkbox"/> Drafting Machine Design</li> <li><input type="checkbox"/> Electrical Drafting</li> <li><input type="checkbox"/> Mechanical Drafting</li> <li><input type="checkbox"/> Sheet Metal Drafting</li> <li><input type="checkbox"/> Structural Drafting</li> </ul> <p><b>ELECTRICAL</b></p> <ul style="list-style-type: none"> <li><input type="checkbox"/> Electrical Engineering</li> <li><input type="checkbox"/> Elec. Engr. Technician</li> <li><input type="checkbox"/> Elec. Light and Power</li> <li><input type="checkbox"/> Practical Electrician</li> <li><input type="checkbox"/> Practical Lineman</li> <li><input type="checkbox"/> Professional Engineer (Elec)</li> </ul> <p><b>HIGH SCHOOL</b></p> <ul style="list-style-type: none"> <li><input type="checkbox"/> High School Diploma</li> </ul> | <ul style="list-style-type: none"> <li><input type="checkbox"/> Good English</li> <li><input type="checkbox"/> High School Mathematics</li> <li><input type="checkbox"/> Short Story Writing</li> </ul> <p><b>LEADERSHIP</b></p> <ul style="list-style-type: none"> <li><input type="checkbox"/> Industrial Foremanship</li> <li><input type="checkbox"/> Industrial Supervision</li> <li><input type="checkbox"/> Personnel-Labor Relations</li> <li><input type="checkbox"/> Supervision</li> </ul> <p><b>MECHANICAL and SHOP</b></p> <ul style="list-style-type: none"> <li><input type="checkbox"/> Diesel Engines</li> <li><input type="checkbox"/> Gas-Elec. Welding</li> <li><input type="checkbox"/> Industrial Engineering</li> <li><input type="checkbox"/> Industrial Instrumentation</li> <li><input type="checkbox"/> Industrial Metallurgy</li> <li><input type="checkbox"/> Industrial Safety</li> <li><input type="checkbox"/> Machine Design</li> <li><input type="checkbox"/> Machine Shop Practice</li> <li><input type="checkbox"/> Mechanical Engineering</li> <li><input type="checkbox"/> Professional Engineer (Mech)</li> <li><input type="checkbox"/> Quality Control</li> <li><input type="checkbox"/> Reading Shop Blueprints</li> <li><input type="checkbox"/> Refrigeration and Air Conditioning</li> <li><input type="checkbox"/> Tool Design</li> <li><input type="checkbox"/> Tool Making</li> </ul> <p><b>RADIO TELEVISION</b></p> <ul style="list-style-type: none"> <li><input type="checkbox"/> General Electronics Tech.</li> </ul> | <ul style="list-style-type: none"> <li><input type="checkbox"/> Industrial Electronics</li> <li><input type="checkbox"/> Practical Radio-TV Eng'g</li> <li><input type="checkbox"/> Practical Telephony</li> <li><input type="checkbox"/> Radio-TV Servicing</li> </ul> <p><b>RAILROAD</b></p> <ul style="list-style-type: none"> <li><input type="checkbox"/> Car Inspector and Air Brake</li> <li><input type="checkbox"/> Diesel Electrician</li> <li><input type="checkbox"/> Diesel Engr. and Fireman</li> <li><input type="checkbox"/> Diesel Locomotive</li> </ul> <p><b>STEAM and DIESEL POWER</b></p> <ul style="list-style-type: none"> <li><input type="checkbox"/> Combustion Engineering</li> <li><input type="checkbox"/> Power Plant Engineer</li> <li><input type="checkbox"/> Stationary Diesel Engr.</li> <li><input type="checkbox"/> Stationary Fireman</li> </ul> <p><b>TEXTILE</b></p> <ul style="list-style-type: none"> <li><input type="checkbox"/> Carding and Spinning</li> <li><input type="checkbox"/> Cotton Manufacture</li> <li><input type="checkbox"/> Cotton Winding and Weaving</li> <li><input type="checkbox"/> Loom Fixing Technician</li> <li><input type="checkbox"/> Textile Designing</li> <li><input type="checkbox"/> Textile Finishing &amp; Dyeing</li> <li><input type="checkbox"/> Throwing</li> <li><input type="checkbox"/> Winding and Weaving</li> <li><input type="checkbox"/> Worsted Manufacturing</li> </ul> |
|--|--|--|---|---|

Name \_\_\_\_\_ Age \_\_\_\_\_ Home Address \_\_\_\_\_

City \_\_\_\_\_ Zone \_\_\_\_\_ State \_\_\_\_\_ Working Hours \_\_\_\_\_ A.M. to P.M. \_\_\_\_\_

Occupation \_\_\_\_\_

Canadian residents send coupon to International Correspondence Schools, Canadian, Ltd., Montreal, Canada. . . . Special tuition rates to members of the U. S. Armed Forces.

# TRAINED MEN NEEDED!

**IN INDUSTRY—ARMED FORCES  
BIG PAY!—GOOD FUTURE!**

- DIESEL                       ELECTRONICS  
 AUTO                          AUTOMATION

NEVER BEFORE has the opportunity been so good for the properly trained mechanic and technician to step into **BIG PAY POSITIONS** with rapid advancement and future security virtually assured.

**YOUR SUCCESS** depends on the quality of training you receive... and the reputation of the school you attend.

**YOUR GUARANTEE** we are giving the best in mechanical and technical training is proved by the fact... High pay jobs in Industry, and ratings in the Armed Forces now waiting for our graduates.

**RESIDENT SHOP TRAINING** is easier and costs less than you may think! We provide you with housing and part-time jobs while in school, plus free nation-wide placement service for graduates.

Check subject above in which you are interested and mail for

**FREE BOOKLET**

**BAILEY**  
**Technical Schools**

Veteran Approved

1634 S. Grand, St. Louis 4, Mo.

Your Future  
IN  
ELECTRONICS  
AND  
AUTOMATION

Your Future  
in...  
DIESEL and  
AUTO  
MECHANICS

Name \_\_\_\_\_ Age \_\_\_\_\_

Street \_\_\_\_\_

Town \_\_\_\_\_ Zone \_\_\_\_\_ State \_\_\_\_\_

## NEVER AT THIS LOW PRICE! GENUINE 135-POWER ACHROMATIC TELESCOPE

with Achromatic Lens and  
4-POWER FINDER attached

ONLY  
**\$18.95**  
PREPAID



### EXTRA BONUS GIFTS:

- 273 page book, "Handbook of the Heavens"
- Magic Star Finder Dial
- 220X & 400X Eyepiece lenses

**5 Magnifications 18X—35X—65X—85X—135X**

Brings the Moon, Planets, Stars, People  
135 times Closer, Clearer, Sharper

Never before has an ACHROMATIC 135X telescope with range finder and tripod sold for anywhere near this amazing low price! Now you can not only explore the heavens and bring the moon, planets, stars 135 times closer, but you can observe all distant objects, people, ships too, because all pictures are erect, not upside down as in all astronomical telescopes. The kind of needle-sharp color-free viewing only a genuine achromatic lens can bring you. Ready for immediate use. 5 precision lenses bring you viewing at 18X—35X—65X—85X—135X. Tubes extend to 43" made of bakelite, finished in camera bellows black, trimmed with gleaming brass. 4 power finder scope (30mm Lens) mounted on main tube is feature usually found on more expensive telescopes—brings difficult objects on target before observing with main scope. For extra stability 5 ft. hardwood folding tripod is equipped with heavy cast iron head fitted with Criterion's famous 360 degree all aluminum mount that locks instantly in any position. Obtainable only from Criterion Co. shipped prepaid. 4 famous gifts—273 page book "Handbook of the Heavens," Magic star finder dial that aids in locating stars ANYWHERE at ANYTIME of the year. 220X & 400X eyepiece lenses included free for experiments. You must be completely satisfied with this super offer or your money back in full. Shipped Complete, nothing else to buy at amazingly low price of **\$18.95**. Without tripod **\$14.95**. Send Cash, Check, or Money Order today.

Dept. PMA18, CRITERION CO., 331 Church St., Hartford, Conn.



You can mystify your friends. You can be the life of the party. Imagine the surprise on your friends faces when a small ball mysteriously jumps from your pocket to a small vase in your hand and back into your pocket. Proves the hand is quicker than the eye. Easy to do. No skill required. Money back guaranteed. Send \$1 today to

**EASY-DO-MAGIC CO.**  
P.O. BOX 159  
THREE RIVERS, MICH.

**WE  
PAY  
POSTAGE**

## SHORTHAND in

**6  
WEEKS**

Famous SPEEDWRITING shorthand, 120 words per minute. No symbols; no machines; uses ABC's. Easiest to learn, write and transcribe. Lowest cost. For business and Civil Service. 350,000 graduates. Typing available. 35th year. Write for FREE booklet to: SCHOOL OF

**Speedwriting**  
Dept. 1511-7, 35 W. 42 St., New York 36 (R)

## ART LEARN AT HOME!

Enjoy glamorous high-pay career or profitable hobby. Learn Commercial Art, Illustrating, Cartooning, Fashion Art, Lettering, T.V., etc. We train you at home. In spare time, 22-pp. art outfit given with first lesson at no extra cost. Write for FREE Book describing easy low-cost method. No obligation. No salesman will call on you. Washington School of Art, Studio 1411, Port Washington, N. Y. (Estab. 1914)

**Exclusive Double-Bearing HEAVY-DUTY PUMPS**  
IRRIGATE • DRAIN • CIRCULATE • SPRAY  
Up to 7,500 GPH. 3,000 GPH from 2 1/2" well. Use 3/4 to 1 HP motor. 1 1/4" inlet; 1" outlet. Stainless shaft.  
TYPE X—2 oilless bronze bearings. **\$10.95**  
Won't rust.  
TYPE XB—Ball bearing model. **\$12.95**  
Postpaid if cash with order. Rush your order today  
**MONEY BACK GUARANTEE**  
Centrifugal and Gear Pumps in All Sizes  
**LABAWCO PUMPS, Belle Mead 2, N. J.**

## BUY WHOLESALE! DISCOUNTS UP TO 80%

Start A Buying Service

Sales come easy for these Nationally Advertised Appliances, Watches, Clothing, Furniture, Housewares, etc.

Send postcard for "Free Wholesale Plan"

**UNITED WHOLESALE SERVICE**  
1265-P Broadway New York 1, N. Y.

## RUPTURED? NEW LASTING RELIEF

ENJOY NEW FREEDOM

of action, amazing peace of mind and comfort at work or play. New pleasures replace rupture pain. The proven, patented MILLER holds your rupture back Day and Night... bringing you new lasting relief as it has thousands of others.  
**FREE!** Write for relief FACTS free. Send name and address to: FRED B. MILLER, Dept. 1-R Exclusive Manufacturer Hagerstown, Maryland



Get FREE FACTS

POPULAR MECHANICS

Copyrighted material

# PRICES SLASHED ON FINE IMPORTED

# ACCORDIONS

## BUY NOW-BUY DIRECT

# SAVE $\frac{1}{2}$ OR MORE



# 5 DAYS FREE TRIAL

## BONUS GIFTS **FREE!**

Home Study Course  
DeLuxe Music Stand  
Year's Supply of Music  
Lifetime Guarantee

Name in Chrome Letters  
Bellows Protector  
Fine Quality Carrying Case  
Music Portfolio

### Small Down Payment—Easy Terms

### Buy Direct from America's Largest Exclusive Dealer of Fine Imported Accordions

You'll *never* buy for less! Rush coupon for exciting FREE Color Catalog of latest model brand new Imported Italian Accordions. You'll save one half — or more — by ordering NOW! Get FREE 5-DAY PLAYING TRIAL with positive money back guarantee. If you decide to keep it, pay only pennies a day on amazing easy terms. We are America's largest exclusive direct accordion dealer. We buy for less—and pass our savings on to you. Each accordion bears the famous brand name of an outstanding manufacturer—each is hand selected for quality and superior tone. Each accordion carries our LIFETIME WARRANTY!

### NEWEST 1958 MODELS NOW HERE

More than 30 brand new models to choose from. Accordions for beginners up to magnificent professional instruments. Personal help in selection if desired. Trade-ins accepted. Get in on the fun and popularity only an accordion can give you. Rush coupon at once for big new FREE Color Catalog and new low wholesale price list. No obligation. Write today.



**PHILHARMONIC Cathedral**

A magnificent accordion for the professional accordionist and those who demand the peak of quality.

## FREE COLOR CATALOG RUSH COUPON

**ACCORDION MANUFACTURERS  
and WHOLESALERS OUTLET**

Dept. R-117, 2003 W. Chicago Avenue,  
Chicago 22, Illinois

Send FREE Color Catalog of newest model accordions; also latest wholesale price list.

Name \_\_\_\_\_

Address \_\_\_\_\_

City \_\_\_\_\_ State \_\_\_\_\_

# ACCORDION MANUFACTURERS AND WHOLESALERS OUTLET

2003 W. Chicago Avenue, Dept. R-117, Chicago 22, Illinois

NOVEMBER 1957

43

# ENGINEERING



Dr. Lee DeForest, Father of Radio, Grandfather of TV and all Electronics, exchanging ideas with Heald Electronics Instructor, Heald College ranks **FIRST West of the Mississippi** in "Who's Who" in America. Send for **FREE** Information Heald Engineering College, Inc. 1963. Van Ness at Post, Dept. P.M. San Francisco, California. Enroll Now for New Term

Thousands of Engineers Needed for Hard Pressed Industry  
**BACHELOR OF SCIENCE DEGREE, 27 MONTHS**

**Degree Courses:**

- Electronic Engineering
- Electrical Engineering
- Highway Engineering
- Mechanical Engineering
- Structural Engineering
- Civil Engineering
- Architecture

**Diploma Courses:**

- TELEVISION  Color TV
- Tool & Die Design
- Architectural Drafting
- Mechanical Drafting
- Structural Drafting
- Surveying
- Estimating
- Master Electrician

Approved for Veterans

NAME \_\_\_\_\_  
STREET \_\_\_\_\_  
CITY \_\_\_\_\_  
STATE \_\_\_\_\_

There's money to be made

**IN THE ORNAMENTAL CONCRETE BUSINESS**

Manufacture—and sell—ornamental concrete products yourself! Easy, simply produced, here is a low-cost, do-it-yourself project that means money—Big Money.

CMC permanent, light-weight, high quality Aluminum Molds give you both ease of production and copyrighted designs that have set a national record of sales success.

Get the full story of this high profit, low cost business. Send today for your copy of the big, fully illustrated book "How to Turn Concrete into Gold." The clear, easy followed "from start to finish" instructions that show you how to produce beautiful, ornamental concrete products. Plus valuable sales and market tips. Catalog of over 200 Specialty Molds. A complete industry manual.



Send \$2.00 for your copy

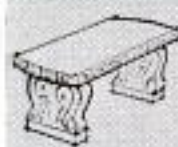

**CMC** CONCRETE MACHINERY COMPANY, INC. DEPT. PM HICKORY, NORTH CAROLINA

## 3 FOR \$29.95

THREE FIRSTS FOR OUR FIRST SALE. **FREE AMMO**  
OUR SPECIAL OFFERING: THREE RIFLES WITH

**MAUSER 11 MM**

Mostly renowned rifle, "The Big 11," Model 71/24, caliber 11 MM Mauser. A "must" for your collection and a new and interesting addition to your shooting outfit. Specifications: bolt action, 7 shot, tubular magazine with 20" barrel.

**MAUSER 8 MM**

Small bore, smoothless powder rifle. The "Gow 88" used by the Kaiser's troops up to our days in the First World War. Finest workmanship throughout. Specifications: bolt action, 5 shot, clip loading, Mannlicher magazine, 22" barrel.

**MANNLICHER 11 MM**

Frankly built Mauser-type military rifle, Model '96, caliber 11 MM Mannlicher. Designed by Ferdinand von Mannlicher for the Imperial Austrian Army. Specifications: 5 shot, clip loader, 22" barrel.

**BONUS — FREE AMMO — FULL MAGAZINE LOAD WITH NECESSARY CLIP WITH EACH RIFLE**

All rifles guaranteed S.E.A. good. Unconditional 10 day money back guarantee. Plenty of additional ammo available for these rifles.

**MILITARY AMMO SALE**

First time at surplus prices, good clean shooting ammo.

1 MM Mauser with .115 dia. bullet for "Gow 88".....	\$7.50 per 100,
1 1/2 mm Mannlicher for Model 71/24 and 20 Aushaus.....	\$8.00 per 100,
11 MM Mauser for Model 71/24.....	\$7.50 per 100,
11 MM Mannlicher for Model 96 Austrian and Swedish.....	\$7.50 per 100,
1 1/2 mm bullet for all French 11 MM rifles and carbines.....	\$7.50 per 100,
1 1/2 mm bullet for all G.I. Bolkan rifles and carbines.....	\$7.50 per 100,

Minimum order, 100 rounds.

## GOLDEN STATE ARMS CORP.

386 W. Green St., Pasadena 219, Calif.

TV DAN, THE MUSCLE MAN SAYS



## I'LL GUARANTEE YOU RIPPING MUSCLES

IN 8 WEEKS OR MONEY BACK. You can have tremendous power, look bigger, have more confidence this tested way. Revolutionary new "Body Mold" congress builds your body in a way no other method can match. Get course FREE with order. Lowest factory price.

**DAN LURIE BARBELLS**  
50 lb. set \$ 8.99 + 1.00 lb. set \$14.99  
150 lb. set \$21.99 + 200 lb. set \$27.99  
Extra 10% off 100 lb. set. 10% cash, insurance C.O.D. FOB Plant  
**DAN LURIE BARBELLS CO.**  
52011 Bristol St., Dept. 759M, Bklyn 12, N.Y.

FREE! SEND FOR NEW SPORTS & HEALTH CATALOG

## \$2.95 OR 2 FOR \$5.00!

TESTED AND GUARANTEED  
Write for free list on all types of telephones. Shipments F.O.B. Simpson, Pa.  
**TELEPHONE ENGINEERING CO., Dept. 11B7, Simpson, Pa.**

## A POSTCARD CAN PUT YOU IN A FINE BUSINESS!

**Rush Card TODAY for FREE OUTFIT!**  
Get into highly profitable, repeat-order shoe business! Sell new line of Air-Cushion comfort shoes to friends, neighbors, folks at work! Over 210 dress, sport, work, safety shoe styles for men, women. Never sold by stores. Just 2 easy orders a day—in spare time—bring you \$217 extra income a month! No investment. Rush name and address TODAY for FREE SELLING OUTFIT!  
**MASON SHOE, Dept. 944, Chippewa Falls, Wis.**



## 5 NEW CRUISER KITS

Many other models. Best values in fiberglass covering kits, marine supplies. 18 Ft. Offshore Cruiser.  
**TAFT MARINE WOODCRAFT**  
Dept. PM-1157 636 39th Ave. N.E. Minneapolis 21, Minn.



LOW AS \$399  
Freight included. FREE COLOR CATALOG

## Build Your Own "Buckboardin' Buggy"

It's easy with our complete kit and clear instructions. Includes steering wheel, clutch, 10" rubber tire wheels, steel axles, all enameled wood chassis parts, bolts, nuts, etc. ready to assemble in a few hours, \$49.50 f.o.b. Fairport. Or buy the complete unit ready to unpack and run, \$59.50 f.o.b. 66" long, 17" wide; easy to push; or power with gasoline motor (available at extra cost.) Satisfaction guaranteed. **HAVE DAD GET YOU ONE FOR CHRISTMAS.** Order now, or ask for free color circular.



"Fun for kids of all ages"

**MAYO BROS. Dept. P Fairport, N. Y.**

POPULAR MECHANICS

**Now available...direct to you from the Publisher**

**BRAND NEW EDITION OF THE WORLD FAMOUS**

# ENCYCLOPAEDIA BRITANNICA



## On Easy...Book a Month Payment Plan

■ Yes, the latest edition of Britannica—the greatest treasure of knowledge ever published—is now being offered on a remarkable, direct-from-the-publisher plan that puts this world-renowned reference library within reach of every family. All 24 volumes will be placed in your home NOW... you pay for it later on convenient budget terms. It's as easy—and as convenient—as buying a book a month.

You may wonder how we're able to make this truly amazing offer. First, because of the great demand for this magnificent set, we have ordered a tremendous printing. Also, by offering this set *Direct from the Publisher*, we have saved many distribution costs. These savings are passed on to you.

### Thousands of Subjects of Practical Value

In the brand-new edition of Britannica you will find thousands of subjects that you and your family will refer to in the course of your normal day-to-day affairs. For example, you'll find special articles on household budgets, interior decorating, medicine and health, home remodeling, child care, adolescent problems, rules and regulations for all sports, every kind of hobby... plus a treasure house of knowledge on *all* subjects. Useable information that can save you many dollars.

### New Edition is Profusely Illustrated

The new Britannica almost "televises" the information to you by means of 23,494 magnificent illustrations. But it does not merely show "attractive" pictures—it is the work of 5,565 of the world's greatest authorities on all information significant to mankind.

### Britannica Often Called Key to Success

The brand-new Britannica—the biggest

### Preview Booklet Offered FREE!

Simply fill in and mail the coupon today, and we will send you... without cost or obligation... a copy of our beautiful, new booklet which contains an exciting preview of the latest edition of Encyclopaedia Britannica. Send no money—not even for postage. It's yours, absolutely free!

In its pages, you will see the most significant scenery on the North American Continent. You'll go on a cruise to France—to the mysterious Orient—to a Pacific Island—or by rocket to the moon!

In color so beautifully etched it gives the illusion of a third dimension, you will see art treasures of famous museums, world landmarks... and scientific wonders.

Just as soon as we receive your coupon, we will send your illustrated free booklet. No obligation, of course. However, since this offer is necessarily limited, please mail the coupon today before it slips your mind.



and greatest edition in our almost 200-year publishing history—is expressly designed to help you enjoy a richer and fuller family life, aid you in achieving greater financial rewards and success in your business or trade, help your children in school, and enable you to speak factually and intelligently on the widest range of subjects.

### FREE Research Service

As a Britannica owner, you would be entitled to *free* research reports on subjects of your choice. These comprehensive and authoritative reports are prepared for you by members of the world-famous Britannica Research Staff, and cover subjects of important interest to you and your family.

**Mail  
Coupon  
Now for  
Free  
Booklet**

ENCYCLOPAEDIA BRITANNICA, Dept. 28-G  
425 N. Michigan Avenue, Chicago 11, Illinois

Please send me, *free and without obligation*, your colorful Preview Booklet which pictures and describes the latest edition of ENCYCLOPAEDIA BRITANNICA in exciting full detail. Also include complete information on how I may obtain this magnificent set, *direct from the publisher*, on the Book a Month Payment Plan.

Name \_\_\_\_\_  
(please print)

Address \_\_\_\_\_

City \_\_\_\_\_ Zone \_\_\_\_\_ State \_\_\_\_\_

In Canada, write E. B. Ltd., Terminal Bldg., Toronto, Ont.

Some make more, some less; T. THORN reports:

**\$690** gross in single  
**MONTH**  
IN MY OWN BUSINESS!

**Start your own business!**

Here's YOUR chance to start a money-making, year-round business of your own and make the success you've dreamed about.

R. O. Donnley took in \$40 in seven hours. O. W. Ware landed a \$750 hotel job. J. S. Corbit grossed \$279.50 his first month. Homes, hotels, offices, clubs, offer you big profit possibilities. Auto upholstery also.

**NO SHOP OR OFFICE NECESSARY.** You clean furniture on customers' premises. No hauling. No high rents. Supplies inexpensive; operate from your home. What you take in is mostly profit.

● If you want to be your own boss—free from layoffs, strikes and bosses, we will help you to start and succeed. Don't delay...read the facts, then decide for yourself.



**MAIL COUPON TODAY FOR FREE BOOK**

**VON SCHRADER MFG. CO.**  
E10 "D" Pl., Racine, Wisconsin

Without obligation rush your **FREE** booklet about how I can start my own permanent, profitable electric Upholstery Cleaning business.

Name \_\_\_\_\_

Address \_\_\_\_\_

City \_\_\_\_\_ Zone \_\_\_\_\_ State \_\_\_\_\_

**Superior's New Model 70 UTILITY TESTER®**  
**FOR REPAIRING ALL ELECTRICAL APPLIANCES**  
**MOTORS • AUTOMOBILES • TV TUBES**

As an electrical trouble shooter the Model 70:

- Measures A.C. and D.C. Voltages, A.C. and D.C. Current, Resistances, Leakage, etc.
- Will measure current consumption while the appliance under test is in operation.
- Incorporates a sensitive direct-reading resistance range which will measure all resistances commonly used in electrical appliances, motors, etc.
- Leakage detecting circuit will indicate continuity from zero ohms to 5 megohms (5,000,000 ohms).
- Will test toasters, Irons, Brillers, Heating Pads, Clocks, Fans, Vacuum Cleaners, Refrigerators, Lamps, Fluorescents, Fans, Switches, Thermostats, etc.
- Will test all TV tubes for open filaments, inter-element shorts, burned out tubes, etc.

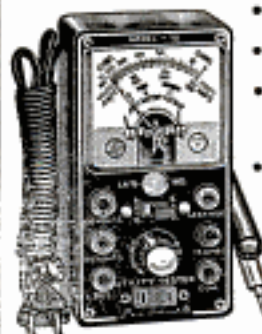

As an Automotive Tester the Model 70 will test:

- Both 6 Volt and 12 Volt Storage Batteries • Generators • Starters • Distributors • Ignition Coils • Regulators • Relays • Circuit Breakers • Cigarette Lighters • Stop Lights • Condensers • Directional Signal Systems • All Lamps and Bulbs • Fuses • Heating Systems • Horns • Also will locate poor grounds, breaks in wiring, poor connections, etc.

Model 70 comes complete with 44 page book written in plain easy-to-understand language. Explains laws of electricity, how to proceed with repairs of appliances and automobile circuits, how to test TV tubes, etc. Only **15<sup>85</sup>**

**SHIPPED ON APPROVAL**  
**NO MONEY WITH ORDER — NO C. O. D.**

Try it for 10 days before you buy. If completely satisfied then send \$3.95 and pay balance at rate of \$4.00 per month for 3 months — No Interest or Finance Charges. **Added:** If not completely satisfied, return to us, no explanation necessary.

**MOSS ELECTRONIC DIST. CO., Inc.**  
Dept. D-403, 3849 Tenth Ave., N.Y. 34, N.Y.

Please rush me one Model 70. If satisfactory I agree to pay \$5.00 within 10 days and balance at rate of \$4 per month until total price of \$15.95 plus postage is paid. If not satisfactory, I may return for cancellation of account.

Name \_\_\_\_\_  
Address \_\_\_\_\_  
City \_\_\_\_\_ Zone \_\_\_\_\_ State \_\_\_\_\_

**NEW MAGIC RADIO WALKIE TALKIE!**

**YOUR OWN POCKET SIZE RADIO STATION!**



BROADCASTS TO ANY HOME OR CAR RADIO WITHOUT WIRES OR HEADLIPS Wt. only 5 oz. Size, 1 1/2 x 2 1/2 x 4 1/2". Built-in telescoping antenna. Powerful Transistor-sensitive microphone, frequency setter, break-in switch! Runs for weeks on self-contained flashlight batteries. Durable plastic case. With this Radio Talkie you CAN TALK TO YOUR FRIENDS UP TO A BLOCK OR MORE AWAY! Talk up to 1 mile or more between two automobiles. INSTANT OPERATION! Just push button to talk! No license needed. Uses inductive field magnetic radiation. Useful and real fun in a million ways! **GUARANTEED TO WORK. 1 YEAR SERVICE GUARANTEE.**  
**SEND ONLY \$2.00.** (cash, c.o. d.) and pay postman \$9.95 COD postage or send \$11.95 for prepaid delivery. **COMPLETE READY TO OPERATE** with instructions and hundreds of ways and tricks for broadcasts thru any radio you desire. Price may go up soon, so get your **NEW POWERFUL RADIO WALKIE TALKIE NOW.** Available only from: **WESTERN RADIO, Dept. RPM-11, KEARNEY, NEBR.**

**LEARN WHILE ASLEEP!**



Exciting details free!

Sleep-Learning Research Association  
P.O. Box 610-A Omaha, Nebraska

**Model Makers!**



**Metal Turning Lathe**  
Only **\$35.00**

F.O.B. Lansing, Ill.

15 1/2" bed with 4 1/2" swing.  
7" between centers.

Satisfaction Guaranteed.

**FREE FOLDER**

Write for it today!

● Rosemoor Manufacturing Co.  
Box 147A, Lansing, Ill.



**DEVELOP A HE-MAN VOICE!**

Write for **FREE** book "How to Strengthen Your Voice for Greater Success" by Eugene Fruchtinger. No obligation. Book will be mailed at once in plain wrapper, postpaid. Just send your name and address. **Plate free. PERFECT VOICE INSTITUTE, 210 S. Clinton St., Studio LT-2, Chicago 6, Ill.**

**SEND ME**



every month so I am sure to see each new issue. Here's

- \$3.50 for 1 year
- \$8.00 for 3 years

name \_\_\_\_\_

address \_\_\_\_\_

city \_\_\_\_\_ zone \_\_\_\_\_ state \_\_\_\_\_

Hand this order to your newsdealer or send it to

**POPULAR MECHANICS**  
200 East Ontario St. Chicago 11, Ill.

POPULAR MECHANICS



# Finish HIGH SCHOOL

**AT HOME**  
Complete 4 Years in 12 Months  
diploma



Learn More! Earn More!  
Enter College, professional or technical schools.  
Advance Socially. Live a Happier, Fuller Life. Individual Courses or complete schedule.

WRITE FOR SCHOOL BULLETIN, Dept. PM117

**ACADEMY FOR ADULTS** 30 W. Washington  
Chicago 2, Illinois

## BIG AUTO NEWS IN SMALL AD



**NEW 3 PASSENGER SPORT CAR COSTS 65% LESS TO BUY TO DRIVE**

It's big inside—small outside. Ideal 2nd car or Sportabout. Fully equipped. Written guarantee. Most Big car features. Write for FREE Literature.

Dept. 504, ESHELMAN, BALTO. 2, MD.  
DEALERS: Write for Distrib. Infor.

### SPECIAL INTRODUCTORY OFFER

## THOR 2.5 AMP DRILL



Super PowerHouse THOR 1 1/2" Speed Drill with full 2.5 Amperes is the Strongest Rated Drill now available at the lowest price. Quality built to handle all power attachments. 115 volts AC or DC. Universal Series wound Motor with type S1-6 FL. U.L. approved lead cord, 1/4" steel capacity, 1/2" hard wood, 2400 & 1500 RPM speeds with offset self aligning ball thrust bearings. U.L. approved momentary contact switch with locking pin, 1/4" geared chuck with key, 9" long, net wt. 4 lbs. FULLY GUARANTEED.

**\$14.45** pp. H.

All power tools at discount prices. No C.O.D.'s. Write for free information. STAR POWER TOOLS, Dept. PM-11, 4820 N. Springfield Ave., Chicago 25, Ill.

## \$250,000 IN ORDERS FROM SMALL CLASSIFIED AD

Yes, you read the above statement correctly. Unbelievable? Of course—BUT IT'S TRUE. I'll gladly send you positive proof. Yes, the actual letter to prove the above statement. Write: F. W. Johnson, Class. Adv. Mgr., Popular Mechanics Magazine, Room 601, 200 E. Ontario, Chicago 11, Ill.

## FREE WHOLESALE CATALOG

MAKE MONEY!! SAVE MONEY!! Buy Tools, Hardware, appliances, photo equipment, sporting goods, power tools, paints and thousands of other nationally advertised products at WHOLESALE COST TO YOU.

get up to 50% off

"SEND FOR FREE 1957 WHOLESALE CATALOG TODAY"

**SILVO HARDWARE COMPANY**

Dept. PM-11, P. O. Box 268, Philadelphia 5, Pa.

## WE DON'T KNOW

all the many uses for these prisms but we do know 1000's of people are finding them useful & fun — how about you?



**PRISMS \$1.50**

Made for U. S. Govt. for tank periscopes. Fine optically ground, big precision prisms with silvered base. Terrific for all types of spectrographic work, in homemade telescopes & other optical systems for bending rays. Makes unusual paper weight (paint your name on it) or conversation piece for mantle. You'll find many other uses. NEW. PERFECT! Cost U. S. Govt. \$25 ea. Now—\$1.50 ea. ppd. or 4 for \$5.00 ppd. Calif. res. add sales tax.

**VOLUME SALES CO., War Assets Div., Dept. PM-1157**  
3930 Sunset Blvd. Los Angeles 29, Calif.

# DIESEL MECHANICS IN DEMAND



Learn to earn big pay in DIESEL in our large, modern equipped Chicago school and shop. No previous experience or training necessary. We help you find living quarters and part time job while in school. Complete, practical courses taught in the following trades, under the supervision of experienced, expert technicians.

APPROVED FOR CIVILIANS  OR GI'S

— CHOOSE YOUR TRADE —

CHECK HERE	WEEKS
<input type="checkbox"/> DIESEL MECHANICS	20
<input type="checkbox"/> AUTO MECHANICS	20
<input type="checkbox"/> BODY & FENDER	17
<input type="checkbox"/> GAS-ARC WELDING	4 - 12
<input type="checkbox"/> REFRIGERATION	14
<input type="checkbox"/> AIR CONDITIONING	9
<input type="checkbox"/> MACHINIST TRADE	30
<input type="checkbox"/> ADVANCED MACHINIST	33
<input type="checkbox"/> PIANO TUNING & REPAIR	36

FREE JOB PLACEMENT SERVICE DURING AND AFTER TRAINING

### ENGINEERING COURSES

These courses teach practical and technical phases and lead to a degree. They are designed to prepare men for supervisory positions in Diesel-Automotive and Refrigeration-Air Conditioning fields. Students with high school education, or equivalent, will be accepted.

<input type="checkbox"/> DIESEL AUTOMOTIVE ENGINEERING	27 months
<input type="checkbox"/> REFRIGERATION & AIR COND. ENGINEERING	18 months
<input type="checkbox"/> WELDING ENGINEERING	18 months

### EARTH MOVING EQUIPMENT OPERATORS TRAINING

Latest, most modern road building and construction equipment on 900 acre training area. Learn grading, terracing, land clearing, etc., on crawler tractors, front end loaders, pay loaders, cranes, etc. 200 hour 5 week course or special week and courses.

Start your career with Greer by checking your interest above and mail coupon for complete information at no obligation.

NAME \_\_\_\_\_ AGE \_\_\_\_\_

STREET \_\_\_\_\_

TOWN \_\_\_\_\_ ZONE \_\_\_\_\_ STATE \_\_\_\_\_

Established 1902

## GREER SHOP TRAINING

Box K, 2236 S. Michigan Ave.  
Chicago 16, Illinois

# UNIMAT



## MINIATURE MACHINE SHOP

"No bigger than a typewriter, outperforms machines many times its size." That's what a popular publication says about UNIMAT in a 3 page feature story. UNIMAT is the precision tool that craftsmen, inventors and hobbyists dream about. You just can't beat it for machining small parts from steel, brass, aluminum, wood and plastic. You'll want a free reprint of this story plus complete information about this amazing 10 in 1 workshop. Write today to:

AMERICAN EDELSTAAL, INC. • UNIMAT DIVISION  
Dept. 311 • 350 Broadway • New York 13, N.Y.



# BE YOUR OWN MUSIC TEACHER

Send for Free Book Telling How Easily You Can Learn Piano, Guitar, Accordion, ANY Instrument This EASY A-B-C Way

NOW IT'S EASY to learn music at home. No tiresome "exercises." No teacher; just START RIGHT OUT playing simple pieces. Thousands now play who never thought they could. Our pictured lessons make it easy as A-B-C to learn to play popular music, hymns, classical, and any other music. Low Cost. Over 900,000 students including TV Star Lawrence Welk. (Our 59th year.)

### Mail Coupon for FREE BOOK

Find out why our method can teach you quickly, easily, inexpensively. Write for Book. No obligation. No salesman will call. Mention your favorite instrument. Mail coupon today.

U. S. SCHOOL OF MUSIC  
Studio A3011,  
Port Washington, N. Y.



FREE BOOK

U. S. SCHOOL OF MUSIC, Studio A3011, Port Washington, N. Y.  
Please send me Free 30-page illustrated Book. I would like to play (Name instrument).

Instrument \_\_\_\_\_ Have you \_\_\_\_\_  
Instrument? \_\_\_\_\_

Name \_\_\_\_\_ (Please Print)

Address \_\_\_\_\_

## PROTECT YOUR TIRES! PROTECT YOUR LIFE!

### Messko TIRE GAUGE

Sudden stops, rough roads, long trips are especially hard on tires. Help prevent disastrous sudden blow-outs... make sure your tires are kept at proper air pressure. Check them with your pocket sized Messko Tire Gauge. Big easy-to-read dial. 100 accuracy. Lasts a lifetime. Get it at your nearest dealer or order today. Send cash, check or money order, save C.O.D. charges and postage.

**\$2.95** postpaid  
including genuine

leather case

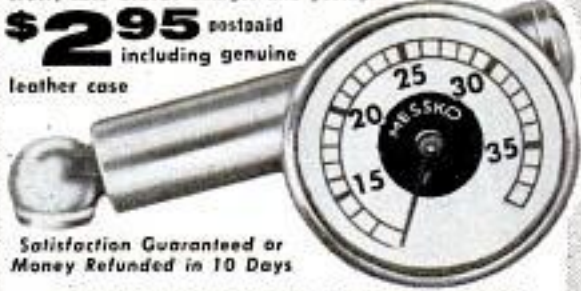

Satisfaction Guaranteed or  
Money Refunded in 10 Days

OMEGA SERVICE PARTS CORP.  
Dept. 110, Empire State Building N. Y. 1, N. Y.

## AMAZING NEW "TI-NEE" RADIO



"TI-NEE" RADIO IS GUARANTEED TO WORK FOR YOUR LIFETIME! USES NO TUBES, BATTERIES OR ELECTRICAL PLUG-INS. Never runs down! SMALLER THAN A PACK OF CIGARETTES! RECEIVES LOCAL RADIO STATIONS MOST ANYTIME, ANYWHERE WITHOUT EXTRA ANTENNA. Uses semi-conductor crystal diode H-Q Tuner. Beautiful black gold plastic cabinet. Built-in Speakerphone.

SEND ONLY \$2.00 (bill, ck, mo and pay)

postman \$4.99 COD on arrival or send \$6.99 for postpaid delivery. SENT COMPLETE READY TO LISTEN—NOTHING EXTRA TO BUY! EVERY! Extra long distance Aerial kit included free to receive stations up to 1,000 miles away. Available only from:

MIDWAY COMPANY, Dept. GPR-11, Kearney, Nebraska



Balance 4" x 9" Base.  
With either Metric or **\$13.00**  
Avoirdupois Weights <sup>paid</sup> Post

Catalog with 3000 illustrations of laboratory and physics apparatus sent for \$2.00 Postpaid.

LABORATORY MATERIALS COMPANY

1528 E. Hyde Park Blvd., Chicago 15, Ill.



## BUILD YOUR OWN

CANOPY, CARPORT GARAGE,  
SUMMER COTTAGE, Etc.



With New SUNCO ALUMINUM  
WONDER PANELS. Low cost, Easy one-man  
assembly with hand tools. At dealers or direct.

WRITE TODAY for FREE illustrated booklet and price list.

SUNCO MFG. CO. • 627 Elgin Ave. • MUSKOGEE, OKLA.



## BUILD and FLY Bensen HELICOPTER

Glider type 'copter—easy to build, simple to fly. Can also be mounted on floats or boat. No pilot's license required. Order 3-view drawings, specs and photo for \$1. Motor powered Gyro-Copter drawings \$2.

Ask about detailed plans and construction kits.  
BENSEN AIRCRAFT CORP., Dept. PM-117  
P. O. Box 2725, Raleigh, N. C.

Send  
\$1 or  
\$2

Name \_\_\_\_\_

Address \_\_\_\_\_

# For the Best Jobs Be an ALLIED TRAINED MAN



Mr. Harry Lebeson, President  
Allied School of  
Mechanical Trades

Allied's resident school is outstanding for the high quality of its vocational training. People from all over America and even from foreign countries come to Allied. And behind every bit of Allied's home study instruction is the practical know-how that has been made possible by more than a quarter of a century of training thousands of men for good paying jobs.



"The best jobs go to Allied trained men" is a statement so often heard that it is important to you. Your chances for success are naturally greater when you get the best training of its kind available. Allied is approved by industry, National Home Study Council, Dept. of Education, Office of Public Instruction, State of Illinois, U. S. Department of Justice. **BE AN ALLIED TRAINED MAN — GET THE FACTS — MAIL COUPON BELOW TODAY!**

## MORE JOBS THAN GRADUATES

As an Allied trained man you can go up fast—to higher and still higher pay or as a successful owner of a business. Due to the great present day industrial expansion programs throughout the country, industry has been clamoring for Allied trained men to fill important jobs. Shortages of Draftsmen, Designers, Tool Engineers, Machinists, Air Conditioning, Refrigeration and Heating Technicians are so widespread that you can pick a highly paid key job and look forward to Achievement and Security. You can begin your training in Short Courses at Home or at Allied Institute, and continue progressively toward an Engineering Degree in 26 months.

## Train at Home or in the Great Allied Shops

Allied's training program permits you to study right at home in your spare time or at the Allied Institute's fully equipped shops and laboratories. Free employment service and housing assistance all through your training period and after your graduation. Our industrial contacts cover the U.S.A.

**DRAFTING-ALL BRANCHES  
TOOL & DIE DESIGNING  
MACHINE DESIGNING  
TOOL ENGINEERING  
MECH. ENGINEERING  
MACHINIST-TOOL & DIE  
AIR CONDITIONING  
HEATING and  
REFRIGERATION**



## FREE BOOKS

tell how YOU can become an ALLIED TRAINED MAN. Write TODAY!

**ALLIED School of Mechanical Trades  
ALLIED INSTITUTE OF TECHNOLOGY**  
1338-42 South Michigan Avenue  
Dept. PM-117, Chicago 5, Illinois

## ALLIED SCHOOL OF MECHANICAL TRADES

**ALLIED INSTITUTE OF TECHNOLOGY**

1338-42 South Michigan Avenue, Dept. PM-117, Chicago 5, Illinois

Gentlemen: Mail me FREE BOOKS explaining ALLIED'S courses of instruction and FREE SAMPLE lesson.

Write date of discharge \_\_\_\_\_

I am interested in the training I have checked below:  Resident  Home Study

DRAFTING—ALL BRANCHES  TOOL ENGINEERING  AIR CONDITIONING  
 TOOL & DIE DESIGNING  MECH. ENGINEERING  HEATING and  
 MACHINE DESIGNING  MACHINIST—TOOL & DIE  REFRIGERATION

NAME \_\_\_\_\_

ADDRESS \_\_\_\_\_

CITY \_\_\_\_\_ COUNTY \_\_\_\_\_ STATE \_\_\_\_\_

# LEARN UPHOLSTERY

in your spare time  
run your own  
business  
**AT HOME**



**FREE BOOK**  
with  
sample  
lessons  
with course  
**YOU MAKE**  
SLIPPER  
CHAIR  
CLUB  
CHAIR  
OTTOMAN  
PLUS  
SLIP COVERS  
Yours to Keep  
or Sell

**BE YOUR OWN BOSS**  
Earn more from the start! Set up your own profitable business, in your own home, enjoy steady income, independence for life—in the booming field of Custom Furniture Upholstery. Right off you start learning with tools, complete frames, fabrics and materials, included FREE with practical UTS course. You learn skilled professional custom upholstery, reupholstery, furniture finishing, repairs, how to make beautiful slip covers, window cornices, cushions and draperies. **EARN WHILE YOU LEARN**, in your spare time **AT HOME**... the UTS easy way.

**FREE ILLUSTRATED BOOK—FREE SAMPLE LESSON**  
Get ready for well-paid job and big profits, from steady work, as your own boss, running your own business. Mail coupon NOW for FREE BOOK! Training in N. Y. School also available.

**APPROVED FOR VETERAN TRAINING**

**UPHOLSTERY TRADES SCHOOL**  
Dept. FS-310, 721 S'way, N. Y. 3, N. Y.

Please send me **FREE** book, "Your New Way to a Successful Career," and **FREE** sample lesson. No obligation—no salesman will call.  
 Home Study     N. Y. School Training

Name: \_\_\_\_\_ (Please Print Plainly)  
Address: \_\_\_\_\_  
City: \_\_\_\_\_ Zone: \_\_\_\_\_ State: \_\_\_\_\_  
 Check if Korean Veteran

# DRAFTING is the way to Big Income OPPORTUNITIES!



Learn at home in your spare time. Become a professional Draftsman. Enjoy good pay, respected position in an ever growing field. **CHRISTY TRAINING** is easy and clear. You learn by making actual drawings, planning production, see things develop. You learn the interesting, easy-to-remember way by doing.

**PAY AS YOU LEARN PLAN**  
CTS will send you 50 illustrated drafting manuals, set of professional drafting instruments, equipment and supplies plus a portable drafting table... everything you need! Send name for **FREE BOOK** and **PAY LATER FORM**. **CHRISTY TRADES SCHOOL**, 4804 N. Kedzie, Dept. DB-3603, Chicago 25.

# GROW ORCHIDS AT HOME

Purple, White, Yellow, Green, Every Rainbow Color

World's Most Thrilling Hobby—Successful home grower offers complete illustrated instructions. Tells how to start. Explains temperature, light and humidity conditions needed to grow Cattleyas, Cymbidiums, Odontoglossums & others in the home. Many Orchids grow without soil, getting food from the air. Some bloom summer-fall. Instructions include real blooming size Orchid plant. **FREE—full details**. Send no money, just name and address. **TROPICAL FLOWERLAND**, Dept. 31A, 100 S. Vermont, Los Angeles 4, Calif.

Hundreds of Families Raising Orchids At Home With Our Help

# "I Made \$14,839 in 1 Year SERVICING RADIATORS!"



Are you earning under \$8,000 a year? Hundreds now making \$10,000-\$12,000-\$15,000 a year servicing auto-truck-tractor radiators the inland way. Easy to learn. Inland, largest radiator equipment mfg., offers complete package equipment, merchandising. \*\*Pays for itself\*\* financing, free training. \$305 down for equipment starts you. Profitable dept. for garage or service station. Write to

**INLAND MFG. CO.**, Dept. PM-11, 1108 Jackson St., Omaha 2, Nebr.

## High School at Home

**MANY FINISH IN 2 YEARS**

No classes. No time wasted going to and from school. Progress as fast as your time and abilities permit. Standard H. S. texts supplied. Thousands enroll each year in this 60-year-old school. Send for **FREE** descriptive booklet.

**AMERICAN SCHOOL**, Dept. H845  
Drexel at 58th St., Chicago 37, Ill.

Without obligation, please send **FREE** descriptive booklet.

Name: \_\_\_\_\_  
Address: \_\_\_\_\_  
Complete Canadian Courses available. Write American School, Dept. H845, 6083 Sherbrooke St. W., Montreal

### TORSO-HEALTH CLUB MEMBERS

gain supremely **ENERGETIC BODIES**. My **FAMOUS COURSES** teach **REJUVENATION** & figure control. Feel **YOUNG & GAY!** Give age, height & weight. Mail \$2. Results or refund.

**ANYONE MATYSEK**, 940 Wilton Drive, Baltimore 27, Md.



**MO-DE-CO**  
The **SAFE BATHROOM CEILING HEATER**  
**ATTRACTIVE — INSTANT HEAT OUT OF CHILDREN'S REACH**

Approved  
1000 Watts  
120 V  
AC-DC

Completely assembled ready to hang exactly like a beautiful light fixture. Connects to standard wiring.

**EASILY INSTALLED DO-IT-YOURSELF**  
**\$22.75** Delivered. check or money order  
**HEAT UNLIMITED**  
Box 1156, Sherman Oaks, Calif.

# YOU MAKE 'EM! WE SELL 'EM! EVERYWHERE...

**YES! MY NATIONWIDE SALES ORGANIZATION WANTS TO WORK FOR YOU!**

Selling what you make at home—sparetime or full time. It's easy to enter this highly profitable field of making cases for photographers, salesmen, musicians, instrument manufacturers, doctors and 1001 others. A few hours of simple work making customized cases not available in the ordinary channels spells out **BIG PROFITS FOR YOU**.

I'll show you, as I have shown hundreds of others how to make real money in this fascinating craft, and don't forget! I sell what you make when you follow my simple plan. Age is no barrier... Write for full, **FREE**, details today!

**ABARSI CASECRAFT** 807 SUNSET BOULEVARD  
Dept. 131, Los Angeles, Calif.

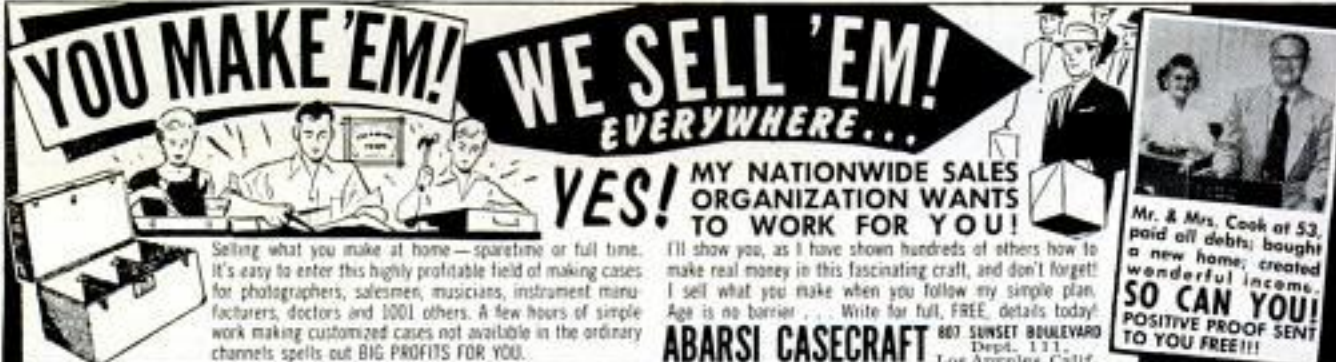

Mr. & Mrs. Cook at 53, paid all debts; bought a new home; created wonderful income. **SO CAN YOU! POSITIVE PROOF SENT TO YOU FREE!!!**

Get  
into

# TELEVISION RADIO-ELECTRONICS

Let National Schools of Los Angeles, a Practical Resident Technical School for over 50 years, train you at home by Shop-Method for unlimited opportunities in All phases of TV, Electronics, Radio.



You get 19 Big Kits  
... all this newest,  
practical equipment.

## GOOD JOBS . . . MORE MONEY SECURITY . . . ALL CAN BE YOURS!

You are needed in the great modern Television-Electronics industry. Trained technicians are in growing demand, at excellent pay, in sales and service, manufacturing, broadcasting, telecasting, communications, research, and many other important branches of the field. National Schools Master Shop-Method Training, with newly added lessons and equipment prepares you *in your spare time*, right in your own home, for these fascinating opportunities.

### YOU EARN WHILE YOU LEARN

Many students pay for their entire training—with spare time earning. We'll show you how you can, too! You receive material that shows you how to earn extra money servicing TV and Radio receivers, appliances, and doing many other profitable jobs.

### YOU GET EVERYTHING YOU NEED

Clear, profusely illustrated lessons, shop-tested manuals, modern circuit diagrams, practical job projects—consultation privilege with our qualified staff.

Don't delay your future another day.  
Send coupon for full information TODAY.

### RESIDENT TRAINING AT LOS ANGELES

If you wish to take your training in our Resident School at Los Angeles, the world's TV capital, start NOW in our big, modern Shops, Labs and Radio-TV Studios. Here you work with latest Electronic equipment—professionally installed—finest, most complete facilities offered by any school. Expert, friendly instructors. Personal attention. Graduate Employment Service. Help in finding home near school—and part time job while you learn. Check box in coupon for full information.



Approved for  
GI Training

**NATIONAL SCHOOLS**  
LOS ANGELES 37, CALIF.

## LEARN ALL 8 PHASES BY SHOP METHOD

1. Television . . . including Color TV
2. Radio . . . AM, FM
3. Industrial Electronics
4. Communications

## OF THE INDUSTRY HOME TRAINING

5. Sound Recording & Hi-Fidelity
6. Automation
7. FCC License
8. Radar & Micro Waves

We give you parts to build a modern TV set . . . all tubes plus large screen Picture Tube . . . and a Superhet Receiver. You also receive a Professional Multitester

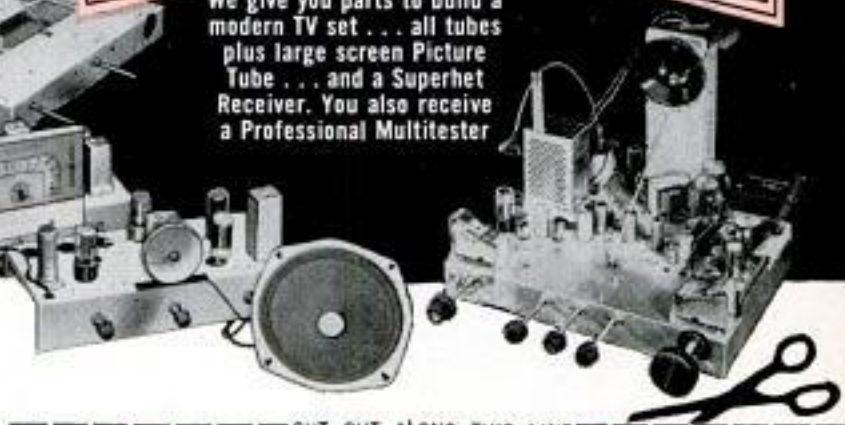

CUT OUT ALONG THIS LINE

### MAIL POSTAGE—FREE COUPON . . . NOW!

1. Fill out coupon in ink.
2. Cut along dotted line and fold coupon.
3. Staple, paste, glue, or tape ends together.
4. Mail today! No postage necessary.

FREE!

Career<sup>TM</sup> Book in TV-Radio-Electronics,  
PLUS actual SAMPLE LESSON.  
No obligation; no salesman will call.



Name \_\_\_\_\_ Age \_\_\_\_\_

Address \_\_\_\_\_

City \_\_\_\_\_ Zone \_\_\_\_\_ State \_\_\_\_\_

Check if interested ONLY in Resident Training in Los Angeles

VETERANS: Give date of discharge \_\_\_\_\_

FOLD ALONG THIS LINE

Postage  
Will be Paid  
by  
Addressee

No  
Postage Stamp  
Necessary  
if Mailed in the  
United States

### BUSINESS REPLY CARD

First Class Permit No. 3087, Sec. 34.9 P.L. 88, Los Angeles, Calif.

POSTAGE WILL BE PAID BY

**NATIONAL SCHOOLS**

4000 South Figueroa Street

Los Angeles 37, California

Dept. RB-117

Copyrighted material

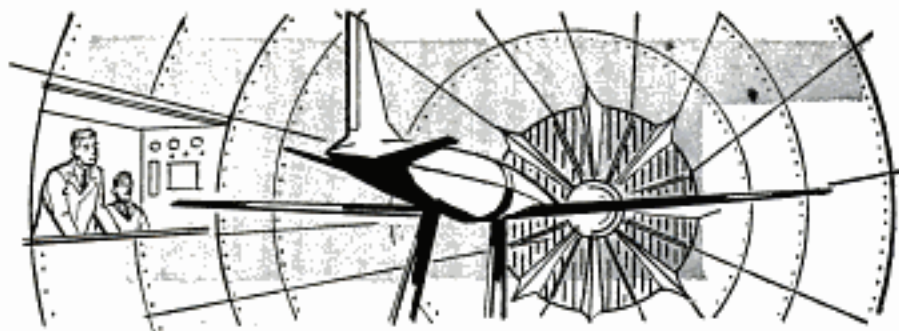

# SKILLS *for* AMERICA

This is the story of the builders of America; the engineers, technicians, specialists, and skilled craftsmen who form the productive core of the most advanced industrial technology in the world.

It is also the personal record of many individuals who are playing an important part in our modern technology due to the work they are doing and the positions they hold. Essentially, *Skills for America* is the story of the kind of men who are custodians of one of our most important American heritages—*craftsmanship*.



Through the creative work of engineers, technicians and other skilled craftsmen and our singular ability to mass produce, we have prospered bountifully as a nation. Yet, as our growth has accelerated so have the demands on industry to produce more and better products. This has created demands for additional skilled and technical personnel far beyond the available supply. While this continues to be a real problem to manufacturers, it has opened up unlimited employment opportunities to men in hundreds of vitally needed skills and trades.

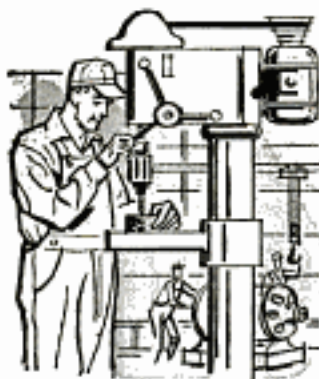

Today, industry in every major competitive field is hiring engineers, engineering technicians, machinists, mechanics, servicemen, skilled craftsmen of all types to do the creative and practical work demanded by a technology that is not only expanding but which continues to revolutionize itself with prospects of increased application of electronics, automation and nuclear energy.



Men who are determined to succeed; who want a future with the challenge of accomplishment; who want the security of knowing that their trade will always be in demand by manufacturers will prepare now for the skilled profession of their choice. The only requirement is adequate training. **The value of technical training cannot be overemphasized. Those who develop special skills in technical fields at once have greater opportunity, move ahead faster, and enjoy greater security.**



We suggest you make your decision **now** to begin planning your future in our modern technology. Build a solid foundation in education first. Consider carefully the Technical Schools, the Trade and Vocational Schools. They have trained thousands of industry's top-salaried men and will give you the personal instruction that can only come from highly skilled professionals.

Correspondence or Home Study Courses are also valuable. They enable you to increase your knowledge in the privacy of your own home, and many Schools supply equipment and instruments with which to work.

You will find many complete courses of study outlined in the pages of Popular Mechanics. After examining those courses of interest to you, you can more efficiently plan the steps which will lead to your chosen career. Employment opportunity will come after you have developed the kind of training industry needs and wants.

Beginning in the December issue, Popular Mechanics is introducing a stimulating series of articles covering specific technical and skilled professions which are in current need by industry. Half of the story of Skills for America has been written by the men who are already trained; those who have already succeeded in industry. Evidence of their success will be shown in this series.



The other half of the story must be written by the men who have yet to be trained—the ones who will make up the *new* Skills for America. Will you be one?

---

We suggest that the second step you may wish to take, after examining the technical and trade courses advertised in this issue, is to write us for a *free* copy of our new career guidance booklet, "SKILLS for AMERICA." Address a post card and send it today to Department SFA, Popular Mechanics Magazine, 200 E. Ontario St., Chicago 11, Ill.

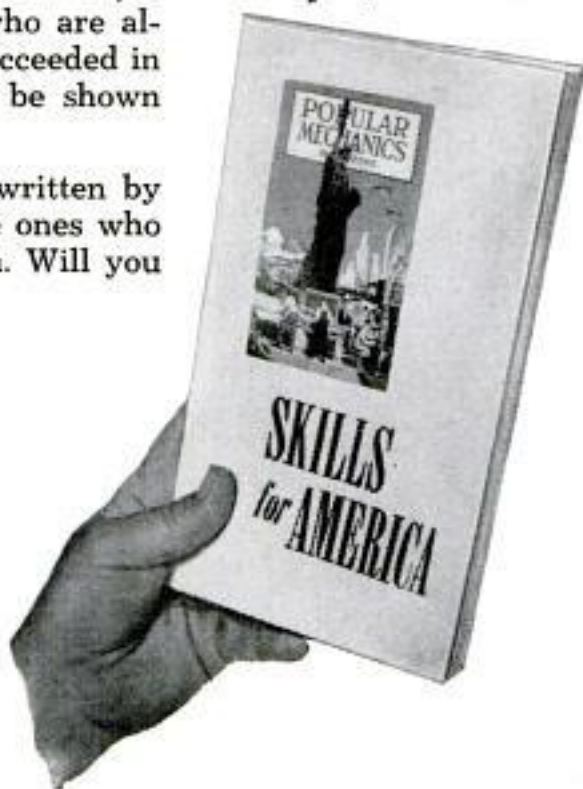

# GLOBAL AIRPOWER



- A. Douglas Skyhawk A4D — 89c
- B. Chance Vought F7U-3 Corsair — 89c
- C. McDonnell Voodoo F-101A — 89c
- D. Grumman F9F-8 Cougar — 79c
- E. Convair B-36 Bomber — 98c
- F. Martin B-57B — 98c
- G. P-39 Airacobra — 89c
- H. Convair F-102A — 89c
- I. Boeing B-52 Stratofortress — 98c
- J. Scorpion F-800 Interceptor — 89c
- K. Douglas D-558-2 Skyrocket — 79c
- L. Republic F84F Thunderstreak — 79c
- M. Convair Tradewind R3T-2 — 98c

Build all the exciting planes on this globe

## with Revell Authentic Kits

Put together your own Global Airpower Fleet of realistic combat plane models by Revell! They're scaled from official blueprints to make every detail authentic, from the hinged nose door and eight whirling propellers on the Convair Tradewind to the "air flow fences" on the Grumman F9F-8 Cougar.

Whether you start your collection with the mighty B-36 bomber or the tiny Douglas Skyhawk, you'll end up with a Global Airpower Fleet to be proud of when you build from Revell Authentic Kits.



Get a world of your own to display them on! Put all your planes in the air at once with a Global Mobile, Revell's unusual new displayer for Global Airpower Fleets. Made of sturdy wrought iron, it holds up to thirteen plane models in an attractive, compact unit. You

can hang it from the ceiling or stand it on a table. Use attached coupon to order your Global Mobile now.

Send coupon with \$3 (check or money order) to: Revell, Inc., Dept. MN  
4223 Glencoe, Venice, Calif.

I enclose \$3. Please rush my Global Mobile Display Pack, including 1 Revell Global Mobile, 12 plastic plane-grip caps, 1 Revell swivel plane base, 1 four-foot nylon suspension cord, special plastic cup lubricant, brightly colored Revell flag, and a sample tube of plastic kit cement.

Name (print) \_\_\_\_\_

Street Address \_\_\_\_\_

City \_\_\_\_\_ Zone \_\_\_\_\_ State \_\_\_\_\_

Wherever  
hobby kits  
are sold!



POPULAR MECHANICS



WORLD'S  
BEST  
WANT-AD  
MEDIUM

# CLASSIFIED ADVERTISEMENTS



Advertisements in this section \$1.25 per word, each insertion, minimum 10 words, payable in advance.

To be inserted under proper classification, copy must be in our office the  
20th of the second month preceding date of issue  
F. W. Johnson, Manager, Classified Advertising  
Popular Mechanics Magazine, 200 East Ontario Street, Chicago 11, Illinois

## YOU'LL PROFIT

By reading and answering the classified ads in this section. Hundreds of opportunities for you to make and save money

### AUTOMOBILES, MIDGET CARS

**HUNDREDS** Of automobile catalogs—Old, new and foreign; dealer books; glossy photographs; shop manuals; free motor magazines listed by non-profit club. Write to get on free mailing list. Auto Maniacs, Stockbridge, Mich.

**SPORTS** Car sketches. Sets of twelve beautiful prints, \$5.00; four, \$2.00. Wood, 8310 Hood, Richmond 27, Virginia.

**BOYS'** Power-driven auto. Build your own. Plans 35 cents. Sypher Co., Sta. F., Toledo, Ohio.

**SAVE** Hundreds of dollars on your next car buy. Get car buyers guide, \$1.00 postpaid. Empire Publishing Company, 2595 South Newton, Denver 19, Colorado.

**BUILD** Midget auto, drawings, pictures, parts list \$1.00. Lee's Midget Autos, Avila-Beach, California.

**SUPERIGNITIONITER**; Starting, pep, mileage, Kaisers, barbells, Vartypers, IBM's, courses. EG, Elmsford, N. Y.

### AUTO SUPPLIES AND EQUIPMENT

**"PROTECTOCAR"** Prevents thief starting car motor with any key. Send \$2.00 for kit. Easily installed. Arko, 108 Elbow Road, North Syracuse 12, N. Y.

**KNOW** Something. 2 cents eliminates automobile battery corrosion. Instructions \$1.00. Sell secret friends, others. Beumer, 113 Willis Ave., Columbia, Missouri.

**NEW** And used parts at savings. Complete guaranteed parts service for all models cars and trucks, 1924 and later. Largest in the West. Jeep and army parts specialists. Newest type shifting hubs for all jeep and all military and latest production front end drive vehicles. \$27.50 and up. Write, Pioneer Auto and Truck Parts Co., 734 W. 13th Avenue, Denver 17, Colo.

**WILLYS** Jeep tops—Convertible tops. Free catalogue. Mor-Nan, Box 123, Boston 14, Mass.

**RING-Valve** job while you drive. \$6.00. World's only product of its kind. Safe! Proven! Guaranteed! Free details. Motaloy, Grantham, Penna.

**AUTO** Accessory and parts catalog. 1957 edition, all new! 228 pages. Save up to 50%. 75,000 items, including Hollywood accessories, hi-speed equipment, rebuilt engines, all parts and accessories for all cars and trucks! Hard-to-get parts! Send 25¢, refundable. J. C. Whitney, 1919 PM Archer, Chicago 16, Ill.

**SAVE** Money on Jeep and army truck parts. Large inventory. Catalogs for Jeep or G.M.C. owners. American Auto Parts Co., 1830 Locust, Kansas City, Mo.

**FREE!** New catalog. Speed, power, mileage increasing equipment. Discounts! Almqvist Engineering, Milford PM5, Penna.

**AUTOMOTIVE** Books. Free catalog. Popular Mechanics Press, 631 N. St. Clair St., Chicago 11.

**FORD T and A parts?** Try best source old model parts, all makes. Wisneski, Milwaukee 7, Wis.

**CAR Bed** conversion kit with complete instructions now available. Works on 2 or 4-door sedans, club coupes, station wagons and convertibles. Convert your car seat into a double or single bed when needed. We manufacture custom made car screens for all makes and model cars. Also "Sportsman DeLite" camping trailers with optional boat carrier and 12 and 14 foot boats. For further information write Car Bed Manufacturing Co., Dept. 4, P.O. Box 213, Panama City, Florida. Dealer inquiries invited.

**FLASH!** Start your car instantly in cold weather. Guarantee 12 volt on 6 volt battery. For starting purpose only. \$1.00 blueprint instruction. K. S. Service, 142, Friant, Calif.

**AERATOR** Injector—Burn water in your car; build in 30 minutes; no moving parts. Plans \$1.00. Motor, Box 68A, Westville, Illinois.

**RING-Valve** job while driving. Only \$3.00 delivered. World's only (patented) product of its kind! Proved reliable! Safe! Money back guarantee! Free circular. Joe Dillon, Authorized Distributor, Box 3231, Bridgeport, Ohio.

**MOTOR** Overhauled while driving. \$3.95 postpaid. Guaranteed safe. Write: Gadsby, 426-PM W. 49th St., New York City, 19.

**WAGON** Jobbers-Salesmen — Terrific profit handling our nationally advertised unconditionally guaranteed Electro Lustre Plated plugs. Full particulars. C. L. Spark Plug, Inc., P.O. Box 34, Corona, California.

**CAR** Burning oil, gas? Losing pep? Try Compression Seal. \$3.95. Information free. Thomas, Box 909-P, Providence 1, R. I.

**STOP** Chrome rust from salts. 50¢ postpaid. Wax Products Co., Escanaba, Mich.

**CHROMIUM** Shine, imported from England, cleans, polishes, preserves shine. Removes rust. \$2 large bottle postpaid. Cloths free with each order. Foreign Products Corporation, 21 Washington St., West Orange, N. J. Satisfaction guaranteed.

**FREE** Giant 1958 parts catalog. Thousands scarce accessories stores don't have. Gadgets, custom equipment. Send 25¢ postage (refundable). Newhouse Automotive Industries, 5805-PM Beverly, Los Angeles 22, Calif.

**DO-It-Yourself** booklets. 24 different booklets each covering an interesting subject. Free catalog. Popular Mechanics Press, 631 N. St. Clair St., Chicago 11.

**LOWEST** Prices—Custom accessories. Free catalog. Texauto, 1114 East First, Austin, Texas.

**FIBERGLASS** Plastic, complete repair kit for dents, holes in autos, boats. Works like putty, sets steel hard. Send \$2.49. Tanasyn Products, Cicero, New York.

### AUTO TRAILERS

**UTILITY** Trailers—Small, two-wheeled, cost government \$180.00 each. Our price, two for \$79.50. Send for complete literature. Contractors Surplus Company, Williamstown, Mass.

**BLUEPRINTS** Vacation trailers. Supplies, literature 10¢. Comstock Trailers, Parsons, Kansas.

**BUILD** Expanding eight foot trailer. Accommodates five. Literature 10¢. Fra-Mar Company, Wilmington, Mass.

### MOTORCYCLES, BICYCLES, MOTORSCOOTERS AND SUPPLIES

**BANKRUPT** Motorcycle bargains at giveaway prices. Catalog bulletin 25¢. Bunco, 146-BK, Covington, Virginia.

1953 **CUSHMAN** \$15. Midget car \$25. Micro-midget \$65, less motors. Motors \$3 up. Evinrude outboard \$10, Whizzer \$7.50. (Mailorder only). Send 25¢ (35¢ for first class mailing) for new 32-page Directory-Catalogue Number Eighty listing these and hundreds of other bargains in new and used motorscooters, midget cars, home-builders parts, plans, etc. Midget Motors Directory, Athens, Ohio.

**RECONDITIONED** Motorcycles and motors, Chromium accessories. Complete stock Indian parts, Expert rebuilding, Fast service. Indian Motorcycle Sales, Kansas City 27, Missouri.

**PARTS**, New, used. List 10¢. Ballak, 811 N. 9th, St. Louis 1, Mo.

**HARLEY - Davidson's** — Used bargains. New, used parts, accessories for all models. Bulletin, catalog 25¢. Knuth's (Factory Dealer), 1753 Muskego, Milwaukee, Wis.

### AVIATION

**BUY** Surplus aircrafts; fuselages; assemblies; aircraft engines; helicopters; instruments; electronics; radiotelephones; misc. Buy direct now from U. S. Government. Depot list and procedure \$1.00. Brody, Box 8-PM, Sunnyside 4, New York City.

**PROPELLERS**, Plans, supplies for airboats and snowplanes. Latest designs, prompt delivery. Catalog 25¢. Banks-Maxwell, Box 3301E, Ft. Worth 5, Texas.

**ACTUAL** Flight training possible on low income. Send \$2.00 for written detailed method plus informative booklet. ATS, Box 715 Hialeah, Florida.

**AVIATION** Surplus bargain catalogue. One dime. Box 22PM10, Thomasville, Penna.

**SMALL** Helicopters theory and guide manual. Drawings. Construction data. \$2.00. Sandhill Aircraft, Box 336, Atkinson, Nebraska.

**COMPLETE** Aviation correspondence courses for all CAA ratings. Write Fielding Aviation Correspondence School, 1803 Chulih Nene, Tallahassee, Florida.

## BATTERIES, GENERATORS

EDISON Nickel storage batteries. Any voltage, any amperage. Unconditionally guaranteed. Power plants, generators, motors. Literature. Hawley Smith Co., Croton Falls 1, N. Y.

## ELECTRICAL SUPPLIES

MAGNETIZER — Magnetizes screwdrivers, etc., only \$1.00 postpaid. Kubiak, Huntingdon Valley, Penna.

LAMP, Electrical parts, wholesale. Thousands of items for repairing, converting. Catalog 25¢. Brown Lamp, Box 305, Clayton 5, Mo.

ELECTRIC Pencil: Engraves all metals \$2.00. Beyer Mfg., 10511-H Springfield, Chicago 43.

DC Power supplies. Laboratory, test units. DC motor controls. Complete line selenium rectifiers, meters, transformers and other replacement parts. Ramyr, Dept. D-1, 1624 East First Street, Los Angeles 33, California.

LAMPS—Parts catalog containing wiring instructions, 25¢. Gyro Lamps, 3438P N.W. 54 Street, Miami, Fla.

## WELDING, SOLDERING, PLATING

BUILD Fast selling welded hand trucks (merchandise, beverage, appliance, etc.). We supply production models (sample "utility" \$9.95). Information, Wilson Steel Products, Childersburg, Alabama.

BUILD-Your-own welder or welder and power combination. Low cost unit connected to used engine lets you weld anywhere. Free booklet tells how. Get into profitable welding business. Write Hobart-weld, Box M-1173, Troy, Ohio.

ELECTROPLATING Equipment, anodes, solutions. All types, including new electroless nickel. Baby shoe metallizing equipment, supplies. Free catalog. Hollywood Bronze Supply, Dept. B-4, 1624 East First, Los Angeles 33, California.

BUY Welding supplies direct from manufacturer. Cable, welding rods, helmets, etc. Portable arc-welders and kits at tremendous savings. Free factory catalog! LeJay Mfg. Co., 2927 Emerson Ave. So., Minneapolis, Minn.

WELDERS, 110/220, \$39.50. Morris, 1070 Inner Drive, Schenectady 3, New York.

A.C. Welders, 4 sizes, lowest prices. Free literature. Holgeron's Service, Canton, Kansas.

ACETYLENE Welding outfits, new \$54.50, arcwelders \$56.50. Eagle Welding, Dept. P.M., 5085 Broadway, Chicago 40, Ill.

## MACHINERY, TOOLS, SUPPLIES

WOODWORKERS. Free homeshop notes and information on new tools. Lee, Box 22M, Rochester 17, N. Y.

MINIATURE Taps, dies, screws, tools. Free folder. Morris, Southbridge, Mass.

LATHE \$38.25 Postpaid, English model engineers. Science Now Company, Catskill, New York.

SEE "Dawn Gage" under Home Crafts-men classification. Dawn Crafts, Buffalo 16, N. Y.

SEALED-Bid sales, government surplus, diversified merchandise, subscription \$3.00. Information folder 25¢. Bidders Service Bureau, Box 522, Niagara Falls, N. Y.

INDICATORS, Federal #CT1 dial—0005 only \$12.50, postage paid. Special aircraft tools. Genex, P.O.B. 665, Sun Valley, Calif.

FAMOUS Payswell sprayer, compressor, motor, gun all in one unit. 50 lbs. pressure. 9 payments available. Will take old sprayers in trade. Further information write Selco Corp., 224 W. 7th St., St. Paul 2, Minn.

POWER Tools, not toys. Discounts. Factory catalogs. World Tool Supply, Box 4404, Joyfield Station, Detroit 28, Mich.

OIL Drum cement mixer assembly kit. Circular. Nu-Way-Do Co., Newaygo, Mich.

## ENGINES, MOTORS, DYNAMOS

SMALL Electric motors. Bargains. Kitco, Dept. 19, Box 212, Monroe, Wisconsin.

ELECTRIC Repairmen. Send for catalog ohmmeters, winding equipment. Motor Industries, Quincy, Illinois.

GAS Engines: Foreclosure sale: 1½ to 7 h.p. Brand new, factory fresh, latest models. Briggs Stratton, Clinton, Lauson. Positively below wholesale prices or your money back, \$23.50 and up (freight paid). Details free. Northern, 172-M Merrimac Street, Boston 14, Mass.

AIR Compressors, light plants, half price. Free folder. IMSCO, 1829 South State, Chicago 16.

DIESEL Injector parts wanted. GM71-110. Bares, 7120 Carnegie, Cleveland 3, Ohio.

½ HORSEPOWER Electric motors, a.c. 110, used, good \$5.00 each, f.o.b. Plant Machinery Corp., Richmond & Norris Sts., Philadelphia 25, Penna.

REWIND Motors yourself. Complete instructions \$1.00. Lewis Mfg., Howell, Michigan.

WINDING Data. 275 motors, single and three phase, \$1.10. Data Company, Box 7631, Kansas City 28, Mo.

## SURVEYING INSTRUMENTS

NEW And guaranteed factory rebuilt transits and levels, sale or rent, with purchase option. We will repair, trade or buy old instruments. Write for list M-81. Warren-Knight Co. (Manufacturers of Surveying Instruments), 136 N. 12th St., Philadelphia 7, Penna.

## BOATS, OUTBOARD MOTORS

FREE Catalog! Boat kits, trailers, fiberglass, marine hardware. Lager Industries, Dept. 11, 3404 Lyndale South, Minneapolis, Minnesota.

FULL Size, cut-to-shape boat patterns, blueprints, 7½-38 feet. Big new 88 pg. illustrated "Build a Boat" catalog of naval architect-designed cruisers, runabouts, skiffs, outboard boats, sailing, racing, houseboats, 50¢. "How to Build a Boat" booklet, \$2.50. Hardware and equipment catalog, \$2.00. Cleveland Boat Blueprint Co., Dept. A-66, Box 1651, Cleveland, Ohio.

CATALOGUE Free—Boating flags, gifts, gadgets. Lighthouse, Box 145-B, Plymouth, Mass.

BIG Powerboat plans catalog, 50¢. Boat kits, reduced prices. Marinecraft, Box 161-M, Brighton, Mass.

MARINE Conversion, Willys to Cadillac, engines, kits and parts. Catalogue and conversion hints free. Barr Marine, 2706 Castor Avenue, Philadelphia 34, Penna.

FORDS And Jeeps 100% marine engines with famous Convo-Kits. Deluxe catalogue 25c coin. Ocomotors, 3637B Lawrence, Philadelphia 40, Penna.

BOAT Plans. Full size patterns. Frame kits. Modern inboards and outboards for amateur builders. Complete new catalog 50¢ or specify requirements. Glen Designs, Box 368, Compton, Calif.

NEW, Used, rebuilt marine motors. Marine conversions, fittings. Free catalog. Stokes Marine Supply, Dept. 24, Coldwater, Michigan.

FIBERGLAS Permanent boat waterproofing. Special 25% discount. Complete kits, \$9.45 up. Guaranteed materials. Easy application. Full instructions. Free literature. Ajax Plastics, Dept. PM, P.O. Box 1823, Fort Worth, Texas.

BUILD Small boats. Booklet 25¢. Catalog free. Popular Mechanics Press, 633 N. St. Clair St., Chicago 11.

MARINE Conversions for Ford and Jeep engines. Catalog 25¢. Lehman Manufacturing Company, 972D Broad Street, Newark 2, New Jersey.

## ATHLETIC EQUIPMENT, BODY BUILDING COURSES

YOURS—A body like a Greek god! Startling, amazingly quick new method explained in free literature. Send name and address to: DeVel-O-Flex, 3607 W. Magnolia Blvd., Burbank, Calif.

OUTSTANDING Physical development! Any age. New guaranteed discovery uses only a rope! Strength, health, muscles. Gain-reduce. Free booklet. Roperise, 4834-A Art, San Diego 15, California.

JUDO. Defeat bullies. 23 complete lessons. \$1.00. 1112 Tipton St., High Point, N. C.

BE Taller! Latest guaranteed ABC method \$1.00. ABC, Box 849-PT, San Francisco 1, California.

BE Taller! Coach's genuine "Inch-a-Time" height-increase system. Wonderful results reported! \$1 complete. Guaranteed. Marty Snyder, Box 193-MP, Union City, N. J.

BARBELLS, Dumbbells. Courses. Free catalogue. Good Barbell Co., Siloam Springs, Arkansas.

BECOME A "Jiu Jitsu" expert! Exciting book shows latest methods! Only \$1.00. "Scientific Boxing" sent free with each order. Money back guarantee! Southland Products, Box 41, Lincolnton 9, North Carolina.

BASKETBALL Players, coaches — Increase shooting average up to 75%. Learn home. \$1.00. Satisfaction guaranteed. Basketball, Box 208, Kilgore, Texas.

## SPORTING GOODS, GUNS, FISHING TACKLE, ARCHERY, TRAPPING

RIFLES, Shotgun, pistols, scopes, ammunition. Dealers prices. Berkshire Gun Rack, Six Lakes, Michigan.

FREE — Giant 1957 wholesale sporting goods catalog. Lowest wholesale prices. Complete line of cameras, sporting goods, appliances, outdoor items. Write today. Santa Fe Distributing Co., 1321 Main Street, Dept. PM, Kansas City, Mo.

TRESEAT Hunters! Increase game kill. Post comfortably. Guaranteed. \$4.95. C. Johnson, Rt. 4, Box 81, Wisconsin Rapids, Wisconsin.

FREE—Below wholesale fishing catalog. Fishing Tackle Mart, Dept. 511, Box 6737, Chicago, Ill.

BULLFIGHTERS: Your name "Spanish-ized" billed as matador on decorative 2x4 foot authentic bullfight poster. \$5.00 postpaid check or money order. O. B. Lynott, Box 7418, Mexico City, Mexico. Satisfaction guaranteed.

"GUN-Gard" silicone treated cloth. Rustproofs guns \$2.95. Bi-Mall Products, 1273 Central, Albany 5, N. Y.

BIG Money raising crickets and 12 inch African fishworms. Free literature. Carter Ranch, Plains, Georgia.

5000 BARGAINS, Firearms, binoculars, war relics. Catalog 50¢. Smith Firearms, Runnemed, N. J.

SAMPLE: 25c Copy of "The Archers Magazine." Send 10c. 1200 Walnut Street, Philadelphia 7, Pennsylvania.

FREE Sporting goods catalogs! Save 70%. Econ-O-Mart, Whippany 2, New Jersey.

MOLDS For fisherman's sinkers, jigs, squids, casting and spinning lures. Free catalog. Sweet's Molds, Tonawanda 1, New York.

JAP Rifle altering to 30-06, \$6.00. Jap-shells, \$3.95. Catalog 5¢. T. P. Shop, West Branch 11, Mich.

COLTS, Remingtons, Winchesters, Lugers, P-38's, Kentuckies, Springfield. Antique-modern guns and gunnery values. Big bargain catalog 50¢. Agramonte's, Yonkers 20, N. Y.

BUILD Barbecue. Complete plans. Booklet 25¢. Free catalog. Popular Mechanics Press, 633 N. St. Clair St., Chicago 11.

## EARTHWORMS

FREE Folder, "How to Make \$3,000 Yearly. Sparetime, Backyard, Raising Earthworms!" Oakhaven 56, Cedar Hill, Texas.

CALIFORNIA Meal worms. Ice bait supreme. Keeps weeks. 200-\$1.00, 1000-\$3.50 postpaid. Dealers and distributors inquire. Crest Bait Distributors, 3328 Madison Avenue, Indianapolis 27, Indiana.

RAISE Domesticated earthworms. Instructions free. Frank H. Barnhart, 209 Lamont, San Antonio, Tex.

FREE Literature—Amazing profits raising giant fishworms and crickets. Carter Redworms, Plains, Georgia.

FREE Booklet tells how retired teacher made \$3000.00 breeding foot long fish worms in basement. Rand's Ranch, 6300 East 23rd, Kansas City, Mo.

BIG Profits — Raising night crawlers, redworms. Soilless method. Three Oaks Ranch, Dresden, Tenn.

## BINOCULARS, TELESCOPES, MICROSCOPES, MAGNIFIERS

**DYNASCOPE.** Sensational new reflector telescope. Send for details. Criterion Co., Dept. DP-38, Hartford, Conn.

**AMAZING Prices** precision binoculars. Folder, "Binocular Selecting," catalog free. Dealers also write. Prentiss Importers, Mercury Bldg., West Los Angeles 35, Calif.

**BINOCULARS, Telescopes, microscope,** terrific values \$3.98 up. Request free money-saving catalog. Criterion, Dept. P-60, Hartford, Conn.

**MICROSCOPE Catalog** free. Research Scientific Supplies, 126 West 23rd Street, New York 11, N. Y.

**REFRACTOR** And reflector telescopes. Also mirrors, lenses, tripods, etc., for making your own telescope. Free illustrated catalog. Suffolk Science, Mattituck, N. Y.

**BUILD Your own reflector telescope.** Complete kit: mirrors, eyepieces, tripod, all other accessories. Request free illustrated literature. Criterion Manufacturing, Dept. DPM-35, Hartford, Conn.

**REFLECTING Telescope, 60X,** completely assembled \$29.75. Guaranteed observatory clearness. Free information. Skyscope, 475 Fifth Avenue, New York City 17.

**REFLECTOR Telescope kits** \$7.25 (3") to \$175 (12"). Mirrors, cells, focusing mounts, tripods, eye systems. Anything, everything in telescopes. Free catalog also ready to use telescopes from \$25. Esco Products, Oakridge, N. J.

**WAR Surplus bargains:** Millions of lenses, instruments, telescopes, binoculars, components and complete line of astronomical telescope items. World's greatest optical market-place! Send only \$1.00 for beginner's 10-lens kit and big instruction booklet Stock 2-CH. Write for catalog "CH," free! Edmund Scientific Co., Barrington, New Jersey.

**POCKET Microscope!** 50X—See nature's wonders, 2500 times magnification. \$1.00 postpaid. DuPont Distributors, 2153 Amsterdam Avenue, New York 32, N. Y.

## PLANTS, SEEDS, BULBS, NURSERY AND GARDEN SUPPLIES

**CACTI** Succulent price list 10¢. Feldman, 1707 Robindale, West Covina, Calif.

**GIBBERELLIN—Amazing plant stimulant.** Free literature. Vidmar Sales, Freeburg, Illinois.

**20 PALM Seedlings** \$2.00. Free tropical plant, seed list. Tashiro, Box 2275, Miami Beach 40, Fla.

**WORLD'S Greatest cash crop.** Free information. Write Ginseng Gardens, Asheville, N. C.

## PETS—DOGS, BIRDS, RABBITS, HAMSTERS, ETC.

**WE Pay \$3.50 lb. dried.** Grow mushrooms, cellar, shed and outdoors. Spare, full time, year round. We have 25,000 customers. Free book. Washington Mushroom Ind., Dept. 171, 2954 Admiral Way, Seattle, Wash.

**BEAUTIFUL Pure white pedigreed police puppies.** Ansonia Kennels, McHenry, N. Dak.

**RAISE Rabbits successfully** by knowing facts. 48 page illustrated book describing 25 breeds. Housing, feeding, breeding, marketing, etc. Plus bulletin. 25 cents. American Rabbit Association, 38 Arba Building, Pittsburgh, Penna.

**MAKE Money raising chinchillas, mink, nutria, rabbits, cavies for us.** Free catalog. Keeney Brothers, New Freedom 2, Penna.

**HAMSTERS—Young Golden pairs, \$2.95, breeders \$3.95.** Free booklet. Jer-Fre's Hamstery, 2425 Hoyt, Muskegon Heights 13, Mich.

**RAISE Rabbits on \$500 month plan.** Plenty markets. Free details. White's Rabbitry, Delaware, Ohio.

**WHITE German shepherd puppies.** Theatrical dog tricks. Knoff, Nashotah, Wis.

**STRAIGHT Cooners!** World's oldest kennel. Combination hounds, rabbit, fox, beagles, deerhounds, bird dogs. Puppies of all breeds. Prices reasonable. Trial. Free catalogue. Raccoon Mountain Kennels, Box 464, Boaz, Alabama.

**SPORTSMEN:** World's largest kennels offers 500 bird dogs, straight cooners, combination hounds, beagle hounds, rabbit hounds, small squirrel dogs, fox and deer hounds. Catalogue free. Smokey Mountain Kennels, Cleveland, Tennessee.

**HAMSTERS—Golden:** young, \$3.00 pair. Fully developed \$4.00 pair. Adirondack Hamstery, Prospect 10-M, N. Y.

**FREE Your pet from fleas, their worst enemy,** with guaranteed Fleacollar. Only 49¢. Protects 24 hours a day. Lasts many weeks. Write for free booklet: Fleacollar, Box 236P, Rochester 1, N. Y.

**ST. Bernard puppies.** Loving lasting gifts. Siegend, Wauke, Iowa, Ph. 7502.

## FUR BEARING ANIMALS

**1000 BRED Mink—Booklet, plans 25¢.** Lake Ontario Ranch, Gravel Road, Webster, N. Y.

**AMAZING Profits** producing fur. Free information. Twentieth year. Voight Farms, Atlanta 2, Texas.

**MINK Raising information free.** Complete. Lake Superior Mink Farm, Superior, Eel, Wisconsin.

**RAISE Mink:** Free booklet, pen plans, inside secrets, feed, care. Mink are money makers. Investigate today. Lawrence Molegard, Brigham City 12, Utah.

## FARMS, FARM LANDS, REAL ESTATE

**FLORIDA At its best—Enjoy life in Lynn Haven, Bay County, on beautiful St. Andrew Bay, northwest Florida.** Near superb Gulf beaches. Cool summers, mild winters. Excellent fishing, hunting. Year-round gardening. Pay less for homestead, house construction. Friendly, conservative community. Brochure free. Chamber of Commerce, Lynn Haven 3, Florida.

**FLORIDA'S Pine Forest Mobile-Home Manor.** Beautifully wooded deluxe trailer sites, 40 by 80 feet, \$345 payable \$15 down, \$15 monthly. Famous Panama City golf resort area. Excellent hunting, fishing, all sports. Also lovely wooded homesteads, low prices, easy terms. Booklet free. Wendell Wood, Fountain, Florida.

**HOMESITES \$15 Monthly—California's** finest garden section. Morro Bay's scenic shores. Wonderful fishing, boating. Fertile soil, softest water, temperate climate, congenial community. Free literature. Richard Otto, Department M, San Luis Obispo, California.

**OPPORTUNITIES!** Government land. U. S., Alaska, Canada. Sledge Surveys, Macon 1, Mississippi.

**CALIFORNIA State government land.** 40 to 640 acre tracts. \$5 acre minimum. 10¢ brings information on available locations, maps of 500,000 acres. Pioneer Ranches, 7419-PM Beverly Blvd., Los Angeles 36, California.

**\$5.00 MONTHLY Buys 40 acres** productive land. Near town. Price \$250.00. Free list. Box 425-P, Carthage, Mo.

**FREE Strout catalog!** Farms, homes, businesses, resorts, retirement properties. Over 2900 values in 34 states. 57 years' service. World's largest! Write Strout Realty, 7-MP So. Dearborn, Chicago 3, Ill.

**FLORIDA.** Nice homesites, 3345 at \$10 monthly. Folder free. Howard Vernor, DeLand, Florida.

## PROFITABLE OCCUPATIONS

**BIG Multicolor wholesale catalog!** Housewares, appliances, clothing, silverware, cookware, luggage, binoculars, radios, phonographs, cameras, recorders, projectors, typewriters, shavers, sporting goods, toys, tools, sewing machines, watches, jewelry. Name brands. Huge discounts. Postcard: Selbyco, Decatur 462, Illinois.

**\$100.00 WEEKLY Spare time** with a tape recorder! Fabulous new business. Entire country wide open! Record weddings, parties, sports events, stereophonic sound, sound-on-sound multiple recordings. Make radio commercials, sound effects. Have fun and make big money in the glamorous business of tape recording. Moneymaking facts free! Dixieland Publishers, Asheboro 2, N. C.

**BIG Profits in welding.** Easy to learn. Low cost training in completely equipped non-profit school. GI approved. Write for free booklet. Hobart Trade School, Box M-1173, Troy, Ohio.

**MAGAZINE Subscriptions—Largest commissions.** Bonus. Qualified Agency, 451BA Kingston, Brooklyn 25, N. Y.

**FREE Book "990 Successful, Little-Known Businesses."** Work home. Plymouth, 1610-43 Street, Brooklyn 4, N. Y.

**REPAIR Porcelain on appliances.** Much needed service! Profitable! Free information. Enamel Repair, 466 Potomac, Buffalo 13, New York.

**MAKE Chipped glass nameplates.** Resilvering mirrors. Electroplating. Outfit prices. Sprinkle, Plater V60, Marion, Ind.

**MUSHROOMS Quicker, easier, cheaper.** Newest facts free. Luxur, 641 South 19th, Newark 3, N. J.

**MONEY Plans! Secret Journal.** Grandpa, two daughters made \$3,500 first month! Work home. Publiccos, Oceanide, Calif.

**OPERATE Profitable home mail-order business.** Details free. Fox, 12022 Pine, Norwalk, Calif.

**HOW To gain promotion, a pay raise;** right where you work, right now. Details free. Ern-Mar Co., Clermont, Florida.

**WE Pay \$3.50 lb. dried.** Grow mushrooms. Cellar, shed and outdoors. Spare, full time, year round. We have over 25,000 customers. Free book. Washington Mushroom Ind., Dept. 99, 2954 Admiral Way, Seattle, Wash.

**SAVE Money! Buy wholesale!** Free catalog general merchandise. Norris, 487-M Broadway, New York City.

**SPARETIME Repeat profits** taking magazine subscriptions. Special offers. Cassell Agency, Boynton Beach, Florida.

**FREE Folio "\$5,000-\$45,000; Unlimited Vacations."** No merchandise. Unknown! Work home, sparetime! Haylings, Carlsbad, Calif.

**BE The Popular Mechanics representative** in your neighborhood and earn big profits in your spare time. Write Popular Mechanics Magazine, Room 305M, 200 E. Ontario St., Chicago 11.

**BIG Money raising fishworms and crickets.** Free literature. Carter Wormery, Plains, Georgia.

**BAKE New greasless doughnuts** in kitchen. Sell stores. Free recipes. Michael Ray, 3605 South 15th, Minneapolis 7, Minn.

**RAISE Pheasants on \$100 week plan.** Little capital and space can make you independent. Free details. Great Central System, Columbus 1, Kansas.

**FREE Book "505 Odd, Successful Businesses."** Work home. Pacific, Oceanide, Calif.

**MAKE Flexible molds.** Cast plaques, figurines. Free sample. Tooker, 1045-M Fairview, Hamilton, Ohio.

**VENDING Machines—No selling.** Operate a route of coin machines and earn amazing profits. 32-page catalog free. Parkway Machine Corporation, Dept. 25, 715 Ensor Street, Baltimore 2, Maryland.

**AUCTIONEERING—Home study course.** Diploma granted. Auction School, Ft. Smith, Ark.

**BUY Wholesale!** Over 10,000 nationally advertised products. Appliances, cameras, sporting goods, housewares, watches, typewriters, tools, clothing, etc. Send postcard today. Buy-Rite, Box 258, Hawthorne 2, New Jersey.

**\$60.00 WEEKLY Sparetime.** Start home Venetian blind laundry. Protected territory. Interesting information free. Burt, 2434EB, Wichita 13, Kansas.

**WANT To make big money at home?** \$10.00 profit in an hour possible with invisible mending. Make tears, holes, disappear from clothing, fabrics. Steady year-round demand from cleaners, laundries, homes. Details free. Fabricon, 6238 Broadway, Chicago 40, Illinois.

**LEARN The high paying newspaper trade** at home. For details write Thomas Smith, P. O. Box A-2987, Sarasota, Fla.

**AMERICA'S Largest wholesale supply.** Buy, sell. Amazing profits. New free plan. Associated Wholesalers, Box 52-DX, Burlington, Iowa.

**HOME Mailorder manual, sources, methods, opportunities, 25¢.** Carnahan Bros., 9810 Acacia, Fontana, Calif.

**FOOD Supplements booming!** Sell super-potent "Supervite," Vitamin Specialties, 5522½ Hollywood, Los Angeles 28.

**EARN Big money.** Information and sample 25¢ refundable. Schwam, Box 936, Miami Beach, Florida.

**LEARN Mailorder faster, better, cheaper, via good books.** Booklet, catalog 25¢ (refundable). Zed Gwartney, Desert Hot Springs, Calif.

### BOOKS, PERIODICALS, PICTURES, POSTCARDS

**BRITISH Book bargains**—Any subject. Catalog free. Transbooks, Box 1-PMQ, Wantagh, N. Y.

**FREE: Catalog!** Hundreds of subjects! Treasure-Site Book Company, 279 South Alden, Philadelphia 39.

**SCIENCE-Mathematics-language booklets!** Free literature. Franks, 3121 South Racine, Chicago 8.

**JOHN Friend, bookfinder,** can get the books you want. Free search service. Box 2570PM, Long Beach 1, California.

**BACK Issues supplied,** reasonable. Stratford Magazines, 354 Palisade Avenue, Jersey City 7, N. J.

**THREE Monthly issues of magazine for older folks,** only 25¢. The Age Outlook, 1015 W. Liberty, Rome, N. Y.

**BOOKHUNTERS! Scarce, miscellaneous books.** Atlantic Book Service, Cedar Street, Charlestown 29, Mass.

**OUT-Of-Print books at lowest prices!** You name it, we find it! Fast service. No obligation. International Bookfinders, Box 3003-PM, Beverly Hills, Calif.

**SPECIAL 30¢—32 Page booklet, "Your Aquarium"** for 15¢. Innes Publ. Co., 12th and Cherry Sts., Philadelphia 7, Penna.

**GET Your job. Valuable report saves time, money, 25¢.** Independent Publisher, Box 1108, Atlanta, Ga.

**NATIONAL Geographic Magazines, 1888-1896.** Periodical Service, Box 463-PM, Wilmington, Delaware.

**"HOME Improvement Guide."** New, amazing 192 page volume. Packed with ideas, plans for remodeling, decorating, landscaping, built-in projects, \$2.50 prepaid. Popular Mechanics Press, 300-HG East Ontario St., Chicago 11.

**RARE Magazines, catalog 10¢.** Nationwide Exchange, Box 1375-P, San Antonio 6, Texas.

**BOOKFINDERS! All subjects.** Send wants! Jaher Book Service, 133 Hazelwood Drive, Westbury, N. Y.

**FREE: Exciting catalog packed with books covering most everything.** Think of it—From cover to cover you will find described and illustrated hundreds of books telling how to fix and how to build almost anything. How to remodel your home; do your own decorating, plumbing, electrical work. Simplified books covering concrete work, carpentry, painting, furniture making and refinishing. How to build your own boat, home workshop tools. Best books on photography, welding, hobbies, homecraft. How to make a home freezer. Send for your free copy now. Popular Mechanics Press, 200-BC East Ontario St., Chicago 11, Ill.

### GAMES, TOYS, NOVELTIES

**PEGLESS Cribbage board.** No pegs. No holes. Just slide the pointers. A beautiful gift item. \$2.95 prepaid. Curtis Products Co., No. Woodstock, N. H.

**PRECISION Pigmy cigarette lighter.** Penny size authentic miniature construction similar Ronson, etc. Cute stylish practical. Order several for gifts, etc. \$2.95. Satisfaction guaranteed. Pigmy Co., 1503 Beecher St. S.W., Atlanta 10, Ga.

**FREE Toy and hobby catalog.** Trilco, 39-31 47 Ave., Long Island City, N. Y.

**GAMES For groups.** Write today. Rain-shine Game Company, Joplin, Missouri.

### MAGIC TRICKS, PUZZLES, JOKER NOVELTIES

**MAGIC Club membership card!** Plus amazing new trick cards! \$1.00. Beck, 684 Irving Park, Chicago 13.

**FREE Disappearing cards with magic catalog, 10¢.** Ward, 60 East 42nd, New York City 17.

**MAGICIAN'S Headquarters.** Professional catalog 25¢. Hocus Pocus, 317 North State, Jackson, Mississippi.

**3100 NOVELTIES, Jokes, tricks, gadgets, funmakers, hobbies.** Big catalog 10¢. Johnson-Smith, D-424, Detroit 7.

**VENTRILOQUISM, easiest method.** Details free. Smith, 2125 N. Bigelow, Peoria, Ill.

**STINKBOMBS.** Disgustingly potent! 12/\$1. Kits, 1451 Drake, San Pablo 10, California.

**FREE Catalog magic, jokes, Houdini escapes.** Great opportunities. Write Heaney, Magician, Oshkosh, Wisconsin.

**VENTRILLO.** Professional voice-throwing instrument and catalog 25¢. Box 971-PM, Philadelphia 5.

**WORLD'S Finest professional magic, Joker novelties.** Giant illustrated catalog 10¢. Top Hat, Evanston 12, Illinois.

**500 TRICKS.** Douglas famous 120-page catalog, only 10¢. Fastest service to magicians for 30 years. Send 10¢ today. Douglas Magicland, Dept. 1, Dallas, Texas.

**BE A magician!** Large professional catalog of latest tricks. 35¢. Ireland, C-109 North Dearborn, Chicago 2, Illinois.

**PROFESSIONAL Catalog, 175 pages, 25¢.** Williams, 900 Plymouth, Ellwood City, Penna.

**DOLLAR Magic set free with catalog 25¢.** 4462-PM Germantown, Philadelphia.

**GO Ventriloquist, all secrets told.** Make money, surprise friends, have fun. Send 35¢ for catalogue of dummies, dialogues, etc. Limited supply. Gough, 303 E. Kickapoo, Hartford City, Indiana.

**WHOLESALE! Thirty 10¢ trick novelties \$1.00!** Profits! 1746-W Market, Philadelphia 3.

**LICENSES And permits, 20 assorted.** \$1.00. Ace, Box 142, Camden 1, New Jersey.

**SENSATIONAL Magician's wand 25¢.** Vanishes handkerchief! Catalog included. Box 1352-PM, Philadelphia 5.

**COMPLETELY Illustrated professional amateur magic catalog 25¢.** Stowell, Woodstock, New York.

**SMOKEBOMBS 25¢, 7 For \$1.00.** Terrific! 4463-PM Greene, Philadelphia 44.

### COINS, TOKENS, CURRENCY

**MERCURY And Morgan dimes.** Meet dates. Good, 3 for \$1.35, very good \$2.35, fine \$3.65. Pesterstein, 67-38 108 Street, Forest Hills 75, N. Y.

**START Your own coin collection.** Information, price lists, 10 different dates. Lincoln cents prior 1921, \$1.00. Louis Bell, Masonic Building, Decatur, Alabama.

**ONE Million dollars Confederate money in \$10's, \$20's, \$50's, \$100's etc.** only \$2.98. Limit four million for only \$10.00. Best Values Company, Dept. M47, 401 Market Street, Newark, New Jersey.

**WORLD'S Greatest magazine for coin collectors and wooden nickel 10¢.** Lawrence, Anamosa, Iowa.

**SELLING: 25 Lincoln pennies, 1909 to 1940 \$1.00.** Box 161, Bay Shore, Long Island, New York.

**CONFEDERATE, Southern obsolete currency, bought, sold.** Cook Coins, Jackson 5, Mississippi.

**WANTED—1822 \$5.00 Gold pay \$10.000.00.** 1913 Liberty head nickel \$4,000.00. 1894-S dime \$2,000.00. 1878-C.C. 30¢ piece \$1,000.00. 1901-S quarter \$40.00-\$400.00. 1922 50¢ \$5.00-\$60.00. 1928 Hawaiian 50¢ \$90.00. 1885 trade dollar \$1,050.00. Uncirculated dollars 1804 to 1839, 1893-S, 1895-P, 1903-O \$100.00-\$5,000.00. Certain dates small cents before 1924, pay up to \$325.00; halfcents \$500.00; 2¢ pieces, \$70.00; 3¢ pieces, \$90.00; halfdimes, \$500.00; dimes before 1943 \$300.00; quarters before 1924 \$1,000.00; half dollars before 1905 \$1,000.00. Hundreds of others worth \$10.00-\$1,000.00. Canadian coins—1921 5¢ silver, \$50.00. 1875 quarters \$50.00, 1921 50¢ \$200.00. Wanted: large cents, gold coins, paper money, etc. Know their true value. Our large illustrated guarantee buying-selling catalogue, send \$1.00. Need catalogue for complete all-coin information before selling coins. None c.o.d. Catalogue dollar refunded on \$20.00 sale. Thousands of persons have sold us coins. Worthycoin Corporation, Leaders Numismatic Quotations, K-412-C, Boston 8, Massachusetts.

**\$100.00 FOR Certain pennies.** Booklet listing prices, 25¢. Lincoln Coins, D-29, Glendale, Arizona.

**INDIAN Cents, 10 different \$1.00, 20 different, folder, \$2.50 postpaid.** Starter collections. Prager, 470 27th Avenue, San Francisco, California.

**22 DIFFERENT Foreign coins before 1945, \$1.00.** Catalog free. Alfred Szego, Box 187, Jackson Heights 72, New York City.

**MEXICAN Coins.** Free bargain list. Spranz, Box 168, Alamo, Texas.

**INDIAN Cents, 3 different 25¢. R & M Coin Co., Box 5, Delanco, N. J.**

**OLD Money wanted.** Do you know that coin collectors pay up to \$100.00 for certain U. S. cents? And high premiums for all rare coins? We buy all kinds. Send 5¢ for large coin folder. May mean much profit to you. Numismatic Co., Dept. 20, Fort Worth, Texas.

**BRILLIANT Uncirculated complete sets:** 1957 coins (10) \$3.75; Jefferson nickels \$32.50; Roosevelt dimes \$17.50; Franklin 1/2 \$32.50. All 3 sets with albums \$85.00. \$5 gold \$11.05; \$10 gold \$22.95; \$20 gold \$43.95. Highest cash prices paid all gold coins, any quantity. Bebec's, 4514 North 30th, Omaha 11, Nebraska.

**U. S. Coin bargains, 12 different Indian cents \$1.00, 20 different Indian cents \$2.00.** 1893 World's Fair half dollar \$1.00. Large cent over 100 years old \$1.00. 1955 uncirculated half dollar \$1.00. 2¢ and 3¢ piece \$1.00, 20¢ piece \$5.00. Ray's Coin Shop, 79 E. Van Buren, Chicago 5, Ill.

**LINCOLN, Indian cents, all dates, 1893-S cent uncirculated and complete price list 25¢.** Penny Mart, PL-7, Box 629, Chicago 90.

**U. S. Coins. Catalogue 10¢.** Hubers, 210 South Sixth Street, Minneapolis.

**CATALOG \$1.** Handbook of United States coins. Bound 126 pages. Illustrated, priced. Kalen, 1444 Primrose Road, N.W., Washington 12, D. C.

**PLEASE Send me your gold coins.** Will send you money and premium. Ship secured. Marcell's 4520 University Ave., San Diego 5, Calif.

**COMMEMORATIVE Half dollar uncirculated \$1.00.** Bargain lists free. Sayers, 1000 Unaka, Johnson City, Tennessee.

**WHOLESALE Coins for dealers, investors.** Lists 10¢. Al Johnson, Box 35, Colorado Springs, Colo.

**LINCOLN Cents, buffalo nickels.** Bargain list 10¢. Hughes, 21 Ottawa, Grand Rapids, Michigan.

**BOOK Collecting coins 75¢ cash.** Joseph Coffin, 1182 Broadway, New York 1, N. Y.

**BARGAINS, U.S. coins: 1893 Columbian world's fair half dollar, \$1.00.** Ten different Indian pennies, 75¢. Two-cent piece, and 3-cent piece, \$1.00. Gold 1/4 eagle, \$9.00. Gold 1/2 eagle, \$12.50. Beautiful coin bracelet, \$1.00. Many coins available. What do you need? Rare Coin Company, 31 North Clark, Chicago 2.

**44 DIFFERENT Uncirculated coins, \$1.00.** Oddehon, Box 482, St. Louis, Mo.

**SILVER Dollars: Uncirculated, 1879p through 1891p, 1897p \$2.00 each.** 1893cc \$15.00. Retail lists 10¢. Holden's, Garwin, Iowa.

**LARGEST Coin magazine, 180 pages, 35¢.** Scrapbook, 7320-J Milwaukee, Chicago 31.

**SAN Francisco mint closed!** Made only cents and dimes in 1955. In short supply and great demand. One each, brilliant uncirculated, for 25¢. Free coin lists with order. Bryson Stamp & Coin Company, 612 White, Toledo 5, Ohio.

**12 DIFFERENT Indian cents, coin list, \$1.00.** Pounds, North Wales, Penna.

**MORGAN Dollars; 1878-87-90-91-92s, \$2.00 ea.** Coin catalogue, 25¢. Shultz, Salt Lake 10, Utah.

**COINS From Formosa, Vatican, etc., plus foreign banknote, 10¢ with coin approvals.** Littleton Coin Co., Littleton 51, New Hampshire.

**U.S. Coins on approval.** Reasonable. Hutchinson, Box 4747, Philadelphia 34, Pennsylvania.

**GET Profit and pleasure in collecting old coins.** Send 10¢ for 56-page illustrated coin catalog. You'll be delighted with it. Send for it now. B. Max Mehl, 370 Mehl Building, Fort Worth, Texas. Largest rare coin establishment in U. S. Established 40 years.

LINCOLN Cents 1910-S, 1913-S, 1921-S, 1923-S, 1924-S, all for \$2. Gasser's, Box 34615, Los Angeles 34, California.

10 MIXED Foreign coins-bills: 10¢. Dwight Musser, Dunbar, West Virginia.

GIANT U. S. coin catalogue 25c. Ace, 314 S. Clark, Chicago 4.

COIN Collectors exchange publication. Sample 25¢. Numismatic News, Iola, Wis.

COIN Collectors magazine samples 25¢. Subscription \$2. Stamps accepted. Eaglet, 229 South 11th St., Newark 7, N. J.

OLD United States gold coins bought. John J. Firpo, 120 Santa Ana Ave., San Francisco 27, Calif.

TRANSPARENT Tubes for rolls. Assorted sizes \$1.00. Letocraft, Box 21, Massillon, Ohio.

PROOF Sets, 1957 set only \$2.50; 1956-\$4.00; 1955-\$8.00; 1954-\$7.00; 1953-\$12.00; 1952-\$20.00; 1951-\$30.00; 1950-\$49.00. Complete sets 1950-1957 inclusive—\$120.00. Postpaid, prompt shipment. Money-back guarantee. Dan's-Dan Moraska, A.N.A., 432-P 23rd Avenue, San Francisco 21, Calif.

MEXICO Mint set centavos—1957, brilliant uncirculated. 5 different beautiful coins. Look like gold! Start a "good neighbor" collection. Makes a beautiful inexpensive gift. One set only \$1.00; 2 sets \$2.75; 10 sets \$8.50. Postpaid. Money-back guarantee. Postal Products Company, Post Mail Order, 5614-MC California St., San Francisco 21, California.

COMPLETE United States coin bargain lists. Indianhead cent, 10¢. Economy Sales, 156-A Dean, Mansfield, Mass.

MASONIC Tokens—All symbols. Pocket size \$1.00. Keepsake, 107 Parker Place, Trenton 9, N. J.

### STAMP COLLECTING

FREE: Mint British Colonies from North Borneo, Caymans, Seychelles, Dominica, Papua, New Guinea, Sarawak, Brunei. Free with approvals. Viking, Great Neck 8, New York.

100 DIFFERENT U. S.—50¢ approvals. Utecht, 1143 North Keeler, Chicago 51.

TOPS! Free book, "How to Collect Stamps." Send for your copy today! Approvals. Littleton Stamp Co., Littleton E1, N. H.

FREE! Giant catalog offering thousands of bargains. Sent with beautiful approvals. Jamestown Stamp Co., Dept. E11PMC, Jamestown, N. Y.

STAMP Finder, world map and encyclopedia of stamp issuing countries only 5¢. Approvals. Goliath Company, Bethlehem K1, New Hampshire.

TERRIFIC Stamp bargain! Israel, Iceland, Vatican assortment—Plus exotic triangle set. Also fabulous British Colonial accumulation. Plus large stamp book. All four offers free. Send 10¢ to cover postage. Empire Stamp Corp., Dept. PM, Toronto, Canada.

66 DIFFERENT British colonies 5¢. Approvals. Casto, Box 357, Dunbar, West Va.

FREE Fifty different with approvals. H. P. Wisheart, Frankfort, Ohio.

900 MIXED U. S. Old-new 25¢. Lists. Weatherby, Medina, Ohio.

FREE French Antarctic territories stamps with request for world approvals. Suncoast Stamps, 3601 29th Avenue South, St. Petersburg, Fla.

FREE! Amazing list! Alphabetical! Two feet long! Stampmart, Hartford 1, Conn.

EARN Scott's albums, catalogues, perf gauges, hinges, watermark detectors, etc., while buying from our foreign approvals. True Value, Box 2098, Santa Ana, Calif.

ANGOLA Mint native costumes set free with approvals. Ted Solberg, Box 1374, Spenard, Alaska.

EXTRAORDINARY Antarctic set free with approvals. Variety Stamps, 57-A Circuit, Newton Highlands 61, Mass.

DEALERS—Wholesale list. Postage 3¢. Frank, 3031 Queensbury, Baltimore 13, Maryland.

OVER 100 Different U. S.—25¢. Israel price list 10¢. A. Feuer, P.O. Box 4785, Tucson, Arizona.

FREE! 107 British colony stamps, all different, from Britain's farflung colonial empire. Catalog value \$2.50. Free stamp magazine. Approvals. Send 10¢ for handling. Act now! Lincoln Stamp Co., St. Catharines 418, Ontario.

SOUTH America! British colonies! Thousands on approval at 2¢ each regardless of catalog. Moffat's, 740-A Milton, Rock Hill, South Carolina.

FREE 200 different good stamps with low priced approval. Joseph Reiner, 6428 Morningside Drive, Kansas City, Mo.

\$5.00 COOLIDGE, Only 15¢. Write for details. U. S. stamps exclusively. Futurama, Box 7282, Miami (Ludlum), Florida.

GIANT U. S. Canada price list, over 100 pages, 700 illustrations, 10¢. Thom, 4808 15th Avenue, Minneapolis 17, Minn.

WOW! 135 All different Germany 10¢. Zeppelins, semi-postals, airmails, high values. Big bargain lists and approvals included. Jamestown Stamp, Dept. A-11PMC, Jamestown, N. Y.

SPA, Tipex, Cipex mint sheets, \$1.00. Sarappo, 167 Cross, Newcastle, Delaware.

SPORT Topicals, 15 different 10¢. Approvals. Smith, 6 Greencroft, Champaign, Illinois.

OUTSTANDING Special! Stamp wallet, 105 stamps 10¢, approvals. Shoaps, 7504 Briarcliff, Cleveland 30, Ohio.

312 MIXED U. S. only 10¢ to Gold Nugget approval applicants. Nothing like them. Kessel's, Box 6116, Tucson, Arizona.

U. S. Investors quantity lists, 10¢. Reynolds, 607 Liberty, Flint 3, Michigan.

MINIATURE Collection Queen Elizabeth sets! Dominica, Virginia, Barbados, Gibraltar, Tristan, Malta. 21 mint bicolors, 25¢. Approvals. Gannon Stamps, Box 931, Canton 1, Ohio.

100 WORLD 10¢. Approvals. Ehrlich, 425 Jefferson Street, N.E., Washington 11, D. C.

PENNY Approvals! Regardless catalogue! Kloster, 4164—32nd St., San Diego 5, Calif.

TEN Israel, free! Popular-priced, attractive approvals accompany. Nymedl, Box 503, Biloxi, Mississippi.

84 DIFFERENT U. S.—20¢. Inexpensive approvals. Coonrod, 714 Garfield, Laredo, Texas.

100 FOREIGN, 20 U. S. commemoratives, 10¢. Approvals. Weckerling, 1304A Choquette, Austin 5, Texas.

SET Of China air mails 10¢ to foreign approval buyers. Golden State Stamps, Box 325p, El Torn, Calif.

404 DIFFERENT Stamps 25¢. Cape Good Hope triangle Ruand-Urandi, jungle set included in Trylons super collection. Catalogs over \$12.00, approval applicants only. Trylon, Box 179-P, Forest Hills 75, N. Y.

14,000 DIFFERENT! Amazing new plan builds your collection systematically, country by country. Only 30¢ weekly. Free details. L. G. Ware, Stepney 75, Conn.

BEAT This if you can: 21 famous stamps from different nations, 1000 different world wide. All genuine. Catalogue over \$25, for \$1.00 to serious adult approval applicants, requesting our excellent approvals. Advise preference. Send references. Satisfaction guaranteed. Cosmophilatelist, 28 N. Pinellas, Tarpon Springs, Florida.

INTRODUCING Our better United States approvals, we offer 15 United States stamps including Columbian, Pan-Pacific, famous American, airs, others; only 10¢. Ocean Stamps, Box 64-PM, Brooklyn 29, New York.

PHILIPPINES—25 Different 5¢, approvals. Dopko, 3482 Laura Lane, Riverside, Calif.

1000 ASSORTED Foreign stamps, mint, triangles, etc., \$2.00. Brodie, 442 North 13th, Terre Haute, Indiana.

40,000 VARIETIES Available on approvals. 1/4¢ upwards. Keigwin, Box 933B, Daytona, Florida.

1000 NICE Mixed stamps 25¢. Approvals accompany. Homer Boster, Route 7, Chillicothe, Ohio.

SPECIAL: United Nations Set, 10¢ with approvals. Noble, Owego 1, New York.

FOREIGN Stamps, approvals 1¢ up. Barr, 467 Oneida, Pittsburgh 11, Penna.

1000 DIFFERENT Worldwide stamps, only \$1.00. Universal, Box 6, Kenosha 5, Wisconsin.

313 DIFFERENT Worldwide 25¢, exotic pictorials, approvals. Edgar, Box 437, Punxsutawney, Penna.

100 DIFFERENT Unused U. S. commemorative stamps \$4.00. Ralphstamps, Mexico, Missouri.

EGYPT 25 Different, 3¢ postage, approvals. Bellet, Mapledale, Hazel Park, Mich.

NEW Illustrated price list free. Jones, Box 343-P, Mineola, New York.

FIFTY Different stamps plus attractive set free to approval applicants. Profit sharing plan. John Schuster, 301 Sandpiper, Playa Del Rey, California.

UNITED States price list, 116 pages, price 25¢. Mark Hanna, 335 Fifth Ave., Pittsburgh 22, Penna.

PINE Sets, packets free to customers. Stamp Farm, Oxford, Wis.

U. S.—25 Different commemoratives 10¢, approvals. Wilber, Box 332, R. D. 7, Schenectady 2, New York.

SEND Two dimes for large U. S. catalogue (illustrated). New-Way Stamp, Lawrence, Mass.

GIANT Diamond, midget triangle, Timor, 26 others, 3¢. Approvals. Carpenter, P.O. Box 310, Claremont, Calif.

FREE, 26 Different British Empire with approvals. Jeans Stamps, 42 Evergreen Road, North Fort Myers, Florida.

U. S. commemoratives, beautiful colonials, airmails, topicals, 3¢ with approvals listing. Bristol, Canton Center, Conn.

1000 STAMPS \$1.00. Good variety, off paper. World wide. Many pictorials. No approvals follow. Satisfaction guaranteed. Whalen, 1435—1st Ave., Oakland 6, Calif.

FREE! Gold Coast! Monaco triangles! Madagascar! Approvals. Keating, 2520-P Boulevard, Jersey City, New Jersey.

100 WORLDWIDE Plus U. S. commemoratives, 10¢, approvals. May, Box 986-M, Coral Gables 34, Florida.

PM's Protect plate blocks. Samples. Lee's, Box 795, Rockford, Illinois.

FREE 50 Worldwide introducing inexpensive approvals. University Stamps, P.O. Box 95, Tamiami Station, Miami 44, Florida.

ASTONISHING Mint collection free, introducing approvals. Philatelic Parade, Pennington, New Jersey.

U. S. Mint flag set, complete, \$1.00. Free list. Brooks, 2323 Avenue X, Brooklyn 35, New York.

APPROVAL Applicants get beautiful stamp packet. Hilltop, Box 696, Haverstown, Penna.

BRITISH Africa colonials. Used, to shilling value, 50 different \$1.00. Real fine assortment. Harrison's Stamps, 1435 First Ave., Oakland 6, California.

MONACO Nudes complete 25¢. Approvals. Royal Stamp Company, Tamaqua, Penna.

SELL Stamps, 75% profit. Information \$2.00. Wholesale, 48 Bartlett St., Rochester 8, N. Y.

50 DENMARK Free. Approvals. Walter Kotowski, 19265 Eureka, Detroit 34, Mich.

FREE! Illustrated prize catalog of stamps, albums, mixtures, packets. Adventurer, Buckland, Connecticut.

BUTTERFLY, Madagascar sets, Monaco Washington, plus 50 different 10¢. Approvals. Bennett, Candor 3, N. Y.

SPACEOPHOBIA? Our 1¢-2¢ approvals cure quickly. BKJ, Astor, Boston 23, Mass.

ELECTRO Stamp Analyzer. Scientific instrument to detect forgeries, flaws, watermarks in stamps. Request folder. Bordas, 616 Flamingo St., Philadelphia 28, Penna.

500 FINE Mixed U. S. 15¢. Wright, 201M Mealey, Hagerstown, Maryland.

FREE! 100 British Empire, 10¢ handling. Approvals included. Kensington Stamps, Buffalo 15, N. Y.

SPECTACULAR U. S. offer, 100 different, including 25 commemoratives, with superior approvals. Stamps, Box 37, Kennebunk, Maine.

FAMOUS Americans, old U. S., flags, presidents, commemoratives with approvals plus surprise packet for 10¢ handling. Metropolitan Stamps, Box 312HF, Jackson Heights, N. Y.

KOREA, 25 Different catalog value \$7.00, yours for only \$2.00. Coast, P.O. 2187K, Santa Ana, California.

**BEAUTIFUL**, Colorful pictorials including diamond-shaped and triangular. 10¢ Approvals. Valley's, Box 414M, Spring Valley, California.

**FREE!** Bahamas, Cayman, Fiji, Trinidad, Honduras, St. Lucia; approval buyers only. Rogers, Box 485M, Albany 1, New York.

**WANTED**—Stamp collections, accumulations. Murray Gold, 62-85p Saunders, Rego Park 74, N. Y.

**BAHAWALPUR** UPU complete set free with approvals. Taconic Stamps, Box 1370, Anram, New York.

**DEALERS** Liquidation. 150 different U. S. Mostly obsolete. Only \$1.00. Youngs, 6108 Costen, Fort Worth, Texas.

**FREE** Surprise packet! Request approvals. Sunnyco, 1267 Tutwiler, Memphis 7, Tennessee.

**EARN** Premiums while buying many stamps 1/2 price. Send for approvals, details. Mor-4-Less Stamps, Box 44, Yorba Linda, California.

**10¢ BRINGS** 20 Hard-to-get Indonesia commemoratives, catalogued over \$1.25, plus reproduction \$50,000.00 British Guiana Penny Red. Penn Stamp, P.O. Box 303, Philadelphia 5.

**250 DIFFERENT** Including pictorials, airmails, 25¢ with approvals. Stalder, 2309 Lamee, Jacksonville 7, Florida.

**RARE** Lithuania #C55-59 triangle airmails, 10¢. Approvals. William Deems, Ravenswood, West Virginia.

**FREE!** 12 British Ceylon bi-colored with temptingly priced approvals. Bushman's, 118 Mississippi Ave., Joliet, Illinois.

**FREE:** Comorro, Hyderabad, Swaziland, Mauritania, Armenia, Nyassaland, with bargain approvals. Box 343, Tamiami, Miami 44, Florida.

**MONACO**, Nudes (3) 5¢. Approvals. Hannay's, 473 Myrtle, Albany 8, N. Y.

**EXCITING** Strange countries packet. Free with approvals! Saxon, Orange, California.

**BARGAIN** Packet 10¢. Approvals. Free premiums. Michael, Box 1623, Annapolis, Maryland.

**"ABE Lincoln"** giant diamond, rainbow colored flag set, Israel, South Korea, 50 others different only 10¢. Approvals. Champlain, Isle La Motte, Vermont.

**PENNY** Approvals that satisfy. Robert Moed, P.O. Box 62, Brooklyn 29, N. Y.

**EXCITING** Surprise lots 25¢, guaranteed value, approvals accompany. Beacon, Box 161, Woodside 71, New York.

**WORLDWIDE**, 50 All different, absolutely free just to introduce our incomparable approvals. Kent Stamp Company, G.P.O. Box 87, Brooklyn, N. Y.

**FIRST U. N. set.** Among world's prettiest. Only 10¢. Approvals. Welles, Box 1246-B, New York City 8.

**AUSTRALIA**, Fifty different, 10¢ with approvals. Molesan, 720 Pomona, El Cerrito 8, California.

**FREE** Ten mint British colonies; given approval applicants. Tropicana, Box 624-M, Oakland Park, Fla.

**FIVE** Different sets French Colonies, 10¢ with approvals. Banner, Box 65, Park Forest, Illinois.

**WORLD'S** Smallest and strangest stamps only 10¢ with approvals. Finney, Box 89, El Monte, Calif.

**FREE** United States illustrated catalog. Bailey, 45 Bromfield, Boston, Mass.

**200 WORLDWIDE** 25¢ Plus surprise packet. Packet list free. Econopackets, Box 168, Riverside 9, Calif.

**U. S. approvals.** Low prices. Eagle Stamps, Romine Ave., Pittsburgh 26, Penna.

**FREE!** 50 Different British Colonies to approval applicants. Pan-American, Box 24, Coconut Grove, Miami 33, Florida.

**5 MINT** British colonies and 100 others 10¢ with approvals. Miller, 219 Fowler Ave., Jersey City 5, N. J.

**ECONOMICAL** 1/4-3/4 Approvals, 33,000 varieties. Dresel, Box 128-N, West Englewood, New Jersey.

**TWO \$5.00** U.S. stamps plus 20 different, 10¢ with U.S. approvals. Irwin, Box 1105, Brooklyn 30, N. Y.

**FREE!** 107 British Colony stamps. All different, from Britain's farflung colonial empire. Catalog value \$2.50. Free stamp magazine, approvals. Send 10¢ for handling. Act now! Niagara Stamp Co., St. Catherine's 71, Ontario.

**UNITED** States commemorative collection containing 33 different—10¢. Approvals. White, 516-A Avenue L, Brooklyn 30, New York.

**SELL** Your surplus good grade stamps. Write, describing fully what you have. Vanroy Shirk, Lebanon, Pennsylvania.

**50 DIFFERENT** Argentine 10¢. Approvals. Reuter, 611 W. 40th Pl., Los Angeles 37.

**AMAZING Offer!** 200 United States stamps—including commemoratives, airmails, high denominations to \$1.00. Only 10¢ to approval applicants! Illustrated bargain lists free. Mystic Stamp Co., Dept. 80, Camden, New York.

**U. S. Classics.** Over 50 yrs. old. 15 selected old-timers. Missing in biggest collections. All 15 at less than 1¢ each. 10¢ with approvals. Jaro, Box 246-T, New York City 8.

**100 STAMPS**, 10¢ With approvals. Smith, 568A Brooks, College Station, Texas.

**OLD** Scarce U.S. seconds on approvals. Slight imperfections, lowest prices. Hernefield, Clintonhill Sta., Newark 8, N. J.

**100 OLD** United States between 1861 and 1935, \$1.00. Roush Stamps, 51 Chestnut, Mansfield, Ohio.

**UNITED** States approvals. Select copies, used—mint. Kingsbury, Fairfax, Vermont.

**ICELAND** 10 Different beautiful stamps for only 10 cents to applicants for our good old fashioned approvals. Old Colony Stamp Co., Dept. A, Milford, Connecticut.

**1-2¢ EACH!** Thousands of exciting worldwide stamps. Free examination. Cole, Box 223-A, Buffalo 21, N. Y.

**225 STAMPS** For only 10¢! This mammoth value includes airmails, pictorials; stamps from strange countries cataloging up to 23¢ each! Also approvals. Mystic Stamp Company, Camden 80, New York.

**100 DIFFERENT** Austria. 10¢. Approvals. Aronson, Box F, Newton Centre 59, Mass.

**WEIRD** Diamond shape coffee stamps. Lovely flower triangle! First American big commemorative. Greenland, idol dancer, etc. Free with approvals. Capital Stamp Co., Ferrysburg 2, Mich.

**25 DIFFERENT** Commemoratives 1893 up 10¢. U. S. approvals. K&B, Box 70, Brooklyn 23, N. Y.

**MINT U. S. at face!** Older commemoratives only in 25¢ packet. Limit one with request for mint U.S. approvals. Western, Box 1689P, Salinas, California.

**500 DIFFERENT** Stamps only 50¢ with approvals. Littleton Stamp Company, Littleton 71, New Hampshire.

**FREE** Packet, beautiful pictorial British Colonials, approvals, 5¢ handling. Murrays, 1020 Rademacher, Detroit 9, Mich.

**25 DIFFERENT** Egypt 5¢. Bargain approvals. Somith, Box 83, (Rugby) Brooklyn 3, N. Y., Dept. 2M.

**ONE** Hundred stamps plus beautiful pictorial mint set only 10¢. Approvals. Robdal, Stamp Department, Riverside, Connecticut.

**STAMP** Collecting outfit, includes packet worldwide stamps, package hinges, watermark detector, millimeter gauge. Everything 10¢ with approvals. Lorain Brown, Marion, Michigan.

**PENNY** Approvals. Thousands. Bargains for pennies. Gifts with purchases. Penny Stamps, Orange 1, California.

**506 DIFFERENT** 50¢; 1012, \$1.10. Approvals. Klondike, 682 Jefferson, Elgin, Illinois.

**NEXT** Ten 3/4 P.D. Artcraft covers \$1.00. Aufderheide, Box 224, Trenton 8, N. J.

**135 DIFFERENT** U.S. commemoratives \$1.00. 50-25¢. Request approvals. Harold Holub, 18 East 198th Street, New York 68, N. Y.

**200 WORLDWIDE** 10¢ To approval applicants. Collins', P.O. Box 125, Shell Beach, Calif.

**FOREIGN** Stamps. 1¢ to 5¢ approvals. Barr. 467 Oneida, Pittsburgh 11, Penna.

**12,000 PENNY** Approvals waiting for you. Many from exotic countries, pictorials, airmails, new issues. Tilbury, Box 882, Newark 1, N. J.

**FREE!** 50 Different Portuguese; colorful, inexpensive approvals. Elkhart, Box 33, Elkhart, Indiana.

**65 DIFF. U.S.A.** 10¢. Approvals. Kem, 14039 Don Julian, La Puente, Calif.

**FREE Beauties!** Japanese souvenir sheets (2) plus exciting Oriental-African approvals. 10¢ handling. Stoddard's, 204 Cornwall St., Salinas, Calif.

**U. S. Commemoratives:** 141 different \$1; 201 different \$2. Moseley, 6 Hanley Downs, St. Louis 17, Missouri.

**SOUVENIR** Sheet Czechoslovakia 1937 10¢ with approvals. Kingman, 30 Empire Street, Yonkers 4, N. Y.

**CANADA**, 100 Different 35¢ with bargain approvals. K. S. Holmes, London, Canada.

**QUALITY** Approvals at 2¢ each. Hadrian, 22 East 29th, New York City 16.

**FREE!** Over 100 different, \$2.50 value, including Israel, British Colonies, U. S., First U. N., Siberia; triangles, animals, sports. Approvals, illustrated catalogue accompany. Send 10¢ for mailing. Gatewood, Box 346, Winston-Salem, N. C.

**DARKEST** Africa Congo, Camerons, Seychelles, Swaziland, Tanganyika, Urundi, free. Fascinating approvals. Royalton, Box 283, Forest Hills 70, N. Y.

**1958 U. S. Illustrated** catalogue free. Stone, 192 Washington, Boston 8, Mass.

**FREE** Sample! Interesting, informative, illustrated. National Stamp News, Anderson, South Carolina.

#### ANTIQUES, RELICS, INDIAN GOODS, CURIOS

**AFRICAN** Curios. Hand made. Interesting subjects. You'll love them. Photo illustrations and price-list free. Jethalal Stores, P.O. Box 920, Mombasa, Kenya.

**ILLINOIS: Gesundheit!**—For sale: several hundred Revolutionary, Civil War, Indian muskets, rifles, carbines, swords, bayonets, powder-horns, bullet molds, holsters, canteens, Kentucky rifles, frontiers, duelling pistols. Stagecoach guns, 50,000 collectors cartridges. Many Confederate items, 10,000 coins, Confederate money, 100,000 Indian relics, arrowheads, spearheads, tomahawks, bannerstones, discoidal. Mounted birds, squirrels, deerheads, steer-horns. Violin wood, agates, fossils, minerals. Gold dollars. Illustrated catalog 35¢. Heicke, Wenona, Illinois.

**SCALPING** Knife, spearhead, thunderbird \$4.00. Catalog free. Arrowhead, Glenwood, Arkansas.

**ANCIENT** Grooved stone tomahawk \$3.00. Indian relic list free. Lear's, Glenwood, Arkansas.

**SELECTED** War arrowhead \$1.00. List 5¢. H. Talburt, Calico Rock, Ark.

#### PRECIOUS STONES, MINERALS

**CUT** Gems, make jewelry—For profit or fun. 100 page magazine tells how; where to get supplies. Sample 25¢ or request free literature. Lapidary Journal, Del Mar 2, Calif.

**GEMS.** Thirty, pocketsize case, including ruby, sapphire, emerald \$3.50. Fifty minerals \$5.00. Reed's, 4930B Palo Alto SE, Albuquerque, New Mexico.

**TEN** New Mexico minerals \$1.50, six fluorescent \$1.00, five crystallized minerals \$1.00, fool's gold 25¢. Minerals, Winston, New Mexico.

**LARGEST** Gem and mineral magazine tells how to have profitable fun with rocks, gems, jewelry. Monthly, \$3.00 year. Sample 25¢. Gems & Minerals, Dept. A10, Mentone, California.

**BEGINNER'S** Mineral study set. \$2.00 postpaid. Mineral Lore, P.O. Box 155, Del Rosa, California.

**MINERAL** Specimens for collectors. All varieties, world wide localities. Choice quality, lowest prices. List free. Plummer's, 4720 Point Loma Ave., San Diego 7, California.

**EARTH** Science, the rockhounds national magazine. Subscription \$2.00. Sample 35¢. Box 1337-PM, Chicago 90, Ill.

**GOLD, Silver, copper ore 50¢.** Gemco, Eisner Avenue, Sheboygan, Wis.

**AMETHYST, Tigereye, turritella, etc.** Christmas special. Pendant \$2.50. Gold or silver. Groff Lapidary, 1367 N. Carolina Ave., N.E., Washington 2, D. C.

TOPAZ, Amethyst, etc., genuine, 20 polished gemstones. Specimens identified, mounted, \$1. Helsenstell, 1429 Sandpiper Dr., Houston 36, Texas.

AGATES, Gems, machines. Free list. Northwest Gems, 2819 North Warner, Tacoma 7, Washington.

DIAMONDS: Discounted, registered, written guarantee. Example: genuine flawless Marshall diamond, 1/4 carat mounted. Your price: \$77.00 plus tax. Write, House of Marshall, 11 Lawrence St., Lyons 1, New York.

#### HOBBIES AND COLLECTIONS

COINS, Stamps, collector items. Lists 10¢. Harold Root, 2801 Lopane Ave., Middletown, Ohio.

HOBBIES, Gifts, stamps, trains, planes, boats. 250 page catalog \$1.00. Joyner's, 221 N. Limestone, Lexington, Ky.

WANTED Old cigarette cards. Write Charles Bray, East Bangor, Penna.

PROPAGANDA Leaflets W. W. II; sample 25¢; Nazi medals, badges, sample 50¢; embroidered swastika and catalog 25¢. Insignia Club, Box 71, Rockaway Park A-94, N. Y.

SEASHELLS From the coast of Florida. For hobbyists, craftsmen, collectors, aquariums. Beautiful assortment of 14, only \$1.00. Shipped prepaid. Seashells, 4209 Bayview, Tampa, Florida.

NAZI Medals listings 10¢. Kingstone, 920 Third, (338) Seattle 4, Washington.

COLLECTORS Matchbook covers. 100 different unused, \$1.00. Catalog 25¢. Album \$3.00. Charles Edelman, 1311-C East 84, Cleveland 3, Ohio.

NAZI Insignia. 12 different \$1.00. Medals, patches, armbands, flags, daggers. Illustrated lists, 15 cents. Hobbyland, 1207 1st St., W., Calgary, Canada.

INVENTING Can be an interesting and profitable hobby. Write for complete particulars. Institute of American Inventors, Dept. 40-E, 635-P St., N.W., Washington 4, D. C.

#### CAMERAS, PHOTO SUPPLIES

PHOTOGRAPHY For pleasure or profit. Learn at home. Practical basic training. Long established school. Free booklet. American School of Photography, 835 Diversey Parkway, Dept. 3442, Chicago 14.

FREE! Free! Send for your new \$2 page photographic bargain book. Over 5,000 new and used items at huge savings. For your free bargain book, write to Dept. 1111, Central Camera Co., Chicago 4, Ill.

COLOR Stereos wanted. All subjects. Send list, description, quality, price. Will exchange. Stereocart Library, P.O. Box 2333, Hollywood Station, Calif.

PRINT 100 Pictures on cloth, etc., \$1.00. Young, Box 655P, Waterloo, Iowa.

ARGUS C-3 outfit \$47.90. Photo equipment, appliances. Discounts to 40%. Free catalog. Mailers Mart, Box 135-MP2, Pelham, New York.

#### PHOTO FINISHING

KODACHROME Processing—8mm roll or 35mm 20 exp., \$1.25. Prompt service. Write for mailer and prices. Color Pix, Dept. P, CPO Box 30, Kingston, N. Y.

FREE! Color snapshot folder. Offers, lists, mailers. Houghton's, Erving, Mass.

12 EXPOSURE Rolls, 39¢. Jumbo prints. Guaranteed work, one day service, Lincoln Studios, Dept. K, Box 13, Lincoln, Nebraska.

8-HOUR Service on deluxe jumbo prints. 8-exposure roll developed and 8 jumbo prints 40¢, 12 exposure 55¢, 16 exposure 70¢; 35mm, 20 exposure 75¢, 36 exposure \$1.25. Jumbo deckle reprints 4¢ each. Contact prints made if specified. Bay Photo Service, P.O. Box 210, Oakland, California.

SUPERIOR Quality. Prompt service. 8 jumbos in album 40¢. 15 contacts 50¢. Jumbo reprints 5¢. Satisfaction guaranteed. Also complete color film finishing service. Write for free circulars and mailers. Fast-X-Photo, Box A, Jersey City, N. J.

ENLARGEMENTS, Heavyweight seven 5x7's or four 8x10's \$1.00. Jack Koons, Huntington Mills, Luzerne County, Penna.

KODACOLOR Prints 25¢. Save over \$1.00 on full roll developed and printed. 8 exposure rolls \$2.25, 12 exposures \$3.45. All color Laboratories, Box 24, Dept. 31, St. Louis, Mo.

PARTICULAR? 8 Jumbos—40¢, 12—30¢. Special; 35 mm., 36 exposures \$1.25. Introductory offer. Flash Photo, Box 36M, Brooklyn 4, N. Y.

#### MOTION PICTURES AND SOUND EQUIPMENT

ALASKA Wildlife Kodachrome movies and slides. Free catalog. Mac's Photo, 315—14th, Anchorage, Alaska.

CATHOLIC 16MM. films. Rentals, 204 North 9th St., Newark 7, N. J.

FREE! Blackhawk's big new 1958 sale catalog new and used 16mm., 8mm. movies; 2" x 2" color slides; used 16mm. sound projectors! Biggest stock in U.S.A.! Cameras, accessories, supplies, too! Blackhawk Films, Davenport 14, Iowa.

RECORDERS, Hi-Fi. Free catalogue. Carstan, 215 E. 88 St., New York City 28.

5,000 8-16MM. Movie films. Free catalogues. International, Greenvale, N. Y.

TAPE Recorders, tape. Unusual values. Free catalog. Dressner, 69-02M 174 St., Flushing 65, N. Y.

FREE Catalog. Save dollars. Fresh 8mm., 16mm. b&w and color film. Home processing equipment. Superior Bulk Film Company, 448 No. Wells, Chicago 10.

MOVIE Camera film: 8mm. roll \$1.50. 16mm. 100' \$3.00. Free processing. Better Films, 742 New Lots, Brooklyn, N. Y.

8-16MM. Films. Free catalogue, with sample film 10¢. Garden, 690 Howard Avenue, Brooklyn, N. Y.

SAVE 50%! Guaranteed-fresh color, b&w. movie film! 8mm., 16mm. Free catalog! Ego-R, 47th Holly, Kansas City 12, Missouri.

8MM Movies 50 ft. \$1.00. Special offer—Animals, cartoons, travel, comedies. Send \$1.00. Movieland Films Inc., 16121M Sherman Way, Van Nuys, California.

#### MUSIC AND MUSICAL INSTRUMENTS

ACCORDIONS — Direct from importer. Save 50% and more! Free trial. Lifetime guarantee. Trades accepted. Free catalog. Write Accordion Manufacturers Outlet, Dept. 117-R, 2903 Chicago, Chicago 32.

SWISS Musical movements (best) \$2.50. Electrical movements \$5.50. Spielman, 131 West 42nd, New York City 36.

SONG Poems wanted. Five Star Music Masters, 630 Beacon Building, Boston.

RECORDS, Hi-Fi. Big discounts. Noelson, Box 211, Wall Street, New York City 5.

VIOLINMAKERS. Repairers. Fine tone wood, and all violin supplies. Send for free wholesale new price list. International Sales, 414-MPM E. Baltimore St., Baltimore 2, Maryland.

STEREOPHONIC Tapes — Low cost! Write for information. John Paul Jones, 655 Main, Lafayette, Indiana.

COMPLETE Service for amateur songwriters. Colonna, Box 888, Burbank, Calif.

ACCORDIONS Wholesale—10 day trial. Free catalog. American Accordion Center, 5529-PM-11, Belmont, Chicago.

MAGAZINE. Old rare phonograph records, 20 pages, 6 introductory issues, \$1.00. Record Search, 131 Hart, Brooklyn 6.

DISCOUNTS—Instruments, accessories. National brands. Tempo Music, 37 Cutler, New London, Connecticut.

WRITE Songs. Big money and reputation. Write for information. J. Gordon Pub. Co., 4700 South California Avenue, Chicago.

SONGPOEMS And lyrics wanted. Mail to: TinPan Alley, Inc., 1650 Broadway, New York 19, N. Y.

SONGS Into dollars. Share \$29 million dollars yearly for new songwriters, song-poets. Songs composed, published, promoted by famous firm. Information, appraisal free. Send to Nerdye Publishing, 8000 Sunset, Hollywood 28PM, California.

POEMS Wanted for new songs. Send poems. Free examination. Immediate consideration. Songcrafters, 2724 Arcade Station, Nashville, Tenn.

POEMS Wanted for new songs. Send poems. Immediate consideration. Crown Music Company, 49-C West 32 Street, New York City.

ELECTRIC Guitars, amplifiers, wholesale. Free catalog. Carvin FMM, Covina, California.

SWISS Musical movements, \$1.90. Helax, 218 West 72nd Street, New York City 23.

ACCORDIONS, Wholesale to everyone. Save up to 60%. All national known brands. Free catalogue. Del Principe, 29 South Cicero, Chicago 44.

POEMS, Songs wanted! Publishing, recording. Bengol, 93 Jefferson, Chelsea 50, Massachusetts.

SONO Request guarantees royalties. Instructions two dollars. Howard Olenik, Mt. Morris, Mich.

SONGS And poems wanted. U.S. Music Studios, Box 222A, Belmont, Mass.

#### RADIO, TELEVISION AND ELECTRONICS

REPLACE Your own TV tubes. Instructions \$1.00. Slate's Television Service, Corsicana, Texas.

KITS—Shortwave radio \$3.50. Sensitive crystal radio 75¢. Alliance, 2059 60th, Brooklyn 4, N. Y.

TRANSISTOR Kits, parts. Free information. Transit, Box 15-F8, Alden Manor, N. Y.

CRYSTAL Radio experimenters write to Hulet, 305 Hope, Lakewood, N. J.

FREE! Giant bargain catalog. Transistor, "Sun" radios, kits, portables, audio, electronics, photographic, optics, tools, household. Write Lektron, 131M Everett Ave., Chelsea, Mass.

CRYSTAL Radio kit \$1.00, preassembled \$1.25, phone \$1.75; catalogue. Clearco Crystal Company, 2968 North 4th, Milwaukee 12, Wisconsin.

GOVERNMENT Surplus. Radios, parabolic reflectors. Amazing picture list 10¢. Meshna, Malden 48, Mass.

#### BUSINESS OPPORTUNITIES

READ The truth about mail order business from beginner's standpoint. 10,000 word idea booklet "How to Build Your Own Mail Order Business" 50¢ postpaid. Promptly refunded if not satisfied. Robert K. Brown, Box 72, North Tonawanda, New York.

COMPLETE Instructions on obtaining your own copyright. Send \$2.00. Advance Press, Addison, Illinois.

PROFITABLE Mailorder merchandise business. Everything supplied. Lester, 2311 Foxhills, Los Angeles 64.

LEARN Mailorder selling. Pays big! Details: Elliott, 252 Gainsboro, Toronto 8, Canada.

CAMERA Owners! Earn \$50.00 weekends! Instructions \$1.00, information free! Kline, 935-PM North Austin, Chicago 51, Illinois.

MACHINELESS Home laminating sample kits \$1.00, free details. Jonmac, Box 87, Overland Branch, St. Louis 14, Mo.

YOU Now have the opportunity of choosing the business opportunity that you most desire. Send \$3.98 for book of 137 business plans, including supply sources, formulas, postal and business information. Or \$3.00 for book of 97 plans. Free consultation. Satisfaction guaranteed or money refunded. Lincoln House, 310 Harvard Street, Brookline 46, Mass.

WAXES Floors without wax. New invention. No more floor wax to buy. Sensational seller. Samples sent on trial. Kristee 113, Akron, Ohio.

SELL African wood carvings, busts, figures, heads, etc. Huge profits. Details free or \$1.00 with sample carving. Kempco, Box 4098, San Diego 4, California.

BUY At wholesale prices! Tremendous savings! Resell to friends, neighbors, everyone at big profits. Enormous selection of highly desirable, nationally advertised merchandise—Benrus, Dormeyer, Oster, Cummins, Brook Park, Richelieu, Remington, Ronson, Pepperell, Farberware. Electrical appliances, cookware, housewares, watches, jewelry, rings, dry goods, clothing, luggage, tools, sporting goods, toys, gifts, etc. Free 1958 color catalog showing 1001 in-demand items. Write today. Merit Home Products, Dept. PM-11, 107 Manhattan Avenue, Brooklyn 6, N. Y.

**FREE** Wholesale catalog hand tooled handbags, billfolds, shoes from Mexico. Walters Company, Box 195, Bellevue, Ohio.

**OPERATE** profitable mailorder business! Write Thomas Bond, 1637-H West Vernon, Phoenix, Arizona.

**FREE** Catalogue full line costume jewelry. New England P.M., 124 Empire, Providence, R. I.

**EARN** \$15.00 Hour as tax expert. I help you start. Whig Carter, 516 Carlisle Ave., Cincinnati 3, Ohio.

**1500 PEOPLE** in one state make money at home. Free information. Mail-Towne, 89 Murray St., New York 7, N. Y.

**CASH** Income collecting local information. No selling. Survey, library. Free details. Dorco, Box 494, Muncie, Ind.

**97 WAYS** To make a million. Start from scratch. Grow big. Others have. You might too. Get free details, fast. Woodward, 1221 Edgewood, Havertown 3-A, Penna.

**PRINT** Without a printing press! Amazing new method! Print colorful signs, banners, cards, posters, glassware; anything at home. Big profits. Moneymaking opportunity! We supply everything. Beautiful sample, home-business plan free! Write Screen-Print Company, NR, Los Angeles 61, California.

**START** Your own business on credit. Your own boss. 1527 dealers sold \$5,000 to \$32,000 in 1956. We supply stocks, equipment on credit. 200 home necessities. Sales experience unnecessary. Pleasant profitable business backed by world-wide industry. Write Rawleigh's, Dept. K-U-PPM, Freeport, Ill.

**GROW** A living miniature forest or orchard (only inches high), that bears tasty tiny fruit at home. Learn amazing dwarfing secrets! Sensational fascinating hobby, profitable home-business opportunity. Free details! Miniature Nurseries, Dept. NR, Gardena, California.

**HOME-Import** mail order business—Import profitable items below wholesale. Experience and product investment unnecessary. Full, spare time. Famous world trader guides you. Free list "157 Imports," details. Mellinger, G70B, Los Angeles 24.

**"HOW To Start a Business"** booklet sent free! If you know any trade, go into business for yourself! Learn the 9 easy steps to follow. We've guided 5,000 others to success. Revealing free booklet yours for the asking! Write! National Business Consultants, Office NR, Los Angeles 61, Calif.

**MAIL** Order advertising agency executive reveals sensational no-risk advertising and merchandise methods. Start in office or home; minimum capital; positive profits. Free details: Impact! 3407 Prospect Avenue, Dept. 11-11, Cleveland 15, Ohio.

**LET** Me sell your products nationally. I'll send you free information on how to establish sparetime-full time Casecraft business. You build! We sell! Everything supplied. Abarsi, 807-SC Sunset, Los Angeles 12, Calif.

**BIG** Multicolor wholesale catalog! Housewares, appliances, clothing, silverware, cookware, luggage, binoculars, radios, phonographs, cameras, recorders, projectors, typewriters, shavers, sporting goods, toys, tools, sewing machines, watches, jewelry. Name brands. Huge discounts. Postcard: Selbro, Decatur 262, Illinois.

**GET** Your vitamins free! Plus terrific profits! No investment. VitaMins, 4801PM Cedardale, Wichita 10, Kans.

**MAKE** Your fortune with postcards. Amazing home work opportunities. Brings in the dollars. Free details. Harvey Sales, 5711 Euclid, Cleveland 3, Ohio.

**GROW** Expensive herbs for us! Big profits home-business of your own. Year around profitability! We supply everything necessary! Send for free amazing facts and revealing plan. National Herb Exchange, Dept. NR, Gardena, Calif.

**MAKE** Extra money. Cash commissions. Everybody buys easy-to-sell advertising book matches. Union label. All sizes. Cuts for all businesses. Powerhouse selling kit free. Steady repeat business. No experience necessary. Superior Match Co., Dept. MX-1157, 7528 S. Greenwood, Chicago 19.

**BECOME** Tax consultant. Graduates earn to \$3,000 every tax season preparing returns evenings. State approved. Union Institute, Hoboken 2E, N. J.

**LEARN** The termite business. Free information. Hamlin Institute, Hamlin, W. Va.

**MAILORDER.** Free book. Shragor Advertising, 2 W. 46, New York City 36.

**ULTRA-Modern** sofa. Buy it for \$250 or make it for about \$30 including 4 inch foam cushion. Benko, 400 E. 66th St., New York 21, N. Y.

**OPERATE** Restaurant or diner. Free booklet reveals plan. Write Restaurant Arts, 111-BU, Fremont, Ohio.

**COLORGLAZED** Concrete pottery made without molds. Patented method. Cemetery products, novelties, tiles. Basement leak-sealing. Money-making projects. Booklet, details free. Men only. National Potteries Company, Grand Rapids, Minnesota.

**ABUNDAVITA** Means better living, bigger bank balances! Campo, 391(A) Grand, Long Beach 14, California.

**SELL** Merlin electronic garage door operators. Make from \$50 to \$75 on every sale. Operate from your home. M. J. Fitzgerald Co., 2815 West Vliet Street, Milwaukee 8, Wisconsin.

**LEARN** Sewing machine repairing. To \$125.00 weekly. Sparetime. Supplies. Add to present business. Write today! Taylor Service, Box 2128, San Bernardino, Calif.

**PROFITABLE** Home mailorder business. Easily started. Master's, 5145 Norwood, Arlington, California.

**CASH** From sawdust, seventy methods. Tin-cans, thirty methods. Newspapers, eighteen methods. Instructions 50¢ each. All three \$1.00. Charles Company, 12-XAP, Norwood, Ohio.

**YOU** Can make money at home in spare time taking magazine renewal subscriptions. No capital or experience necessary. All supplies furnished. Write today! McGregor Magazine Agency, Dept. 110, Mount Morris, Illinois.

**PLASTERCRAFT** Molds and supplies. Follet Studios, Box 362, Moorhead, Minn.

**"50 NEW Home-Business Ideas"** booklet, sample free. Spray exotic velvet-suede on anything. Plockcraft-NR, Los Angeles 61.

**START** Your own typewriter repair business, first job pays for repair course. New England Training Service, Carmel 2, Maine.

**INVISIBLE** Reweaving: \$5 in one hour possible reweaving burns, tears, moth-holes. Spare-full time. Free details. Skill-Weave, Dept. C-1611, 335 W. Madison, Chicago 6.

**RICH** Man's secret! The amazing method that makes all fortunes. Never fails! Literature free. Industries, 1430-M Monroe, Chicago 7, Ill.

**VALUABLE** Distributorship throughout United States. With exceptional high rate of earnings. A business established over 20 years with 200,000 users. Investment \$3,500-\$12,500. Box 1457, 1501 Broadway, New York.

**FREE** Folder. 138 money making plans. Book illustrated. \$100.00 weekly reported. Dover, Chase Ave., Lexington 73, Mass.

**PIANO** Tuning learned quickly at home. Tremendous field! Musical knowledge unnecessary. Information free. Empire School of Piano Tuning, Champaign, Ill. (Founded 1935).

**WANTED:** Home producers, to be subcontractors. Cast plastic products for manufacturers in our clearing house service. Thousands of easily made items required. Cash in at home, without previous experience. Plastic Service Associates, Dept. 11-PM, East Boston 28, Massachusetts.

**MUSHROOMS** Quicker, easier, cheaper. Newest facts free. Luxur, 641 South 19th, Newark 3, N. J.

**START** Your own self-service tube checker route full-part time. Call HI-8660. Write Test 'Ur Own, Box 163, Sta. F, Milwaukee 9, Wis.

**WINDOW** Trimming, display work, \$100 weekly possible spare time. Free details. JEM Trimit, Box 144, Cranford, N. J.

**THEY** Hand him \$100! Free packet Secret Journal. 919 secrets-plans! Work home. Publicac, Oceanside, Calif.

**WANTED** — Limited number intelligent men and women to work at home on exclusive mail order business proposition. No selling, we furnish everything including literature, names, addresses, stock and ship items for you. Free details. Mail Order Distributors (Franchise Division), Los Angeles 61.

**HOW** To grow orchids at home. Profitable, fascinating. Successful home grower shows you how he does it. Free, full details. Orchidland, 100 S. Vermont, Los Angeles 4.

**SIMPLIFIED** Sign system. Letters included make \$25.00 signs. Others get orders, complete them, your directions. Complete \$1.00. Box PM523, Amityville, N. Y.

**YOUR** Photo on stamps. No investment, no stock. Big profits. Free samples. Miniature Photostamps, Box 44-K, New York 67.

**TURN** Rags into riches! Sparetime money-making projects \$1.00. Metro, Box 151H, Oak Park, Illinois.

**\$300 MONTHLY** First year. Growing fishworms sparetime. Free instructions. Golden Farms, Route 1, Lubbock 1, Texas.

**POPCORN** And potato chip equipment. Eakins, Box 933 A7, Springfield, Ohio.

**MONEY** In scrap dealing. Amazing booklet \$1.00. Geo. Turcotte, C. P. 142, St. Sauveur, Quebec, Canada.

**BUILD** Fascinating hobby-business engraving plastics! Make colorful titleplates, bas-reliefs, pendants. Profits to \$5 hour! Sample, details 25¢. Desco Distr's., 5262-R Van Nuys, Van Nuys, California.

**FREE** Franchise profit letter describes nationwide opportunities. Exclusive distributorships, dealerships, agency operations. Write today. National Franchise Reports, PM-528, 333 North Michigan, Chicago 1.

**BE** A landscape contractor. Make \$20 to \$60 a day. Start with smaller projects and work into larger jobs. We show you how. Easy-to-follow home study course. Write for free book. National Landscape Institute, Dept. M-117-C, 11826 San Vicente Blvd., Los Angeles 49, Calif.

**EXCLUSIVE!** 10,000 1957 Gift buyers' names on gummed labels, \$15 per 1000. First time offered. Sara-Kay Imports, Tallahassee, Florida.

**BUY** Wholesale! Thousands nationally advertised products at big discounts. Free wholesale plan. United Wholesalers, 1265-P Broadway, New York City.

**FREE** Lesson. Repair your TV set, or friends. Amazing new Isotronic system trains you to handle any TV service job in one short week! Start your own business. Save up to \$300 on schooling. Write: Electronic Engineering, Dept. AC-17B, 1038 S. LaBrea, Los Angeles 19, Calif.

**LEARN** Flower arrangement and floristry. Start your own business, part or full time. Many good paying positions open. Earn while learning. Send for free book. National Landscape Institute, Studio M-117-C, 11826 San Vicente Blvd., Los Angeles 49, Calif.

**BUY** Direct from factories—Appliances, cameras, watches! Free details! Cam Company, 6810PM-20th Ave., Brooklyn 4, N.Y.

**MIMEOGRAPHING** Services pay sensational local profits. Exciting secret plans exposed! Write: Mabelle Mimeo Shop, Bonham 7, Texas.

**TAKE-OUT** foods. Your own business using successful proven methods. Complete details \$1. Alamo Take-Out Foods, Inc., 1832 Tyler, Hollywood, Florida.

**SELL** Books by mail. Details free. Berryman, 153 Victoria, Northlake, Ill.

**PROFITABLE** Mail order business. Operated from home. Earn extra money pleasantly. Free exciting literature. Write Harvey Sales, 5713A Euclid, Cleveland 3, Ohio.

**SELL** Books by mail. 400% profit. Royal, Box 368-X, Cleveland 27, Ohio.

**REBUILD** Batteries; repair dolls; make rubber stamps. "75 Ideas" free. Universal, Box 1076-A, Peoria, Ill.

**STATUARY** Molds! Super quality liquid rubber. Ajax Products, 734 East 236th Street, Cleveland 23, Ohio.

**LEARN** Real estate thoroughly and enjoyably in your easy chair by listening to records. Excellent profitable profession, full or part-time. Many successful graduates. Lee Institute, Brookline 46, Mass.

**MANUFACTURE** Perfumes, cosmetics, cleaners, polishes. Work home. Catalogue free. International, 6347 Parnell, PM107, Chicago 21, Illinois.

**UNIQUELY** Different postcard projects bring avalanche of mail order cash. Powerful advertising copy furnished. Revealing information free. Craft-Horizon, 2694 So. 10th, Fresno 25, Calif.



**SELL** By mail. Tested methods. Alfano, 19 Pine Street, Closter, New Jersey.

**\$34.70 TWO Hours.** Manufacturing. No selling. Carlayne Castings, 1803 Fremont, Rapid City, South Dakota.

**IMPORT-Export!** Mailorder opportunities. Details, Warner, Box 6, Fort Scott, Kansas.

**FOUR** Color mail order catalogs—Fifty fast-selling items. Orders filled for you. Big profits. Sample, details free. Associated, Box 53-A, Boston 22, Massachusetts.

**"EVERYBODY** Likes candy"—Make professionally home. (Our 47th Year.) Ragsdale Candies, B107, East Orange, New Jersey.

**BRUSH** Plating outfits for plating articles in the home and shop. No tanks necessary, silvering mirrors, spare or full time. Free particulars. Gunmetal Co., Ave. H, Decatur, Illinois.

**BUY Wholesale!** Over 10,000 nationally advertised products. Appliances, cameras, sporting goods, housewares, watches, typewriters, tools, clothing, etc. Send postcard today. Buy-Rite, Box 258, Hawthorne 1, New Jersey.

**MAILORDER.** Learn to sell by mail. Complete course. Low cost. Ransie, Box 1719-A, Richmond 14, Virginia.

**OPERATE** Easy-to-start, profitable home mailorder business! B. Mann, Woodcliff Lake, N. J.

**EARN** To \$100.00 per hour snow-flocking Xmas trees, centerpieces, etc. Flocking, 7061 Belmont Avenue, Chicago 34, Illinois.

**\$60.00 WEEKLY** Sparetime. Start home Venetian blind laundry. Protected territory. Interesting information free. Burt, 2434EP, Wichita 13, Kansas.

**WANT** To make big money at home? \$10.00 profit in an hour possible with invisible mending. Make tears, holes, disappear from clothing, fabrics. Steady year-round demand from cleaners, laundries, homes. Details free. Fabricon, 6234 Broadway, Chicago 40, Illinois.

**WHOLESALE**—Thousands nationally advertised products. Buy, sell. Amazing profits. New, free plan. Associated Wholesalers, 1016-D Starr, Burlington, Iowa.

**OPERATE** Mailorder folio business! Free details. Ballard's, 425 East Catherine, Louisville 3, Ky.

**MAKE** Flexible molds. Cast plaques, figurines. Free sample. Tooker, 1045-R Fairview, Hamilton, Ohio.

**NATURAL** Molding rubber, extra thick. Free sample. W. Wooley, 1016-A Donald, Peoria, Illinois.

**BIG** Money raising fishworms and crickets. Free literature. Carter Farms, Plains, Georgia.

**START** Home business making statuary, plaques, novelties, garden furniture, artificial marble flooring, liquid marble. Make your own flexible molds. Amazing profits. Only \$1.98. Free literature. Popular Mechanics Press, 631 No. St. Clair St., Chicago 11.

**WANT** More business? Here's an amazing opportunity to increase your sales. Talk to thousands of interested readers of "Mechanica Popular." Our Spanish Edition covers the Latin American countries like a blanket. They're real mailorder buyers. Classified rate 75¢ per word. Try an ad in our next issue. Classified Advertising Department, Popular Mechanics Magazine, 200 East Ontario Street, Chicago 11, Ill.

**VENDING** Machines—No selling. Operate a route of coin machines and earn amazing profits. 32-page catalog free. Parkway Machine Corporation, Dept. 26, 715 Ensor Street, Baltimore 2, Maryland.

**MONEY** In saw and lawnmower sharpening sparetime at home. Free book. Virgil Foley Company, Columbia Heights, Minnesota.

**\$70 WEEKLY**—Home, spare time. Simplified mail bookkeeping. Immediate income—easy! Auditax, 34757A, Los Angeles 34.

**TO \$100.00 Weekly.** Sparetime, home operated mailorder business. Successful beginner's plan. Everything supplied. Lynn, 10420-M National, Los Angeles 34.

**BREED** Rare tropical fish at home. Earn big money! Learn secrets! Help fill huge demand. Amazing opportunity! Free plan. Tropical Fish Breeders, Los Angeles 61, Calif.

**MINK** Raising information free. Complete. Lake Superior Mink Farm, Superior, Eel, Wisconsin.

**BE** Appointed state notary public now. Write, Stationers, Boerne, Texas.

**I** Want to send you proof of the wonderful pulling power of Popular Mechanics classified pages. What's your proposition? Write me today. Include literature if possible. F. W. Johnson, Manager Classified Advertising, Popular Mechanics Magazine, 200 E. Ontario St., Chicago 11, Ill.

**COPUBLISH** Mail Sale Advertiser, leading mail order paper. Details, latest copy, dime. Vanroy Shirk, Lebanon, Penna.

**LEARN** Photo-negative portrait retouching. Men, women. \$3 hour possible spare or full time at home. Easy, glamorous. Work for photographers by mail order. Full details sent free. Duval, 100 So. Vermont, Los Angeles 4.

**YOUR** Own name brand business. No investment; no inventory. Part time or full time. Sell famous brands of appliances, housewares, silverware, radios, vacuum cleaners, lamps, tools, clocks, watches, jewelry, etc., etc., over 1000 items. Join thousands of successful independent dealers. Send for free catalog and dealer price list. H. B. Davis Corp., Dept. 11, 145 W. 15 St., New York City.

**11,000 NEW** Prospects daily. Baby record books, shoes, albums. Sell mailorder. Use our literature. Write: No-Co-Ro, Capitola, California.

**WE** Love our mailman—He leaves over \$1000.00 monthly in our rural mailbox. My college professor husband drafted a scientific home mailorder method. We bought a Texas ranch, live as we always wanted. Now we sell the Ranch Mailorder Method. Operates anywhere. Inquire: Eveningshade Ranch, Boerne, Texas.

**BAKE** New greaseless doughnuts in kitchen. Sell stores. Free recipes. M. Ray, 3605 South 15th, Minneapolis 7, Minnesota.

**FIX** Typewriters. Inexpensive home course teaches factory secrets. Free booklet. Athey, Tarentum, Penna.

**MONEY** For you! Big profits! Cast plaster figurines, bookends, plaques at home with XL rubber molds. No experience needed! Write for illustrated, 40-page catalog, only 25¢! Plastic Arts Studios, 3403 So. Madison Street, Department 5, Muncie, Indiana.

**PLATE** Baby shoes, jewelry, gifts, bronze and colored pearl. Free booklet. Platex, 11029 South Vermont, Los Angeles 44.

**FREE** Catalog. Contains hundreds of businesses, farms and income properties throughout U.S., Canada. Specify type and location desired. Deal direct with owners. U. I. Buyers Digest, 1608 Hillhurst, Dept. PM-3, Los Angeles 27, Calif.

**LIQUID** Rubber. Make flexible molds. Free sample. Chaney, 1907-A East Road, Jacksonville 11, Florida.

**START** Home mimeographing business. Pays amazing profits. Literature free. Housel, Lanoka Harbor, N. J.

**BOOKKEEPERS,** Accountants. Operate a bookkeeping service. Part or full time. Amazing simplified system. Wonderful money-making opportunities. Complete information free. National Bookkeeping Publishing Co., Suite 307, 3435 Broadway, Kansas City 11, Mo.

**WE** Pay \$3.50 lb. dried. Grow mushrooms. Cellar, shed and outdoors. Spare, full time, year round. We have 25,000 customers. Free book. Washington Mushroom Ind., Dept. 172, 2954 Admiral Way, Seattle, Wash.

**\$250 WEEK** Cleaning venetian blinds. Patented machinery. Free literature. Robinson, 7213B, Indianapolis 1, Indiana.

**MAKE** \$6.00 To \$10.00 per hour sharpening saws and lawnmowers. Get America's finest equipment as used by thousands of successful shops throughout the United States and Canada. Free literature. No obligation. Max Mfg. Co., 138 Stockton Ave., San Jose 26, Calif.

**ADVERTISING** Executive now reveals tested, authentic mail order instructions offering amazing profit opportunities at home. Write Holiday Publications, 2301 Greyson Road, Duluth, Minnesota.

**FREE** Book "505 Odd, Successful Businesses." Work home. Pacific, Oceanside, Calif.

**INTERNATIONAL** Mailorder business. Complete setup service—Not just instructions. Hermes, 152 West 42, New York City 38.

**PLASTERCRAFT** Molds, liquid rubber, plasters, flocks, candle supplies. Catalog and manual free. Blue Rapids Supply, Blue Rapids, Kansas.

**"MAILORDER** Laws and Regulations," \$1.00. Explains necessary licenses, different taxes, legal requirements, etc. "Mail-order Rules for Beginners," \$1.00 additional. Tasker, 1603 Peach Street, Alexandria, Virginia.

**FREE** Folio "\$5,000-\$45,000. Unlimited Vacations." No merchandise. Unknown! Work home, sparetime! Haylings, Carlsbad, Calif.

**MARY-Mac** agency—motorized vibrator. Cushions, chairs, tables, belts. Mary-Mac Factory, 1012 Powhattan, Dallas, Texas.

**FREE** Folder, "How to Make \$3,000 Yearly, Sparetime, Backyard, Raising Earthworms!" Oakhaven 38, Cedar Hill, Texas.

**UNUSUAL** Opportunity. Free literature. Quill Industries, 2607 South Hamilton, Chicago 9, Illinois.

**CASH** Paid for boxtops! Some, 25¢! Inquire: Boxtops-AK, Cedar Hill, Texas.

**MAKE** \$46 From square foot plywood; jig saw necessary. Free details. Woodart, Bridgewater, Mass.

**\$5,000 YEARLY.** Spare time at home. Nothing to buy. No local selling. Dignified. Guaranteed Home Harvest, Rt. 3, Box 3491-A, Albuquerque, New Mexico.

### MONEYMAKING OPPORTUNITIES

**START** Fire extinguisher service. Big paying home business. Mix chemicals yourself. Free details. Longworth, 6018 Stringer, Fruitport, Mich.

**WEAVERS.** Write for low prices carpet warp, rug filler, looms, parts, inexpensive beam counter. If you have loom, give make, weaving width please. Or. Rug Company, Dept. N715, Lima, Ohio.

**EARN** Sparetime money by mail. Details free. Elvet Bloomfield, Box 24, Station A, St. Joseph, Mo.

**SELL** Perfumes. Easy profits. Free details. Cloche Perfumes, Arden, N. C.

**MAILORDER!** Succeed with profitable, proven methods. B. Mann, Woodcliff Lake, New Jersey.

**FANTASTIC** Profits! Powdered shampoo, 25¢. Adams Soap Mfg., Schodack Landing, New York.

**\$1200.00 MONTHLY** Proved! Rid homes, farms, businesses of termites, rodents, pests. New shortcut methods! Learn everything two weeks! Free success plan. A.P.C.O.A., Dept. 1C, 429 South Western, Los Angeles 5, California.

**CIGARETTES**—Improved roller makes 20 for 9¢. Facts free. Moberly, Box 821, Owensboro, Kentucky.

**YOUR** Secret gold mine. Fabulous profits. Free details. Locate relics, artifacts, antiques. P. Putnam, 466 Hull Avenue, Jerome, Arizona.

**MAKE** Money mailing sample business cards. Vosacek Printing, 4444 Ute, San Diego 17, Calif.

**WIN** Contest money. General Contest Bulletin gives hundreds of tips. Lists current contests, rules. Sample magazine 25¢. General Contests, 1609 1/2 East 5th, Duluth, Minnesota.

**WHOLESALE!** Genuine diamonds and jewelry. Distributors, Box 106D, Hudson, New York.

**HOME** Business Digest guarantees results. Sample, rates 25¢. Harold Hamm, Route 5, Fenwick, Ontario, Canada.

**MAKE** Money growing miniature trees. Free seed. Instructions. \$1.00. Allen, 6414 Seaview, Seattle 7, Washington.

**"INSIDE** Story of Mail Order." New book. Information free. Young, Box 655P, Waterloo, Iowa.

**\$15,000 PROFIT** In one year possible, on \$5.00 cash and just 3 hours attention weekly! Experience unnecessary! Fabulous but true! Proof, complete detailed plan, only \$1.00. Satisfaction or refund! Columbia Enterprises, 8203-P, Grubb Road, Silver Spring, Maryland.

**TYPISTS!** Make money at home! Mailers, 2 Madison, Greencastle, Indiana.

**HOTTEST** Mail order plan ever! Sell photos, films, art novelties. Huge proven profits! Free details! A.M.P.R.O., Dept. 1C, 429 South Western, Los Angeles 5, California.

"HOME Business Digest" has money-making opportunities galore. Sample 25c. Donovan, 79-PM Greenbelt, Levittown, New York.

ATTENTION Typewriter owners. Make handsome profits. Write today. Groves Company, 482, Hastings 8, Nebraska.

DO IT YOURSELF. What? Repair TV, build furniture, make barbecue, plumbing repairs, build boats, do house wiring, remodel home, lay tile, modernize kitchen, repair home, and scores of other things you can do yourself. Books covering each subject, only 25c. Send for descriptive list. It's free. Popular Mechanics Press, 200-LB East Ontario St., Chicago 11, Ill.

BUY Wholesale! 30-80% discounts! Appliances, gifts, typewriters, tools, watches, sporting goods, jewelry, cameras, housewares, etc. Consolidated Distributors, Clifton 28, New Jersey.

FREE Folio "\$5,000-\$45,000, Unlimited Vacations." No merchandise. Unknown! Work home, sparetime! Haylings, Carlsbad, Calif.

READ Progressive Mailtrade, the magazine that tells how to make money by mail. Dime brings sample and special offer. Progressive Mailtrade, Box 357, Sheboygan, Wisconsin.

BIG Money raising, fishworms and crickets. Free literature. Carter Hatchery, Plains, Georgia.

EARN Money evenings copying and duplicating comic cartoons for advertisers. Adservice, Argyle 1, Wisconsin.

SELL Titania gems. Far more brilliant than diamonds. Catalog 10¢. Diamondite, 2420-M 77th, Oakland 5, California.

VENDING Machines—No selling. Operate a route of coin machines and earn amazing profits. 32-page catalog free. Parkway Machine Corporation, Dept. 27, 715 Ensor Street, Baltimore 2, Maryland.

FREE Book "505 Odd, Successful Businesses." Work home. Pacific, Oceanside, Calif.

DOLLARS Every day! It's magical—You keep all the dollars. Setup free. Otto Miller, Box 588-W, Oshkosh, Wis.

JOIN The prosperity parade with a mail order bookshop in your own home. Valuable information free. Practical Publications, 3974-F Milwaukee, Chicago 41, Ill.

\$60.00 WEEKLY Sparetime. Start home Venetian blind laundry. Protected territory. Interesting information free. Burt, 2434ER, Wichita 13, Kansas.

WE Pay \$3.50 lb. dried. Grow mushrooms. Cellar, shed and outdoors. Spare, full time, year round. We have 25,000 customers. Free book. Washington Mushroom Ind., Dept. 173, 2954 Admiral Way, Seattle, Wash.

\$100.00 WEEKLY Spare time with a tape recorder! Fabulous new business. Entire country wide open! Record weddings, parties, sports events, stereophonic sound, sound-on-sound multiple recordings. Make radio commercials, sound effects. Have fun and make big money in the glamorous business of tape recording. Money-making facts free! Dixieland Publishers, Asheboro 2, N. C.

\$100.00 WEEKLY Spare room. Raise redworms soilless way. Odorless. Charlie Morgan, Box 116E, Bushnell, Florida.

IN 1952 I had no job and little money. Today I am retired, own a home, car, and bank account. Anyone can do this regardless of age or education. Free information write Norris Cole, 217 49th Street West, Bradenton, Florida.

BUY Wholesale! Save 65-2/3%! 100,000 name brand appliances, housewares, clothing, furniture, tools, sporting goods—Everything! Free catalogs! National Buyers Service, Box 3338EB, San Francisco, Calif.

SELL Hawaiian perfume. Receive beautiful Hawaiian gifts free. Write for circulars. Walter Eko, 207 Kilaua Ave., Hilo, Hawaii.

MEN And women wanted to start home business in spare time with little table-top rubber stamp machine. Easy to earn up to \$9.80 an hour without previous experience. Full particulars free by mail. Send postcard to Roberts, 1512 Jarvis, Room CR-2-L, Chicago 26, Ill.

MUSHROOMS Quicker, easier, cheaper. Newest facts free. Luxur, 641 South 19th, Newark 3, N. J.

AGED Homemaker nets \$100 weekly! Free packet Secret Journal. 919 secretspans! Work home. Publicas, Oceanside, Calif.

EARN \$50.00 Daily making mats, shoes and mud guards from old tires. S and S Patents Inc., 1307 North Clark St., Chicago 10, Ill.

PUPPET Potholders sell like wildfire at \$1.00! Amuses children, delights housewives! Other novelties. Free details. Edmunds, 9403 Belair Rd., Baltimore 6, Md.

MEN-Women! Start money-making plastic laminating business at home in spare time. Material that costs 11¢ brings back \$2.58. No canvassing or selling but mail orders bring in \$20 a day. Write for full particulars free. Rush name on postcard to Warner, Room CL2-L, 1512 Jarvis, Chicago 26, Ill.

SELL Books by mail. Directory tells wholesale sources. Send \$1.00. Clemons, Box 187-B, Sunnyvale, California.

EARN Sparetime dollars. Work home. Industries, 526M S. Western, Chicago 12.

TYPIST. Mailing list business of your own. Lifetime service; complete instructions, \$1.00. Van's, Box 143, APS, Hot Springs, Arkansas.

FREE Catalog, money making opportunities. Thomas, Box 909-P, Providence 1, R. I.

START Big-pay business at home in spare time. No experience needed to operate little table-top machine for bronzing baby shoes. Make \$5.48 profit on every pair. Full particulars free. Send postcard to Mason, 1512 Jarvis, Room CM-2-L, Chicago 26, Ill.

MAKE Money writing short paragraphs! No tedious study. I tell you what to write, where and how to sell; and supply list of editors buying from beginners. Many small checks add up quickly. Write to sell, right away. Send for free facts. Benson Barrett, Dept. C-27-K, 7484 Clark, Chicago 26.

CASH In on contests now! Get facts that help. Write Sanders & Co., 1762 Euclid, Lincoln, Nebr.

BIG Offer and opportunity mail 10¢. Palm, Box 1221, Baton Rouge, La.

TEN Proven ways to make money in your spare time. Send \$1 to: Homework, 4505 Harriet Ave. So., Minneapolis 9, Minn.

PREPARE Income tax returns at home spare time. \$5.00-\$10.00 per hour. Simplified instructions. It's a honey. Particulars free. Reynard, Box 1265-E, Peoria, Ill.

MAKE Money at home, \$2,000-\$5,000 unlimited. Details free. Fox, 12022 Pine, Norwalk, Calif.

EARN Up to \$10 per hour working at home. My plan can help you become financially independent regardless of age, sex or physical handicaps. Ideal for pensioners, housewives, students, etc. You receive detailed, copyrighted instructions explaining a method I've used successfully for several years. Similar plan used by Readers Digest, N. Y. Times, Washington Post, Wall Street Journal, Los Angeles Times and others. Send \$2. Nothing else to buy. No additional charges. Brennan Associates, 1147 National Press Bldg., Washington 1, D. C.

AMAZING Successes through franchises! Become exclusive franchise holder your territory. Information rushed. National Franchise Reports, PM-528, 333 North Michigan, Chicago 1.

EXTRA Income opportunity, mail 10¢. Dahle, Box 7-PM2, Omaha 10, Nebraska.

MAKE Big easy profits making costume jewelry at home in spare time! Quick, easy to make; easier to sell! Details free! Don-Bar, 3511 W. Armitage, Dept. L-192, Chicago 47, Ill.

AMAZING But true. Slings cannot be made by machine, must be made by hand. Good profit. Cyrus, Post Office Box 8423, South Charleston, W. Va.

#### FORMULAS, PLANS, ETC.

BUILD, Gas heater. J. Meek, Jr., RFD 3, Union City, Tennessee.

FREE, Large formula catalog. Analysis reasonable. Western Chemical, Salem, Oregon.

FORMULAS For latest money-making discoveries. New! Good! Valuable literature free! Miller, Chemist, 1517-D, Tampa, Florida.

SILICONE. The best waterproofing wood, cement, leather, paper. Information. Sonic Chemicals, 181, Rushsylvania, Ohio.

FORMULAS: All kinds, latest, best. Literature free. Kemikal, Park Ridge, Ill.

PRACTICAL Formulas. Lists free. Cummings, Chemist, Gordon Ave., Syracuse 4, N. Y.

LATE, Modern manufacturing formulas. List free. Moon Chemical, Martville, New York.

COSMETICS. Perfumes, latest manufacturing formulas. Folder free. Fiedler, Box 21, Jamaica Plain 30, Mass.

#### PLASTICS

LEARN Plastics fabrication for spare time income. Low cost home training now available. Write for free booklet. Interstate Training Service, Dept. D-3, Portland 13, Ore.

LAMINATING Supplies. Free price list. Solomon, 46 Cornhill, Boston 8, Mass.

BOXES, Plastic. Free list. Author, 170 Bay 23 Street, Brooklyn, N.Y.

PLEXIGLAS. Acetate, vinylite, polyester, fiberglass, epoxy, styrofoam, mold materials. 23 page instructive, informative wholesale-retail catalog. 25¢. Gem-O-Lite, 5527 Cahuenga Blvd., North Hollywood, California.

NEW Liquid casting plastic, clear, colors. Embed real flowers, coins, photos. New manual shows fine things you can make at home and sell at big profit. Send 25¢. Castolite, Dept. M-101, Woodstock, Illinois.

NO Investment! We furnish equipment and supplies for plastic sealing business. Percentage basis, limited offer. Write today. Sipco, 2433 Fletcher Drive, Los Angeles 39, Calif.

#### CHEMISTRY

CHEMICALS. Highest quality. In small quantities; chemistry sets, apparatus and laboratory supplies. 25th year, Catalog 25¢. John H. Winn Co., Inc., 124M West 23 Street, New York 11, N. Y.

CHEMICALS, Supplies catalog, 25¢. Laboratory Sales, Box 161-A, Brighton, Mass.

CHEMICALS And apparatus for industrial, analytical, and private laboratories. Catalog 25¢ Dept. M-50, Biological Supply Co., 1176 Mt. Hope Ave., Rochester 20, N. Y.

ILLUSTRATED Catalog: Chemistry, mineralogy, biology 30¢. Tracey Laboratories, Evanston, Illinois.

SPECTROSCOPE For quick analysis \$3.00. Kutting, 26278 Arastradero, Los Altos, Calif.

CHEMISTRY-Science magazines. Literature free. Lankton, Box 5126-C5, Lansing 6, Michigan.

CHEMISTRY-Mathematics-science booklets! Free literature. Franks, 3121 South Racine, Chicago 3.

EXPERIMENTERS: Bargains catalog, 25¢ (refundable). Hagenow Laboratories, 2414 Clark, Manitowoc, Wisconsin.

AMAZING New book of science. Experiments, formulas, and catalogue of laboratory supplies. Only 25¢. National Scientific Co., Dept. PM-11, 500 West Road, Lombard, Illinois.

#### HELP WANTED

COPYRIGHTED Reports on best paying jobs with travel, adventure, promotions. Construction, aviation, shipping, laborers, clerical, trades, supervisory, factory, unusual opportunities. Many types of work. Skilled and unskilled. Foreign and state-side openings for men and women. Only \$2.00 (\$2.25 airmail), including registration-advisory service. Satisfaction guaranteed. Included absolutely free: Special reports on Alaska, Spanish airbase construction, South American opportunities and husband-wife foreign jobs. Research Services, Suite 514-PMW Meramec Building, St. Louis 5, Missouri.

FREE Information: Earn high pay. All trades. Foreign and U.S.A. job opportunities. Travel paid. Applications, write Dept. 613, National Employment Information, 1020 Broad, Newark, N. J.

WANT Work in Washington? Particulars free. Henderson, 170 Temple Village, Alexandria, Virginia.

**FOREIGN, Alaskan, U.S.A., jobs!** To \$1500.00 monthly! Million Americans employed overseas. Copyrighted reports. Who to contact for highest paying jobs. Laborers, trades, truck drivers, office, engineers, many others. 52 countries—St. Lawrence project, Spain, Latin America, Northern project, Europe. Year registration-advisory service. Application forms. Unconditional money-back guarantee! \$2.00 (airmailed \$2.25). C.O.D.'s accepted. International Reporter, St. Louis 1-PB, Missouri.

**AMERICAN, Overseas jobs, high pay, men, women, transportation paid.** Free information. Transworld, 200T West 34 Street, New York City 1.

**SMALL Southwest college with excellent research facilities is seeking the services of experienced instruments makers.** Beginning salary range \$5000 to \$6000 per annum depending upon qualifications. Excellent climate for health seekers, outdoor recreation, including hunting, fishing, swimming, and golf. Direct letter of application to Arthur P. Stanton, Personnel Manager, Campus Station, Socorro, New Mexico, describing qualifications and salary requirements. Include recent photograph.

#### AGENTS WANTED

**JUST Show our beautiful chenille bedspreads, they sell themselves.** Walker, Flat Lick, Ky.

**ICE Grip makes rubber tires and foot wear stick to icy roads for safe driving and walking.** Big profits. Sample winter's supply 10 tablets \$1.00 prepaid. Ice Grip, Box 1073, Spokane 10, Washington.

**\$1,000.00 A Month for making dramatic 3-second demonstration of amazing lightweight Presto fire extinguisher.** New chemical used by Airforce snuffs out fires instantly. Only \$4.95. Terrific commissions. Millions want it. Free kit. Merlite, 114 E. 32nd, Dept. P-62C, New York City 18.

**SEEKING New product? Get my outfit 47 money-making specialties.** Latest conveniences for home, car. Send no money. Just your name. Kristee 72, Akron, Ohio.

**60% PROFIT On cosmetics—Famous nationally advertised Hollywood cosmetics pay 60%.** Make \$25 day up. Hire others. For free samples, details, write Studio Girl, Glendale, Calif. Dept. 12711G.

**FREE Sample! Beautiful feather pictures.** Siviak, Apartado 9038, Mexico 1, D. F.

**MAKE Money selling outstanding line of regular ties, square ends, reversibles, leather, plaited, bows, knitted, kerchief sets, mufflers.** Free catalog. Philip's Neckwear, 20 West 22nd, Dept. 415, New York City 10.

**MEN, Women, make money spare time plus new car as bonus for encouragement.** Amazing hosiery guaranteed to wear without holes, snags and runs, or replaced free. For example, lovely 60 gauge nylons guaranteed for as long as 1 1/2 years, or replaced free. Write Wilkit, 17711 Washington, Greenfield, Ohio.

**BEAUTIFUL Feather pictures! Free details, sample 20¢ stamps.** Apartado 1668, Mexico 1, D. F.

**FREE Sample. Money making formulas.** Kolamite, Box 572, Dayton 1, Ohio.

**300% PROFIT. Amazing Jiffy fire extinguisher.** Free sample offer. Write quick. S. & S. Manufacturers, 2516 Noriega, San Francisco 22.

**POCKET Calculator \$2.95, refundable, half profit.** Belapoi, 949 Broadway, New York City.

**YOU Can make money at home in spare time taking magazine renewal subscriptions.** No capital or experience necessary. All supplies furnished. Write today! McGregor Magazine Agency, Dept. 100, Mount Morris, Illinois.

**LARGE Profits. New bathroom system removes odors direct from toilet.** Write Stephens Industries, 1389 Major Street, Salt Lake City 10, Utah.

**BIG Profits selling baby book promotion to drug stores.** Tremendous repeat business. Stutson Enterprises, 14 Patterson Rd., Dayton 9, Ohio.

**GADGET, Gag funmaker wholesale catalog free.** Samples 25¢. EN, Dohn-Marks, Broadview, Ill.

**SELL Famous #3 fire extinguisher.** Past sales, liberal profits. Write Fire-Killer, Box 182, Hazleton, Penna.

**GREATEST Specialty deal of today.** Nothing like it on market. Low priced. Practically sells itself. Free details. International Associates, Hyde Park National Bank Bldg., Chicago 15.

**BUY 800,000 Articles direct from manufacturers the world over at lowest prices.** Make up to 1000% profit! Free literature. Glass, Ellwood City 14, Penna.

**WHOLESALE Catalog! Clothing, linens, housewares.** Write Bostonian, 14 Dock Sq., Boston 8, Mass.

**AGENTS—300% Profit selling genuine gold window letters; stores and offices.** Free samples. Metallic Sign Letter Co., 1217-D West Newport, Chicago.

**YOUR Ad in this space will get some good agents for you.** Yes, I'll prove it. Write for Folder "A" right now. F. W. Johnson, Classified Advertising Manager, Popular Mechanics Magazine, 200 E. Ontario St., Chicago 11, Ill.

**GOLD Or silver letters, numbers.** Windows, doors, trucks, 1" to 6". 500% profits. Free samples. Atlas-T, 544 West 79th, Chicago 20.

**PRINTING, Advertising salesmen—Excellent moneymaking sideline selling decalcomania name plates, small quantities.** Automobile initials, sign letters. Free samples. Balco, XL, Boston 19, Mass.

**YOUR Own business—Used suits \$1.50, overcoats 65¢, mackinaws 35¢, shoes 12 1/2¢, ladies coats 30¢, dresses 15¢.** Enormous profits. Catalog free. Nathan Portnoy Associates, 605-AA West 12th Place, Chicago 7.

**TREMENDOUS Profits! Every man, woman and child a customer.** Used suits \$1.50, pants 35¢, dresses 20¢, shoes 20¢. Operate from store, home, car. Free catalog. Superior, 1250-A Jefferson, Chicago 7.

**CHRISTMAS Music cards.** Dorby Music Cards, Box 354, Morristown, New Jersey.

**REAL Diamond rings.** Nationally advertised. Sell direct. Make big middleman's profit. No investment. Experience unnecessary. Free catalog, details. Gleam-light, 107B North Columbus, Mount Vernon, N. Y.

**FOG-Stop windshield cloth.** Instantly removes blurry mist, frost, sleet, snow. Stops windshield fogging. Samples sent on trial. Kristee 70, Akron, Ohio.

**NEW Scientific discovery.** 60 second white wall tire cleaner. Brush, wipe or spray on; hose off. Tires sparkling white. 30 second demonstrator. 400% profit. Private labels. Lifetime opportunity. Write for free sample offer. Pittman's Industries, Porterville, Calif.

**BIG Profits selling ties (\$2.00 value) \$6.50 dozen.** Free catalog. Empire Cravats, 636-PM Broadway, New York City 12.

**EASY Handwork makes fast-selling useful articles.** Sample free. Sunmade Company, Brockton 64, Massachusetts.

#### BUY IT WHOLESALE

**BIG Multicolor wholesale catalog!** Housewares, appliances, clothing, silverware, cookware, luggage, binoculars, radios, phonographs, cameras, recorders, projectors, typewriters, shavers, sporting goods, toys, tools, sewing machines, watches, jewelry. Name brands. Huge discounts. Postcard: Selbyco, Decatur 162, Illinois.

**BUY Wholesale! Discounts to 80%!** Gifts, appliances, housewares, tools, watches, etc. Midwest, IMP-156, Pontiac, Illinois.

**USED And new watches \$2 up.** Free list. Southern Watches, 5-PM So. Wabash, Chicago 3.

**BARGAINS, Joblots, closeouts.** 2000 items. Tremendous savings, clothing, toys, gifts, jewelry, television, etc. 25¢ brings wholesale catalog. \$1.00 merchandise certificate included free. Reliable Jobbing, 311-B North Desplaines, Chicago.

**AT Last! A real man's watch!** A fine jeweled Swiss precision made anti-magnetic, diamond tooled, electronically timed with metal expansion bracelet, a \$50.00 value, 2-year guarantee, only \$10.95. Also for women, same exquisite qualities, \$12.95. A perfect gift for all occasions. Send check or money order. C.O.D. orders send \$2.00 deposit. We pay postage on prepaid orders. Arnold Enterprises, 174 Worcester Turnpike, Wellesley Hills 81, Mass.

**TRUE Wholesale! No service charge.** No minimum. Name brands! Big stock. Catalog \$1, refundable. House of Better Buys, Mail Dept., 722 East Silver Spring, Milwaukee 17, Wisconsin.

**WHOLESALE! Clothing, appliances, jewelry, furniture, etc.** Free wholesale plan. United Wholesalers, 1265-M Broadway, New York City.

**SAVE To 75% on household items, 25¢, refundable.** William Springer, Ocoee, Florida.

**FREE! Giant wholesale catalog.** Housewares, appliances, gifts, electronics, Hi-Fi, optics, bobby, photographic, tools. Lekttron, Inc., 133M Everett Avenue, Chelsea, Mass.

**ELECTRIC Guitars, amplifiers, wholesale.** Free catalog. Carvin PMW, Covina, Calif.

**BUY Wholesale! Over 10,000 nationally advertised products.** Appliances, cameras, sporting goods, housewares, watches, typewriters, tools, clothing, etc. Send postcard today. Buy-Rite, Box 258, Hawthorne 4, New Jersey.

**FREE Wholesale catalog! General merchandise—Christmas gifts.** Big personal savings. Big profits part-time selling. Housewares, 1216-P West 79th St., Chicago 20, Illinois.

**BUY Wholesale! Nationally known brands.** Catalog \$1. (Refundable). D'Auria Sales, Box 355-PM, Jackson, Michigan.

#### SALESMEN—DISTRIBUTORS

**IF You're interested in making money in selling, see the hundreds of exceptional opportunities in Salesmen's Opportunity Magazine.** Send name for your copy, absolutely free. Tell us what you're selling now. Opportunity, 848 N. Dearborn, Dept. 17, Chicago 10, Illinois.

**100% PROFIT. Fast money for you!** Take orders for Sweet Georgia Brown cosmetics. Colored people buy it quick. Free sample. Write Valmor, 2451-PP Michigan, Chicago 16.

**EXCEPTIONAL Opportunity.** Some territories available. U. L. approved electric radiant heat floor pad. No competition, unlimited prospects. Radiant Products, Inc., Monroe, N. C.

**MANILA Dons, Philippine cigars** revolutionary packaging air-tight plastic bags. Insures freshness. Manila Dons, 5768 Mendocino Ave., Oakland 18, California.

**MAKE Money.** Sell sensational dwarf trees, bear giant-size apples, peaches, pears. Ornamental. Also Stark-Burbank standard trees, roses, shrubs, vines, etc. Outfit free. Stark, Desk 30758, Louisiana, Mo.

**\$1,000.00 A Month for making dramatic 3-second demonstration of amazing lightweight Presto fire extinguisher.** New chemical used by Airforce snuffs out fires instantly. Only \$4.95. Terrific commissions. Millions want it. Free kit. Merlite, 114 E. 32nd, Dept. P-62C, New York City 18.

**WILL You wear new suits and topcoats without one penny cost and agree to show them to friends? You can make up to \$30.00 in a day even in spare time, without canvassing.** W. Z. Gibson, Inc., 509 South Throop Street, Dept. R-626, Chicago 7, Illinois.

**AD Matches! Sell amazing designs—10, 20, 30, 40 and 240-light book matches.** Bigger spot cash commissions; every business a prospect. Low prices for high quality. Repeats. Start without experience; men, women; full, part time. Buy nothing! Sales kit furnished. Match Corp., Dept. PM-95, Chicago 32, Illinois.

**CALENDARS, Advertising novelties, matches.** All styles, including religious, varnished, 12 sheet, girls. Hundreds of advertising novelties, book matches, etc. Fleming Calendar Co., Sales Division, 6539 Cottage Grove, Chicago 37, Ill.

**BIG Profits in your own shoe store business!** Free information. Mason Shoe Manufacturing Co., Chippewa Falls 14, Wisconsin.

**AUTOMATIC Bed warming sheet.** You sleep on, not under. Beats electric blankets 10 ways, costs half as much. Generous profits. Electro-Warmth Factory, Danville, Ohio.

**20% COMMISSION On an automotive-premium or give-away, selling to factories, sales organizations, insurance companies, gasoline distributors, etc.** Write Gordon Associates, Inc., First St., Derby, Conn.

**GET** New shirt outfit free. Make \$90.00 weekly on 5 average orders a day. Famous quality made-to-measure dress and sport shirts at \$3.95 up sell fast to all men. No experience needed. Full or part time. Write: Packard Shirt Co., Dept. 520, Terre Haute, Ind.

**MONEY** Back low priced trading stamp plan pays you bigger spot cash profits with steady year 'round income from re-order commissions. Every grocery, gas station, drug store, etc., are quick buyers. Free pocket sales kit. Worth, P-11, 1625 South Michigan Avenue, Chicago 16, Ill.

**INCREASE** Present income \$75 up weekly. Dealers, farmers, agents, demonstrate nationally known Gro-Green liquid fertilizer nutrients. Results guaranteed. Full, part time. Samples free. Campbell Co., Rochelle 303, Illinois.

**MAKE** Extra money. Cash commissions. Everybody buys easy-to-sell advertising book matches. Union label. All sizes. Cuts for all businesses. Powerhouse selling kit free. Steady repeat business. No experience necessary. Superior Match Co., Dept. M-1157, 7528 S. Greenwood, Chicago 19.

**EARN** Easy money taking orders. Send \$1.00 now for your catalog, instructions. \$3.00 merchandise certificate included. Specialties Unlimited, 2403B East Lancaster, Fort Worth, Texas.

**PEOPLE** Just like you have been selling our calendars and advertising specialties to all kinds of businesses for over half a century. We furnish complete samples and pay liberal commissions weekly. No age limit. Write to Cussons, May & Co., Inc., 715 Bowe St., Richmond 20, Va.

### EMPLOYMENT INFORMATION

**FLORIDA** Employment opportunities—\$2.00 for complete report. Free 368 page guide to Florida and Caribbean. Advisory Service, Box 897, Hollywood, Florida.

**CAREERS** For all. Gold Coast, Africa, Canada, U.S.A., construction companies offer high pay for skilled and unskilled staff. Send \$3.00 (\$1 for listed vacancies, application forms and how, where to apply. Careers, P.O. Box 626, Lusaka, Northern Rhodesia.

**ADVENTURE** Jobs, land and sea. Information \$1.00. Allen, 6414 Seaview, Seattle 7, Washington.

**FLORIDA'S** Booming. Statewide opportunity analysis, job plan, contact list airmailed \$2.00. Sun-Glo Service Bureau, Perry 3, Florida.

**COMING** To California? Choice listings; jobs, housing, business opportunities, in San Francisco, Los Angeles, San Diego. 15 page booklet plus free gift. \$1.00. Chesley, 3977 1/2 Texas Street, San Diego 4, California.

**JOB** Consultant expert on Miami Beach, Miami, Fort Lauderdale, Palm Beach area. Don't gamble. Know the facts before you leave. Latest information regarding jobs, salaries, construction, rentals, food prices, etc. Personal questions answered. Classifieds included. Air mail \$2.00. C.O.D. accepted. Job Consultant, Box 425, Oakland Park, Fla.

**ARIZONA** Employment opportunities. Free information. Arizona Employment Consultants, Box 10245, Phoenix, Ariz.

**TRUCK** Drivers, laborers helpers, craftsmen over \$1,000 monthly far northern bases. For information South America, Spain, Europe, Alaska, etc. Foreign job listing \$1.00. Universal, 1110 Commerce Building, St. Paul, Minn.

**10,000,000,000** JOBS, 7000 Qualified counselors at your service. Write today, brochure \$1.00, refundable. Career Planning, 462 Olive, San Diego 3, California.

**UNLIMITED** Job opportunities. Details free. Personnel Associates, Box 1018, Edinburg, Texas.

**WHAT?** \$12,000 A year in wages? That is what I make. So can you. \$2.00 brings you the facts. F. Dasher, 4716 Walther Ave., Baltimore 14, Md.

**BOOMING** Venezuela—Only hours from the States. New data regarding jobs, opportunities, conditions, etc. Salaries to \$1850 monthly U. S. tax exempt. Bonuses, living allowances extra. First-hand information direct \$2.00 (\$2.35 air mailed) checks or money orders only. Paul B. Smith, Apartado 172, Maracaibo, Salina, Venezuela.

**JOBS**, Business opportunities on Florida's famous gold coast. Classified ads local papers, Miami, Ft. Lauderdale, Palm Beach area mailed \$1.00 ea.; all three \$2.50. Hundley, Box 102, Greenacres City, Fla.

### SPECIAL SERVICES

**BIRTH** Certificate necessary for Social Security. Millers Service, Inverness, Fla.

**INFORMATION** On anything. Ferguson Research Specialists, 116-14 141 St., South Ozone Park 36, N. Y.

### EDUCATIONAL AND INSTRUCTION

**COMPLETE** Your high school at home in spare time with 80-year-old school. Texts furnished. No classes. Diploma. Information booklet free. American School, Dept. X845, Drexel at 58th, Chicago 37, Illinois.

**HANDWRITING** Analysis now accepted in college, business, industry. Our men, women who use grapho analysis spare, full time earning more money, getting prestige, success, happiness. Uncrowded, fascinating field for intelligent men, women anxious to get ahead. We need more members. Investigate this growing field where you give a real service to your fellow man. Opportunities unlimited. Free sample lesson and information to all over 21. Write today! IGAS, 2507 National Station, Dept. 1013, Springfield, Missouri.

**DIESEL!** Learn to install, operate and maintain all type engines, spare time. Write for free book. Utilities Diesel Training, Dept. DC-67, 2521 Sheffield, Chicago 14.

**LEARN** By ear with Dormiphone. While you sleep, amazing new scientific invention works for you. Revolutionary Dormiphone tools give you a shortcut to learning languages, correct speech; memorizing facts, figures; ideal for self-improvement, relaxation, habit training. Saves time, effort. So simple, children benefit. Used by educators, psychologists. Write for free book. No obligation. Modernphone, Inc., 320-117 Radio City, New York 20.

**BLUEPRINT** Reading—Train at home. Learn to read blueprints with confidence in 10 easy lessons. Write today Belton School 1059-T North Lawndale, Chicago 51.

**FREE!** Bible study correspondence course, 27 lessons, diploma awarded. Write, enclose stamp. Christian Guidance, 181 Bank, Newark, New Jersey.

**FINGERPRINTING** Course \$12.00. Diploma awarded. School of Fingerprinting, Box 185, Fairfield, Alabama.

**FREE!** Information concerning type-written shorthand. Dictographics, 6196 Walnut, Omaha 6, Nebraska.

**HIGH** School diploma at home. Licensed teachers—Approved materials. Southern States Academy, Box 5344-MX, Station E, Atlanta, Georgia.

**CHARACTER** Analysis. Free brochure. Lucas, 2419 Sunset Boulevard, Los Angeles 26, California.

**FINISH** High School at home, spare time. No classes. Diploma awarded. Write for free catalog. Wayne School, Catalog HP-80, 2527 Sheffield, Chicago 14.

**MACHINISTS'** Ready reference—Inclusive handbook covers drills, tapers, threads, milling, turning, gears, gages, math, etc. 140 pages. 100 tables. Pocket-size. Washable cover. Only \$1.50. Prakken Publications, Dept. M, Ann Arbor, Michigan.

**U. S. Civil Service** tests! Training until appointed. Men-women, 18 up. Start \$224-\$377 month. Experience often unnecessary. Free 36-page book shows jobs, salaries, requirements, sample tests, benefits. Prepare now. Write: Franklin Institute, Dept. F-24, Rochester, N. Y.

**EARN** Degree. Free bulletin. Home-study only. Midwestern Bible School, 1050 Broadripple, Indianapolis.

**FREE** Trial—Complete language course for home study by Linguaphone, the world's standard conversational method. At home, easily, quickly learn to speak French, Spanish, German, Italian, Japanese, Russian, Modern Greek—any of 34 languages. It's like living in another land. Send for free book and details of free trial. No obligation. Try, don't buy. Linguaphone Institute, T-83-117 Radio City, New York 20.

**WELDERS** Earn big money. Easy to learn arc, gas, automatic welding. New equipment, low cost training in non-profit school. GI approved, free booklet. Hobart Welding School, Box M-1171, Troy, Ohio.

**INEXPENSIVE** Correspondence courses—Science, arts, psychology, engineering. Earn diplomas, degrees. Colleges abroad. Aurecas, Central Valley, New York.

**DRAFTSMEN**, Save joining Architect's Book World Club, 7126 Abbott, Miami Beach, Fla.

**MEN** Wanted, age 19 to 45, to train as draftsmen designers at home in spare time. Big pay opportunities. Write for free brochure. American Technical Society, 850 E. 58th St., Dept. PM-1157, Chicago 37, Illinois.

**SCIENCE** Has proven everyone has hidden abilities, yet few know how to find and use them. My personal counseling method, an improvement over those used by leading industries and progressive universities can help you to new greater accomplishments and happiness. Together we can turn your hidden ability into successful and profitable ideas, ideas that work. Many are doing it, so can you. This is not a course, not mass instruction, but my "straight line method" perfected and proven over the years, plus personal collaboration. It can determine your future. Send now for the amazing facts and "A Message to Those Who Dare Take What They Want From Life." Remember, your best investment is in yourself. Write today. D. A. Wing, 1648 Madison S.E., Grand Rapids 7, Michigan.

**THEY** Laughed when I changed my job to a career! 7000 qualified counselors at your service. Don't wait, too late. Brochure \$1.00, refundable. Career Planning, 462 Olive, San Diego 3, California.

**SPEAK**, Sing with power, personality. Home self-training method on records. Amazing details free. Canfield, 2018-A 5th Ave. South, Minneapolis 4, Minn.

**ENGINEERING** Degrees earned through home study. Residence courses also available. Pacific International University, 5719-B Santa Monica Boulevard, Hollywood 38, California.

**WE** Pay \$3.50 lb. dried. Grow mushrooms. Cellar, shed and outdoors. Spare, full time, year round. We have 25,000 customers. Free book. Washington Mushroom Ind., Dept. 174, 2954 Admiral Way, Seattle, Wash.

**MEMORY** Education; more mental power; lesson one free. Memorology Studio, 2016 Sunnyside, Chicago 25, Illinois.

**REFRIGERATION**, Air conditioning. Extension course. Free booklet. Mechanics School, 11029-PX South Vermont, Los Angeles 44.

**LEARN** Mineralogy at home. Diploma course. Portunes being made in minerals. Free catalogue. Mineral Science Institute, Desk 3, 158 East Ontario, Chicago 11.

**SWEDISH** Massage, learn at home. Diploma. Dr. Swanson School Swedish Massage, Illinois licensed vocational school, 3809 Alta Vista Terrace, Chicago, Ill.

**BE** A real estate broker. Study at home. Send for free catalogue. Midwest School of Real Estate, 68 North Chicago Street, Joliet, Illinois.

**TIMESTUDY**—Your key to positive personal profits. Associated Techniques, Box 235, Hollidaysburg, Penna.

**PIANO** Tuning pays. Big money in spare time. Learn at home in 30 days. No musical knowledge necessary. Phonograph, records, tools and instructions furnished. Personal instructions available. Free catalogue. Capital Tuning School, 16 Southwest Second, Fort Lauderdale, Fla.

**EARN** College degrees, correspondence. Metropolitan University, Box 86, Glendale 5, California.

**LEARN** Appliance service and repair. Motors, washers, refrigeration, cleaners, everything. Free booklet. Armstrong, 11027-A South Vermont, Los Angeles 44.

**STUDY** For Doctor's degree of psychology, metaphysics and divinity. Correspondence courses only. College of Divine Metaphysics, Dept. P-M, 2811 North Illinois, Indianapolis 8, Indiana.

**BE** A real estate broker. Study at home. Write for free book today. GI approved. Weaver School of Real Estate, 2018P Grand, Kansas City, Missouri.

**USED** Correspondence courses and books sold and rented. Money back guarantee. Catalog free. (Courses bought.) Lee Mountain, Pisgah, Alabama.

**EARN** While you learn. Auto and diesel mechanics master this top paying trade. Many graduates earn \$100 a week and up. Approved for Korean veterans. For free information write Dept. No. 256, Nashville Auto-Diesel College, Nashville 3, Tenn.

**HELP** Yourself to abundant living. Our courses have aided students to richer fuller lives. Learn secret of contentment, happiness. Earn degrees Ps.D., M.S.D. Write for free book. College of Universal Truth Correspondence School, 23-C E. Jackson, Chicago.

**LEARN** While asleep! Details free. Research Association, Box 610-MC, Omaha, Nebraska.

**BOOKKEEPERS!** Increase your earnings! Operate your own simplified "Dollar-A-Week" bookkeeping and tax service. Full or spare time. Details free. No obligation. Ellis, Box 200, Cedar Grove, North Carolina.

**WANT** A diesel job? New opportunities to increase income. Higher pay. More money. We can help you qualify. Tools. Shop method home training. Write today! Diesel, Tractor, Heavy Equipment Division, Interstate Training Service, Dept. B-3, Portland 13, Oregon.

**INVESTIGATOR** Training. Phillips Secret Service System, 1917-B North Kenneth, Chicago 39.

**USED** Correspondence courses and educational books bought, sold, rented. Free catalog. Educational Exchange, Menlo, Georgia.

**BE** An Investigator. Write for free details. State age. National Detective Academy, 535 East 4th Street, Scottsdale, Ariz.

**PHYSICAL** Therapy and massage. We train you at home. Earn big profits from your own private practice or work with hospitals and doctors. Free catalogue. National Institute, Desk 4, 159 E. Ontario, Chicago, Ill.

**\$1,000 MONTHLY** Possible in collection agency business. Free details. Write Cole Associates, Syracuse 2, N. Y.

**PIANO** Tuning pays. Learned easily at home. GI approved. 59th year. Free booklet. Niles Bryant School, Dept. P, 3731 Stockton, Sacramento 20, Calif.

**SECRET** Investigation. Experience unnecessary. Investigators particulars free. George Wagner, M125 West 86th, New York 24.

**ENGINEERING**, Home study, Midwest Engineering School, 10923 Hillcrest, Hickman Mills, Missouri.

#### PLAYS, STORIES, MANUSCRIPTS

**WANT** Your book published? Learn how we publish, advertise, promote, distribute. Many successes. Free booklet PM. Vantage, 120 West 31, New York City. Midwest office: 220 S. Michigan Ave., Chicago, Ill.

**WANTED:** Book manuscripts, all subjects considered. Greenwich Book Pub., Atten. Mr. Zealand, 430 Fifth Ave., New York City.

#### CARTOONING, COMMERCIAL ART, SHOWCARD & SIGN PAINTING, TATTOOING

**ASK** For free facts about our famous cartooning course. Cartoons-of-the-Month, Roslyn, New York.

**"HOW To Make Money With Simple Cartoons"**—A book everyone who likes to draw should have. It is free; no obligation. Simply address Cartoonists' Exchange, Dept. 911-C, Pleasant Hill, Ohio.

**COMPLETE** Course in art and drawing. 46 lessons \$2.00. Kamm, Oshkosh, Wis.

**BASIC** Art training at home. New plan. Free brochure. Students' Art Club, Kennebunkport, Maine.

**LEARN** Sign painting at home. Free talent test. Ben Kerns, Box 812-PM, Greenville, S.C.

**TATTOOING** Outfits, licensed course. Brochures 25¢. Zeis, 728 Leslie, Rockford, Illinois.

**PAINT** Signs—Master die cut, outline letter patterns. Complete assortment 1 1/2" to 12" high, prepaid \$2.00. Eyerly, 583, Newton, Iowa.

**LEARN** Sign painting with fascinating system. Straley, 410 S. Western, Springfield, Ohio.

**SIGN** Painting—Lessons by mail. Books on lettering, gold leaf, show cards, pictorial. Write: Sign Instruction, 4304 Virginia, Kansas City 10, Missouri.

**YOU** Can entertain with chalk talks. Catalog 10¢. Balda The Cartoonist, Oshkosh, Wis.

**CARTOON** Your way to success! Internationally known instructor, Raye Burns, will personally teach you to create original, salable cartoons at home. Course of 26 lessons only \$2.85. Write for free details. Raye Burns School, Box 3563-P, Cleveland 18, Ohio.

#### ADVERTISING AGENCIES, LETTER WRITERS, FOR ADVERTISERS

**ADVERTISE:** 24 Words. 100 Canadian newspapers \$5.50. Lists free. Advertising Bureau, 10511-C Springfield, Chicago 43.

**ADVERTISING.** Result-getting ads prepared, placed newspapers, magazines, radio, anywhere! Lowest rates. Catalogue free. Baker Advertising Agency, 189 W. Madison, Chicago 2.

**MAILING** Lists most any classification \$5.00 1000. Your circulars mailed with ours \$4.00 1000. Write for our literature. Dixie Mailers, King, N. C.

**WANT** More business? Here's an amazing opportunity to increase your sales. Talk to thousands of interested readers of "Mechanics Popular." Our Spanish Edition covers the Latin American countries like a blanket. They're real mailorder buyers. Classified rate 55¢ per word. Try an ad in our next issue. Classified Advertising Department, Popular Mechanics Magazine, 200 East Ontario Street, Chicago 11, Ill.

**A** Professional writer can do wonders with your sales literature or manuscript. Complete writing service. Established 1925. Harold Kahn, Eola Plaza, Orlando, Fla.

**MILLION** Names. State your needs. P.O. Box 246, Twin Lakes, Wis.

**ADVERTISING** Ratebook leading newspapers, magazines, free. Chicago Advertising Agency, Chicago 4.

**FREE!** 1957 Advertisers Rate and Data Directory. 52 pages! E. H. Brown Advertising Agency, 20 N. Wacker, Chicago 6.

**GUARANTEED** Rural names 1¢ each. W. Allen, 2429 Workman Street, Los Angeles 31, California.

**FREE** Lance advertising writer. Jim Pappas, 3013 Kenwood, Indianapolis, Ind.

#### RUBBER STAMPS AND OFFICE SUPPLIES

**8 HOUR** Service. 3 lines \$1.00. Guaranteed. Bassler, Ludlow, Mass.

**YOUR** Name, address. For pocket or purse, always ready. Send \$1.00. Bixler, Benson, Frankfort, Kentucky.

**RUBBER** Stamps. All kinds. Literature free. Capital Stamp Works, Box 107, Lincoln, Nebraska.

**3 LINES** \$1.00. Pocket or regular. Seeburger's Stamps, Palmyra, Mich.

**QUALITY** Rubber stamps! Distinctive lettering. 3 lines \$1.00. Prompt service. Money-back guarantee. Campfield, 14 Beaufort Circle, Springfield 4, Mass.

#### TYPEWRITERS, DUPLICATORS, OFFICE DEVICES

**BUY** Direct! Sensational new portable typewriter. Low price! Details free. Clifford Sales, 172 Greenwich St., New York 7, N. Y.

**PORTABLE** Typewriter, top quality, low low price, bonus offer. Details free. Ko-Kar Sales, Dept. M, 9 Chamberlin Dr., West Hartford 7, Conn.

**RECONDITIONED** Typewriters, duplicating, printing devices. \$25.00 up. Supplies. Appliances. DixieGraph, King, N. C.

**WHOLESALE** Catalog 10¢. Typewriters! Recorders! Tapes! Radios! Towers, #155, Philadelphia 5.

**REMINGTON** Portable typewriters and adding machines, office machines, new! No down payment, \$1.00 weekly, shipped in factory sealed cases prepaid. Send 25¢ for application. Typewriters, 1527 Potomac, Pittsburgh, Pennsylvania.

#### PRINTING, MULTIGRAPHING, MIMEOGRAPHING, GUMMED LABELS

**500 STATEMENTS** \$3.00. 500 #63; Envelopes, same. Stanley Press, Lake Katrine, N. Y.

**FIFTY** Sheets, twenty-five envelopes. \$1.00 postpaid. Free catalogue. Parisle Offset, Box 2501-C, San Antonio 6, Tex.

**ADS** Running under this heading sell printing. Ask me for proof. I'll gladly send you amazing facts. Ask for Folder "P." P. W. Johnson, 200 E. Ontario St., Chicago 11, Ill.

**TESTIMONIALS.** News items, ads reproduced in quantities. Fame, 291 Ellis, San Francisco 2, Calif.

**1,000 BUSINESS** Cards. Raised letters. \$3.50. Samples. Pioneer, Island Park 40, New York.

**MAIL** Dealers, salesmen, terrific wholesale letterhead deal. Sales, copy-design service too. Murl, Box 748, Dayton 1, Ohio. 30 years experience.

**250 8 1/2 x 11 LETTERHEADS** And 250 6 1/2 envelopes \$4.90 postpaid. Grunzig Press, Avenel, N. J.

**YOUR** Name and address printed on gummed labels. 500—3 lines \$1.00. 15¢ each extra line. 1/2 x 1 1/2. Print clearly. No c.o.d.'s. Addison Mail Order, PM-11, 1840 Addison, Chicago 13.

**10,000 ATTRACTIVE** 2 Color circulars \$20. Stickers, cards. Samples. Fame, 291 Ellis, San Francisco 2, Calif.

**100 WATERMARKED** Letterheads 8 1/2 x 11 and 100 envelopes \$2.00 postpaid. H. Hudson, Centredale 11, R. 1.

**BUSINESS** Cards. 1,000, one color, \$4.85. 1,000, two color, \$5.85. Send check with order. Alt Specialties, Dept. A, 5511 Lewis Ave., Toledo 12, Ohio.

**1000 THERMOGRAPHED** (Raised letter) business cards \$3.47 postpaid. Samples free. M. Pinson, 6770 Yellowstone, Forest Hills 75, N. Y. Active producing agents wanted. Top commissions. Catalog, instructions, supplies, \$1.00 (refundable).

**CIRCULARS,** Booklets, letterheads, envelopes. Estimates, anything! Lonelma Printers, Paulding, Ohio.

**BUSINESS** Printing. Samples, prices free. Howprint, 723-G Eunice, Webster Groves 19, Missouri.

**EMBOSSSED** Business cards. Samples. L. C. Sales, 17 South 9th, Wilmington, N. C.

**TOP** Quality printing, mimeographing. Free literature. Currier, PM, New Lebanon Center, N. Y.

**MIMEOGRAPHING**—Letters, price lists, formulas, instructions. Lowest prices. Lem's Letter Shop, 5710 Stanton, Detroit 8.

**BUSINESS** Printing, rubber stamps. Free catalog. Brose, 196 Clerk Street, Jersey City 5, N. J.

**100 BUSINESS** Cards \$1.00. Printers, 1418 Broadway, Rockford, Illinois.

**BUSINESS** Printing. Top quality. Bottom prices. A. Hanlon, Malvern, Penna.

**BETTER** Grade printing. Reasonable. Estimates. Hamel-Printer, 210 5th Avenue, Suite 1104, New York City 10, N. Y.

**1000 BUSINESS** Cards simulated engraved \$4.90. Include copy with check or money order. Samples if desired. Postage prepaid. Progressive Business Services, 330 East First St., Long Beach 2, Calif.

**OFFSET** Printing—\$8.50, 1000, 8 1/2 x 11. 24 hour service. National Letter, 251 West 42 St., New York City 36.

#### PRINTING OUTFITS AND SUPPLIES

**MAKE** Your own self-molding rubber stamps and printing cuts. Plexirubber, Argyle 1, Wisconsin.

**DO** Your own printing. Save money. Simple rules. We supply everything. Print for others; good profit. Raised printing like engraving too. Have home shop. Details free. Kelsey Presses, V-11, Meriden, Connecticut.

**PRINTING** Presses, type, supplies, lists 3¢. Turnbaugh Service, Mechanicsburg, Penna.

**PRESSES,** Type cabinets, supplies. List for stamp. Lincoln Press Company, 220-J Hartwell, Fall River, Mass.

#### PATENT ATTORNEYS

**INVENTORS:** When you are satisfied that you have invented something of value, write me, without obligation, for information as to what steps you should take to secure a patent. Write Patrick D. Beavers, Registered Patent Atty., 935 Columbian Bldg., Washington 1, D. C.

**CANADA**—Ramsay Company Registered, 373 Bank Street, Ottawa, Canada.

#### PRINTING, MULTIGRAPHING, MIMEOGRAPHING, GUMMED LABELS

**500 STATEMENTS** \$3.00. 500 #63; Envelopes, same. Stanley Press, Lake Katrine, N. Y.

**FIFTY** Sheets, twenty-five envelopes. \$1.00 postpaid. Free catalogue. Parisle Offset, Box 2501-C, San Antonio 6, Tex.

**WRITE** For free proof of invention forms before you disclose your ideas to any one. Adam Fisher & Associates, Established 1911, 6233 Delomar Blvd., St. Louis 5, Mo.

**INVENTORS**—Take these preliminary steps toward patent protection. Sketch and describe your invention. Sign, date and have this disclosure witnessed by two people who understand your invention. Have us make a preliminary search among U.S. patents already granted for similar types of invention. We report on the probable patentability of your invention and recommend your further course of action. Write for our instructive booklet, "Patent Protection for Inventors" and convenient "Evidence of Invention" disclosure form. Victor J. Evans & Co., 331-M Merlin Building, Washington 6, D. C.

**INVENTORS**—If you believe you have an invention, you should find out how to protect it. The firm of McMorrow, Berman & Davidson with offices in Washington, D. C., is qualified to take the necessary steps for you. Send for copy of our patent booklet "How to Protect Your Invention." We will also send you an "Invention Record" form. No obligation. They are yours for the asking. McMorrow, Berman & Davidson, Registered Patent Attorneys, 1347 Victor Building, Washington 1, D. C.

**PATENTS**—Irving L. McCathran, 515 McLachlen Bldg., Washington 1, D. C. Registered Patent Attorney.

**REGISTERED** Patent attorney offers services. Sanders, 6430 Evans, Chicago 37, Illinois.

**C. A. Snow & Co.**—M427, Snow Building, Washington 1, D. C. Registered Patent Attorneys. Write for information.

**PATENTS**, "Proof of Invention" free. E. E. Vrooman, Registered Patent Attorney, 507 McKim Building, Washington 5, D. C.

"INVENTOR'S Guide" and "Record of Invention" free on request. Frank P. Ledermann, Registered Patent Attorney, 154 Nassau Street, New York City.

**INVENTORS**: Without obligation, write for information explaining the steps you should take to secure a patent. John Randolph, Registered Patent Attorney, 203 Columbian Bldg., Washington 1, D. C.

**INVENTION** Record form free and "Patent Information Every Inventor Should Have." Carl Miller, Registered Patent Attorney, Woolworth Building, New York.

**INVENTORS**: Learn how to protect your invention. Unless the inventor is familiar with patent matters, he should engage a competent registered patent attorney or agent to represent him. We are registered to practice before the U. S. patent office and prepared to serve you in handling your patent matters. "Patent Guide for the Inventor" containing detailed information concerning patent protection and procedure with "Record of Invention" form will be forwarded to you upon request—without obligation. Clarence A. O'Brien & Harvey Jacobson, Registered Patent Attorneys, 71A-K District National Building, Washington, D. C.

#### FOR INVENTORS

**PATENT** Searches, \$5.00, copies included. Free protection forms. 48 hour service. Write us first! Patent Service Institute, Albee Building, Washington 5, D. C.

**WHY** Let your ideas remain idle simply because you lack equipment and facilities to complete development? Our technical staff and fully equipped electrical, electronic, electro-chemical, physics, and mechanical laboratory now offers inventors service to perfect, analyze, or test your ideas. For information write Connecticut Research Company, Box 168, Old Lyme, Conn.

**INVENTIONS** And ideas designed for your profit and patented for your best protection at low definite fees. Thirty years experience in developing and patenting inventions in U.S. and foreign countries. Patent searches with valuable report \$15.00. Joseph O'Brien, 132 Nassau Street, New York 38, N. Y.

**PATENT** Searches \$5.00. 48-hour airmail service. Invention protection forms free. Write Patent Engineering Service, 711 14th Street N. W., Washington 5, D. C.

**INVENTORS**: Learn how to protect your invention. Unless the inventor is familiar with patent matters, he should engage a competent registered patent attorney or agent to represent him. We are registered to practice before the U. S. patent office and prepared to serve you in handling your patent matters. "Patent Guide for the Inventor" containing detailed information concerning patent protection and procedure with "Record of Invention" form will be forwarded to you upon request—without obligation. Clarence A. O'Brien & Harvey Jacobson, Registered Patent Attorneys, 71A-K District National Building, Washington, D. C.

**INVENTORS**: Test the commercial value of your patented or unpatented inventions, quickly and inexpensively. Write for free information. Institute of American Inventors, Dept. 40-B, 635-F St., N.W., Washington 4, D. C.

**INVENTORS**, Don't sell your invention patented or unpatented until you receive our offer. Write Cowgill, Box 298, Marion, Ohio.

**FREE** Patent book. Write Blasius, 15-A Park Row, New York City.

**INVENTION** Record form free and "Patent Information Every Inventor Should Have." Carl Miller, Registered Patent Attorney, Woolworth Building, New York.

**PATENT** Searches \$5.00. 48-hour service. Free invention protection forms. Write Raymond L. Smith, Patent Searcher, 620 Sheraton Building, Washington 5, D. C.

**SEARCHES**—Put your patent searches in the hands of a registered patent attorney or agent, as he qualifies to give a worthwhile patentability report. Record of invention form upon request and information on patent protection. Patrick D. Beavers, Registered Patent Attorney, 936 Columbian Bldg., Washington 1, D. C.

**INVENTORS**: Information on patent procedure furnished on request, without obligation. John Randolph, Registered Patent Attorney, 203 Columbian Building, Washington 1, D. C.

**PATENT** Searches, including copies of nearest patents, \$5.00. Reports airmailed within 48 hours. More than 100 registered patent attorneys use my service. For free invention protection forms, write Miss Ann Hastings, P.O. Box 176, Washington 4, D. C.

**BEST** Market for selling your invention is "Gadgets Patents Invention News" readers. Inventors' Service, 107 W. Van Buren, Chicago 5, Illinois.

**INVENTORS**—Send for free Patent Information book and Inventor's Record. Registered Patent Attorney, Associate Examiner, Patent Office 1922-29, Patent Attorney & Advisor, Navy Department 1930-47. Gustave Miller, 117A Warner Building, Washington 4, D. C.

**STYMIED** With your invention? Write Associated Inventors, 372 London Street, San Francisco 12, California.

**FREE** Invention protection form, sales assistance. Inventors Engineering Bureau, Box 4973, Washington 8, D. C.

**INVENTORS!** Have you good, patentable ideas? Write Metzler, 11 West 42nd Street, New York City.

**INVENTORS**—If you believe you have an invention, you should find out how to protect it. The firm of McMorrow, Berman & Davidson with offices in Washington, D. C., is qualified to take the necessary steps for you. Send for copy of our patent booklet "How to Protect Your Invention." We will also send you an "Invention Record" form. No obligation. They are yours for the asking. McMorrow, Berman & Davidson, Registered Patent Attorneys, 1347 Victor Building, Washington 1, D. C.

**INVENTORS**—This firm is registered to practice before the United States Patent Office and available to assist you in the preparation and prosecution of your patent application. "Patent Protection for Inventors" booklet containing detailed information and steps to take toward patent protection sent promptly upon request. No obligation. Victor J. Evans & Co., 332-M Merlin Building, Washington 6, D. C.

#### INVENTIONS WANTED

**INVENTORS**: Hundreds of manufacturers have requested our assistance in locating marketable new products. Complete information free. Institute of American Inventors, Dept. 40-D, 635-F St. N.W., Washington 4, D. C.

**CASH** Buyers for inventions. Write National Inventors Institute, Box 7007, Cleveland 28, Ohio.

**INVENTORS**, Don't sell your invention patented or unpatented until you receive our offer. Write Cowgill, Box 298, Marion, Ohio.

**INVENTIONS** Wanted. Patented or patent pending. 26 years experience promoting inventions. National Service Bureau, 3120 Meramec, St. Louis 18, Mo.

**SUPERIOR** Promotions. Patented; unpatented inventions. Information booklet, free. Superior, 338-344 North Rodeo, Beverly Hills, Calif.

**INVENTIONS** Wanted. Patented; unpatented. Tremendous manufacturers lists. Global Marketing Service, 2420 77th, Oakland 5, California.

**INVENTIONS** Wanted immediately for promoting on cash or royalty. Patented, unpatented. Free booklet outlines royalty rates, requirements. Write Kessler Corporation, 511-1W, Fremont, Ohio.

**ATTENTION** Inventors. We extend our invitation to exhibit your invention at the largest International Inventors Exhibition being held during the 1958 World's Fair at Brussels, Belgium. Non-profit world-wide market facilities. Contact Otto Witt, Official American Correspondent, Box 1481, Milwaukee 1, Wis.

#### MANUFACTURING

**DESIGNING**, Tools, dies, models, manufacturing. Pro Devco, Box 983, Cincinnati 1, Ohio.

**MODELS**—Small lot manufacturing. Metals, plastics, etc. Milburn, Burlington, Kentucky.

**WIRE** Forming stamping tools, dies. Send your print part or sketch. B. L. Tool & Die, B. Lindberg, Prop., 413—26th St., Union City, N. J.

"**OLD** Whittler" read-cut figures make whittling fun! Send \$1.00 for set. The DAE Company, Box 219, Baraboo, Wis.

#### MODELS, MODEL SUPPLIES

**GEARS** And model supplies for the inventors. Send 10¢ for catalog. Pierce Model Works, Tinley Park, Illinois.

**WORKING** Steam engines, boilers, tractors, fittings. Catalog \$1.00. Tiny Power, Corvallis, Oregon.

**LIONEL** Trains—Appliances. Big discounts. Bulletin free. Catalog 25¢. Mack-Bros., 2043P Chicago Ave., Chicago 22.

**SHIP** Models and yacht supplies complete. Large 68 page catalogue 50¢. Bill Wild's, 510 East 11 St., New York City 9.

**SHIP** Models. Most complete line in New England. Kits, fittings, plans, books, tools, engines, motors. 1958 illustrated catalog 35¢. James Bliss & Co., Inc., Dept. 53M, 342 Atlantic Ave., Boston 10, Mass.

**SHIP** Model kits and fittings including clippers, trawler, fishermen, frigates, privateer, radio control tug, etc. Send 25¢ for 1957 catalog. Model Shipways, Box 65, Bogota, N. J.

**BALSA** Wood and model aircraft. 40-page catalog 25¢. Sig Co., Montesuma, Iowa.

**SHIP** And yacht model fittings; blueprints. Send 35¢ for illustrated catalog listing hundreds of items. A. J. Fisher, 1002-1 Etowah Ave., Royal Oak, Mich.

#### HOME CRAFTSMEN

**AMERICA'S** Most complete home craft supply company. Send 10¢ for big colored catalog. Giles & Kendall Co., Huntsville, Alabama.

**LEARN** Art metalcraft and jewelry making. Complete, inexpensive, home training course now available. Special tools and materials furnished. Write for free booklet. Interstate Training Service, Dept. L-3, Portland 13, Oregon.

**FREE** "Do-it-yourself" leathercraft catalogue. Tandy Leather Company, Box 791-T22, Fort Worth, Texas.

**KNOCKDOWN** Cedar chests and lumber. Free price list. Bedford Lumber Company, Shelbyville, Tennessee.

101 **PATTERNS** of smart gifts, novelties, shelves, action windmills. Plus "Make Money Jig Sawing." \$1.00. Mastercraft, 1135M, 7041 Oleott, Chicago 31, Illinois.

**WOODWORKING** And cabinetmaking course for beginning and advanced home craftsmen. Only complete low-cost home training program available. Write for free booklet. Interstate Training Service, Dept. G-3, Portland 13, Ore.

**ALL** Crafts, supplies. Large free catalog. National Handicraft, 199 William Street, New York City 38.

**STYLECRAFT** "Pretraced" leather kits. Handbags, billfolds, filigree belts. Patterns on leather. Just carve, assemble and lace. "Pre-carved" kits also available. Send 25¢ for catalog, free folder. Refunded first order. Apache Leather Company, 2804 E. Washington St., Phoenix, Arizona.

**FREE.** New catalog 2150 artist-drawn design, patterns. Craftplans, 1322-A Wabash, Chicago 5.

"**DAWN** Gage" eliminates callipers, dividers, jigs. Accurately centers round stock for turning or drilling. Matches dowl centers in flat stock. Details free. Dawn Crafts, 215 Commonwealth, Buffalo 16, N. Y.

**LEATHERCRAFT.** Send 10¢ for new 76-page catalog of tools, supplies, kits, including metalcrafts, enameling, ceramics, all other crafts. Complete stock. Reasonable. Since 1910. Sax Bros., Dept. PM-11, 1111 N. 3rd, Milwaukee, Wis.

**FREE.** New big illustrated catalog. Leathercraft, metalcraft, woodcraft kits and supplies. Complete stock, top values, latest ideas. Write today. J. C. Larson Co., Dept. 7827, 820 S. Tripp, Chicago 24.

**OVER 900** Woodworking projects. Books and patterns. Free catalog. Craftsman, 115-C Worth Street, New York City 13.

**LEATHERCRAFT.** Imported and domestic leather, tools, kits, complete catalog, 25¢ refundable. Midas, Box 1253, Dept. J7, Huntington Park, California.

**GET** Greater service from your portable electric hand saw. Build your own guides for precision sawing; easy, inexpensive. Write for free information or send \$3.00 for complete instructions. Hunter S. Macon, 2319 North Denton, South San Gabriel, Calif.

**FREE** Seashells catalog. Instruction book 35¢. Secor's, Bradenton, Florida W.

**LEATHERCRAFT.** Copper enameling, mosaic tile, metal tooling, many more crafts. Complete illustrated catalog 10¢. Kit Kraft, 2211 Studio City, Calif.

I want to send you proof of the wonderful pulling power of Popular Mechanics classified pages. What's your proposition? Write me today. Include literature if possible. F. W. Johnson, Manager Classified Advertising, Popular Mechanics Magazine, 200 E. Ontario St., Chicago 11, Ill.

## DO IT YOURSELF

**TERMITES?** Treat your home yourself. Free information. Hamlin Institute, Hamlin, W. Va.

**SELF**-Storing extension cord holder. Reel type. Small, compact, eliminates tangling. Plans available 25¢. Central, P.O. Box 81, Greendale Station, Worcester 6, Mass.

**BUILD** Your own hi-fidelity kits. Details. Arkay Dist. Co., P.O. Box 581, Church St. Sta., New York 6, N. Y.

**PRECISION** Nylon bearings. Silent, operate in liquids, no lubrication. Make your own mountings. Package 15 bearings, 3/16" to 1/2" shaft sizes, \$2.00. Beverly Sales, 4908 Lincoln Ave., Chicago 25, Ill.

**SAVE \$3.00.** All parts to assemble lovely Catalina salad cutter for \$6.95 postpaid. Catalina sold nationally at \$9.95. Complete with three cones, shredder, shoe-stringer and thin slicer. Order now for that someone special on your gift list. Wells Speciality Company, Inc., North Liberty, Indiana.

**18 PULL**-Size patterns. Save money with easy-to-use, professionally designed full-size patterns. Make money selling beautiful, useful furniture. Make modern step and cocktail tables; metal lamps; cupola; 12-foot outboard. All patterns test-built; sold with money-back guarantee. Get your free list of these convenient, economical patterns today. Popular Mechanics Press, 200-HH E. Ontario Street, Chicago 11, Ill.

**DRAFTING** Table 36"x60" for engineers and architects; light, folding, economical, wood or metal frame. Plans of either \$2. Geo. J. Okunis, 540 Main St., Winchester, Mass.

**GRANDFATHER** Clock movements, barometers, blueprints, kits. Wholesale catalog 25¢. Mason-Sullivan, Noroton, Conn.

**PLAY** Piano without lessons; Six charming classic melodies, \$1. Kirwin, 1029 East 29 St., Brooklyn 10, N. Y.

## WATCHES, OLD GOLD, JEWELRY

**CASH** For old gold, old jewelry, watches, diamonds, silver, gold teeth, etc. 100% full value paid immediately. Satisfaction guaranteed. Mail articles today. Information free. Established 1900. Chicago Gold Smelting & Refining Co., 6 E. Monroe St., Dept. 258, Chicago 3, Ill.

**WATCH** And clock repairing books. Free catalog. North American, 2320-AM, Milwaukee, Chicago 47, Ill.

**RHINESTONES,** Pearls, costume jewelry supplies. Catalog 10¢. Rhinestone kit including catalog, \$1.00. J & M Novelty, Dept. CM-3, Box 173, Broadview, Illinois.

**WATCHMAKERS'** Tools, materials, supplies, watches. Catalog. Gales, Box 1000, Chicago 90, Illinois.

**10 WATCHES** \$18.00. Catalog 20¢. Chronograph repair specialist. Berkwit, 1130 Castlehill, New York 62.

**COSTUME** Jewelry supplies, settings, rhinestones, etc. 88 page illustrated catalog. 25¢. Milady, Box 1328, G.P.O., New York City.

**HIGHEST** Cash for old gold, broken jewelry, gold teeth, watches, diamonds, silverware, spectacles, platinum, mercury. Free information. Rose Refiners, Heyworth Building, Chicago 2.

**WATCHMAKERS'**—Jewelers', machinists' tools. Watchmaking course. Catalog 25¢. Benzale, Culver City, California.

**GOLD,** Silver, platinum, diamonds wanted. Cash immediately, highest prices; appraisals made. Wilmot's, 1067 Bridge, N.W., Grand Rapids 4, Mich.

## RAZORS, BLADES, SHARPENING

**ELECTRIC** Razor in case \$4.95. Guaranteed. Jorine, Snyders Lake 4, Troy, N. Y.

## FOR THE HOME

**GIFTS.** Dinnerware, cookware, jewelry. Lowest prices, free catalog. Jay Godfrey Sales, Box 7, New York 35, N. Y.

**REAL** Savings. Free delivery in U.S.A. Fine shadow box raw oak frames, cut and mitered, ready for you to nail and glue. 3 1/2" shadow box style. Size 10"x14" \$1.64; 12"x16" \$1.80; 16"x20" \$2.34; 18"x24" \$2.55; 20"x24" \$2.66; 24"x30" \$3.00. Remittance with order. Chesapeake Picture Frames, Dept. PM, P.O. Box 533, Baltimore 3, Md.

**FOAM** Rubber furniture cushions. Factory seconds, 50% discount. Free catalog. Perma-Foam, 390-C Nye Avenue, Irvington, N. J.

**PLANS** For making beautiful patio lamps. \$1.00. F. Goss, Box 894, Oil City S.S., Penna.

"**HOME** Improvement Guide." New, amazing 192 page volume. Packed with ideas, plans for remodeling, decorating, landscaping, built-in projects. \$2.50 pre-paid. Popular Mechanics Press, 200-HG East Ontario St., Chicago 11.

## OF INTEREST TO WOMEN

**WANTED** At once, woman with car. Would you like to earn \$35 or more a week in your spare time, calling on housewives in your vicinity, with Rawleigh products? Write Rawleigh's, Dept. K-790-PPM, Freeport, Ill.

**GOOD** Money in weaving. Weave rugs at home for neighbors on \$89.50 Union loom. Thousands doing it. Booklet free. Carcraft Co., Polk St., Boonville, N. Y.

"**8 MISTAKES** Parents Make." Every parent should have this new book about child training. It is free; no obligation. Simply address Parents Association, Dept. 6711, Pleasant Hill, Ohio.

**60% PROFIT** On cosmetics — Famous nationally advertised Hollywood cosmetics pay 60%. Make \$25 day up. Hire others. For free samples, details, write Studio Girl, Glendale, Calif., Dept. 12711G.

**FREE** Discount catalog! Save on gifts, housewares. Archer, Box 516, Newark 1, N. J.

**PROFITS** In Palmloomimg. Details free. Thornton's, Box 153, Bloomington, Illinois.

**WE** Pay \$3.50 lb. dried. Grow mushrooms. Cellar, shed and outdoors. Spare, full time, year round. We have 25,000 customers. Free book. Washington Mushroom Ind., Dept. 176, 2954 Admiral Way, Seattle, Wash.

**DRESSES** 24¢; Shoes 39¢; men's suits \$4.95; trousers \$1.20. Better used clothing. Free catalog. Transworld, 164-S Christopher, Brooklyn 12, N. Y.

**SELL** Fine fabrics. Get yours wholesale. Box 863, Norwalk, Conn.

**FREE**—Big new wholesale catalog! Up to 50% saving for you, family, friends on nationally-known gifts, jewelry, toys, appliances, Christmas cards, etc. Also make money selling part time! Write: Evergreen Studios, Box 846-D, Chicago 42, Ill.

## PERSONAL

**VITAMINS**—Save 45%. Buy direct. All formulas. Free catalogue. Vitaspec, Box 4435M, Philadelphia 40, Penna.

**BIBLE** Questions answered. Stamped envelope. Bylon, 17167 Bentler, Detroit 19, Michigan.

**ENJOY** Health. Free booklet. Ruth's Nutrition, 152 Kearny, PM, San Francisco, Calif.

"**HOW** Can I find out?" You can! Information confidentially developed. Any matter, person, problem. Worldwide. Officially licensed. Established 1922. William Herman, 170 Broadway, New York City.

**PAY** Your bills now. Borrow \$100 to \$600 cash by mail. Easy, quick, private. Repay in small monthly installments over 20 months. Your payments may run 1/2 less than now; have money left over to spend. Loan order blank mailed free in plain envelope. Advise amount needed. State Finance Co., 323 Securities Bldg., Dept. T-227, Omaha 2, Nebr.

**YOUR** Handwriting analyzed \$1.00. Questions answered. Certified Grapho-Analyst, 1518 Sinaloa, Simi, California.

**JOBS,** Homes, opportunities. Los Angeles classifieds \$1.00. Royce Ziegler, 1032 Gladys, Long Beach, California.

**BORROW** Money by mail. \$100 to \$600 from Postal Finance. Employed men, women easily obtain \$100 to \$600 fast, entirely by mail. Repay in small monthly payments. Friends, relatives, employer, tradespeople will not know you are applying for loan. Advise occupation, amount wanted. Postal Finance Company, 200 Keeline Bldg., Dept. 658V, Omaha, Nebr.

**YOUR** Photograph on stamps from snapshots. Free sample. Erdley, Box 4, Lebanon, Penna.

**DALLAS** Classifieds \$1.00. Remails 25¢. A. Urschel, 9446 Forest Hills Blvd., Dallas, Texas.

**LOANS** By mail. Borrow \$50 to \$500. Employed men and women over 25, eligible. Confidential, no co-signers, no inquiries of employers or friends. Repay in monthly payments to fit your income. Supervised by State of Nebraska. Loan application sent free in plain envelope. Give occupation. American Loan Plan, City National Bldg., Dept. PM-11, Omaha, Nebraska.

**CHICAGO**—Mail forwarding address. Business, personal. Low rates. Continental, 20-M West Jackson, Chicago 4.

## REMAILING SERVICE

**AIR** Remails 35¢. I affix Canadian stamps. Ross Hancock, 83 Belhaven Rd., Toronto 8, Canada.

**COLUMBUS** Mail forwarding-receiving address for rent. Details free. William McLaughlin, 800 Stewart, Columbus 6, Ohio.

**SECRET** Mail receiving, forwarding system. \$3 month. Hedgpeh, Box 830, Alhambra 23, California.

**LETTERS** Remailed 25¢. J. Love, 1419 E. 83, Los Angeles 1, Calif.

**MIAMI** Remails 25¢, month \$3.00. Ed. Polaski, 3501 N.W. 54th St., Miami, Fla.

**REMAILS** 25¢. Receiving-forwarding \$3.00 month. V. Kent, P.O. Box 4808, San Francisco.

LETTERS Remailed from Detroit, 25¢ each. Patrick L. Kennedy, 2111 Springdale, Detroit 15, Michigan.

CONFIDENTIAL Remails 25¢. Sanchez, 7012 E. 4th Ave., Denver 20, Colorado.

WORLD-Wide service. Stationery available. Foreign \$2.00. Hawaii 25¢. Kuroda, 1154 Bishop, Honolulu, Hawaii.

FREE New York address. Receiving, forwarding, remailing 25¢. Henry, 173-32 64th Ave., Flushing 65, N. Y.

REMAILS 35¢. Canadian post cards in color \$1.00 dozen. 4 large \$1.00. O. Constantineau, 7634 St. Hubert, Montreal, Que., Canada.

FABULOUS Hawaii—Remails 25¢, classifieds \$1.00. Jaqui, Box 1771, Honolulu.

REMAILINGS Or replies 24¢ (stamps accepted), monthly \$3.00; fast service! Box 2222, Kansas City 42, Missouri.

CALIFORNIA Address receiving, forwarding, 25¢. Don Rains, 19139 Baseline, Glendora, California.

### TREASURE FINDERS

TREASURE. Metal-mineral detectors. M-scope. Used worldwide for treasure hunting. Geiger, scintillation counters, mineralights. From \$14.75. Guaranteed. Time payment plan. Free treasure, uranium information. Free catalog. Fisher Research Lab., Inc., Dept. C-1, Palo Alto, Calif.

FIND Buried treasure, gold and silver, with Goldak's sensational 3½ lb. "find-it" locator, only \$64.50. Write for free literature on complete line of mineral, metal locators; Geiger and scintillation counters. Goldak, 1541 W. Glenoaks Blvd., Glendale, Calif.

LITHIUM. The wonder metal. Free booklet describes prospecting information, uses, etc. Nu Age, Box 142, North Battleford, Sask., Canada.

FREE Literature—Light weight, guaranteed metal detectors, Geiger counters and mineralights. Kits and assembled models. Electronic Applications. Dept. M, Box 8, Arlington 10, Virginia.

GOLD, Silver metal detectors. Geiger counters for uranium. Violites. Sensational new fully guaranteed models. None finer. Information free. Detectron Corp., 5528 Vineland Ave., North Hollywood, Calif.

### FOR SALE—MISCELLANEOUS

TELEPHONES — Old wall telephones, working order. Oak cabinets, hand crank for ringing; \$5 each f.o.b. Telephone Co., Turtle Lake, Wisconsin.

HEARING Aid batteries, wholesale. Free list. Habs, Box 51, York, Penna.

BEAUTIFUL. Laminated holy cards 25¢ each. Laminating Man, 2509 Sierra, Torrance, California.

SHOP On wheels. Inexpensive wheel kit. Free catalog. Ripplinger's, 1926 Gravois, St. Louis 4, Mo.

STINKBOMBS Disgustingly potent! 12/\$1. Kits, 1451 Drake, San Pablo, Calif.

AMAZING Heater heats 12 hrs. for 5¢. Cooker cooks 5 hrs. for 5¢. Lantern burns 12 hrs. for 5¢. Free folio. Hundley, Box 102, Greenacres City, Fla.

### WANTED—MISCELLANEOUS

QUICKSILVER. Platinum, silver, gold. Ores analyzed. Wholesale Terminal, Norwood, Mass.

SCRAP Mercury (quicksilver) containers supplied — Tantalum, tungsten, silver, platinum. Metallurgical Products Company. Established 1909, 35th & Moore Sts., Philadelphia 45, Penna.

### CHRISTMAS SUGGESTIONS

CHRISTMAS Gifts imported from all over the world direct to you, and unusual domestic selection. Send for free catalogue. Imco, P.O. Box 484, San Francisco, Calif.

FABULOUS Gifttime catalogue free. Harold Osterhoudt, R.D. 2, Poughkeepsie, New York.

HELBROS Watches—Wholesale. Men's or ladies' 17 jewel. Retail \$59.75, cost \$36.35. Money back guarantee. Catalog 20 cents (refundable). Beautiful 15 inch vinyl doll. Must see to appreciate. Money back guarantee. Regular \$3.95 value now only \$6.45. Catalog of other Christmas items 10 cents (refundable). Reidier's Sales, 501 Parkway, Schuylkill Haven, Pennsylvania.

SEND For free 4-color catalog showing complete line of "do-it-yourself" kits. Offers over 20 different handicraft projects for Christmas gifts or fund-raising groups. Holiday Handicrafts Inc., Winsted 14, Connecticut.

### MISCELLANEOUS

TABLET T-square used with common 8½"x11" pad makes bulky drawing board and mounting paper unnecessary for small drawings, sketches, charts, accounting forms. Real convenience for busy executives, engineers, inventors, teachers, accountants, office workers, students. Excellent present. \$2.00 postpaid. Dolgorukov Manufacturing Co., Dept. D, Fisher Bldg., Detroit 2, Mich.

HOW To sell your own property. Tested and proven method. Book, signs, documents \$2.50. Spaulding, 1400 S. W. 84th, Portland, Oregon.

GOD Answers prayers. Interesting folder free. Methods Research, Box 2236, Kansas City 42, Mo.

NEW Snow Cone machines. All prices. P.O. Box 7803, Dallas, Texas.

SELL! Buy! Trade! through Trading Post Magazine. Details free! Thorne's, 525 Dewey, Jackson 40, Michigan.

"MIAMI Exclusive" November issue. 10 crammed pages homes, land, jobs, business opportunities, investments, retirement. Only \$1. Six yearly \$5. Guaranteed up-to-date, reliable. Jennings Studio, 8163 N.E. 2 Ave., Miami, Fla.

BIG Multicolor wholesale catalog! Housewares, appliances, clothing, silverware, cookware, luggage, binoculars, radios, phonographs, cameras, recorders, projectors, typewriters, shavers, sporting goods, toys, tools, sewing machines, watches, jewelry. Name brands. Huge discounts. Postcard: Selbyco, Decatur 362, Illinois.

SONGWRITERS: Are you trying to get your songs published? Our members achieving success. National Songwriter's Guild, 16H Ocean Shore Drive, Ormond Beach, Florida.

WRITE Your name in beautiful metallic letters. Looks, feels like expensive engraving. Ideal for Christmas. Free sample. Unique Trades, Box 5516, Chicago 80, Illinois.

DRAFTING Machines, portable. Drafting Equipment Co., Randolph Street, Meadville, Penna.

FREE Catalogue on Hawaiian gift items. Ed & Don's, 1120 Koko Rd., Honolulu.

CLEAR Plastic laminating. Lodge cards, color photos, news clippings, passes, etc. 3"x5" 50¢, 5"x7" \$1.00. Name address hand stamped pocket key protectors any lodge emblem, social security, dog collar plates, etc. 50¢; three \$1.35. Identification necklaces, bracelets \$1.25. Francis Meyer, B-241-A, Milton, Penna.

BEAUTIFUL Portraits done in oils from photographs. Very reasonably priced. Free particulars. Elmer Brunow, 2209 W. Brown, Milwaukee 5, Wisconsin.

WE Create original slogans that will produce results for you. Write Sloganeers, 232-5th Avenue, North, St. Petersburg 1, Fla.

HEARING Aid batteries, factory fresh. Save money. Catalog. Lincoln Electric, 28 Jonathon St., Hagerstown, Maryland.

ORIGINALS. Three genuine Mexican coins made into tie holder. Postpaid. Send \$1.00 to M. C. Schumpert, P.O. Drawer 239, Portales, New Mexico.

SPICED Nuts. Everybody loves 'em. Sample and recipe \$1.00. G. Fuller, 2227 N.E. 79, Portland, Ore.

RECEIVE Mail, magazines, catalogs, opportunities, 10¢. Star Service, Leming, Texas.

SELLING Primitive art woodcarvings, novelties, souvenir, antiques, curio, plaques, handicrafts, etc. Free information. Oscar Daws, 156 Bayan Park, Baguio, Philippines.

LAMINATE In plastic. Wallet size cards, photos. 3 for \$1.00. Free sample. Permasel, 303 N. Tillotson, Muncie, Ind.

PHOTOCOPIES Of any document 50¢. Additional copies 10¢ each. Electro-Copy, 309 N. Union Ave., Chicago 10, Ill.

ZINC Photoengravings. From any photo or illustration. Minimum size 5 sq. inches \$1.76. Free price list. Miller-Hoiles, 437 E. Market, Alliance, Ohio.

YOU Need a Bible. Descriptive literature free. S. L. Bigford, Box 11, Solway, N. Y.

GIFT Shaving set with subscription, \$1.00. Swappers Paradise, Blue Springs, Nebraska.

SADDLES, Boots, western wear, leather supplies. Free catalog. Silver Spur, Box 1785D9, Fort Worth, Texas.

IT'S Smart to shop by mail. Select gifts of nationally-advertised merchandise from your armchair at low discount prices. Watches, jewelry, appliances, luggage, home furnishings, sporting goods, tools, etc. Write today for big free catalog. Midway House, Box 25, Rockford, Illinois.

WORLD'S Smallest Bible 25¢. Five, \$1.00. Fox, 12022 Pine, Norwalk, Calif.

LEARN While asleep! Details free. Research Association, Box 610-MC, Omaha, Nebraska.

RECEIVE Magazine samples, mails, catalogues, offers from everywhere. Get listed 25¢. Rorick, Cincinnati 26, Ohio.

YOUR Name wanted. We'll send 1000 publishers, mailers, wholesalers your name, on our list one year 25¢. Dixie Mailers, King, N. C.

BOOKS On antiques and their prices. Free circular! P. Warman Publishers, Uniontown, Penna.

10¢ COMIC Books 5¢. Details free. Box 1647, Uniontown, Penna.

JAPAN: Buy gifts direct. Dolls, kimono, records, etc., 24 page catalogue, business information — \$1.00. Send money order. Clarence Yamagata, 202 Naka 7 Bldg., Marunouchi, Tokyo.

WE Pay \$3.50 lb. dried. Grow mushrooms. Cellar, shed and outdoors. Spare, full time, year round. We have 25,000 customers. Free book. Washington Mushroom Ind., Dept. 175, 2954 Admiral Way, Seattle, Wash.

BUY Wholesale! Over 10,000 nationally advertised products. Appliances, cameras, sporting goods, housewares, watches, typewriters, tools, clothing, etc. Send postcard today. Buy-Rite, Box 258, Hawthorne 2, New Jersey.

CIGARETTES—Make 20 for 8¢. Facts free. Moberly, Box 810, Owensboro, Kentucky.

MARSHMALLOWS And marshmallow frosting. Make your own from kitchen tested recipes. \$1.00. Korner Candy, P. O. Box 3646 Loring Station, Minneapolis 3, Minnesota.

CESSPOOLS, Septic tanks, clogged drains. How they function and how to keep them working. Free literature. Chemical Cesspool & Drain Cleaning Co., Boston 34, Mass.

STILTS—6 Ft., spliced hardwood poles; heavy aluminum steps, instantly adjusted to any height; strong, durable; in two colors. Prepaid \$4.00. Order now for Christmas! Ye Old Rail, 23 Lexington Ave., New Haven, Connecticut.

SPAIN. Bullfight colorful postage, \$3.00; ten viewcards, \$1.00; two remails, \$1.00. Swell, Madrid-Chamartin, Madre Dios 43, Spain.

WANT More business? Here's an amazing opportunity to increase your sales. Talk to thousands of interested readers of "Mechanica Popular." Our Spanish Edition covers the Latin American countries like a blanket. They're real mailorder buyers. Classified rate 75¢ per word. Try an ad in our next issue. Classified Advertising Department, Popular Mechanics Magazine, 200 East Ontario Street, Chicago 11, Ill.



New 1958  
Sportsman

# WATER & SHOCK RESISTANT WATCH

Compare with Any  
Watch Ticketed  
Up to \$49.95

STILL ONLY

**7.98**  
PLUS TAX



- Bang it!
- Wet it!
- Jolt it!
- Runs Under Water!

Orders Shipped in 24 Hours! Mail Coupon!

We've sold 200,000 watches but this is our greatest! Perfect Christmas gift for every man—16 to 60! Handsome, rugged 1958 Sportsman Water & Shock resistant time-piece—engineered to rigid Swiss precision standards. As different from other low-cost watches as night and day! Bang it! Jolt it! Wet it! Run it thru sand and dirt! It's multi-protected. Even runs under water. \*Compare with brands ticketed at \$49.95 for beauty, design, utility. Don't let our special low price confuse you. Even if we charged you TWICE the price, we couldn't give you a more accurate watch. Check these features: Anti-magnetic. Built-in shock protector. Stainless steel back. Electronically time-checked by honored Swiss craftsmen. Luminous dial. Center sweep second hand. Fine leather strap. Modern applique very thin design. Built for years and years of service

indoors, outdoors, at work or play, on hunting and camping trips, etc. 25,000 already sold—our most popular model by far! You get NEW 1958 MODEL! And you receive the famous Thoresen guarantee of FREE service, FREE annual oiling, FREE adjustment, FREE labor on watch. Guarantee given IN WRITING and good for LIFETIME of this firm! Every order filled same day received. Satisfaction guaranteed or YOUR MONEY REFUNDED—no questions asked! Order by No. 260. \$7.98 plus 80c excise tax. Total: \$8.78. Mail coupon direct to importer: THORESEN, Inc., 585 Water Street, New York 2, N. Y.

Special: Ladies' Model. Same features. Only \$9.50 tax paid. Same guarantee. Thinner, smaller design. DeLuxe packaged. No. 260L. See coupon.

THORESEN, Inc., Dept. 6-M-260  
585 Water Street, New York 2, N. Y.

RUSH Water & Shock Resistant Watch at \$7.98 plus 80c excise tax. Total: \$8.78. My money back if I'm not satisfied.

Check, cash, m.o. enclosed. Send prepaid.

Send COD plus postal fees.

PRINT  
NAME \_\_\_\_\_

ADDRESS \_\_\_\_\_

Check here for Ladies' Model No. 260L. Same terms. Only \$9.50 tax paid.

**WHAM-O** \$1.50 40 LB. FULLY

HITS LIKE A RIFLE—KILLS RABBITS, SQUIRRELS

Powerful, silent, accurate for hunting, target, fouting pests.

Sportsman's choice and world over!

NEW! surgical quality pure pure rubber

HUNTING SLINGSHOT

Heavy duty 7" ash stock. 40 heavy steel balls, extra rubber, target, adapter for shooting arrows.

GUARANTEED: Professional model of Nat'l Slingshot Assn. At dealers, or write WAMO MFG. CO., Box F32 San Gabriel, Calif.

FREE catalog on crossbows, knives, games, pistols, etc.

## GREATEST NEW DEVELOPMENT IN AUTOMOTIVE SAFETY!

TRACTION-MASTERS simply installed on your car assure a smooth, level ride—safe, short stops—faster starts! No dip—no dive—no sway! Improved traction in snow, ice or mud. Tremendous savings on tire, spring, shock and gear life! Blowout protection!

Only **\$42.45** pair

**MONEY-BACK GUARANTEE!**  
Write Dept. PM-11 for FREE BROCHURE with full information.



**Traction-Master Co.**  
2917 W. OLYMPIC BLVD.  
LOS ANGELES 6, CALIF.

# Get into... PLASTIC LAMINATING AT HOME!



**THIS MAN**... is taking out of the machine a Plastic Sealing Job—ordered by mail—only 11c in material cost brings back \$2.59 in cash by mail. Capacity of machine: \$25.00 profit per hour of operation.

Get **ORDERS** and **CASH** from your mailman—do work in **SPARE TIME** at home—or expand into **FULL TIME** business. Send coupon for Free facts about the newest and most fascinating of all home operated businesses. For the first time a simplified machine brings the fabulous profits of **Plastic Sealing** and **Plastic Laminating** within the reach of the small operator. Anyone can learn to operate the machine with a few minutes practice—then with our **Magic Mail Plan** can get mail orders pouring in daily with cash in every envelope. **No canvassing—no selling.** We even

**Make Thousands of Beautiful Art Creations**  
COSTUME JEWELRY • CIGARETTE BOXES  
TRAYS • CANDLESTICKS • COASTERS  
LAMP BASES • BOOK ENDS...ALL IN  
SPARKLING COLORED PLASTIC



**Make \$20 to \$30 a Day by..  
MAGIC MAIL PLAN!**

supply the circulars you mail to bring back cash and orders. Don't waste a minute. Rush your name. We'll send you FREE and postpaid, pictures, prices, details, and all the facts you need to start. Mail coupon or send name on postcard. No charge. Warner Electric Co., 1512 Jarvis Av., Dept. L-2-M, Chicago 26, Ill.

WARNER ELECTRIC CO., 1512 Jarvis Av.  
Dept. L-2-M, Chicago 26, Ill.  
At no cost to me, please rush complete details postage prepaid. I am under no obligation.

Name \_\_\_\_\_  
Address \_\_\_\_\_  
City \_\_\_\_\_ Zone \_\_\_\_\_ State \_\_\_\_\_

**WE WILL ESTABLISH YOU IN YOUR OWN  
MAIL ORDER  
DISCOUNT BUSINESS!**

Suppose you had a partner who offered to set you up in your own business as an Associate Discount Distributor. Suppose this partner has 40 years experience in the mail order field and has sold millions of dollars' worth of merchandise through the mails. Suppose such a partner offered to give you the benefits of this vast experience, supplied you with expertly prepared catalogs and offered to fill your orders for you. Would you miss this opportunity?

You don't need a penny for merchandise because we will fill your orders for you **UNDER YOUR NAME!** We occupy our own building (3 floors); keep large stock on hand and make quick shipments. No service charge for drop shipments. No minimum order. When you receive orders and payment, you keep your profit, remit your low confidential cost to us and we will immediately ship under your name.

You can do all your business by mail. (Of course, you can also sell to your friends or co-workers). What is truly extraordinary is that the catalogs, **PRINTED WITH YOUR NAME AND ADDRESS**, can cost you nothing! We can even supply you with names of mail order buyers on small labels which you can paste on the catalogs and mail.

The complete line includes merchandise in demand all year round by every family. It includes stainless steel tableware (featuring our own **EXCLUSIVE** patterns not obtainable elsewhere); jewelry, watches, dinnerware, housewares, books, appliances, such as percolators, toasters, skillets, irons, etc.; cookware, cutlery, gift items, etc. The wonderful part about all this is that **YOU** can actually **SELL** at discounts up to 75% from the list prices and still make a good profit for yourself!

This is possible because it is so amazingly low. For example, a deluxe Sheffield stainless steel carving and steak knife set, in a magnificent satin lined chest, list price \$49.95, costs **YOU** only \$3.95! New American encyclopedia, list \$8.85, costs **YOU** only \$1.90! Necklace with earrings to match, in gift box with \$19.95 price tag, costs **YOU** only 95¢! You can **SELL** nationally advertised watches at about **HALF** the list price and still make money!

We charge no fee to become an Associate Discount Distributor! We have no "plans," instructions, "memberships" or "franchises" to sell. Our business is to sell merchandise and the only way we can do more business is to be able to help you to make more sales.

**FREE!**

Don't make up your mind now. **GET THE FACTS** and then decide. Coupon or postcard will bring you complete details, catalog, money-making plans, confidential prices to you etc., etc. No deposit. No obligation.

**TOPVAL CORPORATION  
Lindenhurst 12, New York**

**TOPVAL CORPORATION  
Lindenhurst 12, New York.**

Rush, absolutely free and with no obligation on my part, catalog and complete details showing how I can become an Associate Discount Distributor.

Name \_\_\_\_\_

Address \_\_\_\_\_



**unlimited opportunity  
for graduate engineers**

Demand for our engineering graduates exceeds supply. Important firms visit campus regularly to interview seniors. Industrial growth... automation... technical advances create career opportunities for engineers, accountants, management experts. Share rewards awaiting college men... higher income... rapid advancement. Grasp your chance for a better life now! Start any quarter in this world-famed college. *Approved for veterans.*

**Bachelor of Science degree in 27 months**

In Mechanical, Civil, Electrical, Chemical, Aeronautical, Radio (TV-Electronics) Engineering. In 36 months a B.S. in Business Administration (General Business, Accounting, Motor Transport Management majors). Superior students may accelerate, 36-weeks course in Drafting. Intensive program! Technical fundamentals stressed: comprehensive courses with more professional class hours. Small classes: personalized instruction. Enrollment limited to 1800. Preparatory courses, *Beautiful campus*. Well-equipped, new and modernized buildings and laboratories. Enter Jan., Mar., June, Sept. Earnest, capable students (whose time and budget require accelerated courses and modest costs) are invited to write *Jean McCarthy, Director of Admissions*, for catalog and book "Your Career in Engineering and Commerce."



**TRI-STATE COLLEGE**

4117 College Avenue • • • Angola, Indiana



**BARBELLS**

**100  
POUND  
SET  
\$11.80**

Extra Plates Only 10c Pound

**140-Pound, CHROME DELUXE Barbell-Dumbbell set only \$18.80.** This is our feature set and is the finest ever manufactured.

Training with adjustable weight is the **BEST** way to keep fit; the **ONLY** way to develop great strength and a perfect body. As the oldest and best equipped barbell company, **BUR** gives value and prices no one can equal.

**SEND FOR FREE CATALOG.**

**BUR BARBELL CO.  
Lyndhurst 9, New Jersey**

**FREE! 1958 PHOTO GUIDE**

36 pages crammed with newest "how-to" info; lists every type of camera, movie camera, projector, enlarger, accessory. All at low discount prices, easy time payments, generous trade-ins.

**SEND POSTCARD NOW! GRAND CENTRAL CAMERA**  
1 East 43 Street, New York, N. Y. DEPT. 14

**NOW NO ONE CAN KEEP A SECRET FROM YOU! 36 Arca Mag. (6X) only \$325 TELESCOPE**

Amaze your friends... See what they're doing—without being seen! Special! Order now, get free carrying case. Money Back guarantee. Send cash, check, or money order today! 4-range all metal telescope magnifies up to 36 Arca Mag. (6X). Watch ball games, look at the moon, stars, animals, distant buildings... up close. Bright aluminum tube practically unbreakable. Good on hikes, camping trips, can use either short or long distance. Rotating focus eyepiece. No assembling, ready-to-use, no special instructions required!  
**I. J. STONE, Dept. B-11 • 1616 Oak St. • Santa Monica, Calif.**

**BUY BELOW WHOLESALE**

**START YOUR OWN HOME-IMPORT BUSINESS**

Make big profits on thousands of exotic imports. No experience or investment in products needed. Famous world trader guides men and women—shows you how to pocket profits before ordering, how to get free ads, how to start full or spare time home mail-order business or take volume orders from stores. Export opportunities also. Full details, booklet and list of 157 imports showing amazing low foreign prices—**ALL FREE.** Air mail reaches us overnight. Write

**EXAMPLES OF LOW PRICES ABROAD MELLINGER CO., Dept. G25B**  
1717 Westwood, Los Angeles 24, Calif.



# SAVE \$ ON U\$ GOV'T \$URPLUS\$

Our publication "Government Surplus Sales" lists hundreds of items for sale by the U. S. Government at tremendous savings, as low as 1c on a \$1.00.

These are samples of the savings that are being made:

LIFE BOAT ....\$12.00 GRINDER .....\$4.69 SHAPER .....\$15.00 DUMP TRUCK.....\$76.77  
 TRACTOR .....\$75.00 TYPEWRITER ...\$7.51 FREEZER .....\$50.00 SPRAY PAINTER.....\$15.25  
 MOTOR .....\$4.00

Hundreds others listed in our bulletin "Government Surplus Sales" and may be purchased direct from U. S. Government. Hunting, Fishing, Camping, Sporting Equipment, Photographic Equipment and Supplies, Radio and Electronic Equipment, Amphibious Trucks, Jeeps, Boats, Motors, Binoculars, Plumbing, Electrical Equip., Cars, Power Tools, Machinery, Chemicals, Furniture, Office Equipment, Supplies, Scrap, Etc.

How may you receive our bulletin "Government Surplus Sales?" By sending \$1.00 to  
**GOVERNMENT SURPLUS SALES, P. O. Box 169, Department 8-5, East Hartford 8, Conn.**

**1957 CATALOG BOAT KITS** WOOD and FIBERGLAS

EASY TO BUILD - DESIGNED for professional results by the amateur. World's largest selection of top performance, latest design, proms, skiffs, racers, runabouts, sailing boats, cruisers. 8 to 20 ft. Mahogany decks, frames. FREE FREIGHT. SEND FOR FREE CATALOG

Includes fiberglass paints, accessories

**Boat Plans-Patterns-Frame Kits**

Build over 50 modern boats from large scale plans, available with FULL-SIZE patterns, new PRE-FAB frame kits! All types: proms to cruisers, 6 to 25 ft. Best buy for Amateurs! SEND 10¢ for CATALOG.

**Craig Craft**  
 Tonawanda, N. Y.

**HYDRAULIC JACK REPAIRS**

**Earn While You Learn at Home**

Millions of jacks in gas & auto-service stations, truckers, body-shops, riggers, factories, farms need servicing. We show you HOW - easy step by step directions-what tools to use. EARN UP TO \$5 an hour, in spare time, in your own basement or garage. Start your own business NOW. Write for folder #PM11 & free bonus offer.

**Institute of Hydraulic Jack Repair**  
 P.O. Box 50, Bloomfield, N. J.

**Learn LANDSCAPE GARDENING**

A thorough, interesting home study Course for those who wish to become a Landscaper, Garden Consultant, Contractor or Designer for profit or pleasure. Write today for FREE Booklet.

**NATIONAL LANDSCAPE INSTITUTE**  
 Dept. M-117 11826 San Vicente Blvd. Los Angeles 49, Calif.

**Original ARRO-PING VEST POCKET ARCHERY**

for Indoor or Outdoor Fun!

Hours of fun with Arro-Ping - for target and small game - in ramps, rooms or patio, in camp, on hikes and picnics! Live-rubber driver for lightning zip, guide barrel for accuracy. Quiet, safe, cannot be discharged accidentally. Economical - use arrows over and over.

**ARRO-PING CO.**  
 P.O. Box 3067-H, No. End Station, Colorado Springs 11, Colorado

NEW Deluxe Concentration Outfit - only \$2.00  
 You Get - 2 postpaid  
 Pistol-grip stock and driver  
 6 metal-tip arrows (3 conical-point, 3 heavy blunt)  
 3 shafts with 6 interchangeable rubber tips  
 1 slip-on whistle tip

**ORDER TODAY - SATISFACTION GUARANTEED!**

**AMAZING! SAVE UP TO 70%! ABSOLUTELY NEW, NEW TIRES**

not used or recaps. **NEW TIRE GUARANTEE**

670-15	\$7.95	600-16(6)	\$8.95	825-20	\$23.25
710-15	8.45	650-16(6)	10.25	900-20	24.25
760-15	8.95	750-16	12.60	1000-20	27.50
700-16(6)	12.00	700-20	16.50	1100-20	28.50
700-16(6)	12.50	750-20(8)	18.50	1000-22	27.50
700-14 9.75		750-20(10)	21.50	White Walls \$1 extra	

Dealers demand trade-ins & tax on new tires. WE DON'T. More \$ Saved! Read all ADS carefully. Don't confuse "USED" tires with our "NEW" TIRES. Thousands of these fresh standard brand rejects are in use daily.

**SAVE \$3 to \$33 on SNOW TIRES**

**GOODYEAR SUBURBANITE** Silent type & others

Also our **PREMIUM GOODYEAR Full tread** \$9.95  
 3 Full Win - any car tires **TUBE FREE**

All types, factory Mud-Grip Retreaded & slightly used. No trade-in needed. **SPECIAL 12 Mo. GUARANTEE** (Tube Free) White Walls \$2 extra

**\$6.22** any car

**MARVIN BLATT** 6th & Spring Garden Philadelphia, Pa.

Send Check or M.O. & this Ad for fast shipment. FOR Phila. I personally select your tires as if my future depended on it. **BLATT NAME** famous for 42 years in TIRES

**BECOME A ... Machine Tool DRAFTSMAN & DESIGNER**

**Mail Coupon For Free Brochure**  
 Simplified home study training program. Learn every phase of Machine Drafting and Tool Designing. Step up to a better job-big-pay. Use spare hours-no interference with present work. Diploma awarded. Low Tuition.

**American Technical Society**  
 Dept. PM-1157, 850 E. 58th St. Chicago 37, Ill.

Please send me your FREE BROCHURE and full details about Machine Draftsman and Tool Designer training program.

Name.....  
 Address.....  
 City..... State.....

**... TURN CONCRETE INTO GOLD!**

**MAKE UP TO \$75 A DAY IN YOUR OWN BUSINESS**

If you want to have your own business - to start a business on your own - here's your big opportunity! New high speed, low cost General block machine produces up to 1,000 concrete blocks a day. Sell all you make to builders, supply houses, and others for homes, factories, buildings, garages. Cash in on the building boom! You can make profits of 100% to 150% - up to \$75 a day! General block machine equipped with 1/2 h.p. electric motor - or can be supplied with gasoline engine - works anywhere, in little space, indoors or out. Operates on ordinary house light socket. Simple, foolproof 3 step operation - so easy a child can do it. Makes superior 3 core blocks any size from 4" to 12". Also makes chimney, tank, corner and other types. Blocks meet any building code anywhere in the country. Materials - sand, water, cement, available anywhere. Simple illustrated operating instructions and mixing formulae for cement and cinder blocks supplied with each machine. Write for FREE folder with full information.

**MOTOR DRIVEN**

R.L.T. of New York City reports: "MY GENERAL BLOCK MACHINE PAID FOR ITSELF IN FIRST 2 WEEKS!"  
 Hundreds now in use the world over!  
 Write for FREE details today!

**EXTRA** Amazing illustrated Book gives floor plans for 6 sensational concrete block bungalows. Tells how to lay blocks, lay out building lines, mix concrete, build steps, porch and concrete floors all at great savings. Written by experts. Can save many times the cost of the machine! Get it now! No strings attached. Send \$1.

**BOOK SENT FREE IF YOU BUY MACHINE. \$1 REFUNDED IF YOU BUY LATER.**

**GENERAL ENGINES CO.**  
 DEPT. M-117, ROUTE 130, THOROFARE, N. J.

**HOW TO BUILD YOUR OWN CONCRETE BLOCK HOME**  
 Only \$1 Prepaid

Free!

# ALLIED'S 1958

## ELECTRONIC SUPPLY CATALOG

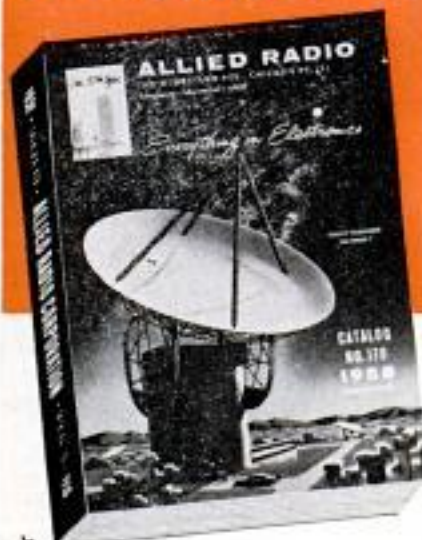

404  
value-packed  
pages

Send  
for it!

SAVE on  
everything in  
electronics

EASY TERMS  
AVAILABLE

### WORLD'S LARGEST STOCKS

Here's everything in Electronics for Experimenters, Builders, Amateurs, Servicemen, Engineers and Hi-Fi Hobbyists:

- Amazing Build-Your-Own KNIGHT-KITS
- Hi-Fi Music Systems & Components
- Recorders & Phono Equipment
- TV Tubes, Antennas, Accessories
- Public Address Systems
- Amateur Station Equipment
- Latest Test Instruments
- Industrial Electronic Supplies
- Parts, Tubes, Transistors, Tools and Books

SAVE on everything in Electronics —get fast, dependable service— send today for your FREE 1958 ALLIED Catalog.

Everything in Electronics  
From One Reliable Source

our 37th year

send for  
**FREE**  
Catalog

## ALLIED RADIO

ALLIED RADIO CORP., Dept. 5-L7  
100 N. Western Ave., Chicago 80, Ill.

Rush FREE 1958 ALLIED 404-Page Catalog

Name \_\_\_\_\_

Address \_\_\_\_\_

City \_\_\_\_\_ Zone \_\_\_\_\_ State \_\_\_\_\_

## WHERE-TO-BUY-IT INDEX

Source of supply appears after items commercially available

### AUTOMOTIVE

Detroit Listening Post.....	107
German tractor has double set of wheels for rails or road.....	123
Electric car has \$12 motor.....	130

### AVIATION

Two noses for Nike get single test.....	14
Boat aids plane take-off.....	106
X-15 may climb 150 miles.....	118
Cantilever airport hangar will hold six DC-8 planes.....	119
Barge sunk in mud flat to recover downed plane.....	144
French-built light jet trainer has V-shaped tail.....	149
Powerful airborne rescue lamp (Arma Div., American Bosch Arms Corp., Roosevelt Field, Garden City, N. Y.).....	156
Air Force planes "home" on flying tankers (Sperry Gyroscope Co., Div. Sperry Rand Corp., Great Neck, N. Y.).....	254

### FARM

Hay pelletizer.....	112
Car rolls along manger to feed cows.....	158
Two sickles on one tractor cut mowing time (Heidrick Bros., Woodland, Calif.).....	158
Alfalfa hopper towed by harvester.....	159
Truck-powered winch loads 100 hay bales in 45 minutes.....	159
Feed stored in truck body.....	220
Separate stalls in dairy barn.....	220
Lifters guide stalks to rolls.....	222

### MISCELLANEOUS

Corrugated-metal roofing makes back-yard castle.....	86
Mosaic-tile table assembled from kit (Venetian Crafts, 2427 Biscayne, Miami, Fla.).....	86
"Passive radar" makes microwave maps.....	104
Mechanical "woodpecker" drills dynamite holes (Trowel Drill Corp., Raleigh, N. C.).....	105
Push-pull terminal truck (Four Wheel Drive Auto Co., Clintonville, Wis.).....	106
English ladder sections double as stretchers.....	118
Wall TV set 16 inches deep (Admiral Corp., 1191 Merchandise Mart, Chicago 54, Ill.).....	118
Alweg monorail train makes experimental run.....	119
Battery-driven propeller tows underwater swimmer.....	119
Telescoping trailer unit carries 850 pounds (Harrington and Richardson, Inc., 320 Park Ave., Worcester 10, Mass.).....	123
Ship for laying pipeline has a built-in "hill".....	131
Ski without snow on plastic mats.....	131
Outdoor tree is plastic (General Plastics Corp., 1400 N. Washington St., Marion, Ind.).....	138
West Berlin glass blowers produce prize Yuletide ornaments.....	136
He makes Christmas trees with goose feathers and wire (Frank Sing, 1535 E. Highpoint Ave., Sunnyslope, Ariz.).....	137
Suction cup on ceiling prevents tree from tipping (Roger Products, Inc., 605 N. Third St., Milwaukee 3, Wis.).....	137
Robot "sees" objects and senses humans.....	144
Back-yard rink for ice skaters (Polymaster Div., Cello-Masters, Inc., Bronx 59, New York City).....	145
Five-ton camera helps build planes (Robertson Photo-Mechanix, Inc., 7440 W. Lawrence Ave., Chicago 31).....	149
Hair-size hole made by drill (Lockheed Missiles, Sunnyvale, Calif.).....	149
Gooseneck spout fights fire (Shell Oil Co., Houston Ship Channel Refinery, Houston, Tex.).....	153
Albuquerque solar building tests radiant-heat system.....	157
Gas-powered vacuum cleaner is anti-litter weapon (Mid East Sales Co., 340 Crescent Ave., Cincinnati 15, Ohio).....	246
"Caddy" for your rifle (Lee Bert, Inc., 900 Lapeer St., Saginaw, Mich.).....	250
Diamonds from peanut butter.....	254
Laminating kit for photos (Therm Appliance Mfg. Co., St. Charles, Ill.).....	262

### SCIENCE

Delaware students shake hands with science.....	40
Square bubbles surprise atomic-energy scientist.....	106
Mechanical aids for the doctor.....	154

### Radio-Television, Electronics

A transistorized instrument amplifier.....	160
Make your TV set safe!.....	163

### Craftsman and Shop Notes Index

#### AUTOMOTIVE

Truck converted to home.....	185
Steel guard protects taillights.....	188
Dowel crossbar in testing tank keeps inner tubes submerged.....	206

#### HOUSEHOLD HINTS

Drawer under stool.....	170
Repairing loose chair rungs.....	192
Tack driven into frame corrects sagging cabinet door.....	192

#### HOUSE AND HOME

Installing storm sash without use of ladder.....	171
Auger becomes lamppost.....	172
Support holds plaster patch.....	176

(Continued to page 76)

### POPULAR MECHANICS

**Complete Power Tool Accessory Set—100 PIECES**  
Designed for use in all 1/4" capacity electric Drills and Motor Chuck.  
A complete power tool accessory set that can handle almost any job of grinding, sawing, cutting, off, polishing, buffing, reaming, sanding, drilling, cleaning, etching, etc. KIT CONTAINS:— Wire Wheel, Mounted Grinding Wheels, Rotary File, Abrasive Cartridge Rolls, Circular Saw Blade, Felt Bob and Wheels, Honing Stones, Jewelers Rouge, Buffing Wheels, Midget Steel Cutters, Bristle Brushes, Abrasive Sheets and sufficient Arbors to accommodate all the unmounted items. **\$4.98**  
Over \$15 value only. **\$4.98**

**BOLT CUTTERS**  
Easy working, positive action cutters to do the job intended. Made with black cast alloy steel handles, drop forged, interchangeable cutters. Compound leverage makes a difficult job easy.  
12" size \$3.95 plus 25c pp & hdg  
18" size \$5.75 plus 25c pp & hdg  
24" size \$8.95 plus 25c pp & hdg

**Gov't Surplus WEBBED TOW CABLE**  
Originally made for U. S. Air Force. Never used. Test proven for towing trucks, cars, etc. 1 1/2 ft. long with extra heavy duty spring snap cable 3/4" wide. Nylon reinforced cable in 1/4" thick and 1 3/4" wide at ends. Useful at home or keep in car for emergencies.  
**\$1.95 plus 35c**  
pp. & hdg.

**Wood Working VISE... \$2.69 plus 25c pp. & hdg.**  
For home and shop... amateur or pro. A mechanically perfect, solidly constructed vise with full 3 1/2" wide jaws that open to 2". Features smooth-working polished steel bars that glide easily back and forth yet firmly and securely lock work for even the finest of precision crafting. Attractive red enamel body.  
Send Check or M.O. C.O.D. fee extra. **MONEY BACK GUARANTEE**  
**SCOTT-MITCHELL HOUSE, INC.** Dept. M-480, 611 Broadway New York 12, N. Y.

**Prices SLASHED 50% on Polyethylene PLASTIC ROLLS!**  
Mfd. by KOPPERS CO., Inc.  
Use As STORM WINDOWS—Dust, Moisture-Proof Protection! TACK IT, STAPLE IT, TAPE IT!  
**100 FT. EXTRA HEAVY .004 GAUGE**  
HEAT SEAL IT, TAPE IT!  
**WATERPROOF, RESISTANT TO DUST, AIR, GREASE—UN-AFFECTED BY HEAT, COLD**  
Protects from dust, dirt, moisture, rust, moths, heat, cold, etc. Transparent! Stains wipe off! Lightweight, strong, inexpensive!  
**For HOME**—Cover auto seats, furniture, mattresses, lamps, rugs, appliances, luggage, silver to prevent tarnish, air conditioners. Use as shower curtains, storm windows. Keep paint off furniture, floors, etc. Wrap food, mothproof wrap clothes.  
**For OUTDOORS**—Cover boats, sports and fishing equipment, tennis courts, cars. Make children's play tents.  
**For GARDENS**—Protect outdoor furniture and equipment, shrubs, plants, newly seeded lawns. Build greenhouses. Cover lawn mowers.  
**For INDUSTRY**—Cover equipment and machinery. Fumigation, oxygen lens, Painter's drop cloth. Floor covers for car trunks, trucks. Chases moisture vapor from crawl spaces, etc. Curling concrete. Keep rain away from outdoor work areas.  
36" x 100 ft. .004 gauge 5 6.95  
54" x 100 ft. .004 gauge 10.95  
84" x 100 ft. .004 gauge 15.95  
120" x 100 ft. .004 gauge 22.95

**EXTRA SPECIAL!**  
50" x 200 ft. .002 gauge—\$9.95  
100" x 200 ft. .002 gauge—\$19.95  
Add 50c to all prices for pp. & hdg.

**THIS LOW-COST STORM WINDOW PLASTIC**

**Protects Family All Winter**

**CUT PRICE TO NEARLY**

**19 CENTS!**

**2 MILLION SOLD FOR 49c**



Why pay up to \$14.00 for glass storm windows when you can insulate with famous TRANS-KLEER for pennies? Transparent like glass yet can't peel, chip, shatter or rattle. Tests prove it has amazing tensile strength. Not affected by snow, sleet, rain or dampness—because it is NON POROUS! Won't crack even at 83 degrees BELOW FREEZING! Use Trans-Kleer year after year. Install in minutes. Just press them inside window frames. No nails, no screws, no tools, no complicated directions—no big installation cost! Merely cut and fit window, press on with Adheso tape—that's all! For airing: Just lift. Then press back in place. When winter's over, fold them away for next year. Two million already sold. Acclaimed by home owners, churches, schools, builders. Shipped flat in rolls measuring 36" x 432"—308 square feet—enough for 10 standard windows. Regular price \$4.95. Our bargain price—direct to consumer—only \$1.98. (Sorry, NO C.O.D.'s). Send check, cash or money order for \$1.98 plus 22 cents to help defray handling and shipping costs. Total: \$2.20. FREE! Giant 90 foot roll of Adheso tape—our reg. \$1.00 size—PROMPT DELIVERY. Satisfaction guaranteed or money back quick! This is original Trans-Kleer—available only by mail—Only from famous THORESEN 51 585 Water Street, New York 2, N. Y.

**MONEY-BACK GUARANTEE!**  
**THORESEN, Inc., Dept. 6-M-74, 585 Water Street, New York 2, N. Y.**  
**RUSH**—Kits Trans-Kleer measuring 108 sq. ft. (10 windows averaging 10.8 sq. ft. ea.) with FREE Adheso Border Tape on 30 day trial—money-back guarantee at only \$1.98 each kit, plus 22c to help defray shipping costs. Total: \$2.20 ea.  
 check, cash, money order enclosed.  
**PRINT NAME** \_\_\_\_\_  
**ADDRESS** \_\_\_\_\_  
**CITY & ZONE** \_\_\_\_\_ **STATE** \_\_\_\_\_  
Canadians: 439 King St., W., Toronto 2B, Ont.

**WHAM-O BLOWGUN SET**  
for target and hunting  
This amazing gun has the accuracy of a rifle. Compression of breath in barrel gives terrific air power. You won't believe your eyes!  
30" precision metal barrel  
3" steel darts  
Average person can hit a 2" bullseye at 30 ft. Excellent for shooting small game. For target fun with friends, set up in patio or den.  
Set includes metal blowgun, rubber mouth-piece, four 5" steel darts and range target.  
Extra darts 6 for \$1. At sports dealers or send: **WAMO MFG. CO., Box Z-25, San Gabriel, California**  
**SPECIAL \$2.98**

**THE FINEST 1/4 MIDGET 1/2 RACE CARS**  
Precision engineered parts in kits or completely built car. A supreme Christmas gift for your boy. Send 10c for illustrated literature... pictures, track and racing rules information, specifications and complete prices.  
**DEVICE MOTOR CO., INC.**  
12019 VOSE ST. NO. HOLLYWOOD, CALIF.

**BARGAINS**  
Lists Every Month Hundreds of Terrific Buys in—  
• BANKRUPT, Closeout, Surplus Goods  
• New and UNUSUAL Items • WHOLESALE ITEMS • BELOW WHOLESALE •  
Sources of 100,000 items wholesale • Rare Money-Makers opportunities • HUNDREDS of TERRIFIC offers in Toys, Books, Household goods, Jewelry, Greeting cards, etc. . . .  
SAMPLE BARGAINS • Famous \$16.00 Perfume at 60c • 50c boxes Everyday Xmas cards, 7c box • \$1.00 toys, 20c • \$1.95 silk ties, 12tc • Pencils, 99c gross • \$17.50 talking dolls at \$7.50 PLUS MANY, MANY OTHERS!!  
**HIG SPECIAL ISSUE NOW OUT! Subscribe NOW! BARGAINS let you BUY BETTER, CHEAPER, NEWER things for yourself or for resale at TREMENDOUS PROFITS.**  
**\$1.00** Buys 8 Big issues—1 Yr. \$2. Reg. Price \$3 year. Spec. Limited time offer to get 10,000 new subscribers. The only magazine of its kind published!  
**FREE! FREE!** With every 1 year Sub. to "Bargains" you get the new 1957 "BUY IT WHOLESALE" Buying Guide—practically gives you sources of 100,000 items wholesale! Scores of Wholesale Bargains, closeout offers, jobbers lists, etc. Many helpful articles on making money. Thousands of copies being sold at \$1.00 each. Yours FREE with every 1 year subscription to Bargains! (No free copies with 6 mo. subscriptions—just 1 year subscriptions.)  
**TOWER PRESS, INC., P.O. Box 591, Lynn 562, Mass.**

**PREPARE FOR BETTER JOB, BIGGER PAY IN SPARE TIME AT HOME**  
Today, choose the job you want—and prepare for it in time you might otherwise waste. Or if you are already in the work you like best, start training now for quicker promotion and increased pay. During the past 60 years AMERICAN SCHOOL has helped ambitious people to reach higher goals. Check subject that interests you and mail coupon for full information.  
**AMERICAN SCHOOL, Dept. 6845, Drexel at 58th, Chicago 37, Ill.**  
Without obligation, please send FREE and postpaid, full particulars about the subject checked below.  

<input type="checkbox"/> Accounting	<input type="checkbox"/> Contracting	<input type="checkbox"/> Mechanical Engineering
<input type="checkbox"/> Apprenticeship Courses	<input type="checkbox"/> Diesel Technician	<input type="checkbox"/> Mechanical Technology
<input type="checkbox"/> Architecture & Building	<input type="checkbox"/> Drafting—Building	<input type="checkbox"/> Metalworking Courses
<input type="checkbox"/> Automotive Technician	<input type="checkbox"/> Drafting—Machine	<input type="checkbox"/> Plumbing—Practical
<input type="checkbox"/> Better Foremanship	<input type="checkbox"/> Electrical Engineering	<input type="checkbox"/> Private Secretary
<input type="checkbox"/> Blueprint Reading	<input type="checkbox"/> Electricity—Practical	<input type="checkbox"/> Retail Merchandising
<input type="checkbox"/> Bookkeeping	<input type="checkbox"/> Electronics—Industrial	<input type="checkbox"/> Salesmanship—Outside
<input type="checkbox"/> Business Management	<input type="checkbox"/> HIGH SCHOOL COURSES	<input type="checkbox"/> Sheet Metal Work
<input type="checkbox"/> Civil Engineering	<input type="checkbox"/> Machinists	<input type="checkbox"/> Tool Making

NAME _____	OCCUPATION _____
HOME ADDRESS _____	CITY _____
STATE _____	AGY _____

Consent: Write American School, Dept. 6845, 6883 Shurbroke St. W, Montreal

**MAIL COUPON NOW**

# ENGINEERING Home Study Courses

**C**COURSES written by world authorities in all branches of engineering. Step-by-step instructions using methods proved successful by thousands of our graduates. One hour each day in your spare time will start you off to higher pay, security, prestige. Check the course you are interested in and we will send you a complete outline of the course with a booklet describing the Institute and our advanced methods of teaching. Send to: Canadian Institute of Science and Technology Ltd., 676 Century Bldg., 412, 5th St. N.W. Wash., D.C.

Civil Eng.  
Surveying  
Architecture  
Forestry  
Mining  
Structural  
Mechanical Eng.  
Industrial Eng. & Management  
Refrigeration  
Heating  
Drafting  
Plastics  
Electrical Eng.  
Radio  
Electronics  
Television  
Aeronautical Eng.  
Aircraft Engineer  
Navigation  
General Education  
Chemical  
Mathematics  
Journalism  
Accounting

NAME.....

ADDRESS.....

CITY..... STATE.....

Course Interested In.....

Canadians: Send to Canadian Institute of Science & Technology Limited, 676 Garden Bldg., 263 Adelaide St. West, Toronto, Ontario.

(Continued from page 74)

Economy for furnace filters.....	177
Solving Home Problems—	
Free "frozen" tumblers.....	178
Floating paraffin ring in aquarium.....	178
Hi-fi records kept clean.....	178
Record paint color and amount required in each room.....	178
Touch up nicks in furniture.....	178
Handy sewing kit.....	179
Hold down corners of curling calendar leaves.....	179
Jig for locating blind holes.....	179
Proper way to pour liquid from square or rectangular can.....	179
Unusual pull for sliding door.....	179
Wall around switch plates kept clean.....	179
Coil springs on thumbscrews keep ceiling fixture tight.....	182
"Extension rule" aids measuring.....	182
Suction cups hold drying rack.....	182
More storage under stairs.....	183
Change room decor with these movable dividers.....	190
Hook-on bird feeder.....	192
Planter made of hornets' nest.....	194
Modern TV lamps.....	199
Fence supports temporary walk.....	200
Gallery doors conceal kitchen.....	204
Improvised easel holds screens.....	204

## MISCELLANEOUS

Easy-to-make picture framing.....	170
"Handles" on doghouse carpet.....	170
Quick-thawing frozen meat.....	170
Utilizing all pigment assures identical paint colors.....	171
Heavy-duty shelf brackets.....	172
Keep wheels from splitting.....	172
Fire hose washes streets.....	176
Happy-hunter pipe rack.....	177
Hair drier is drawing aid.....	180
Save those empty aspirin boxes.....	181
Torch for starting campfire.....	182
Hot paper cup held comfortably with improvised handle.....	186
Concrete form for postholes.....	188
Novel miniature drums made from tin cans.....	188
Tying a cigarette in a knot without breaking the paper.....	188
"Box blocks" will delight any child.....	189
Saw blade perforates paper.....	192
Lamp table made from old-fashioned sewing-machine frame.....	193
Protecting garbage cans.....	198
Door bars sparrows from martin house.....	197
Tetrachloride cleaning makes electric clock run like new.....	197
Handholes in oil drum.....	200
Spindle for binder twine.....	200
Centered door pull adds symmetry.....	205

## OFFICE, SHOP AND STORE

Tailor's chalk kept sharp with notched knife blade.....	193
"Cantilever" desk for the home office.....	195
Cleaning wooden counter tops.....	200
Masking-tape tabs easily removed for data changes on bins.....	212

## ON THE MARKET

Crack filler.....	205
Cupola comes as a do-it-yourself kit.....	205
Mortar-joint spacers.....	205
Screw anchor made of special lead alloy.....	205
Sectional louver.....	205

## PHOTOGRAPHY

Improvised darkroom sink.....	170
Curved backdrop for close-up photos eliminates "horizon".....	172
Dolly for camera tripod made from stove casters.....	188
Lighted card is focusing target.....	194
Photo-scale capacity increased.....	200
Quick repair for chipped trays.....	200

## TOOLS

Protect tools from corrosion.....	198
Handy tool dolly.....	207
Razor-sharp hand tools.....	212
Shopping for Tools—	
Bench-top ultrasonic cleaner.....	218
Precision gauge blocks.....	218
Short-lift jacks.....	218
Tiny motor with built-in reduction gear.....	218
Vise-grip wrench.....	218
Grease gun.....	219
Hydraulically operated dolly.....	219
Multipurpose workshop tool.....	219

## WORKSHOP HINTS

Plastic bottle is glue dispenser.....	170
Miniature bench anvil.....	172
Crosscut jig for wide stock.....	175
Pencil used as thread gauge.....	177

(Continued to page 78)

**NOTICE**—It is the intention of this magazine to provide its readers with information regarding the latest developments in the mechanical arts. Except where otherwise indicated, this magazine has no information as to any unexpired patents in respect of the developments reported herein. In the event that commercial use is to be made of any of the developments reported herein, it is suggested that legal counsel be consulted to avoid liability for patent infringement. It is not the purpose of this magazine to encourage patent infringement but, as indicated, it is the intention of this magazine to report on the latest developments in the mechanical arts.

**Be A FLORIST** Thousands of money making opportunities full or part time. Many start business in own home. Flower arrangement included to enable you to make professional corsages, sprays, etc. Professional material supplied with Home Study Training. Write for FREE Book.

**NATIONAL LANDSCAPE INSTITUTE**  
Studio M-117 11826 San Vicente Los Angeles 49, Calif.

## New PRECISION MAGNIFIER

FEATURING 3  
DIFFERENT STRENGTH  
OPTICAL LENSES

Quick interchangeable, snap-in lens sets of increasing strength (1½, 2¼ and 3½ power). The lenses are unbreakable, scientifically accurate, and molded together for permanent focal alignment. **ROCKET** is light in weight and is adjustable to any head size. Both hands are free for work. Squinting is eliminated as both eyes are used. Can be worn over your own eye glasses. Guaranteed. Pull refund if not completely satisfied.



Only  
**\$12.50**

### ORDER YOURS TODAY

USEFUL FOR  
Photographers  
Hobbyists  
Mechanist  
Philatelists  
Tool & Die-makers  
Jewelers  
Artists  
Coin Collectors  
Cartographers

**STANDARD UNBREAKABLE WATCH CRYSTALS, INC.**

123 East 144th Street, New York, New York

Please send me

Rocket Viewers with 3 interchangeable lens

@ \$12.50

Money Order enclosed

C.O.D.

Send Literature

Name.....

Address.....

City..... Zone..... State.....

**AN IDEAL CHRISTMAS GIFT FOR EVERY HOBBYIST**

**FOR QUICK STARTING...  
SMOOTH ACCELERATION  
STOP STALLS—POOR MILEAGE**

INSTALL A **MILESMASTER**®

**FUEL PRESSURE REGULATOR**



Let Milesmaster help you enjoy better, more economical motoring. Sold everywhere . . . only \$6.95, plus installation.

Money Back Guarantee

Dept. K

**MILESMASTER, INC.** Exeland, Wisconsin

With "DRY LUBE" Wonder Powder Lubricant  
"ONE PUFF'S ENOUGH"

Clean — no mess — won't soil. New squeeze bottle applicator lubricates everything that moves — locks, casters, fishing reels, etc. If your dealer can't supply — order direct. Send coin — mailed prepaid.

**REARDON PRODUCTS** 307P CASS ST. PEORIA 2, ILL.

SMALL BOTTLE 40c  
LARGE ECONOMY BOTTLE 70c

No Leak Lamp

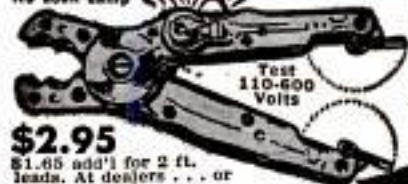

**TEST** Circuits, Fuses, Outlets easily, quickly, safely. Shockproof. Pull fuses 10 to 100 Amp.

**\$2.95**

\$1.65 add'l for 2 ft. leads. At dealers . . . or order direct from us. Mailed POSTPAID for 25c add'l.

**STAR FUSE CO.,** 233 Canal St., New York 13, N. Y.

**STAR TEST-PLIERS**



**SURPLUS SALE**

**\$49.50** NEW TOOL POST GRINDERS REGULAR PRICE \$125.00

1-6 H.P. MOTOR TAKES WHEELS UP TO 1/2"x4" EXTRA OULL EXTERNAL OR INTERNAL \$19.50 MONEY BACK GUARANTEE

**EDWARD J. NOLAN, PULASKI, NEW YORK**

**I'll Send You This Handsome SAMPLE CASE—FREE**



and Show You How to Make Up to \$30.00 in a Day

Mail coupon for this Free Tailoring Sample Case packed with 100 beautiful, big-value suit and overcoat fabrics. Take orders from friends, fellow workers, others, for fine quality, made-to-measure clothes. Pocket big cash profits, in advance. Because wearing our suits and overcoats brings more orders, we make it easy for you to get your own clothes without 1c cost. No experience is needed. **SATISFACTION GUARANTEED.** SEND NO MONEY. Just fill out and mail coupon — today!

**PIONEER TAILORING COMPANY, Dept. R1116**  
CONGRESS & THROOP STREETS - CHICAGO 7, ILLINOIS

**PIONEER TAILORING CO., Dept. R1116**  
Congress & Throop Sts., Chicago 7, Ill.

Dear Sir: I WANT A MADE-TO-MEASURE SUIT TO WEAR AND SHOW, without paying 1c for it. Rush details and Sample Kit of actual fabrics. **ABSOLUTELY FREE.**

NAME \_\_\_\_\_ AGE \_\_\_\_\_

ADDRESS \_\_\_\_\_

CITY \_\_\_\_\_ STATE \_\_\_\_\_

## Kits for Christmas! GENIAC COMPUTER KIT

You can construct over 50 different circuits and 40 different machines that compute, reason, solve puzzles and demonstrate a wide variety of basic computer circuits with the GENIAC electric brain construction kit. Thousands of schools, colleges, industrial firms and private individuals have bought GENIACS since we first brought them on the market.



GENIAC set up to do a problem in check valve research

We have recently added a circuit for composing music, which gives us special pleasure because it was designed by a 16 year old boy who learned about computers from his GENIAC. Dozens of other youngsters have created their own designs for computing circuits, used GENIACS in their school projects and established a solid foundation of information on computers with GENIACS.

Each kit comes complete with Beginners Manual, Study Guide, instructions for building all the machines and circuits, rack (exclusive with our GENIAC), parts tray, and our complete question answering service. When you buy a GENIAC you are buying a first course in computer operation.

Each kit comes with a one week money back guarantee if you are not satisfied.

Price of Kit complete with parts tray, rack, all components, manuals and texts **\$19.95** (postpaid in U. S., add 80c west of Mississippi). (\$2.00 outside United States.)

**SCIENCE KITS, Dept. PM-117, Oliver Garfield Company**  
126 Lexington Avenue New York 16, N. Y.

Want to pass a  
**CIVIL SERVICE TEST?**

**START AS HIGH AS \$4,525.00 A YEAR!**

**Prepare NOW for Next Examinations**  
**Veterans Get Special Preference**

**MEN — WOMEN,**  
**18-55**

Postoffice Clerks-Carriers  
Railway Postal Clerks  
Stenographers  
Accountants  
Immigration  
Patrol Inspectors  
Typists  
Meat  
Inspectors  
Many Other  
Early Jobs

**MAIL COUPON TODAY SURE**

**FRANKLIN INSTITUTE**

Dept. P-93

Rochester 4, N. Y.

(Not Government sponsored)

Sirs: Rush to me, **FREE** of charge, list of many U. S. Civil Service big pay jobs. Send **FREE** 36-page illustrated booklet describing salaries, vacations, benefits, work, etc. Tell me how to prepare for one of these tests.

Name \_\_\_\_\_

Street \_\_\_\_\_

City \_\_\_\_\_ Age? \_\_\_\_\_

New Isotronic Training Method!

## LEARN TV REPAIR IN ONE SHORT WEEK

Now, after 5 years research—a dynamic TV training technique that makes others obsolete! If you've waited for a chance to have your own prosperous business, here's an opportunity to make up to \$150 weekly, almost immediately!

**NO EXPENSIVE TRAINING — NO LONG STUDY!**

You want to get started servicing TV sets — not building them! So, why pay up to \$250 for high-priced lessons and equipment... study long months? Our revolutionary ISOTRONIC method qualifies you to handle any make TV set right away! All the complicated technical theory is already taken care of by our Scientists! This new technique — hailed the most practical in the field — was developed by two of the industry's most respected scientists, in cooperation with every major American TV manufacturer!

**PUT YOUR "KNOW HOW" TO WORK FOR PROFIT!**

In addition to the most streamlined training program of its type, you also benefit from a complete Business Plan that explains fully how to start, conduct, and expand your own TV Service business. Written by expert business consultants. Packed solid with practical know-how instead of theory! Yes, a complete "Business Package" designed to quickly bring you the good things in life that come with your own successful business.

**FREE LESSON PROVES ISOTRONIC METHOD WORKS!**

For conclusive proof, send now for full details and FREE SAMPLE LESSON. Apply it to your own ailing set or a friend's — repair it without a single tool or testing device — convince yourself that the amazing Isotronic method can put you in a profitable TV business of your own, in one short week! Write today — free lesson supply limited! (No obligation, no salesman will call.)

**ELECTRONIC ENGINEERING CO., Dept. A-17B**  
1038 So. La Brea, Los Angeles 19, California

**FREE!**  
Sample  
Lesson

**Just Released!**

**NEW**

## ARMY MINE DETECTOR

**Thousands of Uses**

Model SCR625A. A portable device for detecting metallic and nonmetallic objects. Find buried pipe lines, cables, wires, hidden jewelry, coins, sewer tile, etc.

This unit comes complete with spare tubes, batteries, resonators, and instructions manual — all in wooden chest 8¼" height x 28¼" length x 15" depth. Weight in operation is only 15 pounds. Uses standard batteries.

Shipping weight  
appr. 56 lbs.  
F.O.B. N. Y.  
No C.O.D.'s.  
Send order to:



**COLUMBO TRADING CO., INC.**

395 Canal St., Dept. PM, New York 13, N. Y.

(Continued from page 76)

Cardboard drafting-tool holder.....	180
Compass improvised from comb.....	180
Handy sawhorse has removable legs.....	180
Improvised cabinet catch.....	180
Candle flame speeds saw filing.....	182
"No splinter" nail removal.....	185
Extension ladder wheeled to job with aid of dolly.....	185
Sauce bottle is shop dispenser.....	185
Fluorescent fixture from eaves trough.....	186
Sawhorse easily disassembled for compact storage.....	186
Adjustable depth gauge.....	192
Reconditioning paintbrushes.....	192
Wooden handle in push broom tightened by inverted screw.....	193
Putty knife is nailing guard.....	194
Putty levels wobbling furniture.....	194
Can covers catch drips.....	196
Lines on underlay aid in sketching.....	197
Make handsawing easier.....	198
Upping small-scale capacity.....	198
Guard rail on drafting board protects oversized drawings.....	205
Specialized oil applicator.....	206
Wax paper lubricates clamp.....	208
Holding index pin in "out" position.....	209
Increasing speed range of three-step drives.....	209
Spring tweezers grip tiny screws.....	209
New bite for hammer claws.....	212
Save time when adjusting compass and dividers.....	212
Solder tightens metal screw.....	212
Clear plastic block locates center punch.....	213
Cord reel on power tool provides safe storage.....	213
Hand chucks take tiny drills.....	216
Special V-tool cuts wood threads in a metal lathe.....	216
Spring loading a shaper tool.....	216
Handle for Allen wrench reaches hard-to-get-at places.....	217
Indexing fixtures for milling squares or flats.....	217
Chucking a threaded rod.....	220
Drill clean holes in plywood.....	220
Vertical boring in drill press.....	220

## Two Noses for Nike Get Single Test

Technicians at Wallops Island, Va., recently lobbed a freakish-looking rocket into the sky. The rocket was a Nike with an Honest John first-stage booster and a pair of spear-tipped noses. The National Advisory Committee for Aeronautics explained that using up a high-altitude rocket for every new nose idea gets expensive, so technicians worked out a plan to test two different nose-cone configurations at once. The lift of one balanced the drag of the other during the flight, while delicate instruments measured the heat effects produced in the noses by their different angles of attack. Results of the test will help scientists develop new alloys and nose designs for future missiles.

U.S. Navy Photo from Naval Aviation News



POPULAR MECHANICS



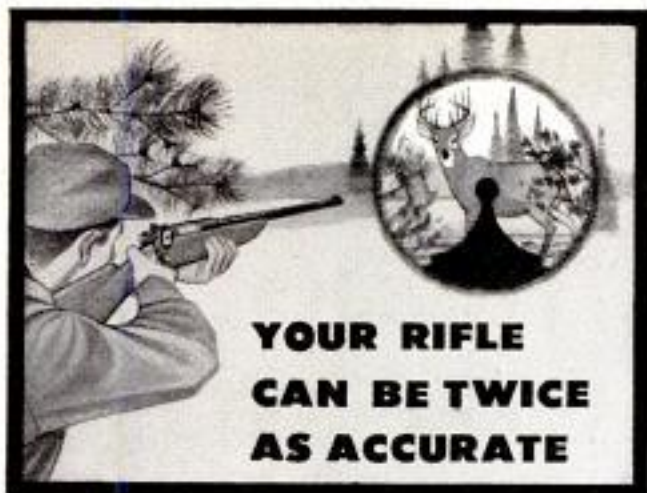

**YOUR RIFLE  
CAN BE TWICE  
AS ACCURATE**

Open rear sights cut the accuracy of modern guns and ammunition *in half*. Lyman precision receiver sights deliver *all the accuracy* built into your rifle.

**SPECIFY LYMAN SIGHTS** With a receiver and front sight combination for all popular rifles, you can have Lyman Sights for your gun for as little as \$6.50. You can't buy more accuracy at any price!

**FREE CATALOG** Discover how you can double your shooting accuracy. Send for free, full-color 24-page catalog. Describes all Lyman Products for Shooters.

**THE LYMAN GUN SIGHT CORP.**  
MIDDLEFIELD • CONNECTICUT

**NEW**  
**ADJUSTABLE STOP FOR POWER SAWS**

Mounts on miter gauge extension rail—or back rail of radial saw—in grooves made on your own rail—cut with your own saw. No rails to buy. Renew anytime—to lengths of your choice. Works either side of blade. Need never be removed. Arm flips back for intermediate cutting without disturbing setting. Has fine adjustment screw insuring accuracy. Promotes safety. (Patented)

**\$3.25** POSTPAID. No COD's.

**THREADED EXTENSIONS DOUBLE USE OF GRINDER**

Threaded extensions. Add buffers — wire wheels — polishers, etc. LEAVE YOUR EMERY WHEELS IN PLACE. For 1/2 inch — 20 thread shafts only. Measure carefully. State right or left side.

**\$1.50** apiece. **\$2.75** a pair POSTPAID. No COD's.

**TEN DAY TRIAL MONEY BACK GUARANTEE.** Free brochure

**RWAnderson Co.**  
1110 W. 68th Street, Los Angeles 44, Calif.

**FREE LAFAYETTE CATALOG**  
JUST OFF THE PRESS!  
NEW 180 PAGE ELECTRONIC CATALOG FEATURING THE BEST BUYS IN THE BUSINESS

Packed with the largest selection of Electronic, Radio and T.V. Parts, and equipment, PA, Hi-Fi systems, tubes, antennas, Transistor Kits, parts and components, Test Equipment, new build your own kits, tools, books, Microscope, drafting equipment, Binoculars, Telescopes, All Radio, TV and Ham supplies—**ALL AT GREAT SAVINGS**—For the economy minded servicemen, dealer, engineer and technician. **CHUCK FULL OF BUYS! SEND FOR YOUR FREE COPY TO-DAY.**

Name \_\_\_\_\_  
Address \_\_\_\_\_  
City \_\_\_\_\_ Zone \_\_\_\_\_ State \_\_\_\_\_

**Lafayette Radio** 165-08 LIBERTY AVE. JAMAICA 33, N. Y.  
Dept. LK

NOVEMBER 1957

# PREFERRED

by Leading  
Appliance Manufacturers  
**NOW AVAILABLE TO YOU!**

**EMERSON ELECTRIC**

**multi  
duti**

**MOTORS**

First choice of manufacturers for 67 years! Now you can choose from 21 different designs from 1/4 to 1 H.P. Write for free catalog No. M-150. The Emerson Electric Mfg. Co., St. Louis 21, Mo.

**EMERSON-ELECTRIC**

of St. Louis . . . Since 1890



**ONE-MAN SAWMILL** LOW \$50.00 DOWN AS . . .

Take BELSAW Portable Sawmill right to the trees—burn out valuable lumber for home and farm—sell to local yards—make up to \$50 a day custom sawing for neighbors. BELSAW lasts a lifetime. No crew needed. Power with tractor or auto engine. Beginners get excellent results. Send today for **FREE BOOK**.

**BELSAW MACHINERY CO.**  
141 3458 Field Bldg. Kansas City 11, Missouri

**BIG PAY JOBS**  
for men who qualify in  
**DIESEL**

**TRAIN NOW FOR A DIESEL FUTURE.** Steady, high-pay jobs await men qualified in Diesel, Tractor, and Heavy Equipment. Are you qualified for job and advancement opportunities in this fast-growing field? You can qualify!

**COMPLETE DIESEL COURSE NOW AVAILABLE.** If you are ambitious and want to get ahead in this big money field, you'll want to know about the complete Diesel home training course now offered by Interstate Training Service. Covers all phases of operation, repair, service. Easy to master in spare time. No interference with present job. Up-to-the-minute. Regularly revised to cover new developments. We invite comparison of material offered. Advisory placement service for our students.

**YOU OWE IT TO YOURSELF** to investigate Interstate Training Service Diesel Training. Thousands agree it has helped them to better jobs...better pay. It can do the same for you!

**WRITE FOR FREE INFORMATION TODAY**

INTERSTATE TRAINING SERVICE, Portland 13, Ore.  
Please see that I receive **FREE 24-page book**, "Getting Ahead in Diesel." (A-3)

NAME \_\_\_\_\_ AGE \_\_\_\_\_  
ADDRESS \_\_\_\_\_  
CITY \_\_\_\_\_ ZONE \_\_\_\_\_ STATE \_\_\_\_\_

79

# Is your car "smoking behind your back"?

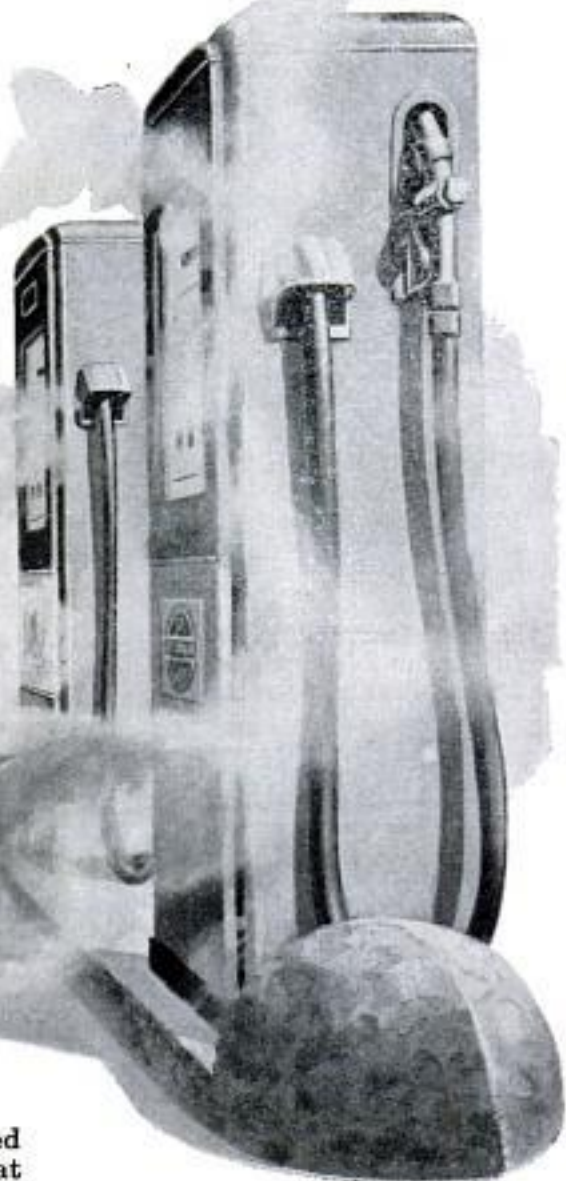

Then see your

## DOCTOR OF MOTORS

Blue smoke usually means trouble—engine wear that's taking its toll in lost power, performance—wasted oil, fuel and money! What to do? See your Doctor of Motors—your skilled mechanic—the man who knows how to restore engine efficiency and that "New Car Feel."

Doctors of Motors everywhere install Perfect Circle 2-in-1 Chrome piston rings to assure top performance.

Perfect Circles are plated with thick, solid chrome that resists wear—*more than doubles* the life of cylinders, pistons and rings.

For long life and responsive power with positive oil control, ask your mechanic to install Perfect Circle piston rings! Perfect Circle Corporation, Hagerstown, Indiana; The Perfect Circle Co., Ltd., 888 Don Mills Road, Don Mills, Ont.

## PERFECT CIRCLE

**2-IN-1 CHROME PISTON RINGS**

*restore that New Car Feel*



You'll be surprised how quickly and economically your dependable Doctor of Motors can bring back a "New Car Feel" to your car. See him now!





Since the war this teak tree fell across the jungle path, leaving just enough room for Landrover to pass

Monsoon and jungle have swallowed up the wartime *Reprinted* trail made famous by General Stilwell. This is the *"PM Highlights"* story of six English youths who, years after, found a new

## Adventure on the Stilwell Road

By Adrian Cowells

WE LEFT "Hellgate," the last Indian post, climbed the 4000 muddy feet of gloomy mountainside and there, poised in Pangsung Pass, we and our escort halted in the rain and made a last brew of coffee.

We were six graduates from Oxford and Cambridge, though with our beards, rainproof jackets and jungle boots there was little to connect us with an English university except the signs on our car doors. They read: "The Oxford and Cambridge Far Eastern Expedition." We had left England five months before and motored across Europe, the Middle East and India to our base camp at Assam. Singapore was our goal. We were trying to find an overland route across the span of Eurasia from London to Singapore.

NOVEMBER 1957

81





Members of the expedition pose with the equipment they carried in their rediscovery of "Vinegar Joe's" road. Included is bridge-building gear and sufficient food to last more than a month

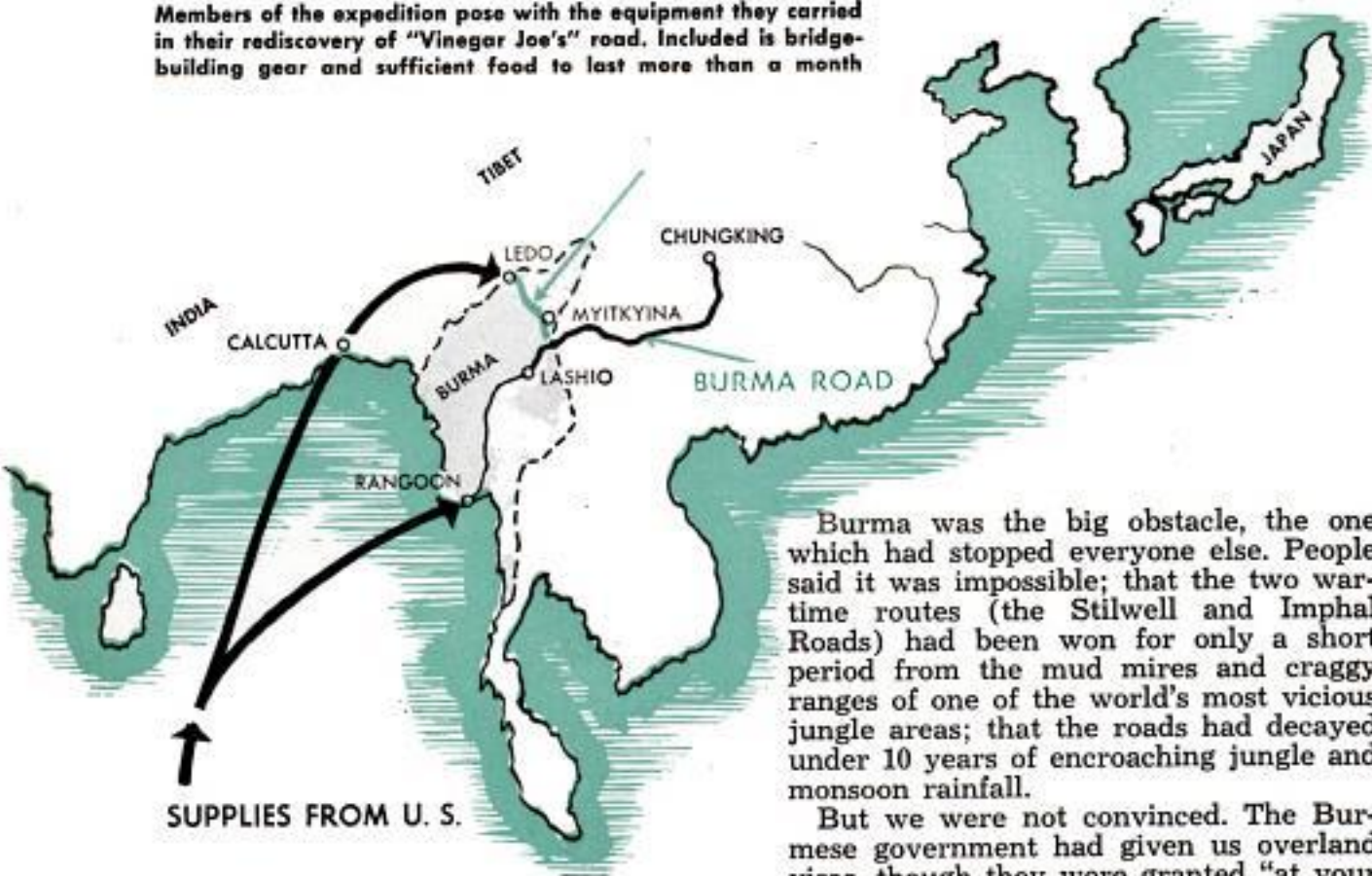

Map shows how the Stilwell Road was driven through to a junction with the older Burma Road. Supplies from the United States came across two oceans to Burma, then up the two roads to the fighting front

Burma was the big obstacle, the one which had stopped everyone else. People said it was impossible; that the two wartime routes (the Stilwell and Imphal Roads) had been won for only a short period from the mud mires and craggy ranges of one of the world's most vicious jungle areas; that the roads had decayed under 10 years of encroaching jungle and monsoon rainfall.

But we were not convinced. The Burmese government had given us overland visas, though they were granted "at your own risk." We had managed to get information on bandit positions. It might be true that no one knew anything about the routes into Burma, but we felt there was



As far as Ledo, the road is part of Indian network and maintained. From this signboard on, it passes into ruin

no harm in finding out for ourselves.

We had tents, camping gear and food to last more than a month; petrol tanks which would take us 1000 miles; power winches to pull the cars up a cliff or out of a river; equipment to build bridges; and two of the toughest four-wheel-drive, 10-gear vehicles in the world, our Landrovers.

And so, as we drank our coffee at the top of the pass, our escort told us what little was known of the road, and we told them what we had learned from conversations with former soldiers and engineers who, years before, had helped build it.

#### Japanese Invade Burma

A week after Pearl Harbor the Japanese had invaded Burma and in a lightning campaign seized the Burma Road, drove a wedge between India and China and cut off Chiang Kai-shek from his supply line to America.

Some of the defeated British, Chinese and American forces in the north jettisoned their vehicles and retreated through the tangled morass of march and jungle which stretched between Myitkyina and India, staggered over the Patkai Hills into Hellgate. They had established the trail which was to become the Stilwell Road, but at that time men called it the "Road of Death."

One of the survivors was Lt. Gen. Joseph Stilwell. "I claim we got a hell of a beating," he said. "We got run out of Burma. I think we ought to go back and retake it." An army of millions of men under his charge was helpless until the supply line was established again.

#### Fantastic Engineering Project

To open the route he planned to blast a highway and oil pipeline from Assam to the old Burma Road. As an engineering project, to be carried out in the face of two Japanese divisions, it seemed fantastic. And because one man forced it into

Washouts have swept away many sections. Expedition built bridges or forded streams up to floor level





India-Burma frontier is marked only by a signboard. This was the first expedition given permission to make the trip in years



On some of the rivers, Army pontoon ferries were still operating, but they frequently went aground some distance from shore. Below, torrential rains had swept away stretches of the road. Such sections had to be rebuilt with branches



creation it was named in his honor—the Stilwell Road.

The road was built by 10 engineer battalions behind a screen of jungle fighters. In that evil land, 200 inches of rain poured down each year, rivers rose 30 feet in a day. When Lord Louis Mountbatten flew over the route, he asked someone the name of the river below. "That's no river," said an American looking down at the sheet of water. "That's Stilwell's road." "Vinegar Joe" himself described it as "Rain, rain, rain, mud, mud, mud, typhus, malaria, dysentery, exhaustion, rotting feet, body sores."

In the mountains, landslides washed bulldozers into 1000-foot jungle chasms. A mule once sank right out of sight in the mud.

#### Mile-a-Day Progress

But the macadam moved inevitably forward. Men of all races, speaking 200 different dialects, struggled ahead thigh-deep in the mud. At a mile a day the road advanced. To build it, the Allies created the longest line of communication of the war—12,000 miles across two oceans, by pipe, rail or river steamer to Assam—and—when the highway was finally finished—by 1079 miles of jungle and mountain to Kunming.

To operate that thin macadam strip, 360,000 square miles had to be conquered at a great loss of human life.

On January 27, 1945, the east-bound armies met those from China and the road was through. Seven months later, atomic smoke mushroomed upward above Hiroshima, heralding the end of the war. From that day the Stilwell Road has been forgotten, decaying into the jungle.

This was the ghost we had come to find.

We set out in silence as our escort bade farewell. The road was gone. What was left was a thinning undergrowth and stone foundations under the mud, mud which lined the track like grease on a garage floor. Our cars slithered between the narrow jungle walls. The track twisted and turned, clinging to the impossible contours of the mountainside, never straight for more than 30 yards. Occasionally we could see,



Explorers pose in a derelict Japanese tank, one of thousands of rusty items of war equipment along road

1000 feet below, the surly green of the jungle in a valley.

### Bridges Down

Soon we realized that our main problem was the streams of that mountainside. Some of the bridges were down, wood yellow with rot, decaying into the water. Sometimes a Landrover stuck in the river bed, and water dashed in one door and out the other as we waded with winch and cable. Sometimes we came to an old Bailey bridge and laid logs across it to provide a surface. On occasion a whole span would sag under us.

But despite it all we descended by the second day into the bowl of the Upper Chindwin. That was our tribute to a great engineering feat: A road so well built that after years of neglect in that impossible environment it still survived. Naturally the macadam was gone, scrub encroaching, bridges swept away. But there was nothing which six men and Landrovers with power winches couldn't overcome.

As we came down into the valley we left the land of the Nagas (their last head-hunting war had been in 1952). We had been warned about them, but the few we saw were timid, small, cheerful and carried nothing but knives. Most of the other forest men had homemade muzzle-loading muskets or wartime rifles loaded with ammunition dated 1942. But none

of them could have been more friendly.

All the way down the road we had been passing the ruins of war. We picked up a torn helmet from the upturned cab of a lorry. We poked inside a tank for snakes, and tried to identify the remains of enormous construction machines. There were stacks of oil drums, mounds of corrugated iron, skeletons of Jeeps and bulldozers. "Did you find any human skeletons?" is a question we are frequently asked. No, not a sign.

### "Anyone for Badminton?"

We traveled down the red dirt until we

(Continued to page 274)

Typical of the effects of 10 years of rainfall is this wreckage of a Bailey bridge, completely covered with vegetation



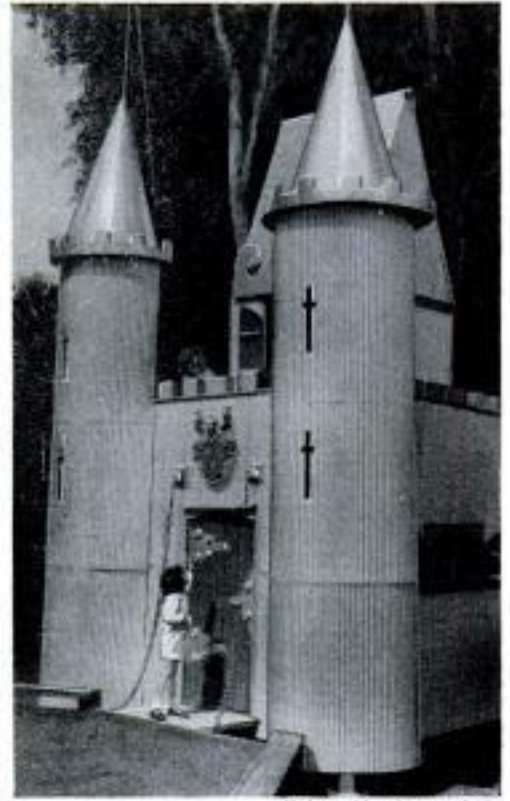
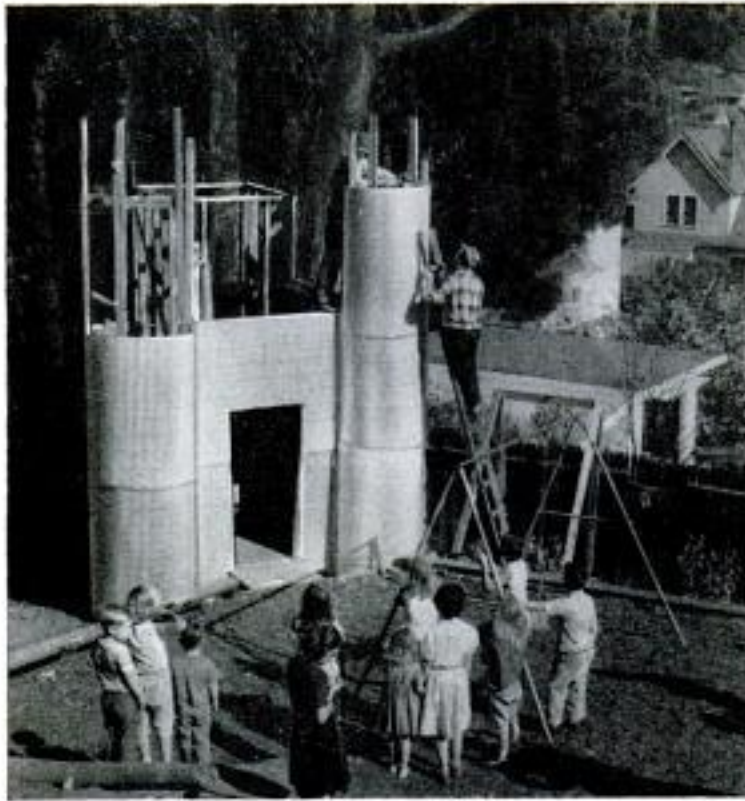

Kaiser Aluminum photo

## Corrugated-Metal Roofing Makes Back-Yard Castle

Aluminum roofing wrapped around a framework of two-by-fours produced a "fairy castle" for the children of Frank

Kane, of San Francisco, Calif. The castle is eight by eight feet in area. The second deck is reached from inside one tower.



## Mosaic-Tile Table Assembled From Kit

All the parts to make a mosaic-tile table are included in a new do-it-yourself kit. The table measures 14 by 14 inches and stands 16 inches high. The legs fit into slotted corner pieces which are glued and screwed to the table top. The tiles are  $\frac{3}{4}$ -inch squares of Italian ceramic in a variety of colors and patterns. Glue from a squeeze bottle is applied in a ribbon to the table top, and a row of tiles is laid along it. Pressure spreads the glue evenly. After all the tiles are laid and the glue is dry, the joints between the tiles are filled with a special grout. The wood parts of the kit are natural walnut and can be given any suitable finish. Two models of the table are available.

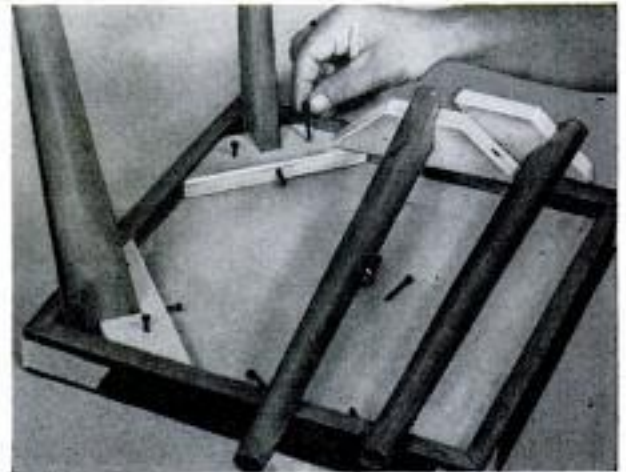
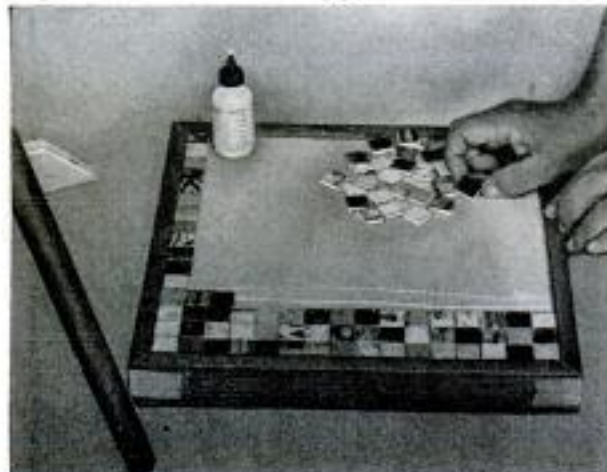



# 1958

## AN APPRAISAL OF THE NEW MODELS

By Arthur R. Railton

**T**OP STORY for 1958? It's tough to pick just one. There's an abundance of mechanical innovations—some of real significance, some of passing interest only.

This year there are more mechanical changes than usual as the companies, in most cases, move into the second year with the same body styling.

Probably the top candidate for honors is the widespread availability of air suspension. Except for Studebaker-Packard and Chrysler Corporation (and don't be surprised if Chrysler has an air-steel option in midseason), the entire industry will be floating around on optional air bags by midseason.

Looming big, too, is the adoption of the unitized body by Lincoln and Ford Thunderbird (yet to be introduced).

A whisker behind, if behind it is at all, comes the all-new Chevrolet chassis, body and engine—a major achievement for any manufacturer, even one in the family of mammoth General Motors.

Less important, perhaps, but of interest are such items as fuel injection, electronic and otherwise, a big crop of lighter but bigger engines, the rise of the acoustical engineer, the completely variable-pitch transmission stator, aluminum brake drums and other accomplishments.

Let's look at some of these developments in greater detail.

### Air Suspension

If you need evidence of how fast the industry can solve a problem when it wants to, look at air suspension. A few years ago, air suspension was a faraway look in Detroit's eyes. It was, engineers said, suitable for trucks and buses, but still a long, long way from the passenger car. It was too complicated, too expensive, too apt to give trouble and, anyway, unnecessary.

What happened? Like a horde of ants pouring in on a picnic sandwich, engineers in various companies went to work. Within two years, three companies have licked the problem and are boasting about the system's simplicity, its long life and its trouble-free nature.

Air suspension does have advantages. Nobody denies that. But it isn't the difference between night and day. It is more the difference between a good day and a perfect, it's-great-to-be-alive day.

Unlike steel suspension, air has almost a zero rebound. It acts, as one engineer describes it, like a dropped ball of putty. It just flattens out, without fuss or bother, smoothing out the wildest rebound.



You can demonstrate the principle of the air bag simply by pushing your fist into a balloon restricted in a cup

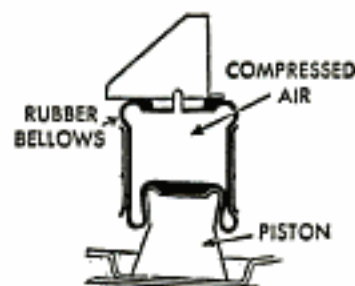

Here's how it works in a car. The body and frame rest atop the bellows, the wheels and axles ride beneath the piston

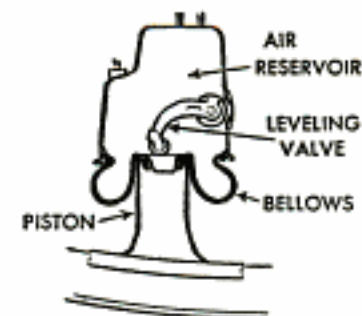

Chevrolet's leveling valves are inside the bags. Other designs mount them separately between frame and axles

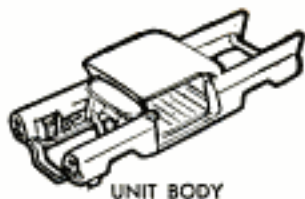

UNIT BODY

Big news indeed is the use of the unit body by Lincoln. It makes the bigger-than-ever car as tight as a bank vault, provides more headroom too



X-FRAME

Chevrolet's X-frame makes it 30 percent more rigid. It also makes possible a smaller turn circle even though it's longer

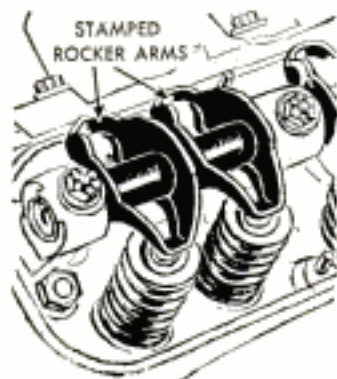

Close-up of rocker arms on '58 Dodge engine, which is one of year's new designs. It is bigger in displacement, yet takes up less underhood space

Such a characteristic is fine on sharp dips or frost heaves, but on a table-smooth boulevard it offers little advantage. The ride is good, of course, but so is it on a well-sprung steel job for less money at the moment.

Air suspension does provide constant height. The car rides the same and maintains the same height whether partially or fully loaded. It makes it unnecessary to compromise for a soft ride and a heavy load. You can have a system that will handle both equally well.

Air solves the trailer-drag problem for the week-ending boater. It will also, in Buick at least (which has an override button to boost the body five inches above its normal height when desired), provide a means of raising the body to move easily through deep snow or rutted back roads.

Most air suspensions are the same. Squeeze an inflated balloon into a large measuring cup and push your fist against it. You are demonstrating how air suspension works. The car has a compressor that provides additional air and a leveling device that meters air into the "balloon" when needed, but the principle is the same. The automobile axles have "fists" on them which push into balloons restricted inside steel grilles. The trapped air is compressed and you ride in comfort—like riding on air, which in fact you are.

Air suspension is simple. Its major complication is the leveling valves. Chevrolet simplifies that by mounting the valves inside the air bags where they are protected. Some systems have fast and slow-leveling devices, others rely on a slow system only. Fast-leveling adherents say when the passengers climb into the car it should level at once. Slow-leveling exponents say the car will level in a few seconds anyway, why complicate the system unnecessarily with additional valving?

Not publicized yet, but certain to be along in the future are all sorts of accessories to use with the air systems: Paint sprayers, tire inflaters, air horns, air brakes and undoubtedly many more.

### Unit Body

Lincoln, in its new plant at Novi, Mich., has invested its future in the unit body. To build unit bodies requires a different assembly operation, different machinery. This is one reason why Ford or Chevrolet with their numerous assembly plants will never be able to make a complete change-over to unit bodies in one model-year. It will have to be an evolutionary change with them, if the change is ever made.

As you know from reading American Motors advertisements, the unit body has no separate frame. In conventional frame-body construction, the frame, a carry-over from the wagon days, holds together all the running gear. Wheels, engine, transmission, axles, all are attached to the frame. The body is built separately, often in another plant. At the right moment in the assembly timetable, the body, all painted, chromed and upholstered, is lowered and bolted to the frame, which is equipped with the running gear. Thus there are two major assembly operations: Chassis assembly and body assembly.

In unit construction, there is no such separation. The rigid floor or underbody is the starting point and the side pieces, fenders and roof are welded to it. Thus the car becomes more and more rigid as it is assembled. Incidentally, American Motors bolts its front fenders on—the rest of the body is welded.

Evidence of this inherent rigidity can be obtained by operating the rear door on a 1958 Lincoln four-door hardtop. Despite the stub pillar to which the short hardtop door is

hinged, the door shuts solidly with no shake or drag. Normally, as hardtop owners know, rear doors on four-door models are mighty limber.

The unit method gives more interior room also, especially headroom. Most important, though, is the tight structure that doesn't creak or groan over rough terrain.

Both American Motors and Lincoln use the unit body and both dip the bodies in paint to assure absolute coverage of all metal, both exposed and unexposed. Lincoln dips its bodies to the tops of the fenders in a plastic-type paint to prevent rusting of lower body panels. American Motors submerges the entire body in the paint to assure body durability. These first coats are followed, of course, by finish coats with the usual spray application.

### Chevy's New Car

Borrowing from the Cadillac book, Chevrolet offers an X-frame devoid of side rails. No unitized design, the X-frame-body combination, nevertheless, is extremely shake-free. A torsion-absorbing tubular center section where the arms of the X cross makes it so. Chevrolet claims it is 30 percent more rigid than the previous frame.

Because of the X-shape, which allows greater lock-to-lock wheel turn, and because Chevrolet now mounts its steering linkage ahead of the front suspension, the turn-circle diameter is smaller despite the added wheelbase (117.5 inches compared with 115.0 last year). The bigger 1958 Chevrolet turns in 37.5 feet, four feet less than the shorter 1957 model.

Coil springs are used on all four wheels by Chevrolet. To prevent rear-axle windup during acceleration there is a U-shaped upper control arm running from atop the differential to the frame members. By designing the chassis for coil springs all around, Chevrolet makes installation of air bags relatively simple, at extra cost of course.

### Other New Features

Every one of the Big Three (GM, Ford and Chrysler) offers a new, bigger engine this year. GM's new engine is in the Chevrolet. Ford's (known as the FET engine for Ford, Edsel and truck) is in the Edsel and will be in the Ford. Chrysler's is shared in varying displacements by Plymouth, Dodge and De Soto. All have big bores, short strokes, high compression ratios.

All three of the new engines have a simplicity that reduces manufacturing complications. All are light in weight, often lighter in fact than the smaller engines they replace. Among the simplifications are stamped rocker arms, in-the-block combustion chambers, fewer water passages, low-silhouette intake manifolds, cleaner exterior lines. All are designed for easier access, especially to spark plugs and tappets. Maintenance-needing parts, such as distributor and fuel pump, are moved to the extreme front of the block in some cases.

Another area of added emphasis this year is acoustics. The acoustics engineer sat way, way back among the drawing boards in the bull pen a few years ago, but now he's up front at all the planning sessions. Cars have become so refined that noise suppression is a critical problem. Pounds and pounds of soundproofing are added to bodies. If you can't keep the noise down, you must muffle or absorb it. Outside the car, the engine may be real noisy, but inside it whispers.

Lincoln's new unit body created a sound problem as unit bodies do. Acoustics engineers solved it by making perforations in the underbody to kill the sounding-board effect.

Fuel injection is offered on some lines at Chrysler. The

(Continued to page 270)

QUIET, PLEASE



FELT DEADENER



SPRAY-ON DEADENER

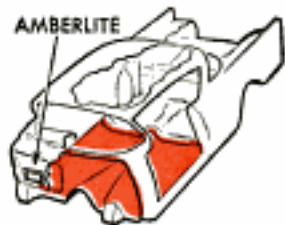

AMBERLITE  
JUTE, PLASTIC FOAM  
AND CARPET

Cars don't get much quieter, it's just that the noise they make is better absorbed. The drawings show how Buick uses various materials to provide you with quiet. Acoustics is an essential part of design

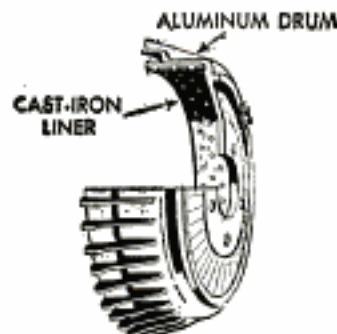

Bigger, faster cars need more brakes. Buick carries finned aluminum drums on its front wheels to minimize brake fade

# HERE'S A QUICK SUMMARY

## STYLING



AMBASSADOR

Ambassador



BUICK

Buick



CHRYSLER

Chevrolet

Chrysler



CONTINENTAL

Corvette

De Soto



IMPERIAL

Dodge

Imperial



PLYMOUTH

Lincoln

Oldsmobile



STUDEBAKER

Packard Hawk

Plymouth



PACKARD

Rambler

Studebaker



CORVETTE



DE SOTO

Hudson and Nash are gone. The Ambassador which replaces them uses the Rambler shell stretched nine inches. Grille is anodized aluminum. Four headlights standard. Rear fins flare outward. Station wagons available in this longer body

Completely new sheet metal, but 1957 shell retained. Port-holes and full wheel cutouts gone. Grille is waffle-ironish. Three-piece rear glass, ribbed roof discontinued. Hood raised to make car "feel" longer from the driver's seat

Looks big and is, being 9 inches longer, 4 inches wider, 2½ inches lower. Front is Chevy-ish, rear is fresh and flashy. Fins are tucked in with strong diagonal lines. Flattened rear fenders. Impala hardtop and convertible tops in luxury

Chrysler little changed. Dual headlights standard. Taillights restyled. Compound windshield on all hardtops, convertible. Mirror mount new. Grille restyled, Windsor's especially

Longer by nine inches, mostly ahead of front wheels to give a 300SL look. Fake louvers in hood. All-new dash has useful passenger grab-bar. All dials now right in front of driver

Double-wrap windshield on all hardtops and convertibles. Four headlights standard. Other exterior changes are in brightwork

Front-end styling, side trim new. Dual headlights standard. One-piece front seat has nonremovable lower cushion

After 1957's success, changes are face-lift variety: New grille-bumper, side trim. Electric door locks optional

Clean, straight lines with look of luxury feature the Lincoln. Distinctive front and rear, it has unique diagonal headlights plus fanciest rear end in the business. Continental has reverse-slant rear glass that goes down, distinctive tail treatment

Usually chrome-free, this year's car is bedecked. Chrome on sides make car seem lower, longer although shell is unchanged. Roof is thinner. Rear window higher. Gone are the '57 struts

First to eliminate all grillwork (others may follow). Packard Hawk has only a narrow slot above plain front bumper. Hood has aircoop. Rear deck has wheel imprint

Four headlights standard. Grille all new. Taillight is round and mounted low on rear fender. New mount for mirror on dash eliminates blind spot caused by third person in front seat

Styling is more conventional: Headlights are back in the fenders; controversial bulge on roof rear ironed flat; front fenders are flattened; rear fenders are finned

Dual headlights standard, except optional on Champions. Roof line lowered. High, canted taillfins are also new

# OF WHAT'S NEW AND WHAT ISN'T

## CHASSIS

## ENGINE—TRANSMISSION

Nine-inch extension to Rambler unit body is just ahead of cowl. Added braces stiffen already rigid package. Steering geometry improved, recirculating balls used. 14-inch wheels

V8 engine develops 270 horsepower with 327 cubic inches. Four-barrel carburetor, dual exhausts standard. Push-button automatic transmission controlled by engine vacuum

Optional air suspension has a high-lift knob so you can raise body 5 inches above normal if desired, as in snow or ruts. Aluminum front brake drums on all but the Special series

New Flight Pitch Dynaflo has three turbines and infinitely variable-pitch stator. Downhill braking feature controls car speed descending steep grades. Fan clutch cuts engine noise

All-new chassis has two-piece prop shaft, coil springs all around. X-frame plus forward-mounted steering gear permits shorter turn circle despite added length. Air suspension available

New engine (348 inches) has combustion chamber in block, a machined extension of cylinder. Piston is peaked for turbulence. Wide-open manifolds. Smaller V8 and Six still available

Windsor on shorter 122-inch wheelbase, sharing Dodge-De Soto shell. New Yorker unchanged. New power steering. Nonslip rear end optional

Compression ratio up (10 to 1); displacement unchanged at 354 inches. 300D series has fuel injection optional. Transmission unchanged

Despite added over-all length, wheelbase still 102 inches. With four-speed gearbox, locking differential, it's a bargain-price race car

Space limits make use of Chevy's big new V8 impossible; 1957 engine retained. Injectors are optional as is four-speed transmission

Like other Chrysler Corporation cars, De Soto offers new power steering, locking differential

All models have new V8 engines with 350 or 361 cubic inches. Electronic fuel injection optional

New power steering requires only 3½ turns from lock-to-lock. Torsion-bar front end retained

All-new V8 added to previous V8 and Six designs. Lighter but more rigid, it comes in two sizes

Longer outboard-mounted rear leaf springs reduce rear-end roll. Torsion bars in front

392-cubic-inch V8 retained. Compression upped to 10 to 1. Transmission unchanged

Unit body welded into a tight package only 56.5 inches high. Dipped in plastic paint to prevent rusting. Trailing arms in rear. Coil springs all around. Air suspension available

New 430-inch V8 is lighter, lower. Horsepower is 375. Water-jacketed intake manifold. Combustion chambers machined in block. No Siamese ports. Transmission has dual-range feature

Air suspension available at extra cost. The 88 series has economy rear axle and economy carburetor, giving 3 more miles per gallon

Compression: 10 to 1. Horsepower down on 88s for economy, up on other cars. Transmission thermostats end upshift delay in cold weather

Uses same chassis as Studebaker Hawk. One-piece driveshaft. Lowered floor pan. Roof line down slightly. New spring rates. 14-inch wheels

Supercharged V8 engine of 275 horsepower. Automatic or handshift transmission. Same power package as in Studebaker Golden Hawk

Basically unchanged from 1957. Available at extra cost is locking differential. All-new power steering has smaller and quieter pump

Optional new V8 has 350 cubic inches, 10 to 1 compression. Lightweight, it also has less over-all height. Fuel-injection is optional

V8 models have 14-inch wheels. Sixes retain 15-inch size. New steering gear, full wheel cutouts reduce turn-circle diameter

V8 develops 215 horsepower, has 8.7 to 1 compression, four-barrel carburetor. Borg-Warner transmission has push-button panel

One-piece driveshaft, 14-inch wheels (optional on Champion), lengthened rear springs

The 185-inch Six and the two V8s (259 and 289 inches) unchanged. Transmissions are also same



DODGE



CHEVROLET

RAMBLER



## Ambassador



American Motors makes its big car, the Ambassador, more competitive in price by designing it on the Rambler shell. Previously, its Hudson and Nash had a separate shell from the Rambler. Nine inches are added to the hood to distinguish it from the smaller car. Its optional automatic transmission is push-button controlled.

## Buick



Many Buick traditions are gone: Portholes, grille and full rear-fender cutouts. Air suspension has high-lift feature that raises body five inches above normal to clear ruts or abrupt ramps. Photo, left, shows air-ride piston with body in extra-high-lift position.

## Chevrolet

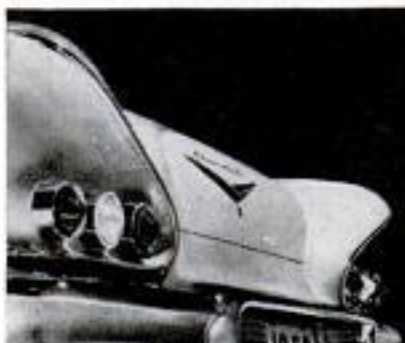

One of the two most changed cars for 1958, it may appear like the 1957 model at first glance. But a view of its flat-fendered rear end corrects that in a hurry. It is big and powerful with a variety of engine sizes and transmissions. It has coil springs all around or, if you can afford it, air suspension for extreme luxury.



## *Chrysler*

Chrysler expects its second year with the dart-shaped styling to be even more successful. Sheet metal is unchanged. Mechanical and production improvements will be emphasized. Windsor models have a new look, using as they do the corporation's smaller body shell for the first time. Power steering has more "feel of the road." Bendix fuel injection available on 300D only.



## *Corvette*

Slightly longer due to extended front overhang, the new Corvette looks more European. It remains the only American production car that is taken seriously by the sports-car set. It offers lots of options, including four-speed gearbox, locking differential, fuel injection.



## *De Soto*

De Soto's most apparent exterior change is the grille and even there the same character remains. All have a new V8 engine, available in 350-inch and 361-inch sizes. Compact, simple and designed for rigidity without bulk, the engine takes up less underhood space than its less powerful predecessor. It is easier to service, lighter in weight. Fuel injection optional only on Adventurers.





## Dodge



Styling changes are minor as Dodge, like all Chrysler divisions, continues the big-fin styling. Grille, taillights and other details are reworked slightly. Four headlights are standard. Dodge offers the corporation's new V8 in 350 and 361-inch displacements. Its wedge-shaped combustion chamber means Chrysler is moving away from the hemispherical design. Retained are the smaller V8 and Six.

## Imperial



With 1957 sales more than triple 1956 figures, Imperial continues its successful styling, making only minor changes. An electric locking system lets you lock all doors by pressing one button. One-piece front seat provides more legroom for rear-seat passengers, more headroom in front. Last year's unhandy turn-signal switch is redesigned. All models are two inches longer than in 1957.

## Lincoln



Without doubt, the year's most interesting design, Lincoln is all new—even its factory. On rough roads or boulevards, its unit body handles like a sports car, rides like a limousine. The huge new engine (430 inches) weighs less than last year's. Fast steering, trailing-arm rear suspension (with air optional), extreme lowness, all make this car a pleasure to drive or ride in.





## **Oldsmobile**

There's a lot new here as Olds aims to recover from a mediocre sales year. Many horizontal trim lines make it look longer, lower. Four headlights, a new grille, the nondivided back window, all emphasize a new look. Radio pulls from dash for use as separate portable, right.



## **Packard**

There's a Hawk in the Packard line for the first time. And it's definitely European, with a shark-mouthed front end—the least cluttered design in the industry. An imprint of a spare tire decorates the rear deck. More Packards will be out later, including a new hardtop.



## **Plymouth**

Considered by many to be the best looker in the 1957 Chrysler family, Plymouth continues its styling another year. It now has four headlights, a new grille (although similar to last year's). The taillight is a single round lens at the base of the soaring tailfin. Extending upward from it is a shiny aluminum bar. Fuel injection is available for top performance. The new V8 engine has 350 cubic inches. Also available are the 318-inch V8 (last year's Fury engine) and the 230-inch L-head Six.



## Rambler



No more going it alone, the Rambler looks more like the other cars with its headlights in fenders and flaring tailfins. Gone, too, is the bulge at the rear of the roof. Seats are redesigned and make the interior appear much larger because of the lower backs. Economy is increased. Turn circles are even smaller.

## Studebaker



Studebaker has adopted 14-inch wheels. Big news is that it will soon be selling the German Goggomobil coupe also, a two-cylinder air-cooled two-seater (not shown here). For pictures and details see *PM*, May 1957, page 48.

## Mercury



Out for big-car business, Mercury has a new line, the Park Lane, 220 inches long on 125-inch wheelbase. Other Mercurys are 213 inches long, have 122-inch wheelbase. All-new engines range from 312 to 400 horsepower. There's a new automatic transmission, too. Air suspension (see cutaways left) optional. Front-end styling new, as are rear fenders. Many new features such as automatic brake adjuster, powered heater controls and lubricated-for-life bearings on front end.

## Bail-out Slide Prevents Injury

No child's plaything is a slick slide used by the Navy to prevent injury to airmen during bail-out drills. It was devised by Lt. Gordon L. Backer, a flight surgeon at Sanford Naval Air Station, Fla. The slide fits up and under the escape chute of the Navy's A-3D bombers. Previously, when the airmen landed on the ground, they tore their parachutes and suffered lacerations, dislocated backs and on one occasion, a broken leg.



## German TV Set Resembles Sailboat

Startling in design, a combination television, radio and phonograph set is the latest innovation in Germany. Called the Comet and resembling a sailboat, the TV section can be rotated in any direction by remote control, swiveling on the base. The base contains the radio-phonograph. This set was on display at the International Radio, Television and Phonograph Exhibition in Frankfurt, and is designed to sell for about \$750 in Germany.

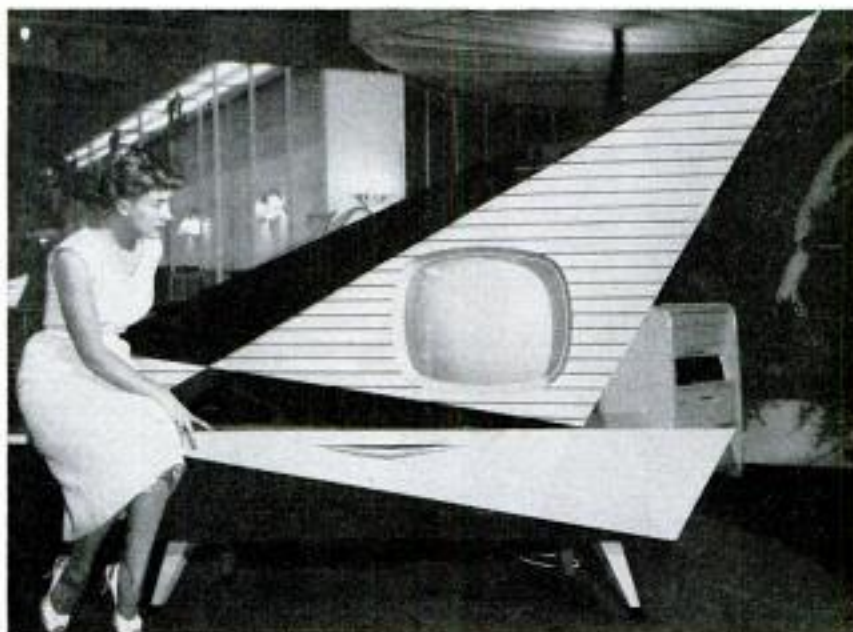

## Skiers Somersault For Winter Fun

Flying through the air with the greatest of ease, daring Norwegians on skis perform tricks. Some skiers do somersaults across the Stryn-Geiranger Highway in the mountains of western Norway as a training exercise.

Pratt and Whitney Aircraft's J-57 and J-75 engines are the first American-built jet engines to be certified by the Civil Aeronautics Board for commercial airliner use.





# Christmas



**PORTABLE PHONOGRAPH-RADIO** needs only four flashlight batteries for power. Transistor set is designed to play 6000 records or 750 hours of radio without battery change. Electric governor keeps turntable speed constant if power wanes  
 Hockland Precision Mfg. Co., Orangeburg, N. Y.

**NONSKID BALL-POINT PEN** that won't skip when writing on slick surfaces has a tip like a round metal sponge. The new porous tip, if greatly magnified, would appear something like the ball through which man is blowing smoke. The thousands of microscopic pits and channels in the pen's ball point permit the ink to flow smoothly to the paper while thousands of grippers on the outside of the ball provide traction to prevent skidding over greasy or glossy writing surfaces  
 The Parker Pen Company, Janesville, Wis.

**GAS-RANGE ROASTER** also can be used for grilling, barbecuing, baking, steaming or deep-frying. It fits into the top of one of the new model ranges, and has its own automatic gas-burner control. Roaster is stored in the range compartment  
 Geo. D. Roper Corp., Rockford, Ill.





# Shopping Center

**ELECTRIC COFFEEMAKER** produces two demitasse cups of the beverage in 60 seconds. Water goes in the reservoir under the ball. A strainer bowl on the double-spout arm holds two teaspoons of ground coffee. It works on a.c. or d.c.

*Leslie Creations, Lafayette Hill, Pa.*

**ELECTRIC CAN OPENER** has a specially designed cutter blade to open any shape of can—round, square or oval. A magnet lifts the lid while the can is automatically held in position. The opener even smooths the edges of cut metal

*Burgess Vibrocrafters, Inc., Graystone, Ill.*

**ADJUSTABLE NIGHT LIGHT** can be set at the brightness level desired by a twist of the regulator knob at the top. The knob turns a small shutter between a seven-watt bulb and a translucent lens. It plugs into standard electric outlets

*General Electric Co., 95 Hathaway St., Providence, R. I.*

**PORTABLE ELECTRIC HEATER** is available in decorator colors. A safety feature is a mercury switch that automatically cuts off electric current to the heater if it is tipped over. A thermostat keeps the heat at the level you select

*Heatmore, Inc., 59 Throop Ave., Brooklyn 6, N. Y.*

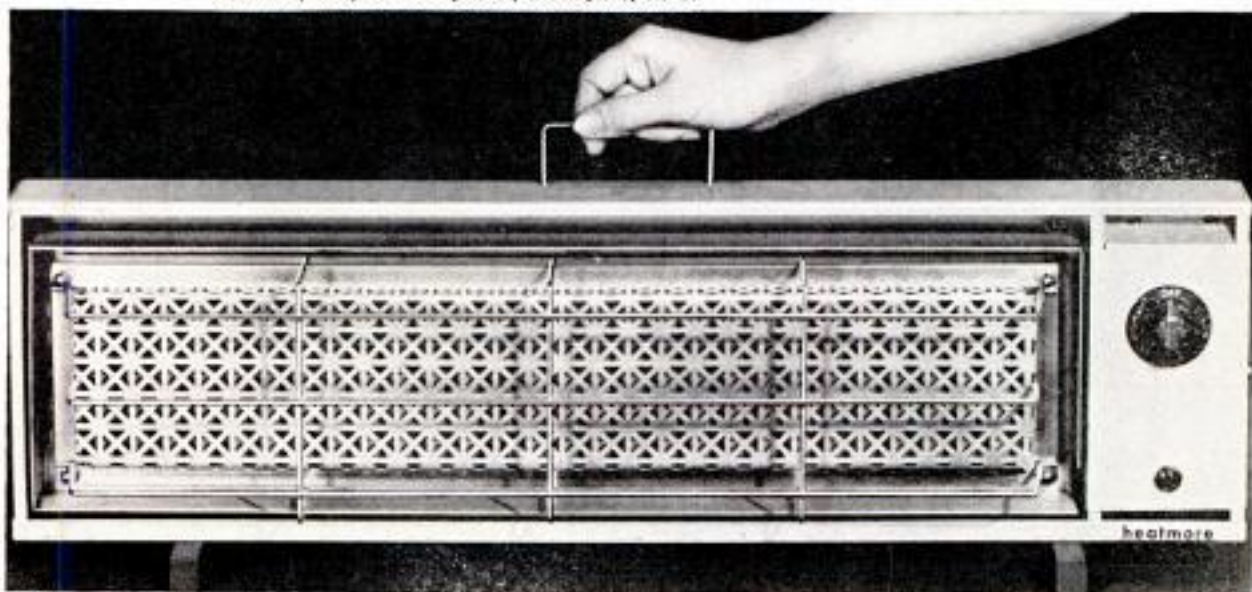



**FORKED-STICK SET** for campfire cooking is made of aluminum. Weighs 17 ounces, is assembled in seconds  
The Porta Company, Inc., 32 Neponset St., Canton, Mass.

**SUITCASE COOLER** holds picnic food for eight people. Each side takes two cans of reusable dry refrigerant  
National Steel Cabinet Co., 2415 N. Pulaski Rd., Chicago 39



# Christmas

**OIL HONE** for sharpening knives and cleavers slowly revolves through a trough of honing oil as the blade is drawn across the abrasive surface. The honing surface is a replaceable 15-inch-long tube that slips over a steel core

Wulff Mfg. Co., Ontarioville, Ill.



**HOME MILK DISPENSER** permits the family to save money by purchasing milk in bulk or in large containers. The refrigerated unit holds 24 quarts in two tanks. There's a separate storage space for butter, eggs and cheese

Norris Dispensers, Inc., 2720 Lyndale Ave., South, Minneapolis 8, Minn.





**D.C. ELECTRIC OUTLET** can be installed in your bathroom to supply direct current for a.c.-d.c. electric shavers, which reportedly operate better on d.c.  
Wellson Electronic Products Co., 15236 Erwin St., Van Nuys, Calif.

**PLASTIC BEACH BAG** can be used to carry your swim suits and picnic lunch. Inflated, it becomes a 30 by 30-inch table, or it can be used as a pillow.  
Plastic Products, Inc., 62 18th St., Brooklyn 32, N. Y.



# Shopping Center

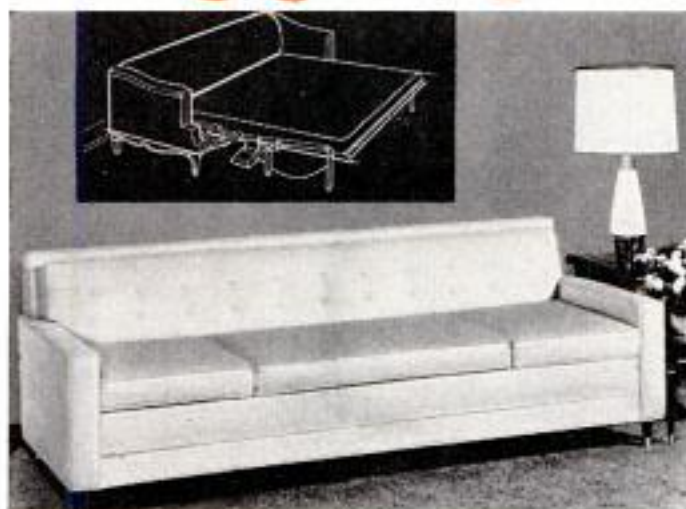

**KING-SIZE SOFA BED** has long, slim, modern lines but it conceals a 54 by 75-inch mattress. Closed, sofa is 32 by 80 inches. Has a special lightweight sofa-to-bed converting mechanism.  
Converta-Sofa, Grand Rapids, Mich.

**RIDING ROTARY MOWER** has foot-pedal control of cutting height and a geared transmission with forward, neutral and reverse. Dump cart, lawn roller, snow-blade attachments available.

The Midland Co., 1200 Rawson Ave., South Milwaukee, Wis.

**KNIFE-LIGHTER** combination has a fingernail file also. The lighter, when not being used, slides into the stainless-steel case. The lighter can be removed from the handle for refueling.

Overland Co.,  
5788 Ventura Blvd.,  
Los Angeles 19, Calif.

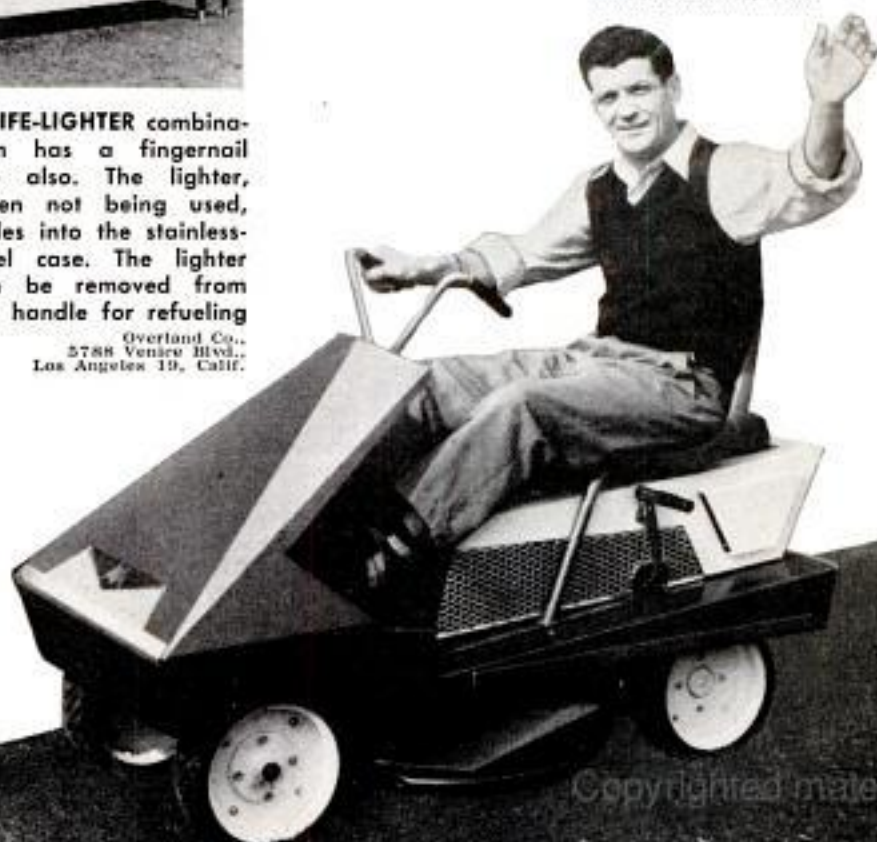



**TOBOGGAN SLED** of aluminum has a ball-joint coupling between fore and aft sections which makes sliding toy steerable. Seat is made of varnished plywood

Mirro, Manitowoc, Wis.

**ELECTRIC BRAIN** for the young scientist can be assembled from a kit without soldering. Flashlight batteries provide power to operate 33 different circuits

Oliver Garfield, 120 Lexington Ave., New York 10.



**SCOOP BALL** is a junior version of jai alai. The hollow plastic ball is thrown and caught in the 14-inch scoop. The game can also be played indoors

Cosom Industries, Inc., 6012 Wayzata Blvd., Minneapolis 16, Minn.



**MINIATURE TRAMPOLIN** is designed to satisfy the jumping urge of small children. It's built of aluminum furniture tubing with a canvas bed

Tekay Products Co., 9140 Meadowlark, Milwaukee 17, Wis.



**TRAIN STOPPER** is a realistic cow for model railroad. Electric train halts as cow crosses track. Train proceeds when cow moves back

A. C. Gilbert Co., 5th Ave. & 25th St., New York City



**PANEL PLAY** lets children use their imagination in designing tents, tanks, trains, forts or houses from set of eight squares of hardboard. No tools are needed to assemble the play panels

Design Industries, 207 Penn Ave., Pittsburgh 21, Pa.



Copyrighted material





**JUNIOR SLEEPING BAG** designed for children between three and six years of age can be used for travel, back-yard camping or as a beach pad. Bag is lined with moisture-repellent acetate

*Julee Comforter Mfg. Co., Holyoke, Mass.*

**TRAVELING CRANE**, one of the newest accessories for toy electric-train sets, lowers a magnetic device and transports culvert sections from the car to the culvert-unloading station

*Lionel Corp., 15 E. 20th St., New York City*



## Center for Youngsters



**SALVAGE BOAT** for the bathtub admiral in your family is equipped with a four-inch, hollow, plastic diver who receives air through a lifeline connected to a pump on the deck. Other equipment includes a cable hoist to lower the diver, ladders and compass

*Ideal Toy Co., 200 5th Ave., New York City*



**RAILROAD HANDCAR** for kiddies operates on 10-inch gauge steel track welded to steel ties. The car has a freewheeling gear system so the pump bar will not accidentally "kick" the children if they let go of it. Pump bar remains stationary when car coasts

*Ottaway Amusement Co., 3045 N. Saint Francis, Wichita, Kans.*

**SAND-BOX SUNSHADE** also is a lid to cover sand box when it is not being used. The canopy is held in place by a pin mechanism and slides up and down the aluminum post. The box, 36 inches in diameter, and 5½ inches deep, also can be used as a wading pool

*Chippewa Plastic Mfg. Co., Inc., 5205 Eastman Rd., Midland, Mich.*



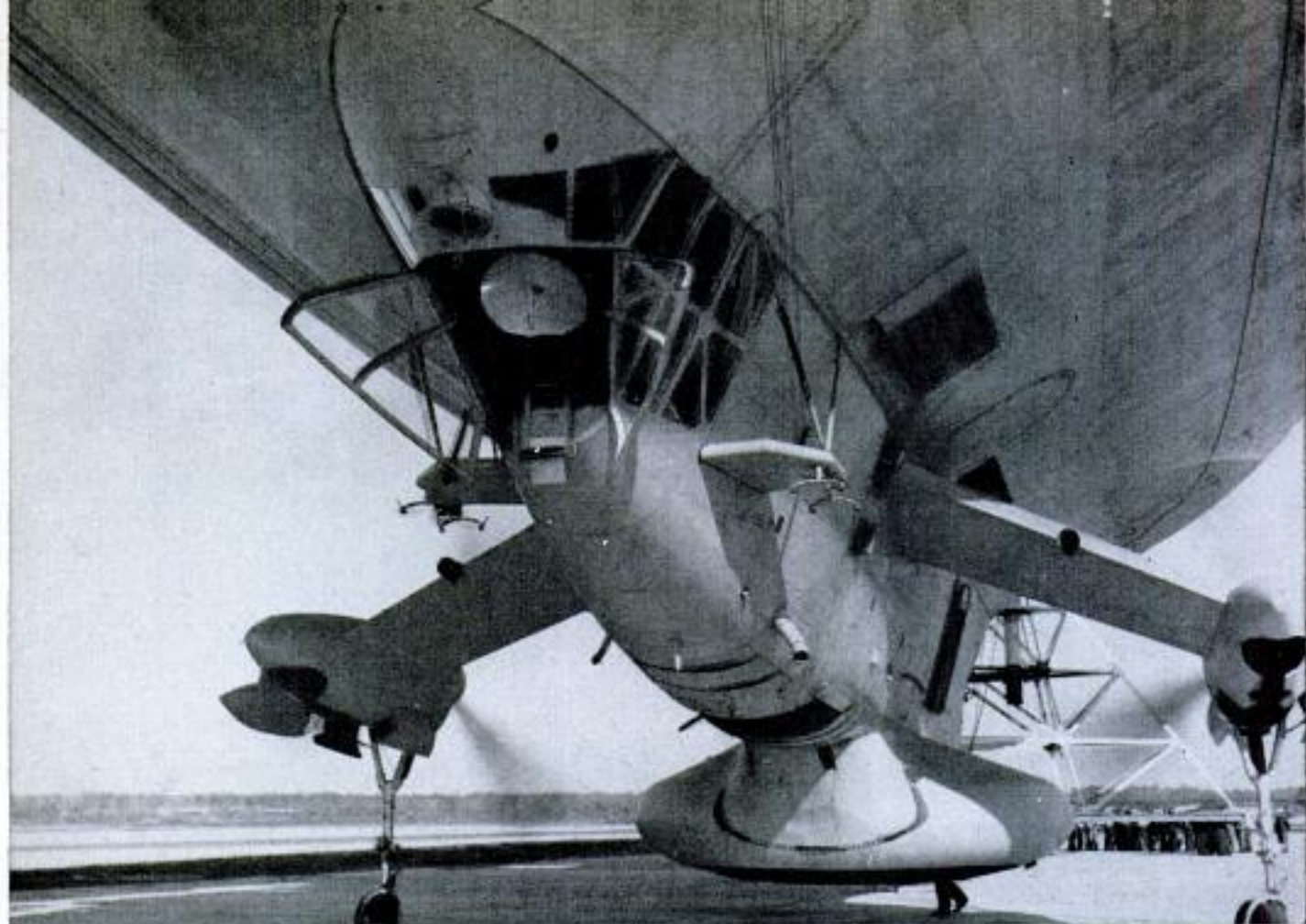

## 'Passive Radar' Makes Microwave Maps

RECENT TESTS with microwave detectors like the dish-shaped antenna inside the blimp cabin, above, may change aerial-reconnaissance methods. The new technique, called "passive radar," locates an enemy by detecting the energy waves radiated by his weapons and factories. Similar experiments are being conducted with infrared detectors. An example of infrared reconnaissance is shown in the aerial photographs at the left. One shows an aircraft factory in New York as it appears in daylight. The other shows the factory as it would appear on infrared film during a blackout. The bright spots are caused by infrared waves generated by aircraft on runways, cars on highways, boilers and machine tools. Passive equipment doesn't generate a signal the enemy can intercept.

104 POPULAR MECHANICS

Copyrighted material



## **MECHANICAL "WOODPECKER" DRILLS DYNAMITE HOLES**

AT THE EAGLE MOUNTAIN iron mine of Kaiser Steel Corporation in California a miner "flies" a unique rig for drilling blasting holes in huge boulders. The big boulders are chunks of ore that were not broken down to manageable size by the large blasts that crumble the ore in the open-pit operation. The drilling rig is known as a travel drill and consists of a 10-foot-long drill and an operator's cage on the end of a 40-foot-long boom. The operator can move the boom to either side and up or down, and can travel along the boom, by means of controls in his cage. He also operates the compressed-air drill, or jackhammer, with which the dynamite holes are cut. The machine can also drill holes in the side wall of the mine as high as 28 feet above the pit floor. The entire travel drill is self-propelled.





Kiekhoefer photo

### Boat Aids Plane Take-off

Heavily loaded seaplanes take off on calm days with an assist from an outboard motor at Flin Flon, Man., Can. Gordon Mitchell uses the method to give his planes additional lift on a smooth lake when the pontoons "stick" to the water's surface.



### Push-Pull Terminal Truck

Built for truck-terminal and piggyback operations, a trailer spotter has two sets of floor pedals and separate or simultaneous power steering for front and rear wheels. Driver can push or pull trailers while facing direction of movement.

### Square Bubbles Surprise Atomic-Energy Scientist

Latest thing in science is the square bubble. They are  $\frac{3}{100,000}$  inch thick and appear when lithium fluoride, irradiated with neutrons, is heated above 1112 degrees F. Lithium fluoride is a glasslike material used to study the effects of neutron

bombardment. The bubbles were a surprise discovery by Dr. Peter Senio in experiments for the Atomic Energy Commission. He is not sure how the bubbles are formed, but believes they will lead to findings in the structure of matter.

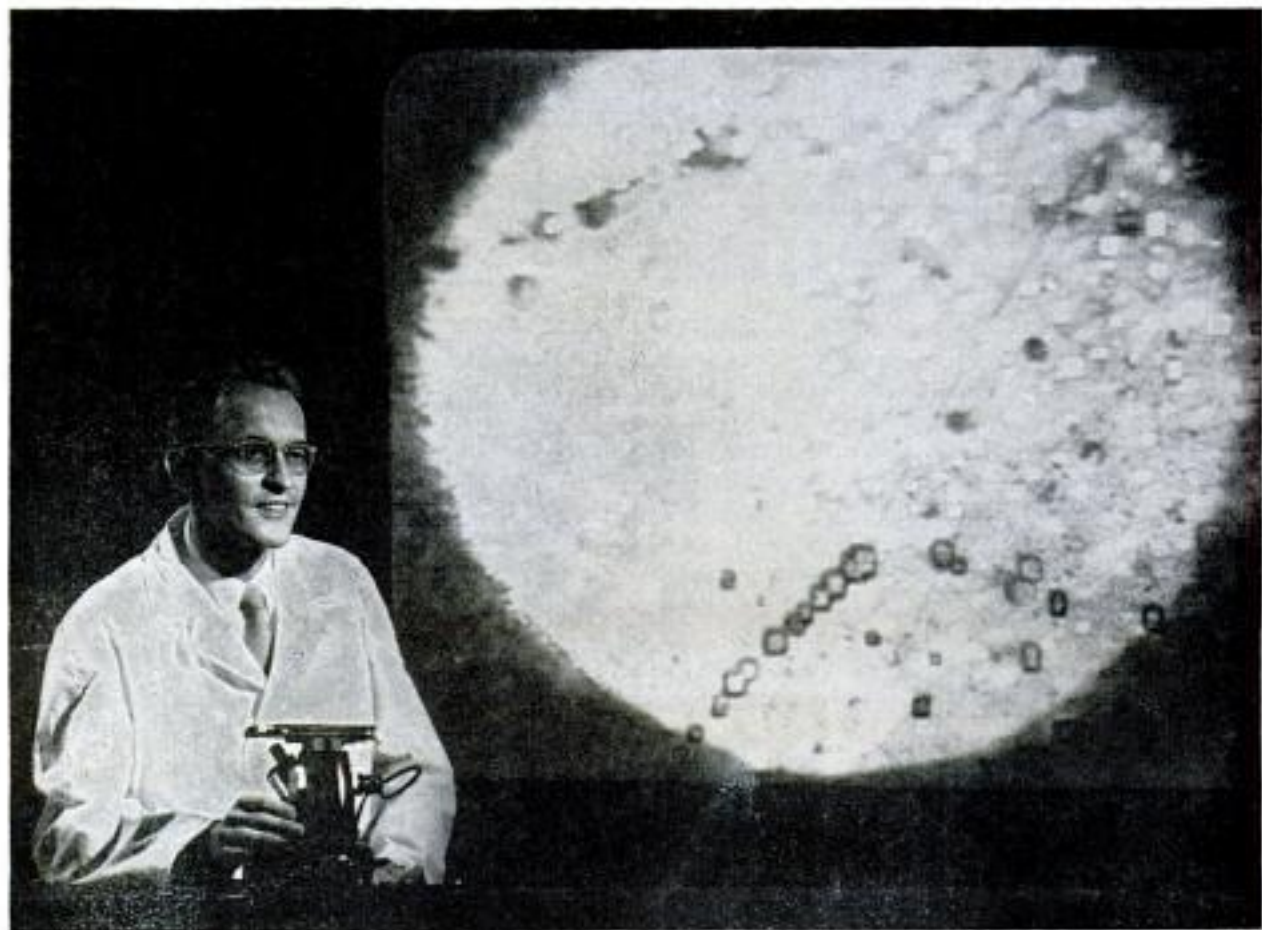

**WHAT DO YOU** think of them? The 1958 cars, that is. Last year we asked the same question and you let us (and the industry) have it. What do you say now?

This secrecy business is a strained one. Two days before the Edsel was first shown to the public, this reporter visited a major competitor's proving ground. There, as natural as you please, sat a 1958 Edsel in the garage. It had thousands of test miles on it. How come? we asked.

Engineers explained it was a mutual-exchange deal. "We give them our new models in advance and they do the same for us. We probably know as much about the Edsel as Ford does by now."

**Of course, the secrecy about new models, as everybody in the industry knows, is to protect retail sales. It is not to hide secrets from competitors. After all, there are thousands of as-yet-unsold current models in showrooms and nothing must make them less attractive to the buyer. The big wheels in automobiles apparently think the public does not expect a new model to come out each year. And they don't want to destroy this illusion.**

Some insiders say a similar fear explains why there won't be a domestic version of a small car to compete with the foreign imports for a long while. You can't suddenly destroy the market for two and three-year-old used cars. It could ruin your dealers.

So instead you bring in Opels, British Fords, Metropolitans and Vauxhalls from overseas to compete with the foreigners. But volume is self-limiting. There are only a limited number of ship bottoms. Thus, there is no chance of enough coming in to hurt domestic sales very much.

#### **Black Marketeering**

On the same subject is the story of the black market in Volkswagens. It's a big business in the United States. It is said that one airline pilot made \$10,000 in the first six months of 1957 buying VWs on the East Coast and selling them in the Midwest. He orders a VW from each dealer in each city he flies into. As the cars are delivered he ships them to a Midwest city and sells them at \$100 profit per car. He sells more VWs than some dealers!

Another racket is that of giving American soldiers due to return to the States from Germany the money to buy a VW at the factory from an employee or direct. The Army ships the soldier's goods home for him free and the guy who advanced the dough for the car waits at the dock to take over in the States. He hands the GI \$100 or so for his trouble and sells the car at a nice profit.

The catch is that many of these cars were built for use in Germany and have illegal

# **Detroit Listening Post**



**By Art Railton**

safety glass, lights and other items. The unsuspecting buyer has to pay to have these changed before registering it.

If you like the big wagon-wheel Ford taillights better than the new oblong variety on the 1958 models, wait for the new Thunderbird. It has four of the big round lights on the back end. It also has some side-panel sculpturing that looks a lot like the 1958 Lincoln.

#### **Look Backward, Please**

Engineers are still trying to solve the rear-view mirror problem. One company is experimenting with a mirror mounted on a short pedestal on the roof above the driver's head. How does he see into it? There's a plastic-windowed hole in the roof through which he looks. The view rearward is unexcelled. The next question is will the public go for a mirror that sticks up from the roof like a mushroom?

**Over three years ago when this column mentioned the problem of rear vision, an Indiana inventor showed us a periscope he had built into the roof of his car (see PM, Sept. 1954, page 154). This may still be the best answer.**

The new, smaller American Motors Rambler, called the American, is to be a thing apart. It will have no annual styling changes. It's got to last 10 years at least. That will keep costs down and, AM hopes, resale values up.

**One report states that the British Motor Corporation (Austin, MG, Morris, Riley and Wolseley) is not going to bring out any new models until sales fall off. This, the company says, will stop the annual slump in sales that comes when the public holds back awaiting a forthcoming new model. American manufacturers claim the opposite. Their theory is that the new styling boosts sales by making current cars appear obsolete.**

As you will notice elsewhere in this issue, displacements are up again—and sharply. And no end is in sight. It looks as though they will continue up to 500 inches.



Golden Gate Bridge section of model shows care taken to reproduce San Francisco Bay exactly in miniature

## SAN FRANCISCO'S

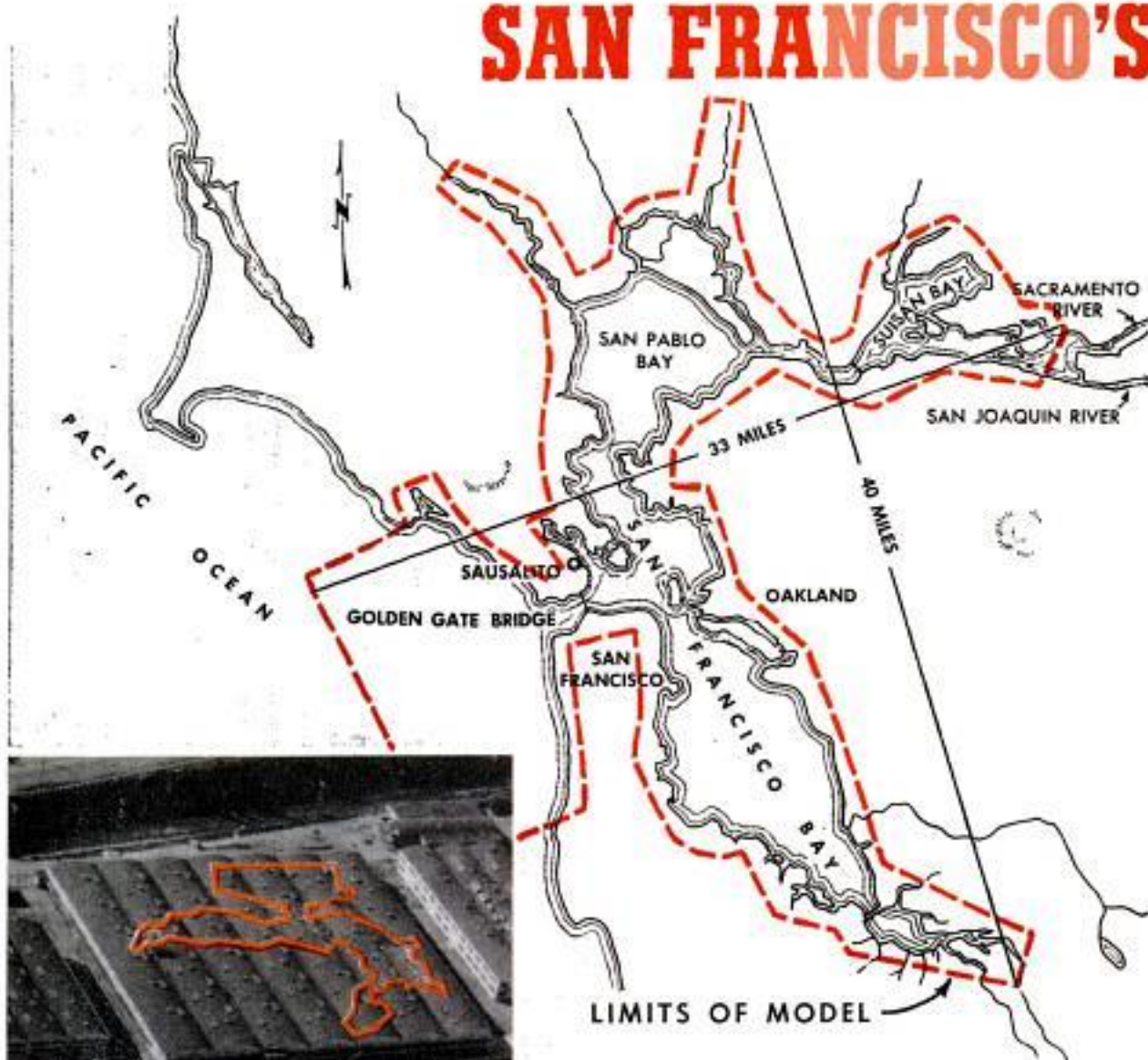

Model is 340 feet long and wide, and its 29,000 square feet represent 550 square miles of bay area. Its tremendous size is outlined at left on warehouse which houses it

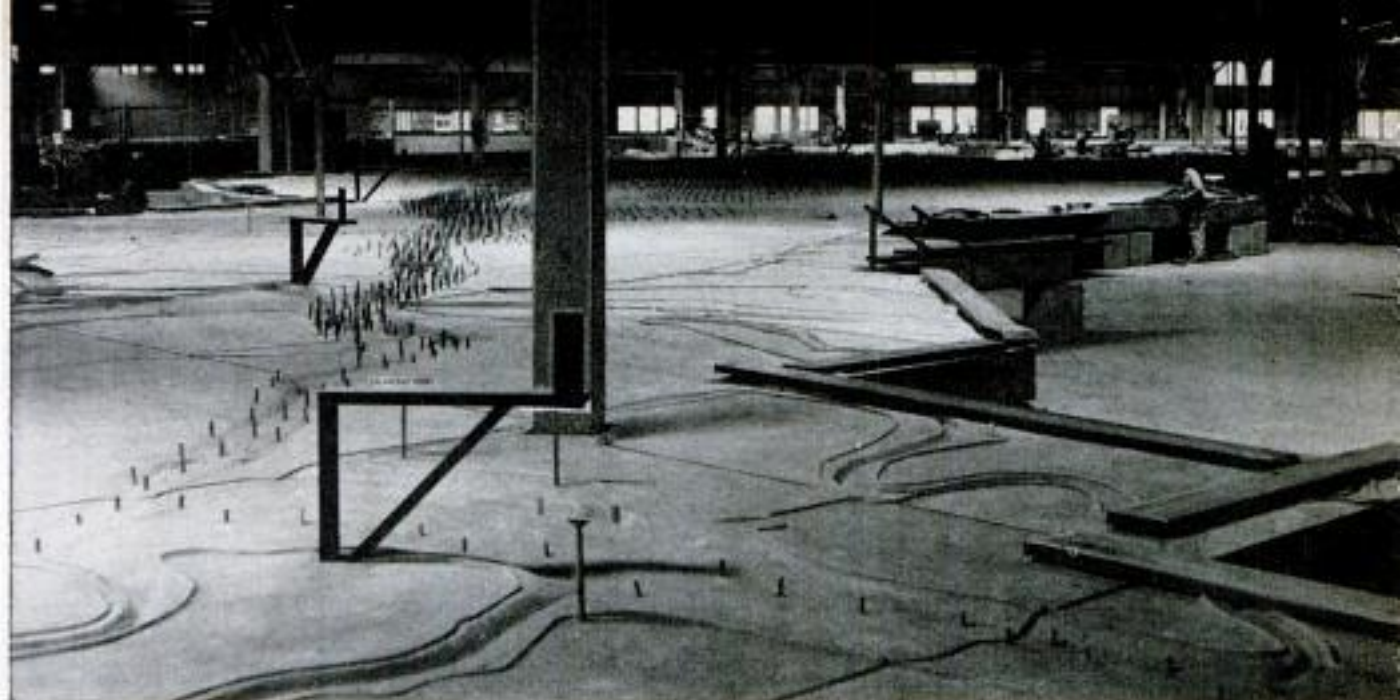

Elevations and contours were carefully scaled one foot to every 1000 horizontal feet and 100 vertical feet

## ACRE OF CONCRETE

by Lee Elam and  
Leo Rosenhouse

IT IS ALMOST impossible for man to duplicate the actions of nature. This is being done in a big way, however, with a remarkable working model of the San Francisco Bay area. The model is an entire acre of concrete and reproduces all the complex inner-workings of the bay area, from the ebb and flow of tides to the movements of silt and water velocities.

The model was built by the U. S. Corps of Engineers. There are a lot of answers the engineers need, and they expect to have most of them by 1960. They will find

out why the generally placid waters sometimes turn into a witch's cauldron, dangerous to even sizable ships.

Just as important to industry and shipping, and the future development of the bay's potential, is the knowledge they will gain on which of the currents build shoals, where the silt comes from and what happens when structures such as bridges and wharves are built in the bay.

Information gained will be important to the vast farming interests along the islands of the Sacramento River that flows into

Model was put together like a giant jigsaw puzzle, involving 158 slabs of concrete weighing five tons each

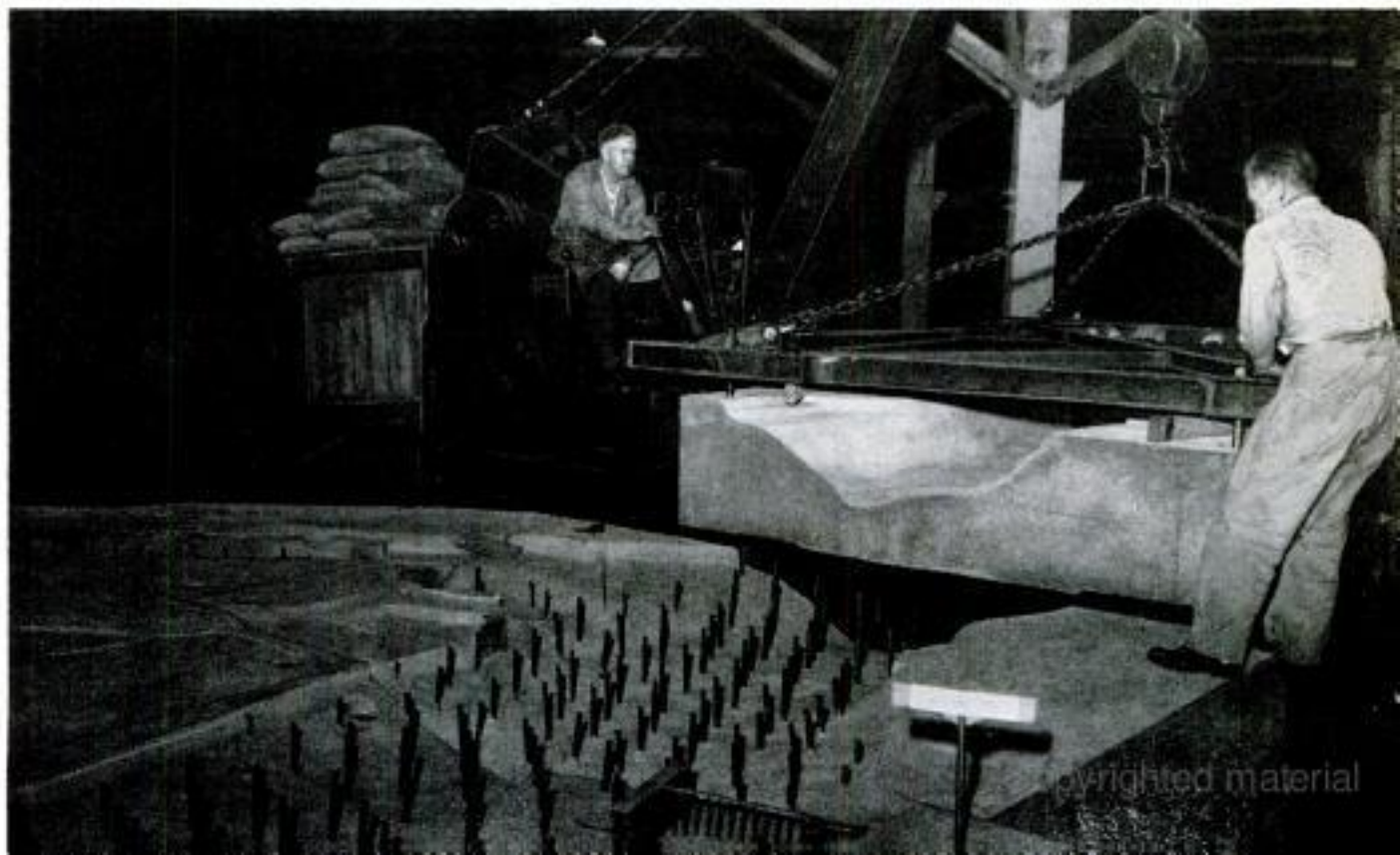

Copyrighted material



Engineer measures tidal movements. Copper strips in the water control the duplicated ebb and flow of tides

San Pablo Bay, and the San Joaquin River that empties into the Sacramento at the bay. For years there has been a gradual increase in the distance the bay's salt water backs up into the rivers and sloughs around the islands and damages farm lands. The cause must be found and methods devised to stop it, or the economy of the area will crumble.

Located in a huge Corps of Engineers' warehouse in Sausalito, a suburb of San Francisco, the huge \$300,000 model has

**This instrument automatically regulates tides in the model. A cycle is completed in 14.9 minutes**

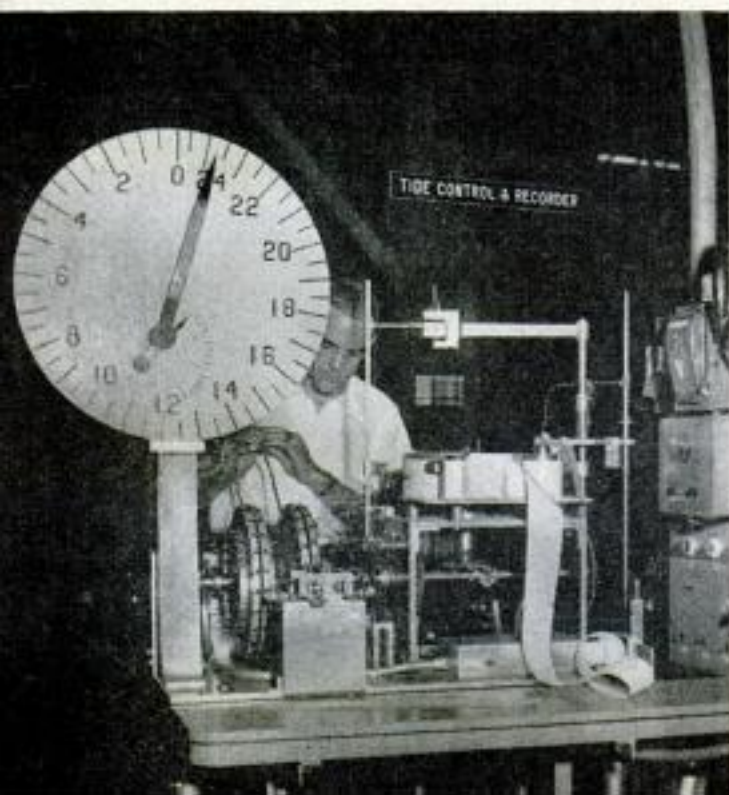

an over-all length and width of 340 by 340 feet. The paved area is 29,000 square feet. It took nature countless centuries to build San Francisco Bay, but man duplicated it in almost perfect miniature in two years.

The model was built under rigidly controlled specifications made possible by examining hundreds of charts of the bay. Thousands of aerial photographs were taken. Boats probed the water with elaborate instruments to gather data on currents, sedimentation and salinity. And hundreds of blueprints were drawn to set down each detail that could be scientifically accumulated. The model was constructed to scale one foot for each 1000 horizontal feet, and one foot for each 100 vertical feet of the area it represents.

The model is made of 158 precast, reinforced 12 by 12-foot concrete blocks weighing five tons each. They are supported at the corners by leveling bolts mounted in rings welded to steel plates embedded in concrete pieces to permit proper adjustment of the model floor to correspond with the elevations of the natural bay.

Each block was poured on a sand foundation. Properly contoured welded wires were fitted to conform to the topography. Top concrete was added to mold these contours. The delicate shaping of the surface was done by expert topographers who relied on engineer's draftings. The blocks were set in place with a crane, like a giant jigsaw puzzle. After all blocks were placed, the openings between them were sealed



with a bituminous jointing material.

The 550 square miles the model represents include a segment of the Pacific Ocean, an area 17 miles beyond and 14 miles north and south of the Golden Gate.

At one side of this ocean area is a sump in which 17 tons of salt are mixed with 118,000 gallons of water to the exact salinity of the ocean and bay waters. The mixing pump has a 4500-gallon-per-minute capacity.

The rise and fall of the tide and accompanying tidal currents in the model bay are created by generating the tide in the model ocean. Salt water is pumped from the storage sump into the ocean head-bay by a pump that discharges 9000 gallons per minute. Ebb and flow are regulated by an automatic tide-control operating a motor-driven valve in a separate outflow pipe connecting the head-bay and sump.

Flow created by the pump is regulated on a time schedule that represents the time of tides, and a complete 24-hour tidal cycle is performed every 14.9 minutes. The tides function the same as they do in the actual bay where their cycle is dictated by the moon and turning of the earth. Four tidal cycles are created every hour, 48 every 8-hour day, 12,240 during 225 annual working days. This explains why a massive amount of needed data can be obtained in a short period of time.

When the investigations are finished around 1960, the Bay will be one of the world's most thoroughly studied harbor areas, shedding new light on the whole science of hydraulics.

At the Sacramento River end of the model, there is a pump that sends fresh water into the river channel coordinated exactly with the salt-water tides. This duplicates nature's clash between these two waters and will reveal how far the tides will force their way up river and leave adjacent farm land damaged by salinity, and what can be done to correct the problem.

To simulate the action of silt, which in nature builds up shoals and sand bars, a light bituminous material called gilsonite has been introduced into the waters. The tides that come through the 3½-foot-deep Golden Gate channel cause it to deposit in the same places that nature does in the bay.

When it is known just what happens to the silt during tides, engineers will be able to reduce by almost half the annual \$2,000,000 it costs to remove an average of eight million cubic yards of material to keep open shipping channels. They will know where to dredge and when.

(Continued to page 266)

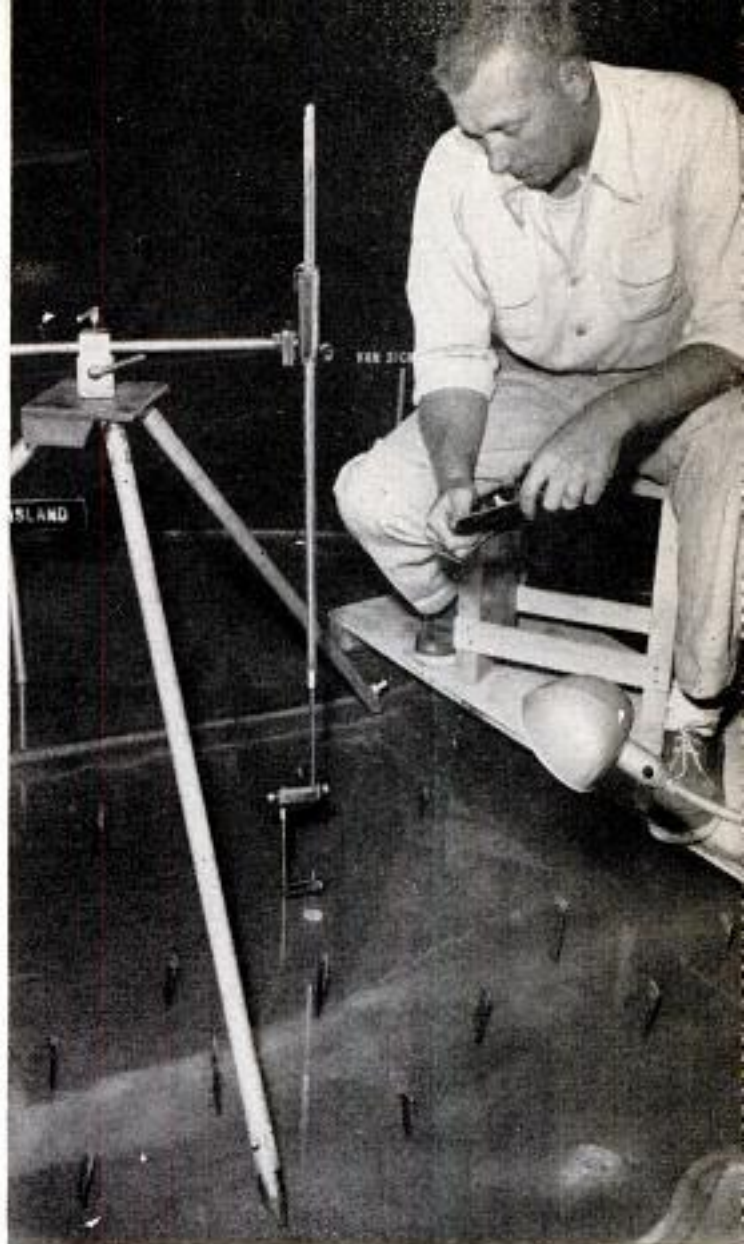

Velocity meters measure flow of tides. Engineers want to know how far tides take salt water up rivers

Slough in \$300,000 model fills with water at high tide and otherwise performs exactly like the bay



# HAY PELLETTIZER



Two-section, 10-ton self-propelled hay pelletizer eats through windrow of alfalfa on a California farm



Elevator at front of rig picks up alfalfa hay from windrow, above, and feeds it into hammer mill. Pellets in truck bed, below, are inspected after they leave hopper at end of rig



**HARVESTING HAY** in pellet form has several advantages for a farmer. The succulent and coarse portions of alfalfa are combined so that livestock get a more balanced diet. A five-ton load of pellets takes the space of about 232 bushels, eliminating the need for massive storage area. The half-inch pellets are easier to handle. Also, pelleting can be accomplished on almost any summer day; the farmer doesn't have to wait for ideal hay weather. The photographs on this page illustrate a hay-pelleting operation on a Rio Vista, Calif., farm. The hay is picked up and dropped into a hammer mill where it is pounded to a fineness that is correct for pelleting. The mill blows it back from this unit to the pellet shaper where steam is introduced to become a binder for the finely ground hay. Pellets drop from this machine into a cooling box where a fan removes enough heat to allow them to be moved out on a lift conveyor to a 1½-ton storage hopper. When the hopper is filled a truck moves up and an auger unloads the pellets into the truck. The finished pellets have a moisture content of about six percent. The power units of the rig burn diesel fuel and the wagon carries a steam generator.

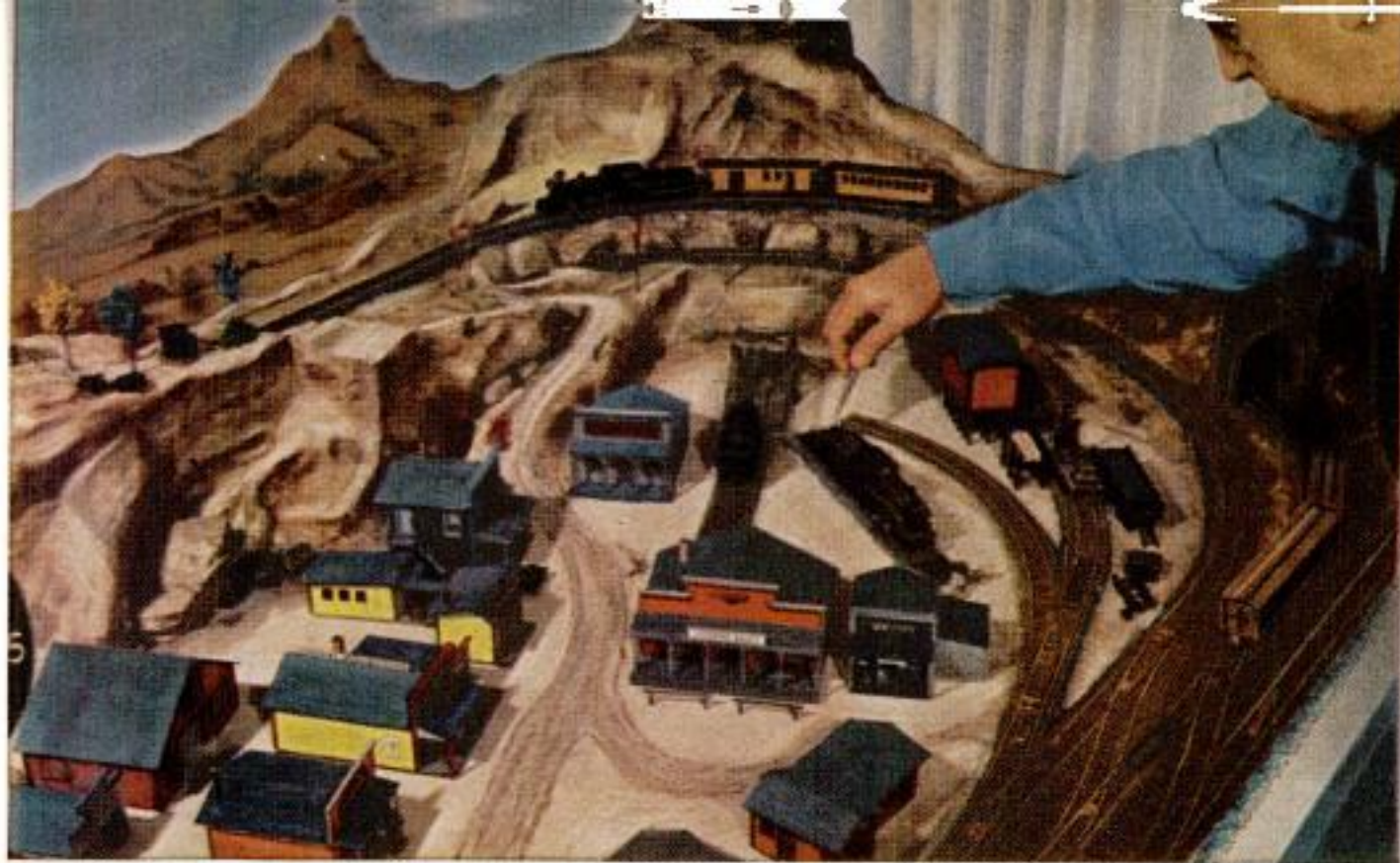

Miniature old-time desert town of Cactus Corners is bustling terminus for this HO-gauge model railroad

**A** PARTMENT DWELLERS, faced with space problems and the ever-present possibility of moving some day, are realists about model railroading. Yet, John Moss, vice-president and design director for Marshall Field and Company, Chicago, refuses to let his apartment buffalo him into re-

stricting his HO-gauge model-train hobby.

In an eight by nine-foot alcove off a guest room in the apartment where the Mosses and their daughter Margo live, modelmaker Moss has installed an intricate train layout, workbench and a tool chest made from an old dental-instrument

# Cactus Valley Railroad-- Apartment Style



**By Robert Dorsett**

*Photos by Donald F. Honick*

Interior of Mike's Lunch, left, shows tiny but realistic details of the models

Rolling stock, below, of early Western vintage, is built mostly from HO kits

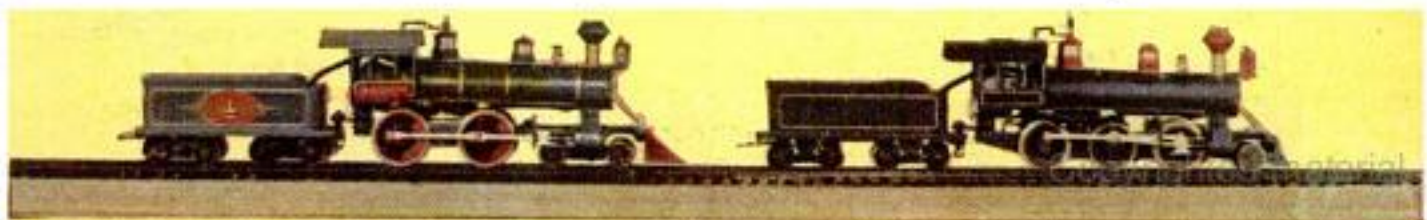



John Moss at the controls of the Cactus Valley Railroad. The length of track totals a little less than one scale mile. Interior of a typical old-fashioned open-end coach, below, is as detailed as the exterior

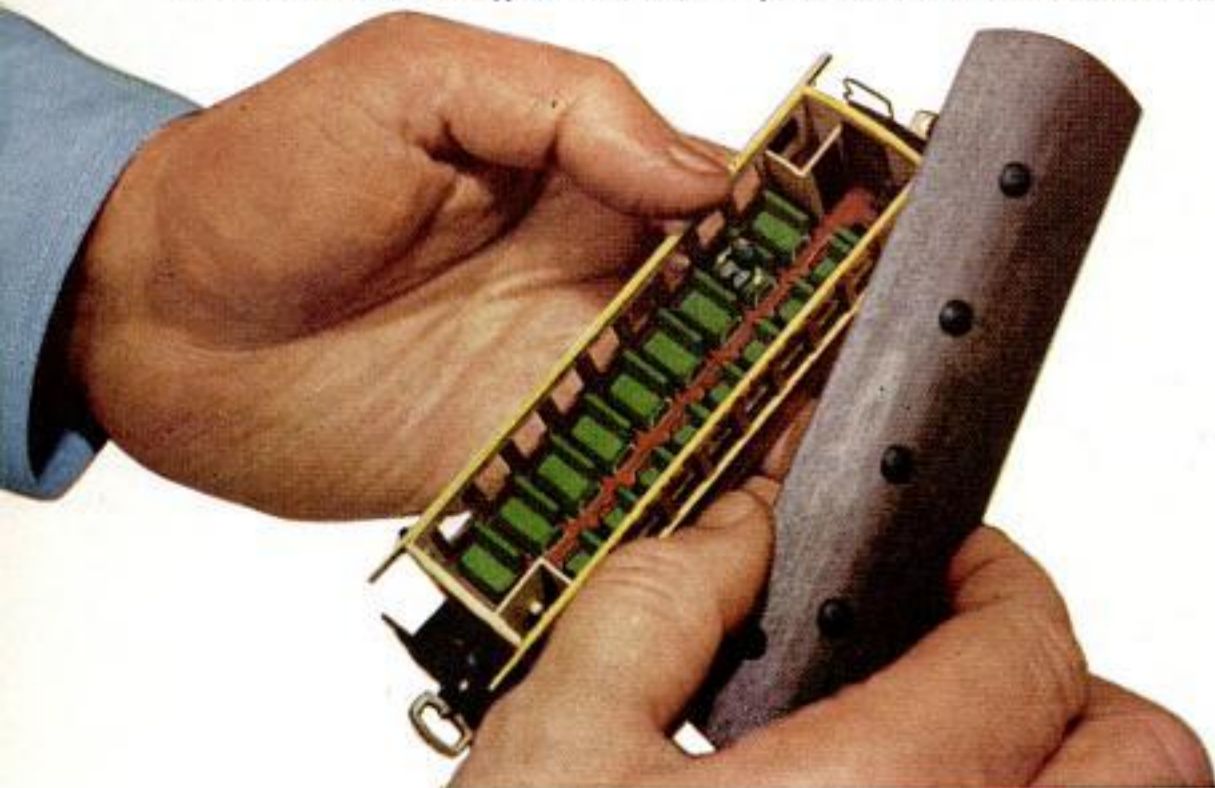

lighted material



Removable tunnel conceals dead-end track. Rugged desert terrain is plaster on chicken wire and cheesecloth

cabinet. The layout can be disassembled quickly into three compact units for easy transfer to a new location. The workbench and tool chest make up an efficient, convenient "maintenance shop" adjacent to the layout.

The entire setup is named the Cactus Valley Railroad. In HO gauge ( $\frac{1}{8}$  inch between tracks) which is at a scale of approximately  $\frac{1}{8}$  inch to one foot, Moss figures he has a little less than one scale mile of track on the layout.

Architecturally trained, Moss slipped easily into his HO-gauge interest about 10 years ago with the assembling of a dock-side engine kit. Gaining momentum, he now has as permanent parts of his layout: A dozen or so locomotives, mostly kit-built, with various valves and pipes added; a crane work car; an assortment of freight cars and coaches; an engine turntable; a water tower; numerous switches and sidings; three tunnels and a collection of kit and "scratch made" buildings which make up the town of Cactus Corners.

This community includes Jackson's Pipe Works, the Longhorn Saloon and the Wells Fargo Co. (from kits) and Moss-created editions of the local jail, railroad stations and the general store. His Splinter Lumber Co. carries a complete stock of white-cedar lumber cut to scale.

Mike's Lunch, another Moss-manufactured item, is doing a nice business (if you'll take the building's roof off for a looksee); and between the waitress and a customer at the counter is as delicious a serving of scale coffee, ham and eggs as a gandy dancer could want before a hard day's work. From soft white-pine strips has come, at a price of three hours nightly effort for  $2\frac{1}{2}$  weeks, an old-time passenger coach with seating and rest-room features detailed to do the Cactus Valley line proud. In pursuit of accurate craftsmanship, Moss has even furnished scale pin-up pictures for the walls of the section house.

Two wood frames covered with insulation board linked by bolts and wing nuts form a foundation for the layout. Arid "cactus



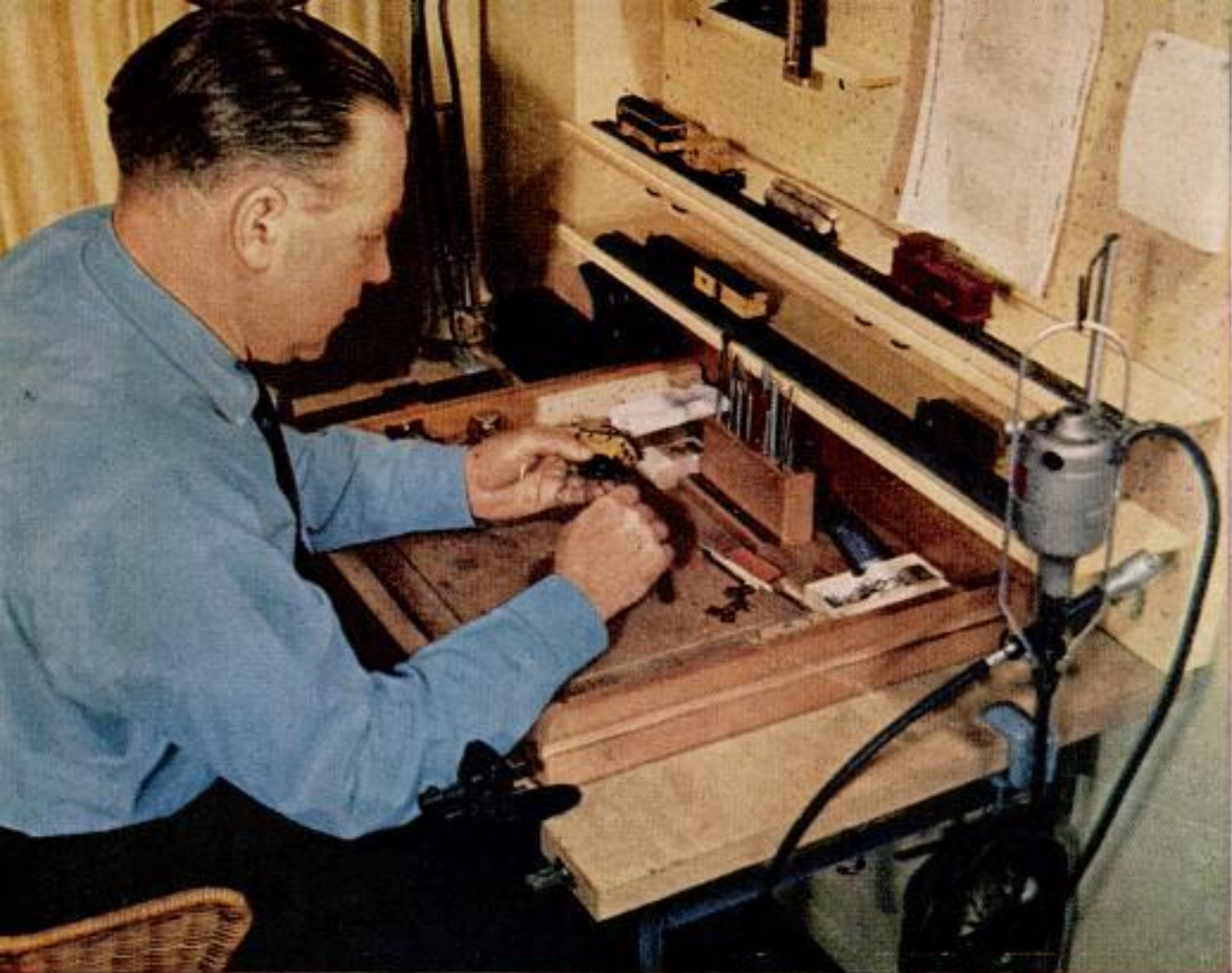

Models are built in removable drawer, keeping tools and parts of project together until job is finished



Orderly storage for parts and tools is provided in the former dental-instrument cabinet, above, which is mounted on casters

country" rises on these boards from a base of wood blocks covered with chicken wire, concealed by cheesecloth and coated with plaster. Water-color and casein tinting on the plaster produces an effective Southwestern atmosphere.

The table on which the layout rests is a four by seven-foot hardboard rectangle on folding metal legs. Control switches are inset along the table edge for convenience in operating the track turnouts. Hinged, the layout can be propped up as one unit for revision and addition of wiring beneath the layout or to the control panel below.

The console consists of perforated hardboard mounted on a wood frame which serves as a boxlike base for wiring and control knobs. The control panel is atop a cut-down teacart and is



# HERE'S HOW TO SELECT

New  
Advanced  
Design

# DELTA P

## SHOWN IN THE WORKSHOP OF YOUR C

(For only a few dollars down you can start

### INDIVIDUAL TOOLS

1. **DELTA HOMECRAFT 14/11 LATHE.** Most modern, most rugged lathe ever developed for the home workshop, yet priced surprisingly low. As shown, equipped with Hand Wheel,  $\frac{1}{2}$  HP Motor, 4-Step Motor Pulley, V-Belt, Switch Rod, and Bench.



2. **DELTA HOMECRAFT SHAPER.** Gives your work that finished "cabinet maker's touch." As shown, equipped with  $\frac{1}{2}$  HP Motor, Motor Pulley, V-Belt, Reversing and On-and-Off Switch, Stand, Retractable Casters.

operations. As shown, equipped with Lamp Attachment,  $\frac{1}{2}$  HP Motor, Stand, and Retractable Casters.

3. **DELTA HOMECRAFT 10" BAND SAW.** One of the most useful of all tools; ideal both for curve cutting and big-capacity straight line sawing. As shown, equipped with Lamp Attachment,  $\frac{1}{2}$  HP Motor, Motor Pulley, V-Belt, Switch Rod, Stand, and Retractable Casters.

6. **DELTA HOMECRAFT BENCH GRINDER.** Keeps cutting tools bright and sharp. Also can be used for buffing, cleaning, and polishing. As shown, equipped with Eye Shields.

4. **DELTA HOMECRAFT DELUXE 4" JOINTER.** Planes smooth, perfect edges; also tapers, chamfers, rabbets, and bevels without added accessories. As shown, equipped with  $\frac{1}{2}$  HP Motor, Motor Pulley, V-Belt, Switch Rod, Stand, and Retractable Casters.

7. **DELTA HOMECRAFT 9" TILTING ARBOR CIRCULAR SAW.** The ideal *first* tool for every home workshop. As shown, equipped with Table Extensions, Blade Guard and Splitter, Belt Guard,  $\frac{3}{4}$  HP Motor, Motor Pulley, V-Belt, Stand, and Retractable Casters.

5. **DELTA HOMECRAFT 11" DRILL PRESS.** Most versatile of all power tools—not only drills, but also does more than 22 other practical

8. **DELTA HOMECRAFT 16" SCROLL SAW.** Big enough for any curve-cutting job you'll want to do, yet safe enough for children to operate. As shown, equipped with Lamp Attachment,  $\frac{1}{2}$  HP Motor, Motor Pulley, V-Belt, Switch Rod, Stand, and Retractable Casters.

## LET DELTACRAFT BOOKS ADD TO YOUR POWER TO

### HARD COVER BOOKS

Here is a library of power tool information only Delta could provide. Each book, bound in durable, attractive hard covers, contains 120 pages of shop-tested ideas and big, clear photographs and drawings. Yet they're only 99c each if purchased from your Delta Dealer or \$1.00 each by mail.



### THE FAMOUS

Oldest and best shop magazine, the GRAM is packed with "how to" projects, detailed drawings, instructions, and handy woodwork tips on tool use. Issue. Only \$1.00

Mail the coupon for complete Deltacraft Library information.

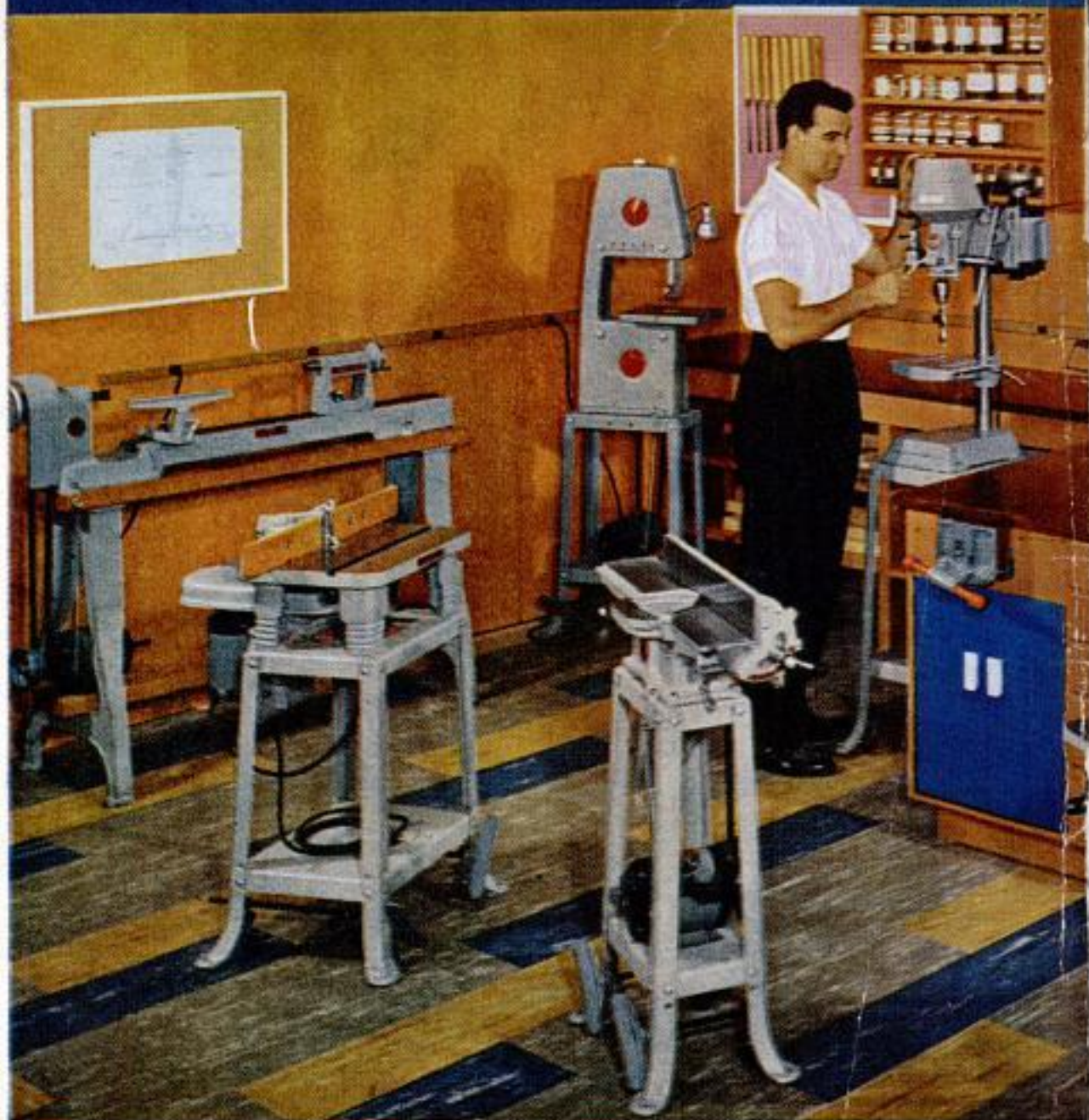

*New  
Advanced  
Design*

**DELTA** **HOMECRAFT® TOOLS MAKE**

**YOU CAN START A SHOP  
LIKE THIS FOR AS LITTLE AS  
\$17.10 down!**

Why be satisfied with less than the best when it's so easy to own the world's finest power tools? And *New Advanced Design* DELTA Homecraft Tools are also the world's most modern power tools, featuring exciting new styling by famed Raymond Loewy Associates, Inc. Their pleasing colors and clean lines reflect the advanced engineering built into them by the oldest and larg-

est maker of power tools.

If you're just starting your home workshop, you'll want to begin with the basic tool of all woodworking—the precision engineered Delta 9" tilting arbor saw. It's the tool you will use first and most often in your workshop.

If you already have a partially equipped shop, you'll want to add more tools, and Delta's complete line (the most complete in the world) allows you to choose exactly the right tools for you.

**CENTER FOR FAMILY FUN.** But whether you're a beginner or a veteran, you'll want a shop as good-looking, and good



1. Open the foldout page
2. Insert this sheet with
  1. Front side touching the free page
  2. Arrow pointing to the fold
3. Slice the folded edge
4. Close the page and slip-sheet



Foldout slip-sheet



GBASlipSheet-001



Folded edge of the page



Inverted Foldout slip-sheet

1. Open the foldout page
2. Insert this sheet with
  1. Front side touching the free page
  2. Arrow pointing to the fold
3. Slice the folded edge
4. Close the page and slip-sheet



1. Follow instructions on the other side

Back

GP455#pback-0018



Inverted Back

1. Follow instructions on the other side

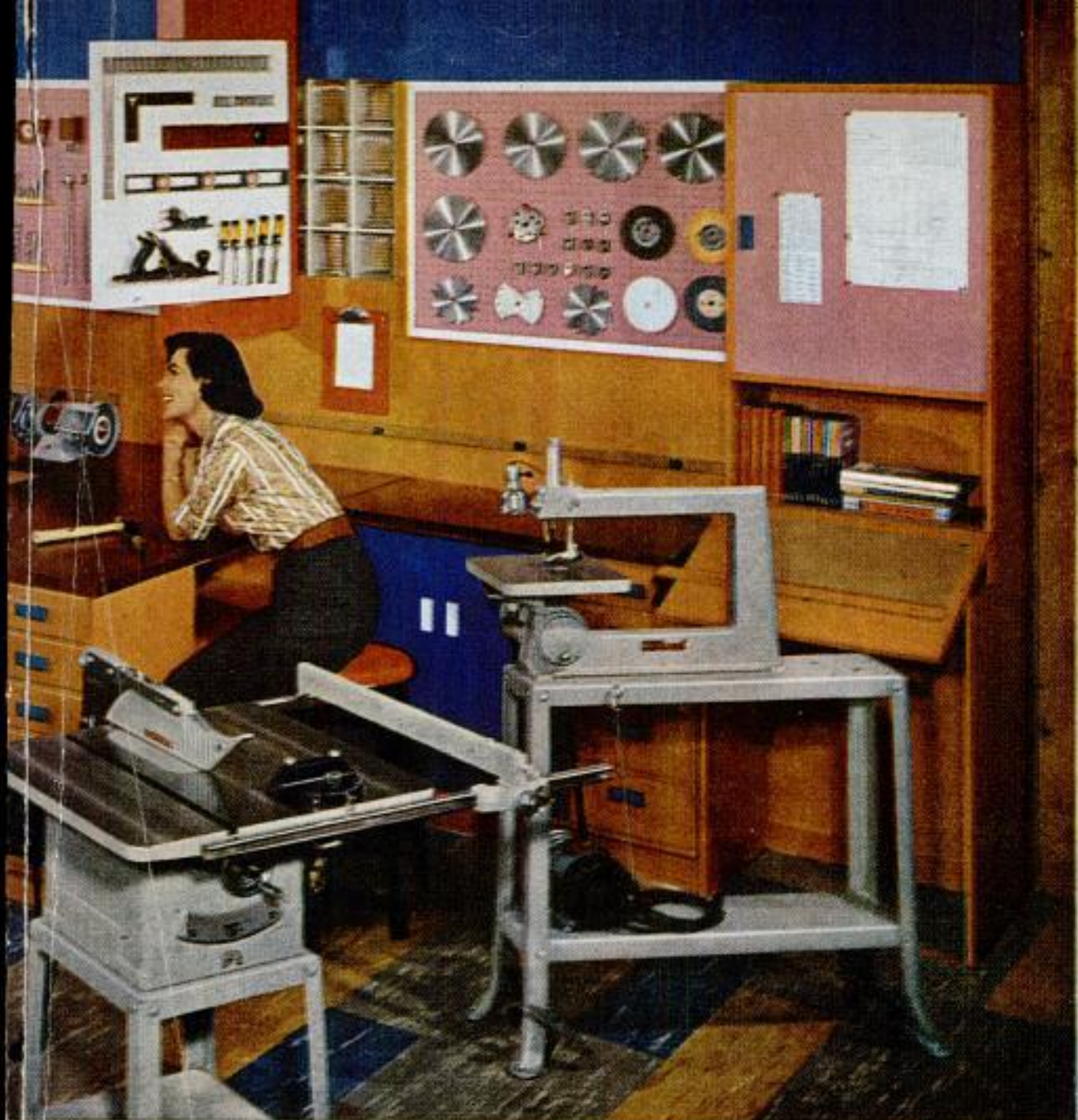

## THIS "DREAM SHOP" COME TRUE IN YOUR HOME!

to work in, as the one shown above. It was designed with the experience gleaned from 30 years of power tool leadership—and you can have it in *your* home for years of family fun.

**HOW TO START YOUR "DREAM SHOP" FOR AS LITTLE AS \$17.10.** The complete plans for the beautiful shop shown above are yours *absolutely free*. All you need to actually start building the shop is a New Advanced Design Delta 9" Tilting Arbor Saw, the basic tool of all wood-working—and you can have that delivered for as little as \$17.10 down! Later you can add other tools, and

sooner than you think you'll have one of the finest home workshops in America.

So start *now* by sending the coupon on the other side of this page. Learn more about each individual tool from the information listed there, and then see New Advanced Design Delta Homecraft Power Tools for yourself.

WHERE TO SEE *New Advanced Design*

### **DELTA** HOMECRAFT POWER TOOLS

Visit your Delta Dealer (he's listed under "TOOLS" in the Yellow Pages) or leading department, hardware and building supply stores. Ask about easy terms to fit your budget.

Copyrighted material

# SEE HOW EASILY YOU CAN OWN ONE OF AMERICA'S FINEST HOME WORKSHOPS

... SIMPLY MAIL COUPON FOR:



## FREE HOME WORKSHOP PLANS

Absolutely without charge, Delta will send you complete plans for *all three workshops* shown on the opposite side, plus step-by-step directions and bills of materials. Start your shop now by mailing the coupon below!



## NEW DELTA WORKSHOP REFERENCE MANUAL

Contains helpful workshop hints that you'll use on almost every job. Also contains complete specifications on *every* New Advanced Design Delta Homecraft Power Tool and accessory to help you select the *right* tools and accessories for your needs. It's free—just mail the coupon.



## NEW DELTACRAFT LIBRARY CATALOG

Lists titles and contents of every volume in the famous Deltacraft Library, which experts agree is the finest, most complete collection of authoritative books on power tools and projects. Just send the coupon below.

Delta Power Tool Division  
ROCKWELL MANUFACTURING COMPANY  
502L N. Lexington Avenue, Pittsburgh 8, Pa.

Yes! I'd like to receive the FREE Delta Workshop Plans for:

Under-The-Stairs Shop  "Dream Shop"  Radial Saw Shop  
plus other materials mentioned above.

Name \_\_\_\_\_

Address \_\_\_\_\_

City \_\_\_\_\_ County \_\_\_\_\_ State \_\_\_\_\_



another product by  
**ROCKWELL**



copyright material

1. Open the foldout page
2. Insert this sheet with
  1. Front side touching the free page
  2. Arrow pointing to the fold
3. Slice the folded edge
4. Close the page and slip-sheet

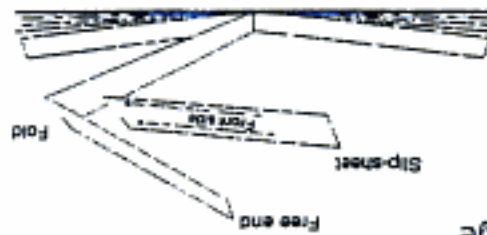

### Foldout slip-sheet

Folded edge of the page



### Inverted Foldout slip-sheet

1. Open the foldout page
2. Insert this sheet with
  1. Front side touching the free page
  2. Arrow pointing to the fold
3. Slice the folded edge
4. Close the page and slip-sheet



1. Follow instructions on the other side

Back

Gbs5lipback-0018



Inverted Back

1. Follow instructions on the other side



*New*  
**Advanced Design** **DELTA "900" RADIAL SAW**

*Most powerful radial saw "all-purpose" workshop ever built for home use!*

Like every New Advanced Design DELTA Tool, the "900" Radial Saw is as rugged as it is good-looking, powered by a full  $\frac{3}{4}$  horsepower motor. And it's so versatile that actually it's a *complete workshop*—you can rip, cross-cut, drill, rout, sand, shape and do many other jobs fast and accurately.

Also shown above is the New Advanced Design Delta Dust Collector. Use it with *any* power tool to keep your shop free of sawdust, and also to clean floors, walls—even to spray paint. It's powerful enough to pick up a 1" steel ball without damaging suction mechanism!

**COMPLETE SHOP PLANS ARE YOURS FREE!**  
*Build the complete, compact workshop shown above in your garage or basement. Send the coupon for free plans today.*



another product by

**ROCKWELL**



Copyrighted material

# SEE

*New Style!  
New Convenience!  
New Built-in Skill!*

# NEW

*Advanced  
Design*



ROCKWELL-BUILT

# DELTA

*Homecraft<sup>®</sup>  
Power Tools*



INTRODUCING THE "NEWEST LOOK"  
IN THE WORLD'S FINEST POWER TOOLS

FEATURING STYLING BY RAYMOND LOEWY ASSOCIATES, INC.

... AND NEW CONVENIENCE-DESIGNED  
WORKSHOPS THAT YOU CAN BUILD  
IN YOUR OWN HOME!



Folded edge of the page



Inverted Foldout slip-sheet

1. Open the foldout page
2. Insert this sheet with
  1. Front side touching the free page
  2. Arrow pointing to the fold
3. Slice the folded edge
4. Close the page and slip-sheet



1. Open the foldout page
2. Insert this sheet with
  1. Front side touching the free page
  2. Arrow pointing to the fold
3. Slice the folded edge
4. Close the page and slip-sheet

Foldout slip-sheet

1. Follow instructions on the other side

Back

Gbasllpback-0018



Inverted Back

1. Follow instructions on the other side

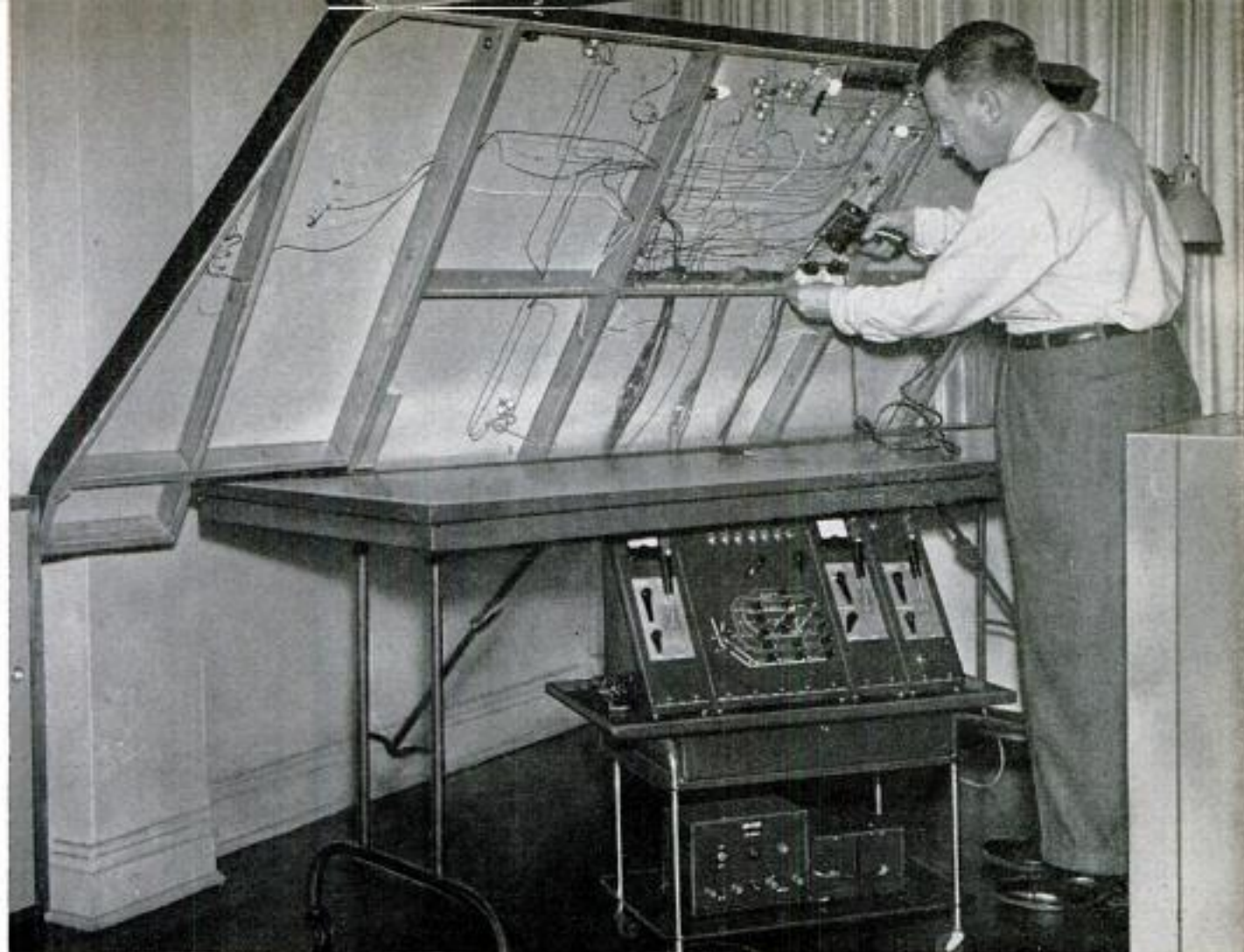

Layout tilts on hinges for easy access to wiring. Table rolls on casters to convenient working position

ried in with a transformer and converter which changes alternating house current into proper-voltage direct current necessary for HO-gauge operation. A drawer under the control panel is a catchall for wiring gear and rolling stock. Casters on the layout table, control panel and tool cabinet give these units maneuverability.

At the workbench a flexible-shaft dental drill is operated from house current, as is an electric sander attached directly to the worktable surface. In the bench drawer are tools and materials for the particular project under way; Moss merely withdraws the drawer, works "inside" it as it rests on the bench, and returns the entire unit to its place, when desired. With this arrangement, time-consuming selection and replacement of tools and parts are unnecessary, and cleaning up can wait until the project has been completed.

In the tool cabinet, Moss altered the door interior to house shelves for storage of six-inch-long blocks of wood. Each block contains files, chisels, small-nail and parts

vials inserted in specially drilled holes. In this way, Moss obtains groups of related tools at one time instead of having to hunt for individual items; the system also eliminates the separate returning of each tool to its niche. Incidentally, Moss has removed carved Victorian mahogany decorations and refinished the cabinet's exterior in bleached mahogany.

Outside of a conventional desire to add more track and switches, the C.V.R.R. president has one future project in mind: Installation of a coal-screening tippie on top of what is now a dead-end tunnel.

Compact, convenient and portable, the Cactus Valley system is adaptable to apartment living as are few model railroads. Who knows? . . . When they see similar set-ups, landlords may build their own HO lines or reduce rent as partial payment for "engineering privileges" on a tenant's network. Anyway, the tenant can't lose.

Moss places the value of his railroad and equipment, acquired over a 10-year period, at several thousand dollars. ★ ★ ★





### X-15 May Climb 150 Miles

Artist's conception shows a rocket plane not officially announced that is expected to break two world records next year by flying 150 miles high at 4000 miles per hour. Being built by North American Aviation for the Air Force and designated the X-15, the craft will gather information on the effects of its re-entry into the earth's atmosphere. It will be about the same size as an F-100 Super Sabre jet airplane. The present known world speed and altitude records are held by the ill-fated Bell X-2 which, before it crashed, flew 2200 miles per hour at 126,000 feet.



### English Ladder Sections Double as Stretchers

Civil Defense workers in London demonstrate a ladder that also can be used as a stretcher to remove injured persons. Developed by the Gloster Aircraft Company, the device is narrower than an ordinary stretcher so it can be passed through small openings. A canvas container protects the patient. Several of the units can be fitted together to make a longer ladder.

### Wall TV Set 16 Inches Deep

Designed for custom cabinet installation, the 21-inch television receiver, below, is manufactured on a chassis narrow enough to fit into walls or shelves only 16 inches deep. The 110-degree wide-angle picture tube makes it easy to install the receiver in shallow space. Dual eight-inch speakers are provided for installation over the receiver or in any desired location.



erial

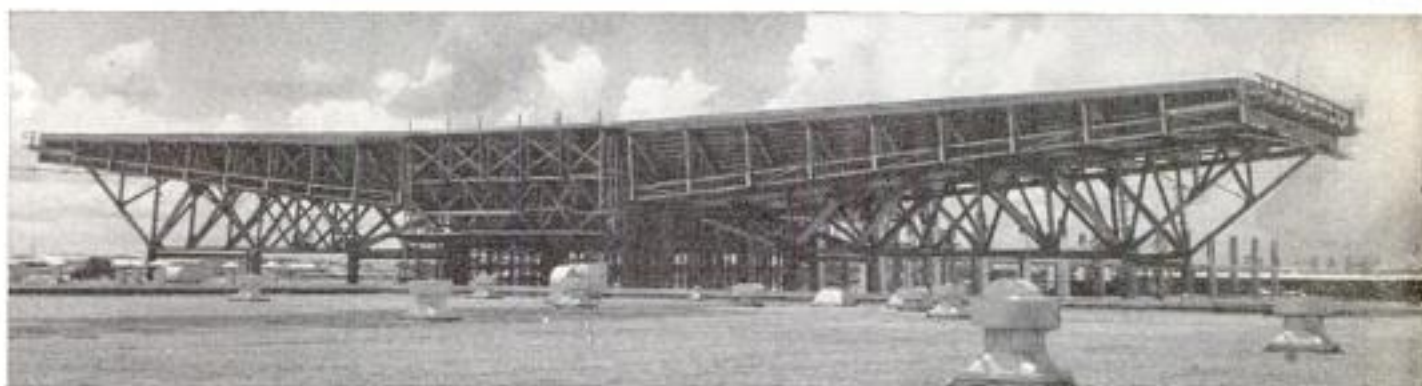

## Cantilever Airport Hangar Will Hold Six DC-8 Planes

Six giant DC-8 jet airliners will be serviced simultaneously in a new hangar at Miami, Fla., International Airport. The structure is believed to have the world's longest span of cantilever concrete with its two "wings" extending 112 feet on each

side of the center section. The roof will withstand hurricane winds of 200 miles per hour. The forms, shown in the bottom photograph, were supported by sand jacks similar to the ones used by the Egyptian pyramid builders.

## Battery-Driven Propeller Tows Underwater Swimmer

Skin divers who really want to go places underwater can now cruise along the bottom of a lake or in sea water while an electric-powered propulsion unit does the work. A propeller driven by a 6 or 12-volt battery is mounted forward on the unit. The underwater enthusiast in the photograph shows how the device is steered by slight movements of the aluminum bar at the rear of the body shell. The manufacturer says the unit can be used at depths up to 100 feet for as long as one hour. Shell is of reinforced plastic.

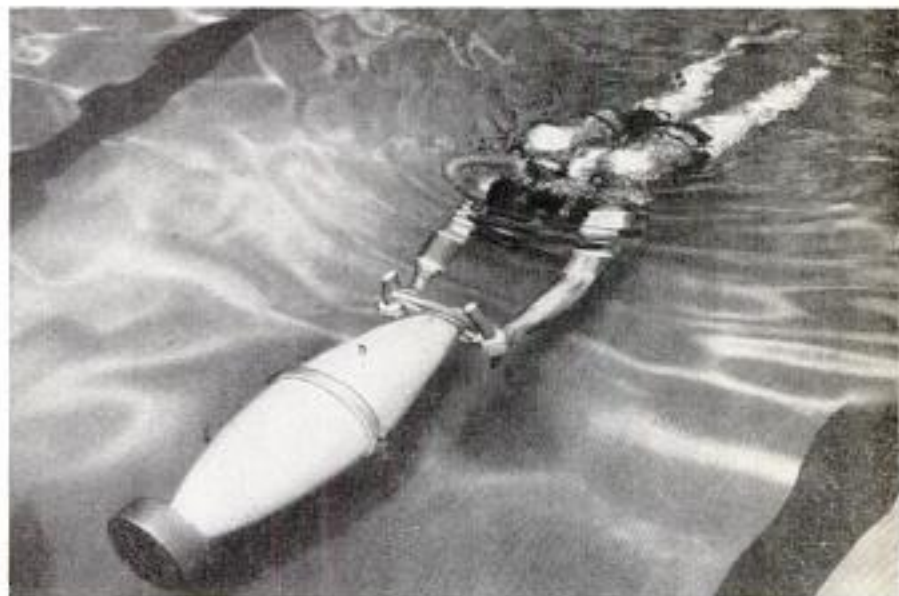

## Alweg Monorail Train Makes Experimental Run

Shown during a trial run at Cologne, Germany, is a full-size model of the Alweg monorail train. The train hit a top speed of 50 miles per hour. Previous tests with a miniature model did not produce satisfactory results. The full-scale prototype reportedly shows more promise. Alweg is an abbreviation of the name of the Swedish manufacturer.



# NOW ELECTRONIC BRAINS ARE TALKING

By Richard F. Dempewolff

**R**ED LEADER—vector one-nine-zero—  
angels two-zero over.”

The crisp order containing flight instructions for a formation of interceptor planes came loud and clear from a black box in a Long Island laboratory. There was an eerie quality to the voice. Each word sounded as though a different person said it. Eeriest of all, though, was the fact that no human

being had put that message together or spoken it. The words had been plucked electronically from a “canned” vocabulary, pieced together and broadcast in proper sequence.

The weird “voice,” demonstrated for *Popular Mechanics* by Charles Poppe, one of its developers at the Fairchild Instrument Corporation’s shining new labora-

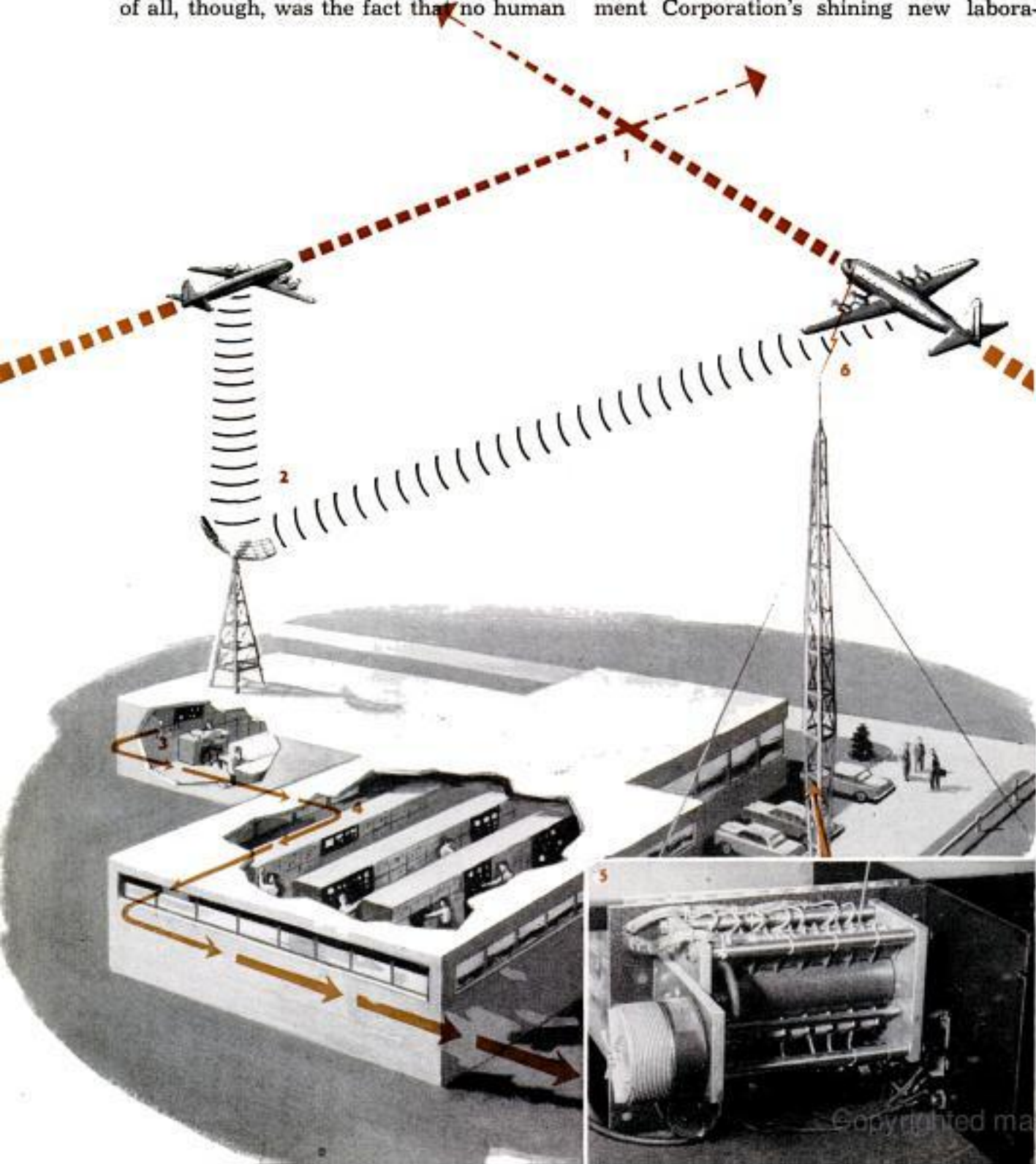

tories in Syosset, N. Y., is, in effect, a set of "vocal cords" that allows an electronic brain to say what it is "thinking" in any language! Known as Automatic Voice Data Link, the compact unit can take output signals from an electronic computer and translate them instantly into a series of verbal messages that can be broadcast to flying aircraft or put out over a public-address system.

The advantage of an electronic brain that can talk is tremendous, according to Poppe and his boss, R. H. Frye. Along our early warning fence, for instance, the vast SAGE computers that calculate the best course and altitude for an intercept, in many cases feed their answers in digital hieroglyphics on coded tape to human operators. These guidance commands must be deciphered and communicated to the lead intercept pilot—usually by voice radio, since few planes have the expensive equipment that can receive and interpret the computer's code. "As big computers become operational," explains Poppe, "the capability to control large numbers of aircraft . . . requires automatic high-speed communications. With human operators relaying guidance commands, over-all system performance may degenerate due to time lags or operator error."

This is where the new voice comes in. As fast as the electronic brain computes course changes for a flight of interceptors closing in on an unidentified plane, the Voice Data Link translates the information into plain English. These commands are broadcast instantaneously to the lead interceptor over a standard voice channel that any military plane is equipped to receive.

All this is achieved by an ingenious feat of mechanical and electronic legerdemain. The heart of the new Voice Data Link is its vocabulary, which Poppe revealed to us by removing the faceplate from the set. Up top, he pointed out a magnetic drum about eight inches long and 2½ inches in diameter. Eighty short sound tracks, one after another, encircled the drum. Above each one, a magnetic playback head was poised. "Each sound track," explained Poppe, "is a recording of one word repeated over and



Bank of toggle switches at base of Voice Data Link allows selection of words to be used in messages

over. The particular vocabulary on this drum was made by the same man. Oddly, we discovered that his voice came out differently on each track—because he recorded over a period of days. On future models, we know we'll have to record a whole drum at one sitting because people's voices change from day to day.

"This prototype vocabulary," Poppe continued, "was designed for ground-control intercept work. It contains recordings of the words 'zero' through 'nine,' as well as call signs, or squadron designator words like 'red,' 'blue,' 'white,' and so on. Besides these there are a number of what I call 'fixed' words that always come up at a certain place in every message that a GCI station would send to a plane in flight. These words like 'leader,' 'vector,' 'angels,' 'range' and 'bearing' can be programmed to come up at the same place in every message just by flipping the proper toggle switches at the base of the set."

In the message that the voice spoke for *Popular Mechanics*, the words LEADER—VECTOR—ANGELS—OVER were the programmed ones. The rest of the message represented the digital electronic impulses that would be supplied by a huge SAGE brain. The big computer, receiving search-radar data on the position and direction of a moving "blip" in the sky, swiftly calculated a course for our fighter planes to follow in order to intercept the blip. The computer's digital electronic answer, instead of punching a tape, triggered a series of certain recording heads over the revolving vocabulary, and out came a line of chatter, preceded by a "beep-beep" that is programmed into every message to alert the pilot. With programmed words in capitals, and words triggered by the brain's impulses in lower case, this is what the message would look like written out:

(Continued to page 252)

Diagram, left, shows how "voice" unit for electronic computer would function in air-traffic control. Paths of two planes show they will collide (1), according to radar waves received by antenna (2). Position, course and other data are compiled in radar shack (3) and fed into computer (4) which quickly figures new course for one plane. Information is fed to Voice Data Link (5) which selects proper word sequences from magnetic-drum vocabulary. New course is automatically transmitted to one of planes (6)



# KEEPING UP WITH THE ATOM



**A BILLION BBs**—traditional pellets of small-fry marksmen—will shield a new “hot cell” for nuclear research. The BBs actually will make the cell portable. The cell, under construction at the Westinghouse radiation and nucleonics laboratory in Pittsburgh, Pa., has half-inch-thick steel walls spaced 15 inches apart. Between the walls are the 35 tons of BBs. They are the equivalent of 10 inches of solid steel in their ability to shield atomic radiations. When the cell is to be moved, the shot can be drained out through openings near the base of the wall.

☆☆☆

**THE GREAT DEBATE** rages on. What amount of radiation will adversely affect our health—and that of generations to come? Scientists, basing their statements on solid research, still debate the point.

According to Dr. Michael A. Bender of Johns Hopkins University, the amount of radiation now considered safe may be much too high. His radiation experiments are the first to be made on normal human cells. The experiments indicate that the 10-roentgen “maximum permissible dose” to the reproductive organs from birth to 30 years of age, set by the National Academy of Sciences, may

be from three to five times too high. The conclusion is that a significant number of tomorrow's children may have defective health if today's fathers receive anywhere near that amount.

And Dr. Curtis Newcombe of the U. S. Radiological Defense Laboratory reports that some individuals may be very near the maximum permissible concentration of cancer-causing strontium-90.

☆☆☆

**WILL THERE BE** a sudden break-through in the research to control the hydrogen bomb?

Dr. William Phelps Allis, who heads up a fusion-research project at the Massachusetts Institute of Technology, recently described progress in the field.

Scientists are trying to contain the super-hot gases of fusion power in a “magnetic bottle.” Doctor Allis indicates that there are “leaks” in the bottle. However, he thinks research may be developing a way to plug the leaks by superimposing another magnetic field on top of the bottle. If the method works, Doctor Allis says scientists will have learned to control fusion.

☆☆☆

**STRETCHING OUT** like a huge gun barrel, below, is HILAC, the University of California's new atom smasher which is expected to produce superheavyweight atoms. Note the size of the man compared to the barrel, which is 90 feet long.

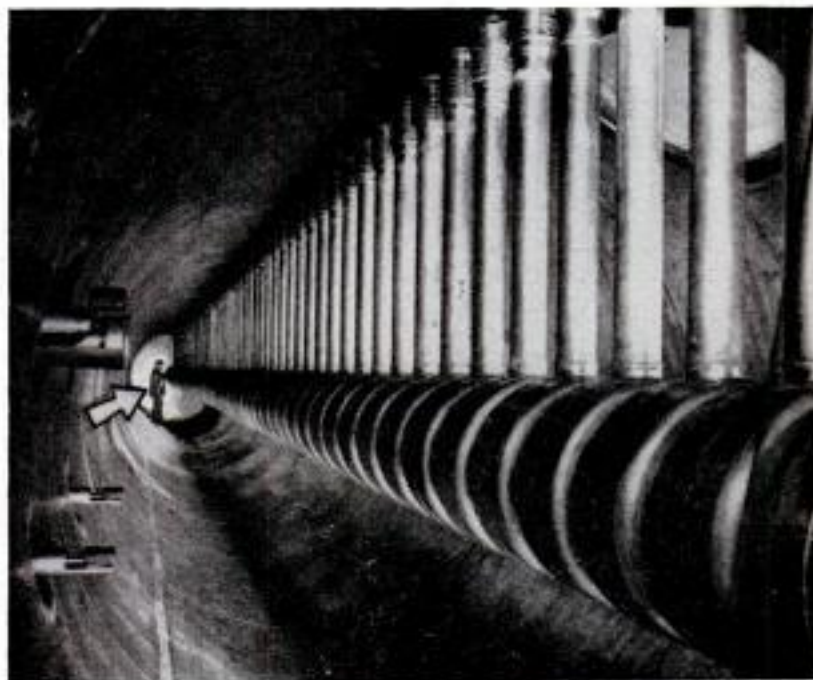



## Telescoping Trailer Unit Carries 650 Pounds

Versatile unit will carry a heavy load (below), or hold a 5 by 7-foot wall tent or 14-foot boat (left)

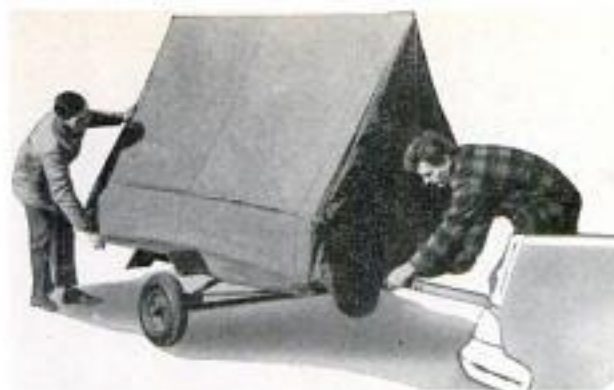

When not in use, this telescoping trailer can be stored in a space approximately 24 by 63 inches. On the road, the trailer can accommodate a boat up to 14 feet long and it can safely carry loads up to 650 pounds. The trailer is equipped with five rubber rollers for hauling boats. It also has automotive-type leaf springs, and oversize 5.00 by 8.00 tires to minimize sinking in sand or mud. The unit also can be quickly converted to a utility trailer with a body measuring 4 by 7 feet and a wall tent can be adapted to the utility body.

## German Tractor Has Double Set of Wheels for Rails or Road

Track wheels of the German railway shunting tractor, below, are lowered hydraulically to lift the road wheels off the ground. It also doubles as a shovel loader

that can lift an 800-pound load to a height of nine feet while other attachments convert it to a snowplow, grasscutter, street sweeper or a fork-lift truck.



# AIRPORT LAYOUT

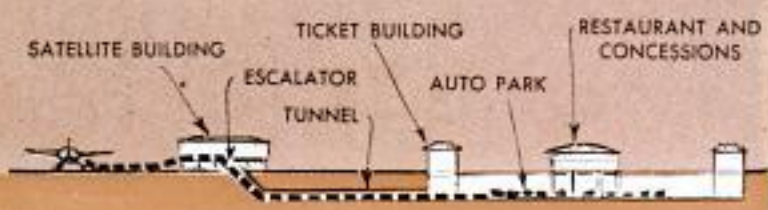
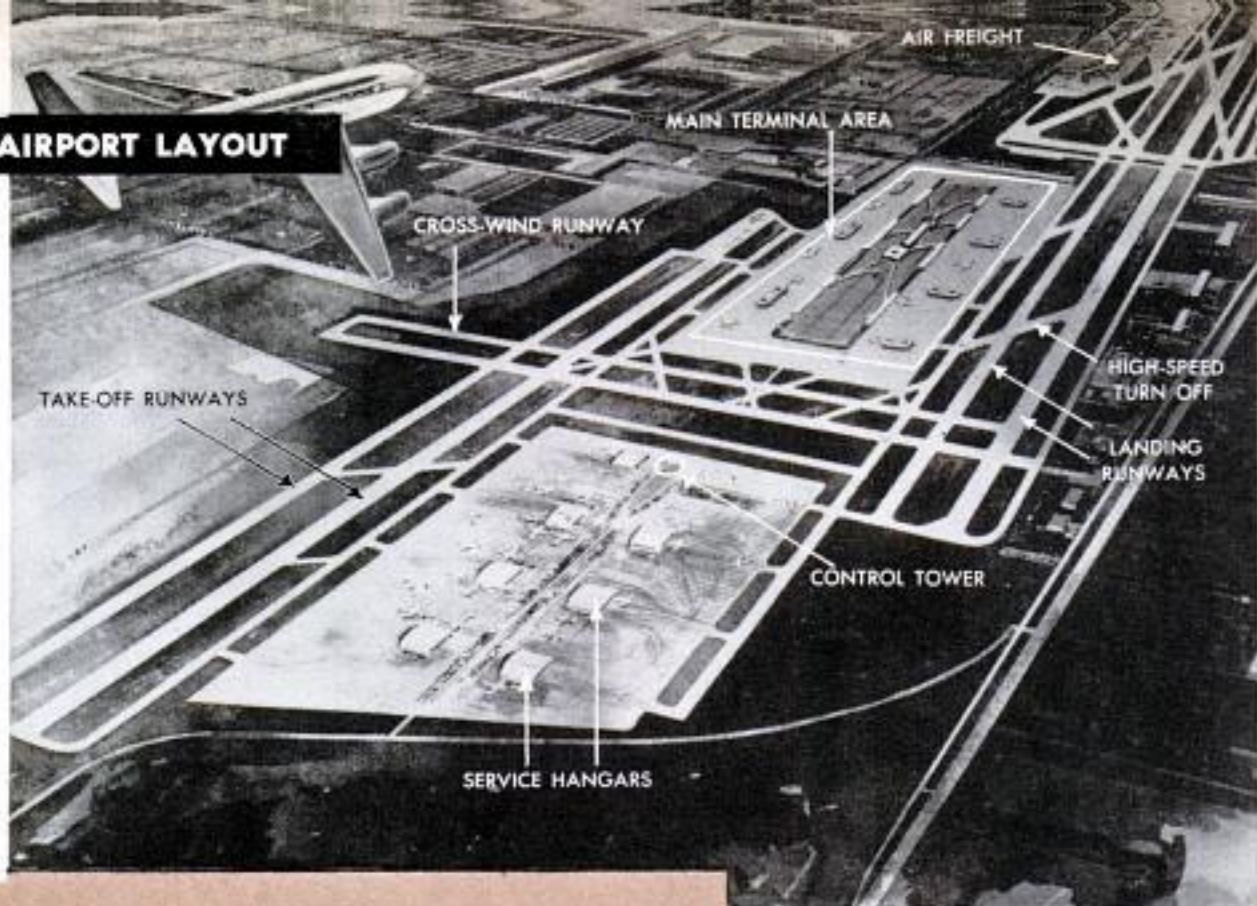

By late 1959, Los Angeles will have this airport designed for the jet age. Take-off and landing runways are widely separated

Close-up of terminal area shows satellite buildings clustered around concessions area. Detail at left shows the passenger route

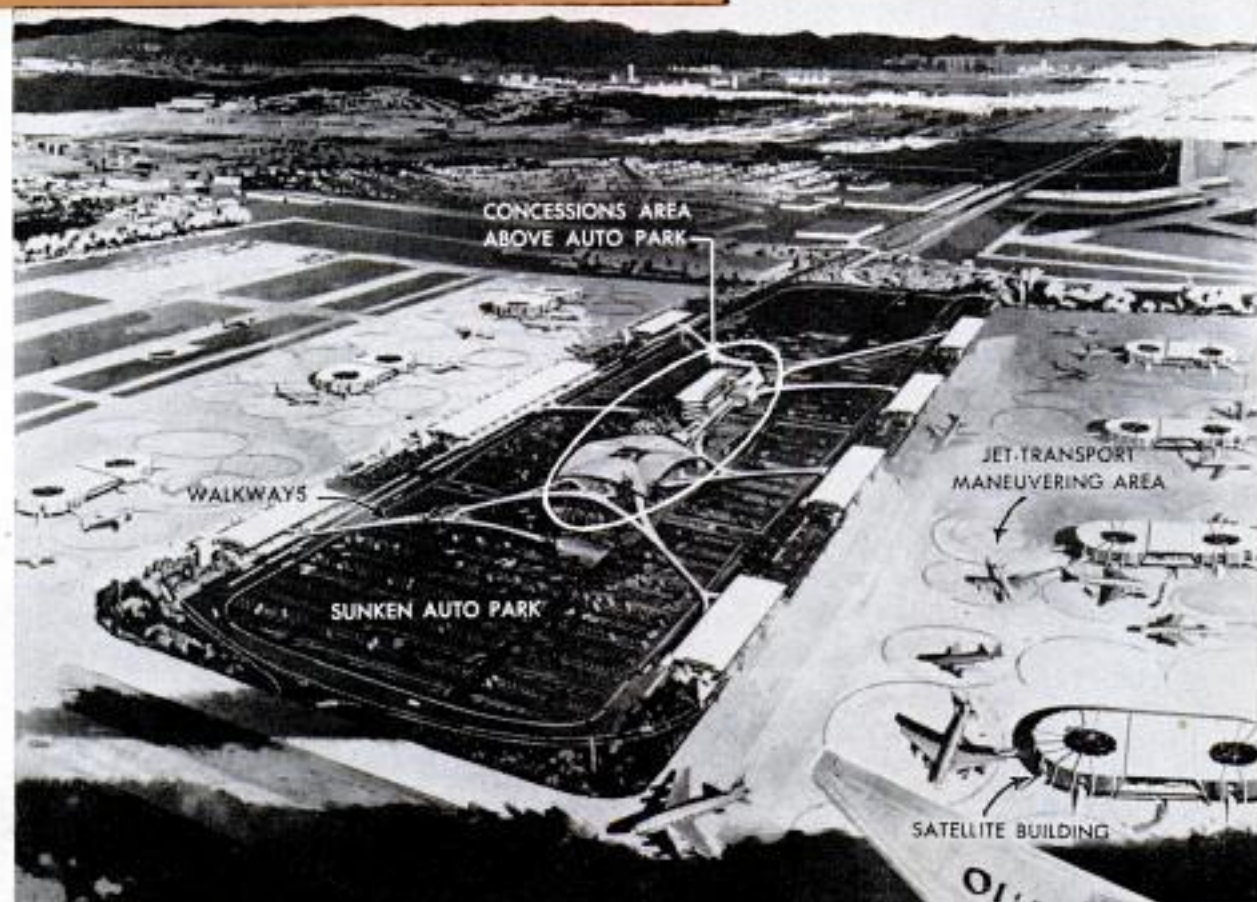

## A PM PANEL OF EXPERTS DISCUSSES

# *Landing Fields for Jetliners*

THE PANEL: J. B. Edwards, Assistant to Chief Engineer, Douglas Aircraft Company; John McDonald, Design Staff Engineer, Lockheed Aircraft Corporation; A. E. Horning, Assistant Regional Administrator (Region 4), Civil Aeronautics Administration; A. R. Bone, Jr., Regional Vice-President, American Airlines

**QUESTION:** Two years from now the airlines will add two new types of large aircraft to their passenger fleets. One is the 400-miles-per-hour propjet Lockheed Electra. The other is the 550-miles-per-hour pure jet and includes the Douglas DC-8, the Boeing 707 and the Convair 880. What will these planes mean to the public?

**BONE:** One aspect of the jet age is that you can leave New York at 5:00 in the afternoon and be in Los Angeles at 7:15.

**Q: In the morning?**

**BONE:** No, the same day. The west-bound flight takes five hours and 15 minutes and you deduct three hours for time change. The flight takes two hours and 15 minutes, clock time.

**Q: Will people be spending more time in taxicabs going to and from the airports than they do in the air?**

**BONE:** It depends on the length of the run, of course. One of the problems is to

improve transportation between a city and its airport, whether on the ground or by helicopter.

**Q: At such fast speeds will you still serve meals in the air?**

**BONE:** The occasions will be reduced. Meals will continue to be served whenever a flight carries through a conventional mealtime.

**Q: Will the jets be able to use the present airports?**

**EDWARDS:** They are designed to use existing facilities at the large terminals, including the present runways. However, a heavily loaded jet departing on a long ocean flight needs a lot of room. The major airports are installing 10,000-foot runways. This provides a safety factor to make it easier to get back to the field in case of engine failure. It also allows for times when there are high temperatures, when a longer take-off run is needed.

### THE PANEL



## SERVICING THE PLANES

If jets are to pay off they must be quickly loaded and unloaded. Drawing shows how baggage containers are preloaded for cargo compartments

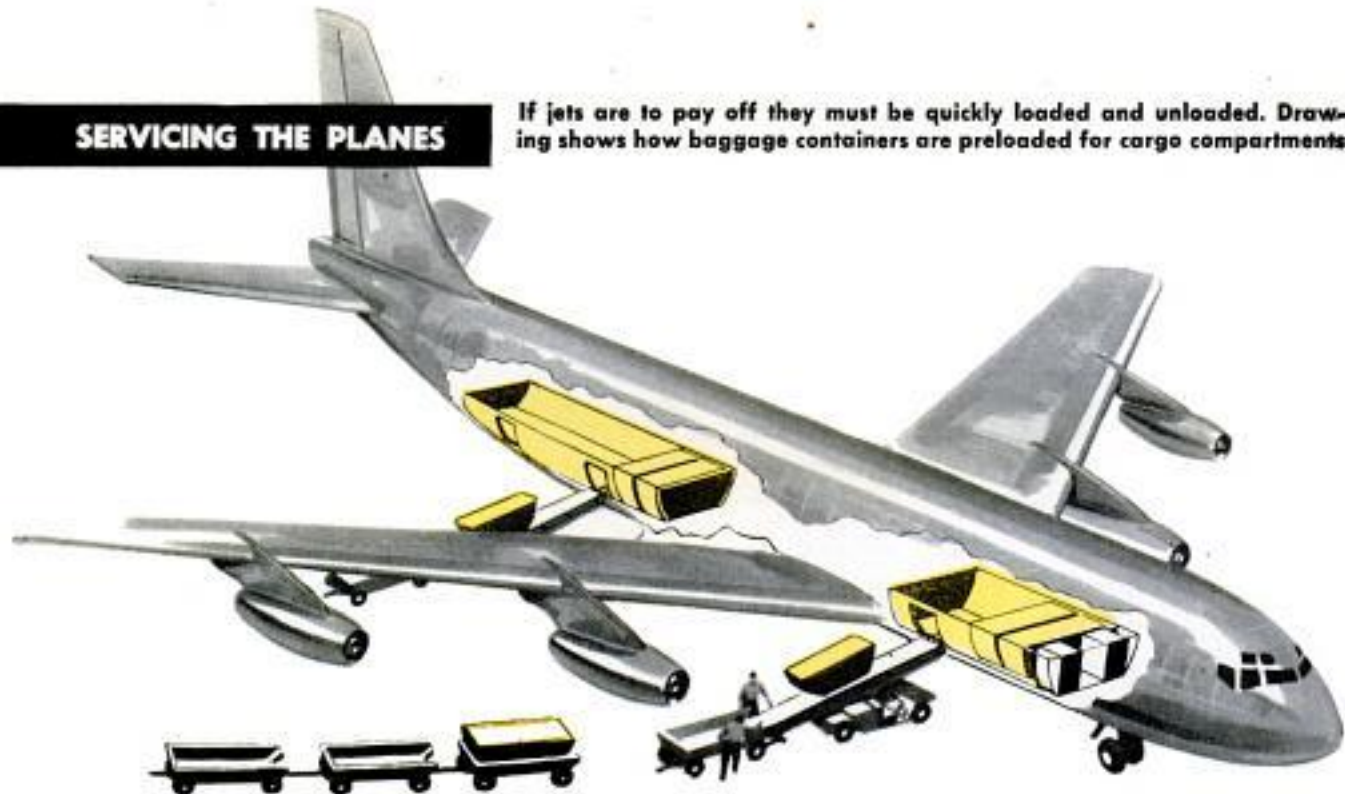

BOEING 707

**Q: Are other changes needed at the terminals?**

**BONE:** The jets are influencing airport design. The whole process of moving people to and from the planes is being streamlined, for passengers don't like to waste time on the ground. This applies to present planes as well as the jets, of course. The \$60,000,000 improvement program at Los Angeles International is a good example of what can be done. At Los Angeles the terminal buildings and parking lot are being

placed in the middle of the airport, between the runways instead of at one side. The terminal is really on two levels and you drive down into the central sunken parking. You park near your own airline ticket office, walk in and validate your ticket and check your baggage, then walk via a tunnel to the adjacent "satellite" building where the planes are parked. Here an Escalator takes you up to a waiting room above ground level. This system is an excellent solution of the problem of handling a great

In the Electra most of the fueling and loading operations are performed on one side of the plane. Galley food is loaded through passenger door, followed by the passengers

LOCKHEED ELECTRA



number of people, all in a hurry, with a minimum of delay. Los Angeles will have gate facilities for 60 transports and expects to serve more than 10,000,000 passengers a year.

**Q: Will these passengers have to wait as long for their baggage as they do now?**

**BONE:** The airlines hope not. Several systems of baggage handling are being studied. Too, American Airlines is working on simplified ticketing to speed up the check-in process. Electronic devices for the necessary calculating are being tested.

**Q: Will the airlines need new facilities for servicing the jets?**

**BONE:** We have just built a \$4,000,000 maintenance hangar at Los Angeles that was designed with the jets in mind. It has 200,000 square feet of floor space and provides working stations for 10 aircraft, based on the dimensions of the Boeing 707. On the windward side, the hangar doors are shaped to fit tightly around a fuselage, leaving the plane's tail outside. This arrangement is suitable for our present DC-6 and DC-7 aircraft as well as for the 707 and the Electra. There is room for parking 20 Flagships on the concrete apron, not counting four more planes in the washing area.

**Q: It is said that a large jet consumes from 6000 to 18,000 gallons of fuel on a single flight, as much as 1½ tank cars. Can such a large amount of fuel be loaded rapidly?**

**EDWARDS:** Ground handling has been given a great deal of thought. A jet is an expensive piece of machinery. It needs to stay in the air. For fuel, there are underwing pressure systems that can take on 1200 gallons per minute. If distilled water is used with the fuel, this also is put on board by a pressure system. We expect a complete turn-around of a DC-8 to be accomplished in 30 minutes.

**MCDONALD:** The Electra is specially designed for rapid servicing. Preloaded

baggage containers, single-point pressure refueling, two doors to the main cabin, all help. Passengers embark on one side of the plane, all the servicing and handling of fluids and cargo is done on the other side. We designed the Electra for a turn-around time of 20 minutes. En-route stations could be cleared with as little as 12 minutes on the ground.

**Q: Many people are afraid the jets are going to be extremely noisy.**

**EDWARDS:** This reaction may be based on listening to military aircraft that often use afterburners on take-off. We hope the new jets will be no noisier than our present transports. Muffling devices will be used. The trick is to accomplish reasonable noise suppression without too much loss of power.

**HORNING:** Duration of the noise will be less because of increased performance.

**EDWARDS:** Yes. A military aircraft has a smaller, thinner wing and consequently its climb-out is closer to the ground. We will climb out at 2600 feet per minute, more than twice as fast as at present.

**Q: One suggestion is to park the jet transport against a silencing structure at the end of the runway and to carry passengers out to the plane by bus. This would keep the noise away from the terminal and save jet fuel. Would this be practical?**

**BONE:** I think it would be impractical. It has been done in Europe and has proven slow and awkward.

**EDWARDS:** We have made tests with a jet aircraft parked against a terminal. Noise was not a particularly bad problem. The power needed for taxiing is only slightly above idling and doesn't produce a tremendous roar. The heated air coming from the exhaust and the odor of the exhaust may be a problem if people are boarding one plane while another is turning nearby. The heat and odor are not objectionable if you expect them, of course. For the public it may be best to use

**Air Force uses noise suppressors with jets. Panel feels they will not be used for commercial jetliners**  
General Sound Control, Inc. photo



## LOADING THE PASSENGERS

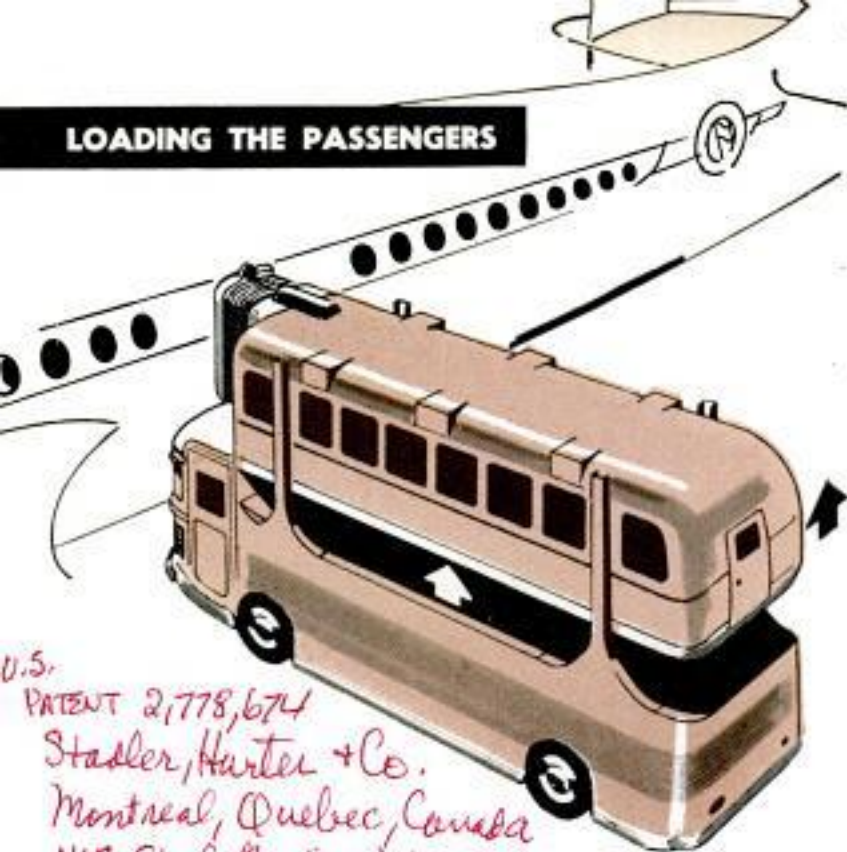

U.S.  
 PATENT 2,778,674  
 Stadler, Harter + Co.  
 Montreal, Quebec, Canada  
 1117 St. Catherine W.

Patented airport bus would carry passengers from terminal to plane, elevate them for direct access to the door. Below, passengers arriving at London airport climb aboard coaches

B.O.A.C. photo



Under test by United Air Lines is a telescoping gangplank which wheels out providing sheltered loading tunnel



enclosed or glassed ramps leading to the planes.

McDONALD: The Electra has a very low ground-idle engine speed, and noise on the ground will be at a very low value. We can set the propeller blades at a zero thrust condition so there is no wind blowing all over the passengers walking to the plane.

**Q: Will there be a high noise level inside the cabin?**

EDWARDS: It will be very much reduced from the present.

McDONALD: In the case of the propjet, one of the principal features is the low noise and vibration inherent in the engine design. We are taking additional measures to ensure a really quiet aircraft.

BONE: The fatigue factor in travel will be greatly reduced by the substitution of jet engines, either propjet or pure jet, for the reciprocating engine. There will be a subconscious relief from vibration for the passengers.

**Q: Would JATO units be of help in getting off the ground? And how about reverse-thrust mechanisms for slowing down after landing?**

EDWARDS: We don't expect to use assistance devices for take-off. As far as the landing situation is concerned, the value of reversing is well-known. We reverse the propellers now, after a plane touches down, to reduce the length of the run. For the jets there is a thrust-reversing system that works even better. We intend to use it.

McDONALD: The propjets, of course, have reversible propellers although reversing won't normally be necessary.

**Q: Jet engines have sucked debris up from the ground on take-off and have torn themselves apart. And what happens if an engine swallows a bird during take-off or in flight? Are these problems of major importance?**

McDONALD: It is minimized in the Electra because the intakes are above the engines and not near the ground. There was another problem, whether hail would damage an engine. Allison did some tests

LOCKHEED AIR TERMINALS  
 Burbank, Calif. copyrighted material

Fruehauf Trailer Co  
10941 Harper Ave  
Detroit, Mich



## CLEARING THE RUNWAYS

Big danger to jet engines is picking up debris from runways. This vacuum sweeper can clean damaging debris from a million square feet of runway per hour

in which they fired artificially hardened hailstones into the intake at 425 miles per hour, varying in size from small stones to a three-pound ball of ice. The hail didn't damage the engines at all. Frankly, we were relieved to learn this.

**EDWARDS:** Military records show that around 49 percent of all damage to jet engines is caused by sucking up objects either from the ground or that have been left by mechanics in the jet intakes. The vortex of air picks up small tools, bolts, paper, almost anything lying on the ground in front of the intake. Some military commanders cut down the damage rate by extreme care in keeping the runways swept. We thought of placing screens across the intakes, to be retracted after take-off, but this obviously would cause a serious power loss and is very dangerous from the standpoint of icing which might shut off the air entirely. In the last few months we have developed what we call an aerodynamic screen. This is simply a supersonic blast of air that is bled from the engine and that is directed at the ground in front of the intake. It prevents the formation of vortices and thus the pickup of any object from the ground. As far as birds are con-

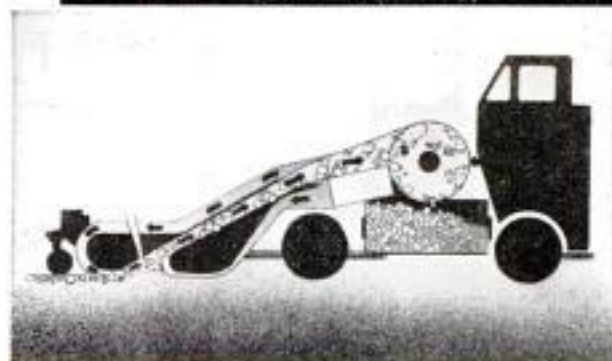

cerned, it will be harder on the bird than on an engine.

**McDONALD:** All of us have been greatly concerned with the possibility of a mechanic leaving nuts or bolts in the intake. All the manufacturers are doing the same thing, designing the intake so there will be no access plates or fittings that would tend to feed pieces to the engine. There is no work for a mechanic to do around the intake ports.

**Q: How will the CAA fit the jets into the traffic picture?**

**HORNING:** By the time the jets are in operation we will have the tools to handle them. I'd like to point out that the CAA has been controlling military jets on the airways and in the terminal areas for several years. We know that jet aircraft can

(Continued to page 258)

Another way to prevent debris from being sucked into engine, left, is to blow air jet just in front of engine  
Douglas Aircraft Company drawing





## Electric Car Has \$12 Motor



Simple? You bet. There's nothing to wear out but the brushes in the small electric motor in the foreground, above. No oil changes, no gas bills, no starting problem on cold mornings. Below, at the left is the charger, beside it are the batteries



LOOKING for a cheap second car? The answer, according to Robert Sewell of Spokane, Wash., is battery power. Sewell, while an electrical engineering student at the University of Idaho, built such a car for a cost of \$24.50 and operated it for a quarter-cent per mile.

The electric motor, a little larger than the generator on most cars, is a five-horsepower, direct-current aircraft motor sold as war surplus for \$12.50. The car, a stripped 1947 Crosley station wagon, was rented for \$10 a year from a junk dealer.

"The motor," Sewell said, "is actually too much for the car. I hope to make another one with two small motors and a direct drive. It should be more efficient."

When the car is descending a hill or slowing down, the motor becomes a generator, pumping electricity into the batteries and also helping with the braking.

The car will go 40 miles per hour. Its batteries are charged from house current. A small charger is carried in the car.

"It makes an ideal second car because of its low upkeep," the builder says. "There are no oil, gas, antifreeze, spark plug or oil-filter costs. The only maintenance is an occasional grease job. All I need for a day's run is about seven cents' worth of electricity to re-charge the batteries."





## Ski Without Snow On Plastic Mats

Winter-sports fans in the photograph above have gathered in shirt-sleeve weather to watch ski jumping on a snowless mountain slope in Bavaria. The runway reportedly is slick as ice because it is covered with thick layers of plastic fibers. As shown in the photograph at the right, the mats of plastic are laid on the runway somewhat like a thatched roof. Beneath the plastic mats is a cushion of peat. The ski jump is located at Bischofsgruen, Germany.



## Ship for Laying Pipeline Has a Built-in "Hill"

One of the most unusual ships ever built is the *Magic*, which has a built-in "hill" running from stern to bow. The *Magic*, now under construction, will lay pipelines in the oil fields of the Gulf of Mexico. The hill is a 260-foot ramp on which the pipe

sections are welded and waterproofed. On each side of the ramp is a giant crane which lifts the pipe sections into place. The *Magic* has a complement of 46 men including pipeline workers. The barge will be moved by pulling on anchors dropped fore and aft.

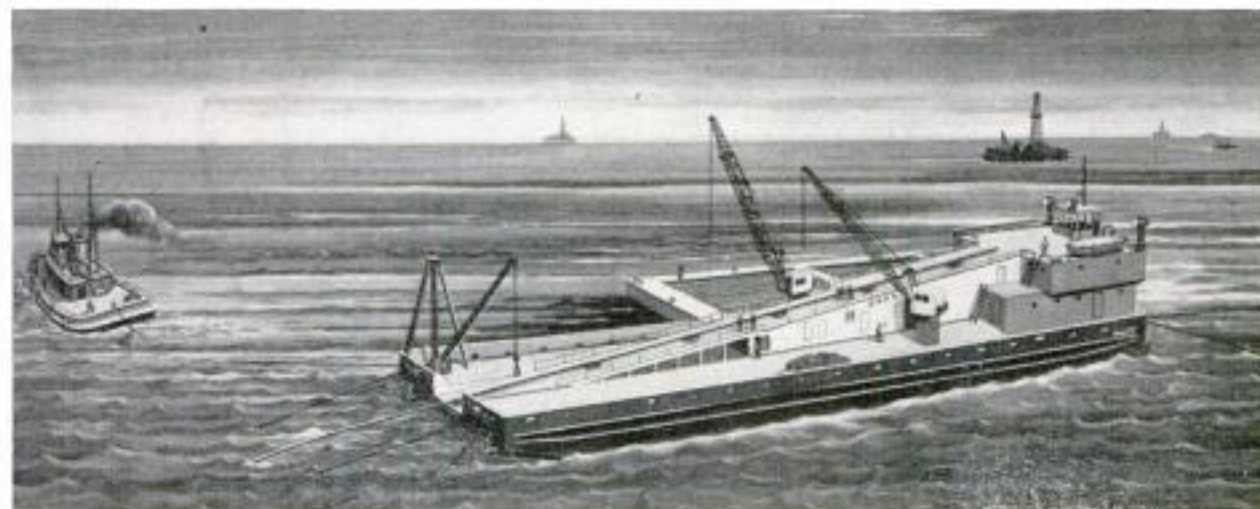



In front of his garishly decorated workshop Pete Logan, left, listens to a customer explain a repair problem

**You need an electric chair, a wooden Indian or maybe a shrunken head? Drop in on Pete Logan of Miami, Fla. . . .**



**By  
Edward Dickson  
and  
Max Hunn**

**"Fixit" Logan makes  
old time cigar-store In-  
dians to order in Miami**

**A** MAN CAME into the shop of Pete Logan in Miami, Fla., threading his way among unusual musical instruments, totem poles and wax-museum figures to find this retired police sergeant whose reputation as "Mr. Fixit" has spread to other countries.

"Will you make a shrunken head of my mother-in-law?" he asked Logan. No longer surprised at the nature of the requests he receives, Logan replied that he would be happy to if the man would provide a photograph from which to work.

Logan made the head. He used chamois skin and tricks of treatment, learned in years of dealing with the unusual, to duplicate the questionable art developed by primitive tribes. The customer's mother-in-law must have had a sense of humor, because the man returned later (bearing no marks of violence) and ordered similar heads made of a number of friends.

Then there was the wealthy South Miami man who lived in a house set far back from the road. This client commissioned Logan to build a miniature railroad with 800 feet of track to run from the road to his house. The newspaper delivery boy was instructed to drop the paper in the train, and the train chugged up to the house with the newspaper. Logan's experience with miniature railroads has been extensive, including the building of a popular train at Miami's ocean-front Crandon Park.

Nor was Logan surprised when an "inventor," complete with detailed plans, asked him to construct a perpetual-motion machine. Logan said he tried to convince the customer that the work would be a

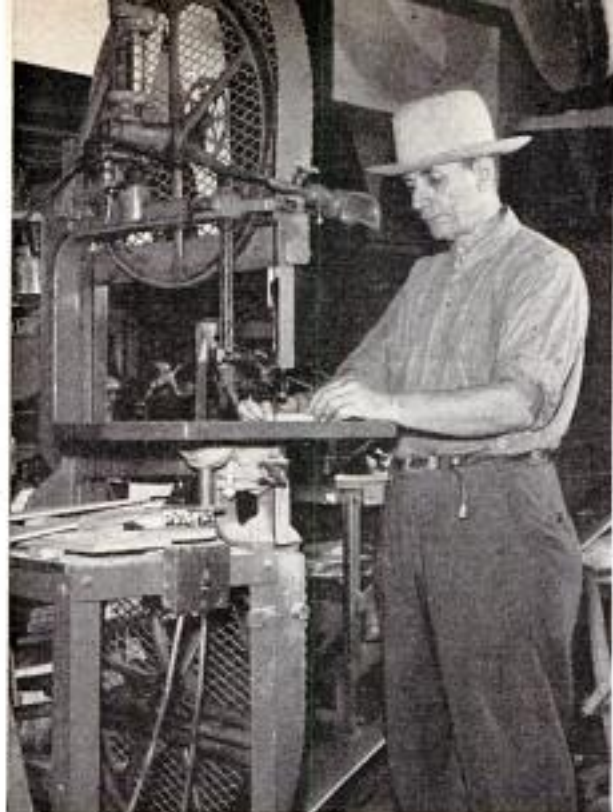

Being left-handed, Logan found a regular bandsaw difficult to operate, so he made this left-handed outfit. He believes it is one of the few in the country



Gay Spanish tunes come from this music box which Logan has repaired. He pumps the handle to start music while young Douglas Jones watches and listens

## FOR CARNIVALS

waste of money, but the man was insistent; thus, Miami's Mr. Fixit added to his list of unique projects the construction of a so-called perpetual-motion apparatus.

Until recently Logan did most of his "fixit" work at a shop in his home. However, at 51 years of age he was eligible for retirement from the Miami Police Department after 31 years of service. He lost no time in setting up a regular establishment—"Logan's Carnival Shop." Gaudy signboards in yellow and red side-show lettering carry out the circus and carnival atmosphere and with characteristic carnival immodesty proclaim Logan "craftsman extraordinary."

A trip through the shop soon confirms his claim. As he explained the nature of his business, he took time out from two projects on which he was working. One job was framing and decorating "crazy mirrors"—the kind that make you appear upside down, tall and skinny, short and fat—for

Made by Logan, this vise holds "horse" carving



Logan works on an eight-foot-tall figure made of plastic laid over glass fiber. This figure, ordered by a Miami Beach motel, will "team up" with a plastic-and-glass-fiber burro to attract attention of passing tourists

a boardwalk show that's in business up in New Jersey.

A few feet away were the nearly completed figures of huge desert wayfarers ordered by a Miami Beach motel to attract attention and to carry out its architectural scheme. In building these figures—a gowned and turbaned traveler and his burro—Logan used glass fiber, which he covered with plastic. At a nearby bench, one of his two assistants, both feminine, was working. The assistant, Dolores Astling, former police radio dispatcher, was putting together a model clipper ship that would serve as a working pattern for the construction of a 10-foot-long craft. The larger vessel would be used by another motel for decorative purposes.

Logan's odd business started many years ago, when he began working with his father on a part-time basis in building and repairing all types of equipment for circuses and carnivals. Throughout the years he worked with the police department, he continued his hobby. Frequently, he obtained leave from police work to handle special requests from shows. Once, he was called to Coventry, England, to check and put in top operating shape all American-built rides used by an amusement park there.





Operating from paper-roll guides, this combination violin-piano music box is being fixed for a museum

Another time he spent several months at an amusement park in Illinois, handling what he describes as his "toughest job." The roller coaster at the park wouldn't roll at one section, and the park's mechanics couldn't find out what was wrong. Logan said he went over the entire layout, checking it and making repeated measurements, because a roller coaster depends on the law of gravity. He finally concluded the track had sunk in various places and told the owner that it would have to be raised. It took a crew of 150 men to jack up the ride to the proper height, but Logan's diagnosis proved to be correct.

A graduate engineer from Brown University, Logan has picked up planning and working knowledge in many fields. He is an electrician, welder, machinist, woodworker, artist, photographic technician and musician (piano and drums). He has accumulated a store of information about odd musical instruments of all types, and work in this field keeps him busy much of the time.

A man in Winnipeg, Canada, sent a broken Swiss music box to Logan. He eliminated the trouble and returned the box in tiptop shape but didn't bill the man because the job had taken so long. The Canadian was so pleased he sent the fixit man a round-trip ticket to California.

Recently, a nationwide search by Logan ended in a Miami secondhand shop. There, he found a 1913 mechanically operated violin-



This 80-year-old forerunner of jukeboxes uses metal plates and has a selector unit similar to late models

and-piano music box. Logan had located and reconditioned it for the museum of his client in Portland, Ore.

Among items on display at his shop is an 80-year-old forerunner of today's jukebox, a pushcart hurdy-gurdy and a rolling Civil War era music box.

In a corner of his shop is an electric drum made by Logan. Inside a wire cabinet are a snare drum and cymbal. Control levers operate each of these electrically, and the controls can be hand or foot manipulated.

In one part of the shop are circus calliopes. Awaiting repair are a music box

(Continued to page 244)

Two electrically operated levers work this trap drum and cymbal, built by Logan. If not melodious, the unit is loud

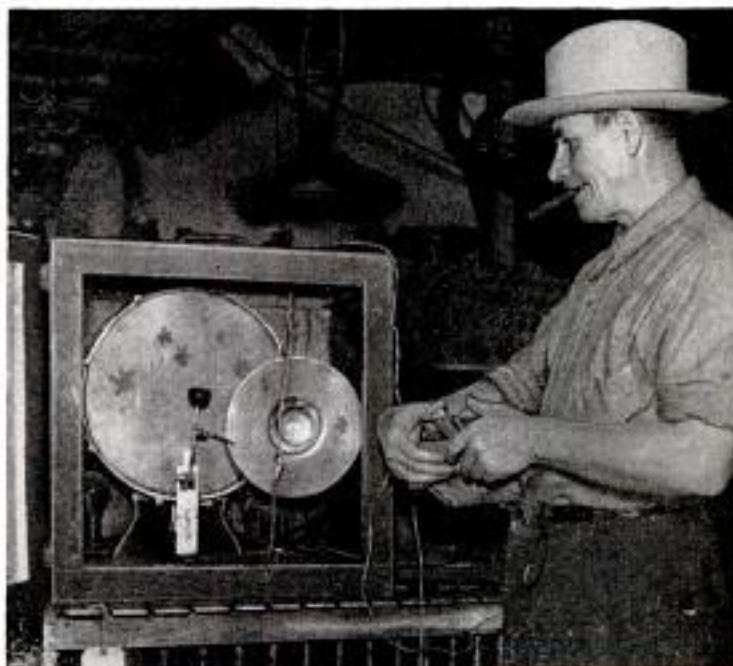



### Outdoor Tree Is Plastic

Wired for lighting and equipped with sockets for standard Christmas-tree bulbs, the artificial outdoor evergreen, above, is made from a sheet of tough plastic. The manufacturer claims the plastic is highly resistant to weather and breakage.

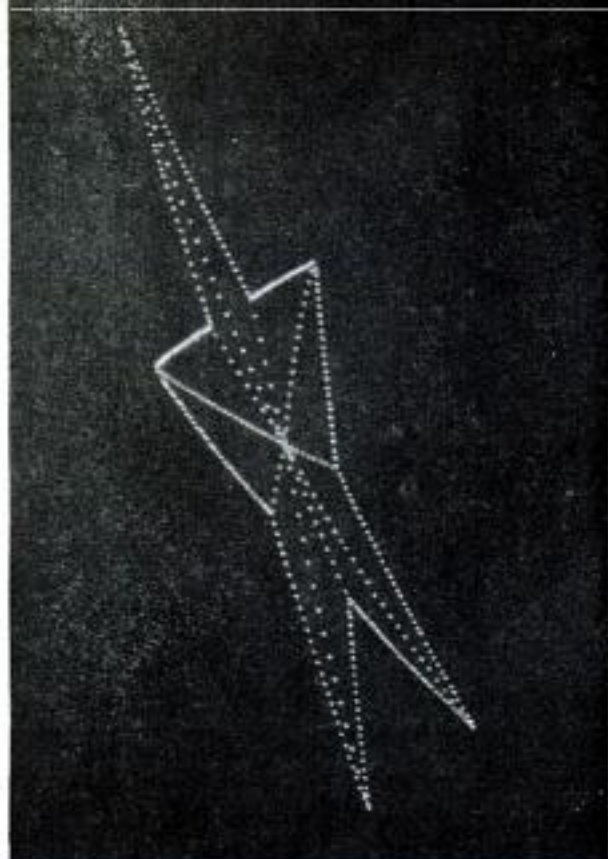

### Star Visible 100 Miles

Erected by the El Paso, Tex., Electric Company on towering Mount Franklin is this giant star which can be seen for 100 miles from the air. It measures over 450 feet at its widest point and its 459 bulbs require nearly 70,000 watts of electric power.

### West Berlin Glass Blowers Produce Prized Yuletide Ornaments

Unusual Christmas tree ornaments are made by skilled glass blowers in West Berlin. A sample of their work and one of the artists at work are shown below. The trans-

parent glass balls are mouth-blown about tiny trees, Santas, angels and other Yule subjects. The ornaments have a base so they can also be used as table decorations.





### Suction Cup on Ceiling Prevents Tree From Tipping

Here's a simple way to prevent a Christmas tree from tipping. A rustproof rod is attached to the ceiling of the room by a rubber suction cup. The rod comes in two 26-inch sections. The top section is the stabilizing rod and is attached to the suction cup. The base rod is hollow and con-

tains a tension spring. The base rod has two metal straps which are fastened to the tree. The stabilizing rod is inserted in the base rod until the top of the base rod is within eight inches of the ceiling. The spring pressure forces the suction cup against the ceiling, holds tree securely.

### He makes Christmas Trees With Goose Feathers and Wire

With a half pound of goose feathers and a half pound of wire, Frank Sing of Sunnyslope, Ariz., can produce a four-foot Christmas tree. The feathers are washed three times and dried thoroughly. Then he attaches a length of 14-gauge wire to a shaft driven by an electric motor. As the

wire turns he winds the feathers around it, wrapping the feathers with a thinner wire. It takes about a minute to wind two feet of feathered wire. The artificial tree branches are inserted in holes drilled in a  $\frac{5}{8}$ -inch dowel. He also makes wreaths and artificial ocotillo (desert shrubs) from feathers.





# Walt Disney's **MECHANICAL WONDERLAND**

By  
Tom McHugh

Photos  
Copyright by  
Walt Disney  
Productions

**T**AKE ONE CREATIVE GENIUS with ideas, engineers with mechanical know-how, a 160-acre orange grove in Anaheim, Calif., and mix thoroughly with \$19,000,000. The result? Disneyland, U. S. A.

Walt Disney, the genius behind this playground, has a mind that is constantly busy with new ideas. In fact, he used to bemoan the fact that there was little to do on week ends.

But that was two years ago. Now, Walt has a new hobby to play with on week ends. Each Saturday he tours Disneyland, checking the operation of the rides and imagining new adventures for his visitors. The park is a veritable multimillion dollar toy for him.

The idea of Disneyland started about 20 years ago—almost as long ago as Mickey Mouse. Walt envisioned a "magic kingdom" based on his own film characters.

This original idea mushroomed into a giant dream with its separate realms of Fantasyland, Frontierland, Adventureland, Tomorrowland and Main Street.

In Fantasyland, for example, Walt wanted visitors to relive the experiences of his cartoons. If they were going to be Peter Pan, they would fly through the air



over London and be pursued by the Crocodile and Mr. Smee.

The ideas sounded wonderful but to convert them into actual rides required the services of some very clever engineers and art directors. Among several, Walt went to Robert Matthey, the man who worked on "man-eating plants" for Tarzan movies and a giant make-believe squid for *20,000 Leagues Under the Sea*.

Walt told Matthey, "In Adventureland, I'd like to have mechanical animals that look real, animals that wiggle their ears and open their mouths."

A few weeks later, Walt went down to Matthey's workshop, which then looked more like a museum with its mass of animal skins and molds. Matthey was particularly proud of a group of alligators that moved in a circle and opened their mouths. Walt, too, was pleased with their operation.

Matthey went on to explain how a special drive belt would fall off and stop the operation if any part failed to work.

Walt then looked at him and said, "But I don't want them to stop."

A few weeks later Walt looked at a redesigned model that didn't have this belt. It didn't need it because Matthey had made the operation of the alligators foolproof. They went through hundreds of cycles in a test tank.

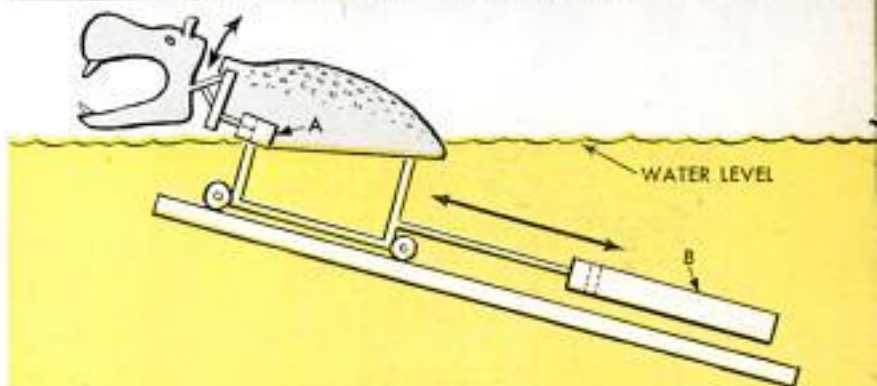
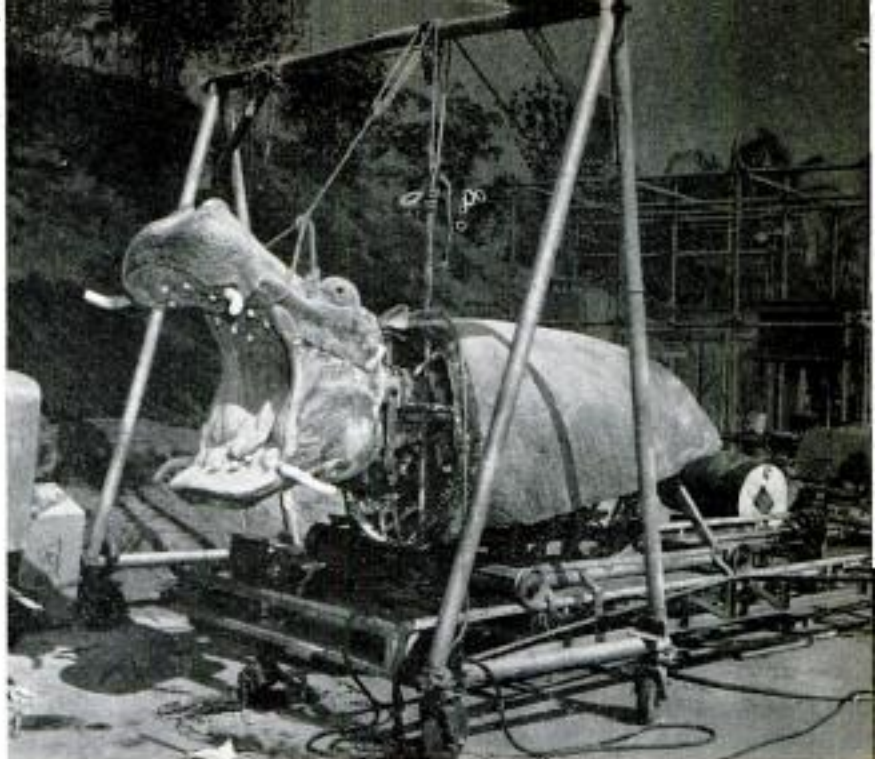

Anatomy of mechanical hippopotamus includes a glass-fiber hide and hydraulic cylinders (A and B) that move head and body

Here's how hippo appears to visitors aboard the jungle-river boat. Boat cuts beam of electric eye to trigger animal action





Peter Pan ship carries its passengers over the London rooftops en route to Never-Never Land. Control panel, at right, flashes lights to report the location of each ship of the Peter Pan ride along overhead monorail



Frontier cabin is left in flames after attack by savages. But flames really come from gas jets and building is concrete



A centrally placed, five-horse-power electric motor ran to a reduction gearbox. The output shaft from here engaged a circular driving chain 20 feet in diameter. This chain pulled the trio of alligators around in a circle.

Levers running from their mouths rode on circular rails alongside the chain. Elevations in the rails then opened the mouths of the 'gators.

As foolproof as this design first appeared, Matthey was rebuffed by a new factor in actual operation. Mud and sand on the bottom of the jungle river soon began eating up the chain.

Matthey is now in the course of testing still another design that won't have the chain. This time, the alligators will float instead of riding on a circular track. They'll also be mounted on an arm that will revolve about a central pivot. Water jets underneath the alligators will push them on their circular path, thus eliminating any moving chain. Rudders similar to those on a submarine will push the 'gators to the surface and then submerge them. These rudders will work off a cam at the center.

"Our biggest problem in building these mechanical animals was one of finding durable materials," Matthey complained. "Animal skins of rubber or fabric soon cracked and split under the vicious attack of sun, wind and rain. We finally chose glass fiber for the animals. We jointed any moving parts much like a suit of armor."

Matthey molded glass-fiber animals like his hippos in giant forms. He saved all his forms for making replacements.

He first thought of running his mechanical hippos with an oil-hydraulic system. But this soon appeared out of the question. Any leaks would contaminate the water and form an ugly slick.

He then chose water as a liquid for his system of plungers and motors. Minor leaks would never show in the jungle river.

The heart of his system, a centrifugal water pump, now pushes water through a large main.

Quick-action valves distribute water to the cylinders in the hippos at the proper time. The valves are controlled by cams which revolve on a shaft. The size and



This time it's alligators threatening the jungle-river boat. Lever on a guide rail opens alligator jaws

shape of the cam determines whether the valve will open quickly or slowly, for a short or long period, and for a small or large portion of water.

These spurts of water move plungers which then move the hippos. The charging hippos, for example, have three cylinders. One pushes the hippo back and forth for eight feet, another pushes it up and down, and still another lifts its head. Smaller hippos have just one cylinder to move them up and down.

Each hippo also has a water motor to wiggle its ears. Seven jets in this motor shoot streams of water against a small turbine. The shaft from the turbine connects

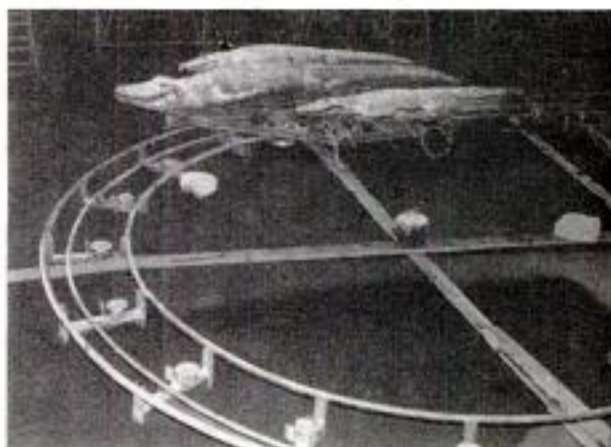

Mechanical alligators, out of water, are seen on framework that rotates on tracks of steel tubing

Blast from train whistle trips sound-actuated switch and motors make rocks tip crazily overhead

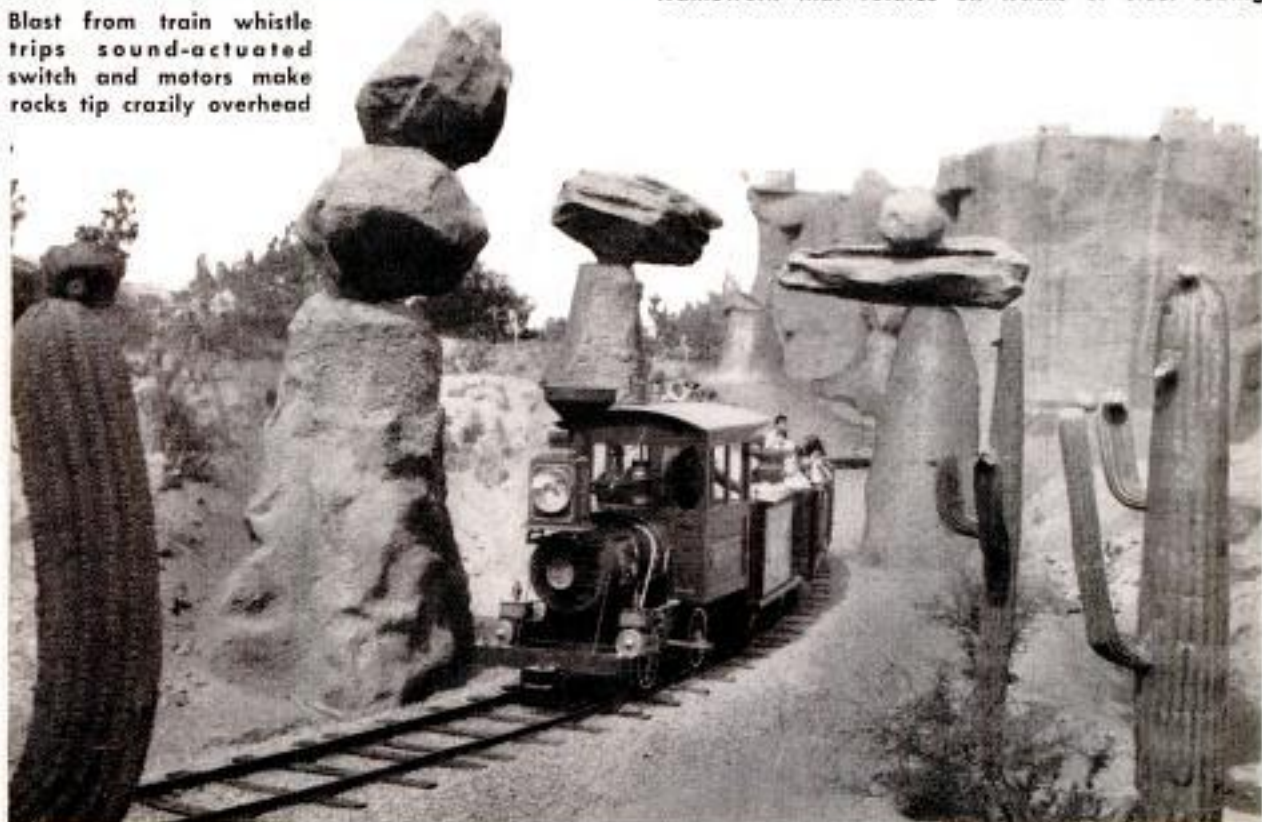

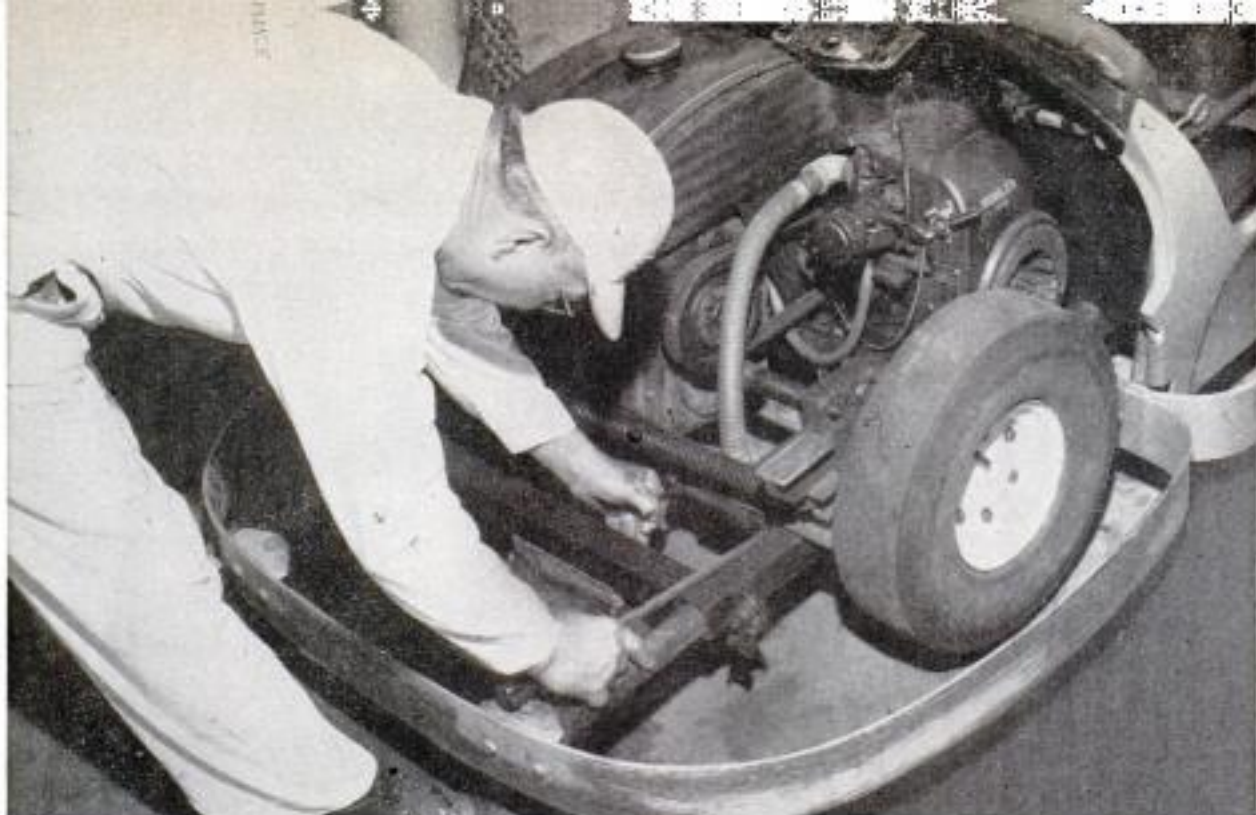

Engine and rear wheel assembly of Autopia cars are removed in a few seconds by disengaging a sliding pin

Midget cars with glass-fiber bodies and gas engines travel Autopia freeway at about nine miles per hour



Mr. Smee aims blunderbuss at approaching Peter Pan ship. Electric motor rocks rowboat back and forth



to rods running to the movable ears much the same as an auto crankshaft connects to rods running to pistons.

Mattey also used plungers in cylinders to operate other attractions.

#### Train Is Illusion

In the Mr. Toad Ride he wanted to imitate the twin headlights of an approaching English train. As the visitor heads straight toward this train in a midget car, a head-on collision seems imminent.

Actually, the approaching train is an illusion. Its headlights are made from two lamps masked in front by two irises, similar to those in cameras. The approaching car trips a switch which operates a solenoid valve. This valve shoots air into a cylinder that in turn opens each iris and pushes them in opposite directions. The "headlights" thus get bigger, brighter and farther apart. A speaker blasting forth the noise of a chugging train completes the illusion.

In another part of this ride, jiggling devils dance weirdly against a fiery background. Here, Mattey used a small motor to turn a cam which hits a microswitch at odd yet frequent intervals. The switch trips a solenoid valve that shoots air against a plunger. The plunger in turn connects to a long spring-steel rod, on the end of which is fastened the devil. Irregular cycling of the valve gives the devil many odd motions.

#### Rugged Test for Tiny Cars

Elsewhere in Disneyland, Bob Gurr, director of special vehicle development, tested his Autopia cars. Nowhere do cars get



rougher daily treatment. But they're as maintenance-free as a midget car can be.

Bob supervised the building of 11 designs, then put each through a grueling 300-hour test. The patrons drove the car all day. Then special drivers took over to run it all night. Mechanics added gas and oil but never laid a wrench to the car.

Some of the early designs lasted only a few hours. Bob hauled these failures back to the machine shop, evaluated them, then redesigned and rebuilt them.

And back they went to Autopia for another test.

#### One Pedal Controls Motion

Finally, the 11th car ground around the course for two weeks without any failures. Bob chose this one as the new Mark IV.

Bob's biggest problem was one of finding a small gas engine to stand up under these

(Continued to page 230)

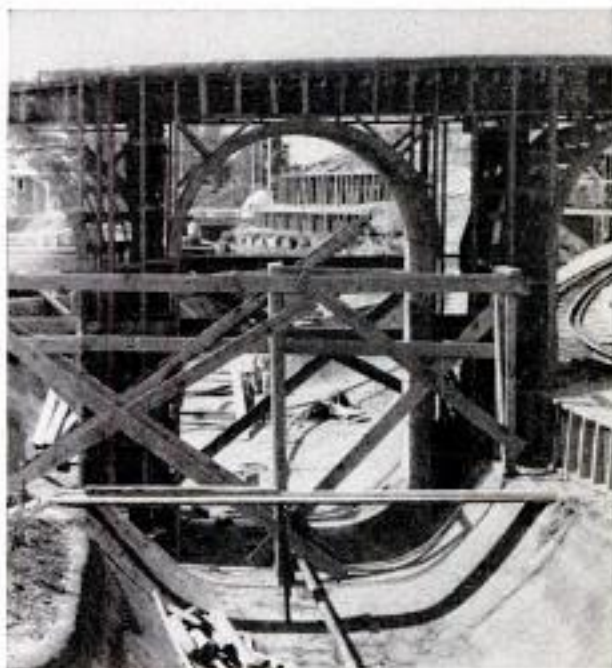
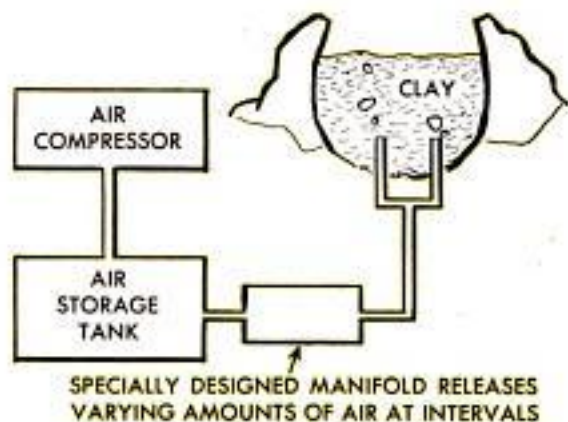
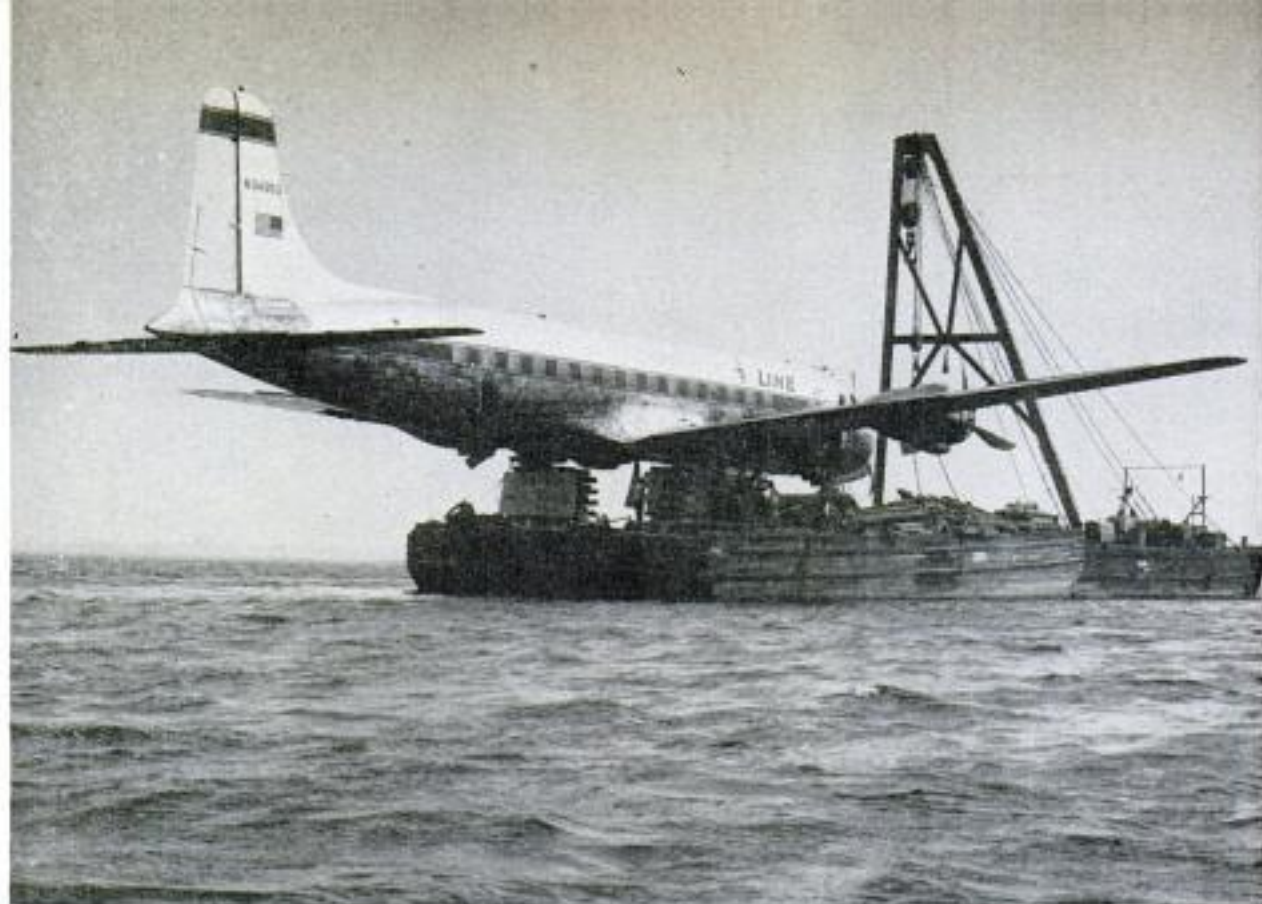

Diagram below shows mechanism of bubbling soft clay, lower right, in Rainbow Desert "paint pots"

Above, before and after views, of Storybook Land. Note monorail on the canal bed to guide small boats





## Barge Sunk in Mud Flat to Recover Downed Plane

Salvaging a plane that made a forced landing on a mud flat on Long Island was a tough problem. Lifting the plane by crane might have sprung its frame. Finally a channel was dredged to the mud flat,

where a barge was sunk. The plane was pulled by a bulldozer onto the barge and the barge refloated. Later the craft was towed to a spot where it could be unloaded. It was flying within a week.

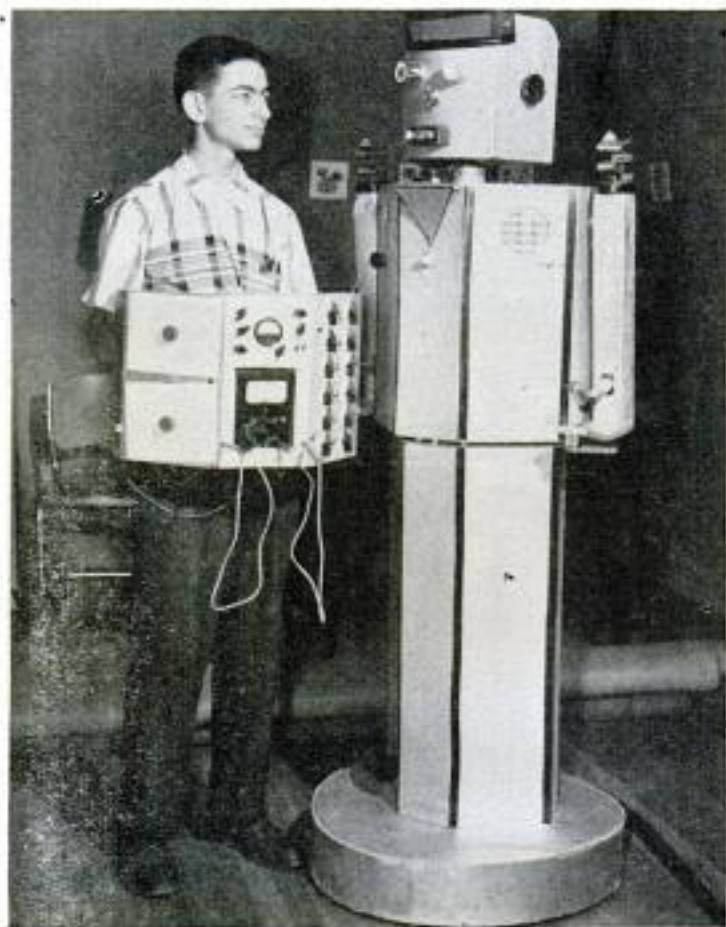

## Robot "Sees" Objects And Senses Humans

Built by a 13-year-old boy, a six-foot robot is capable of "seeing" an object and sensing the presence of a human being. Donald S. Rich of Kew Gardens, N. Y., has also endowed his mechanical man with the ability to move its arms, pick up objects manually or magnetically, roll forward or backward on powered wheels and calculate numerical problems with an electronic computer. The robot's light-bulb eyes send out beams. If the light beams strike an object and are reflected into a photoelectric cell located in the mouth, the robot halts, preventing it from bumping into anything. The robot also senses a human being's presence through a capacity-operated relay. Current induced in the instrument by the proximity of a person will stop the robot. The computer, which adds, subtracts, divides and multiplies, fits on the robot like a vest. Westinghouse provided many of the parts for the robot.



## Back-Yard Rink for Ice Skaters

KIDS CAN ICE SKATE in their own backyard on rinks that can be folded up for between-season storage. The rink consists of edging boards and a one-piece sheet of Bakelite polyethylene film. It can be set up on any level area of the lawn or garden. The edging boards are assembled into a frame with the aid of special channel

strips. The sheet of film then is laid out over the frame and held in place with metal clips. The rink requires about two inches of water to provide a smooth skating surface. The sheet of film will hold the water in place during thaws. The skating rinks are available in sizes ranging from 12 by 12 feet to 18 by 36 feet.

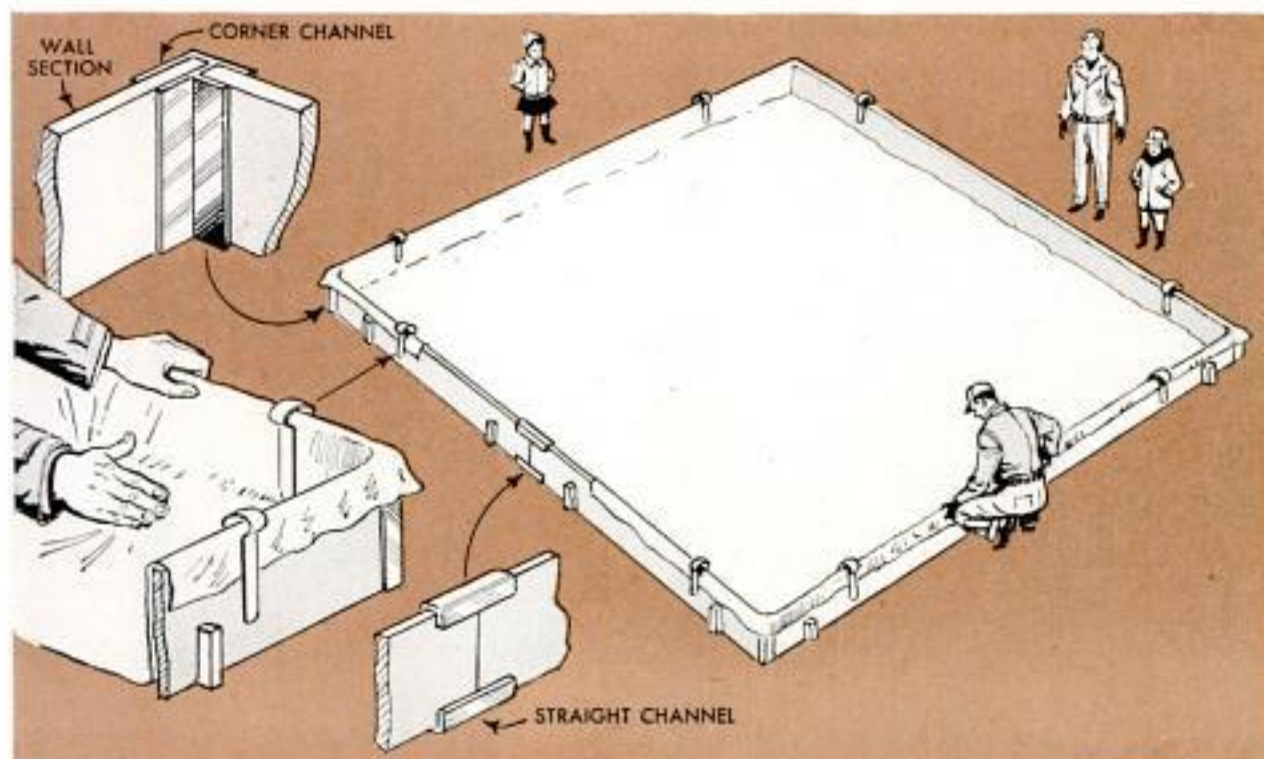



Cadets at the Wisconsin State Crime Laboratory watch the instructor show how to photograph footprints

Future traffic cops learn self-defense so they can handle drunks, criminals or other unruly characters



# School for Courteous Traffic Cops

*By Phil Hirsch*

POPULAR MECHANICS

Copyrighted material





At the scene of an "accident," state-patrol cadets learn that some insignificant clues are the most valuable

**I**T ISN'T OFTEN that a motorist thanks the police for giving him a ticket, but that is exactly what an attorney in Racine, Wis., did recently.

The attorney wrote the following letter to the Wisconsin State Highway Patrol after receiving a summons because of a noisy automobile muffler:

"I want to thank you for the pleasure of receiving a ticket. I was impressed by the officer's clean appearance, his courtesy and his knowledge of the law. I asked him sev-

eral rather complicated questions about my violation. His answers were well thought out and showed a real grasp of the subject."

The patrolman who received these bouquets earned them at the Wisconsin Patrol Academy, which many traffic experts consider the toughest, most thorough police training school in the world. The letter is part of a steady stream of fan mail that has been pouring into state-patrol headquarters ever since October 1955, when the academy opened. Here are a few more:

Cadet instructor trains men in techniques for handling "tough guys" who are searched while they are off balance





Traffic-school students learn proper method of handling injured persons from American Red Cross experts

A woman wrote to tell how an academy graduate came to her rescue when she had a flat tire miles from the nearest town.

A farmer said he would "never forget" how two academy-trained officers saved his young daughter's life. Seriously injured in a head-on collision, the little girl was bleeding profusely when the officers arrived. Quickly, they stopped the bleeding and rushed her to a hospital. "The doctor told me she would have died if your men hadn't known what to do, and done it promptly," the father reported.

Last year, several academy graduates were assigned to a heavily traveled, accident-infested stretch of U. S. Route 41, near Milwaukee. The first three months they were on the job, there were 25 accidents. By comparison, there had been almost twice as many accidents on the same road during the identical period of 1955, without academy-trained officers on the job.

#### Officers Devoted to Duty

Graduates of the new school not only are among the best-trained traffic cops in the world; they also have an unusually intense devotion to duty. Many leave well-paying jobs to join the patrol. One recruit, for example, was making \$600 a month as an engineer; he is now earning \$321 a month as a patrol officer. Another trainee, the father of six children, mortgaged his home to supplement the \$226-a-month salary he would make as a cadet at the academy.

"Men like this aren't likely to lie down on the job, nor are they likely to overlook violations or accept bribes," explains the academy's quiet-voiced Director of Training, Sgt. James L. Karns.



"Well, you see it was like this. . . ." Students gather around fellow cadet being subjected to lie detector

The school is located at Camp McCoy, an Army base northwest of Madison, near the Wisconsin Dells. When the first class was being formed, 1300 men applied. All of them took a 2½-hour written exam and a rigorous physical. Only 50 were finally accepted. You can get some idea of the academy's standards from the fact that its typical cadet has an IQ approximately five points higher than that required by the Army for admission to Officer Candidate School.

The course squeezes the equivalent of a year of college into 13 weeks. From reveille at 6 a.m. until lights out at 11 p.m., recruits have little time to relax. They're in class 10 hours a day during the week and half a day on Saturdays. Each night, they have between two and three hours of homework. Also, there are a number of special details. A couple of nights a week, for example, three or four cadets—under the command of a regular police officer—are sent out to patrol the highways around the academy. They leave at 7, right after dinner, and seldom finish before midnight.

#### Just Like the Army

Every night and morning, the barracks have to be cleaned. The fussiest housewife would find little to criticize if she accompanied academy officers on inspection tour. Floors are scrubbed daily, windows are washed at least once a week. Demerits are handed out if a bed isn't made properly, if there's so much as a scrap of paper on the floor, even if a recruit doesn't line his shoes up properly underneath his bed.

(Continued to page 240)

POPULAR MECHANICS



## French-Built Light Jet Trainer Has V-Shaped Tail

Two Turbomeca Marabore jet engines power this French light jet trainer which features a broad V-shaped tail design.

Fuel is supplied from wing-tip tanks. Periscope binoculars in the front cockpit help the instructor watch the students.

## Five-Ton Camera Helps Build Planes

Thirty feet in length and weighing five tons, this camera was built for a California aircraft plant. It will be used to reproduce templates, or patterns, on plates of steel or aluminum. It can project the image of a drawing to a size of 5 by 12 feet within  $\frac{1}{2000}$  inch accuracy. The lenses alone are valued at \$3000. The huge camera uses film 42 inches wide and it can be focused either by hand or electrically with a special interlocking device.

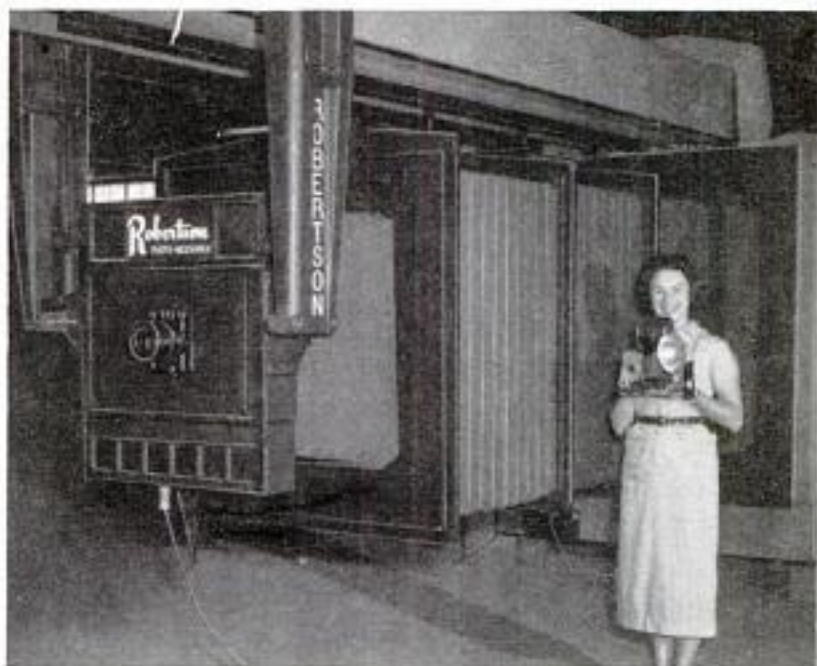

## Hair-Size Hole Made by Drill

Operating at a frequency of 28,000 cycles per second, a tiny brass drill bit tipped with diamond paste can bore a hole about the diameter of a human hair. The sound waves, twice as high in frequency as a person can hear, produce a current which drives the drill like a jack-hammer. The drill was devised for boring holes in ceramic magnets (see inset) which are nearly as hard as diamonds. Fine coil wires are threaded through the holes which are made into the "memory cores" of electronic computers.



Melaleuca pods filled with seeds are shaken to empty the pods. James Stokes gathers the tiny seeds to sell by the pint

## HE DECORATES WITH WEEDS

By Max Hunn

This large piece of Melaleuca bark will be sold by the pound to florists who will sell it as a vase covering



**T**HE BEACHES, PINE and palmetto lands of southwest Florida provide 66-year-old James A. Stokes of Fort Myers with materials for one of the most unusual wholesale florist businesses in the country.

A former constable, Stokes now "takes into custody" such items as sea oats, okra, highland sponge, Melaleuca bark, eucalyptus branches, pine cones, palmetto fronds, floral buttons, cabbage-palmetto berries, fan-tailed millet, sea-grape leaves, Spanish bayonet stalks, ferns and hatpin flowers.

He gathers these plants usually with the help of but one person, since his operation is fundamentally a one-man business. He hauls wild plants to his factory, dries them in the sun, and stores them in an open-sided warehouse until needed.

Although he dyes and tints some items carefully



Palmetto buds are shredded on this nail-studded board. The end product may wind up in your home

by hand, other specialties he sells in their natural state. Several of his customers prefer to do their own coloring. Stokes regularly stocks sea oats, dyed red, purple, yellow



Stokes demonstrates method by which he dyes sea oats. Bunches are dropped into vat of boiling dye

low and green; and eucalyptus and Melaleuca sprays in silver, gold and bronze. He dyes many woodland plants to order.

Retail florists use Stokes' items for

Freshly dyed items hanging in sun are sea oats, eucalyptus and Melaleuca plants, all gathered in Florida





Stokes holds freshly shredded palmetto buds, which he may dye or sell in their natural state to florists

Newest experimental items are Stokes' pampas-grass plumes. These silky samples are hanging in his storage warehouse



dances, dinners, weddings, funerals, home decor and window dressing. Fall is his busy season, when florists stock up for the Christmas trade. But Stokes gathers the year 'round.

In the wholesale business large orders are commonplace. Quoting prices in units of 50, 100 and 500, or per pound and bushel, Stokes thinks nothing of receiving an order for 100,000 eucalyptus clusters or *Melaleuca* branches or for 20,000 sea-grape leaves. Once he was asked to supply two railroad cars of palm buds for the Easter season. He doesn't estimate such orders but carefully counts them out by hundreds.

Stokes has found the *Melaleuca* to be one of his most versatile sources. The branches or sprigs, when dyed, are popular decorations—the bark now is being used to cover vases—and even the tiny *Melaleuca* seeds are valuable. He gathers these by shaking the drying branches over a large, shallow cardboard box. He then sells the seeds by the pint for planting in windbreaks. ★ ★ ★

# GOOSENECK SPOUT FIGHTS FIRE

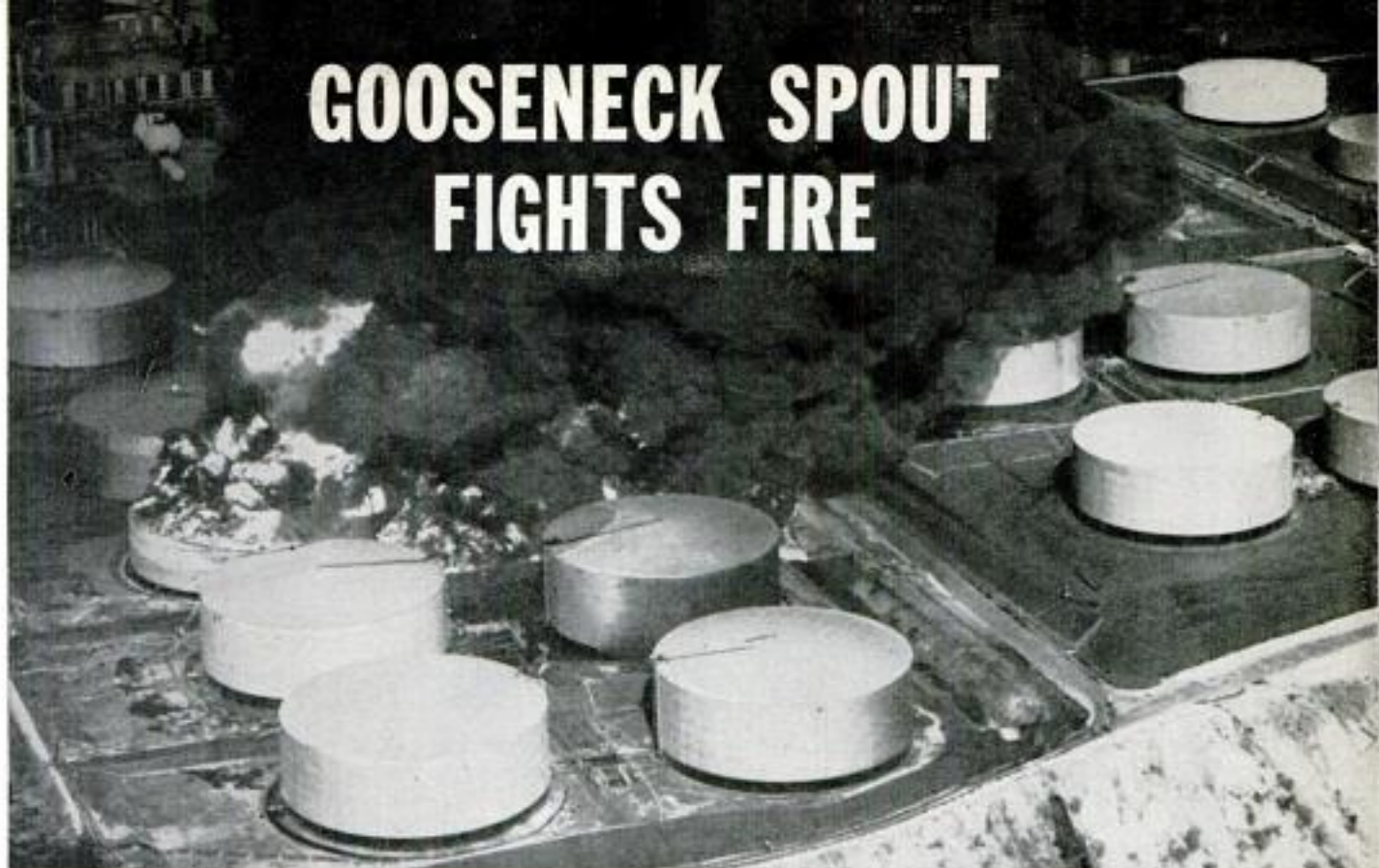

One burning oil tank in a storage farm may start a general holocaust unless fire is quickly controlled

**OIL-TANK FIRES** are brought quickly under control with a newly developed gooseneck spout that shoots foam. It punctures the top of a tank like a giant juice-can opener. The spout is raised into position by hydraulic pressure in three or four minutes. Guided by a guard rail, the spout's sharp "beak" penetrates a plastic cover on the roof of the tank to pour a large quantity of foam on the burning oil. Only four men are needed to handle the tower, which was developed by L. J. Grossheim of the Shell Oil Co.

Newly developed gooseneck-spout tower extinguishes fire in one third the usual time. Tower is raised hydraulically, and spout's "beak" punctures hole in roof to smother fire with foam

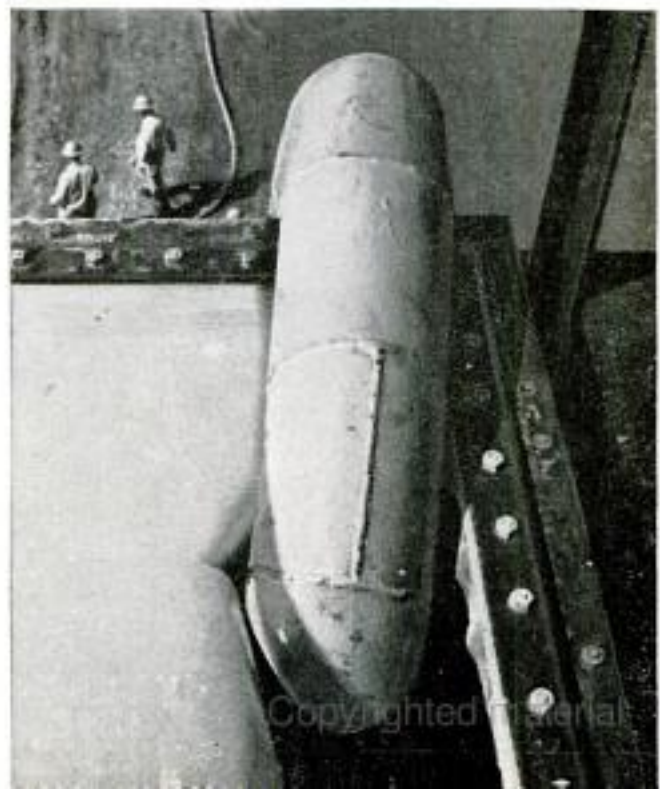
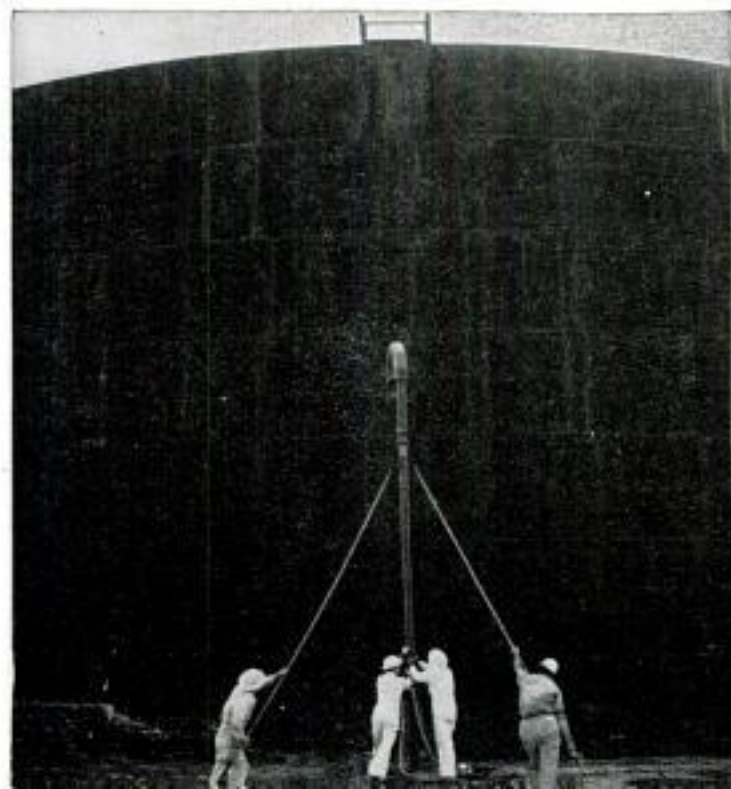

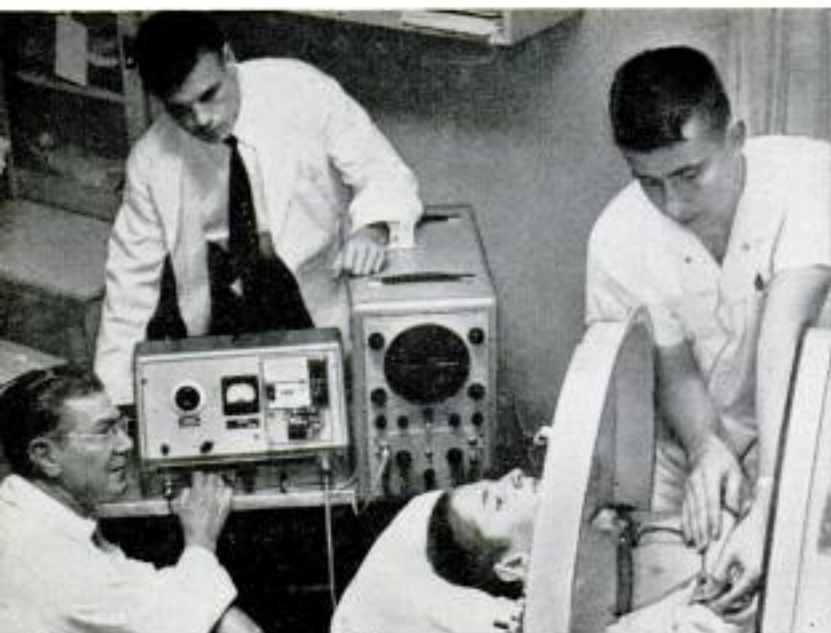

Electronic engineers, above, adjust control equipment for iron lung while an assistant applies electrodes to the first patient to use electronic system. Most victims can still control a few muscles and this contraction generates minute voltages that

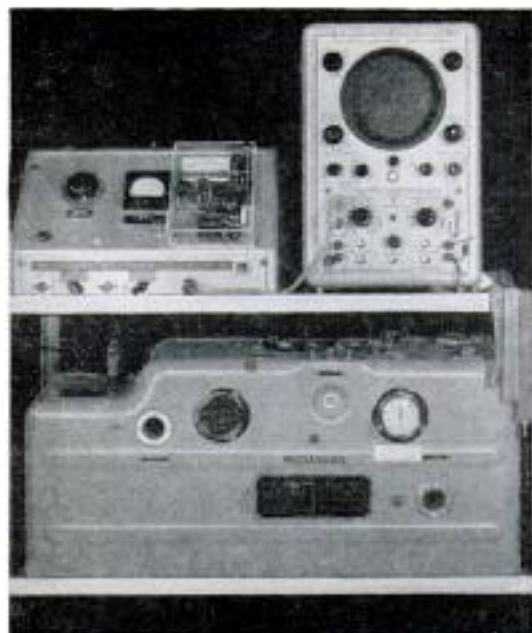

are detected by the electrodes on the patient's skin, then relayed to the electronic gear. Apparatus used, above, shows respirator control, top left, and the monitoring oscilloscope, top right. Conventional Monaghan respirator control and blower is below

## MECHANICAL AIDS FOR THE DOCTOR



Above, a "patient" connected to electronic apparatus is tested for tensions that may lead to such ailments as heart disease, high blood pressure and ulcers. The round screen on the oscilloscope measures the electrical discharge from muscular activity in millionths of a volt. A rapidly fluctuating line on the screen indicates the amount of tension in a patient. If tension is shown, patients are taught to relax

Below, the first artificial larynx of its kind has electronic vocal cords that will help 50,000 afflicted Americans to talk. Powered by transistor generators no bigger than a pencil point, this apparatus can be worn in a man's vest pocket or on a woman's necklace. A "hearing-aid-in-reverse," the "voice box" of the system is held by James R. Trammell of Cleveland, who helped develop the device chiefly for cancer victims who have the highest praise for it





Right, supersonic waves are aimed with pinpoint accuracy to help neurosurgeons perform brain surgery without destroying healthy tissue or causing excessive bleeding. After a portion of the patient's skull has been removed, this apparatus is focused on the part of the brain to be treated. Converging sound waves pass through all other brain tissue without disturbing it except at the focal point of the sound waves. This technique may replace methods involving direct cutting of tissue or coagulation by electrically heated wires inserted in tissue to be destroyed. A result of seven years' experiments on animals, the \$100,000 machine now is available for human brain surgery. It offers new hope to patients



This small water-powered mechanical heart made of plastic soon may replace faulty human hearts. Each artificial heart is about as large as a fist. It contains four flexible chambers surrounded by a stiffer shell. The experimental manmade heart is inserted in the body and connected by a tube running outside the chest wall to a hydraulic pump. Water pressure from this pump presses and releases the chambers the same way an actual heart muscle operates. Blood is pushed in the correct pattern through the four chambers, which have thin valves, and out through rings that connect the chambers with the body's circulatory system. It's from New Zealand



At right, emergency oxygen supplies strapped to a rescuer's back can be carried to a victim of illness or injury. The two-tank, 20-pound unit automatically adjusts oxygen flow to an individual's lungs. A dial on the device can make it force 100 percent oxygen into a person's lungs or suck obstructions from his throat. Two masks are available, one each for victim and rescuer, for use where air has been contaminated. Either mask can be held or strapped onto the wearer. Up to 200 feet of tubing can be attached to this resuscitator, making it possible to lower a lightweight mask to a person trapped in an inaccessible spot during rescue operations



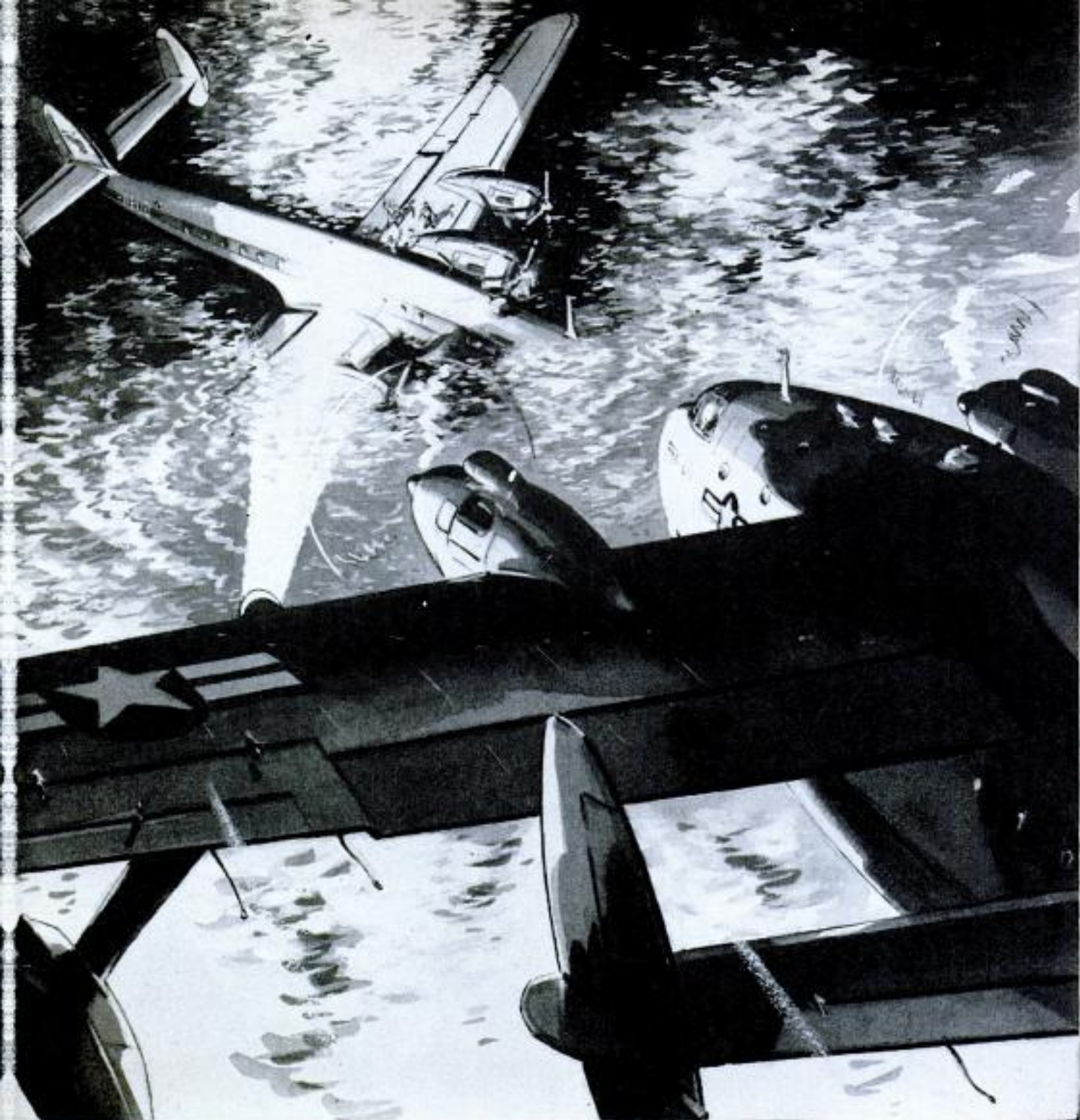

Survivors of ship or aircraft accident at sea can be located in darkness with help of flying searchlight



## Powerful Airborne Rescue Lamp

DEVELOPED originally to locate enemy ships at night, powerful aircraft searchlights are an important aid to air-sea rescue operations. In the photograph, left, is a new searchlight which has a peak output equal to the lights of 10,000 automobiles concentrated on one spot. The lamp can burn as long as the supply of carbons is maintained. Mounted on a helicopter, it can illuminate areas where electric power has been knocked out by tornado or flood.



South wall with 830 square feet of solar-energy collecting plates is sloped 30 degrees from vertical

## Albuquerque Solar Building Tests Radiant-Heat System

SOLAR ENERGY keeps a small office building warm all winter long in Albuquerque and helps to cool it in summer. Outdoor temperatures in the winter drop well below freezing in Albuquerque and yet the temperature inside the building stays at a comfortable 72 degrees. In the summer, with outside temperatures well above 100, the temperature in the solar building never climbs above 78 degrees.

The building and its solar system were designed by Bridgers and Paxton, an engineering firm that occupies part of it. Roger Haines, their chief engineer, says that so far the system is operating at about half the cost of conventional gas heating.

The building uses its sloped south wall as a heat-collecting surface. Water is circulated behind flat backplates in this wall and is heated to as high as 140 degrees by the sun. The water is then pumped to an insulated 6000-gallon storage tank. Hot water from the tank is circulated through radiant-heating coils buried in the floor and also heats the incoming ventilation air. It is then pumped back to the heat collector to absorb more heat.

In prolonged cloudy winter weather the solar collector is bypassed and the hot water in the storage tank is circulated through a refrigeration apparatus. The refrigeration unit acts as a heat pump; it extracts heat from the water and combines this heat with its exhaust heat to maintain the same room temperatures.



Control panel, above, adjusts heating and cooling circuits. Black heat-collecting plates, below, warm water circulating behind them to 140 degrees



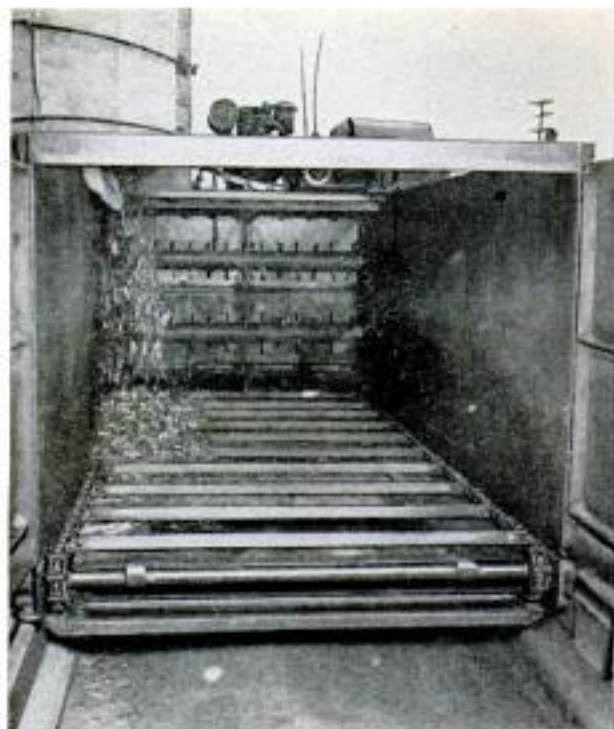

## Car Rolls Along Manger to Feed Cows

Daily feeding time for 200 cows has been cut about two hours by a powered car that drops silage (above right) while running on rails along the manger walls.

Equipped with a three-horsepower engine, the car can move either way along the 310-foot manger. It is loaded from two silos adjacent to the manger.

## Two Sickles on One Tractor Cut Mowing Time

Hay-mowing time can be halved by two mowing sickles mounted on a tractor. One sickle bar is mounted at the side and the

other in front of the tractor. The combination cuts a swath 16 feet wide. Both sickle bars are powered through a dual gearbox.

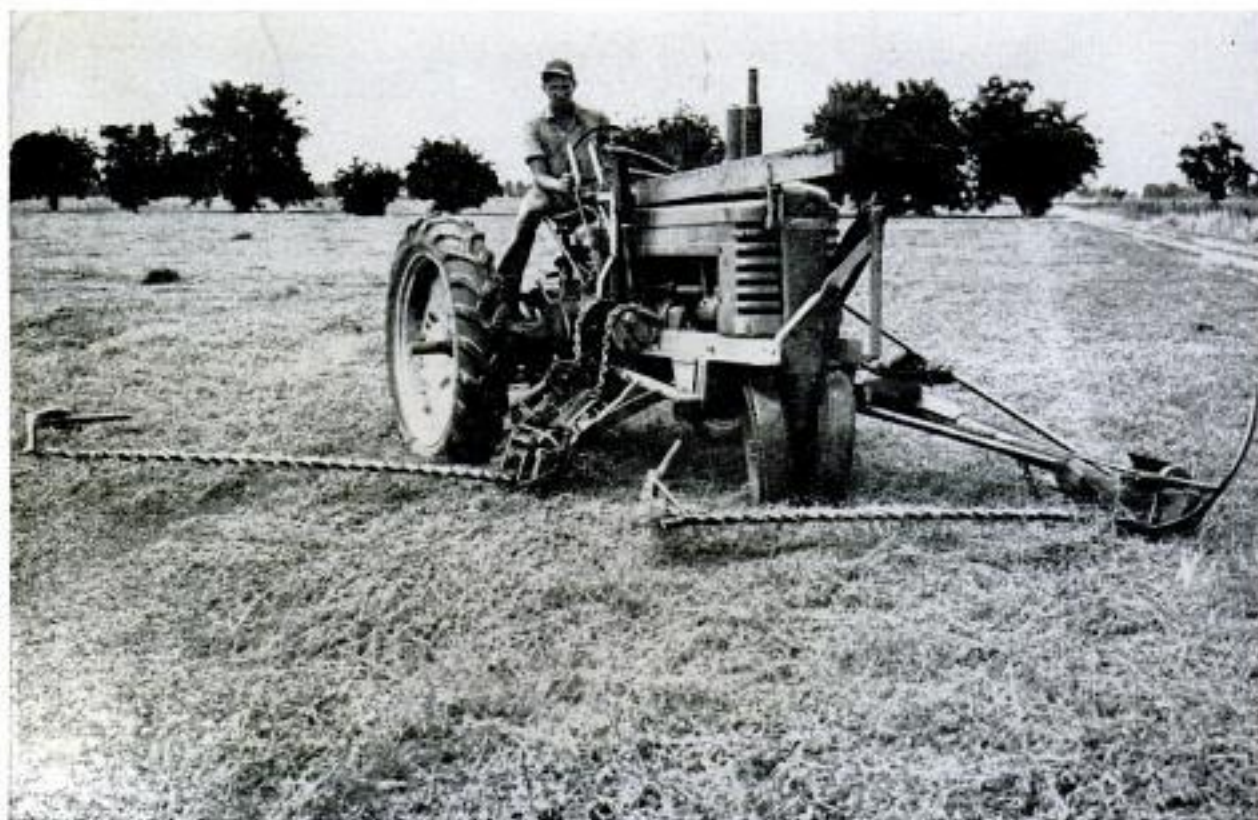



### Truck-Powered Winch Loads 100 Hay Bales in 45 Minutes

One hundred bales of hay are loaded on a truck in 45 minutes by a powered winch fastened under the truck bed. As the driver

guides the vehicle, he operates the winch. Each bale is lifted by cable threaded through pulleys attached to pipe.

### Alfalfa Hopper Towed by Harvester

Cut-up alfalfa now can be fed into a self-dumping hopper towed behind a harvester-chopper. The hopper permits the harvester to operate almost continuously without having to wait for a truck to be driven alongside to receive the chopped alfalfa. While one truck carries away a load of alfalfa, the harvester is under way again filling the hopper. The alfalfa is blown into the front of the hopper. When a truck backs up to the hopper to receive a load, two eight-foot hydraulic rams raise and up-end the hopper over the truck, allowing chopped hay to fall in.

Retracted, the hopper resumes its position behind the chopper. Power for the hydraulic rams is from the chopper engine. This harvester is used on the V. C. Britton ranch, Firebaugh, Calif.





## Transistorized Instrument Amplifier

By Lou Garner

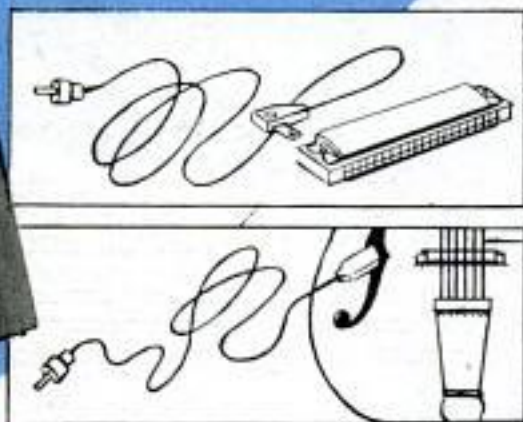

**H**ERE IS a general-purpose audio amplifier with enough gain and power output for typical applications around the home or in small gatherings. It may be used as a phono amplifier, a low-power

Fig. 1. Rear view of assembled system with back cover removed. Cover cut to make controls accessible



public-address amplifier, or as a musical-instrument amplifier.

For applications requiring a relatively low power output, transistorized equipment offers numerous advantages over vacuum-tube circuitry. First, because transistors require only a small amount of operating power, equipment of this type can be battery operated and can be used anywhere with never a thought or worry about the location of the nearest electrical outlet. This, in addition, eliminates the a.c. hum so often encountered in vacuum-tube models. Second, because of the ruggedness and long life expectancy of transistors, extremely reliable and trouble-free performance is obtained. Finally, the use of low-voltage batteries eliminates all danger of electrical shock to the builder as well as the operator.

### Circuit Description

This amplifier uses three low-cost transistors in an R-C coupled arrangement, plus a transformer-coupled power-output stage; see the schematic diagram, Fig. 4. The input stage, TR1, consists of a common-collector amplifier which has relatively low gain but provides the high input impedance desirable in an amplifier of this type. This is followed by two grounded emitter stages which provide

the necessary amplification to drive the 2N255 power transistor used in the output. A "losser type" tone control consisting of C5 and R8 permits treble-frequency attenuation.

Unbypassed emitter resistors, R4 and R7, in the second and third transistor stages serve a dual function: They effectively raise the input impedance of their respective stages, thus minimizing the interstage impedance mismatch and they introduce a small amount of degenerative feedback which, in turn, improves circuit stability and reduces distortion. In all other respects, the circuit is straightforward, with no added frills to increase the cost of construction. Yet, the unit is capable of excellent performance in the applications for which it was designed.

### Construction

You can have as much fun building this

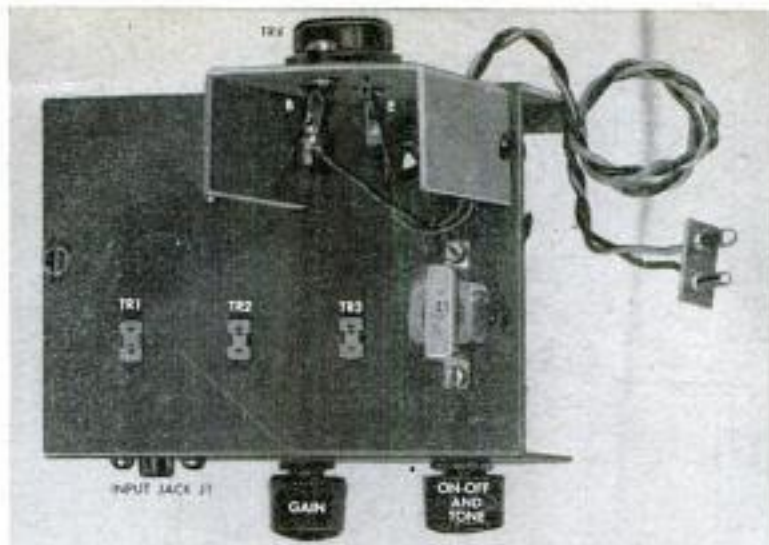
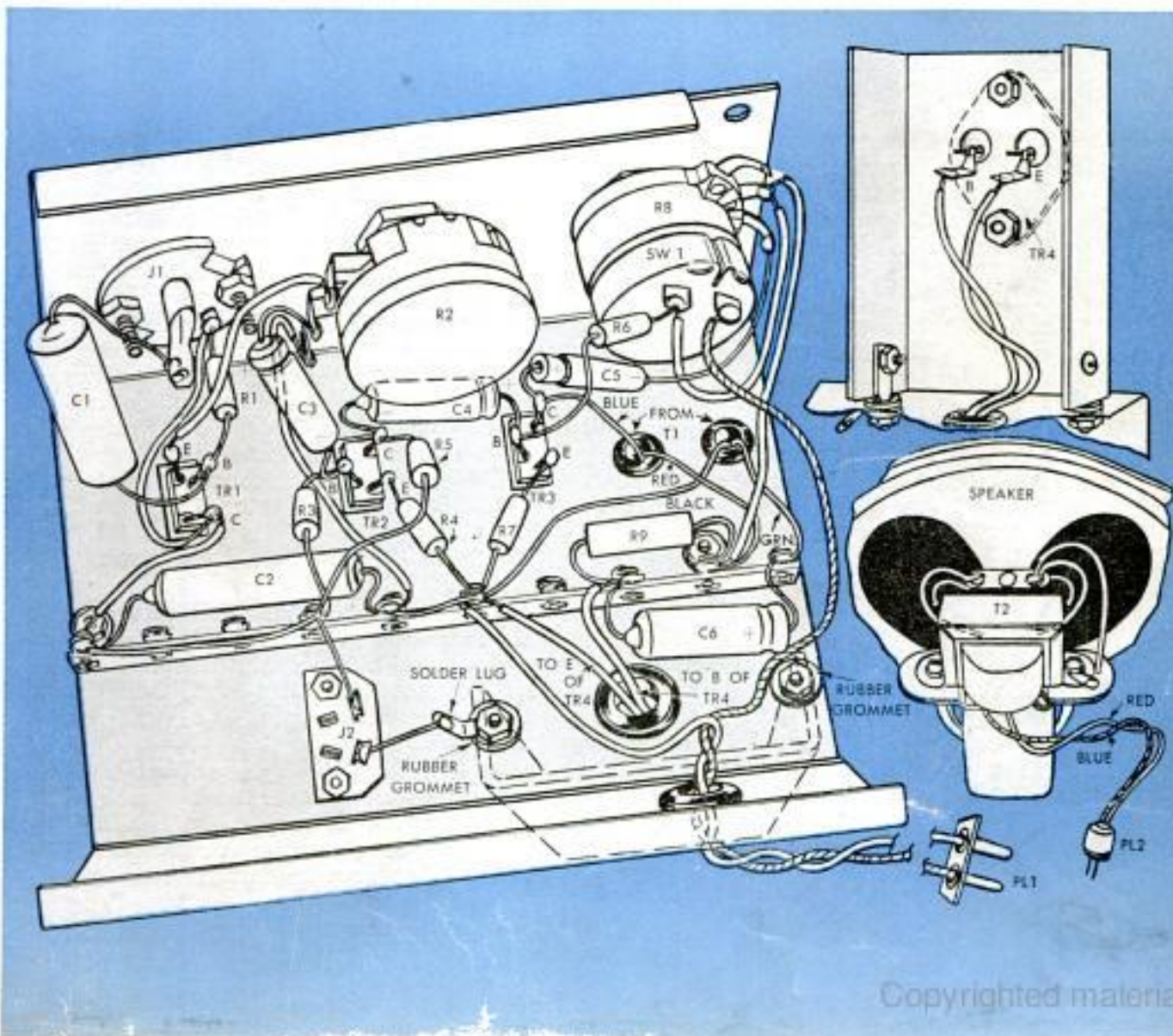

Fig. 2. Top view of amplifier. Note two-chassis construction with smaller unit serving as "heat sink" for the power transistor

amplifier as you will have using it. The necessary components may be purchased, as a complete package, in kit form or, if you already have some of the specified parts on hand, you can save money by buying only the additional parts needed to

Fig. 3. Pictorial wiring diagram of amplifier. Insets show mounting of subchassis and output transformer



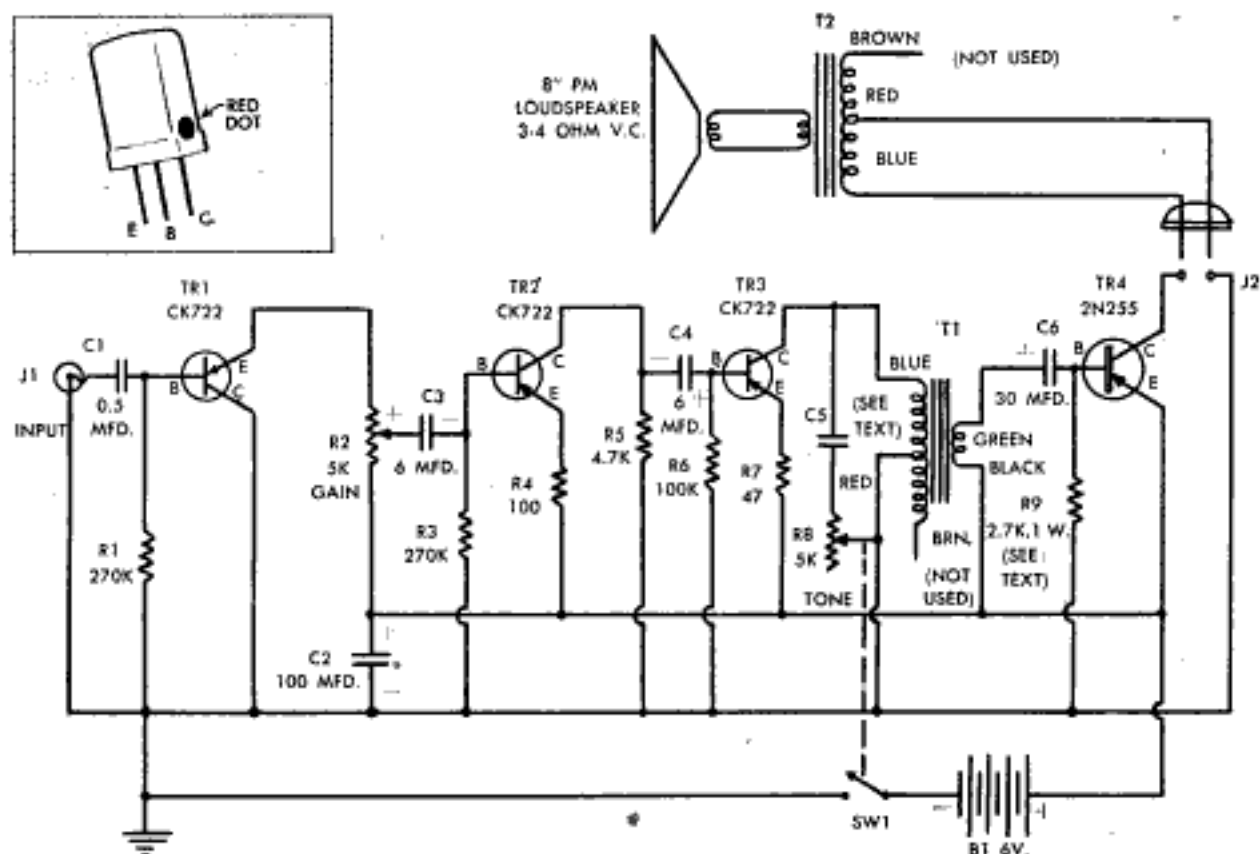

Fig. 4. Amplifier schematic diagram. Inset identifies equally spaced leads of Raytheon CK722 transistor

complete construction of the amplifier.

The main amplifier is assembled on a  $3\frac{1}{4} \times 4\frac{1}{2} \times 2$ -in. aluminum chassis. A separate chassis,  $2\frac{1}{8} \times 1\frac{1}{8} \times 1$ -in., serves as a "heat sink" for the power transistor, TR4, and is mounted on the main chassis with a pair of spade bolts. Rubber grommets or a combination of flat and shouldered fiber washers are used to insulate the heat-sink chassis from the main unit.

Amplifier wiring is illustrated pictorially in Fig. 3. Circuit layout is not particularly critical and the individual builder has considerable freedom of choice in the placement of the parts so that the amplifier can be constructed to fit into practically any available cabinet. It is suggested, however, that the two-chassis layout be maintained and that good wiring practice be followed throughout. The wiring to the input and output elements of each transistor stage should be kept reasonably well separated and short, direct leads should be used in all signal circuits.

If the chassis is homemade, the appearance of the completed unit can be improved if the chassis is given a coat of enamel before the parts are mounted. Controls may be labeled with commercially available decals which should be protected, after application, by two or three coats of sprayed-on, clear acrylic plastic.

All parts, except the three small transistor sockets, are mounted to the chassis

with standard machine screws and nuts. The latter are held securely in place with press-on spring clips which are supplied with the sockets.

Since transistors are easily damaged by the application of excessive heat, the wires to the base and emitter of the 2N255 power transistor are not soldered to these element leads. Instead, the wires which connect these elements into the circuit are soldered to two miniature-tube socket pins (these can be obtained by breaking up any standard seven or nine-pin miniature socket) which are then fastened to the transistor leads for a secure connection. The body of the 2N255 is bolted directly to the heat-sink chassis. Since the transistor's collector element is connected internally to the body, the collector is wired into the circuit by means of a ground lug fastened to one of the heat-sink-chassis spade lugs (see Fig. 2).

Output transformer, T2, is mounted on the frame of an 8-in. PM loudspeaker and the red and blue leads of this unit are connected to the main-amplifier chassis through a simple plug-and-jack arrangement, PL2 and J2.

A sloping-front speaker baffle serves as a cabinet for the entire assembly. Final installation is shown in Fig. 1. Small aluminum brackets and a glued wooden block provide a secure mounting for the 6-volt

(Continued to page 248)



# X698 Make Your TV Set Safe!

By Lothar Stern

IT DIDN'T take an unfortunate accident to acquaint servicemen and technicians with the dangers of television receivers, but the tragic death of a six-year-old boy early last summer, as a result of touching the metal cabinet of a portable set, caused considerable consternation among thousands of TV fans many of whom had purchased the same type of unit. The name of the set is unimportant. It could have been any one of a hundred different models by some of the best-known manufacturers in the field. What is important is the fact that the lethal receiver had successfully passed rigid requirements of the Underwriters Laboratories and that there are millions of sets of similar design in daily use. Even more important is that set owners become acquainted with the conditions that can turn an ordinary receiver into a potential killer.

## Why Sets Can Be Dangerous

In the early days of television, ordinary radio tubes were employed for all TV circuitry. These required a relatively high plate voltage for proper operation and necessitated the use of a power transformer to step up the line voltage to the proper value. The transformer, however, did more than that. It effectively isolated the metal chassis of the set, which is actually a part of the receiver's electrical circuitry, from the power line so that the chassis was neutral and could not acquire an electric charge. But with progress came new tubes capable of operating at lower voltages and, gradually, the heavy and expensive power transformer began to disappear from modern sets. Many of today's receivers, including most portable models, are of the transformerless type. Instead of being isolated from the power line, the metal chassis of such sets is actually connected to one side



Technicians demonstrate how charged metal case of defective TV set can light a lamp. Simultaneous contact with case and grounded object could be fatal

of the line, and herein lies the danger.

One wire of the commercial power line which is fed into your home is grounded at the power station and, again, at a point where the line enters the house. When the line-cord plug of a transformerless set is inserted in the wall outlet so that the wire which is connected to the metal chassis goes to the grounded, or "cold," line wire, Fig. 1A, no danger exists. But, if the plug were reversed in the wall outlet, Fig. 1B, the chassis would be connected directly to the "hot" wire of the power line. In this event, simultaneous contact with the chassis and some externally grounded metal object, such as a water faucet or a radiator, would place your body across the power line just as surely as if you were to place your fingers directly into the wall socket. The result would be a painful or, in some cases, fatal shock.

## Manufacturers' Precautions

Aware of these dangers, no manufacturer would market such a set without installing it in a wooden cabinet or an insulated metal case. With wooden cabinets, great care is taken that all mounting screws or metal parts touching the hot portion of the

(Continued to page 244)

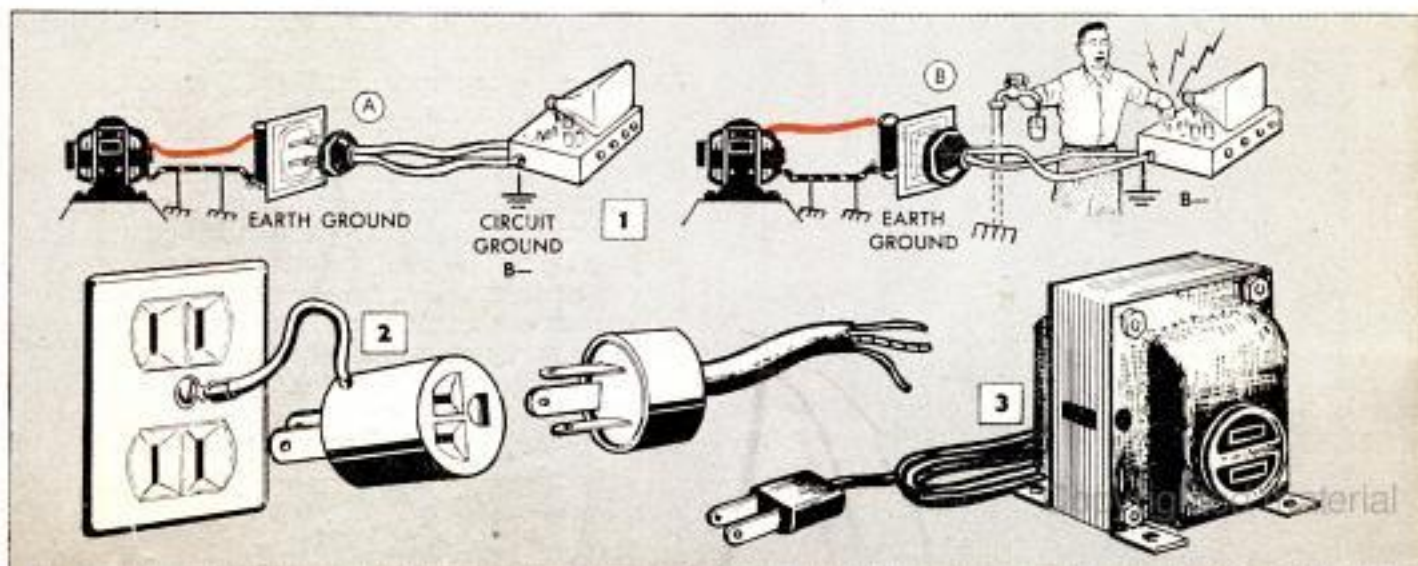

WTM 59

# The CRAFTSMAN

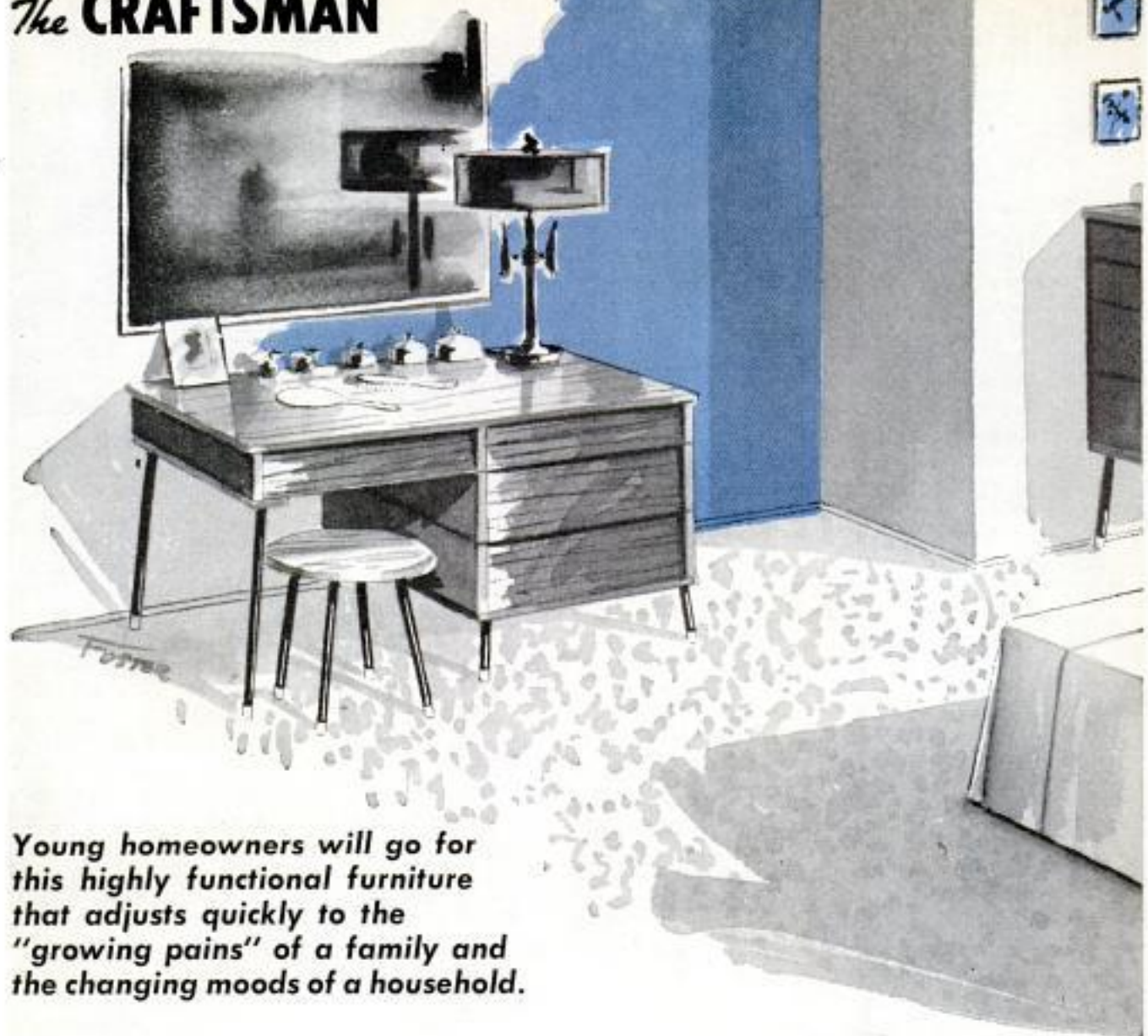

Young homeowners will go for this highly functional furniture that adjusts quickly to the "growing pains" of a family and the changing moods of a household.

## Stacked-Drawer

By Tom Riley



HERE IS build-it-yourself furniture that is ideal for the young couple who have little cash, but own a circular saw and have the desire for fine furnishings. The furniture is easy to make and yet has all the eye appeal and quality look of expensive purchased furniture. You assemble the pieces by stacking two or more individual drawer units, attaching ready-made legs and adding a simple top. This assembly method makes the furniture completely functional. When you tire of one grouping, you can unstack the drawer units and rearrange them to make completely new-appearing pieces. And when more storage space is needed, you simply add another

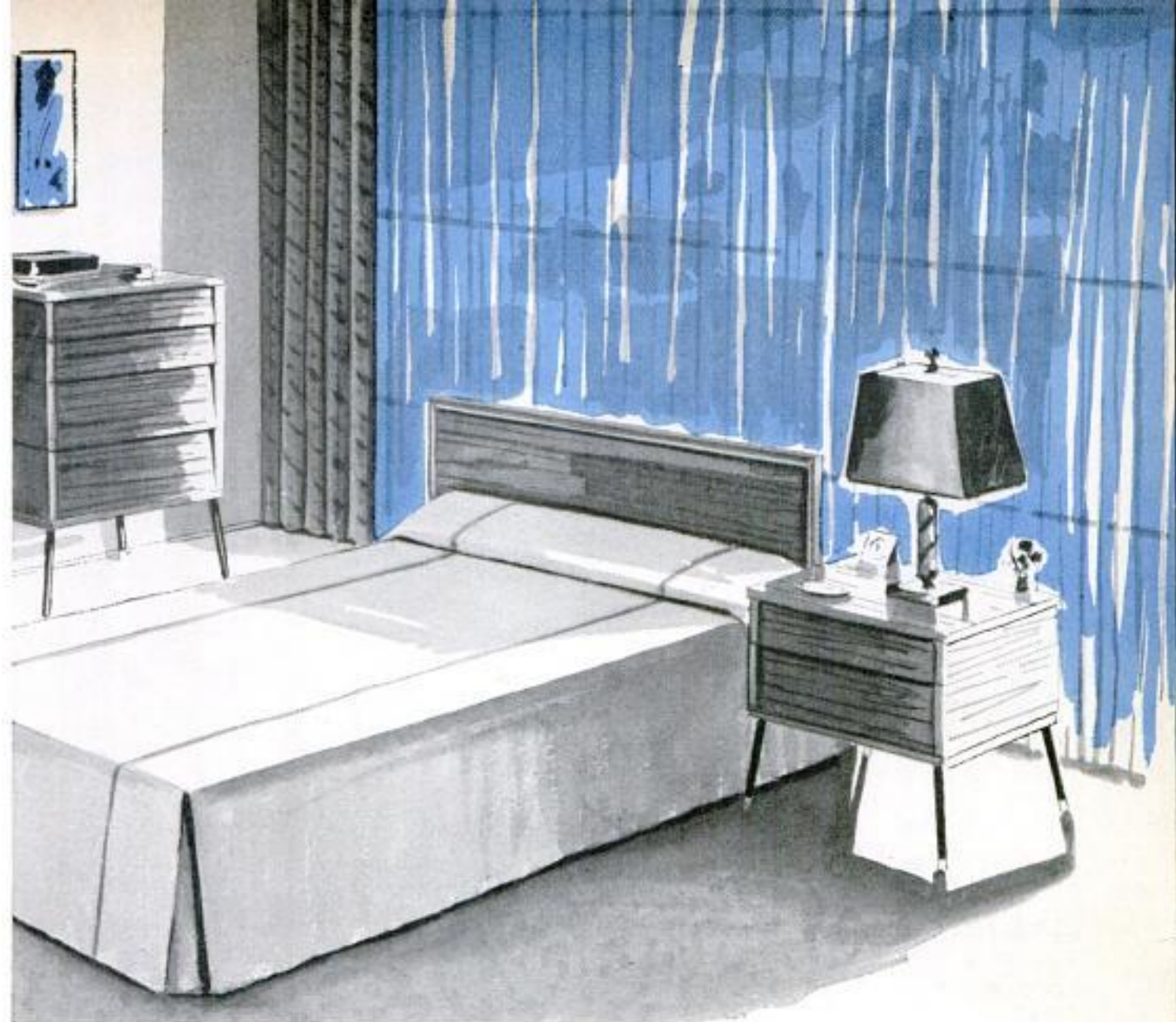

## BEDROOM FURNITURE

drawer to the stack, or make a double chest from a single one by adding a stack alongside. To provide both shallow and deep drawers, the units are built in two heights, 5 in. and 8 in. These two dimensions also allow you to assemble vanity bases and other pieces that will work out to the proper height when using ready-made legs of standard lengths. Fig. 9 shows how legs of various lengths are used on different pieces of furniture and, also, how the drawer units can be assembled to produce a variety of furniture.

### Drawer Units

Building the drawers and their outer frames can be a production job. In other words, you can cut all similar pieces at the same time with the same setting of

your circular saw, simplifying the job and assuring greater accuracy. Only the drawer front and the two sides of the drawer frame need to be hardwood. And these can be either solid stock, or hardwood-faced  $\frac{3}{4}$ -in. plywood. When plywood is used, cover the end grain with plywood-veneer tape. Figs. 2, 3 and 4 give construction details of both the 5-in. and the 8-in. drawers. Note in the right-hand detail in Fig. 2 that the top of the drawer is offset  $\frac{3}{4}$  in. To maintain this offset on both the 5 and 8-in. drawers, different angles must be cut on the drawer sides. On the 5-in. drawers, the sides are cut at an 8-deg. angle; on the 8-in. drawers the sides are cut at 5 deg.

In Fig. 3 a  $\frac{3}{16}$  x  $\frac{3}{16}$ -in. rabbet is indicated along the bottom edges, as well as the front and back of the frame sides. This

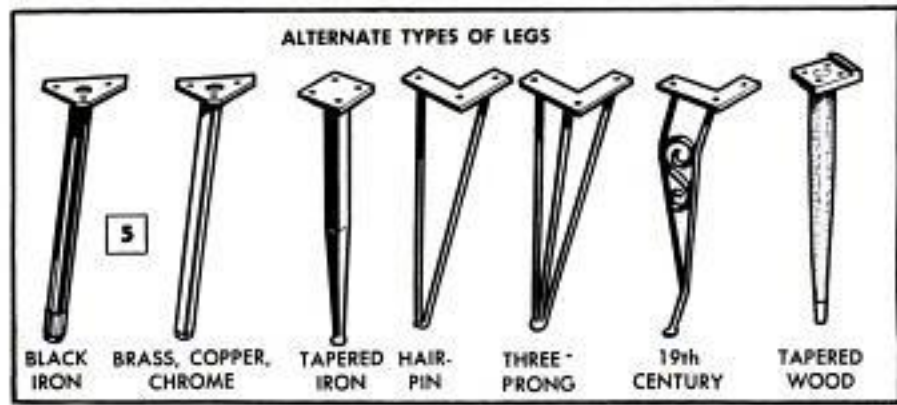
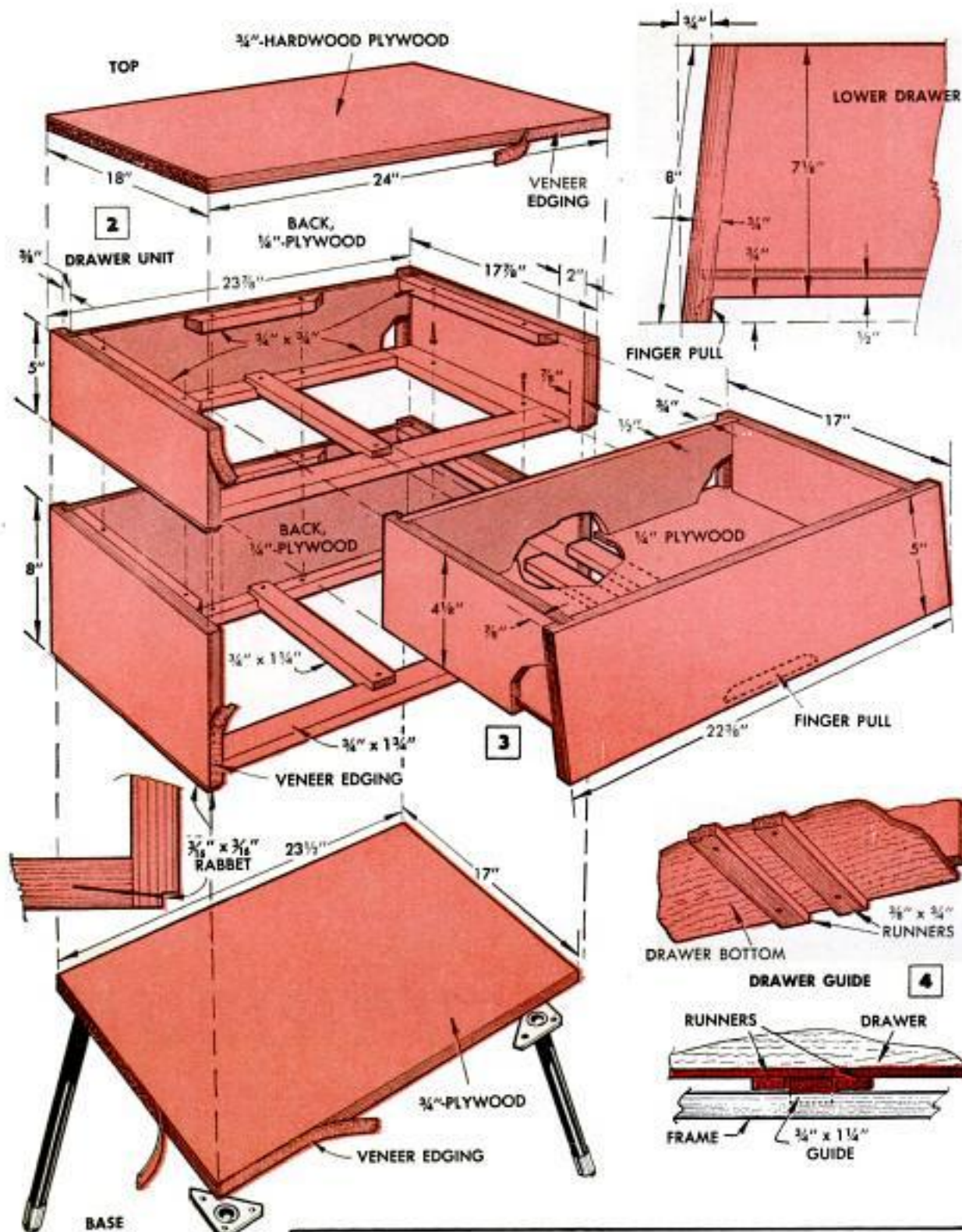



Above, veneer tape is applied to the edges of all plywood. Above right, rabbet is cut along bottom edges, front and back of drawer-frame assemblies

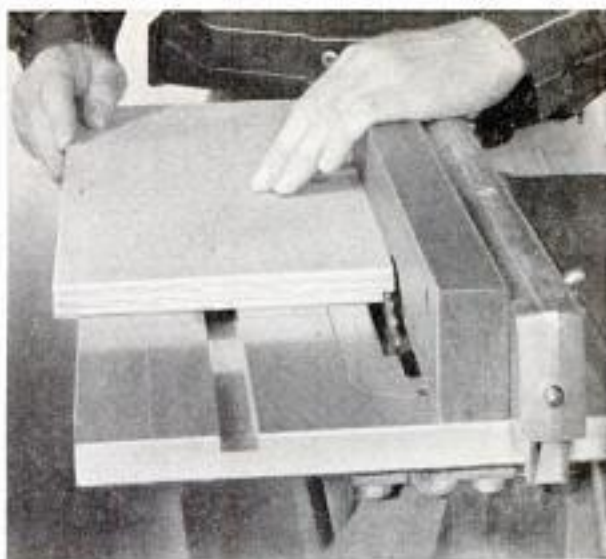

rabbet becomes a decorative groove when the drawers are stacked, and hides any small variation in the width or lengths of the drawers. Handles can be installed on the drawers or they can have hidden finger pulls cut on the inner edge of the bottom of the drawer fronts, as indicated in Figs. 2 and 3. There need be no exposed nails or screws showing on the drawers or frames. Glue and clamp all components of drawers and frames. Use nails on the drawer back only. To attach the inner pieces of the drawer frames, glue and nail or screw from the inside. Where it might seem imperative to nail the front framing into the side pieces, small finishing nails can be hidden by being driven through the rabbet, as indicated in the left-hand detail, Fig. 3. Notch the center drawer guide into the framing so it projects only  $\frac{1}{2}$  in. above the frame. Then turn the assembled drawer-and-frame unit upside down and position the two runners on the drawer bottom.

### Tops and Bases

The simple tops for the stacked-drawer furniture are sheets of  $\frac{3}{4}$ -in. plywood, and will be 24, 48 or 72 in. long to cover a single, double or triple side-by-side assembly. Use hardwood-faced plywood and tape the exposed edges. With all tops 18 in. wide, the dimensions will provide a slight overhang all around to cover any variation in the sizes of individual units. Fig. 1 illustrates the effect of this overhang.

Bases for single or multiple units are cut from sheets of  $\frac{3}{4}$ -in. fir plywood, and should be slightly smaller in dimensions than the bottom of the piece of furniture. This keeps it clear of the drawers and the

One above the other, or side-by-side, drawer units are held together by screws driven through frames

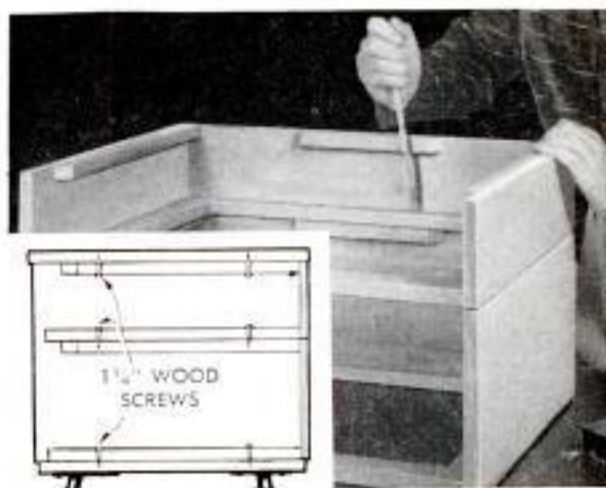
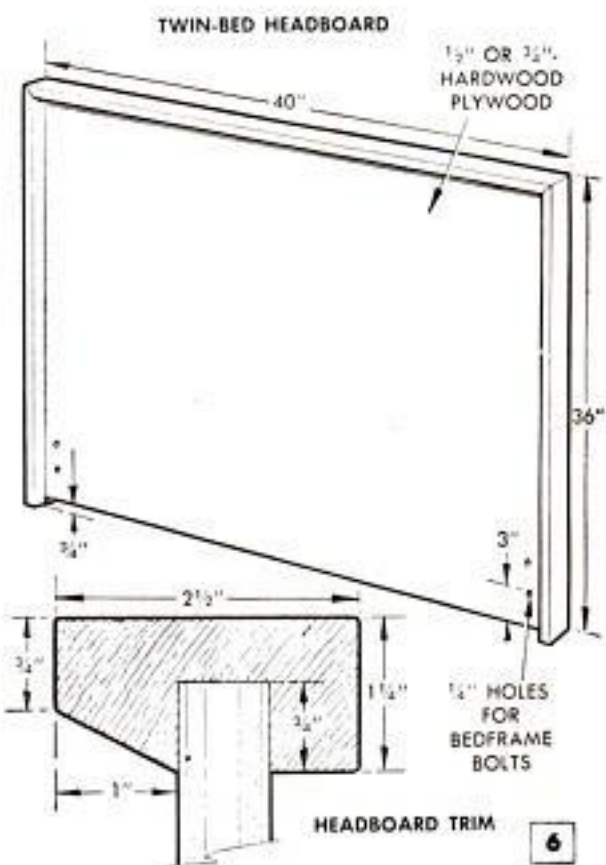

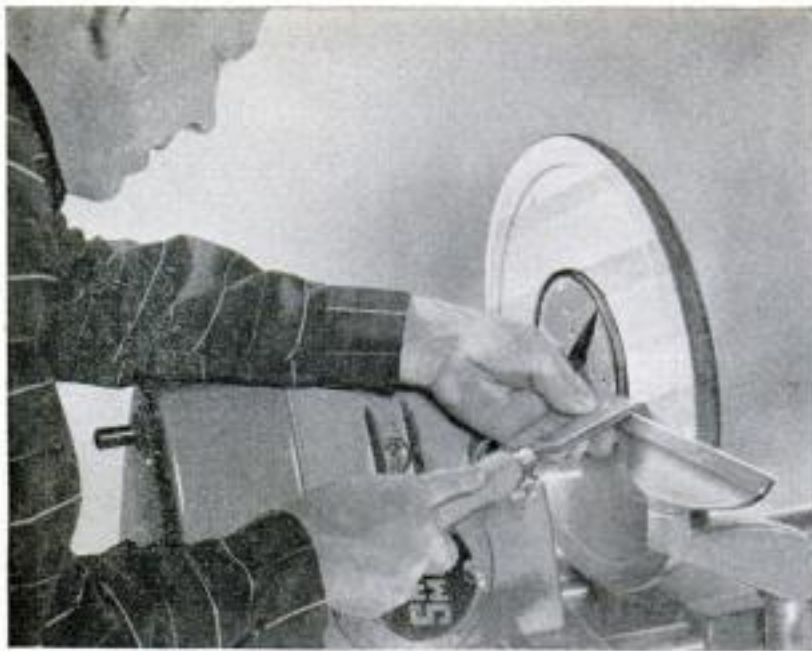

Upper right-hand photo, "chopping block" vanity stool is made by gluing together strips of hardwood of contrasting grain and color. Left-hand photo shows how bevel is turned on bottom of seat for leg angle

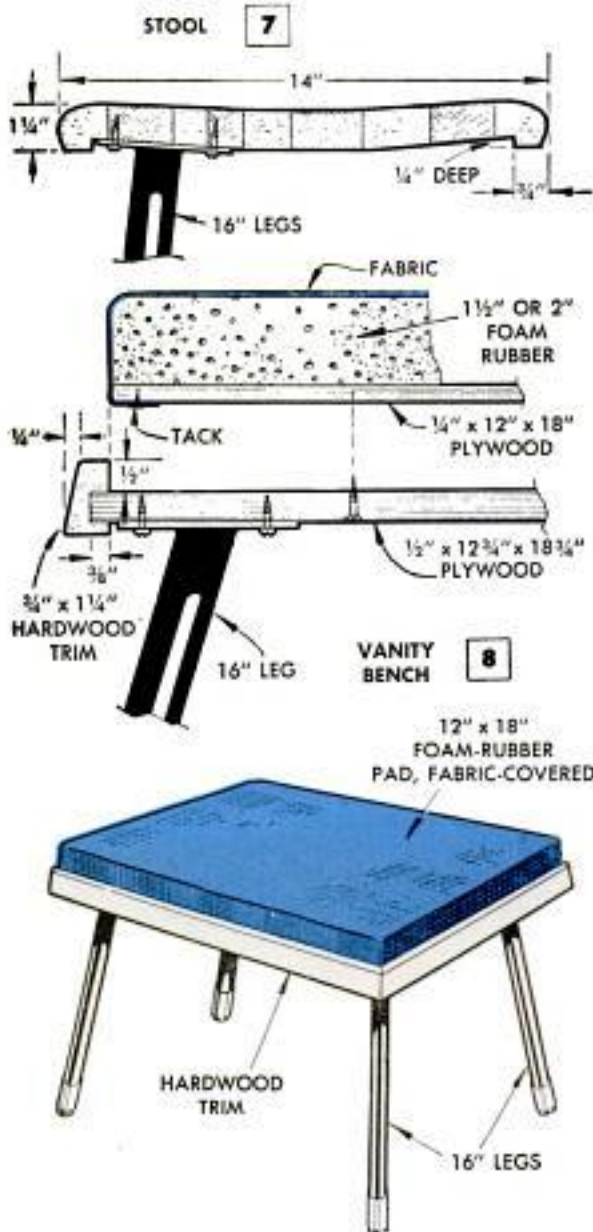

rabbet on the lower edges of the drawer frame. The edges of the base can be taped, or strips of  $\frac{3}{4}$  x 1-in. hardwood can be used. The latter extend  $\frac{1}{4}$  in. below the base to cover the edges of the leg plates.

Matching headboards, Fig. 6, are easy to make. Simply cut a  $\frac{3}{4}$ -in. groove in lengths of trim stock to fit on three sides of a sheet of  $\frac{3}{4}$ -in. hardwood-faced plywood. Miter the two corners of the trim. For a single bed the headboard is 40 in. wide, for a double bed it is 65 in. wide.

### Vanity Stools and Benches

The latest idea in vanity seats is a light-weight three-legged stool. The top can be turned from a single piece of hardwood and ready-made legs attached. Less expensive is the "chopping block" stool, Fig. 7. Scrap lengths of hardwood are glued and clamped together to form the seat which is turned on a lathe. The bottom side of the seat is beveled as indicated, both to hide the leg plates and to give the legs a greater angle. The legs of a three-legged stool must be angled as much as possible to provide stability when sitting near the edge. Detailed in Fig. 8 is a vanity bench, which is preferred for a large vanity. The seat consists of a piece of  $\frac{1}{2}$ -in. plywood to which four legs are screwed. A piece of foam rubber 12 x 18 in. then is cemented to a piece of  $\frac{1}{4}$ -in. plywood and it is covered with fabric that is folded under and tacked to the plywood. This assembly is dropped onto the bench and attached with screws.

Although all furniture described in this article is for a bedroom, stacked-drawer construction also could be used for dining-room and living-room furniture. ★ ★ ★

DOUBLE CHEST

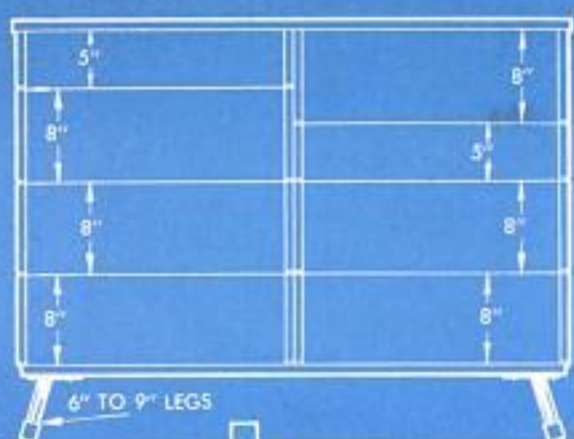

SINGLE CHEST



DRESSING BENCH

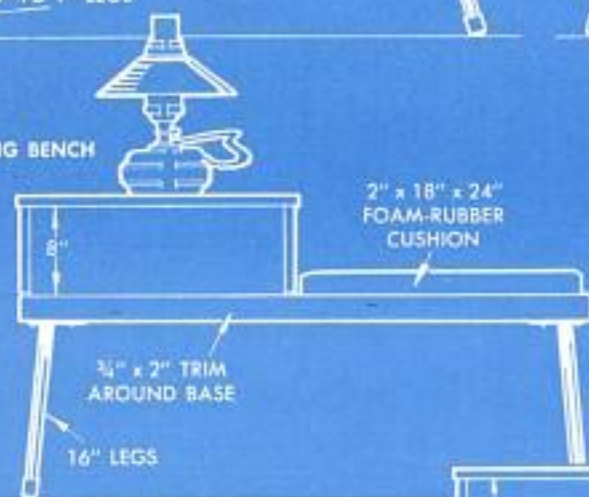

NIGHT STAND



MIRROR

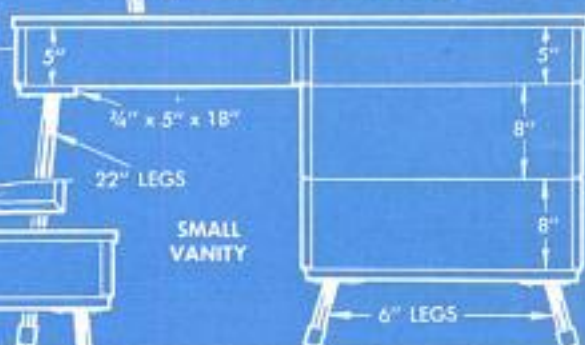

SMALL VANITY

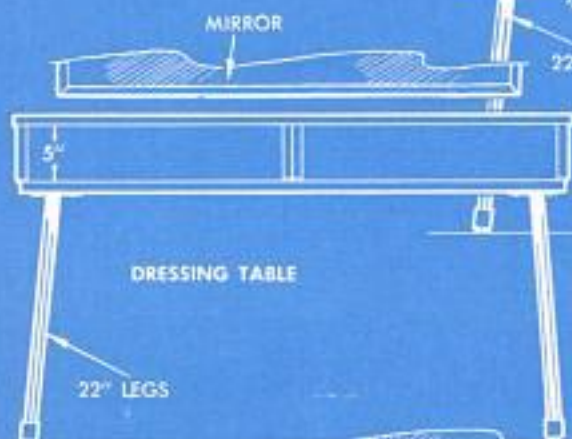

DRESSING TABLE

LARGE VANITY

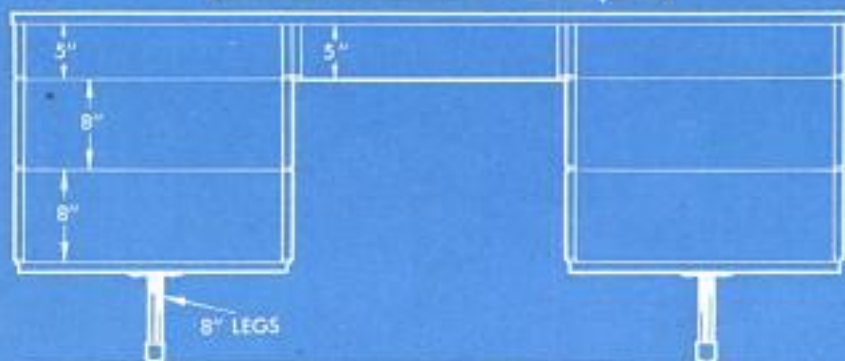



### "Handles" on Doghouse Carpet

Difficulty in removing or replacing a carpet in a doghouse for cleaning is overcome by sewing a hem along each side and inserting dowels in them. The dowels provide convenient "handles" for lifting the carpet out through the narrow door.

### Plastic Bottle Is Glue Dispenser

When applying glue on a number of small surfaces, as when assembling miniatures or models, try using a plastic catchup container for a dispenser. Also, the closed dispenser keeps the glue fresh longer.

### Improved Darkroom Sink

If your darkroom does not have running water for maintaining the developer at the desired temperature, a means of doing this can be improvised. Simply place the developing tray in a larger container and fill the latter with water of the required temperature. Also, the outer container catches any overflow of developer, preventing it from staining the floor or table.

Robert C. Florian, Chicago.



☛ Metal kitchen foil provides an ideal shield when painting a surface that is close to a fixed object.



### Drawer Under Stool

Take advantage of the wasted space under a kitchen stool by installing a small drawer in which small items can be stored. Cleats are attached along the sides of the drawer at the bottom to ride on runners screwed to the stool legs.

### Quick-Thawing Frozen Meat

When it is necessary to thaw frozen meat in a hurry, drop it into a plastic bag and seal the neck of the bag with a rubber band. Place the bag in warm water, and the meat will thaw quickly.

### Easy-to-Make Picture Framing

Ordinary window stop and some  $\frac{3}{4}$ -in. screen molding are all you need to make attractive picture frames quickly. The screen molding is glued and nailed to the back of the stop material to form a rabbet for the glass, after which the built-up strip is cut up and mitered to make a frame of the desired size. A frame with more depth can be formed with cove molding.

Herbert E. Fey, New Braunfels, Tex.

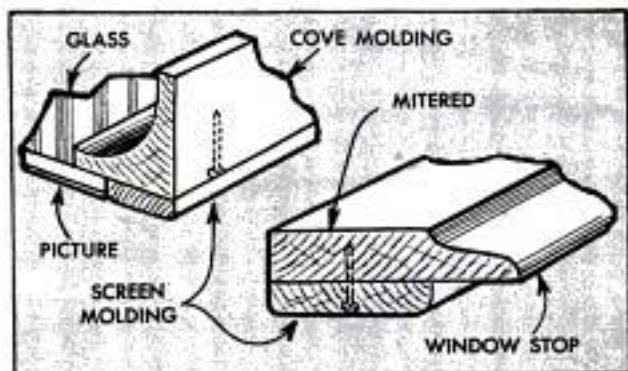

☛ One easy way to dry children's overshoes is to place them over the ends of the legs of an inverted card table.



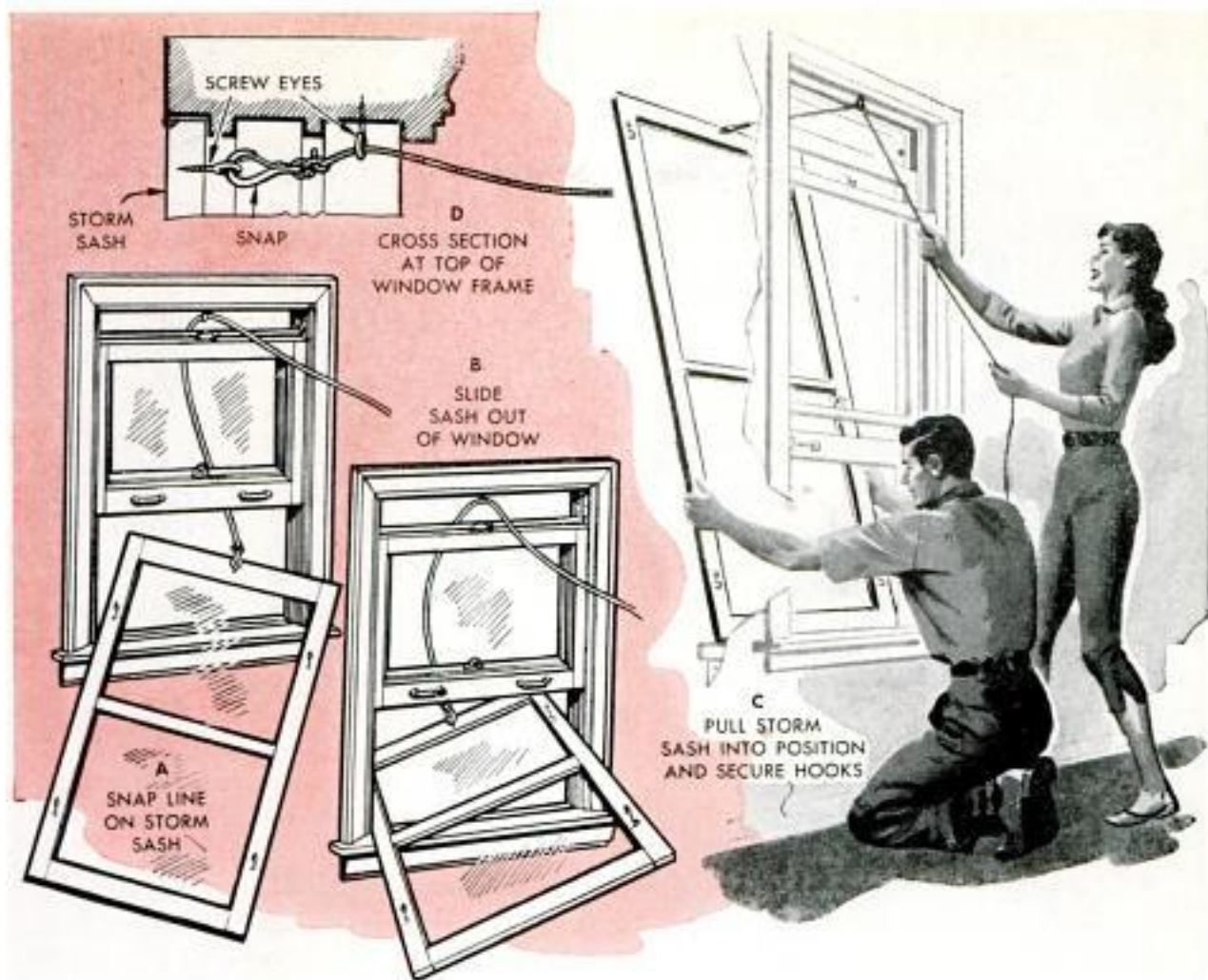

## Installing Storm Sash Without Use of Ladder

You can install full-length storm sash from inside the house and thus completely eliminate the need of a ladder with its customary handling difficulties and attendant hazards by following this simple method. All that is necessary is to have the windows in good operating condition, and have someone available to help you. Each window casing is fitted with a large screw eye. This is driven into the top of the frame, centrally between the sides, and directly over the edge of the lower sash of double-hung windows as shown in detail D. The screw eyes are left in place permanently. Screw eyes also are driven into the top crossrails of the storm sash. Next, a 10 or 12-ft. length of strong rope, such as sash cord, with a swivel snap securely fastened at one end, is brought through the screw

eye in the window casing, and the end with the snap is dropped down on the outside of the window to sill level. The snap is attached to the screw eye in the storm sash, detail A, which then is pushed out of the window while held in a diagonal position as in detail B, since it is wider than the window opening. While a helper pulls on the rope as shown in detail C, you push the sash out and guide it until it can be fastened to the window casing by means of four hooks and eyes. Then the rope can be removed. Storm sash so fastened cannot be swung out for ventilation and must be provided with vents. To remove the sash, you first attach the rope and then follow the exact opposite sequence as used to install it. Screens can be installed and removed in the same way.

### Utilizing All Pigment Assures Identical Paint Colors

Using every bit of coloring from the tube is the secret of exactly duplicating a color when tubes of coloring are mixed with a base paint. To do this, slit each tube of coloring with a razor blade while it is held over the container of paint. Then, after all

the coloring has run out of the tube, drop it into the container and mix the paint thoroughly. When the tube is removed, it will be clean of color, the paint solvents having removed it while the paint was being mixed.—R. J. Ahrens, Somerville, N.J.

## Curved Backdrop for Close-up Photos Eliminates "Horizon"

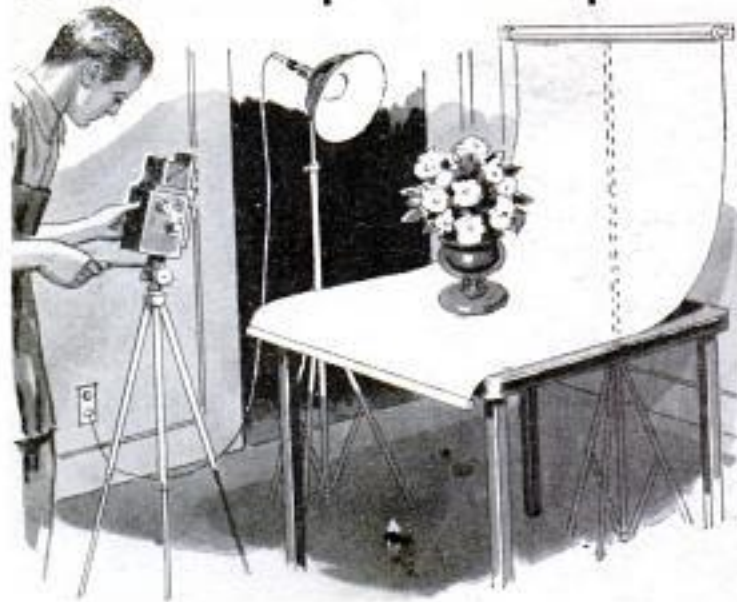

When taking a close-up photo on a table, you can avoid the distracting "horizon" line caused by the table edge by arranging a flexible, vertical backdrop to lie across the table in a sweeping curve. An ordinary window shade is ideal for this purpose. It should be light-colored on one side and dark on the other, and arranged so that either side can be used. The shade is mounted on a wooden cross piece having a blind hole at its center to permit its attachment to a light stand. Shadows produced on the background by subjects to be photographed are eliminated by adequate illumination from a number of lamps.

## Keep Wheels From Splitting

Try this trick to prevent the splitting of large wooden wheels for toys. Before cutting them out, glue wooden splines in slots cut across the grain.

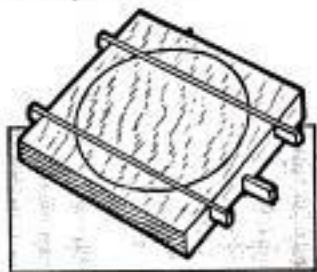

## Auger Becomes Lamppost

Strikingly modern in appearance, the steel post for this yard lantern has its origin in a piece of ordinary farm machinery. It is the auger from a dismantled grain conveyor.—L. H. Houck, Jefferson City, Mo.



## Heavy-Duty Shelf Brackets

When wooden shelf brackets must bear heavy loads, they should be constructed as indicated to provide maximum strength. The top of the vertical member is notched to form a step on which the horizontal member rests. Generally, distances A and B should be about equal. Only three screws are required. Lag screws are used to fasten the bracket securely to a wall stud. The lag screws should be driven into wall studs wherever possible.

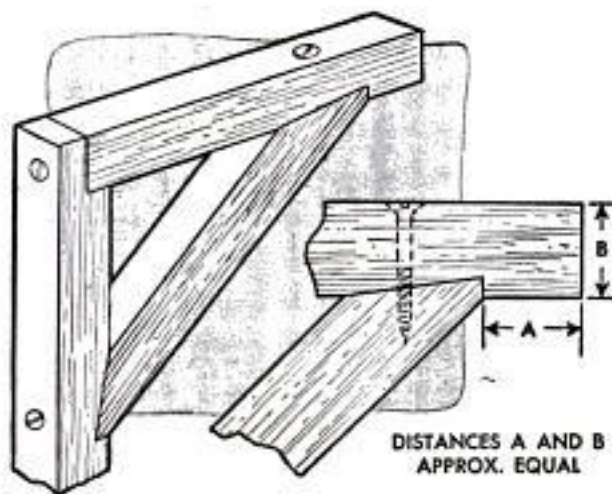

## Miniature Bench Anvil

Dropped into a hole bored in one corner of a workbench, a pipe nipple fitted with a cap makes a handy anvil for straightening nails and other small pieces of work.

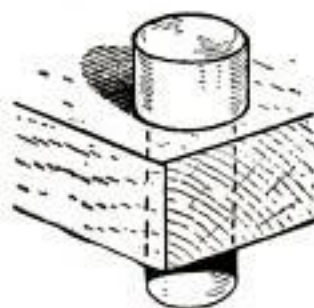



Openings between bricks are filled with a grout made by mixing 1 part portland cement to 3 parts sand

# FROM THE GROUND UP

By John O. Bull

## PART II

**I**N CONTINUING skyward with the chimney part of your fireplace, it is most important that you use a level frequently at the corners so you won't wind up with a leaning tower of Pisa. As described last month, the chimney consists of an inner and outer wall of brick, the

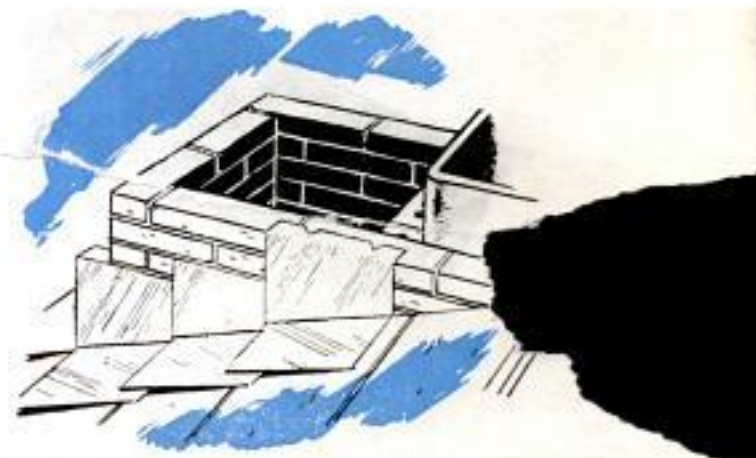

Metal flashing is anchored in mortar by notching with tin snips and then bending edge back at right angles

Left, cross rods 6 to 8 in. down from the top support fill. Center, bricks rest on rods and on shoulders formed at ends by split bricks. Note notched brick. Right, scrap and common brick are utilized for fill





Top of chimney is reached with 18 courses above the ridge. Here fill is completed and ready to be grouted



Grout is forced down between bricks with short 2 x 4. Flue can be flush or left projecting a few inches



inner one being of common brick and enclosing the flue tile. When you arrive at the roof line, copper flashing must be worked into the brick courses to keep roof water from running down between the chimney and the side of the house. The pieces of flashing are added as the courses rise and are bent and lapped in the manner shown. The top of the chimney is reached when you have gone about 18 courses above the roof ridge. However, while you are still three or four courses from the top, steel rods are mortared in place crosswise to support the bricks that cap the well on each side of the flue. These bricks are mortared in place, and as you continue to go up the remaining three or four courses, scrap and common brick are used as fill. When you have reached the top, your chimney should look like the photo in the upper left-hand corner. Notice that except at the four corners, the top course is laid with the bricks placed on edge. Finally, the voids between the bricks are filled with grout and sloped four ways from the flue. You have a choice of keeping the latter flush with the top or a few inches above it. This completes the chimney part.



Above, scrap block and brick are used as hearth fill. Below, fill topped with grout, level with firebrick

Hearth tile is laid in thin layer of mortar. Note tile is  $\frac{3}{4}$  in. above firebrick to form lip for ashes



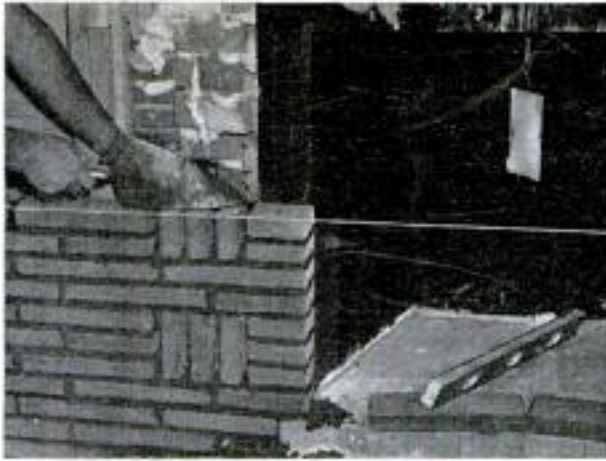

Grillelike openings for the air ducts are formed by cutting the bricks to size and standing them on end

Whether you proceed as extensively as done originally, and face the entire wall with brick, or just face the steel liner itself, the same procedure is followed. In referring to the plan view in Part I, Fig. 8, you'll notice that a 1/2-in. airspace is left between the wall studs and the brick facing, and that the glass-fiber insulation that covers the liner is brought around to fill this space at the front. Do not attempt to mortar over this opening as it will only crack out later.

Start the brick facing even with the inner edges of the liner and carry it each way as far as you wish. Metal wall ties are used every few courses and duct openings are formed on each side, three courses high, by standing the bricks on end at the points where the cold-air ducts are located. A lintel of 3-in. steel angle is used to bridge the fire pit 14 courses up. See Part I, Fig. 5. Five courses up from the lintel a grille is formed of brick as before for the heat ducts. The raised hearth is made six courses high and is filled in with scraps of block and brick, after which it is grouted over and struck off level to provide a solid base for the hearth tile. ★ ★ ★

A grout of equal parts of white sand and white cement is used to fill voids between the hearth tile



NOVEMBER 1957

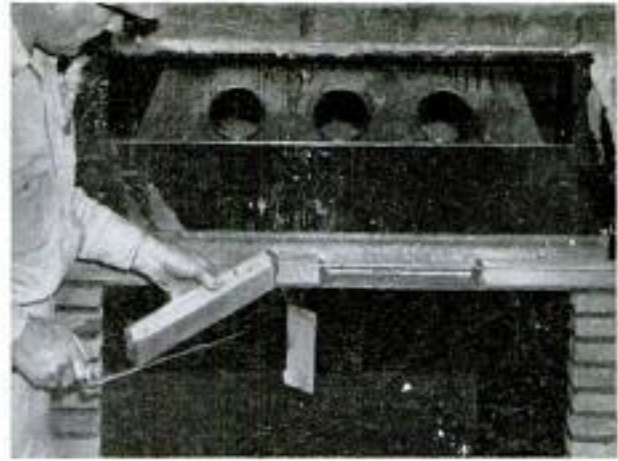

Space across lintel is evenly divided by laying loose brick in place and cutting off where necessary



A 10-percent solution of muriatic acid is used to clean brick of mortar stains, then rinsed with water



Hearth tile is cleaned with sponge and water. Thin coat of linseed oil is then applied and polished



175

## Support Holds Plaster Patch

To patch a hole in a plastered wall that goes through the plaster base, some sort of backing support must be provided to hold the soft plaster in place until it sets. A strong, lightweight back support can be made by stapling a layer of steel wool to a piece of corrugated cardboard, then threading a length of cord or string through the center and anchoring this with a short stick. The steel wool provides some resiliency and flexibility so it will fit snugly against an irregular surface such as keyed plaster on lath. The assembly should be small enough to slip through the hole edgewise, yet large enough to practically close the hole from the rear when pulled back with the cord, which is held while the patch is troweled flush. Large, thick patches usually are built up with several applications of plaster. When the patch is dry, cut off the string and sand the plaster to feather the edges.

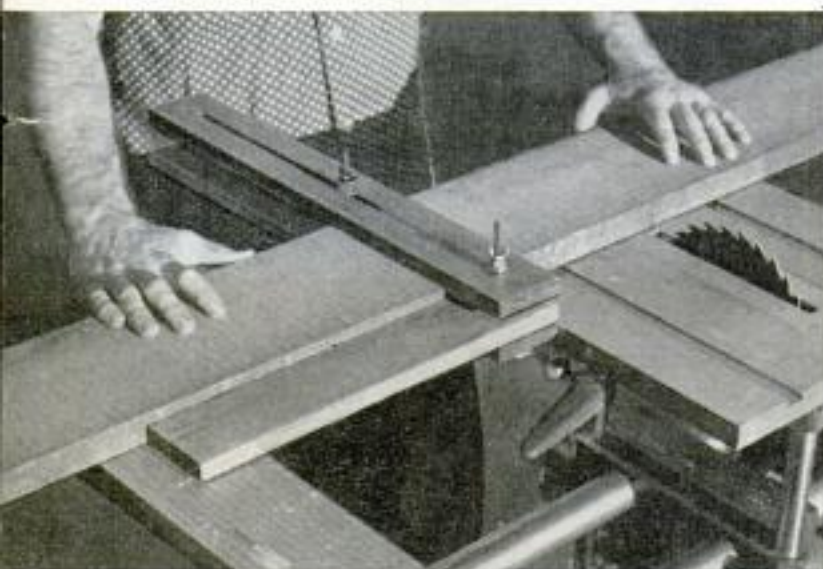
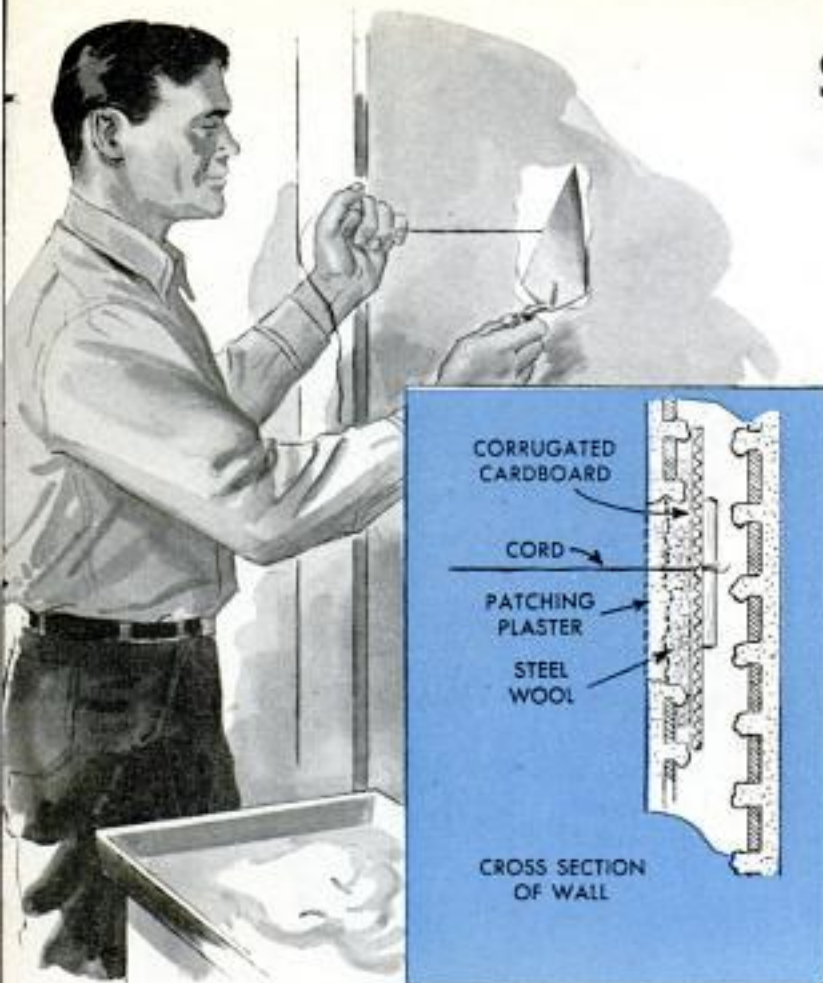

## Crosscut Jig for Wide Stock

If you have ever tried to crosscut a fairly wide piece of stock on a table saw using a regular miter gauge, you will appreciate the advantages of this crosscut jig. It consists of an L-shaped assembly in the form of a try square that clamps to the work and slides along the edge of the saw table. The jig consists of three pieces, two of which are slotted to take clamping bolts. The lower slotted piece is attached to the aligning member with glue and screws so that the two are at exact right angles.—Roy H. Copperud, Stockton, Calif.



## Fire Hose Washes Streets

Ideal for any small town is this street washer used in Kooskia, Idaho. It consists of a 5-ft. length of 2-in. pipe to which four  $\frac{3}{4}$ -in. pipe nipples are welded to provide nozzles. An 8-ft. length of 2-in. pipe is connected to this assembly with an elbow, and extends behind the tractor where a fire hose is coupled to it. Slow driving minimizes wear on the dragging hose.

Roscoe LeGresley, Kooskia, Idaho.

# Happy-Hunter Pipe Rack

Pipe smokers who are hunting enthusiasts will get a chuckle from this "Nimrod and his gun" pipe rack. The single pipe is held by the hunter as though it were a rifle or shotgun, while he poses proudly with his faithful rabbit dog and the game taken in a day of strenuous hunting. The three figures are jigsawed from  $\frac{1}{8}$ -in. hardboard, using patterns drawn with the aid of the squared drawing. Paint the figures as indicated. The base for the rack is cut from  $\frac{3}{4}$ -in. stock and has three slots in it to receive the tabs on the bottoms of the figures, which are glued in place. Cement a piece of felt to the underside of the base to prevent it from scratching polished table-top surfaces.

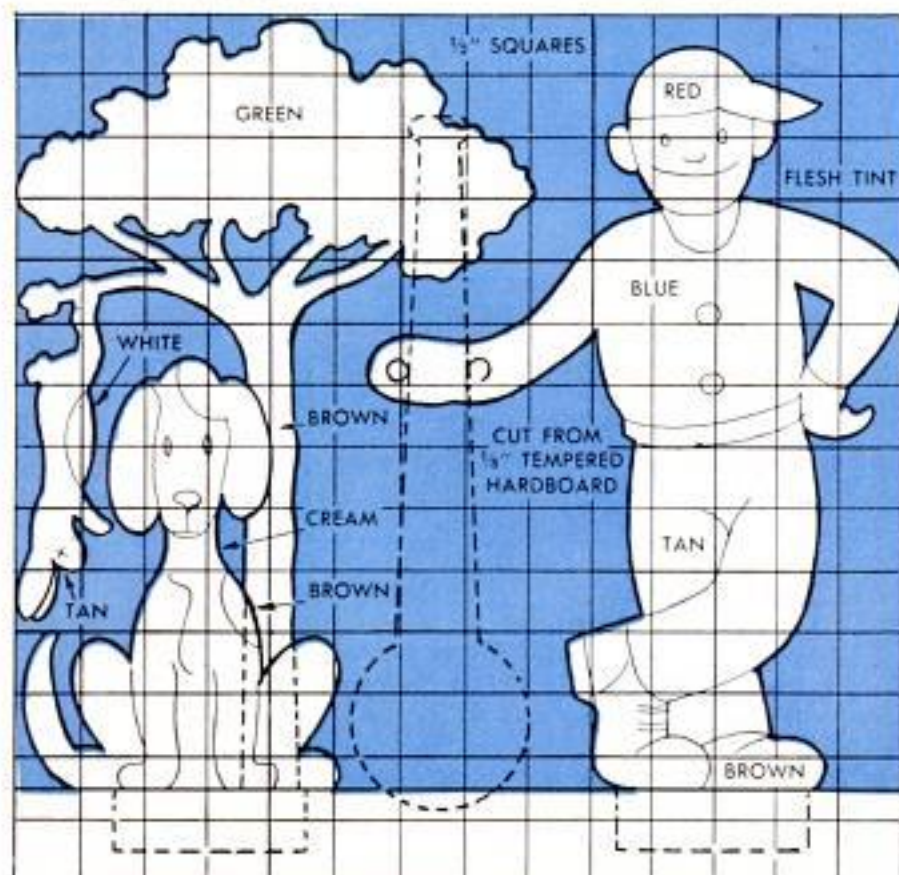

## Pencil Used as Thread Gauge

It sometimes is difficult to tell the number of threads per inch in a tapped hole, and, accordingly, to choose the right screw when you go to the hardware store. Force a sharpened pencil into the hole, rotate it a couple of times and take it with you. The thread will make an impression on the soft wood of the pencil that can be seen easily.

William R. Kemp, Glendale, Ariz.

## Economy for Furnace Filters

One homeowner saves on the cost of replacing the filters in his warm-air furnace by using two 1-in. filters instead of a single 2-in. unit. When the lower filter becomes dirty, it is discarded. The upper filter then is moved down and a new filter is placed on top of it. Thus, only a 1-in. filter needs to be purchased when it is time for renewal of the filters.



# Solving HOME PROBLEMS

**HI-FI RECORDS** will remain clean and free of damaging body oils and perspiration if you remember to handle them only while wearing clean cloth gloves



**NICKS IN FURNITURE** can be touched up by using wax crayons that come in dozens of colors to match any wood. Rub crayon on and polish with soft cloth

**FREE "FROZEN" TUMBLERS** by applying glycerin along rim of lower one, and also between tumblers. Let penetrate a few minutes, then pull tumblers apart

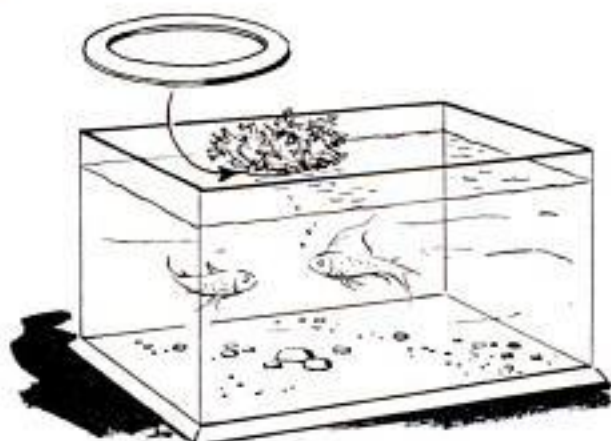

**FLOATING PARAFFIN RING IN AQUARIUM** confines floating plants. Melted paraffin is poured in shallow pan, ring is cut while paraffin is still warm

**RECORD PAINT COLOR AND AMOUNT** required in each room by dipping tongue depressor in paint and marking name of room and quantity of paint on it





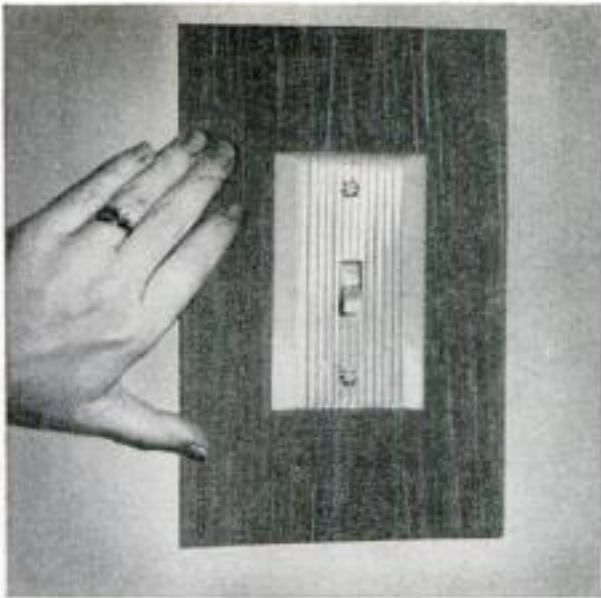

**WALL AROUND SWITCH PLATES** stays clean and smudge-free when scraps of plastic laminate left over from work counters are fitted under plates

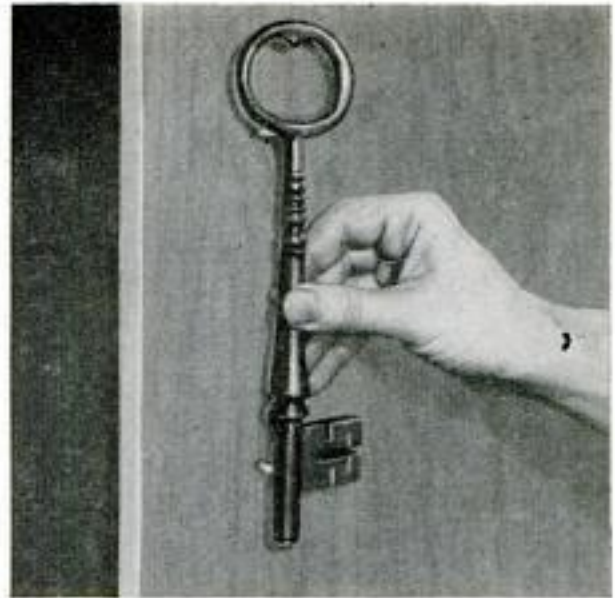

**UNUSUAL PULL FOR SLIDING DOOR** is made from souvenir brass key. Drill and tap blind holes near each end, use pipe spacers and attach from inside



**HANDY SEWING KIT** for traveling can be made from paper matchbook cover. Three shades of thread are wrapped on notched cover, needles and pins are pressed into stubs of torn-off matches. Kit will fit conveniently in your pocket or in purse

**HOLD DOWN CORNERS** of curling calendar leaves by sticking photo-corner mounts on calendar back so they catch lower corners of the leaves as shown



**JIG FOR LOCATING BLIND HOLES** for cabinet door and drawer pulls is made by holding cardboard over flat of pull and punching through to holes with awl

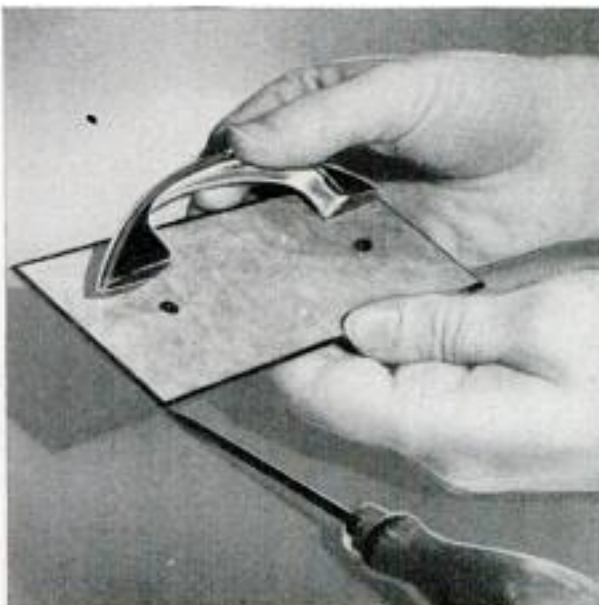

**PROPER WAY TO POUR LIQUID** from square or rectangular can is to have spout at top. Air enters smoothly, prevents gurgling and waste of material





## Handy Sawhorse Has Removable Legs

Quickly disassembled for storage, space-saving sawhorse consists of a length of 2 x 6 and four pipe legs. Four pipe couplings are inserted in holes bored in the 2 x 6 and cemented in place. To assure that the couplings will not turn, drill a hole through the 2 x 6 and couplings, then insert a nail or wood screw as indicated. Crutch tips on the ends of the pipe legs prevent marring the floor.

## Hair Drier Is Drawing Aid

When drafting or drawing with pen and ink, keep a portable hair drier handy to speed up the work. Applying the drier for a few moments will dry an area so further work can be done without smudging.



## Cardboard Drafting-Tool Holder

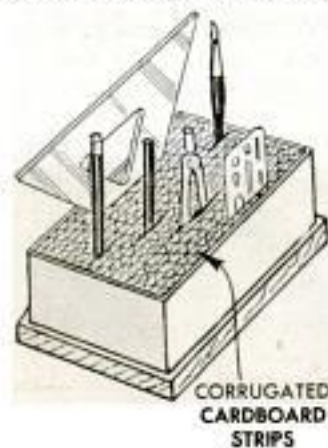

Strips of corrugated board and a cardboard box can be used to make a handy pencil and drafting-tool holder. Spread glue in the bottom of the box and insert the precut strips of corrugated board. Do not glue the strips themselves together. Cement the cardboard box to a wooden base

so that it has sufficient weight to remain in place when tools are removed or inserted.

☞ Clean crystal lamp bases with a solution consisting of a few drops of ammonia in clear lukewarm water, applied with a soft cloth. Rinse with a cloth wrung out in clear water and wipe dry.

## Improved Cabinet Catch

Friction catches for cabinets can be improvised from a spring-type clothespin and a sheet-metal strip. The clothespin first is disassembled to permit countersinking two screws in one leg, which is screwed to the cabinet shelf. The end of the sheet-metal strip, which is 1/2 in. wide, is wrapped around a 16d nail to form a loop. Bent to an L-shape, the strip then is screwed to the cabinet door.

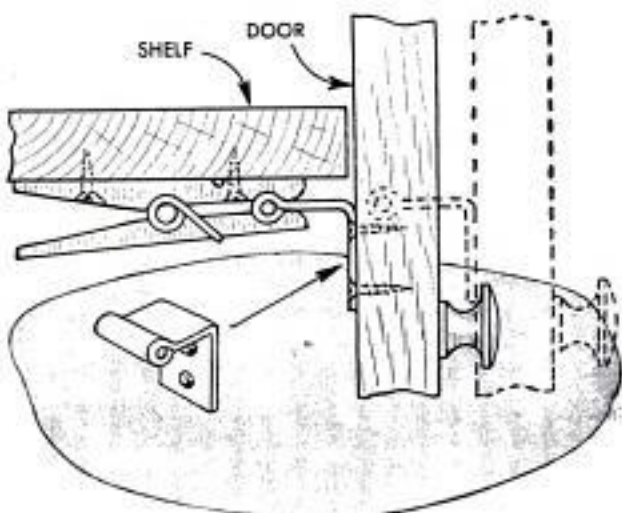

## Compass Improvised From Comb

In an emergency, a compass can be improvised by using a comb, a pin and a pencil. Fine teeth in the comb permit fairly small adjustments in radii.

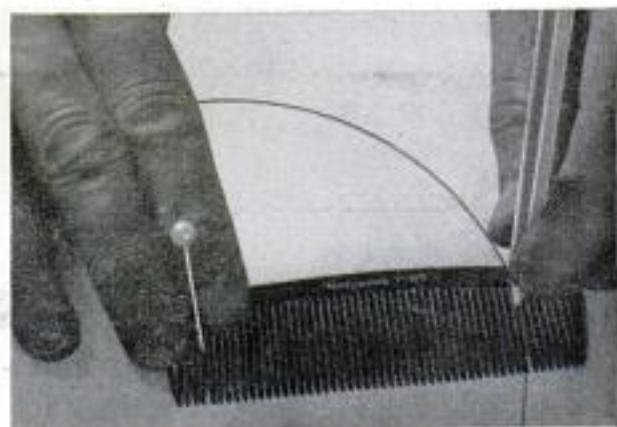



Coins for parking meters are carried conveniently in aspirin tin to which suction cup has been screwed



Space-saving container for lenses and filters is aspirin tin. Filters are protected by fold of cloth

IF YOU ARE A MODELMAKER, photographer, businessman or just a motorist, take a second look at an emptied aspirin box before you discard it. It has not outlived its usefulness. Miniature hinges for modelwork require only that the hinged portion of the aspirin box be cut away. For photographers, the boxes are ideal as compact filter and lens holders. Place each filter inside a fold of cloth, which also can be used for cleaning. Postage stamps, which seem to stick together when carried in pocket, purse or billfold, remain clean and dry when carried in an aspirin box. And while it is impractical to carry a full-size rubber-stamp pad in your pocket, a miniature, pocket-size inking pad is easily made by placing several thicknesses of flannel inside an aspirin box and saturating it with stamp ink. A couple of small rubber stamps and this stamp pad require very little space. Coins for parking meters are kept conveniently at hand in an aspirin box to which a suction cup is screwed. The cup permits the box to be attached to the instrument panel of an automobile.

Simply cutting off hinged portion of an aspirin tin will provide neat hinge for makers of small models

## SAVE THOSE EMPTY ASPIRIN BOXES

By Kenneth Murray



Aspirin tin becomes miniature, pocket-size stamp pad when filled with ink-saturated flannel cloth

Even on humid days, stamps carried in your pocket remain clean and dry inside protection of aspirin tin



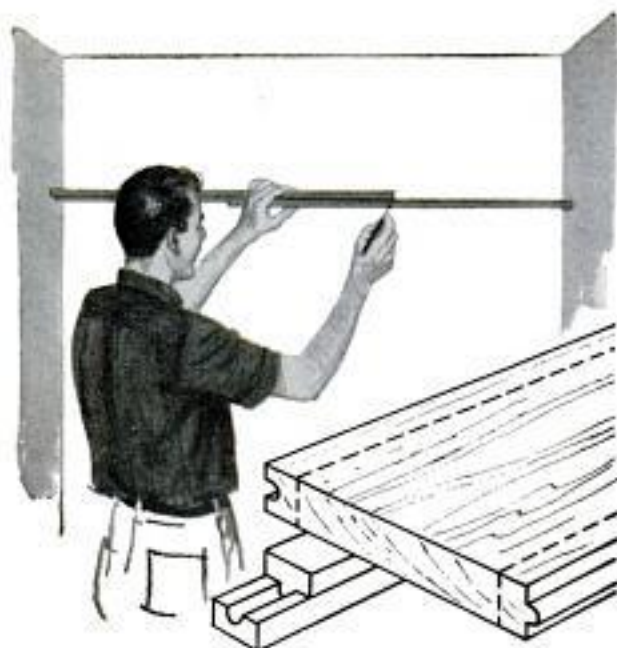

### "Extension Rule" Aids Measuring

Measuring for closet shelves is easy with this handy inside "extension rule." The two sections are cut from a length of tongue-and-groove lumber as in the detail. Use of the rule saves time too, as measurements can be transferred directly to the stock being cut. If the rule cannot be removed in the extended position after measuring, mark the point of overlap on one of the sections as indicated in the illustration and realign after removing.

### Candle Flame Speeds Saw Filing

To make it easier to see that you have correctly filed the teeth of a saw blade, first pass the blade through the flame of a small candle. Filing the teeth will remove the soot deposited by the candle, and show a bright area that is seen easily.



### Suction Cups Hold Drying Rack

This lightweight, metal drying rack for week-end guests is held on the bathroom wall by two suction cups. Constructed of aluminum angles and rods as shown, the rack is easily removed and stored when not in use. All corners and edges should be filed smooth and the completed rack should be enameled to prevent damage to towels. — Sam Grant, New York City.

### Coil Springs on Thumbscrews Keep Ceiling Fixture Tight

Here is inexpensive insurance against the risk of injury caused by a falling overhead-lamp shade in places where vibration tends to loosen the small thumbscrews holding it. The screws are held in place by means of short compression coil springs. These are formed by stretching a tension-type coil spring to separate the coils. Stretching the spring in this manner changes it to a compression spring, and short lengths of it are cut off and placed on the screws.

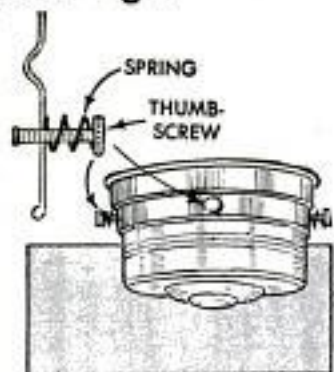

### Torch for Starting Campfire

This birch-bark torch offers a dependable means of starting a campfire under the most adverse weather conditions. Also, it can be used as an emergency flare that will burn brightly for a considerable time. To make the torch, simply cut off the metal portion of a spent shotgun shell. Then, wind strips of dead birch bark around a small twig or splinter of wood and insert the roll in the waterproof section of the shell as shown.

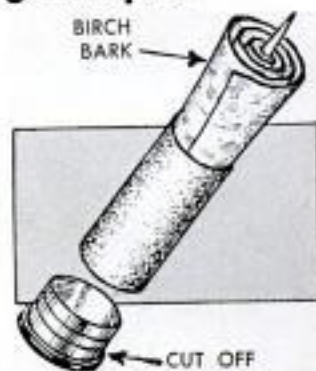

Ben C. Robinson, Newcomerstown, Ohio.



## MORE STORAGE UNDER STAIRS

**S**TORAGE UNDER STAIRS usually amounts to a large closet-type cabinet that tapers to nothing at one end, which means that about one third of it is wasted and becomes a catchall. However, you can get the most from such space and in a most practical way by installing large bin-type drawers, as shown above, which pull out to make access highly convenient. The number and sizes of drawers will vary with each individual situation, but construction of all drawers is similar.

Start construction by removing the plaster and lath, or wallboard, the full width between the studs and down to the baseboard and up to the stairway trim. Next, nail two 2 x 4s to the floor on edge to provide drawer runners. It may be necessary to notch the ends of the 2 x 4s to fit over the 2 x 4 wall plates, or they may have to be blocked up, but in either case they should have their upper edges located slightly higher than the top edge of the baseboard. Now, finish the sides of the wall

opening with wood trim to match that used on the stairway. Also, trim the inner edges of the opening on either side, setting the trim back from the face of the wall trim an amount equal to the thickness of the wood used for the drawer front.

Next, build the drawer or drawers, as the case may be, of  $\frac{3}{4}$ -in. plywood, using glue and screws for all joints. Butt joints are acceptable, but if power tools are available, make dado joints for extra strength, where possible. The inner front can be made of two or more 2 x 4s or a single piece of plywood. Note that the drawer bottom extends  $\frac{1}{2}$  in. beyond the sides. The bottom is the width of the finished wall opening, while the height of the drawer is  $\frac{1}{2}$  to 1 in. less than the height of the finished opening to assure ample clearance. As indicated in the details, the drawer may be a large container, have shelves or be partitioned, depending on what it is to hold.

Nail one  $\frac{3}{4}$  x  $\frac{3}{4}$ -in. guide strip to one runner, slide the drawer in place, then

attach the other guide strip, allowing about  $\frac{1}{8}$ -in. clearance between guides and drawer. Remove the drawer and install a ball caster near the front end of each runner as indicated, and one or more near the rear of the drawer bottom. The casters should be allowed to project only about  $\frac{1}{4}$  in. Replace the drawer and slide it back and forth several times to permit the casters to form grooves in the wood of the runners.

The front of the drawer now can be installed. It may be  $\frac{3}{4}$ -in. plywood like the rest of the drawer, hardwood-faced plywood or any wood of your choice of reasonable thickness. Cut the front to fit the wall opening and attach it to the drawer with  $1\frac{1}{4}$ -in. No. 8 wood screws—no glue—driven from the inside of the drawer. Drill the pilot holes through the inner front slightly oversize, to about  $\frac{5}{16}$  in., so the slant-topped drawer front can be moved slightly in any direction to obtain perfect

alignment with the wall opening. If the stairway should settle in time, the screws can be loosened and the fronts realigned, or they can be removed completely for planing. Glue and nail a small stop block to the inner edge of one runner, and another on the underside of the drawer, positioning them so the drawer will stop when two thirds open. If the underside of the steps is exposed, install a "no tilt" board on the drawer back as indicated, so the ball caster does not quite touch the step. If the underside of the steps is not exposed, secure a board to the stairway framing above the drawer to provide a contact strip for the no-tilt member. The no-tilt piece will have to be installed from inside the closet after the back of the drawer has been lifted to clear the stop blocks and the drawer installed in place. This is done by driving screws through the drawer back while holding the no-tilt piece in place. ★ ★ ★

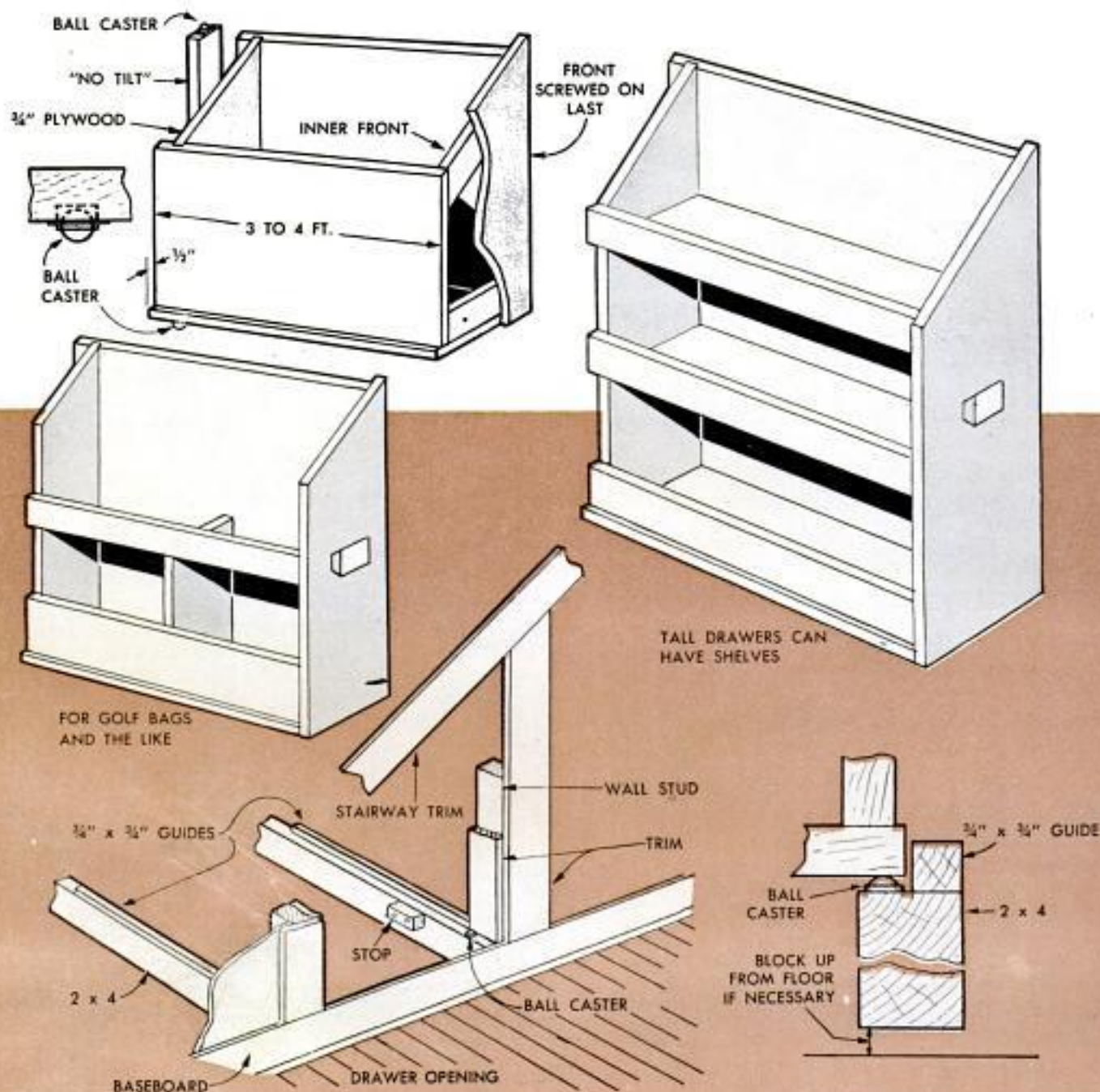

## Extension Ladder Wheeled to Job With Aid of Dolly

Heavy extension ladders are moved about easily when fitted with this one-wheeled dolly that permits them to be rolled, rather than carried, to the job. No holes are drilled through the ladder; the clamping effect of two L-shaped members holds the wheel assembly in place. The tapered member of the assembly has a half-round notch cut in the upper end to permit it to bear firmly against the bottom ladder rung. The dolly is positioned high enough so that it does not interfere with normal use of the ladder. —John W. Nash, Sayville, N. Y.

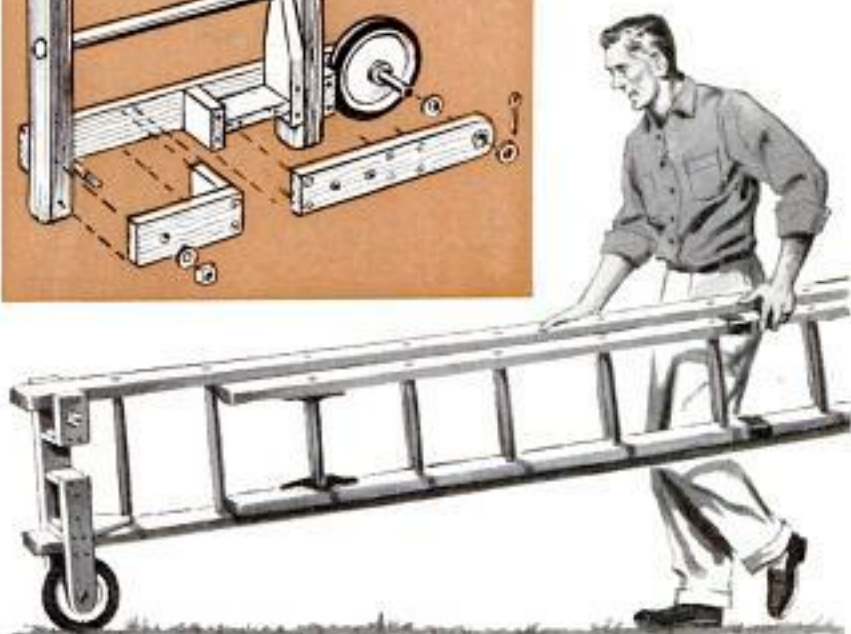
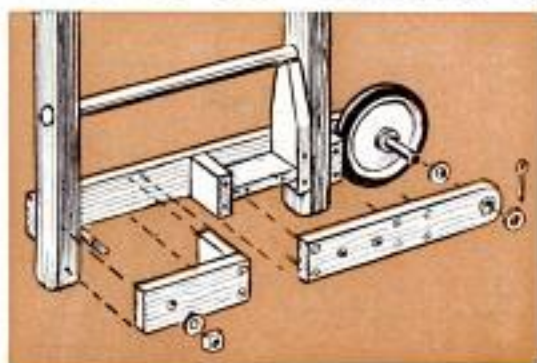

## "No Splinter" Nail Removal

Avoid splintering the face of finished lumber when driving out old nails, by placing the lumber face down on a piece of insulating wall-board. The soft board will permit easy entrance of the head of the nail, but holds back the surface of the wood.

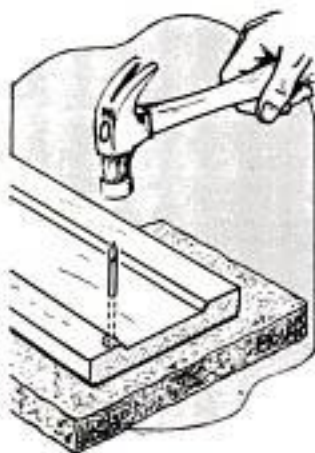

□ When jigsawing thin plywood it is much easier to get a clean cut, if the material is given a coat of shellac first. The shellac forms a hard film that prevents the plywood from tearing along the cut.

Howard E. Moody, Upper Jay, N. Y.

## Sauce Bottle Is Shop Dispenser

Shop fluids that are dispensed a few drops at a time, such as solvent to remove a spot of paint, or turpentine to clean a few smears of paint from your hands, are kept ideally in a soy-sauce bottle. The regular stopper of the bottle has a small opening.



□ Before painting the inside surfaces of a cupboard, remove the doors and shelves. Then paint the back, and then the sides. If the doors will not come off, do not paint the outside until the surfaces on the inside of the cupboard are dry.

## Truck Converted To Home

Constructed from steel angles and 22-ga. sheet steel, this body fits over the bed of a pickup truck to convert it to a mobile home. Center windows on each side swing out, and doors at the rear can be removed for added ventilation. —Fred R. Edwards, Turon, Kans.





### Hot Paper Cup Held Comfortably With Improvised Handle

Next time you are on a picnic and find that coffee has made a paper cup too hot to hold comfortably, improvise an "insulated handle" from a sheet of paper. A paper towel or napkin folded to form a strip of several thicknesses, or a strip of light cardboard, can be used. The strip should be long enough to fit around the cup snugly just under the rim, and extend enough to permit gripping it between thumb and forefinger.

### Sawhorse Easily Disassembled For Compact Storage

Here is a sturdy sawhorse that can be disassembled in a few minutes simply by removing two bolts from the top piece and legs, for compact storage in the workshop or carrying to another job in the trunk of a car. Except for the cross pieces on the legs, the sawhorse is made of 2 x 4s as shown in the detail.

Samuel Searfoss, Syracuse, Ind.

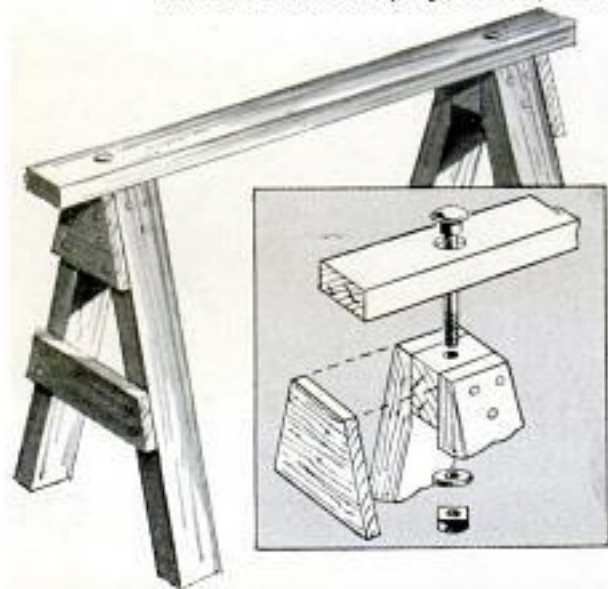

## Fluorescent Fixture From Eaves Trough

By Ralph T. Moore

A FLUORESCENT-LIGHT fixture for a drawing board, over a workbench or other similar installation is easy to make by installing one or two lamps in a reflector assembly made from a length of 5-in. eaves trough as shown in the drawing and details. Either aluminum or galvanized material may be used, in lengths of 50 and 25 in. for 40 and 20-watt lamps, respectively. For end pieces on the reflectors, manufactured end caps are used, or the end pieces can be made by cutting a pattern block of wood and using it for shaping the flanges as shown in Fig. 1. When cutting the metal end pieces, allow  $\frac{1}{2}$  in. for the flanges. Galvanized end pieces are soldered in place, aluminum ones are riveted or bolted. To accommodate two lamps in one fixture, simply cut down the back sides of two equal lengths of trough to leave 1-in. flanges for riveting or soldering the two sections together, as shown in Fig. 3. The end sections for the latter are made in the

Flanges on ends of light fixtures are shaped on wooden pattern block jigsawed from 1-in. stock

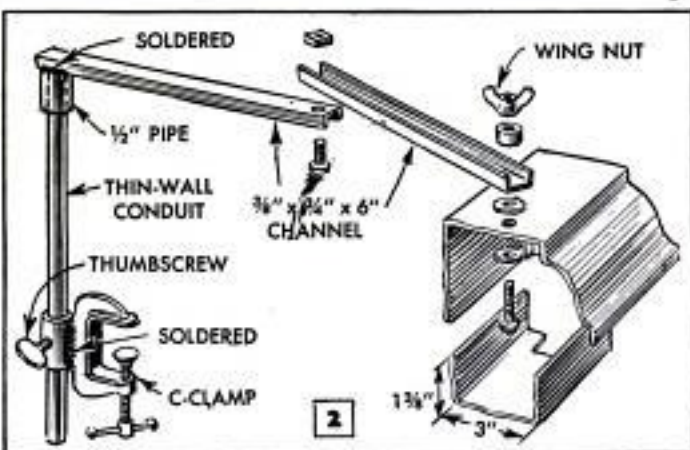

POPULAR MECHANICS





same way as for a single-lamp fixture.

Installation of the lamp circuit, including two end sockets and one starter for each lamp and one ballast of suitable capacity for each fixture, is the same or similar for all fixtures. Follow the diagram for wiring printed on the ballast, or the one shown in the detail. After bolting the sockets, switch and ballast in place, a cover piece  $1\frac{3}{8} \times 3$  in. is formed from 28-ga. galvanized sheet steel and two cutouts made at one end of the cover to accommodate the socket and starter. This cover, the length of which

is determined by the length of the lamp used, is then bolted to the reflector as indicated in the detail. Be sure to insulate all connections and electrical parts mounted on the fixture.

The completed fluorescent fixture can be screwed to a wall, ceiling or other place, or attached to the adjustable brackets, Fig. 2. A thumbscrew on the lower end of each bracket permits adjusting the light to the desired height. The channel-steel members are pivoted for easy adjustment on a horizontal plane. ★ ★ ★

To accommodate 20-watt lamp, a 25-in. length of eaves trough is required, 50-in. length for 40-watt lamp

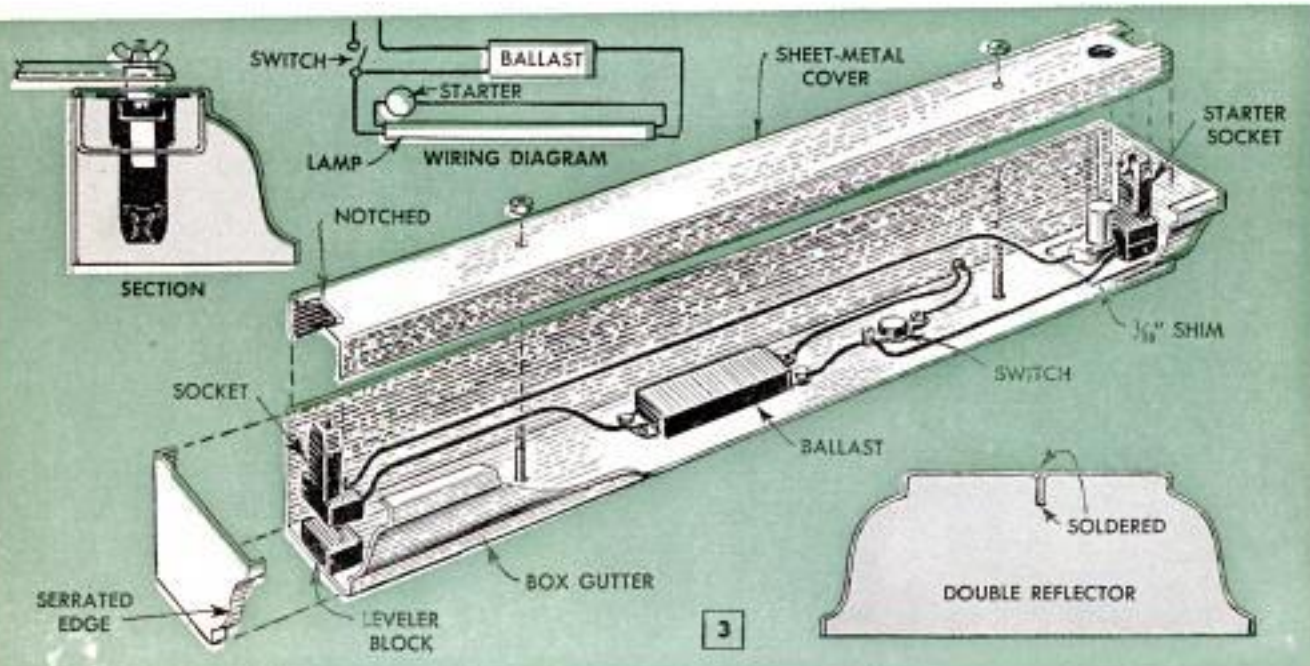

## Dolly for Camera Tripod Made From Stove Casters



Easy movement of a camera tripod to permit shooting from various angles is assured when the tripod is mounted on a dolly consisting of three stove casters. About 9 ft. of heavy cord or light chain is used to keep the casters aligned. The casters and chain fold to form a package that can be carried in a camera-equipment case.

## Novel Miniature Drums Made From Tin Cans

Dress hooks and eyes hold the cords on these novel containers, made to resemble drums. Food tins covered with sheet plastic are used for the containers. The hooks are simply fitted over the top edge of each can, but holes must be punched in the bottoms of the cans to accommodate the ends of the hooks.—Fritz Snyder, Dover, N. J.



## Concrete Form for Postholes

When setting clothesline posts in concrete, dig the forms so that the side of the hole toward the direction of pull is flat. Greater resistance to the pull is offered by the flat surface than would be presented by the usual rounded form.

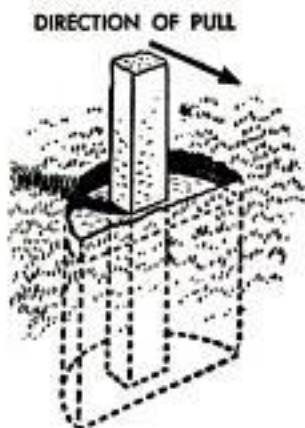

## Steel Guard Protects Taillights

Guards cut from 1/4-in. steel plate are welded over the stoplights and taillights on the trucks used in one orchard to prevent breakage by low tree limbs.

Charles L. Stratton, Windham, N. H.

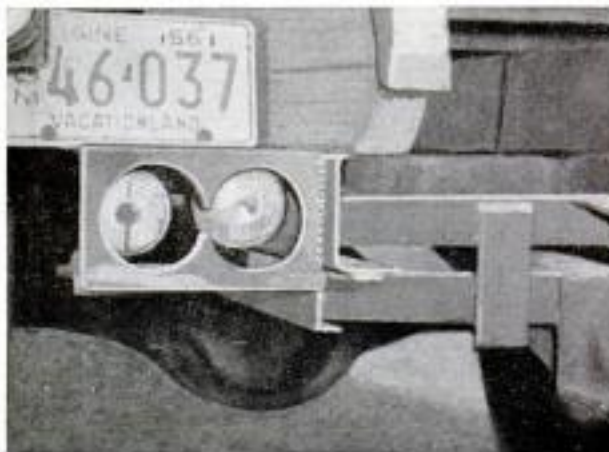

## Tying a Cigarette in a Knot Without Breaking the Paper



Can you tie a cigarette in a knot without breaking the paper? The trick is not as difficult as it might seem. First, the cigarette must be king-size without a filter. Wrap it tightly in a double thickness of cellophane and twist the ends of the cellophane tightly against the ends of the cigarette. The cigarette can then be tied in a knot, straightened and removed from the cellophane and smoked.

# "BOX BLOCKS"

## Will Delight Any Child

YOUNGSTERS love to play with blocks, disks, cylinders and boxes, assembling them in various ways to produce, in their imaginations, anything from a fairy-tale castle to a snorting locomotive. This set of giant "box blocks" will delight any child, including as it does, real axles and wheels that allow him to construct toys that can be wheeled around. Dad will find the set easy to make. Wheels can be bandsawed, axles are lengths of dowel and the solid blocks can be scraps left over from a woodworking project. The boxes should have drawer-type joints.

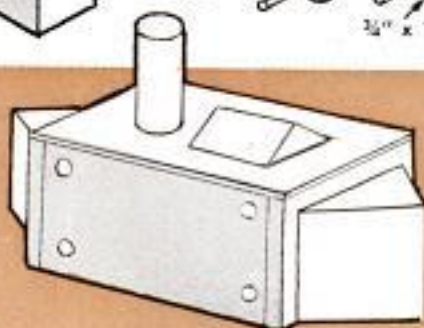
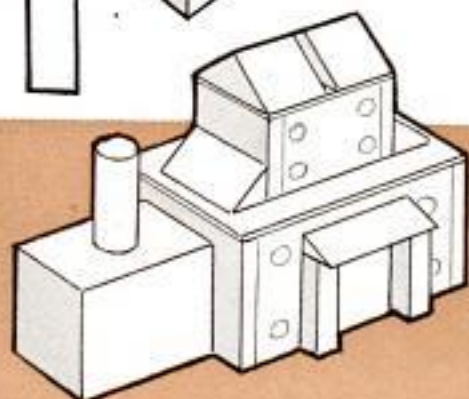
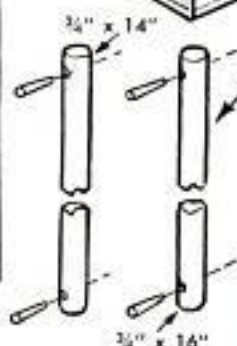
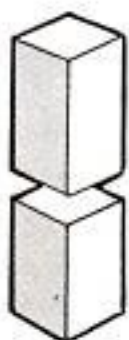
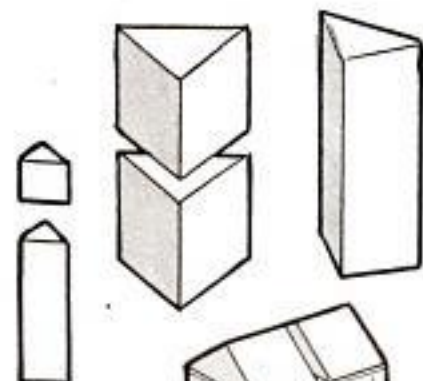
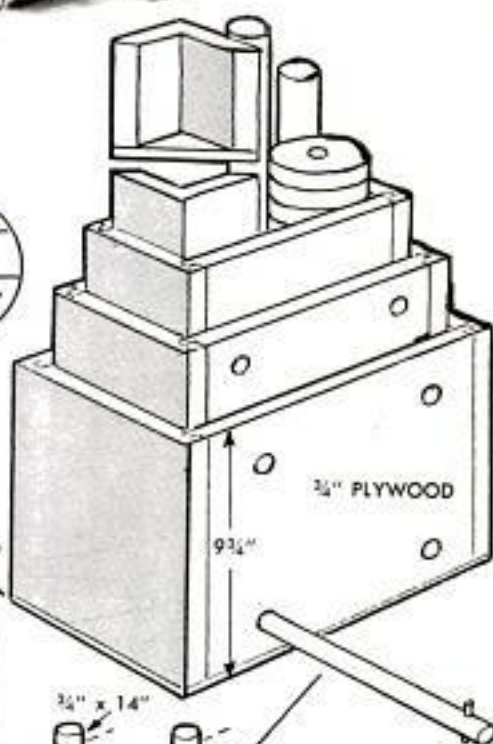
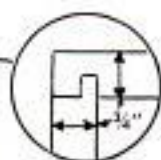
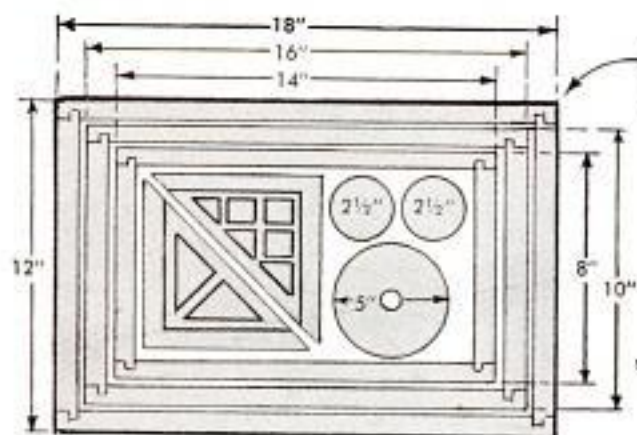

# Change Room

By John Bergen

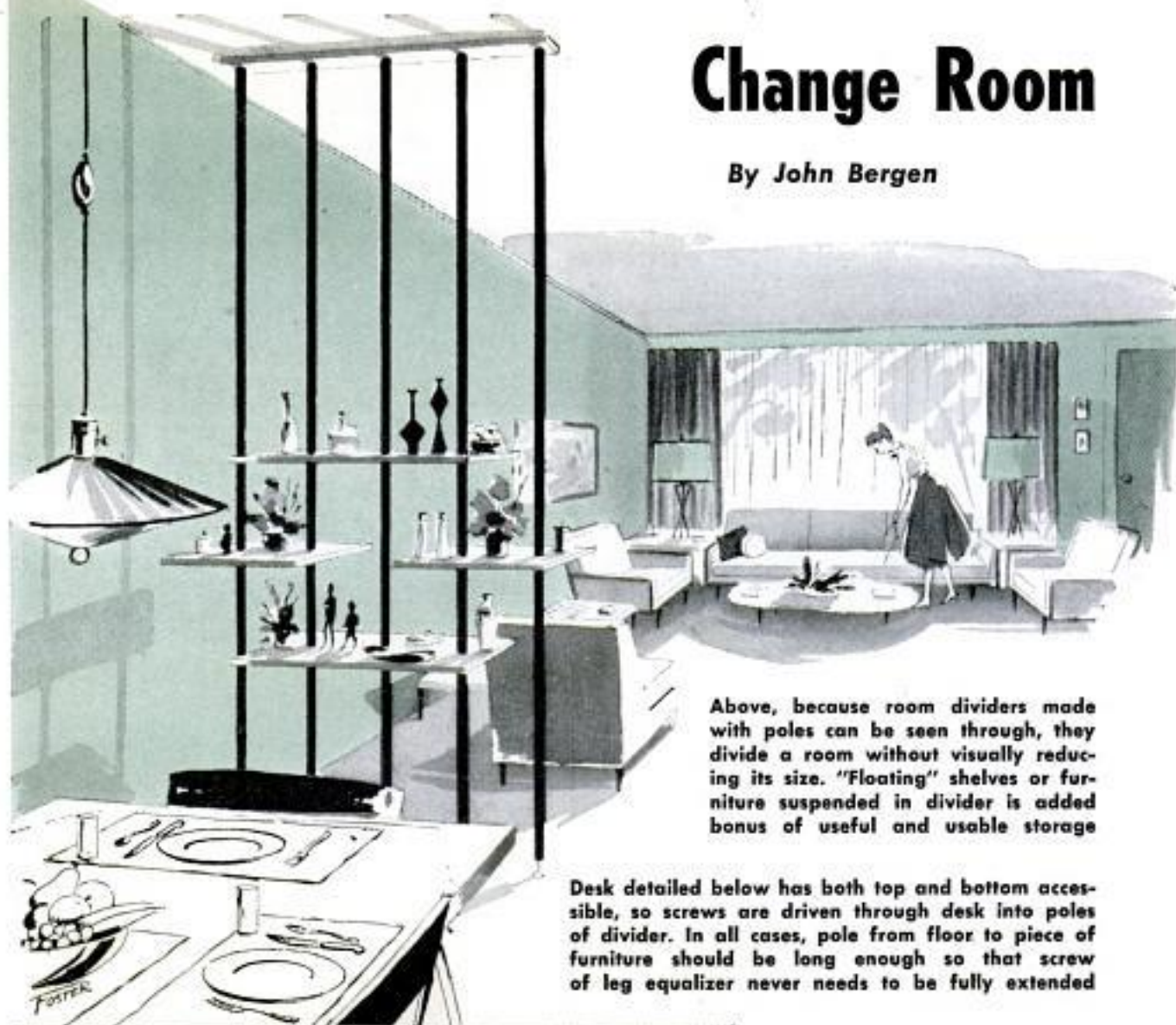

Above, because room dividers made with poles can be seen through, they divide a room without visually reducing its size. "Floating" shelves or furniture suspended in divider is added bonus of useful and usable storage

Desk detailed below has both top and bottom accessible, so screws are driven through desk into poles of divider. In all cases, pole from floor to piece of furniture should be long enough so that screw of leg equalizer never needs to be fully extended

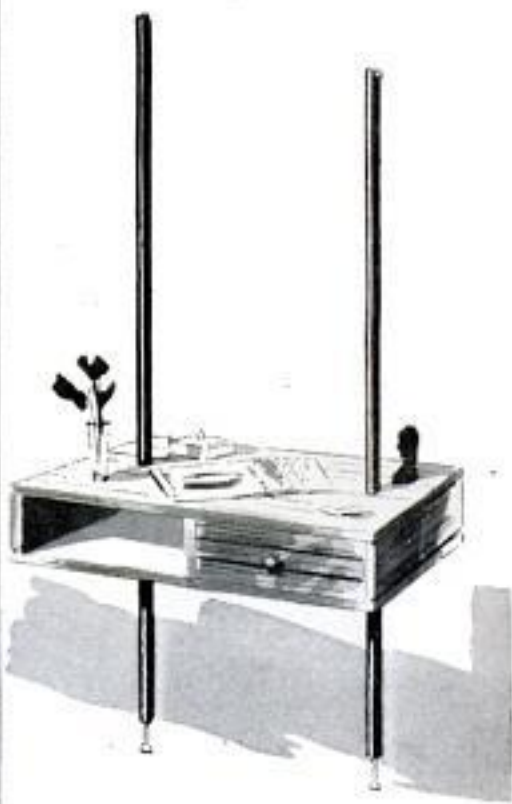
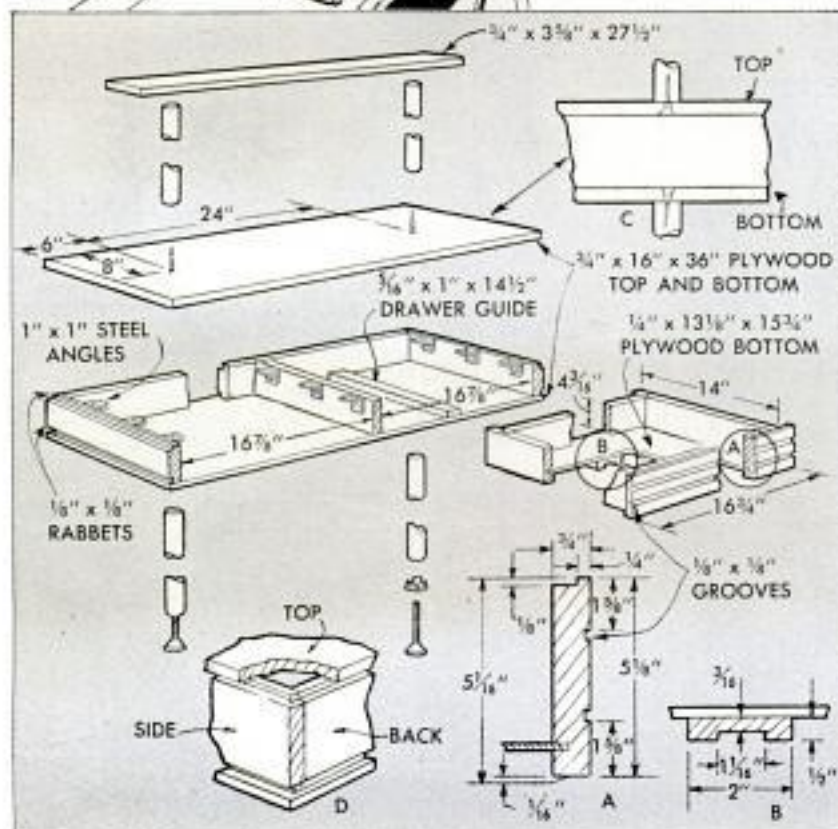

# Decor With These Movable Dividers

To move these dividers to the opposite side of the room, or to another room, just loosen the leg equalizers, or "jacks," which hold them in place.

ROOM DIVIDERS that consist mainly of large-diameter dowels are a popular means of dividing areas in a modern home without visually decreasing the size of a room. With the aid of screw-type furniture-leg equalizers and a number of 1 $\frac{3}{8}$ -in.-dia. closet poles, any craftsman not only can duplicate these room dividers at moderate cost, but can add attractive "floating" furniture as well. The leg equalizers permit the dividers to be wedged against the floor and ceiling, no nails or screws being used to attach the ends. Thus, no damage is done either to the ceiling or to the floor. Also, this method of installation permits the dividers to be moved about easily when it is desired to rearrange furniture or to change the appearance of a room. And if you move to another home, the dividers can be taken down and moved with the other furniture.

Illustrated on these pages are a set of shelves, a writing desk, a telephone table

and a planter that can be incorporated in a room divider. Dimensions of the desk are detailed; the other items consist mainly of flat sheets of plywood or solid stock. The planter can be built as a box, with a lining of copper or aluminum, or simply as a flat table in which openings are cut to receive the metal liners. An apron around the table gives the illusion of greater thickness.

The upper ends of the poles are glued and screwed in holes made in a 1 x 4 bearing plate. Where the poles pass through the shelves, each one can be toenailed by driving a long finishing nail at an angle through the pole and into the shelf from the underside. The top of the bearing plate can be padded with a strip of felt to keep from marking the ceiling. The bearing plate can be painted to match the ceiling if it is desired to make it less conspicuous, or it can be painted to match the poles which might provide a contrast to the rest of the room decor. ★ ★ ★

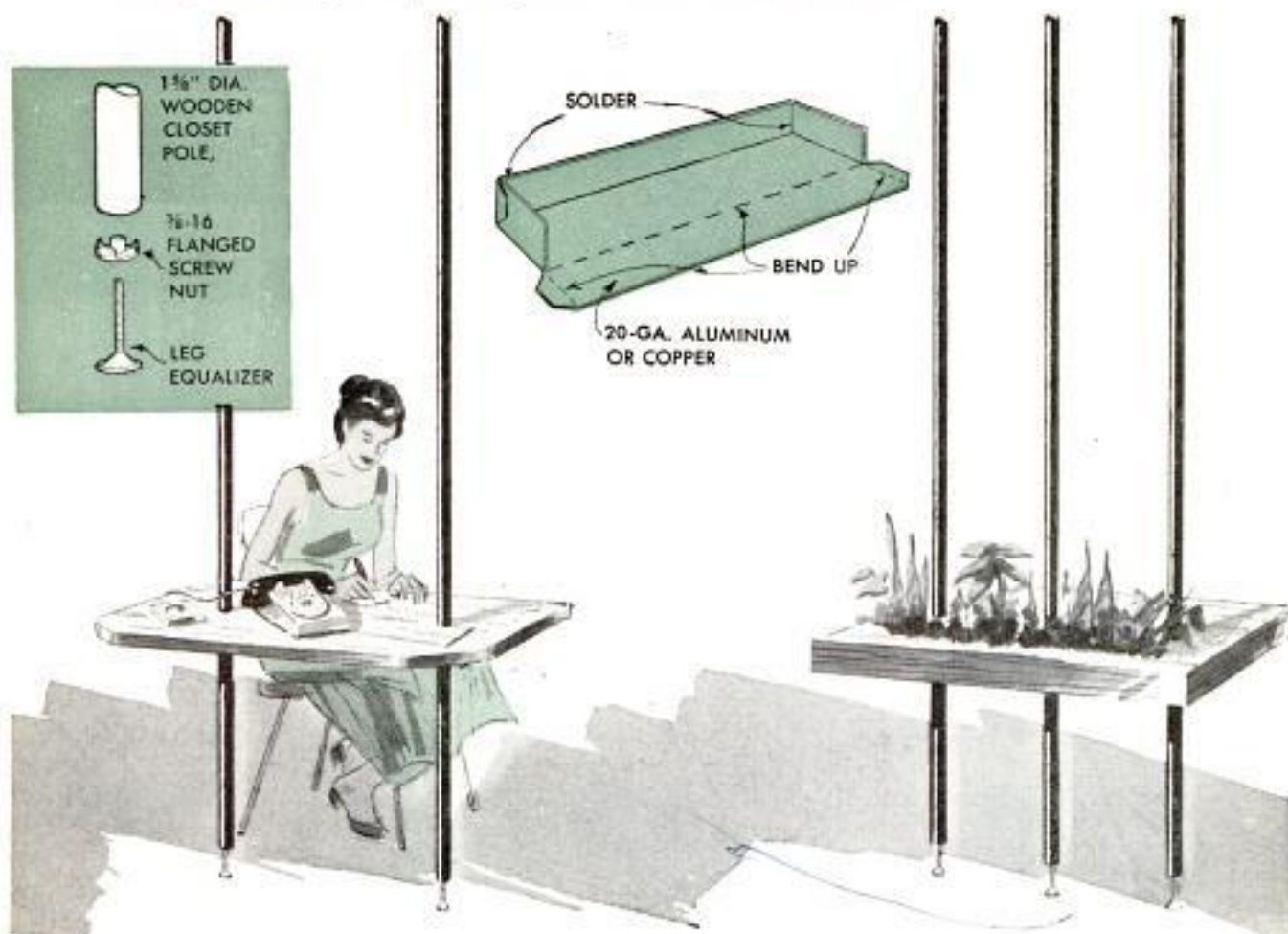

## Tack Driven Into Frame Corrects Sagging Cabinet Door



When the door on a wooden kitchen cabinet sags so that it is difficult to open and close, the defect often can be corrected temporarily with a rubber-headed tack. Drive the tack in the position indicated. As the door is closed, the tack will force the lower edge upward.

## Repairing Loose Chair Rungs

To tighten turned chair rungs or legs that have become loose, wrap the tenons with glue-soaked strips of cloth. Fit the tenons into the legs and clamp tightly with bar clamp until dry.

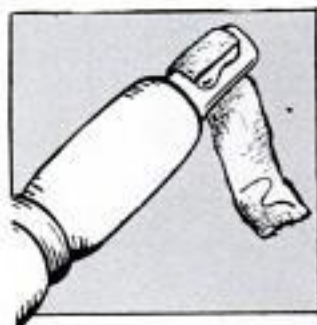

## Hook-on Bird Feeder

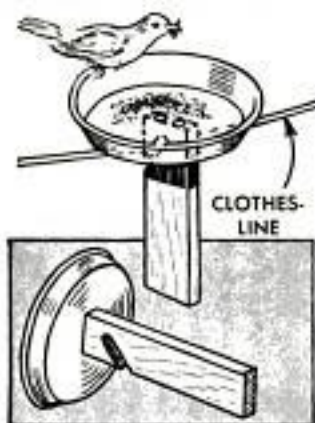

Simply hooked over a clothesline, this bird feeder is easy to remove for filling. It consists of a 2 x 4, notched as indicated, with a cake pan nailed to the end. The weight of the lower portion of the 2 x 4 counterbalances the pan and the birds.

## Adjustable Depth Gauge

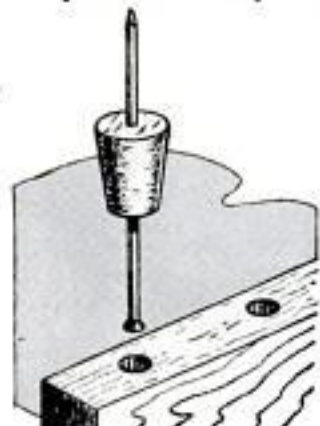

Ideal for checking depth when drilling blind holes for dowels, this simple depth gauge is made by driving a finishing nail through a cork. The gauge is easily adjustable by sliding the cork on the nail. Holds any setting without slipping.

## Reconditioning Paintbrushes

Old paintbrushes that have become frayed and misshapen from much use can be reconditioned by dipping them in a water-soluble adhesive after they have been cleaned thoroughly. When the adhesive has set, reshape the bristles by sanding, then soak in water to remove the adhesive.



## Saw Blade Perforates Paper

Straight-line perforation of a small number of sheets of paper can be done by using a coarse hacksaw blade. Place the paper on a flat, fairly resilient surface, such as linoleum or soft wood, then tap the saw blade until the teeth just puncture, but do not cut, the paper.

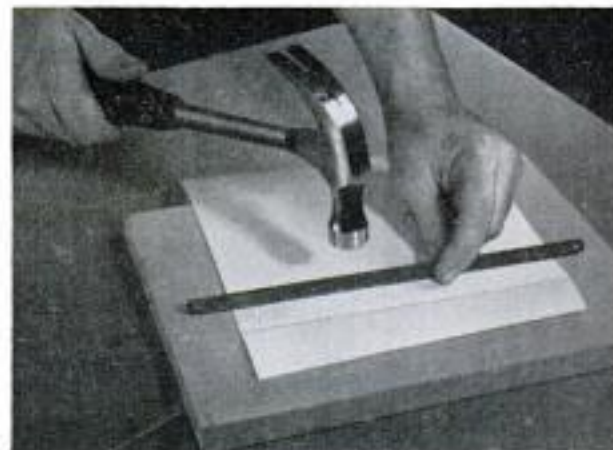

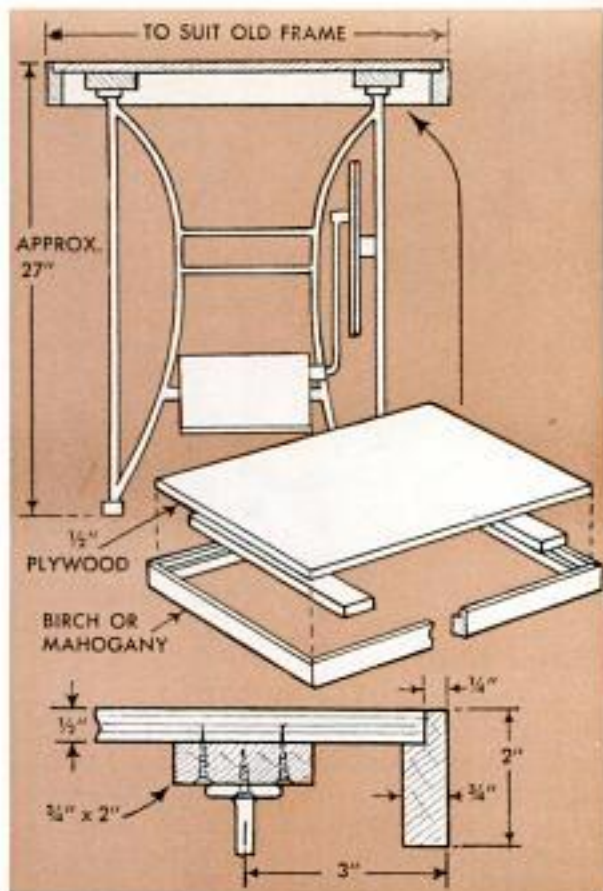

## Lamp Table Made From Old-Fashioned Sewing-Machine Frame

Unique and attractive in appearance, this lamp table with "wrought iron" legs is made from an old-fashioned, treadle-powered sewing-machine frame. The original top on the machine is removed and replaced with one made as shown in the details. Dimensions of the top will vary with different machines, but should be of a size that gives a measurement of 3 in. from the center of a leg to the outside edge of the table-top apron. The 1/2-in.-plywood top is

fitted in a rabbet cut in the apron that is made from 3/4 x 2-in. stock. Corners of the apron are mitered for neater appearance. Two cleats, also cut from 3/4 x 2-in. stock, are screwed to the underside of the plywood top, both to provide rigidity and to permit using longer screws for fastening the top to the sewing-machine frame. The table apron can be light to match the plywood, or dark for contrast. Lock treadle with a bolt.—Hi Sibley, Nuevo, Calif.

## Wooden Handle in Push Broom Tightened by Inverted Screw

When the wooden handle on a push broom no longer can be tightened in the broom because the threads are worn, drop a wood screw into the hole in the broom as shown, so the screw jams between the threads.



☛ When mixing concrete, avoid the use of shale, soft limestone or any material that crumbles or slivers as an aggregate.

## Tailor's Chalk Kept Sharp With Notched Knife Blade

Keeping a sharp edge on the special chalk used to mark clothing for alterations is no problem when a notched knife blade is used. The chalk simply is drawn across a V-notch ground near the heel of the blade of a knife.



☛ An easy way to test the accuracy of a bathroom scale is to place a 5-lb. bag of flour or sugar on it.



### Putty Knife Is Nailing Guard

When nailing quarter round in place, protect the baseboard from denting or splintering due to a misdirected hammer blow by using a wide putty knife. Hold the putty-knife blade against the baseboard directly behind the nail to be driven. Do not let it slip behind the quarter round.

### Putty Levels Wobbling Furniture

Occasionally it is more satisfactory to lengthen the one short leg of wobbling furniture than to shorten any of the others. Put wood putty under the short leg, using wax paper to keep it off the floor, then press down on the item of furniture until it levels. Trim and sand putty to shape.



☐ Furniture scratches may be concealed by rubbing them with a solution of equal parts of boiled linseed oil, turpentine and white vinegar.



### Planter Made of Hornets' Nest

An unusual planter was made for one home from an abandoned hornet's nest. One end of the nest was cut off, loose debris was removed from the inside and the outside was shellacked. A wire was forced through the nest to serve as a hanger after the shellac was thoroughly dry.

### Lighted Card Is Focusing Target

When photographing some subject that is in a dimly lit area, use a playing card held on the end of a flashlight with a rubber band as a focusing target. With the light turned on, the card is visible on the ground glass. Photoflash, of course, provides light for the exposure.



☐ Clogged gas-stove burners should be removed for cleaning, the holes cleared with a pipe cleaner or wire and units washed in hot soapy water before replacing.





## “CANTILEVER” DESK For the Home Office

*includes pigeonhole wall rack with built-in fluorescent light*

**T**HIS ALL-MAHOGANY DESK and wall rack is ideally suited for part-time free-lance writers, owners of small businesses and others who need an office in the home for handling correspondence and keeping records. The secretarial-style desk accommodates a full-size typewriter in a compartment on the right side and the rack above has five compartments, or slots, for filing correspondence and storing

stationery. Both units are attached to the wall studs as shown in the drawing and details, requiring a minimum of space for this compact little office and permitting unrestricted access for cleaning under the desk. A shallow drawer in the left pedestal of the desk provides convenient storage for pencils and other miscellaneous items. A deep drawer under the shallow one permits installation of a handy filing system

DESK		LIST OF MATERIALS			Specifications	
Pieces	Description	Thickness	Width	Length		
1	top	1 3/8"	24"	80"	Hollow-core door or good 1-side 3/4" plywood	
1	typewriter shelf	3/4"	14 1/2"	21"		
4	ends	3/4"	23 1/4"	18"		Good 2-side plywood
2	bottoms	3/4"	23 1/4"	15 1/2"		"
2	backs	3/4"	15 1/2"	17 1/4"	"	
1	door	3/4"	18"	17"	"	
1	drawer front	3/4"	4 1/2"	17"	"	
2	drawer sides	1 1/2"	4"	22 1/2"	"	
2	drawer sides	1 1/2"	12"	22 1/2"	Good 1-side plywood	
1	drawer back	1 1/2"	3 1/8"	14 1/4"		
1	drawer back	1 1/2"	12"	14 1/4"		
2	drawer bottoms	1 1/2"	22 1/2"	16 1/4"		
4	gluing cleats	3/4"	3/4"	1"		
<b>LETTER PIGEONHOLES</b>						
2	ends	3/4"	12"	8 1/4"		
1	top	3/4"	12"	48"		
1	bottom	3/4"	11 1/4"	48"		
1	back	3/4"	4"	48"		
1	apron fascia	3/4"	4"	48"		
4	dividers	3/4"	4"	11 1/4"		

**NOTE:** Unless otherwise specified, material to be solid Philippine mahogany

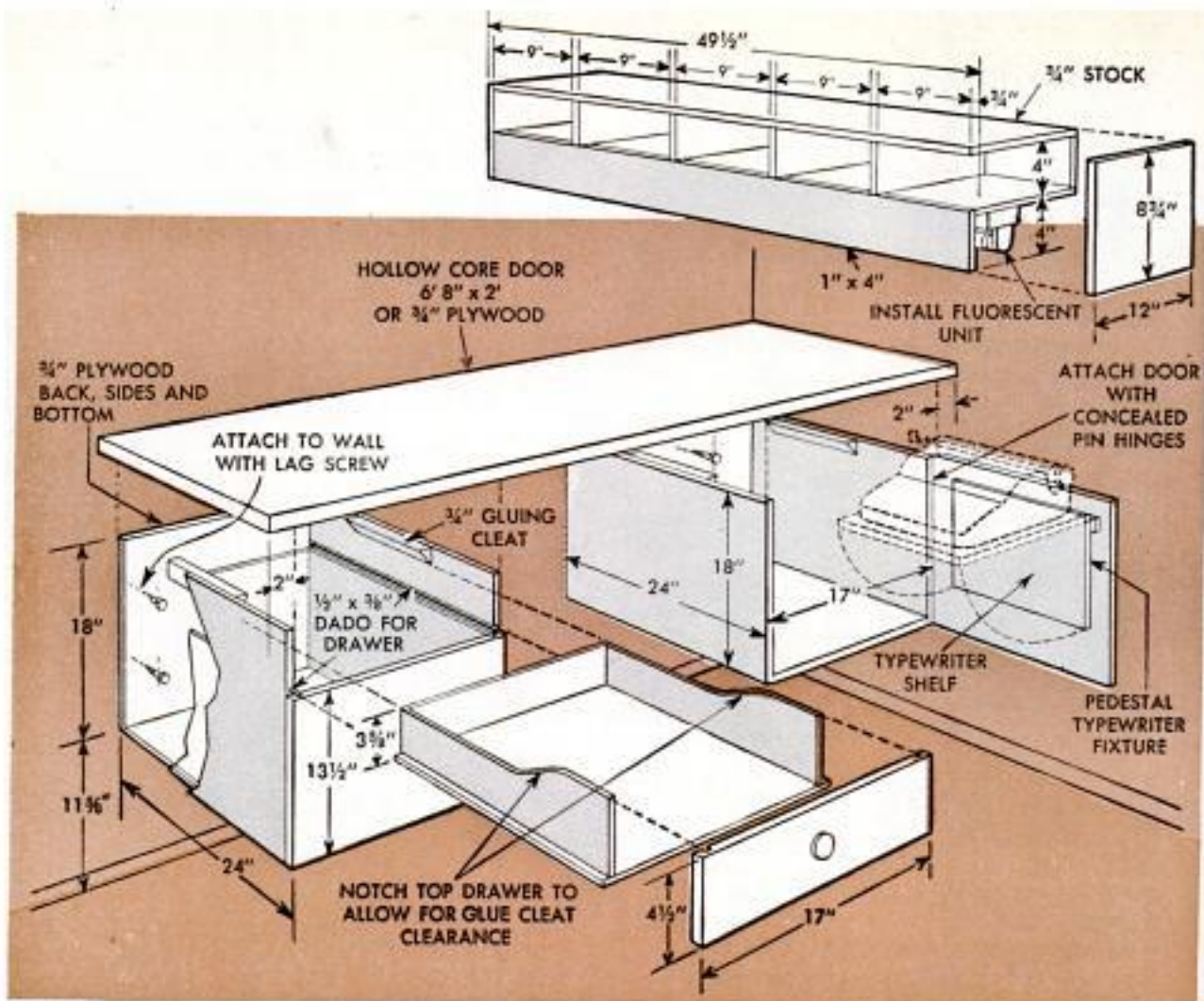

for important papers. The compartment in the right-hand pedestal accommodates a typewriter that is bolted to a hinged shelf attached to the door as shown. The shelf is fitted with a brace to keep it in a horizontal position when the typewriter is in use. The door is attached to the desk with concealed pin hinges so that no part of the hinges is visible when the door is closed.

The combination rack and light can be attached to the wall facing the right side of the desk as illustrated, or it may be installed over the desk as desired. When the rack is located over the back of the desk, the fluorescent unit installed on the underside of it provides an even distribution of light over the entire work area. The latter arrangement is ideal when the entire desk top is needed for drawing or sketching work, laying out a large quantity of material or doing other work.

If you wish, a veneer-faced flush door can be used for the top. Being thicker than plywood, it will improve the looks of the desk. Added thickness to a plywood top can be gained by gluing and screwing 3/4-in. strips around the edges on the underside and then banding them with veneer tape. In this case, extra cross strips should be added to accommodate the gluing cleats.

All members are assembled with glue and wood screws. The completed units can be stained and varnished as desired. The top should be given several coats of spar varnish, or a glass top can be provided. When attaching the desk to a wall, be sure to drive the lag screws into wall studs for proper support. If it is impossible to secure the desk to wall studs, legs or a suitable base can be screwed to the bottoms of the two compartments to provide the proper work height of 30 1/2 in. ★ ★ ★

Courtesy Philippine Mahogany Association

## Protecting Garbage Cans

To discourage rust from forming in garbage cans and wastebaskets, coat the inside with paste wax. An even coating can be applied by melting the wax so it may be spread with an old paintbrush.

196

## Can Covers Catch Drips

When using paint remover to remove the old finish from a chair for example, can covers placed under the legs to catch the drips give better assurance than newspaper against damage to floor or other finish.

POPULAR MECHANICS

## Door Bars Sparrows From Martin House

If you want to keep sparrows and other winter birds out of a martin house until the martins arrive in the spring, install a sliding panel that can be pulled across the entrances on the inside as shown in the detail. The panel is  $\frac{1}{8}$ -in. hardboard slotted to move horizontally on two screws. Nest dividers are set back about  $\frac{1}{2}$  in. to accommodate the panel. When the house is cleaned in the fall, the panel is pushed across the entrance by hand. A cord tied to one end of the panel and led through a hole in the side

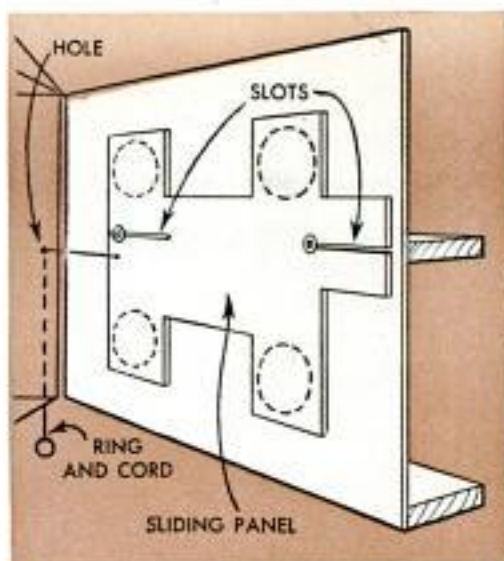

of the house as shown, is used to open the house when the martins arrive.

Enno R. Haan, Evanston, Ill.

## Tetrachloride Cleaning Makes Electric Clock Run Like New

The next time one of your electric clocks begins to run slow or emit an ominous buzzing, don't throw it away. Most likely all that is needed to correct the condition is to remove the accumulation of dust that has filtered through the openings in the back of the case and collected on the moving parts. The actual cleaning is a simple operation. First, remove the screws at the back of the case so that the works can be taken out, being careful not to damage the hands on the clock or scratch the face. When the works have been removed, hold them over an empty coffee can or other container and flush the gears and shafts with carbon tetrachloride using an eye dropper to apply the liquid. After all foreign matter has been removed, flush the parts with clean fluid once more and allow it to evaporate before reassembling the clock. One precaution that must be ob-

served is to hold the works in a position that will prevent cleaning fluid from contacting the coil terminal wires and loosening them. If the clock does not run properly after cleaning it in this manner, the trouble may be in the small synchronous motor that drives the works. Since this motor is a sealed unit, dirt cannot foul it, except at the point where the shaft and pinion extend from the housing and engage the gear that drives the clock. Usually, this trouble can be remedied by removing the motor unit and soaking it in carbon tetrachloride. Then, the end of the motor having the shaft and gear is submerged for an hour in a cleaning-lubricating fluid of the type used by radio servicemen for cleaning switch contacts. Before doing the latter, it may be necessary to heat the motor slightly so that the vacuum created when it cools will draw the fluid into the bearing.

## Lines on Underlay Aid in Sketching

Guide lines marked on underlay sheets can be substituted for vanishing points beyond the edges of the board. On the floor or a large table, mark off several of the sheets with the vanishing points at various distances, making one set of lines solid, the other dotted. You then can mount the drawing over the proper sheet.

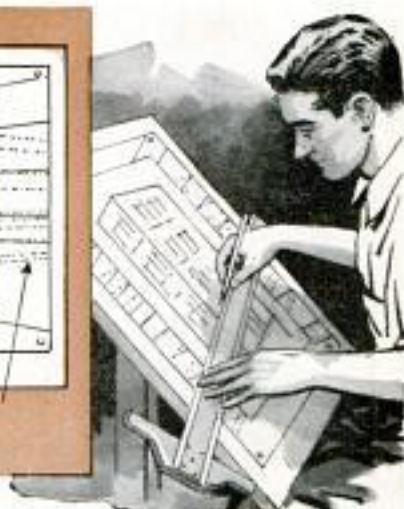



### Protect Tools From Corrosion

Tools that are not used very often can be protected from corrosion by applying a thin coating of an anticorrosive lubricant as shown in the photo. The tools should be coated after each use and each time they are cleaned.

### Make Handsawing Easier

Less effort is needed when using a hand-saw or hacksaw if pressure is applied only on the forward stroke. Also, wear on the teeth will be reduced if the saw is lifted slightly on the return stroke.

### Upping Small-Scale Capacity

When an object you want to weigh exceeds your scale's capacity, try using the setup shown below. A 4-ft. length of rigid pipe serves as a beam that is supported at one end by a fulcrum on a table and at the other end by a fulcrum on the scale. The weight of the pipe is noted on the scale—2 lb. in this instance. Then, the object to be weighed is hung on the pipe at a distance from the table fulcrum equal to one fourth the distance from fulcrum to scale. Again the weight is noted—17 lb., and the 2 lb. subtracted from it. The result, 15 lb., multiplied by 4 equals the total weight of the object.—W. M. Wayne, Miami, Fla.

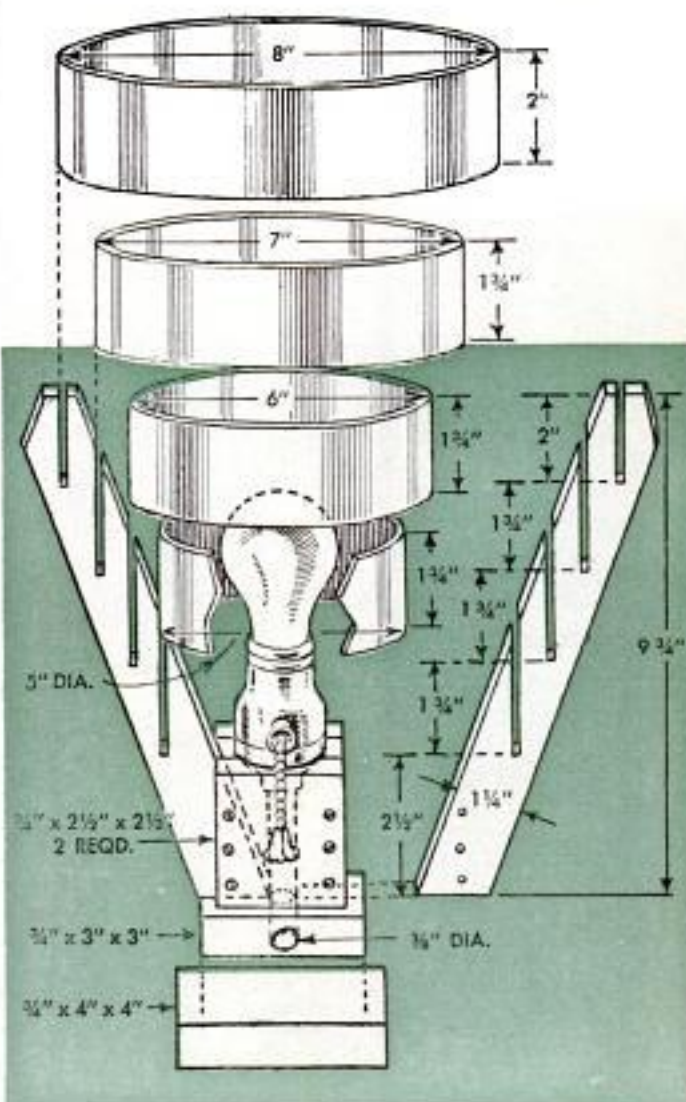
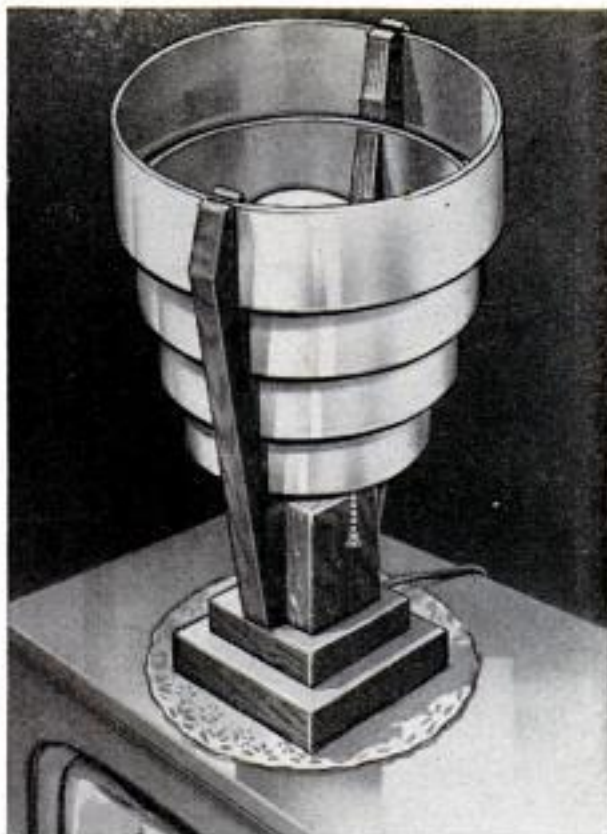
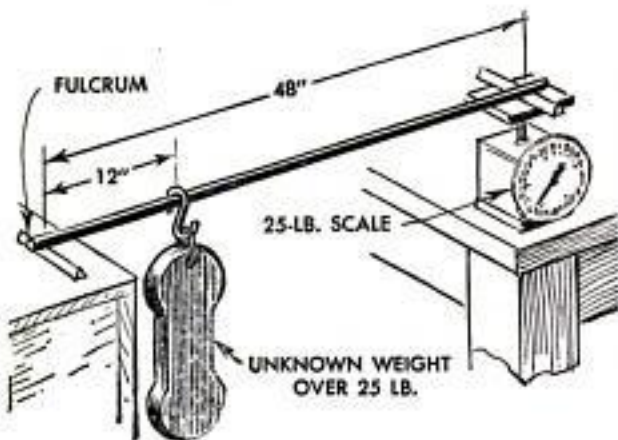

# MODERN TV LAMPS

CALIF.

By M. C. Anderson

15100 THOITS ST., SAN LORENZO,

THE TWO LAMPS illustrated in this article are so easy to make that any homemaker can assemble both of them in one evening. Tiers of metal Venetian-blind slats that form the shade on the lamp shown on the opposite page direct most of the light upward, making it an ideal lamp for use where indirect lighting is desired. To make this lamp, simply cut the various members to size as shown in the details, and make the saw cuts in the arms that support the slats. The arms, cut from  $\frac{3}{4}$ -in. material, should be clamped together when making the saw cuts. Drill the hole in the base for the lamp cord. A pull-chain-type light socket screwed to a length of threaded electrical pipe which is clamped between the two vertical blocks of the base, completes the job. It is important to make the saw cuts exactly as indicated so that the shade tiers overlap  $\frac{1}{4}$  in.

The lamp shown on this page requires even less time to make. Wooden dowels are used for uprights. Two pairs of embroidery hoops, of which the inner one of each pair is screwed to the uprights as shown, provide a means of clamping the translucent-plastic shade. Material for the latter is ob-



Low-wattage bulb in lamp produces soft glow for most effective display of design in plastic shade

tainable in most variety stores. The ends of the plastic lap  $\frac{1}{4}$  in., the lap being centered over one of the dowels at the back of the lamp to prevent light leaks. Pilot holes are drilled for the screws to prevent splitting, and the heads are countersunk for proper clearance between hoops. ★ ★ ★

Ends of plastic material must lap  $\frac{1}{4}$  in. when clamped in hoops. Lap is located over dowel at back of shade

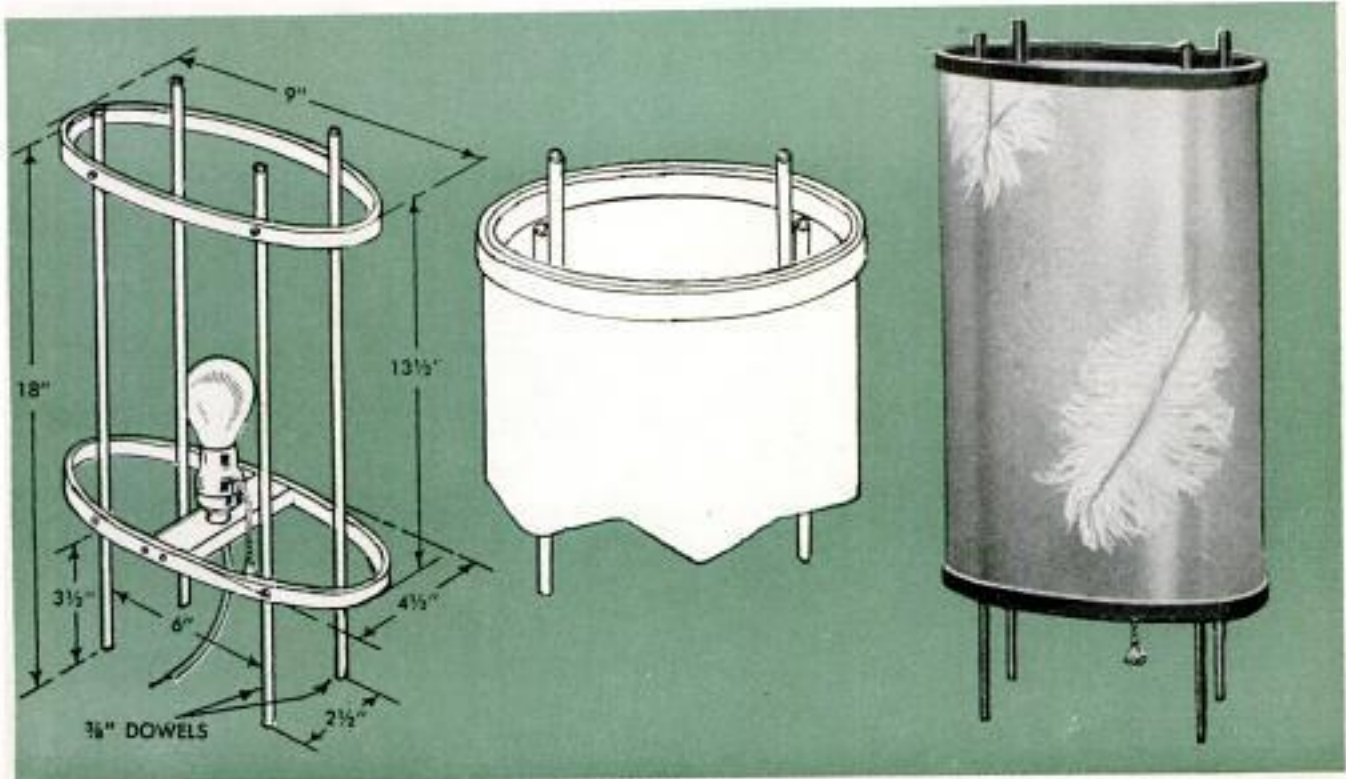



## Fence Supports Temporary Walk

When planks are used as a temporary sidewalk for a new home before the permanent concrete walks are installed, they sometimes have a tendency to sink or slide underfoot when the ground is muddy. To prevent this, first lay snow fencing on the ground to provide a firm, "floating" base.

## Handholes in Oil Drum

To permit easier handling of an oil drum when it is used as a trash container, cut handholes directly in the drum. Mark semicircles near the top edge, flat sides up. Cut only the circular part, fold up resulting flap and cover with split hose.



## Quick Repair for Chipped Trays

When an enameled darkroom tray has been chipped down to the bare metal, a quick, chemical-proof repair can be made with common household paraffin. Hold a lighted match under the chipped spot until the metal heats a bit, then rub the paraffin over the exposed metal until a layer is deposited. This will adhere well with solutions of normal temperature, will not affect photochemicals.



## Cleaning Wooden Counter Tops

Light stains on wooden counters can be removed with scouring powder. Household bleach will remove stains that penetrate the wood surface. After bleaching or scouring, restore natural color with olive oil.

## Photo-Scale Capacity Increased

Darkroom scales, generally equipped with weights that total only a few ounces, can be used to weigh dry materials up to 1 lb. without overloading. Obtain a piece of metal that weighs exactly 1 lb., or, with the aid of a scale, pour dry sand into an empty tin can to produce a 1-lb. weight. The weight then is used as indicated, dry chemicals being poured into a paper bag.

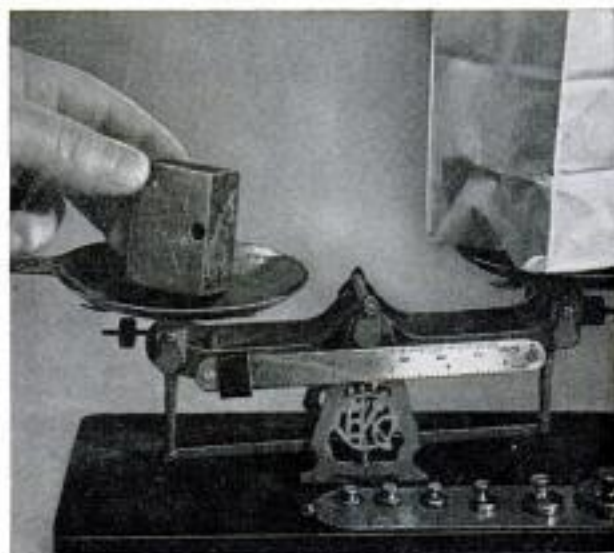

POPULAR MECHANICS

## Spindle for Binder Twine

Waste and tangling of a ball of twine used for odd jobs around the farm are avoided by using a spindle consisting of a length of fork handle fitted in a hole in a square of 2-in. stock. A mower section is driven into the upper end of the spindle as a cutter.

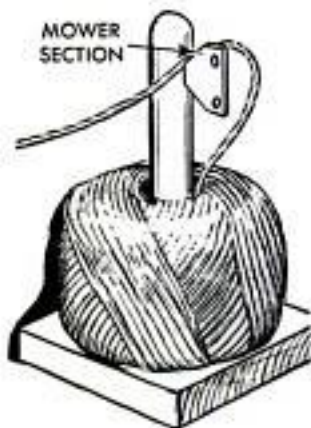



## Air-Drive Outboard Motor Powers Ice-Fishing Sled

*Prototype used 2-cycle, 4-h.p. air-drive outboard motor.* By Ben C. Robinson

**I**F YOU OWN an air-drive outboard motor, don't store it away when winter comes. Instead, clamp it to the transom of this two-man sled and go ice fishing the modern way. Rather than trudging across a frozen lake in search of a good fishing spot, crank up the outboard and whisk across the ice at automobile speeds. Locations that would require hours of walking to reach on foot are only minutes away by this air-driven sled.

The iceboat described in this article, Fig. 1, is rugged and simple to build. It was designed to carry two good-sized men at speeds of about 10 m.p.h. over snow and rough ice, and at speeds up to 40 m.p.h. and more, depending on the horsepower of the motor used, on smooth ice. For the main frame of the sled,  $\frac{1}{4}$  x  $1\frac{1}{2}$  x 2-in. steel angles are used to assure adequate strength. For a one-man version of the

sled, lighter angles could be used. But even with the heavier members, two men can lift the sled after the motor is removed, and slide it onto the bed of a pickup truck, or on a car-top carrier. A few modifications on a regular boat trailer would permit the sled to be carried on it. The details, Fig. 1, show the frame bolted together, which is entirely satisfactory and permits easy disassembly for summer storage. However, an even more rigid frame will result if welded construction is used. No dimensions are



Bait is no problem when ice fishing. The onion-like bulbs on dried goldenrod stalks contain grubs that are tempting morsels to hungry fish

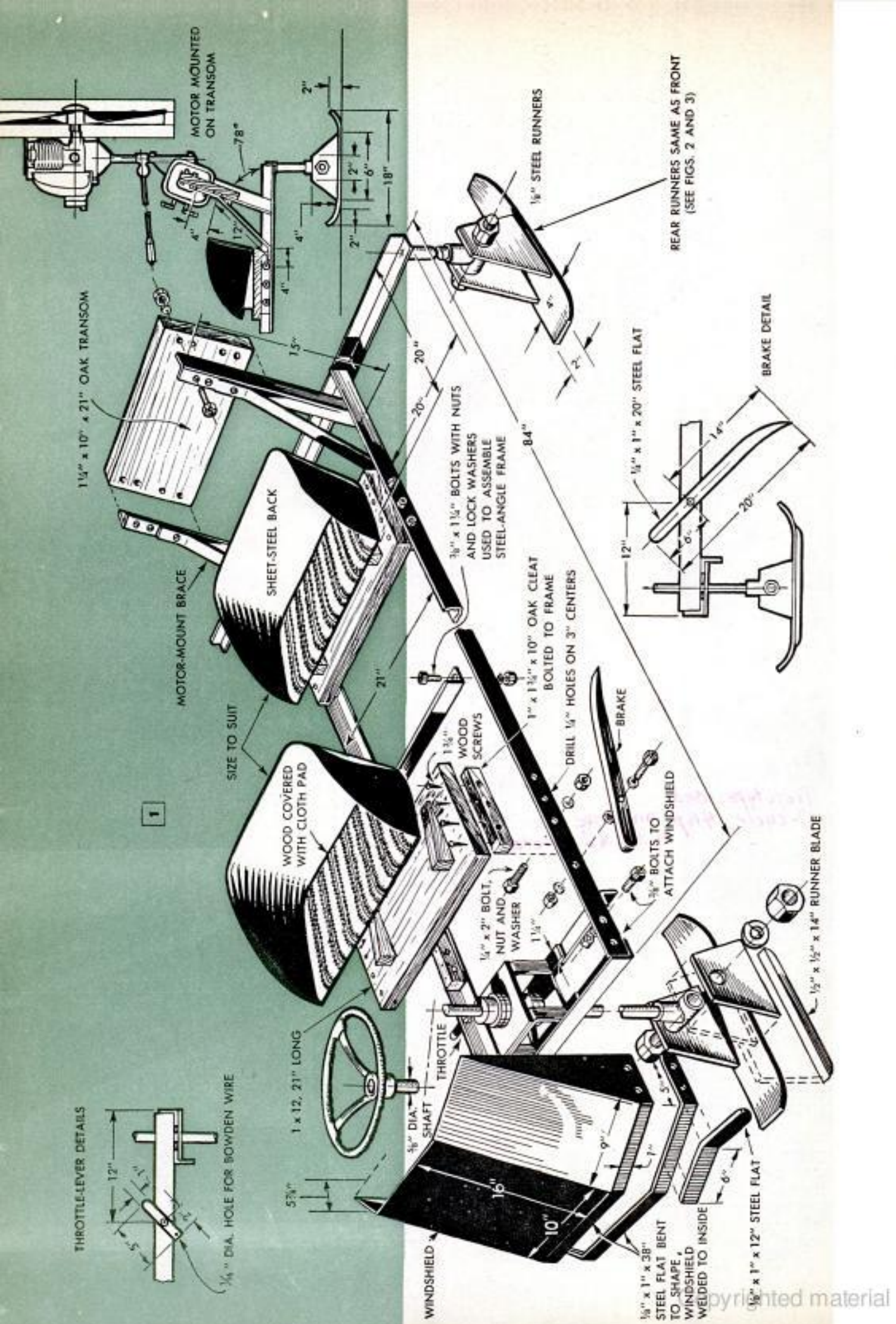



2 STEERING ASSEMBLY AND FRONT RUNNER

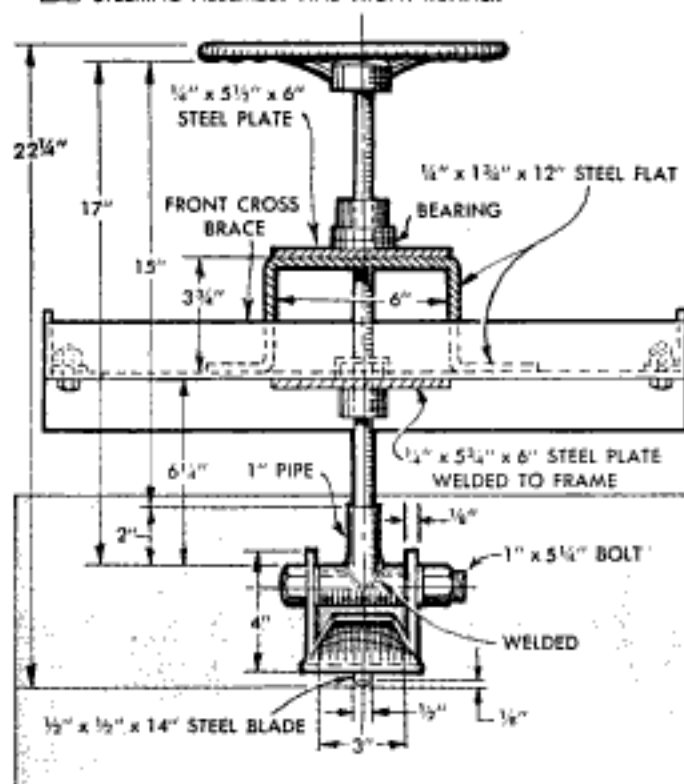

3

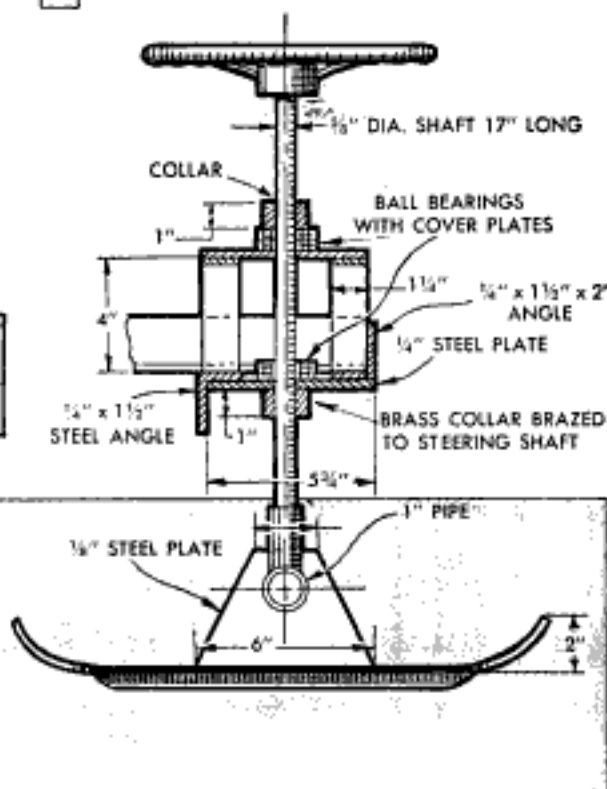

given for the seats. This is to permit the builder to custom-build the seats for himself and his favorite fishing partner. For a deluxe version of the sled, bucket seats from a car or bus, picked up at an automobile graveyard, would add a touch of comfort. It must be kept in mind that any additional weight, such as the bucket seats, will reduce the over-all performance of the sled and make it more difficult to carry.

The windshield, Fig. 1, is bent from sheet metal to the dimensions given. Here again, personal requirements or ingenuity might suggest some modifications. An extension of clear sheet plastic could be added to the metal windshield to provide greater weather protection. Such a windshield addition might be permanent, or could be clamped to the metal portion of the shield with thumbscrews turned into nuts tack-welded to the metal.

As indicated in Figs. 2 and 3, the steering and front-runner assembly are the most complicated parts of the sled, although they are not difficult to fabricate. The steering wheel can be salvaged from a wrecked auto or one can be bent from tubing or pipe. In the latter case, a half wheel, such as used in an airplane, will be adequate, as the front runner is turned through an arc of only 180 deg. or less. The steering shaft is a length of 3/8-in. shafting. It rotates in two ball bearings as indicated, but the weight of the sled is supported on a brass collar brazed to the steering shaft. A second brass collar, above the steering

assembly, is held on the steering shaft with a lock screw and prevents the sled from moving upward on the steering shaft.

Each of the three runners on the sled pivots on a 1-in. bolt that runs through a T-shaped fitting welded from 1-in. pipe. The lower end of the steering shaft is adapted to fit into the fabricated pipe tee in one of two ways: Either by welding a short length of 1-in. shafting to it, or by using an adapter sleeve with an i.d. of 5/8 in. and an o.d. of 1 in. The sleeve is welded to the shaft and to the tee. Short lengths of 1-in. shafting are welded to the frame extensions and into the pipe tees on the two rear runners.

Indicated in Fig. 1 is a single, hand-operated brake. This is efficient for moderate speeds, but should be replaced with a double, foot-controlled brake, if the sled is to be run at higher speeds. Two sharpened shoes, such as shown, are used, one being located on each side of the sled on the ends of a rotating shaft. A foot pedal is welded to one end of the shaft at a convenient angle. A light spring is used to keep the brake up and clear of the ice. A Bowden cable is run from the throttle on the motor to a small lever pivoted on the side of the sled at a point within easy reach of the driver's hand. If the sled is a one-man model, and the driver sits just ahead of the motor, the Bowden-cable setup would not be necessary. In this case, the hand throttle on the motor would be within easy reach. ★ ★ ★



### Improved Easel Holds Screens

When painting screens or reglazing storm sash, they can be positioned at a comfortable working height on an improvised easel, consisting of a wide board rested on one of the rungs of a ladder. One end of the board is allowed to project a couple of inches, while the other end is rested on the ground as shown.



### Gallery Doors Conceal Kitchen

To make a small cottage appear more spacious and attractive, the owner of one such building fitted gallery doors across the Pullman-type kitchen. Between meals the doors are closed, concealing the sink and cabinets. The louvers in the doors provide ventilation necessary to minimize the moisture problem around the sink.



## Enrich Your Life With the Marvels of Hi-Fi! Thrill to a Pocket-Size Transistor Radio . . .

Have you been wanting a Hi-Fi set for your home . . . a portable transistor radio no bigger than your hand . . . and any of the other pieces of electronic equipment that are adding so much enjoyment to modern living? Then here's how you can have them, at merely a fraction of the usual purchase price. Using Popular Mechanics new book—*Electronics Made Easy*—

### *You Can Make These Electronic Devices Yourself!*

This unusually practical book enables you, without any previous experience, to enter the amazing field of electronics for fun or profit. In 192 pages of simple step-by-step instructions and hundreds of illustrations, you learn all about Hi-Fi—exactly what it is and how to build your own Hi-Fi system. You discover how to make the "miracle" transistor radio, how electronic tubes work, how to do radio

servicing, how to use test instruments and make your own, and how to convert old radios into inter-com systems and other devices. It's fun and easy to build your own electronic equipment with the help of this book which contains numerous do-it-yourself projects. Send for your copy of *Electronics Made Easy*. It's your key to the most fascinating hobby of these times **\$2.95** for just.....

Send your order to  
**POPULAR MECHANICS PRESS, 208 East Ontario Street, Chicago 11, Illinois**

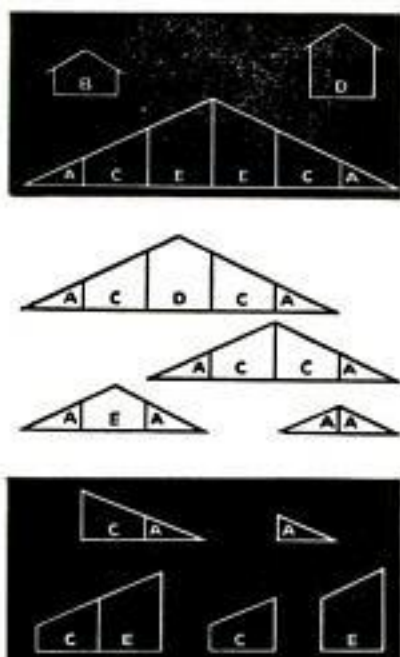

*On the*  
**MARKET**  
*for Do-It-Yourselfers*



**SECTIONAL LOUVER** comes in 2-ft. sections with special slip-joint fasteners. These sections, A to E inclusive in detail above right, make it possible to put together 25 different designs from 2 to 12 ft. wide and with ventilating areas varying from 21 to 614 sq. in. Available for roof pitches with 4 and 5-in. rise per ft. Comes in 2, 4 and 6-section sets or in completed 8-piece unit with screen to fit

Louver Mfg. and Supply Co.,  
3607 Woodale Ave., Minneapolis, Minn.

**SCREW ANCHOR** is made of special lead alloy that gives it exceptional holding power. The alloy is harder than pure lead, resists distortion while being driven in place. Upper end is flared widely so that screw points are easily inserted. Takes either wood screws or sheet-metal screws. Just the thing for attaching shelf brackets, tool panels, pictures, furring strips and screw hooks to masonry

The Rawlplug Co., 212 Petersville Rd., New Rochelle, N. Y.

**CUPOLA** comes as a do-it-yourself kit with all parts cut to size and sanded ready to assemble and finish before installing on garage or barn. Roof is of metal, all other parts being of wood. Installation is simple, as the lower rails, or panels, are left full width for cutting to fit ridge

Harry I. Hoy,  
17W164 Oakdale Dr., Bensenville, Ill.

**CRACK FILLER** comes in a tube ready-mixed. Available in colors to match almost any wall finish, also in four wood tones for furniture and paneling. Special applicator forces material into narrow cracks

Emtree Mfg. Co.,  
Elizabeth 4, N. J.

**MORTAR-JOINT SPACERS** enable do-it-yourselfers to lay bricks with mortar joints of uniform thickness. Spacers control both the horizontal and vertical joints. Only two spacers are required for each individual brick. Spacers are withdrawn from the vertical joints as each brick is laid

Sigl Plumbing and Mfg. Co.,  
430 Delaware Ave., Buffalo 2, N. Y.

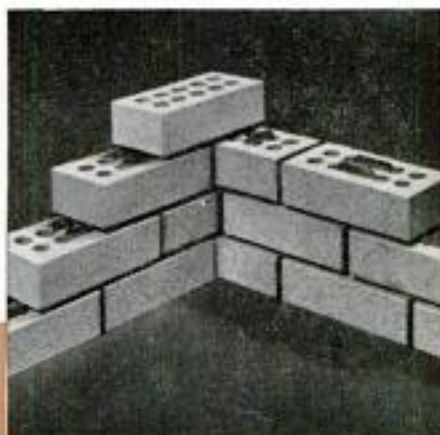



## Guard Rail on Drafting Board Protects Oversized Drawings

Large drawings that overhang a drafting table can be protected against soiling and creasing by having a guard rail on the front edge of the board to prevent the draftsman from leaning against the drawing. The rail can be a fairly heavy curtain rod fitted in brackets, or it may be a piece of tubing flattened and bent at the ends for screwing to the board.

## Specialized Oil Applicator

An applicator made from a glass medicine dropper is as convenient as a hypodermic needle for oiling very fine mechanisms. Heat the glass tip of the dropper in a flame and draw it out to a needlelike point.

## Centered Door Pull Adds Symmetry

Wishing a more symmetrical appearance for some two-door cabinets he had built, one craftsman centered a single door pull on the center line between the doors. Either the leaf from a strap hinge, or a length of steel flat is used as an adapter to offset the pull. Mortise the surface of the door to accommodate the adapter, then screw it in place so the end hole is positioned between the doors. Use a door pull with a large escutcheon plate to conceal the adapter.

—R. E. Clark, Aurora, Illinois.

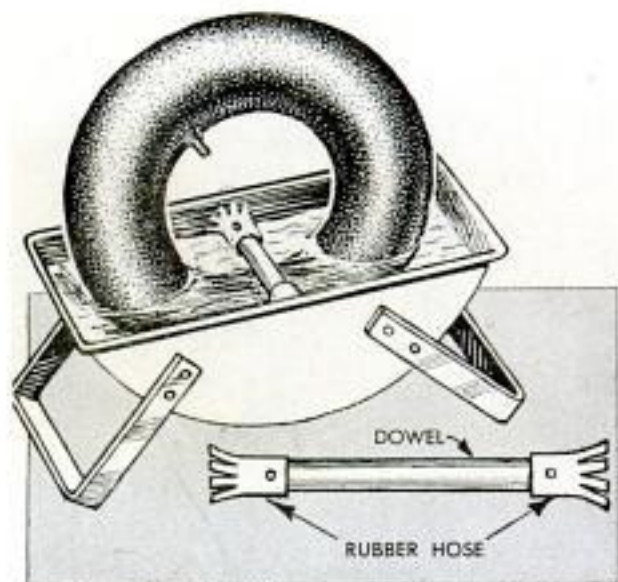
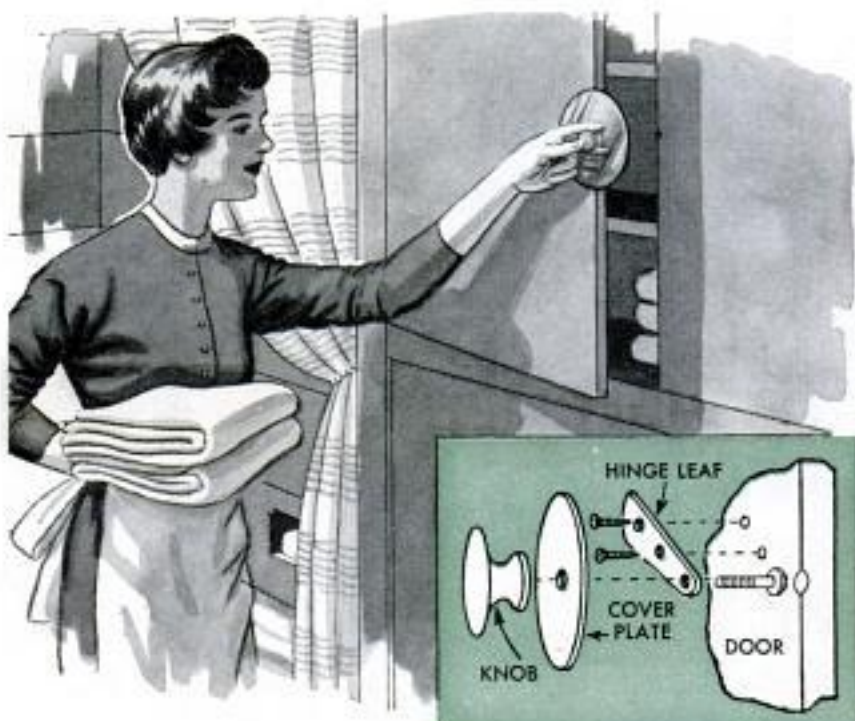

## Dowel Crossbar in Testing Tank Keeps Inner Tubes Submerged

It's much easier to keep an inflated inner tube submerged in a testing tank if a crossbar is fitted in the tank to hold the tube down while it is rotated. The crossbar is a wooden dowel, on the ends of which are fitted short lengths of serrated garden hose. The dowel should be just long enough to permit it to be held between the sides of the tank by the pieces of hose, yet readily removed.

☛ To renew playing cards that have become soiled and sticky from use, wipe them with a piece of cotton dipped in spirits of camphor. Use sparingly, then polish the cards with a soft cloth.

X237

# SHOP NOTES

SN 59

## Handy Tool Dolly

By Howard R. Clark

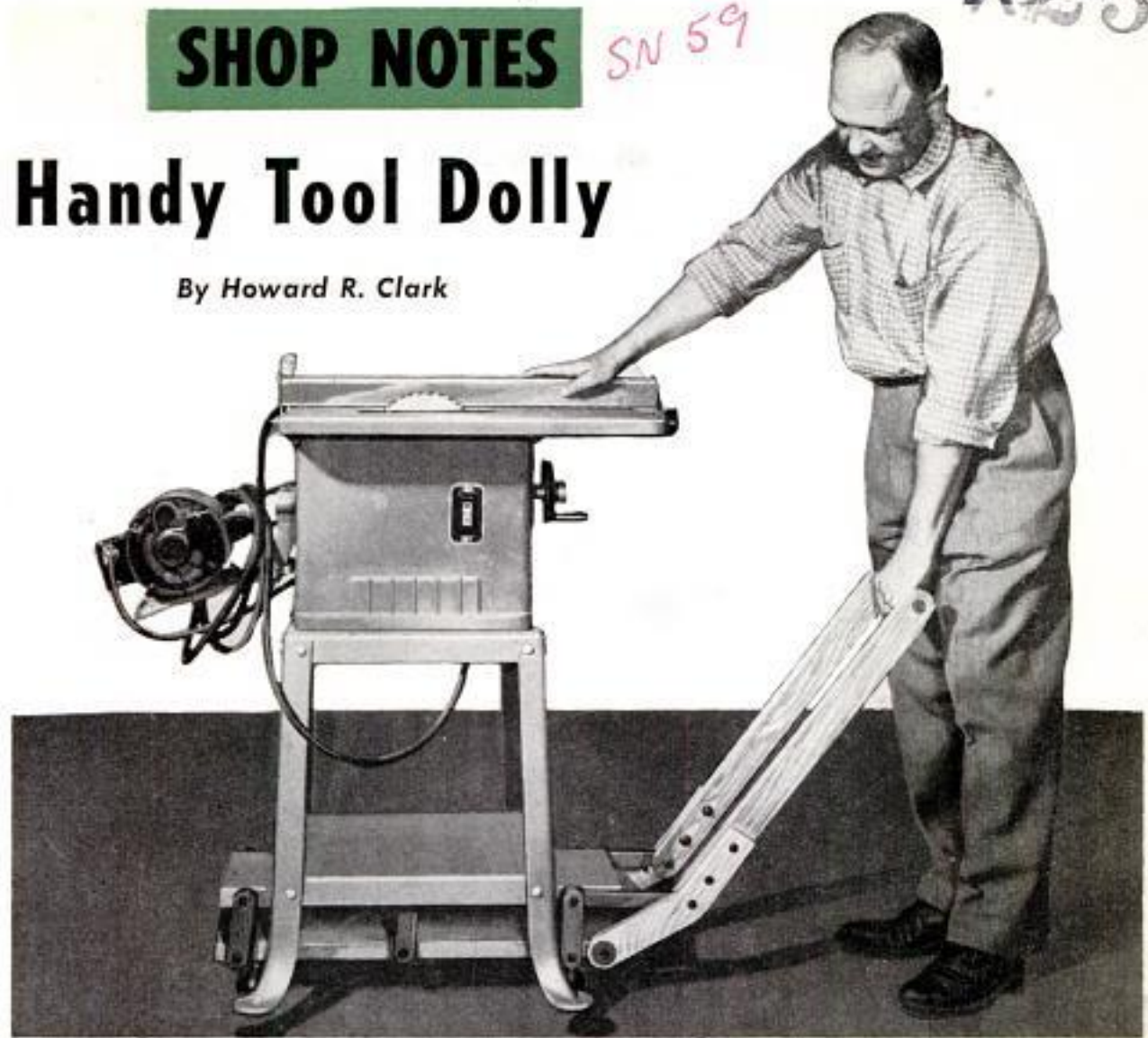

**P**OWER TOOLS ON STANDS are heavy, difficult to move about in the shop singlehanded unless you have this dolly. Then it's easy. Just roll the dolly under the stand as pictured at the right, lower the handle as shown above and away you go. Swiveling casters on the dolly make it easy to spot the machine just where you want it for ripping a long board, or moving it out of the central floor area of the shop for some other operation, such as laying out the lines full size for a boat hull.

The dolly can be made to suit almost any type of open tool stand and it also can be useful when moving other heavy units, such as workbenches. Before you cut stock from the dimensions on the following page, check your tool stands for height to the shelf or rails. You may have to shorten or lengthen the hardwood links or use larger or smaller casters. As dimensioned, the dolly is suited to the type of stand pictured, also other types having a lower shelf or rails at approximately the same height from the floor. The handle bars of the original dolly are minimum length. Where

Above, just lower the handle of the dolly to raise the machine clear of the floor. Below, raising the handle lowers the platform to clear machine table



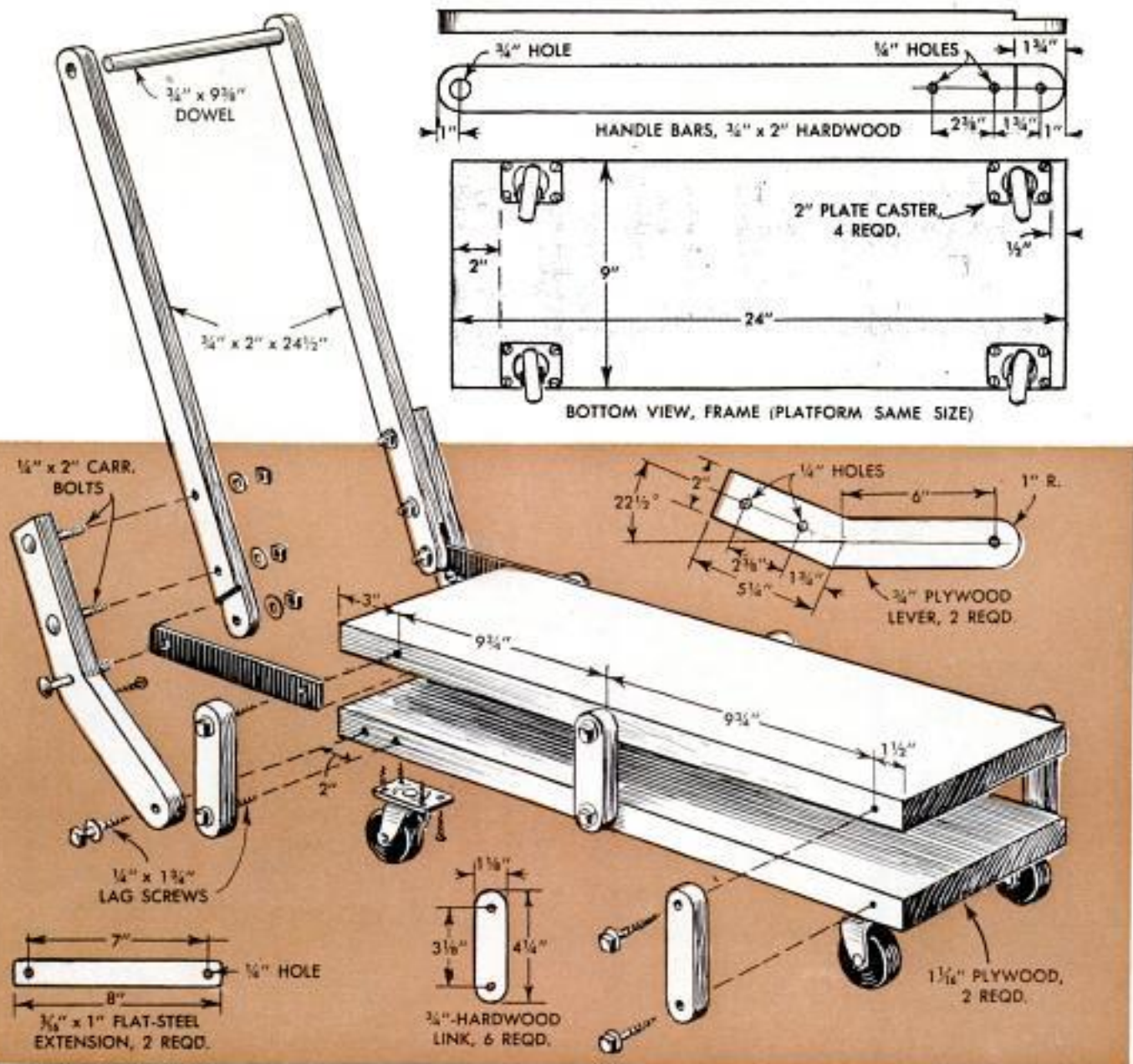

there is more clearance under the machine table, the handle bars can be made somewhat longer. The frame and platform are the same size and are cut from  $1\frac{1}{8}$ -in. plywood. When plywood of this thickness is not readily obtainable, edge-glue strips of solid stock to give the required width. Use maple or oak for the links, as these parts are subjected to considerable stress. Be sure that they are the same length and that the holes are drilled the same distance apart on all six units, as otherwise the

links will tend to bind when raising and lowering the platform. Four swiveling plate casters are specified, but in some cases it will be an advantage to use two swiveling casters at the front (handle) end and two plain, nonswiveling casters at the rear of the frame. This arrangement of the casters makes the dolly easier to maneuver in close quarters, especially when moving a heavy unit. When you move a large unit such as a bench be sure that it is balanced on the narrow width of the dolly. ★ ★ ★

### Wax Paper Lubricates Clamp

Bar-clamp fixtures of the type which are assembled on black pipe sometimes stick and are difficult to move. Generally this is due to rust on the pipe. Clean off the rust and smooth the pipe with abrasive cloth, then rub vigorously with a piece of wax paper.—Ken Murray, Colon, Mich.



SN 59

## Holding Index Pin In "Out" Position

When working an indexing job requiring unusual care, machinists guard against a slip of the indexing pin by placing a special split ring under the knurled knob. The ring, or collar, holds the pin in the "out" position as the crank is turned. The ring also is useful when the head is being used as a rotary table. The ring is cut from a piece of brass tubing.—J. C. Magee, Schenectady, N. Y.

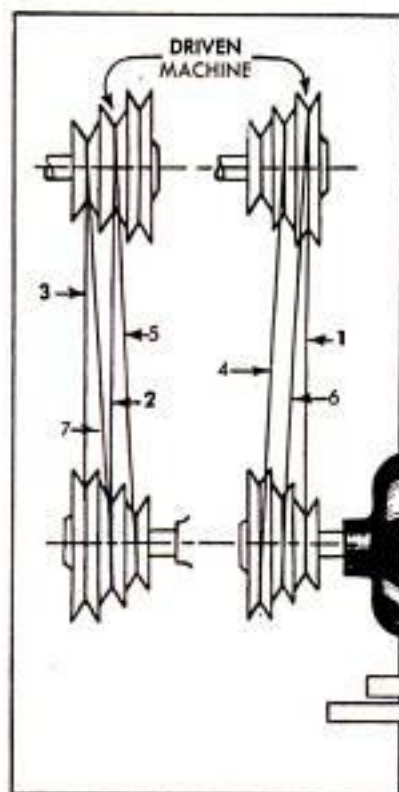
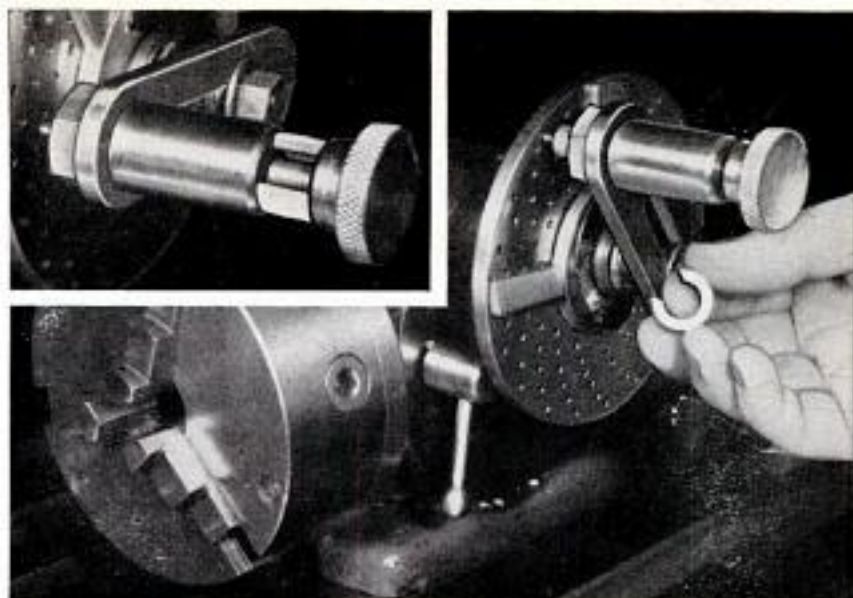
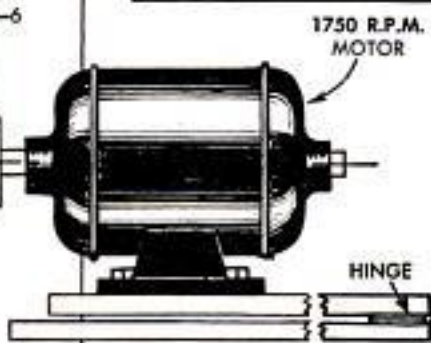

TABLE OF SPEED RATIOS

BELT POSITION	WORK SPEED USING 1750 R.P.M. MOTOR
1	875
2	1750
3	3500
4	2300
5	1150
6	1300
7	2600

## Increasing Speed Range Of Three-Step Drives

Ordinarily, running a machine with misaligned V-belts is not considered good practice, but there are times when the gain in speed range makes the trick permissible on a drill press or lathe. Note the seven positions of the V-belt in the detail at the left. The table gives the various speeds available with the seven positions, using a 1750 r.p.m. motor. In order to make shifting of the belt easy and to compensate for the variations in the center-to-center distances between the pulleys, the motor must be placed on a hinged mount. Of course, this is unnecessary if the machine is already provided with this feature. If the speed of the driven machine is above 3000 r.p.m., this method is not recommended.—Russell Love, San Marino, Calif.



## Spring Tweezers Grip Tiny Screws

Normally closed tweezers made from a length of clock spring or box strapping are just the thing for placing tiny screws. The ends are bent at an angle and notched as in the detail to form jaws that grip the screw just below the head. A rivet at the center keeps the jaws of the tweezers in the closed position.—Walter E. Burton, Akron, Ohio.

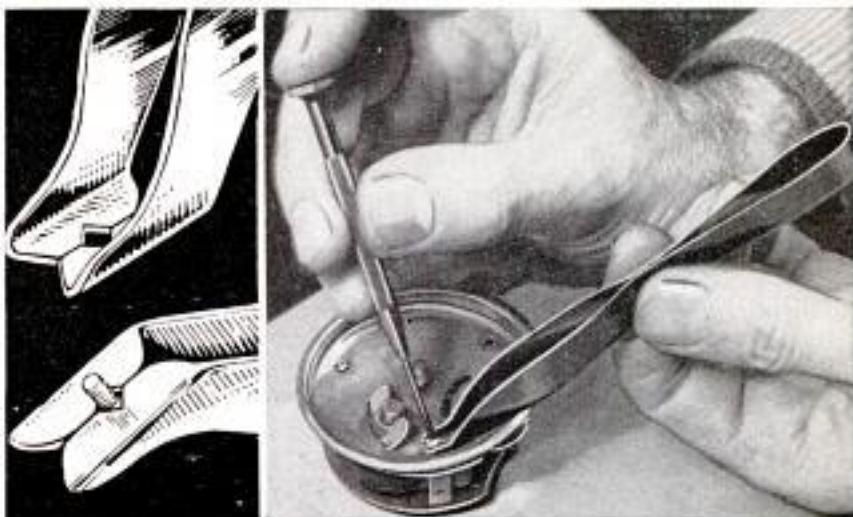

SN  
~~HM~~ 59

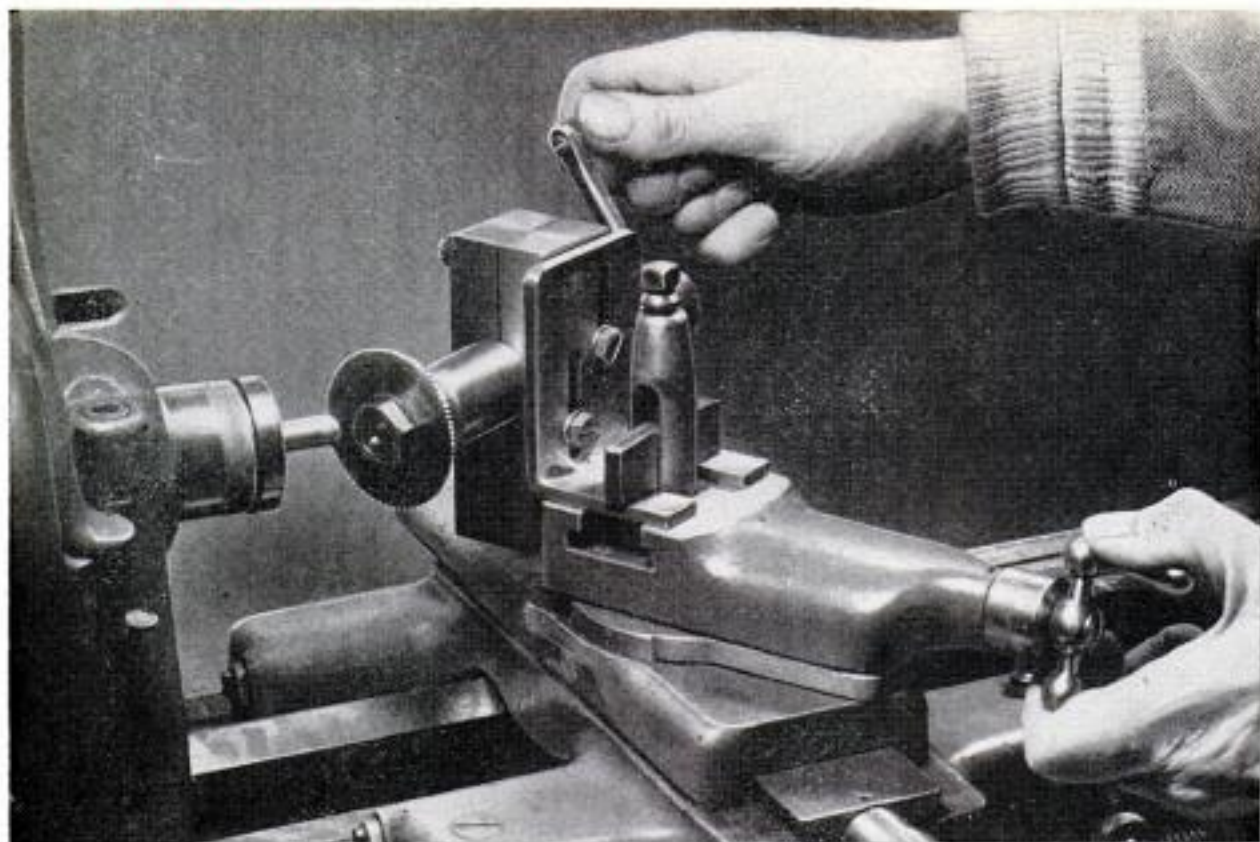

## Mill slots, flats, keyways and squares with this **HAND MILLING ATTACHMENT**

By *Walter E. Burton*

**I**T'S SHOP-MADE, hand-operated and designed to utilize the built-in accuracy of the lathe carriage. Handles light milling, reaming and drilling operations on any workpiece that can be chucked or mounted on a large faceplate. The chuck, which is simply a sleeve with two locking setscrews, takes any milling cutter, drill bit or reamer with  $\frac{1}{2}$ -in. straight shank.

Before you cut any stock, note the dimensions of parts A and B, opposite page, and then check your lathe. You may find it necessary to alter some of the dimensions given. Note also that the holder, or frame, which carries the spindle is slotted to take the bushing, F, which also is slotted. This construction permits adjustments which eliminate both lateral and end play and make it possible to adjust the spindle, part C, for a certain amount of drag, which is desirable when doing some types of work.

The angle bracket, part B, must be finished on the outside faces of the legs. Note that the length of the short leg of the angle is given as  $2\frac{1}{4}$  in. A 3 x 2-in. angle will do as well on a small lathe. Slot as indicated. When the unit is assembled the bracket is held on the tool-post pad by means of a short bar of flat stock as in the

photo above and also at the lower right, opposite page.

The spindle, part C, is shouldered down to two diameters from  $1\frac{1}{8}$  or  $1\frac{1}{4}$ -in. stock. The flats, one taking the setscrew of the collar E, the other the setscrew of the crank D, are filed to a width of  $\frac{1}{2}$  in. and a depth of about  $\frac{1}{16}$  in. The hole in the large end of the spindle is drilled  $\frac{3}{16}$  in. and then reamed to  $\frac{1}{2}$ -in. dia. Reaming should be done after the holes for the  $\frac{1}{4}$ -in. setscrews are drilled and tapped. The spindle collar can be made in the shop, or a ready-made collar can be used. A similar collar also carries the crank D. It is simply drilled and tapped to take the threaded end of the crank arm. The crank handle can be turned down from  $\frac{3}{8}$ -in. stock, or purchased ready-made.

The hole for the bushing should be drilled and reamed in the holder, part A, before slotting either with a hacksaw or on a milling machine. If you make the bushing in the lathe, drill  $\frac{1}{2}$  in. and ream to  $\frac{9}{16}$ -in. dia. before slotting. Use either brass or bronze for the bushing. Ordinary cold-rolled steel will do very well for the other parts, except the angle bracket which is cut from steel angle. ★ ★ ★



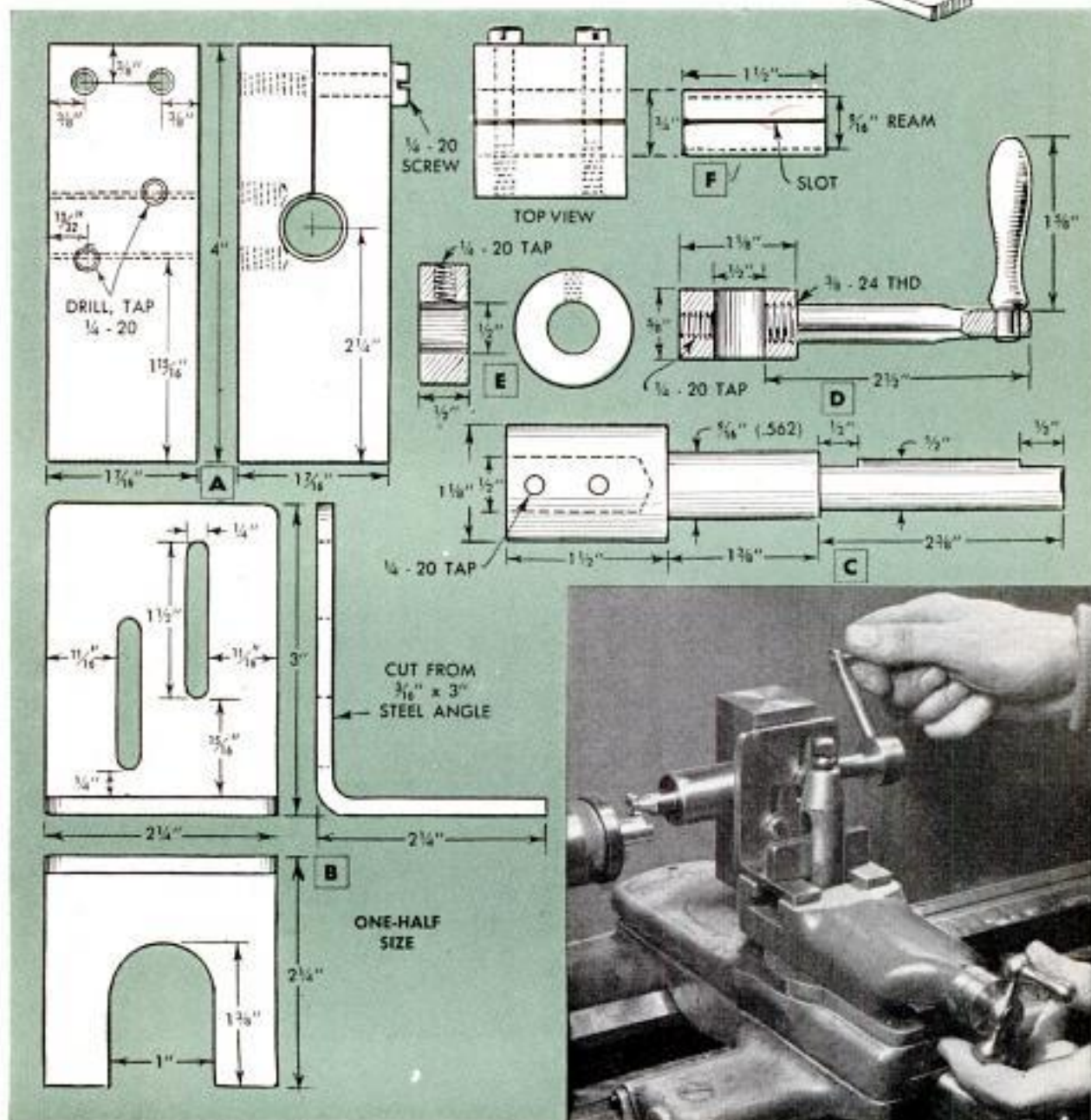
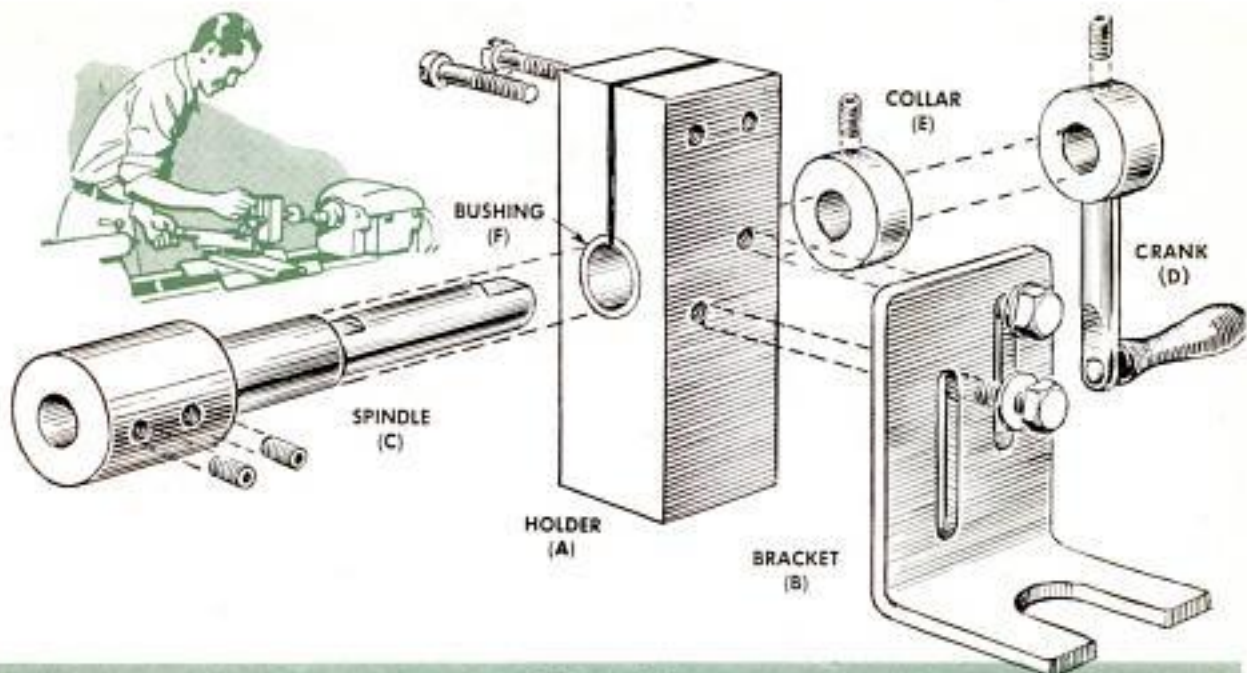

## Masking-Tape Tabs Easily Removed for Data Changes on Bins



When stock changes are made frequently in storage bins, time can be saved when changing tabs, or labels, by writing data on short strips of masking tape. When a change is made the old tape is stripped off and a new tape with new data applied. Writing should be done with a pen.

G. E. Hendrickson, Argyle, Wis.

## Solder Tightens Metal Screw

Self-tapping metal screws tend to loosen when subjected to excessive vibration over a period of time. This usually is due to slight enlargement of the registering holes in the sheet metal. A drop of solder flowed onto the threads near the head of the screw will renew the original grip of the threads.—J. McGinnis, Saddle Brook, N. J.

## Save Time When Adjusting Compass and Dividers

You'll save not only time but also excessive wear on the adjusting screw of the instrument by spinning the nut free on the threads. Grasp the legs of the instrument, either compasses or dividers of the screw-adjusting type, in the left hand as in the detail. Press the legs together until the distance between them is near that desired. Then spin the nut with the right hand to bear against the leg. Slight final adjustments for correct distance are made by turning the nut against the spring pressure. This method not only eliminates undue thread wear but also enables the user to make compass and divider adjustments through a wide range in a fraction of the time otherwise required.

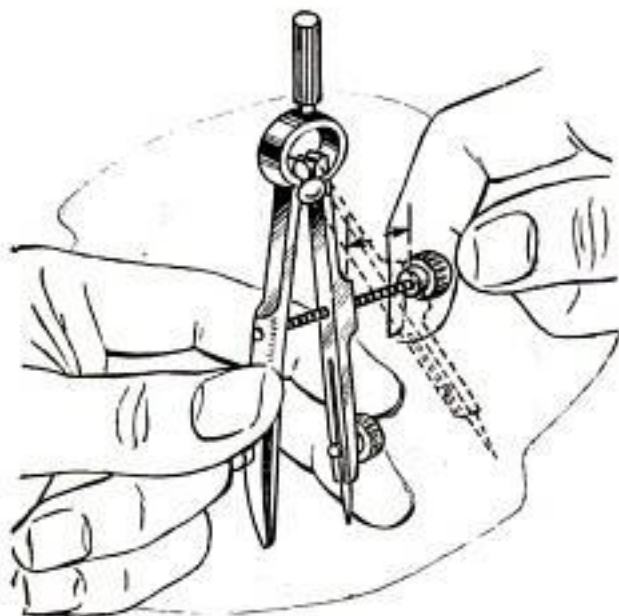

## New Bite for Hammer Claws

On old hammers the slot, or split, between the claws often become so badly worn that it will no longer grip and pull small nails. To give the claws a new and effective bite, place the hammer in a vise and deepen the split with a hacksaw.



## Razor-Sharp Hand Tools

After grinding and oilstoning the edges of chisels and plane irons, leather honing is the final step that produces a really sharp cutting edge. An old razor strop is just the thing. Use a few drops of oil and light pressure.—J. W. Rocke, Huron, S. D.



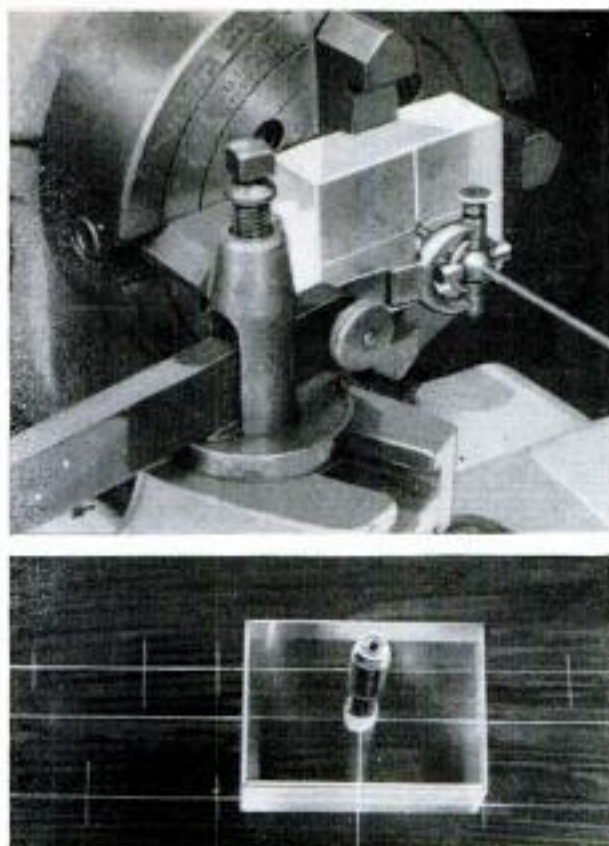

## Clear-Plastic Block Locates Center Punch

Coordinate layout lines scribed on metal can be quickly and accurately center-punched with this transparent-plastic locating block. The latter is cut from  $\frac{3}{4}$ -in. transparent plastic and can be any convenient over-all size. Scribe two sharp lines on the bottom face, the lines intersecting on the face at 90 deg. Center-punch the intersection of the lines and set up in the lathe as pictured, using a wiggler to center the block for drilling the hole for the punch. Drill and ream to  $\frac{7}{16}$ -in. diameter. Polish the cut edges of the block and round the corners slightly. Polish both top and bottom so that fine scribed lines on

the metal are easily seen through it. Make a punch similar to that pictured from  $\frac{3}{8}$ -in. drill rod, shouldering down and grinding from one end for a distance of about  $1\frac{1}{4}$  in. This shank portion of the punch should be an easy sliding fit in the center hole in the locating block. The body of the punch can be knurled if desired. Grind the shouldered end to a 60-deg. angle in the lathe. In use, the locating block is placed on the work as pictured, the guide lines on the bottom of the block being placed directly over those scribed on the work. A light tap on the punch marks the work.

H. J. Gerber, Stillwater, Okla.

## Cord Reel on Power-Tool Stand Provides Safe Storage

Power cords looped loosely over individual machines, or wound into a kinked coil, are not only a potential hazard where shop space is limited. They also abrade quickly, sharp bends may result in insulation breaks and the plugs are likely to be broken if stepped on. The problem is easily solved by making a simple cord reel, or winder, for each machine. A length of  $\frac{1}{8}$  x 1-in. flat steel, bent as indicated at A in the detail, makes a good winder for attaching to the leg of a stand. If no flat steel of suitable size is at hand, make the winder from hardwood, detail B.

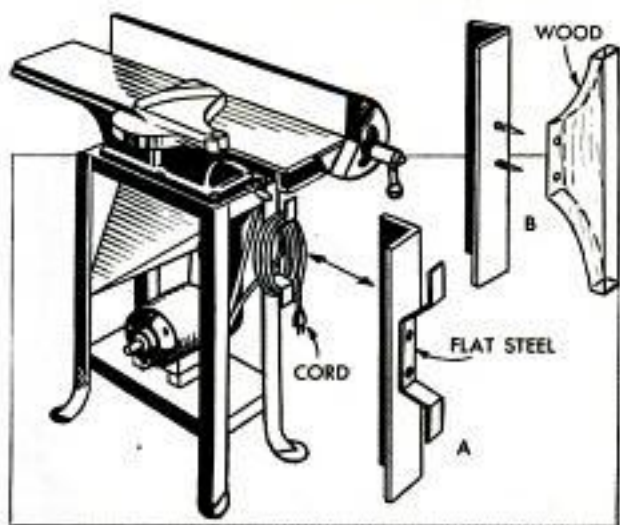

# HOW WOULD

By Chris Nelson

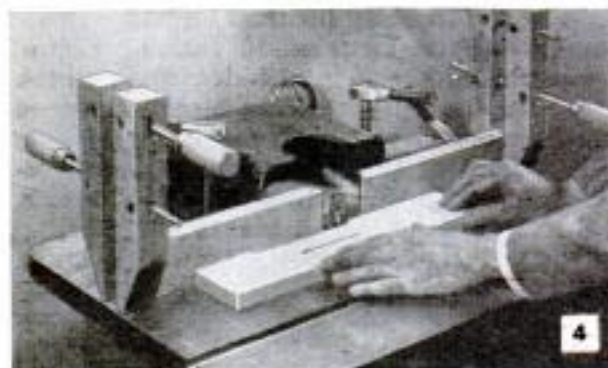
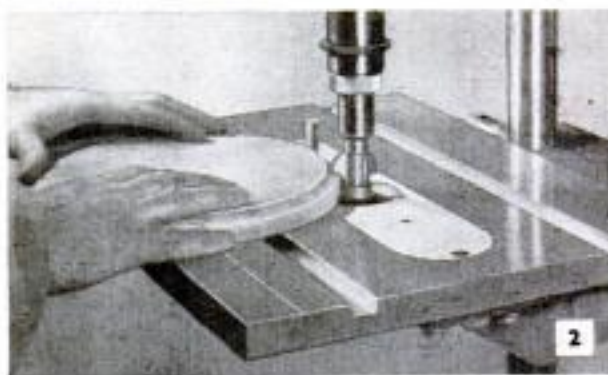

**1. Q—What is a starting pin, referred to in shaper work, and how is it used in practice?**

**A—**The starting pin, as its name implies, is used to support the work firmly at the start of a cut on a curved edge. As the first step, a depth collar, or rubbing collar, is placed on the spindle to limit the depth of cut. Then the pin is screwed into the tapped hole provided in the machine table. Next, the stock is laid on the table in contact with the pin, but clear of the rotating cutter. Then the stock is moved slowly into the cutter, using the starting pin as a fulcrum when making contact with cutter

**2. Q—Is the starting pin also used in shaping the edge of a disk? Do the methods differ?**

**A—**Note the similarity of the operations in Figs. 1 and 2. In Fig. 1 the pin is being used to support stock having a long-radius curve on one edge. In Fig. 2 the edge of a disk is being molded. In both operations the purpose of the pin is the same, to support the work at the start of the cut. Thereafter the depth of cut is controlled by the depth collar, which also supports the work. The critical point in both operations is that instant the cutter engages the stock. Be sure to hold material firmly

**3. Q—Is it possible to make a smooth cut with a shaper across the grain? What is the procedure?**

**A—**Sharp cutters mounted on high-speed spindles will make a smooth cut across the grain as well as with it. When the edges are straight, use a guide fence as pictured. If the table of the machine is grooved, use a miter gauge to guide the stock. When all four edges are to be molded, always run the end-grain cuts first. In both hard and soft woods you will generally do a better job if you make the molding cut in several passes, the finish cut being the lightest of all. This precaution assures smooth work

**4. Q—Is it possible to run a stopped cut, or chamfer, on a spindle shaper?**

**A—**Make the setup with the shaper fence and two clamps to limit the distance the stock can be moved past the cutter. Place one clamp on the fence and place the stock in position with one end against the clamp. Then measure from the free end of the stock a distance equal to the length of the cut desired and place the second clamp. Then swing the stock into the cutter and move it past the cutter until the end is stopped by the second clamp. If stock is longer than regular fence, you can easily make fence extensions to hold the clamps in position

# YOU DO IT?

**5. Q—Can a shaper be used to make a cut on the surface of the stock rather than the edge?**

A—Yes. If you have a machine of the type shown, you can run the cut with the work in the horizontal position. If your shaper is of the vertical-spindle type, then the work must be held in the vertical position against an auxiliary fence. A typical cut is the first half of a drawer joint such as that pictured. In the horizontal position the work is guided by a miter gauge with hold-down. For running this cut in the vertical position, screw a wide auxiliary fence to both members of the regular fence to guide stock



**6. Q—How are the edges of a number of disks shaped to assure a uniform diameter?**

A—Although the job can be done on a vertical-spindle shaper, the setup is pictured on a 9-in. radial saw. Clamp two strips to the table, each at 45 deg. to the spindle (in this case the radial-saw arbor). Test the setting on a waste disk until it gives the desired results. Be sure that the disks are turned or sanded to the same diameter so that the amount of material removed by the shaper cutter will be uniform. Guide strips should always be clamped or wedged securely in position so they cannot shift



**7. Q—How is a shaper set up to cut the glass rabbet in a circular or oval picture frame?**

A—Again you make use of the starting pin, Figs. 1 and 2, except that here you are making an inside instead of an outside cut. Again a depth collar is used on the spindle to limit the depth of cut. With the work in position and clear of the rotating cutter, move it inward so that it bears firmly against the pin. Then bring it slowly into the cutter until it bears against the depth collar. As you bring the work into cutter, start feeding simultaneously. This correlated movement prevents burning of wood

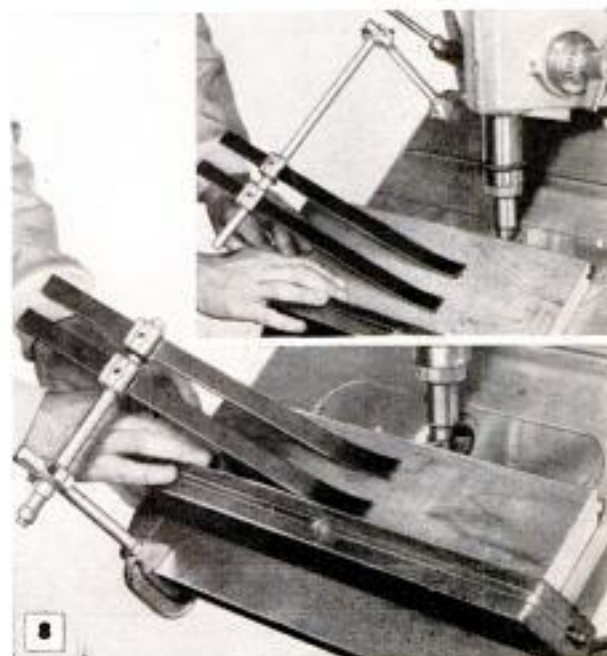

**8. Q—Is it possible to tongue-and-groove beveled edges on an ordinary shaper?**

A—Yes, by using the setup pictured in the two views in Fig. 8 and a pair of matched tongue-and-groove shaper cutters it is possible to make these cuts on beveled edges such as would be used in forming the joints of a hexagonal column. Table must be tilted as pictured, or you can make a fixture and clamp it to a stationary table to hold the stock at the required angle. Run test cuts on waste pieces to assure the proper setting. It is necessary to use hold-downs as there is some outward cutting pressure

**NOTE—In several photos the shaper guard has been omitted for clarity. Always use the guard.**

SN 59

## V-Tool Cuts Wood Threads in a Metal Lathe



Cutting coarse threads on hardwood mounted in a metal lathe is easy to do with a special V-tool you make yourself from a length of sheet metal. First, grind one end to two bevels as in detail B. Then place in the vise and bend to a V-shape as in detail A, the included angle being about 60 deg. Hone to produce as sharp an edge as possible. Then mount in the tool post, using square stock cut to short lengths. The upper piece should be flattened slightly to provide a seat for the tool-post screw. The tool must be mounted so that it cuts well above the center line. Set the lathe to cut 6 threads per inch (8 per inch may fit some tapped holes in wood). Run the lathe at its lowest speed. Cut the thread in two or three passes. — Rex Bush, Columbus, Ohio.

### Hand Chucks Take Tiny Drills

Hand chucks, or pin drills as they are sometimes called, are often used in the drill press when it is necessary to drive tiny twist drills  $\frac{1}{16}$ -in. and under in the fractional sizes, also in smaller letter sizes. The chucks are easily made as detailed, using drill rod for the shank which also forms the closer. Thread, drill and bevel the shank before slotting. Dimensions can be reduced from those given.

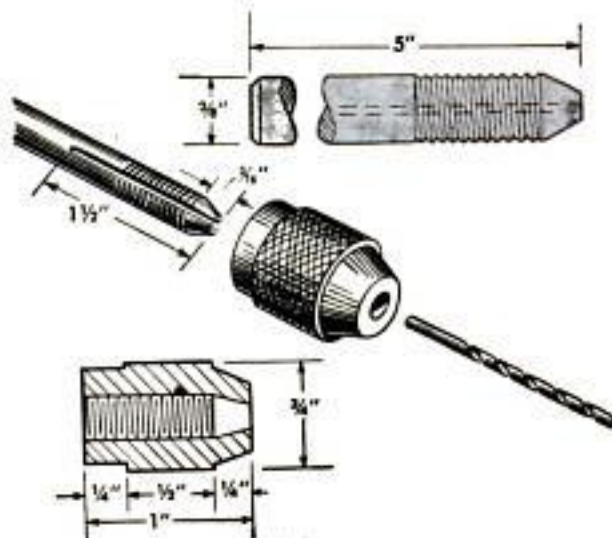

### Spring Loading a Shaper Tool

When taking light cuts with a shaper it sometimes happens that the tool will stick in the up position at the end of the back-stroke. This causes the tool to "miss" on the succeeding workstroke. To correct this tendency, mount a short length of square steel under the cutting tool and place a coil spring between the insert and the shaper head. Locate the end of the spring over the screw holding the swiveling pad.

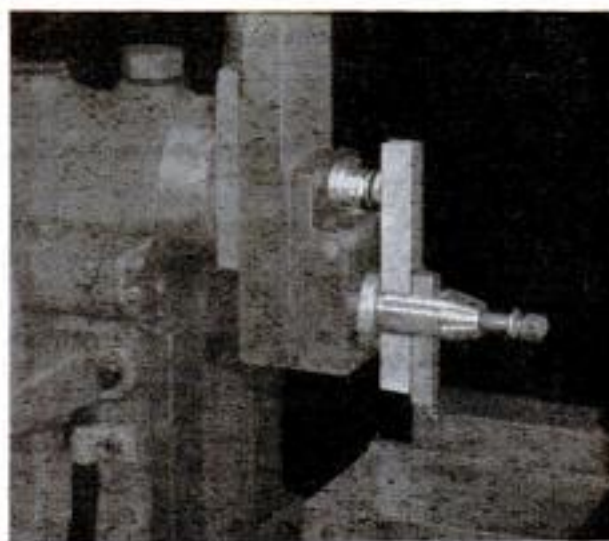

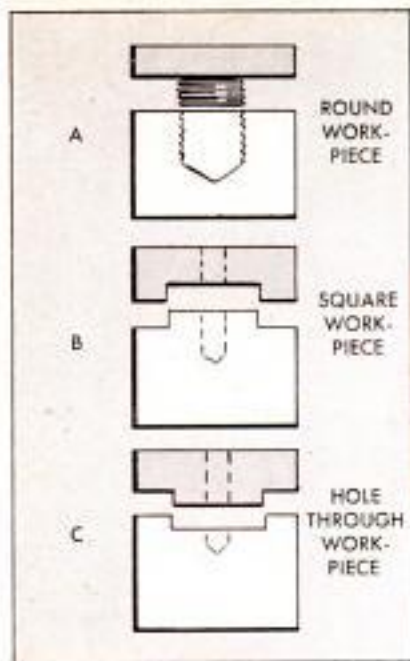

## INDEXING FIXTURES For Milling Squares or Flats

Special jobs that require accurate milling of squares or flats on various types of plugs or caps can be set up in a vise, using a square fixture instead of a dividing head or turntable. Workpieces A, B and C are typical. The indexing square can be shouldered or recessed as in details B and C, or drilled and tapped as in detail A. Where a center hole is permissible, the workpiece can be held with a capscrew for light milling as in details B and C.

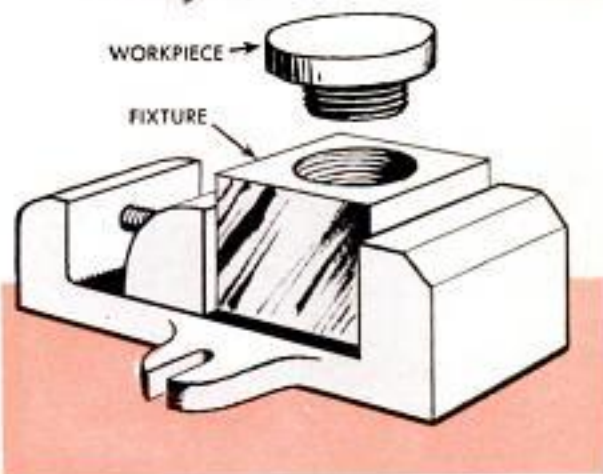

## Handle for Allen Wrench Reaches Hard-to-Get-at Places

When repairing or reconditioning older-type machines, replacement of small parts usually is necessary. When making these replacements, difficulty may be encountered in assembling. A typical example is detailed, the problem being the tightening of a socket setscrew in the hub of a flat-faced pulley. To accomplish the job, the repairmen made an offset handle for turning the Allen wrench in the manner detailed. The handle is drilled transversely with three holes, each of a different diameter to take three sizes of Allen wrenches. The handle made in this way has many other applications in addition to that pictured.—Loaden Godshall, Souderton, Pa.

When the rounded corners on a hex nut stopped an emergency repair job on a farm machine, due to the impossibility of loosening the nut with a wrench, the owner simply ran down a second nut over the first and welded the two together.

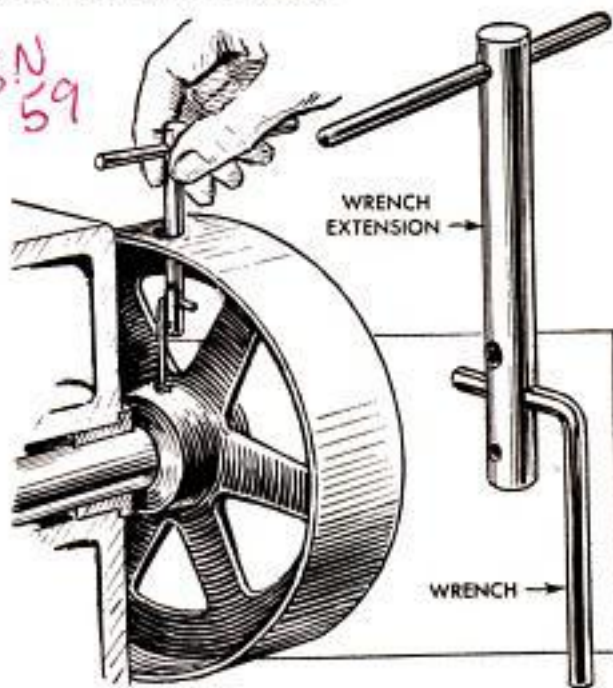

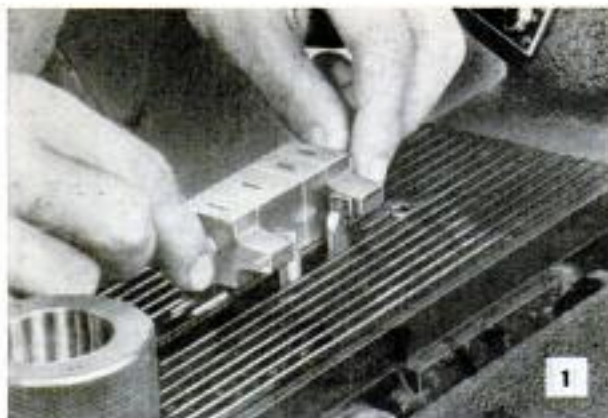

1



2

## SHOPPING

**1. PRECISION GAUGE BLOCKS** offer plus 8 millionths inch, minus nothing, for working accuracy, and plus 4 millionths, minus nothing, for inspection accuracy. The blocks are classified as standard and have been made available with all deviations unconditionally guaranteed to be on the plus side of the nominal block size. The minus-nothing tolerances provide finer accuracy and a minimum-wear factor

Ellstrom Standards Div., Dearborn Gage Co., Dearborn, Mich.

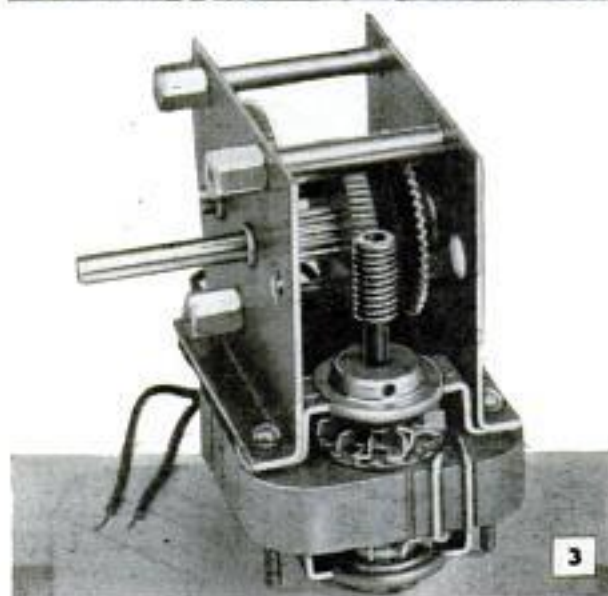

3

**2. BENCH-TOP ULTRASONIC CLEANER** consists of a separate power generator, about the size of a small portable TV set, and two tanks with transducers hermetically sealed in the bases. Alternate use of two or four tanks permits several cleaning stages or the use of different solvents. Cleaning is accomplished by ultrasonic activation of solvents in tanks. Designed for cleaning watch movements, ball bearings, jewelry

Branson Ultrasonic Corp., 37 Brown House Rd., Stamford, Conn.



4

**3. TINY MOTOR WITH BUILT-IN REDUCTION GEAR** has output-shaft speeds ranging from 3 r.p.m. up. Torque is 12-in.-lb. at 3 r.p.m. for continuous-duty applications. Higher output torque can be provided for intermittent duty. One output shaft is furnished on standard motor, but double-shaft extensions and two shafts operating at different speeds are available. Designed to power displays, models

Brevet Products Corp., 601 W. 26th St., New York City 1

**4. VISE-GRIP WRENCH**, or toggle wrench, now has a special release built into the movable lever. This permits the operator to release the jaw, and the work, by light pressure of the thumb or finger. This new feature permits one-hand operation of wrench when tightening or loosening nuts and threaded rods, or when working where space is limited to a short swing of wrench handle. Available in 7, 10-in. sizes

Peterson Mfg. Co., DeWitt, Neb.

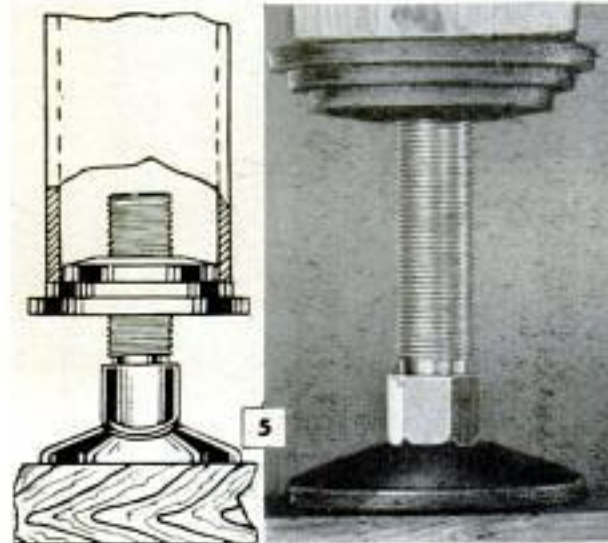

5

**5. SHORT-LIFT JACK** can be used on the top or bottom ends of posts for supporting beams under floors, roofs and porches, also for leveling floors and trailers in parks. Can be placed under lower end of a wooden post as in photo, or, base plate can be reversed and fitted into a pipe as in detail. Fits 3 or 3½-in. pipe. Jack is raised and lowered with a wrench placed on hex section. Maximum lift is 3 in.

Nelson Screw Products, Inc., Logansport, Ind.



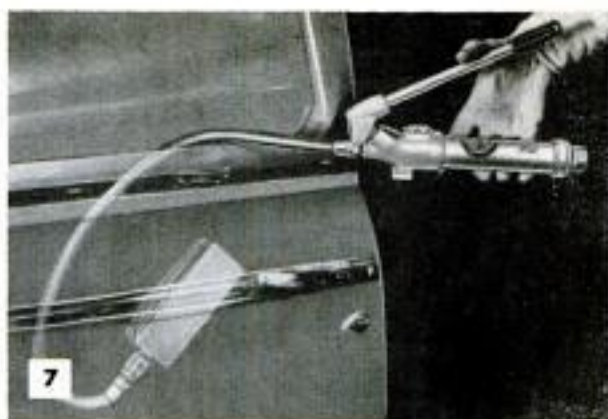

# FOR TOOLS

**6. GREASE GUN** is loaded with a cartridge which is placed in a cylinder in the manner pictured. When the cap is removed from the cartridge and the nozzle screwed in place it takes only one stroke of handle to fill gun ready for use. One cartridge gives about 300 shots of clean lubricant. Pressure developed is sufficient to force grease into any fitting

C. J. Neuman, Ltd., 445 Brighton Rd.,  
South Croydon, Surrey, England

**7. HYDRAULICALLY OPERATED DOLLY** has expanding jaws, or pads, which can be inserted in auto-door panels for ironing out dents. Also can be used effectively at other points in the car body which are inaccessible with regular body-bumping tools. Pads are available in various shapes and face contours. Develops sufficient pressure to straighten any body metal

Blackhawk Mfg. Co., Milwaukee, Wis.

**8. MULTIPURPOSE WORKSHOP TOOL** is built up around a jigsaw having a built-in motor and power takeoff for driving a disk sander, grinding wheel, buffer and a 30-in. flexible shaft. The various attachments are driven direct from the motor through the power takeoff as pictured in the four photos at the bottom of page. Jigsaw has 3-way blade holder, tilting table, spring-type blade guard and hold-down blade locking lever which permits changing blade without wrench or other tools. Machine is mounted on rubber suction feet which hold it in place on bench, reducing vibration to minimum. Cuts to center of 30-in. circle. Table can be raised to utilize full length of blade. Cuts 1 3/4-in. stock, hard or soft wood, plastics, soft metals and steel to 1/16-in. thickness

Dremel Mfg. Co., Racine, Wis.

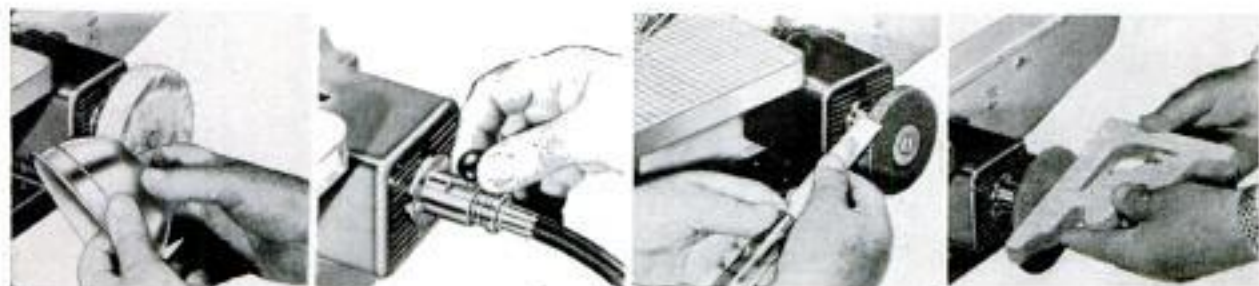

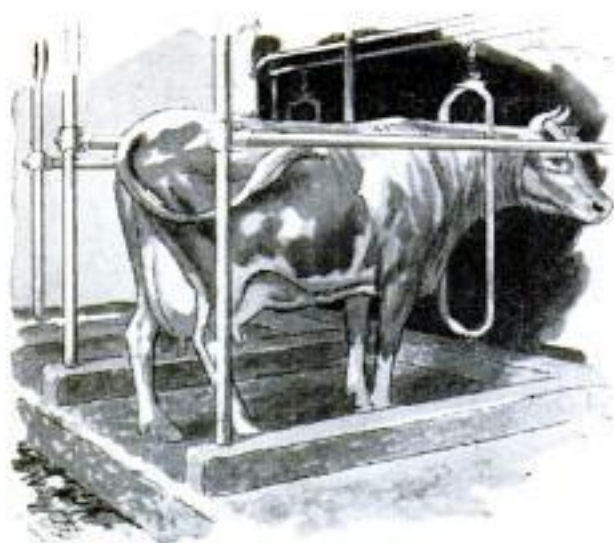

### Separate Stalls in Dairy Barn

Individual stalls in a dairy barn are good insurance against crowding and possible injury when the cows enter and leave the barn. The separate stalls are formed by concrete curbs in which are embedded vertical and horizontal lengths of pipe to form partitions.

### Drill Clean Holes in Plywood



When drilling holes in plywood with an auger bit there is a tendency of the wood to splinter at the edges of the hole. This can be prevented by first pressing a square of cellulose tape on the wood and drilling through it.

### Feed Stored in Truck Body

A discarded truck body of the closed type solves the problem of safe, dry storage of feeds and feed supplements for one farmer. The body is mounted on skids so that it can be moved by tractor from one pasture to another.—K. Imig, Watseka, Ill.



### Vertical Boring in Drill Press

Where accuracy and smooth work are required on light boring jobs, machinists sometimes use a drill press as a boring machine. The drill-press table is counterbored to take a bushing carrying the free end of the boring bar. The counterbore also provides chip and tool clearance. The bushing is machined to a press fit in the counterbored hole. The work setup shown in the detail is typical of several that can be made on a drill-press table of average size, using two clamps. In some instances, three clamps will be necessary. Feed of the drill spindle should be uniformly slow to produce a smooth bore.

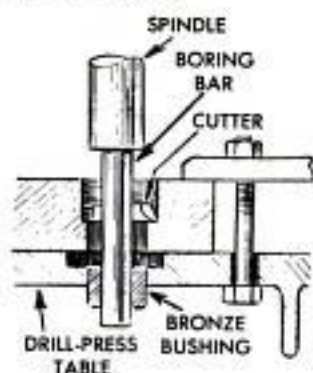

Frank L. Rush, Columbus, Ohio.

### Lifters Guide Stalks to Rolls

A pair of steel rods welded to the upper end of the center divider on a tractor-mounted cornpicker straightens leaning stalks, preventing loss of the ears as the stalks pass into the snapping rolls.

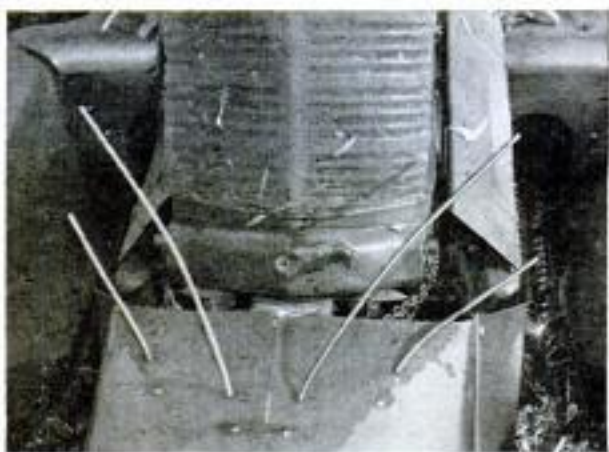

### Chucking a Threaded Rod

When chucking the threaded end of a rod you can avoid damage to the threads simply by wrapping a length of wire into them before tightening the chuck jaws. Use correct-size wire.—Hugh Lineback, Stillwater, Okla.

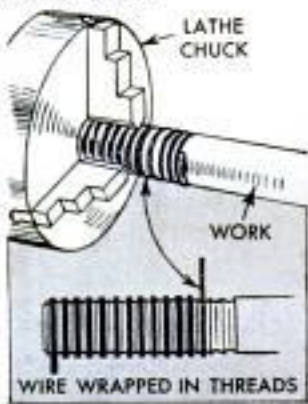

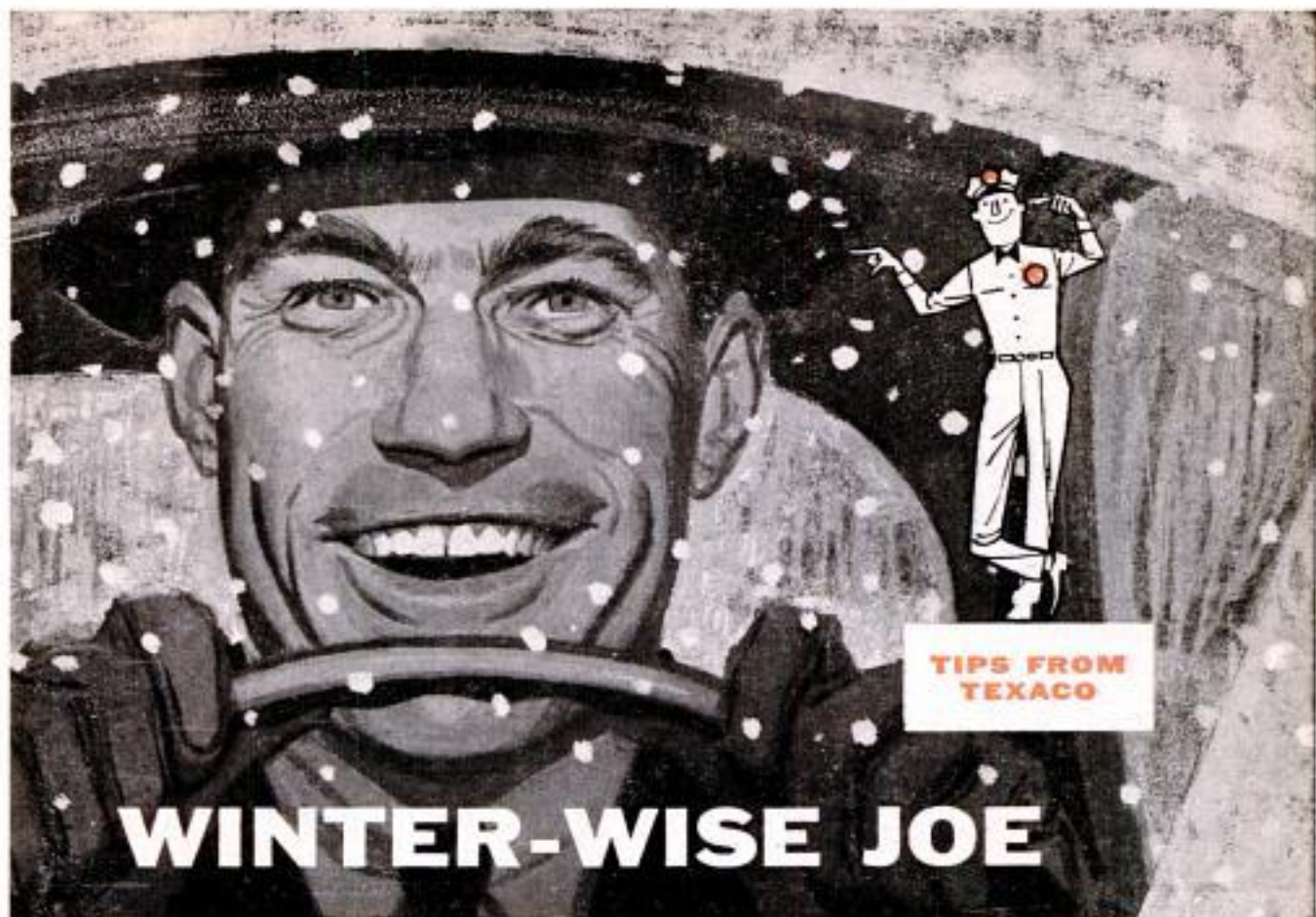

Winter driving problems that bother other drivers don't seem to bother Joe.

If Joe's car door lock freezes up, he heats the key with a match and inserts it. The lock thaws out.

Joe slides pieces of cardboard under the windshield wipers to prevent windshield frosting while his car is parked.

When Joe parks in the snow he always

backs up a little so there'll be space for a running start if the snow freezes or more snow falls.

Joe's Texaco Dealer checks his battery frequently to make sure there'll be plenty of power for starting . . . checks his anti-freeze to be sure of his temperature protection. Joe always favors Texaco products and the careful service Texaco Dealers give his car.

### Start fast and save gasoline

When cold weather congeals ordinary motor oil, starting is slow and you waste gasoline. It pays you to use Havoline Special 10W-30 that flows freely in sub-zero cold, makes starting easier and saves on fuel. And, under high temperature conditions, it doesn't thin out like ordinary oil. You get full lubrication, a cleaner engine and more gasoline saved. Get this finer oil from your Texaco Dealer — *the best friend your car has ever had.*



SAVES . . .  
FROM THE  
START



# TEXACO DEALERS

IN ALL 48 STATES

Texaco Products are also distributed in Canada, Latin America, and Africa.

THE TEXAS COMPANY





## New! Kodak Pony II Camera

*Makes 35mm color slides faster,  
easier than ever. Only \$26.75*

With the new Kodak Pony II Camera you'll take gorgeous color slides, crisp black-and-whites, *right from the start . . .* and do it easier than you ever thought possible.

Here's why: You make only *one setting* for correct exposure—and a guide on the camera tells you how. Focusing is just as easy. You dial the kind of picture you want to take—"Close-up," "Group," or "Scene." Then you frame the picture the way you like it in the big viewfinder—and press the button.

Even if you've never taken a picture before, you can learn everything you need to know about the Kodak Pony II Camera in a matter of minutes. It loads without threading, cocks the

shutter automatically, counts each exposure made, keeps you from making "double exposures." In short, it handles so smoothly that all you have to think about is the fun of taking pictures!

Ask your photo dealer about the Pony II's fast *f/3.9* lens and remarkable operating ease. And remember, you can own a Kodak Pony II Camera for as little as \$2.70 down.

### **New Exposure Value Settings**

All four new Kodak cameras described here are calibrated with exposure value numbers which make picture-taking faster . . . easier than ever. A guide on the camera tells you which number to use to *set everything* for the right exposure.

**EASTMAN KODAK COMPANY, Rochester 4, N. Y.**

**New!**

## KODAK PONY IV CAMERA

*has the deluxe features  
35mm fans asked for!*



Here are some of the *plus* features that make this the finest Pony ever built . . .

Exposure settings are ultrafast. For each picture situation, a guide on the camera tells you which *exposure value number* to use. Simply match this number with the camera settings—and shoot! (Kodak Pony IV Camera has new *exposure value scale* markings as well as conventional shutter-speed and lens-opening settings.)

Focusing is equally fast. You can dial for "Close-ups," "Groups," "Scenes,"—or focus by scale from 2½ feet to infinity. Other Pony IV features: automatic double exposure prevention *plus* a release for intentional multiple exposures; direct body-contact flashholder fittings *plus* a handy accessory clip on top of the camera. And to give you really sharp pictures, the Pony IV has a fast, Lumenized *f/3.5* Kodak Anastar Lens.

New Kodak Pony IV Camera, \$39.95, or as little as \$4 down.

**New!**

## KODAK SIGNET 50 CAMERA

*measures the light  
for every shot!*

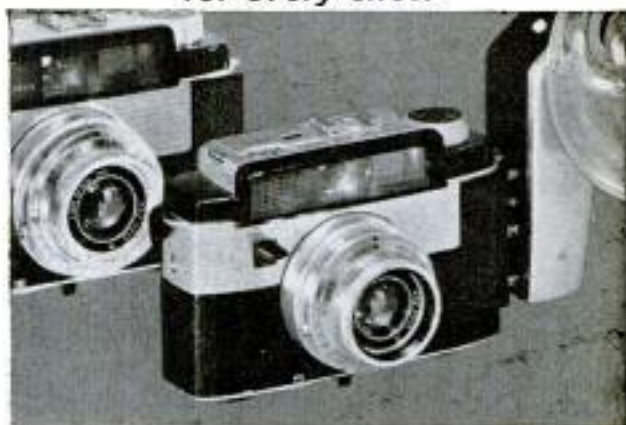

Precision photography has never been simpler! With the Kodak Signet 50 Camera (right) a photoelectric meter tells you the right exposure for a subject. All you do is read the number on the meter, set the same number on the camera—and shoot! An exceptionally fine *f/2.8* lens and an 8-speed Kodak Synchro Shutter let you take top-quality pictures anywhere, any time.

Your photo dealer will gladly show you the new and automatic features that make Signet 50 the fastest, surest operating 35mm camera Kodak has ever built. You can own a beautifully styled Kodak Signet 50 Camera complete with flashholder and two reflectors for \$82.50, or as little as \$8.25 down.

**Kodak Signet 30 Camera** (left) is identical with the Kodak Signet 50 Camera except that it has no built-in light meter, and does not come equipped with flashholder. \$55 or as little as \$5.50 down.

**Ask your photo dealer about these other fine Kodak 35mm Cameras**



**Kodak Signet 40 Camera.** Precision camera with rangefinder and handy dual-reflector flash system, \$74



**Kodak Retina IIIc Camera.** Has coupled rangefinder, ultrafast *f/2* lens, built-in photoelectric meter. \$175



**Kodak Retina IIc Camera.** Has *f/2.8* lens, no exposure meter. \$132

*Prices are list, include Federal Tax,  
and are subject to change without notice.*

**Kodak**  
TRADE MARK

# Need oil control?



## Sealed Power's got it!

**KromeX ring set with new Stainless Steel Oil Ring permits performance never before possible.**

Even under high vacuum condition such as deceleration, Sealed Power's Stainless Steel\* Oil Ring controls oil, eliminates smoking. This ring will not sludge or corrode because of the characteristics of stainless steel. And it has chrome-plated steel side rails for more than double normal ring life. They seat instantly.

### OTHER UNIQUE FEATURES

Sealed Power's Stainless Steel Oil Ring holds full tension at engine operating temperatures. Judged by either your pocketbook or car's performance, Sealed Power's KromeX Ring Set with the Stainless Steel Oil Ring is your best buy.



### GET THIS FREE MANUAL

An illustrated manual on engine care—free, yours for the asking. "Care and Feeding of Engines" is highly informative, could save you a lot of maintenance expense. For your free copy, write Sealed Power, Dept. G-11, Muskegon, Michigan.

\*U. S. Patent No. 2,789,872

# Sealed Power

## PISTON RINGS

**BEST IN NEW CARS! • BEST IN OLD CARS!**

# Clinic for Homemakers



As a service to our readers in solving the hundreds of problems pertaining to a home—inside or out—the editors of *Popular Mechanics* invite you to present your problems to The Clinic Editor for help and advice. Address your questions to The Clinic Editor, *Popular Mechanics Magazine*, 200 East Ontario Street, Chicago 11, Ill.

### Winter Protection For Climbing Rose

*Q—I have a climbing rose which has nearly covered a large wooden trellis. During the last year much of the growth died out. The trellis is located at the northwest corner of the house and is exposed to severe winter winds. Is the exposure the cause of the canes dying, or is it due to disease?*



*B. W.—Minneapolis, Minn.*

*A—*Ordinarily, the climbers are quite hardy, especially those with small blooms in clusters such as the ramblers. In very severe winters they may be damaged somewhat but if the plant is not diseased it will renew itself in a season or two. The large-flowered climbers generally are less hardy. It is possible that the rose disease known as "black spot" has so weakened the plant that it is unusually susceptible to winter injury. The disease can be controlled by spraying with a prepared rose spray during the growing season. In localities where the winters are severe, many gardeners remove the canes from the trellis late in the fall and tie them in a loose bundle. This is laid on the ground and covered with a layer of small twigs. Finally, leaves or coarse straw is used to cover the bundle. Ordinarily, this is sufficient protection.



### Renewing Finish On Old Piano

*Q—I have an old upright piano on which the original finish is checked. The checks are fine and run irregularly over all the finished surfaces. I believe the wood is mahogany. Is there any method of renewing the old finish?*

*J. M.—Lima, Ohio.*

*A—*If you are sure the wood is mahogany and that the finish is not a grained finish over some other wood, then it is possible to do a fairly good job of renewing the original finish provided the checks are merely surface checks and do not go clear through to the wood. One way is to mix fine pumice stone and rubbing oil to a thick paste, place a small quantity in the center of a square of soft cloth and then fold the corners of the cloth over to form a pad. Rub the checked surfaces, first

(Continued to page 226)



## FREE MASONITE PLANS...Easy cut-outs to brighten your home for Christmas!

Big, bright, beautiful cut-outs! Santa and his reindeer to prance across your yard...a Peg-Board® Greeting Card tree...a Nativity scene...snowmen and carolers, angels and choirboys. They're all here, all laid out on a grid pattern. You and the family will have a world of fun tracing these scale patterns on economical, durable Masonite® Primecote® Panels!

### JUST ASK YOUR NEIGHBORHOOD LUMBER DEALER

—He has your plans waiting for you now, *free* plans for all Masonite's Christmas figures. And he has just what you need to bring them to life: Masonite exterior panels. These panels are super-smooth and splinter-free. They cut cleanly, stand firmly. What's more, they're all prime-coated, ready to take on their gay Christmas colors...ready for years of holiday service.

How they'll add to your Christmas spirit —this year and many years to come. These durable Masonite panels take to wintry weather like Santa himself! So act now! Get down to your lumber dealer's...ask him about the full-size tracing patterns for *your* displays...he'll help you with your plans and materials. Or send the coupon below for complete information.



©Masonite Corporation—manufacturer of quality panel products.



Insist on Masonite 3/4" Primecote Panels for your Christmas cut-outs. They're so easy to paint...so weather-resistant...so inexpensive.

### FREE PLANS!

MASONITE® CORPORATION  
Dept. PM-11, Box 777, Chicago 90, Ill.  
In Canada: Masonite Corporation,  
Gatineau, Quebec

Please send me my free Christmas plans and full information about Masonite outdoor panels.

Name .....  
Address .....  
City ..... State .....  
Zone ..... County.....

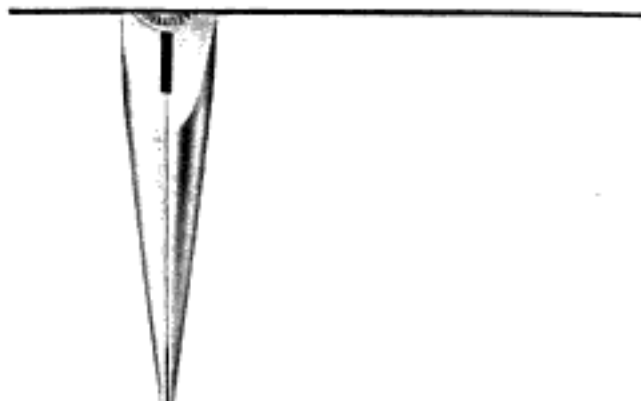

**THE REACH IS RIGHT AND TIGHT**

**with KRAEUTER**

**LONG NOSE PLIERS**

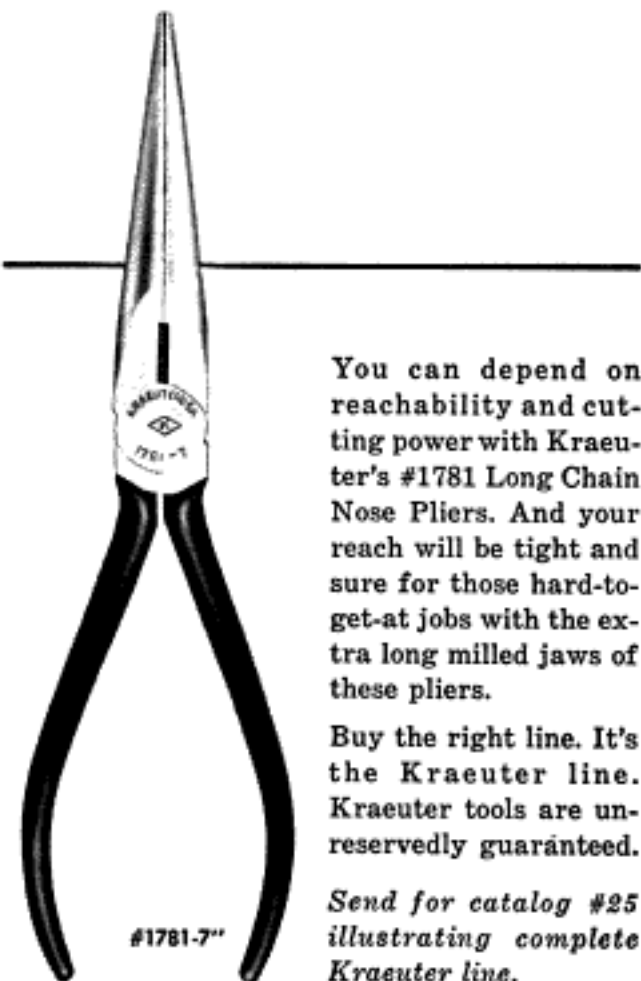

You can depend on reachability and cutting power with Kraeuter's #1781 Long Chain Nose Pliers. And your reach will be tight and sure for those hard-to-get-at jobs with the extra long milled jaws of these pliers.

Buy the right line. It's the Kraeuter line. Kraeuter tools are unreservedly guaranteed.

Send for catalog #25 illustrating complete Kraeuter line.

**BUY THE FINEST  
BUY KRAEUTER  
BUY AMERICAN**

MODERN AS TOMORROW  
**kraeuter & co., inc**  
FOR 100 YEARS THE FINEST IN HAND TOOLS 1860-1960 NEWARK, N. J.



(Continued from page 224)

with a circular motion then with a straight back-and-forth stroke. Continue this procedure until the checks are removed, then polish with rottenstone and oil on a pad in the same manner. Use a high-quality rubbing oil which is especially made for the purpose. Do not apply undue pressure in either the circular or straight strokes as the heat generated, although very little comparatively, may tend to soften the finish.

#### **Chain Loosens Soot In Chimney**

**Q**—My three chimneys are old, unlined and, I suspect, badly coated with soot. One chimney is about 30 ft. high; the other two 18 or 20 ft. high. Only the tallest one has a cleanout door. Is there any easy way of removing the soot from these chimneys?  
*G. H.—Rome, N. Y.*



**A**—One way of loosening the soot in a tall chimney is to lower a chain into the flue from the top. The chain should be long enough to reach nearly to the bottom of the chimney. A light wire chain is best, although any chain will do. After lowering the chain into the flue, swing it with a quick circular movement to give a whipping motion. This will cause the chain to strike the sides of the flue all along its length. The action of the chain will loosen the soot very effectively. Cleanouts should, of course, be installed in the two shorter chimneys. Remove all the loosened soot from the chimneys as it can cause a serious fire should it be ignited by sparks.

#### **Attaching Wooden Strips to Concrete**

**Q**—I'm planning a recreation room in my basement and want to use knotty pine on the wall at one end of the room. My problem is how to fasten the pine boards to the wall, which is concrete. Can you help me?  
*F. M.—Manchester, N. H.*

**A**—First you will have to attach furring strips to the wall to get a nailing base, and to provide space back of the boards for circulation of air. If the wall is the common height of 6½ or 7 ft. from the basement floor to the bottom of the joists, you will need at least three horizontal strips spaced evenly, the first strip placed about 8 in. above the floor. These strips are attached to the concrete wall with lead or fiber screw anchors. To install the anchors, first drill holes to the required depth with a star drill of the correct size. Tap the anchors in place in the holes with light blows of a hammer so as not to upset the ends. Then simply drive ordinary wood screws through the furring strips into the screw anchors just as you would drive the screws into wood.

#### **Metal Weather Strip for Storm Sash**

**Q**—I recently purchased an old house and want to fit storm sash all around to conserve heat. Some of the window frames seem to be warped or pulled out of square. On several, the sills are curved upward at the center, making it almost impossible to get a tight fit of the storm sash. Can you suggest a remedy?  
*B. R.—Waterloo, Iowa.*

**A**—Use metal weather strip of the spring-contact type. This will add to the cost of installation but the fuel savings will more than offset the extra initial cost. Measure the window frames carefully and cut the storm sash to fit with an allowance of about ⅜ to ¼ in. all around. Then nail the metal strip to the edges of the storm-sash frame with the nailing flange flush with the inside corner of both rails and stiles. Apply the weather strip in this manner to the top and bottom rails and to the stiles. When installing the storm sash, use turn buttons rather than hangers for fastening.



**if it's *now, in power tools, too,* Remington, it's right!**

Model 149B— $\frac{3}{4}$ -inch electric drill, AC-DC; 25 to 60 cycle; 115 volts; 2,500 rpm. At \$29.50—more power per dollar—attachments not included.\*



**powers a whole workshop of attachments!**

**OPERATES THESE AND MANY MORE**

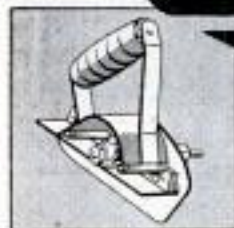

PLANER



SANDER



RECIPROCATING SAW



METAL NIBBLER



HEDGE TRIMMER



SCREW DRIVER



KNIFE SHARPENER

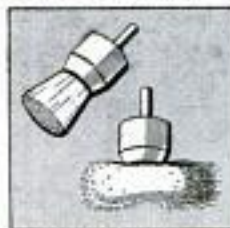

WIRE BRUSH



RAG BUFF WHEEL

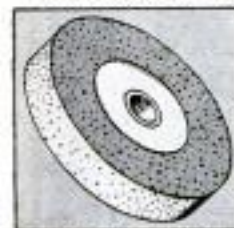

GRINDING WHEEL



DRILL



SLITTING SAW

Here's an electric drill with power to spare! Now you can assemble a complete, low-cost home workshop around just one powerful tool—the Remington 149B drill by Mall. It's precision-built to handle most any job ... to give a lifetime of rugged service. Fits planer, sander, saw and dozens of other attachments. Does many jobs out of the workshop, too, from hedge trimming to car polishing.

\*Specifications and recommended price subject to change without notice.

**SEND FOR FREE, 16-PAGE CATALOG**

showing every type of electric hand tool. Tells what each tool will do. Gives prices and specifications. No cost, no obligation. Send coupon today.



**Mail this coupon today!**

**MALL TOOL COMPANY**  
Division of Remington Arms Company, Inc.  
Bridgeport 2, Connecticut

Please send without obligation **FREE**, illustrated catalog on electric tools.

NAME \_\_\_\_\_

ADDRESS \_\_\_\_\_

CITY \_\_\_\_\_ ZONE \_\_\_\_\_ STATE \_\_\_\_\_

PM-11

**Remington**

**Mall®**

**MALL TOOL COMPANY,**  
Division of Remington Arms Company, Inc., Bridgeport 2, Connecticut  
In Canada: Mall Tool, Ltd., 36 Queen Elizabeth Blvd., Toronto, Ont.

NOVEMBER 1957

227

Copyrighted material

if you  
have to  
glue it . . .

**LET  
ELMER  
DO  
IT!**



Repair or  
build quickly  
with strong  
**ELMER'S®  
GLUE-ALL**

Be a real home "do-it-yourselfer." Build this fold-away work bench easily from Easi-Bild pattern #576 with Elmer's Glue-All. It's easy to apply, fast drying. Glue-All is also ideal for dozens of other uses around the home. Bonds any porous material such as wood, pottery, paper or cloth.

Send 50¢ in cash or money order for full-size Easi-Bild\* Fold-away Bench Pattern No. 576 to Elmer's Pattern Dept., P. O. Box 26, Pleasantville, N. Y.

\*T. M. Reg. Easi-Bild Pattern Co., Inc.



Get a completely waterproof bond with  
**ELMER'S® WATERPROOF GLUE**

It's the glue that boating experts use. Apply on any joint subject to water, weather, acids or alkalis. Super bond is stronger than wood itself!



Bond plastic laminates or plywood wall panels with **ELMER'S® CONTACT CEMENT**

No clamps, nails or presses needed to do professional job quickly. Highly resistant to heat and water. Available in regular or non-flammable type to meet every need.



IF IT'S **Borden's** IT'S GOT TO BE GOOD!  
The Borden Company, Chemical Division  
©1957, The Borden Company



Framing trick mirrors is one of the jobs taken on by Logan. Assistant, Dolores Astling, demonstrates

## Trouble Shooter for Carnivals

*(Continued from page 135)*

made in Spain, and a knee organ that the player holds in his lap and operates from a bellows.

When he needs a special device, he makes it. He has built a left-handed band-saw and a vise that holds merry-go-round horses as he carves on them with chisel and file. He makes the storage batteries he uses in his own car and has built one of the area's first swamp buggies—those strange vehicles used in Everglades travel. In 1926 he made an aircraft which was licensed. He even prints his own letter-heads and business cards. Retirement means anything but that to Pete Logan, trouble shooter deluxe. ★ ★ ★

Logan has this set of high-speed spindles for freehand work on merry-go-round horses. Carving gear is rare

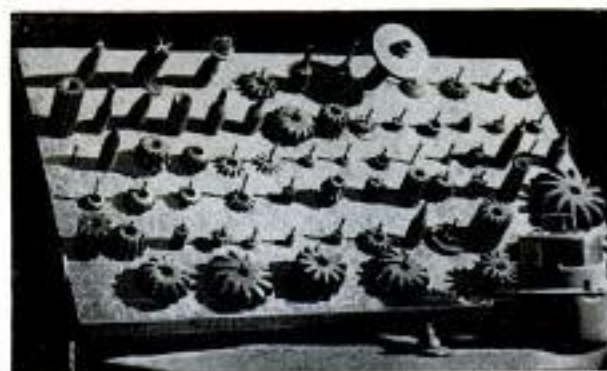

Get your choice in the smart, new  
uniform of choice — **MODERN ARMY GREEN**



**"CHOOSE YOUR TRAINING—I DIDI**  
"I found only the Army guarantees high school graduates their exact job training. There's a course for every need, and it's reserved for you before you enlist, so you're sure to get the training you want. I picked Diesel Mechanics. It was a great course that I could never have afforded otherwise. Your Army Recruiter can show you how to get the training you want, too."

*Victor R. Jones*

• Pvt. Victor R. Jones, Miller, Ohio.



**"CHOOSE YOUR TRAVEL—I DIDI**  
"I wanted to see Europe, and I found only the Army lets you choose your own foreign travel. I picked my exact overseas assignment, and it was even guaranteed before I enlisted. What's more, I enlisted with my brother and we'll stay together all the time we're overseas. You and your buddies can plan your foreign travel just like I did. Your Army Recruiter can show you how."

*Charles R. Carrico*

• Pvt. Charles R. Carrico, Springfield, Ky.



**"CHOOSE YOUR BRANCH—I DIDI**  
"I'm serving the way I wanted to, because I found the Army would let me pick the branch that interested me most. I chose Anti-Aircraft, and I'm getting top leadership training in electronics and guided missiles—a really important field of the future. You can pick the Army branch you like the best, too. Just name it and it's yours—guaranteed before you enlist."

*John D. Finley*

• Pvt. John D. Finley, Colebrook, N. H.

Only in **MODERN ARMY GREEN** can you choose  
your **JOB TRAINING • TRAVEL • BRANCH**



For details on how to choose before enlistment, send for your free booklets today. Or for immediate counseling visit your local Army Recruiter. He's listed in the phone book and will give you all the facts—at no obligation!

**THE ADJUTANT GENERAL** PN-12-57  
Department of the Army  
Washington 25, D.C.  
Attn: AGSN

Please send me the free Army booklets describing special opportunities that only come with Modern Army Green.

Name \_\_\_\_\_

Address \_\_\_\_\_

City \_\_\_\_\_ State \_\_\_\_\_

Date of Graduation \_\_\_\_\_



Engineer of Casey Junior Circus Train sits in front unit but the engine actually is in the second car

## Disney's Mechanical Wonderland

(Continued from page 143)

strains. Another big problem was the method of getting power from the rear-mounted engine to the rear wheels. The small space available left no room for a differential or drive shaft. Bob tried several transmissions, including one that broke down in only one day. He finally selected a heavy gearbox with a pair of V-belts driving from a centrifugal clutch on the engine.

One pedal controls both accelerating and stopping. Gentle pressure on the pedal speeds up the car. Releasing the pedal

Power unit of Casey Junior is a Plymouth auto engine with an automatic transmission. It is linked to the front set of wheels by a chain drive



closes the throttle and engages the power brakes. The car stops within one length at its maximum speed of  $9\frac{1}{2}$  miles per hour.

And this maximum speed is a critical matter. One half mile over this speed just won't do.

At exactly  $9\frac{1}{2}$  miles the car can crash into a brick wall and do no injury to car or occupants. Anything over that speed may produce banged knees. The governor on the cars maintains an exact  $9\frac{1}{2}$  miles uphill or downhill.

### Disney Plans for Future

The imagination that first thought of Disneyland continues to grind away.

For the future, Walt is thinking of ideas for Sleeping Beauty Castle. He plans to tell this story in three-dimensional, animated views. He wants fairies flying through the scenes sprinkling pixie dust. And he wants a life-sized spinning wheel like the princess had when she pricked her finger on the spindle and fell asleep for 100 years.

Walt once complained that when he finished a feature film he couldn't do anything more to it. He has now found the answer to this problem in his new park, a giant hobby which he continually tinkers with and enlarges. ★ ★ ★



*New  
Advanced  
Design*

## **DELTA'SHOP** BIG IDEA FOR SMALL SPACE

**Combination of 4 full size tools  
does 95% of all workshop jobs  
—yet takes space only 3 feet square!**

If you want a *real* workshop, but simply don't have a lot of space, then the New Advanced Design DELTA-SHOP is for you. It's the most *practical* all-purpose combination tool ever built!

Here's why: In a space just 3 feet square it puts at your finger tips a powerful 9" circular saw, a 4" jointer,

an 11" drill press, and an 8½" disk sander—all mounted on one stand and powered by one motor. And because the DeltaShop is a combination of *full-size* tools (not attachments) you can buy it all at once (as little as 10% down), or the easy Tool-At-A-Time way.

**BUILD THIS SPACE-SAVER SHOP!** Delta experts designed the efficient under-the-stairs shop shown above so that you can build it. Plans are yours free—just send the coupon on the other side of this page. Do it *now*—and then see the New Advanced Design DeltaShop!

# POWER TOOLS CHOICE

enjoying them now!)



## DELTA "900" RADIAL SAW

1. Powered by true  $\frac{3}{4}$  HP motor. Saw, drill, rout, sand, grind, shape, cut mouldings and do many other jobs. As shown, equipped with Retractable Leaf Guard, Stand, and Retractable Casters.

## DELTA DUST COLLECTOR

2. The only industrial type dust collector priced for the home workshop! As shown, with  $\frac{7}{8}$  HP Motor, Switch and Cord, Drum, Hose, Casters, and Filter Bags, and equipped with Adapter for Delta "900" Radial Saw.

## DELTA'SHOP

The most practical combination of full-size tools ever built. Consists of 9" Tilting Arbor Circular Saw, 4" Jointer, 11" Drill Press, 8 $\frac{1}{2}$ " Disk Sander,  $\frac{3}{4}$  HP Motor, Motor Pulleys, V-Belts, and Stand. As shown, equipped with Retractable Casters.



## OL FUN AND PROFIT

### DELTA-GRAM

Known home workshop popular DELTA-GRAM with helpful ideas, complete with detailed step-by-step instructions and lists of materials. Giving short cuts and included in every year.



## MONEY-SAVING ACCESSORIES

### Make every Delta Tool an even better investment

Your circular saw becomes a tenoner, cuts mouldings or dados . . . your drill press becomes a grinder, shaper or router . . . your lathe becomes a sander, drill, or does buffing and polishing—in fact, every Delta tool is more versatile, more valuable, when you add the right low-cost Delta accessories.

Delta makes more than 1300 different accessories, each one engineered to increase the range of jobs you can do. For very little money, Delta accessories add a lot of value to your shop, and to your own skill and satisfaction as a craftsman.

SEE NEW  
Advanced Design

# DELTA

## HOMECRAFT POWER TOOLS AT YOUR DELTA DEALER

(listed under "TOOLS" in the Yellow Pages)

or at leading hardware, department,  
and building supply stores.

Because Delta makes the world's most complete line of individual, all-purpose and combination tools, you can count on the man who sells Delta for impartial help in selecting the best type of tool for you. See him today—let him show you the exciting New Advanced Design Delta Homecraft Power Tools. Compare, and make up your own mind.

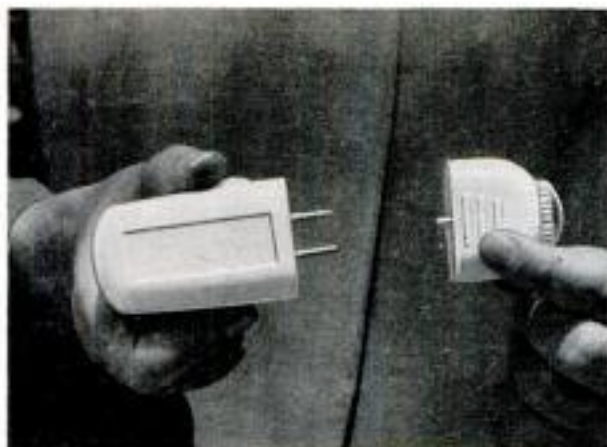

Competition Chemicals, 704 Washington Ave.,  
Box 141, Iowa Falls, Ia.

### Recharge Flashlight Battery By Plugging Into Wall Outlet

Operating on dry cells, a flashlight can be recharged overnight by removing the battery unit and plugging it into a 110-volt alternating-current outlet. The steel-cased unit contains a charger and a limiting device to prevent overcharging. The recharged battery will operate the light for two hours.

### Bavarian Mushroom Slows Tumor Growth

Michigan State University scientists are trying to isolate a substance in a Bavarian mushroom which checks tumor growth in mice and rats. According to folklore, people who ate a certain species of mushroom that grows in the Bavarian-Bohemian Forest did not develop cancer. Cancer research workers decided to test the legend by injecting mice and rats with an extract of the mushroom. They discovered that it slowed the growth of tumors.

### Spray Coating Ends Snow Sticking



Shoveling snow usually is less work if the snow doesn't stick to the blade of your plow or shovel. An aerosol spray now on the market reportedly ends the sticky snow problem with an invisible coating that causes the snow to slide off treated surfaces. It

also can be used on power-driven throwers to prevent snow from clogging the chute. As an added benefit, the spray coating protects the metal parts from rust formation.

Speco, Inc., Cleveland 9, Ohio

# NO "TALK"... ALL ACTION

## NEW DUNLOP SILENT TRACTION

- Bites deeper in snow, mud, slush
- Grips better on slippery surfaces
- Runs quiet on bare roads



**POWERFUL TRACTOR-TYPE SHOULDER BARS DIG DEEP...**power you out of heavy snow, slush or mud!

**MORE GRIPPING EDGES!** Siped traction units provide thousands of gripping edges, minimize danger of skidding—give faster, surer stops and starts on slippery surfaces!

**RIDING RIBS ELIMINATE** "jumping" from lug to lug, assure smooth ride, quiet performance...even on bare roads!

**STABILIZERS** deep in channels support the tread elements, prevent annoying vibration!

**ENTIRE TREAD SELF-CLEANING**—and ruggedly wear-resistant!

This winter, don't shovel out—power out—on Dunlop Silent Traction Tires!  
Your Dunlop dealer has the size and type to fit your car.

You'll go farther...**SAFER**...on tires by

# DUNLOP

...they're **AccuRated**

DUNLOP TIRE AND RUBBER CORPORATION, BUFFALO 5, N. Y.

Kills that chill  
—modern *2-layer* action\*



# Duofold

*2-layer* insulated underwear

\*2-layer ACTION  
makes the difference!

**COTTON**  
for COMFORT  
next to your  
skin... soft,  
absorbent —  
blots up body  
moisture —  
no itch!



**WOOL**  
for WARMTH  
in outer layer...  
virgin wool,  
nature's warmest  
fiber... kills  
evaporation  
chill.

**Best Chill Protection** — Exclusive Duofold 2-layer fabric works two ways: (1) Quickly absorbs body moisture; (2) Evaporates it away from the skin. Keeps you dry and chill-free, indoors and out.

**Nothing Warmer** — Not one but *two* insulating layers. Not one but a complete range of styles and fabric weights.

**Bulk-Free! Itch-Free! Lightweight!** — The last word in wearing comfort. See your Duofold dealer now.

Duofold Inc., Mohawk, N. Y.

Distributed in Canada by Gordon Mackay & Co., Ltd., Toronto, Ontario  
In trim longies-n-T-shirts and union-suits for men; sports styles in Sun Valley Red\* for the entire family; Peppermint Candy Stripe\* for girls and ladies. NEW Powder-Snow Blue\* for ladies... all shrink-resistant.

\*Trademarks

© 1957 Duofold Inc.

## School for Courteous Traffic Cops

(Continued from page 148)

A cadet can be giggered for all sorts of other seemingly minor infractions — if he fails to rise when reciting in class, for example; if his handkerchief isn't tucked into his trouser pocket, or if he doesn't push his chair in under his desk at the end of the class period. Drinking in the barracks, leaving the academy without permission or shirking work details are all grounds for immediate dismissal.

Recruits are bombarded with courses covering the whole gamut of police work; subjects include everything from driver's license law to emergency childbirth, from general semantics to "pursuit and apprehension of traffic violators."

During the accident-investigation course, each cadet is turned loose at the scene of a mock accident and told to find out as much as he can. An old car has been covered with tape at various points to simulate collision damage, and various automobile parts — obtained from junk yards — have been left lying on the ground nearby. The accident scene is complete with a cast of "drivers," "passengers" and "witnesses," played by instructors and students, who answer the cadet's questions with specially prepared statements designed to mislead and confuse him. Here is the sort of thing the cadet has to contend with:

A witness hints vaguely that an old man might have been present when the accident occurred. If the recruit ignores this tip, he flunks the exercise. Many real accidents are solved by pursuing just such tenuous leads.

Another mock accident involves a "cab driver," who freely admits being at fault, and a "banker." Unless the recruit checks thoroughly, he doesn't discover that the banker is really the guilty one. The cabby is trying to cover up because he owes the banker a lot of money.

### Fists Help to Pass Test

The cadet runs into a host of other troubles he can expect to encounter on the job. If a driver has to be taken into custody, for example, his "family" puts up an awful squawk. At other times, the driver plays the role of a drunk, a psychoneurotic or a criminal, in which case the cadet has to employ special arts of persuasion, including his fists, to get his man.

After each mock accident, the cadet must present his findings at a mock trial. A former judge presides at these sessions, and an experienced attorney plays the role of defense counsel. To give students

(Continued to page 256)





IN TOWN TRAFFIC . . . some spark plugs, designed for high speeds, become fouled and cause misfiring and loss of power.



ON THE HIGHWAY . . . some spark plugs, designed for low speeds, invite destructive pre-ignition or misfire causing power loss. Why gamble when . . .

## Auto-Lite Spark Plugs with **POWER TIP** "Fire Up" your engine\* at all speeds!



If you drive both at town-traffic and at highway speeds, here's why you should use Power Tip . . . the first spark plug ignition-engineered for today's engines and today's driving

YOU CAN SEE  
THE BIG NEW  
DIFFERENCE IN  
SPARK PLUGS!



Ordinary Tip    Power Tip

At low speeds, the projecting Power Tip is in the thick of combustion where it gets hot quicker and stays hot to burn fouling deposits away *clean*. At higher speeds, the projecting tip is in the path of the incoming air-fuel mixture where it operates cooler to effectively *check* power-robbing pre-ignition.

Ask your garage or service station to install Auto-Lite Spark Plugs . . . the *only* spark plugs with Power Tip . . . and start enjoying top performance and economy from your car at *all speeds*.

\*Power Tip, with or without Resistor, is ignition-engineered for overhead-valve V-8 engines and for most overhead-valve 6-cylinder engines in all these cars—Buick, Cadillac, Chevrolet, Chrysler, De Soto, Dodge, Plymouth, Ford, Hudson, Imperial, Lincoln, Mercury, Nash, Oldsmobile, Packard, Pontiac, Rambler, Studebaker.

Power Tip protrudes farther into the combustion chamber for better ignition. Fuel burns more evenly and completely to give top performance and economy at all speeds.

# AUTO-LITE® SPARK PLUGS WITH **POWER TIP**

Auto-Lite makes a complete line of spark plugs, including Standard, Resistor, Small-Engine, Transport, Aircraft, and Diesel-Starting.

# The Bombshell News Behind This Fresh, Bold Look



When better automobiles are built Buick will build them

**1. Flight Pitch Dynaflow\***—Those Buick engineers make transmission headlines again. In the eagerly awaited '58 Buick, they've developed a true *infinitely variable* stator for their triple-turbine Flight Pitch Dynaflow. Now those stator blades in the unit swing not to just two or three fixed positions, but literally to a million or more. That means maximum-power angle for starting, if you want it; gradually decreasing angle as your pace increases; and instant response at *any* pace in perfect ratio for the need at hand. The stator's 20 blades throw oil at the pump at 30 gallons per second at high angle. And this oil, moving at a velocity of 180 miles-per-

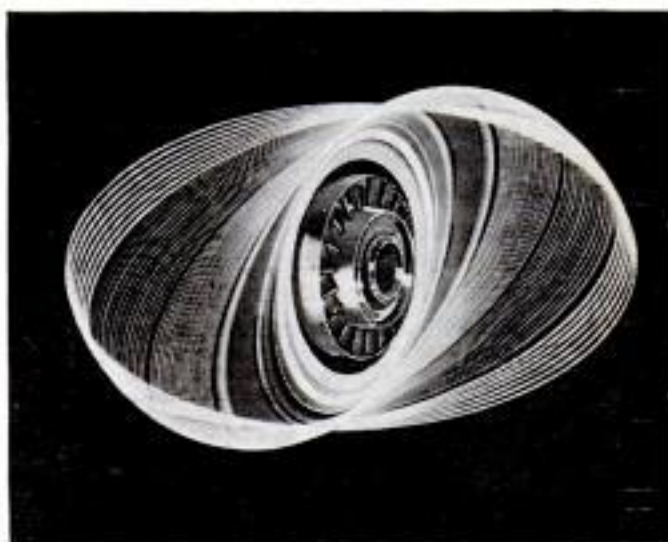

hour, impinges on the turbine blades with a *constant force of 1,140 pounds*. The performance is spectacular.

**2. The B-12000 Engine**—When you talk about engine efficiency, this is the one—the most modern engine it is possible to build for today's fuels. Vertical-valved for extra compactness (world's only vertical-valve V8), this great engine works at a neat 10 to 1 compression, develops a thrust of 12,000 pounds behind every piston's power stroke. That translates into superbly brilliant

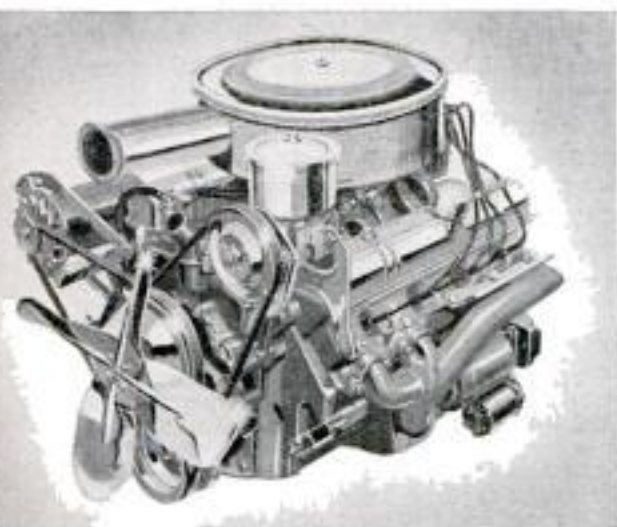

response. A unique center-of-percussion theory is used with "tuned" nodal-point mounting for more controlled rotational motion of the engine, and for increased lateral stability. With the response of this powerful engine, and the instant flexibility of Flight Pitch Dynaflo, you get in this '58 Buick the first big car that's really light on its feet — most nimble Buick ever.

**3. The Miracle Ride** plus Buick Air-Poise Suspension.\* Long years of constantly progressive ride-engineering have brought to a peak today the advantages of Buick's ride basics: X-member frame, full-length torque tube, and coil springs at all four wheels. In the '58 Buick chassis, you get a total of 46 feet of spring steel for torsional absorbence of road shock, which cuts vibrational frequency

to a low of 65 cycles per minute at the front, and to only 58 cycles at the rear. As an option, Buick Air-Poise Suspension replaces the coil springs, works new wonders for the Miracle Ride. To the basic solidity and stability of the Buick chassis—and without any major changes in its design — it adds 4 columns of compressed air with a *variable spring rate*. This keeps the car at one level, automatically, regardless of load or road condition. There's no other ride like it.

**4. Many Significant Changes** are found throughout the new B-58 Buick, since a great many projects long under development suddenly came to full flower this year, in this car: the Dynastar Grille, the clean, fresh styling, the "velvet wall" sound silencing, the new Quadrajets Carburetor, the Air-Cooled Aluminum Brakes,\* and many others. Best thing any knowing car buyer can do is drop in on



his Buick dealer at the first opportunity to take a good long look at these B-58's, then drive one and let it speak for itself.

BUICK Division of GENERAL MOTORS

\*Flight Pitch Dynaflo standard on Limited and Roadmaster 75, optional at extra cost on other Series. Air-Poise Suspension optional at extra cost on all Series. Aluminum Brakes standard on all Series except Special.

See TALES OF WELLS FARGO, Monday Nights, NBC-TV and THE PATRICE MUNSEL SHOW, Friday Nights, ABC-TV



**The Air Born**  **B-58 Buick**

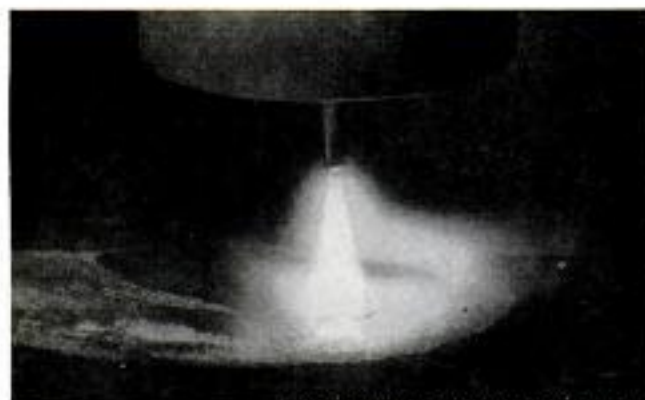

PHOTO COURTESY AIR REDUCTION COMPANY, INC.

## WELDING ARC IN ACTION

stopped with a  
*Pacemaker* **GRAPHIC\***!

There's almost no limit to the versatility of the Pacemaker Speed Graphic\* camera. Whether used by the industrial photographer to show a close-up of a welding arc and the flow of molten metal as in the photo above, or by the serious amateur as a natural complement to his own abilities, no other camera gives the user such tremendous photographic range. That's why better than 90% of all professional and press photographers use it.

If you want to be camera-equipped to take any picture, anytime, day or night, choose a 4 x 5 Pacemaker Graphic. Trade in your present camera as all or part down payment at your Graflex dealer's, listed in the "yellow pages." Priced as low as \$260.00. Take up to 21 months to pay.



AS LITTLE AS  
**\$13<sup>40</sup>** A MONTH

Prices include federal tax where applicable and are subject to change without notice. Prices slightly higher in Canada.

70th Anniversary—1887-1957

# GRAFLEX®

*Price-Winning Cameras*

A SUBSIDIARY OF GENERAL PRECISION EQUIPMENT CORPORATION



\*Trademark

## Make Your TV Set Safe!

(Continued from page 163)

chassis are completely enclosed or otherwise inaccessible. For metal-cased receivers, the chassis is insulated from the case by means of insulating bushings and washers so that no direct contact between case and chassis is possible. But, because of the proximity of an electrically "floating" metal case, the performance of the receiver might be impaired and it is common practice to connect a low-value isolating capacitor between case and chassis. For the high television frequencies this capacitor is, in effect, a short circuit so that the case is actually connected to the chassis. But for the 60-cycle line voltage the capacitor represents almost an open circuit and, therefore, provides sufficient isolation to eliminate the shock hazard.

In view of these precautions, it takes the following unusual, though entirely possible, combination of circumstances to make a TV receiver too hot to handle:

The set would have to be of the transformerless variety.

The set would have to be defective in such a way as to make a hot metal part exposed to the touch. (In metal cabinets, this can occur if the isolation capacitor or a chassis insulator becomes shorted. In wooden cabinets, tampering with the installation may expose a mounting screw. With either type, the removal of control knobs to foil the natural knob-twiddling instinct of the younger set is an invitation for trouble.)

The set would have to be located within reach of an externally grounded metal object. (Kitchens, basements, bathrooms and utility rooms are particularly dangerous locations.)

The line cord would have to be inserted in the outlet so that the chassis is connected to the hot side of the line.

Simultaneous contact would have to be made with the receiver and an externally grounded object. (With the previous conditions satisfied, touching the receiver while standing on a damp cement floor may be dangerous.)

### Reducing the Shock Hazard

One recommended method for eliminating the hot-chassis danger is the installation of polarized wall outlets in all locations where the set is likely to be plugged in, and the use of a correspondingly polarized plug on the end of the receiver line cord. With this method, the plug can be inserted in the outlet only in such a way that the chassis is connected to the grounded side of the line, and all danger is eliminated. However, any wall outlet so modified can not be used for any appliance fitted with the standard type of plug.

A similar modification, one which overcomes the latter disadvantage but affords protection only against hot metal cabinets, is the use of a three-prong plug adapter

(Continued to page 246)



# Why Magna?

— Because MAGNA's new, complete family of superior power tools incorporates the first significant design contributions in over a quarter-century!

HERE'S WHY THE MAGNA 9-IN. SAW-JOINTER gives you industrial capacity and precision: • *Increased Capacity*—built-in table extension makes largest effective table of any 9-in. saw; 4-in. Jointer has longest table, largest fence, over  $\frac{3}{8}$ " depth of cut! • *Ease of Operation*—Saw has One-Knob Control, exclusive Speed-Gear for quick tilt; Jointer operates at any height of saw blade! • *Rugged Durability*—Saw's precision-cast tub front. Massive cast-iron carriage; Jointer has one-piece cast-iron fence! • *Integral Precision*—self-aligning saw fence locks down front and rear with one knob; Jointer has precision-ground surfaces! Mail coupon today for free Magna-Line catalog! © T. W. REG.

Own a Magna 9-in. Saw-Jointer for as little as \$2.30 a week!

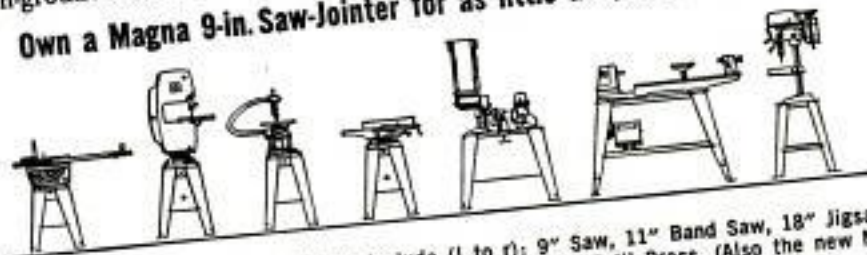

MAGNA-LINE tools for home and industry include (l to r): 9" Saw, 11" Band Saw, 18" Jigsaw, 4" Jointer, 6" Belt Sander, Compressor-Sprayer, 30" Lathe, 12½" Drill Press. (Also the new MAGNA Thrifty-Three: 8" T/A Saw, 12½" Jigsaw, 4" Belt Sander).



MAGNA POWER TOOL CORPORATION  
World's largest independent  
producers of power tools

MAGNA POWER TOOL CORPORATION  
Dept. 702-M, Menlo Park, California, OR  
Dept. 702-M, Box 2808 Fort Wayne, Indiana  
Please send me your free, illustrated MAGNA-LINE catalog:

Name \_\_\_\_\_  
Address \_\_\_\_\_  
City \_\_\_\_\_ Zone \_\_\_\_\_ State \_\_\_\_\_

*image  
not  
available*

# How to fit two boys into one room ...and keep 'em quiet, too!



Put two boys together and they're bound to have fun . . . and bound to make noise, too. But here's a dandy sound-conditioned room that lets 'em roughhouse all they want - yet hushes the noise they make. You can build a room like this yourself . . . even if you're no expert with a hammer and saw. It's easy to do, and costs less than you think. Here's how.

**For the ceiling,** use Gold Bond Decor Tiles - in the handsome new Jackstraw pattern (shown above). They're attractive, inexpensive, and make rooms pleasantly quiet - tiny spaces between the wood fibers actually soak up disturbing noises. Just nail or staple tiles to wood strips applied right over your present ceiling.

**For the walls,** use Gold Bond® Gypsum Grain-board Decorator Panels and Insulation Tiles. Decorator Panels come in four exciting wood-grain finishes, plus Knotty Pine. Go up in a jiffy, too. Saw panels like wood, or score with

a knife and snap. To clean, just wipe with a damp cloth. Insulation Tiles come in rich ivory white, and can be painted if you like. Their interlocking edges hide nails or staples.

**Want plans so you can start building?** Write for free illustrated folder, "How to Remodel Your Attic," to National Gypsum Company, Dept. PM 117, Box 73, Buffalo 13, N. Y. Then see your local Gold Bond dealer. He'll supply everything you need - including helpful advice.



NATIONAL GYPSUM COMPANY



help yourself  
to the  
handiest  
plier  
ever  
designed

CHAN NEL LOCK

No. 420

GRIPS LIKE  
A PIPE  
WRENCH

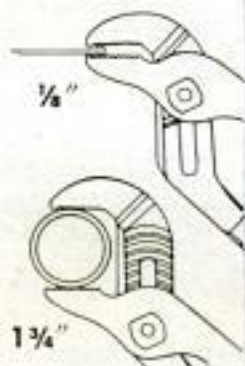

No other plier does so many jobs so well as a Channellock No. 420. Grips anything from a small cotter pin to a 1 3/4" hex nut. And what a grip! Just like a pipe wrench. What's more, Channellocks are streamlined . . . easy to use in hard-to-get-at places. Ask your hardware man for a Channellock plier. You'll soon agree with thousands of other craftsmen . . . Channellock is the handiest plier of them all.

BE SURE IT'S A GENUINE CHANNELLOCK



CHAMPION DEARMENT TOOL Co. MEADVILLE, PA.

## Transistorized Instrument Amplifier

(Continued from page 162)

battery. A kitchen-cabinet drawer pull serves as a carrying handle. Four rubber feet are attached to the bottom of the cabinet to prevent scratching of table tops. As a finishing touch, a piece of perforated aluminum may be cut to provide a back cover for the amplifier.

After the amplifier has been wired, it should be carefully checked against both the pictorial and the schematic diagrams to insure against wiring errors or improperly soldered connections. Particular attention should be paid to the polarity

### LIST OF MATERIALS

**RESISTORS:** R1, R3=270K, 1/2-watt; R2, R8=5K potentiometer (one with s.p.s.t. switch, SW1); R4=100 ohms, 1/2-watt; R5=4.7K, 1/2-watt; R6=100K, 1/2-watt; R7=47 ohms, 1/2-watt; R9=2.7K, 1-watt (see text).

**CAPACITORS:** (all miniature or subminiature) C1=5-mfd., 200-volt tubular; C2=100-mfd., 6-volt electrolytic; C3, C4=6-mfd. 15-volt electrolytic; C5=2-mfd., 6-volt electrolytic (see text); C6=30-mfd., 15-volt electrolytic.

**TRANSISTORS:** TR1, TR2, TR3 = Raytheon CK722; TR4=CBS-Hytron 2N255.

**MISCELLANEOUS:** T1=driver transformer, 500 ohms CT to 8 ohms, Argonne AR-164; T2=output transformer, 48 ohms CT to 3.2 ohms, Argonne AR-503; 8" PM speaker with 3 to 4-ohm voice coil; phono input jack (J1) with matching plug; small two-terminal jack (J2) with matching plug (PL2); 6-volt battery, RCA VS009 and matching connector (see text); main chassis, ICA No. 29077; heat-sink chassis, L.M.B. No. 424-C; baffle for 8" speaker, Lafayette No. SB-11 or equiv. (see text).

**HARDWARE:** Transistor sockets with clips (3), handle, rubber-tack feet (4), knobs (2), terminal strip, ground lugs, screws, nuts, wire, rosin-core solder.

Complete kit of parts available from Lafayette Radio, 165-08 Liberty Ave., Jamaica 33, N. Y.

(+ and - leads) of the electrolytic capacitors and to the connection to the polarized battery plug, PL1. These must be connected as shown in the diagrams to prevent damage to the amplifier when power is applied.

When the wiring has been checked, the three CK722 transistors may be inserted in their sockets. The small insert in Fig. 4 identifies the three equally spaced leads of the CK722s. These leads should be cut off to about 3/8 in. and special care should be used to make sure that the transistor leads coincide with the proper socket pins as labeled in Fig. 3.

### Possible Circuit Modifications

Tone-control action may be modified merely by changing the value of the tone-control capacitor, C5. With the 2-mfd. unit used in the original model, a considerable cut in high frequencies is obtained at maximum tone-control setting. If a lesser degree of treble cut is desired, the capacitor value can be lowered. Or, the tone-control

(Continued to page 250)



# How to get your money's worth from the next battery you buy

Although most batteries look alike, there is a vast difference in the way they perform. So, it will pay you to choose your next battery carefully rather than just "buy a battery." There are good reasons why it will pay you to choose an Exide.



**STARTING POWER . . .** Full-size plates and a more powerful active material than commonly used assure you *more* power than needed for starting—even in the dead of winter. This leaves a big reserve for electrical accessories.

**VITAL FRESHNESS . . .** *Dry Charged* (filled by your dealer) or *Wet* (filled at the factory) your Exide is always alive with long-lasting power.

**LONG LIFE . . .** Your Exide will give you more months and miles of trouble-free service because patented grid alloys are used in the plates. They combat overcharging—major cause of battery failure.

**GUARANTEED SERVICE . . .** You are protected by a nation-wide guarantee ranging from 18 months to 4 years.

**ECONOMY . . .** You can buy an Exide, produced by the company that has pioneered so many battery developments in the past 50 years, for no more than the cost of an ordinary battery. You'll be sure to get your money's worth.



**FREE!** This 32-page manual tells all about batteries. How to test, install, recharge, etc. Write to Dept. 36, Exide Automotive Division, P.O. Box 6266, Cleveland, Ohio.

When it's an

# Exide

...YOU START



# THIS ONE PUTS THE MEAT IN THE FREEZER!

The Marlin Model 336 Carbine is famous for pay-off features. Most important are Micro-Groove Rifling\*, which boosts accuracy by 20-25%, and side ejection, which allows low, dead-center scope mounting and super-strength receiver design.

Now, new improvements make this fine weapon even finer: Newly designed rear sight • Special finish on stock and forearm, to protect the surface and enhance appearance • Handsome, protective pistol-grip cap • Hooded, ramp front sight on Regular and Texan models • Bishop-style Monte Carlo stock on Sporter Deluxe model.

Choose the 336 Carbine that's right for your type of hunting, from five models and four calibers. Ask your dealer about the Marlin Pay-Later Plan.

**ILLUSTRATED:** Model 336-C, Regular Carbine. Calibers 30/30, .32 Sp., .35 Rem. • 20" barrel • Tube holds 6 shots.

**THE NAME FOR GAME**

**\$76<sup>95</sup>\*\***

## Marlin

FINE GUNS SINCE 1870

\*Patent applied for.

\*\*Slightly higher west of the Rockies. Subject to change without notice.

**Marlin Firearms Co.**

**G-117**

P.O. Box 995, New York 17, N. Y.

Please send me your catalog with photo illustrations and complete descriptions of all Marlin Guns. Also send me the new, illustrated 16 page "Marlin Target and Game Record Book", for my personal shooting records. I enclose 25¢ for handling.

Name.....

Address.....

City.....Zone.....State.....

circuit may be omitted entirely, saving the cost of C5 and R9. If this is done, a separate switch, SW1, must be provided for the power-supply circuit.

The undistorted power output of the amplifier may be increased by reducing the value of resistor R9. With the value specified, adequate room volume is obtained before signal overload (and distortion) occurs. The battery life, under typical intermittent operating conditions, should be between 50 and 100 hours. For greater undistorted power, the value of R9 may be dropped to 1500, 1000 or even 820 ohms, but battery life is reduced accordingly.

In addition to the circuit changes, a number of parts substitutions may be made to fit the requirements—and stock—of the individual builder: A smaller or larger loudspeaker may be employed provided it has a 3 to 4-ohm voice-coil impedance; specified battery may be replaced with a longer-lasting Burgess-type 2F4 or with four series-connected flashlight cells; other general-purpose audio transistors may be substituted for the CK722 units (this may require a change in the values of the bias resistors R1, R3 and R6 in order to obtain optimum performance) and, of course, the cabinet and chassis may be changed to meet individual requirements.

Two typical contact microphones are shown in the title illustration. Units such as these are available from most large radio-parts distributors and music stores. A high-impedance, high-output type of pickup is recommended. The 6-ft. shielded cable usually supplied with such pickups must be terminated with a pin plug to fit the amplifier input jack. ★ ★ ★



### "Caddy" for Your Rifle

Rifles may be hung anywhere or carried with a new sling, or "caddy," that hooks through the trigger guard and loops around the end of the barrel. It is made of braided Saran plastic. When used as a sling, a hunter's hands are freed for other activity. It also can be used as a leash for a dog, if you desire.

POPULAR MECHANICS

Special Christmas Offer!

# FREE \$20 Savings Certificate

with Porter-Cable's revolutionary

## 6-in-1 ROUTO-JIG



Now, just in time for Christmas! A Free Gift Certificate with every Porter-Cable Routo-Jig—that saves you \$20.00 when you buy this revolutionary 6-in-1 power tool complete. With its carefully engineered, precision-built attachments, Routo-Jig is a high-speed router, a jig saw, a shaper, a finishing sander, a power plane—even a handy lawn trimmer!

As illustrated, the basic Router costs only \$42.50. And as shown below, you save as much as \$20.00 (including a \$4.00 saving on accessory Dovetail Templet) on Routo-Jig attachments! See the Yellow Pages for nearest Porter-Cable dealer—or write for free 48-page Routo-Jig manual.



**JIG SAW!** Routo-Jig is a new kind of portable jig saw with rotary action — for intricate contours or straight cut-off work in wood up to 1" thick. Combination Router and Jig Saw.....\$49.95



**SHAPER!** Husky Shaper Table makes Routo-Jig a precision Shaper and Joiner, for professional rabber cuts, moulding cuts, joiner work. Shaper Table regularly \$12.00—with Gift Certificate.....\$5.00



**POWER PLANE!** Routo-Jig converts quickly into a smooth-cutting power plane. Instant bevel and depth adjustments. Plane attachment regularly \$12.50—with Gift Certificate.....\$9.50



**SANDER!** Precision-built sander attachment makes Routo-Jig a fast, efficient finishing sander. Orbital motion sands with, against, or across the grain. Sander Attachment regularly \$19.95 — with Gift Certificate .....\$16.95



**GRASS TRIMMER!** With accessory trimmer unit and long, stand-up handle, Routo-Jig takes the work out of grass trimming. Light and handy. Trimmer Attachment regularly \$9.95 — with Gift Certificate .....\$6.95

**Porter-Cable**

*Quality Power Tools*

**PORTER-CABLE MACHINE COMPANY**  
714A N. Salina Street, Syracuse 8, N. Y.  
saws • sanders • shapers  
drills • routers • planes

In Canada: write Porter-Cable, Ltd., Box 5019, London, Ont. Canadian prices slightly higher.

# WILLIAMS

## TOOLS OF INDUSTRY

**NEW IMPROVED LOCKING ADJUSTABLE WRENCHES**



WITH THE  
**HEAVIER... MORE RUGGED**  
"PUSH BUTTON" Locking Device

JUST A FLICK OF THE THUMB OR FINGER  
LOCKS OR UNLOCKS THE ADJUSTMENT INSTANTLY  
AT ANY OPENING YOU SELECT

- POSITIVE LOCK
- RAPID ADJUSTMENT
- ONE HAND OPERATION
- INCREASED SAFETY
- DROP-FORGED ALLOY STEEL
- HEAT-TREATED

**CHROME FINISH**  
For those who demand  
the utmost in  
fit, feel and finish

SIZE	CHROME FINISH		BLACK FINISH	
	NO.	PRICE	NO.	PRICE
6 in.	6L	\$2.39	6BL	\$2.00
8 in.	8L	2.76	8BL	2.42
10 in.	10L	3.55	10BL	3.00
12 in.	12L	5.18	12BL	4.40
15 in.	15L	7.88	15BL	6.95

**BLACK FINISH**  
For those who want  
all of the features  
at lower cost

At most **HARDWARE STORES,**  
**INDUSTRIAL AND AUTOMOTIVE DISTRIBUTORS**



**No. CW-4 CHAIN WRENCH**

CAPACITY 1/2 to 4" O.D.

For close quarter work on PIPE, ROUNDS and  
all types of IRREGULAR SHAPES

Successive bites can be taken  
without removing wrench from the work.

\$4.80 at most **HARDWARE STORES,**  
**INDUSTRIAL-AUTOMOTIVE DISTRIBUTORS**

**"MULTISOCKET"**

No. 1999



DROP-FORGED  
with Two Swivel Heads  
and 8 Different 12 Point Openings

**SMALL HEAD**  
3/8 - 1/2 - 5/8 - 3/4

**LARGE HEAD**  
3/4 - 1 1/4 - 1 1/2 - 1 3/4

For adjusting and repairing CARS, BIKES, CYCLES,  
TRACTORS, MOWERS, APPLIANCES, ETC.

\$4.98 at most **HARDWARE STORES,**  
**INDUSTRIAL AND AUTOMOTIVE DISTRIBUTORS**

WRITE TODAY  
For a copy of Catalog No. 503



**J. H. WILLIAMS & CO.**

417 VULCAN ST., BUFFALO 7, N. Y.

## Now Electronic Brains are Talking

(Continued from page 121)

BEEP-BEEP — red LEADER — VECTOR  
one nine zero—ANGELS two zero—OVER.

If a radio transmitter were hooked up to the voice, the leader of an intercept group climbing into the wild blue yonder would know instantly that he must fly a course of 190 degrees at 20,000-foot altitude in order to find the object that the search radar far below him had picked up in the sky.

Nearly any kind of vocabulary—up to 100 words—can be recorded on a single drum, and in any language. "In areas where NATO forces are stationed," says Poppe, "the complaints against the Frenchman's English and the American's French could be eliminated, if the proper Voice Data Link were hooked to computers engaged in air-traffic control work."

The system can be tied into all kinds of air-traffic control. With such a talking calculator, Frye and Poppe point out that air crashes like the one over the Grand Canyon might be foreseen and prevented. Here's how it would work:

Imagine two planes approaching each other in fog at the same altitude—one flying from New York to Boston; the other heading for Nantucket Island from New York.

CAA radar in Providence picks up both planes and begins tracking them automatically, sending the course, speed and position data on each to an electronic computer. The brain, promptly calculating a collision course for each, would compute a new heading and altitude for one plane, transmitting these in digital or binary code to the Voice Data Link, where the impulses would trigger certain playback heads over the revolving vocabulary.

Instead of code calls, like the red, green and blue used in intercept work, this vocabulary would include the names of airlines. The computer's voice would go out instantly on commercial-airline radio channels with a message such as this: "Northern 307—new heading one eight five—altitude zero eight—over."

From the instant both planes came into radar range, all this would have consumed a matter of seconds.

Poppe envisions dozens of other uses for the unique voice. It could be a voice link between a computer and the radar operator—spilling off data to him while he watches the scope. "It would provide the radar shack with ears as well as eyes," says Poppe.

"In operations where several huge computers are used, one man usually runs his

(Continued to page 254)

**CUT THE BOLT YOU NEED  
TO ANY LENGTH**

**HEAT AND BEND  
TO ANY SHAPE**

24" and  
36" lengths

**7 SIZES**

1/4" 3/16" 1/8" 7/16"  
1/2" 3/8" 3/4"

**REDI-BOLT**  
THREADED STEEL RODS

Ask Your Hardware Dealer or Write

REDI-BOLT, Inc., 5330 Indianapolis Blvd., East Chicago, Ind.

**The Xmas Gift for Dad**



For his home workshop, painting, etc. — Johnson Red Head Portable Air Compressor makes a perfect gift. He'll love it — find scores of uses. Quality built — delivers 3 1/2 cfm of free air and 50 psi. pressure. Only \$44 — less motor. Write for further information.

**JOHNSON SERVICE CO. COMPRESSOR DIVISION**  
MILWAUKEE 1, WISCONSIN

**STANSTRIP\***  
**NEW KIND  
OF SEAL**



*Protects garage doors . . .  
seals out rain, snow, drafts*



StanStrip doubles garage door life by cushioning the shock of closing. At the same time, it seals out rain, snow, dirt and drafts.

StanStrip is molded from specially developed synthetic rubber. You can install it in only a few minutes. It's tough, stays soft and flexible, never sets or deforms. Follows the roughest floor contours. Protect your investment in garage doors with StanStrip. Eight-foot strip costs only \$2.95, 16-foot strip costs \$5.90. At your hardware dealer's now. Install it this week end.

\*Trade-Mark

*The Standard Products Co.* LEXINGTON, KENTUCKY

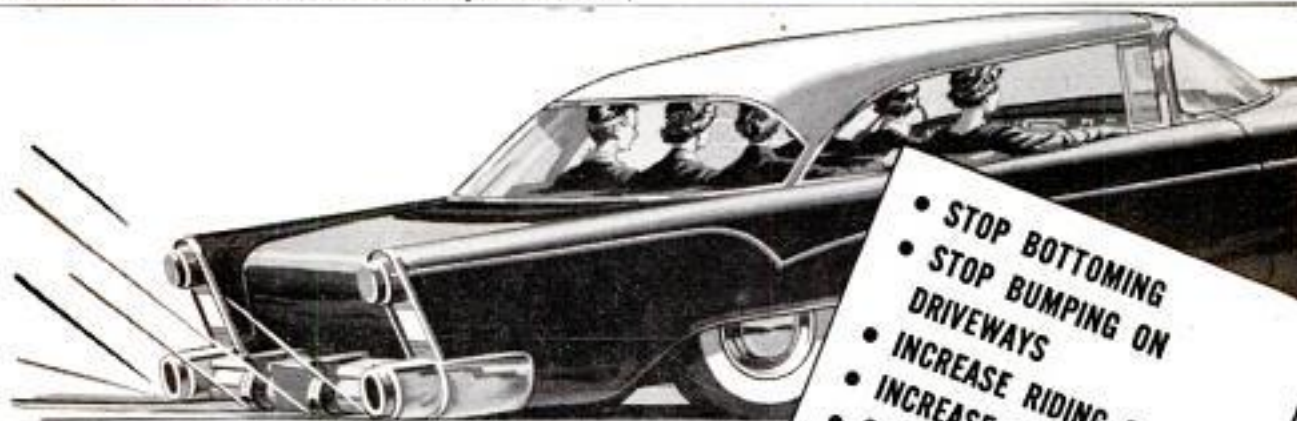

**MONROE LOAD-LEVELERS**  
keep loaded cars level . . .

If you load your car with samples, equipment, etc., if you drive a station wagon or haul a trailer, if you load family and luggage into your car for weekend or vacation trips, you need:

**MONROE LOAD-LEVELERS**

Automatically compensate for lightened load to give a comfortable ride when car is normally loaded.



NOVEMBER 1957

- STOP BOTTOMING
- STOP BUMPING ON DRIVEWAYS
- INCREASE RIDING COMFORT
- INCREASE ROAD CLEARANCE
- STOP SWAYING ON CURVES
- KEEP HEADLIGHTS ON ROAD

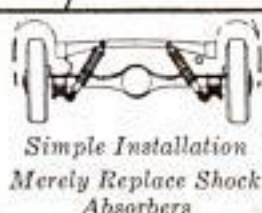

*Simple Installation  
Merely Replace Shock  
Absorbers*

Mail this coupon for free literature

MONROE AUTO EQUIPMENT CO., Monroe, Michigan

Dept. PM

Name \_\_\_\_\_  
Address \_\_\_\_\_  
City \_\_\_\_\_

legs off watching for red lights on a panel a block long," Poppe reveals. "With a trouble-shooting Voice Data Link, instead of lights, the man might be a block away and the voice, hooked to a PA system, would shout to him about any emergency, telling him where and what it was."

Poppe and his associates are looking into the possibility of using the voice in conjunction with big computers that would store ticker-tape data for Wall Street. "The link could be hooked up to telephone lines," says Poppe. "In a brokerage house, anyone could lift up a telephone and dial a special number. The latest quotation on any stock, stored in the brain, would be promptly given over the phone by Voice Data Link."

As Fairchild envisions it, their unique "mouthpiece" may some day enable automatic weather stations to shout their reports via radio to all points of the globe, in a dozen different languages. Inventory memory computers may be talking to accountants in vast industrial organizations, giving verbal accounts of any stock on hand. Oil-company engineers, to find the level of any tank in their vast tank farms spread across the country, will need only dial a phone number. Huge electronic brains, collecting tank-level data from the

entire system continually, will feed the necessary impulses to a Voice Data Link, which will, in plain English, tell the engineer the level of any tank in the entire system at any time.

So far, neither Poppe, nor any of his cohorts has figured what will happen if somebody asks an electronic brain a silly question. Possibly a sarcastic word or two will be programmed into the revolving vocabulary to take care of clowns. ★ ★ ★

---

### **Air Force Planes "Home" On Flying Tankers**

Radar "homing" beacons built by Sperry Gyroscope Co. are used by U. S. Air Force planes to find flying tankers for inflight refueling. A pilot wishing to refuel sends out radar pulses hundreds of miles to trigger a tanker's beacon, which returns a coded reply and location information.

### **Diamonds From Peanut Butter**

Using the carbon in peanut butter as the raw material, scientists at the General Electric Company laboratory have manufactured synthetic diamonds. The carbon was subjected to great heat and pressure to transform it into gems.



## **Two good names are always better than one**

When you buy a portable electric drill look for the name JACOBS on the chuck. It is your extra assurance of top tool performance.

An electric drill is no better than its chuck...the point where the drill's power is put to work. Many heavy duty operations are performed with attachments which are held in the chuck, so a tight, accurate grip — a JACOBS grip — means better work done easier.

All leading manufacturers of portable electric tools equip their drills with Jacobs Chucks. Look for the name JACOBS on the chuck when you buy. Two good names are always better than one.

**The Jacobs Manufacturing Co.  
West Hartford, Connecticut**

POPULAR MECHANICS

**EASY TO SPREAD**  **READY TO USE!**

Applying glue correctly is one of the most important steps in your woodworking project. Be sure parts to be glued are clean, dry and warm. Apply a thin film of Rogers glue to both surfaces; then clamp the joint to remove all air from the glued part. (This must be done for dovetails, tenons and dowels.) Allow enough drying time to permit adhesion to compensate for any shrinkage or expansion. Now you're sure of permanent strength. **SPECIAL OFFER:** A full-sized jar of Rogers glue; a set of easy project plans; a helpful "Rogers Book of Woodworking Shop Notes". Send 20c with your name and address to Rogers Glue, Gloucester, Mass. Ask for Rogers Glue at your local store.



Actual Tensile Strength: Over 3,885 lbs. per sq. inch. Good Coverage — Just a Little Does a Lot.

**ROGERS**  
The strongest glue — lasts forever  
GLOUCESTER, MASS.



**GENUINE ALNICO**  
**MAGNETS**

**AMAZING, PERMANENT, NON-ELECTRIC, HIGHLY PRACTICAL.** Conduct interesting experiments. Hundreds of uses. Retrieve valuable steel items such as guns, tackle from fresh or salt water; tools from tanks & drains. **GUARANTEED.** Try any magnet one week. Money back if you are not well-pleased.

No. M-710 (Wt. 53 oz.) Has pull of 225 lbs. on steel block...	\$16.50
No. M-625 (Wt. 70 oz.) Has pull of 125 lbs. on steel block...	\$9.50
No. M-575 (Wt. 18 oz.) Has pull of 75 lbs. on steel block...	\$6.50
No. M-500 (Wt. 13 oz.) Has pull of 50 lbs. on steel block...	\$4.50
No. M-595 24" Wall Type Tool and Knife Holder, Complete...	\$5.95
No. M-325 12" Wall Type Tool and Knife Holder, Complete...	\$3.25
No. M-300 Kit of Flat Bars 5 Pairs (10 Magnets)...	\$3.00
No. M-250 Kit of Round Rods 5 Pairs (10 Magnets)...	\$2.50
No. M-47 Hot Pad Magnets, 10 for \$1.00...	\$1.00
No. M-85 Hobbyist assortment of 8 small magnets...	\$1.50

Send M.O. or check. We pay postage. Sorry no C.O.D.'s.  
MIAMI MAGNET COMPANY, 3240 N.W. 27th Ave., Miami 42, Fla.



**BUY GREAT NECK HAND TOOLS**  
... for long-lasting performance



**GREAT NECK SAW MFRS., Inc.**  
MINEOLA, N. Y. — SEE YOUR LOCAL STORE



**IMPROVED LAWN MOWER SHARPENER AND BED KNIFE GRINDER**

Sharpen any mower in 10 to 20 minutes. Hand—Power—Reel or Rotary. Modern is actually two machines in one—a Precision Bed Knife Sharpener and a Precision Reel Sharpener. Extra Bed Knife Grinder is Absolutely Unnecessary. New Mower Support makes it possible to sharpen reel without removing bed knife. The fastest precision lawn mower sharpener on the market. Costs Less. Compare Modern's Many Exclusive Features Before Buying. Send for Free Brochure No. 10 5N



**MODERN MANUFACTURING CO.**  
160 North Fair Oaks Ave., Pasadena, California

You can build almost anything with **FIR PLYWOOD**

but remember —









**1 - LOOK FOR THE DFPA QUALITY TRADEMARK**

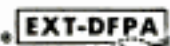

When you see the letters DFPA on panel you know you're getting plywood quality-tested to meet rigid industry standards. DFPA trademarks attest quality, performance and value.

**2 - CHOOSE THE RIGHT GRADE FOR EACH JOB**

<p><b>EXT-DFPA</b></p> <p>Exterior plywood for outdoor &amp; marine use</p>	 
<p><b>PlyPanel®</b> for paneling, most indoor uses</p>	 
<p><b>PlyScord®</b> (unsanded economy panel) for sheathing, backing</p>	 

Choose Exterior-type (waterproof glue) for outdoor and marine uses; Interior-type for inside jobs. Within each type are several appearance grades (panels with one good side, two good sides, etc.). See your lumber dealer. He'll help you choose the right grade, help with ideas and plans.

**SPECIALTY PANELS** include 1. textured plywood with smart grooved, striated or brushed surfaces for special decorative effects; 2. overlaid plywood (smooth, durable resin-fiber surfaces) for extra quality work.



**FREE:** Helpful booklets that show how to buy, use and finish plywood. Also, list of available homecraft plans. Write (USA only) Douglas Fir Plywood Assoc., Tacoma 2, Wash., Dept. 9.

# KLEINS



## AID TO YOUR CRAFTSMANSHIP

These three pliers—a Klein Side Cutting Plier, Long Nose Plier and Oblique Cutting Plier—belong in every workman's kit.

They put the exclamation point after your good workmanship! For a century Klein has stood for the finest in pliers and Kleins are still the standard of comparison by which other pliers are judged.

There is a type and size of Klein Plier for every job—all famous for Klein quality "since 1857."



Your hardware store has Kleins in stock or can get them for you quickly. Look for this new display board. It shows the most popular items in the Klein line.



**Mathias KLEIN & Sons**  
Established 1857 Chicago, Ill., U.S.A.  
7200 McCORMICK ROAD • CHICAGO 45, ILLINOIS

a taste of the treatment they may be subjected to after graduation, the attorney does his best to badger and browbeat them on the stand.

Near the end of a recent 13-week session, officials obtained rather convincing proof that the course was a success. A cook employed at the academy dining hall tripped on a doorstep and sprained her ankle. Two recruits who happened to be nearby put their first-aid training to use and quickly applied a bandage. Later, a doctor who examined their handiwork told the Director of Training, Sergeant Karns: "Your men really did a good job. I was able to send the cook home without any further treatment."

### Training Pays off

A few weeks after this incident, a student was granted leave because his wife was expecting a baby. Unable to get her to the hospital in time, he used his academy training in emergency childbirth to perform the delivery himself.

"When a cadet graduates," explains Sergeant Karns, "he is an expert police officer, equipped to cope with just about any kind of emergency, and just as important, to administer the law fairly and honestly. The course demands a lot from each student, and represents a heavy drain on our taxpayers. But we feel that in the near future, this expenditure of time, effort and money will produce a substantial reduction in accidents and an increased respect for the law among the motorists who use our highways." ★ ★ ★

### Fertilizer Subs for Dynamite

Ammonium-nitrate fertilizer is gaining acceptance as a substitute for dynamite and other blasting materials, according to the Monsanto Chemical Company. It is reported to be extremely safe, cheaper and as effective as most explosives.

### Life of Satellite Predicted

Man-launched earth satellites, reaching heights up to 800 miles from the earth, will last only about nine years due to the drag of atmospheric particles. Density of particles at this height has been estimated at 250 grams per thousand billion billion cubic centimeters by Dr. Theodore E. Sterne of the Smithsonian Astrophysical and the Harvard College observatories. This is a long way from the nonfrictional vacuum of space which Doctor Sterne evaluates at one gram per million billion billion cubic centimeters. In a perfect vacuum the satellite presumably could continue forever.





Something **NEW**  
for your Christmas List!

# 5 POWER TOOLS IN ONE

## NEW Dremel Deluxe MOTO-SHOP

- 1 JIG SAW
- 2 DISC SANDER
- 3 BUFFING WHEEL
- 4 BENCH GRINDER
- 5 FLEXIBLE SHAFT

### Complete Power Workshop In One Compact, Portable Unit

The amazing new Dremel Moto-Shop is the most versatile multi-purpose tool ever invented. Has 1,001 home and shop uses. Basically, it's a 15" Jig Saw with a unique power take-off to which you simply connect other attachments. It then converts to a disc sander, bench grinder, buffing wheel, and a flexible-shaft machine . . . all powered by a BALL-BEARING ROTARY MOTOR.

And this professional-quality, portable power shop can be set up practically anywhere — basement workshop, kitchen counter or card table. Weighs only 12 lbs. As a Jig Saw, it will cut 1 3/4" wood, 18 gauge copper, 1/16" steel — all with same blade. Foolproof blade guard makes it absolutely

safe — even for children. Handles everything from bird-houses to full-size furniture.

The flexible shaft is a complete machine shop in itself. Use it for sharpening, grinding, polishing, drilling, carving. Collet capacity 1/64" to 1/8". Other attachments have hundreds of home and shop uses.

Moto-Shop is the perfect "ALL FAMILY" workshop — safe for even mom and the children. Helps build a close father-son relationship.

**See Your Power Tool Dealer for a Demonstration Today!**

**Model 57 Moto-Shop.** Includes Jig Saw with disc sander attachment only. Other attachments can be added later - - - **\$33.95**

**Deluxe Model 57 Moto-Shop** with all attachments shown - **\$49.95**

Price of attachments only, if purchased separately - - - **\$19.95**

QUALITY POWER TOOLS SINCE 1934

**DREMEL MFG. CO., Dept. 117L, Racine, Wisconsin**

Write for **FREE Catalog**



D-33

THE CHRISTMAS GIFT FOR A LIFETIME ENJOYMENT

## NOW! HOME CRAFTSMEN CAN OWN THIS PROFESSIONAL ARC WELDER

EASY TERMS  
ONLY \$98.50  
F. O. B.

Now you can own a Trindl full 125 amp Industrial Welder at a price far less than smaller machines. With a Trindl 125A you can weld metals up to 1/2 inch thick. Operates off either 110 or 220 volt line, properly wired. 16 heat stages from 20 to 125 amps. Make and repair anything of metal around the home, garage, farm or shop, like a professional. No previous experience or training needed. Full "do-it-yourself" instructions with each machine. Complete only \$98.50 f.o.b. factory, or write for details. Trindl manufactures a complete line of heavy duty welding machines. Dealer inquiries invited.

**TRINDL PRODUCTS Ltd., Dept. T2-M**  
1807 So. Clark St., Chicago 16, Ill.



**FREE**

WRITE FOR  
COMPLETE  
DETAILS AND  
EASY PAY PLAN



**Guaranteed**

12 MONTHS  
IN  
CONTINUOUS  
OPERATION

**LUFKIN**

## MAGNETIC BASE TOOLS SAVE TIME AND TEMPER

### NEW IMPROVED MITI-MITE INDICATOR HOLDER



No. 102A

A new Indicator Holder with a rigid post centered over point of greatest magnetic pull . . . holds even heavy lug-back type indicators securely in position. Newly designed base contains a permanent magnet with an unbreakable plastic outer shell. Base attaches instantly to curved or flat ferrous surfaces. Has a fine adjustment feature. Ideal for all set-ups requiring the use of an indicator.

### MITI-MITE Magnetic Base SURFACE GAGE

A new heavy duty surface gage and indicator holder that has greater range and capacity. Permanent magnet can be turned on or off for easy positioning. Fully adjustable spindle and fine adjustment screw. New-designed scribe has a removable, long wearing carbide tip.



No. 301B

### MITI-MITE Magnetic Base HOLD DOWNS

For securely holding precision work without use of blocks, shims, parallels, etc. Swivel mounted in polished aluminum plates containing two permanent magnets.



No. 903D

### MITI-MITE Magnetic Base FLUORESCENT LITE with Magnifier

Portable, high intensity lighting coupled with a magnifier. Lamps light instantly, operate at body temperature, are protected by chip shield. Adjustable goose neck with full swivel. Strong permanent magnets in base with fingertip release for quick relocating.



No. 350X

488

WRITE FOR FREE MITI-MITE BOOKLET

BUY **LUFKIN** TAPES • RULES • PRECISION TOOLS  
AT YOUR HARDWARE OR TOOL STORE

THE LUFKIN RULE COMPANY, DEPT. PM, SAGINAW, MICHIGAN

## Landing Fields for Jetliners

(Continued from page 129)

fly and maneuver safely in the same traffic pattern with today's conventional transports. The jets will carry fuel reserves just as do present aircraft. The basic requirement is 260 miles to an alternate airport plus one hour of holding. Many long-distance operators carry far greater reserves.

**Q:** From the traffic standpoint, the prop-jets will be flying at conventional altitudes and the pure jets will be flying above the rest of the traffic. Is that right?

**HORNING:** That is right. In April we took over control of all instrument flight in the airspace above 24,000 feet. Previously the CAA exercised such control of the airways only. The 24,000-foot level is a floor below which the present very high frequency and ultra-high-frequency line-of-sight radio is not too good. To control traffic you have to communicate with it. Within a year we hope to control traffic down to 15,000 feet by adding more ground-radio communication facilities.

**Q:** With the airways busier than ever, what is being done to prevent mid-air collisions such as the two transports that collided over Grand Canyon?

**HORNING:** This control of all instrument flying is the number one thing. The next logical step is to extend our present terminal-radar coverage by adding long-range radar that will cover en-route traffic. There is another development, the airborne transponder beacon. It is carried on the plane. In effect it reinforces the radar signals so you can see the plane farther away and through snow or rain. Also, it identifies the plane. This feature is vital when using radar for traffic control.

**Q:** Is there any chance that our jet transports will blow up, as did two British Comets several years ago? They suffered explosive decompression at high altitude.

**EDWARDS:** We are all acquainted with the structural problem that existed in the Comet. Our new jets will be pressurized to give 6500-foot cabin altitude at 40,000-foot flight altitude. They will carry an internal pressure of  $8\frac{2}{3}$  pounds per square inch. There are several things that are mandatory for a safe pressure cabin. One is a heavier fuselage skin. Two, very conservative riveting practices. Three, all doors are of the so-called plug type that can't blow out. Another thing, each window has three panes. The middle and outer panes are each good for eight times the cabin pressure. The inner pane is good for three times the cabin pressure. Any window material can be weakened by what is

(Continued to page 260)

# GROBAN'S GREATEST SURPLUS SALE

All Brand New



## PORTABLE 1000 WATT A.C. LIGHT PLANT

Electricity for Your Comfort  
COMPACT—  
Fits in the trunk of your car  
FAST STARTING

ITEM # 1008-B

**ENGINE:** BRIGGS-STRATTON 2 3/4 H.P.—Equipped with recoil Starter.  
**GENERATOR:** Ball bearing construction 1000 Watts. 115 Volts A.C. 60 cycles. Automatic self-regulating. SAME AS HOUSEHOLD CURRENT  
**SIZE:** 20 1/2" x 12" x 16"  
**Shipping Weight** 100 lbs. boxed  
**PRICE:** Save \$100.00 from \$259.50 list price. Now! F.O.B. Chicago.....NET **159.50**

## BRAND NEW! 6 VOLT ELECTRIC HYDRAULIC PUMP WITH REVERSING SOLENOIDS!



For Jeep—Truck—Car—Tractor

- To Lift Snow Plows
- For Convertible Tops
- For Hydraulic Jacks and Hoists

A few simple connections to battery and a hydraulic cylinder complete the circuit.

INCLUDES — AUTOLITE Motor Driven Pump, Oil Tank, and Pair of Solenoids.

ITEM # 472

Shpg. Wt. 26 lbs. F.O.B. A GROBAN SPECIAL..... **24.50** ea. Chicago

### HYDRAULIC CYLINDERS FOR ABOVE PUMP:

- A. Item 33C — 1 1/2" Bore, 4 1/2" Stroke, Double Acting Clevis Mounting..... **4.95**  
B. Item 122 — 1 1/2" Bore, 8 1/2" Stroke, 3/4" shaft, Double Acting..... **9.95**  
C. Item C-419 — 3" Bore, 6" Stroke, 3/4" Shaft Double Acting, Clevis Mounting..... **12.50**  
**HYDRAULIC HOSE — 4 Ft. x 1/4" with Fittings..... 2.50 ea.**

ITEM # 55

## MULTI-PURPOSE HYDRAULIC PUMP OR MOTOR



Silent, high efficiency, Helical Gear Type Ball Bearing, Hydraulic Pump or Motor. Rated 8 Gal. Per Min. At 1500 R.P.M.—Delivers 1000 P.S.I. Using 6 H.P.—Reversible Rotation—3/4" Pipe Thread Inlet and Outlet Ports—1/4" Drain Port—3/4" shaft with keyway and flat for either direct or pulley drive. Dimensions—3 3/4" x 7 1/4" long, 3 1/4" wide. Shipping weight 18 lbs. F.O.B. Chicago.... **52.50**

## A \$15.00 Value 37-Piece METAL STAMPING SET

STAMPS NAMES, NUMBERS, ON WOOD OR METAL

ITEM # 390-B — FULL ALPHABET, A-Z, NUMBERS 1-9, "&" AND PERIOD. PRECISION HAND TRIMMED, deep cut, hardened TOOL STEEL STAMPS—IN FITTED EASY ACCESS CARTON. Made to rigid U. S. Army specifications.



Only \$5.50 per Set

2 FOR 10.00 PPD.

## MASTER & SLAVE HYDRAULIC REMOTE CONTROL SET



Item # 415—Designed for remote operation of controls on engines, boats, special machinery, etc. Eliminates complicated mechanical linkages, cables, pulleys, etc. The master unit connects to the slave unit with a single 1/4" tube.

When master control lever is moved, slave lever follows exactly. Light, compact, aluminum alloy construction. Dim. of both units: 5 1/4" W. 9" H. 1 3/4" D. (exclusive of handle) Ship. Wt. 8 lbs. F.O.B. Chicago..... **27.50** per pair (Note—tubing not supplied)

## BRAND NEW! U. S. NAVY COST \$92.00 SELF-PRIMING — BRONZE 1" GEAR PUMP

- FOR — • Insecticide Spraying  
• WASH DOWN • SPRINKLING  
• FUEL TRANSFER



BUILT TO EXACTING U. S. NAVY STANDARDS  
FEATURES: • Ball bearing construction • NEOPRENE Pump Gears • Monel Shaft—1" Dia., 2" long  
• Sealed steel idler gears.

OUTPUT: 20 Gal. per Min. 100 lbs. per Sq. In. at 1500 R.P.M.—8 Gal. per Min. at 550 R.P.M. • Standard Base Mounting—3/8" bolt holes • Grease cup included.  
• 1" Pipe Thread Ports. • Dim. 11" L. x 5" H. x 4 1/4" W. Ship. Wt. 16 lbs..... **26.50** EA.

Limited Quantity Order Direct 2 for 50.00 F.O.B. Chicago

## FREE — WINTER '57-'58 CATALOG

60 VALUE-PACKED PAGES of unsurpassed War Surplus and newly manufactured Equipment Bargains for farm, home, factory, workshop. Write letter today.

ORDER DIRECT FROM AD — SATISFACTION GUARANTEED

Send Payment Or Purchase Order Today  
For Phone Orders Call WEBSTER 9-3793

**GROBAN SUPPLY CO. DEPT. PM-11**  
GROBAN BUILDING

1139 S. WABASH AVE. CHICAGO 5, ILL.



## KING MIDGET

ALL NEW. First model change in six years. New bodies, new chassis, new engine. Four wheel hydraulic brakes. Still World's Lowest Priced Car. Drive it for 75c per week. Rider Agents Wanted. Earn your own car. Get the facts. Send 25c for 32 page picture book with complete details, dealers price, etc.

MIDGET MOTORS CORPORATION, Athens 1, Ohio



# MENDS MOST ANYTHING

"HOLDS LIKE IRON"

Used by fine furniture makers. Ideal for home and office. In 3/4 oz. or 2 1/2 oz. sizes.

**NO  
SAG**



MOOG PH Overload Helper Springs add 1200 lbs. extra capacity, correct the cause of "rear-end sag!"

**NO  
SCRAPE**



By restoring proper height to weak rear springs, MOOG PH Overloads prevent bottoming!

**NO  
SWAY**



MOOG PH Overloads stabilize the ride, improve roadability whether car is loaded or not!



**WITH PH  
OVERLOAD HELPER  
SPRINGS** for passenger cars and station wagons

Patent Pending



**MAIL  
THIS**

... for more information on Moog PH Overloads and name of nearest dealer.

Name.....

Address.....

City..... State.....

Moog Industries, Inc. • St. Louis 14, Mo.

called the notch effect. That is, there are sometimes small boys or people of less than average mentality who like to put their initials on the windows of airplanes. This notching weakens the pane. Having a protected pane between the two exposed panes is a very important safety factor. The cockpit windows are of optical glass and have an over-all thickness of about three inches.

**Q: Does the Electra have the same pressure problems as have the pure jets?**

McDONALD: In a certain sense it does, though our operating altitude is not as great and our requirements for cabin pressures are not as severe. We are doing the same sort of thing that Mr. Edwards has described. We are using materials that have a long life expectancy with low risk of fatigue trouble. We are using a rip-stop type of construction that confines any tearing of the skin to local areas.

**Q: Then explosive decompression could not occur?**

McDONALD: Not in the normal sense. However, we have made studies to determine just what a loss of pressure means to an average load of passengers. All the new transports will have provisions for supplying oxygen to each passenger.

**Q: An emergency oxygen mask for each passenger?**

McDONALD: Different designs are being considered. I want to make it particularly clear that the airplane is designed expressly to avoid any loss of pressure. Oxygen becomes a last emergency device.

BONE: We might go back to the traffic problem for a minute. We are investing many millions of dollars in new airplanes and we can't afford to have them standing idle. Unless we have good traffic-control facilities at major airports the advantages of the new aircraft will be nullified.

HORNING: Two things are coming along that will help. One of these is the high-speed turn-off from the landing runway, a turn-off at a 30-degree angle that will permit the airplane to leave the active runway at speeds of up to 90 miles per hour. This is an improvement over the sharp-angle taxiways used today, for which a plane must slow down to 20 miles per hour or so before turning off. The other thing that is going to help is a short-range ground radar with which the tower operators can see the airplanes moving on the ground. For example, when the Los Angeles expansion program is complete the control tower will be between two 10,000-foot runways, one extending to the east and the other to the west. Under adverse weather conditions the tower won't be able to see planes on the

(Continued to page 262)

# WEN

## ELECTRIC POWER TOOLS FOR YOUR HOME WORKSHOP

PROVED BEST FOR THE MONEY BY FAR

### POWER SAW 8 SAWS IN 1



No equal. Cuts anything—2x4's in seconds— $\frac{1}{2}$ " steel—scrolls, circles, dovetails, straights, angles. 3 blades—coarse, medium, fine.

Only \$29.95

Other WEN products—  
"Quick-Hot" Soldering Guns and Kits \$7.95 to \$12.95 Sander-Polishers and Kits \$13.95 to \$19.95 Saw Table \$12.95.

### 2 SPEED POWER DRILL



$\frac{3}{8}$ " drill. 1000-3000 RPM. Speed change simple, positive. Provides right speed for different jobs. With attachments, it's a whole work shop.

Only \$29.95

Superbly made. U.L. approved. Fully guaranteed. Here's top quality at lower cost.



### NEW FEATHER-LIGHT 100-WATT ELECTRONIC SOLDERING GUN



Weights only 19 oz. Heats in 3 seconds. Spotlight. Long reach, long life tips. Ideal for home, shop.

Only \$5.95

**WEN PRODUCTS, INC., 5808 NORTHWEST HIGHWAY, CHICAGO 31, ILL.**

(Export sales, Scheel International, Inc., Chicago)

For Safer Driving in fog, rain or snow... Buy a pair of new

## GENERAL ELECTRIC

### All-Weather Headlamps!

### BUILD YOUR OWN ARC-WELDER

WE SHOW YOU HOW to build powerful D.C. Welders from surplus aircraft generator. Light or heavy work. Easy to build at low cost. Worth hundreds of dollars. **PLANS 386. SEND TODAY.** Includes **FREE** Surplus, Welder, Electrical catalog.



LEJAY MFG. CO., 2907 EMERSON AVE. 50., MINNEAPOLIS, MINN.



### The Modern PLASTIC for lasting Home Repairs

PERMANENTLY mends cracks or holes in wood, tile, stone or plaster. Sticks and stays put—Does not chip, shrink or fall out. Easy to use. Economical. Mold it, chisel it, polish or paint it. The big 4-lb. can is obtainable from your lumber, paint or hardware dealer at \$1.25; or will be shipped direct postpaid (in U. S.) for \$1.50. Complete satisfaction guaranteed or your money refunded.

**DONALD DURHAM CO.**  
Box 804-T Des Moines, Iowa

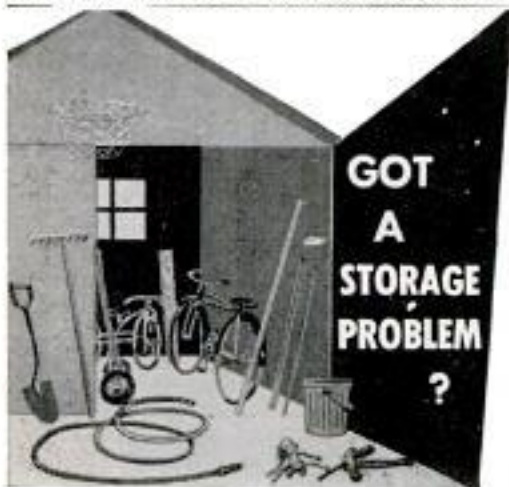

### GOT A STORAGE PROBLEM ?



Then you need **TURNBUCKLES** Perforated Board fixtures to end space-wasting clutter and to keep everything neatly in place until needed.

**TURNBUCKLES** do-it-yourself fixtures come in a wide variety of shapes and sizes... fit easily into any wall-hung perforated board... and hold everything from clothing and kitchen utensils to hand tools and garden equipment.

Send for your free copy of space-saving suggestions for home, farm and workshop.



### TURNBUCKLES, Inc.

BOX 333, MICHIGAN CITY, INDIANA

NAME \_\_\_\_\_

ADDRESS \_\_\_\_\_

CITY \_\_\_\_\_

STATE \_\_\_\_\_

64

for the man  
who wants the  
**BEST**

**TURNER®**  
**Propane TORCH**

- Solder
- Remove paint and putty
- Lay tile
- Light charcoal
- Thaw pipes

Only  
**\$5.95**

**MULTI-TORCH CHEST**

Includes 1 Turner Torch, 1 heavy duty burner, 1 chisel point soldering tip, 1 flame spreader. All in heavy steel chest.



\$13.85 value only **\$9.99**

**TURNER Propane Gas  
CAMP LIGHT**  
**\$12.95**



**TURNER PROPANE  
GAS STOVE**  
**\$24.95**



At hardware, automotive and sporting goods stores

**TURNER BRASS WORKS**  
Sycamore, Illinois



FOR THE TOUGH PULL... **'Tugit'**

This handy lever-operated 'Tugit' Hoist lifts or shifts tons easily, safely. Imagine — only 40 lbs. of pull on the handle to lift 2,000 lbs. A powerful, automatic brake holds the load where you want it. The handle can't kick back and hit you. A flick of the fingertip lever and 'Tugit' is ready for controlled lowering action. Entire mechanism is fully enclosed — never needs oiling.

Portable 'Tugit' operates smoothly in close quarters and at all angles. Ideal for 1000's of lifting or pulling jobs on farms, in repair shops, boat-yards and construction. Get a 'Tugit' for your tool box, truck or car trunk. 1 and 2-ton sizes. Small size weighs only 16½ lbs. Priced from \$65.50 up. See your Shaw-Box Distributor or write for Bulletin 388.

- Spots trailers
- Pulls cars out of mud, snow
- Lifts machinery
- Unearths stumps, boulders
- Erects fences
- Lays pipe
- Lifts boats, motors
- Stretches cables, belts



57B-2

**MANNING, MAXWELL & MOORE, INC.**  
SHAW-BOX CRANE & HOIST DIVISION  
354 W. BROADWAY MUSKEGON, MICHIGAN

runways. We are providing radar for that. In one of the evaluation tests on this radar the boys saw something on the scope out on the main runway and dispatched an airport jeep to learn what it was. It was an 18-inch landing-gear pin with a rag on it. That shows the good resolution of this new equipment.

**Q:** Without this radar control from the tower, can a pilot get lost in a heavy fog after he lands?

**HORNING:** Put it this way—I have.

**Q:** Mr. Bone, what will be the effect of the jets and propjets on passenger volume?

**BONE:** We estimate the airlines will sell 34½ billion passenger miles of transportation in 1961. This is almost double 1955. And this is just domestic traffic.

**Q:** Is there any indication fares will come down?

**BONE:** We are running into increased costs without any increase in fares. We think that fares are too low now. I don't believe any of us know what the situation will be when the jets are in operation.

**Q:** Would anyone care to predict when passengers will be flying at supersonic speeds?

**McDONALD:** I am sure that all the manufacturers are considering preliminary designs of supersonic transports now. Perhaps this same group should get together 10 years from now to discuss the method of their introduction into airline service. ★★★

**Laminating Kit for Photos**

Inexpensive and easy to operate, a laminating kit has been developed to seal photographs, cards and other thin flexible objects in clear plastic. The article is placed between two sheets of four by five-inch plastic, and these are sandwiched between two polish plates to assure a smooth finish. When placed in the press with pressure applied by three screws, the plastic is permanently fused by electrical heating in a few minutes.



POPULAR MECHANICS

Copyrighted material

**WOLVERINE GLOVES**

FEEL  
THAT  
**SOFTNESS**

ENJOY  
THAT  
**COMFORT**



Guard your hands with nature's tough Pigskins. Wolverine's triple-tanning makes 'em super-soft — comfortable. Soak 'em, they dry out soft. Wear longer, cost you less.

*feel that tanned in softness*

rockford, michigan

THE WORLD'S ONLY

## ADJUSTABLE SPIRIT LEVEL

Save time, money and material. Made of aluminum. Light, compact and accurate. Measures above or below horizontal line or right or left of vertical line. Attach to your present level. A must in every tool box. Thousands now being used by carpenters, plumbers and block masons. Send \$4.00 in cash or money order.

PALLETTE, P. O. Box 1207, Miami 7, Fla.

## DINSMORE Compasses

Beautiful, precision made. Designed and styled for modern cars. Dinsmore compasses save you time and money by showing you the right way — the short cuts. An ideal gift for every one who drives.

ONLY COMPASS APPROVED BY AUTO MAKEUP!

WRITE FOR COMPASS HISTORY FOLDER

DINSMORE INSTRUMENT CO., 1802-41 Kelso St., Flint 3, Mich.



TRAVELITE 1955  
VALVE  
GUIDEWAY 1/4 1955  
NOW ILLUMINATED  
SEE YOUR DEALER

Protect your home against  
power interruptions  
with an...

## ONAN Emergency ELECTRIC PLANT

Provides dependable stand-by electricity for heating system, pumps, freezer, lights, appliances. Keeps home safe, livable. Automatic start and stop. Find out how little it costs!

Write for Folder!

**D. W. ONAN & SONS, INC.**  
3259 University Ave. S.E. • Minneapolis 14, Minnesota

A SIZE FOR EVERY NEED  
500 to 75,000 watts.  
Compact, quiet-running.  
Gasoline-powered.  
Priced from \$319.00



## ?? SHOP QUIZ ??

Question 1 \_\_\_\_\_

What's the **EASIEST** way to drive wood screws?

Question 2 \_\_\_\_\_

What's the **EASIEST** way to remove wood screws?

Question 3 \_\_\_\_\_

What's the **EASIEST** way to run nuts or bolts on or off?

Question 4 \_\_\_\_\_

What's the **EASIEST** way to use heavy-duty cutting tools like hole saws, masonry and auger bits?



**ANSWER:**

WITH YOUR ELECTRIC DRILL AND A

## Supreme Versamatic

Reversible speed reduction attachment that fits every power drill. Increases power 7 times. Reverses with one simple twist. A must for every drill owner. **\$14.95** AT LEADING TOOL COUNTERS

By the makers of SUPREME BRAND CHUCKS

**SUPREME PRODUCTS CORPORATION**

2222 S. Calumet, Chicago 16, Illinois

A Division of A-S-R Products Corporation



**Hey, Dad!  
Hey, Son!**

*Merry Christmas  
and happy tool years!*

Stanley Tools are welcome gifts for man and boy. Here are exciting new tools men and boys everywhere love to get their hands on. They make wonderful Christmas gifts. They're on sale now wherever you buy tools.

**Stanley "Glide-O-Matic"** • The rule that remembers. Push-button lock holds blade where you want it, steel scribes mark work exactly, blade rewinds automatically. Easy to read black on white. 8, 10 and 12 ft. lengths. Be precise... say Stanley, it's a good rule.



8 ft. only \$1.98.



Stanley  
SURFORM  
File

Stanley  
SURFORM  
Plane

**Stanley "Surform"** • New miracle speed forming tools of 1001 uses. Easy to use, fast, for expert or beginner. "Surform" files, smooths and forms the surface of wood, plywood, plastics, asphalt, tile, aluminum, etc. File type—\$2.69, Plane type—\$3.69.

**Stanley "Steelmaster"** • The finest hammer ever made. All steel... perfect balance... exclusive heat treating minimizes chipping of hammer face... cushioned Neoprene grip. Beautifully polished, chrome and black finish. 13, 16 and 20 oz. sizes. 16 oz., only \$4.98.

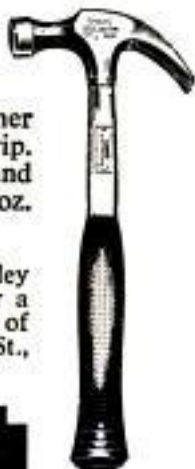

Ask for free check list folder "Stanley Tools for Christmas," or write for a copy to Stanley Tools, Division of The Stanley Works, 62N Elm St., New Britain, Conn.

**STANLEY**



Trippie Mfg. Company, 133 N. Jefferson, Chicago 6, Ill.

### Holiday Lantern Flashes Colored Lights

Four colored lenses revolve continuously in this weatherproof lantern which can be hung over your doorway for a holiday touch, or in the patio for parties. The unit emits 80 red and green flashes per minute. The hanging bracket comes with the lantern.

### Portable Slide Projector

Opened and extended for normal operation, this compact projector for 35-millimeter-film transparencies is only 9½ inches long. However, it can project an evenly illuminated image a distance of 20 feet, enlarging the image 79 times. Heat from a 100-watt projection lamp is vented through a radiator. The unit weighs less than two pounds and is produced in Japan.

The FR Corporation, 851 Brook Ave., New York 51, N. Y.







FROM

## Advance to Cash

652 MILES—32¢



**For less than 1/20th of a cent a mile, a new AC Oil Filter keeps oil clean, protects your engine!**

If you're an average driver, you'll travel over 15 times the distance from Advance to Cash—a total of 10,000 miles each year! And you'll probably encounter the same types of driving from town traffic to country cruising . . . the same types of weather from hot to cold, from fair to foul . . . the same types of terrain from winding hills to level straightaways. The engine of your car will be subjected to all driving conditions.

That's why it's so important to give your engine the added protection of a new AC Oil Filter every 5,000 miles! An AC Oil Filter cleans all of the oil in the engine every 30 seconds at normal speeds . . . protects the precision parts from dirt, dust, grit and bits of metal as small as 1/100,000th of an inch.

The next time you change the oil in your engine—change to a new AC Oil Filter, too. Your nearby AC dealer will tell you how little it costs . . . how much it does for your engine!

AC  THE ELECTRONICS DIVISION OF GENERAL MOTORS

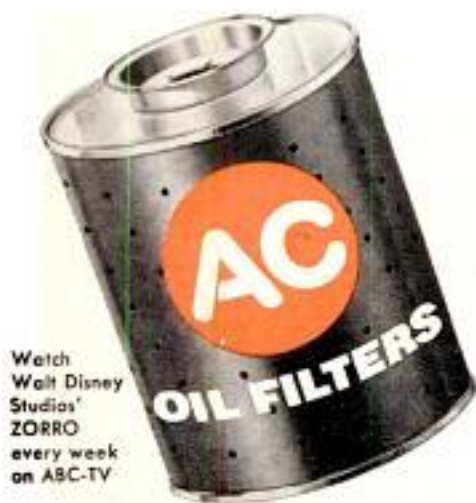

Watch  
Walt Disney  
Studios'  
ZORRO  
every week  
on ABC-TV

**CHANGE OIL AND FILTER, TOO!**

NOVEMBER 1957



265

Copyrighted material

see the amazing new  
EASY-TO-BUILD ELECTRONIC  
**ALLIED knight-kits**



in **ALLIED'S 1958**

**ELECTRONIC SUPPLY CATALOG**

**FREE!**

**BUILD YOUR OWN!  
SAVE MONEY—HAVE FUN**



**404** value-packed pages



**HI-FI KITS**



**HOBBY KITS**



**INSTRUMENT KITS**



**HAM KITS**

**SAVE on Everything in Electronics**

**WORLD'S LARGEST STOCKS**

Everything for Experimenters, Builders, Amateurs, Servicemen, Engineers and Hi-Fi Hobbyists. Get more for your money in Hi-Fi systems and components; build-your-own KNIGHT-KITS; recorders and phono equipment; TV tubes, antennas, accessories; Amateur station equipment; test instruments; industrial electronic equipment—plus the world's largest stocks of parts, tubes, transistors, tools and books. Send today for your **FREE 1958 ALLIED Catalog!**

Everything in Electronics From One Reliable Source  
our 37th year **EASY TERMS AVAILABLE**

**ALLIED RADIO**

send for  
**FREE  
Catalog**

**ALLIED RADIO CORP., Dept. 24-L7  
100 N. Western Ave., Chicago 80, Ill.**

Rush **FREE 1958 ALLIED 404-Page Catalog**

Name \_\_\_\_\_

Address \_\_\_\_\_

City \_\_\_\_\_ Zone \_\_\_\_\_ State \_\_\_\_\_

## San Francisco's Acre of Concrete

(Continued from page 111)

It takes 100,000 gallons of water to fill the model. As the tides ebb and flow, their rate of movement is controlled in the various channels of the bay by 5000 vertical copper strips set in the concrete. Engineers know how fast the tide should flow in each foot of these channels and to bring it to that exactness they bend the strips to desired position to either impede or speed up the flow.

Precise tide gauges, 24 of them to represent the same number that operate in San Francisco Bay, measure elevations of tides. Velocity meters determine water velocity. The model is adjusted so that these and other measurements agree with like measurements in the actual bay, causing the model to act the same as in nature.

San Francisco Bay has never lacked conservation plans, but the integration of those factors which best serve the community into a realistic construction program has been only in the offing over the past several decades. There are six plans that call for controlling the bay's waters. Each of them will be tested to determine what effect it will have on the underfloor surfaces of the waterways.

The plan that holds the most favor with engineers and government officials is the Reber Plan. Its originator is John Reber of San Francisco. His plan envisions two broad earth-fill dams across the narrow necks of the upper and lower sections of the bay. This would control the river runoff water that comes down from the snows of the Sierra Nevada Mountains and would create the world's two largest manmade lakes. He would connect the lakes by a ship canal along the east shore of the bay, and the channel would be reached through a lock.

If the Reber plan were successful, these lakes would end California's water shortage forever and, in addition, would provide unlimited road and rail facilities, furnishing transportation across the bay, new land for factories, military bases and miles of scenic shoreline featuring warm-water beaches.

To determine the effects of such a salt-water barrier on the bay area outside the Golden Gate, and the freshwater lakes, a miniature barrier of exact design is mounted into the model bay and set to operating as planned. By comparison of measurements from the model of water-surface elevations, current velocities and directions, silt deposits and mixing of fresh and salt water, with and without the barrier,

(Continued to page 268)

# NEW! MILLERS FALLS Router-Plane-Shaper

WITH REVOLUTIONARY NEW LINE  
OF LOW-COST ROUTER BITS

Built for  
professional  
performance



**PLANE**  
No. 6826  
Plane Attachment Set  
\$31.95

**ROUTER**  
No. 6800  
Power Unit and Base  
\$39.95

**SHAPER**  
No. 6818 Shaper Attachment  
with built-in motor mount  
\$19.95



3 TOOLS  
IN 1

Imagine! — an exciting new 3-tools-in-1 combination loaded with exclusive features to give professional results — yet priced to bring the adventure of fine cabinet-work within reach of everyone! It's a Router, a Plane, a Shaper! — that will do hundreds of jobs quicker and better — including dado cuts, moldings, fluting, rabbet cuts, dovetail joints, inlaying, planing and shaping. A real precision tool with plenty of power and speed, that anyone can use!

Plus . . . a revolutionary new line of 17 popular Router Bits, made of Special M-2 High Speed Steel — faster, longer-lasting — at 1/3 less cost than other types.

See and buy the Millers Falls Router-Plane-Shaper and its complete line of attachments at your favorite dealer's . . . or write us for name of qualified dealer nearest you.

#### FREE AT YOUR HARDWARE DEALER'S

Folders and full information about the Router-Plane-Shaper and other fine Millers Falls Tools . . . or write

#### CHECK THESE IMPORTANT FEATURES

**POWER UNIT** ✓ Rugged 3 amp. motor ✓ Ball bearings throughout ✓ 30,000 R.P.M. for smoother, faster, cleaner cutting

**ROUTER** ✓ Large 6" dia. base and big hardwood handles for positive control ✓ Direct-reading scale for fine depth adjustment ✓ Exclusive micrometer-screw adjustment for control of cut location ✓ Extra long rods for long reach cuts ✓ Base and non-marking sub-base-take all popular templet guides

**PLANE** ✓ Big 14" shoe ✓ Outboard arbor support ✓ Micrometer-screw adjustment for front-to-rear shoe and cutter alignment ✓ Direct-reading depth adjusting scale ✓ Notched quadrant for quick bevel cuts (—15° to +45°)

**SHAPER** ✓ 1/3 cost of comparable models ✓ Big work surface (24" x 7½") ✓ Built-in motor mount for quick, easy changeovers ✓ Accurate depth adjustment ✓ Adjustable fence ✓ Rugged 1" marine plywood table

Plus . . . a special "package" of exclusive firsts for plastic laminate application!



**MILLERS FALLS COMPANY**

Dept. PM-21, Greenfield, Mass.

**FINEST HAND AND POWER TOOLS MADE FOR HOME AND INDUSTRY**

**THE QUALITY  
THAT'S BUILT INTO SOUTHERN  
ADDS PERMANENCE  
TO YOUR PROJECTS!**



Quality Fasteners—the only fasteners made by Southern Screw—add quality, permanence, satisfaction and beauty to your projects. Buy Southern Screws to help make your work more professional looking—longer lasting, too! Ask for Southern fasteners by name at your local hardware or building supply dealers.

Phillips or slotted in all popular heads; steel, brass, silicon bronze, aluminum, stainless steel, in wide choice of plated finishes.

Get the Home Craftsman's free Technical Chart, TC-4. Shows you how to drill correct pilot holes, and how to select wood and sheet metal screws. Write Box 1360-PM117, Stateville, N. C.

WOOD SCREWS • MACHINE SCREWS & NUTS • TAPPING SCREWS • DOWEL SCREWS • DRIVE SCREWS • STOVE BOLTS • HANGER BOLTS • CARRIAGE BOLTS

Warehouses:  
• NEW YORK  
• CHICAGO  
• DALLAS  
• LOS ANGELES



SOLD THROUGH LEADING WHOLESALE DISTRIBUTORS

**New "PULL-GEAR"  
SPEED-REDUCING PULLEY**



**Provides Correct Speed and Power to Drill Up to 1 3/8" with 1/2 H.P. Motor**

Amazing new internally geared speed reducer doubles drill press capacity. Greater power, greater efficiency, greater productivity. Provides the correct speed and power for larger

drilling, reaming, tapping and boring on light presses. Easily installed in five minutes. Adaptable to all type machines. Spindle speed range approx. 45 to 3000 RPM. Made in 3 motor shaft sizes: 1/2" — 5/8" — 3/4". Write for literature.

WRITE FOR LITERATURE

**THE PULL-GEAR CO.**

25427 Mound Road  
Center Line, Mich.

DEALERS:

Chicago, Ill. — Chicago Supply & Tool Co.  
Cleveland, Ohio — Reynolds Machinery Co.  
Los Angeles, Calif. — Alquist Brothers  
New York City — Rudolf Bass

engineers can forecast what would happen if the barrier were to be constructed.

One thing of importance is to know what will happen to the Golden Gate bar, an undersea mound of sediment extending in a half circle on a six-mile radius beyond the Golden Gate, with its crest submerged to a fairly uniform depth of 30 feet. This bar is heavily influenced by ebbing current velocities developed in the Golden Gate narrows. The currents are the result of a huge tidal prism existing in the bay system which stores and discharges its tidal volume through the Gate during each tidal cycle. Such a barrier as that proposed by Reber might reduce the tidal prism by half and cause the bar to become larger, making the entrance to San Francisco Bay more shallow, and a threat to navigation.

This remarkable acre of concrete is said to hold the answers to the growth and economic future of the West. Engineers insist that around the proper knowledge of how to handle San Francisco Bay will evolve events of national, as well as of Western importance.

Engineers feel that the answers the bay model will provide should prove it to be the most valuable piece of concrete in all the world. ★ ★ ★

**Ride while you work!**

Plow, cultivate, mow, rake, harrow, till, plant, bulldoze, plow snow, spray, saw, maintain beautiful lawns. 5.4 hp. All-gear drive. B-W 4 speed trans. Clutch, diff. 770 lbs. Low cost. Ready to run. Quick-change implements. 100% satisfaction guaranteed.

Write for FREE CATALOG  
COUNTRY SQUIRE TRACTOR CO.  
P.O. Box 107-K-11  
Muskego, Wis.



**COUNTRY SQUIRE TRACTOR**



**Santa Says:**

**"A WONDERFUL HOBBY WORKSHOP GIFT"**

**WITH Warren SAWING WASHERS**

Cut 40 smooth, accurate, parallel grooves — any angle, with your present saw blade. Dial desired width with Micromatic adjustment. Leave on saw for straight cuts. Sizes to fit your arbor — 3/4", 5/8", 3/4", 1" A perfect gift for woodworkers. See your dealer or write!

ONLY \$4.95 PER SET

SEND FOR FREE BOOKLET  
**WARREN WASHERS COMPANY**  
DEPT 31 • BOX 98 • NORTH END STATION • DETROIT, MICH.

# Now You Can Upholster Any Piece of Furniture!

## Upholster—Restyle Any Piece of Furniture Yourself

John Bergen, custom furniture designer, tells and shows you how to transform old out-of-date furniture into brand new smart-looking comfortable furniture in his new book **ALL ABOUT UPHOLSTERING**.

## No Experience Needed

Bergen tells you every step to follow in amazingly clear easy-to-understand step-by-step instructions and then shows you how in hundreds of big, clear drawings and photos. You read and see how to strip the old frame, install new webbing and springs, apply burlap, install stuffing and padding, fit the muslin cover and the final fabric and install trim.

## Use New Materials—Methods

Now you can have furniture upholstered with foam rubber, sagless springs and other new materials that add so much to comfort and durability and are so costly when included in new furniture.

## Save 50% of Usual Cost

Don't pay a small fortune for new furniture when you can make your old furniture better than new! Why pay high prices to have someone else upholster and restyle your old furniture when you can do it yourself for cost of materials alone? It's easy and it's fun.

## Special Chapter on Slipcovers

Learn how to make custom-made slipcovers with professional look and fit. Find out how you can realize tremendous savings by investing a few spare-time hours and the cost of a few yards of fabrics.

## 7-Day Money Back Guarantee

Send for your copy of **ALL ABOUT UPHOLSTERING** today. Read and use it for 7 days. If it isn't entirely satisfactory return it for a full refund.



## USE THIS HANDY ORDER COUPON

POPULAR MECHANICS PRESS, Dept. 1057  
200 E. Ontario St., Chicago 11, Illinois

Gentlemen:

Please send my copy of **ALL ABOUT UPHOLSTERING**. Enclosed is my remittance of \$3.50. If I am not completely satisfied with the book I will return it for a full refund after 7 days.

Name \_\_\_\_\_

Address \_\_\_\_\_

City \_\_\_\_\_

Zone \_\_\_\_\_ State \_\_\_\_\_

## What Do 3 Out of 4 Doctors Recommend to Relieve Pain?

A survey shows 3 out of 4 doctors recommend the famous ingredients of Anacin Tablets to relieve pain of headache, neuritis and neuralgia. Here's why Anacin® gives you better *total* effect in relieving pain than aspirin or any buffered aspirin:

- ➔ **ACTS INSTANTLY:** Anacin goes to work *instantly*. Brings fast relief to *source* of your pain.
- ➔ **MORE EFFECTIVE:** Anacin is like a doctor's prescription. That is, Anacin contains not one but a combination of effective, medically proven ingredients.
- ➔ **SAFER:** Anacin simply can not upset your stomach.
- ➔ **LESSENS TENSION:** Anacin also reduces nervous tension, leaves you relaxed, feeling fine after pain goes. Buy Anacin today.

## EASIER FASTER BETTER!



## KESTER SOLDER

FREE: "Soldering Simplified" 16-page booklet—Send for your copy today.

For General Soldering

**KESTER SOLDER COMPANY**  
4251 Wrightwood Avenue • Chicago 39, Illinois, U.S.A.

## DRAINS

cellars, cisterns, wash tubs; **\$7.95**  
IRRIGATES - CIRCULATES - SPRAYS

Up to 3,000 GPH; 450 GPH 80' high; or 1800 GPH from 25' well. Use 1/8 to 3/8 HP motor. Coupling included free. 1" inlet 3/4" outlet. Stainless steel shaft. Won't rust or clog. Type P—\$7.95.  
CELLAR DRAINER KITS (less motor)  
"Low Boy"—15" high, 1500 GPH.....\$12.95  
"High Boy"—32" high, 3,000 GPH.....\$15.95  
Postpaid if cash with order. **MONEY BACK GUARANTEE**  
LABAWCO PUMPS, Belle Mead 7A, N. J.

## SAVE MONEY on LUMBER with the LOW-COST BELSAW PLANER

### Convert Rough and Random Size Lumber Into Cabinet Finished Stock

Now anyone can make perfect cabinet finished stock from low-cost rough lumber... any size up to 12 3/4 inches wide and 6 inches thick. Turn out high grade finished material at a fraction of the cost you pay lumber yards. Big 42-inch-long bed makes it easy to plane heavy, wide and long pieces... BELSAW self-feeds at 14 to 34 feet per minute.

### USE THIS ONE LOW-COST MACHINE for Planing, Jointing, Sawing, Milling, Tongue and Groove.

You can easily make flooring, siding and many other popular patterns with your Belsaw. Your Belsaw quickly pays for itself with savings on raw materials and profits on finished stock... a highly profitable machine for custom work. Compare Belsaw with any 12-inch planer on the market... Belsaw gives you more essential features—yet costs you \$50 to \$125 less than others.

Send Today for Free Literature on the Belsaw Multi-Duty Planer.

**BELSAW MACHINERY CO** 2058 Field Bldg. Kansas City 11, Mo.

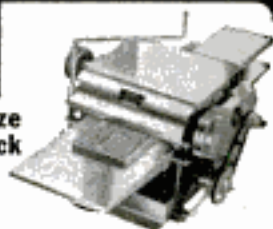



**CASITE gives your car**

## **NEW PEP NEW POWER**

### **Frees sticky rings and valves**

Get increased pick-up and improved engine performance! Casite—the “tune-up in a can”—through the air intake or added to gasoline, restores split-second valve timing and full compression.

### **Prevents hydraulic lifter trouble**

Casite keeps valve lifters clean and free-working. Just put a pint in the crankcase every 1,000 miles, and with every oil change.

### **Assures safe, smooth break-in**

New and rebuilt engines wear-in smoothly and safely with Casite in the oil. Penetrates tight spots—eliminates overheating, scoring.

### **Cuts start-up wear**

Speeds oil flow—protects closely-fitted parts during warm-up periods. Almost doubles engine life.

### **Gets rid of sludge and gum**

Casite removes gum and goo—KEEPS the engine clean—increases power, improves performance, saves gas and repairs, too.

### **Results guaranteed, or double-your-money-back!**

Get Casite at your service station, garage or accessory store.



**HASTINGS MFG. CO., HASTINGS, MICH.**

Piston Rings, Oil Filters, Spark Plugs

## **An Appraisal of the New Models**

(Continued from page 89)

Bendix electronic system which uses transistors to “sense” the engine’s need for more or less fuel is the one Chrysler selected. General Motors offers injection in Chevrolet, but minus the electronics. Ford, American Motors (which first announced the Bendix system in 1957) and Studebaker-Packard (which still has the supercharger) do not offer injection.

Buick mounts aluminum brake drums on the front wheels of its three top lines. The actual braking surface is cast iron, but the drum and cooling fins that surround it are aluminum. Holes in the cast-iron liner fill with aluminum as the drums are cast and act as heat-transfer corridors as well as bonds to hold the two metals together. The bimetal drum is used on the front brakes only because it is there that the major braking effort is made.

Buick also has a full variable-pitch stator in its new triple-turbine transmission. This stator is linked to the throttle so it assumes an infinite number of angles, depending on throttle position. Thus, better torque multiplication is provided when it is needed, better economy when needed. The previous design had only two positions. It switched from one extreme to the other when the throttle was floorboarded.

You’ll see a new symbol on some transmission quadrants this year. It’s a “G” or “Gr” standing for Grade. In descending steep grades, the transmission is put into this retard position and the hydraulic oil of the unit absorbs the car’s energy, slowing it down and helping the brakes. Other automatic transmissions do the same job when in Low or Intermediate.

Push-button transmission made a new convert this year: American Motors offers it in a design very similar to that introduced by Mercury last year. General Motors, Studebaker-Packard, Lincoln and probably Ford (coming out later) still retain the right-hand-operated shift lever.

Oldsmobile has a neat trick for its radio. Designed as a two-way unit, the all-transistor radio can be removed from the dashboard and used as a portable. When you push it back into the dashboard, self-aligning sockets plug it into the car’s battery, antenna and loudspeaker systems. When used separately, it has a small built-in speaker, loop antenna and batteries good for 160 hours’ operation.

It may be that Olds has come up with the most significant news of the year. For the first time in many, many years, a new model has less horsepower and less weight

(Continued to page 272)



# HARGRAVE

The Complete Line of Tested  
**TOOLS**

**INDUSTRIAL QUALITY TOOLS  
FOR EVERY WORKSHOP**



### WRITE FOR FREE CATALOG

Showing a complete line of Clamps for all purposes, openings from 3/4" to 12" and depths from 11/16" to 16", also Chisels, Punches, Masonry Drills for hand and power hammers, Carbide Rotary Drills, Gasket Cutters, File Cleaners, etc.

**See Your Local Hardware Dealer**

**THE CINCINNATI TOOL CO.**

1987 WAVERLY AVE.

CINCINNATI 12, OHIO



Works in seconds!

**Loosens Rusted Bolts  
nuts, screws, "frozen" parts!**

## LIQUID WRENCH

The super-penetrating rust solvent that quickly loosens rust and corrosion.

AT HARDWARE STORES, GARAGES  
SERVICE STATIONS, EVERYWHERE  
**RADIATOR SPECIALTY CO.**  
Charlotte, N. C.

## BUILD YOUR OWN POWER TOOLS-

With

**GIL-BILT PARTS-PLAN  
KITS**

**PLANS  
only  
1.00  
EACH  
POSTPAID**



### 10" TILT/ARBOR SAW

Sturdy wood, steel, and aluminum construction. NEW DEPARTURE ball bearings. Capacity and performance of floor saws selling for \$150.00 and up. Plans, all metal parts in kit with 10" comb. blade \$25.90, less blade \$22.95, F.O.B. St. Louis.

### 12 IN. and 18 IN. BAND SAWS (12" only illustrated)

Ball bearing drive, rigid cast aluminum wheels, rubber tires. Rigid cast aluminum tilt and tension mechanisms. 18 inch saw handles stock to 6" thick, cuts to center of 30" circle. Extra large tilting tables. Capacity and performance of hand saws selling for \$80 to \$300. Plans and all metal parts for 12" band saw \$23.95. Plans and all metal parts for 18" band saw \$39.95.

For shipments up to 400 miles, add 5%; over 400 add 10%. Amount in excess of actual postage will be refunded.

Also Build-it-yourself 6" Belt Sander, Shaper, 8" Tilt-Table Saw. Simplified plans, build easily with hand tools only. Advertised and sold for 10 years, over 33,000 units in use. Money back Guarantee. FREE CATALOG.



**GILLIOM POWER TOOLS**

DEPT. 80-L, LAMBERT FIELD  
ST. LOUIS 31, MISSOURI

NOVEMBER 1957

# How Weldwood Old Craftsman Pine Plywood makes your woodworking projects easier

New, all-pine plywood gives you all the working advantages of clear pine lumber, plus the added strength of rugged plywood construction, and convenience of large panel sizes.

Old Craftsman pine is carefully selected, precision manufactured, and backed by the Weldwood name. Sizes and types to fit your needs. Clean working, smooth sanding, easy finishing, no waste. Try it on your next project. Ask your Weldwood lumber dealer.

**SEND THE COUPON** for Old Craftsman book. Step-by-step directions are a cinch to follow. A 50¢ value—only 25¢ with coupon below.



**PROJECT #9** from the Old Craftsman book (see coupon)—*Early American Hutch* with planter bin in dry-sink. Make it with Old Craftsman Pine Plywood. Stain with Clear Firzite® plus colors-in-oil, and finish with non-yellowing Satinlac®. You can paint Old Craftsman, too, and get beautiful results. Far less face checking and hairline cracking than with ordinary plywood.

WELDWOOD

**old craftsman  
PINE PLYWOOD**

UNITED STATES PLYWOOD CORPORATION

**SEND FOR PINE PROJECTS BOOK TODAY!**

United States Plywood Corporation

PM-11-57

Box 61, New York 46, N. Y.

Please send me my copy of your 96-page book, "Projects You Can Build With Weldwood Old Craftsman Pine Plywood." I enclose 25¢.

Name.....

Address.....

City..... State.....

# NEW BLACK & DECKER 3/4 H.P. HEAVY DUTY ROUTER GIVES YOU MORE



A maximum of power packed into a minimum of weight! That's the new Black & Decker Router . . . one of the lightest, most compact units on the market! And it's loaded with special features for faster, easier, more precise work. This is the *complete* woodworking tool, perfect for beading, grooving, routing, fluting, etc. Compare the power and performance of the new Black & Decker Router with **Only** any other. Then compare price **\$59<sup>50</sup>** and you'll be sold!

## ...and new B&D Router Kit!



**B&D ROUTER KIT** gives you Router, six popular bits, Straight and Circular Guide in handy metal kit for only \$88.00 . . . Save \$5.75.

**WRITE TODAY** for new B&D Router Manual—loaded with project ideas, illustrations, professional tips. Send only 50c with name and address to: *The Black & Decker Mfg. Co., Dept. M117, Towson 4, Md.* (In Canada: P. O. Box 278, Brockville, Ont.)



Look under "Tools-Electric"



# Black & Decker®

World's Largest Maker of Electric Tools

than its previous model. The Oldsmobile 88 has only 265 horsepower compared with 277 horsepower in 1957. Its shipping weight is 3984 pounds compared with 4000 pounds for 1957. It is designed for economy. This may mark a turning point for the industry. If so, remember it was Olds that made the turn first!

Perhaps the most important news (or at least the news that will be most remembered by history) is the death of two distinguished names: Hudson and Nash.

For the first time in 50 years, there is no new Hudson, for the first time in 41 years, no new Nash. Instead there is an Ambassador in the Rambler series, which means a bigger car built on the Rambler shell. Thus the attrition continues. How long it will continue is a question for history.

As the number of American makes diminishes, the number of European imports increases: Vauxhall, Opel, British Ford, and scores more without American sponsorship. Perhaps this is significant—the industry is watching. ★★★

## Cool Shower for Pigs Pays Off at Market

Water-cooled pigs are happy pigs, according to the U. S. Department of Agriculture. The department reports that pigs shipped to market in a trailer equipped with a sprinkler system, like that shown in the photograph below, were quieter and more comfortable than pigs that did not get cool showers during the trip. The sprinkled pigs also were worth more at market because they had lost less weight. The system costs about \$35 per trailer.

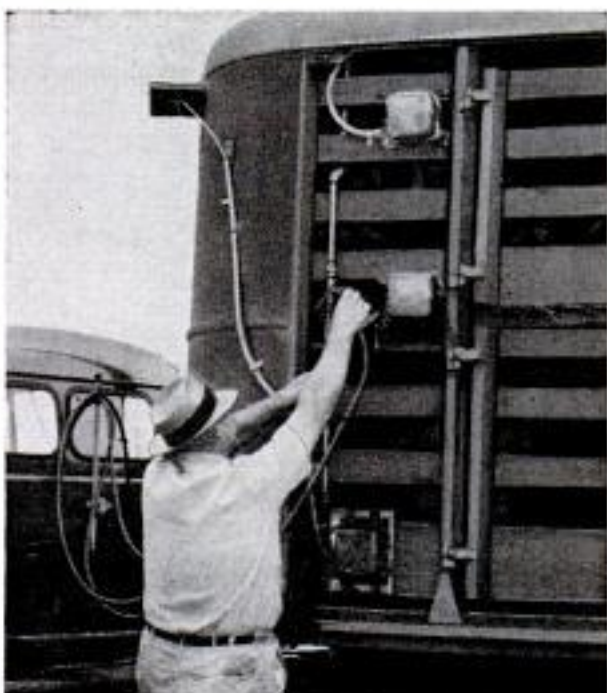





**FREE!**  
 Home Calk  
 Check List  
 Send  
 Postcard  
 to:

Get neater, cleaner calking jobs everytime with new, improved Handi-calk with the exclusive Stop-Flo feature! Stop-Flo POSITIVELY prevents mess... gives easy, convenient stop-and-go calking action! Seal cracks and gaps in your home the easy Handi-calk way... just pull trigger to calk, withdraw plunger rod to stop flow of calk instantly!

**HANDI-CALK DIVISION, Dept. HC-6**  
 2366 WOODHILL ROAD • CLEVELAND 6, OHIO  
 At Leading Hardware, Paint and Building Supply Dealers



**GIVE A FINE INSTRUMENT FOR CHRISTMAS AT LITTLE COST HULL AUTO COMPASS**

**\$5.50 AND \$6.95**

At your dealer or write for literature. MOST COMPASS DRIVERS USE A HULL FAVORITE BOATING ACCESSORY, TOO.



**HULL MFG. CO.** P.O. Box 246-D-11 Warren, Ohio



**The 14' STARFISH** . . . Now you can OWN a \$1,100 registered Planing-Hull Class SAIL BOAT for only \$525, complete. Freight prepaid. It's constructed of "Harborite" Plastic covered plywood, with Dacron Sails and stainless steel and chrome hardware throughout. So EASY to assemble . . . 2/3rds of the work is done in our plant. Just put it together and you're ready to SAIL! Owners claim speeds up to 14 knots. It's the ULTIMATE in a family racing sailboat.

• HULL KIT • HARDWARE & RIGGING KIT • SAIL KIT • ONLY \$175 each, freight collect. COMPLETE KIT \$525. FREIGHT PREPAID. Assembled at our plant, complete, ready to sail, \$1,100 freight prepaid.

PORT MARINE, INC., P.O. Box 704-b, Newport Beach, Calif.

**COMPLETE YOUR HOME WORKSHOP WITH A . . . RELIABLE BENCH FURNACE**

MODEL SHOWN  
**\$52.50**  
 PA



The home hobbyist will find the side door perfect for heating long bars, soldering irons, drills etc. The Reliable Bench Furnace also is equipped with a removable pot for melting all soft metals and alloys.

**FREE!**

Specifications and literature on complete line.



**WRITE TODAY!**  
**RELIABLE MACHINE & MFG. CO., INC.**  
 420 H Ave. N.W. Cedar Rapids, Ia.

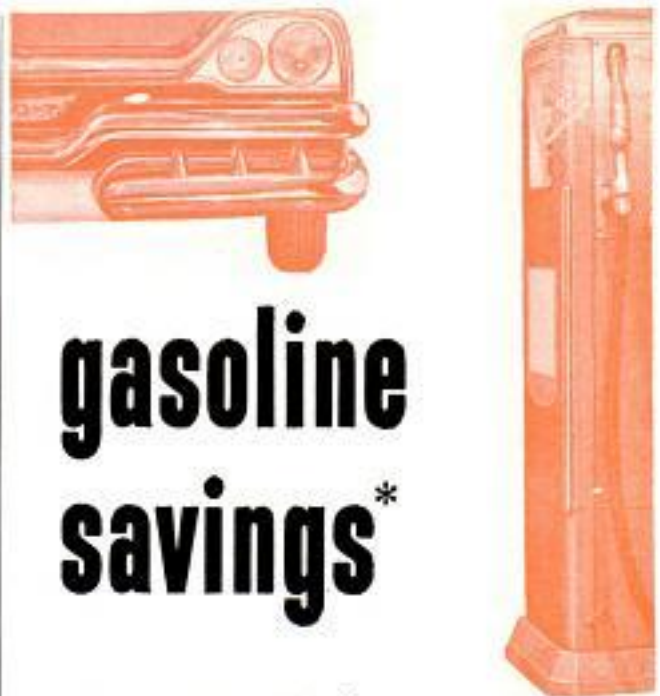

**gasoline savings\***

start with a "full power"

**WILLARD BATTERY**



AS LOW AS  
**\$13.95 EXCHANGE**  
 IN MOST AREAS:

\*Slow-starting engines waste valuable gasoline. Split-second starting with a full-power Willard gives you extra mileage on every gallon . . . cuts down wear on vital engine parts as well. For extra dependability, insist on a full-power Willard!



Children pose proudly on a signpost that marks one of the most important points of the war in Asia—the junction of the Stilwell Road and Burma Road

## Adventure on the Stilwell Road

(Continued from page 85)

crossed the river at Tanai, where we met our first representative of the Burmese government, a local district official in a *lungyi* (sarong). He concealed his surprise and refused to do anything so rude as to ask for our passports. "Would you like a game of badminton?" was all he said. We later learned from him that there was practically no traffic on the higher part of the road, though six trucks a year moved short distances between villages. He was surprised that it was possible to come from India.

We drove on next day through a forest valley, then passed Walawbum, Shaduzup and Kamaing—names attached to nothing but a dozen huts in a jungle clearing and a memory of heavily fought battles. Then the valley disappeared and we entered Myitkyina, past the great airstrip which had been seized by Merrill's Marauders in one of the most successful jungle surprises of the war.

"Boy, oh boy! I sure am glad to see you!" were the first words we heard as we climbed out of the cars. A tall, smiling man came forward to pump our hands. "I sort of got left by the war," he said, and pointed at his "business," a wooden hut with

mechanic's tools outside and, at a guess, a Burmese wife inside.

### Huts Made of Trucks

In fact, most things in that part of Burma have been leftover by the war. Huts were made of upturned trucks, knives ground from car springs, and money earned by banditry with a wartime rifle. Transport was almost entirely by one of the 15,000 Jeeps and trucks the American army is said to have left behind, and I once saw a woman wearing Japanese epaulets hanging like rings from her ears.

We left Myitkyina by a ferry constructed of two Bailey pontoons lashed together and powered by a homemade adaptation of a car engine. On the pontoon ferry was a lorry, in the lorry the band of some Kachin troops who refused to cross until they had played for us. Nine men with bamboo pipes, a drummer and a wild-eyed character who rhythmically beat a jungle knife against the lorry's metal side produced a weird, whimsical melody; all the more whimsical when we realized the tunes were Orientalized renderings of "Swanee River" and "Home Sweet Home," obviously picked up from U.S. troops. They smiled at our camera. They grinned bashfully at our tape recorder. They roared at their sergeant when he ordered them to move. They laughed at everything.

From there we began the mountain climb toward the junction with the Burma Road. It was a dramatic journey. The road climbed and turned like an Alpine race-course, but instead of macadam there were dust and cobbles. We saw a few Jeeps and lorries on the road, the only vehicles that could manage it.

One morning we stopped at a village market while a couple of our men worked on the Landrovers. All manner of natives dressed in all kinds of costumes gaped at us. "Strange-looking Charlies," remarked one of our mechanics as he wiped a black hand across a dusty face, filthy shirt dangling over shaggy shorts, unbathed for a fortnight, the whole apparition crowned by a tufted beard and a disintegrating straw hat. I wonder what the natives were saying.

### Mistaken for Missionaries

As we journeyed we found that, because of our black beards, we were frequently taken for Italian missionaries. We quickly corrected the mistake. A missionary had been shot by bandits only a month before.

One night our camp was a quarter mile from the Chinese border and we could see on the other side what we later learned

(Continued to page 276)



The beautiful Edsel Citation two-door hardtop. All 18 models in the new Edsel line are equipped with Champion spark plugs.

## **Champion welcomes the Edsel to its distinguished roster of 36 great cars**

It's a fact! With the addition of the Edsel—newest member of the Ford family of fine cars—36 great cars throughout the world now use Champions as standard equipment. This means more than twice as many cars use Champions than any other plug. Why? Because Champions give every car—including your car—full-firing power . . . all the power you paid for!



**CHAMPION**

LOOK FOR THE 5 RIBS

Copyrighted material

# Make Child's Play of Gluing Jobs



by **GOODYEAR**

"Bonds Anything to Anything"

Available at chain, hardware  
and hobby stores everywhere.

Pliobond—T. M. The Goodyear Tire & Rubber Company, Akron, Ohio

## FREE PLAN tells how to start your own business FILING SAWS

Here is a steady repeat CASH business you can start in your own basement or garage in your spare time and make up to \$3 or \$5 an hour. You can file hand, band and cross-cut circular saws on the Foley Saw Filer. No eyestrain—no experience needed. "The first

saw I sharpened with my Foley Filer came out 100%"—writes Clarence E. Parsons.

Every saw you sharpen with the Foley Saw Filer brings you more customers. "I rented a two-car garage and have all the work I can do"—Charles H. Smith.

**FREE BOOK**  
Shows How To Start  
Send coupon today.  
No salesman will call.



### SEND COUPON FOR FREE BOOK

FOLEY MFG. CO., 1116-7 Foley Bldg.  
Minneapolis 18, Minn.

Send me free book "Money Making Facts"

Name \_\_\_\_\_  
Address \_\_\_\_\_



was the "Flying Tigers" last airbase. Two of our men poled across the frontier river in a bamboo raft to have a look, landed in China, exchanged a few words with a passing peasant and returned to be "brain-washed" by the rest of us.

Finally one morning our dirt track came to a crossing, and the other road was made of macadam. We had come to the Burma Road, and the end of Stilwell's impossible engineering feat. On a signpost: Kunming 606 miles.

We had started our journey on the Stilwell Road partially to rediscover a war-time campaign. Instead, we had found a smiling, delightful people. The tragedy we had expected lay not in the decay of the road, but in the impact of the war on a primitive people.

In a way, we were glad the highway had become a forgotten one. ★ ★ ★

### Eight-Ounce Hand Gauge Measures Wheel Alignment

It takes only five minutes to check the caster and camber angles of automobile wheels with a new alignment gauge that fits in the palm of your hand. The instrument, made of steel and aluminum, weighs about eight ounces. It has a level but uses no light beams or magnets and has no moving parts. The manufacturer claims the gauge equals the accuracy of more expensive wheel-alignment equipment.

Tric-Kee Tool Company, 79 West Street, Ballston Spa, N. Y.



☞ Bagasse, a fibrous waste product of sugar-cane processing, can now be converted into rayon by a method similar to the production of wood pulp.

## NEW HONEYWELL DECORATOR LIGHT SWITCH!



*Change it  
any way,  
any time*



*to match  
your room's  
decor!*



THE TRANSPARENT decorator plate on the new Honeywell TAP-LITE\* snaps off for easy decorating, cleans easily. Just wipe with a damp cloth. Simple to install. TAP-LITE has screwless terminals. Easy to operate. Tap, it's on. Tap, it's off! Switch and plate \$1.95 at hardware stores.

MINNEAPOLIS  
**Honeywell**



*First in Controls*

\*Trademark

### NEW, IMPROVED CALCULATOR FOR WOODWORKERS only 25c



Instantly gives information on lumber, nails, concrete mixes, painting materials, etc. Convenient, simple to read. Just set dial for nail specifications, to convert linear to board feet, find bit sizes for screws, compare characteristics of woods. 6" diameter heavily varnished cardboard. Send 25c, no stamps, please to Greenlee Tool Co., 2111 Columbia Avenue, Rockford, Illinois.

\$295.00 with  
1/2 Motor

### BARKER MILLING MACHINE

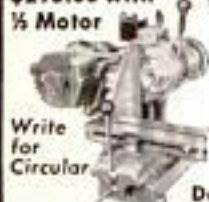

This versatile, sturdy benchmill is ideal for small parts production. 3-Way Hand Lever Travel. Micro feeds available. For milling, profiling, drilling, key seating, end milling, straddle milling, slotting, turning, facing, counter-boring and recessing. (Accessories).

**BARKER ENGINEERING CO.**  
Dept. P • 500 Green Rd. • Cleveland 21, O.



**Wash  
or scrape  
OLD PAINT OFF**

**Low Cost**

**HEAVY-BODIED KLEAN-STRIP**

Non-inflammable paint remover

*Fast • Clean • Safe*

The Klean-Strip Co., Inc. • P. O. Box 10084 • Memphis, Tenn.

## Be Your Own Boss in the Profitable Excavating Business!

### EARN UP TO \$1,000 AND MORE PER MONTH

Wherever you live, you'll find plenty of profitable work the whole year 'round for this versatile outfit . . . not just a "trencher" but an all-purpose excavating machine! Custom operators everywhere are making big money with Sherman Power Diggers. ONE BOUGHT A FARM WITH JUST THREE YEARS' PROFITS! Work for builders, contractors, utilities, and municipalities on such jobs as septic tanks and drainfields, sewer lines, fuel tank installations, foundations and footings, gas and water lines, field tilling and many others. The Sherman Power Digger mounted on a Ford Tractor travels quickly from job to job, digs at a fraction of the cost of manual labor. It's simple to operate, easy to maintain, built to last.

Send now for information about the easy-to-get jobs for your Sherman Power Digger. Let us tell you—without obligation—how you can go into business for yourself with an investment of less than \$5000. Or make a small down payment and pay the balance from earnings.

### SHERMAN PRODUCTS, Inc.

Dept. 1736 Royal Oak, Michigan

NOVEMBER 1957



### Send Now for FREE LITERATURE!

Sherman Products, Inc.  
Dept. 1736 — Royal Oak, Michigan

Send me information on how I can get into the excavation business on my own.

NAME \_\_\_\_\_

ADDRESS \_\_\_\_\_

CITY \_\_\_\_\_ STATE \_\_\_\_\_



You'd never guess . . . .  
he's clearing snow from a highway!

It's true . . . and it's as simple as it looks, too! Snow removal is fast, dependable and safe with Monarch Power Hydraulic Control Equipment . . . cab-controlled for one-man instant action, the Monarch zips snow plows into operation with ease and speed. Fan-belt driven or Electric models are available for practically all makes of vehicles. Proven in service everywhere, over 50,000 Monarch Controls have been sold. See your dealer or write for full details.



POWER **MONARCH** HYDRAULIC CONTROLS

**MONARCH ROAD MACHINERY COMPANY**  
1331 MICHIGAN ST., NE — GRAND RAPIDS 3, MICHIGAN



Greatest  
Xmas Idea  
Since  
Tree Lights!

Makes flames sparkle  
in a rainbow of colors  
as it destroys soot!

## CHIMNEY SWEEP Fireplace Powder

Just sprinkle on burning logs. Exclusive 2-in-1 action makes colorful flames all evening long as it destroys soot. Your home and hearth stay cleaner, merrier.

Realistic birch log sprinkler container looks great on hearth or in log holder. Sold at all hardware and dept. stores, or send \$1.69 (ppd) in check or money order (no C.O.D.'s), to G. N. Coughlan Co., 29 Spring St., W. Orange, N. J.

**GLAMORIZE YOUR**  
*Christmas*  
**CARDS, GIFTS & DECORATIONS**

8 decorator colors of Glitter & Stars **1.00**  
✓ Tube of Wilhold Glitter Glue **Postpaid**

It's easy... Write with Wilhold glitter glue and sprinkle with glitter. It's fun. Personalize even your most inexpensive gifts. **G-90 Gift Kit**

AD #1042 *Send One Dollar today, to*

**WILHOLD PRODUCTS** Los Angeles 31, Calif.; Chicago 44, Ill.

**PRI** **ROAD TO RICHES**

You can be the next uranium millionaire! Government guarantees huge bonus! PRI instruments from \$29.95. See your local dealer today! **FREE CATALOG!**

Write PRI, 4223 PM W. Jefferson  
Los Angeles 16, California

**DEALERS WANTED**

**FIX home & car APPLIANCES YOURSELF**

**NEW! EICO® REDI-TESTER**  
**KIT \$12.95** **Factory-wired \$15.95**

All-in-one MULTI-RANGE ac/dc voltmeter, ammeter, ohmmeter, wattmeter, leakage checker. Locates defects in irons, fans, refrigerators, mixers, air-conditioning, TV & radio tubes and parts, batteries, generators, etc. Easy instruction Book has introduction to electricity & procedures for common repair jobs. Examine EICO's complete line of 50 professional instruments & kits - Write for **FREE Catalog P.M.-11**

Electronic Instrument Co., Inc., 31-02 Northern Blvd., L.I.C., N.Y.

**GET THE HABIT OF READING**  
**OUR CLASSIFIED ADS.**

*Wonderful Opportunities* *Amazing Bargains*

**1 Bit to DRILL - REAM - SAW** IN SHEER METAL, WOOD, ANGLE IRON, TRANSITE, BARELITE.

Fits any 1/4" or 1/2" electric drill or drill press

**New, Low Price \$2.95** **Money-Back Guarantee** **Postpaid 3 for \$8.50**

Drill's own 1/4" starter hole, cuts straight, curves, or angles. Made of finest High Speed, abrasion-resistant steel. Easy to use.

**INTERNATIONAL TWIST DRILL CORP.**  
612 Wyandotte, Kansas City, Mo.

**DEALER INQUIRIES WELCOME**

**DEER HUNTERS!**  
OUR OWN GUNSMITH'S HIGH VELOCITY

**MANNLICHER MODEL \$17.95**  
**SPORTING CARBINE**

Presenting the Moisin-Mannlicher Sporting Carbine for the first time on the national market. This gun has become increasingly popular here in the Sierras during the last few seasons. It is a real bargain in high velocity, precision shooting. **FREE TRIAL:** We include 12 free rounds of target ammunition with each gun. Test your gun without risk and return to us in 10 days if you do not feel it is an outstanding hunter's bargain in every way. Popular 22" bbl. 6-shot, smooth lightning-fast bolt action. Powerful 7.62MM flat trajectory cartridge. Open calibrated sights ideal for brush shooting. **SOFTNOSE HUNTING AMMO SPECIAL:** 20 rds., \$2.95. **TO ORDER:** Send check, cash or money order, \$5 deposit for C.O.D. Shipped F.O.B. Los Angeles, Calif. Resid. add 4% State Tax. **12 FREE RDS. AMMO**

**THE ELLNER COMPANY** Dept. 54, 1206 Maple Ave. Los Angeles 15, Calif.

**Speed up Scroll Sawing with a  
DREMEL Electric MOTO-SAW  
HANDY FOR HOBBYIST OR CRAFTSMAN**



Cuts scrolls like magic  
Safe as a handsaw  
7200 strokes per minute  
Only \$6.85 with 3 blades

You do a professional job on any hobby or household project when you use a Dremel Moto-Saw. You just guide it—it does the work. High-speed reciprocating motor — easily cuts asphalt and rubber tile, Masonite, Formica, wood up to 3/4". Blade-holder faces four ways — saws in any direction. Cuts smooth, no sanding required. Only two moving parts, never needs oiling. Uses 110-120 V. AC. See your hardware or hobby dealer. If he can't supply you order direct from factory on a 5-day trial, money back guarantee. We ship postpaid.

SEE YOUR HARDWARE OR HOBBY DEALER  
**DREMEL MFG. CO • Dept. 117L • Racine, Wis.**

**PUMP FASTER with a "HY-JET"!**

Made of aircraft grade aluminum alloy, this rugged #10 centrifugal pumps up to 4500 G.P.H. Ideal for irrigating—draining—filling—spraying. Uses 1/8 to 3/4 H.P. motor. Rust-proof 1/2" shaft, oilless bearings, 3/4" suction, 1/2" discharge, std. pipe threads, adaptable to garden hose . . . . . \$8.95  
Heavy-Duty HY-JET #20 fills and empties pools, ponds, etc. Extra powerful—up to 8000 G.P.H. Use 1/4 to 3 H.P. motor. Rugged, rust-proof 1/2" shaft, oilless bearing, 1 1/4" suction, 1" discharge, std. threads. . . . . \$11.95  
Prepaid if cash with order. Send Check or M.O. \$2 deposit if COD. Money-back guarantee.



**MACK EQUIPMENT & MACHINE CO., Dept. K-19**  
329 No. Indiana Ave. Atlantic City, N. J.

*the finest*  
**WOOD SCRAPERS**  
*are*  
**Red Devil Tools.**

**why...** YOU SHOULD EQUIP YOUR TRAILER WITH  
**BULL DOG**  
• AXLE ASSEMBLIES  
• JACKS • COUPLERS

Straight or drop axles in single or tandem—capacity up to 10,000 lbs.—any width. Also Torq-Less Axles for all types of trailers.  
**JACKS**—Bull Dog Jacks make hitching and parking a one-man job.  
**COUPLERS**—Bull Dog Couplers hitch or unhitch to trailer in a moment.

Write today for **FREE** Descriptive folder 13R.  
**HAMMER BLOW TOOL COMPANY**  
WAUSAU, WISCONSIN

**Arc  
welding  
PAYS  
BIG!**



**"Build Your Own" gas drive welder  
with this HOBART generator and**

**SAVE \$200 to \$300**

Just connect this low cost 250 amp. unit to any good used auto engine and you're equipped for a highly profitable welding business. Investigate this wonderful opportunity for making more money by mailing the coupon below.

**AC welder-AC power**



200 amp. combination that you can connect to your own power source. Lets you operate where no power lines are available. Furnishes current for welding and power for running tools, lights, motors, etc. Build your own combination welder and power unit with a good used auto engine.

**air-cooled engine driven**



Welds anywhere. Easily mounts on truck or trailer for getting to those profitable emergency repair jobs. Light, rugged, compact and air-cooled. Fine for fabrication purposes and tough enough for continuous operation on light or medium production work.

**utility AC arc welder**



Superior performance, economical operation and general serviceability make this a popular model for small shops, implement shops, auto service shops, plumbing and heating contractors, farm welding, etc. Has same features of the big industrial models. **Welding Lessons** 200 pages fully illustrated, self teaching. **ig \$1.00**

**HOBART BROTHERS CO., BOX M-117, TROY, OHIO Phone FE 2-1223**

HOBART BROS. CO., Box M-117, Troy, Ohio

Without obligation, send me complete information on:

1. "Build Your Own"     3. Air-Cooled, Engine Driven  
 2. AC Welder-AC Power     4. Utility AC Welder  
 Enclosed is \$1. Send me Welding Lessons Book

NAME \_\_\_\_\_  
ADDRESS \_\_\_\_\_  
CITY \_\_\_\_\_ STATE \_\_\_\_\_

**WHAT DO YOU  
KNOW  
ABOUT**

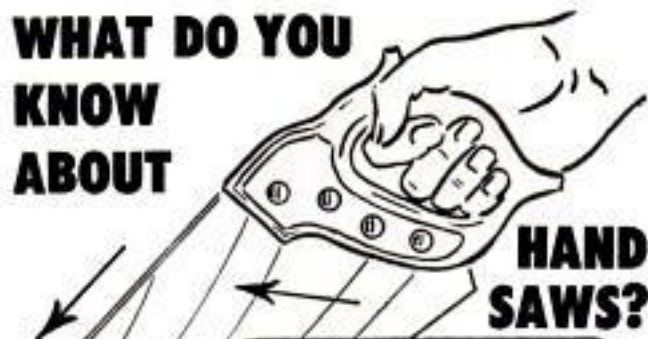

**HAND  
SAWS?**

**TAPER GRINDING**

Two-directional taper grinding means that the blade is thinner at the back than at the tooth line—and tapers from handle to tip. Proper taper grinding gives the blade better clearance in the cut reducing friction and ensures perfect balance and flexibility. SANDVIK Swedish steel hand saws all feature taper grinding over the entire blade... a feature found only in top quality saws.



If you'd like to know more, write today for free booklet "Things You Should Know About Hand Saws". Write Dept. PM



**Sandvik** STEEL, INC.

Saw & Tool Division  
1702 NEVINS ROAD, FAIR LAWN, N.J.  
IN CANADA: P.O. Drawer 1330 Station "O" Montreal 9

**TOOL  
PROTECTION**



For complete protection to precision tools, house them in a Gerstner Chest. Free Catalog to machinists and toolmakers.  
**GERSTNER TOOL CHESTS**  
457 Columbia St., Dayton 7, Ohio



Don't just shave... Use

**AERO  
SHAVE!**  
(and save 20¢)

Never before a lather so rich, so creamy, so fast-acting—for so little money! Get AERO-SHAVE Push-Button Lather.



Not 79¢ Not 69¢ Only **59¢**

**HANDEE** A COMPLETE WORKSHOP IN YOUR HAND



The powerful new Hi-Torque HANDEE grinds, polishes, cuts, saws, engraves, burnishes, cleans. A necessity in every workshop. Works in wood, hardened steel, non-ferrous metals, glass, ceramics. Packed with power and speed (25,000 rpm). Cool running, fits the hand for pencil-point precision. 110 or 220-v. 25 to 60 cycles AC or DC.

with 6 accessories  
**\$23.95**

**TOOL OF 1001 USES!**  
With every type of cutting tool in metal case. **\$32.95**

Order your Handee Today!  
**CHICAGO WHEEL & Mfg. Co.** Dept. PM-11  
1101 W. Monroe Street, Chicago 7, Illinois



**2500 WATT  
A. C. ELECTRIC  
GENERATOR**

115-Volt, 60-Cycle  
A.C., Single Phase

Government Cost \$250.00

**Brand New SURPLUS**  
Fully GUARANTEED

Only **\$125.00** fob

Ideal as a permanent or stand-by unit for electrically IDENTICAL to your house current. Perfect for farms, camps, aboard ship, oil fields, mines, etc. Easily handles lights, refrigerator, deep freeze, oil burner, radio; power for saws, floodlights, drills, pumps, etc. ALL BALL BEARING! Operates at 3600 RPM. Drive with 5 HP or larger engine—or use power take off. Voltage self regulating. Standard base mtg. Two outlets, 3/16" 13" long, 8" dia. Wgt. 65 lbs. Delivers 2500 Watts CONTINUOUSLY!

**SUPPLY LIMITED! ORDER DIRECT FROM AD**  
Free Catalog of other Surplus, Hydraulics  
**ROBERTS ELECTRIC CO., Dept. PM-713, 849 W. Grand, Chicago 22, Ill.**



Sawyer's, Inc., P.O. Box 400, Portland 7, Ore.

**Twin-Lens Viewer**  
Saves Eye Strain

Color-slide viewing without squinting is the claim for a lightweight, single-slide, twin-lens viewer. It takes all 2 by 2, 828, Rollei Super and 127 Super slides. The built-in light is powered by batteries but a transformer unit can be attached to operate it from a wall outlet.

POPULAR MECHANICS

Copyrighted material





**NOW!  
CUT  
CIRCLES  
WITH  
YOUR  
CIRCULAR  
AND  
BAND  
SAW**

**CIRCLE MASTER**



The amazing **CIRCLE MASTER**, a new patented attachment, will permit you to cut all circular shapes on any make bench saw. Simple to use, **CIRCLE MASTER** enables you to cut a perfect, clean and smooth circular shape. Cuts a diameter adjustable up to 30" on small saws, even bigger on large saws. You can make chairs, table tops, wheels, trays, lazy susans, stools, coasters . . . anything that calls for a circular shape. You can make cove cuts, beveled cuts, shoulder cuts, moulding cuts and many others depending upon blade used. You must be completely satisfied or your money back.

Send Check or money order. We pay postage. Only \$4.95

**AMERICAN HOME TOOL CORP.**

DEPT. 311 • 350 BROADWAY • NEW YORK CITY

The newest words in  
Glass Cutting  
"**LUBRICONE  
IMPINGEMENT**"



This is an exclusive **FLETCHER** process for penetrating a lubricous material right into the steel of the glass cutter wheel. It materially increases its efficiency and lengthens its cutting life.

**FLETCHER** glass cutter costs remain the same, so ask for them by name. Your local hardware, paint or lumber dealer will have them. Be sure to ask for a **FLETCHER** glass cutter.

**THE FLETCHER-TERRY CO. • FORESTVILLE, CONN.**

HERE'S PROOF OF PERFORMANCE:

"We purchased our 6300 series lathe primarily because of its low price, and were we surprised! This machine has more 'guts' than most of our machines costing 3 and 4 times as much."

**BROM MACHINE WORKS**

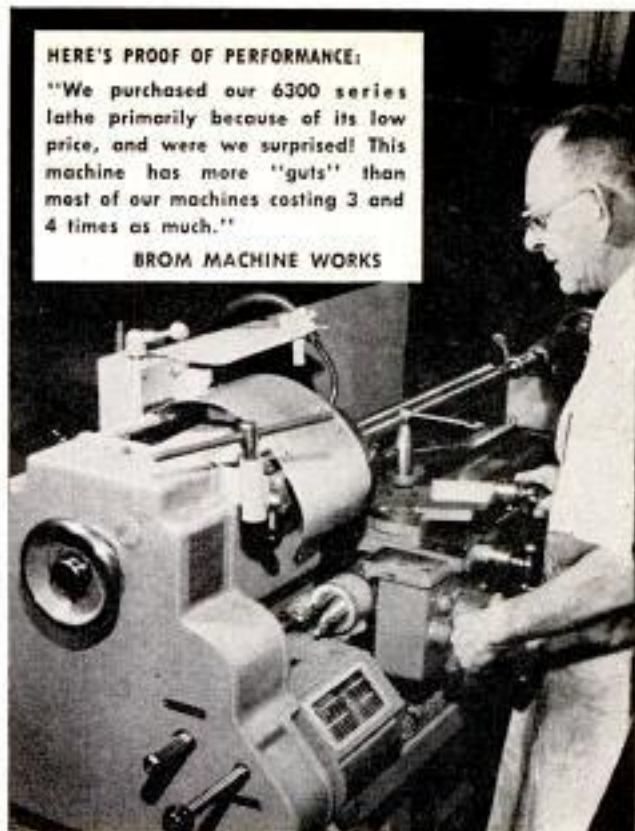

**BOUGHT ON PRICE—  
PRAISED for performance  
CLAUSING 6300 LATHE  
out-performs expensive machines**

The reaction of Brom Machine Works is typical. It is not unusual for purchasers of Clausing lathes to get much more for their money than they had expected.

Flame hardened bed ways at no extra cost. Headstock, apron and quick-change box are totally enclosed—gears and shafts travel in bath of oil—another exclusive. Spindle is forged steel with 1 3/8" bore, hardened and ground ASA—L-00 tapered key-locked nose. Spindle turns on Timken "zero-precision" tapered roller bearings. Tailstock has No. 3 MT ram.

And each Clausing lathe must pass rigid tolerance tests such as: spindle nose run out 0 to .0003" TIR, spindle taper run out at end of 12" test bar, 0 to .0006". A test report accompanies each lathe. See for yourself why Clausing is the lathe for your shop—production, job, experimental, home or school.

WRITE FOR FREE LITERATURE

**CLAUSING**

**CLAUSING DIVISION  
ATLAS PRESS COMPANY**

11-135 N. PITCHER ST. • KALAMAZOO, MICHIGAN

# "ARCO-SAW" does more than a \$100 portable saw!

**ZIPS THRU 2" BOARD IN ONE EASY CUT!**



**ARCO**

**CUTS ANY GROOVE. AN "ARCO" EXCLUSIVE!**



**CUTS ANY ANGLE!**



Build anything from a bookcase to a bungalow with this rugged portable saw. Fits any 1/4" drill. Rips & crosscuts up to 2" board. Exclusive "Dado-Arbor" adjusts for cutting grooves up to 1/2" wide x 1" deep in ONE CUT! Not even a \$100 portable saw has a dado cutter. Has Depth-Bevel-Rip Gages. Safety-yoke permits 1-hand operation. Incl. 5" blade..... **\$12.95**

At Your Dealer or order direct on our Unconditional 10-day Money Back Guarantee. Send check, M.O. (ppd.) C.O.D. plus post.

**ARROW METAL PRODUCTS CO.**

Dept. PM-11 • 421 West 203 St. • New York 34, N.Y.

**ONE POUND OF TEMPERED STEEL**



**\$7.95**  
Postpaid including Leather Sheath

This man-sized multi-purpose hunting knife is one of a kind. No other like it on market today! Made by German cutlery experts from finest Solingen steel. Has genuine stag grip. Has weight and balance of regular hand-axe. Ideal for rugged camp use ranging from pounding tent posts with its broad top edge, to dressing-out big game both quickly and easily! Built for a life-time of use and requires only a small amount of honing to restore its razor sharp edge. **SPECIFICATIONS:** Length overall 15 1/2"; Blade 9 1/4" long, 1 1/2" wide, 3/16" thick; weighs one lb. **ORDER NOW, SUPPLY LIMITED;** send check, cash or M.O. Sorry no C.O.D.'s. Calif. resid. add 4% state tax. **UNCONDITIONALLY GUARANTEED!** If not satisfied return within 10 days.

Dept. 75  
**SEAPORT TRADERS, INC.**  
409 E. 12th St., Los Angeles 15, Calif.

*The 6-Transistor Portable That Plays Anywhere!*



**build your own radio and SAVE**



No other portable gives you so many important features at such a low price. You get a 4" x 6" speaker for "big-set" tone—500 to 1000 hour battery life—unbreakable molded plastic cabinet in Holiday Gray—efficient, all-transistor circuit—and easy, step-by-step assembly instructions and pictorial diagrams. Have fun building and using this fine set. Shpg. Wt. 4 lbs.

**HEATHKIT TRANSISTOR PORTABLE RADIO KIT**

**MODEL XR-1 \$34.95**

(with cabinet, less batteries)

**FREE HEATHKIT CATALOG AVAILABLE**

Describes many more "do-it-yourself" kits for hobby—hi-fi—ham radio—and experimenting. Get your copy now for complete selection of fun projects that save you money.

Pioneer in "do-it-yourself" electronics



**HEATH COMPANY**

BENTON HARBOR 17, MICHIGAN A SUBSIDIARY OF DAYSTROM, INC.

Please send FREE Heathkit Catalog

NAME \_\_\_\_\_

ADDRESS \_\_\_\_\_

CITY & STATE \_\_\_\_\_

**MECHANICAL PENCIL CALCULATOR**  
NEW INVENTION



MATH-WIZ pencil calculator gives answers automatically to addition, multiplication and square root problems. (Indirect subtraction and division.) Easy to operate, comes in gold modulated aluminum casing. Useful gift for students, engineers, draftsmen and in all industry. Only \$4.25 postpaid. No C.O.D.

Not a Slide Rule

**JACK WEISER, Dept. 1, 1233 S. Fairfax Ave., Los Angeles 19, Calif.**

**Here's a brand new "MFG" Boat**

a frisky, 12 1/2-foot runabout, ideal for inland waters... tops for fishing. Lapstrake hull molded in one seamless piece, in matched metal dies. Three mahogany-trimmed models, from \$295. Write for information.



**THE CORRY**

**MOLDED FIBER GLASS BOAT COMPANY, 71 Fourth Avenue, Union City, Penna.**

**D. C. PORTABLE WELDER \$198.00**

Welds anywhere with its own powerful H.D. 4 cycle air cooled Gasoline Engine. 9-10 H.P. Electric started with battery. Engine directly connected to a famous name 30 volt 200 amp. D.C. Generator with force air cooling. Automatic load control. Pull range heat control. Weight 186 lbs. A Guaranteed, well Engineered, proven, high quality Welder all new material. Handles 3/16 rod, welds 1/2 in. steel. Comparable with other 200 amp. gasoline driven Welders costing up to \$795.00. Direct Mail Order from our Factory same location, over 12 years, assembled ready to run F.O.B. (limited time only) \$198.00 cash. COD 50% with order.



**HUNT MECHANICAL ENGINEERING SERVICE**  
DRAWER 1-PM  
OLDSMAR, FLORIDA

**WAR SURPLUS AND OTHER BARGAINS SAVE UP TO 90%**



**"HOMELITE PORTABLE POWER PLANT** Ideal for welding, battery charging, emergency lights for cabins, camps, aircraft, trailers or wherever power needed. Easy rope pull starting. Fully equipped, ready to start. 2000 W., 24 V., 5 H.P. Like NEW. Tested. Shock-mounted. Deluxe type. Net wt. 115 lbs. Gross wt. cased 200 lbs. Approx. GOVT. COST \$700. Now — \$65.00. 2500 W. — \$75.

**P2 GENERATOR KIT \$29.95** Build your own complete make-up package incl. 1 Gen., 24 V., 200-250 Amps; Rheostat, Toggle Switch, Welder's Shield, 30' new welding cable, Voltage Reg. Electrode Holder, Wiring diagram for hookup as welder, Wt. under 100 lbs. Approx. GOVT. COST \$550. NEW. \$29.95.  
**P2 GEN.**, as above, purchased separately — \$24.95.

**R1 GENERATOR KIT** Jack & Heintz or GE. Rated 300 Amps. 24-32 V. With same items as above. Approx. GOVT. COST \$600. Complete 60 lb. kit — \$39.95.

**M1 GENERATOR** Great for trucks, boats, battery charging & other DC equipment. 50 Amps, 24-32 V. 2600-4000 RPM. Wt. 45 lbs. Approx. GOVT. COST \$200. NEW. Only \$15.50.

**MICROMETERS** Black crackle finish frame. Easy-to-read graduations in. Out. NEW. 0-1" cap. \$2.69 ppd. 1-2" cap. \$3.79 ppd.

**DOUBLE-ACTION HYDRAULIC CYLINDERS** — oil or air operated.  
**ROD END BEARING:** 7/8" length of stroke. 5/8" shaft. 1 1/8" bore. 13" overall. Approx. GOVT. COST \$75. New. \$3.95 ea. Special — 2 for \$7.

**DOUBLE SPRING LOADED:** Zerk lubricated end mounting. 7/8" length of stroke, 9/16" shaft. 1 3/8" bore. 13" overall. Spring is removable. Approx. GOVT. COST \$75. NEW. \$3.95 each. 2 for \$7.

**CLEVIS MOUNTING:** Stroke 10 1/2". Bore 2 1/2". Shaft dia. 1". closed length 27". Wt. 28 lb. Approx. GOVT. COST, \$300. NEW. \$20 each. 2 for \$32.50.

**DUPONT EXPLOSIVE RIVETS** Essential wherever blind riveting required. 1/8", 3/32", 3/16" Round & flat heads. Approx. GOVT. COST \$50, 1,000 assorted for only \$5.00 ppd.

**BENDIX GEROTOR PUMP & MOTOR** Use wherever fluid pumping required. Excellent for hydraulic installations. Has 3/4" pipe connections, built-in relief valve adjustable up to 1500 lbs. Max. cap. 6 GPM. 1 1/2 H.P., 24 V. motor. Use on 12 to 30 V. Approx. GOVT. COST \$350. NEW. \$10.95.

**CHRONOMETRIC TACHOMETER** Built to U.S. Navy & Air Force specs. Standard brand. For counting revolutions per min. for any rotating shaft. Can be used on speeds up to 3000 RPM. Accuracy to 1/10 of 1%. Complete with male & female tips & shock-proof case. GOVT. COST \$87.50. NEW. Only \$21.95 ppd.

**140-1 REDUCTION GEAR** For beaching boats, winches, hoists. Ideal for motor in golf or boys electric car. Built-in (removable) DC motor & clutch. Hi torque, 10 speed. Runs on 6-12 or 24 V. Wt. 63 lbs. gross. Approx. GOVT. COST \$300. Like NEW. \$12.00.  
\*225-1 REDUCTION GEAR, as above — \$13.50.

**BUTANE BLOW TORCH KIT** Precision soldering, brazing or metal craft. Starts charcoal fires. Tiny, clean, safe charge, 3500° pinpoint flame. Turns on & off. Featherwt. 7" long. Kit incl. torch, solder, tip, extra fuel cartridge — \$2.95 ppd.  
**BLOW TORCH ALONE** — only \$1.95 ppd.

**HEAVY-DUTY RHEOSTAT** Ideal for regulating voltage on electric welders. Rated 5.75 Ohms, 100 Watts with double windings & dual female 20 amp, 125 V. receptacles. 7" hi x 5 1/4" x 1 3/4" D. Shpg. wt. 2 1/2 lbs. Approx. GOVT. COST \$25. Brand New. \$1.95.

**MAUSER-TYPE VERNIER CALIPER** 6" Vernier Caliper. Glass hardened, lapped measuring surfaces. Fine engraved scales — 1/1000" and 1/10mm. 2 gib adjustments. Friction thumb release. Reg. \$25. Only \$7.95.  
**HELIOS TOOLMAKERS VERNIER CALIPER** — Scales 1/1000" and 1/128" graduations. Roll thumb lock. A \$35 value. NEW. \$6.95. Leather carrying case for caliper — \$1.

**NEW! TERRIFIC! 1958 CATALOG!** Thousands of bargains in war surplus & other items. Hundreds of pictures. Send 25¢ for your copy today! Ppd. prices in USA only. Other prices FOB Culver City, Calif. Send cash, check or money order. 50% deposit on COD.

**AIRBORNE SALES CO., INC. DEPT. PM1157**  
8501 Stellar Drive, Culver City, Calif.

**'How to MAKE MONEY with Simple CARTOONS'**

A book everyone who likes to draw should have. It is free; no obligation. Simply address **FREE BOOK**

**CARTOONISTS' EXCHANGE**  
Dept. 911-A, Pleasant Hill, Ohio

**Find HIDDEN TREASURES**

GOLD, SILVER, PRECIOUS METALS with the Famous Model 27 Metal Detector. Lightweight, ultra-sensitive, low cost. None finer. Also GEIGER COUNTERS for uranium and the VIOLITE for tungsten. INFORMATION FREE

**THE Detectron CORP.**  
5528 Vineland Ave., No. Hollywood, Calif.

**\$3 to \$5 an hour IN SPARE TIME**

**WITH NEW FOLEY PRECISION GRINDER**

Make \$3 to \$5 an hour in your own spare time business. Low cost machine sharpens circular saws, rotary mower blades, ice skates, does sanding, polishing, buffing. Easy to operate — no experience needed. Send coupon today for Free circular. No salesman will call.

**FOLEY MFG. COMPANY**  
1173-7 Foley Bldg.  
Minneapolis 18, Minn.

Send Free Circular on Foley Precision Grinder.

Name \_\_\_\_\_  
Address \_\_\_\_\_

**Boost Your Power!**

**FAN-O-MATIC**  
Automatic FAN RELEASE

Automatically disengages fan at speeds over 40 mph!

At speeds over 35 MPH, standard automobile fans waste horsepower! The FAN-O-MATIC now makes your fan a free-wheeling unit, releasing wasted horsepower at speeds over 40 MPH.

- Increases Available Horsepower . . . up to 15 HP
- Increases Gas Mileage . . . up to 2 mpg.
- Increases Acceleration . . . up to 10%
- Reduces Engine Noise
- Reduces Vibration

ADAPTABLE TO ALL CARS SIMPLE TO INSTALL

Tested and proved on Indianapolis Speedway under supervision of U. S. Auto Club.

At your Garage, Ser. Sta. or Car Dealer!  
If your dealer does not yet have it, ask him to write us for Jobber who can supply him.

**RADIATOR SPECIALTY CO.**  
CHARLOTTE, NORTH CAROLINA

THE IDEAL  
*Christmas Gift*  
 FOR THE BOYS IN  
 YOUR LIFE WHO HAVE A  
 GROWING INTEREST IN  
*Science*

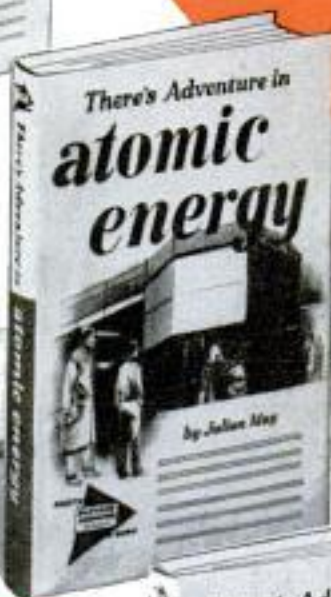
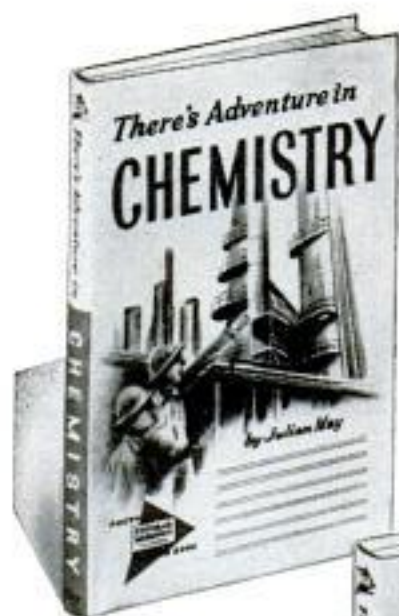

**3 New Exciting  
 Fascinating  
 CAREER-BUILDING  
 ADVENTURE BOOKS**

**There's Adventure In  
 CHEMISTRY**

The mysteries of Chemistry unfold through the adventures of typical American boys. Thrilling fiction, yet scientifically sound. Provides understanding of career opportunities and requirements in Chemistry. Illustrated. 175 Pages . . . . . **\$2.50**

**There's Adventure In  
 ATOMIC ENERGY**

The Atomic Age is here and youth is reaching for simple, understandable information. Here it is, in exciting fiction form, yet factually correct. Explains the career possibilities, whets the boy's desire to go farther. Illustrated. 175 Pages . . . . . **\$2.50**

**There's Adventure In  
 ELECTRONICS**

With all the thrills of adventure stories, the facts about Electronics are given in story form, not only to educate, but also to help the boy judge Electronics as his life's work. Illustrated. 175 Pages. . . . . **\$2.50**

Thrilling adventures in Chemistry, Atomic Energy and Electronics. Told in fascinating fiction style, yet factually accurate, with experiments boys can make. Career aptitude tests are included. Thoughtful gifts for boys age 11 to 17. They'll be grateful!

*Buy Them Wherever  
 Books Are Sold . . . or  
 Order Direct from*

**POPULAR  
 MECHANICS  
 PRESS** 200 East  
 Ontario Street,  
 Dept. M-11  
 Chicago 11,  
 Illinois

Popular Mechanics Press, Dept. M-11  
 200 E. Ontario St., Chicago 11, Ill.  
 Please send the following "There's Adventure" books prepaid. I  
 enclose \$2.50 for each book ordered.

CHEMISTRY     ATOMIC ENERGY     ELECTRONICS

Name \_\_\_\_\_

Address \_\_\_\_\_

City \_\_\_\_\_ Zone \_\_\_\_\_ State \_\_\_\_\_

**KEEP YOUR  
WORKSHOP TOOLS  
SAFE AND ORDERLY**



This 7-drawer machinist's chest has a place for every tool. Extra durable heavy gauge steel. Felt lined drawers protect delicate edges... operate easily. Size: 8½" x 13½" x 20¼". \$27.95 at leading hardware stores. Slightly higher west. Other home workshop models from \$1.25 up.

**WATERLOO VALVE SPRING COMPRESSOR CO.**  
Waterloo, Iowa

**BOAT PLANS-PATTERNS  
FRAME KITS**

A modern up to date series of inboard and outboard designs for the amateur builder. State specific size and type or send 50c for **DIG NEW CATALOG.**



marine **GLEN** designs Box 568T Compton, Calif.

**ESHELMAN TRACTORS** **LOW AS \$99**

Plows-Cultivates-Saws  
Cuts-Dozer-Narrows  
Hauls-Snow Plow-Rolls. Eshelman Tractors, Tillage, Riding Rotary Mowers for Better Lawns and Gardens. Advertised in **GOOD HOUSEKEEPING**. Thousands of satisfied users. Write for Free Literature. Dept. 282, **ESHELMAN**, Balto. 2, Md. \$519.75

Supply Points: BALTIMORE - CHICAGO - ENO

**3 PASS SPORT CAR**  
Ideal 2nd Car or Sportabout.  
Fully Equipped.  
Write For Literature.

**make your own Gems 36.50**

The Gem Maker comes complete with all necessary equipment, including a super-charged diamond blade for sawing, and all the wheels for grinding, shaping and polishing; also complete instructions. The complete equipment as shown, less motor and belt for only \$34.50, f.o.b. Burlington, Wisconsin. Write today for information and literature.

**B&I MANUFACTURING CO.**  
Dept. P, Burlington, Wis.

**G E A R S**

**In Stock - Immediate Delivery**  
Gears, speed reducers, sprockets, thrust bearings, flexible couplings, pulleys, etc. A complete line is carried in our Chicago stock. Can also quote on special gears of any kind. Send in your blueprints and inquiries.

**Send for Complete Catalog No. 10**  
**CHICAGO GEAR WORKS**  
440-50 N. Oakley Blvd., CHICAGO 12, ILL.

**FINEST IN WOODS**  
TOOLS, MATERIALS & SUPPLIES

**145th Anniversary Edition**  
Constantine's latest catalog, 126 pages, many in color. Everything craftsmen need in hard-to-get hardware and supplies. Veneers, Inlays, Carvings, Moldings, Upholstery Supplies, Plans, Sections on many Hand and Power Tools, How-to-do-it and wood finishing articles, 83 inlay designs and big wood identification panel of over 60 woods... all in natural color. Finest book ever offered. Send coupon for copy today!

Send 25c (refunded on 1st order) for this catalog and "Chips and Chats", a Constantine publication, will be sent **FREE!**

**ALBERT CONSTANTINE AND SON, INC.**  
2056E Eastchester Road • New York 61, N. Y.  
NOVEMBER 1957



**GRAVELLY  
Snow Blower**

**Now!  
NEW  
EASE IN  
SNOW REMOVAL**

**With Steering Sulky and Self Starter**

- Powerful Gravelly Tractor—with *push-button Starter, New Steering Sulky and Snowblower*—make snow removal almost child's play!
- You can blow snow—deep or light, wet or dry—wherever you want it, with fingertip maneuverability. 48" Snow Plow also available. 25 year 'round attachments... *All on Easy Pay Plan.*

Write today for **FREE** 24-page "Power vs Drudgery" Booklet!

**GRAVELLY TRACTORS, INC.**  
BOX 1163 DUNBAR, W. VA.

**FIELD-TESTED SINCE 1922**

**IDEAL CHRISTMAS GIFT FOR ANY MAN**

**WELD BRAZE** **4WAY**  
**SOLDER CUT** **ONLY \$14.75**  
f.o.b. factory

**WELDER**  
Complete with Twin Carbon Arc Torch and accessories... to handle all metal-craft work.

Acclaimed by thousands of Homeowners, Mechanics and Hobbyists as the welder of 1901 used. Easily operated from properly wired 110 volt AC or DC line. The ideal gift with a life-long use... Order today on 10 day money back guarantee.

**FOUR-WAY WELDER CO., Dept. F2-M**  
1810 S. Federal St. • Chicago 16, Ill.

**CONSTANTINE'S  
National Woodworking  
CONTEST ...**

**CASH PRIZES**

America's leading supplier of woods and woodworking materials offers you the chance of national recognition for your skill. Win one or more of 300 prizes. Nothing to buy, no entry fee. Contest closes March 31, 1958. Send coupon for details and entry blank.

**MAIL COUPON TODAY!**

**ALBERT CONSTANTINE AND SON, INC., 2056E Eastchester Rd., New York 61, N.Y.**

Enclosed 25c (refunded on 1st order) Send Catalog and **FREE "Chips and Chats."**  Contest details and Entry Blank

Name \_\_\_\_\_

Address \_\_\_\_\_

City \_\_\_\_\_ State \_\_\_\_\_



## It all adds up to one thing:

### Fine bearings mean fine performance!

The skilled mechanic puts a lot of good work into reconditioning an engine . . . and he protects his work by installing Federal-Mogul main, connecting rod and camshaft bearings. Why? Because he knows the bearings are the heart of engine performance and the best replacement bearings cost no more. Most of the 765,000 mechanics in the U.S. and Canada prefer Federal-Mogul bearings—they know they assure fine performance. Ask your mechanic!

## FEDERAL-MOGUL SERVICE

*Division of*

**Federal-Mogul-Bower Bearings, Inc.**

### Mechanics Know . . .

that the black and red Federal-Mogul box identifies the service bearing line as modern as today's engines.

RESEARCH • DESIGN  
METALLURGY • PRECISION  
MANUFACTURING • SERVICE

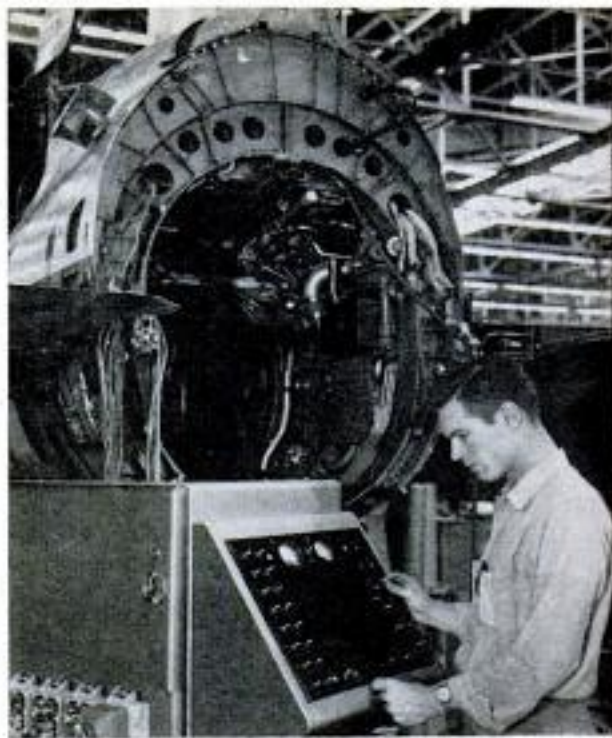

### Fast Tester for Short Circuits

Up to 1200 electrical circuits can be tested and shorts accurately pinpointed in less than a minute with a newly developed instrument. The unit passes electricity through each circuit and small lights on the panelboard tell if the circuits are operating or if any are out. The tester originally was produced for the aviation industry, but it can be applied to any multicircuit assembly.

### Chemical Dip Process Puts Gold Plate on Metal



Discovery of a dipping process for gold plating makes it possible to put a permanent coat of 24-karat gold on a metal surface without electricity or special equipment. The object to be plated is simply immersed in a warm bath of chemicals that attack the original surface of the object. The surface atoms that are shed are replaced by atoms of gold in the solution. The process is called ionic displacement. It reportedly puts a more uniform coat of gold on an object than electroplating methods.

Baker & Co., Inc., 113 Astor Street, Newark 2, N. J.

POPULAR MECHANICS

**SAVE STRAIN  
SAVE SKIN**

WITH  
**Bridgeport  
NEOPRENE  
CUSHION  
GRIP**

**SCREWDRIVERS**

**50%  
GREATER TURNING  
POWER**

16 sizes and styles—Regular and Phillips.  
\$1.00 and \$2.70  
At your hardware store.

- SUPER COMFORTABLE
- NON-SLIP GRIP
- UNBREAKABLE HANDLE
- FULLY GUARANTEED
- ALLOY STEEL BLADE

Resilient Neoprene CUSHION GRIP lets you turn screws tighter with less work—and you don't hurt your hands. Tested and approved by Mechanics

THE BRIDGEPORT HARDWARE MFG. CORP., BRIDGEPORT 5, CONN., U. S. A.

**TRANSFORMER \$24.95 FOB  
WELDER QUINCY**

Complete with everything. Ready to plug in. 110 volts AC. Draws 15-30 Amps. Produces 75 Amps, 5 heats. Welds metal from 1/16" to 1/4" using 1/16" to 3/32" standard rods. Guaranteed unconditionally. 10-day trial. \$5 deposit on C.O.D. Does everything welders costing up to \$75 do. 1/4" welder \$7.95 plus 50c for postage.

ESSAY MFG. CO., INC., Dept. 51, Quincy 69, Mass.

## GOT A LOCK PROBLEM?

To make locks work easier and last longer, add a few drops of LOCK-EASE to any lock mechanism. LOCK-EASE—a graphited fluid flushes out dirt—leaves a long-wearing protective film to seal out rain, snow, salt, ice and dust that cause locks to stick, rust and wear out. LOCK-EASE prevents keys from sticking... locks from freezing. Use LOCK-EASE on car locks, garage locks, padlocks and all door locks in and out of the home. For best results, "LOCK-EASE" locks regularly! 4-oz. "Drop or Stream" can only 49c, everywhere.



**LOCK-EASE®**  
Graphited  
**LOCK  
FLUID**



American Grease Stick Co.  
Muskegon, Michigan



**DISSTON PRESENTS:**

## A 5¼ Pound Electric Hand Saw that cuts Metal, Wood, Plastic

The D-23 Electric Hand Saw brings you entirely new features in fast, versatile cutting for home workshop or professional jobs. Tests prove the D-23 from 15% to 50% faster than competitive saws, whether cutting in wood, metal or plastic. And it's made by DISSTON, a famous name in saws for more than 100 years. Only **\$98<sup>50</sup>**

"ORBITE" Action gives the DISSTON D-23 Electric Hand Saw its fast, clean cut and reduces blade wear. The blade has an orbital motion (3,800 strokes per minute). It cuts on the up-stroke, moves away from the material on the down-stroke. The result is less fraying of edges, truer cuts on circles, scrolls, straight lines or bevels. Extra, easy-to-change blades and detachable electric cord come with the saw.

**H. K. PORTER COMPANY, INC.**  
HENRY DISSTON DIVISION

**FREE BOOKLET.** Mail this coupon today for an illustrated booklet outlining many more convenient and exclusive features of the DISSTON D-23. Instructions tell you how you can get the most out of your electric hand saw.

**H. K. PORTER COMPANY, INC.**  
HENRY DISSTON DIVISION

511 Tacony, Philadelphia 35, Pa.  
Please send me the FREE booklet about the new DISSTON D-23 Electric Hand Saw.

Name \_\_\_\_\_

Street Address \_\_\_\_\_

City \_\_\_\_\_ Zone \_\_\_\_\_ State \_\_\_\_\_

# SURPLUS SALE

WAR SURPLUS  
EXCESS INVENTORY  
BANKRUPT STOCK

## AUTOMATIC AC POWER PLANT

• Brand new leading standard make full automatic start-stop 1500-w 115-v 60-c power plant. Finest ball bearing direct drive. Hi-overload capacity. Makes ideal plant for emergency power failures. Also readily portable for camping trips, etc. Plant starts automatically when any load is switched on. Size 25x18x19 in. Wt. 125 lbs. List \$465.  
SPECIAL .....\$359.49 FOB

## ELECTRIC CLOCK TIMER

• Finest 115-v 60-c electric clock timer. Shows exact time. Will sound built-in alarm at any preset interval. Easy to read numbers. Fine for mounting desks, radio, TV, etc. 3 1/2" dial. Wt. 1 lb. List \$12.50.  
SALE .....\$2.89 Ppd.

## AC-DC ELECTRIC GENERATOR

• Brand new unit suitable for light welder, battery charging, campers light plant, etc.  
• Generates 100 amps at 30-v DC and 1200-w 115-v 800-cycle AC. Marvellous buy! Govt. cost \$295.  
SPECIAL .....\$13.91 FOB.

## ELECTRIC CAR MOTOR

• Use golf or boys electric car. Geared 140 to 1. Run 6 or 12 volt auto storage battery. Easily reversible. Full instr. Wt. 34 lbs. Govt. cost \$250. ....\$19.46 FOB

## EXTENSION TELEPHONE

• Hang-up type standard type phone. Mount on side of desk, on wall, etc. Ringer box (not shown) also furnished. Use as extra-answering set, call out, etc. Nearly new. Perfect.  
Govt. cost \$19.50. SALE \$8.32 Ppd.

## Sensational New Shop Automatic Steam Cleaner

• Amazing new top brand fully automatic oil burning 115-v AC steam cleaner. Generates high pressure steam in 90 sec. Using soapy fluid will clean dirty, greasy engines, motors, tools, etc. in seconds. Makes oil engines look new. Fully guaranteed.  
• Garages, filling stations, machine shops, contractors, large farms, etc. find it indispensable. To start or stop simply press button. No fires to light or valves to turn.  
• Dealers Wanted in every community. Lowest prices in U.S.A. Size 32"x48"x20". Wt. 325 lbs. Complete, ready to use. Write for literature. SPECIAL .....\$298 FOB

## SPORTSMAN'S BARGAINS

• We have many amazing buys in leading brand sporting goods. Guns, knives, boats, etc. Here are a few of our top, closeouts:  
• \$21 Army Jungle Hammock Tent...\$6.95  
• \$15 Sleeping Bag, nylon & wool...\$8.95  
• \$14 Army Coleman Sing. Burner Stove \$10.95  
• \$12 Loading Make Spinning Reel...\$6.98  
• \$10 Top Grain 2-Pc Spinning Rod...\$4.95  
• \$4 Full Grain Hand Gun Holster...\$1.99

## LINESMAN'S CLIMBERS and BELTS

• Genuine Govt. surplus new top brand standard pole climbers and safety belts. All leather straps, pads, safety belt, etc. Designed to fit average man. Learn to climb—wonderful opportunities at excellent wages, power, phone companies. Save 80% Prepaid.  
• Lineman's Climbers complete .....\$7.91 Pr.  
• Lineman's Tool Belt & Safety.....\$11.29 (not illustrated)

## STORAGE BATTERY WINCH

• Powerful fully reversible, ball-bearing gear reduction winch. 2000-3000 lb. pull. Use on 6 or 12-v battery. Holds 40' of 1/4" cable. For trucks, docks, boats.  
Govt. cost \$280. \$46.75 FOB

## SPECIAL OF THE MONTH!

### NEW SUPER POWER 1/4" DRILL

• New model, just released, genuine THOR Electric Drill. Full 2.5 amp. 110-AC motor. Ball thrust bearing, geared chuck, fan cooled, precision design, suitable for finest shop.  
• A real powerhouse equivalent to \$35 super power drills. Use for drilling, polishing, sanding, etc. Has square front housing for special attachments. Fully guaranteed, money back. Special Ppd. Price (limited time only).....\$14.96

### CONTRACTOR'S TILTING-LEVEL

• Combination tilting level with powerful achromatic 10-X optical lens, 360° horizontal index sensitive bubble, full sharp focus control.  
• Excellent for building, leveling, vertical alignment, setting 90° or foundation work, etc. Complete with tripod, carrying case and plumb bob, full instructions. Made by leading instrument company. SPECIAL \$59.50 Ppd.

### HYDRAULIC SPEED REDUCER

• Variable hydraulic speed reducer. Any speed from 0 to 750 rpm by simply throwing a lever. Handle up to 1 1/2 h.p. Use for midjet cars, shop band saws, etc.  
Govt. cost \$400. SPECIAL.....\$47.81 FOB

### OTHER OUTSTANDING SURPLUS BUYS

• Many other buys—air compressors, power plants, hydraulic pumps and cylinders, hose, plastic pipe, electronics. Most Prepaid.  
• \$66 Govt. Gear Reducer, 80 to 1...\$8.49  
• \$42 Weston Circuit Volt-Ohmmeter...\$19.87  
• \$27 Oak Case Magneto Telephone FOB \$8.97  
• \$195 DC 3000-w 115-v Generator FOB \$49.97  
• \$62 Centrifugal Irrigation Pump 1 1/2" \$20.61  
• \$11 Fish and Worm Hand Shocker...\$7.88  
• \$64 Electric Centrifugal Pump, 12-v DC \$9.95  
• \$40 Portable Ice Air Cond. 110 AC.....FOB \$14.97  
• \$25 Standard Dial Telephone.....\$9.95  
• \$195 Personnel Elec. Car Motor 12-v.....FOB \$14.50  
• \$97 Govt. Wind Direct Velocity Unit \$4.95  
• \$10 Govt. Quik Reels Car Safety Belt \$3.79

Order from ad or write for Free Catalog.  
**BURDEN SALES COMPANY**  
813 "O" ST., LINCOLN, NEBRASKA

# FREE 1958 CATALOG!

Over 15,000 bargains in the fields of Hi-Fi, Radio, Television and Electronics!  
Send for Your Copy Today!

**E-Z TERMS!**  
Only 10% Down  
Top Trade-Ins  
Up to 50% Savings on More Than 800 Guaranteed Reconditioned Eqp't. Items!



**WORLD RADIO LABORATORIES**  
The World's Largest Distributor of Amateur Radio Eqp't.  
3415 W. Broadway — Council Bluffs, Iowa  
Leo I. Meyerson PERSONALIZED SERVICE

**MAIL HANDY COUPON**

WORLD RADIO LABORATORIES, INC. PM-71  
3415 W. Broadway — Council Bluffs, Iowa

PLEASE RUSH ME:  Free Catalog  Hi-Fi Booklet  
 Info on Kits  Recond. Eqp't. List

NAME \_\_\_\_\_  
ADDRESS \_\_\_\_\_  
CITY \_\_\_\_\_ STATE \_\_\_\_\_



E. W. Buschman Co., Clifton and Spring Grove, Cincinnati 32, Ohio

## Wheels on Conveyor Turn To Sort Packages

Packages are automatically sorted according to size, weight or classification with a new conveyor switch. The conveyor wheels turn to guide the packages, thus eliminating the need for deflectors. Used by large warehouses, department stores and similar businesses, the three-way switch can be operated by remote control, limit switches, photoelectric cells or other electrical devices. Limit switches automatically classify packages by height. Scale controls divert underweight and overweight packages.



# FREE! COLORFUL 32-PAGE SHOOTIN' BOOK



Family fun!  
Target games!  
Regulation shooting  
tips by a world champion!

"Do-It-Yourself" tips on building an indoor and outdoor range and many other tips on shooting. Real shooting indoors or close-to-home, all year 'round—the safer, accurate, quiet, odorless, "power without powder" way.

WRITE today for "Shootin's Three Times More Fun With A Crosman Pellgun"—supply limited. Crosman Arms Co., Inc., Dept. PM11, Fairport, N.Y.

ONLY *Estwing*  
GIVES YOU A CHOICE OF  
**UNBREAKABLE  
HAMMERS**  
Made and  
Guaranteed by Estwing  
INVENTORS AND ONLY  
SPECIALISTS IN  
UNBREAKABLE HAMMERS  
AND HATCHETS

**NEOPRENE  
GRIP** \$4.75  
16 oz.

Tubular  
Steel Handle  
AT LEADING  
HARDWARE DEALERS

**LEATHER  
GRIP** \$4.75  
16 oz.

One-Piece  
Head and Handle

ESTWING MFG. CO., DEPT. PM-7, ROCKFORD, ILL.

This Ad Worth **\$200**  
on purchase of  
SAF-T-EST  
Sawhorse Brackets

## SAWHORSE BRACKETS-Now!

Rep. \$5.95—While limited supply lasts... Only **\$3.95** PAIR with this ad

Approved and used by professional carpenters, contractors, STRONG—with 2 x 6 ledger, 1 x 4 legs, supports 1500 lbs. at center 4-ft. span. SAFE—no exposed metal to dull tools. EASY to set up, knock down. Satisfaction guaranteed!

SAF-T-EST Co. • 275 Kalamath • Denver 23, Colo.

## SAW SHARPENING IS EASY

Super Filer No. 11 points and sharpens hand and circular saws 6" to 10" with all teeth correct in height, depth, pitch, bevel. When file hits steel roller, teeth are finished. Saw runs true with no side pull. Includes 8" file.

**\$9.95** PPD.

"TRU-CIRCLE" saw set automatically sets teeth at 10° or more. **\$2.95** PPD.

## SUPER SAW FILER No. 6

Automatically controls depth, angle, pitch for all saws. Precision made and calibrated. Use in any vise or clamp. Includes file.

**\$6.50** PPD.

**DOWEL CENTERS**  
Centers inscribe exact location for opposite holes. Pairs for 3/8", 1/2", 5/8", 1" holes. **\$1.00** PPD.

MONEY BACK GUARANTEE—CATALOG FREE  
A. D. McBURNEY, 5908 Hollywood Blvd., Hollywood 28, Cal., Dept. A-117

## HERE'S YOUR COMPLETE POWER TOOL WORKSHOP

FOR ONLY **\$7995**

FACTORY TO YOU



8" SAW

- TRY SUPERSHOP FREE
- WE PAY FREIGHT
- YOU BE THE JUDGE
- EASY PAY PLAN

Why does Power Tools Inc. make such an unusual offer? Our business is manufacturing and selling power tools direct to people like yourself. We have had experience with hundreds of thousands of people regarding their home workshop requirements. Supershop meets these requirements. This has been proven.

The combination of direct selling, advanced design and efficient manufacturing enables us to give the greatest power tool value in America today. That is why we have the courage to make you this offer.

This free trial is truly free. The machine is prepaid to your door and if it does not satisfy you, you return it at our expense. If you keep Supershop you pay the low factory-to-you cash price—or easy payments to fit your budget.

Write for free information. Mail the handy coupon—or send a postcard. We'll mail you colorful brochures on Supershop—and full details on the FREE TRIAL HOME OFFER. Absolutely no obligation.

**POWER TOOLS INC.** 101 YATES AVE. BELOIT, WISCONSIN

**POWER TOOLS INC. • BELOIT, WIS.**

Send me your FREE brochures on Supershop and complete information about the Free Home Trial Plan. I am under no obligation.

NAME \_\_\_\_\_

ADDRESS \_\_\_\_\_

CITY \_\_\_\_\_ STATE \_\_\_\_\_



1/2" DRILL PRESS



8" SANDER



30" LATHE



8" GRINDER

# stock your shop

• SCREWS  
• BOLTS  
• NUTS



**EASY TO GET AT! EASY TO GET OUT!**

Buy your screws in these handy, sparkling, clear-plastic drawer-boxes! Generous quantities of top-quality fasteners at 59¢ per box. Keep them in the ingenious, multi-purpose DraweRack storage system — ready for quick selection and instant use! At your hardware store . . .

ALL WOOD SCREWS ARE  
**SPEEDIZED**  
FOR EASY DRIVING INTO  
EVEN HARDEST WOODS

59¢  
PER BOX



ELCO TOOL & SCREW CORP.

ROCKFORD, ILLINOIS

## HOME REPAIR TIP No. 21



**Mend auto seat covers.** Cover split seams, tears, with tough, stretchy "Scotch" Colored Plastic Tape. Tight-sticking tape is waterproof, washable. Choose red, yellow, green, white, blue, black, brown or clear.  $\frac{3}{4}$ " width 25¢— $1\frac{1}{2}$ " width 50¢—at stores everywhere. Made by Minnesota Mining & Mfg. Co., St. Paul 6, Minnesota.

© 1957, 3M Co.

## NEW FRONT MOUNTED TRACTOR SAW

Clear Brush, Fell Trees WHILE YOU RIDE.  
Cuts Both Horizontal and Vertical



Operator controls Saw from Tractor Seat. Cuts Brush at 2 M.P.H. . . . Trims Hedge, Fells and Stacks up to 24-in. Trees. Tractor Power makes Sawing Faster and Easier.

→ Send Postcard Today for FREE FOLDER and Prices. ←  
BELSAW IMPLEMENT CO., 4108 Field Bldg., Kansas City 11, Mo.

WEAR IT ON  
YOUR BELT!  
IT REELS  
BACK  
YOUR  
KEYS!



## KEY-BAK KEY REEL

Carry your keys on a KEY-BAK key reel. Keeps keys handy! Safely keeps clothing neat. 24" long stainless-steel chain reaches all locks. Pocket-watch size. Sturdily constructed to last for years. GUARANTEED! For all who use and carry keys. Dealers Wanted!

LUMMIS MFG. CO., Pasadena 8, Calif. CTL CO., Wausau, Wis. **\$2.95** Ppd.

## Made \$900 IN SPARE TIME

"I did very well last year with my Foley equipment, about 950 saws in my spare time. About \$900 for me."—Leo H. Mix.

You can make up to \$3 or \$5 an hour in Spare Time. With a Foley Automatic Saw Filer you can file hand, band and circular saws better than the most expert hand filer. Cash business—no canvassing. No eyestrain, no experience needed.

### FREE BOOK "MONEY MAKING FACTS"

shows just how you can start at home in spare time, with small investment, no overhead—and develop into a full-time repair shop. Send coupon today for this practical plan. No salesman will call.



Send Coupon for **FREE BOOK**

**FOLEY MFG. CO.** 1143-7 FOLEY BLDG., MINNEAPOLIS 18, MINN.

Send **FREE BOOK**—  
"Money Making Facts."

Name \_\_\_\_\_

Address \_\_\_\_\_



## PROTRACTOR

Made of anodized aluminum. Three tools in one, does work of square, level and protractor in vertical or horizontal positions. 7-15/16" x 22", complete with instructions. \$19.95 Send cash, check or money order to  
**ROBY R. SPARKS, Box #192 Erie, Pa.**

## WE HAVE A FEW COPIES LEFT



The ALL-NEW 5th Edition of this very popular Handbook is jam-packed with EXCITING ARTICLES, ACTION PICTURES, PLANS, SPECIFICATIONS, ENGINE INFORMATION, TRACK and RACING DATA, HOW TO BUILD A TRACK, ALL RULES and REGULATIONS, etc. for  $\frac{1}{8}$  MIDGETS, MICRO-MIDGETS,  $\frac{1}{4}$  MIDGETS, 500 cc CARS, and FULL-SIZED MIDGETS.

You've never seen a book filled with so much ACTION, EXCITEMENT, and VITAL INFORMATION. It also serves as a COMPLETE CATALOG telling where to buy ENGINES, WHEELS, INDIVIDUAL PARTS, SUPPLIES, and COMPLETE CARS.

WHILE OUR SUPPLY LASTS  
only \$1.00

**MICRO MIDGET RACING** is America's most exciting sport. Now anyone from 18 to 60 can own a real racing car and have all the FUN, THRILLS, and EXCITEMENT of SPEEDWAY RACING. Why don't you too get in on the fun and good times that Micro drivers have.



SEND 25¢ FOR ILLUSTRATED LITERATURE DESCRIBING THE ALL-NEW COMET MICRO MIDGET

COMET MANUFACTURING CORPORATION, Dept. PM-11, Box 74397, Los Angeles 4, Calif.

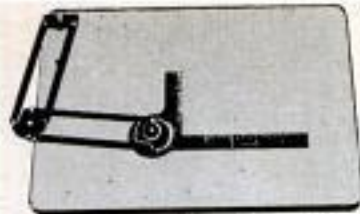

**AMAZING NEW PORTABLE DRAFTING MACHINE AND DRAWING BOARD ONLY 6.95**

Here is a genuine, professional type, scientifically engineered drafting machine. Ideal for use in the Office, Factory, Workshop, Classroom, Art Studio, Home, etc. **SMALL ENOUGH TO FIT IN A BRIEFCASE!** Made of black anodized aluminum with white markings. Complete with 11"x17" Coos Bay Hardboard drawing board. Weighs a mere 2-1/2 pounds. **ORDER YOUR DRAFTETTE TODAY!**



**IMPORTED SLIDE RULES**

Never before such a "SLIDE RULE BARGAIN". We made a tremendous foreign Buy! New 10" LOG-LOG, DECIMAL TRIG Slide Rule. The advanced professional type. For electrical engineers, mechanical engineers, etc. also excellent for thermodynamic calculations. Rust-proof, non-warping top quality bamboo - smooth action slide - 2-color scales calibrated on white chrome facing. Scales include L-LLI-DF-CF-CIF-CIC-D-LL3 and LL2 on one side in register with LLO-LL00-A-B-K-CI-C-D-S-ST & T on the reverse side. Complete with cursor, 16 page instruction book and leather case. Originally sold for \$32.95 NOW... **10.95**

**5-inch POCKET SLIDE RULE**  
Made and finished of the same materials as above. Has precise engine productions on both sides. Face scale has A, B, C, D and K scales. Reverse side has S, L and T scales. One edge is beveled rule in 1/32". The reverse side is graduated in cm to 13 cm. Complete in leather case. **3.33**

**4" VEST POCKET SLIDE RULE**  
Same specifications as above. Face scale has A, B, C, D and K scales. The reverse side has S, L, T scales. Beveled edge divided in 1/32". The reverse edge graduated in cm to 10 cm. Complete in leather case. **2.95**

**3400 RPM 1/2 HP POWER SAW**  
**RIPS - CROSSCUTS**  
**CUTS A FINISHED 2x4 LIKE A KNIFE THROUGH BUTTER**  
COMPARES TO SAWS SELLING UP TO \$49.50 **19.98** Complete with 5-1/2" Blade  
A rugged, professional type, adjustable saw. Will cut any angle from 0 to 45°. Has an adjustable (3 to 6") rip fence. Safety trigger switch on handle. Full 1/2 HP Universal AC-DC, 110-120 Volt, 60 cycle motor. Weighs only 8 1/2 lbs.

**EXTRA SAW BLADES** - Available in Rip, Crosscut or Combination. Please Specify **ONLY 2.25 EA**

**295 WITH CASE 12.95 VALUE**  
**Special 12 Pc. SPORTSMAN'S KNIFE**  
IDEAL GIFT FOR FATHER, SON or FRIEND  
ELIMINATE 12 ITEMS FROM YOUR PACK  
Here is the Perfect, Combination Knife-Tool for every Outdoor Sportsman, Hunter, Camper, Fisherman, Boy Scout, Ranger, Rancher, etc. Think of it! 12, Fine quality Steel Tools, precision made to fold easily into the heavy bone covered body. In one neat, compact unit you have (1) a regular knife, (2) a fork, (3) a spoon, (4) a draw-knife, (5) a bone-saw and fish-scaler, (6) scissors, (7) a can and bottle opener, (8) a cork-strew, (9) awl punch, (10) a screwdriver and (11) a metal file. All this PLUS a genuine leather, belt holster.

**GIVE THE KIDS A THRILL NEW CRYSTAL RADIO**  
Receives standard broadcast stations without using batteries or electricity. Just plug in headset antenna and ground wires - then tune in your favorite program. You will be amazed at the **STRONG, CLEAR SIGNAL**. Has a 100KC tuning range. Comes complete with a Receiver, Antenna and Ground Wires PLUS a 2000 Ohm Headset. The headset alone is worth our price for the entire set. Order Today for Xmas delivery **ONLY 3.95**

**AMAZING 396 PAGE BARGAIN CATALOG**

**NATIONALLY ADVERTISED MERCHANDISE - NEW and USED GOV'T. SURPLUS - FACTORY CLOSOUTS - EXCITING IMPORTS!**  
From EVERYWHERE PALLEY'S brings you items of every description! Camping & Sports Goods, Fishing & Hunting Gear, Tents, Clothing, Skin Diving Equipment, Portable Cooking and Freezing equipment, Marine Supplies, Guns, Cameras & Photo Supplies, Binoculars, Hand & Power Tools, "Do-It-Yourself" Supplies, Housewares, Building Materials, Hobby Kits, "Gadgets" and so many more items it's impossible to list them all. **ORDER YOUR COPY TODAY!**

Send 50¢ (for handling & mailing) 50¢ REFUND on your first order of \$1.00 or more.

**Palley's**

**LARGEST FIRM OF ITS TYPE IN THE WORLD**

**SAVE OVER 50% ON XMAS BARGAINS**

**FREE! WORLD'S SMALLEST MICROSCOPE 150 POWER**  
**FREE WITH YOUR PURCHASE OF \$10.00 OR MORE...**  
A newly developed import - Truly an amazing instrument! Compact, extra-light-weight. Can be carried in pocket or purse. Patented lens provides a full 150 power magnification plus fully corrected light refraction and an automatic light concentrating device. Size: 1-1/2"x1-1/2". Weight: 1/2 oz. Ideal for Scouts, Teachers, Parents, Schools, etc. **FREE** with \$10.00 purchase or send... **1.95**

**AMAZING NEW SCIENTIFIC DESIGN 60 to 600 POWER - 2 EYEPIECE SPECIAL MICROSCOPE**  
**HAS 80 - 120 - 200 - 300 - 400 & 600 POWER MAGNIFICATION WITH ILLUMINATED SUB-STAGE MIRROR and TRIPLE TURRET**  
Now you can change magnification with a simple shift of the dual eyepiece turret. No loss of focus - No re-adjustment. You choose either 10X or 15X eyepiece to use in combination with the objective lenses of an instant notice.  
**NOTE THESE FEATURES**  
Has triple revolving turret with 6X, 20X & 40X precision ground and polished lenses - Dual eyepiece turret with 10X and 15X lenses - NEW patented sub-stage with a built-in, battery operated light...no external light source is necessary - A large sub-stage mirror with a revolving variable iris - All-metal, precision made body inclines through 90° - Fitted hardwood case and 3 glass slides.

**SAVE**

**XMAS SALE Now 14.95**

**SPECIAL 60 to 450 Power MICROSCOPE**  
With NEWLY DEVELOPED SUB-STAGE LIGHT which ELIMINATES NEED for ANY EXTERNAL LIGHT SOURCE.  
Another Palley Optical Bargain. Ideal for scientific inclined Boys & Girls, Adults, Home labs, etc. Has precision ground and polished lenses. Two interchangeable eyepieces of 6X and 15X - Triple revolving turret with 10X, 20X and 30X lenses - Patented sub-stage mirror with self-contained light for use without external light source plus large sub-stage mirror for use with external light source when desired - All metal body which inclines through 90° - Fitted wood case and 3 glass slides. Order WHILE STOCKS are COMPLETE!  
**FREE with MICROSCOPE 8-PIECE DISSECT SET.** Has Scalpel, Scissors, 6 Slides, Tweezers, Magnifying Glass, etc. ....

**HAS 60, 120, 150, 180, 300 and 450 POWER MAGNIFICATION**

**Now 10.95**

**100 - 200 - 300X MICROSCOPE**  
A triple revolving, objective lens turret allows selection of 100, 200 or 300 POWER magnification. Has fine, ground and polished lenses and ALL METAL construction. This instrument is NOT A TOY! Right or left hand rock & pinions make smooth, precise adjustments.

**Now 6.95**

**NEW 20 Power 40mm SPOTTING SCOPE with TRIPOD and CARRYING CASE**  
A real Palley Bargain! Has 20 Power magnification yet is small enough to fit easily in your gun case, knapsack, etc. Lenses are precision ground and polished. Objective lens is fully coated. Adjustable focus eyepiece. With steel tripod & leatherette case. Weight 15 ozs. Overall length of scope 8-3/8". ALL NEW!  
**29.95 VAL. 17.95**

**25 POWER x 30 MM TELESCOPE & TRIPOD**  
Nowhere but at PALLEY'S can you find a buy like this! Here's a scope, complete with a sturdy metal tripod, that you can have a lot of fun with. Use it to spot hits on the target, for star-gazing, interesting views at the beach, etc. Made of aluminum and chrome plated brass. Field: 62 ft. at 1000 yds.  
**25.95 VALUE 5.95**  
IN WHITE, BLACK OR CRACKLE FINISH  
PIGSKIN CASE for above - **2.00 EXTRA**

**FINEST STEEL BAYONET**  
A genuine Infantryman's bayonet. Made of finest tool steel. Has fluted sides and precision honed edge. 9" blade is ideal for many uses. Comes complete with reinforced leather scabbard. **ONLY 2.89**

**NEW NAVY FIGHT KNIFE**  
A dagger design. Has laminated leather handle. Blade is 6-1/2" long, hollow ground on the cutting edge - double edged for 3/8" at the point. Ideal for a skinning or hunting knife. With leather holster. Over all lgh. 11". **3.98**

**27" ARMY MACHETE & CASE**  
Ideal for clearing brush. Made of finest Vanadium Steel. Has 27" blade. Wood handle. Overall lgh. 27". Complete with rugged belt sheath. Save 85%..... **ONLY 1.98**

**Palley's** PRICE F.O.B. Los Angeles, Calif. Send 50¢ Deposit with all C.O.D.'s  
2242 E. VERNON AVE., DEPT. PM-11, LOS ANGELES 28, CALIF

# MECHANIC'S FAVORITE!



Here's the number one choice—



It's the Huot Model 100 DeLux Chest—custom designed for mechanics who want the finest protection plus maximum accessibility for fine tools. Eleven drawers—seven of them cork-lined for protection. Three heavy-duty drawers for large tools—1 extra deep drawer for power tools. Single latch locks entire cabinet. Two-tone oil-resistant finish. Free bulletin describes 12 tool chests.

**HUOT MFG. CO.**

555 No. Wheeler Street, St. Paul 4, Minnesota

## MONEY MEN ALL FREE

THE PLASTEX Industry needs manufacturers on small scale and for big production of Lamp and Clock Sinks, Art Goods and Novelties in Plastex and Marble imitation. Experience unnecessary. 35¢ material makes regular 10¢ store sellers. Rubber moulds furnished for speed production. Small investment brings good returns. We are now placing big Chain Store Orders with manufacturers. Ambitious men have chance for real prosperity. Our Free booklet will interest and benefit you.

**PLASTEX INDUSTRIES, Dept. A**  
3400 Third Ave. New York 56, N. Y.

## BUILD FINE GRANDFATHER CLOCK NOW

The simple sensible SPEEDY Red-Kut way as thousands have—FOR YOURSELF OR SELL AT A GOOD PROFIT. SAVE HUNDREDS OF DOLLARS. SHOP TESTED PLANS "SPIRIT OF THE CENTURY" Narrow waist 31" tall or stately straight side "SPIRIT OF AMERICA." EASY-to-FOLLOW photographs PLANS & LIFE SIZE PATTERNS tell all—plus MOVEMENT BROCHURE \$40 up, of heavy brass weight (Kuemper original) Westminster, tube BELL chime, movements, gorgeous bronze-silver MOVING MOON dials, 34" solid-mahogany case kits. Send \$1.00 today—Both plans RUSH \$1.50 as folks have for forty years.

Kuemper Chime Clock Works, 211 Kuemper Bldg., Minneapolis 16, Minn.

## CLOGGED SEWERS? REMEMBER THE COSTLY PLUMBING BILL—



Chicago—Nov. 1st. Just introduced is a Free Booklet on machines which enable the Home Owner, Janitor or Factory Maintenance Man to Rod-it-himself—

Yet anyone can operate this new Rodding Tool which is whirled down the drain in a few seconds. SINKS, BATHTUBS, TOILETS, URINALS, FLOOR DRAINS, HOUSE TO STREET SEWERS can be cleared of Rags, Grease, Paper, Sand while Cutter blades can be added for removing roots. A new discovery in Swedish Music Wire gives the rod 100% more Flexibility.

Another new unit is the Miller Electric Rodder which has patented cutters that expand automatically to the size of the pipe. It will clean out heavy obstructions in pipe diameters 3" to 12". Smaller Sizes available. But now, what are these Tools worth in COSTLY PLUMBING BILLS SAVED. Tear this Ad out—and write your name and address beside it for FREE BOOKLET on Hand and Electric Units. Obey that urge. No Agent will call. A post-card will do (Chicago Phone Kildare 5-1702).

**MILLER SEWER ROD, Dept. PM-N**

4640 N. CENTRAL AVE.,

CHICAGO 30, ILLINOIS

## AUTOMATIC

MAKES NEW PROFITS

## RETOOHER

for HAND SAWS

Cut new teeth in 50 seconds—only size 4 to 16 points. Old teeth fall off as chips. Easy to operate. A perfect job.



**BURR MFG. CO.**

8933-N VENICE BLVD. LOS ANGELES 34, CALIFORNIA

## NEW 1958 EDITION JUST OUT!



Get This Giant Catalog Of

# WOOD & WOODWORKING MATERIALS

TOOLS—PLANS—SUPPLIES

World's Largest Selection of Finest Domestic and Imported Woods ... Mouldings, Hardware Tools—ALL AT LOW MONEY SAVING PRICES! Your complete wood buying guide and project book. Craftsman is your best, most complete source of finest kiln-dried domestic and rare imported woods, beautiful wood inlays, colorful bandings, matched plywoods, embossed mouldings, carved ornaments, newest woodworking tools, "hard to find" cabinet hardware and fittings ... more than 1,500 items! Packed with newest scroll saw patterns, project ideas and money making plans. Enclose 25c (refunded with first order) to help pay mailing, handling cost. Write

Craftsman Wood Service Co., Dept. A-11  
2729 S. Mary Street, Chicago 8, Ill.

**132 PAGES**

Many in full color

packed with rare, fancy & imported woods ... veneers, plywoods, patterns, tools, ornaments, hardware ... everything for the woodworker.

**MAIL COUPON NOW!**

**CRAFTSMAN WOOD SERVICE CO., Dept. A-11**  
2729 S. Mary Street, Chicago 8, Ill.

Enclosed find 25c. Rush new CRAFTSMAN WOOD CATALOG.

NAME \_\_\_\_\_

ADDRESS \_\_\_\_\_

CITY \_\_\_\_\_ ZONE \_\_\_\_\_ STATE \_\_\_\_\_

BUY and USE  
**CHRISTMAS SEALS**

fight TB

## PORTABLE LIGHT PLANTS

### GIANT 2500 WATT PLANT

110-120 v. 60 cyc. AC, absolutely the best made exclusive dynamically balanced armature; heavy windings develop up to 3000 watt overload for motor starting. Rigid mounted - portable. Powered by an easy starting Briggs or Wisconsin 6 HP engine—complete with all accessories; engine easily disconnected for other uses. Big outlet box, voltmeter, no wiring necessary. Ample current for all purposes. Factory warranty. (Item 31) Wt. 210 lb. Reg. price \$585. Special at... **\$299.50**

Same plant with electric self starter (Item 31a)... **\$359.50**

Generator only and control box... **\$169.50**

**DUAL VOLTAGE** 110-220 available on any of above models for \$28.00 additional.

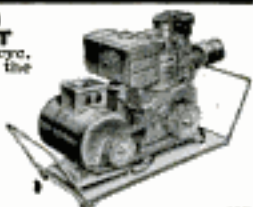

**POWER-FLO 2500 WATT** 115-230 v. 60 cyc. AC. A rugged power plant for heavy duty use. Duplex power distribution provides both 115 v. and 230 v. output at the same time if desired. Powered by a big 8 HP Wisconsin engine with triple V belt drive. Has built-in overload protection. A dependable plant for either standby or regular service. Equipped with electric self-starter. (Can also be started by rope) and plug-in outlet box. (Item 198) Wt. 310 lbs. Factory price... **\$439.50**

**GENERATOR ONLY** belt driven... **\$239.50**



(Item 198)

### HEATING & VENTILATING FAN

(Item 10) Easily installed in furnace pipes. Forces even heat to all rooms. Over range removes kitchen smoke and odors. Powerful, continuous duty motor, 110-120v. AC. Mount in wall or ceiling to ventilate any area. Quiet, super-efficient fan moves huge volume of air. (400 to 600 CFM.)

8" Pipe, wt. 5 lb. .... **\$6.85**  
 9" Pipe, wt. 6 lb. .... **\$7.85**  
 10" Pipe, wt. 7 lb. .... **\$8.85**  
 12" Pipe, wt. 8 lb. .... **\$9.85**

**HEAVY DUTY FAN.** Semi-enclosed motor, suitable for spray booths, restaurant exhausts, poultry houses, etc. 10" Fan, wt. 8 lbs. (Item 10E) ... **\$11.95**

12" Fan, wt. 10 lbs. (Item 10D) ... **\$12.95**

**HIGH SPEED BARN FAN** similar to above, but larger, high speed motor moves huge volume of air.

12" Fan (Item 10G) ... **\$14.95**  
 14" Fan (Item 10H) ... **\$17.95**



### GIANT METAL SHEARS

"PEKTO" Nine inch cutting blade made of special high carbon alloy steel, perfectly aligned and ground. Easily cuts steel plate up to 12 gauge or 1/4" thick. Overall length 40". Wt. 25 lbs. (Item 186) Regular **\$49.50**. While they last... **\$14.95**

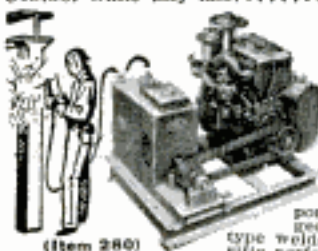

### MASTER DC ARC WELDERS

Now a portable rugged, industrial 5500 (60) volt type welder with terrific performance, yet at a price hundreds of dollars less than you'd expect. Senior model made for years of trouble-free, continuous service. High capacity DC welding unit enables you to tackle any job with confidence—easily welds anything up to 2" plate using from 1/16" to 3/4" rods. Built-in stabilizer and cooling system makes arc easy to strike and hold. Dual control rheostat provides low heat soldering, brazing and welding from 30 to 300 amps. Complete with instructions, guarantee and triple V-belt or flat pulley. Easy to hook up and easy to operate.

**WELDER ONLY—DUAL CONTROL MODEL.** Same as above, but drive with your tractor, jeep or gas engine of 14 HP or more. (Item 28a.) Wt. 210 lbs. \$450 value... **\$119.50**

**WELDER ONLY—INDUSTRIAL MODEL** same as above but with ceramic rotary type rheostat providing 74 different heat settings for all types of welding (Item 28b) **\$139.50**

**COMPLETE POWER MASTER** (Illustrated above) powered by a 16 hp. air cooled Wisconsin engine. Wt. 480 lbs. (Item 28c) Compare with welder costing \$1200. Factory Special... **\$449.50**

**WELDING KIT** Two 10 ft. leads, welding helmet, electrode holder, ground clamp. Sold only with welder at... **\$10.50**

## SAVE middleman profits BUY DIRECT from MASTER MECHANIC factory

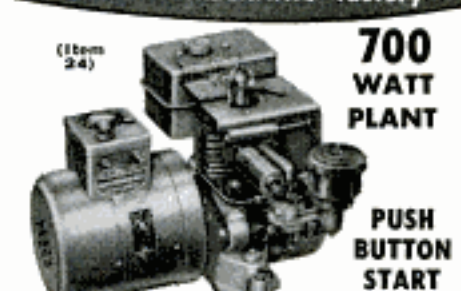

**700 WATT PLANT** (Item 24) 115 v. 60 cyc. AC Powered by a rugged 2.2 HP, easy starting Briggs engine. No wiring necessary; just plug in and operate. Plenty of current for any oil burner, freezer, brooder, emergency lights, etc. which require up to 700 watts. Ideal for television and radios. Complete with voltmeter and built-in winding to charge auto. batteries. (Item 24) Wt. 75 lbs. Easily fits in car trunk. Be prepared if storm knocks out power lines. Regular \$275.00 value... **\$143.50**

**1200 Watt Plant** (Item 45) same as Item 24 but larger generator and engine... **\$199.50**

With 60% greater output... **\$199.50**

We make every type and size of light plants —Write giving us your requirements!

### BATTERY CHARGING GENERATOR

**Push Button Start** A husky, 700 watt plant (designed for battery charging only) that will charge 8 or 12 volt batteries in just minutes! When mounted with two 6 volt batteries it provides a terrific cold weather motor starting unit, as well as a fast charger! Charges all batteries anywhere —no tilting current needed. Ideal for service stations, garages and farms. Comes complete with ammeter and cutout. (Item 821) Wt. 120 lbs. Regularly \$295. Our special, only... **\$119.50**



### FAUCET WATER HEATER

Instant hot water from any faucet for just pennies—sounds unbelievable—but it's true! You just slip MASTER MECHANIC's new Faucet Water Heater over any water faucet, plug it in a wall outlet and you've got steaming hot running water instantly for dishes, shaving, washing baby's bottles, etc. Simple and safe—operates on ordinary 110v. house current—costs only 2 1/2 cents per hour for hot water. Ideal for homes, barns, cabins, trailers, etc. Easily regulated from lukewarm to full hot. Fully guaranteed! (Item 408) Wt. 2 lbs. Factory price F.O.B. ... **\$4.95**

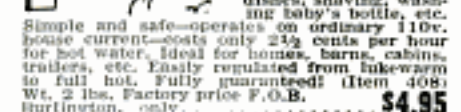

### 52 pc. SOCKET SET

Highest quality, guaranteed non-breakable sockets made by Husky. Beautifully matched chrome. This wall hanger absolutely the best. Contains a complete set of 28 sockets in 1/2" drive, 3/4" drive and 1 1/4" drive, plus all necessary extension bars, sockets, and a speeder, reversible ratchets, etc.; all unbreakable, guaranteed against breakage. A beautiful set of tools that will handle any job! In a big doghouse steel box. Wt. 17 lbs. (Item 205) List price \$62.00. Factory special... **\$29.95**

### CABLE HOIST

**2000 lb. CAPACITY.** A fortunate purchase from the Air Force enables us to offer these brand new 2000 lb. electric cable hoists at a fraction of their value. Perfect for material handling, boat hoists, elevators, lifts, on assembly lines, etc. Two separate 22 ft. lift cables with independent controls permit leveling the load and controlling it perfectly. Rugged ball bearing motors of geared down design 110 volts. Available for A.C. or D.C. Please specify. Makes a terrific portable hoist with our #273 D.C. light plant at \$69.75. Offered at less than 33% of regular cost (Cable not included). Wt. 145 lbs. A.C. Model, Item 847A... **\$149.50**

D.C. Model, Item 847... **\$129.50**



## LESS THAN WHOLESALE

**1500 WATT PLANT** 115v. 60 cyc. AC Push Button Start. Powered by a 3 1/2 HP. Clinton engine. Combines big output with easy portability. Provides emergency power for operating any oil burner, sump pump, freezer, television, lights, communications systems, etc. which require up to 1500 watts. (Item 29) Wt. 140 lbs. Reg. \$475 value. Factory price... **\$239.50**



**1750 Watt Plant** Powered by 4.5 Briggs engine. Electric starting & battery charging built-in! Factory price... **\$279.50**

**MASTER-LITE 2500 Watt Plant** 110/120 v. 60 cyc. AC. A powerful plant, ruggedly constructed and yet designed for easy portability. Can be started by rope or built-in 12 v. electric push button starter. Built-in winding to charge battery. Powered by a big 5.10 HP. Briggs engine, complete with all accessories. Includes control box, voltmeter, and handy plug-in power receptacle. An ideal plant for permanent or stand-by service. Wt. 225 lb. Reg. price \$645.50 (Item 21) Factory Price... **\$329.50**



**3800 Watt Plant** Push Button Start (Item 23) 115 v. 60 cyc. AC. Similar to above, but larger and 30% more capacity. Wt. 270 lbs. Reg. \$760. Factory Price... **\$379.50**

**DUAL VOLTAGE** 110/220 for Item 21 or 23 —\$30 additional.

## EXCLUSIVE! NEW!

### LIGHTWEIGHT WATER COOLED DIESEL GENERATOR PLANT

Never before available! Now offered exclusively by Master Mechanic. A low priced, lightweight, continuous duty Diesel generator set. Powered by a super rugged, exceptionally smooth running, one cylinder Diesel engine. Operates at conservatively 1750 R.P.M. and delivers full 1750-2000 watts of power. Operates on low cost fuel oil. Wt. only 240 lbs. representing a triumph of Diesel Engineering. Complete with fuel filter, oil pressure gauge, control box with duplex receptacle and voltmeter. (Item 830) Special factory price... **\$399.50**

**DIESEL ENGINE** only, as above described 3.5 HP (Item 830a) Wt. 110 lbs. ... **\$249.50**

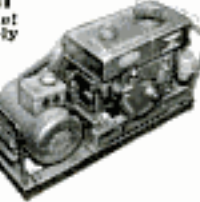

### Double Acting Hydraulic Cylinder

A powerful cylinder mfr'd. by Massey Harris which develops both a pushing and a pulling action. Will push 8,100 lbs., with a 1000 PSI pump pressure. Cylinder is 3 1/2" O.D. with 1 1/2" stroke—standard heavy duty clevises on both ends. Has standard 3/4" pipe thread openings. Can be used for tilting buckets or blades, raising or lowering implements, hydraulic presses, etc. Can also be used as an air cylinder. (Item 802) Wt. 17 lbs. Reg. \$68 value, Special... **\$14.95**

**OTHER DOUBLE ACTING CYLINDERS**

8" stroke — 3" bore... **\$34.00**  
 10" stroke — 3" bore... **34.80**  
 16" stroke — 3" bore... **43.00**  
 24" stroke — 3" bore... **47.50**

We have all sizes of cylinders available.

**HYDRAULIC CONTROL VALVE** — 4 way open center valve with built-in adjustable relief. Controls 1 double, or 2 single acting cylinders. Equalizing feature permits easy control even under heavy loads. 3/4" pipe thread on inlet & outlet, 1/2" on cylinder outlets. Easily mounted, finger tip control. Wt. 16 lbs. (Item 822)... **\$21.95**

**HYDRAULIC KIT**

Complete Hydraulic Kit consists of hydraulic hand pump with built-in 2 gal. reservoir and item 802 hydraulic cylinder described above. Pump has a built in relief valve and is rated at 20 tons. Kit is ideal for presses, jacks, snow-plovers, etc. Pump is 20" long—6" diam. with 3/4" ports. A terrific value! (Item 836). Wt. 50 lbs. ... **\$39.50**

Pump only (Item 836a) only... **\$23.50**



Send check or M.O. Prices F.O.B. Factory. 10 day Money back guarantee. SEND 10c for... **BIG NEW CATALOG** Burlington, Wis.

# WHERE ACCURACY MEANS

# *Economy*

SOUTH BEND  
14½" LATHES

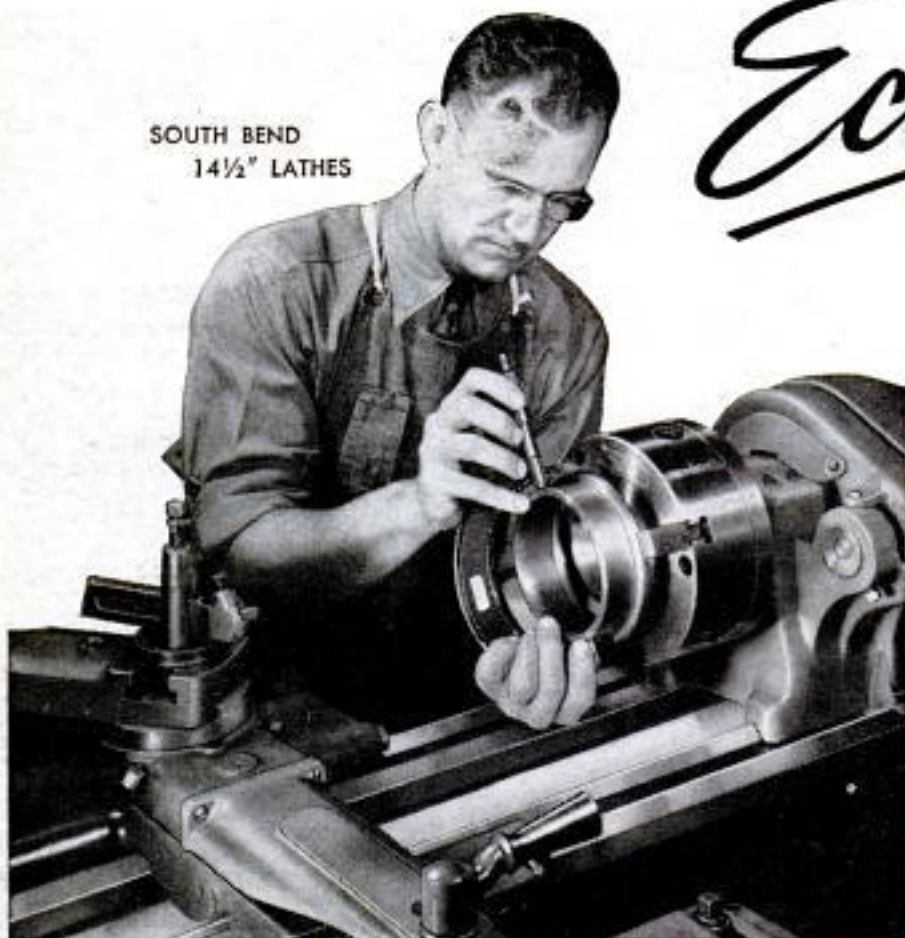

#### HARDENED BED WAYS

Hardened and precision ground for longer life under severe operating conditions.

#### Specifications

Swing—14¾" over bed and saddle wings.

Distances between centers—24½" to 60½" maximum.

Collet capacity—1" maximum.

Spindle bore—1¾"

Spindle speeds—6, 8, 12 or 16 speeds, 15 to 875 r.p.m.

Longitudinal feeds—48

Cross feeds—48

Thread cutting range—48 pitches R.H. or L.H., 4 to 224 per inch.

#### SOUTH BEND ACCURACY GIVES YOU—

More output—no slow-up required to hold close tolerances. Fewer rejects—saves time and materials. Greater operating ease—less fatigue and effort. Top efficiency on every type of operation. Precision and smoothness that often eliminate subsequent grinding, honing or lapping operations. Prices of 14½" lathes start at \$1975.

Send Catalog 5700 describing Engine, Toolroom and Turret Lathes; Milling Machines; Bench Shapers; Drill Presses; Pedestal Grinders and Attachments.

Name \_\_\_\_\_

Address \_\_\_\_\_

City & State \_\_\_\_\_

## SOUTH BEND LATHE



Up to 24 months to pay.

Building Better Tools Since 1906  
SOUTH BEND 22, INDIANA

# MODEL RAILROADING



**DISCOVER THIS  
FASCINATING  
HOBBY!**

Set up your own model railroad in a few square feet anywhere in your home! Gilbert "HO" are authentic miniatures of real trains. Precision-made locomotives and cars are masterpieces of elaborate detail. Choose from six exciting train sets, priced as low as \$24.95. Make sure it's the most realistic . . . . insist on Gilbert "HO", the leader in America's fastest growing hobby.

## GILBERT® HO

*the only HO trains with:*

- REAL PUFFING SMOKE
- "CHOO-CHOO" SOUND EFFECTS
- BUILT-IN R.R. WHISTLES



**USE COUPON FOR FREE CATALOGS**

The A.C. Gilbert Co. New Haven 6, Conn. Dept. 108

Rush me the catalogs checked!

- |  |  |
|--|--|
| <input type="checkbox"/> HO Catalog<br>(full-color printing)                       | <input type="checkbox"/> American Flyer Trains<br>(3/16" scale electric<br>trains) |
| <input type="checkbox"/> Toy Catalog<br>(Chemistry, Micro-<br>scope, Erector Sets) | <input type="checkbox"/> 160-page Model Rail-<br>road Handbook<br>(ENCLOSE 25¢)    |

NAME .....

ADDRESS .....

**THE A.C. GILBERT CO.**  
NEW HAVEN 6, CONN.



## WE BOTTLED THE SOUND... AND SEALED IT!

Imagine driving a V-4 motor with power pulsations bottled and sealed in a sound-tight nacelle! No trace of vibration reaches the boat... it's smooth to the absolute! From crown of hood to waterline, engine and exhaust tubes are sealed tight... a new concept in quiet! It's Evinrude's Starflite V-4 with the "seal of silence." Starflite's perfectly balanced 50 hp 90° V-engine obsoletes other motors. Its advanced "over-square" short stroke, big bore engine (70.7 cu. in.) delivers instant, solid power that's beautiful to behold. See Starflite V-4 power... listen to Starflite quiet... at your Evinrude dealer (listed under "Outboard Motors" in your phone book). Catalog free. Write EVINRUDE MOTORS, 4167 N. 27th St., Milwaukee 16, Wis.

*A Division of Outboard Marine Corporation  
In Canada: Mfd. by Evinrude Motors, Peterborough*



# EVINRUDE

*quiet outboard motors*