

OCT. 1957

BRITISH FORD — HOW GOOD?

35 CENTS

# POPULAR MECHANICS

## MAGAZINE

WRITTEN SO YOU CAN UNDERSTAND IT

REG. U.S. PAT. & TM. OFF. TRADE MARK © 1957 BY FORD MOTOR CO.

**BIG ANNUAL  
HOME  
SECTION**

**M. I. T. Solar House**  
—Page 158

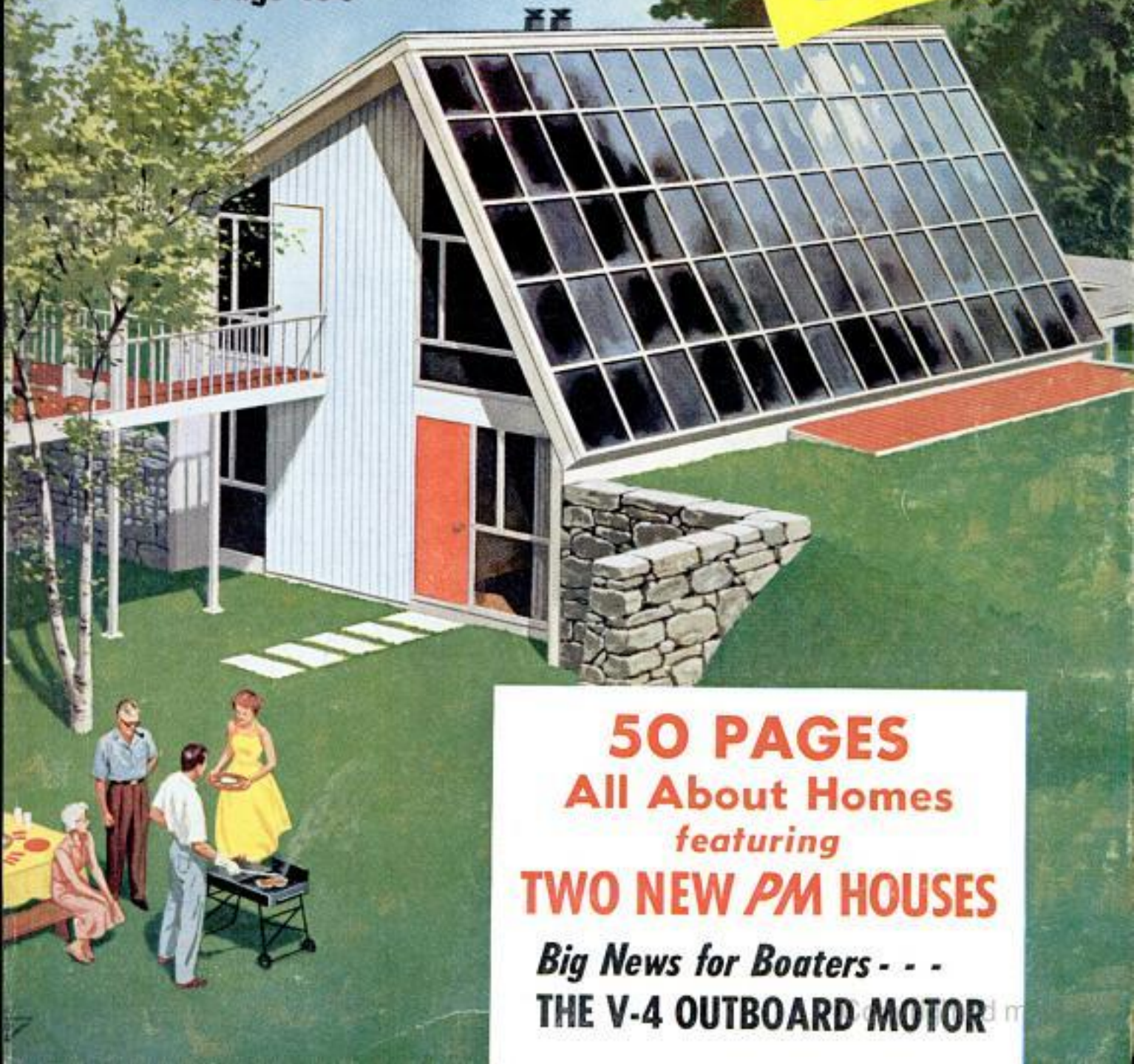

**50 PAGES**  
All About Homes  
*featuring*  
**TWO NEW PM HOUSES**  
*Big News for Boaters - - -*  
**THE V-4 OUTBOARD MOTOR**



*it's Evinrude's  
revolutionary*

# STAR

LOOK CLOSELY . . . that Evinrude V-shape of tomorrow you're admiring will be making outboard news for a long, long time to come!

We call it STARFLITE . . . and if the name suggests performance out of this world . . . we won't deny it. Fact is—it's sensational! It's *the world's first V-4 outboard* . . . a compact, perfectly balanced 90° V-engine with the smoothness and power impulses of an automotive V-8!

More than a new achievement in power . . . Starflite is a *new concept in quiet!* Its mighty engine is cushioned and cradled in a sound-tight nacelle. Noise is *sealed in!* A revelation in effortless power!

Starflite quiet, Starflite smoothness and dramatic Starflite styling are yours in three 1958 models . . . the new 50 hp Starflite V-4 . . . new Four-Fifty

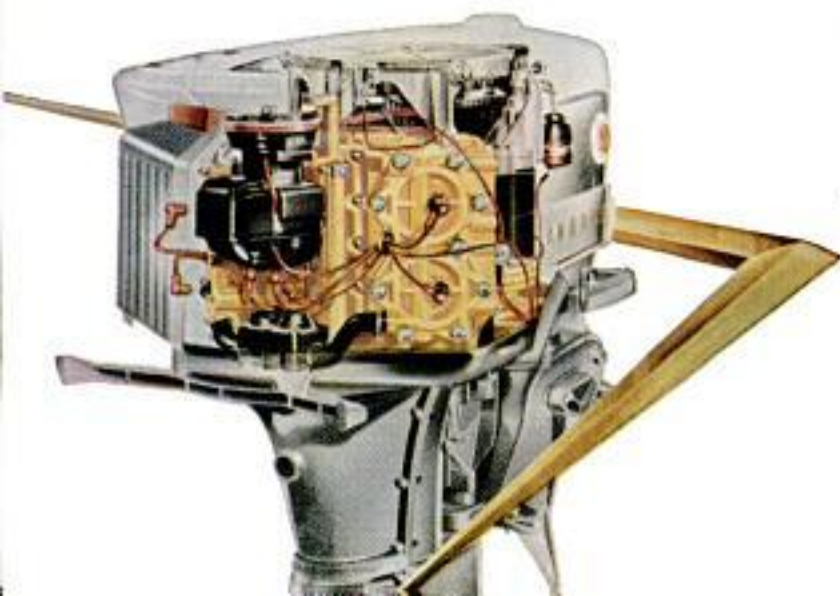

Copyrighted material



you're looking  
at the most  
remarkable  
outboard motor  
ever built

# FLITE V-4

... and the glamorous new Lark "35,"

SEE YOUR EVINRUDE DEALER NOW for wonderfully quiet, smooth-running power in any size from 3 to 50 hp... a sweet-trolling streamlined "10"... a power-packed "18" and "35" with key switch starting... Big Twin power economy with the easiest manual starting ever... 3 handy take-alongs... the smartest-looking Evinrudes yet!

Most '58 Evinrudes are here... and the Starflites are on their way! *Now's the best time to trade-UP!* Ask your Evinrude dealer for *free* colorful catalog (he's listed under "Outboard Motors" in your phone book) or write EVINRUDE MOTORS, 4164 N. 27th Street, Milwaukee 16, Wisconsin.

*A Division of Outboard Marine Corporation*  
In Canada: Mfd. by Evinrude Motors, Peterborough



## EVINRUDE

*quiet outboard motors* Copyrighted material

# "The battery backed up by 2,000,000 miles of testing"

Auto-Lite Sta-ful is tried, tested, and proved for long life and quick, easy starts in the coldest weather. Two years and more than 2,000,000 miles of testing showed the following results:

- Not one battery failed.
- 95% gave better cold-weather starting than required of *new* batteries.
- None of the batteries needed water more than 3 times a year.

You just can't buy a better battery at any price!

**NEEDS WATER ONLY  
THREE TIMES A YEAR\***

\*IN NORMAL CAR USE



Dry Charged...

Fresh when you buy!



**OTHER AUTO-LITE BATTERIES  
AS LOW AS \$13.95**

AUTO-LITE MANUFACTURES OVER 400 PRODUCTS, INCLUDING SPARK PLUGS, BATTERIES, WIRE AND CABLE, AND AUTOMOTIVE ELECTRICAL SYSTEMS . . . SOLD THROUGHOUT THE UNITED STATES AND CANADA.



**What's Winter?** In Texas it means "northers." In Owl's Head, N. Y., the thermometer fluid dives clear into the bulb. Jack Frost moves fast and far.

**Better get set!** Have your Texaco Dealer check radiator, spark plugs, distributor points, battery, and level of your transmission and brake

fluids... change your oil... in short, see to it that you're really all set for safer, surer, cold weather driving.

Snow tires or chains save skids and tow car trips. When it's slippery, "feel" your brakes, don't jam them on. And carry a bucket or bag of sand and maybe a shovel.



### Guaranteed anti-freeze protection!

Your cooling system is checked—and filled with the right amount of Texaco PT. Then you get a *written guarantee* that protection will be maintained all winter long! And this guarantee will be honored by Texaco Dealers in all 48 states. Texaco PT won't boil away even in warm spells; it won't foam and it protects against rust and corrosion. If you value your car and want to beat winter . . . put in the *guaranteed* anti-freeze . . . Texaco PT. At your Texaco Dealer, *the best friend your car has ever had.*

THE TEXAS COMPANY



# TEXACO DEALERS

IN ALL 48 STATES

Texaco Products are also distributed in Canada, Latin America, and Africa

OCTOBER 1957

T

Copyrighted material

# It's easy to build a sound-conditioned game room like this!



Here's a game room where the kids (and you) can raise a rumpus without rousing the whole house and neighborhood. And you can build a room like this in your basement for much less than you might think.

**Gold Bond Acoustamatic Ceiling Tiles** can be stapled—or nailed—easily to wood furring strips applied right on your old ceiling. Both random and regular patterns (see above) have hundreds of perforations that soak up noise. You have a quiet room, and the ivory-white, flame-resistant finish makes the room bright and cheery.

The attractive walls are of Gold Bond Gypsum Wallboard and Insulation Tiles. Tiles come in ivory-white and a random assortment of four lovely pastels. Interlocking edges hide nails or staples. Wallboard goes up fast. Saw panels like wood, or score with a knife, and snap. Finish

with quick-drying Gold Bond Velvet Latex Paint and matching Latex Enamel. Move in!

**Want plans so you can start building?** Write for free illustrated folder, "How to Remodel Your Basement," to National Gypsum Company, Dept. PM 107, Box 73, Buffalo 13, N. Y. Then see your local Gold Bond® Dealer. He'll supply everything you need — including helpful advice.



NATIONAL GYPSUM COMPANY  
POPULAR MECHANICS



# Popular Mechanics Magazine

Registered in U. S. Patent Office and Canada

H. H. WINDSOR, Founder

H. H. WINDSOR, JR., Editor and Publisher

FOREIGN EDITIONS:

MECANIQUE  
POPULAIRE  
(French)

MECANICA  
POPULAR  
(Spanish)

POPULAER  
MEKANIK  
(Danish)

POPULAR  
MEKANIK  
(Swedish)

POPULARE  
MECHANIK  
(German)

Managing Editor

**RODERICK M. GRANT**

Assistant Managing Editor

**WAYNE WHITTAKER**

Shop Notes and Crafts Editor

**JAMES R. WARD**

Associate Editor

**CLIFFORD B. HICKS**

Associate Editor, Automobile

**ARTHUR R. RAILTON**

Associate Editor, Shop Notes and Crafts

**WAYNE C. LECKEY**

Associate Editor, Shop Notes

**W. CLYDE LAMMEY**

Associate Editor

**WILLIAM D. PERKINS**

Radio-Television, Electronics Editor

**LOTHAR STERN**

Assistant Editor, Crafts

**JAY W. HEDDEN**

Assistant Editor, Makeups

**JOHN DALEN**

Art Director, **FRANK BEATTY**

Assistant Editors

**KENNETH ANDERSON** **EARL WOBECK**

**ROBERT HENDRICKSON**

Eastern Editor

**RICHARD F. DEMPEWOLFF**

Empire State Bldg., Room 2006, N.Y.C. 1

Western Editor

**THOMAS E. STIMSON, JR.**

Suite 1010, 3460 Wilshire Blvd.,

Los Angeles 5, Calif.

London Manager

**DOUGLAS W. WEDDERSPOON**

Eagle House, Jermyn St.,

London S.W. 1, England

Director, Bureau of Information

**ALLAN CARPENTER**

200 E. Ontario St., Chicago 11

Advertising Offices

Chicago: 200 E. Ontario St., Whitehall 4-0100;

New York: Empire State Bldg., 350 Fifth Ave.,

Longacre 5-7580; Detroit: General Motors

Bldg., Room 5-118, TRINITY 5-8711; Cleveland:

Hanna Bldg., 1422 Euclid Ave., PROSPECT

1-0456; Los Angeles: 3460 Wilshire, DUNKIRK

2-8458; San Francisco: Russ Bldg., Room

468, 235 Montgomery St., YUKON 2-0823.

Sources of further information not listed in the

index, starting on page 90, about articles in this issue,

frequently are shown in the Where-to-Find-It List

prepared for each issue. A copy may be obtained by

readers, without charge, from Bureau of Informa-

tion, Popular Mechanics, 200 East Ontario Street,

Chicago 11, Illinois.

Published monthly by Popular Mechanics Company,

200 E. Ontario St., Chicago 11, Ill. H. Windsor,

Jr., president; Wm. Harrison Petridge, exec.

vice-pres.; Franklin S. Forsberg, operations vice-

pres.; I. B. F. Windsor, vice-president and secretary;

treasurer; H. H. Windsor III, vice-president; W. T.

Windsor, vice-president; Joseph K. Baell, Jr., ad-

vertising manager; Alan M. Depoe, circulation

manager. Single copy in the United States and

Canada, 35 cents; subscription rates in the United

States and possessions, Canada and countries of

the Pan-American Postal Union, 1 year \$3.50; 2

years, \$6.00; 3 years, \$8.00. To all other coun-

tries add \$1.00 a year over United States prices

for overseas postage. If you plan to move, notify us

at least 30 days in advance so you will not miss

an issue. Give both your old and new addresses.

Entered as Second Class Matter, September 15,

1901, at the Post Office at Chicago, Illinois, under

Act of March 3, 1879. Entered as Second Class

Matter at Post Office Dept., Canada. Registered

as Second Class Matter at the Post Office at

Mexico, D.F., Mexico, June 20, 1950.

Copyright 1957 by Popular Mechanics Company.

Copyright under International Copyright Union.

Copyright in France. All rights reserved under

Pan-American Copyright Union. Printed in the

United States of America.

Volume 108

OCTOBER 1957

Number 4

Address all communications to: 200 E. Ontario St., Chicago 11, Ill.

## In This Issue...

Lightning Tamers of the Airways	-	-	-	-	97
Over-the-Shoulder Bombers	-	-	-	-	106
Our Home at the Bottom of the World	-	-	-	-	115
Here's How to See Through Fog	-	-	-	-	122
Owners Report on the British Ford	-	-	-	-	130
Big News for Boaters! The V4 Outboard	-	-	-	-	140

## Special Section on Housing —

Presenting Two New Houses— the PM Modern and the PM Traditional	-	-	-	-	144
Paper Your Rooms With Cloth	-	-	-	-	152
Ideas for Home Planners	-	-	-	-	154
Concrete Blocks Go Modern	-	-	-	-	156
The House That Stores the Sun	-	-	-	-	158
We Changed Our Ranch House to a Tri-Level	-	-	-	-	163
Easiest Way to Add Space to Your Home	-	-	-	-	166
PM's 1957 Parade of Homes	-	-	-	-	169
We Call It "Our Rock of Gibraltar"	-	-	-	-	176
Look What's Happened to Brick	-	-	-	-	180
Line Your Closets With Cedar	-	-	-	-	186
How to Build a Fireplace	-	-	-	-	190

## For the Craftsman...

How to Make Fancy Candles	-	-	-	-	202
Halloween Fun	-	-	-	-	206
Repair—Don't Junk Broken China	-	-	-	-	210
Sea Captain's Desk	-	-	-	-	214
Drag Strip in Your Basement	-	-	-	-	218
Build This Simple Projection Densitometer	-	-	-	-	223
Using Portable Saws	-	-	-	-	227
Chuck Arbor Cuts Round Tenons	-	-	-	-	237

## Regular Departments...

Detroit Listening Post	-	103	Shopping for Tools	-	240
Solving Home Problems	-	198	On the Market	-	243
How Would You Do It?	-	234	Radio, TV, Electronics	-	245

## Next Month...

ONE YEAR AGO PM's Detroit Listening Post predicted:

A battle rages between those who want dual headlights vertical and those who want them horizontal. The obvious compromise is diagonal. Don't laugh—one company is playing with oblique dual lights.

We won't brag, but diagonal headlights are here. You'll see them (and others) when we present 14 new 1958 cars in November.



Introducing the most practical tool you'll ever own!

# NEW PORTER-CABLE ELECTRIC HAND SAW WITH ORBITAL ACTION!

The saw that does everything 3 times faster!

This versatile tool is actually seven saws in one . . . it's a rip saw, cross-cut saw, coping saw, keyhole saw, scroll saw, jig saw and hack saw! It makes inside cuts without drilling a starting hole — has a comfortable handle, and cuts 2" dressed lumber,  $\frac{1}{4}$ " aluminum and  $\frac{1}{8}$ " steel. For hundreds of jobs — from rough-cutting to intricate scroll work, Porter Cable's Model 152 Saw has no equal! Only **\$54<sup>95</sup>**

(Handy wall kit with accessories, \$5 extra.)

World's only  
orbital action  
hand saw

Most efficient cutting cycle! Blade moves ahead on cutting stroke — moves back and away on relief stroke. No dulling 'drag' — blade runs cooler, lasts far longer, cuts faster.



Easily cuts accurate angles up to 45°.

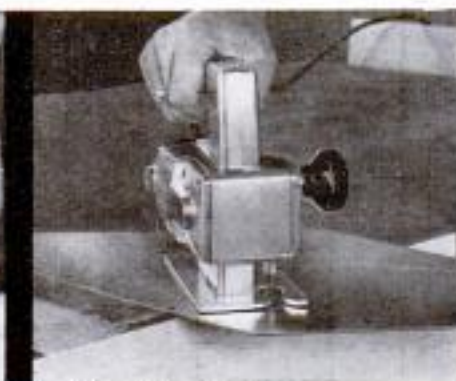

Cuts sheet metal, pipe bar stock quickly.

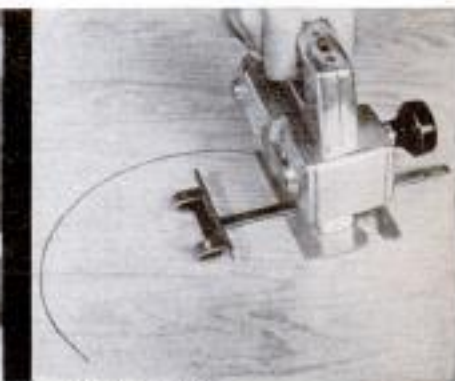

Circle cuts, too, perfectly and quickly.



Model 136 can't be beaten for quality or price.  
ONLY **\$69<sup>50</sup>**

## Get professional results with this 3" Belt Sander!

The famous Model 136 Belt Sander and the new electric Hand Saw make a perfect combination for doing all kinds of jobs easier . . . faster . . . more professionally than ever!

Model 136 produces a fine, straight line finish without ripples or gouges. With the right abrasive, it quickly handles any surfacing job from rough sanding to fine finishing. Simple, positive controls make this Sander easy to operate — and a special belt tension device permits changing abrasives in seconds. Use it in any position.





## IT CUTS

LUMBER  
 PLYWOOD  
 STEEL  
 PLASTICS  
 MASONITE  
 PLEXIGLAS  
 ALUMINUM  
 IRON  
 ASPHALT TILE  
 BRASS  
 BRONZE  
 COPPER  
 LEATHER  
 LINOLEUM  
 RUBBER  
 LUCITE



Starts its own  
inside cuts!



Handy kit mounts on wall  
or workbench.

### SEE YOUR DEALER OR MAIL COUPON TODAY!

PORTER-CABLE MACHINE COMPANY  
 7140 N. Salina Street  
 Syracuse 8, N. Y.

Please send me literature and complete information on your new electric Hand Saw and Model 136 Belt Sander.

Name \_\_\_\_\_

**This One**

Address \_\_\_\_\_



YE4B-U1Q-5Q2K

City \_\_\_\_\_

In Canada: write Porter-Cable, Ltd., Box 5019,  
London, Ont. Canadian prices slightly higher.

## Porter-Cable

*Quality Power Tools*

shapers • saws • sanders  
drills • routers • planes

Kills that chill  
like nothing else will



# Duofold

2-layer  
insulated underwear

**COTTON**  
for COMFORT  
next to your  
skin... soft,  
absorbent—  
blots up body  
moisture—  
no itch!



**WOOL**  
for WARMTH  
in outer layer...  
virgin wool,  
nature's warmest  
fiber... kills  
evaporation  
chill.

**Nothing Warmer!** — Not just one, but *two* insulating layers. Not just one, but a *complete range* of styles and fabric weights. From Alaska to Texas — wherever you live, work or play — you get the warmth you like in Duofold.

**Best Chill Protection, too!** — Exclusive 2-layer construction quickly blots up body moisture, evaporates it *away from the skin*. Kills chill like nothing else will.

**Bulk-free! Itch-free! Lightweight!** — No 'strait jacket' look or feel! For all-weather comfort, outdoors or in, get Duofold today. Duofold, Inc., Mohawk, New York.

Distributed in Canada by Gordon Mackay & Co., Ltd., Toronto, Ontario  
In trim longies-n-T-shirts and union-suits for men; sports styles in *Sam Valley Red*\* for the entire family; *Peppermint Candy Stripe*\* for girls and ladies. *NEW Powder-Snow Blue*\* for ladies...all shrink-resistant.

\*Trademarks

© 1957 Duofold Inc.

## ACROSS THE DESK



### To the Editor:

In the August issue, page 162, illustration 1 is an object for which the magazine states that its identity is unknown. It is quite similar to a smoothing-iron heater my mother used to use. It is placed on top of a coal or wood-burning stove and the



irons are placed inside with the handles sticking up through the slots; the lid with the slots in it helps keep the handles cool and also keeps the heat in. The one my mother had held two irons that slipped in slots with a door on the end, all made of cast iron.

Lt. Comdr. George W. Bedford,  
Remo, Va.

### PM's House Planners

Gerald A. Perkins, Charles F. Norris and Miles F. Mulloy (left to right), the congenial architects who designed the beautiful PM Traditional House on pages 145-146, are not without honor in the Chicago suburb where they toil. They can



(Continued to page 8)



To those who want to enjoy  
an ACCOUNTING CAREER



**IF** you're that person, here's something that will interest you.

Not a magic formula—not a get-rich-quick scheme—but something more substantial, more practical.

Of course, you need something more than just the desire to be an accountant. You've got to pay the price—be willing to study earnestly, thoroughly.

Still, wouldn't it be worth your while to sacrifice some of your leisure in favor of interesting home study—over a comparatively brief period? Always provided that the rewards were good—a salary of \$5,000 to \$10,000 and up?

An accountant's duties are interesting, varied and of real worth to his employers. He has *standing!*

Do you feel that such things aren't for you? Well, don't be too sure. Very possibly they *can* be!

Why not, like so many before you, investigate LaSalle's modern Problem Method of training for an Accounting position?

Just suppose you were permitted to work in an accounting firm under the personal supervision of an expert accountant. Suppose, with his aid, you studied accounting principles and solved problems day by day—easy ones at first—then more difficult ones. If you could do this—and could turn to him for advice as the problems became complex—soon you'd master them all.

That's the training you follow in principle under the LaSalle Problem Method.

Over 4,500 Certified  
Public Accountants among  
LaSalle alumni

Accredited Member, National Home Study Council

## LASALLE EXTENSION UNIVERSITY

A CORRESPONDENCE INSTITUTION

417 S. Dearborn St. Dept. 1064H Chicago 5, Ill.

I want to be an accountant. Send me without obligation, Free Sample Lesson—also "Opportunities in Accounting."

Name.....Age.....

Address.....

City, Zone & State.....



You cover accounting from Basic Accounting right through Principles and Basic Cost Accounting. As you go along, you absorb the principles of Accounting Systems and Federal Income Tax. Then you may choose Office Management, Governmental Accounting, Commercial Accounting, Industrial Accounting, or Public Accounting and prepare for the CPA examinations.

Your progress is as speedy as you care to make it—depending on your own eagerness to learn and the time you spend in study.

Will recognition come? The only answer, as you know, is that success *does* come to the man who is really *trained*. It's possible your employers will notice your improvement in a very few weeks or months. Indeed, many LaSalle graduates have paid for their training—with increased earnings—before they have completed it! For accountants, who are trained in organization and management, are the executives of the future.

### Get Free Sample Lesson—Also "Opportunities in Accounting"

For your own good get all the facts about this completely new and modern accounting training. Write for Free Sample Lesson—also latest book "Opportunities in Accounting." They will prove that Accounting offers brilliant futures to those who aren't afraid of serious home study, and will show the wide range of opportunities that exist today. No cost or obligation. If you want a position of higher income, greater prestige and professional standing... MAIL THE COUPON NOW!

# OPTICAL BARGAINS

## 3" ASTRONOMICAL REFLECTING TELESCOPE

(Famous Mt. Palomar type)

See the Stars, Moon, Planets Close Up!  
60 & 120 Power — An Unusual Buy!

Assembled and Ready to Use! You'll see the Rings of Saturn, the fascinating planet Mars, huge craters on the Moon. Aluminized and overcoated 3" diameter high speed F 10 astronomical mirror. Telescope comes equipped with a 60X eyepiece and a mounted Barlow Lens, giving you 60 & 120 power. Optical Finder Telescope, included. Sturdy, hardwood, portable tripod. Free with scope: Valuable STAR CHART and 272 page "Astronomy Book." Stock No. 85.050-H.....\$29.50 f.o.b. (Shipping wt. 10 lbs.) Barrington, N. J.



## 4 1/4" ASTRONOMICAL TELESCOPE

Mt. Palomar type! Up to 270 Power. A fine Reflector Telescope complete with real Equatorial Mount and Tripod. Aluminum tube, 4 1/4" dia. mirror, rack and pinion focusing eyepiece holder, 2 eyepieces and mounted Barlow Lens for 40X, 90X, 120X and 270X. Shipping weight approx. 25 lbs. Stock No. 85.006-H.....complete, \$74.50 f.o.b. Barrington, N. J.



## NEW! STATIC ELECTRICITY GENERATOR

See a thrilling spark display as you set off a miniature bolt of lightning. Absolutely safe and harmless. Stands 14" high. Turn the handle and two 3" plastic discs rotate in opposite directions. Metal collector brushes pick up the static electricity, store it in the Leyden jar type condenser until discharged by the jumping spark. Countless tricks and experiments. 24 page instruction booklet included. Stock No. 70.070-H.....\$10.95 Postpaid



## New! 2 in 1 Combination! Pocket-Size

### 50 Power MICROSCOPE and 10 Power TELESCOPE

Useful Telescope and Microscope combined in one amazing, precision instrument. Imported! No larger than a fountain pen. Telescope is 10 Power. Microscope magnifies 50 Times. Sharp focus at any range. Handy for spots, looking at small objects. Just plain snooping. Send Check or M.O. Satisfaction Guaranteed. Order Stock No. 30.059-H.....\$4.50 Ppd.



## MOUNTED BARLOW LENS

Double and triple your Telescope's power with a Barlow Lens. Ours is mounted in chrome-plated, brass tubing with variable spacers — just slide this mounted negative lens into your 1 1/4" I.D. eyepiece holder, and use your regular eyepieces in it. Fully guaranteed in please you. Stock No. 30.200-H.....\$8.00 ppd.



## 6X FINDER TELESCOPE

Has cross-hairs for exact locating. You focus by sliding objective mount in and out. Base fits any diameter tube—an important advantage. Has 3 centering screws for aligning with main telescope. 20-mm. diam. objective. Weighs less than 1/2 pound. Stock No. 50.121-H.....\$8.00 ppd.



## BUILD A SOLAR ENERGY FURNACE

Great Project for Geophysical Year!

A fascinating new field. Build your own Solar Furnace for experimentation — many practical uses. Easy! Inexpensive! Use your scrap wood. We furnish instructions. This sun powered furnace will generate terrific heat—2000° to 3000°. Fuses enamel to metal. Sets paper aflame in seconds. Use our Fresnel Lens—14 3/4" diameter...f.l. 14".



Stock No. 70.130-H—package of 1.....\$ 6.00 Pstpd.  
Stock No. 70.131-H—package of 2.....\$11.00 Pstpd.  
Stock No. 70.132-H—package of 4.....\$20.00 Pstpd.

## INFRARED SNIPERSCOPE TELESCOPE & PARTS

See in the dark—without being observed. War surplus Sniperscope M-2. Gov't. cost about \$500. Instrument complete, ready to use. Includes Power Pack. Infrared light source. Will operate from 6 V auto battery. You must furnish battery or transformer. Stock No. 85.053-H.....\$150.00 f.o.b.

Save still more money! Build your own Sniperscope! We will furnish instructions—parts, including: Power Packs, 1P25A image tubes, light units, filters, etc. For details — request FREE Bulletin A-26-H.



**SIMPLE LENS KITS!** Fun for adults! Fun for children! Kits include plainly written, illustrated booklet showing how you can build lots of optical items.

Stock No. 2-H—10 lenses.....\$ 1.00 Postpaid  
Stock No. 5-H—45 lenses.....\$ 5.00 Postpaid  
Stock No. 10-H—80 lenses.....\$10.00 Postpaid

## WRITE FOR FREE CATALOG "H"!

Complete Line of Astronomical Telescope Parts and Assembled Telescopes. Also huge selection of lenses, prisms, war surplus optical instruments, parts and accessories. Telescopes, microscopes, binoculars, etc. Request Catalog "H"!

ORDER BY STOCK NUMBER. SEND CHECK OR MONEY ORDER. SATISFACTION GUARANTEED!  
**EDMUND SCIENTIFIC CO., BARRINGTON, N. J.**

(Continued from page 6)

boast that they take care of their fellow villagers from cradle to grave with buildings of their design that include a medical-professional building, scores of homes, a church, new fire station and an Old English style utility structure in the cemetery of Glen Ellyn. Although their firm is only six years old and its members are all in their 30s, the lights in their offices burn far into the night keeping ahead of clients' demands. A glance at the PM Traditional shows why. They also do modern designs. Perkins is the design expert, Norris looks after structural engineering and Mulloy the mechanical equipment. "Of course, we all overlap in the other fellow's field," said Perkins, "but nobody seems to mind."

John Ridley (below), the well-known

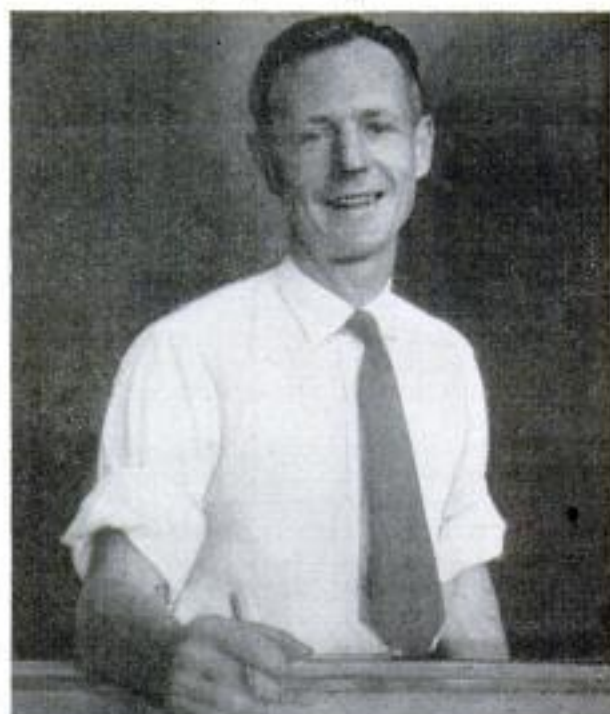

architect, who did the striking PM Modern House, works alone. He is a graduate of the University of Toronto where he won the R.A.I.C. silver medal. If his house has an international flair it's because he has studied in Sweden, England, France and Italy and worked in architectural offices in London and Gothenburg. He has been in Seattle since 1946. Among his awards and prizes is an Honor Award for 1953 from the American Institute of Architects.

## To the Editor:

After reading the article "Our Outboard-Boating Boom" by Don Wharton in the July issue, we would like to point out that the implication and myth that Ole Evinrude, after his row for ice cream across a Wisconsin lake, founded the outboard

(Continued to page 10)

*if you're in your twenties or early thirties, here's a solid-gold opportunity to make*

# BIG MONEY

# BY 35



We're willing to wager that, given the proper guidance and training, you can at least double your present income within the next few years.

We'll put up three interesting and valuable books to help prove this point.

One is the gold-mine of helpful career tips, "How to Succeed."

Another is a handbook outlining opportunities in your particular field of interest (see list in coupon below).

The third is a sample lesson in Basic Mathe-

matics which demonstrates how easily yet how thoroughly I.C.S. helps you master a subject.

These books will be especially useful to you if you are between 20 and 35—provided you want to enjoy the rewards of success before you reach middle age. Actually, the famous I.C.S. method of "Success Conditioning" knows no age limit. It's never too late to learn.

Hurry up your future! Mark and mail the coupon today.

For Real Job Security—Get an I. C. S. Diploma!

I. C. S., Scranton 15, Penna.

Accredited Member,  
National Home Study Council

## INTERNATIONAL CORRESPONDENCE SCHOOLS



BOX 04953K, SCRANTON 15, PENNA.

(Partial list of 257 courses)

Without cost or obligation, send me "HOW TO SUCCEED" and the opportunity booklet about the field BEFORE which I have marked X (plus sample lesson):

- |   |  |  |  |  |
|---|--|--|--|--|
| <p><b>ARCHITECTURE and BUILDING CONSTRUCTION</b></p> <ul style="list-style-type: none"> <li><input type="checkbox"/> Air Conditioning</li> <li><input type="checkbox"/> Architecture</li> <li><input type="checkbox"/> Arch. Drawing and Designing</li> <li><input type="checkbox"/> Building Contractor</li> <li><input type="checkbox"/> Building Estimator</li> <li><input type="checkbox"/> Carpentry and Millwork</li> <li><input type="checkbox"/> Carpenter Foreman</li> <li><input type="checkbox"/> Heating</li> <li><input type="checkbox"/> Interior Decoration</li> <li><input type="checkbox"/> Painting Contractor</li> <li><input type="checkbox"/> Plumbing</li> <li><input type="checkbox"/> Reading Arch. Blueprints</li> </ul> <p><b>ART</b></p> <ul style="list-style-type: none"> <li><input type="checkbox"/> Commercial Art</li> <li><input type="checkbox"/> Magazine &amp; Book Illus.</li> <li><input type="checkbox"/> Show Card and Sign Lettering</li> <li><input type="checkbox"/> Sketching and Painting</li> </ul> <p><b>AUTOMOTIVE</b></p> <ul style="list-style-type: none"> <li><input type="checkbox"/> Automobiles</li> <li><input type="checkbox"/> Auto Body Rebuilding and Refinishing</li> <li><input type="checkbox"/> Auto Engine Tuneup</li> <li><input type="checkbox"/> Auto Technicians</li> </ul> | <p><b>AVIATION</b></p> <ul style="list-style-type: none"> <li><input type="checkbox"/> Aero-Engineering Technology</li> <li><input type="checkbox"/> Aircraft &amp; Engine Mechanic</li> </ul> <p><b>BUSINESS</b></p> <ul style="list-style-type: none"> <li><input type="checkbox"/> Accounting</li> <li><input type="checkbox"/> Advertising</li> <li><input type="checkbox"/> Business Administration</li> <li><input type="checkbox"/> Business Management</li> <li><input type="checkbox"/> Cost Accounting</li> <li><input type="checkbox"/> Creative Salesmanship</li> <li><input type="checkbox"/> Managing a Small Business</li> <li><input type="checkbox"/> Professional Secretary</li> <li><input type="checkbox"/> Public Accounting</li> <li><input type="checkbox"/> Purchasing Agent</li> <li><input type="checkbox"/> Salesmanship</li> <li><input type="checkbox"/> Salesmanship and Management</li> <li><input type="checkbox"/> Traffic Management</li> </ul> <p><b>CHEMICAL</b></p> <ul style="list-style-type: none"> <li><input type="checkbox"/> Analytical Chemistry</li> <li><input type="checkbox"/> Chemical Engineering</li> <li><input type="checkbox"/> Chem. Lab. Technician</li> <li><input type="checkbox"/> Elements of Nuclear Energy</li> <li><input type="checkbox"/> General Chemistry</li> <li><input type="checkbox"/> Natural Gas Prod. and Trans.</li> <li><input type="checkbox"/> Petroleum Prod. and Engr.</li> <li><input type="checkbox"/> Professional Engineer (Chem)</li> <li><input type="checkbox"/> Pulp and Paper Making</li> </ul> | <p><b>CIVIL ENGINEERING</b></p> <ul style="list-style-type: none"> <li><input type="checkbox"/> Civil Engineering</li> <li><input type="checkbox"/> Construction Engineering</li> <li><input type="checkbox"/> Highway Engineering</li> <li><input type="checkbox"/> Professional Engineer (Civil)</li> <li><input type="checkbox"/> Reading Struc. Blueprints</li> <li><input type="checkbox"/> Structural Engineering</li> <li><input type="checkbox"/> Surveying and Mapping</li> </ul> <p><b>DRAFTING</b></p> <ul style="list-style-type: none"> <li><input type="checkbox"/> Aircraft Drafting</li> <li><input type="checkbox"/> Architectural Drafting</li> <li><input type="checkbox"/> Drafting Machine Design</li> <li><input type="checkbox"/> Electrical Drafting</li> <li><input type="checkbox"/> Mechanical Drafting</li> <li><input type="checkbox"/> Sheet Metal Drafting</li> <li><input type="checkbox"/> Structural Drafting</li> </ul> <p><b>ELECTRICAL</b></p> <ul style="list-style-type: none"> <li><input type="checkbox"/> Electrical Engineering</li> <li><input type="checkbox"/> Elec. Engr. Technician</li> <li><input type="checkbox"/> Elec. Light and Power</li> <li><input type="checkbox"/> Practical Electrician</li> <li><input type="checkbox"/> Practical Lineman</li> <li><input type="checkbox"/> Professional Engineer (Elec)</li> </ul> <p><b>HIGH SCHOOL</b></p> <ul style="list-style-type: none"> <li><input type="checkbox"/> High School Diploma</li> </ul> | <ul style="list-style-type: none"> <li><input type="checkbox"/> Good English</li> <li><input type="checkbox"/> High School Mathematics</li> <li><input type="checkbox"/> Short Story Writing</li> </ul> <p><b>LEADERSHIP</b></p> <ul style="list-style-type: none"> <li><input type="checkbox"/> Industrial Foremanship</li> <li><input type="checkbox"/> Industrial Supervision</li> <li><input type="checkbox"/> Personnel-Labor Relations</li> <li><input type="checkbox"/> Supervision</li> </ul> <p><b>MECHANICAL and SHOP</b></p> <ul style="list-style-type: none"> <li><input type="checkbox"/> Diesel Engines</li> <li><input type="checkbox"/> Gas-Elec. Welding</li> <li><input type="checkbox"/> Industrial Engineering</li> <li><input type="checkbox"/> Industrial Instrumentation</li> <li><input type="checkbox"/> Industrial Metallurgy</li> <li><input type="checkbox"/> Industrial Safety</li> <li><input type="checkbox"/> Machine Design</li> <li><input type="checkbox"/> Machine Shop Practice</li> <li><input type="checkbox"/> Mechanical Engineering</li> <li><input type="checkbox"/> Professional Engineer (Mech)</li> <li><input type="checkbox"/> Quality Control</li> <li><input type="checkbox"/> Reading Shop Blueprints</li> <li><input type="checkbox"/> Refrigeration and Air Conditioning</li> <li><input type="checkbox"/> Tool Design</li> <li><input type="checkbox"/> Tool Making</li> </ul> <p><b>RADIO, TELEVISION</b></p> <ul style="list-style-type: none"> <li><input type="checkbox"/> General Electronics Tech.</li> </ul> | <ul style="list-style-type: none"> <li><input type="checkbox"/> Industrial Electronics</li> <li><input type="checkbox"/> Practical Radio-TV Eng'g</li> <li><input type="checkbox"/> Practical Telephony</li> <li><input type="checkbox"/> Radio-TV Servicing</li> </ul> <p><b>RAILROAD</b></p> <ul style="list-style-type: none"> <li><input type="checkbox"/> Car Inspector and Air Brake</li> <li><input type="checkbox"/> Diesel Electrician</li> <li><input type="checkbox"/> Diesel Engr. and Fireman</li> <li><input type="checkbox"/> Diesel Locomotive</li> </ul> <p><b>STEAM and DIESEL POWER</b></p> <ul style="list-style-type: none"> <li><input type="checkbox"/> Combustion Engineering</li> <li><input type="checkbox"/> Power Plant Engineer</li> <li><input type="checkbox"/> Stationary Diesel Engr.</li> <li><input type="checkbox"/> Stationary Fireman</li> </ul> <p><b>TEXTILE</b></p> <ul style="list-style-type: none"> <li><input type="checkbox"/> Carding and Spinning</li> <li><input type="checkbox"/> Cotton Manufacture</li> <li><input type="checkbox"/> Cotton Warping and Weaving</li> <li><input type="checkbox"/> Loom-Fixing Technician</li> <li><input type="checkbox"/> Textile Designing &amp; Dyeing</li> <li><input type="checkbox"/> Textile Finishing &amp; Dyeing</li> <li><input type="checkbox"/> Throwing</li> <li><input type="checkbox"/> Warping and Weaving</li> <li><input type="checkbox"/> Worsted Manufacturing</li> </ul> |
|---|--|--|--|--|

Name \_\_\_\_\_ Age \_\_\_\_\_ Home Address \_\_\_\_\_  
 City \_\_\_\_\_ Zone \_\_\_\_\_ State \_\_\_\_\_ Working Hours \_\_\_\_\_ A.M. to P.M. \_\_\_\_\_  
 Occupation \_\_\_\_\_

Canadian residents send coupon to International Correspondence Schools, Canadian, Ltd., Montreal, Canada. . . . Special tuition rates to members of the U. S. Armed Forces.

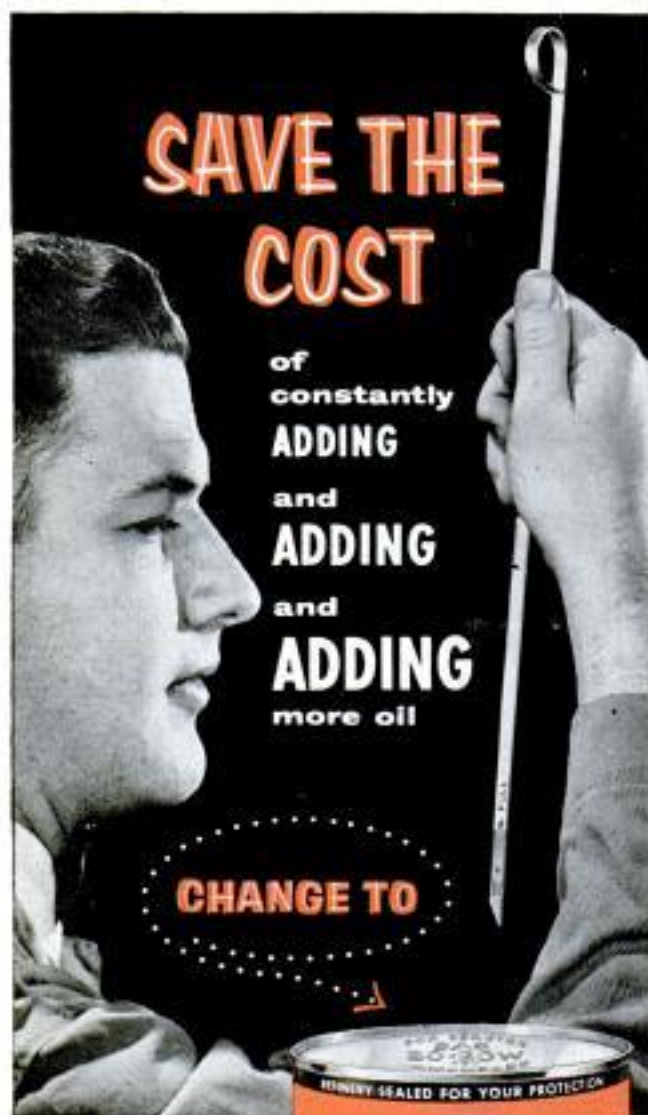

# SAVE THE COST

of constantly  
**ADDING**  
and  
**ADDING**  
and  
**ADDING**  
more oil

**CHANGE TO**



**VALVE  
LIFTER  
STICKING**

Protect the  
Engine  
**Performance  
You Bought**

The quality of Kendall, The 2000 Mile Oil can spell economy for you. It stops high oil consumption — ends valve lifter sticking. To keep your motor younger, longer, ask your favorite dealer for it now.

**BY THE REFINER OF  
KENDALL SUPERB MOTOR OIL**  
KENDALL REFINING COMPANY BRADFORD, PENNA.



Refined from 100% Bradford Pennsylvania Crude Oil—world's richest—by special Kendall processes and an exclusive additive formula.

(Continued from page 8)

industry is incorrect. The first practical production outboard motor was invented by Cameron B. Waterman in 1905, four years prior to Evinrude. Waterman had worked on the motor development since 1903, and placed the Waterman Porto on the market in 1906. Twenty-five motors were produced in 1906; 3000 in 1907; 3000 in 1908 and 6000 in 1909.

Evinrude put his first motor on the market in 1909, and continued in business until the Evinrude Company was sold out to Christopher Meyer in 1913. Waterman Motor Company, however, was not sold by Mr. Waterman until 1916.

These companies were the first two in the outboarding business, but the inventor of the first practical outboard and the first mass-produced outboard was Waterman. In fact, Waterman coined the name "outboard motor."



Enclosed is a photo of the first Porto Motor in use.

Thomas B. King,  
Director of Public Relations,  
Kiekhaefer Corp.,  
Fond du Lac, Wis.

### To the Editor:

In the August issue of PM, Don Hoppe got his facts somewhat confused in the article "He Dreamed Up His Own Narrow-Gauge." The H. T. & W. really exists at this time, the tunnel is not the "Hoosiac," but is the "Hoosac," and it is in both Massachusetts and Vermont, but not in Maine. This railroad is owned by Sam Pinsley who also operates the Sanford & Eastern, Concord & Claremont and Barre & Chelsea, among others. All of these are short lines in New England.

Lindsley Williams,  
Lexington, Mass.



## You Practice **SERVICING** with Kits NRI Sends

Right now, a solid, proven field of opportunity for good pay is servicing the millions of Television and Radio sets now in use. With NRI's Servicing Course, *without extra charge*, you get NRI kits developed especially to give actual practice with Television-Radio equipment. You build, test, experiment with actual Television-Radio receiver circuits; build, use testing equipment. All equipment is yours to keep.

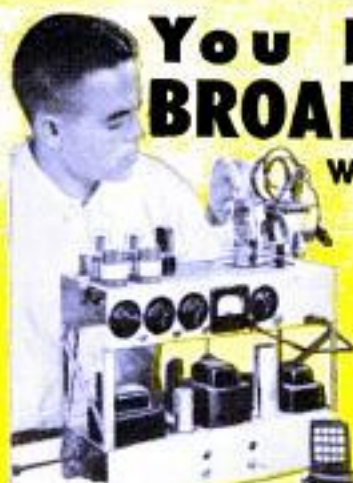

## You Practice **BROADCASTING** with Kits NRI Sends

Clearly written NRI lessons teach TV-Radio-Electronics principles. Right in your own home, during spare time, you gain knowledge, get confidence, building experience, develop skills needed to get and hold jobs in this vast industry. As part of NRI communications training you build low-power Broadcasting Transmitter, other equipment; train for your FCC Commercial Operator's license. You learn by doing.

# I Will Train You at Home in Spare Time to be a **TELEVISION-RADIO** Technician



## TELEVISION Making Jobs, Prosperity

A steady stream of new electronic products is increasing opportunities for TV-Radio Technicians. The millions of Television and Radio sets now in use need servicing. Hundreds of TV and Radio stations on the air offer interesting jobs for Operators and Technicians.



## America's Fast Growing Industry Offers You Good Pay, Success

People look up to and depend on the Technician, more than ever before. His opportunities are great, and are increasing. Become a TV-Radio Technician. At home and in your spare time, you can learn to do this interesting, satisfying work—quality for important pay. NRI is America's oldest and largest home study TV-Radio school with over 40 years' experience and thousands of successful graduates. NRI methods are tested, proved. Successful graduates are everywhere.

## Technical Know-How Brings Better Pay, Advancement

### NRI TRAINED THESE MEN



"My income has steadily increased in Radio. I have advanced to Chief Engineer of TV Station KTIV."—**A. H. SMITH**, Sioux City, Iowa

"Fix sets part time in my shop. Made about \$500 first three months of the year. Could have more but this is about all I can handle."—**FRANK BOBER**, Lorain, O.



"I've come a long way in Radio and Television since graduating. Have my own business on Main Street."—**JOE TRAVERS**, Ashbury Park, New Jersey.

"Before finishing the NRI course I was employed as Studio Engineer at KSMJ. I am now announcing."—**BILL DELLELL**, Grand Island, Nebraska.



New electronic products are boosting the need for more and more trained TV-Radio Technicians. Offices, plants, homes everywhere—are obliged to buy their knowledge and services. For instance, transistor Radios, Color TV, Hi-Fi, were unknown a few years ago. Guided missiles, computing machines, automation would not be possible without this miracle science—Electronics. Police, Aviation, Mobile Two-Way Radio are expanding. The military services reward qualified Technicians with higher rank and pay. To ambitious men everywhere, here is rich promise of fascinating jobs, satisfaction and prestige, increasing personal prosperity.



## Start Soon to Make \$10, \$15 a Week Extra Fixing Sets

NRI students find it easy and profitable to start fixing sets for neighbors and friends a few months after enrolling. Use the Tester built with parts NRI furnishes to locate and correct TV-Radio receiver troubles. Picking up \$10, \$15 and more a week gives substantial extra spending money. Many who start in spare time, soon build full time TV-Radio businesses.

## Mail Coupon—Find Out What Television-Radio Offer You

You don't have to know anything about electricity or Radio to understand and succeed with NRI courses. And you train in your own home—keep your present job while learning. NRI has developed simplified, practical training methods. Ambitious men can get ahead fast. Many successful NRI men did not finish high school. Mailing the coupon can be one of the most important acts of your life. Do it now. Reasonable tuition, on low monthly payments. Let us send you an actual lesson FREE. Judge for yourself how easy it is to learn. A 64-page catalog gives details of opportunities and training. Address: **NATIONAL RADIO INSTITUTE, Dept. 7KA, Washington 16, D.C.**

## Good for Both—FREE

**NATIONAL RADIO INSTITUTE,**  
Dept. 7KA, Washington 16, D.C.  
Mail me Sample Lesson and 64-page Book, FREE,  
(No salesman will call. Please write plainly.)

Name \_\_\_\_\_ Age \_\_\_\_\_  
Address \_\_\_\_\_  
City \_\_\_\_\_ Zone \_\_\_\_\_ State \_\_\_\_\_



## Mail Today—Tested Way to Better Pay

# VALUABLE GIFT FREE

WITH EVERY ORDER

MEN'S SUPERFINE  
**ZEPHIR**  
ONE OF THE WORLD'S  
**THINNEST**  
WATCHES EVER MADE

LOOKS LIKE  
\$75 TO \$100  
WATCHES!

14 KARAT  
GOLD  
COLOR

**SAVE!**

**7<sup>99</sup>**  
PLUS TAX

**UNLIMITED GUARANTEE**  
exclusive of parts  
Repairs on watch, if  
ever needed, absolutely  
FREE. Never a charge for labor,  
handling, adjusting,  
etc. for the LIFETIME  
of this firm! Guarantee  
given in WRITING!



- Precision Made in Switzerland
- Ruggedly Built for Long Life
- Deluxe Gift Packaging

Now yours... the famous ZEPHIR... one of the world's thinnest watches ever made. Handsome, too! It has the looks of watches selling for \$75 to \$100. The case and hands are in the color of 14 Karat gold. It's a reliable time keeper because it has a precision made Swiss movement.

ONLY 5000 LEFT! MAIL COUPON FOR 10-DAY HOME TRIAL!

ZEPHIR watches make appreciated Christmas or Birthday gifts. At our low bargain price you can easily afford one even for that young boy on your list! But you must hurry! This offer is for a short time only! When our present stock of 5000 is gone, we'll have no more at this price. Play safe! Please send your orders NOW! Each watch beautifully gift boxed. LIMIT ONE WATCH PER CUSTOMER because we want to please as many customers as possible. This offer may not be made again No. 209 \$7.99 plus 80c Federal Tax TOTAL \$8.79



Famous 49c  
PLASTIC  
**STORM**  
WINDOWS  
NOW

**19½¢**



Storm windows need not cost up to \$14.00 each. TRANS-KLEER—amazing flexible product of million dollar factory—seals out wintry blasts for pennies. Costs only 19½¢ for standard 10.8 foot window! Transparent like glass. Won't chip, peel or rattle. Weighs ounces yet has amazing tensile strength by laboratory test! Non-porous—resists snow, sleet, rain, humidity up to 53 degrees below freezing. Easy! Quick! Cut & fit inside window. Press on "Magic" Adheso border—no nails—no tools! FOR AIRING—Just lift. Then press back in place. Fold away after this winter. Use year after year!

Shipped flat in rolls measuring 36" X 432" — 108 square feet—enough for 10 standard windows. Regular price \$4.95. Our bargain price—direct to consumer—\$1.98. No C.O.D.'s at this reduced price. Send check, cash or M.O. for \$1.98 plus 22 cents mailing cost, total \$2.20. FREE! Giant 90 foot roll Adheso tape—our reg. \$1.00 size and illustrated instructions given. Order by No. 74 full roll plus Free Adheso Tape complete... \$2.20



**30 DAY SPECIAL!**

NATIONALLY  
ADVERTISED AT **19.95** NOW

**7<sup>99</sup>**

Paint Kitchen in 55 Min.

**POWERFUL ELECTRIC SPRAYER**

Famous Hi-Power automatic electric Paint Sprayer Kit at LOWEST PRICE IN AMERICA! Powerful new motor pump. New swirl nozzle— from stream to fog-spray! New extra mystery nozzle sprays around corners! 80 lb. nozzle pressure. Nuts & bolts cadmium plated. Metal parts bronze or brass. Cuts painting time up to 75%! Safe—easier to clean than brush. Built-in strainer. Takes all liquids. Formerly adv. on TV at 19.95—now 7.99 complete! (30 day special.) NO. 102... 7.99

**FREE!** Gift \*

Free with any order from this page—pens, lighters, cameras, tools, etc.—many one-of-a-kind—too few to advertise. You KEEP your gift even if you return merchandise for refund. Values to \$5.00.

**THORESEN Inc.** Dept. 6-L

585 Water Street, New York 2, N. Y.  
Rush items on 10-day home trial with money-back guarantee. Surprise FREE GIFT mine to keep in any case!

NO.	QUANTITY	ARTICLE	PRICE

- Check, money order, cash enclosed. Send prepaid.  
 Send C.O.D. plus postal fees (NO C.O.D.'s under \$1.98)

Canadians:  
Address 439  
King Street,  
West, Toronto  
28, Ontario

PRINT NAME.....  
ADDRESS.....  
CITY &.....  
ZONE..... STATE.....

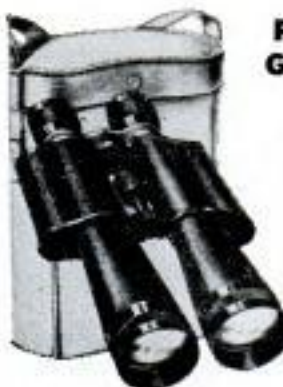

Brand-New 1958 Model!  
**POWERHOUSE GIANT  
GERMAN BINOCULARS**

Formerly  
Advertised **4.98**  
at \$12.95!

We've sold 1,000,000 binoculars in recent years—but this is our best value! New, improved model. Clearer, sharper, better views—up to 40 MILES AWAY! Close-up views even at night! Enjoy "ringside" seats at sports events, boxing matches, etc. Imported direct from Western Germany. Precision lenses. Interior fluoride coated—not plastic! Folds in center on swiveling pivot. "Battleship" construction. Leather straps and carrying case FREE! Formerly advertised at \$12.95—you pay only \$4.98 because you buy direct. No. 66..... \$4.98





# INVENTORS

**L**earn how to protect your invention. The U. S. Patent Laws provide that any new and useful art, machine, article of manufacture, or composition of matter, or any new and useful improvement thereof, may be patented if the act of invention is involved. Therefore, every inventor with a valuable invention should take advantage of the Patent Laws and proceed for patent protection in order to safeguard his rights.

A patent gives the inventor the exclusive right to prevent others from making, using, or selling the invention claimed in the patent for a period of seventeen years.

The Patent Laws were enacted for the benefit of the inventor to give him protection for the features of his invention which are patentable. These features must be properly and concisely set forth and claimed in a formal application for patent, in order to comply with the requirements of the Patent Laws. For that reason, unless the inventor is familiar with patent matters, he should engage a competent registered patent attorney or agent to represent him. We are registered to practice before the U. S. Patent Office and are prepared to serve you in the handling of your patent matters.

A specially prepared booklet entitled "Patent Guide for the Inventor", containing detailed information with respect to patent protection and procedure, together with a "Record of Invention" form will be promptly forwarded to you without obligation upon request.

**CLARENCE A. O'BRIEN & HARVEY JACOBSON**

*Registered Patent Attorneys*

**71-K DISTRICT NATIONAL BUILDING**

**WASHINGTON 5, D. C.**

# Let AUDEL Guides Help You Earn A BIGGER INCOME!

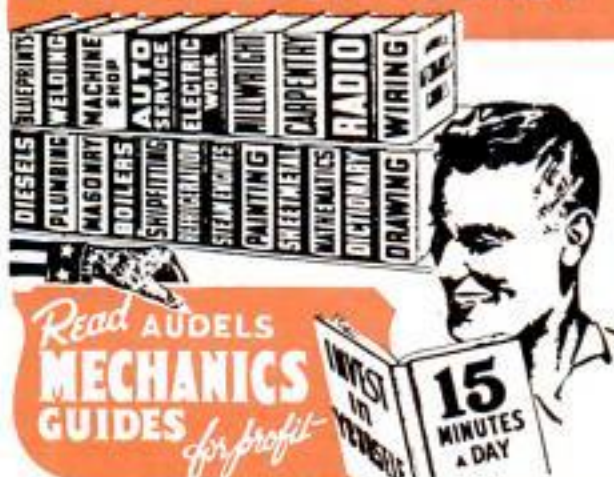

Read AUDELS MECHANICS GUIDES for profit

Every Mechanic can Step Up his Skill with AUDELS GUIDES. Containing Practical Inside Information in a Handy Form. Covers facts and figures of your Trade. All illustrated and explained. Books sent to you for 7 DAYS FREE EXAMINATION. Send No Money Nothing to Pay Postman. Check Books Wanted - Mail Today.

## MAIL ORDER

AUDEL, Publishers, 49 W. 23 St., New York 10, N.Y.

Please send me for FREE EXAMINATION books marked (x) below. If I decide to keep them I agree to mail \$2 in 7 Days on each book or set ordered and further mail \$2 monthly on each book or set until I have paid price plus shipping charges. Otherwise, I will return them.



Check NOW!

You Can Look Over Any Guide In Your Own Home

Start the Easy Payments If Satisfied

MAIL THIS TODAY



- HOME APPLIANCE SERVICE GUIDE, 864 Pages \$6
- AUTOMOBILE MECHANICS GUIDE, 1696 Pages 6
- TRUCK & TRACTOR GUIDE, 1376 Pages 5
- DIESEL ENGINE MANUAL, 640 Pages 3
- MACHINISTS HANDY BOOK, 1728 Pages 6
- WELDERS GUIDE, 608 Pages 3
- BLUE PRINT READING, 448 Pages 3
- MATHEMATICS & CALCULATIONS, 752 Pages 3
- SHEET METAL PATTERN LAYOUTS, 1152 Pgs. 7.50
- SHEET METAL WORKERS HANDY BOOK, 448 Pgs. 2
- MECHANICAL DRAWING GUIDE, 192 Pages 2
- MECHANICAL DRAWING & DESIGN, 480 Pages 3
- TELEVISION SERVICE MANUAL, 480 Pages 3
- RADIODIAGNOSIS GUIDE, 1088 Pages 5
- ELECTRONIC DEVICES, 304 Pages 3
- ELECTRIC MOTOR GUIDE, 1056 Pages 5
- WIRING DIAGRAMS (Light & Power), 304 Pgs. 2
- ELECTRICIANS EXAMINATIONS, 272 Pages 2
- ELECTRIC POWER CALCULATIONS, 480 Pages 3
- HANDY BOOK OF ELECTRICITY, 1520 Pages 5
- ELECTRIC DICTIONARY, 9000 Terms 3
- ELECTRIC LIBRARY, 7000 Pages (10 Book Set) 20
- REFRIGERATION & Air Conditioning, 1360 Pgs. 6
- MILLWRIGHTS & MECHANICS GUIDE, 1248 Pgs. 5
- POWER PLANT ENGINEERS GUIDE, 1568 Pages 5
- ENGINEERS & FIREMANS EXAMS, 544 Pages 2
- PUMPS, Hydraulic & Air Compressor, 1760 Pgs. 6
- OPERATING ENGINEERS LIBRARY (3 Books) 12
- GARDENERS & GROWERS GUIDES (4 Book Set) 6
- CARPENTERS & BUILDERS GUIDES (4 Book Set) 8
- PLUMBERS & Steamfitters Guides (4 Book Set) 8
- MASONS AND BUILDERS GUIDES (4 Book Set) 8
- PAINTERS & DECORATORS MANUAL, 464 Pgs. 2
- HOUSE HEATING GUIDE, 1008 Pages 5
- OIL BURNER GUIDE, 416 Pages 2

Name \_\_\_\_\_  
 Address \_\_\_\_\_  
 Occupation \_\_\_\_\_  
 Employed by \_\_\_\_\_ P10

SAVE SHIPPING CHARGES! Enclose Full Payment With Coupon and We Pay Shipping Charges.

# CAVITEX

Superfine Masonry



## Manufacturing Rights Now Available in 427 Territories

Cavitex offers building owners the ultimate in masonry at sensationally low costs. Designed in line with today's architecture. Long and low. Large color range. Modular in all dimensions. Strong—safe—enduring. Suited to all types of wall construction—8" solid, cavity, partition, veneer.

As a local manufacturing opportunity, Cavitex has tremendous potentials. Local materials are processed by local labor for local consumption. Vast economies effected. That's why Cavitex has price-appeal to buyers and profit-appeal to producers. Hundreds of territories are open.

Cavitex manufacturers operate in franchise-protected territories and with exclusive privileges. Extensive sponsor cooperation. Basic machinery available on lease. Write or wire for book "Opportunity, Unlimited" and tentative reservation of territory.



W. E. DUNN MFG. CO.  
409 W. 24th St., Holland, Mich.

In Canada  
Dunn Masonry Machinery, Ltd.  
844 Dundas Highway  
Cooksville, Ontario

## \$150<sup>00</sup>-\$250<sup>00</sup> Weekly OPERATING AUTO RADIATOR SERVICE SHOP



World's largest radiator shop equipment mfr. will help you set up your own radiator shop—help you get started toward a secure, profitable future. Over 1,000 INLAND shops now operating. First year averages \$6,000 to \$10,000. Many now making much more. Garage or service station can operate as dept. As little as \$305 down for equipment starts you. We will finance balance, furnish complete factory training. Write to

INLAND MFG. CO., Dept. PM-10, 1108 Jackson St., Omaha 2, Nebr.

## RUPTURED

### BE FREE FROM TRUSS SLAVERY

Now there is a new modern Non-Surgical treatment designed to permanently correct rupture. These Non-Surgical treatments are so certain, that a Lifetime Certificate of Assurance is given.

Write today for our New FREE Book that gives facts that may save you painful and expensive surgery, and tells how non-surgically you may again work, live, play and love and enjoy life in the manner you desire. There is no obligation. Excelsior Hernia Clinic, Dept. 8305, Excelsior Spgs., Mo.

First Time Anywhere!

## "TRADE-IN SALE OF OLD SHOES"

SELLS NEW SHOES FOR YOU!

EASY SPARE-TIME CASH FOR EMPLOYED MEN

Your customers get cash for old worn-out shoes in "trade" for new patented Air Cushion dress, work shoes! We handle pick-up of old shoes, give them to charity. You get biggest Commissions, Bonus, Paid Vacation, Free Shoe Offers. Write now for FREE Outfit and exciting details. CHARLES CHESTER SHOE CO. Dept. K573, Brockton, Mass.

POPULAR MECHANICS

**DEVRY TECH CAN PREPARE YOU  
IN SPARE TIME AT HOME AS AN**

# ELECTRONICS TECHNICIAN!



## No Previous Technical Experience or Advanced Education Needed!

Laborers and bookkeepers, store clerks, farmers, salesmen — men of nearly every calling — have taken the DeVry program and today have good jobs or service shops of their own in Electronics.

Here's proof positive that it can be done — done by men like yourself — men who had no previous technical experience, no advanced education.

If you are 17 to 55, we will tell you free how you may prepare for exciting, interesting jobs in Automation Electronics, Radar, Guided Missiles, Communications, Industrial Electronics and many others shown at right. Here is a chance of a lifetime to prepare to cash in on one of today's fastest growing fields. Mail the coupon for details.

DeVry Tech's amazingly practical home method enables you to spend minimum time to get maximum knowledge. In fact, you get exactly the same type of basic training equipment used in our Chicago and Toronto training laboratories — among the finest!

Send coupon for free facts NOW!

### Live-Wire Employment Service

DeVry Tech's Placement Department is in contact with some of the best-known employers in the Electronics field. The service is free to all graduates—and DeVry Tech's record in helping to place men has been outstanding.



### Draft Age?

We have valuable information for every man of draft age, so if you are subject to military service, be sure to check the coupon.

### What a DeVry Tech Diploma Meant to These Men!



G. F. Beane, W. Virginia, was a truck driver. He took the DeVry Tech Training Program, and is now a technical electronics sales representative.



Edward Hahn, Illinois. Was a laborer, now an electronics project engineer with Televiso, Inc. DeVry Tech training helped him prepare for his present position.



Nick Barton, Illinois, came directly from high school to DeVry Tech. Now has his own service shop and tells us he is "literally snowed with work."



George D. Crouch, California, was a retail store clerk. He took the DeVry Program, and today is in the servicing field for himself.

"One of North America's Foremost Electronics Training Centers"



Accredited Member of  
National Home Study Council

**DEVRY TECHNICAL INSTITUTE**

CHICAGO 41, ILLINOIS

FORMERLY

DEFOREST'S TRAINING, INC.



**AN  
INDEX  
to a  
BETTER JOB,  
A BRIGHTER  
FUTURE**

COMMUNICATIONS

RADAR

GUIDED  
MISSILES

TELEVISION

MICRO-WAVES

RADIO

INDUSTRIAL  
ELECTRONICS

COMPUTERS

AUTOMATION  
ELECTRONICS

### Sample Lesson **FREE!**

See for yourself how DeVry Tech trains you for real opportunities in Electronics. We'll also give you a free copy of an interesting booklet, "Electronics and YOU."

### Mail Coupon Today!

DeVry Technical Institute  
4141 Belmont Ave., Chicago 41, Ill., Dept. PM-10-N

Please give me FREE Sample Lesson and your booklet, "Electronics and YOU," and tell me how I may prepare to enter one or more branches of Electronics as listed above.

Name \_\_\_\_\_ Age \_\_\_\_\_

Street \_\_\_\_\_ Apt. \_\_\_\_\_

City \_\_\_\_\_ Zone \_\_\_\_\_ State \_\_\_\_\_

Check here if subject to military training.  
DeVry Tech's Canadian Training Center is located  
at 826 Roselawn Avenue, Toronto 12, Ontario  
2004

# Make More Money Soon Fixing Electric Appliances



**Actual Lesson  
FREE** Fast Growing  
Field Offers  
Good Pay, Security  
Interesting Work

## Learn at Home in Spare Time

Earn more money. Enjoy doing important, interesting work. Learn Electrical Appliance Servicing. This is a field of increasing opportunity. Today there is an average of 8 appliances in every wired home. More than eighty million additional appliances, valued at about 8 billion dollars sold in one year. Find out more about this great, growing field. Find out how NRI can train you, at home and in spare time to be an Appliance Service Technician. See how you can start soon to make extra money servicing appliances.

## Add to Your Income Soon After Enrollment Opportunities Increasing for Service Technicians

NRI Training is practical, thorough. You get easy-to-understand lessons, and NRI supplies parts to build professional type Multi-Use Tester. Use it to get practical experience. Soon, you can add to your income by servicing appliances. Build a profitable *sideline* for your spare time—qualify for a good job—develop a business and be your own boss. As an Appliance Service Technician, your opportunities are broad—your services wanted, gladly paid for, highly regarded in your community.

Appliances are necessary to comfortable, convenient living. Owners pay well to keep them in repair. The field is amazingly big. In addition to major appliances such as electric ranges, air conditioners, refrigerators, there are over 40,000,000 electric irons, 5,000,000 electric blankets, 15,000,000 coffee makers, plus more millions of vacuum cleaners, fans, toasters, mixers, etc.

## Learn and Earn with Tester Diploma when You Finish



Locate appliance troubles easily with Portable Appliance Tester you build. You use it to learn and do actual electric appliance repair jobs. For only \$2.50 with enrollment and \$5 per month, get training including Tester—a small price to pay for increased earnings. Mail coupon for Sample Lesson and Book—your first step toward more interesting work, bigger earnings. **NATIONAL RADIO INSTITUTE, Dept. AK7, Washington 16, D. C.**

TESTING APPLIANCES FOR  
ELECTRICAL TROUBLES

Over 40 Years  
Experience  
Backs Up  
NRI Training



Find Out What  
Appliance Repair  
Offers You

**Mail Coupon** FOR LESSON  
AND BOOK **FREE**

**National Radio Institute**  
Dept. AK7, Washington 16, D. C.

Please send me Electric Appliance Servicing Lesson and Book FREE. (I understand no salesman will call.)

Name \_\_\_\_\_ Age \_\_\_\_\_

Address \_\_\_\_\_

City \_\_\_\_\_ Zone \_\_\_\_\_ State \_\_\_\_\_

ACCREDITED MEMBER, NATIONAL HOME STUDY COUNCIL

# INVENTORS

If you believe that you have an invention, you should find out how to protect it. The first step is to have a search made of the prior pertinent U. S. patents. If a report on this search indicates that the invention appears patentable you can apply for a patent, and the specifications and claims should be prepared.

The firm of McMorrow, Berman & Davidson, with offices in Washington, D. C., is qualified to take the necessary steps for you. We can make a preliminary search on your invention, advise you whether we think it can be patented, and prepare your application for patent.

Unless you are fully familiar with the U. S. Patent Laws, we recommend that you engage the services of a Registered Patent Attorney to protect your interests. The patent laws are *your* laws. A patent gives you the right to prevent others from making, using or selling the invention claimed in your patent for a period of 17 years.

Use these patent laws for your protection. Investigate whether your invention can be patented. If you have what you believe to be an invention, we suggest that you have this firm make a search for you:

*Send for a copy of our Patent Booklet entitled "How To Protect Your Invention," containing information about patent protection and patent procedure. Along with this we will also send you an "Invention Record" form, for your use in writing down and sketching details of your invention. We will mail them promptly. No obligation. They are yours for the asking.*

**McMORROW, BERMAN & DAVIDSON**

*Registered Patent Attorneys*

**PATENTS • COPYRIGHTS • PATENTS**

**135-L VICTOR BUILDING, WASHINGTON 1, D. C.**

## WHAT SECRET POWER DID THIS MAN POSSESS?



BENJAMIN FRANKLIN  
(A Rosicrucian)

WHY was this man great? How does anyone—man or woman—achieve greatness? Is it not by mastery of the powers within ourselves? Know the mysterious world within you! Attune yourself to the wisdom of the ages! Grasp the inner power of your mind! Learn the secrets of a full and peaceful life!

Benjamin Franklin—like many other learned and great men and women—was a Rosicrucian. The Rosicrucians (NOT a religious organization) first came to America in 1694. Today, headquarters of the Rosicrucians send over seven million pieces of mail annually to all parts of the world. Write for YOUR FREE COPY of "The Mastery of Life"—TODAY. No obligation. No salesmen. A non-profit organization. Address: Scribe E.H.W.

THIS BOOK FREE!



## The ROSICRUCIANS

SAN JOSE • (AMORC) • CALIFORNIA

SEND THIS COUPON

Scribe E.H.W.  
The ROSICRUCIANS (AMORC)  
San Jose, California  
Please send me the free book, *The Mastery of Life*, which explains how I may learn to use my faculties and powers of mind.

Name \_\_\_\_\_  
Address \_\_\_\_\_  
City \_\_\_\_\_



## college graduates get ahead faster!

You see it in your own city. They have higher incomes . . . advance more rapidly. Grasp your chance for a better life. Industrial growth . . . automation . . . technical advances create career opportunities for engineers, accountants, management experts. Share rewards awaiting college-trained men. Important firms visit campus regularly to employ Tri-State College graduates. Start any quarter in this world-famed college. Approved for veterans.

### Bach. of Science degree in 27 months

In Mechanical, Civil, Electrical, Chemical, Aeronautical, Radio (TV-Electronics) Engineering. In 26 months a B.S. in Business Administration (General Business, Accounting, Motor Transport Management majors). Superior students may accelerate, 30-week course in Drafting. Internship program; technical fundamentals stressed; comprehensive courses with more professional class hours. Small classes; personalized instruction. Enrollment limited to 1250. Preparatory courses. Beautiful campus. Well-equipped, new and modernized buildings and laboratories. Enter Jan., Mar., June, Sept. Earnest, capable students (whose time and budget require accelerated courses and modest costs) are invited to write Jean McCarthy, Director of Admissions, for catalog and book "Your Career in Engineering and Commerce."



## TRI-STATE COLLEGE

4107 College Avenue • • • Angola, Indiana

## Make \$5 an Hour CASH PROFIT



THE DAY YOU START!  
Start your own business at Home... Sharpen Household, Garden and Shop Tools in Spare Time.

Turn spare time into Big Cash Profits with new Belsaw Sharp-All. No experience needed to sharpen knives, scissors, shears, ice skates, mower blades, hedge trimmers, axes, chisels and circular saws . . . Learn how easily you can start your own spare time business. Amazing low cost easy-payment plan. Send Postcard for FREE BOOK. BELSAW SHARP-ALL CO 718 Field Bldg., Kansas City 11, Mo.

## WE PAY \$3.50 lb.

GROW MUSHROOMS. Cellar, shed and outdoors. Spare or full time, year round. We have over 25,000 customers. FREE BOOK. Washington Mushroom Ind., Dept. 61, 2954 Admiral Way, Seattle, Wash.

## LAW FREE BOOK THE LAW TRAINED MAN

Write today for a FREE copy of illustrated law book, "THE LAW TRAINED MAN," which shows how to earn the professional Bachelor of Laws (L.L.B.) degree through home study of the famous Blackstone Law Course. All necessary books and lessons provided. Moderate cost; convenient monthly terms. Write for FREE law training book today. Blackstone School of Law, 307 N. Michigan Ave. Founded 1890 Dept. 57, Chicago 1, Ill.

## Subscribe to . . . Trailer Topics Magazine

6-Month Trial Subscription \$1



Discover how you can enjoy every modern convenience in your own home for just pennies a day. Read the true-life stories of those who live in mobilehomes and love it.

Only \$3.00 for 2 years.

TRAILER TOPICS MAGAZINE  
Suite 1575 28 East Jackson Blvd. Chicago 4, Illinois

# HELP YOURSELF to a BETTER JOB!

I'LL TRAIN YOU AT HOME TO BE  
A HIGHLY-PAID MECHANIC IN  
**AIR CONDITIONING  
AND REFRIGERATION**

It has been one of America's great industries for years—but the way it's growing, you'd think it was in its infancy! That's why the air conditioning and refrigeration industry appeals so strongly to ambitious men who want better jobs, more security, higher pay.

Over 150 million refrigerating units are in use today—are in need of repair and service. Each year, 3 million refrigerators, 1 million freezers and 2 million air conditioners are produced. Not only homes, but stores, offices, restaurants, motels and transportation systems use some form of refrigeration. Even autos are being made with air conditioners. No wonder trained men are in big demand—are so well paid! Want to be a mechanic in this field? To find out how, just mail coupon for valuable free information!

## AN AMAZING, NEW SHOP-METHOD TRAINING PLAN

After years of research, CTI has developed a wonderfully effective training plan. It enables you to train at home in spare time. You get 23 big kits to build an air conditioner, refrigerator, freezer or milk cooler. You keep all this equipment. You do 10 service and trouble-shooting jobs. CTI brings field training right into your home! You get practical experience as you learn.

## YOU GET EXPERIENCE AS YOU TRAIN BECAUSE YOU PRACTICE WITH COMMERCIAL EQUIPMENT

You get all parts and tools to build a heavy-duty, commercial-type, 34 h.p. refrigeration high-side (illustrated at right.) You receive lesson material which not only makes kit assembly easy, but downright fascinating! Remember, kit training in this field is a CTI "FIRST"



Above left is photo of special tools in just one kit. In another kit (right) you get motor, fan, pulley, service tools. You get other tools, tubing, much equipment, all of finest quality. Kits are sent on a planned schedule so that you learn in easy stages. Kit training develops skill, provides experience, speeds training.



**OPEN A SHOP—  
BE THE BOSS**

The air conditioning and refrigeration industry is a good one in which to start out "on your own." Many CTI graduates have done it, and if you have the determination, you could do it, too! CTI has special information for men who want to go into business. Mail coupon for details.

**COMMERCIAL TRADES INSTITUTE**  
1400 Greenleaf Avenue • Chicago 26, Illinois

**MAIL  
TODAY  
FOR  
FREE BOOK  
AND  
SAMPLE  
LESSON**



R. C. ANDERSON  
President  
CTI

## HOW YOU MAY EARN CASH AS YOU TRAIN

Many students do repairing in their spare time soon after they enroll. A number get part-time jobs, others open shops. With their earnings many students not only pay their tuition, but sometimes have enough money remaining to put in the bank. The reason that students can do field work for profit is that CTI training is practical. Students get their experience as they train—not as low-paid apprentices! But get the complete story on your opportunities. Fill out and mail coupon today.

## COMMERCIAL TRADES INSTITUTE

1400 GREENLEAF AVENUE DEPT. R-419  
CHICAGO 26, ILLINOIS

Tell me how I can qualify for a better job or a business of my own. Send booklet, Success in Air Conditioning & Refrigeration, and Lesson Sample. Both FREE.

Name \_\_\_\_\_ Age \_\_\_\_\_

Address \_\_\_\_\_

City \_\_\_\_\_ Zone \_\_\_\_\_ State \_\_\_\_\_



# DRAFTSMEN



## CASH BIG PAY CHECKS!

Train Now for more success, greater security

LEARN AT HOME IN SPARE TIME  
(or at college in Chicago)

Check the want ads in any newspaper—SEE the big-pay opportunities open to you as a draftsman. What's more, you can learn this well-paid, prestige profession at home—quickly, easily! No special talent needed. Get complete, step-by-step Chicago Tech lessons in the mail, spend a few pleasant hours studying each week. In a short time you'll be a well-trained draftsman, ready to take your pick of many good jobs. Act now!



Free Information—Mail Coupon Today!

Get FREE TRIAL LESSON plus information about C.T.C. practical training. Learn what successful Chicago Tech graduates say about high pay and opportunities in drafting. No charge, or obligation.

## CHICAGO TECHNICAL COLLEGE

N-215 Tech Bldg., 2000 So. Michigan Ave.  
Chicago 16, Illinois

Mail me FREE lesson with facts about big opportunities in DRAFTING.

Name \_\_\_\_\_ Age \_\_\_\_\_

Address \_\_\_\_\_

City \_\_\_\_\_ Zone \_\_\_\_\_ State \_\_\_\_\_

## PAINTING IS EASY!

with the famous

## BURGESS electric SPRAYER

Just plug in and Spray:

- paint • varnish • enamel
- shellac • mothproofers
- garden sprays • water
- insecticides

PAINT 3 to 7 TIMES FASTER!

For the fastest, smoothest painting or spraying job you ever saw, try the Burgess Sprayer. Completely self-contained . . . just plug into regular household outlet, pull the trigger, and paint furniture, floors, walls, screens, cabinets, fences. Fine for mothproofing and garden spraying, too. Sapphire nozzle, handy spray adjuster, new convenient hanging hook, 25 oz. graduated jar. Easier to clean than a brush.



only \$12.95 AT YOUR FAVORITE DEALER

If not available locally send \$12.95 for post-paid delivery. Money-back guarantee.



SEND FOR FREE BOOKLET  
"HOW TO PAINT THE EASY WAY"

BURGESS VIBROCRAPTERS, INC.  
DEPT. A-77 • GRAYSLAKE, ILLINOIS

## SAVE 75% ON

### WORK CLOTHES!

Terrific values you've got to see to believe!



SHIRTS.....4 for \$2.99.....79c

The used, they're sterilized and ready for tough wear. Blue, green or tan. Send neck size.

PANTS to match. Were \$3.95, now only... 99c  
Send waist measure and inside leg length. 4 for \$3.75

COVERALLS \$2.29 SHOPCOATS \$1.79

3 for \$6.75 3 for \$5.00

Wear 'em used, save plenty! Send chest measurement.

MONEY BACK GUARANTEE . . . if not satisfied! Order TODAY! Send \$1.00 deposit on C.O.D. orders. Add 25c for postage on prepaid orders.

GALCO SALES CO. Dept. 1310  
7120 HARVARD AVE. CLEVELAND 5, OHIO

## CABINET MAKING



### LOW COST HOME TRAINING COURSE FOR BEGINNERS & ADVANCED CRAFTSMEN

Make money. Learn skills and secrets of fine woodworking and tool use. Professionally prepared shop method training tells and shows how. Covers everything. Easy to master.

Write for Free Booklet

INTERSTATE TRAINING SERVICE  
DEPT. F3, PORTLAND 13, OREGON



SEND FOR THIS FREE!

Make money. Know how to break and train horses. Write today for this book FREE, together with special offer of a course in Animal Breeding. If you are interested in Gaiting and Riding the saddle horse, check here ( ) Do it today—now.

BEERY SCHOOL OF HORSEMANSHIP  
Dept. 11010 Pleasant Hill, Ohio

## earn as TAX EXPERT

\$15 HOUR

Our students earn as much as \$2,000 in 3 short months preparing income tax returns in spare time. Also operate lucrative year-round Business Tax Service. Dignified home-office business. Experience unnecessary. We train you! help you start. State approved home training program. Write today for free prospectus. UNION INSTITUTE, 68 Hudson, Hoboken 20D, N. J.

## Free Book on Arthritis And Rheumatism

HOW TO AVOID CRIPPLING DEFORMITIES  
Explains why drugs and medicine give only temporary relief and fail to remove the causes; tells all about a specialized non-surgical, non-medical treatment which has proven successful since 1919. Write for this 38-page FREE BOOK today.  
BALL CLINIC Dept. 756 Excelsior Springs, Mo.



## EXTRA MONEY Selling EXCLUSIVE PARAGON Cushion Shoes

Even If Now Employed

Enjoy your own lifetime, independent shoe business without investment. Steady repeats. To \$4.00 pair advance commissions. Big bonus. Make \$50 and more a week in full or spare time. Over 153 latest smart styles. Magic cushion. Easy to start. Write for FREE OUTFIT today!

No. 574 Lo-Line 2 Eyelet Crushed Grain

PARAGON SHOE COMPANY  
79 Sudbury St., Dept. 20, Boston 14, Mass.



## 1957 WINNER - INDIANAPOLIS

**SAM HANKS**, famous race driver and mechanic says:  
**"I'd like a NATIONAL SCHOOLS  
 trained mechanic on my crew anytime!  
 Any employer would!"**

Few racing drivers are as qualified to advise future mechanics as Sam Hanks, who builds and repairs his own racing cars. He holds the American Closed Course record (162.554 m.p.h.) and a host of state and national titles, including the National Midget Championship in '49 and the National A.A.A. crown in '53. At Indianapolis, he placed third in '52 and '53 ... last year, he was runner-up.



# MASTER ALL ENGINES IN ONE MODERN, SHOP-METHOD HOME TRAINING COURSE AUTO-MECHANICS & DIESEL

"NUMBER ONE COURSE IN ITS FIELD," says Sam Hanks, who predicts bright future for men who clip coupon now.

"I've worked alongside National Schools Trained mechanics," reports Sam Hanks. "They're top-notch mechanics, up on the newest advances in automotive engines - even diesel jobs and fuel injection never faze them. That kind of all-around training really *pays off* - no matter where you work. And take it from me, National Schools Trained mechanics are in big demand everywhere. They command top pay, because they learned how to repair fast and right the first time. Do I recommend National Schools Home Training in Auto Mechanics & Diesel? You bet I do."

Prove it to yourself, Men. National Schools of Los Angeles, a leader since 1905, brings its famous training shops into your home - gives you everything you need to make more money in today's big, opportunity filled Auto-Mechanics & Diesel industry.

Earn as you learn. We show you how. Easy to understand lessons, diagrams, manuals. Free Placement Assistance.

APPROVED FOR G. I. TRAINING



Home of National Schools' world-famous Shops

### RESIDENT TRAINING AT LOS ANGELES

If you wish to take your training in our Resident School at Los Angeles, start NOW in our big, modern Shops and Labs, work with the latest Auto and Diesel engines - all types - fuel injection, automatic transmissions, all power equipment - most complete facilities offered by any school. Expert, friendly instructors. Graduate Employment Service. Help in finding home near school - and part time job while you learn. Check coupon for information.

YOU GET AND KEEP ALL THIS EQUIPMENT!



Complete set of professional Tools and All-Metal Tool Box. Same top-quality equipment used by expert mechanics everywhere. Use them, display them proudly.



"Motor Analyzing Set" contains Standard Engine Vacuum Fuel Pump Tester, Remote Starter Switch, Modern Timing Light, Standard Compression Tester. Plus compact carrying case & instructions.

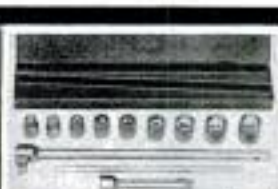

Top-quality Socket Wrench with Fittings. Real professional tools you'll use during your lifetime career in repairing, all types of engines, from foreign cars to big diesel jobs.

<p><b>COURSE COVERS</b></p> <ul style="list-style-type: none"> <li>All engines</li> <li>Fuel injection</li> <li>Automatic Transmissions</li> <li>Overhauling</li> <li>Customizing</li> <li>Servicing</li> <li>Maintenance</li> </ul>	<p><b>PREPARES YOU FOR:</b></p> <ul style="list-style-type: none"> <li>Auto-mechanic jobs</li> <li>Airplane mechanics</li> <li>Farm machinery repair</li> <li>All diesel jobs</li> <li>Experimental Labs</li> <li>Government work</li> <li>Engine specialist</li> <li>All-around mechanic</li> </ul>
--	--

GET THE BENEFITS OF OUR 50 YEARS' EXPERIENCE!



**NATIONAL SCHOOLS**  
 LOS ANGELES 37, CALIF

## NATIONAL SCHOOLS

TECHNICAL TRADE TRAINING SINCE 1905  
 LOS ANGELES 37, CALIFORNIA

MAIL NOW TO  
 NATIONAL SCHOOLS, Dept. DB-107

4000 S. FIGUEROA ST.  
 LOS ANGELES 37, CALIF.

Send for FREE Auto-Diesel Opportunity Book and Sample Lesson.

NAME \_\_\_\_\_ AGE \_\_\_\_\_

ADDRESS \_\_\_\_\_

CITY \_\_\_\_\_ ZONE \_\_\_\_\_ STATE \_\_\_\_\_

Check if interested ONLY in Resident School training at Los Angeles.  
 VETERANS: Give date of Discharge \_\_\_\_\_

**FREE!**  
 VALUABLE BOOK & SAMPLE LESSON  
 - Just Send Coupon!





**YOU**  
can  
acquire

**LAW NIGHTS AT HOME!**  
**LL. B. DEGREE**

LaSalle's famous Law Library—used as reference in many Law libraries and Law offices—has enabled thousands to master Law surprisingly fast, in spare hours at home, for business and professional advancement.

These 14 remarkable volumes, compiled by leading professors and lawyers, cover the whole basic field of Law in condensed, orderly, simplified manner.

You advance rapidly with this great library, plus special lectures furnished. We guide you step-by-step with personalized Problem Method of instruction . . . you learn by doing—handling legal problems—not by memorizing rules.

Send for two FREE booklets, "Law Training for Leadership," and "Evidence," answering questions about Law and its value to you, and telling how LaSalle Law graduates are winning rapid advancement in business and public life. Mail coupon below. No obligation.

**LA SALLE EXTENSION UNIVERSITY**  
**A Correspondence Institution**

417 S. Dearborn St. Dept. 1064-L Chicago 5, Ill.

Send me your two FREE booklets described above, without obligation.

Name.....Age.....

Street.....

City, Zone & State.....

**ART LEARN AT HOME!**

Enjoy glamorous high-pay career or profitable hobby. Learn Commercial Art, Illustrating, Cartooning, Fashion Art, Lettering, T.V., etc. We train you at home, in spare time, 22-pc. art outfit given with first lesson at no extra cost. Write for FREE Book describing easy low-cost method. No obligation. No salesman will call on you. Washington School of Art, Studio 1410, Port Washington, N. Y. (Estab. 1914)

**REPAIR ANY WATCH**



**... Swiss or American**

No previous experience needed to learn modern watch repair. An enjoyable hobby or profitable career. Unique Sweazey System starts you making repairs right away. Develops your skill step by step. Teaches you modern shop methods . . . professional short cuts . . . mistakes to avoid. Learn by personal attendance or spare time home study. Free sample lesson. No obligation. Write today!

**FREE SAMPLE LESSON**

**CHICAGO SCHOOL OF WATCHMAKING**  
2330 N. Milwaukee, Dept. 1107, Chicago 47, Illinois

**Shrinks Hemorrhoids**  
**New Way Without Surgery**

**Science Finds Healing Substance That Relieves Pain—Shrinks Hemorrhoids**

For the first time science has found a new healing substance with the astonishing ability to shrink hemorrhoids and to relieve pain—without surgery.

In case after case, while gently relieving pain, actual reduction (shrinkage) took place.

Most amazing of all—results were so thorough that sufferers made astonishing statements like "Piles have ceased to be a problem!"

The secret is a new healing substance (Bio-Dyne\*)—discovery of a world-famous research institute.

This substance is now available in suppository or ointment form under the name Preparation H.\* Ask for it at all drug counters—money back guarantee. \*Reg. U.S. Pat. Off.

**INVENTORS NEEDED AT ONCE**

If you have an invention you wish to sell outright or license on royalty, write us at once. We are seeking inventions of household items, games, toys, sports items, tools, and mechanical and technical devices. Patented or unpatented. For further information and free brochure outlining manufacturers' requirements, royalty rates, send name (no drawings, please) on letter or postcard at once.

**KESSLER CORPORATION, Dept. 5100, Fremont, Ohio**

**MAKE BIG MONEY AT HOME!**

**INVISIBLE MENDING**  
Pays up to \$10 in an Hour!  
Make moth holes, cigarette burns, tears, rips, disappear from all fabrics. Little-known craft pays extra spare-time profits at home. Write today for exciting details FREE!  
**FABRICON, 6238 Broadway**  
DEPT. 3210 - CHICAGO 40, ILLINOIS

**HIGH SCHOOL DIPLOMA**  
Earn a High School Diploma at home! Prepare for better job, more pay. Study in spare time. No classes. Materials furnished. Certified teachers. Valuable diploma awarded.  
Write Today for Complete Information  
**SOUTHERN STATES ACADEMY**  
Box 144-A Sta. E Atlanta, Georgia

**HYDRAULIC JACK REPAIRS**

**Earn While You Learn at Home**  
Millions of jacks in gas & auto-service stations, truckers, body-shops, riggers, factories, farms need servicing. We show you HOW—easy step by step directions—what tools to use. EARN UP TO \$5 an hour, in spare time, in your own basement or garage. Start your own business NOW. Write for folder #PM10 & free bonus offer.  
**Institute of Hydraulic Jack Repair**  
P.O. Box 50, Bloomfield, N. J.

**I'll Send You This Handsome SAMPLE CASE—FREE**  
and Show You How to Make Up to \$30.00 in a Day  
WRITE for this FREE Tailoring Sample Case packed with 100 beautiful, big-value suit and overcoat fabrics. Take orders from friends, fellow-workers, others, for fine quality, made-to-measure clothes. Pocket big cash profits in advance. Because we serving our suits and overcoats brings more orders, we make it easy for you to get your own clothes without 1c cost. No experience is needed. **SATISFACTION GUARANTEED. SEND NO MONEY.** Rush your name, address, and age—today!  
**W. Z. GIBSON, Inc., 500 South Throop Street**  
DEPT. P-516 CHICAGO 7, ILLINOIS

# AMAZING MUSIC DISCOVERY

## Has You Playing Real Music The Very First Time You Try!

**Thousands Now Play Who  
Never Thought They Could  
— Requires No Teacher — No  
Boring Practice of Scales  
and Exercises . . .  
QUICK, EASY, INEXPENSIVE!**

**I**F you are one of the many thousands who have always wanted to play music, yet hesitate to learn because "it takes too long," or "it costs too much"—here's wonderful news! Now, with this modern home-study method, you can actually play your favorite instrument *the very first time you try*—and you can go on to master that instrument in a much shorter time than you'd ever imagine possible!

### NO "SPECIAL TALENT" REQUIRED

No previous training needed — no "special talent" required. Right from the start, this amazing music discovery will have you playing *real melodies* instead of practicing tedious scales and exercises. Earliest lessons consist of delightful songs, hymns, waltzes, etc. Clear, simple directions and large, show-how pictures teach you exactly what to do, so you can't go wrong . . . even if you don't know a single note of music now! Soon you'll be playing **ALL** your favorite songs and compositions *by note!*

### STOP CHEATING YOURSELF OF THESE JOYS

Over 900,000 people the world over have taken up this easy-as-A-B-C way to learn music. It's all so clearly explained, so easy to understand that even children "catch on" quickly. Yes, **ANYONE** can learn to play piano, violin, accordion, guitar or any other instrument. No inconvenient lesson periods—no expensive hourly tuition. You learn in spare time of your own choosing. *You become your own music teacher . . .* and progress as rapidly or as leisurely as you wish. And lessons are only a few cents each, including valuable sheet music you'll keep always! The whole family can learn for the price of one.

### STOP CHEATING YOURSELF OF THESE JOYS

Why not let this U.S. School of Music method bring the many pleasures of music into **YOUR** life? Popularity! New friends. Gay parties. Good times. More self-confidence and poise. Extra money from playing or teaching. Possibly even a brilliant musical career. Best of all, the deep *personal satisfaction* of being able to create your own music—provide your own entertainment!

**WHICH MUSICAL INSTRUMENT DO YOU WANT TO PLAY?**



**PIANO** "I hope others will discover how easily and cheaply you can learn with this wonderful method."—Mrs. J. C. Rogers, Roanoke Rapids, N. C.



**GUITAR** "It's been fun. It hasn't cost anywhere near as much as a private teacher. Now invited to affairs, dances."—HOWARD HOPKINS, E. Syracuse, N. Y.



**ACCORDION** "I got my start with a U. S. School of Music Course. How easy it is to play this 'teach yourself' way!"—LAWRENCE WELCH, Famous Orchestra Leader



**VIOLIN** "I have played for dances and am now studying Heifetz's 'Hara Stacato' and a couple of concertos."—IVAN W. DAYLEY, Lisco, Noh.

**... OR ANY OF THESE OTHER INSTRUMENTS:**

<input type="checkbox"/> Saxophone	<input type="checkbox"/> Tenor Banjo	<input type="checkbox"/> Flute
<input type="checkbox"/> Trumpet, Cornet	<input type="checkbox"/> Ukulele	<input type="checkbox"/> Steel Guitar
<input type="checkbox"/> Pipe, Hammond, Reed Organ	<input type="checkbox"/> Clarinet	<input type="checkbox"/> Piccolo
<input type="checkbox"/> Trombone		

**900,000 STUDENTS  
59 Successful Years**

### SEND FOR **FREE BOOK**

Let us **SHOW** you why our way to learn music is so **EASY**—and so much **FUN!** See for yourself why our method has been so successful for 59 years. Clip and mail coupon for our valuable 36-page **FREE BOOK**. No obligation, no salesman will call on you. It can mean so very much to you for the rest of your entire life—if you will mail the coupon at right **TODAY!** U. S. School of Music, Studio A3010, Port Washington, N. Y. (Special Reduced Prices on Instruments.)



**U. S. SCHOOL OF MUSIC**  
Studio A3010, Port Washington, N. Y.

I am interested in learning to play, particularly the instrument checked below. Please send me your free illustrated booklet, "How to Learn Music at Home." **NO SALESMAN IS TO CALL UPON ME.**

- |  |  |   |
|--|--|---|
| <input type="checkbox"/> Piano           | <input type="checkbox"/> Pipe, Hammond, Reed Organ | <input type="checkbox"/> Piccolo                  |
| <input type="checkbox"/> Guitar          | <input type="checkbox"/> Tenor Banjo               | <input type="checkbox"/> Modern Elementary        |
| <input type="checkbox"/> Steel Guitar    | <input type="checkbox"/> Ukulele                   | <input type="checkbox"/> Horn                     |
| <input type="checkbox"/> Viola           | <input type="checkbox"/> Clarinet                  | <input type="checkbox"/> Mandolin                 |
| <input type="checkbox"/> Piano Accordion | <input type="checkbox"/> Trombone                  | <input type="checkbox"/> Practical Finger Control |
| <input type="checkbox"/> Saxophone       | <input type="checkbox"/> Flute                     |   |
| <input type="checkbox"/> Trumpet, Cornet |  |   |

Do you have the instrument? .....

Mr. \_\_\_\_\_  
Mrs. \_\_\_\_\_  
Miss \_\_\_\_\_  
(Please Print Carefully)

Address \_\_\_\_\_

City \_\_\_\_\_ State \_\_\_\_\_

(Insert Zone Number, If Any)

If under 18, check here for Booklet A

Some make more, some less; T. THORN reports:

**\$690** gross in single  
**MONTH**  
IN MY OWN BUSINESS!

Start  
YOUR OWN  
Business!



• Here's YOUR chance to start a money-making, year-round business of your own and make the success you've dreamed about. R. O. Donnley took in \$40 in seven hours. O. W. Ware landed a \$750 hotel job. R. Traynor grossed over \$450.00 in five days. Homes, hotels, offices, clubs, offer you big profit possibilities. Auto upholstery also.

**NO SHOP OR OFFICE NECESSARY.** You clean furniture on customers' premises. No hauling. No high rents. Supplies inexpensive; operate from your home. What you take in is mostly profit.

• If you want to be your own boss—free from layoffs, strikes and bosses, we will help you to start and succeed. Don't delay... read the facts, then decide for yourself.

MAIL COUPON TODAY FOR FREE BOOK

VON SCHRADER MFG. CO.  
1110 "D" Pl., Racine, Wisconsin

Without obligation rush your FREE booklet about how I can start my own permanent, profitable electric Upholstery Cleaning business.

Name \_\_\_\_\_  
Address \_\_\_\_\_  
City \_\_\_\_\_ Zone \_\_\_\_\_ State \_\_\_\_\_

**STUDY TO BE A DOCTOR**  
of Psychology or Metaphysics

Obtain a Ps.D., Ms.D., or Ph.D. Be a Teacher, Lecturer or Accredited Practitioner. Teach others how to achieve Health, Happiness and Contentment. Chartered by State. Correspondence Courses only. Write for FREE book telling how.

THE NEOTARIAN FELLOWSHIP  
Desk 8, Pickwick Building Kansas City 6, Missouri

**FREE** OUTFIT STARTS YOU IN  
BIG MONEY SHOE BUSINESS!



Run your own profitable "shoe store" business from home! Represent fast growing million dollar firm in spare or full time. We give you—FREE—complete Starting Outfit that makes you \$217 EXTRA each month for just 2 easy orders a day. Feature 195 fast-selling dress, sport, work shoe styles for men, women. Air-cushion shoes, many special features! Sizes 2½-15—AAAA to EEEE. Sell to friends and folks where you work. Rush postcard for FREE Outfit!

MASON  
SHOE, Dept. 786, Chippewa Falls, Wisconsin



INSURED TIRE SERVICE  
POPULAR BRANDS

FREE INSURANCE POLICY given with each used tire sold. We guarantee the amount of service you pay for.

NOWHERE CAN SUCH QUALITY BE FOUND AT SUCH LOW PRICE!

SPECIAL!  
1.00 off on  
orders for  
Two or  
More used  
tires

YOU CAN'T  
LOSE!!

GOODYEAR SUBURBANITE TYPE SNOW TIRES

New Tire Guarantee—Factory Rebuilt

BEST WINTER TRACTION OF ALL!

670x15 \$9.95 710x15 650x16 650x15 \$10.90

Super Quality — Rugged Performance — 6 Months Insured Service

600x16	\$3.65	670x15	\$3.95	700x16	\$4.45	760x16	\$4.75
650x15	3.85	670x16	4.05	710x15	4.35	820x15	4.95
650x16	4.25	700x15	3.95	760x15	4.45	850x17	4.65

Supreme Quality — Nothing Finer — 12 Months Insured Service

600x16	\$5.25	675x19	\$5.45	700x15	\$10.45	700x20	\$12.50
600x16 (G)	6.75	640x15	4.95	750x16 (H)	15.95	750x20 (H)	15.50
650x16	5.75	670x15	5.35	700x17	11.95	750x20 (I)	17.50
650x16 (G)	7.25	710x15	5.45	750x17	16.45	825x20	21.50
700x16	6.35	760x15	5.95	750x18	10.95	900x20	19.95
750x16 (G)	8.45	800x15	6.35	30x8	11.25	1000x20	20.45
550x18	4.95	820x15	6.35	600x20	10.95	1100x20	21.25
550x17	4.75	550x15	5.35	650x20	11.75	1000x22	21.95
650x16	6.25	670x16	5.15	55x15	5.15	1100x22	22.75
700x15	5.35	700x16 (G)	10.25	32x6 (10)	12.75	1100x24	25.95

Whitewalls \$1.00 extra.

MIDLAND

TIRE SALES

Speedy shipments on Mail Orders. F.O.B. Chicago. Insurance policy sent with each order. Deduct 10% on orders for 2 or more used tires. Send CHECK or MONEY ORDER. No COD's.

3701 S. Normal, Dept. PM-63, Chicago 9, Ill.

REAL ESTATE  
BE A BROKER

PAYS BIG! SEND FOR FREE, BIG, ILLUSTRATED CATALOG NOW! Graduates report making substantial incomes. Start and run your own business quickly. Men, women of all ages, learn easily. Course covers Sales, Property Management, Appraising, Loans, Mortgages, and related subjects. STUDY AT HOME or in classrooms in leading cities. Diploma awarded. Write TODAY for free book! No obligation.

FREE  
BOOK  
TELLS  
HOW

Approved for World War II and Korean Veterans  
WEAVER SCHOOL OF REAL ESTATE (Est. 1936)  
2020K Grand Avenue Kansas City, Mo.

ENGINEERING  
DEGREE IN  
27 MONTHS

B.S. Degree. Aero., Chem., Civil, Elec., Mech. & Electronic Engineering (inc. Radio, TV), 36 mo. B.S. degree in Math., Chem., Physics. Prep courses. Demand for grads. Spacious campus, 20 bldgs.; dorms, auditorium, gym, low rate, Earn board, G.I. approved. Enter Dec., March, June, Sept., Catalog.  
1610 E. Washington Blvd.  
Fort Wayne 2, Indiana  
Keeping pace with progress

INDIANA TECHNICAL COLLEGE

MONEY in WORMS

Big money made raising crickets, hybrid red wigglers and 12 inch African fishworms—Sell by mail—We teach you how to raise and where to sell. Free Literature. Hybrid breeder red wigglers—1000—\$4.5000—\$17.50, postpaid. CARTER WORM RANCH, PLAINS, GEORGIA.

FIX OUTBOARD MOTORS

POWERMOWERS, AND ALL SMALL  
2 & 4-CYCLE GASOLINE ENGINES

Repair your own equipment or MAKE EXTRA MONEY in this growing field. Fully illustrated, easy-to-understand. Home Study Course. Write for FREE information.

LINCOLN TECHNICAL INSTITUTE  
SUITE 10-E, 472 MARKET STREET, NEWARK 5, N. J.

More Comfort Wearing  
FALSE TEETH

Here is a pleasant way to overcome loose plate discomfort. FASTEETH, an improved powder, sprinkled on upper and lower plates holds them firmer so that they feel more comfortable. No gummy, gooey, pasty taste or feeling. It's alkaline (non-acid). Does not sour. Checks "plate odor" (denture breath). Get FASTEETH today at any drug counter.

POPULAR MECHANICS

Copyrighted material

Here's the **EASY, Step-by-Step Way to**

# FIX ANY CAR IN A JIFFY!

Engines, Brakes, Transmissions, Rear Ends, Generators—Yes, Any Part

**BRAND-NEW  
EDITION!**

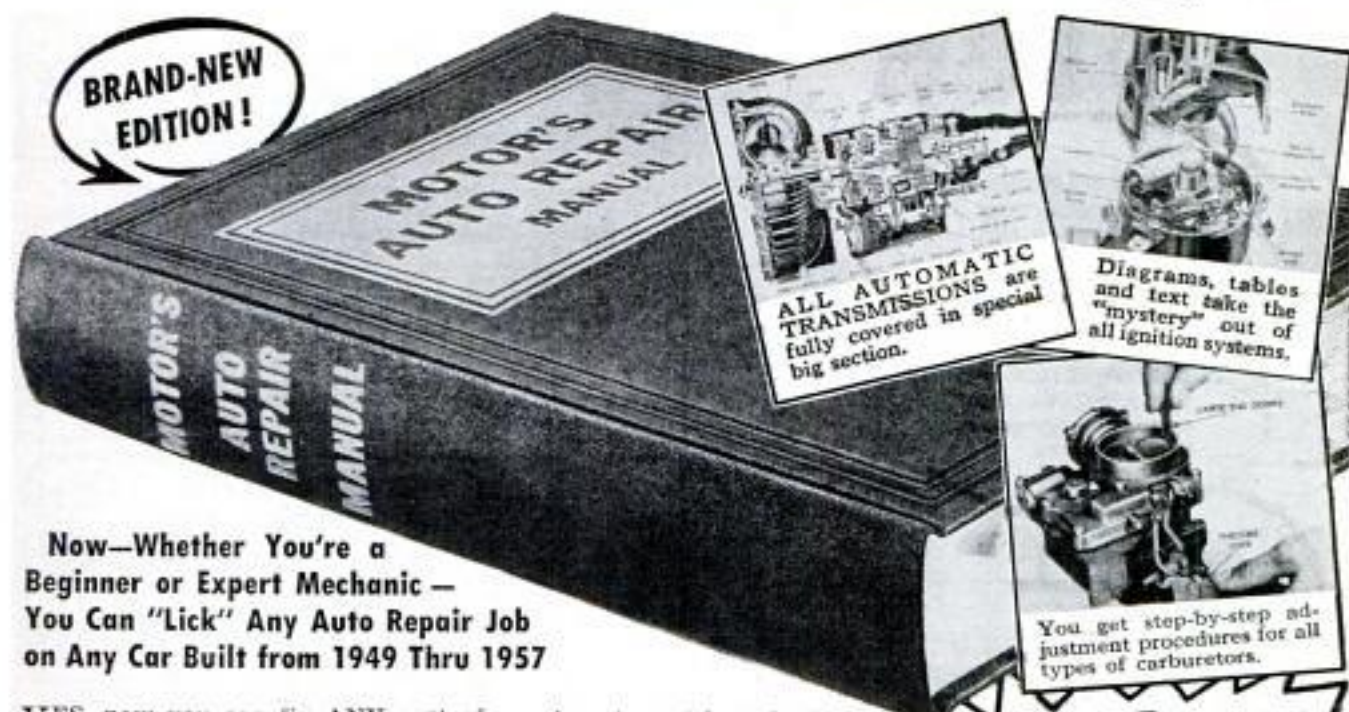

**MOTOR'S  
AUTO REPAIR  
MANUAL**

**ALL AUTOMATIC  
TRANSMISSIONS** are  
fully covered in special  
big section.

Diagrams, tables  
and text take the  
"mystery" out of  
all ignition systems.

You get step-by-step ad-  
justment procedures for all  
types of carburetors.

**Now—Whether You're a  
Beginner or Expert Mechanic—  
You Can "Lick" Any Auto Repair Job  
on Any Car Built from 1949 Thru 1957**

**YES**, now you can fix ANY part of ANY car—quickly, easily, and right! From carburetor adjustment to a complete overhaul, it's easy when you have MOTOR'S famous Auto Repair Manual. It's like having a staff of factory experts and MOTOR'S field-trained engineers beside you, guiding you every step of the way. No wonder so many thousands of beginner and expert mechanics alike use this step-by-step, illustrated giant manual.

MOTOR'S Manual "starts from scratch"—leads you through entire job with easy step-by-step directions, clear "how-to" pictures. Tells you WHERE to start, what TOOLS to use. You just CAN'T go wrong!

**2,900 Pictures! So Complete  
So Simple, You CAN'T Go Wrong!**

**NEW, REVISED** edition covers everything you need to know to repair any car. Over **ONE THOUSAND** giant pages, 2900 "This-Is-How" pictures lead you every step of the way. 291 "Quick-Check" charts—23,436 essential repair specifications. Over 225,000 service and repair facts on ALL 23 different makes from 1949 thru 1957. Instructions and pictures so clear you can't go wrong! Even a green beginner mechanic can do a good job. And if

you're a top-notch mechanic, you'll be amazed by the time and labor-saving methods!

**The "Meat" of Over 160  
Official Shop Manuals**

**OVER  
2½  
MILLION  
COPIES  
SOLD!**

The editors have put together the "know-how" from over 160 Official Shop Manuals and "boiled it down" into one fully-illustrated easy-to-understand guide.

Here's **ILLUSTRATED** step-by-step guidance on Automatic Transmissions, Tune Up, Ignition, Carburetors, Fuel Pumps, Axles, Steering Gears, Rear End, Brakes, **PLUS MUCH MORE.**

**SEND NO MONEY  
Try Book for a Week FREE**

Just mail coupon. (Attach it to postcard

if you wish.) Test book in your garage or shop. **GUARANTEED** to pay for itself in 7 days. If it doesn't, return it, owe nothing. **MOTOR BOOK Dept., Desk 110, 250 West 55th St., New York 19, N.Y.**

**USED BY U. S. ARMED FORCES**

**Brand-New—Covers All These Makes**

Buick	Ford	Packard
Cadillac	Hudson	Plymouth
Chevrolet	Imperial	Pontiac
Chrysler	Jep	Rambler
Clipper	Lincoln	Studebaker
Continental	Mercury	Thunderbird
De Soto	Nash	Willlys
Dodge	Oldsmobile	

**Same FREE Offer  
on MOTOR'S New  
TRUCK MANUAL**

Covers EVERY job on EVERY popular make gasoline truck as well as GM and Cummins Diesel 1949 thru 1957. For FREE trial, check coupon.

**Try Book  
for a Week FREE**

**Beginner Raves About**

**Book**  
"Never knew anything about repairing cars until I got this wonderful book. Easy to see close-up pictures of every part. Has saved for itself time and time again."

—P. Kemper, Wis.

**So Does Expert**

"Have been a mechanic for 25 years. MOTOR'S Manual still takes me out of the tight spots. And it's simple enough to be understood by average person."

—V. Lauria, Nev.

**MAIL COUPON NOW FOR 7-DAY FREE TRIAL  
(Attach to Postcard if More Convenient)**

**MOTOR BOOK DEPT.  
Desk 110, 250 W. 55th St., N.Y. 19, N. Y.**

Rush to me at once (check box opposite book you want):

**MOTOR'S New AUTO REPAIR MANUAL.** If O.K., I will remit \$2 in 7 days, \$2 monthly for 2 months and a final payment of \$6 (plus \$5c delivery charges) one month after that. Otherwise I will return the book postpaid in 7 days. (Foreign price, remit \$3 cash with order.)

**MOTOR'S New TRUCK REPAIR MANUAL.** If O.K., I will remit \$2 in 7 days, and \$2 monthly for 3 months, plus \$5c delivery charges with final payment. Otherwise I will return book postpaid in 7 days. (Foreign price, remit \$10 cash with order.)

Print Name \_\_\_\_\_ Age \_\_\_\_\_

Address \_\_\_\_\_

City \_\_\_\_\_ State \_\_\_\_\_

Check box and save 35c shipping charge by enclosing WITH coupon in envelope entire payment of \$6.95 for Auto Repair Manual (or \$8 for Truck Repair Manual.) Same 7-day return-refund privilege applies.

Any man will enjoy new

# AIRGRATE YELLO-BOLE



### 1. Smokes sweeter!

Imported briar bowl lined with *real honey*. Starts caking the instant you light up. Hence, no break-in.



### 2. Smokes drier and healthier!

Metal grate condenses moisture, tars, nicotine. No wet heel.



### 3. Smokes cooler!

Air-vented chamber draws in fresh air. Aluminum fins and shank throw off heat, cool the smoke.

Famous honey-lining!

\$250

Extra interchangeable bowls—\$1.25 each

"Icepak" Set—Airograte Yello-Bole Pipe plus two extra bowls, \$5.00

Yello-Bole, New York 22

BY THE MAKERS OF KAYWOODIE PIPES

## VALVES STICKING? Get PYROIL

### CLEANS & LUBRICATES

Frees sticky valves, cleans carburetor, tunes motor while you drive. Get more pep & power, more miles per gallon. Write for trial offer. Dept. PM-1.

**GUARANTEED . . . .**



30c  
CAN  
ADD  
TO  
GAS

Nothing finer at any price

**PYROIL** LA CROSSE, WISCONSIN  
TORONTO, CANADA

## HOW TO

### FIX ANY AIR COOLED ENGINE!



Save time and money servicing small engines on power lawn mowers, small tractors, industrial applications, etc. **SMALL ENGINES SERVICE MANUAL** shows how to make expert repairs, tune-up, overhaul or troubleshooting on 200 makes and models. Edited by engineers and professional mechanics. Covers any job on popular 2 or 4-cylinder engines. Includes 1, 2 and 4 cylinder models, light weight and heavy duty, 1 to 37 HP. Contains 25,000 procedures, easy-to-follow instructions, time-saving shortcuts, 6,000 specifications. Parts information on 1,700 items. Only manual of its kind. Order NOW at \$3.45 introductory price. Send check or M.O. Money refunded if you're not satisfied. Clip this.



**SMALL ENGINES SERVICE MANUAL** 1014 Wyandotte St., Dept. 8, Kansas City 5, Mo.

## SCIENTIFIC CRIME DETECTION



### IT'S EASY TO LEARN

Let us teach you in your own home. Learn Finger Printing, Firearms Identification, Police Photography, Criminal Investigation Methods thoroughly, quickly, at small cost. Over 800 Bureau of Identification in the U. S. employ I. A. S. students or graduates. Write today, stating age.

**INSTITUTE OF APPLIED SCIENCE**, 1920 Sunnyside Ave., Dept. 1357  
A Correspondence School Since 1910 Chicago 40, Ill.

## Learn ACCOUNTING Business Administration

Bookkeeping, secretarial and allied subjects at home in your spare time or attend nationally approved resident school. Write for FREE Success Book giving complete details on courses, plans, rates and employment opportunities. G.I. approved. Write Dept. A.

**Hills BUSINESS UNIVERSITY AND  
EXTENSION SCHOOL**  
619 W. MAIN ST., OKLAHOMA CITY 2, OKLAHOMA

## GET RESULTS! RUPTURE RELIEF GUARANTEED!



**RESULTS—OR YOUR MONEY BACK**  
Write now for free booklet and pictures of rupture care. You can be helped . . . work steady, with low cost, easy-to-wear Web Truss. Thousands satisfied.

**WEB TRUSS CO.** Dept. M-10, Hagerstown, Maryland

## Official SEA, AIR & LAND PHOTOS

### SPECIAL INTRODUCTORY OFFER!

1. 4-3 1/2x5 Carrier, Subs and Battleships
2. 4-3 1/2x5 World War II planes
3. 4-3 1/2x5 photos, world's fastest jets
4. 1-8x10 photo, Fairrestal Carrier
5. 1-8x10 photo USN F11F-1 Tiger

Only 23c a set. Send \$1 for all 5. (\$2 value)

Illustr. CAT. with order. Money back guar.

**U. S. SEA & AIR PHOTOS**



DEPT. PE BOX 7584  
LOS ANGELES 5, CALIFORNIA

## DO YOU NEED MONEY?

TO PAY FOR YOUR  
**AERONAUTICAL ENGINEERING  
EDUCATION AND LIVING EXPENSES**  
while attending school in California?

**NORTHROP INSTITUTE'S CO-OP Training Plan** is the answer. Write for complete details. No obligation. Also get free Northrop Catalog describing **TWO YEAR AERONAUTICAL ENGINEERING CURRICULUM**. Remember, there is a waiting list for Northrop Institute Graduates! Approved for Veterans. Send name, address, age and veteran status.

**MAIL TO:** NORTHROP AERONAUTICAL INSTITUTE  
1105 W. Arber Vista Street, Inglewood 1, Calif.

Learn **PRACTICAL RADIO-TV**  
with **25 BIG KITS**

of equipment I send you while  
you train with me . . . for valuable  
shop bench experience . . .



The new Sprayberry Training  
Television receiver, built and tested in sections.

I now offer this fine modern  
oscilloscope.

You build this powerful 2  
Band superhet radio re-  
ceiver.

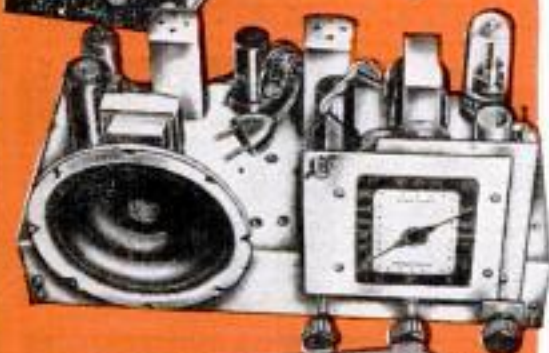

You build the new  
Sprayberry Tester . . . 18-range  
Volt-Ohm-Milliammeter readings.

**Average cost per lesson**  
**ONLY \$3.42**  
Including Kits and Equipment

Prepare for a Good Paying Job — Or Your Own Business!

**"I Will Train You at Home in  
RADIO-TELEVISION  
on Liberal No Obligation Plan!"**

New Equipment! New Lessons! Enlarged  
Course! The true facts are yours in my  
big new catalog . . . **YOURS FREE . . .**  
**JUST MAIL COUPON!**



**Frank L. Sprayberry**  
Educational Director

I can train and prepare you in as little as 10 months to step into the big opportunity Radio-Television service field. Train *without* signing a binding contract . . . without obligating yourself to pay any regular monthly amounts. You train entirely at home in spare hours . . . you train as fast or as slowly as you wish. You'll have your choice of **THREE SPRAYBERRY TRAINING PLANS** . . . planned for both beginners as well as the more experienced man. Get the true facts about the finest most modern Radio-Training available today . . . just mail the coupon for my big new 56 page fact-filled catalog plus sample lesson—both **FREE**.

**Train the Practical Way—with Actual Radio-Television Equipment**

My students do better because I train both the mind and the hands. Sprayberry Training is offered in 25 individual training units, each includes a practice giving kit of parts and equipment . . . all yours to keep. You will gain priceless practical experience building the specially engineered Sprayberry Television Training Receiver, Two-Band Radio Set, Signal Generator, Audio Tester and the new Sprayberry 18 range Multi-Tester, plus other test units. You will have a complete set of Radio-TV test equipment to start your own shop. My lessons are regularly revised and every important new development is covered. My students are completely trained Radio-Television Service Technicians.

**NEWEST DEVELOPMENTS**

Your training covers UHF, Color Television, FM, Oscilloscope Servicing, High Fidelity Sound and Transistors.

**See for Yourself . . . Make Your Own Decision  
... Mail Coupon Today!**

The coupon below brings you my big new catalog plus an actual sample Sprayberry Lesson. I invite you to read the facts . . . to see that I actually illustrate every item I include in my training. With the facts in your hands, you will be able to decide. *No salesman will call on you.* The coupon places you under no obligation. Mail it now, today, and get ready for your place in Radio-Television.

**SPRAYBERRY ACADEMY OF RADIO-TELEVISION**

1512 Jarvis Ave., Dept. 10-T, Chicago 26, Illinois

**Mail This Coupon for Free Facts and Sample Lesson**



SPRAYBERRY ACADEMY OF RADIO-TELEVISION  
Dept. 10-T, 1512 Jarvis Ave., Chicago 26, Ill.

Please rush all information on your **ALL-NEW** Radio-Television Training Plan. I understand this does not obligate me and that no salesman will call upon me. Include New Catalog and Sample Lesson **FREE**.

Name \_\_\_\_\_ Age \_\_\_\_\_  
Address \_\_\_\_\_  
City \_\_\_\_\_ Zone \_\_\_\_\_ State \_\_\_\_\_

# Inventors

Take these necessary preliminary steps promptly to protect your invention by applying for a United States patent—

Sketch and describe your invention. Sign, date and have this disclosure witnessed by two people who understand your invention. Have us make a preliminary search among U. S. patents already granted for similar types of invention. We then report to you on the probable patentability of your invention and recommend your further course of action.

Write for our instructive booklet, "Patent Protection for Inventors" and our convenient "Evidence of Invention" disclosure form. No obligation.

**VICTOR J. EVANS & Co.** *Merlin M. Evans*  
REGISTERED PATENT ATTORNEY

330-L MERLIN BUILDING, WASHINGTON 6, D. C.

## work in cushioned comfort!



STAR BRAND OXFORD  
style 276 in rich Cordovan Color  
(also in 4" Shoe)

ENTIRE FOOT RESTS  
ON THIS LEATHER  
COVERED CUSHION



non-skid, non-marking  
**Oil Resistant**  
corded soles and heels

Rests your feet while you work... perfect for mechanics, filling station men, anyone who works around oil! Soft, resilient full-cushion insoles absorb shock of pounding steps, give snug comfort all day long. Built-in steel shanks. Handsome soft leather uppers... looks like a dress shoe, but is solidly built for rugged service and extra wear. Get a pair today!



## STAR BRAND

*Cush-N-Bilt* WORK SHOES  
"Star Brand Shoes are Better!"

For nearest dealer, write:

ROBERTS, JOHNSON & RAND, Division of International Shoe Co., St. Louis 3, Mo.

## SELL TO UNCLE SAM!



*That's how I made \$20,000 a year — selling junk jewelry to the U. S. Government. Send me your name and I'll show you how I did it.*

### LEARN AT HOME IN ONE EVENING

This is the most fantastic way of making money you ever heard of. That's because you do all your "selling" BY MAIL to one customer—the U. S. Government! Uncle Sam will buy all the old junk jewelry you send in at \$35.00 AN OUNCE for the gold it contains. Just follow my Plan and you can pick up gold on any street in your town. I show you where to find it, what to pay, how to test and how to mail to Uncle Sam for cash. I'll teach you the secrets by which I made \$20,000 a year. No charge for facts. No salesman will call. Send no money—just your name, address on postcard. **Leslie Patton, 335 W. Madison St., Dept. P-910. Chicago 6, Ill.**

## MEN WANTED

Earn \$100 Per  
Week and up  
**AUTO DIESEL  
MECHANICS**

Master a trade with a future—learn Auto-Diesel mechanics in our shops. You learn with tools on real equipment. Earn while you learn. Many of our graduates earn \$100 per week and up. No previous experience necessary. Day and night courses. Approved for veterans. Write for free bulletin.

**NASHVILLE AUTO-DIESEL COLLEGE**

226 7th Ave., N., Dept. 75

Nashville 3, Tenn.

## BRONZE FOUNDRY



Schools • Home Workshops • Inventors

Make your own castings of aluminum, copper, bronze, silver. Foundry sets are available in three sizes including 2400 Deg. F. blast Furnaces. \$26.50; \$33.50; and \$46.00 f.o.b. Marysville or Lakewood. Free Circular.

**KANSAS CITY SPECIALTIES CO.** (Dept.) Box 6022, Marysville, Kans. P-10 or Box 7543, Lakewood, Colo.

## LEARN LOCKSMITHING



Learn fascinating, profitable trade from experts in spare time at home! Age or physical handicap no disadvantage. Year around, steady income. Full or part time. Practical, illustrated lessons. Make money even while learning! All materials and special tools supplied. Free Booklet. **INSTITUTE OF LOCKSMITHING, Dept. P-95 150 PARK AVENUE E. RUTHERFORD, N. J.**

Lic. by N. J. State Board of Ed. Approved for Vets

## TASOPE PHOTO-ENGRAVING PLANTS



Establish your own profitable PHOTO-ENGRAVING business. Make cuts for newspapers, printers, and advertisers. Make etched name plates, plaques etc. Instructions furnished, no experience necessary. Sold direct from factory since 1931. First five hundred cuts sold locally or by mail will pay for plant and pay you well for your time. Write for FREE catalog.

Material Cost  
Of This Cut 34c  
Selling Price  
\$1.00 And Up

**TASOPE, DEPT. PM-10, AURORA, MO.**

## RUPTURED?

Write for New  
Relief  
FACTS FREE!

### ENJOY NEW FREEDOM

of action, peace of mind and comfort at work or play. Proven, patented MILLER holds your rupture back Day & Night—will bring you lasting relief! Has helped thousands of others!

For FREE facts in plain wrapper—  
Send Name and Address to

**FRED B. MILLER, DEPT. 1-P**

Manufacturer, HAGERSTOWN, MARYLAND



ENTIRELY DIFFERENT



# BARGAINS

BUY  
GET



IS THE ONLY BIG  
TABLOID PUBLICATION in  
Existence That Tells You  
WHERE & HOW  
EVERY MONTH

- To Buy Bankrupt, Closeout, Surplus Bargains!
- To Buy at Wholesale!
- Below Wholesale!
- To Buy New & Unusual Items! • To Obtain Details on Rare Money Making Offers!

**Toys, Books, Jewelry, Greeting Cards, Cosmetics, Household Merchandise, Appliances, Industrial Materials, Machinery, Tools, etc.**  
Often as Low as 10c-25c on the Retail Dollar!!

ONE issue of this Sensational NEW publication can save you MORE MONEY than the cost of the entire subscription! You can BUY BETTER, CHEAPER, NEWER THINGS EVERY MONTH OF THE YEAR! You absolutely need every single issue of BARGAINS in order to get the MOST FROM EVERY PENNY YOU SPEND. Each issue carries HUNDREDS of bargain offers — many times SO EXTRAORDINARY that it's hard to believe that they're GENUINE! Buying at WHOLESALE, BANKRUPT, SURPLUS, CLOSEOUT PRICES can save you from 40c to 80c or more on every dollar you spend! THIS MAY BE HARD TO BELIEVE, BUT IT'S THE TRUTH!

### Make FANTASTIC PROFITS Buying Up Bargain Merchandise CHEAP and Selling It CHEAP

Thousands of Salesmen, Dealers subscribe to "BARGAINS." They want to know where to buy BEST in order to sell at low prices for BIG PROFITS. NO REASON why you CAN'T DO THE SAME! Special articles in BARGAINS give you valuable tips on HOW to sell these bargains for BIG PROFITS.

### Unique "Subscribers Shopping Service" Enables You to Buy Big Name Merchandise at TREMENDOUS SAVINGS

You won't find this feature in ANY OTHER MAGAZINE. ONLY "BARGAINS." For subscribers, each month it negotiates bargain offers in famous merchandise at LOW WHOLESALE PRICES and then offers them to subscribers AT NO PROFIT! Enables you to buy in small lots— singly or in quantity at the same prices (sometimes lower) that dealers pay! This SINGLE FEATURE OF BARGAINS IS WORTH THE LOW SUBSCRIPTION PRICE A DOZEN TIMES OVER.

### ONLY Publication of Its Kind!

Search your newsstand high and low. You won't find another publication like it! BARGAINS is available by subscription ONLY. Read the glowing letters by subscribers who WERE AMAZED by this sensational publication!

### SAVE Up to \$1,000 — EARN Up to \$3,000

We honestly believe that it's possible to SAVE up to \$1,000 — and EARN up to \$3,000 within a year by reading "BARGAINS" EVERY MONTH! WHY NOT PROVE THIS FOR YOURSELF? Your subscription automatically includes the BIG 1957 CHRISTMAS SPECIAL ISSUE . . . jam full of terrific, eye-opening holiday BARGAINS!

### NEW! List of Terrific Foreign Bargains!

Every issue — news about wholesale foreign merchandise buys you can make direct! Also news of foreign exporters, mfgs., looking for U. S. agents!

### \$2.00 Per Year — 12 Big Issues

(Regular price \$3.00 per Year)  
Special Limited Time Offer to Get 10,000 New Subscribers!

# FREE DIRECTORY

100,000 ITEMS  
WHERE TO

## BUY-IT-WHOLESALE

- Lists HUNDREDS of Sources for WHOLESALE Bargains!
- Lists HUNDREDS of Surplus, CLOSEOUT, BARGAIN offers!
- Special lists of WHOLESALE, CLOSEOUT JOBBERS! This Directory, being sold everywhere for \$1.00 per copy, is yours free with your 1 year subscription to "Bargains!"



BIG  
1957 EDITION

## Here's a FEW Samples of the Bargains Usually Found in "BARGAINS"

- PENCILS, 57 1/2c per Gross!
- 25c Rudolph the Reindeer Brooches, 2c each!
- Plastic Toy GUNS, 2c each!
- \$1 Mufflers, Scarfs, 12 1/2c each!
- Double edge razor blades, \$1.50 per 1000!
- LADIES APRONS, 6 1/4c each!
- \$2.50 WALLET, 30c each!
- \$1 val. BILLFOLDS, 15c each!
- \$1 Kiddies handbags, 3c each!
- CIGARETTE HOLDERS, 1c each!
- BUTTONS, 144 for 25c!
- NEW phono records, 78 & 45 r.p.m., 7c each!
- 69c Insect Repellent, 5c each!
- New 20" T.V. Pic. tubes, \$21.95 each!
- Famous brand \$18.75 perfume, \$1 each!
- 49c Xmas window decorations, 10c per set!
- \$1-\$3 Hard cover books, 20c each!
- \$200.00 Surplus typewriters, \$23.00 each!
- 50c Everyday greeting cards, 7c per box!
- \$1.95 Men's Silk Ties, 12 1/2c each!
- \$1 val. personal cloth name tapes, 40c for 72!
- 39c Under arm deodorant, 2c jar!
- \$1 Automatic card shufflers, 9c each!
- NEW HAIRNETS, 1/2c each!
- \$15.00 Electric Percolators, \$5.00 each!
- \$1.95 Rudolph Reindeer kiddies toiletry sets, 35c each!
- \$5.50 Lucite Hairbrushes, 65c each!
- New Bobby Pins, 70c per 700 pins!
- \$10 Men's Toiletry Sets, 60c each!
- Calendar Wrist Watches, \$5 each!
- Christmas Seals, 25c per 1000!
- \$2.98 Horse race game records, 30c each!

### PLUS HUNDREDS OF OTHER SENSATIONAL BUYS!

(Above list merely illustrates type of bargains usually found in this paper. Lists naturally change from month to month.)

### DON'T Take Our Word For it — Here's What Subscribers Say About "BARGAINS"!

" . . . Received my 1st issue and may I say IT IS A GREAT MAGAZINE." — M. C., Ark.

" . . . I am very pleased with BARGAINS. I have never seen anything like it." — Mrs. D. M., Maine.

" . . . Just received my 1st copy of "Bargains" and believe me, it is all that you claimed it to be." — T. A., N. Y.

" . . . I was the recipient of my 1st copy a few days ago. I am completely satisfied with the periodical. I also wish to express my appreciation to you for having made the magazine available to me. I shall be pleased to continue my subscription as long as the magazine is available." — W. S., Wash.

Every One OF THESE LETTERS ARE IN OUR FILES & WERE NOT SOLICITED IN ANY WAY OR MANNER!

### Your Money Back IN FULL if the First Issue Doesn't Please You!

LET'S FACE IT . . . Claims, promises are easily made on paper. Can you go wrong in subscribing on this iron-clad MONEY BACK GUARANTEE . . . Your money back in FULL if the first issue that you receive doesn't please you! Can any offer be more POSITIVE, more FAIR than this POWERFUL guarantee?

TOWER PRESS, INC., P.O. Box 591, Lynn, 846, Mass.

TOWER PRESS, INC., P.O. Box 591, Lynn, 846, Mass.

O.K. Here's my \$2.00 for 1 year subscription. Rush me 1st copy! Also my copy of the Free "Buy It Wholesale" guide.

Name \_\_\_\_\_

Address \_\_\_\_\_

City \_\_\_\_\_ State \_\_\_\_\_

Remember, Your Money Back IN FULL if the 1st issue you receive doesn't please you!

# TRAINED MEN NEEDED!

**IN INDUSTRY—ARMED FORCES  
BIG PAY!—GOOD FUTURE!**

- DIESEL                       ELECTRONICS  
 AUTO                          AUTOMATION

NEVER BEFORE has the opportunity been so good for the properly trained mechanic and technician to step into **BIG PAY POSITIONS** with rapid advancement and future security virtually assured.

**YOUR SUCCESS** depends on the quality of training you receive... and the reputation of the school you attend.

**YOUR GUARANTEE** we are giving the best in mechanical and technical training is proved by the fact... High pay jobs in Industry, and ratings in the Armed Forces now waiting for our graduates.

**RESIDENT SHOP TRAINING** is easier and costs less than you may think! We provide you with housing and part-time jobs while in school, plus free nation-wide placement service for graduates.

Check subject above in which you are interested and mail for

FREE BOOKLET

**BAILEY**  
**Technical Schools**

Veteran Approved

1634 S. Grand, St. Louis 4, Mo.

Name \_\_\_\_\_ Age \_\_\_\_\_  
Street \_\_\_\_\_  
Town \_\_\_\_\_ Zone \_\_\_\_\_ State \_\_\_\_\_

Your Future  
IN  
ELECTRONICS  
AND  
AUTOMATION

Your Future  
IN  
DIESEL and  
AUTO  
MECHANICS

## NEVER AT THIS LOW PRICE! GENUINE 135-POWER ACHROMATIC TELESCOPE

with Achromatic Lens and  
4-POWER FINDER attached

**ONLY \$1895**  
PREPAID

### EXTRA BONUS GIFTS:

- 273 page book, "Handbook of the Heavens"
- Magic Star Finder Dial
- 220X & 400X Eyepiece lenses



**5 Magnifications 18X—35X—65X—85X—135X**  
Brings the Moon, Planets, Stars, People  
135 times Closer, Clearer, Sharper

Never before has an ACHROMATIC 135X telescope with range finder and tripod sold for anywhere near this amazing low price! Now you can not only explore the heavens and bring the moon, planets, stars 135 times closer, but you can observe all distant objects, people, ships too, because all pictures are erect, not upside down as in all astronomical telescopes. The kind of needle-sharp color-free viewing only a genuine achromatic lens can bring you. Ready for immediate use, 5 precision lenses bring you viewing at 18X—35X—65X—85X—135X. Tubes extend to 43" made of bakelite, finished in camera bellows black, trimmed with gleaming brass. 4 power finder scope (30mm Lens) mounted on main tube is feature usually found on more expensive telescopes—brings difficult objects on target before observing with main scope. For extra stability 5 ft. hardwood folding tripod is equipped with heavy cast iron head fitted with Criterion's famous 360 degree all aluminum mount that locks instantly in any position. Obtainable only from Criterion Co. shipped prepaid. 4 famous gifts—273 page book "Handbook of the Heavens." Magic star finder dial that aids in locating stars ANYWHERE at ANYTIME of the year. 220X & 400X eyepiece lenses included free for experiments. You must be completely satisfied with this super offer or your money back in full. Shipped Complete, nothing else to buy at amazingly low price of **\$18.95**. Without tripod **\$14.95**.

Send Cash, Check, or Money Order today  
Dept. PMA17, CRITERION CO., 331 Church St., Hartford, Conn.

24 YEARS IN BUSINESS AT THE SAME ADDRESS.

NEARLY EVERYONE BUYS FROM STANDARD.

"We Have No Rent to Pay." That is Why We Can Sell For Less.



Our entire stock of very slightly worn  
**EXTRA MILEAGE TOP GRADE Tires**  
(Written Insurance Guarantee). SEND AD  
**EVERYBODY 10% off ON EVERY  
MAY DEDUCT TIRE**

Free—Tube  
With Each  
Passenger  
Tire

**FREE** If you buy 2 or more Passenger 4-ply tires, WE GIVE ONE  
tire FREE, on each order. Does not include W.W. or Truck  
Tires, or Snow Tires. Write for other sizes.

12 MOS. WRITTEN GUARANTEE WITH EVERY TIRE			
600-16 (G)	\$6.62	800-15	\$6.32
650-16 (G)	7.22	820-15	6.32
670-15	5.52	700-15 (B)	6.72
710-15	5.82	750-16 (B)	9.92
760-15	5.82	750-14	11.82
		700-17	\$10.92
		750-17	11.32
		700-20	11.82
		750-20 (B)	12.82
		750-20 (G)	15.97
		825-20	\$19.52
		900-20	19.52
		1000-20	19.52
		1100-20	20.52
		1000-22	21.52

"EXTRA SPECIAL" TOP GRADE—all size 4-ply pass.  
tires with more TREAD for LONGER WEAR. FAC-  
TORY TESTED TUBE GIVEN—W.W. \$1.00 EXTRA. **\$8.72**

**SNOW TIRES \$8.82** ORDER ANY 4 PLY  
12 MO. GUAR. BLACK WALL  
PASSENGER SIZE

DEEP HEAVY TREAD FOR ROUGH WINTER WEAR.  
Thousands of tires shipped all over the U.S.A. All tires shipped  
F.O.B. Phila. Send Check or M.O. with this ad. Dept. 2, No C.O.D.

**STANDARD** 834 N. Broad St., Philadelphia 30, Pa.

## "How to Make Money with Simple Cartoons"



A book everyone who likes to draw  
should have. It is free; no  
obligation. Simply address

FREE  
BOOK

**CARTOONISTS' EXCHANGE**

Dept. 910-D Pleasant Hill, Ohio

## FREE GERMAN HUNTING KNIFE



4-INCH BLADE

We give you handiest hunting and fishing knife you've ever had!  
Has 4-INCH LONG highly tempered steel blade—VERY SHARP!  
Attractive handle. We send knife FREE to acquaint you with our  
below-wholesale bargains. Please send 25c for handling. NO  
LIMIT—but send 25c handling for each knife. Order TODAY!  
**HUNTING KNIFE, Dept. K-271, Box 881, St. Louis, Mo.**



## Exclusive Double-Bearing HEAVY-DUTY PUMPS

IRRIGATE • DRAIN • CIRCULATE • SPRAY

Up to 7,500 GPM, 2,000 GPM from 25" well. Use 1/2

to 1 HP motor, 1 1/4" inlet, 1" outlet, stainless shaft.

TYPE X—2 oilless bronze bearings. **\$10.95**

Won't rust. . . . .

TYPE XB—Ball bearing model. . . . . **\$12.95**

Postpaid if cash with order. Rush your order today

**MONEY BACK GUARANTEE**

Centrifugal and Gear Pumps in All Sizes

**LABAWCO PUMPS, Belle Mead 2, N. J.**

## FREE!



Last chance for **FREE SAMPLE**  
of Ply-Craft shapes that make  
life-like 3-D models of Birds  
and Dogs. Glue and sandpaper  
included. No Tools Needed.  
Looks as if handcarved from a  
Solid Block. Send 25c to cover  
postage and handling. Or send  
\$1.00 for 4 models and get  
4 models FREE. All different.  
For Children and Grown-Ups.  
**ZENITH CORP., Dept. 63**  
Queens Village 29, New York

## MAKE STRIPES with new PAINT PEN



Single  
1/16"  
stripe  
model  
**\$1.25**

**Straight, curved, single or double**  
With any color paint, stripe furniture, bikes,  
autos, model planes, toys, linoleum, wall-  
board. Clean, crisp decorative lines. Can't  
clog or smear. Also use with glue, tempera,  
textile paint or underglaze... on wood, glass,  
plastic, ceramics, metals, fabrics and paper.

Ask your dealer or order direct.  
**DEALERS** Master paint  
stripping tool  
in display  
carton. Write  
for discounts.  
**HOBBY** "Professional"  
results every  
time. Simple,  
easy to use.  
Order now.  
**MFRS** Ask about  
heavy duty  
industrial  
stripping  
tools.

**DOUBLE STRIPE MODEL \$3.25**  
5 COMBINATIONS. . . .

**WENDELL MFG. CO.**

4234 LINCOLN AVE., Dept. 334  
CHICAGO 18, ILLINOIS

**Complete Kit \$5.00**  
(all 7 tips)

**Extra tips 90c ea.**

Extra 1/4" tip...\$1.20

NOW IT'S **EASY** TO LEARN...

# DRAFTING

AT HOME - QUICKLY - IN YOUR SPARE TIME

**MECHANICAL**

**AERONAUTICAL**

**HERE'S YOUR CHANCE!** No matter where you live... no matter what your present job is, you too can soon be cashing big pay checks and enjoying an assured future in drafting! Never before has there been such a demand for trained draftsmen... the key men in all industry. No profession has a brighter future! Draftsmen get top pay... are in line for promotion to executive positions.

**NO EXPERIENCE NEEDED!** The Cleveland Engineering Institute Courses are the most modern, practical, thorough, drafting courses available. They are fully illustrated; prepared especially for Home Study. If you can read this ad, you can learn drafting under C.E.I.'s guidance. Ours is a tested, proven, up-to-date course that has helped thousands of others on the road to success (many of them with only grammar school training.)

**EARN WHILE YOU LEARN!** Keep your present job while learning drafting at home in your spare time at the speed that

is best for YOU. Many students, as they advance, earn extra money by doing part-time drafting. Many graduates earn more in a single week, as draftsmen, than the entire cost of the course.

**FREE! AFTER YOU GRADUATE, 50 HOURS OF EXTRA TRAINING AT THE INSTITUTE IN CLEVELAND.** This post-graduate training is optional.

**WE HELP YOU GET THAT JOB!** After you have graduated, C.E.I. will help you find a position. Our Job-Finding-Service is the only one of its kind offered by a Home Study School.

**WHAT CAN DRAFTING OFFER YOU?** Find out how a C.E.I. DIPLOMA can bring you a better life--more security--the respect of your employer and people in your community. Without obligating yourself in any way, write for the Cleveland Engineering Institute Success-Book and a Sample Lesson FREE. Industry needs men of action! This means You. MAIL THE COUPON RIGHT NOW!

**VETERAN APPROVED**



**COMPLETE PROFESSIONAL EQUIPMENT.** At no extra cost, C.E.I. will supply you with everything you need--including a slide rule, tools and imported, quality drafting set. Drawing pencils, paper, everything is furnished! There is nothing else to buy!

**FREE LESSON AND SUCCESS BOOK**

**SAMPLE LESSON**

**SUCCESS BOOK**

You Too, Can Have:

**MORE MONEY**

**PROFESSIONAL RATING**

**BIG PAY JOBS**

**BRIGHT FUTURE**

**JOB SECURITY**

**SUCCESS**

**EARNS \$820 MONTH**

"My first position after completing C.E.I.'s course jumped my income from \$350 up \$820 per month."



G. T. Wiseman, Tennessee

**NOW FOREMAN**

"Shortly after completing the C.E.I. course I was made Shop Foreman with a 50 per cent increase in salary."



Wm. Reichers, New York

**BIG PROMOTION**

"I was promoted from the production line ahead of four other men and got a good pay increase after finishing the C.E.I. course."



W. K. Andersen, Wisc.

**GOOD START**

"The drafting job which I got with your assistance is going very good. The C.E.I. Mechanical Drafting Course has given me a real start."



R. Eisenbart, Wisc.

**BIG FUTURE**

"I have been transferred to the Mech. Eng. dept. as a Mechanical Engr. Trainee. C.E.I. has given me a big push towards future success."



R. Hodge, Netherlands Indies

**MAIL COUPON NOW!**

**CLEVELAND ENGINEERING INST., DEPT. PM10G**  
6300 Euclid Ave. Cleveland 3, Ohio

Please RUSH my Free Success Book and Sample Drafting Lesson in  Aeronautical  Mechanical

My Name ..... Age .....

Address .....

City ..... Zone ..... State .....



**CLEVELAND ENGINEERING INSTITUTE**  
ENGINEERING DRAFTING EXCLUSIVELY

# Just Pick the Kind of Body YOU Want

## CHECK THE COUPON BELOW

...Prove to Yourself How EASILY You Can Have It...Almost Overnight!



Just tell me, in coupon below, the kind of body you want—and I'll give it to you SO FAST your friends will be amazed! "Dynamic Tension," my easy, 15-minutes-a-day method, can make your chest and shoulders bulge . . . your arms and legs surge with power . . . your whole body feel "alive!"

### FREE 32-page Illustrated Book

32 pages on how "Dynamic Tension" changed me from a 97-lb. weakling into "World's Most Perfectly Developed Man"—and what it has done for others. Mail coupon NOW! Charles Atlas, Dept. 8-K, 115 E. 23rd St., N. Y. City 10.



CHARLES ATLAS, Dept. 8-K,  
115 East 23rd St., New York 10, N. Y.

Dear Charles Atlas—Here's the Kind of Body I Want:  
(Check as many as you like)

- |   |   |
|---|---|
| <input type="checkbox"/> Slimmer Waist, Hips      | <input type="checkbox"/> More Powerful Arms, Grip |
| <input type="checkbox"/> Broader Chest, Shoulders | <input type="checkbox"/> More Powerful Legs       |
| <input type="checkbox"/> More Weight, Solid       | <input type="checkbox"/> Better Energy, Sleep     |

Send me, absolutely FREE, a copy of your famous book showing how "Dynamic Tension" can make me a new man. 32 pages, crammed with photographs, answers to vital questions, and valuable advice. No obligation.

Name \_\_\_\_\_ Age \_\_\_\_\_

(Please Print or write plainly)

Address \_\_\_\_\_

City \_\_\_\_\_ State \_\_\_\_\_

## FREE! BRITISH ROYAL FAMILY STAMPS

other big offers!



Rush coupon below at once! Here's a once-in-a-lifetime, generous collection of scarce Royal Family stamps — beautiful, exciting stamps from the days of Queen Victoria to the present reign of popular Queen Elizabeth II. This rare offer includes George VI's Coronation, Edward VII and VIII, George V's Silver Jubilee, 3 Royal Visits to the far corners of the Empire and many others — all genuine, all different.

Also, free copy of helpful "Stamp Collector's Guide" plus free color reproduction and story of the World's Rarest Stamp. Other valuable offers included for your free inspection. Offer may be withdrawn soon, so rush coupon today! If coupon is clipped, write direct for big offer to GARCELON STAMP CO., Dept. PM10R, Calais, Maine

GARCELON STAMP CO., Dept. PM10R, Calais, Maine  
Rush FREE Royal Family Stamps and other offers. (PLEASE PRINT)

Name \_\_\_\_\_

Address \_\_\_\_\_

City \_\_\_\_\_ State \_\_\_\_\_

# TRAVEL FOR "UNCLE SAM"!

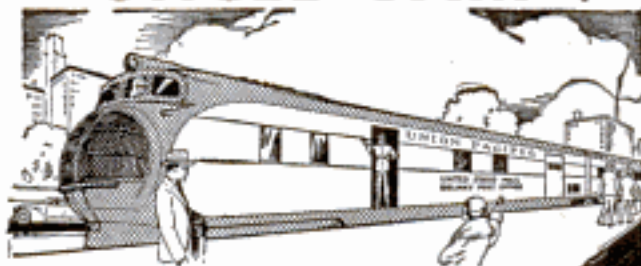

### PREPARE NOW FOR NEXT EXAMS

Many Postal Appointments to be made. MEN—WOMEN. Write immediately for free 36-page book, with list of many positions. It tells how to prepare for one of these tests.

FRANKLIN INSTITUTE (Not Gov't Sponsored)  
Dept. M-93 Rochester 4, N. Y.

**IT'S EASY . . .**  
**MAKE MONEY IN PHOTOGRAPHY**  
If you are over 17—good pay and fascinating work await you in photography! Start making money quickly in sparetime—step into your own studio or exciting career job. LEARN-BY-DOING method trains you at home! Write TODAY for FREE catalog. Also Resident Training. Co-ed. 47th Year. Approved for Veterans.  
**NEW YORK INSTITUTE OF PHOTOGRAPHY**  
Dept. 49, 10 West 33 Street, New York 1, New York  
**47th YEAR**

## Catalog of 3100 Novelties 10c

Send 10c for amazing catalog of novelties, live animals, scientific supplies, hobbies, funmakers, planes & boats, looms, magic tricks, joke articles, unusual seeds, gadget time-savers, cameras, optical goods, projectors, movies, lucky jewelry, religious novelties, disguises, musical instruments, stamps, coins, puzzles, fortune tellers, radios, auto & bike accessories, telescopes, magnifiers, compasses, banks, smokers' gadgets, artists' supplies, printing sets, engines, motors, shockers, knives, billfolds, guns, rifles, sports, books, games, plants, etc. Send 10c (3 for 25c—get for friends!).  
JOHNSON SMITH & CO. Dept. 430 Detroit 7, Michigan

## New Way to Improve YOUR ENGLISH

A command of effective English gives you added advantages and better opportunities. Poor English handicaps you more than you will ever realize. You can improve your English through Sherwin Cody's 100% self-correcting invention, **FREE BOOK**. If you are ever embarrassed by mistakes in grammar, spelling, punctuation, or pronunciation, this new free book "How You Can Master Good English in 15 Minutes a Day" will prove a revelation to you. Send for it now. It is free. No obligation. No salesman will call. Address **SHERWIN CODY COURSE IN ENGLISH**, 5810 Central Drive, Port Washington, N. Y.

## BECOME AN EXPERT IN TRAFFIC and TRANSPORTATION

Traffic men earn \$4,000 to \$10,000 and up. Thousands of firms need experts on rates, tariffs, regulations. We train you thoroughly in spare time at home for executive traffic jobs. Personal training under traffic authorities. Write for free book "Traffic and Transportation."

LASALLE Extension University, 417 So. Dearborn St.  
A Correspondence Institution Dept. 1064-Y, Chicago 5, Ill.

## Million Dollar Inventory — All Famous Brands

**TIRE SALE**  
**AT LESS THAN WHOLESALE!**  
SAVINGS NEVER LESS THAN 50% UP TO 70% OFF REGULAR PRICES  
➔ SEND FOR YOUR FREE CATALOG! ➔  
**RELIABLE TIRE CO.** • 728 MORGAN BLVD. CAMDEN 4, N. J.

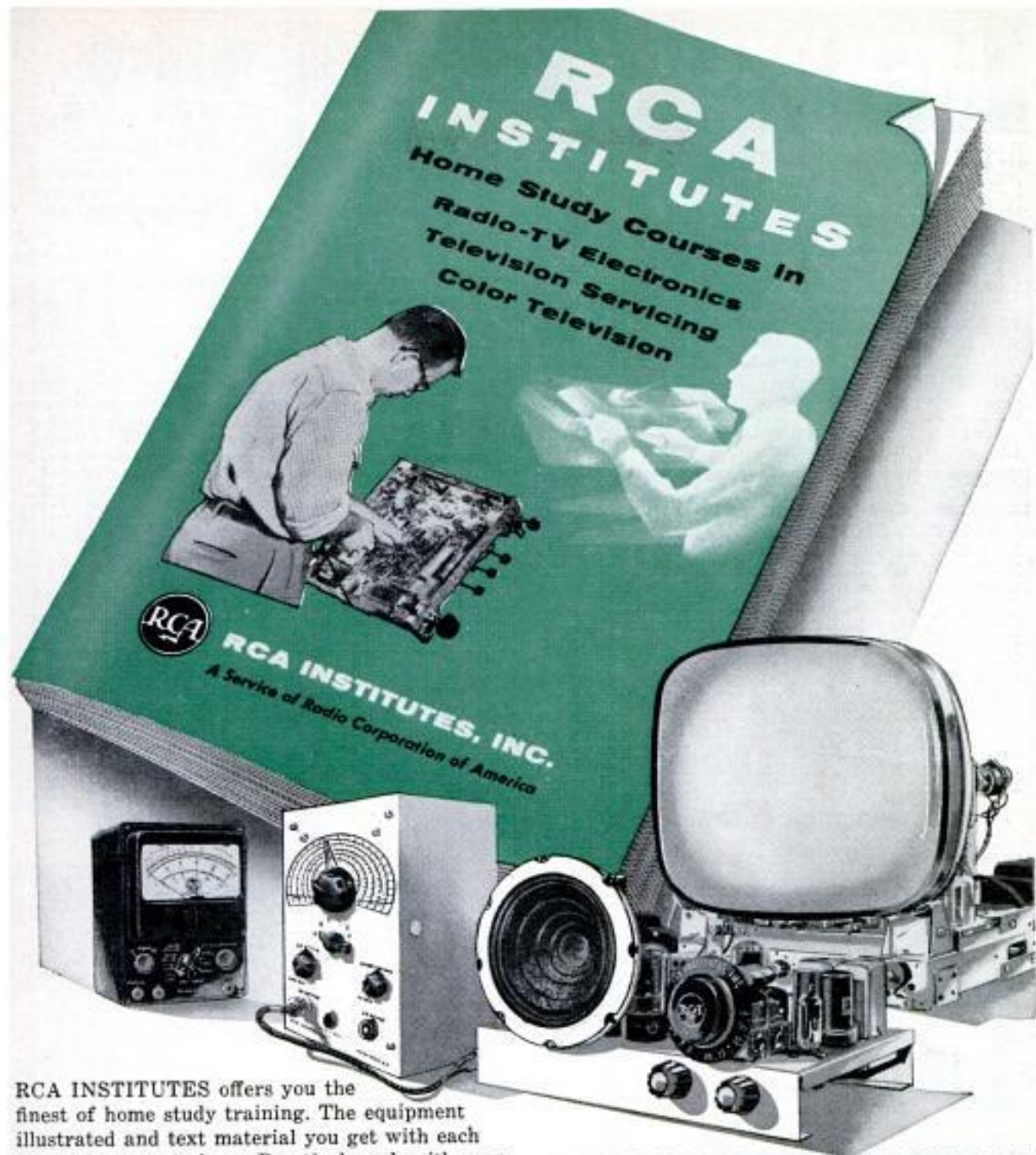

RCA INSTITUTES offers you the finest of home study training. The equipment illustrated and text material you get with each course is yours to keep. Practical work with very first lesson. Courses for the beginner and the advanced student. Pay-as-you-learn. You need pay for only one study group at a time.

**Send for this  
FREE Book Now** 

[ RESIDENT SCHOOL courses in New York City offer comprehensive training in Television and Electronics. Day and evening classes start four times each year. Detailed information on request. ]

**RCA INSTITUTES, Inc. Home Study x PM-107**

350 West Fourth Street, New York 14, N. Y.

Without obligation, send me FREE 52 page CATALOG on Home Study Courses in Radio, Television and Color TV. No salesman will call.

Name ..... please print

Address .....

City ..... Zone ..... State .....

KOREAN VETS! Enter discharge date .....

In Canada—RCA Victor Co., Ltd., 5001 Cote de Liesse Rd., Montreal 9, Que.  
To save time, paste coupon on postcard.

# MEN PAST 40

**Afflicted With Getting Up Nights,  
Pains in Back, Hips, Legs,  
Nervousness, Tiredness.**

If you are a victim of the above symptoms, the trouble may be due to Glandular Dysfunction. A constitutional Disease for which it is futile for sufferers to try to treat themselves at home. Medicines that give temporary relief will not remove the cause of your trouble.

Most men, if treatment is taken before malignancy has developed, can be successfully **NON-SURGICALLY** treated for Glandular Dysfunction. If the condition is aggravated by lack of treatment, surgery may be the only chance.

## NON-SURGICAL TREATMENTS

The **NON-SURGICAL** treatments afforded at the Excelsior Institute are the result of 20 years research by scientific Technologists and Competent Doctors.

The War brought many new techniques and drugs. These added to the research already accomplished has produced a new type of treatment that is proving of great benefit to man as he advances in years.

The Excelsior Institute is devoted particularly to the treatment of diseases of men of advancing years. Men from all walks of life and from over 3,000 cities and towns have been successfully treated. They found soothing and comforting relief and a new health in life.

### EXAMINATION AT LOW COST

On your arrival here, our Doctors who are experienced specialists, make a complete examination. Your condition is frankly explained to you with the cost of treatment you need. Your decision is then made. Treatments are so mild that hospitalization is not necessary — a big saving in expense.

**RECTAL-COLON** Troubles are often associated with Glandular Dysfunction. We can treat these for you at the same time.

# FREE ILLUSTRATED BOOK

The Excelsior Institute has published a New **FREE** Book that deals with Diseases peculiar to men. It could prove of utmost importance to your future life.

Write today. No obligation.



**Excelsior Institute  
Dept. B-975  
Excelsior Springs, Mo.**

Gentlemen: Kindly send me at once your New **FREE** Book on Diseases peculiar to men. I am.....years old.

Name.....  
Address.....  
City.....State.....

**WAR SURPLUS BARGAINS**

STARK'S

## WAR SURPLUS BARGAINS

**\$500,000.00 INVENTORY for QUICK LIQUIDATION**

Surplus items—hundreds of them for home, shop, factory, farm and outdoor use. New items, used items, reconditioned items—all at tremendous savings—all priced for quick sale.

**Page After Page of Values**

This big catalog shows page after page of amazing money saving values. Write for your copy today. Send 10c to cover postage, mailing, etc. Write today! **SEND TODAY FOR YOUR COPY**

# 10c

**STARK'S** 212 W. Madison St.  
Dept. PW-5710  
CHICAGO 6, ILL.

## REAL DIAMOND RINGS

**Sell Direct—Make Big Middleman's Profit With NATIONALLY ADVERTISED Gleamlight Rings**  
No Investment—No Experience Needed

Most exciting new sales presentation beats all competition. Without cost, you get the equivalent of a \$15,000 display. Large stock of top value genuine diamonds—the entire output of our cutting plant—backs you up. Amazing new sales aid, leaflets, and money back guarantee of satisfaction mean many sales, big extra income for you. Write today for free catalog, details.

**14K Gold BRIDAL SET**

With 11 fine quality genuine diamonds weighing one carat. Retail \$600.00; your cost \$230.00. Other 14K gold rings from \$2.65.

**GLEAMLIGHT, 111 No. Columbus Ave., Dept. M-3, Mt. Vernon, N.Y.**

**Mr. "N" Made \$9,700 Last Year By Selling Just 20 KEEP/SAFES a Month!**

Like Mr. "N" you can profit with **KEEP/SAFE**—the fine personal safe that undersells all others. Only safe sold direct. 95% of homes, farms and small businesses are prospects. \$30 to \$71 profit per sale, plus bonuses up to \$12 a safe. Choice territory, chance to become district agent. **FREE DEMONSTRATOR!** Get details, giving address including county.

**JOHN D. BRUSH & CO., INC.**  
575 West Ave. Rochester 11, N. Y.

## MECHANICAL DENTISTRY

To make Crowns, Plates, Bridgework, etc., for Dentists. Easy practical way to learn mechanical dentistry at home in spare time. **FULL EQUIPMENT OF TOOLS AND MATERIALS INCLUDED WITH COURSE.** Low tuition. Easy terms. Write for **FREE BOOK** about this money making profession that is not affected by machine age.

**McCARRIE SCHOOL OF MECHANICAL DENTISTRY**  
207 N. Broad St., Dept. 70, Philadelphia 7, Pa.

### Rubber Stamp Press Outfits Stamp Making Supplies

A profitable home or sideline business mfg. rubber stamps. Stamp Press and all supplies. **FREE** catalog, advice, instruction. Permanent and profitable business. **WRITE TODAY!** Full details!

**CUSTOM MANUFACTURING**  
601-A NO. JEFFERSON, SPRINGFIELD, MO.

## \$8,750 FIRST YEAR... IN YOUR OWN BUSINESS

**Start Part Time... We Furnish Everything**

Build your own lifetime business. We personally train you in your town, furnish all equipment and supplies to clean and mothproof **both** rugs and upholstery **in the home** by world-wide process. Quickly established. No shop needed. Just 2 average jobs a day bring \$8,750.00 NET profit in year. Employ others and **multiply** your earnings. You receive National Advertising, 25 other regular services. Business grows fast due to recommendations, repeat jobs. First in field awarded Parents' Magazine Seal. Easy terms. Send for **FREE** booklet **now**.

**DURACLEAN CO., 7-160 Duraclean Bldg., Deerfield, Ill.**

# For the millions who want to share in Florida's Future



Mr. and Mrs. Frederick Entress, formerly of Hartford, Conn., relax on Port Charlotte's beach. Mr. Entress says "Port Charlotte appealed to us at once and we got such wonderful treatment from the Mackle's staff we made up our minds to settle here."

If you've lacked the time, money and experience to purchase land in Florida, this may well be the opportunity of your lifetime. It's made possible by the combined effort of the General Development Corporation, leading property owner—and the 50 year old Mackle Company, Florida's foremost builder and developer.

## \$10 DOWN, \$10 A MONTH—TOTAL \$795

Remember, this price gives you a full size 80 x 125' lot. No assessments, no extra charges. Just \$10 a month (which includes 5% interest) mere cigarette money you'll never miss. No need to dig into savings. Just by setting aside \$10 a month you can own land in this prosperous growing part of your country.

**Own it, Build on it, Sell it.** Under the Mackle Plan you can easily finance the ownership of land which, in the estimation of Florida's most experienced developers, offers the best promise for increase in land values. You get the benefit of lower prices thanks to the largest-scale operation of its kind.

After two years, Port Charlotte is ready. Areas are developed, homes are up; streets paved and

The Mackle Plan makes it easy to buy land today where Florida's future is brightest...

## PORT CHARLOTTE



If you searched for the choicest section of Florida for investment, vacation or retirement—you'd select Port Charlotte on Florida's Southwest Coast. This is high, dry land, delightful all year 'round with an average annual temperature of 71 degrees. 28 miles of frontage on U.S. 41. Over 40 miles of scenic waterfront; sandy beaches for residents' use; unsurpassed fishing, boating—direct access to Gulf of Mexico.

graded, stores and motels open for business and signs of brisk growth are seen everywhere. Clip the coupon below today!

### No Risk Money-Back Guarantee

The important thing is to secure your property by sending in your \$10 now.

You have 30 full days to decide whether you want to go ahead. If for any reason you change your mind, full deposit will be refunded at your request.

Copyright 1957 by the General Development Corp.



Inquire about the Port Charlotte Division at Florida State Chamber of Commerce, Jacksonville, Florida • Chamber of Commerce, Miami, Florida • Chamber of Commerce, Punta Gorda, Florida.

Port Charlotte Division, General Development Corp.  
P. O. Box 465, Miami 45, Florida

Dept. M1411

Please reserve \_\_\_\_\_ (fill in number desired) lots (each 80 x 125 ft.) I enclose \$10. payment on each. Rush map showing location. My deposit will be returned promptly and without question if I notify you within 30 days. (Please print name exactly as you want it on contract)

NAME \_\_\_\_\_

ADDRESS \_\_\_\_\_

CITY \_\_\_\_\_ ZONE \_\_\_\_\_ STATE \_\_\_\_\_

TELEPHONE NUMBER \_\_\_\_\_

# I have good news for every man who would like to start a little home business of his own

By Don Warner

If you will send me your name, I will tell you about an unusual kind of business that you can start right now—in your own home—in your spare time—without a bit of previous experience.



I will tell you about a little table top machine so small that it takes up only two square feet of space. Yet this "miracle machine" can start making money for you the very first day. Material that costs only 27c turns out a product that sells for \$1.80. Working full capacity, the machine can earn for

you as much as \$9.20 in one hour. Yet it is so simple and easy to operate that a schoolboy can turn out professional work with half an hour's practice.

Send me your name right away and I will rush full particulars by return mail. You pay nothing for this information now or any other time. Read the facts in the privacy of your own home. Then decide what you want to do. No salesman will call to try to sell you anything. Mail the coupon now—or just send a postcard with your name, address. You will hear from me promptly.

**DON WARNER, Suite R2L, 1512 Jarvis Ave., Chicago 26, Ill.**

**DON WARNER, Suite R2L, 1512 Jarvis Ave., Chicago 26, Ill.**

Dear Mr. Warner: Please mail full particulars about how I can get started in a profitable business of my own at home in spare time. Everything you send me is free and it is understood that no salesman will call.

NAME.....  
 ADDRESS.....  
 CITY.....ZONE.....STATE.....

## 250 POWER . . . . .



Complete Telescope Lens Kit **only \$3.49** postpaid

Conquer Space. Explore the Universe. Planets. Moon Craters. New Stars, etc. Complete Lens Kit consists of 80 inch focal length ground and polished objective lens, eyepiece lenses for 50 POWER, 100 POWER, 150 POWER, 200 POWER, 250 POWER, and all necessary lens fittings. Easy to make from simple step by step instructions. (Tripod and mount not included.) Money back guarantee.

**BUSSE SALES CO., Hartford, Conn., Dept. PM 62**

## NEW MODEL 400 SIMPLEX LAWNMOWER SHARPENER

### Many Exclusive Features

The NEW SIMPLEX is the fastest, most accurate straight-line lawnmower grinder ever built . . . gives you all these advantages:

- Grinds all mowments—real type, rotary, hand or power, any size.
- No dis-assembly needed, gas and oil remain in engine, support bar rotates.
- Grinding head feeds both horizontally and vertically, turns 90° for bed knives.
- Fast, positive adjustments, 4-point support on steel base with leveling struts.
- Rugged, long life construction and many other features.

Get the facts on the new SIMPLEX 400 before you buy any sharpener. Send for free brochure today



Small investment returns big profits!

**The Fate-Root-Heath Company**  
 Dept. PM-10 • Plymouth, Ohio

# INVENTORS

PROTECT YOUR INVENTION BY A U. S. PATENT. SEND FOR FREE "INVENTION RECORD" FORM AND "PATENT INFORMATION EVERY INVENTOR SHOULD HAVE."

**CARL MILLER**  
 REGISTERED PATENT ATTORNEY

WOOLWORTH BLDG., 36th FLOOR, 107A  
 NEW YORK CITY

# INVENTORS

Whether an invention is patentable can be substantially determined by a search of the U. S. Patent records. Without obligation, write for information explaining the steps you should take to secure a patent.

**JOHN N. RANDOLPH**  
 Registered Patent Attorney

201 Columbian Building, Washington 1, D. C.

# INVENTORS

Send for PATENT INFORMATION Book and INVENTOR'S RECORD without obligation

**GUSTAVE MILLER**  
 107-PM WARNER BUILDING  
 WASHINGTON 4, D. C.

REGISTERED PATENT ATTORNEY

ASSOCIATE EXAMINER  
 U. S. PAT. OFF. 1922-1929  
 Patent Attorney & Advisor  
 U. S. NAVY DEPT. 1930-1947  
 PATENT LAWYER



# INVENTORS

U. S. Patents protect your inventions. Our free book of "Instructions on Patent Procedure for Inventors," also "Certificate of Invention" form sent without obligation.

**C. A. SNOW & CO.**

REGISTERED PATENT ATTORNEYS  
 428 SNOW BUILDING WASHINGTON 1, D. C.

**GET THE HABIT OF READING OUR CLASSIFIED ADS.**  
 Wonderful Opportunities Amazing Bargains

# INVENTIONS WANTED

If you want to market, or sell, your invention for cash or royalties. Write for our Free Booklet. Send no drawings. We also welcome hearing from firms, or private capital, wishing to review inventions in any field. We will be glad to send notice of our clients' inventions.

**GLOBAL MARKETING SERVICE**  
 2420 77th Ave. Dept. PD Oakland 5, Calif.

# INVENTORS

I shall be pleased to furnish you, upon request, with full information relative to patent procedure—without any obligation on your part.

**PATRICK D. BEAVERS**  
 Registered Patent Attorney

934 Columbian Building Washington 1, D. C.



# For the Best Jobs Be an ALLIED TRAINED MAN



Mr. Harry Lebeson, President  
Allied School of  
Mechanical Trades

Allied's resident school is outstanding for the high quality of its vocational training. People from all over America and even from foreign countries come to Allied. And behind every bit of Allied's home study instruction is the practical know-how that has been made possible by more than a quarter of a century of training thousands of men for good paying jobs.



## MORE JOBS THAN GRADUATES

As an Allied trained man you can go up fast—to higher and still higher pay or as a successful owner of a business. Due to the great present day industrial expansion programs throughout the country, industry has been clamoring for Allied trained men to fill important jobs. Shortages of Draftsmen, Designers, Tool Engineers, Machinists, Air Conditioning, Refrigeration and Heating Technicians are so widespread that you can pick a highly paid key job and look forward to Achievement and Security. You can begin your training in Short Courses at Home or at Allied Institute, and continue progressively toward an Engineering Degree in 26 months.

## Train at Home or in the Great Allied Shops

Allied's training program permits you to study right at home in your spare time or at the Allied Institute's fully equipped shops and laboratories. Free employment service and housing assistance all through your training period and after your graduation. Our industrial contacts cover the U.S.A.



## FREE BOOKS

tell how YOU can become an ALLIED TRAINED MAN. Write TODAY!

**ALLIED School of Mechanical Trades**  
**ALLIED INSTITUTE OF TECHNOLOGY**  
1338-42 South Michigan Avenue  
Dept. PM-10, Chicago 5, Illinois

## ALLIED SCHOOL OF MECHANICAL TRADES

**ALLIED INSTITUTE OF TECHNOLOGY**

1338-42 South Michigan Avenue, Dept. PM-10, Chicago 5, Illinois

Gentlemen: Mail me FREE BOOKS explaining ALLIED'S courses of instruction and FREE SAMPLE lesson.

Vets write date of discharge: \_\_\_\_\_

I am interested in the training I have checked below:  Resident  Home Study

DRAFTING  TOOL & MECHANICAL ENGINEERING  AIR CONDITIONING HEATING and REFRIGERATION

TOOL DESIGNING  MASTER MACHINIST

NAME \_\_\_\_\_

ADDRESS \_\_\_\_\_

CITY \_\_\_\_\_ COUNTY \_\_\_\_\_ STATE \_\_\_\_\_

"The best jobs go to Allied trained men" is a statement so often heard that it is important to you. Your chances for success are naturally greater when you get the best training of its kind available. Allied is approved by industry, National Home Study Council, Central Schools Association, Dept. of Education, Office of Public Instruction, State of Illinois, U. S. Department of Justice. **BE AN ALLIED TRAINED MAN — GET THE FACTS — MAIL COUPON BELOW TODAY!**

- DRAFTING
- TOOL DESIGNING
- TOOL & MECHANICAL ENGINEERING
- MASTER MACHINIST
- AIR CONDITIONING HEATING and REFRIGERATION

# Fateful Warning About Suez Given in Strange 1951 Prophecy

A strange man in Los Angeles known as "The Voice of Two Worlds," is offering, free of charge to the public, an astounding 64-page booklet analyzing famous world prophecies covering these times. Written in 1951, it successfully predicted that the next great world crisis would be at the Suez Canal. It shows that four of the greatest prophecies could not come true until the present time. But now they can, and the years that change the world are at hand. Great dangers but still greater opportunities, confront forward looking people in 1957.

"The Voice of Two Worlds," a well known explorer and geographer, tells of a remarkable system that often leads to almost unbelievable improvement in power of mind, achievement of brilliant business and professional success and new happiness. Others tell of increased bodily strength, magnetic personality, courage and poise.

These strange methods were found in far-off and mysterious Tibet, often called the land of miracles by the few travelers permitted to visit it. He discloses how he learned rare wisdom and long hidden practices, closely guarded for three thousand years by the

sages, which enabled many to perform amazing feats. He maintains that these immense powers are latent in all of us, and that methods for using them are now simplified so that they can be used by almost any person with ordinary intelligence.

The 64-page booklet he is now offering free to the public gives guidance for those who wish to prepare themselves for the momentous days ahead. It gives details of what to expect, and when. Its title is "Beware of These days!"

The book formerly sold for a dollar, but as long as the present supply lasts, it is offered free to readers of this notice.

For your free copy of the astonishing prophecies covering these momentous times, as revealed in this 64-page book, address the Institute of Mentalphysics, 213 South Hobart Blvd., Dept. 636-E, Los Angeles 4, Calif. Send no money. Just your name and address on a postcard or in an envelope will do. No obligation. Readers are urged to write promptly, as only a limited number of the free books have been printed.

Advertisement

**AT LAST! The New Electric**



**RECLAIMO**  
A Wm. Schwabge Product

**For Car Truck & Tractor Engines**

**The Most Efficient Oil Filter In Automotive History!**  
Unequaled three-way action provides triple protection, triple savings —

**FILTERS — RE-REFINES and STABILIZES Crankcase Oil.**

**SAVES Oil — SAVES Gas — SAVES Motor ENDS NEEDLESS OIL CHANGING!**

**JUDGE FOR YOURSELF! WRITE FOR DETAILS AND THREE MONTHS' NO RISK FREE TRIAL OFFER.**

**RECLAIMO MFG. CO.** 6251 Touhy Ave., Dept. M-107, Chicago 30, Ill.

**BE A CAMERA CRAFTSMAN...**



Send for **FREE BOOK!** Many are needed in this big paying field and now as YOU can learn to repair cameras using manufacturer's service methods at home... in your spare time! Instructions, tools, practice equipment — everything you need is included in this approved course! Write for big FREE illustrated booklet that tells you HOW!

**national camera repair school - DEPT. V-10** EMILEWOOD COLORADO

## FREE! CALIFORNIA GARDEN BOOK

New 1957 pictorial round-up of latest ideas in garden arrangement and structures, by famous landscape architects. Dramatic new planters, terraces, fences, arbors, shelters and patios.

Write for **Garden Book**, California Redwood Assn., 572 Sacramento St., San Francisco 11.

# SAVE \$ ON US GOV'T SURPLUS

Our publication "Government Surplus Sales" lists hundreds of items for sale by the U. S. Government at tremendous savings, as low as 1c on a \$1.00.

These are samples of the savings that are being made:

<b>LIFE BOAT</b> ....\$12.00	<b>GRINDER</b> .....\$4.69	<b>SHAPER</b> .....\$15.00	<b>DUMP TRUCK</b> .....\$76.77
<b>TRACTOR</b> .....\$75.00	<b>TYPEWRITER</b> ....\$7.51	<b>FREEZER</b> .....\$50.00	<b>SPRAY PAINTER</b> .....\$15.25
	<b>MOTOR</b> .....\$4.00		

Hundreds others listed in our bulletin "Government Surplus Sales" and may be purchased direct from U. S. Government. Hunting, Fishing, Camping, Sporting Equipment, Photographic Equipment and Supplies, Radio and Electronic Equipment, Amphibious Trucks, Jeeps, Boats, Motors, Binoculars, Plumbing, Electrical Equip., Cars, Power Tools, Machinery, Chemicals, Furniture, Office Equipment, Supplies, Scrap, Etc.

How may you receive our bulletin "Government Surplus Sales?" By sending \$1.00 to **GOVERNMENT SURPLUS SALES, P. O. Box 169, Department 8-5, East Hartford 8, Conn.**

## CONVERT YOUR CAR INTO A BED



Save on Overnight  
Trips—Rest In  
Solid Comfort

### QUICK, EASY CONVERSION

Works on all 2 and 4-door sedans, club coupes, convertibles, station wagons. Fits all Ford, GM, Chrysler & Studebaker products—does not affect seat structure—normal functions or appearance. **GUARANTEED** to work when installed by instructions. **PAYS FOR ITSELF** in three nights lodging. **IDEAL** for hunters, fishermen and travelers. Delighted users everywhere! **\$19.95** Complete conversion kit and instructions

State make, model, whether 2 or 4-door  
SEE YOUR LOCAL DEALER OR  
SEND CASH, CHECK OR MONEY ORDER TO:  
**CAR BED CO., 600 MAGNOLIA AVE., PANAMA CITY, FLA.**

## TELEPHONES

### and ALL SUPPLIES

Room to room, house to garage, private telephone service. **HANDSET CRADLE TELEPHONES** (2) Complete outfit with 100' wire, 2 dry cells, instructions. **\$14.95**

**WORM HARVESTER**—Dan Mac Magneto—gathers fish-worms by electricity. Complete with instructions. **\$6.50**

Illustrated bulletin "AA-18" 10c

**TELEPHONE REPAIR & SUPPLY CO.**  
Dept. AA-18 1760 Lunt Ave., Chicago 26, Ill.

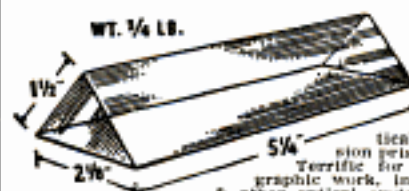

### PRISMS \$1.50

Made for U. S. Govt. Do not think periscopes. Fine optically ground, big precision prisms with silvered base. Terrific for all types of spectrographic work. In homemade telescopes & other optical systems for bending rays. Makes unusual paper weight (point your beam on it) or conversion piece for mirror. You'll find many other uses. **NEW, PERFECT!** Cost U. S. Govt. \$25 ea. Now—**\$1.50** ea. ppd. or 4 for \$5.00 ppd. Calif. res. add sales tax.

**VOLUME SALES CO., War Assets Div., Dept. PM-1057**  
3930 Sunset Blvd. Los Angeles 29, Calif.

### Be an industrial designer

Combine your design abilities with technical aptitudes in Industrial Design training at Art Center School in California. Work under practicing professionals for upper level jobs as automotive stylists, product and package designers. Design offices, stores, motels, showrooms, shopping centers. Constant demand for graduates. Recent placements with Ford, G.M., Kaiser Aluminum, G.E., Raymond Leary and other leading design studios. 700 students. Co-ed. Accredited. B.P.A. Degree. Four-year course can be completed in 2 yrs. 8 mos. by year-round training. New terms Feb., June, Sept. Enroll early. Write Mr. Mead for new catalog. 5353 West 3rd St., Los Angeles 5, California.

## ART CENTER SCHOOL

### MAKE UP TO \$20 A DAY WITH



### EASISHARP

Big profits in your spare time sharpening scissors. We show you how to start making money immediately. This is your chance now to have your own business and a steady income. Sharpen a pair of scissors in less than two minutes. A child can operate it. Weighs only 10 lbs. Every home, barber, tailor, dressmaker—everybody uses scissors and all need sharpening two to four times a year. Don't let some one else beat you to this opportunity. Write immediately to **SERR-EDGE MACHINE CO., 9731 Lorain Ave., Cleveland, Ohio**

**MONEY MAKING SALES PLAN FREE**

Write immediately to **SERR-EDGE MACHINE CO., 9731 Lorain Ave., Cleveland, Ohio**

# How Much Do *you* Want to Make?

**\$15<sup>20</sup>**  
AN HOUR?



"For every hour I have devoted to the PRESTO, I find that I have earned an average of \$15.20 an hour. I am now convinced that extraordinary money can be made in this safety field."  
**William Wydallis, Ohio**

**\$75 TO \$80**  
A WEEK?



Mr. Walter Gable has been selling Presto Fire Extinguishers for over 4 years. This is what he writes: "My selling time has usually averaged less than a day or two a week. These part time sales have brought me as much as \$75.00 to \$80.00 a week."  
**Walter Gable, Md.**

**\$1,000<sup>00</sup>** a Month?



"I think I've succeeded pretty well. I'm making more than \$1,000.00 a month with PRESTO—and I haven't touched bottom yet."  
**Charles Kama, Texas**

### Salesmen Everywhere Rave About New "Sell on Sight" PRESTO Fire Extinguisher



Wouldn't you like to make the kind of money these men made? Their stories are examples of the brilliant success many PRESTO salesmen are meeting everywhere. Here's the reason: PRESTO contains an amazing new chemical—"chlorobromomethane" or "C.B."—developed as secret defense against fire during the war, actually 1 1/2 to 6 times as effective as ordinary extinguishing chemicals on equal-weight basis. This super-efficiency permits PRESTO to be a lightweight, handy extinguisher even a child can use. So inexpensive—only \$4.95—"Sells on sight" to civil defense workers, owners of cars, boats, homes, stores, farms, service stations, factories, offices, and to stores for re-sale. Everyone fears fire, everyone's ready to buy after simple, dramatic demonstration.

### FREE! Everything You Need to Get Started

"SCIENCE'S NEW MIDGET MIRACLE"  
Folks are amazed to learn this new protection costs only

**\$4<sup>95</sup>**

Get started in this rich field now. Don't put it off! Every day you hesitate can cost you \$10, \$15, even \$50 you could be making! Mail coupon NOW for complete illustrated Sales Kit with money-making plans FREE. We'll show you how you can start earning right away—EVEN WITHOUT INVESTING MONEY!

**MERLITE INDUSTRIES, Presto Div.,**  
114 East 32nd St., Dept. P-15B  
New York 16, N. Y.

**Merlite Industries, Inc., Presto Div., Dept. P-15B**  
114 East 32nd St., New York 16, N. Y.

Please send me—FREE—illustrated sales literature, liberal profit plan, order blanks—everything I need to start making good money introducing the miracle Presto Fire Extinguisher.

Name \_\_\_\_\_

Address \_\_\_\_\_

City \_\_\_\_\_ Zone \_\_\_\_\_ State \_\_\_\_\_

IN CANADA: Mopa Co., Ltd., 371 Dowd St., Montreal 1, P.Q.

**I DARE YOU TO FIND AN EASIER WAY  
TO MAKE UP TO \$1,500<sup>00</sup> IN A MONTH!**



**Astounding New Improved  
MOTOR OVERHAUL  
NOW WITH MIRACLE X-303  
Hands You Big-Volume REPEAT  
Business . . . Even Spare Time!**

Introduce amazing new 1G-oz. MOTOR OVERHAUL to fellow-motorists, fleet owners . . . make big money fast! Just add to engine oil and get immediate increases in compression (up to 58%), gas mileage (up to 54%), oil-saving efficiency (up to 900%) . . . and freedom from costly repairs . . . proved by astonishing Independent Laboratory Road Tests. Now contains oil-stabilizer Formula X-303 for instant cold-weather starting, cooler engine in summer. Customers order time and again, hand you a high-profit re-order business you can run in just your spare time! Sells for \$2.98 each; you make up to \$1.78 profit on every can.

**GUARANTEES IMPROVED POWER AND ECONOMY!**

Motorists, large-quantity-buying fleet operators order at once on daring no-risk "You-Be-The-Judge" Unconditional Guarantee, are amazed, delighted when MOTOR OVERHAUL makes good on every promise, re-order time and again!

**FREE!** Rush coupon with name, address TODAY for big Illustrated Sales Kit, big-profit plans, actual copy of startling Lab Road Test Report, daring "You-Be-The-Judge" Guarantee . . . all FREE, no obligation. If you also want full-size \$2.98 MOTOR OVERHAUL to test in your car, enclose only \$2.00, and we ship postpaid. Your money back if not amazed, delighted.

POPE CHEMICAL CO., 224 W. Huron, Dept. Z-3, Chicago 10, Ill.

POPE CHEMICAL CO., 224 W. Huron St., Dept. Z-3, Chicago 10, Ill.

Rush. Entirely FREE and without obligation, Illustrated MOTOR OVERHAUL Sales Kit, Lab Report, daring Guarantee.

Name \_\_\_\_\_

Address \_\_\_\_\_

City \_\_\_\_\_ Zone \_\_\_\_\_ State \_\_\_\_\_

\$2.00 enclosed. Also send full-size \$2.98 MOTOR OVERHAUL postpaid. You will refund my \$2.00 if I'm not delighted with it.

**WE DON'T NEED ENGINEERS**

. . . but they write to us daily to order our  
**GENIAC Electric Brain Construction Kits.**

So do TEACHERS, SCIENTIFIC AMATEURS, INDUSTRIAL FIRMS and schools. (See list below.)

**THOUSANDS OF SATISFIED CUSTOMERS** have bought GENIACS on a 7 DAY REFUND guarantee

We are proud to offer our 1957 Model, with up to the minute improvements for the thousands of new customers who can use them.

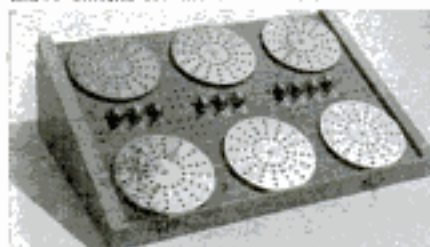

**WHAT IS A GENIAC?**

Here is a picture of the 1957 Model GENIAC in the display rack (\$2.00 separately) which comes with every kit.

GENIAC stands for Genius Semi-Automatic Computer. A kit of specially designed switch decks and racks which permit the user to construct more than thirty different machines (following directions and as many more as he is able to design himself. These machines demonstrate the applications of electric circuitry.

**APPLICATIONS OF GENIAC**

SIMPLE COMPUTER CIRCUITS for binary, decimal adding, subtracting, dividing, multiplying machines. PROBLEMS in symbolic logic, reasoning, comparing. PSYCHOLOGICAL TESTING and EXPERIMENT GAME PLAYING CIRCUITS for tic-tac-toe and nim. ACTUARIAL ANALYSIS.

**SOME OF OUR CUSTOMERS**

Allis-Chalmers • Remington-Rand • International Business Machines • Manual Missionary College • Barnard College • Westinghouse Electric • Phillips Laboratories • General Insurance Co. of America • Lafayette Radio • Rorr Aircraft Co. • Albert Einstein Medical College • Naval Research Laboratories • Board of Education, Tecumseh, Nebraska • Los Angeles Public Schools • Jefferson Union High School • Oklahoma A & M • Courtland Jr. High School • Bell Telephone Laboratories.

**WHAT COMES WITH THE KIT?**

BOOKS—1. SIMPLE ELECTRONIC BRAINS AND HOW TO MAKE THEM . . . 64 page experiment manual.—NEW! 2. MINDS and MACHINES . . . 200 page text on computers, automation and cybernetics.—NEW! 3. WIRING DIAGRAMS for basic GENIAC circuits.—NEW! 4. Beginners Manual for the person who has little or no familiarity with electric circuit.—NEW! 5. GENIAC study guide . . . the equivalent of a full course in computer fundamentals. Hits additional readings. PARTS—PANELS, DISC RACK (for easy assembly and display). Hardware, wire, tools, battery, holder etc. for more than thirty machines. SEND for your GENIAC now. At only \$19.95, a bargain, comes complete with over 400 parts and components, 5 books and manuals. We guarantee that if you do not want to keep GENIAC after one week you can return it for full refund.

Add 80c west of Miss. \$2 outside U.S. Mail Name & Address with check or Money Order to  
**OLIVER GARFIELD CO., DEPT. PM-107 126 LEXINGTON AVE. NEW YORK 16, N.Y.**

**3 FOR \$29.95**

THREE FIRSTS FOR OUR FIRST SALE. **FREE AMMO**

- MAUSER 11 MM**  
15¢  
Mauser repeating rifle. "The Big 11." Model 71/84, caliber 11 MM Mauser, 8 "mag" for your collection and a nice and interesting addition to your shooting gallery. Specifications: bolt action, 7 shot, tubular magazine with recoil, 31" bal.
- MAUSER 8 MM**  
15¢  
Small bore, smokeless powder rifle. The "Gem, 88." Used by the Kaiser's troops against our Doughboys in the First World War. Famous workhorse throughout. Specifications: bolt action, 5 shot, clip loading, Mauser magazine, 27" bal.
- MANNLICHER 11 MM**  
15¢  
"K.K. Caliber" 11 MM Mannlicher (founded by Friedrich Von Mannlicher for the Imperial Austrian Army. Specifications: 5 shot, clip loader, 32" bal.

**GENUINE FREE AMMO — FULL MAGAZINE LOAD WITH NECESSARY CLIP WITH EACH RIFLE**  
All rifles guaranteed N.R.A. good. Unconditional 10 day money back guarantee. Plenty of additional ammo, available for these rifles.

**MILITARY AMMO SALE**  
First time at special prices, good clean shooting ammo.  
8 MM Mauser with .118 dia. bullet for "Gem 88" . . . \$7.50 per 100,  
5 x 50 rim. Mannlicher for Models 88 and 95 Austrian . . . \$6.50 per 100,  
11 MM Mauser for Model 71/84 . . . \$6.50 per 100,  
11 MM Mannlicher for Model 71/84 . . . \$6.50 per 100,  
6 x 6 Italian for all 6.5 Italian rifles and carbines . . . \$7.50 per 100.  
Minimum order, 100 rounds.

**GOLDEN STATE ARMS CORP.**  
388 W. Green St., Pasadena 190, Calif.



**WORLD'S LOWEST PRICED  
ADDING MACHINE**

Counts up to 999,999,999  
**IDEAL FOR BUSINESS AND PERSONAL USE—GUARANTEED ACCURATE.**  
Not a toy, operates with only a finger flick. Adds, subtracts, multiplies, divides. Counts up to one billion. Pays for itself over and over. Ideal Gift—for Business, Income Tax and School use.  
**MONEY BACK GUARANTEE.** Send name and address. Pay postman only \$2.95 plus postage. Beautiful rich-looking Leatherette Case included at no extra cost. Money back in 10 days if not delighted. AGENTS WANTED.

**ONLY \$2.95**  
**TOTAL COST SEND NO MONEY**  
CALCULATOR MACHINE COMPANY  
P.O. Box 126, Dept. V-57, Huntingdon Valley, Penna.

**BUY IT WHOLESALE!**

FOR SELF OR RESELL FOR BIG PROFITS! NAME BRAND APPLIANCES, TOOLS, WATCHES, CAMERAS, PHONOS, SEWING MACHINES, JEWELRY, HOUSEWARES, SPORTING GOODS, TYPEWRITERS, ETC.

GET OUR BIG WHOLESALE CATALOG OF OVER 2,000 PROFIT MAKING ITEMS! POSTCARD BRINGS DETAILS FREE! MAIL TODAY!

**Consolidated DISTRIBUTORS**  
CLIFTON 1, N. J.



**I'LL GUARANTEE YOU  
RIPPLING MUSCLES**

**DAN, THE MUSCLE MAN SAYS**  
IN 6 WEEKS OR MONEY BACK  
You can have tremendous power, look bigger, have more confidence this tested way. Revolutionary new "Body Mold" course builds your body in a way no other method can match. Get course FREE with order. Lowest factory price.

**DAN LURIE BARBELLS**  
50 lb. set \$ 8.95 • 100 lb. set \$14.95  
150 lb. set \$21.95 • 200 lb. set \$27.95  
Extra Wts — 14c per lb. 50% cash, balance C.O.D. FOB Plant  
**DAN LURIE BARBELL CO.**  
52M10 Bristol St., Dept. 7593, Bklyn 12, N.Y.

**FREE! SEND FOR NEW SPORTS & HEALTH CATALOG**



We Try to Ship Your Favorite Brand (Not Recaps)  
**GOOD YEAR** **GOODRICH, U. S.**  
General, Firestone & others, worn slightly.

**12 MONTH GUARANTEE** replace FAST any defective tire, Frt. Excl.  
**SPECIAL! ANY CAR TIRE, BLACK 4 PLY 55** Whitewalls \$1 Extra

Proven thru the years the world's safest, Guar. **TRUCK TIRES**

600-16(G)	\$5.95	700-17	\$9.75	750-20	\$10.95	1000-20	\$18.75
680-16(G)	6.45	750-16	8.75	825-20	17.88	1100-20	21.40
700-16(G)	7.75	750-17	10.75	900-20	18.15	1100-22	23.40



**SAVE \$3 to \$33 on SNOW TIRES**  
**GOODYEAR SUBURBANITE** Silent tires & others

All types, factory Mud-Grip Retreaded & Slightly used, No-trade-in needed. **SPECIAL 12 MO. GUARANTEE** \$6.22 for any car  
Also the PREMIUM DELUXE GOODYEAR Full Tread Guar. 3 Full Years any car

**MARVIN BLATT** 6th & Spring Garden Philadelphia, Pa. Send Check or M.O. & this Ad for fast shipment. For Phila. I personally select your tires as if my future depended on it. **BLATT NAME famous for 42 years in TIRES**

# Time to take out SUCCESS INSURANCE

Chances are you carry life insurance. And health insurance. And insurance on your car.

But a man with a growing family needs "success insurance," too.

Here's how it works: Each week you invest a few hours' spare time and a few dollars in *specialized training at home*. You follow a regular program of self-improvement. On the job, you apply what you learn.

In a few short months, your policy starts to pay off.

First, you win recognition from your employer. Second, you find new opportunities opening up for you. Third, you're one of the first in line for promotion, one of the last to take a cut or be laid off should times get tough.

*And when you get your I. C. S. diploma,*



*you're in a class with leaders in every field of business and industry.*

Specialized training as offered by I. C. S. is as good "success insurance" as you can buy. 257 courses to choose from. Texts are up-to-date, easy-to-follow, authoritative. Instruction is practical, personalized. You learn as you earn, and you pay as you go.

Find out more about I. C. S. "success insurance." Mail the coupon today for three free books: (1) Opportunity Handbook for the field of your choice, (2) 36-page pocket guide, "How to Succeed," (3) sample lesson (Math.) demonstrating the I. C. S. method.

For Real Job Security—Get an I. C. S. Diploma!

I. C. S., Scranton 15, Penna.

Accredited Member,  
National Home Study Council

## INTERNATIONAL CORRESPONDENCE SCHOOLS



BOX 44953K, SCRANTON 15, PENNA.

(Partial list of 257 courses)

- Without cost or obligation, send me "HOW TO SUCCEED" and the opportunity booklet about the field BEFORE which I have marked X (plus sample lesson):
- |  |  |  |  |   |
|--|--|--|--|---|
| <p><b>ARCHITECTURE and BUILDING CONSTRUCTION</b></p> <ul style="list-style-type: none"> <li><input type="checkbox"/> Air Conditioning</li> <li><input type="checkbox"/> Architecture</li> <li><input type="checkbox"/> Arch. Drawing and Designing</li> <li><input type="checkbox"/> Building Contractor</li> <li><input type="checkbox"/> Building Estimator</li> <li><input type="checkbox"/> Carpentry and Millwork</li> <li><input type="checkbox"/> Carpenter Foreman</li> <li><input type="checkbox"/> Heating</li> <li><input type="checkbox"/> Interior Decoration</li> <li><input type="checkbox"/> Painting Contractor</li> <li><input type="checkbox"/> Plumbing</li> <li><input type="checkbox"/> Reading Arch. Blueprints</li> </ul> <p><b>ART</b></p> <ul style="list-style-type: none"> <li><input type="checkbox"/> Commercial Art</li> <li><input type="checkbox"/> Magazine &amp; Book Illus.</li> <li><input type="checkbox"/> Show Card and Sign Lettering</li> <li><input type="checkbox"/> Sketching and Painting</li> </ul> <p><b>AUTOMOTIVE</b></p> <ul style="list-style-type: none"> <li><input type="checkbox"/> Automobiles</li> <li><input type="checkbox"/> Auto Body Rebuilding and Refinishing</li> <li><input type="checkbox"/> Auto Engine Tuneup</li> <li><input type="checkbox"/> Auto Technician</li> </ul> | <p><b>AVIATION</b></p> <ul style="list-style-type: none"> <li><input type="checkbox"/> Aero-Engineering Technology</li> <li><input type="checkbox"/> Aircraft &amp; Engine Mechanic</li> </ul> <p><b>BUSINESS</b></p> <ul style="list-style-type: none"> <li><input type="checkbox"/> Accounting</li> <li><input type="checkbox"/> Advertising</li> <li><input type="checkbox"/> Business Administration</li> <li><input type="checkbox"/> Business Management</li> <li><input type="checkbox"/> Cost Accounting</li> <li><input type="checkbox"/> Creative Salesmanship</li> <li><input type="checkbox"/> Managing a Small Business</li> <li><input type="checkbox"/> Professional Secretary</li> <li><input type="checkbox"/> Public Accounting</li> <li><input type="checkbox"/> Purchasing Agent</li> <li><input type="checkbox"/> Salesmanship</li> <li><input type="checkbox"/> Salesmanship and Management</li> <li><input type="checkbox"/> Traffic Management</li> </ul> <p><b>CHEMICAL</b></p> <ul style="list-style-type: none"> <li><input type="checkbox"/> Analytical Chemistry</li> <li><input type="checkbox"/> Chemical Engineering</li> <li><input type="checkbox"/> Chem. Lab. Technician</li> <li><input type="checkbox"/> Elements of Nuclear Energy</li> <li><input type="checkbox"/> General Chemistry</li> <li><input type="checkbox"/> Natural Gas Prod. and Trans.</li> <li><input type="checkbox"/> Petroleum Prod. and Engr.</li> <li><input type="checkbox"/> Professional Engineer (Chem)</li> <li><input type="checkbox"/> Pulp and Paper Making</li> </ul> | <p><b>CIVIL ENGINEERING</b></p> <ul style="list-style-type: none"> <li><input type="checkbox"/> Civil Engineering</li> <li><input type="checkbox"/> Construction Engineering</li> <li><input type="checkbox"/> Highway Engineering</li> <li><input type="checkbox"/> Professional Engineer (Civil)</li> <li><input type="checkbox"/> Reading Struc. Blueprints</li> <li><input type="checkbox"/> Structural Engineering</li> <li><input type="checkbox"/> Surveying and Mapping</li> </ul> <p><b>DRAFTING</b></p> <ul style="list-style-type: none"> <li><input type="checkbox"/> Aircraft Drafting</li> <li><input type="checkbox"/> Architectural Drafting</li> <li><input type="checkbox"/> Drafting Machine Design</li> <li><input type="checkbox"/> Electrical Drafting</li> <li><input type="checkbox"/> Mechanical Drafting</li> <li><input type="checkbox"/> Sheet Metal Drafting</li> <li><input type="checkbox"/> Structural Drafting</li> </ul> <p><b>ELECTRICAL</b></p> <ul style="list-style-type: none"> <li><input type="checkbox"/> Electrical Engineering</li> <li><input type="checkbox"/> Elec. Engr. Technician</li> <li><input type="checkbox"/> Elec. Light and Power</li> <li><input type="checkbox"/> Practical Electrician</li> <li><input type="checkbox"/> Practical Lineman</li> <li><input type="checkbox"/> Professional Engineer (Elec)</li> </ul> <p><b>HIGH SCHOOL</b></p> <ul style="list-style-type: none"> <li><input type="checkbox"/> High School Diploma</li> </ul> | <ul style="list-style-type: none"> <li><input type="checkbox"/> Good English</li> <li><input type="checkbox"/> High School Mathematics</li> <li><input type="checkbox"/> Short Story Writing</li> </ul> <p><b>LEADERSHIP</b></p> <ul style="list-style-type: none"> <li><input type="checkbox"/> Industrial Foremanship</li> <li><input type="checkbox"/> Industrial Supervision</li> <li><input type="checkbox"/> Personnel-Labor Relations</li> <li><input type="checkbox"/> Supervision</li> </ul> <p><b>MECHANICAL and SHOP</b></p> <ul style="list-style-type: none"> <li><input type="checkbox"/> Diesel Engines</li> <li><input type="checkbox"/> Gas-Elec. Welding</li> <li><input type="checkbox"/> Industrial Engineering</li> <li><input type="checkbox"/> Industrial Instrumentation</li> <li><input type="checkbox"/> Industrial Metallurgy</li> <li><input type="checkbox"/> Industrial Safety</li> <li><input type="checkbox"/> Machine Design</li> <li><input type="checkbox"/> Machine Shop Practice</li> <li><input type="checkbox"/> Mechanical Engineering</li> <li><input type="checkbox"/> Professional Engineer (Mech)</li> <li><input type="checkbox"/> Quality Control</li> <li><input type="checkbox"/> Reading Shop Blueprints</li> <li><input type="checkbox"/> Refrigeration and Air Conditioning</li> <li><input type="checkbox"/> Tool Design</li> <li><input type="checkbox"/> Tool Making</li> </ul> <p><b>RADIO, TELEVISION</b></p> <ul style="list-style-type: none"> <li><input type="checkbox"/> General Electronics Tech.</li> </ul> | <ul style="list-style-type: none"> <li><input type="checkbox"/> Industrial Electronics</li> <li><input type="checkbox"/> Practical Radio-TV Eng'g</li> <li><input type="checkbox"/> Practical Telephony</li> <li><input type="checkbox"/> Radio-TV Servicing</li> </ul> <p><b>RAILROAD</b></p> <ul style="list-style-type: none"> <li><input type="checkbox"/> Car Inspector and Air Brake</li> <li><input type="checkbox"/> Diesel Electrician</li> <li><input type="checkbox"/> Diesel Engr. and Fireman</li> <li><input type="checkbox"/> Diesel Locomotive</li> </ul> <p><b>STEAM and DIESEL POWER</b></p> <ul style="list-style-type: none"> <li><input type="checkbox"/> Combustion Engineering</li> <li><input type="checkbox"/> Power Plant Engineer</li> <li><input type="checkbox"/> Stationary Diesel Engr.</li> <li><input type="checkbox"/> Stationary Fireman</li> </ul> <p><b>TEXTILE</b></p> <ul style="list-style-type: none"> <li><input type="checkbox"/> Carding and Spinning</li> <li><input type="checkbox"/> Cotton Manufacture</li> <li><input type="checkbox"/> Cotton Warming and Weaving</li> <li><input type="checkbox"/> Loom Fixing Technician</li> <li><input type="checkbox"/> Textile Designing</li> <li><input type="checkbox"/> Textile Finishing &amp; Dyeing</li> <li><input type="checkbox"/> Throwing</li> <li><input type="checkbox"/> Warming and Weaving</li> <li><input type="checkbox"/> Worsted Manufacturing</li> </ul> |
|--|--|--|--|---|

Name \_\_\_\_\_ Age \_\_\_\_\_ Home Address \_\_\_\_\_

City \_\_\_\_\_ Zone \_\_\_\_\_ State \_\_\_\_\_ Working Hours \_\_\_\_\_ A.M. to P.M. \_\_\_\_\_

Occupation \_\_\_\_\_

Canadian residents send coupon to International Correspondence Schools, Canadian, Ltd., Montreal, Canada. . . . Special tuition rates to members of the U. S. Armed Forces.

SAVE 1/2 ON ACCORDIONS • SAVE 1/2 ON ACCORDIONS

**BUY DIRECT and SAVE UP TO 1/2 ON ITALIAN ACCORDIONS EASY TERMS**



**AMAZING NO RISK OFFER...**  
Now you can afford a world famous Accordion of finest tone and breathtaking beauty! Low wholesale prices save you half and more.

**5 DAYS FREE TRIAL**

**ACT NOW! FREE—**

- Music Stand
- Home Study Course
- Deluxe Case
- Lifetime Guarantee

**COLOR CATALOG FREE**  
Mail Coupon

**MONEY BACK GUARANTEE**

Buy direct from world's largest dealer. Save 50% or more. 30 newest models to choose from. Extra bonus gifts if you buy now. Satisfaction guaranteed or money back. Trade-ins accepted. Low down payment; pay little as \$10.00 a month. Try before you buy on FIVE DAY TRIAL. Rush coupon now for FREE color catalog and wholesale price list. Write TODAY, Accordion Manufacturers and Wholesalers Outlet, Dept. R-107 2003 W. Chicago Ave., Chicago 22, Ill.

Accordion Manufacturers & Wholesalers Outlet  
2003 W. Chicago Ave., Dept. R107, Chicago 22, Ill.  
Send FREE Color Catalog and price list.

NAME \_\_\_\_\_  
ADDRESS \_\_\_\_\_  
CITY \_\_\_\_\_ STATE \_\_\_\_\_



**DRAW The First Day! NO LESSONS! NO TALENT!**

New Amazing Invention—"Magic Art Reproducer." You can draw Your Family, Friends, Anything From REAL LIFE—Like An Artist Even If You CAN'T DRAW A Straight Line! Anything you want to draw is automatically seen on any sheet of paper thru the "Magic Art Reproducer." Then easily follow the lines of the "picture image" with a pencil for an original "professional looking" drawing. Also reduces or enlarges. SEND NO MONEY! Free 10 Day Trial! Pay Postman on delivery \$1.98 plus postage. Or send only \$1.98 with order and we pay postage. Money Back Guarantee.

NORTON PRODUCTS, Dept. 141, 296 Broadway, N. Y.

**Tells How You Can Learn to MOUNT BIRDS!**



**FREE BOOK MOUNT BIRDS!**

**Learn At Home**

Men, Boys, Hunters, Fishermen, mount and save your lovely wild-game trophies. Be a Taxidermist, Mount Birds, Animals, Heads, Fish, Tax skins. YOU learn easily, quickly in spare time. Have a grand home-museum. The finest and the greatest hobby known, for sportsmen, fun, real profits.

**FREE BOOK**

Yes, FREE, beautiful, strange, valuable BOOK, telling all about Taxidermy. Contains over 100 beautiful game-pictures. And it's yours FREE, if you rush your request. You can mount your trophies too. We can positively TEACH YOU. So GRASP this opportunity. RUSH letter or postal for this amazing FREE BOOK. Don't delay. State your AGE. H. W. SCHOOL OF TAXIDERMY, Elwood Bldg., Omaha 2, Neb.



**HIGH WAGES!**

Make big pay in the construction industry as an operator of Bulldozers, Draglines, Back Hoes, Scrapers and Motor Graders. Learn these skills NOW! Machines of major manufacturers are used in our training program. Contractors need operators of earthmoving machines and pay high wages to our graduates. Don't be satisfied with just a job... learn a career!

Write TODAY for FREE School Catalog, no obligation, to either address

**National School of Heavy Equipment Operation**  
P.O. Box 8243, Dept. D-17  
Charlotte, N. C.

**Western National School of Heavy Equipment Operation**  
P.O. Box 527, Dept. D-17  
Weiser, Idaho

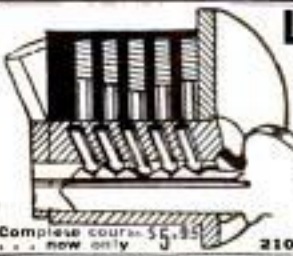

**Locksmithing AND KEY MAKING**

Now Made Easy! Practical up-to-date course teaches you how to pick locks, de-code, make master keys, repair, install, service, etc. Now self-instruction lessons for every handyman, homeowner, carpenter, mechanic, service station operator, fix-it shop, hardware dealer, gunsmith. 50 easy illustrated lessons. Full price only \$5.95 (postpaid) or C.O.D. plus postage. Satisfaction or refund guaranteed.

Complete course \$5.95 now only 5 Nelson-Hall Co., Dept. KT-2, 210 S. Clinton St., Chicago 6, Ill.

**BUILD YOUR OWN SABOT**  
*America's Finest Small Sailboat*

1956 Nat'l. champ  
It's easy to sail,  
easy to assemble in  
12 hrs. All Fibre  
glass hull can't sink  
or leak—Holds 4.

Kit includes:  
Beautiful molded  
hull Dacron racing  
sail, Spruce mast,  
Rudder, Leeboard,  
all hardware glue,  
& paint, Mahogany  
seats. COLORS: Red,  
green, blu, white.

HENRY R. McCUNE  
shipbuilders  
3175 Caheunga Blvd.  
Hollywood 28, Calif.

For a Limited  
time only!

**SAVE \$152**

complete  
Sabot Kit.

**NOW \$198**



Rush my Fibre Glass Sabot Kit postage paid. Enclosed is my check  money order  for \$198.

Name \_\_\_\_\_  
Address \_\_\_\_\_  
Check color: RED  BLU  GREEN  WHITE

Train for a **GOOD JOB**  
and a **REAL FUTURE** in  
*Electricity  
Electronics*  
in the great shops of  
**COYNE**



Largest, Oldest and Best Equipped School of its Kind in U.S. Train the Coyne way for a better job in *Electricity-Electronics*—a field that offers a world of opportunities now and in the years ahead. In industry—in the home—New developments and fabulous growth are creating increasing job opportunities. **AUTOMATION ELECTRONICS**—one of the more recent applications of Industrial Electronics to manufacturing processes—promises to create additional demands for trained Electrical-Electronics men such as we have never seen. Coupon brings details. **LARGEST, OLDEST AND BEST EQUIPPED SCHOOL OF ITS KIND IN U.S.**

**TRAIN IN CHICAGO SHOPS**—Practical work plus technical training. No advanced education or previous experience needed. Lifetime Employment Service to Coyne Graduates.

**START NOW—PAY LATER**—Training offered to **VETS** and **NON-VETS** alike. New liberalized credit terms and Finance Plans. Part-time employment service to students.

**COYNE ELECTRICAL SCHOOL**  
CHARTERED NOT FOR PROFIT  
500 S. Paulina Street, Chicago, Dept. 77-72

**MAIL COUPON FOR FREE BOOK.**

"Guide to Careers" gives you all the facts, answers your questions. All information will come by return mail. No obligation and no salesman will call, so send coupon now!



Coyne Electrical School, Dept. 77-72  
500 S. Paulina St., Chicago 12, Ill.

Send **FREE BOOK** and details of the training you offer in Electricity-Electronics.

Name \_\_\_\_\_

Address \_\_\_\_\_

City \_\_\_\_\_ State \_\_\_\_\_

(I understand no Salesman will call.)

*Secrets of* **VENTRILOQUISM**  
*Now Revealed!*



Easy to learn in 60 to 90 days with our Home Study Course. **RESULTS GUARANTEED.** Make Money! Be Popular! Have Fun! Big Opportunity! Radio, Television, Stage Appearances! For **FREE** information regarding price and terms **WRITE.** You must state your age. Dummy Catalog 25c. **MAHER HOME COURSE OF VENTRILOQUISM** Box 36, Studio E, PM-10, Kensington Station Detroit 24, Michigan

**CONCRETE BLOCK HOME PLANS**

**\$2500 RANCH HOME**



Build your own 25' x 48' Ranch Home complete for \$2500. Forced air heating system available \$295. Contains Liv. Room, kit., three bedrooms, bath, utility room, fireplace, carport, or garage. Blueprints, instructions, and material list \$3.00 ppd. Money back guarantee. Other plans—\$1900 **DUPLEX**, \$1150 **GARAGE APARTMENT**, \$950 **CABIN**. **FREE FOLDER.**

MEMBER ARKANSAS HOME BUILDERS ASSOC.

**BAILEY BUILDERS, 7608 Harmon Drive, Little Rock, Ark.**

**INVESTIGATE ACCIDENTS**

Train quickly in your own home for repeat income in the exciting, secure Claim Investigation and Claim Adjusting field. Our students and graduates are already earning \$4, \$5, \$6 an hour extra **SPARE TIME**—and up to \$10,000 a year Full Time. You need **NO** prior experience or higher education. Your age does **NOT** matter.

**HERE IS YOUR CHANCE FOR ACTION  
AND REAL JOB SECURITY**

As a trained Claim Investigator you will (1) **INVESTIGATE FACTS** and (2) **DISTRIBUTE MONEY** as the representative of wealthy organizations.

No other business offers you greater opportunities for success and security. Here's why: The huge, rapidly expanding Claim Investigation and Adjusting Profession right now distributes more money than any other service industry. And it's growing fast. Over 200 **MILLION ACCIDENTS** must be investigated this year for Insurance Companies, Airlines, Railroads, Steamship Lines, and Government Offices.

**MAIL NOW for FREE BOOK** ➔

**SEND TODAY** for Big, **FREE**, Illustrated Catalog. Learn the exciting facts about Universal Schools' low cost training. No obligation. No salesman will call. **GI APPROVED.**



**UNIVERSAL SCHOOLS**

6801 Hillcrest Ave.  
Dept. PM-10, Dallas 5, Texas

Please rush me your **FREE** book on Claim Investigation. This does not obligate me and no salesman will call.

Name \_\_\_\_\_ Age \_\_\_\_\_

Address \_\_\_\_\_

City \_\_\_\_\_ Zone \_\_\_\_\_ State \_\_\_\_\_

Approved by Government for Korean Veterans



## WARN HUBS

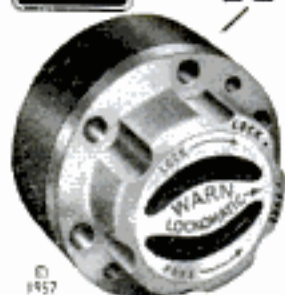

© 1957 WARN

OVER 100,000  
WARN HUBS NOW  
IN USE ON  
4-WHEEL DRIVES  
Models for all  
4 w.ds. to 1 1/2 tons

idle the front drive in 2-wheel drive... stop drag... reduce wear. Warn Hubs mean big savings in gear, engine, tire wear, gas, plus new pep, performance, power, handling ease. And now, with Warn Lock-O-matics, you have economical, drag-free 2-w.d. or tractive 4-w.d. automatically, as you shift! Ask your dealer for Warn Lock-O-matic or Locking Hubs today!

WARN MFG. CO. RIVERTON BOX 7064-A10 SEATTLE 28, WASH.

## Superior's New Model 70 UTILITY TESTER® FOR REPAIRING ALL ELECTRICAL APPLIANCES MOTORS • AUTOMOBILES • TV TUBES

As an electrical trouble shooter the Model 70:



- Measures A.C. and D.C. Voltages, A.C. and D.C. Current, Resistances, Leakage, etc.
- Will measure current consumption while the appliance under test is in operation.
- Incorporates a sensitive direct-reading resistance range which will measure all resistances commonly used in electrical appliances, motors, etc.
- Leakage detecting circuit will indicate continuity from zero ohms to 5 megohms (5,000,000 ohms).
- Will test testers, irons, broilers, Heating Pads, Clocks, Fans, Vacuum Cleaners, Refrigerators, Lamps, Fluorescents, Fans, Switches, Thermostats, etc.
- Will test all TV tubes for open filaments, inter-element shorts, burned out tubes, etc.

As an Automotive Tester the Model 70 will test:

- Both 6 Volt and 12 Volt Storage Batteries • Generators • Starters • Distributors • Ignition Coils • Regulators • Relays • Circuit Breakers • Cigarette Lighters • Stop Lights • Condensers • Directional Signal Systems • All Lamps and Bulbs • Fuses • Heating Systems • Horns • Also will locate poor grounds, breaks in wiring, poor connections, etc.

Model 70 comes complete with 44 page book written in plain easy-to-understand language. Explains laws of electricity, how to proceed with repairs of appliances and automobile circuits, how to test TV tubes, etc. Only \$15.95

**SHIPPED ON APPROVAL  
NO MONEY WITH ORDER — NO C. O. D.**

Try it for 10 days before you buy. If completely satisfied then send \$2.50 and pay balance at rate of \$4.00 per month for 3 months — No Interest or Finance Charges Added! If not completely satisfied, return to us, no explanation necessary.

MOSS ELECTRONIC DIST. CO., Inc.  
Dept. D-390, 3849 Tenth Ave., N.Y. 34, N.Y.  
Please rush me one Model 70. If satisfactory I agree to pay \$2.50 within 10 days and balance at rate of \$4.00 per month until total price of \$13.00 plus postage is paid. If not satisfactory, I may return for cancellation of order.

Name \_\_\_\_\_  
Address \_\_\_\_\_  
City \_\_\_\_\_ State \_\_\_\_\_

## 2 WAY PORTABLE RADIO SET

SENDS — RECEIVES UP TO 20 MILES AS SHOWN with built-in antenna or hundreds of miles with outside antenna. Works on 80 and 40 meter (Novice) amateur radio bands—also Aircraft and overseas broadcast 1.5 to 8 mc. PORTABLE SELF-CONTAINED POWERED WITH STANDARD PORTABLE RADIO BATTERIES. NO AC PLUG-INS NEEDED! Take it with you everywhere you go—on trips, vacations, camping—Keep in contact with home, friends. Has 5 watt crystal controlled transmitter—Sensitive Regenerative Receiver, Send-Receive switch, Wt. only 3 lbs. Size, only 6"x4"x4". TESTED — PROVEN—SIMPLIFIED—PRACTICAL—Full information given on quick easy to get license.



WESTERN RADIO

SE D ONLY \$3.0. (bill, ck. mo. and pay post-man \$11.95 COD postage on arrival or send \$14.95 for postpaid delivery. Complete kit includes all parts, tube, coils, plastoid cabinet, easy instructions. (Set of batteries \$2.00; crystal \$1.25; COMPS " " " " WIRED AND TESTED POSTPAID \$19.95. A regular \$49.95 value—Order now before price goes up. GUARANTEED—AVAILABLE ONLY FROM: DEPT. 8NM-10 KEARNEY, NEBR.



## OWNERS

RE-POWER NOW with a V-8 engine — Use FORD — CHEVROLET — MERCURY in 2 or 4 Whl-Dr. Jeeps, Jeepsers, Sta-Wgn. Trucks or cars. Conversion Kits \$43.25 to \$59.85. If you want fast action call us which engine you wish to use, give us year, Model (2 or 4 Whl-Dr) of your vehicle. Send Min. \$15.00 Dep. and we will ship correct kit. Bal. COD. Send full amt. for Prepaid shipment. Wire, phone or write for free details.

HOOSIER MACHINE PRODUCTS CO.

312 S.E. 6th St. Phone 676 Pendleton, Oregon

Research Clinics      HELP FILL      Patient Aid

**MS HOPE CHEST**

\*MULTIPLE SCLEROSIS

**BUILD Your Own GARAGE**

## Save Up to 50% of Usual Cost!

Build your own garage and save! Wayne Leckey, Popular Mechanics Assistant Shop Notes Editor, tells and shows how in his new book *How to Build Your Own Garage*.

### No Previous Building Experience Required

If you can use a hammer and a saw you can build your own garage. Leckey tells how in simple step-by-step instructions and shows how in big, clear photos, drawings and diagrams. Everything is covered from the laying of the foundation right up to and including applying the final trim.

### 25 Designs—Brick, Frame and Concrete Block Construction. Complete Building Data

There are 25 different designs from which you may choose. Brick, frame and concrete block construction is fully covered. Leckey tells and shows how to pour the foundation, erect the framework, erect the roof, apply insulation and shingles, lay the driveway, install trim, flower boxes, etc. It's all there for you to read and see.

### 7-Day Money Back Guarantee

Get your copy of this valuable book today. Read and use it for seven days and if it isn't entirely satisfactory return it for a full refund. Send only \$3.50 for your copy to Dept. 1057

POPULAR MECHANICS PRESS  
200 E. Ontario, Chicago 11, Ill.

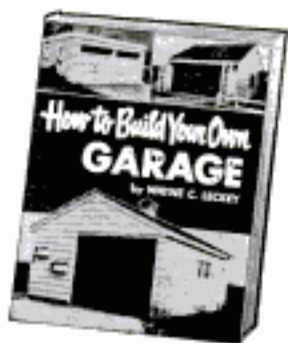

POPULAR MECHANICS

Copyrighted material



**THE MASONIC CASUALTY COMPANY**  
OFFERS  
**ACCIDENT—HEALTH—HOSPITALIZATION INSURANCE AT COST**

- Non Cancellable
- No Medical Examination
- Coverage On or Off the Job
- Includes Death Benefit
- No Paid Agents

**FIRST 3 MONTHS PROTECTION FOR MEMBERSHIP FEE \$2.00 FOR MASONS ONLY under 56 yrs. of age**

**WRITE AT ONCE**

**THE MASONIC CASUALTY COMPANY**  
80 BOYLSTON STREET, Dept. P-10, BOSTON 16, MASS.  
NO AGENT WILL CALL



Over 100,000 top pay jobs are open for  
**Auto Mechanics**  
Now it's easy to train quickly at home



**YOU'VE GOT IT "MADE"  
WHEN YOU LEARN THIS TRADE!**

A national magazine reports, "100,000 mechanics are needed by the motor industry. If you qualify, you can go straight to the top."

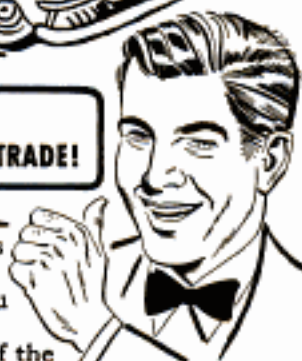

The vice-president of one of the "big three" says, "Technicians not only have excellent security but can count on good pay and promotion." *Don't let lack of training keep YOU from becoming a success! Learn to become a mechanic at home in spare time. Find out how by filling out and mailing coupon below. No cost or obligation.*

**Get Experience Using Tune-Up Kit & Tools**



CTI sends you a Tune-Up Kit, the kind that skilled mechanics use to locate engine troubles. You receive a compression Tester; Vacuum Gauge & Fuel Pump Tester; Ignition Timing Light; portable steel case. You also get mechanic's tools, including socket set. You acquire experience using kits.

**DIESEL MECHANICS OR BODY-FENDER REBUILDING** is yours at no extra cost. Only CTI offers this extra choice. You get fully-rounded training in all three fields.

**Many Students Earn Money as They Train**

Many students earn extra money fixing cars. Some work "on their own," others take part-time jobs in local shops. They add to their experience—often make enough money to pay tuition and buy equipment. A large number have gone in business, made good. Mail coupon for full information—Commercial Trades Institute, Chicago 26, Ill.

**MAIL TODAY FOR 2 FREE BOOKS**

COMMERCIAL TRADES INSTITUTE  
1400 GREENLEAF AVENUE DEPT. A-645  
CHICAGO 26, ILL.

Send booklet, "Big Money in Auto Mechanics," and Sample Lesson. Both FREE.

Name \_\_\_\_\_ Age \_\_\_\_\_

Address \_\_\_\_\_

City \_\_\_\_\_ Zone \_\_\_\_\_ State \_\_\_\_\_



**SHEET METAL MACHINES**

Brakes form angles, locks, pans, etc. Quick eccentric clamp. All steel construction.

15"-18 gauge steel	\$28.00
30"-22 gauge steel	\$37.00
48"-24 gauge steel	\$52.00
Floor stand	\$ 8.00
15"-24 gauge Folder	\$16.50
30" Pan and Box brake	\$60.00
3/4 x 3 Adjustable Bender	\$11.50
16 gauge 7" Bench Shear 3 adj. gauge	\$16.50
30"-20 gauge Curve Former	\$11.50

ORDER DIRECT OR SEND FOR FREE CATALOG  
**VYKE MFG. CO., P-4158 Jason St., Denver 11, Colo.**

**make your own Gems 36<sup>50</sup> FOR**

The Gem Maker comes complete with all necessary equipment, including a super-charged diamond blade for sawing, and all the wheels for grinding, shaping and polishing; also complete instructions. The complete equipment as shown, less motor and belt for only \$36.50. I.e.b., Burlington, Wisconsin. Write today for information and literature.

**B&I MANUFACTURING CO., Dept. P, Burlington, Wis.**

**BUY FAMOUS BRANDS WHOLESALE!**

APPLIANCES CAMERAS  
WATCHES CLOTHING  
TYPEWRITERS JEWELRY  
HOUSEWARES TOOLS  
SPORTING GOODS GIFTS

DISCOUNTS UP TO 80%

All brand new, nationally advertised merchandise. Guaranteed. Huge savings.

Send Postcard For Free Details  
**MIDWEST SALES (PM-156) Pontiac, Illinois**

**Free! SCARCE TRIANGLE COLLECTION**

Get this big valuable collection of triangle stamps... brought to you from the wilds of Africa, Europe, exotic Latin America, etc. All genuine, all different: scarce airmails, commemoratives, giant & midget stamps. EXTRA! Bargain Catalog, "Collectors Manual" and other exciting offers. Send 10c for mailing costs. Supplies limited. ACT NOW!

**Jamestown Stamp Co., Dept. H10PM, Jamestown, N. Y.**

**75 POWER TELESCOPE \$3.98**  
25X-45X-75X

New 3 in one telescopes, 3 variable 25X-45X-75X magnification. Brass bound. 25 power for ultra bright images 45 & 75 power for long range. Guaranteed to bring distant stars, moons, objects, sports 75 times closer.

Most powerful scope sold anywhere near this amazing low price. American made, 5 sections. Opens 36" class 1 ft. contains 4 ground & polished lenses. Can also be used as powerful compound microscope. Directions included. Mass production enables us to offer telescope complete at \$3.98 postpaid. Money back guarantee. Get yours now.

**CRITERION CO., 331 Church St., Hartford, Conn., Dept. PM850**

# ENGINEERING



Dr. Lee DeForest, Father of Radio, Grandfather of TV and all Electronics, exchanging ideas with Heald Electronics Instructor. Heald College Ranks **FIRST** West of the Mississippi in "Who's Who" in America. Send for **FREE** Information Heald Engineering College Est. 1865 Van Ness at Post, Dept. P.M. San Francisco, California Enroll Now for New Term

Thousands of Engineers Needed for Hard Pressed Industry

## BACHELOR OF SCIENCE DEGREE, 27 MONTHS

- Degree Courses:
- Electronic Engineering
  - Electrical Engineering
  - Highway Engineering
  - Mechanical Engineering
  - Structural Engineering
  - Civil Engineering
  - Architecture
- Diploma Courses:
- TELEVISION  ColorTV
  - Tool & Die Design
  - Architectural Drafting
  - Mechanical Drafting
  - Structural Drafting
  - Surveying
  - Estimating
  - Master Electrician
- Approved for Veterans

NAME \_\_\_\_\_  
 STREET \_\_\_\_\_  
 CITY \_\_\_\_\_  
 STATE \_\_\_\_\_



Let me show you

## HOW TO SPEAK AND WRITE LIKE A COLLEGE GRADUATE

I have helped thousands of men and women who have not had college training in English to become effective speakers, writers, and conversationalists. With my new C.I. METHOD, you can stop making mistakes, build up your vocabulary, speed up your reading, develop writing skill, learn the "secrets" of conversation. You don't have to go back to school. Takes only 15 minutes a day at home. Costs little. 32-page booklet mailed FREE upon request. Send me a card or letter TODAY!

Dan Bolander, Career Institute  
 Dept. 10510 25 East Jackson Chicago 4, Illinois

Please mail me your FREE 32-page booklet on English.  
 Name \_\_\_\_\_  
 Address \_\_\_\_\_  
 City \_\_\_\_\_ Zone \_\_\_\_\_ State \_\_\_\_\_

## High School at Home

### MANY FINISH IN 2 YEARS

No classes. No time wasted going to and from school. Progress as fast as your time and abilities permit. Standard H. S. texts supplied. Thousands enroll each year in this 60-year-old school. Send for FREE descriptive booklet.

**AMERICAN SCHOOL, Dept. H745**  
 Drexel at 58th St., Chicago 37, Ill.  
 Without obligation, please send FREE descriptive booklet.

Name \_\_\_\_\_  
 Address \_\_\_\_\_  
 Complete Canadian Courses available. Write American School, Dept. H745, 6083 Sherbrooke St. W., Montreal

# M.R. FARMER

Does This Look Familiar?



Are you paying doctor bills for sick farm animals that YOU might take care of YOURSELF? If so, you should have the



## VETERINARY GUIDE For Farmers

NEW, ENLARGED  
 3rd EDITION  
 BIGGER! BETTER!  
 EVEN MORE USEFUL!

384 Pages • Illustrated  
**\$3.95**

Information You Can Use Every Day  
 Covers Cattle, Horses, Swine, Sheep, Poultry

It pays you to know what diseases can strike your herd; what must be done for stricken animals; how the healthy ones in the herd can be protected; how the outbreaks can be prevented in the future. This is only part of the information you get in the Veterinary Guide for Farmers. Only **\$3.95**.

### Easily Worth Many, Many Times Its Cost

By preventing the loss of only one animal this book can easily be worth a hundred times its cost. Today's high market value of farm animals, together with the high cost of feeding and raising them, makes losses extremely expensive. Stop losses, step up your profits with the Veterinary Guide For Farmers.

Now you can know many of the things the veterinarian knows. You'll learn how to recognize the symptoms of diseases dangerous to your farm animals, and how to treat them yourself. The Veterinary Guide For Farmers is all you need. Completely revised, it's the most useful book of its kind. It tells you what the causes of diseases are and how you can prevent them. New 12-page diagnosis chart helps you identify the disease immediately.

### Simplified • Non-Technical Thoroughly Practical

Written by G. W. Stamm, Edited by Dallas S. Burch, former executive, Bureau of Animal Industry. Presented in the most simple, non-technical terms, its 384 pages are packed with how-to-do-it instructions, pictures, charts, etc., needed on every farm.

### OFFICIALLY ADOPTED IN 26 STATES

Endorsed by Vo-Ag teachers and other leaders. Adopted by "Veterans on the Farm" training classes in 26 states. It has sold more than 250,000 copies. This new edition of the "Vet Guide"—first in seven years—is more inclusive, up-to-date, even more valuable.

Send No Money! Mail Coupon Today!

**POPULAR MECHANICS PRESS, Dept. 1057**  
 200 E. Ontario, Chicago 11, Illinois  
 Rush me a copy of the Veterinary Guide for Farmers immediately. At the end of seven days I will either remit \$3.95 in full payment, or return the book to you in good order and owe nothing.

Name \_\_\_\_\_  
 Address \_\_\_\_\_  
 City \_\_\_\_\_ State \_\_\_\_\_

Check here if you enclose \$3.95. Same return and refund privilege.

# LEARN MEAT CUTTING AT NATIONAL

Pay After Graduation



The steady dependable trade of Meat Cutting taught easily in 8 short weeks. YOU LEARN BY DOING under actual meat market conditions in big modern school at Toledo.

For beginners or men with experience. Get a profitable store of your own. Remember, PEOPLE MUST EAT! Big pay jobs. Free employment help. Thousands of successful graduates.

Buying, cutting, percentage, pricing, advertising, selling, etc. A complete retail meat education. National School established 35 years. Get National training NOW. Pay your tuition in easy weekly payments

after you graduate. Send coupon for FREE 52 page school catalog — TODAY. G.I. approved.

National School of Meat Cutting, Inc., Dept. 50-W, Toledo 4, Ohio

Send me your FREE school catalog on National Training at Toledo in Meat Cutting, Meat Merchandising and Self Service Meats. No obligation. No salesman will call.

Name \_\_\_\_\_ Age \_\_\_\_\_

Address \_\_\_\_\_

City \_\_\_\_\_ State \_\_\_\_\_

Approved for training Korean Veterans

**NEW PLATING SOLUTION** on any object **ELECTROPLATE**  
 ANY OBJECT IN HOME, SHOP, GARAGE.  
 NOW with our NEW ELECTROCHEMICAL outfit. You can easily do your own plating. Not a paint. But a hard durable metal plate, equal to commercial plating. Get your own plating kit with instructions on plating metal and non-metal objects as Tools, Auto Parts, Silverware, Jewelry, Baby Shins and 1001 other articles with Chrome, Nickel, Copper, Gold, etc. **SEND NO MONEY.** Everything sent C.O.D. for the low price of ONLY \$5.95 or send \$5.95 now and receive it postpaid. Money back in 7 days if not satisfied. **M. Z. SALES CO., Dept. G-14, 113 West 42nd St., New York 36, N. Y.**

## HEY KIDS! Here's Your Chance to Drive!

"Buckboardin' Buggy" will give you loads of fun until you reach car-driving age. Good training for your future driving.

Coasts down hill like a dream, or can be safely powered with old lawn mower motor. Complete, crated, ready to unpack and run for only \$59.50 f.o.b. Fairport (without motor); or get complete "Build-yourself" kit and instructions for \$49.50 f.o.b. (Includes all parts, wheels, bolts, steering wheel, clutch, beautifully painted, easy to assemble in a few hours.) Best quality materials, ruggedly built to last years, weighs 60 lbs! Order today, send check or money order. We guarantee satisfaction. Free circular.



MAYO BROTHERS Dept. P FAIRPORT, N. Y.

## "OLD IRONSIDES" MODEL KIT!

Historic U.S. Frigate. Every detail accurate—armaments, spars, longboats with oars. Precision plastic parts, cement, plans. 16 1/2". For catalog send 10c, Dept. M0, 4223 Glencoe, Venice, Calif.



\$2.98

wherever hobby kits are sold



**FREE "How To Start Your Own MAIL ORDER BUSINESS"**  
 Earn from \$50.00 to \$100.00 per week, sparetime. We'll put you in business and furnish you with everything needed. Exclusive new catalog every three months. Offer your customers one item free for every two they buy! Free advertising and no stock for you to buy. We ship for you under your own name. No experience required. Write today for free booklet and franchise data.  
 MAIL ORDER ASSOCIATES, ROCHELLE PARK 35, NEW JERSEY

# Get into... PLASTIC LAMINATING AT HOME!

**THIS MAN...**  
 ...is taking out of the machine a Plastic Sealing Job — ordered by mail — only 11¢ in material cost brings back \$2.55 in cash by mail. Capacity of machine: \$25.00 profit per hour of operation.

Get **ORDERS** and **CASH** from your mailman—do work in **SPARE TIME** at home—or expand into **FULL TIME** business. Send coupon for Free facts about the newest and most fascinating of all home operated businesses. For the first time a simplified machine brings the fabulous profits of **Plastic Sealing and Plastic Laminating** within the reach of the small operator. Anyone can learn to operate the machine with a few minutes practice—then with our **Magic Mail Plan** can get mail orders pouring in daily with cash in every envelope. **No canvassing—no selling.** We even

**Make \$20 to \$30 a Day by... MAGIC MAIL PLAN!**

supply the circulars you mail to bring back cash and orders. Don't waste a minute. Rush your name. We'll send you **FREE** and postpaid, pictures, prices, details, and all the facts you need to start. Mail coupon or send name on postcard. No charge. Warner Electric Co., 1512 Jarvis Av., Dept. L-2-L, Chicago 26, Ill.

**Make Thousands of Beautiful Art Creations**  
 COSTUME JEWELRY • CIGARETTE BOXES  
 TRAYS • CANDLES TIGKS • COASTERS  
 LAMP BASES • BOOK ENDS...ALL IN  
 SPARKLING COLORED PLASTIC

**WARNER ELECTRIC CO., 1512 Jarvis Av. Dept. L-2-L, Chicago 26, Ill.**  
 At no cost to me, please rush complete details postage prepaid. I am under no obligation.

Name \_\_\_\_\_  
 Address \_\_\_\_\_  
 City \_\_\_\_\_ Zone \_\_\_\_\_ State \_\_\_\_\_

# Like to be an Artist?

Take free Art Talent Test! Find out if you have talent worth training. Demand for artists is increasing—for advertising, cartooning, illustrating. Earnings range up to \$500 a week. Thousands got started by taking this simple Art Talent Test. You take it at home in spare time. Test was devised by professional artists to uncover new talent. Offered free. No obligation. Mail coupon today.



ART INSTRUCTION, INC., STUDIO 10137  
500 South 4th Street • Minneapolis 15, Minnesota

Please send me your Talent Test, without cost or obligation.  
(PLEASE PRINT)

Name \_\_\_\_\_ AGE \_\_\_\_\_  
Address \_\_\_\_\_ County \_\_\_\_\_  
City \_\_\_\_\_ Zone \_\_\_\_\_ State \_\_\_\_\_  
Occupation \_\_\_\_\_ Phone \_\_\_\_\_

## LEARN UPHOLSTERY

in your spare time  
run your own  
business  
AT HOME

**FREE BOOK** with sample lessons  
with course  
**YOU MAKE**  
SLIPPER CHAIR  
CLUB CHAIR  
OTTOMAN  
PLUS  
SLIP COVERS  
Yours to Keep or Sell

**BE YOUR OWN BOSS**  
Earn more from the start! Set up your own profitable business, in your own home, enjoy steady income, independence for life—in the booming field of Custom Furniture Upholstery. Right off you start learning with tools, complete frames, fabrics and materials, included FREE with practical UTS course. You learn skilled professional custom upholstery, reupholstery, furniture finishing, repairs, how to make beautiful slip covers, window cornices, cushions and draperies. **EARN WHILE YOU LEARN**, in your spare time AT HOME... the UTS easy way.

**FREE ILLUSTRATED BOOK—FREE SAMPLE LESSON**  
Get ready for well-paid job and big profits, from steady work, as your own boss, running your own business. Mail coupon NOW for FREE BOOK! Training in N. Y. School also available.

**APPROVED FOR VETERAN TRAINING**

**UPHOLSTERY TRADES SCHOOL**  
Dept. FR-310, 721 B'way, N. Y. 3, N. Y.

Please send me **FREE** book "Your New Way to a Successful Career," and **FREE** sample lesson. No obligation—no salesman will call.  
 Home Study     N. Y. School Training

Name \_\_\_\_\_ (Please Print Plainly)  
Address \_\_\_\_\_  
City \_\_\_\_\_ Zone \_\_\_\_\_ State \_\_\_\_\_  
 Check if Korean Veteran

## NEW MAGIC RADIO WALKIE TALKIE!

**YOUR OWN POCKET SIZE RADIO STATION!**  
BROADCASTS TO ANY HOME OR CAR RADIO WITHOUT WIRES OR HOOKUPS! Wt. only 2 oz. Size, 1 1/2 x 3/4 x 1/2". Built-in telescoping antenna. Powerful Transistor—sensitive microphone. Frequency setter, break-in switch! Runs for weeks on self-contained flashlight batteries. Durable plastic case. With this Radio Talkie you CAN TALK TO YOUR FRIENDS UP TO A BLOCK OR MORE AWAY! Talk up to 1 mile or more between two automobiles. **INSTANT OPERATION!** Just push button to talk! No license needed. Uses inductive field magnetic radiation. Useful and real fun in a million ways! **GUARANTEED TO WORK. 1 YEAR SERVICE GUARANTEE.**

**SEND ONLY \$2.00.** (cash, ck, mo) and pay postman \$1.98 COD postage or send \$11.98 for prepaid delivery. **COMPLETE READY TO OPERATE** with instructions and hundreds of ways and tricks for broadcasts thru any radio you desire. Price may go up soon, so get your **NEW POWERFUL RADIO-VOX WALKIE TALKIE NOW.** Available only from: **WESTERN RADIO, Dept. RPM-10, KEARNEY, NEBR.**

## BARBELLS

**100 POUND SET \$11.80**

**140-Pound, CHROME DELUXE Barbell-Dumbbell set only \$18.80.**  
This is our feature set and is the finest ever manufactured.

Training with adjustable weight is the **BEST** way to keep fit; the **ONLY** way to develop great strength and a perfect body. As the oldest and best equipped barbell company, **BUR** gives value and prices no one can equal.

**SEND FOR FREE CATALOG.**  
**BUR BARBELL CO.**  
Lyndhurst 9, New Jersey

Extra Plates Only 10c Pound

## FREE AMAZING NEW BOOK "HOW TO ANSWER ADS"

Never before have you seen anything like this. Tells you in simple language the correct way to answer ads. Gets you quicker replies—better results, and greater satisfaction. Will save you time and money and it's **ABSOLUTELY FREE.** No obligation whatever. Every reader of advertising should have this booklet. Send a postcard for your copy NOW. **F. W. JOHNSON, Popular Mechanics Magazine, Room 600-A, 204 East Ontario Street, Chicago 11, Ill.**

# BUY BELOW WHOLESALE



## Start Your Own HOME-IMPORT Business

Make big profits on thousands of exotic imports. No experience or investment in products needed. Famous world trader guides men and women—shows you how to pocket profits in advance, how to get **FREE ADS**, how to start in your home. **BY MAIL—Full or Spare Time**

Open cash orders, take out the money, deduct your profits, then have the imports shipped direct from abroad. **NO STOCKS TO CARRY** on new plan, no face to face selling. Or handle volume orders for wholesalers, gift or department stores, etc. Export opportunities also.

### FREE SAMPLES—CONTACTS ABROAD

Following our plan you receive free, 8 imports—and membership in International Traders which provides you with monthly bulletins revealing best foreign products with names and addresses of overseas suppliers.

**HUGE UNCROWDED OPPORTUNITY** Each year more imports are offered in U. S. and snapped up by mail order and store buyers alike. And the word "imported" is like magic to the millions who want new, rare, romantic and unusual gifts and possessions. And there seems to be no end to this demand. Others using our plan are now importing at low foreign costs products that sell here at handsome profits. Why not you?

### Act Now for Biggest Profits

Get full details and list of 157 imports showing amazing low foreign prices—**ALL FREE!** There's no obligation whatever. No salesman will call on you. Air mail reaches us over night. Write today.

**MELLINGER COMPANY**  
1717 WESTWOOD BLVD., DEPT. G25A,  
LOS ANGELES 24, CALIFORNIA

EXAMPLES OF LOW PRICES ABROAD

LEARN

# Television RADIO—COLOR-TV



IN THE GREAT SHOPS OF **COYNE**

Great opportunity for a good job or your own business in one of America's fastest growing industries! New stations . . . new sets by the millions . . . and now Color TV . . . all means greater opportunities in a good job or a business of your own.

**Veterans and Non-Veterans**—Get practical training in TELEVISION-RADIO at Coyne in Chicago—old established school—training background of nearly 60 years.

Learn on real equipment—no advanced education or previous experience needed. Lifetime employment service to graduates.

**Finance Plan**—New liberalized credit terms. Enroll now, pay most of tuition later. Part time employment help to students.

**BIG FREE BOOK** Mail coupon. No obligation. No salesman will call. Act NOW.

**COYNE ELECTRICAL SCHOOL**  
CHARTERED NOT FOR PROFIT  
Established 1899

500 S. Paulina, Chicago Dept. 77-3H



**COYNE Electrical School**  
500 S. Paulina St.  
Chicago 12, Ill. Dept. 77-3H

Send **FREE BOOK** and full details of your training in TELEVISION-RADIO

Name \_\_\_\_\_  
Address \_\_\_\_\_  
City \_\_\_\_\_ State \_\_\_\_\_

## WHAM-O BLOWGUN SET for target and hunting

This amazing gun has the accuracy of a rifle. Compression of breath in barrel gives terrific air power. You won't believe your eyes!

can shoot over 200 ft. Average person can hit a 2" bulls-eye at 30 ft. Excellent for shooting small game. For target fun with friends, set up in patio or den.

Set includes metal blowgun, rubber mouth-piece, four 5" steel darts and range target. Extra darts 6 for \$1. At sports dealers or send: WAMO MFG. CO., Box H-25, San Gabriel, California

SPECIAL \$2.98

## MAKE MONEY MAKING SIGNS

DRAW PERFECT LETTERS FAST! IT'S EASY WITH "STENSO" LETTER and FIGURE GUIDES



No training needed. Just put your pencil in the stencil. Ideal for stores, shops, schools, offices, clubs, etc. Pays for itself many times over. Made of sturdy stencil board. Can be used over and over. Numbers and Letters Complete:

**GOTHIC:** 1/2, 3/4, 1, 1 1/4, 1 3/4" includ. **\$1.50**  
 **ROMAN:** 1/2, 3/4, 1, 1 1/2, 2" includ.  
 **OLD ENGLISH:** 1, 1 1/4, 2 1/2" includ. Per Set

### Large Size Stenso Lettering Guides:

- |  |   |
|--|---|
| Letters & Numbers:                         | <input type="checkbox"/> 8" Letters.....set \$4.00  |
| <input type="checkbox"/> 3" Set.....\$1.00 | <input type="checkbox"/> 8" Numbers.....set \$1.75  |
| <input type="checkbox"/> 4" Set.....\$1.75 | <input type="checkbox"/> 12" Letters.....set \$7.50 |
| <input type="checkbox"/> 5" Set.....\$2.50 | <input type="checkbox"/> 12" Numbers...set \$3.50   |
| <input type="checkbox"/> 6" Set.....\$3.25 |   |

At Art, hobby, stationery and variety stores. Or Order By Mail. Print name and address.

Dept. 202, STENSO LETTERING CO., Balto. 18, Md.

OCTOBER 1957

49

# THIS BIG 48 PAGE GIFT CATALOG is YOURS FREE!

• OVER 300 UNUSUAL GIFT ITEMS THAT WILL SURPRISE AND DELIGHT YOU!

New, amazing gifts for young and old! Hard to find items from 59c to \$5.00 not usually available! Sensational toys . . . dolls . . . household items . . . accessories . . . novelties! A quick, convenient way to shop for the UNUSUAL . . . gifts for Christmas, birthdays, etc. that will be remembered! Sent FREE, postpaid on request.



Write at once for your FREE COPY

**HIGHLAND GIFT MART**  
P. O. BOX 3547, HIGHLAND PARK 3, MICHIGAN

• Please rush your big 48 page FREE Gift Catalog.

Name \_\_\_\_\_  
Street \_\_\_\_\_  
City \_\_\_\_\_ State \_\_\_\_\_

## GROW ORCHIDS AT HOME

Purple, White  
Yellow, Green  
Every Rainbow  
Color

World's Most Thrilling Hobby—Successful home grower offers complete illustrated instructions. Tells how to start. Explains temperature, light and humidity conditions needed to grow Cattleyas, Cymbidiums, Odontoglossums & others in the home. Many Orchids grow without soil, getting food from the air. Some bloom summer—others winter, spring, fall. Instructions include real blooming size Orchid plant. FREE—full details. Send no money, just name and address.  
TROPICAL FLOWERLAND, Dept. 31A, 100 S. Vermont, Los Angeles 4, Calif.

**EARN BIG PAY**

**COURSES OPEN IN SHOP METHOD TRADES TRAINING**

THE TRAINED MAN GETS THE BREAKS  
PRACTICAL & HOME STUDY COURSES

- CHECK YOUR COURSE HERE AND MAIL
- WELDING
  - AIR CONDITIONING
  - AUTO MECHANICS
  - DIESEL
  - TELEVISION & ELECTRONICS
  - RADIO
  - PHOTOGRAPHY
  - REFRIGERATION
  - DRAFTING
  - COMMERCIAL ART



For Full Details without obligation write to our information office: Department AW, 3330 University Ave. S.E., Minneapolis, Minn.

IN CANADA  
English—835 Weston Road, Toronto 9, Ontario  
French—65 Jean Talon St., W. Montreal, Quebec.

OPERATING FOR A QUARTER CENTURY  
COAST TO COAST

## New Isotronic Training Method LEARN TV REPAIR IN ONE SHORT WEEK!

Now, after 5 year's research—a streamlined training system that obsoletes all others! In just 7 days you may earn \$150 weekly, without paying up to \$250 for training, studying long months! Developed by electronic scientists in cooperation with major TV mfr's., the new Isotronic method is the most practical ever devised! For conclusive proof, write for details and FREE SAMPLE LESSON. Use it on your own set or a friend's—repair it—convince yourself you can make big money immediately in your own TV business! Hurry—Free Lesson supply limited. Write:  
Electronic Engineering Co., Dept. A-17A  
1038 So. La Brea, Los Angeles 19, Calif.

**WHAM-O** \$1.50 FULLY  
HITS LIKE A RIFLE—KILLS RABBITS, SQUIRRELS.  
Powerful, silent, accurate. For hunting, target, routing pests.  
NEW! Superior quality pure gum rubber. 2 1/2 heavy extra steel balls. Heavy duty 7" ash stock. 40 heavy steel balls, extra rubber, target, adapter for shooting arrows.  
GUARANTEED: Professional model of Nat'l Slingshot Assn. At dealers, or write WAMO MFG. CO., Box K12 San Gabriel, Calif. FREE catalog on crossbows, knives, games, pistols, etc.

Do a Real Professional-Like Job Yourself and SAVE

## HOW to PAINT With Brush and Spray

Covers All Painting Methods and Materials

You can do professional-like painting and finishing jobs yourself and save about two-thirds of the cost. Sam Brown, noted craft authority, makes it so easy for you in his book, HOW TO PAINT WITH BRUSH AND SPRAY. Order your copy now and enjoy this tremendous saving. It covers exterior painting, wall and interior decorating, furniture finishing, concrete painting—every type of painting with brush, spray gun, roller and other methods. Tells what finish is best; what materials to use, etc. No previous experience needed. Fully illustrated. Order by mail. Only \$2.50. Money back if not pressed.

POPULAR MECHANICS PRESS, Dept. PM1057  
200 E. ONTARIO ST., CHICAGO 11, ILL.



## "Cheyenne" HEAVY-DUTY Gun Belt and HOLSTER

Everything to make this out of western heavy-duty tooling cowhide, includes:

- 7 piece Tool Kit \$ 7.45
- Theming Chisel .70
- Wooden Mallet .50
- Slicker .35
- Heat-Loc .35
- Carving Board .80
- Leather Holster Kit \$1.10
- Glue Leatherwork .80
- Instruction Book 2.00
- 1-year subscription .30
- Leather Craftsmen .30
- Total Case .50
- 3 Personal Instructions 1.00

\$28.15

Write for FREE 100 Page CATALOG

\$2815 VALUE

NOW ONLY \$2050 ppd.

**TANDY LEATHER CO. (SINCE 1919)**  
P.O. BOX 791-BG FORT WORTH 1, TEX.

# NEW INVENTION REPLATES AUTO CHROME

with PERMANENT PLATING  
MAKE MONEY! SAVE MONEY!

## FACTORY-NEW BRILLIANCE FOR CAR CHROME

Here at last is the car-owner's answer to all chrome problems... a dramatic new invention—SPEEDPLATER. It actually plates NEW METAL as you brush. And the plating you apply becomes an INDESTRUCTIBLE part of the bumper, grille or trim itself. How your car will shine! You'll be mighty proud when you remove ugly rust spots and replat metal to a NEW SPARKLE... when you bring new, gleaming beauty to worn, dull, even blistered chrome areas of your car. This fast sensational method of brush-plating gives FACTORY-NEW BRILLIANCE that bonds itself onto your car. It forms a hard, sparkling surface that defies all elements!



Quickly Builds-up a Thick, New, Plating With Each Application

SPEED PLATES YOUR CAR!



Enough Solution to plate 3 entire cars

### BUMPERS—GRILLWORK—ALL CAR TRIM RESTORED TO NEW BRILLIANCE!

Here is how easily you replat your car... You simply attach SPEEDPLATER'S clamps to your car's battery, then dip SPEEDPLATE Brush into miracle solution. You PLATE WITHOUT REMOVING PARTS FROM YOUR CAR. Works Fast—yet uses less battery juice than the tiniest light on your car.

### TRY AT OUR RISK

If you want to put a new permanent gleam on YOUR CAR'S CHROME—you can do it right away and not risk a dime. If you are not satisfied with great results it doesn't cost you a penny! Just mail coupon with only \$1 deposit—then pay postman \$11.95 plus postage when your kit arrives. If you send \$14.95 we ship prepaid. Either way you must be COMPLETELY SATISFIED or you may return all in 10 days for FULL CASH REFUND. ACT NOW—Here's What You Get: SPEED-PLATE Brush with Permanent Anode; Wires and Clamps for battery hook-up; Special Buffs and Buffing Compound; Special Metal Polish; Full, Simple Instructions.

### CAR DEALERS & SERVICE STATIONS—Make BIG Profits with Special HEAVY-DUTY OUTFIT!

FACTORY RESULTS and Big Volume Business can make Terrific Profits For You with this Heavy-Duty Outfit. Do your own replating without removing bumpers or grillwork! Increase the value of used cars! Heavy-Duty Outfit Electroplates on current from standard 12 volt storage battery. ENTIRE KIT COMPLETE—Only \$34.95 with enough material to plate dozens of cars! You quickly make back cost on your very first job! Re-order solutions always available from us at rock-bottom cost to you. MONEY-BACK GUARANTEE. Order Now—If C.O.D. send \$5 deposit.

EMPIRE MERCHANDISING CO., 4 North 3rd Ave., Mt. Vernon, N. Y. Dept. P-107

- Please rush the electroplating kit I have checked
- Regular Kit \$14.95 (If C.O.D. send \$1 deposit)
- Heavy-Duty Service Station Outfit, \$34.95 (If C.O.D. send \$5 deposit)
- I enclose full price, send postpaid.

I understand that I must be COMPLETELY SATISFIED or I may return kit in 10 days for immediate CASH REFUND.

Name \_\_\_\_\_  
Address \_\_\_\_\_  
City \_\_\_\_\_ State \_\_\_\_\_

### Make Big Money Plating Other Cars!

Now you can add to your income during spare time... because 8 out of 10 cars on the road today NEED REPLATING. You can charge from \$5 for touch-up to \$10 for replating an entire car. It's easy and there's good money in it for you. When your neighbors see the brilliant plating on your car, they'll surely want you to do the job for them! Replate other things for profit too—faucets, tools, home appliances, cutlery, doctor's and dentist's instruments.

## AMAZING NEW "TI-NEE" RADIO



"TI-NEE" RADIO IS GUARANTEED TO WORK FOR YOUR LIFETIME! USES NO TUBES, BATTERIES OR ELECTRICAL PLUG-INS. Never runs down! SMALLER THAN A PACK OF CIGARETTES! RECEIVES LOCAL RADIO STATIONS MOST ANYTIME, ANYWHERE WITHOUT EXTRA ANTENNA. Uses semi-conductor crystal diode Hi-Q Tuner. Beautiful black wood plastic cabinet. Built-in Speakerphone.

SEND ONLY \$2.00 (bill, ck, postman \$4.00 COD on arrival or send \$6.00 for postpaid delivery.)

SENT COMPLETE HEADY TO LISTEN—NOTHING EXTRA TO BUY EVER! Extra long distance Aerial kit included free to receive stations up to 1,000 miles away. Available only from: MIDWAY COMPANY, Dept. GPM-10, Kearney, Nebraska



### DEVELOP A HE-MAN VOICE!

Write for FREE book "How to Strengthen Your Voice for Greater Success" by Eugene Fuschinger. No obligation. Book will be mailed at once in plain wrapper, postpaid. Just send your name and address. State age. PERFECT VOICE INSTITUTE, 210 S. Clinton St., Studio KY-2, Chicago 6, Ill.

## ENGINEERING DEGREE IN 27 MONTHS

**B. S. DEGREE IN**  
Aeronautical, Chemical, Civil, Electrical, Mechanical and Electronic Engineering (inc. Radio and TV)  
Also B.S. DEGREE in 36 mo. in Mathematics, Chemistry, Physics (inc. Nuclear Physics), Engineering Science prep. courses. Thorough, practical program. Individualized instruction emphasized. Government approved for G.I.'s.  
*Keeping pace with progress in science and engineering*  
Spacious campus, 20 bldgs.; dorms, gym, playing field. Modern, well-equipped labs including new physics lab and wind tunnel. Low tuition. New terms start quarterly. Enter December, March, June or September. Big demand for graduates. Students from 48 states and 40 foreign countries. Many earn a major part of their college expenses in this large industrial center. Send coupon for free catalog and full information. Enroll now!

### INDIANA TECHNICAL COLLEGE

5107 E. Washington Boulevard, Fort Wayne 2, Indiana  
Please send me free information on 27 MO. B.S. DEGREES in:  
Aeronautical  Chemical  Civil  Electrical   
Mechanical  Electronics   
on 36 MONTH B.S. DEGREES in:  
Mathematics  Chemistry  Physics   
Name \_\_\_\_\_  
Address \_\_\_\_\_

## KEEP YOUR... ON BENJAMIN for HIGH H.C. COMP

AIR GUNS & CO., GAS GUNS—Top Quality at LOWEST PRICES!



**BENJAMIN SUPER**  
CO<sub>2</sub> Gas Carbine  
with Reg. Stock as low as \$14.95  
Deluxe Model with Custom Stock (Shown) as Low as \$17.95

Benjamin Air Rifles and Benjamin Air Pistols are Recognized All Over the World for Finest Workmanship and Highest Quality at Lowest Prices. Adjustable Power with Amazing Optimum Force. Fully Guaranteed—Safe—Accurate—Economic. Easy to Use anywhere—12 Models for Target and Small Game BB or 177 or 22.

All Models Benjamin CO<sub>2</sub> Carbine Gas Rifles and Benjamin CO<sub>2</sub> Rocket Gas Pistols Use Standard Size CO<sub>2</sub> Cartridges (available everywhere). 2-Stage Hi-10 Jet Power—High for Small Game—Low for Target—Up to 50 Shots from each Cartridge. No Pumping—Safe—Accurate—Economic—Non Toxic—12 Models BB or 177 or 22.

**FREE!** Catalog All Models Benjamin Air Guns & CO<sub>2</sub> Guns & Supplies. Also, Money-Saving Offer on Hunting & Fishing Accessories.

Send Free Gun Catalog and Special Offer!  
BENJAMIN AIR RIFLE CO., 896 MARION ST., ST. LOUIS 4, MO., U.S.A.  
Name \_\_\_\_\_  
Address \_\_\_\_\_  
City \_\_\_\_\_ State \_\_\_\_\_

# TECHNICIANS WANTED



**GAPS IN INDUSTRY MUST BE FILLED BY MEN TRAINED TO HIGH STANDARDS . . .**

The man who really has the "know-how" will win the best position and highest pay. "Engineering Opportunities" lists many specialized home study courses written by world authorities in: Aeronautical, Civil, Mechanical, Mining, Petroleum, Structural, Electrical, Radio, Television and Plastics etc. Send today for your **FREE** copy of "Engineering Opportunities" to Canadian Institute of Science and Technology Ltd., Century Building, Washington, D.C.

Canadian Institute of Science & Technology Limited, 673 Century Building, 412, 5th Street, N.W., Washington, D.C. Please forward **FREE** of cost or obligation of any kind your 105-page handbook, "ENGINEERING OPPORTUNITIES".

Name.....  
 Address.....  
 Course interested in..... Age.....

Canadian Enquiries: Canadian Institute of Science & Technology, 263 Adelaide St., W., Toronto, Ont.

*The 6-Transistor  
 Portable That Plays  
 Anywhere!*



build your own **HEATHKIT** radio and **SAVE**



**HEATHKIT TRANSISTOR PORTABLE RADIO KIT**

MODEL XR-1 **\$34.95**

(with cabinet, less batteries)

**FREE HEATHKIT CATALOG AVAILABLE**

Pioneer in "do-it-yourself" electronics

Describes many more "do-it-yourself" kits for hobby—hi-fi—ham radio—and experimenting. Get your copy now for complete selection of fun projects that save you money.



**HEATH COMPANY**

BENTON HARBOR 17, MICHIGAN A SUBSIDIARY OF DAYSTROM, INC.  
 Please send **FREE** Heathkit Catalog

NAME.....  
 ADDRESS.....  
 CITY & STATE.....

## EXTRA HEAVY DUTY CLUTCH COMBINATION SPEED REDUCER

COST GOV'T \$375.00

**GUARANTEED EQUAL TO NEW!**



**SPECIAL SALE \$99.00 F.O.B. FULLY GUARANTEED!**

Speed Reducer alone worth triple this low price!  
 • Reduces speed at a 4 to 1 Ratio • These Units hard to get at any price! • Independent Output shafts, each separately controlled by its adjustable clutch • Rated up to 7.5 HP (electric), or 15 HP (gas engine). • Ball and Taper Roller Bearings throughout (smooth, quiet). • Input shaft 1-7/16" diameter. Output shaft 1 1/2" diameter. • Weight 270 lbs.—Dimensions approx. 24 1/2" long x 15" wide x 13" high  
 This **SPEED REDUCER-CLUTCH COMBINATION** can be utilized when low speeds are required . . . for starting heavy loads . . . or, for engaging and disengaging machine operation without stopping input drive. Supply Limited! **ORDER DIRECT FROM THIS AD!** Immediate Delivery! Good Serviceable used Condition (Guaranteed) only \$79.00 F.O.B. **FREE** Catalogue of Reducers, Hydraulics, War Surplus Bargains.

**KARL ORT, Dept. 10M, York, Penna., Tel. 7771**

## Real electric motor **Only \$1.50**

**BRAND NEW** 1 Post paid



"LITTLE GIANT"



**5000 RPM**

**MODEL MAKERS!** MOTORIZED YOUR CARS, BOATS, TRAINS, Erector Sets, etc. This genuine electric motor runs on one or two flash light batteries. Has permanent magnetic field, copper wound rotor and copper commutator, bronze bushings, with steel housing and mounting base. Motor also works as generator. You can make miniature designs for water pumps, lathes, jig saws, drill presses, etc. Once in a lifetime value. Limited supply. Motors \$1.50 each, 2 for \$2.50. Postpaid. Money back guarantee. Send to: **WHOLESALE DIE CO., Box C-12, San Gabriel, Calif.**

## Baby Crying Starts Crib Rocking

Electronics, that marvel of modern living, has even taken the place of dad walking a crying baby to sleep at night. An ingenious Texas father has invented and placed on the market a crib that rocks when the crying of a baby sets off an electronic control. Silent in operation, the motor-driven device continues rocking the crib up to four minutes after the baby stops crying. It has a two-tube electronic unit that filters out other noises except the high-pitched cry of a baby.

Ducky Bed, Inc., 1012 Texas Ave., Lubbock, Tex.

## Adhesive Cools Like Metal

Glue with a strength of 8000 pounds per square inch at a temperature of 450 degrees below zero Fahrenheit has been developed as an aid for atomic research. The synthetic material, called epoxy resin, was needed to bind together copper coils in an electromagnet used in studies of atomic particles. When the coils are cooled with liquid hydrogen the glue contracts at the same rate as the copper.





Fast cutting  
Top quality

**GENSCO**



## SWEDISH WOOD CHISELS

Woodworking projects have that little extra professional touch when Gensco Swedish Wood Chisels are used. They're tops: hand ground, razor sharp blades, Tenite II handles are unbreakable and fire resistant... won't pull loose, sizes from 1/4" to 2".

Buy these accurate cutting, easier to use Gensco Wood Chisels at all leading hardware stores today. Available in sets of 4, 6 or 11 chisels in vinyl coated canvas rolls.



Set 300-4

1/4", 1/2", 3/4" and 1"



Bushman ALL-PURPOSE 21" Bow Saw

**GENSCO** **GENSCO TOOLS**  
A DIVISION OF  
GENERAL STEEL WAREHOUSE CO., INC.  
1832 N. Kostner Ave., Chicago 39, Illinois

not everyone does as well, but E. O. Lockin, who started a business of his own, reports...

for 12 months I've averaged  
**\$800 PER MONTH INCOME** —  
most of it clear profit for me!

Many men have discovered how to be independent, to be free of bosses and layoffs. L. A. Eagles grossed more than \$200 his first week. Others report gross up to \$12,000 per year. How much you make depends largely on you. You need no special skill, no large investment.

**No shop necessary.** Our **ELECTRIC RUG WASHER** cleans rugs, carpets right on floor... helps to show their natural color, beauty. So efficient and safe, used by largest hotels and railroads.

You take no risk. Machines fully guaranteed. Write for full information including how to make big profits in **YOUR OWN BUSINESS.**



MAIL COUPON TODAY FOR FREE BOOK

**VON SCHRADER MFG. CO.,** N10 "R" PL, Racine, Wis.

Without obligation, send your **FREE** booklet containing information about your **ELECTRIC RUG WASHER** and how I can start my own permanent, profitable business.

Name \_\_\_\_\_

Address \_\_\_\_\_

City \_\_\_\_\_ Zone \_\_\_\_\_ State \_\_\_\_\_

## NEW GOV'T. RELEASE! Variable Speed HYDRAULIC SPEED REDUCER



with instantaneous REVERSING

Regularly \$500.00  
Only **\$72.50** fob

Output Speed reversible in either direction from 0 to 750 RPM

USE FOR: Machine tools, reamer drives, conveyors, printing presses, tractors, cars, canning machines, etc.

— This type unit hard to find at ANY price —

Drive with 3/4 to 1 1/2 HP motor at 750 RPM max. Ideal for continuous reversing operation. 3/8" dia. shafts. 11" long. 7 1/2" wide. 7 1/2" high. 32 lbs. Complete with easy instructions and 2 Qt. hydraulic oil.

**FULLY GUARANTEED! SUPPLY LIMITED! ORDER from this AD**

FREE Catalog of other **SURPLUS & HYDRAULIC**

Phone TAYLOR 9-1365

**ROBERTS ELECTRIC CO.** 849 W. Grand, Dept. PM-672, Chicago 22

**HOME GYM**

## muscles fast! NEW SWEDISH METHOD

surest way known--produces amazing results



DIRECT FROM FACTORY

**\$198** avoid

Gain 10 pounds of muscle in 15 minutes a day. Feel vibrant, powerful, more alert. Gain confidence through superior physique. Lose fat... build muscle. Be a winner at sports, attractive to girls. New proven method shows you exactly how to do it. Includes detailed course and exerciser. Send only \$1.98 to:

**TECHRITE CORP.,** Box 3-D, San Gabriel, California

ADJUSTABLE PULL BAR CHEST ARMS BACK LEGS



**\$3.50 VALUE**

## Tire Retreading Is Speeded By Electronic Heat Control

Curing time of retreading tires will be reduced 50 percent by a new method, the Gibbs Electronic Speed Cure, manufacturing rights to which have just been acquired by Goodyear Tire and Rubber Company. Basically the method applies heat to the inside of a tire casing while it is being retreaded in the mold, and at the same time heat is applied from the mold itself. A rubber pad in which wires have been laid in serpentine pattern is placed between the curing tube and the inside of the tire, an electronic control maintaining uniform temperature throughout the curing period. Goodyear reports that more uniform cures by this system will result in longer tread wear.

## Church Has TV "Crying Room"

Parents with restless children watch Sunday services by closed-circuit television in a "crying room" of Bethel Lutheran Church, Madison, Wis. The electronic system also is connected to television sets in a near-by chapel of the heavily attended church, where 400 overflow worshippers participate in the services.

**No shoveling! No chipping!  
No scraping! ICE REM  
melts ice and snow**

There's no reason for using old-fashioned, back-breaking methods of clearing ice and snow. ICE REM pellets melt ice in seconds. Light sprinkling over slippery surfaces stops danger of slips and skids. ICE REM, with its greater thawing capacity, is the original ice remedy. More than 50 million lbs. sold to date.



10 lb. pail **\$1.69**

100 lb. drum **\$13.95**

delivered

See your dealer!

Write for free bulletin! A.A.-6209

**SPECO INC.**

Cleveland 9, Ohio  
Dept. PM-10



**Plastic Steel®**

A DEVCON PRODUCT  
80% steel — 20% plastic

**REPAIRS  
PRACTICALLY  
ANYTHING!**

**AS EASY TO USE AS MODELING CLAY**

With PLASTIC STEEL — the only product of its kind — all you need is a putty knife to make 1001 repairs around the house, garage or shop. It bonds to metals, woods, porcelain, concrete and other surfaces. Hardens to steel-like strength in 2 hours. Won't shrink, expand or corrode. Can be machined.

Permanently fixes broken furniture, appliances, fixtures, pipes and tanks . . . repairs torn car fenders, cracked engine blocks, radiators, etc. Does a professional job . . . saves you time and money.

**NEW HANDY HOME KIT \$ .98**

Also \$1.89 and \$3.95 sizes at leading hardware and hobby stores.

WRITE FOR FREE BOOKLET.

\*PLASTIC STEEL is the registered trade mark for Devcon Corporation's metallic mending and filling compound.



**DEVCON CORPORATION**

175 ENDICOTT STREET, DANVERS, MASS.

**DIESEL  
MECHANICS IN DEMAND**

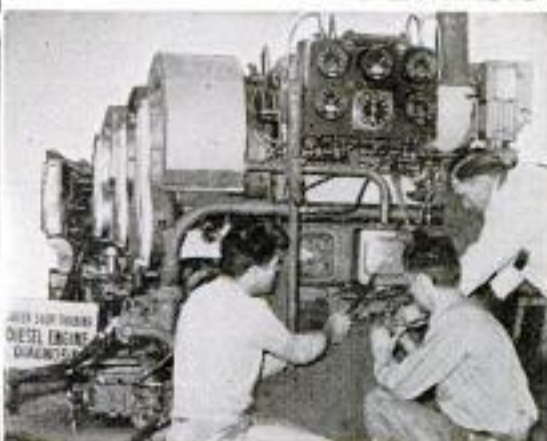

Learn to earn big pay in DIESEL in our large, modern equipped Chicago school and shop. No previous experience or training necessary. We help you find living quarters and part time job while in school. Complete, practical courses taught in the following trades, under the supervision of experienced, expert technicians.

APPROVED FOR CIVILIANS  OR GI'S

— CHOOSE YOUR TRADE —

CHECK HERE	WEEKS
<input type="checkbox"/> DIESEL MECHANICS	20
<input type="checkbox"/> AUTO MECHANICS	20
<input type="checkbox"/> BODY & FENDER	16 1/2
<input type="checkbox"/> GAS-ARC WELDING	4 - 12
<input type="checkbox"/> REFRIGERATION	13 1/2
<input type="checkbox"/> AIR CONDITIONING	8 1/2
<input type="checkbox"/> MACHINIST TRADE	30
<input type="checkbox"/> ADVANCED MACHINIST (includes tool & die)	32 1/2
<input type="checkbox"/> PIANO TUNING & REPAIR	36

**CHOOSE YOUR ENGINEERING COURSE**

These courses are intended as terminal education for men who wish to enter the Diesel-Automotive and Refrigeration-Air Conditioning fields as technicians. These courses are designed to prepare men for supervisory positions. Students with a high school education, or equivalent, will be accepted.

<input type="checkbox"/> DIESEL AUTOMOTIVE ENGINEERING	27 months
<input type="checkbox"/> REFRIGERATION & AIR COND. ENGINEERING	18 months
<input type="checkbox"/> WELDING ENGINEERING	18 months

HEAVY CONSTRUCTION EQUIPMENT OPERATORS TRAINING SCHOOL FOR CIVILIANS—Road Building, Terracing, Land Clearing, etc. Reservations accepted now!

**FREE EMPLOYMENT HELP**

Start your career with Greer by checking your interest above and mail coupon for complete information at no obligation.

NAME \_\_\_\_\_ AGE \_\_\_\_\_

STREET \_\_\_\_\_

TOWN \_\_\_\_\_ ZONE \_\_\_\_\_ STATE \_\_\_\_\_

Established 1902 — Over 50,000 Graduates.  
55 years of continuous trade school experience  
to guide your training.

**GREER SHOP  
TRAINING**  
Box J, 2236 S. Michigan Ave.  
Chicago 16, Illinois

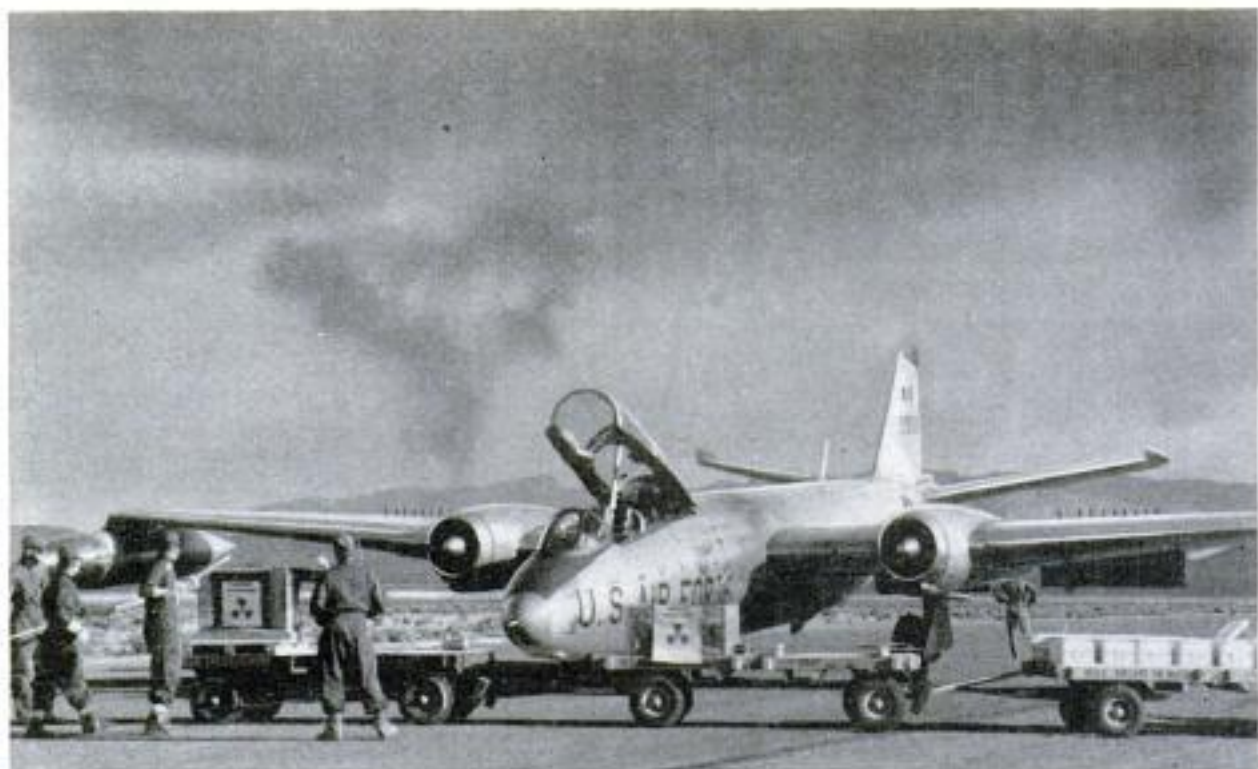

B57 flew into atomic-bomb cloud collecting "hot" samples. Crewmen handle material from safe distance

*Daring Air Force pilots wait for the spreading "mushroom" of an atomic explosion. When the red ball of flame disappears, they dive into the cloud as*

## They Sample "Hot" Clouds

Jet is washed four times to remove radioactive residue. Men wear special equipment, receive minute amount of radiation



**F**LYING JET airplanes through "hot" atomic bomb clouds is the dangerous assignment of an Air Force squadron in Nevada. They collect highly radioactive samples for important studies by the Atomic Energy Commission.

The 4926th Test Squadron (Sampling) at Indian Springs Air Force Base uses specially equipped F84G and B57 jets. Over the AEC atomic test site in Nevada, these courageous pilots dive into nuclear clouds shortly after A-bombs are detonated. Filters in the airplanes collect atomic particles, while tubes gather gaseous samples.

Elaborate care is taken to prevent overexposure to radiation by both the aircraft and ground crews. When the airplanes return from a mission, fork-lift trucks remove the crews to avoid human contact with contaminated surfaces.

The radiation-laden filters are taken from the planes by long-handled tools, rolled into cylinders and put in lead "pigs" for shipment to an AEC laboratory. The gaseous cloud samples are transferred under pressure to lead spheres.

Both the airplanes and the crews receive extensive decontamination. The extent of the precautions are dependent on the size of the atomic blast and the amount of residue collected. Film badges and dosimeters worn by crews, and radiation-detection instruments on planes provide this information.

Since the surfaces of the planes receive the most contamination, they are washed down with different solutions four times. Jet engines present surprisingly few contamination problems. The tremendous rush of air passing through them provides an almost self-cleansing action.

The decontamination ground crews wear special clothing, masks, gloves and shoes. The "hot" material is never handled without the men being a safe distance away, and wearing gloves.

Personnel of the 4926th Squadron receive "scheduled" doses of radiation in performing their work. This is accomplished by rotating their assignments to avoid too much exposure.

A pilot gets one tenth to one roentgen in flying through a "hot" cloud. A roentgen is the measure of the ionization caused by gamma radiation. To be on the safe side, the preferred total radiation exposure allowed sampling pilots is five roentgens per year. No more than 3.9 roentgens of exposure is permitted in any three-month period. Some of the Squadron members have participated in every atomic test since 1950, and have accumulated a total of 35 roentgens. ★ ★ ★



"Pig" on a pole is lead container for atomic cloud samples. Material is shipped to Atomic Energy Commission lab for study



Airman monitors pigs to test radioactivity. Jets catch gaseous samples as they fly through A-clouds

Atomic particles are gathered in filters, which are rolled into cylinders and stored in lead containers



# LUBRIPLATE LUBRICANTS



## Make House Equipment Work Better... Last Longer

LUBRIPLATE IN HANDY TUBES is a waterproof, semi-fluid lubricant. It's white and clean, will not wash off nor run out. Reduces friction and wear, prevents rust and corrosion. Belongs on every work bench, in every tool drawer. Nothing like it... nothing as good.

**YOUR HOUSE EQUIPMENT DESERVES  
THE BEST-USE LUBRIPLATE, YOU'LL  
SEE THE DIFFERENCE IMMEDIATELY!**

At Hardware, Sporting Goods and Marine Stores

### OTHER LUBRIPLATE PRODUCTS

LUBRIPLATE 2-C MOTOR OIL for outboards  
LUBRIPLATE OUTBOARD GREASES for underwater  
parts  
LUBRIPLATE H.D.S. MOTOR OIL for cars, trucks  
and tractors  
LUBRIPLATE AUTO-LUBE "A" for general automo-  
tive lubrication  
LUBRIPLATE Industrial Lubricants for every ap-  
plication

LUBRIPLATE DIVISION, Fiske Brothers Refining Co.  
Newark 5, N. J., Toledo 5, Ohio.



## Become A --- BUILDING CONTRACTOR! MAIL COUPON for FREE BROCHURE

Simplified home study training program. Learn every phase of building, estimating, contracting. Fortunes are made in this line of work every year. Use spare hours—no interference with present work. Diploma awarded. Low tuition rates.

**AMERICAN TECHNICAL SOCIETY**  
Dept. PM-1057, 850 E. 58th Street, Chicago 37, Ill.  
Please send me your FREE Brochure and full details of your building, estimating and contracting training program.

Name \_\_\_\_\_

Address \_\_\_\_\_

City \_\_\_\_\_

State \_\_\_\_\_



## NEW! Evans POWER-TAPE

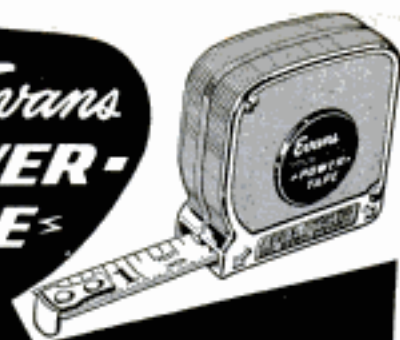

### No More Pushing Blade Back Into Case!

Here's the greatest single mechanical advance in steel tape history! Press the button gently with your thumb—blade returns smoothly. You control the speed. Release the button—blade stops instantly. No "creep," no lost measurements! Chrome-plated case, GIANT sliding end hook—for inside-outside measuring. White steel blade, marked in inches and feet-and-inches—no figuring! Free Tenite carrying case with magnifying lens.

Only  
**\$1.89**  
(10 ft.)

**Unconditionally Guaranteed**

6, 8, 10, or 12 ft. lengths

Get POWER-TAPE today!

Available only at hardware stores

**Evans RULE CO.** Elizabeth, N. J.  
Montreal, Que.



SHOCK ABSORBER

OVERLOAD SPRING

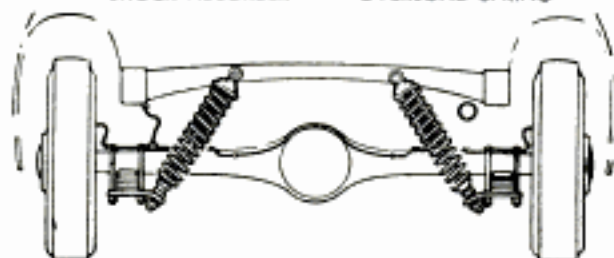

Monroe Auto Equipment Co., Monroe, Mich.

## Combined Spring-Shock Stops Rear-End Sagging

Dragging tail pipes and sky-piercing headlights are eliminated by a combination overload spring and shock absorber that replaces the original shocks on any car. The device, made by Monroe Auto Equipment Co., is said to increase road clearance of a heavily loaded car by more than 30 percent. In a demonstration, the company showed that a four-door sedan equipped with two of the units could be loaded safely with six passengers and 500 pounds of luggage and still maintain a level ride. Stability on curves is also increased, according to the manufacturer. The units are quickly installed.

POPULAR MECHANICS



## DO-IT-YOURSELFERS . . .

### REGLAZE WINDOWS PROFESSIONALLY

By now your local dealer should be stocking this new FLETCHER Glazing Kit consisting of all necessary equipment to do a professional reglazing job. Even an electrical putty softener is included, and an automatic tool for inserting glazier points into the sash. Complete simple instructions tell you how to use each tool. The complete price is only **\$5.98**.

If your dealer is not yet stocking this kit, write Dept. D

### THE FLETCHER-TERRY COMPANY

FORESTVILLE • CONNECTICUT



### NEW HIGH SPEED WHEELS,

**TIRES, TUBES, Bearings**—for use on trailers for boats, campsters, luggage, for portable tool equipment, concrete mixers, dollies, midjet cars, etc.

**\$14.95** each. Includes 8" steel drop center rim and hub, 4:80 X 8:00 4 ply 40 lb. pressure tire, tube, Timken roller bearings, grease retainer, hub cap. Load capacity per wheel 875 lbs. Bearing size 1" for straight axle, 7/8" hub length. Self-load adjusting 0 to 2300 lbs. Individual wheel suspension spring and axle unit—bolt to any frame for 1" bearings. \$5.95 each. Dual axle and spring \$9.95 each (wheel mounted each side of spring). For tandem wheel assembly, use two spring units each side. Interchangeable—single dual or tandem. Sorry no C.O.D. **WRIGHT'S ENGINEERING, 4785 Wightman Street, San Diego 5, California.**

# DIESEL MEN WANTED

## Earn \$100 per week and up AUTO-DIESEL MECHANICS

You learn fast in our school and shops because you learn with tools on real equipment. Experienced instructors explain WHY and show you HOW, then you DO IT YOURSELF with tools on various makes and models. One of the best equipped technical schools of its kind in the United States. Thirty-seven years' experience training men. Successful graduates in 48 states and many foreign countries. Approved for veterans. Day and evening classes. Earn While You Learn. Write for free bulletin.

### NASHVILLE AUTO-DIESEL COLLEGE

226 7th Ave. N., Dept. 86, Nashville, Tenn.

# LET THE WORLD'S STRONGEST MAN Help You Gain a Body to Brag About!

Be the envy of your friends, the admiration of particular girls. Begin AS YOU ARE—skinny, weak, undeveloped, or fat, flabby and short of breath. You can change yourself DAILY into the physical specimen you want to be by means of the four secret fundamentals which I discovered and thoroughly describe and illustrate in my wonder course "Easy Steps to Giant Strength."

I began myself as a puny youth. I was given up to die, but saved by only the prayers of my parents and moved by a deep determination to gain strength, I worked out my system which has meant transforming magic in many lives.

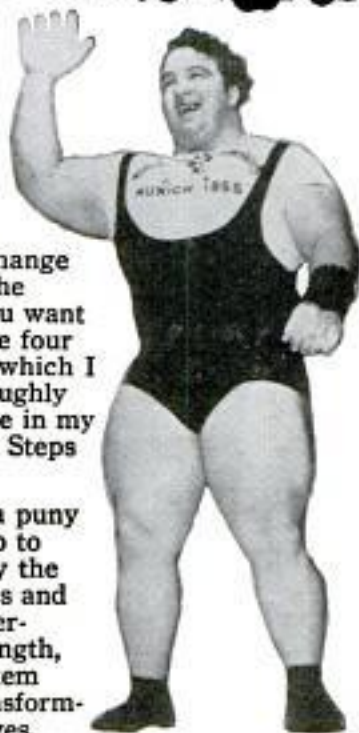

## Send TODAY for FREE Book

OLYMPIC  
CHAMPION

*Paul Anderson*  
**WORLD'S  
STRONGEST  
MAN**

Learn without obligation that there is a sure-fire method for developing the kind of body you would like to have. You can gain weight or lose weight without losing strength. You can build powerful responsive muscles into every inch of your physical frame. You can improve your style and performance in any sport with my tried and proved method. Don't delay—investigate!



## YOU TOO CAN WIN MEDALS & TROPHIES

"I have many medals and trophies won in National, Olympic and World competitions in Russia, Germany and Australia. Let

me fit you for weight lifting competition greatly growing in favor."

**MAIL  
COUPON**

**PAUL ANDERSON**

PM10

Toccoa, Ga.

Send me without obligation your fully illustrated book giving full details of "Easy Steps to Giant Strength." Check marks show the body I want.

- |   |   |
|---|---|
| <input type="checkbox"/> Muscular Development | <input type="checkbox"/> Poise          |
| <input type="checkbox"/> More Weight          | <input type="checkbox"/> Mental Control |
| <input type="checkbox"/> Less Weight          | <input type="checkbox"/> Strength       |
|   | <input type="checkbox"/> Health         |

Name \_\_\_\_\_  
(Please Print)

Address \_\_\_\_\_

City \_\_\_\_\_ Zone \_\_\_\_\_ State \_\_\_\_\_



# Looking for **JOB OPPORTUNITY?** **PLANNING YOUR CAREER?**

## Interested in **PERSONAL ADVANCEMENT?**

**POPULAR MECHANICS** announces the publication of its new career guidance booklet . . . **"SKILLS FOR AMERICA"** which is available *free* to any reader interested in: *job opportunity; career planning; personal advancement; or additional training in chosen careers.*

**"SKILLS FOR AMERICA"** is a new biannual reader service publication issued specifically to help those of our readers who have made up their minds to succeed in business or in a trade. Its pages contain valuable information on such subjects as . . . .

- What trades and skills are in greatest demand by industry today.
- Which skills are receiving the highest pay.

**"SKILLS FOR AMERICA"** will help our readers to decide upon the trade or profession which best suits them. And it will aid readers in planning a course of study to prepare for a chosen vocation.

If you have an earnest desire to get ahead; if you want to guarantee your future employment by training for one of the specialized skills in such critical need by industry today . . . . then send *today* for the Popular Mechanics self-help, career guidance booklet, **"SKILLS FOR AMERICA."** It will be sent **FREE** to you as a reader service by Popular Mechanics. Simply clip and mail the coupon on the opposite page to Popular Mechanics Magazine.

### **Booklet Covers These and Other Skills**

**Accountant**  
**Air Conditioning  
Technician**  
**Automotive Mechanic**  
**Aviation Mechanic**  
**Building Trades**  
**Business-Machines  
Mechanic**  
**Draftsman**  
**Electronics Technician**  
**Master Machinist**  
**Mechanical Engineer**  
**Production Engineer**  
**Tool and Die Maker**  
**and many other trades  
and professions**





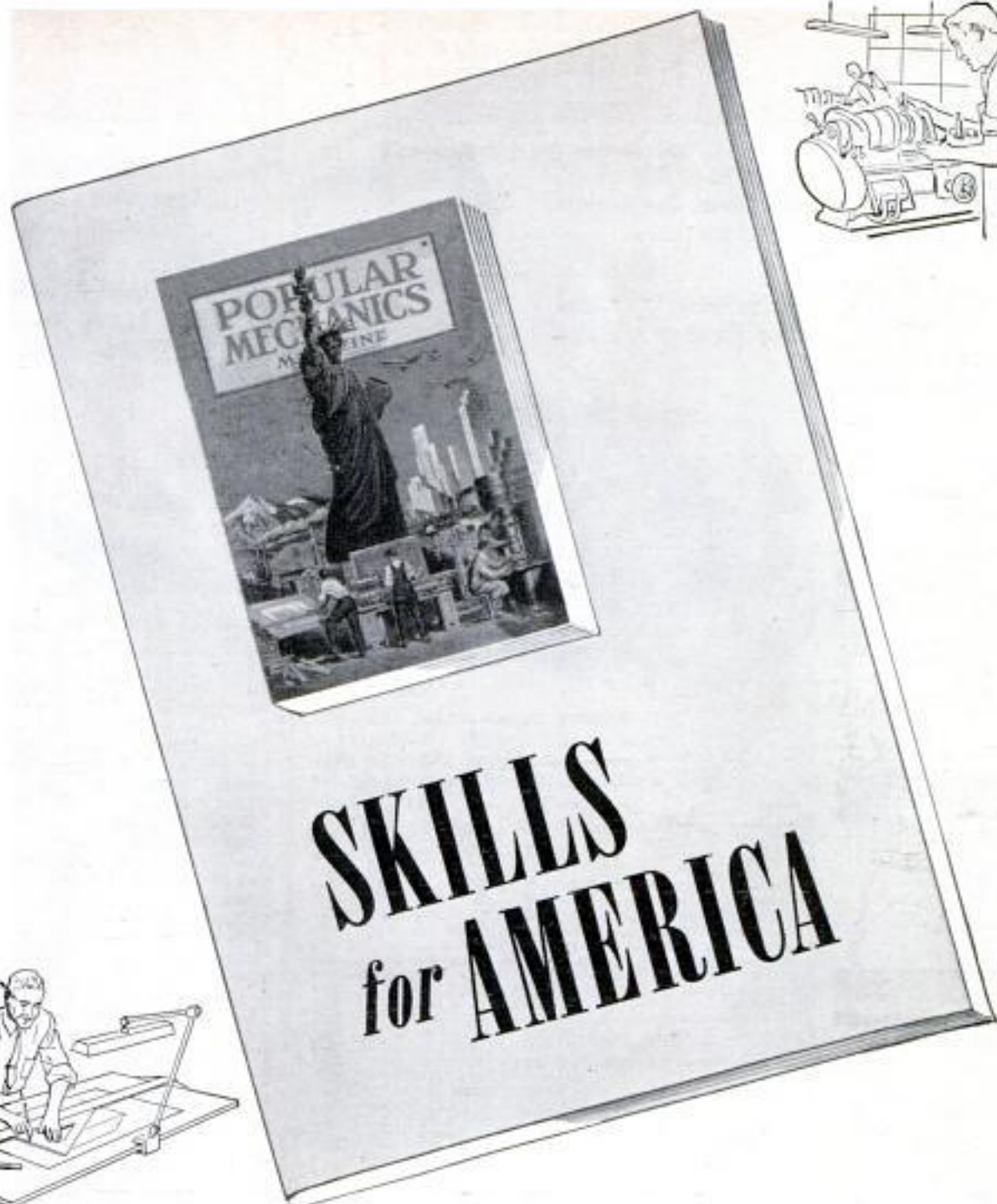

**ATTENTION!**

For copy of "SKILLS FOR AMERICA,"  
mail this coupon today to:

**POPULAR MECHANICS MAGAZINE  
DEPARTMENT SFA  
200 EAST ONTARIO STREET  
CHICAGO 11, ILLINOIS**

Please send copy of  
Career Guidance Booklet,  
"SKILLS FOR AMERICA" to:

Name \_\_\_\_\_  
(PLEASE PRINT)  
Street \_\_\_\_\_  
City \_\_\_\_\_  
State \_\_\_\_\_



From Volume 2  
"CAMPING"—  
pp. 271-287



From Volume 3  
"DRIVING YOUR CAR"—  
pp. 342-387



From Volume 3  
"ELECTRICAL REPAIRS"—  
pp. 417-528



From Volumes 3-4  
"OUTDOOR GAMES"—  
pp. 736-812



From Volume 5  
"HORSEMANSHIP"—  
pp. 1223-1241



From Volume 9  
"SEWING"—  
pp. 3239-3296



From Volume 10  
"TAXIDERM"—  
pp. 2516-2534



From Volume 11  
"TOYS YOU MAKE"—  
pp. 2692-2815

New!

POPULAR MECHANICS

JUNIOR DO-IT-YOURSELF ENCYCLOPEDIA

Guide Your Boy or Girl Into Clean, Constructive Interests . . .

Help Them in School and Through Life . . .

Fully Develop Your Youngster's Natural Talents . . .

. . . with LEARNING THAT LASTS THROUGH LEARNING BY DOING

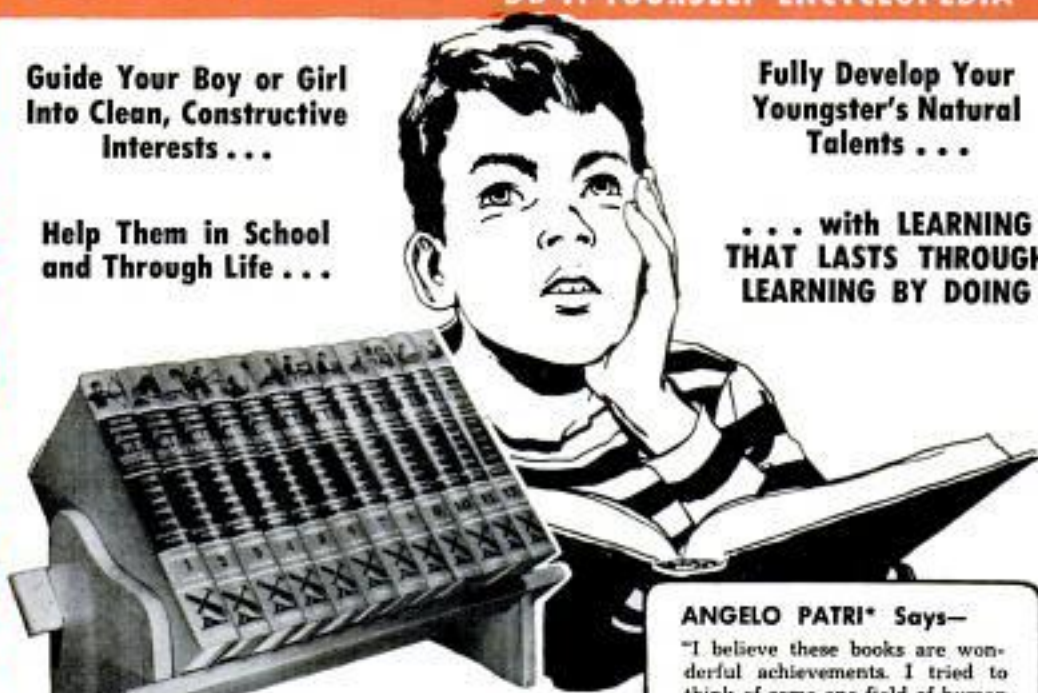

12 Beautiful Volumes — 3,072 Informative Pages — Over 5,000 Pictures, Photos, Charts, Diagrams — Hundreds of Subjects and Projects Children Want to Know About and Do!

Here is a once-in-a-lifetime opportunity to give your children a headstart in school . . . in life . . . in the art of living! Now, with publication of Popular Mechanics Junior Do-It-Yourself Encyclopedia, you can guide your boy and girl into constructive, worthwhile interests, encourage and help them to acquire valuable knowledge, self-confidence and poise . . . and they'll love you for it!

This remarkable set contains everything growing boys and girls want to know about and do. Read these typical comments from leading educators: "The wealth of material presented is fascinating . . . the most comprehensive collection of practical informative material ever assembled in book form for children. My chief feeling as I looked through the set was regret that I did not have something of the kind when I was a child . . ." "It (the set) appears to be entirely unique. I am sure that any boy or girl will find many things of interest in this set and will also learn a great deal from it."

Yes, this set is unique, for it gives your child a rare educational advantage—learning that lasts through learning by doing. Yet these volumes don't look like "teaching" volumes at all. They cover hundreds of subjects to intrigue and delight any child (a few illustrated at left). They're easy to read, with large type, thousands of pictures and diagrams, and each one has immediate interest for children sixteen, twelve—as young as eight years! Here, indeed, next to parental care and love, is the best possible assist you can give your boy and girl in their crucial formative years. It's easily worth many times its \$19.95 price, in lifetime dividends for them and for you. Easy terms if desired. See coupon below.

FREE! Handsome 12-volume book rack as shown included free in this introductory offer. Also Free! Each volume gold stamped with child's name if you enclose full remittance of \$19.95. See details below.

IMPORTANT: Popular Mechanics Junior Do-It-Yourself Encyclopedia is available now by direct orders addressed to this magazine. You will not be able to buy it anywhere else. Place your order below today.

ANGELO PATRI\* Says—  
"I believe these books are wonderful achievements. I tried to think of some one field of human activity that the books did not cover and could not find one unless politics and religion could be counted, and this collection of the world's work was no place for them. I believe that teachers of handicrafts, parents wishing to share their children's interests and forward them, all youth leaders, would find them invaluable. The sections that deal with games and sports are very good. Educationally they are 'Learn by Doing' aids and that is the highest praise I could give any such books."  
\* Famous author, columnist, counselor on child training and behavior

Send No Money! MAIL COUPON TODAY!

POPULAR MECHANICS PRESS • Dept. 1057 • 200 E. Ontario St., Chicago 11

Ship at once, charges prepaid. Popular Mechanics Junior Do-It-Yourself Encyclopedia, 12 volumes with \$2.50 value library book rack, under plan as indicated.  
 Remittance for full payment, \$19.95 enclosed.  
Gold stamp each of the 12 volumes with name as lettered without extra charge.

Send for free examination. I will remit \$4.95 in seven days and pay \$5.00 each month thereafter, until a total of \$19.95 is paid or return the books and rack to you in good order and will owe nothing.

Name \_\_\_\_\_

Address \_\_\_\_\_

City \_\_\_\_\_ Zone \_\_\_\_\_ State \_\_\_\_\_

PRINT NAME FOR GOLD STAMPING HERE \_\_\_\_\_

# WANTED

# MEN AND WOMEN TO JOIN THESE SUCCESSFUL SCREEN-PRINTERS

## NEW ONE-MAN 'HOME PRINTING METHOD' DISCOVERED. BIG PROFIT OPPORTUNITY!

**"I EARN \$400 A WEEK"** says Mr. J. T. Anderson of Inglewood, Calif. Mr. Anderson prints without a Printing Press. He prints signs, posters, greeting cards and banners for local businessmen. Proof positive of Big money to be made in Screen Printing.

**EARN BIG MONEY SPARE TIME - AT HOME!**  
Many people who have discovered Screen-Printing are making up to \$20.00 per hour working in a spare room or closet in their own homes.

**MADE \$60 FIRST WEEK - SWAMPED WITH ORDERS!** writes R. T., Florida. Here's another Screen-Printer earning Big money on first try.

**EARNS 3 TIMES INVESTMENT IN FEW HOURS** says Dennis O. Morati, Mass. Screen-Printer prints signs.



**FREE OFFER RUSH COUPON TODAY!**

### YOU GET ALL THIS AND MORE! YOU DON'T RISK ONE CENT

—everything is sent at our risk! Send coupon today for amazing details. Kit includes complete course instruction secrets, press, designs, inks, plans, solvents, etc.—everything you need. We guide you every step

© 1957 Screen-Print Co., Los Angeles 61, Calif

**YOU CAN QUALIFY IF 1.** You have a place in your home or someplace else in which you can do Screen-Printing. **2.** If you have some spare time available. **3.** If you wish to learn an amazing new process of printing that may bring you Big profits almost overnight. **4.** If you are 20 years or older. If you can answer these four questions "yes," then you're one of the people we want now. Rush coupon today!

**WHAT IS SCREEN-PRINTING?** It's a new, fascinating Home-Printing Technique. Only after a few short days, you may print many beautiful (in 10 colors and more) printing jobs **FOR LESS THAN IT WOULD COST ON A \$5,000.00 PRINTING PRESS.** You'll enjoy every moment creating beautiful multi-colored signs, posters, banners, decals, labels, advertising displays, etc. that sell for Big money anywhere!

**NO EXPERIENCE—NO EXPENSIVE EQUIPMENT NEEDED!** An amazing new home-business where you need **NO ART ABILITY—NO PREVIOUS EXPERIENCE!** You can print, almost immediately, on **PAPER, GLASS, LEATHER, CLOTH—anything!** Work with all colors, even the vivid new **FLUORESCENT "Glow Colors"** there's so much demand for today. It's amazing—but true!

**HELP FILL THE HUGE DEMAND IN YOUR AREA!** You may use your spare time to earn \$20.00 per hour and more. Businessmen in every city, town, and community have learned the advantages of Screen-Printing. You save them 50%—on many printing jobs yet you earn up to 300% clear profit.

**WE SUPPLY EVERYTHING YOU NEED!** Every secret, enough materials to start making money almost immediately can be yours. Never before has such a wonderful opportunity been offered to anyone wanting to start a **BIG PAYING Home-business** of his own. Mail coupon **TODAY—no obligation to you.**

Screen-Print Co., 15127 S. Broadway, Los Angeles 61, Calif., Dept. 210

I can qualify as a Screen-Printer in my area. Please Rush me Free Revealing samples, Opportunity Plan, Home-business outfit details, etc. All this is sent absolutely Free by return mail. I am under no obligation now or ever. No salesman will call.

Name \_\_\_\_\_  
Address \_\_\_\_\_  
City \_\_\_\_\_ Zone \_\_\_\_\_ State \_\_\_\_\_

YOU CAN COUNT on the quality of products advertised in **POPULAR MECHANICS**



# SILVO

HARDWARE CO.

107 - 109 WALNUT STREET  
DEPT. PM-10, PHILA. 6, PA.

## BUY WHOLESALE! MAKE MONEY SAVE MONEY



**ELEC. POWER SAW** does everything—cuts wood, metals, plastics, etc. Will easily cut a 2 x 4 in seconds. Heavy-duty (\$29.95 retail).

**\$19.97** p.p. \$1.00

**FREE WHOLESALE CATALOG**

Get up to **50% off**

**MAKE MONEY!! SAVE MONEY!!** Buy nationally

advertised tools, hardware, appliances, cameras, sporting goods, power tools; plus a large selection of nationally advertised toys & games for your Xmas needs at wholesale cost to you.

"SEND FOR FREE 1958 WHOLESALE CATALOG TODAY."

## PREPARE FOR BETTER JOB, BIGGER PAY IN SPARE TIME AT HOME

Today, choose the job you want—and prepare for it in time you might otherwise waste. Or if you are already in the work you like best, start training now for quicker promotion and increased pay. During the past 60 years **AMERICAN SCHOOL** has helped ambitious people to reach higher goals. Check subject that interests you and mail coupon for full information.

**AMERICAN SCHOOL, Dept. G745, Drexel at 58th, Chicago 37, Ill.**

Without obligation, please send **FREE** and postpaid, full particulars about the subject checked below.

<input type="checkbox"/> Accounting	<input type="checkbox"/> Contracting	<input type="checkbox"/> Mechanical Engineering
<input type="checkbox"/> Apprenticeship Courses	<input type="checkbox"/> Diesel Technician	<input type="checkbox"/> Mechanical Technology
<input type="checkbox"/> Architecture & Building	<input type="checkbox"/> Drafting—Building	<input type="checkbox"/> Metalworking Courses
<input type="checkbox"/> Automotive Technician	<input type="checkbox"/> Drafting—Machines	<input type="checkbox"/> Plumbing—Practical
<input type="checkbox"/> Better Farmanship	<input type="checkbox"/> Electrical Engineering	<input type="checkbox"/> Private Secretary
<input type="checkbox"/> Blueprint Reading	<input type="checkbox"/> Electricity—Practical	<input type="checkbox"/> Retail Merchandising
<input type="checkbox"/> Bookkeeping	<input type="checkbox"/> Electronics—Industrial	<input type="checkbox"/> Salesmanship—Outside
<input type="checkbox"/> Business Management	<input type="checkbox"/> HIGH SCHOOL COURSES	<input type="checkbox"/> Sheet Metal Work
<input type="checkbox"/> Civil Engineering	<input type="checkbox"/> Machinists	<input type="checkbox"/> Tool Making

NAME \_\_\_\_\_ OCCUPATION \_\_\_\_\_  
HOME ADDRESS \_\_\_\_\_ AGE \_\_\_\_\_  
CITY \_\_\_\_\_ STATE \_\_\_\_\_  
CANADIANS: Write American School, Dept. G745, 5083 Sherbrooke St. W., Montreal

**MAIL COUPON NOW**

**WAL-BOARD TOOLS**  
for the DRY-WALL CRAFTSMAN



**HAMMER**  
A versatile striking face, compresses board into perfect dimple for easier "filling", maximum striking power with no bruising or defacing.  
No. WB-11 Price \$6.00

**UTILITY SAW**  
An all-around saw. Cuts wood, masonite, wallboard, etc. Heavy duty blade, sharp point for easy penetration without pre-drilling.  
No. US-71 Price \$1.65

**T-SQUARE**  
Measuring and cutting true sharp openings. 22½" Head 47¾" Blade.  
No. TS-31 Price \$9.00

**CIRCLE CUTTER**  
Cuts sharp clean round holes, up to 12" in diameter. One turn of Handle and the Circle is cut.  
No. AC-31 Price \$4.00

**ROLL LIFTER**  
Heavy duty corrugated lift bar with plenty of leverage and foot room. Forces board against wall as it lifts.  
No. RL 42 Price \$3.00

If Not Available Locally . . . Order Direct.  
**WALLBOARD TOOL and EQUIPMENT CO.**  
1708 Seabright Avenue, Long Beach 13, California—Dept. E  
Dealer inquiries invited.

## CUT PERFECT GROOVES WITH *Warren* WASHERS ON YOUR SAW BLADE!

You Just *DIAL* the Cut Wanted

over 250,000 sets in use!

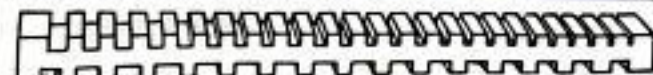

NOT ONE—NOT TWELVE—BUT 40 DIFFERENT CUTS!

Warren Washers—engineered to cut clean, accurate, parallel grooves with your present power saw. 40 micromatic adjustments—just dial the desired width. Actually strengthens blade, eliminates vibration—leave on saw for straight cuts. No burning or chewing. Over 250,000 satisfied users in 48 States and many foreign lands. Be sure to get genuine Warren Washers . . . they're guaranteed!

ONLY \$4.95 SET

FREE! Send for free descriptive booklet. Arbor sizes ½", ¾", 1". See your dealer or write direct.

**WARREN WASHERS CO.**  
Dept. 30, Box 98, North End Station, Detroit, Mich.

## NEW! amazing metal mender

1001 USES



**Magic**

**PLASTIC ALUMINUM**



**REAL METAL in PASTE form!**

- Repairs all Metal • Easy to Use • No Heat or Tools Needed • Dries Metal-Hard in 3 Hours • Waterproof, Gasolineproof & Heatproof up to 600° • Can be Drilled, Filed, Tapped, Threaded when Dry • Solders, Seals, Repairs • Saves Time and Money • For Home, Industry, Autos, Boats, Plumbing
- Magic Plastic Aluminum is the most amazing repair product since the invention of the nail! It is real metal in paste form and has most of the properties of metal. Easy to use by anyone—no tools or heat needed.

At all Hardware, Paint, Department and Auto Supply Stores, \$1.00 — or send \$1.00 direct to: Dept. M-10

**MAGIC IRON CEMENT CO.** 5400 Bower Avenue  
Cleveland 27, Ohio



Longman Mfg. Co., 1134 N. 21st St., Lincoln 3, Neb.

## Two-Way Air Cleaner

With a twist of the wrist the air nozzle of a dual-purpose cleaning tool can be detached and used as a blow gun. Coupled with the vacuum head, as shown in the photograph, dust and dirt can be sucked into a bag or through an eight-foot discharge hose. The tool can be attached to any air line.

POPULAR MECHANICS

Copyrighted material

# UNIMAT



## MINIATURE MACHINE SHOP

"No bigger than a typewriter, outperforms machines many times its size." That's what a popular publication says about UNIMAT in a 3 page feature story. UNIMAT is the precision tool that craftsmen, inventors and hobbyists dream about. You just can't beat it for machining small parts from steel, brass, aluminum, wood and plastic. You'll want a free reprint of this story plus complete information about this amazing 10 in 1 workshop. Write today to:

AMERICAN EDELSTAAL, INC. • UNIMAT DIVISION  
Dept. 10 • 350 Broadway • New York 13, N.Y.

**Special Introductory Offer**  
**THOR 2.5 AMP DRILL**

Available now at the lowest price on the market. This new 2.5 Amps Thor Speed Drill will handle all power attachments, 2400 RPM—115 Volt AC or DC universal series wound motor, 1/4" geared chuck with key. With 6 ft. U.L. approved cord. Self aligning oilless ball bearings. Has momentary contact switch with locking pin. Net wt. 4 lbs. Fully guaranteed. (Write for free information on power tools at discount prices.)

**\$14.45**

ENGINEERING ASSOCIATES, Dept. PM-10 No C.O.D.'s  
Power Tool Division • 29 East Madison St., Chicago 2, Ill.

**SAVE UP TO 50% & MORE!**

**GENUINE DIAMONDS**

Buy diamonds and diamond jewelry half priced from Kaskel's, America's foremost Diamond Specialist. Every diamond is set in a luxurious new mounting . . . graded according to nationally accepted standard . . . and bonded to this effect. For 70 years, we've served 1,000,000 satisfied customers. **CASH OR 12 MONTHS EASY PAYMENTS.**

**30 DAY UNCONDITIONAL MONEY-BACK GUARANTEE.**

References: Your bank or any Rating Agency.

FROM NEW YORK'S LEADING **DIAMOND SPECIALIST**

**KASKEL'S** 41 W. 57 St., Dept. 707-K New York 19

Send FREE CATALOG and Advice about DIAMONDS without obligation. No salesman will call.

NAME \_\_\_\_\_  
ADDRESS \_\_\_\_\_  
CITY \_\_\_\_\_ STATE \_\_\_\_\_

**FREE ILLUSTRATED CATALOG**

OCTOBER 1957

# Free! ALLIED'S 1958 ELECTRONIC SUPPLY CATALOG

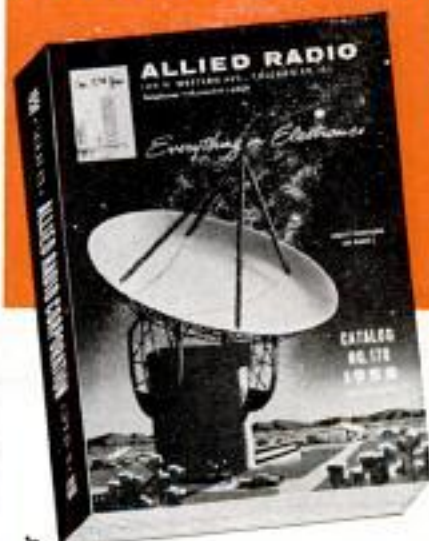

**404**  
value-packed  
pages

Send  
for it!

SAVE on  
everything in  
electronics

EASY TERMS  
AVAILABLE

## WORLD'S LARGEST STOCKS

Here's everything in Electronics for Experimenters, Builders, Amateurs, Servicemen, Engineers and Hi-Fi Hobbyists:



- Amazing Build-Your-Own KNIGHT-KITS
- Hi-Fi Music Systems & Components
- Recorders & Phono Equipment
- TV Tubes, Antennas, Accessories
- Public Address Systems
- Amateur Station Equipment
- Latest Test Instruments
- Industrial Electronic Supplies
- Parts, Tubes, Transistors, Tools and Books

SAVE on everything in Electronics—get fast, dependable service—send today for your FREE 1958 ALLIED Catalog.

Everything in Electronics  
From One Reliable Source

our 37th year

send for  
**FREE**  
Catalog

**ALLIED RADIO**

ALLIED RADIO CORP., Dept. 5-K7  
100 N. Western Ave., Chicago 80, Ill.

Rush FREE 1958 ALLIED 404-Page Catalog

Name \_\_\_\_\_  
Address \_\_\_\_\_  
City \_\_\_\_\_ Zone \_\_\_\_\_ State \_\_\_\_\_

# WEAR THE SHOE THAT'S ALIVE WITH COMFORT!



No. 444

FREE!

Write for helpful booklet — "Better Foot Care with Better Footwear"

Are your feet complaining? Do your working days seem long and tiring? Then isn't it time to try a pair of Red Wing's rugged lightweights with genuine Wedge-Crepe soles and the Original RED WING's "Sweat-Proof" Leather Insoles? Makes mighty soft walking.

**RED WING SHOE COMPANY**

197 MAIN STREET  
RED WING, MINNESOTA



**MEN! Make up to \$1,000 IN A MONTH!**

**without "SELLING"**

Sensational Demand for Low-Priced Fire Alarm PLUS Sure-Fire "No-Selling" Plan Offers Ambitious Men Huge Profit Opportunities



Even beginners cleaning up unbelievable profits with first practical, effective, low priced Fire Alarm. Needed in homes, factories, offices, stores, on farms, etc. Merlite Fire Alarm hangs on wall like a picture . . . no wiring, no installation. It's always on guard, "smells" fire before danger point. When temperature rises, Fire Alarm goes off automatically, howls loud warning that can be heard 1/5 mile, wakes up soundest sleeper, gives precious time to put out fire, call fire department, or escape. Sells for only \$4.95, with profit up to \$2.70 on each one.

**Nearest Thing to Automation Selling**

With our field-tested plan customers sell themselves. No cold canvassing; no hard selling. It's the nearest thing to "Automation Selling." Even a child can use plan successfully with powerful sales tools we give you (which you leave with prospects). This plan makes money for you even while you sleep! No room here to give you full details, but write for amazing facts.

**FREE SALES KIT**

Send no money. Just rush your name and address for all the exciting money-making facts, complete Illustrated Sales Kit, everything you need to make money first day. Learn how selling only 20 Fire Alarms a day brings you \$1,000.00 a month. No competition. Rush your name and address today.

**MERLITE INDUSTRIES, INC. (Alarm Div.)**

114 E. 32nd St., Dept. 5-15B New York 16, N. Y.  
IN CANADA: Mopa Co., Ltd., 371 Dowd St., Montreal 1, P. Q.

# An Introduction to Wonderful Worlds for Young Americans!



One pound Uranium Equal to 2,000,000 pounds of coal

## the Boy Scientist



A Space Platform May Look Something Like This

### New Popular Mechanics Book Packed With Thrilling Facts and Fascinating Information

Get this thrilling Popular Mechanics book for every boy you know. In it, your own boy scientist can pore over the world-shaking discoveries in astronomy, physics, chemistry, sound, electricity, atomic theory and relativity. In the same thrilling pages, he can meet the greats of the world of science such as Galileo, Newton, Franklin, Faraday, Einstein and many others. With its help, he can participate in monumental discoveries by performing the many experiments which are suggested in the book and explained in word and picture.

### The Spark That Opens Up a New World

Written by John Lewellen, noted writer of a dozen books on science and natural history. Preface by Dr. Wilbur Beauchamp, Professor of Education, University of Chicago, who says "the Boy Scientist may well be the spark that starts some boy on the way to becoming a scientist and the Nation's need for scientists is very great."

### Finest Gift for Boys Use "Money Back" Coupon

Is there a boy in your family? Then get him the Boy Scientist. It could be one of the most important books he ever reads. Want to send the supreme gift to some boy you know? Then give him the Boy Scientist too. There is no finer gift for any occasion. Sent postpaid to any address for only \$3.95. Order on Money Back coupon now. If not immensely pleased with the book return in 5 days and the entire purchase price will be refunded.



### Meet These Greats . . . Know Their Achievements

- Galileo . . . the first modern scientist
- Newton . . . the law of gravity and famous three laws of motion
- Boyle . . . and how gases behave
- Archimedes } . . . and
- Pascal } liquids
- Bernoulli } . . . and light
- Huygens } . . . and electricity
- Benjamin Franklin . . . and electricity
- Bequerel . . . radioactive fog
- Einstein . . . theory of relativity
- Rumford . . . heat
- Mersenne . . . the laws of sound
- Tomorrow . . . will bring new discoveries



Prepared in the famous Popular Mechanics easy-to-read and easy-to-understand style. Adults too, will find this a fascinating book.

**Library Cloth Binding**  
6 3/4 x 10 in.  
264 Pages  
277 Illustrations

### Use This "On Approval" Coupon

**POPULAR MECHANICS PRESS**  
Dept. 1057, 200 E. Ontario Street, Chicago 11

Send at once \_\_\_\_\_ copies The Boy Scientist, \$3.95 each. I understand I may return books in 5 days and you will refund full purchase price.

- Remittance for \$\_\_\_\_\_ enclosed. Send postpaid.
- Send COD. I will pay postman.

Name \_\_\_\_\_

Address \_\_\_\_\_

City \_\_\_\_\_ Zone \_\_\_\_\_ State \_\_\_\_\_

Get  
into

# TELEVISION

## RADIO-ELECTRONICS

Let National Schools of Los Angeles, a Practical Resident Technical School for over 50 years, train you at home by Shop-Method for unlimited opportunities in All phases of TV, Electronics, Radio.



LEARN ALL 8 PHASES  
BY SHOP METHOD

OF THE INDUSTRY  
HOME TRAINING

1. Television ... including Color TV
2. Radio ... AM, FM
3. Industrial Electronics
4. Communications

5. Sound Recording & Hi-Fidelity
6. Automation
7. FCC License
8. Radar & Micro Waves

We give you parts to build a modern TV set ... all tubes plus large screen Picture Tube ... and a Superhet Receiver. You also receive a Professional Multitester

You get 19 Big Kits  
... all this newest,  
practical equipment.

### GOOD JOBS ... MORE MONEY SECURITY ... ALL CAN BE YOURS!

You are needed in the great modern Television-Electronics industry. Trained technicians are in growing demand, at excellent pay, in sales and service, manufacturing, broadcasting, telecasting, communications, research, and many other important branches of the field. National Schools Master Shop-Method Training, with newly added lessons and equipment prepares you *in your spare time*, right in your own home, for these fascinating opportunities.

#### YOU EARN WHILE YOU LEARN

Many students pay for their entire training—with spare time earning. We'll show you how you can, too! You receive material that shows you how to earn extra money servicing TV and Radio receivers, appliances, and doing many other profitable jobs.

#### YOU GET EVERYTHING YOU NEED

Clear, profusely illustrated lessons, shop-tested manuals, modern circuit diagrams, practical job projects—consultation privilege with our qualified staff.

Don't delay your future another day.  
Send coupon for full information TODAY.

#### RESIDENT TRAINING AT LOS ANGELES

If you wish to take your training in our Resident School at Los Angeles, the world's TV capital, start NOW in our big, modern Shops, Labs and Radio-TV Studios. Here you work with latest Electronic equipment—professionally installed—finest, most complete facilities offered by any school. Expert, friendly instructors. Personal attention. Graduate Employment Service. Help in finding home near school—and part time job while you learn. Check box in coupon for full information.



Approved for  
GI Training

**NATIONAL SCHOOLS**  
LOS ANGELES 37, CALIF.

CUT OUT ALONG THIS LINE

MAIL POSTAGE—FREE COUPON ... NOW!

1. Fill out coupon in ink.
2. Cut along dotted line and fold coupon.
3. Staple, paste, glue, or tape ends together.
4. Mail today! No postage necessary.

FREE!

Career Book in TV-Radio-Electronics,  
PLUS actual SAMPLE LESSON.  
No obligation; no salesman will call.

Name \_\_\_\_\_ Age \_\_\_\_\_

Address \_\_\_\_\_

City \_\_\_\_\_ Zone \_\_\_\_\_ State \_\_\_\_\_

Check if interested ONLY in Resident Training in Los Angeles

VETERANS: Give date of discharge \_\_\_\_\_

FOLD ALONG THIS LINE

Postage  
Will be Paid  
by  
Addressee

No  
Postage Stamp  
Necessary  
if Mailed in the  
United States

BUSINESS REPLY CARD

First Class Permit No. 3097, Sec. 349 P.L. & R., Los Angeles, Calif.

POSTAGE WILL BE PAID BY

**NATIONAL SCHOOLS**  
4000 South Figueroa Street  
Los Angeles 37, California

Dept. RB-107

**YOU MAKE 'EM! WE SELL 'EM! EVERYWHERE...**

**YES! MY NATIONWIDE SALES ORGANIZATION WANTS TO WORK FOR YOU!**

Selling what you make at home — sparetime or full time. It's easy to enter this highly profitable field of making cases for photographers, salesmen, musicians, instrument manufacturers, doctors, and 1001 others. A few hours of simple work making customized cases not available in the ordinary channels spells out **BIG PROFITS FOR YOU.**

I'll show you, as I have shown hundreds of others how to make real money in this fascinating craft, and don't forget! I sell what you make when you follow my simple plan. Age is no barrier... Write for full, FREE, details today!

**ABARSI CASECRAFT** 887 SUNSET BOULEVARD Dept. 119, Los Angeles, Calif.

Mr. & Mrs. Cook at 53, paid all debts; bought a new home; created wonderful income. **SO CAN YOU! POSITIVE PROOF SENT TO YOU FREE!!!**

**DRAFTING is the way to Big Income OPPORTUNITIES!**

Learn at home in your spare time. Become a professional Draftsman. Enjoy good pay, respected position in an ever growing field. **CHRISTY TRAINING** is easy and clear. You learn by making actual drawings, planning production, see things develop. You learn the interesting, easy-to-remember way by doing.

**PAY AS YOU LEARN PLAN**

CTS will send you 50 illustrated drafting manuals, set of professional drafting instruments, equipment and supplies plus a portable drafting table... everything you need! Send name for **FREE BOOK AND PAY LATER FORM.** **CHRISTY TRADES SCHOOL,** 4804 N. Kedzie, Dept. DB-3503, Chicago 25.

**Every Mason Wants**



We have Masonic books and lodge supplies for Blue Lodge, Chapter, Commandery, Scottish Rite and Shrine. Our Rituals Are Used the World Over. Send for free catalog for Masons, Odd Fellows, Knights of Pythias, Knights of Columbus, etc.

**EZRA A. COOK PUBLICATIONS, INC.**  
P.O. Box 796 34A Chicago 90, Ill.

**2 FOR \$14.95**

**MAGNETO HANDSET INTER-COMM** (rebuilt). For house to barn etc., included 100 ft. of wire and 4 batteries. Additional wire 1¢ per ft. Any number can be connected in same line. Write for **FREE List.** All shipments FOB Simpson, Pa.

**TELEPHONE ENGINEERING CO.**  
DEPT. 10B7 SIMPSON, PA.

**... TURN CONCRETE INTO GOLD!**

**MAKE UP TO \$75 A DAY IN YOUR OWN BUSINESS**

If you want to have your own business — to start a business on your own — here's your big opportunity! New high speed, low cost General block machine produces up to 1,000 concrete blocks a day. Sell all you make to builders, supply houses, and others for homes, factories, buildings, garages. Cash in on the building boom! You can make profits of 100% to 150% — up to \$75 a day! General block machine equipped with 1/2 h.p. electric motor — or can be supplied with gasoline engine — works anywhere, in little space, indoors or out. Operates from ordinary house light socket. Simple, foolproof 3 step operation — so easy a child can do it. Makes superior 3 core blocks any size from 4" to 12". Also makes chimney, sink, corner and other types. Blocks meet any building code anywhere in the country. Materials — sand, water, cement, available anywhere. Simple illustrated operating instructions and mixing formulas for cement and cinder blocks supplied with each machine. Write for **FREE** folder with full information.

**MOTOR DRIVEN**

R. L. T. of New York City reports: "MY GENERAL BLOCK MACHINE PAID FOR ITSELF IN FIRST 2 WEEKS!" Hundreds now in use the world over! Write for **FREE** details today!

**EXTRA**

Amazing illustrated book gives floor plans for 6 sensational concrete block bungalows. Tells how to lay blocks, lay out building lines, mix concrete, build steps, porch and concrete floors all at great savings. Written by experts. Can save many times the cost of the machine! Get it now! No strings attached. Send \$1.

**BOOK SENT FREE IF YOU BUY MACHINE. \$1 REFUNDED IF YOU BUY LATER.**

**GENERAL ENGINES CO.**  
DEPT. M-107, ROUTE 130, THOROFARE, N. J.

**HOW TO BUILD YOUR OWN CONCRETE BLOCK HOME**  
Only \$1 Prepaid

**Finish HIGH SCHOOL AT HOME**

**Complete 4 Yrs. in 12 Months**

Learn More! Earn More! Enter professional or technical schools. Advance Socially. Live a Happier, Fuller Life. Individual Courses or complete schedule. **WRITE FOR SCHOOL BULLETIN.**

**ACADEMY FOR ADULTS**

30 W. Washington, Dept. PM-107, Chicago, Ill.

**SURPLUS SALE**

**\$49.50** NEW TOOL POST GRINDERS  
REGULAR PRICE \$125.00

1-6 H.P. MOTOR  
TAKES WHEELS UP TO 1/2"x4"  
EXTRA QUILL EXTERNAL OR INTERNAL \$19.50

Less Grinding Wheel

**MONEY BACK GUARANTEE**

**EDWARD J. NOLAN, PULASKI, NEW YORK**

**SHORTHAND IN 6 WEEKS**

**Write 120 words per minute**  
**Age no obstacle—LOWEST COST**

Famous **SPEEDWRITING** shorthand. No symbols; no machines; uses ABC's. Easiest to learn and use. Fast preparation for a better position. Nationally used in leading offices and Civil Service. 120 words per minute—50% **FASTER** than Civil Service requirements. Over 350,000 taught by mail or through classroom instruction. The very low cost will surprise you. Typing available. 35th Year. Schools in over 400 cities in U.S., Canada, Cuba, and Hawaii.

Write For Free Booklet To: School of

**DID YOU SEE READER'S DIGEST ARTICLE ON**

**Speedwriting**  
Dept. 1510-7, 55 W. 42 St., N.Y. 36





# CLASSIFIED ADVERTISEMENTS



Advertisements in this section \$1.25 per word, each insertion, minimum 10 words, payable in advance.

To be inserted under proper classification, copy must be in our office the

20th of the second month preceding date of issue

F. W. Johnson, Manager, Classified Advertising

Popular Mechanics Magazine, 200 East Ontario Street, Chicago 11, Illinois

## YOU'LL PROFIT

By reading and answering the classified ads in this section. Hundreds of opportunities for you to make and save money

### AUTOMOBILES, MIDGET CARS

**GUARANTEED** Ring valve job, while you drive, \$6.00 postpaid. No c.o.d.'s. Metaloy, R.D. #1, Box 216, Mogadore, Ohio.

**STOP** Cooling system rust, improve efficiency, save repair costs easy way. Write Laircraft, Box K-5008, Detroit 35, Mich.

**HUNDREDS** Of automobile catalogs—Old, new and foreign; dealer books; glossy photographs; shop manuals; free motor magazines listed by non-profit club. Write to get on free mailing list. Auto Maniacs, Stockbridge, Mich.

**\$4,000,000.00 SOLD** Last year! Only motor lubricants marketed that impregnate metal. Tremendous future for franchised agents. Goodco, 15 E. Reno, Oklahoma City, Okla.

**1957 SUPERIGNITIONER.** Starting, pep, mileage. Kaisers, Varitypers, I.B.M.'s. Barbells, courses. Catalog \$1.00. EG, Elmsford, N. Y.

### AUTO SUPPLIES AND EQUIPMENT

**MAGNETIC** Oil drain plug! Permanent G. E. magnet destroys corrosive engine acids, traps damaging metal particles. Saves engine repairs. Easily installed in 30 seconds. Specify make and year car. Forward \$2.50 to Winnick Auto Parts, 68 Main St., White Plains, N. Y. Free delivery—Money back guarantee.

**REPAIR** Dents, rust holes in the car body, scratches in the paint. Customize. Save the high labor cost. Free information. Bodymechanics, Box 460, Bluefield, West Virginia.

**FREE** Giant 1958 catalog! Thousands scarce accessories, gadgets, stores don't have. Cuts prices! Send 25¢ (refunded first order). Newhouse Automotive Industries, 5803-PM Beverly, Los Angeles 22, Calif.

**JEEPS** And four wheel drive trucks need hubs that free wheel for two wheel drive and locking for four wheel drive. Guaranteed satisfaction. Willys Jeeps \$39.95, Dodge Power Wagon, GMC 150 Series, 1 HCS Series, \$46.50. See nearest tractor supply store, or order direct from Tractor Supply Co., 2700 North Halsted, Chicago 14, Illinois.

**CRANKSHAFT** Grinder, hand operated. Makes bearings fit without taking engine apart. \$3.75. Literature, L. D. McGee, 719 Cascade St., Wenatchee, Wash.

**SPARK-O-Matic** power plugs. More power plus more miles per gallon. Life guarantee. Salesmen wanted. R. J. Catherman, Windsor, Mass.

**RING-Valve** job while driving. Only \$3.00 delivered. World's only (patented) product of its kind. Guaranteed. Proved reliable; safe. Free circular. Joe Dillon, Distributor, Box 323, Bridgeport, Ohio.

**LUBRICATION** Fitting seals protect against road grit. Simplify maintenance. 30 for \$1. Seals, Box 11, Glencoe, Ill.

**"PROTECTOCAR"** Prevents thief starting car motor with any key. Send \$2.00 for kit. Easily installed. Arko, 108 Elbow Road, North Syracuse 12, N. Y.

**FOUR** Cylinder Ford parts. Catalog 25¢. Huber, 15 Emerson, Clifton, New Jersey.

**RUSTPROOF** Cooling system. \$1.00. Guaranteed. Since 1926. Pensue, Scranton 11, Penna.

**KNOW** Something. 2 cents eliminates automobile battery corrosion. Instructions \$1.00. Sell secret friends, others. Beumer, 113 Willis Ave., Columbia, Missouri.

**NEW** And used parts at savings. Complete guaranteed parts service for all models cars and trucks, 1924 and later. Largest in the West. Jeep and army parts specialists. Newest type shifting hubs for all jeep and all military and latest production front end drive vehicles. \$27.50 and up. Write, Pioneer Auto and Truck Parts Co., 734 W. 13th Avenue, Denver 17, Colo.

**WILLYS** Jeep tops—Convertible tops. Free catalogue. Mor-Nan, Box 123, Boston 14, Mass.

**RING-Valve** job while you drive, \$6.00. World's only product of its kind. Safe! Proven! Guaranteed! Free details. Metaloy, Grantham, Penna.

**AUTO** Accessory and parts catalog. 1957 edition, all new! 228 pages. Save up to 50%. 75,000 items, including Hollywood accessories, hi-speed equipment, rebuilt engines, all parts and accessories for all cars and trucks! Hard-to-get parts! Send 25¢, refundable, J. C. Whitney, 1919 PM Archer, Chicago 16, Ill.

**SAVE** Money on Jeep and army truck parts. Large inventory. Catalogs for Jeep or G.M.C. owners. American Auto Parts Co., 1830 Locust, Kansas City, Mo.

**FREE!** New catalog. Speed, power, mileage increasing equipment. Discounts! Almquist Engineering, Milford PMS, Penna.

**OFFENHAUSER**—1957 Catalog available on all items manufactured and distributed. Only 35¢. Offenhauser Equipment Corp., 5156 Alhambra Ave., Los Angeles 32, California.

**HYDRAULIC** Jack repair kits. Repair your own. Send 25¢ to cover cost of price list. Jack Parts Co., 2000 South Claiborne Ave., New Orleans 13, La.

**CHARGE** Batteries automatically. Treatment \$1.00 guaranteed. Literature. Carlton, 3007 Wharton, Philadelphia 45, Penna.

**AUTOMOTIVE** Books. Free catalog. Popular Mechanics Press, 631 N. St. Clair St., Chicago 11.

### AUTO TRAILERS

**BLUEPRINTS** Vacation trailers. Supplies, literature 10¢. Comstock Trailers, Parsons, Kansas.

**BUILD** Expanding eight foot trailer. Accommodates five. Literature 10¢. Frumar Company, Wilmington, Mass.

### MOTORCYCLES, BICYCLES, MOTORSCOOTERS AND SUPPLIES

**RECONDITIONED** Motorcycles and motors, Chromium accessories. Complete stock Indian parts. Expert rebuilding. Fast service. Indian Motorcycle Sales, Kansas City 27, Missouri.

**PARTS**, New, used. List 10¢. Ballak, 811 N. 94th, St. Louis 1, Mo.

**HARLEY** - Davidsons — Used bargains. New, used parts, accessories for all models. Bulletin, catalog 25¢. Knuth's (Factory Dealer), 1733 Muskego, Milwaukee, Wis.

**DOODLEBUG** Motorscooter \$12.50, midget car \$25, less engines. Harley engine \$5, Whizzer \$5, Indian motor and propeller \$6, Maytag \$4 (mailorder only). Send 25¢ (35¢ for first class mailing) for 32 page directory-catalogue number 79 listing these and hundreds of other bargains in motor-scooters, midget cars, home builders parts, plans, etc. Midget Motors Directory, Athens, Ohio.

### AVIATION

**PRICED** Aviation surplus catalog, 10¢. Aero Parts, 8102 Lockheed, Houston, Texas.

**DRONE** Target plane two cylinder Kiekhfer engines. Ort, Thomasville, Penna.

**BUY** Surplus aircrafts; fuselages; assemblies; aircraft engines; helicopters; instruments; electronics; radiotelephones; misc. Buy direct now from U. S. Government. Depot list and procedure \$1.00. Brody, Box 8-PM, Sunnyside 4, New York City.

**PROPELLERS**, Plans, supplies for airboats and snowplanes. Latest designs, prompt delivery. Catalog 25¢. Banks-Maxwell, Box 3301E, Ft. Worth 5, Texas.

**AVIATION** Surplus bargain catalogue. One dime. Box 22PM9, Thomasville, Penna.

**BUY** Surplus aircraft; accessories; engines; instruments; electronics. Direct from U.S. government. List and procedure \$1.00. Aviation Surplus Center, Dept. 30, Eilers, Penna.

### BATTERIES, GENERATORS

**EDISON** Nickel storage batteries. Any voltage, any amperage. Unconditionally guaranteed. Power plants, generators, motors. Literature. Hawley Smith Co., Croton Falls 1, N. Y.

### ELECTRICAL SUPPLIES

**LAMP**, Electrical parts, wholesale. Thousands of items for repairing, converting. Catalog 25¢. Brown Lamp, Box 305, Clayton 5, Mo.

**ELECTRIC** Pencil: Engraves all metals \$2.00. Beyer Mfg., 10511-H Springfield, Chicago 43.

DC Power supplies. Laboratory, test units. DC motor controls. Complete line selenium rectifiers, meters, transformers and other replacement parts. Rammy, Dept. D-1, 1624 East First Street, Los Angeles 33, California.

LAMPS—Parts catalog containing wiring instructions, 25¢. Gyro Lamps, 3433P N.W. 54 Street, Miami, Fla.

MAGNETIZER—Magnetize one to million screwdrivers. \$2.00. Kubiak, Huntingdon Valley, Penna.

### WELDING, SOLDERING, PLATING

ELECTROPLATING Equipment, anodes, solutions. All types, including new electroless nickel. Baby shoe metallizing equipment, supplies. Free catalog. Hollywood Bronze Supply, Dept. B-4, 1624 East First, Los Angeles 33, California.

ACETYLENE Welding outfits new \$54.50; used \$34.50; arcwelders \$56.50. Eagle Welding, Dept. PM, 5083 Broadway, Chicago 40, Ill.

WELDERS, 110/220, \$39.50. Morris, 1070 Inner Drive, Schenectady 3, New York.

NEW And different oxy-acetylene outfit welds, cuts, heats, brazes, with interchangeable tips. No attachments needed. Light, portable. Complete outfit, full instructions, only \$34.50. Special money-saving plan for oxygen and acetylene supply. Write for free literature today: Dept. M, Linde Company, 30 East 42nd Street, New York 17, N. Y.

BUILD-Your-Own welder or welder and power combination. Low cost unit connected to used engine lets you weld anywhere. Free booklet tells how. Get into profitable welding business. Write Hobart-Weld, Box M-1072, Troy, Ohio.

A.C. Welders, 4 sizes, lowest prices. Free literature. Holgeron's Service, Canton, Kansas.

BUY Welding supplies direct from manufacturer. Cable, welding rods, etc. Portable arc-welders and kits at tremendous savings. Free factory catalog! LeJay Mfg. Co., 2927 Emerson Ave. So., Minneapolis, Minn.

### MACHINERY, TOOLS, SUPPLIES

FAMOUS Payswell sprayer, compressor, motor, gun all in one unit. 50 lbs. pressure. 9 payments available. Will take old sprayers in trade. Further information write Selco Corp., 224 W. 7th St., St. Paul 2, Minn.

POWER Tools, not toys. Discounts. Factory catalogs. World Tool Supply, Box 4494, Joyfield Station, Detroit 26, Mich.

OIL Drum cement mixer assembly kit. Circular, Nu-Way-Do Co., Newaygo, Mich.

MECHANICS 50% Savings 6 piece socket set, 3/8 drive with hinge handle. \$10.50 value \$5.95 postpaid. Hisco, 222-236 South Front, Memphis, Tennessee.

BRAND New government surplus 16 piece socket wrench sets. Every size 7/16"-1 1/8". Bargain \$8.00. Satisfaction guaranteed. Davis, 3696 Lakeland, Shreveport, La.

FREE Catalog—Unique tools. Autorola Co., P.O. Box 34, Larchmont, N. Y.

### ENGINES, MOTORS, DYNAMOS

DIESEL Injector parts wanted. GM71-110. Bares, 7120 Carnegie, Cleveland 3, Ohio.

1/2 HORSEPOWER Electric motors, a.c. 110, used, good \$5.00 each, f.o.b. Plant Machinery Corp., Richmond & Norris Sts., Philadelphia 25, Penna.

REWIND Motors yourself. Complete instructions \$1.00. Lewis Mfg., Howell, Michigan.

WINDING Data. 275 motors, single and three phase, \$1.10. Data Company, Box 7631, Kansas City 28, Mo.

GAS Engines: Foreclosure sale: 1 1/2 to 7 h.p. Brand new, factory fresh, latest models. Briggs Stratton, Clinton, Lauson. Positively below wholesale prices or your money back. \$29.95 and up (freight paid). Details free. Northern, 172-M Merrimac Street, Boston 14, Mass.

AMAZING Motor protector stops burn outs. Write Ripplinger, 1928 Gravois, St. Louis 4, Mo.

AIR Compressors, light plants, half price. Free folder. IMSCO, 1829 South State, Chicago 16.

SMALL Electric motors. Bargains. Kitco, Dept. 18, Box 212, Monroe, Wisconsin.

A.C. Generators, 700 watt \$37.50, 1000 watt \$49.50, 2000 watt \$97.00. Trailite, Three Lakes, Wisconsin.

### BOATS, OUTBOARD MOTORS

MARINE Conversion, Willys to Cadillac, engines, kits and parts. Catalogue and conversion hints free. Barr Marine, 2706 Castor Avenue, Philadelphia 34, Penna.

FIBERGLAS Boat coating. Plexiglas boat windshields—Clear, blue, green tints. Wholesale-retail. Instructive information catalog free! Gem-O-Lite, 5329 Cahuenga, North Hollywood, California.

FORDS And Jeeps 100% marine engines with famous Convo-Kits. Deluxe catalogue 25¢ coin. Oscomtors, 3627B Lawrence, Philadelphia 40, Penna.

FIBERGLAS Your boat! Complete kits including color resin. Low as \$8.50. Aqua-Glas, Box 99, Altadena, Calif.

BOAT Plans. Full size patterns. Frame kits. Modern inboards and outboards for amateur builders. Complete new catalog 50¢ or specify requirements. Glen Designs, Box 568, Compton, Calif.

NEW, Used, rebuilt marine motors. Marine conversions, fittings. Free catalog. Stokes Marine Supply, Dept. 24, Coldwater, Michigan.

FIBERGLAS Permanent boat waterproofing. Special 25% discount. Complete kits, \$9.45 up. Guaranteed materials. Easy application. Full instructions. Free literature. Ajax Plastics, Dept. PM, P.O. Box 1323, Fort Worth, Texas.

BUILD Small boats. Booklet 25¢. Catalog free. Popular Mechanics Press, 633 N. St. Clair St., Chicago 11.

MARINE Conversions for Ford and Jeep engines. Catalog 25¢. Lehman Manufacturing Company, 972D Broad Street, Newark 2, New Jersey.

FREE Catalog! Boat kits, trailers, fiberglass, marine hardware. Luger Industries, Dept. M10, 3404 Lyndale South, Minneapolis, Minnesota.

FULL Size, cut-to-shape boat patterns, blueprints, 7 1/2-38 feet. Big new 88 pg. illustrated "Build a Boat" catalog of naval architect-designed cruisers, runabouts, skiffs, outboard boats, sailing, racing, houseboats, 50¢. "How to Build a Boat" booklet, \$2.50. Hardware and equipment catalog, \$2.00. Cleveland Boat Blueprint Co., Dept. A-66, Box 1651, Cleveland, Ohio.

BOAT Kits; reduced prices. Specify requirements. Plans, patterns, frames. Catalog 50¢. Marincraft, Box 161-M, Brighton, Mass.

### ATHLETIC EQUIPMENT, BODY BUILDING COURSES

BEAT The bullies with Jiu Jitsu—Super Judo. Complete course \$1.00. Be taller! Guaranteed instructions \$1.00. ABC, Box 849-N, San Francisco 1, California.

BE Taller! Be taller! Be taller! Coach's genuine "Inch-at-a-time" height-increase system. Great results reported! New edition \$1 complete. Beware imitators. Satisfaction unconditionally guaranteed. Marty Snyder, Box 193-MY, Union City, N. J.

YOURS—A body like a Greek god! Startling, amazingly quick new method explained in free literature. Send name and address to: DeVel-O-Flex, 3607 W. Magnolia Blvd., Burbank, Calif.

BARBELLS, Dumbbells. Courses. Free catalogue. Good Barbell Co., Reading, Penna.

OUTSTANDING Physical development! Any age. New guaranteed discovery uses only a rope! Strength, health, muscles. Gain-reduce. Free booklet. Ropercise, 4834-A Art, San Diego 15, California.

JUDO. Defeat bullies. 23 complete lessons. \$1.00. 1112 Tipton St., High Point, N. C.

### SPORTING GOODS, GUNS, FISHING TACKLE, ARCHERY, TRAPPING

FREE Below wholesale fishing catalog. Fishing Tackle Mart, Dept. 510, Box 6737, Chicago 80, Ill.

RARE Colt gun illustrated catalogue 10¢. Pioneer Books, Harriman, Tennessee.

FREE 152 Page fishing catalog. Includes latest "Do it yourself" kits. Netcraft Company, Dept. B10, Toledo 13, Ohio.

180 PROFUSELY Illustrated pages antique pistols, swords, daggers, armor, etc. 50¢. Robert Abels, M860 Lexington Ave., New York City 21.

RIFLES, Shotguns, pistols, scopes, ammunition. Dealers prices. Berkshire Gun Rack, Six Lakes, Michigan.

FISHERMAN: Save your snagged lures with a weighted spring retriever. Pully guaranteed. \$3.95 complete. Russell's Retriever, 1754 East 71st Place, Chicago 49, Illinois.

BIG Money raising crickets and 12 inch African fishworms. Free literature. Carter Ranch, Plains, Georgia.

5000 BARGAINS, Firearms, binoculars, war relics. Catalog 50¢. Smith Firearms, Runnemed, N. J.

SAMPLE: 25c Copy of "The Archers' Magazine." Send 10c. 1200 Walnut Street, Philadelphia 7, Pennsylvania.

FREE Sporting goods catalogs! Save 70%. Econ-O-Mart, Whippany 2, New Jersey.

MOLDS For fisherman's sinkers, jigs, squids, casting and spinning lures. Free catalog. Sweet's Molds, Tonawanda 1, New York.

JAP Rifle altering to 30-06, \$8.00. Jap-shells, \$3.95. Catalog 5¢. T. P. Shop, West Branch 11, Mich.

BUILD Barbecue. Complete plans. Booklet 25¢. Free catalog. Popular Mechanics Press, 633 N. St. Clair St., Chicago 11.

BLOW-Guns and darts: Start own business. Make inexpensively. Complete instructions \$1.00. Write Jannel, P.O. Box 1802, Milwaukee 1, Wisconsin.

PATENTED Muskrat-mink trap. Guaranteed. Beats steel traps. Request literature. Jack Frost, Somers Point 2, N. J.

COLTS, Remingtons, Winchester, Lugers, P-38's, Kentuckies, Springfields. Antique-modern guns and gunnery values. Big bargain catalog 50¢. Agramonte's, Yonkers 2G, N. Y.

### EARTHWORMS

WONDERFUL Profits raising African night crawlers. We train you and buy production. Details free. Brandt's Wormery, Century Apartments, Davenport, Iowa.

FREE Folder, "How to Make \$3,000 Yearly. Sparetime, Backyard, Raising Earthworms!" Oakhaven 56, Cedar Hill, Texas.

BIG Money raising crickets, hybrid red wigglers and 12 inch African fishworms. Free literature. Bedrun hybrid red wigglers, 3000, \$6.50; 10,000, \$19.95, postpaid with raising instructions. Carter Redworms, Plains, Georgia.

RAISE Earth worms. Profitable, easy instructions 25¢. Lair's Hatchery, Box 84, Virden, Ill.

### BINOCULARS, TELESCOPES, MICROSCOPES, MAGNIFIERS

REFLECTING Telescope, 60X, completely assembled \$29.75. Guaranteed observatory clearness. Free information. Skyscope, 475 Fifth Avenue, New York City 17.

REFLECTOR Telescope kits \$7.25 (3") to \$175 (12"). Mirrors, cells, focusing mounts, tripods, eye systems. Anything, everything in telescopes. Free catalog. Also ready to use telescopes from \$25. Esco Products, Oakridge, N. J.

AMAZING Prices, precision binoculars. Folder, "Binocular Selecting" catalog free. Dealers write. Prentiss Importers, Mercury Bldg., West Los Angeles 25, Calif.

DYNASCOPE—Sensational new reflector telescope. Send for details. Criterion Co., Dept. DP-37, Hartford, Conn.

300 POWER Reflecting telescope complete with finder scope and tripod, \$24.95. Free information. Suffolk Science, Mattituck 5, N. Y.

FREE 40 Page binocular, telescope catalog, \$9.95-\$169.50. Over 100 models. United, 9043 S. Western, A-1708, Chicago 20.

BINOCULARS, Telescopes, microscopes, terrific values \$3.98 up. Request free money-saving catalog. Criterion, Dept. P-59, Hartford, Conn.

**WAR Surplus bargains:** Millions of lenses, instruments, telescopes, binoculars, components and complete line of astronomical telescope items. World's greatest optical market-places! Send only \$1.00 for beginner's 10-lens kit and big instruction booklet Stock 2-CH. Write for catalog "CH," free! Edmund Scientific Co., Barrington, New Jersey.

**POCKET Microscope!** 50X—See nature's wonders, 2500 times magnification. \$1.00 postpaid. DuPont Distributors, 2153 Amsterdam Avenue, New York 32, N. Y.

**BUILD Your own reflector telescope.** Complete kit: Mirrors, eyepieces, tripod, all other accessories. Request free illustrated literature. Criterion Manufacturing, Dept. DPM 34, Hartford, Conn.

### PLANTS, SEEDS, BULBS, NURSERY AND GARDEN SUPPLIES

**WORLD'S Greatest cash crop.** Free information. Write Ginseng Gardens, Asheville, N. C.

**GINSENG.** Goldenseal roots bring up to \$14 pound. Full information. F. M. Collins, Viola, Iowa.

### PETS—DOGS, BIRDS, RABBITS, HAMSTERS, ETC.

**TROPICAL Fish** shipped direct from our own fish farm. Free price list. Lori Fish Farm, Box 256, Miami 44, Fla.

**WE Pay \$3.50 lb. dried.** Grow mushrooms, cellar, shed and outdoors. Spare, full time, year round. We have 25,000 customers. Free book. Washington Mushroom Ind., Dept. 171, 2954 Admiral Way, Seattle, Wash.

**BEAUTIFUL Pure white pedigree police puppies.** Ansonia Kennels, McHenry, N. Dak.

**TROPICAL Fish—Color pictures of 55 species swimming in their natural habitat.** Send 10¢. Miracle Filter Co., Dept. V, P.O. Box 9123, Long Beach, California.

**RAISE Rabbits successfully** by knowing facts. 48 page illustrated book describing 25 breeds. Housing, feeding, breeding, marketing, etc. Plus bulletin. 25 cents. American Rabbit Association, 36 Arba Building, Pittsburgh, Penna.

**MAKE Money raising chinchillas, mink, nutria, rabbits, cavies for us.** Free catalog. Keeney Brothers, New Freedom 2, Penna.

**HAMSTERS—Young Golden pairs, \$2.95, breeders \$3.95.** Free booklet. Jer-Fre's Hamstery, 2425 Hoyt, Muskegon Heights 13, Mich.

**RAISE Rabbits on \$500 month plan.** Plenty markets. Free details. White's Rabbitry, Delaware, Ohio.

**WHITE German shepherd puppies.** Theatrical dog tricks. Knoff, Nashotah, Wis.

**STRAIGHT Cooners!** World's oldest kennel. Combination hounds, rabbit, fox, beagles, deerhounds, bird dogs. Puppies of all breeds. Prices reasonable. Trial. Free catalogue. Raccoon Mountain Kennels, Box 464, Boaz, Alabama.

**SPORTSMEN:** World's largest kennels offers 500 bird dogs, straight cooners, combination hounds, beagle hounds, rabbit hounds, small squirrel dogs, fox and deer hounds. Catalogue free. Smokey Mountain Kennels, Cleveland, Tennessee.

**HAMSTERS—Golden:** young, \$3.00 pair. Fully developed \$4.00 pair. Adirondack Hamstery, Prospect 10-K, N. Y.

**ANGORAS, Chinchillas—Most profitable rabbits!** Particulars free. Grinsteads, Edwardsville, Illinois.

### FUR BEARING ANIMALS

**MINK Raising information free.** Complete. Lake Superior Mink Farm, Superior, E.E.I., Wisconsin.

**RAISE Mink:** Free booklet, pen plans, inside secrets, feed, care. Mink are money makers. Investigate today. Lawrence Moggard, Brigham City 12, Utah.

**BUILD For the future—Raise nutria.** No middle man profit fur bearing animal. Nutria Mutations, 10821 S.E. Powell, Portland 68, Oregon.

**RAISE Rabbits—Nutria.** Choice breeders. Bob Madsen, Lyndon 2, Illinois.

**MINK \$18.00 Each.** Dark and mutations. Blue Sky Mink Ranch, Henry, Ill.

**LARGE Nutria—Mink Foundation** breeding stock. All types. Reasonable. North: Voights, Lomira 8, Wisconsin; South: Voights, Atlanta 2, Texas.

### FARMS, FARM LANDS, REAL ESTATE

**OPPORTUNITIES!** Government land. U. S., Alaska, Canada. Sledge Surveys, Macon 1, Mississippi.

**CALIFORNIA State government land.** 40 to 640 acre tracts. \$5 acre minimum. 104 brings information on available locations, maps of 500,000 acres. Pioneer Ranches, 7419-PM Beverly Blvd., Los Angeles 38, California.

**\$5.00 MONTHLY Buys 40 acres** productive land. Near town. Price \$250.00. Free list. Box 425-P, Carthage, Mo.

**FREE Strout catalog!** Farms, homes, businesses, resorts, retirement properties. Over 2900 values in 34 states. 57 years' service. World's largest! Write Strout Realty, 7-MF So. Dearborn, Chicago 3, Ill.

**FLORIDA.** Nice homesites, \$345 at \$10 monthly. Folder free. Howard Vernor, DeLand, Florida.

**FLORIDA At its best—Enjoy life** in Lynn Haven, Bay County, on beautiful St. Andrew Bay, Northwest Florida. Near superb gulf beaches. Cool summers, mild winters. Year-round gardening. Pay less for homesite, house construction. Friendly, conservative, long-established small city. Brochure free. Chamber of Commerce, Lynn Haven 3, Florida.

**FALCON Dam resort site** at Zapata, Texas. Only \$7.50 per month buys beautiful lot adjoining city. Full price \$179.50. Utilities including city water. Ideal for vacation or permanent living. Write for free photos. B. Matlock, Box 7487, Fort Worth 11, Texas.

**FLORIDA'S Largest suburban development,** now in our 15th year. Choice tung grove homesites, 100 by 300 feet with bearing tung trees for shade and extra income for \$745—Payable \$25 cash, \$25 monthly. Near famous Panama City gulf resort, many lakes, water sports center. Have other lovely wooded homesites low as \$10 monthly. Booklet free. Wendell Wood, Fountain, Florida.

**FARMS \$195. \$10 Monthly.** Descriptions free. Write: Armstrongs, Shook, Mo.

**HENDERSON, Md.** Small acreage. Stocked. Steady monthly income. M. Tiefenthaler.

**50'x125' HOMESITES, \$10 Down, \$10 monthly;** full price \$395; outskirts Bushnell, Hwy. 301; city conveniences; no city taxes; high elevation. Free information. Wm. Blume, Nobleton, Fla.

### PROFITABLE OCCUPATIONS

**WE Pay \$3.50 lb. dried.** Grow mushrooms. Cellar, shed and outdoors. Spare, full time, year round. We have over 25,000 customers. Free book. Washington Mushroom Ind., Dept. 89, 2954 Admiral Way, Seattle, Wash.

**SAVE Money!** Buy wholesale! Free catalog general merchandise. Norris, 487-M Broadway, New York City.

**SPARETIME Repeat profits** taking magazine subscriptions. Special offers. Cassell Agency, Boynton Beach, Florida.

**FREE Folio "\$5,000-\$45,000:** Unlimited Vacations." No merchandise. Unknown! Work home, sparetime! Haylings, Carlsbad, Calif.

**BE The Popular Mechanics representative** in your neighborhood and earn big profits in your spare time. Write Popular Mechanics Magazine, Room 305M, 200 E. Ontario St., Chicago 11.

**BIG Money raising fishworms and crickets.** Free literature. Carter Wormery, Plains, Georgia.

**BAKE New greaseless doughnuts** in kitchen. Sell stores. Free recipes. Michael Ray, 3605 South 15th, Minneapolis 7, Minn.

**RAISE Pheasants on \$100 week plan.** Little capital and space can make you independent. Free details. Great Central System, Columbus 1, Kansas.

**FREE Book "505 Odd, Successful Businesses."** Work home. Pacific, Oceanside, Calif.

**MAKE Flexible molds.** Cast plaques, figurines. Free sample. Tooker, 1045-M Fairview, Hamilton, Ohio.

**VENDING Machines—No selling.** Operate a route of coin machines and earn amazing profits. 32-page catalog free. Parkway Machine Corporation, Dept. 25, 715 Ensor Street, Baltimore 2, Maryland.

**AUCTIONEERING—Home study course.** Diploma granted. Auction School, Ft. Smith, Ark.

**BUY Wholesale!** Over 10,000 nationally advertised products. Appliances, cameras, sporting goods, housewares, watches, typewriters, tools, clothing, etc. Send postcard today. Buy-Rite, Box 258, Hawthorne 3, New Jersey.

**THEY Hand him \$100! Free packet.** "Secret Journal." 919 secrets-plans! Work home. Publicco, Oceanside, Calif.

**\$60.00 WEEKLY Sparetime.** Start home Venetian blind laundry. Protected territory. Interesting information free. Burt, 2434ES, Wichita 13, Kansas.

**WANT To make big money at home?** \$10.00 profit in an hour possible with invisible mending. Make tears, holes, disappear from clothing, fabrics. Steady year-round demand from cleaners, laundries, homes. Details free. Fabricon, 6236 Broadway, Chicago 40, Illinois.

**TRAIN Horses by circus methods.** Write for free booklets. American Horse Training Institute, Dept. 79, Scammon, Kansas.

**LEARN The high paying newspaper trade** at home. For details write Thomas Smith, P. O. Box A-3987, Sarasota, Fla.

**BIG Profits in welding.** Easy to learn. Low cost training in completely equipped non-profit school. GI approved. Write for free booklet. Hobart Trade School, Box M-1073, Troy, Ohio.

**MAKE Money at home, free literature** tells how. Fox, 12022 Pine, Norwalk, Calif.

**AMERICA'S Largest wholesale supply.** Buy, sell. Amazing profits. New free plan. Associated Wholesalers, Box 52-DX, Burlington, Iowa.

**MAGAZINE Subscriptions—Largest commissions.** Bonus. Qualified Agency, 451AA Kingston, Brooklyn 25, N. Y.

**HOME Mailorder manual, sources, methods, opportunities, 25¢.** Carnahan Bros., 9610 Acacia, Fontana, Calif.

**PROFITABLE Hobby.** Raise fishworms. Instructions 35¢. Free literature. Shady Oaks, 18724-Ai Martha, Saratoga, Calif.

**FOOD Supplements booming!** Sell super-potent "Supervite." Vitamin Specialties, 5522½ Hollywood, Los Angeles 28.

**EARN Big money.** Information and sample 25¢ refundable. Schwam, Box 936, Miami Beach, Florida.

**LEARN Mailorder faster, better, cheaper.** via good books. Booklet, catalog 25¢ (refundable). Zed Gwartney, Desert Hot Springs, Calif.

**GAME Bird breeders and Pheasant Gazette.** Explains breeding, hatching, rearing, selling. Pictorial monthly, best bird magazine. \$3.00 year, samples 50¢. 1328 Allen Park, Salt Lake City, Utah.

**MONEY In scrap dealing.** Amazing booklet \$1.00. Geo. Turcotte, C.P. 142, St. Sauveur, Quebec, Canada.

**WE Establish you in your own mail order discount business.** Supply catalogs, letters, envelopes printed with your name and ship your orders. Sell gifts, appliances, watches, housewares, silverware, etc., at discounts to 75%. Catalog and details free. Topval Corp., Lindenhurst 717, N. Y.

### BOOKS, PERIODICALS, PICTURES, POSTCARDS

**NEW Book "How to have a successful aquarium."** Handy guide to better aquarium management. Includes color pictures of 55 tropical fish. Send 50¢. Miracle Filter Co., Dept. V, P.O. Box 9128, Long Beach, California.

**BRITISH Book bargains—Any subject.** Catalog free. Transbooks, Box 1-PMP, Wantagh, N. Y.

**35 ALL Different comic books** without covers, \$1.00 prepaid. Magazine Exchange, Mountain View, Missouri.

**BOOKS Located.** All kinds. Send your lists. Mrs. F. L. Myers, 4115 N. Lawler, Chicago 41.

**BOOKHUNTERS! Scarce, miscellaneous books.** Atlantic Book Service, Cedar Street, Charlestown 29, Mass.

**BARGAIN, Exciting Little Library booklets.** 25¢ each. How to use tools, painting, welding, home improvement, games, models, plastics, lamp making, glass blowing, boats, photographs. Free catalog. Popular Mechanics Press, 200-LB East Ontario St., Chicago 11.

FREE. Catalog No. 53. Current sample copies 1,284 magazines. 1,068 self-help books. Commercial Publications, P.O. Box 44, Franklin, Indiana.

AMERICAN Shetland Pony Journal, beautiful monthly magazine, \$3 year; satisfaction guaranteed. Ken Kimbel, Dept. PM, Plant City, Fla.

"SCIENCE Milestones." Records march of science starting 400 years before Christ, right up to date. Amazing facts revealed. 312 pages packed with startling information that will thrill you. A real history of science. \$5.00. Literature free. Popular Mechanics Press, 200-SM East Ontario St., Chicago 11, Ill.

TAINTER'S, Temple, N. H. Books on everything. Try our search service.

OUT-Of-Print books at lowest prices! You name it, we find it! Fast service. No obligation. International Bookfinders, Box 3003-PM, Beverly Hills, Calif.

SPECIAL 30¢-32 Page booklet, "Your Aquarium" for 15¢. Innes Publ. Co., 12th and Cherry Sts., Philadelphia 7, Penna.

AQUATIC Life—Oldest aquarists magazine. Sample 10¢. Yearly \$2.00, 12 issues. Baltimore 8-15, Maryland.

BACK Physique magazines. Vim, Physique Pictorial, etc. Rijos, 2001 Allston Way, Berkeley, California.

FREE: Illustrated catalog! Many subjects. Treasure-Site Book Company, 279 South Alden, Philadelphia 39.

GET Your job. Valuable report saves time, money, 25¢. Independent Publisher, Box 1108, Atlanta, Ga.

NATIONAL Geographic Magazines, 1880-1958. Periodical Service, Box 465-PM, Wilmington, Delaware.

"HOME Improvement Guide." New, amazing 192 page volume. Packed with ideas, plans for remodeling, decorating, landscaping, built-in projects. \$2.50 prepaid. Popular Mechanics Press, 200-HG East Ontario St., Chicago 11.

RARE Magazines, catalog 10¢. Nationwide Exchange, Box 1375-P, San Antonio 6, Texas.

BOOKFINDERS! All subjects. Send wants! Jabber Book Service, 183 Hazelwood Drive, Westbury, N. Y.

FREE: Exciting catalog packed with books covering most everything. Think of it—From cover to cover you will find described and illustrated hundreds of books telling how to fix and how to build almost anything. How to remodel your home; do your own decorating, plumbing, electrical work. Simplified books covering concrete work, carpentry, painting, furniture making and refinishing. How to build your own boat, home workshop tools. Best books on photography, welding, hobbies, homecraft. How to make a home freezer. Send for your free copy now. Popular Mechanics Press, 200-BC East Ontario St., Chicago 11, Ill.

#### GAMES, TOYS, NOVELTIES

FAMOUS German toy helicopter. Flies up to 60 ft. Assembled in three minutes and off it goes on its sky travels. \$3.98 postpaid. Halaby Imports, 1613 Cedar Ave., Cincinnati 24, Ohio. Dealers' inquiries invited.

FABULOUS Giftime catalogue free. Harold Osterhoudt, R.D. 2, Poughkeepsie, New York.

FREE Toy and hobby catalog. Trlico, 39-31 47th Ave., Long Island City, N. Y.

#### MAGIC TRICKS, PUZZLES, JOKER NOVELTIES

VENTRILLO, Professional voice-throwing instrument and catalog 25¢. Box 971-PM, Philadelphia 5.

WORLD'S Finest professional magic, Joker novelties. Giant illustrated catalog 10¢. Top Hat, Evanston 12, Illinois.

500 TRICKS. Douglas famous 120-page catalog, only 10¢. Fastest service to magicians for 30 years. Send 10¢ today. Douglas Magicland, Dept. 1, Dallas, Texas.

BE A magician! Large professional catalog of latest tricks. 35¢. Ireland, C-109 North Dearborn, Chicago 2, Illinois.

PROFESSIONAL Catalog, 175 pages, 25¢. Williams, 900 Plymouth, Ellwood City, Penna.

GO Ventriloquist, all secrets told. Make money, surprise friends, have fun. Send 35¢ for catalogue of dummies, dialogues, etc. Limited supply. Gough, 203 E. Kickapoo, Hartford City, Indiana.

WHOLESALE! Thirty 10¢ trick novelties \$1.00! Profits! 1746-W Market, Philadelphia 3.

LICENSES And permits, 20 assorted, \$1.00. Ace, Box 142, Camden 1, New Jersey.

SENSATIONAL Magician's wand 25¢. Vanishes handkerchief! Catalog included. Box 1352-PM, Philadelphia 5.

FREE Vanishing cards, catalog 500 amazing magic tricks, bargains! Ward Wizard, 60 East 42nd, New York City 17.

DOLLAR Magic set free with catalog 25¢. 4462-PM Germantown, Philadelphia.

STINKBOMBS. Potent aroma. 12/\$1. Kits. 1452 Drake, San Pablo 10, California.

COMPLETELY illustrated professional amateur magic catalog 25¢. Stowell, Woodstock, New York.

SMOKEBOMBS 25¢. 7 For \$1.00. Terrific! 4463-PM Greene, Philadelphia 44.

CHEMICAL Magic! Free information from Chemical Capers, Box 83, Buffalo 15, New York.

FREE Catalogues! Magical tricks, Joker novelties. Be party livewire! Mandel, 1200 Avenue H, Brooklyn 30, N. Y.

#### COINS, TOKENS, CURRENCY

COMMEMORATIVE Half dollar uncirculated \$1.00. Bargain lists free. Sayers, 1000 Unaka, Johnson City, Tennessee.

WHOLESALE Coins for dealers, investors. Lists 10¢. Al. Johnson, Box 35, Colorado Springs, Colo.

LINCOLN Cents, buffalo nickels. Bargain list 10¢. Hughes, 21 Ottawa, Grand Rapids, Michigan.

ILLUSTRATED Retail catalogue of 800 foreign gold coins 50¢. James Randall, Box 2205, Ft. Lauderdale, Fla.

BOOK Collecting coins 75¢ cash. Joseph Coffin, 1182 Broadway, New York 1, N. Y.

BARGAINS, U.S. coins: 1893 Columbian world's fair half dollar, \$1.00. Ten different Indian pennies, 75¢. Two-cent piece, and 3-cent piece, \$1.00. Gold ¼ eagle, \$9.00. Gold ½ eagle, \$12.50. Beautiful coin bracelet, \$1.00. Many coins available. What do you need? Rare Coin Company, 31 North Clark, Chicago 2.

44 DIFFERENT Uncirculated coins, \$1.00. Oddehon, Box 462, St. Louis, Mo.

SILVER Dollars: Uncirculated. 1879p through 1891p, 1897p \$2.00 each. 1893cc \$15.00. Retail lists 10¢. Holden's, Garwin, Iowa.

LARGEST Coin magazine, 180 pages, 35¢. Scrapbook, T320-J Milwaukee, Chicago 31.

SAN Francisco mint closed! Made only cents and dimes in 1955. In short supply and great demand. One each, brilliant uncirculated, for 25¢. Free coin lists with order. Bryson Stamp & Coin Company, 612 White, Toledo 5, Ohio.

12 DIFFERENT Indian cents, coin list, \$1.00. Pounds, North Wales, Penna.

MORGAN Dollars; 1878-87-90-91-97¢, \$2.00 ea. Coin catalogue, 25¢. Shultz, Salt Lake 10, Utah.

COINS From Formosa, Vatican, etc., plus foreign banknote, 10¢ with coin approvals. Littleton Coin Co., Littleton 81, New Hampshire.

U.S. Coins on approval. Reasonable. Hutchinson, Box 4747, Philadelphia 34, Pennsylvania.

GET Profit and pleasure in collecting old coins. Send 10¢ for 56-page illustrated coin catalog. You'll be delighted with it. Send for it now. B. Max Mehl, 370 Mehl Building, Fort Worth, Texas. Largest rare coin establishment in U. S. Established 40 years.

10 INDIAN Head cents plus price lists, \$1 postpaid. Louis Bell, Masonic Building, Decatur, Alabama.

LINCOLN Cents 1910-S, 1913-S, 1921-S, 1923-S, 1924-S, all for \$2. Gasser's, Box 34615, Los Angeles 34, California.

FREE! We pay \$100.00 each for certain Lincoln head pennies. Sort all U.S. coins for us during your spare or full time. Most coins are now in circulation and can be found easily. Free information. Viroqua Coin Co., Dept. O-1, Viroqua, Wisconsin.

10 MIXED Foreign coins-bills: 10¢. Dwight Musser, Dunbar, West Virginia.

U. S. Coins, Large stock. Hubers, 210 South Sixth Street, Minneapolis.

OLD Money wanted. Will pay fifty dollars for nickel of 1913 with liberty head (no buffalo). We pay cash premiums for all rare coins. Send 5¢ for large coin folder. May mean much profit to you. Numismatic Co., Dept. 20, Fort Worth, Texas.

VALU-Packed American coin catalog, 10¢! Sullivan's, 127-TT East Fourth, St. Paul 1, Minn.

BRILLIANT Uncirculated complete sets, Jefferson nickels \$29.85; Roosevelt dimes \$16.95; Franklin ½ \$29.50. Indian cents, 25 different \$3.99; roll (50) mixed \$4.50. Bebee's, 4514 North 30th, Omaha 11, Nebraska.

"BUGS-Bonnie" uncirculated 1955 halves \$1.75. 1955-s cents roll \$1.70. Erdley, Box 4, Lebanon, Penna.

GIANT U. S. coin catalogue 25¢. Ace, 314 S. Clark, Chicago 4.

COIN Collectors exchange publication. Sample 25¢. Numismatic News, Iola, Wis.

BANK Note \$1. Tecumseh, Michigan replica. 20¢: 10 for \$1; 100 for \$4. Approvals accompany. Sommers, PM10 Jenkins Arcade, Pittsburgh 22, Pennsylvania.

COIN Collectors magazine samples 25¢. Subscription \$2. Stamps accepted. Eaglet, 229 South 11th St., Newark 7, N. J.

10 DIFFERENT Canadian cents before 1930 plus "Canadian Bulletin" 25¢. Marles, Box 833, Calgary, Canada.

OLD United States gold coins bought. John J. Firpo, 120 Santa Ana Ave., San Francisco 27, Calif.

TRANSPARENT Tubes for rolls. Assorted sizes \$1.00. Letocraft, Box 21, Massillon, Ohio.

50,000 COINS, Medals, bills. Lists free. Collectors magazine 25¢. Nagy, 8-K South 18th, Philadelphia 3, Penna.

OLD Confederate bills, 3 different denominations, \$1.00. Historical Novelties, 515 Cherokee Blvd., Chattanooga 5, Tenn.

INDIA, Switzerland, Finland, Austria's coins—10¢. Jolie, 126, Roslyn Heights, N. Y.

LINCOLN Indian cents, all dates. 1955-8 cent uncirculated and complete price list 25¢. Penny Mart, PL-6, Box 629, Chicago 90.

30 DIFFERENT Better mixture foreign coins \$1.00. Alfred Szego, Box 187, Jackson Heights 72, New York City.

PRICES We pay for United States coins. Complete listing 50¢ (refundable). Economy Coin Company, Mansfield, Mass.

PROOF Sets. 1957 set only \$2.50; 1956-\$4.00; 1955-\$6.00; 1954-\$7.00; 1953-\$12.00; 1952-\$20.00; 1951-\$30.00; 1950-\$49.00. Complete sets 1950-1957 inclusive—\$120.00. Postpaid, prompt shipment. Money-back guarantee. Dan's-Dan Morafka, A.N.A., 432-P 23rd Avenue, San Francisco 21, Calif.

MEXICO Mint set centavos—1957, brilliant uncirculated. 5 different beautiful coins. Look like gold! Start a "good neighbor" collection. Makes a beautiful inexpensive gift. One set only \$1.00; 3 sets \$2.75; 10 sets \$8.50. Postpaid. Money-back guarantee. Postal Products Company, Fast Mail Order, 5614-MC California St., San Francisco 21, California.

YOU Read about this outstanding book in the Wall Street Journal. "A Guide to Coin Investment" \$2.75. Order from: Dr. Robert Bilinski, Box 6254-P, San Diego 6, California.

COMPLETE United States coin bargain lists, Indianhead cent, 10¢. Economy Sales, 156-A Dean, Mansfield, Mass.

SILVER Dollars uncirculated, 1879-o through 1892-o, \$2.50 each. Lists. Basons, New Hyde Park, N. Y.

TWO Civil War tokens, coin list, \$1. Delmeco, Box 1123, Wilmington 99, Del.

1 REPLICA Confederate bill, 1 Indian head cent, price list 25¢. Joray's, Box 38, Shouns, Tenn.

MASONIC Tokens—All symbols. Pocket size \$1.00. Keepsake, 107 Parker Place, Trenton 9, N. J.

## STAMP COLLECTING

"ABE Lincoln" giant diamond, rainbow colored flag set, Israel, South Korea, 50 others different only 10¢. Approvals. Champlain, Isle La Motte, Vermont.

IRAQ, Iran, Syria, Lebanon, Egypt, Israel, free! Excellent approvals. Panarama, Box 229, Miami 2, Florida.

PENNY Approvals that satisfy. Robert Moed, P.O. Box 62, Brooklyn 29, N. Y.

EXCITING Surprise lots 25¢, guaranteed value, approvals accompany. Beacon, Box 161, Woodside 77, New York.

WORLDWIDE, 50 All different, absolutely free just to introduce our incomparable approvals. Kent Stamp Company, G.P.O. Box 87, Brooklyn, N. Y.

FIRST U. N. set. Among world's prettiest. Only 10¢. Approvals. Welles, Box 1246-R, New York City 8.

AUSTRALIA, Fifty different, 10¢ with approvals. Molzan, 720 Pomona, El Cerrito 8, California.

COLORFUL Transportation, flag, flower stamps. Perforation gauge. Free to approval applicants. Delton Page, Box 201, East Paterson, New Jersey.

FREE Ten mint British colonies; given approval applicants. Tropicana, Box 624-M, Oakland Park, Fla.

FIVE Different sets French Colonies, 10¢ with approvals. Banner, Box 65, Park Forest, Illinois.

WORLD'S Smallest and strangest stamps only 10¢ with approvals. Finney, Box 89, El Monte, Calif.

FREE Egypt, Angola sets with approvals. Benecras, 3330 Paulding Ave., Bronx 69, New York.

EVERYTHING Goes. Tremendous accumulation. Collections, lots, albums, miscellaneous. Closing out cheap. Lists free. Alateo, Maynard, Mass.

ITALY—100 Different 10¢ with approvals. DeRespinis, G.P.O. Box 771A, New York 1, N. Y.

GIANT Approvals, thousands different, 1¢ and 2¢ each. Wahl's Stamp Exchange, 708P Farragut, Chicago 31, Ill.

BRITISH Colonies, 100 different 10¢, also free albums, catalogs for purchasing approvals. Coast, P. O. 2187A, Santa Ana, California.

FREE United States illustrated catalog. Bailey, 45 Bromfield, Boston, Mass.

ISRAEL, 10 Different free. Approvals. Chippewa, Box 65M, Doylestown, Ohio.

40 AMERICAS. Commemoratives, Latins, British 10¢; penny approvals, wholesale trades. Bristoft, Canton Center, Conn.

200 WORLDWIDE 25¢ Plus surprise packet. Packet list free. Econopackets, Box 168, Riverside 9, Calif.

FREE! Israel, Mozambique Company, Australian commemoratives, coronations, Egyptian overprints. Monaco! Exciting approvals. Foxboro, Box 167, Foxboro, Mass.

FREE! 50 British Colonies. 5¢ handling. Approvals included. Kensington Stamps, Buffalo 15, N. Y.

1957 U. S. Price list, 23¢. Lee's, Box 796, Rockford, Illinois.

SEND Two dimes for large illustrated U. S. catalogue. New-Way Stamp, Lawrence, Mass.

U. S. approvals. Low prices. Eagle Stamps, Romine Ave., Pittsburgh 26, Penna.

START Your own stamp business. Send for free circular. Donald Shepard, Box 1147, Chicago.

FREE! 50 Different British Colonies to approval applicants. Pan-American, Box 24, Coconut Grove, Miami 33, Florida.

QUEEN Elizabeth mint sets! Dominica, Virgins, Barbados, Gibraltar, Tristan, Malta. 21 bicolors, 25¢! Approvals. Gannon Stamps, Box 931, Canton 1, Ohio.

5 MINT British colonies and 100 others 10¢ with approvals. Miller, 219 Fowler Ave., Jersey City 5, N. J.

ECONOMICAL 15¢-3¢ Approvals, 33,000 varieties. Dresel, Box 128-N, West Englewood, New Jersey.

FREE! Amazing list! Two feet long! All countries! Stampmart Company, Hartford 1, Conn. client.

FREE! 107 British Colony stamps. All different. From Britain's farflung colonial empire. Catalog value \$2.50. Free stamp magazine, approvals. Send 10¢ for handling. Act now! Niagara Stamp Co., St. Catherine's 71, Ontario.

UNITED States commemorative collection containing 33 different—10¢. Approvals. White, 518-A Avenue L, Brooklyn 30, New York.

TWO \$5.00 U.S. stamps plus 20 different, 10¢ with U.S. approvals. Irwin, Box 1105, Brooklyn 90, N. Y.

SELL Your surplus good grade stamps. Write, describing fully what you have. Vanroy Shirk, Lebanon, Pennsylvania.

50 DIFFERENT Argentine 10¢. Approvals. Reuter, 611 W. 40th Pl., Los Angeles 37.

AMAZING Offer! 200 United States stamps—including commemoratives, airmails, high denominations to \$1.00. Only 10¢ to approval applicants! Illustrated bargain lists free. Mystic Stamp Co., Dept. 80, Camden, New York.

U. S. Classics. Over 50 yrs. old. 15 selected old-timers. Missing in biggest collections. All 15 at less than 1¢ each. 10¢ with approvals. Jaro, Box 246-T, New York City 8.

100 STAMPS, 10¢ With approvals. Smith, 508A Brooks, College Station, Texas.

OLD Scarce U.S. seconds on approvals. Slight imperfections, lowest prices. Herfield, Clintonhill Sta., Newark 8, N. J.

100 OLD United States between 1861 and 1935, \$1.00. Roush Stamps, 51 Chestnut, Mansfield, Ohio.

UNITED States approvals. Select copies, used—mint. Kingsbury, Fairfax, Vermont.

ICELAND 10 Different beautiful stamps for only 10 cents to applicants for our good old fashioned approvals. Old Colony Stamp Co., Dept. A, Milford, Connecticut.

1-2¢ EACH! Thousands of exciting worldwide stamps. Free examination. Cole, Box 223-A, Buffalo 21, N. Y.

225 STAMPS For only 10¢! This mammoth value includes airmails, pictorials; stamps from strange countries cataloging up to 25¢ each! Also approvals. Mystic Stamp Company, Camden 80, New York.

SELL Stamps to our readers. Your ad in this space will be read by thousands of stamp buyers. I'll prove that to you. Write now for Folder "S." P. W. Johnson, Classified Advertising Manager, Popular Mechanics, 200 E. Ontario St., Chicago 11, Ill.

100 DIFFERENT Austria, 10¢. Approvals. Aronson, Box F, Newton Centre 59, Mass.

WEIRD Diamond shape coffee stamps. Lovely flower triangle! First American big commemorative. Greenland, idol dancer, etc. Free with approvals. Capital Stamp Co., Ferrysburg 2, Mich.

25 DIFFERENT Commemoratives 1893 up 10¢. U. S. approvals. K&B, Box 70, Brooklyn 23, N. Y.

14,000 DIFFERENT! Fascinating new club plan systematically builds your collection. Only 50¢ weekly. Details free. L. G. Ware, Stepney 75, Conn.

MINT U. S. at face! Older commemoratives only in 25¢ packet. Limit one with request for mint U.S. approvals. Western, Box 1689P, Salinas, California.

WORLD'S Best stamp approval bargains for adults. Ehde, Amiret, Minnesota.

500 DIFFERENT Stamps only 50¢ with approvals. Littleton Stamp Company, Littleton 71, New Hampshire.

U. N. 45 Different \$10, complete \$45. Ed Patterson, Box 102, Navarre, Ohio.

FREE Packet, beautiful pictorial British Colonials, approvals, 5¢ handling. Murrays, 1029 Rademacher, Detroit 9, Mich.

103 FOREIGN Stamps, including Pakistan, Scandinavia, Newfoundland, Australia, Africa, Russia, Japan, China, oddities, rarities. Only with approvals. Enclose 10¢ for handling. Lincoln Stamp Company, St. Catharine's 318, Ontario.

25 DIFFERENT Egypt 5¢ Bargain approvals. Somith, Box 83, (Rugby) Brooklyn 3, N. Y., Dept. 2M.

800 WELL Mixed U.S. 25¢. Monjar, 1750 Fairmount, Cincinnati 14, Ohio.

FREE! Giant catalog offering thousands of bargains. Sent with beautiful approvals. Jamestown Stamp Co., Dept. E10PMC, Jamestown, N. Y.

FREE Packet! Angola, Azores, Mongolia, Nepal, Palestine, Fascinating approvals. Coral, Box 7095, Ludlum, Miami 55, Fla.

1000 DIFFERENT World-wide \$1.25. A. E. Batchelder, 242 Home Street, Long Beach 5, Calif.

800 MIXED U.S. Old-new 25¢. Lists. Weasberby, Medina, Ohio.

30 BEAUTIFUL Animals 25¢. Approvals. Kab's, 393 N. Saginaw, Pontiac, Michigan.

GIGANTIC Collection free. Includes triangles, early United States, animals, commemoratives, British Colonies, high value pictorials, etc. Complete collection plus big illustrated magazine all free. Send 5¢ for postage. Gray Stamp Company, Dept. PM, Toronto, Canada.

LIBERIA. Beautiful set of four native flowers, priced at 60¢ in standard catalog, only 10¢. Approvals. Goliath Company, Bethlehem Pl., New Hampshire.

U.S. Stamps. Giant bargain catalog—10¢. Raymax, 35-VZ Maiden Lane, New York City 38.

50 U.S. Commemoratives \$1. N. Hurst, R.D. #1, Murrsville, Penna.

313 DIFFERENT Worldwide 25¢. Exotic pictorials, approvals. Edgar, Box 437M, Punxsutawney, Penna.

77 DIFFERENT U. S.—25¢. approvals. Utechs, 1143D North Keeler, Chicago 51.

FREE Sample stamp newspaper, information on collecting, special lists. Approvals. Littleton Stamp Co., Littleton A1, New Hampshire.

WOW! 135 All different Germany 10¢. Zeppelins, semi-postals, airmails, high values. Big bargain lists and approvals included. Jamestown Stamp, Dept. A-10PMC, Jamestown, N. Y.

EARN Scott's albums, catalogues, perf. gauges, hinges, watermark detectors, etc. while buying from our foreign approvals. True Value, Box 2098, Santa Ana, Calif.

FRESH, Rotating, unusual, stamp stocks. Details, samples, \$1.00. Unsold items exchangeable. Penniston, 208 Anderson, Fairfax, Va.

ONE Hundred stamps plus beautiful pictorial mint set only 10¢. Approvals. Robdal, Stamp Department, Riverside, Connecticut.

STAMP Collecting outfit, includes packet worldwide stamps, package hinges, watermark detector, millimeter gauge. Everything 10¢ with approvals. Lorain Brown, Marion, Michigan.

100 ALL Different United States commemoratives \$1.00. Leo Resheske, Sturtevant, Wisconsin.

300 DIFFERENT Given free with approvals. Particulars. Windsor Stamps, 834 Cornell Ave., Chicago 17.

PENNY Approvals, Thousands. Bargains for pennies. Gifts with purchases. Penny Stamps, Orange 1, California.

506 DIFFERENT 50¢; 1012, \$1.10. Approvals. Klondike, 682 Jefferson, Elgin, Illinois.

NEXT Ten 3¢ F.D. Aircraft covers \$1.00. Auferheide, Box 224, Trenton 8, N. J.

135 DIFFERENT U.S. commemoratives \$1.00. 50-25¢. Request approvals. Harold Holub, 18 East 196th Street, New York 68, N. Y.

GHANA Stamps. Scenic postcards mailed direct from world's newest and most exuberant nation. Better than Ball. Send \$1.00 to Wilpot, Seaman's Mail, New Orleans 18, La. Ghana stamps mailed here 50¢.

200 WORLDWIDE 10¢ To approval applicants. Collins', P.O. Box 125, Shell Beach, Calif.

U. S. Commemoratives: 100 large, all different, \$1.00; 150 all different \$2.00; 200 all different \$3.00; 250 all different \$5. Norman Sparhawk, 21 Fuller, Waltham, Mass.

BRITISH Africa Colonials. Used, two shilling value, 50 different \$1.00. Real fine assortment. Harrison's Stamps, 1435 First Ave., Oakland 6, California.

FOREIGN Stamps, 1¢ to 5¢ approvals. Barr, 467 Oneida, Pittsburgh 11, Penna.

SCARCE Souvenir sheet free with approvals. Variety Stamps, 57-E Circuit, Newton Highlands 61, Mass.

12,000 PENNY Approvals waiting for you. Many from exotic countries, pictorials, airmails, new issues. Tilbury, Box 862, Newark 1, N. J.

PAKISTAN, 25 Different, plus gigantic catalog, 10¢. No approvals. Band, 29-E Haverford, Hicksville, New York.

FREE Sets, packets, conglomeration, mixtures. Details: Stamp Farm, Oxford, Wis.

FREE! 50 Different Portuguese: colorful, inexpensive approvals. Elkhart, Box 33, Elkhart, Indiana.

25 DIFFERENT Bavaria 10¢. Approvals. Foster, P.O. Box 183, Muskegon Hts., Mich.

STAMP Wallet, perforation gauge, approvals. 5¢ handling. Thiese, 9320 San Juan, South Gate, Calif.

94 DIFFERENT U. S. 25¢—or 74 only 10¢. Approvals. Coonrod, 714 Garfield, Laredo, Texas.

65 DIFF. U.S.A. 10¢. Approvals. Kem, 14029 Don Julian, La Puente, Calif.

AMERICA'S Favorite stamps forwarded on approval. Philatelic Roundup, Pennington, New Jersey.

FREE 55 Worldwide introducing inexpensive approvals. University Stamps, P.O. Box 95, Tamiami Station, Miami 44, Fla.

UNITED States three issues pre 1894 free. Collier, Chambliss, Georgia.

U.S. Mint specials! 13 different commemoratives, 25¢; flag set, complete, \$1.00. Free price list, Brooks, 2323P Avenue X, Brooklyn 35, New York.

EXOTIC Collection free! Triangles, animals, sports, others. Request approvals. Baird, Box 8113, Portland 7, Oregon.

FREE—25 Diff. Japan with approvals. Scheerer, Box 301, Pottsville, Penna.

OLD U. S., famous Americans, flags, presidents, commemoratives plus surprise packet with approvals for 10¢ handling. Metropolitan Stamps, Box 312EW, Jackson Heights, N. Y.

FREE Beauties! Japanese souvenir sheets (2) plus exciting Oriental-African approvals, 10¢ handling, Stoddard's, 204 Cornwall St., Salinas, Calif.

100 DIFFERENT 25¢. Inexpensive approvals. Fabian, Box 10056, Tampa 9, Fla.

300 DIFFERENT Around the world—From 50 foreign, intriguing lands, 25¢ with approvals. Mark International, 4528-A Hollywood Avenue, Milwaukee 11, Wisconsin.

60,000 DIFFERENT Stamps on approval by country. Send list of countries wanted. E & G Stamp Company, 1209 6th St., S.E., Winterhaven, Florida.

SIX Stamps picturing locomotives 25¢. Stoddard, Box 29036, Hollywood, California.

BARGAIN! Liberia, Monaco, Mozambique—20 beautiful triangles, pictorials 10¢ to approval applicants. V. De Palma, 3202 Third Ave., Bronx 51, N. Y.

MYSTERY Bag stamp collection, 10¢ with U.S. and foreign approvals. Hill, P.O. Box 51, Defiance, Ohio.

ISRAEL, Egypt, Monaco, 13 different, 10¢ approvals. May, Box 986-F, Coral Gables 34, Florida.

SPECIAL United Nations set 10¢ with approvals. Noble, Owego, New York.

FREE! Free! Round the world packet to approval applicants. Stevison, 131 Dryden Dr., Meriden, Conn.

U. S. Commemoratives: 141 different \$1; 201 different \$2. Moseley, 6 Hanley Downs, St. Louis 17, Missouri.

25 DIFFERENT Egypt 5¢ with approvals. Helen Kaye, 2200 Ocean Avenue, Brooklyn 29, N. Y.

SENSATIONAL Offer! Laos #1 to 22. World's most beautiful stamps. Only \$2.00. Broadway Stamp Company, 1220 Broadway, Yakima, Wash.

ABSOLUTELY No approvals. Nothing free. Offer bargain-packed, money-saving U. S. price lists, 10¢. Chassy, Box 42-PMXB, Babylon, N. Y.

35 DIFFERENT Large U.S. commemoratives 10¢. Ace Stamps, Jamesburg, N.J.

FIFTY Different large commemoratives, pictorials, topicals, 25¢. Satisfaction guaranteed. Approvals. Arrow, Box 411, La Crosse, Wisconsin.

CANADA: U.P.U. set, mint 25¢ with attractive approvals. Rheume, 6391 11th Ave., Montreal 36, Canada.

SOUVENIR Sheet Czechoslovakia 1937 10¢ with approvals. Kingman, 30 Empire Street, Yonkers 4, N. Y.

FREE! 10 British Ceylon bi-colored's. Inexpensive approvals. Bischnann's, 118 Mississippi Avenue, Joliet, Illinois.

SPECTACULAR—100 Different U.S. including 25 commemoratives, 25¢, with U.S. approvals. Stamps, Box 37, Kennebunk, Maine.

STAMP Finder 15¢ approvals. Oak Stamp Co., Box 371A, Chicago 90.

U. S. Commemoratives, 100 mixed 25¢. Ray Worth, 321 So. Cicero, Chicago 44.

FREE! Monaco triangles! Madagascar! Zanzibar pictorials! Approvals. Kenting, 2520-P Boulevard, Jersey City, New Jersey.

CANADA, 100 Different 35¢ with bargain approvals. K. S. Holmes, London, Canada.

QUALITY Approvals at 2¢ each. Hadrian, 22 East 29th, New York City 16.

UNITED States airmail 10 different used and our price and check list only 10¢. Fred Ohl, Woodstock, N. Y.

"OLD Glory" U. S. 4¢ F.D.C. 10¢ with approvals. Kentucky Stamp Company, P.O. Box #251, Paducah, Ky.

FRANCE—100 Commems., \$1 bill, 300 super \$5.00. Lamy, Domats (Yonne), France.

LUXEMBOURG, 25 Different 5¢, approvals. Neal, 5950 Tower, Riverside, California.

FREE! Over 100 different, \$2.50 value, including Israel, British Colonies, U. S., First U. N., Siberia; triangles, animals, sports. Approvals, illustrated catalogue accompany. Send 10¢ for mailing. Gatewood, Box 346, Winston-Salem, N. C.

BEST Buy today! 1000 different worldwide stamps \$1.00. Universal, Box 6, Kenosha 5, Wisconsin.

50 DIFFERENT United States 5¢ with bargain approvals, lists. Bookman, Box 8245-M, Madeira Beach, Fla.

DARKEST Africa Congo, Camerouns, Seychelles, Swaziland, Tanganyika, Urundi free. Fascinating approvals. Royalton, Box 283, Forest Hills 75, N. Y.

SUEZ Canal—27 different Egypt stamps only 10¢ with approvals. Excello Stamp Company, Box 489, Red Bank, New Jersey.

1958 U. S. Illustrated catalogue free. Stone, 192 Washington, Boston 6, Mass.

FREE Sample! Interesting, informative, illustrated. National Stamp News, Anderson, South Carolina.

GOOD Foreign stamps 1-3¢ each. Perry Mayers, 37 Dawson, Belleville 9, New Jersey.

FREE Everything free—Mammoth collection cataloguing \$20.00 also 50 valuable complete sets. 54 gigantic multicolor commemoratives. All volumes Scott's International albums, catalogues, even Master Global albums, free when you buy our sensational foreign approvals. Don't write unless you intend to buy. Bargain Stamps, Redlands, California.

#### HOBBIES AND COLLECTIONS

SEASHELLS From the coast of Florida. For hobbyists, craftsmen, collectors, aquariums. Beautiful assortment of 14, only \$1.00. Shipped prepaid. Seashells, 4209 Bayview, Tampa, Florida.

NAZI Medals listings 10¢. Kingstone, 920 Third, (338) Seattle 4, Washington.

COLLECTORS Matchbook covers, 100 different unused, \$1.00. Catalog 25¢. Album \$3.00. Charles Edelman, 1311-C East 84, Cleveland 3, Ohio.

NAZI Badge 50¢; Iron Cross with ribbon \$1.50; 35 American emblems, introductory offer 50¢; catalog 10¢. Hobbies, Box 71-A, Station "A," Brooklyn, N. Y.

MILITARY Miniatures. Civil War. Custer's Cavalry, American Revolution and U. S. Marines. Illustrated catalog 35¢. Bussler Miniatures, Dept. Z, 40 Howe St., Quincy 69, Mass.

NAZI Insignia, 12 different \$1.00. Medals, patches, armbands, flags, daggers. Illustrated lists, 15 cents. Hobbyland, 1207 1st St., W., Calgary, Canada.

INVENTING Can be an interesting and profitable hobby. Write for complete particulars. Institute of American Inventors, Dept. 40-E, 635-P St., N.W., Washington 4, D. C.

#### PRECIOUS STONES, MINERALS

64 MINERALS, \$6.00. Details free. Minerals Unlimited, 1724 University, Berkeley 3, California.

SAPPHIRE, Topaz, tourmaline, garnet, peridot. Five uncut gem specimens, \$1.00. Ten polished gems, baroque shaped, \$1.00. Free bargain list jewelry, gems. Profitable, easy "do-it-yourself" projects. O'Brien's, 1116M Wilcox, Hollywood 38, Calif.

CUT Gems, make jewelry—For profit or fun. 100 page magazine tells how: where to get supplies. Sample 25¢ or request free literature. Lapidary Journal, Del Mar 2, Calif.

GEMS. Thirty, pocket-size case, including ruby, sapphire, emerald \$3.50. Fifty minerals \$5.00. Reed's, 4930B Palo Alto SE, Albuquerque, New Mexico.

EARTH Science. Rockhounds' National Magazines, subscription \$2.00. Sample 25¢. Box 1357PM, Chicago 90, Illinois.

NEW German scientific synthetic gems! Replacing titania. White. Brilliant. Hard! \$2.00 carat. Order sample today! Mextex, 721PM9 North El Paso Street, El Paso, Texas.

TEN New Mexico minerals \$1.50, six fluorescents \$1.00, five crystallized minerals \$1.00, fool's gold 25¢. Minerals, Winston, New Mexico.

LARGEST Gem and mineral magazine tells how to have profitable fun with rocks, gems, jewelry. Monthly, \$3.00 year. Sample 25¢. Gems & Minerals, Dept. A10, Mentone, California.

DIAMONDS: Discounted, registered with written guarantee. Example: Genuine Marshall diamond, 1/4 carat mounted. Your price: \$77.00 plus tax. Write, House of Marshall, 11 Lawrence St., Lyons 6, N. Y.

#### ANTIQUES, RELICS, INDIAN GOODS, CURIOS

4 PERFECT Arrowheads \$1.00. Smith, 841 N. Tacoma, Indianapolis 1, Indiana.

ANCIENT Grooved stone tomahawk \$3.00. Indian relic list free. Lear's, Glenwood, Arkansas.

SELECTED War arrowhead \$1.00. List 5¢. H. Talburt, Calico Rock, Ark.

ILLINOIS: Gesundheit—For sale: several hundred Revolutionary, Civil War, Indian muskets, rifles, carbines, swords, bayonets, powder-horns, bullet molds, holsters, canteens, Kentucky rifles, frontiers, duelling pistols, Stagecoach guns, 50,000 collectors cartridges. Many Confederate items, 10,000 coins, Confederate money, 100,000 Indian relics, arrowheads, spearheads, tomahawks, bannerstones, discoids, mounted birds, squirrels, deerheads, steer-horns. Violin wood, agates, fossils, minerals. Gold dollars. Illustrated catalog 35¢. Heike, Wenona, Illinois.

#### CAMERAS, PHOTO SUPPLIES

FREE! Free! Send for your new 52 page photographic bargain book. Over 5,000 new and used items at huge savings. For your free bargain book, write to Dept. 1110, Central Camera Co., Chicago 4, Ill.

KODAK, Bell-Howell, discounts to 40%. photo equipment, appliances. Free catalog. Mailers Mart, Box 135-MP, Pelham, N. Y.

PHOTOGRAPHY For pleasure or profit. Learn at home. Practical basic training. Long established school. Free booklet. American School of Photography, 835 Diversey Parkway, Dept. 3442, Chicago 14.

#### PHOTO FINISHING

IMMORTALIZE A photo of your loved one. Send favorite photo or negative and receive a 11" x 14" hand-colored portrait. Include color of eyes and hair. Send \$4.00 with each order to: Jack Holt, 733 Russell St., Bellmore, N. Y.

FREE Roll film with every b&w roll finished. Jumbo album prints, 8 exp. 50¢; 12 exp. 70¢. Free mailers. Prairie Photo, Box 1133, Decatur, Ill.

KODACOLOR Trial offer: Enlarged Kodacolor prints from your negatives 15¢ each with this advertisement. Bell Color, Dept. PM, Englewood, New Jersey.

FREE Kodak "Kodaguide snapshot dial" (exposure calculator) with first film developing order. Free postage both ways. Send for free mailers and prices. Snapshot Photo Service, Box 75202-A, Los Angeles 5, California.

WITH This ad only. 20 billfold photos, one in color, \$1.00. Wallet Photo, Box 470, Fostoria, Ohio.

QUALITY Kodak finishing. 8 exposure roll 40¢; 12 exposure 60¢; 16 exposure 70¢. Reprints 5¢. Fast service. Guaranteed quality. 40 years continuous operation. Be a satisfied customer. We do color. Send for mailers. Mail Order Photo Service, Box 287, Watertown, Wisconsin.

KODACHROME Processing—8mm roll or 35mm 20 exp., \$1.25. Prompt service. Write for mailer and prices. Color Pix, Dept. P, CPO Box 30, Kingston, N. Y.

FREE! Color snapshot folder. Offers, lists, mailers. Houghton's, Irving, Mass.

PARTICULAR? 8 Jumbos 35¢, 12—50¢. Special; 35mm., 36 exposures \$1.10. Flash-Photo, Box 38M, Brooklyn 4, N. Y.

12 EXPOSURE Rolls, 39¢, jumbo prints. Guaranteed work, one day service, Lincoln Studios, Dept. K, Box 13, Lincoln, Nebraska.

TWO Beautiful prints from each picture on roll. 8 exposure 40¢; 12 exposure 50¢. Thirty-six years of satisfied customers. Quick service. Lensphotos, Dept. J-4, Janesville, Wisconsin.

8-HOUR Service on deluxe jumbo prints. 8-exposure roll developed and 8 jumbo prints 40¢, 12 exposure 55¢, 16 exposure 70¢; 35mm. 20 exposure 75¢, 36 exposure \$1.25. Jumbo deckle reprints 4¢ each. Contact prints made if specified. Bay Photo Service, P.O. Box 210, Oakland, California.

SUPERIOR Quality. Prompt service. 8 jumbos in album 40¢, 16 contacts 50¢. Jumbo reprints 5¢. Satisfaction guaranteed. Also complete color film finishing service. Write for free circulars and mailers. Fast-X-Photo, Box A, Jersey City, N. J.

ENLARGEMENTS, Heavyweight seven 5x7's or four 8x10's \$1.00. Jack Koons, Huntington Mills, Luzerne County, Penna.

DO It yourself booklets. 24 subjects. Free catalog. Popular Mechanics Press, 631 N. St. Clair St., Chicago 11.

PHOTO Christmas cards made from your own snapshot negatives. Truly personal and distinctive. 25 cards \$1.85; 100 for \$6.00 including envelopes. Your name imprinted 75¢ extra. Send your negative for free sample and choice of styles. Photo-Mail, Box 216M, New York 10, N. Y.

#### MOTION PICTURES AND SOUND EQUIPMENT

FREE! Blackhawk's big new 1958 sale catalog new and used 16mm., 8mm. movies; 2" x 2" color slides; used 16mm. sound projectors! Biggest stock in U.S.A.! Cameras, accessories, supplies, too! Blackhawk Films, Davenport 14, Iowa.

BULLFIGHT Movies, 8, 16mm. Literature. A Ruotolo, Box 1305, Greenwich, Conn.

RECORDERS, Hi-Fi. Free catalogue. Carstan, 215 E. 88 St., New York City 28.

5,000 8-16MM. Movie films. Free catalogues. International, Greenvale, N. Y.

TAPE Recorders, tape. Unusual values. Free catalog. Dressner, 69-02M 174 St., Flushing 65, N. Y.

FREE Catalog. Save dollars. Fresh 8mm., 16mm. b&w and color film. Home processing equipment. Superior Bulk Film Company, 448 No. Wells, Chicago 10.

MOVIE Camera film: 8mm. roll \$1.50. 16mm. 100' \$3.00. Free processing. Better Films, 742 New Lots, Brooklyn, N. Y.

8-16MM. Films. Free catalogue, with sample film 10¢. Garden, 690 Howard Avenue, Brooklyn, N. Y.

SAVE 50%! Guaranteed-fresh color, b&w. movie film! 8mm., 16mm. Free catalog! Eso-R, 47th Holly, Kansas City 12, Missouri.

PATENTED 8-MM daylight film processors, inexpensive. LeMoine Films, Nevada, Missouri.

16MM Sound films. Free lists. Crawford Films, 412 Page St., Ft. Worth 10, Texas.

8MM Movies 50 ft. \$1.00. Special offer—Animals, cartoons, travel, comedies. Send \$1.00. Movieland Films Inc., 16121M Sherman Way, Van Nuys, California.

#### MUSIC AND MUSICAL INSTRUMENTS

WRITE Songs. Big money and reputation. Write for information. J. Gordon Pub. Co., 4700 South California Avenue, Chicago.

SONGPOEMS And lyrics wanted. Mail to: TinPan Alley, Inc., 1650 Broadway, New York 19, N. Y.

SONGS Into dollars. Share \$29 million dollars yearly for new songwriters, song-poets. Songs composed, published, promoted by famous firm. Information, appraisal free. Send to Nordyke Publishing, 6009 Sunset, Hollywood 28PM, California.

POEMS Wanted for new songs. Send poems. Free examination. Immediate consideration. Songcrafters, 2724 Arcade Station, Nashville, Tenn.

POEMS Wanted for new songs. Send poems. Immediate consideration. Crown Music Company, 49-C West 32 Street, New York City.

ELECTRIC Guitars, amplifiers, wholesale. Free catalog. Carvin PMM, Covina, California.

RECORDS Hi-Fi by mail. Big discounts. Neelson, Box 211, Wall Street, New York City 5.

COMPLETE Music service for amateur songwriters. Write: Colonna, Box 888, Burbank, Calif.

SWISS Musical movements, \$1.90. Helax, 218 West 72nd Street, New York City 23.

ACCORDIONS, Wholesale to everyone. Save up to 60%. All national known brands. Free catalogue. Del Principe, 29 South Cicero, Chicago 44.

POEMS, Songs wanted! Publishing, recording. Bengal, 93 Jefferson, Chelsea 50, Massachusetts.

SONG Request guarantees royalties. Instructions two dollars. Howard Olenik, Mt. Morris, Mich.

ACCORDIONS—Direct from importer. Save 50% and more! Free trial. Lifetime guarantee. Trades accepted. Free catalog. Write Accordion Manufacturers Outlet, Dept. 107-R, 2003 Chicago, Chicago 22.

PHONOGRAPH Records, new, \$12 per 100, 45's, 78's. f.o.b. Compliance., P.O. Box 381, Lansing 2, Michigan.

ACCORDIONS Wholesale—10 day trial. Free catalog. American Accordion Center, 3329-PM-10, Belmont, Chicago.

SONGS And poems wanted. U.S. Music Studios, Box 222A, Belmont, Mass.

USED Jake boxes, Bowlers \$100. Hit records 30¢. Catalog free. Wickens, 1139-M, W. Summer, Appleton, Wisconsin.

RECORDER Flutes. Free catalog, 309 W. Fourth, Los Angeles 13.

VIOLIN Makers supplies. Free catalog, 309 W. Fourth, Los Angeles 13.

HILITES Of songwriting \$2.00. Music writing course \$5.00. Colonna, Box 888, Burbank, Calif.

GUITARISTS! Play 1,001 "tricky" chords first day. Chord-O-Matic dial \$1.98. Trebb Sales, Lorain, Ohio.

FREE Details on writing and selling songs! Johnnie Martinelli, 1182 Broadway, New York City.

#### RADIO, TELEVISION AND ELECTRONICS

CRYSTAL Radio experimenters write to Hulet, 305 Hope, Lakewood, N. J.

FREE! Giant bargain catalog. Transistor, "Sun" radios, kits, portables, audio, electronics, photographic, optics, tools, household. Write Lektron, 131M Everett Ave., Chelsea, Mass.

CRYSTAL Radio kit \$1.00, preassembled \$1.25, phone \$1.75; catalogue. Clearco Crystal Company, 2966 North 4th, Milwaukee 12, Wisconsin.

ATOMOTRON, Model atom smasher, \$14.95. 3-in-1 electromagnet, \$14.95. Cloud chamber, \$32.50; plans, \$1. Send 25¢ for literature. AtomLab, Box 343, Berkeley, California.

DO It yourself. What? Repair TV, build furniture, make barbecue, plumbing repairs, build boats, do house wiring, remodel home, lay tile, modernize kitchen, repair home, and scores of other things you can do yourself. Books covering each subject, only 25¢. Send for descriptive list. It's free. Popular Mechanics Press, 200-LB East Ontario St., Chicago 11, Ill.

BUILD 12 Receivers, transmitter, signal tracer, code oscillator, signal injector. Complete home radio course only \$22.95. No need to spend hundreds of dollars for a course. For a mere fraction of its real value, our course trains you in basic radio. TV, Hi-Fi. Course includes everything you need: tubes, parts, tools, instructions. Write for full information. Also receive free servicing literature on radio, TV, Hi-Fi worth \$1.50. Progressive "Edu-Kits" Inc., Dept. 51B, 497 Union Ave., Brooklyn 11, N. Y.

FREE 404-Page 1958 radio-TV-Hi-Fi and electronics catalog! World's largest stocks, lowest prices. Everything for experimenters, builders, amateurs, servicemen. Latest money-saving build-your-own Knight-kits, Hi-Fi, phonos, recorders, public address, TV accessories. Thousands of parts, tubes, test instruments, tools and books. Write for free copy! Allied Radio Corp., 100 N. Western Ave., Dept. 34-K7, Chicago 80, Illinois.

TUBES—Save 80% on new, guaranteed quality, radio, television tubes. Compare our quality and prices with anyone's. Free plastic wallet with \$10 order. Write Bell Electronics Company, 40 Canal, New York City 2.

FIX Your own TV. Send make and model with two dollars. Pamphlet shows which tube you change to correct troubles. Holly Electronics, 518 Rider, Pampa, Texas.

TRANSISTOR Kits, parts. Free information. Transit, Box 15-P5, Alden Manor, N.Y.

CRYSTAL Radio kit. Assemble with screwdriver, \$1; chemistry set \$1. Catalogue. Kits, 1432 Drake, San Pablo 10, California.

REPAIR Your own TV. Folder lists tubes to check for different TV troubles. 35¢. Winks TV Hints, 4376 Ewing Ave. No., Minneapolis 22, Minnesota.

MUSIC From the sun. Sun-powered transistor radio, \$14.95. Details: Richards, 160 Seem, Emmaus, Penna.

GOVERNMENT Surplus. Radios, parabolic reflectors. Amazing picture list 10¢. Meshna, Malden 48, Mass.

EXPERIMENTERS' Circuit-catalog 25¢, refundable. Laboratories, 328-C Fuller, Redwood City, California.

#### BUSINESS OPPORTUNITIES

START Your own business on credit. Your own boss. 1527 dealers sold \$5,000 to \$32,000 in 1956. We supply stocks, equipment on credit, 200 home necessities. Sales experience unnecessary. Pleasant profitable business backed by world-wide industry. Write Rawleigh's, Dept. J-U-PPM, Freeport, Ill.

PRINT Without a printing press! Amazing new method! Print colorful signs, banners, cards, posters, glassware; anything at home. Big profits. Money-making opportunity! We supply everything. Beautiful sample, home-business plan free! Write Screen-Print Company, OR, Los Angeles 61, California.

BUY At wholesale prices! Tremendous savings! Resell to friends, neighbors, everyone at big profits. Enormous selection of highly desirable, nationally advertised merchandise—Benrus, Dormeyer, Oster, Cummins, Brook Park, Richelleu, Remington, Ronson, Pepperell, Farberware. Electrical appliances, cookware, housewares, watches, jewelry, rings, dry goods, clothing, luggage, tools, sporting goods, toys, gifts, etc. Free 1958 color catalog showing 1001 in-demand items. Write today. Merit Home Products, Dept. PM-10, 107 Manhattan Avenue, Brooklyn 6, N. Y.

DO-It-Yourself booklets. 24 different booklets each covering an interesting subject. Free catalog. Popular Mechanics Press, 631 N. St. Clair St., Chicago 11.

MOTEL-Resort management—Qualify for hundreds fascinating, leisurely, well-paid executive openings. Learn at home. Free booklet. Motel Managers Training School N14DC, 612 S. Serrano, Los Angeles 5.

MAKE Money; 47 eye-catching housewares, gifts. Sell like wild. Work home. Spare time. Samples sent on trial. Kristee 112, Akron, Ohio.

**BUY** Direct from factories—Appliances, cameras, watches! Free details! Cam Company, 6810PM-20th Ave., Brooklyn 4, N.Y.

**MIMEOGRAPHING** Services pay sensational local profits. Exciting secret plans exposed! Write: Moele Mimeo Shop, Bonham 7, Texas.

**EARN** Money repairing Ronson lighters. Free parts list. M. Trading Post, 420 Willis Ave., New York 54.

**PROFITABLE** Mail order business. Operated from home. Earn extra money pleasantly. Free exciting literature. Write Harvey Sales, 5713A Euclid, Cleveland 3, Ohio.

**PROFESSIONAL** Mailorder! Home, office; proven successful money-makers. Industries, 1430-W Monroe, Chicago 7, Illinois.

**WANTED:** Home producers, to be subcontractors. Cast plastic products for manufacturers in our clearing house service. Thousands of easily made items required. Cash in at home, without previous experience. Plastic Service Associates, Dept. 10-PM, East Boston 28, Massachusetts.

**SELL** Books by mail. 400% profit. Royal, Box 368-X, Cleveland 27, Ohio.

**REBUILD** Batteries; repair dolls; make rubber stamps. "75 Ideas" free. Universal, Box 1076-A, Peoria, Ill.

**GROW** Expensive herbs for us! Big profits home-business of your own. Year around profitability! We supply everything necessary! Send for free rare seeds and revealing plan. National Herb Exchange, Dept. OR, Gardena, Calif.

**MAIL** Order advertising agency executive reveals sensational no-risk advertising and merchandise methods. Start in office or home; minimum capital; positive profits. Free details: Impact! 3407 Prospect Avenue, Dept. 11-10, Cleveland 15, Ohio.

**HOME-Import** mail order business—Import profitable items below wholesale. Experience and product investment unnecessary. Full, spare time. Famous world trader guides you. Free list "157 Imports," details, Mellinger, G70A, Los Angeles 24.

**"HOW To Start a Business"** booklet sent free! If you know any trade, go into business for yourself! Learn the 9 easy steps to follow. We've guided 5,000 others to success. Revealing free booklet yours for the asking! Write! National Business Consultants, Office OR, Los Angeles 61, Calif.

**OPERATE** Restaurant or diner. Free booklet reveals plan. Write Restaurant Arts, 110-BU, Fremont, Ohio.

**137 IDEAS** To make a million. An amazing compilation of leading business men's ideas. Complete details free. Joed, Box 69, Glendale, California.

**MAKE** Extra money. Cash commissions. Everybody buys easy-to-sell advertising book matches. Union label. All sizes. Cuts for all businesses. Powerhouse selling kit free. Steady repeat business. No experience necessary. Superior Match Co., Dept. MX-1057, 7523 S. Greenwood, Chicago 19.

**INSTITUTIONAL-Industrial** mailorder business. Complete setup service—Not just instructions. Hermes Advertising, 152-C West 42, New York City 36.

**OPERATE** Profitable mail order business. Write Walter Service, 4159A East 112th, Cleveland 5, Ohio.

**PAINT** Suede on dashboards, signs, radios, toys, figurines—anything! Amazing new discovery finish with beautiful touch and eye appeal. \$10 per hour possible for spare time effort at home. Help fill the huge growing demand. Free actual sample and "150 Home-Business Ideas" booklet. Coast Industries, Dept. OR, Los Angeles 61, Calif.

**NESTLE'S** Coffee, hot chocolate vending. \$149 starts you. Send 25¢ for samples. Solapak Co., 1620 Plymouth No., Minneapolis 11, Minnesota.

**SELL** By mail and direct to offices, stores, homes, schools, churches, clubs. Nifty sealer and moistener for envelopes, labels, trading stamps and anything that sticks. Sample \$1.00 refundable. Mailing circulars \$1.95 M. 110% profit. We drop-ship. Amberland, Box 91, S. Boston, Mass.

**97 WAYS** To make a million. Start from scratch. Grow big. Others have. You might too. Dime brings details, fast. Woodward, 1221 Edgewood, Haverton 3, Penna.

**FREE** Folder describing 137 money making plans. \$100 weekly reported. Dover, 9 Chase Ave., Lexington 73, Massachusetts.

**PROFITABLE** Hobby. Handmade glass figurines. Free literature. Adams, 18724-A Martha, Saratoga, California.

**CASH** From sawdust, seventy methods. Tin-cans, thirty methods. Newspapers, eighteen methods. Instructions 50¢ each. All three \$1.00. Charles Company, 12-XAN, Norwood, Ohio.

**STATUARY** Molds! Super quality liquid rubber. Ajax Products, 734 East 234th Street, Cleveland 23, Ohio.

**LEARN** Real estate thoroughly and enjoyably in your easy chair by listening to records. Excellent profitable profession, full or part-time. Many successful graduates. Lee Institute, Brookline 46, Mass.

**EARN** \$15,000 Yearly. Independent non-competitive business. No merchandise to handle. No traveling. 3 to 6 months work yearly. Start in spare time. Alvin Survey, Box 769-B, Alvin, Texas.

**BUSINESS** Opportunities. Over 1,500 people in one state alone make additional income at home. For free information address, Mail-Towne, 9 Murray St., New York 7, N.Y.

**MANUFACTURE** Perfumes, cosmetics, cleaners, polishes. Work home. Catalogue free. International, 6347 Parnell, PM107, Chicago 21, Illinois.

**UNIQUELY** Different postcard projects bring avalanche of mail order cash. Powerful advertising copy furnished. Revealing information free. Craft-Horizon, 2694 So. 10th, Fresno 25, Calif.

**WORK** Home. Pleasant, profitable mail-order business. Own hours, independence. Expert guidance. Masters, 5145 Norwood, Arlington, California.

**10% BELOW** Wholesale! Thousands of nationally advertised lines! Details, Bard, 4138 Bailey, Cleveland 13, Ohio.

**EARN** Money writing features, fillers. Write to: Underhill, Beebe, Arkansas.

**EARN** Money at home. Learn invisible reweaving at home. Licensed, approved school. Free details. Eastern School of Reweaving, 73 Main Street, Dept. P107, Hempstead, N.Y.

**SELL** By mail. Tested methods. Alfano, 19 Pine Street, Closter, New Jersey.

**BUY** Wholesale, thousands nationally advertised products at big discounts. Free catalogs. United Wholesalers, 1265-F Broadway, New York City.

**\$34.70** TWO Hours. Manufacturing. No selling. Carlsberg Castings, 1803 Fremont, Rapid City, South Dakota.

**LIQUID** Marble—Brushed, dipped! Mold novelties, tile. Particulars free. Marbleizing Service, Edwardsville, Illinois.

**SHARPEN** Lawnmowers. Home business. No expensive equipment needed. Big profits. Free literature. Grind-Rite Lawn Mower Service, 4543 Roswell Rd., Atlanta 5, Georgia.

**EXCEPTIONAL** Mailorder opportunity! Write: George Lenhoff, Box 201, Lincoln 1, Nebraska.

**IMPORT-Export!** Mailorder opportunities. Details. Warner, Box 6, Fort Scott, Kansas.

**ULTRA-Modern** sofa. Buy it for \$250 or make it for about \$30 including 4 inch foam cushion. Benko, 400 East 66th Street, New York City 21.

**SELL** Razor blades, spare time. 500% profit. Free sample, details. Home Ideas, 204P, Short Hills, N.J.

**FOUR** Color mail order catalogs—Fifty fast-selling items. Orders filled for you. Big profits. Sample, details free. Associated, Box 53-A, Boston 22, Massachusetts.

**\$26,500** BY Mail order in two weeks! Amazing radio-mail order method using powerful stations. Start fabulous business on low capital. Product sources supplied. Free details. Broadcast Service, 1412-C2 Great Northern Bldg., Chicago 4.

**WHOLESALE:** \$50,000 Items. Supply source directory 25¢. Idealer, Park Ridge, Illinois.

**RESILVERING** Mirrors, formula 50¢; Two-way lookout mirrors, 50¢; coppered mirrors, 50¢. All \$1.00. Nelko-Mir, Box 3462-P, Chicago 54.

**YOUR** Secret gold mine. Fabulous profits. Free details. Locate relics, artifacts, antiques. P. Putnam, 465 Hull Avenue, Jerome, Arizona.

**CASH** Income collecting local information. No selling. Free details. Dorco, Box 494, Muncie, Ind.

**"EVERYBODY** Likes candy" — Make professionally home. (Our 47th Year.) Regalade Candies, B107, East Orange, New Jersey.

**ENGRAVING,** Carving attachment for hand motor tools, "Dupliscaler" creates new opportunities. Details, sample 25¢. Desco Distr's., 5262-P Van Nuys, Van Nuys, Calif.

**EXCLUSIVE** Distributors. Amazing crushed, aromatic, redwood cedar! Add water, brushed on. Makes permanent cedar closets! Terrific seller stores, homes, trailers, builders, hotels, schools! Low cost, big profits. Free kit. Plant, 90-A Summit Ave., Brookline, Mass.

**TERRIFIC** Selling illusion. Arrow, dagger and sword thru head novelty. Unger Supply, 655 South Wells, Chicago 7.

**START** Your own business with Rollit knife sharpener. Sells easily to stores, homes. Good profit item, easy to use, safe, effective, attractive, guaranteed. Sell full-time or part-time. Territories protected. Write now. Alden Spence's Sons Co., Dept. P-107, 130 Sixth Street, Cambridge, Mass.

**FREE.** We'll set you up in your own mail order business free. We supply you with complete mailing package. You just mail. 30 years of successful dealings are your guarantee. K. Glass, Ellwood City, Penna.

**LET** Me sell your products nationally. I'll send you free information on how to establish spare-time-full time Cascraft business. You build! We sell! Everything supplied. Abarni, 807-SB Sunset, Los Angeles 12, Calif.

**"HOME** Business Digest," published since 1899; home, part-time, mail-selling tips, methods, newest products. Copy 35¢, year \$2.00, 2 years \$3.00. Distributors wanted. Send \$1.00 for information. M. R. Brown, 618 N. Cayuga St., Ithaca, N.Y.

**TAKE-OUT** foods. Your own business using successful proven methods. Complete details \$1. Alamo Take-Out Foods, Inc., 1832 Tyler, Hollywood, Florida.

**FREE** "How to Start Your Own Mail Order Business." Exclusive franchise! Your own catalogs. We ship hundreds of top mail order items for you. Write now! Mail Order Associates, Rochelle Park 39, New Jersey.

**MAILORDER** Envelope business. No investment. Omaha Envelope, 4721-E California, Omaha 3, Nebr.

**SELL** Books by mail. Details free. Berryman, 153 Victoria, Northlake, Ill.

**OUR** Complete plan puts you in business for yourself, part-time or fulltime, manufacturing household necessity used by every housewife. Free details. Room 217, 30 Huntington Ave., Boston 16, Mass.

**MADE** \$10,000.00 Typing at home. Guaranteed profit. Amazing information 10¢. Lenore Felgen, Box 1125-PM, Oak Park, Illinois.

**GROW** A living miniature forest or orchard (only inches high), that bears tasty tiny fruit at home. Learn amazing dwarfing secrets! Sensational fascinating hobby, profitable home-business opportunity. Free details! Miniature Nurseries, Dept. OR, Gardena, California.

**FREE** Folder — "137 Successful Home Businesses." Service, Box 636PM, Newport News, Virginia.

**BRUSH** Plating outfits for plating articles in the home and shop. No tanks necessary, silvering mirrors, spare or full time. Free particulars. Gunmetal Co., Ave. H, Decatur, Illinois.

**BUY** Wholesale! Over 10,000 nationally advertised products. Appliances, cameras, sporting goods, housewares, watches, typewriters, tools, clothing, etc. Send postcard today. Buy-Rite, Box 258, Hawthorne 1, New Jersey.

**EXCLUSIVE** Distributorship available in most areas for world-famous Cadmium battery guaranteed to outlast your car. Tremendous profit opportunity. Investment for merchandise only. Free franchise. Cadmium Battery Corporation, Dept. 102, El Segundo, California.

**START** Your own business with our sample kits. Newest idea in selling. Reorder merchandise as you need it. Write today for full particulars. Division Sales, 3341 W. Roosevelt Rd., Chicago 24, Illinois, Dept. K.

**MAILORDER.** Learn to sell by mail. Complete course. Low cost. Ranso, Box 1719-A, Richmond 14, Virginia.



**HIGHEST Profits** all magazines. Sure success plan. Free catalogue, supplies, prizes. Subscription Service Co., Box 2070, Birmingham, Ala.

**THEY Hand him \$100!** Free packet. "Secret Journal." 919 secrets-plans! Work home. Publicco, Oceanside, Calif.

**OPERATE Easy-to-start, profitable home mailorder business!** B. Mann, Woodcliff Lake, N. J.

**CANDIED Popcorn** and potato chip equipment. Eskins, Box 933-A7, Springfield, Ohio.

**EARN To \$100.00 per hour** snow-flocking Xmas trees, centerpieces, etc. Flocking, 7051 Belmont Avenue, Chicago 34, Illinois.

**\$60.00 WEEKLY** Sparetime. Start home Venetian blind laundry. Protected territory. Interesting information free. Burtl, 2434EP, Wichita 13, Kansas.

**WANT To make big money at home?** \$10.00 profit in an hour possible with invisible mending. Make tears, holes, disappear from clothing, fabrics. Steady year-round demand from cleaners, laundries, homes. Details free. Fabricon, 6234 Broadway, Chicago 40, Illinois.

**NEW Snow cone machines.** All prices. P.O. Box 7803, Dallas, Texas.

**IMPORTING—Exporting.** Modern dropship method. Profitable. Details free. The Hansen Company, 6601-8th Ave. N., St. Petersburg, Fla.

**WHOLESALE—Thousands** nationally advertised products. Buy, sell. Amazing profits. New, free plan. Associated Wholesalers, 1016-D Starr, Burlington, Iowa.

**OPERATE Mailorder folio business!** Free details. Ballard's, 425 East Catherine, Louisville 3, Ky.

**MAKE Flexible molds.** Cast plaques, figurines. Free sample. Tooker, 1045-R Fairview, Hamilton, Ohio.

**NATURAL Molding** rubber, extra thick. Free sample. W. Wooley, 1016-A Donald, Peoria, Illinois.

**BIG Money** raising fishworms and crickets. Free literature. Carter Farms, Plains, Georgia.

**START Home business** making statuary, plaques, novelties, garden furniture, artificial marble flooring, liquid marble. Make your own flexible molds. Amazing profits. Only \$1.98. Free literature. Popular Mechanics Press, 631 No. St. Clair St., Chicago 11.

**UNUSUAL Mailorder opportunity.** Tested. We supply everything. Girard's, Azusa, Calif.

**WANT More business?** Here's an amazing opportunity to increase your sales. Talk to thousands of interested readers of "Mechanica Popular." Our Spanish Edition covers the Latin American countries like a blanket. They're real mailorder buyers. Classified rate 75¢ per word. Try an ad in our next issue. Classified Advertising Department, Popular Mechanics Magazine, 200 East Ontario Street, Chicago 11, Ill.

**VENDING Machines—No selling.** Operate a route of coin machines and earn amazing profits. 32-page catalog free. Parkway Machine Corporation, Dept. 25, 715 Ensor Street, Baltimore 2, Maryland.

**HOME Workshop books.** Free catalog. Popular Mechanics Press, 631 N. St. Clair St., Chicago 11.

**MONEY In saw and lawnmower** sharpening sparetime at home. Free book. Virgil Poley Company, Columbia Heights, Minnesota.

**\$70 WEEKLY—Home, spare time.** Simplified mail bookkeeping. Immediate income—easy! Auditax, 34737A, Los Angeles 34.

**TO \$100.00 Weekly.** Sparetime, home operated mailorder business. Successful beginner's plan. Everything supplied. Lynn, 10420-M National, Los Angeles 34.

**BRED Rare tropical fish** at home. Earn big money! Learn secrets! Help fill huge demand. Amazing opportunity! Free plan. Tropical Fish Breeders, Los Angeles 61, Calif.

**MINK Raising** information free. Complete. Lake Superior Mink Farm. Superior, E.E.I. Wisconsin.

**BE Appointed state notary public** now. Write. Stationers, Boerne, Texas.

I want to send you proof of the wonderful pulling power of Popular Mechanics classified pages. What's your proposition? Write me today. Include literature if possible. F. W. Johnson, Manager Classified Advertising, Popular Mechanics Magazine, 200 E. Ontario St., Chicago 11, Ill.

**COPUBLISH Mail Sale Advertiser,** leading mail order paper. Details, latest copy, dime. Vanroy Shirk, Lebanon, Penna.

**FREE "Franchise Profit Letter"** describes nationwide opportunities. Exclusive distributorships, dealerships, agency operations. Write today. National Franchise Reports, 333 North Michigan, Chicago 1.

**LEARN Photo-negative portrait retouching.** Men, women. \$5 hour possible spare or full time at home. Easy, glamorous. Work for photographers by mail order. Full details sent free. Duval, 100 So. Vermont, Los Angeles 4.

**YOUR Own name brand business.** No investment; no inventory. Part time or full time. Sell famous brands of appliances, housewares, silverware, radios, vacuum cleaners, lamps, tools, clocks, watches, jewelry, etc., etc., over 1000 items. Join thousands of successful independent dealers. Send for free catalog and dealer price list. H. B. Davis Corp., Dept. 11, 143 W. 13 St., New York City.

**11,000 NEW Prospects** daily. Baby record books, shoes, albums. Sell mailorder. Use our literature. Write: No-Co-Ro, Capitola, California.

**WE Love our mailman—He leaves over \$1000.00 monthly** in our rural mailbox. My college professor husband drafted a scientific home mailorder method. We bought a Texas ranch, live as we always wanted. Now we sell the Ranch Mailorder Method. Operates anywhere. Inquire: Eveningshade Ranch, Boerne, Texas.

**BAKE New greaseless doughnuts** in kitchen. Sell stores. Free recipes. M. Ray, 3605 South 15th, Minneapolis 7, Minnesota.

**FIX Typewriters.** Inexpensive home course teaches factory secrets. Free booklet. Athey, Tarentum, Penna.

**MONEY For you! Big profits!** Cast plaster figurines, bookends, plaques at home with XL rubber molds. No experience needed! Write for illustrated, 40-page catalog, only 25¢! Plastic Arts Studios, 3403 So. Madison Street, Department 5, Muncie, Indiana.

**GROW Orchids** at home. Profitable, fascinating. Year 'round, Maine to California. No greenhouse. Successful home grower shows you how to provide proper temperature and air conditions in any well lighted room. Full details and real orchid seeds free. Orchardland, 100 So. Vermont, Los Angeles 4.

**PLATE Baby shoes, jewelry, gifts, bronze and colored pearl.** Free booklet. Platex, 11629 South Vermont, Los Angeles 44.

**START Your own subscription service.** Every family buys magazines. No capital needed. We tell you how, furnish all supplies free. Liberal commissions. Write McGregor Magazine Agency, Dept. 110, Mount Morris, Illinois.

**FREE Catalog.** Contains hundreds of businesses, farms and income properties throughout U.S., Canada. Specify type and location desired. Deal direct with owners. U. I. Buyers Digest, 1608 Hillhurst, Dept. PM-3, Los Angeles 27, Calif.

**LIQUID Rubber.** Make flexible molds. Free sample. Chaney, 1907-A East Road, Jacksonville 11, Florida.

**START Home mimeographing business.** Pays amazing profits. Literature free. Housel, Lanoka Harbor, N. J.

**BOOKKEEPERS, Accountants.** Operate a bookkeeping service. Part or full time. Amazing simplified system. Wonderful money-making opportunities. Complete information free. National Bookkeeping Publishing Co., Suite 307, 3435 Broadway, Kansas City 11, Mo.

**WE Pay \$3.50 lb. dried.** Grow mushrooms. Cellar, shed and outdoors. Spare, full time, year round. We have 25,000 customers. Free book. Washington Mushroom Ind., Dept. 172, 2954 Admiral Way, Seattle, Wash.

**\$250 WEEK Cleaning** venetian blinds. Patented machinery. Free literature. Robinson, 7213B, Indianapolis 1, Indiana.

**MAKE \$6.00 To \$10.00 per hour** sharpening saws and lawnmowers. Get America's finest equipment as used by thousands of successful shops throughout the United States and Canada. Free literature. No obligation. Max Mfg. Co., 138 Stockton Ave., San Jose 25, Calif.

**ADVERTISING Executive** now reveals tested, authentic mail order instructions offering amazing profit opportunities at home. Write Holiday Publications, 2301 Greysohn Road, Duluth, Minnesota.

**FREE Book "505 Odd, Successful Businesses."** Work home. Pacific, Oceanside, Calif.

**INTERNATIONAL Mailorder business.** Complete setup service—Not just instructions. Hermes, 152 West 42, New York City 38.

**PLASTERCRAFT** Molds, liquid rubber, plasters, floccs, candle supplies. Catalog and manual free. Blue Rapids Supply, Blue Rapids, Kansas.

**"MAILORDER Laws and Regulations,"** \$1.00. Explains necessary licenses, different taxes, legal requirements, etc. "Mailorder Rules for Beginners," \$1.00 additional. Tasker, 1603 Peach Street, Alexandria, Virginia.

**FREE Folio "45,000-\$45,000, Unlimited Vacations."** No merchandise. Unknown! Work home, sparetime! Haylings, Carlsbad, Calif.

**MARY-Mac agency—motorized vibrator.** Cushions, chairs, tables, belts. Mary-Mac Factory, 1012 Powhattan, Dallas, Texas.

**FREE Folder, "How to Make \$3,000 Yearly.** Sparetime, Backyard, Raising Earthworms!" Onkhaven 38, Cedar Hill, Texas.

**BOOKLETS—\$1.00.** How to sell by mail order. 1957 business cycle advertising chart. Economist, 343 Fairfield Avenue, Bridgeport, Connecticut.

**UNUSUAL Opportunity.** Free literature. Quill Industries, 3607 South Hamilton, Chicago 9, Illinois.

**CASH Paid for boxtops!** Some, 25¢! Inquire: Bostops-AK, Cedar Hill, Texas.

**MAKE \$46 From square foot plywood;** jig saw necessary. Free details. Woodart, Bridgewater, Mass.

**\$3,000 YEARLY.** Spare time at home. Nothing to buy. No local selling. Dignified. Guaranteed. Home Harvest, Rt. 3, Box 3491-A, Albuquerque, New Mexico.

**SAVE Those newspapers!** They may contain information worth real money! Inquire: Publishers-E, Cedar Hill, Texas.

**START Home business.** Absolutely new. Never before offered. Amazing money making opportunity. Physical handicap no obstacle. Unlimited opportunities. Free samples and information. Peter J. Hahn & Sons Co., 4445 W. Belmont Ave., Chicago 41, Illinois.

## MONEYMAKING OPPORTUNITIES

**MAKE Double profits** selling Whitehall's new photo statuettes and greeting cards. Life-like miniature statues of children, friends, pets, sell on sight. Extra cash with exclusive personalized Christmas cards, stationery, napkins, gifts. Free sample portfolios. Write Whitehall Studios, 307 Cleveland Ave., Elmira, N. Y.

**\$1200.00 MONTHLY Proved!** Rid homes, farms, businesses of termites, rodents, pests. New shortcut methods! Learn everything two weeks! Free success plan. A.P.C.O.A., Dept. 1B, 429 South Western, Los Angeles 5, California.

**OFFICE Men.** Good money year after year, preparing income tax returns spare time at home. No lessons. Only fourteen hours study evenings. Amazingly simplified. Write: Reynard, Box 1265-B, Peoria, Illinois.

**MAKE \$5,000 Yearly** sparetime raising mink, chinchillas, nutria, etc. Free booklet reveals proved plans. Write Furs, 588 Mt. Pleasant Road, Toronto 1, Canada.

**MAKE Big easy profits** making costume jewelry at home in spare time! Quick, easy to make; easier to sell! Details free! Don-Bar, 3511 W. Armitage, Dept. K-192, Chicago 47, Ill.

**"HOME Business Digest"** has money-making opportunities galore. Sample 25¢. Donovan, 79-PM Greenbelt, Levittown, New York.

**\$59.95 BABY Shoe** bronzing machines. Mountings. Foster, 1520 Ardmore, Chicago 25.

**"50 NEW Home-Business Ideas"** booklet free. Coast Industries, B10C, Los Angeles 51.

**HOTTEST Mail order plan ever!** Sell photos, films, art novelties. Huge proven profits! Free details! A.M.P.R.O., Dept. 1B, 429 South Western, Los Angeles 5, California.

**ATTENTION Typewriter owners.** Make handsome profits. Write today. Groves Company, 682, Hastings 2, Nebraska.

**DO IT YOURSELF.** What? Repair TV, build furniture, make barbecue, plumbing repairs, build boats, do house wiring, remodel home, lay tile, modernize kitchen, repair home, and scores of other things you can do yourself. Books covering each subject, only 25¢. Send for descriptive list. It's free. Popular Mechanics Press, 200-LB East Ontario St., Chicago 11, Ill.

**BUY Wholesale!** 30-80% discounts! Appliances, gifts, typewriters, tools, watches, sporting goods, jewelry, cameras, housewares, etc. Consolidated Distributors, Clifton 28, New Jersey.

**ADS Running** under this heading sell printing. Ask me for proof. I'll gladly send you amazing facts. Ask for Folder "P." F. W. Johnson, 200 E. Ontario St., Chicago 11, Ill.

**AMAZING Successes** through franchises! Become exclusive franchise holder your territory. Information rushed. National Franchise Reports, 333 North Michigan, Chicago 1.

**FREE Folio** "\$5,000-\$45,000. Unlimited Vacations." No merchandise. Unknown! Work home, sparetime! Haylings, Carlsbad, Calif.

**GENERAL Contest Bulletin.** Lists contests monthly. Sample, 25¢. 1609½ East 54th, Duluth, Minn.

**READ Progressive Mailtrade,** the magazine that tells how to make money by mail. Dime brings sample and special offer. Progressive Mailtrade, Box 357, Sheboygan, Wisconsin.

**BIG Money raising,** fishworms and crickets. Free literature. Carter Hatchery, Plains, Georgia.

**EARN Money** evenings copying and duplicating comic cartoons for advertisers. Adservice, Argyle 1, Wisconsin.

**SELL Titania gems.** Far more brilliant than diamonds. Catalog 10¢. Diamondite, 2420-M 77th, Oakland 5, California.

**VENDING Machines—No selling.** Operate a route of coin machines and earn amazing profits. 32-page catalog free. Parkway Machine Corporation, Dept. 27, 715 Ensor Street, Baltimore 2, Maryland.

**FREE Book** "505 Odd, Successful Businesses." Work home. Pacific, Oceanside, Calif.

**DOLLARS Every day!** It's magical—You keep all the dollars. Setup free. Otto Miller, Box 388-W, Oshkosh, Wis.

**JOIN The prosperity parade** with a mail order bookshop in your own home. Valuable information free. Practical Publications, 3974-P Milwaukee, Chicago 41, Ill.

**THEY Hand him \$100!** Free packet. "Secret Journal." 919 secrets-plans! Work home. Publicco, Oceanside, Calif.

**\$60.00 WEEKLY Sparetime.** Start home Venetian blind laundry. Protected territory. Interesting information free. Burts, 2434ER, Wichita 13, Kansas.

**FREE Literature,** big money mailorder opportunity. Lairocraft, Box J-5008, Detroit 35, Michigan.

**WE Pay \$3.50 lb. dried.** Grow mushrooms. Cellar, shed and outdoors. Spare, full time, year round. We have 25,000 customers. Free book. Washington Mushroom Ind., Dept. 173, 2954 Admiral Way, Seattle, Wash.

**MAKE Big profits.** Sell imported gift items. Van Gordon Imports, Box 3203, Fort Worth 5, Texas.

**\$100.00 WEEKLY Spare time** with a tape recorder! Fabulous new business. Entire country wide open! Record weddings, parties, sports events, stereophonic sound, sound-on-sound multiple recordings. Make radio commercials, sound effects. Have fun and make big money in the glamorous business of tape recording. Money-making facts free! Dixieland Publishers, Asheboro 2, N. C.

**\$100.00 WEEKLY Spare room.** Raise redworms soilless way. Odorless. Charlie Morgan, Box 116E, Bushnell, Florida.

**IN 1952 I had no job and little money.** Today I am retired, own a home, car, and bank account. Anyone can do this regardless of age or education. Free information write Norris Cole, 217 49th Street West, Bradenton, Florida.

**BUY Wholesale!** Save 66-2/3%! 100,000 name brand appliances, housewares, clothing, furniture, tools, sporting goods—Everything! Free catalogs! National Buyers Service, Box 3334EB, San Francisco, Calif.

**\$1,000.00 MONTHLY** For 26 years! Stay home and enjoy life with the most fascinating mailorder business ever conceived. The postman has put over \$250,000.00 into one mailbox with this plan! Learn how you too can start right now. Facts free! Dixieland Publishers, Asheboro 2, N. C.

**SELL Hawaiian perfume.** Receive beautiful Hawaiian gifts free. Write for circulars. Walter Eko, 207 Kilauea Ave., Hilo, Hawaii.

**MEN And women** wanted to start home business in spare time with little table-top rubber stamp machine. Easy to earn up to \$9.80 an hour without previous experience. Full particulars free by mail. Send postcard to Roberts, 1512 Jarvis, Room CR-2-L, Chicago 26, Ill.

**START Wholesale buying service.** Big profits selling nationally advertised merchandise at big discounts. United Wholesalers, 1265-A Broadway, New York City.

**MEN-Women!** Start money-making plastic laminating business at home in spare time. Material that costs 11¢ brings back \$2.58. No canvassing or selling but mail orders bring in \$20 a day. Write for full particulars free. Rush name on postcard to Warner, Room CL2-L, 1512 Jarvis, Chicago 26, Ill.

**MAKE Money** raising birds. Send 25¢ for instruction booklet, price list and details. James Crosley, Box 61131, Los Angeles 61, Calif.

**START Big-pay business** at home in spare time. No experience needed to operate little table-top machine for bronzing baby shoes. Make \$5.46 profit on every pair. Full particulars free. Send postcard to Mason, 1512 Jarvis, Room CM-2-L, Chicago 26, Ill.

**THINK—And get rich!** Details free. Consultant, Box 101 N, Santa Ynez, Calif.

**BOOTH Seats** cushioned. Make for only \$3.00. Instructions \$1.00. Cameo, Box 6, Shortcreek, Ohio.

**MAKE Money** writing short paragraphs! No tedious study. I tell you what to write, where and how to sell; and supply list of editors buying from beginners. Many small checks add up quickly. Write to sell, right away. Send for free facts, Benson Barrett, Dept. C-27-K, 7464 Clark, Chicago 26.

**CIGARETTES—Improved roller** make 20 for 9¢. Facts free. Moberly, Box 321; Owensboro, Kentucky.

**MAILORDER!** Succeed with professional material. Winter's, 221 Edson, Lombard, Illinois.

**CASH In** on contests now! Get facts that help. Write Sanders & Co., 1762 Euclid, Lincoln, Nebr.

**I Can teach you** how to direct money-raising campaigns for churches, hospitals, institutions. Earned \$3065 in six weeks on my first campaign. Started spare time on \$50. Short low cost course guaranteed by thirty years experience. Unlimited field. William Henry Arbogast, 229 East Mason Avenue, Alexandria, Virginia.

**EARN At home.** Free details. Catalina Enterprises, Box 5095, Tucson, Ariz.

**NEWLYWEDS** Mail plan 50¢; details two other profit-makers. Press, Portage, Ohio.

**BIG Offer** and opportunity mail 10¢. Palma, Box 1221, Baton Rouge, La.

**TYPISTS:** Mailing list. Business of your own. Free lifetime service. Folio \$1. Vans, 728 Rector, Hot Springs, Arkansas.

**MAKE Money,** mailing sample business cards. Vocacek Printing, 4444AI Ute, San Diego 17, Calif.

**FREE Catalogue:** Nationally advertised gifts, watches, jewelry appliances. Buy wholesale for personal needs or resale. Louis Perloff, Department PM, 733 Walnut Street, Philadelphia, Pennsylvania.

**LIFETIME Income,** heirs too. Guaranteed product everyone needs daily the year 'round. Mail or agent operated. Perpetual triple bonus. Two automatic details and starter \$2.00. Refund if dissatisfied. Econoart, Dept. PMA, P.O. Box 444, Iowa City, Iowa.

**WHOLESALE!** Genuine diamonds and jewelry only. Distributors, Box 106A, Hudson, New York.

**PROFITABLE** Imported gifts below wholesale. Free details. Saleable surprise sample, \$1.00. James Vaughan, Gulfport T-R, Florida.

**EASY Cash,** make Christmas gifts, 200 plans, instructions \$1.00. Spielman's, 915 8th Street, Menomonie, Wis.

**\$25-\$50 WEEKLY** For forty minutes work per day at home. Free details. Jo-Ca Electrolater, 7840 Northwest Sixth Court, Dept. D, Miami 50, Florida.

**\$300 MONTHLY Opportunity** mailing circulars! 5E-Stein, 165 Rockaway Pkwy., Brooklyn 12, N. Y.

**TEN Proven ways** to make money in your spare time. Send \$1 to: Homework, 4505 Harriet Ave. So., Minneapolis 9, Minn.

#### FORMULAS, PLANS, ETC.

**FORMULAS** For latest money-making discoveries. New! Good! Valuable literature free! Miller, Chemist, 1517-D, Tampa, Florida.

**SILICONE.** The best waterproofing wood, cement, leather, paper. Information. Sonic Chemicals, 181, Rushsylvania, Ohio.

**FORMULAS:** All kinds, latest, best. Literature free. Kemixal, Park Ridge, Ill.

**PRACTICAL Formulas.** Lists free. Cummings, Chemist, Gordon Ave., Syracuse 4, N. Y.

**LATE, Modern manufacturing formulas.** List free. Moon Chemical, Martville, New York.

**COSMETICS.** Perfumes, latest manufacturing formulas. Folder free. Fiedler, Box 21, Jamaica Plain 30, Mass.

**67 WAYS.** Money-makers. Latest formulas. Write Yale-Murphy, Meriden, Conn.

#### EXPORT — IMPORT

**OPERATE Export, import business** from home. Amazing profits. Free details. M.J.R. Co., 317 Lorton, Burlingame, Calif.

#### CHEMISTRY

**SPECTROSCOPE** For quick analysis \$3.00. Kutting, 26278-K Arastradero, Los Altos, Calif.

**AMAZING** New book of science. Experiments, formulas, and catalogue of laboratory supplies. Only 25¢. National Scientific Company, Dept. PM10, 500 West Road, Lombard, Ill.

**CHEMICALS,** Highest quality, in small quantities; chemistry sets, apparatus and laboratory supplies. 25th year. Catalog 25¢. John H. Winn Co., Inc., 124M West 23 Street, New York 11, N. Y.

**60 PAGE Booklets!** "Beginners Chemistry," "Chemistry," "Physics," "Relativity," "Light," "Astronomy," "Electricity," "Radio," "Useful Tables," "Scientific Oddities," 10¢ each. Franks, 3121 South Racine, Chicago 8.

**CHEMICALS,** Supplies catalog, 25¢. Laboratory Sales, Box 161-A, Brighton, Mass.

**CHEMICALS** And apparatus for industrial, analytical, and private laboratories. Catalog 25¢. Dept. M-50, Biological Supply Co., 1176 Mt. Hope Ave., Rochester 20, N. Y.

**ILLUSTRATED Catalog:** Chemistry, mineralogy, biology 20¢. Tracey Laboratories, Evanston, Illinois.

#### PLASTICS

**NEW Liquid casting plastic,** clear, colors. Embed real flowers, coins, photos. New manual shows fine things you can make at home and sell at big profit. Send 25¢. Castodite, Dept. L-101, Woodstock, Illinois.

**PLASTIC Casting** and mold supplies. Liquid glass, steel, rubber. Catalog 25¢. Gel. Box 261, Union, N. J.

**FLEXIGLAS.** Square foot cost, 1/16", \$1.20; 1/8", \$1.52; 3/16", \$1.86; 1/4", \$2.21; 5/16", \$3.33; 3/8", \$4.36. Colors add 10%. Send 15¢ for postage. Aristocrat Plastics, 23 Sussex Avenue, Newark, N. J.

**LEARN** Plastics fabrication for spare time income. Low cost home training now available. Write for free booklet. Interstate Training Service, Dept. D-3, Portland 13, Ore.

**LAMINATING Supplies.** Free price list. Solomonson, 46 Cornhill, Boston 8, Mass.

**PLEXIGLAS**, Fiberglass, polyester, epoxy, acetate, vinylite, styrofoam, acrylite. In-structive wholesale-retail catalog, free. Gem-O-Lite, 5329 Cahuenga, North Hollywood, Calif.

**BOXES**, Plastic. Free list. Althor, 170 Bay 23 Street, Brooklyn, N.Y.

#### HELP WANTED

**SMALL** Southwest college with excellent research facilities is seeking the services of experienced instruments makers. Beginning salary range \$5000 to \$6000 per annum depending upon qualifications. Excellent climate for health seekers, outdoor recreation, including hunting, fishing, swimming, and golf. Direct letter of application to Arthur P. Stanton, Personnel Manager, Campus Station, Socorro, New Mexico, describing qualifications and salary requirements. Include recent photograph.

**FULL** Or part time sales people wanted. American Maid dishwasher "keeps hands lovely." Ingenious hydro-motor revolves inner dish basket giving automatic, positive "swirl-bath" wash, rinse and air dry. Non-electric. Only mechanical dishwasher which can sit on drainboard, or on its roll-around utility table. Aluminum construction makes weight only 15 lbs., yet affords service for eight. Simple installation consists of attaching snap on hose adapter to faucet. \$129.50 retail. Unconditional 2 year guarantee. King size commissions paid. We supply customer leads and financing. You carry no inventory. Men. Women. Write for descriptive folder, and our proven selling method and proposition. American Dishwasher Corp., 1020 N. Rush St., Chicago 11, Ill.

#### AGENTS WANTED

**WHOLESALE** Catalog! Clothing, linens, housewares. Write Bostonian, 14 Dock Sq., Boston 8, Mass.

**AGENTS** — 300% Profit selling genuine gold window letters; stores and offices. Free samples. Metallic Sign Letter Co., 1217-D West Newport, Chicago.

**YOUR** Ad in this space will get some good agents for you. Yes, I'll prove it. Write for Folder "A" right now. P. W. Johnson, Classified Advertising Manager, Popular Mechanics Magazine, 300 E. Ontario St., Chicago 11, Ill.

**GOLDMINE** Of 600 money makers. Copy free. Specialty Salesman Magazine, Desk 5-B, 307 N. Michigan, Chicago 1.

**GOLD** Or silver letters, numbers. Windows, doors, trucks. 1" to 6". 500% profits. Free samples. Atlas-T, 544 West 79th, Chicago 20.

**PRINTING**, Advertising salesmen—Excellent moneymaking sideline selling decalcomania name plates, small quantities. Automobile initials, sign letters. Free samples. Raico, XL, Boston 19, Mass.

**YOUR** Own business—Used suits \$1.50, overcoats 65c, mackinaws 35c, shoes 12 1/2c, ladies coats 30c, dresses 15c. Enormous profits. Catalog free. Nathan Portnoy Associates, 605-AA West 12th Place, Chicago 7.

**MAKE** Money quick, easy, taking subscriptions from every family in your community. Liberal commissions. We tell you how, furnish all supplies free. Write McGregor Magazine Agency, Dept. 100, Mount Morris, Illinois.

**TREMENDOUS** Profits! Every man, woman and child a customer. Used suits \$1.50, pants 35c, dresses 20c, shoes 20c. Operate from store, home, car. Free catalog. Superior, 1250-A Jefferson, Chicago 7.

**SELL** Famous \$3 fire extinguishers. Fast sales, liberal profits. Write Fire-Kilber, Box 182, Hazleton, Penna.

**BEAUTIFUL** Feather pictures. 200% profit! Free details; sample 20¢ stamps. Sylviak, Apartado 9036, Mexico City.

**CHRISTMAS** Music cards. Dorby Music Cards, Box 354, Morristown, New Jersey.

**SELL** Rubber stamps, printing. Big profits. Free kit. Barber, Marengo, Ohio.

**MEN**—Women agents: Sensational new moneymakers — Beautifully hand-painted, plastic personalized photo enlargements, compacts, rings, bracelets, lockets, etc. Simply take orders, pocket 40% commission. We deliver and collect. Sales outfit free. Novaleo, 3343 North Ave., Chicago 47.

**SCOTCHLITE** Delimitors. Bright at night. Thousands of uses. Free details. Leco, Box 395, Decatur, Georgia.

**EARN \$3.00** Or more per hour spare-time writing orders for appliances, dinnerware, gift items, cutlery, watches, silverware, and jewelry at discount prices. Free catalog and wholesale price sheet along with full details mailed on request. Joseph G. Peters, 2110 12th Street, Wyandotte, Michigan.

**CHRISTMAS** Cards—Impressive albums of deluxe and popular-priced greetings with customer's name imprinted. 150 lavish designs for business and personal use. Wide selection for every taste and budget. You can earn \$300 to \$500 commissions, even in spare time, between now and Christmas. Sales experience unnecessary. We furnish free fully equipped sales kit complete with albums and easy-to-follow selling instructions. Dependable service guaranteed by old established manufacturer. Write Process Corp., 1932 S. Troy, Dept. FC, Chicago 23, Illinois.

**START** A home greeting card-gift shop. Show friends new ideas Christmas, all occasion boxed assortments, gift wrappings. Profits to \$1.00 per box. Write for feature boxes on approval, 64 free personal Christmas card, stationery samples, free catalog. Sensational free offer. New England Art Publishers, North Abington M-105, Mass.

**REAL** Diamond rings. Nationally advertised. Sell direct. Make big middleman's profit. No investment. Experience unnecessary. Free catalog, details. Gleam-light, 107B North Columbus, Mount Vernon, N. Y.

**FOG**—Stop windshield cloth. Instantly removes blurry mist, frost, sleet, snow. Stops windshield fogging. Samples sent on trial. Kristee 70, Akron, Ohio.

**MEN**, Women, make money spare time plus new car as bonus for encouragement. Amazing hosiery guaranteed to wear without holes, snags and runs, or replaced free. For example, lovely 60 gauge nylons guaranteed for as long as 1 1/2 years, or replaced free. Write Wilknit, 17710 Washington, Greenfield, Ohio.

**\$1,000.00** A Month for making dramatic 3-second demonstration of amazing lightweight Presto fire extinguisher. New chemical used by airforce snuffs out fires instantly. Only \$4.95. Terrific commissions. Millions want it. Free kit. Merlite, 114 E. 32nd, Dept. P-60B, New York City 16.

**FANTASTIC** Profits! Shampoo powder 25¢. Adams Soap Mfg., Schodack Landing, New York.

**TERRIFIC** Way to earn extra cash the year round! Sell sensational line of gifts, household items, toys, collector's items and greeting cards. Ideal for starting a gift shop in your own home with no big investment! No experience needed. Send for big free illustrated catalog. Samples on approval. No obligation. North Star, 7-528 Finch Bldg., St. Paul 1, Minnesota.

**60% PROFIT** On cosmetics — Famous nationally advertised Hollywood cosmetics pay 60%. Make \$25 day up. Hire others. For free samples, details, write Studio Girl, Orlendale, Calif. Dept. 12719G.

**POCKET** Calculator \$2.95, refundable. Selling profitable. Belapol, 949 Broadway, New York City.

**WAXES** Floors without wax. New invention. No more floor wax to buy. Sensational seller. Samples sent on trial. Kristee 71, Akron, Ohio.

**EARN** Big money full or part-time. Quickie Spray shines all leather instantly without buffing, brushing. Be first. Rush refundable \$1.00 for demonstrator, selling kit. Franchises available. Jim Richards Shoe Company, Dept. PM-107, Wellesley Hills 81, Mass.

**300% PROFIT**, Amazing fire extinguisher. Whirlwind seller. Free sample offer. Write quick. S. & S. Manufacturing Co., 2516 Noriega, San Francisco 22.

**NEW** Scientific discovery. 60 second white wall tire cleaner. Brush, wipe or spray on; hose off. Tires sparkling white. 30 second demonstrator. 400% profit. Private labels. Lifetime opportunity. Write for free sample offer. Pittman's Industries, Porterville, Calif.

**YOUR** Photo on stamps. No investment. No stock. Big profits. Free samples. Miniature Photostamps, Box 44-H, New York City 67.

**BUSINESS** Kit free! Postcard puts you in business! Complete line 230 shoe styles, also jackets! New discoveries pay big commissions. No investment. Send for free kit. Mason, Chippewa Falls 13, Wisconsin.

**BIG** Profits. Amazing new formula eye-glass cleaner. 50,000 sold locally. Free sample. Raico, 971 No. Holmes, Memphis 12, Tennessee.

**EARN \$10,000** Yearly—Only two sales daily. World's best seller, the Holy Bible (illustrated) Protestant or Catholic. Margareta's, P.O. Box 92, Hazelton 4, Penna.

**AGENTS**. Don't miss "Mail Sale Advertiser", 24 pages. Sample copy including big mail 25¢. Twelve big issues including twelve big mails \$1.00. Martin's Service, 1148-Lawson, Martinsville, Va.

**EARN** Fast profits selling the non-competitive Tire Ice Grip assuring safe icy highway driving for cars and trucks. Box 10 tablets \$1.00 prepaid. Cash with order. Ice Grip, Box 1073, Spokane 10, Wash.

**BIG** Profits selling ties (\$2.00 value) \$6.50 dozen. Free catalog. Empire Gravata, 656-PM Broadway, New York City 12.

**DELICIOUS** Vitamins, priced right, mean fast sales, good profits. \$1.50 sample, \$1.00. Write Vitamins, 2017 Columbus, Muskogee, Oklahoma.

**EASY** Handwork makes fast-selling useful articles. Sample free. Sunmade Company, Brockton 64, Massachusetts.

**RETRACTABLE** Pens. Many styles. 3 samples 50¢. Nucleus Trade, 2440 Amsterdam Ave., New York City 33.

**REFLECTING** Road signs. Sell like wild fire. Prospects everywhere. Wonderful profits. Details free. AA Sign Service, 2914 West 43rd St., Chicago 32, Ill.

#### BUY IT WHOLESALE

**BUY** Wholesale! Discounts to 80%! Appliances, tools, typewriters, clothing, watches, housewares! Midwest, IMP-156, Pontiac, Illinois.

**DISCOUNTS** To 75%. Name brands. Postcard gets \$1.00 credit. catalog. United, M-450 Broad, Newark, N. J.

**ELECTRIC** Guitars, amplifiers, wholesale. Free catalog. Carvin PMW, Covina, Calif.

**USED** And new watches \$2 up. Free list. Southern Watches, Gray, Georgia.

**BUY** Wholesale! Over 10,000 nationally advertised products. Appliances, cameras, sporting goods, housewares, watches, typewriters, tools, clothing, etc. Send postcard today. Buy-Rite, Box 258, Hawthorne 4, New Jersey.

**BUY** Wholesale, appliance, houseware, watches, catalog \$1.00. Holby, 48A, W.H.P., Goldsboro, N. C.

**WHOLESALE** Clothing, appliances, jewelry, furniture etc. United Wholesalers, 1265-M Broadway, New York City.

**BUY** Wholesale! Nationally advertised appliances, housewares, etc. Free catalog. T & M Supply, Box 231, Egg Harbor, N.J.

**FREE** Wholesale catalog! General merchandise — Christmas gifts. Big personal savings. Big profits part-time selling. Housewares, 1216-P West 79th St., Chicago 20, Illinois.

**BRICKLAYERS** — Buy tools wholesale, sell retail. Standard discounts. Details. Horseheads Supply Co., Horseheads, N. Y.

**WHOLESALE** Prices prevail in this beautifully prepared 1958, 300 page, fully illustrated wholesale catalog. Thousands of nationally advertised items at wholesale prices. Send \$1.00 (refundable). Shipped prepaid. D. D. Co., 7127 E. Kellogg, Wichita 18, Kansas.

**BUY** Wholesale! Nationally known brands. Catalog \$1. (Refundable). D'Auria Sales, Box 355-PM, Jackson, Michigan.

**BIG** Multicolor wholesale catalog! Housewares, appliances, clothing, silverware, cookware, luggage, binoculars, radios, phonographs, cameras, recorders, projectors, typewriters, shavers, sporting goods, toys, tools, sewing machines, watches, jewelry. Name brands. Huge discounts. Postcard: Selbyco, Decatur 161, Illinois.

**FREE** Wholesale catalog. Gifts, appliances, housewares, cookware, cutlery, watches, dinnerware, silverware, jewelry, etc. Discounts to 80%. Topval Corp., Lindenhurst 724, N. Y.

**SALESMEN—DISTRIBUTORS**

**MONEY** Back low priced trading stamp plan pays you bigger spot cash profits with steady year 'round income from re-order commissions. Every grocery, gas station, drug store, etc., are "quick" buyers. Free pocket sales kit. Worthmore, P-19, 1825 South Michigan Avenue, Chicago 16, Illinois.

**ADVERTISING** Specialties directory locates manufacturers. \$3.50. Hofert Publisher, Oak Park, Ill.

**AD Matches!** Sell amazing designs—10, 20, 30, 40 and 240-light book matches. Bigger spot cash commissions; every business a prospect. Low prices for high quality. Repeats. Start without experience; men, women; full, part time. Buy nothing! Sales kit furnished. Match Corp., Dept. PM-94, Chicago 32, Illinois.

**ANYONE** Can sell famous Hoover uniforms for beauty shops, waitresses, nurses, doctors, others. All popular miracle fabrics, nylon, dacron, orlon. Exclusive styles, top quality. Big cash income now, real future. Equipment free. Hoover, Dept. K-100, New York 11, N. Y.

**WILL** You wear new suits and topcoats without one penny cost and agree to show them to friends? You can make up to \$30.00 in a day even in spare time, without canvassing. W. Z. Gibson, Inc., 500 S. Throop Street, Dept. P-626, Chicago 7, Illinois.

**AMAZING Opportunity!** New low priced fire alarm protects homes, farms, offices, factories, etc. No wiring. Hangs like picture. Pays up to \$1,100 a month. Free kit. Merlite (Alarm Div.), 114 E. 32nd St., Dept. F-62B, New York 16, N. Y.

**SELL** Imported wood carvings, busts, figures, heads, etc. Huge profits. Details free or \$1.00 with sample carving. Kempo, Box 4098, San Diego 4, California.

**MAKE** Extra money. Cash commissions. Everybody buys easy-to-sell advertising book matches. Union label. All sizes. Cuts for all businesses. Powerhouse selling kit free. Steady repeat business. No experience necessary. Superior Match Co., Dept. M-1057, 7528 S. Greenwood, Chicago 19.

**IF** You're interested in making money in selling, see the hundreds of exceptional opportunities in Salesmen's Opportunity Magazine. Send name for your copy, absolutely free. Tell us what you're selling now. Opportunity, 648 N. Dearborn, Dept. 17, Chicago 10, Illinois.

**100% PROFIT.** Fast money for you! Take orders for Sweet Georgia Brown cosmetics. Colored people buy it quick. Free sample. Write Valmor, 2451-PP Michigan, Chicago 16.

**\$1,000.00 A Month** for making dramatic 3-second demonstration of amazing lightweight Presto fire extinguisher. New chemical used by airforce snuffs out fires instantly. Only \$4.95. Terrific commissions. Millions want it. Free kit. Merlite, 114 E. 32nd, Dept. P-60B, New York City 16.

**AUTOMATIC** Bed warming sheet, you sleep on not under. Beats electric blankets 10 ways, costs half as much. Generous profits. Electro-Warmth. Patented Products Corporation, Danville, Ohio.

**FOOD** Supplement. Guaranteed. Month's supply \$1.00 Information free. Ochen Health Products, 384C Sewell, Akron 19, Ohio.

**WANTED!** 1000 Direct salesmen. Free details. George Lucas, Bellevue, Wash.

**\$200 WEEKLY** Calling on businesses! Victor, Dept. 1421, Box 231, Wausau, Wis.

**MAKE** Money. Sell sensational dwarf trees, bear giant-size apples, peaches, pears. Ornamental. Also Stark-Burbank standard trees, roses, shrubs, vines, etc. Outfit free. Stark, Desk 30708, Louisiana, Mo.

**BULOVA.** Benrus watches, like new, \$4.95 up. Illustrated folder free. Cosmos, 81 E. 125th St., New York City, Dept. 555.

**SELL** Nationally advertised, low-priced power hacksaw to implement dealers, hardware stores, farmers, etc. Liberal commissions. Write Arco Manufacturing Co., Grand Forks, North Dakota.

**EXCEPTIONAL Opportunity.** Some territories available. U. L. approved electric radiant heat floor pad. No competition, unlimited prospects. Radiant Products, Inc., Monroe, N. C.

**EMPLOYMENT INFORMATION**

**BOOMING Venezuela**—Only hours from the States. New data regarding jobs, opportunities, conditions, etc. Salaries to \$1650 monthly U. S. tax exempt. Bonuses, living allowances extra. First-hand information direct \$2.00 (\$2.35 air mailed) checks or money orders only. Paul B. Smith, Apartado 172, Maracaibo, Salina, Venezuela.

**AMERICAN,** Overseas jobs, high pay, men, women, transportation paid. Free information. Transworld, 200N West 34 Street, New York City 1.

**FLORIDA'S** Booming. Statewide opportunity analysis, job plan, contact list airmailed \$2.00. Sun-Glo Service Bureau, Perry 3, Florida.

**EXECUTIVES** Tell who gets hired and why. Details free. National Publications, Box 3731, Washington 7, D. C.

**UNLIMITED** Job opportunities. Details free. Personnel Associates, Box 1018, Edinburg, Texas.

**EARN** High pay: Jobs in South America, the Islands, U.S.A., Europe, Canada, other foreign countries. All trades, mechanics, truck drivers, laborers, office workers, engineers, etc. Chance to travel. Fare paid if hired. Application forms. Free information. Write Dept. 108, National Employment Information, 1020 Broad, Newark, New Jersey.

**RESTLESS?** Try Canada — The money country. List 1000 current jobs, business opportunities, prices, classifieds. \$1.00. McCaskill, 990 King West, Hamilton, Can.

**COMING** To California? Choice listings of jobs, housing, business opportunities, etc. 15 page booklet + free gift \$1.00. Chesleys, 3977½ Texas Street, San Diego 4, California.

**SOUTHERN** California job opportunities. Construction, factory (defense and non-defense), office help, laborers, trades, engineers, trainees. Other types of work also. Included: Many thousands of high-paying jobs now waiting to be filled. Absolute money-back guarantee, \$3.00 complete (airmailed \$3.25). C.O.D.'s accepted (postcard o.k.). California Enterprises, 610 South Broadway, Suite 623, Los Angeles 14, California.

**COPYRIGHTED** Reports on best paying jobs with travel, adventure, promotions. Construction, aviation, shipping, laborers, clerical, trades, supervisory, factory, unusual opportunities. Many types of work. Skilled and unskilled. Foreign and state-side openings for men and women. Only \$2.00 (\$2.25 airmail), including registration-advisory service. Satisfaction guaranteed. Included absolutely free: Special reports on Alaska, Spanish airbase construction, South American opportunities and husband-wife foreign jobs. Research Services, Suite 514-PMV Meramec Building, St. Louis 5, Missouri.

**FOREIGN,** Alaskan, U.S.A., jobs! To \$1500.00 monthly! Million Americans employed overseas. Copyrighted reports. Who to contact for highest paying jobs. Laborers, trades, truck drivers, office, engineers, many others. 52 countries—St. Lawrence project, Spain, Latin America, Northern project, Europe. Year registration-advisory service. Application forms. Unconditional money-back guarantee! \$2.00 (airmailed \$2.25). C.O.D.'s accepted. International Reporter, St. Louis 1-PA, Missouri.

**SPECIAL SERVICES**

**INFORMATION** On anything. Ferguson Research Specialists, 116-14 141 St., South Ozone Park 36, N. Y.

**BIRTH** Certificate service from any state. Millers Service, Inverness, Florida.

**CAN'T** Find out? We help. Free details. N. Sok, Box 1582, Chicago 90.

**EDUCATIONAL AND INSTRUCTION**

**SPEAK,** Sing with power, personality. Home self-training method on records. Amazing details free. Canfield, 2018-A 5th Ave. South, Minneapolis 4, Minn.

**ENGINEERING** Degrees earned through home study. Residence courses also available. Pacific International University, 5719-B Santa Monica Boulevard, Hollywood 38, California.

**AUCTIONEERING** Home study. Sample chant free. Nelson Auction College, Renville, Minnesota.

**WE** Pay \$3.50 lb. dried. Grow mushrooms. Cellar, shed and outdoors. Spare, full time, year round. We have 25,000 customers. Free book. Washington Mushroom Ind., Dept. 174, 2954 Admiral Way, Seattle, Wash.

**MEMORY** Education; more mental power; lesson one free. Memorology Studio, 2016 Sunnyside, Chicago 25, Illinois.

**BOOKKEEPERS!** Comfortable living for life! Operate your own simplified business analysis, bookkeeping, tax service. Full or spare time. Details free. Vanderdrift 35E, Franklin, East Orange, New Jersey.

**REFRIGERATION,** Air conditioning. Extension course. Free booklet. Mechanics School, 11029-PX South Vermont, Los Angeles 44.

**LEARN** Mineralogy at home. Diploma course. Fortunes being made in minerals. Free catalogue. Mineral Science Institute, Desk 2, 159 East Ontario, Chicago 11.

**SWEDISH** Massage, learn at home. Diploma. Dr. Swanson School Swedish Massage, Illinois licensed vocational school, 3809 Alta Vista Terrace, Chicago, Ill.

**BE** A real estate broker. Study at home. Send for free catalogue. Midwest School of Real Estate, 63 North Chicago Street, Joliet, Illinois.

**TIMESTUDY**—Your key to positive personal profits. Associated Techniques, Box 235, Hollidaysburg, Penna.

**PIANO** Tuning pays. Big money in spare time. Learn at home in 30 days. No musical knowledge necessary. Phonograph, records, tools and instructions furnished. Personal instructions available. Free catalogue. Capital Tuning School, 16 Southwest Second, Fort Lauderdale, Fla.

**EARN** College degrees, correspondence. Metropolitan University, Box 88, Glendale 5, California.

**LEARN** Appliance service and repair. Motors, washers, refrigeration, cleaners, everything. Free booklet. Armstrong, 11071-A South Vermont, Los Angeles 44.

**STUDY** For Doctor's degree of psychology, metaphysics and divinity. Correspondence courses only. College of Divine Metaphysics, Dept. P-M, 2811 North Illinois, Indianapolis 8, Indiana.

**HIGH** School diploma at home. Licensed teachers — Approved materials. Southern States Academy, Box 144-MX, Station E, Atlanta, Georgia.

**BE** A real estate broker. Study at home. Write for free book today. GI approved. Weaver School of Real Estate, 2018P Grand, Kansas City, Missouri.

**USED** Correspondence courses and books sold and rented. Money back guarantee. Catalog free. (Courses bought.) Lee Mountain, Pisgah, Alabama.

**EARN** While you learn. Auto and diesel mechanics master this top paying trade. Many graduates earn \$100 a week and up. Approved for Korean veterans. For free information write Dept. No. 256, Nashville Auto-Diesel College, Nashville 3, Tenn.

**HELP** Yourself to abundant living. Our courses have aided students to richer fuller lives. Learn secret of contentment, happiness. Earn degrees Ps.D., M.S.D. Write for free book. College of Universal Truth Correspondence School, 23-C E. Jackson, Chicago.

**LEARN** While asleep! Details free. Research Association, Box 610-MC, Omaha, Nebraska.

**BOOKKEEPERS!** Increase your earnings! Operate your own simplified "Dollar-A-Week" bookkeeping and tax service. Full or spare time. Details free. No obligation. Ellis, Box 200, Cedar Grove, North Carolina.

**WANT** A diesel job? New opportunities to increase income. Higher pay. More money. We can help you qualify. Tools. Shop method home training. Write today! Diesel, Tractor, Heavy Equipment Division, Interstate Training Service, Dept. B-3, Portland 13, Oregon.

**I** Want to send you proof of the wonderful pulling power of Popular Mechanics classified pages. What's your proposition? Write me today. Include literature if possible. P. W. Johnson, Manager Classified Advertising, Popular Mechanics Magazine, 209 E. Ontario St., Chicago 11, Ill.

**INVESTIGATOR** Training. Phillips Secret Service System, 1917-B North Keneth, Chicago 39.

**USED** Correspondence courses and educational books bought, sold, rented. Free catalog. Educational Exchange, Menlo, Georgia.

BE An investigator. Write for free details. State age. National Detective Academy, 535 East 4th Street, Scottsdale, Ariz.

**PHYSICAL** Therapy and massage. We train you at home. Earn big profits from your own private practice or work with hospitals and doctors. Free catalogue. National Institute, Desk 4, 159 E. Ontario, Chicago, Ill.

\$1,000 MONTHLY Possible in collection agency business. Free details. Write Cole Associates, Syracuse 2, N. Y.

**PIANO** Tuning pays. Learned easily at home. GI approved. 59th year. Free booklet. Niles Bryan School, Dept. P, 3731 Stockton, Sacramento 20, Calif.

**COMPLETE** Your high school at home in spare time with 60-year-old school. Texts furnished. No classes. Diploma. Information booklet free. American School, Dept. X745, Drexel at 58th, Chicago 37, Illinois.

**DRAFTING**, Design, blueprint reading. Good paying. Easy to learn at home. Minimum age 17. Write Utilities Engineering Institute, Dept. TC-8, 2525 Sheffield, Chicago 14.

**LEARN** By ear with Dormiphone. While you slumber, amazing new scientific invention works for you. Revolutionary Dormiphonic tools give you a shortcut to learning languages, correct speech; memorizing facts, figures; ideal for self-improvement; relaxation, habit training. Saves time, effort. So simple, children benefit. Used by educators, psychologists. Write today for fascinating free book. No obligation. Modernophone, Inc., 320-107 Mezz. Radio City, New York City 20.

**CARTOONING** For everyone, book \$1. catalog 10¢. Amos, 196 N. Schultz, Columbus 22, Ohio.

**DIAGRAMS** For portable one-tube radios. Excellent reception. 75¢. Radio, P.O. 9232, Rosslyn Station, Arlington 9, Va.

U.S. Civil service tests! Training until appointed. Men-women, 18 up. Start \$234-\$377 month. Experience often unnecessary. Free 36-page book shows jobs, salaries, requirements, sample tests, benefits. Prepare now. Write: Franklin Institute, Dept. M-24, Rochester, N. Y.

**WELDERS** Earn big money. Easy to learn arc-gas-automatic welding. New equipment, low cost training in non-profit school. GI approved, free booklet. Hobart Welding School, Box M-1071, Troy, Ohio.

**FINISH** High School at home, spare time. No classes. Diploma awarded. Write for free catalog. Wayne School, Catalog HP-79, 2527 Sheffield, Chicago 14.

**BLUEPRINT** Reading - Train at home. Learn to read blueprints with confidence in 10 easy lessons. Write today Belton School 1059-S North Lawndale, Chicago 51.

**CHRISTIANS**-Udenominational Bible study. Ministers licensed and ordained. Write. Christian, 181 Bank, Newark, New Jersey.

**SECRET** Investigation. Experience unnecessary. Investigators particulars free. George Wagner, M125 West 86th, New York 24.

**AMAZING** Manikin takes any pose, anatomy cards, instructions, \$1.00 Draw men, women, children. Free literature. Don Davidson, 3653-N Ravenswood, Chicago 13.

**HANDWRITING** Character analysis self-taught. Free brochure. Lucas, 3419 Sunset Boulevard, Los Angeles 26, Calif.

**LEARN** To draw. Three introductory lessons, \$1. You master each lesson before advancing to next. Spayth, 97 Boulevard, Dunellen, N. J.

**ENGINEERING**, Home study. Midwest Engineering School, 10923 Hillcrest, Hickman Mills, Missouri.

**TRANSFORM** Yourself via subconscious. Free publication. Box 847 (H-10), Ocean Park, Calif.

**REMEMBER** 500 Words heard only once. Repeat forward, backwards. Amaze people. First lesson, proof, \$1.00 (refundable). Balco, 971 No. Holmes, Memphis 12, Tenn.

#### PLAYS, STORIES, MANUSCRIPTS

**WANTED:** Book manuscripts, all subjects considered. Greenwich Book Pub., Attn. Mr. Zealand, 489 Fifth Ave., New York City.

**WANT** Your book published? Learn how we publish, advertise, promote, distribute. Many successes. Free booklet PM. Vantage, 120 West 31, New York City.

#### CARTOONING, COMMERCIAL ART, SHOWCARD & SIGN PAINTING, TATTOOING

**BASIC** Art training at home. New plan. Free brochure. Students' Art Club, Kennebunkport, Maine.

**CARTOON** Your way to fame. Minimum age seventeen. Write Director, Cartoons-of-the-Month, Roslyn, New York.

**LEARN** Sign painting at home. Free talent test. Ben Kerns, Box 812-PM, Greenville, S.C.

**TATTOOING** Outfits, licensed course. Brochures 25¢. Zeis, 728 Leslie, Rockford, Illinois.

**PAINT** Signs—Master die cut, outline letter patterns. Complete assortment 1 1/2" to 12" high, prepaid \$2.00. Eyerly, 583, Newton, Iowa.

**YOU** Can entertain with chalk talks. Catalog 10¢. Balda The Cartoonist, Oshkosh, Wis.

**CARTOON** Your way to success! Internationally known instructor. Raye Burns, will personally teach you to create original, salable cartoons at home. Course of 26 lessons only \$2.85. Write for free details. Raye Burns School, Box 3563-P, Cleveland 18, Ohio.

**LEARN** Sign painting with fascinating system. Straley, 410 S. Western, Springfield, Ohio.

**"HOW** To Make Money With Simple Cartoons"—A book everyone who likes to draw should have. It is free; no obligation. Simply address Cartoonists' Exchange, Dept. 910-C, Pleasant Hill, Ohio.

**SIGN** Painting—Lessons by mail. Books on lettering, gold leaf, show cards, pictorial. Write: Sign Instruction, 4304 Virginia, Kansas City 10, Missouri.

150 **UNUSED** Aluminum artist draftsman drawing stands with adjustable lights. Sample \$9.50 postpaid. Industrial, 81 Bowler, Fall River, Mass.

**ARTISTS'** Manikin, anatomy cards, instructions, \$1.00 Free literature. Don Davidson, 3653-A Ravenswood, Chicago 13.

#### ADVERTISING AGENCIES, LETTER WRITERS, FOR ADVERTISERS

**BEFORE** Advertising - Get Instructive Ad-Guide and newspaper-magazine rate-book, free. Chicago Advertising Agency, Chicago 4.

**NAMES:** Rural residents 1¢ each. W. Allen, 2429 Workman Street, Los Angeles 31, California.

**ADVERTISE:** 24 Words, 100 Canadian newspapers \$5.50. Lists free. Advertising Bureau, 10511-C Springfield, Chicago 43.

**ADVERTISING.** Result-getting ads prepared, placed newspapers, magazines, radio, anywhere! Lowest rates. Catalogue free. Baker Advertising Agency, 189 W. Madison, Chicago 2.

**MAILING** Lists most any classification \$3.00 1000. Your circulars mailed with ours \$4.00 1000. Write for our literature. Dixie Mailers, Kings, N. C.

**FREE!** 1937 Advertisers Rate and Data Directory, 52 pages! E. H. Brown Advertising Agency, 20 N. Wacker, Chicago 6.

**WANT** More business? Here's an amazing opportunity to increase your sales. Talk to thousands of interested readers of "Mechanica Popular." Our Spanish Edition covers the Latin American countries like a blanket. They're real mailorder buyers. Classified rate 75¢ per word. Try an ad in our next issue. Classified Advertising Department, Popular Mechanics Magazine, 200 East Ontario Street, Chicago 11, Ill.

#### RUBBER STAMPS AND OFFICE SUPPLIES

**THREE** Line pocket stamp or regular with free pad \$1.00. Barber, Marengo, Ohio.

**CUSHIONED** Stamps, 3 lines \$1.00. Each add. line 25¢. 8 hour service. High Point Stamp Company, Box 1668, High Point, N. C.

**3 LINES** \$1.00. Pocket or regular. Seeburger's Stamps, Palmyra, Mich.

**8 HOUR** Service, 3 lines \$1.00. Guaranteed. Bassler, Ludlow, Mass.

**YOUR** Name and address pocket stamp. Carry in pocket or purse, always inked and ready. Send one dollar to C. V. Bixler, Frankfort, Kentucky.

#### TYPEWRITERS, DUPLICATORS, OFFICE DEVICES

**RECONDITIONED** Typewriters, duplicating, printing devices. \$25.00 up. Supplies. Appliances. DixieGraph, King, N. C.

**WHOLESALE** Catalog 10¢. Typewriters! Recorders! Tapes! Radicals! Towers, #155, Philadelphia 5.

**PORTABLE** Typewriter, top quality, low low price, bonus offer. Details free. Ko-Kar Sales, Dept. 9, 9 Chamberlin Dr., West Hartford 7, Conn.

**REMINGTON** Portable typewriters and adding machines, office machines, new! No down payment, \$1.00 weekly, shipped in factory sealed cases prepaid. Send 25¢ for application. Typewriters, 1527 Potomac, Pittsburgh, Pennsylvania.

#### PRINTING, MULTIGRAPHING, MIMEOGRAPHING, GUMMED LABELS

**BUSINESS** Printing. Samples, prices free. Howprint, 733-G Eunice, Webster Groves 19, Missouri.

**EMBOSSED** Business cards. Samples. L. C. Sales, 17 South 9th, Wilmington, N. C.

**PRINTING** By mail—Send 10¢ for catalog and samples. United Mail Order Service, Box 646, Elyria, Ohio.

**TOP** Quality printing, mimeographing. Free literature. Courier, PM, New Lebanon Center, N. Y.

**MIMEOGRAPHING**—Letters, pricelists, formulas, instructions. Lowest prices. Lem's Letter Shop, 5710 Stanton, Detroit 8.

**BUSINESS** Printing, rubber stamps. Free catalog. Brosse, 196 Clerk Street, Jersey City 5, N. J.

100 **BUSINESS** Cards \$1.00. Printers, 1418 Broadway, Rockford, Illinois.

**BUSINESS** Printing. Top quality. Bottom prices. A. Hanlon, Malvern, Penna.

**ENVELOPES;** Tags; stationery. Lowest prices. Mosher, 282 Davis, Kearny, N. J.

1000 **CARDS**—\$2.75. Free samples. Catalog. Eldan Business Service, 507 Fifth Ave., New York 17, N. Y.

**BETTER** Grade printing. Reasonable. Estimates. Hamel-Printer, 210 5th Avenue, Suite 1104, New York City 10, N. Y.

1000 **BUSINESS** Cards simulated engraved \$4.95. Include copy with check or money order. Samples if desired. Postage prepaid. Progressive Business Services, 339 East First St., Long Beach 2, Calif.

200 **TWO** Color shipping labels 2 1/2 x 4, printed three lines, \$1.95 p.p. 2000 \$5.95. Hamilton's, Box 11, Pocatello, Idaho.

1,000 **BUSINESS** Cards, 2-color, \$5.00. Samples. Harrigan, 251 Esser, Buffalo 7, N. Y.

1000 **EMBOSSED** Business cards \$3.50. Two-color \$5.00. Samples. House of Cards, Box 2481, Long Beach 1, California.

100 **PERSONAL** Post cards \$1.00; ideal short messages, requests. Fisher Mercantile, 5610 East 22, Tucson, Ariz.

1,000 **NAME** And address labels, \$1.00. Stewart's, Box 5988-M, Kansas City 30, Missouri.

10,000 **ATTRACTIVE** Color circulars \$28. Stickers, cards, samples. Fame, 291 Ellis, San Francisco 2, Calif.

**QUALITY** Printing, moderately priced. Samples. Lombard, 295 West 5th, South Boston 27, Mass.

150 **BUSINESS** Cards, \$1.25. First 25 airmailed! Quickcards, Ojai, Calif.

**OFFSET** Printing—\$6.50, 1000, 8 1/2 x 11, 24 hour service. National Letter, 251 West 42 St., New York City 36.

**MAIL** Order dealers, salesmen. Outstanding wholesale letterhead deal. Muri Advertising, Box 743, Dayton 1, Ohio.

1000 **EMBOSSED** Cards \$2.95 postpaid. Samples. Craftex, Box 243, Waltham 54, Mass.

**YOUR** Name and address printed on gummed labels. 500-3 lines \$1.00. 15¢ each extra line. 1/2 x 1 1/2. Print clearly. No c.o.d.'s. Addison Mail Order, PM-10, 1840 Addison, Chicago 13.

**AMAZING** Value. 1,000 "raised letters" business cards, \$3.50. Samples. Pioneer, Island Park 37, New York.

100 LETTERHEADS, 8 1/2 x 11. Watermarked, and 100 #10 envelopes, carefully printed. \$2.00. Postpaid. Race Printers, Hudson, New York.

500 BUSINESS CARDS \$1.50. Catalog free. Tech, Box 748, Freeport, New York.

FREE Catalog. Personal, business printing. Agents wanted. Rogers, Box 6113, Newark, New Jersey.

EXPERT Printing, inquiries welcomed. Tex-O Printers, 1636 Baltimore, Muskogee, Oklahoma.

#### PRINTING OUTFITS AND SUPPLIES

TYPE Cases, cabinets, from manufacturer. Free catalog. King McKay Company, 23179 Telegraph Road, Detroit 41, Michigan.

PRESSES, Type cabinets, supplies. List for stamp. Lincoln Press Company, 220-1 Hartwell, Fall River, Mass.

MAKE Your own self-molding rubber stamps and printing cuts. Plexrubber, Argyle 1, Wisconsin.

DO Your own printing. Save money. Simple rules. We supply everything. Print for others; good profit. Raised printing like engraving too. Have home shop. Details free. Kelsey Presses, V-11, Meriden, Connecticut.

PRINTING Presses, type, supplies, lists 3¢. Turnbaugh Service, Mechanicsburg, Penna.

#### PATENT ATTORNEYS

INVENTORS: Learn how to protect your invention. Unless the inventor is familiar with patent matters, he should engage a competent registered patent attorney or agent to represent him. We are registered to practice before the U. S. patent office and prepared to serve you in handling your patent matters. "Patent Guide for the Inventor" containing detailed information concerning patent protection and procedure with "Record of Invention" form will be forwarded to you upon request—without obligation. Clarence A. O'Brien & Harvey Jacobson, Registered Patent Attorneys, 718-K District National Building, Washington, D. C.

INVENTORS—Take these preliminary steps toward patent protection. Sketch and describe your invention. Sign, date and have this disclosure witnessed by two people who understand your invention. Have us make a preliminary search among U.S. patents already granted for similar types of invention. We report on the probable patentability of your invention and recommend your further course of action. Write for our instructive booklet, "Patent Protection for Inventors" and convenient "Evidence of Invention" disclosure form. Victor J. Evans & Co., 331-L Merlin Building, Washington 6, D. C.

INVENTORS—If you believe you have an invention, you should find out how to protect it. The firm of McMorrow, Berman & Davidson with offices in Washington, D. C., is qualified to take the necessary steps for you. Send for copy of our patent booklet "How to Protect Your Invention." We will also send you an "Invention Record" form. No obligation. They are yours for the asking. McMorrow, Berman & Davidson, Registered Patent Attorneys, 1346 Victor Building, Washington 1, D. C.

REGISTERED Patent attorney offers services. Sanders, 6430 Evans, Chicago 37, Illinois.

CANADA—Ramsay Company Registered, 273 Bank Street, Ottawa, Canada.

C. A. Snow & Co.—M427, Snow Building, Washington 1, D. C. Registered Patent Attorneys. Write for information.

PATENTS. "Proof of Invention" free. E. E. Vrooman, Registered Patent Attorney, 507 McKim Building, Washington 5, D. C.

"INVENTOR'S Guide" and "Record of Invention" free on request. Frank P. Ledermann, Registered Patent Attorney, 134 Nassau Street, New York City.

INVENTORS: Without obligation, write for information explaining the steps you should take to secure a patent. John Randolph, Registered Patent Attorney, 203 Columbian Bldg., Washington 1, D. C.

INVENTORS: When you are satisfied that you have invented something of value, write me, without obligation, for information as to what steps you should take to secure a patent. Write Patrick D. Beavers, Registered Patent Att., 935 Columbian Bldg., Washington 1, D. C.

INVENTION Record form free and "Patent Information Every Inventor Should Have." Carl Miller, Registered Patent Attorney, Woolworth Building, New York.

#### FOR INVENTORS

INVENTORS—This firm is registered to practice before the United States Patent Office and available to assist you in the preparation and prosecution of your patent application. "Patent Protection for Inventors" booklet containing detailed information and steps to take toward patent protection sent promptly upon request. No obligation. Victor J. Evans & Co., 332-L Merlin Building, Washington 6, D. C.

INVENTORS—If you believe you have an invention, you should find out how to protect it. The firm of McMorrow, Berman & Davidson with offices in Washington, D. C., is qualified to take the necessary steps for you. Send for copy of our patent booklet "How to Protect Your Invention." We will also send you an "Invention Record" form. No obligation. They are yours for the asking. McMorrow, Berman & Davidson, Registered Patent Attorneys, 1346 Victor Building, Washington 1, D. C.

INVENTORS: Learn how to protect your invention. Unless the inventor is familiar with patent matters, he should engage a competent registered patent attorney or agent to represent him. We are registered to practice before the U. S. patent office and prepared to serve you in handling your patent matters. "Patent Guide for the Inventor" containing detailed information concerning patent protection and procedure with "Record of Invention" form will be forwarded to you upon request—without obligation. Clarence A. O'Brien & Harvey Jacobson, Registered Patent Attorneys, 718-K District National Building, Washington, D. C.

INVENTORS—Send for free Patent Information book and Inventor's Record. Registered Patent Attorney, Associate Examiner, Patent Office 1922-29, Patent Attorney & Advisor, Navy Department 1930-47. Gustave Miller, 107A Warner Building, Washington 4, D. C.

THINK—And get rich! Details free. Consultant, Box 1017, Santa Ynez, Calif.

PATENT Searches, \$5.00, copies included. Free protection forms, 48 hour service. Write us first! Patent Service Institute, Albee Building, Washington 5, D. C.

WHY Let your ideas remain idle simply because you lack equipment and facilities to complete development? Our technical staff and fully equipped electrical, electronic, electro-chemical, physics, and mechanical laboratory now offers inventors service to perfect, analyze, or test your ideas. For information write Connecticut Research Company, Box 168, Old Lyme, Conn.

FREE Patent book. Write Blasius, 15-A Park Row, New York City.

INVENTIONS And ideas designed for your profit and patented for your best protection at low definite fees. Thirty years experience in developing and patenting inventions in U.S. and foreign countries. Patent searches with valuable report \$15.00. Joseph O'Brien, 132 Nassau Street, New York 38, N. Y.

INVENTORS: Test the commercial value of your patented or unpatented inventions, quickly and inexpensively. Write for free information. Institute of American Inventors, Dept. 40-B, 635-F St., N.W., Washington 4, D. C.

INVENTORS, Don't sell your invention patented or unpatented until you receive our offer. Write Cowgill, Box 298, Marion, Ohio.

PATENT Searches \$5.00. 48-hour airmail service. Invention protection forms free. Write Patent Engineering Service, 711 14th Street N. W., Washington 5, D. C.

INVENTION Record form free and "Patent Information Every Inventor Should Have." Carl Miller, Registered Patent Attorney, Woolworth Building, New York.

PATENT Searches \$5.00. 48-hour service. Free invention protection forms. Write Raymond L. Smith, Patent Searcher, 620 Sheraton Building, Washington 5, D. C.

SEARCHES—Put your patent searches in the hands of a registered patent attorney or agent, as he qualifies to give a worthwhile patentability report. Record of invention form upon request and information on patent protection. Patrick D. Beavers, Registered Patent Attorney, 935 Columbian Bldg., Washington 1, D. C.

INVENTORS: Information on patent procedure furnished on request, without obligation. John Randolph, Registered Patent Attorney, 203 Columbian Building, Washington 1, D. C.

PATENT Searches, including copies of nearest patents, \$6.00. Reports airmailed within 48 hours. More than 100 registered patent attorneys use my service. For free invention protection forms, write Miss Ann Hastings, P.O. Box 176, Washington 4, D. C.

#### INVENTIONS WANTED

INVENTORS: If you have an invention for sale, patented or unpatented, write for free brochure outlining manufacturers' requirements, royalty rates, Kessler Corporation, 510-1W, Fremont, Ohio.

ATTENTION Inventors. We extend our invitation to exhibit your invention at the 1958 World's Fair, largest international invention exposition at Brussels, Belgium. Non-profit world-wide market facilities. Contact Otto Witt, Official American Correspondent, Box 1481, Milwaukee 1, Wis.

CASH Buyers for inventions. Write National Inventors Institute, Box 7007, Cleveland 26, Ohio.

INVENTORS: Hundreds of manufacturers have requested our assistance in locating marketable new products. Complete information free. Institute of American Inventors, Dept. 40-D, 635-F St. N.W., Washington 4, D. C.

INVENTORS, Don't sell your invention patented or unpatented until you receive our offer. Write Cowgill, Box 298, Marion, Ohio.

INVENTIONS Wanted. Patented or patent pending. 26 years experience promoting inventions. National Service Bureau, 3120 Meramec, St. Louis 18, Mo.

SUPERIOR Promotions. Patented; unpatented inventions. Information booklet, free. Superior, 338-344 North Rodeo, Beverly Hills, Calif.

INVENTIONS Wanted now by my manufacturer-clients. Patented, unpatented. Write Gilbert Adams, Patent Broker, 80-S Wall Street, Financial District, New York City.

INVENTIONS Wanted. Patented; unpatented. Tremendous manufacturers lists. Global Marketing Service, 2420 77th, Oakland 5, California.

#### PATENTS FOR SALE

ELECTRIC Plug, "Quick-wire" type. Handiest, most reliable. Kerr, 156 Pinehurst, New York City.

#### MODELS, MODEL SUPPLIES

WORKING Steam engines, boilers, tractors, fittings. Catalog \$1.00. Tiny Power, Corvallis, Oregon.

CATALOGS: 84 Page ships fittings 50¢ with refundable coupon, trains 50¢, collectors soldiers 25¢, radio control 15¢, vehicles, guns 20¢, airplanes 20¢, general hobby 15¢, leathercraft 10¢. Poika, 314M Fifth Ave., New York City 1.

28 PAGE Catalog of scale live steam and park locomotive kits. Yankee Shop, Box 275 M, Danvers, Mass.

LIONEL Trains—Appliances. Big discounts. Bulletin free. Catalog 25¢. Mack-Bros., 2043P Chicago Ave., Chicago 22.

ROCKET Kit two dollars. Simple, inexpensive. Flees out of sight. Model Rocket Society, Deerwood, Minnesota.

SHIP Models and yacht supplies complete. Large 68 page catalogue 50¢. Bill Wild's, 510 East 11 St., New York City 9.

SHIP Models. Most complete line in New England. Kits, fittings, plans, books, tools, engines, motors. 1958 illustrated catalog 35¢. James Bliss & Co., Inc., Dept. SM, 342 Atlantic Ave., Boston 10, Mass.

POWER Models. Unusual steam gasoline and traction engines, fittings, metals. Comprehensive catalog \$1.00. Chas. Cole, Ventura, Calif.

SHIP Model kits and fittings including clippers, trawler, fishermen, frigates, privateer, radio control tug, etc. Send 25¢ for 1957 catalog. Model Shipways, Box 85, Bogota, N. J.

BALSA Wood and model aircraft. 40-page catalog 25¢. Sig Co., Montezuma, Iowa.

SHIP And yacht model fittings; blueprints. Send 35¢ for illustrated catalog listing hundreds of items. A. J. Fisher, 1002-1 Etowah Ave., Royal Oak, Mich.

## MANUFACTURING

ALUMINUM Castings—Small or large runs handled economically. Send specs and blueprints, if available, for prompt estimates. Pattern making. Correspondence invited. Goodell Mfg. Co., 214 North Quincy, St. Francis, Kans.

DESIGNING. Tools, dies, models, manufacturing. Pro Devco, Box 983, Cincinnati 1, Ohio.

MODELS—Small lot manufacturing. Metals, plastics, etc. Milburn, Burlington, Kentucky.

## HOME CRAFTSMEN

LEATHERCRAFT. Copper enameling, mosaic tile, metal tooling, many more crafts. Complete illustrated catalog 10¢. Kit Kraft, 2210 Studio City, Calif.

OVER 900 Woodworking projects. Books and patterns. Free catalog. Craftsman, 115-C Worth Street, New York City 13.

101 PATTERNS Of smart gifts, novelties, shelves, action windmills, plus "Make Money Jig Sawing." \$1.00. Mastercraft, 105M, 7041 Olcott, Chicago 31, Illinois.

FREE. New big illustrated catalog, leathercraft, metalcraft, woodcraft kits and supplies. Complete stock, top values, latest ideas. Write today. J. C. Larson Co., Dept. 7527, 820 S. Tripp, Chicago 24.

WOODWORKERS. Free homeshop notes and information on new tools. Lee, Box 22M, Rochester 17, N. Y.

VIOLIN-Making—A fascinating and rewarding hobby. Free catalogue of quality imported woods, tools. Fred Artindale, Box 71992, Los Angeles 1, Calif.

BUILD Guides for your portable electric saw enabling you to do precision sawing, make perfect duplicate cuts, and do many things you didn't believe possible with this saw. Easy, inexpensive. Write Hunter S. Macon, 2319 Denton, South San Gabriel, Calif.

AMERICA'S Most complete home craft supply company. Send 10¢ for big colored catalog. Giles & Kendall Co., Huntsville, Alabama.

"PRACTICAL Violin Making" with patterns \$1.00. Supplies. Chelsea Fraser, 2025 Stark, Saginaw 4, Mich.

PATTERNS Flying ducks, man sawing wood. Dutch maid churning butter, and 30 lawn ornaments, only \$1.00. Lincoln Studio, Columbia, Conn.

LAMP Size cypress knee with nipple installed \$2.00. Cy Products, Dept. 2-M, Lafayette, La.

NEW Precision "Dawn gauge" accurately centers round stock for turning or drilling. Eliminates callipers and dividers. Also matches dowel and circle centers in flat stock. \$2.95 postpaid. Dawn Crafts, 215 Commonwealth, Buffalo 16, N. Y.

HOBBY Metal. 3 sheets \$1.00. Patterns. Use scissors. Hobby Metal, P.O. Box 403, White Plains, N. Y.

FREE Power tool price list. Unique gift offer! Laircraft, Box E-3008, Detroit 33, Michigan.

FREE Catalog. 1,668 artist-drawn patterns, designs. Craftplans, 1321-A Wabash, Chicago 5.

LEARN Art metalcraft and jewelry making. Complete, inexpensive, home training course now available. Special tools and materials furnished. Write for free booklet. Interstate Training Service, Dept. L-3, Portland 13, Oregon.

I Want to send you proof of the wonderful pulling power of Popular Mechanics classified pages. What's your proposition? Write me today. Include literature if possible. P. W. Johnson, Manager Classified Advertising, Popular Mechanics Magazine, 200 E. Ontario St., Chicago 11, Ill.

FREE "Do-it-yourself" leathercraft catalogue. Tandy Leather Company, Box 791-T22, Fort Worth, Texas.

KNOCKDOWN Cedar chests and lumber. Free price list. Bedford Lumber Company, Shelbyville, Tennessee.

WOODWORKING And cabinetmaking course for beginning and advanced home craftsmen. Only complete low-cost home training program available. Write for free booklet. Interstate Training Service, Dept. G-3, Portland 13, Ore.

ALL Crafts, supplies. Large free catalog. National Handicraft, 199 William Street, New York City 38.

LEATHERCRAFT. Send 10¢ for new 76-page catalog of tools, supplies, kits, including metalcrafts, enameling, ceramics, all other crafts. Complete stock. Reasonable. Since 1910. Sax Bros., Dept. PM-10, 1111 N. 3rd, Milwaukee, Wis.

STYLECRAFT "Pretraced" leather kits. Handbags, billfolds, filigree belts. Patterns on leather. Just carve, assemble and lace. "Pre-carved" kits also available. Send 25¢ for catalog, free folder. Refunded first order. Apache Leather Company, 2804 E. Washington St., Phoenix, Arizona.

LEATHERCRAFT. Imported and domestic leather, tools, kits, complete catalog. 25¢ refundable. Midas, Box 1255, Dept. JT, Huntington Park, California.

## DO IT YOURSELF

GRANDFATHER Clock movements, barometers, blueprints, kits. Wholesale catalog 25¢. Mason-Sullivan, Noroton, Conn.

LAMP And other kits for creative minds. Bruce Specialties Company, Dept. 9PM, Box 305, Hartland, Wis.

PLAY Piano without lessons; Six charming classic melodies, \$1. Kirwin, 1029 East 29 St., Brooklyn 10, N. Y.

18 FULL-Size patterns. Save money with easy-to-use, professionally designed full-size patterns. Make money selling beautiful, useful furniture. Make modern step and cocktail tables; metal lamps; cupola; 12-foot outboard. All patterns test-built; sold with money-back guarantee. Get your free list of these convenient, economical patterns today. Popular Mechanics Press, 200-HH E. Ontario Street, Chicago 11, Ill.

DRAFTING Table 36"x60" for engineers and architects; light, folding, economical, wood or metal frame. Plans of either \$2. Geo. J. Okunis, 540 Main St., Winchester, Mass.

## WATCHES, OLD GOLD, JEWELRY

10 WATCHES \$18.00. Catalog 20¢. Chronograph repair specialist. Berkwit, 1150 Castlehill, New York 62.

COSTUME Jewellery supplies, settings, rhinestones, etc. 88 page illustrated catalog. 25¢. Milady, Box 1328, G.P.O., New York City.

HIGHEST Cash for old gold, broken jewelry, gold teeth, watches, diamonds, silverware, spectacles, platinum, mercury. Free information. Rose Refiners, Heyworth Building, Chicago 2.

WATCHMAKERS—Jewelers', machinists' tools. Watchmaking course. Catalog 25¢. Bengale, Culver City, California.

GOLD, Silver, platinum, diamonds wanted. Cash immediately, highest prices; appraisals made. Wilnot's, 1067 Bridge, N.W., Grand Rapids 4, Mich.

WATCHMAKERS Journal for watchmakers, students, hobbyists. Sample copy 20¢. Dean Co., Box 3218-M, Daytona Beach, Fla.

CASH For old gold, old jewelry, watches, diamonds, silver, gold teeth, etc. 100% full value paid immediately. Satisfaction guaranteed. Mail articles today. Information free. Established 1900. Chicago Gold Smelting & Refining Co., 6 E. Monroe St., Dept. 158, Chicago 3, Ill.

WATCH And clock repairing books. Free catalog. North American, 2320-AL Milwaukee, Chicago 47, Ill.

EXPANDABLE Cuff links. Pull sleeve, link expands. \$1.25. Hannema's, 49 West 108th Street, Chicago 28, Illinois.

WHOLESALE Quality jewelry findings, chains, Fraternal, religious emblems. Catalog 10¢, refundable. PM10-7 Caraday, Box 23, West Hempstead, New York.

WATCHES Like new, \$2.95 up. Free illustrated folder. 81 E. 125th St., Dept. 552, New York City.

## RAZORS, BLADES, SHARPENING

DOUBLE Edge razor blades. Send \$1.00 for 100. Holden, 3063 N. Lima St., Burbank, Calif.

## FOR THE HOME

WATER Softener \$29.95. Works on principle of \$300 unit. Free details. Myers Co., Box 671-PM, Indianapolis 6, Ind.

FOAM Rubber furniture cushions. Factory seconds. 50% discount. Free catalog. Perma-Foam, 390-C Nye Avenue, Irvington, N. J.

BE Your own plumber. You can. Few inexpensive tools and our instructive book, "Home Plumbing Guide," shows and tells you how. Hundreds of photographs and diagrams. Easy to follow. 160 pages. \$3.50. Catalog free. Popular Mechanics Press, 200PG East Ontario St., Chicago 11, Ill.

MELMAC Dinnerware set, 16 pieces. Rainbow color. \$9.95 prepaid. Free catalog. Empire Sales, 2731 Lakehurst, Shreveport, La.

PLANS For making beautiful patio lamps. \$1.00. F. Goss, Box 894, Oil City S.S., Penna.

"HOME Improvement Guide." New, amazing 192 page volume. Packed with ideas, plans for remodeling, decorating, landscaping, built-in projects. \$2.50 prepaid. Popular Mechanics Press, 200-HG East Ontario St., Chicago 11.

## OF INTEREST TO WOMEN

WE Pay \$3.50 lb. dried. Grow mushrooms. Cellar, shed and outdoors. Spare, full time, year round. We have 25,000 customers. Free book. Washington Mushroom Ind., Dept. 176, 2954 Admiral Way, Seattle, Wash.

ASSORTED Dress buttons. Fifteen ten-cent cards \$1.00. Page, 2048 West 53 St., Cleveland 2, Ohio.

DRESSES 24¢; Shoes 39¢; men's suits \$4.95; trousers \$1.20. Better used clothing. Free catalog. Transworld, 164-S Christopher, Brooklyn 12, N. Y.

BEAUTIFUL Head of Christ wallets. Fast selling Christian gift item. Big profit for spare-time workers and fund raising. Sample wallet and wholesale prices \$1.00. Loma Sales, Box 123, Grand Ledge 1, Mich.

SELL Fine fabrics. Get yours wholesale. Box 863, Norwalk, Conn.

FREE—Big new wholesale catalog! Up to 50% saving for you, family, friends on nationally-known gifts, jewelry, toys, appliances, Christmas cards, etc. Also make money selling part time! Write: Evergreen Studios, Box 848-D, Chicago 42, Ill.

STAMPED Linens for embroidery or painting. Buy direct from manufacturer and save. Send for free catalog. Merribee, 18 West 19th St., Dept. 544, New York 11, N. Y.

FREE Discount catalog. Perfect for Christmas. C. P. Marshall, Mail Merchandising, Dept. 2, Payne Road, Bethel, Conn.

"8 MISTAKES Parents Make." Every parent should have this new book about child training. It is free; no obligation. Simply address Parents Association, Dept. 6716, Pleasant Hill, Ohio.

60% PROFIT On cosmetics—Famous nationally advertised Hollywood cosmetics pay 60%. Make \$25 day up. Hire others. For free samples, details, write Studio Girl, Glendale, Calif. Dept. 12710G.

## PERSONAL

PAY Your bills now. Borrow \$100 to \$600 cash by mail. Easy, quick, private. Repay in small monthly installments over 20 months. Your payments may run 1/2 less than now; have money left over to spend. Loan order blank mailed free in plain envelope. Advise amount needed. State Finance Co., 323 Securities Bldg., Dept. S-227, Omaha 2, Nebr.

**15-MINUTE Memory course.** How to remember names, faces, facts, numbers, etc. Amazing. \$1. Bott, 64 E. Jackson, Chicago 4.

**LOANS** By mail. Borrow \$50 to \$500. Employed men and women over 25, eligible. Confidential, no co-signers, no inquiries of employers or friends. Repay in monthly payments to fit your income. Supervised by State of Nebraska. Loan application sent free in plain envelope. Give occupation. American Loan Plan, City National Bldg., Dept. PM-10, Omaha, Nebraska.

**QUESTIONS Answered.** Any subject, problem. Low rates. Information. Research, Box 722, Riverhead, New York.

**ABDOMINAL Sag?** Try Tux posture belt. Write Tux, 127 No. Dearborn, Chicago 2.

**BORROW Money** by mail. \$100-\$600. Anywhere. Air mail service. Postal Finance, 200 Keeline Building, Department 658T, Omaha 2, Nebraska.

**VITAMINS—Save 45%.** Buy direct. All formulas. Free catalogue. Vitaspec, Box 4435M, Philadelphia 40, Penna.

**START Your party, church, home, lodge, veterans, tavern, with a bang.** Get Trobeleswary bags, 2 1/2 dozen \$1.00. Printa-product, 232-34th Ave. No., St. Petersburg 1, Florida.

**BIBLE Questions answered.** Stamped envelope. Bylon, 17167 Bentler, Detroit 19, Michigan.

**ENJOY Health.** Free booklet. Ruth's Nutrition, 152 Kearny, PM, San Francisco, Calif.

**"HOW Can I find out?"** You can! Information confidentially developed. Any matter, person, problem. Worldwide. Officially licensed. Established 1922. William Herman, 179 Broadway, New York City.

#### REMAILING SERVICE

**WONDERFUL** Copenhagen re-airmails. 1 oz., \$1. Holmes, Aeginavej 16, Copenhagen, Denmark.

**TEXAS** Capital remails 25¢. Shelton, 1800 Evergreen, Austin 4, Texas.

**AIR Remails** 35¢. I affix Canadian stamps. Ross Hancock, 83 Belhaven Rd., Toronto 8, Canada.

**REMAILS** 35¢. Journal classified \$1. Confidential. Information. Quickie, 4025 S. Sag., Flint, Michigan.

**REMAILS, 25¢** Each way. \$3.00 monthly. Hale, Box 1, Glenmont, N. Y.

**REMAILING:** New York City — 25¢. Scenic postcard service. Bob Gillespie, 6702 Ridge Boulevard, Brooklyn 20, New York City.

**REMAILS, 35¢.** Montreal, Canada. O. Constantinou, 7634 St. Hubert, Montreal, Que., Canada.

**COLUMBUS** Mail forwarding-receiving address for rent. Details free. William McLaughlin, 800 Stewart, Columbus 6, Ohio.

**SECRET** Mail receiving, forwarding system. \$3 month. Hedgpath, Box 830, Alhambra 23, California.

**LETTERS** Remailled 25¢. J. Love, 1419 E. 83, Los Angeles 1, Calif.

#### TREASURE FINDERS

**GEIGER** Counters. Tremendous savings. Closing out at \$29.95 (was \$119.50!) and up. Genuine RCA. Original factory sealed cartons. New, complete. Catalog "GC" free. Write Barry Electronics Corp., 512 Broadway, New York 12, N. Y.

**TREASURE.** Metal-mineral detectors. M-scope. Used worldwide for treasure hunting. Geiger, scintillation counters, mineralights. From \$14.75. Guaranteed. Time payment plan. Free treasure, uranium information. Free catalog. Fisher Research Lab., Inc., Dept. C-1, Palo Alto, Calif.

**FIND** Buried treasure, gold and silver, with Goldak's sensational 3 1/2 lb. "find-it" locator, only \$64.50. Write for free literature on complete line of mineral, metal locators; Geiger and scintillation counters. Goldak, 1541 W. Glenoaks Blvd., Glendale, Calif.

**FREE—16-Page** manual from world's largest mfr. of prospecting equipment. Detelectron Corp., 5528 Vineland Ave., North Hollywood, Calif.

**LITHIUM.** The wonder metal. Free booklet describes prospecting information, uses, etc. Nu Age, Box 142, North Battleford, Sask., Canada.

**FREE Literature—Light weight, guaranteed** metal detectors, Geiger counters and mineralights. Kits and assembled models. Electronic Applications, Dept. M, Box 8, Arlington 10, Virginia.

#### FOR SALE—MISCELLANEOUS

**WOOD Screws:** Brass 40% off, steel 50% off. Send for price list. Builders Discount Hardware, Box 22, Bladensburg, Maryland.

**SMOKERS.** Free literature. Missouri Meerschmum pipes. Ed Locke, Lac du Flambeau, Wisconsin.

#### WANTED—MISCELLANEOUS

**SCRAP Mercury** (quicksilver) containers supplied — Tantalum, tungsten, silver, platinum. Metallurgical Products Company, Established 1909, 35th & Moore Sts., Philadelphia 45, Penna.

**CASH** For Indian bird stones: antique northwest coast totem, masks, carvings. Send photos. Robert Stolper, 8832 Cynthia Street, Los Angeles, California.

**QUICKSILVER.** Sterling, silver solders, precious metals. Wholesale Terminal, Norwood, Massachusetts.

#### CHRISTMAS SUGGESTIONS

**CHRISTMAS** Gifts imported from all over the world direct to you, and unusual domestic selection. Send for free catalogue. Imco, 1085 Sutter St., San Francisco, Calif.

**SEND** For free 4-color catalog showing complete line of "do-it-yourself" kits. Offers over 20 different handicraft projects for Christmas gifts or fund-raising groups. Holiday Handicrafts Inc., Winsted 14, Connecticut.

#### MISCELLANEOUS

**IT'S** Smart to shop by mail. Select gifts of nationally-advertised merchandise from your armchair at low discount prices. Watches, jewelry, appliances, luggage, home furnishings, sporting goods, tools, etc. Write today for big free catalog. Midway House, Box 25, Rockford, Illinois.

**WORLD'S** Smallest Bible 25¢. Five \$1.00. Fox, 12022 Pine, Norwalk, Calif.

**FLEXIBLE** Steel pocket saw cuts metal, wood, rubber, plastics, trees most everything else. \$1 postpaid. Clarco, Box 149, Brooklyn 17, N. Y.

**LEARN** While asleep! Details free. Research Association, Box 610-MC, Omaha, Nebraska.

**HOW** to remodel, basement, attic. Booklet 25¢. Free catalog. Popular Mechanics Press, 633 N. St. Clair St., Chicago 11.

**RECEIVE** Magazine samples, mails, catalogues, offers from everywhere. Get listed 25¢. Rorick, Cincinnati 26, Ohio.

**YOUR** Name wanted. We'll send 1000 publishers, mailers, wholesalers your name on our list one year 25¢. Dixie Mailers, King, N. C.

**"MAGIC** For everybody." 25¢. Free catalog. Popular Mechanics Press, 631 N. St. Clair St., Chicago 11.

**18 FULL-Size** patterns. Save money with easy-to-use, professionally designed full-size patterns. Make money selling beautiful, useful furniture. Make modern step and cocktail tables; metal lamps; cupola; 12-foot outboard. All patterns test-built; sold with money-back guarantee. Get your free list of these convenient, economical patterns today. Popular Mechanics Press, 200-RR E. Ontario Street, Chicago 11, Illinois.

**BOOKS** On antiques and their prices. Free circular! P. Warman Publishers, Uniontown, Penna.

**10¢ COMIC** Books 5¢. Details free. Box 1647, Uniontown, Penna.

**JAPAN:** Buy gifts direct. Dolls, kimono, records, etc., 24 page catalogue, business information — \$1.00. Send money order. Clarence Yamagata, 202 Naka 7 Bldg., Marunouchi, Tokyo.

**REMODEL** Your own home. Save hundreds of dollars. New, amazing book shows you how. Written so you can understand it. Step by step instructions make it easy. Fully illustrated, 400 photographs, hundreds of diagrams. 160 pages. \$2.95. Literature free. Popular Mechanics Press, 200-RR East Ontario St., Chicago 11, Ill.

**WE** Pay \$3.50 lb. dried. Grow mushrooms. Cellar, shed and outdoors. Spare, full time, year round. We have 25,000 customers. Free book. Washington Mushroom Ind., Dept. 175, 2954 Admiral Way, Seattle, Wash.

**BUY Wholesale!** Over 10,000 nationally advertised products. Appliances, cameras, sporting goods, housewares, watches, typewriters, tools, clothing, etc. Send postcard today. Buy-Rite, Box 258, Hawthorne 2, New Jersey.

**WANT** More business? Here's an amazing opportunity to increase your sales. Talk to thousands of interested readers of "Mechanica Popular." Our Spanish Edition covers the Latin American countries like a blanket. They're real mailorder buyers. Classified rate 75¢ per word. Try an ad in our next issue. Classified Advertising Department, Popular Mechanics Magazine, 200 East Ontario Street, Chicago 11, Ill.

**BUY Wholesale!** Discounts to 80%! Appliances, tools, typewriters, clothing, watches, housewares! Midwest, ZP-156, Pontiac, Illinois.

**CIGARETTES—Make 20 for 9¢.** Facts free. Moberly, Box 810, Owensboro, Kentucky.

**MARSHMALLOWS** And marshmallow frosting. Make your own from kitchen tested recipes. \$1.00. Korner Candy, P. O. Box 3646 Loring Station, Minneapolis 3, Minnesota.

**CESSPOOLS.** Septic tanks, clogged drains. How they function and how to keep them working. Free literature. Chemical Cesspool & Drain Cleaning Co., Boston 34, Mass.

**SOIL** Testing kit for testing acidity and alkalinity of soils. Send \$1.00 to L. Uran, P.O. Box 654, Escondido, Calif.

**MY** Bank balance—New copyright plan gives true balance all times. Book 8 1/2" x 10 1/2" with instructions. Use one for each checking account. One dollar each, six for five dollars. Sovereign Products Company, Huttonsville, Ontario, Canada.

**NEW** Formula eyeglass cleaner, no equal. Special dispenser. Lasts 2 years. Guaranteed. \$1.00. Rakco, 971 No. Holmes, Memphis 12, Tenn.

**DRAFTING** Machines. Drafting Equipment Co., 504 Randolph Street, Meadville, Penna.

**STILTS—6 Ft.** spliced hardwood poles; heavy aluminum steps, instantly adjusted to any height; strong, durable; in two colors. Prepaid \$4.00. Order now for Christmas! Ye Old Rail, 22 Lexington Ave., New Haven, Connecticut.

**BALL** Point rifle pen. Clever rifle action. \$1.00. E. Gresh, 1501 Roosevelt Ave., C-8, Carteret, N. J.

**RELIGIOUS** Jewelry, wallets; Christmas gifts. Eden, 587-A Shaler, Ridgefield, N.J.

**BACK** Seat driver's license, 15¢; 2 for 25¢. "The Driver's Prayer" 25¢. Geo. Gent, Box 484, Tremonton, Utah.

**SOLID** Gold dinner rings with small genuine cut diamond, manufacturer's special, \$10.00 each. Bergmann Enterprises, Box 4434, San Antonio, Texas.

**ZIPPERs.** Talon. Light, medium, heavy duty. 6¢, 8¢, 10¢ per inch. Handbag Hospital, 512 South Broadway, Los Angeles 13, Calif.

**SPAIN.** Bullfight colorful postage, \$3.00; ten viewcards, \$1.00; two remails, \$1.00. Swell, Madrid-Chamartin, Madre Dios 43, Spain.

**INDECIPHERABLE** Secret writing! 10,000 virtually unbreakable codes! In five minutes write code that defies experts. Unobtainable elsewhere. \$2.00. Wencil Products, 2904 N. Keating Ave., Chicago 46, Ill.

**ZINC** Engravings. From any photo or drawing. 5 sq. inches only \$1.76. Free price list. Miller-Holles, 437 E. Market, Alliance, Ohio.



# NO COPS NEEDED...

## for this Family Shootin' Feud

Nobody's angry mad; just mad about shootin'. This family shoots for high score (right in the playroom!) with top-accuracy Crosman Pellguns. It's quiet, safer, powderless shooting, with controlled range and power for limited areas. No delinquency here, juvenile or adult; just clean, wholesome family fun. Find out from your sporting goods dealer.

**FREE!** NEW COLORFUL 32-PAGE GUN BOOK. WRITE CROSMAN ARMS CO., INC., DEPT. PM-10, FAIRPORT, NEW YORK.

Shooting is 3 Times  
More Fun with ...

**Crosman**

Available  
in Canada

World's largest producer  
of pellet rifles and pistols

Power  
Without Powder® **PELLGUNS®**



**NOW NO ONE CAN KEEP A SECRET FROM YOU!** 25x-45x-75x TELESCOPE only \$325 postpaid

Amaze your friends... See what they've doing—without being seen! Money Back guaranteed. Send cash, check, or money order today!

Special: Order now, get free carrying case.

4-range all metal telescope magnifies up to 75 power. Watch ball games, look at the moon, stars, animals, distant buildings... up close. Bright aluminum tube practically unbreakable. Good on hikes, camping trips, can use either 25x, 45x or 75x power instantly. Variable focus eyepiece. No assembling, ready-to-use, no special instructions required!

**L. J. STONE, Dept. D-10 • 1616 Oak St. • Santa Monica, Calif.**

**1957 CATALOG BOAT KITS** WOOD and FIBERGLAS

EASY TO BUILD - DESIGNED for professional results by the amateur. World's largest selection of top performance, latest design, proms, skiffs, racers, runabouts, sailing boats, cruisers. 8 to 20 ft. Mahogany decks, frames. FREE FREIGHT. SEND FOR FREE CATALOG

**Boat Plans-Patterns-Frame Kits** Includes fiberglass paints, accessories

Build over 50 modern boats from large scale plans, available with FULL-SIZE patterns, new PRE-FAB frame kits! All types: proms to cruisers, 6 to 25 ft. Best buy for Amateurs! SEND 10¢ for CATALOG.

**Craig Craft**  
Tonawanda, N. Y.

**NEW! BUILD MUSCLES & HEALTH with BODY BUILDER**

Only \$100 Postpaid

This new Chest Pull Body Builder develops powerful he-man muscles F-A-S-T. Ideal for the beginner to give him a real start in championship muscularity and perfect for the more advanced bodybuilder to combine with his regular training for faster, all around muscle growth. Body Builder is wonderful for developing massive arms, shoulders, chest and back. Mail your order today. Only \$1.00 postpaid. No C.O.D.

**MEDFORD PRODUCTS, Inc.**  
Dept. PM10, P.O. Box 39, Bethpage, New York

**OUR BEST VALUE OF THE YEAR!**

**2 1/2 AMP. SUPER POWER 1/4" THOR SPEEDRILL**

with Geared Chuck—AC-DC 2400 RPM

BRAND NEW!

If your work calls for a "rugged" drill with POWER to SPARE, insist on a 2 1/2 Amp. job... and make sure it's THOR! No finer drill made! Solid steel, heat-treated helical gears; thrust taken on hardened steel ball and plate; gears permanently packed and sealed in LIFETIME grease! Switch, trigger and lock assembly simplifies locking and releasing trigger. You'll be wise to buy 2 at this price. Supplies limited!

**\$14.95** plus 50¢ P.P. & S.T.

**TERMITES IN YOUR HOUSE? GET RID OF THEM YOURSELF!**

Don't pay \$300 and up to eradicate termites from your home or prevent infestation. Do it yourself in one afternoon. Easily! Quickly! Inexpensively with "TERM-OUT"! Send stamp for handbook.

**COMPASS RESEARCH**  
701-A INVESTMENT BLDG., PITTSBURGH 22, PA.

**CHROME VANADIUM 29 Pc. DRILL SET**

60 Pc. Set WIRE GAUGE CHROME VANADIUM DRILLS

Top quality German import high test Chrome Vanadium Drills designed for speed drilling through toughest steels, woods, plastic, iron and aluminum. Precision ground, long-lasting cutting edges. Guaranteed to give years of satisfaction. A full 60 pc. set, Nos. 1 through 60, A \$14.95 value—**\$5.40** NOW ONLY... PLUS 50¢ P.P. & HDLG.

Same set above with Rust Metal Index... **\$6.65** PLUS 50¢ P.P. & HDLG.

Also Available  
**20 Pc. Set - Nos. 61-80 WIRE GAUGE DRILLS**  
In plastic kit with marked pocket for each drill. **\$2.50** ONLY p.pd.

**Get a MURRAY Electro-Stylus for FUN and Profit!**

Turn spare time into real enjoyment—and big profit opportunities! Make Christmas cards by etching plastic or film for contact printing or enlarging. Engrave leather bill-folds, plastic plaques, glass, do silk screen, retouch photographs, make plastic edge-lighted signs—cut beautiful mimeograph or xerograph stencils. Hundreds of hobby and business applications.

Delivers 7200 strokes per minute. No radio interference. For all ages—wonderful gift. A professional instrument—yet anyone can learn to operate it in 10 minutes.

Send check or money order and we pay postage! Includes Electro-Stylus, 2 sharp points, 1 small ball point, 1 large ball point, 1 plastic-cutting point. Diamond point for glass cutting... \$7.95 additional. Rectifier box for Added Punch \$7.95.

**\$14.95**

**MONEY-BACK GUARANTEE**

**ELECTRO-STYLUS**  
Dept. P.M.  
Forsyth, Missouri

**75c ea. for Finest Imported PRECISION PLIERS!**

• Flat Nose • Combination • Diagonal Cutter • End Cutting Nippers • Round Nose • One Side Flat—One Side Round • Snipe

FOR JEWELERS, OPTICAL WORKERS, HOBBYISTS, CRAFTSMEN OF ALL KINDS! These superb European instruments are of deep-forged, heat-treated high quality tool steel, fabricated to most exacting specifications. All-over ground and polished to smooth hard surfaces. Smooth working joints with just the right tension. Jaws meet perfectly to safely and securely hold even the most delicate objects in the hard-to-reach corners and angles. Each plier is 4" long and a veritable gem of precision and strength.

**75c each . . . ALL 7 for \$5.00 p.pd.**

Send Check or M.O. C.O.D. fee extra. **MONEY BACK GUARANTEE**

**SCOTT-MITCHELL HOUSE, Inc.** DEPT. M-454, 611 BROADWAY  
NEW YORK 12, N. Y.

# Soldering is Easy

with  
INSTANT STARTING



## Lenk LIQUEFIED LP PETROLEUM Torch

only \$2.95

THE ONLY THROW-AWAY FUEL-CONTAINER WITH SELF-SEALING SAFETY VALVE.

Here's what you can do:

- regular soldering, sweat fittings,
- silver soldering, refinish furniture,
- remove paint and putty.

Available at Hardware Counters Everywhere

Write for FREE Soldering Instructions

THE **Lenk** MFG. CO.  
FRANKLIN, KENTUCKY



## Air-Powered "Mole" Missile Strings Underground Wires

Driven through the ground by an internal piston, the three-foot projectile in the photograph can drag power lines through a railroad embankment or pull a steel lifting cable beneath a sunken ship. It weighs 53 pounds and can move up to 130 feet per hour, depending on the hardness of the soil. The internal piston is repeatedly hammered by compressed air against a striker plate to push the projectile forward. The tool was designed by a Polish inventor.

Modern fighter aircraft require 25,450 horsepower to fly at a speed of 1000 miles per hour, compared to the 2200 horsepower used by World War II planes to achieve a speed of 450 miles per hour.

## Dial Locates Guitar Chords



Over 1000 six-string chords for the Spanish guitar may be learned with the aid of a new selector that works on the circular slide-rule principle. Chords are shown by finger placement on the fingerboard as the dial is turned.

Tretib Sales, Lorain, Ohio

POPULAR MECHANICS

## New SAND-O-GRIND ALL-PURPOSE WHEEL



### GRINDS • SANDS • BUFFS Anything!

Here's a new shop tool that will do the work of sandpaper, shop file, and an emery wheel. Won't load when removing paint from wood surfaces, yet cuts cement or the hardest steels with alarming speed. Use it with any quarter inch electric drill to do the thousand and one jobs around the shop and home . . . polishing burned pots and pans, sharpening knives, removing paint, removing rust. Satisfaction guaranteed.

The perfect gift for the man with an electric drill. . . . . \$2.95 Postpaid (No C.O.D. please.)

SAND-O-GRIND is so new you may not find it at your local store. Use coupon to order. Dealers please write.

### WESTERN ABRASIVES

2135 S. E. Sixth Ave., Portland, Oregon

Please send \_\_\_\_\_ SAND-O-GRIND wheels @ \$2.95 ea. Check or Money Order enclosed.

Name \_\_\_\_\_  
Address \_\_\_\_\_  
City \_\_\_\_\_ State \_\_\_\_\_

## Now! Do 90% of your WOODWORKING



with this . . .

### DURO MASTER COMBINATION SAW/JOINTER

Here's the most versatile, most practical combination power tool unit ever designed! Performs all of your woodworking jobs accurately, safely, easily—including dadoing, cross-cutting, ripping, tenoning, bevel cutting, rabbeting, taper cutting, plus many others. Both saw and jointer are operated from a single motor and it takes but seconds to switch from unit to unit . . . an exclusive Duro development. Has many other exclusive features.

Saw Jointer Only  
**\$136.00**



Write for **FREE Power Tool Catalog** showing this remarkable unit and the complete Duro line of power tools. Learn how Duro's patented motor mount permits you to run a complete power tool workshop—with 1 motor!

**DURO METAL PRODUCTS CO.**  
2661 No. Kildare Ave., Chicago 39, Ill.

*For Maximum Warm Air Circulation  
and Smokeless Operation, Build  
Masonry Walls Around*

## HEATFORM



Model "A" HEATFORM fireplace has side cool air inlets and front panel warm air outlet.

HEATFORM\* retains the beauty and glow of the open fire. Heating chambers surround the firebox and upper throat. Air drawn from the floor into these chambers is heated by contact with the hot metal and returned and circulated uniformly to all parts of the room and adjoining rooms. This substantially increases the heat delivery with less fuel consumed.

HEATFORM is a perfect guide for the masonry (hearth to flue) preventing construction mistakes.

HEATFORM adds but little to the fireplace cost. It consists of firebox, throat, smoke dome, and properly operated damper, replacing some materials and labor necessary with the ordinary fireplace. Fuel savings will more than offset the small extra cost.



Model "S" HEATFORM affords view of fire from front and either side.



Write for free illustrated brochure

(\* Registered Trademark of

### SUPERIOR FIREPLACE COMPANY

Dept. PM 571  
4325 Artesia Ave.  
Fullerton, Calif.

Dept. PM 571  
601 North Point Road  
Baltimore 6, Maryland

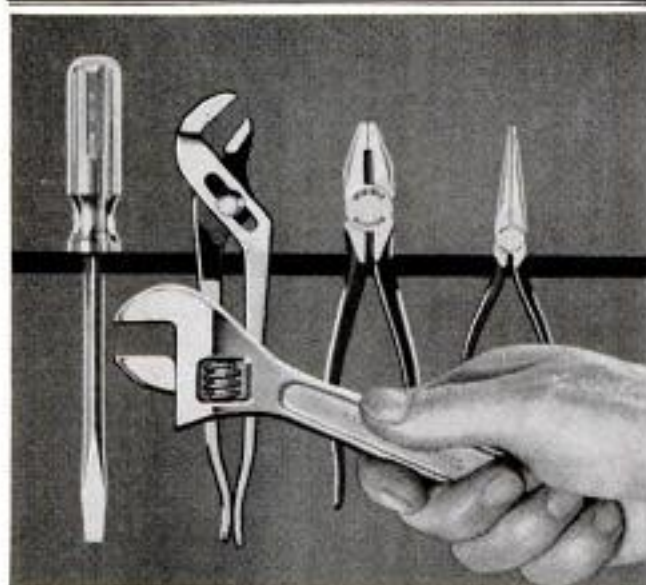

## Home Hobbyist Tools by UTICA

Wherever you see the most useful of all modern hand tools at work you'll find Utica pliers, wrenches, screw drivers, etc. Hallmark of quality in hand tools since 1895! Precision made. Unconditionally guaranteed. At leading hardware stores everywhere!

**UTICA DROP FORGE AND TOOL DIVISION**  
Kelsey-Hayes Co., Utica 4, N.Y.

"Use Utica . . . the tools the experts use"



**YOU MUST SEE THE BOOSE POWER WORKSHOP TO BELIEVE IT**

Only direct drive 8" undertable saw that will cut from 0 to 2½" depth and any angle between 0° and 90°. Principles of operations are simple. Tables and motor can be moved to desired position. Working surface of table is 36" x 20". Material lies flat on table for all operations. Dimensions of machine including base:—36" x 20" x 34½" H, without base — 36" x 20" x 11¾" H. ¾ H.P. Universal Geared Head Motor — 25 to 60 cycle — Single Phase — AC or DC.

PLEASE WRITE FOR LITERATURE AND PRICES ON BOOSE POWER WORKSHOP and optional equipment — Jointer-Shaper, Drill Press and Lathe

DEALER INQUIRIES INVITED

**REAMSTOWN PRODUCTS COMPANY REAMSTOWN, PA.**

**SAND-O-PLANE**

PRODUCTION TOOL FULLY GUARANTEED



MANUFACTURED BY DOLA CORPORATION P. O. BOX NO. 2025 EL MONTE, CALIF.

**\$5.95**

**THE NEWEST IN SANDERS FOR THE EASIEST IN SANDING**

Sands with Rotary Planer Action THE FASTEST METHOD OF SANDING

Ball joint makes disc stay flat on surface... eliminates gouging and swirls. Use on Wood, Metal, Fibre Glass, etc. Approx. 12 sq. in. in contact with surface.

Fits any ¼" cap. electric drill... sands all directions of grain perfectly. Sands best at 1000 R.P.M. or more.

AT LEADING HARDWARE • TOOL STORES • LUMBER YARDS

**Have this TRADE-WIND Ventilating Hood...**

*built into your present kitchen*



Eliminates heat, odors, grease... adds lasting beauty. It's easy to install a Trade-Wind Ventilator in the cabinet over your stove. Choice of 3 hoods in copper and stainless steel, pre-wired with switch and light, ready to install in your kitchen. Also 6 top performance ventilators for kitchen, bath, laundry, workroom. Complete instructions with each unit.



Powerful ventilator is hidden in cabinet.



Touch Bar controls light and 3-speed ventilator.

MAIL COUPON TODAY

Trade-Wind Motorfans, Inc. 7755 Paramount Blvd., Dept. PM Rivera, Calif.

Please send information on Trade-Wind Ventilators.

NAME \_\_\_\_\_

ADDRESS \_\_\_\_\_



**Infrared Appliance Grills, Bakes or Roasts**

Food cooks in a fraction of the normal time in an infrared appliance that grills, bakes and roasts. It will cook a steak in one minute, or bake an apple in five minutes. The unit is made in England.

POPULAR MECHANICS

Copyrighted material

## How to Get ALL THE HEAT YOUR FUEL CAN GIVE



### for coal, coke and wood users

Wasteful and hazardous soot deposits can lead to costly soot fires or coal gas explosions. What's more, soot's tremendous insulating power (even greater than asbestos!) prevents heat from entering the home, causes abnormal heat loss up the chimney. But now you can help eliminate the hazards and problems of soot with absolutely safe, automatic Chimney Sweep Soot Destroyer. Famous Chimney Sweep contains concentrated Anti-soot 29—a new, powerful ingredient that speeds up soot destroying action. In new, easy-to-use sprinkler canister at all hardware stores.

POWDER 16 oz. .69c 38 oz. 1.29



### for oil and kerosene users

One easy step helps clean out both the globs of sludge that clog up fuel lines as well as the accumulations of soot that cause heating unit inefficiency. Simply pour Chimney Sweep Fuel Additive and Soot Destroyer into your tank. Immediately, Chimney Sweep starts and continually promotes scientific catalytic action. This helps bring about the faster, more efficient fuel combustion that is necessary to burn away any impurities during normal operation. Liquid Chimney Sweep really helps clean out heating units to work like new! At all hardware stores.

LIQUID Pt. .1.39 Qt. .2.49

G. N. COUGHLAN CO., West Orange, N. J.

## FREE booklet

### How to finish antiques, furniture, wall cabinets and paneling

Tells how easily you can get lustrous wood finishes that look hand-rubbed. Includes interesting facts, figures, tricks of the trade.

For best results use Heirloom<sup>®</sup>—extra-pale, non-yellowing, non-staining—an extremely tough finish that resists alcohol, water, detergents and rough use. Enhances the beauty and color of natural wood. Will not spot or streak. No primers needed. Choice of four degrees of luster or sheen.

McCLOSKEY VARNISH CO.  
7600 State Rd., Philadelphia 36, Pa.

Name \_\_\_\_\_

Street & No. \_\_\_\_\_

City & State \_\_\_\_\_

(my paint dealer)

(dealer address)

MAIL COUPON FOR BOOKLET No. 13A

## BUY THE ORIGINAL.. BUY THE BEST!



# Mow Cycle '24'

with **VARIABLE SPEED CONTROL**  
plus a host of advanced features!

Mow Cycle, always the leader, now steps out still farther ahead with sensational new advancements . . . engineering features for better control, easier handling, more efficient lawn work. New streamlined styling. Rugged construction.

Simple, safe, dependable. Mow Cycle is so simple even a child can handle it with complete safety. 3½ HP 4-cycle Clinton engine starts easily, is trouble-free, extra quiet.

### A Masterpiece of Engineering

New Mow Cycle Variable Speed—forward and reverse speeds from 0 to 6 MPH.

Dual Rear Tires—Air Cushion type, pneumatic, on 26½" axle. 4-wheel stability.

Hand Lever Blade Clutch, Single 24" Blade, Spring Cushion Seat.

Full line of attachments.

**MAIL  
COUPON  
TODAY**

Mow Cycle '24'—\$234.25

With mowing attachment—\$259.50

Mow Cycle 'Cadet'—\$174.25

With mowing attachment—\$199.50

Musgrave, Inc., Dept. 107, Springfield, Ohio  
Send Free Folder on New Mow Cycle "24" and dealer's name.

My Name \_\_\_\_\_

Address \_\_\_\_\_

City \_\_\_\_\_ State \_\_\_\_\_

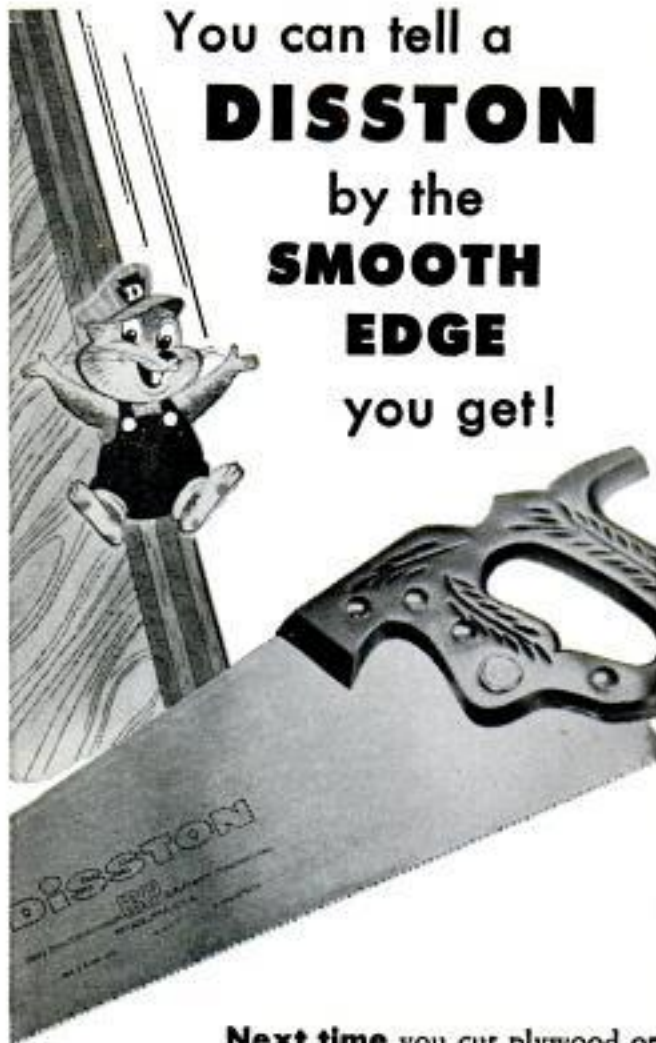

You can tell a  
**DISSTON**  
 by the  
**SMOOTH  
 EDGE**  
 you get!

**Next time** you cut plywood or other well-seasoned woods, use a 10-, 11- or 12-point Disston Hand Saw. Note how easily it cuts . . . what a beautifully smooth finished edge it leaves! That's because these fine-toothed saws are specifically designed for finishing work. Made of fine tool steel, with perfectly tempered and double taper ground blade, Disston Saws give years and years of service, too.

At better hardware dealers... everywhere!



Choose a 5 1/2-point Disston Hand Saw for cutting with the grain.

Choose a 7-, 8- or 9-point Disston Hand Saw for cutting across the grain.

**FREE ILLUSTRATED BOOKLET!** 64-page Disston Saw, Tool & File Manual. Tells how to choose and use tools; how to care for them. Helpful hints on wood and metal working, and selection of materials. For your free copy write today to: *Henry Disston Division, H. K. Porter Company, Inc., Philadelphia 35, Pa.*

**H. K. PORTER COMPANY, INC.**  
 Henry DISSTON DIVISION

## WHERE-TO-BUY-IT INDEX

Source of supply appears after items commercially available

### AUTOMOTIVE

Detroit Listening Post.....	103
Automatic-brake device stops truck at loading dock (Docket Mfg. Co., 3510 Brighton Rd., Denver, Colo.).....	112
Speed control makes it easy and economical to obey the law (Perfect Circle Corp., Hagerstown, Ind.).....	127
"Elevator" truck lowers to ground (Thompson Trailer Corp., 2 Old Court Rd., Pikeville 8, Md.).....	128
Portable steel cabin for vacation trips (Burlington Mfg. Co., 613 S. Roosevelt Ave., Burlington, Iowa).....	128
Driving the British Ford Anglia.....	135
Eight-horsepower engine runs midget sports car (Midget Motors Corp., Athens, Ohio).....	143

### AVIATION

Steam-heated runway melts 10 feet of snow (American Hydro-therm Corp., Long Island City, N. Y.).....	112
Anticollision "eyes" on plane warn pilot of approaching craft (Aeroflet-General Corp., Azusa, Calif.).....	114
Lighted canopy protects Berlin air passengers.....	121
Hawk missiles destroy low-flying planes.....	128
Biggest balloon lift.....	138
Vertical-take-off jet has diverter vanes behind engines (Bell Aircraft Corp., P.O. Box 1, Buffalo 5, N. Y.).....	139
Metal rod stops jet flame-out (Charles Engelhard, Inc., 904 Passaic Ave., East Newark, N. J.).....	284
Superfuels for air force (Olin Mathieson Chemical Corp., Niagara Falls, N. Y.).....	289
Direct-reading altimeter aids aerial navigation.....	294
Planes land on thin ice.....	294

### BOATS

Motorboat is its own trailer with built-in retractable wheels (Hydro-Phibian, P.O. Box 3081, South Decatur, Ga.).....	110
Hydrofoils lift Soviet boat hull above water at high speeds.....	113
Prehistoric principle moves paddle pusher.....	143
Water-absorbing plugs protect stored engines (Newbury Distributors, Dept. 215, 174 Newbury St., Boston, Mass.).....	280

### MISCELLANEOUS

Shelters of sprayed plastic may be houses of future.....	105
Prop drives vehicle 100 miles per hour on ice.....	110
Sub's missile stored in tank.....	110
Copter carrier for French Navy.....	113
Dredge moves on B-17 wheels.....	114
Four-story missile helps solve re-entry problem.....	120
"Operation second sight" puts local news on records for blind.....	121
Rockets hurl fire extinguishers (Grand Rocket Co., P.O. Box 111, Redlands, Calif.).....	126
Automatic loading machine.....	127
Air-supported dome extends swim season (Birdair Structures, Inc., 290 Larkin St., Buffalo 10, N. Y.).....	129
Amplifiers give directional hearing through eyeglass frames (Dictograph Products, Inc., Jamaica, N. Y.).....	138
Cologne theater has four stages.....	138
Electronic organ makes sound from pictures (W. W. Kimball Co., 2085 N. Cornell, Melrose Park, Ill.).....	139
Small diesel trains haul European passengers.....	143
Improved microwave relay system.....	280
Dream workshop has eight tools around T-shaped bench (Delta Power Tools Div., Rockwell Mfg. Co., 400 N. Lexington Ave., Pittsburgh 8, Pa.).....	282
Automatic water fountain uses photoelectric cell (T and S Brass and Bronze Works, Inc., 118 Seventh St., Garden City, L. I., N. Y.).....	284
Buttons reattached in seconds (Birbeck Brothers, Inc., 70 N. York Road, Willow Grove, Pa.).....	284
Black-light exterminator kills night-flying pests (Southeastern Engineering Corp., P.O. Box 883, Goldsboro, N. C.).....	286
Machine makes sauerkraut.....	288
"Stork leg" spectator seats give good view of sports events.....	292
Trees increase with soil feeding (Weyerhaeuser Timber Co., Tacoma 1, Wash.).....	292
Portable chord organ has three-octave range (Magnus Organ Corp., Livingston, N. J.).....	294
Sewing is a breeze with flywheel fan (Rupert Weidner, Inc., 131 W. 45th St., New York City 36).....	296
Weather controls sprinkling unit (S. Reisner Co., 33-42 72nd St., Jackson Heights 72, N. Y.).....	296

### SCIENCE

Animal-bone grafts for humans.....	127
Radio transmitter in capsule sends medical research data.....	129
Destructive wood-rotting fungi may have several practical uses.....	138
Secret of life may be near.....	138
Ring of wind encircles equator.....	296
Fish may prove why animals age.....	292

(Continued to page 92)

Under the Christmas tree this year

a bundle  
of

**Gifts**

you and your family will enjoy making



**APR** With Homasote—the all-purpose insulating-building board—you can make scores of interesting gifts and decorations at little cost, but with great personal satisfaction. Your Christmas tree platform is cut to size—up to 8' x 14'—at your lumber dealer's. You can make a sound-deadening Trainboard (or a convenient Trainboard-Storage Cabinet, with Pattern # 190—50¢). For most of the gifts pictured here, and many more, Homasote supplies free designs. The building know-how is in the 63-page Homasote Handbook, which also lists East-Bild\* Patterns for such life-size figures as the Madonna (Pattern # 540—50¢), or Santa, Reindeer, Choir Boys, etc. Write for the free "33 Ways" Folder, full of gift ideas. For Handbook, please enclose 10¢. Address Dept. K-35. \*T. M. Reg. East-Bild Patterns Company

**HOMASOTE COMPANY**  
Trenton 3, New Jersey

**WHEREVER  
YOU DRIVE...**

**THIS  
IS A  
GOOD  
SIGN**

**CARTER  
CARBURETOR  
SERVICE**

Wherever your automotive travels take you, you're never far from authorized Carter fuel system service. More than 25,000 Carter trained servicemen throughout the United States are authorized to display this sign. You can depend on them to give your car the same skillful, conscientious carburetor, fuel pump and fuel filter service you get from your Carter serviceman at home.

**CARTER CARBURETOR**  
DIVISION OF **QCF INDUSTRIES**  
INCORPORATED  
ST. LOUIS 7, MISSOURI

OCTOBER 1957

91

Copyrighted material

**STOUX POWER PACK**

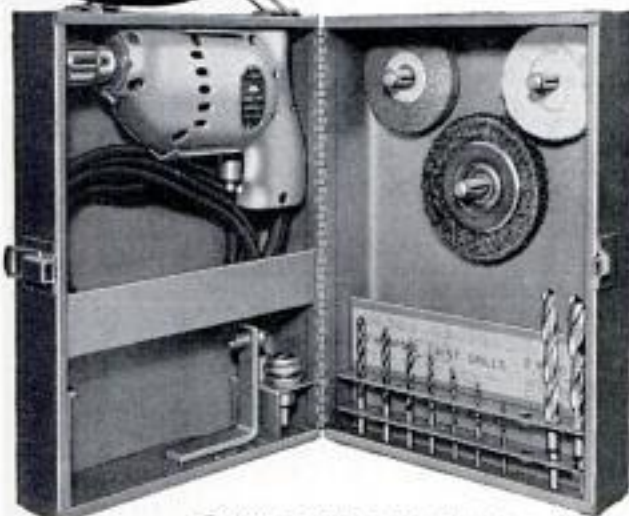

Every man's a handyman with a Stoux 1/4" Drill Kit; because he's equipped to drill in wood or metal, to wire brush, buff, polish or sharpen. The fitted metal case hangs on the wall or goes to job. \$41.75 complete. Drill only—\$24.95. Prices include Stoux Quality.



CHECK THE YELLOW PAGES OR WRITE TO



**ALBERTSON & CO., INC., SIOUX CITY, IOWA, U.S.A.**

# How would your car ride with this load?



## MOOG PH OVERLOADS\* add 1200 lbs. extra capacity!

That "soft spring" ride is fine when you ride *alone*. But to enjoy the same roadability and handling ease when your auto or station wagon is *loaded*, you need Moog PH Overload Helper Springs.

You'll drive with added confidence because these rugged overloads restore correct height to sagging rear springs... stabilize the ride... and improve cornering on turns.

Low-cost installation takes only 15 to 20 minutes using a single wrench!

\*Patent Pending



**MAIL  
THIS**

... for more information on Moog PH Overloads and name of nearest dealer.

Name.....

Address.....

City..... State.....

Moog Industries, Inc. • St. Louis 14, Mo.

(Continued from page 90)

## Radio-Television, Electronics

Voltage regulator transformer (Perma-Power Co., 3102 N. Elston, Chicago) .....	246
Attenuator switch (Technical Appliance Corp., Sherburne, N. Y.) .....	247
High-pass filter (Amphenol Electronics Corp., 1830 S. 54th Ave., Chicago 50) .....	247
Clear-Pix TV Interference Eliminator (Superex Electronics Corp., 4-8 Radford Pl., Yonkers, N. Y.) .....	247
Low-pass filter (Cornell-Dubilier Electric Corp., 1000 Hamilton Blvd., South Plainfield, N. J.) .....	247
Retrace eliminator (Vidair Electronics Mfg. Corp., 578 W. Merrick Rd., Lynbrook, N. Y.) .....	248
Picture-tube booster (Workman TV, Inc., 309 Queen Anne Rd., Teaneck, N. J.) .....	248
Two-set coupler (Amphenol Electronics Corp., 1830 S. 54th Ave., Chicago 50) .....	248

## Craftsman and Shop Notes Index

### AUTOMOTIVE

Wet window and slow speed improve wiper performance.....	205
Auto visor extended by manila envelope.....	216
Altered screwdriver blade removes broken spark plug.....	239

### FARM

Tie rod on gateposts better than braces.....	209
Portable electric-fence posts.....	236
Dairy feeding cart made from old fuel-oil tank.....	239
Furnace fan removes loose husks.....	244

### HOUSE AND HOME

Dual doorbell buttons fool unwanted callers.....	194
Solving Home Problems—	
Dust cover for phonograph turntable.....	198
Emergency ice bag made from rubber glove.....	198
Razor-blade twine cutter.....	198
Rugs hung on line with clamp-type trouser hangers.....	198
Sign for window hung on wire coat hanger.....	198
Shower curtain held against wall.....	198
Fruit-jar rubber on glass tumbler serves as dribble catcher.....	199
Ironing board kept clean.....	199
Keep file cards straight in file box.....	199
Mending fingers of gloves.....	199
Spool of adhesive tape kept in sight.....	199
To keep book ends from sliding apart.....	199
Pipe guard for foot scraper.....	200
Flashlight reveals uneven floor.....	201
Kitchen tool cabinet stores those frequently used items.....	201
Candleholder adds charm.....	204
Line tightened by handy reel.....	204
Stuffed owl is "scarecrow".....	204
Kitchen cabinet provides space for built-in dog kennel.....	213
Shelf and picture frame for modern home.....	217
One-piece chimney extension.....	222
Timer controls outside light.....	236

### HOUSEHOLD HINTS

Rack for drying vacuum bottles tilts out of the way.....	194
Slit paper holds slip upright.....	194
Hidden catch prevents child from opening drawer.....	197
Tubing quiets step-on can.....	200
Cans provide soil bands.....	201
Glove fingers prevent knife cuts.....	209
Pouring milk from gallon bottle made easy.....	209

### MISCELLANEOUS

Candleholder has matchbox in base.....	194
Equal spacing of parallel lines assured with T-square pointer.....	197
Better paintbrush cleaning.....	204
Cloth clamped in clothespin serves as small paintbrush.....	205
Make a "crazy jug".....	205

(Continued to page 94)

**NOTICE**—It is the intention of this magazine to provide its readers with information regarding the latest developments in the mechanical arts. Except where otherwise indicated, this magazine has no information as to any unexpired patents in respect of the developments reported herein. In the event that commercial use is to be made of any of the developments reported herein, it is suggested that legal counsel be consulted to avoid liability for patent infringement. It is not the purpose of this magazine to encourage patent infringement but, as indicated, it is the intention of this magazine to report on the latest developments in the mechanical arts.



## GRAPHIC VISUAL CONTROL



- ☆ Gives Graphic Picture of Your Operations
- ☆ Facts at a Glance — Saves Time and Money
- ☆ Simple — Write on Cards, Post on Board
- ☆ Ideal for Production, Scheduling, Etc.
- ☆ Made of Aluminum — Compact & Attractive

Full Price \$4950 with Cards

**FREE** 24-PAGE BOOKLET NO. A-10  
Without Obligation

### GRAPHIC SYSTEMS

55 West 42nd St. • New York 36, N.Y.

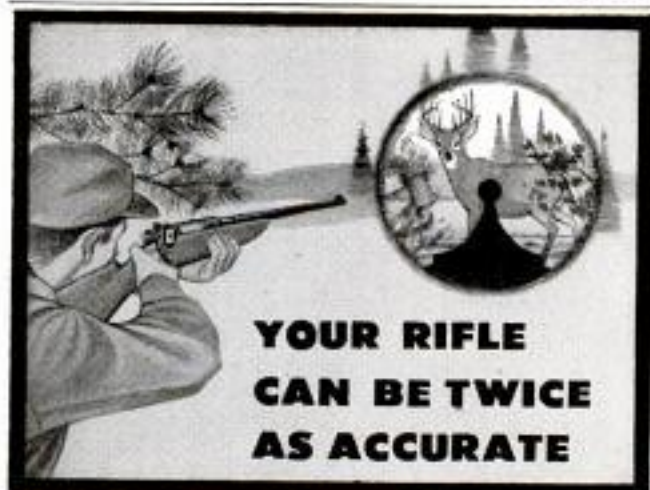

Open rear sights cut the accuracy of modern guns and ammunition *in half*. Lyman precision receiver sights deliver *all the accuracy* built into your rifle.

**SPECIFY LYMAN SIGHTS** With a receiver and front sight combination for all popular rifles, you can have Lyman Sights for your gun for as little as \$6.50. You can't buy more accuracy at any price!

**FREE CATALOG** Discover how you can double your shooting accuracy. Send for free, full-color 24-page catalog. Describes all Lyman Products for Shooters.

**THE LYMAN GUN SIGHT CORP.**  
MIDDLEFIELD • CONNECTICUT

OCTOBER 1957

## SAVE STRAIN!

## SAVE SKIN!

WITH THE *NEW*  
**Bridgeport**  
**NEOPRENE**  
**CUSHION**  
**GRIP**  
**SCREWDRIVERS**

Resilient Neoprene Grip permanently bonded to tough Amberlite handle



**50%** GREATER  
TURNING  
POWER

Tests prove the Cushion Grip allows you to turn screws tighter than ordinary screwdrivers!

#### SUPER COMFORTABLE

Resilient Neoprene grip never hurts the hand — no matter how hard you turn it!

#### NON-SLIP GRIP

Even when wet or oily, your hand won't slip!

#### UNBREAKABLE HANDLE

Hammerproof, shock-proof, non-flammable.

#### FULLY GUARANTEED

Why struggle with ordinary tools? Save work — save the skin on your hands — Do the job better with the Bridgeport Neoprene Cushion Grip Screwdrivers.

Tested and acclaimed by electricians, automotive and industrial mechanics under actual working conditions!

16 sizes and styles — Regular and Phillips — \$1.00 to \$2.70

Boistered blade for maximum strength

Beautifully polished, hardened alloy tool steel blade

Precision cross-ground point



LOOK FOR THIS DISPLAY AT YOUR HARDWARE STORE

THE BRIDGEPORT HARDWARE MFG. CORP.  
BRIDGEPORT, CONN., U. S. A.

(Continued from page 92)

Letters burned on name plate with fingernail polish.....	213
Wax crayons repointed quickly with improvised sharpener.....	216
Ball and chain on collar slows car-chasing dog.....	221
Spice dish made from three spoons.....	221
Tripod supports telescope with aid of adapter.....	221
Backing sheet prevents cards from slipping in typewriter.....	222
Hose is pail-rim "bumper".....	222
Rolled drawings held flat by slotted cardboard tube.....	226
How would you do it?.....	234
Notches cut in mixing hoe clean concrete-form boards.....	236

#### ON THE MARKET

Adjustable leg levels ladder.....	243
Elastic coating protects gutters.....	243
Garden sprayer for insecticide.....	243
Glass-fiber "blanket" for water pipes.....	243
Lock fits over electric plug.....	243
Wall planking of plastic laminated to hardboard base.....	243

#### PHOTOGRAPHY

Tape provides waterproof label.....	194
Plastic bag keeps camera dry during underwater shots.....	197
Bunshade fitted on light meter helps prevent false reading.....	200
Bleach removes print emulsion for recording photo data.....	209
Drier for 35-mm. film made from scrap photomounting board.....	212
Flash-gun clamp modified for use as camera tripod.....	226
Glass jug dries photoprints.....	226

#### TOOLS

Special concave sanding block rounds corners accurately.....	226
Chucking arbor cuts round tenons.....	237
Shopping for Tools—	
Blade on multipurpose saw pivots to eight positions.....	240
Drills for sheet metals.....	240
Power trowel reduces time and labor.....	240
Tubing cutter.....	240
Accessory jigsaw.....	241
Gear-joint pliers.....	241
Measuring wheel for use on maps and blueprints.....	241
Quick-change precision chuck.....	241

Transformer-type a.c. welder.....	241
Two-station lathe toolholder.....	242

#### WORKSHOP HINTS

Making clean breaks in scored glass.....	189
Serviceable wedge clamp made from pipe tape.....	189
Tape-clamping miter joints.....	189
Level "doweled" to straightedge for easier handling.....	200
Lock your power-tool switch.....	212
Tool permits quick marking of boards into equal parts.....	213
Magnet-type knife rack holds tools on ladder.....	222
Auger bit fits power drill.....	231
Calipers set with keyseat clamps.....	231
Centering device aligns work for milling keyways.....	231
Cork seals tailstock sleeve against entrance of chips.....	231
Emergency bracket.....	232
Lathe setup for running a long knurl.....	232
Steel rods pointed with file.....	232
Inserting drill bushing in jig.....	233
Swiveling plate permits accurate positioning of drill vise.....	233
Vise aids in loosening collar.....	233
Follower rest travels with lathe carriage.....	236
Paint thinner removes pitch from circular-saw blade.....	239
Protect that pocket rule.....	239
Improvised jackshaft bearing.....	242
Plastic cosmetics case converted to drill holder.....	242
Chiseling an accurate mortise.....	244
Jigsawed slots in block check table alignment.....	244
Notched plate scraper spots drill bit on vertical surface.....	244

### Fig-Tree-Juice Chemical Treats Burned Human Skin

Fig-tree juice is the source of a new chemical that speeds treatment of burned human skin prior to skin grafting. Called ficin, the substance literally dissolves damaged tissue and can completely clean a third-degree burn in three to five days.

# All New! SHOPMATE JIG SAW

## WITH JIG-LITE

### CUTS 2 x 4'S, PERFECT CIRCLES, BEVELS TO 45°!

**\$29.95**  
COMPLETE

This great new quarter-horse-power husky is a whole shop full of saws in one! Does the work of a rip, band, coping, crosscut, scroll, keyhole and hack saw. Even makes its own starting hole on inside cuts. Three special blades cut everything from metals to leather!

#### Great new features:

- 1 NEW JIG-LITE—powerfullight lets you see as you saw!
- 2 NEW ANGLE ADJUSTMENT—LEFT OR RIGHT—cut 45° bevels on either side!
- 3 NEW RIP AND CIRCLE GUIDE—rip and cut circles with precision: 8" guide!
- 4 NEW AUXILIARY HANDLE—gives feather-touch control; attaches to either side!

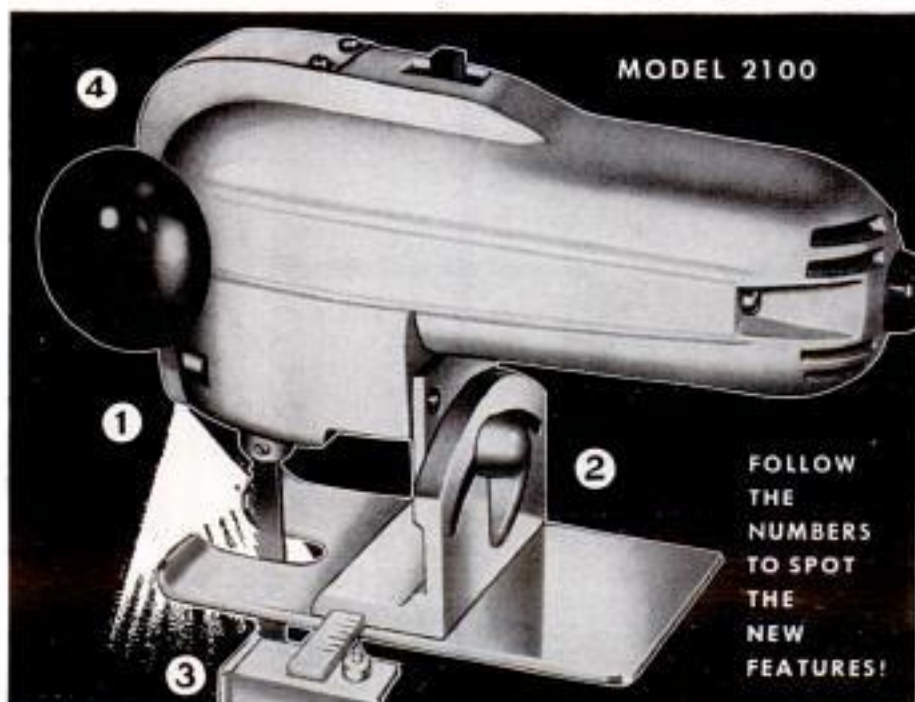

FOLLOW THE NUMBERS TO SPOT THE NEW FEATURES!

PORTABLE ELECTRIC TOOLS, INC., 320 WEST 83rd ST.

CHICAGO 20, ILLINOIS, DEPT. PM10

**NEW MOPAR  
ANTI-FREEZE...  
HOMOGENIZED!**

**GIVES YOU  
COMPLETE  
PROTECTION!**



**MOPAR**  
PERMANENT TYPE  
**ANTI-FREEZE**

ENTIRE SULFIC ACID BASE • WILL NOT  
FOAM OR BOIL AWAY • PREVENTS  
CORROSION • LASTS ALL WINTER

Part No. 1316 209



**MoPar "Dated" Dry-Charge Batteries:  
their life begins the day you buy**

Get a factory-fresh MoPar Dry-Charge Battery . . . your warranted battery life begins the day you buy! MoPar batteries assure maximum power, reserve capacity, long life, compact dependability.



**RIGHT!** New improved MoPar Anti-Freeze comes to you with rust inhibitors, lubricants and other ingredients permanently blended to give you complete winter protection. Both All-Weather Permanent type and Methanol type exceed normal anti-freeze specifications. An official authentic Chrysler Corporation product, made to highest quality standards. Buy MoPar Anti-Freeze from your Plymouth, Dodge, De Soto, Chrysler or Imperial dealer, or leading repair shops everywhere. Get ready for winter now!



MOPAR DIVISION  CHRYSLER MOTORS CORPORATION  
DETROIT 31, MICHIGAN

# AC HOT TIP SPARK PLUGS...

packed

with

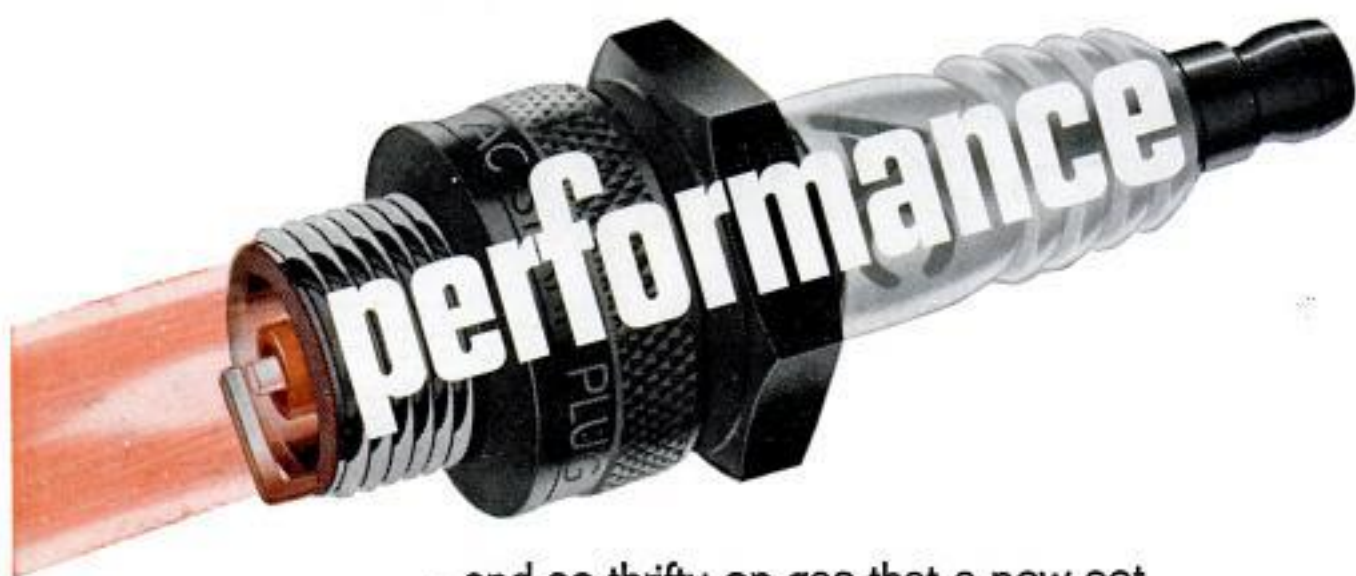

...and so thrifty on gas that a new set can save you three times their cost!

If the spark plugs in your car have gone ten thousand miles or more, you'll be 'way ahead replacing them with a set of new AC Hot Tip Spark Plugs. You'll notice at once how the new set of ACs brings back a satisfying like-new car performance!

You will notice, too, that you are beginning to save money on gas! A new set of ACs can save as much as one gallon of gasoline out of every ten you buy. That's because the exclusive Hot Tip burns off fouling carbon and other deposits, keeps them clean-burning to assure efficient fuel combustion.

On the average, the kind of gas saving ACs can give you would pay for the new set three times over. With top performance and important savings at stake, you can hardly afford to delay. Change now to a new set of AC Hot Tip Spark Plugs. Start saving—and start enjoying your car more.

*ACTION starts with*



**HOT TIP SPARK PLUGS**

AC SPARK PLUG  THE ELECTRONICS DIVISION OF GENERAL MOTORS

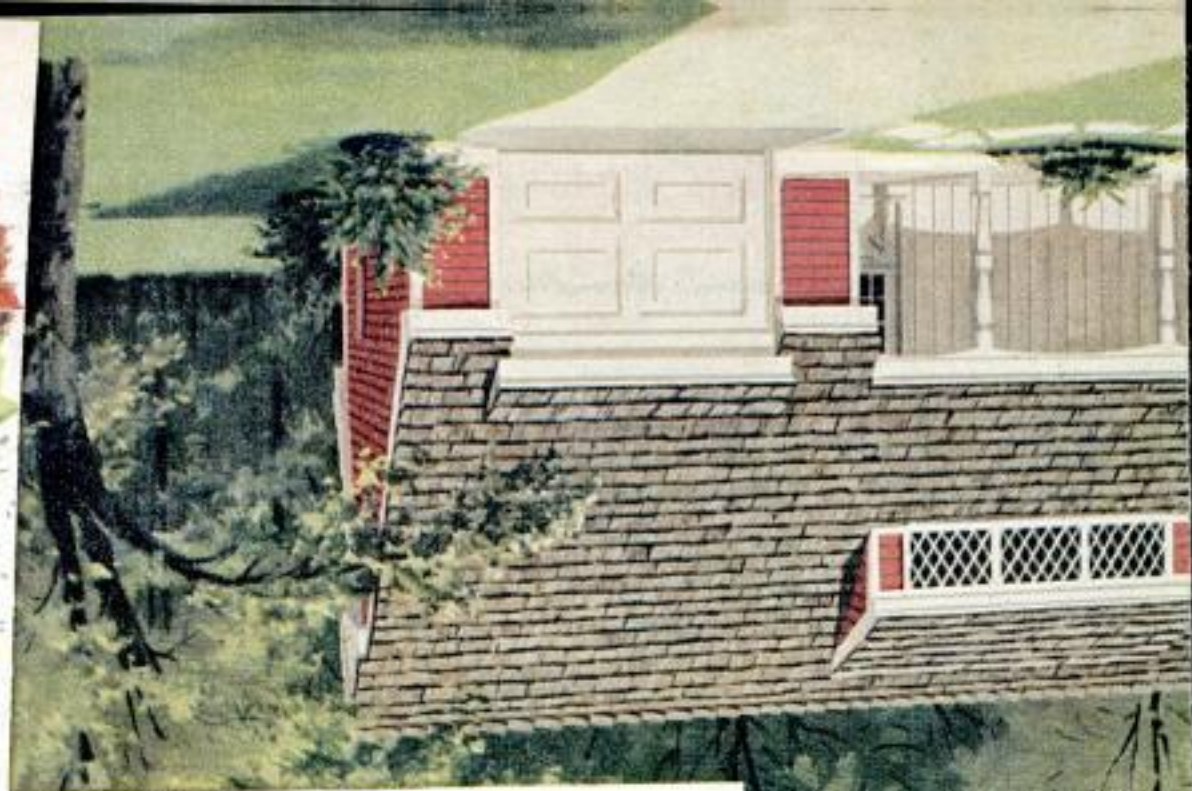

Picturesque and inviting is this modified Cape Cod farmhouse design. It has 1850 square feet of living area with three bedrooms on the second floor. Modern touches include family room

## the PM Traditional

This contemporary home with low-slung roof and sweeping lines provides 1344 square feet of living area. It has three intriguing courts. The facade gives no hint that it is a split-level home

## the PM Modern

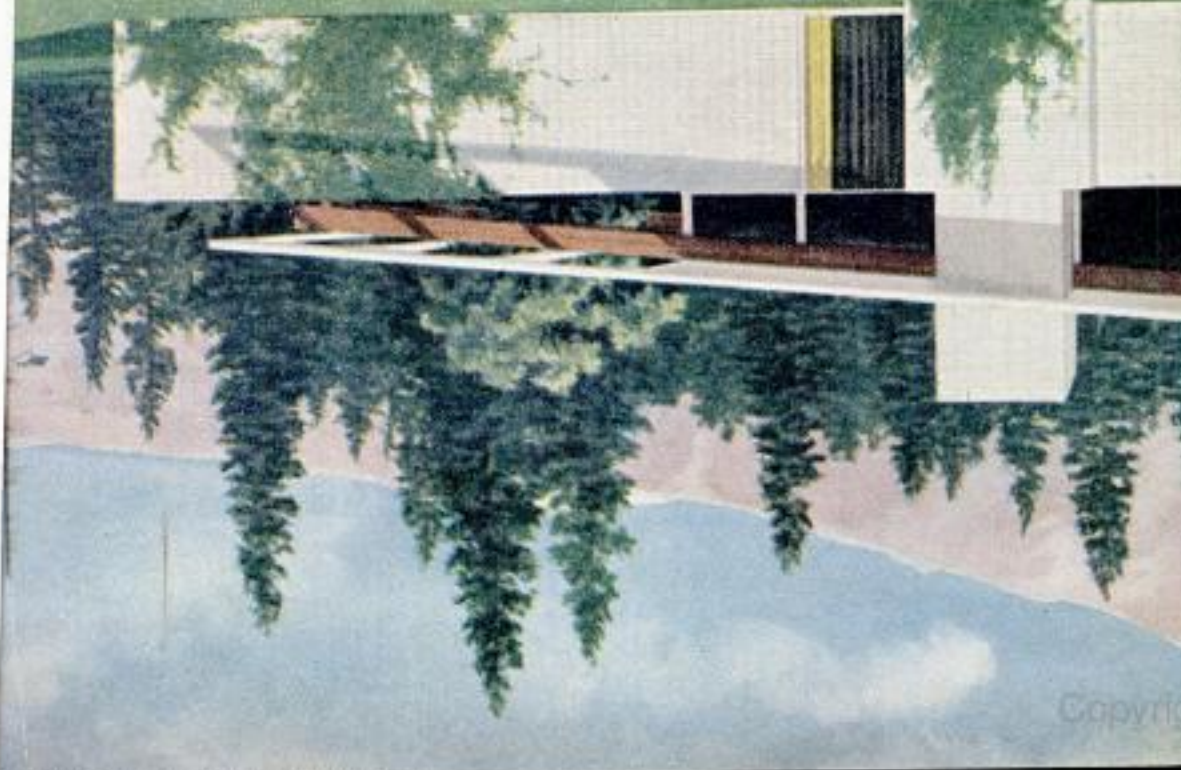



## PM Traditional

Hooded fireplace is center of attraction in the family-TV-dining-all-purpose room. Front door and the double doors to parlor are shown in rear. Kitchen is at left.

## PM Modern

Glass walls of living room give it an indoor-outdoor look with the adjoining entrance court and outdoor-living area. Studio ceiling also adds size to the room. The davenport is built-in.



1. Open the foldout page

2. Insert this sheet with

1. Front side touching the free page

2. Arrow pointing to the fold

3. Slice the folded edge

4. Close the page and slip-sheet

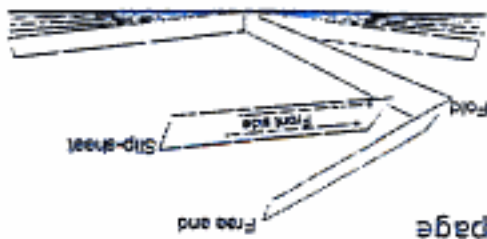

Inverted Foldout slip-sheet

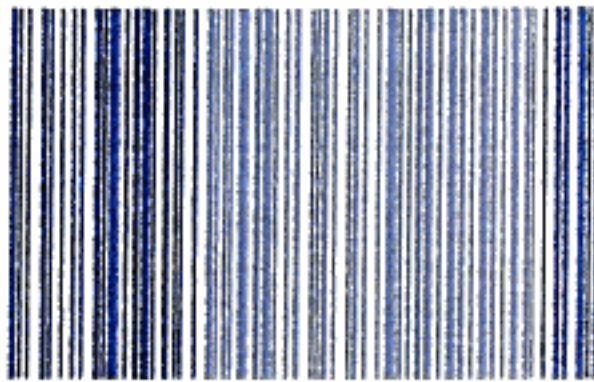

GbsSlipSheet-001



Foldout slip-sheet

Folded edge of the page

1. Open the foldout page
2. Insert this sheet with
  1. Front side touching the free page
  2. Arrow pointing to the fold
3. Slice the folded edge
4. Close the page and slip-sheet



1. Follow instructions on the other side

Inverted Back



GbsSlpBack-001B

Back

1. Follow instructions on the other side



**S**CIENCE HAS TAMED the two top bugbears in aviation radio—lightning and precipitation static. These weather gremlins rank as “minor” nuisances that rarely become serious hazards. Still, they disrupt airline schedules and hinder air defenses that can't relax vigilance when foul weather brews.

Modern all-metal aircraft are inherently well-protected against lightning. Strokes of 100,000 amperes commonly go in one wing tip and out the other, leaving small holes, but bypassing passengers and equipment. Yet even minor structural damage can be costly. And lightning frequently knocks out radio and electronic gear just when it's needed most.

“Precip” static is a more serious and annoying hazard. This is hissing radio interference caused by flight through rain, snow or ice crystals. Through friction, an aircraft may pick up 300,000 volts of static electricity, spraying it off wing tips and propeller blades as St. Elmo's fire. This weird glow is harmless in itself, but the resulting “corona pulses” block long-wave reception, disabling navigation aids.

Today's near-sonic speeds have greatly aggravated precip-static problems. Air Force tests show that when speed doubles, noise may increase 64 times. And experts agree that large, high-speed aircraft, operating at certain high altitudes, are especially susceptible to lightning strikes.

Happily, electronics experts have now devised protective devices that grant virtual immunity from both hazards.

Spearheading this development is Lightning and Transients Research Institute, a Minneapolis study group working under industry, Air Force and Navy contracts. L and T has worked out modern lightning arresters for radio antennas, plus a “diverter-discharger,” an ingenious glass-fiber lightning rod for aircraft. An electronic “blinker” invented by Morris M. Newman, the Institute's director, supplies the *coup de grace* for precip static.

Laboratory lightning bolt, with energy enough to lift 500-ton weight 140 feet, passes through B-29 model without damage

# POPULAR OCTOBER 1957 MECHANICS

WRITTEN SO YOU CAN UNDERSTAND IT  
VOL. 108 NO. 4

## *Lightning Tamers of the Airways*

*By  
Ted Dutton*



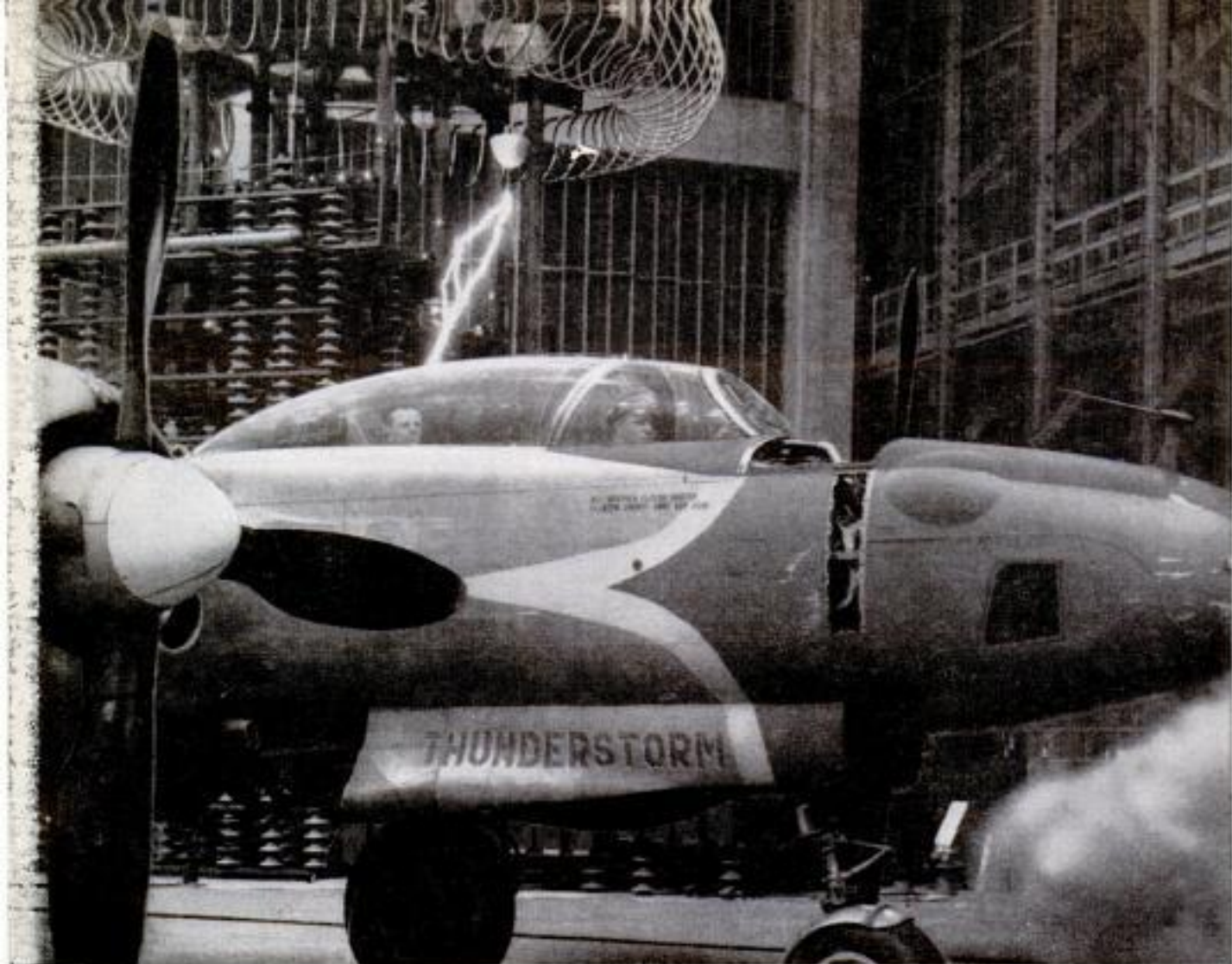

Night-fighter plane takes high-intensity stroke to protective strip on canopy but occupants are not harmed

Hole about the size of a dime was drilled in this jet-trainer tail cone by bolt of natural lightning



How well do they work? Airline electronics engineers, witnessing demonstrations in Minneapolis recently, can testify to their potency.

First, the experts crowded onto a catwalk in the Institute's lab, a former power company substation. Before them stood an up-ended aircraft-wing section, a whip-like diverter-discharger extending two feet from its tip. Overhead loomed the business end of a six-million-volt lightning generator, one of the world's largest.

"Ready?" called the operator from his booth. The engineers squinted and poked fingers in their ears.

"Three, two, one—fire!"

The lab flared white. A terrific crash, like the muzzle blast from an antiaircraft gun, split the silence. For a fraction of a second, a one-million-volt discharge zipped down and sizzled along the lightning rod. Then it vanished, leaving the spectators blinded and deafened.

"No damage at all," commented John Robb, an L and T researcher. The rod has a conductive coating, he explained. Graduated resistances channel the stroke safely to the airframe, localizing burning and pitting on a disposable shank at the base.

For a demonstration of what happens when you don't use lightning arresters on aircraft, Robb led his guests to another section of the lab. Here three generators hummed faintly, charging up for a demonstration shot of so-called "hot" lightning—the long-duration, low-voltage kind encountered in cloud-to-cloud flashes. Hot lightning burns. "Cold" lightning—a briefer, high-voltage variety—has shattering effects.

For safety, the spectators watched from a steel-and-glass enclosure. Came the count-down, then—Wham!

A yellow flash leaped down to an aircraft antenna stretched between terminals on the concrete floor. White smoke filled the room. Molten metal showered in all directions, like a bursting napalm bomb.

"There goes your receiver!" said Robb. He climbed down from the booth and retrieved the wire. It had vaporized in its polyethylene insulation. You can get the same explosive effect even with an arrester, Robb commented, if it's installed inside the fuselage, with ordinary antenna wire used as a lead-in. Cockpit installation requires a heavy inside insulated conductor to guard against explosion and possible fire.

Finally, Robb led the visiting firemen to a copper-sheathed radio shack. Here James Stahmann, a static expert, demonstrated the latest electronic blanker for automatic radio direction finders. The blanker, technically an "interference-rejection circuit," weighs three pounds but costs \$600. It chops out corona pulses 200,000 times per minute, permitting man-made carriers to pass during the comparatively long noise-free periods between noise "peaks."

Stahmann switched on the automatic direction finder. A radio range "beam" and voice weather forecast came from the speaker. "Now for static," said Stahmann. He cut in a corona-pulse generator which simulates interference such as might be encountered by a jet flying in a thunderstorm's ice-crystal anvil top. Deafening static blared from the speaker, blotting out the carrier.

"Now the blanker," said Stahmann. He flipped a switch. Now

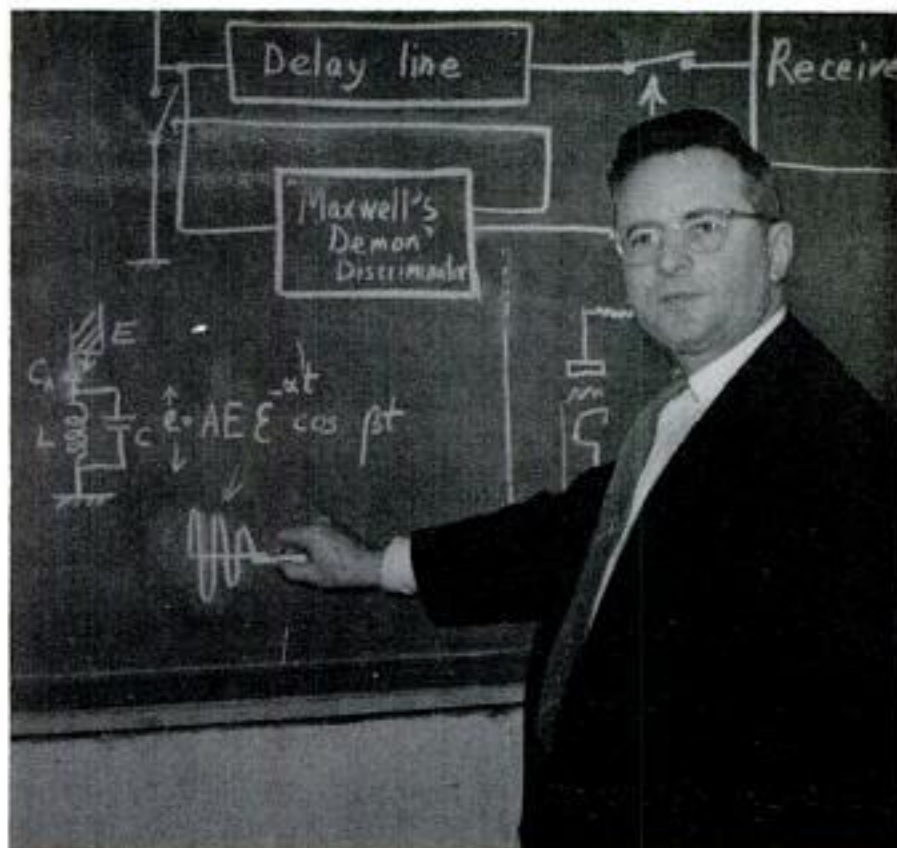

Morris M. Newman, considered world's top expert on lightning protection for aircraft, explains how static "blanker" works

Glass-fiber lightning rod mounted on the jet-fighter canopy channels high-intensity electric stroke safely to the airframe

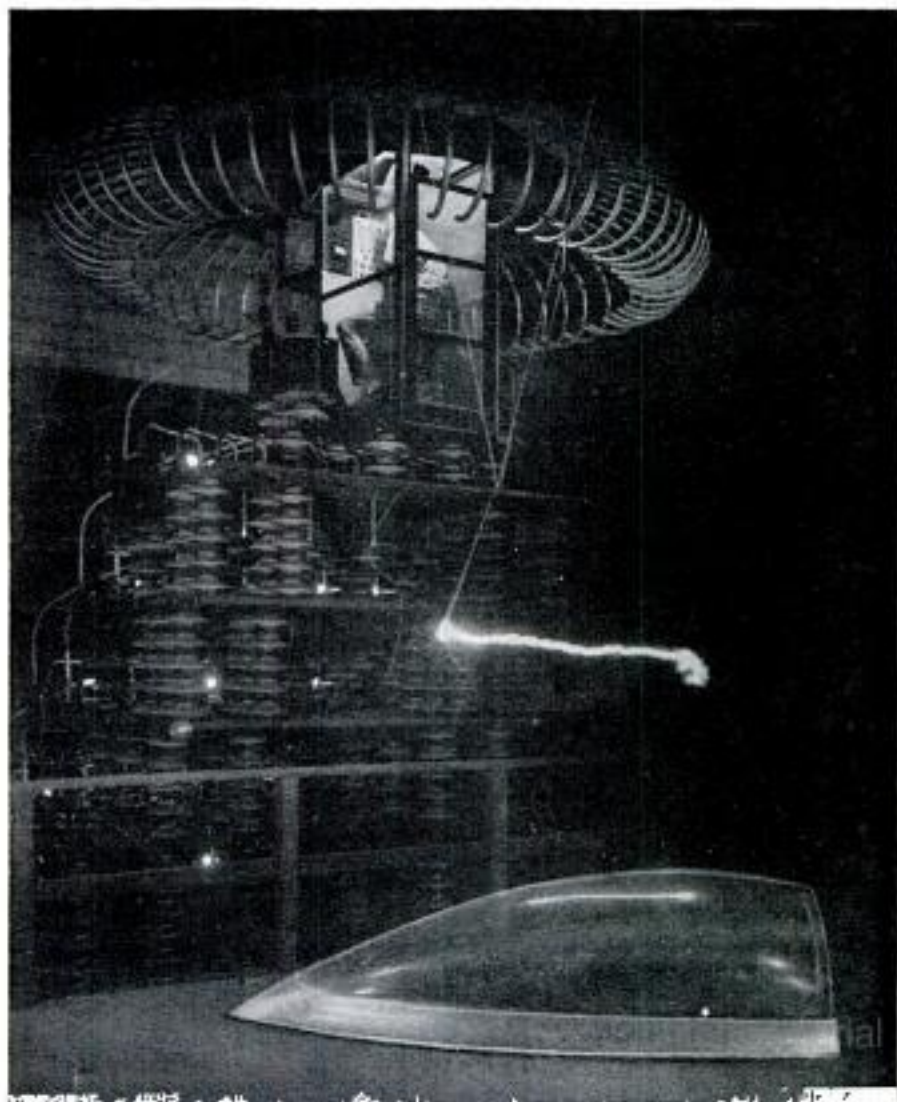

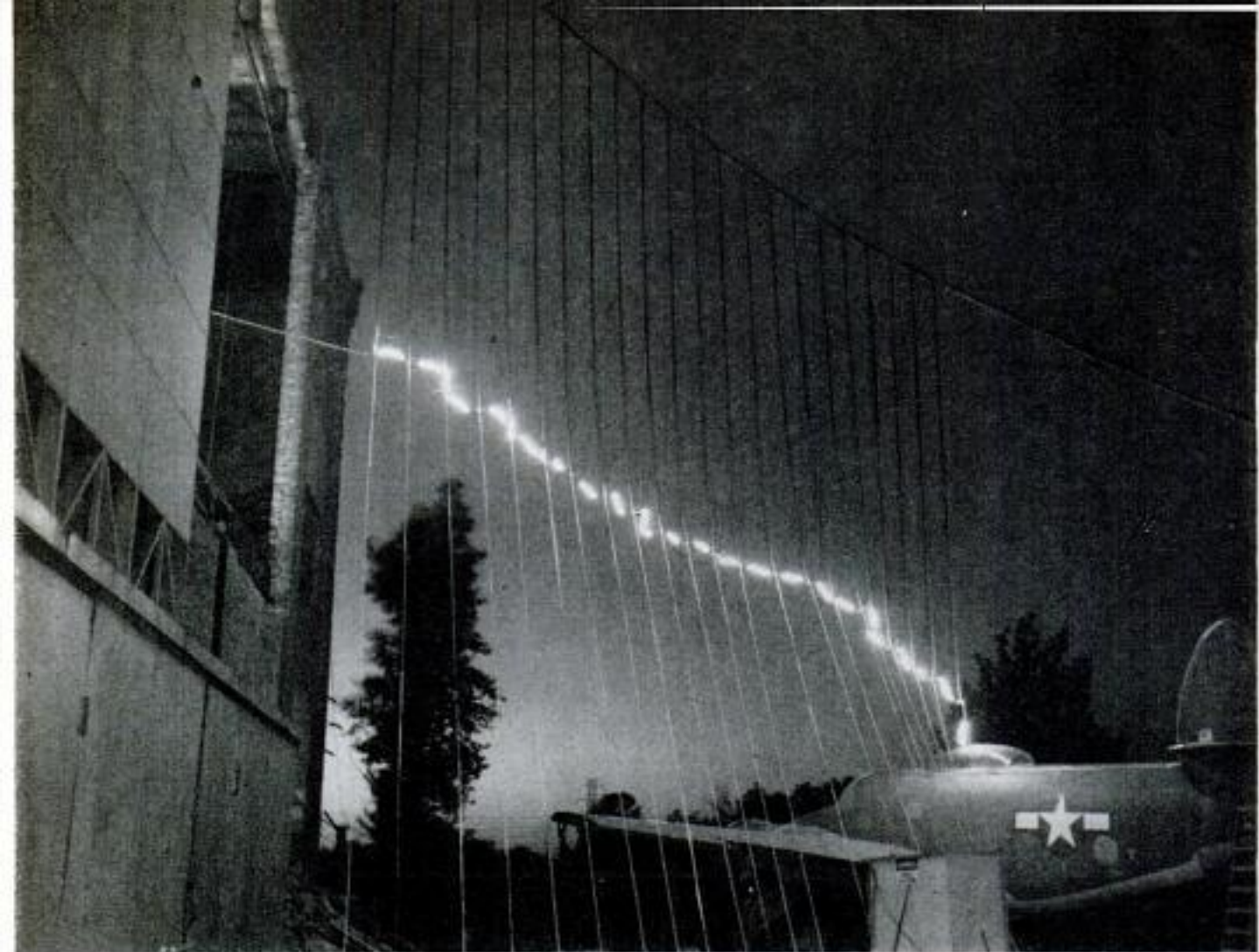

Water-filled hoses guide a 40-foot manmade lightning bolt from laboratory generator to airplane canopy

the signals came in loud and clear.

There followed an equally impressive verification of the blunker's capabilities when used with the compass indicator. With the blunker off, the homing needle shivered, then flopped through a 180-degree arc. Stahmann cut in the blunker. The needle swung obligingly back to zero, the normal homing bearing. There it froze, unperturbed by the static.

The blunker is no laboratory curiosity, but has proved itself in flight, said Stahmann. On B-29 Arctic missions recently, blunkers gave virtually 100 percent

freedom from static with liaison and loran sets. Near Wright Field, in snow, a blunker-equipped F-86 read Indianapolis Radio clearly, 200 miles away. A wing ship, using an unprotected set, couldn't make out Dayton, directly underneath.

This sort of howling success is typical of the results L and T scientists get when they really sink their teeth into a problem. Now, with precip static in hand, they're turning their energies loose on lightning. The blunker has small effect on lightning-produced static. Also, the lightning peril to aircraft is growing as fast as the jet age advances.

For one thing, modern high-speed aircraft get struck far more often than their smaller, slower ancestors. Higher operating altitudes are largely responsible. Lightning hits aircraft most often when the air temperature is 32 degrees or slightly higher. In summer, when most strikes occur, the freezing level stays high—at the flight altitudes of modern pressurized airliners.

Additionally, high-speed aircraft are making increasing use of plastic housings for electronic gear. Plastic, a poor conductor, often gets punctured by lightning, and vital search devices get put out of action. As protection, the Institute is experiment-

Three, two, one—fire! Scientists behind steel-and-glass enclosure watch flash of four million volts

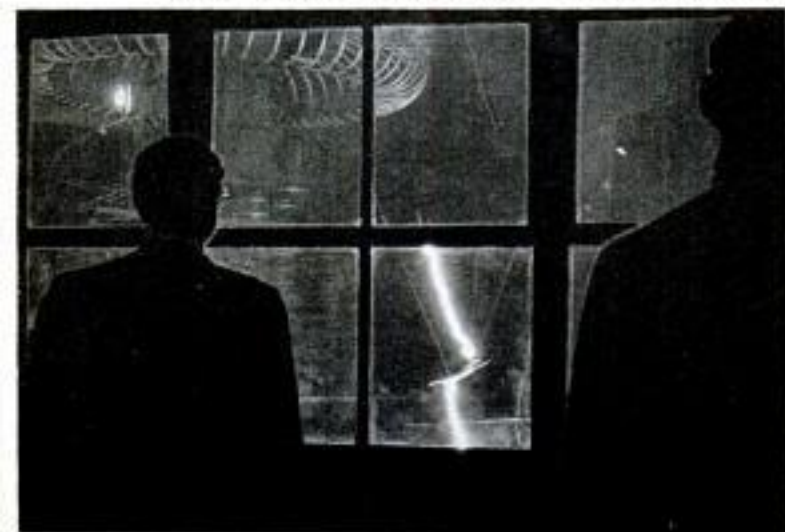

ing with conductive paints and metal grids that won't interfere with radar patterns, but will divert lightning harmlessly from the housing to the airframe.

Other stumblers command L and T attention, including the vital matter of safeguarding volatile new fuels and integral tank systems now being designed for military jets. The diverter-discharger is one answer, but it's insufficient. For one thing, how can you be sure lightning will strike just where you've placed the rod?

Before anyone can solve puzzlers like this, we need to know a great deal more about lightning—its generative process, mechanics and electronic characteristics. To this end, L and T scientists are firing manmade charges approaching four million volts at aircraft parts in the lab. And they've launched a survey calling for all airline pilots to report in detail all lightning hits on airplanes.

#### Boat Will Chase Storms

For more intensive study, they've purchased and equipped history's first "lightning ship," the bronze-hulled, three-masted schooner, *Azara*. On Lake Superior, the *Azara* will chase thunderstorms. Her crew will fire conductors into the air with rockets, and study the natural strokes thus invited. During fair weather, they'll manufacture their own lightning with the ship's lightning generators.



Researcher makes adjustment on electronic blander, which virtually eliminates aircraft radio static

There's small danger in this, Morris Newman contends, and there are vital advantages. Lightning traps, such as the one the Institute maintains atop 447-foot Foshay Tower in Minneapolis, don't get struck often enough. And, with the *Azara*, natural static can be studied far from man-made interference.

With such ambitious aims, the Institute, already considered the world's top authority on flight electrical hazards, stands to make a monumental contribution to aviation safety. And its efforts are materially strengthening our air defenses, now sorely hindered by bad weather. Weatherproof radio and electronic gear could save our bacon, should enemy A-bombers attack during darkness and storm. ★ ★ ★

## Evinrude Announces Its Version of the V4 Outboard



Highlight of Evinrude's line of outboard motors for 1958 is a new V4. Information on the new motor arrived too late to be incorporated into the article on the V4 on page 140 of this issue. Basically the Evinrude and Johnson V4s are the same 50-horsepower motor, with different shrouds and certain other styling differences. Evinrude has two models of the new motor. The Starflite is the deluxe model with electric starting and the finest of styling features. The Four-Fifty is the standard rope-start version of the same motor. This is the first time Evinrude has brought out a production motor of more than 35 horsepower. There are 12 motors in the complete Evinrude line for 1958. The biggest change is in the Lark, the deluxe 35-horsepower motor. The same principle of noise suppression developed for the V4s has been adapted to the Lark. Old-time boosters of the Evinrude line will note one other change: A deep, rich blue is the predominant color of the '58 motors, replacing the paler blue that has been virtually a trademark of Evinrude for many years.

### Manmade Flames Rival Sun's Heat

Scientists now burn chemicals, such as ozone, hydrogen, cyanogen and other gases, to produce flames almost as hot as those on the sun's surface. These lab-made flames are being used to test ceramics and other high-temperature materials.

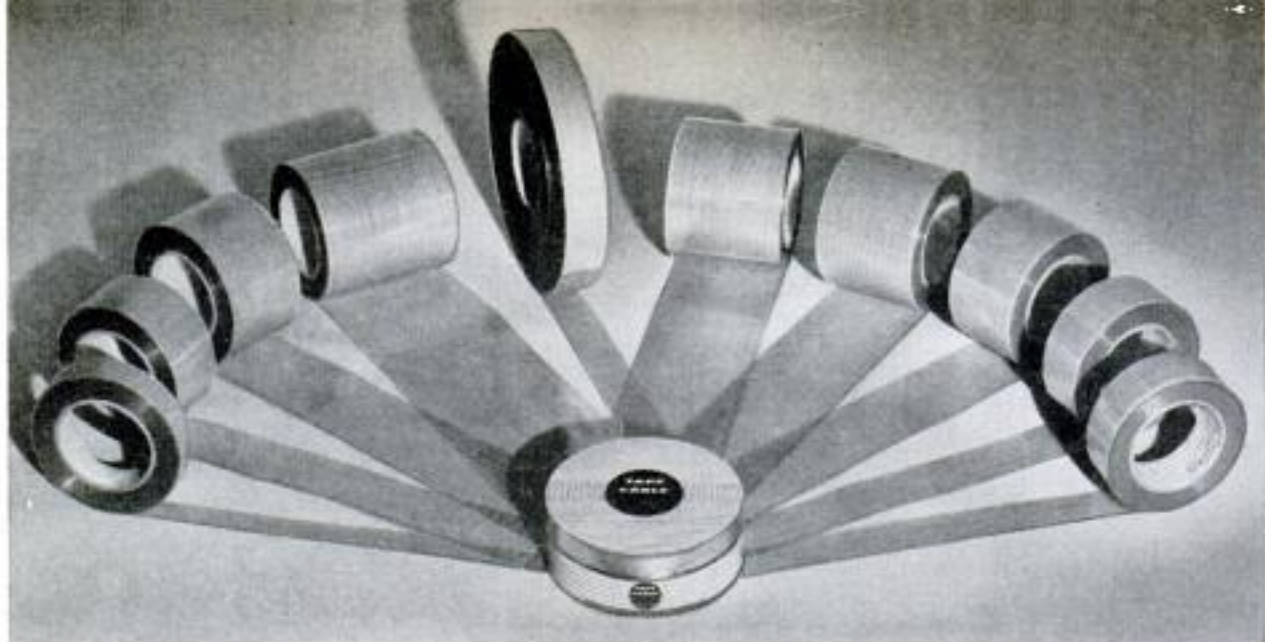

Like rolls of ribbon, newly developed electrical cable in plastic insulation comes in a variety of sizes

## Low-Current Electrical Cable in Tape Form Invented

HAIR-THIN electrical cable in flat ribbon-like rolls has been developed for use in industry and research. Called Tape Cable, it is designed for equipment containing large quantities of low-current cables and wires, and where weight and space are important factors. This includes airplanes, missiles, telephone equipment, electronic computers and other electronic and automation devices.

The cable, only .0015 inch thick, is embedded in a transparent-plastic insulation. It saves up to 85 percent in the use of copper compared to conventional cable with round conductors. It is made in nine sizes, with cables numbering from 9 to 50, in rolls up to 1000 feet long.

Tape Cable is flexible and is said to have high tensile strength, resistance to heat and chemicals and to have a low inter-conductor capacitance. It can be cut with scissors or in an automatic-dispenser machine.

The insulation can be removed from all or part of the cables anywhere on the tape using a special stripping device. The manufacturer reports splices are easy to make, hand soldering is fast and with dip soldering all the connections can be made in one time-saving operation.

The inventor of the new product is William Richter, president of the Tape Cable Corporation, Rochester, N. Y.

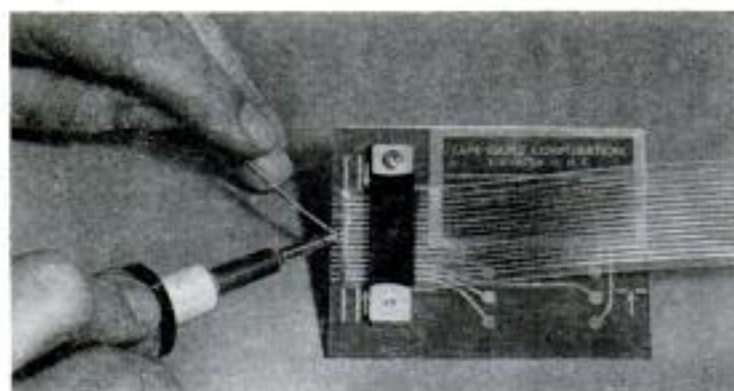

Hand soldering of electrical cable, above, is fast and easy. In dip soldering, all connections are made in one operation

Used with printed wiring, tape's tensile strength is 80 pounds per inch of width—more than in the soldered connections

Simultaneous joining of cables to connectors saves time, eliminates color coding

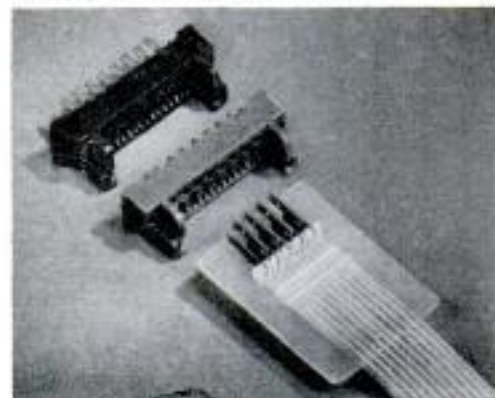
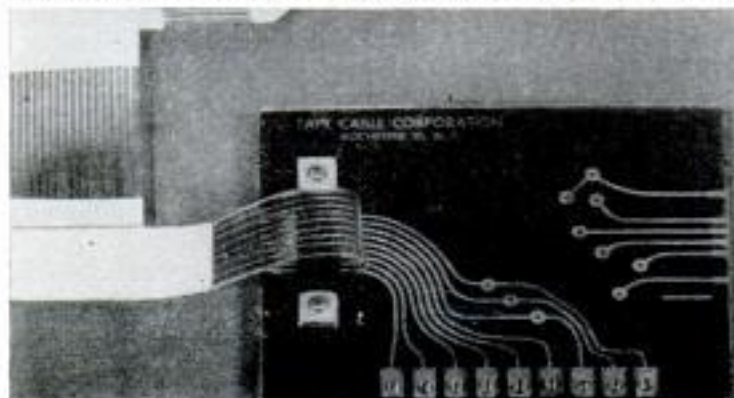

**FORD DENIES IT**—and it does sound almost too fantastic to be true. But there are several 1958 Fords (that's right, 1958) driving 'round the world right now.

For the first time in history, natives in the dark jungles of Burma are seeing a new-model American car before natives of civilized Dearborn, Mich.

The highly secret promotional stunt (known as Project X) will be disclosed with suitable fanfare at the 1958-Ford announcement early in November.

Incidentally, these Fords are having troubles—not mechanical, though. Bangle-fancying natives are prying loose hub caps, trim parts and other miscellaneous pieces to save as family heirlooms. They are keeping the factory busy shipping handmade replacements to remote parts of the world.

This 'round-the-world stunt (and it may be in 80 days, like the movie) is indicative of what the industry will do now that it can't talk about speed, horsepower and performance. Reliability and comfort will be the big sales pitches—plus styling, of course. Who knows, maybe even economy will get a mention?

Just because you can't talk about power doesn't mean you can't make engines more powerful. But, engineers claim, they are more economical, too. Bigger displacements, they argue, allow use of economy rear-axle ratios. The result: Better gas mileage. We await proof, however.

#### Give 'em Air

Air suspension may be common even faster than the optimists predicted. At extra cost, of course. But after all, the automatic transmission costs extra and it's virtually standard today. Experts predict 20 percent of one low-price car will be air-suspended in 1958.

The air system is expected to cost at least \$200 extra, perhaps more. Is it worth it? In a rough-and-tough "blindfold test" of a 1958 air-suspension car and an identical 1958 steel-suspension car, this reporter had to concentrate long and hard to pick out the air ride. If it is that difficult to detect the difference, air suspension may be tough to sell after the gotta-get-the-latest sales are over.

Under normal operating conditions with partial loads and on a good highway or a city street, even engineers admit they can't easily tell the difference.

But air's side advantages may make it worth the premium price. Biggest of these is its constant-height feature. Regardless of load, the car remains level and at a constant height. Bottoming is impossible, even fully loaded. Headlights aim correctly at all times. Driveway scrape is gone.

On long trips, fatigue is noticeably less,

# Detroit Listening Post



By Art Railton

advocates say. The ride differences on good roads are subtle, but the human body relaxes more and is less tired after a long day's drive atop air bags. In a 10-mile test drive, you may not notice much difference, but on a long trip you will, engineers say.

Incidentally, conventional shock absorbers will be obsolete when air suspension is fully developed. With four separate shocks eliminated, cost should come down fast.

#### Double-Duty Headlamps

Presently the industry is talking about adding another filament to the high-beam lamps of four-headlight systems for use as turn indicators. Such an addition would eliminate separate high-intensity turn-signal bulbs in the front of the car. It might even be possible to add a park-light filament and further simplify the stylist's job by getting rid of the fussy small lights that "mess up" front-end designs.

Pontiac did it last year and now it's Buick's turn. The old "trademarks" (port-holes) are gone. The three and four-holers, with all their social connotations, are no more.

In the past (recently, too) cars retained certain visible trademarks to maintain identity despite annual style changes. Packard had its arched radiator shell, Pontiac its chrome streaks, Cadillac its up-turned tail, Ford its taillights and so on. But all of these have gone.

Then along comes Edsel with its vertical grille which seems to be a similar trademark. It remains to be seen if the grille will continue through the years.

At last somebody's admitted it—you can't sit comfortably on a drive shaft. The 1958 Thunderbird has four separate seats, two in front and two in back. The drive-shaft hump is styled into a neat console that contains various push buttons and controls. There's no way to seat three in the front. It will not endear T-Birds to young lovers, but the family man will like it more. This could change the whole concept of the car. ★ ★ ★



Mobile carrier holds 1900-pound rocket in its "cradle," which is attached to polyethylene balloon ready for 100,000-foot trip

## Rocket Platform in the Sky

**CARRIED BY BALLOON** 100,000 feet above the earth, a rocket is to be launched and travel several thousand miles high at a top speed of 17,000 miles per hour. The fourth stage of the rocket will contain complex instruments that will transmit atmospheric information back to earth. Ten solid-propellant rockets will provide 26 seconds of flight, and the last stage will continue into space as a free projectile until it falls back to earth. The balloon is said to be larger than any previously launched, and it is the first time one will be used as a high-altitude rocket platform. The project is sponsored by the Air Force through a contract with Aeronutronic Systems, Incorporated, Los Angeles, Calif.

Left, rocket fires through balloon, is expected to travel several thousand miles high at top speed of 17,000 miles per hour

Balloon is largest ever built, 200 feet in diameter with 3,750,000 cubic feet of helium. It is first air-platform firing attempt

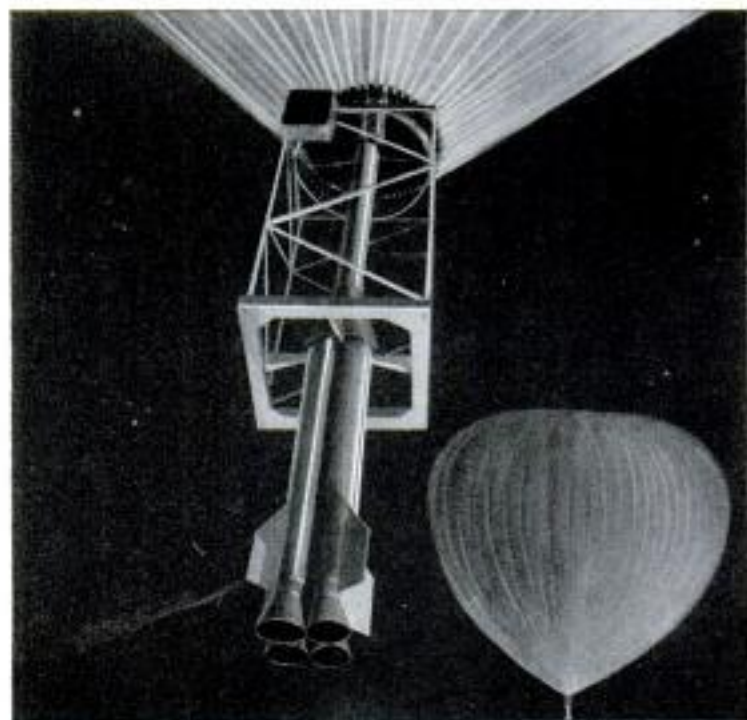



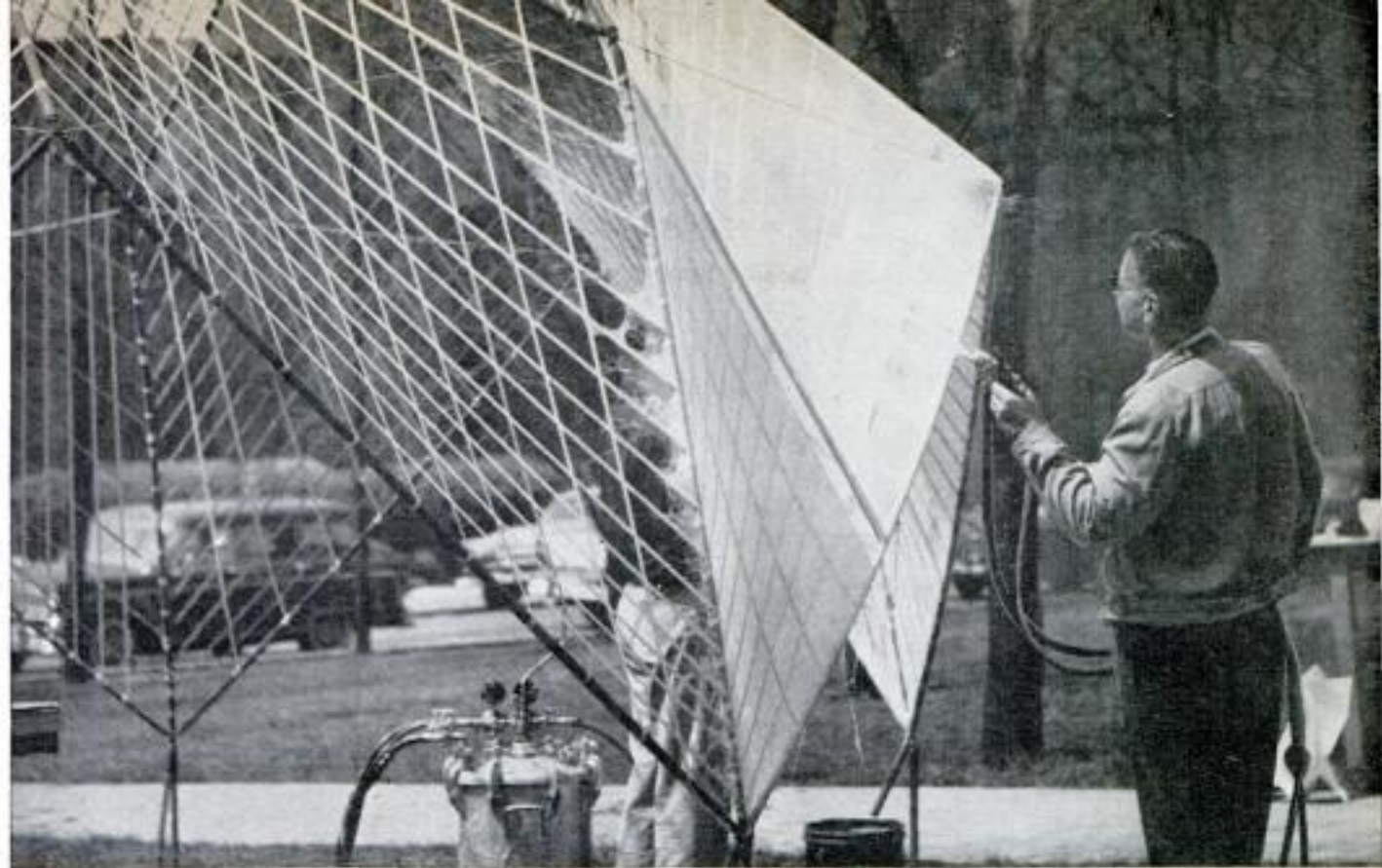

## Shelters of Sprayed Plastic May Be Houses of Future

HOME BUILDERS of the future may be able to erect a house in less than a day, using only steel tubing, cloth tape and a quick-drying plastic spray. The technique, developed to "mothball" ships, is being applied to housing by students at Illinois Institute of Technology. The cloth tape, meshed at six-inch intervals, is sprayed with vinyl fibers, as shown in the photograph at the top of the page. A second coat of vinyl, with white pigment added to keep the sun's rays from deteriorating the plastic, is then applied. As the vinyl hardens, it shrinks, making the structure prestressed.

Chairs and other furniture to match the house can be produced with the same techniques and material

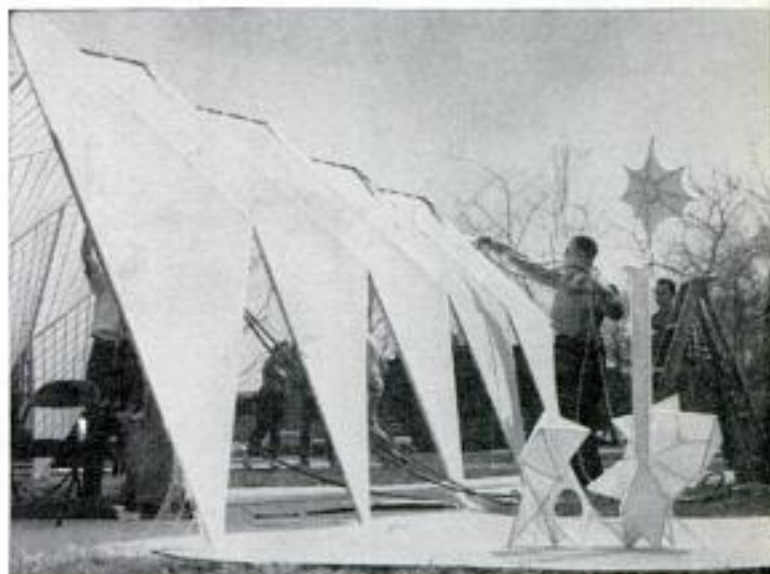

Objects in foreground, above, indicate versatility of plastic spray first used to mothball Navy ships. Finishing touches are applied, below, to a vinyl shelter completed by students in about 15 hours

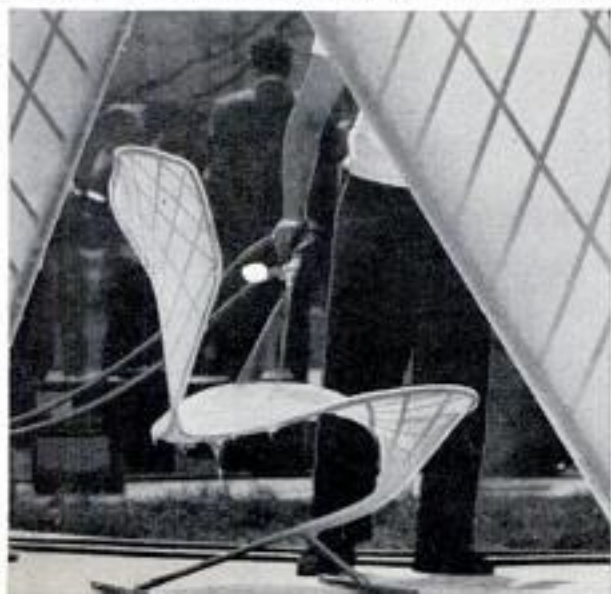

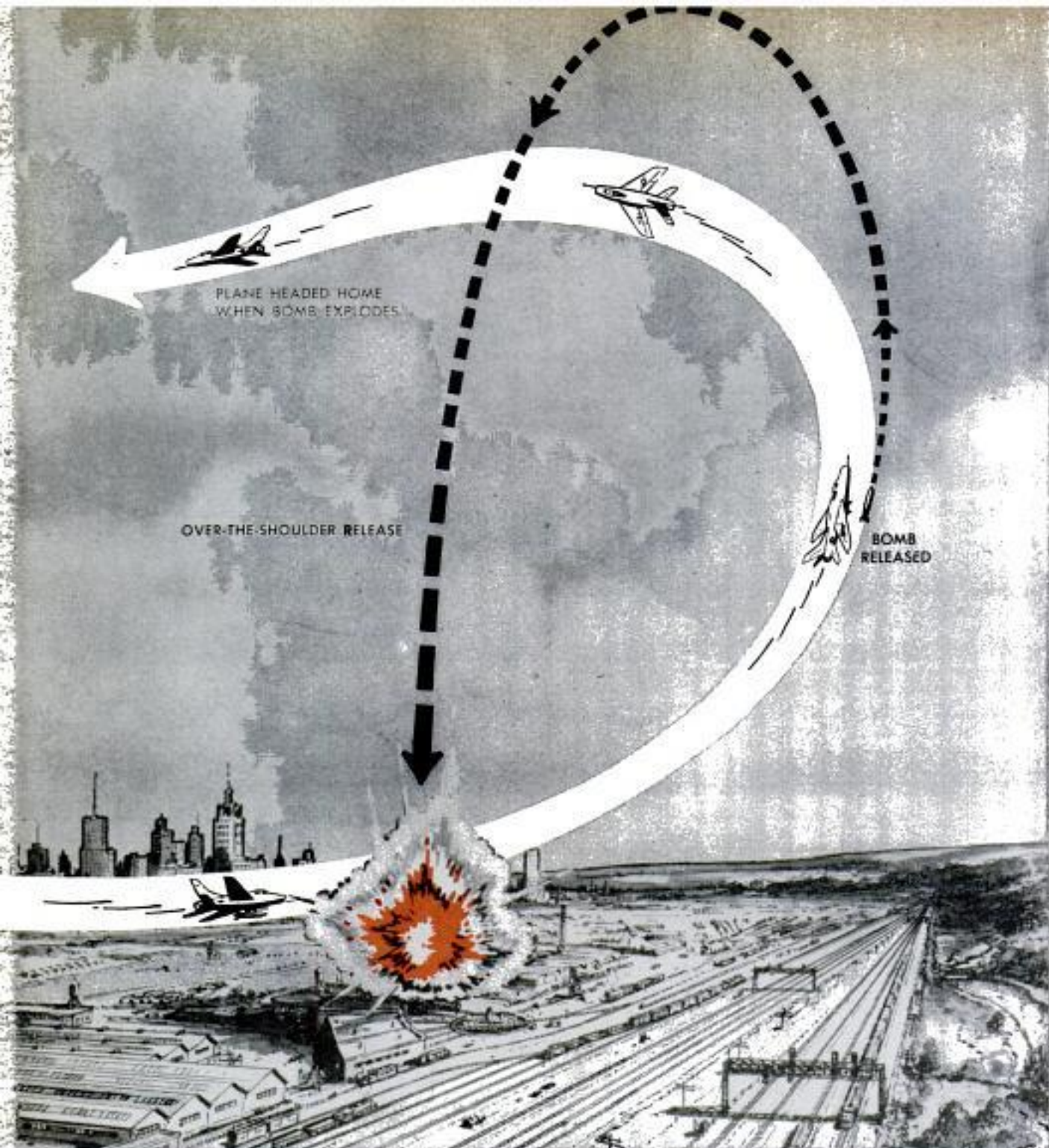

Prompted by electronic device, pilot swings up, releases bomb "over his shoulder," then rolls out and is homeward bound at a safe distance at moment of explosion. Low-altitude approach fools radar defense

*Here is the inside story of a U. S. Air Force "first"—the electronic brain that made possible our*

## **Over-the-Shoulder Bombing**

*By Delmer J. Trester, Ph.D.*

**THE AUTHOR:** Doctor Trester is chief of the Historical Division at the Air Force Special Weapons Center, Albuquerque, N. Mex. A Ph.D. graduate of Ohio State University, he has been an Air Force historian since 1951. He gathered information for this article from a report he wrote, "Atomic Weapon Delivery Developments for Fighter Aircraft."

**H**ERE'S A GLIMPSE of a future war right after hostilities had gotten under way. A U. S. Air Force F-100 Super Sabre fighter-bomber, loaded with an A-bomb, took off and winged its way toward enemy territory. Target: An enemy airfield.

Soon the F-100 pilot spotted a tanker aircraft lazily orbiting over a position previously selected for the refueling rendezvous. The pilots of the two aircraft identified themselves to each other, made the refueling connection, and soon the fighter-bomber pilot disconnected from the tanker.

Changing direction slightly, the fighter-bomber soon dropped to a low altitude and skimmed over the waves to evade detection by enemy coastal radar installations. Suddenly and swiftly he passed the coast and hedgehopped over the enemy countryside, carefully noting his navigation landmarks. Getting closer to the target area, he checked several gadgets on the instrument panel. This was his first low-altitude delivery of a "live" atomic bomb, although he had flown many such missions with dummy atomic weapons.

A last-second check of his position indicated he was on course. Then he began his bombing run. He crossed a railroad track and bridge network and pushed a button which set into action the low-altitude bombing computer and turned on an instrument-panel light. The F-100, still flying at only a few hundred feet altitude, made a beeline directly toward the airfield until a predetermined time had elapsed. Then the signal light went out and the pilot pulled his aircraft up into a tight Immelmann maneuver: A half loop with a roll-out at the top. During the pull-up, the bomb was released at a preset angle and was tossed in a high arc toward the target.

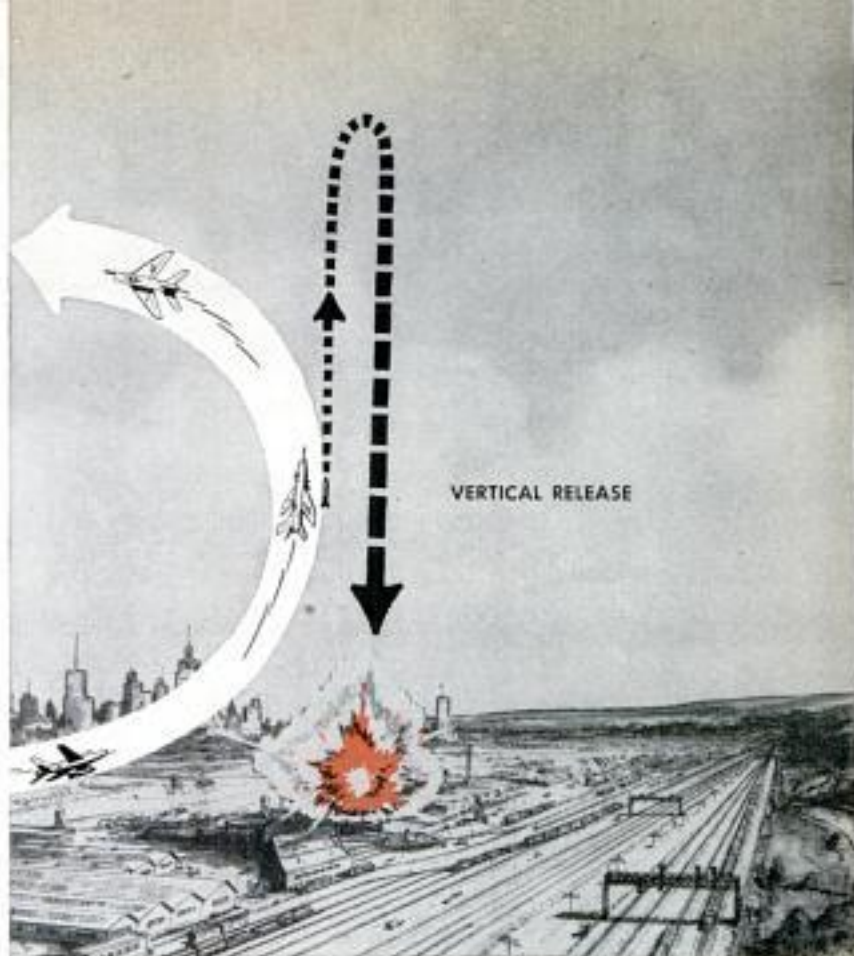

In this maneuver pilot releases bomb vertically over target

The pilot continued his maneuver and when the bomb exploded he was rapidly leaving the target area in the same direction from which he came.

The bomb detonated a few hundred feet over the airfield with a force equal to that which had unleashed such great destruction on Hiroshima and Nagasaki. The airfield's hangars, runways and aircraft were completely destroyed. The F-100 retraced its path and soon was back at its home base, ready to carry out another mission.

Such was a hypothetical retaliatory attack against a hypothetical enemy. But in 1957 the public's concept of the delivery of atomic weapons usually brings to mind

A third method calls for low-angle lob of the bomb as pilot swings up short of his target, turns homeward

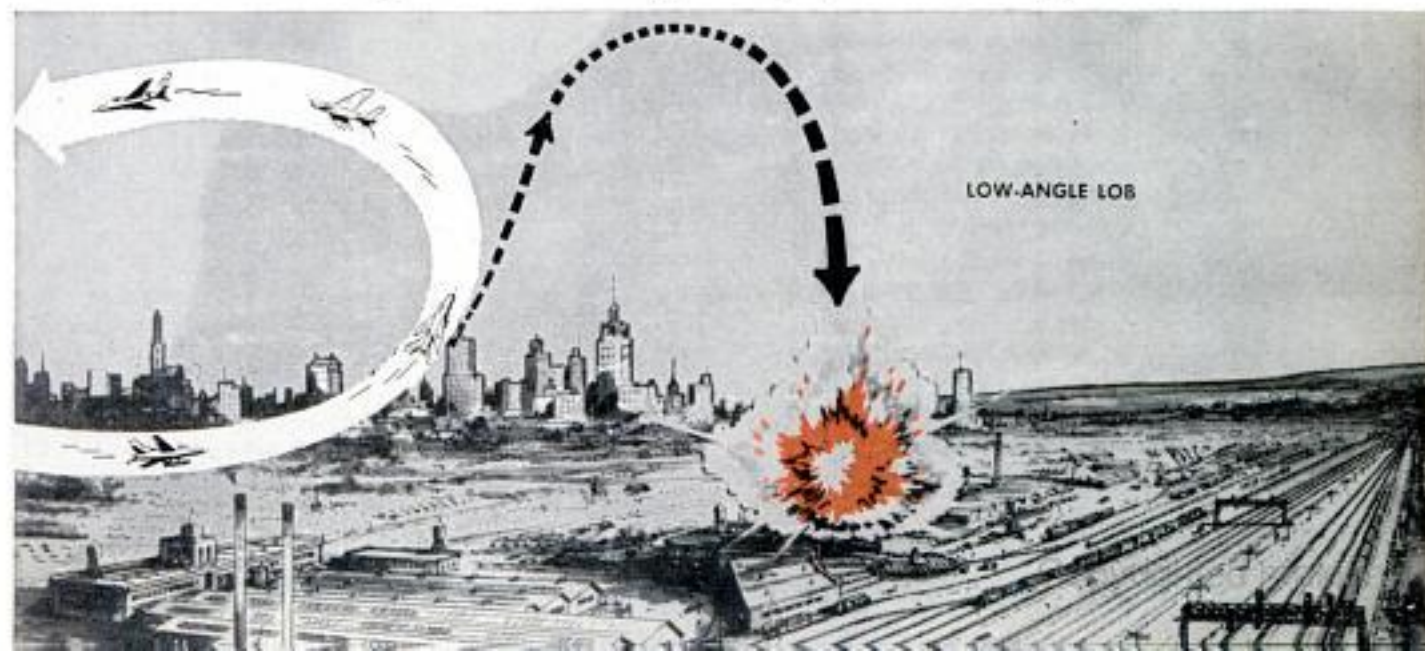

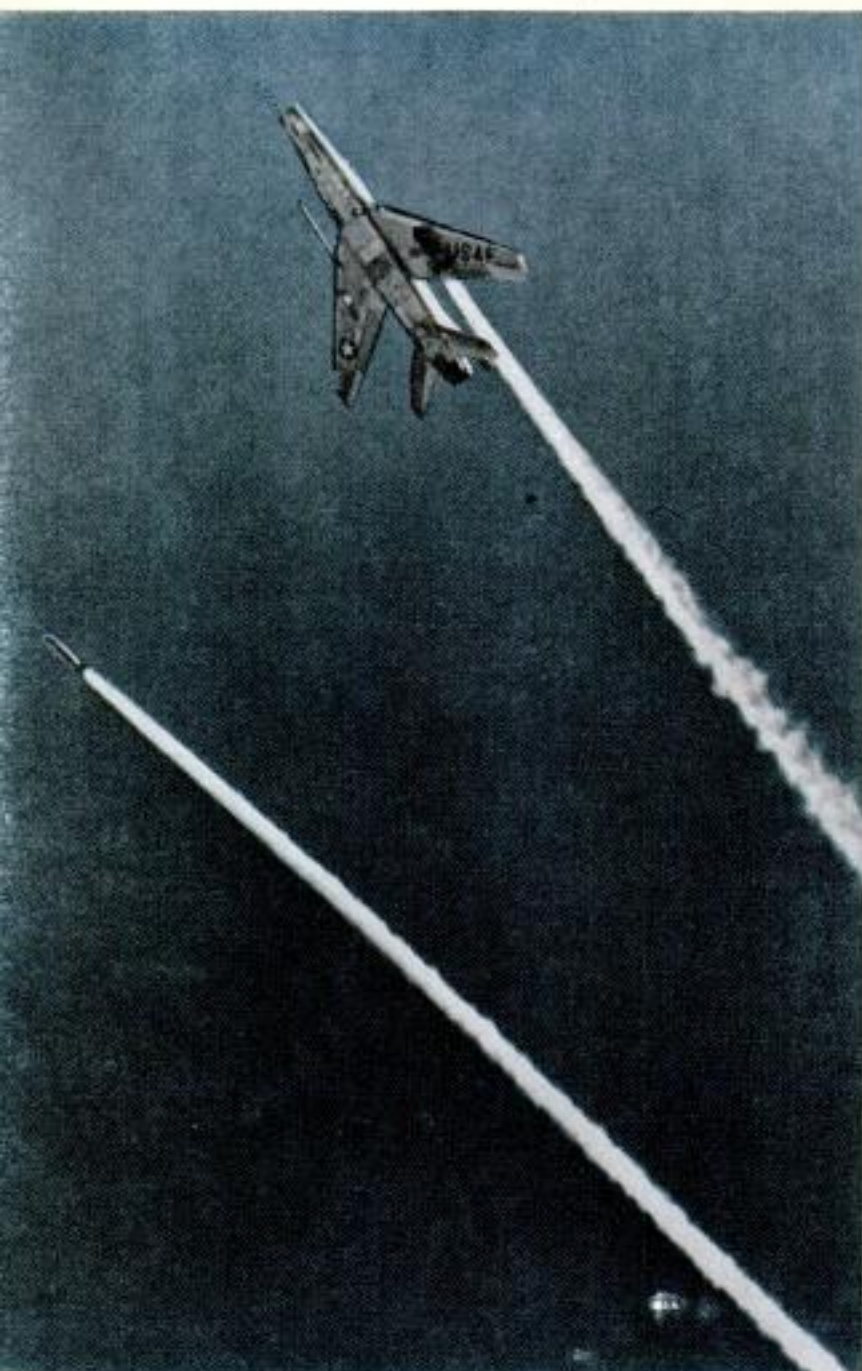

Super Sabre jet demonstrates a bomb toss. The bomb is just beginning its low arc toward target as pilot prepares to pull away

a large bomber, of the B-36, B-47 or B-52 variety, which can drop a high-yield atomic or thermonuclear bomb from an extremely high altitude. Although the Air Force has released information stating that fighter-bombers can carry and deliver A-bombs, that information has neither indicated the extreme importance of this capability nor the revolutionary nature of the delivery methods which the Air Force now has.

The existence of tactical aircraft capable of delivering A-bombs has been and is of overwhelming importance to the protection of Western Europe, the United States' prime military commitment. Should a future enemy prove to be Russia, the Air

Force fighter-bombers can provide a knockout blow to immobilize Soviet air bases and possibly cripple Russian airpower—one of the biggest headaches for the western powers' commander. Destruction of enemy communications and isolation of the battle-field area ranks as the second most important tactical task.

Back in the summer of 1953, Gen. Alfred M. Gruenther, chief of staff for the Allied armies, testified to the key role of fighter-bombers and atomic weapons in the defense of Western Europe. He told the Senate Foreign Relations Committee that the North Atlantic Treaty Organization expected to use its ground forces solely to squeeze enemy troops into concentrated areas, so that they would become suitable tactical atomic-bomb targets.

Fighter-bomber aircraft, such as the F-84, F-86 and F-100 enjoy certain operational advantages over heavy bombers which make them particularly well-suited for tactical bombing raids and which even allow them to reach targets normally limited to the strategic heavy bombers. Fighter-bombers can operate more easily and quickly from short runways and emergency-runway installations. It is easier for fighter-bombers to navigate at low altitudes for penetration of enemy outer defenses and radar installations. And, of course, such aircraft have greater maneuverability and can attain higher speeds than present bomber aircraft. Thus they would be able to take evasive action either in their approach to the target or on the trip back to their home base.

In the past, one of the great shortcomings of fighter-bomber strikes was limited range. But the development of in-flight refueling techniques has erased even this restriction and theoretically allows the fighter-bomber pilot to replenish his fuel tanks so he can equal the range of the heavy bomber.

The conventional method of tactical delivery—before World War II—was the dive-bomb maneuver. It's not certain who was the first pilot to employ the dive-bombing technique, but one of the earliest on record was Leonard W. Bonney, an American aviator who participated in the Mexican Revolution during the years 1913 to 1915. Using spherical dynamite bombs of



In addition to this F-100, the F-84, B-47 and B-57 have all demonstrated ability to toss bombs in various maneuvers. The B-47, however, cannot perform a complete loop without risking the loss of its wings

Mexican design, Bonney carried out his dive-bombing exploits with a Moisant plane in and around Mexico City, Yucatan and Tampico.

Although not used extensively during World War I, many dive-bombing missions were conducted by England, France and the United States. Brig. Gen. "Billy" Mitchell became very familiar with the tactic, understood its implications in warfare and predicted that great strides would be made in dive-bombing.

In the summer of 1921 during joint Army-Navy bombing tests off the Virginia Capes, captured German naval vessels, including the battleship *Ostfriesland*, were sunk to prove the potentialities of air power. However, the maneuver which the pilots employed could probably be more accurately termed glide-bombing than dive-bombing.

The true dive-bombing technique received added emphasis in 1924 and 1925 at Kelly Field, Tex., where Army pilots experimented with the technique in dive angles up to 60 degrees. Subsequent to 1925, both Navy and Marine pilots gave many exhibitions of dive-bombing. Some aviation experts thought one such exhibition at the Cleveland, Ohio, air races inspired Maj. Ernst Udet of the German Air Force to further refine and perfect the operation for the famous Stuka (JU-87) aircraft. This dive bomber received its baptism of fire in the Spanish Civil War when the insurgent forces used it to great advantage in 1938 during their drive to the Mediterranean coast and during the Catalonian offensive. During World War II, the Stuka's tactical operations were extensive and effective, contributing in large measure to early German victories.

Meanwhile, the United States Navy, in the 1927-1928 period, came out with the original Curtiss Helldiver, the first American aircraft specifically designed for dive-bombing. During World War II, of course, the Army Air Forces, the Navy and the Marine Corps used many types of air-

craft in their widespread dive-bombing operations.

In general, such a bombing technique was fairly accurate. But to be accurate, the bomb drop had to be made at low altitude while the aircraft was still in its dive. In the standard dive, the pilot used sights having a depressed sight line, and in tracking the target with such an instrument he had to fly a path which eventually became tangent to the bomb trajectory. The ever-steepening dive caused the pilot difficulty in tracking the target. Modern high-speed aircraft reached a point in the dive where lift forces were at a minimum and the aircraft did not easily respond to its controls. This condition meant a lengthy recovery and a sluggish escape maneuver which served to inflict on the pilot a serious physical as well as psychological hazard. The advent of atomic weapons, moreover, imposed the additional danger of weapon effects.

There was an even greater limitation to dive-bombing which meant serious operational restraints. Close examination of atmospheric and weather conditions surrounding Iron Curtain cities in Germany revealed the alarming fact that there was a three-tenths cloud cover at 6000 feet for 60 percent of the year. An Air Force study showed that a minimum cloud ceiling of 15,000 feet was needed to deliver an atomic bomb of nominal yield and allow the pilot to escape safely.

The obvious answer to this tactical dilemma was the development of a bombing system for fighter-bomber aircraft which would function at extremely low altitudes while providing surety of pilot and aircraft survival.

An urgent requirement was sent to the Air Research and Development Command headquarters at Baltimore, Md. This extremely important segment of the Air Force has as one of its missions the development of new and improved devices and systems for the conduct and support

(Continued to page 298)

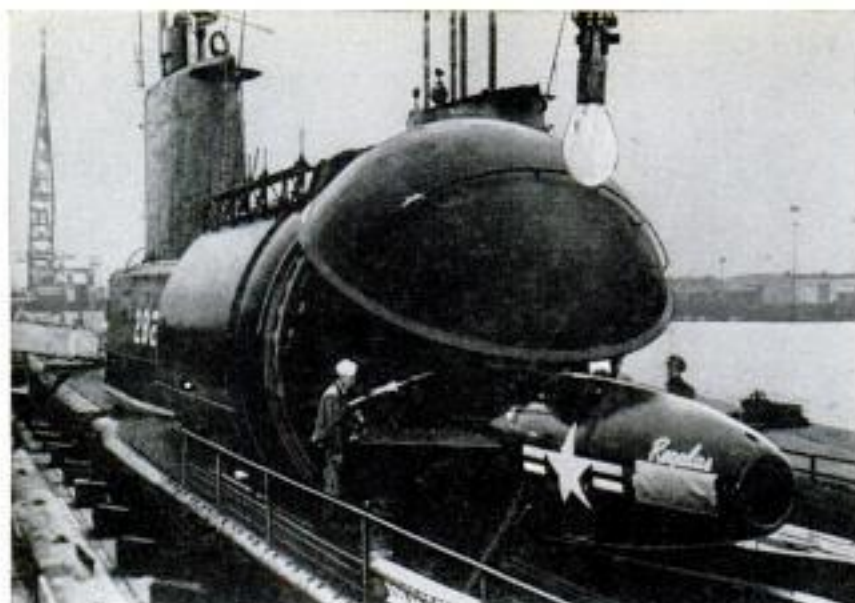

## Sub's Missile Stored in Tank

Safe and dry until needed, the Navy's surface-to-surface guided missile, Regulus, is stored in a huge capsule, shown at left mounted on the aft deck of the submarine, USS *Tunny*.

## Broadside Jolts Ship

Recoil of a full broadside fired by a battleship will push the ship over about two feet.

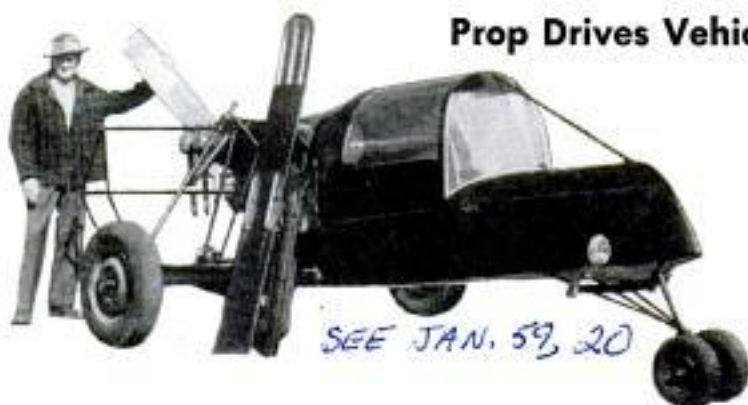

## Prop Drives Vehicle 100 Miles Per Hour on Ice

Powered by a 65-horsepower airplane engine, the vehicle in the photograph, left, travels almost anywhere. The builder, Maynard L. Popp of Okauchee, Wis., claims it can move at 100 miles per hour on ice, a bit less on land or water. Runners are attached for snow and ice travel and pontoons for water. Lack of proper brakes keeps it off the highways.

## Motorboat Is Its Own Trailer With Built-in Retractable Wheels



With built-in, retractable wheels your motorboat will be its own trailer. Singlehandedly, you can push the boat-and-trailer unit into the water, then hop into the craft's front seat and operate hydraulic controls to raise the wheels and float the boat. When you're ready to go home, just drive the boat onto a ramp or beach and, using the same controls, lower the wheels for locking into the trailer position. Connect the special hitch between the boat and your car, and drive away. Built for 14 to 16-foot craft, this trailer system consists of pneumatic-tired wheels mounted on a retractable frame and axle. When retracted, the wheels serve as fenders or floats.



VW fanatics may not like it, but the new model has a flat gas pedal, replacing the bug's unique roller

# Volkswagen Gets More Glass



Dotted oval is the old window shape. New rear glass is 45 percent larger. License "pocket" is reshaped

WHO SAYS some things, like the Volkswagen, never change? The new VW is different, although to the nonenthusiast it still looks like the same little bug.

Major change is an enlarged rear window. Its area is 45 percent greater, most of it being in width. (It is interesting to recall that in the *Popular Mechanics Owners Report* on the VW the most frequent complaint was limited rear vision.)

Also larger, although by only eight percent, is the windshield, a result of narrowing the front pillars considerably.

Other changes: An organ-type accelerator pedal (replacing a roller-type pedal that many women found awkward to use), more widely separated brake and clutch pedals, faster wipers and a redesigned dashboard with a much larger glove box.

What about the engine? It is unchanged except for a slightly different air cleaner.

Windshield is larger, too. Wipers are relocated and wipe a greater area. Blade speed is 50 percent faster



Completely new is the dashboard. Radio speaker mounts behind grille to the left of unchanged speedometer

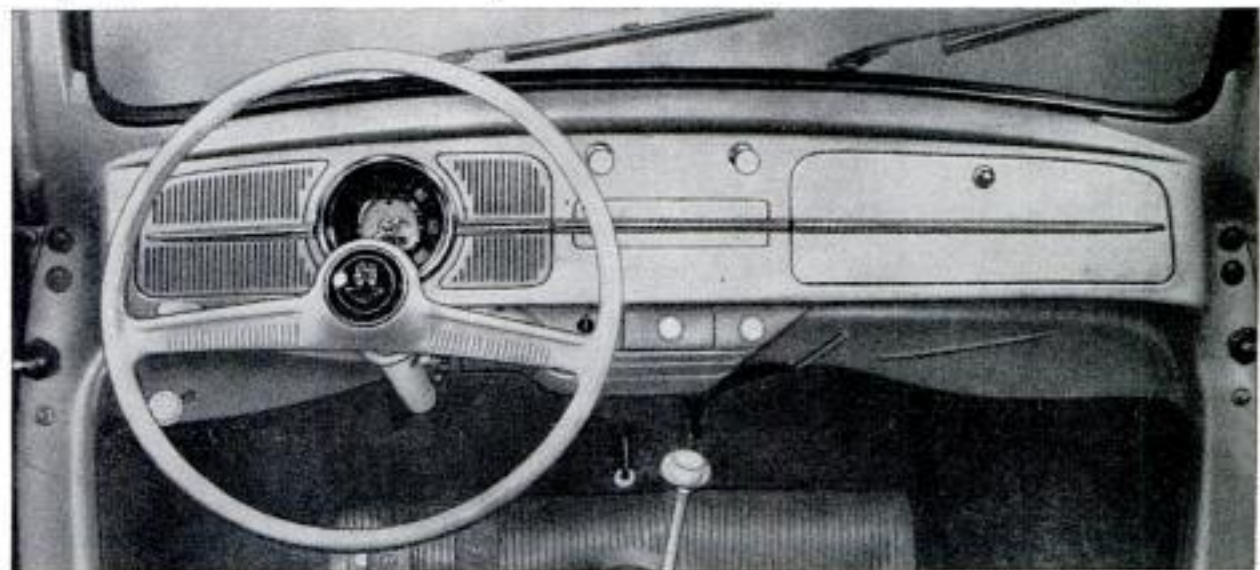

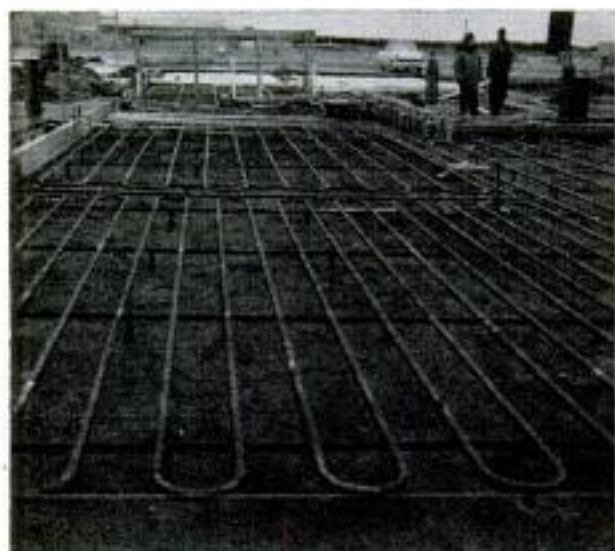

## Steam-Heated Runway Melts 10 Feet of Snow

Looped patterns of steel piping in various designs (above), painted on concrete, show the result of a successful experiment to melt heavy snow from airport runways by steam heat. First, as shown in the photograph at left, different sizes of piping were installed at varying depths and spacings to find the best combination. The experiment was conducted by the American Hydrotherm Corp., and the U. S. Air Force at its Loring Base in Maine, where up to 10 feet of snow falls and the temperature is around 40 degrees below zero F. during an average winter.

## Automatic-Brake Device Stops Truck at Loading Dock

Cargo handler in the photograph, below left, prevents the truck from pinning him against the dock by pressing an arm attached to the rear of the vehicle. The pressure against the arm activates a switch,

sending current to a valve assembly that instantly applies the truck's brakes. Besides saving lives, the device prevents damage to docks and trucks by stopping the truck when the arms touch the dock.





## Copter Carrier For French Navy

Designed primarily as a training ship for French Navy cadets, the vessel shown as a model at right also will be France's first helicopter carrier. In peacetime, the 10,000-ton ship will carry 200 cadets and eight helicopters. In wartime, it can be converted quickly to accommodate 12 heavy copters as well as 700 "helitroopers" for convoy duty or amphibious invasions.



## Hydrofoils Lift Soviet Boat Hull Above Water at High Speeds

Russia recently announced development of its first "winged motor ship" which moves like a conventional boat at low speeds. But at speeds over 35 miles per hour, the wings, or hydrofoils, push the hull above the surface of the water. As a result, water resistance is reduced and less fuel is needed. The photograph above was taken during trial runs when the craft de-

veloped a speed of over 40 miles per hour. One man operates the boat from centralized controls. The Soviet boat is 88 feet long, has a beam of 14 feet and a 700 to 750-horsepower diesel engine. (Editor's note: This may be news to the Russians, but *Popular Mechanics* reported in July 1951 a "winged" boat with similar design and performance developed in Sweden.)



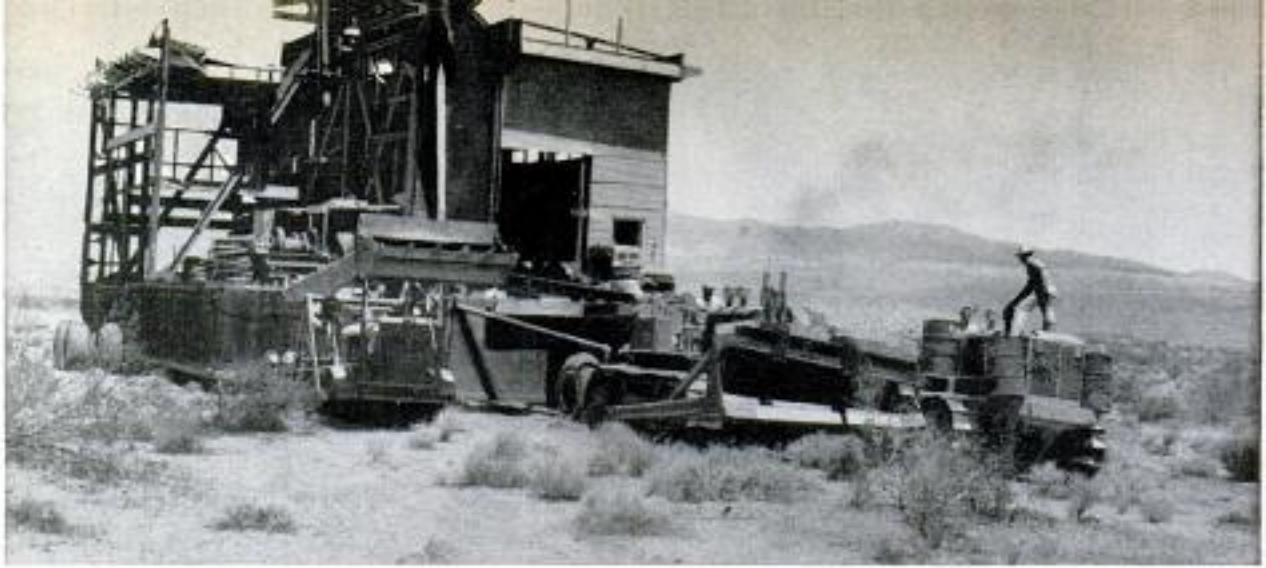

Tractors haul 400-ton dredge across the desert on B-17 wheels. Auto tires pave the way over soft sand



## Dredge Moves on B-17 Wheels

How would you move a 400-ton gold dredge across a range of desert hills from one valley to another? Mining engineer R. A. Naylor developed an ingenious method when contractors wanted a fortune for the 22-mile hauling job. He mounted the dredge on 10 war-surplus B-17 aircraft wheels and tires, then towed it behind three tractors. To avoid plowing the wheels into the ground, Naylor mounted two wheels on the front of the dredge and attached two pairs of wheels at each side. One wheel of each pair was placed six inches in front of its mate to serve as a "pathfinder." Each wheel had its own axle. Today the dredge is resting in its own pond near Red Mountain, Calif., and is mining tungsten ore from a buried placer deposit.

## Anticollision "Eyes" on Plane Warn Pilot of Approaching Craft



Infrared "eyes" have been developed to tell an aircraft pilot that another plane is approaching. The system includes one horizontal and two vertical scanners connected to a cockpit instrument. When the scanners detect infrared, or heat waves from the engines of a dangerously close airplane, an earphone buzz alerts the pilot and the instrument shows its location.

At left are infrared instruments that detect a nearby airplane and tell the pilot how to avoid collision. Drawing shows warning system's effective range

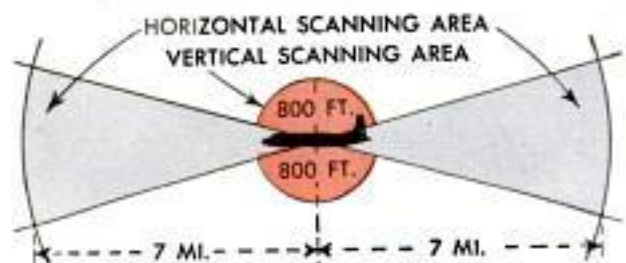

POPULAR MECHANICS

# OUR HOME AT THE BOTTOM OF THE WORLD

By E. H. Hubel

Utility Man's Chief, U. S. Navy

**O**UT ON ANTARCTICA'S 10,000-foot icecap, eight scientists and eight Navy Seabees are sitting out the bitter six-month Polar night—smack-dab on the South Pole. For nearly a thousand miles in every direction Polar storms drive granular snow across the white "desert" with stinging force. Temperatures read in the 120 degree-below-zero range. Shifting auroral draperies emblazon an onyx sky. The silence, when the wind is still, is the silence of outer space.

Until now, no living creature has dared face the rigors of winter night on the South Polar plateau—much less the high frigid region near the Pole, itself. The men living there, led by Dr. Paul A. Siple, senior scientist of our "Deepfreeze" expedition, are trained, hardened Polar experts comprising the United States' International Geophysical Year South Pole team. Their camp, which I helped to build last November and December, is a snug system of buildings and tunnels largely covered by

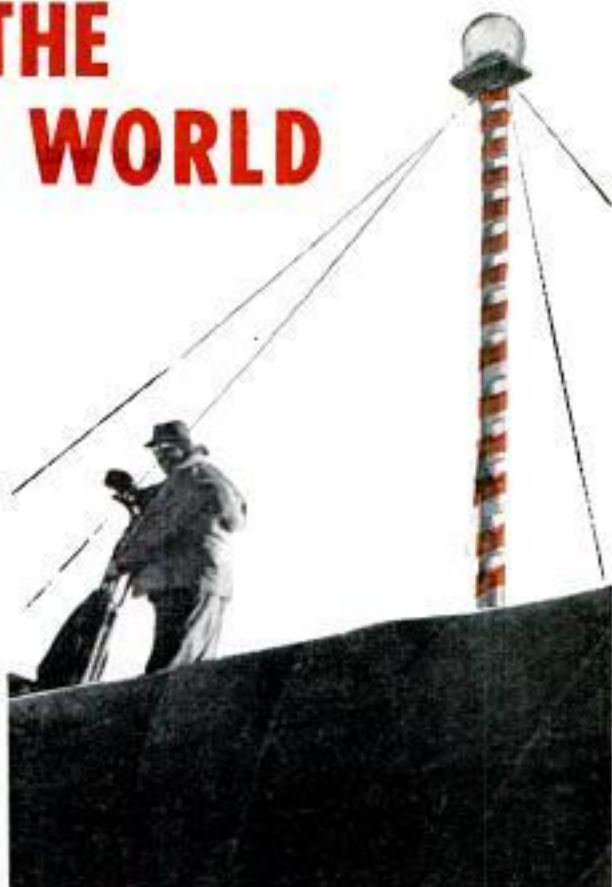

Red-and-white-striped shaft marks the location of the South Pole. Atop the pole is an inverted fish bowl. Big dome on stilts, below, houses radar for tracking weather balloons released twice daily

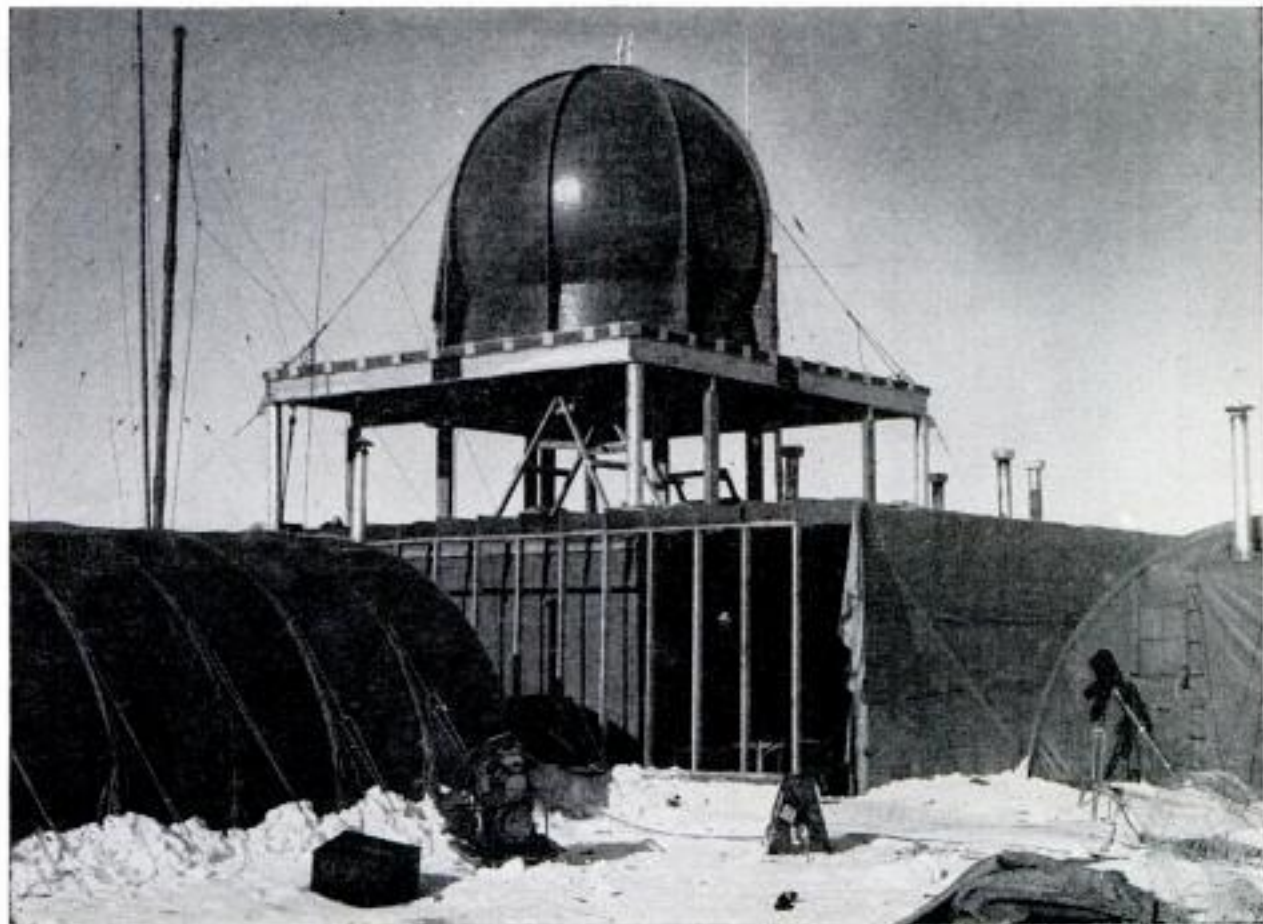

drifting snow. Inside temperatures are nearly as warm as your own home. Hot and cold running water (produced from blocks of snow), showers and recreation facilities provide comforts never heard of in that bleak ice wilderness.

Until Admiral George Dufek, Commander of Task Force 43, landed on the icecap, no one was sure that a base could be built on the South Pole. Five hundred tons of material including a 17-ton D2 tractor, a weasel, nine big prefabricated buildings, plus 10 tons of food and 15,000 gallons of fuel to last 16 men more than a year, had to be moved 700 miles up from sea level to the two-mile-high center of the continent. Hauling that amount of material up the heavily crevassed ice of the Great Beardmore Glacier—which provided a gateway ramp to the Polar plateau for old-time ex-

plorers like Scott and Shackleton—was out of the question. It was doubted, too, that heavy ski-planes could take off or land on the deep, soft drift up there. No one knew what to expect. Plans called for air-dropping everything—including men if it became necessary—from huge Air Force C-124 Globemasters.

As it developed, Antarctica's central crust was solid enough to support our ski-equipped R4Ds and P2Vs, and these became taxis for men and light materials, ferrying back and forth between the ice runway at McMurdo Sound and a smoothed-out strip of snow that we called "Ike's Pike" at our Pole base. It was tough going. Temperatures at the Pole, even during Antarctica's "summer" months of November and December ranged from 30 below to 8 above zero. Skis froze solidly to



Navy Seabee at left is working on portable heater used to warm one of the Jamesway huts in which party lives. Drawing shows South Pole "community"

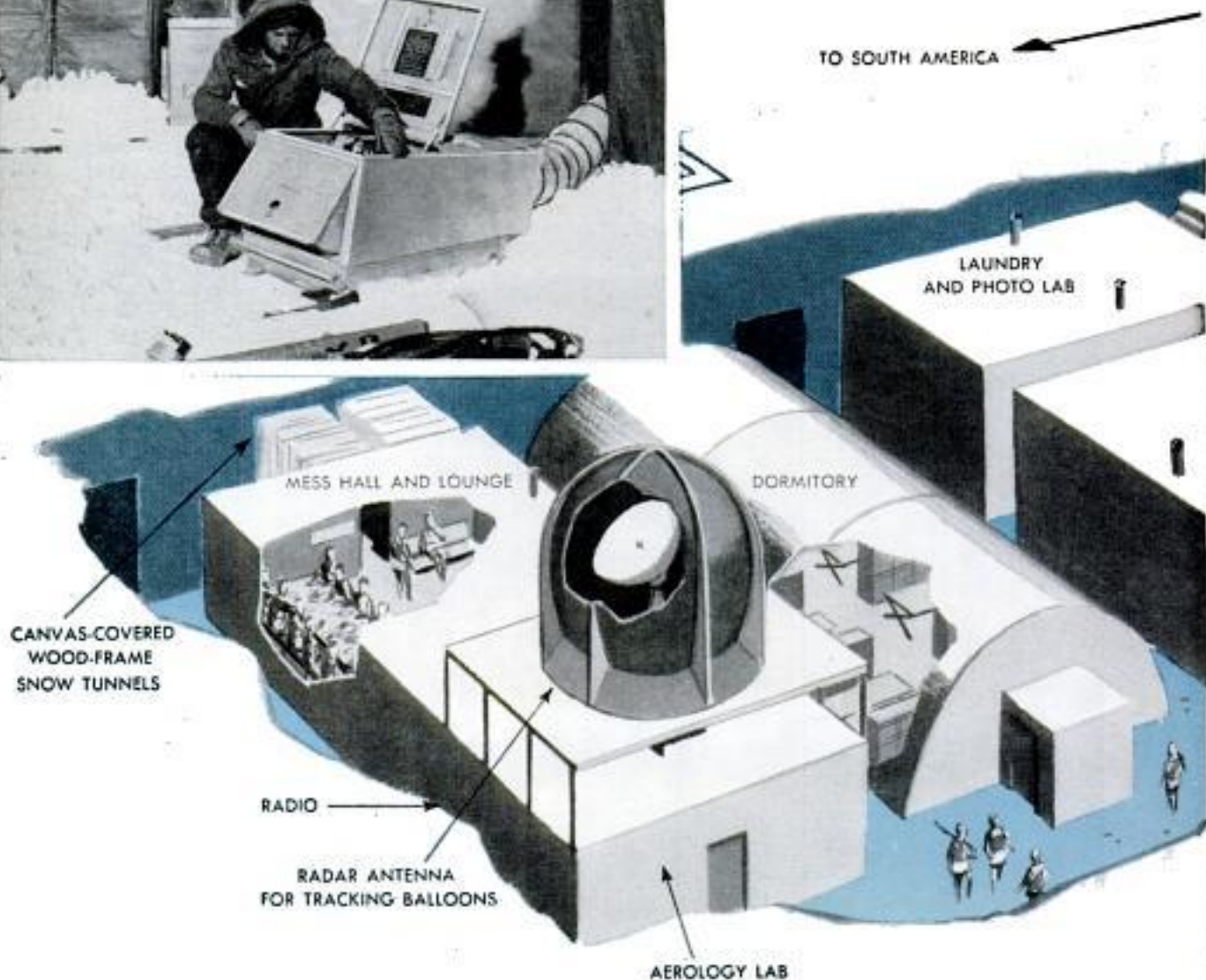

the surface when the planes sat still on it for a few minutes. Huge batteries of JATO bottles lashed to the fuselage were needed to blast them loose and up into the rarefied air. Weird Polar phenomena resulted from these take-offs. Long, white contrails of vapor streamed away behind the planes. These particles quickly froze into ice spicules, accumulating more vapor until, within five minutes after a take-off, billowing surface clouds would roll across the wastes, swallowing everything in a dense ice fog. In half an hour, the sky would be overcast from horizon to horizon, and a complete "whiteout" would have settled in—all from one plane. The sun, shining dimly through the blanket, gathered around it interlocking rings of refracted light, which Doctor Siple called "the five suns."



Navy radioman, above, works on the party's short-wave transmitter, their only link to outside world

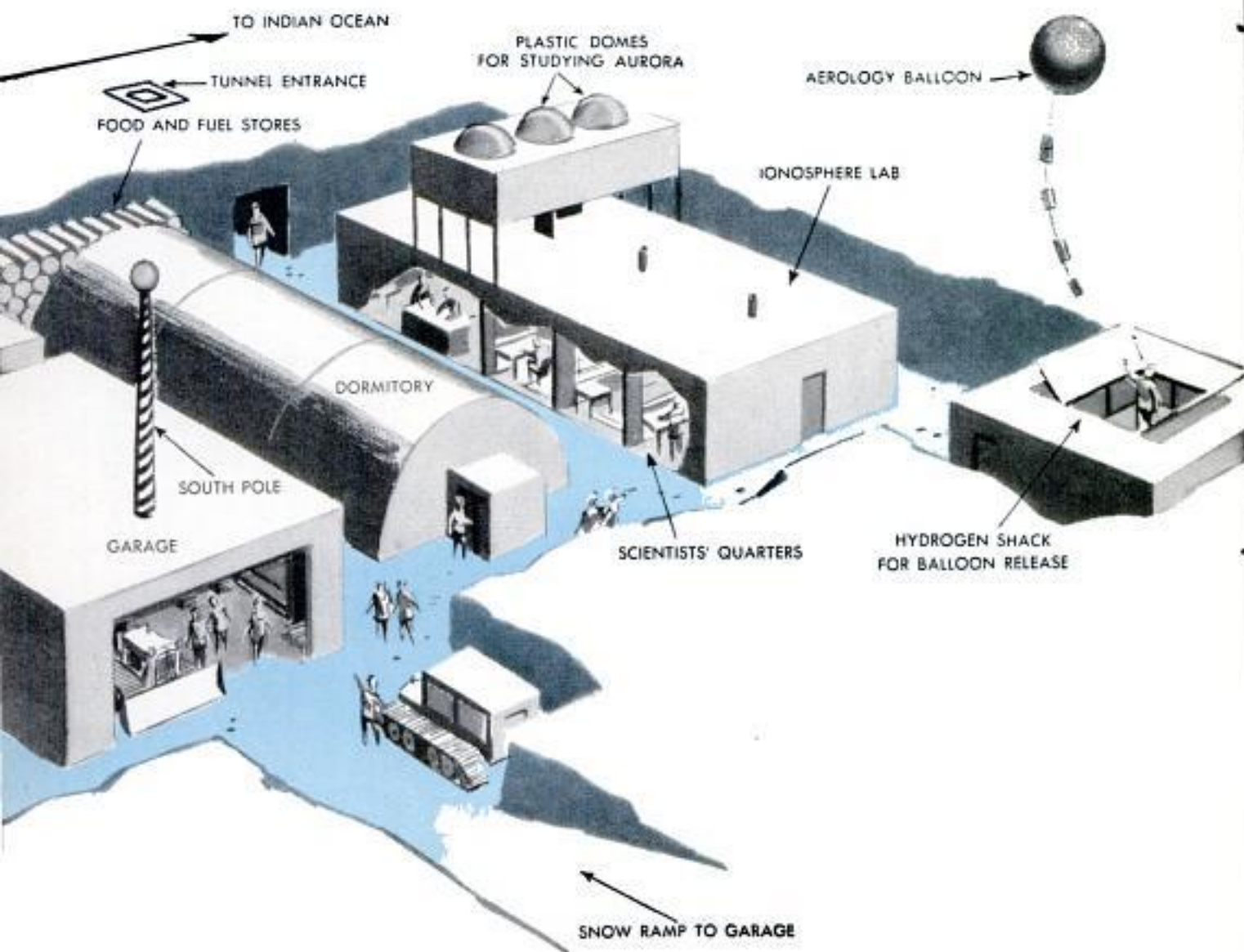



Supplies were flown to South Pole camp when glacier crevasses in these mountains blocked ground travel

Though a spectacular sight, this man-made whiteout condition made our airlift a rugged operation. Planes couldn't land under such conditions. Airdrops had to be directed by ground crews "talking" pilots over the drop area by walkie-talkie radio. These men judged where the planes were simply by the noise of engines high in the overcast. "You are approaching drop area dead ahead," they'd tell the pilot. "You are over the drop area . . . drop now . . ." Seabee crews, lined up to retrieve the gear, would start running when the first speck

of cargo dropped through the overcast.

The first job after landing at the Pole was to pinpoint the position of the earth's southern hub. Eight Seabees were landed on that lift, and for eight days a whiteout made it impossible to "shoot" the sun. When the sky cleared, they discovered they were eight miles from the Pole itself. In a few hours it had been narrowed to  $\frac{1}{2}$  mile. After 120 sun readings they were on it. The rest of the crew, myself included, flew in that day and work began in earnest.

The roar of Globemasters from McMur-

Parachutes billow over the South Pole as a Globemaster drops tons of food, fuel and building materials



do filled the icy wastes. Explosions of snow soared skyward as great bundles of free-dropped lumber hit the plateau. Parachutes bloomed over the South Pole. Small packages drifted down under 24-foot chutes. Sixty-five footers lowered one-ton bundles. Cushioned corrugated platforms we had built under outdoor lights at McMurdo Sound during the previous Polar night floated down laden with 24 fuel drums—each weighing 523 pounds—under three 100-foot canopies. These loads buried themselves three feet in the snow when they hit. One had to be dug out of a 15-foot hole. On windy days chutes dragged their cargoes up to 2½ miles before we could cut them loose.

Running after a multiton cargo skittering around on a 10,000-foot-altitude snow plateau is tough even for conditioned men. All during the past Antarctic winter, our men had hardened up at McMurdo by taking three-day hikes each week across the ice through the frigid night. Living in small tents, eating nothing but pemmican, these 20-mile treks primed us for the survival techniques we'd have to use if it became necessary to walk back from the Pole during an airlift failure. In spite of this toughening up, nearly everyone at South Pole base was sick with anoxia—altitude illness caused by lack of oxygen. Meals wouldn't stay put, exhaustion came quicky and all of us developed heavy coughs. We lost between 20 and 30 pounds in a few weeks. Even robust Dr. Siple, heaving a bag off the plane on his arrival, lugged the



Seabee with frost-covered beard recovers food that buried itself in six feet of snow during airdrop

load halfway to the camp and calmly passed out in the snow for a minute. Before it was over, two men had to be taken out.

Trickiest airdrop was the 17-ton D2. Starting its big diesel engine in the frigid atmosphere might have taken days, so it was dropped—under an elaborate canopy of 100-foot parachutes—with its tracks removed and its motor running. The roaring monster hit with a thud and turned over

(Continued to page 288)

Interior of a Jamesway hut provides snug sleeping quarters for men who live at the bottom of the world



## Four-Story Missile Helps Solve Re-Entry Problem

TALLER than a four-story building, the Lockheed X-17, an Air Force research rocket, has reached the highest speed ever attained by any instrumented missile. It is designed to help solve the most baffling puzzle in the missile field—the re-entry problem. This is the problem of preventing the missile from burning up as it plunges back into the earth's atmosphere. The X-17 subjects test materials and shapes to these conditions. Another Lockheed missile, the X-7, is flashing through the stratosphere to test ramjet engines. The missile is "flown" from a ground command station, and responds to a control similar to a plane's.

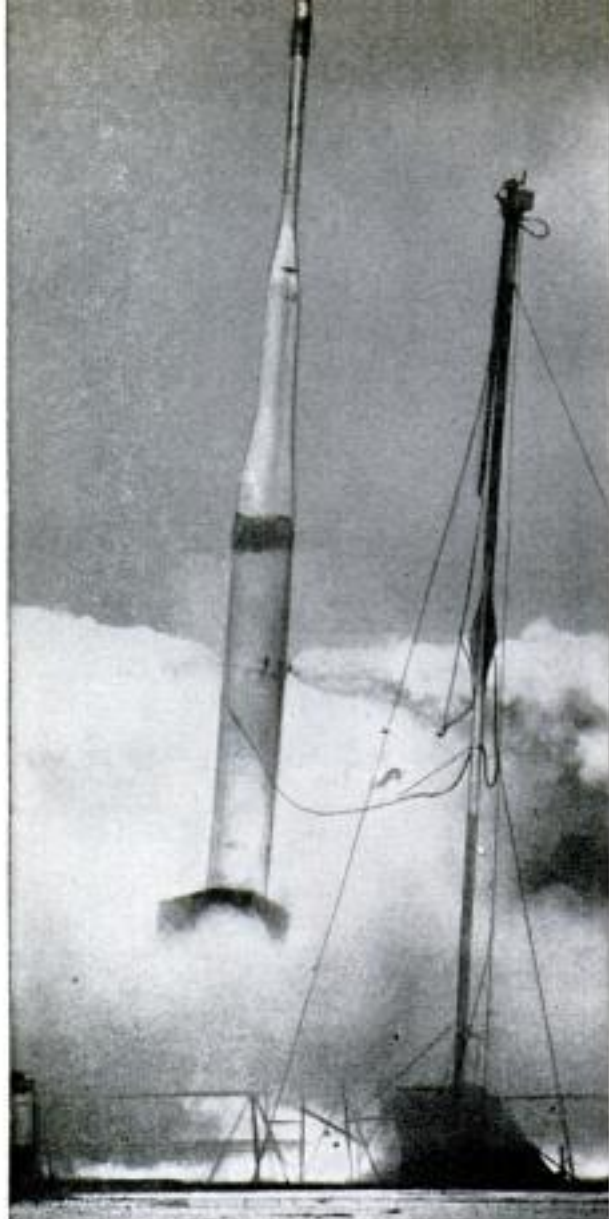

As X-17 blasts off, spin rockets on its side give it a stabilizing twirl. They drop off in a few seconds



Engineer manipulates small stick at a control panel to fly the supersonic X-7 missile by remote control

Exhaust makes a definite pattern as the X-7 flashes through the stratosphere to test ramjet engines

Lockheed photos

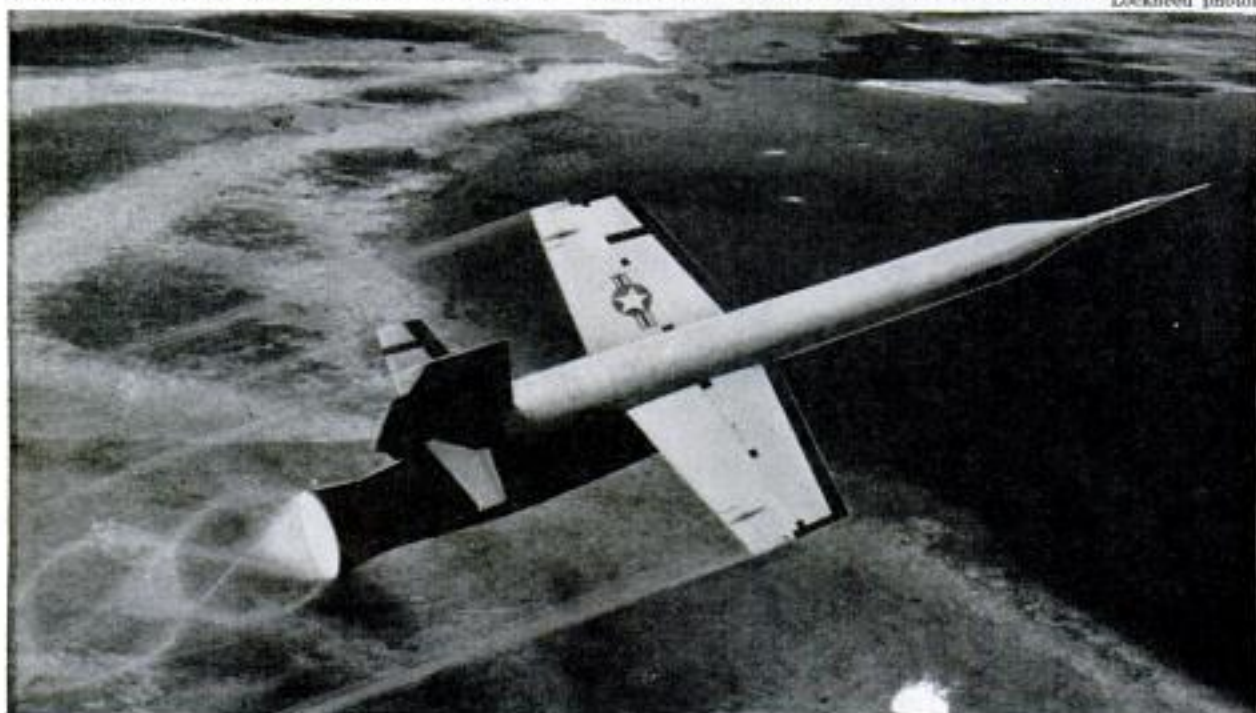





## "Operation Second Sight" Puts Local News on Records for Blind

Stories from community newspapers are provided blind persons in the Bergen County, N. J., area by transcribing the news onto phonograph records. The stories are first read into a tape recorder by volunteers

who are, themselves, handicapped. The stories are transferred from the tape to the disks by means of a dictating machine. The project is sponsored by the Paramus, N. J., Rotary Club.

## Lighted Canopy Protects Berlin Air Passengers

More than 400 fluorescent tubes recently were installed in the ceiling of the passenger-loading platform at Germany's Berlin-Tempelhof airport. Each of the 65-watt tubes is approximately five feet long. They

are arranged in the ceiling so that brightness of the light does not hamper normal vision of passengers and workers. Berlin-Tempelhof is the only airport in Europe with a roofed passenger-loading area.



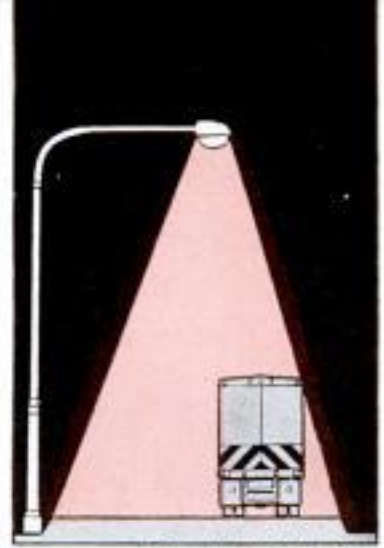

Photos by Elizabeth Marsh

Conventional street light (diagram at right) forces the driver to look into the beam, the worst possible arrangement, says Marsh. Barely visible in the glare is the rear of a truck. The road is almost invisible

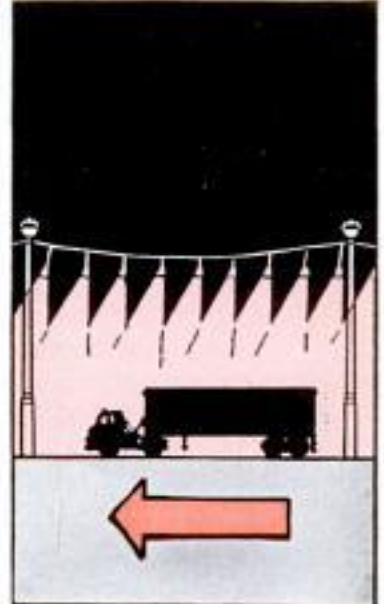

Road lighting in fog is improved by turning off regular street lights and using many spotlights (diagram). This system is being tried on one turnpike. Existing poles and wiring can be used, reducing installation cost

Best of all are low-mounted side lights with sharp horizontal cutoff. The driver looks across the beam, not along it. Fog in all these photos is same density. Sign, obscure in other lighting, is clearly seen here





Professor Marsh loads family car with all types of lights and spends foggy nights field-testing his theories

## Here's How to See Through Fog

*A Pennsylvania State professor creates artificial fog in his own back yard to learn how to fight this highway killer. Here is his prescription.*

By Arthur R. Railton

**F**OG STILL BLINDS man. When its white opaqueness rolls in, traffic snarls and the accident rate mounts.

Six percent of the accidents on the New Jersey Turnpike occur in fog. One fog-

Mounted at bumper height, a powerful spotlight does a good job of piercing fog. Headlights are turned off

caused accident in California involved 54 cars.

Aggravating the problem is the fact that lights which are most efficient in clear weather are less efficient, often downright

Same light, same fog, but spotlight is polarized and driver uses a polarized filter. Less scatter results



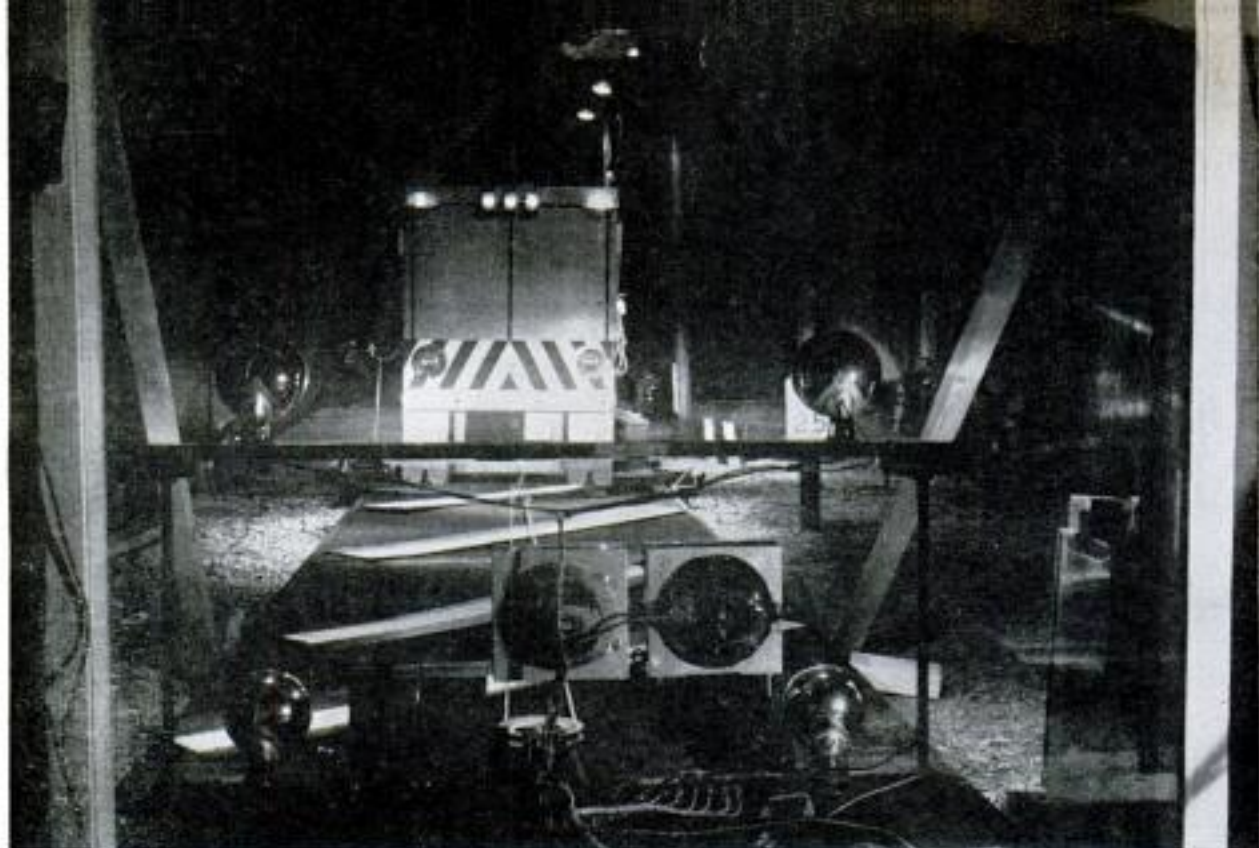

Marsh built a quarter-size mockup of a highway in a tent. Lights in foreground simulate those on a car

hazardous, in a dense night-time fogbank.

But there is hope. Man is beginning to see through fog, thanks to the experiments of Prof. Charles R. Marsh of The Pennsylvania State University.

Eastern turnpike authorities asked Marsh to tackle the fog-lighting problem. As a result of his work, some changes have already been made in turnpike lighting and more will be made in the future.

To find the answers, Marsh built himself a test chamber from an Army surplus tent and inside it he is producing fogs that

exactly duplicate nature's own. He learned that to be effective in a fog, lights must be placed so the driver does not look along the beam. This important principle is valid whether it's a set of headlamps or an overhead highway light.

Unfortunately, most lights violate this principle. Headlights are mounted only slightly below the driver's eyes and he must look right down the light beam into a blinding hot spot of light which obliterates the road completely. Overhead highway lights spread illumination as widely

Inside this 50-foot tent, Marsh duplicates nature's fogs. Mrs. Marsh, foreground, is project photographer

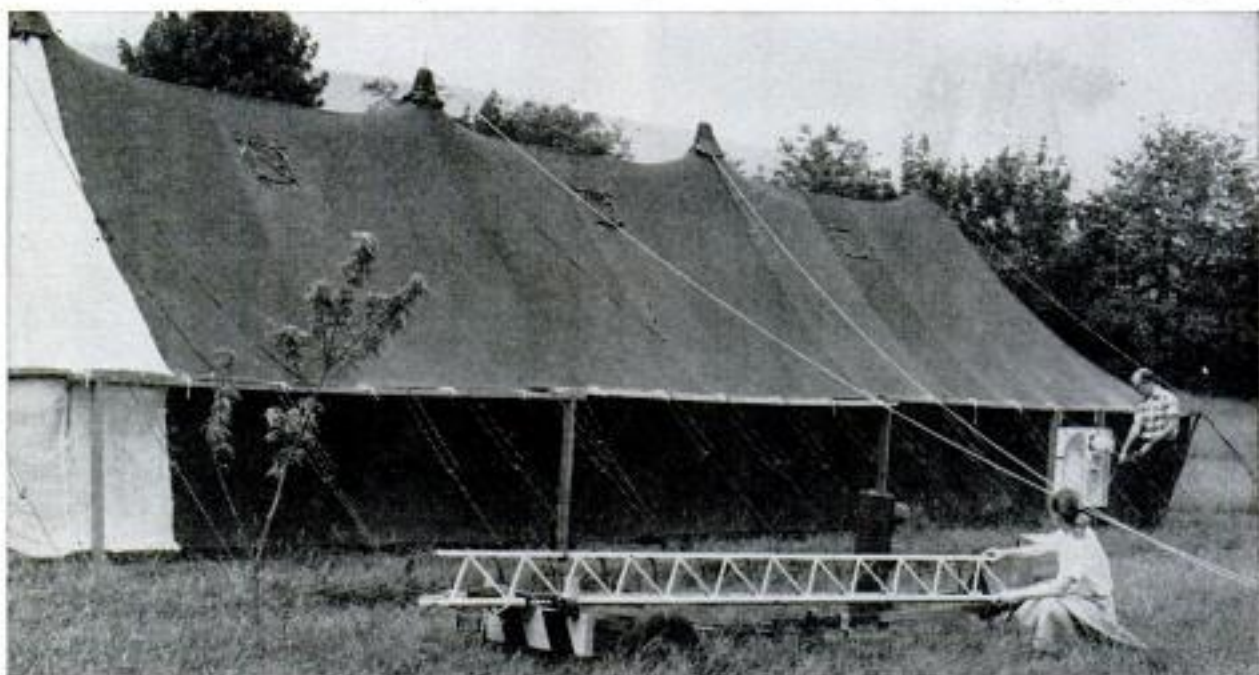

as possible and, as a result, the driver faces a brilliant white cloud, the worst possible arrangement. It is no wonder that fog blinds us, Marsh says: We do all we can to help it.

How would he correct the situation?

He would install special highway lights at places where fog occurs. These lights would be used only in fog and would be controlled by an electric eye that continuously measures fog density. When the fog lights go on, the regular highway lights go off.

One type of fog lighting hangs overhead and consists of small lamps which project a narrow beam sharply downward on the road at right angles to the flow of traffic. The driver does not look along the beam and consequently he sees more highway and less blinding fog.

Another highway light that Marsh developed is mounted low on the shoulder of the road (on a divided highway it would be mounted in the median strip) and it projects light at right angles to the traffic flow. This system, Marsh found, is the most efficient method of highway lighting in fog-bound areas.

For vehicles, Marsh has two recommendations. One is the mounting of special fog headlamps beneath the bumper. This, of course, may be impractical on some cars because of the vulnerable position, but by revising front-end styling the lights could be protected.

More practical is the mounting of a clear-lensed, powerful spotlight at about bumper height. This spotlight should be equipped with a polarizing filter for maximum results and the driver should look through another filter on the windshield. These filters must be oriented at right angles to each other, one polarized horizontally,

(Continued to page 290)

Driver looks through less scatter with a low light (B) than with a high light (A). Fog in all these photos is same density

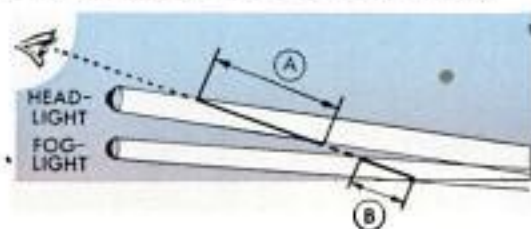

Behind standard headlights, driver faces blinding night fog that makes road invisible and the truck only faintly visible in the distance. Light scattered by fog droplets obscures view



Vision improves sharply when the lights are mounted low, reducing back scatter. Diagram at bottom of page explains why

Vertical-polarized spotlight and horizontal-polarized filter for the driver are the best combination for seeing through fog



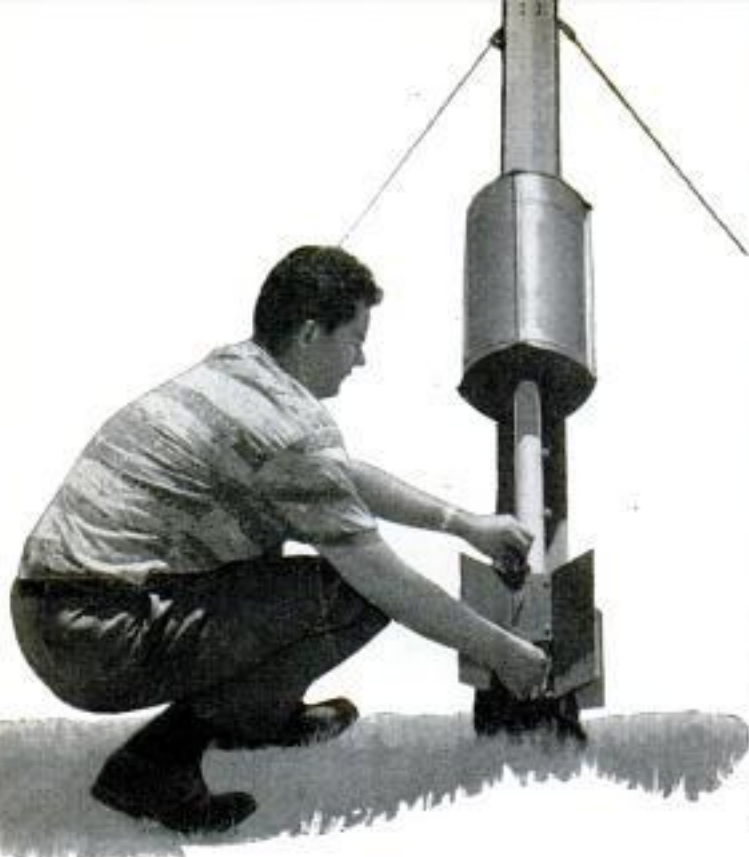

Man at left is attaching igniter wires to rocket which will propel 8½-gallon container of fire extinguisher. Above is a rocket on its way to a fire

## Rockets Hurl Fire Extinguishers

USE OF ROCKETS for fighting forest fires may be an outgrowth of experiments being conducted on the West Coast. The rocket consists of a cardboard container filled with 8½ gallons of water-borate solution that is propelled by a small rocket motor to which stabilizing fins are attached. Range is 400 yards, and with two rocket motors distances of up to 1200 yards can be obtained.

Upon impact the cardboard container is smashed and the extinguishing material is thrown over a wide area. One of the rockets can be assembled, mounted on a wooden launcher, aimed and fired in little more than five minutes.

The rockets were invented by the Grand

Central Rocket Company of Redlands, Calif., builders of the third stage of the Vanguard satellite, for knocking out brush fires in its test area.

Another fire-fighting device perfected by the rocket company is a sturdy 28-inch cardboard tube or "wand" containing ¾ gallon of extinguisher. The material is propelled as far as 40 feet away by liquid gas contained in the bottom of the tube.

The company has also developed a tool to help increase production from oil wells. The device consists of a cylinder filled with gas-producing material. This is lowered down the well and ignited. The effect is that of a single-stroke pump generating 5000 hydraulic horsepower.

Cardboard "wands" propel extinguisher into brush fire. Drawing shows rocket as powerful oil-well pump



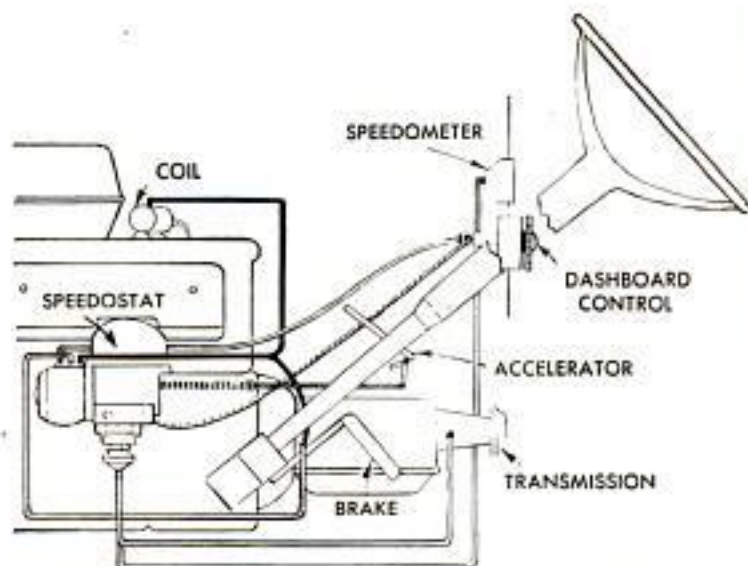

Diagram shows how Speedostat is hooked up. It is expected to cost under \$100. Right, the dash control knob

## Speed Control Makes It Easy and Economical to Obey the Law

It's relaxing to obey the speed law when your car has a mechanical conscience that makes you work harder to go faster than you should. The speed control, called the Speedostat, has a "muscle" that pushes the gas pedal back against your foot when you exceed the preset speed, which you control by a dashboard knob. The pedal pushback serves as an adjustable footrest. You depress the pedal until the added resistance is felt and have no worry about driving too fast. Gasoline economy increases because

the control minimizes accelerator-pedal movement. When more engine power is needed to maintain speed, as in climbing hills, the pedal pressure backs away until the preset speed is reached. If you wish to exceed the preset speed for passing, you can push through the barrier. The device also has a hold button with which you can maintain any preselected speed automatically. You press the button, remove your foot from the gas pedal and car maintains speed uphill or on level highways.

## Automatic Loading Machine

Drop a sack of coal on the platform of a new hydraulic loader and the machine automatically lifts the coal to the desired height. When the sack is removed, the hoist drops back to ground level. A counter stops the machine when a preset number of sacks have been lifted. This English device can be powered by motor or engine.

## Animal-Bone Grafts for Humans

Doctors at the Naval Medical Research Institute, Bethesda, Md., report a way has been found to transplant animal bones to human bodies. The animal bone is treated with a chemical that dissolves all material subject to decay. The bone is then ground up into particles which are packed into the defect in the human bone. Tiny new blood vessels develop in the area, and eventually the grafted material is replaced by new bone growth.

Modern fighter planes require 23,000 feet of electric wiring, as compared to 1500 feet of wiring in the average World War II fighter aircraft.





### **"Elevator" Truck Lowers to Ground**

With a built-in "elevator," a new truck body can be lowered right down to street level for easy loading and unloading. Hydraulic controls move the body up and down. The height can be adjusted to conform to a loading dock of any height up to 54 inches. Railway Express has ordered the first of the units in the expectation that they will cut loading and unloading time materially. The truck has a front-wheel drive, making it possible to eliminate the rear axle and drive shaft so the body can be lowered to the ground.



### **Hawk Missiles Destroy Low-Flying Planes**

Slim and deadly are the new Hawk guided missiles which are used with radar to find and destroy low-flying enemy airplanes. They are designed to operate in the "blind" zone of conventional ground radar equipment. The missiles, 16 feet long and only 16 inches in diameter, will be used in conjunction with the Army's high-altitude air-defense system provided by the Nike missiles. The combination launcher-trailer can be used by fast-moving combat troops, or as a fixed installation. The Hawk missiles are being manufactured by the Raytheon Manufacturing Company.



### **Portable Steel Cabin For Vacation Trips**

Whether you need a small trailer for family vacations and week-end hunting and fishing trips, or as a mobile office or workshop, the rolling cabin in the photograph, left, may answer your needs. It's available either as a do-it-yourself kit or as a completely finished trailer. It is constructed of zinc-plated steel, including the body framing, and the wheel suspension system eliminates the axle—for better road clearance. When not being used for camping trips, this cabin on wheels can be used as a backyard playhouse for the children.





## Air-Supported Dome Extends Swim Season

Here's a way to enjoy your outdoor pool in near-freezing weather. The air-supported plastic dome in the photographs, above and right, adds at least four months to the swimming season in northern climates. A small blower, powered by a one-sixth-horsepower electric motor, maintains the air pressure needed to keep the building rigid, even in high wind and heavy snow. The base is anchored to the concrete walk around the pool. Completely installed in less than two hours, the dome can be folded up and stored in the garage during the hot summer months.



## Radio Transmitter in Capsule Sends Medical Research Data

Broadcasting signals on a frequency of approximately one megacycle, a pill-sized FM radio transmitter may help medical researchers study the human intestinal tract. An FM radio antenna, in the lower left photograph, is used to receive signals from the electronic capsule, which has a broadcast range of about 12 inches. The data is recorded on an oscillograph. The "pill" and

its parts are shown in the lower right photograph. The FM oscillator changes frequency as pressures in the intestinal tract vary. A tiny storage battery, which has a life of 15 hours, supplies the power. After the device is swallowed, it can be manipulated by magnetic forces outside the body and its course can be traced through the body by fluoroscopy.



OCTOBER 1957



129

Copyrighted material

# OWNERS REPORT:

British Ford owners in the states shown in color on the map tell you about their cars in this article



## WHY DO AMERICANS BUY FOREIGN CARS?

*"American cars are beautiful but impractical."*

CALIFORNIA SALESMAN

*"More and more people are aware that chrome and fins are not everything."*

NEW JERSEY HOUSEWIFE

*"People are tired of wasted gas and needless horsepower."*

VERMONT STUDENT

*"Economy. Sensible approach in design. Easy handling in traffic."*

NEW YORK TECHNICIAN

*"Foreign cars help the pocketbook and have a snob-appeal value."*

NEW YORK OFFICE WORKER

*"Foreign cars will eventually help solve parking problems in downtown areas."*

TEXAS MECHANIC

Another load of British Fords docks in Chicago. Sales of it (and all foreign cars) are increasing rapidly





Its 34-foot turn circle permits the Anglia to complete a U-turn in this street with a few feet to spare

## Cheap to Operate, Easy to Handle and Park, Say Owners of English Fords

*By Ford Anglia Owners*

**W**HY ARE SMALL European cars selling so well? What is their appeal?

To find out, *PM* asked hundreds of owners of the British-built Ford about their cars. As you might expect, the feature they like most is economy of operation. But let's hear from the owners themselves. Here are

the best-liked features as they describe them:

*Economical, say 63.4%*

"My old car cost me around \$35 a month for gas and oil. The British Ford costs only \$15 a month including lubrication and oil

Some owners say that the British Ford has been Americanized enough so they do not feel conspicuous in it



# OWNERS' OPINIONS of the BRITISH FORD

## Had trouble with engine?

No trouble .....83.3%  
Some trouble .....15.1%  
Considerable trouble .... 1.6%

## Would like faster acceleration?

Yes, would .....39.9%  
No, would not .....58.3%  
Undecided, no answer.... 1.8%

## Would like more top speed?

Yes, would .....11.2%  
No, would not .....81.3%  
Undecided, no answer.... 7.5%

## Would like more interior room?

Yes, would .....19.6%  
No, would not .....80.4%

## Would like more trunk space?

Yes, would .....13.3%  
No, would not .....86.7%

## Is ride better than U.S. car?

Yes, it's better.....14.0%  
No, it's worse.....30.7%  
About the same.....55.3%

## Is it a second car?

Yes, it's second car.....50.6%  
No, it's only car.....49.4%

## OVER-ALL RATING

Excellent	Average	Poor
68.8%	28.4%	2.8%

## How is dealer service?

Excellent .....39.8%  
Average .....42.7%  
Poor .....17.5%

## Would buy from him again?

Yes, would .....54.4%  
No, would not.....20.9%  
Undecided, no answer....24.7%

## Why did they buy this car?

Gasoline economy .....38.9%  
Initial price .....15.0%  
Small size .....9.4%  
Exterior styling .....9.4%  
American backing .....8.0%

## What should be changed?

Nothing at all.....31.3%  
More power in high.....12.1%  
More comfortable seat... 9.4%  
Four-speed transmission... 9.4%  
Better interior ventilation 5.6%  
Move gearshift ..... 5.3%

## How should U.S. cars be changed?

Make them smaller.....44.5%  
Less horsepower .....20.0%  
Less glamour .....19.6%  
More gas economy.....18.1%  
Lower price ..... 9.8%

## What make car was traded?

British Ford ..... 3.8%  
Other foreign car..... 7.8%  
U.S. Ford product.....16.5%  
Other U.S. make.....45.1%  
No trade, no answer....26.8%

## What car will buy next?

British Ford .....37.6%  
Other foreign make.....16.8%  
American make .....12.9%  
Don't know, no answer..32.7%



Above, although it has no door, the glove compartment extends across entire dash. With radio installed, ash tray comes out. Below, the engine is small and accessible. Scale shows spark setting. Ignition wires screw into cap and can't work loose

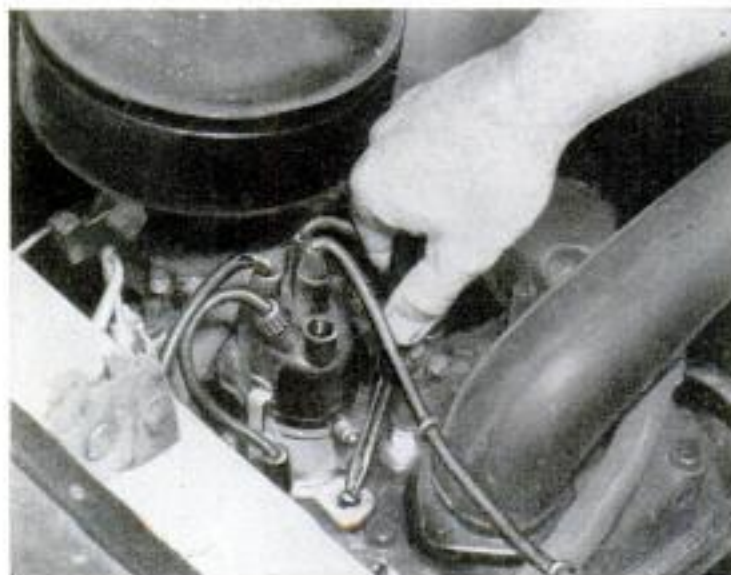

change."—California waitress.

"We made a 6422-mile trip and our car expenses were only \$59.26."—California machinist.

"This car is the answer for the \$5000 to \$6500-a-year family. We can afford to buy and operate this kind of car."—Oregon traffic manager.

### Easy to handle, say 50.9%

"After driving this, my American car feels like a truck."—California owner.

"We have a '57 Cadillac, a '56 Chevrolet and the '57 Anglia. Everyone in the family runs for the small car. No one wants to be bothered with the larger ones."—Florida housewife.

### It's easy to park, say 44.9%

"I go into parking spaces frontwards. Do not have to back into them."—Georgia commercial reporter.

"I like the joy of parking in spaces not big enough for regular cars."—California building inspector.

### Styling is attractive, say 14.0%

"I like its looks although I dislike the looks of most economy foreign cars."—California assistant controller.

### Smallness is good, say 12.1%

"It is small, a decided advantage in many ways."—West Virginia professor.

"I'm an old lady, 74 years old.

The car suits me perfectly. Plenty of room for it in the garage." — Florida retired owner.

**It's comfortable, say 9.4%**

"Not as soft or silent a ride as in big cars, but seating and wheel position are more comfortable for me than my U.S. car."—California field representative.

"Ride is worse than U.S. cars, but this is relative. In some respects, it is better. Ride improves with added weight such as luggage in the trunk. Thus over good highways with the family and some luggage in the car, the ride is surprisingly good."—California warehouse manager.

**Fine visibility, say 8.3%**

"Has square front and you can see both fenders." — New York I.B.M. operator.

**Price is best, say 6.0%**

"What I like most is its low purchase price."—Texas aircraft mechanic.

**Has good interior room, say 5.6%**

"Plenty of legroom. Can easily wear a hat. I am six feet tall."—Massachusetts sales manager.

**Like solid body best, say 5.3%**

"Over-all I think body construction is superior to American cars. My car after 5000 miles of hard driving has no squeaks or rattles."—Michigan salesman.

**There Are Complaints, Too**

Although 26.0 percent of the owners make no complaints at all about their British Fords, others are not so content. Little cars, like big cars, are not completely perfect. Here, in order of frequency of mention, are what owners complain about:

**Needs more power, say 17.4%**

"Although I'm very well pleased with the car, I do feel it is slightly underpowered for today's freeway driving."—California serviceman.

"Lack of power, especially on relatively steep grades and against a strong headwind." — Oregon state employee.

**Seat's uncomfortable, say 9.1%**

"Front seats not comfortable. They curve away from normal position."—California accountant.

(Continued to page 272)



For those who want more room, there's the two-door station wagon. Built on the Anglia chassis, it has same compact body



Above, about 11½ feet long, the wagon is shorter over-all than the sedan. Below, with the rear seat down, the floor is 45 inches long. Rear-door opening is 27 inches high. Rear seat in the wagon is not very comfortable for adults, say some owners



# An Engineer Analyzes the British Ford

By Dale Kelly SAE, Registered Professional Engineer

**MODEL TESTED:** Anglia, two-door sedan with four-cylinder, L-head engine of 71.55 cubic inches.  
Rear-axle ratio: 4.43 to 1. Wheelbase: 87 inches.  
Tires: 5.20 by 13.  
Weight: 1700 pounds with the gasoline tank half full

(56 percent on the front wheels, 44 percent on the rear).  
Mileage on car at time of test: 450 miles. Barometer: 28.96 inches. Temperature: 88 degrees F. Pay load: 200 pounds.



## ACCELERATION TIME FROM STANDING START, IN SECONDS

	0 to 20	0 to 40	0 to 50	0 to 60	¼ mile
Ignition timed for regular gasoline (90 octane Research)	5.1	15.0	23.0	34.5	26.3
No improvement noted when premium fuels used					
<b>Top speed: 68 miles per hour.</b>					



## FUEL ECONOMY IN MILES PER GALLON

	Steady 30 m.p.h.	Steady 50 m.p.h.	Steady 60 m.p.h.	Traffic Route
Ignition timed for regular gasoline	36.5	29.2	25.0	22.0
No improvement noted when premium fuels used				

**ESTIMATED AVERAGE ANNUAL GASOLINE BILL: \$97 for 10,000 miles**  
Based on the exclusive use of regular gasoline



## SPEEDOMETER ERROR (miles per hour)

Speedometer reading	20	30	40	50	60	70	80
True speed	19	28	39	50	61		

## ODOMETER ERROR

Odometer correct within ½ of one percent.



## DRIVER'S VISION (for the average driver—5 feet, 9 inches tall)

Distance at which part of road in front of car could be seen (A in sketch)	10 feet
Distance at which full width of road in front of car could be seen (B in sketch)	15 feet



## GROUND CLEARANCE (unloaded car)

Radius of worst dip that could be crossed (solid line)	15.5 feet
Radius of worst hump that could be crossed (dotted line)	8.0 feet
Deepest rut car could be driven in	7 inches
Curb clearance for door opening	15 inches

## STEERING

Wheel turns from straight ahead to steer outside front wheel in a 100-foot-diameter circle: 0.35 turns

Diameter of smallest circle within which the wheels could complete a circle (curb-to-curb): 32.5 feet

Diameter of smallest walled circle within which the entire car could complete a circle (wall-to-wall): 34.0 feet

Steering-wheel turns, lock-to-lock: 2.1 turns

Steering-wheel diameter: 16 inches

## TRUNK CAPACITY

Number of standard cartons (1 cubic foot each) that could be packed into trunk: 6 cartons

## CENTER OF GRAVITY (unloaded car):

23.9 inches

## WATER RESISTANCE

Good. In splash-pan test the brakes and ignition were not affected. No water entered the body and virtually none entered the trunk. The car could not be put through the high-pressure car wash because the wheel tread would not span the conveyor system.

## MISCELLANEOUS OBSERVATIONS

**Body:** By American standards, headroom is excellent in front, not too good in the rear. Rear-view mirrors, far forward on front fenders, give a good view on both sides. The back windows do not open. To get into the rear seat, you must tilt the entire front bucket seat up and forward; the seat back does not fold down. This makes access to the rear seat almost impossible when someone is sitting in front. A shelf under the dash will hold a narrow parcel 30 inches long. Heater recirculates the air in the car and does not draw in any fresh air. If the gas gauge is suspect, a slightly flexible stick can be pushed through the filler neck to the bottom of the tank.

**Instruments:** The speedometer has been designed as an instrument and not as an ornament. Legibility is excellent. Unfortunately, it is mounted at such an angle that a tall driver has difficulty seeing the grad-

uations between 30 and 50 miles per hour. Both speedometer and odometer are more accurate than those on most American cars, but the odometer lacks a "tenths" dial. Signal lights are used for oil pressure and ammeter.

**Windshield wipers:** Areas swept by the blades overlap so there is no unwiped area in center. Vacuum wipers have no booster pump and when the accelerator is flat to the floor (as it often is) the wipers slow down and stop. A vacuum reserve tank does keep them going on a hill (or any time the accelerator is floored) for about 15 seconds.

**Engine:** Because of its accessibility, the engine should be a joy to the Saturday-afternoon mechanic. Ignition timing is particularly easy to adjust. A scale permits minor adjustments to be made without a timing light. (A few years ago most American cars had such a scale.) The distributor has no vacuum-advance mechanism and has little need for one. Ignition timing for maximum gas mileage at constant speed is almost identical with that for maximum acceleration at full throttle. (American cars with large, lightly loaded engines need extra spark advance for good cruising mileage and this is provided by a vacuum advance.)

**Transmission:** A floor-mounted shift lever controls the conventional three-speed gearbox. Gear ratios are well suited to driving in traffic. For cross-country driving a fourth gear would be a big help. With a piston displacement almost identical with that of the Volkswagen, the Anglia, in high gear has an engine speed and gas consumption slightly less than the Volkswagen in third, but considerably more than the Volkswagen in fourth gear.

**General:** Gas tank holds 8.5 gallons. After the gauge read "empty," the car went about 25 miles before actually running out of gas. This is about what one should expect as a safety margin. Foot brakes were good. Hand brake held on a 14-percent grade.



# DRIVING THE BRITISH FORD ANGLIA

By Floyd Clymer

THIS LITTLE CAR, with an 87-inch wheel-base and a four-cylinder L-head engine of less displacement than a big Harley-Davidson Twin motorcycle, cruises nicely at 55 to 60 miles per hour.

It has excellent suspension and corners well without much roll.

In the mountains I found it had surprising power in second and low. On the toughest test hill in Los Angeles, the little job would do 12 miles per hour over the top. Not bad, when many more powerful cars top it at less than 20 miles per hour. It is geared quite high in top speed for economy reasons and, while it cruises smoothly, I cannot say it is overpowered in high gear. The engine has to be revved up to get its best power on hills as it is not a "lugger."

It has a three-speed transmission of standard shift, the lever extending up through the floorboard. Any person unfamiliar with the car will have no trouble finding the gears. The car is so simple you can loan it to your best friend and he can't abuse it much, even if he tries.

The radiator capacity seems unusually

So practical is the British Ford car that you will find two small cans of touch-up paint in the trunk

small (only 1.8 gallons) but only once in the desert heat of 110 degrees did I notice any tendency to overheat and then for only a short distance.

The hood opens from the rear, a safety feature. Its release lever is located far under the instrument panel — completely out of sight in a most unhandy place. It is very difficult to find.

Below the dash there is a full-length shelf which the British call a package tray, extending to a depth of about 12 inches.

Doors have a solid feel and the handles operate easily. The all-steel body has an integral construction that reduces squeaks and rattles. No water leaks developed during the high-pressure test.

Brakes are excellent. I found little fade even in the mountains. There was no tendency for the car to veer when brakes were applied at any speed. I rate the brakes excellent.

The hand brake is of the pull-up type and is located between the two front bucket seats. The throttle pedal is well located and has a desirable long range of travel. The headlight-dimmer switch is mounted on the flat portion of the floor at the extreme left side. They couldn't have selected a more awkward location for this important switch.

Driver's seat position is good. The car has good legroom in front, not so good in the rear. The front seats can be individually adjusted, being separate. Exceptional rear vision is provided by two mirrors mounted far forward, one on each front fender. These mirrors, once set to suit the driver, are self-aligning even when knocked away. The driver can see along each side of the car for long distances to the rear.

Altogether, the Anglia is an efficient, economical car with good handling characteristics. Besides the Anglia, there are the Prefect (a four-door version of the Anglia), the Consul (a larger four-cylinder model) and the Zephyr Six in the family of British Fords now sold in this country.





When professor releases heavy ball, first in line, its light bump sends lighter ball on other end flying



Ball fired straight up from a moving cannon moves forward with the cannon, drops back into muzzle



Two-foot pencil, viewed partially through slab of plastic, appears broken, demonstrating light refraction

Student holds weights in outstretched arms and whirls on stool. As he pulls in his arms, he whirls faster



Can you sail a boat by blowing air into sail from a fan attached to boat? No, as demonstration proves

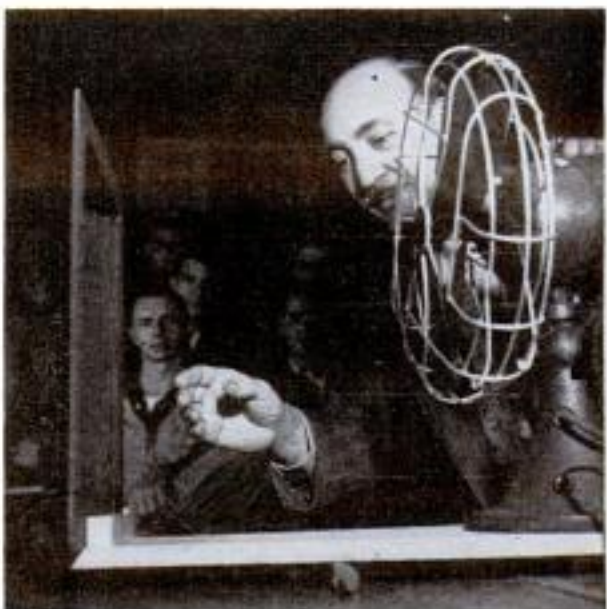





Students duck when he cuts string holding whirling rock. The rock sails harmlessly across in front of class

## Science Showman

**S**TUDENTS OF PHYSICS at Rutgers University see a stage show in the classroom. Their professor, Dr. Ira Freeman, believes that physics can be fascinating. To prove his point, he uses weird, outsize demonstrations which attract student interest and drive home the principles of physics. Doctor Freeman, for example, doesn't ask his students to take the principle of light refraction on faith. Even the most myopic student gets the point when the professor "breaks" a pencil two feet long by holding an oversize slab of plastic in front of it. He fires a ball straight up from a moving cannon, and the ball plunks right back down into the mouth of the cannon. He whirls a rock around his head on a string and suddenly cuts the string when it is straight out toward the audience. Students may duck, but they get the point that an object moving in a circle has a motion tangential to the circle. Science showmanship! ★ ★ ★

Stream of water and hanging wires demonstrate trajectories. The water stream continues to graze the tips of the wires regardless of the angle of the supporting rod and nozzle





## Cologne Theater Has Four Stages

Contrasting with the architecture of the ancient Cologne Cathedral in the background is a newly completed opera house in the German city. Besides its giant main stage, the ultramodern structure has three movable side stages to permit a change of stage settings in the shortest possible time.

### Biggest Balloon Lift

With a volume of 3.75 million cubic feet, the world's largest helium-filled balloon recently lifted the heaviest balloon load—nearly two tons of military equipment—to an altitude of approximately 20 miles.

### Destructive Wood-Rotting Fungi May Have Several Practical Uses

Wood-rotting fungi, which destroy tons of timber annually, may have several practical uses, it was discovered at Syracuse University. When applied to sugar cane or

asparagus stalks, it converts the cellulose into organic acids used by industry. The fungi reproducing rapidly in this process can be used as an animal-feed supplement.

### Amplifiers Give Directional Hearing Through Eyeglass Frames



Directional hearing is made possible for those with hearing difficulties by an amplifying system installed in the earpieces of eyeglasses. Powered by a single battery smaller than a dime, this system has one microphone with independent volume controls for each ear. The microphones are connected to amplifiers and other miniature radio apparatus built into each earpiece. From 10 receivers available, the system offers 100 combinations of hearing to users of the instruments.

### Secret of Life May Be Near

Are scientists on the verge of duplicating life synthetically in the laboratory? The answer may lie in the "DNA" (desoxyribonucleic acid) molecule which recently has been more precisely defined and strongly suggests a self-duplicating mechanism, according to Dr. William S. Beck of the University of California. Thus, an explanation of life in terms of physics and chemistry may be close at hand, he says.



### Vertical-Take-off Jet Has Diverter Vanes Behind Engines

After taking off straight up into the air, helicopter-fashion, an experimental jet then flies forward by changing the position of diverter vanes behind the two engines. These vanes direct the thrust toward the ground for take-off and landing. To fly forward, the vanes are positioned to permit thrust toward the rear of the plane. Con-

pressed-air nozzles in the craft's wing tips and tail control its direction during hovering and slow forward speeds. This is because conventional control surfaces, such as elevators, rudder and ailerons, have no directional effect at such speeds. Called the Y-14, the plane was built by Bell Aircraft Corporation for the U. S. Air Force.

### Electronic Organ Makes Sound From Pictures

Changing patterns of sound waves into musical notes, the electric organ in the photograph, lower right, makes music in much the same way that voices are produced from a motion-picture sound track. In the back of the organ are 12 generating units, covered with aluminum caps. One of the units is shown in an exploded view in the lower-left photograph. When a player

presses a key of the organ, a light bulb flashes a beam of light through a block of lenses. Each lens is shaped to form a special organ effect. The light continues through a picture of the sound wave pattern to a photoelectric cell which translates the pattern into the sound desired. Some of the "sound pictures" are shown on the wall behind the generating unit.

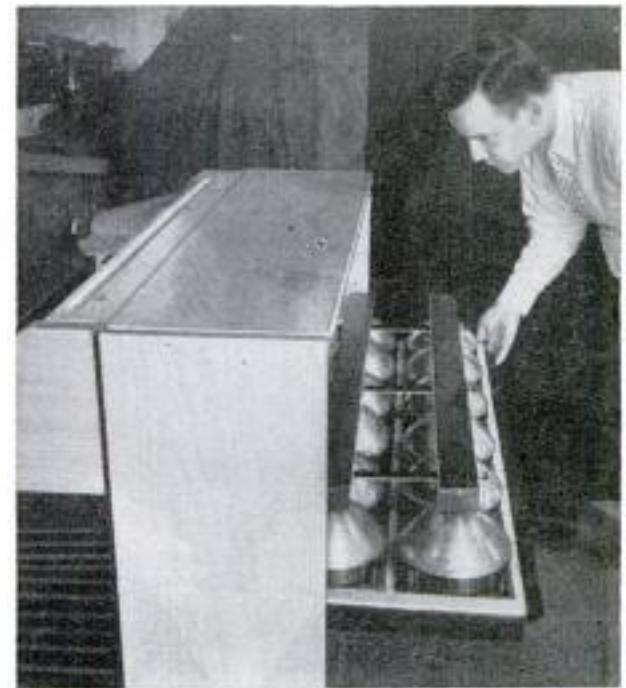

V4 has power to spare for the bigger family boats. Emphasis in styling has been placed on the rear, which is the view of the motor usually seen by others



## BIG NEWS FOR BOATERS! THE V4

By Clifford B. Hicks

**I**T WAS INEVITABLE. The V-type engine has proved so popular with motorists that someone was bound to tempt boaters with a V-type outboard. Both Johnson and Evinrude, in their 1958 lines, will make a big splash with a brand-new and radically different outboard motor, a 50-horsepower V4.

It's a big motor in keeping with the trend toward more power for larger boats. Shown here is the Johnson, but the Evinrude is the same basic motor with a few exterior differences to maintain the identity of the two lines.

The engine has a 70.7-cubic-inch displacement—exceptionally large for an engine of this horsepower. This minimizes strain on the essential parts. A good guess is that it will also give engineers an opportunity to boost the en-



gine's power in the future through relatively minor changes, without major alterations to the basic power head.

Firing impulses of the new motor occur every 90 degrees of rotation of the crankshaft. The big advantage of the V-configuration is that the crankshaft can be shortened. This makes the motor lower in silhouette than an in-line motor of comparable horsepower, but because the cylinders are spread into a vee, the motor is considerably wider. To mount the motor, Evinrude and Johnson are persuading boat manufacturers to go to a standard transom height of 20 inches. However, the V4 can be installed on a 15-inch transom.

Novel features of the V4 are a twin-barrel, downdraft carburetor and a water cooling system controlled by a thermostat. Water is recirculated in the cooling system and cold water is drawn in only when needed. Thus the



The 50-horsepower V4, biggest motor of the line, meets the smallest, a three-horsepower job. The V4 weighs about 200 pounds, has a lifting ring and a tilt-assist spring. Below, the all-new motor has sufficient power to pull six water skiers simultaneously

# OUTBOARD

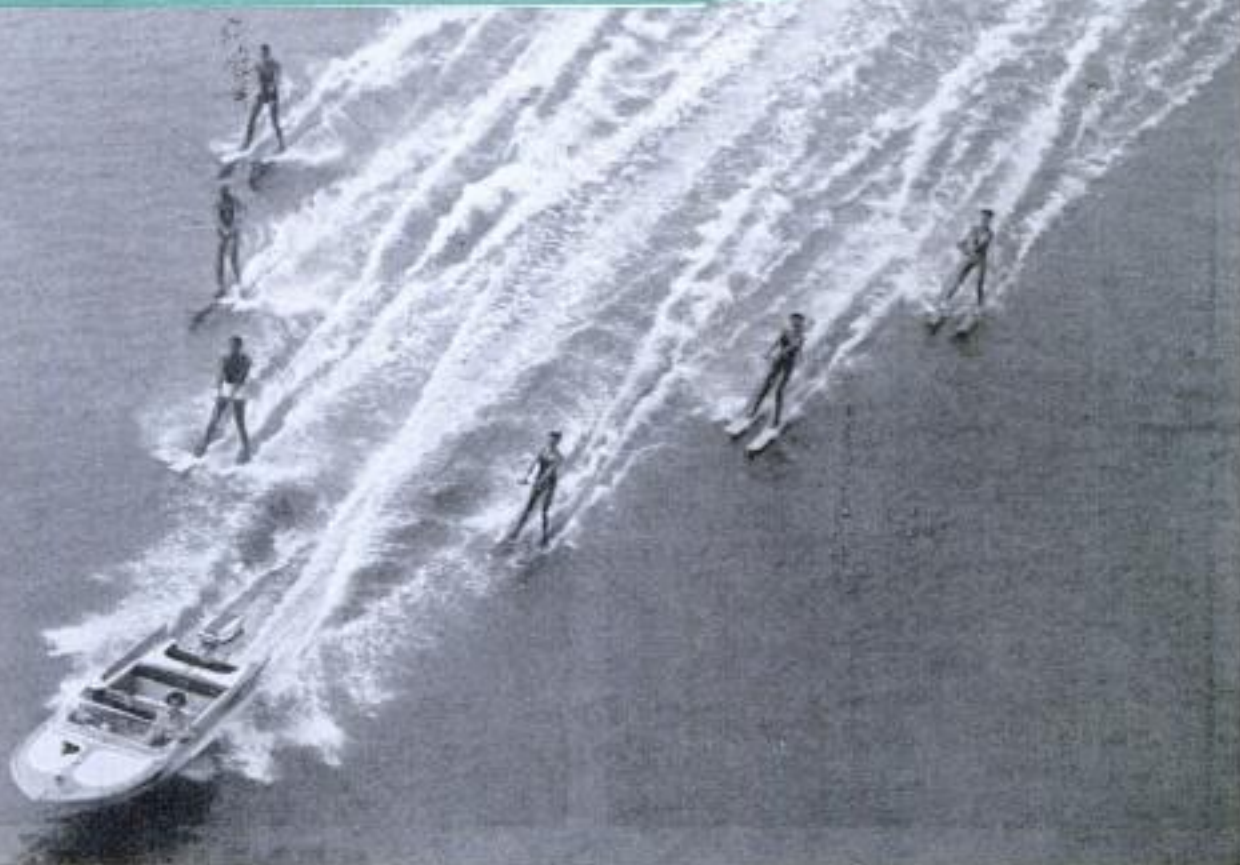

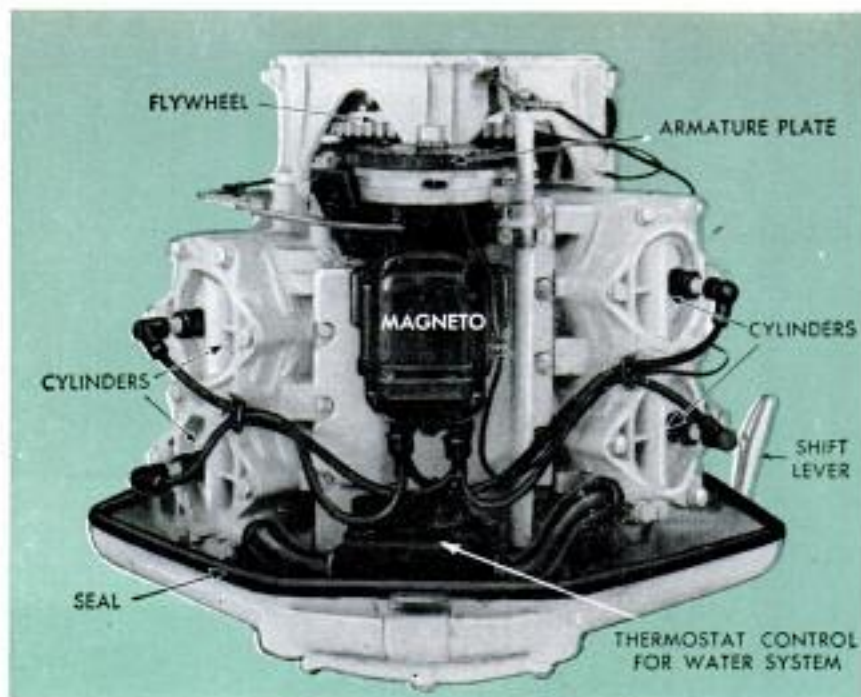

From shroud to propeller, V4 has sleek but powerful lines. Shroud is airtight except for one baffled air-intake port. Left, parts are easily accessible when shroud is removed

motor continually runs at the proper temperature for peak efficiency.

The high-styled motor has a shroud with four holes that appear to be exhaust ports. Actually they serve no function and are styling features. The spark plugs and carburetor are accessible through small rubber-sealed doors.

One of the big innovations is the silencing system. Current motors depend upon rubber pads and springs to reduce vibration and noise. In the V4, the motor cover and all outside parts above the gear case are mounted rigidly to the transom, with the

engine itself completely separated from the cover and mounted to the transom independently. The motor cover thus becomes a silencer, airtight except for a baffled intake port.

The V4 weighs about 200 pounds. To make it easier to handle, it has a built-in lifting ring that folds back out of the way. A tilt-assist spring helps tilt the motor out of the water and a lock keeps it out.

When you spot one of the new V4s, it's worth a close look. It's an attractive package, representing years of work by a good many engineers. ★★★

Motor has one access port in front for carburetor adjustments, two in the rear for servicing plugs

Shot from rear shows the squat but wide silhouette. Low center of gravity is a safety feature of the V4

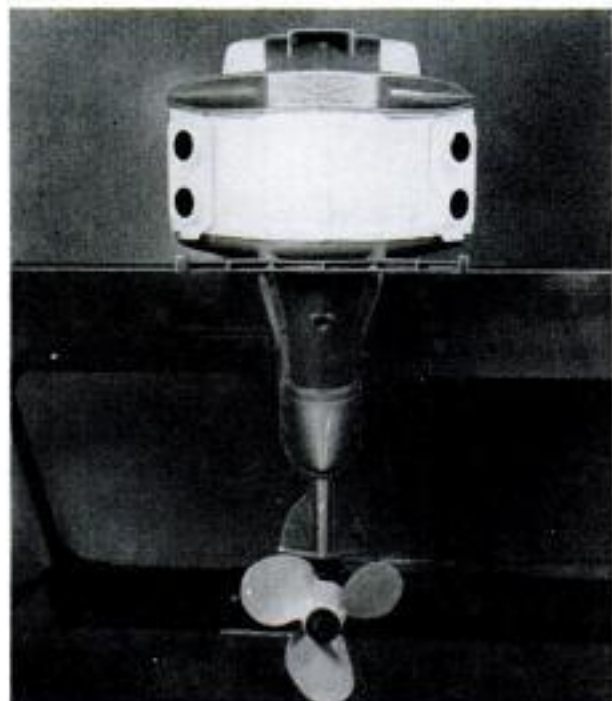



## Eight-Horsepower Engine Runs Midget Sports Car



Four-cycle, single-cylinder air-cooled engines power the new midget sports cars shown in the photographs, above. Bore of the  $8\frac{1}{4}$ -horsepower engine is 3 inches, the stroke is  $3\frac{1}{4}$  inches and the piston displacement is 23 cubic inches. The tiny vehicle has an automatic transmission. A short shift lever under the front edge of the seat

has forward drive, neutral and reverse positions. Steel disk wheels are 5.50 by 8 and tires are 18 inches high. The car makes a 360-degree turn in a circle of only  $13\frac{1}{2}$  feet radius.

### Prehistoric Principle Moves Paddle Pusher

Using two paddles copied from the fins of reptiles that lived millions of years ago, Friedrich Budig of Offenbach, Germany, claims he can maneuver his boat with only one fourth the effort needed with ordinary hand paddles. Each stroke of the twin fins, downward as well as upward, propels his craft smoothly along the Rhine River. He supports the rowing movements with his arms.



### Small Diesel Trains Haul European Passengers

Trans-European express trains which carry 122 passengers in air-conditioned comfort now clip along at 85 miles per hour through Belgium, France, Italy, Luxembourg, Holland and Switzerland. Pulled by a diesel-electric engine, each train usually has four cars including the diner. Seats are available in one "class" only. Extra fare is charged on these special trains which save many hours of time.



PRESENTING THE POPULAR MECHANICS

# ANNUAL HOME SECTION

The next 50 pages are devoted to homes and ideas pertaining to the home. Here you may find an answer to a special need, whether it be a remodeling job, a new fireplace or a full-fledged dream home. This is our fifth annual Home Section.—Wayne Whittaker

Introducing—

## Two Homes for 1957:

### the PM Modern

JOHN RIDLEY, the noted Seattle architect who designed the inviting PM Modern House for 1957, likes both glass walls and the open plan—as well as privacy. In fact, he is such a strong advocate of privacy in his personal life that he and his family live on a picturesque island serviced by ferry boats. Although everybody cannot live on an island, privacy can be assured in a contemporary home by other means such as walls and fences. Ridley believes that the three-bedroom brick and wood PM Modern House—presented on these pages—proves this statement. The home offers well-planned use of glass walls, doors and, of course, windows, to provide beauty and indoor-outdoor livability

(Continued to page 151)

### the PM Traditional

WHEN IT COMES to taste in houses, there are two definite kinds of people: Those who like modern or contemporary architecture and those who don't. It is for the latter group that the PM Traditional House presented on these pages was planned.

Despite the thumbs-down attitude toward traditional homes by the leading schools of architecture—not one in the United States offers a course in such traditional designs as Cape Cod or Georgian—there are millions of people who still prefer the quiet beauty of this type of home.

When we decided to present a PM Traditional House—in contrast to the outstanding contemporary home also shown on these pages—our

(Continued to page 151)

Blueprints for both the PM Modern and PM Traditional houses are available. Write: Plans Department, Popular Mechanics Magazine, 200 East Ontario St., Chicago 11



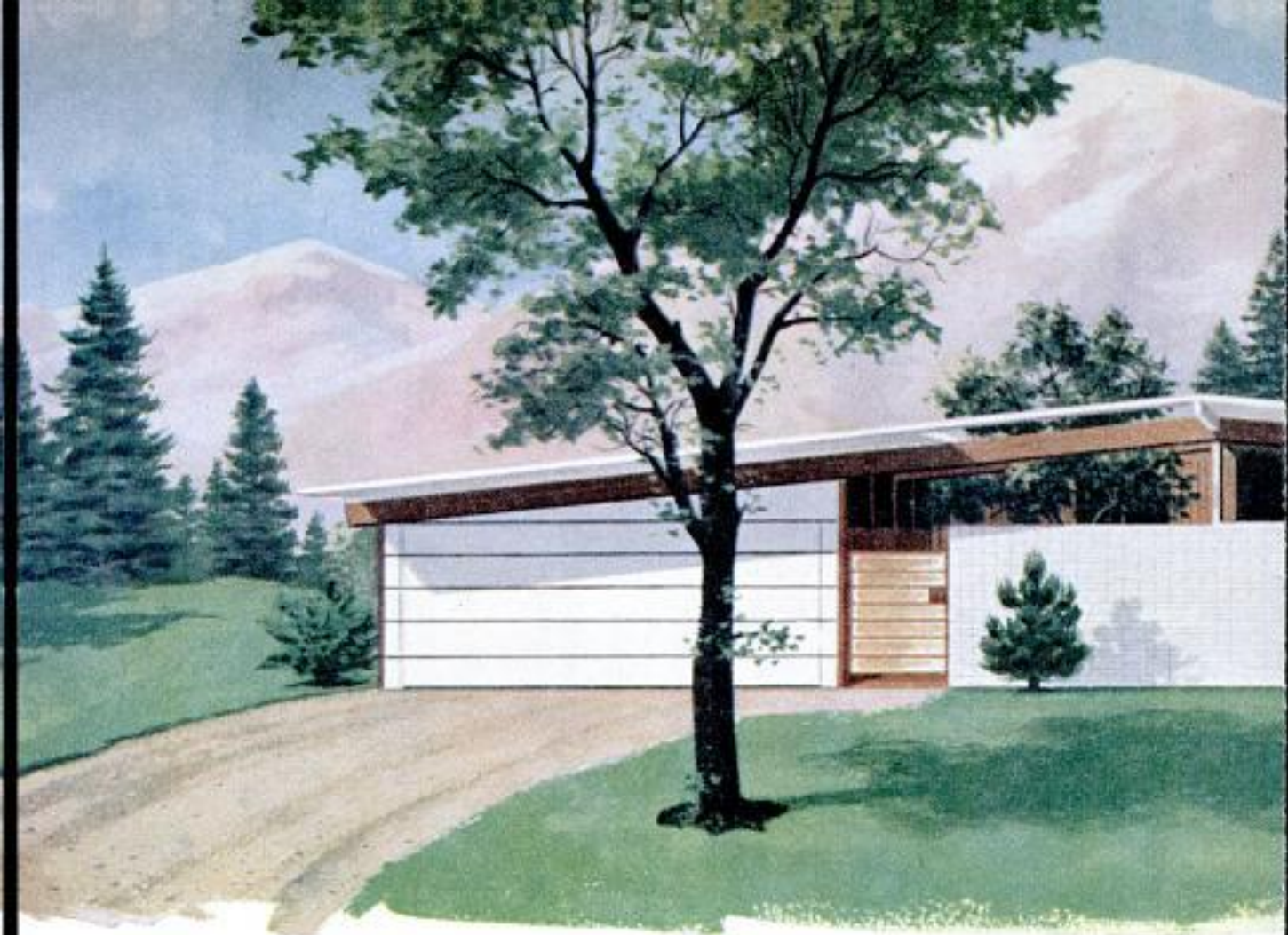

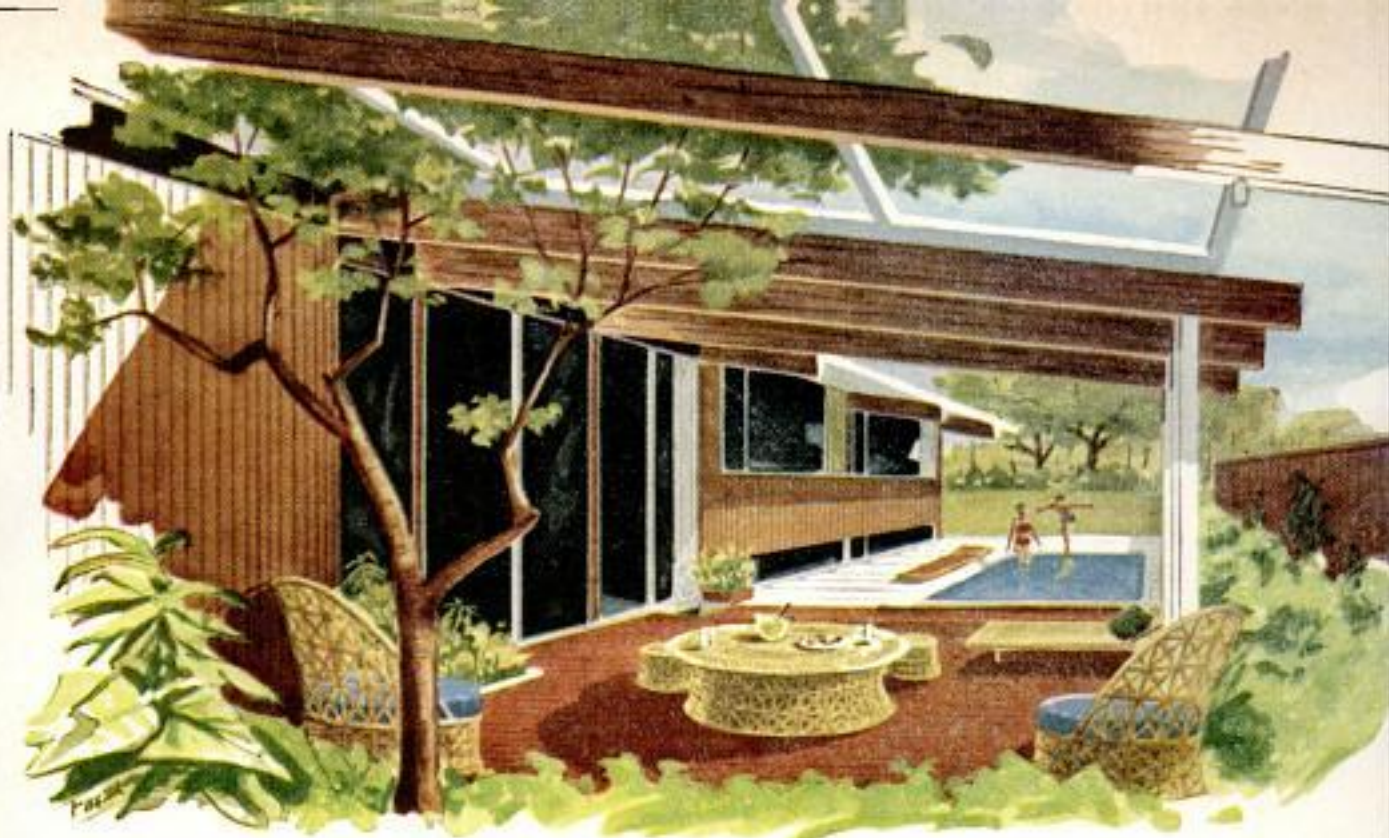

This partially roofed outdoor-living area is one of the delightful features of the PM Modern house. The patio floor is brick set in sand, and the deck around the pool is scored concrete. Pool space may be used for garden. Glass doors are to living room

*Interiors for both homes by  
Marshall Field and Company's  
Home Planning Bureau*

Sliding glass doors at one end of the family room (just across the page) open on this patio and outdoor-living area which provide good modern flair to the house

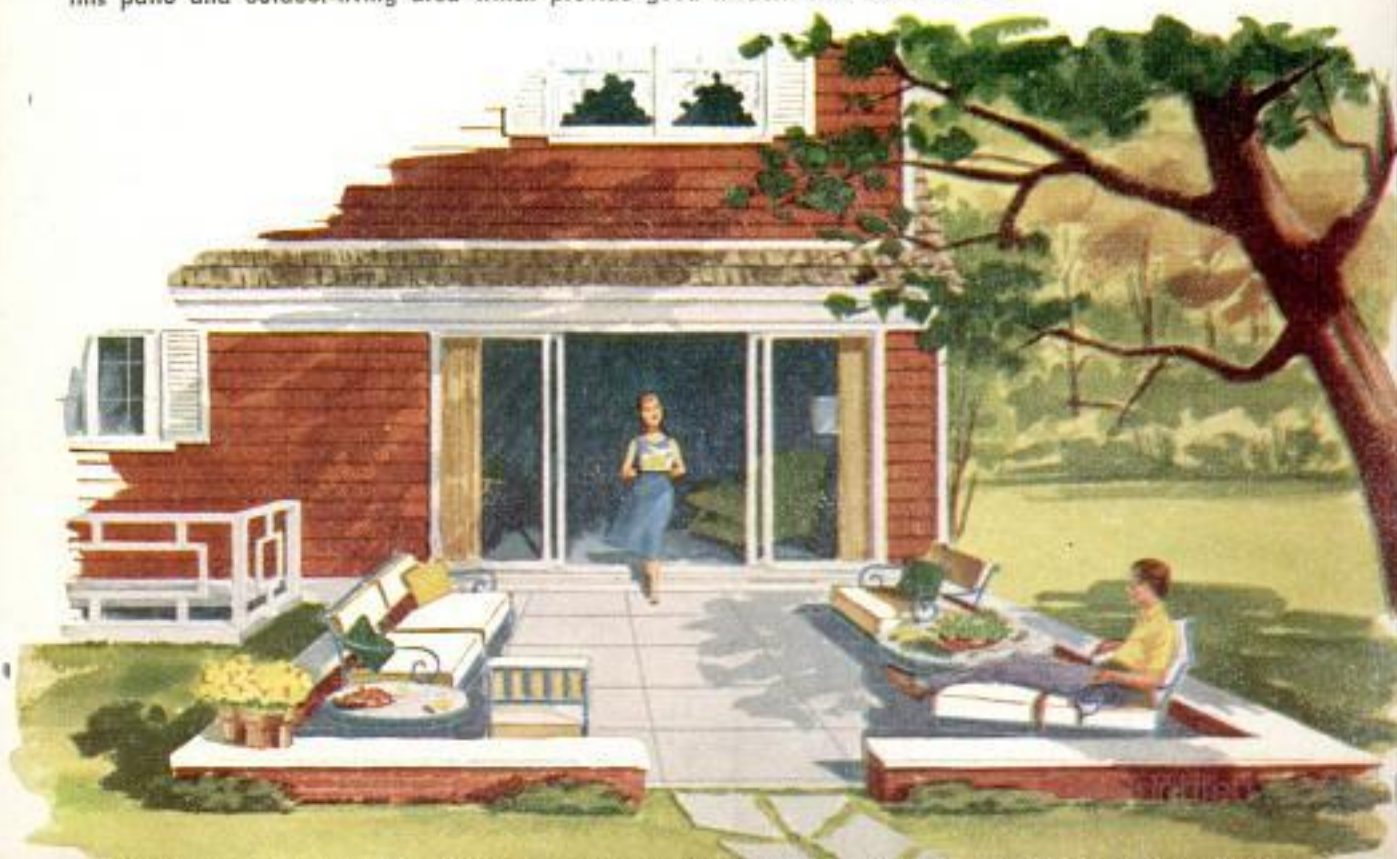

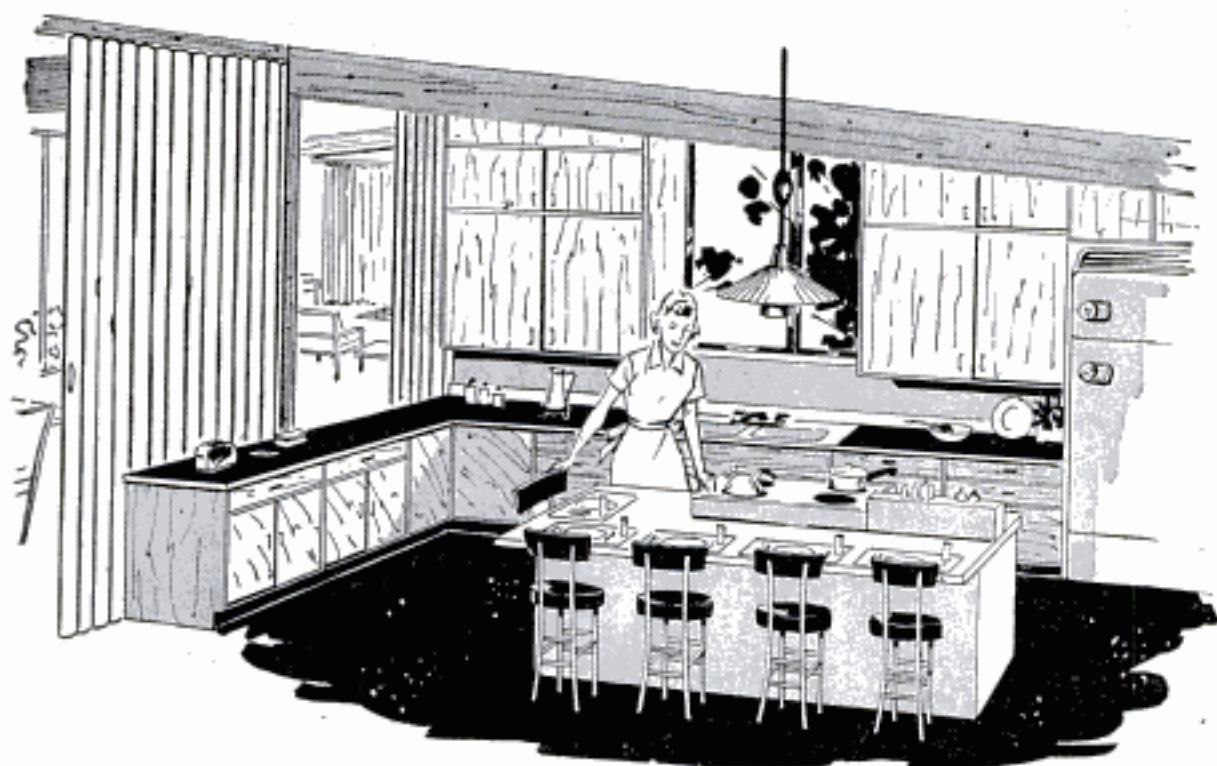

Kitchen of the PM Modern features an island breakfast bar and range. Windows over sink look out toward entrance court. Folding partition (left) opens to family room

PM Traditional kitchen has wickerwork cabinet doors and raised oven. Diamond-paned windows look out to rear yard. Across the room are a dining nook and planning desk

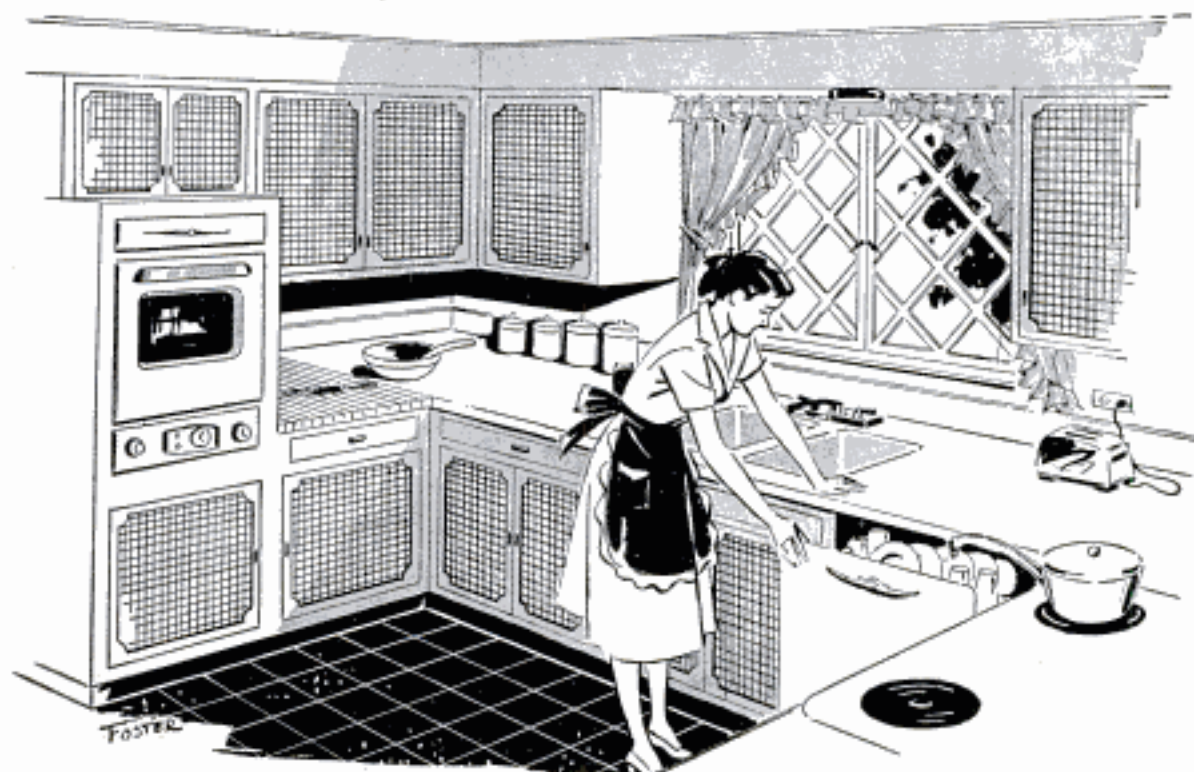

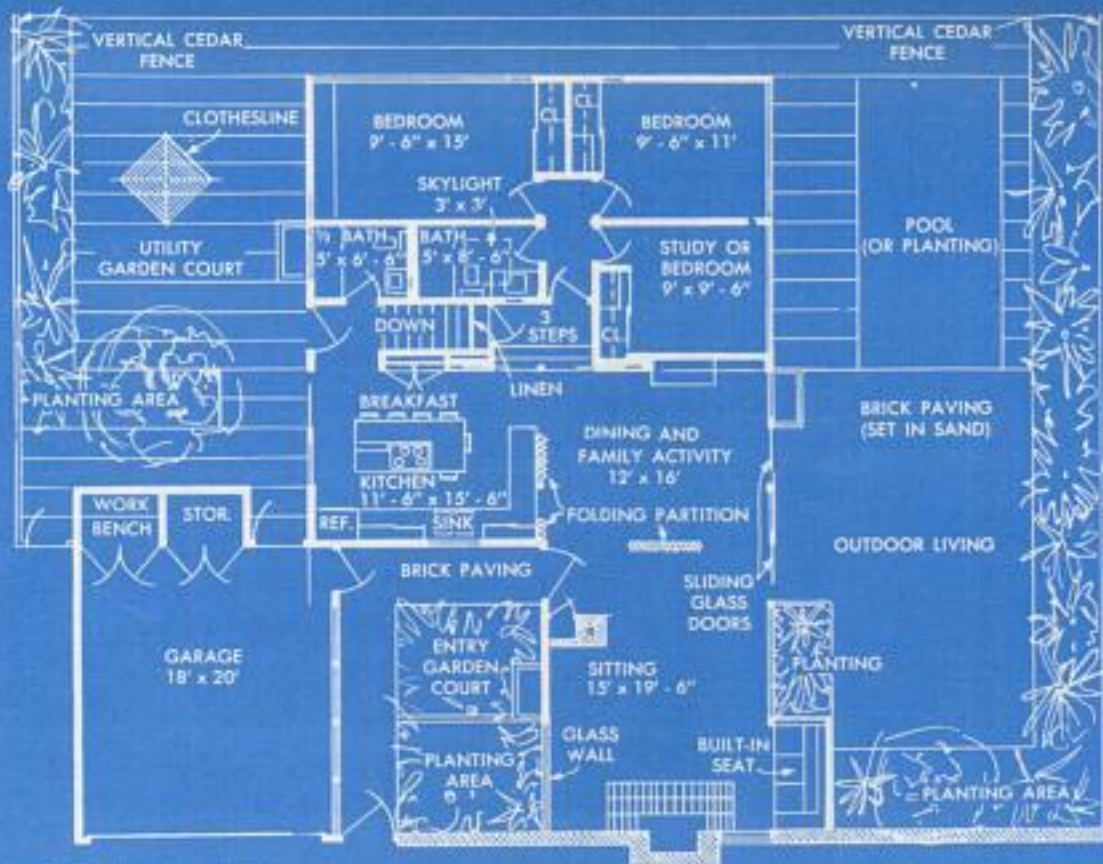

*the PM Modern*



*the PM Traditional*



without condemning the family to a gold-fish-bowl existence. The same applies to the home's open plan (minimum use of solid room partitions). This affords needed versatility for modern informal living. Kitchen, breakfast, dining and living areas adjoin each other with little feeling of separation. However, folding partitions are provided for occasions when the family desires the privacy of a separate kitchen, dining or living room.

"I use accordion-type partitions to achieve indoor privacy," says Ridley, "and on the outside the same effect is obtained with wing walls, enclosed courts, screen fences and landscaping."

The enclosed garden-court entrance at the front of the house "protects" the partial glass wall on one side of the living room. A wing wall, extending beyond the house proper, provides both shelter and privacy for the outdoor-living area. The glass side of the living room and dining area opens onto this secluded outdoor-living space. The wing wall and extended roof give this medium-sized home—1344 square feet of living area, not including the two-car garage—a luxurious big-house look. Beamed

(Continued to page 264)



Workshop in the PM Modern House is located in sunny end of the basement under raised section of house

Floor plan copyright 1957, John Ridley

problem was to find a top-notch firm of architects to do the job. Among those considered was the firm of Perkins, Norris and Mulloy, who practice in the Chicago area.

Our first glimpse of the building which houses their offices—low, sleek and modern with big slabs of glass and rough-textured brick in the suburb of Glen Ellyn—was discouraging. This building of their own design is about as traditional as the plastic House of the Future in Disneyland.

Three alert young architects—all in their sunny thirties—greeted this writer in their smart contemporary reception room. This room has walnut-paneled walls, cork floors and a low-slung aquamarine davenport against one wall.

"A traditional house?" repeated Gerald A. Perkins, the 34-year-old senior member of the successful firm. His glance met those of his partners, Charles F. Norris and Miles F. Mulloy. Both Perkins and Norris are graduates of the justly famed School of Architecture at the University of Illinois. Mulloy learned his profession as he says "the hard way, in night schools, in architects' offices and on building projects."

Norris lifted a thoughtful finger to his

(Continued to page 268)

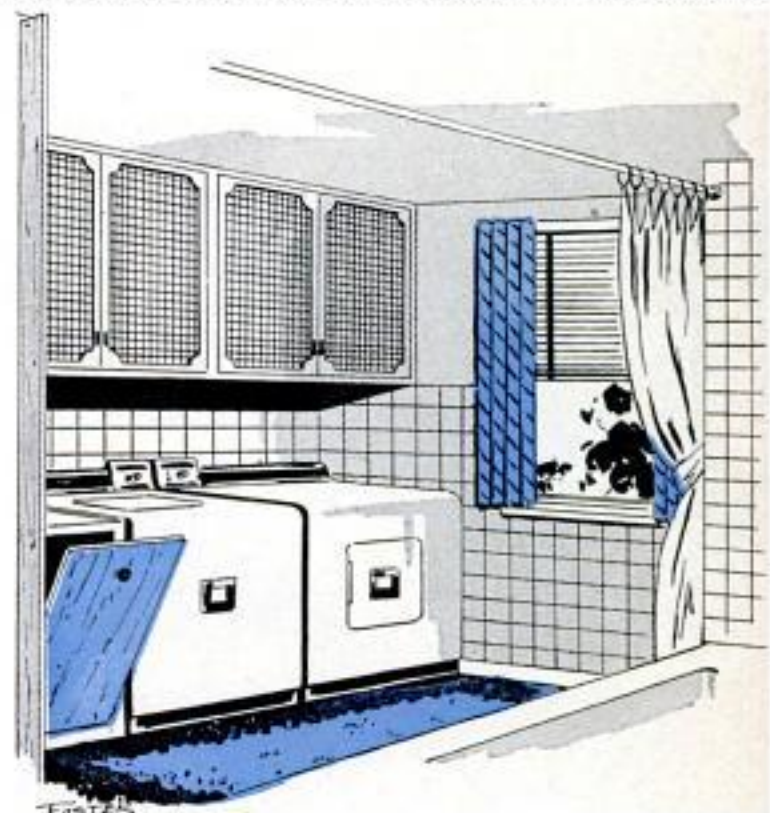

Ingenious upstairs laundry in the bathroom (washer and drier) is a modern feature of the PM Traditional House. There is also laundry space in basement. Cabinets above utilities have doors of wickerwork

# PAPER Your Rooms With CLOTH

By Ralph Treves

**B**ESIDES BOASTING an array of new modern patterns and colors, coated-textile wall coverings have been made easier for the do-it-yourselfer to apply. Now the material comes trimmed ready for hanging and in a 24-in., easy-to-handle width. Unlike wallpaper, coated textile, despite its weight, will not tear when coated with paste, and it can be worked by stretching and contracting the cloth so adjoining patterns line up perfectly. Regular wallpaper paste is used, but to make it hold better, wall sizing is added to the paste in the proportions of one small package of sizing to each pound of paste.

Wall preparation is important. While the cloth may be applied to a painted wall and will satisfactorily cover hairline cracks, deep cracks in the plaster should be filled with a patching compound, such as Spackle. In covering a high-gloss paint, it is best to score it deeply with coarse sandpaper and then coat it with glue sizing. New plaster walls, of course, should be sized, too.

Before cutting strips, check position of matching pattern. Number strips and pile in consecutive order



Cut the strips about 1 in. longer than actual ceiling measurement to allow enough for final fitting

As with wallpaper, proper placement of the starter strip is important. This is assured by dropping a plumb line from the ceiling line 23 in. from a corner, placing the first strip to this line and running a wooden ruler down the corner to mark the cloth. The edge of the cloth is cut accord-

Apply heavy coating of paste. Wall sizing is added to give greater bond to hold heavy textile to wall





Plumb line is dropped 23 in. from corner. This tests trueness of corner and provides guide for first strip

ingly and a new plumb line is made to allow the trimmed edge to turn the corner about  $\frac{1}{2}$  in. Avoid running a full-width panel around a corner as it will not adhere properly. Instead, cut the panel lengthwise so it extends a short distance on the adjacent wall. Then apply the remainder of the strip

Work each strip with finger tips to merge corresponding sections of pattern. Watch for any air bubbles

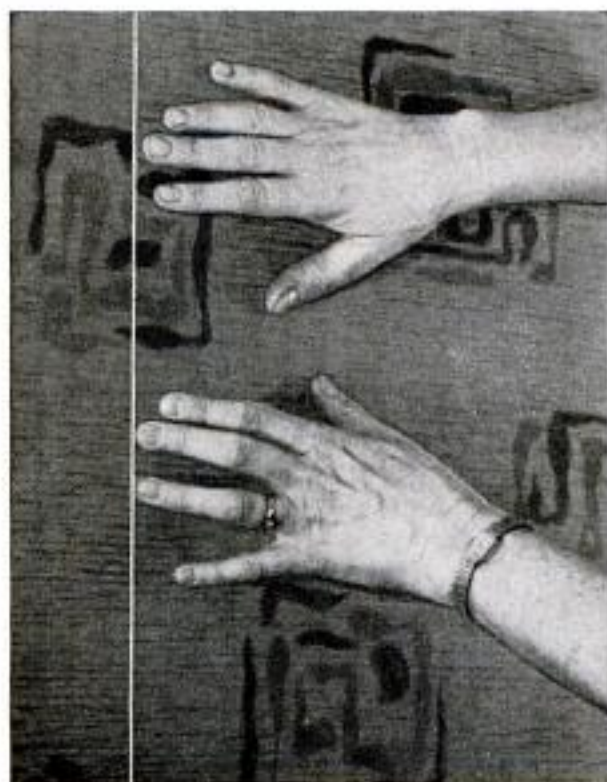

OCTOBER 1957



Brush out strip to smooth it, working from center outward to remove wrinkles. Damp cloth can be used

to the cut edge to make the pattern continuous. From here you proceed the same way as you would in hanging wallpaper, cutting the strips about 2 in. longer than necessary and making sure the patterns match. Apply a fairly heavy coat of paste, carefully brushing out all lumps. ★ ★ ★

Trim top and bottom edges by pulling fabric away from wall and cutting with scissors. Smooth back on



153

# IDEAS FOR HOME PLANNERS

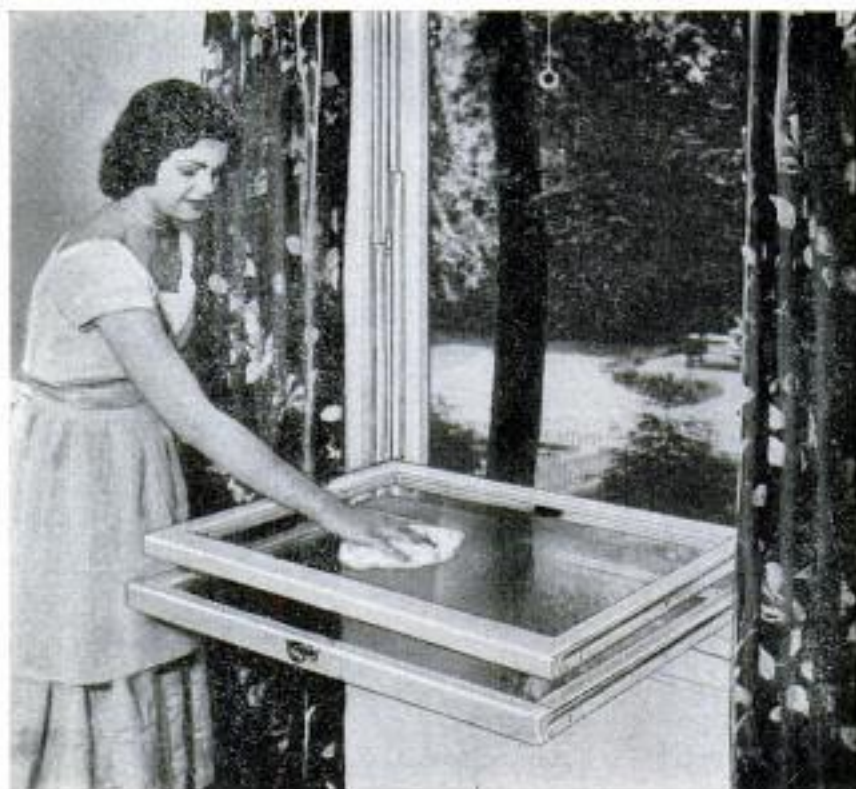

**TILTING WINDOWS** swing inward to any desired angle for easy cleaning. No part of the sash projects outdoors to interfere with the screens. Both upper and lower sashes are hinged at the bottom and both can be moved up and down in the usual way. Insulating glass with a  $\frac{1}{4}$ -inch airspace, is optional  
Brown-Graves Co., Akron 1, Ohio

**PRIME-COATED SIDING** made of hardboard is available in 12-inch-wide boards and 4-by-8-foot grooved or plain panels. Each piece is prime-coated at the factory on the face, back, ends and edges. Angle-cut edges on the horizontal siding keep side walls dry and clean by carrying moisture to the outer edge

Insulite, Minneapolis 1, Minn.

**EXPERIMENTAL AIR CONDITIONER**, below, is part of a heating-cooling package installed next to an outside wall to eliminate long, complicated connections. Cooling coils from the condensing unit run through the wall to a plenum under the furnace. The cooler has two-ton capacity; furnace is down-flow gas type

Frigidaire Div., General Motors Corp., Dayton 1, Ohio

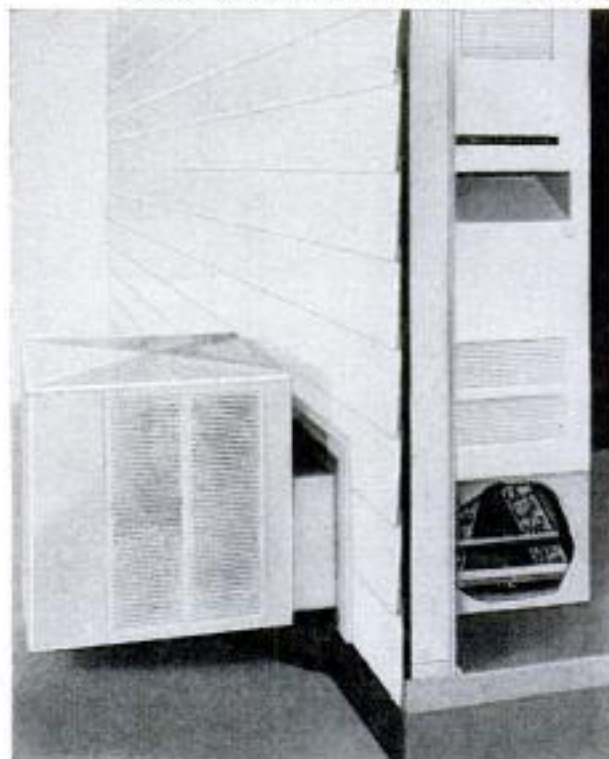
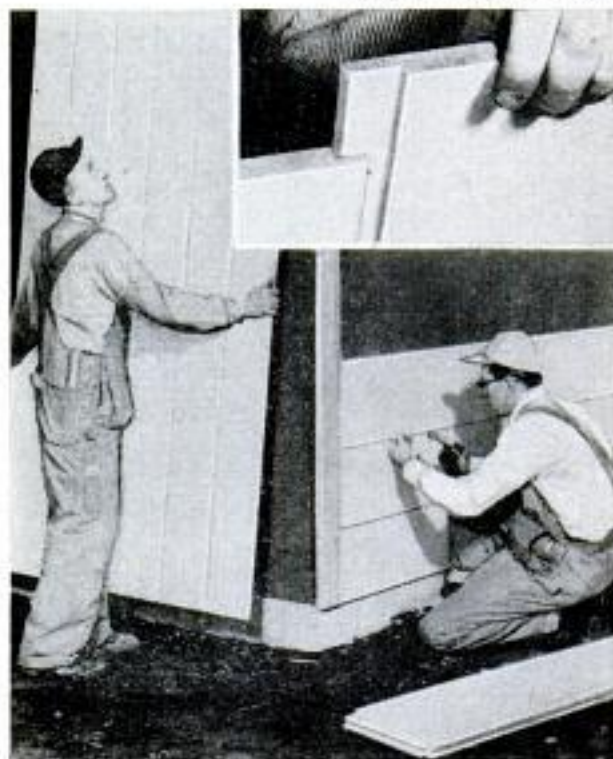



**CORNER DRAWERS** that help solve storage problems are made in a wedge shape of welded steel. They revolve about a vertically positioned rod inside the cabinet and make use of about 90 percent of the corner space that usually is wasted. A unit of three or four drawers can be installed in about two hours without the need for special tools. They're adaptable to any decorating scheme.

Home Steel Products, Inc., 1528 Vassar Ave., N.W., Canton, Ohio



**MARBLE TILE**, right center, is a half inch thick and comes from quarries in Vermont for use on walls, floors, fireplaces and countertops of homes. Like other tiles, they are applied with an adhesive and can be cut or shaped to fit around pipes or corners. They are relatively light in weight. Three sizes, 8 by 8, 8 by 12 and 12 by 12 inches, are available in 18 natural patterns and colors.

Vermont Marble Co., Proctor, Vt.

**GUTTER GUARDS**, lower right, protect against clogged gutters and downspouts. They are supplied in two-foot lengths and are easily installed. An aluminum molding snaps on the outer lip of the gutter while the galvanized wire cloth tucks under the shingles. Guards for copper gutters are produced with a plastic film over the molding to prevent electrolytic action of the metals.

Lockhart Manufacturing Corp., 6350 E. Davison, Detroit 12, Mich.



**AWNING WINDOW CRANK**, below, eliminates the need for a separate locking mechanism. When the crank is turned, the vent moves outward until it clears the weather seal. Only then does it swing upward. When vent is open, the mechanism holds it rigid. The closing procedure reverses the action with the vent locked when closing is completed. Vents can be removed from the inside.

R.O.W. Sales Co., Freeland, Mich.

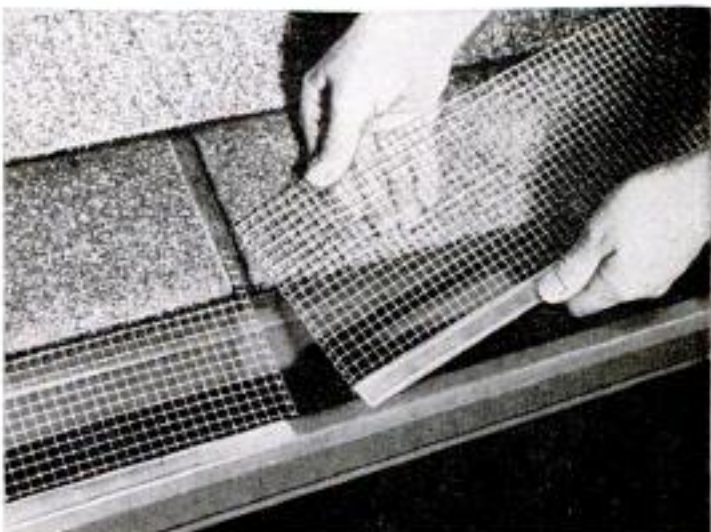
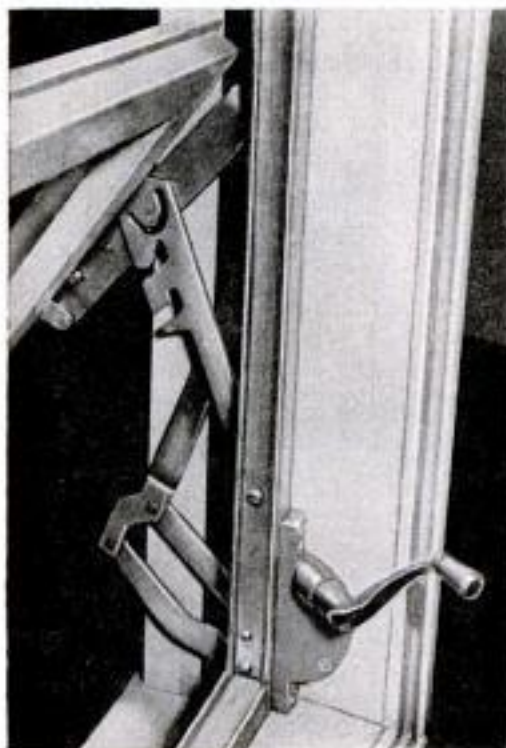



National Concrete Masonry Association photos

Cinder block adapts to long, low look of professional golfer Lloyd Mangrum's home in Apple Valley, Calif.

## Concrete Block Goes Modern

By Kenneth Anderson

**V**ERSATILITY IS THE KEY WORD for modern concrete masonry. If you have been thinking of concrete blocks only in terms of the traditional three-core stretcher units used in commercial buildings, it's time to take a fresh look. Manufacturers today are producing concrete blocks in a multitude of shapes and sizes. The new types of blocks have the same advantages of strength, permanence and economy. But they can now be used in a variety of textures and patterns limited only by the imagination of the builder.

Modern blocks are especially adaptable to modern home design and the outdoor-living trend. The long, low look of golf champion Lloyd Mangrum's home at Apple Valley, Calif. (top of page), is achieved with the use of eight-inch cinder-concrete blocks for all the exterior walls. Most of the interior walls, also, are cinder block. With the exception of the bath and dressing-room areas, the interior concrete-block walls were left exposed but painted.

Distinctive yet economical use of concrete block produces a latticelike outside wall for carport

The entire house area was built on compacted dirt fill with a four-inch-concrete floor slab. Ducts running under the slab link a central heating-and-cooling plant with perimeter-type diffusers in the various rooms. All doors and windows are of the steel sliding type and the entire house has a six-foot-wide overhang.

Concrete block is versatile enough to meet the building needs of homeowners in any part of the country. It withstands the blazing sun and sand of the arid Southwest as well as the subzero winter winds of the far North. In the hot and humid Gulf area it has the added advantage of being termite-resistant. Concrete block can be tinted to blend with natural surroundings and it can be combined with other building materials for special effects.

Modern concrete block is becoming popular as a material for building carports and garden fences. It can form a solid wall for privacy or be used in an open grille-type pattern for ventilation. ★ ★ ★

Enclosing paved patio with concrete-masonry units gives you some privacy without blocking breezes

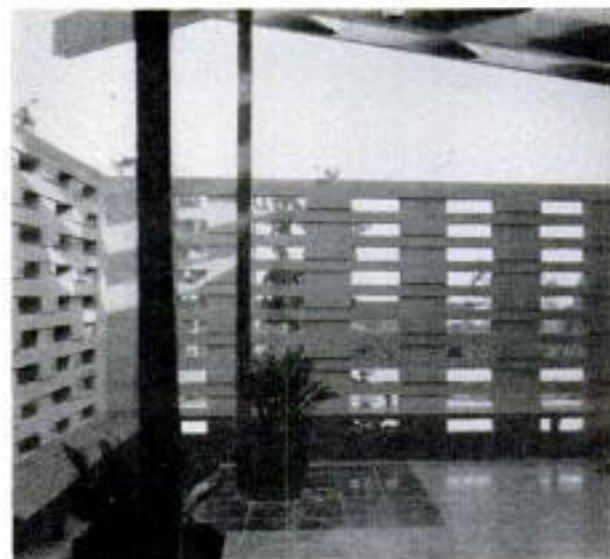
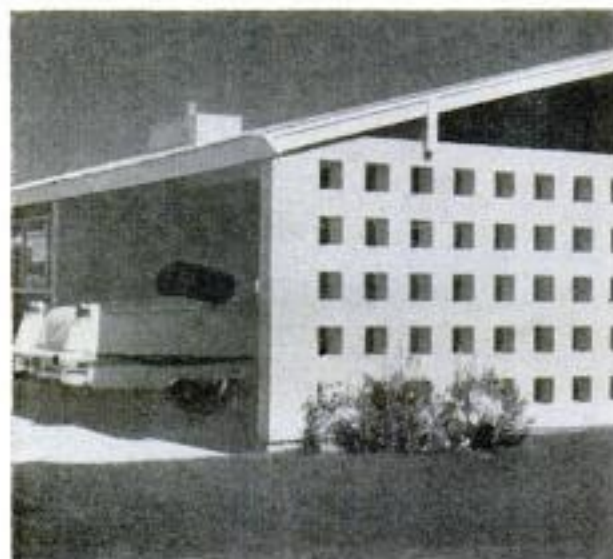

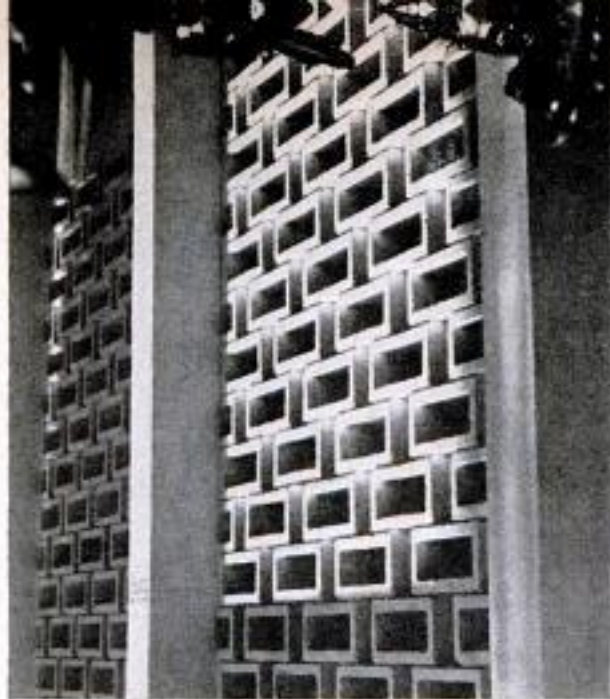

Custom-made single-core units produce this grille



Single-core blocks project from standard-block wall

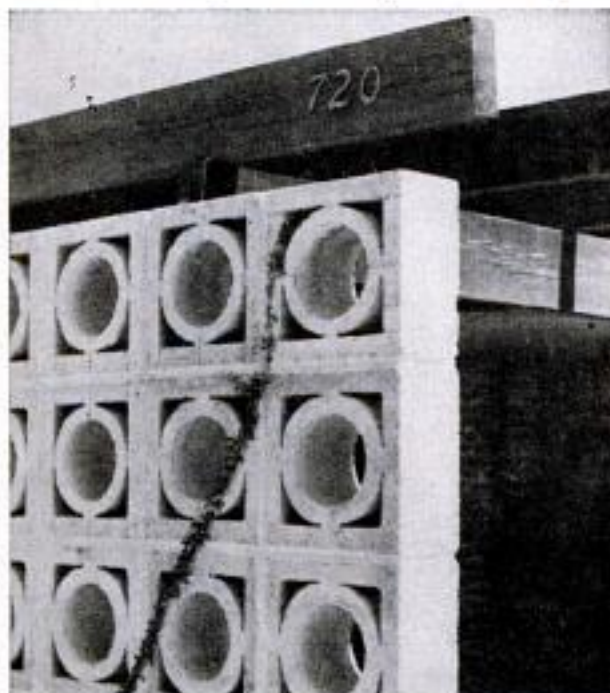

Regular chimney block, above, comes in many sizes

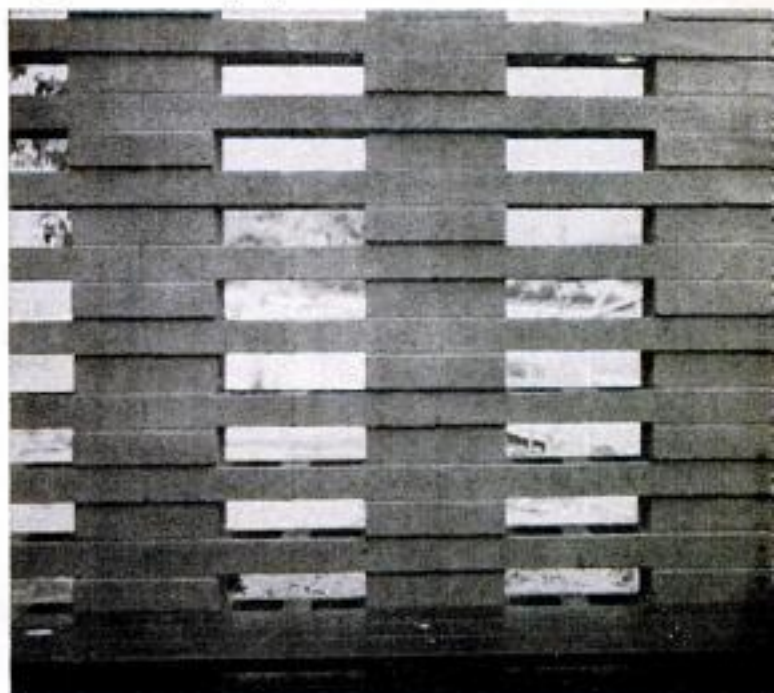

Half-height two-core units, above, form patio wall

Endwise blocks produce 3-D effect on curved wall

Recessed standard units in a running-bond pattern

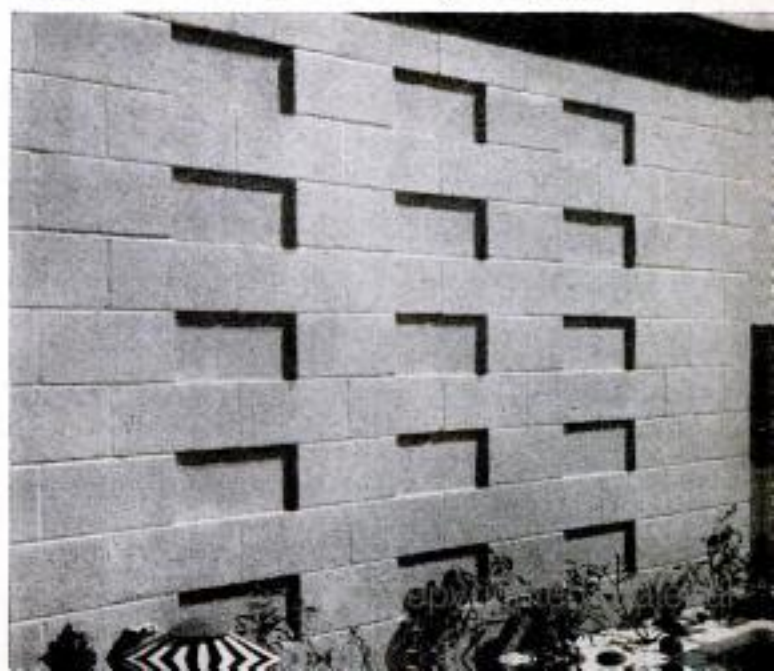
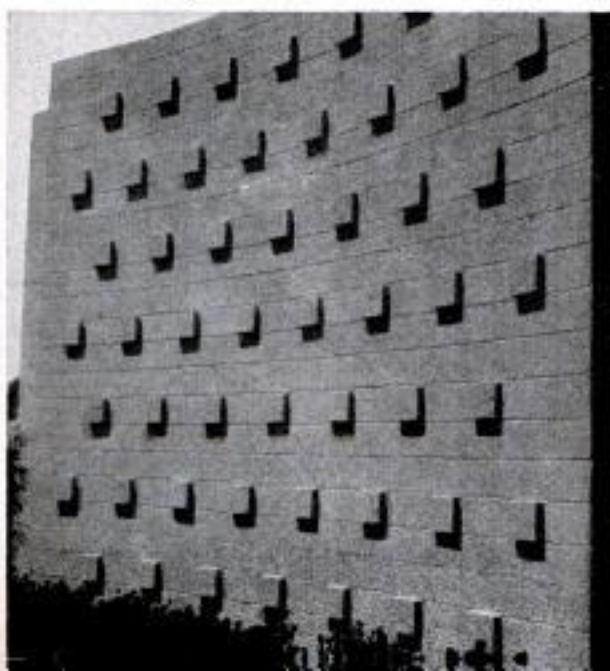

(see MAY 62, p. 178)

# The HOUSE THAT STORES THE SUN

Heated in winter and cooled in summer by solar radiation, this house is the culmination of 19 years of special research at M.I.T.

By Richard F. Dempewolff

**H**OW WOULD YOU LIKE a slick, modern home that—even in the northern part of the country—runs an annual heating bill of only \$50?

That's about what it will cost to provide year-round hot water, 72-degree comfort during New England's cold winters, plus air conditioning on hot summer days for a house completed this year in Lexington, Mass. Sitting high on a ridge with sweeping view, the eye-catching, two-story modern dwelling has several curious features that set it apart instantly from more conservative neighbors. Its long, paneled and nearly windowless side walls are half buried in the earth so that solid terraces extend from the second floor. The end walls, with intricate glass areas, reach down to grade level. In effect, the house snuggles in a "ditch." The living room, accessible from the terrace, is on the second floor along with the master bedroom. Dining room, kitchen and two more bedrooms are on the ground level.

Most startling, however, is one vast,

steeply sloping side of the roof entirely of glass panels that glint in the sun. Oddly, this is neither glass wall nor roof—but serves a little as both. Behind that 640-square-foot expanse lies the real secret of the house. This is the heart of a heating system that collects heat from the sun, stores it in the cellar and uses it in measured quantities to keep the house warm and comfortable in winter.

For nearly 20 years, the intriguing prospect of harnessing the sun to supply home-heating requirements has kept the builders of this unique dwelling busy. They are known as the Space Heating Committee of the Solar Energy Conversion Project. Established under a fund left by Godfrey L. Cabot, this team of scientists and engineers from Massachusetts Institute of Technology, in Cambridge, began in 1938 to study ways of trapping the sun's energy so it could be put to work.

"Space heating, hot-water supply and absorption-refrigeration air conditioning are an especially fertile field for solar-

Diagram of the new M.I.T. solar house at Lexington, Mass., shows in detail how the system will function

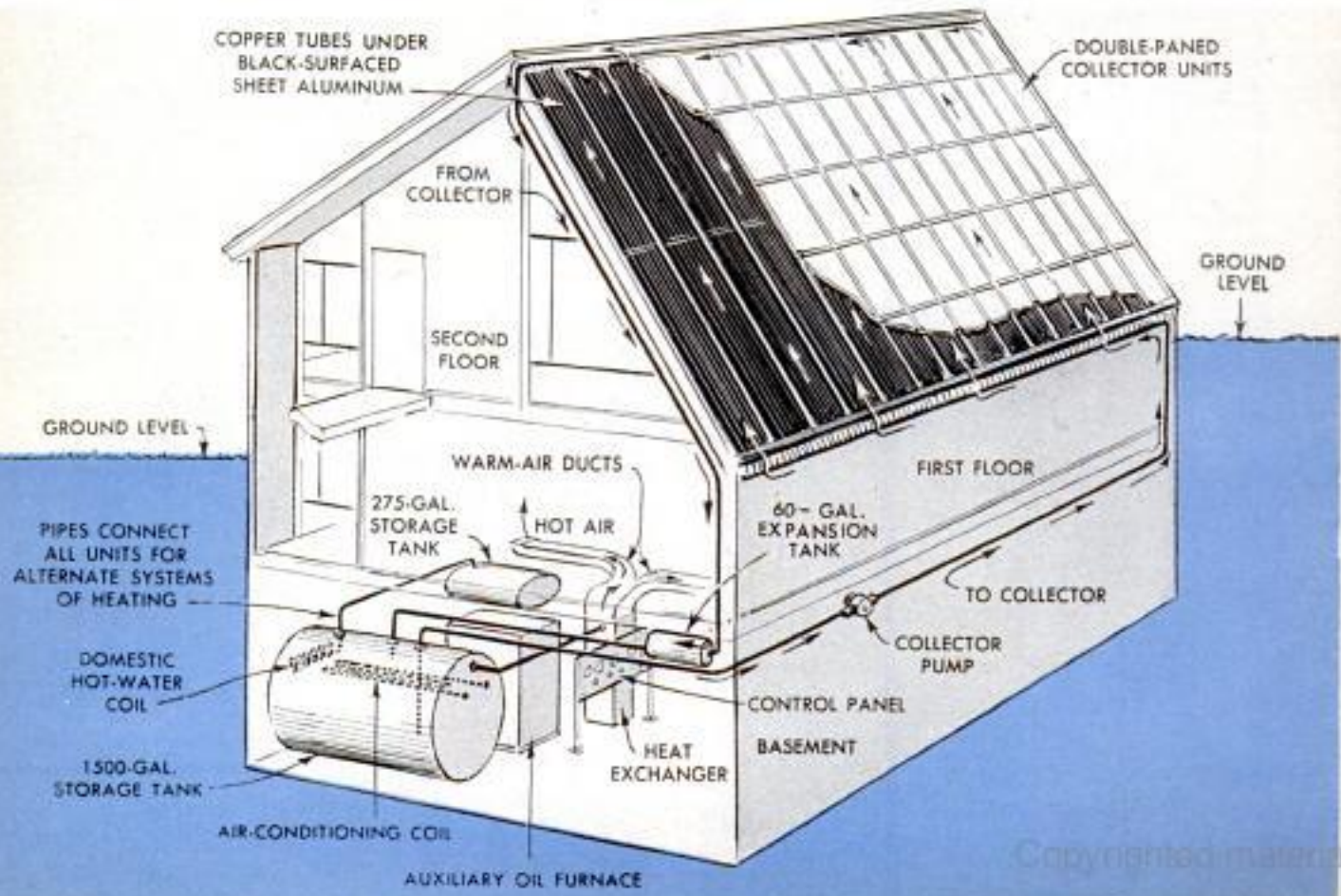

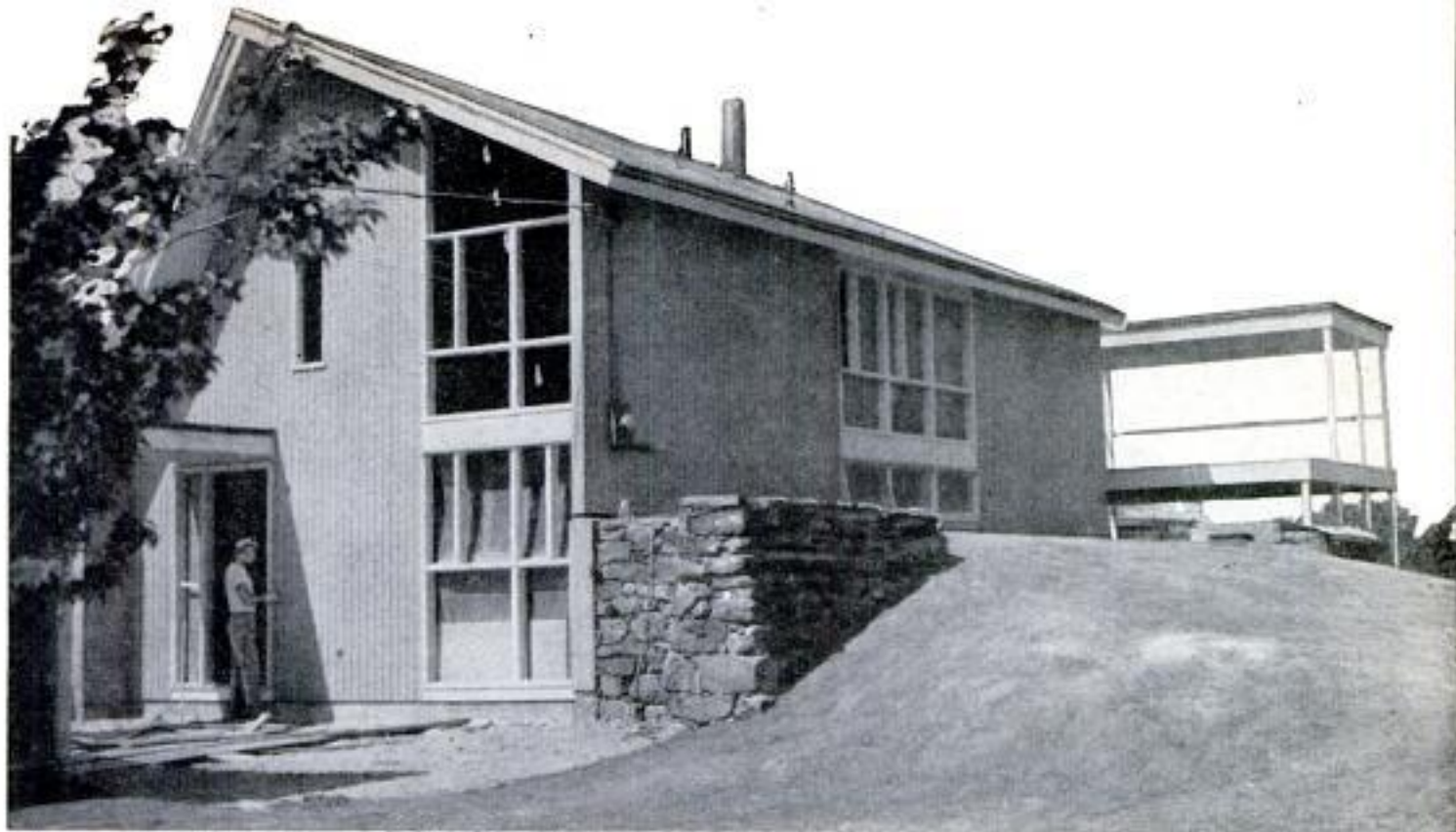

View from northeast, with side away from sun partly buried in hill to cut heat loss. Floor plan is below



Drawing of house, as seen from southwest, shows earth banked as high as the heat collector. Glass area covers 640 square feet

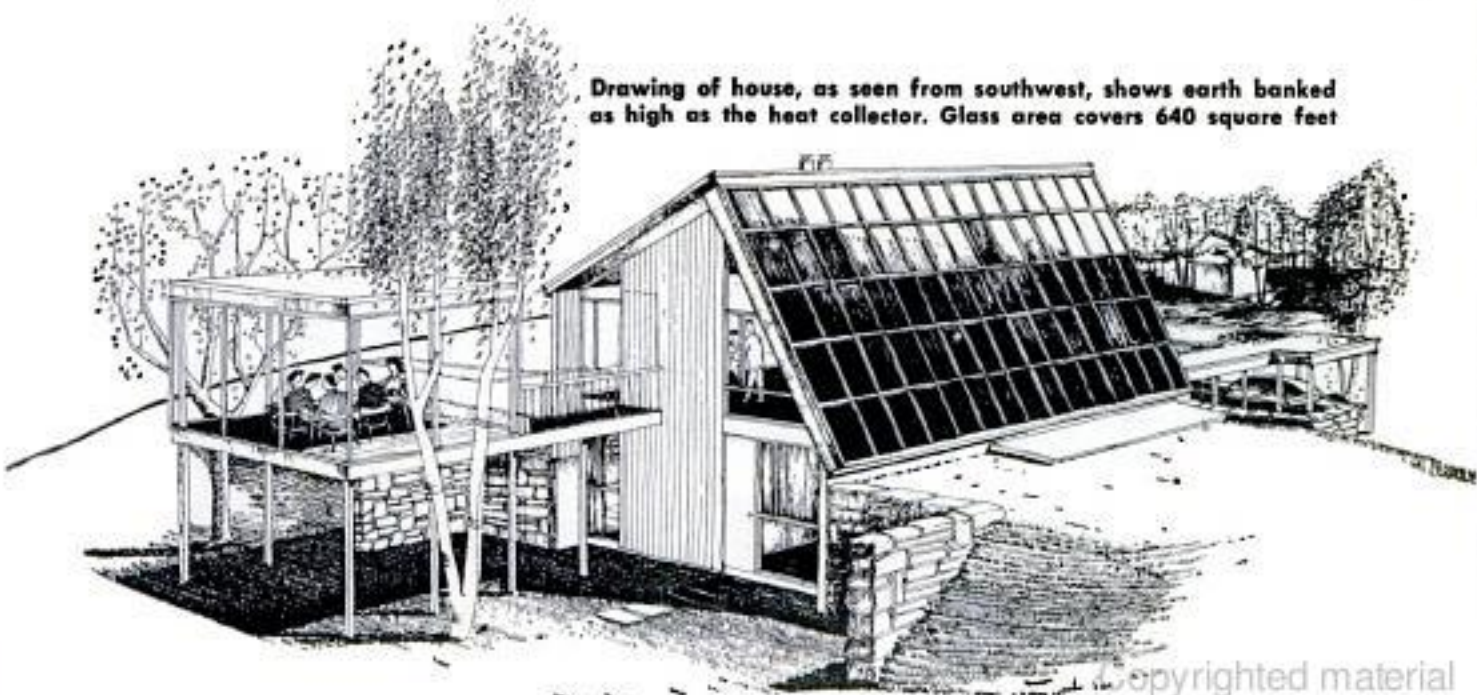

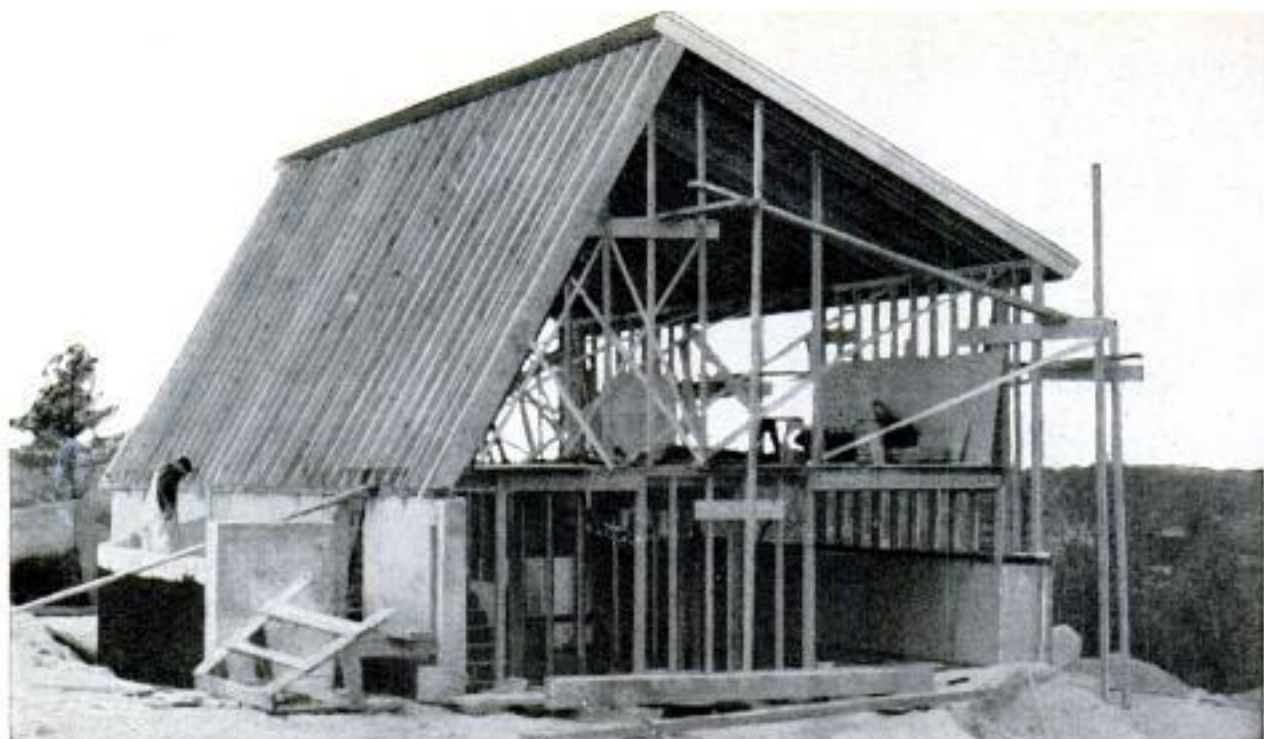

Construction stage of solar house, above, shows steeply sloping rafters that will hold 75 collector units

energy use," explains one of the engineers, "since the fossil fuels normally used for these jobs deliver much higher temperatures than are needed. So this was an area where we concentrated effort." Today, under Chairman Lawrence B. Anderson, their efforts are on the verge of paying dividends.

Robert J. Pelletier, research associate on the project, can show you stacks of blueprints and sketches in M.I.T.'s school of architecture testifying to the early studies that were made with various types of collector panels to absorb the sun's rays. Three experimental houses were built. "The first," recalls Pelletier, "was just a two-room laboratory for testing various collectors."

The second solar house at M.I.T. was a

row of cubicles with a triple-glazed south wall. Experimental water-tank heat-storage systems were tested in it. Ten years ago, this became the committee's third house—but its first real solar home—when a collector and storage tank were installed, and a small student family moved in. That house was purposely underdesigned to require auxiliary heat. But from it came the know-how that went into the construction of the latest experiment in Lexington.

The solar experts' "dream house" looks like a uniquely conceived modern home in the \$18,000 to \$20,000 price class, although this hand-built prototype cost much more. The big collector surface extends the entire length of the building. Tilting skyward at



Workman on ladder, below, is putting black paint on aluminum heat-absorbing material

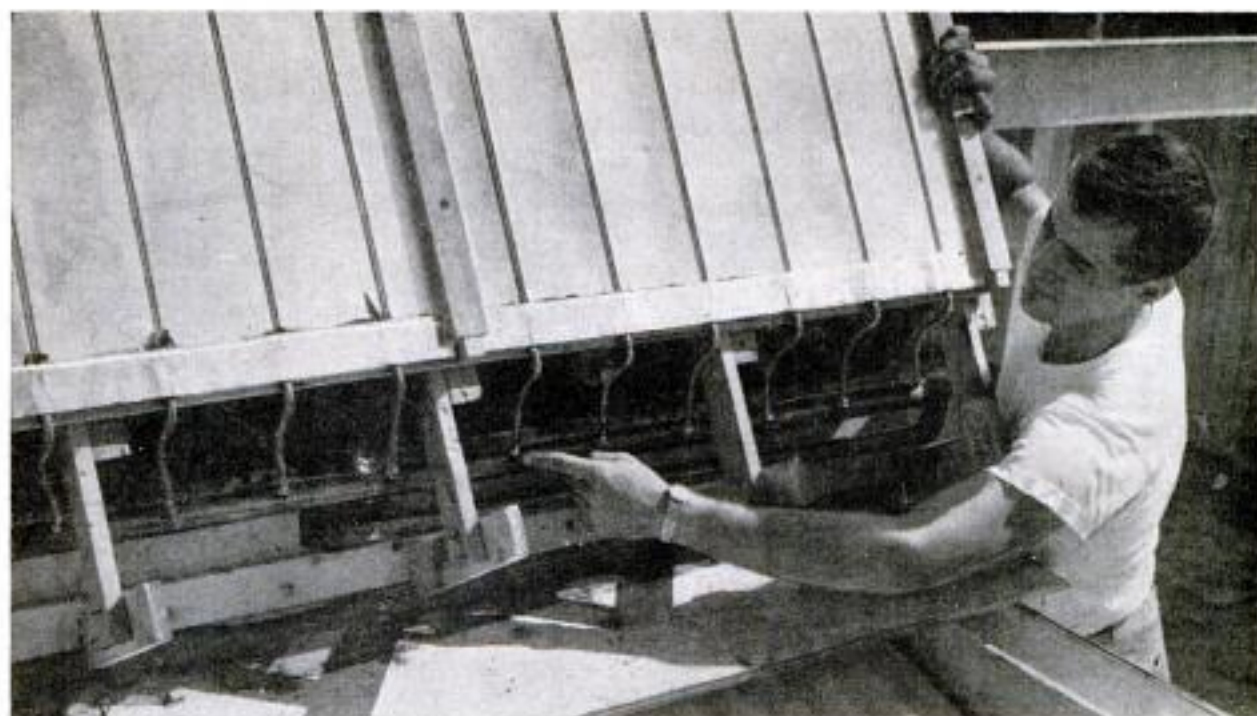

Photograph above and diagrams below illustrate method of circulating water through heat-collector units

an angle of 60 degrees, it resembles the extended side of a salt-box-type roof that some imaginative artist might have designed as a tremendous studio window. Instead of facing north light, however, it looks to the south so it can catch optimum sunshine.

### Many-Celled Collector

The collector, measuring about 16 by 40 feet, is made up of many individual cells. Each is a glass-covered insulated box, about 2½ by 16 feet, in which the sun's heat is absorbed by a black-surfaced aluminum sheet. "The sun's short-wave radiation easily penetrates two layers of glass," explains Pelletier. "But the heat radiation from the metal is long-wave, and glass will stop it. So, the heat is trapped in the insulated box."

Water, pumped through a grid of piping fastened to the underside of the aluminum sheets, picks up the heat and, warmed to about 150 degrees, circles back to a 1500-gallon storage tank in the cellar. This massive cylinder—about five feet in diameter and nine feet long—is hidden in a huge box of loose insulation that keeps its cargo hot. From this big reservoir of "canned sunshine," the heated water is pumped as needed through a heat exchanger. Here, the warmth is transferred from the water to air,

(Continued to page 276)

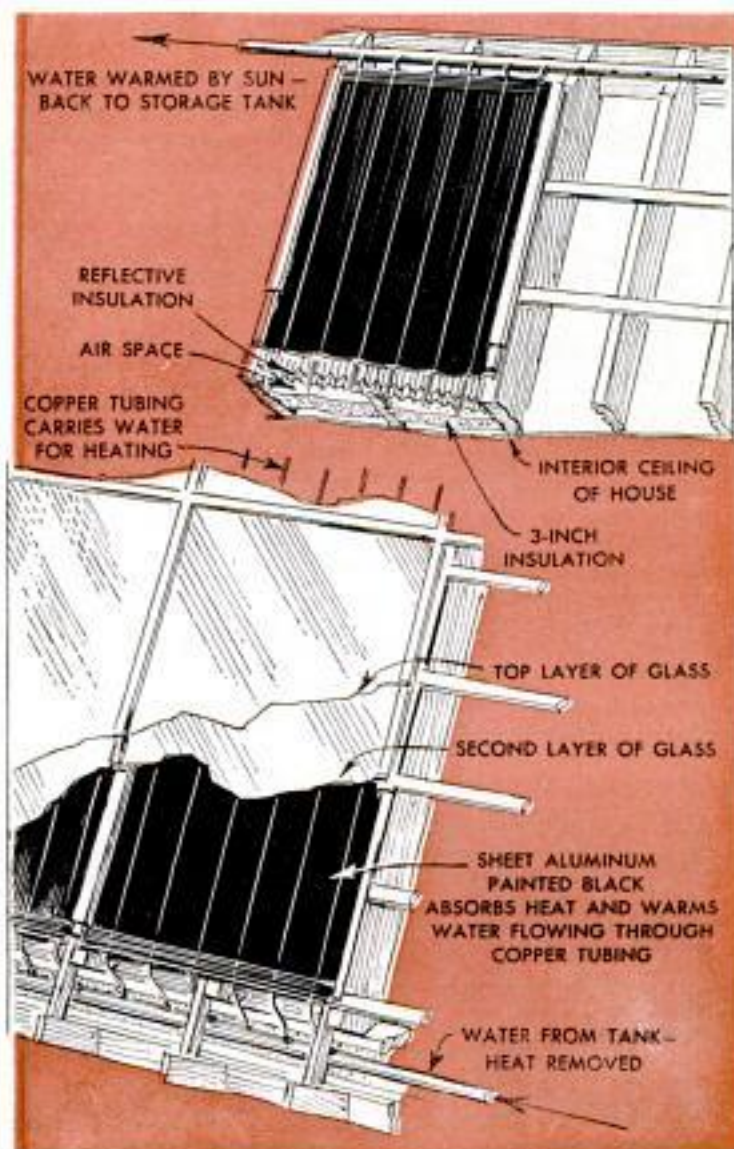

# Is It a Good Buy?

## BUILDER'S REPUTATION



Does the builder take pride in his product or is he more interested in the money he can make? Talk with owners of other homes erected by the builder. Was a qualified architect consulted in planning the house? Have storm sewers, other extras been provided?

## NEIGHBORHOOD

Is it a new neighborhood with a future or an old area on the decline? Is it near slums or factories, or close to heavily traveled streets? Check the zoning laws—they may allow a rendering plant next door. Proper location can be most important in buying a house



## KITCHEN AND BATH



Are the kitchen and bath up-to-date? Does the kitchen have adequate light and ventilation? There should be enough counter space and room for new appliances. The kitchen floors should be grease-resistant. Do you have to climb stairs to reach a bathroom? Is lavatory lighting adequate?

## STORAGE

Are the closets and cabinets designed for your needs? You may want separate storage areas for out-of-season clothing and clothes for current use. Are the closets lighted or do you have to grope in the dark? Will you need closets for toys or for household tools?



## LANDSCAPING



Good lawn and shrubs add to the resale value as well as the appearance of a house. But shrubs should not be of the nuisance varieties that attract insects or make a mess of the yard. Yard should be adequate for fun and graded to drain water from house

## BASEMENT



Does the basement have proper drainage? A good basement can be converted to a workshop, a rainy day playroom or a storage area. But be sure the basement isn't damp or easily flooded. Are the walls sealed against water? The stairway should be safe and well-lighted

## TRAFFIC PLAN

Where do the doorways lead? Can the bedrooms be isolated from areas where other members of the family may be entertaining? Is the kitchen close to an outside entry or do you carry groceries through the living room? Study a copy of the floor plan of the house



## BEDROOMS

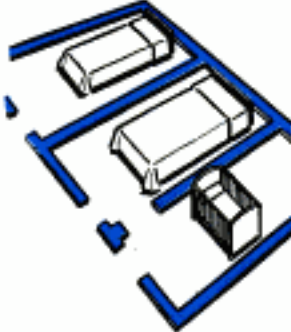

Nearly three fourths of all home buyers want at least three bedrooms; some prefer four. Bedrooms should have adequate ventilation and privacy. Space for the bed should not be broken by doors, windows, heat ducts or closets. Not more than two persons should sleep in same bedroom

## HEATING

Ask a heating contractor whether the furnace will be adequate for the size of the house and the climate. Also, will it be big enough if you add a room? Are heating ducts insulated? Trend is toward central air conditioning, so check the cost of adding a cooling unit



## COST TO BUILD



Bargains in real estate are rare but you may get more floor space per dollar in a bigger and older house. Find out what it would cost to build a new house to suit your personal needs. Then figure the cost of buying an older house and remodeling it to suit your taste



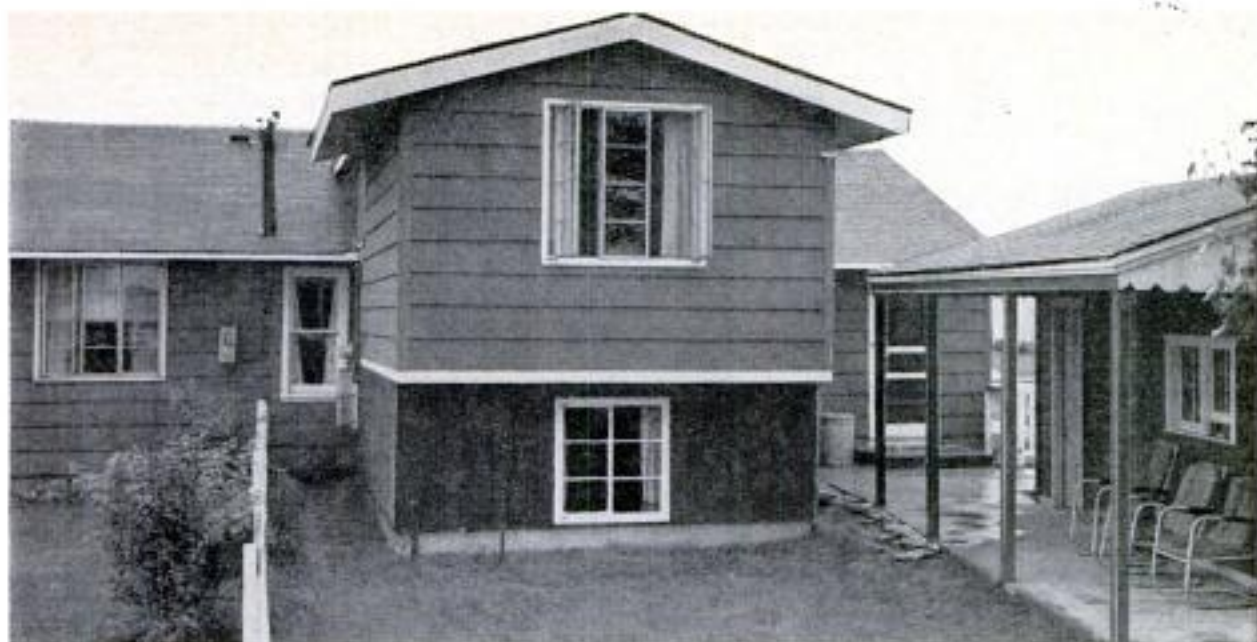

Here's the split-level addition that added 448 square feet of living area at a total cost of about \$1820

## *Because We Needed a Third Bedroom We Changed Our* **RANCH HOME TO A TRI-LEVEL**

*By Bob and Merry McShane*

**T**HE DECISION to add a room to our duplex ranch house was forced upon us. We liked our town and our neighbors and we liked being close to schools and shopping, but we had real space problems. Our lot is not large and we could only build to a maximum of 30 percent of the lot area—an ordinary room addition would give us one more bedroom, but no more. The children still would have no place to play indoors and our four girls were becoming more and more of a strain on that one bathroom. Somehow, the idea of building a split-level addition was born.

When the idea first came, we dismissed

it as impractical. The Hometown, Ill., building code is strict and we felt we'd never get permission to build our house higher than the neighbors' houses. Besides, we were afraid that such an addition might look odd and ungainly in the midst of 1700 long, low ranch homes. Then solutions started arriving. Why not start at the depth that we'd have to go with the footings? That would leave more space above. After a few weeks of drawing and figuring, measuring and replanning, we came up with a workable plan. The two new levels could be built without going any higher than the existing ridge—and we still wouldn't have

The addition can't be seen from front of the house. Its peak is no higher than the original ridge line





Above, interior of recreation room. New rooms appear on floor plan, below, as tinted areas. Original bath is now stairway



to risk building a deep basement that would be damp and dark. Most important, the plan gave us an additional half bath, a larger full bath, two extra closets, a big bedroom and a playroom which could be reached directly from the kitchen. With crossed fingers, we submitted the plan for our building permit. We received not only approval but congratulations and best wishes from the architects who comprise our Building and Zoning Department.

We soon found out, of course, that it's a long way from a beautiful plan to the finished product. Our troubles started right away when we found that we'd have to dig the excavation by hand — no machinery could work well in that tight space. Surprisingly, the job moved right along, thanks to the help of a good neighbor who appeared almost every evening saying he just wanted to "get in shape again." By the time we had dug 35 cubic yards of dirt out of that hole, we were all in shape!

We poured a concrete slab in the excavation with broad, deep footings all around and a line of drantile around the perimeter draining into a sump located beneath the stairs. Concrete blocks were laid in a horizontal stack bond, 11 courses high, painted on the inside and covered with siding on the outside to match the existing house finish. About the time the walls were at ground level we resisted the urge to make it into a swimming pool—despite the wails of our crew of juvenile sidewalk superintendents.

The job of moving our whole plumbing system was more than we had anticipated. It was at least two weeks before all the

fixtures in the house were in operating condition at one time. We have this advice for any amateur who has to move a bathroom: Don't even try to reuse the basic plumbing system. Just build the new one, at least one complete bathroom all ready to hook up. Then salvage whatever you can when you tear out the old system. The extra cost would be well worth it — and would save you a great deal of aggravation.

A long four-by-six beam, reinforced with steel angle bars, enables us to maintain full ceiling height in the bedroom. The rafters rest on the beam and on the top plate of the outside walls.

We taped and sanded all the wallboard joints, installed plastic wall tile in the baths and paneled the end wall of the recreation room with rustic cedar siding—the same material that is used on the lower part of the outside walls. The upper siding material is 1/4-inch hardboard which we ordered from a factory that produces it as prime-coated siding and furnishes a rabbeted shadow strip to build up the bevel. It's easy to install and holds a coat of paint beautifully.

The lower room is 12 by 18 feet and the upper room projects 16 inches beyond the 18-foot length. Our basic house was only 720 square feet and the addition of 448 square feet brings the total to 1168.

Here's the approximate breakdown of material costs: Plumbing and sewerage, \$310; masonry and concrete, \$240; heating materials, \$145; electric supplies, \$210; millwork and doors, \$140; lumber, siding, roofing, insulation, paint and tile, \$775. The total cost was about \$1820, or \$4 per square foot for two extra rooms. ★ ★ ★



Rear view of home before split-level addition was started. Earthmoving machines couldn't operate in small space so excavation was by hand



Concrete-block walls are started, above, on concrete-slab floor. The white lines on the photograph below indicate the framing for the upper level and location of a new window for one of the original bedrooms





Fleetside Window photos

Exterior and interior views show how porch was converted into a year-round family room. Window walls combine a fixed picture window with jalousie panels

## The Easiest Way to Add Space

*By Clifford B. Hicks*

**W**HEREVER YOU LIVE or whatever the climate, there's a potential extra room in your home if you have a porch or breezeway.

Enclosing a porch is the easiest and least-expensive way to add space for one reason—the roof, floor and one or more of the walls already are in existence. All you have to do is add the remaining climateproof walls and provide heat for the resulting room.

In years gone by it was difficult to convert a porch into a satisfactory year-round room. Old-fashioned windows wouldn't lock out the cold and old-fashioned furnaces wouldn't deliver the extra heat.

Today the heating problem is easily solved. Many forced-air furnaces will provide adequate heat for an additional room, so all you need is another outlet to the



porch. If you can't solve the problem this way, you can heat the extra room with one of the new high-styled space heaters. Some fit between studs with little projection into the room.

By far the easiest way to add walls is simply to add windows. Modern windows are available in an amazing array of types and sizes. When you find the right width in the right type, you can simply stack up the windows to the height you wish. All the modern types, including jalousies, are weatherstripped and virtually airtight. The resulting window walls will keep out winter winds almost as efficiently as existing walls.

These three pages show ideas for converting porches into family rooms and bedrooms, but each porch presents its own problems. You can give your porch enclo-



Andersen Corp. photos

Beautiful room shown above started out as the unimpressive open porch at right. In this case awning-type windows were used to provide full ventilation whenever desired. The strong horizontal lines of the windows make the enclosed porch appear larger

sure your own distinctive touch through choice of type and size of windows and doors. Most important, the completed room should conform with the existing architecture, whether it be modern or traditional in style. (Photographs of outstanding projects are continued on next page.)

Screened porch below served as the basis for a two-room addition to this two-story house. Porch was permanently enclosed and additional room built above it. Corner posts of the original porch were covered with siding to match the second floor of the home

Bolacreen Co. photos

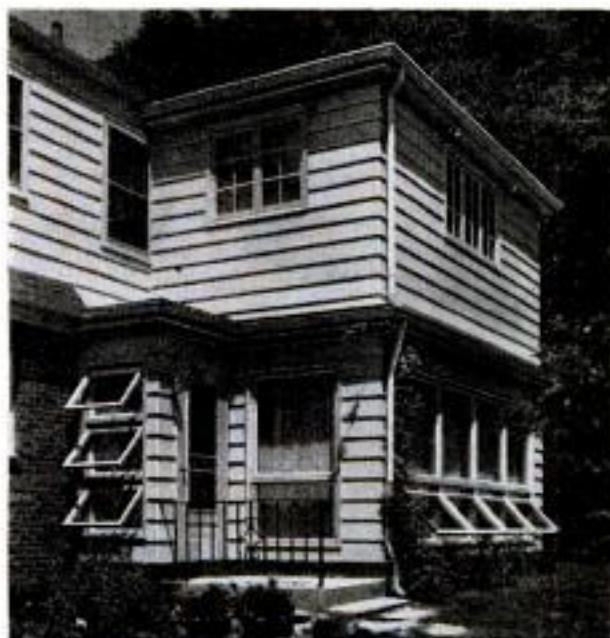

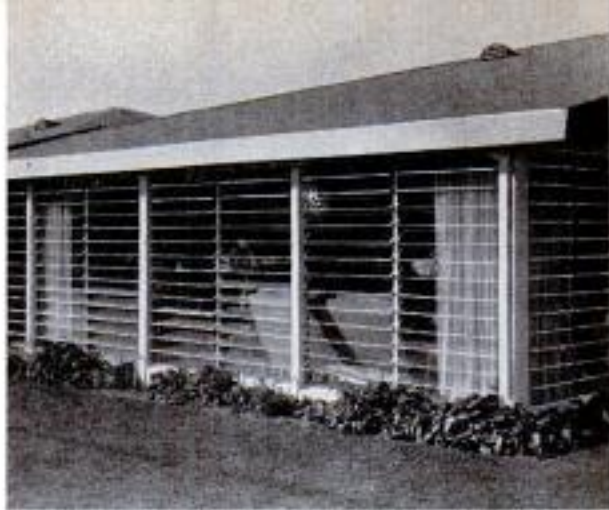

Sun-Sash Co. photos

This project started with a roofed patio. With the roof, floor and one wall already in existence, the homeowner only had to add three climateproof walls. He selected modern jalousie windows, giving him three walls of glass. Because of the continuous roof line, the resulting room seems part of the original home



Andersen Corp. photo

Modern windows stack to form window walls. In many cases windows fit together and need no framing members between them. There are sizes to fit any need



Western Pine Assn. photo

Feature of this all-purpose room, converted from a porch, is the big sliding glass door—in effect a movable wall—which closes off or opens up the outdoors

Jalousie windows give complete ventilation even when it's raining. During the winter months, the inside screens can be replaced with storm sash if desired

Ludman Corp. photo

More formal is a porch area enclosed with picture windows and jalousies. This provides excellent view of the garden without sacrificing good ventilation

Ludman Corp. photo

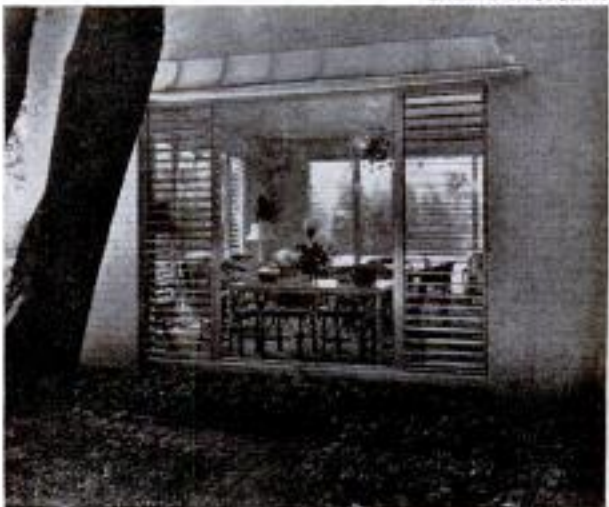

# PARADE OF HOMES

*Good design and construction, livability and price were the basis for the selection of these outstanding homes across the country.*



MARYLAND

Three bedrooms, two baths  
Floor area—1900 square feet  
Price—\$22,000 (without lot)

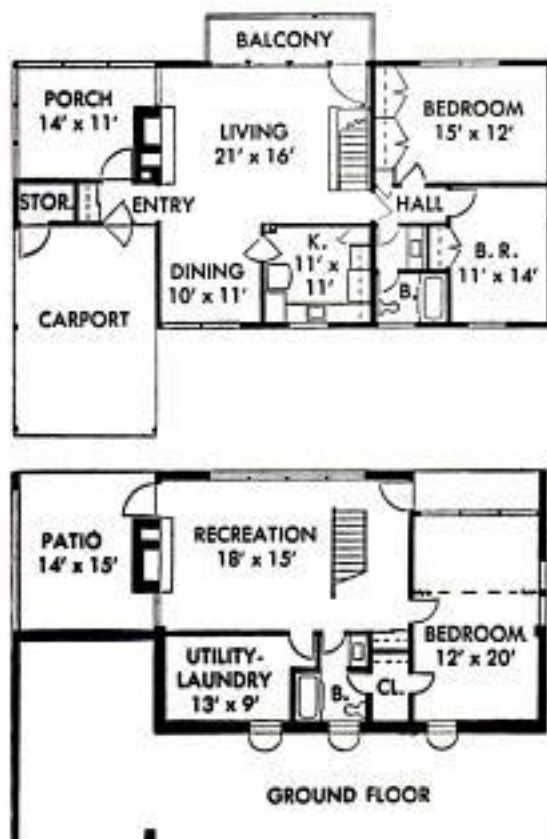

Ideally located on the top of a hill looking across a wooded ravine toward the Potomac River, this home was designed by Francis D. Lethbridge, A.I.A., of the firm Keyes & Lethbridge of Washington, D. C. It was built by the Bennett Construction Company, Bethesda, Md., in the suburb of Glen Echo Heights. The front of the house (below) is one story and the rear two, due to the hillside site. It is actually a two-story house with no basement. Big windows, porch and patio across the back take full advantage of the view. A balcony outside the living room adds interest. The foundation is concrete slab; framing, Douglas fir; exterior, brick and textured-redwood plywood; roof, built-up white crushed coral; floors, oak, vinyl and ceramic tile; extras, range, refrigerator, disposer; heat, gas-fired furnace, forced warm air

Photos by Fred J. Maroon



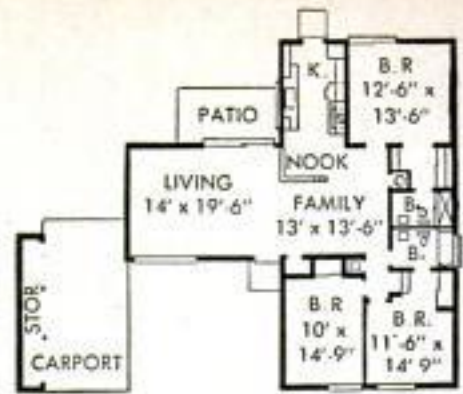





## ARIZONA

Three bedrooms, two baths  
Floor area—1240 square feet  
Price—\$10,950 (including lot)

Markow photo

One of the best buys in the country is this sleek modern house built by John F. Long in Glendale, Ariz., and designed by Ragnar C. Qvale. The layout of this glamorous house exemplifies the best in open planning and indoor-outdoor living. Living, family room, kitchen, eating nook and rear patio form a free-flowing center for family activity. Around this are the bedrooms, two with dressing rooms. Foundation is slab; floors, asphalt tile; exterior, concrete block; roof can be flat or gable; many extras



## NEVADA

Three bedrooms, two baths  
Floor area—1200 square feet  
Price—\$13,950 (including lot)

The price of this house includes a complete air-conditioning system, dishwasher, disposer and a paved patio. It was built in Las Vegas, Nev., by McKellar and Associates of Menlo Park, Calif. It was designed by Rombough, Inc., Oakland, Calif. The plan features a big garage at the front of the house which can also be used as a porch, a patio with access to the master bedroom and family room, and a good traffic pattern for everyday living. Foundation is slab; exterior, stucco and board-and-batten; roof, built-up



## MISSISSIPPI

Three bedrooms, two baths  
Floor area—1275 square feet  
Price—\$17,000 (without lot)

Combination living-dining and family-room-kitchen areas give this house built by Carter & Fly of Jackson, Miss., a feeling of spaciousness. The architect is Edward I. Welty. Foundation is concrete with crawl space; exterior, grooved hardboard; roof, marble chip; floors, hardwood, vinyl and cork; all lighting, valance type; windows, aluminum; baths, ceramic tile; heating-air conditioning, underfloor system; extras, built-in range, dishwasher, disposer, landscaping

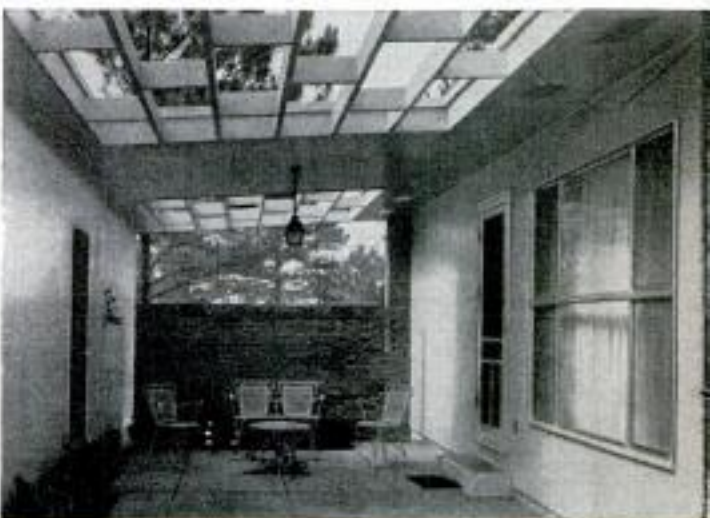

## CALIFORNIA

Three bedrooms, two baths  
Floor area—1180 square feet  
Price—\$15,230 (including lot)

Outdoor-living areas are integrated in the open-plan arrangement of this pleasing home designed by Palmer & Krisel of Los Angeles and built by the Larwin Company in Buena Park, Calif. It is zoned for adults and children. Foundation is slab. House won National Association of Home Builders' design award



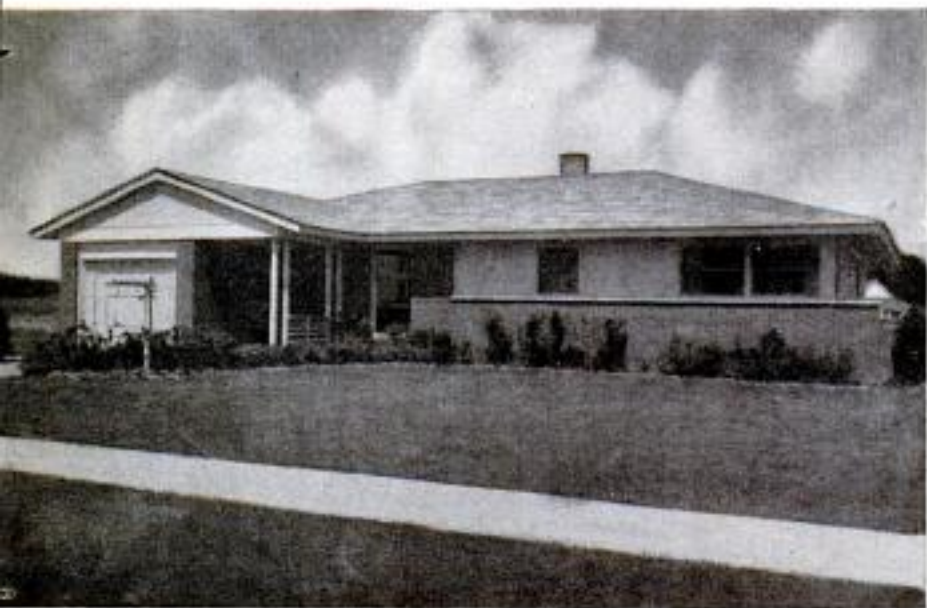
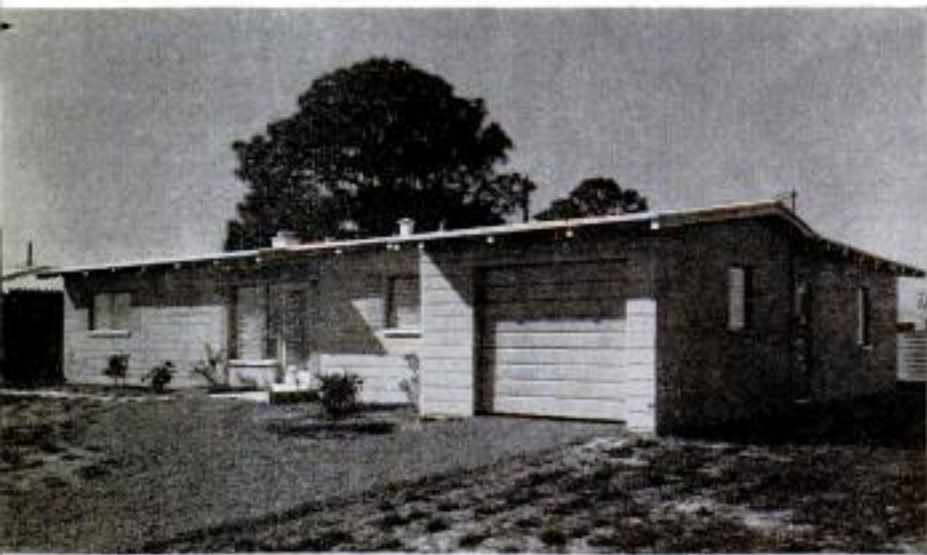
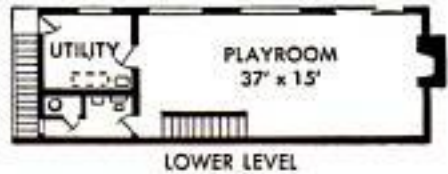
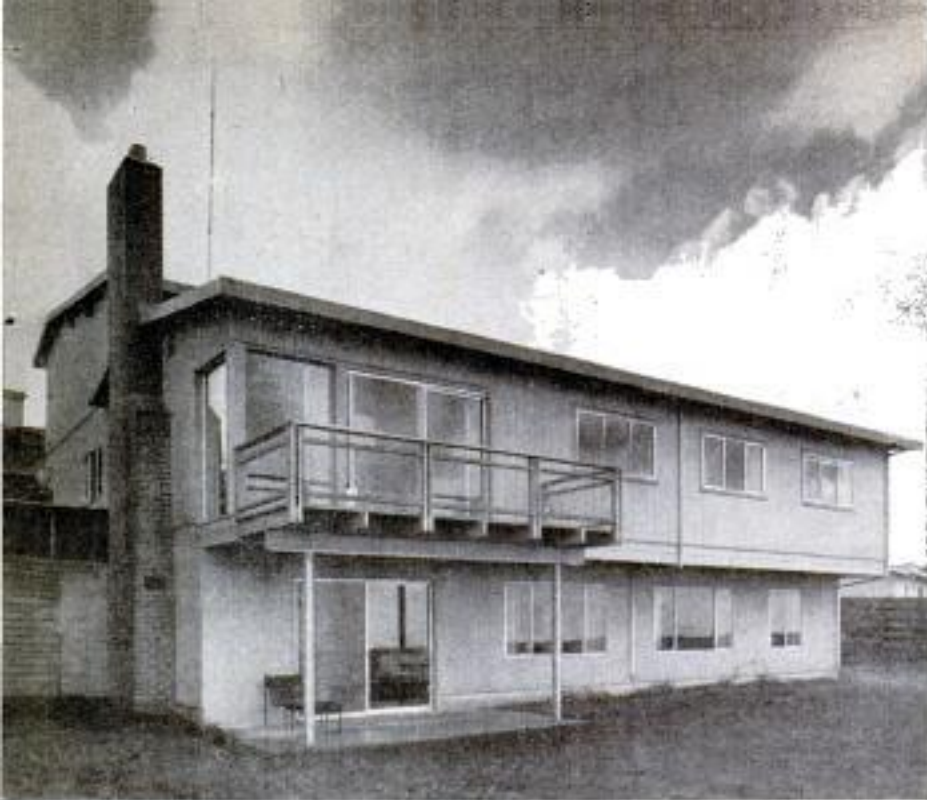

Photos by Frank Fritz

POPULAR MECHANICS

Copyrighted material



Photos by F. R. Parsons

## CALIFORNIA

Three bedrooms, 2½ baths  
 Floor area—2032 square feet  
 Price—\$25,300 (including lot)

Designed for a hillside overlooking San Francisco Bay in Oakland, Calif., this imaginative house with the garage in the "attic" was built by Oddstad Homes, Inc., Redwood City. Special feature is the big family room on lower level. Exterior is stucco and wood siding; interior, dry-wall; roof, built-up. Extras include built-in range, front landscaping, finished patio and complete fencing. Main level has a balcony outside living room at rear of house

## FLORIDA

Three bedrooms, two baths  
 Floor area—1170 square feet  
 Price—\$15,400 (including lot)

Florida Builders, Inc., of St. Petersburg, feature this home as being designed around a swimming pool and patio. Both pool and patio are enclosed in glass-fiber screen set in aluminum framing. Foundation is concrete slab; exterior, concrete block; roof, built-up and fully insulated. The heat is forced air; floors are terrazzo and the baths are tiled. Sliding glass doors open on to the patio. Extras include a G-E counter-top range and oven and—the 14½ by 21-foot enclosed swimming pool in the rear

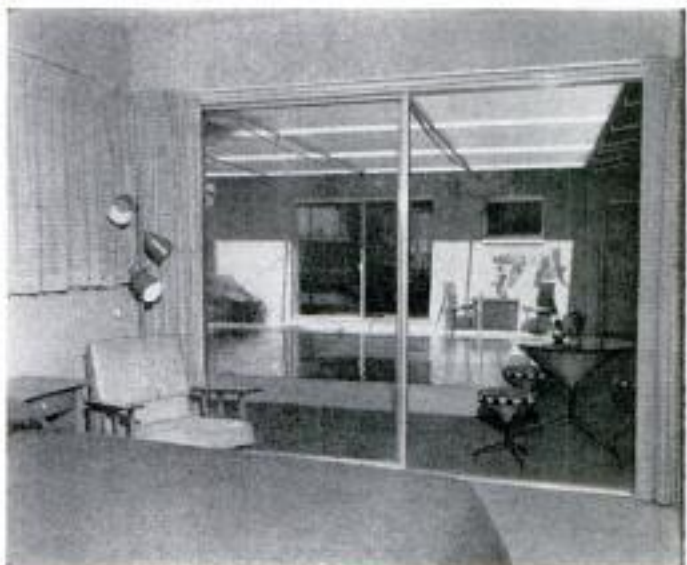

## ILLINOIS

Three bedrooms, two baths  
 Floor area—1320 square feet  
 Price—\$19,950 (including lot)

Features of this house are the big living room with sliding glass doors opening on a rear patio, eight closets, large storage space in garage and a washer-drier laundry that comes with the house. It was built by the Centex Construction Co., of Dallas, Tex., in their newly created Chicago suburb of Elk Grove Village. Architects are A. J. Del Bianco and Associates. Exterior, brick and hardboard; interior, dry-wall; floors, oak parquet and vinyl; extras; range, washer-drier combination, and disposer



# UPDATE THOSE OLD **PANEL DOORS**

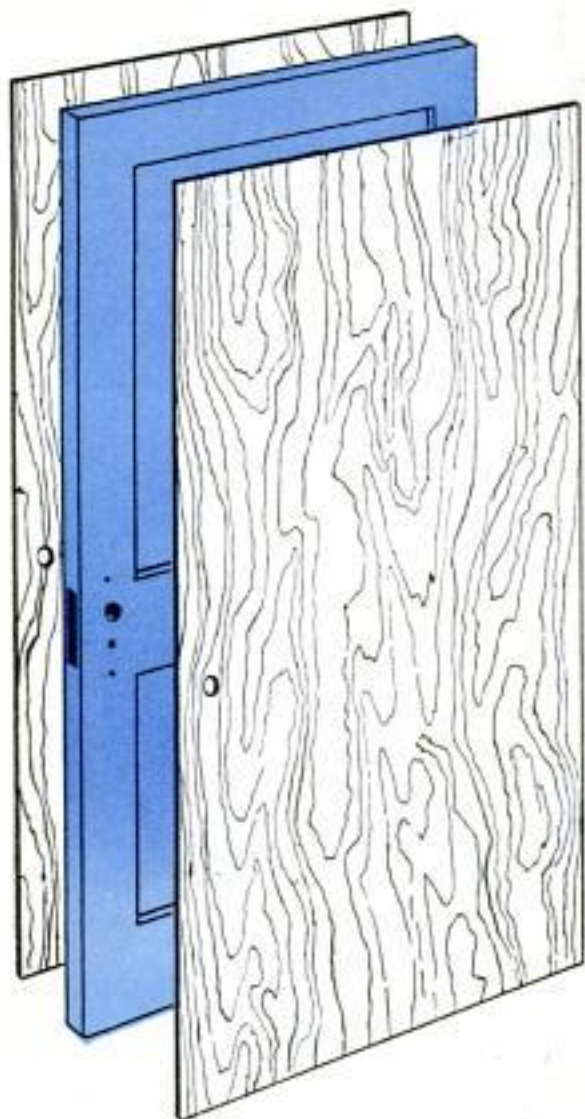

**W**HEN REMODELING and modernizing an older home, don't let old-fashioned paneled doors stand out like sore thumbs. Like the rest of the room, they too, can be remodeled and converted to modern flush doors at moderate cost, and the choice of materials is wide, up to, and including, rare hardwoods.

The method of remodeling the doors is to cover each side with a solid sheet of material. Hardboard, plain or perforated, wood-grained plastic laminate and thin hardwood-faced plywood are a few of the materials that can be used. In the case of plastic laminate, the recessed panels of the door should first be filled with plywood to make them flush. The first step in remodeling is to remove all door hardware. Next, a piece of plywood is cut to fit the door, allowing about  $\frac{1}{8}$  in. extra all around for trimming. The surface of the

Below, after door hardware has been removed, and a piece of plywood cut slightly oversize to fit the door, mastic is spread over stiles and rails. At right, plywood sheet is dropped onto the door over the mastic





Plywood is pressed firmly into mastic at all points, weights are applied and mastic allowed to dry 24 hr.



After plywood has been attached to both sides and mastic has set, wood is sanded with fine-grit paper

rails and stiles is coated with mastic, then the plywood is dropped onto the door and carefully pressed into contact at all points. Weights now are placed on the plywood and the mastic is allowed to dry for about 24 hr. The opposite side of the door is treated in the same manner. The edges of the plywood then are beveled and sanded as shown in detail A. A second method of protecting the edges of the plywood is shown in detail B. Here, a rabbeted strip has been screwed to both edges of the door. First, a strip is ripped from each edge of the door to compensate for the thickness of the strip. A light sanding with fine-grit paper is necessary on hardwood-faced plywood. Rough sanding has already been done at the factory. Doorstops in the frame must be removed and moved back the thickness of the added material.

A pilot hole is drilled through the plywood to locate the lock opening, then a scrollsaw is used to enlarge the hole to accommodate the knob-and-lock assembly. The final step is to reinstall the knob and hinges and rehang the door. ★ ★ ★

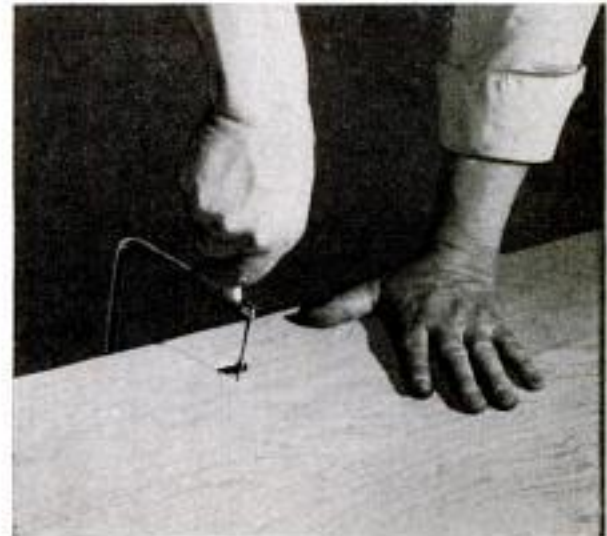

Pilot hole drilled in plywood locates lock opening, scrollsaw then is used to cut opening full size

Final step in making flush door out of paneled door is to install the lock assembly and other hardware

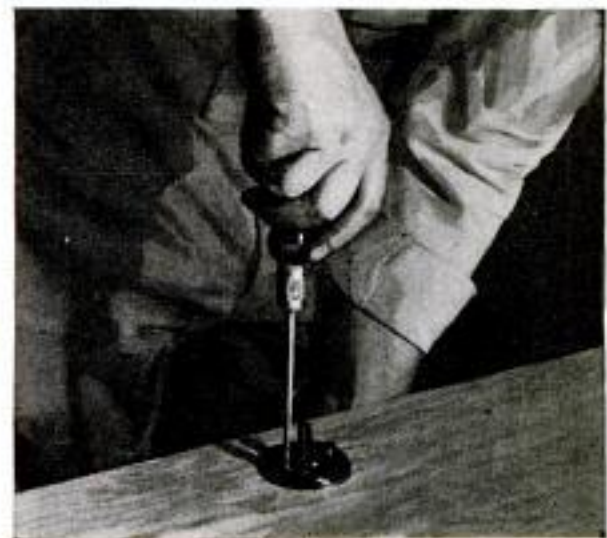
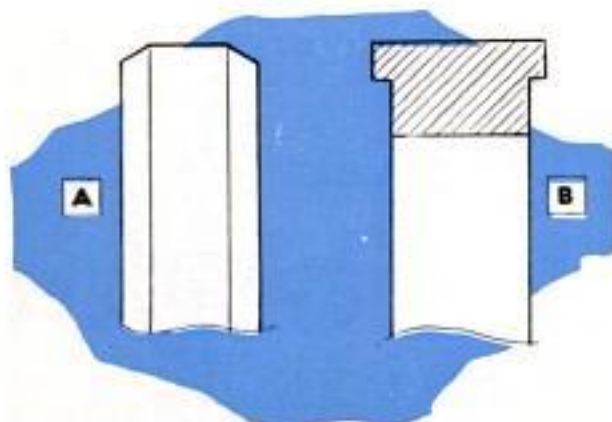

# We Call it "OUR"

*It took ambitious Les and Gail Bakken of Minneapolis five years to build this \$45,000 home themselves. It cost them \$21,000 for materials and the extra labor they had to hire.*

**By Gail Bakken**



Every stone and shingle on this house was personally tailored by the Les Bakkens. It has nine rooms

Floor plan provided family with a house to "grow into." A finished three-room apartment is in the basement

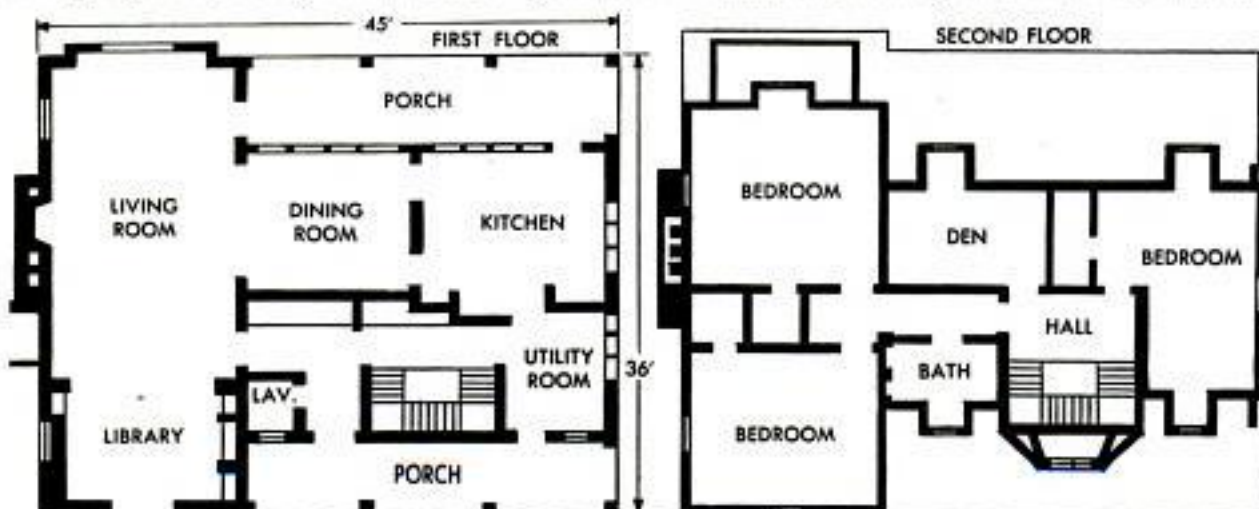

# ROCK OF GIBRALTAR"

**WE WERE IN LOVE** with our lot. A wooded two acres four miles north of Minneapolis, it overlooked a lively stream as it emptied into the Mississippi. It is the kind of spot where one would be content to spend a lifetime.

Too often we had seen families putting much money and effort into building a small house within their present means, only to outgrow it in a few years. Then they would have to go through all that work and worry again—the back-breaking job of landscaping, expensive new draperies and furnishings, the cost and wear and tear of moving. After doing this several times, and after their families were grown, they would finally blossom into a pretentious house they didn't need any more.

We wanted *the* house now, on this lot we loved, and while our family was young enough to enjoy it with us. We wanted a house to grow "into," not "out of." The only way we could do this on our average income was to do much of the work ourselves and to sacrifice present comforts for something really good in the future.

The Bakkens hauled 50 tons of rock ("just the kind we wanted, rugged and varicolored") in small trailer



This is how house looked during what Mrs. Bakken calls "the hopeless stage." Below, open side of basement gives three-story effect





Stone-fireplace wall of living room has authentic rustic look. Mantel was made from plank found in river

Drawing shows how Bakkens applied stonework. "We worked this all out ourselves," says Mrs. Bakken

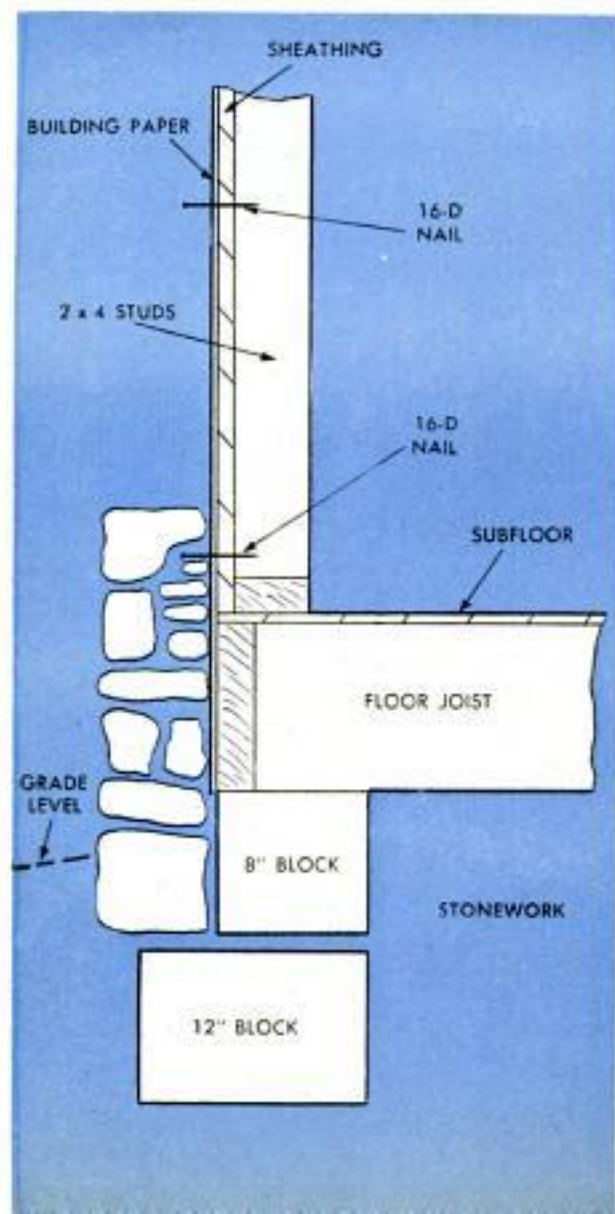

As our home was to be Early American, in the pioneer spirit, we decided to make these sacrifices and to live the part. A \$400 prefabricated garage was erected temporarily on the property and converted to living purposes. The next two years were spent roughing it, while we worked on our house.

A wood stove was our only source of heat. There was no telephone, and for the first year, no electricity. Our electric refrigerator served an unusual purpose. Instead of keeping the food cold, on the coldest nights when the wood fire went out, this well-insulated box kept the food from freezing!

Only when looking back, do we realize there was nothing to sit on in that cabin but three hard straight-backed chairs. At the time, we were either on our feet working, sitting on the hard chairs eating or so tired from our active life we were flat on our backs in bed! Not until later did we realize we didn't have such a thing as an easy chair.

Wanting a house good to look at, as well as substantial in size, we engaged Hans Larson to draw our plans. A top Minneapolis specialist in Early American architecture, he was willing to work with us in doing as much of the work ourselves as we could. He charged a 7 percent fee for drawings and supervision. Instead of coming out to the site to oversee, he told us, step by step, what should be done, and we did it ourselves, or supervised on subcontracted jobs. His final price was on a cubic-foot



basis. It came to about \$1500, but we feel it was well-spent. He saved us from making many foolish steps, and the basic layout has proved its worth. The house has 2256 square feet of floor area, not including the basement, and would cost about \$45,000 to have built today by a contractor. The materials and extra labor cost us \$21,000.

As we studied the blueprints, sometimes the size of the undertaking and the maze of details it involved threatened to overwhelm us. But Larson said to take one problem at a time and the project would gradually unfold.

As we could not start the actual building until spring, we spent that first winter hauling limestone from quarries and old foundations. Friends asked if we were building a "Rock of Gibraltar" and we said, "Yes." With our trailer we hauled over 50 tons of rock—just the kind we wanted, rugged and varicolored, ranging from rusty orange through yellow and into the grays. This whole amount cost \$74. Stiffly cut commercial stone we did not like as well would have cost \$20 per ton delivered. Approximately \$1000 for the same amount! Although this was an unusual saving, it is an example of the economies we enjoyed by doing the work ourselves and scouting around for materials. We also made shakes for the siding and shingles the first winter. Our first tussle with the cedar butts from which we were going to cut our shakes laid the groundwork for the building of the rest of the house. It proved the truth of what Larson had told us and showed us what we could do if we put our minds to it.

My husband, Les, had planned to do the shake splitting all by himself, as it naturally seemed to be a man's job. But his work as lunchroom manager required long hours. On the other hand, I had only five-year-old Sally and a one-room cabin to take care of. Instead of waiting for my already-busy husband to do everything, it seemed I could hasten the time we would move into our house by doing some of the work, too.

At first those huge cedar stumps, obtained from a local pole yard, seemed terribly formidable squatting there in the snow. But I placed my wedges in the center of one of them and gave them a few blows with the wooden mallet. To my surprise, it cracked neatly open! Quartering it was easier. And shaving off one-inch shakes with a froe made to order by a blacksmith was fun. I had not only won a victory over the cedar stump, but found that I might be able to do many other "impossible" things toward building our house.

That spring we started the actual building. Les sacrificed his two-week vacation. We made our own forms, rented a cement

(Continued to page 258)



"This is the first step in making cedar shakes," reports the author. "It's much easier than it looks"



Les takes his turn at splitting shakes as the pile grows. Below, solid-stone wood box on outside of living-room wall can be filled from the outside. Stonework is tied into the wall and corner of chimney



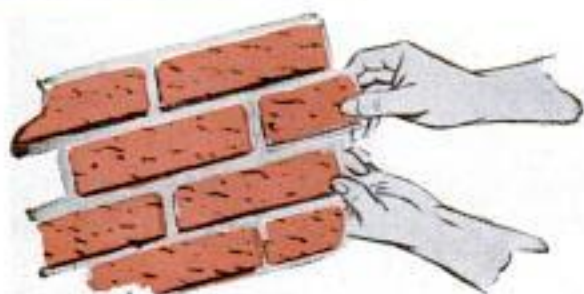
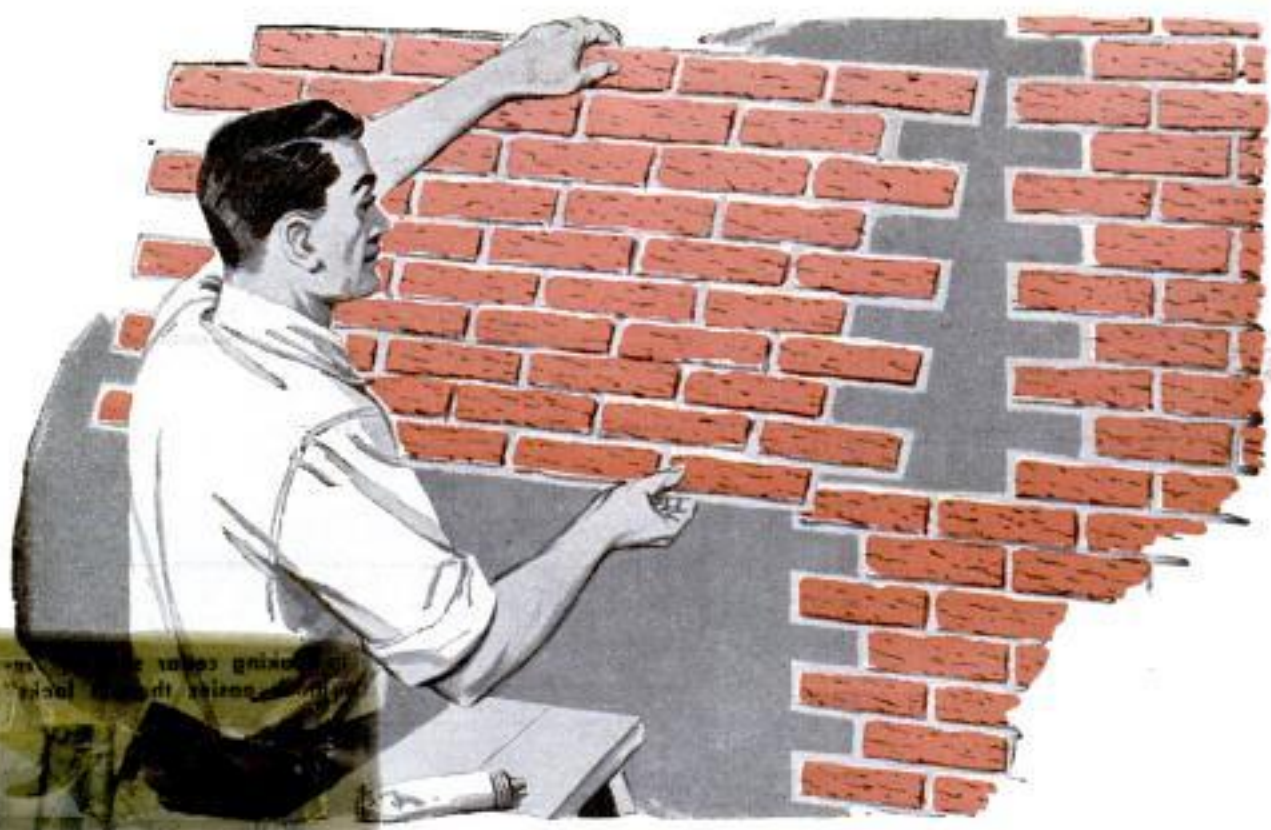

Ends of brick panels are precut so half bricks can be snapped out to form interlocking mortar joints



Bead of adhesive is applied to the mortar lines on back of panel. Both vertical and horizontal are coated

# Look What's Happened to "BRICK"

By Wayne C. Leckey

**M**MORTAR HAS GIVEN WAY to glue and nails in the laying of an array of simulated brick and stone products that are made to order for the do-it-yourselfer. Closely resembling actual brick and stone, many of these new home-modernizing materials are so simple to apply that anyone can be his own "bricklayer."

There are at least a half-dozen brands that are recommended for interior-wall

application and of these you have a choice of vinyl, cork and nonceramic. There are others of fired clay that can be used inside and out which are merely nailed on. Still another permits the "stone" to be molded directly on the wall with special forming molds.

The brick and stonelike paneling shown on these two pages is Decro-Wall—a vinyl product which is embossed to give an



How Decro-Wall can be used in kitchen to add a brick accent. Being of plastic, brick can be washed to clean it

The Decro-Wall Corp. photos



Brick is easily cut with scissors, knife or razor blade for fitting at sills, casings and wall ends



Electric corner-bending iron does neat job on inside and outside corners. Iron softens brick in seconds

Three of many Decro-Wall stone and brick patterns available. Material also can be painted special color

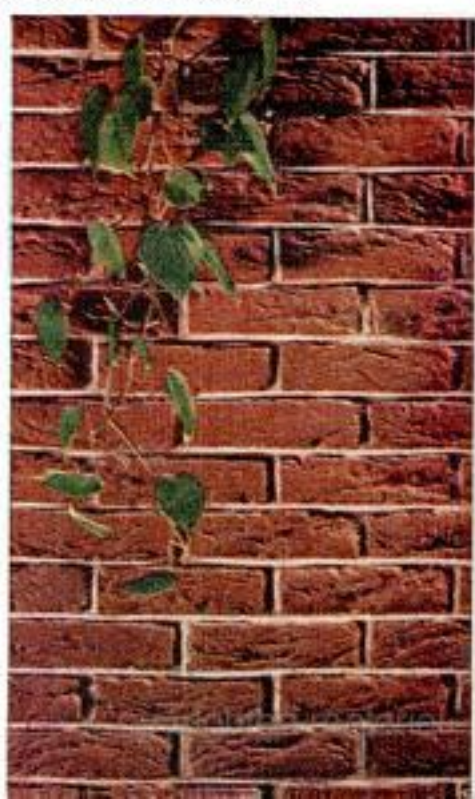



Vermiculite Mfg. Co. photos

Fireplace wall, and planter below, show what can be done with Z-Brick to add accent to uninteresting walls

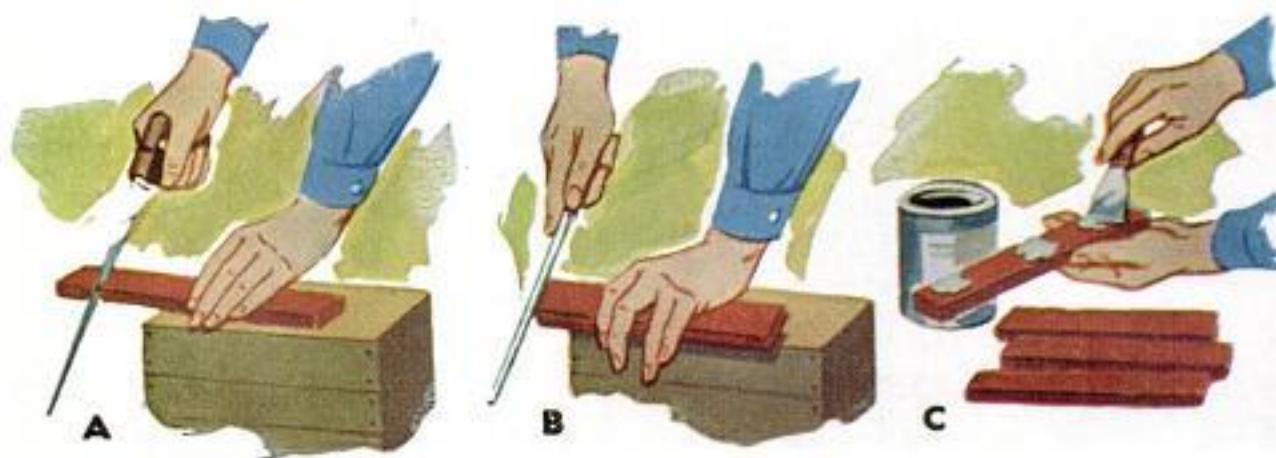

A. Lightweight brick saws like wood. B. Mortar joint is restored on sawed end with round file. C. Only three dabs of adhesive on back affix brick firmly

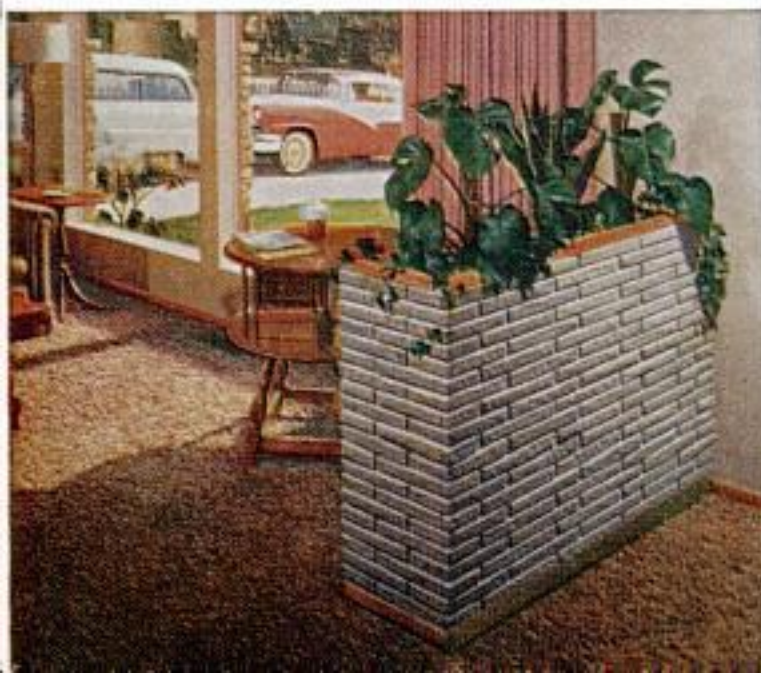

authentic three-dimensional appearance. It can be applied to any wall surface—concrete block, wood, papered or plastered—and, when cemented, becomes exceptionally rigid and durable. It comes in some 23 different colors and patterns and in panels of about seven square feet. The ends are die-cut to simplify notching so the panels will interlock in joining them. A special adhesive in tube form is run along the back of all simulated-mortar joints, after which the panel is pressed against the wall and the mortar joints rubbed with a blunt tool to insure proper contact. The material is



Cork Specialties, Ltd. photo

Above and right, this material is called Bricork. Bricks stand in relief in a solid slab of real cork

easily cut with scissors, and a special bending tool is available for creasing the panels when fitting to inside and outside corners.

Z-Brick is another decorator brick and two of the many smart brick accents it can add to modern interiors are pictured at the left. This noncombustible product, which has a texture similar to Roman brick, is made in the form of individual bricks, but measures only  $\frac{7}{8} \times 1\frac{1}{2} \times 12$  in. Here again, no mortar is used in facing a wall with them, each brick is cemented in place with a special mastic-type adhesive. Made of Vermiculite, pigment and cement, the material cuts about as easily as wood, detail A, and weighs about as little. Where it is necessary to cut the brick, the mortar joint is restored at the end with a round file, detail B. You have a choice of three decorator colors, red, green and gold.

Three of the popular brands in cork are Bricork, Corbrik and E-Z Brick. Bricork is made of solid cork, 1 in. thick and in panels  $12 \times 36$  in. Mortar joints  $\frac{1}{4}$  in. deep make the brick pattern stand out in relief. The porous texture of cork makes the over-all effect amazingly realistic. It cuts like wood and is applied with nails or waterproof mastic. It can be readily painted any color and sells for less than \$3.00 per panel.

Corbrik differs in that it consists of  $\frac{3}{8}$ -in.-thick cork bricks affixed to a tough paper backing. Panels interlock and overlap to form an unbroken pattern and are applied like wallpaper, using regular wallpaper paste. You can buy it in white, red, and red and black, as well as buff. Retailers for a little over \$4.00 per panel which measures about  $26 \times 33$  in.

E-Z Brick are thin pieces of cork the size of a brick which are applied to the wall individually with adhesive. A template is furnished to help space and align the brick courses. A kit for \$5.95 buys enough for 10 sq. ft. Comes in neutral gray, ready for painting the desired color.

Brick-It offers a novel application in that the brick or stone pattern is first worked out on the wall with a series of horizontal



Below, spacing-and-aligning template simplifies laying of E-Z Brick— $\frac{3}{8}$ -in.-thick bricks of painted cork



Courtesy: Mastercraft Products

Below, another cork-type brick is Corbrik which consists of  $\frac{3}{8}$ -in. brick bonded to a paper backing. Comes in red, white, with contrasting mortar joints

Courtesy Corbrik Co., Inc.





In laying Brick-It, brick pattern is laid out on wall with horizontal and vertical strips of sticky tape



Next a cementlike coating is troweled over the tape to a specified thickness and allowed to set 5 min.

Courtesy Nash Mfg. Co.

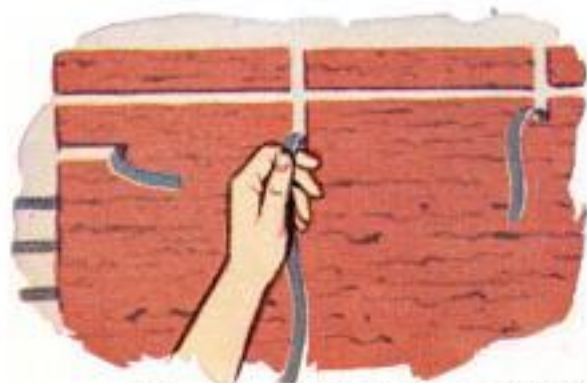

The tapes (left sticking out at edges) are peeled off to produce mortar lines which separate the bricks

and vertical strips of tape. A special troweling mixture is applied over the tape and then after a 5-min. setting interval, the strips of tape are carefully peeled off to form mortar joints. The completed job hardens overnight. May be had in brick red or white and, of course, can be painted

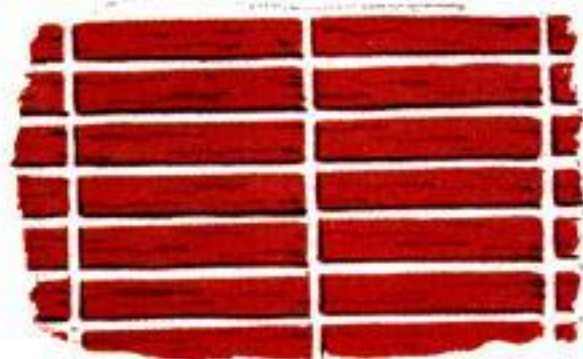

Finished job has realistic 3D appearance. May be left as is or painted over with any flat-type wall paint

any color with flat wall paint; 80 sq. ft. can be covered for less than \$10.00.

A new colored-concrete mix, called Bondstone, which does not require a base coat, provides a low-cost simulated stone for old and new construction alike. Shallow metal pans embossed with a cut-stone pat-

Bondstone differs from similar products in that no base coat is necessary to bond it. Works on inside walls, too

Emco Cement Products, Inc. photo



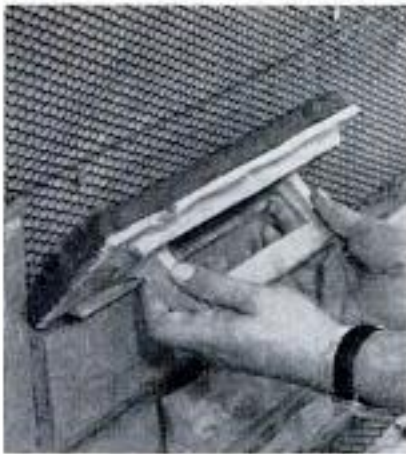

Special "cake pan" molds are filled with nonsagging-concrete mixture



"Stone" mold is pressed lightly to embed it in metal-lath surface

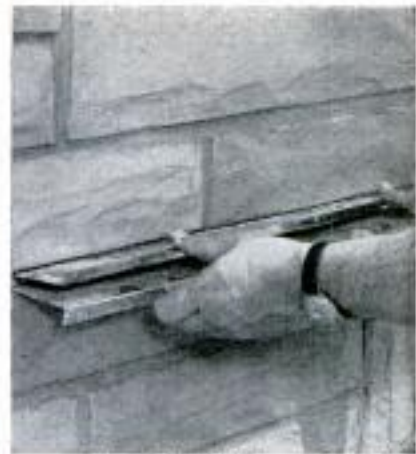

"Stones" are aligned with special tool, excess cement is brushed off

Emco Cement Products, Inc. photo

tern are filled on the job and then pressed against a wire-mesh-covered surface. Nonsagging mixture keeps stones from falling off as they are individually formed. Bond-stone provides an excellent stone facing for an old-fashioned fireplace.

Two new clay products aimed at the do-it-yourselfer are Nailon brick and SCR Re-Nu-Veneer. Both are of fired clay,  $\frac{3}{4}$  in. thick, and designed to be surface-mounted with nails or clips. The detail at the right shows how Nailon brick is applied, and how the rabbeted edges of the brick partly conceal the nailheads. Mortar in a calking gun can be used to fill the joints between the bricks. Corner bricks are end-rabbeted to overlap the others and produce a water-tight corner when calked. In the case of the SCR brick, the clips are attached to the bricks first, after which nails are driven through the clips to anchor the individual bricks of each course. After the units are nailed on, the joints are filled with a pressure-type gun and pointed as in conventional masonry.

More complete information pertaining to any of the products mentioned can be had from the manufacturers. ★ ★ ★

SCR Re-Nu-Veneer brick is held with special metal clips. Comes in regular and L-shapes for corner use

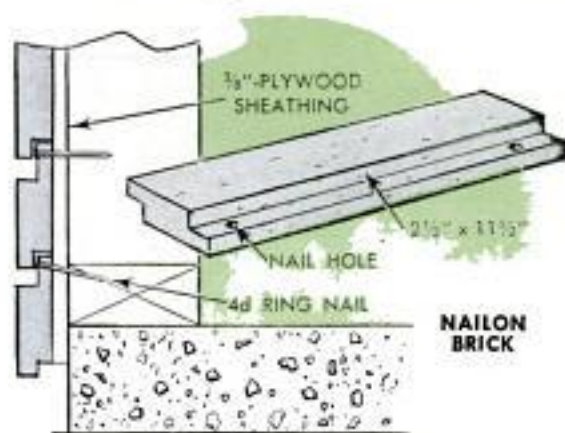
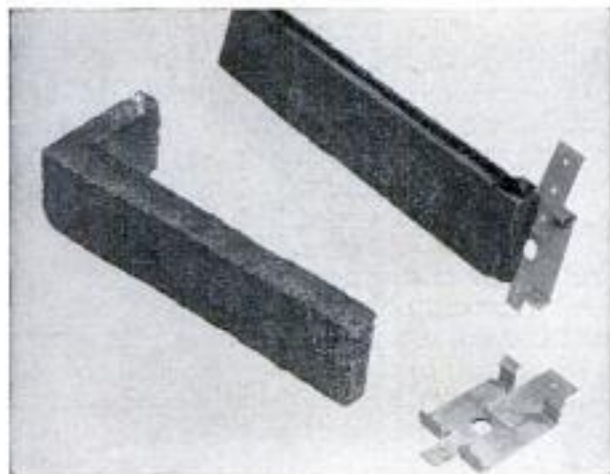

Ludowici-Celadon Co. photo

Above, quick way of filling joints in Nailon brick without mess, is to put mortar in regular calking gun

Structural Clay Products Inst. photo

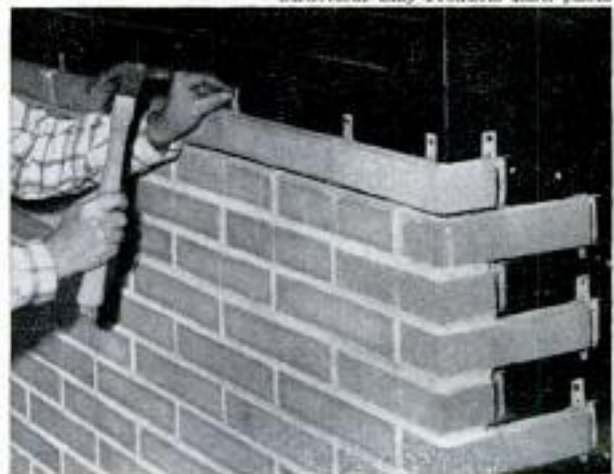

WTM 59



Door on closet above has been widened so that every inch of storage space is readily accessible. Added space for storage of off-season footwear is provided by well built between floor joists under the closet

Aromatic Red Cedar Closet Lining Mfg. Assn. photo



Aromatic red cedar for lining closet is available in tongue-and-groove strips, nails in place quickly

186

## **BUILDING S-P-A-C-E IN YOUR CLOSETS**

**W**HETHER YOUR HOME is an old or new one, it is quite likely that your family feels there is not enough closet space. Fortunately, in most cases the actual problem is the lack of access to all parts of a closet. The answer to this problem is a moderately simple remodeling job that will permit full utilization of existing closet space. Primarily, the remodeling consists of widening the closet door to the full width or length of the closet by removing the wall between the closet and the adjacent room. This single operation will, in most cases, almost double the usable space in a

POPULAR MECHANICS

Copyrighted material



closet. All closets shown in this article have this feature of a full-width door.

Generally, a closet wall will not be a load-bearing one, but this should be checked before any wall studding is cut. If the wall is a load-bearing member, use a jack and post against a piece of plywood on the ceiling until the removed section of the wall is replaced by a header consisting of two 2 x 4s on edge supported by double 2 x 4 studs under each end.

Where possible, sliding doors should be installed in the new opening, so that floor space in the room is conserved. Sliding doors need not be recessed into the wall, as are the doors shown on the closets in the illustrations in this article. Doors slightly wider than half the width of the door opening can be used. These doors run on overhead tracks so they bypass each other, thus either half of the closet is accessible by moving both doors to the opposite end. Folding doors, consisting of two or more sections for each door, also are spacesavers. This type door has an overhead track, as well as one on the floor, and when open, projects only half the distance required for a one-section solid door. Even one-section hinged doors can be used to advantage for additional storage space in a closet. Racks are available that clip over the top edge of the door and project from the door far enough to support quite a few garments on hangers. When hinged doors are reinforced by having three or four hinges instead of the usual two, they can be fitted with shelves or racks for shoes and socks, tie racks, small drawers for jewelry, cosmetics or other light-weight objects, and even mirrors, as shown in the illustration at the top of page 188.

In one instance, a homeowner increased closet capacity for off-season footwear by cutting an opening in the floor and building a box between the floor joists. Flooring was used to make a lid for this compartment, which is ideal for overshoes and rubbers, and can also accommodate sporting footwear, such as waders, baseball spikes and football shoes. If the box were made long enough, it would be perfect for storing golf clubs and other sports equipment.

OCTOBER 1957

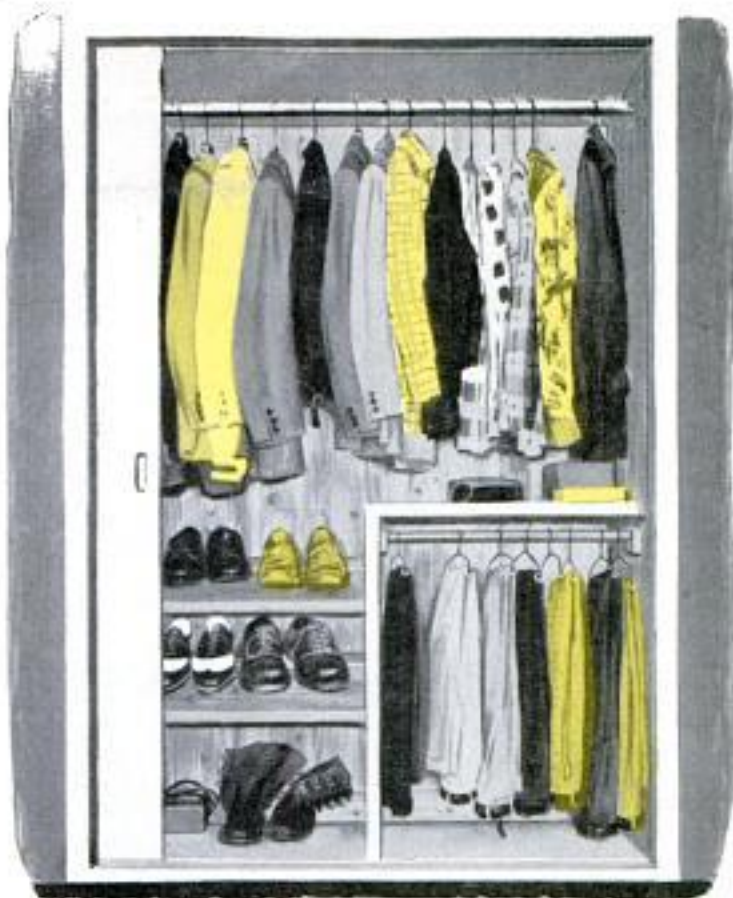

One arrangement for efficiently utilizing all available space in closet is illustrated above. Note that door is full width

In closet below, original clothes pole has been moved up, a second pole installed lower down, so closet capacity is doubled



187



Built under roof, adjacent to attic rooms, this closet represents maximum utility of available space

Another simple means of increasing closet storage space is to move the original clothes pole up to a point within a couple of inches of the ceiling, then install another pole just low enough so that it will clear garments hung on the upper pole. Coats, trousers and jackets can be hung on the upper pole, while most topcoats, overcoats, raincoats and dresses can be hung on the lower pole without touching the floor.

If a closet is used by only a man or a boy, an arrangement such as shown at the top of page 187 is ideal. The clothes pole has been moved up from its original position, and shelves for shoes, plus a compartment for hanging trousers, have been installed in the lower part of the closet. A somewhat similar arrangement could be used for a girl's closet, the shelves and compartment being redesigned to accommodate skirts, sweaters and blouses.

When bedrooms are built into attic space, the area under the eaves on each side of

the rooms offers almost unlimited space for closets. Such a closet is shown above. Drawers built into the wall of the closet, plus a mirror on the closet door, make it unnecessary to have a dresser or vanity table in the bedroom itself, thus saving floor space.

In all cases of remodeling a closet, it is suggested that aromatic red cedar be used to line the inside. Tongue-and-groove cedar planking is easy for anyone to apply, eliminating the need for patching or plastering, and produces an attractive surface that requires little maintenance. The fragrant aroma of the wood will keep the closet fresh-smelling and moth-resistant for many years. Another practical feature that should be included in any closet-remodeling job is a bright light. For greatest convenience, install a door-operated switch, so that simply opening the door will turn on the light and make everything in the closet clearly visible. ★ ★ ★

### **Steel Washers in Glass Gliders Prevent Damage From Weight**

When glass gliders are used under the legs of heavy furniture, casters on the legs concentrate the weight in one spot, and will cause the glider to break. To minimize this possibility, slip a large steel washer between the glider and the caster.

J. Metford, Hyde Park, Ont., Can.

### **Tip of Calking Gun Heated To Remove Dried Compound**

To clean the tip of a calking gun when the calking compound has been allowed to dry and set hard, heat the tip with a torch. The compound will soften and can be ejected from the gun by working the trigger in the usual manner. If the cartridge tip is plastic, dip in hot water.

## Tape-Clamping Miter Joints

Mitering solid-pine paneling around an outside corner can be done without the necessity of surface nailing the cornering boards. Rip the edges of the boards to 45 deg. and plane lightly to a true fit. Trial fit the boards in position, then spread a thin film of glue on the joining surfaces. Replace the boards and tack in position, driving the nails at the edges as you would in nailing tongue-and-groove flooring. Then tape the mitered joint with  $\frac{3}{4}$ -in. masking tape, drawing the tape tightly and spacing the strips as indicated in the photo. The strips of tape will hold the joint until the glue sets, making nailing unnecessary. Use as many strips of tape as necessary.

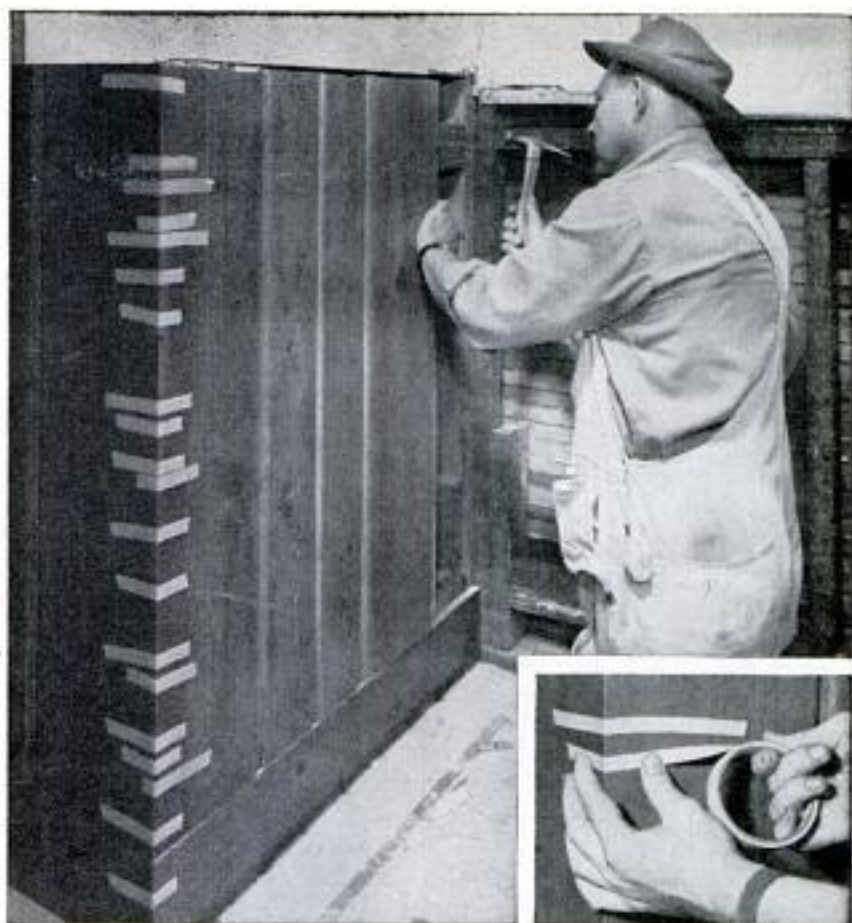

Western Pine Association photo

## Serviceable Wedge Clamp Made From Pipe Tape

If the width of the panel you are gluing up exceeds the reach of the bar clamps at hand, improvise wedge clamps from perforated steel pipe tape, or hanger strap. Bend a length of the tape to a U-shape so the holes register. The legs should be about 4 in. longer than the width of the panel. Fit a block of hardwood between the right-angle bends as detailed. Then slide the clamp over the panel, drop a nail or pin through one pair of holes and drive a hardwood wedge between the pin and stock.

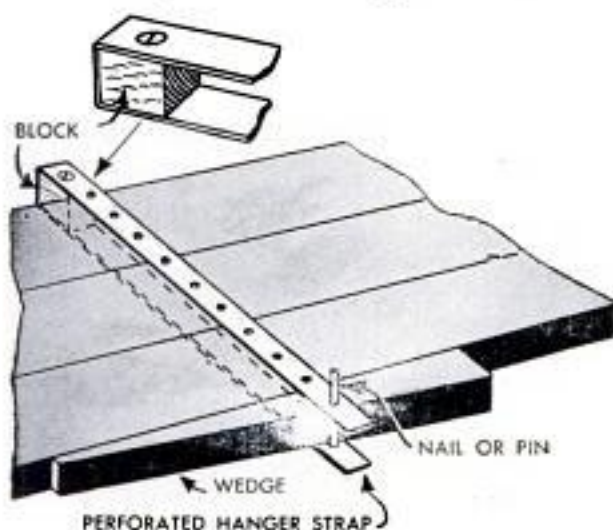

OCTOBER 1957

## Making Clean Breaks In Scored Glass

If you attempt a clean break across a large pane of glass by tapping the underside directly under the score, you may end up with an irregular edge due to the tendency of the break to wander. Try this procedure: Pad the bench top with several thicknesses of newspaper. Lay the glass on the paper pad and make the score with one continuous stroke of the glass cutter. Move the pane so that the score is directly over the edge of the bench. Raise the pane about 1 in. and bring it down sharply.



189

X283

# FROM THE GROUND UP

brick by brick you can have  
the fireplace you have  
always wanted

By John O. Bull

## PART I

WHAT WAS ONCE considered taboo for even the most capable handy man to touch, fireplace building is no longer a "hands off" project. Now, steel fireplace liners, which guarantee a proper-drawing fireplace, make it possible for the ambitious homeowner to do the job without fear of smoking himself out. The skill once required to brick

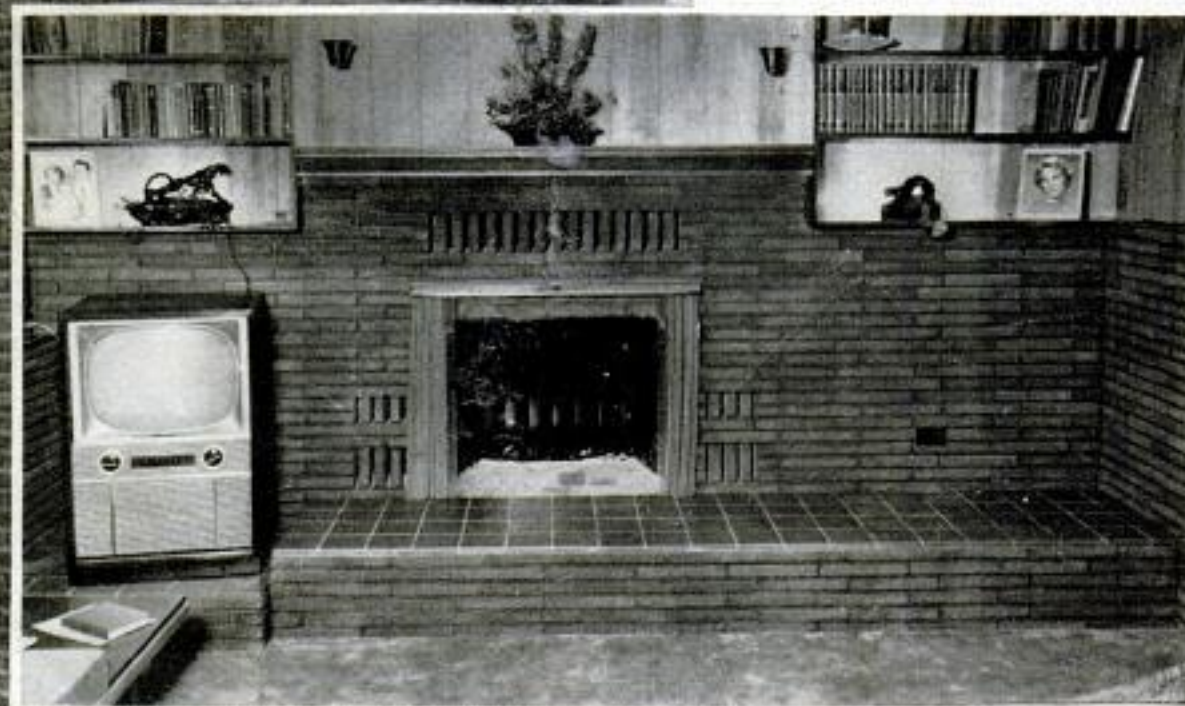

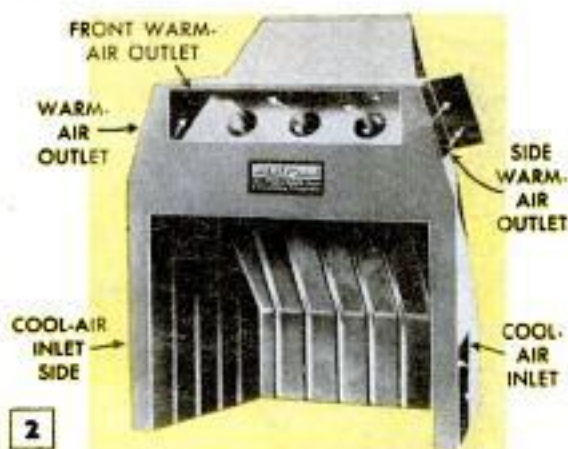
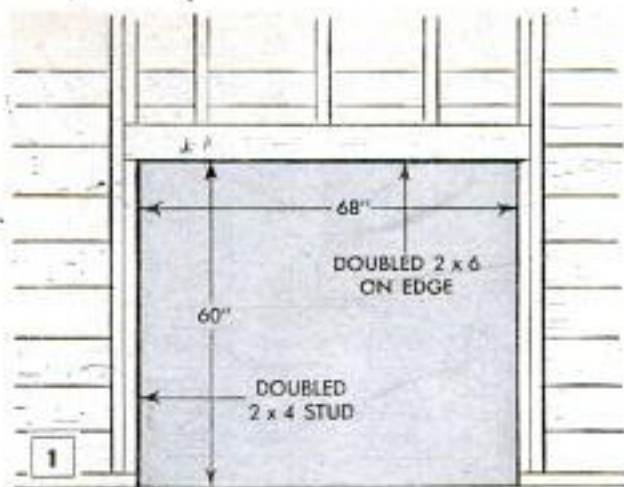

Superior Fireplace Co. photo

This is the heart of the fireplace, the steel liner, which assures amateur builder a proper-drawing unit

up the working innards of a fireplace has been lessened considerably by having this vital part (the smoke chamber) already preassembled within the liner itself. Essentially, you merely brick up around it. As for laying the bricks, it's not as difficult as you may think. By working slowly and carefully, and keeping the corners plumb, you'll wind up surprising yourself.

This, the first part of a two-part article, takes you through the steps of building a fireplace around a Heatform liner, Fig. 2. The steps are essentially the same even though you may prefer to change the interior hearth treatment used in the original. In this particular installation, the dwelling has a slab-type floor which affords ample support for the hearth. Where the structure has a crawl space or a basement, the flooring members should be strengthened by doubling the joists and adding crossheaders where necessary to safely carry the load.



Here the steel liner is being set in a bed of mortar on top of concrete, blocks and brick base. Note that liner is placed to bring front about  $\frac{1}{2}$  in. back from a line drawn flush across the inside wall

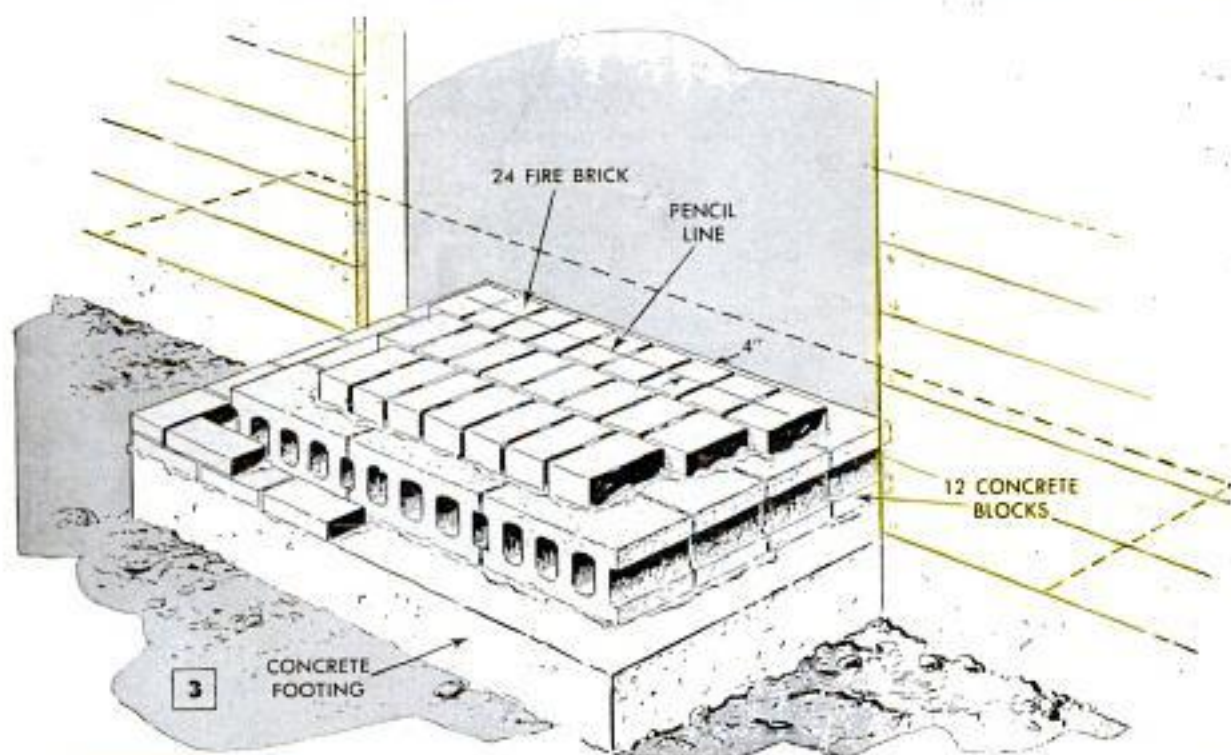



Because of rough texture of Roman brick, side of level is used to check corners

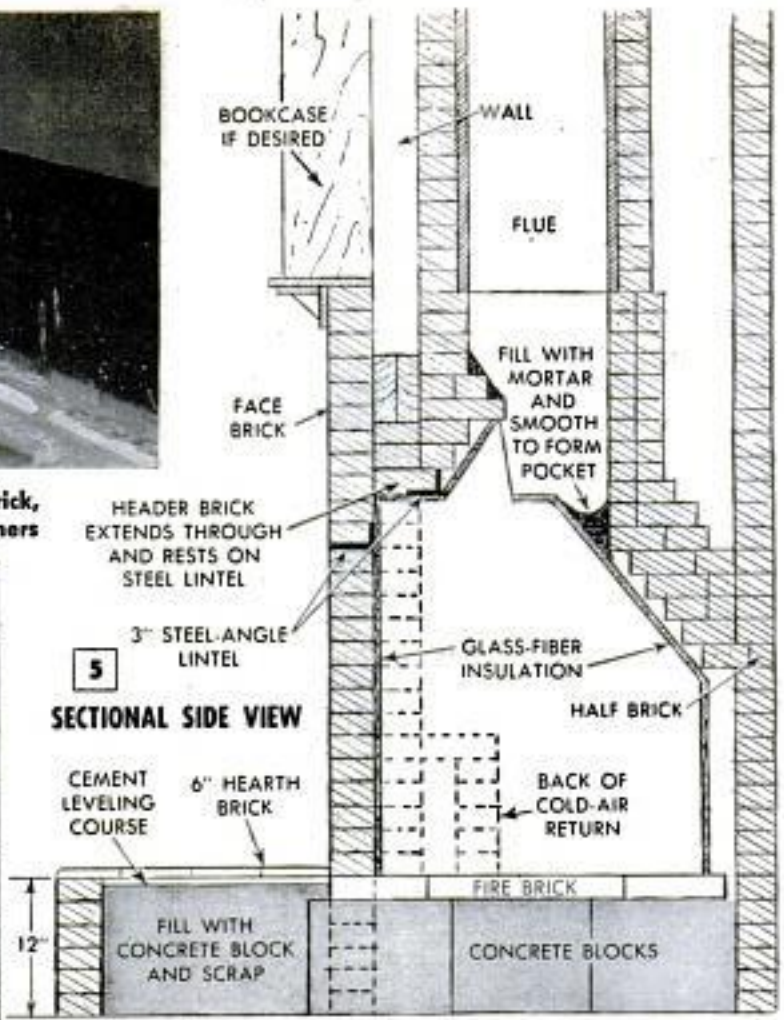

**5**  
**SECTIONAL SIDE VIEW**

Outside wall of fireplace is anchored to framed opening with corrugated sheet-metal ties which are placed between every six or eight courses and nailed. Side-view drawing shows proper placement of common brick

Layer of glass-fiber insulation, which is added to steel liner, is held in place with coating of mortar

Besides acting as insulation, glass fiber also serves as spacer to keep common brick from touching liner





Left, steel liner is encased with common brick. Cross-row of brick in background forms back of cold-air duct. Center and right, brick is corbeled 30 deg. to form 12 x 12-in. flue opening. Inside is buttered with mortar

Fig. 1 shows the size of the rough opening required in the wall and the manner in which it should be framed. The outside chimney and the steel liner rest on a concrete foundation consisting of a concrete footing, concrete blocks and firebrick, mortared in the arrangement shown in Fig. 3. The steel liner sits on top of this in a bed of mortar. Footing for the concrete foundation should go to a depth of at least three feet and the overall size should be large enough to provide room for a wall of bricks on three sides. This outside wall is anchored to the house wall at each side with regular corrugated sheet-metal ties which are nailed to the framed opening and mortared between every six or eight courses. When the brick courses reach about a foot high, you should stop and cover the outside of the steel liner with glass-fiber insulation. This is held in place with mortar which is troweled on the liner and the insulation pressed into it. With this done, you begin to encase the liner itself with common brick, starting at the bottom on the sides, Fig. 7, and at the back 16 courses up, Fig. 5. Note the arrangement of these bricks at the front, which help support the flue tile and how the header bricks rest on a 3-in. steel lintel across the top of the liner. Notice, too, how a shelf is formed, Fig. 6, to provide a supporting ledge for the inner wall of Roman brick. In building up the corbel brick, plaster the inside to produce a smooth surface. An airspace of about 1 in. should be left between the common brick and the steel liner. Continue to work to the top, laying an inside and an outside wall as you go.

(To be continued)

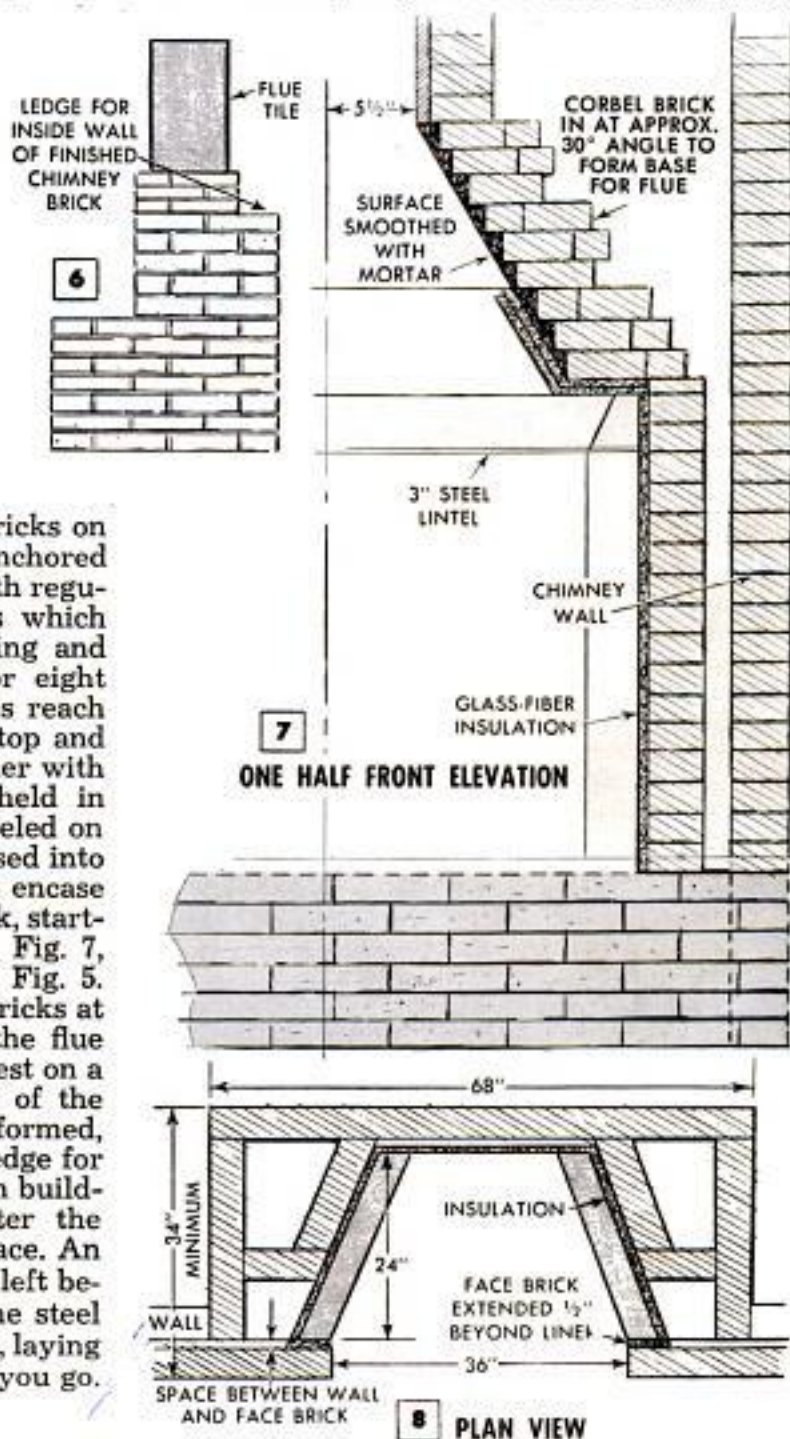



### Rack for Drying Vacuum Bottles Tilts out of the Way

A good way of drying vacuum bottles is to invert them over dowels fitted in a tilting rack such as the one shown. The rack is mounted on a shelf with enough clearance above to permit tilting the bottles against the wall so that they are out of the way when drying.

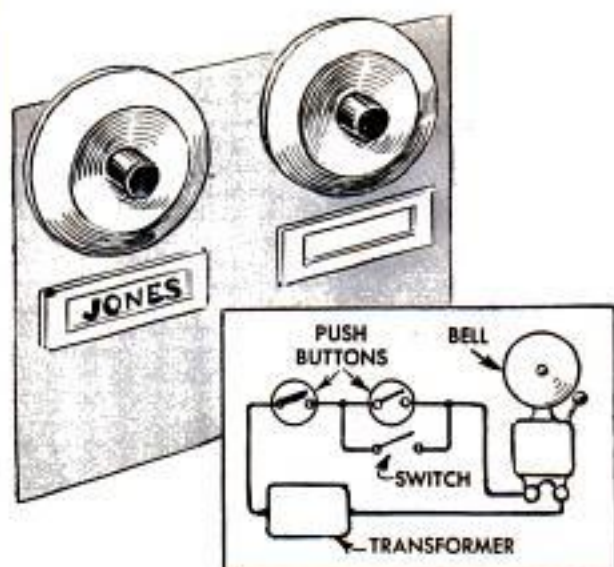

### Dual Doorbell Buttons Fool Unwanted Callers

If you are bothered by too many salesmen or children ringing your doorbell, try the hookup shown above. Your bell will ring only when both push buttons are pressed simultaneously. Of course, it is necessary to inform wanted callers of the change.—Frank Shore, New York City.

### Tape Provides Waterproof Label

Waterproof labels for your photochemical bottles can be made by writing or printing the desired information in ink or china-marking pencil on the back (gummed side) of a strip of cellulose tape as in the drawing.



### Slit Paper Holds Slip Upright

Plant slips are kept upright in a glass of water by one housewife by placing a sheet of paper with a slit in it over them as shown. After pulling the leaves through the slit, the paper is secured with a rubber band.

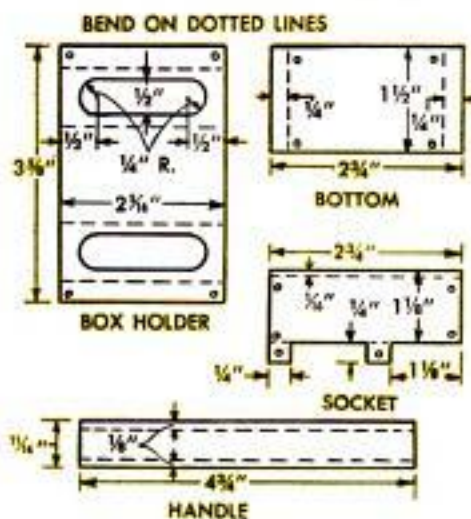

### Candleholder Has Matchbox in Base

Here is a sheet-metal candleholder and matchbox holder with a hammered finish you can make in one evening. The one shown was made of aluminum, but brass or copper can be used as well. After shaping and peening the various members on a wooden block or dowel as required, they are riveted together with cigar-box nails and felt is glued to bottom.





## HUNTER— SPARE THOSE ANTLERS

By Lewis J. Fish



LACK OF CASH or—even worse—lack of your wife's consent to mount the head of the buck you shot, does not mean that the trophy need be discarded. The antlers, most important part of the head anyway, can be made into many useful and ornamental items, such as the modernistic lamp, the rustic book ends, novel ink-

well and woody knife handle pictured in this article.

Antlers can be sawed, drilled and sanded as shown in the photos at the top of the next page, much the same as wood. The bony material is extremely tough and has almost no grain to invite splintering or splitting as when working with wood. The

Below, natural grooves on length of deer antler made into handle for hunting knife, provide positive grip





Left, when removing branch at base of antler used for lamp, leave gnarled base for strength and beauty. Center, to retain good looks of antler used for book end, remove as little material as necessary. Right, after selecting and cutting antler of proper diameter for knife handle, drill hole to accommodate shank

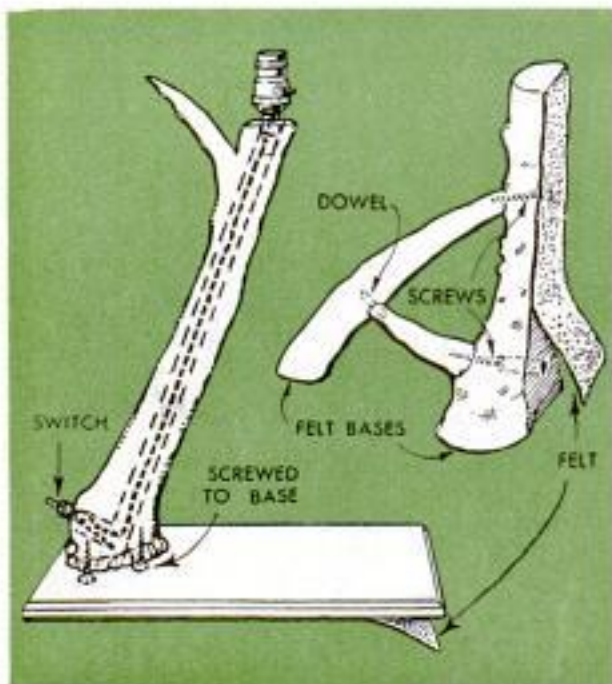

variety of shapes and gnarled formations found on these bony projections on the heads of the male members of the deer family, afford unlimited possibilities for custom crafting objects of your own design. Only a few are mentioned here, but the methods of working with this material, as given in succeeding paragraphs, will apply to any project undertaken.

When driving a screw in an antler, a hole nearly as large as the screw must be drilled first. The material is so tough that

### Drill Holes in Concrete Faster

When using a portable power drill with a carbide-tipped bit to drill into concrete and the bit contacts a piece of aggregate, use a star drill to break the hard material. This will give the carbide-tipped bit a fresh bite for faster, easier drilling and reduce wear on the bit. Avoid overheating the drill bit or motor.—Ted Fenn, Skokie, Ill.

you will break the screw when trying to drive it into an undersized hole in a large piece. If driven into an undersized hole in a very small piece, such as the tip of an antler, the screw will split the material. Drilling the length of an antler can be accomplished with a piece of stiff wire after a hole has been drilled through the hard section at the base. The wire will follow the line of least resistance—the porous core of the antler.

A stain that will blend with the color of the antlers is made by mixing one part mahogany stain, one part raw umber (tinting pigment for oil-base paints), with one part linseed oil. A coat of lacquer over the stain will add luster and protect the finish from moisture. Felt glued to the flat surfaces of objects that are placed on furniture, as the lamp and book end shown in the drawings, prevent them from scratching the finish and add a professional touch to the pieces.

When it is necessary to install electrical parts in an antler, as the switch in the base of the lamp shown in the photo at the upper-left corner of this page, the bony material is removed by drilling and cutting with a carving knife. Then, the switch is positioned in the hole as desired and sealed in place with a wood filler of matching color. Plaster of paris, household-type cements and other sealing materials may be used on other installations where applicable. Varnish stain applied on the filler, helps to blend it with the antler. ★ ★ ★

### Aid for Installing Door Pulls

An easy way to determine the correct points at which holes must be drilled for installing door or drawer pulls, is to measure the distance between the mounting holes with a pair of dividers. Then, punch the points of the dividers into the wood at the desired location and drill the holes for all the screws.

## Hidden Catch Prevents Child From Opening Drawer

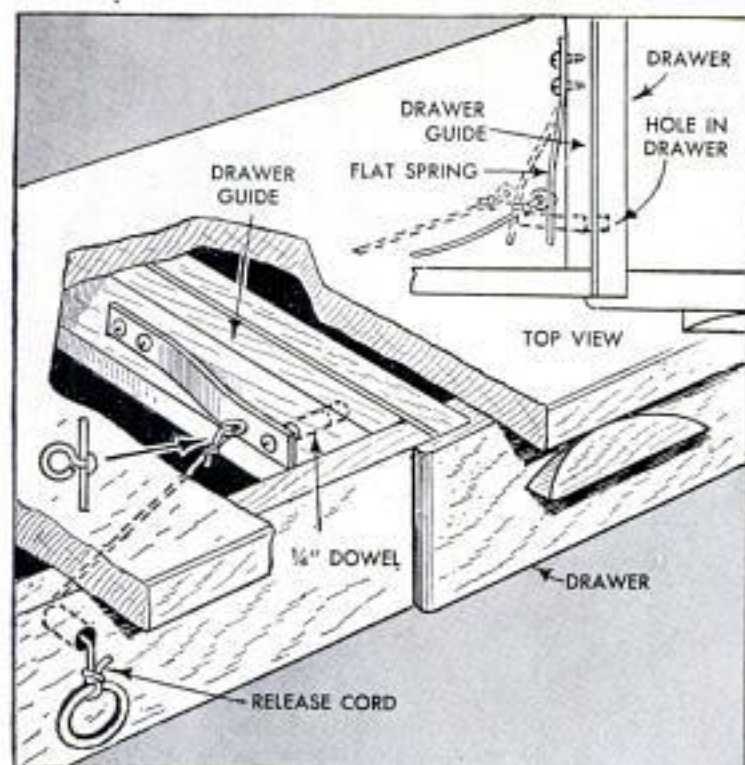

To prevent a small child from opening drawers in your home, install a self-locking hidden catch, like the one shown, on each drawer. The catch consists of a short length of spring steel which is fastened at one end to the outside of the drawer guide and fitted with a dowel on the other end. To install the catch, first drill a hole for the dowel through the drawer guide and partly into the side of the drawer. Then screw the spring-and-dowel assembly to the drawer guide so that the dowel passes freely through the hole. If there is access to the catch from below the drawer, no release mechanism is necessary. Otherwise, fasten a cord to the catch as shown, running it out through the front panel. When engaged, the dowel automatically locks the drawer. A small knob can be attached to the release cord instead of the ring.

## Plastic Bag Keeps Camera Dry During Underwater Shots

High cost of waterproof camera containers didn't keep Homer Groening of Portland, Ore., from taking underwater photos. He found that by placing his camera in a bag formed of clear sheet plastic and tying it tightly shut with a length of surgical tubing, he could keep the camera dry and still operate the controls and wind the film. Moisture that might form and condense on the lens was absorbed by placing a small bag of silica-gel crystals inside the plastic bag. The amount of air inside the bag determines the safe depth to which the camera may be taken, although it has been found safe at depths up to 20 ft.



## Equal Spacing of Parallel Lines Assured With T-Square Pointer

Rapid ruling of parallel lines of a given spacing can be done with a pointer stuck to the underside of your T-square. The pointer can be cut to the shape shown from stiff cardboard, light sheet metal or colored celluloid and is held in place with a tab of cellulose tape. Set for the desired spacing, the pointer is simply aligned with each previously drawn line in ruling each succeeding line. Width of spacing is varied by repositioning the pointer.

☛ Nylon thread is ideal for sewing raincoats or shower curtains, as it will not shrink when wet.



# Solving HOME PROBLEMS



**WHEN HANGING RUGS** on a line to beat them, or dry them after washing, use clamp-type trouser hangers. The hangers grip strongly and leave no marks, as clothespins may do



**"ROOM FOR RENT" SIGN** taped to a wire coat hanger is made convenient to remove or hang in window. Hanger merely hooks on center rails

**HOLD END OF SHOWER CURTAIN** so it does not pull away from wall by driving self-tapping screw into rod to hold end curtain ring

**DUST COVER FOR PHONOGRAPH** turntable can be lid of hat-box or disk 1 in. oversize cut from cardboard. Edge of disk is notched, bent down to form a 1/2-in. flange which is taped



**IMPROVISED ICE BAG**, when none is available for a sudden emergency, can be made from a rubber glove. Fill it with ice, then twist the end shut and tie it securely. Wrap the glove in a cloth before it is applied

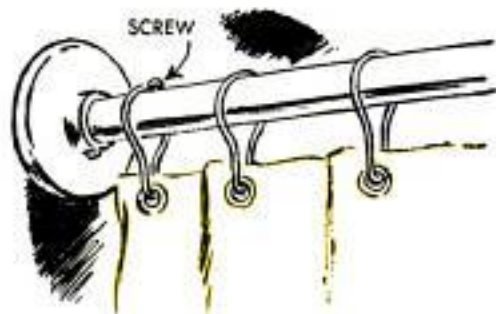

**RAZOR-BLADE TWINE CUTTER** is made by sandwiching double-edged razor blade between two pieces of plywood cut to shape shown. Minimum of blade projects for safety





**FRUIT-JAR RUBBER** slipped over glass tumbler used by baby acts as a dribble catcher to prevent liquids from running to bottom of tumbler where they could stain the cloth when tumbler is placed on table

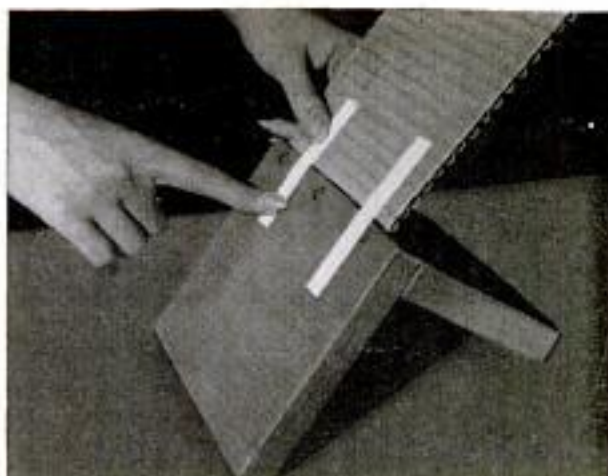

**TO KEEP BOOK ENDS** from sliding apart when weight of heavy books falls against them, tape a piece of corrugated cardboard to each book end. The weight of the books now will hold the book ends in place

**KEEP FILE CARDS STRAIGHT** when there are only a few in the box by springing a piece of light cardboard between cards and back of box. Cardboard should be about 1½ in. longer than the file box

**SPOOL OF ADHESIVE TAPE** is kept in plain sight when it is fitted over a bottle cork cemented to the inside of a medicine cabinet. Tape spool should fit snugly on the cork so it will not drop off accidentally

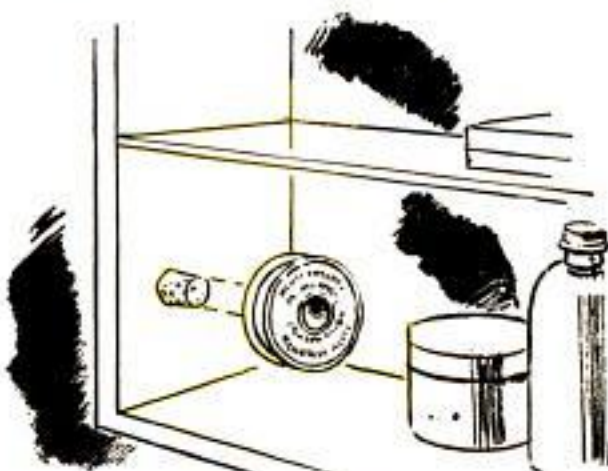
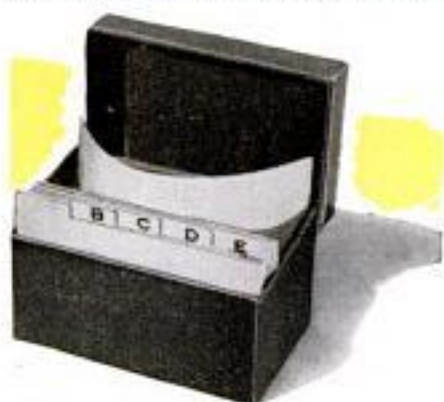

**CLEAN** ironing board is assured when the end is covered with plastic or fabric bag that prevents it from being soiled by floor

**MENDING THE FINGERS OF GLOVES** requires a long, slender darning egg. Ideal for this task is the handle of a silver dinner knife. A plastic-handled knife also is good

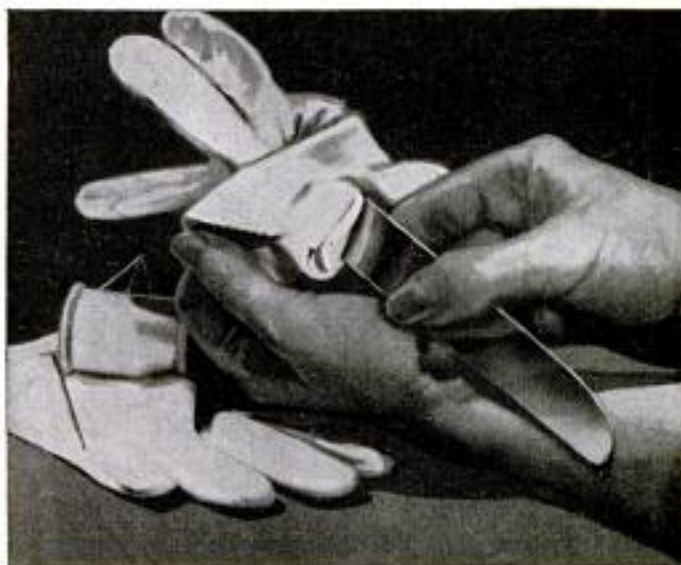

SLIPOVER BAG OF PLASTIC OR FABRIC

## Level "Doweled" to Straightedge for Easier Handling



To simplify the job of holding a wooden level on a straightedge when plumbing vertical surfaces, such as doorframes, fit the straightedge with projecting dowels. Holes drilled in the bottom edge of the level fit over the dowels, permitting level and dowel to be handled as a unit.

## Tubing Quiets Step-On Can

Closing the lid of a kitchen step-on can will be less noisy if a length of rubber tubing is fitted over the rim. Likewise, tubing applied to the bottom of the can will keep it from skidding about and prevent marking the floor. Simply slit the tubing.

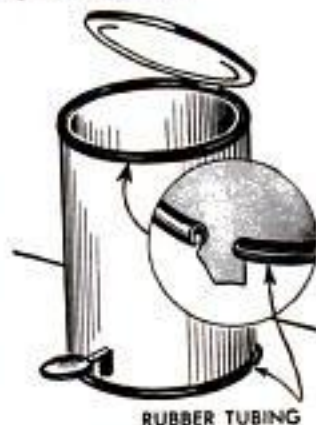

## Sunshade Fitted on Light Meter Helps Prevent False Reading

If your light meter is fitted with a sunshade as indicated, overhead sunlight will not reach the photocell to cause a false reading, the main factor in many underexposed shots. The shade permits the meter to be directed at the subject, rather than the ground, which is the method generally used to avoid getting a reading of direct sunlight. When the meter must be located at the camera position, as with a movie camera, the sunshade is especially advantageous. Light sheet metal is used to make the sunshade, brass or copper being more easily worked than steel. The spring of the metal should be sufficient to keep the shade in place. Paint the underside of the shade a dull black to prevent light reflections.

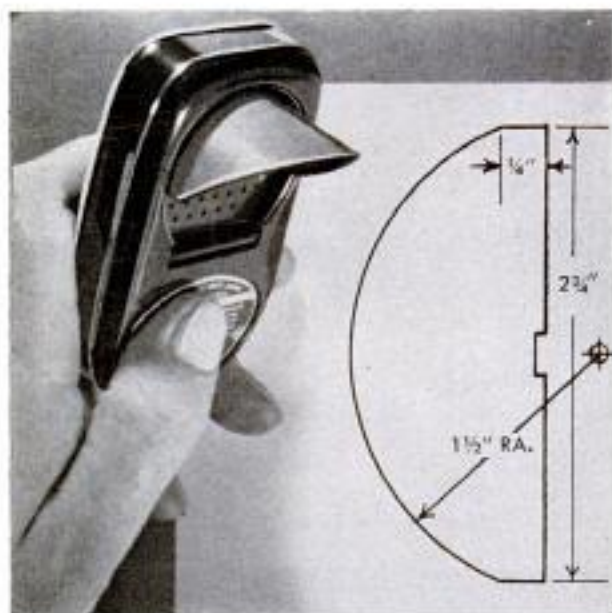

## Pipe Guard for Foot Scraper

Possible injuries from a sharp-edged foot scraper can be avoided by fitting it with a guard. The guard consists of a length of 1-in. or 1 1/4-in. pipe, slotted as indicated and pivoted on one end of the scraper. To permit the guard to be lifted off with the foot, make it about 3 in. longer than the scraper as in the illustration.

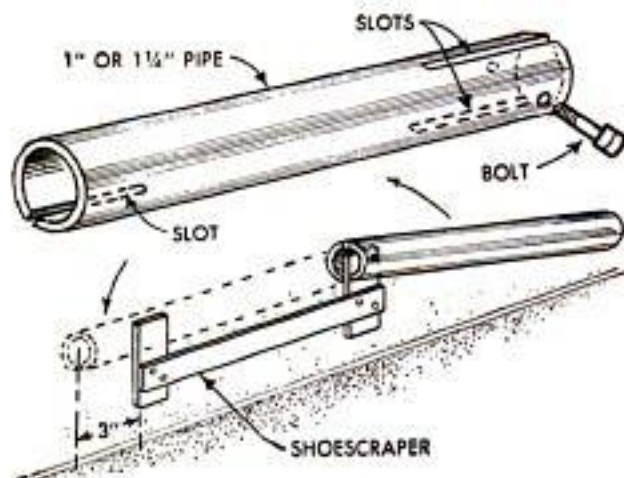

When wearing roller skates on shoes which permit the skate clamps to slip off the soles, fit a heavy rubber band over the toes of the shoes and the ends of the skates to help hold the latter in place.

## Kitchen Tool Cabinet Stores Those Frequently Used Items

Tools and materials needed by the housewife for simple repair jobs are kept in this neat little cabinet attached to the kitchen wall. Made of plywood and pine lumber, the cabinet has holders on the inside of the door for a hammer, screwdriver, pliers and scissors. Holders for the latter three are made from blocks of wood as in the details, and a broom clamp is used for the hammer. For a twine dispenser, a length of mailing tube with part of it cut away is glued to the bottom shelf over a  $\frac{1}{2}$ -in. hole.

Dick Hutchinson, San Gabriel, Calif.

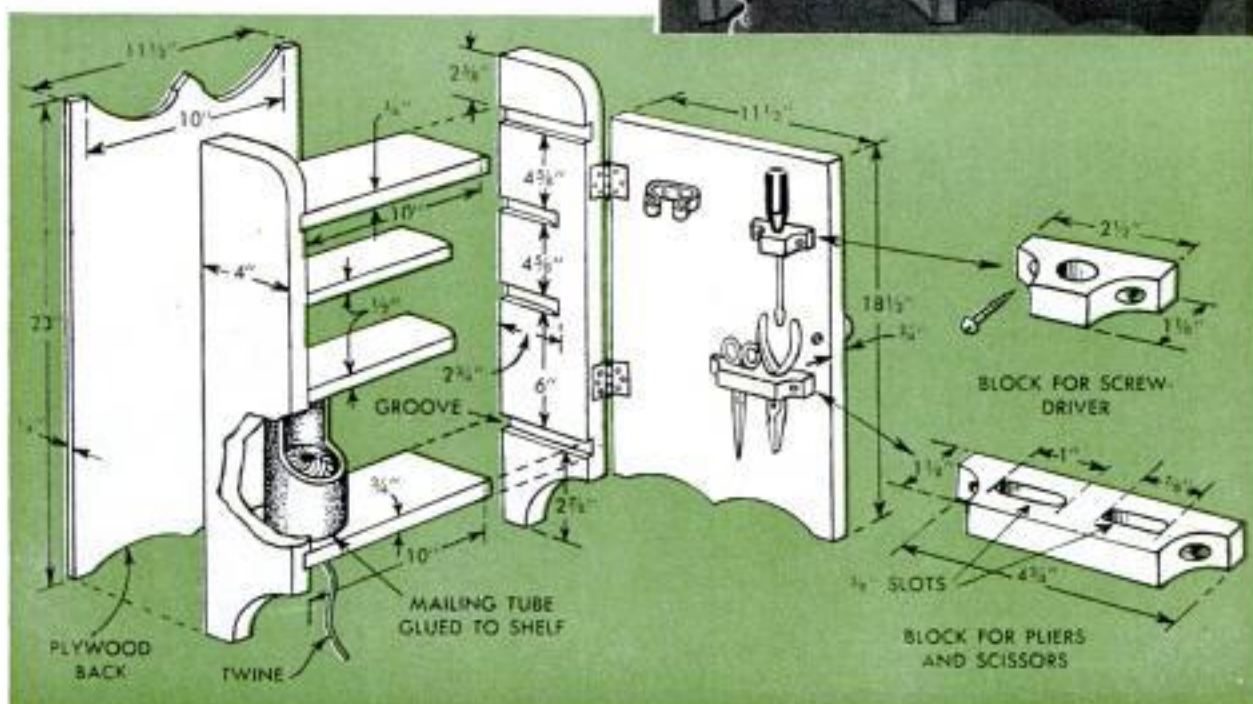

## Cans Provide Soil Bands

You'll find open-end tin cans much better than paper soil bands since they won't come apart like paper ones and disturb the root system when handling seedlings. Start the seedlings by standing the metal sleeves in shallow trays or cake tins. When ready to be transplanted, dampen the soil and push the root ball out the bottom with the thumbs.



OCTOBER 1957

## Flashlight Reveals Uneven Floor

When a floor is not to be sanded before laying linoleum or tile, a flashlight can be used to check for unevenness. Simply play the beam of light over the floor as shown, and watch for shadows cast by raised edges of boards. These can be planed to provide a level surface. An underlayment should be used over a badly cupped floor.



201

Copyrighted material

## ***Fancy Candles are Easy to Make***

**W**HETHER YOU PREFER the type wrapped in a flowering vine, or the kind wound with a spiral sash, you will find these gay and festive candles ideal for centerpieces or wherever an unusual decoration is needed. Despite their expensive appearance, the candles cost little to make and, although they seem complicated, actually are simple to create. No artistic skill is required; just follow the step-by-step instructions in the photographs on these pages. ★ ★ ★



Flower-entwined candle requires small artificial flowers that have fairly long stems, so that they can be wound spirally along full length of candle

Dip the flowers in the hot wax. It may be necessary to dip them several times to assure a heavy coating. Place the dipped flowers on a sheet of wax paper



Finished pairs of candles are admired by young lady who made them. One pair is entwined with flowers, other pair has spirally wound, gold-flecked sash



White candles now are melted down to provide wax. Use low heat to prevent igniting it. Remove from heat and let cool until it has cloudy appearance

Place lower end of colored candle on wax paper and rotate it slowly while letting wax from lighted white candle drip on its full length as shown below







Wrap waxed flowers around the colored candle and hold them in place with staples. Do not use staple gun, as it may damage either the flowers or candle



Other candle for pair is treated in same manner with drippings of white candle and wrapped with flowers. Cover staples with wax drippings from white candle



Brush the candle drippings with touches of gold or silver paint. If you have no small brush, such as shown, use one from a discarded bottle of nail polish



Sash for second type of candle is piece of soft cloth twice the length of candle. Twist this into a rope and dip it into melted wax several times

Below, while rope is still hot, wrap it around candle, cut off excess length. Below, right, pour melted wax, same color as candle, over candle and rope



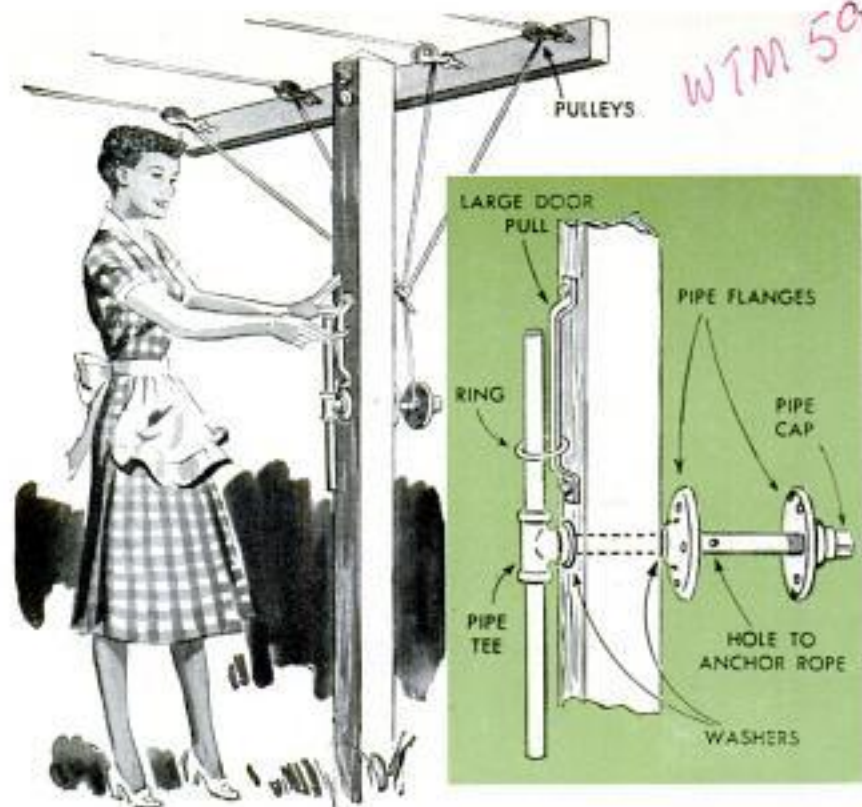

## Line Tightened By Handy Reel

Keeping a multiple clothesline taut is no problem if this reel is used. Made of  $\frac{3}{4}$ -in. pipe and fittings, including two floor flanges to provide a drum for the line, the reel rotates in a hole bored in one post. A large washer on each side of the post provides bearing surfaces. To hold the reel handle after the lines have been tightened, a large door pull is screwed to the post and fitted with a ring that drops over the handle. All lines run over pulleys mounted on the crossarm with eyebolts so they pivot freely, and terminate in a single line anchored to the reel.

## Better Paintbrush Cleaning

For a more thorough cleaning of paintbrushes, spread the bristles laterally with a pencil or splinter of wood so that a toothbrush or other similar cleaning tool can be used to remove paint from the inside of the brush where it tends to accumulate and resists removal by ordinary methods. Also, to assure longer useful life, a paintbrush should always be suspended by the handle when it is stored, to prevent damage to the bristles.

## Stuffed Owl Is "Scarecrow"

If you are troubled with sparrows roosting in your garage, follow the example of one homeowner who mounted a stuffed owl in a conspicuous location inside the garage. Because sparrows are deathly afraid of an owl, few of them will stop long enough to investigate whether or not the bird is real. And because the stuffed owl so closely duplicates in appearance its natural, motionless pose in life, it is not likely to reveal the deception.

## Candleholder Adds Charm

This decorative candleholder will add a touch of charm to your home, yet can be useful in the event of electric-power failure. The base is three plywood disks covered with sheet aluminum and nailed together. Reflector and socket are cut from aluminum, using the patterns in the detail, and bent to shape. Tabs on the reflector are nailed to the underside of the top disk. A handle is shaped as shown. If embossed aluminum is not used,peen the metal, then polish with steel wool.

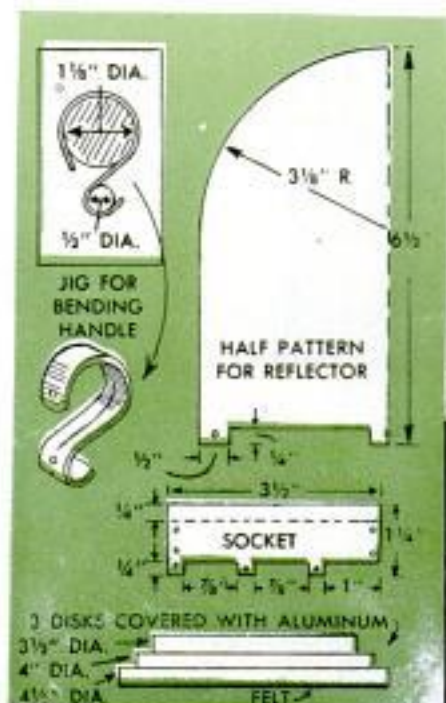



## MAKE A

# "CRAZY JUG"

During the period of austerity following the Civil War, "crazy jugs" were an inexpensive method of expression originated by teen-agers of that era. As much a conversation piece today as when first conceived, the jugs require imagination, rather than skill, to produce the most interesting results. The jug can tell a story with a series of related items, or simply be a random collection of odds and ends, such as arrowheads, brightly colored beads, odd-shaped buttons, sea shells, dice, coins and similar objects. Coat a 1-gal. clay jug with a ½-in. layer of putty, leaving the handle clear, and press the objects into it. Then set the jug in a cool, dry location until the putty hardens. For added effect, touch up open areas of the putty with gold or silver paint.

Grover Brinkman, Okawville, Ill.

Needed for "crazy jug" are: Clay jug, enough putty to coat it completely and collection of bric-a-brac

After jug is coated with putty, objects are pressed into it, then jug is set aside until putty hardens



### Wet Window and Slow Speed Improve Wiper Performance

A windshield wiper will do a better job and last longer if the wiper is not turned on until the windshield is thoroughly wet and the wiper operated at the slowest speed possible. Turning on the wiper full speed, particularly when the window is partly dry, causes dust particles to abrade the rubber blade. A fast-moving blade tends to skip, too.—R. C. Hansell, Philadelphia, Pa.

### Cloth Clamped in Clothespin Serves as Small Paint Brush

The next time you have a small paint job to do and don't have a suitable brush, try using a small roll of cloth clamped in the jaws of a spring-type clothespin. Any size of cloth roll can be used, depending upon the requirements of the job, and the cloth can be secured in the clothespin at an angle that is most convenient for the work.—Robert L. Sargisson, Berwyn, Ill.

# Fun for



**C**LEVER COSTUMES and interesting games are what make a Halloween party fun. Here are three costumes that are bound to provoke comment and laughter, and a game called the "spook race" that fits right into the witch-ghost-goblin atmosphere of this October celebration. Dimensions for the costumes can be changed to accommodate youngsters of different ages. ★ ★ ★

Antique automobiles are always attention getters, and when a youngster arrives at a party "wearing" one, he's bound to have fun

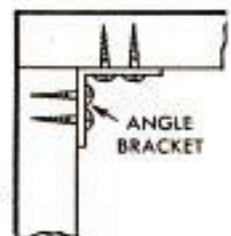
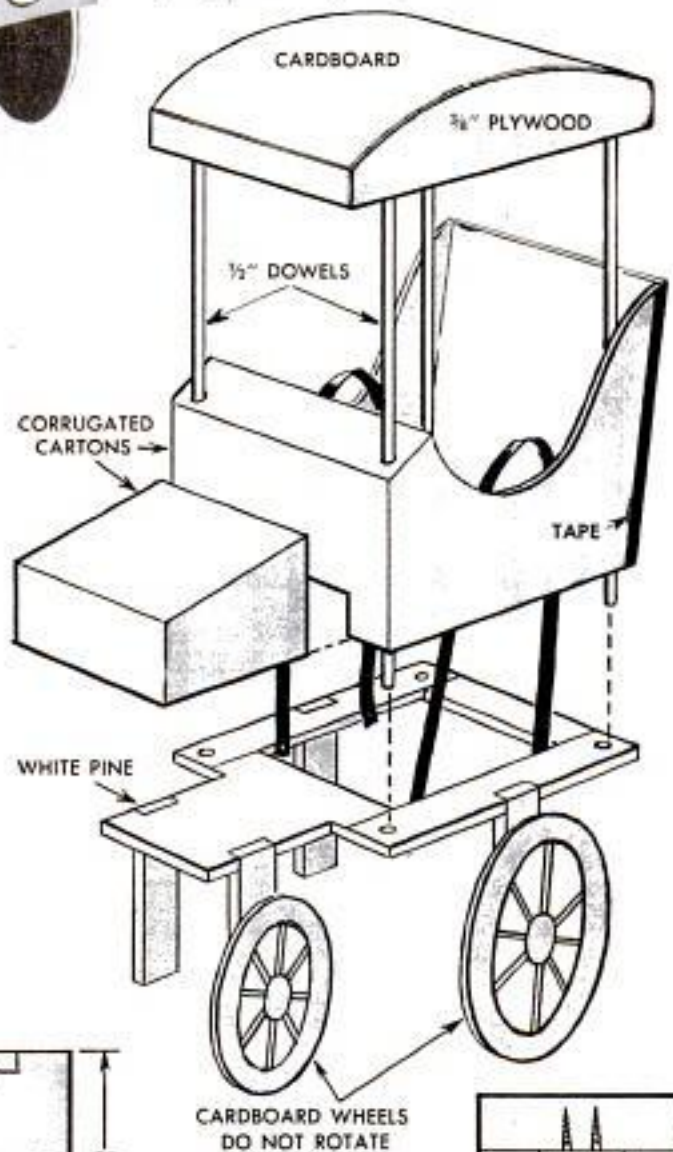
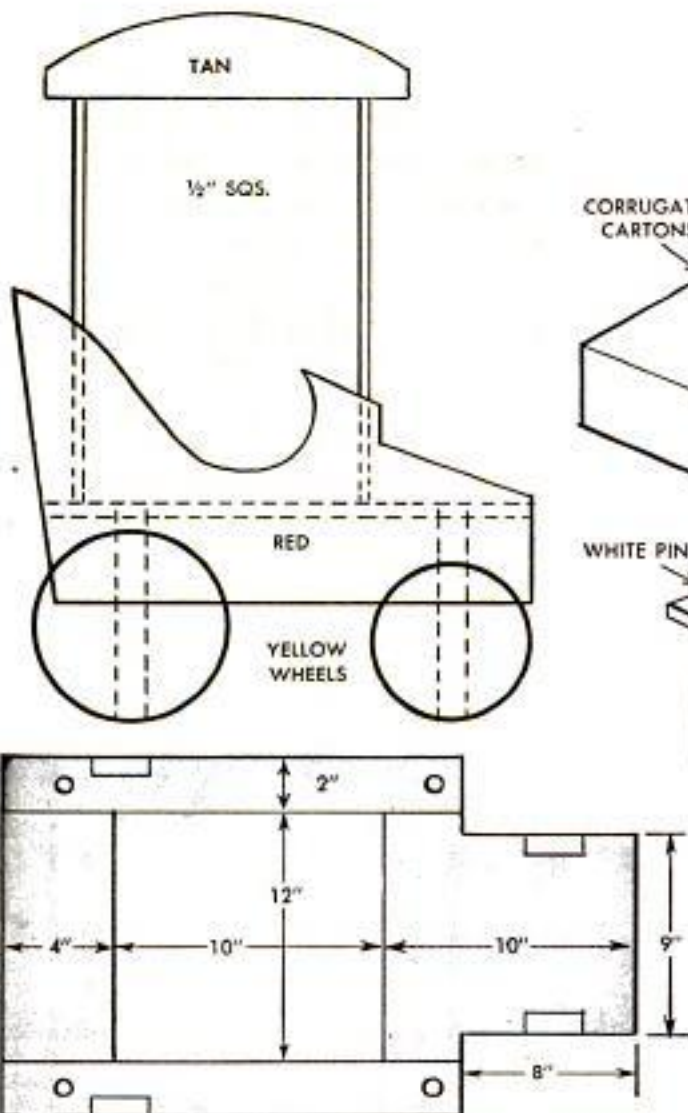

# Your Halloween Party

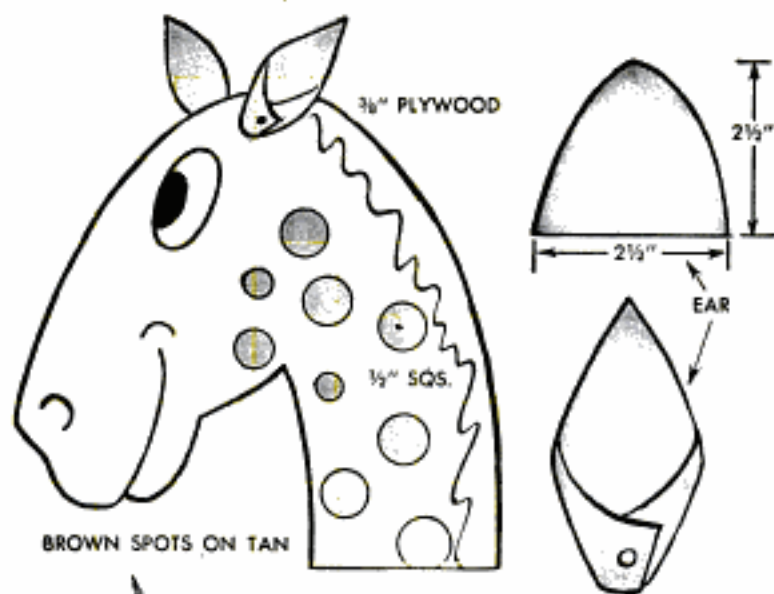

Horses and the wild West have appeal for all youngsters. After the Halloween party this sturdy bronco probably will see service as a cow pony on the backyard ranch. Ears for the horse are cut and folded from leather or plastic; the tail is a whisk broom

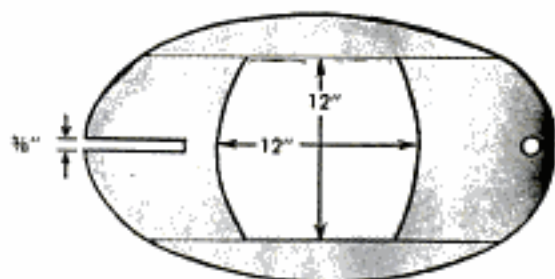
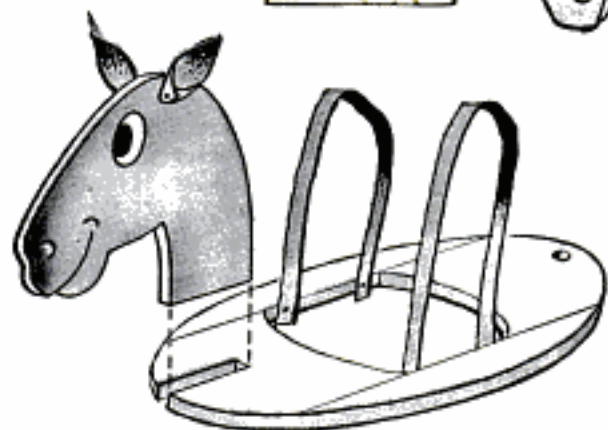

Mask from costume shop is worn by "bird in gilded cage." If the bird can't eat the jelly-bean "bird seeds," the other guests at the party can and will enjoy them

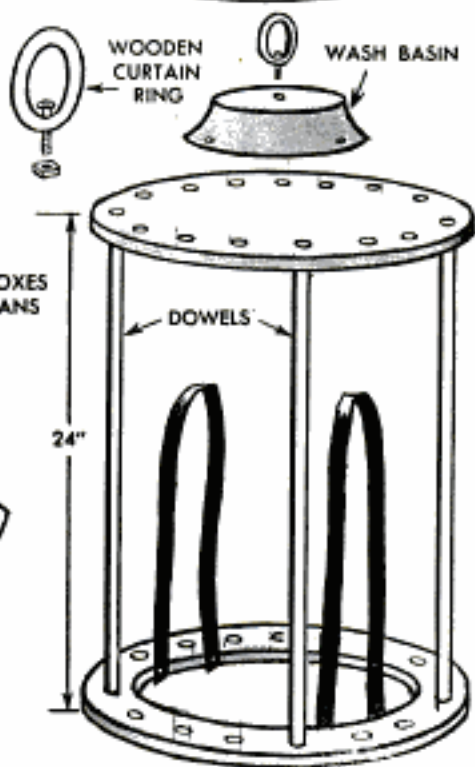
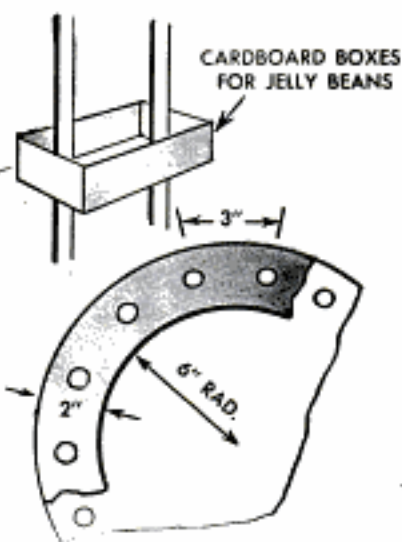

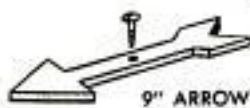
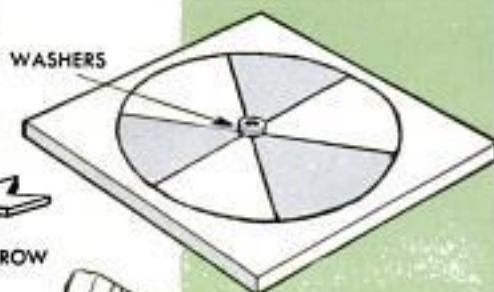
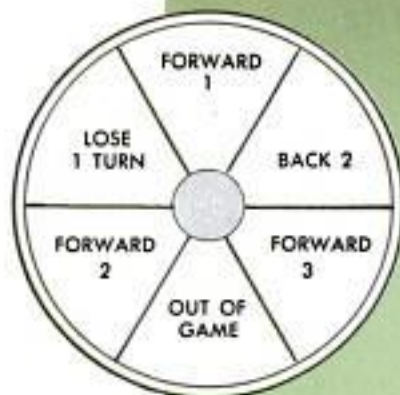

Fast elimination of players in the "spook race" is assured by the "out of game" space on the spinner board, thus permitting all guests at the party to participate. Prizes should be wrapped in unusual shapes so that winners do not know what they have won until their package is unwrapped completely



CARDBOARD CONES FILLED WITH MARBLES



WRAP HALF DOLLAR IN SMALL BOX

ORANGE RESEMBLES BASEBALL



PACKAGE RESEMBLES GUN, SMALL GIFT INSIDE

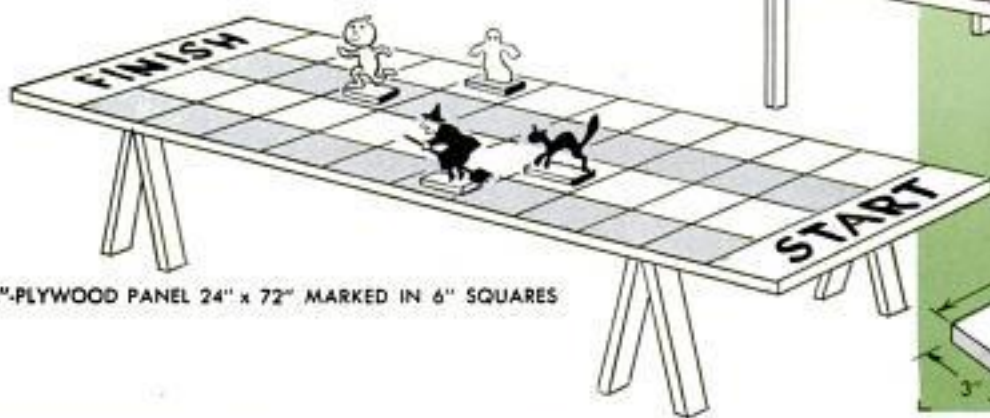

$\frac{3}{4}$ "-PLYWOOD PANEL 24" x 72" MARKED IN 6" SQUARES



BASE FOR FIGURES

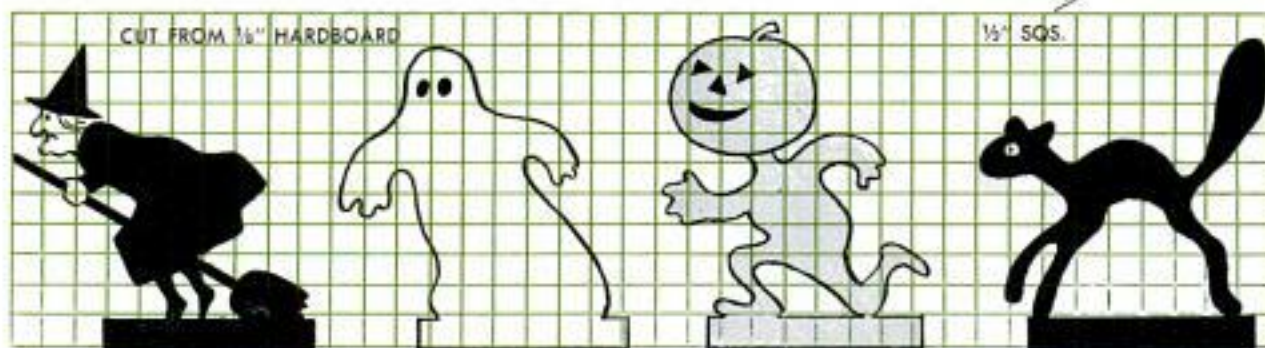
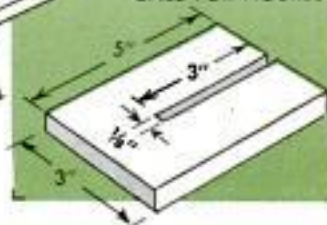

CUT FROM  $\frac{1}{2}$ " HARDBOARD

$\frac{1}{2}$ " SQS.

## Pouring Milk From Gallon Bottle Made Easy

Pouring milk or distilled water from a gallon bottle is much easier for housewives and children when the bottle is placed in a tilting holder such as the one shown. Plywood or pine lumber  $\frac{1}{2}$  in. thick can be used for making the holder as shown in the drawing. When cutting the sides, be sure the edges that are to form a part of the base are at right angles to the back for a distance equal to two thirds of the diameter of the bottle for proper stability and easy tilting. A slot in the upper end of the back provides a hand hold, and two coats of spar varnish, or a good grade of enamel, are applied before decorating with decals.

Enno R. Haan, Evanston, Ill.



## Bleach Removes Print Emulsion For Recording Photo Data

When you wish to write data on the front of a snapshot, the glossy emulsion is easily removed with full-strength liquid bleach. To do this, cover the lower portion of the print with masking tape as shown in the photo. Then, swab the exposed area with bleach and wipe off the emulsion with a dry cloth or tissue.—Ken Murray, Colon, Mich.

## Glove Fingers Prevent Knife Cuts

Fingers from old rubber gloves slipped on the thumb and index finger of your right hand, will prevent knife knicks in your thumb when cutting fruits and vegetables with a paring knife. Also, they will keep the knife from causing roughness or a calloused spot on the index finger.

## Tie Rod on Gateposts Better Than Braces

Using a tie rod between gateposts produces a neater appearance than braces, and usually is more effective. Use extra-long posts and tie them together at the top with a  $\frac{1}{2}$ -in. steel rod. Thread it at both ends so that nuts and washers can be used on each side of each post. Cedar posts that have been treated against rot are best suited for gates. If pine 4 x 4s must be used, set them in concrete, or bolt them to flat steel pieces set in concrete to project several inches above ground.

C. F. Marley, Nokomis, Ill.





WTM 59

**REPAIR**

## DON'T JUNK BROKEN CHINA

**M**AYBE ALL THE KING'S HORSES and men couldn't reassemble Humpty Dumpty, but the chances are, if he were to stage his falling act today, modern adhesives could do a pretty good job of putting him together. Thanks to materials now available, successful china repair is within the ability of the home craftsman.

Several types of cement are used for repairing ceramic materials, one of the newest being a two-part catalyst adhesive. Selection of an adhesive or cement is determined by the function of the piece that is to be repaired, whether it merely will be displayed for ornamental purposes, or will be used for holding hot food or drink, etc.

Before attempting to repair a broken ar-

ticle, it is important that joining surfaces be clean and dry. Often a piece to be repaired, such as the china-doll leg shown in Fig. 4, will have been glued previously with an adhesive that did not hold, or it may have been badly assembled so that the glued joints were out of alignment. Before repairing the piece again, every trace of the old cement should be removed. Joints made with water-soluble cement can be opened by soaking them in hot water and the softened cement removed with a brush. The distributor of a resin-type cement suggests that, while joints sealed with a resin cement may withstand repeated washings with soap and water, they can be loosened by prolonged soaking in hot water.





After both parts of catalyst-type cement are mixed, solution must be used at once

For stubborn cases, a special "china washing" powder is available at your local hobby shop.

When cementing pieces of china, some brands of adhesives require clamping of the joint to produce a good bond, but others do not, according to the manufacturers. The mere supporting of a damaged piece when repairing it can be a problem. A device used by some repair shops consists of a small box of dry sand in which the object is partly buried. For simple holding of glued parts in proper alignment, cellulose tape or adhesive tape can be used as in Figs. 4 and 5. Other materials that are useful for clamping or applying pressure to joints are rubber bands, elastic cord, strands of rubber and small-diameter steel springs. In some cases, weights can be strategically placed to exert pressure on a joint, or special "presses" improvised, such as the one shown in Fig. 3. To effect a good repair of broken china, it is important that the surfaces of a joint be in alignment. A good test for this is to rub a fingernail across the joint. You should be able to move it in either direction without catching the nail on a sharp edge. Excess cement can be scraped or wiped off. If left to harden, the remaining adhesive is scraped off with a knife, after which a solvent is used for final cleaning.

Hardening of most cements used on ceramic material can be hastened by moderate heating up to 200 degrees F. This may be helpful during humid weather when it might otherwise not be the best time for repair work. Some materials, such as alabaster and marble, should not be subjected to heat in excess of 100 degrees F.



Above, catalyst-type cement is applied to both edges of saucer pieces with toothpick. Two largest pieces are coated first and cement allowed to set before assembling smaller pieces



Above, pressure is applied to saucer by rubber band pulling on felt-padded lever. Rubber tubing on nails protects saucer

Below, adhesive tape and elastic cord bind doll-leg pieces



### Types of Cement

Of the hundreds of adhesives on the market, most can be classified in one of the following types: Solvent-type household cement, synthetic-resin emulsion and two-part catalyst cement.

Solvent-type cements generally harden by evaporation of a solvent. They may be marked "waterproof," and characteristically are clear and colorless. Some are opaque or, if clear when applied, tend to turn yellow or brown with age. The usual procedure for cementing china, crockery, etc.,



China horse is held in proper position for easy gluing of broken legs by burying part of body in dry sand. Tape applies sufficient pressure for good bond

is to allow some of the solvent to evaporate from the applied cement before pressing the pieces together. Because the solvent must evaporate from the edges of joints, developing maximum strength may take days or a week.

A typical cement of the synthetic-resin type is described as being suitable for the special requirements of antique repairing, and to be satisfactory for gluing practically every material except metal. Application conditions require priming of very porous surfaces with cement, which is allowed to dry 5 min. Then, the joints are recoated and assembled. After a week of "curing," usage has shown that repaired pieces can be washed with soap and water. While joints are water-resistant, they are not necessarily waterproof.

Two-part catalyst cements are the latest type of adhesives covered in this article to appear on the market. The cement base, or glue, will not undergo hardening, which is by chemical action, until the catalyst has been added as shown in Fig. 1. Mixed cement must be used rather quickly—within 20 to 45 min., depending upon the brand used. For small jobs, it is possible to mix only a small portion of each part, but it is important to measure exactly the proper proportions of glue and catalyst to develop maximum bonding strength. The mixed adhesive is spread thinly on each surface to be joined and the pieces assembled immediately. The repair resists alcohol, boiling water and the chemical action of foods.

When repairing a broken object, the usual procedure is to assemble the largest pieces first as in Fig. 2, allowing the cement to set before adding the next piece. This prevents moving previously cemented pieces out of position when subsequent ones are pressed into place. ★ ★ ★

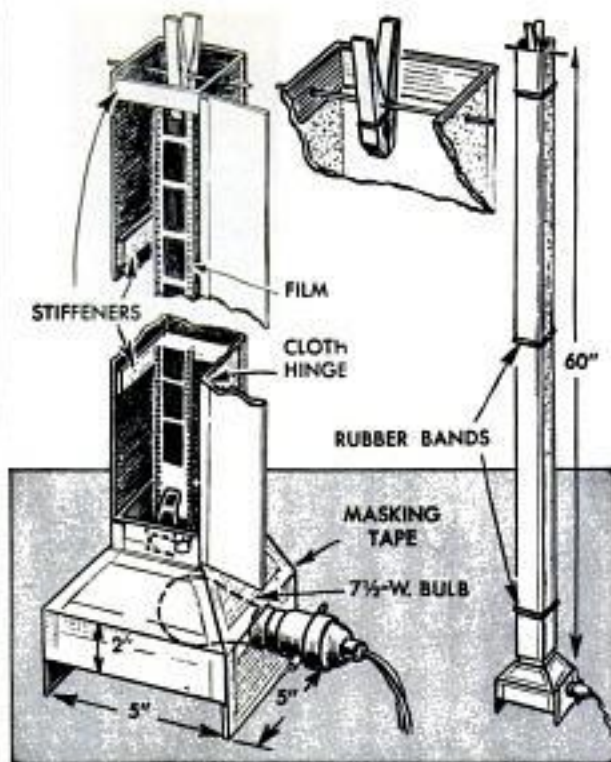

### Drier for 35-mm. Film Made From Scrap Photomounting Board

This chimney-type 35-mm. film drier permits forced drying of film with a minimum amount of heat that is supplied by a  $7\frac{1}{2}$ -watt bulb. The 5-ft. chimney and base are made of photomounting board cut to size and joined with masking tape. Stiffeners, cut from strips of mounting board and glued to the inner wall of the chimney as shown, provide reinforcement. The full-length door swings on a cloth hinge glued to the door and chimney and is held in a closed position by three rubber bands. A wire pin fitted in the top of the chimney, with a clothespin attached as shown, permits hanging the film in the drier.

### Lock Your Power-Tool Switch

To prevent unauthorized persons from using power tools or other machinery fitted with toggle switches, locate a screw eye on each side of the switch and lock it with a bicycle lock as shown.



## Kitchen Cabinet Provides Space for Built-in Dog Kennel

If you are an owner of a small dog like Buck, he will love this novel kitchen kennel which is built right into one of the compartments in a cabinet sink. Matched lumber is used for the sides, and the floor is covered with linoleum of the same pattern used on the kitchen floor. A square of 1-in. foam rubber, placed on the floor at the rear of the kennel, provides a comfortable mattress that is easy to clean. To protect the front edge of the linoleum, a length of  $\frac{1}{2}$  x  $\frac{1}{2}$ -in. metal angle is nailed over the exposed edge.—Elsie L. Stebbings, San Francisco, Calif.



## Tool Permits Quick Marking Of Boards Into Equal Parts

Laying out a board into equal divisions is a simple matter with this tool. Pins at the ends are held firmly against the edges of the board so that a sharp pencil point held, for example, at the midway point between the pins will always mark the center of the board as the tool is slid along. Also, the tiny countersunk holes permit marking a board so that it can be cut into thirds, quarters and eighths. The tool can be made longer than shown if desired.

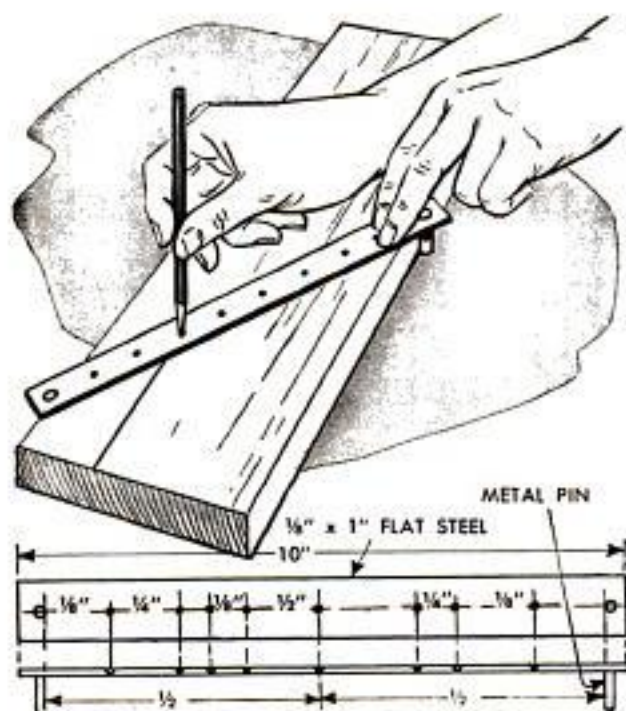

OCTOBER 1957

## Letters Burned on Name Plate With Fingernail Polish

It's no trick at all to make a neat signboard or cottage name plate which will last indefinitely. Simply print or write the letters with fingernail polish and then ignite them. If one application of polish and burning does not burn deeply enough, repeat the process. After the lettering has been finished, two coats of spar varnish on both sides of the signboard will not only improve its appearance, but will also provide added protection.

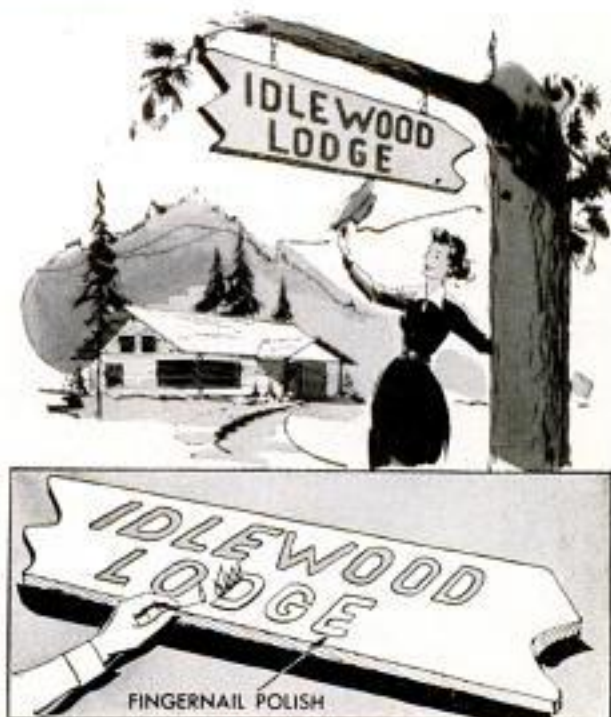

213



## THE SEA CAPTAIN'S DESK

*By following the construction in all details you can build a copy of this valuable antique*

**W**HEN PLACED ON A TABLE and opened, as pictured below, the desk provides inkwell, penholder and a padded writing surface. Closed and locked, it is carried like a chest. The original, shown closed in the photo on the opposite page, is made of pine and veneered on the sides, ends and top with figured mahogany. You can simplify the job of assembly by using solid mahogany for sides, ends and top.

Assemble the desk as a solid box, then cut it apart on a circular saw. The upper section of the desk—upper when it is

The desk is shown opened and ready for writing



closed—requires only the installation of cleats to support the velvet-covered writing surface. The lower section of the desk has the drawer installed first, complete with a secret drawer at the back, then the inner bottom and vertical partition are fitted in place. On one side of the partition, the desk is divided into three sections. One section is fitted with a lid, one is divided into three spaces for inkwells and the one in the center is fitted with a grooved block to hold pens. The lower corners of one end of the block are beveled; pushing down on that end tips up the block to allow it to be removed to disclose another secret compartment. On the opposite side of the partition, cleats are attached to the inner surfaces of the desk to support the  $\frac{1}{2}$ -in. panel that forms the writing surface. A  $\frac{1}{8}$ -in. rod is dropped through a hole drilled into one edge of the desk and part-way through the drawer front to "lock" the drawer. The rod projects slightly so it can be grasped. All hardware should be solid brass with antique finish. ★ ★ ★

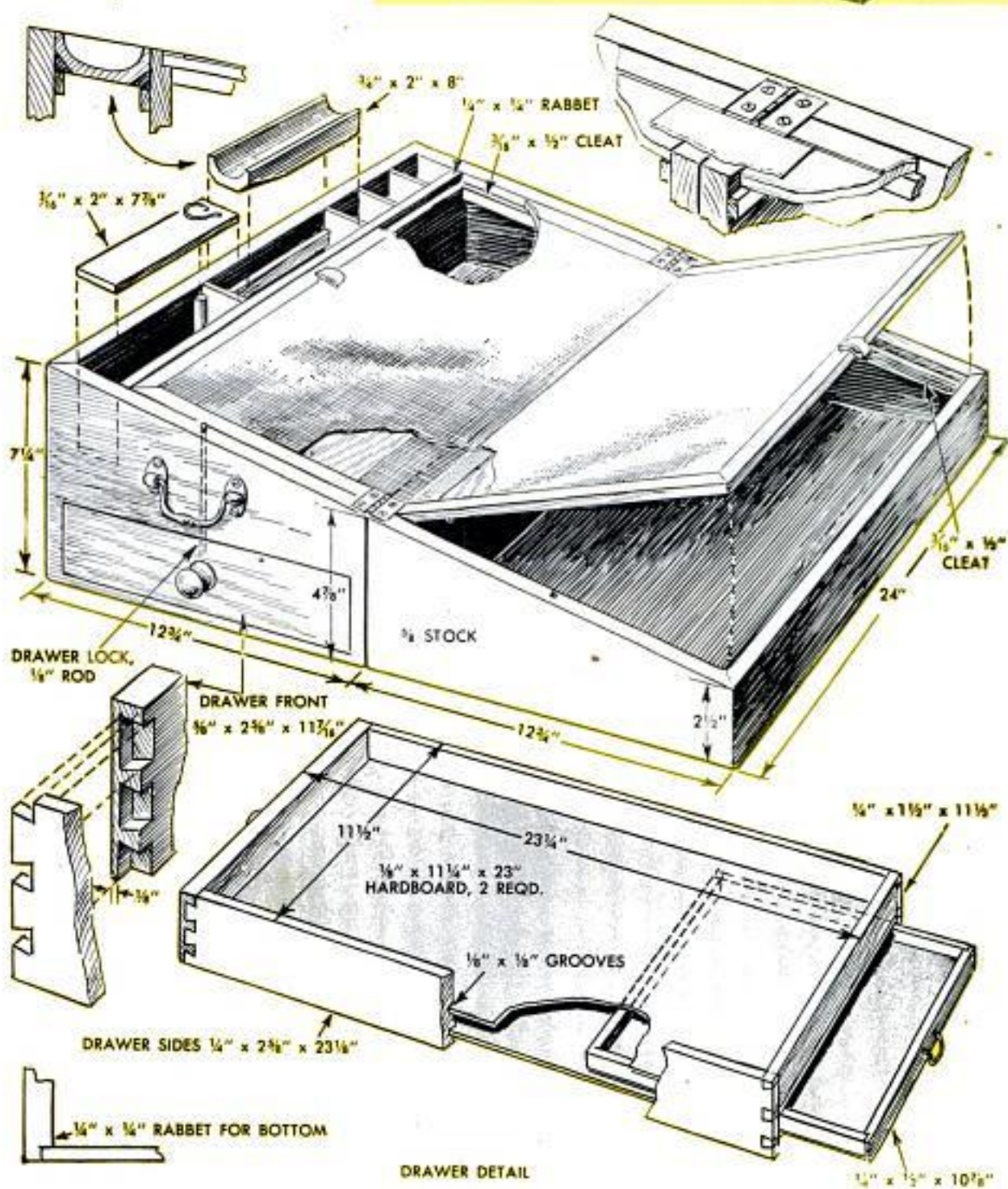



### Auto Visor Extended By Manila Envelope

An easy way of "stretching" the sun visor on your car to provide more shade is to slip a heavy Manila envelope over the end of it as shown. If an envelope of the required size is not available, one can be made from heavy wrapping paper. A rubber band stretched around the envelope will prevent it from being blown off the visor when driving with open windows.

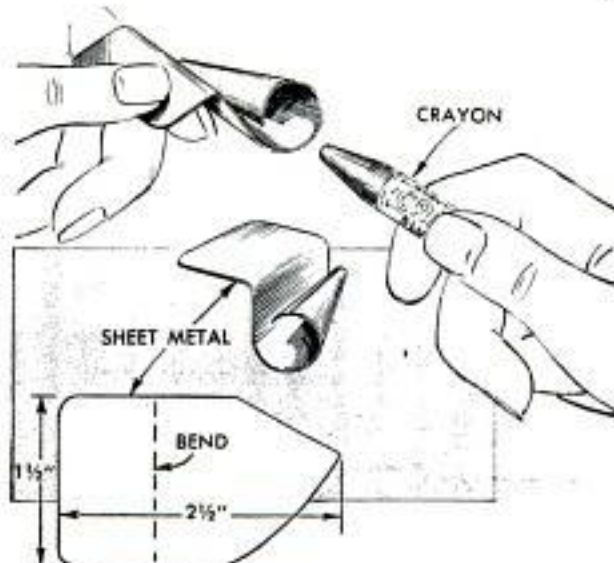

### Wax Crayons Repointed Quickly With Improved Sharpener

This improvised crayon sharpener is a handy gadget for supervisors of children's play groups, nursery schools and other groups using wax crayons in quantity. Pointed crayons are necessary for delicate shading and tend to encourage better work. The sharpener is cut from heavy sheet metal and formed as shown. The cutting edge is bent inward to provide a "bite."

## Do-It-Yourself MATERIALS GUIDE

for the Homeowner and Handyman

### Cross Indexed for Easy Use

If you've ever walked into a hardware store without knowing exactly what you need (and walked out without being sure of what you'd bought), you'll want a copy of this new guide that lists *all* the specifications for *all* Do-It-Yourself materials. With this book, you'll know exactly what to look for, and how to save money when you buy.



Need to know how long a 50d (penny) nail is? In the Do-It-Yourself Materials Guide, charts like the one at the left (4½ times larger in the book) will show you it's 5¾ inches.

The chart at the right, of common wood-screw sizes and gauges, is typical of the dozens of illustrations (all much larger) in the book. Now you'll know how to choose and where to use building and hobby materials.

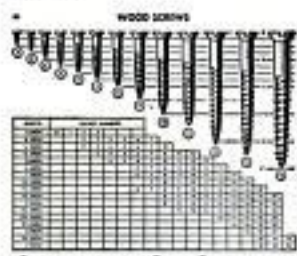

### A Key to Buying and Using:

- |             |          |          |
|-------------|----------|----------|
| Adhesives   | Fuses    | Plumbing |
| Bolts       | Glass    | Plywood  |
| Bricks      | Hinges   | Roofing  |
| Conduit     | Locks    | Siding   |
| Doors       | Millwork | Tile     |
| Glass fiber | Paint    | Wiring   |

... Plus 31 other basic products. For only \$2.95 you can get this 160-page guide that will *save you time and money every time you buy supplies*. So send your order today to:

**POPULAR MECHANICS PRESS, 200 East Ontario Street, Chicago 11, Illinois**



## Shelf and Picture Frame for Modern Home

WTM  
59

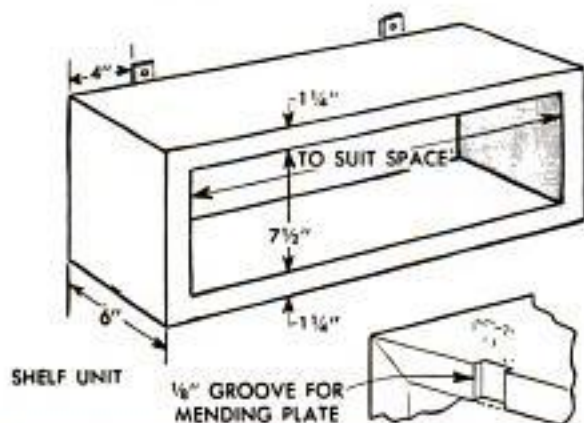

A PLEASING EFFECT is achieved in this individual shelf unit by using thicker-than-usual lumber and enclosing the ends. The shelves were made as shown of 1 1/4 x 6-in. redwood but other woods and thicker stock may be used with equal effectiveness. Pieces are mitered at corners.

The novel picture frame shown in the photo and the drawing below is easy to make. Any size picture can be accommodated simply by making the brass-angle frame the size desired and increasing the lengths of the brass rods proportionately.

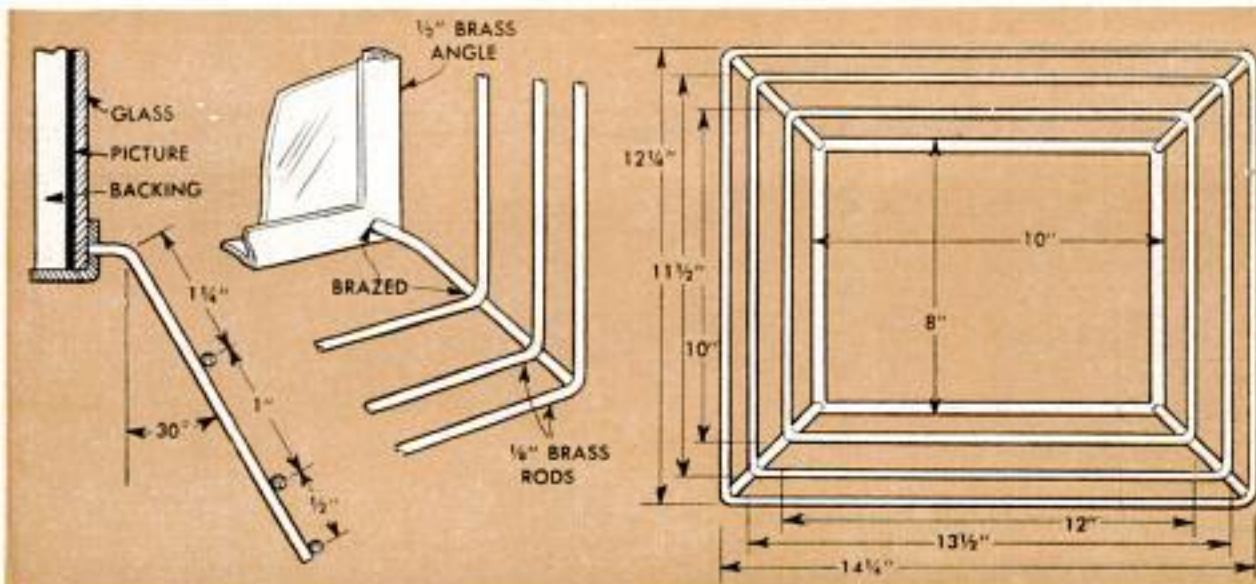

# "Drag Strip" in Your Basement

By Ronald L. Anderson

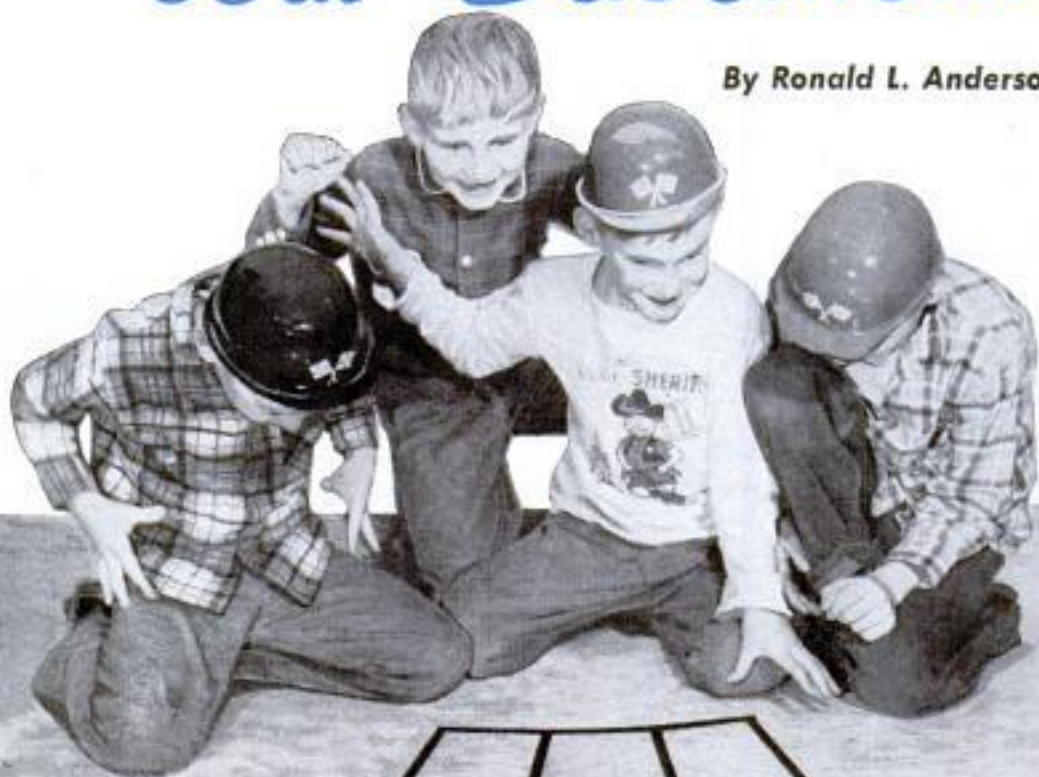

1



2



**A**DDING POWER to plastic scale-model cars built from kits brings the thrills and excitement of real-car racing to what ordinarily is a shelf-model hobby. Racing is done on a "drag strip" a couple of feet wide painted on a basement floor, Fig. 1. Length of the track will vary with the size of a basement, but should be as long as possible to let the little cars reach top speed.

"Engines" for the cars are tiny electric motors, Fig. 4, powered by flashlight dry cells. Costing about \$2.00, the motors are available at most hobby shops. Because different types of these motors vary in power output, cars should be raced in "classes" so that cars with equal power will compete. The winner in a particular class will be the one that is "tuned" the sharpest. Such tuning consists of making the car as light as possible, and reducing friction to a minimum. Using extra dry cells, detail, Fig. 7, will make a motor run faster, but there is the possibility of burning the brushes due to excess voltage. Check the name plate of a motor to determine its maximum capacity.

One manufacturer of the miniature electric motors provides a complete line of accessories, including several types of reduction gears, motor shafts, pulleys, belts and mounting brackets. The shape and size of a car will determine the type of drive system to use, three being available, but in most cases a 15-to-1 speed reduction is necessary. The first drive system uses a worm gear on the motor shaft and a pinion gear on the driving axle, Figs. 3 and 4. The second system is a friction drive with the motor shaft rotating against a tire. Rubber tubing slipped over the shaft provides a more positive drive. A plastic wheel should be replaced with one that has a rubber tire. The third drive system consists of pulleys on motor shaft and axle, driven by a spring belt, similar to the type used on movie projectors.

First step in constructing a powered car is to assemble it according to directions, leaving out the dummy motor, seat and any other interior units. Sedans, because of more inside room, provide easier installation of the motor and batteries, see left-hand cars, Fig. 2, but racing roadsters and convertible coupes, right-hand car, Fig. 2, and cars in Fig. 5, can be used, although they require more careful planning for the location of the motor and batteries. A



Above, after car is assembled and pinion gear is on axle, hold motor in position to check mesh of gears

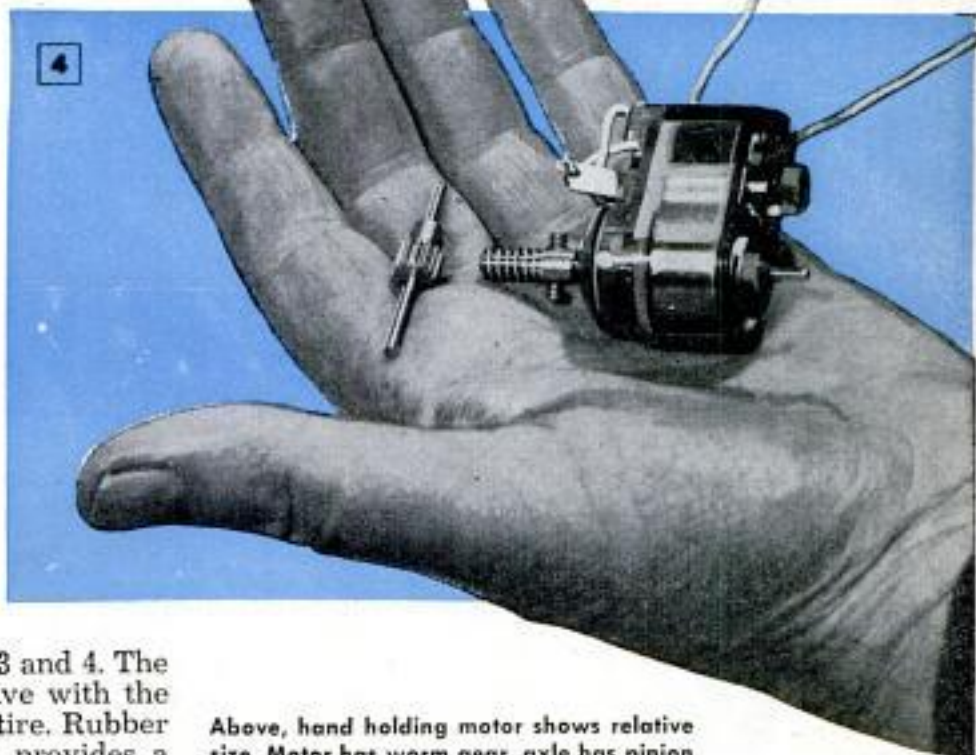

Above, hand holding motor shows relative size. Motor has worm gear, axle has pinion

Below, "souped up" convertible has four dry cells for added power. Pencil indicates friction drive





Discarding dummy engine and seat when assembling car provides room for electric motor and dry cells

worm-and-pinion-gear drive installation in a roadster-type body is shown step-by-step in Figs. 3, 6, 7 and 8.

After the car has been assembled, in this case with a 14-tooth pinion on the front axle, which meshes with a worm on the motor shaft to provide a 15-to-1 reduction, the upper half of the car body is removed. Hold the motor in place with your thumb, Fig. 3, and check the positioning to make

sure the gears mesh smoothly. Mount the motor in place with machine screws and an aluminum strip  $\frac{3}{8} \times 2\frac{1}{4}$  in. long. A pad of foam rubber,  $1 \times 1\frac{1}{2}$  in., cushions the motor. Insulate the mounting screws with tape to prevent them from contacting the wires.

Next, wire in a canopy switch and drill a mounting hole for it in a convenient location. Be sure it will not interfere with the dry cells, Figs. 7 and 8. Now, with a fine-bladed jigsaw, cut off the bottom of the rear deck of the car so two pen-light dry cells can be slipped into the car. Standard-battery boxes may be trimmed to fit, or the dry cells can be taped together. To "hop up" the car, a second set of dry cells can be placed near the center of the car. Wiring is shown in the details in Fig. 7.

Now the car is ready to run. Place a few drops of oil on all gears and bearings and turn on the switch. Adjust the front mounting screw, Fig. 8, until the motor turns its highest r.p.m. Place it on the starting line with several other cars, snap the switches and watch them rush down the track. To eliminate a scramble for the speeding cars at the end of the race, and to prevent damage, use a padded 2 x 4 for the finish line.

★ ★ ★

Dry cells are inserted in opening cut under rear deck of car. Wiring diagram is shown in details

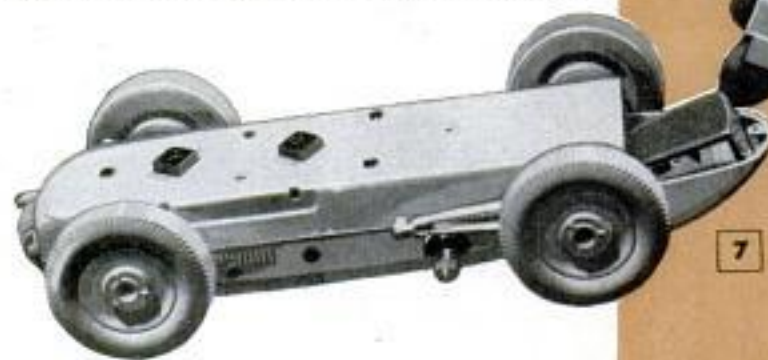

Car is "tuned" by adjusting gear clearance with front screw of motor mount while motor is running

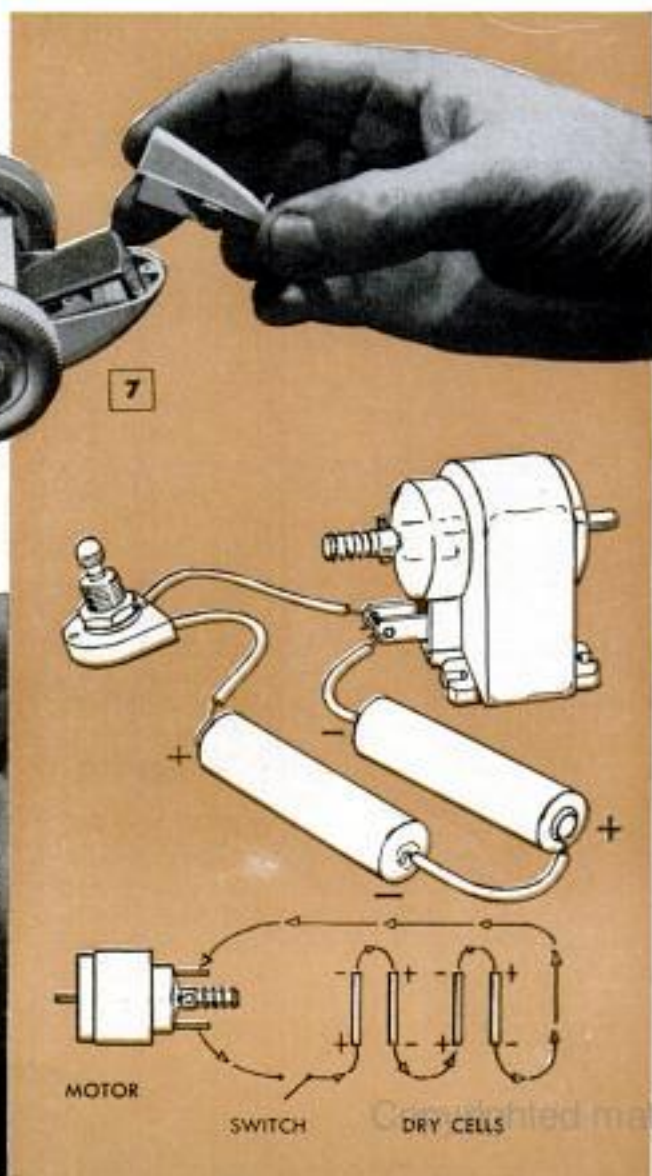
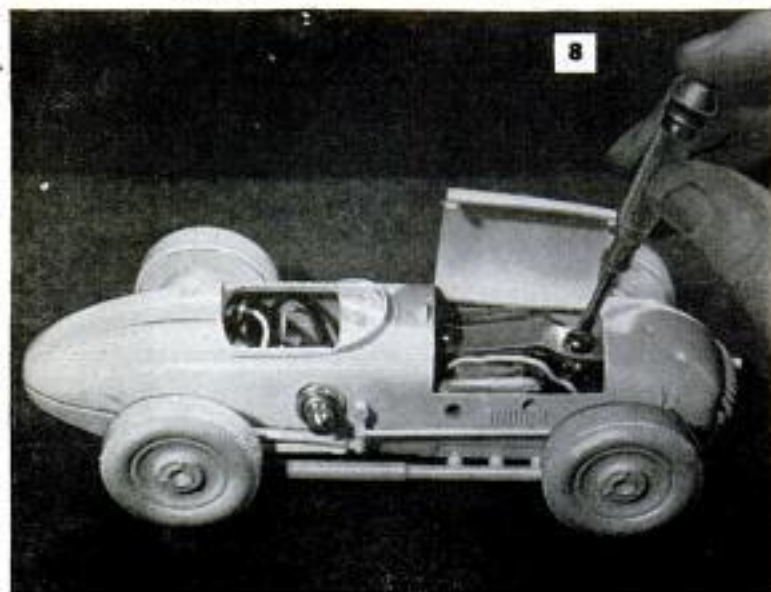

MOTOR

SWITCH

DRY CELLS

Copyrighted material



## Ball and Chain on Collar Slows Car-Chasing Dog

If your dog has the dangerous habit of chasing automobiles, and scolding and punishment do not seem to do any good, try this device worked out by Maurice Peacock, Radnor, Pa. It consists of a solid-rubber ball drilled to receive an eyebolt to which a short length of chain is attached. A snap swivel on the other end of the chain permits it to be attached to the dog's collar. The chain should be of a length that positions the ball a couple of inches above the ground. When the animal runs, the ball strikes his front legs and the chain wraps partly around one of his legs, throwing him off stride. The dissuader will work equally well on large or small dogs.

## Spice Dish Made From Three Spoons

Three round-bowl soup-spoons are used to make this interesting spice dish. The handles are cut off the spoons and the bowls soldered together as indicated. "Legs" for the dish are formed by shaping the handles over a length of pipe or dowel with the aid of a soft-faced mallet. Use stainless-steel spoons when possible, as soldering heat may cause plating to peel.—S. S. Palestrant, Bronx, N. Y.

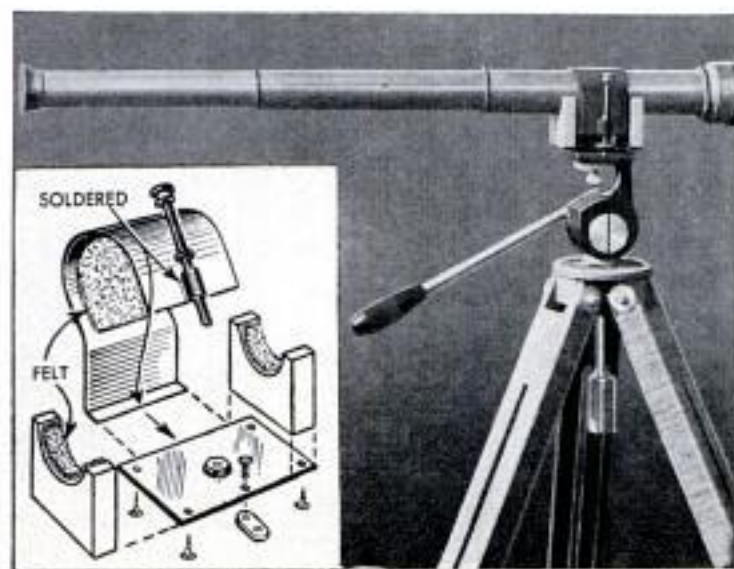
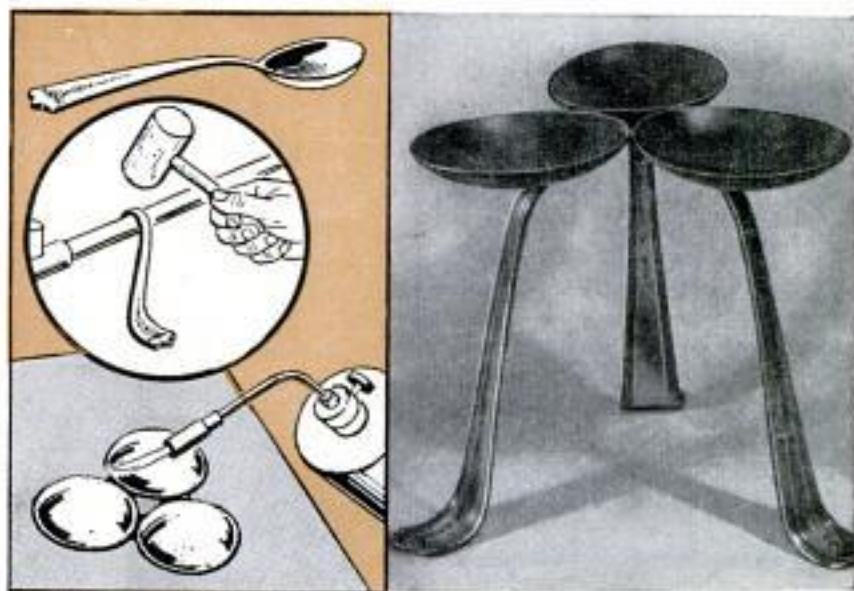

## Tripod Supports Telescope With Aid of Adapter

Any camera tripod can be used as a telescope support with the aid of this adapter. No dimensions are given as they will vary with each telescope. The base, cut from heavy sheet metal, has a  $\frac{1}{4}$ -20 nut soldered over a  $\frac{3}{16}$ -in. hole to accommodate a standard tripod screw. Hardwood is used for the cradles, light sheet metal for the clamp. A short length of tubing soldered to the clamp receives a locking screw that turns into a tapped hole in a bracket screwed to the base. The screw has a dry-cell terminal nut soldered to it.



### Hose Is Pail-Rim "Bumper"

Lengths of small-diameter hose, slit open and placed over the rims of galvanized pails and metal wastebaskets, prevent the containers from damaging kitchen cabinets and walls when accidentally knocked against them. Once the hose is slipped in place, it will remain on the rim until removed for cleaning.



Attached to a telephone directory, a small magnifying glass will make the fine print easy to see.

### Magnet-Type Knife Rack Holds Tools on Ladder

A magnetic knife rack screwed to the back edge of the top step of a stepladder provides a convenient place for keeping tools and metal material needed on a job. It will be found especially handy for holding small screws and other tiny parts that might be used in applying hardware.

### Backing Sheet Prevents Cards From Slipping in Typewriter

Small cards or labels can be prevented from slipping out of position when typing on them if they are secured on a sheet of paper as shown in the drawing. To do this, simply cut diagonal slits in the sheet of paper



so that the corners of the cards or labels can be inserted. The slits must be made carefully so that the cards lie parallel with the top of the sheet.

### One-Piece Chimney Extension

Cut from a single piece of sheet metal and bent as indicated, this chimney extension can be installed in a few moments. Its lower end slips into the flue tightly so it will remain snugly in place even when subjected to considerable wind pressure. Yet, when necessary, it can be removed without difficulty.

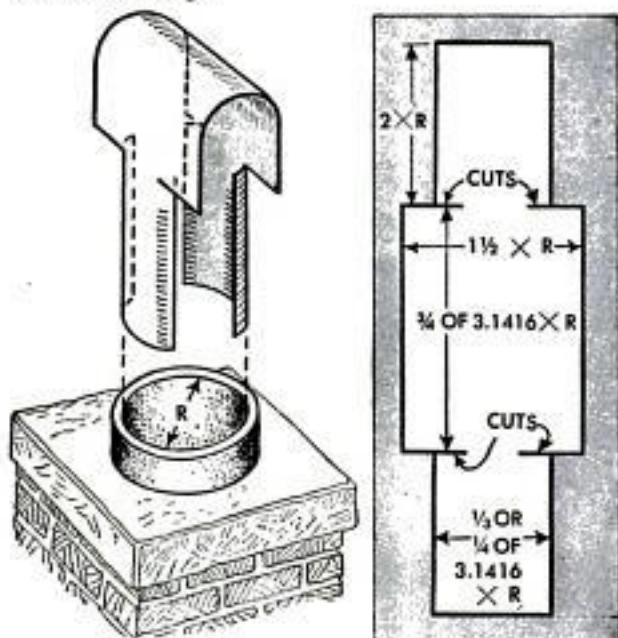

Do not allow sawdust to accumulate on the workshop floor. It is considered a fire hazard.

# DENSITOMETER

## Speeds Photo Enlarging

By E. H. Leftwich

FOR THE amateur photographer who prefers to do his own photo enlarging, here is an inexpensive, easy-to-build electronic unit that will save darkroom time and cut waste of enlarging paper. The unit simply measures the degree of contrast between the lightest and darkest areas of a negative so that it can be classified in one of the five groups shown in the sample negative-contrast ratio table, Fig. 5, and a proper exposure time determined.

The exposure time listed opposite each of the five contrast ratings in Fig. 5 applies to a specific type of enlarging paper, developer and the developing time recommended for the developer. However, it takes only a few minutes to determine these values for the type of paper and developer you use. To do this, the following procedure is recommended:

1. Place the negative to be classified in the enlarger, focus and set the aperture of the enlarger lens at f:11.

2. Remove the protective cap from the photocell (PH-1, Fig. 2) and hold the latter on the easel in the lightest area (shadows) of the projected image. With the power button, Fig. 1, (SW-1, push switch, Fig. 4) depressed, set the sensitivity control so that a reading of 40 is obtained on the microammeter as shown in the illustration at the upper right.



Below, plastic bottle cap is used to cover "eye" of photocell when latter is not in use to protect it from dust



1

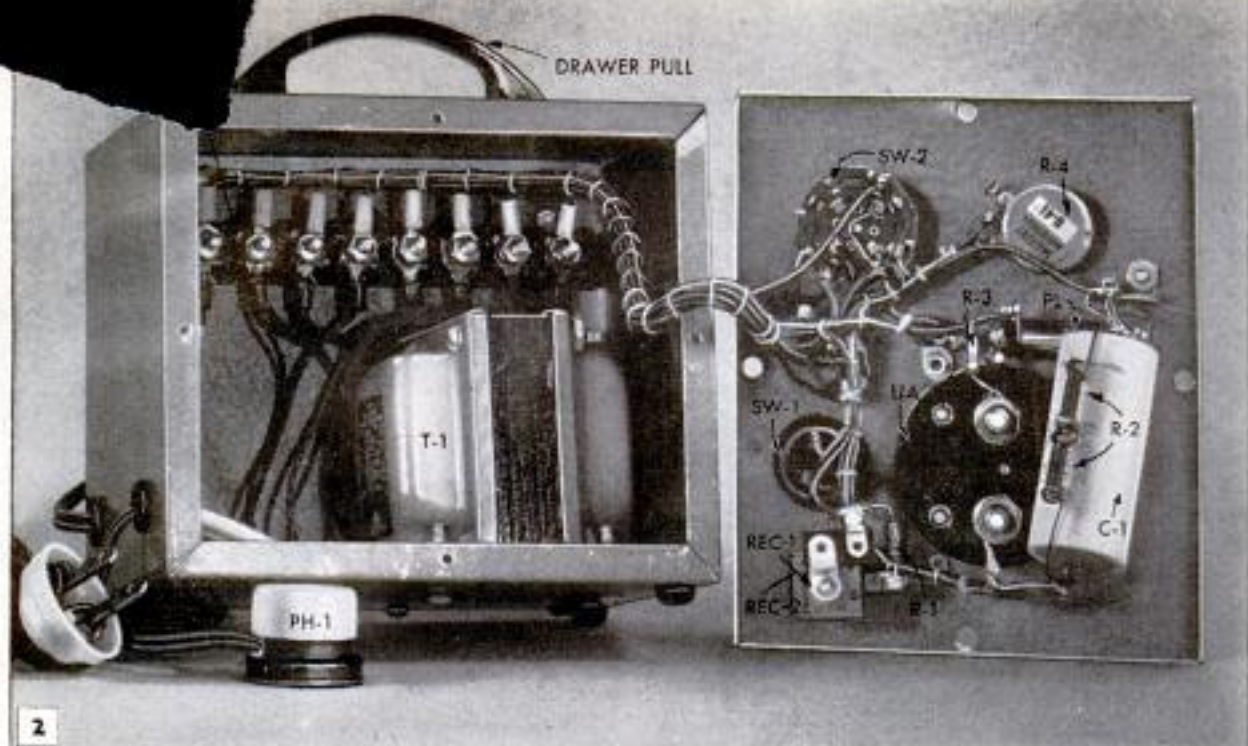

All parts are mounted on front panel of utility cabinet except transformer and terminal strip, which are bolted to the bottom and back respectively. Four metal screws secure the front panel to the cabinet

3. Then, move the photocell to the darkest area (highlights) of the projected image and take a reading for that area to determine the contrast ratio between the lightest and darkest areas: e.g., a "lightest" reading of 40 and "darkest" reading of 10 would result in a contrast ratio of 4:1 and a contrast rating of "normal."

4. After checking the negative-contrast table, Fig. 5, for the recommended contrast number of enlarging paper to be used, test strips are made to determine the exposure time required to produce a good print. It is necessary to follow all of these steps exactly as outlined for the first negative processed in each of the five contrast ratings. When processing subsequent negatives, it is necessary only to determine the contrast ratio, as in steps 1, 2 and 3, and provide an aperture setting that will give a microammeter reading of 40 when the photocell is placed in the darkest area of the negative. The same type of paper, same developer and development time must be used for processing negatives as were used for establishing the negative-contrast ratios and accompanying exposure times. Also, the same procedure applies when determining a table of ratios for processing color negatives, except that only one contrast number of printing or enlarging paper will be listed.

#### Building the Densitometer

Layout and construction of the densitometer are shown in Figs. 2 and 3. To

prevent cluttering of the cabinet-layout diagram, Fig. 3, only the most important dimensions are given. All components are mounted and wired as shown in Figs. 2, 3 and 4, using the parts and materials recommended in the materials list on the opposite page. *Caution:* Observe proper polarity of rectifiers when wiring them.

The photocell body is made from an a.c. attachment plug by disassembling the plug and drilling a 1/2-in. hole in the center to accommodate the cell. Then, the cell wires are pushed through the bottom slots in the plug and a 1/4-in. hole drilled in the side of the plug near the bottom to admit the photocell cord. After the cell wires are joined to the cord, cold plaster is poured around the cell, being careful not to touch the leads, which might cause current leakage and result in a false reading. Finally, a fiber disk is cemented to the bottom of the plug and the photocell is ready to be connected to the proper leads in the cabinet. A plastic bottle cap can be used to cover the photocell when the unit is not in use, as shown in Fig. 1.

If a terminal strip is not used, hookup wires are run directly to the components. After the wiring is completed, check it against the schematic diagram, Fig. 4, to make sure that no errors in wiring have been made. To insure accurate meter readings, the unit should be used at about the same time each day. If there is considerable fluctuation of the line current, a voltage regulator should be used. ★ ★ ★

## LIST OF MATERIALS

**RESISTORS**—all  $\frac{1}{2}$ -watt (K=1000 ohms) R-1=22K; R-2=1 meg.; R-3=12K; R-4=100K potentiometer, Mallory type linear taper, U-41.

**CAPACITORS**—C-1=1 mfd., 400-volts, Cornell-Dubilier.

**MISCELLANEOUS**—T-1=Power transformer, sec. 500 volts-20 ma. and 6.3 volts-2 amp. Triad-type R-3A (use one half of rated 500 v.); UA=microammeter, 0 to 50 microamperes, GE or equivalent; REC, REC=(two) selenium rectifiers, Federal miniature-type 1263A, 65 ma.; SW-1=push-button switch, Grayhill-type 4001; SW-2=2-position rotary switch, Mallory-type 3142J; PH-1=photocell, Clairex-type CL-1; VR-1, VR-2=voltage-regulator tubes (optional), Mallory-type 6308; PL=pilot lamp, 6 or 8-volts.

**HARDWARE**—terminal strip, 9-terminal, chassis mtg.; utility cabinet, ICA-type 29812; dial plate and pointer knob for R-4; 10-ft. line cord; 10-ft. No. 18-7 tinned copper hookup wire; 2 rubber grommets,  $\frac{3}{8}$  x  $\frac{1}{2}$ -in.; 1 pkg. single tie points; handle for utility cabinet.

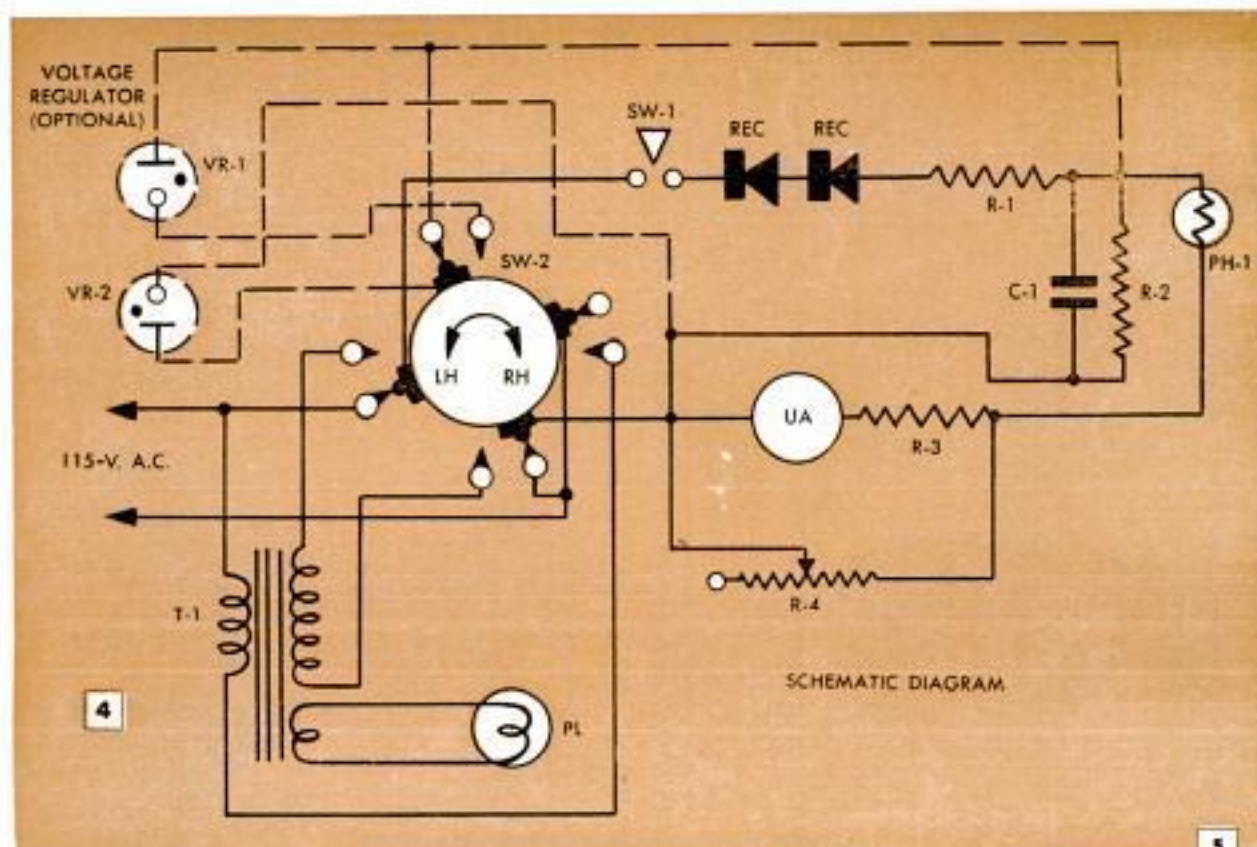
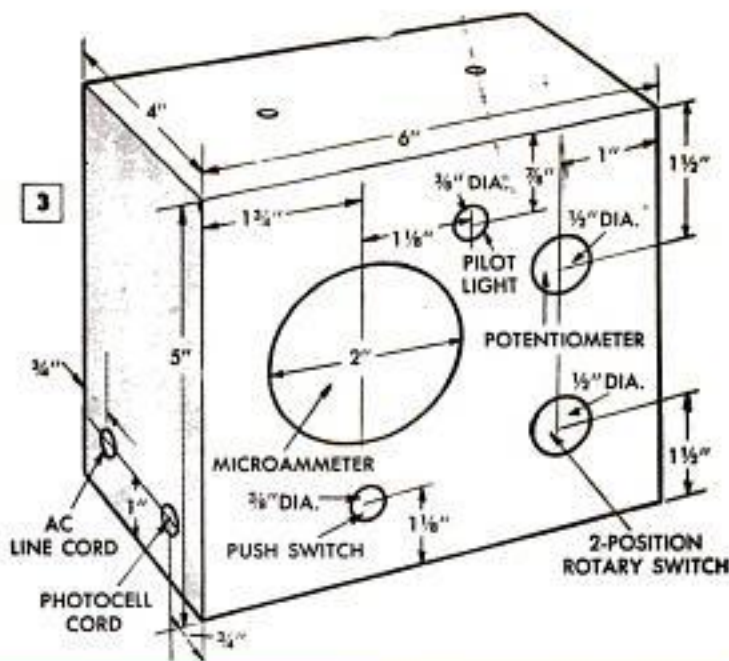

## NEGATIVE-CONTRAST RATIOS

LOW READING *	PAPER NUMBER	EXPOSURE (SECONDS)	CONTRAST RATIO	CONTRAST RATING
2.5	1	8	16:1	VERY HIGH
5	2	12	8:1	HIGH
10	2	8	4:1	NORMAL
20	3	9	2:1	LOW
30	4	8	1.33:1	VERY LOW

\* With potentiometer dial set for microammeter reading of 40 when taking all low readings.



## Rolled Drawings Held Flat By Slotted Cardboard Tube

To hold a rolled drawing flat while it is being checked, slip a slotted length of 2-in. cardboard mailing tube over it as indicated. The slot should run the full length of an 8 or 10-in. tube and be about  $\frac{1}{2}$  in. wide.

## Timer Controls Outside Light

Hooking an automatic timer into the wiring circuit of his outdoor floodlight was the method used by one homeowner to save footsteps and to make sure the light would not be left on accidentally. He estimates the time it will take to do some job outside, sets the timer for that duration, then goes to work. A few moments after he walks into the house, the light turns off.

## Flash-Gun Clamp Modified For Use as Camera Tripod

Spring clamps from flash-gun extensions can be adapted for use as tripods on light-weight cameras by removing the light reflector and attaching the camera with a regular tripod screw. To hold a darkroom safe-light on the clamp, use a knurled nut.

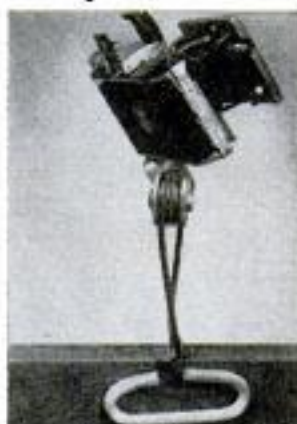

## Glass Jug Dries Photoprints

When no ferrotype plates are available, photographic prints can be dried smoothly and quickly by using a large glass jug. Coat the outside of the jug with wax, preferably ferrotype wax, to prevent the prints from sticking. To speed drying, the jug can be filled with warm water.



## Special Concave Sanding Block Rounds Corners Accurately

Rounding the corners of a piece of work by hand without leaving flat spots is no problem with this concave sanding tool. It is jigsawed from a scrap of 2-in. wood to the shape shown, after which the handle end is rounded to give a comfortable grip and a strip of garnet paper is glued to the concave edge. In use, the tool is held horizontally at all times as it is pushed back and forth across the corner of the work. This imparts a rolling action to the tool as it rises and falls with each stroke so that the point of contact is always at right angles to the radius center. Thus the corner is quickly cut down to form a perfectly rounded corner. Of course, the size of the concave radius in the tool limits the size of the radius that can be sanded and must be made to suit the work at hand.

Robert L. Sargisson, Berwyn, Ill.



Canvas paint applied to fiber rugs will protect them against wear and prolong their usefulness.



# SHOP NOTES SN 59



Photo courtesy Skil Corp.

## PORTABLE POWER SAWS

speed up work of professionals, stretch those spare-time hours in your home workshop

By Tom Riley

**YOUR PORTABLE SAW** is probably the most versatile of the one-hand power tools. It will perform almost any operation that can be done with a handsaw. In addition, it cuts grooves, dados and slots in wood and drives an abrasive wheel through metals and masonry. It tilts for cutting stock at an angle and the blade raises and lowers to adjust the depth of cut. When remodeling or building, Fig. 2, you carry the saw to the job. Or, turn it upside down and attach to the bottom of a specially designed table, Fig. 3, and you have an efficient stationary saw for the shop.

Blade diameter is used to determine the size of portable saws, as 4, 6, 8-in. and so on to those larger sizes which are not commonly used by builders and home craftsmen. The 6, 7 and 8-in. saws are perhaps the most popular as they are comparatively light and easily handled. Saws in the three sizes are designed to cut through 2-in. stock (nominally 1 $\frac{3}{4}$  in.) when the blade



Photos courtesy Black & Decker Mfg. Co.

Above, portable saw is used freehand or mounted under table, below, and used as a stationary saw



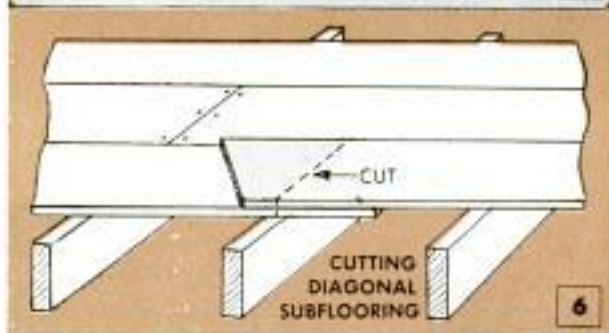
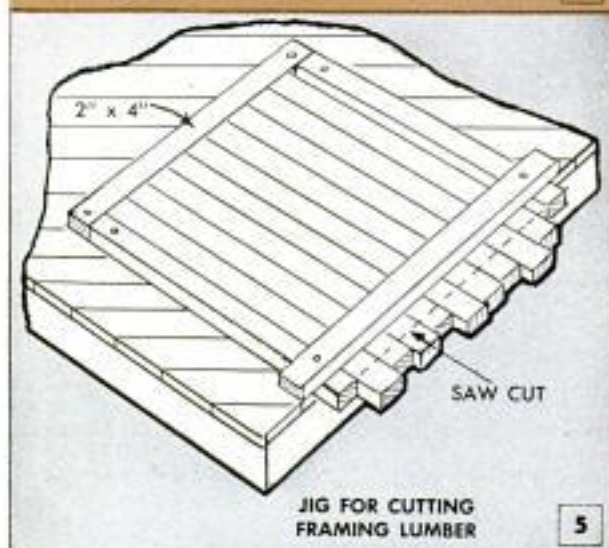
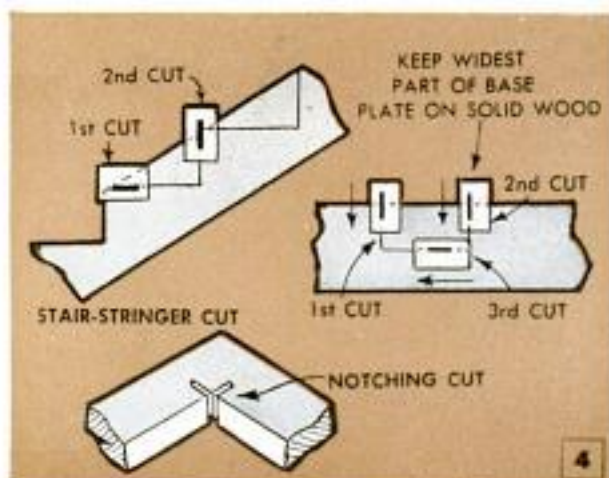

is set to cut to the full depth. The smaller sizes are usually best-suited to the uses of the home craftsman. On small construction and remodeling jobs where cabinet accuracy is not necessary, most of the typical cuts are made freehand to a penciled line. On most of the smaller saws, the base plate is notched or otherwise marked on the center line of the blade. This makes it easy after a little practice to follow a penciled line.

Figs. 1 and 2 picture typical freehand cuts, Fig. 1 showing the method of making a pocket cut in a board or panel without sawing in from an edge. The size of the opening is marked on the stock. Then the saw is placed with the blade on the line and after closing the switch the tool is lowered slowly. After cutting through, the tool is moved forward until the cut reaches a corner. Then the process is repeated on the remaining side and the ends of the opening. In Fig. 2, the operator is trimming the projecting ends of roof boards.

One basic rule followed by all experienced operators of portable saws is that of keeping the widest part of the base plate on solid stock, Fig. 4, as the cut is made. The main reason for this is that the saw is easier to control. If the saw is supported only on the narrow part of the plate as the cut is made, there is always the chance that the portion of the stock being cut off will spring away, or break off before the cut is finished. This can cause the saw to tilt unexpectedly and either bind or damage the work.

Another point to keep in mind in connection with operating technique is the distance the blade projects below the work when a cut is being made, Fig. 12. If you adjust the blade to the first position with the teeth just cutting through the stock, the

Photos courtesy Stanley Electric Tools



cut will be somewhat smoother but you will have to apply some pressure to keep the blade cutting uniformly. If the blade is adjusted to the second position, Fig. 12, with the points of the teeth running well below the bottom face of the stock, the angle of tooth contact will be greatly reduced and the saw will require very little hand pressure to move it through the wood. However, the cut will be less smooth and there will be a tendency of the wood to splinter along the kerf on the top face of the stock. When this is objectionable, turn the stock over and mark dimension lines on the bottom face. As a rule, adjusting the blade to run about  $\frac{3}{8}$  to  $\frac{1}{2}$  in. below the lower face of the stock will give best results.

Builders speed up the job of cutting studs to length by building the jig detailed in Fig. 5. They nail 2 x 4s to the subfloor of the structure in the manner shown. Then the required length of the studs is determined, and the guide, also a 2 x 4, is nailed across the open end of the jig to serve as a guide for the baseplate of the saw. Care must be taken to see that the jig is square and that the guide is correctly located. Then the studs to be cut to length are placed in the jig with the ends against the backstop. One pass of the portable saw does the trick.

Cutting angle butt joints when laying diagonal subflooring is done with a portable

Photo courtesy Porter-Cable Machine Co.,

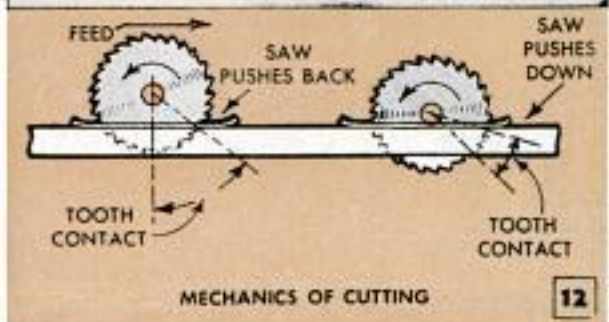
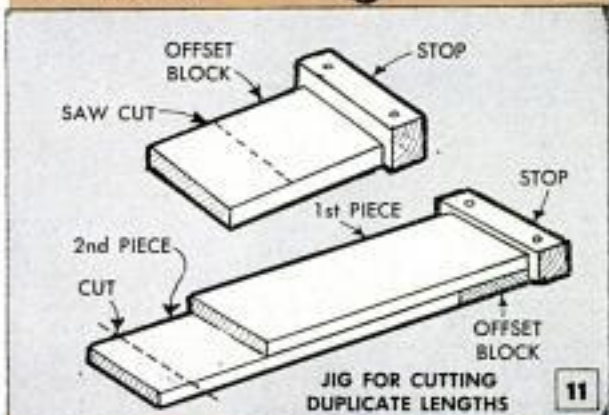
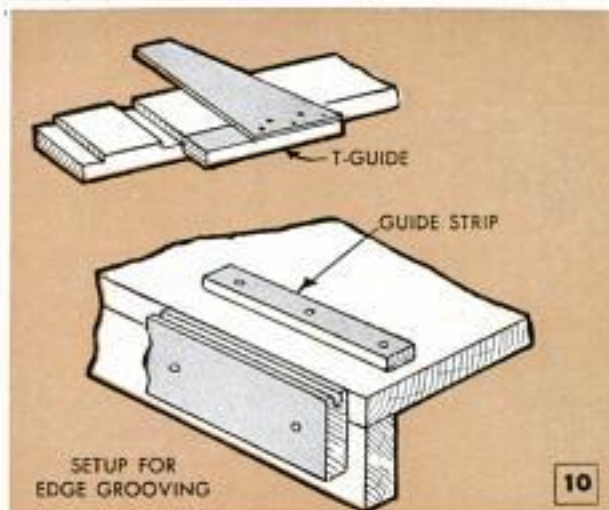

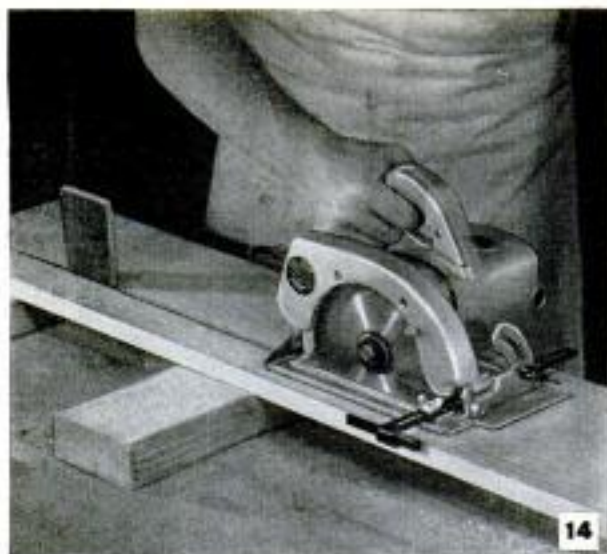

Photo courtesy Stanley Electric Tools



General purpose combination blade crosscuts, rips hard, soft wood and comes in 6 and 8-in. dia.

Planer blade runs without set, is used in cabinet joinery where a smooth cut is first requirement

Crosscut blade designed for crosscutting hard and soft wood. Gives a cleaner cut across the grain

Nail cutting, or flooring blade, is used in reclaiming used lumber and in cutting through flooring

Carbide-tipped blade cuts wood and composition materials faster with less frequent resharpening

Abrasive disk cuts masonry units, slate, tile, cement boards, metal. Exceptionally fast, efficient

saw as in Fig. 6. Just lay the boards one on top of the other, line them up and cut through both on the center line of the joist.

Figs. 8, 9, 13 and 14 picture various guided cuts with portable saws. Fig. 8 demonstrates how a cut rafter can be used as a guide for the saw when cutting a number of rafters to length and to the proper angle. A small, straight strip clamped across a plywood panel guides the saw, as in Fig. 9, when you need a true cut. The panel is laid on three square pieces of stock to raise it above the bench top. In Fig. 13, a compound-angle cut is being made with a guide designed specially for use with portable saws. The guide adjusts from 0 to 45 deg. either right or left and by adjusting the base plate on the saw almost any compound angle desired can be cut. Nearly all small portable saws have accessory ripping guides, Fig. 14.

Either the T-guide, Fig. 10, or the angle guide, Fig. 13, can be used for dadoing or rabbeting. For this work you use a dado head instead of the saw blade. The dado head cuts the dado or rabbet in one pass. Grooving can be done with the setup shown in the lower detail, Fig. 10. If nail or screw holes are objectionable in the work, both the guide strip and the work can be clamped in position. To cut off a number of pieces to duplicate lengths, nail or screw a stop to the bench, or a board. Then cut an offset block as in the upper detail, Fig. 11, running the base plate of the saw against the stop. Then use the offset block in the position shown in the lower detail.

Cutting masonry and tile units with a portable saw usually is done with a flexible abrasive wheel, or disk, as in Figs. 7 and 15. In cutting tile, Fig. 7, the work must be supported to prevent it from turning as the cut is made. Although the work usually is done freehand, special care must be taken to prevent the disk from drifting. ★ ★ ★

## Centering Device Aligns Work for Milling Keyways

When cutting keyways with a vertical miller the work can be centered by fitting a dial indicator on a rod which is chucked in the spindle. The fixed jaw of a vise clamped to the machine table is set parallel to one direction of table travel to obtain a zero reading. Then clamp the work in the vise and rotate the dial indicator to contact each jaw alternately as shown. When identical readings are obtained against both jaws, the work is centered.

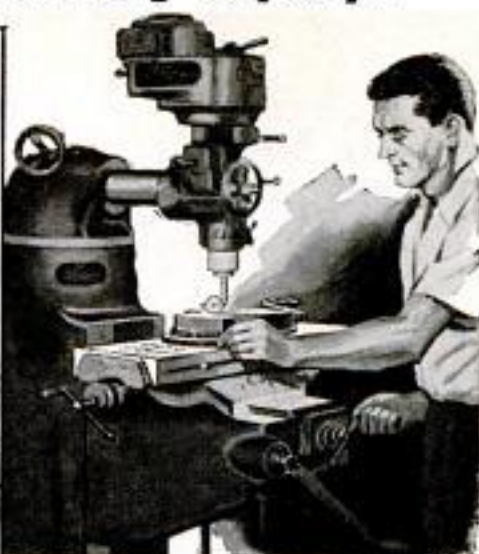
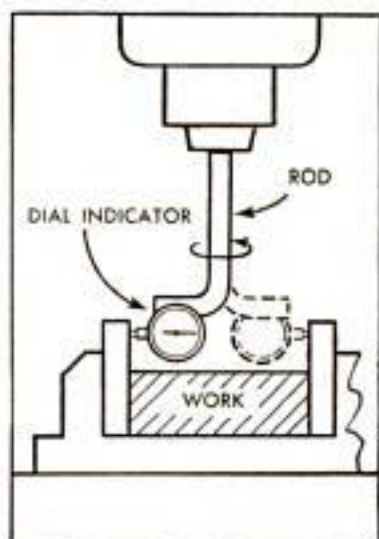

## Auger Bit Fits Power Drill



A standard auger bit cannot be used in a power drill as the screw tip penetrates the wood too rapidly and jams the tool. However, it is a simple matter to adapt a bit to efficient power-tool use. To do so, grind off half the

screw tip, remove one of the starting spurs, and cut off the square taper at the top, leaving a round shank. The half screw permits retraction of the bit if it feeds too fast, removal of one spur reduces the power required to turn the bit in the work, and the round shank fits the chuck of the power drill.

## Cork Seals Tailstock Sleeve Against Entrance of Chips

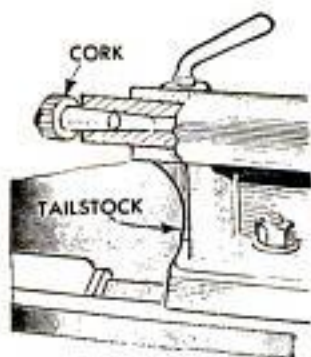

When the tailstock center is removed for re-grinding, or for any other reason, careful operators always plug the tapered sleeve with a cork to prevent metal particles and chips from entering. The smallest metal

chip will prevent the center from seating properly and may cause inaccuracy of the work and possible tool breakage.

## Calipers Set With Keyseat Clamps

Two keyseat clamps mounted on a scale simplify the accurate setting of calipers. Since both sides of the standard keyseat clamp will be perpendicular to the surface of the scale or ruler they can be used to set both inside and outside calipers. Set the inside edges flush with the desired measurement marks on the scale and then adjust the caliper jaws until they touch the sides of both clamps very lightly. A metal scale should be used so that the screws in the clamps cannot leave indentations or scores which will prevent accuracy in future settings.

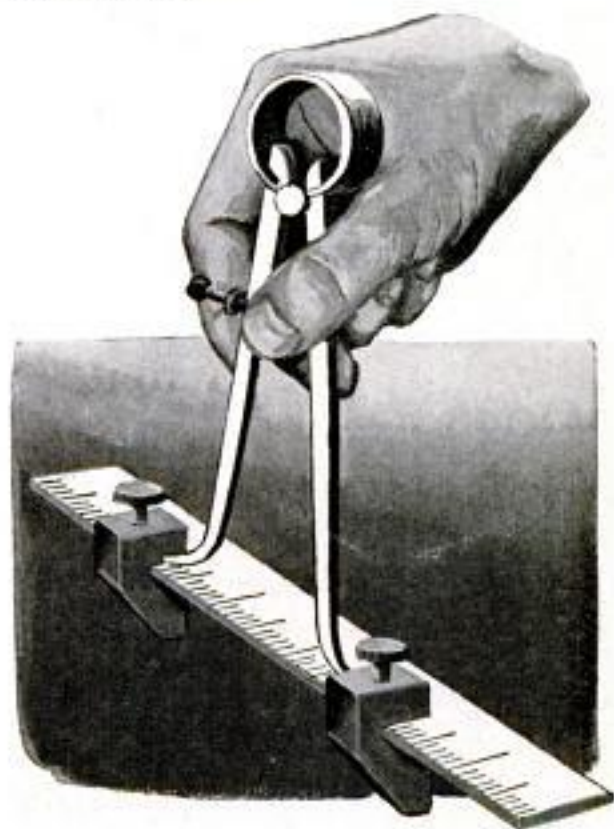

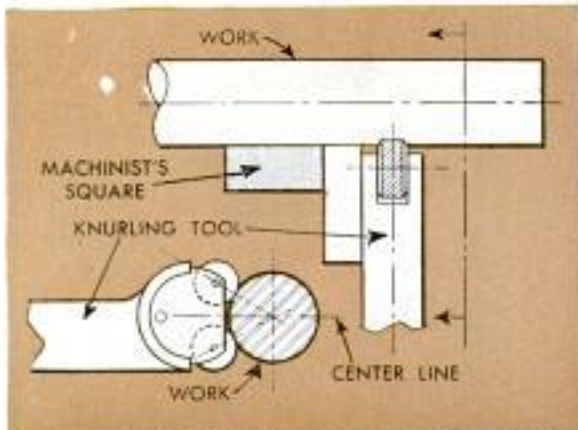

## Lathe Setup for Running a Long Knurl

Running a long knurl, such as that on a handle, calls for a careful setup. The work should be mounted between centers and driven by a dog rather than by the chuck. If the stock is to be shouldered, then the knurl should be run before the shoulder cut is made. Otherwise the work may have a tendency to spring away from the knurling rolls. After the work has been mounted between centers, set the lathe for the slowest speed through the back gears and square the knurling tool with the work as pictured. For clarity in the photo, the knurling tool is shown farther forward than its normal working position. Also make

certain that the tool is set on the center line of the work as in the detail. Then, after starting the lathe, run the carriage to the right to the starting position at the end of the stock. Position the carriage so that the knurls cut about half their width when engaged. Then bring the knurls up to the work, engage them and run the cut to a depth of about  $\frac{1}{64}$  in. for a medium knurl. Apply cutting oil, engage the longitudinal feed of the carriage and run the first cut. Reverse the carriage, force the knurling tool to cut about  $\frac{1}{64}$  in. deeper and allow it to feed back to the starting point.

F. L. Rush, Columbus, Ohio.

## Emergency Bracket

Drive a nail into a tree or post, hang a hammer on it as pictured and you have a bracket for supporting a spring scale, lantern or plumb bob. Bracket will support a fairly heavy weight if large nail is used.—S. Clark, E. Bradenton, Fla.

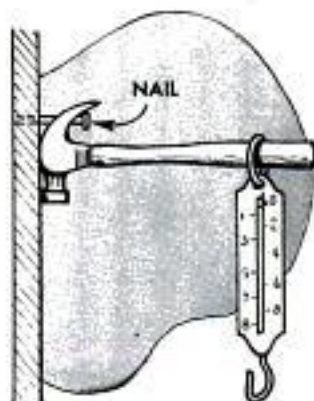

## Steel Rods Pointed With File

Using the setup detailed you can point small metal rods perfectly. Slot a block of hardwood to take the file in a tight fit. Chuck the rod, place the file so that it contacts the rod and move it back and forth as the rod rotates.

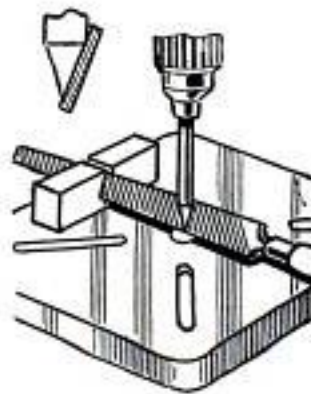

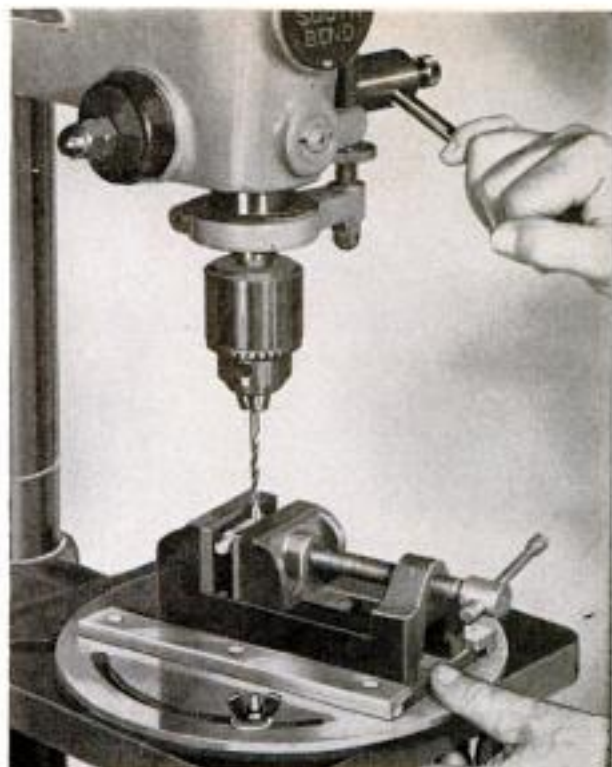
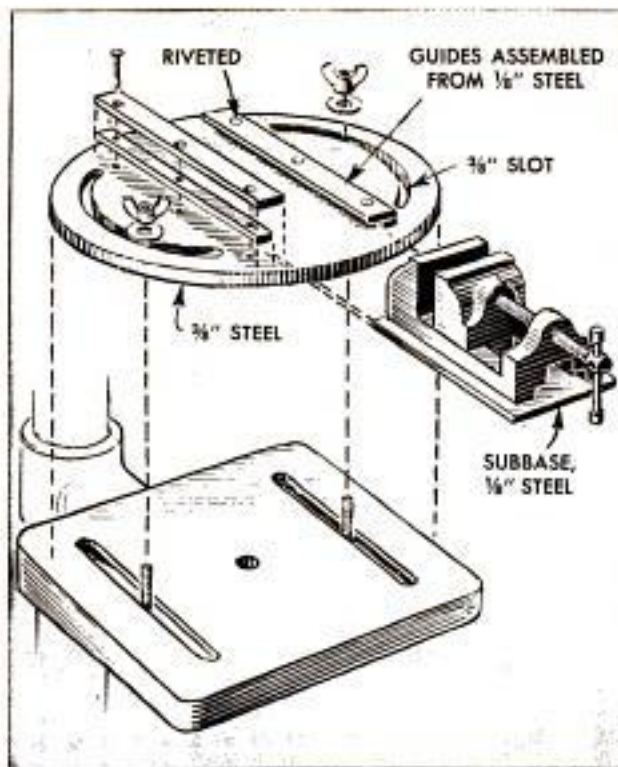

## Swiveling Plate Permits Accurate Positioning of Drill Vise

Where precise angle drilling is not required, this swiveling plate, or holder, permits the drill vise to be positioned for handling a wide range of work. Although the detail specifies  $\frac{3}{8}$ -in. steel for the plate, it will give satisfactory service on small drill presses when made from  $\frac{1}{4}$ -in. stock. The diameter of the plate should be

just slightly less than the width of the drill-press table. The slots are milled or cut with a hacksaw. A subbase of  $\frac{1}{8}$ -in. steel screwed to the bottom of the drill vise fits between guides assembled from strips of  $\frac{1}{8}$ -in. flat steel and riveted or screwed to the plate as indicated.—Alfred T. Bullock, South Norfolk, Va.

## Vise Aids in Loosening Collar

Split collars of the type tightened with a screw often are difficult to loosen or adjust due to pressure against the screw. To avoid damaging the screw slot or socket if a socket-head screw is used, place the collar in a vise and close the jaws with light pressure. With just the right pressure on the collar the screw generally will loosen.

Frank LaSaracina, New York City.

## Inserting Drill Bushing in Jig

When inserting drill bushings in a jig made up in the shop for some special job, it's essential that the bushing be pressed into the hole in the jig in a straight line. Lacking an arbor press for this job, use the bench vise, applying light pressure to start the bushing. If the holes in the jig have been reamed, break (bevel) the corners very slightly with a countersink.

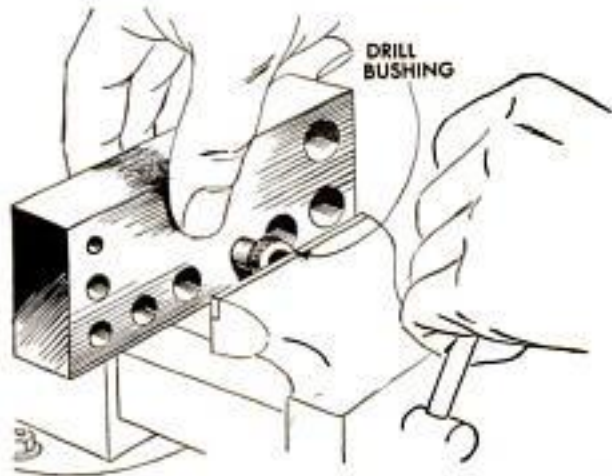

# HOW WOULD

By Chris Nelson

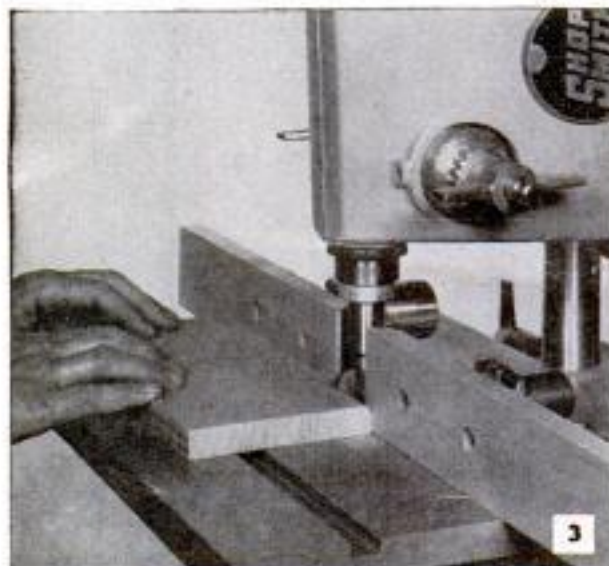
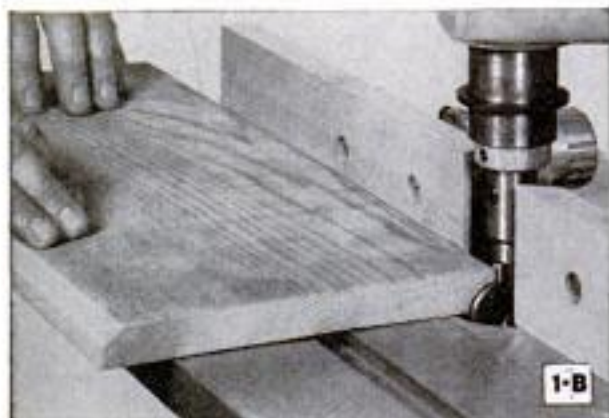
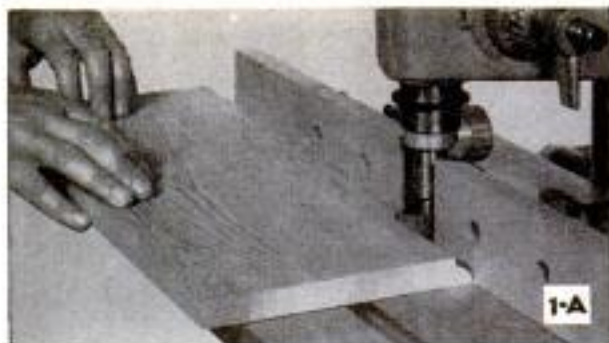

**1-A, 1-B. Q—How is a drop-leaf-table joint cut accurately on a shaper?**

A—Use the straight shaper fence as in photos 1-A and 1-B. The joint consists of two matching moldings, a quarter-round molding (sometimes referred to as a "thumb" mold) and a cove molding. Two cutters are required, both ground to the same radius so the finished cuts will match. The quarter round is run on the table top and the cove cut on the drop leaf

**2. Q—How is splintering at the corners avoided when running moldings with and across grain?**

A—When molding the edges of a table top, or any type of work that requires moldings run on three or four edges, make the first cuts across the grain. Then when the final cuts are run with the grain any splinters at the corners will be removed. Molding cuts made across grain will be smoother if the cut is run slowly in two or more passes of the work

**3. Q—How can a single shaper cutter be made to run two kinds, or shapes, of moldings?**

A—The cutter in Fig. 1-B is the same cutter as that shown in Fig. 3. It has two cutting edges, or shapes. In Fig. 1-B it is making a cove cut while in Fig. 3 it has been raised to make a quarter-round, or in this case, a rounding-over cut. By combining the shapes several different moldings often can be made with a single cutter. Use care in making the settings

**4. Q—When the molding cutter removes only a part of the edge how is the guide fence adjusted?**

A—The two members of the shaper fence must be adjusted so that they are in line, that is, in the same plane. In this way the fence will guide the stock past the cutter in a straight line, giving it full support for the entire distance of its travel. Always check this setting with a straightedge and lock the shaper fence before starting the machine

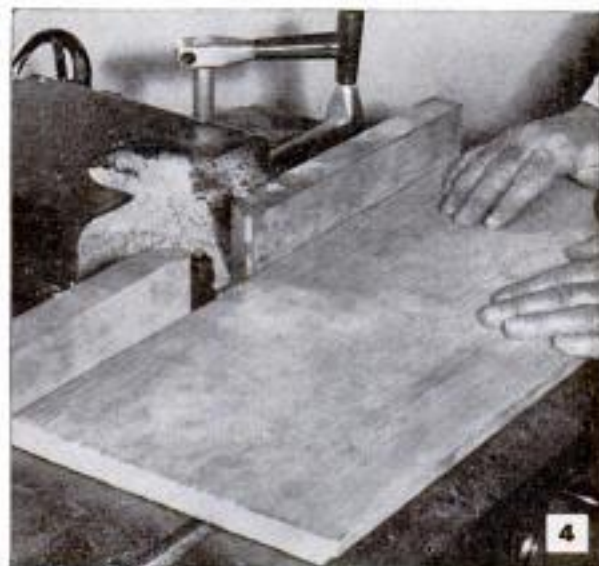



# YOU DO IT?

## 5. Q—How are narrow moldings, such as picture moldings, made safely on a shaper?

A—Don't attempt to run strip moldings on a spindle shaper. Run a molding of the desired shape on the edge of a wide piece of stock, then rip off the molded edge. If you are making a picture molding, run glass rabbet before ripping the strip from wide stock. When running several moldings be sure shaper fence is locked to prevent it from shifting during operation

## 6. Q—What guides the stock and holds the cut to a uniform depth when making a curved molding?

A—Shapers and shaper accessories for drill presses usually are furnished with spindle collars and a starting pin. A collar of the correct diameter is placed on the spindle under the cutter. The stock bears against this collar as the cut progresses. Starting pin guides the stock at the start of the cut

Caution: In Fig. 6 the ring guard is shown in the raised position for clarity. When making curved cuts always use the guard in the lowered position.

## 7. Q—When molded edges are required on comparatively narrow stock, what is the best procedure?

A—Adjust the two members of the fence so that they are in line. Check with straightedge. Then make cuts across the grain first, using a miter gauge to guide the narrow stock. Make these cross-grain cuts in two or more passes. This will assure a smooth molding and the stock is more easily held in position. Finish by running the cuts with the grain as shown

## 8. Q—What type of molding cuts require offsetting the shaper fence?

A—The shaper fence must be offset whenever you use a molding cutter that removes material from the entire edge of the stock. The offset should be equal to the depth of cut at its shallowest point, except in the case of a straight cutter where offset should equal depth of cut. Offset in this manner, the fence supports the stock along full length of cut

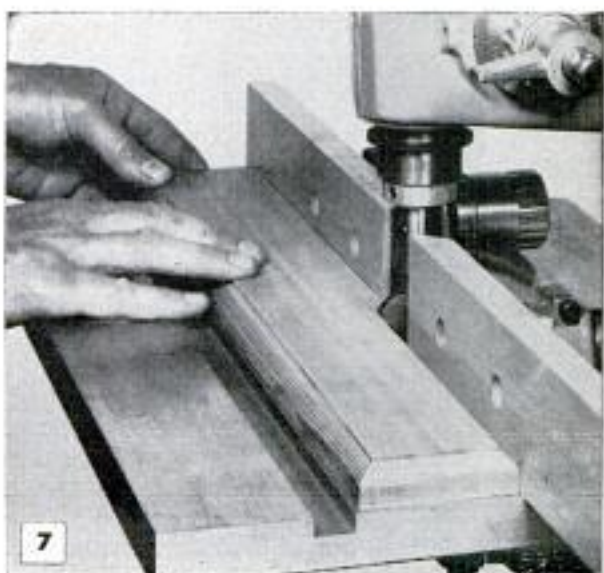
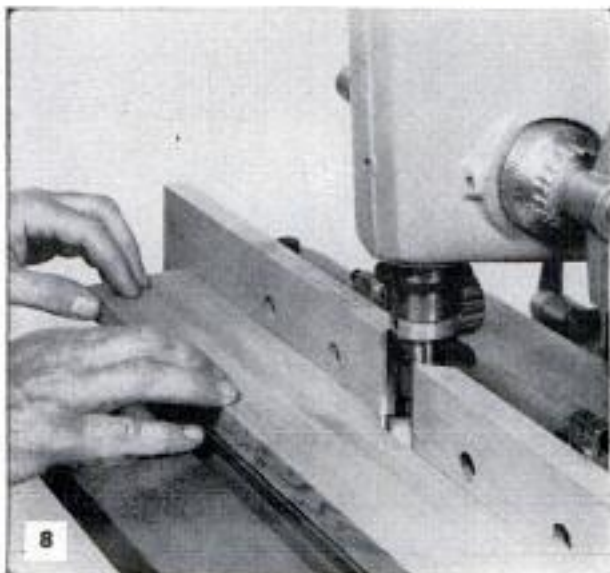

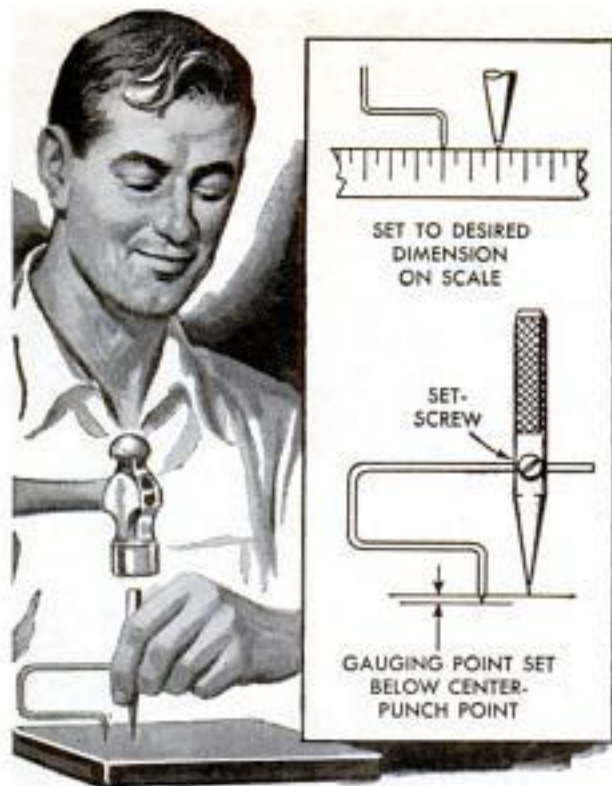

### Simple Center Punch With Gauge Locates Equidistant Points

With this space-gauging center punch you can make a layout for a series of equally spaced holes without having to measure the distance between holes. To make the tool, drill and tap a hole in a center punch to receive a setscrew that will hold the gauging rod. Use  $\frac{1}{8}$ -in. drill rod for the gauge, bending it so the point is slightly below the point of the punch. After setting the gauge to the desired dimension for the distance between the holes, punch the center of one hole. Position the point of the gauge in this hole for spotting the location of the next center point.

H. J. Gerber, Stillwater, Okla.

### Portable Electric-Fence Posts

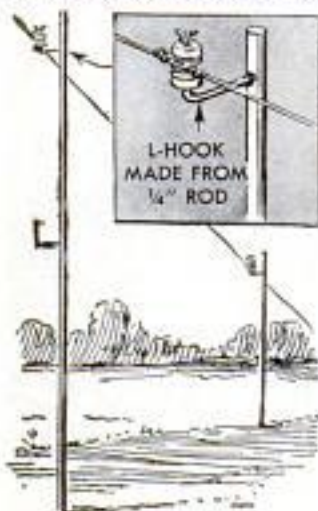

Posts for supporting one or two strands of electric fence were made by one farmer from lengths of steel rod on which L-shaped hooks were welded. The ends of the hooks were slotted, then slightly spread to hold the insulators snugly. The posts are lightweight, portable and easy to drive with a hammer.

### Notches Cut in Mixing Hoe Clean Concrete-Form Boards

To permit quick removal of dried concrete from the upper edges of form boards, one construction worker ground two V-notches in the sides of a mixing hoe. After the boards have been staked in place, the hoe simply is pulled along them as indicated, thus permitting a level and straightedge to be placed across them for accurate alignment.

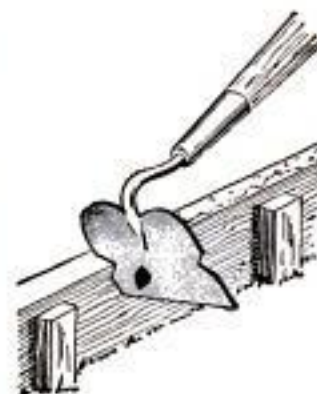

### Follower Rest Travels With Lathe Carriage

A follower rest that supports the work near the cutting point is necessary when turning work to small diameters between centers. This one is shop-made from  $\frac{1}{4}$ -in. flat steel, the materials being sawed and filed to the general shape indicated. Before cutting the vee, care should be taken to locate it by measuring accurately the lathe-center height from the tapped holes in the carriage mounting pad. After the vee has been thus located and cut, the edges should be filed and ground at right angles to the faces. File a chip-clearance groove at the bottom of the vee. Cut a slot near the lower end to permit horizontal adjustment of the rest for work of varying diameters.

C. W. Woodson, Chicago.

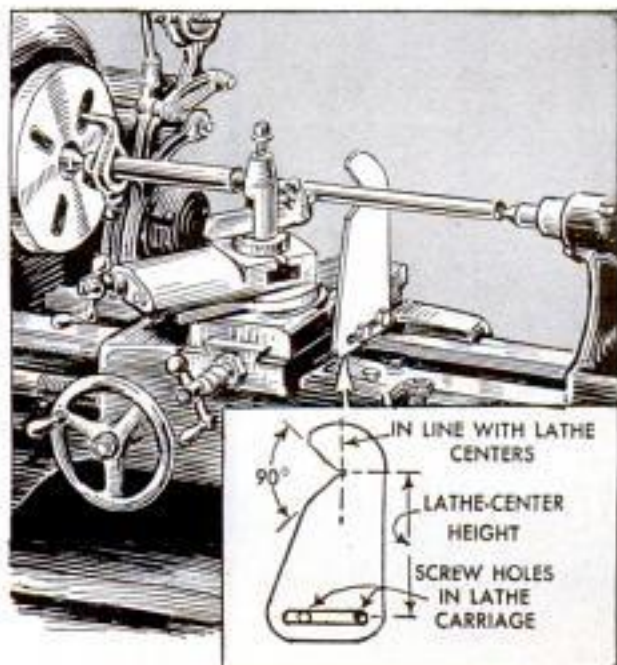

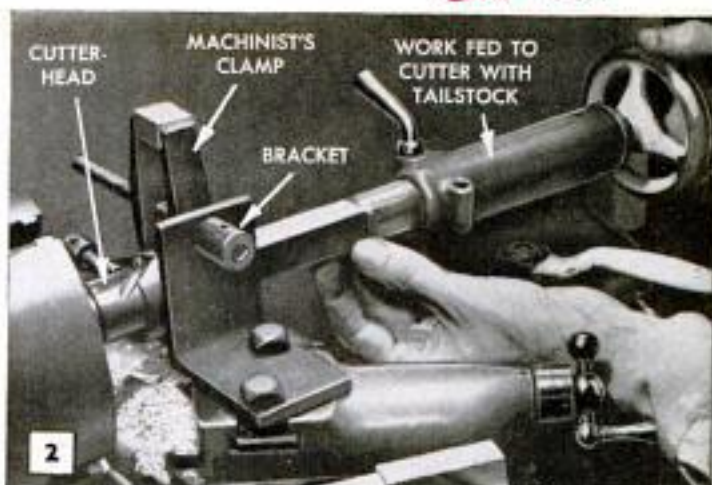

# CHUCKING ARBOR CUTS ROUND TENONS

By Walter E. Burton

**E**VER TRY to cut a round tenon on square stock by hand? If you have, then you can fully appreciate this chucking arbor which does the job accurately in a fraction of the time needed to do the trick by other methods not utilizing power equipment. In Fig. 1, you see the arbor set up in the drill press, the tenon partially cut. In Fig. 2, the cutterhead is shown mounted on a short sleeve and set up in a metal-turning lathe. The arbor also can be used in a wood lathe, Fig. 7.

As detailed in Fig. 3, the complete arbor consists of three parts: The cutterhead, the

sleeve, or spindle, and an adapter. The dimensions given are intended only to suggest the relative sizes of the parts. The cutterhead is shouldered, counterbored and internally threaded in the lathe, Figs. 4 and 5. It then is V-slotted with a hacksaw as in Fig. 3. After slotting, a part of the waste must be removed with a cold chisel. Both faces of the vee are then smoothed with a flat file and a round-bottom clearance groove is cut into the counterbore with a round file. Next, a hole is drilled and tapped at right angles to one face of the vee to take a screw holding the cutter, or blade.

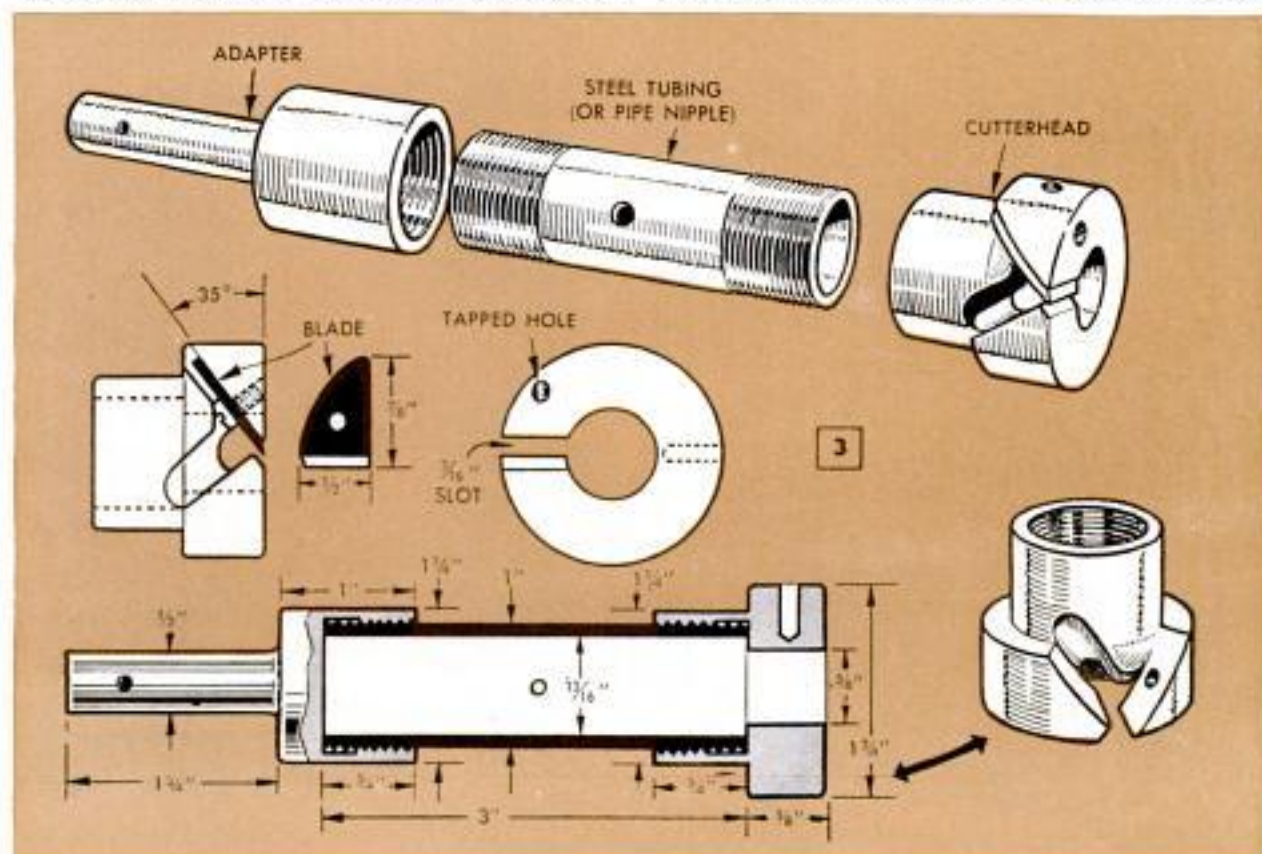

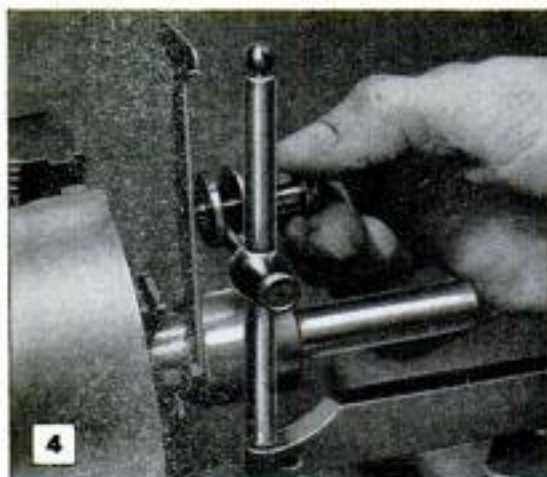

File the cutter seat to an angle of 35 deg. with the face of the head, Fig. 3.

The adapter is shouldered, bored and internally threaded in a manner similar to the cutterhead. If the arbor is to be used exclusively in a lathe the sleeve length can be reduced to 1½ in. and only one end need be threaded. The adapter, which is necessary only for use in a drill press or a wood lathe, can be omitted entirely. Steel tubing with a fairly heavy wall is best for the sleeve, Fig. 3. A pipe nipple is second choice. When the adapter is used it will be seen from the lower detail, Fig. 3, that the length of the sleeve determines the maximum length of the tenon that can be cut. A tenon length of 4 in. is about the maximum length practical. If the arbor is made much longer the overhang becomes so

great that it may cause the cutterhead to drift offcenter.

A suitable cutter, or blade, can be made from a short length broken from a discarded machine-hacksaw blade. Grind off the teeth, shape to the contour required to fit the blade seat on the cutterhead, and grind and hone to a keen cutting edge.

Fig. 6 shows a typical setup on a metal lathe. The machinist's clamp is not tightened on the stock. It only serves as a guide for the stock being fed to the cutterhead of the chucking arbor. In the setup for a wood lathe the clamp rides on the tool rest and serves only to prevent the stock from turning. Before starting to run the tenon, cut the waste from the four corners of the stock as shown in Fig. 7, the upper right-hand detail. ★ ★ ★

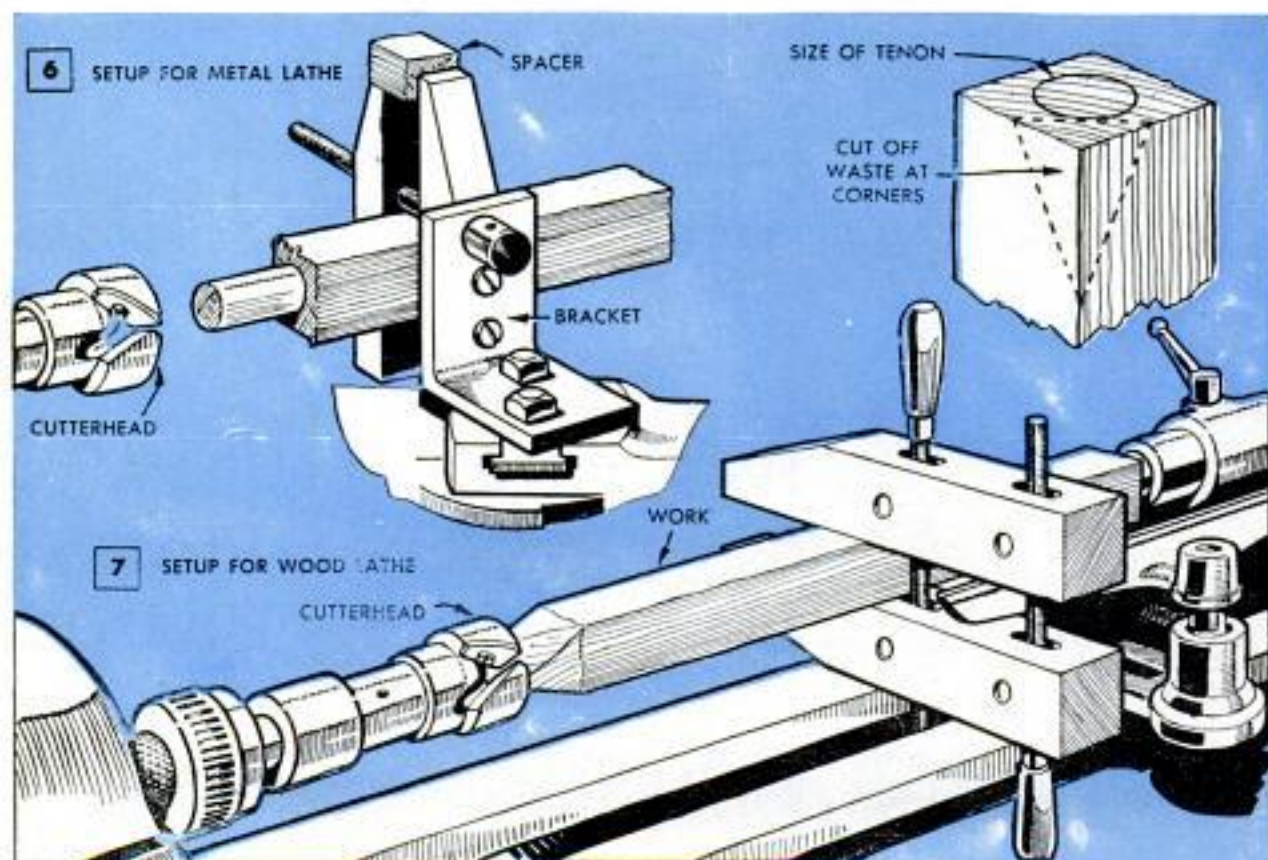

## Dairy Feeding Cart Made From Old Fuel-Oil Tank

Cutting a large oil tank in half lengthwise and dividing it into compartments provided an ideal feeding cart for one dairyman. The partitions were welded in place, after which wheels were added, two in front and a pivoted one at the rear. These can be of any convenient size, preferably wheels fitted with rubber tires.

Charles L. Stratton, Windham, N. H.

## Paint Thinner Removes Pitch From Circular-Saw Blade

Gum and pitch that collect on your circular-saw blade, also dado blades, reduce tooth clearances to such an extent that the blade no longer cuts smoothly. A frequent wiping with a cloth dipped in paint thinner will keep the blades gum and pitch free.

Frank A. Javor, Newark, N. J.



## Protect That Pocket Rule

Carrying a 6-in. steel rule, or scale, loosely in your pocket with coins or other small tools can round the edges and scratch or dent the graduations. Protect the rule by carrying it in a special individual pocket of leather or plastic. A discarded leather or plastic comb case is just the thing as it usually is provided with a clip for attaching to the shirt pocket.

☐ To protect exterior plywood, seal the edges properly, prime the panels before they are put into place, and use quality exterior paints. For edge sealing, use a heavy coat of lead and oil paint. Prime the back of the plywood panels in advance when used in areas that are unusually damp.



## Altered Screwdriver Blade Removes Broken Spark Plug

Removing the threaded portion of a spark plug that has broken off in the cylinder head usually is done with a tool made specially for the purpose. When this tool is not at hand you can do the trick with a screwdriver. Grind bevels on the edges of the blade as detailed. Use care in grinding not to draw the temper of the blade. Insert the altered blade in the open end of the broken portion of the plug and tap the handle lightly to engage the beveled edges. Apply a few drops of penetrating oil to the threads. Hold the handle of the driver and turn the blade gripping the flat portion with a small wrench.

C. E. Packer, Oak Park, Ill.



# SHOPPING FOR TOOLS



**1. DRILLS FOR SHEET METALS** cut from the outside in, produce clean holes in thin stock without burring and without distortion of material. Also drill clean holes in plastic, nylon, laminate and hardboard. Available in individual sizes or as a kit of 10 drills. Drills are guided by a tapered point, or pilot, which is spring-loaded

Jancy Engineering Co.,  
508 S. Pine St., Davenport, Iowa

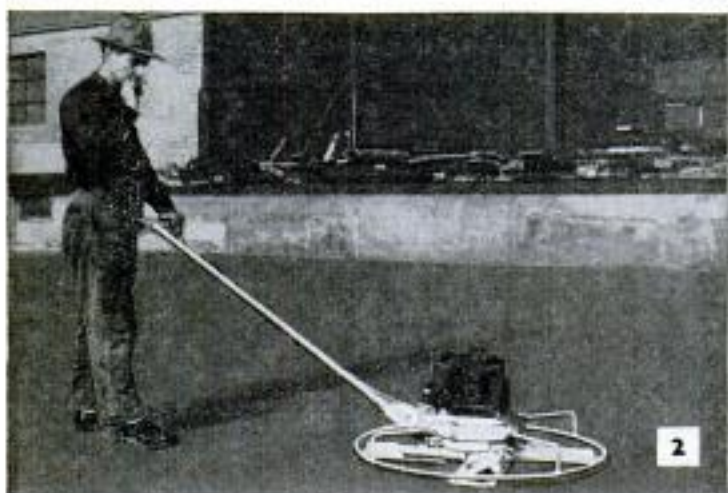

**2. POWER TROWEL** reduces time and labor required to finish large concrete slabs. Blades are power-adjusted to any position for floating and finishing. Trowel, which consists of four adjustable blades, or "trowels," is 34 in. in diameter and is gear-driven from engine. The engine idles when the operator releases the handle

Master Vibrator Co., 167 Stanley Ave.,  
Dayton 1, Ohio



**3. TUBING CUTTER** is designed for cutting plastic tubing, as well as thin-wall conduit. Handles tubing varying from  $\frac{1}{8}$  to  $1\frac{1}{8}$  in. in diameter. The wide, flat face of rollers makes a smooth, straight cut without crushing or distorting the tubing. An attached reamer is pivoted so that it will be out of the way when not in use

Erie Tool Works, Erie, Pa.

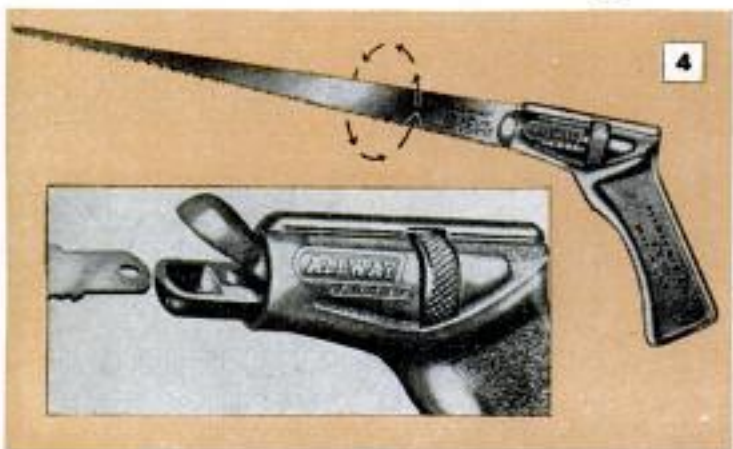

**4. BLADE** on this multipurpose saw pivots to eight positions in relation to handle position. Blade is held in a hinge-type chuck which locks with a camming action, holding blade securely in any one of the positions. Pistol-grip handle is designed for a comfortable handhold for sawing in a normal position or work overhead

Allway Mfg. Co., 1513-33 Olmstead Ave.,  
Bronx 62, N. Y.



POPULAR MECHANICS

Copyrighted material



6

**5. TRANSFORMER-TYPE A.C. WELDER** is especially designed for operation on rural electric power lines. Controls provide five-step coarse adjustment for conventional a. c. welding, as well as for certain inert-gas welding operations. The 180-amp. (at 25 v.) a. c. transformer is the diverter-path type with magnetic control for safety

Hobart Bros. Co., Troy, Ohio

**6. GEAR-JOINT PLIERS** has a novel five-position gear-locking joint which holds without slipping in any of the five positions. Alligator-type jaws open to 1½ in. and remain parallel throughout entire opening range. Shape of handles and angle of jaws give an interlocking action. Jaws have heat-treated wire-cutting slots

H. R. Basford Co., 235 Fifteenth St., San Francisco 3, Calif.

**7. MEASURING WHEEL** for use on maps and blueprints can be set to any conventional scale, will give distance or dimension readings when used in accordance with instructions which come with unit. Measuring wheel actuates a pointer which travels along a graduated scale as wheel rotates. Scale adjusts to different values

RidgeWood Sales Co., 64-16 Palmetto St., Ridgewood 27, L.I., N. Y.

**8. QUICK-CHANGE PRECISION CHUCK** has runout tolerance of .00039. Specially designed inserts permit tool changes without stopping machine spindle. Operates horizontally or vertically; will rotate clockwise or counterclockwise without any mechanical change. Several sizes of inserts and sleeves available for each toolhead

Karl A. Neise, 404 Fourth Ave., New York City 16

**9. ACCESSORY JIGSAW** works as a portable unit when driven by an electric drill, or as a stationary jigsaw when set up in a drill press. Drill-press depth stop is inverted and lower end inserted in handle to steady jigsaw and free both hands for guiding work. Cuts wood or metal, makes pocket cuts, curved cuts, rips and crosscuts

Delisaw, 2632 Prospect Ave., Kansas City 28, Mo.

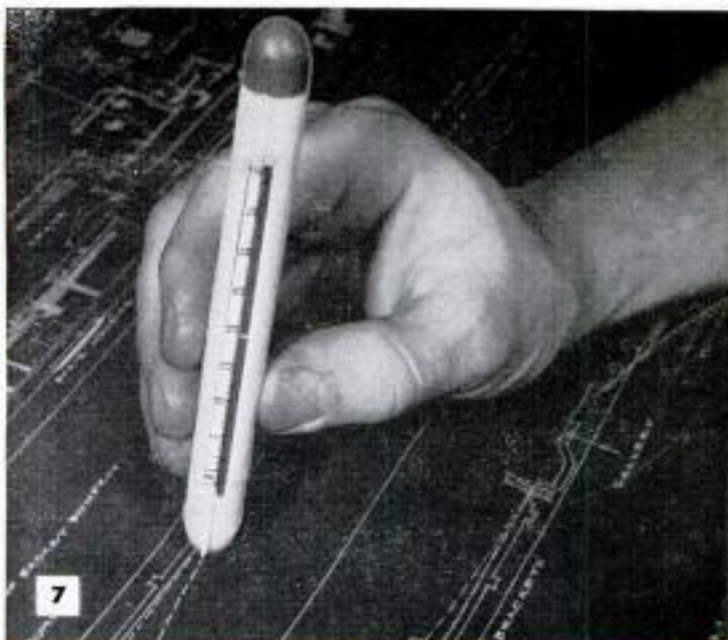

7

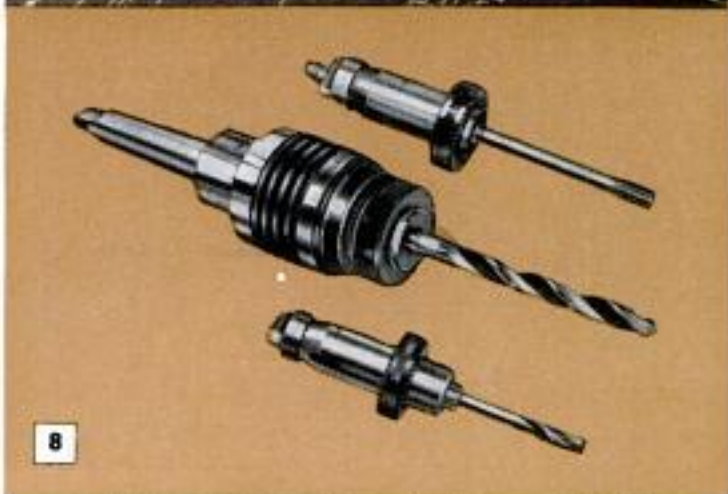

8

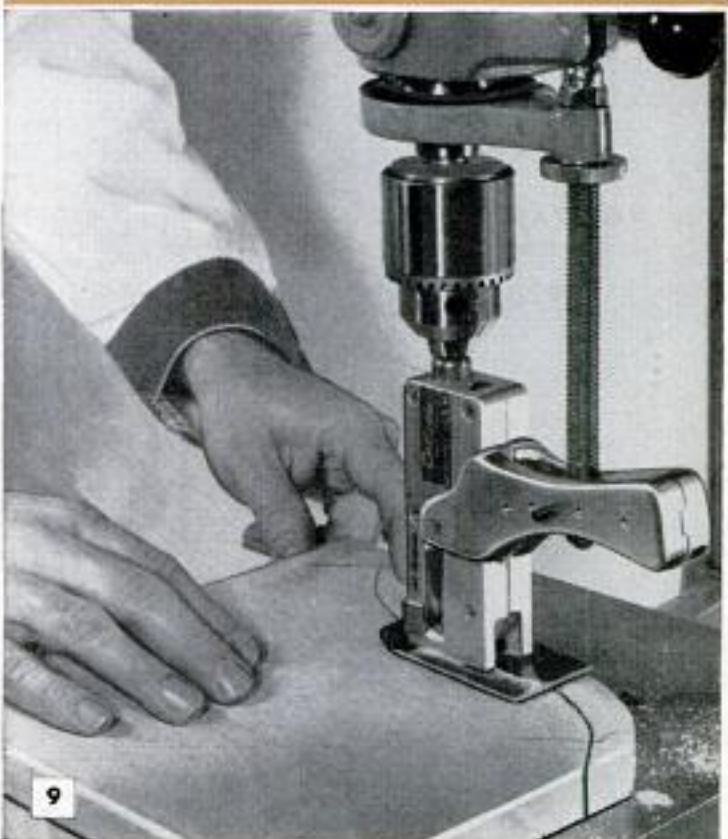

9

## T-Handled Chisel Holder Cushions Hammer Blows

A handle, assembled from pipe fittings and sponge rubber, cushions the shock of the hammer blows when cutting metal with a cold chisel. A rod passing through the pipe nipple forming the handle holds the chisel in place when the pipe cap on the end of the handle is tightened.



## Plastic Cosmetics Case Converted to Drill Holder

A cosmetics case having a screw-type base makes a good holder for small drills. Wind a short length of corrugated cardboard into a roll and press into the case to form individual compartments for the drills. Oil the drills to prevent rust.

Frank A. Javor, Newark, N. J.



## Two-Station Lathe Toolholder

Lacking a multiple-station toolholder for the lathe you can adapt a shaper toolholder to this special purpose. In the setup pictured, a shaper holder is fitted with a tool bit ground on each end to perform two operations with the lathe spindle reversed. The first cut, using the rear end of the cutting tool, bores to diameter. The second cut, with the cross slide moved forward, runs a relief groove. Such a set up can save time in the job shop.

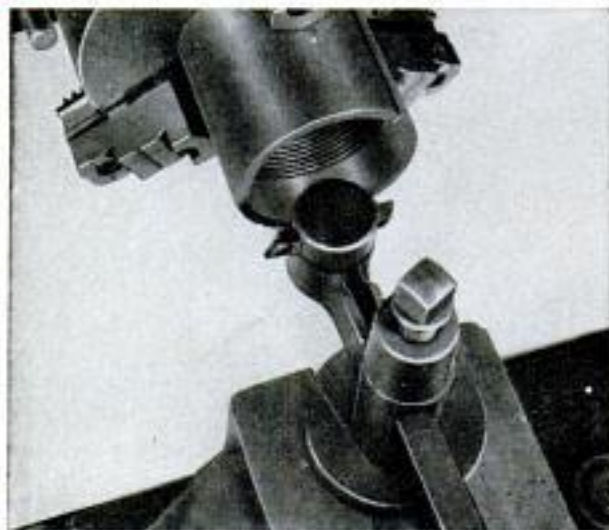

## Improved Jackshaft Bearing

Serviceable bearings for a light jackshaft can be made by using plastic caps of the type frequently supplied with detergent containers. These are two-piece, consisting of a cap and a threaded sleeve. Make brackets of the required height as suggested in the detail, insert the threaded sleeve and screw on the cap. Smooth the end of the shaft with a fine abrasive. Lubricate with light oil. — Chas. Grener, La Porte, Ind.

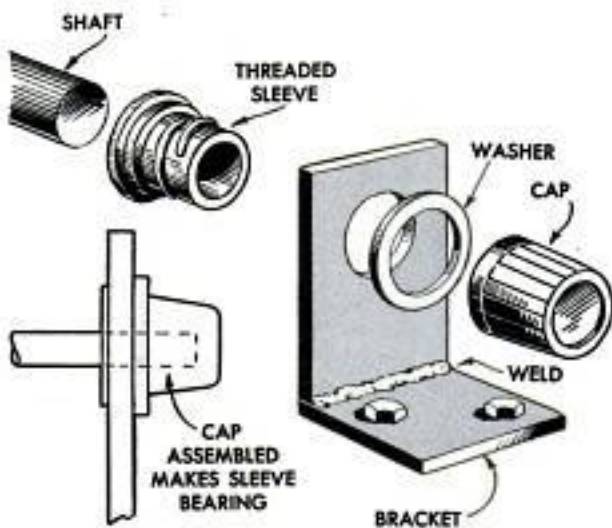



*On the*  
**MARKET**  
*for Do-It-Yourselfers*

**WALL PLANKING** (right), in random widths, consists of a wood-grained plastic laminated to a base of 1/4-in. hardboard. Planks are attached to furring strips  
Woodall Industries, Inc., 3500 Oakton St., Skokie, Ill.



**PLUG LOCK** (above) fits over prong of an electric plug, prevents unauthorized use when locked with the key supplied. Prevents accidents, protects equipment  
Riverside Mfg. Co., Woodstock, Va.



**ELASTIC COATING** specially compounded for protecting inside surfaces of gutters and making repairs to breaks in the metal. Comes as a complete kit  
Best Home Finishes, Box 4037, Euclid 23, Ohio

**GLASS-FIBER "BLANKET"** helps to prevent water pipes from freezing, also eliminates condensation during summer. Kit contains 50 ft. of wrapping, 3 in. wide  
Fibreglass-Evercoat Co., Inc.,  
7220 Vine St., Cincinnati 16, Ohio



OCTOBER 1957

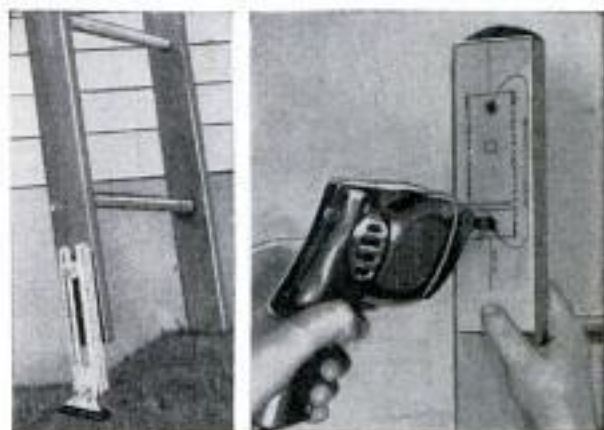

**ADJUSTABLE LEG** provides a means of leveling a ladder on uneven ground. Comes with pattern for drilling attachment holes. Adjusts flush when not in use  
Bolas Products Corp., 60-73 Summit St., Newark 4, N. J.

**GARDEN SPRAYER** handles any sprayable insecticide. Pressure is supplied by cartridge which is good for 1/2 hr. on-off spraying. Takes one quart of liquid  
Van-Ren Industries, 2464 Morris Ave., Union, N. J.



243

## Notched Plate Scraper Spots Drill Bit on Vertical Surface



A rubber plate scraper with a notch centered across the width makes a good holder, or guide, for starting a drill bit on a vertical surface. Saves the time necessary to make a punch mark.

## Jigsawed Slots in Block Check Table Alignment

Checking the alignment of the jigsaw blade with the table is done by cutting two adjacent slots in a piece of waste stock. After making the first shallow cut, reverse the stock and make another shallow cut about  $\frac{1}{4}$  in. from the first. If the slots are parallel, the table is aligned with the blade.

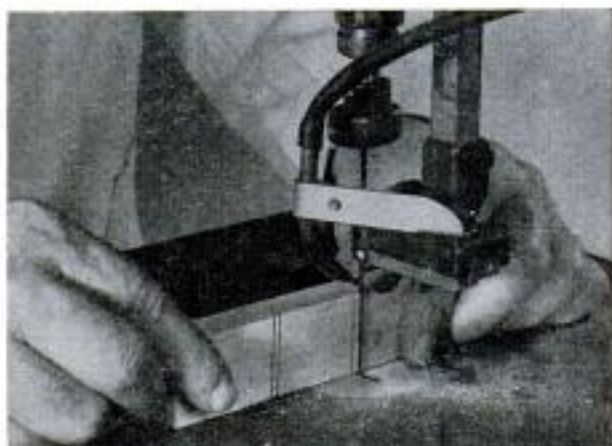

## Furnace Fan Removes Loose Husks

Most of the loose husks can be removed from ear corn at the elevator by mounting a furnace-blower unit so that the air blast is directed across the elevator hopper. Some experimenting may be necessary in the placement of the blower to assure that the full blast of air catches the ears as they roll from the trailer box into the hopper.

A. M. Wettach, Mt. Pleasant, Iowa.



## Chiseling an Accurate Mortise

After scoring the outline of the mortise on the stock and drilling adjacent holes to remove most of the waste, take time to make the squaring guide detailed. True one edge of the block, notch out the ends and clamp to the stock with one edge flush with the mortise. In this position the block serves as a guide for the vertical chisel cuts used in squaring the mortise.

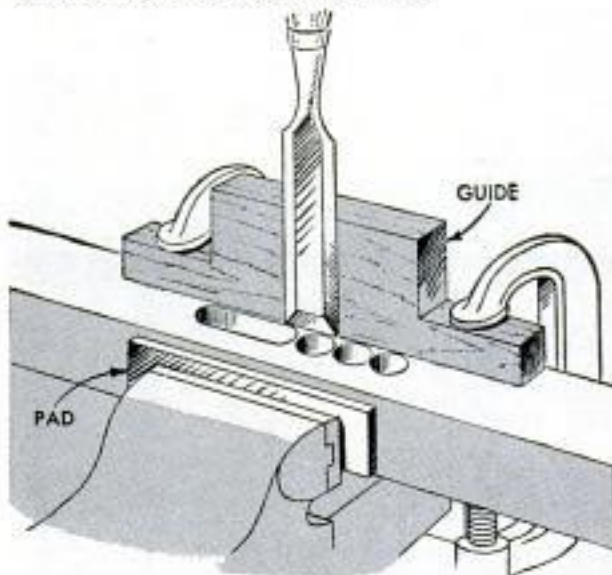

POPULAR MECHANICS

## Prescriptions for Common TV Troubles

By Lothar Stern

TAKE AN ORDINARY television set, place it in a small apartment in a crowded neighborhood, add a couple of amateur transmitters and perhaps a strong FM station and you have all the ingredients needed for a king-size headache. For no matter how good the receiver may be, conditions are ripe for any number of troubles which can mar the picture beyond the point of comfortable viewing. Many of the troubles are caused not by the receiver itself, but by external conditions which no amount of set adjustment will remedy. Yet, they can often be corrected merely by using the proper antenna, or by the simple installation of an inexpensive TV accessory.

Take, for example, the case of the shrinking picture, Fig. 1A. During the day the set may provide a perfectly good picture, but just as you settle down for an evening of watching your favorite programs the picture starts to shrink, leaving dark bands along one or more edges of the screen. Such a situation is rather common in large apartment buildings and in older homes where electrical wiring is inadequate to meet the demands of today's electrical living. During daylight hours, when the electric current drawn from the power line is rather small, the voltage at the various wall outlets is approximately 115 volts. But in the evening, as lights are turned on and more appliances are put to work, a portion of this voltage (sometimes as much as 10 or 15 volts) is lost in the power line due to the excessive current drain. This loss can seriously impair the performance of a television receiver, causing small picture size, reduced brightness and even an annoying loss of synchronization.

The solution to this particular problem is illustrated in Fig. 2. It consists of a simple switch-type voltage regulator installed between the wall outlet and the TV line cord. When the line voltage drops, a mere flick of the switch restores proper operating conditions and a normal picture.

### Chasing the TV Ghost

The ghosts and goblins which in the past have limited their activities to haunting old and abandoned houses are getting bolder. Today, in search of entertainment, they are invading our cities and towns and may settle down in any home where a television set is installed.

While the modern ghost is no longer a frightening apparition, he is certainly a vexing reality. For ghost is the name given to reflected TV signals which can cause two or more identical images to appear on the television screen at the same time (see Fig. 1B).

The illustration in Fig. 3 shows the reason for these ghosts. A transmitting antenna sends out its signals in all directions. Part of this signal travels directly to the receiving antenna and causes a picture to appear on the screen. Signals traveling in other directions, however, may strike reflecting objects such as large buildings, water tanks,

*Patterns courtesy Motorola, Inc.*

1

A

B

C

D

E

F

G





Appearance and installation of a typical voltage regulator transformer. Three-position switch may be adjusted for high, low or normal line voltage

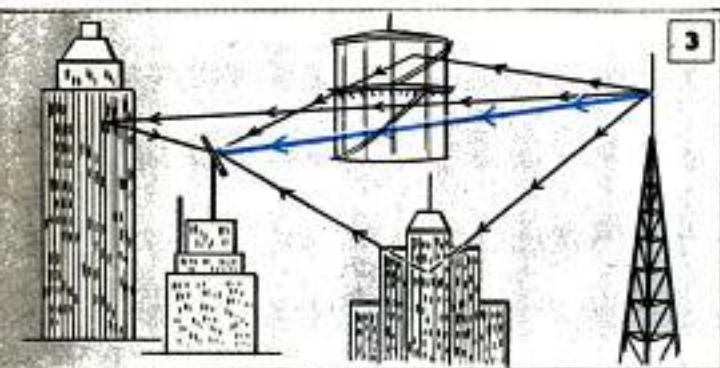

Reflected signals added to direct signal, shown in blue, result in multiple images, or ghosts, on screen

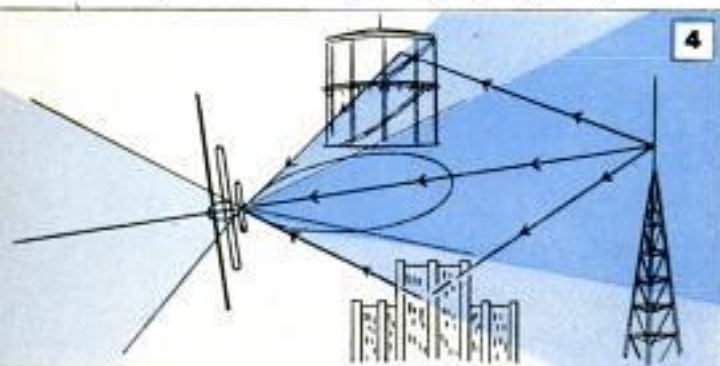

Directional pattern of typical in-line antenna, above, compared with indoor unit, below. Heavy blue areas indicate direction of maximum signal pickup, light blue—poor pickup, white—negligible or no pickup

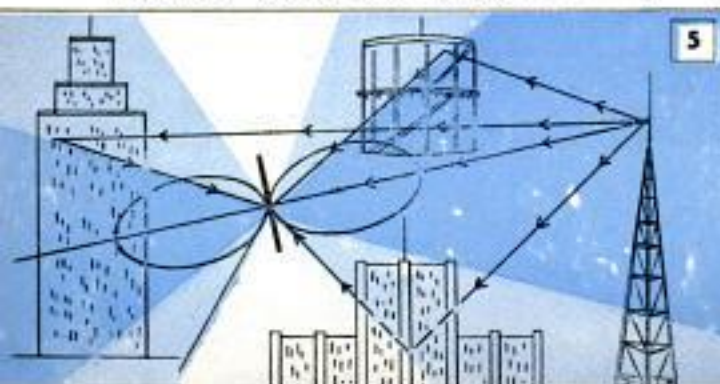

etc., and be deflected towards the receiving antenna. These deflected signals reach the receiver a short instant later than the direct one, causing additional images to appear on the screen. Due to the time difference between the arrival of the signals, the various pictures on the screen do not coincide, giving rise to the annoying ghost images.

Getting rid of the ghosts often requires nothing more than a slight rotation of the receiving antenna. The reason for this is shown in Fig. 4, where the directivity pattern, or loop, of a simple roof-mounted in-line antenna is superimposed on the foregoing drawing. All antennas, from the simplest dipole to the most elaborate multi-channel yagi, have some sort of directivity pattern although the number and shape of the loops may vary considerably for the different types. Since an antenna will pick up signals only from the direction encompassed by these loops, the unit in Fig. 4 can easily be positioned to reject all but one of the signals which may be headed in its direction.

Compare the pattern of the in-line antenna with that of an indoor or built-in type, Fig. 5, and you can readily see why the latter are often useless, even in strong-signal areas where they can extract enough energy from a passing wave to provide a normally good picture. No matter how such an antenna is turned, it will still pick up at least two signals, causing a minimum of one ghost to appear on the screen.

A properly positioned directional antenna will usually keep out the ghosts, but in some cases, particularly where the signal is very strong, a ghost image may be picked up by the antenna lead-in rather than by the antenna itself. Rerouting the lead-in, relocation of the antenna to permit the use of the shortest possible lead-in or, in extreme cases, the use of shielded coaxial cable with suitable matching transformers to replace the customary twin-line will eliminate this condition.

#### Excessive-Signal Troubles

In general, the greater the number of elements in a particular antenna, the more pronounced is its directional effect, and at the same time, the more energy it will extract from a passing signal. These two characteristics, which go together, make a highly directional antenna especially well-suited for fringe-area reception. But in urban locations where the directional effect of a good antenna may be needed for ghost elimination, the associated high gain of such a unit can be a decided detriment.

Fig. 1C shows what can happen when the signal is strong enough to overload the receiver. The picture bending, coupled with

excessive contrast and, often, an associated rasping buzz in the sound makes it impossible to watch the program. Of course, not all overload conditions are as severe as the one illustrated, and milder forms are sometimes tolerated rather than corrected. But the simplicity of the remedy makes it unnecessary to put up with even a minor annoyance of this type.

The solution consists of the installation of an attenuator switch between the lead-in and the antenna-input terminals of the set, Fig. 6. With such a switch the signal applied to the receiver can be reduced in strength by varying amounts, to eliminate any overload condition.

Installation of a directional antenna for ghost reduction in urban areas may cause another problem. Obviously, if the antenna discriminates against unwanted ghosts, it is also insensitive to desired signals from stations located in a different direction. Where a receiving antenna is surrounded by a number of stations, the use of an antenna rotator which, at the touch of a control lever, turns the antenna in any direction represents the ideal solution.

#### Reducing Interference

Interference has been a source of annoyance ever since the invention of radio. While we have learned to live with many of the extraneous sounds and noises that tend to mar radio reception, the interference to television sets is usually far more objectionable.

Television interference can take many forms and be caused by many different factors. Yet, by the proper installation of a suitable antenna and through the use of a filter or combination of filters, most forms of TV interference can be greatly reduced, if not entirely eliminated.

There are two general types of television interference: The kind caused by broadcast equipment such as used by radio amateurs, FM stations and other communications services, and pulse-type interference caused by automobile ignition systems, electric appliances, fluorescent lights and diathermy equipment. The former results in a number of vertical or diagonal lines which may be stationary, see Fig. 1D, or may wiggle across the screen in a particularly annoying fashion. The latter will show up as random horizontal streaks as in the case of ignition interference, Fig. 1E, or as a partial obliteration of a small section of the picture as with diathermy interference and that of certain other electrical appliances, Fig. 1F.

Most interference due to communications and industrial equipment, diathermy and ignition noise reaches the receiver via the antenna system. The frequencies of such

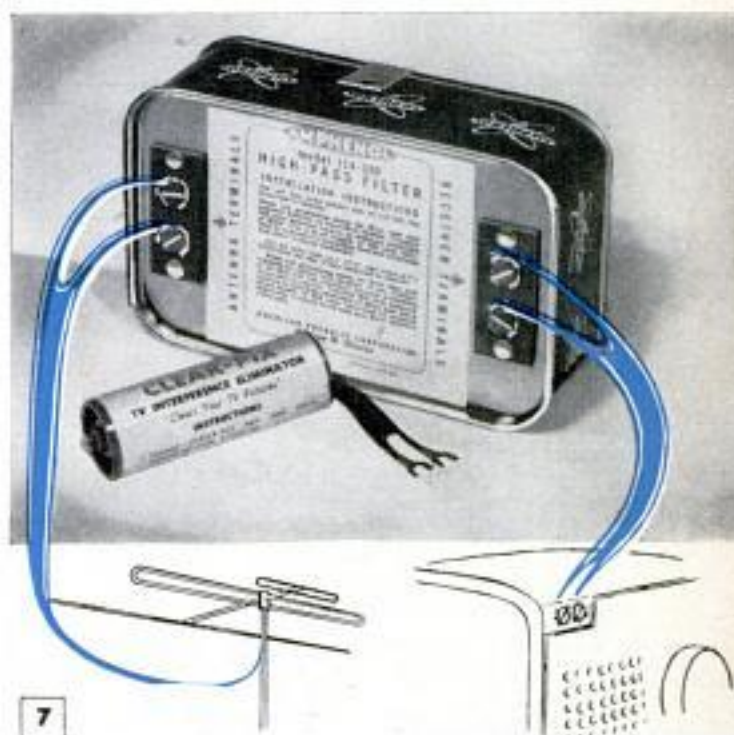
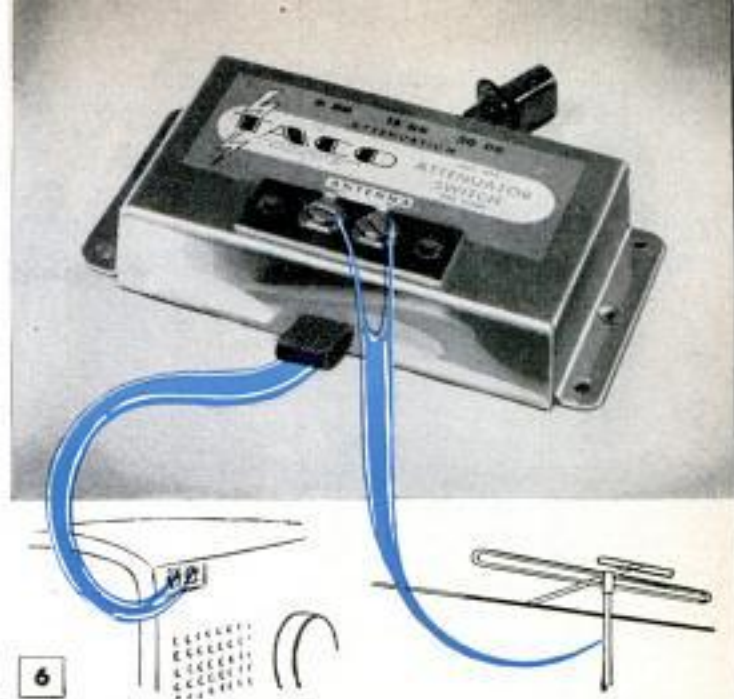

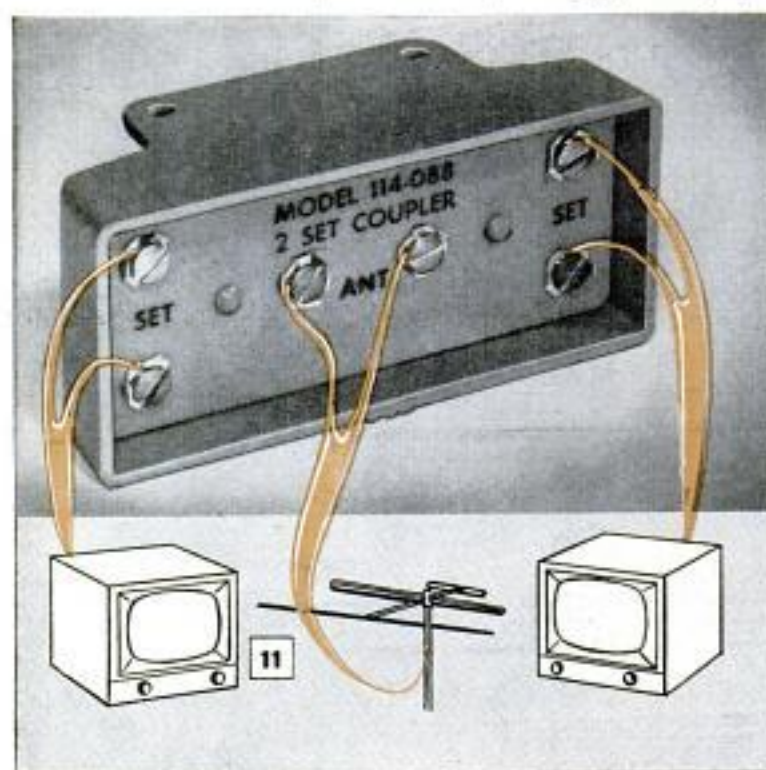
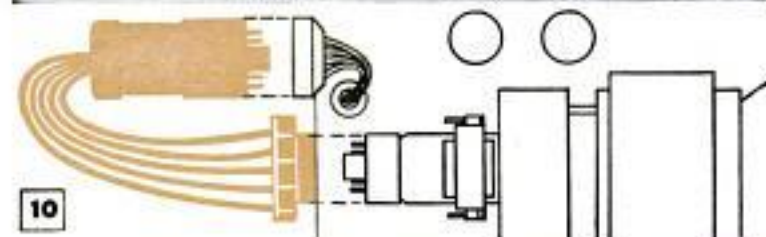
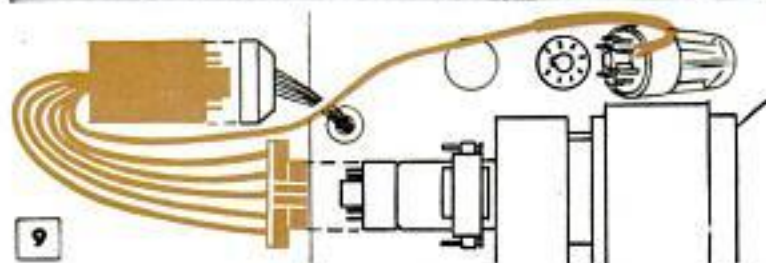

interference are usually below 50 megacycles and these can be kept out of the receiver through the simple installation of a high-pass filter as shown in Fig. 7. The filter requires no adjustment and automatically eliminates any and all interfering signals below the TV-band frequencies. Television signals, however, are permitted to reach the receiver unattenuated.

Interference due to FM stations can often be cleared up through the proper orientation of a directional antenna, as in the case of ghost elimination. But, if the offending FM station lies in the same direction as the TV transmitter, an adjustable filter, shown unattached in Fig. 7, must be employed. Such units are designed to eliminate specific frequencies near the TV band, and careful adjustment usually permits the interference to be tuned out.

Electrical equipment and appliances, such as cash registers, shavers, fluorescent lights and the like, often transmit their interfering signal by means of the power line. Against this type of annoyance a low-pass filter (line filter), Fig. 8, will prove highly effective. If the interfering device is known, the filter should be installed directly between the a.c. wall outlet and the line cord of the device. In this way, the interference is kept out of the power line entirely and cannot affect any receiver. Where the interfering device is unknown, the filter can be used between the outlet and the receiver line cord. In such cases, an additional high-pass filter is sometimes required since some of the interference may be radiated by the power line and picked up by the receiving antenna.

#### Eliminating Retrace Lines

During daytime televiewing a high degree of picture-tube brightness must be used to prevent a washed-out appearance of the picture. But advancing the brightness control often causes the appearance of fine white diagonal lines on the screen. In newer sets these

(Continued to page 254)

**There's an easy answer  
to this tough storage problem**

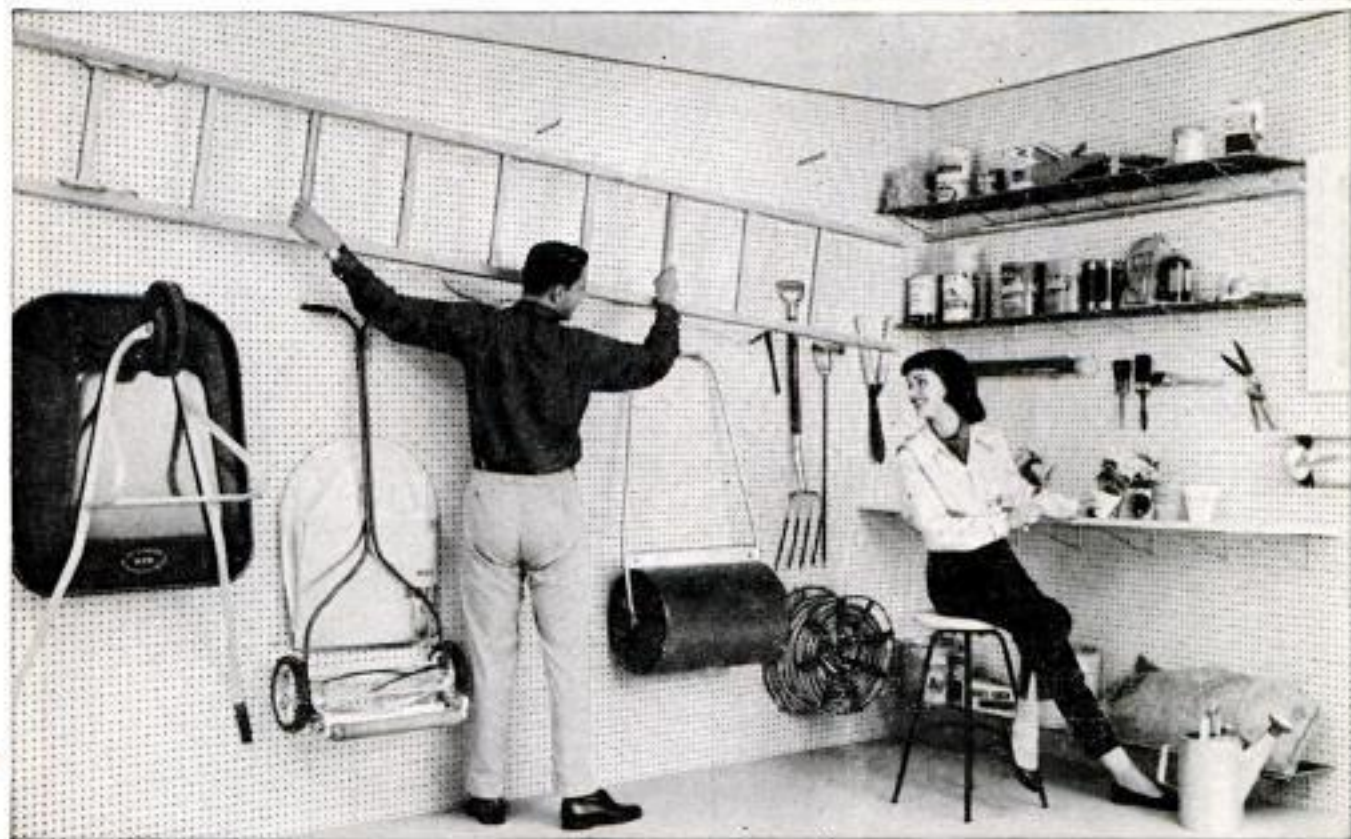

*Heavy Duty*

**Let MASONITE® PEG-BOARD® put garage walls to work**

You can have 33% more storage space with 1/4" heavy-duty Peg-Board panels and accessories for as little as \$27.00.\* Clever slip-in-a-hole fixtures support just about anything—your heaviest garden tools, shelves and equipment, bench top and hand tools—and

there you have it, a Working Wall! Enjoy a neat, attractive garage, and quickly, too; just ask your building materials dealer about heavy-duty Peg-Board panels and fixtures. Mail the coupon below for other interesting ways to use Peg-Board products.

\*Wall area 8' x 12'. Heavy-Duty 1/4" Peg-Board Panels \$24.60. Accessories \$1.96

©Masonite Corporation—manufacturer of quality panel products



MASONITE CORPORATION  
Dept. PM-10, Box 777, Chicago 90, Ill.  
In Canada: Masonite Corporation, Gatineau, Quebec  
Please rush me a copy of the "Home Owners' Guide to Masonite Peg-Board Panels and Fixtures."  
Name.....  
Address.....  
City.....State.....  
Zone.....County.....

Prevent oil waste—  
even under  
high vacuum!



## Sealed Power KromeX Piston Ring Sets

Sealed Power's new Stainless Steel\* Oil Ring is now in KromeX ring sets which require super oil rings for top performance. This oil ring permits performance never before possible in modern, high compression engines (1952 models and later). This oil ring is already being used in every new car and truck built by a million-car-a-year manufacturer.

### PAYS OFF IN ECONOMY AND PERFORMANCE

No smoking under high vacuum conditions. Will not corrode or sludge. Your engine continues to perform as manufacturer intended it to.

Sealed Power Stainless Steel holds full tension at engine operating temperatures. This assures more than double the ring life you're accustomed to. Judged by either your pocketbook or car's performance, Sealed Power's KromeX Ring Set with the Stainless Steel Oil Ring is your best buy.



### INDISPENSABLE MANUAL

An illustrated manual on engine care—free, yours for the asking. "Care and Feeding of Engines" is highly informative, could save you a lot of maintenance expense. For your free copy, write Sealed Power, Dept. G-10, Muskegon, Michigan.

\*U. S. Patent No. 2,789,872

# Sealed Power

## PISTON RINGS

BEST IN NEW CARS! • BEST IN OLD CARS!

## Clinic for Homemakers



As a service to our readers in solving the hundreds of problems pertaining to a home—inside or out—the editors of *Popular Mechanics* invite you to present your problems to The Clinic Editor for help and advice. Address your questions to The Clinic Editor, *Popular Mechanics Magazine*, 200 East Ontario Street, Chicago 11, Ill.



### Lumber Warps

**Q**—I keep a small amount of hardwood lumber on a rack in my basement workshop. It is stored on the rack the year 'round and I add a few pieces occasionally to replace those used. Some of the wider pieces have warped. Why? They were flat when placed on the rack. How can I straighten them?

N. D., Pa.

**A**—When you received the stock from the dealer it probably had been kiln-dried to a moisture content of 7 to 10 percent. Storage conditions which bring about a variation in the moisture content of the stock may cause the wood to warp. In a basement, humidity would be reduced to a very low level during the winter months, and would reach a comparatively high level during the summer when the heating equipment is not in operation. Hardwoods stored under such varying conditions would be likely to warp, except those pieces which have been quartersawn. We think it likely you would do better to store your hardwood stock in the garage, not an ideal place, but better than the average basement where temperature and especially humidity vary widely and over such long periods of time. It is not practical to attempt to straighten, or flatten, stock as thick as  $\frac{3}{4}$  in. by wetting or applying pressure. Of course, you can take it to the mill and have it planed flat, reducing the thickness to perhaps  $\frac{1}{2}$  in. or less. Another way is to rip wide boards that have warped, or cupped, and joint the edges square. In this way you will preserve the original thickness and the strips can be edge-glued to build up to whatever width is required.



### Watering Evergreens

**Q**—My evergreen planting consists of several varieties, both the tall and low-growing types. My neighbor tells me that these should be thoroughly watered in the fall, preferably just before the ground freezes. He says the ground should be soaked to a depth of 4 or 5 ft. to be sure of reaching the entire root system. Why is this necessary?

J. L., Del.

**A**—Your neighbor has given you the correct instructions, although, of course, he is undoubtedly thinking of carrying out this procedure only when

(Continued to page 252)





**BRIGHTEN ANY ROOM** with luxurious Weldwood Paneling. This cheerful birch V-plank paneling gives a random-plank effect, yet comes in 4' x 8' sheets that are prefinished to save you hours of labor . . . and costs only \$65 for a full 12' x 8' wall.

## Make an old room new again with easy-to-install Weldwood paneling



**INSTALL PANELS** with nails concealed in V-grooves, or with Weldwood Contact Cement, on furring strips over studs, or over old walls. Bonds permanently, on contact, without clamps.

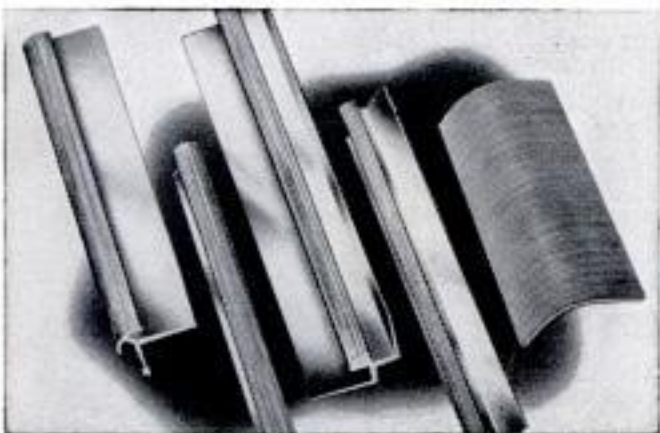

**EMPHASIZE JOINTS** with Weldwood Veneer-Faced Aluminum Moldings to match panel wood. Also available: Weldwood Hardwood Trim, in a variety of woods and styles.

You can enrich a room with wood paneling easily and less expensively than you may think.

Weldwood Prefinished Paneling comes in a handsome variety of woods and finishes, all ready to install. Each panel is factory sanded, waxed, and rubbed like fine furniture to bring out the true wood beauty and protect its surface. Or, you may buy Weldwood Paneling unfinished at lower cost.

Weldwood Paneling's beauty grows as time goes on . . . and with hardly any care. It's guaranteed for the life of your home! See Weldwood Paneling at your lumber dealer's, or at any of our 87 offices.



### Weldwood<sup>®</sup> PANELING

A Product of United States Plywood Corporation

Weldwood Glues—Flexible Wood-Trim<sup>®</sup>—Firzite<sup>®</sup>—Satinlac<sup>®</sup>

United States Plywood Corporation  
Box 61, New York 46, N. Y.

PM10-57

- Send me the name of my nearest Weldwood dealer.  
 Please send me a copy of the full-color, 20-page decorating book, "Beautify Your Home with Weldwood Paneling." I enclose 10¢.

NAME.....

STREET.....

CITY.....STATE.....

## How to select a paintbrush



*A good brush performs better... wears longer... saves you money*

In selecting a good paintbrush, the first thing to look for is (1) a full head of bristles in a firm setting.

Then, look closely at the individual bristles. They should be (2) finely tapered with slightly curled tips.



Make sure a generous portion of the bristles have tips which are (3) split—"flagged."

Your final assurance of a brush which will give excellent painting performance is bristles which (4) vary in length.



A brush with these qualities has a greater working and paint-holding capacity—eliminates excessive dipping. It will (5) release a finish smoothly and evenly on any surface. You save time, paint with ease, do a professional-looking job.

### Now, better performance with improved TYNEX® nylon bristles

When buying a paintbrush, look for (6) the trademark TYNEX on the handle. Quality paintbrushes made with bristles of TYNEX nylon give you better performance. They pick up a full load of paint



at every dip and lay on a smooth, streak-free coat. And brushes bristled with TYNEX have durable bristles that (7) clean easily... rinse thoroughly... dry quickly—are always ready for re-use.

**FREE**—additional facts everyone should have on choosing and using a paintbrush.

To get this valuable information without cost or obligation, just send your name and address to E. I. du Pont de Nemours & Co. (Inc.), Polychemicals Dept., Rm. 6510, Du Pont Building, Wilmington 98, Del.

TYNEX is the registered trademark for Du Pont nylon bristles.



**TYNEX®**  
NYLON BRISTLES

BETTER THINGS FOR BETTER LIVING . . . THROUGH CHEMISTRY

rainfall is a little less than normal. Unlike deciduous trees and shrubs, which shed their leaves in the fall and become dormant, your evergreens do not cease growth entirely at the onset of cold weather. To maintain growth during the winter months it is necessary that moisture be available to the root system below the frost line. This is the main reason for making sure that the soil around the roots is kept moist during a dry fall, the precaution being doubly important when the planting is in a sandy or gravelly soil on a slope where the subsurface water drains away more rapidly than in heavier soils. A mulch of peat moss conserves the moisture.

### Concrete-Floor Cracks



**Q**—My basement floor is badly cracked, actually broken into sections over nearly the whole area. I moved here less than a year ago, so don't know just what happened. I lifted a broken section and dug down about 2 ft. below the floor. There appeared to be sand all the way down to this depth. Would this be a cause of the floor breaking up?

W. D., Ohio

**A**—Possibly, although to us it would seem there are several unknown factors. How thick was the section of the slab you lifted? What is the present condition of the foundation walls? You do not mention water seepage and for this reason we assume you are located on a rise where there is better than average drainage in all directions. Going further on assumption alone we can guess that the floor slab was laid directly on the sandy subgrade without tamping and that the slab was troweled much too thin to withstand normal use. It also is possible that a faulty concrete mix was used. Just what to do to remedy the defect is rather difficult to suggest at such long range, but it would seem reasonable to suppose that a standard procedure should produce a satisfactory repair. It might be permissible to leave the original floor as it is and use it as a part of the fill, but we think it would be best to remove it entirely and place a new fill of coarse gravel or crushed stone to a depth of 6 in. or more. Measure the ceiling height to be sure you are allowing sufficient clearance, or standing room. The fill should be thoroughly tamped, covered with a 1½-in. grout coat. When the latter has set, follow with a waterproof membrane, wire reinforcing and finish with a poured slab at least 2 in., or better, 3 in. thick. Provide expansion joints along all four walls. These should be sealed with hot asphalt after the concrete sets.

### Concealing Metal Posts

**Q**—The center beam in my basement is supported on round metal posts, or columns. I want to divide the basement into rooms and one wall is at the center directly under the center beam. I had thought of replacing the metal posts with wooden ones. Would this be practical?—C. S., N. J.

**A**—Why not consider boxing in the posts? Judging from your description, this would be the recommended procedure. Replacing the metal posts supporting the center beam would be a rather extensive undertaking, as the structure would have to be supported on jacks while the change was being made. Then, of course, there is the additional problem of adequate concrete piers. By boxing in the existing supporting posts you would avoid the extra labor involved, and by selecting the wood used in the square columns you would finish with an attractive job. A nailing base at the lower ends of the metal supporting posts is easily made by using two short lengths of 2 x 4 stock, each piece cut to the same length as the inside measurement of the proposed wooden column. Make a semi-circular cut in from the edge of each piece, the depth of the cut equal to half the diameter of the metal post. Then drill holes in each piece for bolts and clamp the two members to the column.

*The new age of space is here...*

and the future  
belongs to the  
airman

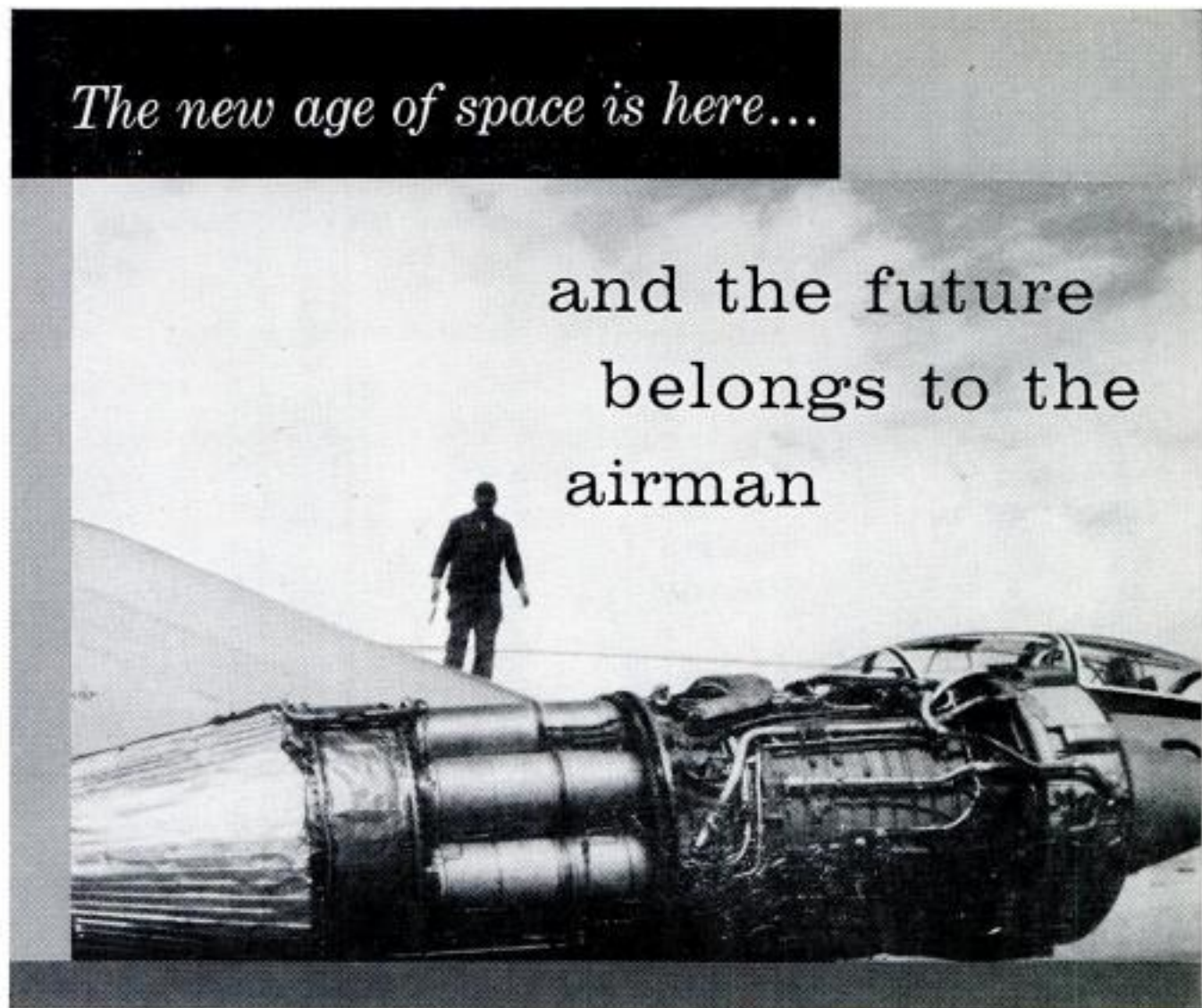

You have read about the early Age of Flight...grown up in the Jet Air Age. Now, as a young man, you stand on the threshold of a new age in which man will conquer outer space. It will be the age of trained technicians—those who have backgrounds in rocketry, jet propulsion, electronics, mechanics and allied fields. And nowhere else is such training so available or so complete today as in the U.S. Air Force. Consider this fact as you plan your future. By joining the Air Force, you will, of course, meet your military obligation. But much more important, you will prepare yourself for unlimited opportunities in the new Age of Space. See your local Air Force Recruiter today—or mail the coupon.

*You go places  
faster in the*

**U. S. AIR FORCE**

**PASTE COUPON ON POSTCARD AND MAIL TO:**

Airman Information, Dept. PM-1321  
Box 7608, Washington 4, D. C.

Please send me more information on my opportunities in the U.S. Air Force. I am between the ages of 17-34 and reside in U.S.A. or possessions.

NAME \_\_\_\_\_

ADDRESS \_\_\_\_\_

CITY \_\_\_\_\_ ZONE \_\_\_\_\_ STATE \_\_\_\_\_

if you have to glue it . . .

**LET ELMER  
DO IT!**



Repair or build  
quickly with strong

**ELMER'S®  
GLUE-ALL**

Use Elmer's modern plastic glue for any porous material such as wood, paper, cloth or pottery. It's easy to apply, fast drying and won't stain. Takes the goo out of gluing. Perfect for the home workshop.



Get a completely waterproof bond with  
**ELMER'S® WATERPROOF GLUE**

It's the glue that boating experts use. Apply on any joint subject to water, weather, acids or alkalis. Super bond is stronger than wood itself!



Bond plastic laminates or plywood wall panels with  
**ELMER'S® CONTACT CEMENT**

No clamps, nails or presses needed to do professional job quickly. Highly resistant to heat and water. Available in regular or non-flammable type to meet every need.



Check **ELMER'S Glue Chart**  
for the right glue for the job.

IF IT'S **Borden's**  
IT'S GOT TO BE GOOD



The Borden Company, Chemical Division

## Prescriptions for Common TV Troubles

(Continued from page 248)

lines are eliminated automatically by circuits within the receiver, but many older models are not provided with such improvements. In these, the retrace lines can be blanked out easily and inexpensively through the use of a retrace eliminator, as shown in Fig. 9.

The eliminator is installed between the base of the picture tube and the picture-tube socket, with an extra wire going to the plate pin of the set's vertical output tube. This can be done in a matter of minutes with no tools other than a screwdriver with which to remove the back of the cabinet. The eliminator applies a blanking pulse to the picture tube which cuts off the electron beam during the time that the retrace lines normally appear on the screen. The picture itself is not affected in any way.

To purchase the correct retrace eliminator, you must know whether the picture tube in your set is grid or cathode modulated. If this information is not available, just tell your dealer the make and model number of your set, and he will be able to select the correct eliminator.

### New Life for Old Picture Tubes

There comes a time in the life of every TV set when the picture on the screen gradually becomes darker and darker, see Fig. 1G, until finally there is not enough screen illumination to permit proper picture contrast even at maximum brightness-control setting. A serviceman called to repair the difficulty is likely to pronounce those dreaded words, "It's the picture tube." Now, picture-tube replacement is not difficult. But, because this tube is the most expensive single component in the entire set, its replacement is costly even if you are able to do the job yourself. It is good economy, therefore, to obtain as much service as possible from such a tube before relegating it to the junk pile.

Loss of illumination is not an indication that the picture tube has reached the end of its useful life. It merely means that its cathode, when heated by the filament to the normal temperature, is no longer able to emit an adequate number of electrons. Increasing the filament voltage raises the cathode temperature and restores proper electron emission. In this manner, the useful life of the tube is often extended by many months. Fig. 10 shows a typical picture-tube booster, or brightener, which does just that. Like the retrace eliminator, this unit is installed between the base of

(Continued to page 256)

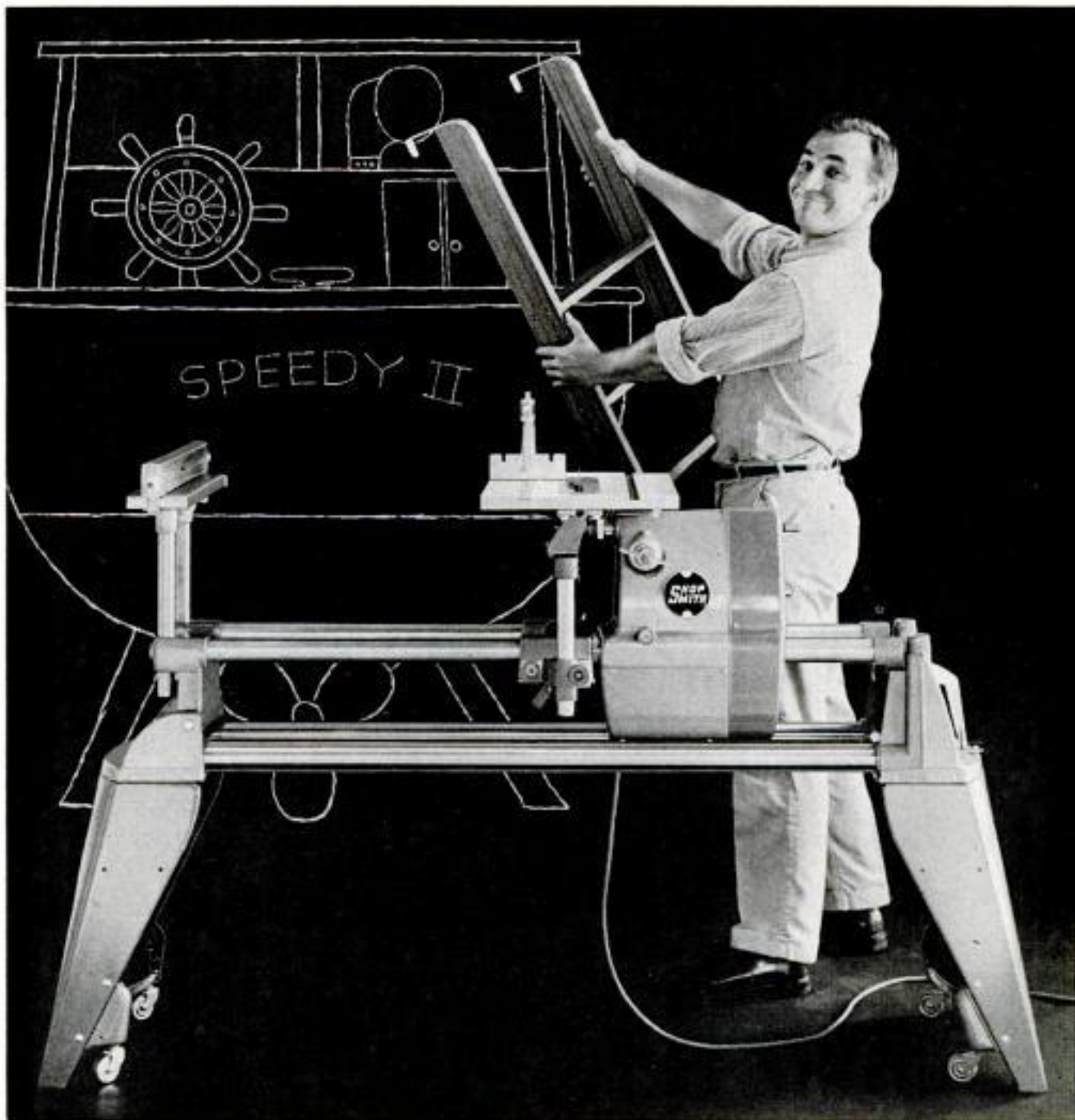

## It's amazing — the things you can build with SHOPSMITH!®

Maybe you won't begin by building a cabin cruiser—but you *could* with your SHOPSMITH! For boats, like most other projects, require a saw, drill press, sander, lathe and horizontal drill. Only SHOPSMITH gives you, in one magnificently engineered unit, all the tools you need to build *any* project from *start to finish*. Only SHOPSMITH is a complete power shop—no extra tools to buy. And unlike one-speed power tools, SHOPSMITH gives you exclusive Speed-Dial with correct, *safe* tool speeds for any woodworking operation. Visit your leading hardware or department store, lumber yard, or any Montgomery Ward; find out why over a quarter-million men now own SHOPSMITH. For two helpful free books on home workshops, write Dept. 301-M, Magna Power Tool Corporation: Menlo Park, Calif., or Box 2808, Ft. Wayne, Ind. ® T. M. REG.



MAGNA POWER TOOL CORPORATION

ONLY SHOPSMITH LETS YOU COMPLETE THE JOB!

**PRECISION FEATURES**  
**POPULAR PRICE**

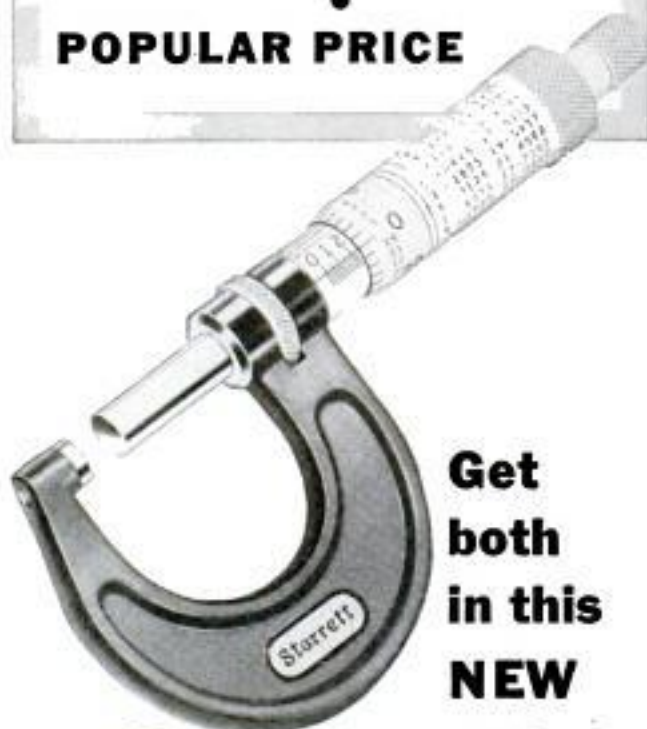

**Get  
 both  
 in this  
 NEW**

**Starrett**

No. 436 0-1 inch

**MICROMETER CALIPER**

Balanced design, rugged construction, new specially forged tapered frame with deep throat, no-glare rust-resistant Satin Chrome Finish on thimble and sleeve, easy-to-clean black frame, quick-reading figures . . . these big Starrett features plus many more are yours at a very moderate price.

Models available with or without lock nut, ratchet stop or friction thimble. Graduated .001", .0001" or Metric. Also available in larger sizes up to 24 inches.

**BIG NEW CATALOG—FREE**

Describes and illustrates over 3000 Starrett Tools. Send the coupon.



**STARRETT TOOLS** are carried by leading Industrial Supply Distributors and Hardware Tool Stores.

THE L. S. STARRETT COMPANY  
 Dept. AP, Athol, Mass., U. S. A.

Please send my free copy of the big new Starrett Catalog No. 27.

Name.....

Occupation.....

Address.....

City..... Zone..... State.....

the tube and its socket. Boosters are available at prices ranging from about \$1 to \$6, depending on their flexibility; a small price to pay for extending the life of the far more expensive tube.

The more expensive boosters not only cause increased cathode emission, but also relieve the condition brought about by a cathode-to-filament short circuit within the tube. This common trouble causes the tube to operate at maximum brightness at all times, regardless of the brightness-control setting.

Most servicemen will be happy to install such boosters for a very nominal service fee. Some will even put in the booster on a rental basis, taking back the unit and subtracting its cost from the picture-tube-replacement charge when this finally does become necessary.

**Two Sets—One Antenna**

A single antenna can serve two or more TV sets if there is sufficient isolation between the sets to prevent interaction, and a good match is preserved between the antenna and the receivers. A multiset coupler serves both functions.

The installation of a typical 2-set coupler is shown in Fig. 11. Here, the lead-in from the antenna is connected to one set of terminals on the coupler while additional leads run from the end terminals to each of the receivers. Couplers for more than two sets are also available and are just as easily installed.

**Accessories Readily Available**

TV accessories for the purposes described are made by a number of different manufacturers. The ones illustrated can be found in catalogues of most major radio-parts distributors. The catalogues are available free of charge and you can obtain a list of some of the largest distributors by writing to the *Popular Mechanics* Radio, TV and Electronics Dept. and enclosing a stamped, self-addressed envelope. ★ ★ ★

**Ring of Wind Encircles Equator**

The earth is encircled by a ring of wind around the equator at an altitude of about 100,000 feet, reports Dr. Clarence E. Palmer of the University of California. It is a steady easterly wind that blows all the time approximately 73 miles per hour and extends several degrees on either side of the equator.

☛ A German inventor has obtained a U. S. patent on a false tooth which has a metal "filling" to make it appear more like a natural tooth with a filling.

# How many of these projects are you planning for your home?

- Installing ceiling tile
- Reupholstering
- Building furniture
- Installing insulation
- Making picture frames
- Making or repairing screens
- Installing low-voltage wiring
- Installing built-in speakers
- Tacking chicken wire to shelters, cages, storage bins



**The Bostitch T5 Tacker helps you do all these better and faster!**

Just aim and squeeze. A rugged staple gets a powerful grip exactly where you want it. Can't mar surfaces. Approved by leading makers of ceiling tile, used by professional craftsmen. Wonderful in tight places!

- Erecting tree and shrub shelters
- Laying roofing paper
- Re-canvassing lawn furniture
- Installing insulation
- Installing wooden under-course shingles
- Applying cornerite
- Applying felt and waterproof paper to exterior walls
- Installing flashing paper
- Laying underfelt for roofing
- Installing vapor barriers



**The Bostitch H2B Stapling Hammer helps you do all these better and faster!**

Use this high-speed, self-feeding stapling hammer on all these jobs—and wherever you want light tacking or nailing. Holds 160 staples. One-hand operation—other hand's free to position work. Lightweight with a long reach. Takes the fatigue out of drawn-out jobs.

- Building trellises or arbors
- Applying asphalt shingles
- Applying metal lath to studding
- Laying underflooring
- Applying metal discs for built-up tar and gravel roofs
- Applying corrugated paper for installing blown-type rock wool



**The Bostitch H4 Stapling Hammer helps you do all these better and faster!**

Big jobs go fast when you work with the H4. Every easy blow drives a staple  $\frac{3}{4}$ " deep. Staple legs spread inside work for more holding power than a nail. For roofing you need less staging, finish 4 times faster than with hammer and nails!

See these time-and-money-saving Bostitch Staplers at your Building Supply Dealer's—or mail the coupon.

**Fasten it better and faster with**

## BOSTITCH®

BOSTITCH, 550 Briggs Drive, East Greenwich, Rhode Island

Please send me information on the following:

- T5 Tacker
- H4 Stapling Hammer
- H2B Stapling Hammer
- Ceiling Tile Installation Handbook

Name \_\_\_\_\_

Address \_\_\_\_\_

City \_\_\_\_\_ Zone \_\_\_\_\_ State \_\_\_\_\_

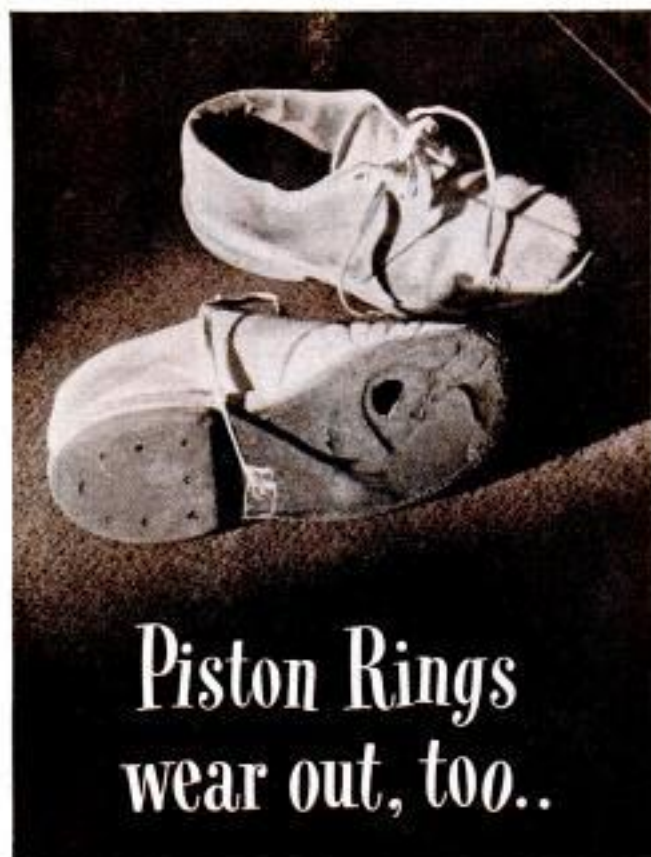

## Piston Rings wear out, too..

You can't see the wear on your piston rings. But you can feel it—in your engine's loss of power—and in your pocketbook.

At the first sign of oil-pumping, smoking exhaust or loss of power, ask your motor specialist for a ring check-up. If your car needs new rings, you'll be money ahead on gas and oil . . . and avoid big repair bills later on by installing new Hastings Piston Rings now.

They stop oil-pumping, seal compression and provide the special lubrication worn engines need.

Don't gamble with the power and economy that are built into your engine. Restore it, keep it, enjoy it. Get new rings. And be sure they're Hastings—the only rings engineered exclusively for replacement service in your car. Truly the best money you can spend on your car.

**HASTINGS MANUFACTURING CO. • HASTINGS, MICH.**  
Piston Rings, Casite, Wear Reducer,  
Oil Filters, Spark Plugs



**TOUGH** on oil-pumping • **GENTLE** on cylinder walls

## We Call It "Our Rock of Gibraltar"

(Continued from page 179)

mixer and laid the footings ourselves. With the help of a friend experienced in concrete work, we laid the blocks for the basement. When we couldn't figure out the next step from the blueprint, we looked at other homes in the same stage of construction and asked questions of workmen and experts. If we still didn't know how to proceed, we could always call Larson, and he would explain the details.

Some of the more difficult or technical jobs we had done by professionals, such as laying the concrete floor, putting in the basic plumbing, installing the furnace and much of the electrical work.

We first planned to hire a stonemason to lay the limestone and the brick-veneer portion of the basement which our hillside location left above ground. But stonemasons were scarce and busy. Finally we coaxed a retired mason to spend a few days helping us get started doing it ourselves. As Les was usually away at work, the stonemason showed me what to do. After that, I did most of the stonework and brickwork myself.

### Amateurs vs. Professionals

Larson had complained that in a home of this type, done purposely rough (many pioneer American builders were actually amateurs themselves), it was hard to get professional masons to lay stone and brick uneven enough for the rustic effect desired. This was one thing we could do better than the professionals—lay bricks crooked!

Les would mix up a batch of mortar before going to work in the morning, and I would lay it up, while our daughter, Sally, played nearby. She seemed to be just as contented as if I had spent my spare time at coffee parties and embroidery. In fact, there are countless interesting things for a child to play with and observe around a building project. By noon, the mortar would be used up and I would still have time to do the little housework necessary.

The second winter swept down on us like a hawk, catching us and our uncompleted basement unprepared. We did manage, however, to get it closed in, and to cover it with what would eventually be the floor joists and subfloor of the main level. Over this we put a temporary waterproof layer of tar paper.

That winter was spent splitting shakes (a seemingly endless job), pine paneling parts of the basement living quarters that were not stone and in other inside jobs.

(Continued to page 260)



# A Craftsman Kromedge blade from Sears

will last up to 5 times longer than an ordinary blade!



## 1/2 PRICE INTRODUCTORY SALE!

Save 1/2 on CRAFTSMAN Kromedge 6 1/4-in. steel slicer blade—with purchase of any Kromedge Hollow-ground or Carbide-tipped Blade! It's the only blade of its kind on market, for cutting thin sheet metal up to 1/32-in. thickness. For bench or electric hand saw. Fits 1/2-in. round arbor; knock out bushing for 3/8-in. Offer good until October 30, 1957.

Regular Price 2.89  
Sale Price 1.45



Guaranteed All-Chromed Cutting Edge

**Recorded Tests Prove It!** CRAFTSMAN Kromedge saw blades—impregnated with hard chrome—cut up to five times longer than ordinary steel blades. Yet, Kromedge blades actually cost you less! These circular blades are built better from the start. They're tempered under pressure, heat-treated, evenly tensioned to run true. Accurately ground for better balance and surface finish. Kromedge hollow-ground combination blade (pictured above) for fine finish work, ripping, crosscutting, mitering. 8-inch size, **4.49.**

## AND HERE'S THE ULTIMATE! TUNGSTEN-CARBIDE BLADES LAST 20 TIMES LONGER!



Tipped with the hardest metal made by man!

**ACTUALLY YOUR BEST LONG-TERM BUY!** Tungsten-carbide—the hardest metal made by man—is brazed into the tip of each cutting tooth to provide 20 times longer blade life than untipped steel blades! They stay sharper, cut faster, use less power. Heat-treated in electrically controlled furnaces, teeth ground with diamond wheels to exacting tolerances. For ripping, crosscutting, mitering, beveling. 8-inch size, **9.95.**

### Sears has Kromedge Blades for every type and size of electric hand or bench saw!

See Kromedge Blades at the Craftsman Home Workshop display at your nearest Sears Retail Store... or order from Sears Catalog in your own home, by Mail, Phone or at your nearest Sears Catalog Sales Office.

Satisfaction Guaranteed or Your Money Back. SEARS, ROEBUCK AND CO.—In Canada at Simpsons-Sears Ltd.

© 1957, SEARS, ROEBUCK AND CO.



# NOW! CUT ALMOST ANYTHING

with **WISS** "Mighty Midget" Snips!

No. V-13

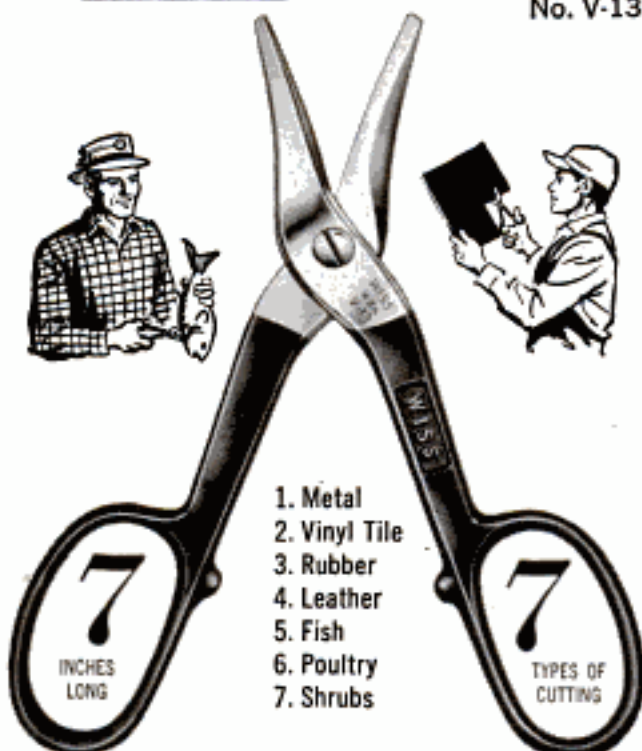

**ONLY \$2.25!** "Mighty Midget" Solid Steel Snips fit easily into your pocket or fishing tackle box. Make straight and curved cuts. At leading hardware and tool stores. Get a pair soon!

OTHER WISS SNIPS  
FOR HOME, FARM, AND  
PROFESSIONAL  
CRAFTSMEN

**CIRCULAR and  
STRAIGHT CUT**  
**\$3.10 and  
\$4.10**



Versatile as "Mighty Midget" snips. 10" model cuts 24 gauge metal; 13" model cuts 21 gauge.

**REGULAR**  
**\$2.60**  
to  
**\$3.80**



For powerful straight cutting. Four different sized models. Good for all sheet metal work, 25-20 gauge.

**METAL MASTER**  
**M-3**  
**\$4.25\***



Tremendous power! Only 10" long. Make intricate straight or curved cuts in 18 gauge metal, with half the normal effort!

\* Slightly higher in Denver and West. Vinyl handle grips optional and extra.

**J. WISS & SONS CO., NEWARK 7, N. J.**

**WISS... always a cut above competition**

The second summer, while still living in the cabin, we hired a carpenter to work with us at framing up the rest of the house. He set the window and door frames, made to order by a regular millwork firm. We did the sheathing and put on the roof boards. We covered the roof with heavy tar paper to shed rain and snow and were ready for another winter! (More shake splitting, painting and staining windows.)

The following October we took a big step. We moved into the basement, which, with one entire side above the ground and overlooking the river, was more like a comfortable three-room bungalow. Actually, this was our future recreation room and workshop. But after the primitive way we had lived for two years, it was a magic wonderland to us!

Instead of laboriously carrying water, hoarding it and eking it out a cupful at a time, we could now cause manmade hot and cold springs to flow forth at the touch of a faucet! A flowing stream underneath us carried away our waste! Clean, ash-free heat was kept within a few degrees of the temperature we wanted by a touch of the finger to the thermostat!

## Cabin Is Rented

That winter we rented the cabin to another young couple. The next spring they bought it and moved it to a lot of their own. Considering the rent received and the price we sold it for, our two years living in the cabin cost about \$200. The approximately \$1500 we saved by not having to pay rent those two years went toward buying materials for our house.

Two more years were spent in our basement while finishing the rest of the house and taking time out for the birth of our son, Bruce. During this period, we did our own insulating and finished the stonework and brickwork. The plywood floors we installed ourselves and had them covered with either linoleum or carpeting.

The main-floor paneling we wanted especially nice, so we had experts do this. We did, however, carve our own molding by hand and put it up. We also wallpapered and did much of the painting and finishing ourselves. The plastering and bathroom tilework was done professionally.

After two years in the basement, we were ready for the next big step—moving upstairs. As usual, in spite of all the work we did ourselves, the cost mounted higher than we expected. So we rented out the basement as an apartment. It is still being rented.

Usually a big house, even once it is up, is expensive to maintain. But here again

(Continued to page 262)

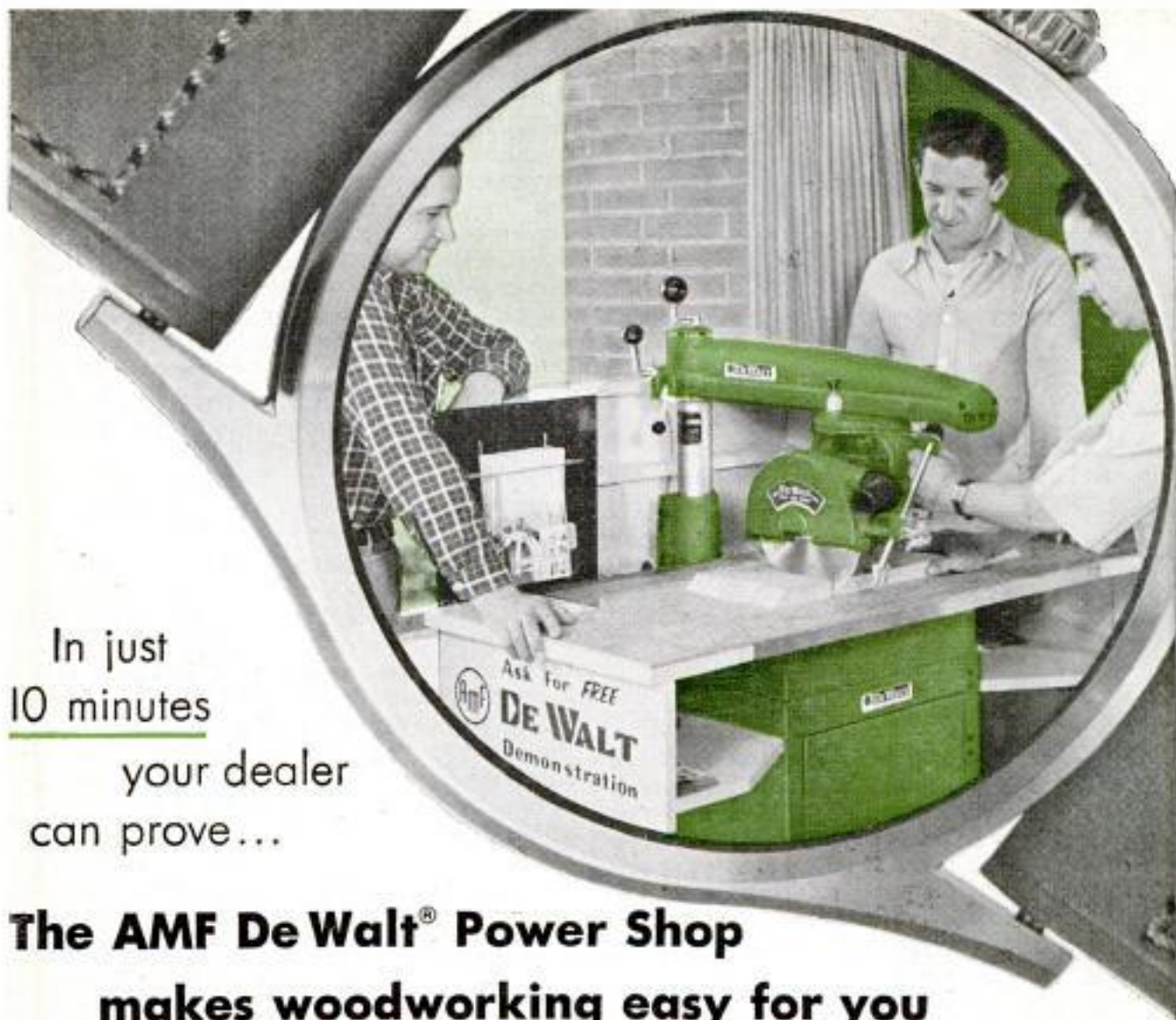

In just  
10 minutes  
your dealer  
can prove...

## The AMF DeWalt® Power Shop makes woodworking easy for you



**SEE** Safer, easier  
top-side cutting



**SEE** Direct-drive power,  
no belts, no pulleys



**SEE** DeWalt's exclusive  
safety features



**SEE** Layout marks visible  
every cut, no mistakes



**SEE** Work moves straight—  
saves 75% floor space



**SEE** DeWalt becomes 12  
professional tools in 1

See for yourself why DeWalt's original radial arm design, big capacity, and unsurpassed accuracy make it the finest, most valuable all-purpose power tool you can own.

Your dealer will quickly show you how a DeWalt saves the cost of a shop full of tools — makes all home woodworking fast, easy, safe... fun! How you can make furniture, build in cabinets, finish off the attic or basement, make home repairs... do all those things you've always wanted, *even if you've never used a power tool before!*

See your Franchised DeWalt Dealer for a Free, convincing demonstration today! Easi-Budget Terms — 10% down, 2 years to pay!

Owners! Send for valuable new DeWalt Woodworking Manual, just \$3.95 pp.

Send the coupon for free booklet and name of nearest DeWalt dealer.



DeWalt Inc., Dept. PM-710, Lancaster, Pennsylvania  
Subsidiary of AMERICAN MACHINE & FOUNDRY COMPANY

- Send FREE colorful 20-page Booklet and name of dealer.  
 I enclose \$3.95 (check or m.o.) for DeWalt woodworking manual.

Name \_\_\_\_\_

Address \_\_\_\_\_

City \_\_\_\_\_ Zone \_\_\_\_\_ State \_\_\_\_\_

# NEW Mossberg C-Lect-Power scope



\$24<sup>95</sup>

Twist of fingers makes change instantly to either 2.5 or 5 power. The ideal scope for 22 caliber hunting and target use. A precision-made optical instrument. New 7-lens system with all lens surfaces hard coated to assure bright, sharp image and with Mossberg's popular internal adjustment of cross hair reticule.

### New "Tip-on" Mount

Rugged, yet simple. Mounts quickly and easily on Mossberg and all other 22 caliber rifles with grooved receivers—just "tip-on" and tighten screws.

Rifle shown is MODEL 146B... 22 cal., bolt action repeater with largest magazine capacity in the world. Holds 30 Shorts or 20 Long Rifle cartridges. \$35.95.\* One of many Mossbergs.

**FREE:** Send for catalog showing the new C-LECT-POWER scope with "Tip-on" mount. Also Mossberg's 4-power "Slide-on" scope, MODEL 4M4, with internal adjustment feature (\$10.95) and all Mossberg rifles and shotguns. There's a Mossberg dealer near you. He'll be glad to show you these fine models.

\*ST. HIGHER WEST OF ROCKIES

# Mossberg

for accuracy

O. F. MOSSBERG & SONS, Inc.  
79710 St. John St., New Haven 5, Conn.

we are glad to have enjoyed the services of a good architect. He planned so the upkeep would be kept at a minimum. The cedar shakes of the roof and second-floor siding do not have to be touched with paint or stain. They just continue to weather a silver gray, and should last as long as we do. The outside trim is treated with a dark-brown creosote stain. We will go over this ourselves every two or three years. It is much easier than painting. Specks of dirt on the trim just fall away once the creosote has soaked in. The stones and brickwork, of course, never have to be touched.

As for the interior, inexpensive handmade rugs and hand-painted secondhand furniture blend perfectly with the casual Early American decor. The pine paneling mellows to the nicks and scuffing of children at play.

Having built this way, we have grown with the house—learned to tackle a big job and see it through, no matter what the difficulties. It was hard, and there were times when we wondered why we ever started it. Much of the work is not perfect.

But it has given us a fuller meaning of the word "home." As long as we live here, the memory of the cool earth of the excavation that first hot summer, the scolding of the red squirrel as we invaded his kingdom, the golden autumn leaf swirling into our mortar, and the many people who helped us, will linger in its walls and enrich its meaning to us.

Even the discomforts of those first winters of pioneering had their purpose. For the comfort of our finished home is even more delicious in contrast. Even now, such a simple act as flicking on a light switch brings memories of filling kerosene lamps, trying to work by their flickering light and cleaning their blackened chimneys. Such a commonplace thing as a light bulb has become a great wonder to be treasured!

It is good, too, to know we will not have to move from the creek and river we love into something bigger and that the trees we planted and nursed along are now bearing fruit for us—not someone else. It is good to know that we will be here for many springs to come to enjoy the blossoms of the lilac bushes and bulbs we planted—and most of all—the home we built ourselves.

★ ★ ★

### Beans Are Booming

Soybean production in the United States has increased from 4.9 million bushels in 1925 to 455.9 million bushels in 1956, according to an official of Cargill, Inc., grain-handling and processing firm.



**FREE!** "FRIENDLY HOME IDEAS"—85 photographs, many in color, feature traditional and contemporary ideas for building, decorating and remodeling using cheerful Western Pines. Write for your FREE copy to WESTERN PINE ASSOCIATION, Dept. 210-N, Yeon Bldg., Portland 4, Oregon.

## Space to put things—work desk, too!

All in this easy-to-build Western Pines unit

It's practically a home office, all in one. And what a breeze to build!

Clean-cutting, soft-textured, carefully seasoned Western Pines make for pure pleasure in the workshop.

And nothing takes paint, stains and varnishes more beautifully than these handsome, easy-to-work, economical woods.

See your lumber dealer for an estimate.

## The Western Pines

<b>Idaho White Pine</b>	and these woods from the Western Pine mills
<b>Ponderosa Pine</b>	
<b>Sugar Pine</b>	
	WHITE FIR • INCENSE CEDAR
	RED CEDAR • DOUGLAS FIR
	ENGELMANN SPRUCE
	LOGSPOLE PINE • LARCH

are manufactured to high standards of seasoning, grading, measurement

TODAY'S WESTERN PINE TREE FARMING  
GUARANTEES LUMBER TOMORROW

*the finest*  
**FLOOR POLISHERS**  
*are*  
**Red Devil Tools.**

**Change your oil  
and filter NOW!**



**MENDS  
MOST ANYTHING**

*"HOLDS LIKE IRON"*

Used by fine furniture makers. Ideal for home and office. In ¾ oz. or 2½ oz. sizes.



**Good  
Craftsmanship  
starts with a**

## COLUMBIAN VISE



You can't really do any job well without a dependable vise. Columbian D43½

Workshop Vise is guaranteed by the world's largest

vise builder. Channel steel beam, cold-rolled steel screw, replaceable heat-treated steel jaw faces, permanent pipe jaws... many more features.

**Jaw Width . . . 3½ in.      Pipe Capacity . . . ½- 1¼ in.**  
**Jaw Opening . . . 4 in.      Weight . . . 16 lbs.**

Vises are also available with 4-inch jaws (D44) and 5-inch jaws (D45). See your Dealer.

**WRITE FOR FREE CATALOG**  
\*add \$1 west of Rockies.

**\$11.90\***  
delivered

**COLUMBIAN VISE & MFG. CO.**  
DEPT. PM43 • CLEVELAND 4, OHIO

*At Last!*

**A "TOOTHLESS" PLIER  
THAT GRIPS  
WITHOUT GOUGING**



**CHANNELLOCK**

**No. 415 Smoothjaw PLIER**

Just  
The Thing  
For Chrome  
Fixtures and  
Fittings



One of the handiest tools you'll ever use . . . the new "toothless", smooth-jaw plier that grips without gouging. Just the ticket for gripping chrome-plated fittings, plastic, wood and other smooth surfaces. Especially handy on chrome sink-fixtures and other hard-to-handle jobs. Jaws quickly adjustable to full 2" opening. Get yourself a Channellock No. 415 Smoothjaw Plier. You'll find it's "the right tool" on scores of jobs in home and shop.

**Ask Your Hardware Man For A  
CHANNELLOCK Smoothjaw PLIER**

MADE ONLY BY

**CHAMPION DEARMENT TOOL CO.  
MEADVILLE, PENNSYLVANIA**

## The PM Modern

(Continued from page 151)

studio ceilings within and the indoor-outdoor effect gained by the generous use of glass, give a feeling of spaciousness.

Let's take a look at the exterior of the house before stepping inside. The white-painted brick wall across the front is six feet high, broken only by a single glass panel and the fireplace chimney. Above the wall are fixed windows. A translucent plastic gate at one end of the wall leads into the entrance court. The house wall at the rear of the court is redwood. The low-pitched built-up roof covered with white marble chips is broken to provide sunlight for the entrance court and part of the outdoor-living area.

This outdoor-living space is one of the special delights of the PM Modern House. At one end of the partly shaded brick patio is the lounging area and at the other a swimming pool 10 by 20 feet. The pool is optional and the space it occupies may be used for shrubs or a flower garden. The fences (see plan) shown on either side of the house are also optional and probably would not be used on a big suburban lot. However, the PM Modern is designed for both suburban and urban living.

### Glamour Inside and Out

Let's open the gate and step into the entrance, or garden court. A brick-paved walk leads through the planting area to the front door. Here the visitor enters a section of the house that is between the dining-family-activity room and the formal living room. The glamorous outdoor-living area can be seen directly ahead through the sliding glass doors.

The combined areas of the dining-family-activity room and the living-sitting room occupy a space 15 by 31½ feet. An accordion-type partition sliding on overhead tracks can be used to separate the dining-family section (16 by 12) from the more formal living area, depending on the family mood. Sliding glass doors turn the dining space into a dining lanai if the weather permits.

The core of the kitchen is an ingeniously planned breakfast bar. Cooking elements and a built-in oven are installed on the side nearest the L-shaped workcounter. When the island bar is not used for breakfast or snacks it becomes a convenient service counter. The sink is placed on the L-shaped counter below a window overlooking the entrance court.

"The circulation of the entire house is planned around the kitchen," says Ridley,

(Continued to page 266)

# New Black & Decker $\frac{3}{4}$ HP <sup>Heavy Duty</sup> Router

## ...the complete woodworking tool!

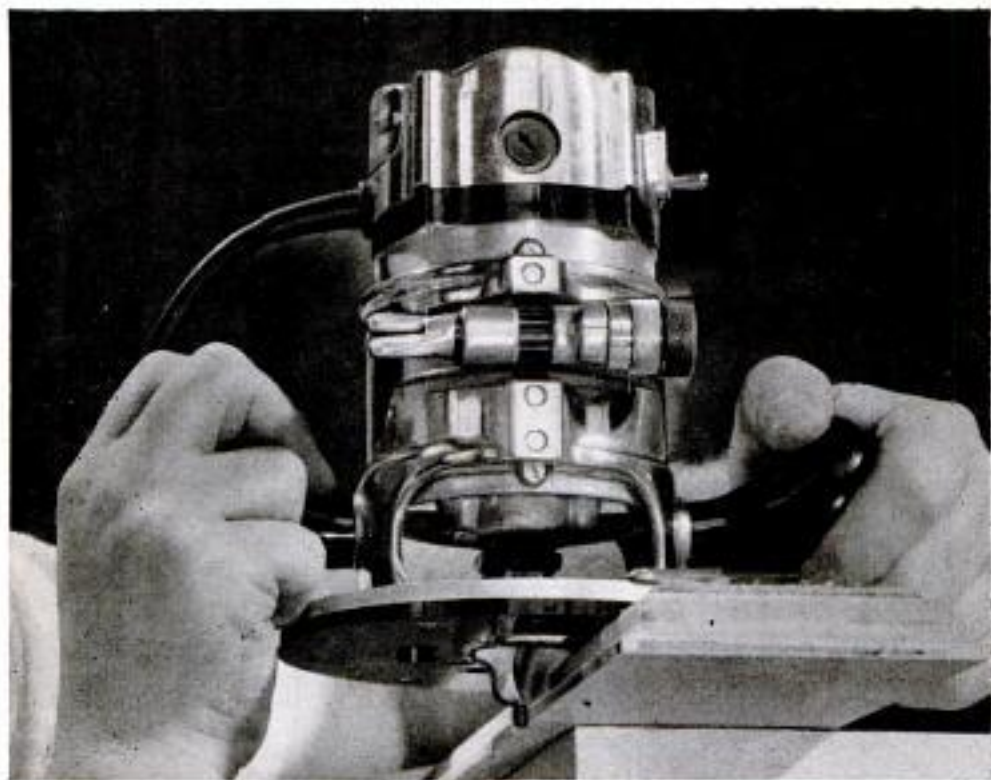

### Easy to use, gives professional results!

If you've thought of a Router as a one-job tool, then look at the pictures on the right. The versatile Black & Decker Router handles dozens of cuts—beading, grooving, routing, fluting, inlay work. Ideal for building furniture, cabinets, hanging doors, shutters, weatherstripping, etc.

Light and compact, this new B&D Router has extra power to do every job in a jiffy. Special features for easier handling, accurate adjustment and fast bit changing. Only **\$59<sup>50</sup>**

Compare the power—compare the price!



**B&D ROUTER KIT** gives you Router, six popular cutters, Straight and Circular Guide in handy metal kit for only \$88.00—save \$5.75

**WRITE TODAY** for new B&D Router Manual—loaded with illustrations, project ideas, professional tips. Send only 50c with name and address to: The Black & Decker Mfg. Co., Dept. M107, Towson 4, Md. (In Canada: P. O. Box 278, Brockville, Ont.)



Find Your B&D Dealer in the "Yellow Pages"

Look under "Tools-Electric"



# Black & Decker®

World's Largest Maker of Electric Tools



Template routing



Mortise & tenon joints



Molding cuts



Dovetail joints



Dado cuts



Inlay work

# Looking for Something?



## TRAVEL BUREAUS

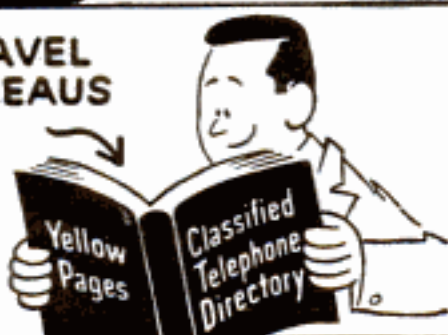

**FROM FUR BUSINESS  
TO TRAVEL BUREAUS**  
*whatever you need-*

Find It Fast  
In The  
**Yellow Pages**



Ads with this emblem make your shopping easier

"but the traffic patterns go around the work area, not through it. The placement of the kitchen saves steps as the family goes to the activity areas, the utility court off the kitchen, lavatory, the basement workshop and the three bedrooms and bath."

The bedrooms and bath are in a section of the house that is raised three steps, making the home a split level which is not apparent from the outside. This arrangement gives added privacy and quiet to the bedrooms and at the same time provides for a much lighter basement. The two rear bedrooms are divided by ceiling-high cabinets that may be shifted to meet changing family needs.

The family laundry may be housed either in the basement or (in the form of a combination washer-drier) in the lavatory near the kitchen. The heating system is warm-air, perimeter-type with closely spaced floor registers below the glass areas to provide a warm-air curtain which absorbs both cold and condensation. Provision is made for optional air conditioning. Ample storage space is provided in the basement.

### Place for Sunny Workshop

The basement space under the raised bedroom area, planned for a big workshop, is exceptionally sunny with windows on three sides. It would be possible to put two bedrooms here and an extra bathroom—making the house a five-bedroom, 2½-bath home.

The house construction is basically simple, a rectangle with a row of supports down the center supporting regularly spaced roof beams which extend to cover outer areas such as the outdoor-living section and the garage. This home can be built with a carport instead of a garage, at some saving of money. Ridley favors the carport which he says "enhances the pleasing appearance by eliminating the garage door and side wall."

"The PM Modern is my idea of an all-out contemporary (modified modern) house," says Ridley. "It is not a case of modern ideas worked into a traditional shell. The contemporary look of this house is the result of 'doing what comes naturally' all the way through. This requires the kind of planning that suits our modern way of living. We place things exactly where we want them, such as glass areas. In a traditional house you are restricted by a style derived from the days when glass could be made only in small panes. Today's wide range of construction methods allows us to do new and original things that provide more enjoyment, warmth and beauty in our daily living." ★★★



# let fast, easy Strypeeze remove paint!

- Stays wet—stays put
- Removes all finishes
- Harmless to hands or wood
- Cuts every layer



Get right down to bare wood fast with the *guaranteed* paint remover—Strypeeze—the fastest selling paint remover in America.

Available at paint and hardware stores everywhere



**Kwikkeeze** cleans all brushes fast! Even the hardest brush softens in a jiffy with KWIKKEEZE. No rinsing, no mess. Perfect for all bristles.

## SAVOGRAN

Dept. 1004, 25 Huntington Ave., Boston, Mass.

Please send me new illustrated booklet, "How to Remove and Restore All Finishes". Enclosed find 25¢.

Name \_\_\_\_\_

Address \_\_\_\_\_

# POWERFUL!

Man, here's *light!* 1/4-mile beam — 15,000 beam candle power. Compact, easy to carry, built to last! Uses two 6-volt batteries. See your dealer.

DELTA ELECTRIC CO., Marion, Ind.

**\$7.25**

less battery.



## Delta POWER-KING ELECTRIC LANTERN

## SAVE MONEY ON YOUR COMPRESSED AIR

buy this complete SMITH 45-P air compressor

Right for spray painters, plumbers, contractors, monument shops, tire changing trucks, maintenance shops, quarries, utilities many other users. Delivers 45 plus cu. ft. per minute; pressure up to 150 PSI. Powered by Wisconsin 4-cyl. air-cooled engine, uses less than 1 gal. gasoline an hour! Most compact, biggest-value compressor for its capacity anywhere! Other models to 230 cfm.



write for  
**FREE**  
brochure

**GORDON SMITH & COMPANY, Inc.**

411 College Street, Bowling Green, Ky.

OCTOBER 1957



**Prize  
Reproduction  
or General  
Repairs . . .  
Make it Last—  
with  
Southern  
Screws**

For a job that holds up, and looks professional, use Southern Screws. They speed you on your job, because they are precision made from finest metals to start fast and hold tight.

Ask for them at your local dealer, in flat, round or oval heads, Phillips or slotted; steel, brass, silicon bronze, aluminum, stainless steel, and plated finishes.

Write Southern Screw Company, Box 1360-PM107 Statesville, N. C., for free reprint "How They Make 10 Million Wood Screws a Day."

- Wood Screws • Machine Screws & Nuts •
- Tapping Screws • Dowel Screws • Drive Screws •
- Stave Bolts • Carriage Bolts • Hanger Bolts

### Warehouses:

- NEW YORK
- CHICAGO
- DALLAS
- LOS ANGELES



Sold through leading Hardware and Building Supply Dealers

for the look  
of craftsmanship...



## FOAMFLEX<sup>®</sup>

### DOOR WEATHERSTRIP

seals cold out...  
seals heat in

- Installs in 10 minutes with saw and hammer.
- Exclusive closed-cell vinyl foam permanently bonded to beveled molding strips.
- Molds to warped or uneven surfaces; even installs over old weatherstripping.
- Silences closing doors.
- Makes air conditioning more efficient.
- Never absorbs moisture.
- Can be painted without hardening.
- Stays flexible at 50 degrees below zero.
- Comes in pre-cut lengths for your convenience! Two 7' lengths and one 3' length of  $\frac{1}{4}$ " x  $\frac{3}{4}$ " clear beveled wood molding. Nails included.

Patent Pending



More than enough to  
weatherstrip average door! Only \$2.29!

Get FOAMFLEX Door Weatherstrip at hardware and building supply stores... or write for further information.

**JW Mortell**  
COMPANY  
KANKAKEE, ILL.

## The PM Traditional

(Continued from page 151)

brow. "We occasionally do a traditional job. Do you have in mind something of about three bedrooms, a medium-sized home, bath and a half, something in the way of modified Cape Cod with maybe the flavor of a prairie farmhouse?"

Mulloy spoke up. "Possibly a barn-red paint job?"

"With white shutters and trim," added Perkins.

Norris produced a pencil and Perkins spread a big white sheet of paper on the low table before the davenport. Three heads bowed over the paper as it shifted from partner to partner. There were mumbled remarks:

"Got to have a shelter over the door... what's wrong with a family room in a traditional house?... and air conditioning?... No, let's make it L-shaped... just the place for a patio for the outdoor-living angle... cedar shakes of course, got to have cedar shakes..."

"We don't at all mind doing a traditional house," said Perkins, "as long as it is functional within and takes into consideration the way a modern family lives."

The PM Traditional—designed to be set on a minimum 60-foot lot—has 1850 square feet of living area on its two floors, 980 on the first floor and 870 on the second. The garage occupies 361 square feet of space. Located on the first floor are the kitchen, family-TV-dining and all-purpose room, the parlor and a lavatory. The parlor with its nine-foot beamed ceiling is located in the forward-projecting section of the house. This attractive room has a red-brick fireplace and five windows. The wall at the fireplace end of the room is wood paneling painted white. The other three are papered. This room, as a glance at the floor plan will show, is located well off the beaten path of family traffic and is also ideal for late entertaining because there are no bedrooms above it.

Back of the living room is the family and general-activity room. Alongside the wall nearest the kitchen is a gate-leg table which can be opened for dining. This room, too, has a fireplace but it is much more informal than the one in the parlor. It has a metal hood and barbecue grill which add to the relaxed atmosphere of the room. Beside the fireplace is a storage closet for folding tables, games and other paraphernalia. Sliding glass doors at the far end of the room open onto the patio. The decorators at Marshall Field and Company's Home Planning Bureau were entranced with this

room and planned a dozen ways to outfit it. (Their final result is shown in the color illustrations.)

The family room opens into the kitchen, which is 14 feet 4 inches by 11 feet. This room provides the usual facilities plus eating space in one corner and a planning desk. There is plenty of counter and cabinet space and two cheerful windows over the sink. An interesting up-to-date touch is the wickerwork on the cabinet doors. A door on the garage side of the kitchen leads to a small hall which affords access to the first-floor lavatory, the garage, steps to the full basement and the secondary front door. This house actually has the luxury of two front doors, one for family traffic and one for company. The architects have placed a convenient milk box beside the "family" door. Another handy feature is a large closet in the back hall. Stairs in this hall lead to the basement which also has an outside entrance, specially designed for lugging cumbersome objects in and out of the workshop.

#### Kitchen Is "Nerve Center"

Perkins points out that the kitchen in this house is set into the traffic pattern as the "nerve center" of the home. This room has easy access to all the vital activity areas. In the family room, just around the corner from the kitchen are the stairs that lead up to the three bedrooms, bath and storage areas on the second floor. There are eight closets on this floor alone (all with louvered doors) including the twin closets in two of the bedrooms, a single closet in the middle bedroom, and closets for toy, linen and utility storage.

An unusual feature of this floor is that the laundry is housed in the bathroom in the form of a washer and drier.

"Anybody who has a large family knows that a second-floor laundry makes sense," says Perkins. "We have also provided laundry space in the basement."

An especially pleasing aspect of the second floor is the lighting of the stair well and upper hall from a strip of diamond-paned windows set in a dormer which also adds a decorative touch to the front of the home. The cedar-shake shingles, barn-red paint and white shutters, the sheltered entrance and big brick chimney give this house an air of hospitality and warmth.

The construction of the house is conventional with poured-concrete foundation, beveled-wood siding, full insulation in side walls and attic space. The flooring throughout the house is hardwood with the exception of the family room, kitchen, bath and lavatory floors which are of attractive asphalt tile. ★ ★ ★

for the look  
of craftsmanship ...



**WEATHERSTRIP**  
with your fingertip

and **Mortite**

**seal cold out!**

**seal heat in!**

- No tacks, no tools—simply press into place
- Applied inside or outside
- Soft ropelike strands unroll like a ribbon
- Adheres to any clean, dry surface
- Never cracks, chips or peels
- Can be painted over

MORTITE HAS HUNDREDS OF USES AROUND THE HOME, FARM, SHOP, COTTAGE!

*Use as crack filler, sealer, gasket caulker and plugger-upper!*



**BARGAIN BOX** Only \$1.25! Enough Mortite to seal 5 or 6 windows.

**ECONOMY BOX** Only 98¢! Enough for 4 windows.

**JUNIOR BOX** Only 29¢! Covers about 16 ft. enough for 1 window.

*At hardware and home supply stores!  
For more information, write*

**JW Mortell**  
COMPANY  
KANKAKEE, ILL.

*For peak  
performance with dependability!*

# MERCURY'S THE

NEW ENGINES WITH MORE WORKHORSE POWER... MORE SAFETY FEATURES... MORE MODELS TO CHOOSE FROM... NEW IN PERFORMANCE... NEW IN DISPLACEMENT... NEW IN FUEL ECONOMY... NEW IN STYLING... NEW IN COLOR... PLUS AN IMPRESSIVE ARRAY OF NEW MERCURY FIRSTS! MODERN IN EVERY WAY!

MERCURY'S ON THE MOVE. Compare and you'll choose Mercury... for every boating pleasure. Mercury has built more fours and sixes than *all* outboard manufacturers combined. Building thousands of V-fours for the air force plus years of designing and testing square fours, opposed fours, radial engines, big bore twins, V-twins and 3-cylinder engines have *proved* that only Kiekhaefer in-line design delivers the most, and in 1958 even more, horsepower per pound, horsepower per cubic inch, horsepower per dollar and more miles per gallon. Mercury owners know, and scores of endurance records prove, that nothing *outruns* a Mercury, nothing *outlasts* a Mercury. *Dependability with a punch... in twins, fours and sixes.* As in 1957—the biggest news for '58 will come from Mercury!

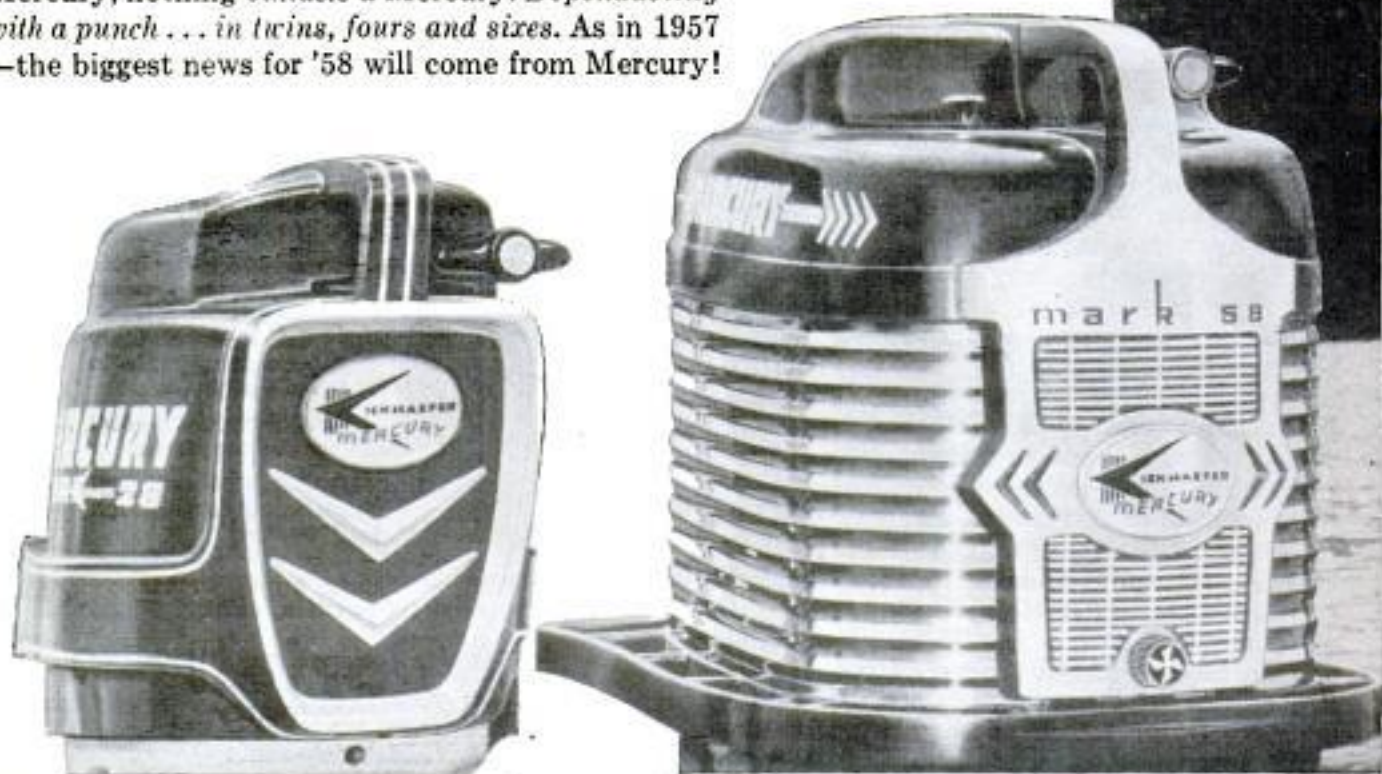

Way ahead in **1958**

# GREATEST

## 4 Great New Outboards

### NEW MARK 78

Most powerful production outboard, 6-in-line, 66 cu. in. displacement.

### NEW MARK 58

A new high in 4-cylinder performance, 44 cu. in. displacement.

### NEW MARK 28

Power Pack Twin, 22 cu. in. displacement.

### MARK 10 *Trol-Twin*,

the new slant in outboards.

And for '58... proved and improved, the Mark 6, Mark 25, Mark 30, Mark 55 and the Mark 75.

Whatever your boating need, Mercury's got it. Choose from 9 basic models—6 to 60-plus work-horse power. For full particulars, see your dealer now. Watch for more Mercury firsts! Write for FREE illustrated catalog.

© 1957 Kiekhafer Corporation, Fond du Lac, Wisconsin

Own Your Mercury Now for as Little as 10% Down—Up to 24 Months to Pay!

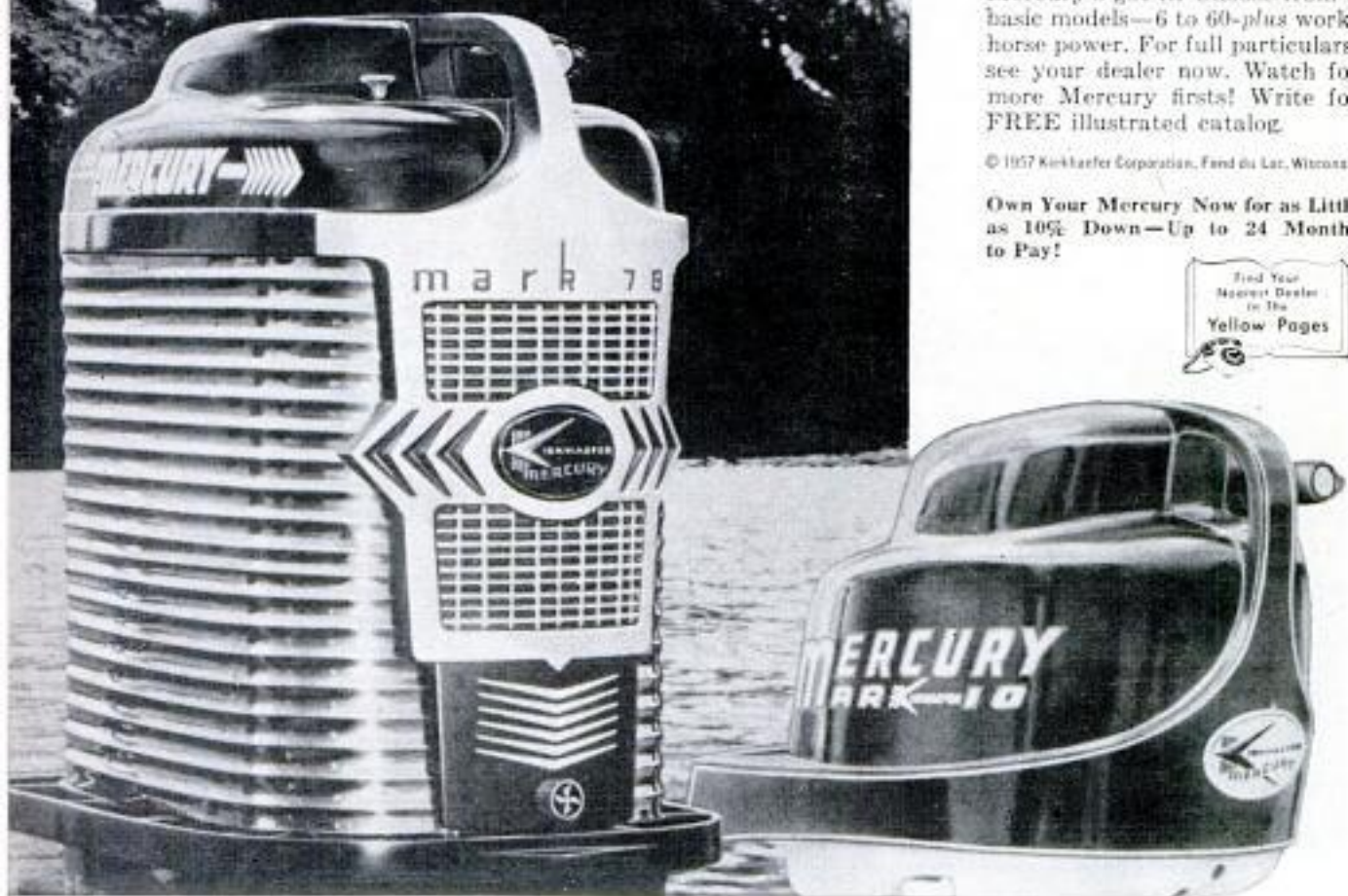



## particular drivers, particularly, need Ajustomatic Shock Absorbers

More and more owners of late-model, high-performance automobiles are demanding what only Gabriel Ajustomatic shock absorbers offer: • Freedom to choose soft, normal or firm ride—to suit your driving habits • A new experience in superior stability, control and roadability.

Gabriel Ajustomatics are standard (export) or optional (domestic) on *nine* different makes of U. S. cars in 1957. Thousands of late-model sports cars, station wagons and other automobiles in use today attest their value. If you are dissatisfied with the conventional controls supplied on your present car, switch over.



AJUSTOMATIC SHOCK ABSORBERS

## Owners' Opinions of British Ford

(Continued from page 133)

"Driver's seat not long enough from front to back to make a six-foot driver's legs comfortable."—California teacher.

"Seat should be redesigned so you sit in it, not on it."—California circulation manager.

### *Gas mileage not as advertised, say 8.3%*

"I get 30 miles per gallon on trips. I don't get the 40 miles per gallon I was told I would."—California apprentice.

### *Starter motor jams, say 7.5%*

"Starter should be improved. It jams too often."—District of Columbia economist.

### *Needs a four-speed transmission, say 7.2%*

"Could use a fourth gear for better mileage at high speed. Mileage drops to 25 miles per gallon at 70 miles per hour."—California minister.

"Gear ratios awkwardly spaced. Large flat space between second and third."—California tool designer.

### *Bothersome body rattles, say 6.4%*

"Rattles badly on bumpy roads and cobblestones."—New Jersey engineer.

### *Hard ride, say 6.0%*

"When you ride over expansion joints it feels the same as riding in a truck."—New York wire lather.

### *Shifting not easy, say 5.3%*

"Half the time it sticks in low and you hit reverse jamming it out on the way to second."—Florida teacher.

### *Parts are scarce, expensive, say 5.3%*

"Dealer does not carry sufficient stock of parts."—Texas Army officer.

"The largest Ford service in Memphis, Tenn., was not able to replace a broken carburetor cover and said there would be a seven-day wait for a new carburetor from Detroit. Also I have been waiting two months for new body parts to come from England."—New York teacher.

"Dealer does not yet have his own repair shop. This should not be allowed."—Oregon state employee.

"Must take it to foreign-car service station since it is too narrow for conventional ramp and I don't like their prices for servicing and parts."—Florida nurse.

### *Wipers give trouble, say 5.3%*

"Windshield wipers are no good if you accelerate or are pulling up a grade."—California plant operator.

(Continued to page 274)

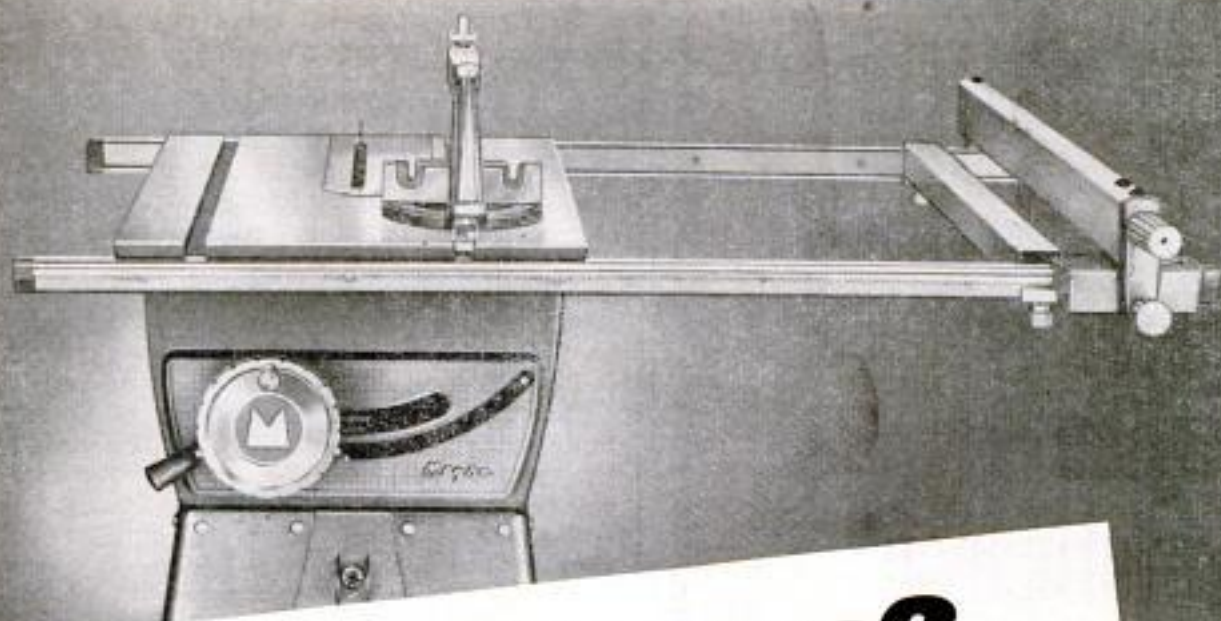

# Why Magna?

—Because MAGNA's new, complete family of superior power tools incorporates the first significant design contributions in over a quarter-century!

Here's why the MAGNA 9-IN. TILT ARBOR SAW tops them all: • *Increased Capacity*—exclusive "Helping Hand", a built-in table extension permitting rip cuts up to 26", 125% more effective table area! • *New Ease of Operation*—one-knob control for blade height and tilt, exclusive Speed-Gear (45° tilt in only 10 turns, no roll-back!) • *Integral Precision*—self-aligning fence locks down front and rear with one knob! • *Rugged Durability*—solid-cast tub front with self-contained trunnion; massive cast-iron carriage! Basic Saw only \$119.95, delivered! (MAGNA 8" T/A Saw only \$66.88.) Mail coupon today for free Magna-Line catalog!

Own the Magna 9-in. Saw for as little as \$1.26 a week!



MAGNA-LINE tools for home and industry include (l to r): 9" Saw-Jointer, 11" Band Saw, 18" Jigsaw, 4" Jointer, 6" Belt Sander, Compressor-Sprayer, 30" Lathe, 12 1/2" Drill Press. (Also the new MAGNA Thrifty-Three: 8" T/A Saw, 12 1/2" Jigsaw, 4" Belt Sander.)



MAGNA POWER TOOL CORPORATION  
World's largest independent  
producers of power tools

® T. M. REG.

Dept. 701-M, MAGNA POWER TOOL CORPORATION  
Menlo Park, Calif., OR Box 2808, Fort Wayne, Ind.  
Please send me your free, illustrated MAGNA-LINE catalog:

Name \_\_\_\_\_  
Address \_\_\_\_\_  
City \_\_\_\_\_ Zone \_\_\_\_\_ State \_\_\_\_\_

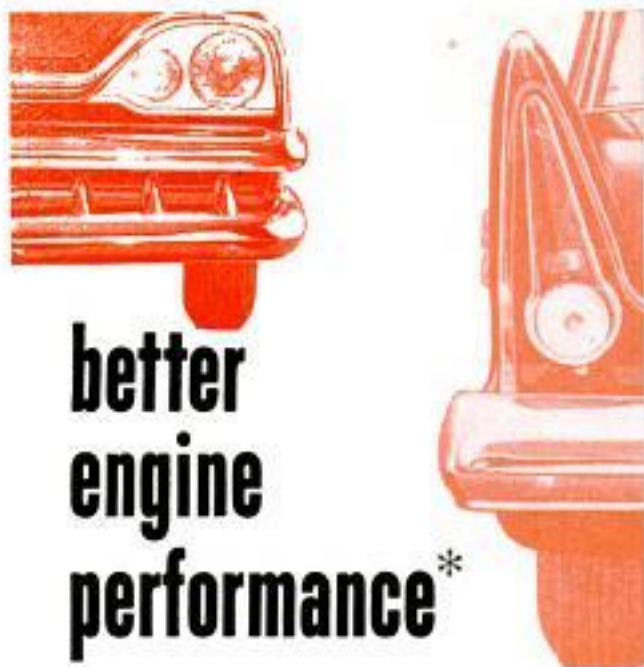

**better  
engine  
performance\***

**starts with a**

**"full power"**

**WILLARD  
BATTERY**



**\*Faster starting, with a Willard Battery, saves wear on valves, rings and other vital engine parts . . . cuts gasoline and maintenance costs, too! For extra dependability, insist on a full-power Willard!**

**Starts hard when cold, say 5.3%**

"Difficult to start, especially in cold weather."—New York teacher.

#### **Will Sales Climb?**

We asked the owners of the British Ford if they felt sales of foreign cars would increase in this country in the next 10 years. Overwhelmingly, they say sales will increase. Only 3.4 percent feel that sales will not increase and many of these base their answers on what they feel is the certainty that American manufacturers would bring out small competitive cars.

Does owning a foreign-made car have any important disadvantages? We asked the owners that question and 67.0 percent say it does not, 26.8 percent say it does.

We asked them what one suggestion they would make to the American automobile industry in the light of their experience with the British Ford. Nearly half of them (44.5 percent) say Detroit should make cars smaller. Others (20.0 percent) say horsepower should be lowered and 19.6 percent say they should reduce the glamour, chrome or ostentation of the cars.

Surprisingly enough, costs of operating and buying cars rank only fourth and fifth with 18.1 percent asking for greater gas mileage and 9.8 percent suggesting a lower price for American cars.

Here are some quotations to illustrate the owners' suggestions:

"Reduce the size of the American car."  
—Connecticut technical writer.

"Produce a small, maneuverable, economical, easily serviced four-passenger car for city driving." — Virginia government worker.

"Stop the trend toward higher horsepower." — California border patrolman.

"Forget the crazy horsepower acceleration contest."—California teacher.

"Stop building big toys for overgrown little boys."—District of Columbia musician.

"Start all over with cars the size of the 1920 models. No gadgets." — Vermont lawyer.

"The American public, with its native good sense, will eventually reject the phony scheme Detroit has foisted upon them, based on initial price, annual restyling and high depreciation. I have purchased my last American car unless the present trend is reversed."—Texas engineer.

There you have the summary. The good and the bad, the reasons why and why not. For expert opinion of the way the British Ford performs turn to page 134 where Engineer Dale Kelly reports on his tests and page 135 where veteran driver Floyd Clymer gives his driving impressions.



*Now you can get the motor used to power millions of America's most popular appliances...*

**EMERSON ELECTRIC**

**multi  
duti  
MOTORS**



For 67 years Emerson-Electric motors have been the first choice of leading appliance manufacturers. Now, Emerson-Electric is offering you these famous motors, engineered with you in mind. Twenty-one different designs from 1/4 to 1 H.P. Get yours today, or write for Free Catalog No. M-125. The Emerson Electric Mfg. Co., St. Louis 21, Mo.

**EMERSON-ELECTRIC**



*For Your Home, Shop or Commercial Use*

of St. Louis... Since 1890

**Jiffy SAWHORSE BRACKETS**

NO NAILS NO SCREWS NO BOLTS

Now a sawhorse in a jiffy! Just use Jiffy Brackets and 2x4s. Sold by hdw. and bldg. supply stores everywhere, or order direct. \$1.95 A pair. *Higher W. Coast*

GRAND HAVEN STAMPED PRODUCTS CO.  
Grand Haven, Mich.



**"THINGS TO MAKE ON TOOLS YOU OWN"**

NEW DELTA hard bound book illustrates and clearly describes a wide selection of useful projects designed to be built on each of the basic tools you own—only \$1.00. Send for FREE folder on complete Delta Library; Delta Power Tool Div., Rockwell Mfg. Co., 502K N. Lexington Ave., Pittsburgh 8, Pa.

**Automatic Saw Set...**

**MAKE EXTRA PROFITS!**

Set 400 teeth per minute on hand or band saws, 4 to 16 point, with the BeMaCo Automatic Saw Set. Fast, accurate, true hammer-anvil action sets teeth uniformly, eliminates tooth breakage. Used profitably by saw shops and manufacturers everywhere. Every machine positively guaranteed!

Write for details—today!



**BEAVER MFG. CO.**

PO Box 434

800 1515 AVENUE • INGLEWOOD, CALIF.

Saw  
Machine  
Division  
30-C

Hanging  
a door  
is simple...



with  
**McKINNEY  
Non-Mortise  
Hinges**

Install directly on door and jamb. No chiseling or cutting required. A screwdriver is all you need to do a professional job. Made of heavy gauge steel... choice of fine finishes. Send for illustrated literature.

McKinney Manufacturing Company  
1715 Liverpool Street, Pittsburgh 33, Pa.

Please send Non-Mortise Hinge literature to:

Name \_\_\_\_\_

Address \_\_\_\_\_

City \_\_\_\_\_ Zone \_\_\_\_\_ State \_\_\_\_\_

OCTOBER 1957

275

Copyrighted material

Don't call  
a doctor...



This rule has loose joints . . . they're weak and worn. It's ready to fold up forever. Don't call a doctor. Get a new one. This time, be precise . . . say Stanley, it's a good rule.



Take this new Stanley "100 PLUS" No. X226 6 ft. Extension Rule for example. No comparable rule lasts longer. It never gets "rule arthritis." Its joints have been permanently lubricated. They're young and springy. They can take it. The black, deep-cut markings with their protective plastic finish wear four times longer than those on thin-skinned rules that may suffer from "tired ink." Buy No. X226, and make a note of how long it measures up for you. You'll agree that Stanley Rules are your best buy.

Have you seen the new Stanley Glide - O - Matic? This smooth acting tape rule locks blade in place, marks work with metal scribes and retracts automatically. The best in tape rules. 8, 10 and 12 ft. lengths. Try one yourself and see.

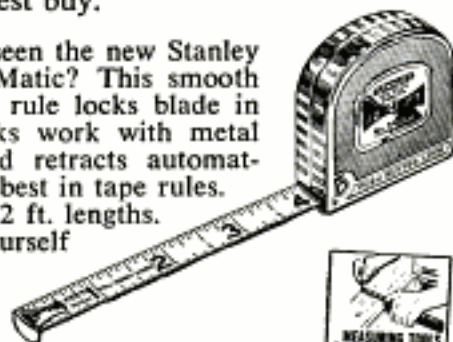

For free booklet "Measuring Tools and How To Use Them" write Stanley Tools, Division of The Stanley Works, 620 Elm Street, New Britain, Conn.



# STANLEY

The Tool Box of the World

## The House That Stores the Sun

(Continued from page 161)

via metal fins—like an automobile radiator in reverse. In the unit, whirring fans push the warmed air through ducts into various rooms of the house, while the water goes back to the collector to be heated again. A heating coil in the big tank supplies domestic hot water.

"The earlier house," Pelletier reveals, "had to have storage water at 110 degrees before its radiant-heating panels were effective. The Lexington system can squeeze heat from stored water that is only heated to 95 degrees, which makes it far more efficient in a cold climate."

What happens in summer, when broiling sun beats down on the glass? "Since the water is at atmospheric pressure in the system it can't get over 212 degrees," says Pelletier. "The collector is used chiefly for heating domestic water. The rest of the heat is dissipated to the outdoors through the collector."

What about bleak stretches of gray weather in New England's winter? "If the cloudy period were preceded by sunny days—not too cold—the storage system could carry over a maximum three-day period," Pelletier observes. "You'll always get some help from the solar system even when most heat is being supplied by the auxiliary furnace. The system is designed to collect the maximum feasible amount of energy from the same sun that shines on every house and use that energy to the maximum."

### Draperies Prevent Heat Loss

The sun alone, however, will provide some 80 to 85 percent of all heating requirements of the house. What about the rest? Down in the cellar, a small automatic oil furnace kicks in whenever the sun isn't doing its job well enough. This little furnace can throw enough heat to supply all the needs of the house during long, overcast periods—warming water in an auxiliary 275-gallon tank to do the job. The domestic hot-water system is also connected with this smaller tank. A motor-operated valve makes the change-over when the house thermostat senses that the water in the big tank is getting too cool.

Except for the change-over from winter to summer operation, and vice versa, the entire system is automatic. All the solar-house owner needs to worry about is to close the tight-fitting draperies on his windows each night to cut heat loss. These are the only visible interior items in a solar home that differ from any conventional

(Continued to page 278)

POPULAR MECHANICS

## "TINY ATOM" ELECTRIC MOTORS for HOBBY—RESEARCH—INDUSTRY

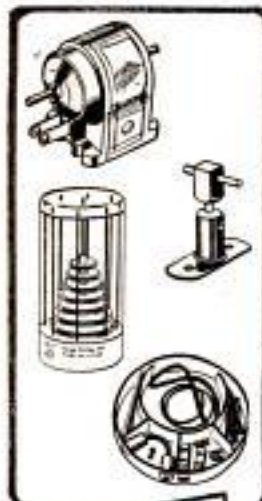

Order your choice of four miniature battery-operated motors—one for every use—from 1½ to 12 volts—and today's BIGGEST VALUES IN THE HOBBY FIELD. These motors, with the accessories in kits listed below, provide all types of drives for hobby items, toys, research and industrial devices. Make wonderful gifts.

- No. 8-100 Hi-Drive Motor, 3-6V. . . . . \$2.50
- No. 9-100 Same for 12V. . . . . \$3.00
- \*No. 3-100 Tiny Atom Motor, 1½-3V. . . . . \$2.00
- For higher voltage. . . . . \$2.50
- No. 3113N Tiny Atom motor assembly kit with many acc. . . . . \$3.50
- \*No. 26 Couplings kit. . . . . \$1.50
- No. 12 Solid shaft supports kit \$2.50
- \*No. 14 Adjustable shaft supports kit. . . . . \$3.00
- \*No. 77 Set of 7 large pulleys, 6 shafts and 3 belts. . . . . \$3.00
- No. 3700 Large accessories kit. . . . . \$3.00
- No. 3000 Vari-speed gear unit. . . . . \$4.00
- No. 1049 Gear train with Hi-Drive motor No. 8-100. . . . . \$5.95
- Same with No. 9-100 Motor. . . . . \$6.45

\* Item Illustrated. Ask for FREE Cat. All Wilson's motors have Permanent Alnico Magnets.

Remit with order and we pay postage in U.S.A. No C.O.D. Add 3% Sales Tax for delivery in Ohio. Write Dept. PM.

For quick delivery see your local dealer — or order direct



**WILSON'S OF CLEVELAND**

425 Lakeside Ave., N.W. • Cleveland 13, Ohio

## HOME REPAIR TIP No. 28



**WRAP SPLINTERED HANDLES** of tools or implements with tough, waterproof "SCOTCH" 33 Plastic Tape. Thin, stretchy plastic tape sticks tightly and makes a smooth, sliver-free grip.

Good for electrical repairs, mending rainwear, too. 39¢, 75¢ sizes at stores everywhere. © 1957, Minnesota Mining & Mfg. Co., St. Paul 6, Minn.



**GOLF CARS**  
Also ideal for Airports, Estates, Factories, etc. Write for literature.

## ESHELMAN TRACTORS

LOW AS \$99

Plows-Cultivates-Saws  
Dozer-Narrows-Rolls  
Hauls-Snow Plow  
Eshelman Tractors, Tillers, Riding Rotary Mowers for Better Lawns and Gardens. Advertised in Eshelman HOUSEKEEPING. Thousands of satisfied users. Write for Free Literature. Dept. 267, ESHELMAN, Balto. 2, Md. 5549.75

Shipping Points: BALTIMORE - OHIO - CINCINNATI - KANSAS CITY - ST. LOUIS



## KING MIDGET

ALL NEW. First model change in six years. New bodies, new chassis, new engine. Four wheel hydraulic brakes. Still World's Lowest Priced Car. Drive it for 75c per week. Rider Agents Wanted. Earn your own car. Get the facts. Send 25c for 32 page picture book with complete details, dealers price, etc. **MIDGET MOTORS CORPORATION, Athens 1, Ohio**

# Earn BIG MONEY Arc WELDING

**"Build Your Own"**

**SAVE \$200 to \$300** with this generator for building your own portable welder

For very low cost you can immediately get into the highly profitable welding business. With Hobart's "Build Your Own" unit, you can have a highly efficient welding machine by simply connecting a Hobart generator to a good used auto engine.



### "HUSKY BOY" 200 amp.

Welds anywhere. Easily mounts on truck or trailer for getting to those profitable emergency repair jobs. Light, rugged, compact and air-cooled. Fine for fabrication purposes and tough enough for continuous operation on light or medium production work.

### AC WELDER-AC POWER

200 amp. combination that you can connect to your own power source. Lets you operate where no power lines are available. Furnishes current for welding and power for running tools, lights, etc. Build your own combination welder and power unit with a good used auto engine.



### UTILITY AC WELDER

Superior performance, economical operation and general serviceability make this a popular model for small shops, implement shops, auto service shops, plumbing and heating contractors, farm welding, etc. Has the same features of the big industrial models.



Welding Lessons. 200 pages fully illustrated, with charts and diagrams. Self teaching. **\$100**

**HOBART BROS. CO., BOX M-107, TROY, OHIO**  
Phone FE 2-1223

HOBART BROTHERS CO., BOX M-107, TROY, OHIO

Without obligation, send complete information on:

- 1. Build Your Own.
- 2. Husky Boy
- 3. AC Welder/AC Power
- 4. Utility AC Welder
- Send Welding Lessons Book, enclose \$1.00.

Name \_\_\_\_\_

Address \_\_\_\_\_

City \_\_\_\_\_ State \_\_\_\_\_

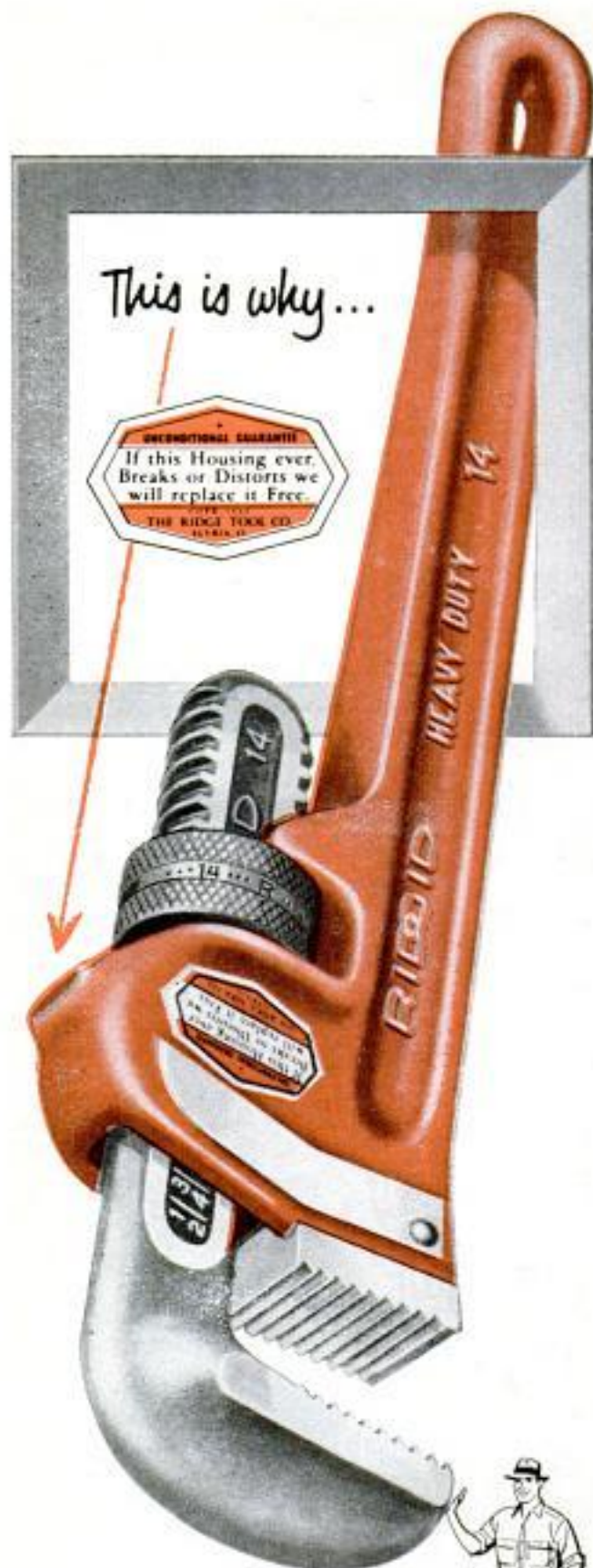

... the world's most popular pipe wrench is the best one in your tool kit. At your nearest Hardware Store.

home interior. "When spring arrives," explains Pelletier, "the solar-house owner simply flips a switch and turns a few valves. The switch shuts off the auxiliary furnace. The valves disconnect the big tank from the solar collector and switch the flow pattern. Sun-heated water then flows through the small tank where it provides domestic hot water only. In the big tank, a small refrigeration unit takes over, chilling the water to 45 degrees. The fans in the heat exchanger can now blow cool air through the house ducts, providing air conditioning, if desired.

#### Location Is Limited

The solar-house dweller has several options. He can keep his home cool or not cool in summer by flicking a switch control on the refrigeration unit. On cool days in early or late summer, he can cut in the auxiliary furnace to warm things up.

Building the house in Lexington wasn't easy. "You approach a project like this," says Pelletier, "with the researcher's maxim in mind: 'If anything can possibly go wrong—it will.'"

"First you must find a lot with proper exposures. Some developers were reluctant to sell us land for fear our building might affect other sales. Then, designing a solar house within a tight framework is tough. You'll have one blind, windowless side with an arbitrary slope where the collector goes. Location of rooms and windows is limited by the constant consideration of heat loss versus necessity for lightness and airiness."

The design chosen for the Lexington house combines the largest-possible living area with the smallest-possible collector area. By setting the building in a ditch and banking the side walls with earth to second-floor level, engineers were able to cut heat loss considerably. "A fact often overlooked," Pelletier points out, "is that a solar-house builder must go easy on big southern windows. On sunny winter days too much south window can make the house so hot you have to ventilate it, and heat is wasted."

#### Other Solar Homes

Great care must be taken in designing collector panels. Since they form part of the roof structure, they must be raintight. They must also be impervious to dust. One of the old solar houses at M.I.T. had panels that allowed dust and vapor to enter. So much "smog" accumulated that the glass fogged and heat transmission was cut back noticeably. The collector on the Lexington house was designed to be dustproof and slopes so sharply that it is self-cleaning. As a result, windows are mostly odd-shaped

(Continued to page 280)

# Tense, Nervous Headaches Need This Relief

A survey shows 3 out of 4 doctors recommend the famous ingredients of Anacin to relieve pain. Here's why Anacin® gives better *total* effect in pain relief than aspirin or any buffered aspirin:

- ➔ **ACTS INSTANTLY:** Anacin goes to work instantly. Brings fast relief to source of your pain.
- ➔ **MORE EFFECTIVE:** Anacin is like a doctor's prescription. That is, Anacin contains not one, but a combination of medically proven ingredients.
- ➔ **SAFER:** Anacin simply can not upset your stomach.
- ➔ **LESSENS TENSION:** Anacin also reduces nervous tension, leaves you relaxed, feeling fine after pain goes. Buy Anacin Tablets today!



Works in seconds!  
**Loosens Rusted Bolts**  
 nuts, screws, "frozen" parts!

## LIQUID WRENCH®

The super-penetrating rust solvent that quickly loosens rust and corrosion.

AT HARDWARE STORES, GARAGES  
 SERVICE STATIONS, EVERYWHERE  
**RADIATOR SPECIALTY CO.**  
 Charlotte, N. C.

## NEW 1957 CATALOG 200 MODELS—SAVE 2/3 BOAT KITS

**EASY TO BUILD**—Designed for the amateur. Over 200 Models. Prams to Cruisers, 8 to 21 ft. Fanned hulls. Semi and Custom finished. Save 50%... Now NEW Sea Ray Molded FIBERGLAS BOAT KITS. Truly professional results. NO upkeep. SAVE 2/3 assembly time. 12 to 16 ft. Utilities and Runabouts. SEND 35c for 64 page Boat Kit & 24 page Sea Ray Catalogs. SEND \$1.00 for both plus "Boating Handbook". Dealers inquire for franchise.

**BOAT PLANS & PATTERNS**  
**Frame-Pac Kits**  
 World's largest selection over 200 plans, full-size patterns, frame-pac kits! Designed strictly for amateurs! All types: prams, kayaks, racers, runabouts, catamarans, houseboats, cruisers - inboard-outboard 6-40' wood-plywood-steel!  
 Send 35c for PLAN CATALOG  
 Catalog PLUS "Boatbuilding Handbook" \$1.00  
 WRITE NOW! CUSTOM CRAFT, BUFFALO 7L, N. Y.

**DO IT YOURSELF**

It's Easy With...



Soldering's really a "clinch" . . . when you use time-tested, reliable KESTER . . . available everywhere.

**FREE!** "Soldering Simplified" . . . 16-page how-to-solder booklet. At your dealer or write direct.

**KESTER SOLDER COMPANY**  
 4251 Wrightwood Avenue Chicago 39, Illinois

# Master LAMINATED Padlocks



protect

your

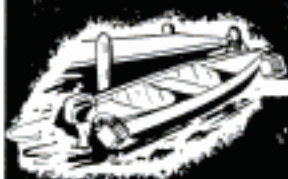

property

and



valuables!

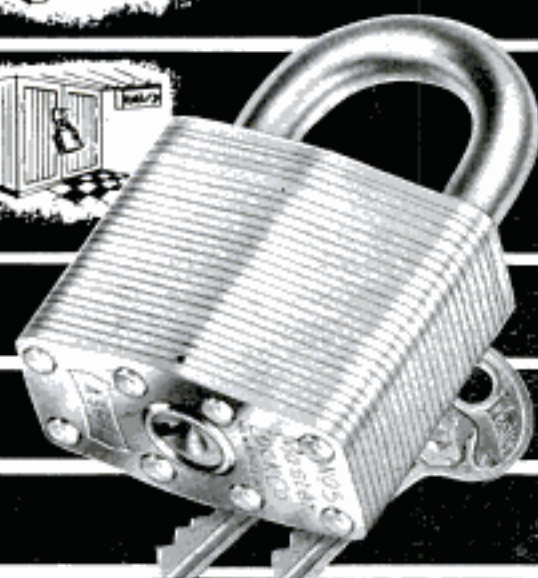

\$1.25 to \$4.00, in a variety of sizes, at locksmiths and hardware stores everywhere

**Master Lock Company.**

MILWAUKEE 45, WISCONSIN

World's Largest Padlock Manufacturers

# NO "TALK"... ALL ACTION

## NEW DUNLOP SILENT TRACTION

- Bites deeper in snow, mud, slush
- Grips better on slippery surfaces
- Runs quiet on bare roads



**POWERFUL TRACTOR-TYPE SHOULDER BARS DIG DEEP...**power you out of heavy snow, slush or mud!

**MORE GRIPPING EDGES!** Siped traction units provide thousands of gripping edges, minimize danger of skidding—give faster, surer stops and starts on slippery surfaces!

**RIDING RIBS ELIMINATE** "jumping" from lug to lug, assure smooth ride, quiet performance...even on bare roads!

**STABILIZERS** deep in channels support the tread elements, prevent annoying vibration!

**ENTIRE TREAD SELF-CLEANING**—and ruggedly wear-resistant!

This winter, don't shovel out—power out—on Dunlop Silent Traction Tires!

Your Dunlop dealer has the size and type to fit your car.

You'll go farther...**SAFER**...on tires by

# DUNLOP

...they're **AccuRated**

DUNLOP TIRE AND RUBBER CORPORATION, BUFFALO 5, N.Y.

affairs in the end walls, cut to conform with the sloping roof lines.

Actually, the new solar house is not the first attempt to make the sun heat a livable dwelling. At least three others have been built in recent years. A famous one, also in Massachusetts, used batteries of cans full of Glauber's salt to store the collected heat. In the process of crystallizing and melting, the salt took on or gave off heat as called for by the house. However, the system required considerable auxiliary electric heat during long, cloudy spells in Boston's climate.

Two other solar homes—one in Arizona and another in Colorado—store their heat in huge bins of crushed rock. Solar experts are watching these private experiments with great interest. The Lexington house is an attempt to produce a prototype dwelling that may some day be the basis for a solar home within reach of you and me.

Can you build one today at a price comparable to what we'd have to pay for a conventional house? According to Anderson, although the system employed in the Lexington house has been proved effective, it still is economically impractical for general use in a northern climate such as New England's.

"Solar heating," he points out, "is probably now economically feasible in areas where there is ample clear weather and where the cost of fossil fuels is abnormally high.

"It is true," says Professor Anderson, "that the cost of heating the Lexington house will be very low, but the initial cost of equipment will be too high to justify an installation by the average home builder in the near future." ★ ★ ★

## Water-Absorbing Plugs Protect Stored Engines



You can eliminate harmful moisture condensation on the inside of a stored engine by replacing its spark plugs with plugs containing water-absorbing crystals, according to the manufacturer. The plugs can be used year after year.

☐ A microwave relay system capable of handling more than 10,000 telephone conversations, or 12 television programs plus 2500 telephone conversations, has been developed by Bell Telephone Laboratories.

## How to get more light on the road from your present headlamps!



1. Since headlamps are detachable, they are subject to road shock and vibration which can jar them out of position and mis-direct their light.

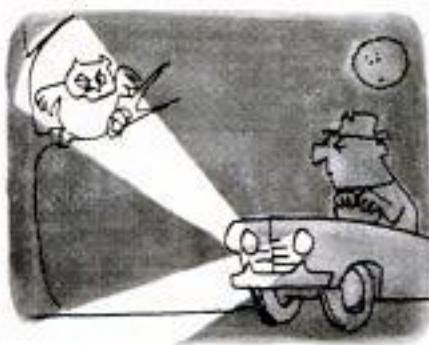

2. A very slight change in their position (so insignificant you can't even see the change) makes a big difference in the light you get down the road.

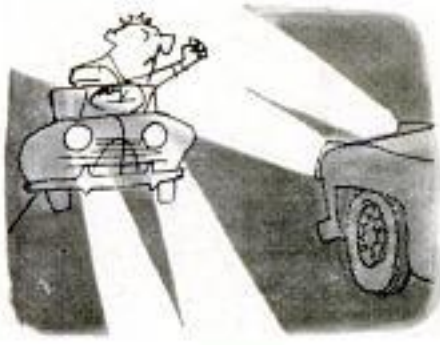

3. Ever have oncoming motorists "flash" their lights...believing you were driving with your "brights"?—when it was your *lower beam*... aimed high!



4. When headlamps are aimed low, the beam is too short... and you might not see in time to stop in time.



5. Your dealer can tell if headlamps are mis-aimed, and he can aim them accurately in minutes, even in daytime.



6. So, to get *more light* where it is needed... from your present headlamps... have them aimed *today!*

## ... and, if your headlamps are over 2 years old, here's how to get even more light!

Take a look at your *unlighted* headlamps. If they look like those at right, even re-aiming won't give you all the light you need. They should be replaced with new G-E *All-Weather* Headlamps that are all glass... their reflectors always stay shiny. When driving on the *lower beam*, G-E *All-Weather* Headlamps let you see better in fog, rain or snow and against the glare of oncoming traffic. Their *upper beam* reaches far and wide for safer driving on the open road.



**WATER DROPLETS** inside the lens not only scatter the light, but they also help discolor metal reflectors. This can't happen with G-E *All-Weather* Headlamps—*moisture can't possibly get inside.*



**DISCOLORED REFLECTORS** absorb light rather than reflect it, causing a loss of up to 50% of the original light output. Dirt and moisture can never enter G-E *All-Weather* Headlamps so the reflectors always stay shiny.



**BLACKENED BULBS** in old-style headlamps block out the light from the filament and cause a dangerous drop in light output. This can't happen with G-E *All-Weather* Headlamps because there are *no inner bulbs!*

Get a pair of G-E *All-Weather* Headlamps today—and have your dealer aim them when he puts them in. You'll see the difference tonight. General Electric Co., Miniature Lamp Dept., Nela Park, Cleveland 12, Ohio.



*Progress Is Our Most Important Product*

**GENERAL  ELECTRIC**

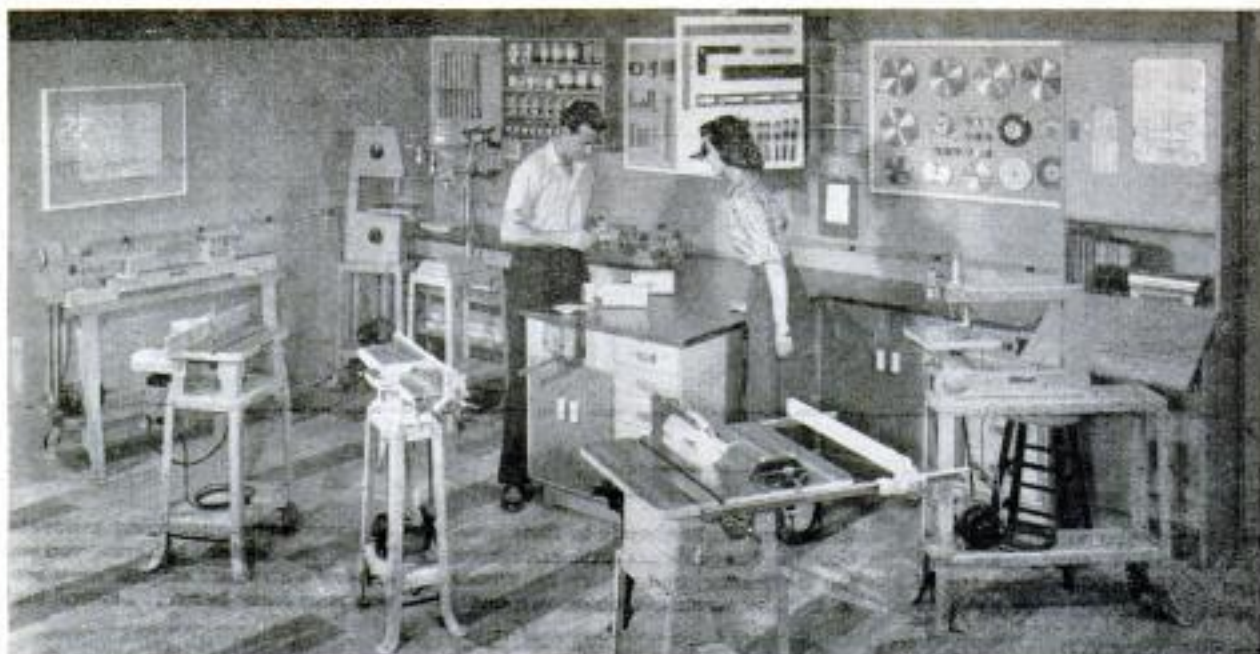

Photo courtesy Delta Power Tools Div., Rockwell Manufacturing Co.

## Dream Workshop Has Eight Tools Around T-Shaped Bench

Raymond Loewy, the noted industrial designer, has come up with a dream workshop for craftsmen. In the shop are eight single-purpose power tools and 30 square feet of workbench area. The bench itself is T-shaped and splits the shop into two areas so two members of the family can work on

different projects simultaneously. A swinging tool panel and a planning desk are other features of the shop. The eight streamlined tools, also styled by Loewy, are a lathe, band saw, scroll saw, drill press, tilting-arbor circular saw, jointer, shaper and grinder.

## CELO-GLOSS IS BEST

- For storm windows, doors
- For carport closures
- For greenhouses
- For patio windbreaks



Build your own storm windows, hot boxes for seedlings, greenhouse . . . easily, quickly, with Cel-O-Glass plastic coated screen. Full protection against wind and rain. Admits sun's healthful rays. Cuts with scissors, easily tacked in place. No sash, no putty necessary.



### LOW-COST STORM WINDOW KITS

Save on fuel, gain real protection with R-V-Lite Storm Window Kits! Heavyweight, weatherproof clear vinyl plastic, tough and pliable, easy to install. Kits contain 36" x 78" sheet of vinyl, molding strips, plenty of nails. Indoor kits include 18' of pressure-sensitive tape. See your hardware dealer, or write:

**ARVEY CORPORATION** R-V-LITE DIVISION  
SINCE 1903 3500 N. Kimball Ave. Chicago 18, Ill.

at a price YOU can afford

**TRANSMIX**  
UTILITY MIXER



Mixes while transporting • Dumps hydraulically • Attaches in minutes • No holes to bore • No gears • 1 or 1½ bag capacity • Eliminates wheelbarrows • Unconditional guarantee • For complete FREE folder, write:  
**UNIVERSAL PULLEYS COMPANY**  
 336 N. Mosley, Wichita, Kansas

## Find HIDDEN TREASURES

GOLD, SILVER, PRECIOUS METALS with the Famous Model 27 Metal Detector. Lightweight, ultra-sensitive, low cost. None finer. Also GEIGER COUNTERS for uranium and the VIOLITE for tungsten. INFORMATION FREE

THE *Detectron* CORP.  
 5528 Vineland Ave., No. Hollywood, Calif.



Protect your home against power interruptions with an...

## ONAN Emergency ELECTRIC PLANT

Provides dependable stand-by electricity for heating system, pumps, freezer, lights, appliances. Keeps home safe, livable. Automatic start and stop. Find out how little it costs!

Write for Folder!

**D. W. ONAN & SONS, INC.**  
 3257 University Ave. S.E. • Minneapolis 14, Minnesota

A SIZE FOR EVERY NEED  
 500 to 75,000 watts.  
 Compact, quiet-running.  
 Gasoline-powered.  
 Priced from \$319.00





#### WHITE CLAD MEZURALL

Ideal for the hand craftsman. Snow white line double graduated with feet and inches, and consecutive inches.  $\frac{1}{2}$ " wide line in 6, 8, 10 and 12 ft. lengths. 6 ft. only 98c.



#### WHITE CLAD SUPER MEZURALL

Wide  $\frac{3}{4}$ " line extends further unsupported. Same accurate easy to read double graduations as regular Mezurall. Strong die-cast case. 10 and 12 ft. lengths. 10 ft. only \$2.39.



#### EXECUTIVE THINLINE

The ideal pocket tape. Thin and light, and accurate . . . like a fine watch. Bold black figures on snow white line. 6 and 8 ft. lengths. 6 ft. only \$1.50, beautifully gift boxed.



#### WHITE CLAD BANNER

A necessity for gardening, decorating and construction. Tempered steel blade graduated to 8ths. Rust resistant steel case covered with handsome maroon vinyl. 25, 50, 75 and 100 ft. lengths. 50 ft. only \$5.00.



#### X-46 EXTENSION WOOD RULE

Extra strong for heavy duty use. 6" fitted brass slide for accurate inside measurements. Bold markings embedded in wood and plastic coated wear longer. 6 ft. length only \$2.50.



#### PRECISION TOOLS

Lufkin precision tools are favorites of the most exacting craftsmen. Illustrated is the full finish Chrome Clad mike with exclusive cam lock, friction thimble, and carbide tipped anvil and spindle.

## IT COSTS LESS TO USE GOOD MEASURING TOOLS

**choose the ones best for you  
from the only complete line**

The success of any project, from bird house to bridge, depends on accurate measurements. You can make accurate measurements easily . . . and save time, timber and temper . . . only with good measuring tools that are suited to your needs.

You can buy with confidence when you select a measuring tool bearing the Lufkin name. It has represented accuracy, durability and convenience since 1869 . . . it represents your most economical buy.

The next time you're passing a tool display, give a thought to your measuring tools — then pick up

the Lufkin tape, rule and precision tools you need. They're at hardware, lumber and tool dealers everywhere.

BETTER MEASURE WITH

# LUFKIN

483

TAPES • RULES • PRECISION TOOLS

THE LUFKIN RULE COMPANY, Saginaw, Michigan

# INSTALL YOUR OWN ANTENNA TOWER!

PUT IT UP WITH EASE—  
NO CONCRETE NECESSARY

## SPAULDING STRATO-TOWER

PATENT PENDING

- No Guy Wires
- All Galvanized
- Free Standing

Model X44CB (32' Tower plus 8' mast and cylinder base) ONLY \$79.95  
Antenna Not Included

Tower package includes the adjustable tower-to-base adapters, other necessary hardware for assembly.

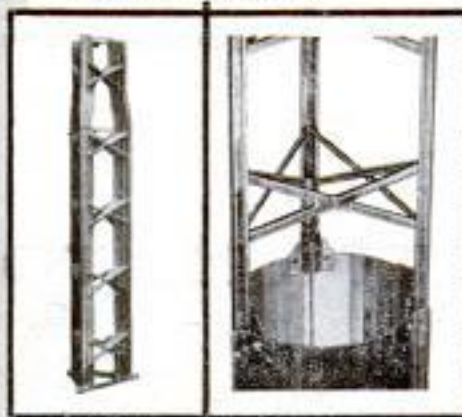

Tower Package Ready For Shipment

How Tower Mounts On Cylinder Base

Other Models Available From 16' to 64'

\*f.o.b. factory

If your dealer cannot supply you, send your check and order direct.

### SPAULDING PRODUCTS CO.

550 West Barner Street  
Frankfort • Indiana

Canada: Delhi Metal Products Co.  
Delhi, Ontario

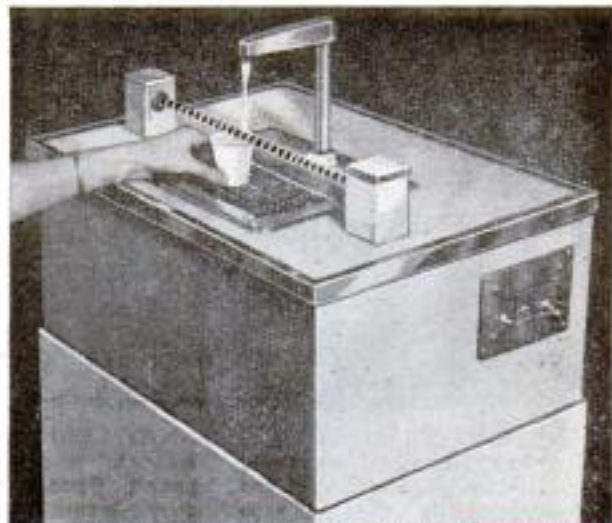

T and S Brass and Bronze Works, Inc., 147 Seventh St.,  
32 URBAN Ave., WESTBURY, ~~Queens-City~~, L. I., N.Y.

### Automatic Water Fountain Uses Photoelectric Cell

Breaking a light beam under the spout of an automatic water fountain starts the water flowing instantly. When a paper cup, or other container used to break the beam, is removed, the water shuts off. No levers, pedals or manual operation of fountain parts is necessary. Made of stainless steel, the fountain is 42 inches high and can cool 15 gallons per hour.

### Metal Rod Stops Jet Flame-Out

No larger than a pencil stub, a platinum-alloy rod has been developed to prevent flame-outs in jet-airplane engines. The engines operate like a blowtorch, and in certain circumstances will stop if obstructed by air turbulence, water or ice entering the air intakes. When one of the rods is placed in an engine's exhaust section, it is kept so hot that when a flame-out occurs the fuel gases are automatically reignited.

### Buttons Reattached in Seconds

In a few seconds and without needle and thread you can reattach a loose or fallen button to your clothes by a new pin-and-fastener combination. Pass the pin through the eyelets of the button and garment, slip the fastener over the pin points and lock the unit in place. The pins and fasteners are rust-resistant and designed to withstand dry cleaning and laundering. The pins come in three sizes.



Birkbeck Brothers Inc., 70 N. York Rd., Willow Grove, Pa.

if it's **Remington,** *now, in power tools, too,* it's right!

Model 149B— $\frac{1}{4}$  inch electric drill, AC-DC; 25 to 60 cycle; 115 volts; 2,500 rpm. At \$28.50—more power per dollar—attachments not included.\*



**powers a whole workshop of attachments!**

**OPERATES THESE AND MANY MORE**



PLANER



SANDER



RECIPROCATING SAW



METAL NIBBLER



HEDGE TRIMMER



SCREW DRIVER



KNIFE SHARPENER



WIRE BRUSH

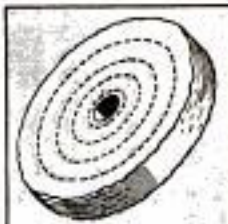

RAG BUFF WHEEL



GRINDING WHEEL



DRILL



SLITTING SAW

Here's an electric drill with power to spare! Now you can assemble a complete, low-cost home workshop around just one powerful tool—the Remington 149B drill by Mall. It's precision-built to handle most any job ... to give a lifetime of rugged service. Fits planer, sander, saw and dozens of other attachments. Does many jobs out of the workshop, too, from hedge trimming to car polishing.

\*Specifications and recommended price subject to change without notice.

**SEND FOR FREE, 16-PAGE CATALOG**

showing every type of electric hand tool. Tells what each tool will do. Gives prices and specifications. No cost, no obligation. Send coupon today.



**Mail this coupon today!**

**MALL TOOL COMPANY**  
Division of Remington Arms Company, Inc.  
Bridgeport 2, Connecticut

PM-10

Please send without obligation **FREE**, illustrated catalog on electric tools.

NAME \_\_\_\_\_

ADDRESS \_\_\_\_\_

CITY \_\_\_\_\_ ZONE \_\_\_\_\_ STATE \_\_\_\_\_

**Remington**

**Mall®**

**MALL TOOL COMPANY,**  
Division of Remington Arms Company, Inc., Bridgeport 2, Connecticut  
In Canada: Mall Tool, Ltd., 36 Queen Elizabeth Blvd., Toronto, Ont.

OCTOBER 1957

285

Copyrighted material

# NICHOLSON FILES

## FOR PLASTICS



- New sink top
- Corrugated patio roof
- Toys and models
- Bathroom tile
- Plastic-laminated furniture

Modern plastics are available in many forms to help beautify your home. Most of them can be cut, drilled, and worked like wood. And, of course, they can be filed. That's important when you're trying to get perfect joints and fits.

When you buy your "raw materials," make sure you've got all the tools you need to finish the job: Nicholson or Black Diamond files. Your hardware or building supply dealer will recommend the ones you need. Be prepared—get your files when you buy your materials . . . and work without delay.

**Free to Home Craftsmen:** "File Philosophy," big illustrated book on selection, use and care of files. Write for yours soon.



**NICHOLSON FILE COMPANY**

22 Acorn Street, Providence 1, R. I.

(In Canada: Nicholson File Company of Canada Ltd., Port Hope, Ontario)



# NICHOLSON FILES

**A FILE FOR EVERY PURPOSE**



### Machine Makes Sauerkraut

Since sauerkraut is to the German people what hot dogs are to Americans, it seems only natural that a German inventor would develop a special cabbage-cutting machine. Heads of cabbage are fed into the top, where sets of spiraled knives turn at a high rate of speed and cut them up evenly. The sauerkraut then falls into a pan below.

### Black-Light Exterminator Kills Night-Flying Pests

Night-flying insects are lured to their doom by a new ultraviolet exterminator. Operating from an extension cord, this portable, weatherproof device has sharp blades on either side that move at 1500 revolutions per minute. The unit weighs 17 pounds. Its motor and lamp require as much electricity as a 40-watt light bulb.

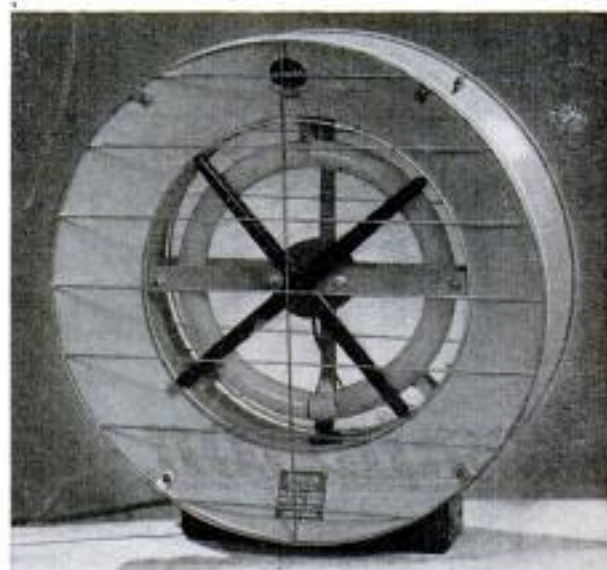

line  
'em



up  
with  
a

# Stevens 77-SC

with Savage Super-Choke  
and recoil pad

Here's a featherweight repeater loaded with value and versatility—and Savage offers it to you complete with \$30 worth of extras for only \$77.75. Equipped with recoil pad and Savage Super-Choke which reduces recoil by 30% or more without loss of shot velocity.

This is the pump-gun you'll use for *all* kinds of shooting— instant selection of any choke setting from full through cylinder. Has 6-shot, hammerless action with a safety fire control—trigger must be released and pulled for each shot.

Other outstanding features include: receiver and trigger guard gracefully streamlined into the full pistol grip, tapered extension beavertail slide handle grooved for firm grip, handsome walnut stock with fluted comb. In 12, 16 or 20 gauge.

**Also MODEL 77**—12, 16 or 20 ga. 26" barrel, improved cylinder choke; 28" barrel with modified or full choke; 30" barrel, full choke, 12 ga. only—\$65.75.

There are Savage, Stevens and Fox shotguns and rifles for every shooter and every kind of shooting. *Write for free rifle or shotgun catalog. Savage Arms Corporation, Chicopee Falls 19A, Massachusetts.*

ALL PRICES SUBJECT TO CHANGE SLIGHTLY HIGHER IN CANADA

## Savage



SAVAGE • STEVENS • FOX FIREARMS



Heavy Duty, All Steel  
**TOOL CHEST**  
**\$25<sup>90</sup>** F.O.B.  
ST. PAUL

**WHERE ELSE**

can you get 4 drawers with built-in locking system, sliding on compound glides—at this price! Baked blue-gray enamel. 26" x 12 1/4" x 12 1/4". Your money back if not satisfied! Write for bulletin, describing this and 12 other models.

**HUOT MANUFACTURING CO.**

555 No. Wheeler St., St. Paul 4, Minn.



**CRAFTSMAN'S**  
woodworking  
**MATERIALS**



**132 PAGES**  
Many in  
full color

packed with rare, fancy & imported woods... veneers, plywoods, patterns, tools, ornaments, hardware... everything for the woodworker.

Get This NEW Catalog of  
**WOOD & WOODWORKING**  
EQUIPMENT

**WORLD'S LARGEST SELECTION OF FINEST DOMESTIC AND IMPORTED WOODS... MOULDINGS, HARDWARE, TOOLS,—ALL AT LOW MONEY SAVING PRICES!**

Your complete wood buying guide and project book. Craftsman is your best, most complete source of finest kiln-dried domestic and rare imported woods, beautiful wood inlays, colorful bandings, matched plywoods, embossed mouldings, carved ornaments, newest woodworking tools, "hard to find" cabinet hardware and fittings... more than 1,500 items! Packed with newest scroll saw patterns, project ideas & money making plans. Enclose 25c (refunded with first order) to help pay mailing, handling cost. Write now! **Craftsman Wood Service Co., Dept. A-10 2729 S. Mary Street - Chicago 8, Ill.**

**HANG FIXTURES SECURELY**



USE **MOLLY**  
SCREW ANCHORS

**THE PERFECT FASTENER to hold anything in walls, floors, ceilings**

With Molly you can install fixtures exactly where you want... not just where studs are. Won't pull through. Spider backing reinforces area in which used. Fixtures can be removed and replaced in same anchor. Easy to install without disfiguring wall. Inexpensive, guaranteed. Ask your hardware dealer for genuine Molly... the name is stamped on the cap.

**150,000,000**  
IN USE



SEND  
**\$1.00 FOR**  
SAMPLE BOX  
OF 12



200 N. 5th ST. • READING, PA.

Enclosed is \$1.00 for which please send me a sample box of 12 Mollys postpaid.

NAME \_\_\_\_\_

ADDRESS \_\_\_\_\_

CITY \_\_\_\_\_

ZONE \_\_\_\_\_

STATE \_\_\_\_\_

## Our Home at the Bottom of the World

*(Continued from page 119)*

on its side as wind caught the chutes. But the engine was still going strong, and in a few hours we had jacked it back on its feet.

More planes arrived with more materials and men. By the end of the eighth day, our working Seabee crew numbered 24 men. Out of the sky came sleds and dogs. A weasel floated down, broke its battery, so we had to use the dogs until a replacement arrived. By the end of my first day we had located and marked all the drops and moved many to the camp area. One of the big Jamesway huts was erected and fitted with space heaters, so most of us slept in heated quarters our first night on the South Pole!

The Jamesway is a neatly packaged affair, perfect for airdrop. Its box unfolds to make the floor. Its heavy, insulation-padded canvas cover drapes over curved beam sections to make a Quonset-shaped hut with a floor area of about 24 by 40 feet. The nonstandard foundation trusses we set it on were too long for dropping, so were cut in half and rebolted on the ground. Even so, 10 of us assembled it in eight hours. Two of these structures are now

permanent dormitories at South Pole base. The rest are insulated buildings on snowshoe foundations similar to the structures used at Little America and McMurdo Sound (see *Popular Mechanics*, April 1956 issue).

Days began at 9 a.m., erecting the buildings, and framework for the wire mesh and burlap that will form tunnels between buildings when drifting snows bury the camp this winter. By noon, the first airlift Globemaster usually arrived, followed by two or three more during the afternoon. All cargoes had to be retrieved the day they parachuted, but with the D2 and weasel to help, the job was easier. Between midnight and 3 a.m., we "hit the sack." All the while we were there, the sun circled the sky 24 hours a day.

It wasn't all work. At Christmas time, the Air Force dropped us Christmas trees flown in from New Zealand, plus ornaments, mail and gifts. Carols were sung around the space heaters in the finished buildings, and a big dinner with all the fixings was served.

South Pole base construction had a timetable of three months for completion. The job was finished in six weeks. Atop the garage and shop in the center of the cluster of buildings, Dr. Siple erected a genuine red-and-white-striped "South Pole." On



top of it was fastened an inverted fish bowl that Siple had had mirrored in New Zealand for special photographic effects. The day the base was completed, an American flag was run up the South Pole and flies there today. Beneath it, in their sub-snow network of tunnels and buildings, scientists conduct their IGY work. Twice daily, radiosonde balloons are released from a hatch in the inflation building, where aluminum chips, lye and water from melted snow produce the hydrogen gas. Under a 15-foot-diameter radome on stilts above the drifting snows, a big radar antenna tracks the balloons to 70,000 feet. Readings from the train of instruments are radioed back to earth, providing data on wind, barometric pressure, temperature and humidity. This is exchanged by radio with scientists at other Antarctic bases. From this data will come the first significant South Polar weather maps in history. Through a shaft leading up from the science building, ionosphere and aurora specialists climb to another building on stilts above the snow, where they can study the cold night sky through plastic viewing domes without going outdoors.

Facilities for magnetic studies and other scientific projects also are contained in this compact base. Dr. Siple, Antarctica's ice expert, is digging a hole 100 feet deep to

study the make-up of the ice plateau. When we left, the four-foot wide shaft was already down to the 20-foot level.

Until daylight comes again and planes can once more fly in to the bottom of the world, these men will remain completely cut off, except by radio contact with other bases nearly 1000 miles across the frigid wastes. But they'll be about as comfortably isolated as anyone can be at the South Pole. ★ ★ ★

*The views expressed in this article are the views of the author and do not necessarily reflect the views of the United States Navy.*

### Superfuels for Air Force

Semicommercial production of high-energy fuels for the Air Force has begun at Niagara Falls, N. Y. Olin Mathieson Chemical Corporation announced that full-scale production is expected by 1959. The superfuels will increase jet-aircraft range up to 50 percent and eliminate high-altitude engine failure. (See "Mystery Fuels for the Missile Age" in the July 1957 issue of *Popular Mechanics*.)

☛ Flying time without overhaul for a J-57 jet engine has been extended to 1000 hours, the equivalent of more than 20 flights around the world.

# NEW HARLEY-DAVIDSON

## DUO-GLIDE

with a new concept in riding comfort and power

For a miracle ride swing aboard the DUO-GLIDE — absolutely the finest motorcycle in the world! Sleek, powerful and instantly obedient it's truly a masterpiece by the industry's top-flight engineers and craftsmen.

New swinging-arm rear suspension coupled with Hydra-Glide front fork and spring-loaded seat post provide an unbelievably smooth ride. Exclusive hydraulic rear brake marks another Harley-Davidson first. Other features include special, performance-upping engine refinements and a wide choice of brilliant new color combinations.

See it, try it and you'll agree that solo or with a buddy, you get a miracle ride on the DUO-GLIDE. Ask your dealer about his liberal trade-in deal and new convenient terms. Or, write for free literature.



**HARLEY-DAVIDSON MOTOR CO.**  
Dept. P, Milwaukee 1, Wis.

DUO-GLIDE —  
with 74 O.H.V. power  
plant ... the ultimate  
in motorcycling!

## Here's How to See Through Fog

(Continued from page 125)

the other vertically. Yellow "fog" lenses are no more effective than clear lenses in illuminating the road, says Marsh.

Marsh cautions that any fog light must be used instead of, rather than in addition to, regular lighting. Don't burn headlights and fog lights at the same time.

In the absence of special fog-lighting equipment, Marsh offers these suggestions:

- Don't depend upon parking lights or taillights for protection. Oncoming or overtaking drivers usually see your car before they see these small lights. This is especially true in day fogs.

- In daytime fog, burn your headlights on the high beam no matter whether in city or country. Watch the mirror for overtaking cars. When one approaches, warn the driver of your presence by blinking your right-turn indicator or by lightly applying the brakes to operate the stop lights (by the way, Marsh and other lighting experts prefer the term "brake lights" because they go on each time the brakes are applied regardless of whether a stop is made or not).

- While experts cannot officially recommend it due to legal complications, most will admit that when fog gets thick enough, the driver can best protect his rear by continuous operation of the turn-signal lights. These high-intensity lamps pierce the fog much better than normal taillights.

- Truckers should not rely on amber marker lamps in day fog but should install higher-powered lamps. Where legal, truckers should add a switch to burn both rear turn indicators continuously for rear-end protection. Actually, steady lamps probably give better protection than flashing lamps in fog. In fact, Marsh believes all cars should have a special fog switch to operate both rear turn indicators steadily in a fog.

- White fog lamps mounted as low as is legal give more usable light than the new sealed-beam lamps in fog.

- If you must stop in the fog (and this is extremely hazardous) pull off the road as far as possible. Set warning flares 100 to 300 feet behind the car. Leave a piece of luggage or some other large object on the shoulder at least 50 feet behind the car to warn other drivers that they are off the road. Drivers often follow the lights of a parked car, thinking it is moving, and crash into it in fog. By putting a suitcase on the shoulder you will make them realize they are in the wrong lane. The suitcase may be ruined, but your car, and possibly your life may be saved. ★ ★ ★



### high-quality hand tools for finer workmanship

Do the job easier and better with GREENLEE tools. Auger bits, electric-drill bits, other boring tools, chisels, gouges, spiral screw drivers, push drills, and many more. All expertly made of top-quality materials for long life, fine results. At leading hardware and building supply dealers. Write for folder, Greenlee Tool Co., 2110 Columbia Avenue, Rockford, Illinois.

TOOLS FOR CRAFTSMEN  
**GREENLEE**  
G





**MODERN****IMPROVED LAWN MOWER SHARPENER  
AND BED KNIFE GRINDER**

Sharpen any mower in 30 to 20 minutes. Hand—Power—Reel or Rotary. Modern is actually two machines in one: a Precision Bed Knife Sharpener and a Precision Reel Sharpener. Extra Bed Knife Grinder is Absolutely Unnecessary. New Mower Support makes it possible to sharpen reel without removing bed knife. The fastest precision lawn mower sharpener on the market. Costs Less. Compare Modern's Many Exclusive Features Before Buying. Send for Free Brochure No. 10 SN

**MODERN MANUFACTURING CO.**

160 North Fair Oaks Ave., Pasadena, California

**GENUINE ALNICO  
MAGNETS**

**AMAZING. PERMANENT. NON-ELECTRIC. HIGHLY PRACTICAL.** Conduct interesting experiments. Hundreds of uses. Retrieve valuable steel items such as guns, tackle from fresh or salt water; tools from tanks & drains. **GUARANTEED.** Try any magnet one week. Money back if you are not well-pleased.

No. M-710 (Wt. 53 oz.) Has pull of 225 lbs. on steel block... **\$16.50**  
 No. M-625 (Wt. 70 oz.) Has pull of 125 lbs. on steel block... **\$9.50**  
 No. M-575 (Wt. 18 oz.) Has pull of 75 lbs. on steel block... **\$6.50**  
 No. M-500 (Wt. 13 oz.) Has pull of 50 lbs. on steel block... **\$4.50**  
 No. M-562 24" Wall Type Tool and Knife Holder, Complete... **\$5.95**  
 No. M-325 12" Wall Type Tool and Knife Holder, Complete... **\$3.25**  
 No. M-300 Kit of Flat Bars 2 Pairs (10 Magnets)... **\$3.00**  
 No. M-250 Kit of Round Rods 5 Pairs (10 Magnets)... **\$2.50**  
 No. M-47 Hot Pad Magnets, 10 for \$1.00... **.50 for \$4.87**  
 No. M-35 Hobbyist assortment of 8 small magnets... **\$1.50**

Send M.O. or check. We pay postage. Sorry no C.O.D.'s.

MIAMI MAGNET COMPANY, 3240 N.W. 27th Ave., Miami 42, Fla.

**FIND THE WOOD STUD IN YOUR WALL  
WITH A FORD DOWSER BALL**

Indispensable when hanging pictures, mirrors, shelves; and when making alterations. The original Stud Finder. **YOU MAY NEED ONE TOMORROW!** The roll of the ball finds the actual STUD in the wall.

**NO MAGNETS!**

Only \$2.00 ppd. Money-back guarantee; no C.O.D.'s please. Usual trade discounts to dealers.

**\$2.00**

**FORD PRODUCTS** Dept. P-7  
PORT CHESTER, N.Y. **POST PAID**

**NEW!****9.2 H.P. RIDING  
CRAWLER only \$895<sup>00</sup>**

**OUTWORKS ANY TRACTOR ITS SIZE** Ideal for clearing, grading, plowing, field or row crops, yard work. Big tractor ruggedness, quality. Anyone can operate. Borg-Warner 3-speed and reverse trans., cone clutch steering. Tractor with blade, floating drawbar, PTO, spd, any- in U.S. 8205. Wt. 925 lbs. Guaranteed. Accessories available. At dealers or direct.

**LAYTRAC  
Power! Traction!**

where in U.S. 8205. Wt. 925 lbs. Guaranteed. Accessories available. At dealers or direct.  
**LAYTRAC, 25488 Airport Way, Seattle 4, Wn.**

**KITCHEN FAN AND HOOD**

CHOICE OF 3 FINISHES  
COPPERTONE, WHITE,  
ALUMINUM.

SAVE  
UP TO  
\$35.00

**TOP  
VALUE!****SPECIAL!****\$29<sup>95</sup>**  
COMPLETE

Westair 36" All Steel Hood, With Powerful 500 CFM 5 Yr. Guarantee Fan and Automatic Backdraft Shutters.

LARGEST SELECTION FANS, BLOWERS, BLADES, GUARDS, ETC.  
**WESTAIR FAN & BLOWER CO.**  
5450 GRAND RIVER DETROIT 8, MICHIGAN

**Install shelves, drawers  
and sliding doors with****HARDWARE  
ASSEMBLIES****the easy way to do-it-yourself****K-V ADJUSTABLE SHELVES**

K-V 80-180  
for Open Wall  
Shelves



K-V 233-239  
for Set-in  
Shelves

K-V Do-It-Yourself Kits

You can build modern, sturdy, adjustable shelves quickly with K-V Shelf Assembly hardware. These steel electroplated assemblies come with easy-to-follow instructions for mounting shelves on walls or in built-ins.

**K-V DRAWER SLIDES**

Easy-to-install K-V drawer slides won't stick or jam, give you noiseless operation. Five light to heavy duty models made of finest steel, including an under-drawer slide for drawers with no side clearance.



K-V 1300 Drawer Slide

**K-V SLIDING DOOR HARDWARE**

You can install K-V Sliding Door Hardware without special tools. New improved steel track gives noiseless, free-running operation always. Complete installation kits in variety of sizes for wood, glass doors, 992 Roll-Ezy Assembly shown.

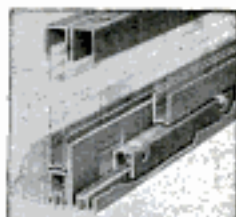

K-V 1 Clothing Corner



K-V 3 Garment Bracket

**AND MORE THAN  
40 K-V CLOSET  
FIXTURES**

let you remodel closets easily and inexpensively. K-V closet fixtures keep closets uncluttered and keep clothes looking their best. Can be installed with a screwdriver.

Look for K-V fixtures at leading lumber dealers, hardware and department stores.

**KNAPE & VOGT MFG. CO.**  
GRAND RAPIDS, MICHIGAN

# WILLIAMS

## TOOLS OF INDUSTRY

**NEW IMPROVED LOCKING ADJUSTABLE WRENCHES**



WITH THE  
**HEAVIER... MORE RUGGED**  
**"PUSH BUTTON" Locking Device**

JUST A FLICK OF THE THUMB OR FINGER  
LOCKS OR UNLOCKS THE ADJUSTMENT INSTANTLY  
AT ANY OPENING YOU SELECT

- POSITIVE LOCK
- RAPID ADJUSTMENT
- ONE HAND OPERATION
- INCREASED SAFETY
- DROP-FORGED ALLOY STEEL
- HEAT-TREATED

**CHROME FINISH**  
For those who demand  
the utmost in  
fit, feel and finish

**BLACK FINISH**  
For those who want  
all of the features  
at lower cost

SIZE	CHROME FINISH		BLACK FINISH	
	NO.	PRICE	NO.	PRICE
6 in.	6L	\$2.39	6BL	\$2.00
8 in.	8L	2.76	8BL	2.42
10 in.	10L	3.55	10BL	3.00
12 in.	12L	5.18	12BL	4.40
15 in.	15L	7.88	15BL	6.95

At most **HARDWARE STORES,**  
**INDUSTRIAL AND AUTOMOTIVE DISTRIBUTORS**



### No. CW-4 CHAIN WRENCH

CAPACITY  $\frac{1}{2}$  to 4" O.D.

For close quarter work on PIPE, ROUNDS and  
all types of IRREGULAR SHAPES

Successive bites can be taken  
without removing wrench from the work.

\$4.80 at most **HARDWARE STORES,**  
**INDUSTRIAL-AUTOMOTIVE DISTRIBUTORS**

### "MULTISOCKET"

No. 1999



DROP-FORGED  
with Two Swivel Heads  
and 8 Different 12 Point Openings

**SMALL HEAD**  
 $\frac{3}{16}$  -  $\frac{1}{2}$  -  $\frac{3}{8}$  -  $\frac{1}{2}$

**LARGE HEAD**  
 $\frac{3}{8}$  -  $\frac{1}{2}$  -  $\frac{3}{4}$  -  $\frac{3}{4}$

For adjusting and repairing **CARS, BIKES, CYCLES,**  
**TRACTORS, MOWERS, APPLIANCES, ETC.**

\$4.98 at most **HARDWARE STORES,**  
**INDUSTRIAL AND AUTOMOTIVE DISTRIBUTORS**

WRITE TODAY

For a copy of Catalog No. 503



## J. H. WILLIAMS & CO.

417 VULCAN ST., BUFFALO 7, N. Y.



### "Stork Leg" Spectator Seats Give Good View of Sports Events

Now you can be taller than the people who stand in front of you at parades and sporting events. New tripod chairs are made from three six-foot lengths of  $\frac{3}{4}$ -inch steel conduit. Short lengths of pipe are welded to the conduit for added strength near the center bolt. Chains keep the legs from slipping, and short pieces of conduit are welded to the tripod legs as steps. The seats are canvas with leather-reinforced pockets that slip over the tops of the legs.

### Trees Increase With Soil Feeding

Soil nutrients are increasing the production of Douglas-fir seed cones up to six times as much as unfed trees in experiments by Weyerhaeuser Timber Co.

### Fish May Prove Why Animals Age

Studies of fish may be the answer to why animals grow old, according to an Indiana University zoology professor, Shelby Gerking. This is because a fish's age can be accurately determined from its scales and bones. Contrary to the belief that fish don't grow old but keep on growing until killed by accident or disease, Professor Gerking's research indicates that they do age and the faster they grow the earlier they appear to die.

**TRAP  
DUST  
AND  
ODOR\***  
**IN YOUR  
HOME**  
*automatically*

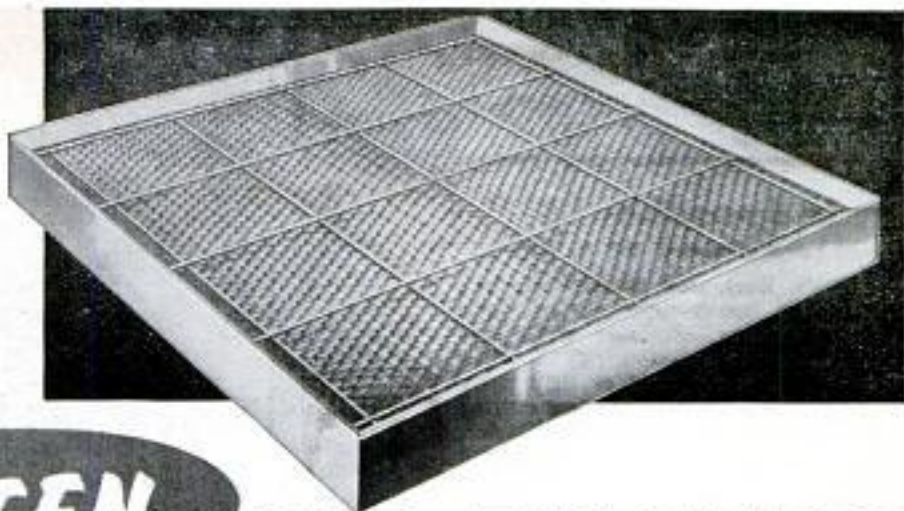

**EZ KLEEN**

\*AUTOMATIC ODOR  
REMOVAL with  
**RP SUPER handi-koter**

The scientifically compounded adhesive for re-coating EZ Kleens that traps dust, dirt, pollen AND absorbs odors from the air stream circulating through your furnace or air conditioner



**AIR FILTERS**  
ALUMINUM . . . WASHABLE  
**LOWEST COST AIR FILTER BUY**

**FOR FURNACE OR AIR CONDITIONER**—Only clean filters efficiently trap more dust and dirt, permit better air circulation, reduce fuel and power costs, increase comfort. With washable EZ Kleens, you can have clean, efficient filters constantly—without frequent shopping. As often as necessary — wash, recoat with adhesive and replace EZ Kleens — they're good as new, last for years. Research Products Corporation, Dept. 227, Madison 10, Wis.

**SEE YOUR DEALER OR TELEPHONE DIRECTORY**  
IN CANADA: HICKS-BAKER LTD., 234 Madison St., Winnipeg;  
E. G. SPALL & CO., LTD., 601 York Road, Guelph, Ont.



**ROAD TO RICHES**

You can be the next uranium millionaire! Government guarantees huge bonus! PRI instruments from \$29.95. See your local dealer today! FREE CATALOG!

Write PRI, 4223 PM W. Jefferson  
Los Angeles 16, California

**DEALERS WANTED**



**BOAT PLANS-PATTERNS  
FRAME KITS**

A modern up to date series of inboard and outboard designs for the amateur builder. State specific size and type or send 50c for BIG NEW CATALOG.



marine **GLEN** designs Box 568T Compton, Calif.

**Sharpen ALL CIRCULAR SAWS**  
**THE QUICK-WAY\*** patented

Model  
PG-12  
Complete  
No  
extras  
to buy.  
**\$19.95**  
Postage  
Paid



Sharpens, joints, gums and retools all cross-cut, rip, standard and master combinations, miter, planer and radial saw blades to 12" diameter. Precision sharpening guaranteed by special index. Dials. New safety guide prevents tilting or gouging. Mounting block and special \$3.00 grinding wheel furnished. Fits bench, table and radial swing saws. Thousands of satisfied users. Featured in leading publications. Order today. Send check, cash or money order. We pay postage in U.S.A. Free Booklet "How to Sharpen Circular Saws."

**QUICK-WAY SAW CO.**  
136 Tompkins Street Cortland, N.Y.

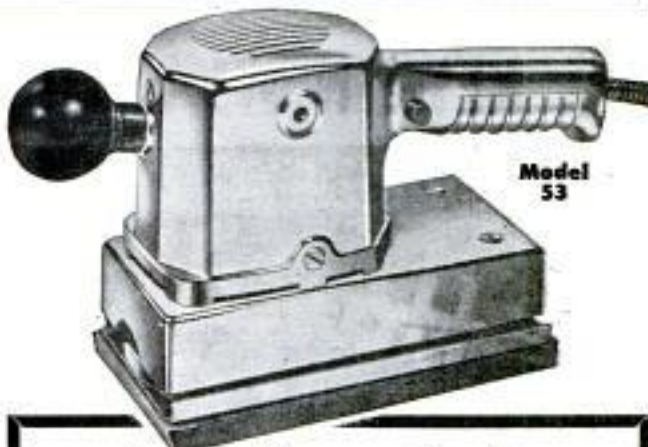

Model  
53

**The Secret of  
Scratch-free Sanding!**

Ask any expert—the secret of a perfect finish is to sand with the wood grain! That's what the old-time craftsman did when he sanded by hand. And so do you, when you use a Dremel Straight-Line Action Sander—except that a powerful motor does all the work.

With Dremel Straight-Line Action, you leave no cross-grain scratches or orbital swirl marks to mar the finish of your project.

Dremel sanders are compact, lightweight, and easy to grip and handle. Don't be fooled by "look-alikes" or "looks-alikes" alone. Ask your dealer for a demonstration. Then compare their price, performance, and ease of handling. You're sure to pick a Dremel — and you'll be glad you did.

**See Your Power Tool Dealer Today**  
**Dremel Straight-Line-Action Power Sanders**  
3 popular models — \$14.85 to \$37.50

**FREE** Power Tool Catalog on the Complete Dremel Line. Write today!

Quality Power Tools Since 1934

**DREMEL MFG. CO.**

DEPT. 117K

RACINE, WIS.



**More cutting power** ✓  
for 1/4" electric drills

**Irwin Speedbor "88"**

most revolutionary bit in years

Irwin's Exclusive Hollow Ground Point and spade-type cutters bore faster, deeper, cleaner with less power. Try the Speedbor "88" in your small 1/4" electric drill or drill press and see. Get smooth, effortless cutting action in hard or soft woods, plaster, plywood, plastics — even hardrock maple! Forged in one piece from solid bar of high carbon steel, hardened full length to stay sharp. And remember . . . the hollow ground point is exclusive with Irwin's Speedbor "88". Buy individual sizes or sets from your independent hardware dealer.

No. 886-R plastic roll set of 6, sizes 3/8" to 1", only \$4.50



only  
**75¢**  
each  
any size,  
1/4" to 1"

**IRWIN**  
Wilmington, Ohio

- the original solid center auger bit
- screw drivers • screw driver bits

**NEW! NEW! NEW!**

No-Mess **CALKING** Method

**Handi-calk**

with **STOP-FLO**®

**No Drip** ♦ ♦ **No Ooze . . . No Puddle!**

• Now, get neat, clean calking jobs everytime with new, improved Handi-calk with the exclusive Stop-Flo feature! Magic plastic Stop-Flo Button gives positive, stop-and-go calk control. Now it's easier, more convenient to seal cracks and gaps with quality Handi-calk. Simply pull trigger to calk, withdraw gun plunger rod to stop calk flow instantly!

**FREE!**

Home Calk

Check List

Send

Postcard

to:

**HANDI-CALK DIVISION, Dept. HC-5**

2366 Woodhill Road • Cleveland 6, Ohio

At Leading Hardware, Paint and Building Supply Dealers



**Portable Chord Organ**  
Has Three-Octave Range

Weighing only 15½ pounds, this chord organ can be operated anywhere that a 110-volt alternating current is available. It has a piano-type keyboard with 37 keys plus 12 bass buttons, each of which produces a full chord in both majors and minors. The keyboard covers three full octaves. The wood cabinet is 25½ inches long and 10½ inches wide. With about 20 minutes' practice, anyone can play this organ, according to the manufacturer.

**Direct-Reading Altimeter**  
Aids Aerial Navigation

Airmen can read altitude directly in feet from the dial of a new electronic altimeter, instead of having to interpret readings from an altimeter scope. The APN/42 mechanism, accurate to within 40 feet at 60,000-foot altitude, will replace electronic altimeters in U.S. Air Force planes. Designed for aerial reconnaissance and navigation, the APN/42 sends a radar signal to the ground, measures the time taken by the signal to return, and transposes time into feet on the dial. The new altimeter is half the size of earlier models.

**Planes Land on Thin Ice**

The Air Force, compiling data on the bearing strength of ice, has succeeded in landing wheeled aircraft weighing more than 60 tons on Arctic Sea ice little more than four feet thick.



## ENDS STUCK DRAWER NUISANCE FOREVER!

# Roll-eez<sup>®</sup>

### SET "A" ROLLER BEARINGS FOR WOODEN DRAWERS

- EASY, QUICK TO INSTALL IN FURNITURE, BUILT-INS
- MAKES WOODEN DRAWERS OPERATE SMOOTHLY EVEN IN HOT, HUMID WEATHER

Stop breaking your back trying to open that stuck drawer! Sensational Roll-eez Set "A" cures the cause of stuck drawer troubles by eliminating friction of wood-against-wood and maintaining drawer alignment. Made of noiseless, self-lubricating NYLON rollers mounted on steel frames. Each drawer set includes simple instructions and nails. Anyone can install. Used by cabinetmakers to provide lasting convenience in homes of every price range. At Hardware, Building Supply dealer. If he does not stock, remit to factory.

Action Compares with Costly Slides



Nail two Roll-eez "N" to rail at drawer opening. If drawer has center guides, nail third Roll-eez "N" on top of back in middle, and Roll-eez "M" on bottom of back, straddling guide.

49¢  
SET FOR ONE DRAWER



JOBBER DEALERS WRITE

Building, Remodeling? Ask Builder to Equip Cabinets with Roll-eez. So inexpensive.

Junior-Pro Prod. Co., Dept. M, 118 E. Marceau, St. Louis 11, Mo.



**The 14' STARFISH** . . . Now you can OWN a \$1,100 registered Planing Hull Class SAIL BOAT for only \$525, complete. Freight prepaid. It's constructed of "Harborite" Plastic covered plywood, with Dacron Sails and stainless steel and chrome hardware throughout. So EASY to assemble . . . 90% of the work is done in our plant. Just put it together and you're ready to SAIL! Owners claim speeds up to 16 knots. It's the ULTIMATE in a family racing sailboat.

- HULL KIT • HARDWARE & RIGGING KIT • SAIL KIT • ONLY \$175 each, freight collect. COMPLETE KIT \$525. FREIGHT PREPAID. Assembled at our plant, complete, ready to sail, \$1,100 freight prepaid.

PORT MARINE, INC., P.O. Box 704-B, Newport Beach, Calif.



## DRAINS cellars, cisterns, wash tubs; \$7.95 IRRIGATES - CIRCULATES - SPRAYS

Up to 3,000 GPM; 450 GPM 80' high; or 1800 GPM from 25' well. Use 1/6 to 3/4 HP motor. Coupling included free. 1" inlet; 3/4" outlet. Stainless steel shaft. Won't rust or clog. . . . Type P—\$7.95. HEAVY DUTY BALL-BEARING PUMP, up to 7,500 GPM; or 3,000 GPM from 25' well. 1 1/2" inlet; 1" outlet. \$12.95. Postpaid if each with order. MONEY BACK GUARANTEE. Centrifugal and Gear Pumps in All Sizes. LABAWCO PUMPS, Belle Mead 7, New Jersey



## KEY - BAK KEY-REEL

Carry your keys on a KEY-BAK key-reel. Keeps keys handy! Safest! Keeps clothing neat. 24" long stainless-steel chain reaches all locks. Pocket-watch size. Sturdily constructed to last for years. GUARANTEED. For all who use and carry keys. Dealers Wanted!

LUMMIS MFG. CO., Pasadena 8, Calif. CIL CO., Wausau, Wis. \$2.95

ONLY *Estwing* GIVES YOU A CHOICE OF **UNBREAKABLE HAMMERS**  
Made and Guaranteed by Estwing INVENTORS AND ONLY SPECIALISTS IN UNBREAKABLE HAMMERS AND HATCHETS



ESTWING MFG. CO., DEPT. PM-6, ROCKFORD, ILL.

# REPLACE YOUR OLD WOOD CELLAR DOOR



## WITH A MODERN ALL-STEEL BILCO DOOR

# DO IT YOURSELF IN JUST 3 TO 4 HOURS

Think of it! Only a few hours of pleasant work to replace your unsightly, troublesome wood hatchway with a lifetime, weathertight BILCO . . . the door installed on tens of thousands of new homes.

**PAYS FOR ITSELF!** Cost so little, yet never needs repair or replacement. Operates at a touch. Smooth, trim appearance adds amazing new beauty to your home.

Rush coupon TODAY for free folder "How to replace your wornout wood hatchway" showing sizes and prices.



### AMERICA'S FINEST BASEMENT DOOR

THE BILCO CO. DEPT. 768C NEW HAVEN, CONN.

Gentlemen: Please send me free folder and name of nearest dealer.

Name \_\_\_\_\_

Street \_\_\_\_\_

City \_\_\_\_\_ State \_\_\_\_\_

Remove old



Wash it off! Scrape it off!  
It's easy either way with

## HEAVY-BODIED KLEAN-STRIP



One application of Heavy-Bodied Klean-Strip will easily and quickly peel off several layers of paint or any other finish. Semi-paste consistency makes it ideal for use on overhead or vertical surfaces. Non-flammable, needs no neutralizer or afterwash.

**THE KLEAN-STRIP CO., INC.**  
2340 S. Lauderdale, Memphis, Tenn.

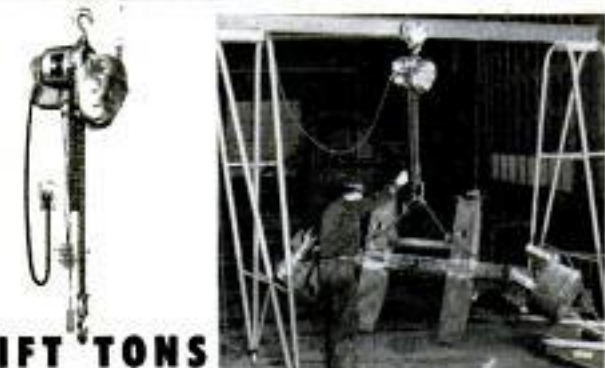

## LIFT TONS WITHOUT STRAINING A MUSCLE GET A 'Budgit'® ELECTRIC HOIST

Here's a real back-saver — saves time and effort when working on trucks, boats, cars — on countless lifting jobs.

'BUDGIT' IS A COMPLETE HOIST. Comes ready to hang up, plug in and operate. Has two automatic brakes for extra safety; each alone can hold the load. Braking is fast — you can "spot" loads accurately.

MORE 'BUDGIT' HOISTS USED THAN ANY OTHER. All users praise these efficient, economical hoists. AC and DC models; also others that operate on a 12-V or two 6-V batteries are used on trucks or in areas without electric power.  $\frac{1}{8}$  to 2 ton sizes. Priced from \$149.

See your "Shaw-Box" Distributor  
or write for Bulletins 402 and 404.



**MANNING, MAXWELL & MOORE, INC.**  
SHAW-BOX CRANE & HOIST DIVISION  
354 W. BROADWAY MUSKOGON, MICHIGAN

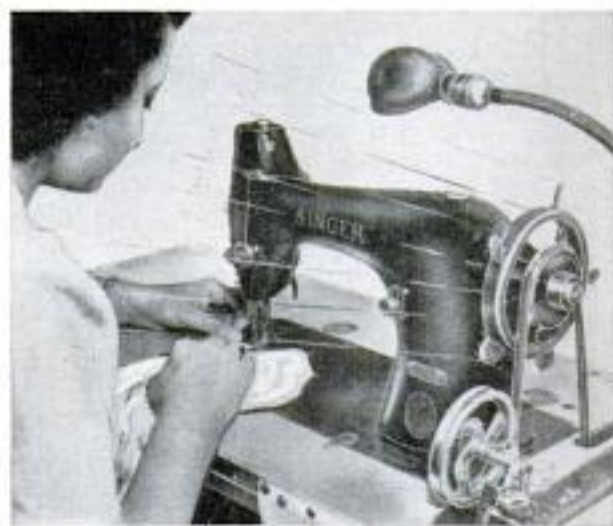

## Sewing Is a Breeze With Flywheel Fan

Molded of pure gum rubber, the fan in the photographs slips over the flywheel of standard sewing machines. The blades have no metal parts and can be handled at high speeds without injury, according to the manufacturer. The blades fold back on contact. Besides keeping the operator cool and comfortable, the fan is intended to blow lint and dust away from the machine, thus reducing the wear on moving parts.

## Weather Controls Sprinkling Unit

When water is needed for lawn or garden, an electronic unit will turn it on or off automatically according to the weather. Connected to the sprinkling system and plugged into any electrical outlet, the control will turn the water on if the weather is dry, leave it off when there is rain.

There are now 39 Canadian television stations providing programs for the 65 percent of all Canadian families that own receiving sets.

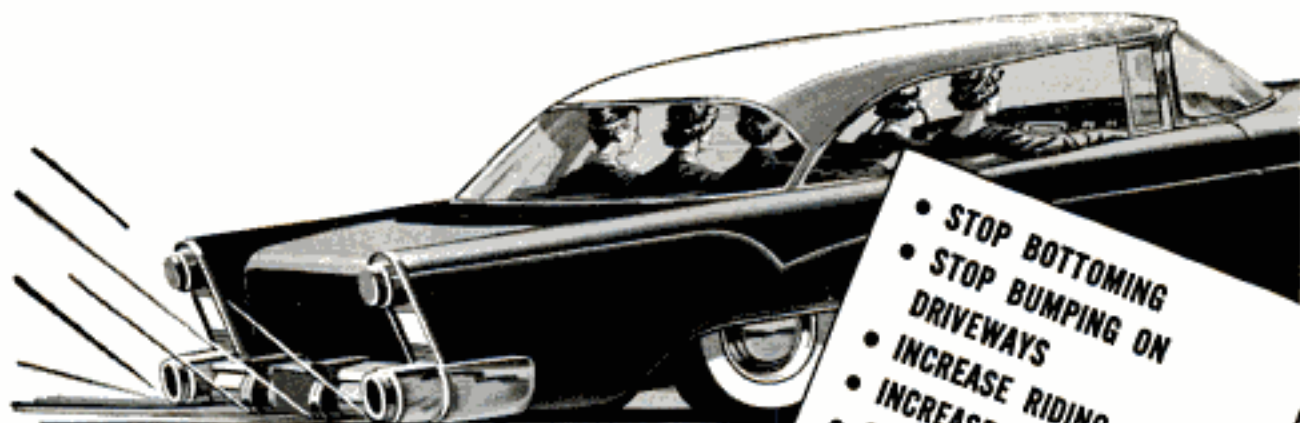

- STOP BOTTOMING
- STOP BUMPING ON DRIVEWAYS
- INCREASE RIDING COMFORT
- INCREASE ROAD CLEARANCE
- STOP SWAYING ON CURVES
- KEEP HEADLIGHTS ON ROAD

## MONROE LOAD-LEVELERS

keep loaded cars level . . .

If you load your car with samples, equipment, etc., if you drive a station wagon or haul a trailer, if you load family and luggage into your car for weekend or vacation trips, you need:

### MONROE LOAD-LEVELERS

Automatically compensate for lightened load to give a comfortable ride when car is normally loaded.



Simple Installation  
Merely Replace Shock Absorbers

Mail this coupon for free literature

Dept. PM

MONROE AUTO EQUIPMENT CO., Monroe, Michigan

Name \_\_\_\_\_

Address \_\_\_\_\_

City \_\_\_\_\_

PRECISION BUILT



Cabinet-making at its finest gives you a chest to be proud of. Free catalog to machinists and toolmakers.  
**GERSTNER TOOL CHESTS**  
457 Columbia St., Dayton 7, Ohio



**GRAVELLY** with Starter makes Snow Removal **A SNAP**

- Save your heart! . . . Powerful Gravelly Tractor with push-button starter, 48-inch Snowplow attachment takes all the work from snow removal!
- 23 DIFFERENT TOOLS**
- 23 attachments to save your time and work all year long. *Easy Pay Plan . . . only 20% down, 18 months on balance.* Write today for FREE 24-page "Power vs Drudgery" Booklet.



**GRAVELLY TRACTORS, INC.**  
BOX 1063 DUNBAR, W. VA.

**FIELD-TESTED FOR 34 YEARS**

**YOU GET MORE POWER, STRONGER GRIP with**



**P&C PLIERS**

For tough jobs you'll find P&C pliers hold up best. Scientifically heat treated jaws, tempered cutters, deeply milled teeth and extra firm-grip handles make P&C pliers America's favorites . . . more power in your grip.



Shop from the colorful P&C Tool Merchandisers, in more than 12,000 stores coast to coast. Send 10c for tool catalog.

**P&C TOOL COMPANY**

Box 5926, Portland 22, Oregon  
Warehouse: Schiller Park, Ill.

Subsidiary of Pendleton Tool Industries, Inc.

## Over-the-Shoulder Bombing

(Continued from page 109)

of air warfare. Command officials shuttled the requirement to one of its centers, the Wright Air Development Center, in Dayton, Ohio, which has a long and distinguished history of aviation "firsts." One of the center's Armament Laboratory engineers, Lt. Col. John A. Ryan, studied the low-altitude bombing problem, cast out a number of possible solutions and came up with a brilliant idea which was a revolutionary departure from conventional fighter-bomber delivery techniques. First bearing the name of its inventor, the Ryan Toss-Bomb Computer, the device became known officially as the Low Altitude Bombing System. Subsequently, with the usual Air Force inclination for brevity and abbreviation, it became known simply as LABS.

### Upside-Down Bombing

LABS added to a rapidly growing list of what the Air Force likes to refer to as "black boxes"—small, compact units of electrical circuits and devices which supply aircraft, missiles and machines with electronic brains. The LABS computer, in effect, turned the dive-bombing maneuver upside down. Instead of approaching the

target from a high altitude and dropping the bomb vertically, the LABS computer made possible a low-altitude approach and a release which tossed the bomb in a high trajectory toward the target. To accomplish this release, the pilot flew an Immelmann maneuver. LABS added a circuslike acrobatic trick to the Air Force bomb-delivery techniques.

The story of the LABS computer, from its inception to an operational capability within a brief span of 16 months, is a noteworthy accomplishment of Air Research and Development Command teamwork. Soon after Ryan worked out the theory, he and Maj. John W. Hanlen, another armament laboratory engineer, incorporated some ideas for improvement and put together a "breadboard" model of the device and demonstrated the LABS intricacies to research and development officials at Air Force headquarters and the Air Research and Development Command. Everywhere it was well received.

Shortly afterwards, Ryan and Hanlen made contract arrangements with the Massachusetts Institute of Technology to fabricate a number of service test articles. The LABS computer was not a major "hardware" development task because most of the components were already in

(Continued to page 300)

Make your home a Christmas showplace

with **FIR PLYWOOD**



...and these  
**LIFE-SIZE**  
PASTE-ON CUT-OUT  
**DECORATIONS**

printed in  
brilliant color  
on heavy paper  
ready to paste on  
FIR PLYWOOD

CREATE colorful outdoor displays with these realistic, life-size Christmas figures. Use them on your lawn, porch or rooftop. Ideal for homes, stores, schools. Easy to use. No painting or drawing. Simply paste durable paper patterns on fir plywood and cut out with saw. Fir plywood makes figures strong, sturdy, good for a lifetime of Christmases. Order several today.

Jolly 6' Santa . . . . . 50c ea.  
(plus 24" Christmas Wreath cutout)

6' long Sleigh . . . . . 50c ea.  
(plus 24" Noel Trio cutout)

5' long Reindeer . . . . . 50c ea.  
(plus 17" Christmas Bells cutout)

Two 4' Angels . . . . . 50c pair  
(plus 24" Christmas Candle cutout)

Three 4' Choir Boys . . . . 50c set  
(plus Music Scroll cutout)

(All individually packaged)

Orders cannot be filled after Nov. 25. Shipped prepaid. Good USA only. No C.O.D.'s.

**DOUGLAS FIR PLYWOOD ASSOCIATION • Dept. 9X, Tacoma 2, Wash.**



# NEW! MILLERS FALLS Router-Plane-Shaper

WITH REVOLUTIONARY NEW LINE  
OF LOW-COST ROUTER BITS

Built for  
professional  
performance



PLANE  
ATTACHMENT SET  
No. 6826 only \$31.95\*  
(\*without Power Unit)

ROUTER  
(Power Unit and Base)  
No. 6800 only \$39.95

SHAPER ATTACHMENT  
(with built-in motor mount)  
No. 6818 only \$19.95\*  
(\*without Power Unit)

3 TOOLS  
IN 1

Imagine! — an exciting new 3-tools-in-1 combination loaded with exclusive features to give professional results — yet priced to bring the adventure of fine cabinet-work within reach of everyone! It's a Router, a Plane, a Shaper! — that will do hundreds of jobs quicker and better—including dado cuts, moldings, fluting, rabbet cuts, dovetail joints, inlaying, planing and shaping. A real precision tool with plenty of power and speed, that anyone can use!

Plus . . . a revolutionary new line of 17 popular Router Bits, made of Special M-2 High Speed Steel — faster, longer-lasting — at 1/3 less cost than other types.

See and buy the Millers Falls Router-Plane-Shaper and its complete line of attachments at your favorite dealer's . . . or write us for name of qualified dealer nearest you.

## CHECK THESE IMPORTANT FEATURES

**POWER UNIT** ✓ Rugged 3 amp. motor ✓ Ball bearings throughout ✓ 30,000 R.P.M. for smoother, faster, cleaner cutting

**ROUTER** ✓ Large 6" dia. base and big hardwood handles for positive control ✓ Direct-reading scale for fine depth adjustment ✓ Exclusive micrometer-screw adjustment for control of cut location ✓ Extra long rods for long reach cuts ✓ Base and non-marking sub-base take all popular templet guides

**PLANE** ✓ Big 14" shoe ✓ Outboard arbor support ✓ Micrometer-screw adjustment for front-to-rear shoe and cutter alignment ✓ Direct-reading depth adjusting scale ✓ Notched quadrant for quick bevel cuts (—15° to +45°)

**SHAPER** ✓ 1/3 cost of comparable models ✓ Big work surface (24" x 7½") ✓ Built-in motor mount for quick, easy changeovers ✓ Accurate depth adjustment ✓ Adjustable fence ✓ Rugged 1" marine plywood table

Plus . . . a special "package" of exclusive *firsts* for plastic laminate application!

FREE AT YOUR HARDWARE DEALER'S  
Folders and full information about the Router-Plane-Shaper and other fine Millers Falls Tools . . . or write



MILLERS FALLS COMPANY  
Dept. PM-20, Greenfield, Mass.

FINEST HAND AND POWER TOOLS MADE FOR HOME AND INDUSTRY

Do it now with

**DAP**™



Use DAP Caulking Compound to fill cracks around windows, door frames, anywhere. Saves heat. Stops insects, drafts, rot. Fast, easy. Get tube, cartridge or can and free do-it-yourself booklet at your nearest hardware, paint or building supply dealers.

**DICKS-ARMSTRONG-PONTIUS, Inc.**  
General Offices: Dayton, Ohio

## 24 Drilling Combinations with Parker No. 4 Wood Screw COUNTERSINK BIT SET



Drills and countersinks to flush, putty or plug depths for 8 most popular screw sizes. Depth-a-dapter adjusts easily on all 4 bits.

At your  
hardware  
Dealer's  
Only  
**\$1.70**  
per set

**PARKER MANUFACTURING CO.**  
WORCESTER 1, MASS., U.S.A.

existence and needed only modification and assembly into one unit. Just as quickly as the Institute's engineers had inserted the last screw in the models, Major Hanlen dispatched the computers to Air Force testing agencies.

The Air Force Special Weapons Center, at Albuquerque, N. Mex., soon began test activities. These tests were the first the Air Force had formally undertaken with the toss-bombing technique. Because only theoretical studies of such tactics were available, the Center's 4925th Test Group (Atomic) initially used 500-pound practice bombs to gain fundamental pilot proficiency and prove general LABS computer suitability. Both objectives were quickly attained after relatively few drops at the Aberdeen Bombing Mission Precision Range at Edwards Air Force Base, Calif. Directly afterward, the test group started dropping atomic-weapon dummies at the Los Lunas Bombing Range, N. Mex., as well as at Edwards.

### Tests Were Encouraging

It did not take the Special Weapons Center long to submit an exceedingly encouraging report on its test operations. The LABS computer proved more accurate than expected. Furthermore, the test personnel estimated that a pilot could become accurate with the LABS delivery technique in a short period of time.

Not long after the development of the initial LABS computer, some of the engineers and combat-experienced pilots associated with the development and testing realized that from a practical standpoint there were possible restrictions to the system. What if the approach to the target were obscured by bad weather? What if the pilot were forced to seek "targets of opportunity?" Under these circumstances it would not be possible to fly a pre-planned or "canned" mission.

To correct this deficiency, Major Hanlen quickly introduced modifications. The new LABS model allowed higher angles of release. Under these conditions the pilot uses the same basic Immelmann maneuver. However, the weapon is not released until the aircraft is in a vertical position. Following release, the bomb continues going straight upward due to its initial velocity which the aircraft gives it. After the bomb loses this velocity its nose flips over and it falls directly downward toward the target.

The same modification allowed for still another delivery pattern—even more unique. Again the Immelmann maneuver is used, only this time after the pilot has

(Continued to page 302)

# For that "Professional" finish

use

## BEAR BRAND

# SANDPAPERS

sheets • discs • belts

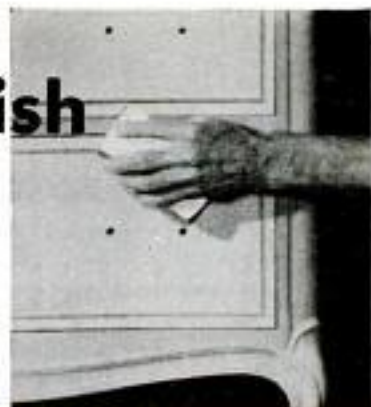

### The same used by industry, manufacturers, and fine craftsmen

Sandpapers are important tools for the home craftsman, handyman or mechanic. They not only make the simplest handiwork glisten with beauty—but are actual cutting tools that do many different kinds of jobs on wood, metal, plaster, plastics or other fabricated materials.

And coated abrasives, with the famous Bear-in-Triangle trademark, have proved the standard for faster cutting... longer lasting... best quality in every industry, for every task. Now... you can use the same BEHR-MANNING sandpapers on your own projects.

**EASY DOES IT** Watch for the handy, easy-to-select SANDPAPER RACK in your favorite hardware or paint store. It provides a wide variety of grits for every purpose... also available in Handy Packs of Sander Sheets, Discs, and Belts.



## BEHR-MANNING CO.

TROY, N. Y.

A DIVISION OF NORTON COMPANY

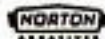

Behr-Manning Products: Coated Abrasives • Sharpening Stones • Pressure-Sensitive Tapes  
Norton Products: Abrasives • Grinding Wheels • Grinding Machines • Refractories

Send this coupon for your free copy of the helpful grit selection chart. Address Dept. PM-10.

Name \_\_\_\_\_

Street \_\_\_\_\_

City \_\_\_\_\_ State \_\_\_\_\_

OCTOBER 1957

301

Copyrighted material

handle  
won't break  
head  
can't loosen  
grip  
won't slip

all these features  
at a low price

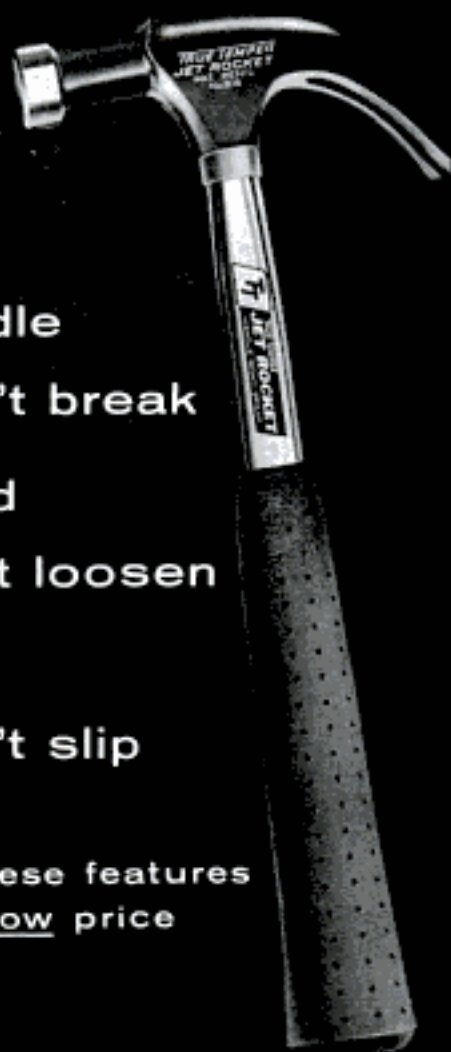

Here's the most useful tool you can own - a JET ROCKET hammer by True Temper. You'll never break that tubular steel handle in normal use. The forged steel head can't come off. The cushion grip soaks up shock, won't slip. The JET ROCKET is perfectly balanced - a pleasure to use. See it now at your hardware dealer's. True Temper, 1623 Euclid Avenue, Cleveland 15, Ohio.



JET ROCKET hatchet  
and belt axe, too.  
Same tough, safe  
construction as  
the hammer.

**TRUE TEMPER®**



Finest quality in Hammers, hatchets, axes • Shears  
Shovels • Garden, lawn and farm tools • Fishing  
tackle • Golf-club shafts • Railroad products

passed directly over the target. The bomb is released at a still higher angle from the original flight path. In this manner the bomb goes *backward* toward the target in a high arc, the pilot again crosses over the target and at bomb burst he is headed in the same direction from which he came. In Air Force language this maneuver is referred to as the "toss back" or "over the shoulder" release.

These additional releases further increased the acrobatic repertoire of the basic LABS device and allowed considerable flexibility in its operational use.

Other than LABS accuracy, reliability and the new techniques, there were two vital secondary factors concerned with atomic-weapons size and weapon effects which played important roles in the LABS delivery.

#### Progress in Atomic Weapons

By the time LABS was under development, atomic weapons were already small enough to be carried by fighter-bombers. Following World War II the Atomic Energy Commission had pursued an intense development and improvement program on all parts of atomic weapons. This endeavor paid off handsomely in several extremely important areas—a more efficient use of fissionable materials, improvement of design, better reliability of ordnance components, and reduction in over-all bomb size. This progress lifted several atomic weapons from the aura of the laboratory and listed them for widespread active military duty. It was common knowledge that the bombs dropped on Hiroshima and Nagasaki were not far removed from laboratory gadgets.

By 1953 the Atomic Energy Commission had exceeded its original estimates on both the production and variety of atomic weapons. These facts prompted Maj. Gen. John S. Mills, then commander of the Special Weapons Center, to advance the theory that "new designs of atomic weapons are being developed to further our capability to permit economical use of atomic weapons against a wider variety of targets."

Noting the development of an entire family of weapons, General Mills asserted that the Air Force could "deliver varied kinds of atomic weapons against varied targets with varied aircraft types."

Granted that the Air Force fighter-bombers could carry A-bombs and deliver them from low altitudes, what assurance did the pilot have that he or his aircraft would survive the terrible holocaust he created? There are four phenomena of an A-bomb blast which have to be considered by mission planners—wind pressure at

(Continued to page 304)

## NEW HONEYWELL DECORATOR LIGHT SWITCH!



Change it  
any way,  
any time



to match  
your room's  
decor!



THE TRANSPARENT decorator plate on the new Honeywell TAP-LITE\* snaps off for easy decorating, cleans easily. Just wipe with a damp cloth. Simple to install. TAP-LITE has screwless terminals. Easy to operate. Tap, it's on. Tap, it's off! Switch and plate \$1.95 at hardware stores.

MINNEAPOLIS  
**Honeywell**



First in Controls

\*Trademark

**BUILD FINE GRANDFATHER CLOCK NOW**

The simple sensible *SPEEDY Red-i-Kut* way as thousands have—FOR YOURSELF OR SELL AT A GOOD PROFIT. SAVE HALF. SHOP TESTED PLANS "SPIRIT OF THE CENTURY" Narrow Walnut 8 1/2" tall or stately straight side "SPIRIT OF AMERICA" EASY-TO-FOLLOW photostocky PLANS & LIFE SIZE PATTERNS tell all—plus MOVEMENT BROCHURE (Kuempel original) \$40 up, of heavy brass weights Westminster, tube chime, movements, gorgeous bronze-silver MOVING MOON dial, 3 1/2" solid-mahogany case kits. Send \$1.00 today—Both plans \$1.50 RUSH.

Kuempel Chime Clock Works, 10 Kuempel Bldg., Minneapolis 16, Minn.

**HANDEE** A COMPLETE WORKSHOP IN YOUR HAND

The powerful new Hi-Torque HANDEE grinds, polishes, cuts, saws, engraves, burnishes, cleans. A necessity in every workshop. Works in wood, hardened steel, non-ferrous metals, glass, ceramics. Packed with power and speed (25,000 rpm). Cool running. Fits the hand for pencil-point precision. 110 or 220-v. 25 to 60 cycles AC or DC.

TOOL OF 1001 USES!  
With every type of cutting tool in metal case. **\$32.95**

Order your Handee Today!  
**CHICAGO WHEEL & Mfg. Co.** Dept. PM-10  
1101 W. Monroe Street, Chicago 7, Illinois

with 6 accessories **\$23.95**

**5 NEW CRUISER KITS** LOW AT \$399

Many other models. Best values in fiberglass covering kits, marine supplies.

18 Ft. Offshore Cruiser

**TAFT MARINE WOODCRAFT**  
Dept. PM-1057 636 39th Ave. N.E. Minneapolis 21, Minn.

## Is this happening to Your Home?



Doors jammed



Windows sticking



Plaster cracking



Sagging floors

Then you need....

## Brainard's new improved TEL-O-POST the original adjustable jack post

**TEDDY TEL-O-POST SAYS:** "Some signs are obvious...others harder to find..."



corrects or prevents sag from excessive weight of heavy appliances or pianos.



corrects or prevents sag from rotted supports under porches.

**TEDDY SAYS:** Try me... | ...in Farm Buildings



**BRAINARD BUILDING PRODUCTS** of the Sharon Steel Corp.

Griswold St., Dept. B-4, Warren, O.

Send for Teddy Tel-O-Post to the Rescue Booklet.

Name \_\_\_\_\_

Address \_\_\_\_\_

City \_\_\_\_\_ State \_\_\_\_\_

See your Hardware or Building Supply Dealer accept no substitutes...ask for TEL-O-POST the original adjustable jack post

# NEW!



## SKILSAW

### 6 1/2" MODEL 536

COMPLETELY NEW SAW  
FOR THE HOME CRAFTSMAN

Makes every cut required—even 2" lumber at 45° bevel. New, hi-speed motor—over 1 horsepower. With precision, helical gears. Transmits full motor power to blade for high cutting speed. Model 536 also features the Variable-Torque clutch—an exclusive of SKIL. Protects against motor burn-out, excessive gear-wear. Every new feature means professional SKIL quality in a saw at a home workshop price. Try it at your favorite hardware or building supply. SKIL Model 536 6 1/2" saw—\$54.95.



**MOST POWERFUL  
DRILL MADE FOR  
THE MONEY!**

See for yourself! Look at the amperage rating on the nameplate of any 1/2" drill. There's where the power is. And SKIL Model 549 beats them all! Only \$29.95.



Made only by SKIL Corporation, manufacturer of famous SKIL and SKILSAW products, 5033 Elston Avenue, Chicago 30, Illinois. In Canada: 3601 Dundas Street West, Toronto 9, Ontario.

the blast-wave front, gust velocities following the wave front, thermal (heat) radiation and nuclear radiation. Taking data from atomic tests in the Pacific and the Nevada test sites, the Wright Air Development Center's engineers and mathematicians carefully combined all of the dangerous A-bomb effects on graphs and charts in terms of distance from the point of explosion. Against this data they figured exactly how far the aircraft had to be at bomb-burst time to escape the A-bomb's effects. Because of various bomb yields and because each aircraft had different flying capabilities, a large variety of combinations had to be calculated to suit all conditions. Exactly how large an atomic weapon can be safely delivered by fighter-bombers is still secret information.

#### Computer Ready for Production

Following the tests at the Special Weapons Center, the LABS computer was ready for production. The Wright Air Development Center, along with the Air Materiel Command, arranged for the negotiation of the computer contract with the Minneapolis-Honeywell Regulator Company of Minneapolis, Minn.

But Lieutenant Colonel Ryan and Major Hanlen did not consider their job finished upon securing production approval. After the computers rolled off the assembly line, these two men accompanied the computers to the operational aircraft, supervised installation, trained pilots and maintenance personnel in LABS operation and gave briefings to fighter-bomber commanders and crews in all aspects of the LABS capabilities.

To a large degree, as with most developments in the Air Force, the LABS computer was a team effort. In addition to the development of the computer itself, other engineers in the Air Research and Development Command contributed much intuition, ingenuity and industry on other facets of the fight-bomber atomic capability. There were many vexing problems associated with the carriage and release of the atomic weapons which had to be solved before the computer had a chance to operate. But the bulk of the credit for LABS rightly belongs to Ryan and Hanlen.

Without question, the ability of the Air Force fighter-bombers to toss atomic bombs at tactical targets has added another good strong punch to the fighting strength of the nation. ★ ★ ★

British coal miners are increasing the efficiency of blasting by pumping water into the coal, thereby spreading the blast.



Don't just shave... Use

# AERO SHAVE!

(and save 20¢)

Never before a lather so rich, so creamy, so fast-acting—for so little money! Get AERO-SHAVE Push-Button Lather.

**AERO SHAVE**  
push-button  
**LATHER**

Not ~~79¢~~ Not ~~69¢~~ Only **59¢**

Be **GOOD** to your **WOOD**  
...deft-finish it

SEALS,  
PRIMES,  
FINISHES



...dries in 30 minutes.

Interior **WOOD FINISHING**  
made easy.



Deft seals, primes and finishes, nothing else to use, no thinning. Deft dries in 30 minutes. You get a 3-coat BAR TOP finish in hours instead of days. No waxing or oiling needed. Deft does it all from start to FINISH. Deft will not darken with age.

Deft Belongs In Every Home Work Shop

- **Roll It On** application will save time on paneling, floors, desk and table top areas.
- **Steel Wool** the final coat for smooth fine-furniture finish, buff-finish with dry cloth for high gloss.
- **Deft-finish Floors** and use them the same day.
- **Smooth Operation.** Use on window slides and drawer runners. The more you use them the smoother they operate.
- **Coat Interior Brass.** Protects metal against tarnish.
- **Deft-finish In Lathe.** Apply Deft to turned wood in lathe. When dry, spin against steel wool for lustrous finish. Excellent for detail work such as picture frames and carving.
- **Clean, Non-sticky** protective coating for tools, metal parts as well as wood handles.
- **Stains, Fillers, Glaze.** Apply Deft, as over raw wood. Many special effects may be achieved with Deft.

Wherever  
paints  
are sold, or  
write for  
free booklet.

Desmond Brothers  
1826 W. 54th St.,  
Los Angeles 62, Calif.  
Please send me more  
information on Deft.

Name \_\_\_\_\_  
Address \_\_\_\_\_  
City \_\_\_\_\_ Zone \_\_\_\_\_ State \_\_\_\_\_  
P. M. -57

**SAVE MONEY on LUMBER**  
with the **LOW-COST**  
**BELSAW PLANER**

• Convert Rough and Random Size Lumber Into Cabinet Finished Stock

Now anyone can make perfect cabinet finished stock from low-cost rough lumber... any size up to 12 1/4 inches wide and 6 inches thick. Turn out high grade finished material at a fraction of the cost you pay lumber yards. Big 42-inch-long bed makes it easy to plane heavy, wide and long pieces... BELSAW self-feeds at 14 to 34 feet per minute.



USE THIS ONE LOW-COST MACHINE for Planing, Jointing, Sawing, Milling, Tongue and Groove.

You can easily make flooring, siding and many other popular patterns with your Belsaw. Your Belsaw quickly pays for itself with savings on raw materials and profits on finished stock... a highly profitable machine for custom work. Compare Belsaw with any 12-inch planer on the market... Belsaw gives you more essential features—yet costs you \$50 to \$125 less than others.

Send Today for Free Literature on the Belsaw Multi-Duty Planer.

**BELSAW MACHINERY CO** 2058 Field Bldg. Kansas City 11, Mo.

**BENDS HARD OR SOFT TUBING!**

Any angle up to 180°!

No. 364-FH —  
for 3/16 to 3/4"  
O.D. tubing



**IMPERIAL TUBE BENDERS** Make neat, accurate bends. Choice of lever, gear and spring types—sizes to 1 1/8" O.D.

SEND 10¢ for VALUABLE HANDBOOK and CATALOG

THE IMPERIAL BRASS MFG. CO.  
1212 W. Harrison St. Chicago 7, Ill.  
Send 36-page Imperial Tube Working Handbook and Catalog. Also name of nearest dealer.

Name \_\_\_\_\_  
Address \_\_\_\_\_  
City \_\_\_\_\_ Zone \_\_\_\_\_ State \_\_\_\_\_



**MAKE YOUR OWN  
BOLTS, BRACES,  
HANGERS!**



**REDI-BOLT®  
THREADED STEEL RODS**

Save repair and construction time. Just cut to length; heat and bend; add std. nuts. Seven sizes: 1/4", 5/16", 3/8", 7/16", 1/2", 5/8", and 3/4". Handy lengths of 24" and 36". Available in galvanized or blue rust-resistant finish.

Sold in Leading Hardware Stores

**REDI-BOLT, Inc.**

5330 Indianapolis Blvd., East Chicago, Indiana

Advertised products are backed by their manufacturers. Select them from POPULAR MECHANICS advertising pages



Carlson Products Corp., 10225 Meach Ave., Cleveland 5, Ohio

**Quick-Setting Cement Speeds Job  
Of Laying Plastic Pipe**

With a handsaw and quick-setting cement, one worker can install 100 feet of a new plastic sewer pipe in 40 minutes. Ten feet of this four-inch pipe, which also is available in two-inch to six-inch sizes, weighs 14½ pounds. To connect pipe and coupling, the worker brushes solvent on the outside ends of the pipe and the inside surface of the coupling and pushes them together. This forms a strong weld that is moisture, corrosion and shock-resistant.

**Echoes of Ultrasonic  
Waves Detect Cancer**

Ultrasonic waves can be beamed into the human body like radar to detect early cancer, a group of medical researchers reported in the *Journal of the Acoustical Society of America*. They say different types of tissues give different echoes, which can be recorded on an electronic instrument. The strength of the echo indicates the diseased condition of the tissue. One examination provides medical information unobtainable by any other means, including X ray, the researchers said.

**Cooling Helps Cattle Fattening**

Electric fans are aiding the fattening of cattle in experiments at the University of California. The tests indicated a 32 percent greater gain per day among fanned cattle on hot days when compared to those not kept cool.

**KAY-TITE Special**

**MAKES BASEMENT WALLS DRY FOR ONLY 3½¢ PER SQ. FT.!**

Here's the most revolutionary boon to homeowners with damp, leaky walls! With KAY-TITE SPECIAL there is no need to pre-wet the surface or remove other finishes before applying. It controls water seepage on porous or non-porous surfaces. It can be brushed on walls of concrete, cinder block, brick, stucco, stone, etc. KAY-TITE SPECIAL transforms wet basements into dry, colorful rooms.

**Masonry Coating Products, Inc.**  
790 Broad St., Dept. PM10, Newark, N.J.  
Please ship immediately 10 lb. can of KAY-TITE SPECIAL @ \$5.00 (makes 1 gallon), postage prepaid. No C.O.D.'s. Check color desired:

Cream  Spanish Buff (Sepia)  Brick Red  Rose  Grey  White  
 Blue  Yellow  Buff (Tan)  Light Green

Name .....  
Address .....  
City & State .....

NEW REVOLUTIONARY NEW





# 5 POWER TOOLS IN ONE

## NEW Dremel Deluxe MOTO-SHOP



### Complete Power Workshop In One Compact, Portable Unit

The amazing new Dremel Moto-Shop is the most versatile multi-purpose tool ever invented. Has 1,001 home and shop uses. Basically, it's a 15" Jig Saw with a unique power take-off to which you simply connect other attachments. It then converts to a disc sander, bench grinder, buffing wheel, and a flexible-shaft machine . . . all powered by a BALL-BEARING ROTARY MOTOR.

And this professional-quality, portable power shop can be set up practically anywhere — basement workshop, kitchen counter or card table. Weighs only 12 lbs. As a Jig Saw, it will cut 1 3/4" wood, 18 gauge copper, 1/16" steel — all with same blade. Foolproof blade guard makes it absolutely

safe — even for children. Handles everything from bird-houses to full-size furniture.

The flexible shaft is a complete machine shop in itself. Use it for sharpening, grinding, polishing, drilling, carving. Collet capacity 1/64" to 1/8". Other attachments have hundreds of home and shop uses.

Moto-Shop is the perfect "ALL FAMILY" workshop — safe for even mom and the children. Helps build a close father-son relationship.

**See Your Power Tool Dealer for a Demonstration Today!**

**Model 57 Moto-Shop.** Includes Jig Saw with disc sander attachment only. Other attachments can be added later . . . **\$33.95**

**Deluxe Model 57 Moto-Shop** with all attachments shown — **\$49.95**  
Price of attachments only, if purchased separately . . . **\$19.95**

QUALITY POWER TOOLS SINCE 1934

**DREMEL MFG. CO., Dept. 117K, Racine, Wisconsin**

Write for **FREE Catalog**



D-33



**BUY GREAT NECK HAND TOOLS**

. . . for long-lasting performance

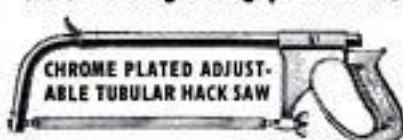

**GREAT NECK SAW MFRS., Inc.**

MINEOLA, N. Y. — SEE YOUR LOCAL STORE

**WELD**

**BRAZE**

**SOLDER**

**CUT**

**4WAY**

ONLY

**\$14.75**

f.o.b. factory

**WELDER**

Complete with  
Twin Carbon Arc  
Torch and ac-  
cessories . . . to  
handle all metal-  
craft work.

Acclaimed by thousands of Homeowners, Mechanics and Hobbyists as the welder of 1001 uses. Easily operated from properly wired 110 volt AC or DC line. The ideal gift with a life-long use. . . Order today on 10 day money back guarantee.

**FOUR-WAY WELDER CO., Dept. F2-K**  
1810 S. Federal St. • Chicago 16, Ill.

see the amazing new  
**EASY-TO-BUILD**  
**ELECTRONIC knight®-kits**



in **ALLIED'S 1958**

**ELECTRONIC SUPPLY CATALOG**

**FREE!**

**BUILD YOUR OWN!  
 SAVE MONEY—HAVE FUN**



**404** value-packed pages



**HI-FI KITS**



**HOBBY KITS**



**INSTRUMENT KITS**



**HAM KITS**

**SAVE on Everything in Electronics**

**WORLD'S LARGEST STOCKS**

Everything for Experimenters, Builders, Amateurs, Servicemen, Engineers and Hi-Fi Hobbyists. Get more for your money in Hi-Fi systems and components; build-your-own KNIGHT-KITS; recorders and phono equipment; TV tubes, antennas, accessories; Amateur station equipment; test instruments; industrial electronic equipment—plus the world's largest stocks of parts, tubes, transistors, tools and books. Send today for your **FREE 1958 ALLIED Catalog!**

Everything in Electronics From One Reliable Source  
 our 37th year **EASY TERMS AVAILABLE**

**ALLIED RADIO**

send for  
**FREE**  
 Catalog

**ALLIED RADIO CORP., Dept. 24-K7  
 100 N. Western Ave., Chicago 80, Ill.**

Rush **FREE 1958 ALLIED 404-Page Catalog**

Name \_\_\_\_\_

Address \_\_\_\_\_

City \_\_\_\_\_ Zone \_\_\_\_\_ State \_\_\_\_\_



### Mechanical Bassinet Rocks Baby

Rocking motion of an electrically powered bassinet keeps young Eddie Garey, Jr., of West Memphis, Tenn., quiet for hours. The baby's father designed the bassinet. An electric motor beneath the basket maintains the slow, rocking motion.

### Meteor Trails Reflect Radio Signals

Voice and teletypewriter radio signals reflected from meteor trails enable messages to be sent 800 to 1500 miles at a time. This system permits reliable communications by use of transmitters of lower power than those required by conventional high-frequency transmitting stations, the U.S. Air Research and Development Command reports. As small size and varying time in interval between meteors make continuous transmission impossible, messages are sent at several times the standard teletypewriter rate of 60 words per minute.

### Scientists Create Element 102

Nobelium is the name proposed for the new element, 102 on the periodic chart, made in a cyclotron at Sweden's Nobel Institute for Physics. Only 30 to 40 atoms of nobelium were produced and, because its half life is 10 to 12 minutes, the original supply of the element has disintegrated. Curium was bombarded with ions of carbon-13 to make nobelium. It has not been found in nature but may appear in the explosion of big stars or hydrogen bombs.

*Maurice Pool*

... 25-year driving veteran and automotive engineer, says:



**"It's a fact...good drivers get good gas mileage"**



"Here at the proving ground, we check fuel consumption right down to fractions of an ounce, under every kind of driving condition."



"We can actually measure the gas wasted by this kind of driving, with its unnecessary acceleration, needless stops and starts."

Rochester carburetors are engineered to give you economical operation . . . quality-built to manufacture more miles from every gallon of gas!

Your Rochester Carburetor Specialist will help you enjoy top economy for the life of your car. See him regularly . . . he's a graduate of the finest service training available anywhere . . . he's worked with General Motors and United Motors Service experts . . . he's by far your best bet for low-cost, high-mileage maintenance!

Rochester carburetors are standard equipment for Chevrolet, Pontiac, Oldsmobile, Buick and Cadillac cars. Rochester Products Division of General Motors, Rochester, New York.



"Good driving—staying in lane, observing speed limits, and keeping alert at all times—can cut gas consumption by as much as 50%."



"Good drivers keep cars in good shape! Have your carburetor and other mechanical parts checked regularly by a trained specialist!"

**R** **ROCHESTER**  
**CARBURETORS**

*Specified as original equipment on more new cars than any other carburetor*





**Handiest  
Adhesive**



for all

**Household Jobs**



**Pliobond**  
by **GOOD YEAR**

"Bonds Anything to Anything"



Available at chain, hardware  
and hobby stores everywhere.

Pliobond—T. M. The Goodyear Tire & Rubber Company, Akron, Ohio

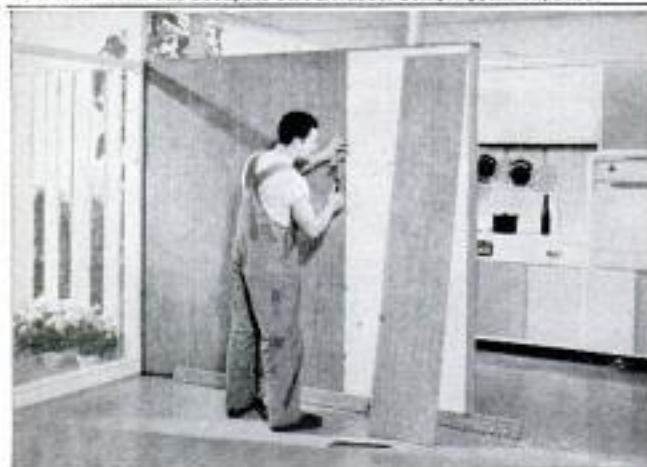

**Modernize a room in a weekend  
with soilproof Marlite paneling!**

In a few hours you can turn an out-moded room into a modern interior with Marlite paneling. Marlite Planks (16" x 8") and Blocks (16" square) go up fast over new walls or old. The soilproof plastic finish resists smudges and stains; cleans with a damp cloth. See your lumber dealer for Marlite in distinctive wood finishes, marble patterns, "Companion Colors"—or write for free decorating ideas book. Marlite Division of Masonite Corporation, Dept. 1042, Dover, Ohio.



**Marlite**

plastic-finished paneling

ANOTHER QUALITY PRODUCT OF MASONITE® RESEARCH

**H**

**HARGRAVE**

The Complete Line of Tested  
**TOOLS**

**INDUSTRIAL QUALITY TOOLS  
FOR EVERY WORKSHOP**



**WRITE FOR FREE CATALOG**

Showing a complete line of Clamps for all purposes, openings from 3/4" to 12" and depths from 1 1/16" to 16", also Chisels, Punches, Masonry Drills for hand and power hammers, Carbide Rotary Drills, Gasket Cutters, File Cleaners, etc.

See Your Local Hardware Dealer

**THE CINCINNATI TOOL CO.**  
1987 WAVERLY AVE. CINCINNATI 12, OHIO

STANDARD  
FLASHLIGHT  
BATTERY



NEW RECHARGEABLE BATTERY

**Tiny Dry Cell Is Rechargeable**

Able to hold a charge for 10 years, a miniature dry-cell battery has the additional advantage of being rechargeable. The battery is composed of lead lead-oxide and silver powder plus a potassium hydroxide electrolyte contained in five absorber pads. It is expected to cost about 50 percent more than the conventional flashlight battery if and when put into commercial production. Its advantages of long life, constant voltage and durability are said to outweigh the added cost.

POPULAR MECHANICS

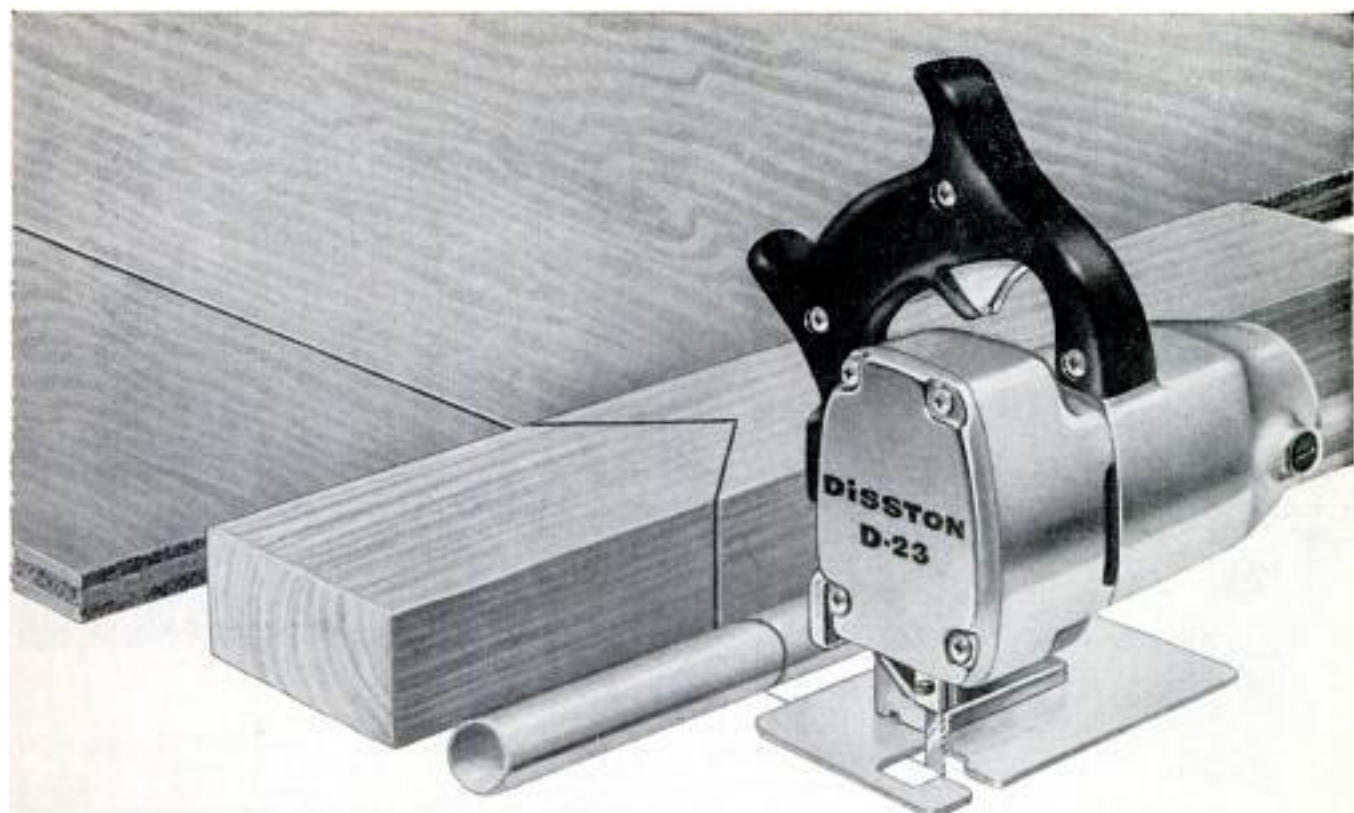

NOW, A VERSATILE, 5¼ POUND  
TOOL THAT CUTS WOOD, METAL, PLASTIC

# DISSTON

## D-23 ELECTRIC HAND SAW



**HERE'S A GREAT NEW DISSTON** tool for both professionals and hobbyists with a name famous for good saws for more than 100 years. The DISSTON D-23 has proved itself 15% to 50% faster than any competi-

tive electric saw. It has extra easy-to-change blades for cutting plywood, 2 x 4's, plank lumber, sheet metal, pipe, tubing and plastics. It saws straight lines, circles, scrolls or bevels with a true, fray-less cut. Only \$98.50

**"ORBITE" ACTION.** The blade of the DISSTON D-23 has an orbital motion (at 3,800 strokes per minute). It cuts on the upstroke, moves away from the material on the downstroke. The result is a fast, professional work with minimum wear on the blade.

**FREE BOOKLET:** Write today for an illustrated booklet about many more convenient and exclusive features of the DISSTON D-23. Address: H. K. Porter Company, Inc., Henry Disston Div., 510 Tacony, Philadelphia 35, Pa.

**H. K. PORTER COMPANY, INC.**  
Henry DISSTON DIVISION

# BUILD WELDER OR LIGHT PLANT General SALE NEW HYDRAULIC CYLINDERS

**instruc. incl. TYPES AMPS VOLTS PRICE**  
 G.E. 200 amps, 24V New \$17.50 Used \$12.95  
 R-1 & Helmitz, G.E. or Ford 200 24 \$24.50  
 G.I. 160-250 amps, 30V, New \$15.50 used \$9.95

**V-BELT PULLEY KIT.** Fits R-1, P-1, 2-1 or AC-DC Generators has two bearing block plates, 4 bearings, triple groove V-pulley, Dr. shaft and flex. coupling \$17.80

**New G.E. #511 Generator**

**AC-DC WELDER KIT**  
 Makes ideal light plant & Battery Charger. Rated 1250 Watts, 115V, A.C. & 200 Amps, 30V D.C. including 1 Volt. regulator, 1 reverse c. relay, 1 Solenoid idling device, 1 electrode holder, 1 toggle switch, 1 Helmitz, 1 rheostat and instructions \$38.50. AC-DC generator if bought separate \$24.50

Kit as above with R-1, G. Helmitz or G.E. 200 amp, ren. \$38.50. Kit with 160-250 amps, ren. \$28.50. R. Kit with New G.E. 200 amp, ren. \$34.50

**Reactor Coil Arc Stabilizer** heavy duty for R-1, P-1, G-1 and AC-DC generators approx 7"x3"x4". Wt. 11 lbs. #HCT00 \$10.95

**Gear Unit 1:1 ratio 10 H.P. \$5.95**

**WATER PUMP WITH MOTOR** 3/4 H.P. D.C. runs on 6 or 12V. D.C. Adj. press. 1" ports, 200 G.P.H. \$12.95, 400 G.P.H. \$14.95. 900 G.P.H. 1/4 H.P. 3/4" ports \$17.50

**UTILITY TOOL KIT** Runs on 6-12-24 V. Includes reduction gear motor, base, 2 handles, 3-jaw chuck takes up to 3/4" drill, switch & cord \$10.75 with flexible shaft Approx 30" L. incl. m. shaft arbor \$12.95

**SAVE ON SURPLUS MOTORS**  
 6-12-24V. DC H.P. R.P.M. Shaft Price  
 Deico 8 or. in. 120 3/16x1/16" \$3.95 2/7.00  
 Deico 3/4 8.2 amp 5/16x1" \$5.50 2/8.50  
 Deico 1 1/8 6.5 amp 7/32x2" \$4.75 2/8.20  
 Bendix 1/4 4000 RPM 28-32V. AC-DC \$4.50 2/7.90  
 Gear Red. mtr. 2711 or 311 1 1/8 HP 3900 RPM \$4.00  
 Peeco 3/4 HP 2300 RPM 3/32" shaft \$8.95 2/14.00  
 as 2 speed, reversible add 15% postage

**HYDRAULIC PUMP BARGAINS** 1500 P.S.I. M.F.G. TYPES H.P.M. G.P.H. Price  
 Peeco Gear 1500 198 \$12.95  
 Peeco Gear 4300 360 \$14.50  
 Peeco Gear .447 cu. in. 270 \$18.50  
 Stratopower .450 cu. in. 3750 400 \$17.50  
 Vickers .507 cu.in. rev. \$18.50 .410 c.l.r. \$16.50

Air or Oil	Bo. In.	Stroke	Shaft	D. Action	Price
#11	1 1/2"	6"	5/8"		\$7.50
#12	2 1/2"	4"	5/8"		\$8.50
#127	4 1/2"	10 3/4"	1-3/16"		\$27.90
#111	3 1/2"	2 1/4"	1 1/4"		\$22.50
#111	3"	2 1/4"	1-3/16"		\$20.95

**NEW HYDRAULIC SYSTEM KIT**  
 #400 R. Heavy duty Power Driven. Rated 14,000 lbs. lift. Consists of 2 D.A. hyd. cylinders, 3" bore x 24" stroke, each rated 7000 lbs. with 1000 P.S.I., 1 four way hyd. control valve with built in relief #821, 1 Vickers hyd. pump, 400 G.P.H., 100 P.S.I., 3750 RPM, 1 hyd. 2 gal. reservoir, 1 Purolator hyd. filter, 1 gauge 0-2000 P.S.I. all hose & fittings. Value \$184.10, save \$90.00. Kit price \$94.10. Kit with two #511 cyl. \$79.95

**BARGAINS FROM PREVIOUS ADS** (details free). Accumulators, 2000 P.S.I., 3" dia. \$5.50, 12" dia. \$15.50. Speed Reducer 10:1 ratio, 2 H.P. \$6.45. Peeco Hyd. Flow equalizer, 1500 PSI \$9.95. New Tachometer Indicator 0-10,000 \$7.50. New Weaver hyd. hand pump 2000 PSI, 20" handle \$9.95

**GENERAL SALVAGE CO. CHECK OR M.O.**  
 2022 E. 27 St., Dept. 81, Kansas City 27, Mo.

**SAW SHARPENING IS EASY**  
 Super Filer No. 11 joints and sharpens hand and circular saws 6" to 10" with all teeth correct in height, depth, pitch, bevel. When file hits steel roller, teeth are finished. Saw runs free with no side pull. Includes 8" file. **\$9.95 PPD.**

**"TRU-CIRCLE" saw set** automatically sets teeth at 10° or more. **\$2.95 PPD.**

**SUPER SAW FILER No. 6**  
 Automatically controls depth, angle, pitch for all saws. Precision made and calibrated. Use in any vise or clamp. Includes file. **\$6.50 PPD.**

**DOWEL CENTERS**  
 Centers inscribe exact location for opposite holes. Pairs for 1/4", 3/8", 1/2" holes. **\$1.00 PPD.**

MONEY BACK GUARANTEE—CATALOG FREE  
 A. D. McBURNEY, 5908 Hollywood Blvd., Hollywood 28, Cal., Dept. A-107

## DREMEL Electric MOTO-TOOL

**Handiest Tool You Can Own**  
 Grinds Carves Engraves Drills Routs Sharpens  
 Craftsman or hobbyist, you'll find a thousand-and-one practical uses in the home or workshop for the amazing Moto-Tool. Handles like a pencil. Saves time, makes every job easier—and gives your finished job a professional look.

Since 1936, the Dremel Moto-Tool has been widely used as a precision tool in industry. It develops 27,000 RPM—the fastest, most powerful tool of its kind.

Buy a Moto-Tool—it will pay for itself in no time.



**MOTO-TOOL MODEL NO. 2**  
 (wgt. 13 oz. shown above) **\$19.95**



**MOTO-TOOL MODEL NO. 1** **\$12.85**

**MOTO-TOOL KIT NO. 2 (as shown)**  
 Incl. Model No. 2 Moto-Tool, 23 accessories (high speed cutters, grinder, polishers, etc.) **\$27.50**  
 in a sturdy steel case **\$21.50**

**MOTO-TOOL KIT NO. 1** **\$21.50**

SEE YOUR DEALER or write for FREE catalog on the complete Dremel line of power tools.

Quality Power Tools since 1934  
**DREMEL MFG. CO., Dept. 117K, Racine, Wis.**

## GREATEST NEW DEVELOPMENT IN AUTOMOTIVE SAFETY!

TRACTION-MASTERS simply installed on your car assure a smooth, level ride—safe, short stops—faster starts! No dip—no dive—no sway! Improved traction in snow, ice or mud. Tremendous savings on tire, spring, shock and gear life! Blowout protection!

Only **\$42.45** pair

**MONEY-BACK GUARANTEE!**  
 Write Dept. PM-10 for FREE BROCHURE with full information.

**Traction-Master Co.**  
 2917 W. OLYMPIC BLVD.  
 LOS ANGELES 6, CALIF.

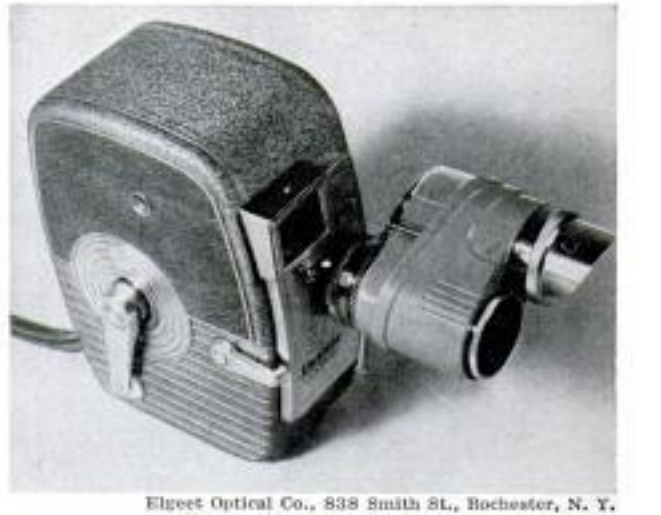

## Lens-Meter Attachment Improves Movie-Camera Accuracy

Home movies can be improved with a combination lens and exposure meter attachment. It fits any eight millimeter "D" mount camera. By turning a lever to match the lens-opening arrow with the meter's light-indication needle, the correct exposure is set automatically. The device is accurate because the meter is located close beside the lens and both receive the same amount of light. It is particularly valuable when using color film.

Elgect Optical Co., 838 Smith St., Rochester, N. Y.

**DRAFTITE\***

## NEW WEATHERSTRIP

*has unique pile that seals out costly drafts*

No home insulation job is complete until doors are tightly sealed with DraftTite, the weatherstrip built like the kind used in cars to seal out drafts at high speeds.

DraftTite traps millions of dead air cells in tightly packed "piles" anchored in rubber on aluminum strips. Cold and wind can't penetrate. Lasts a lifetime, won't mat, deteriorate, buckle, harden or waterlog. Costs only \$1.98 to permanently seal an average door frame, 69¢ for the bottom. Installs in minutes. At your hardware dealer's now.



\*Trade-Mark

*The Standard Products Co.* LEXINGTON, KENTUCKY

## Precision Grinder Brings QUICK CASH INCOME!

Make \$3 to \$5 an hour in your own spare time business. Low cost Foley Grinder sharpens circular saws, ice skates, rotary mower blades, also sands and polishes. No experience needed. Write today for free illustrated information and sample handbills that will help you start. No salesman will call.



**FOLEY MFG. COMPANY** 1073-7 Foley Bldg. Minneapolis 18, Minn.

Buy nationally advertised products. Ask with confidence for the brands advertised in POPULAR MECHANICS



## FOLDING SAWHORSE BRACKETS



- FOLD THE LEGS AND HANG 'EM ON THE WALL
- FOLDS FLAT, ONLY 3" THICK WHEN FOLDED
- LIGHTWEIGHT, EASY TO CARRY, BUT STRONG
- LABORATORY TESTED FOR 2000 POUNDS

SPACESAVER FOLDING SAWHORSE KIT includes, metal brackets for 2 folding sawhorses, list of all materials needed, complete instructions for cutting and assembling your own FOLDING SAWHORSES only.....\$1.00

THE MARTIN COMPANY, 6604 Winnebago Ave., St. Louis 9, Mo.

OCTOBER 1957

## ?? SHOP QUIZ ??

Question 1 \_\_\_\_\_

What's the **EASIEST** way to drive wood screws?

Question 2 \_\_\_\_\_

What's the **EASIEST** way to remove wood screws?

Question 3 \_\_\_\_\_

What's the **EASIEST** way to run nuts or bolts on or off?

Question 4 \_\_\_\_\_

What's the **EASIEST** way to use heavy-duty cutting tools like hole saws, masonry and auger bits?



# ANSWER:

WITH YOUR ELECTRIC DRILL AND A

# Supreme Versamatic

Reversible speed reduction attachment that fits every power drill. Increases power 7 times. Reverses with one simple twist. A must for every drill owner.

**\$14.95**  
AT LEADING  
TOOL  
COUNTERS

By the makers of SUPREME BRAND CHUCKS

**SUPREME PRODUCTS CORPORATION**

2222 S. Calumet, Chicago 16, Illinois

A Division of A-S-R Products Corporation

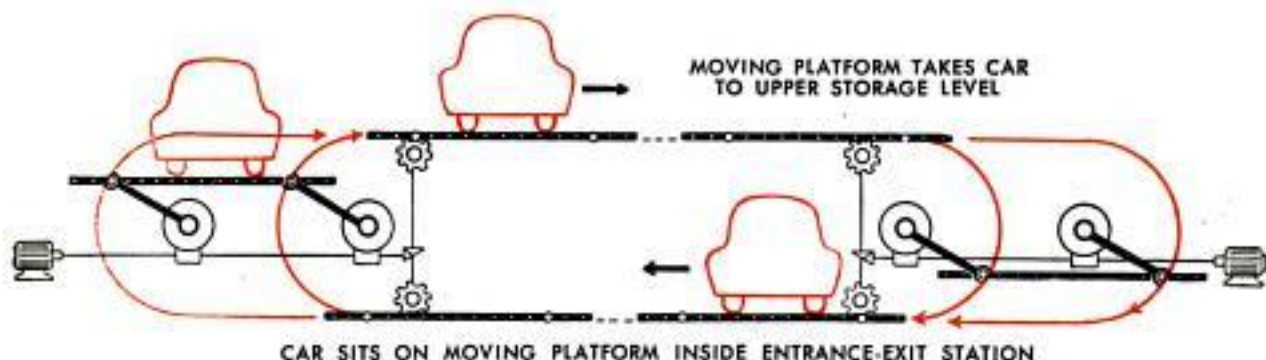

## Moving Platforms Park Cars on German Lot



German cars park on a mechanical assembly based on electrically driven moving platforms with a swing-around junction between upper and lower levels. The cars are held on individual platforms linked to form a continuous circuit. Each movement brings an empty space or car to the entrance-exit station.

Modern fighter planes require 23,000 feet of electric wiring, as compared to 1500 feet of wiring in the World War II fighter aircraft.

### Save that PAINT BRUSH — now more valuable than ever

Perfect  
for  
NYLON BRUSHES

BEFORE



AFTER

10c  
25c

KEEP  
BRUSHES  
LIKE  
NEW  
WITH  
DIC-A-DOO



At Paint,  
Hardware, Dept.,  
and 5 & 10¢ Stores

Patent Cereals Co.

Geneva, New York



The amazing CIRCLE MASTER, a new patented attachment, will permit you to cut all circular shapes on any make bench saw. Simple to use, CIRCLE MASTER enables you to cut a perfect, clean and smooth circular shape. Cuts a diameter adjustable up to 30" on small saws, even bigger on large saws. You can make chairs, table tops, wheels, trays, lazy susans, stools, coasters . . . anything that calls for a circular shape. You can make cove cuts, beveled cuts, shoulder cuts, moulding cuts and many others depending upon blade used. You must be completely satisfied or your money back. Send Check or money order. We pay postage.

ONLY \$4.95

AMERICAN HOME TOOL CORP.

DEPT. 21 • 350 BROADWAY • NEW YORK CITY



ORDER DIRECT  
FROM AD

SURPLUS AT  
FRACTION OF  
GOV'T COST

**TOP VALUE  
SPECIALS**

SHOP BY MAIL  
AND SAVE AT  
GROBAN'S

SATISFACTION  
GUARANTEED

**BRAND NEW**

**WALKER  
5-TON  
HYDRAULIC  
LIFT KIT**

FOR — • SNOW PLOWS • TO  
DUMP FARM WAGONS • ADJUST  
DEPTH OF PLOWS • HYDRAU-  
LIC PRESS • HYDRAULIC JACK.

THE COMPLETE KIT CONSISTS  
OF: 1—Walker Hydraulic Hand  
Pump—Rated 1500 lbs. per sq. inch  
with 2 gal. hydraulic reservoir • Re-  
lease valve • Filler plug and air vent

ITEM  
#KW-  
116

• 28" steel handle. Fine for hydraulic presses; snow plows, jacks.  
Dimensions: 6" Diameter, 29" long with 3/4" pipe  
thread port. Pump Assembly Item #P449..... **23.50**

1—6 Ft. length double wire braid rubber covered  
hydraulic hose—tested to 20,000 lbs.! Item #27H4... **3.95**

1—Hydraulic Cylinder, 3" bore, 6" stroke. Husky 3/4" solid steel  
shaft. Will lift 10,000 lbs. using 1500 lbs. of pump pressure.  
Clevis mountings that take 3/4" diameter pins. May be used for  
single or double action service. Overall length  
17 1/4"—retracted. Item #C419..... **12.50**

1-Gallon hydraulic fluid furnished free with each kit.  
Plus all necessary hydraulic fittings. Total ship. wt.—40 lbs.

**COMPLETE KIT PRICE**..... **38.95** F.O.B. CHICAGO  
(ALL OF ABOVE INCLUDED)

**1 1/2 H.P. HYDRAULIC SPEED REDUCER**

with FINGERTIP CONTROL



USE FOR: • Reamer Drives • Midget  
Cars • Feed Mills • Canning Machines  
• Conveyors • Lathes • Milling Ma-  
chines • Motor Boats • Cream Sepa-  
rators • Garden Tractors •

Variable output speeds from 0  
to input speed available by  
moving control handle. Locking  
handle maintains setting. Use in-  
put power of 1/2 to 1 1/2 H.P. Shafts 3/4"  
diam. Input rotation counter-clockwise  
facing shaft. Input speed 750 R.P.M.  
7 1/2" x 7 1/2" x 11 1/2". Output rotation

ITEM #115  
reversible. Ship. wt. 31 lbs. Complete with 2 qts. of  
oil and full instructions. F.O.B. Chicago..... **72.50**

**GROBAN FOUR-WAY OPEN CENTER  
HYDRAULIC CONTROL VALVE**



ITEM #126—Four-way open center control valve,  
with built-in adjustable relief valve factory set  
at 1000 P.S.I. Spring loaded neutral position.  
For use with one double acting cylinder. In neu-  
tral position cylinder is locked and pump un-  
loaded. Can be used as single unit or mounted in  
series. Has 3/4" pipe thread inlet and  
outlet. 1/2" pipe thread cylinder  
ports. Finger grip handle. Ship.  
wt. 10 1/2 lbs.

**AN OUTSTANDING BUY!**  
F.O.B. Chicago..... **23.50**

**A \$15.00 VALUE 37-PIECE  
METAL STAMPING SET**

MADE TO RIGID U. S.  
ARMY SPECIFICATIONS  
STAMPS NAMES, NUMBERS,  
ON WOOD OR METAL

FULL ALPHABET, A-Z. NUM-  
BERS 1-9, "0", and PERIOD.  
ITEM #390-B—PRECISION HAND  
SHIMMED, deep cut, hardened  
TOOL STEEL STAMPS—IN  
FITTED EASY ACCESS CARTON.



\$5.50 per Set

**2 FOR 10.00** PPD.

**BRAND NEW 1 H.P. 12 VOLT  
ELECTRIC MOTOR**

ITEM #308 — • For electric wheel  
chairs (Pop. Mech. design—Mar. 1953).

• For electric golf carts.

• For self-propelled scooters, children's  
midget cars.

Rated 1 H.P.—100 amps., 5600 R.P.M.,  
12 volts, D.C.—This double shaft motor of  
ball-bearing construction may be run on 6  
volts for lower horsepower requirements—Standard 3/4" shafts,  
flange mountings.—Dimensions: 9"x4 1/2"x4 1/2".



Ship. wt. 19 lbs. A real value at..... **12.50** F.O.B. Chicago

**2 H. P. ELECTRIC MOTOR**

ITEM #315—24 Volts, 90 Amps., 4000 RPM, Spline shaft both ends.  
Style similar to above. Mfgd. by Hobart or Diehl.

F.O.B. Chicago..... **13.00**

**HIGGINS BRONZE  
CENTRIFUGAL PUMP**

PUMPS ALMOST ANYTHING

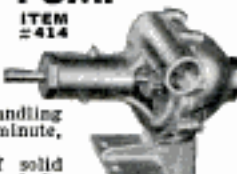

ITEM #414

Fine for: — • Irrigation • Sump  
Pumping • Sewer Drainage • 75 gal-  
lons per minute @ 2400 R. P. M.

Higgins Type PNB, Model R, marine  
bilge pump. Open Impeller design for handling  
muddy water. Delivers 75 gallons per minute,  
30 foot head with 3/4 H.P. motor.

Pump body and impeller are made of solid  
bronze, with alloy steel 1/2" diameter shaft,  
1 3/4" long. Rotation of the pump is clockwise. Inlet has 1 1/2"  
pipe thread. Plain 1 1/2" outlet for hose connection. Di-  
mensions 12"x7"x8". Shipping weight 23 lbs.

F.O.B. Chicago..... **23.50**

**FREE! NEW FALL-WINTER CATALOG**  
60 PAGES of unsurpassed War Surplus  
and new Equipment Bargains for farm,  
home, factory, workshop. Write today.

Send Payment Or Purchase Order Today  
For Phone Orders Call Webster 9-3793

**GROBAN SUPPLY CO. DEPT. PM-10**  
GROBAN BUILDING

1139 S. WABASH AVE. CHICAGO 5, ILL.

**PM TAG of  
INTEGRITY**

More than 1,300,000  
families read POPULAR  
MECHANICS every  
month for valuable sug-  
gestions and product information. It is your assur-  
ance of quality workmanship with quality products

**MAKE SURE YOUR CAR  
WILL GET YOU THERE**

1. by getting a FALL TUNE-UP

2. by getting a  
**HULL AUTO COMPASS**

\$6.95 AND \$5.50

AT YOUR DEALER'S OR WRITE FOR LITERATURE  
**HULL MFG. CO.** P.O. Box 266-D-10  
Warren, Ohio



**WELD IT YOURSELF IN A JIFFY!**



Weld, Cut, Brazo, Solder; Iron, Steel, Brass, Bronze, Aluminum and other  
metals safely and easily. Make your wrought iron furniture, porch railings,  
fences, knick-knacks and other metal specialties. With this fine equipment  
anyone can do professional-like work with little practice. Tool and equipment  
breakdowns are annoying and costly. Don't let them bother you. The Dynamic  
will pay for itself quickly in both time and money and is designed to  
operate from any properly wired 110 volt AC line.

Order your Dynamic Industrial type transformer Arc Welder  
for Workshop or Industrial use today. Order from this ad.

Literature on larger equipment available on request.

**DYNAMIC WELDER COMPANY, 1808 S. Federal Street, Dept. D2-K, Chicago 16, Illinois**

**EASY PAY PLAN**

Low down-payment.  
Pay as you weld.  
Money back guaran-  
tee. Send for details.  
Complete outfit.

**Only \$38.50**

F.O.B. Factory



**THE REACH IS RIGHT AND TIGHT**

**with KRAEUTER**

**LONG NOSE PLIERS**



#1781-7"

You can depend on reachability and cutting power with Kraeuter's #1781 Long Chain Nose Pliers. And your reach will be tight and sure for those hard-to-get-at jobs with the extra long milled jaws of these pliers.

Buy the right line. It's the Kraeuter line. Kraeuter tools are unreservedly guaranteed.

Send for catalog #25 illustrating complete Kraeuter line.

BUY THE FINEST  
BUY KRAEUTER  
BUY AMERICAN

MODERN AS TOMORROW

**kraeuter & co., inc**

FOR 100 YEARS THE FINEST IN HAND TOOLS 1860-1960 NEWARK, N. J.



### Atomic Lamp Burns 12 Years

Switch lamps for the New York Central System's new automatic yards will burn brightly for 12 years without maintenance or refueling. They are filled with a special gas called "krypton isotope 85" which reacts with a phosphor coating on the glass to produce a glow. When the brightness wanes the lamps can be restored to their original luminosity by refilling them with the krypton isotope. The krypton lamp in the photograph is being demonstrated by New York Central President A. E. Perlman. The railroad's atomic laboratory also is studying the possible use of tritium, another radioactive material, as a source of lamp energy.

### Enzyme Dissolves Blood Clots

Deadly blood clots may soon be dissolved by an enzyme injected into the blood stream. Yale University scientists report significant progress in purifying the enzyme, known as plasmin. Preliminary tests on human patients are under way. Judging from animal experiments, a blood clot should dissolve and the blood return to normal a few hours after injection. Existing drugs help prevent the formation of clots, but until now doctors have had no satisfactory means of dissolving a clot.

### Cold Engines Start With Spray

Any type of gasoline or diesel engine will start in extremely cold or damp weather when a flammable fluid is sprayed from an aerosol can directly into the air cleaner or intake air stream. The starting fluid is inert, making it safe to use and store, and is effective from 65 degrees below zero to 180 degrees above zero Fahrenheit.

Spray Products Corp., P.O. Box 584, Camden, N. J.

# SURPLUS SALE

• War Surplus  
• Excess Inventory  
• Bankrupt Stock

## PORTABLE POWER GENERATOR

• Genuine General Electric ball bearing 115-v 3000-w direct current generator. Ideal for powering portable saws, drills, contractors lights, sanders, etc.  
• Ready to use. Size 11"x11"x20". Wt. 160 lbs. Shaft 1"x3". Speed 2400 RPM. Govt. Cost \$195. . . . . **SALE \$49.47 FOB**



## WIND INDICATOR

• Finest Govt. wind direction and speed instrument. Attractive satin silver finish etched dial, opal lites show direction. Buzzer and lite indicates velocity. Operates on 110-v AC. Unit requires roof top transmitter. Easily constructed. Govt. cost \$97.50. **SALE \$14.95 Ppd.**



## GOLF CAR MOTOR

• Use for golf, boys, factory cars. Powerful, expensive ball-bearing, 140 to 1 gear reduction motor. Runs on 6 or 12-v storage battery. Easily reversible. Full instructions. Wt. 34 lbs. Govt. cost \$250. **SALE \$19.46 FOB**



## DIAL TELEPHONE

• Modern hi-efficiency attractive dial phone. Use for extension to main line on private systems. Use several for complete private system, etc. Complete with ringer, dial, etc. Govt. cost \$25.50. **SALE \$9.95 Ppd.**



## SURVEYORS LEVEL

• Accurate brand new latest model fully adjustable precision level with 14-power optically true telescope. Vertical focus. Sensitive spirit level. Use for land leveling, foundation work, surveying, etc.  
• Furnished complete with 8 1/2" graduated rod, polished case, tripod, etc. **SPECIAL \$54.75 Ppd.**



## AC-DC ELECTRIC GENERATOR

• Brand new 6-v suitable for light welder, battery charging, campers light plant, etc.  
• Generates 100 amps or 30-v DC and 1200-w 115-v 800-cycle AC. Marvellous buy! Govt. cost \$295. . . . . **\$13.91 FOB**



## HI-CURRENT TRANSFORMER

• Heavy duty 115-v AC transformer. Secondary 24-v at up to 30 amps.  
• Excellent for driving boys electric car, motors, other AC series type motors. Many applications. Wt. 11 lbs. Govt. cost \$19.50. **SALE \$11.29 FOB**



## BATTERY ELECTRIC WINCH

• Powerful, fully reversible ball bearing gear reduction winch. Runs on 6 or 12 volt truck or car battery. 1000-2000 lb. pull. Holds 40 ft. 1/4" cable. Use truck, boat, docks, etc. Govt. cost \$280. **SALE \$46.75 FOB**



## STEEL LETTER INDUSTRIAL STAMPS

• Finest steel stamp. Large size. 3/4". Mark on copper, steel, wood, leather. Reduce loss of tools by theft.  
• All letters of alphabet. Wood box 3x3 1/2 x 9 1/2". Govt. cost \$14.25. . . . . **SALE \$6.95 Ppd.**



## GIANT ARMY KITE

• Wonderful spectacular advertising unit. Will haul banners aloft (even a man), pull boats, etc. Made of strong silken fabric. Collapsible frame. Easy to set up or knock down. Will launch in ordinary breeze. Size 14'x 10'x3'. Wt. 25 lbs. Govt. cost \$125. **SALE \$16.99 FOB**



## SPECIAL OF THE MONTH!

### MAGNETO HAND CRANK PHONE

• Attractive light oak compact case, hand crank generator signal type with dry cell talking current. Use on rural phone line, for house-to-house, extension phone, etc. Latest craze is "old fashioned phone" in den or party room.  
• Will work on modern systems. An outstanding buy! Wt. 16 lbs. List \$26.50. **SALE \$8.97 FOB**

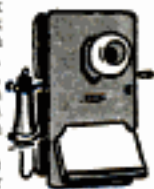

### ELECTRIC CLOCK TIMER

• Finest 115-v 60-c electric clock timer. Shows exact time. Will sound built-in alarm at any preset interval. Easy to read numbers. Fine for mounting desks, radio, TV, etc. 3 1/2" dia. Wt. 1 lb. List \$12.50. **SALE \$2.89 Ppd.**



### 5000 WATT POWER PLANT

• Wonderful buy! Army surplus plant 5000-w, 115/230-v, 60-c, 1-phase, 3-wire Hercules engine. Weather proof housing. Push button start-stop. Use emergency, stand-by, contractors, etc. Govt. cost \$1300. **SALE \$497.50 FOB**



### OTHER OUTSTANDING SURPLUS BUYS

• We have hundreds of other bargains including air compressors and accessories, etc. All styles power plants, hydraulic cylinders and pumps, electric equipment, etc. Typical specials are listed below:

- \$62 Irrigation Pump, 1 1/2" . . . . . \$24.61
- \$35 Stainless Steel Air Tank . . . . . \$16.95
- \$11 Fish and Worm Shocker . . . . . \$6.99
- \$21 Army Jungle Tent Hammock . . . . . \$6.95
- \$425 Hydraulic Cylinder Reducer . . . . . \$47.81
- \$64 Electric 12-v D-C Pump . . . . . \$9.95
- \$66 Gear Reducer, 80 to 1 . . . . . \$8.49
- \$195 Electric Car Motor 12-v . . . . . \$14.42

Order from ad or write for Free Catalog.



### BURDEN SALES COMPANY

812 "O" St., LINCOLN, NEBRASKA



## 10" TILT/ARBOR SAW BUILD-IT-YOURSELF from GIL-BILT KITS-PLANS

Sturdy wood, steel, and aluminum construction. NEW DEPARTURE ball bearings. Capacity and performance of floor saws selling for \$150.00 and up. Plans, all metal parts in kit with 10" comb. blade \$25.90, less blade \$22.98. P.O.B. St. Louis. Detail PLANS-PATTERNS only \$1.00 postpaid.

Build-it-yourself 12" and 18" Bandsaws, 6" Belt Sander, Shaper. Simplified plans, build easily with hand tools only. Advertised and sold for 10 years, over 33,000 units in use. Money back guarantee. **FREE CATALOG.**

**GILLIOM POWER TOOLS, Dept. 80-K, Lambert Field, St. Louis 21, Mo.**

Buy nationally advertised products. Ask with confidence for the brands advertised in POPULAR MECHANICS



# STOP

## ENGINE STALLS-VAPOR LOCK-LOW MILEAGE

INSTALL A **MILESMASTER**

## FUEL PRESSURE REGULATOR



Let Milesmaster help you enjoy better, more economical motoring. Sold everywhere . . . only \$6.95, plus installation.

Money Back Guarantee

**MILESMASTER, INC.** Exeland, Wisconsin

# FINEST IN WOODS

TOOLS, MATERIALS & SUPPLIES

## 145th Anniversary Edition

Constantine's latest catalog. 126 pages, many in color. Everything craftsmen need in hard-to-get hardware and supplies. Veneers, Inlays, Carvings, Mouldings, Upholstery Supplies, Plans. Sections on many Hand and Power Tools, How-to-do-it and wood finishing articles. 88 inlay designs and big wood identification panel of over 60 woods . . . all in natural color. Finest book ever offered. Send coupon for copy today!



Send 25c (refunded on 1st order) for this catalog and "Chips and Chats", a Constantine publication, will be sent FREE!

## CONSTANTINE'S National Woodworking CONTEST . . .

**CASH PRIZES**

America's leading supplier of woods and woodworking materials offers you the chance of national recognition for your skill and win one or more of 309 prizes. Nothing to buy, no entry fee. Contest closes March 31, 1958. Mail coupon for FREE details and entry blank today!

## MAIL COUPON TODAY!

Enclosed 25c (refunded on 1st order) Send Catalog and FREE "Chips and Chats".

Name \_\_\_\_\_  Contest details and Entry Blank.  
Address \_\_\_\_\_  
City \_\_\_\_\_ State \_\_\_\_\_

**ALBERT CONSTANTINE AND SON, INC.**  
2056D Eastchester Road • New York 61, N. Y.

OCTOBER 1957

317

# Johnson Red-Head Portable Air Compressor



## FOR

- HOME WORK SHOPS • HOME PAINTERS
- DO-IT-YOURSELFERS • BOAT OWNERS
- CHARCOAL CHEFS • GARDENERS
- FARMERS • KENNEL OWNERS

The Johnson Red Head Air Compressor is a powerful piece of equipment—not a play-thing. You can do a "professional" job with the Johnson Red Head. Can pay for itself many times over. Paint — Spray — etc.

### CHECK THESE "RED HEAD" FEATURES

- 100% BALL BEARING** and needle roller bearing construction.
- PISTON-TYPE UNIT.** Provides oil-free air. Built-in features eliminate pulsations.
- NYLON THRUST WASHER** keeps shaft in alignment. Neoprene seal tested through thousands of hours of trouble-free operation.
- LIGHTWEIGHT AND COMPACT.** 14" long, 8" wide, 10" high. Weighs less than 30 lbs. with motor. Easy to carry to any location.
- NO STORAGE TANK NEEDED.** Delivers 3½ cfm of free air and 50 psi pressure.
- FORCED AIR INTERNAL COOLING.** Aluminum die cast housing ribbed and reinforced for greater strength and maximum cooling.
- GUARANTEED PERFORMANCE.** Quality materials and advanced engineering. Simple, oilless, efficient.
- FOR USE WITH** any 1725 rpm ¼ h.p. or larger fractional horsepower electric motor. Power take-off or gas engine can also be used.

**\$44** LESS MOTOR



"Red Head" Compressor Kit includes: gun, 15 ft. air hose, fittings, 4" pulley on compressor, 26" V-belt, 3½" pulley for mounting on ¼ to ½ h.p. motor . . . weight less than 30 lbs. — easily portable.

FOR 75 YEARS  
Manufacturers of  
Pneumatic  
Temperature and Air  
Conditioning Control  
Systems.

Made by  
**JOHNSON SERVICE CO.**  
COMPRESSOR DIVISION  
MILWAUKEE 1, WISCONSIN

Write for Catalog on our Full Line of Compressors



Blu-Burn-R Products, Inc., Monroe, Wis.

## Portable Percolator

Completely portable, a percolator with a built-in burner will operate up to 12 hours and provide 200 cups of coffee from a disposable fuel can. It burns low-pressure butane gas, and the fuel can serves as a handle.

## Yankee Clam Meets Southerner— Result: Huskier Baby Clams

Curious biologists wondered what would happen if a clam from up north met a clam from down south. A boy clam and a girl clam, that is. After a three-year study at the Virginia Fisheries Laboratory, the answer is—the hybrid baby clams grow faster than their parents. More than 400 clams were planted in the experiments and marked for identification. During the period studied, the hybrid clams grew a half inch larger than the northern clams. The offspring of the southern clams did not survive the second winter. The biologists theorize that clam producers may be able to improve the yield and quality of their crop by hybridization just as farmers improve their land crops.

## Rings of Snow Circle Saturn

Using an infrared spectrometer, University of Chicago astronomer Gerard P. Kuiper has determined that the rings around the planet Saturn are composed of small snow crystals. Infrared light rays pierce haze and make water appear black and vegetation white on special films. The scientists said very little infrared light is reflected from the rings and they appear very dark on the spectrometer. He added that two of the moons of Saturn appear partly covered by snow.



**DURO**  
THE ORIGINAL

# PLASTIC ALUMINUM

the key to your Repair Problems!



REPAIR Holes and Dents in Autos



REPAIR Holes and Leaks in all Boats



REPAIR Leaky Gutters and Downspouts



SEAL Plumbing Leaks

**\$1.00**  
LARGE  
5 1/2 OZ.  
TUBE

THE ORIGINAL "METAL IN PUTTY FORM"

Available at hardware, auto, paint and variety stores everywhere or write

WOODHILL CHEMICAL MFG. CO. 1395 East 33rd St. - Cleveland 14, Ohio  
"Originators and World's Largest Mfrs. of Plastic Aluminum"



**EASY TO GET AT!** ... IN THIS  
Drawer Rack  
**EASY TO GET OUT!**  
... FROM THIS BOX

THE **BEST**  
WAY TO BUY AND KEEP SCREWS

No more fumbling in cramped quarters — just pull out the plainly-marked drawer you want, and pick out with your fingers the screws you need.

**59¢**

**MORE FOR YOUR MONEY!**

COMPARE what you get in any "STOCK your SHOP" box with the quantity available for the same money in other packages! Each "STOCK your SHOP" label tells how many in each box.

PER BOX

ALL ELCO WOOD SCREWS ARE SPEEDIZED TO DRIVE EASY IN HARD WOODS

## stock your shop

SCREWS • BOLTS • NUTS

LOOK FOR THEM IN YOUR HARDWARE STORE

### Brand New! Portable Light Plants

**WITH PUSH BUTTON STARTER.**

Be prepared for power failures! Provides plenty of current for receivers, transmitters, antenna motors, emergency lights, etc. Perfect for radio hams, civil defense, trailers and camps. **700 Watts—115 v., 60 cyc., AC.** Powered by rugged 2.2 H.P., 4 cyc., Briggs-Stratton or Clinton gas engine. No wiring necessary, just plug in and operate. Complete with tote handle, voltmeter and built-in winding for charging 6 v. auto battery. **Only generator at this low price with radio shielding!** Easily handles any appliance that requires up to 700 watts.

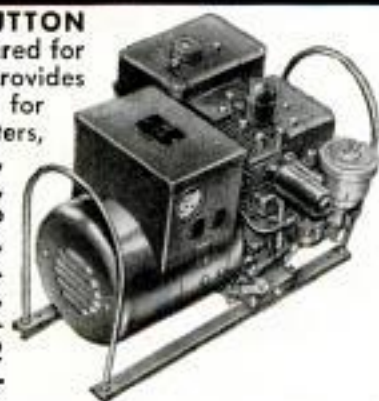

(A76). Shpg. wt. 77 lbs. .... **\$143.50**

1200 Watts (A126). Wt. 90 lbs. Same as above but larger engine & generator, more capacity ..... **\$195.50**

2500 Watts (A256). Wt. 225 lbs. Similar to above, bigger, heavier and develops more power..... **\$325.50**

**MONEY BACK GUARANTEE . . . ORDER TODAY!**

**GENERAL ELECTRONIC SERVICE INC.**

P.O. Box 9, Dept. PM-10, Burlington, Wisconsin

**HAVE FUN!**

**SAVE MONEY**

**TRY SUPERSHOP FREE**  
Factory To You — \$79.95

Think of the fun you'll have and the money you'll save with your own big capacity workshop. Picture yourself sawing with the 8" ball bearing saw. Or drilling in steel with the vertical drill press. You bore with the horizontal drill — exclusive with SUPER-SHOP. You sand with the 8" disc sander. You turn with the 30" lathe. You sharpen tools on the 5" grinder.



**VERTICAL DRILL PRESS**

You are invited to TRY SUPERSHOP FREE. We will pay all shipping expense. Write for full details of this amazing FREE TRIAL PLAN. Mail postcard now.

**POWER TOOLS INC.**

100 Yates Ave.  
Beloit, Wis.

# "ARCO JIG-SAW" cuts any shape, any material!

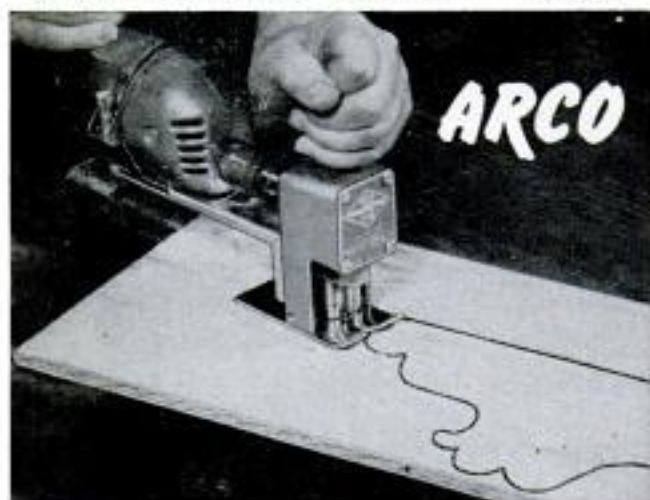

Cuts Perfect Circles with Exclusive Circle-Cutter



Makes Straight & Parallel Cuts with Exclusive Rip-Gage.

"Arco Jig-Saw," guaranteed to fit every 1/4" drill, cuts any pattern in woods, plastics, metals—even cuts 2x4's! Has same capacity and outperforms the most expensive saws because of ARCO'S exclusive adjustable Circle-Cutter (up to 20" diam.) and Rip Gage.

Cuts its own starting hole. "Air-Jet" blows away saw-dust. With blade..... **\$10.95**

6 Extra Assorted Blades for wood, plastics, metals..... **\$1.95**

At Your Dealer or order direct on our Unconditional 10-day Money Back Guarantee. Send check, M.O. (ppd) C.O.D. plus post.

**ARROW METAL PRODUCTS CO.**

DEPT. PM-10, 421 WEST 203 STREET, NEW YORK 34, N. Y.

## SEE YOUR DEALER

Two steps to professional results in your workshop: (1) check POPULAR MECHANICS for helpful "how to" suggestions; (2) discuss your project with your dealer. He knows the importance of working with quality products. They're advertised in POPULAR MECHANICS.



## SNOWED UNDER? MONARCH Controls Your Plow ... automatically!



JEEPS



TRUCKS

POWER

**MONARCH**  
HYDRAULIC

CONTROL

Snow removal is fast, dependable and safe with Monarch Power Hydraulic Control Equipment . . . cab-controlled for one-man instant action, the Monarch zips snow plows into operation with ease and speed. Fan-belt driven or Electric models are available for practically all makes of vehicles. Proven in service everywhere, over 50,000 Monarch Controls have been sold. See your dealer or write for full details.

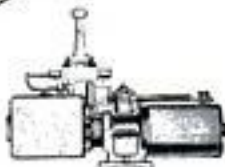

The Monarch DYNAMIGHT Model HEP (as illustrated) combines all parts in one package for ready installation on new or existing equipment.

**MONARCH**  
ROAD MACHINERY COMPANY  
1331 MICHIGAN STREET, N.E., GRAND RAPIDS 3, MICHIGAN



Rough-N-It Products, Box 142, Overland Park, Kans.

## Zippered Lean-to "Lengthens" Wagon

Adding about two feet to the usable length of a station wagon, a fabric enclosure permits comfortable camping in the car. It has a large screen for ventilation and a zippered curtain to make it airtight if weather requires. It takes about an hour to adapt the wagon for the enclosure, thereafter installation or removal takes only a few minutes. The fit is snug enough so the car can be driven at highway speeds with the enclosure in place.

POPULAR MECHANICS

**WAR SURPLUS** AND **OTHERS** **SAVE UP TO 90%**



**SPECIAL ON \$4770 NAVY AUXILIARY POWER UNITS AIR COOLED**

Ideal for your shop, camp, cottage, farm, trailer, home, boat or mines. Makes a terrific welder for any size job. Also excellent for auxiliary power in pumping wells, operating saws, or wherever power is needed.

30D-1A Lawrence, 24V, 2 Cylinder opposed 4-cycle 10 1/2 H.P. comes complete with various generators which can be attached to standard stud mounting. Shpg. Wt. cased 350 lbs. Like new. Type 2 CMT-89-140 amps., 24V—\$125. Type P1, 200 amps., 24V—\$137.50. AC-DC NEAS (DC side 24V, 200 amps., AC side 10.5 amps., 1200 watts), 800-cycle 2400 RPM—\$142.50.



**ARC WELDER KIT \$27.95.** Build your own complete make-up package consisting of 1 Aircraft DC Generator, electric photo-lite 160-240 amps, 24 volt, RPM from 2000 up, 1 Rheostat, 1 Giant Toggle Switch, 1 Ammeter, 1 Shunt, 0 to 240 Amps, 40' of new welding cable, 1 Electrode Holder, 1 Welder's Shield, 1 Voltage Regulator, Wiring diagram for hookup as welder. Wt. under 100 lbs. Approx. GOVT. COST \$475. Like new, perfect—\$27.95.

DC Generator (only) — same as above . . . if purchased separately: \$12.50.

**R1 GENERATOR KIT** Jack & Heints or GE. Rated 300 Amps, 24-32 Volts. With same items as above incl. 300 Amp Ammeter. Approx. GOVT. COST for kit \$600. Complete kit only \$39.95. Wt. 60 lbs.



**HEAVY-DUTY RHEOSTAT** Designed for heavy-duty use with Air Force heated suits. Ideal for regulating voltage on electric welders, model trains, lights, generators; controls soldering irons, etc. Rated 5.75 ohms, 100 watts with double windings and dual female 25 amp, 125 volt receptacles. Size: 7" H x 5 1/4" W x 1 3/4" D. Shpg. Wt. 2 1/2 lbs. Approx. GOVT. COST \$25. Brand new, \$1.95.



**FAMOUS B-16 KOLLSMAN AIRCRAFT COMPASS** Finest compass ever made. In current use on large and small planes. Ideal for boats, cars, trucks, etc. Graduated in 5° increments. Liquid filled, lighted, poly-plane compensator. Panel mounting: 3 1/4" dia. face, 4 1/2" in depth. Checked & tested in our own lab. Approx. GOVT. COST \$130. Like NEW, \$12.95 ppd.



**REVERSIBLE RATCHET WRENCH**

For diesels, ships, farm machinery, trucks, bridges, oil fields, all heavy equipment. Terrific leverage, 4" Lowell, safety steel, sockets for 2 3/8", 2 9/16" & 3 1/8" hexagon nuts. Navy surplus. Approx. GOVT. COST \$215 a set. Wt. 50 lbs. NEW! Now \$10.95 per set.

**BENDIX PUMP & MOTOR** Can be used for pumping fuel, oil or wherever hydraulic pressure is required. Pump has 1" connections, built-in relief valve, adjustable up to 1500 lbs. Max. capacity 6 GPM. 1 1/2 H.P., 24 volt motor, 4000 RPM. Can be used on 12 to 36 volts. Approx. GOVT. COST \$350. NEW — \$10.95.



**DUPONT EXPLOSIVE RIVETS!** A must for the man who works with sheet metal. A hot soldering iron placed on the head of the rivet will explode and mushroom the other end of the rivet self-bucking itself. 1/8" - 5/32" - 3/16". Round and flat heads. Approx. GOVT. COST \$50.00 a 1,000. NEW, 1,000 assorted, \$5.00 ppd.

**NEW IMPROVED MAUSER-TYPE VERNIER CALIPERS** Quick, handy, accurate, 6" Vernier Calipers. Glass hardened, lapped measuring surfaces. Fine engraved scales—1/1000" and 1/10mm for inside, outside & depth measurements. Friction thumb release, larger capacity, 2 giv adjustments. Reg. \$20. Now only \$7.95. Leather case \$1 extra.

**MICROMETERS** Black crackle finish frame. Easy-to-read graduations in .001, NEW, 0-1" cap. \$2.69 ppd. 1-2" cap. \$3.79 ppd.

**140-1 REDUCTION GEAR** Make your own winches, hoists, wagon unloaders, stump pullers or fence stretcher. Sturdy aircraft quality. Built-in (removable) 24 Volt DC motor & clutch. High torque. Low speed, 100's of uses. Wt. 42 lbs. Approx. GOVT. COST \$300. Like NEW, \$12.00. \*223-1 Reduction Gear, same as above — \$13.50.

**JUST OUT! 1958 CATALOG. BIGGEST YET! FANTABULOUS!** Thousands of bargains in war surplus & other items. Hundreds of pictures. A must for the value minded! Send 25c for your copy today! Postpaid prices in USA only. Other prices FOB Culver City, Calif. Send check, cash or money order, 50% deposit required for COD orders.

**AIRBORNE SALES CO., INC. DEPT. PM1057**  
8501 Stellar Drive, Culver City, Calif.

**"WE PAID FOR OUR HOME with a Foley Saw Filer"**



Here is the true story of Leslie Patrick—as told by his wife, who wrote us about their success in a town of 12,000.

"I can truthfully say that when Mr. Patrick got his Foley, he made a good and wonderful investment. When we moved here in March, 1946, we had only a Model A Pickup and all our belongings were in it. Since then, my husband has done so well with his Foley Saw Filing Machine and repair shop that we bought a house and paid for it and have two nice boys; bought a new car and built an addition to our house; and he has got a lot of new machines in the shop that a person needs in business. Nicest of all, it is all paid for."

**Make up to \$3 or \$5 an hour**

With the Foley Automatic Saw Filer you can sharpen hand, band, and circular saws just like new. Start in spare time, in your garage or basement. No experience needed. Build up a steady, repeat CASH business which will buy YOU a home or new car. Send coupon for FREE BOOK—"Money Making Facts". No salesman will call.



**FOLEY MFG. CO., 1016-7 Foley Bldg., Minneapolis 18, Minn.**

Send Free Book "Money Making Facts".

Name \_\_\_\_\_

Address \_\_\_\_\_

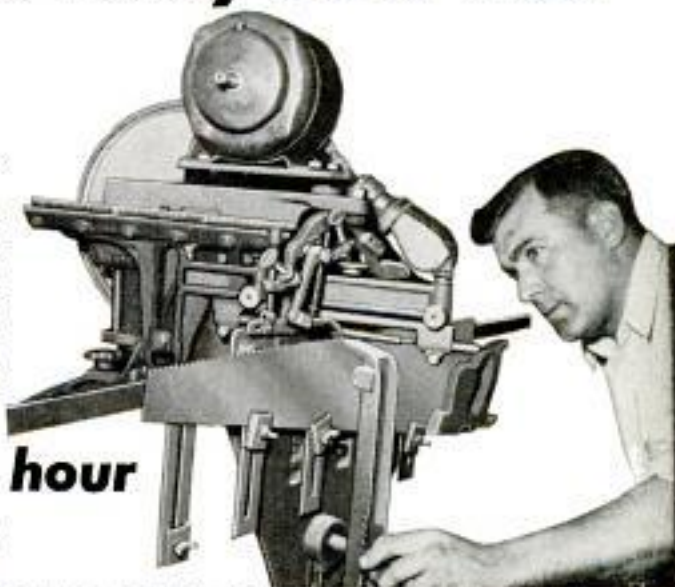

FOR **BEST RESULTS**  
USE *Atlas*

*Atlas*  
**15" DRILL PRESS**

The most useful tool for your shop — and America's greatest drill press value! With accessories, it gives you a whole shop full of tools . . . for mortising, carving, routing, sanding, and buffing as well as drilling. And Atlas is built to last you a lifetime — with exclusive "floating-drive", six-splined spindle and drive sleeve, 4 sealed-for-life ball bearings and extra-heavy construction throughout for maximum rigidity and accuracy! See it — compare it before you buy!

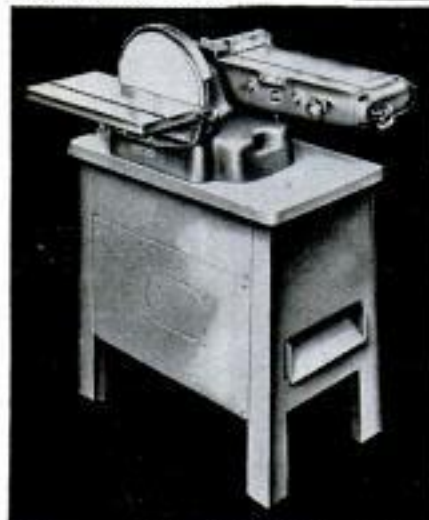

*Atlas*  
**BELT and  
DISC  
SANDER**

This versatile tool is the ideal sander for shop use. It sands boards of any width, flat surfaces, angles, curves — metals, plastics. Has 10" diameter disc. 4" belt operates in both vertical and horizontal positions. Table tilts 45° and can be used with either disc or belt. Table is precision ground for smooth work feeding, and grooved for mitre gauge to simplify duplicate work. New heavy-duty, pyramid metal stand comes completely assembled, ready for use . . . has thick wood top . . . fully encloses motor and belt. See it at your Atlas dealer's!

WRITE FOR ILLUSTRATED LITERATURE



*Atlas Press Company*

10-24 N. Pitcher St., Kalamazoo, Mich.

**QUALITY MACHINE TOOLS SINCE 1911**



Linde Co., Div. of Union Carbide Corp.,  
30 E. 42nd St., New York City 17

**Larger Synthetic Sapphire Disks  
Now Being Manufactured**

Synthetic industrial sapphire disks up to five inches in diameter are now being grown and fabricated. Previously, only smaller sizes could be manufactured. The photograph shows a finished disk at left, with an unfinished one as grown in an oxy-hydrogen furnace. The disks are used in mercury-vapor tubes, infrared and ultraviolet devices and in various electronic instruments.

**Versatile Beam Compass**

By adding a third block to an aluminum-beam compass, the drawing instrument can be used to scribe ellipses of from 10 to 65 degrees. Used as a simple compass, two aluminum blocks are set on the beam—one to hold the pivot pin and the other to hold the lead point. Circles ranging in diameter from 3/4 inch to 24 inches can be produced by the compass. To draw an ellipse, the three blocks are set according to instructions furnished by the manufacturer and the figure is scribed with the aid of an ordinary triangle. The instrument will produce ellipses from a minimum radius of 7/16 inch to a maximum radius of 12 inches.

Aero Engineers Sales Co., Box 85 E, Azusa, Calif.

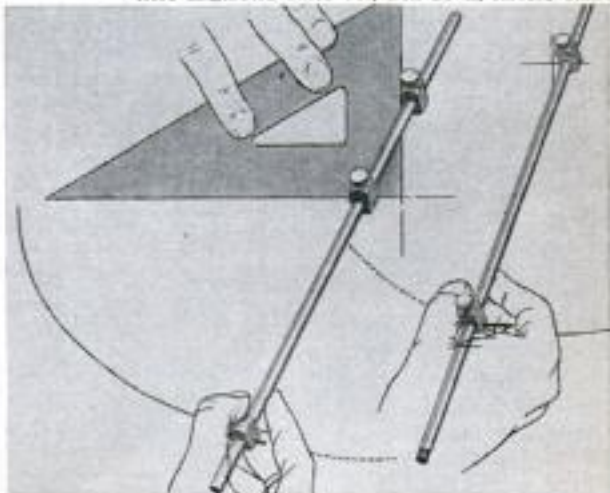



Use 'em  
together

No. 10  
only \$1.89

the **STAR** Hack Saw Blade  
& the **STAR** "Lever-Lock" Frame ...

Get Better Metal Cutting Results  
Change Blades Faster



**Exclusive!**

One-piece solid Heat-Treated Back



**Exclusive!**

"Lever-Lock"...change Blades  
Instantly.



**Exclusive!**

Tenite handle molded around steel  
back for greatest strength...perfect  
balance!

AT ALL LEADING HARDWARE STORES

**It's Yours!**

...Info-packed booklet on metal cutting.  
Send 10¢ in coin.

Clemson Bros., Inc., Middletown, N. Y., U. S. A.,



**CREATE EXTRA ROOMS.** Anyone can install these handsome PELLA WOOD FOLDING DOORS. Close for privacy—open for free flowing space. Ideal closures for closets, utilities, extra sleeping areas. Handsome veneers of natural pine, oak, birch and Philippine mahogany. Order unfinished and save. Factory assembled. Complete with hardware.

**Pella** WOOD FOLDING  
DOORS

FREE IDEAS—MAIL COUPON

**ROLSCREEN COMPANY**, Dept. 1-111, Pella, Iowa

Send free 6-page folder on PELLA WOOD FOLDING DOORS.

NAME \_\_\_\_\_

ADDRESS \_\_\_\_\_

CITY \_\_\_\_\_ ZONE \_\_\_\_\_ STATE \_\_\_\_\_

**Be Your Own Boss in the Profitable Excavating Business!**

**EARN UP TO \$1,000  
AND MORE PER MONTH**

Wherever you live, you'll find plenty of profitable work the whole year 'round for this versatile outfit . . . not just a "trencher" but an all-purpose excavating machine! Custom operators everywhere are making big money with Sherman Power Diggers. **ONE BOUGHT A FARM WITH JUST THREE YEARS' PROFITS!** Work for builders, contractors, utilities, and municipalities on such jobs as septic tanks and drainfields, sewer lines, fuel tank installations, foundations and footings, gas and water lines, field tilling and many others. The Sherman Power Digger mounted on a Ford Tractor travels quickly from job to job, digs at a fraction of the cost of manual labor. It's simple to operate, easy to maintain, built to last.

Send now for information about the easy-to-get jobs for your Sherman Power Digger. Let us tell you—without obligation—how you can go into business for yourself with an investment of less than \$5000. Or make a small down payment and pay the balance from earnings.

**SHERMAN PRODUCTS, Inc.**

Dept. 1736 Royal Oak, Michigan

OCTOBER 1957



**Send Now for FREE LITERATURE!**

**Sherman Products, Inc.**

Dept. 1736 — Royal Oak, Michigan

Send me information on how I can get into the excavation business on my own.

NAME \_\_\_\_\_

ADDRESS \_\_\_\_\_

CITY \_\_\_\_\_

STATE \_\_\_\_\_

Schupack's Amazing Tool Bargains! Save up to 100%!

**75 Mounted Wheels & Miniature Cutters.** Regular \$11.00 value **\$4.90**  
 For cutting and grinding on cast wood, metal or plastic. Includes 24 mt. wheels and points on 3/32" shank; 24 miniature cutters on 3/32" shank; 25 short shank mt. cutters. Will fit all electric drills and hand grinders.

**FLEXIBLE SHAFT—ONLY \$8.50** Post-paid  
 Fits all electric drills & hand power tools. 35 3/4" long. Oilite bearings. Core of specially wound, high carbon steel wire in flexible steel casing. Will accommodate tool shafts up to 1/4" dia. For lathes, electric drills, etc.

**2 DRUM SANDERS**  
 With 12 Bands in Assorted Grits. 1 1/2" dia. x 11" long on 1/4" arbor with 12 bands. Post-paid \$1.50  
 One drum, 1" dia. x 1" long on 1/4" arbor with 6 extra sleeves. Post-paid \$1.00

**8 Carbon Steel Wood Bits for Braces.** Assorted sizes. 3/32" to 5/8". For drilling on wood or metal. \$1.75 P.P.

**15 Assorted Drills.** From 1/16" to 1/4" high speed steel and carbon. Only \$3.95 P.P.

**30 Assorted Drills.** High speed steel & carbon. Up to 1/2" dia. \$2.75 P.P.

**12 Assorted Drills.** High speed and carbon steel from 1/8" to 1/2" dia. \$3.60 P.P.

**12 Miniature Cutters.** For cutting wood, plastic or metal. Assorted shapes on 3/32" shank. \$1 P.P.

**12 MOUNTED WHEELS and points** on 1/4" Shank. \$2.95  
 38 for \$7.50 P.P.  
 For grinding on plastic, wood, soft & hard metals. Regular Value \$4.40. 18 Mounted points on 3/32" shank \$2.50; 12 mt. wheels on 1/4" shank \$3.60.

**ADAPTER CHUCK**  
 With 2 interchangeable collets, opening from 3/32" to 1/2", on 1/4" mandrel. \$1.50 P.P.  
 Adapter Chuck. From 60 to 80 on 3/32" In. Mandrel \$1.00

**7 H.S. and carbon drills** from 6" to 12" in length. Assorted sizes up to 1 1/2" diam. for drilling in hard to reach places. A set of 7 \$10.00 val. for only \$1.95 P.P.

**7 Larger Drills.** From 1/4" to 1-1/4" High speed \$7.50 P.P. steel and carbon \$2.95 P.P.

**3 Woodworkers Drills.** From 1/4" to 3/4" on 1/2" shank. \$2.95 P.P.

**2 Circular saws.** On 2 Mandrels—all at one low price. 1" diameter saws on 1/2" mandrels. For cutting wood, plastic or soft metals. \$1.50 P.P.

**32 H.S. steel drills,** threaded shanks from 3/32" to 1/4". Reg. \$9.50 value, only \$2.00 P.P.

**18 Rotary Cutters** P.P. \$5.85

Assorted sizes cutter on 1/4" or 3/32" shank. Will fit all hand grinders. Ideal for cutting wood, metal, or plastic. Brand new. No C.O.D.'s New Catalog 10c.

CHUPACK SUPPLY CO. 130 COTTAGE GROVE AVE. DEPT. PM-15 CHICAGO 12, ILL.

Buy nationally advertised products. Ask with confidence for the brands advertised in POPULAR MECHANICS

PM TAG of INTEGRITY



Just pull the trigger...  
**spray paint!**

The easier, better way to paint! Job's done in minutes. Finish is smooth, flawless. Speedy Sprayer is a real professional tool, favorite of craftsmen for over 35 years! At stores everywhere. 890 Outfit, including gun, hose, less motor, only \$39.95



FREE! "How to Spray" booklet and literature. Write!

WHEEL KIT \$7.50 EXTRA

W. R. BROWN CORP., 2635 N. Normandy, Chicago 35

## 4-WHEEL DRIVE OWNERS

21 MODELS INCLUDING JEEPS

## NEW AXLE POSITIONER

... Instant, positive engagement

### FRONT DRIVE WITH FREE-LOCK HUBS

#### LOW OPERATING COSTS

All parts stop ONLY WHEELS MOVE



In 2-wheel drive no parts moving

### NO Rocking to Engage Hubs

Engaging hub is instant and positive with the new Axle Positioner. First time available in any hub Unconditionally guaranteed for 1 year!

See your dealer or write for FREE literature.

## FREE-LOCK CORPORATION

6301 N. Federal Blvd. Denver 21, Colorado



Buried gold—silver—metal objects

## HIDDEN TREASURE!

...is easy to find with GOLDAK'S "FIND-IT", a powerful 3 1/2 lb. locator; only \$64.50 complete with earphones, batteries and instructions. Write for FREE literature full line metal, mineral locators, geiger, scintillation counters.

GOLDAK CO., 1542-10 Glenoaks Blvd. Glendale, Calif.



## TRANSFORMER WELDER \$24.95 FOR QUINCY

Complete with everything. Ready to plug in. 110 volts AC. Draws 15-30 Amps. Produces 75 Amps, 5 heats. Welds metal from 1/16" to 1/4" using 1/16" to 3/32" standard rods. Guaranteed unconditionally. 10-day trial \$5 deposit on C.O.D. Does everything welders costing up to \$75 do. 1/2" welder \$7.95 plus 50c for postage.

ESSAY MFG. CO., INC., Dept. 51, Quincy 69, Mass.



## \$12.00 3 FOOT LATHE

( Shipped Express Collect )

LIMITED TIME FACTORY OFFER

Real production lathe with 6" swing; all cast iron and steel construction; complete as shown; satisfaction guaranteed or money refunded. Send check, cash, or M.O. Send 10c for catalog on this and other tool bargains.

AMERICAN MACHINE & TOOL CO., Inc., Repersford 2, Pa.

## FREE AMAZING NEW BOOK "HOW TO ANSWER ADS"



Never before have you seen anything like this. Tells you in simple language the correct way to answer ads. Gets you quicker replies—better results, and greater satisfaction. Will save you time and money and it's ABSOLUTELY FREE. No obligation whatever. Every reader of advertising should have this booklet. Send a postcard for your copy NOW. F. W. JOHNSON, Popular Mechanics Magazine, Room 600-A, 204 East Ontario Street, Chicago 11, Ill.

## MONEY for MEN ALL DATA FREE

THE PLASTEX Industry needs manufacturers on small scale and for big production of Lamp and Clock Stands, Art Goods and Novelties in Plastex and Marble imitation. Experience unnecessary. The material makes regular 10c store sellers. Rubber moulds furnished for speed production. Small investment brings good returns. We are now placing big Chain Store Orders with manufacturers. Ambitious men have chance for real prosperity. Our Free booklet will interest and benefit you.

**PLASTEX INDUSTRIES, Dept. A**  
 3400 Third Ave. New York 5, N. Y.



### 115V, 60 CYCLE AC SURPLUS COMPRESSOR BARGAIN

These were used by the Navy to keep gunnery instruments dry and free of salt water & corrosion. Motor & compressor are a single unit. Compressor normally delivers up to 15 PSI. Can be converted to deliver up to 35 PSI. Motor operates on normal house current of 115V, 60 cycle AC & is rated 1/10 HP. Turns 1725 RPM. Comes with 0-15 PSI gauge. UNCONVERTED, without filters, . . . . . **2195**  
CONVERTED to 35 PSI, without filters, . . . . . **2495**  
Equipped with Special Filters for use as moisture-free air supply, inflating, spraying, etc. . . . . **2795**  
AIR STORAGE TANK = Ideal for use with above compressor. Has 280 cu. in. cap. Size 6" x 14-1/2". Tested to 400 PSI. 1/4" ports. **295**

### 3400 RPM 1/2 HP POWER SAW



**RIPS - CROSSCUTS**  
**CUTS A FINISHED 2x4 LIKE A KNIFE THROUGH BUTTER**

COMPARES TO SAWS SELLING UP TO \$49.50 **1998** Complete with 5-1/2" Blade

A rugged, professional type, adjustable saw. Will cut any angle from 0 to 45°. Has an adjustable 0 to 6" rip fence. Safety-trigger switch on handle. Full 1/2 HP Universal AC-DC, 110-120 Volt, 60 cycle motor. Weighs only 6 1/2 lbs.

EXTRA SAW BLADES - Available in Rip, Crosscut or Combination. Please Specify. **ONLY 235 EA**

**SAVE 50%**

### PHILIPPINE MANOGANY LUAN PLYWOOD

For Paneling Dens, Offices, etc. Use in Cabinets, Furniture, etc. Rotary-cut. Both sides sanded. Bonded with finest resin adhesive. Face side jointed. Shipped at lowest rates.

**FREE SAMPLE ON REQUEST**

3MM (1/8") x 3 FT. x 6 FT. **179** PER SHEET  
\$589 VALUE  
MINIMUM ORDER 8 SHEETS

1/4" x 4 FT. x 8 FT. **449** PER SHEET  
\$950 VAL.  
MIN. ORDER 4 SHEETS

### TRANSLUCENT FIBERGLAS PANELS

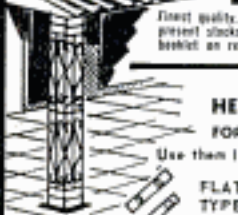

Direct quality. Available in many widths and lengths. An excellent color selection in present stocks. Ideal for use in the home or office. **FREE SAMPLE** and instruction booklet on request. **85c Val. for 49c SQ. FT.**

### NEW! DECORATIVE! HEAVY WROUGHT IRON TRELLIS

FOR PATIO ROOF SUPPORTS-DIVIDERS, etc. Use them INDOORS or OUTDOORS! Heavy 1-1/8", black tubular iron supports with a beautiful wrought iron filigree between them. 3 ft. high (can be cut to 7 ft.), 12" wide. In either flat or corner type. Mounting flanges included.

**SAVE 50%**

FLAT TYPE **995** EA.  
CORNER TYPE **1795** EA.

### DECORATE with this "LUAU" NET KIT

Transform your den, lounge, playroom or patio with this exotic South Sea Island decor. The 4' x 5' net contains 2 cork floats, star fish, sea fan, glass float, tiger covary & pink currens. Ideal for home, night club, etc. **495**

### SPECIAL 60 to 450 Power MICROSCOPE

With NEWLY DEVELOPED SUB-STAGE LIGHT which ELIMINATES NEED for ANY EXTERNAL LIGHT SOURCE. Take advantage of our tremendous foreign par chase. Ideal for use by the Amateur, Scientist, Student, in Home Laboratory for study of insect, tissue, minerals, microbes, liquids, etc.

- 1. Triple Revolving Turret with 10X, 20X and 30X precision ground and polished lenses.
- 2. Two interchangeable eyepieces of 6X and 15X.
- 3. Patented Sub-Stage with self-contained light. No other light source necessary.
- 4. Large sub-stage mirror for use with external light source when desired.
- 5. All metal body. & Hardwood Case with 3 glass slides.



HAS 60, 120, 150, 180, 300 and 450 POWER MAGNIFICATION

**PRE XMAS SALE NOW 1095** INCLUDING DISSECT SET

### 100 - 200 - 300X MICROSCOPE

A triple revolving, objective lens turret allows selection of 100, 200 or 300 POWER magnification. Has fine, ground and polished lenses and ALL METAL construction. This instrument is NOT A TOY! Right or left hand rack & pinions make smooth, precise adjustments. **NOW 695**



### SPECIAL MARINE TYPE REMOTE READING MAGNESYN COMPASS SYSTEM

Ideal for navigation of small to medium size boats. Complete system includes Remote transmitter, Remote Compass Indicator and Electric Inverter. Can be operated from 12 or 24 volt DC input. Inverter gives 26 volt, 400 cycle, 1 phase output required. **3995**

### B-16 FLOATING CARD COMPASS

Ideal for small boats, autos, aircraft, etc. Full flooring card, liquid damped, has internal compensating magnets. 2" diameter face with lighted dial. Rear panel mounting. Super Palley Bargain . . . . . **975**  
SAME type as above but with external compensating magnets and caging device . . . . . **1495**

### U.S.A.F. MAGNETIC COMPASS

Standard navigational equipment on Army Aircraft. Rotating verge range ring. Calibrated in 1° increments 0 to 360°. Two parallel grid wires for N-S alignment. Rubber lined. Ideal for private planes, boats, etc. . . . . **1750**

### Special Electric AUTOMATIC PILOT SERVO UNIT

Ideal for reversible motion applications. Has a 1/20 HP, 24 VDC, 2270 RPM continuous duty motor. A 133 to 1 gear reduction train gives 17 RPM take-off speed. Twin, plate clutches are solenoid operated. A special galvanometer reads percent of rotation. Free wiring diagram. **1995**  
COST GOV'T APPROX. \$500.00

### NEW NYLON AIR CORPS LIFE VEST

Nylon cover with pure gum rubber inner liner. Inflated by CO2 cartridge or by mouth. Has adjustable web-strap harness & 2 pockets. **NEW 895**

### NEW ARMY CANTEEN & RISSUE CUP AND BELT

A one quart canteen and aluminum cup fit into the insulated canvas cover. Choice of web type pistol belt or cartridge belt with pockets. The canteen is new Korean War Surplus. **229**



**GENUINE NAVY FLEECE LINED WATERPROOF WINTER COAT**  
**ONLY 1995**

### FLIGHT BOOTS

Sheepskin Lined  
Has genuine leather uppers & rubber lowers. Soles have NON-SKID tread. Zipper front closure. Size: Small, Med., Large. . . . . **695**

### HYDRAULIC REMOTE CONTROL MASTER & SLAVE

When connected with 1/2" tubing and filled with oil they act as a precision remote control transmission unit. Moving Master handle causes Slave arm to respond in exact motion from 0 to 90°. Ideal for remote machinery controls, etc. Available in New and Used condition. No. H-EX-15U Both units used \$27.50 No. H-EX-15SU Both Units **NEW \$42.50**

### NEW 16 QUART OIL DRAIN

All metal construction. Top slants to receiving hole. Funnel sloped on end for easy pouring. Has two carrying handles. A removable handle fits either end. Size is 5 1/4" TD-1/4" x 18" long. **ONLY 249**

### PREFORMED WIRE ROPE

5/32" Galv. carbon, 7x7 . . . . . 45c ft.  
1/4" alloy steel, fiber core, 6x26/9ft.

### WORLD'S MOST AMAZING BARGAIN CATALOG

**396 PAGES**

**NATIONALLY ADVERTISED MERCHANDISE - NEW and USED GOV'T. SURPLUS - FACTORY CLOSEOUTS - EXCITING IMPORTS!**  
From EVERYWHERE PALLEY'S now bring you items of every description! This fabulous catalog contains Hand & Power Tools, Microscopes, Binoculars, Industrial and Building Materials, Housewares, Office Equipment, Sport & Outdoor Equipment, Cameras, Photo Supplies, Hobby Kits & "Gadgets", Electrical & Radio Supplies, Motors & Generators and a HUGE selection of Surplus Hydraulic Cylinders, Pumps, Valves, etc.  
We are now one of the foremost manufacturers of CUSTOM-MADE HYDRAULIC CYLINDERS. Our tremendous volume enables us to sell for BELOW MASS PRODUCTION PRICES!



**Send 50¢** - LIMITED EDITION! ORDER YOURS NOW!  
(for handling & mailing) 50¢ REFUND on your first order of \$1.00 or more.  
**ORDER BY MAIL** TERMS: 3rd class, Cash or Money Order, 50% Deposit with C.O.D. Prices F.O.B. Los Angeles, Calif. Warehouse.  
**Palley's** 2263 EAST VERNON AVE., DEPT. PM-10, LOS ANGELES 58, CALIF.



## CLOGGED SEWERS? CLEANED INSTANTLY SAVES PLUMBING BILLS —

CHICAGO—Oct. 1st. Just introduced is a Free Booklet on a New Discovery which enables the Home Owner, Janitor, or Factory Maintenance to clean any Clogged Sewer Drain.

Yet anyone can operate this new Plumbers Flushing Gun which releases air pressure on a solid shaft of water cleaning the most stubborn stoppages up to 200 feet. TOILETS, SINKS, URINALS, BATHTUBS, FLOOR DRAINS, and HOUSE-TO-STREET SEWERLINES clogged with Grease, Rags, Sand, Roots, and paper melt away instantly when struck by the Hammer-like blow of this new unit.

There is no need to remove wall or pipe, or Grease Trap. A special attachment allows water to flow from the faucet through the Gun while air is released on the pipe. Vents or stacks are no obstacle, as force tends to strike wherever the water lays. But now, what is this Plumbers Flushing Gun worth in COSTLY PLUMBING BILLS SAVED? Tear this Ad out—and write your name and address beside it for FREE BOOKLET. Obey that urge. No agent will call. A postcard will do (Chicago Phone Kildare 5-1702) MILLER SEWER ROD CO., DEPT. PM-0, 4640 N. Central Ave., Chicago 30, Illinois.

## NOW You Can DRILL, SAW, REAM, CUT ... ALL WITH ONE BIT!

Beaver's new improved Hi-Speed side cutting drill bit can be used on any electric drill, drill press, lathe, etc. Made from the finest American hi-speed steel. 3 1/2" long, 2" side cutting section, 1/2" diameter. Designed to cut steel, wood, plastic, aluminum, etc. MONEY back guaranteed. Specify types desired. All Purpose, Wood and Heavy Metal. BUY From Your Dealer or send check or money order today. Dealer & jobber inquiries invited. Ideal Gift.

BEAVER DRILL & TOOL CO., 3006J McDoe Trafficway, Kansas City, Mo.



**BEAVER  
Hi-SPEED-SAW  
DRILL BITS**

ONLY  
**\$245** each 3 for  
\$7.00

**Jet King**  
POCKET-SIZE

**BUTANE  
BLOW  
TORCH**

**SOLDERS!  
BRAZERS!  
FIXES LEAKS!**



ONLY  
**\$195**  
WITH CHARGER

Every do-it-yourself and hobby fan needs this Kidde JET KING butane Blow Torch. Just the tool you've been looking for to do dozens of jobs in home or hobby... TV, appliance, lamp, radio or plumbing repairs... precision soldering, brazing or metal craft. Useful, too, for starting charcoal fires. A tiny, clean, safe charger does the job.

Each charger gives 30 minutes of intense 3500° pinpoint flame; turns on and off. Extra chargers, 49¢ per box of 2. Money back guarantee. At leading hardware and hobby stores... or send check or money order, we pay postage.

**Kidde**

KIDDE MANUFACTURING CO., INC.  
Dept. PM-10  
42 Farrand Street, Bloomfield, N. J.

Please send me \_\_\_\_\_ JET KING BLOW TORCHES plus \_\_\_\_\_ boxes extra chargers (limit 2 boxes per torch).

My check , money order  for \$\_\_\_\_\_ is enclosed.

Name \_\_\_\_\_

Street \_\_\_\_\_

City \_\_\_\_\_ State \_\_\_\_\_

SAVE 1/2 - 2/3 THE PRICE OF FACTORY-BUILT BOATS

**BOAT  
KIT  
CATALOG  
Free!**

Write:

Runabouts, cruisers, convertibles, fishing; 43 models, 8 through 18 ft. Freight paid, \$39.25 up. Assembled and finished by experienced owners. Luger boats equal factory-built in speed, handling, style, beauty; yet save you 1/2 to 2/3. Owners say: "Fastest boat on river." "Pleasure to assemble." "Everyone admires my Luger." Thousands in use. Send for big, free boat kit catalog; also lists fiberglass, hardware, accessories, trailers, paint. Write for catalog today.



**LUGER INDUSTRIES, INC.** DEPT. 3404 Lyndale S.  
B-10 Minneapolis 8, Minn.



**BUILD YOUR OWN**

**CANOPY, CARPORT GARAGE,  
SUMMER COTTAGE, Etc.**

With New **SUNCO ALUMINUM  
WONDER PANELS.** Low cost, Easy one-man assembly with hand tools. At dealers or direct.

WRITE TODAY for FREE illustrated booklet and price list.

**SUNCO MFG. CO. • 627 Elgin Ave. • MUSKOGEE, OKLA.**



WELLES EXCLUSIVE PRESS

**Print Your Own**

Cards, Stationery, Advertising, Circulars, labels, photo and movie titles, church work, tags, etc. Save money. Sold direct from factory only. Raised printing like engraving, too.

**Own a Printing Business**

Print for Others, Good Profit. Have home shop. Junior press \$15; Senior \$29 up. We supply everything. Easy rules. Pays for self in short time. Write for free catalog of outfits and all details. **KELSEY PRESSES, C-37 Meriden, Conn.**

**NEW! Completely UP-TO-DATE!**

**Manual for  
PLYMOUTH  
OWNERS**



**COVERS ALL MODELS 1941 to 1957. Gives you more from your Plymouth for less. So accurate mechanics can use it... so simple a woman can understand it**

Now fix it yourself and save money on Plymouth repairs. With this Popular Mechanics book you prevent trouble... enjoy care-free driving... increase trade-in value... get sparkling performance... and avoid major repairs by fixing minor troubles before they get serious. Not just a re-hash of service manuals, but a completely updated version of the famous 1950 PM book written by automotive expert Ed Packer, with the assistance of the Chrysler Corporation. Covers latest Plymouth features: power brakes, torque bar suspension, automatic transmission, tubeless tires, air conditioning, etc. Motor specifications are given for all models 1941-57. Contains 272 pages, more than 350 photos, diagrams, tables, charts, breakdown drawings, plus clear, non-technical directions that make all repairs as simple as ABC. Shows you how to diagnose troubles by feel, sound, sight, smell and performance.



**MONEY BACK IF IT DOESN'T SAVE MORE THAN IT COSTS!**

One minor repair will save the cost ten times over. Read it. Then you decide. If you don't see that you'll save more than the cost, send it back for refund. **SEND NO MONEY.** Send postcard. Ask for PLYMOUTH Manual. Postman will deliver C.O.D. for \$3.50 plus postage. Or, save postage by sending \$3.50 with order. Save its cost on your next repair. Send today.

**POPULAR MECHANICS PRESS, Dept. 1057**  
200 E. Ontario St. • Chicago 11, Illinois

**POPULAR MECHANICS**

## PORTABLE LIGHT PLANTS

**PORTO-POWER 1750 Watt Plant**  
115/130 v. 60 cyc. AC.  
Push button start. Powered  
by a 4.5 HP Briggs engine.  
Combines com-

portness and easy portability with higher output for handling heavier starting loads. Ideal for operating oil burners, sump pumps, freezers, television, lights, communication systems, etc. Perfect for contractor's power tools. (Item 20), Wt. 146 lbs. Factory Special Price **\$279.50**

**MASTER-LITE 2500 Watt Plant**  
115/120 v. 60 cyc. AC. A power-

ful plant, ruggedly constructed and yet designed for easy portability. Can be started by rope or built-in 12 v. electric push button starter. Built-in windings to charge battery. Powered by a big 5.10 HP Briggs engine, complete with all accessories. Includes control box, voltmeter, ammeter, and handy plug-in power receptacle. An ideal plant for permanent or stand-by service. Wt. 226 lbs. Reg. price \$344.00 (Item 21) Factory Price **\$329.50**

**DUAL VOLTAGE 110/220 for Item 21—\$30 additional.**



(Item 20)



(Item 21)

**BUY at FACTORY PRICES**  
direct from  
**MASTER MECHANIC**

**LESS THAN WHOLESALE**

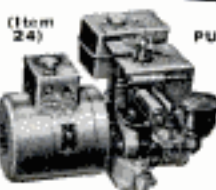

**700 WATTS PUSH BUTTON START**  
115 v. 60 cyc. AC. Powered by a rugged 2.2 HP easy starting Briggs engine. No wiring necessary; just plug in and operate. Plenty of current for any oil burner, freezer, brooder, emergency lights, etc. which require up to 700 watts. Ideal for television and radios. Complete with Voltmeter and built-in winding to charge 6 v. auto batteries. (Item 24) Wt. 75 lbs. Easily fits in car trunk. Be prepared if storm knocks out power lines. Reg. \$270 value **\$143.50**  
**800 Watt Plant (Item 44)..... \$169.50**  
**1200 Watt Plant (Item 45) same as Item 24 but larger generator and engine with 50% greater output..... \$199.50**

## GIANT 2500 WATT PLANT

110-120 v. 60 cyc. AC. Absolutely the best made exclusive dynamically balanced armature; heavy windings developed up to 3000 watt overload for motor starting. Skid mounted—portable. Powered by an easy starting Briggs or Wisconsin 6 HP engine—complete with all accessories; engine easily disconnected for other uses. Big outlet box, voltmeter, no wiring necessary. Ample current for all purposes. Factory warranty. (Item 31) Wt. 210 lb. Reg. price \$585. Special at..... **\$299.50**  
Same plant with electric self starter (Item 31a)..... **\$359.50**



**DUAL VOLTAGE 110-220 available on any of above models for \$28.00 additional.**  
Generator only and control box..... **\$169.50**

We make every type and size of light plants—Write, giving us your requirements!

## CABLE HOIST



**2000 lb. CAPACITY.** Only a fortunate purchase from the Air Force enables us to offer these brand new 2000 lb. electric cable hoists at a fraction of their value. Perfect for material handling, as a boat hoist, an elevator, lift, on assembly lines, etc. Two separate 22 ft. lift cables with independent controls permit leveling the load and controlling it perfectly. Rugged ball bearing motors of geared down design are 110 volts AC-DC. Operate on the hi-line or use our Little Giant generator plant for portable field operation. A hoist of this quality would normally sell at \$495.00. (Item 847) **\$139.50**

of this quality would normally sell at \$495.00. (Item 847) **\$139.50**

## HEATING & VENTILATING FAN

(Item 10) Easily installed in furnace pipes. Forces even heat to all rooms. Over range removes kitchen smoke and odors. Powerful, continuous duty motor, 110-120v. AC. Mount in wall or ceiling to ventilate any area. Quiet, super-efficient fan moves huge volume of air. 1400 to 500 CFM.  
8" Pipe, wt. 5 lb. .... **\$6.85**  
9" Pipe, wt. 6 lb. .... **\$7.85**  
10" Pipe, wt. 7 lb. .... **\$8.85**  
12" Pipe, wt. 8 lb. .... **\$9.85**

**HEAVY DUTY FAN.** Semi-enclosed motor, suitable for spray booths, restaurant exhausts, poultry houses, etc. 10" Fan, wt. 8 lbs. (Item 10E)..... **\$11.95**  
12" Fan, wt. 10 lbs. (Item 10B)..... **\$12.95**  
**HIGH SPEED BARN FAN** similar to above, but larger, high speed motor moves huge volume of air.  
12" Fan (Item 10F)..... **\$14.95**  
14" Fan (Item 10G)..... **\$17.95**



## EXCLUSIVE! NEW! LIGHTWEIGHT WATER COOLED DIESEL GENERATOR PLANT

Never before available! Now offered exclusively by Master Mechanic. A low priced, lightweight, continuous duty Diesel generator set. Powered by a super rugged, exceptionally smooth running, one cylinder Diesel engine. Operates at conservative 1750 r.p.m. and delivers full 1750-2000 watts of power. Operates on low cost fuel oil. Wt. only 240 lbs. representing a triumph of Diesel Engineering. Complete with fuel filter, oil pressure gauge, control box with duplex receptacle and voltmeter. (Item 830) **\$399.50**  
**DIESEL ENGINE only, as above described 3.5 HP (Item 830a)..... \$249.50**  
Wt. 116 lbs.

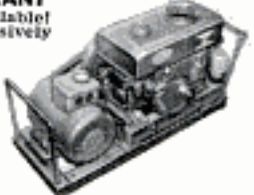

## FAUCET WATER HEATER

Instant hot water from any faucet for just pennies—sounds unbelievable—but it's true! You just slip MASTER MECHANIC'S new Faucet Water Heater over any water faucet, plug it in a wall outlet and you're got scalding hot running water instantly for dishes, shaving, washing baby's bottle, etc. Simple and safe—operates on ordinary 110v. house current—costs only 2 1/2 cents per hour for hot water. Ideal for homes, farms, cabins, trailers, etc. Easily regulates from lukewarm to full hot. Fully guaranteed! (Item 408) Wt. 2 lbs. Factory price F.O.B. Burlington, only..... **\$4.95**



## JET FLOW BLOWER

Tremendous air movement (1800 CFM) and quiet operation make this double inlet 10" turbine blower unbeatable for heating, cooling, drying and air conditioning. Ideal for attic or barn ventilation, converting gravity heating to forced air; spray booth exhausts, etc. Operates with any bearings. Includes variable speed motor pulley and belt. Dimensions 19" h x 18" x 16 1/2". Outlet opening 13" x 11 1/4". Wt. 45 lbs. Item 245. Reg. \$54.50. **Factory Special..... \$29.50**



## 9 TON HYDRAULIC PRESS

A tremendously powerful hydraulic press, capable of exerting 18,000 lbs. pressure. Pays for itself many times over—straightening bent connecting rods, king pins, crankshafts, axles, link pins, and bars—or pushing out frozen bearings and bushings. Developed pressure under precise control and visible at all times on accurate gauge. Complete with both large and small anvils and jigs to straighten any kind of curve or bend. (Item 464) Wt. 110 lb. Actual list price \$365. Our special close-out price..... **\$69.50**



**SCREW TYPE PRESS.** Nine ton capacity. See Sept. Pop. Mech.'s ad for details—or write. Complete, Wt. 150 lbs. (Item 797)..... **\$49.50**

Send check or M.O. Prices f.o.b. Factory. 10 day Money back guarantee. SEND 10c for... **BIG 1957 Catalog**  
**MASTER MECHANIC MFG. CO., DEPT. 212 Burlington, Wis.**

## Double Acting Hydraulic Cylinder



A powerful cylinder mfr'd. by Massey Harris which develops both a pushing and a pulling action. Will push 8,100 lbs. with a 1000 PSI pump pressure. Cylinder is 3 1/2" dia. with 6 1/2" stroke—standard heavy duty clevis on both ends. Has standard 1/2" pipe thread openings. Can be used for lifting buckets or blades, raising or lowering implements, hydraulic presses, etc. Can also be used as an air cylinder. (Item 802) Wt. 17 lbs. Reg. \$68 value. Special..... **\$14.95**

**OTHER DOUBLE ACTING CYLINDERS**  
8" stroke — 3" bore..... **\$34.00**  
10" stroke — 3" bore..... **34.80**  
16" stroke — 3" bore..... **43.00**  
24" stroke — 3" bore..... **47.50**

We have all sizes of cylinders available.

**HYDRAULIC CONTROL VALVE**—4 way open center valve with built-in adjustable relief. Controls 1 double, or 2 single acting cylinders. Equalizing feature permits easy control even under heavy loads. 3/4" pipe thread on inlet & outlet, 1/4" on cylinder outlets. Easily mounted, finger tip control. Wt. 16 lbs. (Item 822)..... **\$21.95**

## HYDRAULIC KIT



Complete Hydraulic Kit consists of hydraulic hand pump with built-in 2 gal. reservoir and item 802 hydraulic cylinder described above. Pump has a built in relief valve and is rated at 20 tons. Kit is ideal for pressing D jacks, snow-plows, etc. Pump is 29" long—3" diam. with 3/8" ports. A terrific value! **\$39.50** (Item 836). Wt. 50 lbs. **Pump only (Item 836a) only..... \$23.50**

## GIANT METAL SHEARS



Nine inch cutting blade made of special high carbon alloy steel, perfectly aligned and ground. Easily cuts steel plate up to 12 gauge or 1/4" thick. Overall length 48". Wt. 23 lbs. (Item 156) Regular..... **\$14.95** 8-49.50. While they last.

## PORTABLE BOOM HOIST

Here is a big 3000 to 10,000 lb. capacity boom hoist at a fraction of the actual cost to the Gov't.—that can pay for itself on one job! Engine hoist is made of high strength alloy steel. Can be mounted as a stationary crane in yards or on buildings; or as a mobile crane on trucks for use as a wrecker. Massive telescoping steel boom is quickly extended from 10 to 20 ft. with a built-in winch. Ideal for erecting buildings, hoisting materials, loading machinery, unloading hill cars, lifting boats from water, laying in sewer pipe, etc. (Item 801) Wt. 650 lbs. Orig. cost over \$350. **Special..... \$89.50**



## MASTER DC ARC WELDERS

Now! a portable rugged type welder with terrific performance, yet at a price hundreds of dollars less than you'd expect. Senior model made for years of trouble-free, continuous service. High capacity DC welding unit enables you to tackle any job with confidence—easily welds anything up to 2" plate using from 1/16" to 1/4" rods. Built-in stabilizer and cooling system makes easy to strike and hold. Dual control provides low heat soldering, brazing and welding from 30 to 300 amps. Complete with instructions, guarantee and triple V-belt or flat pulley. Easy to hook up and easy to operate. **WELDER ONLY — DUAL CONTROL MODEL.** Same as above, but drive with rear tractor, seen or gas engine of 14 HP or more. (Item 88a.) Wt. 110 lbs. \$499 value. **\$119.50**  
**WELDER ONLY—INDUSTRIAL MODEL** same as above but with ceramic rotary type rheostat providing 74 different heat settings for all types of welding (Item 88b) **\$139.50** \$500.00 value.  
**COMPLETE POWER MASTER** (Illustrated above) powered by a 16 hp., air cooled Wisconsin engine. Wt. 480 lbs. (Item 280) Complete with welder costing \$1200. **Factory Special..... \$449.50**



(Item 280)

**WELDING KIT** Two 10 ft. leads, welding helmet, electrode holder, ground clamp. Sold only with welder at... **\$10.50**

# SOUTH BEND

**Built Better  
for Better  
Service**

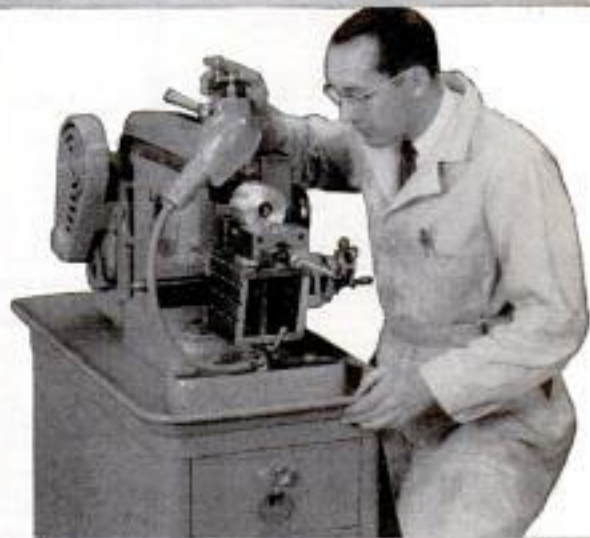

Illustrations: Top, 9" Lathes from \$276. Left, Pedestal Tool Grinders from \$268. Right, 7" Bench Shapers from \$573.

Compare South Bend Machine Tools with other makes of similar size and capacity, regardless of price. It will be easy to see why they are a better value. Quality makes the difference: greater accuracy—dependability—versatility which pay off in higher efficiency and production. You get more for your money when you buy South Bend. Check coupon and mail today for more information.

## FREE Catalog 5700

80 pages, over 300 illustrations. Send coupon today for your copy.

### SOUTH BEND LATHE

BUILDERS OF PRECISION MACHINE TOOLS SINCE 1906



As low as 10% down.  
Up to 24 months to pay.

SOUTH BEND LATHE, South Bend 22, Indiana

Please send free catalog and complete information on items checked:  9" Lathes,  10" Lathes,  13" Lathes,  14½" Lathes,  16" Lathes,  16-24" Lathes,  Turret Lathes,  Milling Machines,  Shapers,  Pedestal Tool Grinders,  Drill Presses.

Name.....Street.....

City.....Zone...State.....

# Arrow's T-50 automatic nailer

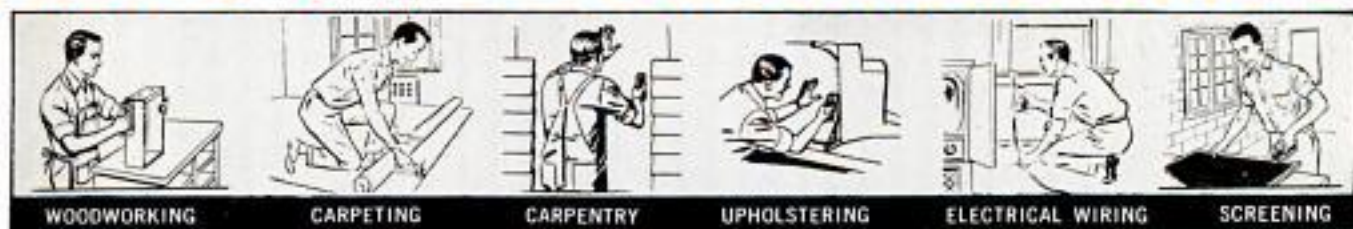

## does all these nailing jobs

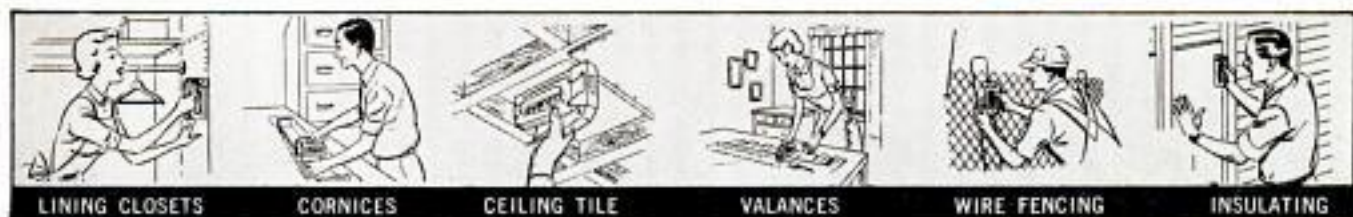

## 10 times faster than a hammer!

Here's the tool no work bench should be without! Do hundreds of nailing jobs with this powerful chrome plated, all steel Arrow Automatic Nailer! Shoots a staple wherever you'd drive a nail! Easier! You always have one hand free to hold material! Faster! Shoots 100 staples a minute! Cheaper! 100 2 pronged staples cost less than 5¢. Same machine takes 6 different staples sizes from 1/4" to 9/16" leg.

**Price: \$12.50**

New! **ARROW'S CEILTILE STAPLE**... the only staple designed especially for ceiling tile! Guarantees freedom from hidden fractures!



T-50

Here are many more uses of the T-50:

carpentry • upholstery • woodworking • ceiling tile • wire fencing • wood veneer • decorations • metal lath • carpeting base • wire screening • bulletin boards • roofing felt • hi-fi insulation • electric & TV wire • wood siding • shingles • venetian blind tapes • leatherette • barbed wire • cornices • shelf lining • plastic covering • netting • weatherstripping • window shades • lining closets • mesh • linoleum flooring • display signs • cornerite • canvas covering • carpeting • insulation



### Ordinary Staple

Often fractures the unseen back of the tile flange.

Staple loses 50% holding power; often pops right out.

Sagging, wavy ceilings result... tiles buckle.



### Arrow's CEILTILE Staple

- Unique leg design locks into wood, drives flush, holds tight!

- Flange is never fractured... CEILTILE penetrates perfectly!

- Cementcoating provides extra holding power!

Supply of 5,000 CEILTILE staples, only \$3.50

Also packed 1,000 to a box.

Arrow's Ceiltile Staple — TESTED and APPROVED by:

**Gold Bond**  
NATIONAL PRODUCTS

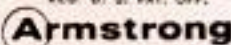

and other leading manufacturers!

All Arrow products available at your local hardware, lumber yard or building supply dealer.

**ARROW FASTENER CO., INC.** 1 JUNIUS STREET, BROOKLYN 12, NEW YORK

# The POWER TOOL FOR BUSY PEOPLE



## WELLER SANDER

Model 700  
only  
**\$14.95**

For the bustling handyman who does everything or the weekender who wants to get done fast . . . the Weller Power Sander is the most useful tool you can invest in.

The Weller Power Sander and Polisher has more than twice the sanding area of any sander in its price class. It gets jobs done faster and easier. The straight-line action



sands satin-smooth with the grain and it goes all the way into corners. The low design is only 2 $\frac{1}{8}$ " high and

goes under radiators and other hard to reach places.



The Weller Power Sander features a positive paper grip that cannot slip and needs no special tools for paper replacement.

Powerful reciprocating motor has no gears, never needs lubricating. Lightweight design fits snugly in hand and is ideal for vertical sanding—feathering dry wall seams, etc. Guaranteed 1 year.



SANDS WITH GRAIN



GETS INTO CORNERS



UNDER LOW PLACES



LIGHT & COMPACT



POLISHES & BUFFS

# Weller

ELECTRIC CORP., Easton, Pa.

Also available in complete sanding kit, including: all-metal case for carrying or storing, assorted sandpaper and polishing cloth. Weller model 700K \$16.95