

POPULAR MECHANICS

MAGAZINE

WRITTEN SO YOU CAN UNDERSTAND IT

REG. TRADE MARK, GPO AT WASHINGTON, D.C.

NET U.S. 34¢ PER COPY

Here it is— **The EDSEL**
—page 92



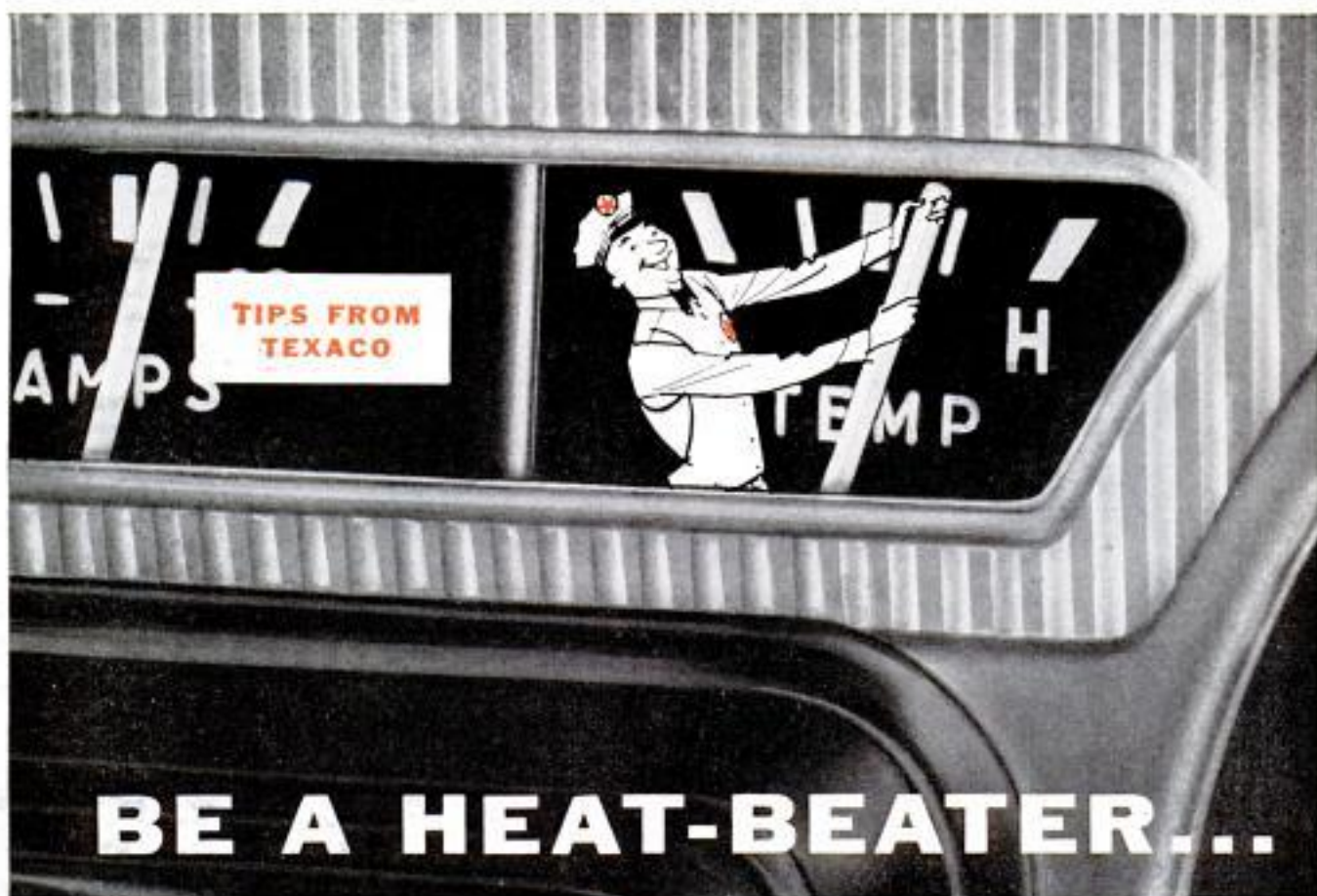

SIZZLING PAVEMENTS! Drivers swelter! *Cars suffer, too . . . need good care . . . like this:*

Item: Battery water takes wing fast . . . check it weekly . . . keep the level $\frac{3}{8}$ " above the plates. Use *distilled* water for longer battery life.

"TEMP" shows hot! Oil level okay? Water level okay? Maybe the fan belt needs tightening. Perhaps outside of radiator is clogged

with bugs, leaves, etc. Cooling system may be clogged with rust and require flushing. Dirty air cleaners can air-starve the engine. See "Mr. Service" at the Texaco station.

Watch tire pressure. Inflate correctly in the morning when cool. Low-pressure flexing overheats tires . . . shortens life, causes blow-outs. Your Texaco Dealer will be glad to check your tires.



THERMOMETER-BEATING OIL

Heat thins ordinary motor oils. Now, thanks to Texaco research, a new Havoline Special 10W-30 oil that stays full-bodied and full-lubricating to protect your engine at sizzling temperatures, yet stays fluid to give easier starts in sub-zero weather. Use this *one grade* the year 'round. More than that, this remarkable oil keeps engines clean for full power-packed performance. Get it from your Texaco Dealer, *the best friend your car has ever had.*

TEXACO DEALERS
IN ALL 48 STATES

Texaco Products are also distributed in Canada, Latin America, and Africa

THE TEXAS COMPANY



How I retired in 15 years with \$300 a month

"Europe, here I come! First, I'm going to visit cousins I've never seen outside of London. Then I'll just travel about. All my life I've been wanting to go to Europe, and at last I have the time—and the money to do it. How can I afford to spend savings for this trip? You see, I have a lifetime income—a check for \$300 a month as long as I live.

"Come to think of it, a young English cousin was indirectly responsible for my being retired now. Back in 1940, during the Battle of Britain, we took Paul to live with us. He was ten. He often talked about his home—the village my family came from. The more I listened, the more I wanted to go to England after the war.

"I had a good job at the time, with a promising future. But when I actually got down to considering going to Europe, I realized I'd never be able to take off more than two weeks at a time unless I could retire someday. Yet retiring seemed impossible. I had never saved much. I was nearly forty.

"But, one day, while I was waiting at the barber's for Paul and my boys, I happened to be glancing through a magazine and noticed an ad about a way to retire. It was called the Phoenix Mutual Retirement Income Plan. It said if I started young enough—in my forties or sooner—this plan

could provide an income of \$10 to \$300 a month for life. I sent for the booklet that very morning.

"In a few days the booklet arrived in the mail. My dreams suddenly became possibilities. This plan was made specifically for someone like me. Why I'd even be able to retire earlier than I had ever expected.

"Of course, I compared Phoenix Mutual to other retirement methods. But the more I compared, the more clearly I saw it was best for me. Just as soon as I could, I applied and qualified for my Phoenix Mutual Retirement Income Plan.

"To think I'm actually on my way to see Paul! It's hard to believe he's grown up now, and married. My next check for \$300 is waiting for me in London. I've never felt so care-free in my life. And I'm still young, with years to look forward to."

Send for Free Booklet. This story is typical. Assuming you start at a young enough age, you can plan to have an income of \$10 a month to \$3,600 a year or more—beginning at age 55, 60, 65 or older. Send the coupon and receive, by mail and without charge, a booklet which tells all about Phoenix Mutual Plans. Similar plans are available for women—and for employee pension programs. Don't delay. Send for your copy now.



ESTABLISHED 1851

PHOENIX MUTUAL

Retirement Income Plan

GUARANTEES YOUR FUTURE

OVER 100 YEARS OF LIFE INSURANCE PROTECTION
FOR BUSINESS AND FAMILIES

COPYRIGHT 1957, BY PHOENIX MUTUAL LIFE INSURANCE COMPANY

SEPTEMBER 1957

PHOENIX MUTUAL LIFE INSURANCE CO.
227 Elm Street, Hartford 15, Conn.

Please send me, without obligation, your free 28-page book showing new retirement income plans.

Plan for Men Plan for Women

Name _____

Date of Birth _____

Business Address _____

Home Address _____

This One



GTNG-4PP-G1TW

DOWN
IN BED



DOWN IN
THE MOUTH



DOWN IN
THE POCKET



A long winter's ahead . . . don't let it get you down!

Here is why it's LENNOX
for better winter living

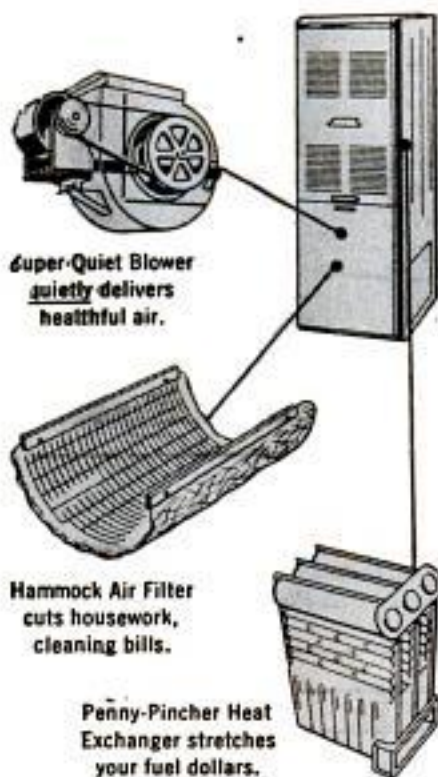

Super-Quiet Blower
quietly delivers
healthful air.

Hammock Air Filter
cuts housework,
cleaning bills.

Penny-Pincher Heat
Exchanger stretches
your fuel dollars.

Get set now for happier, healthier
winter living . . . with up-to-date
LENNOX WARM AIR HEATING!

This winter live in air that's always the perfect temper-
ature, humidity-controlled, freshened and filtered-clean,
gently and quietly circulated to every room. Choose the
best—choose Lennox, made by the world leader in home
comfort. Costs less than you may think!—and you're all
set to add summer air conditioning!

FREE HEATING SURVEY! Call your Lennox Com-
fort Craftsman, your community's heating and air condi-
tioning dealer-expert. He's listed in the Yellow Pages.
Ask about the Lennox Easy Pay Plan.

More families buy

LENNOX



world leader in all-season air conditioning for the home

©1957 Lennox Industries Inc., Heating and Air Conditioning, founded 1895; Marshalltown and Des Moines, Iowa; Syracuse, N. Y.; Columbus, O.; Decatur, Ga.; Ft. Worth; Los Angeles; Salt Lake City. In Canada: Toronto, Montreal, Calgary, Vancouver.

Popular Mechanics Magazine

Registered in U. S. Patent Office and Canada

H. H. WINDSOR, Founder

H. H. WINDSOR, JR., Editor and Publisher

FOREIGN EDITIONS:

MECANIQUE
POPULAIRE
(French)

MECANICA
POPULAR
(Spanish)

POPULÆR
MEKANIK
(Danish)

POPULÄR
MEKANIK
(Swedish)

POPULÄR
MECHANIK
(German)

Managing Editor

RODERICK M. GRANT

Assistant Managing Editor

WAYNE WHITTAKER

Shop Notes and Crafts Editor

JAMES R. WARD

Associate Editor

CLIFFORD B. HICKS

Associate Editor, Automotive

ARTHUR R. RAILTON

Associate Editor, Shop Notes and Crafts

WAYNE C. LECKEY

Associate Editor, Shop Notes

W. CLYDE LAMMEY

Associate Editor

WILLIAM D. PERKINS

Radio-Television, Electronics Editor

LOTHAR STERN

Assistant Editor, Crafts

JAY W. HEDDEN

Assistant Editor, Makeup

JOHN DALEN

Art Director, **FRANK BEATTY**

Assistant Editors

KENNETH ANDERSON **ROBERT DORSETT**
ROBERT HENDRICKSON **EARL WOBECK**

Eastern Editor

RICHARD F. DEMPEWOLFF

Empire State Bldg., Room 2908, N.Y.C. 1

Western Editor

THOMAS E. STIMSON, JR.

Suite 1010, 3460 Wilshire Blvd.,

Los Angeles 5, Calif.

London Manager

DOUGLAS W. WEDDERSPOON

Eagle House, Jermyn St.,

London S.W. 1, England

Director, Bureau of Information

ALLAN CARPENTER

200 E. Ontario St., Chicago 11

Advertising Offices

Chicago: 200 E. Ontario St., Whitehall 4-0100;

New York: Empire State Bldg., 350 Fifth Ave.,

Longacre 5-7580; Detroit: General Motors

Bldg., Room 5-118, TRinity 5-8711; Cleveland:

Hanna Bldg., 1422 Euclid Ave., PRospect

1-0456; Los Angeles: 3460 Wilshire, DUNkirk

2-8458; San Francisco: Russ Bldg., Room

468, 235 Montgomery St., YUKon 2-0823.

Sources of further information not listed in the

index, starting on page 74, about articles in this issue,

frequently are shown in the Where-to-Find-It List

prepared for each issue. A copy may be obtained by

readers, without charge, from Bureau of Informa-

tion, Popular Mechanics, 200 East Ontario Street,

Chicago 11, Illinois.

Published monthly by Popular Mechanics Company,

200 E. Ontario St., Chicago 11, Ill. H. H. Wind-

sor, Jr., president; Wm. Harrison Fetridge, exec.

vice-pres.; Franklin S. Forsberg, operations vice-

pres.; D. F. Windsor, vice-president and secretary;

treasurer: H. H. Windsor III, vice-president; W. T.

Windsor, vice-president; Joseph R. Buell, Jr., ad-

vertising manager; Alan M. Deyoe, circulation

manager. Single copy in the United States and

Canada, 35 cents; subscription rates in the United

States and possessions, Canada and countries of

the Pan-American Postal Union, 1 year \$3.50; 2

years, \$6.00; 3 years, \$8.00. To all other coun-

tries add \$1.00 a year over United States prices

for overseas postage. If you plan to move, notify us

at least 30 days in advance so you will not miss

an issue. Give both your old and new addresses.

Entered as Second Class Matter, September 15,

1903, at the Post Office at Chicago, Illinois, under

Act of March 3, 1879. Entered as Second Class

Matter at Post Office Dept., Canada. Registered

as Second Class Matter at the Post Office at

Mexico, D.F., Mexico, June 20, 1930.

Copyright 1957 by Popular Mechanics Company.

Copyright under International Copyright Union.

Copyright in France. All rights reserved under

Pan-American Copyright Union. Printed in the

United States of America.

Volume 108

SEPTEMBER 1957

Number 3

Address all communications to: 200 E. Ontario St., Chicago 11, Ill.

In This Issue...

You Can Make a Plant Do Tricks	-	-	81
Here It Is — The Edsel	-	-	92
Brains for Planes	-	-	98
What's Happening to the Weather	-	-	106
Field Day in the Saddle	-	-	121
The Organ That Plays Stalactites	-	-	128
The Owners Report on the '57 Dodge	-	-	134
A Dentist Builds a Ferryboat	-	-	142
Michigan's House of Magic	-	-	146

For the Craftsman...

Storage Planter	-	-	161
Winter Insurance for Your Garden	-	-	170
Give Caged-Animal Shots a Natural Look	-	-	176
Deluxe Playhouse Has Water and Lights	-	-	178
Fun on the Lazy-B	-	-	186
Blue-Jay Weather Vane	-	-	190
Bimetallic Machinist's Hammer	-	-	208

Regular Departments...

Detroit Listening Post	-	-	89
Keeping Up With the Atom	-	-	105
What's New for Your Home	-	-	154
Radio, TV and Electronics	-	-	157
Solving Home Problems	-	-	174
Shopping for Tools	-	-	218
On the Market for Do-It-Yourselfers	-	-	220
Clinic for Homemakers	-	-	224

Next Month...

HOMES, HOMES, HOMES — 50 pages of them and everything pertaining to them will be a special feature in the October issue. The full-color pages will introduce two new PM homes, one in sleek modern style and the other in modified Cape Cod with a prairie-farmhouse flavor



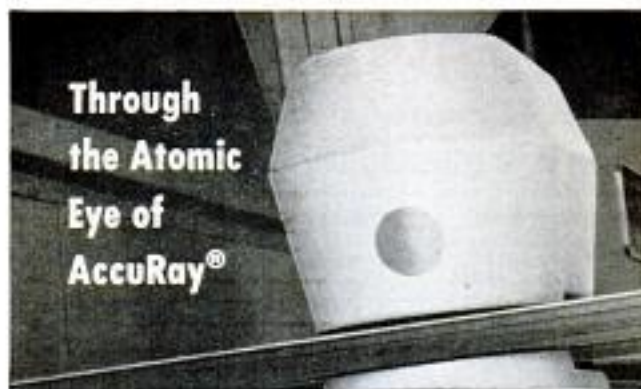

Through
the Atomic
Eye of
AccuRay®

Dunlop now brings you **SAFER TIRES**

YOU'RE SAFER than ever on a matched set of Dunlops... because Dunlop now uses the latest advances in atomic control to bring you even stronger, cooler-running, better-balanced tires with extra mileage built-in.

The remarkably precise nucleonic action of AccuRay assures uniform application of an exact amount of protective rubber to every cord ply. There's no danger of premature failure due to uneven, excessive or inadequate ply coating.



You owe yourself and family the extra safety and comfort of Dunlop AccuRated Tires. Your Dunlop dealer will give you the "inside story" that makes Dunlop your best tire value today. He has a complete selection of Dunlop tires in Nylon or Super Hi-Test Rayon.

**You'll go farther,
SAFER... on tires by
DUNLOP**

They're AccuRated

DUNLOP TIRE AND RUBBER CORPORATION, BUFFALO 5, N. Y.

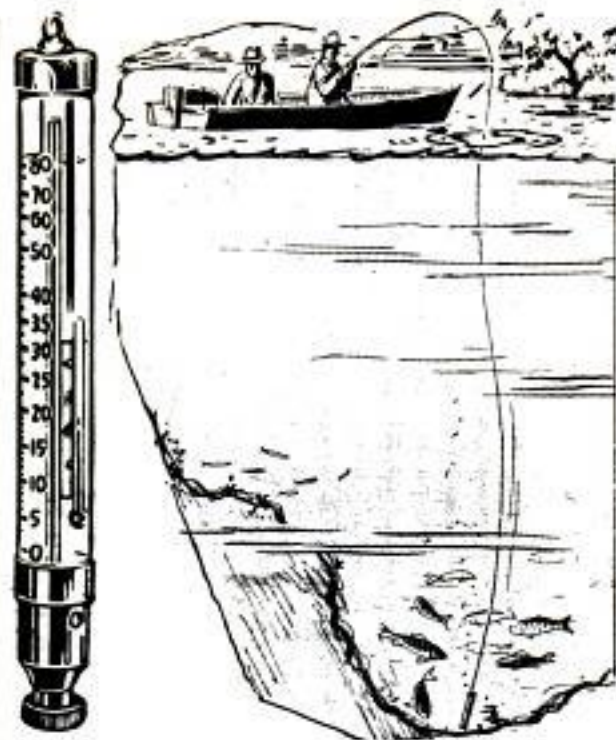

Thermometer for Fishermen Helps Prove Theory

Anglers who believe that fish are caught at certain depths and water temperatures can prove this theory with a combination depth-gauge-and-thermometer unit. It consists of a plastic tube containing a thermometer and two calibrated scales. Attached to a fishing line, this tube is lowered into water. The level of water trapped inside registers on the larger scale as depth in feet. The thermometer scale indicates water temperature at that depth. Water may be drained by turning a valve and shaking the tube.

Self-Adjusting Watch

Setting its hands to the correct time is all that's needed to speed up or slow down a new watch, regulating it automatically. Inside the case is a mechanism that controls shifts of the regulator within one hundredth millimeter. The device does this without affecting normal winding or setting the hands if the watch runs down.

Roller-Tripod Carries Pail

Buckets of water now can be moved easily across the floor on a tripod attachment. The tripod rolls on three pneumatic tires that turn in a full circle.



Black & Decker® U-3

—packs more power—does more jobs!



GEARED CHUCK same as used by industry for extra holding power and accuracy.



HIGH-QUALITY HELICAL GEARS give quieter, smoother flow of power from motor.



FAMOUS B&D-BUILT MOTOR has 45% more power, 100% greater torque (turning force).



SLIM, TRIM HANDLE is shaped to fit the hand for better control. Bright, highly polished housing stays new looking.



3-WIRE CABLE has industrial-type ground wire for extra safety in operation.

Look for the 3-prong plug

Insist on
Black & Decker's
U-3
—the 1/4" drill with the
quality difference

Power pays off when you drive B&D attachments

- Trims hedges
- Saws wood
- Drives screws
- Sands any surface
- Polishes any material...and DRILLS!

Most drills can bore holes without trouble. But driving attachments really separates the tools from the toys. That's why we gave the

Black & Decker U-3 Drill extra power, extra torque, extra quality. Insist on the U-3 Drill and B&D attachments by name at your dealer's —don't accept less than the best!



Look under "Tools-Electric"



Black & Decker®

World's largest maker of Portable Electric Tools



SEND COUPON FOR HANDY IDEA BOOK!

THE BLACK & DECKER MFG. CO.
Dept. MO97, Towson 4, Md.

Please send me a copy of your "Handy Tips" booklet. I enclose 25c to cover cost of handling and mailing.

Name.....

Address.....

City..... State.....

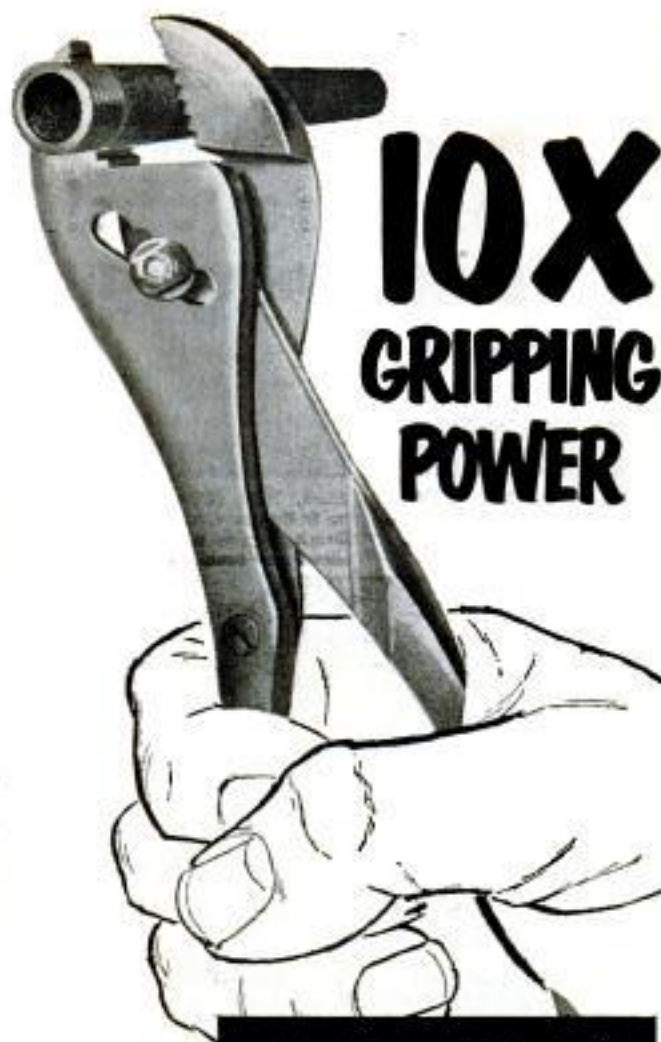

Proto's "Multi-Plier" increases gripping pressure ten times at jaws.

ANOTHER REASON YOU'LL
**PREFER
PROTO**
PLIERS

There's no substitute for the right plier. Choose the pliers you need at your Proto dealer. Send 10¢ for 84 page catalog describing entire line to Proto Tool Company, 2209 Santa Fe Ave., Los Angeles 54, Calif.

PROTO GIVES YOU
A BIG SELECTION

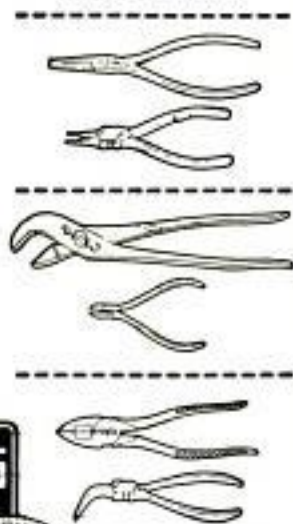

PROTO TOOLS
PROTO means Professional Tools

DIVISION OF



ACROSS THE DESK



To the Editor:

I have just read the article entitled "Protect Yourself Against Windstorm Damage," by Mr. E. R. Haan, in the June 1957 issue of *Popular Mechanics*.

I am very impressed with this article and, if possible, would like to have permission to use it for Civil Defence purposes.

Civil Defence in Canada is organized on a voluntary basis, except for a few key personnel representing either municipal, provincial or federal government. The writer is a representative of the Ontario Provincial Government in charge of a region consisting of six counties. From time to time he is called upon to give lectures to voluntary trainees on the subject of "Home Protection Under Atomic Attack" and "Home Protection in Natural Disaster."

The manner in which the subject article would be of value is as a basis for a lecture on home protection in a natural disaster and a précis of lecture notes to be handed to the trainees. Should your approval be forthcoming, the diagrams illustrated, the type of joints to be used in home construction and the type of shelters to be constructed would be reproduced in this précis. The précis would not be sold, but would be issued gratis to the Civil Defence volunteers attending the lecture.

It would be necessary to submit a copy of this précis to Civil Defence Headquarters, Ontario, for approval and it is quite possible that should the chief training officer for Civil Defence in the province of Ontario approve of this précis, he would wish to submit it to the Dominion of Canada Civil Defence Authorities for issuance to Civil Defence formations across the country. In all cases the précis would be issued free of charge to enrolled Civil Defence volunteers.

I have read a considerable number of articles on this subject and have no hesitation in stating that Mr. Haan's article is much superior to anything that I have read before. I sincerely hope that you will be able to give me permission to make use of the article as a basis for lecture purposes.

B. F. C. Houston,
Co-ordinator, Region #3,
Dept. of Planning and Development,
Civil Defence Branch,
Province of Ontario

Permission granted and thanks for the compliments.—Ed.

(Continued to page 8)

THIS FREE SAMPLE LESSON

will prove that you can become an expert

ACCOUNTANT...AUDITOR

OR CPA



This well-paid LaSalle-trained Accountant's success could be yours.

FREE SAMPLE LESSON

We offer you this free sample lesson so that you can prove to yourself that you CAN master Accounting—quickly, thoroughly—in spare time at home.

You will see exactly how LaSalle's famous "Problem Method" works...how you are led step-by-step through actual accounting work—learning by doing and not by study of theory alone. First you tackle easy problems, then more difficult ones—until soon you master them all. And at every step you have the close personal guidance of LaSalle's large staff of expert accountants and CPA instructors.

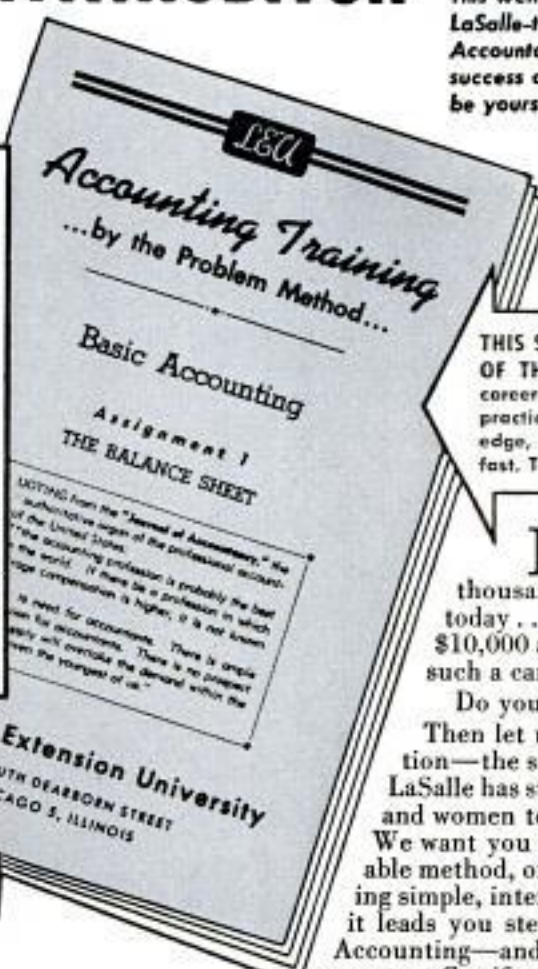

THIS SAME LESSON HAS STARTED HUNDREDS OF THOUSANDS toward well-paid accounting careers—in business, government, and public practice as CPAs. Even without previous knowledge, progress is rapid—earning power climbs fast. This sample lesson will show you why.

IF you have been envying the high incomes and good jobs enjoyed by thousands of men and women Accountants today... incomes ranging from \$5,000 to \$10,000 and more per year... why not launch such a career for yourself?

Do you doubt that you can?

Then let us send you—without cost or obligation—the same Lesson Number One with which LaSalle has started several hundred thousand men and women toward successful accounting careers. We want you to see for yourself how this remarkable method, originated by LaSalle, makes Accounting simple, interesting, practical, and certain... how it leads you step-by-step to a complete mastery of Accounting—and on up to the Certified Public Accountant Certificate if you so aspire. It doesn't matter

whether you've had previous bookkeeping experience, or whether you don't know a debit from a credit. Whether you wish to qualify as an expert accountant, advanced accountant, cost accountant, auditor, government accountant, income tax specialist, or public accountant... you'll find in LaSalle's Problem Method the exact plan to prepare you rapidly and inexpensively—in spare hours at home—without losing a day from your present job.

So right now, today... if you are an adult, employed, and earnestly ambitious for rapid advancement in one of the highest paying fields of business... send your name and address on the coupon below. We'll send you the free sample lesson—plus our illustrated book outlining today's career opportunities and how you can qualify for them. A coupon like this has started many thousands toward greater success. It can do the same for you. Mail it today!

Accredited Member, National Home Study Council

Clip Coupon... Mail TODAY!

LaSalle Extension University... A Correspondence Institution

Dept. 964 H, 417 S. Dearborn Street, Chicago 5, Illinois

YES, I want to see how LaSalle's "Problem Method" works... Send me free sample lesson—also your book, "Opportunities in Accounting"... without cost or obligation.

Name..... Age.....

Street Address.....

City, Zone & State.....



One out of every 13 of all CPAs in the U.S. has been trained by the LaSalle Problem Method

GOOD-PAY JOBS IN 6 BIG FIELDS

If you were an expert accountant right now, chances are you would find yourself in one of the best paid fields of business.

There are several big fields of opportunity open to men and women trained in accounting... opportunities that are wide open and highly inviting, offering maximum income and job security in good times or bad. And under LaSalle's "Problem Method" you can start earning while still learning—either in spare-time or full-time employment... or in business for yourself with no capital required.

Get the latest information by sending for our illustrated booklet, "Opportunities in Accounting"—plus free sample lesson. The coupon at right will bring both to you without cost or obligation. LaSalle Extension University, 417 S. Dearborn St., Chicago 5, Illinois.



Wartime Jeeps Take to Rails

Many wartime Jeeps declared surplus by the Allied Forces Headquarters in Europe are still serving in civilian and police jobs in Europe. The Italian State Railways have put some of the veteran Jeeps into service hauling materials for construction and repair over the iron road. The four wheels with tires were replaced by four small railway wheels. Private companies own these

rail-Jeeps and haul maintenance material under contract with the Italian State Railways.

Francis C. Fuerst,
Pieve Ligure, Italy

To the Editor:

What happens in case of power failure when the Hiller cloud car (July 1957 PM) is in the air?

Barney Barnes,
Mountain View, Calif.

Hiller Helicopters of Palo Alto, Calif., who are developing the ducted-fan air sedan described in the July issue, answer this one: "The matter of safety

in event of power failure was an immediate problem with the original Flying Platform, and there appear to be two ways around it: (a) use the principle of multiengine power so that the craft will fly in event of one engine out and (b) equip passengers with parachutes which will open at low altitudes. On the prototype version of our Flying Platform we are using the multiengine

(Continued to page 10)

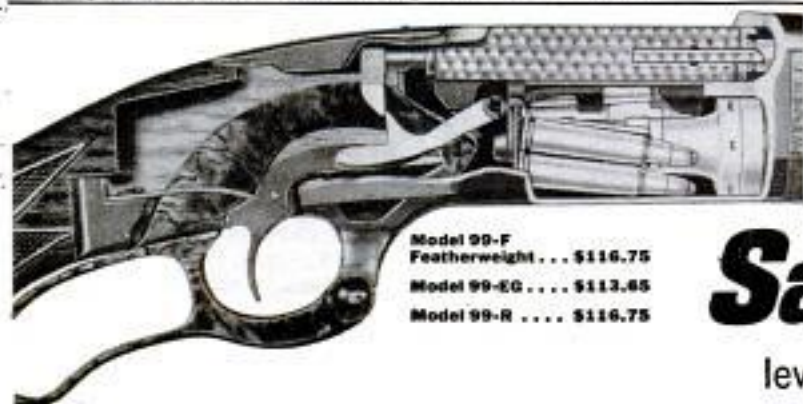

Model 99-F
Featherweight . . . \$116.75
Model 99-EG . . . \$113.65
Model 99-R . . . \$116.75

inside story
on the

Savage 99

lever action big game rifle

Exclusive rotary magazine and action are fully enclosed . . . loads and unloads quickly, easily . . . cartridges protected from dirt and moisture . . . balance the same no matter how many rounds in magazine. Unique cartridge count indicator shows number of cartridges in magazine . . . safety indicator tells instantly by sight or touch whether hammer is cocked.

Available in 3 great models (each drilled and tapped for popular receiver and 'scope mounts) and 5 great calibers: .250-3000 Savage, .300 Savage, .243 Win., .308 Win. and .358 Win.

There are Savage, Stevens and Fox shotguns and rifles for every shooter and every kind of shooting. Write for free rifle or shotgun catalog. Savage Arms Corporation, Chicopee Falls 16A, Mass.



all prices
subject to
change
slightly higher
in Canada

Savage
TRADE MARK

SAVAGE • STEVENS • FOX FIREARMS



POPULAR MECHANICS



This man is a "security risk"!

Age, 29. Married. Two children. High school education. Active in local lodge, church, veterans' organization. Employed by large manufacturing concern. Earns \$82 a week.

Sounds like an Average Joe. And he is. Too average! He's got a job. It pays fairly well. He's satisfied.

But here's the catch. With the right kind of training, this young

man could be stepping into better jobs. He could be making \$7-8000 a year. He could be cashing in on those spare-time hours he now wastes.

As it stands now, he's stuck in his job. Can't seem to make any headway. He's reluctant to try. So he just hangs on.

This man is a "Security Risk" to his wife and children.

His family probably will never enjoy the comforts, the prestige, the good living that could be theirs. If hard times come, they are almost sure to be hurt. For an Average Joe can't expect to compete with trained men when the chips are down.

A man like this would do well to start a planned program of self-improvement. In his spare time. In a field related to his interests and abilities. Right NOW!

One good way to start—a way proved by hundreds of thousands of once-Average Joes who are making good today—is to enroll for special training with a recognized correspondence school. One like I. C. S., the oldest and largest in the world.

Don't you be a "Security Risk." Mail the coupon for full, free details while there is still time.

For Real Job Security—Get an I. C. S. Diploma! I. C. S., Scranton 9, Penna. Member, National Home Study Council

INTERNATIONAL CORRESPONDENCE SCHOOLS



BOX 93953J, SCRANTON 9, PENNA.

(Partial list of 257 courses)

Without cost or obligation, send me "HOW TO SUCCEED" and the opportunity booklet about the field BEFORE which I have marked X (plus sample lesson):

- | | | | | |
|--|--|--|---|---|
| <p>ARCHITECTURE and BUILDING CONSTRUCTION</p> <ul style="list-style-type: none"> <input type="checkbox"/> Air Conditioning <input type="checkbox"/> Architecture <input type="checkbox"/> Arch. Drawing and Designing <input type="checkbox"/> Building Contractor <input type="checkbox"/> Building Estimator <input type="checkbox"/> Carpentry and Millwork <input type="checkbox"/> Carpenter Foreman <input type="checkbox"/> Heating <input type="checkbox"/> Interior Decoration <input type="checkbox"/> Painting Contractor <input type="checkbox"/> Plumbing <input type="checkbox"/> Reading Arch. Blueprints <p>ART</p> <ul style="list-style-type: none"> <input type="checkbox"/> Commercial Art <input type="checkbox"/> Magazine & Book illus. <input type="checkbox"/> Show Card and Sign Lettering <input type="checkbox"/> Sketching and Painting <p>AUTOMOTIVE</p> <ul style="list-style-type: none"> <input type="checkbox"/> Automobiles <input type="checkbox"/> Auto Body Rebuilding and Refinishing <input type="checkbox"/> Auto Engine Tuneup <input type="checkbox"/> Auto Technician | <p>AVIATION</p> <ul style="list-style-type: none"> <input type="checkbox"/> Aero-Engineering Technology <input type="checkbox"/> Aircraft & Engine Mechanic <p>BUSINESS</p> <ul style="list-style-type: none"> <input type="checkbox"/> Accounting <input type="checkbox"/> Advertising <input type="checkbox"/> Business Administration <input type="checkbox"/> Business Management <input type="checkbox"/> Cost Accounting <input type="checkbox"/> Creative Salesmanship <input type="checkbox"/> Managing a Small Business <input type="checkbox"/> Professional Secretary <input type="checkbox"/> Public Accounting <input type="checkbox"/> Purchasing Agent <input type="checkbox"/> Salesmanship <input type="checkbox"/> Salesmanship and Management <input type="checkbox"/> Traffic Management <p>CHEMICAL</p> <ul style="list-style-type: none"> <input type="checkbox"/> Analytical Chemistry <input type="checkbox"/> Chemical Engineering <input type="checkbox"/> Chem. Lab. Technician <input type="checkbox"/> Elements of Nuclear Energy <input type="checkbox"/> General Chemistry <input type="checkbox"/> Natural Gas Prod. and Trans. <input type="checkbox"/> Petroleum Prod. and Engr. <input type="checkbox"/> Professional Engineer (Chem) <input type="checkbox"/> Pulp and Paper Making | <p>CIVIL ENGINEERING</p> <ul style="list-style-type: none"> <input type="checkbox"/> Civil Engineering <input type="checkbox"/> Construction Engineering <input type="checkbox"/> Highway Engineering <input type="checkbox"/> Professional Engineer (Civil) <input type="checkbox"/> Reading Struc. Blueprints <input type="checkbox"/> Structural Engineering <input type="checkbox"/> Surveying and Mapping <p>DRAFTING</p> <ul style="list-style-type: none"> <input type="checkbox"/> Aircraft Drafting <input type="checkbox"/> Architectural Drafting <input type="checkbox"/> Drafting Machine Design <input type="checkbox"/> Electrical Drafting <input type="checkbox"/> Mechanical Drafting <input type="checkbox"/> Sheet Metal Drafting <input type="checkbox"/> Structural Drafting <p>ELECTRICAL</p> <ul style="list-style-type: none"> <input type="checkbox"/> Electrical Engineering <input type="checkbox"/> Elec. Engr. Technician <input type="checkbox"/> Elec. Light and Power <input type="checkbox"/> Practical Electrician <input type="checkbox"/> Practical Lineman <input type="checkbox"/> Professional Engineer (Elec) <p>HIGH SCHOOL</p> <ul style="list-style-type: none"> <input type="checkbox"/> High School Diploma | <ul style="list-style-type: none"> <input type="checkbox"/> Good English <input type="checkbox"/> High School Mathematics <input type="checkbox"/> Short Story Writing <p>LEADERSHIP</p> <ul style="list-style-type: none"> <input type="checkbox"/> Industrial Foremanship <input type="checkbox"/> Industrial Supervision <input type="checkbox"/> Personnel-Labor Relations <input type="checkbox"/> Supervision <p>MECHANICAL and SHOP</p> <ul style="list-style-type: none"> <input type="checkbox"/> Diesel Engines <input type="checkbox"/> Gas-Elec. Welding <input type="checkbox"/> Industrial Engineering <input type="checkbox"/> Industrial Instrumentation <input type="checkbox"/> Industrial Metallurgy <input type="checkbox"/> Industrial Safety <input type="checkbox"/> Machine Design <input type="checkbox"/> Machine Shop Practice <input type="checkbox"/> Mechanical Engineering <input type="checkbox"/> Professional Engineer (Mech) <input type="checkbox"/> Quality Control <input type="checkbox"/> Reading Shop Blueprints <input type="checkbox"/> Refrigeration and Air Conditioning <input type="checkbox"/> Tool Design <input type="checkbox"/> Tool Making <p>RADIO, TELEVISION</p> <ul style="list-style-type: none"> <input type="checkbox"/> General Electronics Tech. | <ul style="list-style-type: none"> <input type="checkbox"/> Industrial Electronics <input type="checkbox"/> Practical Radio-TV Eng'g <input type="checkbox"/> Practical Telephony <input type="checkbox"/> Radio-TV Servicing <p>RAILROAD</p> <ul style="list-style-type: none"> <input type="checkbox"/> Car Inspector and Air Brake <input type="checkbox"/> Diesel Electrician <input type="checkbox"/> Diesel Engr. and Fireman <input type="checkbox"/> Diesel Locomotive <p>STEAM and DIESEL POWER</p> <ul style="list-style-type: none"> <input type="checkbox"/> Combustion Engineering <input type="checkbox"/> Power Plant Engineer <input type="checkbox"/> Stationary Diesel Engr. <input type="checkbox"/> Stationary Fireman <p>TENTILE</p> <ul style="list-style-type: none"> <input type="checkbox"/> Carding and Spinning <input type="checkbox"/> Cotton Manufacture <input type="checkbox"/> Cotton Warping and Weaving <input type="checkbox"/> Loom Fixing Technician <input type="checkbox"/> Textile Designing <input type="checkbox"/> Textile Finishing & Dyeing <input type="checkbox"/> Throwing <input type="checkbox"/> Warping and Weaving <input type="checkbox"/> Worsted Manufacturing |
|--|--|--|---|---|

Name _____ Age _____ Home Address _____

City _____ Zone _____ State _____ Working Hours _____ P.M. to P.M. _____

Occupation _____ Canadian residents send coupon to International Correspondence Schools, Canadian Ltd., Montreal, Canada. . . . Special tuition rates to members of the U. S. Armed Forces.

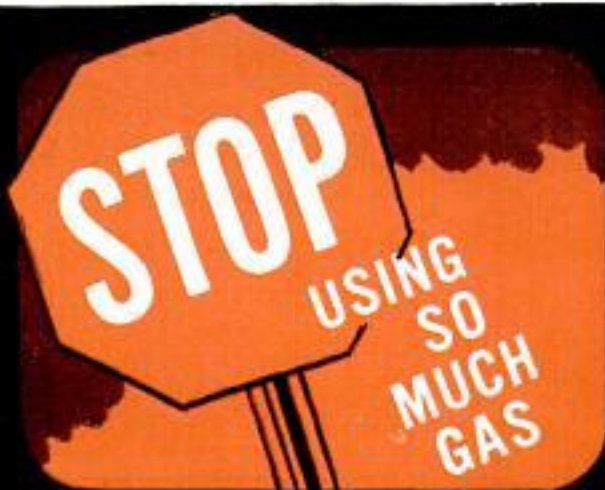

CLEAN YOUR CARBURETOR

with



- Your carburetor is dirty, and it's costing you money! Gasoline gum clogs every carburetor—reduces gas mileage and power. Save money. Give your car more power. Clean your carburetor with GUMOUT.
- GUMOUT cleans carburetors quickly and easily . . . saves time, money and gas . . . gets rid of stalling, slow starting, rough idling.
- Just add GUMOUT to your gas tank. It cleans the carburetor while you drive.
- Buy GUMOUT at auto supply stores, or wherever automotive products are sold. There's nothing like it!



send for **FREE**

46-page "CARBURETOR HANDBOOK"
It's loaded with helpful information
about your car's fuel system.

GUMOUT DIVISION
Pennsylvania Refining Company
2671 Lisbon Road, Cleveland 4, Ohio

(Continued from page 8)

technique, and probably this same approach would be used for other wingless craft of the future."

To the Editor:

I have made about a dozen of your radio projects and a few dozen of your wood-working projects. The biggest hit with me was your *Crusette* (May 1954). I have made *Crusette* on a 1:10 scale (toy boat with minimotor), on a 1:5 scale (radio-controlled boat) and on a 4:5 scale. The remarkable thing about *Crusette* plans is



that they give you a good boat, no matter what scale. This is most unusual. It is well known among modelers that, e.g., a 1:20 scale airplane won't fly or at least won't give performance.

The 4:5 scale *Crusette* is a very pleasant craft. Weighing only 150 pounds, I can carry it on the top of the car (small European make). With a 5.5 horsepower outboard motor I have clocked her at 16 m.p.h. I had to lower the spray rails, though, to keep her from diving too deep at the stern.

Thanks for all the satisfaction your projects have given me through the years. I think I'll go for the *Sea Knight* now (May, June, July 1957).

M. De Clercq,
Teacher of Mathematics,
Gentbrugge, Belgium

To the Editor:

Concerning your article "Everybody's Going Sailing" in July, a more appropriate title would be "Everybody's Going Swimming." It should read, "In heavy weather, you'll be hiking over the windward rail"—not lee rail.

Thomas Adams,
Suffern, N. Y.

We're all wet.—Ed.

Learn Radio-Television

Servicing or Communications by Practicing at Home in Spare Time

N. R. I. SENDS kits with which you practice building circuits common to Radio and TV sets. You LEARN-BY-DOING to locate Radio-TV troubles. As part of N. R. I. Servicing Course, you build Vacuum Tube Voltmeter and AC-DC receiver. Use VTVM to conduct experiments, earn extra money fixing sets in spare time.

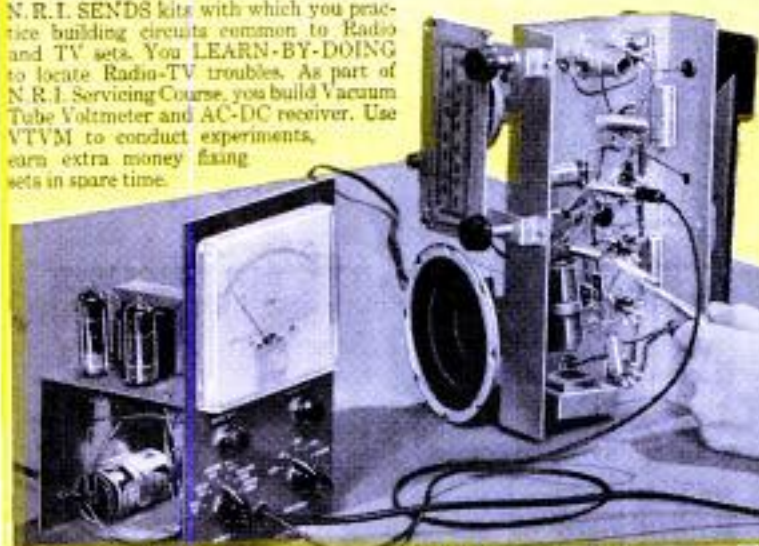

RADIO-TV BROADCASTING (see above) offers important positions as Operators and Technicians. **RADIO-TV SERVICING Technicians** (see below) needed in every community. Their services are respected, their skill appreciated.



Fast Growing Field Offers You Good Pay, Success, Bright Future



J. E. SMITH
founder

Bigger than ever and still growing fast. That's why Radio-TV has special appeal to ambitious men not satisfied with their job and earnings. More than 4,000 Radio and TV stations. More than 150 million home and auto Radios, 40 million TV sets. Color TV promises added opportunities. For the trained man, there are good jobs, bright futures in Radio-TV Servicing or Broadcasting.

Training PLUS opportunity is the ideal combination for success. So plan now to get into Radio-TV. The technical man is looked up to. He does important work, gets good pay for it. Radio-Television offers that kind of work. NRI can supply training quickly, without expense of going away to school. Keep your job while training. You learn at home in your spare time. NRI is the **OLDEST** and **LARGEST** home study Radio-TV school. Its methods have proved successful for more than 40 years.

Added Income Soon - \$10, \$15 a Week in Spare Time

Soon after enrolling, many NRI students start to earn \$10, \$15 a week in spare time fixing sets. Some pay for their training and enjoy extra luxuries this way. Some make enough to start their own Radio-TV shops. NRI training is practical—gets quick results. Easy to understand, well illustrated lessons teach you basic principles. And you LEARN-BY-DOING by practicing with kits of equipment which "bring to life" things you study.

Find Out What NRI Offers

NRI has trained thousands for successful careers in Radio-TV. Study fast or slow—as you like. Diploma when you graduate. Mail coupon now. Paste it on a postcard or mail in envelope. **ACTUAL LESSON FREE.** Also 64 page catalog that shows opportunities, shows equipment you get. Cost of NRI courses low. Easy terms. **NATIONAL RADIO INSTITUTE, Dept. 71A, Washington 16, D. C.**

N.R.I. TRAINED THESE MEN FOR SUCCESS



"I was repairing Radios by 10th lesson. Now have good TV job." **M. R. LINDEMUTH, Fort Wayne, Ind.**



"Doing spare time repairs on Radio and TV. Soon servicing full time." **CLYDE HIGGINS, Waltham, Mass.**

"I had a successful Radio repair shop. Now I'm Engineer for WHPE." **V. W. WORKMAN, High Point, N. C.**



"There are a number of NRI graduates here. I can thank NRI for this job." **JACK WAGNER, Lexington, N. C.**



VETERANS Approved Under G. I. Bills

SEND FOR BOTH FREE

National Radio Institute

Dept. 71A, Washington 16, D. C.

Mail me Sample Lesson and 64-Page Catalog FREE. (No salesman will call. Please write plainly.)

Name _____ Age _____

Address _____

City _____ Zone _____ State _____

Accredited Member National Home Study Council



This Remington Typewriter PAYS FOR ITSELF Puts \$10 to \$50 in Your Pocket Every Week!

- Yours for Only \$1 Down!
- No Salesmen, No Canvassers, No Representatives Ever Call!
- Typewriter Shipped to Your Door FREE Anywhere in U.S.A.
- 100% Full Factory Warranty!

ATTENTION READERS! This \$1-a-week offer plus FREE Gifts as shown below NOT available anywhere else — only by mail and only from Thoresen, Inc., 585 Water Street, New York 2, N.Y. Foremost coast-to-coast Remington Rand dealer. Thousands of typewriters already mailed. Rush coupon below for yours TODAY!



SENSATIONAL GOOD NEWS! Now you may have the brand-new, latest-model Remington Quiet-Riter shipped to you by mail for only \$1. Yes, just ONE DOLLAR brings you the most modern, most advanced, most beautiful portable in the world — and in your choice of exciting decorator colors!

REMINGTON PAYS FOR ITSELF — MAKES MONEY FOR YOU!

Yes, along with your typewriter, you receive our copyrighted manual that shows you how to make from \$10.00 to \$50.00 a week with your typewriter . . . in your spare time **RIGHT AT HOME!** This manual is ours exclusively. It cannot be purchased anywhere, at any price. It helps you make your Remington **PAY FOR ITSELF** — even bring you a weekly profit! And it's yours **FREE** — available only from us by mail!

STUDENTS WHO TYPE GET 38% BETTER GRADES!

What will **YOUR** children be when they grow up? Tests by leading educators prove that boys and girls who type get up to 38% better grades. Typewritten work is neater, easier to read — and study from! Teachers like to receive typed reports, homework, compositions, etc. A Quiet-Riter is one of the finest investments you can make in your children's future. It inspires them to do even better school work, helps them forge ahead in class after class, become **LEADERS!** And the Quiet-Riter keeps helping your children in elementary school, in high school and right through college!

SAVE MONEY! DIRECT TO YOU AT LOW FACTORY PRICE!

The Quiet-Riter is a streamlined masterpiece that performs like big office machines that cost \$275.00 plus tax. It has a full office-size 48-character keyboard and other office machine features. Many business firms, doctors, lawyers and other professionals — who could easily afford to pay \$275.00 — actually **PREFER** the Quiet-Riter for their offices and homes. Yet the Quiet-Riter (Remington's very best home typewriter) is factory-priced at **LESS THAN HALF THAT \$275.00 FIGURE . . . only \$130 plus tax.** YOU SAVE MONEY! Best news of all, you pay only \$1 now and just a \$1 a week — paid monthly. **TAKE 3 FULL YEARS TO REMIT!** Everything done by mail.

BUILT TO LAST A LIFETIME!

A typewriter will be used by every member of the family for years and years . . . and years! It should be built to withstand rugged use and handling. Don't "sink" your money into cheaper, inferior models that may fall apart after six months — then bring you aggravation and mounting repair bills. These models have **FEWER KEYS, FEWER FEATURES,** are much **SMALLER,** have **INFERIOR** construction, and their resale value depreciates fast to "almost nothing." Don't be penny wise and pound foolish! The best is the most economical in the long run. Your Quiet-Riter is built to last, with ordinary attention, a full **LIFETIME!** What's more, it has **HIGHER** cash value, **HIGHER** re-sale value, **HIGHER** trade-in value. It's favorite among writers, executives, teachers, students, housewives — and small businessmen too!



RUSH \$1 NOW BEFORE OUR OFFER ENDS!

But you must act now. Even Remington with its vast production facilities cannot keep up with the demand. Mail this coupon below with one dollar.

RUSH ONE DOLLAR FOR YOUR TYPEWRITER!

**THORESEN, Inc., Dept. 6-K-145
585 Water Street, New York 2, N. Y.**

Here is my dollar (cash, check or money order) toward delivery of the new Remington Rand Quiet-Riter. Include carrying case, typing manual **FREE,** and valuable manual on how I can earn up to \$50.00 a week also **FREE!** Only after I receive my typewriter, will I send you \$1 weekly, paid monthly.

CHECK THE TYPEWRITER COLOR YOU WANT

Gray Green Brown

PRINT NAME _____

ADDRESS _____

CITY _____ ZONE _____ STATE _____

Check Here if Under 21 Check Here if Housewife

Free Free

57 Ways to Make
from \$10 to \$50

Weekly in Spare Time!



Along with your Quiet-Riter you receive the valuable, copyrighted manual "57 Ways to Make Extra Money with Your Typewriter." Truly a goldmine of help! Opens doors of opportunity you never knew existed. Shows you what to do, how to do it, step by step. Housewives, men, students in every walk of life now make good extra cash **REGULARLY** — including many **WHO NEVER TYPED BEFORE!** It's easy and it's fun! Work right at home in spare hours. No experience or special talents needed. Manual can be worth **HUNDREDS OF DOLLARS** to you in business secured — but it's yours **FREE** to prove to you, as we've proven to others, typewriter can **PAY FOR ITSELF!** But this manual is ours alone, cannot be bought anywhere.

We Pay All Shipping!

Your typewriter comes in its original factory-sealed carton with Remington's guarantee of Satisfaction, Protection, and Service **IN WRITING** and is delivered **PREPAID.** We pay all handling, crating, shipping and insurance costs. You don't pay another cent until 30 days **AFTER** you receive & are using the machine. Even then you remit only \$1 a week, paid monthly. We ship anywhere in U.S.A. Everything done by mail. No salesmen ever call. This is the one and only offer of its kind in America! Thousands of typewriters already distributed to folks. Letters of praise pour in almost daily. "I've earned \$22.00!" . . . "Typewriter is beautiful!" "Son's marks up 10 points!"

Free

Self-Instruction Book

Starts you on "touch typing" in 5 minutes! Some principles as \$40.00 business college courses — yet you pay not one cent for our accelerated "course-in-print." Everybody learns how to type — from junior to dad himself!

Free

500 Firms Who Use
Typewritten Lists —

Some in Your Vicinity!

These firms are swamped with **MILLIONS** of envelopes, cards, letters to address. They **LOSE MONEY** if they don't have enough help to get the work done. Get your share of this business. No matter where you live, there are firms in **YOUR VICINITY!** Earn \$1.00 to \$2.00 an hour — and more — in spare-time work — **RIGHT AT HOME!** We list names, addresses & the right people to contact. No time, effort or expense spared to compile this valuable list. This list cannot be purchased anywhere — ours alone! Yet we give it **FREE** with your typewriter! This amazing \$1-a-week offer plus **FREE** gifts available only by mail — and only from famous **THORESEN, Inc., 585 Water Street, New York 2, N. Y.** Foremost coast-to-coast Remington typewriter dealer!

Free

Carrying Case Free
of Any Extra Cost!

Luxurious! Handsome! As elegant as a fine piece of luggage — with safety lock — yours free of any extra cost. Hurry! This is the offer you've seen advertised in *The American Home*, *VFW*, *Moose* and *Elks* Magazines, *N.Y. Herald Tribune*, *Harper's Bazaar*, *Puck*, etc. Typewriters shipped on first-come, first-served basis. Don't lose out on the most sensational offer of its kind! This offer is ours exclusively — only by mail — Only from us! Mail coupon with only one dollar for everything!

INVENTORS

Learn how to protect your invention. The U. S. Patent Laws provide that any new and useful art, machine, article of manufacture, or composition of matter, or any new and useful improvement thereof, may be patented if the act of invention is involved. Therefore, every inventor with a valuable invention should take advantage of the Patent Laws and proceed for patent protection in order to safeguard his rights.

A patent gives the inventor the exclusive right to prevent others from making, using, or selling the invention claimed in the patent for a period of seventeen years.

The Patent Laws were enacted for the benefit of the inventor to give him protection for the features of his invention which are patentable. These features must be properly and concisely set forth and claimed in a formal application for patent, in order to comply with the requirements of the Patent Laws. For that reason, unless the inventor is familiar with patent matters, he should engage a competent registered patent attorney or agent to represent him. We are registered to practice before the U. S. Patent Office and are prepared to serve you in the handling of your patent matters.

A specially prepared booklet entitled "Patent Guide for the Inventor", containing detailed information with respect to patent protection and procedure, together with a "Record of Invention" form will be promptly forwarded to you without obligation upon request.

CLARENCE A. O'BRIEN & HARVEY JACOBSON

Registered Patent Attorneys

71-J DISTRICT NATIONAL BUILDING
WASHINGTON 5, D. C.

**Yes!...
Take it FREE!**

Mathematics Made Simple

FREE

TO INTRODUCE
YOU TO A
NEW DISCOVERY
IN HOME
EDUCATION

Fill the Gaps in Your Family's Education With This Amazing **MADE SIMPLE** Self-Teaching Program

Covering the following subjects:

- | | | | |
|------------------|-------------------------|---------------------|------------------|
| Mathematics | Everyday Law | Word Mastery | Art Appreciation |
| English | Spanish | The Art of Speaking | Philosophy |
| Chemistry | French | The Art of Writing | Astronomy |
| Physics | Psychology | World Literature | Chess |
| Biology | Business Letter Writing | World History | Contract Bridge |
| American History | Bookkeeping | Music Appreciation | |



HERE'S YOUR chance to discover the famous, proven MADE SIMPLE method and get this richly-bound volume, MATHEMATICS MADE SIMPLE absolutely free!
This big handsome book is part of a new, practical, self-teaching program that offers you and your family a chance to master important up-to-date subjects we use in business, conversation and reading. Your children will find this program invaluable in doing their homework and getting higher grades. **WRITING, SPEAKING, PSYCHOLOGY, LAW LITERATURE, HISTORY, MATHEMATICS, BOOKKEEPING, WORD POWER**... these are only some of the useful, profitable subjects necessary for advancement on the job and socially. The Made Simple self-teaching method makes a part of you... in as little as 15 minutes a day!

NO MONEY TO SEND! MAIL COUPON TODAY!

Made Simple Books, Dept. M-360
220 Fifth Avenue, New York 1, N. Y.
Please send me **MATHEMATICS MADE SIMPLE** absolutely FREE. At the same time, send, on approval, the next Self-Teaching volume, **ENGLISH MADE SIMPLE**. After 7 days examination, if I decide to keep this book, I will pay only the subscriber's special low price of \$1.98 plus a few cents postage and handling.
I will be entitled to receive each following deluxe volume of the Made Simple Self-Teaching Program when ready (2 volumes a month will be released) at the same low price, sending no money in advance.
I may return or will pay for any book within 7 days after receiving it. I may cancel my reservation after buying one, two, or as many books as I please and you agree to send me no further volumes after you receive my cancellation. In any case, **MATHEMATICS MADE SIMPLE** is mine to keep — **ABSOLUTELY FREE!**
Name _____
Address _____
City _____ Zone _____ State _____

All You Want to Know About Mathematics... in Clear, USABLE FORM!

Do you wish you could use arithmetic, algebra, geometry and trigonometry to save time and money... to win job promotions and good grades? Do you wish you could handle a slide rule or solve problems in business math quickly and easily? Do you and your family want to know more about MATHEMATICS because it is the basic cornerstone of modern civilization?

If you answer "yes," this handsome volume is what you're looking for. **MATHEMATICS MADE SIMPLE** can be worth hundreds of dollars to you this year alone. But it's yours FREE if you act at once! The fascinating contents include:
• **"HIGH SPEED" ARITHMETIC.** 3 ways to add faster. How to figure profit, loss, interest, percentage, taxes. Short cuts with decimals. Quick multiplication and division methods. Fractions, square roots, etc.
• **GEOMETRY AND TRIGONOMETRY.** Axioms and theorems made simple. How to

figure angles, volume, areas. What surveyors do. Longitude and latitude. Sines, cosines, tangents. How logarithms simplify multiplication. Measuring very large or distant objects. Tables of logs and angle functions.

• **ALGEBRA.** Principles of Algebra. How equations help solve everyday problems quickly. Ratio and proportion. Positive and negative numbers. How to use a slide rule. Square and cube roots, simultaneous equations, etc.

• **OTHER PRACTICAL PROBLEMS.** Constructing graphs, charts, blueprints, etc. Weights and measures. English money. Board feet. Solve "home handyman" problems. Bushel, cord, metric measure. Calculate acreage, etc. PLUS hundreds of other topics. There's no confusing language, no complicated diagrams and charts. Anybody can understand the MADE SIMPLE method. To introduce this wonderful new plan, we offer this big book **MATHEMATICS MADE SIMPLE** absolutely FREE. Simply mail coupon now!

Here's How These New Richly-Bound Made Simple Volumes Use Everyday Situations to Teach Science, Business, Cultural and School Subjects — Assure Complete Mastery for Faster Job Advancement, Better School Grades... Richer, Fuller Living — in 15 Minutes a Day!

You Learn What You Want — Like Having College Instructors in Your Own Home... For Only Pennies a Day!

The MADE SIMPLE method teaches you easily and naturally—in a practical, useful manner and not by memorizing lists and rules. Instead of the confused explanations that clutter up most books, MADE SIMPLE uses clear, everyday language that everybody can understand. The "handpicked" expert authors include lawyers, C.P.A.'s, Associate and Full Professors of leading colleges, instructors from Princeton, De Paul, City College of New York, Rutgers and many others.

Best of all, you never have to buy any materials or extra books or outlines to round out your courses. Each MADE SIMPLE volume is complete in itself. They start from the beginning, assume no previous knowledge of the material and lead you quickly and carefully through every phase of the subject.

Complete Explanations, Simple Illustrations Make Every Point Clear—No Previous Knowledge of the Subject Required

Let's look at one of the books and see how the MADE SIMPLE method makes every point absolutely clear by using simple, everyday illustrations and examples.

In **PHYSICS MADE SIMPLE**, in the section on air pressure, you see this experiment which you can do right now in your own home. "Hold one edge of a piece of letter paper against your chin just below your lower lip, with the paper hanging over and down. If you now blow above the paper, it will rise to a horizontal position as if pulled upward in the air stream." By using only a piece of paper, you have performed an experiment that demonstrates the important principles involved in

light and streamlining.

It's as easy as that! In other books, you would first "blough through" Bernoulli's Law, Boyle's Law and other technical terms. Here, however, you read a simple explanation, do an interesting experiment and then learn the required technical terms. As a result they will mean something to you. That's why the MADE SIMPLE method has worked for thousands of people who needed more help than you may think you do. You would expect to pay three to four dollars apiece for these 8 1/2 x 11 1/4 inch beautifully bound, richly stamped library volumes. But if you take advantage of this amazing FREE offer, you pay only \$1.98 per volume. You can stop whenever you want. Meanwhile you are building a permanent reference set for your home — a handsome educational "tool" the whole family will use again and again.

See for yourself without risk. Send for your FREE book, **MATHEMATICS MADE SIMPLE**



NOW READY! ENGLISH MADE SIMPLE

With your FREE book, you will also receive another handsome, richly illustrated library volume, **ENGLISH MADE SIMPLE** for FREE examination. This is a valuable, practical "course" shows you how to write and speak clear, expressive English. You learn how to punctuate sentences correctly; how to build a better vocabulary; how to write effective personal and business letters. Here's a rich treasury of useful and profitable guides to good English usage!



Cast your ballot for a successful future!

256 I.C.S. COURSES



Whether you stand at a machine or sit at a desk . . . whether you're making \$75 a week or \$75 hundred a year . . . whether your interest is Power Plants or Paper Pulp, Advertising or Electronics . . . chances are I.C.S. has exactly the course you need to get ahead.

I.C.S. is not only the oldest and largest correspondence school. It also offers the most courses. 256 in all. Each one success-proved by graduates who rose to top technical and administrative positions. Chief engineers. Superintendents. Foremen. Managers. Executive assistants.

I. C. S. Courses cover bedrock facts and theory plus practical, on-the-job applications. No skimping. Texts

are prepared by leading business and industrial authorities working with I.C.S. editors and educators. They are constantly being reviewed and revised in line with current developments.

As an I.C.S. student, you study in your spare time, set your own pace. No time lost getting to class or waiting for slower students to catch up. If you wish, I.C.S. will make progress reports to your employer. You win recognition as a "comer," one who is ready to move ahead. Thousands of students report pay increases and promotions within a few months of enrollment. All graduates win the coveted, approved I. C. S. diploma.

3 FREE BOOKS! Check the subject that interests you in the coupon below. I. C. S. will rush you (1) a special book outlining your opportunities in this field, (2) the 32-page gold mine of career tips, "How to Succeed," (3) a sample I. C. S. lesson (Math.) demonstrating the famous "I. C. S. Method." "X" MARKS OPPORTUNITY.



For Real Job Security—Get an I. C. S. Diploma!

I. C. S., Scranton 9, Penna.

Member, National Home Study Council

INTERNATIONAL CORRESPONDENCE SCHOOLS



BOX 23953J, SCRANTON 9, PENNA.

(Partial list of 257 courses)

Without cost or obligation, send me "HOW TO SUCCEED" and the opportunity booklet about the field BEFORE which I have marked X (plus sample lesson):

- | | | | | |
|--|--|--|--|---|
| <p>ARCHITECTURE and BUILDING CONSTRUCTION</p> <ul style="list-style-type: none"> <input type="checkbox"/> Air Conditioning <input type="checkbox"/> Architecture <input type="checkbox"/> Arch. Drawing and Designing <input type="checkbox"/> Building Contractor <input type="checkbox"/> Building Estimator <input type="checkbox"/> Carpentry and Millwork <input type="checkbox"/> Carpenter Foreman <input type="checkbox"/> Heating <input type="checkbox"/> Interior Decoration <input type="checkbox"/> Painting Contractor <input type="checkbox"/> Plumbing <input type="checkbox"/> Reading Arch. Blueprints <p>ART</p> <ul style="list-style-type: none"> <input type="checkbox"/> Commercial Art <input type="checkbox"/> Magazine & Book Illus. <input type="checkbox"/> Show Card and Sign Lettering <input type="checkbox"/> Sketching and Painting <p>AUTOMOTIVE</p> <ul style="list-style-type: none"> <input type="checkbox"/> Automobiles <input type="checkbox"/> Auto Body Rebuilding and Refinishing <input type="checkbox"/> Auto Engine Tuneup <input type="checkbox"/> Auto Technician | <p>AVIATION</p> <ul style="list-style-type: none"> <input type="checkbox"/> Aero-Engineering Technology <input type="checkbox"/> Aircraft & Engine Mechanic <p>BUSINESS</p> <ul style="list-style-type: none"> <input type="checkbox"/> Accounting <input type="checkbox"/> Advertising <input type="checkbox"/> Business Administration <input type="checkbox"/> Business Management <input type="checkbox"/> Cost Accounting <input type="checkbox"/> Creative Salesmanship <input type="checkbox"/> Managing a Small Business <input type="checkbox"/> Professional Secretary <input type="checkbox"/> Public Accounting <input type="checkbox"/> Purchasing Agent <input type="checkbox"/> Salesmanship <input type="checkbox"/> Salesmanship and Management <input type="checkbox"/> Traffic Management <p>CHEMICAL</p> <ul style="list-style-type: none"> <input type="checkbox"/> Analytical Chemistry <input type="checkbox"/> Chemical Engineering <input type="checkbox"/> Chem. Lab. Technician <input type="checkbox"/> Elements of Nuclear Energy <input type="checkbox"/> General Chemistry <input type="checkbox"/> Natural Gas Prod. and Trans. <input type="checkbox"/> Petroleum Prod. and Engr. <input type="checkbox"/> Professional Engineer (Chem) <input type="checkbox"/> Pulp and Paper Making | <p>CIVIL ENGINEERING</p> <ul style="list-style-type: none"> <input type="checkbox"/> Civil Engineering <input type="checkbox"/> Construction Engineering <input type="checkbox"/> Highway Engineering <input type="checkbox"/> Professional Engineer (Civil) <input type="checkbox"/> Reading Struc. Blueprints <input type="checkbox"/> Structural Engineering <input type="checkbox"/> Surveying and Mapping <p>DRAFTING</p> <ul style="list-style-type: none"> <input type="checkbox"/> Aircraft Drafting <input type="checkbox"/> Architectural Drafting <input type="checkbox"/> Drafting Machine Design <input type="checkbox"/> Electrical Drafting <input type="checkbox"/> Mechanical Drafting <input type="checkbox"/> Sheet Metal Drafting <input type="checkbox"/> Structural Drafting <p>ELECTRICAL</p> <ul style="list-style-type: none"> <input type="checkbox"/> Electrical Engineering <input type="checkbox"/> Elec. Engr. Technician <input type="checkbox"/> Elec. Light and Power <input type="checkbox"/> Practical Electrician <input type="checkbox"/> Practical Lineman <input type="checkbox"/> Professional Engineer (Elec) <p>HIGH SCHOOL</p> <ul style="list-style-type: none"> <input type="checkbox"/> High School Diploma | <ul style="list-style-type: none"> <input type="checkbox"/> Good English <input type="checkbox"/> High School Mathematics <input type="checkbox"/> Short Story Writing <p>LEADERSHIP</p> <ul style="list-style-type: none"> <input type="checkbox"/> Industrial Foremanship <input type="checkbox"/> Industrial Supervision <input type="checkbox"/> Personnel-Labor Relations <input type="checkbox"/> Supervision <p>MECHANICAL and SHOP</p> <ul style="list-style-type: none"> <input type="checkbox"/> Diesel Engines <input type="checkbox"/> Gas-Elec. Welding <input type="checkbox"/> Industrial Engineering <input type="checkbox"/> Industrial Instrumentation <input type="checkbox"/> Industrial Metallurgy <input type="checkbox"/> Industrial Safety <input type="checkbox"/> Machine Design <input type="checkbox"/> Machine Shop Practice <input type="checkbox"/> Mechanical Engineering <input type="checkbox"/> Professional Engineer (Mech) <input type="checkbox"/> Quality Control <input type="checkbox"/> Reading Shop Blueprints <input type="checkbox"/> Refrigeration and Air Conditioning <input type="checkbox"/> Tool Design <input type="checkbox"/> Tool Making <p>RADIO, TELEVISION</p> <ul style="list-style-type: none"> <input type="checkbox"/> General Electronics Tech. | <ul style="list-style-type: none"> <input type="checkbox"/> Industrial Electronics <input type="checkbox"/> Practical Radio-TV Eng'g <input type="checkbox"/> Practical Telephony <input type="checkbox"/> Radio-TV Servicing <p>RAILROAD</p> <ul style="list-style-type: none"> <input type="checkbox"/> Car Inspector and Air Brake <input type="checkbox"/> Diesel Electrician <input type="checkbox"/> Diesel Engr. and Fireman <input type="checkbox"/> Diesel Locomotive <p>STEAM and DIESEL POWER</p> <ul style="list-style-type: none"> <input type="checkbox"/> Combustion Engineering <input type="checkbox"/> Power Plant Engineer <input type="checkbox"/> Stationary Diesel Engr. <input type="checkbox"/> Stationary Fireman <p>TEXTILE</p> <ul style="list-style-type: none"> <input type="checkbox"/> Carding and Spinning <input type="checkbox"/> Cotton Manufacture <input type="checkbox"/> Cotton Warping and Weaving <input type="checkbox"/> Loom Fixing Technician <input type="checkbox"/> Textile Designing <input type="checkbox"/> Textile Finishing & Dyeing <input type="checkbox"/> Throwing <input type="checkbox"/> Warping and Weaving <input type="checkbox"/> Worsted Manufacturing |
|--|--|--|--|---|

Name _____ Age _____ Home Address _____

City _____ Zone _____ State _____ Working Hours _____ A.M. to P.M. _____

Occupation _____

Canadian residents send coupon to International Correspondence Schools, Canadian, Ltd., Montreal, Canada. . . . Special tuition rates to members of the U. S. Armed Forces.

OPTICAL BARGAINS

3" ASTRONOMICAL REFLECTING TELESCOPE

(Famous Mt. Palomar type)
See the Stars, Moon, Planets Close Up!
60 & 120 Power — An Unusual Buy!

Assembled and ready to use! You'll see the Rings of Saturn, the fascinating planet Mars, huge craters on the Moon. Aluminized and overcoated 3" diameter high-speed $f/10$ astronomical mirror. Telescope comes equipped with a 60X eyepiece and a mounted Barlow Lens, giving you 60 & 120 power. Optical Finder Telescope, included. Sturdy, hardwood, portable tripod. Free with scope: Valuable STAR CHART and 272 page "Astronomy Book."
Stock No. 85,050-H \$29.50 f.o.b.
(Shipping wt. 10 lbs.) Barrington, N. J.



4 1/4" ASTRONOMICAL TELESCOPE

Mt. Palomar type! Up to 270 Power. A fine Reflector Telescope complete with real Equatorial Mount and Tripod. Aluminum tube, 4 1/4" dia. mirror, rack and pinion focusing eye-piece holder, 2 eyepieces and mounted Barlow Lens for 40X, 60X, 120X and 270X. Shipping weight approx. 25 lbs. Stock No. 85,006-H ... complete, \$74.50 f.o.b. Barrington, N. J.



NEW! STATIC ELECTRICITY GENERATOR

See a thrilling spark display as you set off a miniature bolt of lightning. Absolutely safe and harmless. Stands 14" high. Turn the handle and two 5" plastic discs rotate in opposite directions. Metal collector brushes pick up the static electricity, store it in the Leyden jar type condenser until discharged by the jumping spark. Countless tricks and experiments. 24 page instruction booklet included.
Stock No. 70,070-H \$10.95 Postpaid



New! 2 in 1 Combination! Pocket-Size

50 Power MICROSCOPE and 10 Power TELESCOPE

Useful Telescope and Microscope combined in one amazing, precision instrument. Imported! No larger than a fountain pen. Telescope is 10 Power. Microscope magnifies 50 Times Sharp focus at any range. Handy for spots, looking at small objects, just plain snooping. Send Check or M.O. Satisfaction Guaranteed. Order Stock No. 30,059-H \$4.50 Pspd.



4" STAINLESS STEEL, ADJUSTABLE HOSE CLAMPS

Very handy around the house and shop. Hold wire fence to posts. Join and hold pipe and connectors; join flexible tube to rigid pipe, male and female connectors of all kinds. Use to stop leaking seals even in corrosive solutions. Adjustable from 3/8" to 4 1/2". Original cost 65¢ each. War Surplus — 200,000 units available (write for large quan. prices).
Stock No. 50,163-H—12 Clamps \$3.00 Postpaid



DIRECT MEASURING POCKET MICROSCOPE

— 50 POWER

Fountain pen size, makes direct reading measurements; for checking small parts and dimensions under powerful magnification. Precision, glass etched reticle calibrated for measurements up to 1/10" by .001" divisions.
STOCK NO. 30,225-H \$7.95 Pspd.



BUILD A SOLAR ENERGY FURNACE

A fascinating new field. Build your own Solar Furnace for experimentation—many practical uses. Easy! Inexpensive! We furnish instructions. This sun powered furnace will generate terrific heat—2000° to 4000°. Fuses enamel to metal. Sets paper aflame in seconds. Use our Fresnel Lens — 14 3/4" diameter ... f.l. 14".



Stock No. 70,130-H—package of 1 \$ 6.00 Pspd.
Stock No. 70,131-H—package of 2 \$11.00 Pspd.
Stock No. 70,132-H—package of 4 \$20.00 Pspd.

50-150-300 Power MICROSCOPE

Only \$14.95

3 Achromatic Objective Lenses on Revolving Turret!

Imported! The color-corrected, cemented achromatic lenses in the objectives give you far superior results to the single lenses found in the microscopes selling for \$9.95! Results are worth the difference! Fine rack and pinion focusing.
Stock No. 70,008-H \$14.95 Postpaid



SIMPLE LENS KITS! Fun for adults! Fun for children! Kits include plainly written, illustrated booklet showing how you can build lots of optical items.

Stock No. 2-H—10 lenses \$ 1.00 Postpaid
Stock No. 5-H—45 lenses \$ 5.00 Postpaid
Stock No. 10-H—80 lenses \$10.00 Postpaid

WRITE FOR FREE CATALOG "H"!

Complete Line of Astronomical Telescope Parts and Assembled Telescopes. Also huge selection of lenses, prisms, war surplus optical instruments, parts and accessories. Telescopes, microscopes, binoculars, etc. Request Catalog "H"!

ORDER BY STOCK NUMBER. SEND CHECK OR MONEY ORDER. SATISFACTION GUARANTEED!
EDMUND SCIENTIFIC CO., BARRINGTON, N. J.

DIESEL MEN WANTED

Earn \$100 per week and up AUTO-DIESEL MECHANICS

You learn fast in our school and shops because you learn with tools on real equipment. Experienced instructors explain WHY and show you HOW, then you DO IT YOURSELF with tools on various makes and models. One of the best equipped technical schools of its kind in the United States. Thirty-seven years' experience training men. Successful graduates in 48 states and many foreign countries. Approved for veterans. Day and evening classes. Earn While You Learn. Write for free bulletin.

NASHVILLE AUTO-DIESEL COLLEGE

226 7th Ave. N., Dept. 86, Nashville, Tenn.

BE A LOCKSMITH

Learn at Home
Free Booklet

Learn fascinating, profitable trade from experts in spare time at home! Age or physical handicap no disadvantage. Year around, steady income. Full or part time. Practical, illustrated lessons. Make money even while learning! All materials & special tools supplied.

INSTITUTE OF LOCKSMITHING, Dept. P-94
15 PARK AVENUE RUTHERFORD, N. J.

Lic. by N. J. State Board of Ed. Approved for Vets

HIGH SCHOOL DIPLOMA



Earn a High School Diploma at home! Prepare for better job, more pay. Study in spare time. No classes. Materials furnished. Certified teachers. Valuable diploma awarded. Write Today for Complete Information

SOUTHERN STATES ACADEMY
Box 144-A Sta. E Atlanta, Georgia

OWN a BUSINESS!



Earn \$8,750.00 your First Year!

Start part time if you wish. We locally train you, furnish everything to clean and mothproof rugs, upholstery on location by world-wide process. Quickly established. No shop needed. Just 2 average jobs a day bring \$8,750 net profit in year. Employ others and multiply profits. You get National Advertising, Parents' Seal, 25 other regular services. Easy terms. Send today for free booklets.

DURACLEAN CO., 7-169 Duraclean Bldg., Deerfield, Ill.

HOW TO

TURN
Concrete
INTO
Gold



A MUST FOR EVERYONE CONCERNED!

This MANUAL Tells You How To Make Handsome Profits From Concrete Items YOU CAN MAKE

All you need is a mold or two and a little determination. This Manual contains large, clear pictures, gives prices and description of more than 200 different molds you can buy direct from the manufacturer. AND...process trade secrets that make production a snap. Take the first step Today!!!

SEND ONLY \$2.00 FOR YOUR COPY (Quoted to you by First Class Mail)

CONCRETE MACHINERY COMPANY, INC.
Dept. PM Hickory, N. C.

INVENTORS

If you believe that you have an invention, you should find out how to protect it. The first step is to have a search made of the prior pertinent U. S. patents. If a report on this search indicates that the invention appears patentable you can apply for a patent, and the specifications and claims should be prepared.

The firm of McMorrow, Berman & Davidson, with offices in Washington, D. C., is qualified to take the necessary steps for you. We can make a preliminary search on your invention, advise you whether we think it can be patented, and prepare your application for patent.

Unless you are fully familiar with the U. S. Patent Laws, we recommend that you engage the services of a Registered Patent Attorney to protect your interests. The patent laws are *your* laws. A patent gives you the right to prevent others from making, using or selling the invention claimed in your patent for a period of 17 years.

Use these patent laws for your protection. Investigate whether your invention can be patented. If you have what you believe to be an invention, we suggest that you have this firm make a search for you.

Send for a copy of our Patent Booklet entitled "How To Protect Your Invention," containing information about patent protection and patent procedure. Along with this we will also send you an "Invention Record" form, for your use in writing down and sketching details of your invention. We will mail them promptly. No obligation. They are yours for the asking.

McMORROW, BERMAN & DAVIDSON

Registered Patent Attorneys

PATENTS • COPYRIGHTS • PATENTS

135-K VICTOR BUILDING, WASHINGTON 1, D. C.

LET CAR EXPERTS GUIDE YOUR HANDS THROUGH ANY AUTO REPAIR



**QUICKLY--
EASILY--RIGHT!**

**FREE
7-DAY
TRIAL**

**MOTOR'S
AUTO
REPAIR
MANUAL**



SUPPOSE you had an automobile factory engineer standing right beside you . . . guiding your hands through every step of even the toughest car repair job! Think how you'd "whiz through" every job! No wonder, then, 2,500,000 MOTOR'S Auto Manuals have been sold. No wonder so many thousands of beginners and expert mechanics alike are already using MOTOR'S brand-new AUTO REPAIR MANUAL. It shows you, in step-by-step words and pictures, factory-approved repair procedures for fixing ANY part of ANY car, 1949 through 1957!

No guesswork! MOTOR'S Manual "starts from scratch" — leads you through entire job with easy step-by-step directions, clear "how-to" pictures. Tells WHERE to start, what TOOLS to use, how to remove, repair and replace parts. You CAN'T go wrong.

1000 Big ILLUSTRATED Pages
NEW, REVISED, ENLARGED Edition contains the "meat" from over 160 OFFICIAL shop manuals—simplified for YOU in Over 1,000 big pages, 21,436 essential repair specifications. More than 2,900 "this-is-how" pictures, 226,000 service and repair facts. Leads beginners every step of the way. Time-saving factory repair procedures for experts. Used by U. S. Army and Navy.

Try Book FREE 7 Days

Just mail coupon. (Attach it to postcard if you wish.) Make Manual PROVE what it's got. Unless you agree this is the greatest time and work saver ever—return book in 7 days, pay nothing. Mail coupon to: MOTOR Book Dept., Desk 19, 250 W. 55th St., New York 19, N. Y.

Brand New—Covers All These Makes

- | | |
|-------------|-------------|
| Buick | Jeep |
| Cadillac | Lincoln |
| Chevrolet | Mercury |
| Chrysler | Nash |
| Clipper | Oldsmobile |
| Continental | Packard |
| De Soto | Plymouth |
| Dodge | Pontiac |
| Ford | Rambler |
| Hudson | Studebaker |
| Imperial | Thunderbird |
| Willis | |

Same FREE Offer On MOTOR'S Brand-New Truck Repair Manual

Covers EVERY job on EVERY popular make gasoline and Diesel truck made from 1949 thru 1957. For FREE 7-Day Trial, check the proper box in coupon.



**MAIL COUPON NOW FOR 7-DAY FREE TRIAL
(Attach to Postcard if More Convenient)**

MOTOR BOOK DEPT.

Desk 19, 250 W. 55th St., New York 19, N. Y.

Rush to me at once (check box opposite book you want):

MOTOR'S New AUTO REPAIR MANUAL. If O.K., I will remit \$2 in 7 days, \$2 monthly for 2 months and a final payment of \$6 (plus 35¢ delivery charges) one month after that. Otherwise I will return the book postpaid in 7 days. (Foreign price, remit \$9 in cash with order.)

MOTOR'S New TRUCK REPAIR MANUAL. If O.K., I will remit \$2 in 7 days, and \$2 monthly for 3 months, plus 35¢ delivery charges with final payment. Otherwise I will return books postpaid in 7 days. (Foreign price, remit \$10 in cash with order.)

Print Name..... Age.....

Address.....

City..... State.....

Check box and save 35¢ delivery charge by enclosing WITH coupon in envelope entire payment of \$6.55 for Auto Manual (or \$8 for Truck Manual). Same return-refund privilege.

PAINTING IS EASY!

with the famous **BURGESS**
electric SPRAYER

Just plug in and Spray:

- paint • varnish • enamel
- shellac • mothproofers
- garden sprays • water
- insecticides

PAINT 3 to 7 TIMES FASTER!

For the fastest, smoothest painting or spraying job you ever saw, try the Burgess Sprayer. Completely self-contained . . . just plug into regular household outlet, pull the trigger, and paint furniture, floors, walls, screens, cabinets, fences. Fine for mothproofing and garden spraying, too. Sapphire nozzle, handy spray adjuster, new convenient hanging hook, 25 oz. graduated jar. Easier to clean than a brush.



only **\$12.95** AT YOUR FAVORITE DEALER

If not available locally send \$12.95 for post-paid delivery. Money-back guarantee.

SEND FOR FREE BOOKLET
"HOW TO PAINT THE EASY WAY"

BURGESS VIBROCRAPTERS, INC.
DEPT. A-75 • GRAYSLAKE, ILLINOIS

I'll Send You This Handsome SAMPLE CASE—FREE



and Show You How to Make
Up to \$30.00 in a Day

WRITE for this FREE Tailoring Sample Case packed with 100 beautiful, big-value suit and overcoat fabrics. Take orders from friends, fellow-workers, others, for fine quality, made-to-measure clothes. Pocket big cash profits in advance. Because wearing our suits and overcoats brings more orders, we make it easy for you to get your own clothes without the cost. No experience is needed. SATISFACTION GUARANTEED. SEND NO MONEY. Rush your name, address, and age—today!

J. C. FIELD & SON, INC., Harrison & Throp Sts.
DEPT. N-1716 • CHICAGO 7, ILLINOIS

Full Color—Wall Size International WORLD MAP

It's wall size! 33 inches x 50 inches. Heavy duty durable stock in 8 full colors with clear type to instantly identify any corner of the globe. All in precision detail. Smart as a mural. Educational for children's rooms, den, office, civic schools, etc. Order Direct today. Send \$1.00 each prepaid or 3 for \$2.75. Also available \$1 each or any assortment of 3 for \$2.75 same map of U.S.A., Europe & Near East, Asia, Africa, Australia & Pacific Islands, North America, South America. Guaranteed.

\$1

TERRY ELLIOTT CO., DEPT. MP-75

135 East 44th St. New York 17, N. Y.



INSURED TIRE SERVICE POPULAR BRANDS

FREE INSURANCE POLICY given with each used tire sold. We guarantee the amount of service you pay for.

**NOWHERE CAN SUCH QUALITY
BE FOUND AT SUCH LOW PRICE!**

SPECIAL!
Deduct 10% on orders for 4 or more used tires

**YOU CAN'T
LOSE!!**

Super Quality — Rugged Performance — 6 Months Insured Service

600x16	\$3.65	670x16	\$3.95	700x16	\$4.45	760x16	\$4.75
650x16	3.85	670x16	4.05	710x16	4.55	820x16	4.95
680x16	4.25	700x16	3.95	760x16	4.45	880x17	4.65

Supreme Quality — Nothing Finer — 12 Months Insured Service

600x16	\$5.25	675x19	\$5.45	700x15	\$10.45	700x20	\$12.50
600x16	6.75	640x16	4.95	750x16	15.95	750x20	15.50
650x16	5.75	670x16	5.35	700x17	11.95	750x20	17.50
680x16	7.25	710x16	5.45	780x17	16.45	825x20	21.50
700x16	6.35	760x16	5.95	790x16	10.95	800x20	19.95
750x16	8.45	800x16	6.35	30x5	11.25	1000x20	20.45
850x16	4.95	820x15	6.35	600x20	10.95	1100x20	21.25
880x17	4.75	850x16	5.35	650x20	11.75	1000x22	21.95
880x16	5.25	670x16	5.15	32x6	11.95	1100x22	22.75
700x15	5.35	700x16	10.25	32x6	12.75	1100x24	25.95

Whitewalls \$1.00 extra.

**MIDLAND
TIRE SALES**
Speedy shipments on Mail Orders. F.O.B. Chicago. Insurance policy sent with each order. Deduct 10% on orders for 2 or more used tires. Send CHECK or MONEY ORDER.—No COD's.
3701 S. Normal, Dept. PM-62, Chicago 9, Ill.

**DEVRY TECH CAN PREPARE YOU
IN SPARE TIME AT HOME AS AN**

ELECTRONICS TECHNICIAN!



No Previous Technical Experience or Advanced Education Needed!

Laborers and bookkeepers, store clerks, farmers, salesmen — men of nearly every calling — have taken the DeVry program and today have good jobs or service shops of their own in Electronics.

Here's proof positive that it can be done — done by men like yourself — men who had no previous technical experience, no advanced education.

If you are 17 to 55, we will tell you free how you may prepare for exciting, interesting jobs in Automation Electronics, Radar, Guided Missiles, Communications, Industrial Electronics and many others shown at right. Here is a chance of a lifetime to prepare to cash in on one of today's fastest growing fields. Mail the coupon for details.

DeVry Tech's amazingly practical home method enables you to spend minimum time to get maximum knowledge. In fact, you get exactly the same type of basic training equipment used in our Chicago and Toronto training laboratories — among the finest!

Send coupon for free facts NOW!

Live-Wire Employment Service

DeVry Tech's Placement Department is in contact with some of the best-known employers in the Electronics field. The service is free to all graduates—and DeVry Tech's record in helping to place men has been outstanding.



Draft Age?

We have valuable information for every man of draft age; so if you are subject to military service, be sure to check the coupon.

What a DeVry Tech Diploma Meant to These Men!



G. F. Beane, W. Virginia, was a truck driver. He took the DeVry Tech Training Program, and is now a technical electronics sales representative.



Edward Hahn, Illinois. Was a laborer, now an electronics project engineer with Televiso, Inc. DeVry Tech training helped him prepare for his present position.



Nick Barton, Illinois, came directly from high school to DeVry Tech. Now has his own service shop and tells us he is "literally snowed with work."



George D. Crouch, California, was a retail store clerk. He took the DeVry Program, and today is in the servicing field for himself.

"One of North America's Foremost Electronics Training Centers"



Accredited Member of
National Home Study Council

DEVRY TECHNICAL INSTITUTE
CHICAGO 41, ILLINOIS

FORMERLY

DEFOREST'S TRAINING, INC.



**AN
INDEX
to a
BETTER JOB,
A BRIGHTER
FUTURE**

COMMUNICATIONS

RADAR

GUIDED
MISSILES

TELEVISION

MICRO-WAVES

RADIO

INDUSTRIAL
ELECTRONICS

COMPUTERS

AUTOMATION
ELECTRONICS

Sample Lesson **FREE!**

See for yourself how DeVry Tech trains you for real opportunities in Electronics. We'll also give you a free copy of an interesting booklet, "Electronics and YOU."

Mail Coupon Today!

DeVry Technical Institute
4141 Belmont Ave., Chicago 41, Ill., Dept. PM-9-N

Please give me FREE Sample Lesson and your booklet, "Electronics and YOU," and tell me how I may prepare to enter one or more branches of Electronics as listed above.

Name _____ Age _____

Please Print

Street _____ Apt. _____

City _____ Zone _____ State _____

Check here if subject to military training.
DeVry Tech's Canadian Training Center is located
at 626 Reselawn Avenue, Toronto 12, Ontario

2004

DRAFTSMEN



**CASH BIG
PAY CHECKS!**

Train Now for
more success,
greater security

LEARN AT HOME IN SPARE TIME
(or at college in Chicago)

Check the want ads in any newspaper—SEE the big-pay opportunities open to you as a draftsman. What's more, you can learn this well-paid, prestige profession at home—quickly, easily! No special talent needed. Get complete, step-by-step Chicago Tech lessons in the mail, spend a few pleasant hours studying each week. In a short time you'll be a well-trained draftsman, ready to take your pick of many good jobs. Act now!



Free Information—Mail Coupon Today!

Get FREE TRIAL LESSON plus information about C.T.C. practical training. Learn what successful Chicago Tech graduates say about high pay and opportunities in drafting. No charge, or obligation.

CHICAGO TECHNICAL COLLEGE

M-215 Tech Bldg., 2000 So. Michigan Ave.
Chicago 16, Illinois

Mail me FREE lesson with facts about big opportunities in DRAFTING.

Name _____ Age _____

Address _____

City _____ Zone _____ State _____



DOUBLE PROFITS FOR YOU WITH PHOTO STATUETTES AND GREETING CARDS

Sell NEW amazingly life-like miniature Photo Statuettes of children, friends or pets. Made from favorite photographs or snapshots. Sell on sight. Perfect for Christmas gifts. EXTRA CASH with Whitehall's Easy-to-Sell Name Imprinted Christmas Cards. Stationery, Napkins, Gifts. Write today for FREE Sample Portfolios.

WHITEHALL STUDIOS, 397 Cleveland Ave., Elmira, N.Y.

MAKE MORE \$ IN SPARE TIME HOURS!

Use "IDEAL"

Lawnmower Sharpener

New attachment makes Model 300 "Ideal" a perfect reel and rotary blade grinder—also sharpens shears, other tools! Ideal's exclusive "hook" grinding method insures quick, easy results every time. Compare all facts and you'll buy "Ideal"—leading mower sharpener for 55 years. Make more money—write for free catalog.

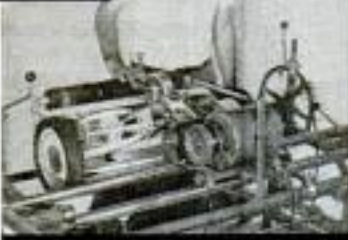

Sharpens All Mowers

• REEL TYPE • HAND
• ROTARY • POWER

The FATE-ROOT-HEATH Co., Dept. PM-9, Plymouth, Ohio

GIANT BALLOONS — 3 for \$1.25



Surplus U.S. Govt. (New average) Neoprene weather target balloons.
FOR FUN in the backyard! at parties, picnics, etc! Young and old love 'em.
FOR ADVERTISING—Attracts crowds to civic events, business openings, trade shows, fairs. Low cost, high return! Paint on sales message, seen for miles!
FOR PROMS—Makes any dance more festive. Ideal for high school or college affairs! The more you use the better.

3 ft. dia. 49c ea. (SPECIAL! 3 for \$1.25) Approx. inflated sizes
Postage paid on prepaid orders. Calif. res. add sales tax.

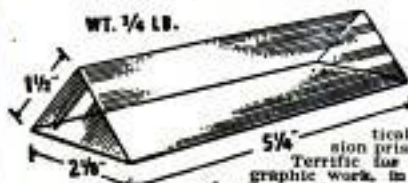

WT. 1/4 LB.

PRISMS \$1.50

Made for U. S. Govt. for tank periscopes. Fine optically ground, big precision prisms with silvered base. Terrific for all types of spectrographic work, in homemade telescopes & other optical systems for bending rays. Makes unusual paper weight (paint your name on it) or conversation piece for mantle. You'll find many other uses. NEW. PERISCOPE! Cost U. S. Govt. \$25 ea. Now \$1.50 ea. ppd. or 4 for \$5.00 ppd. Calif. res. add sales tax.

VOLUME SALES CO., War Assets Division
3930 Sunset Blvd., Dept. PM-937, Los Angeles 29, Calif.



GROW ORCHIDS AT HOME

**BIG PROFITS
SPARE OR
FULL TIME**

World's most thrilling hobby—profitable home business.

Hundreds of Families
Raising Orchids At
Home With Our Help

Send for FREE information on temperature, light & humidity. Orchids used in the home. Purple Orchids, white, yellow, every rainbow color. Many grow without soil, getting food from the air. Successful home grower offers complete growing instructions—tells how to market Orchid flowers & plants to neighbors, hotels, florists for good profits. Also Mail Order from big city, small town or farm. Instructions include Blooming-size Orchid plant. Send name and address for real ORCHID SEEDS, full details & "Quick-Profit" Plan—ALL FREE.

TROPICAL FLOWERLAND, Dept. 319, 100 So. Vermont, Los Angeles 4, Calif.



Rubber Stamp Press Outfits Stamp Making Supplies

A profitable home or sideline business mfg. rubber stamps. Stamp Press and all supplies. FREE catalog, advice, instruction. Permanent and profitable business. WRITE TODAY! Full details!

CUSTOM MANUFACTURING
601-A NO. JEFFERSON, SPRINGFIELD, MO.



MONEY in WORMS

Big money made raising crickets, hybrid red wigglers and 12 inch African fishworms—Sell by mail—We teach you how to raise and where to sell. Free literature. Hybrid breeder red wigglers—1000—\$4, 5000—\$17.50, postpaid. CARTER WORM RANCH, PLAINS, GEORGIA.

Free Book on Arthritis And Rheumatism

HOW TO AVOID CRIPPLING DEFORMITIES

Explains why drugs and medicine give only temporary relief and fail to remove the causes; tells all about a specialized non-surgical, non-medical treatment which has proven successful since 1919. Write for this 36-page FREE BOOK today.

BALL CLINIC Dept. 756 Excelsior Springs, Mo.



\$220.00 PROFIT...FAST!

I Sold 44 KANT-SLAM DOOR CHECKS
to Just 4 Customers! Says Segrest of Texas

Join Our Exceptional Men Who Make Big Money Every Day

Amazing new invention . . . world's lowest-priced hydraulic door check stops slamming doors, closes heaviest doors gently, smoothly, positively. Guaranteed 3 years. Every home, office, factory, building needs 1 to 20 . . . and you make up to \$5.00 profit on each one! Repeat orders, too. You can make really big money with KANT-SLAM!

FREE! Send name, address NOW for complete money-making details. No obligation.
KANT-SLAM CO., Dept. M-14, Bisonfield, Ind.



POPULAR MECHANICS

Copyrighted material

GOOD NEWS for men who need GOOD JOBS!

E. C. ANDERSON
President
COMMERCIAL TRADES
INSTITUTE

BE A TRAINED MECHANIC IN AIR CONDITIONING AND REFRIGERATION

Why let the high cost of living get you down when there's such good money to be made in the Air Conditioning and Refrigeration field! Yes, this old, established, but fast-growing industry needs thousands of trained mechanics to install, repair and service the 150 million refrigeration units in use today. And the industry is growing! Last year, over 3 million refrigerators, 1 million freezers and 2 million air conditioners were sold. Small wonder there's a shortage of trained men! And those who are in the field earn top wages, work steady, put money in the bank!

Train at home in spare time for a better job in this uncrowded industry. For complete information, fill out and mail coupon. Do this today.

23
BIG KITS
to build
AIR CONDITIONER
REFRIGERATOR
FREEZER or
MILK COOLER

**Great new way to learn
by practicing at home
with real equipment!**

At left, Mr. Anderson demonstrates the commercial type, heavy-duty, 1/2 h.p. refrigeration high-side which you build as part of your training.

You get sound experience by training with CTI kits

Why leave home or give up your job to attend a resident school? Train at home in spare time! CTI sends you easy-to-understand instruction and 23 training kits. You get all parts and tools to build a 1/2 h.p. refrigeration condenser. You do 10 service and trouble-shooting jobs—build a freezer, refrigerator, air conditioner or milk cooler. You get practical training—intensive experience. (Two of the 23 kits are shown at left.) Act now! Mail coupon! No obligation.

Many students earn cash as they train

Many students, soon after they start training, do repairing in spare time. They work with local dealers evenings and week-ends. Others go "on their own." They earn extra cash, get added experience. Some land full-time jobs while students, and quite a number open shops. All this is possible because CTI training is so practical.

An opportunity for a business of your own!

Students often build up a list of customers which includes not just homes, but office buildings, shops, food stores and industrial plants. They contract to do servicing on a fee basis, or simply answer calls. The Air Conditioning and Refrigeration field offers plenty of opportunity for independence. Own a shop—Be the boss!



MAIL COUPON TODAY FOR 2 FREE BOOKS

COMMERCIAL TRADES INSTITUTE

1400 GREENLEAF AVENUE
CHICAGO 26, ILLINOIS

DEPT. R-395

Rush me your booklet, Success in Air Conditioning & Refrigeration, and Sample Lesson. Both FREE.

Name _____ Age _____

Address _____

City _____ Zone _____ State _____



"TRAINING YOU CAN TRUST"



**YOU
can
acquire**

LAW NIGHTS AT HOME! LL. B. DEGREE

LaSalle's famous Law Library—used as reference in many Law libraries and Law offices—has enabled thousands to master Law surprisingly fast, in spare hours at home, for business and professional advancement.

These 14 remarkable volumes, compiled by leading professors and lawyers, cover the whole basic field of Law in condensed, orderly, simplified manner.

You advance rapidly with this great library, plus special lectures furnished. We guide you step-by-step with personalized Problem Method of instruction . . . you learn by doing—handling legal problems—not by memorizing rules.

Send for two FREE booklets, "Law Training for Leadership," and "Evidence," answering questions about Law and its value to you, and telling how LaSalle Law graduates are winning rapid advancement in business and public life. Mail coupon below. No obligation.

LA SALLE EXTENSION UNIVERSITY

A Correspondence Institution

417 S. Dearborn St. Dept. 964-L Chicago 5, Ill.

Send me your two FREE booklets described above, without obligation.

Name.....Age.....

Street.....

City, Zone & State.....

Free! 75 ORIENTALS

Brought to you from the farthest ends of the earth—these exotic valuable genuine STAMPS of the Orient! 75 all-different from Borneo, Siam, China, Japan, Hong Kong, Malaya, Sarawak, Singapore,—and other exciting mysterious lands of the Far East. EXTRA! Free booklet, bargain lists, fascinating offers for your free examination. Send 10c for mailing costs.

JAMESTOWN STAMP CO., DEPT. C0PMM, JAMESTOWN, N. Y.



Want to pass a U. S.

CIVIL SERVICE TEST?



MEN — WOMEN, 18-55. Thousands of positions open. Prepare NOW for next examinations. Write immediately for free 36-page book, with list of many positions and particulars telling how to prepare. Grade school education often sufficient. Veterans get preference.

FRANKLIN INSTITUTE

(Not Government Sponsored)

Dept. L-93, Rochester 4, N. Y.

Shrinks Hemorrhoids New Way Without Surgery

Science Finds Healing Substance That Relieves Pain—Shrinks Hemorrhoids

For the first time science has found a new healing substance with the astonishing ability to shrink hemorrhoids and to relieve pain — without surgery.

In case after case, while gently relieving pain, actual reduction (shrinkage) took place.

Most amazing of all — results were so thorough that sufferers made astonishing statements like "Piles have ceased to be a problem!"

The secret is a new healing substance (Bio-Dyne*)—discovery of a world-famous research institute.

This substance is now available in suppository or ointment form under the name Preparation H.* Ask for it at all drug counters—money back guarantee. *Reg. U. S. Pat. Off.



\$150⁰⁰-\$250⁰⁰ Weekly OPERATING AUTO RADIATOR SERVICE SHOP

World's largest radiator shop equipment mfr. will help you set up your own radiator shop — help you get started toward a secure, profitable future. Over 1,000 INLAND shops now operating. First year averages \$8,000 to \$10,000. Many now making much more. Garage or service station can operate on dept. A little as \$505 down for equipment starts you. We will finance balance, furnish complete factory training. Write to

INLAND MFG. CO., Dept. PM-9, 1108 Jackson St., Omaha 2, Nebr.

'How to Make Money with Simple Cartoons'



A book everyone who likes to draw should have. It is free; no obligation. Simply address

FREE BOOK

CARTOONISTS' EXCHANGE
Dept. 99-D Pleasant Hill, Ohio

REAL ESTATE BE A BROKER

PAYS BIG! SEND FOR FREE, BIG, ILLUSTRATED CATALOG NOW! Graduates report making substantial incomes. Start and run your own business quickly. Men, women of all ages learn easily. Course covers Sales, Property Management, Appraising, Loans, Mortgages, and related subjects. **STUDY AT HOME** or in classrooms in leading cities. Diploma awarded. Write TODAY for free book! No obligation.

Approved for World War II and Korean Veterans
WEAVER SCHOOL OF REAL ESTATE (Est. 1916)
2020R Grand Avenue Kansas City, Mo.

FREE BOOK TELLS NOW

**Better Than
Your Own**

SHOE STORE AT HOME



**Two-Eyelet
Hit With
Cushioned
Comfort**

No investment, no experience needed. Just show magic cushion comfort to friends, neighbors, co-workers. Advance commissions to \$4.00 a pair, plus Cash Bonus. Paid Vacation, \$25.00 Reward Offer. Outstanding values for men, women, children. Money back guarantee. Shoe samples supplied without cost. Write TODAY for FREE new 84 page catalog and full details.

TANNERS SHOE CO., 522 BROCKTON, MASS.

POPULAR MECHANICS

New Rubber Stamp Business Pays Beginners ^{UP} _{TO} \$9.20 an hr.

Start at home in spare
time with this little
table top machine

The multi-million dollar Rubber Stamp Business—once controlled by a few big companies—is now being taken over by small home operators—one in each community throughout the U.S. Men and women who have this inexpensive machine can turn out huge quantities of Rubber Stamps with special wording that buyers once were forced to order from big cities. Material costing only 27¢ makes a stamp that sells for \$1.80. The machine that does the work is simple and easy to operate and it turns out as many as six Rubber Stamps at a time each with different wording such as names, addresses, notices, stock numbers, prices and other "copy" needed by offices, factories and individuals. Working full capacity, it can earn as much as \$9.20 an hour for the operator! Now you can get into the big-pay business yourself, with your own home as headquarters. You don't need any experience. We supply everything, including complete instructions and eight ways to get business coming in fast. Start making up to \$9.20 an hour from the very beginning. Cash in on the profitable Rubber Stamp Business in your community right away.

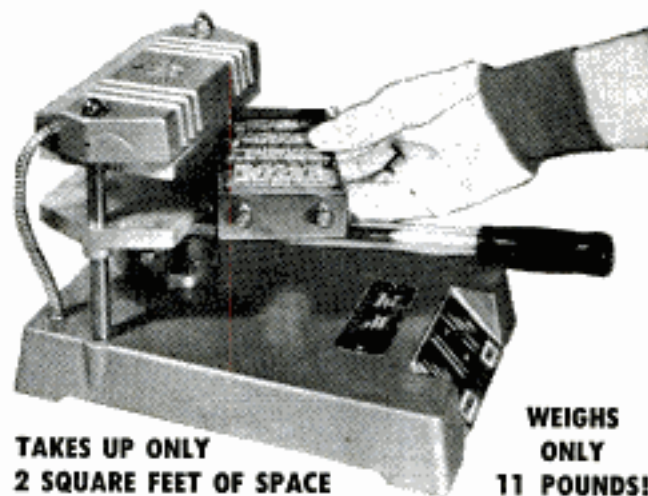

TAKES UP ONLY
2 SQUARE FEET OF SPACE

WEIGHS
ONLY
11 POUNDS!

Read the complete and fascinating Rubber Stamp story in a big 110-page Book recently published by the Warner Electric Company. The book is profusely illustrated with more than 100 pictures and photographs. And you can read it for a full two weeks without risking a penny of your own money.

Here's what the new WARNER PLAN Tells You about Making Money with RUBBER STAMPS

CHAPTERS

1. HOW TO have fun now and at the same time provide for a secure and prosperous future.
2. HOW TO check the advantages of operating a Rubber Stamp Business in your own community.
3. HOW TO acquire a general knowledge of the business based on a brief history of the Rubber Stamp.
4. HOW TO visualize the scope of the Rubber Stamp market.
5. HOW TO make a Rubber Stamp (general outline).
6. HOW TO assess the value of Warner Equipment.
7. HOW TO get acquainted with the "Tools of your Trade."
8. HOW TO make a Rubber Stamp (Specific procedure).
9. HOW TO mount a vulcanized Rubber Stamp.
10. HOW TO make "Special" Rubber Stamps.
11. HOW TO cut plastic Matrix Board for the chase.
12. HOW TO get the right price for the Rubber Stamps you make.
13. HOW TO price your complete Rubber Stamp Line.
14. HOW TO figure costs so you will be sure of a substantial profit on all the work you turn out.
15. HOW TO set up your workshop.
16. HOW TO get the most out of Warner's "Eight Tested Sources for Getting Business."
17. HOW TO operate at peak efficiency when YOU ARE YOUR OWN BOSS.
18. HOW TO get started on a cash outlay so small that you can get back your entire investment inside of two weeks.

NEW WARNER SUCCESS PLAN

Tells How to Build — Step by Step — to
big profits and Personal Independence
READ THIS PLAN FOR 2 WEEKS
ENTIRELY AT MY RISK.



110 Pages
More Than 100
Pictures

Now Ready to Mail
Tell Me Where To
Send Your Copy
USE COUPON

In this amazing Plan you will find exact and detailed instructions for starting a Home Business in spare time—without giving up your present job and without risking the loss of a single pay check. The Warner Plan shows you—with pictures, photographs and drawings—just how to make Rubber Stamps just as good as those turned out by the big companies. It shows how to get orders without canvassing or house-to-house selling. It shows you how to expand, how to get others to work for you and how to be SURE of at least twice the money you made on your present job for a life of personal independence.

But don't make any decision now. Read the Plan first—entirely at my risk. Then—after you have made a careful investigation—after you have talked things over with your family—only then do you decide what you want to do.

The thing to do now is to get full details which I will send you FREE. No salesman will call to urge you to buy anything. Mail coupon today—or just send me a postcard—and I will see that complete information goes out to you by return mail—postage paid.

RUBBER STAMP DIVISION

1512 Jarvis Ave., Dept. R-2-K, Chicago 26, Illinois

RUBBER STAMP DIVISION
1512 Jarvis Avenue, Dept. R-2-K
Chicago 26, Illinois

**SEND NO
MONEY**

Please rush full particulars about the little machine that can get me started in the profitable Rubber Stamp Business at home in spare time. Everything you send me is FREE. No salesman will call.

Name _____

Address _____

City _____ Zone _____ State _____

REFRIGERATION AIR CONDITIONING INFORMATION IN A HANDY FORM

ASK TO
SEE
IT!



Every Serviceman, Mechanic & Operator can use AUDEL'S REFRIGERATION & AIR CONDITIONING GUIDE, containing Practical, Inside Trade Information on the whole subject of Refrigeration & Air Conditioning. Tells How to Service, Operate & Repair Modern Household, Commercial & Industrial Units & Air Conditioning Systems. 1360 Pages, 46 Chapters Fully Illustrated & Indexed for Quick Reference.

1001 FACTS

This big, highly indorsed book, easy to understand, gives useful basic principles on How to Repair & Install Compressors, Control Devices. How to locate Electric Motor Troubles. How to Service & Adjust Cold Storage Lockers, Quick Freezing Units, Dairy & Market Refrigerators, Ice Cream & Soda Fountains, How to Maintain Water Coolers, Marine Refrigeration, Plant Auxiliaries, Ice Making, Ammonia Plants, Brine Systems, Servicing Air Conditioning Systems, Replacement of Refrigerants including Freons, Heat Transmission & Pressure Temperature Charts, Tables, Duct Systems, Safety Codes, etc.

\$6 ANSWERS YOUR QUESTIONS

Get this Information for Yourself. Mail Coupon today.
COMPLETE • PAY ONLY \$2 A MONTH ←

Every Mechanic can Step Up his Skill with AUDEL'S GUIDES. Containing Practical Inside Information in a Handy Form. Covers facts and figures of your Trade. All illustrated and explained. Books sent to you for 7 DAYS FREE EXAMINATION. Send No Money Nothing to Pay Postman. Check Books Wanted - Mail Today.

MAIL ORDER

AUDEL, Publishers, 49 W. 23 St., New York 10, N.Y.



Please send me for FREE EXAMINATION books marked (x) below. If I decide to keep them I agree to mail \$2 in 7 Days on each book or set ordered and further mail \$2 monthly on each book or set until I have paid price plus shipping charges. Otherwise, I will return them.

Check
NOW!

You Can
Look Over
Any Guide
In Your
Own Home

Start the
Easy Pay-
ments If
Satisfied

MAIL
THIS
TODAY



- HOME APPLIANCE SERVICE GUIDE, 864 Pages \$6
- AUTOMOBILE MECHANICS GUIDE, 1696 Pages. 6
- TRUCK & TRACTOR GUIDE, 1376 Pages..... 5
- DIESEL ENGINE MANUAL, 640 Pages..... 3
- MACHINISTS HANDY BOOK, 1728 Pages..... 6
- WELDERS GUIDE, 608 Pages..... 3
- BLUE PRINT READING, 448 Pages..... 3
- MATHEMATICS & CALCULATIONS, 752 Pages... 3
- SHEET METAL PATTERN LAYOUTS, 1152 Pgs. 7.50
- SHEET METAL WORKERS HANDY BOOK, 448 Pgs. 2
- MECHANICAL DRAWING GUIDE, 192 Pages... 2
- MECHANICAL DRAWING & DESIGN, 480 Pages 3
- TELEVISION SERVICE MANUAL, 480 Pages... 3
- RADIOMANS GUIDE, 1088 Pages..... 5
- ELECTRONIC DEVICES, 304 Pages..... 3
- ELECTRIC MOTOR GUIDE, 1056 Pages..... 5
- WIRING DIAGRAMS (Light & Power), 304 Pgs. 2
- ELECTRICIANS EXAMINATIONS, 272 Pages .. 2
- ELECTRIC POWER CALCULATIONS, 480 Pages 3
- HANDY BOOK OF ELECTRICITY, 1520 Pages.. 5
- ELECTRIC DICTIONARY, 9000 Terms..... 3
- ELECTRIC LIBRARY, 7000 Pages (10 Book Set) 20
- REFRIGERATION & Air Conditioning, 1360 Pgs. 6
- MILLWRIGHTS & MECHANICS GUIDE, 1248 Pgs. 5
- POWER PLANT ENGINEERS GUIDE, 1568 Pages 5
- ENGINEERS & FIREMANS EXAMS, 544 Pages .. 2
- PUMPS, Hydraulic & Air Compressor, 1760 Pgs. 6
- OPERATING ENGINEERS LIBRARY (3 Books) 12
- GARDENERS & GROWERS GUIDES (4 Book Set) 6
- CARPENTERS & BUILDERS GUIDES (4 Book Set) 8
- PLUMBERS & Steamfitters Guides (4 Book Set) 8
- MASONS AND BUILDERS GUIDES (4 Book Set) 8
- PAINTERS & DECORATORS MANUAL, 464 Pgs. 2
- HOUSE HEATING GUIDE, 1008 Pages..... 5
- OIL BURNER GUIDE, 416 Pages..... 2

Name

Address

Occupation.....

Employed by.....

SAVE SHIPPING CHARGES! Enclose Full Payment
With Coupon and We Pay Shipping Charges. P9

NEW Self-Contained SPRAY GUN

FOR HOUSEHOLD JOBS!

Requires NO Hoses,
Cords or Compressors

Completely Portable . . . Goes to
the Job Without Attachments!

It's unique - this amazing spray gun you can carry as easily as a water pistol! Powered by inexpensive CO₂ cartridges! Container holds 21 oz., reloads in a flash. Nozzle adjusts from stream to finest spray. Sprays paints, insecticides, etc. At your dealer's or order direct. Remit in full and we'll ship postpaid. Or send \$2, pay postman balance plus COD fee.



ONLY
\$19.95
with 10
cartridges

SULLIVAN-BECKER CO., Dept. 117-J, Kenosha, Wis.

Make \$5 an Hour CASH PROFIT



THE DAY YOU START!

Start your own business at Home...
Sharpen Household,
Garden and Shop
Tools in Spare Time.

Turn spare time into Big Cash Profits with new Belsaw Sharp-All. No experience needed to sharpen knives, scissors, shears, ice skates, mower blades, hedge trimmers, axes, chisels and circular saws . . . Learn how easily you can start your own spare time business. Amazing low cost easy-payment plan. Send Postcard for FREE BOOK. BELSAW SHARP-ALL CO 718 Field Bldg., Kansas City 11, Mo.

TASOPE PHOTO-ENGRAVING PLANTS



Material Cost
Of This Cut 34¢
Selling Price
\$1.00 And Up

Establish your own profitable PHOTO-ENGRAVING business. Make cuts for newspapers, printers, and advertisers. Make etched name plates, plaques etc. Instructions furnished, no experience necessary. Sold direct from factory since 1931. First five hundred cuts sold locally or by mail will pay for plant and pay you well for your time. Write for FREE catalog.

TASOPE, DEPT. PM-9, AURORA, MO.

LAW FREE BOOK



Write today for a FREE copy of illustrated law book, "THE LAW TRAINED MAN," which shows how to earn the professional Bachelor of Laws (LL.B.) degree through home study of the famous Blackstone Law Course. All necessary books and lessons provided. Moderate cost; convenient monthly terms. Write for FREE law training book today.

Blackstone School of Law, 307 N. Michigan Ave.

Founded 1890

Dept. 56, Chicago 1, Ill.



Troubled with GETTING UP NIGHTS, Pains in BACK, HIPS, LEGS, Tiredness

If you have these symptoms then your troubles may be traced to Glandular Dysfunction . . . a constitutional disease. Medicines that give temporary relief will not remove the cause of your trouble. Neglect of Glandular Dysfunction often leads to premature old age and sometimes incurable malignancy.

The past few years men from over 3,000 communities have been successfully treated here at the Excelsior Institute. They have found soothing relief and a new outlook in the future of life.

The Excelsior Institute, devoted to the treatment of diseases peculiar to older men by NON-SURGICAL methods has a NEW FREE BOOK that tells how Glandular Dysfunction may be corrected by proven NON-SURGICAL treatments. This book may prove of utmost importance in your life. Write today. There is no obligation.
Excelsior Institute, Dept. B929, Excelsior Springs, Mo.

1957 WINNER - INDIANAPOLIS

SAM HANKS, famous race driver and mechanic says:
"I'd like a NATIONAL SCHOOLS
trained mechanic on my crew anytime!
Any employer would!"

Few racing drivers are as qualified to advise future mechanics as Sam Hanks, who builds and repairs his own racing cars. He holds the American Closed Course record (182.954 m.p.h.) and a host of state and national titles, including the National Midget Championship in '49 and the National A.A.A. crown in '52. At Indianapolis, he placed third in '52 and '53 ... last year, he was runner-up.



MASTER ALL ENGINES IN ONE MODERN, SHOP-METHOD HOME TRAINING COURSE

AUTO-MECHANICS & DIESEL

"NUMBER ONE COURSE IN ITS FIELD," says Sam Hanks, who predicts bright future for men who clip coupon now.

"I've worked alongside National Schools Trained mechanics," reports Sam Hanks. "They're top-notch mechanics, up on the newest advances in automotive engines - even diesel jobs and fuel injection never faze them. That kind of all-around training really *pays off* - no matter where you work. And take it from me, National Schools Trained mechanics are in big demand everywhere. They command top pay, because they learned how to repair fast and right the first time. Do I recommend National Schools Home Training in Auto Mechanics & Diesel? You bet I do."

Prove it to yourself, Men. National Schools of Los Angeles, a leader since 1905, brings its famous training shops into your home - gives you everything you need to make more money in today's big, opportunity filled Auto-Mechanics & Diesel industry.

Earn as you learn. We show you how. Easy to understand lessons, diagrams, manuals, Free Placement Assistance.

APPROVED FOR G. I. TRAINING



Home of National Schools' world-famous Shops

RESIDENT TRAINING AT LOS ANGELES

If you wish to take your training in our Resident School at Los Angeles, start NOW in our big, modern Shops and Labs, work with the latest Auto and Diesel engines - all types - fuel injection, automatic transmissions, all power equipment - most complete facilities offered by any school. Expert, friendly instructors. Graduate Employment Service. Help in finding home near school - and part time job while you learn. Check coupon for information.

YOU GET AND KEEP ALL THIS EQUIPMENT!



Complete set of professional Tools and All-Metal Tool Box Same top-quality equipment used by expert mechanics everywhere. Use them, display them proudly.



"Motor Analyzing Set" contains Standard Engine Vacuum Fuel Pump Tester, Remote Starter Switch, Modern Timing Light, Standard Compression Tester Plus compact carrying case & instructions.



Top-quality Socket Wrench with Fittings. Real professional tools you'll use during your lifetime career in repairing, all types of engines, from foreign cars to big diesel jobs.

COURSE COVERS

- All engines
- Fuel injection
- Automatic Transmissions
- Overhauling
- Customizing
- Servicing
- Maintenance

PREPARES YOU FOR:

- Auto-mechanic jobs
- Airplane mechanics
- Farm machinery repair
- All diesel jobs
- Experimental Labs
- Government work
- Engine specialist
- All-around mechanic

GET THE BENEFITS OF OUR 50 YEARS' EXPERIENCE!



NATIONAL SCHOOLS
 LOS ANGELES 37, CALIF

FREE!
 VALUABLE BOOK & SAMPLE LESSON
 - Just Send Coupon!



NATIONAL SCHOOLS

TECHNICAL TRADE TRAINING SINCE 1905
 LOS ANGELES 37, CALIFORNIA

MAIL NOW TO
 NATIONAL SCHOOLS, Dept. DB-97

4000 S. FIGUEROA ST.
 LOS ANGELES 37, CALIF.

Send for FREE Auto-Diesel Opportunity Book and Sample Lesson.

NAME _____ AGE _____

ADDRESS _____

CITY _____ ZONE _____ STATE _____

Check if interested ONLY in Resident School training at Los Angeles.

VETERANS: Give date of Discharge _____

INVENTORS

WE recommend that you take the following preliminary steps toward patent protection. Make a disclosure of your invention; sign, date and have your disclosure witnessed by two people who understand your invention; authorize us to conduct a preliminary search among previously granted U. S. patents for similar types of invention. We give you a report on the probable patentability of your invention and our recommendation for further course of action.

Let us send you a copy of our instructive booklet, "Patent Protection for Inventors" and our convenient "Evidence of Invention" disclosure form. No obligation.

VICTOR J. EVANS & Co. *Merlin M. Evans*
REGISTERED PATENT ATTORNEY
330-K MERLIN BUILDING, WASHINGTON 6, D. C.

MAKE STRIPES with new PAINT PEN

Straight, curved, single or double
With any color paint, stripe furniture, bikes, autos, model planes, toys, linoleum, wall-board. Clean, crisp decorative lines. Can't clog or smear. Also use with glue, tempera, textile paint or underglaze... on wood, glass, plastic, ceramics, metals, fabrics and paper.
Ask your dealer or order direct.

DEALERS Master paint striping tool in display carton. Write for discounts.
HOBBY "Professional" results every time. Simple, industrial easy to use. Order now.
MFRS Ask about heavy duty industrial striping tools.

DOUBLE STRIPE MODEL \$3.25
5 COMBINATIONS.

Single 1/16" stripe model \$1.25

Other single stripe models 1/64", 1/32", 3/64", 5/64", 3/32" & 1/8"

Complete Kit \$5.00 (all 7 tips)

Extra tips 90c ea.
Extra 1/4" tip...\$1.20

WENDELL MFG. CO. 4234 LINCOLN AVE., Dept. 333 CHICAGO 18, ILLINOIS



Let me show you

HOW TO SPEAK AND WRITE LIKE A COLLEGE GRADUATE

I have helped thousands of men and women who have not had college training in English to become effective speakers, writers, and conversationalists. With my new C. I. METHOD, you can stop making mistakes, build up your vocabulary, speed up your reading, develop writing skill, learn the "secrets" of conversation. You don't have to go back to school. Takes only 15 minutes a day at home. Costs little. 32-page booklet mailed FREE upon request. Send me a card or letter TODAY!

Don Bolander, Career Institute
Dept. 1059 25 East Jackson Chicago 4, Illinois

BECOME AN EXPERT IN

TRAFFIC

Traffic men earn \$4,000 to \$10,000 and up. Thousands of firms need experts on rules, tariffs, regulations. We train you thoroughly in spare time at home for executive traffic jobs. Personal training under traffic authorities. Placement counsel and help. Write for free 46-page book "Traffic Management—the Fast Growing Profession."

LASALLE Extension University, 417 So. Dearborn St.
A Correspondence Institution Dept. 954-T Chicago 5, Ill.

LEARN PLASTICS



COMPLETE LOW COST SHOP METHOD HOME TRAINING NOW AVAILABLE

Get in on Big Money opportunities in Plastic molding, casting, forming, carving, etc. Earn as you learn with Interstate's professionally prepared course. All plastic materials furnished.

WRITE FOR FREE BOOKLET INTERSTATE TRAINING SERVICE
DEPT. C-3, PORTLAND 13, OREGON

Get Yourself FIXED FOR LIFE in the Big Pay Shoe Business!

I'LL PUT UP THE MONEY TO GIVE YOU A FLYING START!



It's no trick at all to make big money—FULL OR SPARE TIME—with America's most comfortable shoes! Amazing new "Spring-Step" cushion invention proves it by actual demonstration. Only ORTHO-VENT has it! There is no other shoe in the world like it. Repeat orders are sure, steady. One try and a customer is sold for life. Profits are BIG. Orders are sure and easy with the most amazing 2-minute demonstration in the history of the shoe business. No experience needed. No investment to make. Everything, including actual cut-aways, furnished free! Be the big-pay ORTHO-VENT man in your territory. Write TODAY! E. C. Brand, Sales Manager.

I GIVE PRODUCERS THEIR OWN SHOES AS A BONUS!

ORTHO-VENT SHOE COMPANY
1179 Brand Road SALEM, VIRGINIA



MEN! Make up to \$1,000 IN A MONTH!

without "SELLING"

Sensational Demand for Low-Priced Fire Alarm PLUS Sure-Fire "No-Selling" Plan Offers Ambitious Men Huge Profit Opportunities



Even beginners cleaning up unbelievable profits with first practical, effective, low priced Fire Alarm. Needed in homes, factories, offices, stores, on farms, etc. Merlite Fire Alarm hangs on wall like a picture... no wiring, no installation. It's always on guard, "smells" fire before danger point. When temperature rises, Fire Alarm goes off automatically, howls loud warning that can be heard 1/5 mile, wakes up soundest sleeper, gives precious time to put out fire, call fire department, or escape. Sells for only \$4.95, with profit up to \$2.70 on each one.

Nearest Thing to Automation Selling
With our field-tested plan customers sell themselves. No cold canvassing; no hard selling. It's the nearest thing to "Automation Selling." Even a child can use plan successfully with powerful sales tools we give you (which you leave with prospects). This plan makes money for you even while you sleep! No room here to give you full details, but write for amazing facts.

FREE SALES KIT

Send no money. Just rush your name and address for all the exciting money-making facts, complete Illustrated Sales Kit, everything you need to make money first day. Learn how selling only 20 Fire Alarms a day brings you \$1,000.00 a month. No competition. Rush your name and address today.

Dramatic LIGHTED-MATCH DEMONSTRATION

Sensitive! Lighted match triggers Alarm in 3 seconds!

MERLITE INDUSTRIES, INC. (Alarm Div.)

114 E. 32nd St., Dept. 5-15A New York 16, N.Y.
IN CANADA: Mopa Co., Ltd., 371 Dowd St., Montreal 1, P. Q.

Train in Big
COYNE
Shops

GREAT OPPORTUNITY FIELDS!



Instructor helping students check the wiring and trace the circuits of television receivers.

Instructor explaining operation and testing of a large Motor Generator.

This big fire-proof building is occupied entirely by Coyne.

TELEVISION-RADIO

COLOR TV

Here at COYNE you're trained for Testing, Trouble-Shooting and Servicing on AM and FM Radio Units, Auto Radio, Television, etc. Thousands of Coyne trained men in good jobs or own well paying TV-Radio businesses.

ELECTRICITY

ELECTRONICS

Big opportunities everywhere—city, town and country, in Power Plant Work, Motors, Industrial Electronics, Armature Winding, Home and Factory Wiring, Appliances, Refrigeration, Maintenance, Illumination, etc.

**OLDEST AND BEST
EQUIPPED SCHOOL OF
ITS KIND IN THE U.S.**

Send Coupon
Below for
**BIG FREE
BOOK**



"Guide to Careers in
ELECTRICITY-ELECTRONICS
and TELEVISION-RADIO"
Book and details come to
you by return mail. No
salesman will call.

WE TRAIN YOU IN CHICAGO

Our famous Practical-Technical method gives you practical experience on a massive outlay of equipment plus necessary technical training right here in the great Coyne shops.

Training in Refrigeration and Electric Appliances can be included.

Training offered
to **VETERANS** and
NON-VETS alike

START NOW—PAY LATER

Enroll now, pay most of tuition later. Part time employment help for students. Lifetime employment service to Graduates. Frequent starting dates.

B. W. COOKE, JR., President

COYNE
ELECTRICAL SCHOOL

FOUNDED 1899

A TECHNICAL TRADE INSTITUTE OPERATED NOT FOR PROFIT
500 S. PAULINA STREET, CHICAGO, Dept. 67-72H

ELECTRICITY ★ RADIO ★ TELEVISION ★ REFRIGERATION ★ ELECTRONICS

MAIL COUPON TODAY

COYNE ELECTRICAL SCHOOL
500 S. Paulina St., Chicago 12, Ill., Dept. 67-72H

Send BIG FREE book and details of all the training you offer. This does not obligate me and no salesman will call. I am especially interested in:

ELECTRICITY-Electronics TELEVISION-Radio-Color TV

Name.....

Address.....

City.....State.....



WARN HUBS



1957
WARN

OVER 100,000
WARN HUBS NOW
IN USE ON
4-WHEEL DRIVES

Models for all
4 w.ds. to 1 1/2 tons

idle the front drive in
2-wheel drive... stop
drag... reduce wear.

Warn Hubs mean big
savings in gear, engine,
tire wear, gas, plus new
pep, performance, power,
handling ease. And
now, with Warn Lock-
O-matics, you have economic,
drag-free 2-
w.d. or tractive 4-w.d.
*automatically, as you
shift!* Ask your dealer
for Warn Lock-O-matic
or Locking Hubs today!

WARN MFG. CO. RIVERTON BOX 6064-A9
SEATTLE 98, WASH.



MECHANICAL DENTISTRY

A profession offering unlimited opportunities. Most modern and complete course embracing every branch from Plating to Porcelain Work, which prepares you to work for Dentists or start your own business. Individual instruction—practical training in day or night school. No books—no classes. Catalog upon request.
McGARRIE SCHOOL OF MECHANICAL DENTISTRY
207 N. Broad Street Dept. 69 Philadelphia 7, Penna.

C-10

**Beauty by
Colorcrete
Can Earn
High Incomes**



Beautifying buildings by Colorcrete is a business opportunity awaiting men of modest capital everywhere. Owners of homes, stores, motels, schools — almost any type of construction—are looking for means to give lifetime eye-appeal to drab or dirty concrete, stucco and similar masonry surfaces. Colorcretors can do such jobs, in little time and at little cost, and pocket generous profits. Colorcrete is a cementitious material, applied by air pressure. Tough, tenacious, enduring; 30 colors. Investigate this low-investment enterprise by writing for the Opportunity Book.

COLORCRETE INDUSTRIES, INC.
570 Ottawa Ave., Holland, Mich.
CANADA: 1020 Dundas Highway, Cooksville, Ont.

COLORCRETE



LEFAX

TECHNICAL DATA BOOKS

POCKET SIZE • LOOSE LEAF

Printed on loose leaf, 6 hole, 6 3/4" x 3 3/4" bond paper, each book contains about 140 pages of technical data, condensed, accurate, essential, for engineer, technical worker, teacher, student, business men

\$1.25
each

Architecture	Surveying Tables	Machine Design	Radio
Home Heating	Highway Eng'g.	Machinist's Data	Television & FM
Illumination	General Math	Mech. of Materials	Electricity, AC
Electrician's Data	Math Tables	Pwr. Trans. Mach.	Electricity, DC
Builder's Data	Physics	Thermo. Tbls. &	AC Motors and
Lumber Data	Trig-Log Tables	Charts	Generators
Air Conditioning	Gen'l Chemistry	Phys. & Thermo-	Conversion Tabl.
Building Constr.	Chemical Tables	dynamic Data	Steel Welding
Reinf. Concrete	Analytic Chem.	Metallurgy	Form Data
Piping Data	Mech'l Drawing	Hydraulics	Transformers,
Surveying		Metals	Relays & Meters

Write for FREE catalogs (2000 listings). See how helpful LEFAX can be to you. Send \$1.25 book, or \$6 for any five books to

LEFAX PUBLISHERS, Dept. PM-97, PHILADELPHIA 7, PA.

REFILLS 13 for \$1 Value 49c Each (\$1.79 Value Each)

To Fit Every Retractable Pen Made, including:
"Script" "Eversharp" "Paper Mate" "Sheaffer" "Waterman" "Wearaver." Over 200 others (except Parker Jotter)
One make per \$1 order. Choice of Red, Blue, Black, Green or Brown Ink.

Choice of Red, Blue, Black or Green Ink
Add 10c shipping charge. Money back guarantee. Quantity and imprint prices on request.

BARCLAY DISTRIBUTORS

DEPT. 2 86-24 PARSONS BLVD. JAMAICA, N. Y.

**ENGINEERING
DEGREE IN
27 MONTHS**

B.S. Degree, Aero., Chem., Civil, Elec., Mech. & Electronic Engineering (inc. Radio, TV), 36 mo. B.S. degree in Math., Chem., Physics. Prep courses. Demand for grads. Spacious campus. 20 bldgs.; dorms, auditorium, gym. Low rate. Earn least \$3.1 approved. Enter Sept., Dec., March, June. Catalog.
1697 E. Washington Blvd.
Fort Wayne 2, Indiana
Keeping pace with progress

INDIANA TECHNICAL COLLEGE

**JEOP
HENRY-J
KAISER**

OWNERS

RE-POWER NOW with a V-8 engine — Use FORD — CHEVROLET — MERCURY in 2 or 4 Whl-Dr. Jeeps, Jeepsers, Sta-Wgn, Trucks or cars. Conversion Kits \$43.25 to \$59.95. If you want fast action tell us which engine you wish to use, give us year, Model (2 or 4 Whl-Dr) of your vehicle. Send Min. \$15.00 Dep. and we will ship correct kit, Bal. COD. Send full amt. for Prepaid shipment. Wire, phone or write for free details.

HOOSIER MACHINE PRODUCTS CO.

312 S.E. 6th St. Phone 676 Pendleton, Oregon

SELL TO UNCLE SAM!



That's how I made \$20,000 a year — selling junk jewelry to the U. S. Government. Send me your name and I'll show you how I did it.

LEARN AT HOME IN ONE EVENING

This is the most fantastic way of making money you ever heard of. That's because you do all your "selling" BY MAIL to one customer—the U. S. Government! Uncle Sam will buy all the old junk jewelry you send in at \$35.00 AN OUNCE for the gold it contains. Just follow my Plan and you can pick up gold on any street in your town. I show you where to find it, what to pay, how to test and how to mail to Uncle Sam for cash. I'll teach you the secrets by which I made \$20,000 a year. No charge for facts. No salesman will call. Send no money—just your name, address on postcard. **Leslie Patton, 335 W. Madison St., Dept. P-99, Chicago 6, Ill.**

Do You Laugh Your Greatest Powers Away?

THOSE STRANGE INNER URGES

You have heard the phrase, "Laugh, clown, laugh." Well, that fits me perfectly. I'd fret, worry and try to reason my way out of difficulties — all to no avail; then I'd have a hunch, a something within that would tell me to do a certain thing. I'd laugh it off with a shrug. I knew too much, I thought, to heed these impressions. Well, it's different now—I've learned to use this inner power and I no longer make the mistakes I did, because I do the right thing at the right time.

This FREE BOOK Will Prove What Your Mind Can Do!

Here is how I got started right. I had heard about hypnosis revealing past lives. I began to think there must be some inner intelligence with which we were born. In fact, I often heard it said there was; but how could I use it, how could I make it work for me daily? That was my problem. I wanted to learn to direct this inner voice, master it if I could. Finally, I wrote to the Rosicrucians, a world-wide frater-



nity of progressive men and women, who offered to send me, without obligation, a free book entitled *The Mastery of Life*.

That book opened a new world to me. I advise *you* to write today and ask for your copy. *It will prove to you* what your mind can demonstrate. Don't go through life laughing your mental powers away. Use the coupon below or write: Scribe D.E.R.

USE THIS GIFT COUPON

SCRIBE D.E.R.
The Rosicrucians (AMORC)
San Jose, California

Please send free copy of *The Mastery of Life*,
which I shall read as directed.

Name.....

Address.....

City..... State.....

The ROSICRUCIANS (AMORC) San Jose, Calif. (Not a religious organization)

Check the Kind of Body You Want



Charles Atlas

... and I'll Show You How EASILY You Can Have It!

Just tell me, in coupon below, the kind of body you want—and I'll give it to you SO FAST your friends will be amazed! "Dynamic Tension," my easy, 15-minutes-a-day method, will make your chest and shoulders bulge... arms and legs surge with power... your whole body feel "alive!"

FREE BOOK Learn how I became "World's Most Perfectly Developed Man"—Mail coupon! **CHARLES ATLAS, Dept. S-J, 115 East 23 Street, New York City 10, N. Y.**

CHARLES ATLAS, Dept. S-J, 115 East 23rd St., New York 10, N. Y.

Dear Charles Atlas: Here's the Kind of Body I want!
(Check as many as you like)

- | | |
|--|--|
| <input type="checkbox"/> More Weight—Solid—in the Right Places | <input type="checkbox"/> Powerful Arms, Legs, Grip |
| <input type="checkbox"/> Broader Chest, Shoulders | <input type="checkbox"/> Slimmer Waist, Hips |
| | <input type="checkbox"/> Better Sleep. More Energy |

Send me absolutely FREE a copy of your famous book showing how "Dynamic Tension" can make me a new man—32 pages, crammed with photographs, answers to vital questions, and valuable advice. No obligation.

NAME _____ AGE _____
(please print or write plainly)
ADDRESS _____
CITY _____ STATE _____

EXAMINE FREE . . . new complete home work shop guide on do-it-yourself

OVER 100 THINGS TO MAKE

ALUMICRAFT

Aluminum Projects for Your Home

by Emanuele Stieri

Now you can turn this "bright star of metals" into beautiful, useful objects for your home. Cuts, shapes, polishes easier than wood! Tools, materials, working drawings . . . everything illustrated step by step.

HOBBY OR PROFITABLE BUSINESS

Here's exciting new handcraft fun . . . profit too building for others. Expand your talents. Combine aluminum and wood. You need nothing but this book for expert results.

SEND NO MONEY.

Mail coupon for 10-day FREE EXAMINATION copy right away.



Stools
Chairs
Tables
Storm Sash
Louvers
Lamps
Toys, Trays



Beds
Doors
Baskets
Carts



PRENTICE-HALL, INC., Dept. 5688-L1
Englewood Cliffs, N. J.

Send ALUMINUM PROJECTS book. In 10 days I'll return it, or remit \$4.95, plus postage, in full payment.

Name _____
Address _____
City _____ Zone _____ State _____

SAVE: Send \$4.95 and we'll pay postage. Refund and return privilege guaranteed.

BUY WHOLESALE!

FOR SELF OR RESELL FOR BIG PROFITS! NAME BRAND APPLIANCES. TOOLS. WATCHES. CAMERAS. PHONES. SEWING MACHINES. JEWELRY. HOUSEWARES. SPORTING GOODS. TYPEWRITERS, ETC.

SAVE 30-80%

SAVE \$50.25!
PRISMATIC BINOCULARS

Precision built for brilliant magnification! Coated achromatic 6x30 lenses, individual focusing, folds on center pivot. FREE hard leather case.

\$14.75
p.p.d.
Money Back Guarantee

POWERFUL All-Purpose PAINT SPRAYER



\$7.72
p.p.d.
Money Back Guarantee

Apply paint, enamel, varnish, lacquer, etc. 50% faster! Completely self contained, no extras to buy! Just plug in — press trigger and spray! A professional job every time!

GET OUR BIG WHOLESALE CATALOG OF OVER 2,000 PROFIT MAKING ITEMS! POSTCARD BRINGS DETAILS FREE! MAIL TODAY!

Consolidated DISTRIBUTORS
CLIFTON 1 N. J.

Be an industrial designer

Combine your design abilities with technical aptitudes in Industrial Design training at Art Center School in California. Work under practicing professionals for upper level jobs as automotive stylists, product and package designers. Design offices, stores, motels, showrooms, shopping centers. Constant demand for graduates. Recent placements with Ford, G.M., Kaiser Aluminum, G.E., Raymond Loewy and other leading design studios, 700 students. Co-ed. Accredited. B.P.A. Degree. Four-year course can be completed in 2 yrs. 8 mos. by year-round training. New terms Feb., June, Sept. Enroll early. Write Mr. Mead for new catalog, 5353 West 3rd St., Los Angeles 5, California.

ART CENTER SCHOOL

BUILD FINE GRANDFATHER CLOCK NOW

The simple sensible SPEEDE Red-i-Kut way as thousands have—FOR YOURSELF OR SELL AT A GOOD PROFIT. SAVE HALF. SHOP TESTED PLANS "SPIRIT OF THE CENTURY" Narrow waist 80" tall or stately straight side "SPIRIT OF AMERICA." EASY-TO-FOLLOW photopack PLANS & LIFE SIZE PATTERNS tell all—plus MOVEMENT BROCHURE \$40 up also heavy brass weight Westminster, tube chime, movements, gorgeous bronze-silver MOVING MOON dials, 3 1/4" solid-mahogany case kits. Send \$1.00 today—both plans \$1.50 RUSH.

Kuempel Chime Clock Works, 29 Kuempel Bldg., Minneapolis 16, Minn.

MAKE BIG MONEY AT HOME!

INVISIBLE MENDING

Pays up to \$10 in an Hour!
Make moth holes, cigarette burns, tears, rips, disappear from all fabrics. Little-known craft pays extra spare-time profits at home. Write today for exciting details FREE!
FABRICON, 6238 Broadway DEPT. 329, CHICAGO 40, ILLINOIS

Learn ACCOUNTING Business Administration

Bookkeeping, secretarial and allied subjects at home in your spare time or attend nationally approved resident school. Write for FREE Success Book giving complete details on courses, plans, rates and employment opportunities. G.I. approved. Write Dept. A.

Hills BUSINESS UNIVERSITY AND EXTENSION SCHOOL
619 W. MAIN ST. OKLAHOMA CITY 2, OKLAHOMA

MEN! WE FIT W-I-D-E FEET!

E to EEEE Only
Sizes 5 to 13

Real comfort at last for w-i-d-e feet! We specialize in wide sizes and offer you styles you like to wear but can't find in the width you need. Fine dress shoes, work shoes, casuals, smart hand-sewn genuine moccasins. Top quality. Popular prices.

Money Back Guarantee
Not sold in stores. Write for FREE catalog today. No obligation! No agent will call.

HITCHCOCK SHOES, Hingham 28, Mass.



FREE CATALOG

Write Today

Prepare for a Good Paying Job — Or Your Own Business

Learn PRACTICAL RADIO-TV
with **25 BIG KITS**

of equipment I send you while
you train with me . . . for valuable
shop bench experience . . .



The new Sprayberry Training Television receiver, built and tested in sections.

I now offer this fine modern oscilloscope.

You build this powerful 2 Band superhet radio receiver.



You build the new Sprayberry Tester . . . 15-range Volt-Ohm-Milliammeter readings.

**Average cost per lesson
ONLY \$3.42
Including Kits and Equipment**

**"I Will Train You at Home in
RADIO-TELEVISION
on Liberal No Obligation Plan!"**

New Equipment! New Lessons! Enlarged Course! The true facts are yours in my big new catalog . . . **YOURS FREE . . .**

JUST MAIL COUPON!



**Frank L. Sprayberry
Educational Director**

I can train and prepare you in as little as 10 months to step into the big opportunity Radio-Television service field. Train *without* signing a binding contract . . . without obligating yourself to pay any regular monthly amounts. You train entirely at home in spare hours . . . you train as fast or as slowly as you wish. You'll have your choice of **THREE SPRAYBERRY TRAINING PLANS . . .** planned for both beginners as well as the more experienced man. Get the true facts about the finest most modern Radio-Training available today . . . just mail the coupon for my big new 56 page fact-filled catalog plus sample lesson—both **FREE.**

Train the Practical Way—with Actual Radio-Television Equipment!

My students do better because I train both the mind and the hands. Sprayberry Training is offered in 25 individual training units, each includes a practice giving kit of parts and equipment . . . all yours to keep. You will gain priceless practical experience building the specially engineered Sprayberry Television Training Receiver, Two-Band Radio Set, Signal Generator, Audio Tester and the new Sprayberry 18 range Multi-Tester, plus other test units. You will have a complete set of Radio-TV test equipment to start your own shop. My lessons are regularly revised and every important new development is covered. My students are completely trained Radio-Television Service Technicians.

NEWEST DEVELOPMENTS'

Your training covers UHF, Color Television, F.M., Oscilloscope Servicing, High Fidelity Sound and Transistors.

**See for Yourself . . . Make Your Own Decision
. . . Mail Coupon Today!**

The coupon below brings you my big new catalog plus an actual sample Sprayberry Lesson. I invite you to read the facts . . . to see that I actually illustrate every item I include in my training. With the facts in your hands, you will be able to decide. *No salesman will call on you.* The coupon places you under no obligation. Mail it now, today, and get ready for your place in Radio-Television.

SPRAYBERRY ACADEMY OF RADIO-TELEVISION

1512 Jarvis Ave., Dept. 10-5, Chicago 26, Illinois

Mail This Coupon For Free Facts and Sample Lesson



SPRAYBERRY ACADEMY OF RADIO-TELEVISION
Dept. 10-5, 1512 Jarvis Ave., Chicago 26, Ill.

Please rush all information on your ALL-NEW Radio-Television Training Plan. I understand this does not obligate me and that no salesman will call upon me. Include New Catalog and Sample Lesson **FREE.**

Name _____ Age _____

Address _____

City _____ Zone _____ State _____



PLAY RIGHT AWAY

ANY INSTRUMENT

—even if you don't
know a single note now!

NOW it's EASY to learn ANY instrument. No boring exercises. Even if you don't know a single note now, we'll have you playing delightful pieces RIGHT AWAY—right from your FIRST lesson! And properly, BY NOTE. Simple as A-B-C. Make amazing progress. No special "talent" needed. Learn at home in spare time, without a teacher. Low cost! Soon you can play any piece you wish. 900,000 students including TV Star Lawrence Walk. (59th successful year.)

FREE 36-PAGE ILLUSTRATED BOOK

—Just send this ad, with your name and address filled in below to: **U. S. School of Music, Studio A309, Pert Washington, N. Y.** (No obligation; no salesman will call.)



Name _____

Address _____

"I'M MAKING MORE THAN \$1000 a Month Haven't Touched Bottom Yet!"



C. KAMA

—reports Charles Kama, Texas, one of many who are "cleaning up" with orders for PRESTO. Science's New Midget Miracle Fire Extinguisher. So can YOU!



Amazing new kind of fire extinguisher. Tiny "Presto" does job of bulky extinguishers that cost 4 times as much, are 8 times as heavy. Ends fires fast as 2 seconds. Never corrodes.

Guaranteed for 20 years! Over 2 million sold! Sells for only \$4.95.

Show it to civil defense workers, owners of homes, cars, boats, farms, etc., and to stores for resale—make good income. H. J. Kerr reports \$20 a day. Wm. Wydallis \$15.20 an hour. FREE Sales Kit. No obligation.

MERLITE INDUSTRIES, Dept. P-15A
PRESTO DIV., 114 E. 32 St., New York 16, N.Y.
Canada: Mopac Co., Ltd., 371 Bowd St., Montreal 1, P.Q.

SHORTHAND IN 6 WEEKS

Write 120 words per minute
Age no obstacle—LOWEST COST

Famous SPEEDWRITING shorthand. No symbols; no machines; uses ABC's. Easiest to learn and use. Fast preparation for a better position. Nationally used in leading offices and Civil Service. 120 words per minute—50% FASTER than Civil Service requirements. Over 350,000 taught by mail or through classroom instruction. The very low cost will surprise you. Typing available. 34th Year. Schools in over 400 cities in U.S., Canada, Cuba, and Hawaii. Write For Free Booklet. © 1957, School of Speedwriting, N.Y.C.

DID YOU SEE
READER'S DIGEST
ARTICLE ON

Speedwriting

Dept. 1509-7, 55 W. 42 St., N.Y. 36

NOW NO ONE CAN KEEP
A SECRET FROM YOU!

20x-40x-60x only \$299
TELESCOPE postpaid

Amaze your friends... See what they're doing—without being seen!

Special Order now, get Free carrying case.

Money back guarantee. Send cash, check or money order.

3-range all metal telescope magnifies up to 60x power. Watch ball games, look at the moon, stars, animals, distant buildings... up close. Bright aluminum tube, made for long use. Good on hikes, camping trips, can use either 20x, 40x, or 60x power instantly. Variable focus eyepiece. No assembling, ready-to-use, no special instructions required.

L. J. STONE, Dept. T-B-9 • 1016 Oak St. • Santa Monica, Calif.

FIX OUTBOARD MOTORS POWERMOWERS, AND ALL SMALL 2 & 4-CYCLE GASOLINE ENGINES

Repair your own equipment or MAKE EXTRA MONEY in this growing field. Fully illustrated, easy-to-understand. Home Study Course. Write for FREE information.

LINCOLN TECHNICAL INSTITUTE
SUITE 9-E, 472 MARKET STREET, NEWARK 5, N. J.

DRAW The First Day! NO LESSONS! NO TALENT!



New Amazing Invention—"Magic Art Reproducer." You can draw your Family, Friends, Anything From REAL LIFE—Like An Artist! Even if YOU CAN'T DRAW A STRAIGHT LINE! Anything you want to draw is automatically seen on any sheet of paper thru the "Magic Art Reproducer." Then easily follow the lines of the "picture image" with a pencil for an original "professional looking" drawing. Also reduces or enlarges. SEND NO MONEY! Free Trial! Pay Postman on delivery \$1.98 plus postage. Or send only \$1.98 with order and we pay postage. Money Back Guarantee.

NORTON PRODUCTS, Dept. 140, 295 Broadway, N. Y.

WEAR IT ON
YOUR BELT!
IT REELS
BACK
YOUR
KEYS!



KEY-BAK KEY REEL

Carry your keys on a KEY-BAK key reel. Keeps keys handy! Safe! Keeps clothing neat. 24" long stainless-steel chain reaches all locks. Pocket-wash size. Sturdily constructed to last for years. GUARANTEED! For all who use and carry keys. Dealers Wanted!

LUMMIS MFG. CO., Pasadena 8, Calif. CTL CO., Wausau, Wis. \$2.95 Post.

RUPTURED

BE FREE FROM TRUSS SLAVERY

Now there is a new modern Non-Surgical treatment designed to permanently correct rupture. These Non-Surgical treatments are so certain, that a Lifetime Certificate of Assurance is given.

Write today for our New FREE Book that gives facts that may save you painful and expensive surgery, and tells how non-surgically you may again work, live, play and love and enjoy life in the manner you desire. There is no obligation. Excelsior Hernia Clinic, Dept. 8305, Excelsior Spgs., Mo.

POPULAR MECHANICS



RCA INSTITUTES offers you the finest of home study training. The equipment illustrated and text material you get with each course is yours to keep. Practical work with very first lesson. Courses for the beginner and the advanced student. Pay-as-you-learn. You need pay for only one study group at a time.

**Send for this
FREE Book Now** 

[RESIDENT SCHOOL courses in New York City offer comprehensive training in Television and Electronics. Day and evening classes start four times each year. Detailed information on request.]

RCA INSTITUTES, Inc. Home Study x PM-97

350 West Fourth Street, New York 14, N. Y.

Without obligation, send me FREE 52 page CATALOG on Home Study Courses in Radio, Television and Color TV. No salesman will call.

Name please print

Address

City Zone State

KOREAN VETS! Enter discharge date

In Canada—RCA Victor Co., Ltd., 5001 Côte de Liesse Rd., Montreal 9, Que.

To save time, paste coupon on postcard.

"TOOK IN \$217 FIRST 10 DAYS"

Some make more, some less

We help you to start Your
Own All-Year Business

Make Big Money! With our easily operated, highly efficient wall washer, Chas. Stelle took in \$217 gross in first ten days. E. L. Goss took in more than \$10,000 in one year. E. C. Taber wrote, "I made \$400 gross in two weeks." And no wonder—this machine washes walls 6 times faster and better than by hand. **Your Money-making Opportunity.** Enjoy independence—freedom from bosses, layoffs. Customers everywhere—homes, offices, schools, etc. Expenses low, profits high. No shop necessary; operate from home. Can start spare time until your full time is available.

Lose no time. Get all facts without obligation

FREE BOOK! MAIL COUPON TODAY!

- VON SCHRADER MFG. CO.
- 910 "W" Pl., Racine, Wisconsin
- Send at once (no obligation) your FREE booklet containing information about your
- WALL WASHING MACHINE and how I can start my own permanent, profitable business.
- Name _____
- Address _____
- City _____ Zone _____ State _____



NEVER AT THIS LOW PRICE! GENUINE 135-POWER ACHROMATIC TELESCOPE

with Achromatic Lens and
4-POWER FINDER attached **ONLY \$18.95**
PREPAID

EXTRA BONUS GIFTS:

- 273 page book, "Handbook of the Heavens"
- Magic Star Finder Dial
- 220X & 400X Eyepiece lenses

5 Magnifications 18X—35X—65X—85X—135X

Brings the Moon, Planets, Stars, People
135 times Closer, Clearer, Sharper

Never before has an ACHROMATIC 135X telescope with range finder and tripod sold for anywhere near this amazing low price! Now you can not only explore the heavens and bring the moon, planets, stars 135 times closer, but you can observe all distant objects, people, ships too, because all pictures are erect, not upside down as in all astronomical telescopes. The kind of needle-sharp color-free viewing only a genuine achromatic lens can bring you. Ready for immediate use. 5 precision lenses bring you viewing at 18X—35X—65X—85X—135X. Tubes extend to 43" made of bakelite, finished in camera bellows black, trimmed with gleaming brass. 4 power finder scope (30mm Lens) mounted on main tube is feature usually found on more expensive telescopes—brings difficult objects on target before observing with main scope. For extra stability 5 ft. hardwood folding tripod is equipped with heavy cast iron head fitted with Criterion's famous 360 degree all aluminum mount that locks instantly in any position. Obtainable only from Criterion Co. shipped prepaid, 4 famous gifts—273 page book "Handbook of the Heavens." Magic star finder dial that aids in locating stars ANYWHERE at ANYTIME of the year. 220X & 400X eyepiece lenses included free for experiments. You must be completely satisfied with this super offer or your money back in full. Shipped Complete, nothing else to buy at amazingly low price of **\$18.95**. Without tripod **\$14.95**. Send Cash, Check, or Money Order today

Dept. PMA16, CRITERION CO., 331 Church St., Hartford, Conn.



This FREE Lesson Proves You Can

Learn TV Repair in one short week!

SAVE \$200.00
and more—
IMMEDIATE
PROFITS

BOTH FREE!
Write!



Why pay up to \$250 for training—study months or years? My new SIMPLIFIED TV REPAIR METHOD lets you make \$10 to \$20 the first day! No confusing electronic "double talk"—but a wealth of practical "know how." 1000's have already proved that if you can replace a lightbulb, you can make good money immediately, repairing all makes of sets. It's amazing—and, it's true! For proof send for FREE Sample Lesson and Business Plan now! No salesman will call. ELECTRONIC ENGINEERING, Dept. A-179, 1038 So. LaBrea, L. A., California



WORLD'S LOWEST PRICED ADDING MACHINE

Counts up to 999,999,999
IDEAL FOR BUSINESS AND PERSONAL USE—GUARANTEED ACCURATE.
Not a toy. Operates with only a finger flick. Adds, subtracts, multiplies, divides. Counts up to one billion. Pays for itself over and over. Ideal Gift—for Business, Income Tax and School Use.
MONEY BACK GUARANTEE. Send name and address. Pay postman only \$2.95 plus postage. Beautiful rich-looking Leatherette Case included at no extra cost. Money back in 10 days if not delighted. AGENTS WANTED.

CALCULATOR MACHINE COMPANY
P.O. Box 126, Dept. U-57, Huntingdon Valley, Penna.



Easy to make your own BOWS—ARROWS—EQUIPMENT

Illustrated Hand-Book 84 pgs. \$1, tells you how! Large Colored Catalog 5c—Send for it!

Ask your dealer for "Stemmler's Archery" (Oldest Mfr. in U.S.A.)

L. E. STEMMLER CO.

Manorville (Box 1) L. I., N. Y.



DRAINS cellars, cisterns, wash tubs; \$7.95 IRRIGATES - CIRCULATES - SPRAYS

Up to 3,000 GPH; 450 GPH 80' high; or 1800 GPH from 25' well. Use 1/6 to 3/4 HP motor. Coupling included free. 1" inlet; 3/4" outlet. Stainless steel shaft. Won't rust or clog. Type P—\$7.95. HEAVY DUTY BALL-BEARING PUMP. Up to 7,500 GPH; or 3,000 GPH from 25' well. 1 1/2" inlet; 1" outlet. \$12.95. Postpaid if cash with order. MONEY BACK GUARANTEE. Centrifugal and Gear Pumps in All Sizes. LABAWCO PUMPS, Belle Mead 7, New Jersey

BRONZE FOUNDRY



Schools • Home Workshops • Inventors

Make your own castings of aluminum, copper, bronze, silver. Foundry sets are available in three sizes including 2400 Deg. F. blast furnaces. \$26.50; \$33.50; and \$46.00 f.o.b. Marysville or Lakewood. Free Circular.

KANSAS CITY SPECIALTIES CO. (Dept.) Box 6022, Marysville, Kans. P-9 / or Box 7543, Lakewood, Colo.

RUPTURED? NEW LASTING RELIEF

ENJOY NEW FREEDOM

of action, amazing peace of mind and comfort at work or play. New pleasure replaces rupture pain. The proven, patented MILLER holds your rupture back Day and Night... bringing you new lasting relief as it has thousands of others.
FREE! Write for relief FACTS free. Send name and address to:
FRED B. MILLER, Dept. 1-N
Exclusive Manufacturer
Hagerstown, Maryland

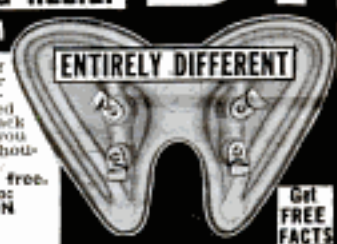

Get FREE FACTS

WAR SURPLUS BARGAINS

WAR SURPLUS BARGAINS

\$500,000.00 INVENTORY for QUICK LIQUIDATION

Surplus items—hundreds of them for home, shop, factory, farm and outdoor use. New items, used items, reconditioned items—all at tremendous savings—all priced for quick sale.

Page After Page of Values

This big catalog shows page after page of amazing money saving values. Write for your copy today. Send 10c to cover postage, mailing, etc. Write today! **SEND TODAY FOR YOUR COPY**

10c

STARK'S 212 W. Madison St.
Dept. PM-579
CHICAGO 6, ILL.

A POSTCARD PUTS YOU IN BUSINESS!

Earn \$84.00 EXTRA a Month on just 5 Sales a Week!

Go into business without spending a cent! My powerful FREE Sales Kit makes it easy to take orders for Mason's fast-selling line of leather jackets. Your friends, relatives, outdoor workers will grab these from you, paying you Big Profits on each order! Just sell 5 of our popular Pleece-lined Leather jackets a week, to make \$84 extra income a month! Besides jackets of Horsehide, Capeskin leather, Suede, Nylon, Gabardine, Wool... take orders for 174 fine shoe styles for men, women, including popular Air-Cushioned work shoes. People MUST buy from you, because we do not sell through stores! To start at once, rush postcard for your free money-making Sales Kit!

MASON SHOE MFG. CO., Dept. 784, Chippewa Falls, Wisconsin

FREE KIT!



BE A CAMERA CRAFTSMAN...

Send for FREE BOOK!

More are needed in this big paying field and now you can learn to repair cameras using manufacturer's service methods of focus... in your spare time! Repairs, tools, practice equipment—everything you need is included in this approved course! Write for big FREE illustrated booklet that tells you MORE!

national camera repair school - DEPT. V-9 ENGLEWOOD COLORADO

SCIENTIFIC CRIME DETECTION

IT'S EASY TO LEARN

Let us teach you in your own home. Learn Fingerprinting, Firearms Identification, Police Photography, Criminal Investigation Methods thoroughly, quickly, at small cost. Over 800 Bureaus of Identification in the U. S. employ I. A. S. students or graduates. Write today, stating age.

INSTITUTE OF APPLIED SCIENCE, 1920 Sunnyside Ave., Dept. 1356 Chicago 40, Ill.
(A Correspondence School Since 1918)

24 YEARS IN BUSINESS AT THE SAME ADDRESS. NEARLY EVERYONE BUYS FROM STANDARD.

"We Have No Rent to Pay." That is Why We Can Sell For Less.

Our entire stock of very slightly worn **EXTRA MILEAGE TOP GRADE** Tires. (Written Insurance Guarantee). **SEND AD**

EVERYBODY 10% off ON EVERY TIRE

Free—Tube With Each Passenger Tire

FREE If you buy 2 or more Passenger 4-ply tires, WE GIVE ONE tire FREE, on each order. Does not include W.W. or Truck Tires, or Snow Tires. Write for other sizes.

12 MOS. WRITTEN GUARANTEE WITH EVERY TIRE					
800-16 (6)	\$6.62	800-18	\$6.32	700-17	\$10.92
825-20	\$10.52	825-20	\$10.52	825-20	\$10.52
850-16 (6)	7.22	820-15	6.32	750-17	11.32
870-15	8.52	700-15 (6)	8.72	700-20	11.82
710-15	5.82	750-16 (8)	9.92	750-20 (8)	12.82
760-15	5.82	750-14	11.52	750-20 (10)	15.92
				1000-22	21.52

"EXTRA SPECIAL" TOP QUALITY all size 4-ply pass. \$8.72

FREE TIRE with 2 or more of these also—W.W. \$1.00

Extra Factory Tested Tube given—GIANT TIRE SALE. EA.

SNOW TIRES \$8.82 ORDER ANY 4 PLY PASSENGER SIZE 12 MO. GUAR. BLACK WALL DEEP HEAVY TREAD FOR ROUGH WINTER WEAR.

Thousands of tires shipped all over the U.S.A. All tires shipped F.O.B. Phila. Send Check or M.O. with this ad. Dept. 2. No C.O.D.

STANDARD 834 N. Broad St., Philadelphia 30, Pa.

America Is Short 100,000 Auto Mechanics!

WHY NOT BE ONE?



It's easy to train at home for a TOP-PAY JOB with a BIG FUTURE!

Stop worrying because you need a better job—or because you need more pay! **Over 100,000 jobs are waiting right now for newly-trained auto mechanics.** Here's why: There are 60 million cars and trucks on the road—and one-third need heavy repairs. Over 7 million new vehicles are made annually—also need service. No wonder the demand is big for auto mechanics—why pay is tops, work is steady!

YOU CAN LEARN AUTO MECHANICS in months, at home in spare time. Let CTI train you with its famous Shop Method. It's easy. It's fast. *Mail coupon for free details.*

You Practice with Tune-Up Kit and Tools



CTI training is practical. You get a valuable Tune-Up Kit, the kind that experienced mechanics use to locate engine troubles. You receive a Compression Tester; Vacuum Gauge & Fuel Pump Tester; Ignition Timing Light; portable steel case. You also get a set of professional mechanic's tools, including socket set with extension. You'll use instruments and tools to practice, to make repairs, to earn money as you train. (Note: Diesel Mechanics or Body-Fender Repair instruction too—at no extra cost.)

Many Students Make Money as They Train

Soon after they begin training, many students fix cars for others. They not only acquire useful experience—they also earn money. Their earnings help pay tuition, buy shop equipment, start many in business. *Mail coupon for details.*

COMMERCIAL TRADES INSTITUTE

1400 GREENLEAF AVENUE DEPT. A-622
CHICAGO 26, ILLINOIS

Send booklet, *Big Money in Auto Mechanics*, and Sample Lesson. BOTH FREE.

Name _____ Age _____

Address _____

City _____ Zone _____ State _____

MAIL TODAY

"Tell Me What You Want



PAUL ANDERSON,
World Champion,
Gold Medal
Olympic Champion,
Official World
Record Holder,
The Strongest
Man in the World

- Health Strength More Weight
 Less Weight Mental Control
 Poise Muscular Development

**I WILL SHOW YOU
How To Get It"**

**Says Paul Anderson
Strongest Man in the World**

"I was thin, underweight and almost died of Bright's Disease in my youth. My parents' prayers brought me through and my determination to gain strength led to my discovery of four great secrets. This discovery explained and applied, as I show you how to do it, will give you giant strength in easy steps."

GET FREE BOOK—MAIL COUPON

Write today and learn how vigor, health, a fine physique, the admiration of friends can be yours. Follow the simple instructions of my course—only a few minutes a day and you can build your body as I have built mine. You can win trophies as I have won them and be in the limelight—in sports, social events, etc. Act NOW!

PAUL ANDERSON
Toccoa, Ga.

PM9

Without obligation please send me your free book fully illustrated and describing your 4-secret body building system.

Name _____ (Please Print)

Address _____

City _____ Zone _____ State _____

OUR BEST VALUE OF THE YEAR!

**2 1/2 AMP. SUPER POWER
1/4" THOR SPEEDRILL**

with Geared Chuck—AC-DC 2400 RPM



**BRAND
NEW!**

\$14.95
plus 50c
hdg.

If your work calls for a "rugged" drill with POWER to SPARE, insist on a 2 1/2 Amp. job . . . and make sure it's THOR! No finer drill made! Solid steel, heat-treated helical gears; thrust taken on hardened steel ball and plate; gears permanently packed and sealed in LIFETIME grease! Switch, trigger and lock assembly simplifies locking and releasing trigger. You'll be wise to buy 2 at this price. Supplies limited!

Bigger Drills at Lower Price!

**4 pc.
High Chrome
SPEED SET**
Reg. \$42.50
NOW
\$9.95
plus 50c
pp., hdg.

Another of Scott Mitchell's famous tool bargains! The original \$42.50 price is right on the package, but you pay only \$9.95! The reason? A large tool wholesaler needed warehouse room badly. So he closed out a large quantity of these high quality drill sets to us! A wonderful buy for advanced hobbyists, carpenters, construction workers, factories, machine shops! Made of high quality, specially hardened steel, with turned down shanks to fit all 1/2" electric drills. Zip through hardwoods, aluminum, iron, plastics, even the toughest steel! Sizes: 3/8", 3/4", 1". Come in numbered pocket, snap closure tool roll. Extra Special! 11 Pc. Set, Reg. \$99.50, NOW ONLY \$29.95 plus \$1 pp., hdg. Same features as 4 pc. set. Sizes: 9/16", 5/8", 1 1/16", 1 1/8", 1 1/4", 1 3/16", 1 1/2".

AMAZING BLOCK & TACKLE

• PORTABLE—weighs 13 ozs. fits in pocket!
• One Hand Operation
• POWERFUL—lifts up to 1000 pounds!

For
• HUNTERS • HANDYMEN
• FARMERS • TRUCKDRIVERS
• YACHTSMEN • MOTORISTS

The great strength, small size, complete portability of the Midget Block & Tackle gives it many uses. In car, home, factory, farm. For sportmen; loading deer, boats, etc. For lifting heavy articles anywhere! Best grade aluminum. Steel axles. Lubricated for life! Two lifting slings, top and bottom. Heavy welded steel rings. Slings can be doubled for extra strength. With 60 ft. nylon cord, 5-1 ratio, 1000 lb. test. Carrying bag, instructions. 1 yr. guarantee. **\$9.95** ppd.

Also Available—Tiny Babe! Lifts up to 2000 lbs.! With 100 ft. nylon cord, 7-1 ratio, 2000 lb. test, 15 oz. wgt. Twice as powerful as **\$12.95** ppd. \$9.95 model, only **\$12.95** ppd.

Send Check or M.O. C.O.D. fee extra **MONEY BACK GUARANTEE**

SCOTT-MITCHELL HOUSE, INC. Dept. M-436, 611 Broadway New York 12, N. Y.

INVENTORS

PROTECT YOUR INVENTION BY A U. S. PATENT. SEND FOR FREE "INVENTION RECORD" FORM AND "PATENT INFORMATION EVERY INVENTOR SHOULD HAVE."

CARL MILLER
REGISTERED PATENT ATTORNEY

WOOLWORTH BLDG., 36th FLOOR, 97A
NEW YORK CITY

INVENTORS

Whether an invention is patentable can be substantially determined by a search of the U. S. Patent records. Without obligation, write for information explaining the steps you should take to secure a patent.

JOHN N. RANDOLPH

Registered Patent Attorney

201 Columbia Building, Washington 1, D. C.

INVENTORS

Send for **REGISTERED PATENT**
PATENT INFORMATION **ATTORNEY**

Book and **INVENTOR'S RECORD** ASSOCIATE EXAMINER
without obligation U. S. PAT. OFF. 1922-1929

GUSTAVE MILLER Patent Attorney & Advisor
97-PM WARNER BUILDING U. S. NAVY DEPT. 1930-1947
WASHINGTON 4, D. C. **PATENT LAWYER**

INVENTORS

U. S. Patents protect your inventions. Our free book of "Instructions on Patent Procedure for Inventors," also "Certificate of Invention" form sent without obligation.

C. A. SNOW & CO.

REGISTERED PATENT ATTORNEYS

428 SNOW BUILDING WASHINGTON 1, D. C.

INVENTORS

I shall be pleased to furnish you, upon request, with full information relative to patent procedure—without any obligation on your part.

PATRICK D. BEAVERS

Registered Patent Attorney

934 Columbian Building Washington 1, D. C.

Enjoy the Fascinating Story
of the Horseless Carriage in

Popular Mechanics

AUTO ALBUM

166
Illustrations

The most intriguing book about the automobile ever printed. It's thrilling, fascinating and informative. From the very first gasoline-propelled buggy to the cars of today and the atomic auto of the future. The first cars—the men who made them—the scrambled start and the development of the fabulous auto industry—the story of auto racing—the growth of the Nation's highways. 166 thrilling action pictures—old-time cars—racing cars—early auto advertising—automotive oddities. Roll call of names of more than 2000 autos made in the U.S. included. Ideal gift book. Cloth bound, only \$3.00 by mail. Money back if not pleased.

POPULAR MECHANICS PRESS, Dept. PM-957
200 East Ontario Street Chicago 11, Illinois



**A HIGHLY
RESPECTED TRADE—
START SOON TO
EARN EXTRA MONEY
IN SPARE TIME**

Learn at Home IN YOUR SPARE TIME to Fix Electrical Appliances

To build a better future, get into a field where there's much important work and the security that comes from knowing a good trade. Servicing electrical appliances offers that OPPORTUNITY. Every wired home has an average of 8 electrical appliances. Up to 10 million new appliances are sold every year and owners pay well to keep them in repair. That's making a fast-growing need for trained men.

Start Soon to Earn \$3, \$4, \$5, an Hour Extra in Your Spare Time

Start soon to fix electric toasters, clocks, fans, vacuum cleaners and other appliances for neighbors and friends. Work in your basement, garage or spare room. Pick up \$3 to \$5 an Hour *extra that way*. It's easy to increase your earning power—to pay for this training many times over with your spare time earnings.

Learn and Earn with Multi-Use Tester Built with Parts We Send

This course includes the parts to build a portable, sturdy Appliance Tester that helps you locate electrical defects quickly and easily. You use it to learn and do actual electrical appliance repair jobs. If you want better pay learn this good trade. No need to give up your present

job. You can train at home in your spare time for only \$2.50 down and \$5.00 a month. A small price to pay for increased earnings, a more secure future. Paste coupon below on a 2c postal or mail in envelope for free book and sample lesson. Address **National Radio Institute, Dept. AJ7, Washington 16, D.C.**

**2c TO MAIL THIS
COUPON MAY START
YOU TO SUCCESS
LESSON AND BOOK
FREE**



NATIONAL RADIO INSTITUTE, Dept. AJ7, Washington 16, D. C.

Please send me Electric Appliance Training lesson and book free. (No salesman will call.)

Name Age

Address

City Zone State

ACCREDITED MEMBER NATIONAL HOME STUDY COUNCIL

LEARN UPHOLSTERY

in your spare time
run your own
business
AT HOME



FREE BOOK
with
sample
lessons
with course
YOU MAKE
SLIPPER
CHAIR
CLUB
CHAIR
OTTOMAN
PLUS
SLIP COVERS
Yours to Keep
or Sell



BE YOUR OWN BOSS
Earn more from the start! Set up your own profitable business, in your own home, enjoy steady income, independence for life—in the booming field of Custom Furniture Upholstery. Right off you start learning with tools, complete frames, fabrics and materials, included FREE with practical UTS course. You learn skilled professional custom upholstery, reupholstery, furniture finishing, repairs, how to make beautiful slip covers, window cornices, cushions and draperies. **EARN WHILE YOU LEARN**, in your spare time AT HOME... the UTS easy way.

FREE ILLUSTRATED BOOK—FREE SAMPLE LESSON
Get ready for well-paid job and big profits, from steady work, as your own boss, running your own business. Mail coupon NOW for FREE BOOK! Training in N. Y. School also available, APPROVED FOR VETERAN TRAINING

UPHOLSTERY TRADES SCHOOL
Dept. FO-310, 721 B'way, N. Y. 3, N. Y.

Please send me FREE book "Your New Way to a Successful Career," and FREE sample lesson. No obligation—no salesman will call.
 Home Study N. Y. School Training

Name _____ (Please Print Plainly)
Address _____
City _____ Zone _____ State _____
 Check if Korean Veteran

... TURN CONCRETE INTO GOLD!



MAKE UP TO \$75 A DAY IN YOUR OWN BUSINESS

If you want to have your own business — to start a business on your own — here's your big opportunity! New high speed, low cost General block machine produces up to 1,000 concrete blocks a day. Sell all you make to builders, supply houses, and others for homes, factories, buildings, garages. Cash in on the building boom! You can make profits of 100% to 150% — up to \$75 a day! General block machine equipped with 1/2 h.p. electric motor — or can be supplied with gasoline engine — works anywhere, in little space, indoors or out. Operates on ordinary house light socket. Simple, foolproof 3 step operation — so easy a child can do it. Makes superior 3 cone blocks any size from 4" to 12". Also makes chimney, sink, corner and other types. Blocks meet any building code anywhere in the country. Materials — sand, water, cement, available anywhere. Simple illustrated operating instructions and mixing formulae for cement and binder blocks supplied with each machine. Write for FREE folder with full information.

MOTOR DRIVEN

R.L.T. of New York City reports: "MY GENERAL BLOCK MACHINE PAID FOR ITSELF IN FIRST 2 WEEKS!"
Hundreds now in use the world over!
Write for FREE details today!

EXTRA
Amazing illustrated book gives floor plans for 6 sensational concrete block bungalows. Tells how to lay blocks, lay out building lines, mix concrete, build steps, porch and concrete floors all at great savings. Written by experts. Can save many times the cost of the machine! Get it now! No strings attached. Send \$1.

BOOK SENT FREE IF YOU BUY MACHINE. \$1 REFUNDED IF YOU BUY LATER.

GENERAL ENGINES CO.
DEPT. M-97, ROUTE 130, THOROFARE, N. J.

HOW TO BUILD YOUR OWN CONCRETE BLOCK HOME
Only \$1.00 Postpaid

GIANT 6 FOOTERS

59c



Wow! Genuine Neoprene government surplus (never used) . . . giant 6 ft. across, 21 ft. around . . . at a fraction of original cost. Durable. Can paint on advertising message, inflate and fly. Visible for miles. Great for attracting crowds to fairs, openings, school proms, gas stations. Fun for young and old in backyards or picnics, at the beach, etc. use as water markers & buoys. Order today — only 59c each.
Special: 2 for \$1.00; 5 for \$2.00; 13 for \$5.00. No C.O.D.

P.O. Box M-27104, Hollywood 27, Calif.

FREE "How To Start Your Own MAIL ORDER BUSINESS"

Earn from \$10,000 to \$20,000 spare time. We'll put you in business and furnish you with everything needed. Exclusive new catalog every three months . . . Offer your customers one item free for every two they buy! Free advertising and no stock for you to buy. We ship for you under your own name. No experience required. Write today for free booklet and franchise data.

MAIL ORDER ASSOCIATES, ROCHELLE PARK 27, NEW JERSEY



Mr. "N" Made \$9,700 Last Year By Selling Just 20 KEEP/SAFEs a Month!

Like Mr. "N" you can profit with KEEP/SAFE — the fine personal safe that undersells all others. Only safe sold direct. 85% of homes, farms and small businesses are prospects. \$30 to \$71 profit per sale, plus bonuses up to \$12 a safe. Choice territory, chance to become district agent. FREE DEMONSTRATOR! Get details, giving address including county.

JOHN D. BRUSH & CO., INC.
575 West Ave. Rochester 11, N. Y.

earn as TAX EXPERT

\$15 HOUR

Our students earn as much as \$3,000 in 3 short months preparing income tax returns in spare time. Also operate lucrative year-round Business Tax Service. Digitized home-office business. Experience unnecessary. We train you, help you start. State approved home training program. Write today for free prospectus.

UNION INSTITUTE, 68 Hudson, Hoboken 20C, N. J.

250 POWER



Complete Telescope Lens Kit only **\$3.49** postpaid

Conquer Space, Explore the Universe, Planets, Moon Craters, New Stars, etc. Complete Lens Kit consists of 80 inch focal length ground and polished objective lens, eyepiece lenses for 20 POWER, 100 POWER, 150 POWER, 200 POWER, 250 POWER, and all necessary lens fittings. Easy to make from simple step by step instructions. (Tripod and mount not included.) Money back guarantee.

BUSSE SALES CO., Hartford, Conn., Dept. PM 61

Take the **ache** out of

GUMS RUBBED SORE BY FALSE TEETH

Get quick-soothing relief of sore, throbbing gums by applying medically-formulated NUM-ZIT Adult Strength. Thousands of false teeth wearers have already had this blessed relief. Pleasant-tasting NUM-ZIT eases discomfort while you break in new false teeth. Works wonders, too, for relief of toothache, neuralgic pains. Keep it handy for quick first aid. At all drug counters.

Adult NUM-ZIT
Another fine Purepac product

POPULAR MECHANICS

REPAIR ANY WATCH



... Swiss or American

No previous experience needed to learn modern watch repair. An enjoyable hobby or profitable career. Unique Sweazey System starts you making repairs right away. Develops your skill step by step. Teaches you modern shop methods . . . professional short cuts . . . mistakes to avoid. Learn by personal attendance or spare time home study. Free sample lesson. No obligation. Write today!

**FREE
SAMPLE
LESSON**

CHICAGO SCHOOL OF WATCHMAKING
2330 N. Milwaukee, Dept. 197, Chicago 47, Illinois

Finish HIGH SCHOOL AT HOME

Complete 4 Yrs. in 12 Months

Learn More! Earn More! Enter professional or technical schools. Advance Socially. Live a Happier, Fuller Life. Individual Courses or complete schedule. **WRITE FOR SCHOOL BULLETIN.**

ACADEMY FOR ADULTS

30 W. Washington, Dept. PM-97, Chicago, Ill.

Official SEA, AIR & LAND PHOTOS

SPECIAL INTRODUCTORY OFFER!

1. 4-3 1/2 x 5 Carrier, Subs and Battleships
2. 4-3 1/2 x 5 World War II planes
3. 4-3 1/2 x 5 photos, world's fastest jets
4. 1-8x10 photo, Ferretal Carrier
5. 1-8x10 photo USN F11F-1 Tiger

Only 25¢ a set. Send \$1 for all 5.
(\$2 value)

Illust. CAT. with order. Money back guar.

U. S. SEA & AIR PHOTOS



DEPT. PE BOX 75084
LOS ANGELES 5, CALIFORNIA

STUDY TO BE A DOCTOR

of Psychology or Metaphysics

Obtain a Ph.D., M.A., or Ph.D. Be a Teacher, Lecturer or Accredited Practitioner. Teach others how to achieve Health, Happiness and Contentment. Chartered by State. Correspondence Courses only. Write for FREE book telling how.

THE NEOTARIAN FELLOWSHIP

Desk B, Pickwick Building Kansas City 6, Missouri

BUY FAMOUS BRANDS WHOLESALE!

- APPLIANCES
- WATCHES
- TYPEWRITERS
- HOUSEWARES
- SPORTING GOODS
- CAMERAS
- CLOTHING
- JEWELRY
- TOOLS
- GIFTS

DISCOUNTS UP TO 80%

All brand new, nationally advertised merchandise. Guaranteed. No returns.

Send Postcard For Free Details

MIDWEST SALES (PM-156) Pontiac, Illinois



wamo FENCING FOILS

These handsome swords are made of fine carbon spring steel and are ideal for learning the art of fencing

special price TWO for \$2.98

or can be hung as wall display in den. The polished metal guards with blood red and silver cordons, beautifully set off the solid alder grips. Once used in deadly combat, now an exciting sport. A real bargain, \$2.98 with instructions and safety tips. At sports dealers or send:

WAMO MFG. CO., Box 21-B, San Gabriel, Calif.

Your choice of school is highly important to your career in



**INDUSTRIAL
ELECTRONICS**



**RADIO-
TELEVISION**



**ELECTRONICS
COMMUNICATIONS**

Become an
ELECTRICAL ENGINEER
or an
ENGINEERING TECHNICIAN
at

MSOE in Milwaukee

Choose from courses in:
ELECTRICAL ENGINEERING
Bachelor of Science degree in 36 months.
Communications or Electrical Power option.

ENGINEERING TECHNOLOGY
Assoc. in Applied Science degree—in 18 months.
Electronics Communications
Electrical Power.

MSOE—located in Milwaukee, one of America's largest industrial centers—is a national leader in electronics instruction—with complete facilities, including the latest laboratory equipment, visual aid theater, amateur radio transmitter—offers 93 subjects in electrical engineering, electronics, radio, television, electrical power, and electricity.

Advisory committee of leading industrialists. Courses approved for veterans. Over 50,000 former students. Excellent placement record.

Previous educational, practical, and military experience evaluated for advanced credit.



TERMS OPEN SEPTEMBER, JANUARY, APRIL, JULY

Write today!
Choose wisely—your future depends on it.

MILWAUKEE SCHOOL OF ENGINEERING

Dept. PM957, 1025 N. Milwaukee St.
Milwaukee 1, Wisconsin

Send FREE career booklets. (Please print)

I am interested in _____ (Name of course)

Name _____ Age _____

Address _____

City _____ Zone _____ State _____

Eligible for veteran's educational benefits? Yes _____ No _____

TRAINED MEN NEEDED!

**IN INDUSTRY - ARMED FORCES
BIG PAY! - GOOD FUTURE!**

- DIESEL ELECTRONICS
 AUTO AUTOMATION

NEVER BEFORE has the opportunity been so good for the properly trained mechanic and technician to step into **BIG PAY POSITIONS** with rapid advancement and future security virtually assured.

YOUR SUCCESS depends on the quality of training you receive... and the reputation of the school you attend.

YOUR GUARANTEE we are giving the best in mechanical and technical training is proved by the fact... High pay jobs in Industry, and ratings in the Armed Forces now waiting for our graduates.

RESIDENT SHOP TRAINING is easier and costs less than you may think! We provide you with housing and part-time jobs while in school, plus free nation-wide placement service for graduates.

Check subject above in which you are interested and mail for

FREE BOOKLET

BAILEY
Technical Schools

Veteran Approved

1634 S. Grand, St. Louis 4, Mo.

Name _____ Age _____
Street _____
Town _____ Zone _____ State _____

Your Future
in
ELECTRONICS
AND
AUTOMATION

Your Future
in
DIESEL and
AUTO
MECHANICS

MONEY BACK

Guarantee



NEW TIRES—FACTORY ADJUSTED, NOT SECONDS

Take advantage of this terrific money-saving opportunity. We've made a sensational purchase of 5 carloads of nationally advertised factory fresh tires... tires with treads so thick that you can be sure of top performance and thousands and thousands of safe driving miles. Many of these "like new tires" have as little as 500 to 1,000 miles on them... many have even less. All tires sold on a first come, first serve basis... at these **LOW, LOW PRICES**. Our quality tire is your insurance for complete driving safety!

640 x 15	\$5.00	760 x 15	\$6.50
650 x 15	\$5.50	800-820 x 15	\$6.75
670 x 15	\$5.75	600 x 16	\$5.75
710 x 15	\$6.25	650 x 16	\$6.00

BONDED TIRES, Inc.

30 Windsor Avenue, Mineola, L. I., N. Y.

O.K. rush me _____ Tires _____ Size _____
(number)

Total remittance enclosed \$ _____

NAME _____

ADDRESS _____

CITY _____ ZONE _____ STATE _____

Send check or money order. No C.O.D. please. Prices F.O.B. Mineola. Add local sales tax, if any.

BUY BELOW WHOLESALE

START YOUR OWN HOME-IMPORT BUSINESS

Make big profits on thousands of exotic imports. No experience or investment in products needed. Famous world trader guides men and women—shows you how to pocket profits before ordering, how to get free ads, how to start full or spare time home mail-order business or take volume orders from stores. Export opportunities also. Full details, booklet and list of 157 imports showing amazing low foreign prices—**ALL FREE**. Air mail reaches us overnight. Write **MELLINGER CO., Dept. 6259** 1717 Westwood, Los Angeles 24, Calif.

NEW 18 ft. OFFSHORE CRUISER KIT

17 Models as low as \$42.00 (freight included). Fiberglass boat covering kits, marine supplies, etc.

TAFT MARINE WOODCRAFT
Dept. PM-957 • 636 39th Ave. N. E. • Minneapolis 21, Minn.

ART LEARN AT HOME!

Enjoy glamorous high-pay career or profitable hobby. Learn Commercial Art, Illustrating, Cartooning, Fashion Art, Lettering, T. V., etc. We train you at home, in spare time. Low cost, 22-pc. art outfit free of extra cost. Write for **FREE** Book describing easy method. No obligation. No salesman will call on you. Washington School of Art, Studio 149, Port Washington, N. Y. (Etab. 1914)

LOCKSMITHING

Practical Up-to-Date Course — **ONLY \$5.95**

53 illustrated self-instruction lessons. Easy to learn. Full price only \$5.95 postpaid—or C.O.D. plus postage. Satisfaction guaranteed or full refund! **NELSON HALL CO., 210 S. Clinton St., Dept. JT-2, Chicago 6, Ill.**

A POSTCARD CAN PUT YOU IN A FINE BUSINESS!

Rush Card TODAY for FREE OUTFIT! Get into highly profitable, repeat-order shoe business! Sell new line of Air-Cushion comfort shoes to friends, neighbors, folks at work! Over 210 dress, sport, work, safety shoe styles for men, women. Never sold by stores. Just 5¢ orders a day—in spare time—bring you \$17 extra income a month! No investment. Rush name and address TODAY for **FREE SELLING OUTFIT!** **MASON SHOE, Dept. 785, Chippewa Falls, Wis.**

FREE AMAZING NEW BOOK "HOW TO ANSWER ADS"

Never before have you seen anything like this. Tells you in simple language the correct way to answer ads. Gets you quicker replies—better results, and greater satisfaction. Will save you time and money and it's **ABSOLUTELY FREE**. No obligation whatever. Every reader of advertising should have this booklet. Send a postcard for your copy **NOW**. **F. W. JOHNSON, Popular Mechanics Magazine, Room 600-A, 204 East Ontario Street, Chicago 11, Ill.**

PUMP WATER FAST!

Drains Wash Tubs, Cellars, Cisterns. Famous #7 pumps 2800 gph. 420 gph. at 75' high or 1600 gph. from 25' well. Sturdy rustproof alloy metal. Six blade impeller. 3/4" inlet, 1/2" outlet. Standard pipe threaded. Uses any 1/4 to 1/2 H.P. Motor. Will not leak or clog. Iron clad guarantee. Send check, M.O., or sent C.O.D. **\$795 IN U.S.**

Irrigate, Fill Tanks, Draw Well Water. Heavy duty #8 pumps 7000 gph. —1000 gph. 75' high 3000 gph. from 25' well. Rustproof alloy metal. 8 blade impeller. 1" inlet, 1" outlet. Standard pipe threaded. Will not leak or clog. Iron clad guarantee. Send check, M.O., or sent C.O.D. **\$1195**

Free Catalogue—Gear Pumps, Large Centrifugal Pumps, Deep and Shallow Well Pumps, Sump Pumps.

MOORE MANUFACTURING CO.
SWEDSBORO 1, NEW JERSEY

POPULAR MECHANICS

LEARN MEAT CUTTING AT NATIONAL

Pay After Graduation



The steady dependable trade of Meat Cutting taught easily in 8 short weeks. YOU LEARN BY DOING under actual meat market conditions in big modern school at Toledo.

For beginners or men with experience. Get a profitable store of your own. Remember, PEOPLE MUST EAT! Big pay jobs. Free employment help. Thousands of successful graduates.

Buying, cutting, percentage, pricing, advertising, selling, etc. A complete retail meat education. National School established 35 years. Get National training NOW. Pay your tuition in easy weekly payments

after you graduate. Send coupon for FREE 52 page school catalog — TODAY. G.I. approved.

National School of Meat Cutting, Inc., Dept. 50-V, Toledo 4, Ohio

Send me your FREE school catalog on National Training at Toledo in Meat Cutting, Meat Merchandising and Self Service Meats. No obligation. No salesman will call.

Name _____ Age _____

Address _____

City _____ State _____

Approved for training Korean Veterans

ELECTROPLATE IT YOURSELF!

NOW using NEW plating kit. It's easy to electroplate any object with the same LUSTER and DURABILITY as done by the most expensive equip. Complete kit and instructions on plating metal and non-metal objects, with Nickel, Chrome, Copper, Gold, etc. ONLY \$2.95. SEND NO MONEY—everything sent C.O.D., plus postage—OR send \$1.95 now and receive it postpaid. Money back in 7 days if not satisfied.

M. Z. SALES CO., Dept. G-13, 113 W. 42nd St., New York 36, N. Y.

NEW! HMS BOUNTY MODEL KIT!

Famed mutiny ship. Every detail accurate—cannon, launch, rigging. Precision plastic parts, cement, plans. 14 1/2". \$2.98. For catalog, send 10c to Dept. M9, 4223 Glencoe, Venice, Cal.

wherever hobby kits are sold

\$2.98

Resell
American Etc.

AMAZING NEW "LIFETIME" RADIO

"TI-NEE" RADIO IS GUARANTEED TO WORK FOR YOUR LIFETIME! USES NO TUBES, BATTERIES OR ELECTRICAL PLUG-INS. Never runs down! SMALLER THAN A PACK OF CIGARETTES! RECEIVES LOCAL RADIO STATIONS MOST ANYTIME, ANYWHERE WITHOUT EXTRA ANTENNA. Uses semi-conductor crystal diode Hi-Q Tuner. Beautiful black gold plastic cabinet. Built-in Speakerphone.

SEND ONLY \$2.00 (bill, ck, m.o. and pay)

postman \$4.99 COD on arrival or send \$8.99 for postpaid delivery. SENT COMPLETE READY TO LISTEN—NOTHING EXTRA TO BUY EVER! Extra long distance Aerial kit included free to receive stations up to 1,000 miles away. Available only from:

MIDWAY COMPANY, Dept. GPM-3, Kearney, Nebraska

What Every Farmer Should Know About Taking Care of Farm Animals

The Most Popular Veterinary Guide Ever Printed

Written in plain understandable language. It covers symptoms, causes of disease and prevention, and treatment of cattle, swine, sheep, horses and poultry and warns when to call in the professional veterinarian. Names, terms and phrases made clear in a separate section. Over 100,000 copies of this book are in use on American farms. 275 pages. Fully illustrated. Only \$3.95. Order today under money-back guarantee. This practical and helpful VETERINARY GUIDE FOR FARMERS prepares the farmer to perform many routine veterinary tasks—provides quick information that can often save the life of an animal—prevents disease in herds—saves money on the farm in a hundred different ways.

**POPULAR MECHANICS PRESS, Dept. 957
200 E. Ontario St. Chicago 11, Ill.**

Offer Your Motorist - Friends GUARANTEED Improvement in MOTOR COMPRESSION ...PEP...and ECONOMY...

and MAKE UP TO \$1,500.00 IN A MONTH!

No matter how old your friend's cars are, unconditionally guarantee them astonishing increases in compression, gas mileage and oil saving, even let them judge for themselves! Amazing new product backs you up 100%. hands you opportunity to make big money.

Build Big-Profit REPEAT Business Spare Time With New, Improved BIGGER, BETTER MOTOR OVERHAUL NOW WITH NEW MIRACLE FORMULA X-303

Folks try MOTOR OVERHAUL and re-order from you time and again. Fleet operators buy large quantities on daring "You-Be-The-Judge" Guarantee. Sensational Independent Laboratory Report proves that only moments after MOTOR OVERHAUL is added to engine oil, compression increases up to 58%, gas mileage up to 54%, oil-saving up to 900%. New larger size, still only \$2.98; make up to \$1.78 profit on each one. Now with oil-stabilizer Formula X-303 for faster cold-weather starts, cool engine in summer!

FREE! Tear Out This Ad NOW...

and rush it with your name, address for complete money-making plans, actual copy of sensational Lab Road Test Report, daring Guarantee . . . all FREE, no obligation. If you also want a full-size \$2.98 can of MOTOR OVERHAUL to test, enclose only \$2.00. We ship postpaid. Money back if you wish.

POPE CHEMICAL CO., 224 W. Huron, Dept. Y-3, Chicago 10, Ill.

CONVERT YOUR CAR INTO A BED



Save on Overnight
Trips—Rest In
Solid Comfort

QUICK, EASY CONVERSION



Works on all 2 and 4-door sedans, club coupes, convertibles, station wagons. Fits all Ford, GM, Chrysler & Studebaker products—does not affect seat structure—normal functions or appearance. **GUARANTEED** to work when installed by instructions. **PAYS FOR ITSELF** in three nights lodging. **IDEAL** for hunters, fishermen and travelers. Delighted users everywhere! Complete conversion kit and instructions **\$19.95**

State make, model, whether 2 or 4-door
SEE YOUR LOCAL DEALER OR
SEND CASH, CHECK OR MONEY ORDER TO:
CAR BED CO., 600 MAGNOLIA AVE., PANAMA CITY, FLA.

NEW MAGIC RADIO WALKIE TALKIE!

YOUR OWN POCKET SIZE RADIO STATION!
BROADCASTS TO ANY HOME OR CAR RADIO WITHOUT WIRES OR HOOKUPS! Wt. only 5 oz. Size, 1 1/2 x 2 1/2 x 4 1/2". Built-in telescoping antenna. Powerful Transistor-sensitive microphone, frequency setter, break-in switch! Runs for weeks on self-contained flashlight batteries. Durable plastic case. With this Radio Talkie you CAN TALK TO YOUR FRIENDS UP TO A MILE OR MORE AWAY! Talk up to 1 mile or more between two automobiles. **INSTANT OPERATION!** Just push button to talk! No license needed. Uses inductive field magnetic radiation. Useful and real fun in a million ways! **GUARANTEED TO WORK, 1 YEAR SERVICE GUARANTEE.**

SEND ONLY \$2.00. Cash, ck, mol and pay postal \$2.25 (COD postage or send \$11.98 for prepaid delivery). **COMPLETE READY TO OPERATE** with instructions and hundreds of ways and tricks for broadcasts thru any radio you desire. Price may go up soon, so get your **NEW POWERFUL RADIO WALKIE TALKIE NOW**. Available only from **WESTERN RADIO, Dept. RPM-9, KEARNEY, NEBR.**



Superior's New Streamlined Model TD-55

TUBE TESTER

Quickly and Efficiently Tests Radio and TV Tubes including: Seven Pin Miniatures; Eight Pin Subminors, Octals and Octals; Nine Pin Neovals



YOU CAN'T INSERT A TUBE IN THE WRONG SOCKET. It is impossible to insert the tube in the wrong socket when using the new Model TD-55. Separate sockets are used, one for each type of tube base. If the tube fits in the socket it can be tested.

"FREE-POINT" ELEMENT SWITCHING SYSTEM. The Model TD-55 incorporates a newly designed element selector switch system which reduces the possibility of obsolescence to an

absolute minimum. Any pin may be used as a filament pin and the voltage applied between that pin and any other pin, or even the "tap-cap."

CHECKS FOR SHORTS AND LEAKAGES BETWEEN ALL ELEMENTS. The Model TD-55 provides a super sensitive method of checking for shorts and leakages up to 5 Megohms between any and all of the terminals.

ELEMENTAL SWITCHES ARE NUMBERED IN STRICT ACCORDANCE WITH R.M.A. SPECIFICATION.

One of the most important improvements, we believe, is the fact that the 4 position fast-action snap switches are all numbered in exact accordance with the standard R.M.A. numbering system. Thus, if the element terminating in pin No. 7 of a tube is under test, button No. 7 is used for that test.

The Model TD-55 comes complete with operating instructions and charts. Use it on the bench—use it for field calls. A streamlined carrying case, included at no extra charge, accommodates the tester and book of instructions.

26⁹⁵ F.O.B. N.Y.C.

**SHIPPED ON APPROVAL
NO MONEY WITH ORDER—NO C.O.D.**

Try it for 10 days before you pay. If completely satisfied then send \$6.95 and pay balance at rate of \$6.00 per month for 4 months — No Interest or Finance Charge Added. If not completely satisfied, return to us, no explanation necessary.

MOSS ELECTRONIC DIST. CO., INC.
Dept. D-383, 3849 Tenth Ave., New York 34, N.Y.
Please rush one Model TD-55. If satisfactory I agree to pay \$6.95 within 10 days and balance at rate of \$6 per month. If not satisfactory, I may return for cancellation of account.
Name _____
Address _____
City _____ Zone _____ State _____

FOR BIG MEN ONLY!



SIZES WIDTHS

10 to 16 AAA to EEE

We specialize in **LARGE SIZES ONLY**—sizes 10 to 16; widths AAA to EEE. Dress, sport, casual and work shoes, golf shoes; insulated boots; socks; slippers; rubbers; overshoes; shoe trees. Also ... sport shirts in your exact, extra-long sleeve length. Enjoy perfect fit in your hard-to-find size at amazingly low cost. Satisfaction Guaranteed. Sold by mail only. Write for **FREE Style Book TODAY!**
KING-SIZE, INC., 336 Brockton, Mass.

SEND FOR FREE CATALOG

75 POWER TELESCOPE \$3.98

New 3 in one telescopes, 3 variable 25X-45X-75X magnification, brass barrel, 25 power for ultra bright images 45 & 75 power for long range. Guaranteed to bring distant stars, moons, objects, sports 75 times closer.



CRITERION CO., 331 Church St., Hartford, Conn., Dept. PMB49

GET THIS HOT-AIR-BALLOON KIT

Wonderfully instructive model, teaches scientific principle while having fun. About 3' in diameter; with care can be raised many times. Good for children about 9 to 16. Kit contains necessary parts and easy-to-follow instructions.

Send \$1.00 today to

BALLOONCRAFT

P.O. Box 8839 Tampa 4, Florida

YES! SEND



directly
to my door
every month

I am enclosing
 \$3.50 for 1 year
 \$8.00 for 3 years

name _____
address _____
city _____ zone _____ state _____

Hand this order to your newsdealer or send it to
POPULAR MECHANICS
200 East Ontario St. Chicago 11, Ill.



NOW IS GOOD TIME TO PLANT
 or
CAN BE PLANTED SPRING—SUMMER—FALL—WINTER
 (If ground is not frozen)

BLUE-GREEN MONDO GRASS

TRADE MARK REGISTRATION APPLIED FOR U. S. PATENT OFFICE

This ad will not appear again this year . . . Demand exceeds supply. Reserve order now.
REQUIRES NO MOWING — MAKES WORLD'S MOST BEAUTIFUL LAWN

View of one of the lawns surrounding the lovely \$200,000 home of Sargess Pickering, owner of Mondo Grass Company, on the beautiful beach of the Gulf of Mexico; the entire 7 lawns, sidewalk, shoulders and neutral grounds are planted solidly in Mondo Grass, truly one of the most attractive show places of the South.

Our Blue-Green Mondo Grass is described by the U. S. Department of Agriculture as quote "Ophiopogon Japonicus, technically called ground cover (formerly called Mondo Japonicus) is native to Northern China and should withstand severe degree of freezing; drought tolerant, evergreen, commonly called Mondo Grass" unquote.

It is a grass relative to the Lily with paper thin blades 1/16" wide. This sod-forming EVERGREEN, low-growing oriental genus is currently used by many owners of distinctive homes in America for lawn grass. Now we can offer this exclusive Blue-Green Mondo Grass at popular prices.

SO HARDY IT CAN BE PLANTED ANYTIME, it is recommended for beautiful lawns where mowing is not desired. Blue-Green Mondo Grass retains its color the year-round; thrives in shade or sun; extremely hardy, rarely requires watering; fantastically beautiful, drooping low to the ground in weeping style year after year. **REQUIRES NO MOWING.**

Ideal for heavy shaded areas or sun, dry or wet. FREE folder of testimonials and many photos of Mondo lawns sent on request. Mondo is resistant to diseases; insects and animals will not feed on it. Stops erosion, grows compactly, crowding out other grass and weeds, multiplies rapidly, approximately 100 times (10,000%) first year, if properly handled. Enhances property value. So sensational we expect to revolutionize lawn-making. For good coverage first year plant 2" to 6" apart. Numerous rooted blades to sprig.

Planting and culture instructions with each order. Remittance with order. Shipped prepaid. **MONEY-BACK GUARANTEE:** If not completely delighted you may return at once for refund. Open account to A-1 rated firms buying 1,000 sprigs or more, FOB Biloxi.

ORDER TODAY . . . YOU CAN'T LOSE!!

Guaranteed to grow or we will replace. Sprigs shipped in damp moss.

25 SPRIGS \$2.98

50 Sprigs 5.00	1,000 Sprigs \$79.00
100 Sprigs 9.00	5,000 Sprigs or more per 1,000 50.00

MONDO GRASS CO., Dept. PM-9, Biloxi, Miss.

I enclose \$_____ for _____ Ship (check one) Now _____
 Prepaid Shipment _____ At Proper Planting Time _____
 sprigs Mondo Grass. _____ Or When? _____

NAME _____
 ADDRESS _____
 CITY _____ STATE _____

DAN THE MUSCLE MAN OF TV FAME SAYS



I'LL GUARANTEE YOU RIPPLING MUSCLES IN 6 WEEKS OR MONEY BACK
 You can have tremendous power, look bigger, have more confidence this tested way. Revolutionary new "Body Mold" courses builds your body in a way no other method can match. Get course FREE with order. Lowest factory price.
DAN LURIE BARBELLS
 50 lb. set \$ 8.98 • 100 lb. set \$14.98
 150 lb. set \$21.98 • 200 lb. set \$27.98
 Extra wts. — 1 lb. per lb. 50% cash, balance C.O.D. FOB Plant
DAN LURIE BARBEL CO.
 52MB Bristol St. Dept. 7591, Bklyn 12, N. Y.
FREE! SEND FOR NEW SPORTS & HEALTH CATALOG.

YOU TOO Can Play a Hohner Harmonica the very first day!

Surprise your friends and family! Enjoy new popularity! Following the simple diagrams in Dr. Spaeth's New Easy Method Book you can play popular tunes on a Hohner Marine Band Harmonica right off. You don't need to know music. If you can read this ad you can play!



Leaders in Harmonicas and Accordions for 100 Years

This 35¢ Book **FREE** for a limited time

M. HOHNER, INC., Dept. M-97
351 Fourth Avenue, New York 10, N. Y.
 Please send me New Easy Method Book.

Name _____
 Address _____
 City _____ Zone _____ State _____



SEND FOR THIS FREE!

Make money. Know how to break and train horses. Write today for this book FREE, together with special offer of a course in Animal Breeding. If you are interested in Gaiting and Riding the saddle horse, check here () Do it today—now.

BEERY SCHOOL OF HORSEMANSHIP
 Dept. 1109-D Pleasant Hill, Ohio

HEY KIDS! Here's Your Chance to Drive!

"Buckboardin' Buggy" will give you loads of fun until you reach car-driving age. Good training for your future driving.

Coasts down hill like a dream, or can be safely powered with old lawn mower motor. Complete, crated, ready to unpack and run for only \$59.50 f.o.b. Fairport (without motor); or get complete "Build-yourself" kit and instructions for \$49.50 f.o.b. Includes all parts, wheels, bolts, steering wheel, clutch, beautifully painted, easy to assemble in a few hours. Or build it from our original plans and instructions, \$5, postpaid. Best quality materials, ruggedly built to last years, weighs 60 lbs! Order today, send check or money order. We guarantee satisfaction. Free circular.



MAYO BROTHERS Dept. P FAIRPORT, N. Y.

"THE FUTURE BELONGS TO

Skilled hands, technically trained minds, and creative thinking are in critical demand by industry, laboratory, government and institution today. Shortages of skilled and scientific manpower are the key to unlimited future employment opportunity for those who meet the qualifications.

America is what it is today because of the dynamic combination of men, machines, and driving ambition.

Even though we as a people make up only 7% of the world's population and live on a mere 6% of the world's land, we own 76% of the world's automobiles, watch 78% of its television sets, and are busy producing about one-half of the free world's material goods.

There's a reason for our vast material ownership and for our amazing volume of production. Credit can be given to a creative group no larger than one-half of one percent of our population; namely, the 950,000 scientists and engineers working in America today. From their labors have come the formulas and designs that have developed our technology to the point where a few are able to create and effect production of so much for so many. The other half of the production team is the 8.7 million skilled craftsmen who apply the scientific and engineering principles to the building of modern homes, assembly lines, jet aircraft and the like.

These specialists are the creators and builders of American industry. Our future progress depends on them. However, rapid discoveries in science, and technology, constant improvements in production technique, consumer pressure for new products, our expanding defense requirements, and the search for substitutes for our dwindling resources, have created a demand for scientists, engineers, technicians and skilled craftsmen far beyond our supply.

At no other time since World War II has the need for skilled manpower been so great, nor the opportunities for employment so attractive. And the future appears unlimited! Men willing to master a skill or specialize in one of the engineering fields will be able to write their own ticket! A major company recently predicted that within a few years 60% of its production will be devoted to products for which there is no use at the present time. In America, every 10 minutes someone develops a new product or improvement, and a patent is granted.

But right now industry wants men who will

become the skilled masters of automation; men to design and install electronic-controlled manufacturing; men with the vision to make atomic energy a constructive tool of industry. An estimated 66,700 new scientists and engineers are wanted next year; and 1965 will see a need for 429,000 more than today. Some 210 atomic reactor operators will be at work by 1960; and by 1980, about 18,670 will be required. At least 250,000 skilled craftsmen must be trained every year just to maintain our present work force.

Men with vision, who like to plan their future, will begin to prepare themselves for these and the thousands of other skilled jobs that must be filled. Why not measure your interests and ambitions against the opportunities waiting for you?

Guide yourself by the industries showing the greatest employment increases over past years. This indicates growth. Industries shown below are expected to continue expanding.



Take a look at the five occupations on the opposite page. According to the U. S. Department of Labor, there are serious shortages of specialists and skilled men in these classifications. What kind of work is of greatest interest to you?

Lay plans for your future, and then take the kind of action that will guarantee it. Qualify as a specialist, a technician or skilled craftsman by going after the proper education and training. This experience can be gained easily from several sources, including the nationally known trade or vocational schools who are preparing many of industry's top-paid men. We suggest you look for these excellent schools in the pages of Popular Mechanics and examine their courses.

The challenge has been made by American industry to all men of ambition who seek a good job, interesting work and an important role in our advancing technology. In the traditional American way, meet the challenge of opportunity with the training to match the job. The future can belong to you if you're prepared for it.

For more information regarding opportunity, advancement, and job success write for the new Popular Mechanics booklet, "Skills For America." It will be sent FREE on request. Write Dept. SFA, Popular Mechanics, 209 East Ontario Street, Chicago 11, Illinois.

Industry	Employment Growth Record	Percentage Increase	Total 1956 Employment
AIRCRAFT	239,000 565,000	236.4	804,000
AUTOMOBILE MANUFACTURING	776,000 15,000	1.9	791,000
ATOMIC ENERGY	49,000 101,000	206.1	150,000
CONSTRUCTION	1,982,000 1,055,000	53.2	3,037,000
ELECTRONICS	336,000 229,000	68.2	565,000
INDUSTRIAL CHEMICALS	299,000 128,000	42.8	427,000
MACHINERY MANUFACTURING	2,111,000 260,000	12.3	2,371,000

Legend:  Indicates number of employees within industry during 1947  Indicates growth in number of employees within industry between 1947 and 1956

THOSE PREPARED FOR IT"

ENGINEERS

Engineering is the inventive and development arm of industry and is truly the profession of the future. Aeronautical, Chemical, Electrical and Mechanical Engineers are wanted in unprecedented numbers, and never have so many industries vied so strongly with each other for engineering talent. Starting salaries are excellent; there's no limit to advancement except ability and eagerness to accept responsibility and work. A graduate degree with all the education and training it implies is fundamental to success in this field today.

TECHNICIANS

Referred to as industry's semiprofessional, the technician assists the engineer in every stage of production, from theory and research to drawing board, construction and finished product. Presently, 5 to 7 technicians are needed for every engineer in industry or laboratory. Draftsmen, Diesel, Air Conditioning, Laboratory, Tool Design, Electronics, and Instrumentation Technicians are wanted in large numbers. Qualifications are mathematics, physical science and specialized training in chosen field. Employment outlook is excellent due to emphasis by industry on research and development in which technicians play a major role.



Ford Motor Co. photo

MECHANICS AND REPAIRMEN

One of the fastest growing occupations in America today, skilled mechanics and repairmen are critically needed in almost every industry. The trend toward increased automation of production, the use of more expensive and complicated machinery, plant expansion, broader application of electronics including computers, expanding use of office machines, and of course increased sales of air conditioning, refrigeration, automobiles, etc., have opened thousands of jobs for men with skilled training. There is a special need for Automobile and Airplane Mechanics, Business Machine Servicemen, Electronic Servicemen, Diesel Mechanics, Maintenance Electricians, Refrigeration-Air Conditioning Mechanics and skilled men to install and maintain heavy industrial machines. Training is a must, for complexity of many machines requires a high degree of skill.



SEPTEMBER 1957



Official U. S. Navy photo

MACHINING OCCUPATIONS

Nearly every product of American industry contains metal parts or is manufactured by machines made of metal. The machining trades, consisting of Tool and Die Makers, all-round Machinists, and Machine Tool Operators, are among the most important skilled craftsmen in industry. Their work is varied and complex with high standards of accuracy. Training and practical experience includes broad knowledge of the machining properties of metals, shop practice, machine operations and mathematics. This highly skilled trade provides excellent background for advancement into Foreman positions and administrative work. Tool and Die Makers are among the highest paid craftsmen in all manufacturing and are in great demand now.



BUILDING TRADES

Immediate and future job opportunities are excellent in any of the more skilled building trades. Carpenters, Painters and Pipefitters, Bricklayers, Operating Engineers, Construction Electricians will be in growing demand due to doubling of construction activity expected over the next ten years. Prospects of growth in building, continued technological development in construction methods and equipment, and increased maintenance jobs will make it possible for a man with experience to succeed handsomely in establishing his own contracting and construction business.

See also Revised 1957 Edition of "Occupational Outlook Handbook" written by U. S. Department of Labor and available from Superintendent of Documents, U. S. Government Printing Office, Washington 25, D. C.

45

UNIMAT



MINIATURE MACHINE SHOP

"No bigger than a typewriter, outperforms machines many times its size." That's what a popular publication says about UNIMAT in a 3 page feature story. UNIMAT is the precision tool that craftsmen, inventors and hobbyists dream about. You just can't beat it for machining small parts from steel, brass, aluminum, wood and plastic. You'll want a free reprint of this story plus complete information about this amazing 10 in 1 workshop. Write today to:

AMERICAN EDELSTAAL, INC. • UNIMAT DIVISION
Dept. 397 • 350 Broadway • New York 13, N.Y.

FREE 1958 CATALOG!

Over 15,000 bargains
in the fields of Hi-Fi,
Radio, Television
and Electronics!

Send for Your,
Copy Today!

E-Z TERMS!

Only 10% Down
Top Trade-Ins
Up to 50% Savings
on More Than
800 Guaranteed
Reconditioned
Eqpt. Items!



WORLD RADIO LABORATORIES
The World's Largest Distributor of Amateur Radio Eqpt.
3415 W. Broadway — Council Bluffs, Iowa
Leo J. Meyerson PERSONALIZED SERVICE

MAIL HANDY COUPON

WORLD RADIO LABORATORIES, INC. PM-7
3415 W. Broadway — Council Bluffs, Iowa

PLEASE RUSH ME: Free Catalog Hi-Fi Booklet
 Info on Kits Recond. Eqpt. List

NAME _____

ADDRESS _____

CITY _____

STATE _____

LEARN HELICOPTER REPAIR IN 10 EASY LESSONS



BIG PAY— GOOD FUTURE IN THIS NEW FIELD

There's BIG MONEY waiting for you in this newest of careers! Our personalized, easy-to-master 10-lesson course will teach you every important phase of helicopter repair and maintenance right in your own home. Written and supervised by experts, the home study course is practical, down to earth, contains no theory, and is fully designed to help you enter quickly into this new, well-paying field.

Send today for interesting details and literature. No obligation, of course.

SOUTHERN CROSS HELICOPTER INSTITUTE
378 Baldwin Avenue (Dept. PM-1) Jersey City, N. J.



GOLF CARS
Also ideal for Airports, Estates, Factories, etc. Write for literature.

ESHELMAN TRACTORS

LOW AS \$99

Plows-Cultivates-Saws
Doser-Harrow-Rolls
Mauls-Snow Plow
Eshelman Tractors,
Tillers, Riding Rotary
Mowers for Better
Lawns and Gardens.
Advertised in GOOF
HOUSEKEEPING. Thousands of
satisfied users.
Write for Free Literature.
Dept. 245, ESHELMAN, Balto. 2, Md. \$549.75



Shipping Points: BALTIMORE - CHICAGO - KENOSHA - MILWAUKEE

make your own Gems 32.50 F.O.B.

The Gem Maker comes complete with all necessary equipment, including a super-charged diamond blade for sawing, and all wheels for grinding, shaping and polishing; also complete instructions. The complete equipment as shown, less motor and belt, for only \$32.50, f.o.b., Burlington, Wisconsin. Write today for information and literature.

B & I MANUFACTURING CO.
Dept. P, Burlington, Wis.

NEW! Completely UP-TO-DATE!

Manual for PLYMOUTH OWNERS



COVERS ALL MODELS 1941 to 1957. Gives you more from your Plymouth for less. So accurate mechanics can use it . . . so simple a woman can understand it

Now fix it yourself and save money on Plymouth repairs. With this Popular Mechanics book you prevent trouble . . . enjoy care-free driving . . . increase trade-in value . . . get sparkling performance . . . and avoid major repairs by fixing minor troubles before they get serious. Not just a re-hash of service manuals, but a completely updated version of the famous 1950 PM book written by automotive expert Ed Parker, with the assistance of the Chrysler Corporation. Covers latest Plymouth features: power brakes, torque bar suspension, automatic transmission, tubeless tires, air conditioning, etc. Motor specifications are given for all models 1941-57. Contains 272 pages, more than 350 photos, diagrams, tables, charts, breakdown drawings, plus clear, non-technical directions that make all repairs as simple as ABC. Shows you how to diagnose troubles by feel, sound, sight, smell and performance.



MONEY BACK IF IT DOESN'T SAVE MORE THAN IT COSTS!

One minor repair will save the cost ten times over. Read it. Then you decide. If you don't see that you'll save more than the cost, send it back for refund. SEND NO MONEY. Send postcard. Ask for PLYMOUTH Manual. Postman will deliver C.O.D. for \$3.50 plus postage. Or, save postage by sending \$3.50 with order. Save its cost on your next repair. Send today.

POPULAR MECHANICS PRESS, Dept. 957
200 E. Ontario St. Chicago 11, Illinois

Make SURE, SAFE INSULATED ELECTRICAL CONNECTIONS

The New SUPER ~~CHAMP~~ Hand Tool

The ONE Tool for ALL Wire Sizes used in Home Wiring, Appliances, Automobiles.

DOES ALL THESE THINGS BESIDES

CRIMPS Solderless Terminals and Connectors without solder or tape for safe connections.

STRIPS Wire sizes #22-#10. Gauges assure proper length for sure, safe crimp.

CUTS Wire, making clean, sharp cut through insulation and Conductor.

SHEARS Bolts and screws without damaging threads — no filing or hack sawing.



comes with
PRE-INSULATED



FREE with Each TOOL

ORDER DIRECT—USE COUPON

Only
\$3.95
Post Paid

Satisfaction guaranteed or money back. Send check or money order for \$3.95.

T. W. Berger
National Distributor
Manufactured by
AMP INCORPORATED

T. W. Berger
National Distributor Champ Tool
Dept. SE, Suite 401, 1700 Walnut St., Phila. 3, Pa.

Send me post paid the new Super Champ Hand Tool. I am enclosing \$3.95. (Incl. state sales tax where applicable)

check money order

NAME

ADDRESS

CITY.....ZONE.....STATE.....

1957 CATALOG BOAT KITS WOOD and FIBERGLAS

EASY TO BUILD - DESIGNED for professional results by the amateur. World's largest selection of top performance, latest design, prams, skiffs, racers, runabouts, sailing boats, cruisers. 8 to 20 ft. Mahogany decks, frames. FREE FREIGHT. SEND FOR FREE CATALOG

Boat Plans-Patterns-Frame Kits Includes fiberglass paints, accessories

Build over 50 modern boats from large scale plans, available with FULL-SIZE patterns, new PRE-FAB frame kits! All types: prams to cruisers, 6 to 25 ft. Best buy for Amateurs! SEND 10¢ for CATALOG.

Craig Craft
Tonawanda, N. Y.

LEARN TO MOUNT BIRDS

ANIMALS, FISH, PETS

Be a Taxidermist. Save your hunting TROPHIES. Have a fine home-museum. Hunters, save and MOUNT your beautiful DUCKS, QUAIL, DEER, TAN skins, FURS. Great Fun. Spare-time PROFITS. TELL ALL about it. 100 fine wild-game pictures, 48 pages. SEND TODAY, don't delay. Get this WONDERFUL FREE BOOK, MEN AND BOYS. Learn Taxidermy. Double your hunting pleasure. Rush letter or POSTAL today. STATE YOUR AGE, N. W. SCHOOL OF TAXIDERMISTRY, Dept. 2509, Omaha, Neb.

Get into.. PLASTIC LAMINATING AT HOME!

Get ORDERS and CASH from your mailman—do work in SPARE TIME at home—or expand into FULL TIME business. Send coupon for Free facts about the newest and most fascinating of all home operated businesses. For the first time a simplified machine brings the fabulous profits of Plastic Sealing and Plastic Laminating within the reach of the small operator. Anyone can learn to operate the machine with a few minutes practice—then with our Magic Mail Plan can get mail orders pouring in daily with cash in every envelope. No canvassing—no selling. We even supply the circulars you mail to bring back cash and orders. Don't waste a minute. Rush your name. We'll send you FREE and postpaid, pictures, prices, details, and all the facts you need to start. Mail coupon or send name on postcard. No charge. Warner Electric Co., 1512 Jarvis Av., Dept. L-2-K, Chicago 26, Ill.

Make \$20 to \$30 a Day by.. MAGIC MAIL PLAN!

Make Thousands of Beautiful Art Creations
COSTUME JEWELRY • CIGARETTE BOXES
TRAYS • CANDLESTICKS • COASTERS
LAMP BASES • BOOK ENDS...ALL IN SPARKLING COLORED PLASTIC

THIS MAN... is taking out of the machine a Plastic Sealing Job—ordered by mail—only 11¢ in material cost brings back \$2.50 in cash by mail. Capacity of machine: \$25.00 profit per hour of operation.

WARNER ELECTRIC CO., 1512 Jarvis Av. Dept. L-2-K, Chicago 26, Ill.
At no cost to me, please rush complete details postage prepaid. I am under no obligation.

Name.....
Address.....
City.....Zone.....State.....

YOUR NEIGHBORHOOD NEEDS AN ELECTRICAL APPLIANCE



TROUBLE SHOOTER

Men needed to repair and service all kinds of Electrical Appliances—AUTOMATIC WASHERS - DRYERS - IRONS - VACUUMS - TOASTERS - REFRIGERATORS - FANS - HOME FREEZERS - AIR CONDITIONERS —home and industrial motors, etc.—also home and industrial wiring.

Big, Year-'Round Profits!
HELP US FILL HUGE DEMAND

MODERN BIG PROFIT ONE-MAN BUSINESS YOURS AT HOME — SPARE OR FULL TIME.

No previous experience needed. New, visual "Shop-Practice" method quickly shows you how. Hundreds of plain-as-day "How to" photos and drawings make it easy. A corner of garage, porch, attic, or basement is all the space needed. No costly leases—no big overhead. We show you how to make business come to you.

NEW 30-DAY INCOME PLAN!
Shows you how to start your own Big Profit Business without investment—no big overhead

Send for this FREE BOOK! AIR MAIL COUPON NOW!



BIG MONEY, SECURE FUTURE—INDEPENDENCE.
F. V. in N. Y. says, "I made \$300 in 3 months while studying." T. E. H. in W. Va. says, "Made \$14 a day while learning."

EVERYTHING FURNISHED—including BIG TOOL KIT
Instructions are complete and include a Tool Kit and Appliance Tester. Everything furnished to help you build your own big-profit business at home. Our new 30-day income plan shows you how to start making money almost at once. Send no money—just your name and address on coupon below. I will rush you FREE complete success plan with full details. Do it NOW—BE FIRST!

PACIFIC TRAINING SCHOOL, Dept. P-579
11029 So. Vermont Ave., Los Angeles 44, Calif.

PACIFIC TRAINING SCHOOL, Dept. P-579
11029 So. Vermont Ave., Los Angeles 44, Calif.

Gentlemen: Rush me postpaid your FREE plan for success in the Appliance Repair Business and the Free Book Entitled "The Appliance Repair Business and You" and remember I am under no obligation.

Name _____
Address _____
City _____ Zone _____ State _____

Catalog of 3100 Novelties 10c

Send 10c for amazing catalog of novelties, five animals, scientific supplies, hobbies, funmakers, planes & boats, looms, magic tricks, joke articles, unusual seeds, gadget time-savers, cameras, optical goods, projectors, movies, lucky jewelry, religious novelties, disguises, musical instruments, stamps, coins, puzzles, fortune tellers, radios, auto & bike accessories, telescopes, magnifiers, compasses, banks, smokers' gadgets, artists' supplies, printing sets, engines, motors, shockers, knives, billfolds, guns, rifles, sports, books, games, plants, etc. Send 10c (3 for 25c—get for friends!).
JOHNSON SMITH & CO. Dept. 428 Detroit 7, Michigan

Become A --- BUILDING CONTRACTOR!

MAIL COUPON for FREE BROCHURE

Simplified home study training program. Learn every phase of building, estimating, contracting. Fortunes are made in this line of work every year. Use spare hours—no interference with present work. Diploma awarded. Low tuition rates.

AMERICAN TECHNICAL SOCIETY
Dept. PM-957, 850 E. 58th Street, Chicago 37, Ill.

Please send me your FREE Brochure and full details of your building, estimating and contracting training program.

Name _____
Address _____
City _____ State _____

2 WAY PORTABLE RADIO SET

SENDS - RECEIVES UP TO 10 MILES AS SHOWN

with built-in antenna or hundreds of miles with outside antenna! 80 and 40 meter amateur radio bands (receives also Aircraft and overseas broadcasts 3 to 8 mc.). PORTABLE SELF-CONTAINED POWERED WITH STANDARD LOW COST PORTABLE RADIO BATTERIES. NO AC PLUG-INS NEEDED! Take it with you everywhere you go—on trips, vacations, camping—Keep in contact with home, friends, Has 5 watt crystal controlled transmitter—Sensitive Regenerative Receiver. Send receive switch. Wt. only 3 lbs. Size, only 6"x4"x4". TESTED—PROVEN—SIMPLIFIED—PRACTICAL—Full information given on quick easy to get license. **SEND ONLY \$3.00** (bill, ck, mo) and pay postman \$11.95 COD postage on arrival or send \$14.95 for postpaid delivery. Complete kit includes all parts, tube, coils, plated cabinet, easy instructions. (Set of batteries—\$2.95; crystal \$1.25) COMPLETELY WIRED AND TESTED POSTPAID \$19.95. A regular \$49.95 value—Order now before price goes up. GUARANTEED - AVAILABLE ONLY FROM:



WESTERN RADIO Dept. BNM-9 KEARNEY, NEBR.

BARBELLS

100 POUND SET \$11.80

140-Pound, CHROME DELUXE Barbell-Dumbbell set only \$18.80. This is our assure set and is the finest ever manufactured. Training with adjustable weight is the BEST way to keep fit; the ONLY way to develop great strength and a perfect body. As the oldest and best equipped barbell company, BUR gives value and prices no one can equal.

Extra Plates Only 10c Pound

SEND FOR FREE CATALOG.
BUR BARBELL CO.
Lyndhurst 9, New Jersey

HELPFUL BOOKS

Send post card asking for FREE catalog
Popular Mechanics Press, 200 E. Ontario, Dept. 601, Chicago 11

LET 10 MAIL ORDER EXPERTS HELP YOU Start a Profitable Mail Order Business! AT A COST OF JUST 50c PER MONTH!!

Get into the exciting and fabulous Mail Order Business! Operate from your home. Get new fat cash orders every day by mail! Let our staff of 10 mail order authorities show you how to operate a business—What to sell—How to start—How to sell it—How to actually MAKE MONEY IN MAIL ORDER. Get personal answers to many of your questions. AT A RIDICULOUS COST TO YOU OF JUST 50c PER MONTH! Free information.

MAIL ORDER BUSINESS, Box 591, Lynn 606, Mass.

SEND ME



every month so I am sure to see each new issue. Here's

\$3.50 for 1 year
 \$8.00 for 3 years

name _____
address _____
city _____ zone _____ state _____

Hand this order to your newsdealer or send it to
POPULAR MECHANICS
200 East Ontario St. Chicago 11, Ill.

STONE MASONS TRADE SECRETS

Never before revealed to the Public . . . Learn these jealously guarded Trade Secrets that will give you the confidence to undertake all types of beautiful stone work, such as: walls, steps, fireplaces, patios, etc.

This fully illustrated manual gives step by step instructions revealed by "Old World Craftsmen," that are unknown to many in the trade today.

Save huge sums of money by expertly doing the work yourself, or make this "High Pay" trade your new and profitable livelihood. Send \$5.00 today for this amazing manual . . . satisfaction guaranteed.

THE STONE MASON

P. O. Box 115 Brightwood Station
SPRINGFIELD, MASSACHUSETTS

ISRAEL STAMP COLLECTION Only 25c



Usually selling for \$1.00 and more, this packet of 25 ALL DIFFERENT ISRAEL stamps including the ancient Hebrew coin sets, 12 Tribes Issue, High Holy Days, Running Stag, Airpost, Children's Issue, etc. All this is yours for only 25c to introduce our bargain approval offers. EXTRA: 48-Page Stamp Dictionary & Guide incl. FREE. STAMPEX CO., Box 47-NM, White Plains, N.Y.

HYDRAULIC JACK REPAIRS



Earn While You Learn at Home

Millions of jacks in gas & auto-service stations, truckers, body-shops, riggers, factories need servicing. We show you HOW—easy step by step directions—what tools to use. EARN UP TO \$5 an hour, in spare time, in your own basement or garage. Start your own business NOW. Write for folder #PM9 & free bonus offer.

Institute of Hydraulic Jack Repair

P.O. Box 50, Bloomfield, N. J.

WE PAY \$3.50 lb.

GROW MUSHROOMS. Cellar, shed and outdoors. Spare or full time, year round. We have over 25,000 customers. FREE BOOK. Washington Mushroom Ind., Dept. 61, 2954 Admiral Way, Seattle, Wash.

IT'S EASY . . . MAKE MONEY IN PHOTOGRAPHY

If you are over 17—good pay and fascinating work await you in photography! Start making money quickly in spare time—step into your own studio or exciting career job. LEARN-BY-DOING method trains you at home! Write TODAY for FREE catalog. Also Resident Training. Co-ed. 47th Year. Approved for Veterans.
NEW YORK INSTITUTE OF PHOTOGRAPHY
Dept. 49, 10 West 33 Street, New York 1, New York
47th YEAR

TELEPHONES

and ALL SUPPLIES

Room to room, house to garage, private telephone service. HANDSET CRADLE TELEPHONES (2) Complete outfit with 100' wire, 2 dry cells, instructions. \$14.95

WORM HARVESTER — Dan Mac Magneto—gathers fish-worms by electricity. Complete with instructions. \$6.50

Illustrated bulletin "AA-17" 10c

TELEPHONE REPAIR & SUPPLY CO.
Dept. AA-17 1760 Lunt Ave., Chicago 26, Ill.



IN ONLY 2 YEARS

he'll have an
ASSOCIATE of SCIENCE
DEGREE in...

ELECTRONICS ENGINEERING DESIGN

The increasingly acute shortage of engineering talent assures unlimited opportunities in electronic and aviation fields. A 2-year intensive course at Embry-Riddle—an approved technical institute—leads to a Degree and specialization in rewarding careers such as servo and instrumentation engineer, electro-mechanical engineer, electronic design engineer, and materials and process engineer.

Embry-Riddle's constant supervision, concentration on essentials, and minimum required instruction of 25 hours per week assures you the education your future requires.

You'll enjoy Miami's perfect year-round climate for study and training.

Take your big step now. Think BIG—think Aviation! Mail coupon for pictorial brochure and complete outline of curricula.



TRAINING
AUTHORIZED
UNDER
G.I. BILLS

MAIL THIS COUPON TODAY

DEAN OF ADMISSIONS, Dept. 29
Embry-Riddle Aeronautical Institute
Miami 30, Florida

Without obligation, please send FREE and post-paid full particulars.

- ELECTRONICS ENGINEERING DESIGN
 AERONAUTICAL ENGINEERING DESIGN
 A. & P. TECHNICIAN FLIGHT

Name..... Age.....

Address.....

City..... State.....

I am a (check one) Veteran Non-Veteran

Train at Home or in the Big Allied Shops

AIR CONDITIONING HEATING & REFRIGERATION

Get into this high paying field. Learn easily and quickly in your spare time AT HOME or in 100 HOURS OF SUPERVISED SERVING IN OUR CHICAGO SCHOOL. Tools and equipment supplied. Mail coupon today for free book and sample lesson—no obligation.



ALLIED SCHOOL OF MECHANICAL TRADES
ALLIED INSTITUTE OF TECHNOLOGY
1338-42 So. Michigan Ave., Dept. PM-9A, Chicago 5, Ill.

Gentlemen:
Mail me FREE BOOKS explaining ALLIED'S training program in AIR CONDITIONING, HEATING, and REFRIGERATION.

I am interested in resident training Home study

Name _____ Age _____

Address _____

City _____ County _____ State _____

High School at Home

MANY FINISH IN 2 YEARS

No classes. No time wasted going to and from school. Progress as fast as your time and abilities permit. Standard H. S. texts supplied. Thousands enroll each year in this 60-year-old school. Send for FREE descriptive booklet.

AMERICAN SCHOOL, Dept. H645
Drexel at 58th St., Chicago 37, Ill.

Without obligation, please send FREE descriptive booklet.

Name _____

Address _____

Complete Canadian Courses available. Write American School, Dept. 100-15, 6080 Sherbrooke St. W., Montreal

New PRECISION MAGNIFIER

FEATURING 3 DIFFERENT STRENGTH OPTICAL LENSES

Quick interchangeable, snap-in lens sets of increasing strength (1½, 2¼ and 3¾ power). The lenses are unbreakable, scientifically accurate, and molded together for permanent focal alignment. ROCKET is light in weight and is adjustable to any head size. Both hands are free for work. Additional lens sets of greater strength will be available at \$3 a set. Squinting is eliminated as both eyes are used. Can be worn over your own eye glasses. Guaranteed. Full refund if not completely satisfied.



Only
\$12.50

ORDER YOURS TODAY

USEFUL FOR
Photographers
Hobbyists
Machinist
Philatelists
Tool & Diemakers
Jewelers
Artists
Coin Collectors
Cartographers

STANDARD UNBREAKABLE WATCH CRYSTALS, INC.

123 East 144th Street, New York, New York

Please send me

Rocket Viewers with 3 interchangeable lens

@ \$12.50

Money Order enclosed

Send Literature

C.O.D.

Name _____

Address _____

City _____ Zone _____ State _____



Chalk-Chuck Inc., 5011 E. 32nd Ave., Denver 7, Colo.

Chalk-Holding Pencil Clips on Your Pocket

Colored-chalk pencils, eliminating use of broken and dusty chalk, can be carried neatly on your pocket like other clip-on devices. The aluminum holder can be loaded from either end. Pushing down a button on the holder releases the chalk.

Apply-It-Yourself Mechanical Tourniquet

Mechanical tourniquets, which bleeding persons can apply to themselves, may become as much a part of first-aid kits as gauze and tape. This device consists of two metal plates, a thumbscrew and a nylon strap for tying the tourniquet in place. A simple turn of the thumbscrew forces one of the plates to press on a severed artery.

McClement and Richmond, 114 W. Oak St., W. Frankfort, Ill.



Aluminum plants use 320,000 gallons of water to produce a ton of the light metal.

Get into

TELEVISION

RADIO-ELECTRONICS

Let National Schools of Los Angeles, a Practical Resident Technical School for over 50 years, train you at home by Shop-Method for unlimited opportunities in All phases of TV, Electronics, Radio.



LEARN ALL 8 PHASES
BY SHOP METHOD

OF THE INDUSTRY
HOME TRAINING

1. Television . . . including Color TV
2. Radio . . . AM, FM
3. Industrial Electronics
4. Communications
5. Sound Recording & Hi-Fidelity
6. Automation
7. FCC License
8. Radar & Micro Waves

We give you parts to build a modern TV set . . . all tubes plus large screen Picture Tube . . . and a Superhet Receiver. You also receive a Professional Multitester

You get 19 Big Kits
... all this newest,
practical equipment.

**GOOD JOBS . . . MORE MONEY
SECURITY . . . ALL CAN BE YOURS!**

You are needed in the great modern Television-Electronics industry. Trained technicians are in growing demand, at excellent pay, in sales and service, manufacturing, broadcasting, telecasting, communications, research, and many other important branches of the field. National Schools Master Shop-Method Training, with newly added lessons and equipment prepares you *in your spare time*, right in your own home, for these fascinating opportunities.

YOU EARN WHILE YOU LEARN

Many students pay for their entire training—with spare time earning. We'll show you how you can, too! You receive material that shows you how to earn extra money servicing TV and Radio receivers, appliances, and doing many other profitable jobs.

YOU GET EVERYTHING YOU NEED

Clear, profusely illustrated lessons, shop-tested manuals, modern circuit diagrams, practical job projects—consultation privilege with our qualified staff.

Don't delay your future another day.
Send coupon for full information TODAY.

RESIDENT TRAINING AT LOS ANGELES

If you wish to take your training in our Resident School at Los Angeles, the world's TV capital, start NOW in our big, modern Shops, Labs and Radio-TV Studios. Here you work with latest Electronic equipment—professionally installed—finest, most complete facilities offered by any school. Expert, friendly instructors. Personal attention. Graduate Employment Service. Help in finding home near school—and part time job while you learn. Check box in coupon for full information.



Approved for
GI Training

NATIONAL SCHOOLS
LOS ANGELES 37, CALIF.

CUT OUT ALONG THIS LINE

MAIL POSTAGE—FREE COUPON . . . NOW!

1. Fill out coupon in ink.
2. Cut along dotted line and fold coupon.
3. Staple, paste, glue, or tape ends together.
4. Mail today! No postage necessary.

FREE! Career Book in TV-Radio-Electronics,
PLUS actual SAMPLE LESSON.
No obligation; no salesman will call.



Name _____ Age _____

Address _____

City _____ Zone _____ State _____

Check if interested ONLY in Resident Training in Los Angeles

VETERANS: Give date of discharge _____

FOLD ALONG THIS LINE

Postage
Will be Paid
by
Addressee

No
Postage Stamp
Necessary
if Mailed in the
United States

BUSINESS REPLY CARD

First Class Permit No. 2087, Sec. 34.9 P.L. 88, Los Angeles, Calif.

POSTAGE WILL BE PAID BY

NATIONAL SCHOOLS

4000 South Figueroa Street
Los Angeles 37, California

Dept. RB-97



Tractor Controlled Up to 15 Miles Away

With the controls located in a vehicle or helicopter, a U. S. Army "Tournadozer" can be operated by remote control at a distance of up to 15 miles. The robot tractor is equipped with a standard military radio receiver which actuates its levers and pedals by radio impulse from the transmitter.



BUILD and FLY Bensen HELICOPTER

Glider type 'copter—easy to build, simple to fly. Can also be mounted on floats or boat. No pilot's license required. Order 3-view drawings, specs and photo for \$1. Motor powered Gyro-Copter drawings \$2.

Ask about detailed plans and construction kits.
BENSEN AIRCRAFT CORP., Dept. PM-97
P. O. Box 2725, Raleigh, N. C.

Send
\$1
or
\$2

Name.....
Address.....



2 FOR \$14.95
MAGNETO HANDSET INTER-COMM
(rebuilt). For house to barn etc., included 100 ft. of wire and 4 batteries. Additional wire 1¢ per ft. Any number can be connected in same line. Write for FREE List. All shipments FOB Simpson, Pa.
TELEPHONE ENGINEERING CO.
DEPT. 987
SIMPSON, PA.

\$300.00 Profit Monthly FROM SMALL CLASSIFIED AD

That's a sweet profit for any mail order advertiser. Of course, he's thrilled—Who wouldn't be. Would you like to read of his experience? Write me, F. W. Johnson, Classified Advertising Mgr., Popular Mechanics Magazine, Room 604, 200 E. Ontario, Chicago.

SAVE \$ ON U\$ GOV'T \$URPLU\$

Our publication "Government Surplus Sales" lists hundreds of items for sale by the U. S. Government at tremendous savings, as low as 1c on a \$1.00.

These are samples of the savings that are being made:

LIFE BOAT\$12.00	GRINDER\$4.69	SHAPER\$15.00	DUMP TRUCK.....\$76.77
TRACTOR\$75.00	TYPEWRITER ...\$7.51	FREEZER\$50.00	SPRAY PAINTER.....\$15.25
	MOTOR\$4.00		

Hundreds others listed in our bulletin "Government Surplus Sales" and may be purchased direct from U. S. Government. Hunting, Fishing, Camping, Sporting Equipment, Photographic Equipment and Supplies, Radio and Electronic Equipment, Amphibious Trucks, Jeeps, Boats, Motors, Binoculars, Plumbing, Electrical Equip., Cars, Power Tools, Machinery, Chemicals, Furniture, Office Equipment, Supplies, Scrap, Etc.

How may you receive our bulletin "Government Surplus Sales?" By sending \$1.00 to
GOVERNMENT SURPLUS SALES, P. O. Box 169, Department 8-5, East Hartford 8, Conn.



An Introduction to Wonderful Worlds for Young Americans!

—the Boy Scientist

One pound Uranium Equal to 2,600,000 pounds of coal



A Space Platform May Look Something Like This

New Popular Mechanics Book Packed With Thrilling Facts and Fascinating Information

Get this thrilling Popular Mechanics book for every boy you know. In it, your own boy scientist can pore over the world-shaking discoveries in astronomy, physics, chemistry, sound, electricity, atomic theory and relativity. In the same thrilling pages, he can meet the greats of the world of science such as Galileo, Newton, Franklin, Faraday, Einstein and many others. With its help, he can participate in monumental discoveries by performing the many experiments which are suggested in the book and explained in word and picture.

The Spark That Opens Up a New World

Written by John Lewellen, noted writer of a dozen books on science and natural history, Preface by Dr. Wilbur Beauchamp, Professor of Education, University of Chicago, who says "the Boy Scientist may well be the spark that starts some boy on the way to becoming a scientist and the Nation's need for scientists is very great."

Finest Gift for Boys Use "Money Back" Coupon

Is there a boy in your family? Then get him the Boy Scientist. It could be one of the most important books he ever reads. Want to send the supreme gift to some boy you know?

Then give him the Boy Scientist too. There is no finer gift for any occasion. Sent postpaid to any address for only \$3.95. Order on Money Back coupon now. If not immensely pleased with the book return in 5 days and the entire purchase price will be refunded.



Meet These Greats . . . Know Their Achievements

- Galileo . . . the first modern scientist
- Newton . . . the law of gravity and famous three laws of motion
- Boyle . . . and how gases behave
- Archimedes } and
- Pascal } Liquids
- Bernoulli }
- Huygens . . . and light
- Benjamin Franklin . . . and electricity
- Bequerel . . . radioactive fog
- Einstein . . . theory of relativity
- Rumford . . . heat
- Mersenne . . . the laws of sound
- Tomorrow . . . will bring new discoveries



Prepared in the famous Popular Mechanics easy-to-read and easy-to-understand style. Adults too, will find this a fascinating book.

Library Cloth Binding
6 3/4 x 10 In.
264 Pages
277 Illustrations

Use This "On Approval" Coupon

POPULAR MECHANICS PRESS

Dept. 957, 200 E. Ontario Street, Chicago 11

Send at once _____ copies The Boy Scientist, \$3.95 each. I understand I may return books in 5 days and you will refund full purchase price.

- Remittance for \$_____ enclosed. Send postpaid.
- Send C.O.D. I will pay postman.

Name _____

Address _____

City _____ Zone _____ State _____

ENGINEERING



Dr. Leo DeForest, Father of Radio, Grandfather of TV, all Electronics, exchanging ideas with Heald Electronics instructor. Heald College Ranks FIRST West of the Mississippi in "Who's Who" in America. Send for FREE Information Heald Engineering College Est. 1882. Van Ness at Post, Dept. P.M. San Francisco, California. Enroll Now for New Term

Thousands of Engineers Needed for Hard Pressed Industry
BACHELOR OF SCIENCE DEGREE, 27 MONTHS

- Degree Courses:
- Electronic Engineering
 - Electrical Engineering
 - Highway Engineering
 - Mechanical Engineering
 - Structural Engineering
 - Civil Engineering
 - Architecture

- Diploma Courses:
- TELEVISION Color TV
 - Tool & Die Design
 - Architectural Drafting
 - Mechanical Drafting
 - Structural Drafting
 - Surveying
 - Estimating
 - Master Electrician

Approved for Veterans

NAME _____
STREET _____
CITY _____
STATE _____

the inside story of
PATENT NO. 2,442,945*

ALDOR
THERMO-REACTOR
SPARK PLUGS

The ONLY FULLY AUTOMATIC spark plug in the world! Engineered especially for today's new car HIGH-COMPRESSION engine! You get MORE miles per gallon, GREATER horsepower, under any and every driving condition — INSTANTLY — AUTOMATICALLY!

Millions in daily use in the U.S., and in over 30 foreign countries! GUARANTEED TO OUTLAST & OUTPERFORM ANY OTHER PLUG!

Aldor's specially designed D-N* ELECTRODE insures peak resistance to pitting and burning and assures INSTANT STARTING!

- NO FOULING in stop and go city driving...
- NO PRE-IGNITION at high speed open road driving. AUTO-MATICALLY!

ALDOR Thermo-Reactor Spark Plugs are on sale at most better Auto Accessory Stores, Garages and Service Stations—Ask for them by name! If not available locally, send check or money order, or C.O.D. (stating year, make and model of car or type of engine) to:

A. L. DOERING SPARK PLUG CORP.
3 Station Plaza, Bayside 61, N. Y.

Manufacturers of the world famous OIL FIRING Spark Plug since 1914

THE ONLY SPARK PLUG IN THE WORLD WITH THE PATENTED AUTOMATIC "BUILT-IN-BRAIN"*



*The PATENTED THERMOSTATIC DISK is an engineering marvel that gives you AUTOMATIC spark adjustment for both high and low speeds—SOME THING NO OTHER PLUG CAN DO! Power response is faster and smoother than ever — from a standing start, easing along in traffic, or passing at cruising speeds!

At low speed, stop & go city driving, the Thermo-Reacting Reactor Disk AUTOMATICALLY snaps away from the electrode causing a voltage buildup. This produces the HOT spark that burns away ALL carbon deposits and PREVENTS FOULING!

At high speed driving, the Thermostatic Reactor Disk AUTOMATICALLY snaps back to the electrode reducing voltage flow and producing the COLD plug that PREVENTS PRE-IGNITION and compression loss!

The Patented Thermo-Reactor is also built into the World Famous ALDOR OIL-FIRING non-fouling spark plug for older engines and worn engines using excessive amounts of oil! SELF-CLEANING. WILL NOT FOUL - Actually FIRES IN OIL!



Thermo-Reactor plugs also sold under the following trade name:



DIESEL MECHANICS IN DEMAND

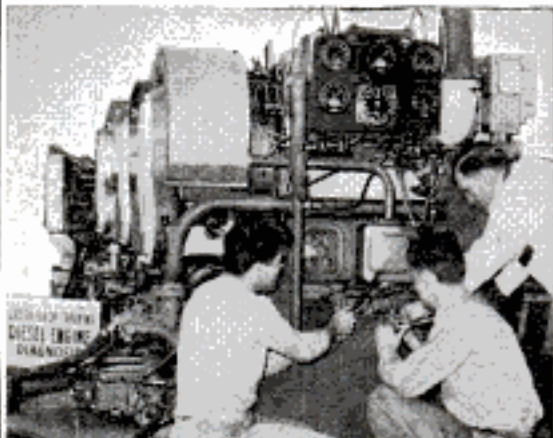

Learn to earn big pay in DIESEL in our large, modern equipped Chicago school and shop. No previous experience or training necessary. We help you find living quarters and part time job while in school. Complete, practical courses taught in the following trades, under the supervision of experienced, expert technicians.

APPROVED FOR CIVILIANS OR GI'S

— CHOOSE YOUR TRADE —

CHECK HERE	WEEKS
<input type="checkbox"/> DIESEL MECHANICS	20
<input type="checkbox"/> AUTO MECHANICS	20
<input type="checkbox"/> BODY & FENDER	16 3/4
<input type="checkbox"/> GAS-ARC WELDING	4-12
<input type="checkbox"/> REFRIGERATION	13 1/2
<input type="checkbox"/> AIR CONDITIONING	8 1/2
<input type="checkbox"/> MACHINIST TRADE	30
<input type="checkbox"/> ADVANCED MACHINIST (includes tool & die)	32 1/2
<input type="checkbox"/> PIANO TUNING & REPAIR	36

CHOOSE YOUR ENGINEERING COURSE

These courses are intended as terminal education for men who wish to enter the Diesel-Automotive and Refrigeration-Air Conditioning fields as technicians. These courses are designed to prepare men for supervisory positions. Students with a high school education, or equivalent, will be accepted.

- DIESEL AUTOMOTIVE ENGINEERING.....2 years
 REFRIGERATION & AIR COND. ENGINEERING.....18 months

HEAVY CONSTRUCTION EQUIPMENT OPERATOR TRAINING SCHOOL FOR CIVILIANS—Road Building, Terracing, Land Clearing, etc. Reservations accepted now!

FREE EMPLOYMENT HELP

Start your career with Greer by checking your interest above and mail coupon for complete information at no obligation.

NAME _____ AGE _____

STREET _____

TOWN _____ ZONE _____ STATE _____

Established 1902 — Over 50,000 Graduates.

55 years of continuous trade school experience to guide your training.

GREER SHOP TRAINING

Box 1, 2236 S. Michigan Ave.
Chicago 16, Illinois



college graduates get ahead faster!

You see it in your own city. They have higher incomes . . . advance more rapidly. Grasp your chance for a better life. Industrial growth . . . automation . . . technical advances create career opportunities for engineers, accountants, management experts. Share rewards awaiting college-trained men. Important firms visit campus regularly to employ Tri-State College graduates. Start any quarter in this world-famed college. Approved for veterans.

Bach. of Science degree in 27 months

In Mechanical, Civil, Electrical, Chemical, Aeronautical, Radio (TV-Electronics) Engineering. In 26 months a B.S. in Business Administration (General Business, Accounting, Motor Transport Management majors). Superior students may accelerate. 26-weeks course in Drafting, *Intensive program*: technical fundamentals stressed; comprehensive courses with more professional class hours. *Small classes*: personalized instruction. Enrollment limited to 1000. Preparatory courses. *Residential campus*. Well-equipped, new and modernized buildings and laboratories. Enter Sept., Jan., Mar., June. Earnest, capable students (whose time and budget require accelerated courses and modest costs) are invited to write Jean McCarthy, Director of Admissions, for catalog and book "Your Career in Engineering and Commerce."



TRI-STATE COLLEGE

497 College Avenue • • • Angola, Indiana

CHEMISTRY

FREE CHEMISTRY COURSES!
 Discover how quickly you can acquire a DIPLOMA in Chemistry through easy home-study courses! You may be eligible for a FREE enrollment in ANY of our courses! Send for free catalog of fascinating Chemistry courses and Chemistry Kit! First 3 lessons, chemicals, equip., only \$1.00. No obligation. NATIONAL SCHOOL OF CHEMISTRY, P.O. Box 606L, Redwood City, Calif.



MASTER MIND!

Learn Short-Cut Mathematics

Juggle figures, do baffling number tricks. Make people gasp at your marvelous lightning-quick mind. Multiply 4 figures by 4 figures without using old-fashioned multiplication! Big cloth-bound volumes fully illustrated course for self-instruction.

Sharpen up Your Brain Power

Includes worked-out problems, answers, etc. Sensational bargain, only \$3.95 postpaid or COD plus postage. Satisfaction guaranteed or refund. Order this amazing "Short-Cut Mathematics" today!

NELSON-HALL CO., 210 S. Clinton St.
Dept. 2JT-2 Chicago 6, Ill.

\$3.95 Complete

FREE WHOLESALE CATALOG

MAKE MONEY!! SAVE MONEY!!
 Buy Tools, Hardware, appliances, photo equipment, sporting goods, power tools, paints and thousands of other nationally advertised products at WHOLESALE COST TO YOU.

"SEND FOR FREE 1957 WHOLESALE CATALOG TODAY!"

SILVO HARDWARE COMPANY

Dept. PM-9, P. O. Box 288, Philadelphia 5, Pa.

get up to
50%
off

How to Build Your Own GARAGE



Save as Much as 50% of Usual Construction Costs

Get Popular Mechanics' brand new book *How to Build Your Own Garage* by Wayne Leckey, Assistant Shop Notes Editor, and find out how you can build your own garage at savings of 50% of usual cost. Leckey tells in famous step-by-step instructions and shows in big, clear photos, drawings and diagrams how to perform every building operation from laying the concrete to installing the final trim. There are 25 designs. Brick, frame, and concrete block fully covered. Send \$3.50 for your copy. 7-day money back guarantee.

POPULAR MECHANICS PRESS, 200 E. Ontario, Chicago 11, Ill.

WORLD'S
BEST
WANT-AD
MEDIUM

CLASSIFIED ADVERTISEMENTS



Advertisements in this section \$1.25 per word, each insertion, minimum 10 words, payable in advance.

To be inserted under proper classification, copy must be in our office the

20th of the second month preceding date of issue

F. W. Johnson, Manager, Classified Advertising

Popular Mechanics Magazine, 200 East Ontario Street, Chicago 11, Illinois

YOU'LL PROFIT

By reading and answering the classified ads in this section. Hundreds of opportunities for you to make and save money

AUTOMOBILES, MIDGET CARS

STOP Cooling system rust, improve efficiency, save repair costs easy way. Write Laircraft, Box K-5008, Detroit 35, Mich.

HUNDREDS Of automobile catalogs—Old, new and foreign; dealer books; glossy photographs; shop manuals; free motor magazines listed by non-profit club. Write to get on free mailing list. Auto Maniacs, Stockbridge, Mich.

AUTO SUPPLIES AND EQUIPMENT

RING-Valve job while you drive, \$6.00. World's only product of its kind. Safe! Proven! Guaranteed! Free details. Molloy, Grantham, Penna.

TURNPIKE Automatic foot throttle \$2.49. Real driving comfort. Money back if returned within sixty days. No c.o.d. The Dow Mechanical Corporation, Thompsonville, Connecticut.

1909-1932 FORD New parts catalog 25¢. Mark, 15 Emerson, Clifton, New Jersey.

AUTO Accessory and parts catalog. 1957 edition, all new! 238 pages. Save up to 50%. 75,000 items, including Hollywood accessories, hi-speed equipment, rebuilt engines, all parts and accessories for all cars and trucks! Hard-to-get parts! Send 25¢, refundable. J. C. Whitney, 1919 PM Archer, Chicago 16, Ill.

SAVE Money on Jeep and army truck parts. Large inventory. Catalogs for Jeep or G.M.C. owners. American Auto Parts Co., 1830 Locust, Kansas City, Mo.

FREE! New catalog. Speed, power, mileage increasing equipment. Discounts! Almsquist Engineering, Milford PM5, Penna.

OFFENHAUSER—1957 Catalog available on all items manufactured and distributed. Only 35¢. Offenhauser Equipment Corp., 5156 Alhambra Ave., Los Angeles 32, California.

AUTOMOTIVE Books. Free catalog. Popular Mechanics Press, 631 N. St. Clair St., Chicago 11.

NEON Car ornaments—In shape of Jet airplane. Flashes red, blue, green, or gold with each revolution of engine. You can tell your engine r.p.m. Mounts on hood or fenders. State what color you wish ornament to flash. \$6.95 each. Heb Manufacturing Co., Box 1498, Grand Junction, Colorado.

FORD T and A parts? Try best source odd model parts, all makes. Wisneski, Milwaukee 7, Wis.

AMAZING "Compression-Seal" gives ring-valve treatment while you drive! Adds years to motor! Only \$1.95 postpaid or c.o.d. plus charges. Fully guaranteed! Details free. Pazer Sales Co., Dept. 11-1, 198 East 52nd Street, Brooklyn 3, New York.

CHARGE Batteries automatically. Treatment \$1.00, guaranteed. Literature. Carlton, 3007 Wharton, Philadelphia 48, Penna.

MOTOR Overhauled while driving. \$3.95 postpaid. Write Gadsby, 426-PM, W. 49 St., New York City 19.

NEW And used parts at savings. Complete guaranteed parts service for all models cars and trucks, 1924 and later. Largest in the West. Jeep and army parts specialists. Newest type shifting hubs for all Jeep, army and navy, and latest production front end drive vehicles. \$27.50 and up. Pioneer Auto and Truck Parts Co., 734 W. 13th Avenue, Denver 17, Colorado.

HYDRAULIC Jack repair kits. Repair your own. Send 25¢ to cover cost of price list. Jack Parts Co., 2000 South Claiborne Ave., New Orleans 13, La.

\$7.50 VALUE. 6-Volt motor and gear for windshield wiper. \$1.00 plus c.o.d. charges. While they last. Universal Associates, 1115 W. Lill Ave., Chicago 14, Ill.

BAG O'Bolts. Assorted English sizes, \$1.09 p.p. Satisfaction or money refunded. IMI, 2612 East 75th St., Chicago 49, Dept. B.

LOOK. Auto mechanics and service station operators. New combo air nozzle inflates tires, blows out gas lines, operates grease guns, air tools, etc. \$2.95 postpaid. Guaranteed satisfaction. R & J Products, Box 97, Vanceburg, Kentucky.

AUTO TRAILERS

TRAILER Building manual \$1.00. Booklet 30¢. Kamcraft, Box 1153, Milwaukee 1, Wis.

BLUEPRINTS Vacation trailers. Supplies, literature 10¢. Comstock Trailers, Parsons, Kansas.

BUILD Expanding eight foot trailer. Accommodates five. Literature 10¢. Framar Company, Wilmington, Mass.

MOTORCYCLES, BICYCLES, MOTORSCOOTERS AND SUPPLIES

DOODLEBUG Motorscooter \$12.50, midget car \$25, less engines. Harley engine \$5. Whizzer \$5. Indian motor and propeller \$5. Maytag \$4 (mailorder only). Send 25¢ (35¢ for first class mailing) for 32 page directory-catalogue number 79 listing these and hundreds of other bargains in motorcycles, midget cars, home builders parts, plans, etc. Midget Motors Directory, Athens, Ohio.

NSU And BMW motorcycles. 2 to 35 h.p., singles and twins, chaindrive and shaft-drive. Butler & Smith, P.O.B. 45, New York 24, N. Y.

RECONDITIONED Motorcycles and motors. Chromium accessories. Complete stock Indian parts. Expert rebuilding. Fast service. Indian Motorcycle Sales, Kansas City 27, Missouri.

MIDGET Auto \$25.00; 1954 Whizzer \$20.00; Cushman motorscooter \$25.00; motorcycle \$10.00. Rush 25¢ (35¢ first class mail) for new catalog #960 listing amazing bargains in motors, midget cars, motorcycles, motorbikes, construction plans. Associated, Box 534, Toledo, Ohio.

PARTS. New, used. List 10¢. Ballak, 811 N. 9th, St. Louis 1, Mo.

HARLEY - Davidsons — Used bargains. New, used parts, accessories for all models. Bulletin, catalog 25¢. Knuth's (Factory Dealer), 1753 Muskego, Milwaukee, Wis.

AVIATION

SPACE Satellite sensation, geophysical year souvenir. Flies higher than a 12 story building; performs 5 aerial maneuvers; durable metal. \$1.00 each postpaid. No c.o.d.'s please. Guaranteed. Satellite, Box 252, Rossville, Ga.

PRICED Aviation surplus catalog, 10¢. Aero Parts, 8102 Lockheed, Houston, Texas.

BUY Surplus aircrafts; fuselages; assemblies; aircraft engines; helicopters; instruments; electronics; radiotelephones; misc. Buy direct now from U. S. Government. Depot list and procedure \$1.00. Brody, Box 8-PM, Sunnyside 4, New York City.

PROPELLERS, Plans, supplies for airboats and snowplanes. Latest designs, prompt delivery. Catalog 25¢. Banks-Maxwell, Box 3301E, Ft. Worth 5, Texas.

AVIATION Surplus bargain catalogue. One dime. Box 22PM9, Thomasville, Penna.

ELECTRICAL SUPPLIES

ELECTRIC Pencil: Engraves all metals \$2.00. Beyer Mfg., 10311-H Springfield, Chicago 43.

MAGNETIZER—Magnetize one to million screwdrivers. \$2.00. Kubink, Huntingdon Valley, Penna.

BOOK 200 Electric stunts \$1.00. Kutting, 26278 Arastradero, Los Altos, Calif.

LAMP. Electrical parts, wholesale. Thousands of items for repairing, converting. Catalog 25¢. Brown Lamp, Box 305, Clayton 5, Mo.

DC Power supplies. Laboratory, test units, DC motor controls. Complete line selenium rectifiers, meters, transformers and other replacement parts. Ramyr, Dept. D-1, 1624 East First Street, Los Angeles 33, California.

LAMPS—Parts catalog containing wiring instructions, 25¢. Gyro Lamps, 3438P N.W. 54 Street, Miami, Fla.

WELDING, SOLDERING, PLATING

BUILD-Your-Own welder or welder and power combination. Low cost unit connected to used engine lets you weld anywhere. Free booklet tells how. Get into profitable welding business. Write Hobart-weld, Box M-972, Troy, Ohio.

WELDERS. 110/220, \$39.50. Morris, 1070 Inner Drive, Schenectady 3, New York.

ELECTROPLATING Equipment, anodes, solutions. All types, including new electrodeless nickel. Baby shoe metallizing equipment, supplies. Free catalog. Hollywood Bronze Supply, Dept. B-4, 1624 East First, Los Angeles 33, California.

ACETYLENE Welding outfits new \$54.50; used \$34.50; arcwelders \$56.30. Eagle Welding, Dept. PM, 5085 Broadway, Chicago 40, Ill.

MACHINERY, TOOLS, SUPPLIES

MECHANICS Tools and electric products. Substantial savings. Postage paid, 25¢ for catalog. Hisco, 222-236 South Front, Memphis, Tennessee.

LATHE Owners. New precision "Dawn gauge" eliminates calipers and dividers for centering all round stock up to 2". Marks exact center in one quick operation. Also matches dowel and circle centers in flat stock. \$2.95 postpaid. Dawn Crafts, 215 Commonwealth, Buffalo 16, N. Y.

FAMOUS Payswell sprayer, compressor, motor, gun all in one unit, 50 lbs. pressure. 9 payments available. Will take old sprayers in trade. Further information write Selco Corp., 224 W. 7th St., St. Paul 2, Minn.

MINIATURE Taps, dies, screws, tools. Free folder. Morris, Southbridge, Mass.

POWER Tools, not toys. Discounts. Factory catalogs. World Tool Supply, Box 4404, Joyfield Station, Detroit 28, Mich.

SURVEYING INSTRUMENTS

NEW And guaranteed factory rebuilt transits and levels, sale or rent, with purchase option. We will repair, trade or buy old instruments. Write for list M-79, Warren-Knight Co. (Manufacturers of Surveying Instruments), 136 N. 12th St., Philadelphia 7, Penna.

SURVEYING Water level, cheaper to own than do without. Labor, material under \$10.00. Free details. Instructions \$1.00. M. Mercier, 74-3rd St., San Francisco 3, Calif.

ENGINES, MOTORS, DYNAMOS

GAS Engines: Foreclosure sale: 1½ to 7 h.p. Brand new, factory fresh, latest models. Briggs Stratton, Clinton, Lauson. Positively below wholesale prices or your money back. \$29.95 and up (freight paid). Details free. Northern, 172-M Merrimac Street, Boston 14, Mass.

SMALL Electric motors. Bargains. Kiteco, Box 212, Dept. 17, Monroe, Wisconsin.

AIR Compressors half price. Free folder. IMSCO, 1629 South State, Chicago 16.

OSCILLATING Steam engine. Details free. Gilbert Cope, Box 71-B, West Chester, Penna.

DIESEL Injector parts wanted. GM71-110. Bares, 7120 Carnegie, Cleveland 3, Ohio.

½ HORSEPOWER Electric motors, a.c. 110, used, good \$5.00 each, f.o.b. Plant Machinery Corp., Richmond & Norris Sts., Philadelphia 25, Penna.

REWIND Motors yourself. Complete instructions \$1.00. Lewis Mig., Howell, Michigan.

WINDING Data. 275 motors, single and three phase, \$1.10. Data Company, Box 7631, Kansas City 28, Mo.

BOATS, OUTBOARD MOTORS

FULL Size, cut-to-shape boat patterns, blueprints, 7½-38 feet. New 86 page illustrated "Build-A-Boat" catalog of naval architect-designed cruisers, runabouts, skiffs, outboard boats, sailing, racing, houseboats, 50¢. "How to Build a Boat" booklet, \$2.50. Hardware and equipment catalog \$1.50. Cleveland Boat Blueprint Co., Dept. A-66, Box 1651, Cleveland, Ohio.

FREE Catalog! Boat kits, trailers, fiberglass, marine hardware. Lager Industries, Dept. M9, 3404 Lyndale South, Minneapolis, Minnesota.

MARINE Conversion, Willys to Cadillac, engines, kits and parts. Catalogue and conversion hints free. Barr Marine, 2706 Castor Avenue, Philadelphia 34, Penna.

MOLDED Fiberglass boats or kits. Marinecraft, Box 161-M, Brighton, Mass.

BOAT Stabilizer—Adds speed and prevents galloping or floundering. Easy to bolt to transom. Satisfaction guaranteed. Only \$4.95 ppd. The Marine House, P. O. Box 7594, Orlando, Fla.

FIBERGLASS For boats and repairs. Direct prices and free literature. Lukas, 17W286 Karban, Villa Park, Illinois.

FIBERGLAS Boat coating. Plexiglas boat windshields—Clear, blue, green tints. Wholesale-retail. Instructive information catalog free! Gem-O-Lite, 5529 Cabuenga, North Hollywood, California.

ELECTRIC Outboard plans \$1.00. Ken Lewis, 1050 N. Clara Ave., DeLand, Fla.

FORDS And Jeeps 100% marine engines with famous Convo-Kits. Deluxe catalogue 25¢ coin, Oscomotors, 3627B Lawrence, Philadelphia 40, Penna.

FIBERGLASS Your boat! Complete kits including color resin. Low as \$8.50. Aquaglas, Box 99, Altadena, Calif.

BOAT Plans. Full size patterns. Frame kits. Modern inboards and outboards for amateur builders. Complete new catalog 50¢ or specify requirements. Glen Design, Box 568, Compton, Calif.

NEW, Used, rebuilt marine motors. Marine conversions, fittings. Free catalog. Stokes Marine Supply, Dept. 24, Coldwater, Michigan.

FIBERGLAS Permanent boat waterproofing. Special 25% discount. Complete kits, \$9.45 up. Guaranteed materials. Easy application. Full instructions. Free literature. Ajax Plastics, Dept. PM, P.O. Box 1323, Fort Worth, Texas.

BUILD Small boats. Booklet 25¢. Catalog free. Popular Mechanics Press, 633 N. St. Clair St., Chicago 11.

ATHLETIC EQUIPMENT, BODY BUILDING COURSES

BARBELLS, Dumbbells. Courses. Free catalogue. Good Barbell Co., Reading, Penna.

100 TRICK Knockouts for self-defense \$1.—1¢ each. Priest, Box 251, Evanston 1, Illinois.

BE Taller! Coach's genuine "Inch-At-A-Time" system, new edition, \$1 complete. Satisfaction guaranteed. Marty Snyder, Box 195-RS, Union City, New Jersey.

OUTSTANDING Physical development! Any age. New guaranteed discovery uses only a rope! Strength, health, muscles. Gain—reduce. Free booklet. Roperclise, 4834-A Art, San Diego 15, California.

BE Taller! Complete guaranteed instructions \$1.00. ABC, Box 849-M, San Francisco 1, California.

SPORTING GOODS, GUNS, FISHING TACKLE, ARCHERY, TRAPPING

FISHERMAN: Save your snagged lures with a weighted spring retriever. Fully guaranteed. \$3.95 complete. Russell's Retriever, 1754 East 71st Place, Chicago 49, Illinois.

FISHERMEN: Trap minnows 20-below to 90-above. Copyrighted "bait attractor" instructions \$1.00. Guaranteed. Discount gun, tackle list free. Sportsmen Buying Service, White 15, South Dakota.

FREE Below wholesale fishing catalog. Fishing Tackle Mart, Dept. 59, Box 6737, Chicago, Ill.

COLTS, Remingtons, Winchester, Lugers, P-38's, Kentuckies, Springfields. Antique-modern guns and guncessory values. Big bargain catalog 50¢. Agramonte's, Yonkers 2, N. Y.

FREE—Giant 1957 wholesale sporting goods catalog. Lowest wholesale prices. Complete line of cameras, sporting goods, appliances, outdoor items. Write today. Santa Fe Distributing Co., 1321 Main Street, Dept. PM, Kansas City, Mo.

ANTIQUE Guns, swords, weapons! Huge illustrated monthly catalog. Hundreds items each issue. \$1.00 year. 12 fabulous catalogs. N. Flayderman, Kennebunk, Maine.

160 PROFUSELY Illustrated pages antique pistols, swords, daggers, armor, etc. 50¢. Robert Abels, M860 Lexington Ave., New York City 21.

RIFLES, Shotgun, pistols, scopes, ammunition. Dealers prices. Berkshire Gun Rack, Six Lakes, Michigan.

BIG Money raising crickets and 12 inch African fishworms. Free literature. Carter Ranch, Plains, Georgia.

5000 BARAINS, Firearms, binoculars, war relics. Catalog 50¢. Smith Firearms, Runnede, N. J.

SAMPLE: 25¢ Copy of "The Archer's Magazine." Send 10¢. 1200 Walnut Street, Philadelphia 7, Pennsylvania.

FREE Sporting goods catalogs! Save 70%. Econ-O-Mart, Whippany 2, New Jersey.

MOLDS For fisherman's sinkers, jigs, squids, casting and spinning lures. Free catalog. Sweet's Molds, Tonawanda 1, New York.

JAP Rifle altering to 30-06, \$6.00. Jap-shells, \$3.95. Catalog 5¢. T. P. Shoe, West Branch 11, Mich.

BUILD Barbecue. Complete plans. Booklet 25¢. Free catalog. Popular Mechanics Press, 633 N. St. Clair St., Chicago 11.

EARTHWORMS

BIG Money raising crickets, hybrid red wigglers and 12 inch African fishworms. Free literature. Bedrun hybrid red wigglers. 3000, \$6.50; 10,000, \$19.95, postpaid with raising instructions. Carter Redworms, Plains, Georgia.

RAISE Earth worms. Profitable, easy instructions 25¢. Lairs Hatchery, Box 84, Virden, Ill.

HULA-HULA wigglers are better! Inquiry, information free. Kean, Ladonia, Texas.

\$13.50 GETS \$25.20 Back. Free details. Brandt's Wormery, Century Apartments, Davenport, Iowa.

FREE Folder, "How to Make \$3,000 Yearly. Sparetime, Backyard, Raising Earthworms!" Oakhaven 56, Cedar Hill, Texas.

TAXIDERMY

AMERICA'S Most complete taxidermy supply house. Send 10¢ for big, beautifully illustrated catalog. Penn Taxidermy, PM7, Hazleton, Penna.

BINOCULARS, TELESCOPES, MICROSCOPES, MAGNIFIERS

BINOCULARS, Telescopes, microscopes, terrific values \$3.98 up. Request free money-saving catalog. Criterion, Dept. P-58, Hartford, Conn.

300 POWER Reflecting telescope complete with finder scope and tripod, \$24.95. Free information. Suffolk Science, Mattituck 5, N. Y.

MICROSCOPE Slides, free list. Bay, 409 Roosevelt, San Francisco 14, California.

WAR Surplus bargains: Millions of lenses, instruments, telescopes, binoculars, components and complete line of astronomical telescope items. World's greatest optical market place! Send only \$1.00 for beginner's 10-lens kit and big instruction booklet Stock 2-CH. Write for catalog CH, free! Edmund Scientific Co., Barrington, New Jersey.

BUILD Your own reflector telescope. Complete kit: Mirrors, eyepieces, tripod, all other accessories. Request free illustrated literature. Criterion Manufacturing, Dept. DPM-33, Hartford, Conn.

REFLECTING Telescope, 60X, completely assembled \$29.75. Guaranteed observatory clearness. Free information. Skyscope, 475 Fifth Avenue, New York City 17.

REFLECTOR Telescope kits \$1.25 (3") to \$175 (12"). Mirrors, cells, focusing mounts, tripods, eye systems. Anything, everything in telescopes. Free catalog. Also ready to use telescopes from \$25. Esco Products, Oakridge, N. J.

MICROSCOPE Catalog free. Research Scientific Supplies, 126 W. 23rd, New York City 11.

AMAZING Prices, precision binoculars. Folder, "Binocular Selecting" catalog free. Dealers write, Prentiss Importers, Mercury Bldg., West Los Angeles 25, Calif.

DYNASCOPE. Sensational new reflector telescope. Send for details. Criterion Co., Dept. DP-34, Hartford, Conn.

PLANTS, SEEDS, BULBS, NURSERY AND GARDEN SUPPLIES

GINSENG. Golden seal roots bring up to \$14 pound. Full information, F. M. Collins, Viola, Iowa.

WORLD'S Greatest cash crop. Free information. Write Ginseng Gardens, Asheville, N. C.

20 PALM Seedlings \$2.00. Free tropical plant, seed list. Tashiro, Box 2275, Miami Beach 40, Fla.

PETS—DOGS, BIRDS, RABBITS, HAMSTERS, ETC.

PETS Postpaid—Alligator \$3.00; Iguana \$3.00; tortoise \$2.00; box turtle \$1.50. Snakes, amphibians, mammals, curios. Catalog 10¢. Ray Singleton, Rattlesnake, Florida.

KEEP Your dog free of fleas without powders, sprays or ointments. Use trouble-free Fleacollar. Guaranteed. Information free. Write: Fleacollar, Room 236, Rochester 1, N. Y.

HAMSTERS—Golden: young, \$3.00 pair. Fully developed \$4.00 pair. Adirondack Hamstery, Prospect 10-J, N. Y.

WE Pay \$3.50 lb dried. Grow mushrooms, cellar, shed and outdoors. Spare, full time, year round. We have 25,000 customers. Free book. Washington Mushroom Ind., Dept. 171, 2954 Admiral Way, Seattle, Wash.

BEAUTIFUL Pure white pedigreed police puppies. Anronia Kennels, McHenry, N. Dak.

RAISE Rabbits successfully by knowing facts. 48 page illustrated book describing 25 breeds. Housing, feeding, breeding, marketing, etc. Plus bulletin. 25 cents. American Rabbit Association, 35 Arba Building, Pittsburgh, Penna.

MAKE Money raising chinchillas, mink, nutria, rabbits, cavies for us. Free catalog. Keeney Brothers, New Freedom 2, Penna.

HAMSTERS—Young Golden pairs, \$2.95. breeders \$3.95. Free booklet. Jer-Fre's Hamstery, 2425 Hoyt, Muskegon Heights 13, Mich.

RAISE Rabbits on \$500 month plan. Plenty markets. Free details. White's Rabbitry, Delaware, Ohio.

WHITE German shepherd puppies. Theatrical dog tricks. Knoff, Nashotah, Wis.

STRAIGHT Cooners! World's oldest kennel. Combination hounds, rabbit, fox, beagles, deerhounds, bird dogs. Puppies of all breeds. Prices reasonable. Trial. Free catalogue. Raccoon Mountain Kennels, Box 464, Boaz, Alabama.

LIVE Texas horned toads, \$1.25 each. Pair, \$2.00. Postpaid, guaranteed. Tex's, Box 253, Brownwood, Texas.

SPORTSMEN: World's largest kennels offers 500 bird dogs, straight cooners, combination hounds, beagle hounds, rabbit hounds, small squirrel dogs, fox and deer hounds. Catalogue free. Smokey Mountain Kennels, Cleveland, Tennessee.

FUR BEARING ANIMALS

RAISE Mink: Free booklet, pen plans, inside secrets, feed, care. Mink are money makers. Investigate today. Lawrence Mølgard, Brigham City 12, Utah.

RAISING Fabulous nutria and luxurious mink is easy, interesting, profitable. Information free. North: Voight Fur Ranch, Lomira 8, Wisconsin. South: Voight Farms, Atlanta 2, Texas.

MINK Raising information free. Complete. Lake Superior Mink Farm, Superior, EEL, Wisconsin.

FARMS, FARM LANDS, REAL ESTATE

TEXAS Land near mammoth lake. Excellent fishing and hunting, ideal climate, rich soil, gardening, flowers. City water, phones, electricity. Total cost per tract only \$179.50. \$5.00 down payment, \$7.50 monthly. Title policy. Write for free photos, maps. Hugh Matlock, Dept. 246, Pipe Creek, Texas.

FLORIDA—Delightful living, near Gulf, on bays, bayous. Brochure. Chamber of Commerce, Lynn Haven 8, Florida.

GUIDE To Paradise—25¢. PHS, P. O. Box 746, Paradise, California.

OPPORTUNITIES! Government land, U. S., Alaska, Canada. Sledge Surveys, Macon 1, Mississippi.

CALIFORNIA State government land, 40 to 640 acre tracts. \$5 acre minimum. 104 brings information on available locations, maps of 500,000 acres. Pioneer Ranches, 1419-PM Beverly Blvd., Los Angeles 36, California.

\$5.00 MONTHLY Buys 40 acres productive land. Near town. Price \$250.00. Free list. Box 425-P, Carthage, Mo.

FREE Strout catalog! Farms, homes, businesses, resorts, retirement properties. Over 2900 values in 34 states. 37 years' service. World's largest! Write Strout Realty, 7-MP So. Dearborn, Chicago 3, Ill.

OZARKS! \$9 Acre. Listings, information free. Write: Armstrongs, Shook, Missouri.

FLORIDA, Nice homesites, \$345 at \$10 monthly. Folder free. Howard Vernor, DeLand, Florida.

PROFITABLE OCCUPATIONS

INVESTIGATE Accidents—Earn \$750 to \$1,000 month. Thousands of airlines, insurance companies, steamship lines urgently need claim investigators. We train you home spare time. Placement counsel and help. Free book, now! No obligation. Universal Schools, T-9, Box 8202, Dallas 5, Texas.

LEARN Lawnmower sharpening. No expensive machine needed. Very profitable. Literature. Grind-Rite Lawnmower Service, 5843 Roswell Rd., Atlanta 5, Georgia.

BIG Profits in welding. Easy to learn. Low cost training in completely equipped non-profit school. OI approved. Write for free booklet. Hobart Trade School, Box M-973, Troy, Ohio.

WE Establish you in your own mail order discount business. Supply catalogs, letters, envelopes printed with your name and ship your orders. Sell gifts, appliances, watches, housewares, silverware, etc., at discounts to 75%. Catalog and details free. Topval Corp., Lindenhurst 617, N. Y.

WE Pay \$3.50 lb. dried. Grow mushrooms. Cellar, shed and outdoors. Spare, full time, year round. We have over 25,000 customers. Free book. Washington Mushroom Ind., Dept. 99, 2954 Admiral Way, Seattle, Wash.

SAVE Money! Buy wholesale! Free catalog general merchandise. Norris, 487-M Broadway, New York City.

SPARETIME Repeat profits taking magazine subscriptions. Special offers. Cassell Agency, Boynton Beach, Florida.

FREE Folio "\$3,000-\$45,000: Unlimited Vacations." No merchandise. Unknown! Work home, sparetime! Haylings, Carlsbad, Calif.

BE The Popular Mechanics representative in your neighborhood and earn big profits in your spare time. Write Popular Mechanics Magazine, Room 305M, 200 E. Ontario St., Chicago 11.

BIG Money raising fishworms and crickets. Free literature. Carter Wormery, Plains, Georgia.

BAKE New greaseless doughnuts in kitchen. Sell stores. Free recipes. Michael Ray, 3605 South 15th, Minneapolis 7, Minn.

HOME Mailorder beginner's manual, sources, methods, opportunities, 25¢. Carnahan Bros., 9610 Acacia, Pontiana, Calif.

RAISE Pheasants on \$100 week plan. Little capital and space can make you independent. Free details. Great Central System, Columbus 1, Kansas.

FREE Book "505 Odd, Successful Businesses." Work home. Pacific, Oceanside, Calif.

MAKE Flexible molds. Cast plaques, figurines. Free sample. Tooker, 1645-M Fairview, Hamilton, Ohio.

VENDING Machines—No selling. Operate a route of coin machines and earn amazing profits. 32-page catalog free. Parkway Machine Corporation, Dept. 25, 715 Ensor Street, Baltimore 2, Maryland.

AUCTIONEERING—Home study course. Diploma granted. Auction School, Ft. Smith, Ark.

BUY Wholesale! Over 10,000 nationally advertised products. Appliances, cameras, sporting goods, housewares, watches, typewriters, tools, clothing, etc. Send postcard today. Buy-Rite, Box 258, Hawthorne 3, New Jersey.

THEY Hand him \$100! Free packet. "Secret Journal." 919 secrets-plans! Work home. Publicco, Oceanside, Calif.

SAVE Bottle caps. Make attractive wall plaques. Instructions 50¢. Campbell, 87 Poplar Ave., Bronx 65, N. Y.

\$60.00 WEEKLY Sparetime. Start home Venetian blind laundry. Protected territory. Interesting information free. Burt, 2434ES, Wichita 13, Kansas.

WANT To make big money at home? \$10.00 profit in an hour possible with invisible mending. Make tears, holes, disappear from clothing, fabrics. Steady year-round demand from cleaners, laundries, homes. Details free. Fabricon, 6236 Broadway, Chicago 40, Illinois.

SHARPEN Shears in one minute. Also side line sales. Correct angle mounted honing stone, sample \$1.00. Page, 1820 Cleveland, Niagara Falls 2, N. Y.

TRAIN Horses by circus methods. Write for free booklets. American Horse Training Institute, Dept. 79, Scammon, Kansas.

LEARN The high paying newspaper trade at home. For details write Thomas Smith, P. O. Box A-3987, Sarasota, Fla.

REPRESENTATIVES Wanted in all cities of the world to handle business missions, transactions, etc. Box 83, Station R, Montreal, Canada.

REPAIR Porcelain on appliances. Much needed service! Profitable! Free information. Enamel Repair, 466 Potomac, Buffalo 13, New York.

MAGAZINE Subscriptions—Largest commissions. Bonus. Qualified Agency, 4512A Kingston, Brooklyn 25, N. Y.

PROFITABLE Hobby—Raise fishworms. Instructions 35¢. Free literature. Shady Oaks, 18724-AI Martha, Saratoga, Calif.

BOOKS, PERIODICALS, PICTURES, POSTCARDS

FREE: Illustrated catalog! Many subjects. Treasure-Site Book Company, 279 South Alden, Philadelphia 39.

BRITISH Book bargains—Any subject. Catalog free. Transbooks, Box 1-PMO, Wantagh, N. Y.

WOMAN On low Social Security would appreciate subscriptions for Coronet, \$3.00 a year. Mrs. A. Weaver, Box 473, Hillsboro, Ill.

BACK Issues magazines supplied. Keller, 654 Grand St., Brooklyn, N. Y.

GET Your job. Valuable report saves time, money, 25¢. Independent Publisher, Box 1108, Atlanta, Ga.

NATIONAL Geographic Magazines, 1888-1956. Periodical Service, Box 463-PM, Wilmington, Delaware.

"HOME Improvement Guide," New, amazing 192 page volume. Packed with ideas, plans for remodeling, decorating, landscaping, built-in projects. \$2.50 pre-paid. Popular Mechanics Press, 200-HQ East Ontario St., Chicago 11.

RARE Magazines, catalog 10¢. Nationwide Exchange, Box 1375-P, San Antonio 6, Texas.

BOOKFINDERS! All subjects. Send wants! Jaher Book Service, 183 Hazelwood Drive, Westbury, N. Y.

"SCIENCE Milestones." Records march of science starting 400 years before Christ, right up to date. Amazing facts revealed. 312 pages packed with startling information that will thrill you. A real history of science. \$5.00. Literature free. Popular Mechanics Press, 200-8M East Ontario St., Chicago 11, Ill.

BOOKHUNTERS! Scarce, rare, miscellaneous books. Atlantic Book Service, Cedar Street, Charlestown 29, Mass.

FREE: Exciting catalog packed with books covering most everything. Think of it—From cover to cover you will find described and illustrated hundreds of books telling how to fix and how to build almost anything. How to remodel your home; do your own decorating, plumbing, electrical work. Simplified books covering concrete work, carpentry, painting, furniture making and refinishing. How to build your own boat, home workshop tools. Best books on photography, welding, hobbies, homecraft. How to make a home freezer. Send for your free copy now. Popular Mechanics Press, 200-8C East Ontario St., Chicago 11, Ill.

SAMPLE: 30¢ copy of "The Aquarium." Send 10¢ to 12th and Cherry Sts., Philadelphia 7, Penna.

BARGAIN, Exciting Little Library booklets. 25¢ each. How to use tools, painting, welding, home improvement, games, models, plastics, lamp making, glass blowing, boats, photographs. Free catalog. Popular Mechanics Press, 200-LE East Ontario St., Chicago 11.

GAMES, TOYS, NOVELTIES

FREE Toy and hobby catalog. Trilco, 39-31 47th Ave., Long Island City, N. Y.

MAGIC TRICKS, PUZZLES, JOKER NOVELTIES

AMAZING New tricks! Catalog 25¢. Hocus Focis, 317 North State, Jackson, Mississippi.

RATTLESNAKE Egg trick. When opened apparently it hatched! 50¢. Mudale, Baird, Texas.

FREE! Vanishing cards, bargain catalog. 500 Tricks, Ward, 60 East 42nd, New York City.

STINK Bombs. Disgustingly potent 12/31. Kits, 1450 Drake, San Pablo 10, California.

WORLD'S Finest professional magic, Joker novelties. Giant illustrated catalog 10¢. Top Hat, Evanston 12, Illinois.

500 TRICKS. Douglas famous 120-page catalog, only 10¢. Fastest service to magicians for 30 years. Send 10¢ today. Douglas Magicland, Dept. 1, Dallas, Texas.

BE A magician! Large professional catalog of latest tricks. 35¢. Ireland, C-109 North Dearborn, Chicago 2, Illinois.

PROFESSIONAL Catalog, 175 pages, 25¢. Williams, 940 Plymouth, Ellwood City, Penna.

VENTRILOQUISM, easiest method. Details free. Smith, 2125 No. Bigelow, Peoria, Ill.

COINS, TOKENS, CURRENCY

OLD Money wanted. Will pay \$100.00 for 1894 dime, S mint, \$50.00 for 1913 Liberty head nickel (not buffalo). Big premiums paid for all rare coins. Send 5¢ for large coin folder. May mean much profit to you. Numismatic Co., Dept. 20, Fort Worth, Texas.

COMMEMORATIVE Half dollar uncirculated \$1.00. Bargain lists free. Sayers, 1600 Unaka, Johnson City, Tennessee.

WHOLESALE Coins for dealers, investors. Lists 10¢. Al Johnson, Box 33, Colorado Springs, Colo.

1955 UNCIRCULATED Half dollar \$1.00. Scarce 1950-D uncirculated nickel \$1.00. Ray's Coin Shop, 79 E. Van Buren Street, Chicago 5, Illinois.

LINCOLN Cents, buffalo nickels. Bargain list 10¢. Hughes, 21 Ottawa, Grand Rapids, Michigan.

SILVER Dollars: 1880-o through 1891-o, \$2.50 each. List 10¢. Bason, New Hyde Park, N. Y.

WANTED Indian head cents. Ralph Short, 87 Ballantyne, Utica 3, N. Y.

LINCOLN, Indian cents, all dates. 19558 cent uncirculated and complete price list 25¢. Penny Mart, PL-5, Box 629, Chicago 90.

ILLUSTRATED Retail catalogue of 800 foreign gold coins 50¢. James Randall, Box 2205, Ft. Lauderdale, Fla.

BOOK Collecting coins 75¢ cash. Joseph Coffin, 1182 Broadway, New York 1, N. Y.

FREE 1957 U. S. coin evaluation sheet showing estimated value of over 800 coins, 14-5¢-10¢-25¢ 1859 thru 1957 in our new coin album plus list of number minted each coin. Album and both lists only \$2.50 p.p. Satisfaction guaranteed. Lenco Sales, Box 67, Aberdeen, Maryland.

CASH Paid for U. S. coins and gold pieces. Thousands of dollars spent monthly. Are yours valuable? Send \$1 for illustrated catalog listing prices we pay. Bowers Coinco, A-3 Second National Bank Building, Wilkes-Barre, Penna.

FLYING Eagle plus large cent \$2.00. Rhode, 105 Windsor, Reading, Penna.

BELGIUM, Switzerland, Austria, Mexico's coins—10¢. Jolie Coins, Roslyn Heights, N. Y.

TEN Different Indian cents and five Lincoln cents before 1933 \$1.00. Price list free. Jeray's, Box 38C, Shoups, Tenn.

30 DIFFERENT Fascinating foreign coins \$1.00. Catalog free. Alfred Szego, Box 187, Jackson Heights 72, New York City.

OLD United States gold coins bought. John J. Firpo, 120 South Ana Ave., San Francisco 27, Calif.

DEALERS—Investors. United States uncirculated rolls cents, nickels, dimes, quarters, halves. For free price list write to: M. Hirschhorn, 3408 Northern Boulevard, Long Island City 1, N. Y.

LARGEST Selection of Morgan and Peace dollars at the lowest prices. Try me. Also trade dollars. I. E. Chex, 6321 N. Artesian Ave., Chicago 45, Illinois.

OROW Money at home!—Proof sets of coins grow rapidly in value! In 1936 a proof set cost \$1.81. Today, it is worth over \$400! Each set contains 5 beautiful coins: 1¢, 5¢, 10¢, 25¢, 50¢; hand-struck by the mint, especially for collectors. Proof sets are treasures as investments, and make wonderful gifts. Get yours now: 1957 set only \$3.00; 1956-\$5.00; 1955-\$7.00; 1954-\$8.00; 1953-\$13.00; 1952-\$26.00; 1951-\$35.00; 1950-\$53.00; Complete set 1950-1957 inclusive—\$140. Postal Products Co., Fast Mail Order, 5614MC California St., San Francisco 21, California.

BARGAINS, U. S. coins: 1893 Columbian world's fair half dollar, \$1.00. Ten different Indian pennies, 75¢. Two-cent piece, and 3-cent piece, \$1.00. Gold ½ eagle, \$9.00. Gold ¼ eagle, \$12.50. Beautiful coin bracelet, \$1.00. Many coins available. What do you need? Rare Coin Company, 31 North Clark, Chicago 2.

44 DIFFERENT Uncirculated coins, \$1.00. Oddehon, Box 482, St. Louis, Mo.

SILVER Dollars: Uncirculated, 1879p through 1891p, 1897p \$2.00 each. 1883cc \$15.00. Retail lists 10¢. Holden's, Garwin, Iowa.

LARGEST Coin magazine, 180 pages, 35¢. Scrapbook, 7320-J Milwaukee, Chicago 31.

SAN Francisco mint closed! Made only cents and dimes in 1955. In short supply and great demand. One each, brilliant uncirculated, for 25¢. Free coin lists with order. Bryson Stamp & Coin Company, 612 White, Toledo 5, Ohio.

12 DIFFERENT Indian cents, coin list, \$1.00. Pounds, North Wales, Penna.

MORGAN Dollars: 1878-87-90-91-97s, \$2.00 ea. Coin catalogue, 25¢. Shultz, Salt Lake 10, Utah.

FREE! Foreign coin, banknote and coin collectors illustrated catalog to approval service applicants. Send 3¢ postage. Tatham Coinco, Springfield 30, Mass.

COINS From Formosa, Vatican, etc., plus foreign banknote, 10¢ with coin approvals. Littleton Coin Co., Littleton 51, New Hampshire.

BARGAIN Lists, Indianhead cent, 10¢. Economy Sales, 156-A Dean, Mansfield, Mass.

U. S. large cent and coin bargain lists, only \$1. Delmaco Products, Box 1123, Wilmington, Del.

U. S. Coins on approval. Reasonable. Hutchinson, Box 4747, Philadelphia 34, Pennsylvania.

GET Profit and pleasure in collecting old coins. Send 10¢ for 56-page illustrated coin catalog. You'll be delighted with it. Send for it now. B. Max Mehl, 370 Mehl Building, Fort Worth, Texas. Largest rare coin establishment in U. S. Established 40 years.

10 INDIAN Head cents plus price lists, \$1 postpaid. Louis Bell, Masonic Building, Decatur, Alabama.

BARGAINS—\$5 Gold \$11.95; \$10 gold \$21.95; \$20 gold \$42.95. Also paying highest prices all gold coins, any quantity. Bebee's, 4514 North 30th, Omaha 11, Neb.

LINCOLN Cents 1910-S, 1913-S, 1921-S, 1923-S, 1924-S, all for \$2. Gasser's, Box 34615, Los Angeles 34, California.

10 MIXED Foreign coins—bills: 10¢. Dwight Musser, Dunbar, West Virginia.

STAMP COLLECTING

WOW! 135 All different Germany 10¢. Zeppelins, semi-postals, airmails, high values. Big bargain lists and approvals included. Jamestown Stamp, Dept. A-9PMC, Jamestown, N. Y.

STAMP Finder, world map and encyclopedia of stamp issuing countries only 5¢. Approvals. Goliath Company, Bethlehem K1, New Hampshire.

"ABE Lincoln" giant diamond, rainbow colored flag set, Israel, South Korea, 50 others different only 10¢. Approvals. Champlain, Isle La Motte, Vermont.

IRAQ, Iran, Syria, Lebanon, Egypt, Israel, free! Excellent approvals. Panorama, Box 239, Miami 2, Florida.

PENNY Approvals that satisfy. Robert Mead, P.O. Box 62, Brooklyn 29, N. Y.

DEALERS—Wholesale list, Postage 3¢. Frank, 5031 Queensberry, Baltimore 13, Maryland.

EXCITING Surprise lots 25¢, guaranteed value, approvals accompany. Beacon, Box 161, Woodside 77, New York.

WORLDWIDE Mixture, 500, 25¢. Brookside Stamps, Box 133, Mendon, Mass.

VALU-Packed American stamp catalog, 10¢. Sullivan, 127-T East 4th, St. Paul 1, Minn.

BEAUTIFUL Collection free to approval applicants. 10¢ handling. American Stamp, 5253 Powderhorn Sta., Minneapolis, Minn.

WORLDWIDE, 50 All different, absolutely free just to introduce our incomparable approval. Kent Stamp Company, G.P.O. Box 87, Brooklyn, N. Y.

FIRST U. N. set. Among world's prettiest. Only 10¢. Approvals. Welles, Box 1246-R, New York City 8.

125 DIFFERENT United States — \$1.00 approvals. Utechts, 1143J North Keeler, Chicago 51.

COLLECTION Monaco stamps featuring wedding of Princess Grace Kelly; also Presidents Eisenhower, Lincoln, Washington, Roosevelt and others. Only 10¢ to introduce approvals. Littleton Stamp Co., Littleton 51, New Hampshire.

EXTRAORDINARY Antarctic set free with approvals. Variety Stamps, 57-A Circuit, Newton Highlands 61, Mass.

WORLD'S Biggest stamp bargain! 1000 different worldwide \$1.00. Universal, Box 6, Kenosha 5, Wisconsin.

AUSTRALIA, Fifty different, 10¢ with approvals. Molzan, 720 Pomona, El Cerrito 8, California.

FREE! Giant catalog offering thousands of bargains. Sent with beautiful approvals. Jamestown Stamp Co., Dept. B9PMC, Jamestown, N. Y.

307 DIFFERENT Stamps 25¢, including India, China, Vatican, Russia, British Colonies, Japan, Africa, Scandinavia, Pakistan, Newfoundland, Australia, exceptions, unusuals. Only with approvals. Lincoln Stamp Company, St. Catharine's 218, Ontario.

ABSOLUTELY No approvals. Offer bargain-packed, money-saving U. S. price list covering multitude interests, 10¢. Chassy, Box 42-PMX, Babylon, N. Y.

TERRIFIC Stamp bargain! Israel, Iceland, Vatican assortment—Plus exotic triangle set. Also fabulous British Colonial accumulation. Plus large stamp book. All four offers free. Send 10¢ to cover postage. Empire Stamp Corp., Dept. PM, Toronto, Canada.

75 DIFF. U.S.A. 15¢. Approvals. Kem, 14039 Don Julian, La Puente, Calif.

500 WORLD Mixture 25¢. Approvals. C. Whitney, 5800 Division South, Grand Rapids 8, Michigan.

COLORFUL Transportation, flag, flower stamps. Perforation gauge. Free to approval applicants. Delton Page, Box 201, East Paterson, New Jersey.

EGYPT 25 Different, 3¢ postage. Approvals. Bellet, Mapledale, Hazel Park, Mich.

FREE Mint set! Request approvals. Stampeo, 1267 Tutwiler, Memphis 7, Tenn.

FREE Ten mint British colonies; given approval applicants. Tropicana, Box 624-M, Oakland Park, Fla.

40,000 VARIETIES Available on approvals. ½¢ upwards. Keigwin, Box 938B, Daytona, Florida.

500 FINE Mixed U. S. 15¢. Wright, 201M Mesley, Hagerstown, Maryland.

100 FOREIGN, 20 U.S. commemoratives, 10¢. Approvals, Weckerling, 3210K Hancock, Austin 3, Texas.

FREE: Mint British Colonies from North Borneo, Caymans, Seychelles, Dominica, Papua, New Guinea, Sarawak, Brunel. Free with approvals. Viking, Great Neck 8, New York.

DARKEST Africa! Congo, Camerouns, Seychelles, Swaziland, Tanganyika, Urundi, free! Fascinating approvals. Royalton, Box 283, Forest Hills 75, N. Y.

200 DIFFERENT Worldwide plus 66 different U.S. 25¢. Approvals. Casto, Box 337, Dunbar, W. Va.

FIVE Different sets French Colonies, 10¢ with approvals. Banner, Box 63, Park Forest, Illinois.

MISSION Mixtures, U. S. pound \$1.00, five pounds \$3.50; foreign lot \$1.00, pound \$5.00. Winston Lillis, R. #3, Box 409-M, Columbia, Miss.

ICELAND, Surinam, Curacao, Trinidad, Transvaal, free. Interesting, inexpensive approvals follow. Cedar, Box 475, Barron, Wisconsin.

25 AIRMAILS, 10¢. Bargain approvals. Warden, Box 68, Sierra Madre, Calif.

FREE! Israel, Monaco, Philippines, Others. Approvals. Klein, Box 34M, Long Island City 6, N. Y.

ANIMALS—South African set 20¢ with approvals. Shull, Box 451, Bloomington, Indiana.

FREE—Exotic Congo flower stamps. Approvals. Greentree Stamp, Little Silver, New Jersey.

WORLD'S Smallest and strangest stamps only 10¢ with approvals. Finney, Box 89, El Monte, Calif.

FREE! Coronations, triangles, sports, animals. Monaco Pipex; given approval applicants. Exotic, Box 482-M, Coral Gables 34, Fla.

MONACO Nudes mint 10¢. Approvals. Barricks, 1600 Seward, Detroit 6, Mich.

30 DIFFERENT U. S. comms, 15¢ with approvals. Hall, 2300 Cromwell, Norfolk 9, Va.

FREE Egypt, Angola sets with approvals. Benzras, 3330 Paulding Ave., Bronx 69, New York.

KOREA Boy Scouts (2) 20 cents with approvals. Theo. Marlin, 3713 Baldwin, El Monte, Calif.

FREE With top value approvals, 100 worldwide stamps, plus color reproduction \$50,000.00 British Guiana "penny red." Penn Stamp, P. O. Box 303, Philadelphia 5.

SPECTACULAR! Old U. S., famous Americans, flags, presidents, commemoratives with approvals plus valuable premium for 10¢ handling. Metropolitan Stamps, Box 313WN, Jackson Heights, N. Y.

BARGAIN—100 Different U. S. including 25 commemoratives, 25¢, with U. S. approvals. Stamps, Box 37, Kennebunk, Maine.

FREE: Ten ancient, modern locomotives. Approvals. Stamp Center, Box 76, Brooklyn 26, New York.

MONACO New Princess Caroline issue, 5 values only 15¢ with approvals. El Montecito Stamps, 1356 Danielson Rd., Santa Barbara, Calif.

FREE! Over 100 different, \$2.50 value, including Israel, British Colonies, U. S., first UN, Siberia; triangles, animals, sports. Approvals, Illustrated lists included. Send 10¢ for mailing. Gatewood, Box 346, Winston-Salem, N. C.

EVERYTHING Goes. Tremendous accumulation. Collections, lots, albums, miscellaneous. Closing out cheap. Lists free. Alatele, Maynard, Mass.

PERU. Special mixture, 300, \$1.00 bill. Bongiovanni. Gremlos 426, Lima, Peru.

CONFEDERATE \$1000.00 BILL. 607 originals reprint 20¢ with lists. Premier, State Life Bldg., Indianapolis 4.

WINGED Wheel set plus 55 all different free with interesting approvals. (5¢ handling). Stamp Imports, Peterborough, Ontario, Canada.

QUEEN Elizabeth pictorials, Fiji, Montserrat, St. Kitts, Sierra Leone, etc. 20 different colonies only 10 cents. Approvals, Vulcan, Box 9053, Birmingham 9, Alabama.

JAPAN B6-7, Bombing Pearl Harbor—10¢. Approvals. William Deems, Ravenswood, West Virginia.

FREE 55 Worldwide inexpensive approvals. University Stamps, P. O. Box 95, Tamiami Station, Miami 44, Florida.

ITALY—100 Different 10¢ with approvals. DeRespinis, G.P.O. Box 771A, New York 1, N. Y.

GIANT Approvals, thousands different, 1¢ and 2¢ each. Wahl's Stamp Exchange, 7008P Farragut, Chicago 31, Ill.

U. S. Mint specials! 13 different commemoratives, 25¢; flag set, complete, \$1.00; four different souvenir sheets, \$1.00. Free price list. Brooks, 2352P East 23rd Street, Brooklyn 29, New York.

BRITISH Colonies, 100 different 10¢, also free albums, catalogs for purchasing approvals. Coast, P. O. 2187A, Santa Ana, California.

500 WORLDWIDE Mixture. Big variety, 25¢. Monjar, Fairmount, Cincinnati 14, Ohio.

BULGARIA: Fifty different exciting pictorials, Animals, flowers, trucks. This valuable collection, only 15 cents with approvals. Boger, Box 152, North Wales, Penna.

10 ISRAEL 10¢. Approvals. Brinkman, 4241 Live Oak, Arcadia, California.

100 STAMPS Free with bargain approvals. Guyton, Box 1275, Monroe, Louisiana.

FREE Gift certificate with U. S. and foreign approvals. Hill, P. O. Box 51, Defiance, Ohio.

FREE! Monaco triangles! Madagascar! Zaragoza pictorials! Approvals. Keating, 2520-P Boulevard, Jersey City, New Jersey.

FREE United States illustrated catalog. Bailey, 45 Bromfield, Boston, Mass.

ISRAEL, 10 Different free. Approvals. Chippewa, Box 65M, Doylestown, Ohio.

40 AMERICAS, Commemoratives, Latins, British 10¢; penny approvals, wholesale trades. Bristol, Canton Center, Conn.

1888 STAMP \$3.00 Cat., mint, 3 dimes, with approvals. Rare, Box 633, Miami 33, Florida.

200 WORLDWIDE 25¢ Plus surprise packet. Packet list free, Econopackets, Box 168, Riverside 9, Calif.

FREE! Israel, Mozambique Company, Australian commemoratives, coronations, Egyptian overprints, Monaco! Exciting approvals. Foxboro, Box 167, Foxboro, Mass.

FREE! 50 British Colonies, 5¢ handling. Approvals included. Kensington Stamps, Buffalo 15, N. Y.

MINT Collection cataloging \$1.75 only 10¢ to approval buyers. Philatelic, Pennington, New Jersey.

COMORRO, Hyderabad, Swaziland, Mauritania, Armenia, Nyassaland. Free bargain approvals. Tamiami, Box 342 (Tamiami) Miami 44, Florida.

PRICE List, foreign and U. S. No approvals. Stamps, 5000 Miami, St. Louis 9, Mo.

UNITED States. Fine mint airmails, #C7, #C8, #C9, #C10. Only \$1.15. Approvals accompany. Whiton Paine, Westport 11, Connecticut.

FREE! 50 Different British Colonies to approval applicants, Pan-American, Box 24, Coconut Grove, Miami 33, Florida.

1957 U. S. Price list, 25¢. Lee's, Box 796, Rockford, Illinois.

SEND Two dimes for large illustrated U. S. catalogue. New-Way Stamp, Lawrence, Mass.

U. S. approvals. Low prices. Eagle Stamps, Romine Ave., Pittsburgh 26, Penna.

KENYA—Queen set to 1/- free with approvals. Lee Hoover, Box 3594, Portland 8, Oregon.

START Your own stamp business. Send for free circular. Donald Shepard, Box 1147, Chicago.

SENSATIONAL U.S. U.N. illustrated catalog free. Stone, 193 Washington, Boston 8, Mass.

PENNY Approvals regardless catalogue. Kloster, 4184 52nd St., San Diego 5, Calif.

QUEEN Elizabeth mint sets! Dominica, Virgins, Barbados, Gibraltar, Tristan, Malta, 21 bicolors, 25¢! Approvals. Gannon Stamps, Box 931, Canton 1, Ohio.

5 MINT British colonies and 100 others 10¢ with approvals. Miller, 219 Fowler Ave., Jersey City 5, N. J.

200 DIFFERENT Including P.D.R. triangle also scarce war ration stamps, 10¢ to approval applicants. Avalon Stamp Co., Dept. M, Springfield, Mass.

ECONOMICAL 5¢-3¢ Approvals, 35,000 varieties. Drosel, Box 128-N, West Englewood, New Jersey.

FREE! Amazing list! Two feet long! All countries! Stampmart Company, Hartford 1, Connecticut.

FREE! 107 British Colony stamps. All different, from Britain's farflung colonial empire. Catalog value \$2.50. Free stamp magazine, approvals. Send 10¢ for handling. Act now! Niagara Stamp Co., St. Catherine's Tl. Ontario.

UNITED States commemorative collection containing 33 different—10¢. Approvals. White, 516-A Avenue L, Brooklyn 30, New York.

TWO \$5.00 U.S. stamps plus 20 different, 10¢ with U.S. approvals. Irwin, Box 1105, Brooklyn 30, N. Y.

SELL Your surplus good grade stamps. Write, describing fully what you have. Vanroy Shirk, Lebanon, Pennsylvania.

50 DIFFERENT Argentine 10c. Approvals. Reuter, 611 W. 40th Pl., Los Angeles 37.

AMAZING Offer! 200 United States stamps—including commemoratives, airmails, high denominations to \$1.00. Only 10¢ to approval applicants! Illustrated bargain lists free. Mystic Stamp Co., Dept. 80, Camden, New York.

U. S. Classics. Over 50 yrs. old. 15 selected old-timers. Missing in biggest collections. All 15 at less than 1c each. 10c with approvals. Jaro, Box 246-T, New York City 8.

100 STAMPS, 10¢ With approvals. Smith, 508A Brooks, College Station, Texas.

OLD Scarce U.S. seconds on approvals. Slight imperfections. Lowest prices. Herfield, Clintonhill Sta., Newark 8, N. J.

100 OLD United States between 1861 and 1935, \$1.00. Roush Stamps, 51 Chestnut, Mansfield, Ohio.

UNITED States approvals. Select copies, used—mint. Kingsbury, Fairfax, Vermont.

ICELAND 10 Different beautiful stamps for only 10 cents to applicants for our good old fashioned approvals. Old Colony Stamp Co., Dept. A, Milford, Connecticut.

1-2¢ EACH! Thousands of exciting worldwide stamps. Free examination. Cole, Box 223-A, Buffalo 21, N. Y.

225 STAMPS For only 10¢! This mammoth value includes airmails, pictorials; stamps from strange countries cataloging up to 25¢ each! Also approvals. Mystic Stamp Company, Camden 80, New York.

SELL Stamps to our readers. Your ad in this space will be read by thousands of stamp buyers. I'll prove that to you. Write now for Folder "S." F. W. Johnson, Classified Advertising Manager, Popular Mechanics, 200 E. Ontario St., Chicago 11, Ill.

100 DIFFERENT Austria, 10¢. Approvals. Aronson, Box P, Newton Centre 59, Mass.

WEIRD Diamond shape coffee stamps. Lovely flower triangle! First American big commemorative. Greenland, idol dancer, etc. Free with approvals. Capital Stamp Co., Ferrysburg 2, Mich.

25 DIFFERENT Commemoratives 1893 up 10¢. U. S. approvals. K&B, Box 70, Brooklyn 23, N. Y.

14,000 DIFFERENT! Fascinating new club plan systematically builds your collection. Only 50¢ weekly. Details free. L. G. Ware, Stepney 75, Conn.

MINT U. S. at face! Older commemoratives only in 25¢ packet. Limit one with request for mint U.S. approvals. Western, Box 1689P, Salinas, California.

HOBBIES AND COLLECTIONS

COLLECTORS Matchbook covers. 100 different unused, \$1.00. Catalog 25¢. Album \$3.00. Charles Edelman, 1311-G East 84, Cleveland 3, Ohio.

NAZI Insignia. 12 different \$1.00. Medals, patches, armbands, flags, daggers. Illustrated lists. 15 cents. Hobbyland, 1207 1st St., W., Calgary, Canada.

MILITARY Miniatures. Civil War, Custer's Cavalry, American Revolution and U. S. Marines. Illustrated catalog 35¢. Bussler Miniatures, Dept. Z, 40 Howe St., Quincy 69, Mass.

INVENTING Can be an interesting and profitable hobby. Write for complete particulars. Institute of American Inventors, Dept. 40-E, 635-F St., N.W., Washington 4, D. C.

NAZI Badge 50¢; Iron Cross with ribbon \$1.50; 35 American emblems, introductory offer 50¢; catalog 10¢. Hobbies, Box 71-A, Station "A," Brooklyn, N. Y.

BIGGEST Book buy—"Colt Firearms." Free literature. Serven Books, Santa Ana, Calif.

PENCIL Collectors. 200 different advertising pencils. 20 unused pencils \$1.00. Price list included. Hobbies Inc., Box 744, Sterling, Colo.

WANTED Old cigarette cards. Write Charles Bray, East Bangor, Penna.

NAZI Navy flag \$10.50. National flag \$6.50. Both \$15.00. Catalog 35¢. Griffin and Gray, B-2, 72-05 67th Street, Glendale 27, N. Y.

PRECIOUS STONES, MINERALS

LARGEST Gem and mineral magazine tells how to have profitable fun with rocks, gems, jewelry. Monthly, \$3.00 year. Sample 25¢. Gems & Minerals, Dept. A-9, Mentone, California.

MINERAL Specimens for collectors. All varieties, world wide localities. Choice quality, lowest prices. List free. Plummer's, 4720 Point Loma Ave., San Diego 7, California.

AGATE. Buy direct. Polished sample 25¢. Price list included. Roberts, Box 744, Sterling, Colo.

DIAMONDS, Genuine, solid gold rings, ladies mountings \$25.00, \$35.00, \$50.00 each plus tax. Refund guaranteed. Georges, 14 King St., Troy, N. Y.

400,000,000 YEAR Ordovician fossils. Five classified \$1.00. MacKenzie's, Northfield, Minn.

EARTH Science. Rockhounds' National Magazine, subscription \$2.00. Sample 25¢. Box 1357PM, Chicago 90.

SAPPHIRE, Topaz, tourmaline, garnet, peridot. Five uncut gem specimens, \$1.00. Ten polished gems, baroque shaped, \$1.00. Free bargain list jewelry, gems. Profitable, easy "do-it-yourself" projects. O'Brien's, 1118M Wilcox, Hollywood 33, Calif.

CUT Gems, make jewelry—For profit or fun. 100 page magazine tells how: where to get supplies. Sample 25¢ or request free literature. Lapidary Journal, Del Mar 2, Calif.

ANTIQUES, RELICS, INDIAN GOODS, CURIOS

ANCIENT Grooved stone tomahawk \$3.00. Indian relic list free. Lear's, Greenwood, Arkansas.

COTTON Bolls from Texas. Six large fluffy bolls \$1.00 postpaid. Marshall Cole, Greenville, Texas.

SELECTED War arrowhead \$1.00. List 5¢. H. Talburt, Calico Rock, Ark.

CAMERAS, PHOTO SUPPLIES

PHOTOGRAPHY For pleasure or profit. Learn at home. Practical basic training. Long established school. Free booklet. American School of Photography, 835 Diversey Parkway, Dept. 3442, Chicago 14.

PHOTOGRAPHERS—Enlarge your negatives on pre-sensitized China dishes. Easy as projection paper. Beautiful gifts, tremendous profits. Rush \$1.60 for sample. Free particulars. Zed Gwartney, 66-301 Acoma, Desert Hot Springs, Calif.

GET Our prices first! 6¢ stamps brings bargain catalog. Imperial, Dept. PM1, 34 Park Row, New York City 38.

FREE Catalogue wholesale photo supplies. Mel-Jo, P.O. Box F, Hillside, N. J.

PIC-Kwick exposure dial, only \$2, gives best camera settings instantly! Details free. Russell Love, 24 California St., San Francisco 11.

PHOTO FINISHING

FREE! Color snapshot folder. Offers, lists, mailers. Houghton's, Erving, Mass.

PARTICULAR? 8 Jumbos 35¢, 12-50¢. Special; 35mm., 36 exposures \$1.10. Flash-Foto, Box 36M, Brooklyn 4, N. Y.

12 EXPOSURE Rolls, 39¢. Jumbo prints. Guaranteed work, one day service, Lincoln Studios, Dept. K, Box 13, Lincoln, Nebraska.

TWO Beautiful prints from each picture on roll. 8 exposure 40¢; 12 exposure 50¢. Thirty-six years of satisfied customers. Quick service. Lensphotos, Dept. J-4, Janesville, Wisconsin.

8-HOUR Service on deluxe jumbo prints. 8-exposure roll developed and 8 jumbo prints 40¢, 12 exposure 55¢, 16 exposure 70¢; 35mm. 20 exposure 75¢, 36 exposure \$1.25. Jumbo deckle reprints 4¢ each. Contact prints made if specified. Bay Photo Service, P.O. Box 310, Oakland, California.

SUPERIOR Quality. Prompt service. 8 jumbos in album 40¢, 16 contacts 50¢. Jumbo reprints 5¢. Satisfaction guaranteed. Also complete color film finishing service. Write for free circulars and mailers. Fast-X-Foto, Box A, Jersey City, N. J.

ENLARGEMENTS, Heavyweight seven 5x7's or four 8x10's \$1.00. Jack Koons, Huntington Mills, Luzerne County, Penna.

DO IT YOURSELF booklets. 24 subjects. Free catalog. Popular Mechanics Press, 631 N. St. Clair St., Chicago 11.

PHOTO Christmas cards made from your own snapshot negatives. Truly personal and distinctive. 25 cards \$1.85; 100 for \$6.00 including envelopes. Your name imprinted 75¢ extra. Send your negative for free sample and choice of styles. Photo-Mail, Box 216M, New York 10, N. Y.

YOUR Photograph on stamps from snapshots. Sample 3¢. Erdley, Box 4, Lebanon, Penna.

FREE Kodak "Kodaguide snapshot dial" (exposure calculator) with first film developing order. Free postage both ways. Send for free mailers and prices. Snapshot Photo Service, Box 73202-A, Los Angeles 3, California.

WITH This ad only. 20 billfold photos, one in color, \$1.00. Wallet Photo, Box 470, Postoria, Ohio.

QUALITY Kodak finishing. 8 exposure roll 40¢; 12 exposure 60¢; 16 exposure 70¢. Reprints 5¢. Fast service. Guaranteed quality. 40 years continuous operation. Be a satisfied customer. We do color. Send for mailers. Mail Order Photo Service, Box 297, Watertown, Wisconsin.

KODACHROME Processing—8mm roll or 35mm 20 exp., \$1.25. Prompt service. Write for mailer and prices. Color Pix, Dept. P, CPO Box 30, Kingston, N. Y.

MOTION PICTURES AND SOUND EQUIPMENT

FREE 16MM. sound color travel films. Brand new for showing at clubs. Not commercial. Fully entertaining. Guided Tours, Box 107, Ocala, Florida.

16MM. Sound films. Lists free. Crawford Films, 412 Page St., Ft. Worth 10, Texas.

"ENTIRE Life of Christ" 8mm silent, 16mm narrated, sacred music for sale or rental. Hemenway Film Co., 424 Little Building, Boston 16, Mass.

16MM. Sound movies. Rented, sold. Hunteon Rental Service, Bellows Falls, Vt.

FREE! Big catalog of 8mm and 16mm movies. Imperial, Dept. PM2, 34 Park Row, New York City 38.

FREE! Blackhawk's big new 1938 sale catalog new and used 16mm., 8mm. movies; 2" x 2" color slides; used 16mm. sound projectors! Biggest stock in U.S.A.! Cameras, accessories, supplies, too! Blackhawk Films, Davenport 14, Iowa.

BULLFIGHT Movies. 8, 16mm. Literature. A Ruotolo, Box 1265, Greenwich, Conn.

RECORDERS, Hi-Fi. Free catalogue. Carstan, 215 E. 88 St., New York City 28.

5,000 8-16MM. Movie films. Free catalogues. International, Greenvale, N. Y.

TAPE Recorders, tape. Unusual values. Free catalog. Dressner, 69-02M 174 St., Flushing 65, N. Y.

FREE Catalog. Save dollars. Fresh 8mm., 16mm. b&w and color film. Home processing equipment. Superior Bulk Film Company, 448 No. Wells, Chicago 10.

MOVIE Camera film: 8mm. roll \$1.50. 16mm. 100' \$3.00. Free processing. Better Films, 742 New Lots, Brooklyn, N. Y.

8-16MM. Films. Free catalogue, with sample film 10¢. Garden, 690 Howard Avenue, Brooklyn, N. Y.

SAVE 50%! Guaranteed-fresh color, b&w. movie film! 8mm., 16mm. Free catalog! ESO-R, 47th Holly, Kansas City 12, Missouri.

MUSIC AND MUSICAL INSTRUMENTS

ACCORDIONS Wholesale—10 day trial. Free catalog. American Accordion Center, 5329-PM-9 Belmont, Chicago.

SWISS Musical movements, \$1.90. Helax, 218 West 72nd Street, New York City 23.

ACCORDIONS, Wholesale to everyone. Save up to 60%. All national known brands. Free catalogue. Del Principe, 29 South Cicero, Chicago 44.

SWISS Music movements (best) \$2.50. Electrically driven \$3.50. Spielman, 131 West 42nd, New York City 36.

ACCORDIONS—Direct from importer. Save 50% and more! Free trial. Lifetime guarantee. Trades accepted. Free catalog. Write Accordion Manufacturers Outlet, Dept. 97R, 2003 Chicago, Chicago 22.

POEMS, Songs wanted! Publishing, recording. Bengol, 93 Jefferson, Chelsea 50, Massachusetts.

VIOLINMAKERS, Repairers. Fine tone wood, and all violin supplies. Send for free wholesale price list. International Sales, 414-MPM E. Baltimore St., Baltimore 2, Maryland.

GUITARISTS—Sensational Chord-O-Matic dial simplifies 1001 tricky chords. Guaranteed \$1.98. Trebb Sales, Lorain, Ohio.

SONG Request guarantees royalties. Instructions two dollars. Howard Olenik, Mt. Morris, Mich.

DISCOUNTS—Instruments, accessories, national brands. Tempo Music, 37 Cutler, New London, Connecticut.

WRITE Songs. Big money and reputation. Write for information. J. Gordon Pub. Co., 4700 South California Avenue, Chicago.

SONGPOEMS And lyrics wanted. Mail to: TinPan Alley, Inc., 1630 Broadway, New York 19, N. Y.

SONGS Into dollars. Share \$29 million dollars yearly for new songwriters, song-poets. Songs composed, published, promoted by famous firm. Information, appraisal free. Send to Nordyke Publishing, 6000 Sunset, Hollywood 28PM, California.

POEMS Wanted for new songs. Send poems. Free examination. Immediate consideration. Songcrafters, 2724 Arcade Station, Nashville, Tenn.

SONG Poems wanted. Five Star Music Masters, 630 Beacon Building, Boston.

POEMS Wanted for new songs. Send poems. Immediate consideration. Crown Music Company, 49-C West 32 Street, New York City.

ELECTRIC Guitars, amplifiers, wholesale. Free catalog. Carvin PMM, Covina, California.

RECORDS Hi-Fi by mail. Big discounts. Noelson, Box 211, Wall Street, New York City 5.

COMPLETE Music service for amateur songwriters. Write: Colonna, Box 888, Burbank, Calif.

DO-IT-YOURSELF booklets. 24 different booklets each covering an interesting subject. Free catalog. Popular Mechanics Press, 631 N. St. Clair St., Chicago 11.

RADIO, TELEVISION AND ELECTRONICS

FREE 404-Page 1968 Radio-TV-Hi-Fi and Electronics Catalog. World's largest stocks, lowest prices. Everything for experimenters, builders, amateurs, servicemen. Latest money-saving build-your-own Knight-kits, Hi-Fi, phonos, recorders, public address, TV accessories. Thousands of parts, tubes, test instruments, tools and books. Write for free copy! Allied Radio Corp., 100 N. Western Ave., Dept. 34-JT, Chicago 80, Illinois.

CRYSTAL Radio experimenters write to Hulet, 305 Hope, Lakewood, N. J.

FREE! Giant bargain catalog. Transistor, "Sun" radios, kits, portables, audio, electronics, photographic, optics, tools, household. Write Lektron, 131M Everett Ave., Chelsea, Mass.

CRYSTAL Radio kit \$1.00, preassembled \$1.25, phone \$1.75; catalogue. Clearco Crystal Company, 2966 North 4th, Milwaukee 12, Wisconsin.

KITS: Shortwave radio \$3.50. Crystal radio 60¢. Alliance, 2059 60th, Brooklyn 4, N. Y.

ANY Schematic, \$1.00. Return mail. Brown, 78-E Walnut, Philadelphia 44, Penna.

CONVERT Standard test prods to self-holding connectors in seconds. Free your hands, save time, speed servicing with new E-Z-Hook tips. Safe, easy to use. Connections won't pull off; release instantly with light pressure. Eliminate aggravations. Make testing more fun. Colors: Red, black, orange. \$1.00 each, 3 for \$2.67 postpaid. Satisfaction guaranteed or money back. Send check, money order today. E-Z-Hook Test Products, Box 105, 1536 Woodburn, Covington, Kentucky.

ATOMOTRON, Model atom smasher, \$14.95. 3-in-1 electromagnet, \$14.95. Cloud chamber, \$32.50; plans, \$1. Send 25¢ for literature. AtomLab, Box 343, Berkeley, California.

DO IT yourself. What? Repair TV, build furniture, make barbecue, plumbing repairs, build boats, do house wiring, remodel home, lay tile, modernize kitchen, repair home, and scores of other things you can do yourself. Books covering each subject, only 25¢. Send for descriptive list. It's free. Popular Mechanics Press, 200-LB East Ontario St., Chicago 11, Ill.

BUSINESS OPPORTUNITIES

BRUSH Plating outfits for plating articles in the home and shop. No tanks necessary, silvering mirrors, spare or full time. Free particulars. Gunmetal Co., Ave. H, Decatur, Illinois.

BUY Wholesale! Over 10,000 nationally advertised products. Appliances, cameras, sporting goods, housewares, watches, typewriters, tools, clothing, etc. Send postcard today. Buy-Rite, Box 258, Hawthorne 1, New Jersey.

EXCLUSIVE Distributorship available in most areas for world-famous Cadmium battery guaranteed to outlast your car. Tremendous profit opportunity. Investment for merchandise only. Free franchise. Cadmium Battery Corporation, Dept. 102, El Segundo, California.

START Your own business with our sample kits. Newest idea in selling. Re-order merchandise as you need it. Write today for full particulars. Division Sales, 3341 W. Roosevelt Rd., Chicago 24, Illinois, Dept. K.

MAILORDER. Learn to sell by mail. Complete course. Low cost. Ranso, Box 1719-A, Richmond 14, Virginia.

HIGHEST Profits all magazines. Sure success plan. Free catalogue, supplies, prizes. Subscription Service Co., Box 2070, Birmingham, Ala.

WORK Home, pleasant, profitable. Own hours. Hundreds of ideas. Information free. Master's, 5145 Norwood, Arlington, Calif.

SELL Merlin electronic garage door operators. Make from \$50 to \$75 on every sale. Operate from your home. M. J. Fitzgerald Co., 2815 West Villet Street, Milwaukee 8, Wisconsin.

THEY Hand him \$100! Free packet, "Secret Journal," 919 secrets-plans! Work home. Publicoe, Oceanside, Calif.

DOLLARS Every day! Sensational mail item. Make 200 per hour, kitchen table. Angora House, 1058-2, Springfield, Illinois.

OPERATE Easy-to-start, profitable home mailorder business! B. Mann, Woodcliff Lake, N. J.

MAKE Attractive, durable, building plastic, easily, 800% profit. Exclusive district. Bays Laboratory, Cedaredge, Colo.

CANDIED Popcorn and potato chip equipment. Eakins, Box 933-A7, Springfield, Ohio.

EARN To \$100.00 per hour snow-flocking Xmas trees, centerpieces, etc. Flocking, 7061 Belmont Avenue, Chicago 34, Illinois.

\$60.00 WEEKLY Sparetime. Start home Venetian blind laundry. Protected territory. Interesting information free. Burtt, 2434EP, Wichita 13, Kansas.

WANT To make big money at home? \$10.00 profit in an hour possible with invisible mending. Make tears, holes, disappear from clothing, fabrics. Steady year-round demand from cleaners, laundries, homes. Details free. Fabricon, 6234 Broadway, Chicago 40, Illinois.

NEW Snow cone machines. All prices. P.O. Box 7803, Dallas, Texas.

IMPORTING—Exporting. Modern dropship method. Profitable. Details free. The Hazen Company, 6601-8th Ave. N., St. Petersburg, Fla.

WHOLESALE—Thousands nationally advertised products. Buy, sell. Amazing profits. New, free plan. Associated Wholesalers, 1016-D Starr, Burlington, Iowa.

OPERATE Mailorder folio business! Free details. Ballard's, 425 East Catherine, Louisville 3, Ky.

MAKE Flexible molds. Cast plaques, figurines. Free sample. Tooker, 1045-B Fairview, Hamilton, Ohio.

NATURAL Molding rubber, extra thick. Free sample. W. Woolley, 1016-A Donald, Peoria, Illinois.

BIG Money raising fishworms and crickets. Free literature. Carter Farms, Plains, Georgia.

START Home business making statuary, plaques, novelties, garden furniture, artificial marble flooring, liquid marble. Make your own flexible molds. Amazing profits. Only \$1.98. Free literature. Popular Mechanics Press, 631 No. St. Clair St., Chicago 11.

UNUSUAL Mailorder opportunity. Tested. We supply everything. Girard's, Azusa, Calif.

WANT More business? Here's an amazing opportunity to increase your sales. Talk to thousands of interested readers of "Mechanics Popular." Our Spanish Edition covers the Latin American countries like a blanket. They're real mailorder buyers. Classified rate 75¢ per word. Try an ad in our next issue. Classified Advertising Department, Popular Mechanics Magazine, 200 East Ontario Street, Chicago 11, Ill.

VENDING Machines—No selling. Operate a route of coin machines and earn amazing profits. 32-page catalog free. Parkway Machine Corporation, Dept. 26, 715 Ensor Street, Baltimore 2, Maryland.

HOME Workshop books. Free catalog. Popular Mechanics Press, 631 N. St. Clair St., Chicago 11.

MONEY In saw and lawnmower sharpening sparetime at home. Free book. Virgil Foley Company, Columbia Heights, Minnesota.

\$70 WEEKLY—Home, spare time. Simplified mail bookkeeping. Immediate income—easy! Auditax, 34707A, Los Angeles 34.

TO \$100.00 Weekly. Sparetime, home operated mailorder business. Successful beginner's plan. Everything supplied. Lynn, 10420-M National, Los Angeles 34.

BREED Rare tropical fish at home. Earn big money! Learn secrets! Help fill huge demand. Amazing opportunity! Free plan. Tropical Fish Breeders, Los Angeles 61, Calif.

MINK Raising information free. Complete. Lake Superior Mink Farm, Superior, E.E.I., Wisconsin.

COPUBLISH Mail Sale Advertiser, leading mail order paper. Details, latest copy, dime. Vanroy Shirk, Lebanon, Penna.

LEARN Real estate by listening to records. Lee Institute, Brookline 46, Mass.

I Want to send you proof of the wonderful pulling power of Popular Mechanics classified pages. What's your proposition? Write me today. Include literature if possible. F. W. Johnson, Manager Classified Advertising, Popular Mechanics Magazine, 200 E. Ontario St., Chicago 11, Ill.

FREE "Franchise Profit Letter" describes nationwide opportunities. Exclusive distributorships, dealerships, agency operations. Write today. National Franchise Reports, 333 North Michigan, Chicago 1.

LEARN Photo-negative portrait retouching. Men, women. \$5 hour possible spare or full time at home. Easy, glamorous. Work for photographers by mail order. Full details sent free. Duval, 100 So. Vermont, Los Angeles 4.

YOUR Own name brand business. No investment; no inventory. Part time or full time. Sell famous brands of appliances, housewares, silverware, radios, vacuum cleaners, lamps, tools, clocks, watches, jewelry, etc., etc., over 1000 items. Join thousands of successful independent dealers. Send for free catalog and dealer price list. H. B. Davis Corp., Dept. 11, 145 W. 15 St., New York City.

11,000 New Prospects daily. Baby record books, shoes, albums. Sell mailorder. Use our literature. Write: No-Co-Ro, Capitola, California.

COLORGLAZED Concrete pottery made without molds. Patented method. Cemetery products, novelties, tiles. Basement leak-sealing. Money-making projects. Booklet, details free. Men only. National Potteries Company, Grand Rapids, Minnesota.

CASH From sawdust, seventy methods. Tin-cans, thirty methods. Newspapers, eighteen methods. Instructions 50¢ each. All three \$1.00. Charles Company, 12-DXT, Norwood, Ohio.

BE Appointed state notary public now. Write, Stationers, Boerne, Texas.

WE Love our mailman—He leaves over \$1000.00 monthly in our rural mailbox. My college professor husband drafted a scientific home mailorder method. We bought a Texas ranch, live as we always wanted. Now we sell the Ranch Mailorder Method. Operates anywhere. Inquire: Eveningshade Ranch, Boerne, Texas.

BAKE New greaseless doughnuts in kitchen. Sell stores. Free recipes. M. Ray, 3605 South 15th, Minneapolis 7, Minnesota.

FIX Typewriters. Inexpensive home course teaches factory secrets. Free booklet. Atbey, Tarentum, Penna.

MONEY For you! Big profits! Cast plaster figurines, bookends, plaques at home with XL rubber molds. No experience needed! Write for illustrated, 40-page catalog, only 25¢! Plastic Arts Studios, 3403 So. Madison Street, Department 5, Muncie, Indiana.

GROW Orchids at home. Profitable, fascinating. Year 'round. Maine to California. No greenhouse. Successful home grower shows you how to provide proper temperature and air conditions in any well lighted room. Full details and real orchid seeds free. Orchidland, 100 So. Vermont, Los Angeles 4.

PLATE Baby shoes, jewelry, gifts, bronze and colored pearl. Free booklet. Platex, 11029 South Vermont, Los Angeles 44.

START Your own subscription service. Every family buys magazines. No capital needed. We tell you how, furnish all supplies free. Liberal commissions. Write McGregor Magazine Agency, Dept. 110, Mount Morris, Illinois.

SELL By mail. Tested methods. Alfano, 19 Pine Street, Closter 2, New Jersey.

FREE Catalog. Contains hundreds of businesses, farms and income properties throughout U.S., Canada. Specify type and location desired. Deal direct with owners. U. I. Buyers Digest, 1608 Hillhurst, Dept. PM-3, Los Angeles 27, Calif.

LIQUID Rubber. Make flexible molds. Free sample. Chaney, 1907-A East Road, Jacksonville 11, Florida.

CASH Income collecting local information. No selling. Survey, library. Free details. Dorco, Box 494, Muncie, Ind.

FLORIDA Manufacturer seeks new product or process, preferably related to ceramic field, but will consider any patented item with good market possibilities. Will purchase outright or license. Send full information to Methods Engineering Council, 199 S. E. 24th St., Fort Lauderdale, Fla.

AFRICAN Camel saddles wholesale. Send one dollar for air mailed sample and details. African Gifts, 44 Blvd. de Paris, Casablanca, Morocco.

FREE! Complete mailorder business. Terrific profits! No investment. Vita-Mins, 4801PM Cedardale, Wichita, Kans.

START Home mimeographing business. Pays amazing profits. Literature free. Housel, Lanoka Harbor, N. J.

SHINE Shoes without polish. New invention. Lightning seller. Shoes gleam like mirror. Samples sent on trial. Kristee 111, Akron, Ohio.

PRINT Without a printing press! Amazing new method! Print colorful signs, banners, cards, posters, glassware; anything at home. Big profits. Moneymaking opportunity! We supply everything. Beautiful sample, home-business plan free! Write Screen-Print Company, SR, Los Angeles 61, California.

MAKE Extra money. Cash commissions. Everybody buys easy-to-sell advertising book matches. Union label. All sizes. Cuts for all businesses. Powerhouse selling kit free. Steady repeat business. No experience necessary. Superior Match Co., Dept. MX-937, 7528 S. Greenwood, Chicago 19.

WE Establish you in your own mail order discount business. Catalogs, sales letters, etc., printed your name can cost you nothing. No stock investment. We ship orders. Sell gifts, appliances, housewares, cookware, cutlery, dinnerware, silverware, jewelry, watches, etc., at big discounts. Catalog, details free. Topval Corp., Lindenhurst 818, N. Y.

GROW Expensive herbs for us! Big profits home-business of your own. Year around profitability! We supply everything necessary! Send for free rare seeds and revealing plan. National Herb Exchange, Dept. SR, Gardena, Calif.

"HOW To Start a Business" booklet sent free! If you know any trade, go into business for yourself! Learn the 9 easy steps to follow. We've guided 5,000 others to success. Revealing free booklet yours for the asking! Write! National Business Consultants, Office SR, Los Angeles 61, Calif.

START Your own business on credit. Your own boss. 1527 dealers sold \$5,000 to \$32,000 in 1956. We supply stocks, equipment on credit. 200 home necessities. Sales experience unnecessary. Pleasant profitable business backed by world-wide industry. Write Rawleigh's, Dept. I-U-PPM, Freeport, Ill.

LEARN T.V. servicing new simplified way at home. Save \$300 on training. Free sample lesson! Write, Electronic Engineering, Dept. AC-179, 1038 S. LaBrea, Los Angeles 19, California.

MAIL Order advertising agency executive reveals sensational no-risk advertising and merchandise methods. Start in office or home; minimum capital; positive profits. Free details: Impact! 3407 Prospect Avenue, Dept. 11-9, Cleveland 15, Ohio.

MAKE Money growing miniature trees on your window sill. Free seed and plan. Miniature Nurseries, Dept. SR, Gardena, Calif.

HOME-Import mail order business—Import profitable items below wholesale. Experience and product investment unnecessary. Full, spare time. Famous world trader guides you. Free list "157 Imports," details. Mellinger, G709, Los Angeles 24.

PAINT Suede on dashboards, signs, radios, toys, figurines—anything! Amazing new discovery finish with beautiful touch and eye appeal. \$10 per hour possible for spare time effort at home. Help fill the huge growing demand. Free actual sample and "150 Home-Business Ideas" booklet. Coast Industries, Dept. SR, Los Angeles 61, Calif.

WE Pay \$3.50 lb. dried. Grow mushrooms. Cellar, shed and outdoors. Spare, full time, year round. We have 25,000 customers. Free book. Washington Mushroom Ind., Dept. 173, 2954 Admiral Way, Seattle, Wash.

VENETIAN Blind laundry machines for sale. Used. Guaranteed. \$300.00. Torpedo, 15 Hillside Ave., Upper Darby, Penna.

REBUILD Batteries; repair dolls; make rubber stamps; "60 Ideas" free. Universal, Box 1078-A, Peoria, Ill.

ARE You now employed? Add \$3.25 hourly to income spare time. Sell famous air cushion shoes. Comm., bonuses. Samples supplied. Charles Chester Shoes, 945 Brockton, Mass.

BOOKKEEPERS, Accountants. Operate a bookkeeping service. Part or full time. Amazing simplified system. Wonderful money-making opportunities. Complete information free. National Bookkeeping Publishing Co., Suite 307, 3435 Broadway, Kansas City 11, Mo.

WISELY Invested mailorder dollars. Establish industrial-institutional mail-order business. Complete setup service offered—Not just instructions. Hermes Advertising, 152-C West 42, New York City 36.

BUY At wholesale prices! Resell at big profits. Brand name merchandise—Appliances, cookware, housewares, watches, jewelry, rings, dry goods, clothing, luggage, tools, sporting goods, toys, gifts, etc. Free 1958 color catalog. Write today. Merit Home Products, Dept. PM-9, 107 Manhattan Ave., Brooklyn 6, New York.

\$250 WEEK Cleaning venetian blinds. Patented machinery. Free literature. Robinson, 7213B, Indianapolis 1, Indiana.

CORPORATION Wishes to lease or purchase patent on small automotive accessory item. P.O. Box 302, Highgrove, Calif.

IMPORT-Export! Free dropship plan! Warner, Box 6, Fort Scott, Kansas.

\$10.00 PER Hour net profit in monument cleaning business. Free details. X-Pert Monument Cleaning Company, 465 Potomac, P88, Buffalo 13, N. Y.

MAKE \$6.00 To \$10.00 per hour sharpening saws and lawnmowers. Get America's finest equipment as used by thousands of successful shops throughout the United States and Canada. Free literature. No obligation. Max Mfg. Co., 138 Stockton Ave., San Jose 28, Calif.

ADVERTISING Executive now reveals tested, authentic mail order instructions offering amazing profit opportunities at home. Write Holiday Publications, 2301 Greysolon Road, Duluth, Minnesota.

EARN Money at home. Learn invisible reweaving at home. Licensed, approved school. Free details. Eastern School of Reweaving, 73 Main Street, Dept. P97, Hempstead, N. Y.

INTERNATIONAL Mailorder business. Complete setup service—Not just instructions. Hermes, 152 West 42, New York City 36.

MAKE Chipped glass nameplates. Resilvering mirrors. Electroplating. Outfits furnished. John Sprinkle V60, Marion, Indiana.

PLASTERCRAFT Molds, liquid rubber, plasters, floccs, candle supplies. Catalog and manual free. Blue Rapids Supply, Blue Rapids, Kansas.

"MAILORDER Laws and Regulations." \$1.00. Explains necessary licenses, different taxes, legal requirements, etc. "Mail-order Rules for Beginners." \$1.00 additional. Tasker, 1603 Peach Street, Alexandria, Virginia.

WANTED: Home producers, to be subcontractors. Cast plastic products for manufacturers in our clearing house service. Thousands of easily made items required. Cash in at home, without previous experience. Plastic Service Associates, Dept. 9-PM, East Boston 28, Massachusetts.

MANUFACTURE Thin, lightweight, concrete stone inexpensively from new, amazing, plastic mold. Exact detail and color of natural stone reproduced. Small investment, big profits. Sell homeowners, contractors, etc. Send \$1.00 for complete details, sample stone and mold. Superior, Dept. 102, 5645 Manchester, St. Louis 10, Mo.

FREE Book "305 Odd, Successful Businesses." Work home. Pacific, Oceanside, Calif.

EARN \$3.00 Hour taking orders of appliances, etc. at discount prices. Beauchamp Company, 856 East 156 St., Bronx, N. Y.

MEN—\$20.00 Puts you in your own business. Make up to \$800.00 monthly repeatedly. Same customers. \$1.00 brings complete instructions. Formulas. Worth hundreds. Sanitas, Box 4043, Kingsport, Tenn.

FREE Polio "\$5,000-\$45,000. Unlimited Vacations." No merchandise. Unknown! Work home, sparetime! Haylings, Carlsbad, Calif.

OUR Plans are money makers; sell church groups, business men, newlyweds. Press, Portage, Ohio.

MARY-Mac agency—motorized vibrator. Cushions, chairs, tables, belts. Mary-Mac Factory, 1012 Powhattan, Dallas, Texas.

FREE Folder, "How to Make \$3,000 Yearly. Sparetime, Backyard, Raising Earthworms!" Oakhaven 38, Cedar Hill, Texas.

BOOKLETS—\$1.00. How to sell by mail order. 1957 business cycle advertising chart. Economist, 343 Fairfield Avenue, Bridgeport, Connecticut.

OPERATE Restaurant or diner. Free booklet reveals plan. Write Restaurant Arts, 19-BU, Fremont, Ohio.

PROFITABLE Mailorder merchandise business. Everything supplied. Lester, 2311 Foxhills, Los Angeles 64.

UNUSUAL Opportunity. Free literature. Quill Industries, 3607 South Hamilton, Chicago 9, Illinois.

CASH Paid for boxtops! Some, 25¢! Inquire: Boxtops-AK, Cedar Hill, Texas.

PROFITABLE Hobby. Handmade glass figurines. Free literature. Adams, 18724-A Martha, Saratoga, Calif.

MAKE \$46 From square foot plywood;igsaw necessary. Free details. Woodart, Bridgewater, Mass.

CLEAN Clogged drains electrically. Do it yourself. Write Electric Drain Cleaning Co., Allston 34, Mass.

\$5,000 YEARLY. Spare time at home. Nothing to buy. No local selling. Dignified. Guaranteed. Home Harvest, Rt. 3, Box 3491-A, Albuquerque, New Mexico.

DUPULISCALER. Engraving, carving attachment opens wide new profitable business-hobby field! Details, work sample 25¢. Desco Distr's. 5262-C Van Nuys, Van Nuys, Calif.

GOLD, Silver, platinum: how to refine, test, make alloys, solders, etc. "The Jeweler's Melting Pot." Formerly \$5.00, now \$3.90. No c.o.d.'s. Frank Herman, 1529 Liberty St., Los Angeles 26, Calif.

BE Your own boss. Learn how to start making money spare time using U. S. government approved methods. \$1.00 sent to Ace, Box 155-A, Danville, Calif., can start a carefree future for yourself and family.

MEN-Women! An income for life! Work at home. Spare-full time. Big money. Number of companies will buy all you produce for them. Easy work. \$5.00-\$15.00 hour possible. Start now. Send only \$1.00 for copyrighted "Money-Maker." Lynn Publishers, Lynn 5, Mass.

SAVE Those newspapers! They may contain information worth real money! Inquire: Publishers-E, Cedar Hill, Texas.

MAKE Your fortune with post cards! Amazing home work opportunity. Brings in the dollars! Free exciting particulars. Harvey A. Sales, 5713 Euclid Avenue, Cleveland 3, Ohio.

LIFETIME Repeat income home mail business with only \$2.50 capital. Send \$1.00 for manual sample included. F. Marcusky, 538 W. Mahanoy, Mahanoy City, Penna.

\$26,500 BY Mail order in two weeks! Amazing radio-mail order method using powerful stations. Start fabulous business on low capital. Product sources supplied. Free details. Broadcast Service, 1412-C1 Great Northern Bldg., Chicago 4.

FREE "How to Start Your Own Mail Order Business." Exclusive franchise! Your own catalogs. We ship hundreds of top mail order items for you. Write now! Mail Order Associates, Rochelle Park 22, New Jersey.

START Home business. Absolutely new. Never before offered. Amazing money making opportunity. Physical handicap no obstacle. Unlimited opportunities. Free samples and information. Peter J. Hahn & Sons Co., 4445 W. Belmont Ave., Chicago 41, Illinois.

MONEYMAKING OPPORTUNITIES

START Big-pay business at home in spare time. No experience needed to operate little table-top machine for bronzing baby shoes. Make \$5.46 profit on every pair. Full particulars free. Send postcard to Mason, 1512 Jarvis, Room CM-2-J, Chicago 26, Ill.

\$100.00 WEEKLY Spare time with a tape recorder! Proven facts free! Dixieland Publishers, Asheboro 4, N. C.

MEN And women wanted to start home business in spare time with little table-top rubber stamp machine. Easy to earn up to \$9.80 an hour without previous experience. Full particulars free by mail. Send postcard to Roberts, 1512 Jarvis, Room CR-2-S, Chicago 26, Ill.

ATTENTION Typewriter owners. Make handsome profits. Write today. Groves Company, 682, Hastings 8, Nebraska.

DO It yourself. What? Repair TV, build furniture, make barbecue, plumbing repairs, build boats, do house wiring, remodel home, lay tile, modernize kitchen, repair home, and scores of other things you can do yourself. Books covering each subject, only 25c. Send for descriptive list. It's free. Popular Mechanics Press, 200-LB East Ontario St., Chicago 11, Ill.

BUY Wholesale! 30-80% discounts! Appliances, gifts, typewriters, tools, watches, sporting goods, jewelry, cameras, housewares, etc. Consolidated Distributors, Clifton 28, New Jersey.

ADS Running under this heading sell printing. Ask me for proof. I'll gladly send you amazing facts. Ask for Folder "P." F. W. Johnson, 200 E. Ontario St., Chicago 11, Ill.

AMAZING Successes through franchises! Become exclusive franchise holder your territory. Information rushed. National Franchise Reports, 333 North Michigan, Chicago 1.

FREE Folio "\$5,000-\$45,000. Unlimited Vacations." No merchandise. Unknown! Work home, sparetime! Haylings, Carlsbad, Calif.

GENERAL Contest Bulletin. Lists contests monthly. Sample, 25¢. 1809½ East 5th, Duluth, Minn.

READ Progressive Mailtrade, the magazine that tells how to make money by mail. Dime brings sample and special offer. Progressive Mailtrade, Box 357, Sheboygan, Wisconsin.

BIG Money raising, fishworms and crickets. Free literature. Carter Hatchery, Plains, Georgia.

EARN Money evenings copying and duplicating comic cartoons for advertisers. Adservice, Argyle 1, Wisconsin.

SELL Titania gems. Far more brilliant than diamonds. Catalog 10¢. Diamonite, 2420-M 77th, Oakland 5, California.

VENDING Machines—No selling. Operate a route of coin machines and earn amazing profits. 32-page catalog free. Parkway Machine Corporation, Dept. 27, 715 Ensor Street, Baltimore 2, Maryland.

FREE Book "505 Odd, Successful Businesses." Work home. Pacific, Oceanside, Calif.

PRIZE Contests provide fabulous and confidential home income opportunities! Here's how and where to win your share! Send stamp! National Contest Bulletin, Box 2685-P, Miami 16, Florida.

DOLLARS Every day! It's magical—You keep all the dollars. Setup free. Otto Miller, Box 388-W, Oshkosh, Wis.

JOIN The prosperity parade with a mail order bookshop in your own home. Valuable information free. Practical Publications, 3974-P Milwaukee, Chicago 41, Ill.

MAKE Money, mailing sample business cards. Vosacek Printing, 4444PI Ute, San Diego 17, Calif.

MEN—Women! Start money-making plastic laminating business at home in spare time. Material that costs 11¢ brings back \$2.58. No canvassing or selling but mail orders bring in \$20 a day. Write for full particulars free. Rush name on postcard to Warner, Room CL-2-S, 1512 Jarvis, Chicago 26, Ill.

THEY Hand him \$100! Free packet. "Secret Journal." 919 secrets-plans! Work home. Publicco, Oceanside, Calif.

DOLLARS For you in mailorder. Dime brings magazines, information. Palm, Box 1221, Baton Rouge, La.

\$60.00 WEEKLY Sparetime. Start home Venetian blind laundry. Protected territory. Interesting information free. Burt, 2434ER, Wichita 13, Kansas.

SELL Merchandise by mail using four color catalogs! Fifty fast selling items! Orders filled for you! Sample, plans free! NMMA, 618 Washington, Boston 24-A, Massachusetts.

FREE Literature, big money mailorder opportunity. L Aircraft, Box J-5008, Detroit 35, Michigan.

OVER 1500 Men, women, children in one state make money at home. Full time, spare time. Free details. Mall-Towne, 9 Murray St., New York 7, N. Y.

MAKE Money writing short paragraphs! No tedious study. I tell you what to write, where and how to sell; and supply list of editors buying from beginners. Many small checks add up quickly. Write to sell, right away. Send for free facts. Benson Barrett, Dept. C-27-J, 7464 Clark, Chicago 26.

EXECUTIVE Secrets revealed! Learn about business. How to earn profits. How to operate your own business. How to better yourself and your family's income. Taught by experts. Free details write. National Business Consultants, Office P9C, Los Angeles 61, Calif.

\$250.00 WEEK Spare time profit possible. Earn at home with new fascinating printing method. \$3 starts you, send no money now. Free confidential facts and valuable samples. Screen-Print, 29C, Los Angeles 61.

WE Pay \$3.50 lb. dried. Grow mushrooms. Cellar, shed and outdoors. Spare, full time, year round. We have 25,000 customers. Free book. Washington Mushroom Ind., Dept. 173, 2954 Admiral Way, Seattle, Wash.

MAKE Big profits. Sell imported gift items. Van Gordon Imports, Box 3203, Fort Worth 5, Texas.

\$100.00 WEEKLY Spare time with a tape recorder! Fabulous new business. Entire country wide open! Record weddings, parties, sports events, stereophonic sound, sound-on-sound multiple recordings. Make radio commercials, sound effects. Have fun and make big money in the glamorous business of tape recording. Money-making facts free! Dixieland Publishers, Asheboro 2, N. C.

"50 NEW Home-Business Ideas" booklet free. Coast Industries, B9C, Los Angeles 61.

I can teach you how to direct money-raising campaigns for churches, hospitals, institutions. Earned \$3,065 in six weeks on my first campaign. Started spare time on \$50. Two months course guaranteed by thirty years experience. Low cost. Unlimited field. William Henry Arboqast, 229 East Mason Avenue, Alexandria, Va.

TRUE Wholesale prices. Any size orders. No service charges. Catalog \$2, refundable. House of Better Buys, 722 East Silver Spring, Milwaukee 17, Wisconsin.

MAILORDER—Brokerage, proven money-making lines. Elichs, 3635 Marvin, Toledo, Ohio.

"MAKE More money with less work." Your original, exclusively created Sloganeers' slogan will produce results. Write: Sloganeers, 232-5th Ave. No., St. Petersburg 1, Fla.

MAKE Big easy profits making costume jewelry at home in spare time! Quick, easy to make; easier to sell! Details free! Don-Bar, 3511 W. Armitage, Dept. J-192, Chicago 47, Ill.

FOOD Supplements booming! Sell super-potent "Supervite." Vitamin Specialties, 5522½ Hollywood, Los Angeles 28.

EASY Extra money selling unusual Christmas ornaments. Seven Seas, New Hyde Park, N. Y.

YOUR Own business—Learn what method will turn your \$9.60 into \$96.00 or \$20.00 into \$240.00. Details free. Pittman, Box 992-D, Porterville, Calif.

NEWEST Product report included in oldest mail order magazine "Home Business Digest." Hurry, find out the newest products on market! 12 issues \$3.00, 6 issues \$2.00. Sample copy 35¢. Distributors wanted. Send \$1.00. M. R. Brown, 616 N. Cayuga St., Ithaca, N. Y.

END Money worries—Sell latest popular ties and boxed tie-handkerchief sets. Free details. Olect Ties, 397 E. 47th, New York City.

\$100.00 WEEKLY Spare room. Raise redworms soilless way. Odorless. Charlie Morgan, Box 118E, Bushnell, Florida.

STEADY income: Earn top money. Genealogy, Information \$1.00. 1 Little Smith Street, Poughkeepsie, N. Y.

INDEPENDENCE. Write for information, you'll be glad you did. E. B. Chamberlain, Box 173, Hicksville, Ohio.

OWN-Operate profitable home mailorder business. \$20,000 yearly not unusual. Masters, 5145 Norwood, Arlington, Calif.

CASH in on contests now; get facts that help. Write Sanders & Co., 1762 Euclid, Lincoln, Nebr.

WE Buy all varieties, snakes, lizards, turtles, toads, frogs. Details 25¢. Biological Exchange, Dept. 16b, 1211 Wagner Way, El Paso, Texas.

IN 1952 I had no job and little money. Today I am retired, own a home, car, and bank account. Anyone can do this regardless of age or education. Free information write Norris Cole, 217 49th Street West, Bradenton, Florida.

BUY Wholesale! Save 66-2/3%! 100,000 name brand appliances, housewares, clothing, furniture, tools, sporting goods—Everything! Free catalogs! National Buyers Service, Box 3338EB, San Francisco, Calif.

HOTTEST Mail order plan ever! Sell photos, films, art novelties. Huge proven profits! Free details! A.M.P.R.O., Dept. 1A, 429 South Western, Los Angeles 5, California.

MAKE \$15,000 Yearly at home on \$5.00 and 3 hours weekly. No experience necessary. Proof, details, complete plan only \$1.00. Satisfaction or refund. Columbia Enterprises, #203 Grubb Rd., Silver Spring, Maryland.

BIG Home earnings for you simply answering questions! Leroy Hoda, 2170 Quesada Ave., San Francisco 24, Calif.

OFFICE Men. Good money year after year, preparing income tax returns spare time at home. No lessons. Only fourteen hours study evenings. Amazingly simplified. Write, Reynard, Box 1265-A, Peoria, Illinois.

\$1,000.00 MONTHLY For 26 years! Stay home and enjoy life with the most fascinating mailorder business ever conceived. The postman has put over \$250,000.00 into one mailbox with this plan! Learn how you too can start right now. Facts free! Dixieland Publishers, Asheboro 61, N. C.

\$1200.00 MONTHLY Proved! Rid homes, farms, businesses of termites, rodents, pests. New shortcut methods! Learn everything two weeks! Free success plan. A.P.C.O.A., Dept. 1A, 429 South Western, Los Angeles 5, California.

FORMULAS, PLANS, ETC.

LATE, Modern manufacturing formulas. List free. Moon Chemical, Martville, New York.

FORMULAS For latest money-making discoveries. New! Good! Valuable literature free! Miller, Chemist, 1517-D, Tampa, Florida.

SILICONE. The best waterproofing wood, cement, leather, paper. Information. Sonic Chemicals, 181, Rushsylvania, Ohio.

LIFETIME Business! Manufacture extremely profitable products! Lists free! Thermolab, Peoria 4, Ill.

FREE Formula catalog. Anything analyzed. Reasonable. Western Chemical, Salem, Oregon.

FORMULAS: All kinds, latest, best. Literature free. Kemikal, Park Ridge, Ill.

PRACTICAL Formulas. Lists free. Cummings, Chemist, Gordon Ave., Syracuse 4, N. Y.

CHEMISTRY

HIGHEST Quality chemicals in small quantities; chemistry sets, apparatus and laboratory supplies. 25th year. John H. Winn Co., Inc., 134M West 23 St., New York 11, N. Y. Catalog 25¢.

60 PAGE Booklets! "Beginners Chemistry," "Chemistry," "Physics," "Relativity," "Light," "Astronomy," "Electricity," "Radio," "Useful Tables," "Scientific Oddities," 10¢ each. Franks, 3121 South Racine, Chicago 8.

CHEMICALS, Supplies catalog. 25¢. Laboratory Sales, Box 161-A, Brighton, Mass.

AMAZING New Book of Science, Experiments, formulas, and catalogue of laboratory supplies. Only 25¢. National Scientific Co., Dept. PM-9 500 West Road, Lombard, Illinois.

CHEMICALS And apparatus for industrial, analytical, and private laboratories. Catalog 25¢. Dept. M-50, Biological Supply Co., 1176 Mt. Hope Ave., Rochester 20, N. Y.

ILLUSTRATED Catalog: Chemistry, mineralogy, biology 20¢. Tracey Laboratories, Evanston, Illinois.

PLASTICS

LEARN Plastics fabrication for spare time income. Low cost home training now available. Write for free booklet, Interstate Training Service, Dept. D-3, Portland 13, Ore.

LAMINATING Supplies. Free price list. Solomonson, 45 Cornhill, Boston 8, Mass.

PLEXIGLAS, Fiberglass, polyester, epoxy, acetate, vinylite, styrofoam, acrylic, instructive wholesale-retail catalog, free. Gem-O-Lite, 5529 Cahuenga, North Hollywood, Calif.

BOXES, Plastic. Free list. Aithor, 170 Bay 23 Street, Brooklyn, N. Y.

NEW Liquid casting plastic, clear, colors. Embed real flowers, coins, photos. New manual shows fine things you can make at home and sell at big profit. Send 25¢. Castolite, Dept. K-101, Woodstock, Illinois.

PLEXIGLAS. Square foot cost: 1/16", \$1.20; 1/8", \$1.52; 3/16", \$1.86; 1/4", \$2.21; 3/8", \$3.23; 1/2", \$4.36. Colors add 10%. Send 15¢ for postage. Aristocrat Plastics, 23-25 Sussex Ave., Newark, N. J.

AGENTS WANTED

RUN Spare-time greeting card and gift shop at home. Show friends samples of our new 1957 Christmas and all occasion greeting cards and gifts. Take their orders and earn to 100% profit. No experience necessary. Costs nothing to try. Write today for samples on approval. Regal Greetings, Dept. 70, Ferndale, Michigan.

AGENTS Sell fur-like cape stoles. Large profits. Free photos. J. A. Mig. Co., 1740 Westwood Avenue, Long Branch, N. J.

EXCLUSIVE Line of personal initialed buckles, belts, cap badges, 3,000 emblems, uniforms, shirts, caps, etc. Hook-Fast, Dept. PM, Roanoke, Virginia.

WHOLESALE Catalog! Clothing, linens, housewares. Write Bostonian, 14 Dock Sq., Boston 8, Mass.

AGENTS — 300% Profit selling genuine gold window letters; stores and offices. Free samples. Metallic Sign Letter Co., 1217-D West Newport, Chicago.

YOUR Ad in this space will get some good agents for you. Yes, I'll prove it. Write for Folder "A" right now. P. W. Johnson, Classified Advertising Manager, Popular Mechanics Magazine, 200 E. Ontario St., Chicago 11, Ill.

GOLDMINE Of 600 money makers. Copy free. Specialty Salesman Magazine, Desk 5-B, 307 N. Michigan, Chicago 1.

GOLD Or silver letters, numbers. Windows, doors, trucks, 1" to 6". 500% profits. Free samples. Atlas-T, 344 West 79th, Chicago 20.

PRINTING, Advertising salesmen—Excellent moneymaking sideline selling decalcomania name plates, small quantities. Automobile initials, sign letters. Free samples. Ralco, XL, Boston 19, Mass.

YOUR Own business—Used suits \$1.50, overcoats 85¢, mackinaws 35¢, shoes 12½¢, ladies coats 30¢, dresses 15¢. Enormous profits. Catalog free. Nathan Portnoy Associates, 605-AA West 12th Place, Chicago 7.

EASY Handwork makes fast-selling articles. Sample free. Sunmade Company, Brockton 84, Massachusetts.

MAKE Money quick, easy, taking subscriptions from every family in your community. Liberal commissions. We tell you how, furnish all supplies free. Write McGregor Magazine Agency, Dept. 100, Mount Morris, Illinois.

TREMENDOUS Profits! Every man, woman and child a customer. Used suits \$1.50, pants 35¢, dresses 20¢, shoes 20¢. Operate from store, home, car. Free catalog. Superior, 1250-A Jefferson, Chicago 7.

SELL Famous \$3 fire extinguishers. Fast sales, liberal profits. Write Fire-Killer, Box 182, Hazleton, Penna.

CHRISTMAS Cards—Impressive albums of deluxe and popular-priced greetings with customer's name imprinted. 150 lavish designs for business and personal use. Wide selection for every taste and budget. You can earn \$300 to \$500 commissions, even in spare time, between now and Christmas. Sales experience unnecessary. We furnish free fully equipped sales kit complete with albums and easy-to-follow selling instructions. Dependable service guaranteed by old established manufacturer. Write Process Corp., 1952 S. Troy, Dept. PB, Chicago 23, Illinois.

RIFLE Pen, new, distinctive, exclusive (patented), receptive market, self seller, a thing of beauty, simulated gold plated finish, rifle action mechanism, tremendous sales potentials, samples two for \$1.00, postpaid. Jomar, Dept. 11, Box 727, Round Lake, Illinois.

SELL By mail and direct to offices, stores, homes, schools, churches, clubs Nifty sealer and moistener for envelopes, labels, trading stamps and anything that sticks. Sample \$1.00 refundable. Mailing circulars \$1.95 M. 110% profit. Amberland, P.O. Box #91, So. Boston, Mass.

NEW Christmas card discount selling plan pays you more! Make \$100 cash easy in spare time. 250 finest gift and card sellers. Many exclusive! Personal album free, other samples on approval. \$1.25 gift free for promptness. Cardinal, 1400 State, Dept. 79-D, Cincinnati 14.

BEAUTIFUL Feather pictures. 200% profit! Free details; sample 20¢ stamps. Sylviak, Apartado 9036, Mexico City.

MAKE Money! New, different commission circulars. Free samples. Damm, Inc., Box 148, Flushing 52, N. Y.

MAKE \$50-\$300 Extra money fast. Show big value \$1.00-\$1.25 Christmas, everyday greeting card assortments, gift wrappings, costume jewelry, gifts, stationery. Profits to 100%. Cash bonus. Write for newest assortments on approval, free gift offer, free album name imprinted Christmas cards, catalog, details. Hedenkamp, 361 Broadway, Dept. PM-52, New York City.

DRYCLEANS Clothing for only 10¢ per garment. Lightning seller. Saves dry-cleaning bills. Samples sent on trial. Kristee 68, Akron, Ohio.

\$1,000.00 A Month for making dramatic 3-second demonstration of amazing lightweight Presto fire extinguisher. New chemical used by airforce snuffs out fires instantly. Only \$4.95. Terrific commissions. Millions want it. Free kit. Merlite, 114 E. 32nd, Dept. P-58A, New York City 16.

MAKE \$50-\$75-\$100 Again and again. Show friends new idea Christmas, all occasion boxed assortments, gift wrappings. Profits to \$1.00 per box. Write for feature boxes on approval, 64 free personal Christmas card, stationery samples, free catalog. Sensational free offer. New England Art Publishers, North Abington M-95, Mass.

80% PROFIT On cosmetics—Famous nationally advertised Hollywood cosmetics pay 80%. Make \$25 day up. Hire others. For free samples, details, write Studio Girl, Glendale, Calif., Dept. 1279G.

NEED Money? \$50 yours. Sell only 100 boxes new Christmas cards. Other amazing offers. Free samples imprinted cards. Feature box assortments on approval; free catalog. 100 profitable items. Work with a national leader. Write today. Pen-N-Brush, Dept. PM9, 139 Duane Street, New York City 13.

IF You want to earn money fast, I'll send you free sample stocking of newest stretch DuPont nylons to sell at only \$1 a pair. American Mills, Dept. 624, Indianapolis 7, Ind.

MEN, Women, make money spare time plus new car as bonus for encouragement. Amazing hosiery guaranteed to wear without holes, snags and runs, or replaced free. For example, lovely 60 gauge nylons guaranteed for as long as 1½ years, or replaced free. Write Wilkmit, 1779 Washington, Greenfield, Ohio.

TURN Your spare time into profits! Friends, neighbors, relatives buy these unusual gifts, gadgets, toys, jewelry, gift wraps and greeting cards on sight. Over 600 terrific new items—Up to 100% profit! Send for sensational money-making free catalog now. Start to make big money immediately on Christmas sales! Samples on approval. Write Greetings Unlimited, 7-42 Park Square, St. Paul, Minnesota.

SEEKING New products? Get my outfit 47 money-making specialties. Latest conveniences for home, car. Send no money. Just your name. Kristee 69, Akron, Ohio.

GUARANTEED — Moneymaking. 10¢. Charles R. Williams, Route 2, Clarksville, Tennessee.

PRIVATE Eye door lookout. You see intruders. They can't see you. Sells like wildfire. Big profit. Free literature. Michael Broado, Box 231, Duluth, Minn.

\$2.00 PAYS \$56.00. Capitalize on new discovery of metallurgical chemists. Perfect business for life. Write—Miracle Products, P.O.B. 1544, Oakland, California.

SELL Sparkling glitter! Decorate ornaments, gifts, greeting cards, etc.; 6 sparkling colors in shaker cans with glue, mounted on blister display card. 100% selling profit. Send \$1.00 for sample, sales details. Ames, Box 709, Selma, Alabama.

YOUR Photo on stamps. No investment—No stock. Big profits. Free samples. Miniature Photostamps, Box 44-F, New York City 67.

BIG Wholesale catalogue free. Discounts to 80%. Reliable Distributors, 2931-M Derbigny St., Metairie, Louisiana.

SELL Aluminum embossed name plates for mailboxes, lawn, posts. Write: Star-metal Company, Stirling Rd., Warren Twp., Plainfield 3, New Jersey.

ROBOT Pens—Automatic. Sample \$1.00. Exclusives, Box 601, Rome, New York.

EARN To \$3 hour writing orders for appliances, dinnerware, cutlery, watches, cookware, etc. At post paid discount prices. Catalog and details free. Reidler's Sales, 501 Parkway, Schuylkill Haven, Penna.

CLOSEOUTS! Bankrupt stock! Bargains galore. Nationally advertised merchandise as low as 10¢ on the dollar. "Bargain Magazine" tells you where. Sample 25¢. Glass, Ellwood City 1, Penna.

CHRISTMAS Music cards. Dorby Music Cards, Box 354, Morristown, New Jersey.

HOW To make more money quickly. Sell fast selling Biblical "good luck" jewelry. Buy direct. Free plan. Olect Mfrs., 305 E. 47, New York City.

SELL Rubber stamps, printing. Big profits. Free kit. Barber, Marengo, Ohio.

A Gold mine! New Jiffy fire extinguisher. Latest scientifically developed chemical powder smothers fires instantly. Priced low. Guaranteed. Details free. S & S Manufacturing Co., 2516 Noriega, San Francisco.

RETRACTABLE Pens. Many styles. 3 samples 50¢. Nucleus Trade, 2440 Amsterdam Ave., New York City 33.

SCHOOL Seniors—Be popular with classmates. Have spending money galore. Details free. Craftcards, Box 235-L, Pittsburgh 19, Pennsylvania.

ALL New Scripture-text Christmas cards, stationery and exciting gift items. Free information. Cicero Bible Press, 2301-X Roosevelt Road, Broadview, Illinois.

BUY IT WHOLESALE

BUY Wholesale! Standard brands. Housewares, sporting goods, appliances, jewelry, etc. Catalog \$1.00 refundable on first purchase. Charles Campbell, P.O. Box 1037, Gardena, California.

WHOLESALE Catalog \$1.00, \$3.00 refunded. Hayes, 3039 Durt Rd., Barberton, Ohio.

FREE Wholesale catalog. Gifts, appliances, housewares, cookware, cutlery, watches, dinnerware, silverware, jewelry, etc. Discounts to 80%. Topval Corp., Lindenhurst 624, N. Y.

BARGAINS, Joblots, closeouts. 2000 items. Tremendous savings, clothing, toys, gifts, jewelry, television, etc. 25¢ brings wholesale catalog. \$1.00 merchandise certificate included free. Reliable Jobbing, 311-B North Desplaines, Chicago.

BUY Wholesale! Discounts to 80%! Appliances, tools, typewriters, clothing, watches, housewares! Midwest, IMP-156, Pontiac, Illinois.

DISCOUNTS To 75%. Name brands. Postcard gets \$1.00 credit. catalog. United, M-450 Broad, Newark, N. J.

BIG Multicolor wholesale catalog! Housewares, appliances, clothing, silverware, cookware, luggage, binoculars, radios, phonographs, cameras, recorders, projectors, typewriters, shavers, sporting goods, toys, tools, sewing machines, watches, jewelry. Name brands. Huge discounts. Postcard: Selbyco, Decatur 180, Illinois.

ELECTRIC Guitars, amplifiers, wholesale. Free catalog. Carvin PMW, Covina, Calif.

USED And new watches \$2 up. Free list. Southern Watches, Gray, Georgia.

BUY Wholesale! Over 10,000 nationally advertised products. Appliances, cameras, sporting goods, housewares, watches, typewriters, tools, clothing, etc. Send postcard today. Buy-Rite, Box 258, Hawthorne 4, New Jersey.

TERRIFIC Discounts. Catalogue \$1.00 (refundable). Billera, 38 Circle, Hicksville, New York.

BUY Wholesale, appliance, houseware, watches, catalog \$1.00. Hobby, 48A, W.H.P., Goldsboro, N. C.

SALESMEN—DISTRIBUTORS

SELL Electrical waterproofing necessity factories, shops. Typical order, \$17.50 profit. Box 5672, Cleveland, Ohio.

FAST Selling revolutionary knife sharpener. Last a lifetime and fully guaranteed. Will sharpen stainless steel. Send \$1.00 for sample and information or \$6.00 for dozen. 100% profit. Min-It Knife Sharpener Co., 4667 1/2 York Blvd., Los Angeles 41, Calif.

AMAZING Insecticide line. Safe indoors, outdoors. Sells fast. Demonstrates. Great repeater. Wonderful profits. Distributors opportunity. Write Sayer Associates, 428P3 Portland Bldg., NW, Washington 5, D. C.

EARN \$200 Weekly distributing our amazing Acorn magnetic card holder line. County franchises available. Standard, 120 Broad, Newark 4, N. J.

ANYONE Can sell famous Hoover uniforms for beauty shops, waitresses, nurses, doctors, others. All popular miracle fabrics, nylon, dacron, orlon. Exclusive styles, top quality. Big cash income now, real future. Equipment free. Hoover, Dept. J-160, New York 11, N. Y.

AD Matches! Sell amazing designs—10, 20, 30, 40 and 240-light book matches. Bigger spot cash commissions; every business a prospect. Low prices for high quality. Repeats. Start without experience; men, women; full, part time. Buy nothing! Sales kit furnished. Match Corp., Dept. PM-93, Chicago 32, Illinois.

\$1,000.00 A Month for making dramatic 3-second demonstration of amazing lightweight Presto fire extinguisher. New chemical used by airforce snuffs out fires instantly. Only \$4.95. Terrific commissions. Millions want it. Free kit. Merlite, 114 E. 32nd, Dept. P-58A, New York City 18.

EXCLUSIVE "Trade-in sale" of old shoes sells new Air Cushion shoes for you! Highest commission, bonus. Paid vacation. Samples supplied. Charles Chester Shoes, 944 Brockton, Massachusetts.

CALENDARS, Advertising novelties, matches. All styles, including religious, varnished, 12 sheet, girls. Hundreds of advertising novelties, book matches, etc. Fleming Calendar Co., Sales Division, 6539 Cottage Grove, Chicago 37, Ill.

MAKE Extra money. Cash commissions. Everybody buys easy-to-sell advertising book matches. Union label. All sizes. Cuts for all businesses. Powerhouse selling kit free. Steady repeat business. No experience necessary. Superior Match Co., Dept. M-957, 7528 S. Greenwood, Chicago 19.

SOFT, A unique powdered toilet soap, with coconut oil, for shaving, shampoo, bathing. Send \$3.00 for each dozen cans. Distributors, jobbers write for maximum schedule. Adams Soap Mfg., Schodack Landing, New York.

MONEY-Making opportunity! Take big profit orders for world famous patented varieties fruit trees. Also flowering shrubs, roses, vines. Big sales outfit free. Stark Bro's, Desk 30198, Louisiana, Missouri.

IF You're interested in making money in selling, see the hundreds of exceptional opportunities in Salesmen's Opportunity Magazine. Send name for your copy, absolutely free. Tell us what you're selling now. Opportunity, 648 N. Dearborn, Dept. 17, Chicago 10, Illinois.

100% PROFIT. Fast money for you! Take orders for Sweet Georgia Brown cosmetics. Colored people buy it quick. Free sample. Write Valmor, 2451-PF Michigan, Chicago 16.

BIG Earnings! 1000 job opportunities! Write. George Lucas, Bellevue, Wash.

MONEY Back low priced trading stamp plan pays you bigger spot cash profits with steady year 'round income from re-order commissions. Every grocery, gas station, drug store, etc., are "quick" buyers. Free pocket sales kit. Worthmore, P-9, 1825 South Michigan Avenue, Chicago 16, Illinois.

NEW, Amazing collection system. Collects old bills speedily. Sells fast to merchants, doctors, manufacturers. Wonderful profits. Free details. Nationwide, North Madison 5, Ohio.

\$200 WEEKLY Calling on businesses! Victor, Dept. 1419, Box 231, Wausau, Wis.

OUTSTANDING Sales opportunity, introducing new completely guaranteed product, 7 years research make it best in field. Tremendous market. Territory and earnings unlimited. Sales training for you and your crews. Write for details, R. L. Barton, Barton Bldg., Galesburg, Illinois.

EMPLOYMENT INFORMATION

UNLIMITED Job opportunities. Details free. Personnel Associates, Box 1018, Edinburg, Texas.

EARN High pay: Jobs in South America, the Islands, U.S.A., Europe, Canada, other foreign countries. All trades, mechanics, truck drivers, laborers, office workers, engineers, etc. Chance to travel. Fare paid if hired. Application forms. Free information. Write Dept. 108, National Employment Information, 1020 Broad, Newark, New Jersey.

FLORIDA'S Booming! Hundreds of jobs. Special statewide analysis airmailed \$2.00. Sun-Glo Service Bureau, Perry 2, Florida.

COPYRIGHTED Reports on best paying jobs with travel, adventure, promotions. Construction, aviation, shipping, laborers, clerical, trades, supervisory, factory, unusual opportunities. Many types of work. Skilled and unskilled. Foreign and state-side openings for men and women. Only \$2.00 (\$2.25 airmail), including registration-advisory service. Satisfaction guaranteed. Included absolutely free: Special reports on Alaska, Spanish airbase construction. South American opportunities and husband-wife foreign jobs. Research Services, Suite 514-PMU Meramec Building, St. Louis 5, Missouri.

FOREIGN, Alaskan, U.S.A., jobs! To \$1500.00 monthly! Million Americans employed overseas. Copyrighted reports. Who to contact for highest paying jobs. Laborers, trades, truck drivers, office, engineers, many others. 52 countries—St. Lawrence project, Spain, Latin America, Northern project, Europe. Year registration-advisory service. Application forms. Unconditional money-back guarantee! \$2.00 (airmailed \$2.25). C.O.D.'s accepted. International Reporter, St. Louis 1-PZ, Missouri.

BOOMING Venezuela—Only hours from the States. New data regarding jobs, opportunities, conditions, etc. Salaries to \$1650 monthly U. S. tax exempt. Bonuses, living allowances extra. First-hand information direct \$2.00 (\$2.35 air mailed) checks or money orders only. Paul B. Smith, Apartado 172, Maracaibo, Salina, Venezuela.

AMERICAN, Overseas jobs, high pay, men, women, transportation paid. Free information. Transworld, 200L West 34 Street, New York City 1.

ST. Louis, Chicago, New York newspapers, Sundays, \$1.00. Periodicals, Box 55, St. Louis, Mo.

WANTED: Experienced Chevrolet mechanic to work in long established Chevrolet dealership. Ernest Allen Motor Company, 615 Commerce St., Fort Worth, Tex.

COMING To California? Choice listings of jobs, housing, business opportunities, etc. 15 page booklet + free gift \$1.00. Chesleys, 3977 1/2 Texas Street, San Diego 4, California.

EXECUTIVES Tell who gets hired and why. Details free. National Publications, Box 3731, Washington 7, D. C.

AVIATION Jobs—Names and addresses of companies to contact. \$1.00. Fitzgerald, (Chicago Division), Dept. A-6, 815 Country-side Drive, Wheaton, Illinois.

SPECIAL SERVICES

5,000 CIRCULARS Mailed any size \$7.50. R. V. Myers, 1134 W. Fullerton Ave., Chicago 14, Ill.

INFORMATION On anything. Ferguson Research Specialists, 116-14 141 St., South Ozone Park 36, N. Y.

EASY Retirement on \$100 per month. Complete information. \$1.00. 315 Pueblo, Lakeland, Fla.

EDUCATIONAL AND INSTRUCTION

LEARN "By ear" with Dormiphone. While you slumber, amazing new scientific invention works for you. Revolutionary Dormiphonic tools give you a shortcut to learning languages, correct speech; memorizing facts, figures; ideal for self-improvement, relaxation, habit training. Saves time, effort. So simple children benefit. Used by educators, psychologists. Write today for fascinating free book. No obligation. Modernophone, Inc., 320-097 Mezz., Radio City, New York City 20.

DRAFTING—Building or mechanical. Learn at home in spare time, at low cost, from 80-year-old school. Information free. Write American School, Dept. D645, Drexel at 58th, Chicago 37, Illinois.

EASILY Make \$65 week as practical nurse. Learn quickly at home. No high school necessary, no age limit. Write today for free booklet, lessons. Post Graduate Hospital School of Nursing, 34E97 Auditorium Bldg., Chicago, Ill.

WELDERS Earn big money. Easy to learn arc, gas, automatic welding. New equipment, low cost training in non-profit school. GI approved, free booklet. Hobart Welding School, Box M-971, Troy, Ohio.

U. S. civil service tests! Training until appointed. Men-women, 18-55. Start high as \$340.00 month. Experience often unnecessary. Get free 36-page book showing jobs, salaries, requirements, sample tests, benefits. Write today: Franklin Institute, Dept. L-24, Rochester, N. Y.

DRAFTING, Design, blueprint reading. Good paying. Easy to learn at home. Minimum age 17. Write Utilities Engineering Institute, Dept. TC-7, 2525 Sheffield, Chicago 14.

WRITE Shorthand in four days. Learn at home. Only \$2.98. Take notes three times faster. Free literature. Fineline, 303-P Fifth Avenue, New York City 16.

"HOW To Train Horses"—A book everyone who likes horses should have. Free. No obligation. Simply address Beery School of Horsemanship, Dept. 1109-C, Pleasant Hill, Ohio.

FINISH High school at home, spare time. No classes. Diploma awarded. Write for free catalog. Wayne School, Catalog HP-78, 2527 Sheffield, Chicago 14.

BLUEPRINT Reading—Train at home. Learn to read blueprints with confidence in 10 easy lessons. Write today Belton School 1059-R North Lawndale, Chicago 51.

WE Pay \$3.50 lb. dried. Grow mushrooms, Cellar, shed and outdoors. Spare, full time, year round. We have 25,000 customers. Free book. Washington Mushroom Ind., Dept. 174, 2954 Admiral Way, Seattle, Wash.

AUCTIONEERING Home study. Sample chant free. Nelson Auction College, Renville, Minnesota.

COMPLETE Your high school at home in spare time with 60-year-old school. Texts furnished. No classes. Diploma, Information booklet free. American School, Dept. X845, Drexel at 58th, Chicago 37, Illinois.

SPEAK, Sing with power, personality. Home self-training method on records. Amazing details free. Canfield, 2018-A 5th Ave. South, Minneapolis 4, Minn.

ENGINEERING Degrees earned through home study. Residence courses also available. Pacific International University, 5719-B Santa Monica Boulevard, Hollywood 38, California.

MEMORY Education; more mental power; lesson one free. Memorology Studio, 2016 Sunnyside, Chicago 25, Illinois.

BOOKKEEPERS! Comfortable living for life! Operate your own simplified business analysis, bookkeeping, tax service. Full or spare time. Details free. Vanderdrift 35E, Franklin, East Orange, New Jersey.

USED Correspondence courses, educational books bought, sold, rented, catalog free. Vernon, 624 Mohawk, Rossville, Ga.

EARN Degree from college abroad, taking test. No traveling. Numerous fields. Aureab, Central Valley, New York.

REFRIGERATION, Air conditioning. Extension course. Free booklet. Mechanics School, 11029-PX South Vermont, Los Angeles 44.

LEARN Mineralogy at home. Diploma course. Fortunes being made in minerals. Free catalogue. Mineral Science Institute, Desk 2, 159 East Ontario, Chicago 11.

SWEDISH Massage, learn at home. Diploma. Dr. Swanson School Swedish Massage, Illinois licensed vocational school, 3809 Alta Vista Terrace, Chicago, Ill.

BE A real estate broker. Study at home. Send for free catalogue. Midwest School of Real Estate, 68 North Chicago Street, Joliet, Illinois.

TIMESTUDY—Your key to positive personal profits. Associated Techniques, Box 235, Hollidaysburg, Penna.

EARN Degree. Free bulletin. Home-study only. Midwestern Bible School, 1050 Broadripple, Indianapolis.

PIANO Tuning pays. Big money in spare time. Learn at home in 30 days. No musical knowledge necessary. Phonograph records, tools and instructions furnished. Personal instructions available. Free catalogue. Capital Tuning School, 16 Southwest Second, Fort Lauderdale, Fla.

EARN College degrees, correspondence. Metropolitan University, Box 88, Glendale 5, California.

LEARN Appliance service and repair. Motors, washers, refrigeration, cleaners, everything. Free booklet. Armstrong, 11027-A South Vermont, Los Angeles 44.

STUDY For Doctor's degree of psychology, metaphysics and divinity. Correspondence courses only. College of Divine Metaphysics, Dept. P-M, 2811 North Illinois, Indianapolis 8, Indiana.

HIGH School diploma at home. Licensed teachers — Approved materials. Southern States Academy, Box 144-MX, Station E, Atlanta, Georgia.

BE A real estate broker. Study at home. Write for free book today. GI approved. Weaver School of Real Estate, 2018P Grand, Kansas City, Missouri.

USED Correspondence courses and books sold and rented. Money back guarantee. Catalog free. (Courses bought.) Lee Mountain, Pisgah, Alabama.

EARN While you learn. Auto and diesel mechanics master this top paying trade. Many graduates earn \$100 a week and up. Approved for Korean veterans. For free information write Dept. No. 256, Nashville Auto-Diesel College, Nashville 3, Tenn.

HELP Yourself to abundant living. Our courses have aided students to richer fuller lives. Learn secret of contentment, happiness. Earn degrees Ps.D., MsD. Write for free book. College of Universal Truth Correspondence School, 23-C E. Jackson, Chicago.

LEARN While asleep! Details free. Research Association, Box 610-MC, Omaha, Nebraska.

BOOKKEEPERS! Increase your earnings! Operate your own simplified "Dollar-A-Week" bookkeeping and tax service. Full or spare time. Details free. No obligation. Ellis, Box 209, Cedar Grove, North Carolina.

WANT A diesel job? New opportunities to increase income. Higher pay. More money. We can help you qualify. Tools. Shop method home training. Write today! Diesel, Tractor, Heavy Equipment Division, Interstate Training Service, Dept. B-J, Portland 13, Oregon.

I Want to send you proof of the wonderful pulling power of Popular Mechanics classified pages. What's your proposition? Write me today. Include literature if possible. F. W. Johnson, Manager Classified Advertising, Popular Mechanics Magazine, 200 E. Ontario St., Chicago 11, Ill.

INVESTIGATOR Training. Phillips Secret Service System, 1917-B North Kenneth, Chicago 29.

USED Correspondence courses and educational books bought, sold, rented. Free catalog. Educational Exchange, Menlo, Georgia.

MIDLAND Linotype School. Charles City, Iowa. Civilian and veteran courses. Free placement. Established 1909.

BE An investigator. Write for free details. State age, National Detective Academy, 535 East 4th Street, Scottsdale, Ariz.

PHYSICAL Therapy and massage. We train you at home. Earn big profits from your own private practice or work with hospitals and doctors. Free catalogue. National Institute, Desk 4, 159 E. Ontario, Chicago, Ill.

\$1,000 MONTHLY Possible in collection agency business. Free details. Write Cole Associates, Syracuse 2, N. Y.

PLAYS, STORIES, MANUSCRIPTS

WANTED: Book manuscripts, all subjects considered. Greenwich Book Pub., Attn. Mr. Zealand, 489 Fifth Ave., New York City.

WANT Your book published? Learn how we publish, advertise, promote, distribute. Many successes. Free booklet PM. Vantage, 120 West 31, New York City.

CARTOONING, COMMERCIAL ART, SHOWCARD & SIGN PAINTING, TATTOOING

"HOW To Make Money With Simple Cartoons"—A book everyone who likes to draw should have. It is free; no obligation. Simply address Cartoonists' Exchange, Dept. 99-C, Pleasant Hill, Ohio.

CARTOON Your way to fame and money. Learn easily. Sell to 75 leading cartoon syndicates. Big profits. Complete course \$2.00, 5 day guaranty. Gowanda Mail Order Co., Dept. P, Gowanda, New York.

BASIC Art training at home. New plan. Free brochure. Students' Art Club, Kennebunkport, Maine.

YOU Can entertain with chalk talks. Catalog 10¢. Balda The Cartoonist, Oshkosh, Wis.

CARTOON Your way to fame. Minimum age seventeen. Write Director, Cartoons-of-the-Month, Roslyn, New York.

LEARN Sign painting at home. Free talent test. Ben Kerns, Box 812-PM, Greenville, S.C.

TATTOOING Outfits, licensed course. Brochures 25¢. Zeis, 728 Leslie, Rockford, Illinois.

AMAZING Sign system. Earn while learning. Straley, 410 S. Western, Springfield, Ohio.

DRAW Men, women, children in any pose. Simple anatomy instructions and my amazing artists' anatomical figure. \$1.00. Free literature. Don Davidson, 3653 Ravenswood, Chicago 13.

PAINT Signs—Master die cut, outline letter patterns. Complete assortment 1½" to 12" high, prepaid \$2.00. Eyerly, 583, Newton, Iowa.

PAINT Signs, cartoons. Quickest way to learn. Trace letters. Learn to draw. \$2.00. Sign Instruction, 4304 Virginia, Kansas City 10, Mo.

ADVERTISING AGENCIES, LETTER WRITERS, FOR ADVERTISERS

FREE! 1957 Advertisers Rate and Data Directory, 52 pages! E. H. Brown Advertising Agency, 20 N. Wacker, Chicago 6.

ADVERTISING Ratebook leading newspapers, magazines, free. Chicago Advertising Agency, Chicago 4.

ADVERTISE: 24 Words, 100 Canadian newspapers \$5.50. Lists free. Advertising Bureau, 10511-C Springfield, Chicago 43.

ADVERTISING, Result-getting ads prepared, placed newspapers, magazines, radio, anywhere! Lowest rates. Catalogue free. Baker Advertising Agency, 189 W. Madison, Chicago 2.

MAILING Lists most any classification \$5.00 1000. Your circulars mailed with ours \$4.00 1000. Write for our literature. Dixie Mailers, King, N. C.

WANT More business? Here's an amazing opportunity to increase your sales. Talk to thousands of interested readers of "Mechanics Popular." Our Spanish Edition covers the Latin American countries like a blanket. They're real mailorder buyers. Classified rate 75¢ per word. Try an ad in our next issue. Classified Advertising Department, Popular Mechanics Magazine, 200 East Ontario Street, Chicago 11, Ill.

RUBBER STAMPS AND OFFICE SUPPLIES

RUBBER Stamps. All kinds. Literature free. Capital Stamp Works, Box 187, Lincoln, Nebraska.

3 LINES \$1.00 Cushioned. Seeburger's Rubber Stamps, Palmyra, Mich.

FOUR Lines with your own business emblem in self-inking case, \$2.00. Details free. Alro, Box 566-M, Nyack, N. Y.

BEAUTIFUL Park Avenue script. 3 lines, \$1.00. Evero Co., Box 5377, Phoenix, Arizona.

FREE Rubber stamp catalog. S. Eddy, 7 Greensacres Ave., W. Hartford 7, Conn.

THREE Lines finest quality, \$1.00. Arendt, 505 Lapham, Milwaukee 4, Wis.

THREE Line pocket stamp or regular with free pad \$1.00. Barber, Marengo, Ohio.

TYPEWRITERS, DUPLICATORS, OFFICE DEVICES

PORTABLE Typewriter, top quality, low low price, bonus offer. Details free, Ko-Kar Sales, Dept. M, 9 Chamberlin Dr., West Hartford 7, Conn.

REMINGTON Portable typewriters and adding machines, office machines, new. No down payment, \$1.00 weekly. Shipped in factory sealed cases prepaid. Send 25¢ for application. Typewriters, 1527 Potomac, Pittsburgh, Pennsylvania.

BUY Direct! Brand new typewriters, 50% off! Free catalogue. Clifford Sales, 173 Greenwich St., New York 7, N. Y.

RECONDITIONED Typewriters, duplicating, printing devices, \$25.00 up. Supplies, Appliances, DixieGraph, King, N. C.

PRINTING, MULTIGRAPHING, MIMEOGRAPHING, GUMMED LABELS

PERSONAL Printed stationery, 350 pieces \$2.98. Stewart's, Box 5098, Kansas City 30, Missouri.

ATTRACTIVE Stickers, labels, cards, circulars. Samples. Fame, 291 Ellis, San Francisco 2, Calif.

BUSINESS Printing. Samples, prices free. Howprint, 723-G Eunice, Webster Groves 19, Missouri.

EMBOSSED Business cards. Samples. L. C. Sales, 17 South 9th, Wilmington, N. C.

PRINTING By mail—Send 10¢ for catalog and samples. United Mail Order Service, Box 646, Elyria, Ohio.

TOP Quality printing, mimeographing. Free literature. Currier, PM, New Lebanon Center, N. Y.

MIMEOGRAPHING—Letters, pricelists, formulas, instructions. Lowest prices. Lem's Letter Shop, 5710 Stanton, Detroit 8.

OFFSET Printing — \$6.50 1000, 8½x11, 16 lb. National Letter, 231 W. 43 St., New York City 36.

BUSINESS Printing, rubber stamps. Free catalog. Brose, 196 Clerk Street, Jersey City 5, N. J.

BUSINESS, Personal printing. W. Simons, 1027 Madison Street, Henderson, Kentucky.

100 BUSINESS Cards \$1.00. Printers, 1418 Broadway, Rockford, Illinois.

200 TWO Color letterheads, envelopes \$4.50. Compass Press, Box 613, Gainesville, Texas.

AMAZING Value, 1,000 "raised letters" business cards, \$3.50. Samples. Pioneer, Island Park 35, New York.

YOUR Name and address printed on gummed labels. 500—3 lines \$1.00. 15¢ each extra line. ½ x 1½. Print clearly. No c.o.d.'s. Addison Mail Order, PM-9, 1840 Addison, Chicago 13.

BUSINESS Printing. Top quality. Bottom prices. A. Hanlon, Malvern, Penna.

CUSTOM Printing, reasonable. Estimates on anything. Andrews Printing, Graham, N. C.

ENVELOPES; Tags; stationery. Lowest prices. Mosher, 282 Davis, Kearny, N. J.

1000 CARDS—\$2.75. Free samples. Catalog. Eldan Business Service, 507 Fifth Ave., New York 17, N. Y.

100 WATERMARKED Letterheads 8 1/2 x 11, and 100 6 3/4 envelopes attractively printed. \$2.00 postpaid. H. Hudson, Centredale 11, R. I.

FREE Catalog. Business, personal printing. D M Press, Sebastopol, California.

BETTER Grade printing. Reasonable. Estimates. Hamel-Printer, 210 5th Avenue, Suite 1104, New York City 10, N. Y.

PRINTING OUTFITS AND SUPPLIES

MAKE Your own self-molding rubber stamps and printing cuts. Flexirubber, Argyle 1, Wisconsin.

TYPE Case specialists. Buy from manufacturer. Free catalog. King McKay Company, 23179 Telegraph Rd., Detroit 19, Michigan.

PRESSES, Type cabinets, supplies. List for stamp. Lincoln Press Company, 220-G Hartwell, Fall River, Mass.

DO Your own printing. Save money. Simple rules. We supply everything. Print for others; good profit. Raised printing like engraving too. Have home shop. Details free. Kelsey Presses, V-11, Meriden, Connecticut.

PRINTING Presses, type, supplies, lists 24. Turnbaugh Service, Mechanicsburg, Penna.

PATENT ATTORNEYS

REGISTERED Patent attorney offers services. Sanders, 6430 Evans, Chicago 37, Illinois.

CANADA—Ramsay Company Registered, 273 Bank Street, Ottawa, Canada.

C. A. Snow & Co.—M427, Snow Building, Washington 1, D. C. Registered Patent Attorneys. Write for information.

PATENTS. "Proof of Invention" free. E. E. Vrooman, Registered Patent Attorney, 507 McKim Building, Washington 5, D. C.

"INVENTOR'S Guide" and "Record of Invention" free on request. Frank P. Ledermann, Registered Patent Attorney, 134 Nassau Street, New York City.

INVENTORS: Learn how to protect your invention. Unless the inventor is familiar with patent matters, he should engage a competent registered patent attorney or agent to represent him. We are registered to practice before the U. S. patent office and prepared to serve you in handling your patent matters. "Patent Guide for the Inventor" containing detailed information concerning patent protection and procedure with "Record of Invention" form will be forwarded to you upon request—without obligation. Clarence A. O'Brien & Harvey Jacobson, Registered Patent Attorneys, 718-G District National Building, Washington, D. C.

INVENTORS: Without obligation, write for information explaining the steps you should take to secure a patent. John Randolph, Registered Patent Attorney, 203 Columbian Bldg., Washington 1, D. C.

INVENTORS—Take these preliminary steps toward patent protection. Sketch and describe your invention. Sign, date and have this disclosure witnessed by two people who understand your invention. Have us make a preliminary search among U.S. patents already granted for similar types of invention. We report on the probable patentability of your invention and recommend your further course of action. Write for our instructive booklet, "Patent Protection for Inventors" and convenient "Evidence of Invention" disclosure form. Victor J. Evans & Co., 331-K Merlin Building, Washington 6, D. C.

INVENTORS: When you are satisfied that you have invented something of value, write me, without obligation, for information as to what steps you should take to secure a patent. Write Patrick D. Beavers, Registered Patent Atty., 935 Columbian Bldg., Washington 1, D. C.

INVENTION Record form free and "Patent Information Every Inventor Should Have." Carl Miller, Registered Patent Attorney, Woolworth Building, New York.

INVENTORS—If you believe you have an invention, you should find out how to protect it. The firm of McMorro, Berman & Davidson with offices in Washington, D. C., is qualified to take the necessary steps for you. Send for copy of our patent booklet "How to Protect Your Invention." We will also send you an "Invention Record" form. No obligation. They are yours for the asking. McMorro, Berman & Davidson, Registered Patent Attorneys, 1344 Victor Building, Washington 1, D. C.

FOR INVENTORS

WHY Let your ideas remain idle simply because you lack equipment and facilities to complete development? Our technical staff and fully equipped electrical, electronic, electro-chemical, physics, and mechanical laboratory now offers inventors service to perfect, analyze, or test your ideas. For information write Connecticut Research Company, Box 168, Old Lyme, Conn.

INVENTORS—If you believe you have an invention, you should find out how to protect it. The firm of McMorro, Berman & Davidson with offices in Washington, D. C., is qualified to take the necessary steps for you. Send for copy of our patent booklet "How to Protect Your Invention." We will also send you an "Invention Record" form. No obligation. They are yours for the asking. McMorro, Berman & Davidson, Registered Patent Attorneys, 1343 Victor Building, Washington 1, D. C.

INVENTORS—This firm is registered to practice before the United States Patent Office and available to assist you in the preparation and prosecution of your patent application. "Patent Protection for Inventors" booklet containing detailed information and steps to take toward patent protection sent promptly upon request. No obligation. Victor J. Evans & Co., 332-K Merlin Building, Washington 6, D. C.

INVENTIONS Wanted now by my manufacturer-clients. Patented. Unpatented. Write Gilbert Adams, Patent Broker, 80-A Wall Street, Financial District, New York City.

INVENTORS—Send for free Patent Information book and Inventor's Record. Registered Patent Attorney, Associate Examiner. Patent Office 1922-29, Patent Attorney & Advisor, Navy Department 1930-47. Gustave Miller, 97A Warner Building, Washington 4, D. C.

INVENTION Ghosting. What is your problem. Edwin Finkbeiner, 1621 N. Frederic St., Burbank, Calif.

FREE Patent book. Write Blasius, 15-A Park Row, New York City.

INVENTORS: Learn how to protect your invention. Unless the inventor is familiar with patent matters, he should engage a competent registered patent attorney or agent to represent him. We are registered to practice before the U. S. patent office and prepared to serve you in handling your patent matters. "Patent Guide for the Inventor" containing detailed information concerning patent protection and procedure with "Record of Invention" form will be forwarded to you upon request—without obligation. Clarence A. O'Brien & Harvey Jacobson, Registered Patent Attorneys, 718-G District National Building, Washington, D. C.

INVENTIONS And ideas designed for your profit and patented for your best protection at low definite fees. Thirty years experience in developing and patenting inventions in U.S. and foreign countries. Patent searches with valuable report \$15.00. Joseph O'Brien, 132 Nassau Street, New York 38, N. Y.

INVENTORS: Test the commercial value of your patented or unpatented inventions, quickly and inexpensively. Write for free information. Institute of American Inventors, Dept. 40-B, 635-F St., N.W., Washington 4, D. C.

INVENTORS. Don't sell your invention patented or unpatented until you receive our offer. Write Cowgill, Box 298, Marion, Ohio.

PATENT Searches \$5.00. 48-hour airmail service. Invention protection forms free. Write Patent Engineering Service, 711 14th Street N. W., Washington 5, D. C.

INVENTION Record form free and "Patent Information Every Inventor Should Have." Carl Miller, Registered Patent Attorney, Woolworth Building, New York.

PATENT Searches \$5.00. 48-hour service. Free invention protection forms. Write Raymond L. Smith, Patent Searcher, 620 Sheraton Building, Washington 3, D. C.

SEARCHES—Put your patent searches in the hands of a registered patent attorney or agent, as he qualifies to give a worthwhile patentability report. Record of invention form upon request and information on patent protection. Patrick D. Beavers, Registered Patent Attorney, 936 Columbian Bldg., Washington 1, D. C.

INVENTORS: Information on patent procedure furnished on request, without obligation. John Randolph, Registered Patent Attorney, 203 Columbian Building, Washington 1, D. C.

PATENT Searches, including copies of nearest patents, \$5.00. Reports airmailed within 48 hours. More than 100 registered patent attorneys use my service. For free invention protection forms, write Miss Ann Hastings, P.O. Box 176, Washington 4, D. C.

INVENTIONS WANTED

IF Your invention is adaptable to promoting we will contract for selling on cash or royalty. Free booklet outlines royalty rates, requirements. Kessler Corporation, 59-1W, Fremont, Ohio.

INVENTORS: Hundreds of manufacturers have requested our assistance in locating marketable new products. Complete information free. Institute of American Inventors, Dept. 40-D, 635-F St., N.W., Washington 4, D. C.

INVENTORS. Don't sell your invention patented or unpatented until you receive our offer. Write Cowgill, Box 298, Marion, Ohio.

INVENTIONS Wanted. Patented or patent pending. 26 years experience promoting inventions. National Service Bureau, 3120 Meramec, St. Louis 18, Mo.

SUPERIOR Promotions. Patented; unpatented inventions. Information booklet, free. Superior, 338-344 North Rodeo, Beverly Hills, Calif.

INVENTIONS Wanted now by my manufacturer-clients. Patented, unpatented. Write Gilbert Adams, Patent Broker, 80-B Wall Street, Financial District, New York City.

WANTED New patentable ideas for doll carriages, children's tables, chairs and rockers by a reputable manufacturer. Send illustration with full details to L. O. Reuther, 3032-23rd Avenue South, Nashville 12, Tenn.

INVENTIONS Wanted. Patented; unpatented. Tremendous manufacturers lists. Global Marketing Service, 2420 77th, Oakland 5, California.

INVENTORS! Manufacturers look to us for new ideas, patents. Nation-wide contacts. Write Inventors Creative Service, 354 South Spring, Los Angeles 13, Calif.

INVENTIONS Wanted by our manufacturer-clients. Patented or unpatented. International Development Corp., 1424 K St., NW., Washington, D. C.

MODELS, MODEL SUPPLIES

SHIP Models and yacht supplies complete. Large 68 page catalogue 50c. Bill Wild's, 510 East 11 St., New York City 9.

POWER Models. Unusual steam gasoline and traction engines, fittings, metals. Comprehensive catalog \$1.00. Chas. Cole, Ventura, Calif.

SHIP Models. Most complete line in New England. Kits, fittings, plans, books, tools, engines, motors. 1958 illustrated catalog 35c. James Bliss & Co., Inc., Dept. SM, 342 Atlantic Ave., Boston 10, Mass.

BALSA Wood and model aircraft. 40-page catalog 25c. Sig Co., Montezuma, Iowa.

SHIP And yacht model fittings; blueprints. Send 35c for illustrated catalog listing hundreds of items. A. J. Fisher, 1062-1 Etowah Ave., Royal Oak, Mich.

SHIP Model kits and fittings including clippers, trawler, fishermen, frigates, privateer, radio control tug, etc. Send 25¢ for 1957 catalog. Model Shipways, Box 85, Bogota, N. J.

MANUFACTURING

MODELS—Small lot manufacturing. Metals, plastics, etc. Milburn, Burlington, Kentucky.

DESIGNING, Tools, dies, models, manufacturing. Pro Devco, Box 983, Cincinnati 1, Ohio.

HOME CRAFTSMEN

101 FULL Size patterns. Smart, new, gifts, novelties, lawn figures, shelves, action windmills, alphabets. Plus "Make Money Jig Sawing." Only \$1.00. Mastercraft 95M, 7041 Olcott, Chicago 31, Illinois.

FREE Power tool price list. Unique gift offer! Laircraft, Box E-5008, Detroit 35, Michigan.

LEATHERCRAFT. Send 10¢ for new 76-page catalog of tools, supplies, kits, including metalcrafts, enameling, ceramics, all other crafts. Complete stock. Reasonable. Since 1910. Sax Bros., Dept. PM-9, 1111 N. 3rd, Milwaukee, Wis.

FREE Catalog. 1,668 artist-drawn patterns, designs. Craftplans, 1321-A Wabash, Chicago 5.

89 JIG Saw patterns. Beautiful shelves, ornaments, novelties, plus "How, Where to Sell." \$1.00. Mastercraft, 94M, 7041 Olcott, Chicago 31, Illinois.

LEARN Art metalcraft and jewelry making. Complete, inexpensive, home training course now available. Special tools and materials furnished. Write for free booklet. Interstate Training Service, Dept. L-3, Portland 13, Oregon.

FREE Shellworkers catalog, instruction book 35¢. Secor's, Bradenton, Florida P.M.

KNOCKDOWN Cedar chests. Lumber and veneers. Free price list. Giles & Kendall Company, Huntsville, Ala.

FREE "Do-it-yourself" leathercraft catalogue. Tandy Leather Company, Box 791-T22, Fort Worth, Texas.

KNOCKDOWN Cedar chests and lumber. Free price list. Bedford Lumber Company, Shelbyville, Tennessee.

I want to send you proof of the wonderful pulling power of Popular Mechanics classified pages. What's your proposition? Write me today. Include literature if possible. F. W. Johnson, Manager Classified Advertising, Popular Mechanics Magazine, 200 E. Ontario St., Chicago 11, Ill.

WOODWORKING And cabinetmaking course for beginning and advanced home craftsmen. Only complete low-cost home training program available. Write for free booklet. Interstate Training Service, Dept. G-3, Portland 13, Ore.

ALL Crafts, supplies. Large free catalog. National Handcraft, 199 William Street, New York City 38.

DO-It-Yourself booklets. 24 different booklets each covering an interesting subject. Free catalog. Popular Mechanics Press, 631 N. St. Clair St., Chicago 11.

STYLECRAFT "Pretraced" leather kits. Handbags, billfolds, filigree belts. Patterns on leather. Just carve, assemble and lace. "Pre-carved" kits also available. Send 25¢ for catalog, free folder. Refunded first order. Apache Leather Company, 2804 E. Washington St., Phoenix, Arizona.

BOOKS; Hundreds of subjects. Big catalog free. Popular Mechanics Press, 200-BC East Ontario St., Chicago 11.

FREE. New big illustrated catalog, leathercraft, metalcraft, woodcraft kits and supplies. Complete stock, top values, latest ideas. Write today. J. C. Larson Co., Dept. 7427, 820 S. Tripp, Chicago 24.

LEATHERCRAFT. Imported and domestic leather, tools, kits, complete catalog, 25¢ refundable. Midas, Box 1255, Dept. J7, Huntington Park, California.

RETRACTO-Matic safety knives. Write Campbell Tools Co., 1424 Barclay Road, Springfield, Ohio.

BEAUTIFUL Early American furniture, easily built from full size plans. Write for free project folio. Old South Patterns, P.O. Box 11143, Charlotte 9, N. C.

MAKE Money making picture frames. Write for free catalog of all styles of moldings. International Sales, 414-PM East Baltimore St., Baltimore 2, Md.

LEATHERCRAFT. Copper enameling, mosaic tile, metal tooling, many more crafts. Complete illustrated catalog 10¢. Kit Kraft, 229, Studio City, Calif.

DO IT YOURSELF

GRANDFATHER Clock movements, barometers, blueprints, kits. Wholesale catalog 25¢. Mason-Sullivan, Noroton, Conn.

FIX Your own television. Troub-l-ator dial shows tubes to replace; adjustments to make. Mail \$1. S & S Products, 1419 H St., Washington 5, D. C.

INCREASE Compression. Automobile, truck motors. Price \$3.95. Pensue, Scranton 11, Penna.

LAMP And other kits for creative minds. Bruce Specialties Company, Dept. 9PM, Box 305, Hartland, Wis.

DO-It-Yourself booklets. 24 different booklets each covering an interesting subject. Free catalog. Popular Mechanics Press, 631 N. St. Clair St., Chicago 11.

SENSATIONAL Offer. Build at home your own water well drilling rig out of wood. Construction cost approximately \$35.00. Complete blueprints and drilling instruction. Send \$8.00. Roy Vulgamore, Route #7, Chillicothe, Ohio.

MOWER Kits and parts. Also complete mowers. Write for free plans and literature. Triangle, Dept. M-7, Fort Scott, Kansas.

HOUSE Wiring—Electrical repairs. 32-page booklet 25¢. Popular Mechanics Press, 631 N. St. Clair St., Chicago 11.

OIL Drum cement mixer assembly kit. Circular. Nu-Way-Do Co., Newaygo, Mich.

HOW To read blueprints. Amazing booklet 25¢. Free catalog. Popular Mechanics Press, 631 N. St. Clair St., Chicago 11.

18 FULL-Size patterns. Save money with easy-to-use, professionally designed full-size patterns. Make money selling beautiful, useful furniture. Make modern step and cocktail tables; metal lamps; cupola; 12-foot outboard. All patterns test-built; sold with money-back guarantee. Get your free list of these convenient, economical patterns today. Popular Mechanics Press, 200-HH E. Ontario Street, Chicago 11, Ill.

WATCHES, OLD GOLD, JEWELRY

WATCHMAKERS Journal for watchmakers, students, hobbyists. Sample copy 20¢. Dean Co., Box 3218-M, Daytona Beach, Fla.

WATCH And clock repairing books. Free catalog. North American, 2320-AK Milwaukee, Chicago 47, Ill.

WATCHMAKERS' Tools, materials, supplies, watches. Catalog. Gales, Box 1000, Chicago 90, Illinois.

PREFERRED Source for quality settings and stones. Manufacture costume jewelry at home. Extensive catalog 25¢. A. V. Cuff Co., 216-P Fifth Ave., New York 10, N. Y.

10 WATCHES \$18.00. Catalog 20¢. Chronograph repair specialist. Berkwit, 1150 Castlehill, New York 62.

COSTUME Jewelry supplies, settings, rhinestones, etc. 88 page illustrated catalog. 25¢. Milady, Box 1328, G.P.O., New York City.

HIGHEST Cash for old gold, broken jewelry, gold teeth, watches, diamonds, silverware, spectacles, platinum, mercury. Free information. Rose Refiners, Heyworth Building, Chicago 2.

WATCHMAKERS'—Jewelers', machinists' tools. Watchmaking course. Catalog 25¢. Bengale, Culver City, California.

GOLD, Silver, platinum, diamonds wanted. Cash immediately, highest prices; appraisals made. Wilmet's, 1087 Bridge, N.W., Grand Rapids 4, Mich.

RAZORS, BLADES, SHARPENING

RAZOR Blades, very good double edge blades, send \$1.00 for 100. Chic Sales, Dept. H, Box 274, Alameda, California.

FOR THE HOME

NEW Fast acting knife sharpener, 24 adjustments. Will sharpen all knives, including stainless steel. Last lifetime, fully guaranteed. \$1.00. No c.o.d. Min-It Knife Sharpener Co., 4667 1/2 York Blvd., Los Angeles 41, Calif.

PLANS For making beautiful patio lamps, \$1.00. F. Goss, Box 894, Oil City S.S., Penna.

"HOME Improvement Guide." New, amazing 192 page volume. Packed with ideas, plans for remodeling, decorating, landscaping, built-in projects. \$2.50 prepaid. Popular Mechanics Press, 200-HG East Ontario St., Chicago 11.

FOAM Rubber furniture cushions. Factory seconds. 50% discount. Free catalog. Perma-Foam, 390-C Nye Avenue, Irvington, N. J.

BE Your own plumber. You can. Few inexpensive tools and our instructive book, "Home Plumbing Guide," shows and tells you how. Hundreds of photographs and diagrams. Easy to follow. 160 pages. \$3.50. Catalog free. Popular Mechanics Press, 200PG East Ontario St., Chicago 11, Ill.

OF INTEREST TO WOMEN

GETTING Married? Invitations, napkins, everything. Samples. Decco, Box 3215-M, St. Louis 3.

STAMPED Licenses for embroidery or painting. Buy direct from manufacturer and save. Send for free catalog. Merrilee, 15 West 19th St., Dept. 503, New York 11, N. Y.

60% PROFIT On cosmetics—Famous nationally advertised Hollywood cosmetics pay 60%. Make \$25 day up. Hire others. For free samples, details, write Studio Girl, Glendale, Calif. Dept. 1279G.

WE Pay \$3.50 lb. dried. Grow mushrooms. Cellar, shed and outdoors. Spare, full time, year round. We have 25,000 customers. Free book. Washington Mushroom Ind., Dept. 176, 2954 Admiral Way, Seattle, Wash.

ASSORTED Dress buttons. Fifteen ten-cent cards \$1.00. Page, 2048 West 53 St., Cleveland 2, Ohio.

WEDDING Invitations. Free samples. Ritz, 1514 East 49th St., Cleveland 3, Ohio.

DRESSES 24¢; Shoes 39¢; men's suits \$4.95; trousers \$1.20. Better used clothing. Free catalog. Transworld, 164-S Christopher, Brooklyn 12, N. Y.

BEAUTIFUL Head of Christ wallets. Fast selling Christian gift item. Big profit for spare-time workers and fund raising. Sample wallet and wholesale prices \$1.00. Loma Sales, Box 123, Grand Ledge 1, Mich.

HOLD Cosmetic parties. Earn \$25 for 3 hours work. Make 60% profit. Hire others. Everything furnished. Send name for full details and free usable samples. Write Studio Girl Cosmetics, Party Div., Dept. 1279R, 3618 San Fernando Rd., Glendale, Calif.

TOY Club for children. Give age, sex, 3 months \$4.50. Proxy, 1456 Walnut St., So. Plainfield, N. J.

SELL Fine fabrics. Get yours wholesale. Box 363, Norwalk, Conn.

FREE—Big new wholesale catalog! Up to 50% saving for you, family, friends on nationally-known gifts, jewelry, toys, appliances, Christmas cards, etc. Also make money selling part time! Write: Evergreen Studios, Box 848-D, Chicago 42, Ill.

BOOKS: Hundreds of subjects. Big catalog free. Popular Mechanics Press, 200-BC East Ontario St., Chicago 11.

PERSONAL

BIBLE Questions answered. Stamped envelope. Bylon, 17167 Bentler, Detroit 19, Michigan.

ENJOY Health. Free booklet. Ruth's Nutrition, 152 Kearny, PM, San Francisco, Calif.

"HOW Can I find out?" You can! Information confidentially developed. Any matter, person, problem. Worldwide. Officially licensed. Established 1922. William Herman, 170 Broadway, New York City.

BOOKS: Hundreds of subjects. Big catalog free. Popular Mechanics Press, 200-BC East Ontario St., Chicago 11.

BORROW Money—By mail. \$100 to \$600 from Postal Finance. Employed men, women easily obtain \$100 to \$600 fast, entirely by mail. Repay in small monthly payments. Friends, relatives, employer, tradespeople will not know you are applying for loan. Advise occupation, amount wanted. Postal Finance Company, 200 Keeline Bldg., Dept. 7-R, Omaha, Nebr.

LOANS By mail. Borrow \$50 to \$500. Employed men and women over 25, eligible. Confidential, no co-signers, no inquiries of employers or friends. Repay in monthly payments to fit your income. Supervised by State of Nebraska. Loan application sent free in plain envelope. Give occupation. American Loan Plan, City National Bldg., Dept. PM-9, Omaha, Nebraska.

MECHANICS, Engineers, operators. Get your trade identification card. G. A. Hunter, Pacofi via Sandspit, B. C., Canada.

REMAILING SERVICE

REMAILS, 35¢, Montreal, Canada. O. Constantineau, 7634 St. Hubert, Montreal, Que., Canada.

AIR Remails 35¢. I affix stamps. This is permanent address. Ross Hancock, 83 Behaven Rd., Toronto 8, Canada.

COLUMBUS Mail forwarding-receiving address for rent. Details free. William McLaughlin, 800 Stewart, Columbus 6, Ohio.

SECRET Mail receiving, forwarding system. \$3 month. Hedgpath, Box 830, Alhambra 23, California.

REMAILS 25¢. Booklet about Paradise 25¢. P.H.S., P.O. Box 746, Paradise, Calif.

MIAMI Remails 25¢, month \$3.00. Ed. Polaski, 3501 N.W. 56th St., Miami, Fla.

LETTERS Remailed 25¢. J. Love, 1419 E. 83, Los Angeles 1, Calif.

CHINA, Letters air remailed from Taipei, Taiwan, China. \$1.00 half ounce. Box 1626, San Francisco.

RE-Airmails from Britain. \$1. Francis, Honeyboro, Neyland, Pembrokehire, Great Britain.

REMAILING 25¢: Receiving-forwarding, monthly rates. Enterprises, Box 186, Hialeah, Florida.

TREASURE FINDERS

LITHIUM. The wonder metal. Free booklet describes prospecting information, uses, etc. Nu Age, Box 143, North Battleford, Sask., Canada.

FIND Buried treasure, gold and silver, with Goldak's sensational 3½ lb. "find-it" locator, only \$64.50. Write for free literature on complete line of mineral, metal locators; Geiger and scintillation counters. Goldak, 1541 W. Glenoaks Blvd., Glendale, Calif.

TREASURE. Metal, mineral detectors. M-Scope. Used worldwide for treasure hunting. Mineralights, Geiger, scintillation counters. Prices from \$14.75. Fully guaranteed. Use our time payment plan. Free booklets on treasure hunting, uranium prospecting. Free catalog. Fisher Research Lab, Inc., Dept. PM-C1, Palo Alto, Calif.

GOLD, Silver, metal detectors. Geiger counters for uranium. Violites. Sensational new fully guaranteed models. None finer. Information free. Detectron Corp., 5528 Vineland Ave., North Hollywood, Calif.

FREE Literature—Light weight, guaranteed metal detectors. Geiger counters and mineralights. Kits and assembled models. Electronic Applications. Dept. M, Box 3, Arlington 10, Virginia.

FOR SALE—MISCELLANEOUS

HEARING Aid batteries, wholesale. Free list. Habs, Box 51, York, Penna.

OLD Original crank telephones. Wiring diagrams, parts, inter-comms. Catalog 10¢. Telephone Company, Turtle Lake, Wisconsin.

WOOD Screws: Brass 40% off, steel 50% off. Send for price list. Builders Discount Hardware, Box 22, Bladensburg, Maryland.

WANTED—MISCELLANEOUS

CASH For Indian bird stones; antique northwest coast totem, masks, carvings. Send photos. Robert Stolper, 8832 Cynthia Street, Los Angeles, California.

QUICKSILVER. Sterling, silver solders, precious metals. Wholesale Terminal, Norwood, Massachusetts.

SCRAP Mercury (quicksilver) containers supplied — Tantalum, tungsten, silver, platinum. Metallurgical Products Company, Established 1909, 35th & Moore Sts., Philadelphia 45, Penna.

ATTENTION Small manufacturers. We want wrenches, auto accessories. We sell, invoice, and handle promotion for you. What have you? Give full details. International Sales Organization, Established 1919, Box 818, Cleveland 22, Ohio.

WANTED: A teacher for musical hand-saw. S. N. Elliott, 2419 Herman Ave., Tuscaloosa, Ala.

MISCELLANEOUS

"MAN Shall not live by bread alone, but by every word of God"—Holy Bible. Information free. S. L. Bigford, P.O. Box 11, Solvay, N. Y.

LEARN While asleep! Details free. Research Association, Box 610-MC, Omaha, Nebraska.

BOOKS: Hundreds of subjects. Big catalog free. Popular Mechanics Press, 200-BC East Ontario St., Chicago 11.

HOW To remodel, basement, attic. Booklet 25¢. Free catalog. Popular Mechanics Press, 633 N. St. Clair St., Chicago 11.

RECEIVE Magazine samples, mails, catalogues, offers from everywhere. Get listed 25¢. Rorick, Cincinnati 26, Ohio.

YOUR Name wanted. We'll send 1000 publishers, mailers, wholesalers your name, on our list one year 25¢. Dixie Mailers, King, N. C.

"**MAGIC** For everybody." 25¢. Free catalog. Popular Mechanics Press, 631 N. St. Clair St., Chicago 11.

18 FULL-Size patterns. Save money with easy-to-use, professionally designed full-size patterns. Make money selling beautiful, useful furniture. Make modern step and cocktail tables; metal lamps; cupola; 12-foot outboard. All patterns test-built; sold with money-back guarantee. Get your free list of these convenient, economical patterns today. Popular Mechanics Press, 200-HH E. Ontario Street, Chicago 11, Illinois.

BOOKS On antiques and their prices. Free circular! P. Warman Publishers, Uniontown, Penna.

I want to send you proof of the wonderful pulling power of Popular Mechanics classified pages. What's your proposition? Write me today. Include literature if possible. F. W. Johnson, Manager Classified Advertising, Popular Mechanics Magazine, 200 E. Ontario St., Chicago 11, Ill.

10¢ COMIC Books 5¢. Details free. Box 1647, Uniontown, Penna.

REMODEL Your own home. Save hundreds of dollars. New, amazing book shows you how. Written so you can understand it. Step by step instructions make it easy. Fully illustrated, 400 photographs, hundreds of diagrams. 160 pages. \$2.95. Literature free. Popular Mechanics Press, 200-BC East Ontario St., Chicago 11, Ill.

JAPAN: Buy gifts direct. Dolls, kimono, records, etc., 24 page catalogue, business information — \$1.00. Send money order. Clarence Yamagata, 202 Naka 7 Bldg., Marunouchi, Tokyo.

WE Pay \$3.50 lb. dried. Grow mushrooms. Cellar, shed and outdoors. Spare, full time, year round. We have 25,000 customers. Free book. Washington Mushroom Ind., Dept. 175, 2954 Admiral Way, Seattle, Wash.

CATHOLIC Gifts, necessities catalog. Free. Eden, 587-A Shaler, Ridgefield, N. J.

BUY Wholesale! Over 10,000 nationally advertised products. Appliances, cameras, sporting goods, housewares, watches, typewriters, tools, clothing, etc. Send postcard today. Buy-Rite, Box 256, Hawthorne 2, New Jersey.

WANT More business? Here's an amazing opportunity to increase your sales. Talk to thousands of interested readers of "Mechanica Popular." Our Spanish Edition covers the Latin American countries like a blanket. They're real mailorder buyers. Classified rate 75¢ per word. Try an ad in our next issue. Classified Advertising Department, Popular Mechanics Magazine, 200 East Ontario Street, Chicago 11, Ill.

CEMETERY Markers \$6.00. Memorial plates \$3.95. Free literature. Ralph Wall, 1728 Mayville, Zanesville, Ohio.

SELL! Buy! Trade! through "Trading Post Magazine." Details free! Thorne's, 525 Dewey, Jackson 46, Michigan.

BUY Wholesale! Discounts to 50%! Appliances, tools, typewriters, clothing, watches, housewares! Midwest, ZP-158, Pontiac, Illinois.

CIGARETTES—Make 20 for 9¢. Facts free. Moberly, Box 810, Owensboro, Kentucky.

RECEIVE Mail, magazines, catalogs, opportunities, 10¢. Star Mailers, Leming, Texas.

PLASTIC Steel pocket saw cuts metal, wood, rubber, plastics, trees most everything else—\$1 postpaid. Clarco, Box 149, Brooklyn 17, N. Y.

TELEPHONES—Old wall telephones, working order. Oak cabinets, hand crank for ringing; \$5 each, f.o.b. Telephone Co., Turtle Lake, Wisconsin.

MARSHMALLOWS And marshmallow frosting. Make your own from kitchen tested recipes, \$1.00. Korner Candy, P. O. Box 3646 Loring Station, Minneapolis 3, Minnesota.

CESSPOOLS. Septic tanks, clogged drains. How they function and how to keep them working. Free literature. Chemical Cesspool & Drain Cleaning Co., Boston 34, Mass.

FOOD—Supplement. Guaranteed. Month's supply \$1.00. Information free. Ochsens Health Products, 384B Sewell, Akron 19, Ohio.

70 BIBLE Lessons 25¢. Bulletin, Box 87, Cathedral Station, New York 25, N. Y.

AMAZING Luminous liquid. Instantly transforms colored pictures into 3D realism, with Black Light. Greatest discovery in color brilliance. Tremendous money-maker. Sample processed pictures and full details 25¢. Research, 1842PM Byron, Chicago 13.

BEAUTIFUL Portraits done in oils from photographs. Very reasonably priced. Free particulars. Elmer Brunow, 2206 W. Brown St., Milwaukee 3, Wisconsin.

DO-It-Yourself booklets, 24 different booklets each covering an interesting subject. Free catalog. Popular Mechanics Press, 631 N. St. Clair St., Chicago 11.



Draweracks can be stacked in many ways

PUT **stock your shop** IN YOUR SHOP!

EASY TO GET AT!

With ONE HAND you can reach and get... *instantly*... exactly the size and type of screw you want. "STOCK your SHOP" is a smart, new, convenient, and economical way to buy and store screws. Try a few boxes. You'll like them!

SCREWS IN NEW CLEAR PLASTIC BOXES

FOR EASY DRIVING, ALL WOOD SCREWS ARE SPEEDIZED

An invisible lubricating film on "STOCK your SHOP" Wood Screws makes them *easy* to drive in even the hardest woods! This *free* extra feature eliminates bent and broken screws, prevents sore and aching hands. Ask for "STOCK your SHOP" the next time you buy screws.

ELCO TOOL & SCREW CORP., ROCKFORD, ILL.



EASY TO GET OUT!

59¢ PER BOX



LOOK FOR THIS SELF-SERVE DISPLAY AT YOUR STORE



DEVELOP A HE-MAN VOICE!

Write for FREE book "How to Strengthen Your Voice for Greater Success" by Eugene Fenchinger. No obligation. Book will be mailed at once in plain wrapper, postpaid. Just send your name and address. State age. **PREFECT VOICE INSTITUTE, 210 S. Clinton St., Studio JT-2, Chicago 6, Ill.**



Have a Motorized Shop at Low Cost

Make Your Own **POWER TOOLS**

Popular Mechanics Book Shows How to Make 60 Machines from Scrap and Discarded Materials

Get SIXTY POWER TOOLS AND HOW TO BUILD THEM, the sensational new Popular Mechanics book. Build your own lathe, drill press, sander, circular and band saw and other power tools at a cost of only a few dollars each. Use old auto parts, pipe and wood and odds and ends that cost little or nothing. Every detail of construction is given in plain language you can understand and follow. Hundreds of pictures and plans show every step to follow in making the power tools you want. Clip this ad and mail with name, address and only \$2.50, or we will send C.O.D. (U.S.A.). You'll be amazed with the fine, practical tools you can make and how little they cost. Your money back if you return the book in 7 days. Order today.



Over 250 Pictures

POPULAR MECHANICS PRESS, Dept. 957, 200 E. Ontario St., Chicago 11



FIX home & car APPLIANCES YOURSELF

NEW! EICO REDI-TESTER KIT \$12.95 Factory-wired \$15.95

All-in-one MULTI-RANGE ac/dc voltmeter, ammeter, ohmmeter, wattmeter, leakage checker. Locates defects in fans, refrigerators, mixers, air-conditioning, TV & radio tubes and parts, batteries, generators, etc. Easy instruction book has introduction to electricity & procedures for common repair jobs. Examines EICO's complete line of 50 professional instruments & kits - Write for FREE Catalog PM-9

Electronic Instrument Co., Inc., 33-30 Northern Blvd., L.I.C. 1, N.Y.



"Strato" Missile Tested at Sea

Sea Slug medium-range test missiles, designed to hit the highest flying aircraft, zoom into the stratosphere from HMS *Girdle Ness*, a British guided-weapons research ship. The Sea Slug is operated from unexposed positions in the ship. The launcher is loaded automatically.



Portable Facsimile Flashes Photos

Developed by U. S. Army Signal Corps engineers, a portable radio facsimile set can deliver a photograph to a person 40 miles away five minutes after the photographer clicks the shutter. Polaroid film produces in one minute a print transmitted in three minutes; another minute develops the facsimile print.

POPULAR MECHANICS

\$1 Brings You \$18

SPRAY IT WITH SUEDE! \$10 BRINGS YOU \$180

Discover Flok-Kraft and Earn \$\$\$\$\$ AT HOME!



JOIN these men!

"Got \$100 job first day... Premises of several more jobs already" ... C.H.E. Maryland "Getting Flok-Kraft orders faster than I can handle them spare time" ... W.R. Wyoming. "Quick \$140 order from store... lined up 5 other orders in 4 hours" ... H.G.R. Wisconsin. Help fill huge growing demand in your area. Write today!

Earn up to \$15.00 per hour spare time. Amazing new Velvet-fiber spray instantly makes any object (Lamps, Radio & TV Cabinets, Figurines, Signs, Auto dash boards, toys, furniture, draperies—anything) worth expensive \$\$\$\$\$ Prices... like magic, you can spray anything with this beautiful new suede-like finish that feels like rich Velvet.

Earn up to \$300.00 per Week Spare Time Imagine, materials cost only 3c per square foot. (Average TV or radio cabinet can be beautifully sprayed with this startling new 3-dimensional Velvet finish in 15 minutes at a cost of only 34c in materials. Your charge for this job is at least \$10.00.)

Representatives in your Area urgently needed Own your own business. Work at home in your spare time. Help fill the huge growing demand for this amazing new beautiful Velvet-fiber finish. Orders come from stores, offices, homes, architects, auto dealers, everywhere. Possible \$20,000,000 worth of jobs to be done. Investigate today—be first in your area!

Actual samples in 16 Radiant Colors, Booklet of 50 Home Business Opportunities and Confidential Details all sent free! Write: COAST INDUSTRIES, Los Angeles 61, Calif. Dept. B-9



FREE!

SALE

20 X 50 REGULARLY \$74.50 SAVE \$44.55!

High powered, whisper-weight (27 oz.) color corrected, Achromatic binoculars. 7" high! EZ to hold, EZ to focus, instant finger-tip adjustment. **SALE PRICE FOR THIS SALE ONLY** including case and straps! Made in Japan. **USE 30 DAYS. \$29.95** If not satisfied return for refund. Add \$1 postage, handling. Add 25% Tax. UNITED BINOCULAR CO., 9641 S. Western, CRF-1608, Chicago 20, DEALERS WANTED



c.o.d.'s require \$2 deposit.

MECHANICAL PENCIL CALCULATOR NEW INVENTION



MATH-WIZ pencil calculator gives answers automatically to basic addition, multiplication and square root problems, indirect subtraction and division. Easy to operate, comes in gold anodized aluminum casing. Useful gift for students, engineers, draftsmen and in all industry. Only \$2.25 postpaid, No C.O.D. JACK WEISER, Dept. 1, 1233 S. Fairfax Ave., Los Angeles 19, Calif.

YOU CAN BUILD A VIOLIN FOR PLEASURE OR PROFIT

Now you can build a rich toned mellow violin modeled after a famous "Strad." YOU CAN MAKE A STRADIVARIUS VIOLIN contains 8 full scale plans plus complete instructions. You work directly from the plans with no confusing scale of dimensions to translate. Detailed instructions for each step including varnishing and stringing—even shows how to build your own tools. Cloth bound. Order today from **POPULAR MECHANICS PRESS \$3.50** Dept. 957, 200 East Ontario Street, Chicago 11, Illinois



PM TAG of INTEGRITY

More than 1,300,000 families read POPULAR MECHANICS every month for valuable suggestions and product information. It is your assurance of quality workmanship with quality products

PREPARE FOR THE BEST JOBS IN INDUSTRY

TRAIN at HOME in Your Spare Time or at ALLIED INSTITUTE in Chicago

- MECH. ENGINEER
- DRAFTSMAN
- TOOL DESIGNER
- TOOL ENGINEER
- MASTER MACHINIST
- AIR CONDITIONING HEAT & REFRIGERATION

MORE JOBS THAN GRADUATES

Shortages of Draftsmen, Designers, Tool Engineers, Machinists, Air Conditioning technicians are so widespread that you can pick a highly paid key job and look forward to Achievement and Security. You can begin your training in Short Courses at home or at Allied Institute, and continue progressively toward an Engineering Degree in 31 months. Allied is approved by Industry, National Home Study Council, Central Schools Association, Dept. of Education, Office of Public Instruction, State of Illinois, U. S. Dept. of Justice.

SEND FOR FREE BOOKS

ALLIED SCHOOL OF MECHANICAL TRADES 1338-42 South Michigan Ave., Dept. PM-9, Chicago 5, Ill.

Send me without obligation information on your courses:

- HOME STUDY RESIDENT VETERAN NON VETERAN
 DRAFTING ENGINEERING AIR CONDITIONING

NAME _____
ADDRESS _____
CITY _____ COUNTY _____ STATE _____



The 14' STARFISH Now you can own a \$1,100 reg. 1-tored Planing Hull Class SAIL BOAT for only \$525, complete. Freight prepaid. It's constructed of "Hartwick" Plastic covered plywood, with Inuron Sails and stainless steel and chrome hardware throughout. So EASY to assemble... 2/3rd of the work is done in our plant. Just put it together and you're ready to SAIL! Owners claim speeds up to 16 knots. It's the ULTIMATE in a family racing sailboat.
• HULL KIT • HARDWARE & RIGGING KIT • SAIL KIT • ONLY \$175 each, freight collect. COMPLETE KIT \$525. FREIGHT PREPAID. Assembled at our plant, complete, ready to sail, \$1,100 freight prepaid.
PORT MARINE, INC. P.O. Box 704-b Newport Beach, Calif.

KEEP YOUR... EYE ON BENJAMIN for HIGH H.C. COMP AIR GUNS & CO. GAS GUNS—Top Quality at LOWEST PRICES!

BB BB or 177 or 22
 BENJAMIN SUPER CO2 Gas Carbine with Reg. Stock as low as \$14.95 Deluxe Model with Custom Stock (Shown) as low as \$17.95

Benjamin Air Rifles and Benjamin Air Pistols are Recognized All Over the World for Finest Workmanship and Highest Quality at Lowest Prices. Adjustable Power with Amazing Optimum Force. Fully Guaranteed—Safe—Accurate—Economical. Easy to Use anywhere—12 Models for Target and Small Game BB or 177 or 22. All Models Benjamin CO2 Carbine Gas Rifles and Benjamin CO2 Rocket Gas Pistols Use Standard Size CO2 Cartridges (available everywhere). 2-Stage Hi-Lo Jet Power—High for Small Game—Low for Target—Up to 50 Shots from each Cartridge. No Pumping—Safe—Accurate—Economical—Non Toxic—12 Models BB or 177 or 22.

FREE Catalog All Models Benjamin Air Guns & CO2 Guns & Special Offer on Hunting & Fishing Accessories. Send Free Gun Catalog and Special Offer! BENJAMIN AIR RIFLE CO., 896 MARION ST., ST. LOUIS 4, MO., U.S.A. Name _____ Address _____ City _____ State _____ MAIL TODAY!

When you buy TOOLS, EQUIPMENT and MATERIALS

remember...

you buy
better

when you buy...

Quality

from your **QUALITY** dealer

You buy best when you buy nationally advertised brands.

You can be sure the tools, equipment and materials you buy are right for the job when you select nationally-advertised brands sold by your quality dealer.

Nationally advertised brands cost no more and assure longer life with better results. They are backed by the manufacturers and dealers who sell them.

Make it a point to talk with your dealer about the products best suited for your needs. He makes it his business to know what products will do the job best. Your dealer is your workbench partner. Let him help you.



You'll save time and money, too, if you'll look through **POPULAR MECHANICS** for information and suggestions that will help in your selection. Products advertised in **POPULAR MECHANICS** are among the finest made. You can be sure of their quality. **POPULAR MECHANICS** publishes more product information on tools, equipment and materials than any magazine of its kind. Ask your dealer. He reads **POPULAR MECHANICS**, too.

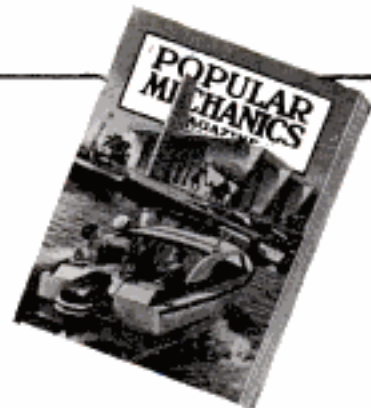

**Home is what you make it
— and your dealer can help.**

SPRINGFIELD 30/06 RIFLES AGAIN!

**SHARP, CLEAN BORES
4 GROOVES, THE FINEST!**



**AMMO
SPECIALS:**

Box of 20 rds. G.I. target, 150 gr. . . \$2.00
100 rds. G.I. target, 150 gr. \$7.50
20 rds. professionally loaded soft point hunting, 150 gr. \$2.95
20 rds. Rem. or Western Commercial soft point, 110 gr., 150 gr., 229 gr., YOUR CHOICE \$4.75

**GOLDEN STATE
ARMS CORP.**

386 W. Green St., Pasadena 134 Calif.

ACCESSORIES, BARGAINS

Trings, U.S. gov't regulation coinide
New . . . \$1.95 Used95c
Sawed handle cleaning rod, 3 pc. & tips
soft brass, Gov't issue . . . \$1.95
Brushes: U.S. Army brass, official, New,
2 for25c
Oil: G.I. gun oil, 6 oz. can25c
Patches: G.I. cleaning patches, flannel
(200)75c
Solvent: G.I. gun cleaning solvent,
6 oz.25c
Gun Case: G.I. olive drab, heavy-duty, brand
new condition, heavy gov't spec.
zipper \$1.95
Saddle scabbards, U.S. official top quality
cowhide, riveted and stitched, NEW \$4.95

TO ORDER: Send check, cash or money
order, \$10 deposit for C.O.D. Shipped RR
Ex., charges collect F.O.B. Pasadena, Calif.
resid. add 4% state tax. 10-DAY MONEY
BACK GUAR. Dealers inquire.

ON SALE JUST \$39.95

HUNTERS:

For the first time in 2 1/2 years, we can again offer the famous U.S. Springfield '03 Caliber 30/06. These are guaranteed, very good inside and out, clean sharp rifling. This is most accurate military rifle ever made, most popular hunting rifle and caliber in world. Soft-nose ammo sold everywhere. Single Springfields sell as high as \$75. Get yours now while they last!

SPECIFICATIONS:

Model: '03. Bbl.: 24", 4 groove (not 2 groove).
Sights: Famous Springfield sights adjustable to 2700
yds. Windage and elevation. Stocks: Gov't selected
American Walnut. Caliber: 30/06. Numbers: all high
numbers. Packing: Guns shipped to us in orig. army
cosmoline. We degrease and oil lightly. Shipped in
heavy duty protective packing case. ALL MILITARY
PARTS; no hurry-up war time stampings. Wt: approx.
8 1/2 lbs. Shipping Wt: 10 lbs.

**ADD THOUSANDS OF \$\$
TO THE VALUE OF
YOUR HOME!**



New PM Book tells and shows how to
handle power tools like an expert—and
make valuable property improvements



A thorough knowledge of power tools and how to use them will enable you to perform hundreds of major and small projects around your home at tremendous savings, and increase its value significantly. Now, with the aid of "Getting Started with Power Tools," it's easy, fun, safe . . . to do more home remodeling and repair jobs, make beautiful furniture, toys and boats, or execute other more ambitious projects you have wanted to do, but never could. This remarkable book, in 160 pages of easy-to-understand text and scores of illustrations, shows you all about the interesting and profitable avocation of working with power tools. Special attention is given to the type of learning problems encountered by the novice. Each major type of power tool is illustrated with captions showing all its parts. But this book is written for the skilled craftsman as well. It tells what you should look for in planning a power tool shop, and how to lay it out for greatest efficiency. It stresses safety procedures that will benefit even the experienced workman. Various attachments are shown that will give one tool many uses, thus saving on the total investment. Never before has a book on power tools been written for the home craftsman that provides as much basic information for the novice, and as many down-to-earth work hints for the expert, as "Getting Started with Power Tools." Order your copy today, with a money-back guarantee if not pleased. Send your check or money order to the address below in the amount of only **\$2.50**

CONTENTS

- Ch. 1 - Selecting power tools
- Ch. 2 - Installing power tools
- Ch. 3 - Portable power tools
- Ch. 4 - Operating the circular saw
- Ch. 5 - Dado-head techniques
- Ch. 6 - Drill-press operations
- Ch. 7 - Operating the bandsaw
- Ch. 8 - How to use the jigsaw
- Ch. 9 - Working with the wood lathe
- Ch. 10 - Wood-shaper techniques
- Ch. 11 - Fundamentals of the jointer

POPULAR MECHANICS PRESS
Dept. 957, 200 East Ontario St.,
Chicago 11, Illinois

HAVE ELECTRICITY ANYWHERE!

**Bendix
PORTABLE GENERATOR**

Take this lightweight 110 V, 60 cycle AC generator anywhere for full 750 watts of light and power. Small, compact, completely self-contained. Weighs only 49 lbs. 2 HP engine runs up to 3 hours on single tank-full. Rewind starter; built-in muffler. Mail coupon now.



DEALER INQUIRIES INVITED

Bendix Aviation, North Hollywood, Calif.
Send literature on your 750 W Generator.

Name _____
Address _____

DO YOU NEED MONEY?

**TO PAY FOR YOUR
AERONAUTICAL ENGINEERING
EDUCATION AND LIVING EXPENSES**
while attending school in California?

NORTHROP INSTITUTE'S CO-OP Training Plan is the answer. Write for complete details. No obligation. Also get free Northrop Catalog describing **TWO YEAR AERONAUTICAL ENGINEERING CURRICULUM**. Remember, there is a waiting list for Northrop Institute Graduates! Approved for Veterans. Send name, address, age and veteran status.

MAIL TO: NORTHROP AERONAUTICAL INSTITUTE
1105 W. Arbor Vitae Street, Inglewood 1, Calif.

**PREPARE FOR BETTER JOB, BIGGER PAY
IN SPARE TIME AT HOME**

Today, choose the job you want—and prepare for it in time you might otherwise waste. Or if you are already in the work you like best, start training now for quicker promotion and increased pay. During the past 60 years **AMERICAN SCHOOL** has helped ambitious people to reach higher goals. Check subject that interests you and mail coupon for full information.

AMERICAN SCHOOL, Dept. G645, Drexel at 58th, Chicago 37, Ill.
Without obligation, please send **FREE** and postpaid, full particulars about the subject checked below.

<input type="checkbox"/> Accounting	<input type="checkbox"/> Contracting	<input type="checkbox"/> Mechanical Engineering
<input type="checkbox"/> Apprenticeship Courses	<input type="checkbox"/> Diesel Technician	<input type="checkbox"/> Mechanical Technology
<input type="checkbox"/> Architecture & Building	<input type="checkbox"/> Drafting—Building	<input type="checkbox"/> Metalworking Courses
<input type="checkbox"/> Automotive Technician	<input type="checkbox"/> Drafting—Machine	<input type="checkbox"/> Plumbing—Practical
<input type="checkbox"/> Better Farmmanship	<input type="checkbox"/> Electrical Engineering	<input type="checkbox"/> Private Secretary
<input type="checkbox"/> Blueprint Reading	<input type="checkbox"/> Electricity—Practical	<input type="checkbox"/> Retail Merchandising
<input type="checkbox"/> Bookkeeping	<input type="checkbox"/> Electronics—Industrial	<input type="checkbox"/> Salesmanship—Outside
<input type="checkbox"/> Business Management	<input type="checkbox"/> HIGH SCHOOL COURSES	<input type="checkbox"/> Sheet Metal Work
<input type="checkbox"/> Civil Engineering	<input type="checkbox"/> Machinists	<input type="checkbox"/> Tool Making

NAME _____ OCCUPATION _____ AGE _____
HOME ADDRESS _____
CITY _____ STATE _____
Canadians Write American School, Dept. G645, 6083 Sherbrooke St. W, Montreal

MAIL COUPON NOW

**EARN
BIG
PAY**

**COURSES OPEN
IN SHOP METHOD
TRADES
TRAINING**

THE TRAINED MAN GETS THE BREAKS
PRACTICAL & HOME STUDY COURSES

- CHECK
YOUR
COURSE
HERE
AND
MAIL**
- WELDING AIR CONDITIONING
 - AUTO MECHANICS DIESEL
 - TELEVISION REPAIR
 - ELECTRONICS PHOTOGRAPHY
 - REFRIGERATION DRAFTING
 - COMMERCIAL ART



For free Booklet and Full Details without obligation,
write to our information office located at: 3330 University
Ave. S.E., Minneapolis, Minn.

IN CANADA:
English—835 Weston Road, Toronto 9, Ontario.
French—85 Jean Talon St., W. Montreal, Quebec.

**OPERATING FOR A QUARTER CENTURY
COAST TO COAST**

SEPTEMBER IS FIX-UP MONTH!
Save dollars on home repairs with

Plastic Steel®

A DEVCON
PRODUCT
80% STEEL
20% PLASTIC



AS EASY TO USE AS MODELING CLAY

A completely new way to make permanent repairs
to furniture, toys, tools, models. Fixes leaking
pipes, tanks, radiators, cracked engine blocks.

Bonds to metals, wood, porcelain, glass, concrete
and other surfaces . . . becomes hard and tough
as steel in 2 hours . . . can be machined.

NEW HANDY HOME KIT 98c

Also \$1.89 and \$3.95 sizes at leading hardware
and hobby stores. WRITE FOR FREE BOOKLET.

DEVCON CORPORATION
175 Endicott Street, Danvers, Mass.

WHERE-TO-BUY-IT INDEX

AUTOMOTIVE

Gasoline computer tells miles per gallon (Mileomatic, Dept. B, Box 637, Hyattsville, Md.)..... 78
Hy-Fy-R gives hotter spark (Hy-Fy-R Div., Three Motors, Inc., 845 Madison St., Oak Park, Ill.)..... 86
Detroit Listening Post..... 89
Trailer-Jeep steers from kitchen..... 112
Off-road transport (R. O. LeTourneau, Inc., Longview, Tex.)..... 113
World's longest military truck totes 40-ton tanks..... 146

AVIATION

Lightweight with a heavyweight's punch..... 90
Missile truck totes Corporal..... 97
Tracker "sees" tiny object four miles up in air..... 97
Big squeegee for hangars..... 113
Fastest jet day fighter?..... 113
Doughnut plane waits for hellum..... 126
Landing helicopters depend on "doughnuts"..... 127
Lightweight helicopter operates from truck..... 145
TWA's "flying maintenance base" uses jet-assist power..... 149
Parachute lands British rocket..... 153

MISCELLANEOUS

Roller-tripod carries pall..... 4
Self-adjusting watch (Benrus Watch Co., 50 W. 44th St., New York City 36)..... 4
Thermometer for fishermen helps prove theory (Zornemann Products Co., 2117 Rockwell Rd., Aurora, Ill.)..... 4
Inexpensive home fire alarm (A & A Sales, 1419 H. St., N.W., Washington 5, D. C.)..... 78
Frameless Dutch motorbike assembled from steel plate (International Distributing Corp., 1006 W. Main St., Owosso, Mich.)..... 88
Handicapped team develops wheelchair (George Spurgeon and John Tracy, Opportunity, Wis.)..... 88
Fast-acting thermometer..... 96
Use electric drill to start power mower (Simmons Starter Corp., Albany 1, N. Y.)..... 96
Homes afloat..... 102
Archers test "shotgun arrow" (National Marine Co., Cadillac, Mich.)..... 104
"Mole" camera photographs tomb before excavation..... 111
Toss-away filters for home pools (Hugh H. Graham and Associates, Inc., New Britain, Conn.)..... 112
Dirt and compost mixer..... 113
Balloon used for scaffold..... 116
Mosquitoes killed by fog-spray system attached to hose (Skeeter-Kill Co., 1010 Cleveland St., Clearwater, Fla.)..... 116
Automatic machine sorts 15,000 letters per hour..... 117
Solar batteries power helmet radio for use day or night..... 117
Double piggyback for Australian trains..... 120
Does Harry Graus have the world's smallest garden?..... 126
Pupils study math with calculators..... 126
Archer shoots telephone lines across canyons..... 132
Ladder platform and hoist provide convenient workspace (Munson Co., Fenton, Mich.)..... 132
Air-dropped radar antennas inflated at combat area..... 133
Mobile half-track radio station..... 133
Custom sprinkler has plastic pipe and push-in nozzles..... 140
Mobile automatic laundry follows Yosemite campers..... 140
Largest reservoir in Asia..... 141
Rubberized houseboat at German fair..... 141
Traffic radar unit monitors pitched balls (Admiral Corp., 1191 Merchandise Mart, Chicago 54)..... 141
Vendors on trains use chef's carts..... 149
World spanner and helmet radio..... 149
Beach pipelines to aid Marines..... 156
Golf meter measures drive..... 156
Plastic capsules hold hooks (Kemper Mfg. Co., Box 545, Chino, Calif.)..... 156
Fraction computer (Sheridan Advertising Specialities, 26026 Grand River Ave., Detroit 17, Mich.)..... 230
Synthetic textile from paper-pulp waste..... 236
Tape and machine splice film without loss of frames (E. Z. Set Products, 7731 E. Vandorf St., South San Gabriel, Calif.)..... 246

SCIENCE

Antibiotic kills housefly..... 96
Keeping up With the Atom..... 105
Plastic bags replacing glass bottles for blood..... 116
Solar furnace to test atomic heat effects..... 141
Frostbite remedy (National Drug Co., Philadelphia 44, Pa.)..... 156

WHAT'S NEW FOR YOUR HOME?

Kitchen-cabinet doors and drawer fronts quickly changed..... 154
Sugar dispenser releases any amount desired..... 154
Window jack for stuck windows..... 154
World globe turns in all directions..... 154
Indoor barbecue..... 155
Light switch permits "tuned in" illumination..... 155
Needle threader..... 155
Picnic table has six sides..... 155

Radio-Television, Electronics

A build-your-own variable-reluctance pickup for hi-fi experimenters..... 157

(Continued to page 76)

ACCORDION PRICES SMASHED



SAVE 50% AND MORE DURING THIS GREAT SALE

5 Days' FREE TRIAL

Hurry! Get in on these sensational accordion values. America's largest exclusive accordion dealer selling out finest brand new accordion overstock! Fabulous savings. Leading brands in more than 30 new models. Small down payment. Easy terms. Trade-ins accepted. Chance of a lifetime.

FREE for promptness . . .
 ● FREE Lessons
 ● Music Stand
 ● Deluxe Case
 ● Lifetime Guarantee

FREE COLOR CATALOG & Wholesale Prices

Learn how easily you may own and play a fine accordion. Rush name and address for big FREE Color Catalog and new low wholesale price list. No obligation. WRITE TODAY!

ACCORDION MANUFACTURERS AND WHOLESALE OUTLET
 2003 W. CHICAGO AVE., Dept. R-97, CHICAGO 22, ILLINOIS

SPEED REDUCER CLUTCH COMBINATION TRANSMISSION

GOVT. COST

\$262.00

SPECIAL SALE!

\$495.00 fob



BRAND NEW SURPLUS

Speed Reducer alone worth triple this low price!

• Reduces speed at a 3-to-1 Ratio • These units hard to get at any price!
 • 2 Independent Outlet shafts, each separately controlled by its adjustable clutch
 • Rated up to 3.6 HP (electric), or 7.5 HP (gas engine)
 • Ball and Taper Roller Bearings throughout (smooth, quiet)
 • Input shaft 1-3/16" diameter, Output shaft 1 1/2" diameter
 • Weight 108 lbs.—Dimensions approx. 17 1/2" long x 8" wide x 8" high
 This SPEED REDUCER-CLUTCH COMBINATION can be utilized when low speeds are required . . . for starting heavy loads . . . or, for engaging and disengaging machine operation without stopping input drive. Supply limited!
ORDER DIRECT FROM THIS AD! Immediate Delivery!
 FREE Catalog of Hydraulics, Generators, Surplus
 Phone: TAYLOR 9-1365

ROBERTS ELECTRIC CO., Dept. PH-682, 849 W. Grand, Chicago 22, Ill.

MEN WANTED

Earn \$100 Per Week and up
AUTO DIESEL MECHANICS

Master a trade with a future—learn Auto-Diesel mechanics in our shops. You learn with tools on real equipment. Earn while you learn. Many of our graduates earn \$100 per week and up. No previous experience necessary. Day and night courses. Approved for veterans. Write for free bulletin.

NASHVILLE AUTO-DIESEL COLLEGE

226 7th Ave., N., Dept. 75

Nashville 2, Tenn.

Build a Boat for Fun or Profit

Popular Mechanics

23 BOATS
 You Can Build



Complete Patterns and Working Drawings
 Build the boat you have always wanted. Build it for fun or to sell at a profit. Get Popular Mechanics 23 BOATS YOU CAN BUILD — row boats, canoes, sail boats, power boats and other craft including a 25 ft. cabin cruiser that sleeps four; 11 1/2 ft. car-top row boat; 8 ft. duck boat; 15 ft. sailing knockabout — in all, 23 of the most popular boats. Book includes more than 500 photos, plans, diagrams and working drawings, plus step by step instruction that anyone can follow. Only simple tools needed. Material list of lumber, hardware, fittings, etc. included. Order today, under money-back guarantee. Only \$2.75 postpaid.

POPULAR MECHANICS PRESS, Dept. 957, 200 E. Ontario St., Chicago 11

How to select a paintbrush

A good brush performs better... wears longer... saves you money



1



2



3

In selecting a good paintbrush, the first thing to look for is (1) a properly tapered "cutting edge" of bristles which vary in length and are secured in a firm setting.

Then look closely at (2) several individual bristles. They should be finely tapered with slightly curled tips. Make sure a generous portion of the bristles have tips that are split or "flagged."

A brush with these qualities will give you (3) excellent performance. It has a greater working and paint-holding capacity—eliminates excessive dipping. The brush will release a finish smoothly and evenly on any surface. You save time, paint with ease, do a professional-looking job. And remember, a truly good brush will last longer, saving you money in the long run.

Now, better performance with improved TYNEX® nylon bristles



4



5



6

When buying a paintbrush, look for the trademark TYNEX on the handle (4). Quality paintbrushes made with bristles of TYNEX nylon give you (5) better performance. They pick up a full load of paint at every dip and lay a smooth, streak-free coat. And brushes with TYNEX have durable bristles that (6) clean easily . . . rinse thoroughly . . . dry quickly — are always ready for re-use.

FREE — additional facts you should have on choosing and using a paintbrush. To get this information without cost or obligation, send name and address to E. I. du Pont de Nemours & Co. (Inc.), Polychemicals Dept., Room 659, Du Pont Building, Wilmington 98, Delaware.

TYNEX is the registered trademark for Du Pont nylon bristles.



TYNEX®
 NYLON BRISTLES

BETTER THINGS FOR BETTER LIVING . . . THROUGH CHEMISTRY

Free! **ALLIED'S**
1958
ELECTRONIC SUPPLY CATALOG

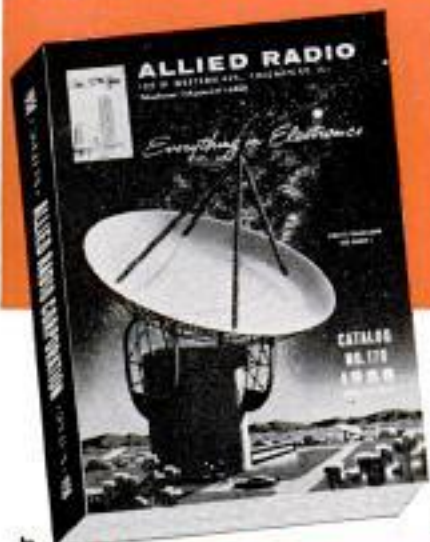

404
value-packed
pages

**Send
for it!**

**SAVE on
everything in
electronics**

**EASY TERMS
AVAILABLE**

WORLD'S LARGEST STOCKS

Here's everything in Electronics for Experimenters, Builders, Amateurs, Servicemen, Engineers and Hi-Fi Hobbyists:

- Amazing Build-Your-Own KNIGHT-KITS
- Hi-Fi Music Systems & Components
- Recorders & Phono Equipment
- TV Tubes, Antennas, Accessories
- Public Address Systems
- Amateur Station Equipment
- Latest Test Instruments
- Industrial Electronic Supplies
- Parts, Tubes, Transistors, Tools and Books

SAVE on everything in Electronics—get fast, dependable service—send today for your FREE 1958 ALLIED Catalog.

Everything in Electronics
From One Reliable Source

our 37th year

send for
FREE
Catalog



ALLIED RADIO

ALLIED RADIO CORP., Dept. 5-J7
100 N. Western Ave., Chicago 80, Ill.

Rush FREE 1958 ALLIED 404-Page Catalog

Name _____

Address _____

City _____ Zone _____ State _____

(Continued from page 74)

Craftsman and Shop Notes Index

FARM

Electric-fence insulators removed without damage.....207
Extra tow bracket on tractor fits high equipment drawbars.....207
Screen funnel on barn wall keeps out unwanted bees.....207
Water fountain in poultry house protected against freezing.....207
Adjustable rack on elevator speeds loading of bales.....211
Angle-iron bracket supports hog trough.....211
Dump-body farm trailer powered by hydraulic piston.....211

HOUSE AND HOME

Dummy wall receptacle provides "safe" for valuables.....164
Glass kept mud-free by grass.....164
Jar is weatherproof note holder.....164
Molding strip on garage door carries off rainwater.....164
Queen Anne mirror and wall shelf.....166
Solving Home Problems—
Cleaning soiled hat band.....174
Bed slats kept in place.....174
Paint data is recorded on hardboard scrap.....174
Prevent Venetian-blind slats from scratching woodwork.....174
Steam iron easily refilled.....174
Wood screws rubbed with soap turn more easily.....174
Garbage cans coated with roofing cement.....175
Handy holder for paper bags.....175
Paint and cooking odors removed.....175
Surface marks removed from furniture.....175
Tinting plastic switch and wall plates.....175
Wrought-iron legs prevented from marking floors.....175
Cleaning a hot-water tank.....185
Candleholders and centerpieces from lipstick caps.....189
Cutting rafters without a framing square.....196
Your water softener.....198
Auxiliary bars double towel-rack capacity.....200
Valuable small items hidden inside top rail of door.....200
Ball-bearing weather vane has waterproof mounting.....204
Cord loops taped to closet door provide temporary hat hangers.....204
Sand removed from well water by water tank in supply line.....204

MISCELLANEOUS

More efficient mousetrap.....164
Holder anchors dog's food dish.....168
Masking tape strengthens chalk.....168
Inexpensive porch table.....169
Reel assures kite control.....173
Toy train-track sections held by rubber bands.....173
Quick method for spacing hand-drawn lettering.....185
Peening tightens gun barrels.....211
Oil dipstick easily read.....213

PHOTOGRAPHY

Bounce flash made easy with swivel attachment.....168
Paint identifies photo filters for easy selection.....173
Photo copying is easy.....201
Photoflood control box simplifies lighting.....202

SHOPPING FOR TOOLS

Adjustable counterbore.....218
Dual-claw hammer.....218
Portable table saw controlled with foot switch.....218
Twist drill has cutting edges on flutes.....218
Pipe seal.....219
Raising blocks for drill presses.....219
Roughness scales serve as comparators.....219
Scraper removes paint from bricks and stonework.....219
Slip-on jaws for adjustable pliers.....219

WORKSHOP HINTS

Jar lid seals spray gun.....168
Soaped straightedge won't slip when cutting glass.....168
Tape keeps glue off wood.....168
Tips on soldering tubing.....185
Sawhorse is adjusted for height by extension rail.....200
Simplify hanging yardstick.....200
Fan base holds flashlight.....204
Burnishing puts a fine finish on wood or metal.....205
Compressed air tempers steel.....206
Sweat soldering improved.....211
Milling-machine fixture indexes hexagon shape.....212
Pencil clip on small tool holds it in pocket.....212
Socket screw used as wrench.....212
Clamp on milling-machine switch prevents starting error.....213
Keeping file teeth clean.....213
Out-of-round machining produces self-locking box lid.....213
Improved indicator centers work in four-jaw chuck.....216
Width of grinding-wheel face measured with micrometer.....216

NOTICE—It is the intention of this magazine to provide its readers with information regarding the latest developments in the mechanical arts. Except where otherwise indicated, this magazine has no information as to any unexpired patents in respect of the developments reported herein. In the event that commercial use is to be made of any of the developments reported herein, it is suggested that legal counsel be consulted to avoid liability for patent infringement. It is not the purpose of this magazine to encourage patent infringement but, as indicated, it is the intention of this magazine to report on the latest developments in the mechanical arts.



Treadle Moves Scaffold Jack

You can literally kick your way to the top with a scaffold jack manufactured in England. A metal bar bites into the four-by-four poles to keep the platform from sliding down and each push of the foot treadle raises the entire assembly 18 inches. To lower the platform, you hold the bar away from the pole with your foot and turn a crank.

Film Viewer Projects Positive Image Directly From Negative

Enlarged positive images are projected directly from the negatives in a German film-viewing unit. The picture is projected by a 1000-watt lamp onto a fluorescent screen excited by ultraviolet light to effect a reversal of the negative's light values. The result is a positive image.



CASITE gives your car

NEW PEP NEW POWER

Frees sticky rings and valves

Get increased pick-up and improved engine performance! Casite—the "tune-up in a can"—through the air intake or added to gasoline, restores split-second valve timing and full compression.

Prevents hydraulic lifter trouble

Casite keeps valve lifters clean and free-working. Just put a pint in the crankcase every 1,000 miles, and with every oil change.

Assures safe, smooth break-in

New and rebuilt engines wear-in smoothly and safely with Casite in the oil. Penetrates tight spots—eliminates overheating, scoring.

Cuts start-up wear

Speeds oil flow—protects closely-fitted parts during warm-up periods. Almost doubles engine life.

Gets rid of sludge and gum

Casite removes gum and goo—KEEPS the engine clean—increases power, improves performance, saves gas and repairs, too.

Results guaranteed, or double-your-money-back!

Get Casite at your service station, garage or accessory store.



HASTINGS MFG. CO., HASTINGS, MICH.
Piston Rings, Oil Filters, Spark Plugs

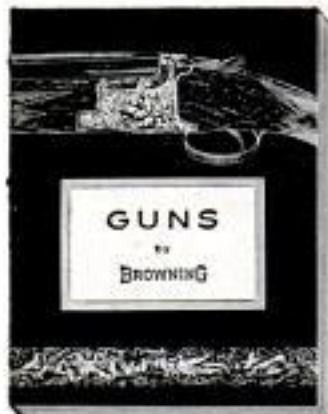

IF
INTERESTED
IN
GUNS

WRITE
FOR
FREE
COPY

BROWNING'S NEW BOOKLET Contains:

Factual information on the shotgun—covering such subjects as barrel length, stock fit, choke, gauge and many others, including analysis of the proper gun for the purpose.

Basic principles to better shooting with explanations on effective range, shooting stance, correct gun position, proper lead.

Details on the shotgun shell, its components, the recommended load, shot size and powder charge for various game.

Each Browning gun and its features are illustrated in color and fully described including detailed specifications and prices—Automatic-5 Shot, Double Automatic, Superposed Over-Under, .22 Automatic Rifle, Automatic Pistols.

Browning Arms Co., Dept. K,
St. Louis 3, Mo.

BROWNING

HELPFUL BOOKS

Send post card asking for **FREE** catalog

Popular Mechanics Press, 200 E. Ontario, Dept. 601, Chicago 11

ENGINEERING DEGREE IN 27 MONTHS

B. S. DEGREE IN

Aeronautical, Chemical, Civil, Electrical, Mechanical and Electronic Engineering (inc. Radio and TV)

Also B.S. DEGREE in 36 mo. in Mathematics, Chemistry, Physics (inc. Nuclear Physics) Engineering Science prep. courses. Thorough, practical program. Individualized instruction emphasized. Government approved for G.I.'s.

Keeping pace with progress in science and engineering

Spacious campus, 20 bldgs.; dorms, gym, Playing field. Modern, well-equipped labs including new physics lab and wind tunnel. Low tuition. New terms start quarterly. Enter September, December, March or June. Big demand for graduates. Students from 48 states and 40 foreign countries. Many earn a major part of their college expenses in this large industrial center. Send coupon for free catalog and full information. Enroll now!

INDIANA TECHNICAL COLLEGE

597 E. Washington Boulevard, Fort Wayne 2, Indiana

Please send me free information on 27 MO. B.S. DEGREES in:

Aeronautical Chemical Civil Electrical
Mechanical Electronics

on 36 MONTH B.S. DEGREES in:

Mathematics Chemistry Physics

Name _____

Address _____



Inexpensive Home Fire Alarm

Hanging on the wall is an inexpensive home fire alarm operated by a dry-cell battery. It emits a loud buzzing if the surrounding temperature reaches 150 deg. F.

Gasoline Computer Tells Miles Per Gallon

You don't have to be a mathematician to calculate your car's gasoline mileage. A plastic computer now on the market figures your miles per gallon automatically. You set the speedometer reading at the bottom of the dial when you have the tank filled, lock the setting and put the computer in the glove compartment. When the tank is refilled, you set the new speedometer reading and the miles per gallon figure appears at the top of the dial, opposite the number of gallons purchased.



Users say painting's fun . . .

Try Sheffield QUIK-SPRAY ALUMINUM

—the easy way to spruce up!



Push-button aluminum painting is fun, users tell us. That's why thousands of home-handy people today are buying brands like Sheffield Quik-Spray (made with ALCOA® Aluminum Pigment by Sheffield Bronze Paint Co., Cleveland, Ohio).

An aluminum paint like Sheffield Quik-Spray forms a metallic seal—gives a decorative finish, as well. It dries quickly, looks like new for years. Dingy attics, home shop areas, lawn furniture, toys, garden tools—all come to new life with a bright, cheerful coat of aluminum paint. Here are the advantages:

- *High durability*—a tough film of metal resists wear, cuts the maintenance nuisance.
- *Great hiding power*—one coat covers soiled and discolored surfaces (aluminum pigment is opaque).
- *Moisture resistance*—unique "leafing" property of aluminum paint keeps surfaces dry, prevents deterioration.
- *Attractive appearance*—aluminum paint dresses up interiors and exteriors. It looks clean—it's easy to keep clean.

ALCOA does not make paint, but ALCOA Aluminum Pigments are used in most high-quality brands. Available in either "spray-on" cans or conventional containers, brands like Sheffield are at dealers everywhere.

Write today for ALCOA's informative booklet, *Painting With Aluminum*. Use the coupon.



Sheffield's new pistol-grip handle converts in seconds to spray gun.

Dingy attics come alive under a bright coat of aluminum.



Home shops look better (and stay that way). Nothing hides stains like aluminum paint.

Economical aluminum paint gives all yard tools a clean, well kept look.



Aluminum Company of America, Paint Service Bureau
1718-J Alcoa Building, Pittsburgh 19, Pennsylvania

Please send your free booklet, *Painting With Aluminum*.

Name _____

Address _____

City _____ Zone _____ State _____

NEW! MILLERS FALLS Router-Plane-Shaper

WITH REVOLUTIONARY NEW LINE
OF LOW-COST ROUTER BITS

Built for
professional
performance



**PLANE
ATTACHMENT SET**
No. 6826 only \$31.95*
(*without Power Unit)

ROUTER
(Power Unit and Base)
No. 6800 only \$39.95

SHAPER ATTACHMENT
(with built-in motor mount)
No. 6818 only \$19.95*
(*without Power Unit)



**3 TOOLS
IN 1**

Imagine! — an exciting new 3-tools-in-1 combination loaded with exclusive features to give professional results — yet priced to bring the adventure of fine cabinet-work within reach of everyone! It's a Router, a Plane, a Shaper! — that will do hundreds of jobs quicker and better — including dado cuts, moldings, fluting, rabbet cuts, dovetail joints, inlaying, planing and shaping. A real precision tool with plenty of power and speed, that anyone can use!

Plus . . . a revolutionary new line of 17 popular Router Bits, made of Special M-2 High Speed Steel — faster, longer-lasting — at 1/3 less cost than other types.

See and buy the Millers Falls Router-Plane-Shaper and its complete line of attachments at your favorite dealer's . . . or write us for name of qualified dealer nearest you.

FREE AT YOUR HARDWARE DEALER'S
Folders and full information about the Router-Plane-Shaper and other fine Millers Falls Tools . . . or write

CHECK THESE IMPORTANT FEATURES

- POWER UNIT** ✓ Rugged 3 amp. motor ✓ Ball bearings throughout ✓ 30,000 R.P.M. for smoother, faster, cleaner cutting
- ROUTER** ✓ Large 6" dia. base and big hardwood handles for positive control ✓ Direct-reading scale for fine depth adjustment ✓ Exclusive micrometer-screw adjustment for control of cut location ✓ Extra long rods for long reach cuts ✓ Base and non-marking sub-base take all popular templet guides
- PLANE** ✓ Big 14" shoe ✓ Outboard arbor support ✓ Micrometer-screw adjustment for front-to-rear shoe and cutter alignment ✓ Direct-reading depth adjusting scale ✓ Notched quadrant for quick bevel cuts (—15° to +45°)
- SHAPER** ✓ 1/3 cost of comparable models ✓ Big work surface (24" x 7 1/2") ✓ Built-in motor mount for quick, easy changeovers ✓ Accurate depth adjustment ✓ Adjustable fence ✓ Rugged 1" marine plywood table

Plus . . . a special "package" of exclusive firsts for plastic laminate application!



MILLERS FALLS COMPANY
Dept. PM-19, Greenfield, Mass.

FINEST HAND AND POWER TOOLS MADE FOR HOME AND INDUSTRY

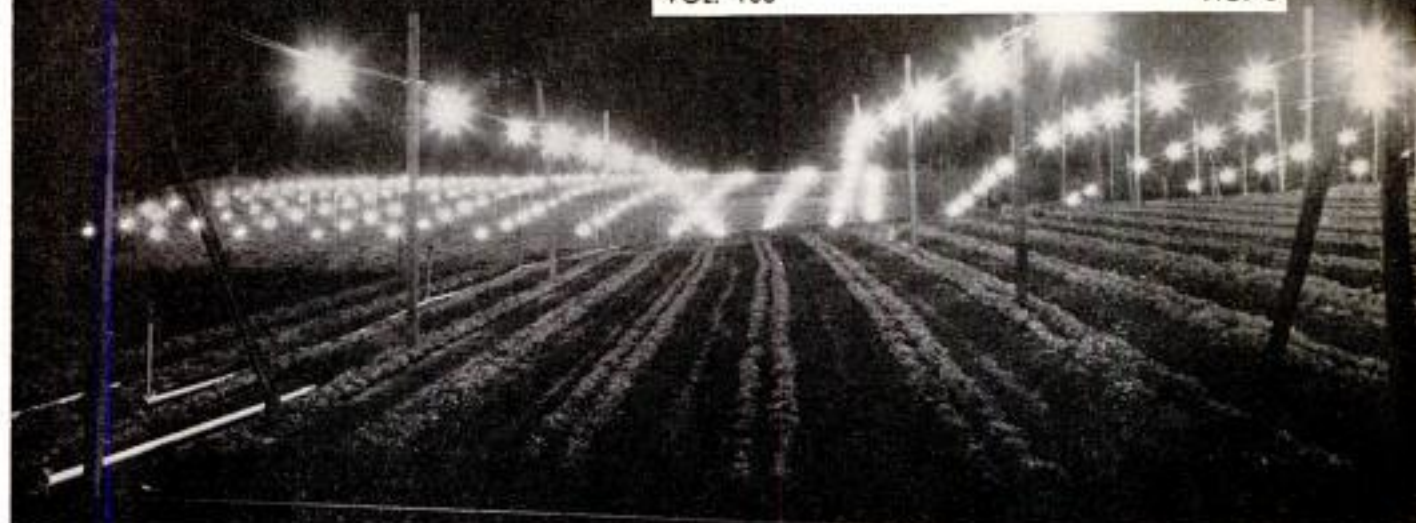

General Electric photo

Chrysanthemum growers shorten nights by brief period of artificial light, postponing flowering until desired

Polka-dot tomatoes and midsummer chrysanthemums? Nothing to it if you know how to control the light switch nature has built into your plants. By playing with lights you'll find

You Can Make a Plant Do Tricks

By Clifford B. Hicks

HERE IS NEWS for anyone with a green thumb. Scientists of the U. S. Department of Agriculture have come up with a startling and basic discovery about plants. Using this discovery, you can make chrysanthemums bloom in midsummer and surprise your neighbors with polka-dot tomatoes. You can force one seed to germinate and prevent an identical seed from sprouting.

So little is known about this truly basic discovery that any home gardener can learn further facts for himself. It's a fine opportunity for the amateur to perform basic research with no more equipment than a few electric bulbs.

This is the discovery: Many plants and

seeds have a built-in "switch" (or perhaps a group of switches), and by "turning on" this switch at the right time you can cause the seeds to germinate and the plants to blossom. By "turning off" the switch you produce the opposite effect. Actually, the switch can be flicked on and off indefinitely, and the plant or seed will always respond to the last position of the switch!

All you need to flick this switch is a relatively short shot of artificial light.

The effect of artificial light on plants has been investigated for decades, but until recently little was known about how the night-day, on-off cycle causes plants to blossom. This light-dark influence on plants is called photoperiodism. A somewhat

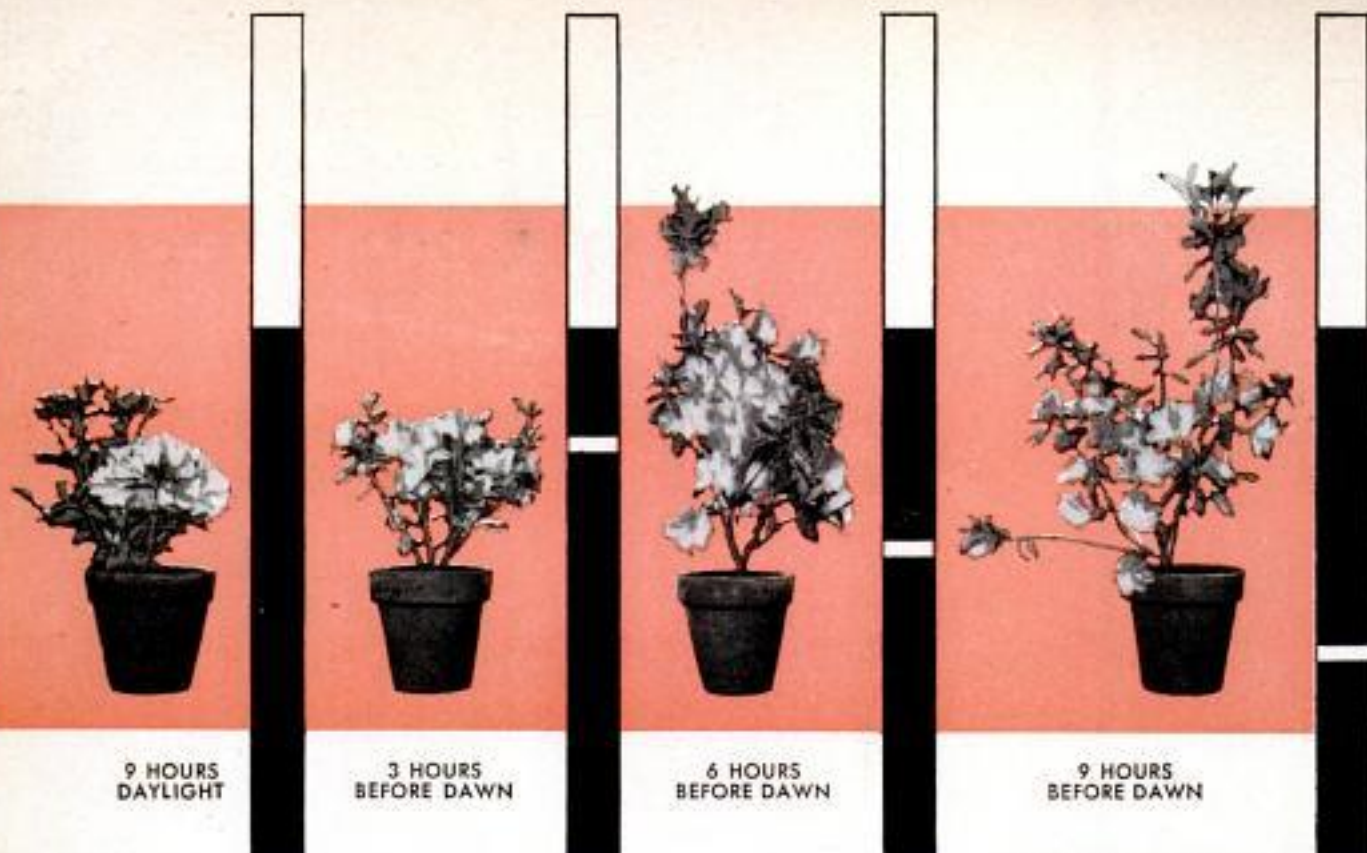

U. S. Department of Agriculture photos

Shortening the night has a big effect on azaleas. Vertical bar represents 24 hours, black section the night period. Small white sections show short periods of artificial light to "wake up" the plant early

similar response to light causes some seeds to germinate and fruits to color.

The first hint of the importance of photoperiodism cropped up back in 1920, when two USDA scientists found that a certain type of tobacco would flower only when the daylight period was short and the night was long, regardless of any variations in temperature and humidity. Apparently something happened to the tobacco plant

during the short day to cause it to flower. Other plants showed the same reaction, so scientists began splitting plants into two categories, "short day" and "long day," depending upon the duration of daylight which caused them to flower. A few plants apparently were not influenced by the length of the day.

Within the past several years Dr. H. A. Borthwick and his associates at the Plant

Laboratory at Beltsville has 106 fluorescent tubes as well as filament bulbs to test effects of light



Industry Station, Beltsville, Md., have carried through experiments which prove to them that earlier researchers were on the right track but were riding the wrong train. Actually it is the *length of night* instead of the duration of daylight that causes plants to flower. At first glance it would appear that they simply are looking at the other side of the same coin. But here's the critical difference, and the one simple fact that throws open a wide field of research, even to the amateur: If you break the night period in the middle with even a short shot of artificial light (a few seconds to an hour, depending upon the plant) you can cause short-night plants to flower and prevent the flowering of long-night plants. In effect, you set off the alarm clock to wake up the plant, even though it still may undergo a good many hours of darkness before dawn.

Flowering is just one of the effects you can produce by setting off the alarm to fool the plant. A shot of light near the middle of the night promotes bulbing in onions, prevents the flowering of chrysanthemums and poinsettias, and induces runnering of strawberries. It will cause pea seedlings to put on a spectacular burst of growth and some seeds to germinate—all out of season.

A gardener in Haiti who knew something of photoperiodism came to Doctor Borthwick a few years ago for suggestions on putting the phenomenon to work in his garden. As a result, he floodlighted his flower beds. Then he turned on the lights for a few minutes in the middle of each night. His flowers (they happened to be



U. S. Department of Agriculture photos
Spectrograph at Beltsville gave first clue to wavelength that produces the effects. It breaks white light into spectrum. When various wavelengths were tested on plant leaves, red was found to be the key

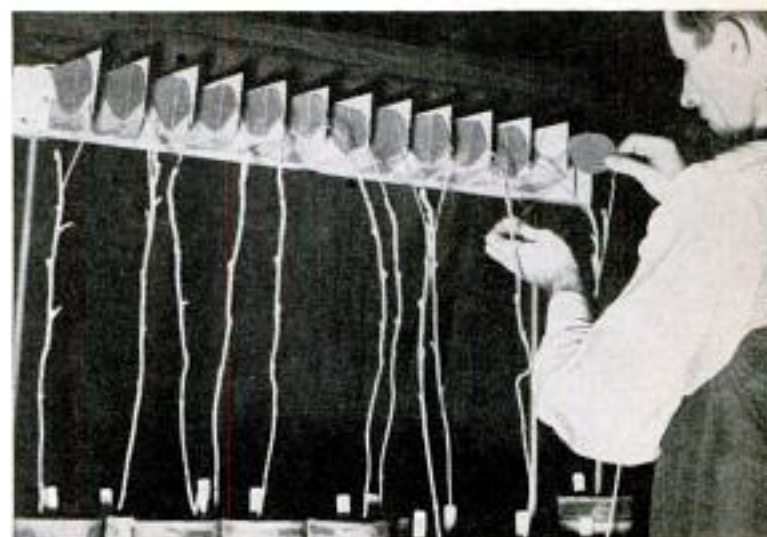

In experiments with the spectrograph, individual leaves of different plants are mounted so each leaf receives a specific wavelength. Effects on each plant then are noted. Drawing below shows how you can make pink, red or polka-dot tomatoes from green ones

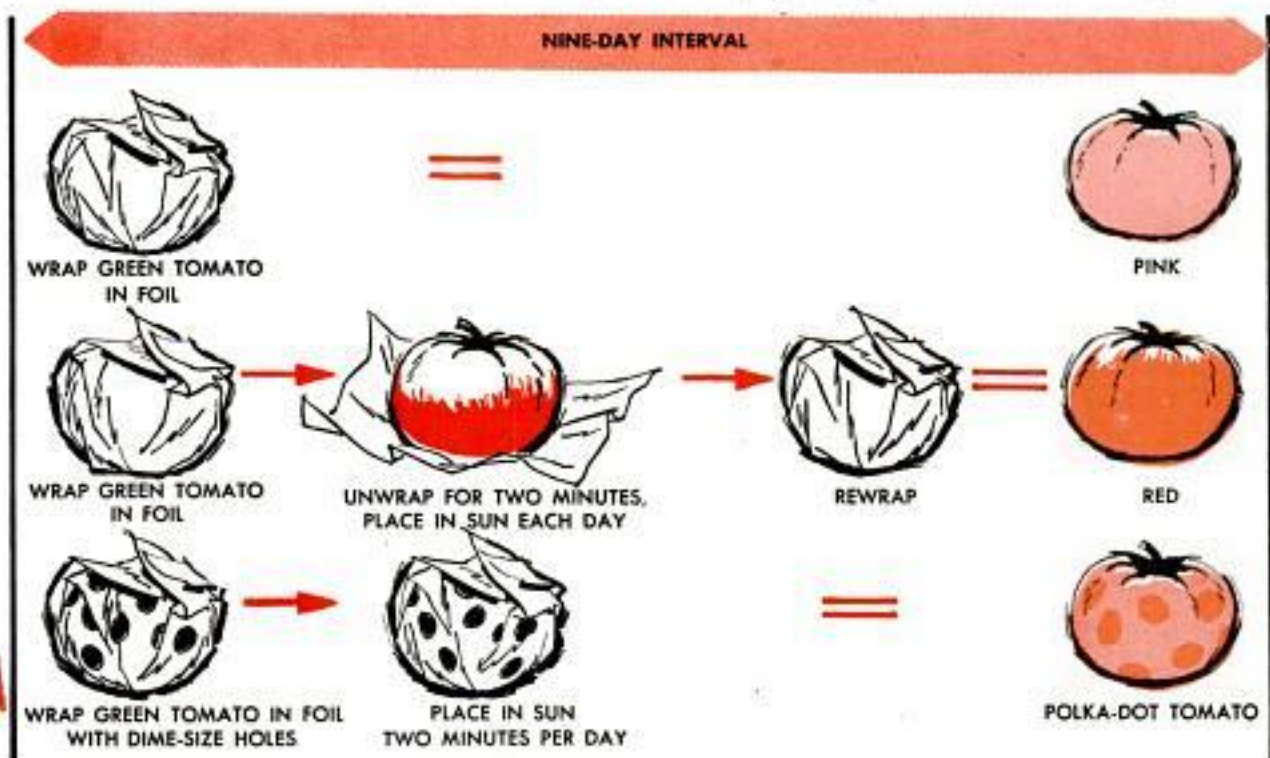



Lengthen the night to make your mums flower in midsummer. Cover them late in afternoon, uncover in morning

short-night varieties) bloomed spectacularly. The hundreds who came to see the sight wondered why their gardens wouldn't bloom out of season, too.

Using this same basic discovery, commercial chrysanthemum growers have multiplied their income. The chrysanthemum, a late-fall plant, requires a long night to bloom. Today, when the nights are long, the grower switches on floodlights for a few minutes in the middle of the night to prevent the plants from blossoming, so he can force them to blossom later, out of season. When the nights are short he covers the plants for a while in the late afternoon or early morning, extending the period of darkness to bring the plants to

blossom. Thus he can send them to market in full flower almost the year 'round. There are more than 600 varieties of mums, with specific lighting instructions for each.

Obviously it isn't the total amount of light energy that causes a chrysanthemum to flower or not to flower. A few minutes of low-level artificial light will convince the plant that it's not yet time to produce a blossom. This amount of radiation, compared to the total radiation from the sun during daylight hours, is a drop in the solar bucket. So scientists at Beltsville asked themselves the next logical question: What is it, in white light, that produces these effects?

Red Light Is the Key

White light, of course, is a mixture of all colors (wavelengths) of the spectrum. When the researchers began experimenting with individual colors, they soon found that red light was the key. Red was so effective that an exposure of only 20 seconds would "close the switch" to prevent long-night soybeans from flowering. The same wavelength also "opens the switch" to cause short-night plants to blossom.

But the strangest discovery of all by Doctor Borthwick and his workers was that the reaction is reversible. Some years ago scientists, experimenting with lettuce seed, found that red light woke up the seed, causing it to germinate, but far-red light, just between red and infrared, put the awakened seeds back to sleep again. The Beltsville scientists then discovered that seeds would respond, time after time, to the last position of the switch, and this same on-off effect also applies to the flowering of plants. The logical conclusion is that the red and far red in natural sunlight flick the switch at dawn, one way or the other, depending upon the position of the switch through the night.

This reversible effect of red and far-red light is also shown in the ripening of tomatoes. What makes an off-season tomato pink instead of the rich orange-red of the

Opposite flowering effects of long nights and short nights are shown by ordinary wheat and poinsettia

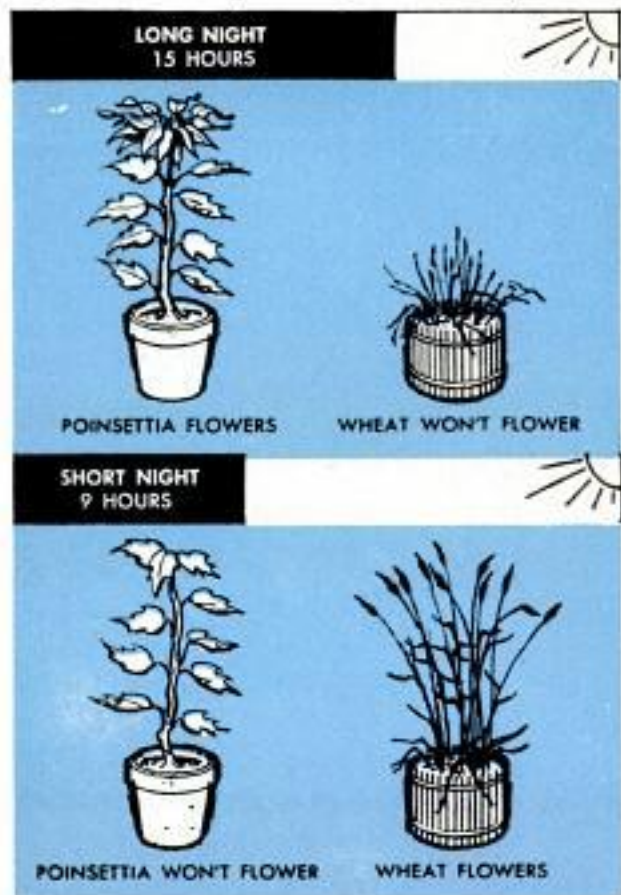

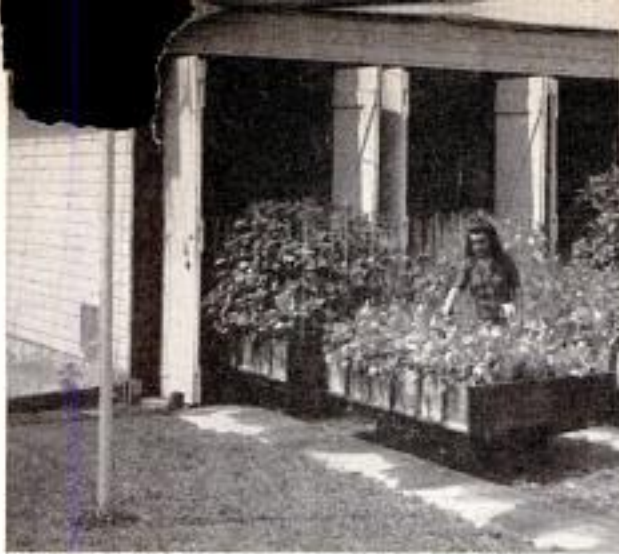

U. S. Department of Agriculture photo

At Beltsville, length of night is varied by wheeling trucks loaded with plants in and out of a shed

in-season one? Off-season tomatoes are usually picked green and ripened in the dark. In the skin of the tomato is a pigment, colorless until the tomato ripens. Red light causes this pigment to turn yellow, and the pink of the flesh viewed through the yellow pigment produces the bright orange-red color of a fine tomato. Exposing the tomato to far-red light undoes the work of the red, keeping the skin colorless. At Beltsville they reverse this effect repeatedly, then let the tomato ripen. It always has the color characteristic of the last position of the switch.

Because such research requires little equipment, it's an open invitation to the man with the green thumb.

Fun for Amateur Gardeners

"Any amateur gardener can have fun experimenting with these effects in his own home," says Dr. Robert J. Downs, plant physiologist at Beltsville. "All you need are some seeds, plants or green tomatoes and some lights. You'll need two kinds of lights—fluorescent lamps and some ordinary incandescent bulbs. Fluorescent supplies an adequate amount of red, but practically no far red. Incandescent supplies an abundance of both red and far red.

"In some experiments you may want only red light. You can get it simply by wrapping fluorescent tubes with red cellophane, which prevents wavelengths shorter

than red from reaching the test object. If you want far red only, you must either use incandescent bulbs or the sun itself, and filter this light through two layers of red and two layers of blue cellophane. This filters out all the wavelengths shorter than far red. In fact, you'll swear you're getting practically no light at all, which is true. Since incandescent bulbs become quite hot, you can't actually wrap them in cellophane. Instead, place your test object in a cardboard box and fasten the cellophane over the top."

The easiest way to picture the effects you are producing is to think of the dimmer switch on your auto headlights. Regardless of whether the lights are bright or dim, a press of the button will produce just the opposite effect. In plants, natural sunlight throws the switch one way or the other, depending upon the type of plant. With a shot of artificial light at midnight, you press the button to throw it in the opposite direction. The plant uses either the red or the far-red part of the spectrum, depending upon how nature has set its switch.

Basement Laboratory

If the basement of your home has a reasonably stable temperature you can use it for your experiments. For most warm-season flowers and vegetables a temperature of 60 to 68 degrees is ideal. However,

(Continued to page 232)

In your home experiments, avoid hot spots shown at left by installing incandescent bulbs close together

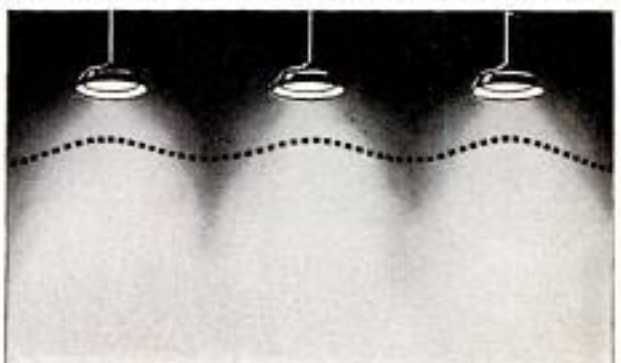
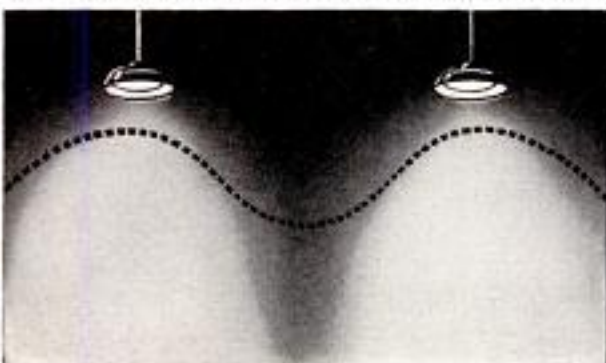

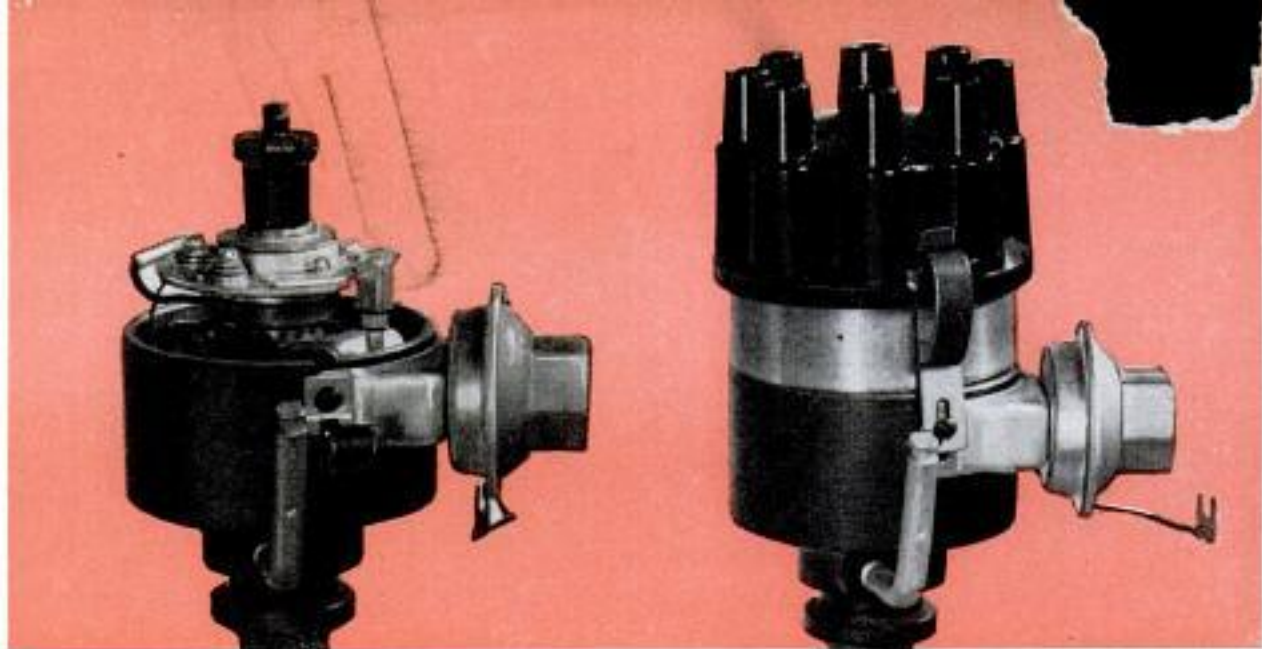

Left, Hy-Fy-R unit installed in distributor. Right, metal spacer ring and cap-clip adapters are part of unit

Hy-Fy-R Gives Hotter Spark

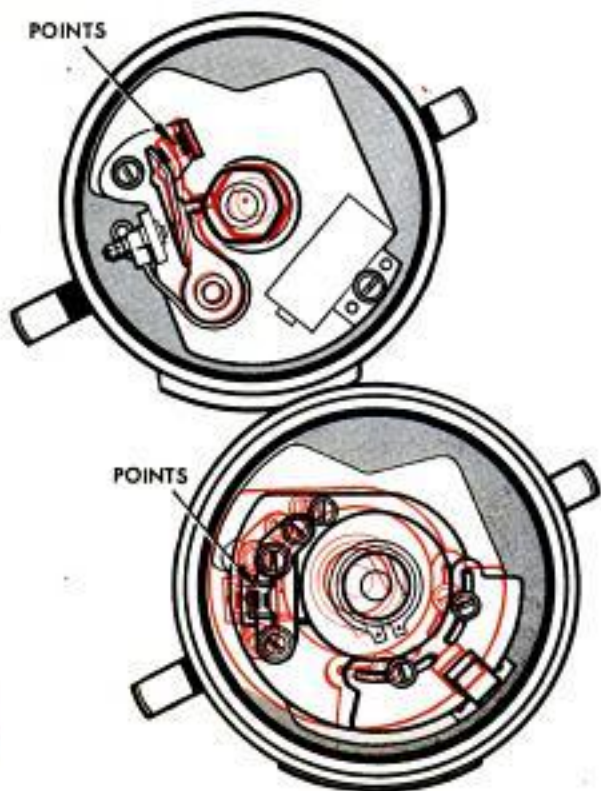

INCREASED HORSEPOWER, better gasoline mileage and smoother idling are claimed as the advantages of the Hy-Fy-R ignition system for automobiles by its manufacturer. Roller bearings open and close the points in this unit, which fits into a regular distributor without changing it in any way. Points are preset at the factory at .010 in., and never need adjusting. Spring pressure on the points is 6 lb. instead of the usual ounces in a standard distributor, which assures faster closing of the points. A single roller bearing on the point assembly is actuated by roller bearings on the inner race of the unit, one bearing taking the place of each of the lobes on the cam of a standard distributor. Because the ignition points are in a separate unit, the gap between them remains constant even though the distributor shaft may wobble. In a standard distributor, a wobbling shaft causes the points to be too close when it is in one position, too far apart when it is in another. Should the Hy-Fy-R at anytime cause trouble, removing one wire and a rubber block between the regular points brings back stock ignition.

Above, effect of wobbling shaft on standard and Hy-Fy-R ignition. Below, Hy-Fy-R is disassembled easily



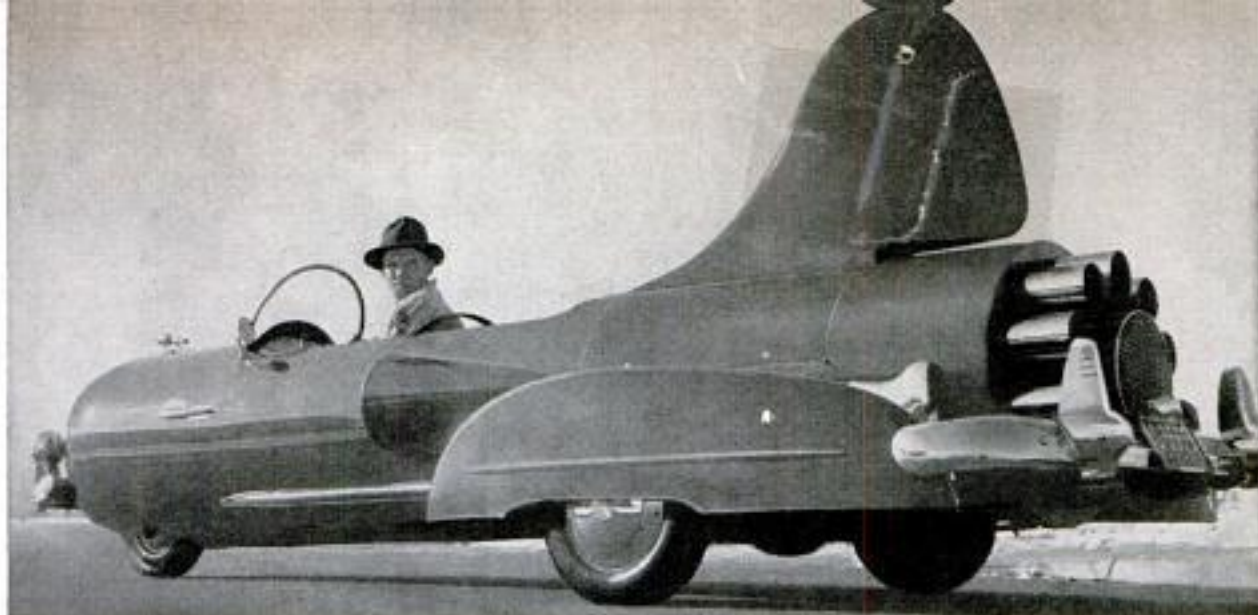

Homemade Sports Car Looks Jet-Propelled

Motorists around Grove City, Ohio, are startled by the sight of a bright-red jet-propelled auto cruising down the highway. Actually the car isn't jet-propelled, but a ring of exhaust pipes at the tail gives that impression. The novel sports car was built over a period of six years by Stanley Eakin. It is a three-wheeled two-seater powered by a rear-mounted 60-horsepower engine. Although the car is only 36 inches high, a huge rear fin sweeps up to a height of more than 67 inches.

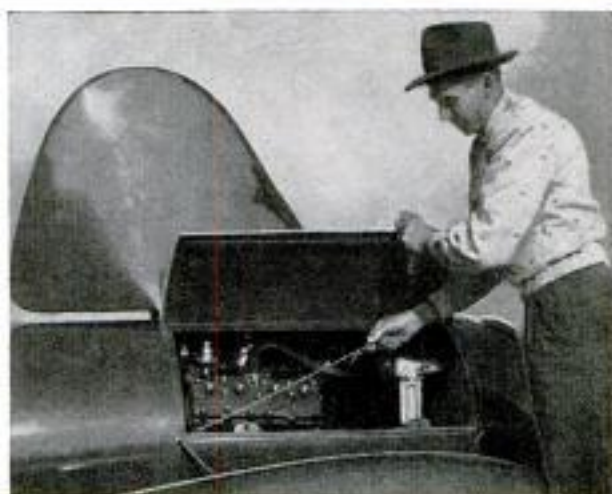

Panels Produce Images From Electrical or Optical Signals

Images and other visual displays are produced on flat glass panels through a new process developed by Sylvania. On one type of panel a mobile dot can be manipulated electrically. Another type can "remember" the track of a mobile spot of light, and still another can reproduce a motion picture. The panels have thin coatings of materials

which are sensitive either to electricity or light. When electrical or optical signals and a power source are applied to the panels, visual displays or images are produced which correspond to the signals. Such displays could represent information for computers, radar, air-traffic control systems and various instruments.

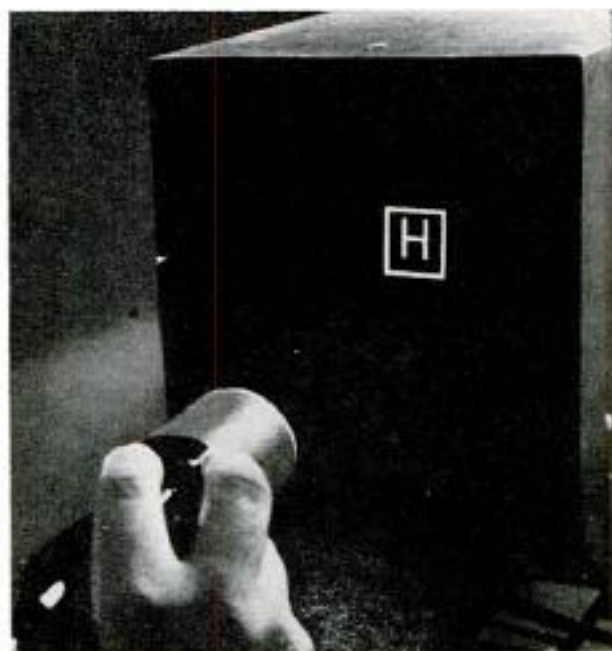

Handicapped Team Develops Wheelchair

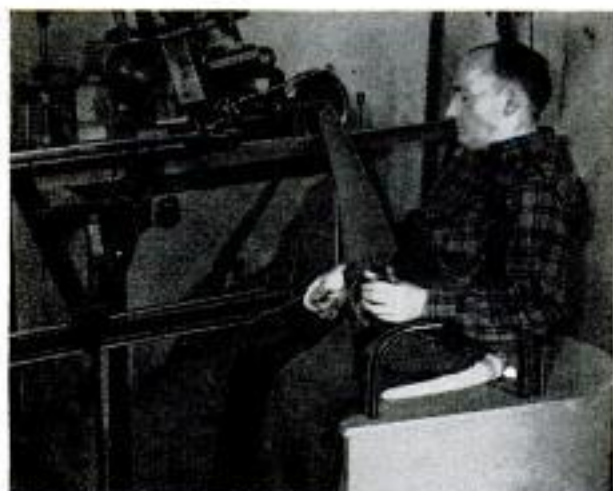

Sightless George Spurgeon (top right) and John Tracey, who has polio-impaired legs, teamed up to make the motorized wheelchair in which Tracey sits. An earlier model is in front of them. Tilting of a control rod steers the chair. In "neutral" gear the wheels are locked so Tracey can work at his automatic saw-filing machine (left). About 38 inches long and 22½ inches wide, the chair has a wrap-around bumper, motors for each wheel and a battery charger.



Frameless Dutch Motorbike Assembled From Steel Plate

Aerodynamic design is featured in the construction of a 1.6-horsepower motorcycle, left, from parts of pressed steel. The manufacturer, in Holland, claims this type of body is stronger than a conventional motorbike frame. The motor is concealed in the body in front of the pedal position. The fuel tank holds 1.5 gallons but the vehicle reportedly gets 160 miles per gallon. There are saddles for two passengers. By tipping up the front saddle, you'll find a tool compartment. The rear fork has hydraulic springing for easier riding with heavy loads or on bumpy roads. An adjusting ring allows the operator to set the beam of the headlight for full or dim light. The machine also has a two-speed gear.

EDSEL'S HERE (see page 92) and we await public reaction. This is an uncertain year to be invading the middle-price field, a field that was booming when Edsel plans were okayed in 1955, but is down sharply today.

American Motors feels good and with reason. Rambler is going well. Its six-cylinder models are sold out for the year. Dealers are crying for more. In today's market, that's enough to make any car maker feel good and especially American Motors. But there's more good news. At least a part of the industry is admitting AM has been right all along about the unit body.

Unitized construction, long an American Motors feature, will be used in the 1958 Lincoln and Thunderbird. And Ford engineers are discovering its advantages: Rigidity, reduced weight, more room, better door fits, easier quality control.

And, too, American Motors chief, George Romney, is understandably pleased about the trend toward small cars. Harlow H. Curtice, president of General Motors, has been saying for years that when the small-car market becomes big enough to be important, GM would be in it. Well, as you know, GM is in it so it must be important.

Smaller Rambler

However, even Romney lacked enough confidence in the small car. He stopped building his 100-inch-wheelbase Rambler two years too early. You'll soon be seeing the revival of that model. The 100-inch wheelbase made the original Rambler a success, but it was dropped in favor of the 108-inch model to make room for four doors.

The decision to bring back the smaller Rambler indicates the increasing strength of the small-car market. We have not (at this writing) seen the new model, but we'll guess it will be the same car that was built two years ago with minor changes. It would be impossible as well as foolhardy for American Motors to tool up now for a new shell. They may be able to use the new overhead-valve Six, but even that might not be possible (or necessary). That two-door 1955 Rambler was mighty stylish and, if it sells for about \$1700, it will be a strong competitor for the foreign cars.

Next year's Thunderbird will be a breed apart. It is unlike the present model. For one thing, it's a bigger car. It seats four. And its unitized body will be built for Ford by an outside company (Budd). It's hard to see how Ford can continue the "personal" label on this bigger car which, incidentally, is surprisingly dignified in appearance.

Not just the T-Bird is bigger. Chevrolet will be bigger, Lincoln will be bigger, Mercury, Cadillac and Pontiac, too. There will be a flood of new engines—all bigger. How-

Detroit Listening Post



By Art Railton

ever, the engines will be lighter as engineers work out simpler, cheaper designs.

All this bigness is confusing at a time when Rambler plans to revive its little car, when Studebaker claims its Scotsman is on back order (incidentally there will be no Mercedes-engined Studebaker in 1958), and Buick and Pontiac dealers grab at the limited number of Vauxhall-Opel franchises. A mixed-up business? You said it.

Who Will Get Hurt?

Question: Will the new Americanized imports cut into foreign-car sales or into sales of Ford, Chevrolet and Plymouth?

Answer: Who knows? Some Detroit planners predict the American-backed imports will squash the mushrooming foreign-car business. Importers disagree. They claim that these small cars, such as the Vauxhall and Opel, will make foreign cars more desirable. General Motors, they claim, has now made ownership of the small European car socially acceptable.

Volkswagen finally admits that its cars do back up. Shortly it will enlarge its rear window so drivers can see behind them.

Four headlights will be common in 1958, a fact that could aggravate an already serious glare problem. When was the last time you had your headlights aimed? It takes only a dent in a fender to throw headlight aim off dangerously. With bumpers and fenders interrelated in today's cars, even a minor bumper collision may throw off headlight aim. With brighter four-lamp illumination, the problem is intensified and the lighting industry is justifiably concerned. You check your tires—why not check your lights?

Rear-end styling of some 1958 cars may frighten you at first. Stylists have jazzed up the rear end so, on at least one make, it looks exactly like a front grille from a distance. When you see it down the road ahead of you, you think it's some nut in the wrong lane. Maybe we'll soon be burning taillights in the daytime so we'll know which end is which! ★ ★ ★

Lightweight With a Heavyweight's Punch - - - France's *Mirage III*

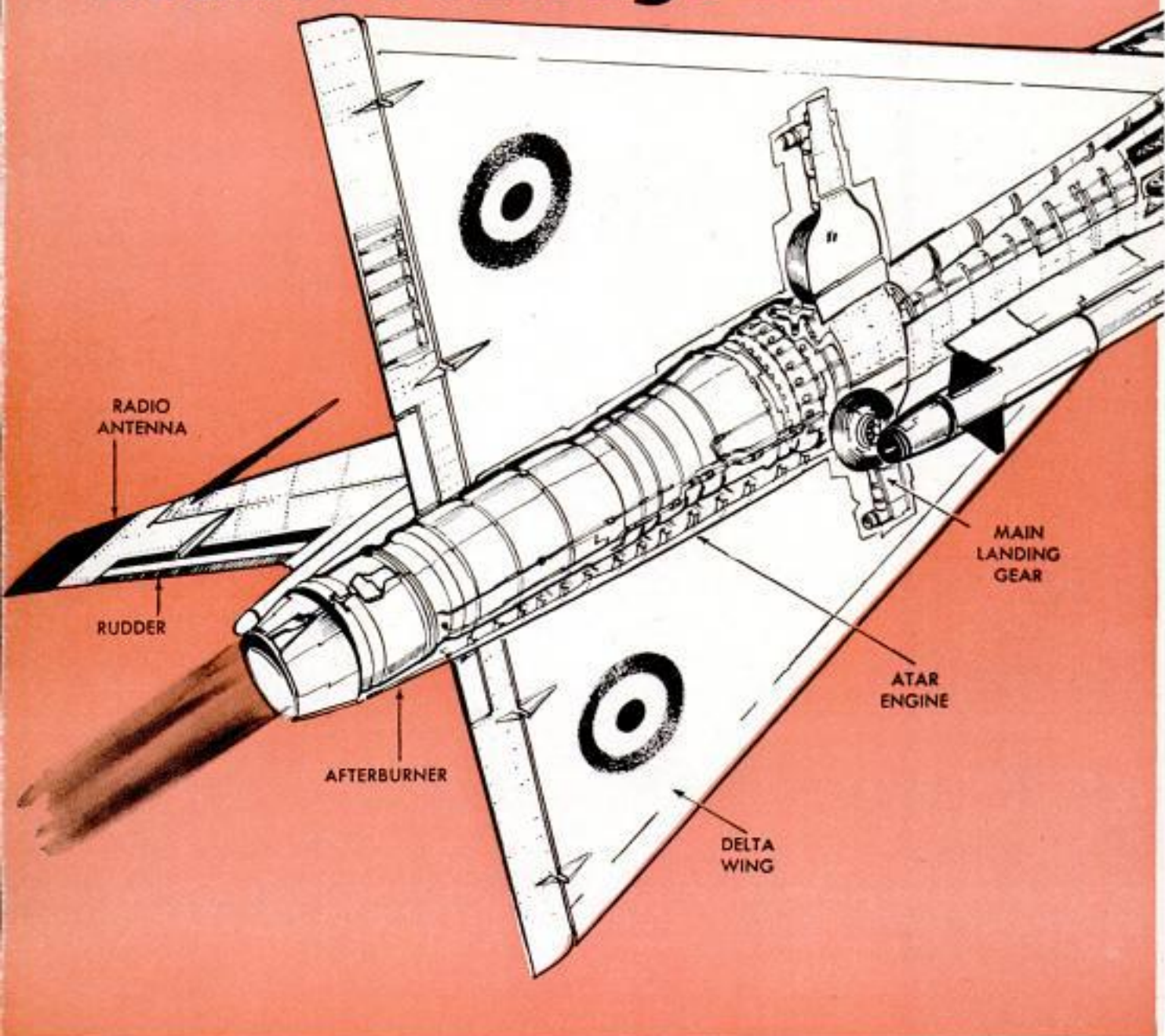

S MALL, LIGHT, FAST and high-flying but with the striking power of a heavyweight is France's newest jet interceptor, *Mirage III*.

It's a delta wing and looks like a miniature U. S. Air Force F-102. The mighty midget has a horizontal flight potential of Mach 2, twice the speed of sound, and in recent tests it hit Mach 1.5. Its ceiling is 80,000 feet.

Designed to knock out high-flying enemy bombers, *Mirage III* is tiny by American

standards—26-foot wingspan, 37-foot fuselage and a mere 10 feet high. Its armament is two 30-mm. cannon, or bombs, or an air-to-air homing missile, the latter carried externally under the fuselage.

The missile shown in the above cutaway drawing is a Matra RO15 air-to-air guided rocket. It's 10 feet long, weighs 330 pounds and is powered by a two-stage engine.

Mirage III, which was manufactured by the Dassault Company, is powered by a Snecma Atar 101G axial-flow turbojet en-

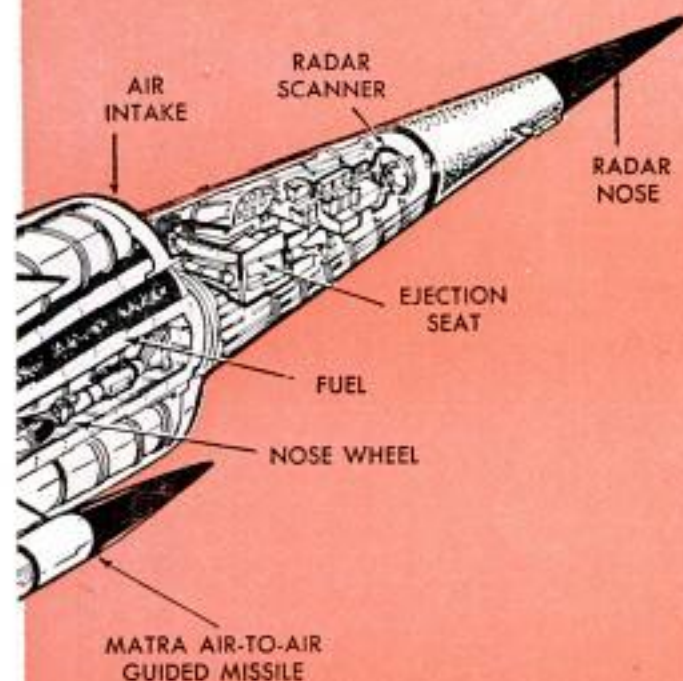

Illustrated by
Thomas Turner



gine with afterburner. Its thrust is 9700 pounds, and the engine is also used in the Super Mystere, France's equivalent of the U. S. Super Sabre.

The cockpit is well forward in an unusually small nose compared to other aircraft of this category. The canopy is not the conventional balloon type, but is based on cross sections resembling the Norman arch of French architectural tradition. This provides better visibility than most other modern interceptors, and the knife-edged windshield allows excellent aerodynamic flow. The fairing of the canopy extends into a long dorsal fin that may contain fuel in its forward compartment.

Two Air Intakes

The semicircular air intakes are on either side of the pilot. They converge into a central duct just forward of the engine. The main fuel tanks are housed behind the pilot and between these ducts.

Like the F-102, *Mirage III* has "area rule" (Coke-bottle effect) applied to its fuselage, enabling the aircraft to slip through the higher drag regions. The plane's low wing makes possible a short and light main landing gear. The legs fold inward toward each other, and the nosewheel is long, due to the tail-down landing approach necessary with delta-wing aircraft.

Wing Edge Has Sharp Sweepback

The sweepback of the wing leading edge is about 60 degrees. The trailing-edge flaps and ailerons have external fairings on control pickups due to the thinness of the wing at that point. Trim tabs are on the inboard side of the wing. The vertical stabilizer is the same general shape as the wing, but with a slight sweepback to the trailing edge to give the aircraft a sleek look.

Although intended for the French Army Air Force, the country's navy is also interested in *Mirage III* for carrier use. ★ ★ ★

Looking like a small U. S. F-102 (see drawings at left). France's *Mirage III* prepares for a take-off



Here it is --



IF SOMEONE SAID to you, "Here's \$250,000,000—go out and build a car that will sell in the medium-price field," what kind of a car would you build?

Just such a problem faced the Ford Motor Company back in 1948 when it decided it needed another line of cars to help Mercury fill the gap between Ford and Lincoln.

Years of planning followed. There were the usual setbacks and delays (some were unusual, such as a two-year slackening of effort during the Korean conflict).

Then, in 1954, stylists were ordered to go to it. "Let's see what it would look like," the top brass said.

What they saw, they must have liked because a year later the project was given the final okay. What up to then had been planning and speculation, now became rolling-for-keeps, chips-are-down reality.

Since that April day in 1955, Richard E. Krafve, general manager of the new division, has been up to his ears (and at times he may have felt over his head) in a car which turned out to be the Edsel.

The Edsel planners started out by insisting that the styling be distinctive (but not bizarre, they cautioned). The car must be easily identified. They wanted folks to say every time one went by—"There's the new Edsel."

In a business like this, they reasoned, there's no time for slow starters, especially in a race against veterans like Pontiac, Dodge and Oldsmobile.

Nor could there be any confusion with other makes in the Ford family of cars. Family resemblances were fine—even essential, but no more than that. There's no market for cars that look alike.

Distinctive without being ostentatious, the grille has an inner ring designed to withstand minor bumps

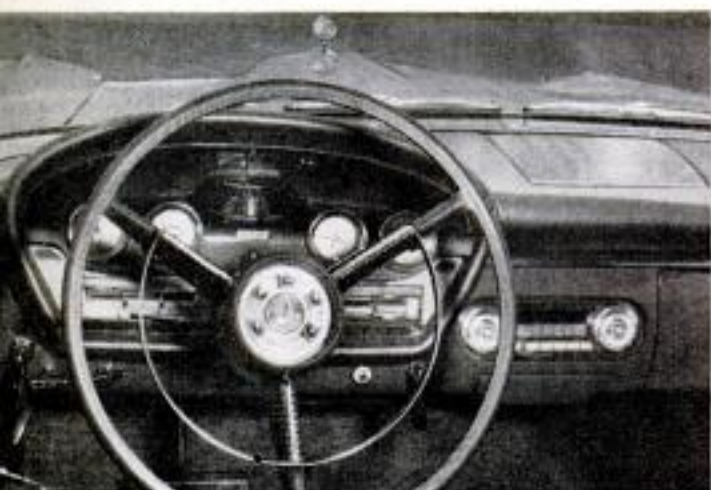

Tapering bulge atop hood makes it seem a block long. Transmission buttons are in steering wheel



the EDSEL

By
Arthur R. Railton

The Edsel looks different. Grilles on most American cars are low and horizontal, Edsel's is high and vertical. Other cars tend toward the vertical in the rear, Edsel is horizontal. Front or rear, coming or going, it is distinctive.

You will have to decide for yourself if it is attractive. That's a personal judgment. But all will agree that it's quickly recognizable. And it was planned that way.

The long-range planners demanded that the E-car (as it was called then) provide comfortable, relaxed performance at highway speeds. There was no intention of building the "draggin-est" or the fastest. Good performance, yes, but no spinning tires, no roaring exhausts.

Their aim was to appeal to the up-and-coming, young executive, not to the flashy sport nor the ultraconservative old fossil.

The Edsel does perform well at highway speeds. It runs quietly and comfortably. It handles easily and responds agilely in traffic. If necessary, it will "scat," but it's not a car for the wheel spinner.

Edsel comes in four series plus a station-wagon line: Ranger and Pacer on the low-price end using the "A" shell (shared with Ford); Corsair and Citation on the top end using the "B" shell (shared with Mercury).

You can spot the B-shell by its flat, sharply cutoff roof with the indented center trough. The curved, thicker roof without indentation is the A-shell. Wheelbases are different: From axle to axle, the A-shell is

118 inches long; the B-shell is 124 inches.

Station wagons are built on a 116-inch wheelbase shared with Ford wagons. Its exterior styling is very similar to the Ford, except for its front end, which is typically Edsel.

First thing you notice when you slip behind the wheel is the control panel for the push-button transmission. It is where the horn button used to be, right in the hub of the steering wheel. The push buttons are electric, not mechanical as on Mercury and Chrysler cars.

Incidentally, in case you're concerned, the panel doesn't rotate with the wheel. The hub remains stationary as the wheel spins around it.

A safety device makes the control virtually childproof. You can now leave the car parked on a hill and not worry that the kids might set it rolling. The ignition key locks the Park button so it can't be disengaged until the key is turned.

The Edsel is a comfortable car and one reason is its seat design. The seat is shaped to feel like an easy chair at your rich uncle's club. Instead of fading off at the top, the back cushion angles forward slightly against the shoulders. Edsel engineers have a term for the new seat shape. It is designed to conform to the "modern slump," they say.

The instrument panel is different, too. Its speedometer looks more like the boxed compass on a ship than a miles-per-hour

Horizontal taillights and concave rear fenders quickly identify the Edsel. This is the Citation hardtop





Cable (under fingers) pulls lever which turns cogwheel (end of pencil) to adjust brake automatically

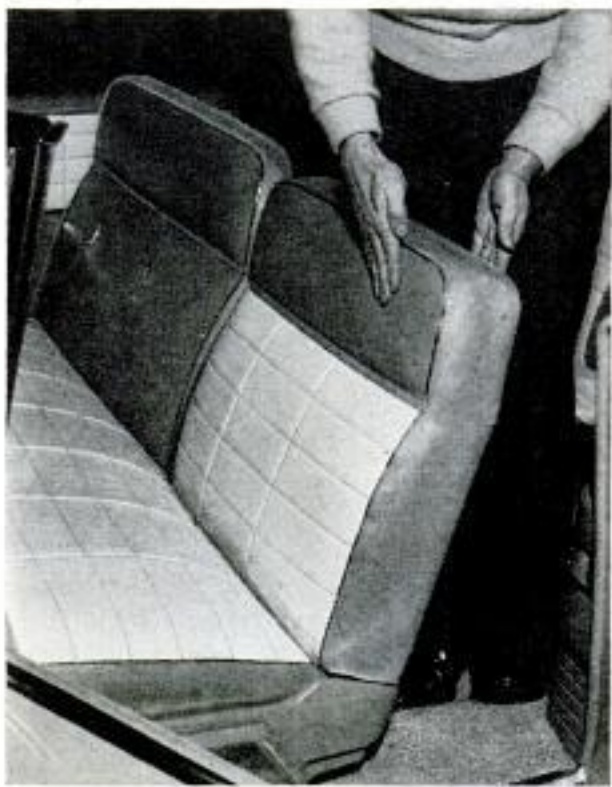

Top portion of seat back slants forward to provide shoulder support—secret of the comfortable seats

Manhole view of Edsel's stern emphasizes horizontal taillights. Half of each extends into the trunk lid



meter on a car. A horizontal drum about six inches in diameter rotates on a vertical pivot like the compass on a ship. The weight of the big drum dampens out annoying surges often present in needle-type instruments. It gave the engineers some headaches before they designed out the inertia lag on acceleration and deceleration.

Any dashboard is a temptation to the accessory lover. Edsel's especially. The factory will install any of the following in a special opening in the dashboard if you so desire: A tachometer, a compass or an inside-outside thermometer. There is also a speedometer light that changes colors as speed increases to warn you of danger. Another effortsaving accessory is a remote trunk latch that unlocks the trunk at a touch of a button.

Edsel has horsepower, too, although the industry is not supposed to talk about it above a whisper this year. One engine is the 361-cubic-inch V8 of 303 horsepower. The other is the 410-cubic-inch V8 of 345 horsepower. Compression ratio on both is 10.5 to 1.

As far as the chassis is concerned, the Edsel is conventional—no radical innovations here. Sharing frames with Ford and Mercury as it does, the Edsel must share underpinning, too.

There will be air suspension, but not on Job One (as Detroit calls the first production models to come off the line). It will be offered as an extra-cost item available sometime around mid-October.

Edsel's air-bag system will be based on a trailing-arm rear suspension. Air bags on all four wheels (complete with automatic leveling valves) provide the ultimate solution to the problem of compromising for light and heavy loads, rough and smooth pavements. But it's not ready now and you won't find it on the Edsels you peek under on announcement day. You'll have to wait a couple of months for it to materialize.

Self-adjusting brakes come with every Edsel. Every time you back the car up and apply the brakes a cogwheel inside the brake drum "senses" whether the brake needs adjustment. If it does, an adjusting lever nudges the cogs, taking up the brake. It operates only when backing up to prevent overadjusting that might result after successive panic stops during which overheated drums would have expanded to give a false "reading" to the sensing mechanism about lining clearances.

Engine accessibility has been improved in the new Edsel engines. Distributor, fuel pump, coil, oil filter and dipstick are moved forward to be more easily reached. (Of course, the fact that the hood now hinges

(Continued to page 256)



Edsel's station wagons share the Ford shell. This is the Bermuda, the top line of wagons



Distributor (pencil points to it) is mounted forward on the engine, designed for service accessibility



Front-hinged hood is a safety factor, but it does limit accessibility of forward-mounted distributor

Ranger is low-price series. It shares the Ford body shell and is nine inches shorter than the big Edsel



ONE OF OUR READERS picked up his phone the other day and dialed our Editorial Department. He had been looking at the 1957 Ford Skyliner, the convertible with the disappearing steel top.

"Take a look at page 43 of your January 1936 issue," he said.

We did. The 21-year-old story is reproduced here.

It only confirms the old adage—there's nothing new under the sun.

Latest Foreign Auto Has a Disappearing Top

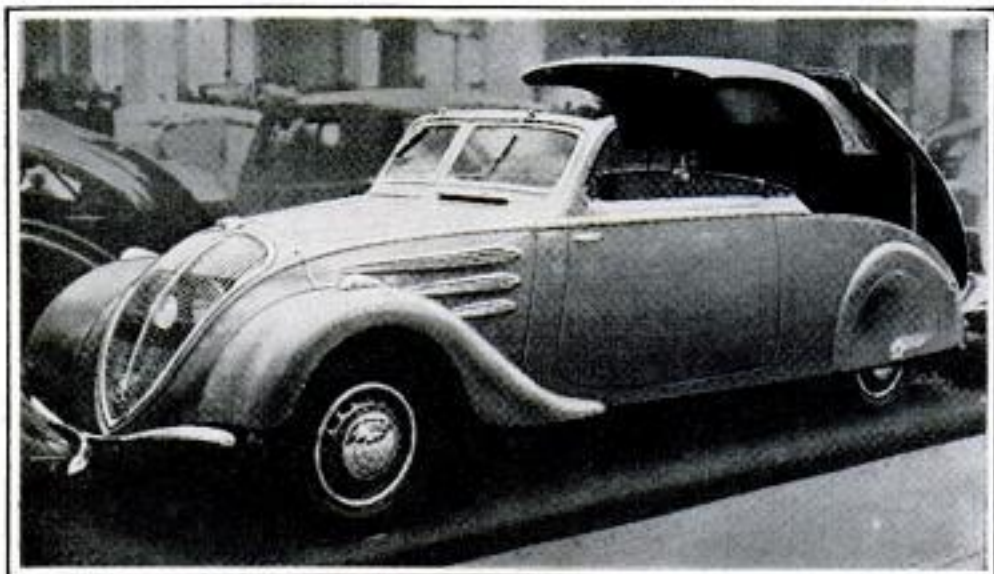

One of the Latest Foreign-Built Motor Cars Features Disappearing Top; Note How Cover of Rear Deck Rises to Make Space for the Top; the Cover Then Lowers When the Top Is in Place

Automatic disappearing top and concealed head lamps are two features of the latest model Peugeot, a French automobile. The lamps are set closer together than on American cars and are inclosed,

and partially hidden, by a radiator grille. Controls in the driving compartment cause the top to slide automatically to the rear where it fits compactly into the rear deck, converting the vehicle into an open car.

Use Electric Drill to Start Power Mower



More than 50 million magnets are produced and used in the United States each year. One bomber takes over 200 magnets to keep its instruments functioning.

Now you can start your small combustion engines—in power mowers, garden tractors, outboard motors or chain saws—with your electric drill. A device on the market is held in the chuck of the drill, with the other end applied to the nut of the flywheel shaft. The starter also can be used on engines equipped with recoil-type starters by removing the recoil mechanism.

Antibiotic Kills Housefly

Flavensomycin, a new antibiotic that kills both fungi and insects, has been found by researchers at Milan, Italy. When tested as an insecticide, the antibiotic proved 10 times more effective against the common housefly than DDT.

Fast-Acting Thermometer

Temperature changes are registered one millionth second after they occur with an industrial thermometer developed by Cornell Aeronautical Laboratory, Inc. Household thermometers lag about 10 to 30 seconds behind changes in temperature.

Missile Truck Totes Corporal

Multiton radar-guided missiles like the Corporal, shown in the photo at right, can now be rushed to launching sites and raised to firing position by a vehicle designed for that purpose. The British government has ordered an undisclosed number of the missile haulers. All the wheels of the vehicle are driven by separate electric motors which, in turn, are powered by diesel generators. Six other electric motors are located over the machine for steering and missile-handling functions of the boom. After raising the missile to a vertical position, the hauler eases it onto a launcher. The operator then lowers the boom and returns for more missiles.



Tracker "Sees" Tiny Object Four Miles up in Air

Flight performance of missiles, aircraft and bombs, now is being recorded by the nation's first completely mobile optical-tracking system—the telescopic photographic recorder. This six-ton unit is capable of photographing an object, two by seven inches, at an altitude of four miles. All similar-type optical systems used for missile tracking are mounted on stationary platforms. This unit, delivered to Eglin Air Force Base, Fla., can be operated remotely or directly by trained personnel.

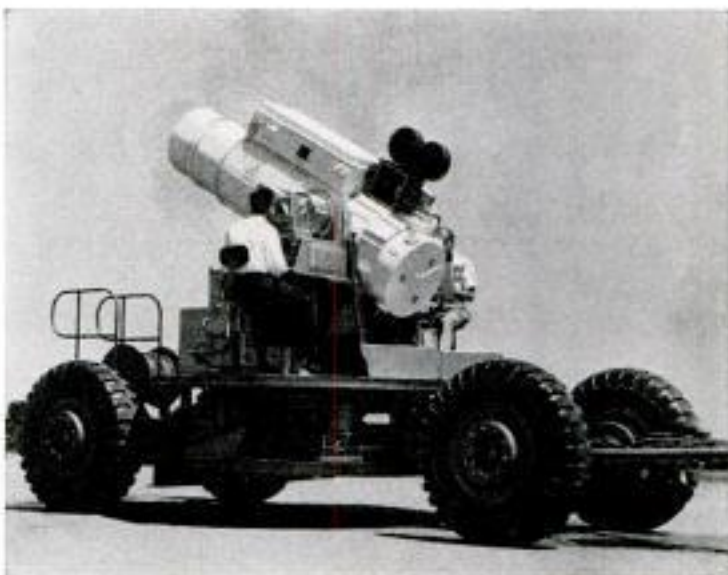

Next Month---Homes

To celebrate our fifth annual Home Section we are presenting two new *PM* houses designed specially for our readers—one Modern and the other Traditional. Plans for both are available. Also featured in the 50-page section of the October issue are interesting new building materials and unusual wall coverings, ways to add that needed extra room to your house, and *PM's* Parade of Homes.



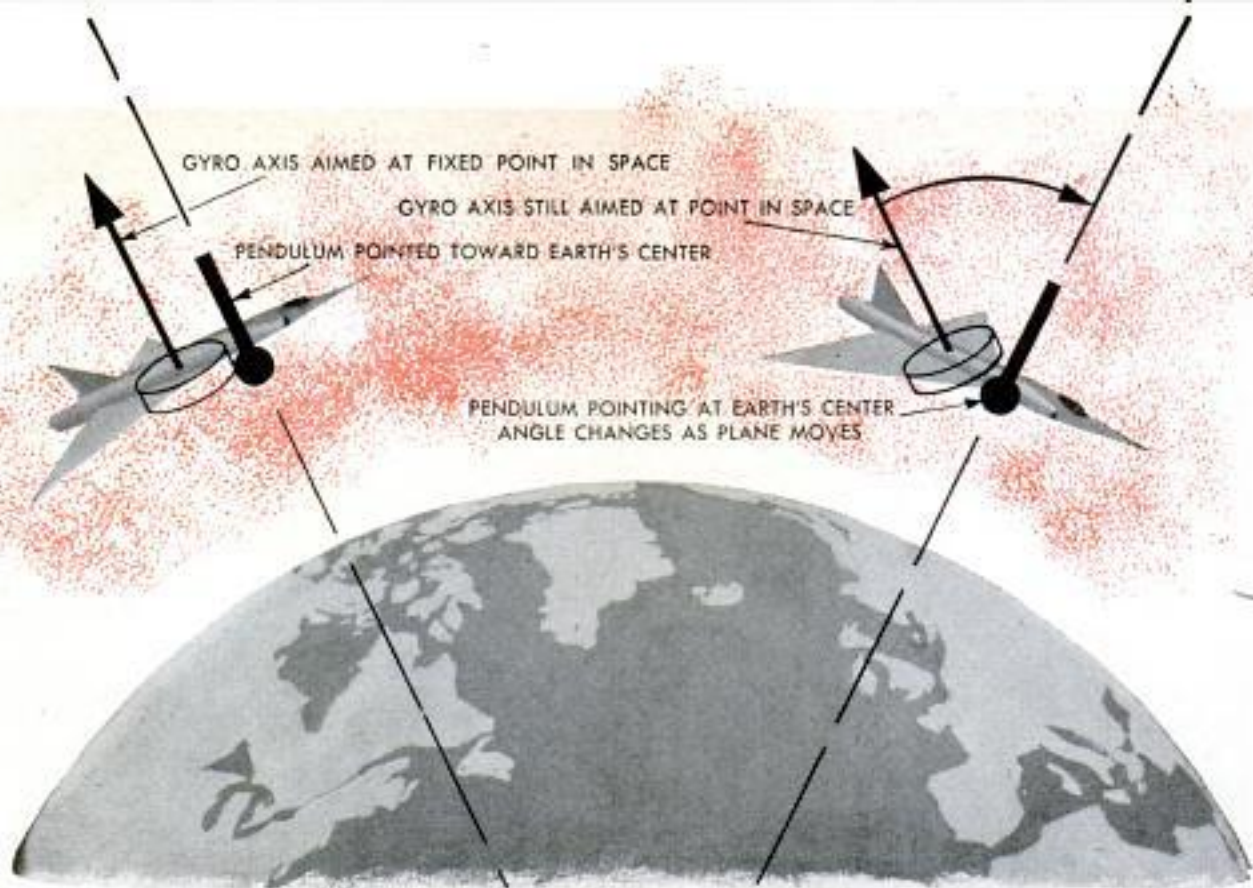

As plane moves, angle of gyro and pendulum changes. Autopilot makes corrections to keep plane on course

Brains for Planes

Massachusetts Institute of Technology photo



By Richard F. Dempewolff

IF THE WIZARDS working over complex diagrams of aviation's newest electronic brains have their way, it won't be long before you'll climb aboard a transcontinental airliner in any weather at all. You'll ride almost noiselessly, close to the speed of sound, straight as an arrow to your destination. And you'll land right on time—in blizzard, rain or fog—even though the clouds are sitting right on the airstrip. "Stacking," while tower technicians work feverishly to bring you in or send you to an alternate airport, will be an old-fashioned problem of the "pioneer days." Most startling of all is the fact that there won't be any pilot in the cabin of your plane. Gyros, transistors, vacuum tubes and humming condensers will do the flying.

Equipment to do the job is no drawing-board dream. It's already flying planes. While the human pilot sits back and looks at the view below, two of these hair-raising systems will navigate his plane anyplace over the earth without any prompting from pilot or ground-based signal stations. One uses a unique type of radar to do the job; the other, gyros that always know where

Engineer Draper shows action of pendulum (large arrow) and gyroscope mounted on large plane model



RADAN, a smaller version of "66," has a switch panel and dial indicating drift angle and ground speed



Rotating antennas, tucked in the belly of a jet fighter, throw out twin beams ahead of the craft

they are. Another new brain even saves a pilot the trouble of landing his plane. Invisible gremlins nudge the controls this way or that, setting down the plane in a perfect landing no matter what the weather or ceiling. If the strip happens to be the heaving deck of an aircraft carrier, his electronic chauffeur will make split-second corrections and decisions—even to the point of taking a wave-off if the deck drops away at the crucial instant of touchdown.

One jet pilot whose plane is a flying laboratory of such electronic gear summed it up neatly. "That thing has grown up," he said. "It doesn't really need me any more."

Some of the new air-minded brains are eerily efficient. Early this year, a B-47 bomber with Maj. Mont Smith at the controls, took off from March Air Force Base

in California, poked its nose into the wandering jet stream and followed it all the way to Hanscom Air Force Base in Massachusetts. The big jet bomber made the 2700-mile trip in three hours and 47 minutes at an average ground speed of 714 miles per hour.

Plane Follows Jet Stream

More remarkable than the unofficial record he set was the fact that Smith had managed to stay in the wandering jet stream. The big wind, six or seven miles high, twists and turns with unpredictable whimsey. Few pilots can stay with it for long even if they do find it. But Major Smith's free ride on the 165-mile-per-hour tail wind was no stroke of luck. "The '66' put me in the stream and kept me there,"

Any variations in plane's attitude are sensed by reflected-beam signals, and course is corrected by computer

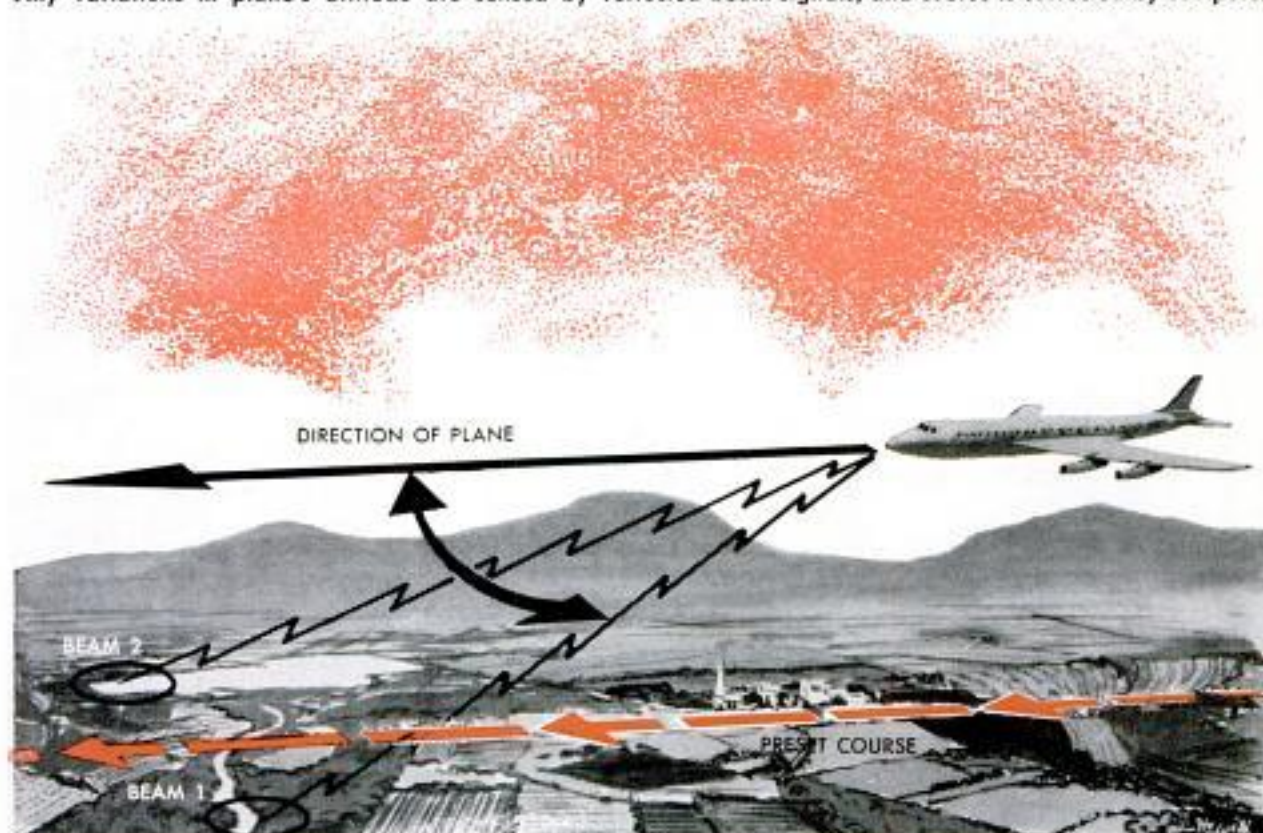



With radar beams bouncing off the landing gear, Navy fighter makes perfect landing without pilot's help

he said. The major referred to a collection of black boxes in the bomber's cramped cabin.

The 66, known officially as AN/APN-66, is a complicated affair developed by General Precision Laboratory in Pleasantville, N. Y. Its secret lies in the harnessing of a strange physical phenomenon known as the Doppler effect. Sound waves from swiftly moving objects have a curious habit of changing pitch in the ears of a fixed observer. Nearly everyone has noticed the swift fall in the wail of a locomotive whistle as the train roars past. That change in pitch is Doppler effect. Scientists have known for a long time that electromagnetic waves do

the same thing, and it is this fact that GPL engineers employ in their family of new navigational brains—including the complex 66, a simpler 85-pound version that is known as RADAN, and several other variations for special jobs.

In each type a transmitter sends out two radar beams—like the long antennae of an insect—toward the ground ahead of the plane. By sensing the amount of frequency change in the signal that bounces back to the plane, the gadget's brain (a miniature electronic computer used in conjunction with the 66) can tell if the plane is shifting to left or right, and by how much. The computer instantly passes the word to an

Equipment for ACLS is mounted in a trailer for tests. Computer sends out orders as radar locates the plane



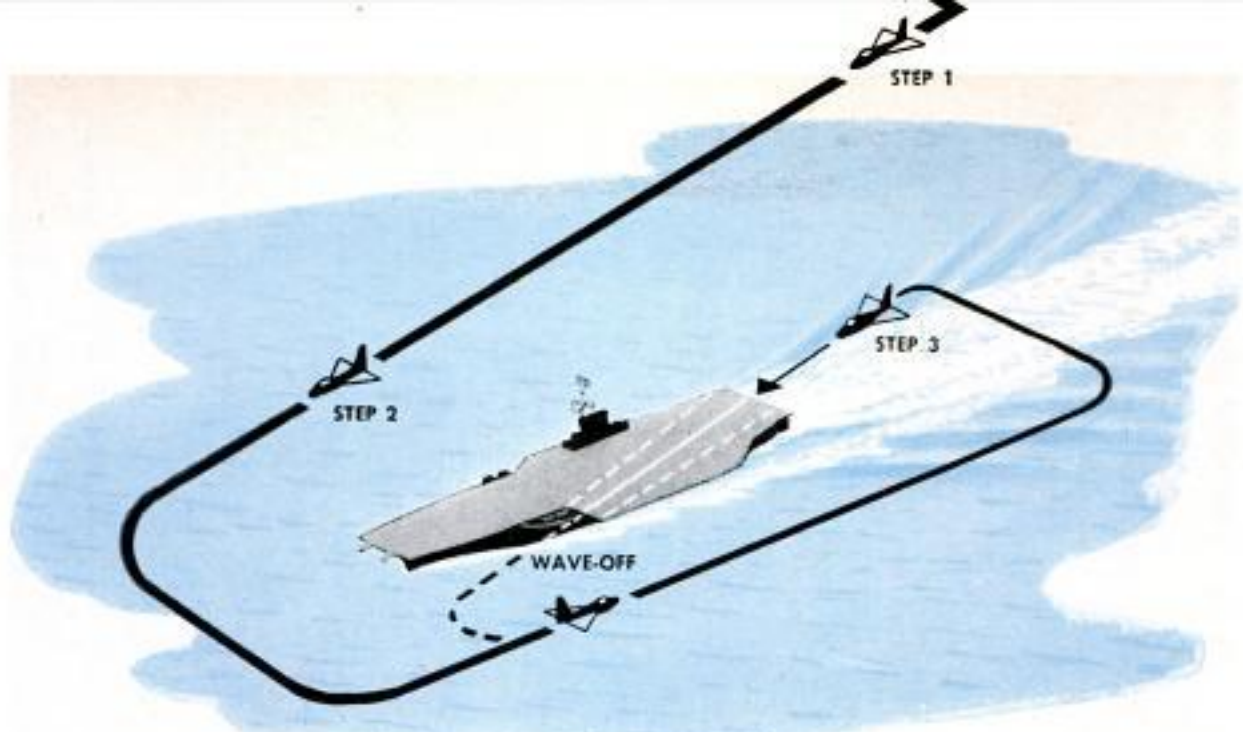

Step 1: Radar locates the plane. Step 2: Computer directs plane into the landing pattern. Step 3: The plane is landed by automatic control. Step 4: If conditions are not right, plane is automatically waved off

automatic pilot that nudges the controls and steers the plane back where it belongs.

That's not all. Using the same radar pulses, the device's brain also measures the plane's actual ground speed by calculating the degree of frequency change. The faster the plane goes, the greater the frequency shift becomes in the reflected signal.

The pilot isn't flying the plane anyway. The 66 is telling the autopilot where to go, and it is flying the plane. If Major Smith wants to fly a great-circle course from Dallas to New York, for instance, he turns a little knurled knob on an instrument,

System requires only one man to watch equipment. So far it has completed more than 1200 landings in tests

setting it at the proper latitude and longitude of the Dallas airport. Then he sets another row of numbers on an adjacent counter to the latitude and longitude of, say, Mitchel Field on Long Island. After take-off he can lock the autopilot to the 66 and pull out a good book to read while the plane flies itself to Mitchel Field. Nobody needs to check wind changes or plot corrections for compass variations en route, because the 66 is conveniently sensing all these changes and feeding them to the computer, which directs the autopilot to make proper course corrections. If the pilot should suddenly decide to head in at Baltimore or go on to Montreal, all he needs to do is set up the proper coordinates on his destination dial, and the computer will automatically feed the new course and steering signals to the autopilot.

Light Announces Destination

But let's assume Major Smith continues to New York as planned. As the craft moves along, the dial that was set at the latitude and longitude of Dallas airport is constantly changing. At any instant of flight its reading gives the precise location of the plane at that point. If the major is otherwise occupied when the plane arrives over New York, he doesn't need to worry. A red light flashes on the instrument panel announcing "destination reached."

Military security prevents the use of specific figures regarding the accuracy of the 66, but GPL engineers readily admit that on a flight of several thousand miles, the electronic wizard will bring an aircraft so close to its precise destination that, when the light goes on, the pilot can look down

(Continued to page 250)





Marine Division, Falls City Flying Service, Louisville, Ky.

Eight feet wide and 28 feet long, this aluminum *Marinette* can move at speeds of 12 to 15 miles per hour

Homes Afloat

THOUSANDS OF HOUSEBOATS now moving along our nation's more protected, shallower waterways testify to an American trend toward amphibious living. To build these "water-borne, power-pro-

pelled apartments," do-it-yourselfers can buy bare hulls or complete houseboat kits. The purchaser who wants a finished craft can choose from sizes chiefly in the popular 20 to 30-foot lengths of scow or twin hulls made of plywood (plain or glass-fiber covered), aluminum and steel. Prices in the popular sizes vary from \$1200 to around \$7000, depending on furnishings and motors. Some of the fancier models cost \$75,000 or more.

Installed singly or in tandem, motors are a question of personal preference. Many manufacturers construct houseboats to take motors of 25 horsepower, with maximum speeds of about 12 miles per hour.

Twenty-foot boats will accommodate most families, with folding berths above regular berths, cooking stove, sink, storage space and a marine toilet.

In the 30-foot class, a houseboat may



Typical floor plan shows: 1. Sun deck; 2. Bed; 3. Lounge; 4. Galley; 5. Dinette; 6. Closet; 7. Bath; 8. Rear cabin; 9. Berths; 10. Rear deck; 11. Controls

This 30-foot houseboat serves as blind for shooting ducks as well as floating home for relaxed living

River Queen Boat Works, Gary, Ind.



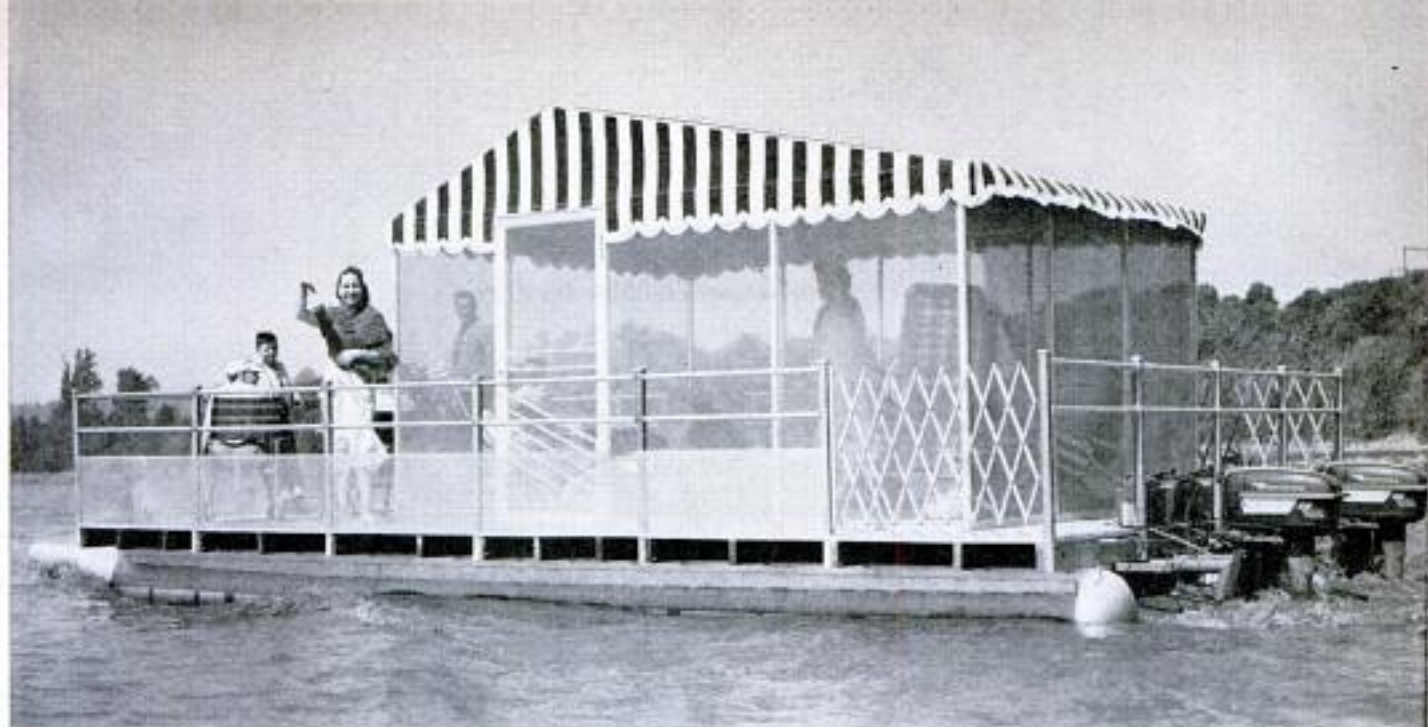

Harley Sales Co., Kansas City, Mo.

Looking like water-borne screened porch, this craft has an entertainment area extending 16 by 24 feet

have all the conveniences of a modern city home, including hot water heater, LPG refrigerator and range, pressure water system and electric-lighting plant.

Then, there is the two-story, 59-foot, 65-ton houseboat owned by Julian Burch of Miami, Fla. It has three bedrooms, galley, dinette and two baths on the lower deck. Above are two sun decks and a 40-foot lounge. ★ ★ ★

Right, comfortable houseboat boasts a dinette, galley, upper and lower berths and lots of elbow room



Stanley Mobile Homes, Dixon, Ill.

Left, four persons can live comfortably in this 29-foot combination houseboat and trailer home which can be towed by car

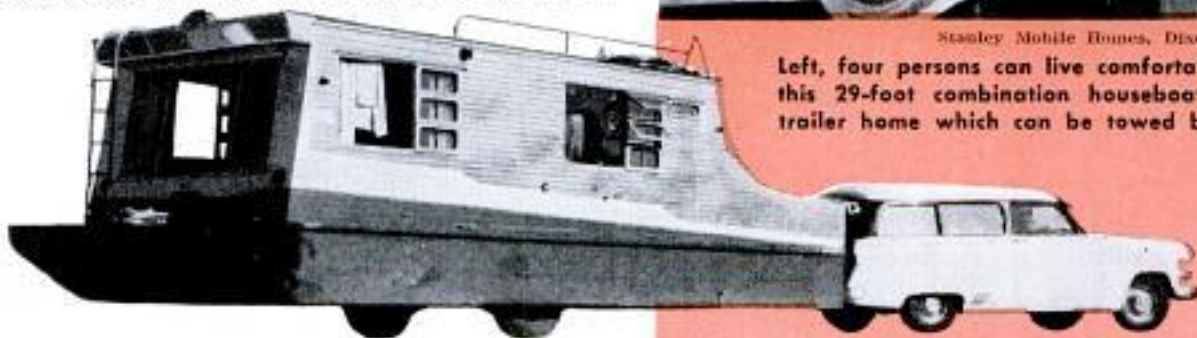

This trailer-boat is at home on land or water. It is 28 feet long and requires draft of only 5½ inches

Neptuna Corp., Glendale, Calif.



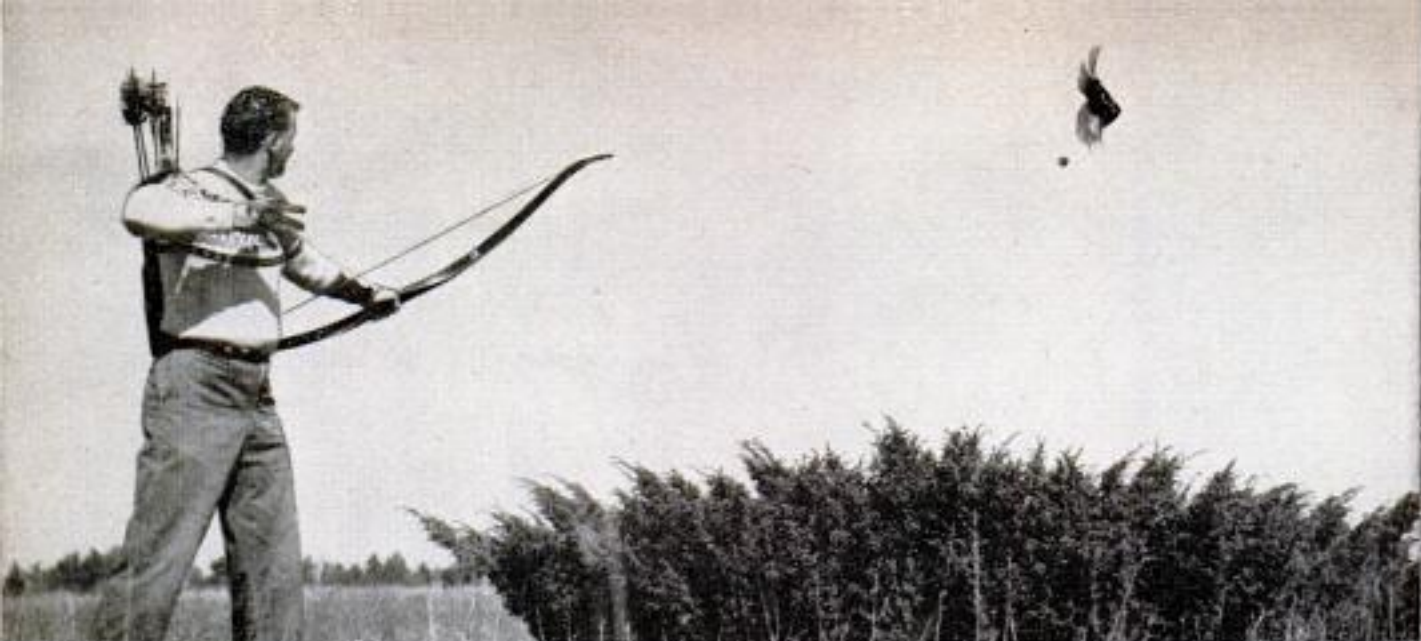

Pheasant begins to fall after being hit by "shotgun arrow" missiles. Feathered shaft is dropping below bird

Archers Test "Shotgun Arrow"

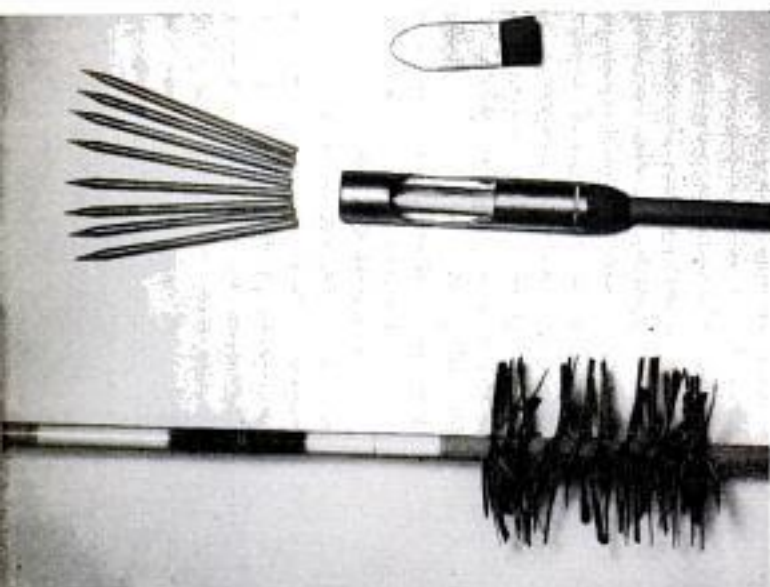

Above, parts of shotgun-arrow are: top, clip; middle, missiles and hollow head; bottom, feathered shaft

Below, Alex Martin, inventor of the shotgun-arrow, checks the pattern of missiles fired at a target



BOW HUNTERS will find themselves on an equal footing with "shotgunners" this fall, thanks to a projectile called the "shotgun arrow."

Alex Martin, Traverse City, Mich., has developed this new arrow after three years of research. The arrow carries 8 to 12 steel-tipped missiles which fit in an expendable clip inside a hollow container. A cluster of feathers on a standard shaft acts as an air brake, allowing the missiles to outrun the parent arrow after it has been fired. However, this pompon does not affect the arrow's accuracy or striking power.

The cluster of missiles will spread about 18 inches at 12 yards, considered a good pattern for most running or flying small game. Points can penetrate a wooden backstop to $\frac{1}{2}$ -inch depth if blunt missiles are used; the hunting heads have barbs.

When an archer shoots, the shotgun-arrow starts to drop almost immediately, held back by the feathers. The missiles speed on in a straight line.

Shotgun-arrow patterns are similar to patterns of a shotgun shell. In fact, clay pigeons can be downed with this arrow. And the cost of an arrow is roughly comparable to the cost of a shotgun shell.

In trapshooting with this weapon, archer Bob Thomas of Cadillac, Mich., broke 50 percent of the clay pigeons tossed aloft by Ken Uptegraft, another archer, on the first day Thomas tried shotgun-arrows.

Tested for killing power in a game preserve, the shotgun-arrow has proved equal to its trapshooting record. Steel-tipped missiles were deadly on flying pheasants.

This fall, bowmen will fire the arrow at small game. Confident of the missiles' effect, Thomas says: "Alongside clay pigeons, small game should be a cinch!"



KEEPING UP WITH THE ATOM



SCIENTISTS CAN take a mighty long look around corners through that tube shown at right. Believed to be the world's longest periscope, the 90-foot tube permits engineers to sit safely in a shielded room and observe a hot reactor in operation. The periscope, installed at the AEC's National Reactor Testing Station, will be used in development work on a nuclear engine for aircraft.

☆☆☆

EARTHQUAKE WAVES caused by H-bomb explosions pass through the inner core of the earth, according to two British scientists. The waves were recorded at stations halfway around the world from the point of H-bomb detonation, and help prove that the earth possesses an inner core. From the information available from seismographs, scientists can reconstruct the exact moment when the fireball was formed.

☆☆☆

PILLS TO PROTECT humans from death by radiation are under development at the College of Medicine, University of Tennessee. The protective chemical in the pill has been found to be 100 percent effective in mice exposed to lethal doses of radiation. Human trials are under way. The biggest remaining problem is to find a way to keep a high level of it in the body tissues, since

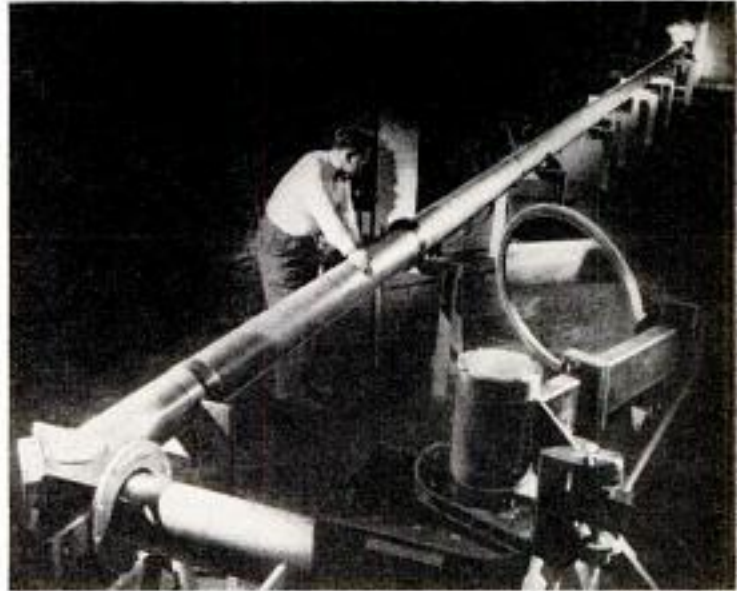

General Electric photo

it is quickly excreted by the kidneys.

In a similar field of research, two University of British Columbia scientists have demonstrated that a high calcium diet will reduce the absorption of strontium 90 from atomic fallout. When the body takes in too much calcium, it begins to reject it, and strontium 90 is rejected at the same time.

☆☆☆

TAMING THE H-BOMB is the goal of a scientific search launched by the General Electric Research Laboratory. A research team is studying the fusion process because "it employs the most basic technical skills of the electrical industry." Dr. Guy Suits, vice president and director of research, points out that the program cannot compare in scope with the AEC's famous Project Sherwood, but will focus the skills of the electrical industry on the problem. "My own view," Doctor Suits has stated, "is that five additional years of research will be required to make possible a realistic appraisal of the fusion process; in 10 years we may be at the point of technical feasibility; pilot-plant production of fusion power will not begin for 20 years; and competitive power production lies beyond that."

☆☆☆

RADIOACTIVE GOLD, left, is serving science at Sutter's Mill, Calif., where gold was discovered in 1849 to touch off the famous rush. The gold is dropped in the river upstream and detected by a geiger counter in studies which will aid irrigation and land-reclamation work.



Are winters getting milder than in the good old days? Are summers hotter and springs wetter? Tornadoes, hurricanes, droughts and floods more frequent? *Popular Mechanics* invited three of the foremost weather experts in the United States to tell you

What's Happening To the Weather

The Panel: Dr. H. E. Landsberg, Director, Office of Climatology, U. S. Weather Bureau, Washington, D. C.; Dr. Sverre Petterssen, Professor of Meteorology and Director, Weather Forecasting Research Center, University of Chicago, and Dr. Hurd C. Willett, Professor of Meteorology, Massachusetts Institute of Technology, Cambridge, Mass. The Place: Popular Mechanics Building, Chicago.

QUESTION: Before we launch into our big question on what is ahead in weather for the next 50 years, it might be a good idea to get your reactions to weather cycles—both long-range and short. Do these cycles tell you anything about future weather conditions?

LANDSBERG: No, I don't think so, because we know little about the underlying factors which cause today's weather rhythms. Hence, we can't say that the same factors will still influence the same weather tomorrow.

WILLETT: However, I believe you will agree these factors have some suggestion of recurrence on a rough timetable.

PETTERSSSEN: Actually, I don't think we have enough accurate records for a

long enough period of time to tell with certainty. Also, from what we know, climate changes have been more radical in this century than in the last.

Q: Does this mean we are near the end of a weather cycle?

WILLETT: For about 30 years at the end of the 18th century it was quite warm in eastern North America and in western Europe. Then, following 1790, it turned colder in Europe, and afterward in the United States. The peak of the warmth here was 10 or 15 years after Europe. This is very similar to what seems to be happening right now and during the past 40 years.

LANDSBERG: The warm spell you refer to probably wasn't as extreme as the one we are in. For example, there is con-

Chart by Dr. Willett compares sunspot activity with the weather, predicts a cold-and-wet period ahead

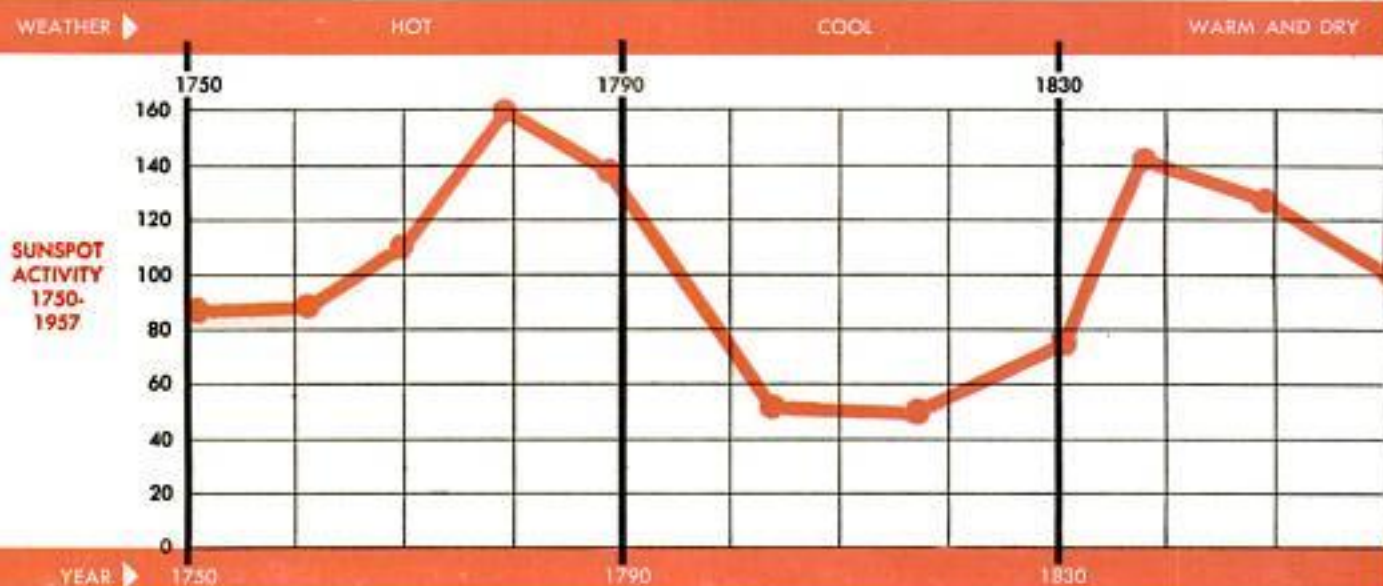



Panelists include a top government weather expert and two prominent university professors of meteorology

siderable melting and breaking up of the North Pole ice which was not observed before. This indicates *we are undoubtedly in the warmest period of almost 1000 years.*

Q: To what extent are these weather variations connected with sunspot activity?

WILLETT: They seem to occur in cycles of about 40 years. For example, the period 1755-1795 was one of relatively high sunspot activity, similar to the one we're in now. In fact, the activity pattern of that period so closely resembles the present one that we can use it to forecast current sunspot variations. We have been in a period of high sunspot activity, accompanied by high temperatures and dry weather since about 1915. It is my opinion that *we are now entering a period of much lower sunspot activity, indicating that*

cooler and wetter weather lies ahead.

LANDSBERG: I basically agree with this. We have some correlation between the weather and sunspot activity. However, we do not know what it is since the sunspot is only a symptom of something going on in the sun, and not a real cause-and-effect relationship with the weather here.

Q: What exactly are sunspots?

WILLETT: They are cool areas on the surface of the sun. The net effect of sunspot disturbance, but not of the spots themselves, is to send us more radiation in the shorter wavelengths—ultraviolet—than we get during a period of little activity. Also, during periods of high sunspot activity the earth is bombarded with more corpuscular radiation (electrical particles) from the sun.





Photos courtesy American Geographical Society

Sequence of photos shows how Arctic warmth has melted one glacier. Above is Alaskan glacier in 1889



Same glacier in 1935 had lost 3900 feet of its "tail" since 1889. Even vegetation made an appearance

Photo taken in 1950 from same location as 1935 shows the glacier almost gone, another 2600 feet melted



Q: Since the earth's winds have such a strong influence on the weather, have there been any spectacular changes in them the past 40 years?

LANDSBERG: Yes, there has been a tremendous increase in the volume and intensity of air movements around the world in a westward direction, the so-called "westerly circulation."

PETTERSEN: And in a north-south direction, too. Since the beginning of this century, air movements have been faster into the Arctic and faster out of it. Also, the weather and temperatures are very dependent on how many cyclones (low-pressure systems) and anticyclones (high-pressure systems) there are. *In the past 40 years the number of cyclones has increased about 50 percent over the northern part of the North Atlantic, and the number of anticyclones has increased over Europe.* This has caused a major warming of the Arctic.

Q: What are some of the other unusual weather occurrences during the warm period that is supposed to be ending now?

PETTERSEN: In the first place, we don't know for sure if it is ending. It might be another 10 or 15 years before we can verify it. If the warm trend continues there will be some remarkable changes. *Already the North Pole ice has decreased something like 40 percent in volume. If this continues till the end of the century there will be very little summer ice in the Arctic, or only small patches of it.* Another 50 years and the weather will be the same as about 2000 years ago. With this, of course, would be a northward migration of vegetation, fish and animal life. Actually, this has been going on for the last 30 or 40 years. Halibut, cod and other fish are found farther north every year, and I understand the cardinal is now a regular inhabitant of Ontario.

Q: What else would happen if the warm trend continues?

PETTERSEN: Cyclones would continue to move northward. With this might go a northward spread of the anticyclones in the middle latitudes, which we know are drying out the climate in the lower latitudes. I think the changes would be quite severe.

LANDSBERG: To a certain extent, this is already happening. Some areas in the Middle Eastern part of the world have become drier in the past 40 years. Practically the same thing is happening in our own Southwest, where there have been marked tendencies toward drier spells, such as in the 1930s and the droughts of recent years.

Q: If we are in an extremely warm period now, why is it we can get bitter-cold weather at times?

LANDSBERG: In the history of weather,

during warm periods there have been record snowfalls and low temperatures and, conversely, during cold periods there have been some heat waves. This indicates there is a lot of latitude in the weather with respect to specific instances without affecting the long-range trend.

Q: Are there any manmade causes for the recent drought in the Southwest?

LANDSBERG: Not the drought itself. It was caused by changes in the general circulation of air. But in some areas you will find the drought has been held back by good farming and conservation practices.

Q: What happens to ground-water levels in a drought area?

LANDSBERG: It depends on irrigation. The unfortunate thing is that in some areas of the Southwest the ground-water levels have been lowered as much as 100 feet in some places by large-scale irrigation operations.

PETTERSEN: *I think our water problem is more serious than most people realize. With increasing population, increasing use per capita and taking water*



DR. PETTERSEN: *"If the current warm trend continues there will be some remarkable changes in the weather. Already the North Pole ice has decreased something like 40 percent in volume. If this continues, there will be very little summer ice in the Arctic."*

out faster than nature can replace it we are already in a mild crisis, and 50 years from now I think we shall not be better off.

LANDSBERG: The situation is not entirely hopeless. We still have the ocean water. I foresee the day when it will be distilled and sent all over the country by pipelines.

Q: How bad was the recent drought in the Southwest compared to other droughts?

WILLETT: It was about average. Droughts seem to occur approximately every 20 years, together with high sunspot activity. They shift north and south with this cycle. The drought of the 1930s was the farthest north of any of our recurrent droughts, and also the worst. The more recent one has occurred farther to the south. *I believe there will be a lessening of the drought in the Southwest. It has been through its extreme phase.*

Q: How will the earth satellite help in providing weather information and in forecasting?

LANDSBERG: In two ways. One is that

we no longer will have to rely on sunspots to determine solar activity. We will be able to make continuous measurements of solar intensities without atmospheric interference. The other is heat balance. We will be able to measure the exact amount of solar energy reflected back by the earth.

WILLETT: The satellite will not aid weather forecasting directly. But it will

DR. WILLETT: "We are now entering a period of much lower sunspot activity, indicating cooler and wetter weather ahead . . . I believe there will be a lessening of the drought in the Southwest, for it has been through its extreme phase."



help us understand how the earth's atmospheric system works, and must eventually lead to improvement in forecasting.

Q: Is it generally agreed among meteorologists that all weather on earth has its origin in the sun?

LANDSBERG: It certainly starts with the incoming radiation.

PETTERSSEN: The sun is the only source of energy. Although it is this energy that drives the entire machinery of our weather, you can't blame any particular change in the weather on solar activity. All the sun does is supply us with energy. How it is used in the atmosphere, the oceans and in the earth is something else again.

Q: Will observations from the satellite be able to track such weather phenomena as the hurricanes which have recently plagued the East Coast?

LANDSBERG: No, not immediately. You know, on the average we have had more hurricanes in the past five years than in the preceding 25 years. In some years, the hurricanes have been off their usual tracks. The northward motion and intensification of the belt of westerly winds have pushed them farther north than usual. Also there has been a warming of the ocean waters, which helps intensify them.

WILLETT: As you know, I say we are entering a colder, wetter weather period. This means more west winds in the lower latitudes. That will terminate the high-pressure ridge on the Atlantic Coast which has been bringing northward warm water and hurricanes. So according to my forecast, the hurricanes will tend to return to their tracks of earlier years, either in the Gulf of Mexico or staying off the Atlantic Coast, not affecting the Middle and North

Atlantic states to the extent that they have recently.

Q: Do you all accept the sunspot interpretation of climatic change?

WILLETT: That is the basis of my long-range forecasts. I accept it to a degree of say 70 percent.

LANDSBERG: I would stick closer to 55 percent.

PETTERSSEN: It is difficult to translate these things into figures, but there should be a better-than-even chance.

Q: What is your opinion of manmade methods of changing the weather, such as seeding a cloud to make it rain?

PETTERSSEN: I believe most scientists will agree that we have no conclusive evidence. Seeding, as you know, has worked well to dissolve shallow clouds. But experiments with deep clouds, and you have to have a deep one to get any amount of rain, have not been so convincing. The basic thing is that in seeding you can only hope to achieve results when the cloud is almost ready to let loose rain anyway. Then it is extremely difficult to determine if you have done anything useful. It's of little use just taking out the moisture that is in a cloud. What you want is for the cloud to reproduce itself in moisture content.

LANDSBERG: It's a matter of cost. After all, if you have to carry enough seed in the form of dry ice up to a cloud to get moisture out of it, there's a breaking point in making it a profitable undertaking.

WILLETT: It will never be important in drought situations. The essential charac-



DR. LANDSBERG: "We are undoubtedly in the warmest period of almost 1000 years . . . On the average we have had more hurricanes in the past five years than in the preceding 25 years . . . In some years, hurricanes have been off their usual tracks."

teristic of a drought is the absence of clouds. So you wouldn't have anything to seed in the first place.

Q: Do atomic explosions affect the weather?

LANDSBERG: No. Only within the explosion itself.

PETTERSSEN: They have little effect even in their near vicinity. The amount of energy in an A-bomb is no more than that of a medium-size thunderstorm.

(Continued to page 246)



Inventor Lerici, right, finds drilling spot where his underground camera will reveal tomb's contents



Flash camera at end of tube is lowered into tomb, where 24 exposures are made in a complete circle

"Mole" Camera Photographs Tomb Before Excavation

ANCIENT TOMBS, hidden from the eyes of man for centuries, are being photographed by a unique camera previous to excavation to determine if the expensive and time-consuming work will be worthwhile. The camera, invented by Carlo L. Lerici, wealthy Italian industrialist and amateur archeologist, is a revolving flash

camera at the end of a tube. It is lowered into a tomb through a drilled hole. The camera makes 24 exposures as it travels in a complete circle. Aerial photographs and sound-wave devices locate the burial sites. Lerici calls his invention the "Eye of Minos," after the mythical judge of the underworld.

Relics of a long-dead civilization, these valuable vases were excavated after discovery by camera

Revolving camera with probing needle at end of tube is inserted through the top of 2500-year-old tomb

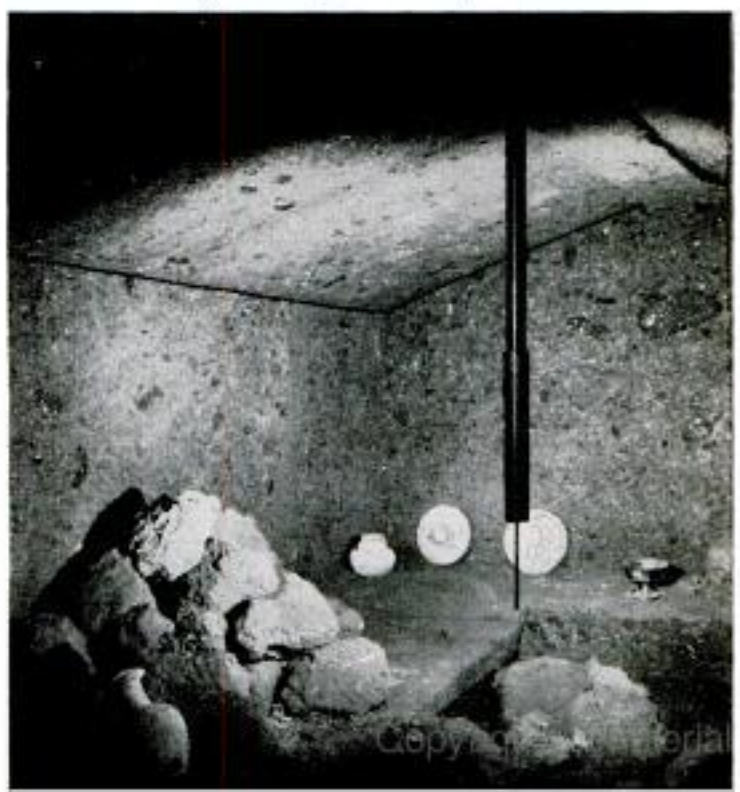



How to travel without leaving home. Trailer-Jeep combination drives through front wheels with controls inside the kitchen

Trailer-Jeep Steers From Kitchen

Few motorists can duplicate the rare feat of H. Paul Prigg of Miami, Fla., who has driven from Coast to Coast while sitting in the kitchen of his home. The home is an 8 by 20-foot house trailer welded to a Jeep. The steering wheel, controls and instruments are fastened to a kitchen wall. A folding chair serves as the driver's seat. The trailer body is made of aluminum sheet fastened to steel channel. Cruising speed is 40 miles per hour. The trailer contains a complete bathroom, gas range, refrigerator and beds for two children and two adults.



Toss-Away Filters For Home Pools

Homeowners with backyard swimming pools now can filter the water supply with replaceable cartridges which are inserted in the filter housing. They remove algae and dirt particles and can be discarded when loaded with deposit. The complete filter system, available in four models, can be installed in either a surface or a sunken pool.

Off-Road Transport

All-wheel drive gives a new vehicle the ability to haul 70,000 pounds of freight through territory barren of roads or railroads. An electric motor is geared to each wheel. When one wheel loses traction, its share of the machine's horsepower is transferred to other wheels. The driver pushes a finger switch to steer.



Fastest Jet Day Fighter?

Lockheed Aircraft's XF-104 Starfighter is reported to be the fastest jet day fighter in the world. Top speed is still secret. Test pilot for this plane is Tony LeVier, director of flying operations at Lockheed's California division. This aircraft (*Popular Mechanics*, Sept. 1954, page 104) is 55 feet long and 21 feet 11 inches from wing tip to wing tip. Pods at the ends of the drooping, knife-edge wings are fuel tanks. The plane is powered by a Curtiss-Wright J-65 jet engine.



Big Squeegee for Hangars

Pulled by a diesel tractor, a 15-foot-wide squeegee saves 400 man-hours weekly in sweeping hangars free of water at the Marine Corps Air Station at Kaneohe Bay, Hawaii. Sgt. Larry F. Stutts made the device from large timbers, discarded rubber strips and a few pieces of angle iron. Two men can now do the cleanup job in half a day. It formerly took a crew of 50 an entire day to clean a single hangar.



Dirt and Compost Mixer

Compost is mixed with dirt by a small power machine developed in Germany. The dirt and compost are shoveled into a hopper and emerge on the other side of the machine, thoroughly mixed by two rotating knives. The machine handles material as fast as two men can shovel it. The gasoline engine also powers the single wheel which moves the machine from place to place.





FLYING FOREST-FIRE FIGHTERS

Using road as a firebreak, tanker plane widens firebreak area by spraying brush with water and chemical

By Thomas E. Stimson, Jr.

Testing helicopter against spot fires, pilot uses pull line to open valve in flexible-plastic tank

ON A RECENT AFTERNOON a group of forest rangers drove into the mountains to look over a remarkable sight. They went to see with their own eyes a new fire-fighting technique that had stopped a raging brush fire in its tracks only a few hours before.

Making their way through tinder-dry brush, they reached an area where the bushes and clumps of trees were coated white. This was the borate line, the insulated belt. Beyond it the fire had burned everything in sight; on this side of the belt the brush hadn't been touched. The wide swath of chemical had been laid down that morning by a pair of small tanker aircraft, right in front of the flames.

Air attack was used against 25 forest fires in the West last year. It was a deciding factor in stopping 14 of the fires, a definite help in 10 more. Only once was it a failure. On this occasion, a pilot missed his target in the smoky atmosphere and laid his chemical in front of the backfire instead of on the main fire line.

Forest pilots have tried water-bombing a conflagration but much of the water turns to mist in the hot air over the flames. Drenching the area in front of the fire is better, though some of the water evaporates when fire reaches it.

Best of all is to lay down a mixture of water and sodium calcium borate. The sticky boraxlike suspension adheres to everything it touches and covers leaves, twigs and branches with a fire-retarding coat. Sprayed from the air to cover a 75-foot-wide area, it slows down a hot fire until it can be fought from the ground, or creates sidelines across which a fire can't creep.

Last year seven agricultural crop dusters fought forest fires in California all the way from the Oregon border to San Diego. They operated from roads or small landing strips, even from meadows. They had 125-gallon dump tanks.

Most of the fire-fighting planes are biplanes that were built as military trainers and later converted into dusters. They have limited capacity as tankers. A new low-wing monoplane designed especially for agricultural and forestry work is now undergoing tests. Called the Transland AG-2, it is based on studies made at Texas A. & M. College to develop the best all-around design for an airplane for crop dusting, spraying fire-fighting and similar work. As a tanker it can carry 200 gallons of water or chemical and can operate very close to the ground at 58 percent of engine power.

In addition to using airplanes, the Forest Service is studying helicopters as another fire-fighting aid. The whirlybirds have already shown that they can rapidly transport small crews across country to a fire. Now they are being tested for such jobs as laying lightweight linen hose and for knocking out small spot fires. ★ ★ ★



Helicopter, above, is used in Forest Service experiments to lay as much as 1500 feet of linen hose across rough country



Air view shows borate line across tinder-dry brush. Fire burned up to insulated line, did not get across to heavy growth

Airplane, below, is laying a water-borate line in advance of flames. Some planes carry 200 gallons of chemical and water





Balloon Used for Scaffold

Standing on a platform erected at the top of a balloon 24 feet in diameter, a painter has decorated the dome inside St. Peter's Church in Yvetot, France. The contractor borrowed a French Air Force balloon, built a small "porch" on the deflated bag, filled it with hydrogen, and sent painter and scaffold to the ceiling, where the job was accomplished.

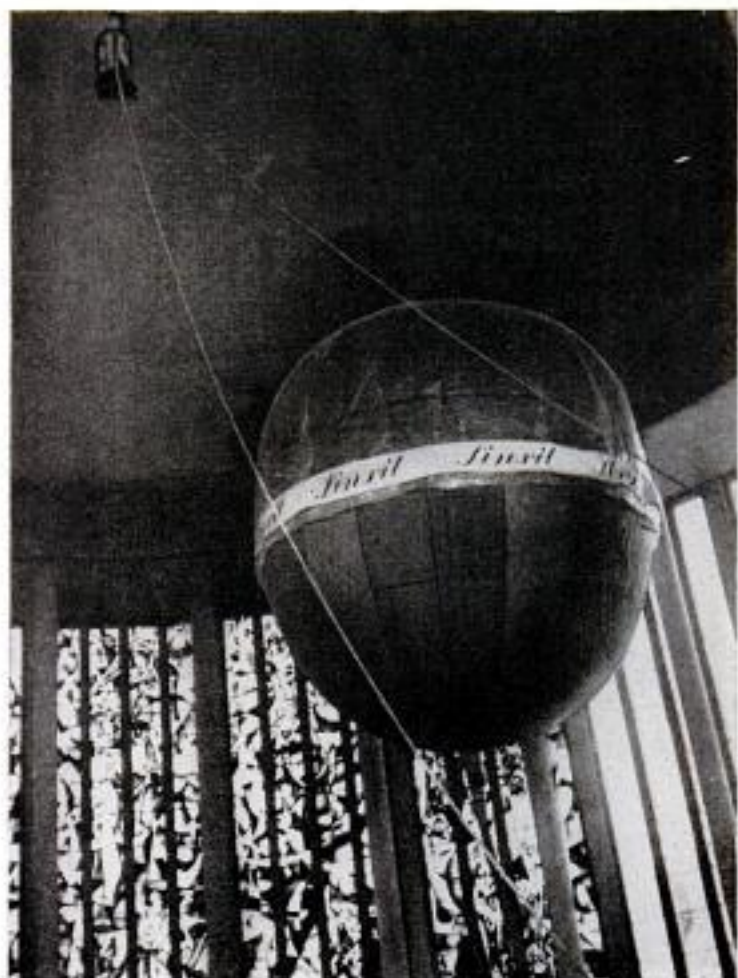

Plastic Bags Replacing Glass Bottles for Blood

Plastic bags are replacing glass bottles as containers for blood transfusions in the U. S. Army Medical Corps. They are unbreakable, disposable and occupy less stor-

age space. A bag is placed under the shoulder of a patient and the weight of his body forces the blood to flow at an even rate into his arm.

Mosquitoes Killed by Fog-Spray System Attached to House

Insecticide, sprayed from fog nozzles in plastic tube encircling a building, rids an area of mosquitoes for about seven hours. A valve-operated tank releases compressed gas to force insecticide from another tank

through piping to the nozzles. There the droplets are ejected as an almost invisible fog. Three-minute treatments will blanket shrubbery and other hiding places without harming humans, animals or vegetation.

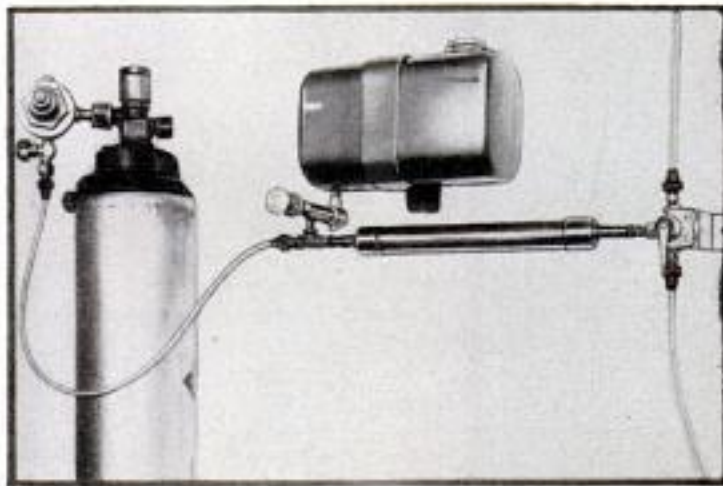



Automatic Machine Sorts 15,000 Letters Per Hour

Able to handle 15,000 letters per hour, the first automatic mail-sorting machine in the United States postal service has been installed at Silver Spring, Md. Five operators, seated at control boards on the top deck, send the mail to 300 pigeonholes beneath them by pressing the appropriate

symbol keys. By comparison, five men working fast by hand can sort about 7500 letters into 75 pigeonholes. The machine weighs 31,000 pounds, is 50 feet long, 13 feet high and 10 feet wide. It was designed and built in Europe, and is similar to others now in use there and in Canada.

Solar Batteries Power Helmet Radio for Use Day or Night

Long rows of silicon wafers on the crown of a military helmet convert solar energy into electricity to power a two-way radio. The tiny solar cells also charge four nickel-cadmium storage batteries for nighttime operation. A completely transistorized power converter was designed by U. S. Army

Signal Corps engineers to raise the approximately 4.5 volts of the solar nickel-cadmium battery combination to the 50 volts needed to operate the transmitter. The helmet radio previously used dry cells which were good for only one day if used continuously.





James Verde photo

Unusual automobile bears striking resemblance to real plane

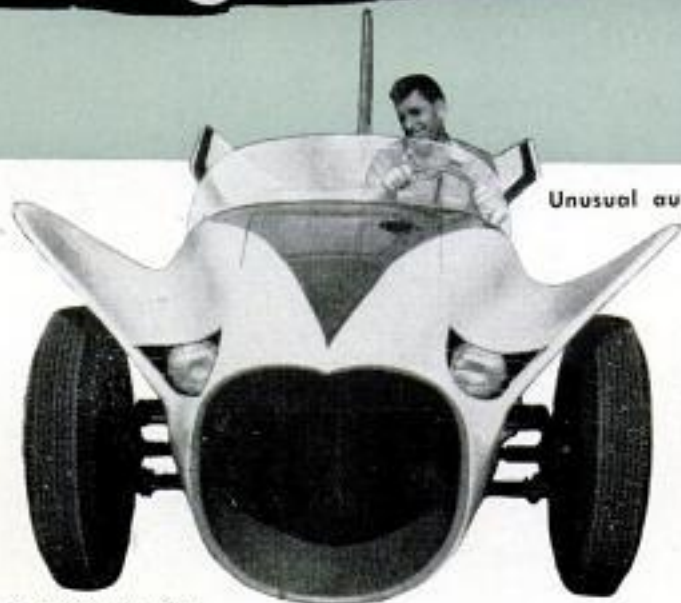

Burke Johnson photo

You'd expect the automobile "mascot" of an air squadron to be built of scrapped-aircraft parts. This time an ancient British car was transformed into a

Sabre Jet for the Road

RESIDENTS OF Phoenix, Ariz., are no longer startled when they drive along a highway and meet what looks like an F-86 Sabre Jet airplane coming at them. They know it's only the unusual automobile "mascot" of a nearby Air National Guard unit.

The aluminum three-wheel Sabre Jet car, with clipped winglike fenders, nose air scoop and tail section inspired by the actual aircraft, was entirely designed and built by members of the Arizona 197th "Copperheads" Fighter Interceptor Squadron. They did it in their spare time, involving 864 man-hours over a period of six months.

The project began when Lawrence Bell, assistant adjutant general of the Guard, saw a 1934 British-built B.S.A. (Birmingham Small Arms Co.) car for sale. It was a high, boxlike machine resembling a 1917 Dodge coupe, but he thought it could be fixed up as a squadron mascot and as a unique recruiting device that could be used

for parades and other special occasions.

When the car arrived at squadron headquarters and it was explained what General Bell had in mind, there was much shaking of heads among the men. But T/Sgt. Richard Bell, an artist and a squadron crew chief, grasped the idea and designed a body. Then someone thought of presenting the car to General Bell at the Copperheads' 10th anniversary celebration in six months.

So by the time the car was stripped to its essentials, it had grown into a squadron project. When the time came to build a seat, one of the men, an upholsterer, made it. The beautifully constructed body was provided by a pair of brothers, T/Sgt. Donald Cunningham and Capt. William Cunningham, a pilot. They own an automobile-body shop near Phoenix.

Although they came so close to the deadline that the car's paint was still wet, still it was ready for presentation to General Bell at the squadron's anniversary banquet. Later it was exhibited at a Phoenix auto-



Three-wheel Sabre Jet car was built of aluminum from an old British auto, can travel 80 miles per hour

mobile show, and attracted more attention than some of the new cars.

The car seats three passengers, and its top speed is 80 miles per hour. The water-cooled B.S.A. four-cylinder engine transmits power through a three-speed gearbox to the swing axles of the two front wheels. It will average 30 to 35 miles per gallon of gasoline and the tank holds 5½ gallons.

Suspension in front is by a system of transverse leaf springs, and the single rear wheel has a leaf-spring and tube setup. Shock absorbers are the friction type. The mechanical brakes work off the differential

in front, and are the standard drum and shoe in the back.

The body was fabricated from aluminum sheets, .064 inch in thickness, which were formed and welded over a frame of welded tubular aluminum. Then the body was sandpapered and lacquered.

The car's jetlike tail is 6 feet, 4 inches high and its over-all length is 17 feet, 4 inches.

The wheels are the same size, being a conversion of the B.S.A. center hubs and the rims from a 1952 Buick. The body rides only 5½ inches off the ground. ★ ★ ★

Three of the men who worked on the car are, from left: Thomas Bernard, Richard Bell, Donald Cunningham





Double Piggyback for Australian Trains

BECAUSE AUSTRALIA'S railroads run on five different gauges of track, broad-gauge trains sometimes carry narrow-gauge equipment to save the time and expense of unloading and reloading shipments. The double-piggyback train, above, was photographed at Copley, in South Australia. The map, below, shows the three

major track widths now in use. In addition, there are railways with gauges of 2 feet 6 inches, in Victoria, and 2 feet, in Queensland. Australia's multiple-gauge problem is the result of independent development of railways by the various states in the 19th Century. A campaign now under way would make 4 feet 8½ inches standard.

5-FT. 3-IN. GAUGE
 3-FT. 6-IN. GAUGE
 4-FT. 8½-IN. GAUGE
 OVERLAND HIGHWAY

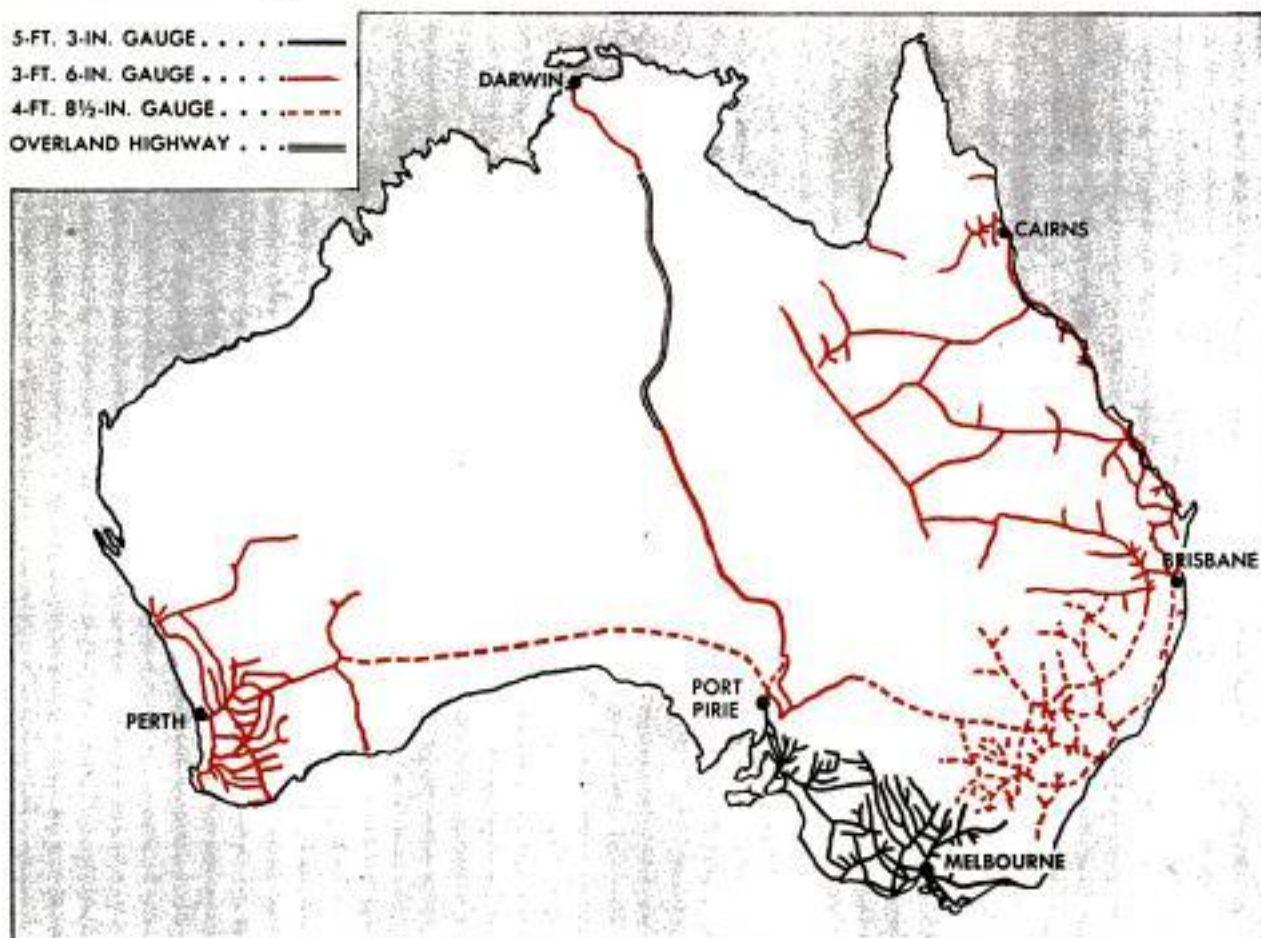



"Drag racing" the hard way. If the rider drops the rope or his partner slips off the hide, they lose the race

Field Day

IN THE SADDLE

WHILE OUR MOTORIZED AGE has virtually eliminated the horse from farm work, this beautiful friend of man has become one of his principal means of recreation. The modern equestrian can

have almost unlimited fun from the back of his horse.

He has become quite adept at devising new kinds of races and team competitions. A group of horsemen may get together for

By
F. Leland Elam

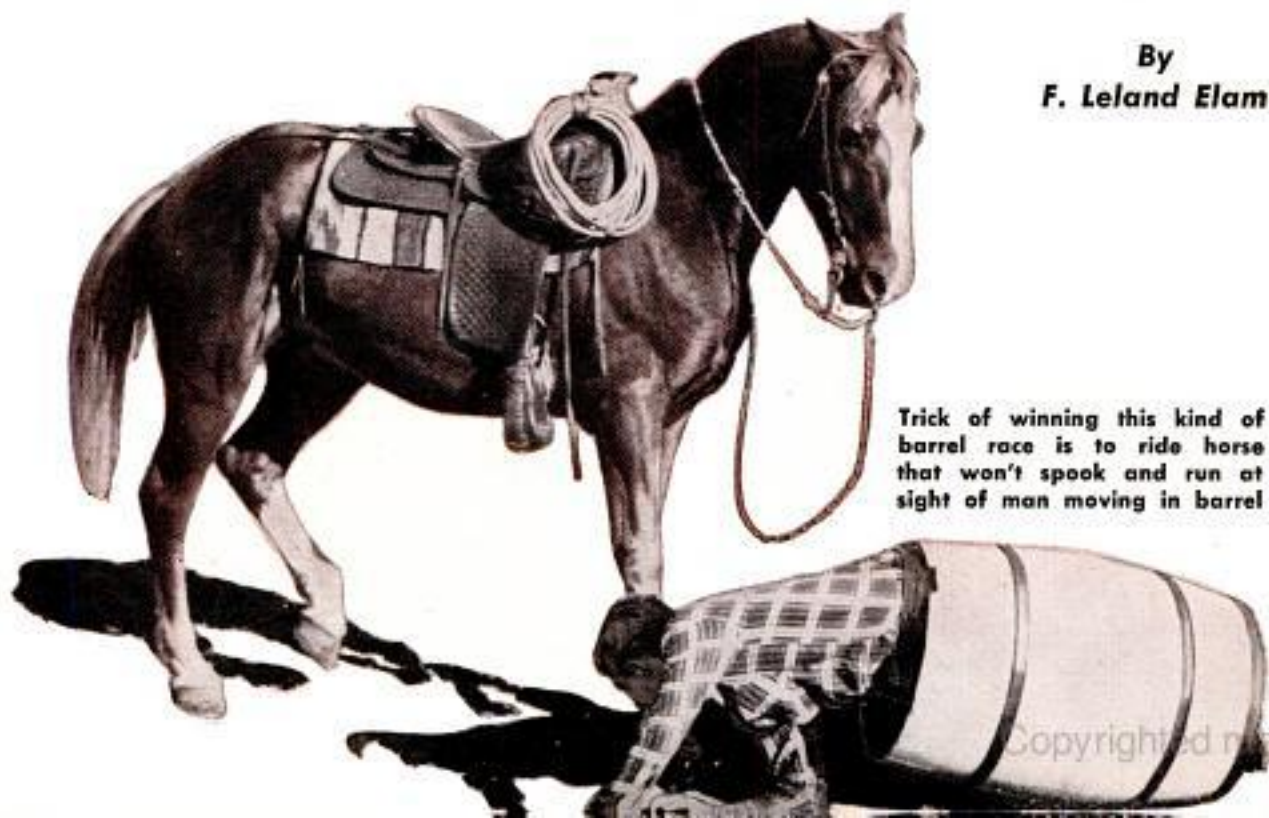

Trick of winning this kind of barrel race is to ride horse that won't spook and run at sight of man moving in barrel



Only the horses are allowed to touch the big ball as opposing teams try to push it across the finish line



In keyhole race, horse must dash through corridor, turn around, run out again without stepping over line

an afternoon of fun and put their horses through all kinds of competitive events. These are called play days. There is also the gymkhana which is set up as a definitely organized competition, similar to horse shows.

Play days generally include such events as team competition and exceptionally unusual races which do not fit into the gymkhana plan, as well as any of the gymkhana-type events. An excellent example of the team competition is "palmetto polo," a game developed by fun-loving horsemen in Florida. Some feel it is a legalized form of mayhem. It is a game similar to standard or society polo but with certain rules which make it more appealing to ordinary horsemen. Theoretically at least, it is less dangerous than the society





Ever try to spear a two-inch ring with a six-foot pole? You need complete control of horse, hand and eye

type of polo. But seeing one match will convince anyone that it is possible for a player to get his head battered.

The game is played with special mallets having a wedge-shaped hard-rubber tip and an air-filled rubber ball about 10 inches in diameter. The field is 240 feet long, 120 feet wide and divided into five

zones. One man from each team is in each zone and cannot cross the dividing lines. Goals are scored as in normal polo, by knocking the ball between goal posts at either end of the field.

In most places where this game is played the arenas are dry and dusty. This adds a certain something to palmetto polo that high-society polo doesn't have, namely dust. It is not unusual for the ball, or on

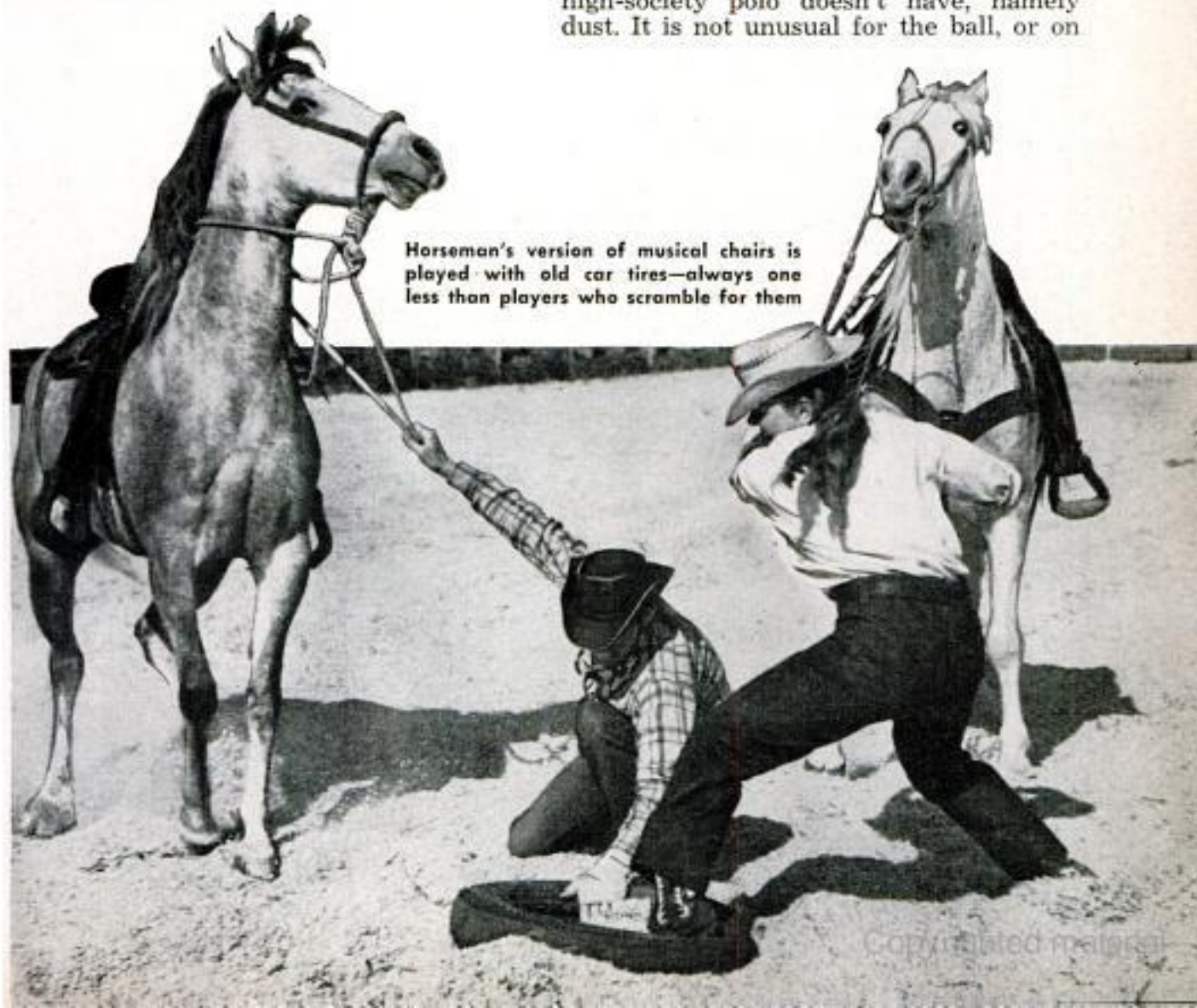

Horseman's version of musical chairs is played with old car tires—always one less than players who scramble for them

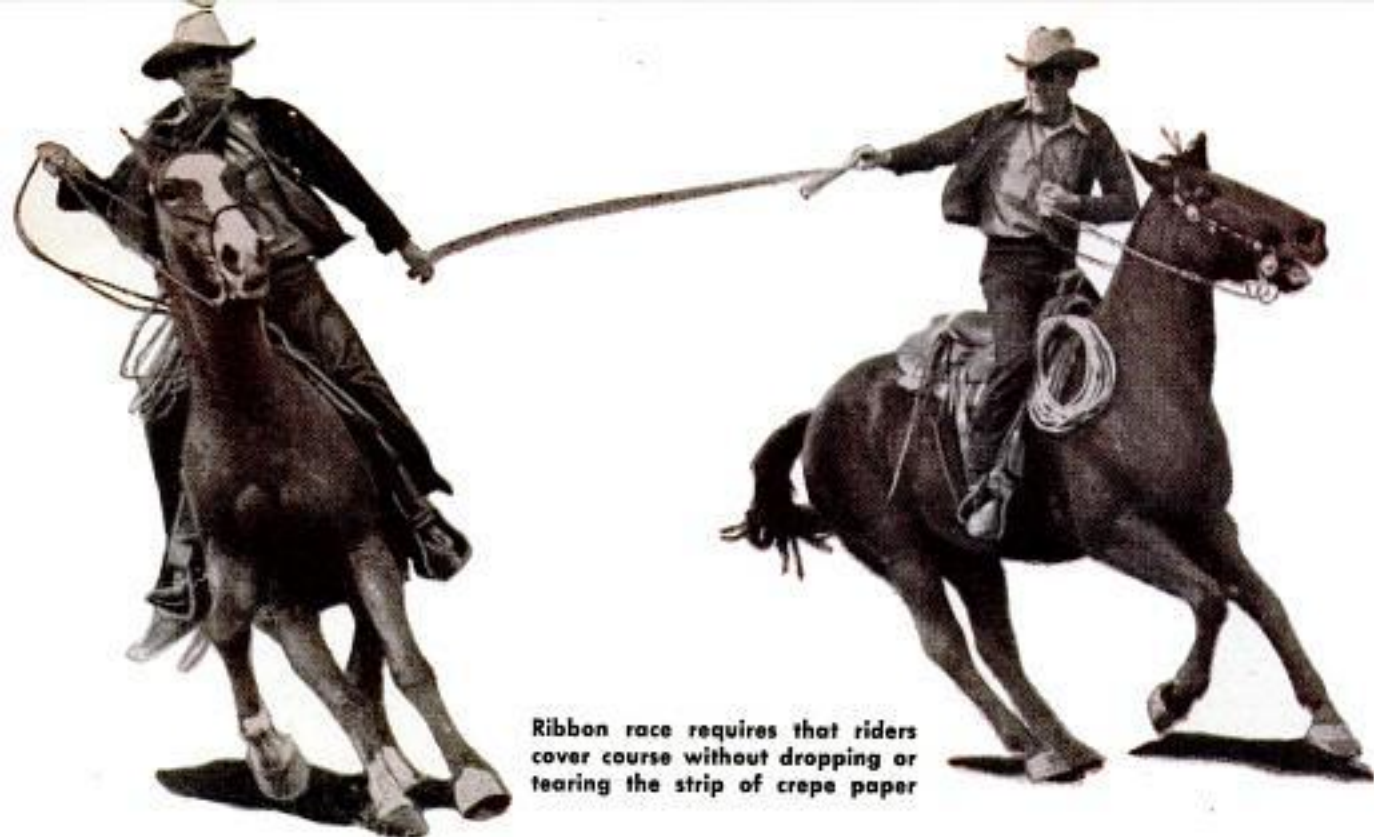

Ribbon race requires that riders cover course without dropping or tearing the strip of crepe paper

occasion even a player, to get lost in clouds of dust.

The original gymkhana were old Anglo-Indian (East Indian) meets where various types of races were held. These races were short and perhaps were the foundation from which developed the modern quarter-mile dash for quarter horses. Later a second variety, the pagol, or "funny races," were added to the meets. The Indian term pagol has been dropped and all such races come under the category of the gymkhana.

One game that has become quite popular in the Western states is pushball in which a giant leather air-filled ball, obtained through war-surplus stores, is pushed about a field by teams of five men. To start the game, the ball is placed in the center of the field. The teams rush toward it and attempt to push it across the goal line of the opposing team. Pushing is done by horses only and they seem to thoroughly enjoy the experience. The game is played in 10-minute quarters. The team scoring the most goals wins.

The usual events in a modern gymkhana include ring spearing, five-man relay, key-hole race, pole bending and quadrangle stake race. To these are generally added some of the funny races.

In pole bending and the quadrangle stake race, upright poles are used as markers to guide the horse along the proper course. The poles used in all such events are round pine, 1½ inches in diameter and 7 feet high. The bottom is inserted in a stand that will hold the stake rigid but which will tip when hit by animal or rider. One of the best methods of holding the pole is to insert it in a can filled with concrete.

In the quadrangle stake race, the course is around four stakes placed in the form of a 25-yard square. Two stakes in the center, 5 yards apart, form the starting line. A running start is made from 20 feet back. The first two turns are left turns around stakes, then passing down through the center stakes again and the last two turns are right turns. The finish is when the rider passes between the two center stakes again. There are two-second penalties for knocking down a stake or touching any stake with the free hand.

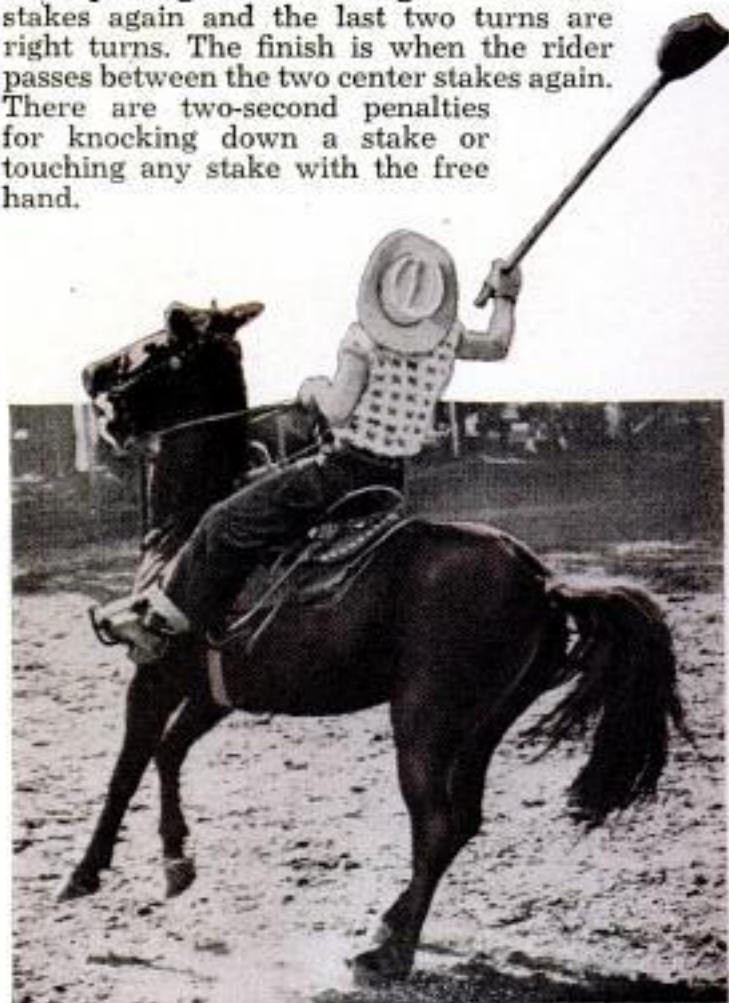



Rider going over pole-bending course swings to the left of one pole, then to the right of the next pole

The course in pole bending is 100 feet long, with six poles in a straight row spaced 20 feet apart. A contestant moves to a starting line 20 feet back from the first stake and is then on course. The rider may pass the first pole on either side, then pass successive poles on alternate sides, turn the sixth pole and return in the same manner. Start and finish timing is done as the horse's nose passes the pole. The timer lines

up at the first pole. Penalty is two seconds for either knocking a pole down or touching it with a free hand.

The keyhole race is an event that is unusually good for turning a horse in a small area. The course is shaped somewhat like a huge keyhole. There is a 20-foot-diameter circle. Entry to the circle is via a four-foot-wide, four-foot-long corridor. The keyhole

(Continued to page 238)

Polo with brooms, less dangerous than mallets, is widely enjoyed





Doughnut Plane Waits for Helium

When inflated with helium, this doughnut-shaped plane is expected to travel straight up, hover and fly horizontally at speeds up to 50 miles per hour. Jim West of Atlanta, Ga., the plane's inventor, used a vacuum cleaner to inflate the aircraft's wing for demonstration. However, government restrictions on helium have grounded Jim and his plane indefinitely.

Pupils Study Math With Calculators

Fifth grade pupils at Cedar Grove, N. J., Memorial School use pint-sized calculating machines to help them learn to add, subtract, multiply and divide. Educators claim children using machines gain half a year in computation and reasoning over pupils taught by conventional methods. Students work problems first by pencil; check answers on the machine.



Does Harry Graus Have the World's Smallest Garden?

Raising plants in thimbles and caps from toothpaste tubes and bottles is a hobby for Harry Graus of Brooklyn, N. Y. He waters with an eye dropper, rakes with a tooth-

pick, and uses a barley-and-tea fertilizer mixture. Below left is his coleus and ivy plant in a thimble. Below right, he waters his boxwood plant.





Sikorsky S-55 helicopter makes simulated emergency landing on water with inflated, rubberized "doughnuts"

Landing Helicopters Depend on "Doughnuts"

INFLATABLE LANDING GEAR now permits helicopters to alight safely on water or ground in routine and emergency situations. Power for the flotation equipment flows from a supply of 3000-pounds-per-square-inch compressed air. This is stored in a 900-cubic-inch steel or glass-fiber sphere in the copter. The pilot pushes a button in the cabin to work electrically a valve that allows compressed air to flood via pneumatic line to each wheel. Here, the air discharges from perforations in a ring-shaped unit and forces free air to inflate four rubberized-nylon-fabric landing "doughnuts." At 1¼-pounds-per-square-inch pressure, the rear floats contain 66 cubic inches of air, while the nose floats—planed for taxiing—contain 58 cubic inches of air. Full inflation requires four to five seconds. The self-regulated pneumatic apparatus, weighing less than 50 pounds, prevents over and under-inflation. With floats, the entire system totals 170 pounds. After each doughnut landing, the floats are manually deflated after which they are re-folded for future use.

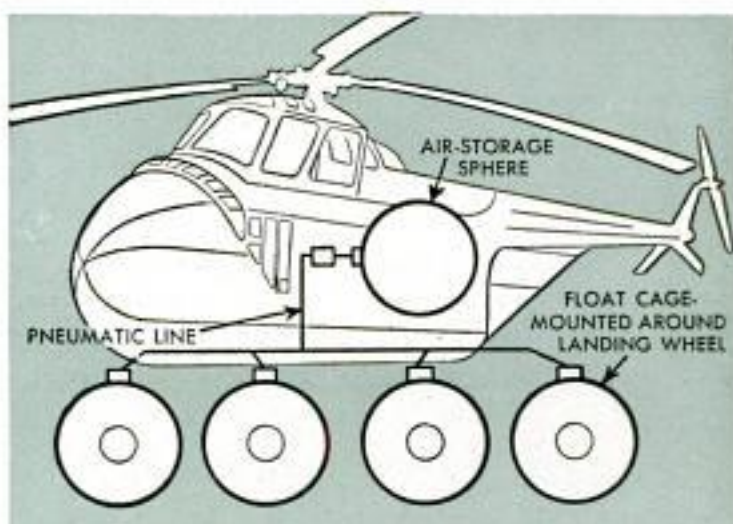

Above, diagram indicates storage chamber with 3000 pounds per square inch of compressed air and pneumatic lines to floats around wheels. Below, copter uses floats in ground landing



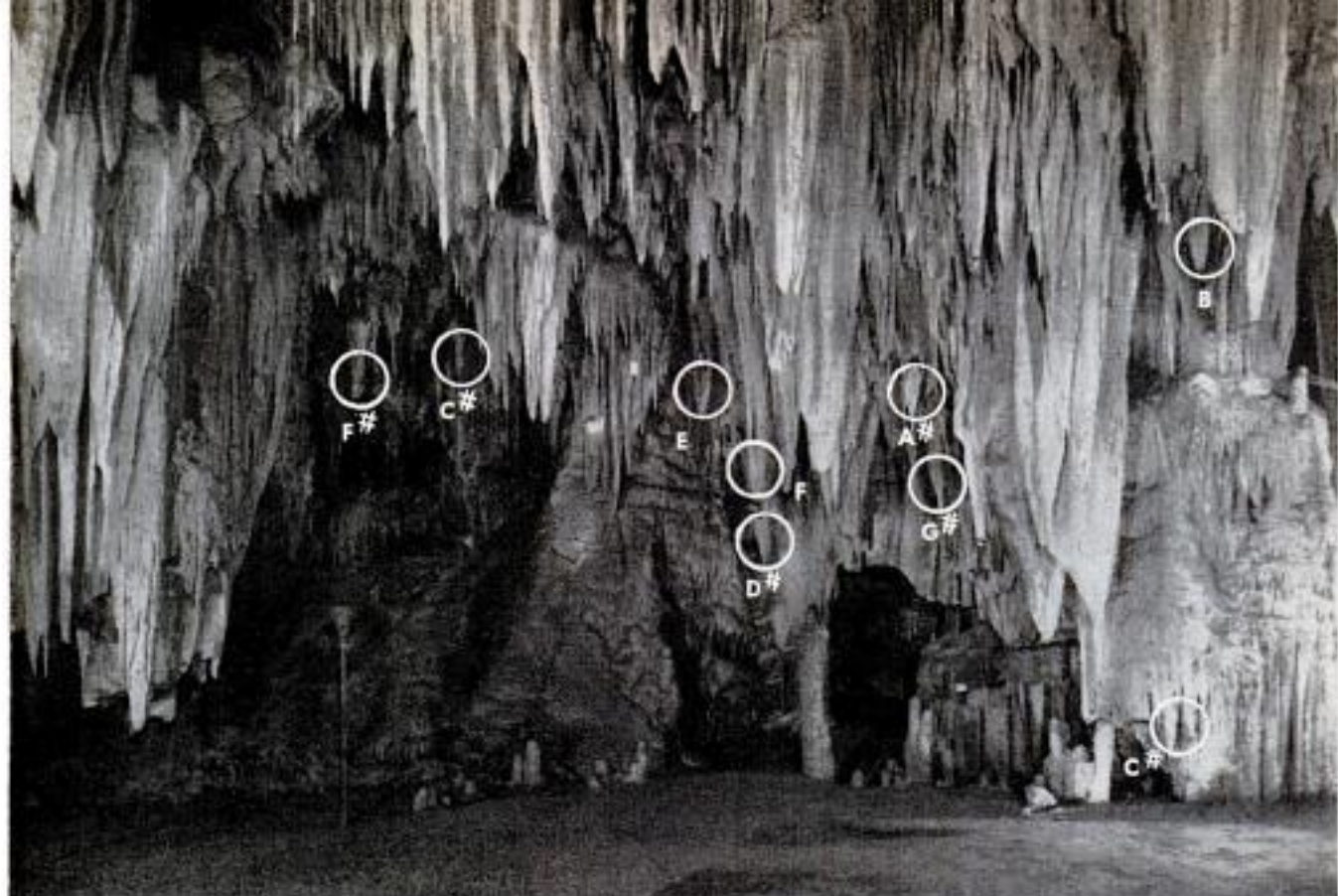

Heart of organ is the huge "ballroom." Circled stalactites are carefully selected for their tone and pitch

The Organ That

Inventor Sprinkle, who is also an accomplished organist, sits at console deep underground. Stalacpipe Organ covers 2½ acres

By F. Dorothy Wood

THREE YEARS AGO a distinguished scientist took his young son to Luray Caverns, in Virginia, as a special treat on the lad's fifth birthday. During the escorted tour of the cave, their guide struck a stalactite at just the right spot to bring forth a deep, rich musical tone. To the scientist, who is also an accomplished musician, the sound was the vibrant, rich tone of an organ.

From this incident has come one of the world's most impressive musical instruments, the Stalacpipe Organ. Today, as you walk through the great "ballroom" of the cavern 250 feet down, you literally walk into the heart of this remarkable instrument, for you are surrounded by stalactites that play the individual tones. Visitors stand enthralled as melody and chords play all around them. No tinkly tunes these, but full-throated music rolling through the cavern.

The man who visited the cave that day with his five-year-old son



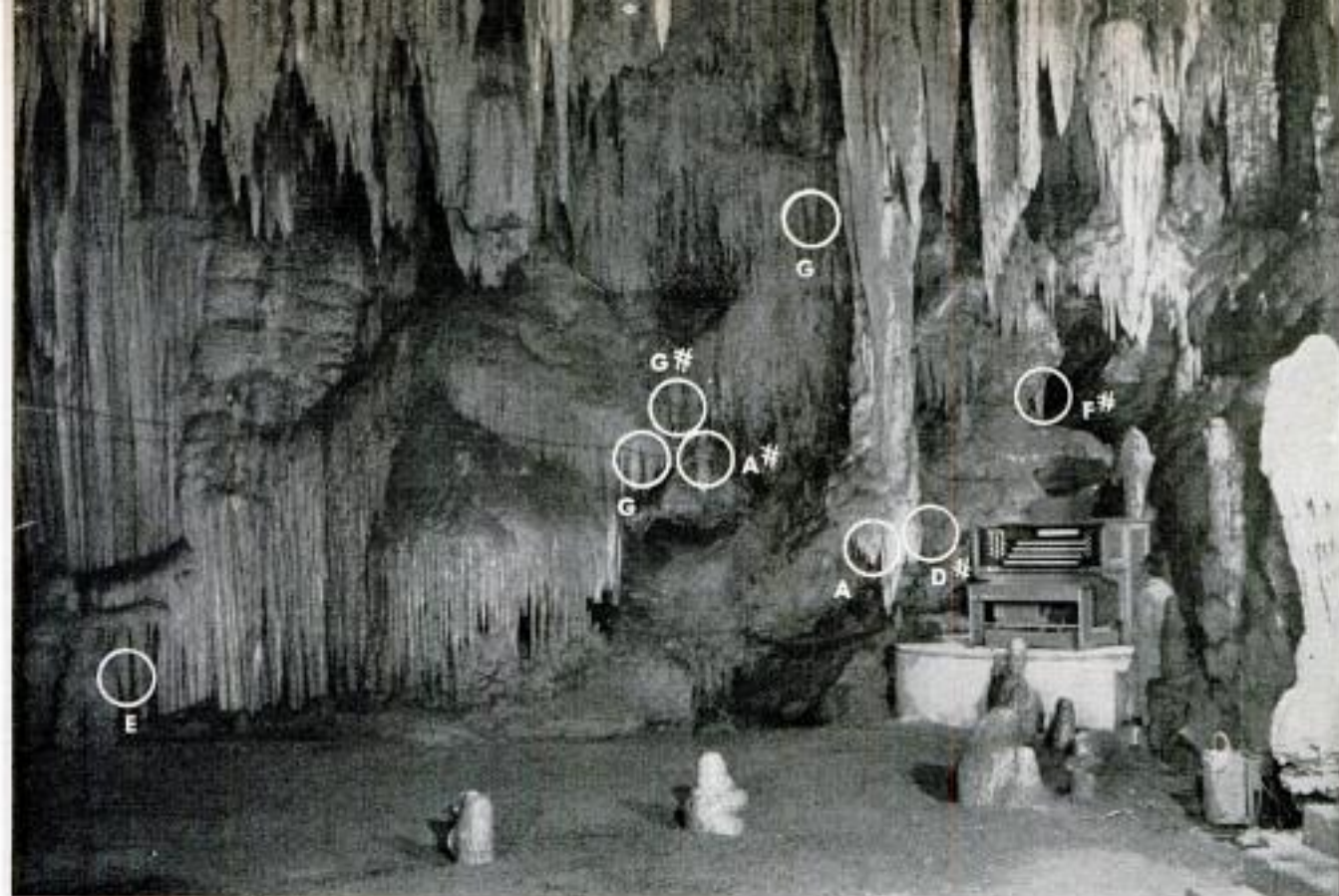

Plays Stalactites

Photos by Michael Lackovitch

is Leland W. Sprinkle, electronic scientist at Air Force Headquarters in the Pentagon, with a full-time job that includes operation of the Air Force UNIVAC. For the past three years he has spent every spare-time minute developing and building the Stalacpipe Organ.

Basically, the music is produced by rubber-tipped plungers striking stalactites Sprinkle has carefully selected. The plungers, electrically powered and electronically controlled, are actuated in one of two ways: Manually, by playing the console, which is very much like that of a standard organ; or automatically, by turning a plastic belt into which holes have been melted.

To Sprinkle, the organ is far from finished despite its ability to produce fascinating music. He feels, after three years of work, that he has made a fairly good start!

Now in operation are three octaves of an ultimate five, in one division, and a few additional tones

Sprinkle grinds a stalactite to bring it up to exact pitch. Skillful grinding frequently improves the tone quality, too





Visitors literally stand in the middle of the organ as they listen to combinations of stalactites sound chords around them

Rubber-tipped plunger, triggered by solenoid, strikes stalactite a sharp blow to produce the tone, precisely on pitch

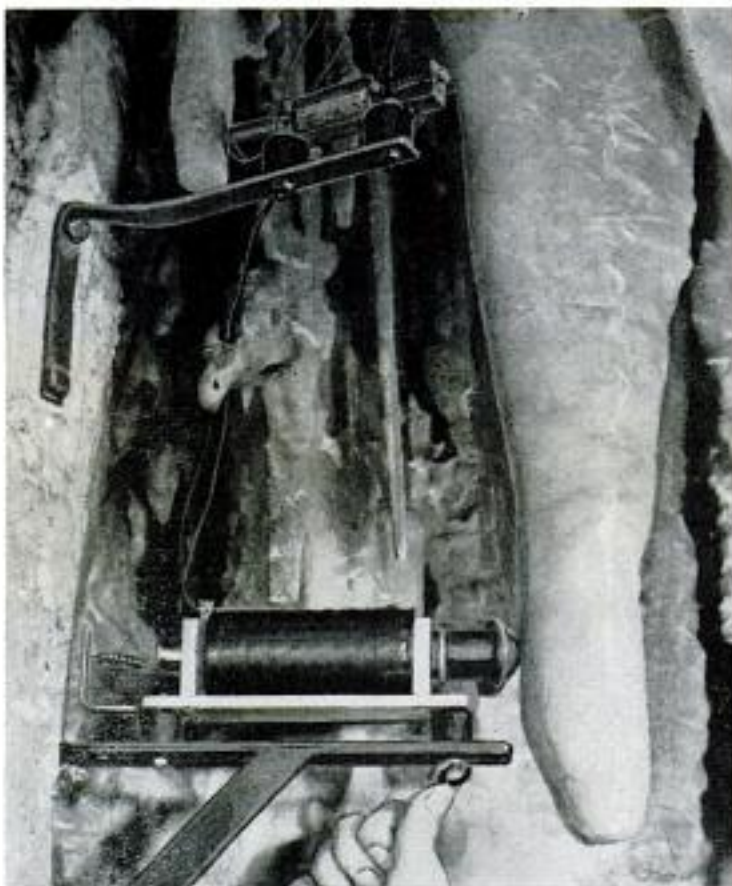

and couplers. This is about $\frac{1}{50}$ of the console's potential. Sprinkle selects, tunes and wires a separate stalactite for each note of every octave, and each flat or sharp.

Finding the Stalactites

First he prospects the walls for a stalactite that is highly resonant. Not all of them are; in fact, only an occasional one produces a tone beautiful enough to make it a candidate. (The most beautiful formations are likely to be duds, musically.) Sprinkle tests a potential "prize" with a tuning fork to see if it comes near a desired pitch.

Once such a stalactite is found, one other requirement must be met: There must be a neighboring formation near enough so that a plunger can be attached to it, since no wiring or metal can come in contact with the vibrating pipe.

Then Sprinkle brings the stalactite to exact pitch by grinding it at the tip to shorten it. Sometimes the amount taken off is quite a chunk, sometimes only a fraction of an inch. The gauge used here is no tuning fork but a set of precision oscillators, to which each note is compared directly and brought to exact concert pitch.

With the pipe in tune, Sprinkle next mounts the plunger assembly, a tailor-made solenoid. The plungers themselves and their tips vary in size according to the structure of the stalactites.

When the solenoid is securely in place, it can be fired by a quick burst of direct current. The plunger shoots forward, strikes the stalactite and springs back to cocked position. Result: A clear, vibrant tone, loud or soft depending upon the force of the blow. With an octave of these, you can finger out a tune; with three octaves the Stalacpipe Organ is born.

But an organ is an instrument of great versatility, producing at one moment the volume and incredible range of a magnificent choir, at another the isolated, pure tones of a solo flute. How could solid rock be employed to develop a comparable versatility?

Five Divisions on Console

To answer this challenge, Sprinkle has installed five divisions on the Stalacpipe Organ's



Unknown passage through the cave was discovered when assistants searched for route to lay electrical cables

console: Cathedral, solo, echo, pedal and harmonic. These are tailored not only to meet the special handicaps of the cave, but to take advantage of its opportunities. It is a real experience in stereophonic sound to stand in the heart of the instrument and listen to harmonic or cathedral effects roll in from all directions.

The console itself, manufactured to order by the Klann Organ Supply Company, has stops that are not named but numbered, to match the numbered ranks of stalactites.

Numerous stalactites for virtually all stops have been tuned and tagged and will be used in additional development. The present organ covers about 2½ acres; the potential organ, through use of speakers, could cover some 64 acres. Sprinkle hopes to continue the development with the aid of Grafton Campbell and Julian Taylor, two young men from the cavern's staff who have helped him for the past three years.

High above the ballroom is the control room of the organ, a cavern about the size of Constitution

(Continued to page 242)

Each octave has a separate electronic assembly on the control platform. Roll of punched plastic is recording of organ number

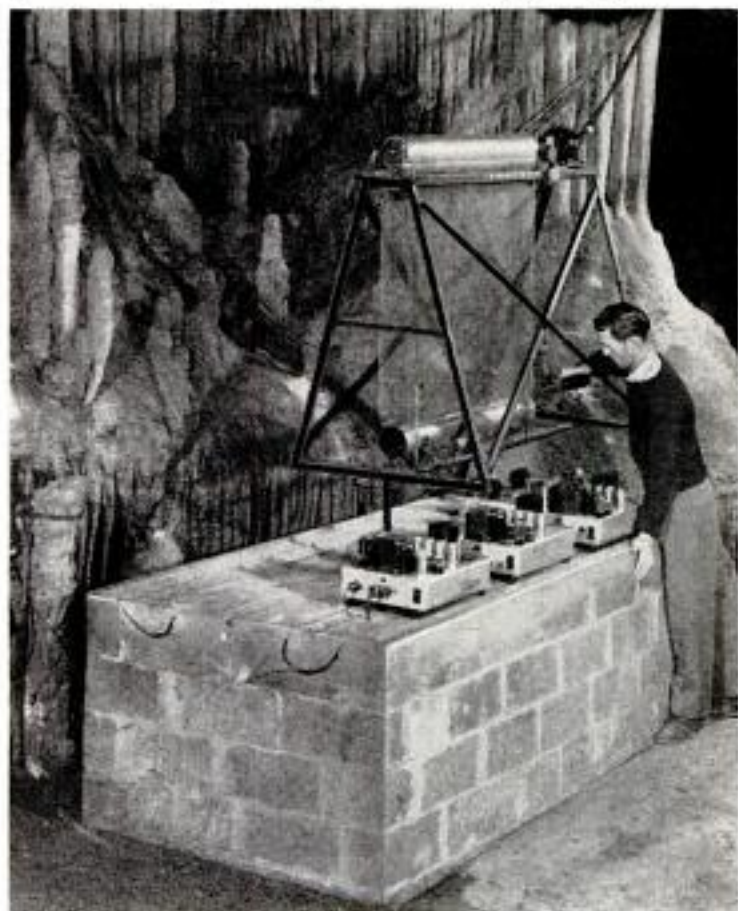



Ladder Platform and Hoist Provide Convenient Workspace

Erection of a 30-pound metal platform on the top of a standard ladder will provide convenient workspace. A hoist attachment facilitates raising of tools and materials to a worker on the platform. One man can



build the "shelf" in a few seconds. Made of rustproof magnesium, the three-by-three-foot unit folds compactly for transport or storage. Two ladders and two platforms can serve as the base for a plank scaffold.

Nylon Saves Weight for Navy

By using molded nylon in certain electrical fittings on aircraft carriers, the Navy is saving 30 to 45 tons of weight in each new carrier.

Air Conditioning From Paper

Wastepaper fires a boiler that generates steam to operate a 700-ton air-conditioning system for a department store at White Plains, N. Y.



Archer Shoots Telephone Lines Across Canyons

Modern day Robin Hood in the photo, left, is about to shoot an arrow to another telephone pole, 400 feet away. Attached to the arrow is a nylon line which is fastened to a rope. The rope, in turn, is attached to a telephone wire. The archer helps the Pacific Telephone Company string wire across California canyons infested with rattlesnakes and poison oak. The nylon line uncoils at the rate of 150 feet per second as the arrow pulls it over the terrain, so rugged that even the 30-foot poles have to be carried to the site on the shoulders of linemen.

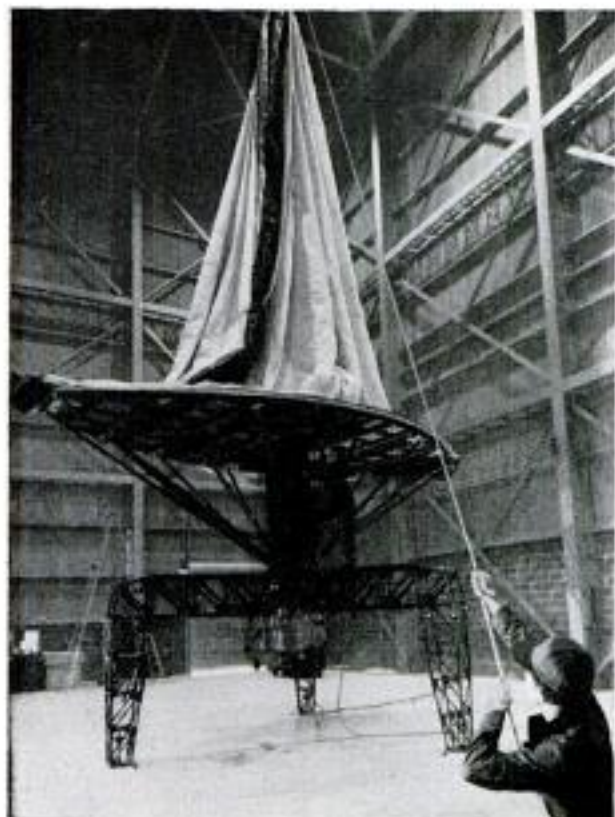

Designed for air-drops in combat areas, this antenna weighs 1690 pounds, compared to 10,000 pounds for equivalent existing metal antennas and supports

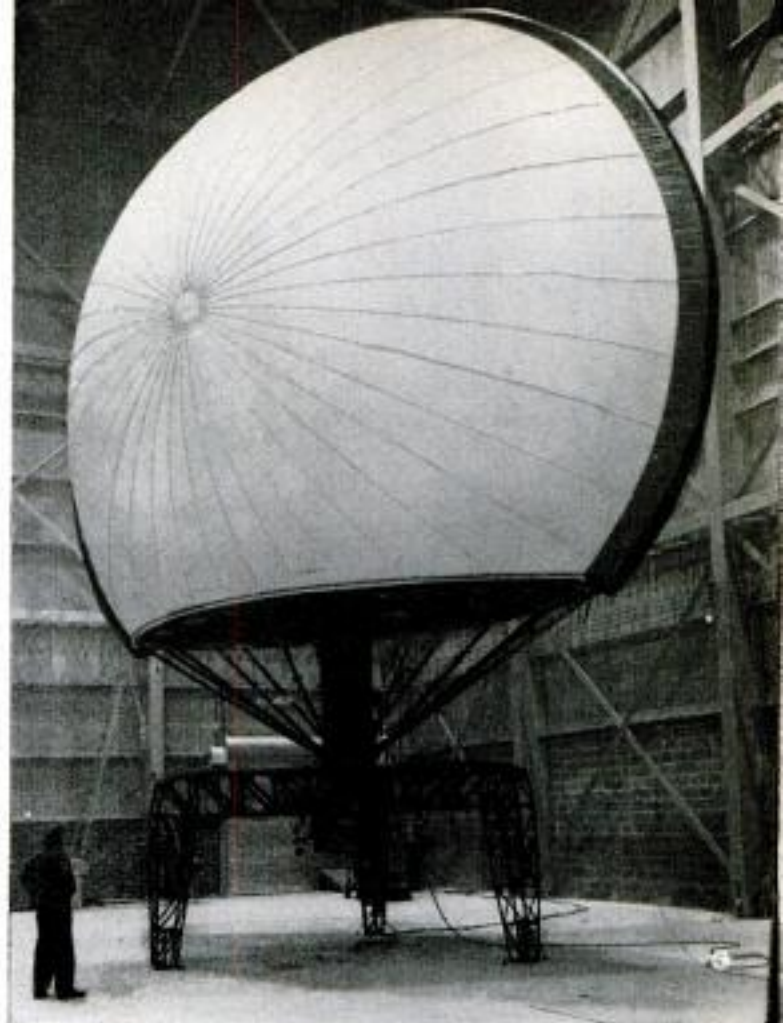

Air-Dropped Radar Antennas Are Inflated at Combat Area

Inflated radar antennas made of vinyl-coated glass-fiber cloth can be air-dropped into tactical areas with lightweight radar sets. Protected by an air-supported radome, 30-foot-high antennas detect hostile aircraft. A magnesium structure supports the antenna, which is preformed to the shape of a double parabolic reflector coated on one inside surface with vaporized alumi-

num to reflect radar waves. This antenna weighs 1690 pounds, compared with 10,000 pounds for equivalent metal antennas and support structures. Disassembled in minutes and packed in 200-pound, airlift containers, the antenna, radome and radar elements are dropped on a target. Gunfire will not easily disable these units, as a constant stream of air maintains inflation.

Mobile Half-Track Radio Station

Radio news broadcasts, ranging from sports to disaster topics, originate from a rebuilt Army surplus half-track vehicle operated by station WHLM of Bloomsburg, Pa. The mobile unit has its own radio equipment and generator, soup kitchen, refrigerated food, medical supplies and an emergency heater.

Old Wood Strong as New

Recent testing of the floor joists of a 105-year-old building in Washington, D. C., prove that old wood is just as strong as new wood, the U. S. Forest Products Laboratory reports.



OWNERS REPORT:



Dodge owners in 42 states took part in this Owners Report

CORONET SIX

Over-All Rating

Excellent	Average	Poor
44.7%	36.7%	18.6%

THE OWNER of the low-price Dodge Coronet Six is less happy with his car than the V8 owner. However, he is more satisfied with its gas economy.

He is less enthusiastic about the car's good points than the V8 owner and seems to get poorer service from his dealer. He praises Dodge's exterior styling most of all and complains most about water leaks.

HERE'S WHAT DODGE SIX OWNERS SAY

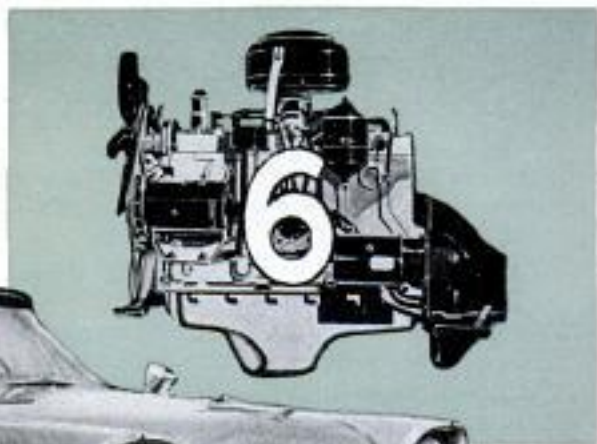

HERE'S WHAT DODGE V8 OWNERS SAY

THE OWNER of the low-price Coronet V8 has had less trouble than the Six owner. He is well-satisfied with the car's top speed and acceleration.

He bought his Dodge because of its sleek styling and he generally approves of the styling trend of the industry. He would like better workmanship in his next Dodge and also more gasoline economy.

CORONET V8

Over-All Rating

Excellent	Average	Poor
53.9%	39.9%	6.2%



Seitzmann photo

Dodge owners complain most about water leaks. Here, a four-door sedan is undergoing the PM splash-pan test

Owners Praise Dodge's Styling, Handling Ease

By Dodge Owners

NORMALLY, A PM Owners Report asks owners in all price levels about their cars—from the cheapest model in each line to the most expensive. This coverage provides a sampling of what any buyer can expect.

But in our 1957 Dodge survey, all owners are in the low-price Coronet line. This is Dodge's price leader. It is only \$100 or so above the "low price three's" deluxe models.

By limiting our survey to Coronets we can compare the relative merits of the Six and the V8 because Dodge offers the Six only in this price class.

Which is the better value for the money, the Six or the V8? Is it smart to buy a low-price model in any line? We hope this survey will help answer these questions.

Our Dodge Owners Report does show there is apparently more reason than just power for the increasing demand for V8 engines. In virtually every category, Dodge V8 owners are happier with their cars than owners of the Dodge six-cylinder models.

"Excellent over-all," is the way 53.9 percent of the V8 owners describe their cars (compared with 44.7 percent of the six-cylinder owners). "Poor over-all," say 6.2 percent of the V8 owners (compared with 18.6 percent of the six-cylinder owners).

It is this way all along the line. The V8 owners like their cars better than the six-cylinder owners, apparently with reason.

Nearly twice as many six-cylinder owners as V8 owners have had "considerable" engine trouble (12.3 percent for the Six, 6.2 percent for the V8). It appears that the six-cylinder engine is not as trouble-free as you would assume.

Generally, though, these owners register the same likes and dislikes. The differences are of degree only, for the most part. Both groups state overwhelmingly that they bought this new Dodge because of its styling: 44.1 percent of the V8 owners and 35.7 percent of the six-cylinder owners say styling is the one feature that most convinced them to buy Dodge.

Previous ownership ranks second with both groups of owners, although only half as many V8 owners give this reason as six-cylinder owners.

The best-liked feature of both Six and V8 owners is also exterior styling. Here again the V8 owners are more enthusiastic. Six-cylinder owners place riding comfort second on the best-liked list, handling ease and roadability third and fourth in that order.

V8 owners place handling ease second, riding comfort third and power or performance fourth on the list.

As you might expect, performance failed to place very high on the six-cylinder list, being in tenth place.

Also as you might expect, more owners of the six-cylinder models want faster acceleration (although the figure is only 28.8



Owners praise Dodge's styling highly, but complain about the narrow opening into the rear seat. There is only nine inches clearance with door wide-open



Dodge taillights extend almost as far back as bumper, making them extremely vulnerable to damage

By mounting the spare far forward, Dodge provides a trunk big enough to swallow up a full-size bicycle

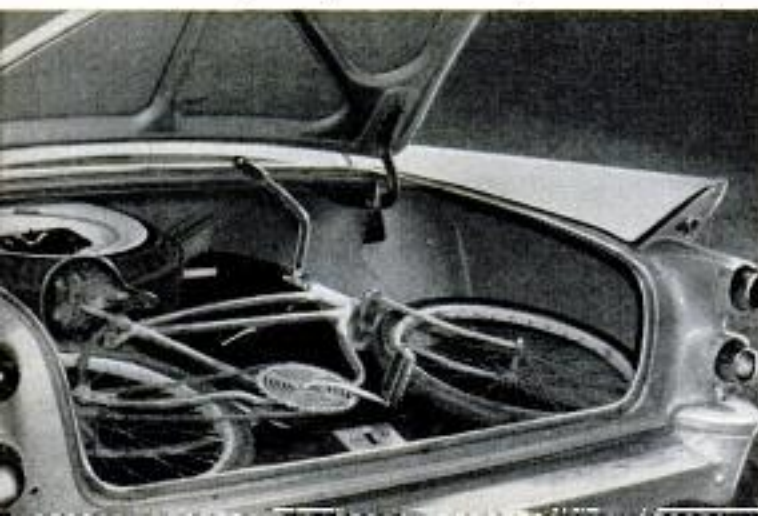

percent at that). Only 18.2 percent of the V8 owners ask for more acceleration.

As for higher top speed, neither group seems to want it very much, 10.8 percent of the six-cylinder owners and 8.5 percent of the V8 owners requesting it.

Both groups want the entire industry to provide better body workmanship. V8 owners want more miles per gallon and many six-cylinder owners want even less horsepower. There is a surprisingly important percentage in each group that would like the industry to build smaller cars.

The Owners Talk

Here are quotations that illustrate what the owners have to say, good and bad, about their 1957 Dodges:

"I like its advanced styling. It makes other cars look like ice wagons built in the year 1900."—Texas salesman.

"During three months' ownership I have almost daily had passers-by take unusual notice of car. Could be termed a 'head turner.'"—Massachusetts engineer.

"I gave my wife a choice of anything less than Cadillac's price. She took to the Dodge looks and I can't say that I blame her."—Arkansas physician.

"You only have to sit behind the wheel and all the world stops, watches and admires. You feel like a king, you are so proud."—Ohio widow.

"Handles like a baby carriage."—New York inspector.

"Easy to handle on the road and you don't have a tired feeling after a long trip."—Missouri airline employee.

"Easy for a woman to handle. Never seems bulky."—Illinois owner.

"Completely relax when driving it."—Illinois telephone employee.

"Particularly like the way the car rides. No swing or sway."—Ohio foreman.

"Like the Torsion-Aire ride most."—Illinois farmer.

"Excellent power and getaway in the V8 engine."—Ohio housewife.

"V8 engine gives me the jump I want to

Much of the glove box is useless because the hinges are apt to crush whatever you put in it, say owners

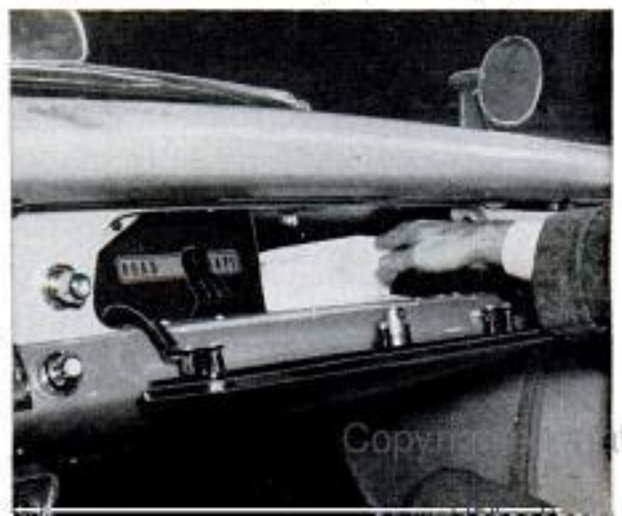

take off. Am not interested in speeds over 65, merely the jump."—Maryland student.
 "Feeling of security on curves at high speeds."—Illinois factory manager.
 "I get a feeling of being part of the car."—Wisconsin forester.

But They Complain

"The car leaks water. It's impossible to sit in right-front seat in even the mildest storm."—New York teacher.

"It is necessary for me to wear boots to use the car on rainy days."—Florida housewife.

"Leaks. During winter months, there were blocks of ice six inches high on each side inside the trunk."—Illinois teacher.

"Ruined \$200 worth of vitamin samples because trunk gets flooded in any rain."—Rhode Island salesman.

"Designers did a fine job on the body, but they ought to spend a little more time on building the car better. Body construction and painting carelessly done. If the car was inspected, which seems unlikely, someone is guilty of gross negligence."—Chicago janitor.

"I, myself, put in nine bolts that were missing. Dodge should have been ashamed to let my car pass inspection."—Maryland owner.

"Poor attention to interior finish. Padded dash material cut too short and has pulled away from windshield molding. Roof upholstery cut too skimpy, pulled away."—New York accountant.

"Low gas mileage. With gas prices on the increase and miles per gallon on the decrease I have been toying with the idea of buying a foreign car."—Texas engineer.

"Gas mileage very poor. I will not buy another car that doesn't get over 13 miles per gallon if I can help it."—Illinois farmer.

"The salesman sold us on the Six (we preferred the V8) because of gas economy. We have found that the Six burns nearly half again as much gas as the V8."—Texas bookkeeper.

"Rattles. Also can't stop brakes from squealing."—New York bookkeeper.

"Brake drums had to be turned at 800 miles, at 1300 miles and are still not right."—Colorado Air Force captain.

"Quite a lot of paint chipping."—California owner.

"Had a defective coil which made this six-cylinder engine hard to start."—Minnesota businessman.

More Compliments

"Window area is surprising. It seems at first almost like sitting outdoors."—Vermont electrician.

"Corners beautifully at high speeds. No

(Continued on page 228)

What Coronet Owners Say About the 6 V8

Had trouble with engine!		
No trouble	59.1%	69.1%
Some trouble	28.6%	24.7%
Considerable trouble	12.3%	6.2%
Would like faster acceleration!		
Yes, would	28.8%	18.2%
No, would not.....	58.6%	72.5%
Undecided, no answer.....	12.6%	9.3%
Would like more top speed!		
Yes, would	10.8%	8.5%
No, would not.....	54.5%	73.3%
Undecided, no answer.....	34.7%	18.2%
How is dealer service!		
Excellent	34.6%	36.4%
Average	30.8%	40.5%
Poor	34.6%	23.1%
Would buy from him again!		
Yes, would	33.2%	38.9%
No, would not.....	37.8%	26.3%
Undecided, no answer.....	29.0%	34.8%
What car will buy next time!		
Another Dodge	35.0%	46.2%
Other Chrysler product.....	14.1%	8.5%
General Motors make.....	12.0%	9.3%
Ford Motor make.....	4.7%	4.5%
Other makes	4.7%	3.2%
Don't know yet.....	29.5%	28.3%
What make was traded this time!		
Another Dodge	32.9%	27.1%
Other Chrysler make.....	21.4%	17.0%
General Motors make.....	15.4%	25.1%
Ford Motor make.....	10.2%	15.8%
Other make	8.1%	6.5%
No trade, no answer.....	12.0%	8.5%
Why did they pick Dodge!		
Exterior styling	35.7%	44.1%
Previous ownership	20.0%	11.2%
Price	4.3%	5.6%
Trade-in allowance	3.8%	4.3%
What should be changed!		
Nothing at all.....	25.2%	33.5%
Wider-opening rear door.....	13.8%	5.0%
Better body work.....	12.4%	13.7%
Improve seat design.....	1.4%	9.9%
Rear-view mirror	7.1%	5.0%
Stop body leaks.....	5.7%	5.6%
Lower floor hump.....	5.2%	5.6%
More gas economy.....	1.7%	5.6%
Best-Liked Features		
Exterior styling	34.3%	44.7%
Riding comfort	31.4%	36.0%
Handling ease	24.8%	37.9%
Roadability	16.2%	18.6%
Visibility	15.2%	13.0%
Performance, power	8.1%	26.1%
Most-Frequent Complaints		
None at all	17.6%	14.3%
Water leaks	37.6%	34.8%
Poor body assembly	21.4%	19.3%
Rattles	14.8%	13.7%
Speedometer trouble	10.5%	7.5%
Brake trouble	9.0%	11.2%
Poor gas economy	8.6%	18.6%
Do They Approve Industry Style Trends?		
Yes, approve	75.2%	87.0%
No, disapprove	11.7%	8.5%
No answer	13.1%	4.5%

An Engineer Analyzes the 1957 Dodge V8

By Dale Kelly SAE, Registered Professional Engineer

MODEL TESTED: Four-door sedan with D-500 engine, four-barrel carburetor, dual exhausts, TorqueFlite automatic transmission, power steering and power brakes.

Rear-axle ratio: 3.18 to 1. Wheelbase: 122 inches. Tires: 8.50 by 14. Weight: 4122 pounds with gas

tank half-full (56 percent of weight on front wheels, 44 percent on the rear).

Mileage on car at time of test: 650 miles. Barometer: 29.10 inches. Temperature: 68 degrees F. Pay load: 200 pounds.



ACCELERATION TIME FROM STANDING START IN SECONDS

	0 to 20	0 to 40	0 to 60	0 to 80	¼ mile
Ignition timed for regular gas (90 octane Research)	2.7	7.6	12.3	22.0	18.8
Ignition timed for premium gas (97 octane Research)	2.5	7.3	11.7	21.0	18.5
Ignition timed for super fuel (105 octane Research)		7.3	11.5		



FUEL ECONOMY IN MILES PER GALLON

	Steady 30 m.p.h.	Steady 50 m.p.h.	Steady 70 m.p.h.	Traffic Route
Ignition timed for regular gasoline (90 octane Research)	19.6	15.9	13.0	10.0
Ignition timed for premium gasoline (97 octane Research)	19.0	16.2	13.7	9.7

On the traffic route the car makes 10 full stops per mile and is driven fast enough to average 15 miles per hour.

ESTIMATED AVERAGE ANNUAL GASOLINE BILL: \$193 for 10,000 miles



SPEEDOMETER ERROR (Miles per hour)

Speedometer speed	20	30	40	50	60	70	80
True speed	22	31	41	50	58	68	77

ODOMETER ERROR

Distance registered for an actual 100 miles: 104.5 miles



DRIVER'S VISION (for an average driver—5 feet 9 inches tall)

Distance at which part of road in front of car could be seen (A in sketch)	19 feet
Distance at which full width of road in front of car could be seen (B in sketch)	24 feet



GROUND CLEARANCE (unloaded car)

Radius of worst dip that could be crossed (solid line)	31.5 feet
Radius of worst hump that could be crossed (dotted line)	18.5 feet
Deepest rut car could be driven in	7.4 inches
Curb clearance for door opening	13.5 inches

MISCELLANEOUS

STEERING

Wheel turns from straight ahead to steer outside front wheel in a 100-foot-diameter circle: 0.75 turn.

Diameter of smallest circle in which wheels could complete a circle (curb-to-curb): 43 feet.

Diameter of smallest walled circle within which the entire car could complete a circle: 46 feet.

Steering-wheel turns, lock-to-lock: 3.7 turns.

Steering-wheel diameter: 17 inches.

TRUNK CAPACITY

Number of standard cartons (1 cubic foot each) that could be packed into trunk: 17 cartons.

CENTER OF GRAVITY (unloaded car)

Height of center of gravity: 23.0 inches.

WATER RESISTANCE

Pair. In splash pan and high-pressure car wash, the brakes were not affected and practically no water entered the car. However, in splash pan, water got into two spark-plug wells and had to be siphoned out before the engine would run on all cylinders.

OVER-ALL DIMENSIONS

Length: 212 in. Width: 78 in. Height: 59.6 in.

OBSERVATIONS

Instruments: All gauges have needle pointers. Speedometer is unorthodox. I fail to see that it is any

better. Readability of all instruments is good and would be excellent except for chromed panel in which they are set.

Transmission: TorqueFlite is a torque converter followed by a gearbox with three speeds, one direct and two through planetary gears. The test car, accelerating wide open from a standstill in Drive, shifted from 1st to 2nd at 25 m.p.h., from 2nd to 3rd at about 60. With a light throttle, the same shifts occurred at 7 m.p.h. and 12 m.p.h., respectively. Downshifts are possible at any speed up to about 60 by flooring the accelerator.

Spare tire: The spare, located at extreme front of trunk, may be more difficult to put in and take out, but its location provides much more usable luggage room.

Vision: Good, except that the view straight back from outside rear-view mirror consists largely of the tailfin of one's own car and any view of a following car can be seriously obscured.

General: After gas gauge read "Empty," car went about 30 miles before actually running out of gas. This is about what one should expect. Power-brake vacuum reserve provided two to three full applications with engine dead. Park brake held on a 14 percent grade.



Driving the DODGE CORONET V8

By Floyd Clymer

THE CORONET four-door hardtop V8 was driven a distance of 651 miles in my test.

I found it had tremendous zip and performance. Many may rate styling as Dodge's best point, but I consider handling and roadability outstanding. I have never driven a car that performed better or handled with less effort around sharp curves and over rough back roads. Dodge's torsion-bar front suspension reduces sideways and body roll sharply. There is less "floating" or bouncing than in previous models. The shocks do a good job of controlling the ride. There is excellent rear-end stability.

Regardless of the speed at which I drove, there was minimum engine and body vibration. Even on rough roads there was but slight front-fender vibration, less than on most cars. No squeaks or rattles developed.

The four-barrel carburetor is partly responsible for this car's good acceleration. Even in 112-degree desert heat, there was no overheating.

Dodge brakes are excellent. There was very little fade. There seems to be less grab than in most brakes.

TorqueFlite is a thoroughly sturdy and dependable transmission and has been perfected to the point where I would rate it the best of all automatics.

I found it best to use premium gas and the three-speed transmission helped gasoline economy somewhat.

The driving position is comfortable although the brake pedal should be nearer the floor, in my judgment. It is too high above the throttle. Instruments are well-located, directly in front of the driver, and there is no vision obstruction. I like Dodge's needle indicators better than the flashing lights that are common today. The electric wipers have variable speeds.

The speedometer has no needle indicator. Speed is indicated by an unusual red band that is not a ribbon, but rather a series of red columns that move upward in five-mile graduations to form a horizontal column. It is not as good as a needle or as a straight sliding ribbon.

The hand brake operates independently of the wheel brakes in the Chrysler Corporation tradition. It works on a drum around the drive shaft just behind the transmission.

The door to the glove compartment is wide, but the compartment itself is small.

The center rear-view mirror is mounted at the cowl front and there is considerable blockage of vision when there are three persons in the front seat. Another mirror mounted on the left side of the body just ahead of the windshield gives good rear vision, except that a car directly behind is difficult to see because of the extremely high rear-fender tip.

In most instances I found these high Dodge fender tips to be helpful when parking or backing out of driveways, but I think they are too big. They should be about two inches lower and somewhat narrower.

The metal cover over the steering-wheel spokes, although having a satin finish, causes too many reflections in the driver's eyes when the sun is in a certain position. I especially noticed this at midday in the hot sun of the Mojave Desert.

I don't like the outside door handles. You open the door by pulling a bar outward and upward. This is rather awkward and requires too much hand movement.

The trunk is spacious. The spare tire position is unconventional, being mounted horizontally far forward on the shelf above the rear axle.

The lock to the trunk lid should be improved. It also should be self-locking, in my opinion. I don't like the idea of having to use a key to lock the lid each time I close it.

Photograph shows how the dramatic rear fender does block view of driver through outside rear mirror

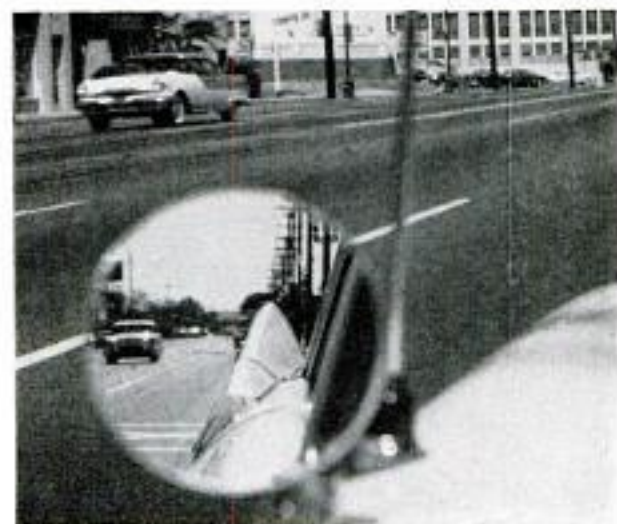



Mobile Automatic Laundry Follows Yosemite Campers

Now vacationers in California's Yosemite National Park can hike through the forests all day and toss their clothing into an automatic washer at the end of the trail. This bit of civilization for campers is provided by a semitrailer, called a Laundrecar, that follows a regular weekly route through the various campgrounds in Yosemite Valley. Inside the trailer are 10 automatic washing machines and two gas driers. Eight electric outlets for irons are mounted in the exterior wall. Ironing boards are provided by the Laundrecar. Heat for the gas driers and the wash water is provided by LP gas carried on the trailer.



Custom Sprinkler Has Plastic Pipe and Push-in Nozzles

For an area of the yard needing frequent sprinkling there's a plastic pipe now available that can be made to fit most any situation. Small self-threading nozzles are inserted in the pipe at desired locations, and an area up to four feet wide can be watered.

The length it can be made depends upon water pressure. Anchor pins hold the pipe on the ground. The nozzles produce a flat spray, designed to water the base of plants. The pipe, which can be left in place the year 'round, connects to a garden hose.

Easily inserted, push-in-type nozzles, below left, can be placed at points along plastic pipe where needed



Traffic Radar Unit Monitors Pitched Balls

Radar "scouts" electronically check the exact speeds of pitched or batted balls for the Kansas City Athletics in early training. This speed meter weighs 26 pounds, is operated by a 12-volt storage battery, and is set up beside or behind the catcher. When a baseball is pitched, a beam traveling at the speed of light is transmitted from the radar set and reflected simultaneously from the moving ball back to the same antenna and a calibrated dial, which indicates the speed.



Solar Furnace to Test Atomic Heat Effects

Concentrated heat comparable to an atomic explosion will be generated by a solar furnace under construction by the U. S. Army. It will test materials for use by soldiers to protect them from the heat effects of nuclear and other weapons. The flat-mirror heliostat reflects the sun's rays to the concentrating mirror. Then they are bounced back through the attenuator, which controls their intensity, to be focused in a four-inch-diameter beam inside the test chamber. When the device is completed, it will be 125 feet long by 40 feet wide. It is being built at Natick, Mass.

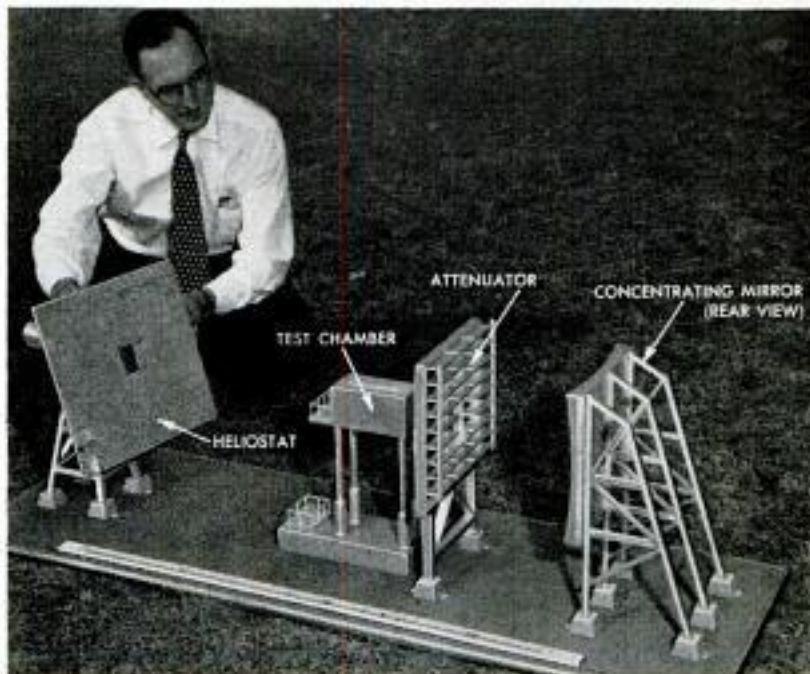

Rubberized Houseboat → At German Fair

From a tent and a war-surplus rubber raft, a German exhibitor improvised a houseboat. Frames hold up the tent, which is attached to the sides of the boat. The idea was demonstrated recently at a trade fair in Leipzig, Germany.

Largest Reservoir In Asia

Reputed to be the largest man-made lake in Asia is the Hirakud Reservoir, recently completed, which covers 288 square miles of India's Mahanadi River valley. The project will furnish irrigation water and electric power. The dam, at Orissa, is three miles long and is flanked by 13 miles of dikes.



After the last patient has gone, this dentist uses his office as a workshop to bring the old side-wheeler Sausalito back to life . . . as a model



Top, soap solution is painted around wax figure before completion of plaster die. Wax, melted out, then is replaced with dental plastic

Center above, Dr. Thomas I. J. Snead swaps places with his patients after hours to work on parts for his model of the ferryboat *Sausalito*

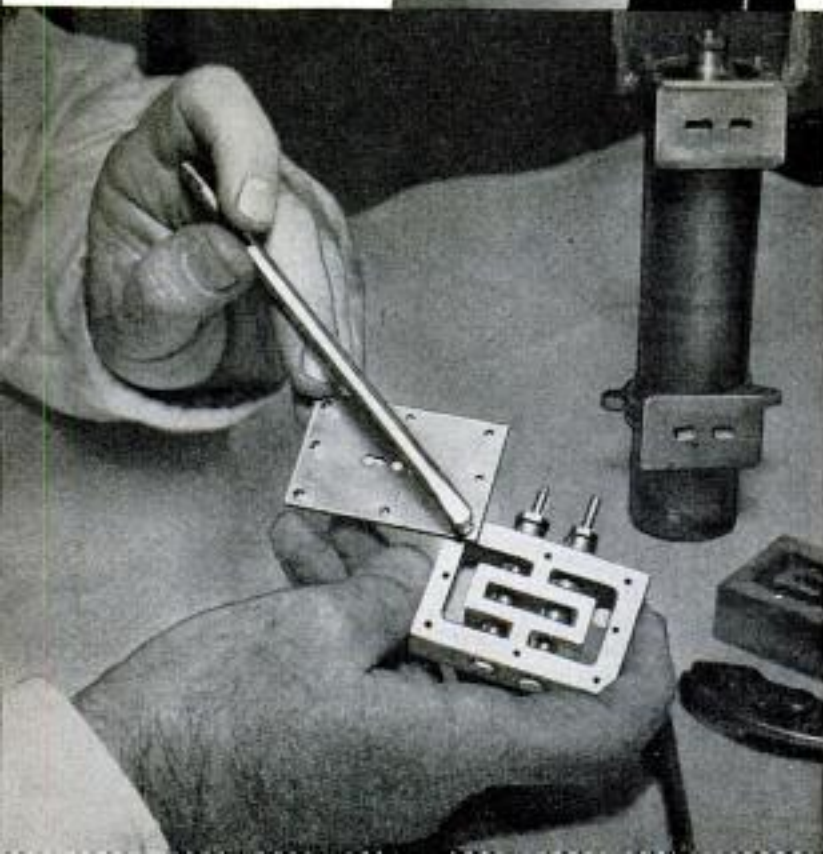

Left, using a dental tool with a section of an Allen wrench welded to its handle, Doctor Snead attaches cover to valve chest for model's engine



Above, the dentist adjusts the pilot house on the 64-inch-long, 40-pound scale model of the *Sausalito*

Below, the original ferryboat *Sausalito*, shown here in an old photo, was built in 1896 to carry 3000 passengers



A Dentist Builds a Ferryboat

By George S. Wells

Photos by Ken Molino

A FAIRFAX, CALIF., DENTIST has built an exact scale model of a famous old San Francisco Bay ferryboat almost entirely with the materials and tools of his profession.

Such a model ordinarily would go under glass. But Dr. Thomas I. J. Snead has powered this vessel with a handmade scale model of the craft's vertical-beam engine. Using this type of power, now obsolete on America's waterways, the side-wheeler *Sausalito* can steam about on its own.

Dental Lab Is Workshop

Doctor Snead spent more than four years on his project to bring back to life the romantic ferryboat he rode as a boy. Except for the hull, turned out in his shop at home, the model is the product of his dental laboratory where he worked at night after the last of his patients had gone.

With no blueprints available, he had to settle for a set of specifications, which he found to be incomplete and partially inaccurate. A combination of trigonometric calculations, scale projection and tracing of

photographs helped him work out missing details.

Duplicating the archaic engine was a problem until Doctor Snead ran across a diagram of it in an 1878 encyclopedia. Following the diagrams and his list of specifications, he formed engine parts in dental wax with dental tools and then cast the parts in brass.

Tiny windows, deck posts, railings and other fittings also were carved first in dental wax. Dies were made of a fireproof material that normally is used to make crowns and bridges; brass counter dies then were cast. Most fittings finally were cast in acrylic, a clear plastic used to make palates, and painted or colored.

Dental Drill Becomes "Lathe"

Doctor Snead carved his engine parts, such as cylinder heads, valve chests and valves, in wax or turned them by handling his dental drill as a makeshift lathe. Final casts were made in the centrifugal-casting machine that usually serves in making crowns and partial dentures. The only

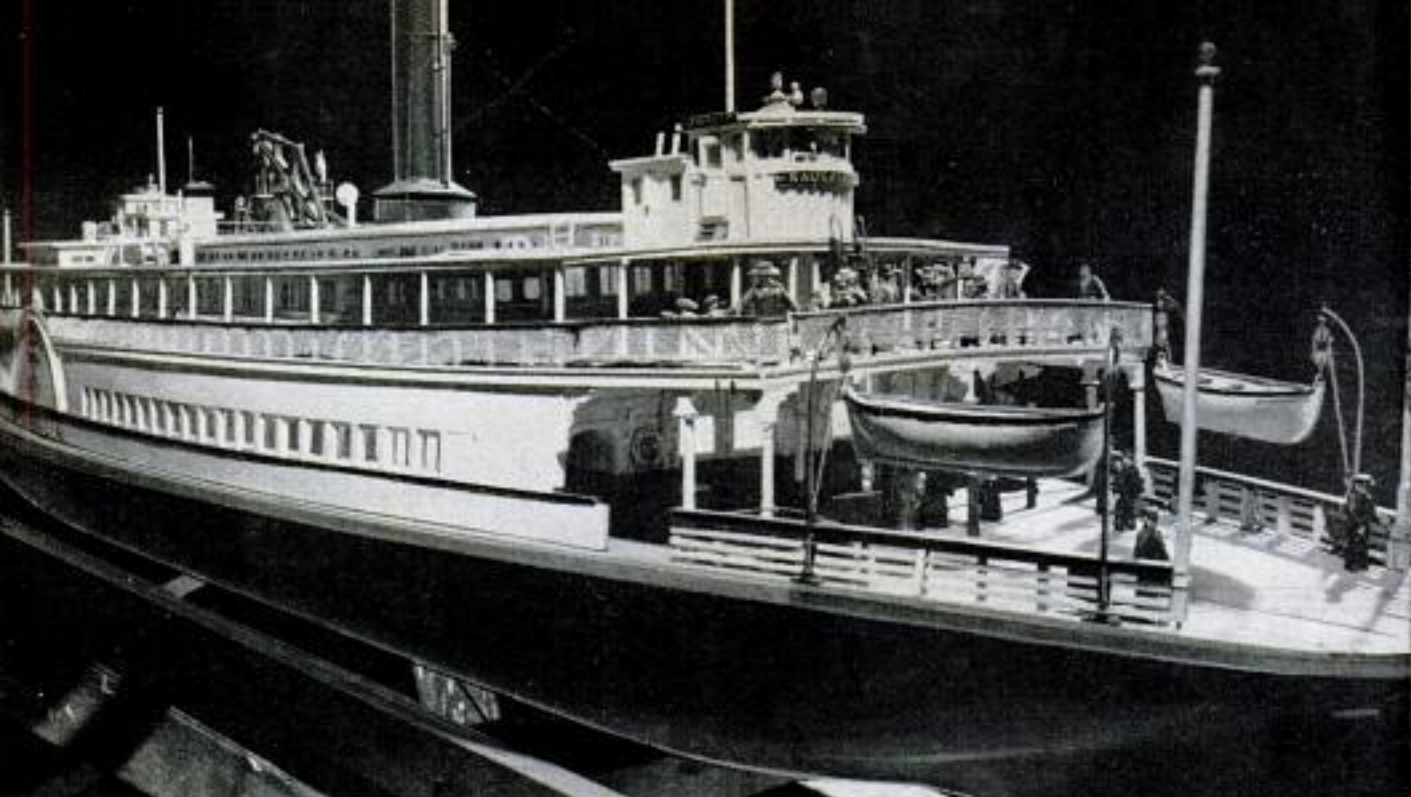

Close-up of model shows some of careful detail including copper mesh installed below upper-deck railings

engine part not made from scratch in his lab is the boiler which he "located through ads in *Popular Mechanics*."

Small figures stand on the decks. Like the ferryboat, these are scaled $\frac{1}{4}$ inch to the foot. Each individual is an authentic copy of a real person appearing in photographs of the ferry taken during its days of operation from 1896 to 1931.

The original *Sausalito* had a length of 256 feet; beam of 68 feet 3 inches; and a

hull 15 feet deep and 34 feet wide. It floated 7 feet 6 inches deep in the water. Doctor Snead's 64-inch-long model weighs 40 pounds, including the 15-pound engine. Draft, horsepower and action in the water duplicate scalewise those of the original ferryboat. Only variation in the engine model is the addition of lead weights to the flywheels to prevent duplication of the old *Sausalito's* penchant for "hanging on dead center." ★ ★ ★

Lifelike scale figures ride the model. Man on upper deck reads newspaper with World War I headlines





Locomotives Wrapped in Cocoons Stand by for Emergency

When emergency strikes, 100 locomotives at the U.S. Army depot, Ogden, Utah, literally will be removed from cocoons for action. At a cost of \$2200 per engine, whose average value is \$90,000, cocoons cover

locomotives ranging from 45 to 131 tons. Cocooning consists of a layer of burlaplike cloth wound around the engine, three coats of plastic sprayed on, a coating of tar and an outside film of aluminum paint.

Lightweight Helicopter Operates From Truck

Four men can lift and carry the 1800-pound British Fairey Ultra Light helicopter. This whirlybird can fly 105 miles per hour and will cruise at 85 miles per hour. The copter can be carried complete with pilot, fuel, spare parts and provisions, on a standard British Army three-ton truck, which also serves as the landing and take-off deck for this aircraft.



World's Longest Military Truck Totes 40-Ton Tanks

Two 560-horsepower air-cooled gasoline engines power the U.S. Army's experimental tank transporter, believed to be the world's largest military highway vehicle. Four drivers, two front and two back, use

a telephone to coordinate movement of the 90-foot truck. The big truck can carry a 40-ton tank on the transporter but it can haul emergency loads up to 60 tons. With side platforms, it's 11 feet 6 inches wide.



Magic

By Edward Janicki



Recil Bordner, partner of Percy Abbott in their magic business, enters the plant through a decorated wall

Family act finds Percy Abbott pushing a sword through a box, as Mrs. Abbott, daughter Linda, and son Jules assist in trick





An Abbott customer performs the suspension trick at one of the firm's annual "Magical Get-Togethers"

SOME OF THE WEIRDEST THINGS this side of darkest Africa happen in Colon, Mich. Once, you could have seen a human body "crucified." At another time a person was "burned alive."

Colon residents have stoically learned to take such things in stride. These citizens are well aware that Percy Abbott or a colleague may be behind these doings.

Abbott runs one of the world's most unusual businesses—a magic factory, devoted to making the apparatus with which a magician works. The "crucifixion" and "burning alive" dramas are among hundreds of magical acts performed at Abbott's annual "Magical Get-Together." This event brings wizards from various parts of the world to swap tales, get new magic tricks, and bewilder each other and the public.

Regarding the crucifixion trick, all Abbott will admit is that the act depends on the little-understood Yogi philosophy as presented by a Peruvian Inca. A celebrated conjurer, Marvelo the Magician offered the burning-alive spectacle.

While Abbott's firm is operated primarily for the amateur magician, many professionals use his devices. His catalogue lists more than 3000 tricks and illusions, ranging in price from a few cents to custom-built equipment costing more than \$1000.

The factory is not operated on an assembly-line basis but aims at fine craftsmanship. In fact, on some occasions one item has been made for the sole use of a single professional magician. Abbott estimates that he has turned out between 150 and 200 original effects per year in the past 25 years.

Son of a magician, Abbott was born 70 years ago in Australia. After mastering

magical skills from his father, he one day became a professional sorcerer himself. As such, he pulled rabbits out of everything from a Bowery bowler to an Egyptian fez. He visited India, China and other countries, picking up new knowledge of magic.

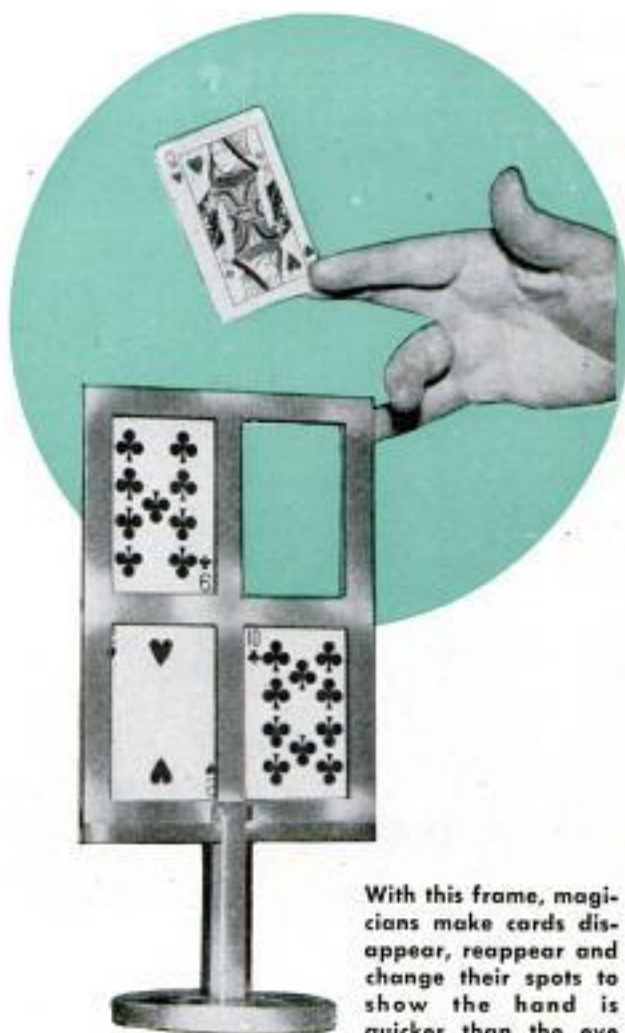

With this frame, magicians make cards disappear, reappear and change their spots to show the hand is quicker than the eye



Abbott's son, Jules, allows himself to be chained, then walks away. "It's muscular control," he says

Below are Abbott stock-in-trade items: disappearing golf balls, lemons, oranges and handkerchiefs

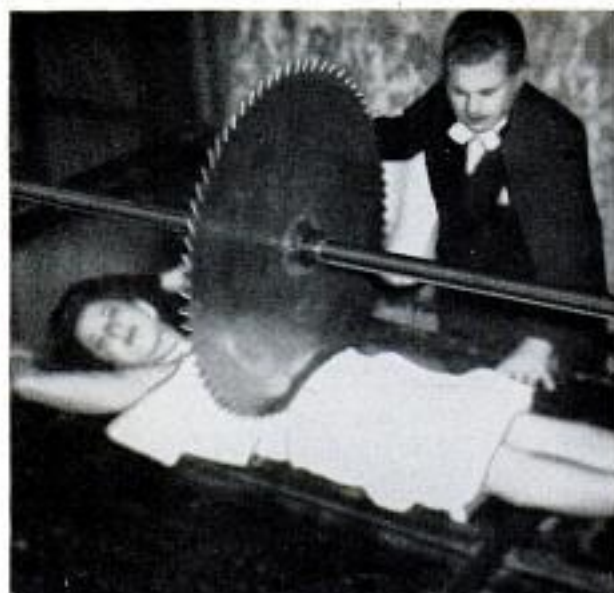

Carefully guided by a magician, this circular saw "cuts" through the body of a beautiful assistant

How did he get into the business of making magic tricks? "Show business was all I had ever known," he recalls, "and I did not want to travel and raise a child with my American wife." One night he was looking over an accumulation of bits of string, rope, playing cards, thimbles, safety pins and other gear well known to magicians. Suddenly, he had an idea for a new trick based on a new principle in magic. Hurriedly, he built "the thing."

Abbott called in his wife, who was preparing their meal, and said "Will you look at a trick, honey? We're going to start a magic business by making tricks, and this is the first one." The device consisted of the instant disappearance of a glass of liquid. Abbott called the ruse "Squash" after an Australian drink of the same name. And his business was born.

Magical Get-Togethers attract professionals and many eager amateurs, including doctors, lawyers, artists, professors and newspapermen, Abbott says.

He recalled the time when "several of our charming rogues" framed a brash young novice who had done too much bragging about his magical abilities. The conspirators allowed him to put another person (wise to the scheme) into a deep "sleep." However, when it came time for the unsuspecting novice to arouse his victim, the sleeper didn't respond.

Horrified, the young magician called on his colleagues to help him awaken the man from his trance. None would oblige. One onlooker suggested that the novice call an ambulance and rush the victim to the hospital "since the stunt could be fatal." This scared the performer so effectively that, on the pretext of dashing madly away for an ambulance, he left town. ★ ★ ★

World Spanner And Helmet Radio

In the picture at right, according to the Army, are the world's mightiest long-range radio transmitter and the world's smallest field radio. Both were developed by the U. S. Army Signal Corps Laboratories. The transmitter can beam vital messages to any spot on earth. Its effective power is 24 million watts. The miniature helmet radio hardly covers a hand.



Vendors on Trains Use Chef's Carts

Passenger-train attendants who walk the aisles with a basket of sandwiches and a pot of coffee are giving way to men pushing stainless-steel and plastic chef's carts. A tinkling bell signals the approach of a cart, fitted with vacuum-insulated containers to keep the coffee hot and the soft drinks cold. The Pennsylvania Railroad has acquired the carts for use on its New York-Philadelphia-Washington trains.



TWA's "Flying Maintenance Base" Uses Jet-Assist Power

First commercial application of jet-assist power reportedly has been made by Trans-World Airlines at Orly Field, Paris, France. A 1000-pound-thrust Fairchild J-44 jet engine has been installed atop the fuselage

for added takeoff, climb and in-flight power. This TWA jet and propeller-powered Fairchild C-82 serves as a "flying maintenance base" carrying spare parts, engines, commissary and other equipment.



Tomorrow's Outboard— What Shape Will It Be?

Outboard-motor designers have been experimenting with all kinds of shapes—flat fours and sixes, radials, Vs, even jets. Here's a quick look at some of their concoctions.

MANUFACTURERS OF outboard motors, contrary to their counterparts in the auto industry, settled years ago on a basic type of engine—the in-line. Without doubt there are significant differences between the makes of motors. But over the years the in-line generally has been favored, whether it was a two, four or—in the case of this year's Mercury Mark 75—a six-cylinder job. With one or two exceptions over the years, cylinders have simply

been stacked directly on top of each other.

But designers haven't been resting on the past. Through the years, engineers of the Kiekhaefer Corporation have built a good many test motors of unusual types. They've even tried jets, though they feel a true jet is too dangerous for outboard use. On these pages are a few of their experimental motors. But nothing stands still. It's a sure bet that in the near future some firm will turn to one of the types below. ★ ★ ★

In-line Motors



These are the current stand-bys. The diagram shows how cylinders, fired in sequence, rotate crankshaft. As more cylinders are added, the motor becomes smoother because there are more firing impulses per revolution. Until recently, most manufacturers stayed with alternate-firing twins, increasing the bore size for greater horsepower. Mercury, however, expanded upward into the four, and last year into the six-cylinder engine shown below right. The experimental motor below left is a three-cylinder job. Tests showed it would require three carburetors or a complicated manifolding system. Alternate-firing in-line engines are the most compact in width for the horsepower, are smooth-running, idle well and are economical to build. However, they become higher in silhouette as cylinders are added

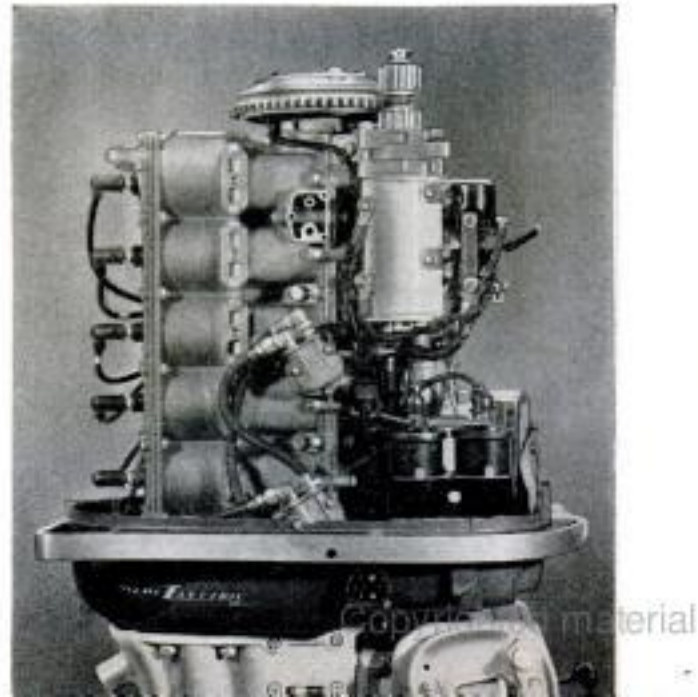
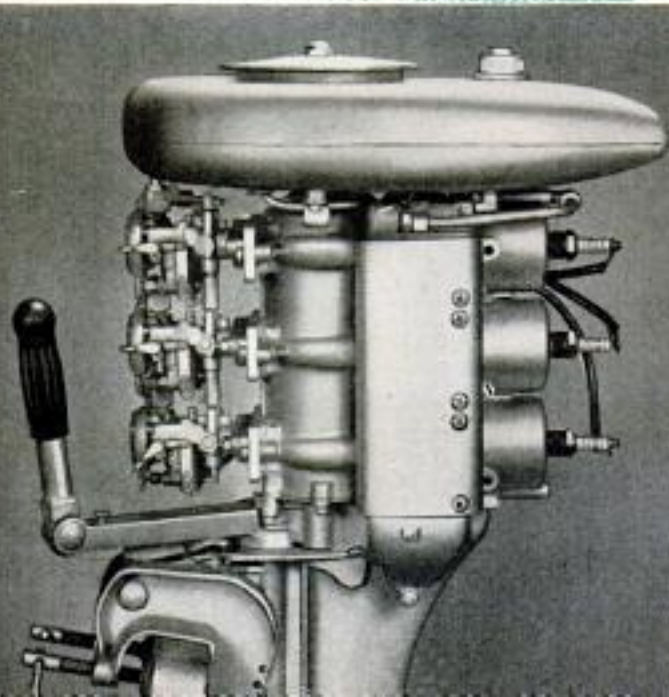

"Flat" or "Square" Motors

A "square" motor is, in effect, two in-line motors geared together to turn a common driveshaft. The photo shows an experimental flat or square four, which actually was made by welding together a pair of two-cylinder in-line engine blocks. Each pair of cylinders turns its own crankshaft, and the two shafts are geared to turn the driveshaft. The resulting engine is extremely compact, and basically is inexpensive to manufacture because the blocks and many of the parts are common to existing in-line engines. However, the one additional part

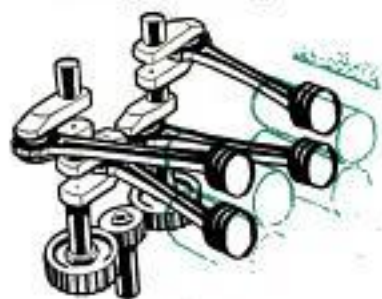

necessary is a gearing system, and this is the major disadvantage of the flat or square-type motor. The required gearing tends to be both noisy and expensive. For this reason the square type probably will never see service as an outboard motor

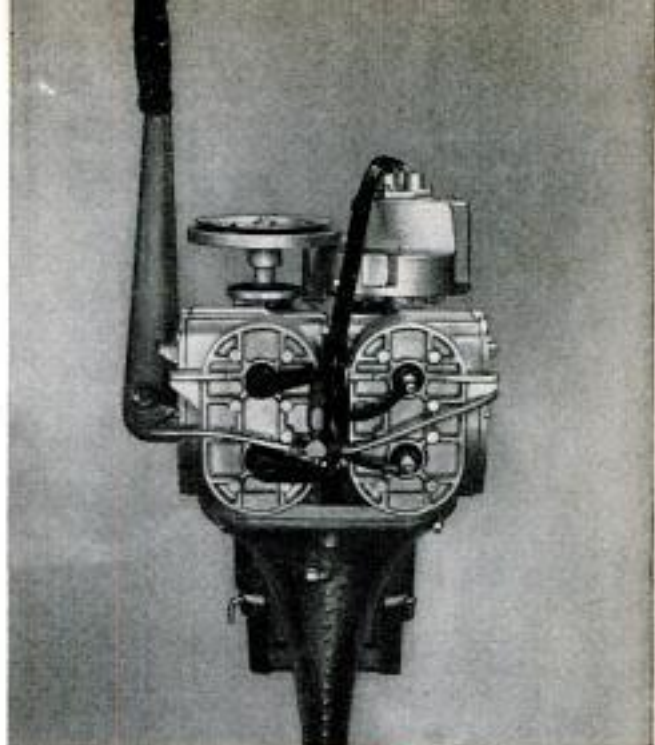

Opposed Motors

These motors, sometimes called split singles, have pairs of cylinders operating in opposition from throws of a crankshaft that are 180 degrees apart. This makes a highly efficient, perfectly balanced motor with a short crankshaft, relatively inexpensive to manufacture. It has obvious advantages for some portable power requirements. Below left are shown small two-cylinder opposed motors which were built to power aircraft-target planes but which could easily be adapted to outboard use. Below (right) is an experimental opposed four, showing cylinders obviously mounted in pairs in staggered relation to each other. The biggest disadvantage of an opposed twin is the need for a larger flywheel, which in turn causes more shake. An opposed four is difficult—and besides can be dangerous—to crank

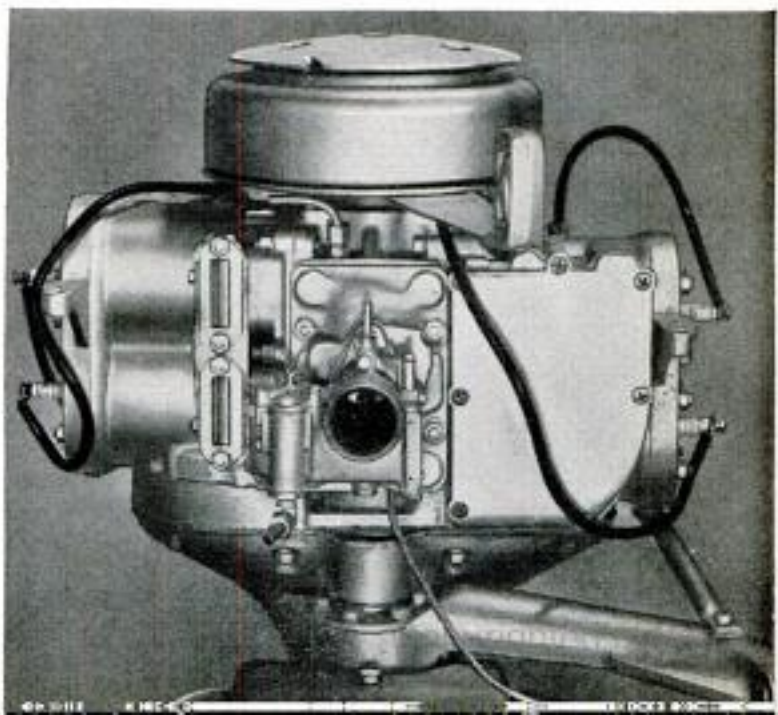
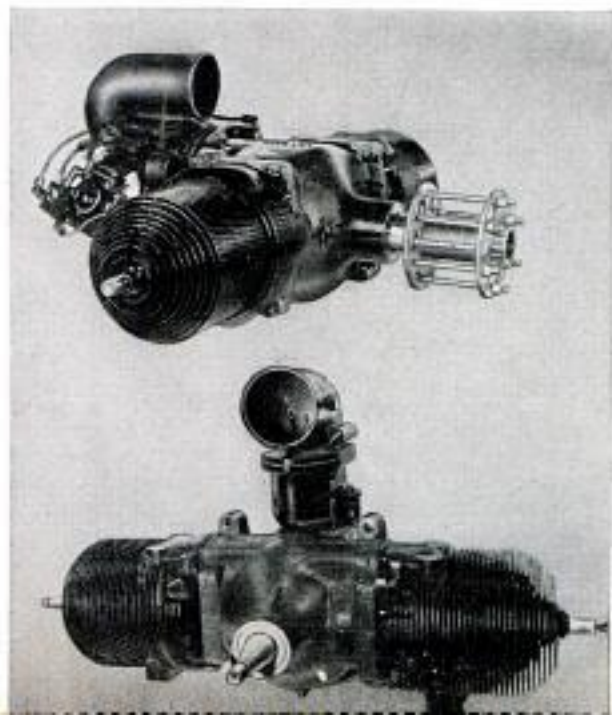

Radial Motors

This type of motor is the old stand-by of the aircraft industry. Regardless of the number of cylinders, they all operate off the same throw of the crankshaft, as illustrated in the diagram of the three-cylinder radial below. At left is an experimental three-cylinder radial. In view of its efficiency as an aircraft engine, why wouldn't such a motor be ideal for outboard use? Mainly because absence of the usual pumping action in the cylinders makes costly superchargers necessary. The cost of an efficient supercharger can run as high as the cost of the rest of the motor. This would make a radial outboard motor too expensive

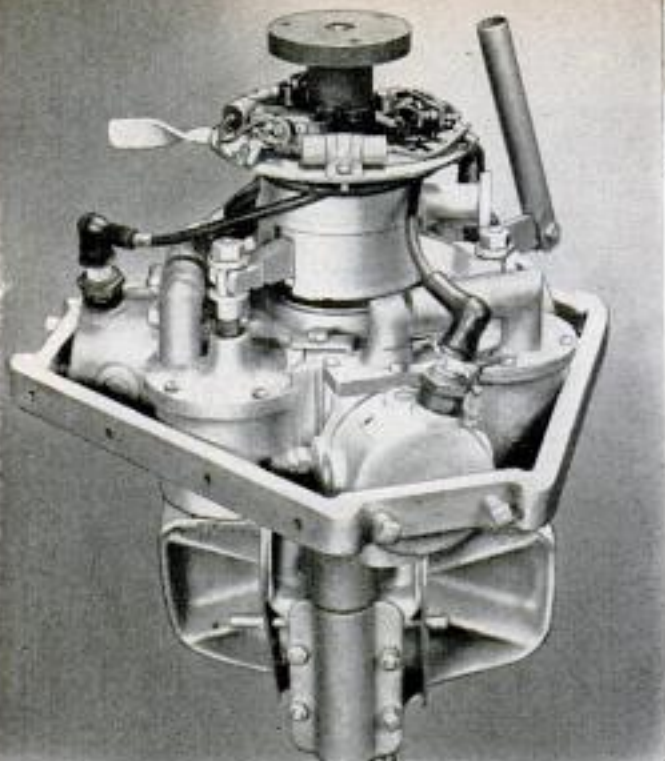

V-Type Motors



Most popular of the automobile engines today is the V-type. Why not an outboard V? A possible arrangement for such a motor is diagrammed at left. The photos below show an experimental V2 and an experimental V4. A V-design permits a shorter crankshaft, which has two advantages. A short crankshaft does not tend to "wind up" under stress, as a longer one may do. And the shorter shaft, in the case of an outboard motor, permits a lower silhouette. However, when the cylinders are spread into a vee, the resulting motor becomes wider. Thus a V-type outboard, when one is produced, will be both lower and wider than an in-line engine of comparable horsepower. Because of the rigidity of the short crankshaft and the popularity of V-type auto motors, the vee seems the most likely candidate for a new type of outboard, a type that might make its bow any time

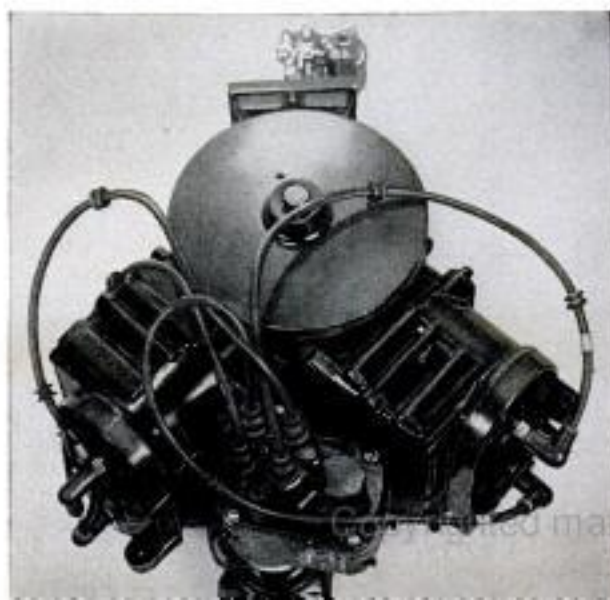
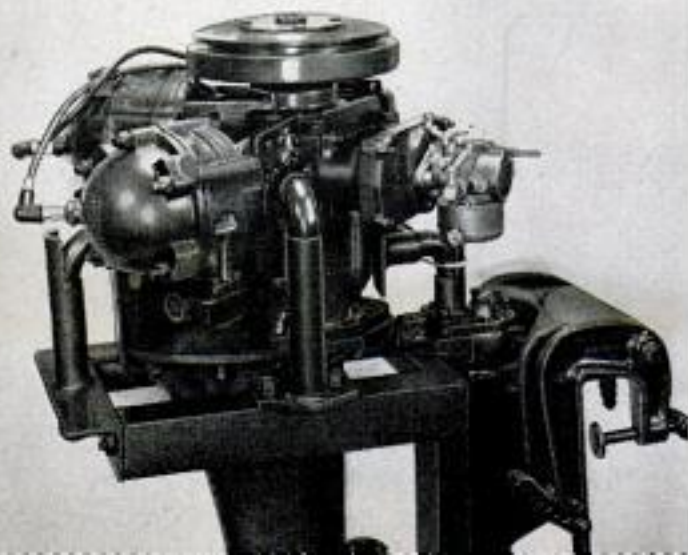



Parachute Lands British Rocket

TAKING OFF at the Woomera Rocket Range in South Australia, above, is the new British ramjet-powered Bobbin. The Bobbin was designed to be recoverable for examination after firing by providing a parachute that opens near the end of the flight. The parachute slows the rate of descent, thus minimizing damage to the missile when it lands on its spiked nose. The test missile is powered by Thor Motors and is produced by Bristol Aircraft Ltd. and Bristol Aero-Engine.

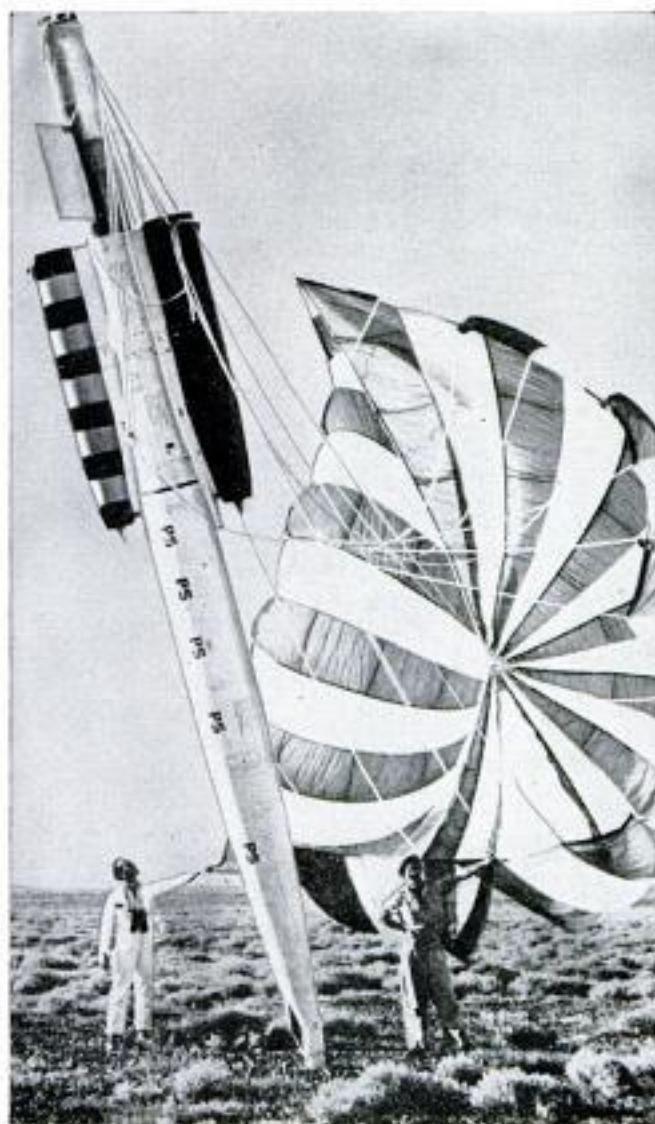

SEPTEMBER 1957



153

Copyrighted material

WHAT'S NEW FOR Your Home



WINDOW JACK applies uniform pressure to open most any type of stuck window. Tension legs are adjustable from 21 to 40 inches and larger windows can be opened with the use of a block. The manufacturer reports the all-metal jack does not damage sash because it allows windows to open gradually

Nestar Products Co., 6509 Hough Ave., Cleveland 3, Ohio

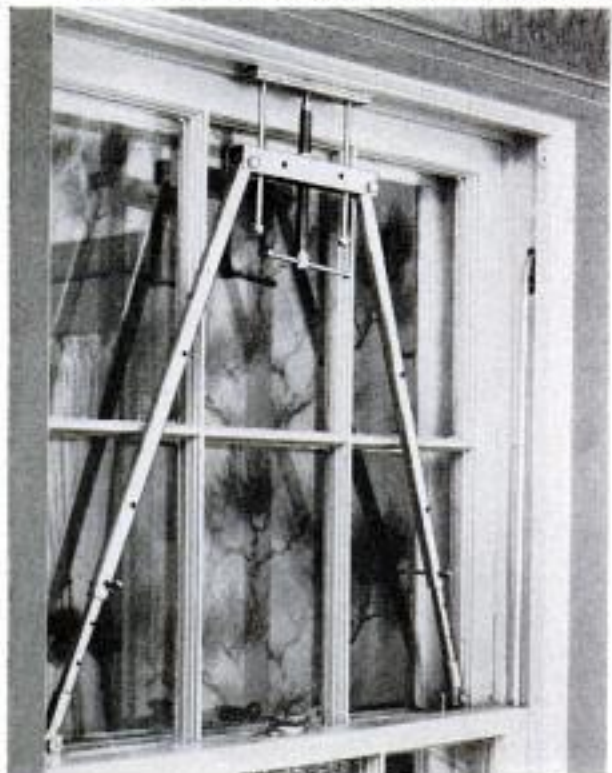

154



WORLD GLOBE turns in all directions for viewing of any area topside. Like a gyroscope, the globe is mounted in a metal ring completely encircling it and this is attached to a half ring. Turning the full ring determines which half of the world is on top, and the globe spins in the usual way

Replote Globes, Inc., 1901 N. Narragansett Ave., Chicago 39

KITCHEN-CABINET doors and drawer fronts can be easily and quickly changed to provide a new decor or to match and contrast with other color schemes. Of nonwarping wood and available in six colors, no tools are needed to change either the doors or drawer fronts since they slide on and off steel frames

Whirlpool-Seeger Corp., St. Joseph, Mich.

SUGAR DISPENSER will release any amount desired by pressing a button. Imported from Holland, it will hold 90 teaspoons of sugar, is made of spun metal, weighs 2¾ ounces, is insect, moisture and spill-proof, and its mechanism is guaranteed for one year. The dispenser is available for \$2 postpaid

Freeman Enterprises, 109 Church St., Laconia, N. H.



POPULAR MECHANICS

Copyrighted material



LIGHT SWITCH, above, permits "tuned in" illumination. Turning dial adjusts incandescent bulbs to four levels of lighting. The switch is mounted on a transparent panel, under which can be placed inserts to harmonize or blend with the wall colors

Minneapolis-Honeywell Regulator Co.,
2753 Fourth Ave. S., Minneapolis 8, Minn.



INDOOR BARBECUE is built into a kitchen cabinet and gives meat a smoky flavor without using charcoal. It cooks with a bed of ceramic "coals" heated by a 4000-watt 220-volt electric element, and is fitted with a hardwood top when not in use

Stanthony Corp., 5341 San Fernando Rd., W.,
Los Angeles, Calif.

NEEDLE THREADER is so accurate that it can insert four threads simultaneously through a needle eye small enough to require a dozen tries by human hand. Thread is looped over the hook and when plunger is pulled back needle is threaded

Wink Needle Threader Co.,
P.O. Box 252, Cos Cob, Conn.



PICNIC TABLE is six-sided and features a Lazy Susan in the center. Able to accommodate up to 12 people, it is built of white pine, supported by 1½-inch steel tubing, occupies an area less than eight feet square and weighs 168 pounds

Midwest Metal Stamping Co., Kellogg, Iowa





Beach Pipeline To Aid Marines

Movement of heavy fuel drums across assault beaches by Marines has been replaced by a pipeline with collapsible tanks and small pumps. Buoyant fuel lines extend from supply ship to bulk-fuel unloading stations ashore.

Frostbite Remedy From Citrus Fruits

Hesperidin, found in citrus fruits, has the ability to reduce significantly the amount of gangrene resulting from frostbite in animals. Biologists will attempt to duplicate these experiments on humans, according to Dr. J. Morton Beiler of the National Drug Company, Philadelphia, Pa.

Plastic Capsules Hold Hooks

Snagproof, unbreakable hook holders will remove one blight from an angler's life. The hollow plastic balls snap open to receive a hook and when closed, prevent snagging of clothing. Hooks, ranging in sizes from 6 through 16, fit the holders. These colored spheres also can be used to code favorite hooks or leaders.



Golf Meter Measures Drive

Australian golfers can measure distance and direction of each drive on a device that permits them to hit the golf ball only three feet. When they drive, the ball pulls on a nylon cord and spring attached to a meter. This measures the distance of the drive up to 300 yards. If the ball is hit off center, the meter swivels to record the direction.





A Build-Your-Own Variable-Reluctance Pickup for Hi-Fi Experimenters

By John E. Turner

THERE ARE comparatively few components in a high-fidelity music system that an individual can build from "scratch." Equipment manufacturers tend to lull the audiophile into a sense of do-it-yourself with a vast array of kits for the home builder. But, in most cases, these kits are so well engineered that one requires only a set of screwdrivers, a pair of pliers and just a little mechanical ability to complete such a project. To start with the basic materials, do one's own layout, cutting and drilling, and finally to complete the assembly and adjustments of the finished product is far more challenging.

The variable-reluctance pickup described in this article is the result of several months' effort to develop a unit which can be constructed by the home experimenter, and whose performance characteristics will compare favorably with those of better quality commercial pickups. It is built, for the most part, with materials which are easily obtainable, and it can be fabricated in its entirety with only a few basic hand tools.

To obtain satisfactory results it is imperative that the hobbyist follow the dia-

grams with reasonable care. In particular, the dimensions of the moving mass and the cambric strip, the diameter of the foam-rubber pad and of the coil center hole, and the quality of the dampening jelly are rather critical. On the other hand, the resistance of the coil, the size of the bar magnet, the thickness and width of the pole pieces, and the thickness of the foam-rubber pad can vary somewhat from the specifications without causing any serious difficulty.

Although this is definitely not a project for a rank beginner, the more experienced hobbyist should have little difficulty in duplicating the original model and obtaining satisfactory performance. Construction is facilitated by following the sequence of steps given below.

Preparation of Materials

STEP 1. BASE BLOCK. Prepare a balsa-wood block in accordance with the dimensions given in the drawing of detail 1. The two $\frac{3}{32}$ -in. holes (just to the right of the $\frac{1}{4}$ -in. hole) will eventually be used for fastening the pickup to the tone-arm head. If the standard spacing indicated in the drawing does not match tapped mounting

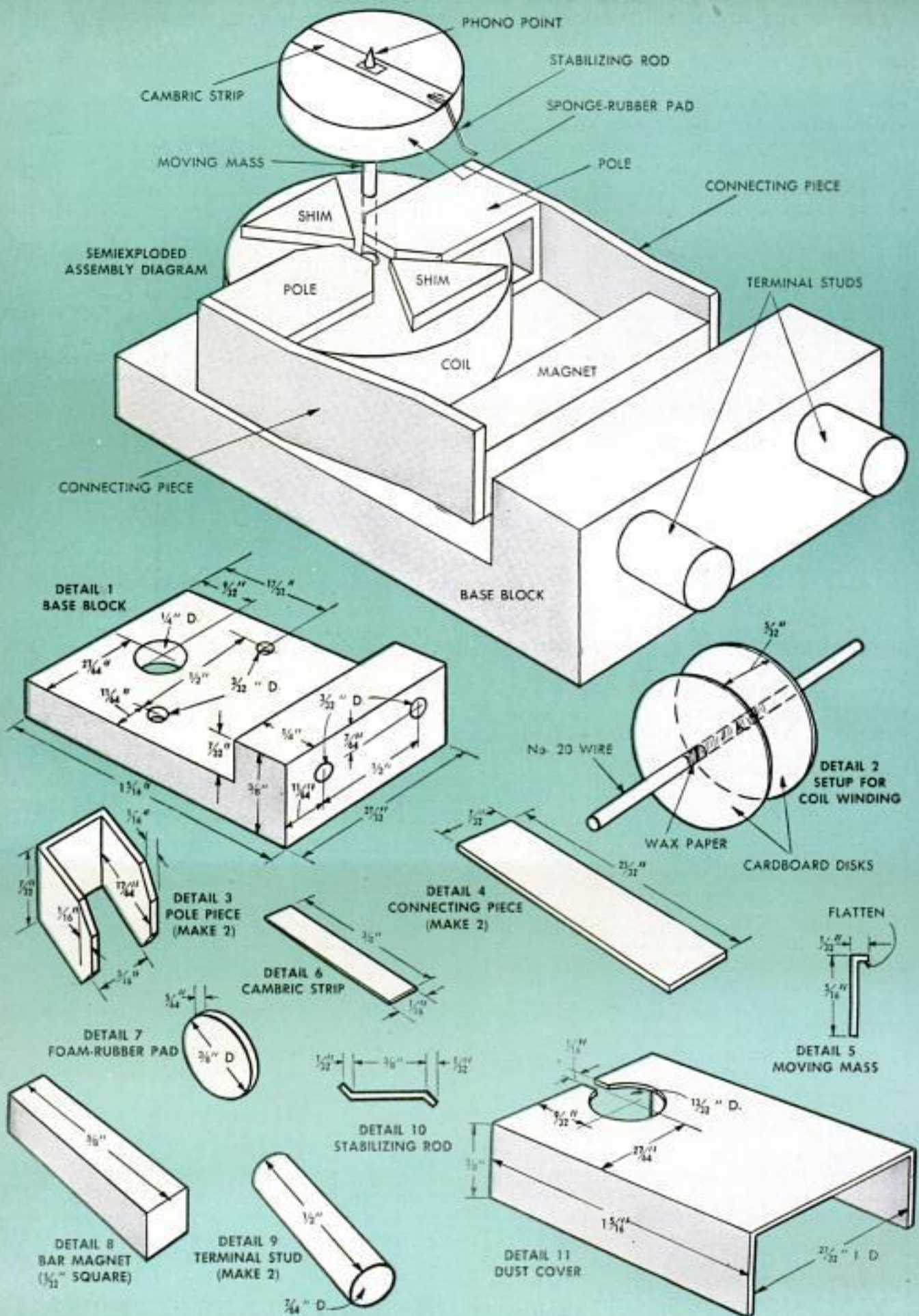

holes in the head with which the pick-up will be used, appropriate changes should be made at the time the block is laid out for drilling.

STEP 2. COIL. Coil winding is simplified by the setup illustrated in detail 2. Use a length of No. 20 wire, or a $\frac{3}{16}$ -in. drill, as a mandrel. First, wrap a strip of wax paper, about $\frac{1}{16}$ in. wide, around the mandrel, not more than two layers thick, and secure it in place with a dab of airplane cement at the outer edges. Next, cut out two $1\frac{1}{2}$ -in.-dia. disks from a file folder or similar cardboard material, and pierce the centers of the disks with a heavy sewing needle to such a diameter that they will fit snugly over that portion of the mandrel which is covered with the wax paper. After the disks are oriented perpendicularly to the mandrel, and properly spaced, apply a small amount of airplane cement to the outside junctions of the disks and the wax paper so that the disks will remain in place.

After the cement is thoroughly dry, coil winding can begin. Wrap about 2 in. of No. 40 enameled wire around the left side of the mandrel and fasten it in place with a small piece of cellulose tape. This forms one lead of the coil which will be soldered later to one of the terminal studs. Actual coil winding is accomplished simply by grasping the mandrel between thumb and forefinger of each hand and rotating the assembly, in either a clockwise or counterclockwise direction, until the space between the two cardboard disks is filled flush to the outside circumference of the disks. Maintain moderate tension on the wire so that a tight coil will result.

After the winding is completed, cut the wire, leaving about 2 in. for the second lead. Tightly wrap the completed coil with cellulose tape to prevent it from unraveling and from falling apart as the coil is removed from the mandrel.

To free the coil from the mandrel, take a razor blade and carefully cut the glued joints at the junction of the cardboard disks and the wax paper. Remove the severed end of the wax paper from one side of the mandrel and slide the coil off toward the same end. The center hole of the coil

should be clean, but if any pieces of the wax paper or glue have become lodged in it, they should be carefully removed since they will interfere with the insertion and functioning of the moving mass.

The resistance of the completed coil will vary somewhat, depending on how tightly it was wound, but it should be in the vicinity of 380 ohms.

STEP 3. POLE PIECES (detail 3). The pole pieces are made from the laminations of a discarded radio-receiver output transformer, or similar unit. As mentioned earlier, the dimensions of these pieces may vary slightly in thickness and width, as this is of little consequence. The soft iron of the laminations is easily formed with a pair of needle-nose pliers, and it can be cut to the desired size with an ordinary pair of diagonal cutters.

STEP 4. CONNECTING PIECES (detail 4). The comments for step 3 also apply here. In addition, the connecting pieces may have to be bent slightly (see assembly diagram) if the pole-piece assembly and the magnet are not of the same width.

STEP 5. MOVING MASS (detail 5). The moving mass is made of No. 28 soft iron wire. The base should be flattened with a pair of needle-nose pliers to provide a place for the attachment of the phono point. The dimensions should not exceed those indicated in detail 5, lest the mass be increased appreciably.

STEP 6. FOAM-RUBBER PAD AND CAMBRIC STRIP. The foam-rubber pad is made from a large earring pad cut to the diameter shown in detail 7. When purchased, the earring pads are usually mounted on cambric, which can be used to prepare the $\frac{1}{16}$ in. x $\frac{3}{8}$ -in. strip shown in detail 6.

STEP 7. STABILIZING ROD (detail 10). This part is also made from No. 28 soft iron wire. Its function, in conjunction with the cambric strip just described, is to limit the front-to-rear movement of the moving mass.

STEP 8. PERMANENT MAGNET (detail 8). Of all the components used, the magnet may be the most difficult to procure. However, such parts are frequently obtainable from electronic equipment dealers and houses specializing in the merchandising of surplus goods. The magnets supplied with some small magnetic door latches are suitable.

STEP 9. TERMINAL STUDS (detail 9). These can be made from an ordinary 6d nail with the cut ends filed to remove burrs. Tinning the entire stud will improve conductivity and facilitate the eventual soldering of the coil leads to the studs.

FINAL ASSEMBLY. Press the terminal studs into the balsa block so that they

LIST OF MATERIALS

Balsa-wood block.
Bar magnet, approximately $5/8$ in. x $5/32$ in. sq.
Foam-rubber earring pad with cambric backing.
Soft-iron laminations from discarded transformer.
6d nail.
File folder or similar cardboard material.
No. 20 wire, used as coil-winding mandrel.
No. 28 soft iron wire.
No. 40 enameled copper wire.
Wax paper.
Wheel-bearing grease.
Airplane cement.
Rubber cement.
Cellulose tape.
Diamond or sapphire stylus.

protrude about $\frac{1}{16}$ in. on the coil side of the block. Apply a little airplane cement to the opposite ends of the studs at the points where they emerge from the block.

Slip the two pole pieces over the coil and push them together towards the center until the front edges of the pole pieces are just aligned with the center hole of the coil. If all dimensions have been carefully observed, the coil will just fill the pole pieces when aligned as directed.

Apply airplane cement to one face of the pole pieces and mount the coil assembly on the balsa block so that the center hole of the coil is concentric with the $\frac{1}{4}$ -in. hole in the upper part of the block. The purpose of the latter hole is to permit the ultimate alignment of the moving mass.

Apply cement to one face of the magnet and affix it to the block at a point about $\frac{1}{16}$ in. above, and perpendicular to the terminal studs.

Attach the connecting pieces between the pole pieces and the two ends of the bar magnet, bending them as necessary to insure good contact at all points. Although the magnetic flux of the magnet may appear to be strong enough to hold the connecting pieces in position, it is best to apply a little airplane cement at all four points to assure permanency of the joints.

Using rubber cement, affix the cambric strip to the foam-rubber pad.

Snip the phono point of a diamond or sapphire needle from its shank and cement the point to the flattened tang of the moving mass. (It is not always feasible to remove the phono point, alone, from its shank. Experience has shown that it is better to snip off a small portion of the shank with the point. This should be done underwater to eliminate the possibility of losing such a minute mass.)

Place the foam-rubber pad, with the cambric strip up, on a piece of balsa wood and, aligning the moving-mass assembly at a point central and perpendicular to the pad, press it all the way through the pad with a pair of needle-nose pliers. The flattened tang of the moving mass should now rest on the cambric strip and cement should be applied sparingly to this juncture.

Cut two triangular-shaped cardboard shims, the same thickness as the pole pieces, and fasten these to the coil with rubber cement in the position shown in the assembly drawing.

Fill the center hole of the coil with a good grade of wheel-bearing grease to serve as a dampening agent. (Because of the small hole diameter, a hypodermic syringe is very convenient for inserting the grease. In the absence of such apparatus, a small toothpick may be used in

order to accomplish the same purpose.)

Apply a small amount of rubber cement to the exposed surfaces of the cardboard shims and to the pole pieces throughout an area approximately equal to that of the lower surface of the rubber pad. Position the rubber pad, together with its associated moving mass, over the coil assembly and insert the shank of the moving mass in the center hole of the coil. This is the most critical part of the entire assembly since the tolerances are very small and the mass must be perfectly centered in the hole to insure distortionless performance. Alignment can be observed from the back of the balsa block through the $\frac{1}{4}$ -in. hole. A 10 or 20-power magnifying lens will be most helpful in successfully completing this part of the assembly.

Cement the stabilizing rod in position, with one end resting on the edge of the cambric strip and the other resting on the bar magnet, as shown in the photograph.

Complete the assembly by soldering the coil leads to the ends of the terminal studs. Before soldering, the enamel insulation must be removed from the ends of the coil leads. This can be easily accomplished with a small piece of steel wool. When the soldering is completed, coil continuity should be checked with an ohmmeter, if such an instrument is available.

All that remains to be done is the mounting of the pickup in its pickup head and the final test. The drawing of a suitable dust cover is given in detail 11, but it is best not to install this until after the unit is tested and you are certain that no further adjustments are required. The dust cover simply slips over the base block and is secured with a little rubber cement. (*Editor's Note:* The dust cover illustrated was for an earlier model in which the stabilizing rod was mounted on the front edge of the cambric strip. With the rod in its present position, the $\frac{1}{16}$ -in. slot shown in the cover must extend toward the rear of the $\frac{1}{32}$ -in. hole in order to clear the stabilizing rod.)

Construction Hints

Cement, wherever called for, should be applied sparingly to create a strong bond and provide a neat appearance.

The use of insufficient dampening agent (wheel-bearing grease) may result in excessive "needle talk" and subsequent distortion. For best results, the coil center hole must be filled to capacity.

This pickup was found to track satisfactorily with a stylus pressure of about 6 grams, and best undistorted output was obtained with the pickup working into a 100,000-ohm load. ★ ★ ★

8 4 82

WTM 59

The CRAFTSMAN



An Occasional Piece for Colonial Furnishings

STORAGE PLANTER

By John Bergen

USED AS A ROOM DIVIDER or merely placed against a wall, this attractive planter serves a dual purpose. Its greenery adds a charming touch to a colonial setting and its base provides a roomy storage compartment that can be put to good use in every home.

Where a low planter is preferred, the piece can be made without the trellis. You have a choice of several appropriate woods, namely, knotty pine, redwood and cypress. The material list below gives the sizes and

number of pieces needed, all of which are stock lumber, and the pull-apart drawing on the following page shows clearly how the whole affair goes together.

Since the back will show when the planter is used as a room divider, construction details will vary somewhat in adding 3/4-in. paneling all around. Also, all four corners of the base should be mitered and both front and back rails scrollsawed. Otherwise, construction remains unchanged. Start with the base. Notice in section details E

MATERIAL LIST

(KNOTTY PINE, REDWOOD OR CYPRESS)

BASE

- 2 pcs.—2 x 4 x 16 in.—Rim side rails
- 1 pc.—2 x 4 x 30 in.—Rim front rail
- 1 pc.—2 x 4 x 22 3/4 in.—Rim back rail
- 6 pcs.—1 x 6 x 24 3/4 in.—Side members
- 6 pcs.—1 x 6 x 19 in.—Door members
- 1 pc.—1 x 2 x 108 in.—Cleat material
- 1 pc.—3/4 x 2 3/4 x 108 in.—Cleat material
- 1 pc.—3/4 x 3 3/4 x 28 1/2 in.—Back base
- 1 pc.—3/4 x 3 3/4 x 30 in.—Front base
- 1 pc.—3/4 x 3 3/4 x 16 in.—Side bases
- 1 pc.—1/2 x 14 x 27 in.—Shelf (fir plywood)

- 1 pc.—1/2 x 15-3/16 x 28 1/2 in.—Bottom
- 1 pc.—1/4 x 27 3/4 x 25 1/4 in.—Back (hardboard)
- 4 flush-type colonial hinges
- 2 1 1/4-in.-dia. colonial knobs
- 2 3/8-in.-dia. bullet catches with strikes
- 1 pc.—sheet metal 22 x 36 in.—Plant trough

TRELLIS

- 2 pcs.—1 x 4 x 36 in.—Ends
- 2 pcs.—1 x 4 x 24 1/2 in.—Top and bottom
- 2 pcs.—1 x 4 x 17 1/2 in.—Shelves
- 4 dowels—1-in.-dia. x 36 in. long

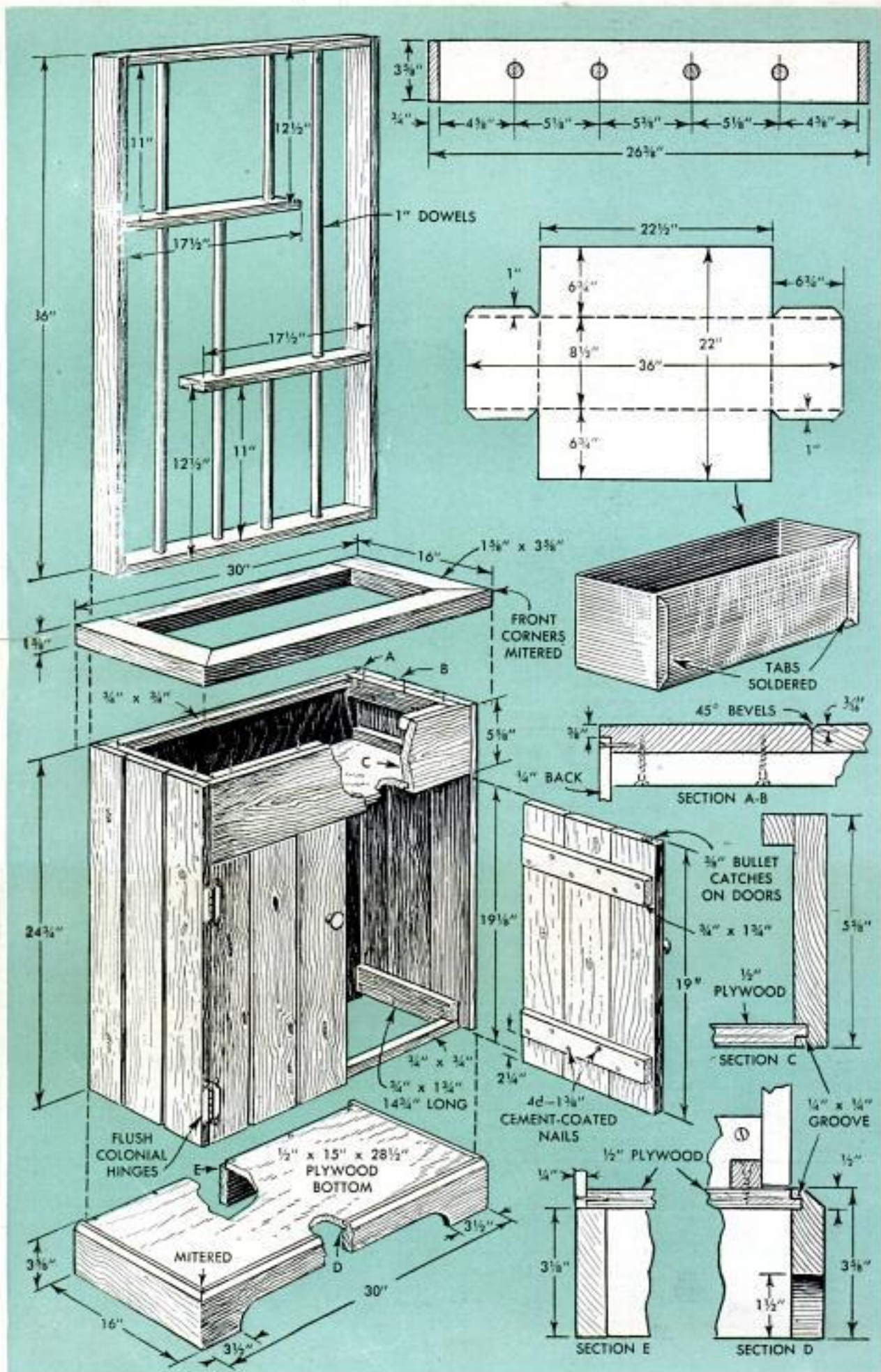

and D that the plywood used for the top is fitted flush with the top edges of the side rails. Three edges are rabbeted to fit grooves in the inner faces of the rails, while the back edge is left square for nailing into the 3 $\frac{1}{8}$ -in. back rail. This forms a rabbet along the rear edge to house the $\frac{1}{4}$ -in. back panel. The chamfered edge around the three sides of the base can be planed after assembly.

The pieces that make up the ends of the storage compartment are made into 15 $\frac{1}{4}$ -in. panels by screwing them to cleats placed at top and bottom. The cleats are made 1 in. shorter than the width of the built-up ends to allow for the thickness of the back and the doors. Note in section detail A-B that a rabbet is cut along the rear edge of each end panel and that a V-joint is formed between the individual boards by prechamfering the meeting edges slightly.

The trough compartment is formed by gluing and nailing the built-up ends to an L-shape assembly made up of a front board and a bottom board, joined in the manner shown in detail C. A $\frac{3}{4}$ -in.-sq. cleat at each end provides support for the bottom board. Similar cleats along the front and back at the top take the screws that anchor the rim. The latter is made as a separate frame from 2 x 4 material. If the planter is to be used as a room divider, all four corners of the rim should be mitered to look best. Otherwise, the rear corners need only be butted. Dowels or splines at the mitered joints make the best construction, but an easier way is to simply glue and nail them and later conceal the nailheads with wood putty. The rim is placed flush at the back and centered so it overhangs $\frac{3}{4}$ in. at the sides and front. Glue it in place first and then drive the screws up through the cleats in predrilled holes. A short stubby screwdriver will do best here. As a room divider it might look better to let the rim overhang all around in which case the width of the rim frame should be increased to 16 $\frac{3}{4}$ in. The doors are made up in the same manner as the ends, chamfering the edges of random pieces to produce V-joints and gluing and screwing them to cleats placed across the back. If you don't care to make the sheet-metal liner yourself, take

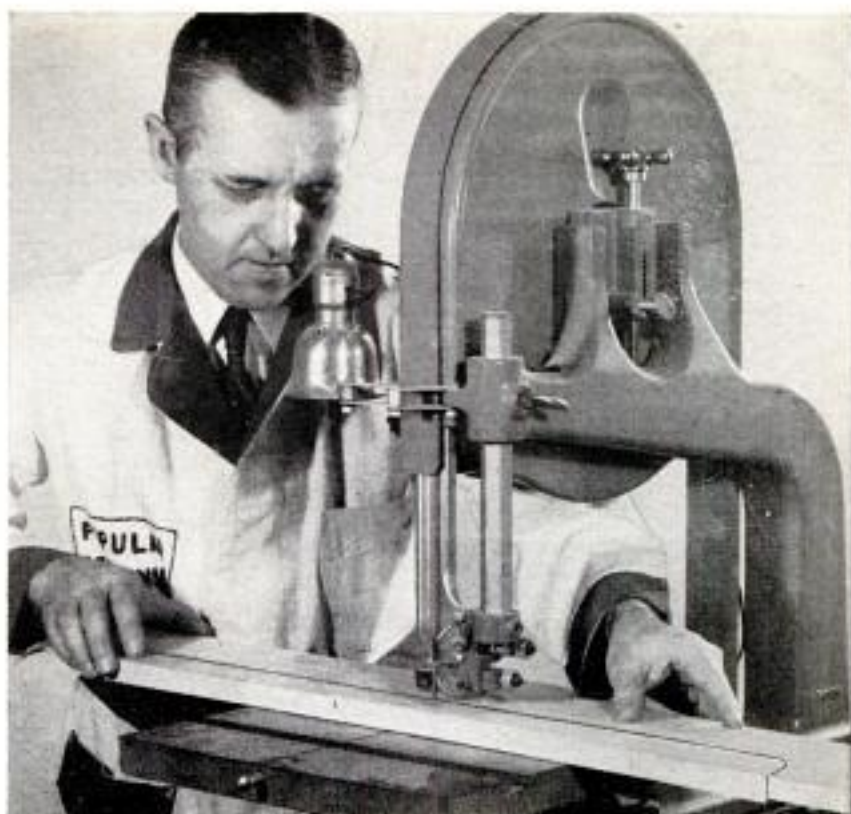

Toe-hole cutout in base apron is quickly cut with bandsaw. Both front and back aprons should be similarly cut when planter is room divider

the pattern given to your local tin shop. If you make it yourself, buy a sheet of 22-gauge metal and cut it just like the pattern. By clamping a board 8 $\frac{1}{2}$ in. wide and 36 in. long to the middle of the sheet metal, you can do a neat job of bending up the sides and tabs. You'll have no trouble in bending the ends inward. Notice that the tabs are on the outside.

The base is attached to the upper part of the planter by driving screws up through the plywood top and into the end cleats. Additional rigidity is gained in nailing the back panel in the rabbet at the back. A $\frac{3}{4}$ -in.-sq. cleat is fitted across the front to provide a ledge strip for the doors. If you wish, shelves can be added to the storage compartment. In doing so, cleats should be first screwed to the ends to support the shelves. They can be left loose or glued.

The trellis section is a simple affair that is made from 1 x 4 material and 1-in. dowels. To assure perfectly aligned holes in the four cross pieces for the dowel uprights, stack the pieces in their respective positions, clamp, and drill through the four members at one time. By drilling through from the bottom, you can easily make blind holes in the members the dowels do not pass through. The dowels are locked in place by cross nailing, and the butted corners of the frame are merely glued and nailed. A couple of roundheaded screws will hold the trellis to the rim of the planter, flush with the back. ★ ★ ★



Molding Strip on Garage Door Carries off Rainwater

A one-piece overhead garage door sometimes will catch and hold rainwater when left open so that the person closing it may receive an unexpected shower. To prevent this, tack a strip of picture-frame molding near the bottom edge of the door to serve as an "eaves trough."

Jar Is Weatherproof Note Holder

Notes to the milkman are kept safe from rain and wind when they are slipped into a glass jar that screws onto its own lid which is fastened to the wall near the door.



More Efficient Mousetrap

An ordinary mousetrap is made more efficient by driving a tack into the underside near one end and allowing it to project, so the trap can be hung vertically on the edge of a baseboard as indicated in the photograph.



Use the dusting brush of your vacuum cleaner to clean phonograph records as they are rotated on the turntable.

Dummy Wall Receptacle Provides "Safe" for Valuables



Few intruders would suspect a wall receptacle of being a hiding place for rings and other jewelry. The dummy receptacle consists of an outlet box installed in the wall horizontally in the usual way just above the baseboard. The receptacle is attached permanently to the cover plate by a single screw. The attachment ends of the receptacle are altered so they can be hooked over the heads of screws projecting from the box.

Glass Kept Mud-Free by Grass

You can prevent mud from splashing your windows every time it rains by simply spreading lawn clippings or peat moss over the soil in window boxes and potted plants on a window sill. The clippings or moss also help retain moisture for the plants and make excellent mulch.

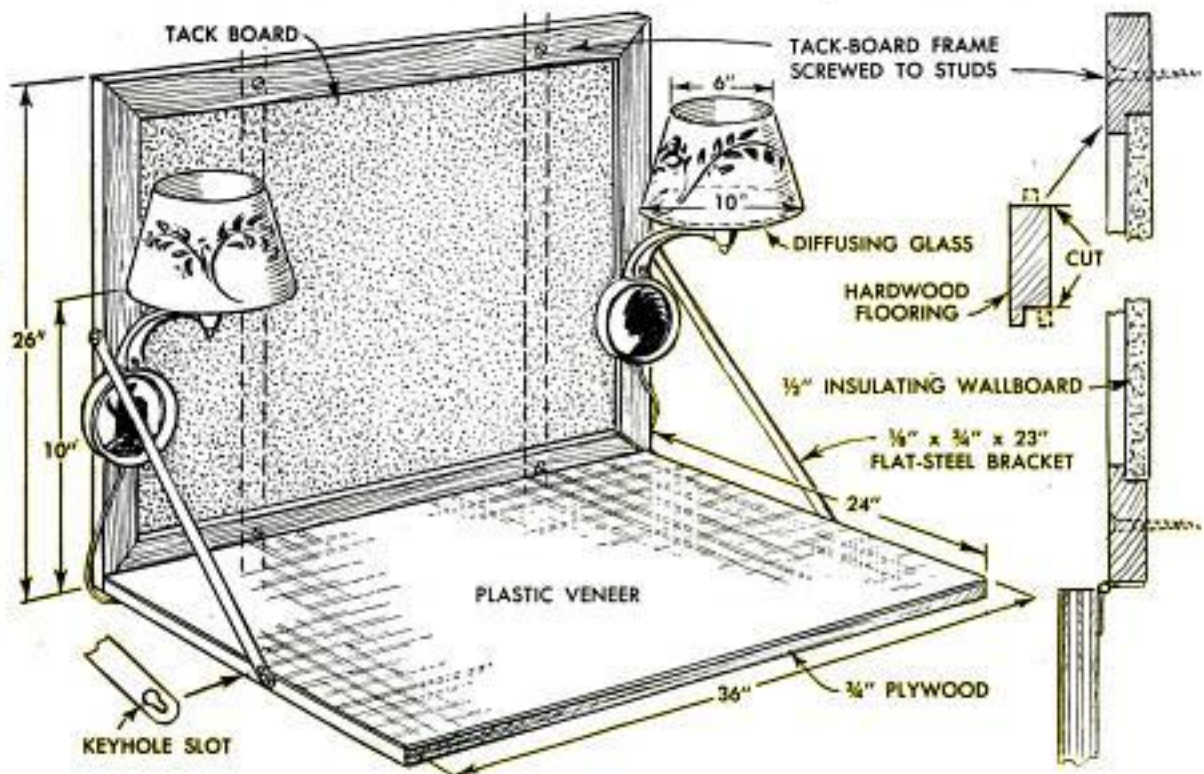

Photo courtesy General Electric Corp.

Fold-Down Desk Features Ideal Lighting for Study

Space-saving and attractive, this student's desk has a plywood top covered with easily cleaned plastic laminate. The tack board—or bulletin board—is a piece of insulating wallboard framed with lengths

of tongue-and-groove flooring from which one lip of the groove has been cut. Eyestrain is eliminated by using wall-mounted lights of the size indicated and 150-watt lamps that have built-in diffusion





Queen Anne Mirror and Wall Shelf

By C. W. Woodson

EARLY QUEEN ANNE is the period represented by the graceful design of this mirror and companion wall shelf. Mahogany-faced $\frac{1}{4}$ -in. plywood is used throughout for the shelf, and also for the jigsawed panels above and below the mirror. The frame around the mirror glass is made from ornamental picture-frame molding that you buy.

Mirror

Start construction of the mirror by making the frame, which has mitered corners. Before assembling, saw a groove in the upper and lower members to accommodate the plywood panels, as indicated in the lower left-hand detail. Next, make a pattern of the upper and lower panels by enlarging the squared drawings in the detail. Trace the patterns on the plywood and cut

them out with a jigsaw. Sand the edges smooth and glue the panels to the mirror frame. Now, set the glass mirror in the frame and glue and nail narrow cleats to the inside edges of the frame to keep the mirror in place. Cleats also are glued to the plywood panels as indicated in the lower left-hand detail and a piece of $\frac{3}{16}$ -in. plywood is glued and nailed over the mirror back as indicated, both to protect and to stiffen the plywood panels.

Wall Shelf

Both sides of the wall shelf are jigsawed at the same time to assure that they are identical. The sides then are mortised to receive tenons cut on the shelf ends and the assembly is glued together. A pattern is made for the back, cut out, then nailed to the back edges of the sides. ★ ★ ★

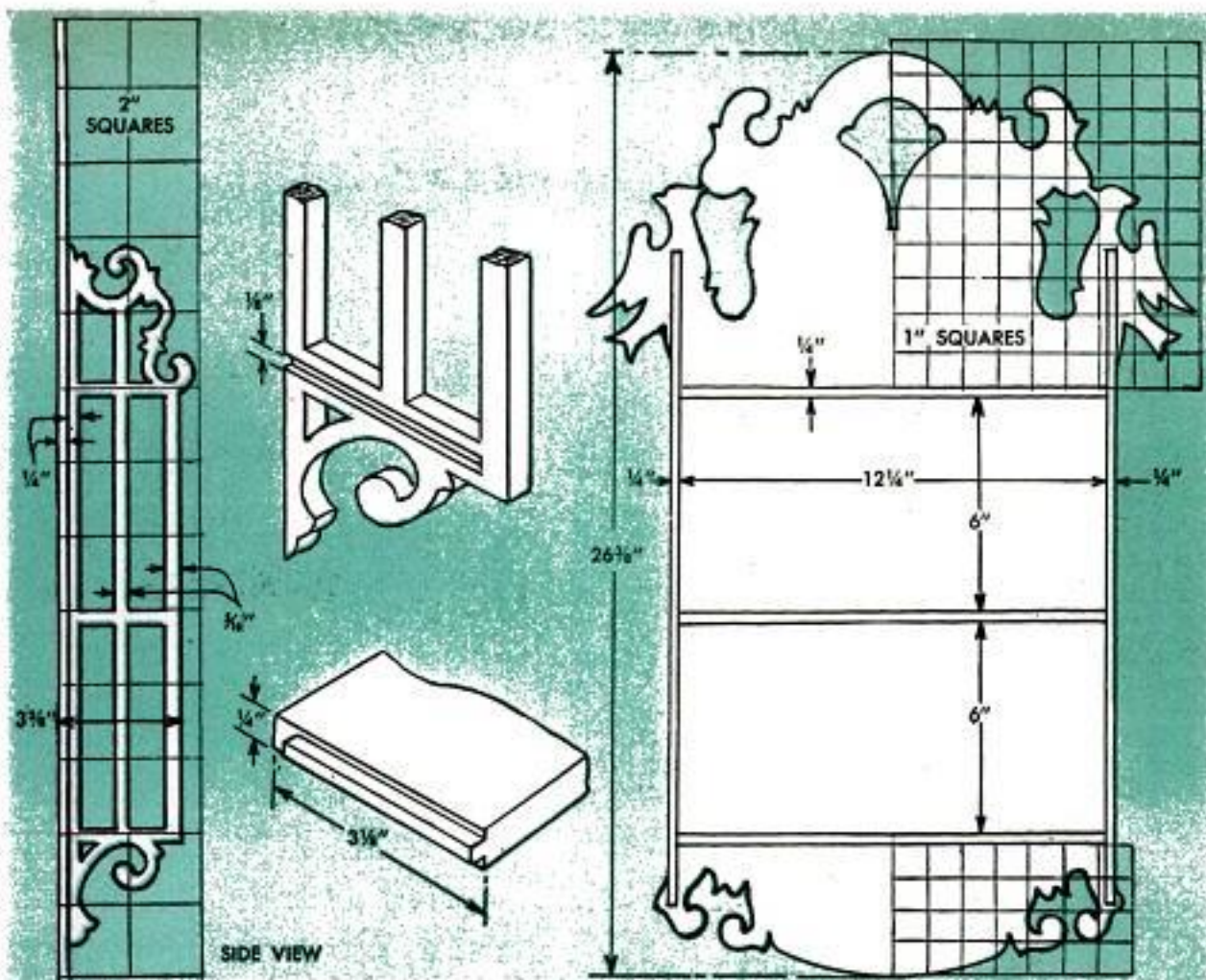

Patterns for the plywood panels are made by enlarging the squared drawings on this page. Mirror size can be changed but will require modifying all patterns

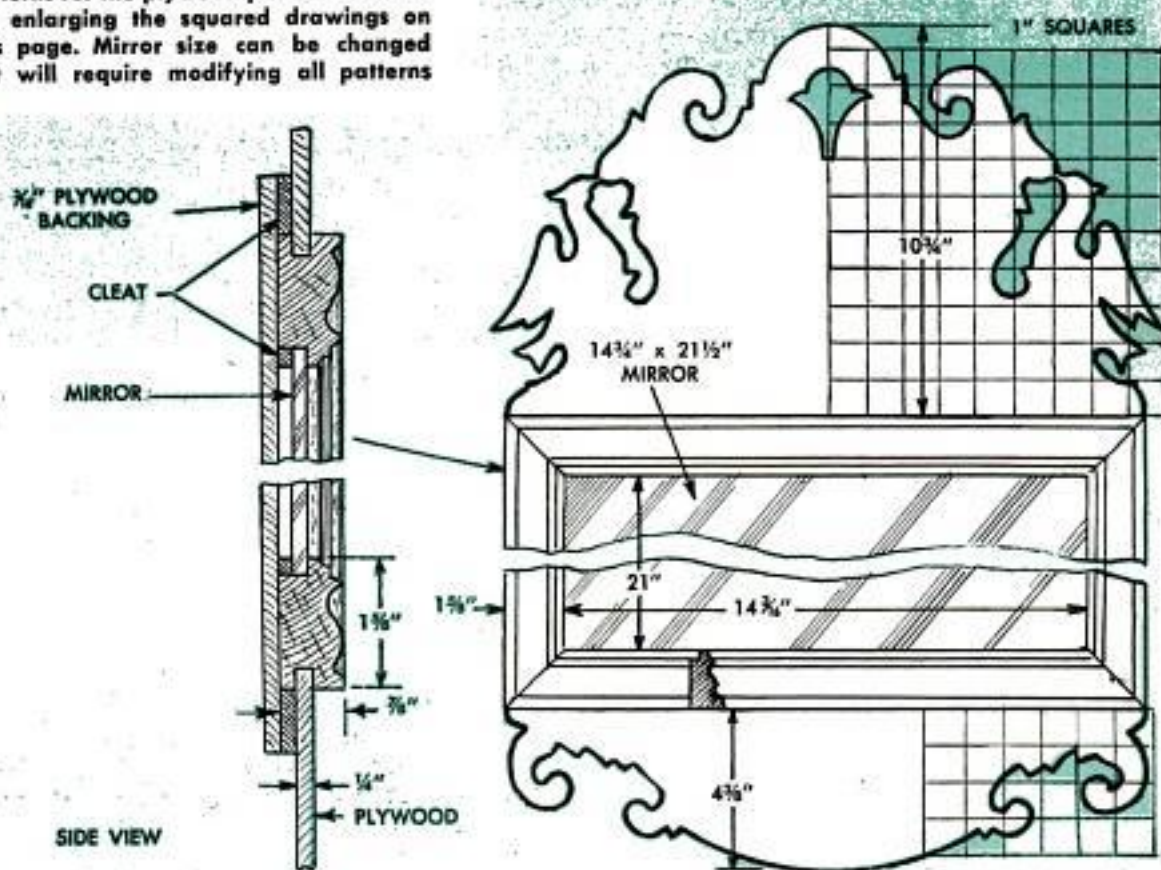



Soaped Straightedge Won't Slip When Cutting Glass

It is easier to hold a straightedge in place when using it as a guide for cutting glass if soap is rubbed on the underside. When making a long score on a pane of glass, the hand holding the straightedge should be moved several times to be in a better position to control the lateral force exerted by the cutter.

Tape Keeps Glue off Wood

Before gluing wood that is to be stained, one craftsman applies strips of masking tape flush with the joining edges. The tape prevents absorption of excess glue forced out of the joint by clamping. After the tape is stripped off the stain will "take" uniformly clear to the edges.

Jar Lid Seals Spray Gun

Mason-jar lids provide a means of sealing most spray-gun cups when the contents of several are being used intermittently in touch-up work. Also, the capped cup can be cleaned by agitating thinner in it.



Bounce Flash Made Easy With Swivel Attachment

Bounce-flash pictures can be taken without removing the flash unit from the camera by screwing a tripod tilt-top head to the flash-unit bracket. When the bracket is slipped into the accessory clip on the camera, the unit is ready for use. The tilting head permits the reflector to be swiveled in any direction.

Masking Tape Strengthens Chalk

Masking tape wrapped around a stick of chalk prevents it from breaking in small pieces when writing, even under heavy pressure. Also, the tape prevents chalk particles from adhering to the fingers and is easily peeled from the writing end as the length of the stick is reduced.

Holder Anchors Dog's Food Dish

Your dog will not overturn his food dish if it is supported on the ground by a wire holder. The holder is made by twisting together the ends of two lengths of wire and forming a hoop as in the detail.





INEXPENSIVE

Porch Table

Information
courtesy
Masonite Corp.

EVEN ITS CLEAN DESIGN suggests that this attractive porch table be used for cool, summertime living. Combining simple construction and low materials cost, it is an ideal project for an amateur craftsman who wants to try his hand at building furniture, or the experienced woodworker who wishes to build something that will require a minimum of time and labor.

The one-piece top of the table is cut from a sheet of $\frac{1}{4}$ -in. tempered hardboard; the

framework under the top is assembled from 1 x 2 stock and is mitered at the corners. Cross pieces are 15 in. apart. The hardboard top is glued to the frame, clamps being used to hold the assembly until the glue dries. Wrought-iron hairpin legs can be purchased in various lengths and are easily attached with wood screws. Finish the top by applying one coat of shellac or sealer, then brushing on two coats of gloss varnish and one of dull varnish.

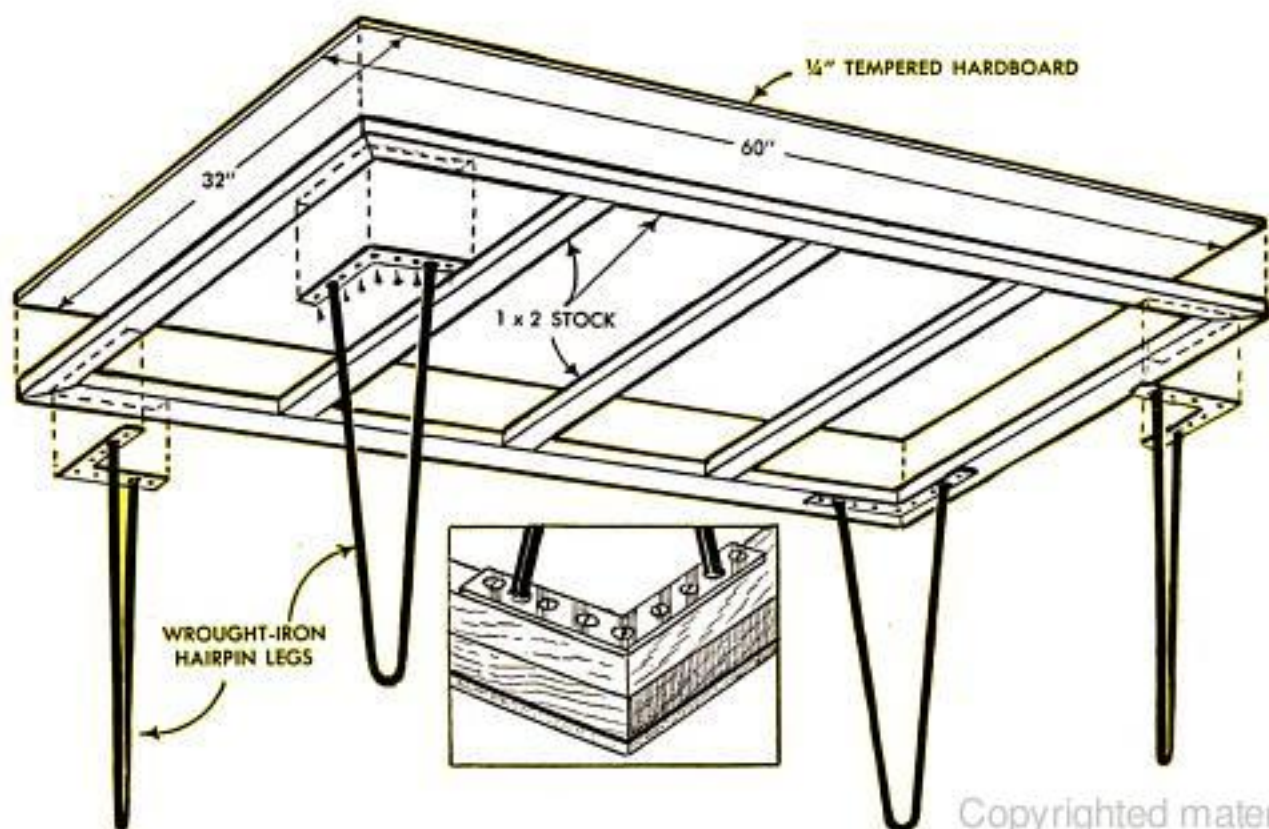

Copyrighted material



Spring bulbs should be taken from the ground in fall and potted for forcing. Pot them about the second or third week in October and store in cold frames so they remain dormant until removed in January



In January the potted spring bulbs are removed from the cold frames and taken indoors or into a hothouse to artificially induce them to start their spring growth. Bulbs treated this way will bloom in March

Winter Insurance for Your Garden



Dead leaves and grass clippings can be made into valuable mulch by treating them with commercial compost-producing preparations



Given a little assistance, your flowers will winter well, bloom early.

ABOUT THE MIDDLE OF OCTOBER is the time to dig up and pot spring bulbs if you want to force them for early blooming. Store the potted plants in cold frames until January, then move them indoors or into a hothouse. They will bloom in March. Annual plants should be dug up before the first frost, potted and taken indoors. Replant them outside in spring. To assure vigorous peony bushes, prune the stalks down to within a few inches of the ground in fall. Cover the root area with several inches of mulch, such as peat moss, composted material or a blanket of straw 2 or 3 in. thick.

Annuals that would be destroyed by winter weather should be taken out of the ground before the first frost and placed in pots. The plants will grow all winter indoors and then can be replanted outdoors

Peony bushes have fresh growth every spring and the old stalks must be cut down to provide room for the new growth. Prune the old stalks down to within a few inches of the ground as shown in the photograph

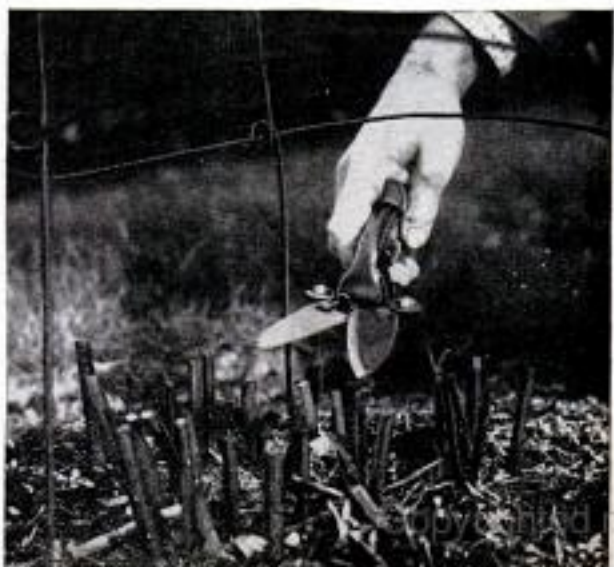



Requiring especially good care if they are to last through the winter are rosebushes. To protect these plants, pile soil around the roots and about halfway up the main stem of the plant. Rosebushes are not pruned in the fall, but in the early spring



To make sure that the dirt piled around the rosebush does not thaw, once it has frozen, straw or hay is piled over the dirt to insulate it. This is done after the ground has frozen thoroughly. Straw also is piled around the rosebush to protect it



Trees and shrubs, although hardier than flowers, also require protection.

Freezing does not hurt most plants, rather it protects them. Alternate thawing and freezing is what does the damage, breaking the roots and sometimes heaving the plants above ground level. Insulation by mulching, therefore, is required. Pile soil about 8 in. high around a rosebush, then completely surround the bush with straw. Some trees, such as figs, are unusually sensitive and should be wrapped completely with waterproof paper, as well as having their roots protected with a heavy layer of mulch. Soft trees, such as rose trees, should be wrapped in straw or hay of the type that has long strands, which provides a "blanket" around the tree. Older trees are hardy enough to go through a winter with no assistance, but young trees, because their roots are close to the surface, can be killed by freezing. For this reason, the roots should be insulated with mulch.

Soft trees, such as rose trees, should be wrapped completely in straw or hay that has long strands, permitting it to be tied around the tree like a blanket. The straw protects the tree against winter weather and early buds against the spring frosts



Fig trees and some dwarf fruit trees are extremely sensitive to weather extremes and must be wrapped completely in waterproof paper and the roots well mulched

Roots of young trees should be protected against the damage that can be caused by alternate thawing and freezing, which may break them or heave them out of the ground. Insulate around the root area with a layer of mulch after the ground has frozen





Winterizing treatment for a lawn begins late in the fall with the application of fertilizer and lime, distributed evenly over the lawn with a spreader



Next operation after fertilizer and lime are spread on lawn is to aerate it with one of a number of devices to assure that air and food reach grass roots



After the entire lawn has been aerated thoroughly, spread a top-dressing, such as peat humus, over it

About a month after applying the top-dressing, sweep the lawn to remove debris. Mechanical sweeper pictured makes this job a simple one

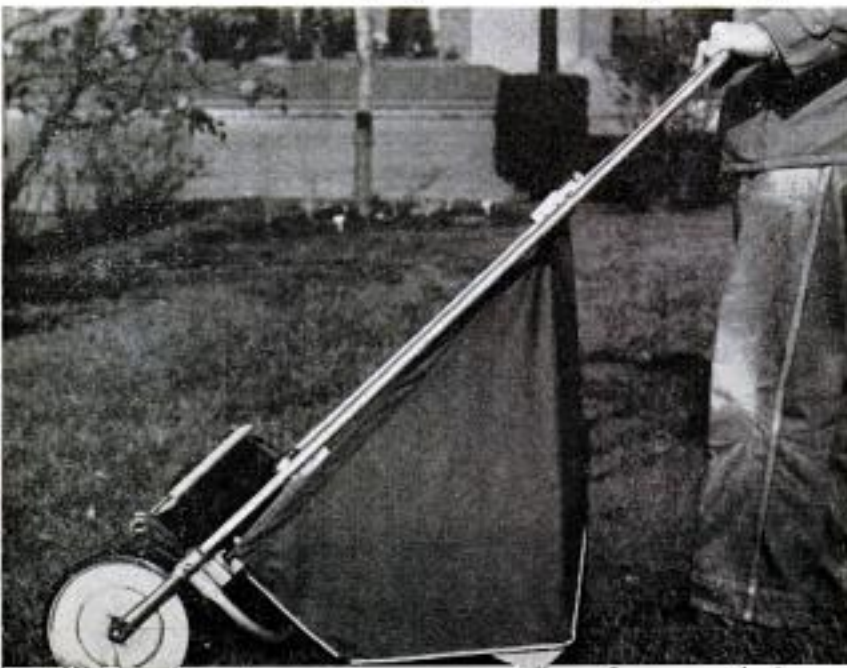

“Scalp treatment” for lawn readies it for winter.

Preparation of your lawn in the fall will have much to do with its health the following spring. The first step in winterizing a lawn is to spread fertilizer and lime, making sure the materials are evenly distributed. A spreader designed for this purpose will give the best results. After the fertilizer has been spread, aerate the lawn with a spiked disk, plate or roller to assure that both air and food reach the grass roots. After aerating the lawn, apply a top-dressing; peat humus is excellent. A month after the top-dressing has been applied, sweep the lawn thoroughly to remove any debris. Mechanical sweepers, mounted on wheels and fitted with rotating brushes make this job a simple one, but an ordinary straw broom will do just as well, although requiring more time. The lawn now is ready for winter. To further guarantee a healthy lawn, there is a precaution to take during the winter. If possible, avoid piling snow very high on a lawn when cleaning walks and drives. The weight of banked snow seems to encourage “snow mold,” which often causes large areas of grass to turn brown and die. ★ ★ ★

Reel Assures Kite Control

Paying out and taking in kite string can be done quickly with this simple reel. It gives positive control and reduces the possibility of the string being jerked from the hands and the kite getting away. The reel consists of a piece of $\frac{3}{4}$ -in. plywood cut to the shape and dimensions shown in the detail. Two $\frac{1}{2}$ -in. dowels are glued in drilled holes to provide handles. All edges are rounded and the entire reel sanded smooth, varnished, then sanded again and coated with paste wax. Repeated waxing will produce a slick finish.

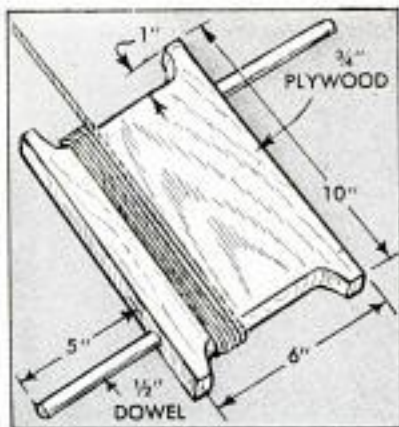

Toy Train-Track Sections Held by Rubber Bands

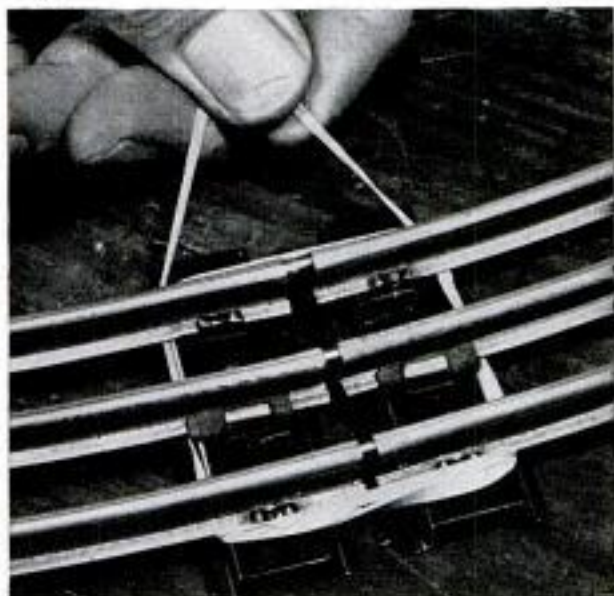

When sections of track for a toy electric train are not screwed or tacked to a special board they often pull apart from the motion of the trains, or the joints become loosened enough to cause a poor electrical connection. To prevent this, stretch a rubber band around the "ties" at each joint as shown in the photograph. This method of securing the sections can be used on any style or gauge of track and permits quick dismantling when the tracks are to be stored away. Also, the rubber bands will hold the joints firmly enough so that a fairly large-sized layout can be moved or picked up without any sections becoming disconnected. The idea also works well on tracks for wind-up-type trains where younger children are apt to pull the track sections apart while they are playing.—Fritz Snyder, Dover, N. J.

Paint Identifies Photo Filters For Easy Selection

To solve the problem of quickly finding a particular filter in your camera equipment, paint the lid of the container the same color as the filter. Auto touch-up paints are ideal for this purpose as they come in a large variety of colors. For filters that have no color, such as the color-compensating type, write the number of the filter on the case with India ink. If the cases are of plastic, clean them with carbon tetrachloride before writing or painting.

Robert C. Florian, Chicago.



Solving HOME PROBLEMS



REFILLING A STEAM IRON is easy, when an empty plastic shampoo bottle of the type shown, is used for pouring the water. Any other plastic bottle with removable spout is suitable for this purpose



WOOD SCREWS turn more easily in tight-fitting holes when threads are rubbed with a slightly wet bar of laundry soap as shown above. The soap lubricates the threads as they turn in the wood

PAINT DATA is recorded on hardboard scrap dipped in paint used on a job. Board is then cut to size for easy filing. When necessary to repaint, or touch-up repaired surface, simply consult paint-data file

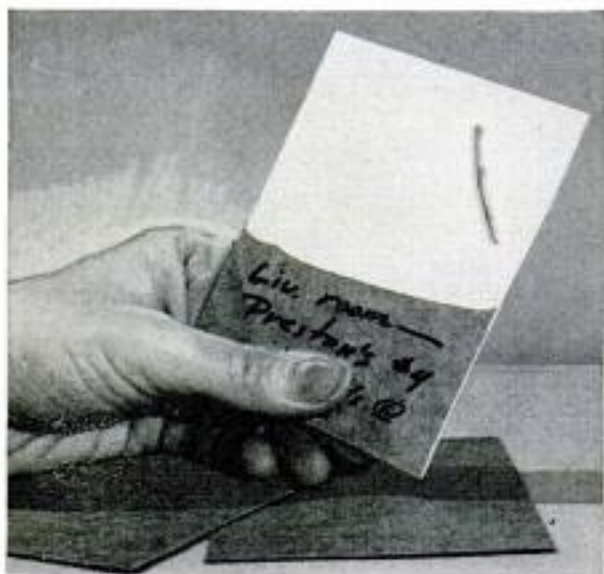

174



VENETIAN-BLIND SLATS won't scratch woodwork on window frame if short lengths of rubber hose are slotted and slipped over the ends of one or two of lower slats. Also, blind operates more quietly



SOILED BAND on felt hat need not be removed when cleaning it with cleaning fluid. Simply insert strip of aluminum foil between the band and crown as shown to prevent absorption of the fluid by the felt

BED SLATS that tend to work out of position and drop the spring and mattress to the floor, can be made to remain in place by screwing cleats near the ends of each slat as shown in the drawing below

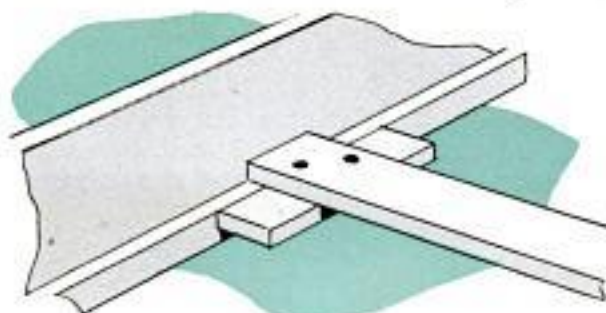

POPULAR MECHANICS

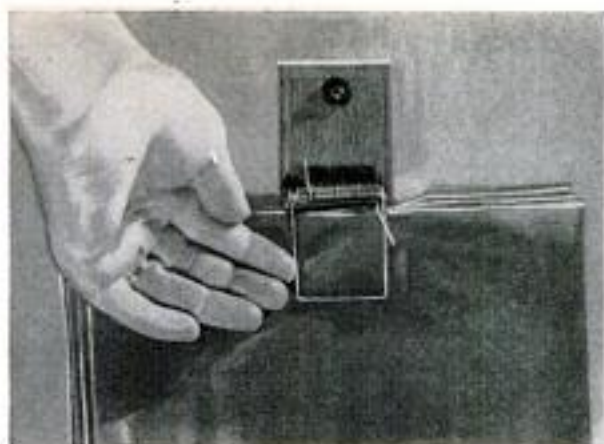

SPRING-TYPE MOUSETRAP is handy holder for paper bags, receipts or note paper, when it is screwed to inside of kitchen-cabinet door as shown above. Simply remove bait pan and the trigger

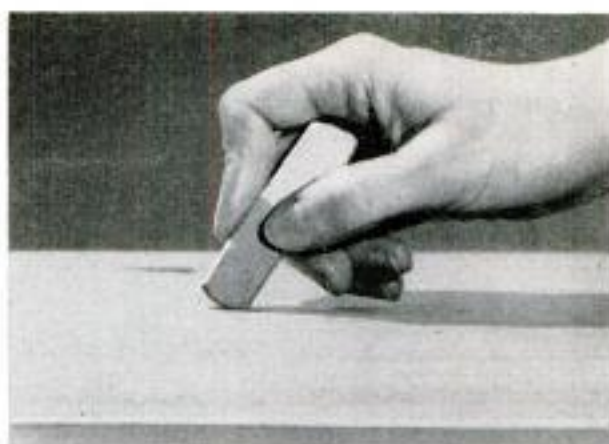

SURFACE MARKS on fine furniture that cannot be removed with a mild cleaning solution, usually can be rubbed off with an ink eraser. Application of polish on cleaned spot will restore original luster

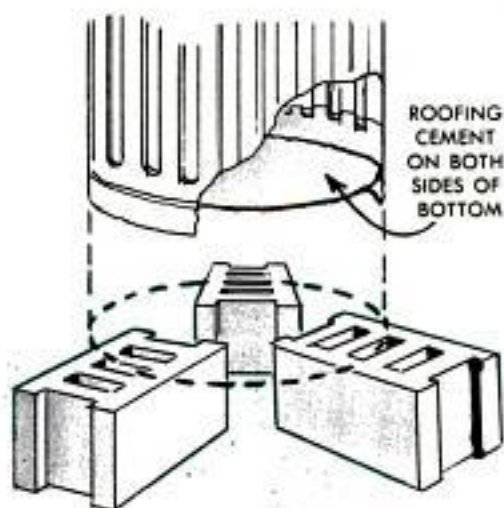

YOUR GARBAGE CAN will last longer if a coating of roofing cement is applied on both sides of the bottom. Also, a base should be provided that will permit air to circulate under cans as shown above

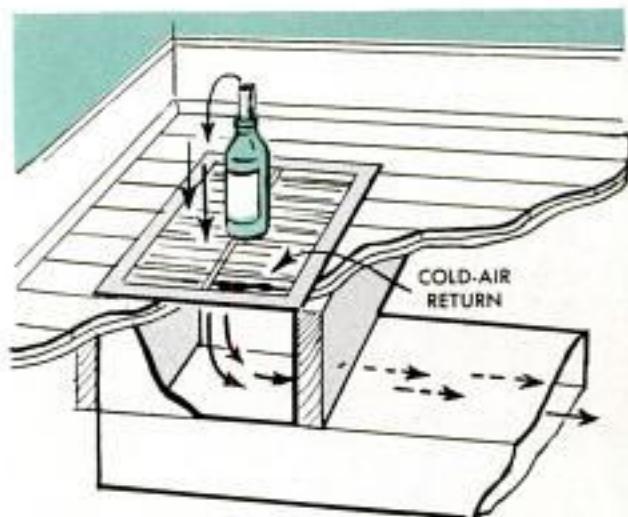

PAINT AND COOKING ODORS can be removed from house provided with forced-air heating by placing open deodorant bottle on cold-air return as shown above. Also, deodorant may be placed inside return

WROUGHT-IRON LEGS of the type shown below will not mark linoleum or wooden floors when a short length of rubber hose is slipped over the lower end of each leg

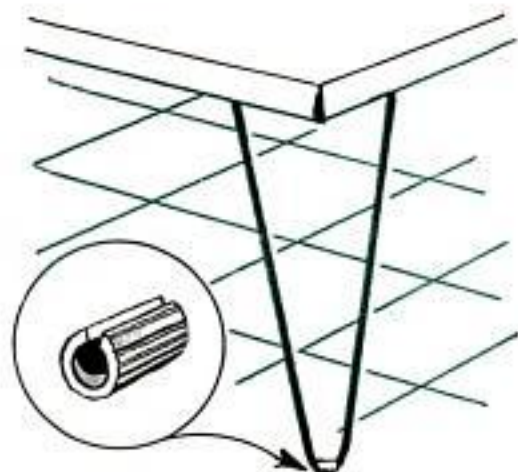

TINTING PLASTIC SWITCH and wall plates to harmonize with room furnishings is easy. Just wipe liquid food colors on plastic with soft cloth or cleansing tissue. To change or renew colors, simply remove plate and wash with cold water



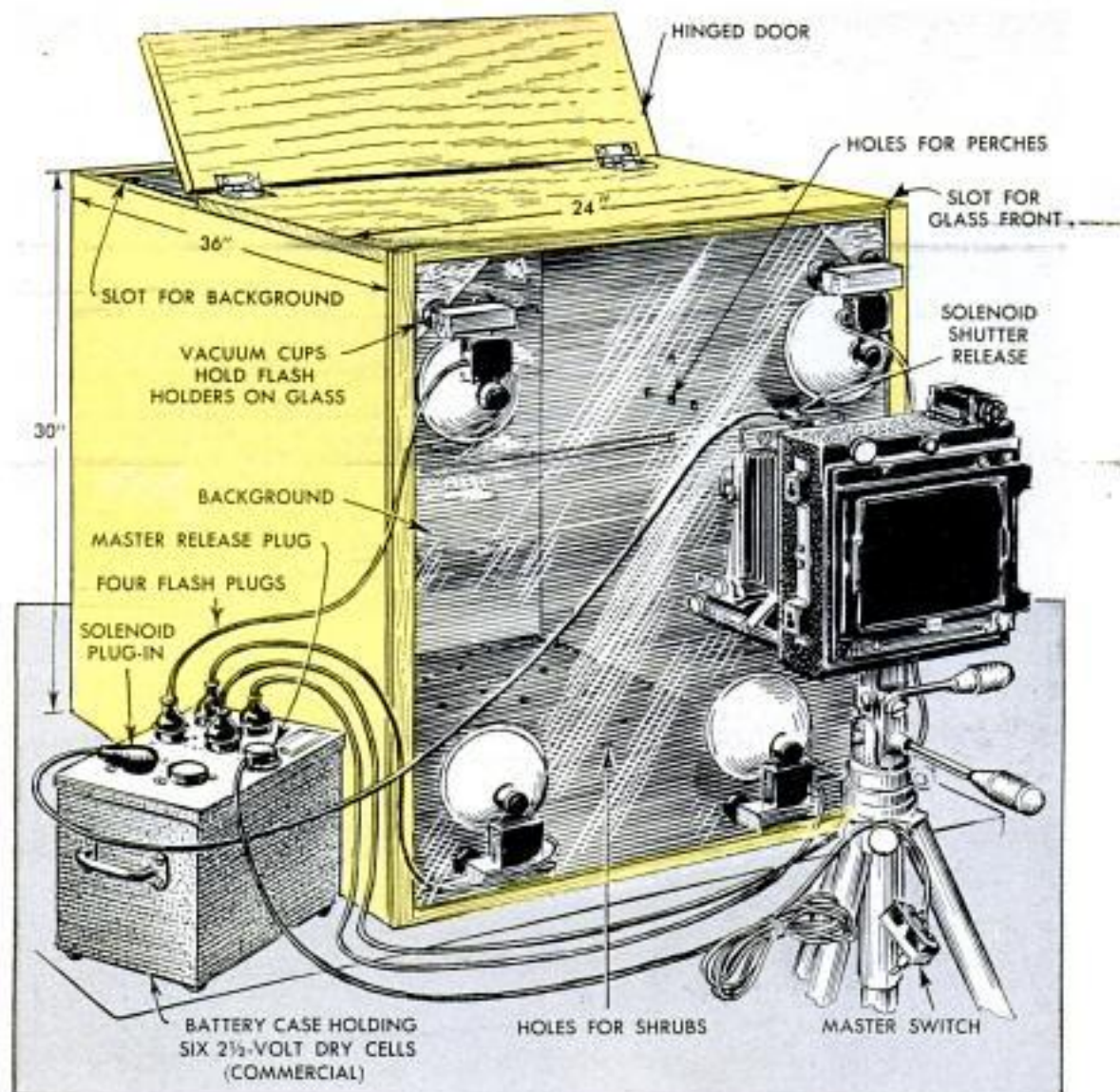

Give Caged-Animal Shots a Natural Look

By Henry H. Sheldon

GETTING WILD ANIMALS to "sit" for portraits is easy when you have a box with a glass front for a cage in which to confine their movements while waiting for an unusual shot. A background of a colored enlargement of scenery appropriate to the habitat of the animal being photographed, actual ground cover and simulated trees provide a realistic setting for some terrific photos.

Four flash units secured to the glass front by suction cups as shown provide adequate lighting. These are synchronized with the camera. This is done by plugging an extension cord into the solenoid shutter release on the camera and the solenoid plug-in on the lid of the battery case. The solenoid plug-in is connected to the

flash receptacles on the lid, with a master switch wired into the circuit for operating the shutter and flash units when desired.

The box is made of ½-in. plywood as in the drawing. Two slots at the back accommodate a background board with an enlargement of a nature scene attached, and two slots at the front accept the sheet of glass. Holes drilled in the sides and bottom of the box permit inserting small branches and twigs, also tufts of grass, to provide a setting not unlike the animal's habitat as shown in the color photos on the next page. A colored enlargement depicting the animal's native haunts is attached to the background board to complete the setting. ★ ★ ★

Sitting on branch of tree overhanging lovely lake in South America, peach-faced lovebirds look into camera's lens—could be, but actually they were photographed in the photo box



Left, portrait of bobcat in photo box with background of cedar branches and flash highlight on left only. Below, mink is glamorized on bac'ground of blue silk



Right, use of elaborate ground cover and heavy foliage affords suitable habitat for mountain beaver from St. Helens, Wash., and induces him to feel at ease





Deluxe Playhouse **has water and lights**

By C. W. Woodson

ANY YOUNG LADY will feel like a fairy-tale princess when she is the proud owner of this enchanting playhouse that includes the modern magic of electric lights, running water and a heating plant. With the little house located in a corner of the back yard, Mother knows her daughter and friends are safely off the street, and she can check on the children's well-being in a moment.

Construction of the playhouse starts with staking-out the foundation, as shown in the detail at the bottom of page 180. Assure that the main 6 x 8-ft. foundation is square by measuring the diagonals, both of which should be exactly 10 ft. Cedar posts 5 in. in diameter are cut in 2-ft. lengths (longer in areas of severe frost) and sunk in holes dug just inside the stakes as indicated in the upper detail on page 180. Use a long

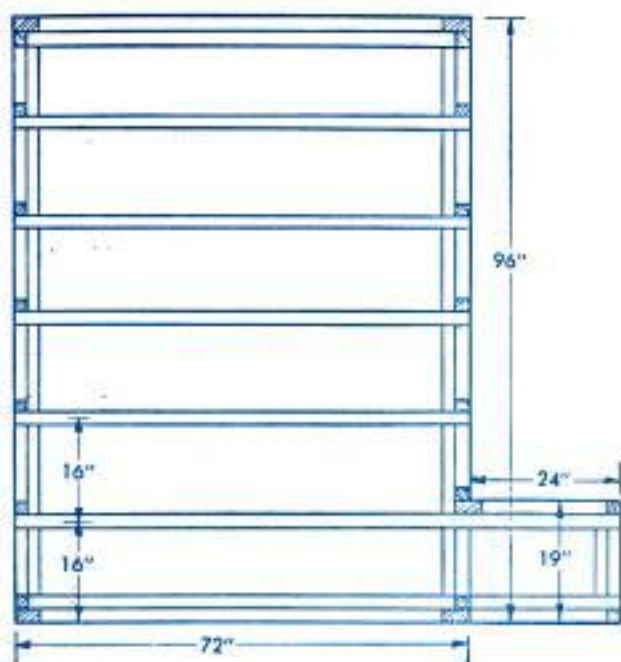

straightedge and level all the posts. A handful of gravel under a low post will bring it up to the right height. The foundation posts should project about 4 in. above the ground, which is high enough to permit ample air circulation under the building to prevent rot, while still being low enough for pleasing appearance. Sills, which can be either 4 x 4s or two 2 x 4s on edge, now are spiked to the foundation posts. Recheck the level of the foundation and shim up the sill where necessary. The floor joists next are toenailed to the sills. The joists are 2 x 4s on edge, and are spaced 16 in. on centers. After the first joist is nailed in place, a spacer block, lower right-hand detail, page 181, can be used to speed the work and assure accurate spacing. The joist plan at the left shows the joists in place and the location of wall studs that are spiked directly to the sills alongside the floor joists. Wall studs and roof beams are 2 x 2s, with the exception of the corner-post studs, which may be 2 x 4s, lower right-hand detail, page 181, to provide a nailing surface for the interior wall covering. An alternate corner-post arrangement,





in which 2 x 2s are used, is shown in the right-hand center detail on page 181.

Carefully check all details on page 181 to familiarize yourself with the methods of framing the building, as well as noting the locations of openings for the door, windows and fireplace. The curved roof members of the projecting portion of the building—which can be used as a closet or storage area—are bandsawed from two

pieces of solid stock. The fireplace opening in the back wall is as wide as the space between two wall studs and should be high enough to provide ample space for the electric heater that is to be installed in this area. The framing members over the

5" x 24" POST →

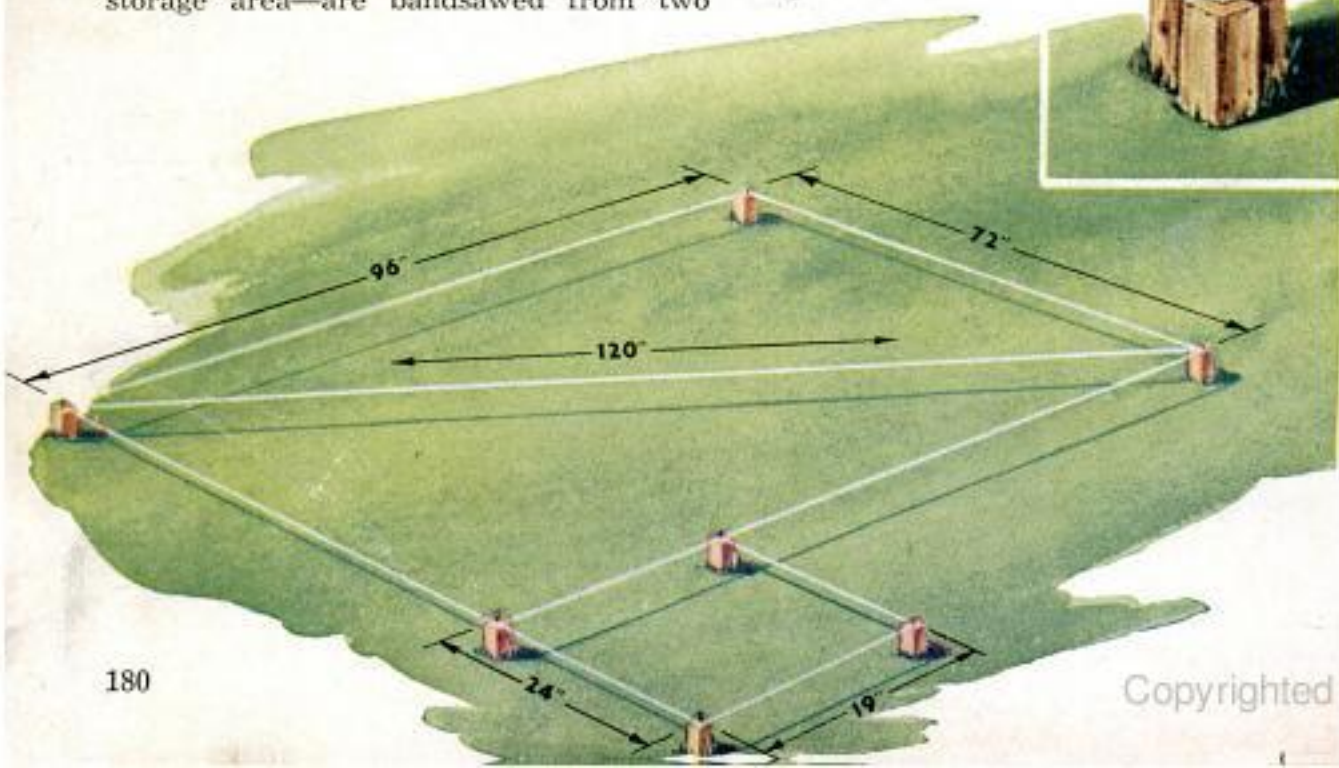
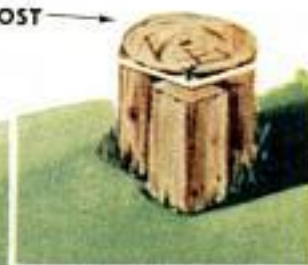

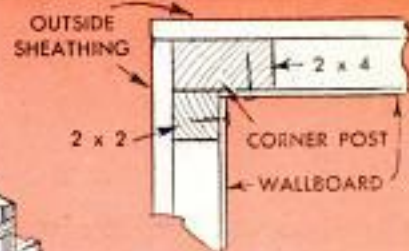
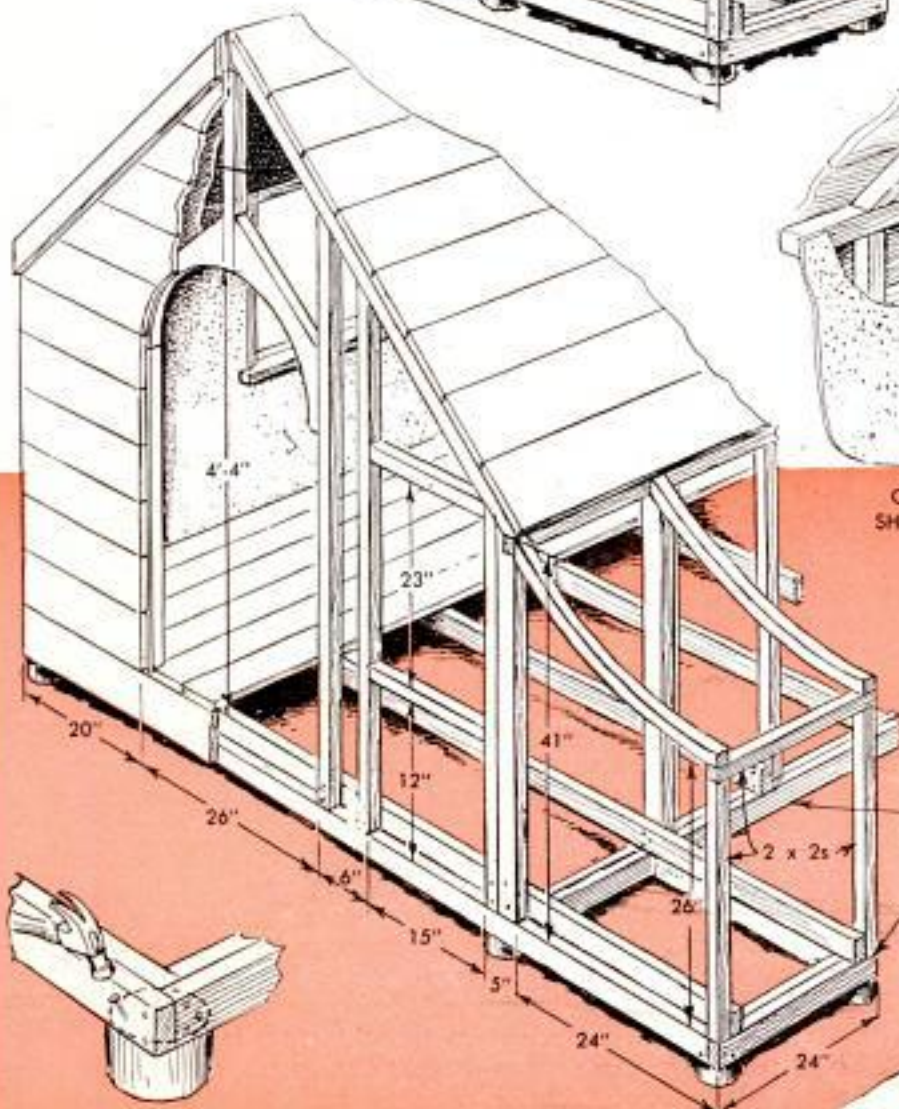
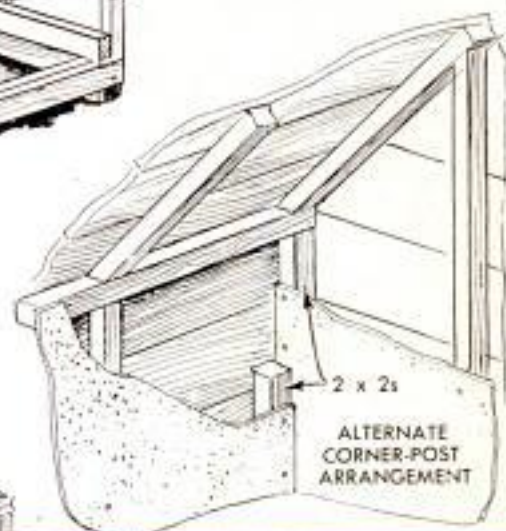
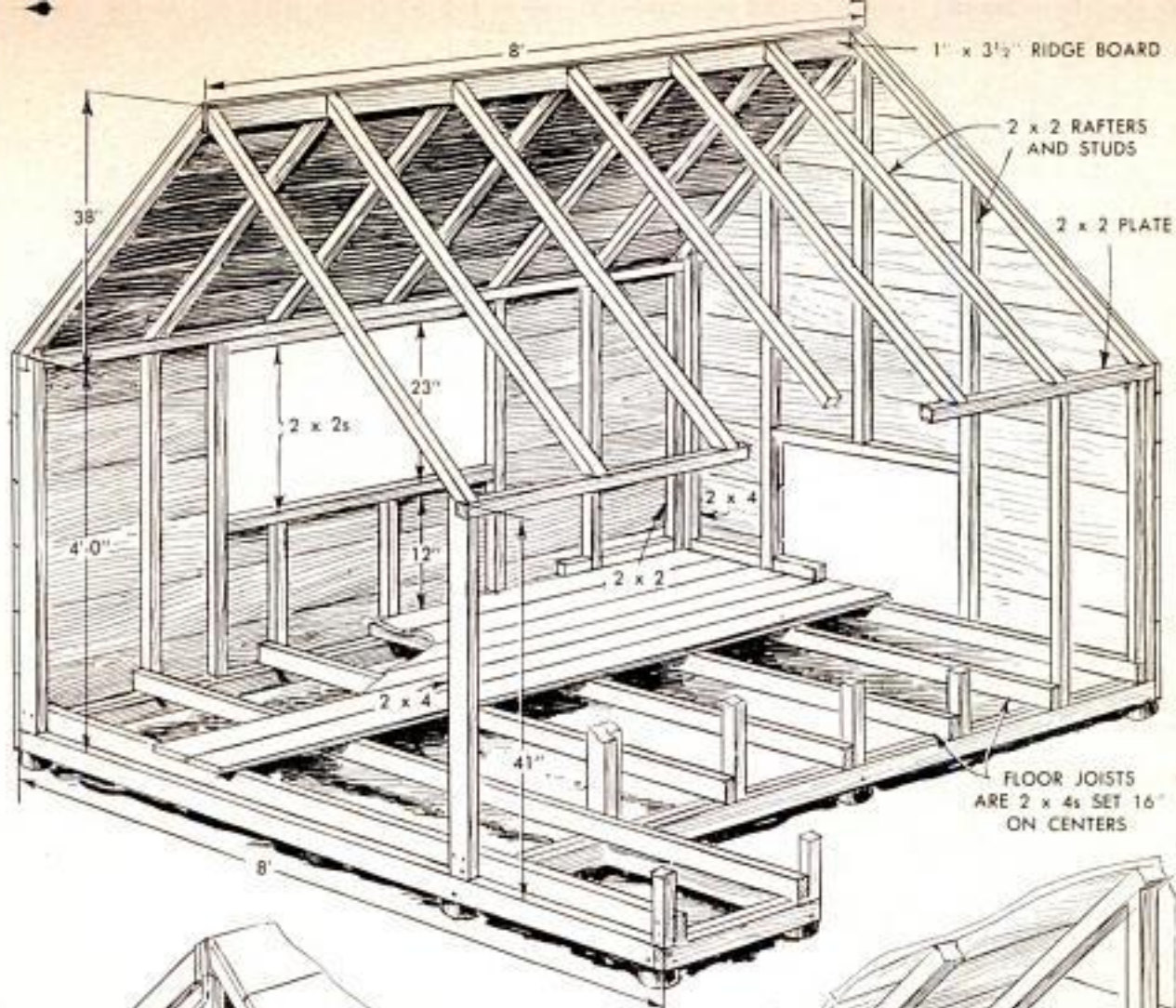

ALL SILLS ARE DOUBLE 2 x 4s SET ON EDGE AND NAILED TOGETHER

SPACER BLOCK

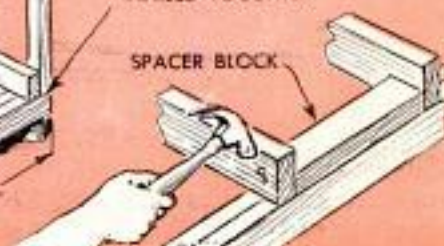
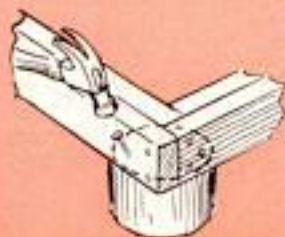

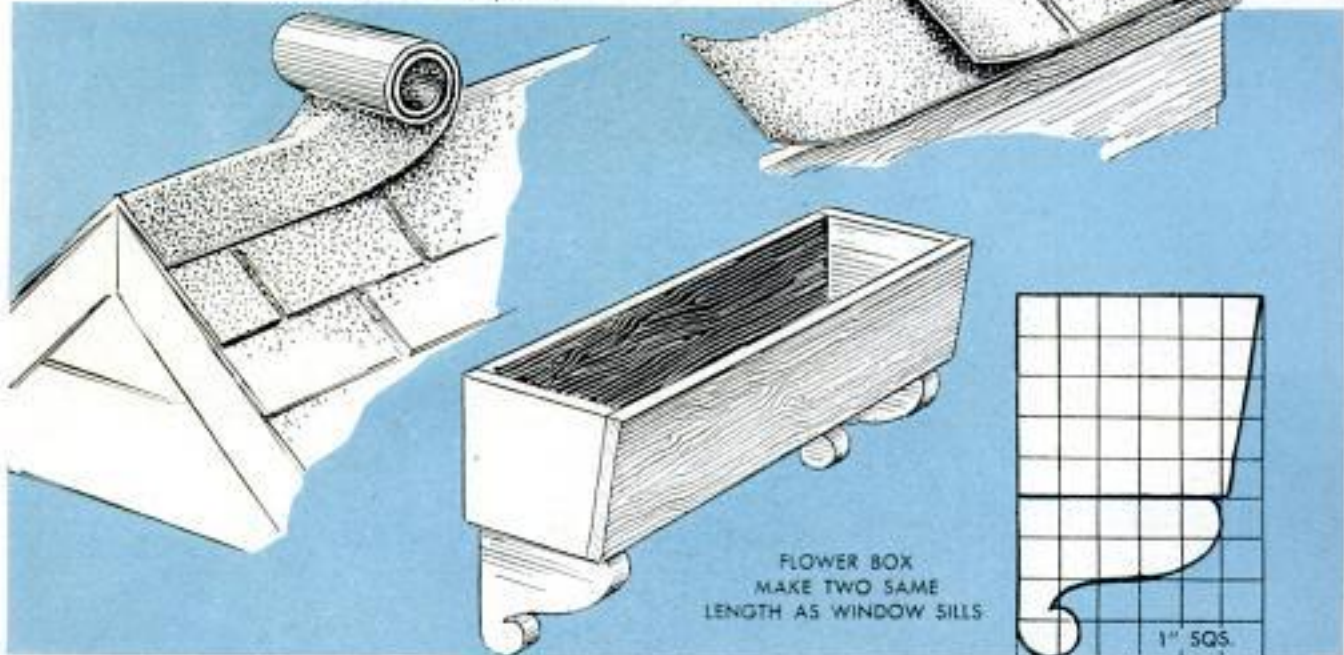
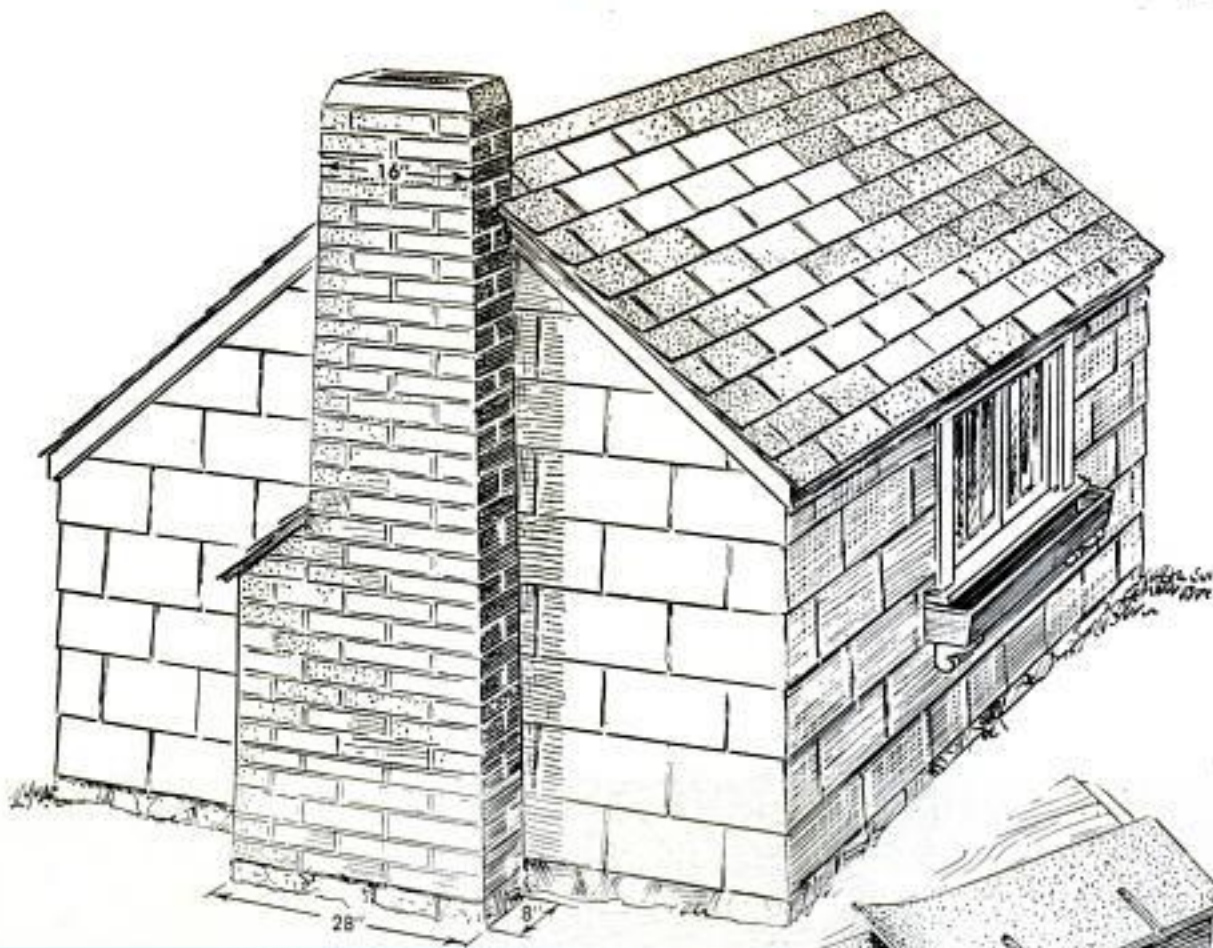

FLOWER BOX
MAKE TWO SAME
LENGTH AS WINDOW SILLS

1" SQS.

door opening are bandsawed from solid stock, using a 13-in. rad., or the pattern for the outside door trim on page 183 may be used to determine the curve of the inner edges of the framing members. Note that the lower ends of these members are the width of a 2 x 2 on which each will rest. This provides a double 2 x 2 member on each side of the door opening for additional strength.

Tongue-and-groove sheathing is used for the floor of the playhouse, for roof planking and for wall sheathing. The sheathing goes on quickly and will assure a rigid

structure. Around door, window and fireplace openings, the sheathing is applied so it is flush with the inside edges, as per details on page 181. After the sheathing is applied, the chimney can be constructed. It consists of 1 x 8s fastened to cleats that are nailed to the sheathing. The rear face of the chimney then is nailed to the side pieces. The rear elevation of the playhouse detailed above shows the shape of the chimney, and indicates how the top of the offset in the chimney is shingled with the same material used on the roof. Imitation brick siding is used to cover the chim-

WINDOW DETAILS

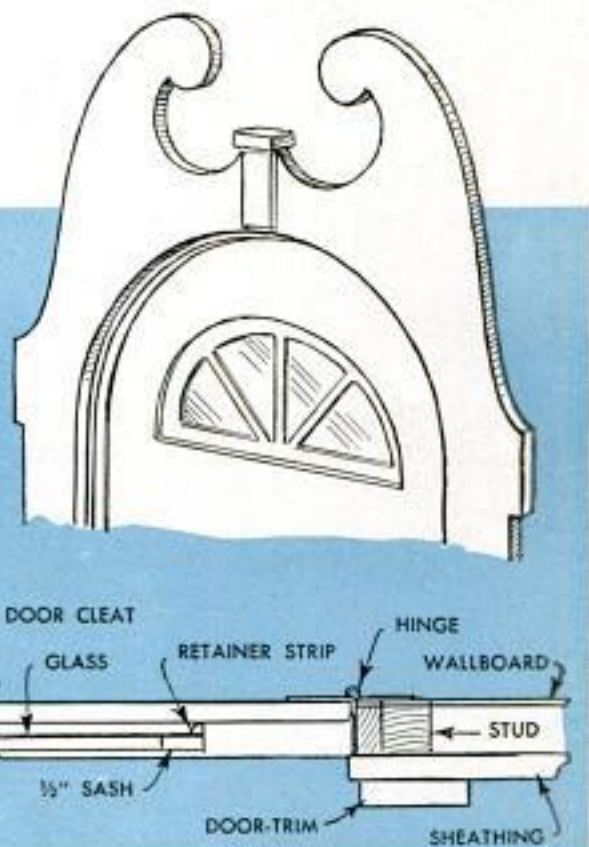
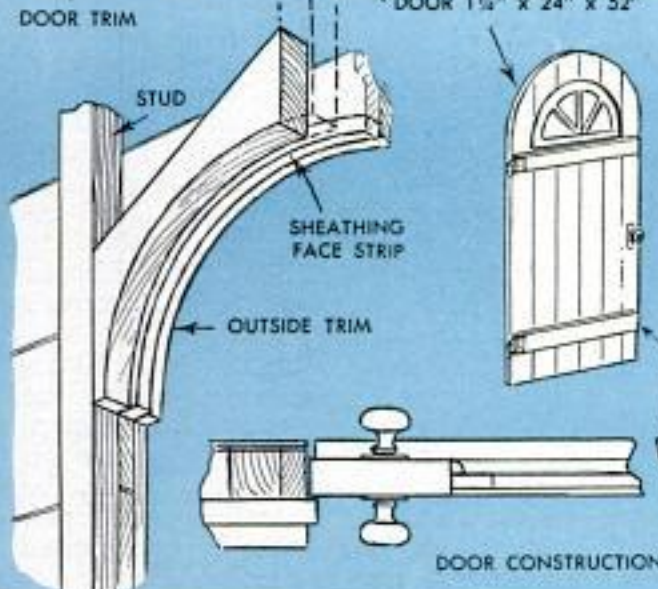
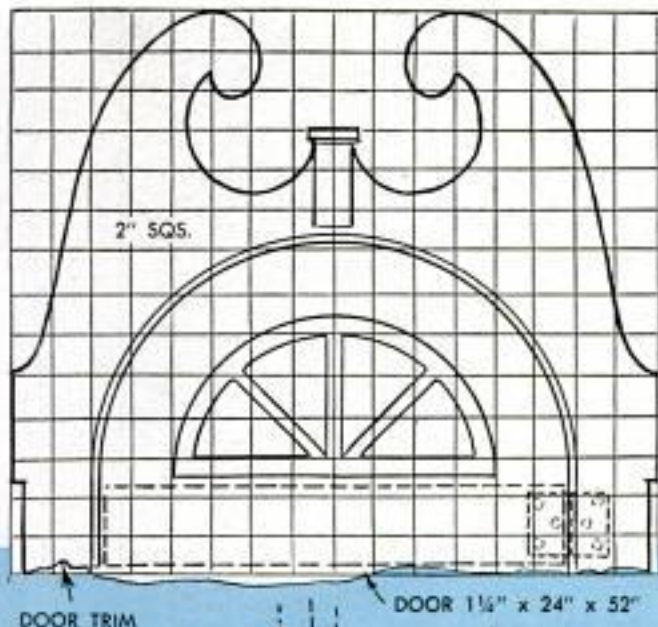
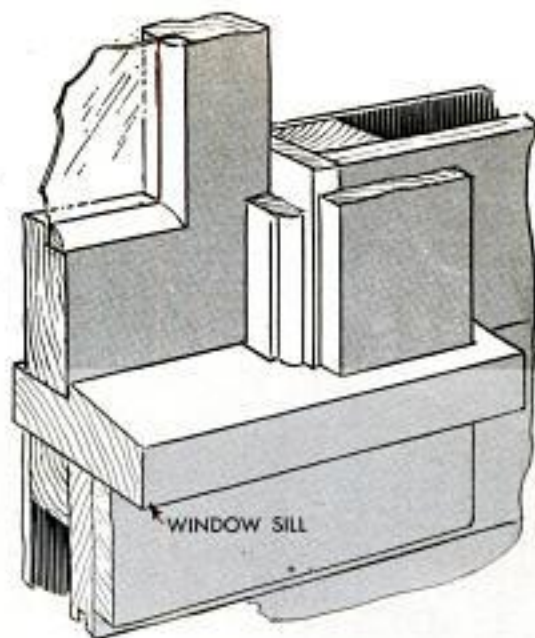
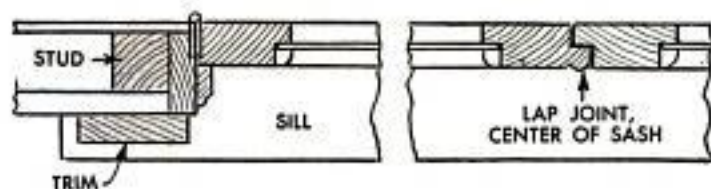

ney, and the top of the chimney is sealed against the weather by a sheet-metal or plywood cap. The latter is painted white to contrast with the red of the brick siding. Metal flashing is installed between the chimney and the roof, and also between the chimney offset and the sheathing.

Inside the chimney a horizontal plywood panel is installed just above the fireplace opening. It should be covered with metal so that it reflects the heat of an electric heater into the playhouse. The heater located in the fireplace is used to warm the little house on chilly days in early spring

and late fall, permitting the house to be used a couple of months longer each year. To protect the lower edges of the chimney from ground moisture, it should rest on a stone or brick foundation.

Window-frame construction for the playhouse is detailed at the top of this page. If your workshop does not have facilities for building the window sash, it may be possible to use a stock window by altering the opening to suit, or a window can be ordered custom-built through most lumber yards. The double window on the side of the playhouse should be hinged to swing in,

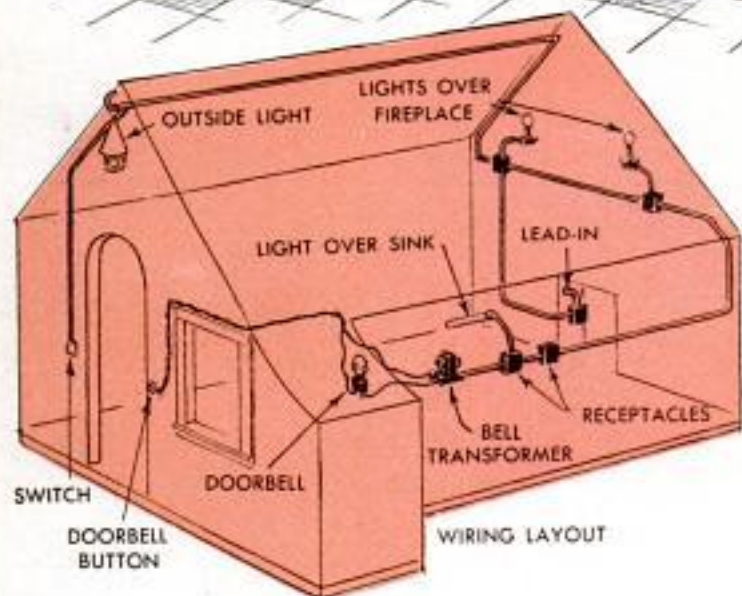
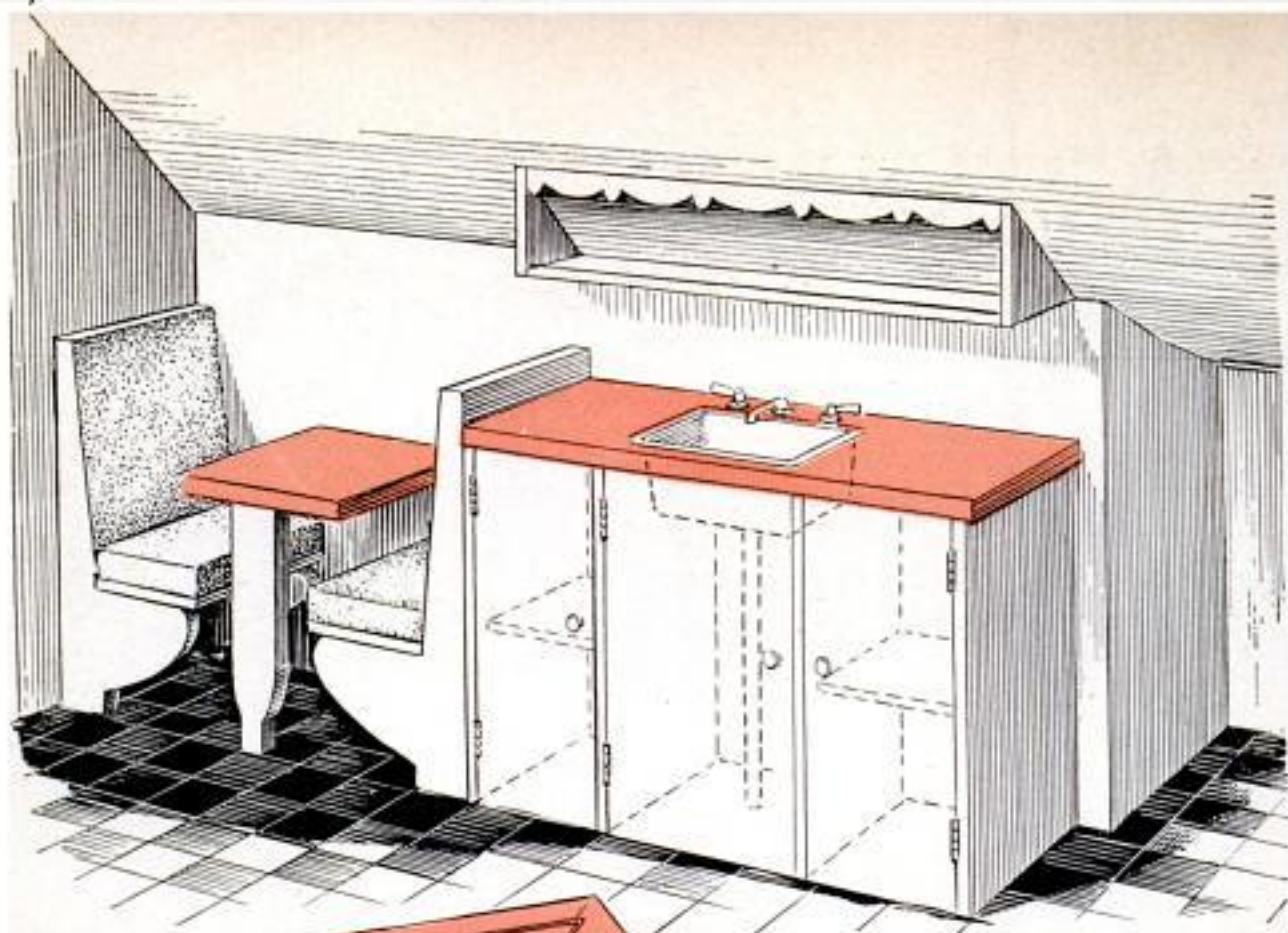

while the single window beside the door is fixed permanently in its frame, the door providing necessary ventilation.

The arched front door, lower details, page 183, is built up from 1 $\frac{1}{4}$ -in. clear pine strips glued edge-to-edge. Two cleats are glued and screwed to the inside surface of the door. The top of the door is rounded on a bandsaw and the fan-shaped window opening is cut out with a keyhole saw. A single piece of glass is fitted into this opening, divider strips and edge molding being cemented to the face of the glass and to the inside edge of the opening.

The scroll over the door is part of the outside trim and is cut from a single piece of plywood, using the squared pattern on page 183. Straight trim is run from the lower edge of the arch to the door sill.

After the house trim is in place it should be primed, and all joints calked, since these cannot be done after the shingles are attached. The roof now is shingled, using fire-resistant, slate-surfaced shingles of the square-end type, laid 4 $\frac{1}{2}$ in. to the weather. The side walls of the house are covered with 24-in. prestained shingles with 9-in. exposure to the weather. Flower boxes can be attached beneath the windows.

If local codes require it, wiring in the playhouse should be done by a licensed electrician, according to the diagram on this page. Running water and a drain for the playhouse sink are plastic garden hose. The sink set in the counter top is a plastic or metal basin such as used in house trailers and boats. Other built-in furniture can consist of a breakfast nook as shown in the illustrations, or toy furniture can be used. For ease of cleaning, the playhouse floor is covered with linoleum. Either hardboard or insulating wallboard can be used for interior covering of the walls. Both can be painted to provide a cheerful appearance and ease of cleaning.

Added luxuries, such as a radio, record player or television set can be added to the furnishings of the playhouse, depending on the age and interests of the residing princess. But no matter what the furnishings, childhood magic will be there. ★ ★ ★

Quick Method for Spacing Hand-Drawn Lettering

A quick method for drawing lettering in a specific space is first to rough out the word on a sheet of paper—or printed copy may be used as shown—and extend vertical lines down from each letter. Next, draw a line on another sheet of paper to indicate the length of the finished lettering and place it at an angle across the vertical lines so the lines from the first and last letter align with the ends of the line. Finally, mark off the space for each letter. The above method will produce a line longer than the original copy. To pro-



duce a line shorter than the original copy, place the copy on the diagonal.

Tips on Soldering Tubing

When sweat soldering copper tubing to a valve, be sure to remove the valve spindle with the attached washer, which can be damaged by heat. Also, for sweat joints, wait about five seconds after heating before applying solder to allow the heat to be distributed throughout the metal.

Cleaning a Hot-Water Tank

Even a rustproof hot-water tank should be cleaned periodically by draining to prevent the accumulation of dirt, scale and rust particles. Best time to drain a tank is early in the morning before water has been drawn from it. Loose particles will have settled to the bottom where they drain off.



Enrich Your Life With the Marvels of Hi-Fi! Thrill to a Pocket-Size Transistor Radio . . .

Have you been wanting a Hi-Fi set for your home . . . a portable transistor radio no bigger than your hand . . . and any of the other pieces of electronic equipment that are adding so much enjoyment to modern living? Then here's how you can have them, at merely a fraction of the usual purchase price. Using Popular Mechanics new book—*Electronics Made Easy*—

You Can Make These Electronic Devices Yourself!

This unusually practical book enables you, without any previous experience, to enter the amazing field of electronics for fun or profit. In 192 pages of simple step-by-step instructions and hundreds of illustrations, you learn all about Hi-Fi—exactly what it is and how to build your own Hi-Fi system. You discover how to make the "miracle" transistor radio, how electronic tubes work, how to do radio

servicing, how to use test instruments and make your own, and how to convert old radios into inter-com systems and other devices. It's fun and easy to build your own electronic equipment with the help of this book which contains numerous do-it-yourself projects. Send for your copy of *Electronics Made Easy*. It's your key to the most fascinating hobby of these times **\$2.95** for just.....

Send your order to
POPULAR MECHANICS PRESS, 208 East Ontario Street, Chicago 11, Illinois

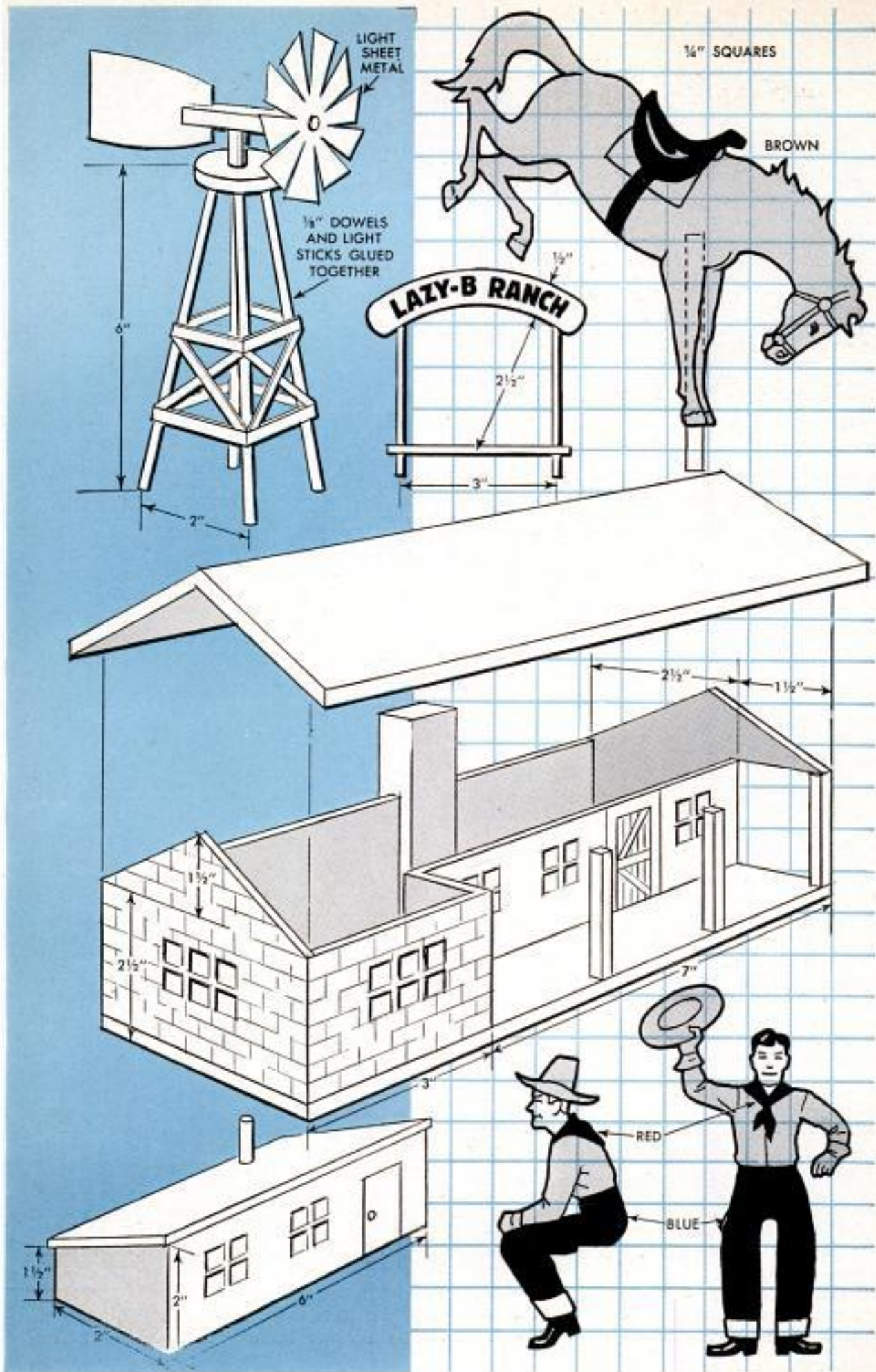



Fun on the Lazy-B

By Hi Sibley

THERE IS NO PROBLEM of toys being tumbled over easily with this Lazy-B Ranch outfit, as all trees, animals and other figures are fitted in holes in a sheet of perforated hardboard. The Lazy-B "range" is just 2 ft. square, which makes it small enough to fit on an average card table, yet large enough to allow plenty of room for broncobusting, herding cattle and fighting off rustlers. Fences can be rearranged, buildings moved and trees "replanted" to suit a child's fancy. With the infinite number of arrangements possible, the ranch will keep children fascinated for hours on end—an ideal rainy-day toy.

The perforated-hardboard base for the ranch is mounted on a frame made of lengths of $\frac{1}{2}$ x $\frac{1}{2}$ stock, mitered at the corners. It is glued and nailed to the hardboard. The ranch house and the small outbuilding are cut from $\frac{3}{8}$ -in. plywood and then are neatly scored to represent adobe-brick walls and shingled roofs. Windows are painted on, but can be cut out if more realism is desired. The ranch-house door also can be hinged. If there are cow girls in the family, it might be advisable to hinge the roof of the ranch house also, or

make it completely removable, so they can do a little housekeeping while the men are tending to the business of ranching.

Fences for the Lazy-B spread are $\frac{3}{8}$ -in. strips cut from perforated hardboard. Fence posts, which are $\frac{1}{8}$ -in. dowels, are fitted in every fourth hole in the rails. Holes in the fence rails and the perforated-hardboard base of the ranch align exactly, so the fences can be set up anywhere on the range. Dowels used on the fence, as well as on the other figures, should project $\frac{1}{4}$ in. below the bottoms of the objects to which they are attached.

Dowels used to support the figures and trees should be flattened on one side to present a larger surface for gluing. Only one dowel is used on each figure, thus permitting it to be turned to face in any direction. If two dowels were spaced 1 in. apart on a figure to match the holes in the base, the figures could not be placed diagonally as the distance is more than 1 in.

All figures, trees, etc., are cut from $\frac{1}{8}$ -in. hardboard, using the squared details included in this article. An alternate method is to cut figures of the correct size from a child's picture book. Cement the pictures

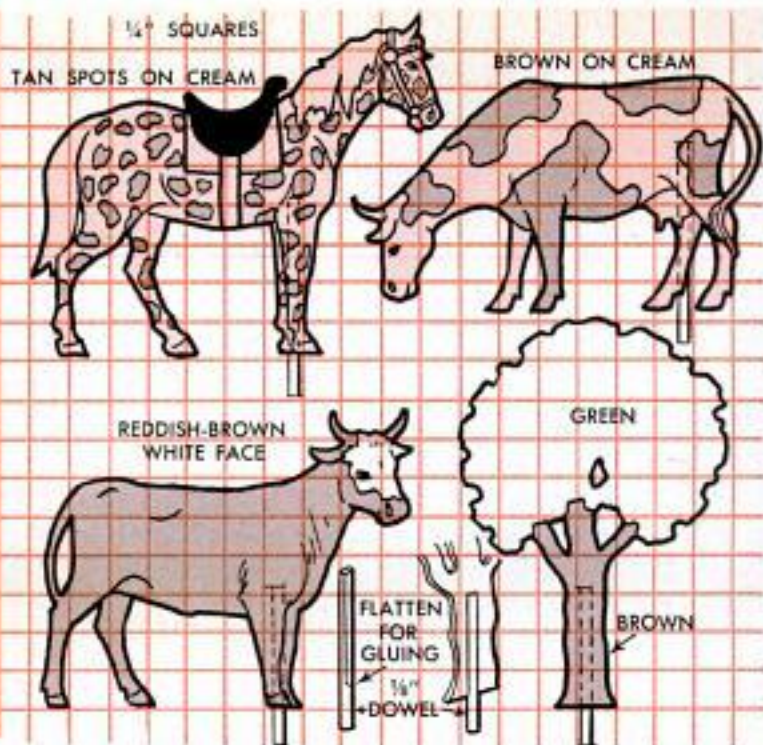
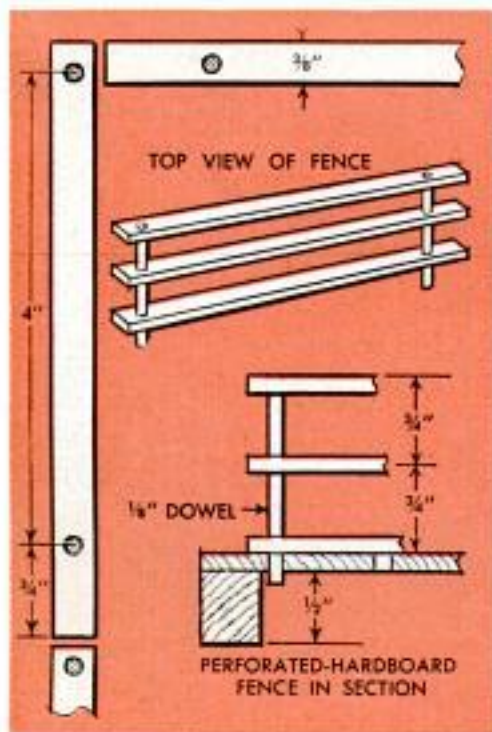

When perforated-hardboard fence rails are cut as dimensioned, adjoining sections will be 1/16 in. apart

directly to the hardboard and jigsaw around them. Whichever method is used, stack several pieces of hardboard together, so that a number of copies of each figure are cut out at the same time. This also speeds up the job.

Paint the walls of the adobe buildings brown and the roof red. For a weathered effect on the roof, stain it a light brown instead of painting it. Fence rails and posts can be painted with a thinned mixture of white paint. Most of the paint will be absorbed by the hardboard and dowels, and the resulting finish will provide a weath-

ered appearance. The hardboard base of the ranch can be varnished, but should be left a natural color. Painting it green to represent grass, or brown to simulate earth might be confusing, as the corral and ranch house will be moved from place to place on the board. Green grass in the corral, or sand for a lawn might look odd. One suggestion would be to pour fine, dry sand over the wet varnish on the base. When the varnish is dry, excess sand is brushed away and the over-all appearance will have the typical sandy appearance of the soil in many parts of the Southwest. ★★

Lacquer Thinner Renews Grip of Slippery Typewriter Platen



It takes only a few minutes to renew the grip of a slippery typewriter platen when it is rubbed with a cloth moistened with lacquer thinner. If the platen can be removed, it is advisable to clean it away from the machine to avoid damaging the finished surfaces of the typewriter. Periodic cleaning of the platen in this manner will keep its surface in good condition.

Secured Piano Lids Prevent Injury to Tots' Fingers

Small children can be prevented from closing a piano-keyboard lid on their fingers if a wooden wedge is forced between one edge of the open lid and the piano. Also, a friction-type cabinet catch installed on a piano-bench lid will prevent tots from lifting the latter.

CANDLEHOLDERS—

and centerpieces from lipstick caps
in wooden cutouts

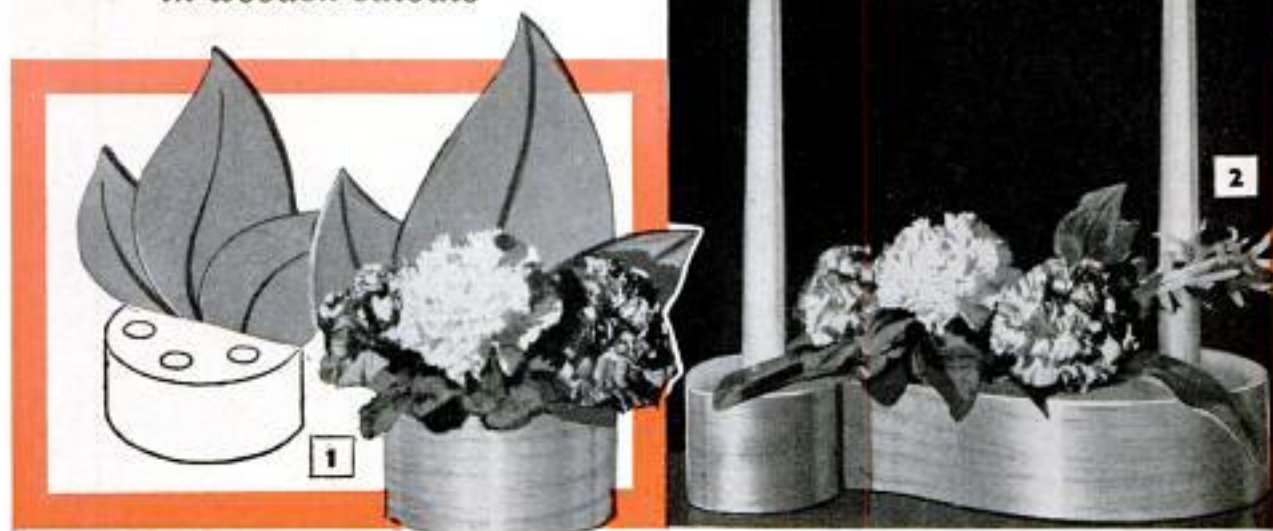

Metal caps from lipstick tubes are fitted in holes bored in these holders to provide water containers

SIMPLE GEOMETRIC SHAPES cut from hardwood blocks are the basic units for these attractive candle and flower holders that can be used as centerpieces, book ends and wall shelves. Metal caps from lipstick tubes are set in holes drilled in the holders to provide water containers. Short-stemmed flowers, difficult to arrange in other types of containers, fit neatly in the caps. Fig. 1 illustrates a simple wall shelf, consisting of a semicircular block fitted with a plywood back scrollsawed in a leaf shape. The leaf is painted green with darker green "veins." The squared drawing in Fig. 3 gives the dimensions of

this planter. In Fig. 2 is illustrated a centerpiece that is a double scroll. It also is dimensioned in Fig. 3. Detail A in Fig. 4 shows a simple rectangular block unit, several of which can be combined to provide an extended centerpiece for a long table, or otherwise arranged as in detail AA. Detail B in Fig. 4 shows clever flower holders that double as book ends, as in detail BB. Detail C in Fig. 4 shows a C-shaped unit, multiples of which can be arranged in an almost infinite number of ways. Diameters of the holes in the unit will depend on the sizes of candles and lipstick tubes used.

Bess A. Lee, Littleton, Colo.

Details below give dimensions of various types of candleholders cut from hardwood block and plywood

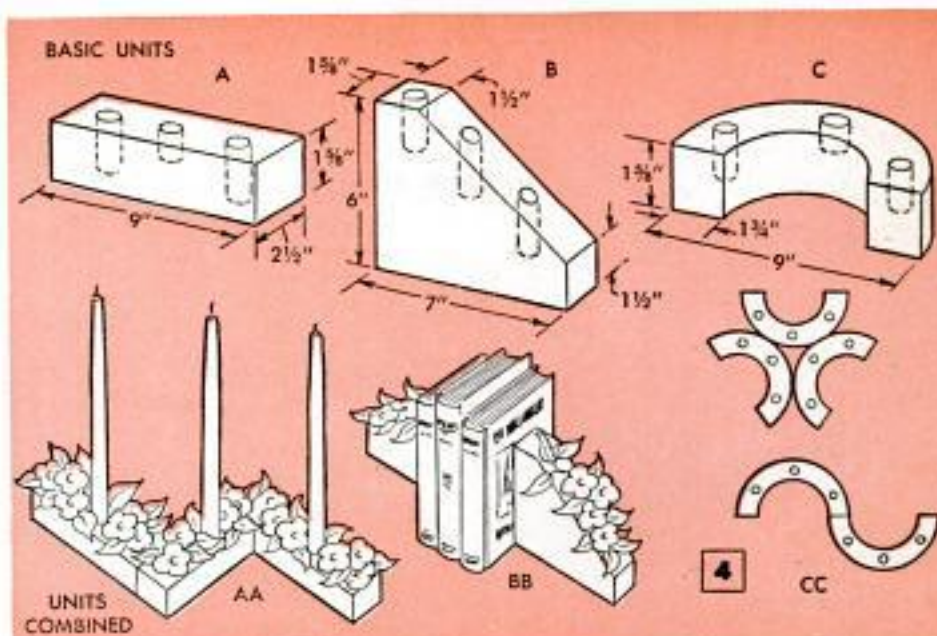
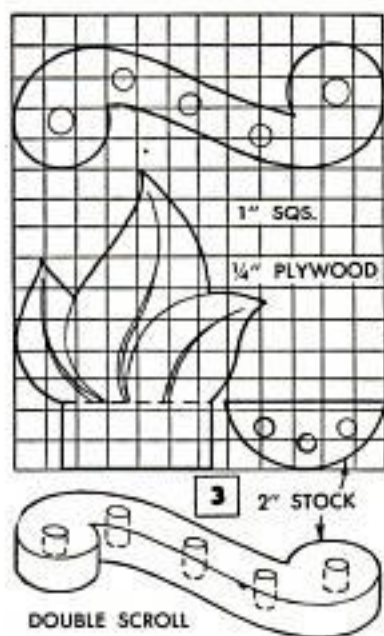

X781



ANIMATED

Blue-Jay

WEATHER VANE

HOVERING on a pole in your flower garden, this "flying" blue jay, which makes an unusual and interesting lawn decoration, takes on considerable realism in the slightest wind. The wings rise and fall in a lifelike manner as the beak slowly opens and closes. The ornate fan tail rotates with sufficient speed to create unusual color patterns as the bird swings to face each slight variation in wind direction. Its lifelike coloring helps to make it a rare conversation piece among bird watchers everywhere.

By H. W. Bull

9 NORWICH COURT
MIDLAND, MICH.

Making the Body

Make the body first. In this way you will

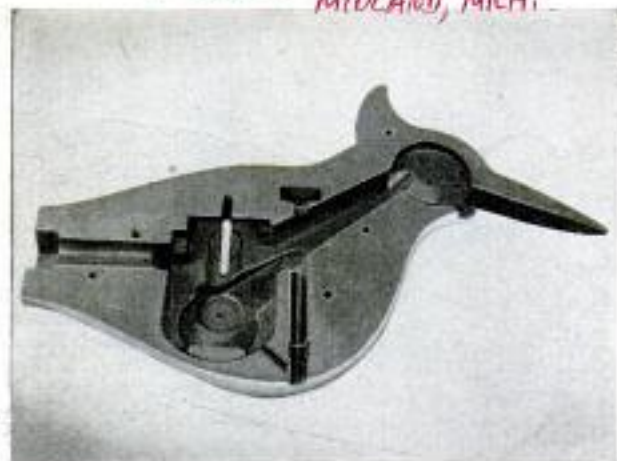

1



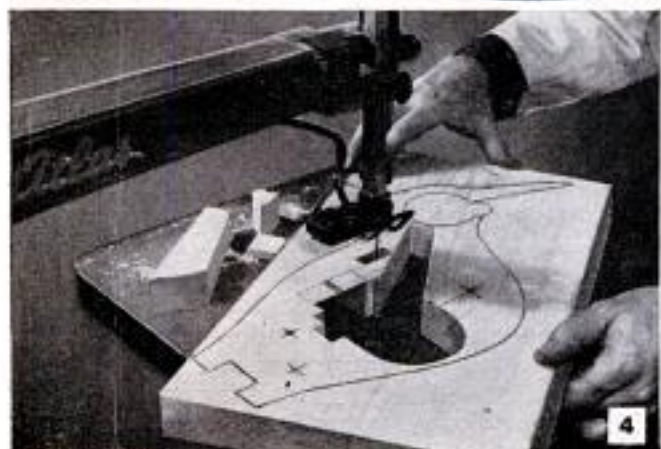
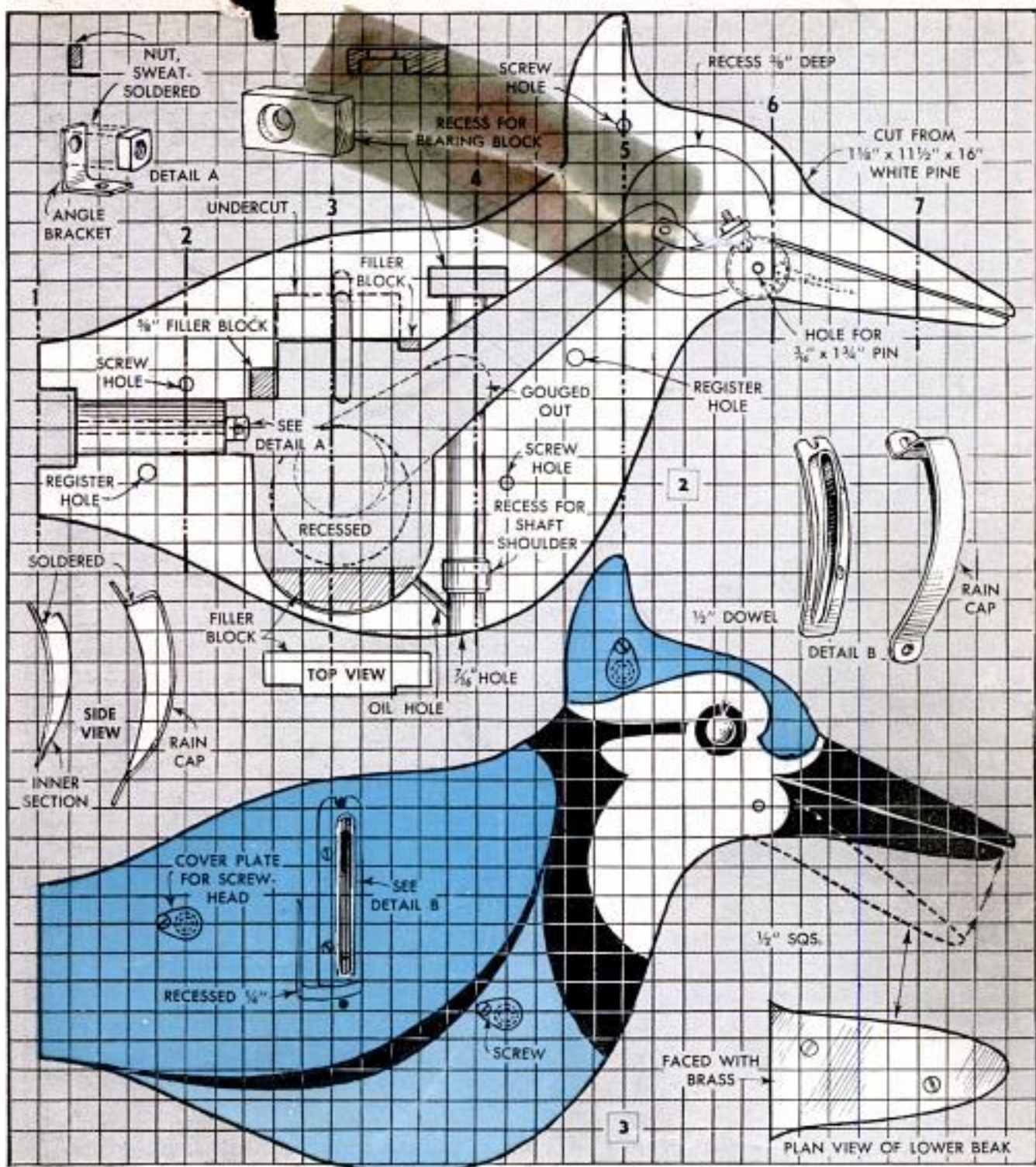

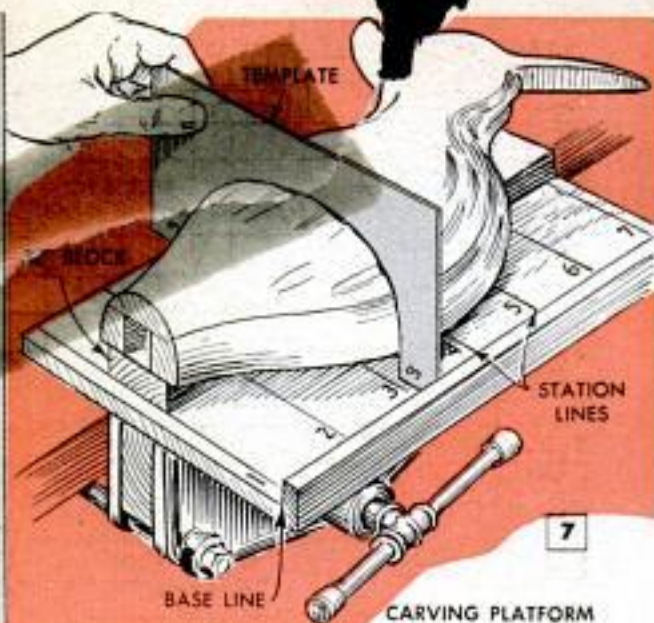
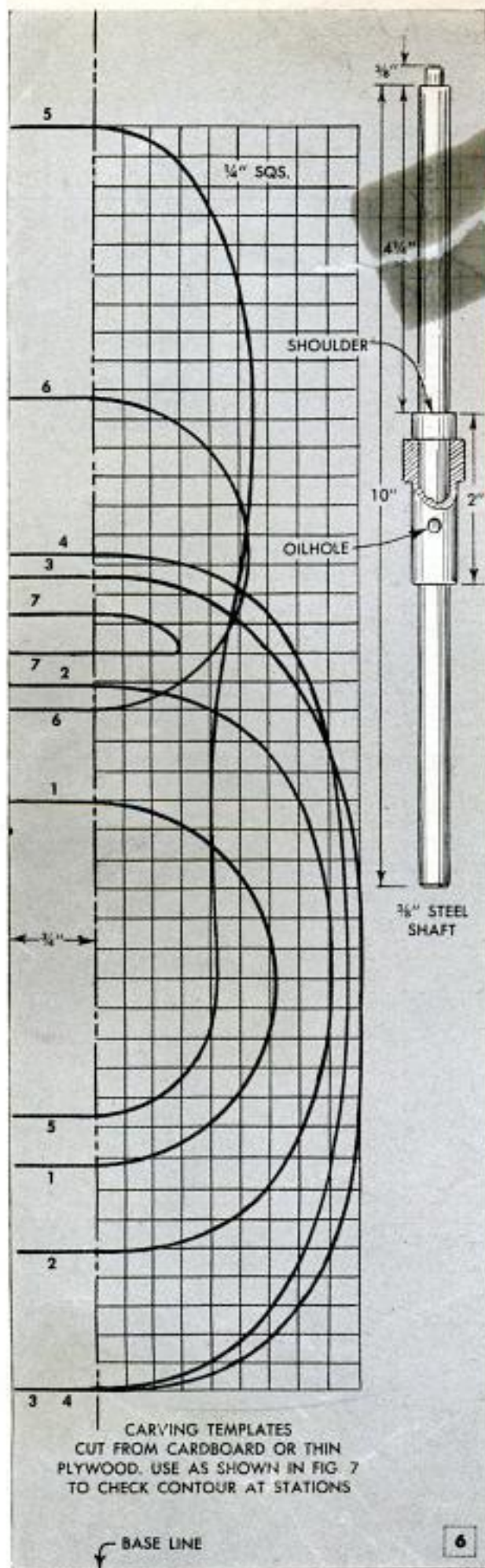

find it easier to follow through with the construction steps. The body of the bird consists of two sections which are made right and left-hand. As shown in Fig. 1, both have cavities for the wing and bill-actuating mechanism. Although the photos show that the cavity of one differs somewhat from the other, for all practical purposes both could be hollowed out the same. Each section of the body is made of two pieces of $1\frac{1}{8}$ -in. soft pine, 11 in. wide and 16 in. long, which, after being hollowed out, are glued together to form one half. By making each half from two pieces, you actually can jigsaw a lot of the cavity. The first step is to make a paper pattern following Fig. 2. Where filler blocks are indicated in the pattern, disregard these and plan on sawing out the areas. It is easier to glue these in later. Jigsaw all the shaded area as in Fig. 4, working one piece as a left-hand unit and the other right-hand. The second, or outside, layer of each section requires a certain amount of recessing to assure clearance for the working parts. It's not too important how neatly this is done, most of it can be cut away with an expansive bit and a gauge and chisel. Just don't go too deep. Study the photos in Fig. 1. Before gluing both layers of each half together, undercut the area indicated at a 40 to 45-deg. angle. Each half now consists of a block $2\frac{1}{4}$ in. thick which can be bandsawed as in Fig. 5 to give the rough profile.

Registering holes are drilled in the sections for pins which align the halves when placing them together. The pins can be short pieces of dowel or tubing. You'll notice in studying the pattern that a $\frac{1}{4}$ -in. slot is made completely through each outside layer to let the wing shafts protrude. You'll also notice that the head is recessed $\frac{3}{8}$ in. deep on the inside to provide

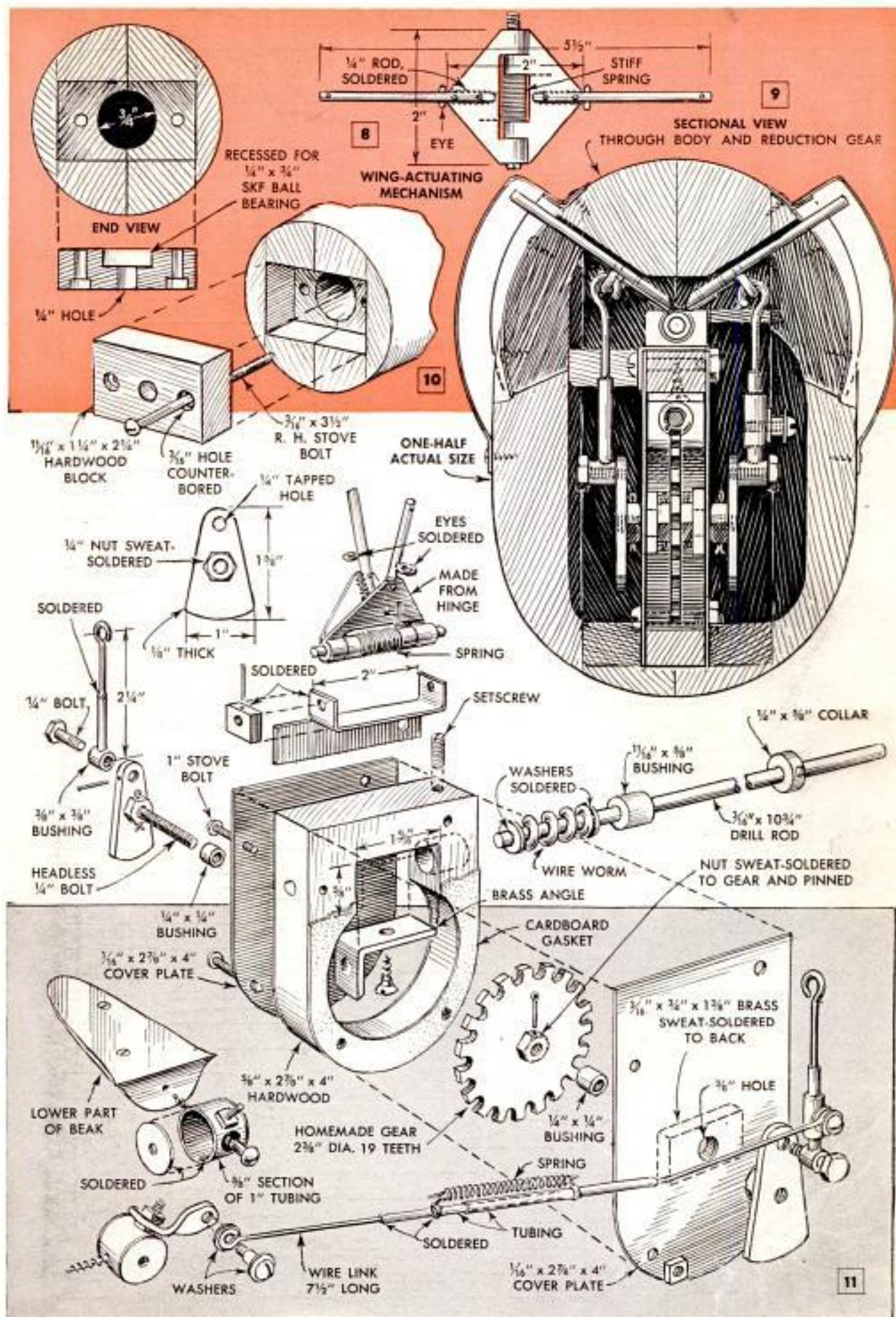

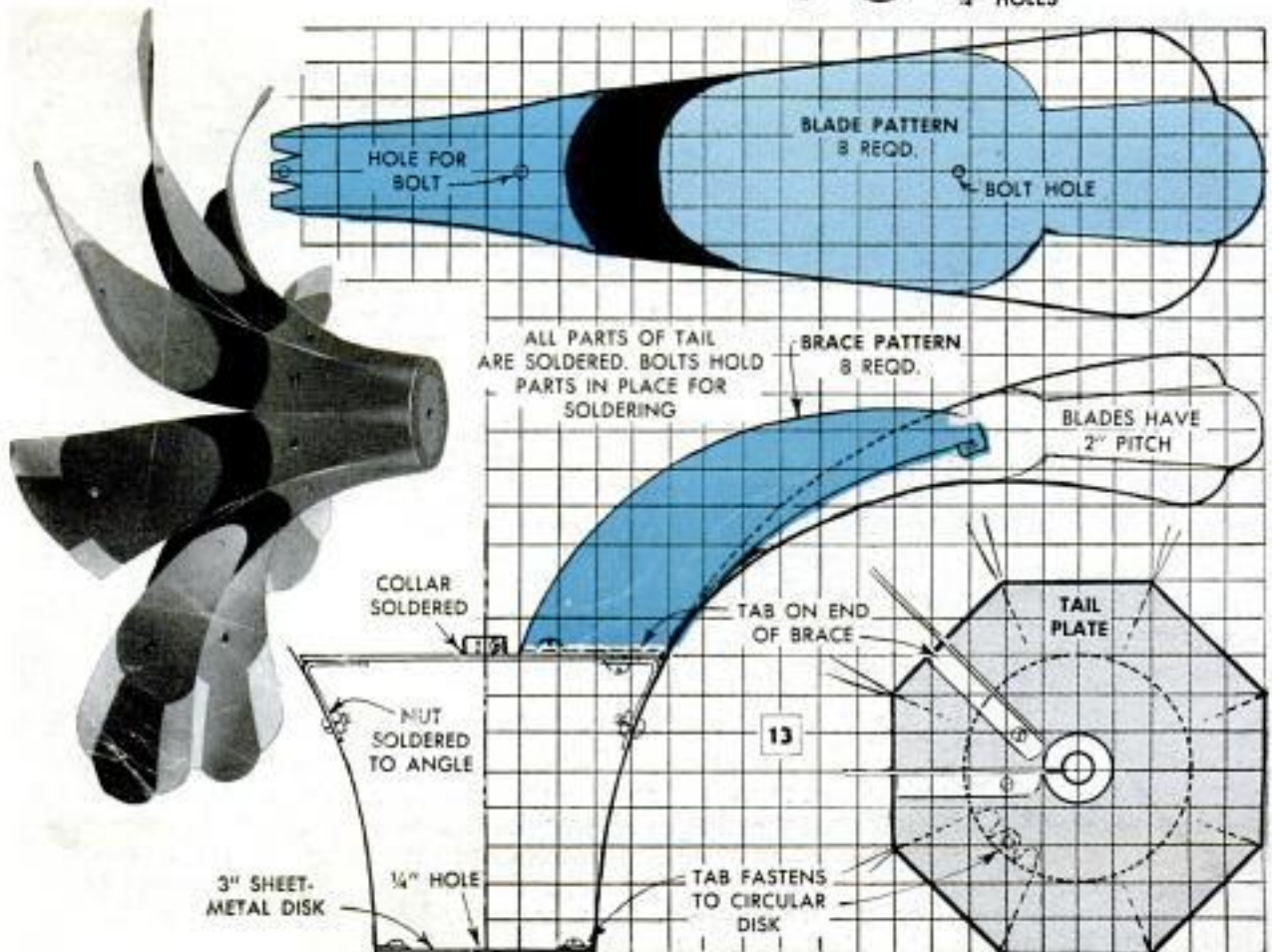
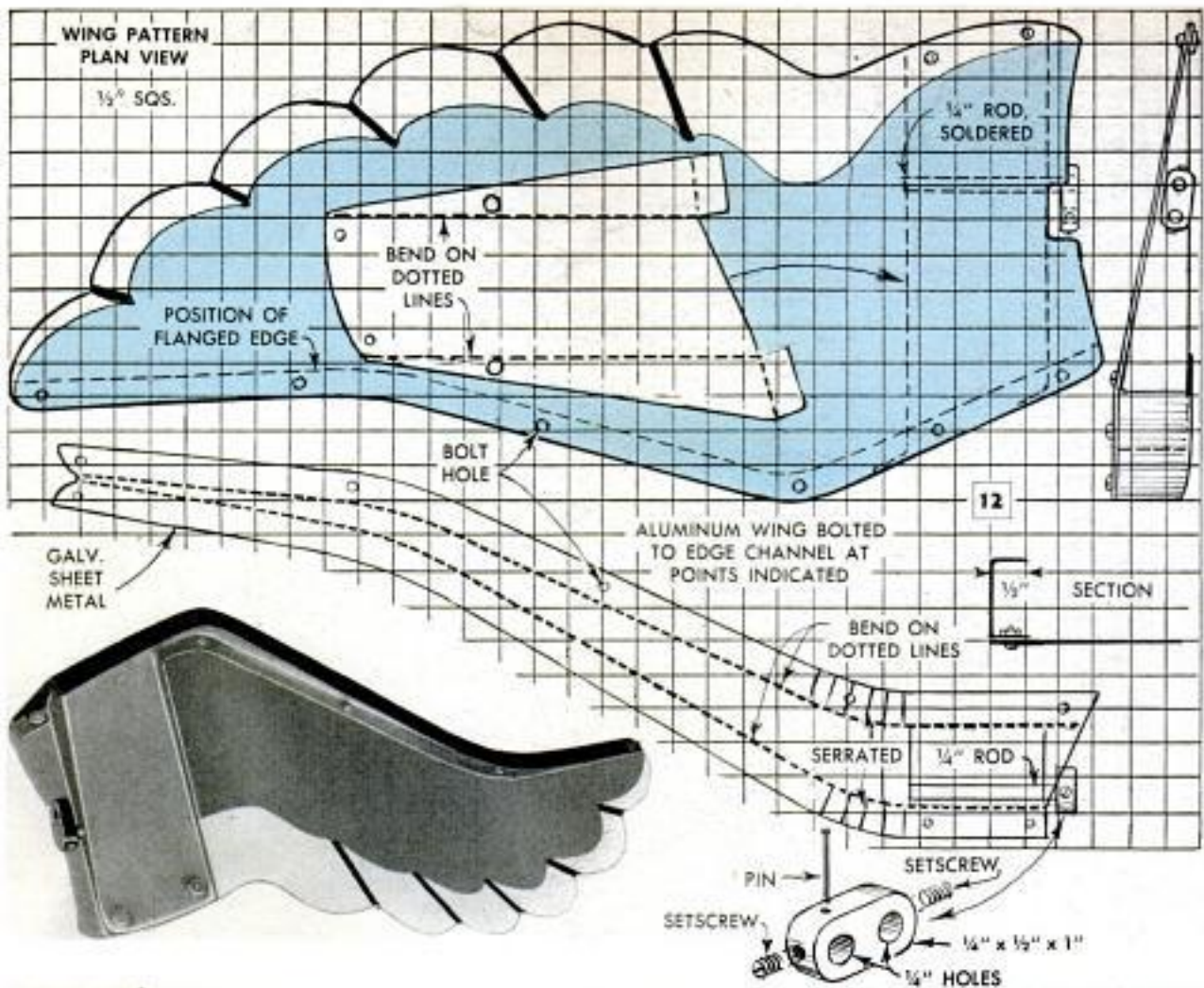

clearance for the mechanism which actuates the beak, the lower half of which pivots on a steel pin made from a headless screw and turned into a hole at the point indicated.

Holes for the tail and mounting shafts should be made while the body is still in block form and can be clamped in a vise. Place the halves together and bore the tail hole with a $\frac{3}{4}$ -in. bit and the other at right angles to it with a $\frac{7}{16}$ -in. bit. In each case, spot the bit on the parting line so that you bore half of the hole in each half. The recess in the end, Fig. 10, was automatically formed at the time you jigsawed the interior. This recess is for a wooden block which seats a ball bearing. The block is held in the recess with two long stove bolts. Nuts soldered to small metal angles are located in the cavity so the bolts may be turned up tightly. See detail A, Fig. 2.

Carving the Body

You are ready to carve the body. Each half is carved separately. For this you will need to make a carving jig like the one shown in Fig. 7. As you can see, it consists of a base board about 12 in. wide which is screwed to a vertical member for clamping in a vise. Seven station lines, $2\frac{1}{2}$ in. apart, are ruled across the board and numbered. The bird is supported $\frac{3}{4}$ in. above the base board by a scrap about $2\frac{1}{2}$ in. wide and placed at the center. This is first screwed to the bird from the underside and then to the base board from the top.

In addition to the carving jig you will need a set of contour templates. These are drawn on lightweight cardboard following Fig. 6, each one measuring 4 x 12 in. They, too, should be numbered to correspond with the station lines on the carving jig.

Making the Reduction Gear

The "heart" of the bird consists of a small worm-type reduction gear that is driven by a shaft propelled by the tail. It provides the up-and-down movement to the wings as well as to the beak. Crank arms on the reduction gear actuate the wings, while a spring-loaded connecting rod of wire attached to one of the crank arms, actuates the beak. The spring cushions the closing of the beak and prevents damage. The pull-apart drawing in Fig. 11 shows how the reduction gear is assembled around a centerpiece of hardwood that houses the worm and gear. This is packed with grease and sealed with cardboard gaskets between the metal cov-

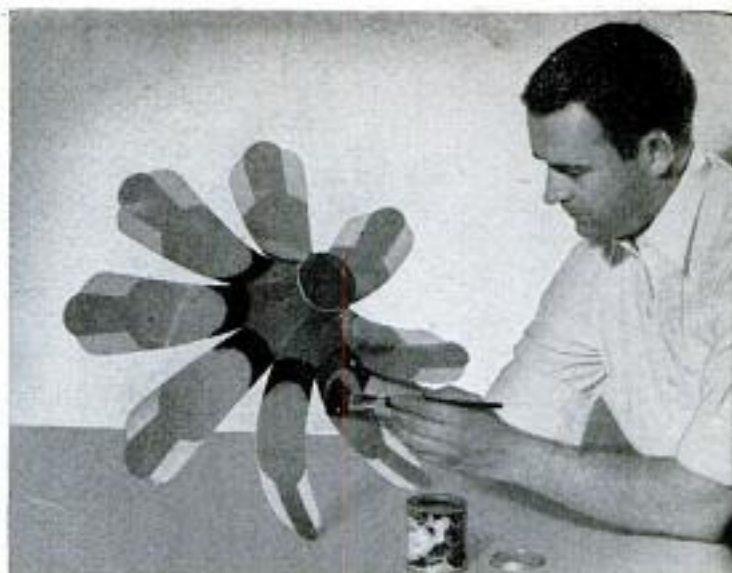

Follow the color scheme in Fig. 13 for painting the outside of the tail vanes. Reverse the color scheme on the inside, painting what's white, dark blue, and the light-blue areas white

ers. The worm is made by winding a $\frac{1}{8}$ -in.-dia. rod around the $\frac{1}{4}$ -in. shaft and soldering in place. You'll notice that part of the wing-shaft assembly is an altered hinge which is fitted with a stiff spring to offset the weight of the wings and to give a smooth positive action, free of play. This part is detailed in Fig. 8. The sectional view in Fig. 9 shows how the completed mechanism fits inside the bird and how the wing shafts extend through the slots in the body. These slots, incidentally, are covered with rain caps consisting of an inner and outer section. They are fashioned to the shapes shown in detail B, Fig. 2, from sheet metal and soldered together so they will conform to the contour of the body. Each part is attached separately with small screws, the inner part being placed in a partial recess cut in the body. Three wood screws hold the halves of the bird tightly together, after which the screw heads are concealed with cover plates. See Fig. 3.

Wings and Tail

The wings and tail are detailed in Figs. 12 and 13. The wings are made right and left-hand and are formed from sheet aluminum to make them as light as possible. The wings attach to their shafts with steel blocks fitted with setscrews. The tail is comprised of eight vanes fashioned from galvanized sheet metal which are bolted and soldered together to a hollow hub. The curve of the vanes lets the bird swing from side to side during a high wind and in doing so, spill the wind. The tail is attached to the shaft with a setscrew-fitted collar soldered to the hub. The vertical mounting shaft for the bird is detailed in Fig. 6. The upper end rests on a bearing ball seated in a hardwood block. ★ ★ ★



Cutting Rafters Without a Framing Square

By Louis Martin Reitz

ALTHOUGH a professional carpenter who specializes in building roofs may need a thorough knowledge of the many uses of a framing square, such skill is not necessary for the average home craftsman who wants only to put a roof on a garage or other simple structure. Instead, the one-roof builder can use scale drawings to determine the correct angles to cut on the ends of the rafters, and also to determine the lengths of the rafters.

Because related buildings, such as a garage and home, should have roofs with the same pitch, the first thing to do is to determine the pitch of the house roof. Technically, pitch is the span of a house divided by the rise. Span is the distance from the outside of one wall, excluding sheathing and siding, to the outside of the opposite wall. Rise is the vertical distance from a horizontal line drawn across the tops of the opposite walls and at a point midway of the rafters at the peak of the roof. The approximate point is given, because it actually is determined by a line drawn parallel to the edges of the rafters from the point of the bird's-mouth, or plate, cut near the lower end of the rafters, as indicated in the upper detail. Although it is handy to know this terminology, it is not necessary for building a roof. Three methods can be used by the home craftsman to copy the pitch of a house roof. One way, if the attic is unfinished, is to copy directly from the roof. Three strips of wood are used, two being held against the rafters at

the peak, then clamped or nailed together, with the third strip used as a brace for the pattern. The second method is to measure the outside of the house to find the span and rise, and thus the pitch. A third method is to make a number of scale drawings of the garage, with roofs of various pitches drawn on it. The one that looks closest to matching the house pitch is the one to use.

When the pitch has been determined, a scale drawing is made; $\frac{1}{4}$ in. to the ft. generally being the easiest scale to handle. The drawing should be like the upper detail on the opposite page. Using a square, vertical lines are extended from the ends of the span and at the rise. The lines should extend about 6 in. past the rafter line, so the angles at the rafter ends can be transferred to a length of 1-in. stock that is cut to make a jig. If the roof is to extend beyond the walls, which is the best construction, the scale drawing should include the bird's-mouth cut, the bottom cut of which is parallel to the cuts on the rafter ends. The heel cut is parallel to the span. The bird's-mouth cut primarily is to keep the garage walls from being forced outward. The lengths of the rafters also are determined on the scale drawing. Remember that the upper end of each rafter must be shorter by half the thickness of the ridge board, which is 1-in. stock. On the lower end, allowance must be made for the 1-in. facing strip if the eaves are to be boxed. When the lengths of the rafters have been determined, shorten or lengthen the tail

measurement so that standard lengths of 2-in. lumber can be used to minimize waste. Standard lengths are in multiples of 2 ft.

The rafter jig has a cleat nailed to its upper edge near each end as indicated in the details. Fitting the jig over the 2-in. stock will permit drawing the angles for both ends and the bird's-mouth. As a rule of thumb, spans of 6 ft. or less require a 2 x 4, spans of 6 to 10 ft. take a 2 x 6 or 2 x 8, and a 14-ft. span needs a 2 x 10. For spans longer than 14 ft., a 2 x 12 is used.

If unplanned lumber is used, it may not be accurately dimensioned, and may be bowed or have knots or cracks in it. Allow-

ance must be made for these irregularities. If the lumber is arched, keep the crown of the arch upward, so a snow load on the roof will keep the lumber under compression and will not allow the roof to sag, as would be the case if the crown were down. When lumber is wide or off size, the jig will keep the top of that particular rafter aligned with the tops of the other rafters. If lumber has large knots or checks in it, keep the knots and the open ends of the checks upward, so the load on the roof will compress the damaged spot, rather than force it open. On badly damaged stock, it is necessary to install cleats. ★ ★ ★

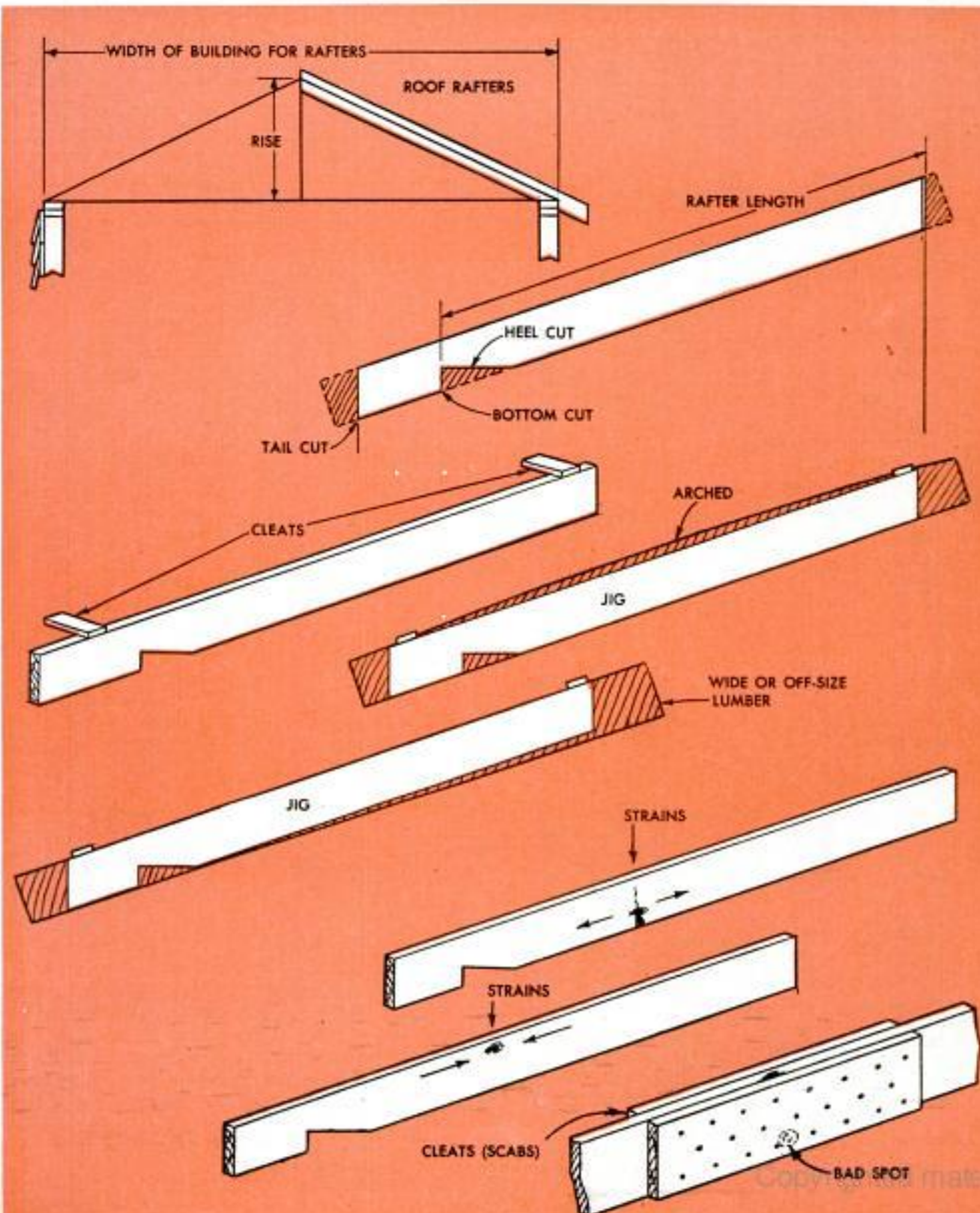

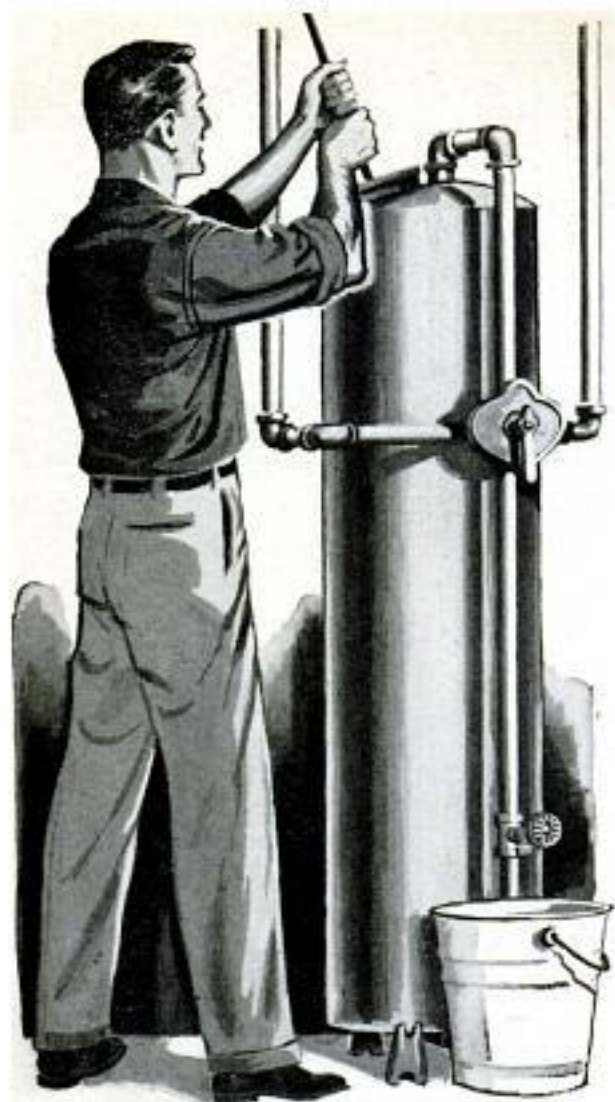

YOUR WATER SOFTENER

is always on the job when you follow a regular maintenance schedule

By B. W. Nies

ALTHOUGH a home water softener is a simple and reliable appliance, it requires proper maintenance to assure its efficient operation. A thorough understanding of the principle on which a water softener works will aid the homeowner in doing a better job of keeping it at top efficiency.

The simplest and most common type of home water softener consists of a tank containing a thick bed of tiny synthetic-resin or mineral beads, supported on a layer of gravel. When the incoming "raw" water flows downward through this bed, the "hard" calcium and magnesium ions are taken up by the resin, and "soft" sodium ions are released in exchange. When the resin has given up all of its sodium ions, it must be recharged or regenerated with a strong solution of common salt (sodium chloride). During recharging, the softening process is reversed so that the accumulated calcium and magnesium salts are released from the resin beads and washed down the drain.

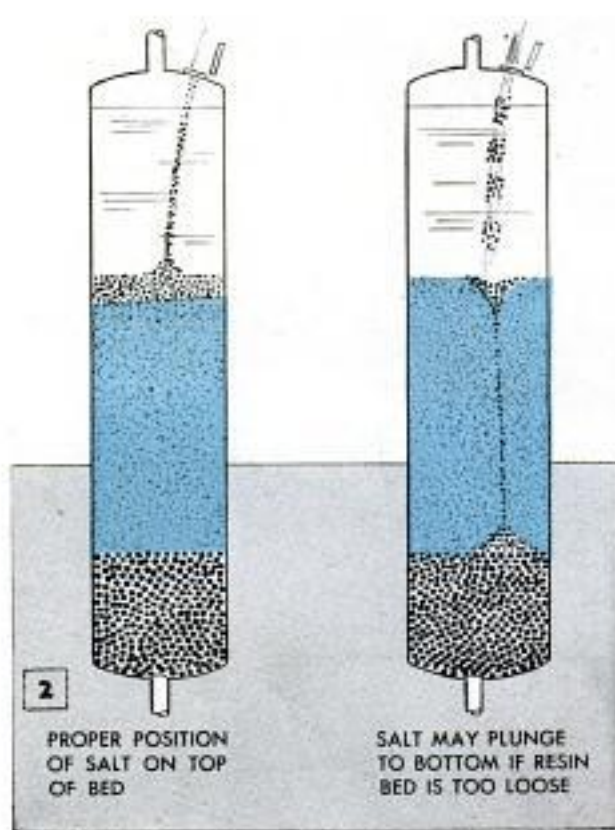
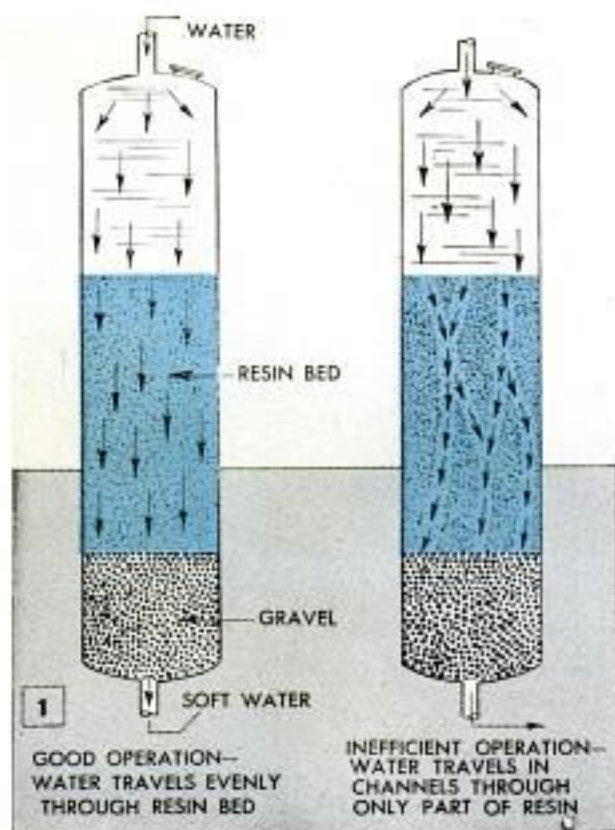

The softener will operate most efficiently when the resin bed is in a condition that permits all the resin beads to contact the raw water during the softening cycle, left-hand detail, Fig. 1. Any factor which removes some of the particles from operation will not only reduce efficiency, but will produce need for frequent regeneration. Such a condition will exist when the raw water travels only through channels in the resin, right-hand detail, Fig. 1, rather than evenly through the bed. To "fluff" the resin bed to uniform density, it generally is standard practice to "backwash" the bed by reversing the water flow when regenerating the softener, left-hand detail, Fig. 3. This operation also flushes away sediment that is filtered out of the water and settles on top of the resin bed. However, if water pressure is low, only part of the resin bed may be stirred, center detail, Fig. 3, and the sediment will not be flushed away. On the other hand, excessive pressure may stir the resin so violently that it will "boil up" too far and some may be washed down the drain. Water pressure can be checked by noting the action of the water and resin bed when the cap of the softener tank is removed.

Backwashing is done in the following manner: First, turn the control valve to "backwash." Then, open the drain valve on the softener and drain it until the water runs clear. Next, turn the control valve to "off." Remove the cap on the softener and drain water until it is about even with the top of the resin bed. Use a stick or rod to gently break up the sediment crust, turn

the control valve to "backwash" and let the water rush in at full pressure until it reaches the top of the tank. This effectively boils up the bed, right-hand detail, Fig. 3. Now, replace the cap and continue backwashing in the normal manner until the discharge water is clear. Check the drain to make sure no resin is being washed out of the tank. Finally, turn the control valve to "soften" or "rinse" and run water through the tank to settle the resin bed, which will assure that the salt will not drop down through the bed, right-hand detail, Fig. 2. Salt, either granulated or in pellets, now is added if the softener is of the direct-salting type. Rock salt may be used if the softener has a separate brine tank. Drain out just enough water to make room for the salt, and add it slowly, spreading it over the surface of the water, left-hand detail, Fig. 2. While the salt solution is being passed through the bed, keep the water flow moderate to allow an appreciable time for the salt to dissolve and react with the resin. Taste the discharge water with the tip of your tongue. A very bitter taste means the operation is right, while a faint bitter taste means raw water is channeling through part of the bed and not all of the resin is being regenerated. If a strong salt taste persists after the bitter taste stops, it means an excess of salt is being used. Reduce the amount of salt until the salt taste persists just enough to show it is present. Salt consumption often may be decreased as much as 50 percent without reducing softening efficiency. ★ ★ ★

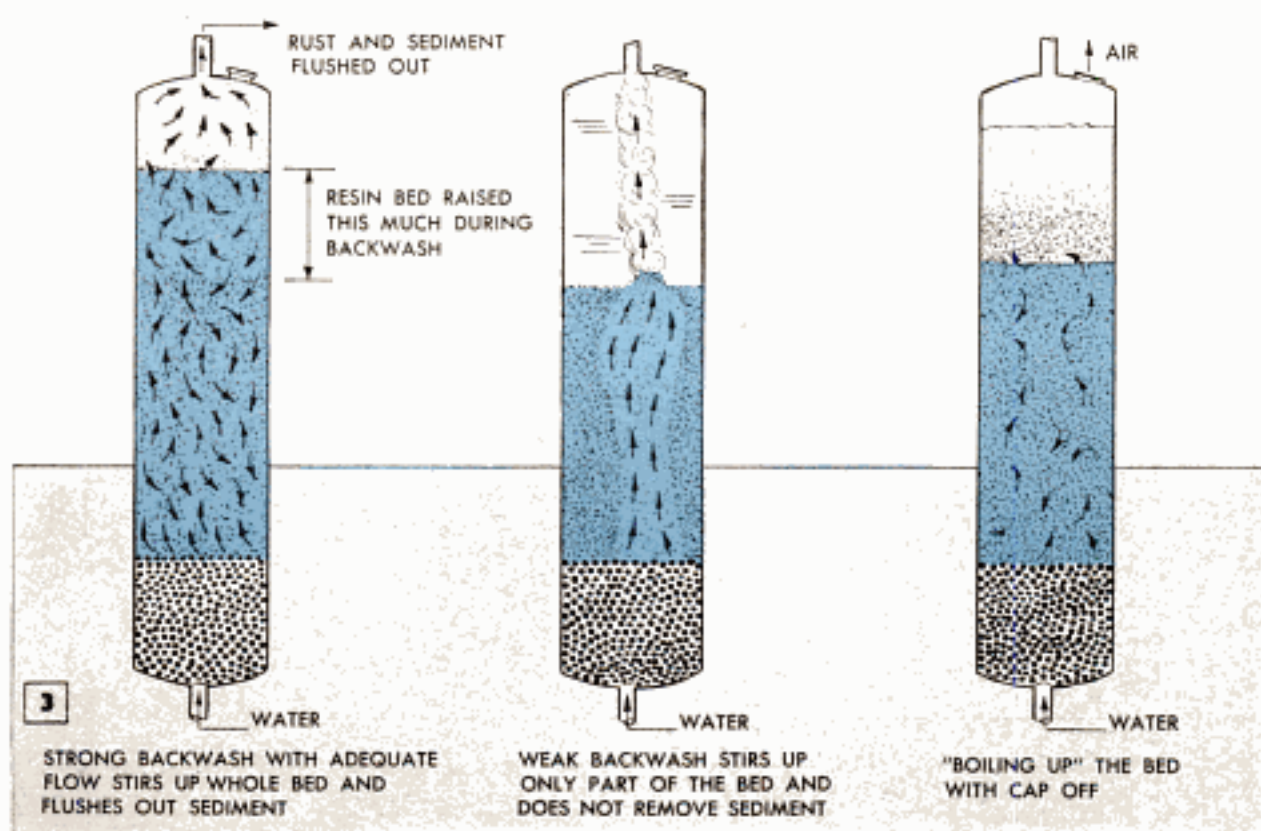

Auxiliary Bars Double Towel-Rack Capacity



It takes only a few moments to double the capacity of bathroom towel racks when it becomes necessary to take care of extra guests. Auxiliary bars of nonrusting metal, stored away conveniently, simply are slipped onto the racks as indicated. The hook-shaped ends of the extra bars are made to grip the arms of the racks, bearing upwards, while the portions of the bars crossing the racks bear downwards.

Simplify Hanging Yardstick

Hanging a yardstick on a nail beyond your reach is no problem when a "guide nail" is used. The latter is located so that when the edge of the yardstick contacts it, the hole aligns with the hanger nail.

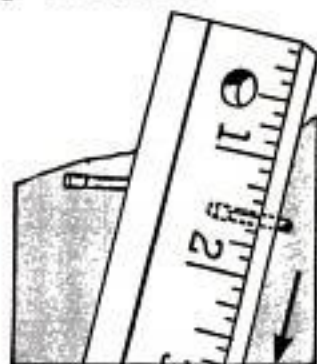

Valuable Small Items Hidden Inside Top Rail of Door

Although within easy reach, a relatively safe location for small items of value is in the top edges of doors. Several holes 1 in. in dia. and about 1½ to 2 in. deep bored in the top of a door will provide a hiding spot for rings and even small watches. Stuff cotton or cloth in the holes to prevent the jewelry from rattling.

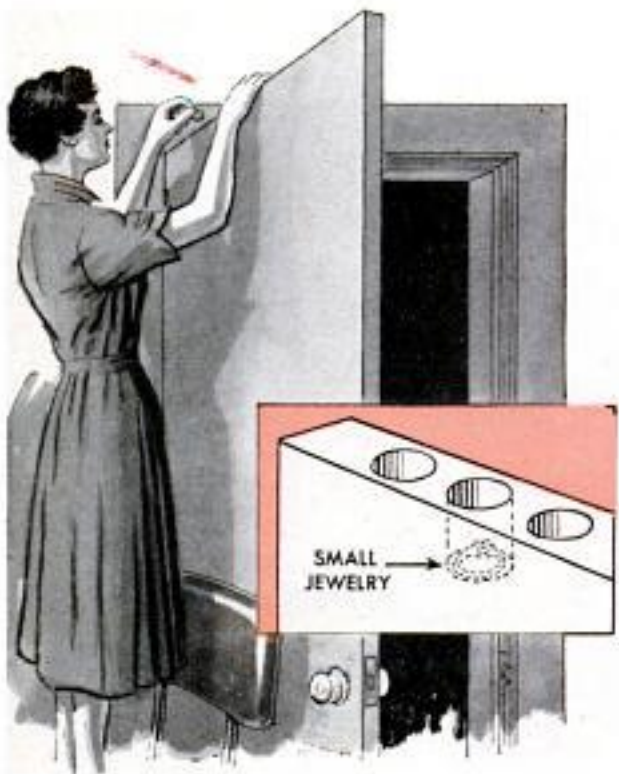

Sawhorse Is Adjusted for Height By Extension Rail

This extension rail can be added to almost any sawhorse to provide the extra height that sometimes is needed for certain jobs. The rail consists of a cross piece and two vertical legs that slide in U-shaped metal sleeves screwed to the end plates of the sawhorse. Each leg of the extension rail has holes drilled in it 2 in. apart to permit vertical adjustment.

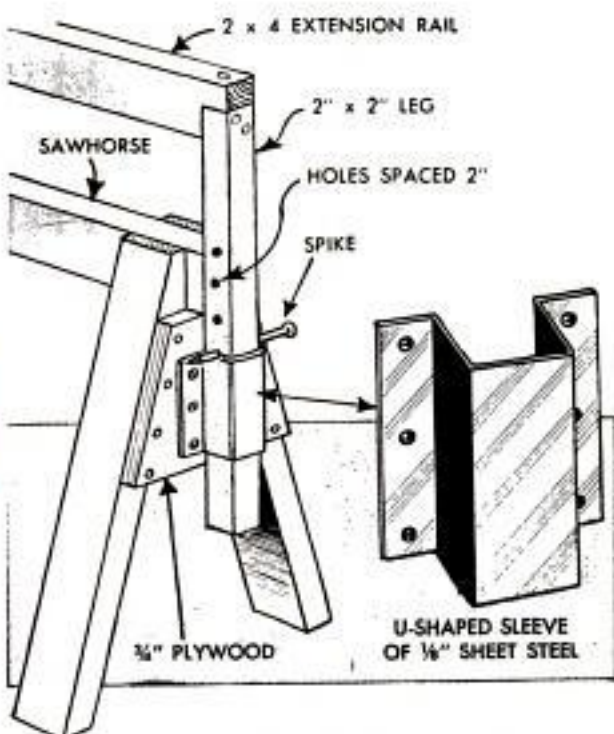

Photo Copying Is Easy—

when the camera is mounted on a sliding door

By William G. Waggoner

IN ADDITION to picture taking, your camera and elevator tripod can be used for photo copying simply by mounting them on a bracket screwed to the sliding door of your darkroom. The holder for the material to be photographed is mounted on the wall opposite the camera as in the illustration.

The mounting bracket is made of a pipe tee screwed on a 15-in. length of pipe threaded at both ends. The latter is screwed into an undersize hole drilled in a hardwood block as shown in the drawing. A length of piano hinge screwed to the block and the door, and a broom holder screwed to the door, permits the entire bracket to be folded against the door when not in use.

Vertical adjustment of the copy camera is made by elevating the tripod to the desired position and then locking it in place by tightening the thumbscrew fitted in a hole tapped in the pipe tee. Lateral movement of the copying unit is checked by means of a foot-action

door holder installed at the bottom edge of the sliding door.

Photo below, tripod is locked in position when thumbscrew is tightened against shoulder on elevator column. For tripods without a similar shoulder, tripod is locked by tightening thumbscrew lightly against column

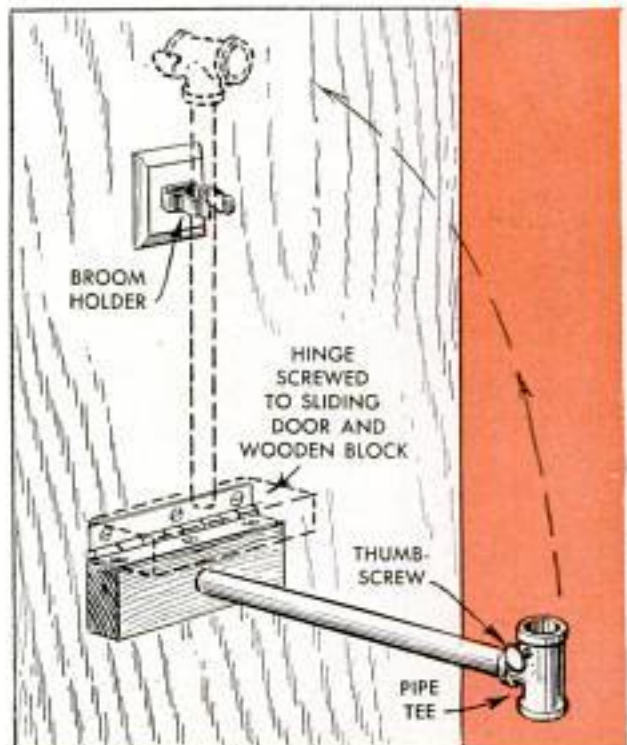
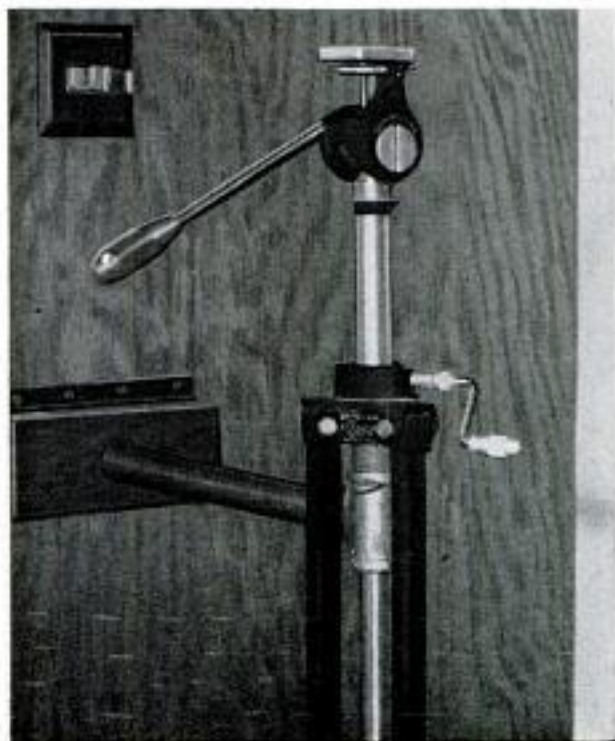
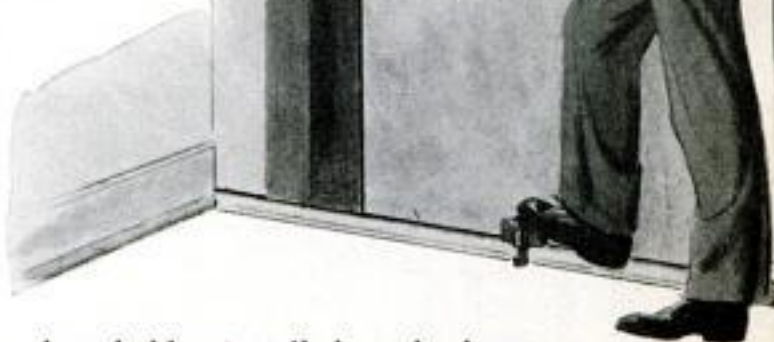

Photoflood Control Box Simplifies Lighting

By Howard R. Clark

HERE IS an electrical control box that will enable you to turn on by remote control the floodlights desired and regulate their intensity without moving from the camera. When pictures are taken away from the home, you have an extension cord and necessary light switches in one unit. Constructing the control box and installing the electrical parts are relatively simple as shown in the drawings and wiring diagram. Note that a jumper wire must be added between terminals on the left side of each four-way switch.

When in use, the unit is hung on the camera tripod as shown at the left. With a floodlamp plugged into each duplex receptacle and both four-way switches in the "up" position, two lamps will burn in series at reduced intensity. When both switches are down, the lamps burn at full brightness. When the left-hand switch is down and the right-hand one is up, the lamp plugged in the right-hand receptacle will burn at full brightness while the lamp connected to the other receptacle will be off. The lower switch merely turns on power supply. ★ ★ ★

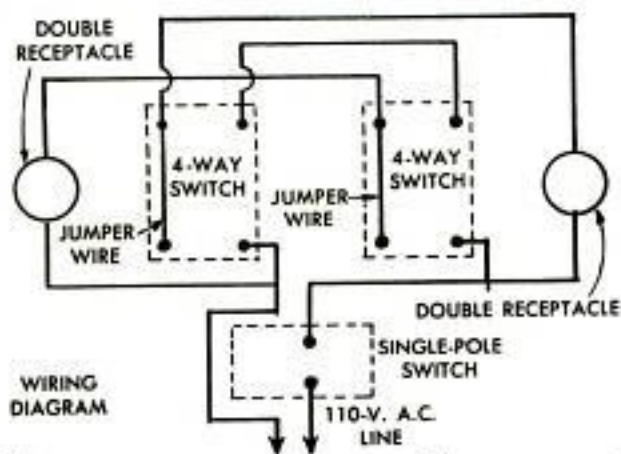

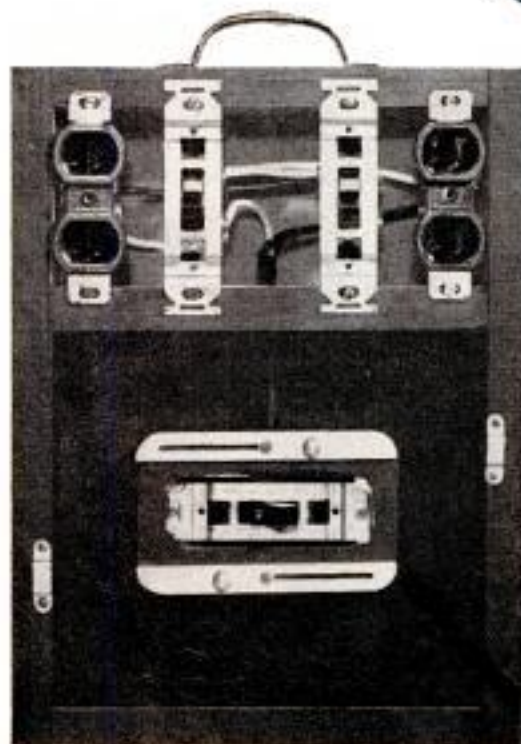
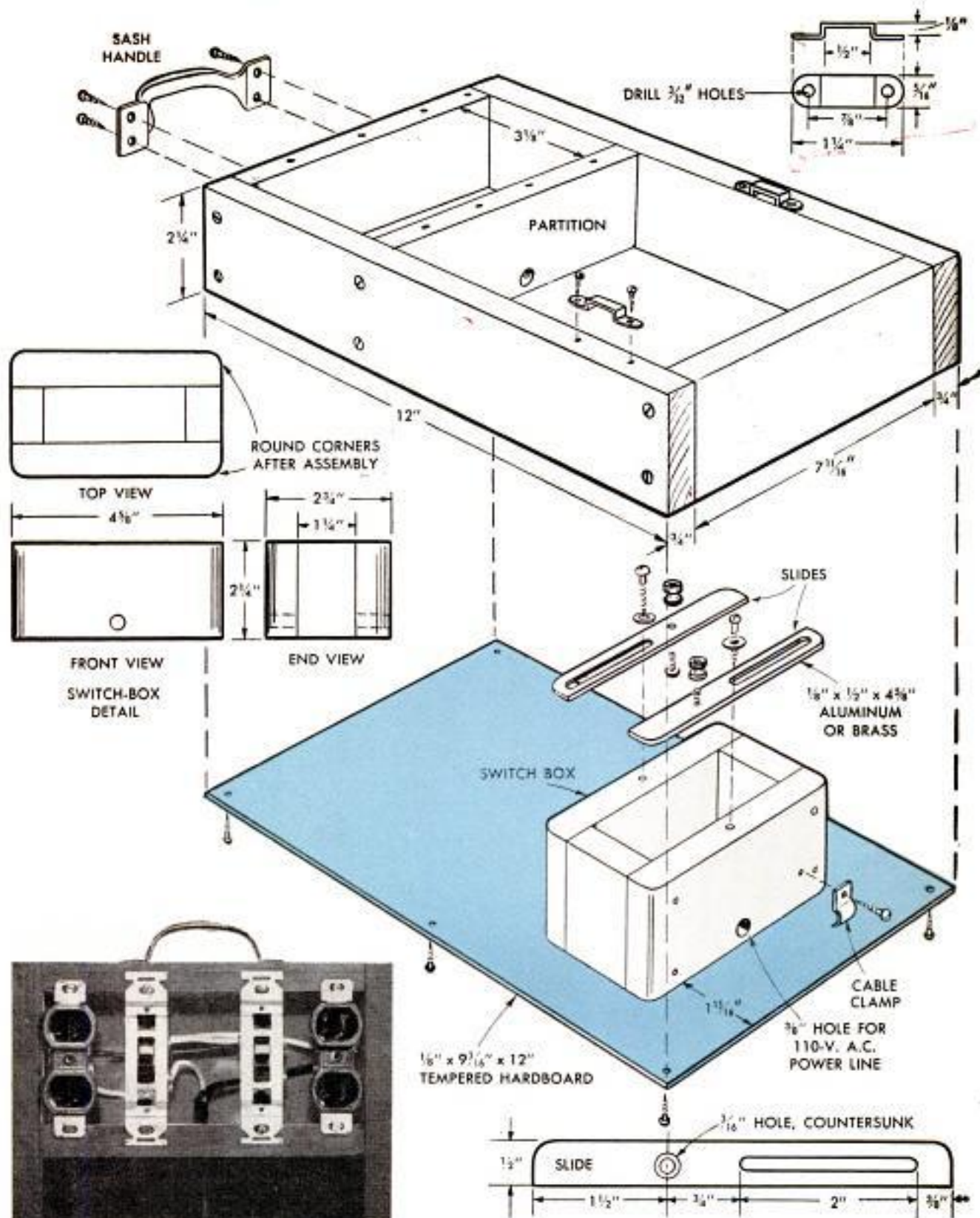
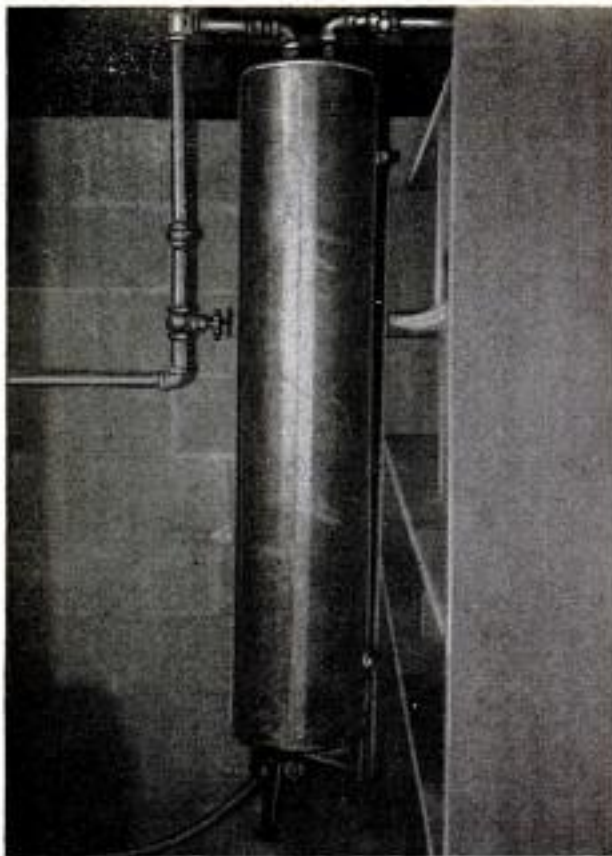

Photo opposite page, when necessary to take photos away from home studio, extension cord, switches and receptacles are conveniently carried in one unit. Cord wrapped around switch box is held in place by extending two metal slides on box

Drawings above, after gluing and nailing switch box and screwing bottom to the latter and control-box frame, all surfaces are enameled and electrical parts installed. Knurled nuts shown on metal slides are light-fixture canopy nuts



Sand Removed from Well Water By Water Tank in Supply Line

A sand trap, made from an old water tank as shown, removes sand from a well-water system to prevent it from damaging valves and fittings. Sand-laden water enters the tank at the top and flows through a vertical pipe within the tank before being discharged at the bottom where the sand is deposited. The outlet at the top of the tank is connected to the supply line. A valve installed in the bottom permits easy flushing of the tank.

D. E. Marshall, Manhattan, Kans.

Cord Loops Taped to Closet Door Provide Temporary Hat Hangers



Temporary hangers for men's hats are provided by one housewife by taping several cord loops about 28 in. long to the inside of the door on the guest closet as shown in the drawing. From 8 to 10 hats can be accommodated in this way. When not in use, the hangers are stored on a hook.

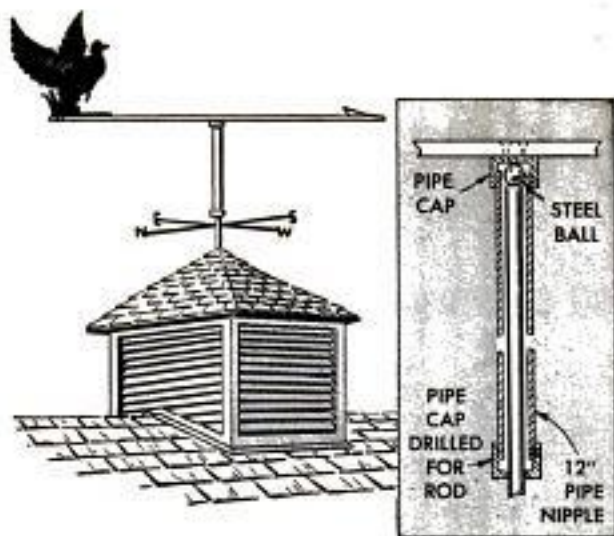

Ball-Bearing Weather Vane Has Waterproof Mounting

Any weather vane can be provided with a rainproof, ball-bearing mounting simply by installing it on a swivel made from two pipe caps, pipe nipple and rod as shown in the drawing. A steel ball, packed in grease inside the capped pipe nipple, provides a lubricated bearing surface between the rod and vane. Sizes of the parts are determined by the size of the vane.

Fan Base Holds Flashlight

When using a flashlight for lighting emergency repair work, one mechanic clamps it on the base of a discarded electric fan with a hose clamp as shown in the photo. The flashlight is quickly removed for normal use when desired.

Frank A. Javor, Newark, N. J.



SHOP NOTES

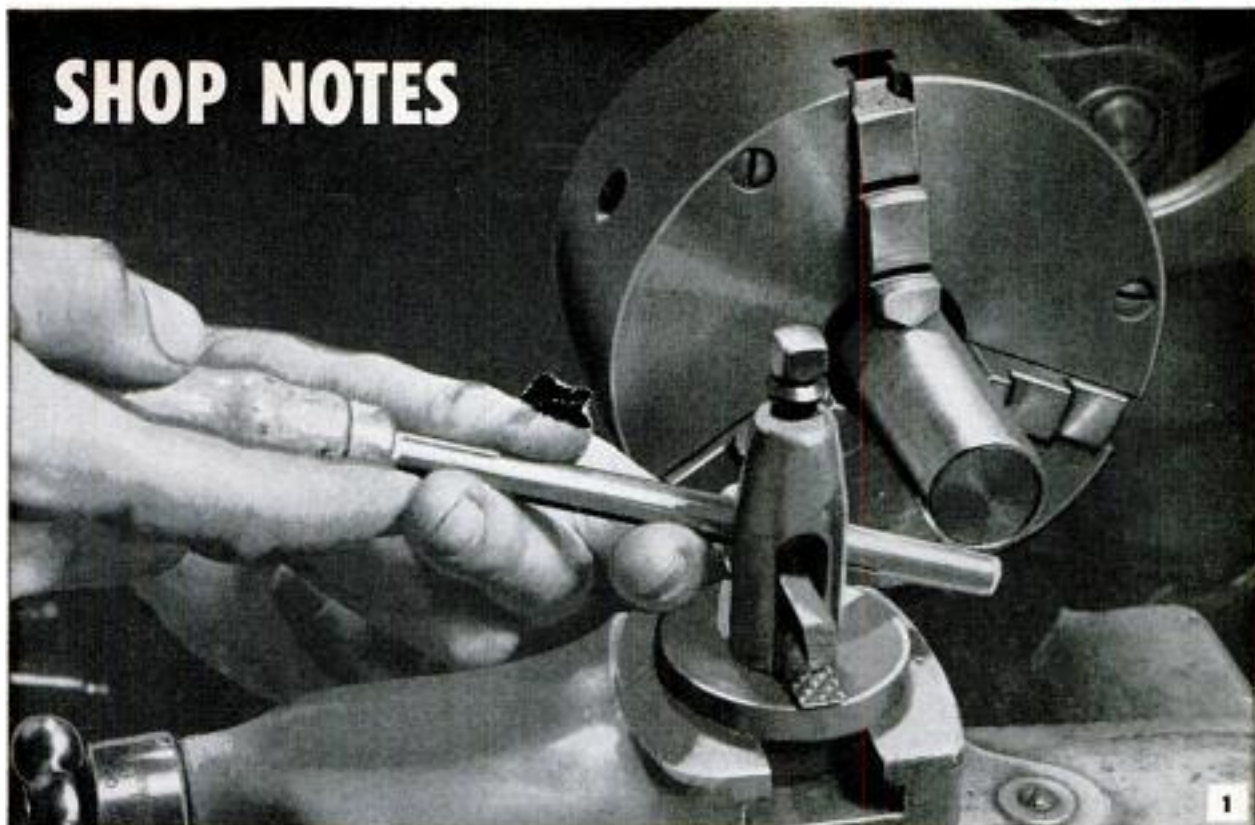

BURNISHING puts a fine finish on wood or metal

By Walter E. Burton

BURNISHING is a method of eliminating surface irregularities without removing material from the surface of the stock. The procedure differs from grinding, sanding and machining. It has a fairly wide range of applications from finishing costly dies to simple polishing of small wood and metal parts in the home workshop.

Simple burnishing on metal, Figs. 1 and 6, forms an infinite number of tiny facets which have the effect of changing the reflective properties of the surface, making it appear highly polished. On wood the process "lays the fibers," making the wood appear to be glass-smooth and lacquered in its natural color. Both metal and wood are velvety smooth to the touch after burnishing. Of course, not all metals and kinds of wood can be burnished. Cast iron and soft aluminum generally do not respond satisfactorily to the action of the burnisher. Neither do the coarse-grained woods such as ash. But most of the other common metals and hardwoods, especially the finer tropical hardwoods, can be given



HAND AND POWER-DRIVEN BURNISHERS

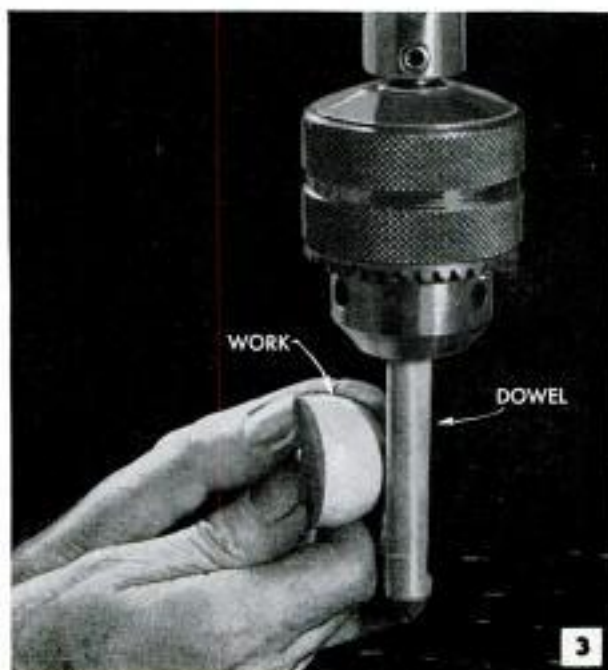

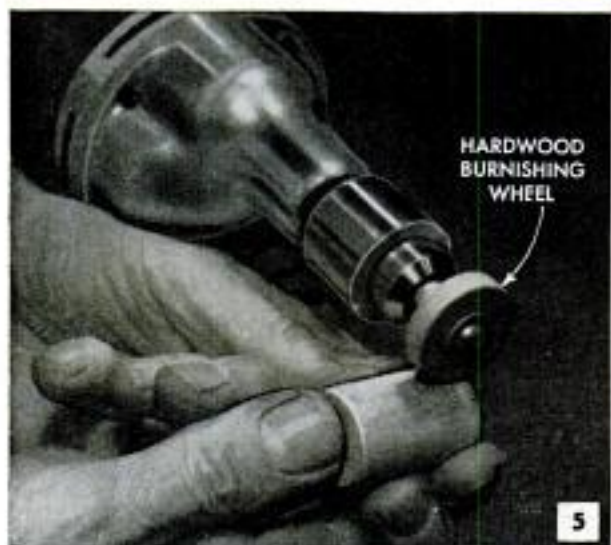
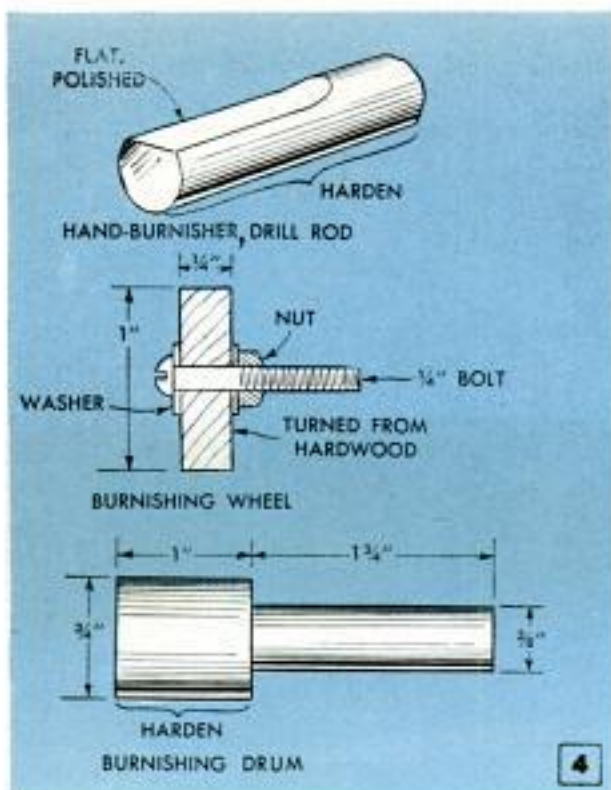

a superfine finish by burnishing alone. In the home shop applications are practical only for such work as refinishing and repairing jewelry, highlighting bronze statuary, renewing carvings, finishing model parts and small wooden novelties.

Burnishing can be done by hand, with a hand-operated tool, or with a power-operated tool. In the first instance the work is held stationary and the tool is moved over the surface in a series of strokes covering the area to be burnished. Figs. 3 and 5 are typical examples of the use of a power-operated burnisher. Representative types of hand and power-operated burnishers are shown in Fig. 2, details A to F inclusive. Those in details A, E and F are designed to be driven either in a drill press or portable drill, Figs. 3 and 5. The power burnishers A and F are detailed further in Fig. 4. The burnisher D, Fig. 2, for use in a lathe freehand, also is detailed in Fig. 4 and shown in use in Fig. 1. Burnisher D, Fig. 2, is made from drill rod, while burnisher C is made by grinding the teeth from the four sides of a square file and fitting a handle. The burnisher B is simply a small twist drill having the shank cut at an angle and the cut surface ground and polished. It is held in a pin-drill chuck and is intended for fine work on small parts.

One of the tricks in getting a fine finish on either wood or metal is to keep the tool moving and at the same time apply a uniform pressure. This is more especially true where the burnisher is power-driven and considerable heat is generated in the process. As a rule, wood is burnished dry, but most metals will take a finer finish when a light oil is used to dissipate heat and prevent any possibility of scoring the surface. When burnishing freehand as in Fig. 1, the tool is held in one hand and the lathe carriage moved slowly left and right with the handwheel. When burnishing with a crowned tool (a diamond wheel dresser also can be used) in a holder as in Fig. 6, the automatic longitudinal feed of the lathe carriage can be used, or the tool fed manually with the handwheel. It should be noted that in such setups, the tool (burnisher) should contact the work slightly below the center line. This position of the tool will offset any tendency to score the surface. As a rule when burnishing metal, the speed of the lathe spindle should not exceed 300 to 500 r.p.m. ★ ★ ★

Compressed Air Tempers Steel

After grinding very hard cutting tools that cannot be cooled in water without making them brittle, one machinist cools them by directing a stream of compressed air on the heated parts.

Electric-Fence Insulators Removed Without Damage

Electric-fence insulators can be removed undamaged from wooden posts or stakes by means of a claw hammer and a 1¼-in. pipe coupling. Slip the coupling over the insulator and use it as a fulcrum for pulling the nail holding the insulator. This prevents cracking the porcelain or bending the nail.

Stanley Clark, East Bradenton, Fla.



Screen Funnel on Barn Wall Keeps out Unwanted Bees

When one farmer discovered that bees were entering a barn through a knothole in a wall, he got rid of them by shaping a funnel from screen wire and tacking it over the hole. The bees could leave easily through the funnel because the large end was against the knothole. They did not return, since it was difficult for them to find the small opening in the outer end of the funnel.

Extra Tow Bracket on Tractor Fits High Equipment Drawbars

The problem of towing farm machinery and equipment equipped with drawbars higher than the tow bar on the tractor was solved by one farmer who welded an offset bracket to the top of the tractor tow bar. Formed from heavy steel salvaged from an old gang plow, the bracket was bent in opposite directions at each end. The section between the two bends was equal to the difference in height. Welded to the tow bar a short distance in from the end, the bracket serves as an alternate point for hitching to the tractor. Thickness of the metal is governed by the slot in the drawbars.

A. M. Wettach, Mt. Pleasant, Iowa.

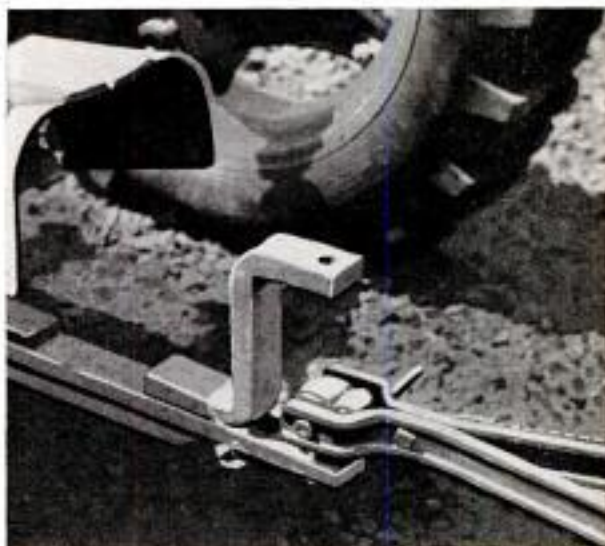

Water Fountain in Poultry House Protected Against Freezing

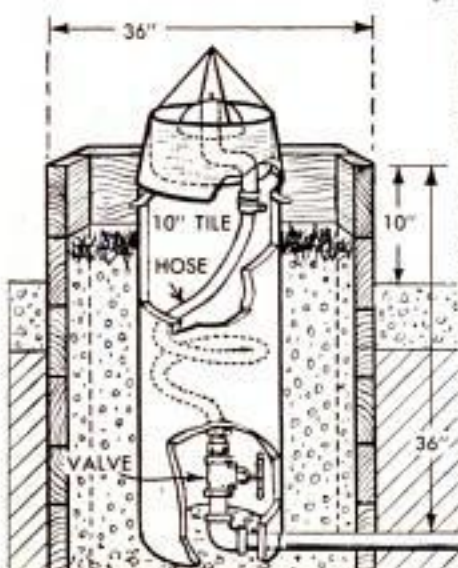

One Iowa farmer placed the automatic fountain in his poultry house on the end of a 10-in. tile buried vertically in the center of a 3-ft.-sq. wooden box filled with loose gravel which projects above the concrete floor. Water is delivered below the frost line to a shutoff valve at the bottom of the tile. A rubber hose, long enough to permit raising the fountain for cleaning or reaching the shutoff valve, supplies water as needed.

SN ~~107A~~ 59

BIMETALLIC MACHINIST'S HAMMER

By Joseph M. Giambalvo

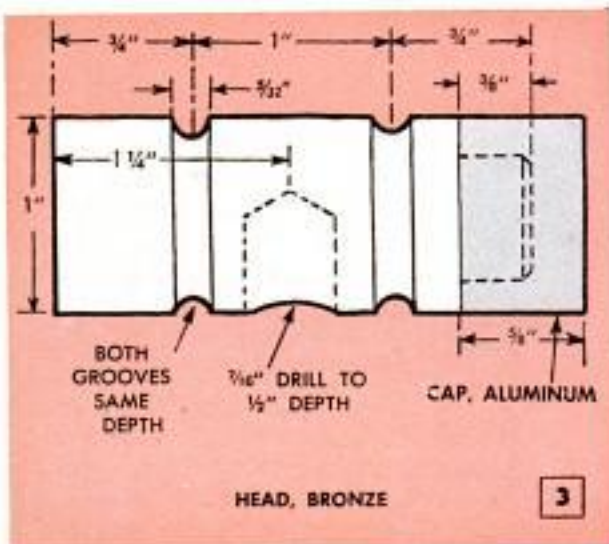
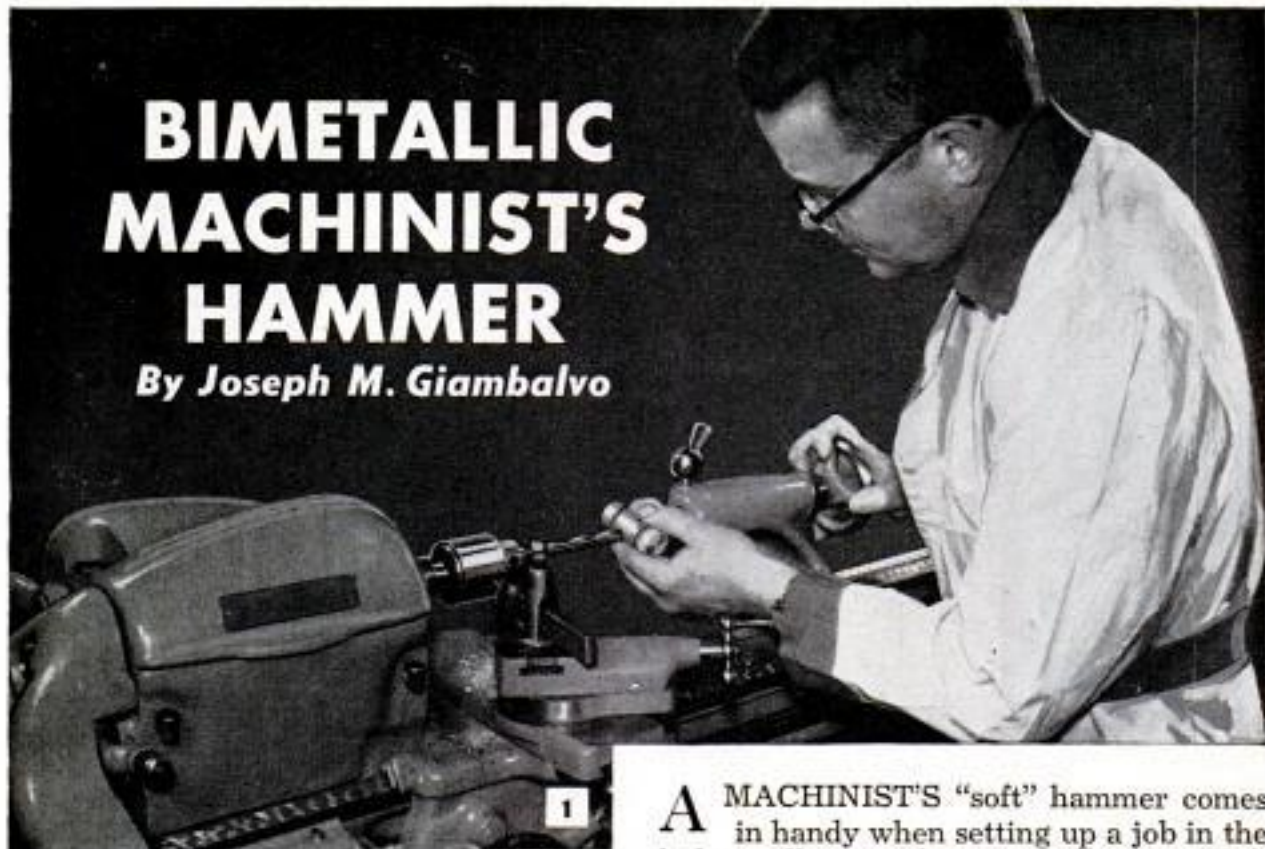

A MACHINIST'S "soft" hammer comes in handy when setting up a job in the lathe, milling machine or drill press. With the chuck, vise or strap clamps eased onto the work it usually takes only a light tap or two with the hammer to bring an indicator to the correct reading, Fig. 2, or position semifinished work for the final cut. The soft hammer also is used in assembly of finished parts where it is necessary to strike positive blows without the rebound of the rubber or rawhide mallet, and without denting or marring finished metal surfaces or sharp edges.

A bimetallic hammer, such as that shown in Fig. 6, is especially useful both in set-up and assembly work. The polls (ends of the head) are of different metals, one of bronze and one of aluminum. This combination greatly extends the hammer's range of usefulness where it is necessary to strike nonmarring blows. The hammer serves a twofold purpose in the school shop. It's an excellent project for advanced machine-shop courses and when finished it becomes a useful tool.

As dimensioned in Fig. 3, the head will weigh about 10 oz. when finished. This is a good average weight for precise and easy handling. Although the details in Figs. 7 and 10 show a press fit of the aluminum cap, or poll, and an easy fit of the handle in the head, you have a choice of procedures in carrying out these two steps. Some machinists prefer to have the handle threaded into the head rather than slip-fitted and soldered as in Figs. 7 and 10. In this procedure the head is drilled through, counter-bored and tapped, and the end of the

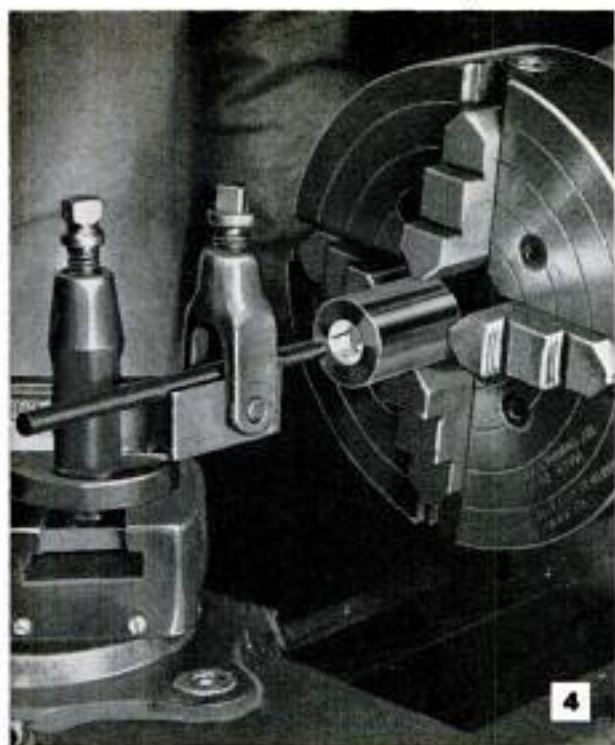

handle is shouldered, clearance-grooved and threaded. This type of assembly is quite satisfactory if you form more nearly a full-depth thread, say about 80 to 90 percent. This will assure that the handle seats solidly when turned into the head. The shoulder on the handle should be undercut slightly and must fit the counterbore snugly, otherwise the head may tend to loosen with use.

Much the same procedure can be followed when fitting the aluminum cap to the head. Although these procedures are not detailed, they can be carried out with only slight changes in the dimensions given in Figs. 3, 7 and 10.

Fig. 3 details the hammer head assembled, that is, with the cap fitted in place. The head is turned from bronze to 1 in. in diameter and is grooved and drilled for the handle, Fig. 1. The hole for the handle, also the center lines of the grooves, are located as in Fig. 8. Note that when the head is assembled with the cap in place the hole

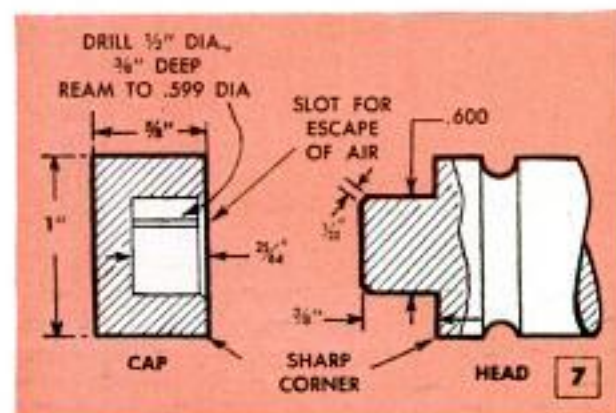

It will be noted that the polls (ends of the head) of this hammer are not crowned. Rather they are faced square across with sharp corners, as in Figs. 3 and 7. Although many users will prefer flat polls, crowned polls with chamfered edges are, of course, optional. Height of crown should not exceed .015. Less is better, about .005 to .008 being a good average. Break (chamfer) the corners about 1/64 in. at 45 deg.

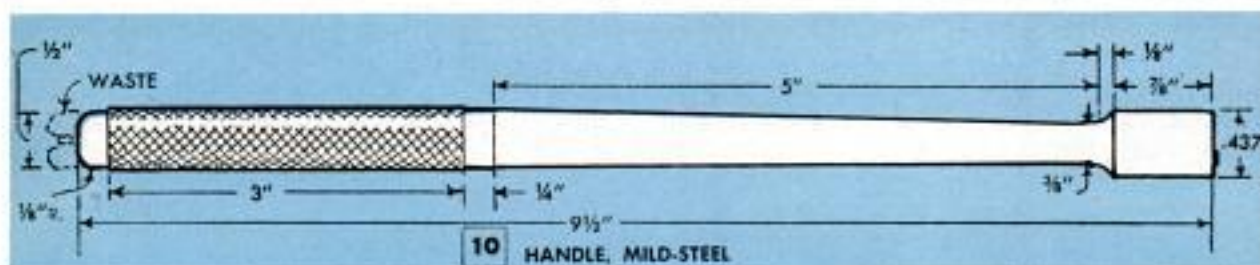
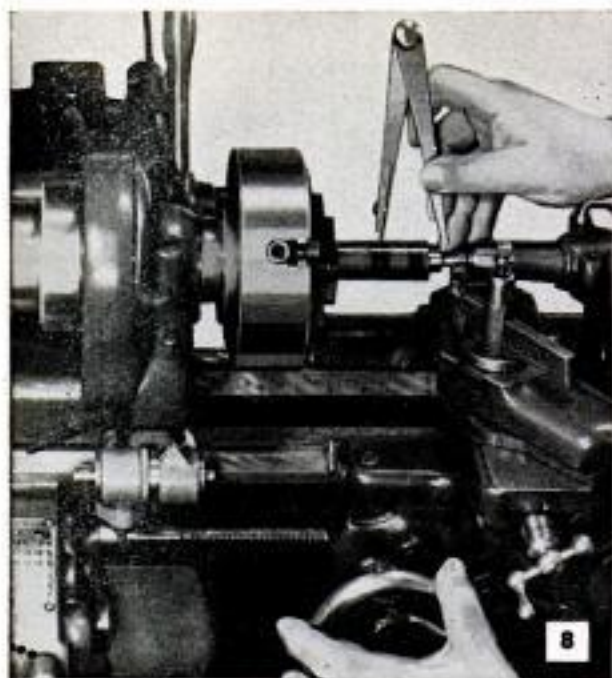

taking the handle is off-center. This is done purposely in order to more nearly balance the head. Important steps in machining the head and cap for a press fit are shown in Figs. 4, 5 and 7. After the bore in the cap has been checked for correct diameter (ream if you have a correct-size stub reamer) cut a shallow slot to permit air to escape as the parts are pressed together. This is done with the work at rest, Fig. 4. The boring tool is simply run in and out by hand-operating the lathe carriage, moving the tool about .002 at each stroke. The corner of the bore is chamfered $\frac{1}{32}$ in. at 45 deg. and a corresponding chamfer is run on the end of the tenon shouldered on the head. For a press fit some machinists prefer to run the chamfers at a somewhat greater angle, say about 60 deg. If available use an arbor press to assemble the cap and head. Otherwise do the job in an accurate vise, shimming the parts if neces-

sary to assure correct alignment. After this step is completed, chuck the head and take a final light finishing cut all over, or polish with an abrasive.

The handle, Figs. 9 and 10, is a simple lathe job. Start with a 10-in. length of cold-rolled stock and rough the taper and the fillet at the small end of the taper. Run 3 in. of fine knurl on the big end of the handle. Finish by filing and polishing with abrasive. Before turning the small end of the handle to the final dimension, .437, be sure to check the diameter of the hole in the head. In making this check remember that the handle is sweat-soldered into the head and this calls for an allowance of .002 or so.

Then clean the parts thoroughly, tin the joining surfaces and press together. Heat with a flame until the solder flows. Remove any excess solder from the joint while it is still soft. ★ ★ ★

Checking Dual Vacuum Pumps for Diaphragm Perforations

On most late-model cars fouled plugs and carbon deposits often are taken as symptoms of frozen piston rings. Another cause of similar symptoms should be checked before accepting this diagnosis as final. A tiny perforation in the diaphragm of either of the vacuum pumps can cause

oil to be drawn into the cylinders with the fuel mixture. To check for this defect, disconnect the lines and, with the engine running, hold a paper towel over the openings. If there is a leak, oil discoloration will appear on the paper.

George N. Frecker, San Francisco, Calif.

Adjustable Rack on Elevator Speeds Loading of Bales

Loading bales on this portable elevator is simplified by the addition of a bale rack taken from a discarded stationary baler. Two pipe legs, cross-braced with steel rods, pivot to allow the rack to tilt to any angle or fold flat onto the elevator for transport. The lower end of the rack pivots on brackets bolted to the elevator.

Angle-Iron Bracket Supports Hog Trough



For sturdy hog-trough supports, angle-iron brackets constructed as shown can be bolted one on each end of the trough. Each bracket is 2 ft. wide at the base, 8½ in. high and extends 6½ in. on either side of the trough. A length of

angle iron may be bent into the shape illustrated by cutting the inner flange, or pieces of angle iron cut to the specified sizes may be welded together to form the bracket.—Clifford Cruzen, Wright, Iowa.

Sweat Soldering Improved

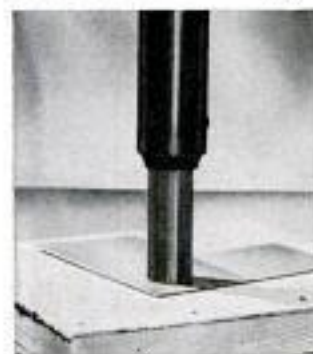

If your soldering iron has a removable tip, a better job of sweat soldering can be done with the tip reversed as shown. The flat end has greater contact with the work for more uniform heating.

Peening Tightens Gun Barrels

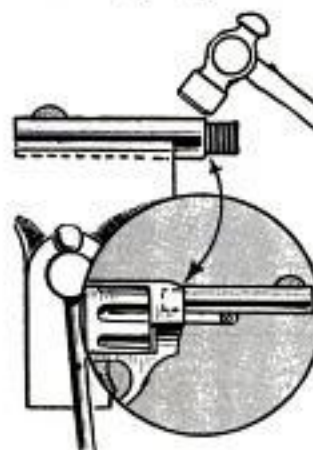

When a revolver or rifle barrel will not tighten at the correct position when it is replaced in the frame, one gun enthusiast who does his own gunsmithing peens the barrel shoulder lightly as indicated, which corrects the condition.—R. V. Thompson, Clinton, Iowa.



Dump-Body Farm Trailer Powered By Hydraulic Piston

This dump-body trailer was made by hinging an old truck body to a two-wheeled trailer and fitting a hydraulic piston between the front of the trailer and the front of the truck bed. The hydraulic piston is from a tractor scoop. Coupled to the hydraulic system of the tractor, the dump body can be raised or lowered smoothly and quickly with any kind of load.

Charles L. Stratton, Hollis, N. H.



ⓘ Be sure oil stains are well mixed before using. When in storage the pigment settles and unless remixing is complete the stain will not give a uniform color.

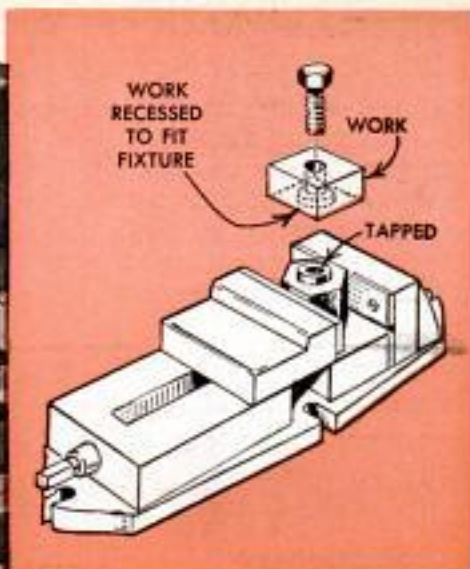

Only part to make in this setup is the master pattern, or fixture, which is held in milling-machine vise. Standard hex stock also can be used

Milling-Machine Fixture Indexes Hexagon Shape

Confronted with the problem of filling an order for a number of hexagon shapes in a hurry, one job-shop machinist improvised the setup pictured. First, a master hexagon shape was milled from a blank of round stock, then shouldered to form a projection about $\frac{1}{8}$ in. in height, which was center-drilled and tapped. This part becomes the indexing fixture which is placed in the machine vise. The workpieces are then recessed to fit the projection on the master indexing fixture and center-drilled so that

they can be fastened to the fixture with a capscrew. The vise is then adjusted to the correct angle on the machine table and a first cut taken on the workpiece. When the first cut has been run, the vise jaw is loosened and the fixture and workpiece rotated to bring adjacent faces of the fixture into position for the second cut. This procedure is repeated after each successive cut until the desired shape has been formed. Either hexagon or octagon shapes can be milled with reasonable accuracy.



Pencil Clip on Small Tool Holds It in Pocket

Your nail set, punch or other small tool will not drop out of your shirt or overall pocket if a pencil clip is slipped over the tool as shown. Available in stationery and ten-cent stores, the clips can be shaped to fit the shank of a square or hexagonal tool. In some cases it may be necessary to solder or weld the clip to the tool.

Socket Screw Used as Wrench

A socket-head screw can be used as a wrench when a regular socket-wrench set is not at hand. Also, you can sometimes reach a small hex nut with a socket screw when regular socket-wrenches won't turn the trick. By drilling a small hole near the end of the threaded section of the screw and inserting a nail you have a practical T-wrench.

Out-of-Round Machining Produces Self-Locking Box Lid

One novel application of out-of-round machining is a self-locking lid on a cylindrical container, such as a jewelry box or stamp dispenser made from thin-walled brass or aluminum tubing. Mount the work in a 3-jaw chuck as pictured. Tighten the chuck jaws to hold the work, then give the chuck wrench an extra half turn or so. This will distort the tubing slightly, detail A. Score the surface lightly at the point where the lid portion is to be cut from the body. Turn a groove (with one edge at the scored line) $\frac{1}{16}$ in. wide and to a depth equal to half the thickness of the tube wall. Measure the diameter at the bottom of the groove. Cut off at the scored line (edge of groove nearest the chuck). This leaves a shoulder on the body of the turning approximately $\frac{1}{8}$ in. long and out-of-round as in detail B. Slacken the chuck jaws about $\frac{1}{8}$ turn of the wrench. Then, using a boring tool, run a shoulder cut internally

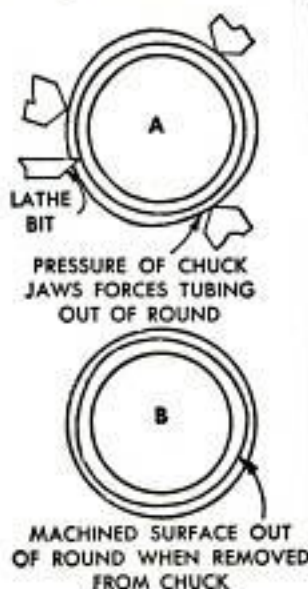

on the lid "ring" to a depth of about $\frac{3}{32}$ in. and to a diameter equal to that of the groove before cutting off the body. If careful measurements have been made, the shouldered parts will fit together snugly at one point. It may be necessary to file the shouldered portion lightly to obtain an easier fit. Turning the lid slightly will cause the two parts to lock.

Walter E. Burton, Akron, Ohio.

Clamp on Milling-Machine Switch Prevents Starting Error

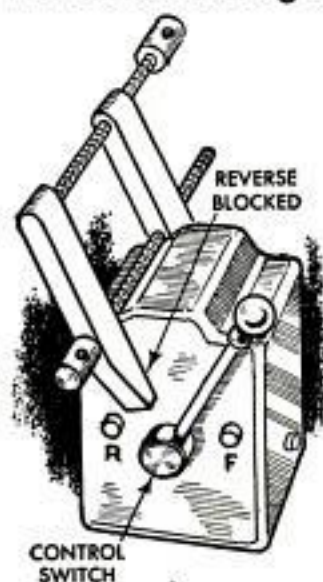

One man placed a parallel clamp over the switch housing of his milling machine, as shown, to prevent starting the machine in the wrong direction. End mills and cutters running backward for any length of time will become dull and possibly break. The clamp is placed so it limits switch-lever movement to the right direction.

Oil Dipstick Easily Read

Because oil dipsticks in both the crankcase and the transmission were of bright metal, making them difficult to read, one motorist darkened the sticks with gunbluing solution. The resulting dull finish permits the oil level to be seen clearly.

Lewis C. Rudd, Kansas City, Mo.

Keeping File Teeth Clean

Powdered graphite is more effective in keeping file teeth clean when working soft metal than the usually recommended chalk. The chalk itself may become embedded in the file teeth and present a removal problem. Simply apply a thin film of graphite on the file from one of the handy applicators now available at most hardware stores.

Ken Murray, Colon, Mich.



SN ~~107M~~ 59

To do the job

LATHE TOOLS

must be sharp

By C. W. Woodson



IN COMMON metal-lathe operations the cutting tool moves in two directions in a horizontal plane—parallel with the lathe bed when machining work between centers and at right angles to the bed when facing work. These movements largely determine the form, or profile, of the tool bit at the cutting edge. Eight of the standard shapes are shown on the opposite page. There are, of course, others, the profiles being ground for special jobs. In the detail on tool terminology, below right, the terms are intended to be descriptive rather than conclusive. The tool forms pictured are those of common lathe tools and do not apply to the carbide and ceramic tools designed for high-production schedules. The hand of the tool is determined by the position of the cutting edge when viewing the tool endwise, looking at the cutting end. Note the center detail at the right. The left-hand tools are designed to cut toward the tailstock when machining stock between centers. The right-hand tools cut in the opposite direction. It's the usual practice to set the point of the tool on center as in the upper detail at the right, the distances A and B, which determine the overhang, being held to the minimum.

Although any tool with end and side clearance will cut, machinists generally hold the forms quite closely to those detailed when grinding. Variations are permissible for special purposes. As an example, the end clearance can vary from 5 to 8 deg. and the back rake, or top rake, from 0 on the brass tool to 5 deg. on tools used for other metals. Machinists doing fine work such as that on instruments and similar jobs requiring clean work, hone the cutting edges after grinding. ★★★

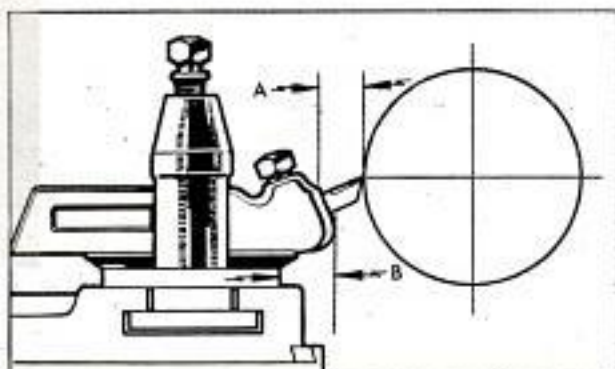

In regular work, tool is set with point on center. Distances A and B determine the overhang of tool and holder and normally should be held to minimum

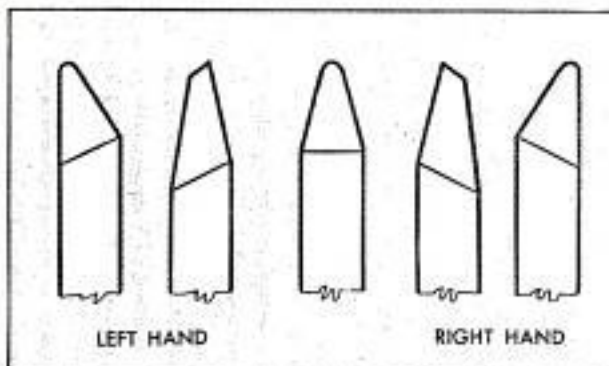

Right or left hand is determined by position of cutting edge when viewing tool endwise, looking at cutting end. Roundnose tool cuts in either direction

In usual practice, clearance angles are held to minimum to provide maximum support for cutting edge. Tools will function over fairly wide range of angles

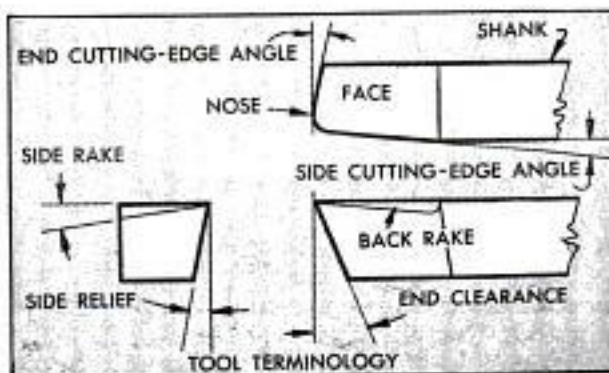

POPULAR MECHANICS

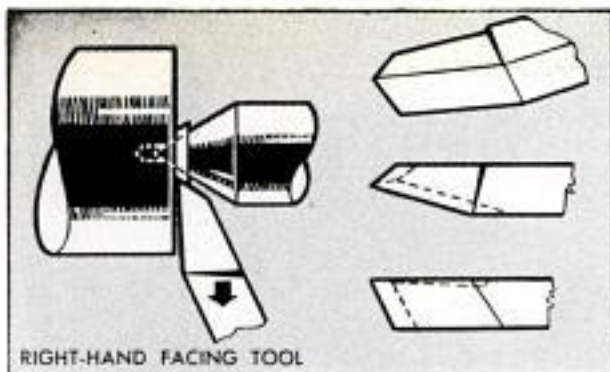

RIGHT-HAND FACING TOOL

Facing tool is worked outward from center when finishing ends of shafts or sides of shoulders. Point usually is ground to 58 deg. for working to center

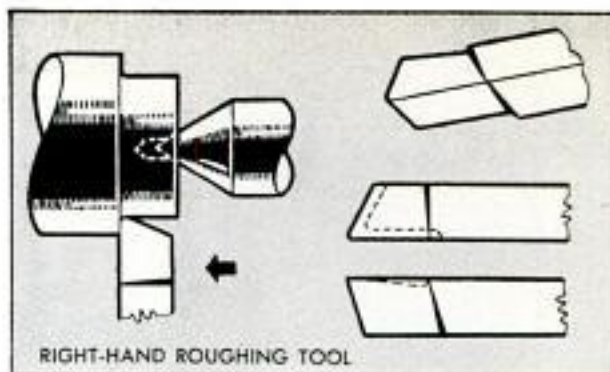

RIGHT-HAND ROUGHING TOOL

Purpose of roughing tool is to remove stock quickly. Cuts freely, but leaves rough surface. When working this tool always leave stock for finishing

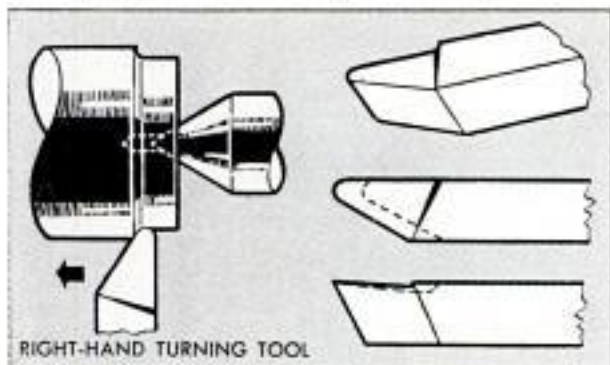

RIGHT-HAND TURNING TOOL

Right-hand tool works to the left, cut beginning at tailstock end of work between centers. Not suitable for heavy cuts. Leaves clean surface at slow feeds

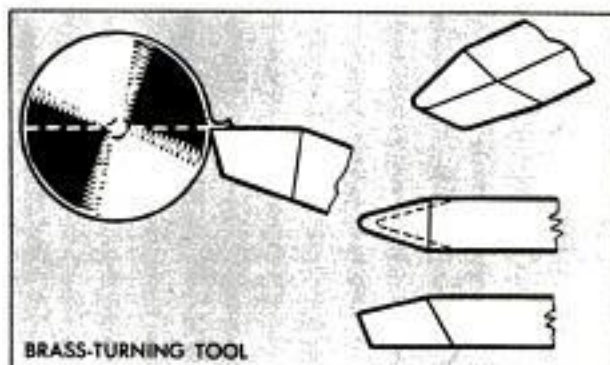

BRASS-TURNING TOOL

Brass tool is ground with negative rake. Tool is mounted with cutting point precisely on center line, as otherwise it may score work or leave chatter marks

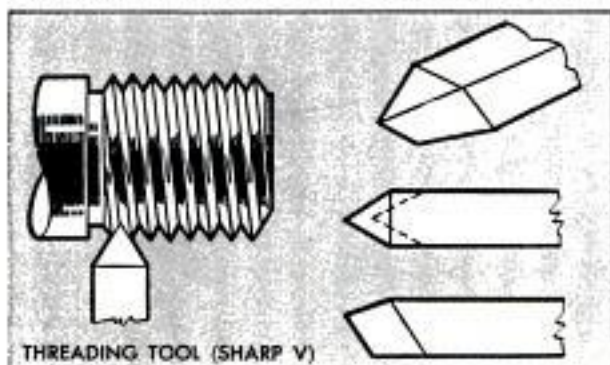

THREADING TOOL (SHARP V)

Sharp-V threading tool usually is ground to 60-deg. included angle at point and with negative rake. It must be set on center line (at lathe-center height)

Finishing tool is ground with a straight cutting edge and is frequently honed to produce a finish comparable with grinding. Take a very light cut

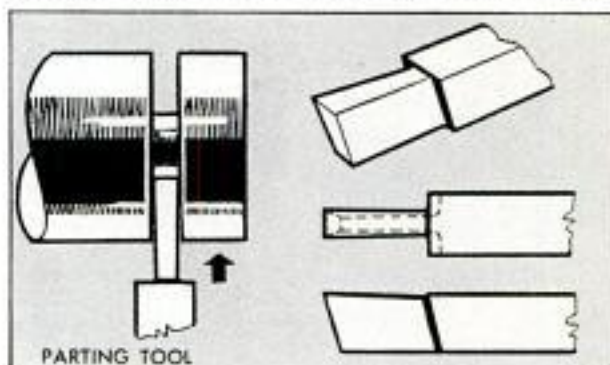

PARTING TOOL

Parting tool also must be set on center line. It is resharpened by grinding end only. Note that the sides are ground to slight angle to provide clearance

Roundnose tool is ground with right and left-hand cutting edges. Cuts in two directions. Tool is frequently ground with a negative rake for special work

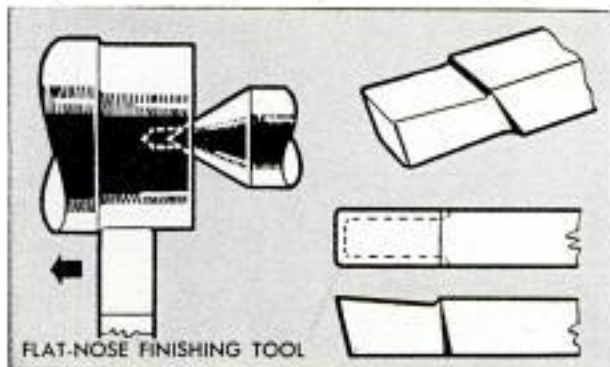

FLAT-NOSE FINISHING TOOL

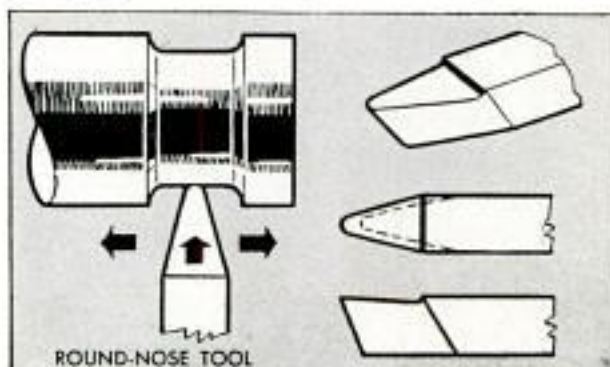

ROUND-NOSE TOOL

Improved Indicator Centers Work in Four-Jaw Chuck

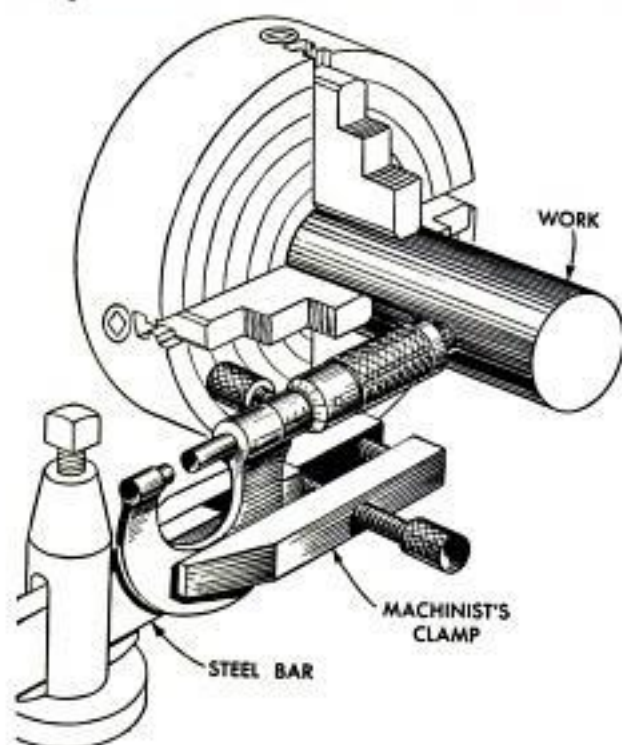

You can improvise an accurate indicator for centering work in a four-jaw chuck by using an ordinary work mike, a machinist's clamp and a bar of tool steel that will fit in the toolholder. Insert the bar in the holder and clamp the mike to it with the machinist's clamp as pictured. Adjust so that the center of the mike thimble (sleeve) is on the center line of the lathe. Adjust the work in the chuck freehand to run as nearly true as possible by eye. Then run the thimble of the mike out until it contacts the work lightly. Take the reading on the mike and rotate the work a quarter turn. Readjust the mike thimble and take another reading. Adjust the work in the chuck to compensate as nearly as possible for the variation in readings and repeat the process until the reading is the same at four positions of the work. Tighten the chuck jaws and recheck. If there is no change in readings, the work is centered accurately enough for all practical purposes.

C. W. Woodson, Chicago.



Width of Grinding-Wheel Face Measured With Micrometer

There are times when it is necessary to know the precise width of a grinding wheel at several points on the periphery. It won't do to touch the wheel with the measuring surfaces of the anvil and spindle of the mike as the polished faces are almost certain to be scored. Instead, you first mike two pieces of tool steel and jot down the reading. Then, using these pieces as pads, the thickness of the wheel can be measured as shown. Simply deduct the thickness of the pads from the reading.

Frank La Saracina, New York City.

POPULAR
MECHANICS
MAGAZINE

OCTOBER
HOME
SECTION

See Our Annual Home Section - - - Next Month

Somewhere in our 50-page October Home Section you may find just the answer to your housing problem, whether it be adding a room to your house, finding something new in wall covering, building a fireplace or an entire new home. We are celebrating the fifth anniversary of this section by presenting two new specially designed houses in full color—one Modern and one Traditional. Both are exciting and planned for 20th-century living.

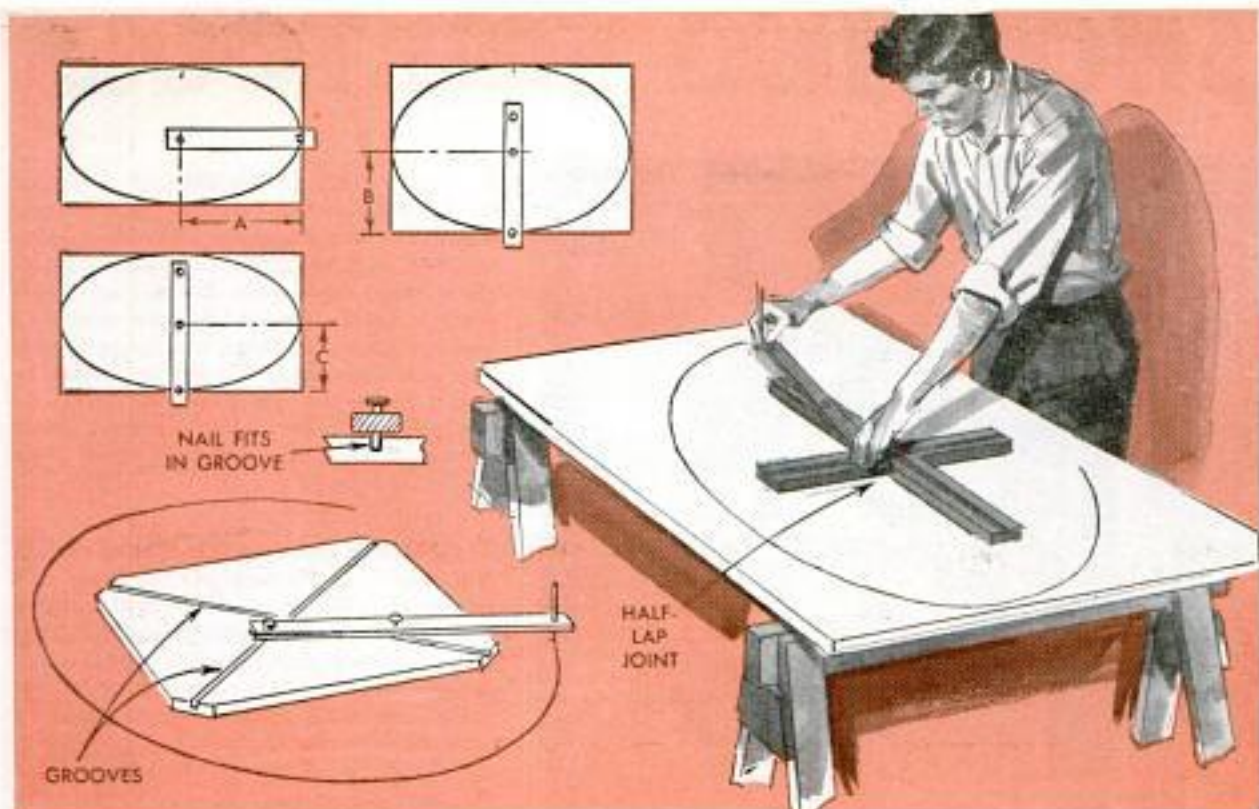

Jig for Accurate Layout of Elliptical Form

Old-time joiners used this method when laying out an oval table top or mirror frame. As the first step, you determine the size of the oval you require by laying out width and length as a rectangle. Note the three upper details on which the ovals are shown for clarity. Strike horizontal and vertical center lines on the rectangle. Then make a scribing arm from a $\frac{1}{4}$ x 1-in. strip of hardwood, the length slightly greater than half the length of the ellipse required. Place the strip on the layout as in the upper left-hand detail and make a pencil mark on the strip at the point where the center lines intersect and another at the line indicating the end of the rectangle. Drill a hole at the latter point to take a pencil in a tight fit. Drill a hole at the mark on the opposite end of the strip to take a 10d nail in a snug fit. Press the nail into the hole and cut off square, leaving about $\frac{1}{4}$ in. projecting. Now, note how variations

in distances B and C affect the shape of the oval. Place the strip on the vertical center line with the pencil point on the line indicating the side of the rectangle. Mark the strip for the hole taking the second nail at the intersection of the center lines. Drill, insert the nail and cut off square, the projection being about $\frac{1}{4}$ in. Next, make the guide for the strip, using a square of $\frac{1}{4}$ -in. plywood as in the lower left-hand detail, or two half-lapped strips as in the illustration at the right. The former is preferable. Cut $\frac{1}{8}$ -in. grooves in the plywood square at right angles. Turn the panel on which the oval is to be scribed upside down and make the layout on the bottom. Place the plywood square at the center, tack it lightly and then place the scribe in position. Strike the oval in one sweep of the pencil, holding the scribe with the left hand so that the flattened nail points engage the guiding grooves.

Dividers Set With Micrometer

A micrometer can save a lot of time when setting dividers for laying off distances of less than 1 in. which are expressed decimally. First calculate the distance involved, set the mike accordingly and lock the spindle. Then hold the mike and dividers as pictured and adjust the divider points so that they touch the surfaces of the anvil and spindle lightly.



SHOPPING FOR TOOLS

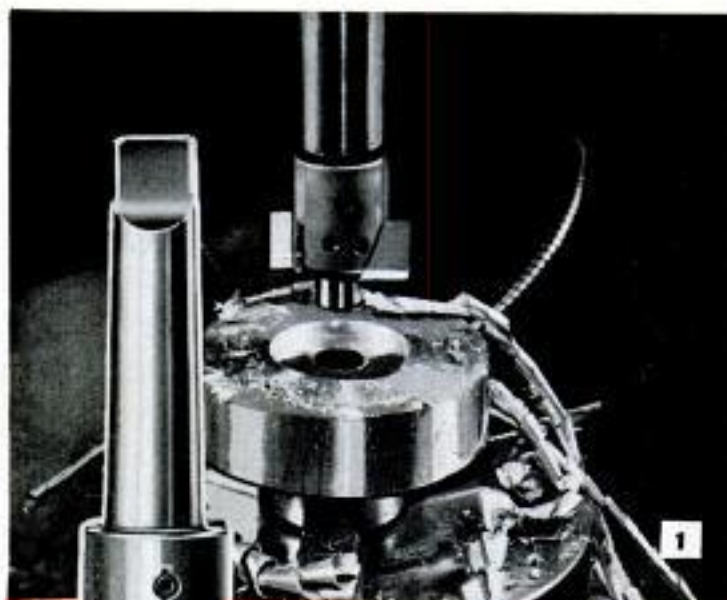

1. ADJUSTABLE COUNTERBORE and spot facer works in steel forgings, heat-treated steels, cast iron, aluminum alloys and stainless steel. Adjustable to hold specific diameters after regrinding. Blades are positively locked in position by two setscrews bearing against the front tool faces. Blades also are V-tongued, the tongues riding in slots milled in body, or shank, for maximum strength. All sizes take standard pilots

Robert H. Clark Co., 9330 Santa Monica Blvd., Beverly Hills, Calif.



2. PORTABLE TABLE SAW is controlled with foot switch, cuts wood, plastic, brass and aluminum trim, glass fiber and rubber, also ceramic tile with abrasive disk. Comes with 5-7/16-in. combination blade, miter gauge, guard and a.c.-d.c. motor. Table forms one side of sheet-metal carrying case, the latter serving as a base when machine is in use. Accessories fit into base for transport or storage. Weighs only 24 lb. Buzzmaster, Inc., 336 N. Central Ave., Chicago 44



3. TWIST DRILL has cutting edges ground on flutes. Drills a 1/4-in. hole in the conventional manner, then cuts laterally in any direction. Makes accurate through mortises, slots to any desired width by running adjacent cuts, pierced designs, such as a cloverleaf, in thin stock. Works in wood, soft metal and plastic and can be used in a drill press or a 1/4 or 1/2-in. portable electric drill, also in larger hand drills

Drill-Aid Co., P.O. Box 543, Carthage, Mo.

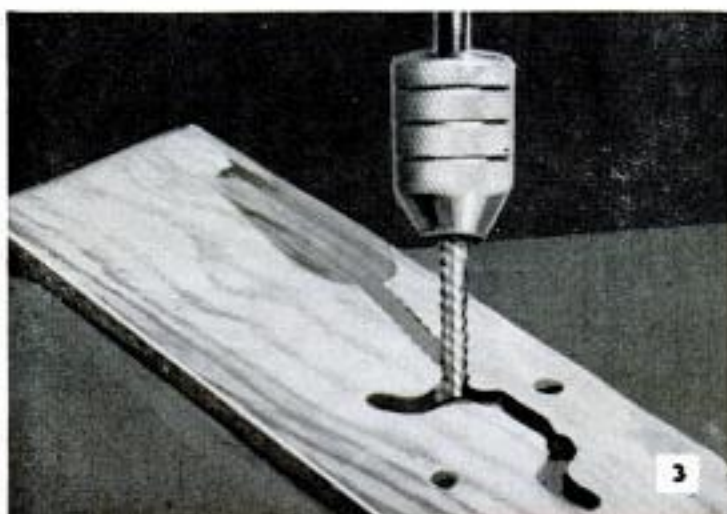

4. DUAL-CLAW HAMMER does away with need for an extra leverage block when pulling large nails. Simply lift nail with regular claws as far as it will go without increasing pressure on hammer handle. Then shift to second pair of claws and withdraw nail entirely. Photo shows nail partially withdrawn and second pair of claws in use. Reduces handle breakage to minimum. Comes with standard 16-oz. head

A. Cripe Tool Mfg. Corp., Box 155, Holly, Mich.

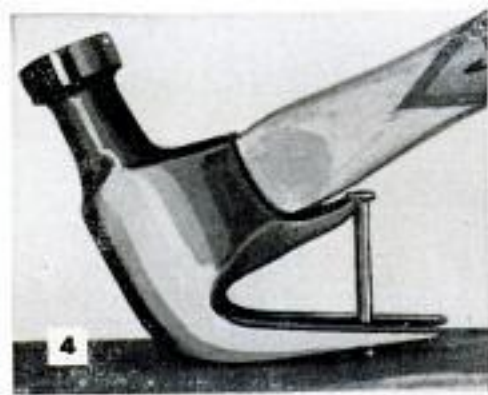



5

5. ROUGHNESS SCALES serve as comparators in the drafting room, machine shop and inspection room where it is necessary to compare or designate surface-finish requirements on machined, ground or lapped work. Especially useful in the small shop where the scope and nature of the work do not warrant investment in electronic equipment of a type designed for this work

Rupert & Co., Ltd., Chapel St., Levenshulme, Manchester 19, England

7. RAISING BLOCKS, or mules, are designed for supporting and positioning work on drill presses and surface plates for finishing operations requiring accuracy and stability. Vees milled at each end of individual blocks are accurately machined in line, making blocks usable as a drill jig for round stock. Available in two sizes

Illinois Metal Products, 429 W. Superior St., Chicago 10

8. PIPE SEAL originally developed for use in the aircraft industry finds applications in other fields. Now used on oil, water, gas, steam, beverage, vacuum and chemical pipelines in sizes varying from 1/8 to 2 1/2 in., the seal consists of a hexagon nut fitted with an insert of tough plastic which seals the pipeline against leakage

Flick-Reedy Corp., 2040 N. Hawthorne Ave., Melrose Park, Ill.

9. SLIP-ON JAWS for adjustable pliers, inset A, come in sets and provide a means of seating and removing various types of rivets. A typical operation on brake-drum linings is shown in photo B. Lining rivets can be removed or seated in one simple operation. Can be used wherever jaws of pliers will reach beyond the edge of the material

Timesaver Tool Corp., 8444 Calumet Ave., Hammond, Ind.



8



6

6. SCRAPER REMOVES PAINT from bricks, stonework, stucco and concrete blocks before repainting. Also removes minor discolorations and all loose material from masonry and mortar joints. Plastic shield protects operator from flying particles

AutoScraper, 2860 W. Valley Blvd., Alhambra, Calif.



7

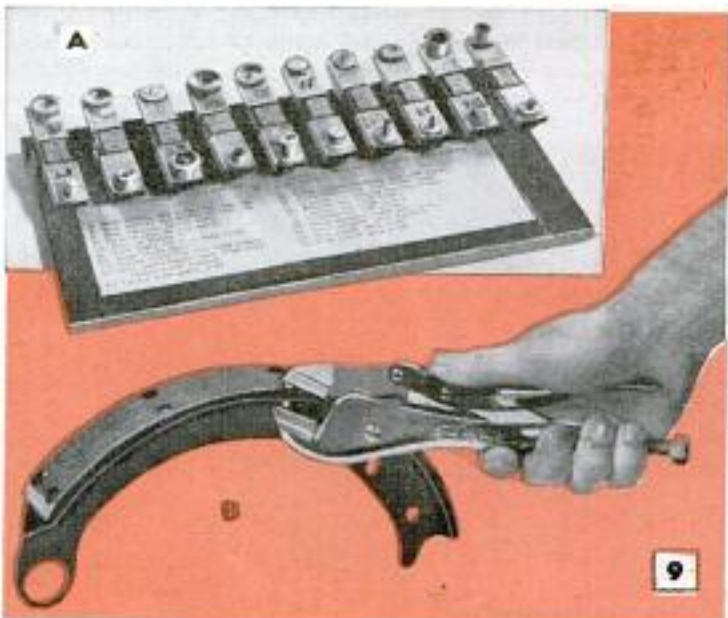

9

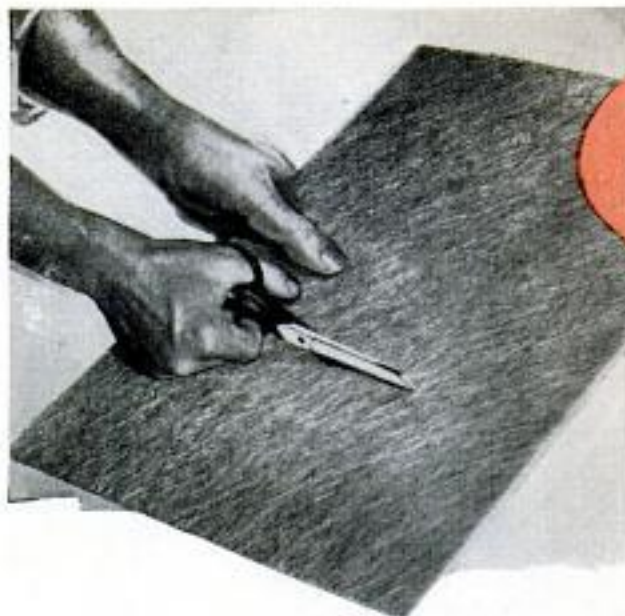

On the
MARKET
for Do-It-Yourselfers

FILTER MATERIAL made from vegetable fibers and bonded into a rigid panel makes frame unnecessary. Especially designed for room-type air conditioners
C.L.H. Co., P.O. Box 8427, Houston, Tex.



SQUEEZE TUBES contain grease and oil which is specially compounded to provide lubrication and rust protection for shotguns and rifles. Can also be used on tools. Comes as kit of two tubes
Lehigh Chemical Co., Chestertown, Md.

PLASTIC ALUMINUM mends metal without heat or use of tools. Repairs leaking fuel lines, radiators and sheet-metal ducts. Sets in three hours. Available in handy applicator-type tube
Magic Iron Cement Co., 5403 Bower Ave., Cleveland, Ohio

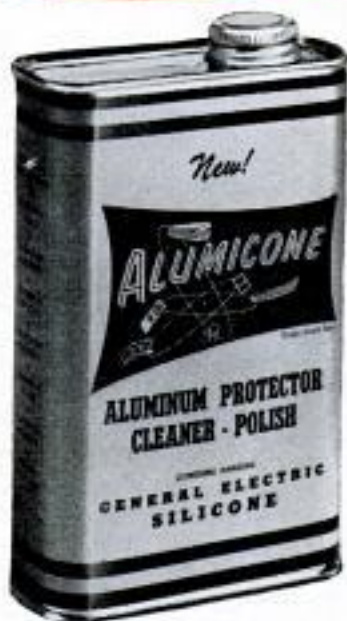

ALUMINUM POLISH has been developed for use on aluminum doors and window frames. Cleans metal, restores original brightness, leaves an invisible coating
Mark "A" Products, P.O. Box 24, New York City 66

SNAP-TYPE COUPLING consists of a nipple, which is screwed onto faucet or sill cock, and a coupling attached to hose. Assembled, parts form a leakproof joint
Snap-Tite, Inc., 201 Titusville Rd., Union City, Pa.



POPULAR MECHANICS

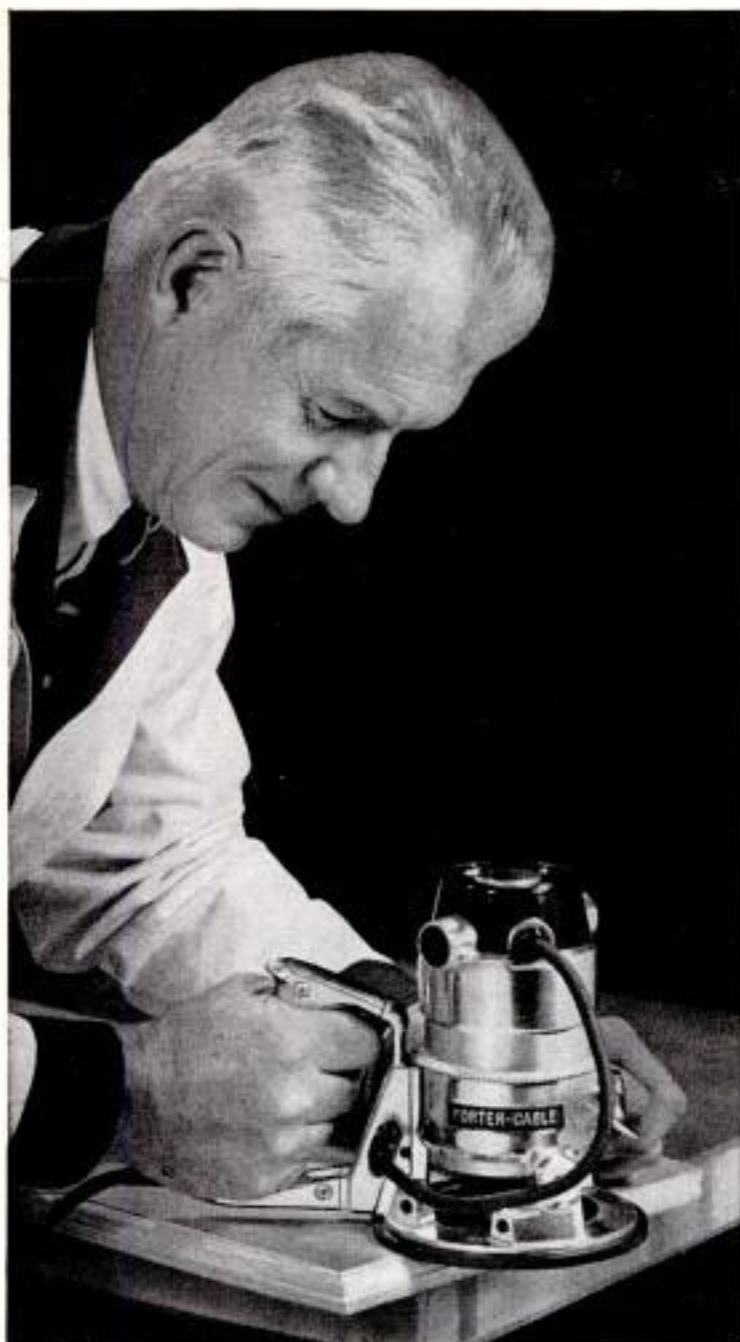

Now - Porter-Cable offers
**the newest,
 most complete
 router line
 anywhere!**

There never has been a quality line of Routers and accessories so complete, so outstanding in design, in versatility, in solid value.

- A full 1 $\frac{1}{4}$ h.p. Router at \$79.50
- A full 5 amp. Router at \$49.50
- Famous Model 100 Router—now full $\frac{7}{8}$ h.p.—still \$57.50
- New 1 $\frac{1}{2}$ h.p. Router—revolutionary pistol grip and trigger switch—\$130

Plus the only big capacity Shaper Table using interchangeable motors; two outstanding new Plane Attachments; six new door-hanging and Router-Plane kits; and a full line of accessories for each.

See these new professional quality tools at your Porter-Cable dealer today —or write for full information now.



Famous Model 100 Router
 now with full $\frac{7}{8}$ h.p.

Designed with more power than ever. Does all professional cuts with greater ease and accuracy. Features include: non-marking base, precision ball bearings and a high-speed, interchangeable motor that may be used for Power Plane and Shaper. An outstanding value at only \$57.50.



New Model 150-P
 16" Plane Attachment

World's finest production plane. Use with your choice of 3 router motors. Trigger switch for safer, instant-power control. Planes up to 2 $\frac{1}{4}$ " wide. Fingertip depth control is adjustable up to 3/32" cut. Only \$49.50 complete with cutter. Without trigger switch, only \$44.50.

Porter-Cable

Quality Power Tools

PORTER-CABLE MACHINE COMPANY
 7149 N. Salina Street, Syracuse 8, N. Y.

**sanders • routers • saws
 drills • shapers • planes**

In Canada: write Porter-Cable Ltd., Box 5019,
 London, Ont. Canadian prices slightly higher.

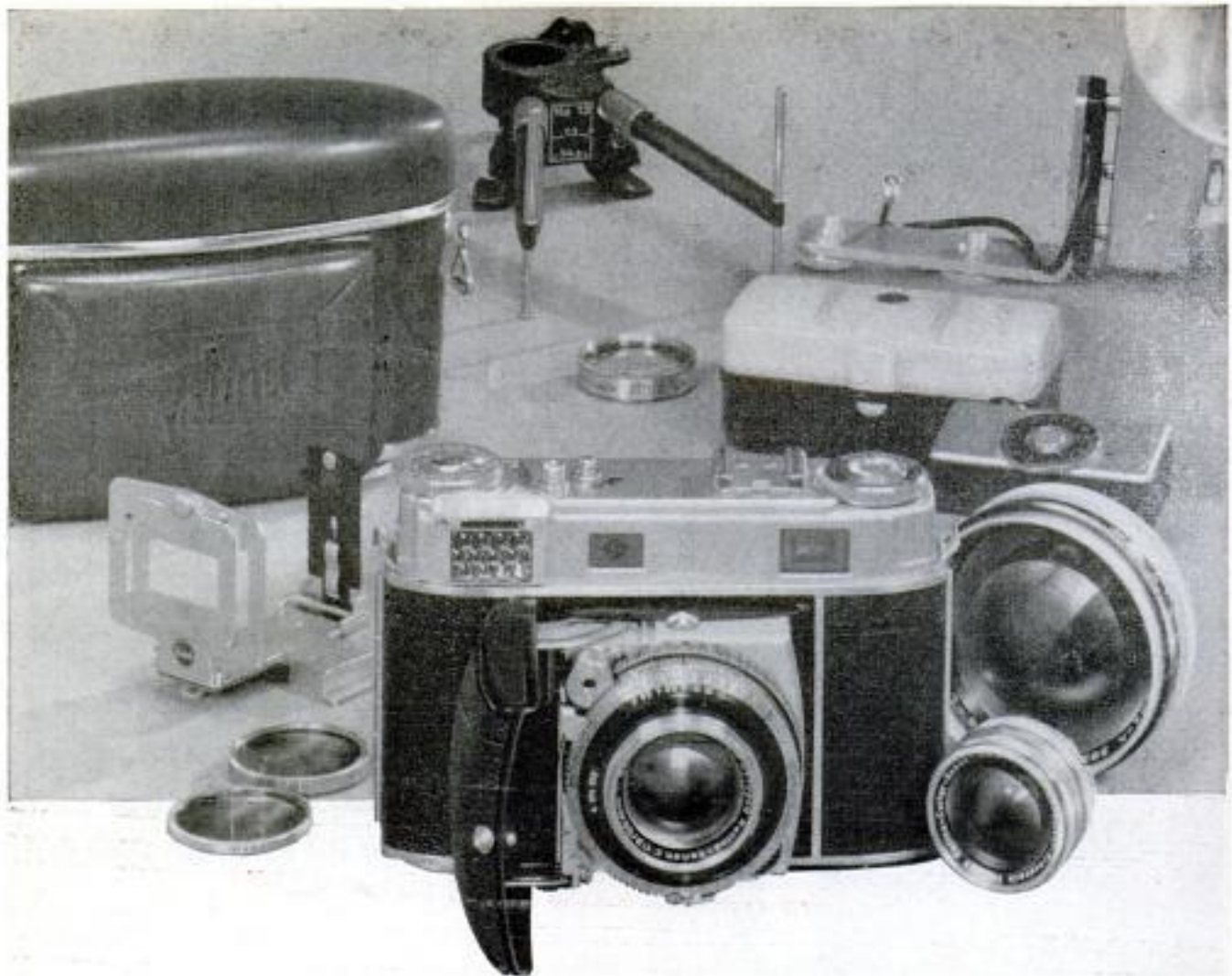

You'll never outgrow a Kodak Retina Camera!

Two great Kodak Retina models to choose from—each the heart of a complete system of photography...

"The most exciting camera I've ever used!" That's how Kodak Retina owners describe this camera.

Whichever famous model of Retina you choose, you'll enjoy the wonderful feeling of confidence that goes with owning a truly top-quality picturemaker. And as the heart of a *complete system of photography*, a Retina's versatility is almost limitless. Whatever field of 35mm picturemaking intrigues you next month... next year... you'll have a

camera thoroughly capable of helping you explore it.

Ask your photo dealer to demonstrate the host of exciting picture-taking features that are available *only* in the Retina. And ask, too, about the wonderful family of special Kodak Retina Photo Aids described on the next page. They'll open the doors to a lifetime of new picture-taking adventures.

Kodak Retina IIc Camera *f/2.8*, \$132—*or as little as \$13.20 down*. Retina IIIc Camera, *f/2* with built-in exposure meter (shown above), \$175—*or as little as \$17.50 down*. See these famous Kodak Retina Cameras *soon*.

From table-top close-ups to telephoto views . . .

These—and many other—Kodak Retina Photo Aids will help you enjoy new adventures in picture taking!

Kodak Retina Curtar Lens Component, 35mm f/5.6—Takes only a jiffy to switch to this lens component for wide-angle views indoors, panoramic shots outdoors. Focuses $2\frac{1}{2}$ feet to infinity, **\$59**

Kodak Retina Longar Lens Component, 80mm, f/4—R-e-a-c-h-e-s across space for telephoto close-ups of distant scenes, candid shots of children and pets. Focuses from $6\frac{1}{2}$ feet to infinity, **\$80**

Kodak Retina 35-80 Optical Finder—Fits clip on top of camera to show field covered by 35mm and 80mm lenses. Complete with leather case, **\$15.50**

Kodak Retina 50-80 Sports Finder—Folding, open-frame finder shows field of action covered by 50mm and 80mm lenses. With leather case, **\$8.25**

Kodak Retina Close-Range and Viewfinder Kit, Model B—Two auxiliary lenses for short-range photography, plus parallax-correcting viewfinder combined with rangefinder to fit clip on top of camera, **\$36.50**

Kodak Retina Close-up Kit, Model B—Wonderful for hand-held close-up work. Complete with field-guide holder, field guides and auxiliary lenses for picture taking from 4 fixed film-to-subject distances from $11\frac{1}{4}$ down to $5\frac{15}{16}$ inches, **\$42.50**

Kodak Retina Microscope Adapter Kit, Model B—Contains everything needed to adapt a Retina to nearly any microscope for producing photomicrographs, **\$62.50**

Kodak Retina Flashholder Bracket—Complete with cords and tips for attaching your choice of a variety of Kodak and Kodalite Flashholders, **\$2.95**

Kodak Retina Field Case, Model B—Fully protects your camera, yet keeps it ready for instant action. Finest quality top-grain cowhide, metal trimmed and reinforced, **\$14.50**

Many other Kodak Retina Photo Aids are available—filters, lens hoods, lens hood extension, filter cases, etc. See your photo dealer.

Prices are list, include Federal Tax where applicable, and are subject to change without notice.



Close-up made with one of the field guides and auxiliary lenses in the Kodak Retina Close-up Kit



Regular view with the Kodak Retina 50mm lens that comes with the camera



Wide-angle view with the auxiliary Kodak Retina Curtar Lens Component, 35mm, f/5.6

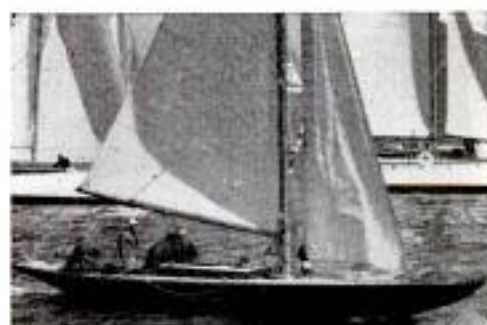

Telephoto view with the auxiliary Kodak Retina Longar Lens Component, 80mm, f/4

EASTMAN KODAK COMPANY, Rochester 4, N. Y.

Kodak
TRADE MARK

It's set the
automotive world
on its ear...

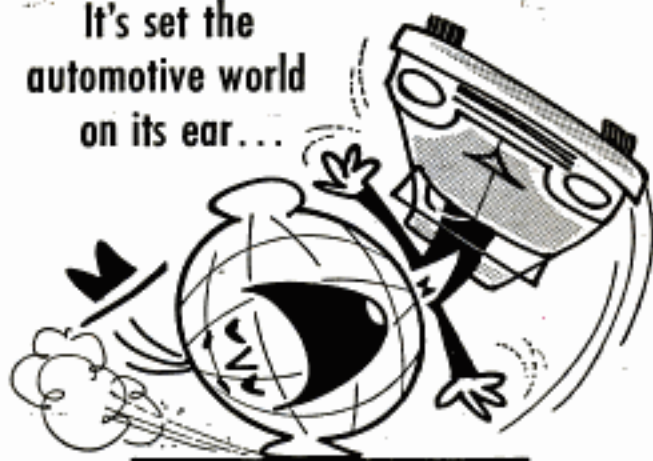

Sealed Power's New STAINLESS STEEL* OIL RING

*U. S. Patent No. 2,789,872

It does things no other piston ring can do. It's an engineering first—permits unsurpassed oil savings and engine performance in today's high compression engines. Already being used as original equipment by a million-car-a-year manufacturer!

Here's what it does for you

- 1 Controls oil, saves oil as never before possible. Properties of stainless steel permit design advances previously impossible. No smoking under high vacuum conditions.
- 2 Will not corrode or sludge. Stainless steel finish can't corrode—sludge can't form. Engine continues to perform as manufacturer intended.
- 3 Stainless steel holds full tension at engine operating temperatures . . . actually hardens in use. This assures more than double the ring life you're accustomed to.

FREE OFFER

If you're interested in how to maintain your car properly, write for our illustrated manual, "Care and Feeding of Engines." It's yours for the asking. You'll find its illustrated pages informative, helpful, crammed with tips which may save you money. For your free copy, write Sealed Power, Dept. G-9, Muskegon, Michigan.



Sealed Power

PISTON RINGS

BEST IN NEW CARS! • BEST IN OLD CARS!

Clinic for Homemakers



As a service to our readers in solving the hundreds of problems pertaining to a home—inside or out—the editors of *Popular Mechanics* invite you to present your problems to The Clinic Editor for help and advice. Address your questions to The Clinic Editor, *Popular Mechanics Magazine*, 200 East Ontario Street, Chicago 11, Ill.



Seeding Time

Q—My lawn was started this spring, regular grass seeding with a rye-grass cover. Of course, the cover crop made a rapid and lush growth but now I notice that the regular grass seeding did not catch in spots. I don't want to dig up my lawn and start over again. Can I apply new seeding over the old with any reasonable chance of success?—O. N., Mass.

A—Much depends on the fertility level of the soil, the weather and other factors. We are assuming from your description of the present condition of the lawn that you have a satisfactory stand of the regular grass on at least a portion of the area involved. In such cases a top-dressing method of reseeding has been fairly successful. There is always the chance that you will lose a percentage of the new seed but even so we think the method worth a trial. As the first step, mow the lawn fairly close, about an inch or so. Apply fertilizer to the entire lawn, taking special care to obtain a uniform application on those areas where the seeding is thin or where there is little or none at all. Then seed these latter areas, the rate of seeding being a little heavier than that ordinarily used in starting a new lawn. Follow this immediately with a very light top-dressing of black soil. Rake this to a uniform depth of not more than $\frac{1}{2}$ in., using a lawn broom, not a garden rake. Then water immediately with a light, fine spray. Keep the top-dressed areas damp for at least 10 days.

Painting Stone Masonry

Q—The foundation walls of my home are of stone. Some of these are very large, 3 to 5 ft. long and up to 1 ft. thick. I have excavated under a part of the house with the idea of providing more room in the basement. The inner surfaces of the walls are rough and irregular due to the manner in which they were laid up. How can I finish the walls?
I. H., Pa.



A—What you do depends on what you consider attractive. If the appearance of the walls as they are, that is, the aged texture of the stonework, is

(Continued to page 226)

IF YOU "like to get under the hood . . ."



*you can get a great training . . . and
start a great future . . .*



in the **U.S. AIR FORCE!**

Your talent with engines—or any mechanical ability—can pay big dividends, when it is backed up with solid training. And that's what you get when you serve in the U. S. Air Force. The Air Force offers you opportunities to learn one of over 40 career fields—training that will stand you in good stead, wherever your future may lie.

Start developing your valuable talents today—and go places *faster*—in the U. S. Air Force. See your local Air Force Recruiter—or mail the attached coupon.

Paste Coupon on Postcard and mail to:

Airman Information, Dept. M-79-PM2
P.O. Box 7608, Washington 4, D. C.

Please send more information on my opportunities for enlisting in the U.S. Air Force. I am between the ages of 17-34 and reside in U.S.A. or possessions.

NAME _____

ADDRESS _____ AGE _____

CITY _____ ZONE _____ STATE _____

if you
have to
glue it . . .

LET
ELMER
DO
IT!



Repair or
build quickly
with strong
**ELMER'S®
GLUE-ALL**

Be a real home "do-it-yourselfer." Build this fold-away work bench easily from Easi-Bild pattern #576 with Elmer's Glue-All. It's easy to apply, fast drying. Glue-All is also ideal for dozens of other uses around the home. Bonds any porous material such as wood, pottery, paper or cloth.

Send 50¢ in cash or money order for full-size Easi-Bild* Fold-away Bench Pattern No. 576 to Elmer's Pattern Dept., P. O. Box 26, Pleasantville, N. Y.

*T. M. Reg. Easi-Bild Pattern Co., Inc.



Get a completely waterproof bond with
ELMER'S® WATERPROOF GLUE

It's the glue that boating experts use. Apply on any joint subject to water, weather, acids or alkalis. Super bond is stronger than wood itself!



Bond plastic laminates or plywood wall panels with **ELMER'S® CONTACT CEMENT**

No clamps, nails or presses needed to do professional job quickly. Highly resistant to heat and water. Available in regular or non-flammable type to meet every need.



IF IT'S **Borden's** IT'S GOT TO BE GOOD!

The Borden Company, Chemical Division

©1957, The Borden Company

objectionable, then you may have to consider plastering the surface with a cement plaster or installing a false wall of knotty pine, red cedar or some other type of planking suited to the purpose. Either step will be rather expensive comparatively and also will involve considerable labor and time, especially if you should attempt the job yourself. If, on the other hand, the texture of the natural stone is acceptable in appearance, then we would simply clean the surfaces of the walls with a wire brush to remove all loose particles and apply a coat of masonry waterproofer. This material is available in soft, pastel colors and produces a flat finish.



Furnace Noise

Q—When the furnace fan is operating we hear a peculiar drumming sound in one of the ducts carrying heat to the second floor. I adjusted the damper, or vane, in the duct but this made little, if any, difference. Is there any way to stop the noise?
T. R., Minn.

A—The source of noise in an extensive duct system is often difficult to locate with certainty. You describe it as a "drumming" sound and this would lead us to suspect right away that it cannot be due to the normal expansion and contraction of the metal, but must be due to a rapid vibration of metal under tension at some point in the duct system. This could be due to air pressure, a partial vacuum, to a condition of strain not present at the time of installation but imposed by settling of the structure, or some change in the duct system itself. Usually the surest remedy is to install a vibration dampener. Just where to locate this in your heating system would have to be determined by a careful on-the-spot inspection while the furnace is in operation. In general, the most effective dampener suitable for installation on a home heating system is made by cutting out a section of duct about 6 in. long and installing a covering sleeve made from heavy canvas. Normally this would be installed on a horizontal run of the duct from which the noise appears to be coming. Place a sheet of asbestos under the canvas sleeve. Close the ends of the sleeve with drawstrings.

Defective Pressure Water System

Q—Water for my home is supplied by a pressure water system. During the past few months the water pressure seems to be lowering constantly, although at a very slow rate. There appears to be plenty of water in the well and the pump apparently is operating properly. I have examined the entire system for leaks. There are none. What could be wrong?—J. N., Del.

A—Have you checked the operation of the air-inlet valve? Air-inlet valves on pressure systems seldom give trouble, but in your case it is likely that the valve has been damaged or is stuck in the closed position. The purpose of the valve is to admit a small amount of air at each stroke of the pump and thus maintain the correct air-water ratio in the pressure tank. We suggest that you examine the valve and if it is defective it should, of course, be replaced.

Floor Tile Loosen

Q—Less than a year ago I laid linoleum floor tile in my bathroom. Lately I noticed that several of the tiles had loosened along the edge of the bathtub and under the lavatory. After taking these out I found that the joining tiles could be lifted easily. Can you tell me what was wrong?—C. O., Colo.

A—It would appear from your description that something unusual is the cause of the trouble. It is possible, of course, that moisture condensing on a cold-water pipe is somehow reaching the sub-floor or the underlayment, if the latter was used. This could cause failure of the cement. Another possibility is the presence of wax or oil on the tile or the underlayment or subfloor. We suggest that you recement several of the tiles and note results after a period of time. If they still loosen, then it may be necessary to relay the entire floor.

Let fast, easy Strypeeze remove paint!

- Stays wet—stays put
- Removes all finishes
- Harmless to hands or wood
- Cuts every layer



Get right down to bare wood fast with the *guaranteed* paint remover—Strypeeze—the fastest selling paint remover in America.

Available at paint and hardware stores everywhere



Kwikkeeze cleans all brushes fast! Even the hardest brush softens in a jiffy with KWIKKEEZE. No rinsing, no mess. Perfect for all bristles.

SAVOGRAN

Dept. 904, 25 Huntington Ave., Boston, Mass.

Please send me new illustrated booklet, "How to Remove and Restore All Finishes". Enclosed find 25¢.

Name _____

Address _____

FREEZER TIPS...



TO PROTECT frosting on decorated cakes, first freeze cake unwrapped. Then remove cake from freezer, wrap and seal tight with

"SCOTCH" Brand Freezer Tape. Write label right on the tape itself! Moisture-resistant tape seals, holds fast in sub-zero cold to foil, film, paper, Saran or other wraps. Get "SCOTCH" Freezer Tape now, 35¢ or 98¢ in cutter-edge carton. ©1957, Minnesota Mining & Mfg. Co., St. Paul 6, Minn.

KEEP YOUR WORKSHOP TOOLS SAFE AND ORDERLY



This 7-drawer machinist's chest has a place for every tool. Extra durable heavy gauge steel. Felt lined drawers protect delicate edges... operate easily. Size: 8½" x 13½" x 20¼". \$27.95 at leading hardware stores. Slightly higher west. Other home workshop models from \$1.25 up.

WATERLOO VALVE SPRING COMPRESSOR CO.
Waterloo, Iowa

SEPTEMBER 1957

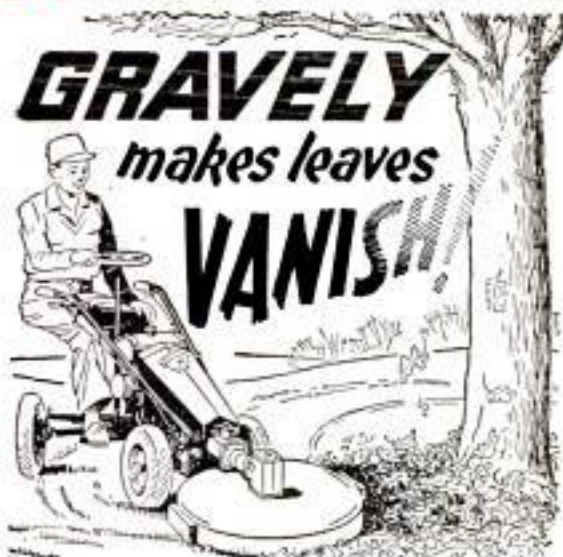

GRAVELY

makes leaves

VANISH!

ROTARY MOWER—LEAF MULCHER

- Mulches 30" width! . . . Twice the power of ordinary mulchers . . . gets rid of leaves *fast!* . . . 5-HP.
- New Steering Sulky, New Optional Starter, New Rotary Cultivator — 23 attachments for year-round work, Snowblower, Snow Plow, Chain and Circular Saws for Fall and Winter jobs . . . *Finance Plan available!*

Write today for FREE 24-page "Power vs Drudgery" Booklet!



GRAVELY TRACTORS, INC.
BOX 963 DUNBAR, W. VA.

FIELD-TESTED SINCE 1922

grips like a pipe wrench

**a cinch
to handle**



CHAN NEL LOCK

No. 420

Terrific gripping power on any shape $\frac{1}{8}$ " to $1\frac{3}{4}$ " size. Long and streamlined . . . easy to use in hard-to-get-at places! Some of the reasons why Channellock is the favorite plier of craftsmen everywhere. And Channellock will be your favorite, too . . . for the same reasons. No other plier does so many jobs so well. Ask your hardware man for a Channellock No. 420.

BE SURE IT'S A GENUINE CHANNELLOCK



CHAMPION DEARMENT TOOL Co. MEADVILLE, PA.

Owners Praise Dodge's Styling, Handling Ease

(Continued from page 137)

dip in front end when making hard stops."—Louisiana salesman.

"Like push-button shift in place where a child cannot reach it."—New York truck driver.

"Spacious trunk. Spare tire does not interfere with luggage space."—New Jersey salesman.

"Plenty of room inside yet not too large."—Indiana tool and die maker.

"I looked at a lot of cars before buying and found that Chrysler products are easier to get into and out of than any others because the windshield post does not protrude into the doorway nearly as much."—Maryland salesman.

"I have three small children and I buy a four-door sedan with center posts because it is safer. There is less chance of them falling out when climbing from front to rear seats than in pillarless job."—New York police sergeant.

Here is an interesting combination of opinions about the same car, one from the husband and one from the wife:

The husband says, "Roadholding is excellent, driver's seat comfortable, trunk is vast and car has a good ride." The wife says, "Styling is good, push buttons convenient and interior is luxurious." The husband is a New York teacher.

And Other Complaints

"Position of rear-view mirror is poor. Rear vision is too easily obscured by rear-seat occupants. Fin obscures much of vision through outside mirror."—Washington chemical engineer.

"Speedometer seems to be a weak point. Clicking and winding noises which you generally find only in old cars."—New Mexico lumber dealer.

"Had trouble with door latches. So hard to open that strangers think door is locked. Back doors open only about half as wide as they should and fat people have an awful time getting into back seat."—Massachusetts sales manager.

"Left torsion bar has terrible squawk up to five miles per hour. Dealer says he has seven other owners with same complaint. His mechanic worked all one day on one car and it still makes the same noise."—Michigan truck dispatcher.

"Rear bumper is not out far enough to protect lights. Have broken the lights twice already."—Indiana housewife.

"Right door handle on this cab has had to be replaced three times in three months.

(Continued to page 230)

CAR OWNERS:
Get More Than
Just "Warning Light"
Indications!

For really safe engine protection
install a

STEWART-WARNER

AMMETER AND OIL PRESSURE GAUGE



only
\$8.40

Fits all cars! Easy to install!

In addition to battery and oil warning lights, your car needs these Stewart-Warner gauges! A battery warning light tells you only if the generator is working—not how much current is being used. An ammeter tells RATE of current flow—indicates when there is danger of burning out a generator. And, unlike an oil warning light, an oil pressure gauge tells EXACT oil pressure—helps to assure safe engine operation!

Complete "do-it-yourself" kit

Consists of:

Ammeter • Oil Pressure Gauge
Twin-gauge Panel for under-dash
mounting • Installation instructions



See your dealer today—or write

STEWART-WARNER

Instrument Division

Dept. AM-97, 1840 Diversey Parkway, Chicago 14, Illinois

"THINGS TO MAKE ON TOOLS YOU OWN"

NEW DELTA hard bound book illustrates and clearly describes a wide selection of useful projects designed to be built on each of the basic tools you own—only \$1.00. Send for FREE folder on complete Delta Library: Delta Power Tool Div., Rockwell Mfg. Co., 502J N. Lexington Ave., Pittsburgh 8, Pa.

DO-IT-YOURSELF . . . WITH

SAKRETE

Perfectly balanced, dry-mixed concrete and mortar in a bag. Just add water, mix and use! See your building supply dealer, lumber dealer or hardware store—today!



Look for the Bag with the Yellow Diamond!

Protect your home against
power interruptions
with an . . .

ONAN Emergency ELECTRIC PLANT

Provides dependable stand-by electricity for heating system, pumps, freezer, lights, appliances. Keeps home safe, livable. Automatic start and stop. Find out how little it costs!

Write for Folder!

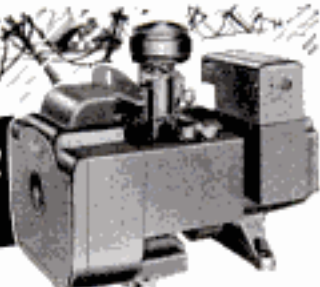

A SIZE FOR EVERY NEED
500 to 75,000 watts.
Compact, quiet-running.
Gasoline-powered
Priced from \$319.00

D. W. ONAN & SONS, INC.
3255 University Ave. S.E. • Minneapolis 14, Minnesota

CELO-GLASS IS BEST

- For storm windows, doors
- For carport closures
- For greenhouses
- For patio windbreaks



Build your own storm windows, hot boxes for seedlings, greenhouse . . . easily, quickly, with Cel-O-Glass plastic coated screen. Full protection against wind and rain. Admits sun's healthful rays. Cuts with scissors, easily tacked in place. No sash, no putty necessary.



LOW-COST STORM WINDOW KITS

Save on fuel, gain real protection with R-V-Lite Storm Window Kits!

Heavyweight, weatherproof clear vinyl plastic, tough and pliable, easy to install. Kits contain 36" x 78" sheet of vinyl, molding strips, plenty of nails. Indoor kits include 18' of pressure-sensitive tape. See your hardware dealer, or write:



ARVEY CORPORATION
SINCE 1903

R-V-LITE DIVISION

3500 N. Kimball Ave. Chicago 18, Ill.

SEPTEMBER 1957

229

New rifle for you?

WHY WAIT ANY LONGER TO OWN THAT NEW GUN YOU WANT — WHEN YOU CAN HAVE IT NOW!



On the Marlin Pay-Later Plan, a small down-payment puts a new Marlin rifle or shotgun in your hands right now, and you pay for it easily on the monthly plan that fits your budget best.

The simple, convenient Marlin Plan is the only one that protects your investment with insurance. In the event of death or 90-day total disability, it automatically makes all remaining payments for you!

In the complete Marlin line is the gun that's perfect for the type of hunting you do—or would like to do. Along with their famous, exclusive features, today's Marlins offer several new ones you'll want to know about. Mail the coupon, and look up your Marlin dealer!

Marlin Model 336 Regular Carbine

30/30 .32 SP. .35 Rem.

Micro-Groove Rifling* improves accuracy by 20-25%

\$7695** Down-payment only **\$795**

THE NAME FOR GAME

Marlin

FINE GUNS SINCE 1870

*Patent applied for
**Slightly higher west of the Rockies. Subject to change without notice

Marlin Firearms Co. G-97

P.O. Box 995, New York 17, N. Y.

Please send me your catalog with photo illustrations and complete descriptions of all Marlin Guns. Also send me the new, illustrated 16 page "Marlin Target and Game Record Book", for my personal shooting records. I enclose 25¢ for handling.

Name.....

Address.....

City.....Zone.....State.....

Special guards had to be installed after a series of injuries to passengers' fingers when closing door from outside."—New York cab driver.

"I chose the six-cylinder engine because I thought it would give me all the horsepower I want plus economy. It looks like I made a mistake. It's noisy and uses too much gas."—Kansas aircraft inspector.

"Glove compartment is of practically no use. Door hinge crushes contents when it is closed."—Tennessee salesman.

"I bought too cheap a model. Should have bought a Custom Royal. Too much difference in quality."—Kansas secretary.

"Rear windows hard to roll up and down."—Texas natural-gas engineer.

"This part of Arizona is very hot. Lots of sunshine all year. The car has too much glass area for so much sunshine."—Arizona carpenter.

"I do not like the part of the warranty that says the customer must go to the dealer where the car was bought if it is less than 50 miles from his home. I am sure that we pay for this service and the customer should be able to choose which dealer he wants to service his own car."—Ohio electrician.

Those are the opinions of the owners of the 1957 Dodge Coronets, both Sixes and V8s. Next month the British Ford. ★ ★ ★

Fraction Computer

Fractions of an inch can be added or subtracted quickly with a hand-operated, dial-type computer. Consisting of two aluminum disks, this device gives an immediate answer to such problems as $\frac{19}{64}$ inch plus $\frac{1}{8}$ inch plus $\frac{7}{32}$ inch. The top disk is dialed to the right for addition and to the left for subtraction and may be used for fractions or decimal equivalents, and for mixed fractions and decimal equivalents.

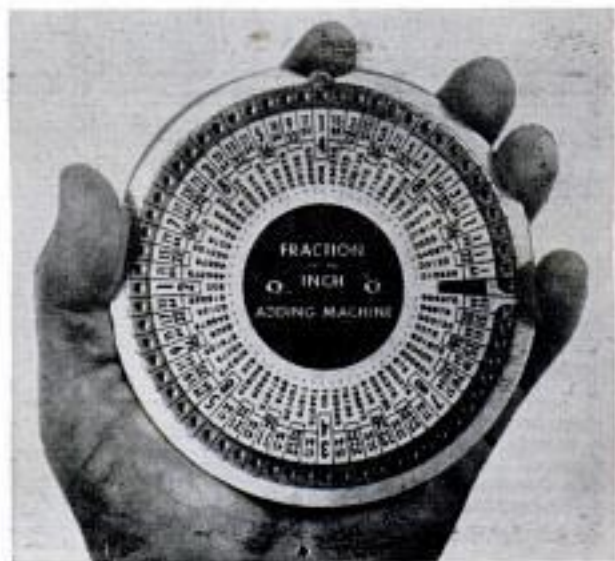

POPULAR MECHANICS

Copyrighted material

"The battery backed up by 2,000,000 miles of testing"



Auto-Lite Sta-ful is tried, tested, and proved for long life and quick, easy starts in the coldest weather. Two years and more than 2,000,000 miles of testing showed the following results:

- Not one battery failed.
- 95% gave better cold-weather starting than required of *new* batteries.
- None of the batteries needed water more than 3 times a year.

You just can't buy a better battery at any price!

**NEEDS WATER ONLY
THREE TIMES A YEAR***

*IN NORMAL CAR USE

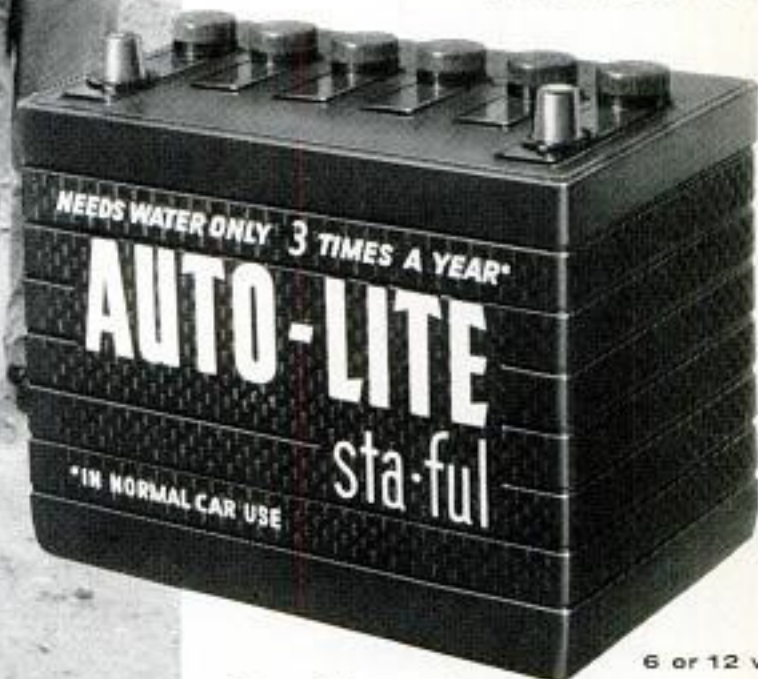

6 or 12 volt

Dry Charged...

Fresh when you buy!



**OTHER AUTO-LITE BATTERIES
AS LOW AS \$13.95**

AUTO-LITE MANUFACTURES OVER 400 PRODUCTS, INCLUDING SPARK PLUGS, BATTERIES, WIRE AND CABLE, AND AUTOMOTIVE ELECTRICAL SYSTEMS . . . SOLD THROUGHOUT THE UNITED STATES AND CANADA.

Copyrighted material

see the amazing new
EASY-TO-BUILD
ELECTRONIC knight-kits



in **ALLIED'S 1958**

ELECTRONIC SUPPLY CATALOG

FREE!

**BUILD YOUR OWN!
SAVE MONEY—HAVE FUN**

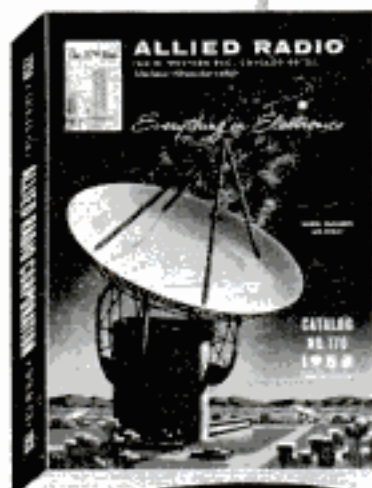

404 value-packed pages



HI-FI KITS



HOBBY KITS



INSTRUMENT KITS



HAM KITS

SAVE on Everything in Electronics

WORLD'S LARGEST STOCKS

Everything for Experimenters, Builders, Amateurs, Servicemen, Engineers and Hi-Fi Hobbyists. Get more for your money in Hi-Fi systems and components; build-your-own KNIGHT-KITS; recorders and phono equipment; TV tubes, antennas, accessories; Amateur station equipment; test instruments; industrial electronic equipment—plus the world's largest stocks of parts, tubes, transistors, tools and books. Send today for your **FREE 1958 ALLIED Catalog!**

Everything in Electronics From One Reliable Source
our 37th year **EASY TERMS AVAILABLE**

ALLIED RADIO

send for
FREE
Catalog

**ALLIED RADIO CORP., Dept. 24-J7
100 N. Western Ave., Chicago 80, Ill.**

Rush **FREE 1958 ALLIED 404-Page Catalog**

Name _____

Address _____

City _____ Zone _____ State _____

You Can Make a Plant Do Tricks

(Continued from page 85)

you can still have fun and some success if the temperature of your workroom varies somewhat beyond this range.

To prepare your "lab," simply suspend a fixture or fixtures above a bench or table. A two-lamp fluorescent fixture should be suspended approximately 18 inches above the foliage. It will cover an area about 18 inches wide and as long as the tubes. The spacing of incandescent fixtures is somewhat more critical, as they tend to produce hot spots and shadows. Note the drawing on page 85.

If you want to invest money instead of labor, you can buy a commercial or home-type growth chamber with built-in lighting. Some of these chambers also monitor the heat and have a built-in time clock to operate the lights.

To see results, you must divide your plants into two or more groups and use one batch as a control group. Then you can observe the differences between the groups. In your first experiments expose both groups to natural, identical sunlight throughout the day. Then during the night expose one group to your artificial-light source for a few minutes, but keep the other group in total darkness. You'll soon observe big differences between the two groups of plants.

By now you may be so intrigued that you'll want to experiment further. There are several byways you can explore. Try reducing the duration of the artificial light, or its intensity, to find out how short a period or how little light will still produce a reaction. You can also use the cellophane filters to observe the very restricted wavelengths that are actually causing the reactions in the plants.

Don't be discouraged if you observe no results in your first experiments. You may have chosen the wrong plants. A minority of plants have an indeterminate photoperiodism—that is, they are not particularly affected by the length of the night.

Plants for Your Experiments

You can be sure of results, though, if you use plants which already are known to be affected. Doctor Downs suggests you try common weeds first, such as cocklebur (a very sensitive long-night plant), lambs quarter or pigweed. If you want something more satisfactory than weeds to show for your experiments, try such long-night plants as chrysanthemum and poinsettia.

(Continued to page 234)

What Do 3 Out of 4 Doctors Recommend to Relieve Pain?

A survey shows 3 out of 4 doctors recommend the famous ingredients of Anacin Tablets to relieve pain of headache, neuritis and neuralgia. Here's why Anacin® gives you better *total* effect in relieving pain than aspirin or any buffered aspirin:

- ➔ **ACTS INSTANTLY:** Anacin goes to work *instantly*. Brings fast relief to *source* of your pain.
- ➔ **MORE EFFECTIVE:** Anacin is like a doctor's prescription. That is, Anacin contains not one but a combination of effective, medically proven ingredients.
- ➔ **SAFER:** Anacin simply *can not* upset your stomach.
- ➔ **LESSENS TENSION:** Anacin also reduces nervous tension, leaves you relaxed, feeling fine after pain goes. Buy Anacin today.

Works in seconds!



**Loosens Rusted Bolts
nuts, screws, "frozen" parts!**

LIQUID WRENCH®

The super-penetrating rust solvent that quickly loosens rust and corrosion.

AT HARDWARE STORES, GARAGES
SERVICE STATIONS, EVERYWHERE
RADIATOR SPECIALTY CO.
Charlotte, N. C.

3 oz. CAN
30c

BUILD YOUR OWN ARC-WELDER

WE SHOW YOU HOW to build powerful D.C. Welders from surplus aircraft generator. Light or heavy work. Easy to build at low cost. Worth hundreds of dollars. **PLANS 39c. SEND TODAY.** Includes **FREE** surplus, Welder, Electrical catalogs.



LEJAY MFG. CO., 2907 EMERSON AVE. SO., MINNEAPOLIS, MINN.

DINSMORE Compasses

Beautiful, precision made. Designed and styled for modern cars. Dinsmore compasses save you time and money by showing you the right way—the short cut. An ideal gift for every one who drives.



TRAVELITE \$3.95
ILLUMINATED GUIDEWAY \$4.95
NEW ILLUMINATED SEE YOUR DEALER

WRITE FOR COMPASS HISTORY FOLDER

DINSMORE INSTRUMENT CO., 1802-37 Kellea St., Flint 3, Mich.

KING MIDGET

ALL NEW. First model change in six years. New bodies, new chassis, new engine. Four wheel hydraulic brakes. Still World's Lowest Priced Car. Drive it for 75c per week. Rider Agents Wanted. Earn your own car. Get the facts. Send 25c for 32 page picture book with complete details, dealers price, etc.



MIDGET MOTORS CORPORATION, Athens 1, Ohio

MAKE MINE KLEINS



Your skill—the quality of work you do—is controlled in no small measure by the quality of the tools you use.

That's why electricians and good workmen everywhere insist on Klein Pliers—standard of quality by which others are judged "since 1857."

In the complete Klein line you will find pliers exactly suited for every job you do. See your hardware store or Klein distributor for the Klein Pliers you need.



Your hardware store has Kleins in stock or can get them for you quickly. Look for this new display board. It shows the most popular items in the Klein line.

Mathias KLEIN & Sons
Established 1857
Chicago, Ill., U.S.A.
7200 McCORMICK ROAD • CHICAGO 45, ILLINOIS

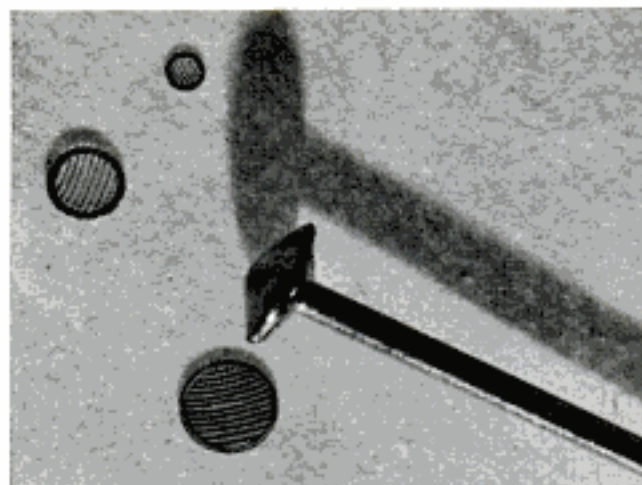

Photo Courtesy Sperry Gyroscope Company

That Spike You See is a Pin!



TAKEN WITH A
**PACEMAKER
GRAPHIC!**

The Speed Graphic* photo above was taken to show the tiny size of electronic tube grids in comparison with the head of a pin. It demonstrates another facet of the Speed Graphic's amazing versatility. By using its long bellows draw plus a short focus lens, direct magnification of objects may be obtained on the negative.

No camera you can buy will give you such tremendous photographic range and a lifetime of outstanding pictures. Specifically designed to take any picture, any time, day or night, it is no wonder that better than 90% of all professional and press photographers use it! Trade in your present camera as all or part down payment at your Graflex dealer, listed in the "yellow pages." Take up to 24 months to pay. Priced as low as \$260.00.

*Trade Mark

Prices include federal tax where applicable and are subject to change without notice. Prices slightly higher in Canada.

70th Anniversary—1887-1957

GRAFLEX®

Prize-Winning Camera

A SUBSIDIARY OF GENERAL PRECISION EQUIPMENT CORPORATION



You can experiment with chrysanthemums without any artificial lights whatever. Chrysanthemums don't ordinarily flower until fall, but you can surprise your friends with spectacular blossoms in mid-summer. As you come home from work at five or six o'clock in the afternoon, put a light-tight box over the plant. In the morning when you leave for work, remove the box. This gives the plant a longer night. Continue the treatment until the buds begin to open. The plants will take it from there.

If you want to experiment with the germination of seeds, Doctor Downs suggests seeds of Grand Rapids lettuce, or *Lepidium* (a common weed sometimes called peppergrass). Place the seeds on wet paper towels inside a couple of transparent plastic sandwich boxes. Then wrap the boxes with black cloth or aluminum foil. After 24 hours unwrap one box and expose it to light for five minutes. Rewrap it, and keep both boxes wrapped for three or four days. When you unwrap them, you'll find that the light-exposed seeds will have germinated almost 100 percent while practically none of the others will have germinated. Some kinds of seeds will not germinate at all at high temperatures, so keep the seeds where the temperature is at most 70 degrees, or even lower.

Polka-dot Tomatoes

And watch the reaction of your friends to your polka-dot tomatoes! Start your experiments with a couple of green tomatoes. Place two of them on a windowsill, one wrapped in aluminum foil, the other exposed to ordinary sunlight. In nine or ten days they will ripen and you can compare the color. One will be bright orange-red, the other an off pink. Follow up this experiment with another in which you reduce the time on the windowsill to a few hours, then a few minutes a day. You'll find that even two minutes of light per day will produce the vine-ripened color. Now add another tomato, this one to be your special polka-dot variety. Wrap it in aluminum foil except for a few holes about the size of a dime. You'll come up with a pink tomato with red spots on it, a sight to shake your neighbors.

Perhaps you can observe some striking examples of photoperiodism in your own yard. Trees growing near a street light often retain their leaves much longer in the fall. Some trees and ornamental shrubs may even be injured during the first cold days of winter because the short nights (caused by the street light) have prevented them from entering the dormant condition

(Continued to page 236)

why...

YOU SHOULD EQUIP YOUR TRAILER WITH

BULL DOG

• AXLE ASSEMBLIES
• JACKS • COUPLERS

Straight or drop axles in single or tandem—capacity up to 10,000 lbs.—any width. Also Torq-Less Axles for all types of trailers.

JACKS—Bull Dog Jacks make hitching and parking a one-man job.

COUPLERS—Bull Dog Couplers hitch or unhitch to trailer in a moment.

Write today for **FREE** Descriptive folder 13M.

HAMMER BLOW TOOL COMPANY
WAUSAU, WISCONSIN

GENUINE ALNICO

MAGNETS

AMAZING, PERMANENT, NON-ELECTRIC, HIGHLY PRACTICAL. Conduct interesting experiments. Hundreds of uses. Retrieve valuable steel items such as guns, tackle from fresh or salt water; tools from tanks & drains. **GUARANTEED**. Try any magnet one week. Money back if you are not well-pleased.

No. M-710 (Wt. 5 1/2 oz.) Has pull of 225 lbs. on steel block... \$16.50
 No. M-625 (Wt. 70 oz.) Has pull of 125 lbs. on steel block... \$9.50
 No. M-575 (Wt. 18 oz.) Has pull of 75 lbs. on steel block... \$4.50
 No. M-500 (Wt. 13 oz.) Has pull of 50 lbs. on steel block... \$4.50
 No. M-303 Kit of Flat Bars 5 Pairs (10 Magnets)... \$3.00
 No. M-253 Kit of Round Rods 5 Pairs (10 Magnets)... \$2.50
 No. M-87 Hot Pad Magnets, 10 for \$1.00... 50 for \$4.87
 No. M-35 Hobbyist assortment of 8 small magnets... \$1.50

Send N.O. or check. We pay postage. Sorry no C.O.D.'s.

MIAMI MAGNET COMPANY, 3240 N.W. 27th Ave., Miami 42, Fla.

PRI

ROAD TO RICHES

You can be the next uranium millionaire! Government guarantees huge bonus! PRI instruments from \$29.95. See your local dealer today! **FREE CATALOG!**

Write PRI, 4223 PM W. Jefferson
Los Angeles 16, California

DEALERS WANTED

Do a Better Job with DREMEL STRAIGHT-LINE ACTION SANDERS

Send for **FREE** Power Tool Catalog

DREMEL MFG. CO.
RACINE, WIS.

Model 53

\$14.85 to \$34.85

"DO IT YOURSELF"

IT'S EASY WITH

KESTER SOLDER

Soldering's really a "cinch"... when you use time-tested, reliable KESTER... available everywhere.

FREE! "Soldering Simplified"... 16-page how-to-solder booklet. At your dealer or write direct.

KESTER SOLDER COMPANY
4251 Wrightwood Avenue Chicago 39, Illinois

Remodeling?

Save Money! Save Time!

See SEARS!



One stop at SEARS takes care of everything!

- ☆ PLANNING ☆ ESTIMATES ☆ FINANCING
- ☆ TOOLS ☆ INSTALLATION ☆ MATERIALS

At Sears you make all remodeling arrangements under one roof—at one time. No delay. No separate financing needed. Sears remodels any room—bath, kitchen, bedroom, recreation room; Sears can also arrange for adding rooms, heating, wiring, plumbing, roofing, siding, painting. Ask about Sears Modernizing Credit Plan... **NO MONEY DOWN**—up to 36 months to pay! Read all about it in Sears new 24-page booklet.

FREE 24-PAGE BOOKLET

Send Coupon Today!

Take to any Sears Store or Catalog Office or mail to Sears, Roebuck and Co., Dept. 139, 925 So. Homan Ave., Chicago 7, Ill. for free booklet. JA-97152.



Please check which improvements you are interested in:

- | | | |
|------------------------------------|--------------------------------------|-------------------------------------|
| <input type="checkbox"/> BATHROOM | <input type="checkbox"/> INSULATION | <input type="checkbox"/> FLOOR TILE |
| <input type="checkbox"/> PAINT | <input type="checkbox"/> KITCHEN | <input type="checkbox"/> HEATING |
| <input type="checkbox"/> PLUMBING | <input type="checkbox"/> WALLPAPER | <input type="checkbox"/> WIRING |
| <input type="checkbox"/> WALL TILE | <input type="checkbox"/> OTHER _____ | |

NAME _____

ADDRESS _____

CITY _____

STATE _____

NEAREST SEARS STORE _____

CATALOG SALES OFFICE _____

PS-9

LONGER-LASTING EASIER APPLIED!

IDEAL FOR ALL CAR FINISHES,
INCLUDING NEW ACRYLIC
LACQUER FINISHES

FAST

45 to 60 minutes to
clean, glaze, polish
most cars! One easy
application!

EASY

Rub on, let dry and
wipe off! No harsh
abrasives!



MAC'S SUPER GLOSS CO., INC.

Los Angeles 42, Calif.
Cincinnati 26, Ohio

DON'T WAX IT—MAC'S IT!

NEW...

an accurate
pocket tape
rule that's
really
convenient
to carry!



actual size

LUFKIN

EXECUTIVE THINLINE

194

at hardware, lumber and
tool dealers everywhere

necessary for them to survive the cold weather.

Not long ago a greenhouse operator noticed that his poinsettia plants were failing to flower, with Christmas not far away. Just in time he discovered that an electric sign was upsetting the sleep of his plants, turning a long night into a short one. By shielding the plants he forced them to flower in the nick of time for Christmas trade.

Another field wide open to research is the effect of photoperiodism on animals and man. A few experiments indicate that animals may be as sensitive to light-dark cycles as plants. The metabolism of men and animals speeds up under the influence of light. Therefore it is best to give dairy cows and other producing animals as much light as they want. On the other hand, animals which are to be slaughtered should be kept in the dark as much as possible. This depresses their metabolism.

Winter mink pelts are much finer than those produced during the summer, but one researcher has shown that he can make mink produce prime pelts in the heat of summer simply by placing the animals in the dark for a part of each day, thereby lengthening the night. Other experiments indicate that variations in the light-dark cycle, rather than the temperature, have striking effects on the migration of birds, the seasonal breeding periods of animals and the hibernation habits of some creatures.

It's an odd fact of science that the effects of the first occurrence on earth—the night-and-day cycle—are only now being investigated. ★ ★ ★

Synthetic Textile From Paper-Pulp Waste

Lignin, once a troublesome waste product of paper manufacture, can now be converted into a textile plastic by first changing it into vanillin. The vanillin is converted into protocatechuic acid, from which the textile is produced. The new fiber reportedly has good dyeing properties, low water absorption and a melting point above 400 degrees Fahrenheit. About one third of the wood used in paper making is lignin, a "glue" in which the cellulose is embedded. Although lignin also can be used in linoleum, soil conditioners and tanning agents, the chemical accumulates in quantities far exceeding demand and it cannot be dumped into streams because it would cause serious pollution.

World War II Navy fighter aircraft cost an average of \$125,000 per plane. Today, a jet fighter is valued at about \$1,250,000.

Wash or scrape
OLD PAINT OFF

Low Cost

HEAVY-BODIED KLEAN-STRIP

Non-inflammable paint remover

Fast • Clean • Safe

The Klean-Strip Co., Inc. • P. O. Box 10084 • Memphis, Tenn.



THE ROUTER... what it is and does

This 40-page book with 100 illustrations tells you. Write Stanley Electric Tools, 629 Myrtle St., New Britain, Conn., enclosing 50¢. Ask for ROUTER BOOK.

STANLEY

For Safer Driving in fog, rain or snow... Buy a pair of new

GENERAL ELECTRIC

All-Weather Headlamps!



'Budgit'
HOIST SPEEDS BOAT HANDLING

'Budgit' Hoists are the most used electric hoists in the world. Farmers, machinists, auto repair men, large and small plants—all like its many quality features. It has few moving parts, non-fracturing hooks, one hand control, and many others. No exposed wiring!



Whether you own a boat, rent boats or build them, here's the easy, fast way to get them in and out of the water. The 'Budgit' Electric Hoist, does the job in a few minutes without back-breaking work. Just hang the hoist up, plug it in and you are ready to save on every lift.

DOES ALL KINDS OF HOISTING
Placing boats on trailers with the 'Budgit' is a cinch. It can handle engines, shafts, propellers—any weight up to 2 tons. A 500-lb. load can be lifted 10 feet in less than 20 seconds. Hoisting is safe. The 'Budgit' is built tough for attention-free service. It has two brakes. Each alone can hold the full load. It is economical—uses only a few cents' worth of current a day. 1/2 to 2 ton sizes. AC, DC and 12-volt battery-operated models. \$149 up. See your Shaw-Box Distributor for details or write us for Bulletins 402 and 404.



MANNING, MAXWELL & MOORE, INC.
SHAW-BOX CRANE & HOIST DIVISION
354 W. BROADWAY • MUSKEGON, MICHIGAN



HERE'S A MONEYMAKER FOR YOU!

make up to \$3 or \$5 an hour with the **FOLEY SAW FILER**

Ask yourself these three questions: 1. Do I really want to get ahead *faster*? 2. How can I do it? 3. Am I willing to use my spare time? If you answer "Yes" to questions 1 and 3—then we have a positive answer for you on No. 2. Men make up to \$3 or \$5 an hour sharpening hand, band and circular saws with Foley Saw Filers. No experience needed, to turn out sharp, smooth-cutting saws with this automatic machine. Start in spare time—no canvassing.

HERE'S THE WAY TO START

Read "Money Making Facts"—shows you how others have added hundreds or thousands of dollars to their incomes in this steady, repeat, CASH business. Start your own business in your basement or garage, no overhead, small investment. Send for "Money Making Facts"—mail coupon now. No salesman will call.

HERE'S PROOF

"When Mr. Patrick got his Foley Saw Filer in March 1946 he made a good and wonderful investment. He has done so well that we bought a house and paid for it; bought a new car, built an addition to our house. Nicest of all, it's all paid for." Mrs. Leslie Patrick.

"I made \$765 last year filing saws, and it sure comes in handy. I do this work in my spare time."
—James B. Williams

"Last year's profit amounted to \$3,000. Not so bad for a one-man outfit."
—Charles C. Hough.

"I have done 4 or 5 thousand saws in my spare time in the 4 1/2 years since I got the outfit, and they are all coming back with repeat orders."
—Len Crego.



FOLEY MFG. CO., 916-7 Foley Bldg., Minneapolis 18, Minn.

Send me free book "MONEY MAKING FACTS"

NAME _____

ADDRESS _____

"How in the World Does Mossberg do it?"



Two major improvements in
rifle design!



NEW 342 and 342K

5 lb., 22 cal. carbine with 7-shot clip magazine. **\$31⁹⁵**

First big advance since the bolt action rifle was invented. A hammerless, closed-in action with no bolt

or striker exposed. Assures smooth performance, no distraction of aim...plus added eye-appeal and streamlining.



Hammerless closed-in action.



NEW 352 and 352K

5 lb., 22 cal. auto carbine with 7-shot clip magazine. **\$37⁹⁵**

First clip-type automatic to take all three 22 caliber cartridges—Short, Long and Long Rifle. A convenience thousands of shooters have wanted—another Mossberg exclusive—in this beautiful, inexpensive little carbine. Shoots 7 shots in less than 2 seconds.

These *de luxe* features on all four models—genuine walnut stock in custom-type Monte Carlo design with sling strap on left. Two-position, hinged fore-end of black Tenite. "K" models have open sights, the others have peep and military front sights.



FREE: Colorful catalog of Mossberg sporting firearms. Send today...and see these thrilling new models at your dealer's!
Rifle prices \$1 higher west of Rockies

Mossberg
for accuracy

O. F. Mossberg & Sons, Inc.
79709 St. John St., New Haven, Conn.

Field Day in the Saddle

(Continued from page 125)

is marked off on the ground with powdered lime. The horse must enter and exit through the corridor from the starting line and make a complete turn inside the circle. If he steps outside or a foot swings out over the line at any point, he is eliminated from competition.

Ring spearing can be individual or team fun. With a few sticks of lumber, some old pool cues, a roll of wire and a handful of harness rings, fun on a horse can hark back to the Middle Ages when armed horsemen charged across the tilting lists in competition for the favor of a king, or the hand of a fair lady.

A Ring on the Run

To set up a ring-spearing course, three standards are arranged 33 $\frac{1}{3}$ yards apart, with the starting line the same distance from the first standard. Number 8 or 10-gauge wire hangs down from an arm on each standard to hold a clip and ring. Rings should measure two inches inside. The bottom part of the ring must be seven feet from the ground and the arm holding the ring and clip far enough to one side and high enough to give plenty of clearance to horse and rider. Spears should be a minimum of six feet long. A running start is made and the rider is timed from the starting line until he passes the last standard.

Relay events generally require five riders to a team. Relays are set up in different ways but the most accepted is to have a rider start from a line, run the length of the course, travel around a stake and return to the starting line where a second rider is given a baton. The first team to finish is the winner.

Horseplay for Laughs

While the original gymkhana embraced races that were mostly competition between individuals, the modern horseman has added some entirely different types of fun, one being events for two-man teams. Among these are the race-and-mount team, cowhide race and the ribbon race.

In one funny race a ribbon is used to guide the destiny of the competitors. It is quite interesting because it takes considerable skill and horse control. Each team of two persons is given a six-foot length of crepe-paper ribbon, three inches wide. They must hold the ribbon stretched out between them as they race from a starting line at one end of the field to a finish line at the other end without breaking the ribbon. The contortions most teams go through

(Continued to page 240)

NEW HONEYWELL DECORATOR LIGHT SWITCH!



Change it
any way,
any time



to match
your room's
decor!



THE TRANSPARENT decorator plate on the new Honeywell TAP-LITE® snaps off for easy decorating, cleans easily. Just wipe with a damp cloth. Simple to install. TAP-LITE has screwless terminals. Easy to operate. Tap, it's on. Tap, it's off! Switch and plate \$1.95 at hardware stores.

MINNEAPOLIS
Honeywell



First in Controls

•Trademark

NEW ADJUSTABLE STOP FOR POWER SAWS

Mounts on miter gauge extension rail—or back rail of radial saw—in grooves made on your own rail—cut with your own saw. No rails to buy. Renew anytime—to lengths of your choice. Works either side of blade. Need never be removed. Arm flips back for intermediate cutting without disturbing setting. Has fine adjustment screw insuring accuracy... Promotes safety. (Patented)

\$3.25 POSTPAID. No COD's.

THREADED EXTENSIONS DOUBLE USE OF GRINDER

Threaded extensions. Add buffers—wire wheels—polishers, etc. LEAVE YOUR EMERY WHEELS IN PLACE. For 1/2 inch—90 thread shafts only. Measure carefully. State right or left side.

\$1.50 apiece. \$2.75 a pair POSTPAID. No COD's. TEN DAY TRIAL MONEY BACK GUARANTEE. Free brochure

RW Anderson Co.

1110 W. 68th Street, Los Angeles 44, Calif.



Get This NEW Catalog of
WOOD & WOODWORKING EQUIPMENT

WORLD'S LARGEST SELECTION OF FINEST DOMESTIC AND IMPORTED WOODS... MOULDINGS, HARDWARE, TOOLS,—ALL AT LOW MONEY SAVING PRICES!

Your complete wood buying guide and project book. Craftsman is your best, most complete source of finest kiln-dried domestic and rare imported woods, beautiful wood inlays, colorful bandings, matched plywoods, embossed mouldings, carved ornaments, newest woodworking tools, "hard to find" cabinet hardware and fittings... more than 1,500 items! Packed with newest scroll saw patterns, project ideas & money making plans. Enclose 25c (refunded with first order) to help pay mailing, handling cost. Write now! Craftsman Wood Service Co., Dept. A-9 2729 S. Mary Street - Chicago 8, Ill.

132 PAGES
Many in full color
packed with rare, fancy & imported woods... veneers, plywoods, patterns, tools, ornaments, hardware... everything for the woodworker.

Find HIDDEN TREASURES

GOLD, SILVER, PRECIOUS METALS with the Famous Model 27 Metal Detector. Lightweight, ultra-sensitive, low cost. None finer. Also GEIGER COUNTERS for uranium and the VIOLITE for tungsten. INFORMATION FREE

THE *Detectron* CORP.

5528 Vineland Ave., No. Hollywood, Calif.

INVISIBLE GLOVE

ENDS PAINT-STAINED HANDS

Before you paint or start a dirty job in the house, garden or garage, rub Du Pont PRO-TEK hand cream on your hands and arms. It keeps sticky stains away from your skin... then washes off quickly, taking the grime with it. Get Du Pont PRO-TEK at drug, hardware, paint and auto supply stores.

Du Pont PRO-TEK



Better Things for Better Living
... through Chemistry



ELECTRIC WELDER AC or DC 110 Volts

The "Little Marvel" all-metal welder. 5-year written guarantee. Welds 1/8" metal or money back. Repairs tanks, tools, fenders, machine parts, etc. Complete with everything—rods, unit, eye shield, directions. \$7.95 plus 50c postage. Flame torch accessory for soldering, cutting, brazing \$3.95 complete with carbons, brass rods, flux. \$2.00 Deposit on C.O.D. 75 ampere 1/4 inch Transformer Welder \$24.95 F.O.B.

ESSAY MFG. CO., Dept. 51, Quincy 69, Mass.

\$7.95 Complete



The Modern PLASTIC for lasting Home Repairs

PERMANENTLY mends cracks or holes in wood, tile, stone or plaster. Sticks and stays put—Does not chip, shrink or fall out. Easy to use. Economical. Mold it, chisel it, polish or paint it. The big 4-lb. can is obtainable from your lumber, paint or hardware dealer at \$1.25; or will be shipped direct postpaid (in U. S.) for \$1.50. Complete satisfaction guaranteed or your money refunded.

DONALD DURHAM CO.
Box 804-T Des Moines, Iowa

greater
gas
mileage*
starts with a

"full power"

**WILLARD
BATTERY**

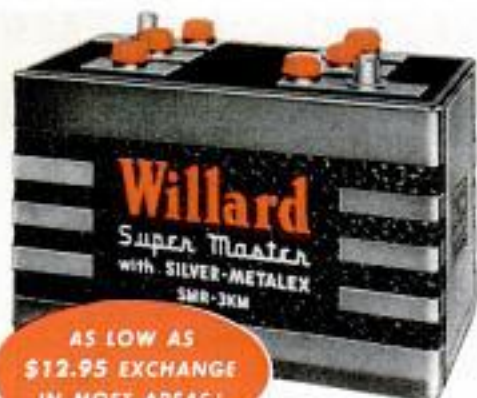

*Faster starting, with a Willard, saves fuel for extra miles of driving . . . saves wear on vital engine parts as well. For extra dependability, always insist on a full-power Willard Battery!

to keep from breaking the ribbon brings a load of laughs.

The hide race is always a thriller. All that is needed for a team is a cowhide, a strong lariat, two strong men and a horse. One man rides the horse and the other lies flat on the hide. A rope attached to the hide is held in the hand of the mounted partner. At a given signal the horses are started toward a finish line pulling the hide and the man. A dropped rope or a man spilled from the hide spells defeat. The one to cross the finish line first is the winner.

Some Horses Won't Play

In the race-and-mount event a rider starts with his horse at one end of the arena and races to the other end where his partner is waiting. This partner must mount behind the rider while the horse is still in motion. At this point the fun begins. Many horses will not cooperate in this kind of mounting. The first team to cross the finish line is the winner.

There are any number of kinds of barrel races. In most, the horse is ridden over a course on which he must go around barrels, making certain turns in specified directions. Riding designs can be quite varied. Scoring is on quickest time from start to finish. A touched barrel counts a point against the participant.

One of the most exciting barrel races is in the funny race class. Large wooden barrels with both ends knocked out are placed on their sides, halfway between the starting and finish lines. There is a barrel for each rider, who at a signal rides to his barrel, dismounts, ground ties the horse, crawls through the barrel and remounts, and rides to the finish line. That is, he mounts if the horse is still there. In most instances the sight of the rider attempting to crawl through a barrel is something the horse can't stand, so he takes off. That makes for real fun with plenty of action.

The flag race can be handled in several ways. One preferred method is to set up teams of six men. Three members face each other from opposite ends of the arena. Each group is equipped with a flag on a pole. A man from each team rides to the arena center and exchanges flags in a marked circle. Each rides back to the starting line and transfers the flag to a waiting member. The first team to complete all exchanges wins.

So important has fun on horseback become to the modern horsemen that many horse shows include from two to five of the gymkhana or funny races. Everyone likes to watch riders having fun with their horses, for it is as exciting to watch as it is to compete. ★ ★ ★

2 NEW CRAFTSMAN TOOLS FOR '58



New Pick-Off Rip Fence

increases speed and accuracy on Sears new

1958 CRAFTSMAN 8-inch BENCH SAW!



New Centralized

Controls cut set-up time on all new **1958 CRAFTSMAN 4 $\frac{3}{8}$ -inch JOINTER-PLANER**

Now all controls are right out in front—easy to reach from your normal operating position. That includes the new, automatic table-locking device and the faster-acting depth of cut control, for faster set-ups and greater accuracy. The new table on this CRAFTSMAN Jointer-Planer is a full 30 inches long. Futuristic design is functional, too. This ALL-NEW 4 $\frac{3}{8}$ -inch Jointer-Planer sells for only \$7.50 down, \$1.75 per month. Cash Price \$74.50.

You can pick up and accurately set down this new rip fence anywhere on the saw table...in seconds. One knob controls depth of cut and angle of tilt. The massive, modern-styled front panel has a new raised tilt indicator dial that's easier to read. And now the motor mount on this 1958 CRAFTSMAN 8-inch saw is unitized—actually a part of the saw itself. All-new, all-modern, this saw is the proud beginning of any shop. Yet it sells for only \$7.50 down, only \$1.75 a week in convenient monthly payments on Sears Easy Payment Plan. Cash Price \$74.95.

NEW RAISED TILT INDICATOR DIAL slants out for easier reading, has longer, more visible needle pointer.

NEW PICK-OFF RIP FENCE can be picked up, set down anywhere. More positive locking. New fluted face.

NEW UNITIZED MOTOR MOUNT now integral part of saw. Motor and mechanism move as one unit.

See the Craftsman Home Workshop Display at your nearest Sears Retail Store . . . or order from Sears catalog in your own home, by mail or phone or at the Sears Catalog Sales Office.

Sears Easy Payment Plan

Financing is easy at Sears because you deal only with Sears. Buy either of these tools—plus any other workshop supplies—on one convenient Sears Easy Payment account!

SEARS, ROEBUCK AND CO.—
In Canada at SIMPSONS-SEARS, LTD.
Prices may vary in some areas.



© 1957 SEARS, ROEBUCK AND CO.

SATISFACTION GUARANTEED OR YOUR MONEY BACK



Buy Southern for top Quality by USA standards. Southern makes every screw it sells to rigid specifications.

Buy Southern by the box to save money. End worrisome trips for dribble purchases. "EZ-to-C" label identifies size, head, and finish instantly.

Southern screws are available at your hardware dealer or building supplier. In steel, brass, silicon bronze, aluminum, stainless steel. Standard plated finishes, from 3/16" to 6" in size.

Write today for your FREE Southern TC-4 folder showing how to select and use proper size screws, and how to drill pilot holes. Ask for your FREE copy of: "How They Make 10 Million Wood Screws a Day." Box 1360 PMS-7, Statesville, North Carolina.

WOOD SCREWS • MACHINE SCREWS • TAPPING SCREWS • DOWEL SCREWS • DRIVE SCREWS • STOVE BOLTS • CARRIAGE BOLTS • HANGER BOLTS

- Warehouses:
- NEW YORK
 - CHICAGO
 - DALLAS
 - LOS ANGELES



Sold Through Leading Wholesale Distributors



Sprinkle prospects walls with a tuning fork to find stalactites approximately on pitch with good tones

The Organ That Plays Stalactites

(Continued from page 131)

Hall. Its floor is so gashed by deep chasms that there is barely enough level floor space to accommodate a four by six-foot concrete platform. At one side of this platform is a control panel.

The platform itself holds the electronic assemblies—tubes, condensers and relays—that control and activate the firing of the

(Continued to page 244)

Final tuning is done with the aid of an electronic oscillator, much more precise than a tuning fork

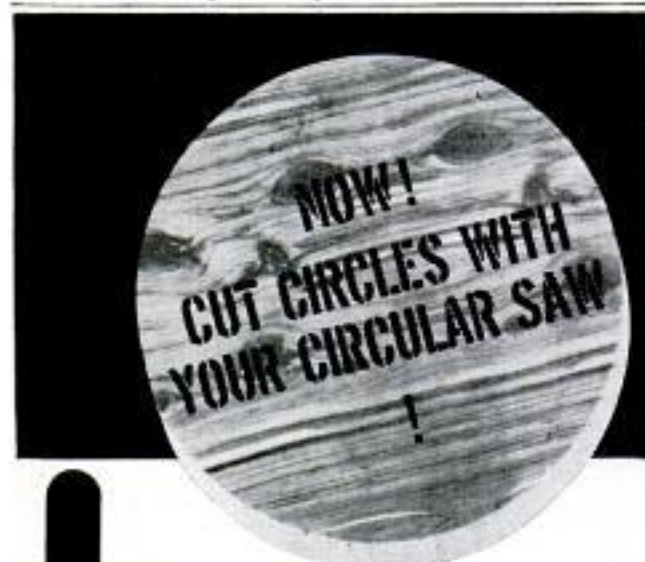

The amazing CIRCLE MASTER, a new patented attachment, will permit you to cut all circular shapes on any make bench saw. Simple to use. CIRCLE MASTER enables you to cut a perfect, clean and smooth circular shape. Cuts a diameter adjustable up to 30" on small saws, even bigger on large saws. You can make chairs, table tops, wheels, trays, lazy susans, stools, coasters . . . anything that calls for a circular shape. You can make cove cuts, beveled cuts, shoulder cuts, moulding cuts and many others depending upon blade used. You must be completely satisfied or your money back. Send Check or money order. We pay postage.

ONLY \$4.95

AMERICAN HOME TOOL CORP.

DEPT. 2 • 350 BROADWAY • NEW YORK CITY

READY CUT HOMES

\$2150 AND UP DIRECT FROM MILL

YOU SAVE the items which help make today's building cost expensive: high labor cost, contractor's profit and overhead, insurance, architect's fees. Cut-to-Fit eliminates usual lumber and material waste, also costly mistakes. Anyone can assemble. Simple, easy-to-follow plans furnished and each part numbered. Complete with all lumber, roofing, nails, glass, hardware, paint, doors, windows. Freight paid. Low-cost building plans sold separately if desired. 57 Homes and Floor Plans.



**5 EASY PAY PLANS
COLOR CATALOG**



INTERNATIONAL MILL & TIMBER CO.
Dept. PM97 Bay City, Mich.

BUY GREAT NECK HAND TOOLS
... for long-lasting performance



**Precision Balanced
NAIL HAMMER**

One-piece, forged steel, rubber-cushioned, no-slip grip

GREAT NECK SAW MFRS., Inc.
MINEOLA, N. Y. — SEE YOUR LOCAL STORE

Print Your Own



Cards, stationery, circulars, etc. Save money. Print for Others, Good Profit; easy rules sent. Raised Printing like engraving, too. Junior press \$10; Senior \$29 up. Sent direct from factory only. We furnish everything. Write for free details. **KELSEY PRESSES, Y-37 Meriden, Connecticut**

**CLEANS
IN SECONDS**

**PROCESS
33**

PAINT BRUSH AND ROLLER CLEANER

Cleans in seconds — keeps 'em like new. Switch from one color to another in 33 seconds. Re-usable — keeps original strength! **ONLY 69¢ FT.**

AT HARDWARE & DEPARTMENT STORES



MODERN IMPROVED LAWN MOWER SHARPENER AND BED KNIFE GRINDER

Sharpen any mower in 10 to 20 minutes. Hand—Power—Reel or Rotary. Modern is actually two machines in one, a Precision Bed Knife Sharpener and a Precision Reel Sharpener. Extra Bed Knife Grinder is Absolutely Unnecessary. New Mower Support makes it possible to sharpen reel without removing bed knife. The fastest precision lawn mower sharpener on the market. Costs Less. Compare Modern's Many Exclusive Features Before Buying. Send for Free Brochure No. 10 SN



MODERN MANUFACTURING CO.
160 North Fair Oaks Ave., Pasadena, California

Build Your Own arc welder

**SAVE \$200 to \$300! GET INTO
big paying jobs**

Easy to own...easy to use!

Highly profitable welding jobs can be yours—right away—with a lightweight, portable Build Your Own model. This home-built welder can give you performance comparable to that of a factory-built outfit. No other business offers the profit potential that welding does—for such a low initial investment!

1



2

"Husky Boy" 200 amp.
Welds anywhere. Light, rugged, compact, and air cooled. Easily mounts to your trailer for traveling to the profitable emergency repair jobs.

3

AC Transformer Type

295 amp. AC Welder for operating on single phase 220 volt power. Just right for production and repair work in shops. A welder that quickly pays for itself out of extra earnings.



4



AC Welder, AC Power
200 amp. combination that you can connect to your own power source. Furnishes current for welding and power for running tools, lights, etc. With the aid of a good used auto engine, you can build your own portable combination welder and power unit. Mail coupon today for full details and free "Build Your Own" booklet. Gets you started in a highly profitable welding business.

Welding Lessons 200 pages fully illustrated, with charts and diagrams. Self-teaching. **\$1.00**

HOBART BROTHERS CO., Box M-97, Troy, O.
Phone FE 2-1223

HOBART BROTHERS CO., Box M-97, Troy, Ohio

Without obligation, send complete information on:

- 1 BUILD YOUR OWN 3 AC TRANSFORMER
 2 "HUSKY BOY" 4 AC WELDER, AC POWER
 Tell me about the Hobart Non Profit Welding School
 Send Welding Lessons Book. I enclose \$1.00.

Name _____

Address _____

City _____ State _____

Colorful
Comfortable
 Get Kraeuter's
 All New
 "CG" Pliers

in red, blue,
 green, yellow & orange



KRAEUTER has done it again. Now for the first time you can secure comfort and color along with KRAEUTER quality at no increase in cost.

Every KRAEUTER solid joint plier has a cushion grip of thick vinyl to make your tough jobs easy. All KRAEUTER "CG"* cushion grips provide easy identification—easy to locate in your tool box—ideal for departmental color coding in your plant. All KRAEUTER "CG"* cushion grip pliers assure you comfort and ease on the job.

Whether you use side cutters, diagonals, lineman's or one of the other quality pliers in KRAEUTER's long line, you will find "CG"* cushion grips a standard feature at regular prices.

Ask your distributor for KRAEUTER "CG's"* today and put ease in your work.

*CG Cushion Gripped Pliers

BUY THE FINEST
 BUY KRAEUTER
 BUY AMERICAN

AS MODERN AS TOMORROW

kraeuter & co., inc

FOR 100 YEARS THE FINEST IN HAND TOOLS 1860-1960 NEWARK, N. J.



solenoid plungers. Each octave has its own assembly, which can be replaced as a unit in case of trouble.

No trained organist could be expected to work for hours in a cave each day. Therefore, Sprinkle has built a mechanism for playing the organ automatically, which also is mounted on this platform. It consists of an endless belt of thin, tough plastic, 40 inches wide, rolling over an aluminum cylinder. Melted into the belt are holes corresponding to the notes of the recorded selection. As the belt moves, tiny metal brushes touch the cylinder through the holes, triggering the proper solenoids.

Switches Determine Volume

Variations in volume are also achieved in the control room, so that a selection may swell into triumphant chords or drop almost to a whisper, all automatically. When the plastic belt is prepared, the organist, stationed in the ballroom, telephones recommended volume effects to an operator at the control panel. On the panel are three switches that offer eight variations in volume, which the operator manipulates to carry out the recommendations. He also flicks a fourth switch, its two positions labeled "forget" and "remember," to wipe out undesirable effects or preserve desirable ones.

Sprinkle faced problems that sometimes seemed insurmountable. Against the unrelenting dampness of the cave, the console platform and the platform in the control room had to be heated with built-in electrical units, which keep the tops of the two platforms dry enough to gather dust.

But the problem of the condensers was knottier. The resistance of the solenoid was so low that a condenser gave up its charge too fast, and quickly developed hot spots. Would any condenser stand up to this kind of punishment? Would the Stalacpipe Organ die before it could ever be heard in recital?

Sprinkle, approaching the problem from the other end, began working over the solenoid. He multiplied the resistance of the solenoid coil 30 times. This not only slowed down the discharge rate of the condenser to a satisfactory level but actually developed a more substantial thrust of the plunger. Result: A stronger tone which required one less condenser.

Soon you will be able to buy recordings of numbers played on the incredible Stalacpipe Organ. As you listen to the beautiful music in the comfort of a dry, warm home, think for a moment of the problems overcome by inventor-scientist Leland W. Sprinkle in developing one of the most unusual musical instruments ever built. ★★

Professional Mechanics' TOOL CHEST FOR YOUR HOME WORKSHOP



This may be the lowest cost full-sized chest in America! 4 sliding drawers in blue-gray rugged steel cabinet. 26" x 12 1/2" x 12 1/4". Keep your valuable tools safe, clean and always at your fingertips.

\$25.90 F.O.B. ST. PAUL

FREE BULLETIN



HUOT MFG. CO.
555 No. Wheeler St., St. Paul 4, Minn.



9.2 h.p.

LAYTRAC RIDING CRAWLER
OUTWORKS ANY TRACTOR ITS SIZE

MORE POWER—MORE TRACTION!

Laytrac works where others bog down! No slipping, drifting, tipping on slopes. Rugged, easy to operate. Big tractor quality! Borg-Warner 3-speed and reverse transmission, cone clutch steering, 925 lbs., including blade, floating drawbar, P.T.O. Guaranteed. Accessories available. At dealers or direct. Write for literature.

Lowest Cost RIDING CRAWLER in U.S. anywhere \$895

LAYTRAC, 2548-A Airport Way, Seattle 4, Wa.

HUNTERS HOIST

The Hoist with a Lock—No More Tying Off

CAPACITY 750 POUNDS

Weights 12 ounces. 5-1 ratio. 10 foot span. Synthane Pulleys. Brass Bearings. Steel Bolts. Steel Hooks. Nylon Line. A Quality Product.

\$7.95

postpaid



HUNTER MFG. CO., Pratt, Kansas

ANY SEASON . . . ANY ROAD

A HULL AUTO COMPASS

Repeatedly Earns Your Gratitude by Eliminating

• Confusion • Wrong Turns • Lost Bearings

Beaconlite \$6.50 *Streamline* \$4.95



HULL MANUFACTURING CO., P. O. Box 246-D-9, Warren, Ohio

Free book on home workshops!

"What To Look For When You Buy Power Tools" gives you up-to-the-minute information on how to select and buy power tools, tells you how to set up ideal workshop at home. FREE!

Write Dept. 508-M MAGNA POWER TOOL CORPORATION
Menlo Park, California, OR Box 2808, Ft. Wayne, Indiana

NEW 1957 CATALOG

200 MODELS—SAVE 2/3

BOAT KITS

EASY TO BUILD—Designed for the amateur. Over 200

Models. Plans to Cruisers, 8 to 21 ft. Farned hulls Semi and Custom Finished. Save 50%... Now NEW Sea Ray Molded FIBERGLAS BOAT KITS. Truly professional results. NO upkeep. SAVE 2/3 assembly time. 12 to 16 ft. Utilities and Runabouts. SEND 35c for 64 page Boat Kit & 24-page Sea Ray Catalogs. SEND \$1.00 for both plus "Boating Handbook". Dealers inquire for franchise.

BOAT PLANS & PATTERNS
Frame-Pac Kits

World's largest selection; over 200 plans, full-size patterns, frame-pac kits! Designed strictly for amateurs! All types: prams, kayaks, racers, runabouts, catamarans, houseboats, cruisers - inboard-outboard 6-40" wood-plywood-steel! Send 35c for PLAN CATALOG Catalog PLUS "Boatbuilding Handbook" \$1.00

WRITE NOW! CUSTOM CRAFT, BUFFALO 7L, N. Y.

INSTALL YOUR OWN ANTENNA TOWER!

PUT IT UP WITH EASE—
NO CONCRETE NECESSARY

SPAULDING STRATO-TOWER

PATENT PENDING

- No Guy Wires
- All Galvanized
- Free Standing

Model X44CB (32' Tower plus 8' mast, and cylinder base) ONLY \$79.95
Antenna Not Included

Tower package includes the adjustable tower-to-base adapters, other necessary hardware for assembly.

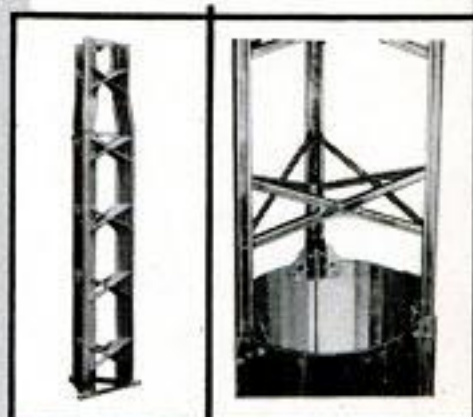

Tower Package Ready For Shipment

How Tower Mounts On Cylinder Base

Other Models Available From 16' to 64'

*f.o.b. factory

If your dealer cannot supply you, send your check and order direct.

SPAULDING PRODUCTS CO.

550 West Barner Street
Frankfort • Indiana

Canada: Delhi Metal Products Co.
Delhi, Ontario

What's Happening to the Weather

(Continued from page 110)

LANDSBERG: I remember the first A-bomb experiments in Nevada. There was a flurry of publicity as to whether or not the explosions influenced tornadoes. It so happened that the opposite took place—at that time there were fewer tornadoes than in the preceding or succeeding year.

Q: How far ahead can the weather be accurately forecast?

PETTERSEN: The usual period is 24 to 36 hours, sometimes longer, sometimes less depending on conditions.

LANDSBERG: Some attempts have been made to provide extended forecasts, but the longer you make them the less accurate they are.

Q: Is there any scientific fact in some of the weather superstitions, such as the ground hog seeing his shadow?

LANDSBERG: I wouldn't call them superstitions. Some have a basis in fact, others do not. In most cases the animal is "hindcasting," reflecting something that is already happening. For example, the bird migration is often thought of as indicating an impending winter storm. But actually they are taking advantage of high winds to do their flying. There is no question they

used pressure-pattern flying long before man thought of it in an airplane.

LANDSBERG: Concerning ground-hog day, I wouldn't shrug it off completely. There are certain things we call singularities in weather. Around the beginning of February, if there is a cold spell with clear weather, then there is a certain amount of persistence of that type of weather.

Q: What is the status of using computing machines in processing weather information and weather forecasting?

PETTERSEN: At the present time, experienced weather forecasters can forecast wind and weather better than the machines. However, because of the complicated data involved, if you are dealing with winds at the higher altitudes then there is very little difference between a man and a machine-made forecast.

LANDSBERG: If anything, there is a shifting in advantages to the machine in upper-level forecasting. One thing to remember is that the machine cannot be any more accurate than the information fed into it. We lack so much accurate weather data, from over the oceans which are $\frac{2}{3}$ of the world, and from areas with inadequate weather observations.

PETTERSEN: Real progress is being made with these machines, and there is
(Continued to page 248)

**TRAP
DUST
AND
ODOR*
IN YOUR
HOME**

automatically

EZ KLEEN

*AUTOMATIC ODOR
REMOVAL with
RP SUPER handi-koter

The scientifically compounded adhesive for re-coating EZ Kleens that traps dust, dirt, pollen AND absorbs odors from the air stream circulating through your furnace or air conditioner.

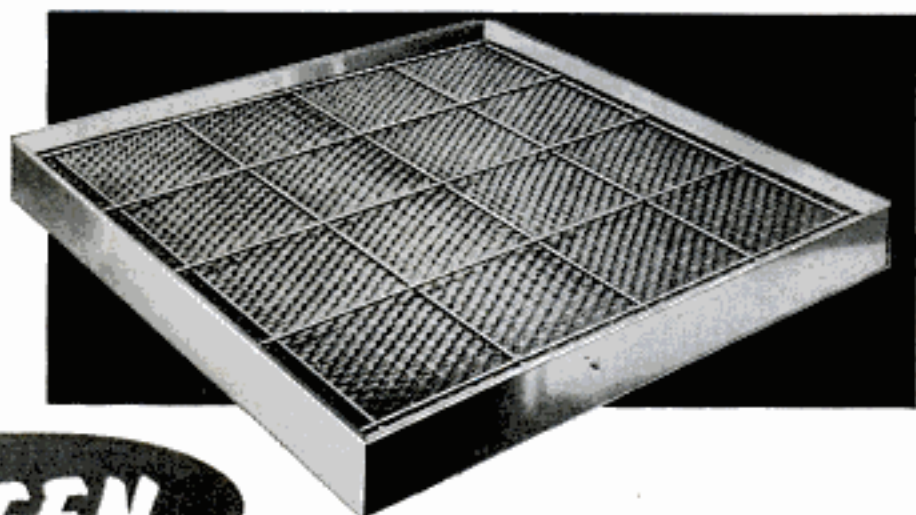

AIR FILTERS
ALUMINUM . . . WASHABLE
LOWEST COST AIR FILTER BUY

FOR FURNACE OR AIR CONDITIONER—Only clean filters efficiently trap more dust and dirt, permit better air circulation, reduce fuel and power costs, increase comfort. With washable EZ Kleens, you can have clean, efficient filters constantly—without frequent shopping. As often as necessary—wash, recoat with adhesive and replace EZ Kleens—they're good as new, last for years. Research Products Corporation, Dept. 227, Madison 10, Wis.

SEE YOUR DEALER OR TELEPHONE DIRECTORY

IN CANADA: HICKS-BAKER LTD., 234 Madison St., Winnipeg

E. G. SPALL & CO., LTD., 601 York Road, Guelph, Ont.

WOLVERINE GLOVES

GRAB IT *softly, surely*



NEW
full grain
pigskin

Full grain pigskin that's buckskin-soft, wears like horsehide. Has dress-glove look, sure-fingered fit, a feel you've never felt before in hardy work gloves. Tough, pliable, economical. Full or reverse grain.

feel that tanned-in softness

rockford, michigan

How to make strong plywood joints with Weldwood glues



BUTT JOINTS are simplest. For thinner plywood, reinforce with block of wood. Be sure wood surfaces make snug contact. Apply glue to all surfaces (two coats on end grain) and clamp. When possible, reinforce joints with nails or screws.

RABBIT JOINTS look neat, give added strength to drawers, chests, cupboards. Make slot with dado cutters, or several overlapping passes with regular saw blade. Apply glue to both surfaces, clamp, and nail or screw if possible.



DADO JOINTS in $\frac{3}{8}$ " plywood increase gluing area, are made by dadoing off $\frac{1}{16}$ "-notch from end of one member. Reinforce with nails from both top and side of joint.

USE THE RIGHT GLUE

Weldwood Plastic-Resin Glue makes well-fitting joints stronger than the wood itself. Easy-to-mix powder, light tan color, resists moisture, sets in 5 to 6 hours.

Weldwood Presto-Set Glue is ideal for uses where tight clamping or good fit is difficult. Quick-drying, washable, ready-to-use white glue comes in handy squeeze bottle.

Weldwood Waterproof Resorcinol Glue should be used in joints in Exterior-Grade plywood for outdoor furniture, boats, and other work exposed to extreme dampness. Exceptionally strong, completely waterproof, sets overnight.

Weldwood®
ADHESIVES, FLEXIBLE WOOD-TRIM®
FIRZITE®, SATINLAC®

Products of United States Plywood Corporation
55 West 44th Street, New York 36, N. Y.



WELDWOOD ADHESIVES — 4 types—a glue for every purpose in a size for every need.



FLEXIBLE WOOD-TRIM—real wood veneers in handy rolls, for covering exposed edges.

\$1 DESIGN SECRETS REVEALED \$1

Share the confidential information used by a successful industrial designer, "Dimensions of Human Figure, Male & Female," now released in easy-to-use booklet. 48 clear simple charts, 1198 dimensions of human figures in various functional positions. Ideal guide for home-craftsmen and do-it-yourselfers. Determine proper height for shelves, cupboards, chairs, tables, furniture, shop equipment, proper clearances.

DIMENSIONS OF HUMAN FIGURE BOOKLET \$1
(No C.O.D.'s please) Send \$1.00 in cash, check or money order to:
**CLEVELAND DESIGNERS, DEPT. B, BOX 3839
SHAKER SQUARE STATION, CLEVELAND 20, OHIO**

GOT A LOCK PROBLEM?

To make locks work easier and last longer, add a few drops of **LOCK-EASE** to any lock mechanism. **LOCK-EASE**—a graphited fluid flushes out dirt—leaves a long-wearing protective film to seal out rain, snow, salt, ice and dust that cause locks to stick, rust and wear out. **LOCK-EASE** prevents keys from sticking... locks from freezing. Use **LOCK-EASE** on car locks, garage locks, padlocks and all door locks in and out of the home. For best results, "LOCK-EASE" locks regularly! 4-oz. "Drop or Stream" can only 49c, everywhere.



LOCK-EASE®
Graphited
LOCK
FLUID



American Grease Stick Co.
Muskegon, Michigan



On the road or off the road

Fine bearings mean fine performance!

Whether you build roads or drive on them, smooth, trouble-free power is essential for fine performance. That's why operators of truck fleets and all kinds of heavy-duty off-the-road equipment use Federal-Mogul heavy-duty bearings—they are engineered for heavy-duty performance. And that's why most mechanics recommend and use Federal-Mogul car engine bearings—they are engineered for top road performance! Ask your mechanic!

FEDERAL-MOGUL SERVICE

Division of

Federal-Mogul-Bower Bearings, Inc.

Mechanics Know . . .

that the black and red Federal-Mogul box identifies the service bearing line as modern as today's engines.

RESEARCH • DESIGN
METALLURGY • PRECISION
MANUFACTURING • SERVICE



a tremendous growth potential. After all, there is a limit to the amount of information a man can carry in his head, whereas the machine is equipped to handle millions of figures.

Q: With the advent of better computing machines and more information, will the period of accurate weather forecasting be extended?

PETTERSEN: Not radically.

WILLETT: I don't believe the prospect of getting specific forecasts of more than four or five days ahead is something we can ever hope for. Certainly, we will be able to improve the present level of forecasting, and perhaps extend it somewhat longer.

PETTERSEN: If we are ever able to go beyond three or four days in forecasting, the only hope is that we can combine physical and statistical techniques and solve the problems by using more weather data and improved computers. ★ ★ ★

Tape and Machine Splice Film Without Loss of Frames

Splicing of 8 and 16-mm. film can be completed without loss of a single frame by a new transparent-tape splicing set. This perforated tape permits splicing which does not show on the screen. Found stronger than the film base, the tape can be removed and reapplied or used to repair tears and perforations without loss of frames. The splicing machine has a cast-aluminum body, adjustable hardened-steel cutters and eight film-alignment pins.

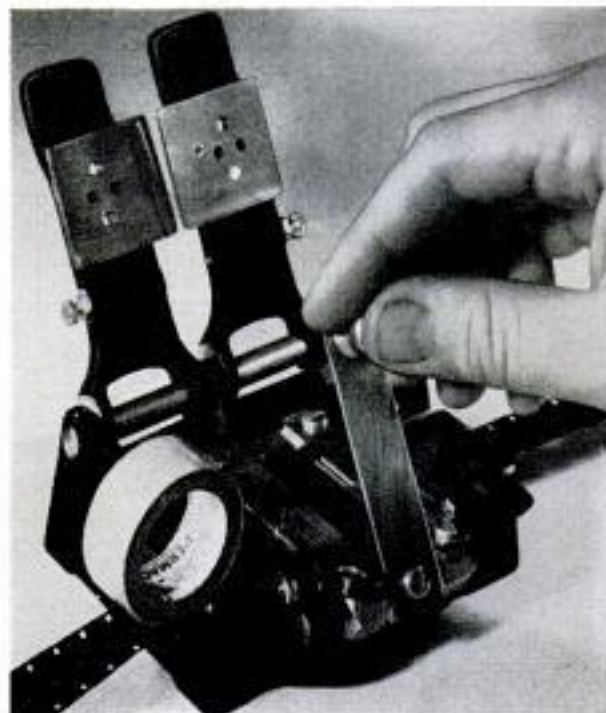

POPULAR MECHANICS

Be Your Own Boss in the Profitable Excavating Business!

Custom Operators of Sherman Power Diggers Earn Up to \$1,000 and More Per Month

Wherever you live, you'll find plenty of profitable work the whole year 'round for this versatile outfit . . . not just a "trencher" but an all-purpose excavating machine! Custom operators everywhere are making big money with Sherman Power Diggers. One bought a farm with just 3 years' profits! Work for builders, contractors, utilities, and municipalities on such jobs as

- SEPTIC TANKS and DRAINFIELDS •
- SEWER LINES • FUEL TANK INSTALLATIONS • FOUNDATIONS and FOOTINGS
- GAS and WATER LINES • FIELD TILLING and many others. The Sherman Power Digger travels quickly from job to job, digs at a fraction of the cost of manual labor. It's simple to operate, easy to maintain, built to last.



Send now for complete information about the easy-to-get jobs for your Sherman Power Digger. Let us tell you—without obligation—how you can go into business for yourself with an investment of less than \$5000. Or make a small down payment and pay the balance from your earnings.

SHERMAN PRODUCTS, Inc.
Dept: 1736 Royal Oak, Michigan



10" TILT/ARBOR SAW BUILD-IT-YOURSELF from GIL-BILT KITS-PLANS

Sturdy wood, steel, and aluminum construction, NEW DEPARTURE ball bearings. Capacity and Performance of floor saws selling for \$150.00 and up. Plans, all metal parts in kit with 10" comb. blade \$25.95, less blade \$22.95. F.O.B. St. Louis. Detail PLANS-PATTERNS only \$1.00 postpaid.

Build-it-yourself 12" and 18" Bandsaws, 6" Belt Sander, Shaper, Simplified plans, build easily with hand tools only. Advertised and sold for 10 years, over 33,000 units in use. Money back guarantee. FREE CATALOG.

GILLIOM POWER TOOLS, Dept. 80-J, Lambert Field, St. Louis 21, Mo.

UNMATCHED



Gerstner Chests are unequalled in quality and performance. Free Catalog to machinists and toolmakers.

GERSTNER TOOL CHESTS
457 Columbia St., Dayton 7, Ohio

KITCHEN FAN AND HOOD

CHOICE OF 3 FINISHES
COPPERTONE, WHITE,
ALUMINUM.



SAVE
UP TO
\$35.00

TOP
VALUE!

SPECIAL!

\$29⁹⁵

COMPLETE

Westair 36" All Steel Hood, With Powerful 500 CFM 5 Yr. Guarantee Fan and Automatic Backdraft Shutters. LARGEST SELECTION FANS, BLOWERS, BLADES, GUARDS, ETC.
WESTAIR FAN & BLOWER CO.
5850 GRAND RIVER DETROIT 8, MICHIGAN

Soldering is Easy

with

INSTANT STARTING



Lenk

LIQUEFIED LP PETROLEUM

Torch

only \$2⁹⁵



THE ONLY THROW-AWAY FUEL-CONTAINER WITH SELF-SEALING SAFETY VALVE.

Here's what you can do:

- regular soldering, sweat fittings,
- silver soldering, refinish furniture,
- remove paint and putty.

Available at Hardware Counters Everywhere

Write for FREE Soldering Instructions

THE **Lenk** MFG CO.

FRANKLIN, KENTUCKY

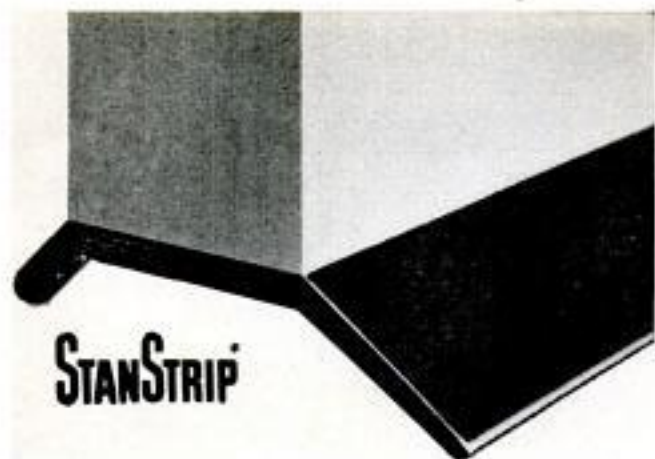

NEW KIND OF SEAL

Protects garage doors . . .
seals out rain, snow, drafts

StanStrip doubles the life of garage doors by cushioning the shock of closing. At the same time, it permanently seals the door bottom against rain, snow, dirt and drafts.

And you can install it in only a few minutes.

StanStrip is molded from a special synthetic rubber developed expressly for this kind of service.

It's tough . . . to withstand abrasion and impact. It stays soft and flexible in the coldest weather. It never sets or deforms. It follows the raggedest floor contours to make the tightest possible seal.

You've invested a lot of money in your overhead garage doors and you'll want to protect that investment.

You can protect an eight-foot door for only \$2.95 with StanStrip. A sixteen-foot strip costs only \$5.90. Your hardware or building supply dealer has StanStrip now. Install it this week end. *Trade Mark



Brains for Planes

(Continued from page 101)

and see the strip someplace in his circle of vision on a clear day.

As an extra bonus, 66 also senses the plane's drift caused by cross winds. Until now, this was a problem that had to be worked out tediously by a navigator using triangulation, or data from drift meters which are good only in fair weather when the ground is visible.

This feature of the brainy Doppler navigator is the one that enabled Major Smith to follow the river of jet wind all the way from West Coast to East. Leaving March Base, he headed out to intersect the jet stream, whose general location had been supplied by the weathermen. He knew he was in the stream when the 66 informed him that he was being carried swiftly sideways toward the east. Finally, when his sideways movement reached maximum on the drift dial, Smith knew he was in the middle of the jet stream. He swung his plane downwind, until the drift-angle reading was zero, indicating that he was riding with the wind. Then he tied in the automatic pilot. Locked to "zero drift," the autopilot proceeded to steer the plane in any direction necessary to keep the drift angle at zero. Hence the B-47 automatically stayed pointed directly downstream, following the jet wind along its wandering course, and collecting a 165-mile-per-hour kick all the way to Massachusetts.

Today, more than \$50,000,000 worth of AN/APN-66 navigators are contracted for. Though most of this is military, indications are that it won't be long before a 66 will be flying you when you travel by air. Overseas carriers are expected to use them first.

Brain for Plane or Missile

If the 66 seems uncanny, another navigational brain—on the secret list until a few weeks ago—recently showed off its ability to do much the same job without reference to compass, radio or radar signals, or other usual aids. Developed at Massachusetts Institute of Technology under the direction of a stocky engineer, Dr. Charles S. Draper, the eerie system, known as "inertial guidance," can tell a plane or missile exactly where it is in relation to earth or stars in space at any given moment of flight. Sunspots, magnetic interference and enemy jamming attempts have no effect on the system, since it requires no electronic eyes or ears.

The inertial-guidance system's sense of direction is born in a complex array of instruments that sense and transmit every

The Standard Products Co.
LEXINGTON, KENTUCKY

tiny waver of the craft to an electronic brain that tells the automatic pilot how to steer. One of these sensory gadgets is a tiny gimbal-hung gyroscope whirling at 12,000 revolutions per minute in a shiny cylinder no bigger than a frozen-juice can. The axis of this high-speed midget always stays pointed in the same direction no matter how the craft wavers around it.

Besides the gyro, the system employs an electronically controlled pendulum that always points to the center of the earth no matter what the vehicle's speed or attitude. The angle between the gyro's fixed axis, and the rod of the pendulum pointing to earth's core, changes slightly as the plane moves along. It changes violently if the craft wavers, dips or climbs. Tiny accelerometers constantly measure the changing angle, translate it into terms of changing speed of the craft in any direction. This data is flashed to an electronic brain that signals the automatic pilot to make proper corrections to keep the vehicle on a preset course.

Besides all this, a precision clock, making corrections for the earth's rotation as the craft speeds over the globe, enables the brain to calculate its exact latitude and longitude at any instant of flight.

Navigator for Satellite?

The first 2700-pound inertial-guidance navigator flew a B-29 from Massachusetts's Bedford Airport to Los Angeles in February 1953 while pilot C. L. "Chip" Collins sat with folded hands bemoaning the fact that "I've just lost my job." The bulky test navigator brought the plane within 10 miles of its target before Collins took the controls. Since then, much of the system's nightmare of wiring and humming parts has been whittled down to miniature size. Its actual bulk is classified. But it's small enough so that the Navy's intermediate-range Polaris missile is getting an inertial-guidance navigator. And chances are that when the big three-stage rocket pitches the first manmade satellite into outer space next year, one of these brainy navigators will be manning the controls.

Just as brainy as the 66 and the gyro navigator is another electronic wizard—Bell Aircraft's new Automatic Carrier Landing System (ACLS), which electronically plucks planes from the air and sets them down gently on fogbound airstrips or heaving carrier decks.

Here's how it works: Ensign Jones returns from a mission to find his carrier lost somewhere beneath him in a thick blanket of fog hugging the waves. Ordinarily in such weather he'd head for an alternate

(Continued to page 252)

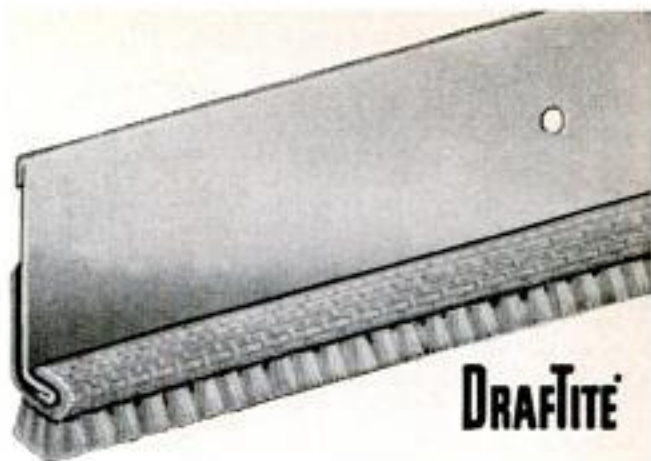

NEW WEATHERSTRIP has unique pile that seals out costly drafts



No home insulation job is complete until doors are tightly sealed with DraftTite . . . the new kind of weatherstrip.

Here's weatherstrip built like the kind used to seal out drafts in your car at speeds of 60 miles per hour or better.

Thousands of stiff, tightly packed "piles" enclose millions of dead air cells that cold and wind can't penetrate. Anchored in rubber and attached to rustproof aluminum strips, DraftTite weatherstrip lasts a lifetime.

It can't mat like felt. It won't deteriorate and deform like rubber. It won't buckle and bend like ordinary metal. It never hardens, never gets waterlogged. Once it's fitted, your doors are permanently sealed against the toughest winter weather.

Buy it now from your hardware or building supply dealer. It costs only \$1.98 to seal an average door frame and 69c for the door bottom. Installs in minutes. *Trade Mark

The Standard Products Co.
LEXINGTON, KENTUCKY

**Bore 35 standard holes
with just one tool**

**New IRWIN
Expansive Bit**
lets you dial your size

Just turn the dial and you're set to go with this new Irwin Expansive bit. No hunting for the size you need. Fits all hand bit braces. Clean, fast, accurate boring action from $\frac{3}{8}$ " to 3"—35 standard hole sizes in all!

And what a really fine precision tool to own. It's drop-forged from special bit steel, heat treated full length, machined for accuracy and sharpness, highly polished, too. Two cutters supplied with each bit. Model No. 21 with $\frac{5}{8}$ " to $1\frac{3}{4}$ " boring range also available. Ideal for home handyman, professional woodworker, or farm. See your independent hardware dealer soon.



**No. 22
Micro
Dial
only
\$3.80**
 $\frac{3}{8}$ " to 3"
boring
range

IRWIN

Wilmington, Ohio

the original solid
center auger bit
•
screw drivers
screw driver bits

Jet King
POCKET-SIZE
**BUTANE
BLOW
TORCH**

**SOLDERS!
BRAZERS!
FIXES LEAKS!**



ONLY
\$1.95
WITH CHARGER

Every do-it-yourself and hobby fan needs this Kidde JET KING butane Blow Torch. Just the tool you've been looking for to do dozens of jobs in home or hobby...TV, appliance, lamp, radio or plumbing repairs...precision soldering, brazing or metal craft. Useful, too, for starting charcoal fires. A tiny, clean, safe charger does the job.

Each charger gives 30 minutes of intense 3500° pinpoint flame; turns on and off. Extra chargers, 49¢ per box of 2. Money back guarantee. At leading hardware and hobby stores... or send check or money order, we pay postage.

Kidde

KIDDE MANUFACTURING CO., INC.
Dept. PM-9

42 Farrand Street, Bloomfield, N. J.

Please send me _____ JET KING BLOW TORCHES plus _____ boxes extra chargers (limit 2 boxes per torch).

My check , money order for \$_____ is enclosed.

Name _____

Street _____

City _____ State _____

landing spot—or even ditch, rather than risk smashing himself and a deckful of parked planes. But there's no problem now. Having homed in on the ship's radio equipment, he knows she is right under that layer of milk, so he starts circling.

Down below, in the electronic glow of the CIC room, a sailor monitor has seen a blip from Jones's plane on the search radar. At that instant Jones flicks a switch in his fighter cockpit; a light flashes in the CIC room, telling the monitor: "I'm ready to be controlled." The monitor pushes a button on the console in front of him. That's all. From there on, the transistors and humming tubes are in charge. A white light flashes on Jones's instrument panel, announcing: "We've got you." The landing-system's radar locks in on the craft, tracking and feeding data on its position and altitude to a computer. Radio commands from the computer flash to a receiver on the plane where they are converted into signals that direct the automatic pilot.

"The human pilot doesn't really need to be told he's locked in," explains Campbell Hill, Bell engineer. "You can actually feel the system take over. The plane doesn't drift. Controls move magically under your hands and feet."

Computer Lands Plane

Banking and turning by itself, the craft finally heads through the fog directly for the deck. Ensign Jones sees his throttle move back under the guiding force of electronic gremlins. Radar impulses from the ship, bounced from a tiny "corner reflector" on the plane's extended landing gear, keep constant track of the craft as it moves in. With split-second timing, the computer tells the autopilot to "cut engine" as wheels skim the lip of the deck. If a gust of wind lifts a wing, or the ship rolls the wrong way, the brain commands the autopilot to "take it away." Instantly, throttles pour on fuel, the plane banks to the left to avoid the ship's island, and away goes Ensign Jones for a free ride while the gremlins try again.

So far, in land-based tests, a mobile prototype of the Bell system has completed more than 1200 landings with high precision. At landing speeds of nine feet per second, planes sat down within an area 10 by 22 feet around a designated landing point. At speeds of two feet per second, touchdowns stayed inside an area 10 by 100 feet. What if a rack of tubes burns out and the system fails? "At any instant," says Hill, "the pilot can throw a 'disengage' switch and take over."

Sea trials for the equipment should be

(Continued to page 254)

SAVE 1/2 - 2/3 THE PRICE OF FACTORY-BUILT BOATS

**BOAT
KIT
CATALOG
Free!**

Runabouts, cruisers, convertibles, fishing; 43 models, 8 through 18 ft. Freight paid, \$39.25 up. Assembled and finished by experienced owners. Luger boats equal factory-built in speed, handling, style, beauty; yet save you 1/2 to 2/3. Owners say: "Fastest boat on river." "Pleasure to assemble." "Everyone admires my Luger." Thousands in use. Send for big, free boat kit catalog; also lists fiberglass, hardware, accessories, trailers, paint. Write for catalog today.



Write:

LUGER INDUSTRIES, INC. DEPT. 3404 Lyndale S.
B-9 Minneapolis 8, Minn.

the finest

GLASS CUTTERS

are

Red Devil Tools.



HOLT'S

Piston Seal

20 years on the market. No one else can claim this. Forms self-lubricating seal around pistons. Lasts for thousands of miles. Do it yourself. It's easy. **GUARANTEED.** Order NOW. Mailed Promptly, **POSTPAID**, for only \$4.95.

TREGLOWN CO., Inc., Fanwood 139, N. J.

- reduces oil consumption
- restores compression
- stops piston slap
- increases miles per gallon
- improves performance
- makes engine quieter

Write for full details

MONEY MEN ALL FREE

THE PLASTEX Industry needs manufacturers on small scale and for big production of Lamp and Clock Stands, Art Goods and Novelties in Plastex and Marble imitation. Experience unnecessary. Age material makes regular 10¢ store sellers. Rubber moulds furnished for speed production. Small investment brings good returns. We are now placing big Chain Store Orders with manufacturers. Ambitious men have chance for real prosperity. Our Free booklet will interest and benefit you.

PLASTEX INDUSTRIES, Dept. A
3400 Third Ave. New York 56, N. Y.

TOP VALUE SPECIALS!

SURPLUS ITEMS AT FRACTION OF ORIGINAL GOV'T. COST

AT GROBAN'S

HIGGINS BRONZE

CENTRIFUGAL PUMP

PUMPS ALMOST ANYTHING

ITEM #414

Fine for: — • Irrigation • Sump Pumping • Sewer Drainage • 75 gallons per minute @ 2400 R. P. M.

Higgins Type PNB, Model R, marine bldge pump. Open Impeller design for handling muddy water. Delivers 75 gallons per minute, 30 foot head with 3/4 H.P. motor.

Pump body and impeller are made of solid bronze, with alloy steel 3/2" diameter shaft, 1 3/4" long. Rotation of the pump is clockwise. Inlet has 1 1/2" pipe thread. Plain 1 1/2" outlet for hose connection. Dimensions 12"x7"x8". Shipping weight 23 lbs. F.O.B. Chicago. **23.50**



MASTER & SLAVE

HYDRAULIC REMOTE CONTROL SET

Item #415—Designed for remote operation of controls on engines, boats, special machinery, etc. Eliminates complicated mechanical linkages, cables, pulleys, etc. The master unit connects to the slave unit with a single 1/4" tube.

When master control lever is moved, slave lever follows exactly. Light, compact, aluminum alloy construction. Dim. of both units: 5 1/4" W. 9" H. 1 3/4" D. (exclusive of handle) Ship. Wt. 8 lbs. F.O.B. Chicago. **27.50** per pair

(Note—tubing not supplied)



2 H.P. 24 VOLT

ELECTRIC MOTOR

ITEM #315—Rated 24 volts D.C. 90 amps, 4000 R.P.M. Has 1/2" spline shaft on both ends of motor, ball bearing construction, as specified for use with electric wheelchair design Popular Mechanics March Issue, 1953. Shipping Wt. 21 lbs. Dimensions: 11" x 5" x 6 1/2". F.O.B. Chicago. **13.00**



1-H.P. — 12 VOLT ELECTRIC MOTOR

Item #308. 100 Amps, 5600 R.P.M. Double shaft ball-bearing construction. F.O.B. Chicago. **12.50**

Send Payment Or Purchase Order Today

Order Direct from ad. Satisfaction guaranteed

For Phone Orders Call WEBSTER 9-3793

FREE — NEW, FALL 1957 CATALOG

60 PAGES—Chockfull of unsurpassed War Surplus and newly manufactured Equipment Bargains for farm, home, factory, workshop. Write letter today.

GROBAN SUPPLY CO. Dept. PM-9
1139 S. WABASH AVE., CHICAGO 5, ILL.

**USED BY U. S. ARMED FORCES
MACHINE TOOL RECONDITIONING**

& THE ART OF HAND SCRAPING (2nd printing)
SEND FOR FREE FOLDER DESCRIBING ILLUSTRATED BOOK

MACHINE TOOL PUBLICATIONS, 382 Holly Ave., St. Paul 1, Minn.

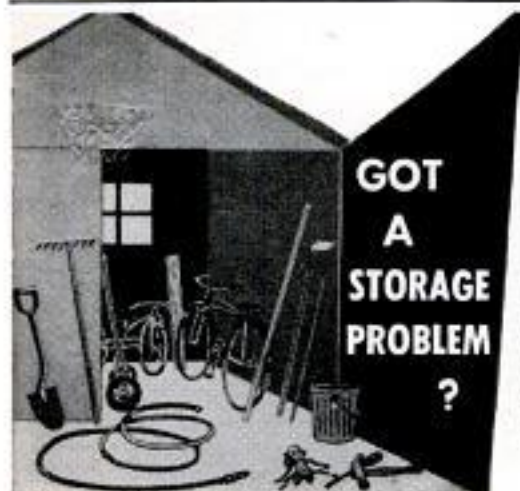
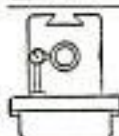

**GOT
A
STORAGE
PROBLEM
?**



Then you need **TURNBUCKLES** Perforated Board fixtures to end space-wasting clutter and to keep everything neatly in place until needed.

TURNBUCKLES do-it-yourself fixtures come in a wide variety of shapes and sizes . . . fit easily into any wall-hung perforated board . . . and hold everything from clothing and kitchen utensils to hand tools and garden equipment.

Send for your free copy of space-saving suggestions for home, farm and workshop.



TURNBUCKLES, Inc.
BOX 333, MICHIGAN CITY, INDIANA

NAME _____
ADDRESS _____
CITY _____ STATE _____

See Them Now!

2 NEW HOMELITE Chain Saws

... both 6 Horsepower!

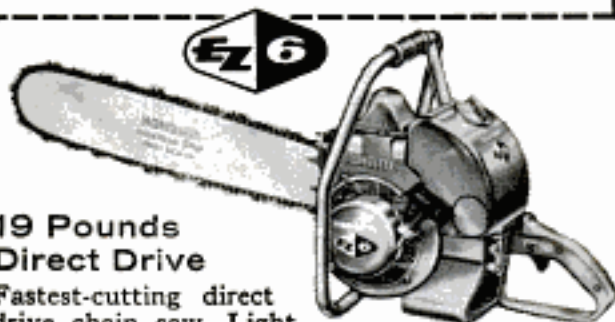

19 Pounds Direct Drive

Fastest-cutting direct drive chain saw. Light weight goes anywhere easily. Cuts 8" oak in 4 seconds, 18" pine in 14 seconds. Perfect for cutting firewood, clearing campsites, building shelters.

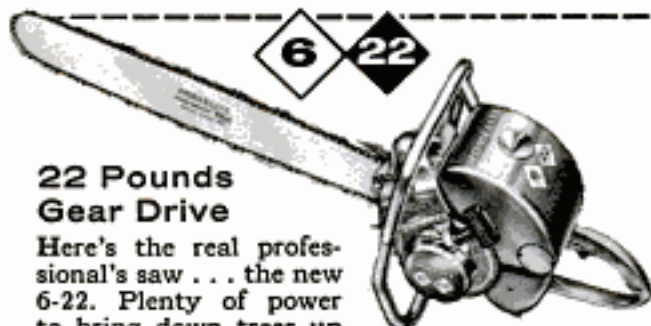

22 Pounds Gear Drive

Here's the real professional's saw... the new 6-22. Plenty of power to bring down trees up to 7 feet in diameter, fells 20" trees in 18 seconds. Perfectly balanced for easy handling. Makes any type of cut in any position... fells, bucks, limbs, notches, trims.

LAST CHANCE TO WIN! CONTEST CLOSSES SEPT. 30!

You may have three chances to win! Grand Prize: a free Homelite chain saw every year for life, PLUS 25 chain saws being given away by Homelite District Offices, PLUS hundreds of chain saws awarded by Homelite dealers in their own local contests. Nothing to buy, nothing to write, no obligation! See your Homelite Dealer today! Contest limited to residents of the United States and subject to local, state, county and city laws.



HOMELITE

A DIVISION OF TEXTRON INC.

9109 RIVERDALE AVE., PORT CHESTER, N. Y.
Homelite builds and sells more chain saws than any other company in the world.

In Canada: Terry Machinery, Ltd.

under way as you read this. Bell engineers, studying ship motion at sea, have built into their computer certain limits of speed and attitude of plane over the deck, beyond which the system quits trying to land the craft. In such instances, the brain automatically orders a wave-off.

According to Bell's engineers, the Navy is interested in ACLS not only because of its all-weather potential, but because it would enable the planes of wounded and fatigued pilots to be safely landed aboard carriers following rugged missions. The enthusiastic electronic experts are also quick to predict the system's use in commercial aircraft. They point out that it would enable airliners to fly in any weather and land under "ceiling zero" conditions. When combined with a cross-country navigational system (like the 66), they point out, "it could make possible completely automatic flight under all weather conditions. ★ ★ ★"

Computer-Microscope for Trees Tells Rate of Growth and Age

Age and annual growth rate of trees now are calculated automatically by an electronic computer-microscope invented by Swedish scientists. Used to forecast forest resources, the machine counts the number of concentric rings and the widths between them of wood taken from a tree trunk. The number of rings tells the age, and the widths between indicate the growth rate.

Automatic Bailer Keeps Boat Dry

Any boat that planes or moves fast enough to create a vacuum behind it can accommodate an automatic-bailing mechanism. As the craft goes forward, a vacuum at its base draws excess water out of the vessel by way of the bailer's drainage channel. The only moving part in this aluminum apparatus is a plastic "check ball" that floats up and closes the opening in the top of the bailer when the boat slows down or comes to a stop.

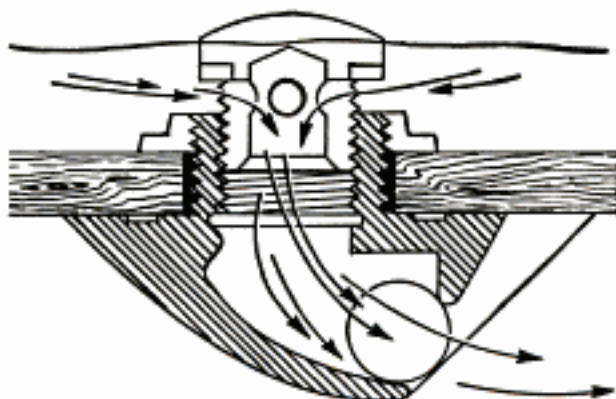

POPULAR MECHANICS

Here's the Adhesive with **The Strength of 10 Men**

Pliobond BY **GOOD YEAR**

"BONDS ANYTHING TO ANYTHING" Available at chain, hardware and hobby stores everywhere.

Pliobond—T. M. The Goodyear Tire & Rubber Company, Akron, Ohio

Heavy Duty Bench Type ALLEN PUNCH PRESSES

Model B-2
2 ton - \$97.50
Tilting model
\$127.50
Job-less motor

164 Different Model Combinations
1 to 5 ton capacities
Moderate in price
Fully guaranteed
See your supply dealer or write for Free catalog giving complete information and prices on our Bench Type Punch Presses.

ALVA ALLEN INDUSTRIES, Dept. PM, Clinton, Mo.

3 CU. FT. MIXER 3975
DIRECT FROM MFR.

Fills long felt need for small mixer for concrete, feed, fertilizer, seed and many other materials. Saves 3/4 cost of ready mixed concrete. Pays for itself on first job.

3 Cu. Ft. Drum—Mixes 2 Cu. Ft. Concrete \$39.75
5 Cu. Ft. Drum—Mixes 3 Cu. Ft. Concrete 49.50

FOB Pulaski, N. Y. Cash, Check or M. O. Money back guarantee.

UNITED STATES FORGE AND FOUNDRY CO.
CONSTRUCTION EQUIPMENT DIV. PULASKI, NEW YORK

SEE YOUR DEALER

Two steps to professional results in your workshop: (1) check **POPULAR MECHANICS** for helpful "how to" suggestions; (2) discuss your project with you dealer. He knows the importance of working with quality products. They're advertised in **POPULAR MECHANICS**.

PM TAG of INTEGRITY

HOLD-E-ZEE®
the Original **AUTOMATIC GRIP SCREWDRIVERS**

FINEST MATERIALS AND WORKMANSHIP

LOK-BLOK® makes blade twist and impact proof.
GRIPPER recedes deep into handle, giving full blade use.
SPECIAL BIT fits both types cross-point screws.

—YET COST NO MORE THAN ORDINARY SCREWDRIVERS!
At Leading Dealers Everywhere

UPSON BROS., INC., ROCHESTER 14, N. Y.

COMPLETE YOUR HOME WORKSHOP WITH A . . . RELIABLE BENCH FURNACE

MODEL SHOWN \$52.50 PA

The home hobbyist will find the side door perfect for heating long bars, soldering irons, drills etc. The Reliable Bench Furnace also is equipped with a removable pot for melting all soft metals and alloys.

FREE!
Specifications and literature on complete line.

WRITE TODAY!
RELIABLE MACHINE & MFG. CO., INC.
420 H Ave. N.W. Cedar Rapids, Ia.

NOW! HOME CRAFTSMEN CAN OWN THIS PROFESSIONAL ARC WELDER

EASY TERMS ONLY \$98.50 F.O.B.

Now you can own a Trindl full 125 amp Industrial Welder at a price far less than smaller machines. With a Trindl 125A you can weld metals up to 1/2 inch thick. Operates off either 110 or 220 volt line, properly wired. 16 heat stages from 20 to 125 amps. Make and repair anything of metal around the home, garage, farm or shop, like a professional. No previous experience or training needed. Full "do-it-yourself" instructions with each machine. Complete only \$98.50 f.o.b. factory, or write for details. Trindl manufactures a complete line of heavy duty welding machines. Dealer inquiries invited.

TRINDL PRODUCTS Ltd., Dept. T2-J
1807 So. Clark St., Chicago 16, Ill.

FREE
WRITE FOR COMPLETE DETAILS AND EASY PAY PLAN

Guaranteed
12 MONTHS IN CONTINUOUS OPERATION

don't let NAILPOX ruin your home . . .
use ALCOA ALUMINUM NAILS



WHY RISK THIS



WHEN YOU WANT THIS

NAILPOX is the staining that results when nails rust.

You can prevent nailpoX by using Alcoa® Aluminum Nails. They can't rust or cause unsightly rust stains. They need no countersinking or puttying. Paint lasts longer. Make sure builder uses them, and use them on jobs that you do yourself. Alcoa Aluminum Nails are available from your local hardware, lumber or building supply dealer.

Look for Alcoa Nails in this distinctive package . . . distributed nationally by Macklanburg-Duncan, Oklahoma City, Okla.



THE ALCOA HOUR
TELEVISION'S FINEST LIVE DRAMA
ALTERNATE SUNDAY EVENINGS



Just pull the trigger . . .
spray paint!

The easier, better way to paint! Job's done in minutes. Finish is smooth, flawless. Speedy Sprayer is a real professional tool, favorite of craftsmen for over 35 years! At stores everywhere. 890 Outfit, including gun, hose, less motor, only \$39.95

Speedy Sprayer

Wheel it to the job!



FREE! "How to Spray" booklet and literature. Write!

WHEEL KIT
\$7.50 EXTRA

W. R. BROWN CORP., 2635 N. Normandy, Chicago 35

Here It Is—The Edsel

(Continued from page 95)

at the front offsets much of the gain. Edsel explains this by saying that the new engine design was under way before the comparatively new front-hinged hood was decided upon.)

Other novel features of the Edsel include a triple-thermostat cooling system which successively opens up the heads, the block and finally the radiator during engine warm-up. This system is designed to reduce choke time and increase gasoline economy and heater performance.

Power steering on the Edsel is an integral design that has a torsion-bar control for a valve regulating the amount of assist. The

EDSEL SPECIFICATIONS

	Ranger-Pacer	Corsair-Citation
Wheelbase	118.0	124.0
Over-all length	209.0	218.8
Over-all height	56.4	56.8
Over-all width	76.8	79.8
Displacement	361.0	410.0
Horsepower	300	345
Bore and stroke	4.05x3.50	4.20x3.70
Compression ratio	10.5 to 1	10.5 to 1

more you turn, the more the assist. The pump for the unit, incidentally, will be built into the front of the engine, mounted at the end of the crankshaft. There will be no extra fan belt required to drive the pump. The first Edsels off the line will have the conventional belt-driven pumps, but the in-

(Continued to page 257)

Integral power-steering unit has torsion-bar control (pencil points to it) to regulate amount of assist

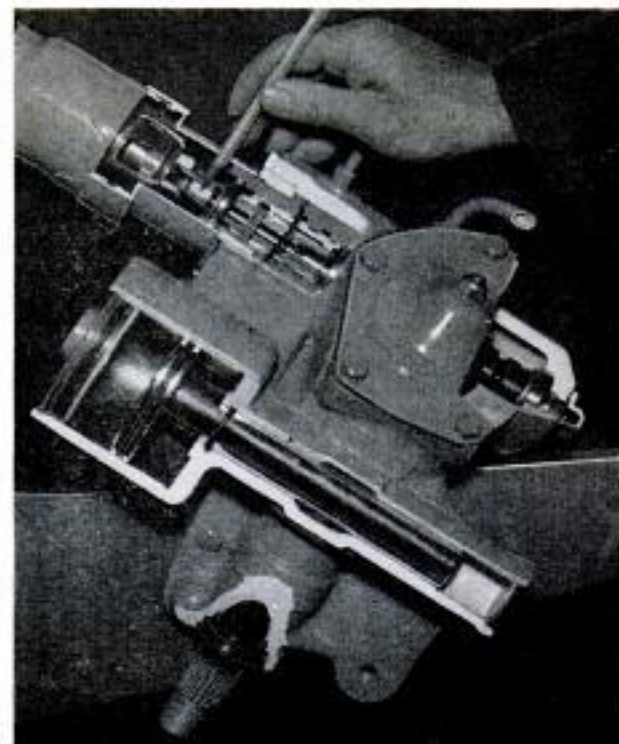

POPULAR MECHANICS

Copyrighted material.

tegral pump will be available soon after introduction date, Edsel says.

Color-conscious motorists who shudder at some combinations of hues on today's cars will appreciate Edsel's decision to use only matching or harmonizing colors.

An important part of the Edsel sales effort (as with all makes) is psychological. The luxurious feeling of the front seat is part of this. Also part of the psychological warfare is the hood configuration. As you sit behind the wheel of the Edsel, tapering creases make the hood seem to extend miles out in front. There is a lot of the Mark II Continental in this sensation. It's not a big car, but to the driver it seems to be. And that is expected to help sales.

Will it succeed? It's no easy task, Edsel admits. No all-new car has been successful since the Mercury was introduced in 1938. Ford's reputation and its millions of devoted customers will help, of course, but it must get sales from other makes if it is to succeed. Edsel is jumping into the ring at a rough moment. The medium-price field is sagging and the veterans in it are in no mood to share customers with any upstart.

Edsel's aim is to provide Ford owners who want to move up with another car in the Ford family. With only Mercury between Ford and Lincoln, the Ford Motor Company has been losing customers to competition. Edsel is here to plug that gap.

It will be an interesting battle. ★ ★ ★

Diving Board for Small Pools

Ideal for the small swimming pool is a compact diving board occupying less than four feet of deck space and extending a few inches over the water. The laminated fir board is attached to two arched steel springs, which are anchored in three or four inches of cured-concrete deck by patented fasteners that drill the holes.

Towle Manufacturing Co., Walnut Creek, Calif.



SEPTEMBER 1957

don't let CORROSION ruin your jobs...
use ALCOA ALUMINUM FASTENERS



GET THIS



NOT THIS

Ordinary plated fasteners peel, blister and rust.

But not Alcoa® Aluminum Fasteners. These Alcoa Fasteners are solid aluminum. They cannot rust. No unsightly stains will spoil the appearance of your work.

For every home repair or workshop project, the very best fasteners you can use are made from Alcoa Aluminum. Your hardware, lumber or building supply dealer has a complete stock of screws, nuts, bolts and washers.

Look for Alcoa Fasteners in this distinctive package . . . distributed nationally by Macklanburg-Duncan, Oklahoma City, Oklahoma.



YOUR GUIDE TO THE BEST IN ALUMINUM VALUE

SUPREME Versamatic

REVERSIBLE SCREW DRIVER
AND SPEED REDUCER



fits all
power
drills

First time ever! It REVERSES!



Drive and remove screws with Supreme Versamatic. Versamatic reduces speed 7 to 1, increases power 7-fold. Reverses with one twist. Handles even the largest screws with ease. Also for nut running (adapter furnished); tapping; and all heavy duty drilling where speed reduction is needed. Fingertip control means safe, fast work. Complete set \$14.95.

($\frac{1}{2}$ " chuck extra). At hardware stores or direct from

SUPREME PRODUCTS Corp., 2222 S. Calumet, Chicago 16

257



Modernize a room in a weekend with soilproof Marlite paneling!

In a few hours you can turn an out-moded room into a modern interior with Marlite paneling. Marlite Planks (16" x 8') and Blocks (16" square) go up fast over new walls or old. The soilproof plastic finish resists smudges and stains; cleans with a damp cloth. See your lumber dealer for Marlite in distinctive wood finishes, marble patterns, "Companion Colors"—or write for free decorating ideas book. Marlite Division of Masonite Corporation, Dept. 942, Dover, Ohio.



Marlite

plastic-finished paneling

ANOTHER QUALITY PRODUCT OF MASONITE® RESEARCH

FLETCHER

WHO CAN'T CUT GLASS?

HAVE YOU TRIED THE NEWLY IMPROVED LUBRICONE IMPINGED WHEEL?
(an exclusive feature by FLETCHER, glass cutter manufacturers since 1903)



SEND FOR THIS FREE CARD. IT TELLS YOU "HOW TO CUT GLASS"
It explains how to cut circles, drill holes, etc.

IT'S FREE

THE ILLUSTRATED GLASS CUTTER CAN BE PURCHASED FROM YOUR LOCAL DEALER
Ask for it by name, FLETCHER

THE FLETCHER-TERRY CO., Dept. D, Forestville, Conn.

SAW SHARPENING IS EASY

Super Filer No. 11 joints and sharpens hand and circular saws 6" to 10" with all teeth correct in height, depth, pitch, bevel. When file hits steel roller, teeth are finished. Saw runs true with no side pull. Includes 8" file. **\$9.95 PPD.**



"TRU-CIRCLE" SAW set automatically sets teeth at 10° or more. **\$2.95 PPD.**



SUPER SAW FILER No. 6

Automatically controls depth, angle, pitch for all saws. Precision made and calibrated. Use in any vise or clamp. Includes file. **\$6.50 PPD.**



DOWEL CENTERS

Centers inscribe exact location for opposite holes. Pairs for 3/4", 3/8", 1/2" holes. **\$1.00 PPD.**

MONEY BACK GUARANTEE—CATALOG FREE

A. D. McBURNEY, 5908 Hollywood Blvd., Hollywood 28, Cal., Dept. A-97

Exclusive Double-Bearing HEAVY-DUTY PUMPS



IRRIGATE • DRAIN • CIRCULATE • SPRAY
Up to 1,500 GPH, 3,000 GPH from 25" well. Use 1/4 to 1 HP motor, 1 1/4" inlet, 1" outlet. Stainless shaft. TYPE X—2 oilless bronze bearings. **\$10.95**
Won't rust. TYPE XB—Ball bearing model. **\$12.95**
Postpaid if cash with order. Rush your order today

MONEY BACK GUARANTEE

Centrifugal and Gear Pumps in All Sizes

LABAWCO PUMPS, Belle Mead 2, N. J.

MAKE \$10-\$20 AN HOUR

Full or part time, work anywhere.

Serrate and sharpen table, steak knives. Every restaurant, hotel, etc., repeat customers. Write today for proven daily profit plan. Guaranteed.



CUTTER-CRAFT

58-C So. Raymond Pasadena, Calif.



Every Boy Should Have This Build-It-Yourself Book for Boys!

It's natural for boys to want to make things—to fuss with tools—to fashion the kind of things "kids" want. So give boys the Build-It-Yourself Book for Boys. Encourage a youngster to express himself through the sensational new Popular Mechanics book that shows how to make 56 different things every boy dreams about. It covers science, mechanics, electricity, modeling and other fields. 192 pages of easy-to-follow instruction and 469 how-to-do-it pictures.

56 Toys, Games, Gadgets, Models, Boats, Electrical Devices, Cars and Other Things Boys Can Make at Home

How to make—Airplane Models, Aquaplane, Archery Kit, Bird Houses and Shelter, Boats, Bobsleds, Boomerangs, Cannon Toy, Electric game, Electric Motors, Garage Toy, Helicopter Toy, Hunting Knife, Hydroplane Model, Kites, Log Cabins, Marble Game, Microscope, Printing Press, Radio Sets, Rafts, Railroad Modeling, Shooter, Scooter, Sidewalk Cars, Sprinkler Truck, Squirt Gun, SS United States Model, Surfboard, Tank Toy, Taxidermy, Telegraph Set, Telephone, Tree House, Water Skis, Weather Instruments, Toboggan, Worktable. Build-It-Yourself for Boys sent postpaid for \$2.50 or COD, charges additional. Money refunded if you are not pleased after 5 days' use. Mail order to address below.

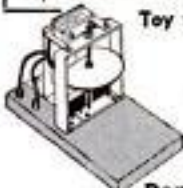

Toy motors



Boomerangs

"Ju-be"—the punt.



POPULAR MECHANICS PRESS

Dept. 957, 200 E. Ontario St., Chicago 11

POPULAR MECHANICS



Two good names are always better than one

When you buy a portable electric drill look for the name JACOBS on the chuck. It is your extra assurance of top tool performance.

An electric drill is no better than its chuck...the point where the drill's power is put to work. Many heavy duty operations are performed with attachments which are held in the chuck, so a tight, accurate grip — a JACOBS grip — means better work done easier.

All leading manufacturers of portable electric tools equip their drills with Jacobs Chucks. Look for the name JACOBS on the chuck when you buy. Two good names are always better than one.

The Jacobs Manufacturing Co.
West Hartford, Connecticut

WOODWORKERS!

- Brand new 145th Anniversary Edition of Constantine's Manual for Craftsmen — 128 pages, many in full color.
- Complete selection of rare and fancy imported and domestic woods, veneers, inlays, carvings, mouldings, hard-to-get items, hardware, upholstery supplies, plans, patterns and Do-It-Yourself information. Send 50¢ (refunded on first order) for this big catalog and reference guide.

ALBERT CONSTANTINE & SON, INC.

2056-C Eastchester Rd., New York 61, N. Y.

KAY-TITE Special

**MAKES
BASEMENT WALLS
DRY FOR ONLY
3½¢ PER SQ. FT.!**

Here's the most revolutionary boon to homeowners with damp, leaky walls! With **KAY-TITE SPECIAL** there is no need to pre-wet the surface or remove other finishes before applying. It controls water seepage on porous or non-porous surfaces. It can be brushed on walls of concrete, cinder block, brick, stucco, stone, etc. **KAY-TITE SPECIAL** transforms wet basements into dry, colorful rooms.

When ordering specify color desired: Buff (tan), Spanish Buff (deep tan), Brick Red, Gray, Cream, Green, Blue, Rose, Yellow, White. No C.O.D.'s. Shipped postage paid. 10 lb. can of **KAY-TITE SPECIAL** @ \$5.00 (makes 1 gallon).

Masonry Coating Products, Inc.
790 Broad St., Dept. PM-9 / Newark, N. J.

REVOLUTIONARY NEW

REVOLUTIONARY NEW

REVOLUTIONARY

NEW

REVOLUTIONARY

NEW

Brand New! Portable Light Plants

WITH PUSH BUTTON

STARTER. Be prepared for

power failures! Provides

plenty of current for

receivers, transmitters,

antenna motors,

emergency lights,

etc. Perfect for radio

hams, civil defense,

trailers and camps.

700 Watts—115 v.,

60 cyc., AC. Pow-

ered by rugged 2.2

H.P., 4 cyc., Briggs-

Stratton or Clinton

gas engine. No wiring necessary, just plug in and

operate. Complete with tote handle, voltmeter and

built-in winding for charging 6 v. auto battery.

Only generator at this low price with radio

shielding! Easily handles any appliance that re-

quires up to 700 watts.

(A76). Shpg. wt. 77 lbs.....

\$143.50

1200 Watts (A126). Wt. 90 lbs. Same as above

but larger engine & generator,

more capacity

\$195.50

2500 Watts (A256). Wt. 225 lbs. Similar to above,

bigger, heavier and develops

more power.....

\$325.50

MONEY BACK GUARANTEE . . . ORDER TODAY!

GENERAL ELECTRONIC SERVICE INC.

P.O. Box 9, Dept. PM-9, Burlington, Wisconsin





**I'VE EYES FOR GUYS
who use
AERO
SHAVE!**



Save 20¢ a Can!

Get wise! Get rich, creamy AERO SHAVE . . . the smoothest, slickest lather bomb of all! Three beard softeners plus Lanolin! *Feel—save the difference!* 3 months supply 59¢.

AERO SHAVE 59¢

NEW, IMPROVED CALCULATOR FOR WOODWORKERS only 25¢

Instantly gives information on lumber, nails, concrete mixes, painting materials, etc. Convenient, simple to read. Just set dial for nail specifications, to convert linear to board feet, find bit sizes for screws, compare characteristics of woods. 6" diameter heavily varnished cardboard. Send 25¢, no stamps, please to Greenlee Tool Co., 2109 Columbia Avenue, Rockford, Illinois.

Amazing do-it-yourself discovery!

Metaltone

T.M.

*...the new spray finish
paint with a
hammered metal look.*

An amazing spray finish that gives a hammered metal look to most any surface...wood, leather, metal, etc.

PROTECTS as it beautifies with a flexible coating resistant to acids, alkali, water, corrosion.

QUICK, EASY TO USE! Sprays on with no muss or fuss...no brush marks. Ideal for home, workshop, anywhere.

ECONOMICAL, BIG 16-OZ. SPRAY CAN... Assorted metallic colors including copper and clear plastic.



**ONLY
\$1.79**

Available at hardware, paint, hobby and department stores or write:

FLAMEMASTER CHEMICALS, INC.
Culver City, California



By Don Hoppe

EXPERTS WARN US that we face a growing shortage of scientists and engineers. Less has been said about the need for technicians to assist these professionally trained men, but it is becoming painfully obvious that for every engineer a squad of from two to 10 draftsmen is needed. A glance at the "help wanted" pages readily reveals this need.

The backlog of engineering work has reached such proportions that some consulting firms have draftsmen working on an unlimited-overtime basis. Some companies offer bonuses of up to \$300 to their employees for each new qualified man they bring in. In addition to high salaries, such inducements as free insurance programs, profit-sharing plans, bonuses, paid vacations and free coffee are offered to lure prospective employees to the larger firms.

In the major metropolitan areas, a senior structural draftsman may command a basic salary of about \$600 a month, but with fringe benefits and unlimited-overtime programs much greater earnings are possible. One highway-engineering company, engaged in a rush program to complete plans for a multi-million-dollar Eastern expressway, willingly paid overtime salaries that ran as high as \$2000 a month in order to meet the promised deadline. Many firms working at a more moderate pace have an overtime program that allows a good man to make \$200 per week. And bonuses can run as high as \$2000 a year in firms that have profit-sharing plans.

How does a draftsman get started and how does he rise to a \$7500 to \$12,000-a-year position? Many engineering offices have excellent on-the-job training programs. Through such programs, young men who have sufficient basic education and an aptitude for drawing may soon establish well-paying careers. Others get their initial training through correspondence school courses, specialized trade schools or technical schools. Some have completed drafting or engineering courses at colleges or universities. It is still a man's world, although the ladies maintain a

(Continued to page 262)

WAR SURPLUS AND OTHER BARGAINS SAVE UP TO 90%

BUILD YOUR OWN ARC WELDER, LIGHT PLANT OR BATTERY CHARGER

Complete Kit \$39.95

Kit consists of: 1 Famous Navy NEA-5 Generator. Combination AC-DC Type. AC voltage — 115 V. DC voltage—24 V. 200-300 Amps. 2 complete generators in 1 . . . 2 separate fields & 2 separate armatures on same shaft yet no larger than reg. aircraft generator. Ideal for home, farm & shop lighting plants by hooking wires to AC side which will give 1200 watts. DC side can be used for charging batteries, welding & operating war surplus low voltage hobby motors & equipment. Also in kit: 1 Voltage Regulator DC. 1 Voltage Regulator AC. 1 Reverse Current Relay. 1 Ammeter and Shunt. 1 Voltmeter. 0 to 30 Volts. 1 Rheostat. 1 Electrode Holder. 1 Giant Toggle Switch. Welder's Shield. Wiring diagram for hookup as welder. Wt. under 100 lbs. Approx. GOVT. COST \$600. Kit. **\$39.95** Navy NEA-5 Generator (only) — same as above . . . if purchased separately: **\$27.50.**

R1 GENERATOR KIT Jack & Helms or GE. Rated 300 Amps. 24-32 Volts. With same items as above incl. 300 Amp Ammeter. Approx. GOVT. COST for kit \$600. Complete kit only **\$39.95.** Wt. 60 lbs.

HEAVY-DUTY RHEOSTAT Designed for heavy-duty use with Air Force heated suits. Ideal for regulating voltage on electric welders, model trains, lights, generators; controls soldering irons, etc. Rated 5.75 ohms, 100 watts with double windings and dual female 25 amp. 125 volt receptacles. Size: 7" H x 5 1/4" W x 1 3/4" D. Shpg. Wt. 2 1/2 lbs. Approx. GOVT. COST \$25. Brand new, only **\$1.95.**

BENDIX PUMP & MOTOR

Can be used for pumping fuel, oil or wherever hydraulic pressure is required. Pump has 1" connections, built-in relief valve, adjustable up to 1500 lbs. Max. capacity 6 GPM. 1 1/2 H.P., 24 volt motor, 4000 RPM. Can be used on 12 to 36 volts. Approx. GOVT. COST \$350. NEW — **\$10.95.**



DUPONT EXPLOSIVE RIVETS! A must for the man who works with sheet metal. A hot soldering iron placed on the head of the rivet will explode and mushroom the other end of the rivet self-bucking itself. 1/8" - 5/32" - 3/16". Round and flat heads. Approx. GOVT. COST \$50.00 a 1,000. NEW. 1,000 assorted. **\$5.00** pcd.



140-1 REDUCTION GEAR Make your own winches, hoists, wagon unloaders, stump pullers or fence stretchers. Sturdy aircraft quality. Built-in removable 24 Volt DC motor & clutch. High torque. Low speed. 100's of uses. Wt. 42 lbs. Approx. GOVT. COST \$300. Like NEW. Only **\$12.** *225-1 Reduction Gear, same as above — **\$13.50.**



FAMOUS B-16 KOLLSMAN AIRCRAFT COMPASS Finest compass ever made. In current use on large and small planes. Ideal for boats, cars, trucks, etc. Graduated in 5° increments. Liquid filled. Lighted, poly-plane compensator. Panel mounting: 3 1/2" dia. face, 4 1/2" in depth. Checked & tested in our own lab. Approx. GOVT. COST \$150. Like NEW. **\$12.95** pcd.



MICROMETERS Black crackle finish frame. Easy-to-read graduations in .001. N.W. 0-1" cap. **\$2.69** pcd. 1-2" cap. **\$3.79** pcd.



JUST OUT! 1958 CATALOG. BIGGEST YET! FANTABULOUS! Thousands of bargains in war surplus and other items. Hundreds of pictures. A must for the value minded! Send 25c for your copy today!

Postpaid prices in USA only. Other prices FOB Culver City, Calif. Send check, cash or money order. 50% deposit required for COD orders.

AIRBORNE SALES CO., INC. DEPT. PM957
8501 Stellar Drive, Culver City, Calif.



Are your chances against cancer any better today?

The answer's yes . . . IF! Formerly, we could cure one out of every 4 cancer patients. Today, it's one out of 3. So why the big IF? Because the odds against cancer depend on you. Only you can give us the money we need to keep research going full speed. Remember, time is *everything* with cancer. Send a check *now* to "Cancer", care of your local Post Office.

American Cancer Society



MENDS MOST ANYTHING

"HOLDS LIKE IRON"
Used by fine furniture makers. Ideal for home and office. In 1/4 oz. or 2 1/2 oz. sizes.

HELPFUL BOOKS

Send post card asking for FREE catalog
Popular Mechanics Press, 200 E. Ontario, Dept. 601, Chicago 11

AMERICA'S MOST EXCITING SPORT

MICRO-MIDGET RACING is America's fastest growing sport. Now anyone from 18 to 60 can own a real racing car and have all the thrills and excitement of **SPEEDWAY RACING.**

The all-new 1957 **COMET** is the ultimate in Micro-Midgets and has no equal. Send 25c for illustrated literature describing all details.



The HANDBOOK for SMALL RACING CARS

The ALL-NEW 5th Edition of this very popular Handbook is jam-packed with **EXCITING ARTICLES, ACTION PICTURES, PLANS, SPECIFICATIONS, ENGINE INFORMATION, TRACK and RACING DATA, HOW TO START A RACING CLUB, HOW TO BUILD A TRACK, ALL RULES and REGULATIONS, etc., for 1/4 MIDGETS, MICRO-MIDGETS, 1/2 MIDGETS, 500 cc CARS, and FULL-SIZED MIDGETS.** You've never seen a book filled with so much **ACTION, EXCITEMENT, and VITAL INFORMATION.** It also serves as a **COMPLETE CATALOG** telling where to buy **ENGINES, WHEELS, INDIVIDUAL PARTS, SUPPLIES, and COMPLETE CARS.** All for **ONLY \$1.00.**

COMET MANUFACTURING CORPORATION
Dept. PM-9, Box 74397
Los Angeles 4, Calif.

LUBRIPLATE LUBRICANTS



Make Cars Run Better . . . Last Longer!

LUBRIPLATE AUTO-LUBE "A" is the perfect water proof, grease type all-purpose auto lubricant. Does not wash off nor run out. Reduces friction and wear. Prevents rusting. Protects your car investment. Ideal for chassis, wheel bearings, universals and other car parts.

Your car deserves the best. . . .
Use **LUBRIPLATE**—You'll see the difference immediately!

At Better Service Stations and Car Dealers

OTHER LUBRIPLATE PRODUCTS

LUBRIPLATE H.D.S. MOTOR OIL for cars, trucks and tractors
LUBRIPLATE 2-C MOTOR OIL for outboards
LUBRIPLATE OUTBOARD GREASES for underwater gears
LUBRIPLATE in handy tubes for sports and household uses
LUBRIPLATE Industrial Lubricants for every application.

LUBRIPLATE DIVISION, Fiske Brothers Refining Co.,
Newark 5, N. J., Toledo 5, Ohio.



IMPERIAL—easiest operating of all tube cutters!

Hi-Duty® No. 274-F tube cutter has free-wheeling action. Makes clean, right-angle cuts on hard or soft tubing, 1/8 to 1" O.D. Retractable reamer. Spare cutting wheel at no extra cost. Other Imperial cutters to 2 1/4" O.D. Also benders, flaring tools, sawing vices.
Sold by leading Industrial, Refrigeration, Plumbing and Automotive Supply Houses everywhere.

SEND 10c for VALUABLE HANDBOOK and CATALOG

THE IMPERIAL BRASS MFG. CO.
1212 W. Harrison St. Chicago 7, Ill.
Send 36-page Imperial Tube Working Handbook and Catalog. Also name of nearest dealer.

Name _____

Address _____

City _____ Zone _____ State _____



persistent minority in the drafting rooms.

Regardless of the source of their basic training, those who reach the higher-paying jobs have this in common: They are creative members of an engineering or research team and must be able to contribute actively to the development of their firm's product. They know this product or service thoroughly, so they can translate ideas into detailed drawings without excess supervision. And, finally, their work reflects craftsmanship in its neatness and accuracy.

The drawing board is the beginning of nearly all the constructive and productive activity that man undertakes. Consequently there are numerous types of draftsmen. Architectural, structural, mechanical, civil engineering, statistical, topographic, aircraft, piping, electrical, chemical engineering, tool design and product design are some of the major classifications. Since many of the engineering fields overlap, it is possible for a good draftsman to become experienced in more than one major field, thereby increasing the employment opportunities open to him.

What preparation is necessary in order to study drafting? A high school education or its equivalent is basic. Mathematics and science courses are the most helpful. Mechanical drawing and shop courses are valuable, too. Some kinds of drafting require considerably more mathematics than others but all draftsmen in the engineering fields (which now offer the most opportunity) should have a working knowledge of algebra, geometry and trigonometry. Of the science courses, physics is probably the most useful.

Salaries for drafting trainees range from \$300 to \$400 per month in the major employment areas. To enter one of these programs, the trainee must be able to do the more elementary drawings in pencil or ink and do neat and attractive lettering. A beginner is often judged by his lettering.

After his initial employment, the future depends on the aptitude and industry of the trainee. In two years he may be able to accept employment as a regular draftsman. And after five years he may be regarded as a senior draftsman.

The future for the trained draftsman promises to be as good or better than the past few years. Our great highway building programs are well under way, but the greatest expansion is still to come. We still have a tremendous backlog of municipal improvement work. And we are on the threshold of new eras in automation, electronics and atomic power. These developments will absorb our engineering talent for years to come. And this means a continuous need for draftsmen. ★ ★ ★

**GIGANTIC
SAVE-TO-70%**

MAIL SALE

**WAR SURPLUS
EXCESS INVENTORY
BANKRUPT STOCK**

BATTERY WINCH

• Powerful fully reversible, ball-bearing gear reduction winch. 1000-2000 lb. pull. Use on 6 or 12-v battery. Holds 40' of 1/4" cable. For trucks, docks, boats. Govt. cost \$280. FOB \$46.75

DIAL PHONE

• Modern dial type. Use for extension, private line, etc. Self contained transmission circuit easy to connect. List \$25. Ppd. \$9.95

SPEED REDUCER

• Variable hydraulic. Speed zero to 750 rpm. Up to 1 1/2 h.p. Use midget cars, hand saws, etc. Govt. cost \$400. FOB \$47.81

ELECTRIC CAR MOTOR

• Use golf or boys electric car. Geared 140 to 1. Run 6 or 12 volts. Easily reversible. Full instr. Wt. 34 lbs. Govt. cost \$250. FOB \$19.46



ELECTRIC PUMP

• Runs on 12-volt battery. Centrifugal type. Many uses. Govt. cost \$84. Ppd. \$9.95

HYDRAULICS — PUMPS — COMPRESSORS

- Hydraulic Cylinders 1 1/2"x0".....\$4.89
- Hydraulic Pump Elec.....\$13.95
- Stainless 12X24 in. Air Tank.....\$18.95
- Air Compressor, 150 lbs.....\$19.95
- Pressure Regulator.....\$2.95
- Pressure Gauge 100 lbs.....\$1.89
- Industrial Paint Gun.....\$11.95
- Air Tank 10X18 in.....\$8.79
- Irrigation Pump, 2 1/2".....\$49.71
- Irrigation Pump, 1 1/2".....\$24.61
- Astronomical Telescope.....\$36.50
- Finest 7x50 Binoculars.....\$26.81
- 115-V 800-Cycle 1200-W Generator \$13.91

POWER PLANTS

• Amazing boys. Army and regular plants and generators. Both DC and AC units. Low as \$59.50

ICE AIR CONDITIONER

• Uses earned ice. Has twin turbine blowers. 3 models. (1) 110-v AC. (2) Car 6-v. (3) Car 12-v. Natl. Adr. 839.50. SALE, FOB \$14.97

SPECIAL OF THE MONTH!

ELECTRIC CLOCK TIMER

• Finest 115-v 60-c self-starting electric clock-timer. Shows exact time also will sound built-in alarm signal at some preset time. Size dial 3 1/2". Wt. 1 lb. • Ideal for building into desks, furniture, radio-TV sets, laboratory units, etc. Attractive white dial with red minute numerals and black hands. Easy to mount. • Made by leading company for special Govt. application. A 4-star buy! List \$12.50. Prepaid Sale.....\$2.89



OUTSTANDING BARGAINS

- Plastic Water Pipe 3/4", per ft.....12c
- Gear Reduction Unit, 85-to-1.....\$8.49
- Gear Reduction Motor, 54-to-1.....\$4.97
- Hand Winch, boats, trucks.....\$8.95
- Farm Weed Spray Outfit.....\$69.95
- Machinists Calipers, in case.....\$3.19
- Hydraulic Hand Pumps.....\$10.95
- Army Prismatic Periscopes.....\$1.95
- Furnace Blower with motor.....\$21.95
- Fish and Worm Shock Generator.....\$3.89
- Govt. Jungle Hammock Tent.....\$6.95
- Farm Magneto 5-Bar Phones.....\$12.95
- Air-Power Tree Trimmer.....\$8.50

Order from ad or write for new free catalog.

BURDEN SALES COMPANY

811 "O" St., LINCOLN, NEBRASKA

TWO WAYS TO BUY BETTER

Your dealer knows the right products for your needs—quality products that are nationally advertised. POPULAR MECHANICS brings you a monthly roundup of valuable "how to" information and product advertising. Read POPULAR MECHANICS every month—then talk to your dealer.



100 BEST Woodworking Projects

Selected by Popular Mechanics Editors

Enjoy the fun of making things. Revel in the pride of the craftsman when neighbors and friends admire your handiwork. Get 100 BEST WOODWORKING PROJECTS, complete with simplified instruction, plans, diagrams and more than 400 how-to-do-it pictures. Make all kinds of furniture — chairs, tables, desks, bed room furniture. Make baby carriages, clock cases, lamps, book shelves, fireplaces, attic ladder, folding screen, kitchen accessories, games, swings, storage bins, garden sets, etc., at little or no cost. Send only \$2.00 with name and address today. Money back if not pleased.

POPULAR MECHANICS PRESS, Dept. 957
200 E. ONTARIO STREET CHICAGO 11, ILL.

The "Must" for All
Home Workshops



WHAT DO YOU KNOW ABOUT



HAND SAWS?

HIGH CROWN

... means that the tooth line is curved or arched. This arched tooth arrangement gets fewer teeth engaged in the wood at a time ... reducing friction, making cutting easier ... faster. SANDVIK Swedish Charcoal Steel Hand Saws feature this high crown. This is only one of SANDVIK'S many exclusive advantages. Before you buy any hand saw, ask your dealer to show you a SANDVIK.



Want to know more? Write today for the new 16 page booklet that tells all. "Things You Should Know About Hand Saws." It's free! Dept. PM

Sandvik SAW & TOOL

Division of Sandvik Steel, Inc.

1704 NEVINS ROAD, FAIRLAWN, N. J.

IN CANADA: P.O. Drawer 1330, Station "O," Montreal 9

Short Cuts with WILHOLD WHITE GLUE

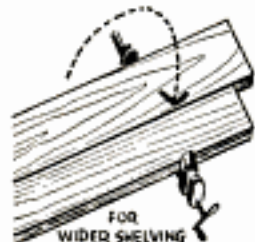

SAVE WOOD SCRAPS

... with edge gluing

Glue edges of scrap wood together with Wilhold white Glue. Clamp for 20 to 30 minutes. Then machine. Strong as a solid board. A Short Cut money saver. AD #1037

Paint, Hardware, Lumber, Variety Stores. Or write
WILHOLD PRODUCTS Los Angeles 31, Calif.; Chicago 44, Ill.

WISE-GRIP Now This Easy to Open!

A squeeze of the hand locks jaws onto work with 2,000 lbs. pressure!



Press "Easy Release" and jaws spring apart— instant!



EASY DOES IT with the new Vise-Grip! Squeeze, and jaws lock tight...press Easy Release and jaws click apart. Really a whole tool kit by itself! Quickly adjusts to any size work — for use as a Locking Wrench, Super-Pliers, Hand Vise, Clamp, and Wire Cutter. Get the new Vise-Grip and feel the power it gives you. 7" and 10" models, wire cutter optional, only \$2.15 to \$2.95.

AT YOUR HARDWARE STORE • MADE ONLY BY PETERSEN MFG. CO., Dept. M-9, DeWitt, Nebr.



BUILD YOUR OWN GUN CABINET!

It's EASY! With Gunberth Plans & Kits All details on Plans, Kits and Hardware are listed in big, beautifully illustrated . . .

"HANDBOOK"—Catalog Finished cabinets in 82 different styles also available. Get your copy NOW!

Only \$1.00 ppd. (Refundable first order!)

COLADONATO BROS.
Dept. G30 Hazleton, Pa.



Model Makers!

Metal Turning Lathe
Only \$35.00

F.O.B. Lansing, Ill.
15 1/4" bed with 4 1/2" swing.
7" between centers.

Satisfaction Guaranteed.
FREE FOLDER
Write for it today!

Rosemoor Manufacturing Co.
Box 147A, Lansing, Ill.



CAN YOU HANG A PICTURE SO IT WILL STAY STRAIGHT?

A SIMPLE, SURE,
EASY METHOD — \$1.00
Money Refunded if Not Satisfied

Write C. L. VENARD
111 NORTH MADISON PEORIA, ILLINOIS

WELD **BRAZE**
SOLDER **CUT**



Acclaimed by thousands of Homeowners, Mechanics and Hobbyists as the welder of 1001 uses. Easily operated from properly wired 110 volt AC or DC line. The ideal gift with a life-long use...Order today on 10 day money back guarantee.

FOUR-WAY WELDER CO., Dept. F2-J
1810 S. Federal St. • Chicago 16, Ill.

4WAY
ONLY
\$14.75
f.o.b. factory
WELDER
Complete with
Twin Carbon Arc
Torch and ac-
cessories . . . to
handle all metal-
craft work.

RETAIL PRICE \$125.00
FACTORY TO YOU \$79.95

SUPERSHOP includes precision-built 8" tilting table saw, vertical and horizontal drill press, 30" lathe, sander, grinder. 100% BALL BEARING. Write for FREE catalog, full details, trial plan. Easy Pay Plan.

POWER TOOLS, INC.

109 YATES AVENUE
BELLOIT, WIS.

POPULAR MECHANICS
MAGAZINE

OCTOBER HOME SECTION

See Our Annual Home Section—Next Month

Two new PM homes specially designed for our readers are featured in full color in our fifth annual October Home Section. One is Traditional, the other Modern. Plans for both are available. Also featured in the 50-page section are the latest in wall coverings, concrete blocks and other building materials, ways to add space to your house, how to build a fireplace, how to line a closet with cedar and scores of other useful ideas. Special articles take you on a visit to a unique solar house, an ambitious do-it-yourself home in Minnesota and on a cross-country tour with our own Parade of Homes.

SPECIAL ENGINE GENERATOR SALE!

115 VOLT ELECTRIC STARTING

Field tested by Palley engineers and proved in a wide variety of applications from stands by power for commercial and home use to portable power for contractors' tools, police & fire departments, etc. Versatile—easy to service—durable... and at low Palley price!

PALCO 1500-WATT GENERATOR

Compact, lightweight, readily portable. Able to handle the starting load of repulsion-induction or capacitor type motor up to 1/3 HP as well as a minimum lighting load. Electric starting with any 12 volt battery. Complete with Clinton 1200 series, 3.6HP, 3600 RPM engine and 15 VDC outlet for charging batteries. Equipped with hi-lo charge rate switch and ammeter. Price does not include cradle.

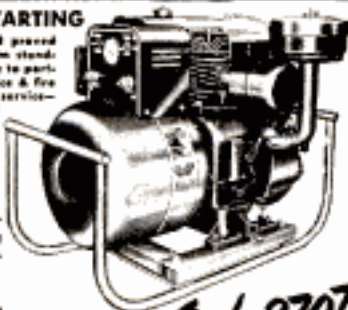

Only 270⁷⁵
No. P-115-18

115 V 2500-WATT • ELECTRIC START ENGINE GENERATOR

The size used most in the construction and electrical trades. Easily handles the starting load of 1/2 HP motor plus ample capacity for added lighting etc. Comes equipped with hi-lo charge rate switch and ammeter. Briggs & Stratton No. 14FB, 5.25 HP, 3600 RPM engine. Starts with any 12 volt battery. Price does not include cradle as illustrated.

359⁹⁵

115 V 3500 WATT POWER GENERATOR

A rugged, heavy duty model equipped with the famous Briggs & Stratton No. 22AFB, 9 HP., 3500 RPM engine. Will handle starting current of a 1 HP electric motor with enough additional capacity for appliances, lights etc. Will deliver 115 volts, 60 cycle current. Has 15 VDC outlet for use as battery charger, etc. Comes with hi-lo charge switch and ammeter. Cradle not included in price.

436⁵⁰

GENERATOR CARRYING CRADLE Designed especially for the engine-generator units described above. Made of tubular steel with all-welded construction. Provides utmost portability.

109^{5EA}

NOTE: Power ratings given above is under FULL LOAD.

NEWLY DEVELOPED 3000 PSI 4-WAY HYDRAULIC VALVE IDEAL FOR ALL HIGH PRESSURE SYSTEMS

HEAVY DUTY — OPEN CENTER — SLIDING PISTON WITH BUILT-IN RELIEF VALVE

Only 32⁷⁵

These valves can be connected in series to operate two or more hydraulic cylinders independently or in unison. Sliding piston type with open or closed center in neutral. Maximum flow 10 GPM. Operating pressure to 3000 PSI. Built-in relief valve adjustable from 500 to 3000 PSI. High strength malleable steel body. Inlet and outlet are 1/2" standard pipe ports. Cylinder ports are 3/8".

IN OPEN STOCK

Valve No. H-V13-5 — as described above

Valve No. H-V13-6 — As above but has detents to hold lever in either extended position until returned to neutral manually

**32⁷⁵
32⁷⁵**

4-WAY CLOSED CENTER VALVES

Valve No. H-V13-7 — Same as H-V13-5 but has closed center neutral position

Valve No. H-V13-8 — Same as H-V13-6 but has closed center neutral position

**32⁷⁵
32⁷⁵**

SPECIAL GOV'T SURPLUS HYDRAULICS

3000 PSI HYDRAULIC CYLINDER



This is the finest, genuine Gov't Surplus stock. Bore is 2 1/4", shaft is 1", stroke is 4" and the eye-to-eye length is 13 1/2". All ports are 1/4" AN. These have been used but are in excellent condition. **\$12.50**



SURPLUS 2000 PSI HYDRAULIC CYLINDER

Has all steel barrel with chromed shaft and aluminum caps. Bore is 1 3/4", shaft is 1", Stroke is 15 3/8", overall length is 22". All ports are 3/8" AN with 9/16" 18 thread. Here's a real bargain buy!

No. H-1405U — Used — **\$11.75** No. H-1405U — OVERHAULED **\$15.75**

2000 PSI HYDRAULIC CYLINDER

Small, but a rugged dependable performer. Bore 1", Shaft 5/8", Stroke 1-1/8", Lath 6". **4⁷⁵**

SURPLUS GEARS

85 to 1 GEAR RATIO

For use where tremendous power at a low take-off speed is desired. Drives thru a train of 6 gears rotating on self-lubricating, hi-speed roller bearings. Take-off shafts are 1/4" and 3/8" **5⁹⁵
USED
8⁹⁵**



WICKERS HYD. ANGLE PUMPS

Made to top aircraft specs.

Cat. No.	GPM	PSI	RPM	Price
H-P4A	5.3	1000	3000	\$22.50*
H-P5A	2.7	1500	3000	25.75*
H-P4U	6	1000	3000	22.50*

*Used but excellent condition.
— NOTE: We also stock Hydraulic Motors as well as many other hydraulic pumps.

LARGEST FIRM OF ITS TYPE IN THE WORLD



2 1/2x - 4x or 6x RIFLESCOPES

10 DAY MONEY-BACK GUARANTEE!

YOUR CHOICE! SAME PRICE!

INCLUDING MOUNT
2 1/2x — Overall lgh. 9 1/2"
30 ft. field of view at 100 yds.
4x — Overall lgh. 9 1/2"
30 ft. field of view at 100 yds.
6x — Overall lgh. 10 1/4"
30 ft. field of view at 100 yds.



NEW PAL-MASTER SCOPES

for TARGET • BENCH REST or HUNTING

Choice of 3 different powers of the same LOW PRICE! **9⁹⁵ WITH MOUNT**

COMPARE THESE QUALITY SCOPE FEATURES:

- 1—ADJUSTMENTS Positive Internal Direct Reading Windage & Elevation Knobs
- 2—LENSES Top quality Optical Glass —precision ground, polished, color corrected, no distortion, hard coated glass-to-air surfaces.
- 3—EYE RELIEF 2 1/2" to 4 1/2". Safe on heavy recoil.
- 4—RETICLE Sharp, Clear Cross-Hair.
- 5—FOCUS is Lock-Tight. Won't "shoot off."
- 6—BARREL Rustproof, Extra Durable Steel
- 7—Guaranteed to perform perfectly on ANY RIFLE.
- 8—Made by leading American Optical firm.

MOUNT INCLUDED WITH SCOPE

SIDE or TOP MOUNTS available with scope to fit most rifles. When ordering specify type mount, gun model number and brand.

AIR CORPS 16 POCKET VEST

Ideal for Hunter, Rifleman, etc. Has 14 individual, outside pockets for small objects, 2 inner pockets (11"x 8") and a leather pistol holster. Sturdy, yet lightweight with adjustable tie-straps on the back for a snug, comfortable fit. **3⁴⁹**



PORTABLE SHOVEL

G.I. Surplus. 20" handle. Blade folds to form pick. Copy in car for emergency. **1⁷⁹**

ARMY MACHETE

22" Vanadium steel blade & wood handle. Sheath included. **1⁹⁸**

ARMY PICMAT TOCK

Ideal for use around the Camp or Garden. New Army Surplus. Small, easy to use. Has a 12" steel head with a Mattock on one side and a Pick on the other. Has a 16-1/2" hardwood handle. Complete with sheath... **1⁹⁸**

1/6 HP 6000 RPM LINEAR ACTUATOR

Thread-adjustable drive shaft travels 3" either direction in 15 seconds. Will stand compression or tension load of 800 lbs. Static load 1750 lbs. Motor is 24VDC., 11.5 amps., series wound. Rated 1/6 HP. Turns 6000 RPM. One minute intermittent duty. Extended length 17", retracted 14". **9⁹⁵**

NOTE: Many more types in stock. Write us your special requirements.

BOLO KNIFE

15 INCH **ONLY 1⁹⁸**

Made of top quality, Vanadium Steel, ideal for clearing brush, etc. Complete with belt sheath.

NEW 16 QUART OIL DRAIN

All metal construction. Top slants to receiving hole. Funnel shaped on end for easy pouring. Has two carrying handles. A removable handle fits either end. Size is 5"x 10-1/4" x 18" long. **ONLY 2⁴⁹**

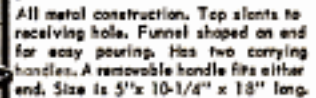

AIR PRESSURE TANK

G-1 Type, Stainless Steel. Shatterproof and rustless. Built to withstand up to 400 PSI with high safety factor. Has 1/4" pipe ports. Ideal for use in Air Storage for painting, spraying, etc. Can also be used for water storage, as a buoy, etc. Size: 12 1/2" diam. x 24" length. **NEW and UNLTD 16⁹⁵ USED 12⁹⁵**

WORLD'S MOST AMAZING BARGAIN CATALOG

1957 EDITION — 396 PAGES

NATIONALLY ADVERTISED MERCHANDISE — NEW and USED GOV'T. SURPLUS — FACTORY CLOSEOUTS — EXCITING IMPORTS!

From EVERYWHERE PALLEY'S now bring you items of every description! This fabulous catalog contains Hand & Power Tools, Microscopes, Binoculars, Industrial and Building Materials, Housewares, Office Equipment, Sport & Outdoor Equipment, Cameras, Photo Supplies, Hobby Kits & "Gadgets", Electrical & Radio Supplies, Motors & Generators and a HUGE selection of Surplus Hydraulic Cylinders, Pumps, Valves, etc.

We are now one of the foremost manufacturers of CUSTOM-MADE HYDRAULIC CYLINDERS. Our tremendous volume enables us to sell for BELOW MASS PRODUCTION PRICES!

Send 50¢ (for handling & mailing) LIMITED EDITION! ORDER YOURS NOW! 50¢ REFUND on your first order of \$1.00 or more.

PRICE F.O.B. Los Angeles, Calif. Send 50¢ Deposit with all C.O.D.'s.

Palley's 2263 E. VERNON AVE., DEPT. PM-9 LOS ANGELES 58, CALIF.



"ARCO-SAW" does more than a \$100 portable saw!



ZIPS THRU 2" BOARD IN ONE EASY CUT!



CUTS ANY GROOVE. AN "ARCO" EXCLUSIVE!



CUTS ANY ANGLE!

Build anything from a bookcase to a bungalow with this rugged portable saw. Fits any 1/4" drill. Rips & crosscuts up to 2" board. Exclusive "Dado-Arbor" adjusts for cutting grooves up to 1/2" wide x 1" deep in ONE CUT! Not even a \$100 portable saw has a dado cutter. Has Depth-Bevel-Rip Gages. Safety-yoke permits 1-hand operation. Incl. 5" blade.....

\$12.95

At Your Dealer or order direct on our Unconditional 10-day Money Back Guarantee. Send check, M.O. (ppd.) C.O.D. plus post.

ARROW METAL PRODUCTS CO.

Dept. PM-9 421 West 203 St. New York 34, N.Y.

BOAT PLANS-PATTERNS FRAME KITS

A modern up to date series of inboard and outboard designs for the amateur builder. State specific size and type or send 50c for BIG NEW CATALOG.



marine **GLEN** designs Box 568T Compton, Calif.

Help Fill the MS*

- Research
- Clinics
- Patient Aid



*MULTIPLE SCLEROSIS

Whatever the job, you'll do it better with nationally advertised products. Ask for products advertised in POPULAR MECHANICS

PM TAG of INTEGRITY

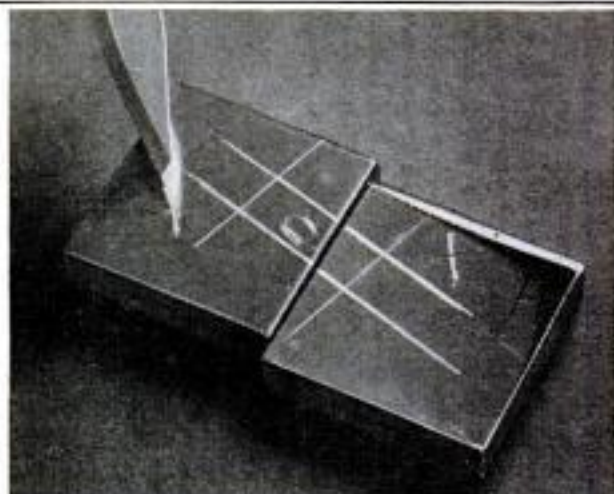

Material Made From Glass Can Scratch Steel

Hard enough to score blocks of steel (above), although made from glass, a new material called Pyroceram has been developed and is reported to have a variety of potential uses. It is made by mixing additional ingredients with the raw materials of a glass batch, which is cooled and then put through a special heat-treating process. First application of the material is for hypersonic guided-missile radomes. The before-and-after photograph, above right, shows how heat-treatment turns the transparent glass to opaque. However, it can

also remain transparent. The three-foot lighter-than-aluminum cones will protect sensitive directional equipment in missile noses from the sudden extreme temperatures of hypersonic flight. Other possible uses for the material, according to the manufacturer, include aircraft parts, engine components, oil and chemical piping, heat-conducting range tops, cooking and eating ware and curtain walls for industrial buildings. Pyroceram was invented by Dr. S. Donald Stookey of the Corning Glass Works.

PORTABLE LIGHT PLANTS

GIANT 2500 WATT PLANT

110-120 v. 60 cyc. AC. Absolutely the best made - exclusive dynamo-cally balanced armature; heavy windings develop up to 5000 watt overload for motor starting. Skid mounted - portable. Powered by an easy starting Briggs or Wisconsin 6 HP engine—complete with all accessories! engine easily disconnected for other uses. Big outlet box, voltmeter, no wiring necessary. Ample current for all purposes. Factory Warranty. (Item 31) Wt. 210 lbs. Reg. price \$585. Special at..... **\$299.50**

Same plant with electric self starter (Item 31a)..... **\$359.50**

DUAL VOLTAGE 110-220 available on any of above models for \$28.00 additional. Generator only and control box..... **\$169.50**

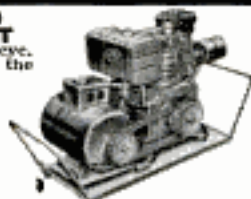

SAVE middleman profits
get **MASTER MECHANIC'S**
direct factory prices

EXCLUSIVE! NEW! LIGHTWEIGHT WATER COOLED DIESEL GENERATOR PLANT

Never before available! Now offered exclusively by Master Mechanic. A low priced, lightweight, continuous duty, Diesel generator set. Powered by a super rugged, exceptionally smooth running, one cylinder Diesel engine. Operates at conservative 1750 r.p.m. and delivers full 1750-2000 watts of power. Operates on low cost fuel oil. Wt. only 240 lbs. representing a triumph of Diesel Engineering. Complete with fuel filter, oil pressure gauge, control box with duplex receptacle and voltmeter. (Item 830) Special factory price..... **\$399.50**

DIESEL ENGINE only, as above described 3.5 HP (Item 830a) Wt. 116 lbs..... **\$249.50**

700 WATTS PUSH BUTTON START 115 v. 60 cyc. AC. Powered by a rugged 2.2 HP easy starting Briggs engine. No wiring necessary! just plug in and operate. Plenty of current for any oil burner, freezer, toaster, emergency lights, etc. Which require up to 700 watts. Ideal for television and radios. Complete with Voltmeter and built-in winding to charge B.V. auto batteries. (Item 24) Wt. 75 lbs. Easily fits in car trunk. Be prepared if storm knocks out power lines. Reg. \$275 value..... **\$143.50**

1200 Watt Plant (Item 45) same as Item 24 but larger generator and engine with 50% greater output..... **\$199.50**

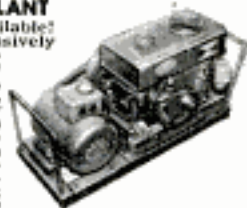

LESS THAN WHOLESALE

1500 WATT PLANT

115 v. 60 cyc. AC. Push Button Start. Powered by a 3 1/2 HP. Clinton engine. Combines big output with easy portability. Provides emergency power for operating any oil burner, steam pump, freezer, television. Lights, communications systems, etc. which require up to 1500 watts. (Item 22) Wt. 110 lbs. Reg. \$475 value. Factory price... **\$239.50**

1750 Watt Plant Powered by 4.5 Briggs engine. Electric starting & battery charging built-in! Factory price... **\$279.50**

2500 WATT PLANT—Push Button Start (Item 21) 110/120 v. 60 cyc. A.C. A rugged powerful plant. Reg. \$645. Spec. **\$329.50**

3500 Watt Plant Push Button Start (Item 23) 115 v. 60 cyc. AC. Similar to above, but larger and 35% more capacity. Wt. 270 lbs. Reg. \$760. Factory Price..... **\$379.50**

DUAL VOLTAGE 110/220 for Item 21 or 23—\$30 additional. We make every type and size of light plants—Write, giving us your requirements!



EXTENSION CORD

Heavy duty and very flexible. Neoprene 14-2 cable. 20 year quality. Wt. 12 lbs. (Item 185) 100 ft. Complete with rubber plug and outlet. A terrific buy at only **\$8.95**

No. 10-2 Power Cable. Heavy duty. Very flexible. 30 ft. with male and female fittings. Wt. 4 lbs. (Item 818b)..... **\$5.15**
20 ft. without fittings (818a)..... **\$4.15**
50 ft. (Item 592) with fittings..... **\$13.45**
100 ft. (Item 135) with fittings..... **\$25.95**

No. 12-2 Power Cable. Very flexible rubber covered, special outside shield for grounding power loads, etc. 50 ft. (Item 190) Wt. 8 lbs. **\$6.95.** 100 ft. (Item 200)..... **\$12.95**

No. 8-2 Conductor Power Cable. 80 ft. heavy duty. Very flexible rubber covered with male & female plug (Item 817)..... **\$12.95**



SCREW-TYPE PRESS

A tremendously powerful screw capable of exerting nine tons of pressure. Pays for itself straightening bent parts, or pushing out bearings and washings. Ideal for manufacturing and assembly operations. Because of precise control. Massive 1 1/2" screw permits precise control over vertical travel. Extra heavy ribbed yoke has a throat 2 1/2" high; depth capacity for working into the center of an 1 1/2" object. Includes 8" x 15 1/2" vise-type table and two pushing arbors. Wt. 150 lbs. (Item 797). Reg. \$149.50. Special..... **\$49.50**

HYDRAULIC PRESS. Nine ton capacity. See Aug. Pop. Mech's. ad for details—or write. Complete. Wt. 110 lbs. (Item 464)..... **\$69.50**

Double Acting Hydraulic Cylinder

A powerful cylinder mfd. by Massey Harris which develops both a pushing and a pulling action. Will push 8,100 lbs., with a 1000 PSI pump pressure. Cylinder is 3 3/4" O.D. with 4 1/2" stroke—standard heavy duty clevis on both ends. Has standard 3/4" pipe thread openings. Can be used for tilting buckets or blades, raising or lowering implements, hydraulic presses, etc. Can also be used as an air cylinder. (Item 802) Wt. 17 lbs. Reg. \$68 value. Special..... **\$14.95**

OTHER DOUBLE ACTING CYLINDERS
8" stroke - 3" bore..... **\$34.00**
10" stroke - 3" bore..... **34.80**
10" stroke - 3" bore..... **43.00**
24" stroke - 3" bore..... **47.50**

We have all sizes of cylinders available.
HYDRAULIC CONTROL VALVE—4 way open center valve with built-in adjustable relief. Controls 1 double, or 2 single acting cylinders. Equalizing feature permits easy control even under heavy loads. 3/4" pipe thread on inlet & outlet. 1/2" on cylinder outlets. Easily mounted, finger tip control. Wt. 34 lbs. (Item 822)..... **\$21.95**

Variable Speed Selector

Heavy duty, made by E. F. Goodrich for industrial use. Provides instant speed changes for any drive. For machine tools, dryers, printing, conveyors, production lines, hoists—any operation requiring variable speed. Employs reliable "trouble free" planetary system. No hydraulic power losses. Infinite range, smooth operation, easy installation. 3 sizes: 1/2-1 hp., 3/4-1 1/2 hp., 1-2 hp., 2-3 hp., 2-3 hp., wt. 105 lbs.; Reg. list \$228, \$252 and \$252. Our prices **\$79.50, \$89.50 and \$114.50**



FAUCET WATER HEATER

Instant hot water from any faucet for just pennies—noads unobtrusive—just install. You just plug MASTER MECHANIC'S new Faucet Water Heater over any water faucet, plug it in a wall outlet and you've got steaming hot running water instantly for dishes, shaving, washing baby's bottle, etc.

Simple and safe—operates on ordinary 110v. house current—costs only 2 1/2 cents per hour for hot water. Ideal for homes, bars, cabins, trailers, etc. Easily regulated from lukewarm to full hot. Fully guaranteed! (Item 408) Wt. 2 lbs. Factory price F.O.B. Burlington, only..... **\$4.95**

HEATING & VENTILATING FAN

(Item 10) Easily installed in furnace pipes. Forces even heat in all rooms. Over range removes kitchen smoke and odors. Powerful, continuous duty motor, 110-120v. AC. Mount in wall or ceiling to ventilate any area. Quiet, super-efficient fan moves huge volume of air, 1400 to 600 CFM.
8" Pipe, wt. 5 lbs..... **\$6.85**
9" Pipe, wt. 6 lbs..... **\$7.85**
10" Pipe, wt. 7 lbs..... **\$8.85**
12" Pipe, wt. 8 lbs..... **\$9.85**

HEAVY DUTY FAN. Semi-enclosed motor, suitable for spray booths, restaurant exhausts, poultry houses, etc. 10" Fan, wt. 8 lbs. (Item 108)..... **\$11.95**
12" Fan, Wt. 10 lbs. (Item 109)..... **\$12.95**

HIGH SPEED BARN FAN similar to above, but larger, high speed motor moves huge volume of air.
12" Fan (Item 106)..... **\$14.95**
14" Fan (Item 107)..... **\$17.95**

GIANT METAL SHEARS

Nine inch cutting blade made of special high carbon alloy steel, perfectly aligned and ground. Easily cuts steel plate up to 12 gauge or 1/4" thick. Overall length 40". Wt. 23 lbs. (Item 158) Regular **\$49.50.** While they last..... **\$14.95**

Send check or M.O. Prices f.o.b. Factory. 10 day Money back guarantee. SEND 10c for... **BIG 1957 Catalog**

LANDING MAT

TREMENDOUS SAVINGS

Invaluable for stabilizing muddy roads and off-road areas. Used widely for shoring in excavations and mines. Ideal heavy reinforcing for concrete. Makes super strong curbs, retaining walls, docks, sheds, truck sides, gratings, enclosures, etc. Hundreds of uses. Available at less than 50% of cost. Mat is made of 1"x3/16" steel bars riveted and welded together into strong sheets 24" wide x 12 ft. long. (120 lbs. each) Individual sections can be hooked together. Fortune War Surplus purchase makes possible this low price—less than half of production cost. **\$99.00** per ton

JET STEAM MASTER

Now, a super efficient portable steam generator that produces live steam at 100 lbs. pressure in 60 seconds from a cold start! Produces large volume of high pressure steam on 2 pints of fuel oil. Instantly cleans sticky grease, dirt, rust, old paint, etc. of implements and farm machinery. Pays for itself in a few weeks. Sterilizes soil. Sterilizes as it cleans—milk equipment, etc. Fully automatic—oil fired with new, built-in lifetime bronze water circulating pump. Draws water from faucet or bucket, simple and safe—anyone can use it! Built-in safety valve. Complete with 12 ft. of high-pressure steam hose and new triple efficiency steam gun that automatically mixes in soap solution if desired. Wt. 250 lbs. Item 463. Special factory price..... **\$349.50**

MASTER DC ARC WELDERS

Now! a portable rugged, industrial type welder with terrific performance, yet at a price hundreds of dollars less than you'd expect. Senior model made for years of trouble-free, continuous service. High capacity DC welding unit enables you to tackle any job with confidence—easily welds anything up to 2" plate using from 1/16" to 1/4" rods. Built-in stabilizer and cooling system makes arc easy to strike and hold. Dual control rheostat provides for heat soldering, brazing and welding from 50 to 300 amps. Complete with instructions, guarantee and triple Y-belt or flat pulley. Easy to hook up and easy to operate. **WELDER ONLY - DUAL CONTROL MODEL.** Same as above, but drive with your tractor, jeep or gas engine of 14 HP or more. (Item 280) Wt. 110 lbs. \$450 value..... **\$119.50**

WELDER ONLY - INDUSTRIAL MODEL same as above but with ceramic rotary type rheostat providing 74 different heat settings for all types of welding (Item 38b) \$500.00 value..... **\$139.50**

COMPLETE POWER MASTER (Illustrated above) powered by a 14.6 hp., air cooled Wisconsin engine. Wt. 480 lbs. (Item 280) Compares with welder costing \$1200. **\$449.50** Factory Special.....

WELDING KIT Two 10 ft. leads, welding helmet, electrode holder, ground clamp. Sold only with welder at..... **\$10.50**

Wt. 110 lbs. \$450 value..... **\$119.50**

Wt. 480 lbs. (Item 280) Compares with welder costing \$1200. **\$449.50**

Wt. 480 lbs. (Item 280) Compares with welder costing \$1200. **\$449.50**

Wt. 480 lbs. (Item 280) Compares with welder costing \$1200. **\$449.50**

Wt. 480 lbs. (Item 280) Compares with welder costing \$1200. **\$449.50**

Wt. 480 lbs. (Item 280) Compares with welder costing \$1200. **\$449.50**

SOUTH BEND Light Ten Precision Lathes are ideal

for the machining of small precision parts. They are accurate, smooth, fast and easy to operate which results in exceptional efficiency on all operations. This productiveness, combined with low initial cost, gives you more actual value for your money. Write for complete information—there are possibly many places you can profitably use these precision lathes.

SPECIFICATIONS

Swing over bed—10". Distances between centers—16" to 34". Collet capacity— $\frac{3}{4}$ ". Spindle bore— $\frac{7}{16}$ ". Spindle speeds: twelve—48 to 1435 r.p.m. approx., sixteen—52 to 1365 r.p.m. approx. Available in bench, metal column base and floor models with power and manual feeds and change gears or quick change gear box. Also, toolroom models. Prices start at \$369 f.o.b. factory.

**More
Value
for Your
Money**



RECENT PURCHASERS

Allegheny Ludlum Steel Corp.
Federal Reserve Bank of New York
State University of New York
Rayco Tool & Die Co.
South Carolina Electric & Gas Co.
General Electric Co.
United Shoe Machinery Corporation
Eder Instrument Co.
Atomica International
Borger Gas Engine Co.
Prospect Tool & Manufacturing Co.
Northern Michigan College
Signode Steel Strapping Co.
Borough of Queens Sewer Maint.
Lindell Electric Control Corp.
Empire State Laboratories
United Nations (Receiving Area)
Sandia Corporation
Reynolds Metals Company
United Service
Bridgeport Jig Boring Co.



**Send for this
Helpful Book**

Every lathe operator needs this information-packed handbook, *How to Run a Lathe*. Written in a clear, easy-to-understand style. 128 pages, 360 illustrations. 50c postpaid.



SOUTH BEND LATHE

SOUTH BEND 22, INDIANA

Builders of Lathes, Milling Machines, Shapers, Drill Presses, Pedestal Grinders



Why settle for **part-time** protection?

Hastings Oil Filter Cartridges keep oil clean all the time—from filter change to filter change.* The reason is Densite.

Densite—an amazing new type of filtering material—is made of millions of selected cotton fibres, pressure packed so oil must flow through countless tiny openings, pass many surfaces of fibres. The most microscopic abrasives cling to these fibres—and stay there!

Next filter change, ask for Hastings . . . and get *full-time* protection!

*When replaced as normally recommended. This fact proved by tests conducted in accordance with U. S. Bureau of Standards procedure.



HASTINGS MANUFACTURING COMPANY • HASTINGS, MICHIGAN
Also makers of Piston Rings, Casite, Wear Reducer, Spark Plugs



Step right up, folks,
for the main attraction-
WINSTON flavor!

Chances are good you'll really go for Winston! You'll like the rich, full flavor. You'll also like this pure snow-white filter. It's a Winston exclusive, and it does the job so well you get pleasantly rich flavor with every easy draw. Get Winstons! They're for you.

R. J. REYNOLDS TOBACCO CO., WINSTON-SALEM, N. C.



Smoke **WINSTON** America's best-selling, best-tasting filter cigarette!

Copyrighted material