

AUGUST 1957

35 CENTS

POPULAR MECHANICS

MAGAZINE

WRITTEN SO YOU CAN UNDERSTAND IT

REG. TRADE MARK, GSE AT BRITAIN, No. 40428

Fold-Up Home for the Road

— Page 107

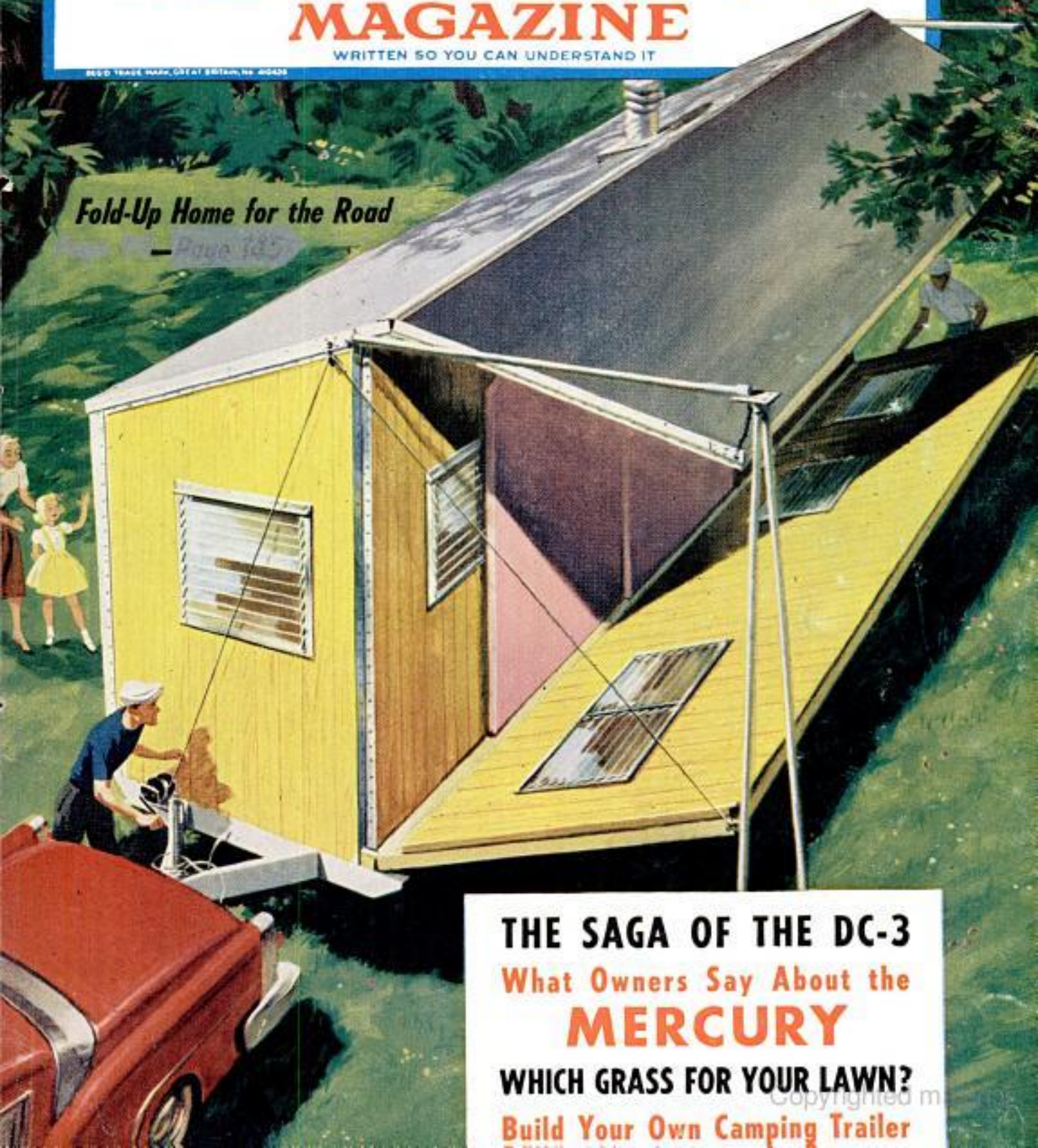

THE SAGA OF THE DC-3

What Owners Say About the
MERCURY

WHICH GRASS FOR YOUR LAWN?

Build Your Own Camping Trailer

Copyrighted m

"You have more to say about gas mileage than you think!"



Mauri Rose

One of America's top professional drivers for over 25 years, three-time Indianapolis 500-mile winner.

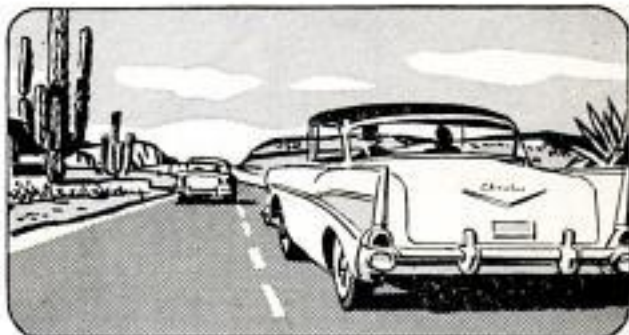

"Speed plays an important part in your car's gas consumption. Stock cars are built for peak efficiency at cruising speed, not top speed. Speeders not only take unnecessary chances, but also waste gas."

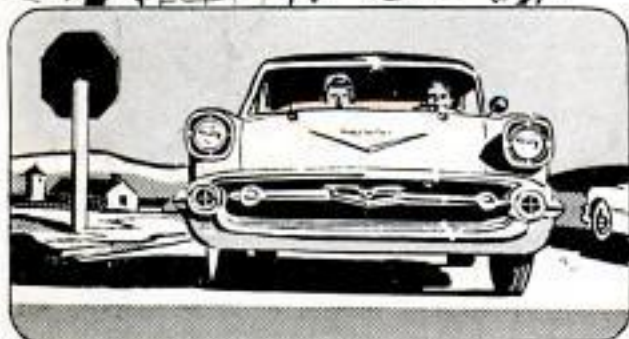

"A pro knows it doesn't pay to race away from stops. Accelerating hard in low gears eats holes in gas mileage. And it's not worth the wear on your engine . . . you get there just as soon taking it easy."



"And to be sure you have the final say on gas mileage, have your carburetor and other vital engine parts checked regularly by a factory-trained mechanic. Don't wait until your car starts to act up!"

When tune-up time rolls around for your car, be sure to see a Rochester Carburetor specialist. He is thoroughly trained in all phases of carburetion by GM and UMS experts. He'll give your car the kind of care that only a factory-trained mechanic can. When it comes to long life and dependable

service, he knows that Rochester Carburetors are second to none. They're precision-built for top performance on high-compression engines. And Rochester Carburetors deliver just the right mixture, at just the right time, to squeeze extra mileage out of every gallon of gas.

R **ROCHESTER**
CARBURETORS

Standard equipment on Cadillac, Buick, Oldsmobile, Pontiac and Chevrolet.

ROCHESTER PRODUCTS DIVISION OF
GENERAL MOTORS CORPORATION, ROCHESTER, N. Y.



Exclusive!



A new Thor SpeedDrill

with
SUPER POWER

New model 20 Thor $\frac{1}{4}$ " SpeedDrill, weight 4 lbs., length 9".

Full 2.5 amperes... power to spare for any attachment

Here's real big news for the man who wants more than just a new drill—Thor gives you this new $\frac{1}{4}$ " SpeedDrill with enough surplus energy to become the basic power plant for sanding, polishing, saw and other popular attachments. This new Thor SpeedDrill delivers a full 2.5 amperes of power right to the chuck—right where you need it. It is the only drill ever engineered in advance to handle a complete selection of attachments. Check the square housing behind the chuck spindle—it is built-in for easier change

of accessories. Thor's new SpeedDrill is quality-built throughout—precision Thor armature, a ball thrust bearing, universal motor, geared chuck and key.

But just wait until you visit your hardware dealer's and see the low price on this powerhouse. You can take this SpeedDrill home for under \$20.00—a value equal to drills selling up to \$35.00. Ask to see model 20 Thor $\frac{1}{4}$ " SpeedDrill. SpeedWay Manufacturing Co., division of Thor Power Tool Company, Prudential Plaza, Chicago 1, Illinois.



THOR POWER TOOL COMPANY, CHICAGO

Branches in all principal cities

World's largest exclusive manufacturer of portable air and electric tools

Exclusive Gem-Grinding makes the BIG DIFFERENCE in HEADLAMPS

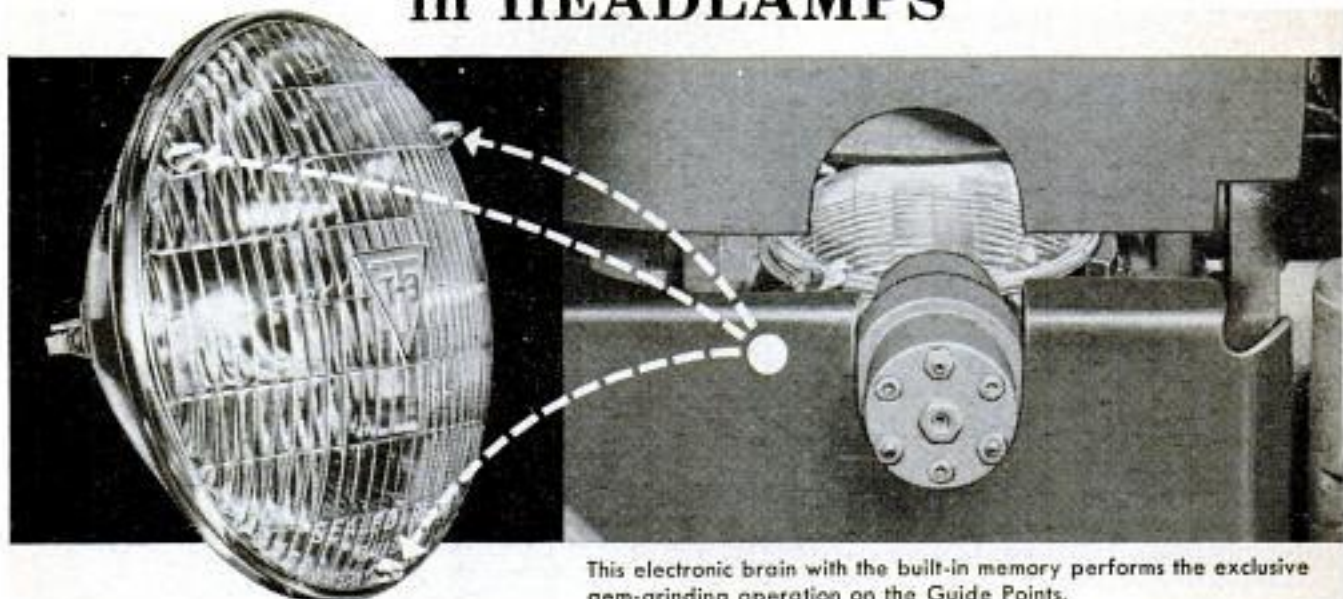

This electronic brain with the built-in memory performs the exclusive gem-grinding operation on the Guide Points.

Accuracy to 1/10,000th of an inch insures precise calibration between aiming plane and filament of each headlamp.

You get **MORE**
when you get

GUIDE

Guide goes one step further than other manufacturers to give you the most accurate aiming plane of automotive headlamps . . . exclusive gem-grinding of the "Guide Points". This added accuracy in the headlamps is translated into more light aimed right on the road ahead. It gives you that extra visibility to ease eyestrain . . . those extra seconds to take action! For pleasanter, surer, safer nighttime driving, have a new set of T-3 Safety-Aim Headlamps installed in your car.

You get up to 80 feet more seeing distance on low beam—right where you need it on the right side of the road for the benefit of both yourself and the oncoming driver. Now, through the precise T-3 Safety-Aiming System . . . exclusive gem-ground "Guide Points" and tandem Safety-Aimers . . . you can have Guide T-3 Headlamps in your car aimed perfectly—in minutes, in daylight. Get the finest lights for nighttime driving—get **GUIDE** Safety-Aim Headlamps.

T-3
Safety-Aim
HEADLAMPS



BUY IN PAIRS WHERE YOU SEE

AC-SPARK PLUG  THE ELECTRONICS DIVISION OF GENERAL MOTORS

Popular Mechanics Magazine

Registered in U. S. Patent Office and Canada

H. H. WINDSOR, Founder

H. H. WINDSOR, JR., Editor and Publisher

FOREIGN EDITIONS: MECANIQUE POPULAIRE (French) MECANICA POPULAR (Spanish) POPULAER MEKANIK (Danish) POPULAR MEKANIK (Swedish) POPULARE MECHANIK (German)

Volume 108 AUGUST 1957 Number 2

Address all communications to: 200 E. Ontario St., Chicago 11, Ill.

In This Issue...

The Saga of the DC-3	65
How You Can Spot the Satellite	73
Gold Cup Racers Aim at 200 Miles Per Hour	82
Trailer Home Folds for Travel	90
What You Can Learn on an Economy Run	100
Which Grass for Your Lawn?	106
Seagoing Game Wardens	113
The Owners Report on the '57 Mercury	118
He Dreamed Up His Own Narrow-Gauge	126
They Find Water on the Desert	131

For the Craftsman...

Trailer for Campers	145
The Swing Is to Door Furniture	150
Build the Sea Knight—Part IV	166
You Can Handle Those Small Concrete Jobs	174
"Solder Clamping" Small Parts	185
Use the Right Hanger	189

Regular Departments...

Detroit Listening Post	94
What's New for Your Home	138
Radio, TV and Electronics	141
Solving Home Problems	158
How Would You Do It?	194
Shopping for Tools	198
On the Market for Do-It-Yourselfers	200
Clinic for Homemakers	202

Next Month...

Two things are under wraps in this photo. One we will unveil in next month's PM. It is the new Edsel car. You'll read all about it in September. That other thing, though, will stay under wraps: It's PM photographer Don Honick who is most at home under his focusing cloth



Managing Editor
RODERICK M. GRANT

Assistant Managing Editor
WAYNE WHITTAKER

Shop Notes and Crafts Editor
JAMES R. WARD

Associate Editor
CLIFFORD B. HICKS

Associate Editor, Automotive
ARTHUR R. RAILTON

Associate Editor, Shop Notes and Crafts
WAYNE C. LECKEY

Associate Editor, Shop Notes
W. CLYDE SHAMPEY

Associate Editor
WILLIAM D. PERKINS

Radio-Television, Electronics Editor
LOTHAR STERN

Assistant Editor, Crafts
JAY W. HEDDEN

Assistant Editor, Makeup
JOHN DALEN

Art Director, **FRANK BEATTY**

Assistant Editors
KENNETH ANDERSON **ROBERT DORSETT**
ROBERT HENDRICKSON **EARL WOBECK**

Eastern Editor
RICHARD F. DEMPEWOLFF
Empire State Bldg., Room 2906, N.Y.C. 1

Western Editor
THOMAS E. STIMSON, JR.
Suite 1010, 3400 Wilshire Blvd.,
Los Angeles 5, Calif.

London Manager
DOUGLAS W. WEDDERSPOON
Eagle House, Jernyn St.,
London S.W. 1, England

Director, Bureau of Information
ALLAN CARPENTER
200 E. Ontario St., Chicago 11

Advertising Offices
Chicago: 200 E. Ontario St., Whitehall 4-0100;
New York: Empire State Bldg., 350 Fifth Ave.,
LONgacre 5-7380; Detroit: General Motors
Bldg., Room 5-118, TRinity 5-8711; Cleveland:
Hanna Bldg., 1422 Euclid Ave., PRospect
1-0456; Los Angeles: 3400 Wilshire, DUNKirk
2-8458; San Francisco: Russ Bldg., Room
468, 235 Montgomery St., YUKon 2-0823.

Sources of further information not listed in the index, starting on page 58, about articles in this issue, frequently are shown in the Where-to-Find-It List prepared for each issue. A copy may be obtained by readers, without charge, from Bureau of Information, Popular Mechanics, 200 East Ontario Street, Chicago 11, Illinois.

Published monthly by Popular Mechanics Company, 200 E. Ontario St., Chicago 11, Ill. H. H. Windsor, Jr., president; Wm. Harrison Petridge, exec. vice-pres.; Franklin S. Forsberg, operations vice-pres.; D. F. Windsor, vice-president and secretary-treasurer; H. H. Windsor III, vice-president; W. T. Windsor, vice-president; Joseph R. Busell, Jr., advertising manager; Alan M. Deyne, circulation manager. Single copy in the United States and Canada, 35 cents; subscription rates in the United States and possessions, Canada and countries of the Pan-American Postal Union, 1 year \$3.50; 2 years, \$6.00; 3 years, \$8.00. To all other countries add \$1.00 a year over United States prices for overseas postage. If you plan to move, notify us at least 30 days in advance so you will not miss an issue. Give both your old and new addresses. Entered as Second Class Matter, September 15, 1903, at the Post Office at Chicago, Illinois, under Act of March 3, 1879. Entered as Second Class Matter at Post Office Dept., Canada, Registered as Second Class Matter at the Post Office at Mexico, D.F., Mexico, June 20, 1950. Copyright 1957 by Popular Mechanics Company. Copyright under International Copyright Union. Copyright in France. All rights reserved under Pan-American Copyright Union. Printed in the United States of America.

AUGUST 1957

3

Looking for Something?



PHOTOGRAPHIC
EQUIPMENT
& SUPPLIES

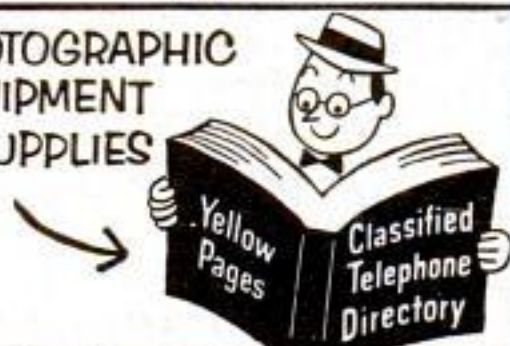

FROM PHOTOGRAPHIC SUPPLIES
TO STEEPLE JACKS
whatever you need

Find It Fast
In The
Yellow Pages



Ads with this emblem make your shopping easier

Grounded Church Steeple

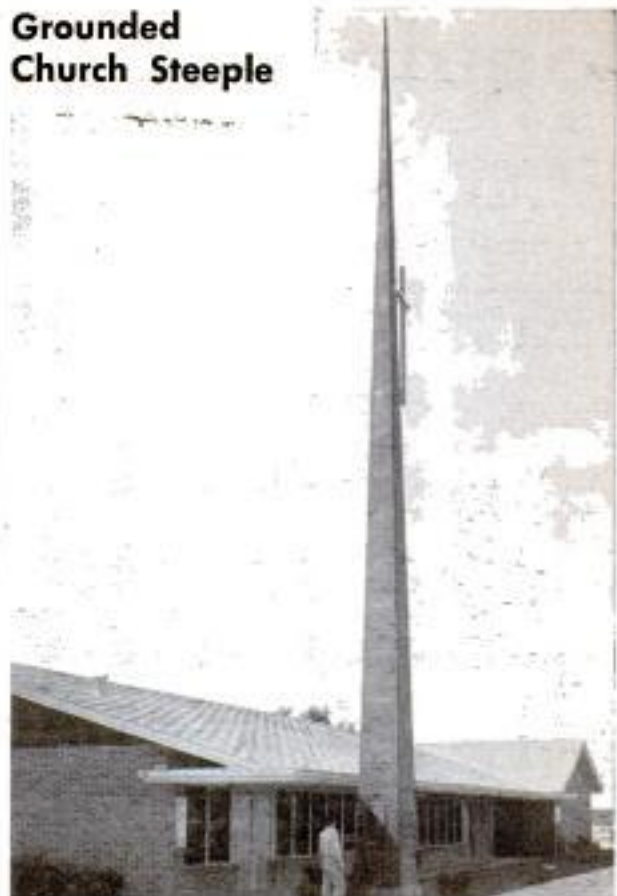

Built on the ground instead of the roof, the steeple of Memorial Presbyterian Church in Phoenix, Ariz., is 60 feet high and made of copper sheet. The base is supported by steel pipe in concrete and the copper covers a plywood frame, braced by angle iron. The aluminum cross near the top of the spire measures 10 feet high.

New Alloys Mean Faster, Longer Flights

Two new alloys may permit jet aircraft and guided missiles to travel faster and farther. Both alloys possess high strength at high temperatures. Magnesium-thorium, developed by Dow Chemical Co., is a replacement for aluminum and magnesium. W545, a product of Westinghouse Electric Corp., contains iron, nickel, chromium, molybdenum, titanium and boron. Magnesium-thorium is 30 percent lighter than aluminum alloys and has withstood 700 degrees F. for 100 hours without change in its basic properties. W545, when heated to 1200 degrees F. and subjected to 75,000 pounds per square inch, has resisted such conditions for 300 hours without breaking.

☾ Volcanoes on Mars erupt about as frequently as those on earth, according to a report before the American Astronomical Society.

IF YOU *like to build the models...*



*work on the big ones... and start
a great future...*



in the **U. S. AIR FORCE**

If you have mechanical ability, electronic ability—or both—the U.S. Air Force offers you unparalleled opportunities to develop your skills and train for an exciting and rewarding career. Whatever your future may be, *you'll go places faster* with the experience you gain in the U.S. Air Force. In addition, you will have the chance for interesting travel, further education and all forms of recreational activity. Get on the all-volunteer, *young men's team!* See your Air Force Recruiter, or mail the attached coupon, now.

Airman Information, P.O. Box 7608, M-96-PM
Washington 4, D.C.

Please send me more information on my opportunities for enlisting in the U.S. Air Force. I am between the ages of 17-34 and reside in U.S.A. or possess:

Name **This One**

Name

Address

City



YJNP-JER-6FJT



**particular drivers, particularly,
need Ajustomatic Shock Absorbers**

More and more owners of late-model, high-performance automobiles are demanding what only Gabriel Ajustomatic shock absorbers offer: • Freedom to choose soft, normal or firm ride—to suit your driving habits • A new experience in superior stability, control and roadability.

Gabriel Ajustomatics are standard (export) or optional (domestic) on *nine* different makes of U. S. cars in 1957. Thousands of late-model sports cars, station wagons and other automobiles in use today attest their value. If you are dissatisfied with the conventional controls supplied on your present car, switch over.



AJUSTOMATIC SHOCK ABSORBERS

ACROSS THE DESK



Cool Pup

Air conditioning is not reserved for the privileged human in Dallas, Tex. "Baby," a blue-blooded St. Bernard owned by Dr. Murry Schonfeld, has her own private



quarters with year-round climate control and seldom emerges when the thermometer rises above 80 degrees on a summer day.

To the Editor:

My father owned a large selection of tools, a good many of which were made by my grandfather who was a combination blacksmith and Methodist preacher. He also had a fine library. Anyone was welcome to come to his home, use his tools or read his books, but take them off the place—Never! Consequently he never lost a book or a tool.

Now that the do-it-yourself vogue is here, and as most of us have a good many close neighbors, Father's method is out if you want to keep your friends.

I would like to submit a little advice to people who borrow tools and people who are obliged to loan them.

If you are a chronic borrower of tools, the best way to break yourself of the habit is to go buy some. You have no idea of the inconvenience you are causing your neighbor. Nine times out of ten he will never tell you.

Of course there may be times you need a tool that you would seldom use: Make arrangements with the owner when the tool

(Continued to page 8)



To those who want to enjoy
an **ACCOUNTING CAREER**



IF you're that person, here's something that will interest you.

Not a magic formula—not a get-rich-quick scheme—but something more substantial, more practical.

Of course, you need something more than just the desire to be an accountant. You've got to pay the price—be willing to study earnestly, thoroughly.

Still, wouldn't it be worth your while to sacrifice some of your leisure in favor of interesting home study—over a comparatively brief period? Always provided that the rewards were good—a salary of \$5,000 to \$10,000 and up?

An accountant's duties are interesting, varied and of real worth to his employers. He has *standing!*

Do you feel that such things aren't for you? Well, don't be too sure. Very possibly they *can* be!

Why not, like so many before you, investigate LaSalle's modern Problem Method of training for an Accounting position?

Just suppose you were permitted to work in an accounting firm under the personal supervision of an expert accountant. Suppose, with his aid, you studied accounting principles and solved problems day by day—easy ones at first—then more difficult ones. If you could do this—and could turn to him for advice as the problems became complex—soon you'd master them all.

That's the training you follow in principle under the LaSalle Problem Method.

You cover accounting from Basic Accounting right through Principles and Basic Cost Accounting. As you go along, you absorb the principles of Accounting Systems and Federal Income Tax. Then you may choose Office Management, Governmental Accounting, Commercial Accounting, Industrial Accounting, or Public Accounting and prepare for the CPA examinations.

Your progress is as speedy as you care to make it—depending on your own eagerness to learn and the time you spend in study.

Will recognition come? The only answer, as you know, is that success *does* come to the man who is really *trained*. It's possible your employers will notice your improvement in a very few weeks or months. Indeed, many LaSalle graduates have paid for their training—with increased earnings—before they have completed it! For accountants, who are trained in organization and management, are the executives of the future.

**Get Free Sample Lesson—Also
"Opportunities in Accounting"**

For your own good get all the facts about this completely new and modern accounting training. Write for Free Sample Lesson—also latest book "Opportunities in Accounting." They will prove that Accounting offers brilliant futures to those who aren't afraid of serious home study, and will show the wide range of opportunities that exist today. No cost or obligation. If you want a position of higher income, greater prestige and professional standing . . . MAIL THE COUPON NOW!

**Over 4,500 Certified
Public Accountants among
LaSalle alumni**

Accredited Member, National Home Study Council

LASALLE EXTENSION UNIVERSITY

A CORRESPONDENCE INSTITUTION

417 S. Dearborn St. Dept. 864-H Chicago 5, Ill.

I want to be an accountant. Send me without obligation, Free Sample Lesson—also "Opportunities in Accounting."

Name.....Age.....

Address.....

City, Zone & State.....



(Continued from page 6)

is to be returned and return it *at that time*. Regardless of the condition of the article you borrowed, clean it up and oil it before you take it back. If it is an edge tool, sharpen it if you know how. Never, *never* lend a borrowed tool to anyone else. You may think the owner is a good fellow and won't mind, but you can be assured he will.

Now, to the fellow who has tools and has borrowing neighbors: First, mark all your tools so there is no doubt of ownership. Have a place for each tool so that you know when one is missing. If you have a lot of tools loose in a drawer or locker, you won't miss a tool until you need it and by that time you may forget it is loaned and think it's mislaid.

The biggest handicap in loaning tools is not having the tool when you need it. It never fails that the tool you loan is the very one you need. I have overcome some of the troubles of loaning tools by having a good many duplicate tools which I have accumulated just to loan.

W. J. Langworthy,
Texas City, Tex.

To the Editor:

Among the interesting articles in your March issue the report on Fords leads the list. As the owner of a sedan and pickup

made by Ford, and running back to the Model-T, I know the subject.

Your reports show that the majority of the buyers of all makes are always satisfied. This is merely human nature, because many people won't admit they have been displeased, much as many marriages exist merely because a divorce reflects on their intelligence.

It seems to me that a majority of drivers know little about what cars should be, or could be, and therefore are pleased with newness and novelties. It is much like asking juveniles to vote on a balanced diet. Lollipops, bubble gum, soda pop, hamburgers and hot dogs would lead the list.

This driver's complaint is with several things, one being the ratio of useful space to total bulk. Cars are designed by artists and the engineers squeeze the machinery into the design. Cars should be designed around the passenger (with particular thought given the driver). The first requisite should be a reasonably level and roomy floor; wells, humps, tunnels, etc., have no place in a comfortable car.

Next should be considered the line of sight. Up, down, forward, sideways and to the rear. Modern cars are too low to give easy vision to the driver. Curved windshields are noisy, expensive and distort

(Continued to page 10)

Now you can get the motor used to power millions of America's most popular appliances...

EMERSON  **ELECTRIC**

multi
duti
MOTORS



For 67 years Emerson-Electric motors have been the first choice of leading appliance manufacturers. Now, Emerson-Electric is offering you these famous motors, engineered with you in mind. Twenty-one different designs from $\frac{1}{4}$ to 1 H.P. Get yours today, or write for Free Catalog No. M-136. The Emerson Electric Mfg. Co., St. Louis 21, Mo.



EMERSON-ELECTRIC



For Your Home, Shop or Commercial Use

of St. Louis... Since 1890



What's your boss saying about you?

The door is usually open. Today it's closed. They're talking about you... about your future. You don't have to hear to know what they're saying. Because there's nobody who knows more about you and your present job than you.

O.K. ... So you have "experience." Five years on the same job.

Have you *mastered* the job... learned everything there is to know about it?

If your answer is "yes," success is right around the corner. But if the answer is "no," then your experience doesn't amount to much. And chances are these things are true about you: you just "coast" along with things... you do nothing and go

home all tired out. **BEWARE!** Those are danger signals. Unless you take a fresh look at things, you'll be doing the same job at the same salary for the next five years. And the next five.

What you can do about your future

If you want to succeed... make more money, earn the respect of your family and community... you have to take the bull by the horns. Success doesn't just come along. You have to meet it halfway. So act NOW and make your experience mean something. Add I. C. S. training to your record and start going places. Do it at home, in your spare time, for a few cents a day.

Does it work? These facts answer that. A recent survey shows that in a single 120-day period, 1973 I. C. S. students were promoted to better jobs. If you had acted a year ago, one of them could have been you. So mail the coupon below today.

Pick your favorite subject

257 I. C. S. courses to choose from. 203 expert I. C. S. instructors to give you personal help. No time or expense going to and from classes. No interference with business and social life.

Your first step

Sit down *right now* and fill out the coupon below. Check your favorite subject. I. C. S. will send you FREE and without obligation of any sort, three books. One, "How to Succeed," tells you how to start climbing to the top. Second book outlines the opportunities in the field of your choice. Also, a free sample lesson in basic mathematics.



For Real Job Security—Get an I. C. S. Diploma!

I. C. S., Scranton 9, Penna.

Member, National Home Study Council

INTERNATIONAL CORRESPONDENCE SCHOOLS



BOX 45953H, SCRANTON 9, PENNA.

(Partial list of 257 courses)

Without cost or obligation, send me "HOW TO SUCCEED" and the opportunity booklet about the field BEFORE which I have marked X (plus sample lesson):

- ARCHITECTURE and BUILDING CONSTRUCTION
- Air Conditioning
- Architecture
- Arch. Drawing and Designing
- Building Contractor
- Building Estimator
- Carpentry and Millwork
- Carpenter Foreman
- Heating
- Interior Decoration
- Painting Contractor
- Plumbing
- Reading Arch. Blueprints
- ART
- Commercial Art
- Magazine & Book illus.
- Show Card and Sign Lettering
- Sketching and Painting
- AUTOMOTIVE
- Automobiles
- Auto Body Rebuilding and Refinishing
- Auto Engine Tuneup
- Auto Technician

- AVIATION
- Aero-Engineering Technology
- Aircraft & Engine Mechanic
- BUSINESS
- Accounting
- Advertising
- Business Administration
- Business Management
- Cost Accounting
- Creative Salesmanship
- Managing a Small Business
- Professional Secretary
- Public Accounting
- Purchasing Agent
- Salesmanship
- Salesmanship and Management
- Traffic Management
- CHEMICAL
- Analytical Chemistry
- Chemical Engineering
- Chem. Lab. Technician
- Elements of Nuclear Energy
- General Chemistry
- Natural Gas Prod. and Trans.
- Petroleum Prod. and Engr.
- Professional Engineer (Chem)
- Pulp and Paper Making

- CIVIL ENGINEERING
- Civil Engineering
- Construction Engineering
- Highway Engineering
- Professional Engineer (Civil)
- Reading Struc. Blueprints
- Structural Engineering
- Surveying and Mapping
- DRAFTING
- Aircraft Drafting
- Architectural Drafting
- Drafting Machine Design
- Electrical Drafting
- Mechanical Drafting
- Sheet Metal Drafting
- Structural Drafting
- ELECTRICAL
- Electrical Engineering
- Elec. Engr. Technician
- Elec. Light and Power
- Practical Electrician
- Practical Lineman
- Professional Engineer (Elec)
- HIGH SCHOOL
- High School Diploma

- Good English
- High School Mathematics
- Short Story Writing
- LEADERSHIP
- Industrial Forumanship
- Industrial Supervision
- Personnel-Labor Relations
- Supervision
- MECHANICAL and SHOP
- Diesel Engines
- Gas-Elec. Welding
- Industrial Engineering
- Industrial Instrumentation
- Industrial Metallurgy
- Industrial Safety
- Machine Design
- Machine Shop Practice
- Mechanical Engineering
- Professional Engineer (Mech)
- Quality Control
- Reading Shop Blueprints
- Refrigeration and Air Conditioning
- Tool Design
- Tool Making
- RADIO, TELEVISION
- General Electronics Tech.

- Industrial Electronics
- Practical Radio-TV Eng'g
- Practical Telephony
- Radio-TV Servicing
- RAILROAD
- Car Inspector and Air Brake
- Diesel Electrician
- Diesel Engr. and Fireman
- Diesel Locomotive
- STEAM and DIESEL POWER
- Combustion Engineering
- Power Plant Engineer
- Stationary Diesel Engr.
- Stationary Fireman
- TEXTILE
- Carding and Spinning
- Cotton Manufacture
- Cotton Winding and Weaving
- Loom Fixing Technician
- Textile Designing
- Textile Finishing & Dyeing
- Throwing
- Winding and Weaving
- Worsted Manufacturing

Name _____ Age _____ Home Address _____
 City _____ Zone _____ State _____ Working Hours _____ A.M. to P.M. _____
 Occupation _____

Canadian residents send coupon to International Correspondence Schools, Canadian, Ltd., Montreal, Canada. . . . Special tuition rates to members of the U. S. Armed Forces.

OPTICAL BARGAINS

3" "PALOMAR, Jr." REFLECTING TELESCOPE See the Stars, Moon, Planets Close Up! 60 & 120 Power — An Unusual Buy!



Assembled and Ready to Use! You'll see the Rings of Saturn, the fascinating planet Mars, huge craters on the Moon. Aluminized and overcoated 3" diameter high-speed f/10 ventilated mirror. Telescope comes equipped with a 60X eyepiece and a mounted Barlow Lens, giving you 60 & 120 power. Optical Finder Telescope, included. Sturdy, hardwood, portable tripod. Free with scope: Valuable STAR CHART and 136 page "Astronomy Book." Stock No. 85,050-H.....\$29.50 f.o.b. (Shipping wt. 10 lbs.) Barrington, N. J.

4 1/4" ASTRONOMICAL TELESCOPE



4 1/4" "Palomar, Jr." Up to 270 Power. A fine Reflector Telescope complete with real Equatorial Mount and Tripod. Aluminum tube, 4 1/4" dia. mirror, rack and pinion focusing eye-piece holder, 2 eyepieces and mounted Barlow Lens for 40X, 90X, 180X and 270X. Shipping weight approx. 25 lbs. Stock No. 85,008-H... complete, \$74.50 f.o.b. Barrington, N. J.

NEW! STATIC ELECTRICITY GENERATOR

See a thrilling spark display as you set off a miniature bolt of lightning. Absolutely safe and harmless. Stands 14" high. Turn the handle and two 9" plastic discs rotate in opposite directions. Metal collector brushes pick up the static electricity, store it in the Leyden jar type condenser until discharged by the jumping spark. Countless tricks and experiments. 24 page instruction booklet included. Stock No. 70,070-H.....\$10.95 Postpaid



New! 2 in 1 Combination! Pocket-Size 50 Power MICROSCOPE and 10 Power TELESCOPE



Useful Telescope and Microscope combined in one amazing, precision instrument. Imported! No larger than a fountain pen. Telescope is 10 Power. Microscope magnifies 50 Times. Sharp focus at any range. Handy for spots, looking at small objects, just plain snooping. Send Check or M.O. Satisfaction Guaranteed. Order Stock No. 30,059-H.....\$4.50

4" STAINLESS STEEL ADJUSTABLE HOSE CLAMPS

Very handy around the house and shop. Hold wire fence to posts. Join and hold pipe and connectors; join flexible tube to rigid pipe, male and female connectors of all kinds. Use to stop leaking seals even in corrosive solutions. Adjustable from 3 1/2" to 4 1/2". Original cost 65c each. War Surplus — 200,000 units available (write for large quan. prices). Stock No. 50,163-H—12 Clamps...\$3.00 Postpaid



DIRECT MEASURING POCKET MICROSCOPE — 50 POWER

Fountain pen size, makes direct reading measurements; for checking small parts and dimensions under powerful magnification. Precision, glass etched reticle calibrated for measurements up to 1/10" by .001" divisions. STOCK NO. 30,225-H.....\$7.95 Postpd.



BUILD A SOLAR ENERGY FURNACE

A fascinating new field. Build your own Solar Furnace for experimentation—many practical uses. Easy! Inexpensive! We furnish instructions. This sun powered furnace will generate terrific heat—2000° to 4000°. Fuses enamel to metal. Sets paper aflame in seconds. Use our Fresnel Lens — 14 1/4" diameter... f.l. 14".

Stock No. 70,130-H—package of 1.....\$ 6.00 Postpd.
Stock No. 70,131-H—package of 2.....\$11.00 Postpd.
Stock No. 70,132-H—package of 4.....\$20.00 Postpd.

50-150-300 Power MICROSCOPE Only \$14.95

3 Achromatic Objective Lenses
on Revolving Turret!

Imported! The color-corrected, cemented achromatic lenses in the objectives give you far superior results to the single lenses found in the microscopes selling for \$9.95! Results are worth the difference! Fine rack and pinion focusing. Stock No. 70,008-H.....\$14.95 Postpaid



SIMPLE LENS KITS! Fun for adults! Fun for children! Kits include plainly written, illustrated booklet showing how you can build lots of optical items.

Stock No. 2-H—10 lenses.....\$ 1.00 Postpaid
Stock No. 5-H—45 lenses.....\$ 5.00 Postpaid
Stock No. 10-H—80 lenses.....\$10.00 Postpaid

WRITE FOR FREE CATALOG "H"!

Complete Line of Astronomical Telescope Parts and Assembled Telescopes. Also huge selection of lenses, prisms, war surplus optical instruments, parts and accessories. Telescopes, microscopes, binoculars, etc. Request Catalog "H"!

ORDER BY STOCK NUMBER SEND CHECK OR MONEY ORDER. SATISFACTION GUARANTEED!
EDMUND SCIENTIFIC CO., BARRINGTON, N. J.

(Continued from page 8)

vision. In my dream car the windshield will be just a flat sheet of clear glass, slanting inward from top to bottom. Eliminated would be corner posts projecting into the front doors, windshield wings and window frames. The Model-A had a window which on the first turn of the crank moved to the rear and then down. It worked on a lot of Model-As, why can't it be used today? The windshield wing is a thumb-nail buster, a vision obstruction and the source of a nerve-destroying wail.

In my dream car the driver will be moved nearer the center, his left elbow will be free to move and his seat will be adjustable. The cushioning will be firm; soft cushions are not the answer to driving comfort, especially on long trips. I like the firm cushions of my pickup much better than the squashy seats of the sedan.

J. Carleton Esty,
Lavallette, N. J.

Are You Science Minded?

A good many science-minded readers have pointed out an error in the quiz "Are You Science Minded?" in the June issue. The problem: One kilowatt is equivalent to 2,654,200 foot-pounds per hour. One horsepower is equivalent to 33,000 foot-pounds per minute. How many kilowatts are equal to one horsepower?

The correct answer is $\frac{33,000 \times 60}{2,654,200}$.

We regret the error in the copy furnished to us by Science Service, and salute our science-minded readers.

To the Editor:

Billy Osborne of Elkhorn, Wis., is the envy of the youngsters in his neighborhood as his father made him a power-driven car from salvaged parts. The car is powered by a lawn-mower motor, the wheels are those of a wheelbarrow, the steering wheel was salvaged from a car and the attractive little seat was made from plywood.

Wally E. Schulz, Elkhorn, Wis.



Learn Radio-Television

or Electric Appliance Repair by Practicing at Home in Spare Time

Job and Career
Opportunities
for
**RADIO-TV
TECHNICIANS**

APPLIANCES FOR
CAL TROUBLES

Sample
Lesson
and Catalog
FREE

Fixing Electric Appliances Pays Good Money

Get into a field where there is important work and opportunity. Millions of Electric Appliances are sold every year. Every wired home now has an average of 8. Owners pay well to have them fixed quickly, properly. This is your opportunity for a better job, your own part time or full time business. NRI can give you the training you need, at home in your spare time.

You need proper equipment to service today's automatic appliances.

With NRI course you get parts to build professional type, multi-use Appliance Tester. It takes the guesswork out of servicing. You use it to get practical experience, conduct experiments. You get easy to understand lessons, train at home as fast or as slow as you like.



Start Soon to Make \$10 to \$15 a Week Extra in Spare Time

Soon after starting many NRI men earn extra cash fixing toasters, clocks, fans, vacuum cleaners, etc., or radio and TV sets, for neighbors and friends. Keep your job while learning and earning. Work in your basement, garage, spare room.

You'll be amazed how easily, quickly you, too, can start earning many extra dollars. Find out about NRI... a school that for more than 40 years has been training men, through home study, for success, good pay jobs.

MAIL COUPON TODAY
Find Out What NRI—Oldest and Largest
Radio-Television School Offers You

Bigger than ever and still growing. That's why Radio-Television has special appeal to an ambitious man not satisfied with his job and earnings. More than 4000 Radio and TV stations on the air, 150 million home and auto radios plus 40 million Television sets to be serviced. Color TV promises added opportunities.

Training PLUS opportunity is the ideal combination for success. Plan now to get into Radio-TV. The technical man enjoys prestige. He does important work, gets good pay for it. NRI can supply training quickly, without expense of going away to school. You learn at home in spare time. NRI training is LEARN-BY-DOING. NRI sends you kits of parts for practical experience; they "bring to life" things you study.

Fast Growing Radio-TV Field Offers Good Pay—Success—Extra Income

For the trained man there are good jobs, a bright future in Radio-TV Servicing or Broadcasting. Soon after enrolling, many NRI students start to earn extra cash fixing neighbors' sets in spare time. Some pay for their training and enjoy extra luxuries this way. Some make enough to start their own full time Radio-TV shops. NRI has trained thousands for successful careers in Radio-TV. Study fast or slow—as you like. Diploma when you graduate. Mail coupon now. Paste on a postcard or mail in envelope. You get SAMPLE LESSON FREE. Also 64-page Catalog that shows opportunities, equipment you get. Cost of NRI Courses low. Easy terms. NATIONAL RADIO INSTITUTE, Dept. 7HA, Washington 16, D.C.

LESSON and CATALOG FREE

NATIONAL RADIO INSTITUTE, Dept. 7HA, Washington 16, D.C.
(CHECK ONE PLEASE—NO SALESMAN WILL CALL)

Radio-Television—Please send me FREE Sample Lesson and 64 Page Catalog on Radio-Television Servicing and Communications.

Electric Appliances—Please send me FREE Sample Lesson and Catalog on your Electric Appliance Servicing Training.

Name..... Age.....

Address.....

City..... Zone..... State.....

ACCREDITED MEMBER, NATIONAL HOME STUDY COUNCIL

**WORLD FAMOUS
POWERFUL!**

Black Eagle GERMAN BINOCULARS



Enjoy
25 MILE VIEWS!

Importer's Special!
OUR 3.98 VALUE 99c
10 DAY TRIAL!

We've sold over 1,000,000 binoculars—but this is our greatest low price value! Now yours, our reg. \$3.98 Black Eagle German binoculars at a sensational money saving discount! This offer made to win 25,000 new customers. Remember—these are Germany's famous power binoculars with some features found in expensive binoculars. Black Eagle brings in distant objects, animals, people, etc. so sharp and clear you will be amazed! Hi-PI views up to **25 MILES AWAY!** Unbreakable lenses! Synchronized center focusing. Lightweight construction—views for hours without arm fatigue! Enjoy a "ringside" seat at all sports events. Rush 99 cents. Mail coupon now for prompt delivery. **10 DAY TRIAL.** Satisfaction guaranteed or money back. Act now! Temporary price reduction—will be withdrawn after present stock is sold out.
Order by NO. 78.....99c

1/2 Price!
1.98



BIG!
9 inches
Long When
Open!

NO. 18...1.98

OVER 500,000 SOLD AT \$3.95

Steel manufacturing and labor costs have gone up! Get your 10-in-1 knife while **HALF-PRICE** still in effect! 10 tools in one! Saw! File! Scissors! Jack-knife! Awl! Small Knife! screwdriver! Bottle Opener! Corkscrew! Can Opener! Each separate. Easy to open and close. No jamming or slipping. Rugged Korium steel. Lifetime of use. Carry on person, keep in tool shop, kitchen, basement, garage, car. Take on hunting, fishing, camping trips. Replaces multitude of tools you can't find when you need them! Play safe. Order two, three or more—for yourself and friends!

**Paint Kitchen in
55 Minutes!**
Famous Sprayer 1/2 Price!

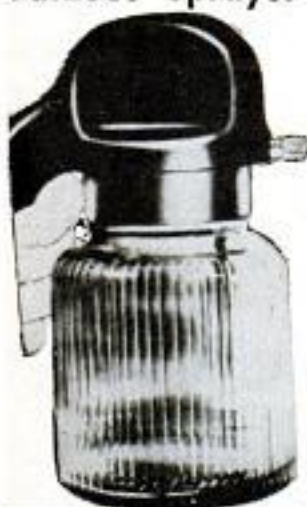

9.95
complete

Famous Hi-Speed automatic electric sprayer cuts painting time 75%. Do average kitchen in less than hour. Spray screens, doors, walls, garden furniture, etc. 101 uses. Spray insecticides on plants. Most pro f clothes. Lubricate car. New 1957 model. Cleans itself. Built-in strainer. New improved electro-magnetic motor-compressor. Push button & spray. Same sprayer formerly advertised on TV for \$19.95—now half-price. Complete kit—no extras.
NO. 102...\$9.95

**ADVERTISED ON
T.V. FOR 19.95**

Black Forest

BRAND

HUNTING KNIFE
Reg. \$3.95 **99c**
NOW ONLY

The genuine, the famous Black Forest brand—world's most popular hunting knife—yours almost as a gift! Its beauty has won recognition for design throughout sports circles. Hand-forged by experienced craftsmen! Hi-carbon Korium steel blade that's sharp enough to shave with! Lifetime of rugged, faithful use in skinning wild animals, cutting hemp, branches; hunting small game makes accurate, silent weapon, carving roasts, turkeys at home. Approx. 10 inches long. FREE Deluxe Leather Scabbard! More than 100,000 sportsmen considered it a bargain at \$3.95. You get it for only 99c. You SAVE \$3.00! Truly our biggest hunting knife bargain in 15 years!
NO. 76.....99c

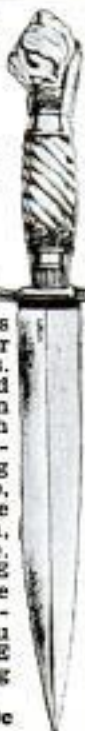

**100 Blue Steel
Blades**

New!
First-
Quality

1c ea.



Sensational value! Genuine BLUE surgical steel blades—not 20 for 99c but 100 for 99c! Guaranteed to give some close shaves as famous brands costing 5 times more—or money back! Fits any double-edge razor perfectly. Why help pay for costly TV commercials? "Everything's the same but the name... and the price." Still not convinced. Then send for trial order. Use 10 blades. If not satisfied, return balance for FULL refund.
NO. 131.....100 for 99c

**WATER & SHOCK
RESISTANT WATCH!**

Compare
with
Watches
Costing
up to
49.95
7.98



We've sold 200,000 watches—but this is our most fabulous bargain! New 1957 Geneva. Stainless steel screw back. Built-in shock protector. Anti-magnetic. Center sweep second hand. Luminous dial. Deluxe Gift packaged! Precision Swiss make. Unlimited guarantee of service & repair FREE. Compare with \$49.95 watches for beauty & design. Runs under water! NO. 260...\$7.98 plus 80c excise tax. Total \$8.78

THORESEN, Inc., Dept. 6-H

585 Water Street, New York 2, N. Y.

RUSH items listed below. My money back if I am not satisfied.

Check, cash or m.o. enclosed. Send prepaid. Send COD, plus postal fees (No COD's under 1.98)

NO.	QUANTITY	ARTICLE	PRICE

PRINT NAME _____

ADDRESS _____

CITY & ZONE _____

STATE _____

Canadians: Address 439 King St., W., Toronto 2B, Ont.



INVENTORS

Learn how to protect your invention. The U. S. Patent Laws provide that any new and useful art, machine, article of manufacture, or composition of matter, or any new and useful improvement thereof, may be patented if the act of invention is involved. Therefore, every inventor with a valuable invention should take advantage of the Patent Laws and proceed for patent protection in order to safeguard his rights.

A patent gives the inventor the exclusive right to prevent others from making, using, or selling the invention claimed in the patent for a period of seventeen years.

The Patent Laws were enacted for the benefit of the inventor to give him protection for the features of his invention which are patentable. These features must be properly and concisely set forth and claimed in a formal application for patent, in order to comply with the requirements of the Patent Laws. For that reason, unless the inventor is familiar with patent matters, he should engage a competent registered patent attorney or agent to represent him. We are registered to practice before the U. S. Patent Office and are prepared to serve you in the handling of your patent matters.

A specially prepared booklet entitled "Patent Guide for the Inventor", containing detailed information with respect to patent protection and procedure, together with a "Record of Invention" form will be promptly forwarded to you without obligation upon request.

CLARENCE A. O'BRIEN & HARVEY JACOBSON

Registered Patent Attorneys

71-H DISTRICT NATIONAL BUILDING

WASHINGTON 5, D. C.

WHAT ALL AUTO MECHANICS WANT TO KNOW

1696 PAGES



This Big Practical Book gives full information with working diagrams covering the principles, construction, ignition, service and repair of modern cars, trucks and buses.

Diesel Engines, Hydraulic & Fluid Drives Fully Explained.

A complete Guide of 1696 Pages, with over 1500 illustrations showing inside views of working parts, with instructions for service jobs.

IT PAYS TO KNOW

How to fit pistons—How to locate engine knocks. How to fit connecting rod bearings—How to service main bearings—How to recondition valves—How to time valves—How to adjust fan belts—How to adjust carburetors and chokes. How to rebuild a clutch—How to service automatic transmissions—How to service brakes—How to adjust steering gear—How to cope with ignition troubles—How to service distributors—How to time ignition—How to "tune up" an engine.



\$6 COMPLETE - PAY \$2 A MO.
TO GET THIS ASSISTANCE FOR YOURSELF SIMPLY FILL IN AND MAIL COUPON TODAY.

Step up your own skill with the facts and figures of your trade. Audel's Mechanics Guides contain Practical Inside Trade Information in a Handy Form. Fully illustrated and Easy to Understand. Highly Endorsed. Check the book you want for 7 DAYS FREE EXAMINATION. Send No Money. Nothing to pay postman.

MAIL ORDER



Check NOW!

You Can Look Over Any Guide In Your Own Home

SAVE SHIPPING CHARGES!

Enclose Full Payment With Coupon and We Pay Shipping Charges

AUDEL, Publishers, 49 W. 23 St., NEW YORK 10, N. Y.

Please send me for FREE EXAMINATION books marked (x) below. If I decide to keep them I agree to mail \$2 in 7 Days on each book or set ordered and further mail \$2 monthly on each book or set until I have paid price plus shipping charges. Otherwise I will return them.

- HOME APPLIANCE SERVICE GUIDE, 864 Pages \$8
- AUTOMOBILE MECHANICS GUIDE, 1696 Pages. 6
- TRUCK & TRACTOR GUIDE, 1376 Pages..... 5
- DIESEL ENGINE MANUAL, 640 Pages..... 3
- MACHINISTS HANDY BOOK, 1728 Pages..... 6
- WELDERS GUIDE, 608 Pages..... 3
- BLUE PRINT READING, 448 Pages..... 3
- MATHEMATICS & CALCULATIONS, 752 Pages... 3
- SHEET METAL PATTERN LAYOUTS, 1152 Pgs. 7.50
- SHEET METAL WORKERS HANDY BOOK, 448 Pgs. 2
- MECHANICAL DRAWING GUIDE, 192 Pages... 2
- MECHANICAL DRAWING & DESIGN, 480 Pages 3
- TELEVISION SERVICE MANUAL, 480 Pages... 3
- RADIOMANS GUIDE, 1088 Pages..... 5
- ELECTRONIC DEVICES, 304 Pages..... 3
- ELECTRIC MOTOR GUIDE, 1056 Pages..... 5
- WIRING DIAGRAMS (Light & Power), 304 Pgs. 2
- ELECTRICIANS EXAMINATIONS, 272 Pages... 2
- ELECTRIC POWER CALCULATIONS, 480 Pages 3
- HANDY BOOK OF ELECTRICITY, 1520 Pages.. 5
- ELECTRIC DICTIONARY, 9000 Terms..... 3
- ELECTRIC LIBRARY, 7000 Pages (10 Book Set) 20
- REFRIGERATION & Air Conditioning, 1360 Pgs. 6
- MILLWRIGHTS & MECHANICS GUIDE, 1248 Pgs. 5
- POWER PLANT ENGINEERS GUIDE, 1568 Pages 5
- ENGINEERS & FIREMANS EXAMS, 344 Pages 2
- PUMPS, Hydraulic & Air Compressor, 1760 Pgs. 6
- OPERATING ENGINEERS LIBRARY (3 Books) 12
- GARDENERS & GROWERS GUIDES (4 Book Set) 8
- CARPENTERS & BUILDERS GUIDES (4 Book Set) 8
- PLUMBERS & Steamfitters Guides (4 Book Set) 8
- MASONS AND BUILDERS GUIDES (4 Book Set) 8
- PAINTERS & DECORATORS MANUAL, 464 Pgs. 2
- HOUSE HEATING GUIDE, 1008 Pages..... 5
- OIL BURNER GUIDE, 416 Pages..... 2

Name _____
Address _____
Occupation _____
Employed by _____

Shrinks Hemorrhoids New Way Without Surgery

Science Finds Healing Substance That Relieves Pain—Shrinks Hemorrhoids

For the first time science has found a new healing substance with the astonishing ability to shrink hemorrhoids and to relieve pain—without surgery.

In case after case, while gently relieving pain, actual reduction (shrinkage) took place.

Most amazing of all—results were so thorough that sufferers made astonishing statements like "Piles have ceased to be a problem!"

The secret is a new healing substance (Bio-Dyne*)—discovery of a world-famous research institute.

This substance is now available in suppository or ointment form under the name Preparation H.* Ask for it at all drug counters—money back guarantee. *Reg. U. S. Pat. Off.

I'll Send You This Handsome SAMPLE CASE—FREE



and Show You How to Make Up to \$30.00 in a Day

WRITE for this FREE Tailoring Sample Case packed with 100 beautiful, big-value suit and overcoat fabrics. Take orders from friends, fellow-workers, others, for fine quality, made-to-measure clothes. Pocket big cash profits in advance. Because wearing our suits and overcoats brings more orders, we make it easy for you to get your own clothes without the cost. No experience is needed. SATISFACTION GUARANTEED. SEND NO MONEY. Rush your name, address, and age—today!

W. Z. GIBSON, INC., 500 South Throop Street DEPT. L-516 CHICAGO 7, ILLINOIS

MONEY in WORMS

Big money made raising crickets, hybrid red wigglers and 12 inch African fishworms—Sell by mail—We teach you how to raise and where to sell. Free literature. Hybrid breeder red wigglers—1000—\$4.5000—\$17.50, postpaid. CARTER WORM RANCH, PLAINS, GEORGIA.



Easy to make your own BOWS—ARROWS—EQUIPMENT

Illustrated Hand-Book 84 pgs. \$1, tells you how! Large Colored Catalog 5c—Send for it!

Ask your dealer for "Stemmler's Archery" (Oldest Mfr. in U.S.A.)

L. E. STEMMLER CO. Manorville (Box 1) L. I., N. Y.

BUY WHOLESALE!

FOR SELF OR RESELL FOR BIG PROFITS! NAME BRAND APPLIANCES, TOOLS, WATCHES, CAMERAS, PHONES, SEWING MACHINES, JEWELRY, HOUSEWARES, SPORTING GOODS, TYPEWRITERS, ETC.

SAVE 30-80%



\$14.75 p.p.t. Money Back Guarantee

SAVE \$50.25! PRISMATIC BINOCULARS

Precision built for brilliant magnification! Coated achromatic 6x30 lenses, individual focusing, folds on center pivot. FREE hard leather case.



\$7.72 p.p.t. Money Back Guarantee

POWERFUL All-Purpose PAINT SPRAYER

Apply paint, enamel, varnish, lacquer, etc. 50% faster! Completely self contained, no extras to buy! Just plug in — press trigger and spray! A professional job every time!

GET OUR BIG WHOLESALE CATALOG OF OVER 2,000 PROFIT MAKING ITEMS! POSTCARD BRINGS DETAILS FREE! MAIL TODAY!

Consolidated DISTRIBUTORS CLIFTON N. J.

Can you profit by their mistakes?

"Not getting enough education"

You needn't make that mistake. You can get that better job, those big promotions, the regular raises that so many I. C. S. students report. And you can do it without

"going to school," without interfering with your present job or your social life.

YOU can study with I. C. S. at home, in your spare time!



"Wrong choice of career"

When you study with I. C. S. you have 257 courses to choose from. And part of our job here at I. C. S. is not only giving you instruction

but making sure you pick the course that's right for you!

YOU get expert guidance FREE from I. C. S.!



"Failed to seize opportunities"

Your opportunity is right here on this page. Don't pass it by. Don't put it off. Mail the coupon now and let us send you our 3-book career kit.

YOU get 3 FREE books if you mail the coupon today!

1. 36-page gold mine of information, "How to Succeed."
2. Career Catalog outlining opportunities in your field.
3. Sample I. C. S. lesson (Math.).



For Real Job Security—Get an I. C. S. Diploma!

I. C. S., Scranton 9, Penna.

Member, National Home Study Council

INTERNATIONAL CORRESPONDENCE SCHOOLS



BOX 70953H, SCRANTON 9, PENNA.

(Partial list of 257 courses)

Without cost or obligation, send me "HOW TO SUCCEED" and the opportunity booklet about the field BEFORE which I have marked X (plus sample lesson):

- | | | | | |
|--|--|--|--|---|
| <p>ARCHITECTURE and BUILDING CONSTRUCTION</p> <ul style="list-style-type: none"> <input type="checkbox"/> Air Conditioning <input type="checkbox"/> Architecture <input type="checkbox"/> Arch. Drawing and Designing <input type="checkbox"/> Building Contractor <input type="checkbox"/> Building Estimator <input type="checkbox"/> Carpentry and Millwork <input type="checkbox"/> Carpenter Foreman <input type="checkbox"/> Heating <input type="checkbox"/> Interior Decoration <input type="checkbox"/> Painting Contractor <input type="checkbox"/> Plumbing <input type="checkbox"/> Reading Arch. Blueprints <p>ART</p> <ul style="list-style-type: none"> <input type="checkbox"/> Commercial Art <input type="checkbox"/> Magazine & Book illus. <input type="checkbox"/> Show Card and Sign Lettering <input type="checkbox"/> Sketching and Painting <p>AUTOMOTIVE</p> <ul style="list-style-type: none"> <input type="checkbox"/> Automobiles <input type="checkbox"/> Auto Body Rebuilding and Refinishing <input type="checkbox"/> Auto Engine Tuneup <input type="checkbox"/> Auto Technician | <p>AVIATION</p> <ul style="list-style-type: none"> <input type="checkbox"/> Aero-Engineering Technology <input type="checkbox"/> Aircraft & Engine Mechanic <p>BUSINESS</p> <ul style="list-style-type: none"> <input type="checkbox"/> Accounting <input type="checkbox"/> Advertising <input type="checkbox"/> Business Administration <input type="checkbox"/> Business Management <input type="checkbox"/> Cost Accounting <input type="checkbox"/> Creative Salesmanship <input type="checkbox"/> Managing a Small Business <input type="checkbox"/> Professional Secretary <input type="checkbox"/> Public Accounting <input type="checkbox"/> Purchasing Agent <input type="checkbox"/> Salesmanship <input type="checkbox"/> Salesmanship and Management <input type="checkbox"/> Traffic Management <p>CHEMICAL</p> <ul style="list-style-type: none"> <input type="checkbox"/> Analytical Chemistry <input type="checkbox"/> Chemical Engineering <input type="checkbox"/> Chem. Lab. Technician <input type="checkbox"/> Elements of Nuclear Energy <input type="checkbox"/> General Chemistry <input type="checkbox"/> Natural Gas Prod. and Trans. <input type="checkbox"/> Petroleum Prod. and Engr. <input type="checkbox"/> Professional Engineer (Chem) <input type="checkbox"/> Pulp and Paper Making | <p>CIVIL ENGINEERING</p> <ul style="list-style-type: none"> <input type="checkbox"/> Civil Engineering <input type="checkbox"/> Construction Engineering <input type="checkbox"/> Highway Engineering <input type="checkbox"/> Professional Engineer (Civil) <input type="checkbox"/> Reading Struc. Blueprints <input type="checkbox"/> Structural Engineering <input type="checkbox"/> Surveying and Mapping <p>DRAFTING</p> <ul style="list-style-type: none"> <input type="checkbox"/> Aircraft Drafting <input type="checkbox"/> Architectural Drafting <input type="checkbox"/> Drafting Machine Design <input type="checkbox"/> Electrical Drafting <input type="checkbox"/> Mechanical Drafting <input type="checkbox"/> Sheet Metal Drafting <input type="checkbox"/> Structural Drafting <p>ELECTRICAL</p> <ul style="list-style-type: none"> <input type="checkbox"/> Electrical Engineering <input type="checkbox"/> Elec. Engr. Technician <input type="checkbox"/> Elec. Light and Power <input type="checkbox"/> Practical Electrician <input type="checkbox"/> Practical Lineman <input type="checkbox"/> Professional Engineer (Elec) <p>HIGH SCHOOL</p> <ul style="list-style-type: none"> <input type="checkbox"/> High School Diploma | <ul style="list-style-type: none"> <input type="checkbox"/> Good English <input type="checkbox"/> High School Mathematics <input type="checkbox"/> Short Story Writing <p>LEADERSHIP</p> <ul style="list-style-type: none"> <input type="checkbox"/> Industrial Foremanship <input type="checkbox"/> Industrial Supervision <input type="checkbox"/> Personnel-Labor Relations <input type="checkbox"/> Supervision <p>MECHANICAL and SHOP</p> <ul style="list-style-type: none"> <input type="checkbox"/> Diesel Engines <input type="checkbox"/> Gas-Elec. Welding <input type="checkbox"/> Industrial Engineering <input type="checkbox"/> Industrial Instrumentation <input type="checkbox"/> Industrial Metallurgy <input type="checkbox"/> Industrial Safety <input type="checkbox"/> Machine Design <input type="checkbox"/> Machine Shop Practice <input type="checkbox"/> Mechanical Engineering <input type="checkbox"/> Professional Engineer (Mech) <input type="checkbox"/> Quality Control <input type="checkbox"/> Reading Shop Blueprints <input type="checkbox"/> Refrigeration and Air Conditioning <input type="checkbox"/> Tool Design <input type="checkbox"/> Tool Making <p>RADIO, TELEVISION</p> <ul style="list-style-type: none"> <input type="checkbox"/> General Electronics Tech. | <ul style="list-style-type: none"> <input type="checkbox"/> Industrial Electronics <input type="checkbox"/> Practical Radio-TV Eng'g <input type="checkbox"/> Practical Telephony <input type="checkbox"/> Radio-TV Servicing <p>RAILROAD</p> <ul style="list-style-type: none"> <input type="checkbox"/> Car Inspector and Air Brake <input type="checkbox"/> Diesel Electrician <input type="checkbox"/> Diesel Engr. and Fireman <input type="checkbox"/> Diesel Locomotive <p>STEAM and DIESEL POWER</p> <ul style="list-style-type: none"> <input type="checkbox"/> Combustion Engineering <input type="checkbox"/> Power Plant Engineer <input type="checkbox"/> Stationary Diesel Engr. <input type="checkbox"/> Stationary Fireman <p>TEXTILE</p> <ul style="list-style-type: none"> <input type="checkbox"/> Carding and Spinning <input type="checkbox"/> Cotton Manufacture <input type="checkbox"/> Cotton Warming and Weaving <input type="checkbox"/> Loom Fixing Technician <input type="checkbox"/> Textile Designing <input type="checkbox"/> Textile Finishing & Dyeing <input type="checkbox"/> Throwing <input type="checkbox"/> Warming and Weaving <input type="checkbox"/> Worsted Manufacturing |
|--|--|--|--|---|

Name _____ Age _____ Home Address _____

City _____ Zone _____ State _____ Working Hours _____ A.M. to P.M. _____

Occupation _____ Canadian residents send coupon to International Correspondence Schools, Canadian, Ltd., Montreal, Canada. . . . Special tuition rates to members of the U. S. Armed Forces.

NEW BODIES FOR OLD!



**I've Made New Men Out of
Thousands of Other Fellows...**

**"Here's what I did for
Thomas Manfre. Now read
what I can do for you."**

-Charles Atlas

GIVE me a skinny, second-rate body — and I'll cram it so full of handsome, bulging new muscle that your friends will grow bug-eyed! . . . I'll wake up that sleeping energy of yours and make it hum like a high-powered motor! Man, you'll feel and look different! You'll begin to LIVE!

**Let Me Make YOU a NEW MAN—
IN JUST 15 MINUTES A DAY**

You wouldn't believe it, but I myself used to be a 97-lb. weakling. Fellows called me "Skinny." Girls made fun of me behind my back. THEN I discovered—"Dynamic Tension." And it turned me into such a complete specimen of MANHOOD that today I hold the title "THE WORLD'S MOST PERFECTLY DEVELOPED MAN."

My Secret — "Dynamic Tension"

When you look in the mirror and see a healthy, strapping fellow smiling back at you—then you'll realize how fast "Dynamic Tension" GETS RESULTS! "Dynamic Tension" is the 1939, NATURAL method you can exercise in the privacy of your room—JUST 15 MINUTES EACH DAY — while your chest and shoulder muscles begin to swell, ripple . . . those arms and legs of yours bulge . . . and your whole body starts to feel full of zip and go! And you'll be using the method which many great athletes use for keeping in condition—prize fighters, wrestlers, baseball and football players, etc.

FREE My 32-page Book—Not \$1. or 10c — But FREE

Send NOW for my famous book, showing how "Dynamic Tension" can make me a new man. 32 pages, crammed with photographs, valuable advice, answers to many vital questions.

This book is a real prize for any fellow who wants a better build. Yet I'll send you a copy absolutely FREE. It may mean the turning point in your whole life! Rush the coupon to me personally: **CHARLES ATLAS, Dept. 8-H, 115 East 23rd St., New York 10, N. Y.**



**CHARLES ATLAS, Dept. 8-H
115 East 23rd St., New York 10, N. Y.**

Send me—absolutely FREE—a copy of your famous book, showing what "Dynamic Tension" can do for me. 32 pages, crammed with actual photos, advice. I understand this book is mine to keep, and sending for it does not obligate me in any way.

Name _____ Age _____
(Please print or write plainly)

Address _____

City _____ State _____



DIESEL MEN WANTED

**Earn \$100 per week and up
AUTO-DIESEL MECHANICS**

You learn fast in our school and shops because you learn with tools on real equipment. Experienced instructors explain WHY and show you HOW, then you DO IT YOURSELF with tools on various makes and models. One of the best equipped technical schools of its kind in the United States. Thirty-seven years' experience training men. Successful graduates in 48 states and many foreign countries. Approved for veterans. Day and evening classes. Earn While You Learn. Write for free bulletin.

**NASHVILLE AUTO-DIESEL COLLEGE
226 7th Ave. N., Dept. 86, Nashville, Tenn.**

BUILD YOUR OWN AIR CONDITIONERS

From Junked Refrigerators for a Few Dollars
INSTRUCTION BOOKS SHOW YOU HOW . . . 75c EACH

"HOW TO BUILD a Low Cost Air Conditioner"
"HOW TO BUILD an Automobile Air Conditioner"
"HOW TO BUILD a Low Cost Home Freezer"
"HOW TO BUILD an Electrostatic Precipitator"
"HOW TO BUILD a Low Cost Dehumidifier"

Complete "Install-It-Yourself" Air Conditioner kits for home and automobile, 2 Ton capacity. Brand New Parts—\$124.50 and up.

KOOL ENGINEERING CO., Dept. R-8, 3716 Belmont, Chicago 18, Ill.

SPECIAL OFFER
2 Books—\$1.00
3 Books—\$1.50
or all 5 for \$2.00

FREE!
Instructions
and Literature
on kits.

IT'S EASY . . . MAKE MONEY IN PHOTOGRAPHY

If you are over 17—good pay and fascinating work await you in photography! Start making money quickly in sparetime—step into your own studio or writing career job. LEARN-BY-DOING method trains you at home! Write TODAY for FREE catalog. Also Resident Training. Co-ed. 47th Year. Approved for Veterans.

NEW YORK INSTITUTE OF PHOTOGRAPHY
Dept. 49, 10 West 33 Street, New York 1, New York

47th YEAR

REAL ESTATE BE A BROKER

PAY BIG! SEND FOR FREE, BIG, ILLUSTRATED CATALOG NOW! Graduates report making substantial incomes. Start and run your own business quickly. Men, women of all ages, learn easily. Course covers Sales, Property Management, Appraising, Loans, Mortgages, and related subjects. **STUDY AT HOME** or in classrooms in leading cities. Diploma awarded. Write TODAY for free book! No obligation. Approved for World War II and Korean Veterans.

WEAVER SCHOOL OF REAL ESTATE (Est. 1926)
2020R Grand Avenue Kansas City, Mo.

FREE BOOK TELLS NOW

EXTRA MONEY Selling EXCLUSIVE PARAGON Cushion Shoes

Even If Now Employed

Enjoy your own lifetime, independent shoe business without investment. Steady repeats. To \$4.00 pair advance commissions. Big bonus. Make \$50 and more a week in full or spare time. Over 153 latest smart styles. Magic cushion. Easy to start. Write for **FREE OUTFIT** today!

PARAGON SHOE COMPANY

79 Sudbury St., Dept. 20, Boston 14, Mass.



No. 574
Lo-Line
2 Eyelet
Crushed
Grain

INVENTORS

If you believe that you have an invention, you should find out how to protect it. The first step is to have a search made of the prior pertinent U. S. patents. If a report on this search indicates that the invention appears patentable you can apply for a patent, and the specifications and claims should be prepared.

The firm of McMorrow, Berman & Davidson, with offices in Washington, D. C., is qualified to take the necessary steps for you. We can make a preliminary search on your invention, advise you whether we think it can be patented, and prepare your application for patent.

Unless you are fully familiar with the U. S. Patent Laws, we recommend that you engage the services of a Registered Patent Attorney to protect your interests. The patent laws are *your* laws. A patent gives you the right to prevent others from making, using or selling the invention claimed in your patent for a period of 17 years.

Use these patent laws for your protection. Investigate whether your invention can be patented. If you have what you believe to be an invention, we suggest that you have this firm make a search for you:

Send for a copy of our Patent Booklet entitled "How To Protect Your Invention," containing information about patent protection and patent procedure. Along with this we will also send you an "Invention Record" form, for your use in writing down and sketching details of your invention. We will mail them promptly. No obligation. They are yours for the asking.

McMORROW, BERMAN & DAVIDSON

Registered Patent Attorneys

PATENTS • COPYRIGHTS • PATENTS

135-H VICTOR BUILDING, WASHINGTON 1, D. C.



LAW TRAINING FOR BUSINESS

(In spare time at home)
Earn L.L.B. Degree

Thousands of men and women who never intend to practice Law are studying it in spare time at home as an aid to business advancement.

Today Law is involved in practically every business decision. In many lines of work it is almost indispensable. Law training develops keen, clear, quick, correct and decisive thinking.

You can study LaSalle's American Law and Procedure right in the privacy of your own home—progressing as rapidly as your time and ability permit. For nearly 50 years we have helped over 1,350,000 ambitious people get ahead in the business world.

A MOST UNUSUAL LAW LIBRARY

This training includes the 14-volume LaSalle Law Library—AMERICAN LAW AND PROCEDURE—that is the basis of all our instruction service. This library has been compiled by leaders in the field of Law. It covers the whole field in an orderly and simple manner that is easy to learn and understand. Collateral reading and printed lectures, furnished at regular intervals, supplement the texts. Law instructors personally supervise your program. Under the LaSalle method you learn by actually solving legal problems—not just memorizing rules.

WRITE FOR TWO FREE BOOKS

Send the coupon below TODAY and find out how you can qualify for the many fine openings available to the law-trained man. In our FREE books "Law Training for Leadership" and "Evidence" you will find answers to your questions about the study of Law and the LaSalle method.

—MAIL COUPON TODAY— LA SALLE EXTENSION UNIVERSITY A Correspondence Institution

417 S. Dearborn St. Dept. 864-L Chicago 5, ILL.
Please send me, FREE, "Law Training for Leadership" and "Evidence."

Name.....
Address.....
City.....Zone.....State.....

RAZOR BLADE PLANES



ONLY 98¢ each AT HARDWARE DEALERS
If not yet available in your area, you may order by mail. Include 25¢ additional for postage and handling.
— DEALERS WRITE FOR INFORMATION —
WILSON BROS. Dept. PM-8 SPRINGFIELD, MISSOURI

\$150⁰⁰-\$250⁰⁰ Weekly

OPERATING
AUTO RADIATOR SERVICE SHOP



World's largest radiator shop equipment mfr. will help you set up your own radiator shop — help you get started toward a secure, profitable future. Over 1,000 INLAND shops now operating. First year averages \$6,000 to \$10,000. Many now making much more. Garage or service station can operate as dept. As little as \$305 down for equipment starts you. We will finance balance, furnish complete factory training. Write to

INLAND MFG. CO., Dept. PM-8, 1108 Jackson St., Omaha 2, Nebr.

CABINET MAKING

LOW COST HOME TRAINING COURSE FOR BEGINNERS & ADVANCED CRAFTSMEN

Make money. Learn skills and secrets of fine woodworking and tool use. Professionally prepared shop method training tells and shows how. Covers everything. Easy to master.



INTERSTATE TRAINING SERVICE
DEPT. F3, PORTLAND 13, OREGON

Write for Free Booklet

NOW NO ONE CAN KEEP A SECRET FROM YOU! **TELESCOPE** only \$299 postpaid



Amaze your friends... See what they're doing—without being seen! Special: Order now, get free carrying case. 3-range all metal telescope magnifies up to 60 power. Watch ball games, look at the moon, stars, animals, distant buildings... up close. Bright aluminum tube, made for long use. Good on hikes, camping trips, can use either 20x, 40x, or 60x power instantly. Variable focus eyepiece. No assembling, ready-to-use, no special instructions required.

I. J. STONE, Dept. T-8-B • 1616 Oak St. • Santa Monica, Calif.



Troubled with GETTING UP NIGHTS, Pains in BACK, HIPS, LEGS, Tiredness

If you have these symptoms then your troubles may be traced to Glandular Dysfunction... a constitutional disease. Medicines that give temporary relief will not remove the cause of your trouble. Neglect of Glandular Dysfunction often leads to premature old age and sometimes incurable malignancy.

The past few years men from over 3,000 communities have been successfully treated here at the Excelsior Institute. They have found soothing relief and a new outlook in the future of life.

The Excelsior Institute, devoted to the treatment of diseases peculiar to older men by NON-SURGICAL methods has a NEW FREE BOOK that tells how Glandular Dysfunction may be corrected by proven NON-SURGICAL treatments. This book may prove of utmost importance in your life. Write today. There is no obligation.

Excelsior Institute, Dept. 8929, Excelsior Springs, Mo.

DeVry Tech Specializes in Training Men

IN THEIR SPARE TIME AT HOME TO BECOME

Electronic Technicians

Did you ever stop to think how much your happiness depends on having the right job? Getting your bills paid, living the life you want, doing the kind of work you like . . . ?

The right job (a promotion) with your present employer, or a good job with a new employer, would help solve such problems for you, wouldn't it?

DeVry Tech, with a successful 26-year record of training men for industry, offers you a real opportunity for a better job or your own profitable service shop . . . in one or more branches of the fast-growing field of Electronics.

We can show you a way to a more interesting and brighter future without interfering with your present job. We can give you all of this in your spare time at home . . . or in our well-equipped Chicago or Toronto training centers.

Find out how Electronics may give you a brighter and more profitable tomorrow. It will cost you nothing to get the facts. Fill in coupon below. We think this information is worth a postage stamp, don't you?

ELECTRONICS AT WORK AT DEVRY TECH

Jack Dempsey, T. J. Lofeber, President, watch student Joe Skala solve a problem with the Electronic Analog Computer in DeVry Tech's Chicago training center.



AN INDEX TO A BETTER JOB, BRIGHTER FUTURE

Radar	Industrial Electronics
Automation Electronics	Computers
Guided Missiles	Radio
Television	Remote Control Systems
Communications	Broadcasting
Micro-Waves	Your Own Service Shop

NO PREVIOUS TECHNICAL EXPERIENCE, NO ADVANCED EDUCATION REQUIRED

Live-Wire Employment Service

DeVry Tech's Placement Department is in contact with some of the best-known employers in the Electronics field. The service is free to all graduates — and DeVry Tech's record in helping to place men has been outstanding.



DRAFT AGE?

We have valuable information for every man of draft age; so if you are subject to military service, be sure to check the coupon.

A SAMPLE LESSON FREE!

See for yourself how DeVry Tech trains you for real opportunities in Electronics. We'll also give you a free copy of an interesting booklet, "Electronics and YOU."

"One of North America's Foremost Electronics Training Centers"



Accredited Member of National Home Study Council

DEVRY TECHNICAL INSTITUTE

CHICAGO 41, ILLINOIS

FORMERLY

DEFOREST'S TRAINING, INC.



MAIL COUPON TODAY

DeVry Technical Institute

4141 Belmont Avenue, Chicago 41, Ill., Dept. PM-8-N

Please give me a FREE Sample Lesson and your booklet, "ELECTRONICS AND YOU," and tell me how I may prepare to enter one or more branches of Electronics as listed above.

Name _____ Age _____

Street _____ Apt. _____

City _____ Zone _____ State _____

Check here if subject to military training

± 1092 DeVry Tech's Canadian Training Center is located at 626 Roselawn Avenue, Toronto 12, Ontario

DRAFTSMEN



**CASH BIG
PAY CHECKS!**

Train Now for
more success,
"greater security"

**LEARN AT HOME IN SPARE TIME
(or at college in Chicago)**

Check the want ads in any newspaper—SEE the big-pay opportunities open to you as a draftsman. What's more, you can learn this well-paid, prestige profession at home—quickly, easily! No special talent needed. Get complete, step-by-step Chicago Tech lessons in the mail, spend a few pleasant hours studying each week. In a short time you'll be a well-trained draftsman, ready to take your pick of many good jobs. Act now!



Free Information—Mail Coupon Today!

Get FREE TRIAL LESSON plus information about C.T.C. practical training. Learn what successful Chicago Tech graduates say about high pay and opportunities in drafting. No charge, or obligation.

CHICAGO TECHNICAL COLLEGE

K-215 Tech Bldg., 2000 So. Michigan Ave.
Chicago 16, Illinois

Mail me FREE lesson with facts about big opportunities in DRAFTING.

Name _____ Age _____
Address _____
City _____ Zone _____ State _____



New 1957
4-STYLE
CHRISTMAS
ASSORTMENT
OF 24 CARDS

FREE SAMPLES
Name Imprinted
Christmas Cards

**Make \$50, \$75, \$100 Extra Money
Start A Greeting Card
& Gift Shop At Home**

Show friends New Ideas in Christmas, All Occasion greeting card assortments, gift wrappings, home and gift items. It's easy—it's fun! Profits to \$1.00 per box. Bonus—It's fun! Profits to \$1.00 per box. Bonus—Write today for Free Starting Outfit, Fund Raising Plan, Free Catalog, Selling Guide, all details of Extra Money Plan and Sensational Free Offer. Act Now!

NEW ENGLAND ART PUBLISHERS
North Abington E-836, Mass.

**MAKE STRIPES with
new PAINT PEN**

Straight, curved, single or double
With any color paint, stripe furniture, bikes, autos, model planes, toys, linoleum, wall-board. Clean, crisp decorative lines. Can't clog or smear. Also use with glue, tempera, textile paint or underglaze... on wood, glass plastic, ceramics, metals, fabrics and paper. Ask your dealer or order direct.

DEALERS Master paint striping tool in display carton. Write for discounts.
HOBBY "Professional" results every time. Simple, easy to use. Order now.
MFRS Ask about heavy duty industrial striping tools.

DOUBLE STRIPE MODEL \$3.25
5 COMBINATIONS. . . .

WENDELL MFG. CO. 4234 LINCOLN AVE., Dept. 322
CHICAGO 18, ILLINOIS

Single
1/16"
stripe
model
\$1.25

Other single \$1.75
stripe models
1/8", 1/32", 3/64",
5/64", 3/32" & 1/8"

Complete Kit \$5.00
(all 7 tips)

Extra tips 90c ea.

Extra 1/4" tip...\$1.20



**INSURED TIRE SERVICE
POPULAR BRANDS**

FREE INSURANCE POLICY given with each used tire sold. We guarantee the amount of service you pay for.

NOWHERE CAN SUCH QUALITY BE FOUND AT SUCH LOW PRICE!

SPECIAL! Deduct 10% on orders for two or more used tires.

YOU CAN'T LOSE!!

Super Quality	Rugged Performance	6 Months Insured Service
600x16 \$3.65 670x15 \$3.95 700x16 \$4.45 760x16 \$4.75	650x15 3.85 670x16 4.05 710x15 4.35 820x15 4.95	650x16 4.25 700x15 3.95 760x15 4.45 850x17 4.65

Supreme Quality	Nothing Finer	12 Months Insured Service
600x16 \$5.25 475x19 \$5.45 700x15 \$10.45 700x20 \$12.50	600x16 (6) 6.75 640x18 4.95 750x16 (8) 15.95 750x20 (8) 15.50	650x16 5.75 670x15 5.35 700x17 11.95 750x20 (10) 17.50
650x16 (6) 7.25 710x15 5.45 750x17 16.45 825x20 21.50	700x16 6.35 750x15 5.95 750x15 10.95 900x20 19.95	750x16 (6) 8.45 800x15 6.35 30x5 11.25 1000x20 20.45
550x18 4.95 820x15 6.35 600x20 10.95 1100x20 21.25	550x17 4.75 550x15 5.35 650x20 11.75 1000x22 21.95	650x15 5.25 670x16 5.15 32x6 (8) 11.95 1100x22 22.75
700x15 5.35 700x16 (6) 10.25 32x6 (10) 12.75 1100x24 25.95	Whitewalls \$1.00 extra.	

**MIDLAND
TIRE SALES**

Speedy shipments on Mail Orders. F.O.B. Chicago. Insurance policy sent with each order. Deduct 10% on orders for 2 or more used tires. Send CHECK or MONEY ORDER.—No COD's.
3701 S. Normal, Dept. PM-61, Chicago 9, Ill.



**BUILD YOURSELF A "HE-MAN" BODY
In Only 6 Weeks or Money Back!**

Fastest, surest method known... with famous

DAN LURIE BARBELLS

Special low prices... 50 lb. set \$ 8.98 * 100 lb. set \$14.98
150 lb. set \$21.98 * 200 lb. set \$27.98
14c per lb. F.O.B. 50% Deposit required

FREE! If you act fast. Complete exclusive body mold training course. 68 Photos with your order.

DAN LURIE BARBELL CO.
52MB Bristol St., Dept. 759H, Bklyn 12, N.Y.
AMERICA'S FAMOUS TV STRONG MAN

**\$495 down starts you in your
OWN \$25,000 yr. Business**

World-wide organization seeks reliable men. Start part time if you wish. We locally train you, furnish everything to clean & mothproof rugs, upholstery on location. No shop needed. Quickly established. Just 3 average jobs a day bring \$25,000 in business. Employ helpers and multiply profits. We back you with National Advertising, Parents' Seal, 25 other regular services. \$495 down required. Balance on easy terms. Send for FREE booklets.
DURACLEAN CO., 7-168 Duraclean Bldg., Deerfield, Ill.

BE A LOCKSMITH

Learn fascinating, profitable trade from experts in spare time at home! Age or physical handicap no disadvantage. Year around, steady income. Full or part time. Practical, illustrated lessons. Make money even while learning! All materials & special tools supplied.

Learn at Home
Free Booklet
INSTITUTE OF LOCKSMITHING, Dept. P-93
15 PARK AVENUE RUTHERFORD, N. J.
Lic. by N. J. State Board of Ed. Approved for Vets

GET LATEST OFFICIAL AIRCRAFT PHOTOS

SPECIAL INTRODUCTORY OFFER!

1. 4 3 1/2 x 5 photos, world's fastest jets.
 2. 4 3 1/2 x 5 World War II planes.
 3. 4 3 1/2 x 5 of Rockets, Missiles.
 4. 1 8 x 10 Boeing B-52 Jet Bomber.
 5. 1 8 x 10 Lockheed F-104 Starfighter.
- Only 25c a set. Send \$1 for all 5. (\$2 value)

Illustr. CAT. with order. Money back guar.

AVIATION PHOTO EXCHANGE DEPT. PE BOX 7588A
LOS ANGELES 5, CALIFORNIA

Don't Neglect Slipping

FALSE TEETH

Do false teeth drop, slip or wobble when you talk, eat, laugh or sneeze? Don't be annoyed and embarrassed by such handicaps. **FASTEETH**, an alkaline (non-acid) powder to sprinkle on your plates, keeps false teeth more firmly set. Gives confident feeling of security and added comfort. No gummy, gooey, pasty taste or feeling. Get **FASTEETH** today at any drug counter.

Here's the **BEST DEAL YET.**

for the man who needs a **BETTER JOB - MORE MONEY**

If you're just "breaking even"... if you're "in the hole" every month... if your wife wants to look for work—you need more money, a better job! You can have a good job with top pay and security in the old, established, but *fast-growing* Air Conditioning and Refrigeration industry. This field needs 20,000 newly-trained mechanics every year. It needs ambitious men to open service shops. *It needs you!* Don't say you're no mechanic! We know that. We also know we can train you at home to become a skilled mechanic. CTI has a real good deal for you. *Just fill in and mail coupon and we'll rush full details.*

E. C. ANDERSON
President
CTI

**NOW YOU CAN LEARN
AIR CONDITIONING
AND REFRIGERATION
by practicing at home
with real equipment!**

YOU GET "FIELD EXPERIENCE" AS YOU TRAIN

You train at home in spare time. CTI sends you 23 big kits of parts and tools. You assemble a commercial-type, heavy-duty, 1/4 h.p. refrigeration high-side (illustrated at right.) Then you build an air conditioner, refrigerator, freezer or milk cooler. All equipment included with training! No extra cost.



You Get Kits Like These

At left is photo of tools included in just one kit. You get other tools, tubing, much equipment. Kits are sent on a planned schedule so that you learn in easy stages. You learn fast, too!



In another kit (right) you get motor, fan, pulley, service tools. Kits develop skill, let you get experience, eliminate years of low-pay apprenticeship.

YOUR BIG CHANCE TO OPEN A SERVICE SHOP

Want to be independent—be your own boss? The air conditioning and refrigeration field is one of the best. It's big, uncrowded, packed with opportunity. Start small and grow big. Many



students do service work on a monthly fee basis—do repairing for shops, food stores, meat markets, etc. Others answer home calls. In time, they build up a customer list, open a shop. You could, too!

FIRST GET THE FACTS—THEN DECIDE



Add to Your Income by Earning Cash as You Train

CTI training is practical, just like working on actual jobs. Like other students, you'll want to do repair work for profit soon after starting. Many students pay their tuition this way, add to their incomes, even get started in a business. Get the facts about this. *Mail coupon.*

COMMERCIAL TRADES INSTITUTE • 1400 Greenleaf Ave. • Chicago 26, Illinois

MAIL COUPON TODAY FOR 2 FREE BOOKS

COMMERCIAL TRADES INSTITUTE

1400 GREENLEAF AVENUE
CHICAGO 26, ILLINOIS

DEPT. R-388

Rush me your booklet, *Success in Air Conditioning & Refrigeration*, and *Sample lesson*. Both FREE.

Name _____ Age _____

Address _____

City _____ Zone _____ State _____



"TRAINING YOU CAN TRUST"

Free! AIRMAIL COLLECTION



Get this spectacular collection of all-different, genuine Airmails from strange, far-away countries in Asia, Africa, Europe, the exotic Orient! World's largest airmail, scarce \$27 stamp, old Zeppelin, many, many others. A truly remarkable collection containing stamps worth up to 40c each at catalog prices! **EXTRA:** new illustrated booklet "Men Against the Sky." **PLUS** Bargain Catalog and other unusual offers. Send 10c for mailing. Mail coupon today!

JAMESTOWN STAMP CO. Dept. FB PM JAMESTOWN, N. Y.



RUSH my Free Airmail Collection and other offers. I enclose 10c for mailing costs.

Name

Street

City State

Make \$500 an Hour CASH PROFIT THE DAY YOU START!



START YOUR OWN BUSINESS AT HOME... SHARPEN HOUSEHOLD, GARDEN AND SHOP TOOLS IN SPARE TIME

Now you can turn spare time into Big Cash Profits with new Belsaw Sharp-All. Sharpen knives, scissors, shears, snips, ice skates, mower blades, hedge trimmers, grass whips, axes, chisels, screw drivers, scrapers and saws... just about any household, garden and shop tool. Your own CASH business with no inventory. No calls to make. No experience needed.

Learn how easily you can start your own spare time business. Amazing low cost easy-payment plan. Send postcard for FREE BOOK.

BELSAW SHARP-ALL CO

718 Field Bldg.

Kansas City 11, Missouri



college graduates get ahead faster!

You see it in your own city. They have higher incomes... advance more rapidly. Grasp your chance for a better life. Industrial growth... automation... technical advances create career opportunities for engineers, accountants, management experts. Share rewards awaiting college-trained men. Important firms visit campus regularly to employ Tri-State College graduates. Start any quarter in th's world-famed college. Approved for veterans.

Bach. of Science degree in 27 months

In Mechanical, Civil, Electrical, Chemical, Aeronautical, Radio (TV-Electronics) Engineering. In 26 months a B.S. in Business Administration (General Business, Accounting, Motor Transport Management majors). Superior students may accelerate. 36-weeks course in Drafting, Intermediate program: technical fundamentals stressed: comprehensive courses with more professional class hours. Small classes: personalized instruction. Enrollment limited to 1500. Preparatory courses. Beautiful campus. Well-equipped, new and modernized buildings and laboratories. Enter Sept., Jan., Mar., June. Earnest, capable students (whose time and budget require accelerated courses and modest costs) are invited to write Jean McCarthy, Director of Admissions, for catalog and book "Your Career in Engineering and Commerce."



TRI-STATE COLLEGE

487 College Avenue • • • Angola, Indiana

Free Book on Arthritis And Rheumatism

HOW TO AVOID CRIPPLING DEFORMITIES

Explains why drugs and medicine give only temporary relief and fail to remove the causes; tells all about a specialized non-surgical, non-medical treatment which has proven successful since 1919. Write for this 36-page FREE BOOK today.

BALL CLINIC Dept. 756 Excelsior Springs, Mo.

TASOPE PHOTO-ENGRAVING PLANTS



Material Cost Of This Cut 34c Selling Price \$1.00 And Up

Establish your own profitable PHOTO-ENGRAVING business. Make cuts for newspapers, printers, and advertisers. Make etched name plates, plaques etc. Instructions furnished, no experience necessary. Sold direct from factory since 1931. First five hundred cuts sold locally or by mail will pay for plant and pay you well for your time. Write for FREE catalog.

TASOPE, DEPT. PM-8, AURORA, MO.

WE PAY \$3.50 lb.

GROW MUSHROOMS. Cellar, shed and outdoors. Spare or full time, year round. We have over 25,000 customers. FREE BOOK. Washington Mushroom Ind., Dept. 61, 2954 Admiral Way, Seattle, Wash.

Hotels Call for Trained Men

Record-breaking travel means nation-wide opportunities and a sound substantial future for trained men in hotels, motels, clubs, apartment house positions. Fascinating field; fine living; quick advancement. You can qualify at home or through resident classes in Washington. Previous experience proved unnecessary. Placement Service FREE. Write for FREE Book. Course approved for All Veteran Training. 41st Year. LEWIS HOTEL TRAINING SCHOOL, Room CM-312, Wash. 7, D.C.

FOR BIG MEN ONLY!



SEND FOR FREE CATALOG

SIZES WIDTHS

10 to 16 AAA to EEE

We specialize in LARGE SIZES ONLY—sizes 10 to 16; widths AAA to EEE. Dress, sport, casual and work shoes, golf shoes; insulated boots; size; slippers; rubbers; overshoes; shoe trees. Also sport shirts in your exact, extra-long sleeve length. Enjoy perfect fit in your hard-to-find size at amazingly low cost. Satisfaction Guaranteed. Sold by mail only. Write for FREE Style Book TODAY!

KING-SIZE, INC., 305 Brockton, Mass.

POPULAR MECHANICS

Copyrighted material

Use your Day Off to Boost Your Income

Get started in a Little "One Man" Home Business that Can Bring in an Extra \$60 for Ten or Twelve Hours of Your Spare Time Work. No experience Needed. Use Your Own Home as Your Workshop and Office.

This is the most fantastic home business you ever heard of. Yet the entire operation is so simple and easy that you can get the hang of it in no time. The secret is in the little machine pictured here at the right. As you can see, this machine is so small that you or your wife can operate it anywhere—in a corner of your kitchen, basement, garage or any other place where there's a couple of square feet of space.

This machine can start making money for you right away because it can make \$60 or more for ten or twelve hours work. Just operate the machine on your day off and maybe two or three evenings a week and you can quickly reach the point where you're making more money "on the side" than you earn on your regular job. Then you can devote full time to the work or keep on with a "double income" just working the machine on your days off and any other odd hours you can spare. It's a wonderful way to make extra money in your spare time if you really set your mind to it.

What this machine actually does—for the first time—is to bring the fabulous profits of Plastic Sealing and Plastic Laminating within reach of the small operator. You might think that "getting into plastics" would require heavy, expensive equipment. It doesn't. The machine is so small and it has been so simplified that anyone can afford the small cost and anyone can learn how to do the work in a few minutes of reading. After that, it's easy to turn out professional work with one hour of practice.

The beauty of a home business like

this is that anyone can start making money the very first day. No house-to-house canvassing is required. No face-to-face selling. That's because we give you complete instructions that tell you exactly how to take in big daily profits just filling a demand that already exists. We show you seven simple plans by which you get business coming to you.

One of the very profitable markets is in "Laminating." Thousands of people right in your own locality are looking for a way to protect valuable cards, photographs, documents and papers from wear, soil and damage. The machine does this kind of work and the profits are almost unbelievable. For example, 11c worth of raw material can turn out a product worth as much as \$2.50. But that's only one of the ways the machine makes money. It also turns out all kinds of artistic giftwares for which there is a big demand everywhere. These exclusive "one-of-a-kind" creations bring orders at 10 to 20 times the cost of the materials. And we give you complete, illustrated instructions for making these fast-selling giftwares with your little table-top machine.

Everything is explained in a simple step-by-step instruction manual. This manual tells you how to operate the machine—how you can get business coming in at a profitable clip right from the start—how you can start with one machine and build up to the



This man is taking a Plastic Sealing Job out of his machine. The raw material cost him 11c. The product has a retail value of \$2.50—23 times more than the cost.

point where you can hire others to do the work for you—how to achieve personal independence without long hours of study or previous experience.

We will lend this book to you with the understanding that it is yours free if you purchase a machine. Or the copy we lend you can be returned if you decide not to go in the business. Reading it will not cost you anything.

If you are interested in a nice little home business that can bring in an extra \$60 or more for ten or twelve hours work in spare time, then send me your name. All information on the book and the machine will be sent free and postage prepaid. No salesman will call to bother you. Send name today—on coupon or postcard—and find out about this wonderful, new fast-growing money-making home business.

Warner Electric Company

1512 Jarvis Avenue, Dept. L-2-J
Chicago 26, Illinois

Warner Electric Company, Dept. L-2-J
1512 Jarvis Ave., Chicago 26, Ill.

Gentlemen: Please send information that shows how I can start a profitable Plastics Business in my home in spare time. Everything you send will be mailed to me free and postage prepaid. No salesman will call on me and I am not under any obligation to go ahead with the business and there is no charge for this information now or any other time.

NAME.....
ADDRESS.....
CITY.....ZONE.....STATE.....

LEARN UPHOLSTERY

in your spare time
run your own
business
AT HOME



FREE BOOK
with
sample
lessons

with course
YOU MAKE
SLIPPER
CHAIR



**CLUB
CHAIR**



OTTOMAN

PLUS
SLIP COVERS
Yours to Keep
or Sell

BE YOUR OWN BOSS

Earn more from the start! Set up your own profitable business, in your own home, enjoy steady income, independence for life—in the booming field of Custom Furniture Upholstery. Right off you start learning with tools, complete frames, fabrics and materials, included **FREE** with practical UTS course. You learn skilled professional custom upholstery, reupholstery, furniture finishing, repairs, how to make beautiful slip covers, window cornices, cushions and draperies. **EARN WHILE YOU LEARN**, in your spare time **AT HOME**... the UTS easy way.

FREE ILLUSTRATED BOOK—FREE SAMPLE LESSON
Get ready for well-paid job and big profits, from steady work, as your own boss, running your own business. Mail coupon NOW for **FREE BOOK!** Training in N. Y. School also available.

APPROVED FOR VETERAN TRAINING

UPHOLSTERY TRADES SCHOOL
Dept. FM-310, 721 B'way, N. Y. 3, N. Y.

Please send me **FREE** book "Your New Way to a Successful Career," and **FREE** sample lesson. No obligation—no salesman will call.
 Home Study N. Y. School Training

Name _____ (Please Print Plainly)
Address _____
City _____ Zone _____ State _____
 Check if Korean Veteran

Yours FOR JUST 10¢



This \$4.95 Regular Size Presto Fire Extinguisher for Letting Us Prove How YOU CAN MAKE UP TO \$1,000⁰⁰ A MONTH!

C. Kama of Texas Making Even More—Said, "Haven't Touched Bottom Yet!"



We **DARE** make this amazing offer because we're certain that once you actually use a **PRESTO** to put out a demonstration fire in a bucket—you'll realize why it "sells on sight" to car owners, homes, stores, farms, boats, offices, factories, and to stores for re-sale. **PRESTO's** startling chemical is 1½ to 6 times as effective as ordinary extinguisher chemicals on equal-weight basis... permits light, handy extinguisher even a child can use!

Here's Our Daring 10c Offer!

Send your name and address with only 10c **TODAY**—and we'll send you a regular \$4.95 **PRESTO** at once. Then you can demonstrate this miracle fire extinguisher to yourself and friends and see for yourself. If not amazed, return **PRESTO** to us and we'll refund your 10c. Or keep it at this big saving when you order 6 or more. You can't lose. You risk nothing. We'll also send you **FREE** a complete Sales Kit to help you get started. Act now. Write to **MERLITE INDUSTRIES** (Presto Div.), 114 E. 32nd St., Dept. X-15Z, New York 16, N.Y. In Canada: Mopa Co., Ltd., 371 Dowd St., Montreal 1, P. Q.

Bean's Free Fall Catalog

Ready August 15

Fully illustrated, 108 pages, showing Hunting Footwear, Clothing, and one hundred and twenty other leather and canvas specialties of our own manufacture for campers and hunters.



L. L. Bean, Inc., 118 Main St., Freeport, Maine
Mfrs. Hunting and Camping Specialties



SHEET METAL MACHINES

Brakes form angles, locks, pans, etc. Quick eccentric clamp. All steel construction.

15"–10 gauge steel	\$26.00
36"–22 gauge steel	\$37.00
48"–24 gauge steel	\$52.00
Floor stand	\$ 8.00
15"–24 gauge Folder	\$16.50
30" Pan and Box brake	\$60.00
¼ x 3 Adjustable Bender	\$11.50
16 gauge 7" Bench Shear 3 adj. gauge	\$16.50
30"–20 gauge Curve Former	\$11.50

ORDER DIRECT OR SEND FOR FREE CATALOG

VYKE MFG. CO., P-4158 Jason St., Denver 11, Colo.



Own and Play the ACCORDION

for fun...for popularity...for profit!

SAVE UP TO 50%
on famous
ITALIAN MAKES

5 DAY FREE TRIAL

Buy direct at amazing savings from America's biggest importer of fine Italian made accordions. **5 DAY FREE TRIAL!** Easy Terms. Free Lessons—Easy to learn. Personalized selection service. Trade-ins accepted. Write today for big Color Catalog and our low wholesale prices. **FREE!** Accordion Manufacturers & Wholesalers Outlet
2093 West Chicago Avenue • Dept. R-87 • Chicago 22, Illinois



MECHANICAL DENTISTRY

To make Crowns, Plates, Bridgework, etc., for Dentists. Easy practical way to learn mechanical dentistry at home in spare time. **FULL EQUIPMENT OF TOOLS AND MATERIALS INCLUDED WITH COURSE.** Low tuition. Easy terms. Write for **FREE BOOK** about this money making profession that is not affected by machine age.

MCCARRIE SCHOOL OF MECHANICAL DENTISTRY
207 N. Broad St., Dept. 68, Philadelphia 7, Pa.

ENGINEERING DEGREE IN 27 MONTHS

B.S. Degree, Aero., Chem., Civil, Elec., Mech. & Electronic Engineering (inc. Radio, TV), 36 mo. B.S. degree in Math., Chem., Physics, Prep courses, Demand for grads. Spacious campus, 20 bldgs., dorms, auditorium, gym. Low rate. Earn board, G.I. approved. Enter Sept., Dec., March, June. Catalog: 1687 E. Washington Blvd. Fort Wayne 2, Indiana. Keeping pace with progress.

INDIANA TECHNICAL COLLEGE

75 POWER TELESCOPE \$3.98
25X—45X—75X

New 3 in one telescopes, 3 variable 25X—45X—75X magnification, Brass bound, 25 power for ultra bright images 45 & 75 power for long range. Guaranteed to bring distant stars, moons, objects, sports 75 times closer.

Most powerful scope sold anywhere near this amazing low price. American made, 5 sections. Opens 36" closes 1 ft.; contains 4 ground & polished lenses. Can also be used as powerful compound microscope. Directions included. Mass production enables us to offer telescope at \$3.98 postpaid complete money back guarantee. Get yours now. **CRITERION CO., 331 Church St., Hartford, Conn., Dept. PMB 48**



POPULAR MECHANICS

Copyrighted material



SEE FOR YOURSELF How to Fix Any Part of Any Car!

QUICKLY, EASILY and RIGHT on the very first try



THIS GIANT PICTURE BOOK SHOWS YOU STEP-BY-STEP HOW TO SERVICE OR REPAIR EVERY CAR BUILT FROM 1949 THRU 1957

Whether You're a Beginner or an Expert Mechanic—This Manual Can Help You "Breeze Through" the Toughest Auto Repair Job

2,500,000
COPIES SOLD!

DON'T waste time, money, energy by trying to guess how to fix a car! Do what the experts do. No matter what make or model car—whether it's a simple carburetor adjustment or a complete overhaul—simply look up the job in the index of **MOTOR'S NEW AUTO REPAIR MANUAL**. Turn to page covering job. Follow the clear, illustrated, step-by-step instructions. See for yourself how easy it is!

No guesswork! **MOTOR'S Manual** takes nothing for granted. Tells you where to start. What tools to use. Then it leads you easily and quickly through the entire operation!

Over 2,900 Pictures! So Complete, So Simple, You CAN'T Go Wrong!

BRAND-NEW EDITION covers everything you need to know to repair 157 chassis models. Over **ONE THOUSAND** giant pages, 2,900 "This-Is-How" pictures, 291 "Quick-Check" charts, 23,436 essential specifications. Over 225,000 service and repair facts. Instructions and pictures are so crystal-clear you just can't go wrong!

Some FREE 7-DAY Offer on MOTOR'S New TRUCK REPAIR MANUAL



Covers **EVERY** job on **EVERY** popular make gasoline truck made from 1949 thru 1957—as well as GM and Cummins Diesels. For **FREE TRIAL**, check proper box in coupon.

Meat of Over 160 Official Shop Manuals

Engineers from every automobile plant in America worked out these time-saving procedures for their own motor car line. Now the editors of **MOTOR** have gathered together this wealth of "Know-How" from over 160 Official Shop Manuals, "boiled it down" into crystal-clear terms in one handy indexed book!

**SEND NO MONEY
Try Book for a Week FREE**

Just mail coupon. (Attach it to postcard, if you wish.) Test book in your own garage or shop. It's **GUARANTEED** to pay for itself in 7 days. If it doesn't, return it, and owe nothing. Rush coupon for your **FREE-TRIAL** copy. **MOTOR Book Dept.**, Desk 18, 250 W. 55th St., New York 19, N. Y.

Amazed Self and Friends—"I amazed myself and my friends, too. Now do jobs that stumped me before."
—Michael Baliesky, Newark, N. J.



So Complete and Easy to Understand—"So complete, easy to understand—have done jobs with Manual I would not have attempted without it."
—G. L. Vanerstrom, Mich.



**MAIL COUPON FOR
FREE
7-DAY TRIAL
OF MOTOR'S AUTO REPAIR MANUAL**

No obligation. No risk.
If not delighted, return book and owe nothing.

**MAIL COUPON NOW FOR 7-DAY FREE TRIAL
(Attach to Postcard if More Convenient)**

MOTOR BOOK DEPT.
Desk 18, 250 W. 55th St., New York 19, N. Y.

Rush to me at once (check box opposite book you want):

MOTOR'S New AUTO REPAIR MANUAL. If O.K., I will remit \$2 in 7 days, \$2 monthly for 2 months and a final payment of 95c (plus 35c delivery charges) one month after that. Otherwise I will return the book postpaid in 7 days. (Foreign price, remit \$9 cash with order.)

MOTOR'S New TRUCK REPAIR MANUAL. If O.K., I will remit \$2 in 7 days, and \$2 monthly for 3 months, plus 35c delivery charges with final payment. Otherwise I will return book postpaid in 7 days. (Foreign price, remit \$10 cash with order.)

Print Name.....Age.....

Address.....

City.....State.....

Check box and save 35c shipping charge by enclosing **WITH** coupon in envelope entire payment of \$4.50 for Auto Manual (or \$5 for Truck Manual.) Same 7-day return-refund privilege.

INVENTORS

WE recommend that you take the following preliminary steps toward patent protection. Make a disclosure of your invention; sign, date and have your disclosure witnessed by two people who understand your invention; authorize us to conduct a preliminary search among previously granted U. S. patents for similar types of invention. We give you a report on the probable patentability of your invention and our recommendation for further course of action.

Let us send you a copy of our instructive booklet, "Patent Protection for Inventors" and our convenient "Evidence of Invention" disclosure form. No obligation.

VICTOR J. EVANS & Co. *Merlin M. Evans*
REGISTERED PATENT ATTORNEY
330-J MERLIN BUILDING, WASHINGTON 6, D. C.

MAKE BIG MONEY WITH Amazing New JACKET!



IT'S INSULATED!

Send for your FREE Sales Kit!

Here's an easy new way to make extra cash! Take just 2 combination orders a day in spare time for these sensational new Insulated jackets and make \$68.00 EXTRA CASH in one week! Made with same type insulation as Army Coldbar suit, this "miracle" jacket keeps you WARM in subzero weather!... DRY in downpours (can't absorb water)!... protected from strong WINDS! It's light-weight, covered with Nylon, has detachable hood. **SPECIAL FEATURE!** Men wearing this Insulated Jacket plus Mason's Insulated BOOTS and PANTS can float indefinitely! Mason products are not sold in stores, so folks in your town must buy from YOU! Your FREE Outfit also features 150 other fast-selling Mason shoes, jackets for men, women! Act quick be FIRST in town to take orders for amazing new Insulated jackets, boots, shoes! Run a big spare-time business. Send for FREE Kit today! MASON SHOE MFG. CO., Dept. 782, CHIPPEWA FALLS, WIS.

As a Cavitec manufacturer you can supply all the units to build all the walls of the "Cavalier" for



*National Average

\$962¹³*

Blueprints available \$15.00 per set



Superfine masonry at sensationally low price explains why the local manufacturing of Cavitec has such great potentials as a community enterprise. Local processing of local materials effects vast economies... enables low prices to builders yet upward of 100% mark-up on basic costs. Hundreds of choice franchise-protected territories still open. Machine available on lease. "Cavalier", shown above, indicates the kind of price-appeal which helps sell Cavitec for every type of residential, commercial and industrial construction. Write at once for "Opportunity, Unlimited" and tentative reservation of territory.

16" long
2 1/4" high
8" and 4" thick
• Modular dimensions
• Large voids for insulation quantities
• Range of 14 shades and tones
• Striated or plain face



W. E. DUNN MFG. CO.
409 W. 24th Street, Holland, Michigan
844 Dundas Highway, Cooksville, Ont.

SHORTHAND in 6 WEEKS

Famous SPEEDWRITING shorthand. 120 words per minute. No symbols; no machines; uses ABC's. Easiest to learn, write and transcribe. Lowest cost. For business and Civil Service. 350,000 graduates. Typing available. 34th year. Write for FREE booklet to: SCHOOL OF

6 WEEKS

© 1957

Speedwriting

Dept. 1508-7, 55 W. 42 St., New York 36

earn as TAX EXPERT

\$15 HOUR

Our students earn as much as \$3,000 in 3 short months preparing income tax returns in spare time. Also operate lucrative year-round Business Tax Service. Digitized home-office business. Experience unnecessary. We train you; help you start. State approved home training program. Write today for free prospectus.

UNION INSTITUTE, 68 Hudson, Hoboken 208, N. J.

\$2.95 OR 2 FOR \$5.00!

TESTED AND GUARANTEED

Write for free list on all types of telephones. Shipments F.O.B. Simpson, Pa. TELEPHONE ENGINEERING CO., Dept. 887, Simpson, Pa.

BECOME AN EXPERT IN TRAFFIC and TRANSPORTATION

Traffic men earn \$4,000 to \$10,000 and up. Thousands of firms need experts on rates, tariffs, regulations. We train you thoroughly in spare time at home for executive traffic jobs. Personal training under traffic authorities. Write for free book "Traffic and Transportation."

LASALLE Extension University, 417 So. Dearborn St. A Correspondence Institution Dept. 864-T, Chicago 5, Ill.

Learn CARBURETOR and IGNITION



Start Training at Home For This Clean, High-Class Type of Position

Get in line for a raise—or for more profits in your own shop. Learn testing and adjusting with latest-type scientific motor tune-up equipment. This enables you to locate the trouble exactly, and fix it fast—handling and getting paid for more jobs per day. There's money in this, and it's clean, high-class work which gets the respect and confidence of your customers.

Send for FREE SAMPLE LESSON Carburetor and Ignition Specialization offers very superior opportunities for better pay and bigger profits because relatively few mechanics know anything about this time-saving, money-making new test equipment. Now our spare-time home-study method teaches you the principles and shortens your shop training. Ambitious men (age 18-55): Send for full FACTS and FREE SAMPLE LESSON at once. Write today to

UTILITIES ENGINEERING INSTITUTE
2525 Sheffield Ave., Dept. OC-7, Chicago 14

POPULAR MECHANICS

GIANT 6 FOOTERS 59c



Wow! Genuine Neoprene government surplus (never used) . . . giant 6 ft. across, 21 ft. around . . . at a fraction of original cost. Durable. Can paint on advertising message, inflate and fly. Visible for miles. Great for attracting crowds to fairs, openings, school proms, gas stations. Fun for young and old in backyards or picnics, at the beach, etc. use as water markers & buoys. Order today — only 59c each.
Special: 2 for \$1.00; 5 for \$2.00; 13 for \$5.00. No C.O.D.

P.O. Box M-27104, Hollywood 27, Calif.

SAVE MONEY! **PRINTING** **WHY PAY MORE?**

1,000 Embossed Business Cards . . .	\$4.95
1,000 8 1/2 x 11 Bond Letterheads . . .	8.95
1,000 8 1/2 x 8 1/2 Bond Statements . . .	7.45
1,000 8 1/2 x 8 1/2 Bond Billheads . . .	7.45
1,000 No. 6 1/2 Small Envelopes . . .	6.95
1,000 No. 10 Large Envelopes . . .	7.95
1,000 No. 6 1/2 Window Envelopes . . .	7.45
1,000 Gummed Shipping Labels . . .	5.95

WRITE FOR SAMPLES and PRICE LIST
Hundreds of Other Items at Real Low Prices.
Send Check with Order — SATISFACTION GUARANTEED
FREDRICKS-MORROW, 407 E. Michigan St., Dept. F-1, Milwaukee, Wis.

FREE GERMAN STEEL HUNTING KNIFE

4-INCH BLADE

We give you handiest hunting and fishing knife you've ever had! Has 4-INCH LONG highly tempered steel blade—VERY SHARP! Attractive handle. We send knife FREE to acquaint you with our below-wholesale bargains. Please send 25c for handling. NO LIMIT—but send 25c handling for each knife, order TODAY!
HUNTING KNIFE, Dept. K-252, Box 881, St. Louis, Mo.

Exclusive Double-Bearing HEAVY-DUTY PUMPS
IRRIGATE • DRAIN • CIRCULATE • SPRAY
Up to 7,500 GPH. 3,000 GPH from 20" well. Use 1/2 to 1 HP motor. 1 1/4" inlet; 1" outlet. Stainless shaft.

TYPE X—2 oilless bronze bearings. **\$10.95**
Won't rust.
TYPE XB—Ball bearing model. **\$12.95**
Postpaid if cash with order. Rush your order today
MONEY BACK GUARANTEE
Centrifugal and Gear Pumps in All Sizes
LABAWCO PUMPS, Belle Mead 2, N. J.

START YOUR OWN MONEY-MAKING BUSINESS

Clean rugs on customers' floors—upholstery in their homes—even painted walls—with highly efficient electric machines which are making big money for others and giving them independence. Write today for complete information. It's FREE!

VON SCHRADER MFG. CO., Dept. 810 "R" PL., Racine, Wis.

CONVERT YOUR CAR INTO A BED

Save on Overnight Trips—Rest In Solid Comfort

QUICK, EASY CONVERSION

Works on all 2 and 4-door sedans, club coupes, convertibles, station wagons. Fits all Ford, GM, Chrysler & Studebaker products—does not affect seat structure—normal functions or appearance. **GUARANTEED** to work when installed by instructions. **PAYS FOR ITSELF** in three nights lodging. **IDEAL** for hunters, fishermen and travelers. Delighted users everywhere!
Complete conversion kit and instructions **\$14.95**
State make, model, whether 2 or 4-door
SEND CASH, CHECK OR MONEY ORDER TO:
CAR BED CO., 600 MAGNOLIA AVE., PANAMA CITY, FLA.

MAKE MORE MONEY get into

TELERAMA • ALL 8 BRANCHES OF TELEVISION ELECTRONICS • RADIO • IN ONE DYNAMIC, MODERN SHOP METHOD, HOME TRAINING COURSE

You get and keep ALL this modern, newest, practical equipment!

* Registration applied for



YOU COVER ALL 8 BRANCHES IN ONE MASTER COURSE, ONE LOW TUITION

1. Television—including color TV
2. Radio — FM & AM
3. Industrial electronics
4. Sound recording and Hi-Fidelity
5. Preparation for FCC License
6. Automation
7. Radar & Sonar
8. Communications

- Parts to build a modern TV set, including large screen Picture Tube.
- Parts to build a powerful Superhet Receiver, standard broadcast and short wave.
- Parts to conduct many experiments and build — • Continuity Checker • RF Oscillator • TV Circuits • Audio Oscillator • TRF Receiver • Signal Generator
- Professional Multitester
- A MUST for all technicians

FOR MEN WHO WANT TO EARN MORE MONEY! Another great advance in Home Study Training. Let National Schools, of Los Angeles, a practical Technical Resident Trade School for over 50 years, train you at home by Shop-Method, for today's unlimited opportunities in ALL 8 BRANCHES of the Television, Electronics, Radio industry

YOU DO MANY PRACTICAL JOBS — including servicing, circuit analysis. Build a modern TV set from ground up, with equipment kits we send you, including a new large-screen picture tube and professional Multitester, at no additional charge. You receive an experiment lesson with each kit. **EARN AS YOU LEARN.** Graduate Employment Service.

SEND FOR FREE FACT-BOOK AND SAMPLE LESSON

RESIDENT TRAINING AT LOS ANGELES
If you wish to take Resident Training at Los Angeles in our big, modern Shops, Labs, and Section check special box in coupon for full information.

NATIONAL SCHOOLS
4000 S. FIGUEROA ST., LOS ANGELES 27, CALIF.

NATIONAL SCHOOLS
TECHNICAL TRADE TRAINING SINCE 1905
Los Angeles, California

GET FAST SERVICE — MAIL NOW TO
NATIONAL SCHOOLS, DEPT. RB-87
4000 S. FIGUEROA ST.
LOS ANGELES 27, CALIF.

Rush free TV-Radio "Opportunity" Book and sample lesson. No salesman will call.

NAME _____ BIRTHDAY _____ 19__

ADDRESS _____

CITY _____ ZONE _____ STATE _____

Check if interested ONLY in Resident School Training at Los Angeles
VETERANS: Give date of discharge.

FREE! BRITISH AFRICAN STAMPS



Rush coupon today. Exciting offer! Newest issue Elizabeth II stamps — all mint, all different, all yours, — absolutely FREE! Scarce, beautiful, 2-color stamps from obscure African countries — Nigeria, Basutoland, Gambia, St. Helena — many others! And MORE — free copy helpful "Stamp Collector's Guide" — free color reproduction and story World's Rarest Stamp — free 1/2 penny Falkland Island stamp. Other valuable offers for your free inspection. Limited offer, so rush coupon today! If coupon has been clipped, rush 10¢ for postage and handling to GARCELON STAMP CO., Dept. PM8B, Calais, Maine.

GARCELON STAMP CO., DEPT. PM8B, Calais, Maine
Rush FREE mint British African Stamps and other offers. Enclosed 10¢ for postage and handling. (PLEASE PRINT)

NAME _____
ADDRESS _____
CITY _____ STATE _____

NEW 1957 GEOPHYSICAL YEAR MODEL OF GENUINE 135-POWER ACHROMATIC TELESCOPE

with Achromatic Lens and 4-POWER FINDER attached

ONLY \$18.95 PREPAID

EXTRA BONUS GIFTS:

- 273 page book, "Handbook of the Heavens"
- Magic Star Finder Dial
- 220X & 400X Eyepiece lenses

5 Magnifications 18X—35X—65X—85X—135X

Never before has an ACHROMATIC 135X telescope with range finder and tripod sold for anywhere near this amazing low price. POSITIVELY SHOWS planets, stars, craters, people and all distant objects. Compound Achromatic coated lens guarantee performance. Adjustable 18X—35X—65X—85X—135X for any condition of brightness, greater range of powers, color free needle-sharp views only possible with Achromatic corrected lens. Trimmed with gleaming brass extends to 43". 4X finder scope (30MM LENS) gives brilliant clear views. Brings difficult objects on target before viewing. 5 ft. folding tripod with heavy cast iron head fitted with Criterion's famous universal 360 degree aluminum mount assures stability, locks in any position. Remote controls. This amazing 135X Achromatic telescope obtainable only from Criterion. Shipped ready for use together with 4 bonus gifts: 273 page "Handbook of Heavens," Magic Star Finder, also 220X & 400 eyepiece lenses free for experiments. Shipped complete, nothing else to buy at amazing price of \$18.95, without tripod \$14.95.

ALSO SPECIAL 40X—80X—120X TELESCOPE WITH TRIPOD \$11.95 POST PAID

5 section telescope with 5 precision lenses, opens to 36" closes to 12". 5 ft. hardwood tripod, cast head, aluminum 360 degree mount. Erect clear images. Bonus gifts: 273 page Handbook of Heavens, Star Finder. You must be completely satisfied with these instruments or money promptly refunded. Send cash, check or money order today.

Dept. PMA15, CRITERION MFG. CO., 331 Church St., Hartford, Conn.

2 WAY PORTABLE RADIO SET SENDS — RECEIVES UP TO 10 MILES AS SHOWN

with built-in antenna or hundreds of miles with outside antenna! 80 and 40 meter amateur radio bands (voice) also Aircraft and overseas broadcasts (3 to 8 mc.) PORTABLE SELF-CONTAINED POWERED WITH STANDARD LOW COST PORTABLE RADIO BATTERIES. NO AC PLUG-INS NEEDED! Take it with you everywhere you go—on trips, vacations, camping—keep in contact with home, friends. Has 5 watt crystal controlled transmitter—Sensitive Regenerative Receiver. Send receive switch. Wt. only 3 lbs. Size, only 6"x4"x4". TESTED—PROVEN—SIMPLIFIED—PRACTICAL—Full information given on quick easy to get license.



SEND ONLY \$3.00 (bill, ck, mo) and pay postman \$11.95 COD postage on arrival or send \$14.95 for prepaid delivery. Complete kit includes all parts, tube, coils, plastic cabinet, easy instructions, (set of batteries—\$2.05) crystal \$1.25). COMPLETELY WIRED AND TESTED POSTPAID \$19.95. A regular \$49.95 value—Order now before price goes up. GUARANTEED — AVAILABLE ONLY FROM:

WESTERN RADIO Dept. BNM-8 KEARNEY, NEBR.

SAVE \$9.00

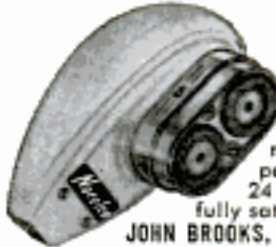

NORELCO Men's Electric Shaver. Latest model, brand new and fully guaranteed. Complete with case, cord and cleaning brush. Regularly retails at \$24.95. Our price \$15.95 postage paid. All orders filled within 24 hours. Your money back if you are not fully satisfied. Send check or money order to: JOHN BROOKS, Dept. 677, Box 212, St. Louis 3, Mo.

BALANCE YOUR OWN WHEELS

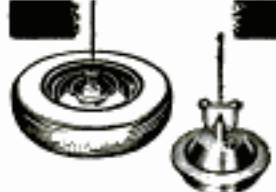

A precision DO-IT-YOURSELF wheel balancer designed for high-speed driving... Avoid high balancing costs... drive safely on balanced wheels — carry in your car. GUARANTEED Balances within 1/4 oz. — absolutely reliable. Same unit formerly sold to garages at higher costs — Order direct, check or money — \$21.95 order — prepaid in U.S.

WHEEL BALANCER CORBIN, KANSAS

STUDY TO BE A DOCTOR

of Psychology or Metaphysics

Obtain a Ph.D., Ms.D., or Ph.D. Be a Teacher, Lecturer or Accredited Practitioner. Teach others how to achieve Health, Happiness and Contentment. Chartered by State. Correspondence Courses only. Write for FREE book telling how.

THE NEOTARIAN FELLOWSHIP

Desk B, Pickwick Building Kansas City 6, Missouri

Build your own JET ENGINE!



Order these plans today
9. HOT ROD BICYCLE, Compressor jet engine. Power blower with afterburner. \$1.49.
12. JAPANESE EXPERIMENTS. Miniature pulse jet engine. Big drawings. \$3.95.
14. STOVE PIPE SIZE OF PULSE JET ENGINE. Make experimental engine with cheap fireclay material. With performance curves and helicopter application \$4.95. Send order today. Get other information too. Helicopter. Ram jet. Turbo jet. Rush order.

J. HOUSTON MAUPIN, Dept. 52, Tipp City, Ohio

FIX OUTBOARD MOTORS

POWERMOWERS, AND ALL SMALL 2 & 4-CYCLE GASOLINE ENGINES

Repair your own equipment or MAKE EXTRA MONEY in this growing field. Fully illustrated, easy-to-understand, Home Study Course. Write for FREE information.

LINCOLN TECHNICAL INSTITUTE SUITE 8-E, 472 MARKET STREET, NEWARK 5, N. J.



WORLD'S LOWEST PRICED ADDING MACHINE

Counts up to 999,999,999 IDEAL FOR BUSINESS AND PERSONAL USE—GUARANTEED ACCURATE. Not a toy. Operates with only a finger flick. Adds, subtracts, multiplies, divides. Counts up to one billion. Pays for itself over and over. Ideal Gift—for Business, Income Tax and School use. MONEY BACK GUARANTEE. Send name and address. Pay postman only \$2.95 plus postage. Beautiful rich-looking Leatherette Case included at no extra cost. Money back in 10 days if not delighted. AGENTS WANTED.

CALCULATOR MACHINE COMPANY P.O. Box 126, Dept. P-57, Huntingdon Valley, Penna.

SAVE 1/2 - 2/3 THE PRICE OF FACTORY-BUILT BOATS

BOAT KIT CATALOG Free!

Write:

Runabouts, cruisers, convertibles, fishing; 43 models, 8 through 18 ft. Freight paid, \$39.25 up. Assembled and finished by inexperienced owners. Luger boats equal factory-built in speed, handling, style, beauty; yet save you 1/2 to 2/3. Owners say: "Fastest boat on river," "Pleasure to assemble," "Everyone admires my Luger." Thousands in use. Send for big, free boat kit catalog; also lists fiberglass, hardware, accessories, trailers, paint. Write for catalog today.



UGER INDUSTRIES, INC. DEPT. 3404 Lyndale S.
B-8 Minneapolis 8, Minn.



Rubber Stamp Press Outfits Stamp Making Supplies

A profitable home or sideline business mfg. rubber stamps. Stamp Press and all supplies. FREE catalog, advice, instruction. Permanent and profitable business. WRITE TODAY! Full details!

CUSTOM MANUFACTURING

601-A NO. JEFFERSON, SPRINGFIELD, MO.



Learn ACCOUNTING

Business Administration

Bookkeeping, secretarial and allied subjects at home in your spare time or attend nationally approved resident school. Write for FREE Success Book giving complete details on courses, plans, rates and employment opportunities. G.I. approved. Write Dept. A.

Hills BUSINESS UNIVERSITY AND EXTENSION SCHOOL
629 W. MAIN ST. OKLAHOMA CITY 2, OKLAHOMA

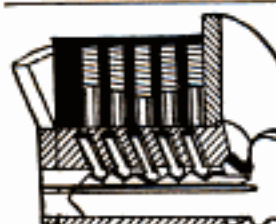

Locksmithing AND KEY MAKING

Now Made Easy! Practical up-to-date course teaches you how to pick locks, de-code, make master keys, repair, install, service, etc. Now self-instruction lessons for every handyman, homeowner, carpenter, mechanic, service station operator, fix-it shop, hardware dealer, gunsmith. 33 easy illustrated lessons. Full price only \$8.95 postpaid or C.O.D. plus postage. Satisfaction or refund guaranteed.

Complete course \$5.85
... now only \$2.95

Nelson-Hall Co., Dept. NY-2
210 S. Clinton St. Chicago 6, Ill.

Also Eshelman TRACTORS, Riding ROTARY MOWERS, ROTARY TILLERS at amazing savings. Write for Free Literature

ESHELMAN GOLF CAR

GASOLINE ENGINE

36 HOLES PER GAL. GAS UP TO 10 MILES PER HR.

Costs a fraction of most other cars. Ideal for golfers. Also as runabouts for factories, airports, estates, etc. Write for free literature.

Dept. 377, ESHELMAN, 109 Light St., Balto. 2, Md. PATENTED

Shipping Points: BALTIMORE - CHICAGO - NEW YORK

TELEPHONES

and ALL SUPPLIES

Room to room, house to garage, private telephone service. **HANSET CRADLE TELEPHONES** (2) Complete outfit with 100' wire, 2 dry cells, instructions. \$14.95

WORM HARVESTER—Dan Mac Magneto—gathers fish-worms by electricity. Complete with instructions. \$6.50

Illustrated bulletin "AA-16" 10c

TELEPHONE REPAIR & SUPPLY CO.

Dept. AA-16 1760 Lunt Ave., Chicago 26, Ill.

Over 100,000 top pay jobs are open for Auto Mechanics

Now it's easy to train quickly at home



YOU'VE GOT IT "MADE"
WHEN YOU LEARN THIS TRADE!



A national magazine reports, "100,000 mechanics are needed by the motor industry. If you qualify, you can go straight to the top." The vice-president of one of the "big three" says, "Technicians not only have excellent security but can count on good pay and promotion." Don't let lack of training keep YOU from becoming a success! Learn to become a mechanic at home in spare time. Find out how by filling out and mailing coupon below. No cost or obligation.

Get Experience Using Tune-Up Kit & Tools

(included with training)



CTI sends you a Tune-Up Kit, the kind that skilled mechanics use to locate engine troubles. You receive a compression Tester; Vacuum Gauge & Fuel Pump Tester; Ignition Timing Light; portable steel case. You also get mechanic's tools, including socket set. You acquire experience using kits.

DIESEL MECHANICS OR BODY-FENDER REBUILDING is yours at no extra cost. Only CTI offers this extra choice. You get fully-rounded training in all three fields.

Many Students Earn Money as They Train

Many students earn extra money fixing cars. Some work "on their own," others take part-time jobs in local shops. They add to their experience—often make enough money to pay tuition and buy equipment. A large number have gone in business, made good. Mail coupon for full information—Commercial Trades Institute, Chicago 26, Ill.

MAIL TODAY FOR 2 FREE BOOKS

COMMERCIAL TRADES INSTITUTE
1400 GREENLEAF AVENUE
CHICAGO 26, ILL. DEPT. A-596

Send booklet, "Big Money in Auto Mechanics," and Sample Lesson. Both FREE.

Name _____ Age _____

Address _____

City _____ Zone _____ State _____



BE YOUR OWN MUSIC TEACHER

Send for Free Book Telling How Easily
You Can Learn Piano, Guitar, Accordion,
ANY Instrument This EASY A-B-C Way

NOW IT'S EASY to learn music at home.
No tiresome "exercises." No teacher;
just **START RIGHT OUT** playing simple pieces.
Thousands now play who never thought they could.
Our pictured lessons make it easy as A-B-C to learn
to play popular music, hymns, classical, and any
other music. Low Cost. Over 900,000 students includ-
ing TV Star Lawrence Welk. (Our 59th year.)

Mail Coupon for FREE BOOK

Find out why our method can teach
you quickly, easily, inexpensively.
Write for Book. No obligation. No
salesman will call. Mention your fa-
vorite instrument. Mail coupon today.

U. S. SCHOOL OF MUSIC
Studio A308,
Port Washington, N. Y.



U. S. SCHOOL OF MUSIC, Studio A308, Port Washington, N. Y.
Please send me Free 36-page Illustrated Book. I would like to
play (Name instrument).

Instrument _____ Have you _____
Instrument? _____
Name _____
(Please Print)
Address _____

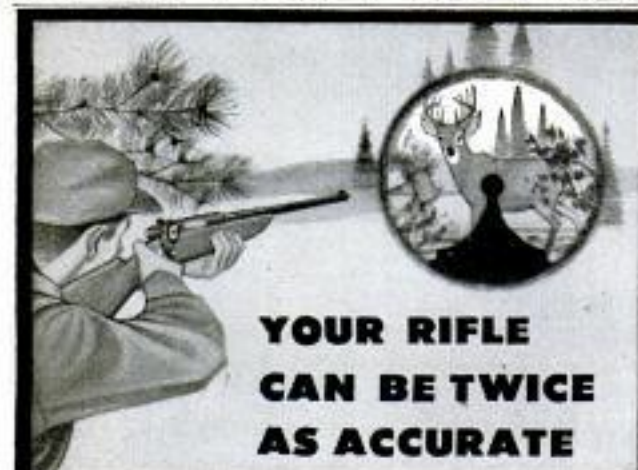

**YOUR RIFLE
CAN BE TWICE
AS ACCURATE**

Open rear sights cut the accuracy of modern
guns and ammunition in half. Lyman *precision*
receiver sights deliver all the accuracy
built into your rifle.

SPECIFY LYMAN SIGHTS With a receiver and
front sight combination for all popular rifles,
you can have Lyman Sights for your gun for
as little as \$6.50. You can't buy more accu-
racy at any price!

FREE CATALOG Discover how you can *double*
your shooting accuracy. Send for free,
full-color 24-page catalog. Describes all
Lyman Products for Shooters.

THE LYMAN GUN SIGHT CORP.
MIDDLEFIELD • CONNECTICUT

Million Dollar Inventory — All Famous Brands



SAVINGS NEVER LESS THAN 50% UP TO 70% OFF REGULAR PRICES

SEND FOR YOUR FREE CATALOG!

RELIABLE TIRE CO. • 728 MORGAN BLVD.
CAMDEN 4, N. J.

Be an industrial designer

Combine your design abilities with technical aptitudes in Industrial
Design training at Art Center School in California. Work under prac-
ticing professionals for upper level jobs as automotive stylists, product
and package designers. Design offices, stores, motels, showrooms, shop-
ping centers. Constant demand for graduates. Recent placements with
Ford, G.M., Kaiser Aluminum, G.E., Raymond Loewy and other lead-
ing design studios. 700 students. Co-ed. Accredited, B.P.A. Degree.
Four-year course can be completed in 2 yrs. 8 mos. by year-round
training. New terms Feb., June, Sept. Enroll early. Write Mr. Mead
for new catalog. 5353 West 3rd St., Los Angeles 5, California.

ART CENTER SCHOOL



national camera repair school - DEPT. V-8

A POSTCARD

CAN PUT YOU IN A
FINE BUSINESS!

Rush Card TODAY for FREE OUTFIT!

Get into highly profitable, repeat-order shoe busi-
ness! Sell new line of Air-Cushion comfort shoes
to friends, neighbors, folks at work! Over 200
dress, sport, work, safety shoe styles for
men, women. Never sold by stores. Just 2 easy
orders a day—in spare time—bring you \$21 extra
income a month! No investment. Rush your card
today for FREE SELLING OUTFIT!
MASON SHOE, Dept. 783, Chippewa Falls, Wis.



MR. FARMER!

Here's What Every Farm Family
Should Know About Taking Care
of Farm Animals in the
NEW, ENLARGED 3rd EDITION



384 Pages • Illustrated
\$3.95

Information
You Can Use Every Day
Covers Cattle, Horses,
Swine, Sheep, Poultry

It pays to know what
diseases can strike
your herd; what must
be done for stricken
animals; how healthy
ones in the herd can
be protected; how
outbreaks can be pre-
vented. Get the Vet
Guide. Only \$3.95.

BIGGER! BETTER! EVEN MORE USEFUL!
"VETERINARY GUIDE
For Farmers"

Now you can know many of the things the
veterinarian knows. You'll learn how to
recognize the symptoms of diseases dan-
gerous to your farm animals, and how to
treat them yourself. The Veterinary Guide
For Farmers is all you need. Completely
revised, it's the most useful book of its
kind. It tells what the causes of diseases are
and how you can prevent them. Included is
a full chapter on artificial breeding.
Simplified • Non-Technical
Written by G. W. Stamm, Edited by Dallas
S. Burch, former executive, Bureau of Ani-
mal Industry. Presented in the most simple,
non-technical terms, its 384 pages are
packed with how-to-do-it instruction, pic-
tures, charts, etc., needed on every farm.
Easily Worth Many Times Its Cost
By preventing the loss of only one animal
this book can easily be worth a hundred times
its cost. Today's high market value of farm
animals, together with the high cost of feed-
ing and raising them, makes losses extreme-
ly expensive. Stop losses. Step up your prof-
its with the Veterinary Guide For Farmers.
Order today from address below.

WINDSOR PRESS (div. of Popular Mechanics)
Dept. 857, 200 E. Ontario St., Chicago 11, Ill.

SAVE 75%

ON

WORK CLOTHES!

Terrific values you've got to see to believe!

SHIRTS.....4 for \$2.99.....79c

The used, they're sterilized and ready for tough wear. Blue, green or tan. Send neck size.

PANTS to match. Were \$3.95, now only... 99c
Send waist measure and inside leg length. 4 for \$3.75

COVERALLS \$2.29 SHOPCOATS \$1.79
3 for \$6.75 3 for \$5.00

Wear 'em used, save plenty! Send chest measurement.

MONEY BACK GUARANTEE . . . if not satisfied! Order TODAY! Send \$1.00 deposit on C.O.D. orders. Add 25c for postage on prepaid orders.

GALCO SALES CO. Dept. 138
7120 HARVARD AVE. CLEVELAND 5, OHIO



HIGH SCHOOL DIPLOMA

Earn a High School Diploma at home! Prepare for better job, more pay. Study in spare time. No classes. Materials furnished. Certified teachers. Valuable diploma awarded.

Write Today for Complete Information
SOUTHERN STATES ACADEMY
Box 144-A Sta. E Atlanta, Georgia



OWNERS

RE-POWER NOW with a V-8 engine—Use FORD—CHEVROLET—MERCURY in 2 or 4 Whl-Dr. Jeeps, Jeeps, Jeeps, 5-1/2-Ton, Trucks or cars. Conversion Kits \$43.25 to \$59.89. If you want fast action tell us which engine you wish to use, give us year, Model (2 or 4 Whl-Dr) of your vehicle. Send Min. \$15.00 Dep. and we will ship correct kit, Bal. C.O.D. Send full amt. for Prepaid shipment. Wire, phone or write for free details.

HOOSIER MACHINE PRODUCTS CO.

312 S.E. 6th St. Phone 676 Pendleton, Oregon



WARN HUBS



© 1957 WARN

OVER 100,000
WARN HUBS NOW
IN USE ON
4-WHEEL DRIVES

Models for all
4 w.ds. to 1 1/2 tons

idle the front drive in 2-wheel drive... stop drag... reduce wear.

Warn Hubs mean big savings in gear, engine, tire wear, gas, plus new pep, performance, power, handling ease. And now, with Warn Lock-O-matics, you have economical, drag-free 2-w.d. or tractive 4-w.d. automatically, as you shift! Ask your dealer for Warn Lock-O-matic or Locking Hubs today!

WARN MFG. CO. RIVERTON BOX 6064-AR SEATTLE 28, WASH.

Train for a GOOD JOB
and a REAL FUTURE in

*Electricity
Electronics*
in the great shops of
COYNE

Largest, Oldest and Best Equipped School of its Kind in U.S. Train the Coyne way for a better job in *Electricity-Electronics*—a field that offers a world of opportunities now and in the years ahead. In industry—in the home—New developments and fabulous growth are creating increasing job opportunities. **AUTOMATION ELECTRONICS**—one of the more recent applications of Industrial Electronics to manufacturing processes—promises to create additional demands for trained Electrical-Electronics men such as we have never seen. Coupon brings details. **LARGEST, OLDEST AND BEST EQUIPPED SCHOOL OF ITS KIND IN U.S.**

TRAIN IN CHICAGO SHOPS—

Practical work plus technical training. No advanced education or previous experience needed. Lifetime Employment Service to Coyne Graduates.

START NOW—PAY LATER

Training offered to VETS and NON-VETS alike. New liberalized credit terms and Finance Plans. Part-time employment service to students.

COYNE ELECTRICAL SCHOOL
CHARTERED NOT FOR PROFIT

500 S. Paulina Street, Chicago, Dept. C7-72



MAIL COUPON FOR FREE BOOK.

"Guide to Careers" gives you all the facts, answers your questions. All information will come by return mail. No obligation and no salesman will call, so send coupon now!



Coyne Electrical School, Dept. C7-72
500 S. Paulina St., Chicago 12, Ill.
Send FREE BOOK and details of the training you offer in Electricity-Electronics.

Name _____

Address _____

City _____ State _____

(I understand no Salesman will call.)



**MEN! Make up to
\$1,000 IN A
MONTH!
without "SELLING"**

Sensational Demand for Low-Priced Fire Alarm PLUS Sure-Fire "No-Selling" Plan Offers Ambitious Men Huge Profit Opportunities



Even beginners cleaning up unbelievable profits with first practical, effective, low priced Fire Alarm. Needed in homes, factories, offices, stores, on farms, etc. Merlite Fire Alarm hangs on wall like a picture . . . no wiring, no installation. It's always on guard, "smells" fire before danger point. When temperature rises, Fire Alarm goes off automatically, howls loud warning that can be heard 1/3 mile, wakes up soundest sleeper, gives precious time to put out fire, call fire department, or escape. Sells for only \$4.95, with profit up to \$2.70 on each one.

Nearest Thing to Automation Selling

With our field-tested plan customers sell themselves. No cold canvassing; no hard selling. It's the nearest thing to "Automation Selling." Even a child can use plan successfully with powerful sales tools we give you (which you leave with prospects). This plan makes money for you even while you sleep! No room here to give you full details, but write for amazing facts.

FREE SALES KIT

Send no money. Just rush your name and address for all the exciting money-making facts, complete Illustrated Sales Kit, everything you need to make money first day. Learn how selling only 20 Fire Alarms a day brings you \$1,080.00 a month. No competition. Rush your name and address today.

**Dramatic
LIGHTED-MATCH
DEMONSTRATION**
Sensitive!
Lighted match
triggers Alarm
in 3 seconds!

MERLITE INDUSTRIES, INC. (Alarm Div.)

114 E. 32nd St., Dept. 5-152 New York 16, N.Y.
IN CANADA: Mopa Co., Ltd., 371 Dowd St., Montreal 1, P. Q.

AMAZING NEW "LIFETIME" RADIO

"TI-NEE" RADIO IS GUARANTEED TO WORK FOR YOUR LIFETIME! USES NO TUBES, BATTERIES OR ELECTRICAL PLUG-INS. Never runs down! SMALLER THAN A PACK OF CIGARETTES! RECEIVES LOCAL RADIO STATIONS MOST ANYTIME, ANYWHERE WITHOUT EXTRA ANTENNA. Uses semi-conductor crystal diode Hi-Q Tuner. Beautiful black gold plastic cabinet. Built-in Speakerphone.



SEND ONLY \$2.00 (bill, ck. mo and pay postman \$4.99 COD on arrival or send \$6.99 for postpaid delivery. SENT COMPLETE READY TO LISTEN—NOTHING EXTRA TO BUY EVER! Extra long distance aerial kit included free to receive stations up to 1,000 miles away. Available only from:
MIDWAY COMPANY, Dept. GPM-B, Kearney, Nebraska

**GIANT BALLOONS
— 3 for \$1.25**



Surplus U.S. Govt. (New coverage) Neoprene weather target balloons.
FOR FUN in the backyard; at parties, picnics, etc! Young and old love 'em.
FOR ADVERTISING—Attracts crowds to civic events, business openings, trade shows, fairs. Low cost, high returns! Paint on sales message, seen for miles!
FOR PROMS—Makes any dance more festive. Ideal for high school or college affairs! The more you use the better.

3 ft. dia. 49c ea. (SPECIAL! 3 for \$1.25) 5 ft. dia. 99c ea. Postage paid on prepaid orders. Calif. res. add sales tax.

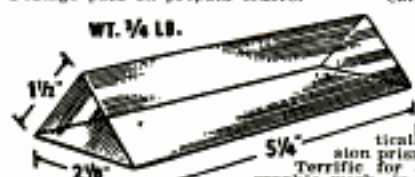

**PRISMS
\$1.50**

Made for U. S. Govt. for tank periscopes. Fine optically ground, big precision prisms with silvered base. Terrific for all types of spectrographic work, in homemade telescopes & other optical systems for bending rays. Makes unusual paper weights (paint your name on it) or conversation piece for mantle. You'll find many other uses. NEW PERFECT! Cost U. S. Govt. \$25 ea. Now—\$1.50 ea. ppd. or 4 for \$5.00 ppd. Calif. res. add sales tax.

VOLUME SALES CO., War Assets Division
3930 Sunset Blvd., Dept. PM-857, Los Angeles 29, Calif.

WAR SURPLUS BARGAINS

WAR SURPLUS BARGAINS

\$500,000.00 INVENTORY for QUICK LIQUIDATION

Surplus items—hundreds of them for home, shop, factory, farm and outdoor use. New items, used items, second-hand items—all at tremendous savings—all priced for quick sale.

Page After Page of Values

This big catalog shows page after page of amazing money saving values. Write for your copy today. Send 10c to cover postage, mailing, etc. Write today! **SEND TODAY FOR YOUR COPY**

10c

STARK'S 212 W. Madison St.
Dept. PM-578
CHICAGO 6, ILL.

Print Your Own

Cards, Stationery, Advertising, Circulars, labels, photo and movie titles, church work, tags, etc. Save money. Sold direct from factory only. Raised printing like engraving, too.

Own a Printing Business

Print for Others, Good Profit. Have home shop. Junior press \$15; Senior \$29 up. We supply everything. Easy rules. Pays for self in short time. Write for free catalog of outfits and all details.

KELSEY PRESSES, C-37 Meriden, Conn.

LAW FREE BOOK THE LAW TRAINED MAN

Write today for a **FREE** copy of illustrated law book, "THE LAW TRAINED MAN," which shows how to earn the professional Bachelor of Laws (LL.B.) degree through home study of the famous Blackstone Law Course. All necessary books and lessons provided. Moderate cost; convenient monthly terms. Write for **FREE** law training book today.

Blackstone School of Law, 307 N. Michigan Ave.
Founded 1890 Dept. 50-C, Chicago 1, Ill.

SEND ME

POPULAR MECHANICS MAGAZINE

every month so I am sure to see each new issue. Here's

\$3.50 for 1 year
 \$8.00 for 3 years

name _____
address _____
city _____ zone _____ state _____

Hand this order to your newsdealer or send it to
POPULAR MECHANICS
200 East Ontario St. Chicago 11, Ill.

OUR AD HAS BEEN IN THIS MAGAZINE LONGER THAN ANY OTHER TIRE CO. NEARLY EVERYONE BUYS FROM STANDARD. 50 Years of Combined family experience in High Quality tires. "We Have No Rent to Pay." That is Why We Can Undersell All Competition.



24 YEARS AT THIS ADDRESS
TUBE FREE WITH EVERY PASSENGER TIRE

Our entire stock of very slightly worn
EXTRA MILEAGE TOP GRADE Tires,
(Written Insurance Guarantee). SEND AD

EVERYBODY 10% off ON EVERY TIRE



FREE if you buy 2 or more Passenger 4-ply tires. WE GIVE ONE tire FREE, on each order. Does not include W.W. or Truck Tires, or Snow Tires.

12 MOS. WRITTEN GUARANTEE WITH EVERY TIRE					
600-16	\$5.52	640-15	\$4.22	700-16(6)	\$7.52
600-16(6)	5.92	670-15	5.52	750-16(10)	10.72
650-15	5.72	710-15	5.52	750-17	9.52
650-16(6)	6.62	760-15	5.82	750-20(8)	11.92
750-16(6)	7.52	800-15	5.92	825-17	10.32
850-15	5.52	820-15	5.92	825-20	18.92
700-15	4.92	700-16(6)	7.32	850-20	9.82
				1000-20	17.92
				1100-20	19.92

"EXTRA SPECIAL" TOP QUALITY all size 4-ply pass. \$7.82
FREE TIRE with 2 or more of these also.—W.W. \$1.00
Extra Factory Tested Tube given—GIANT TIRE SALE. EA.

Thousands of tires shipped all over the U.S.A. All tires shipped F.O.B. Phila. Send Check or M.O. with this ad. Dept. 2. No C.O.D.
STANDARD 834 N. Broad St., Philadelphia 30, Pa.



1 IMPORTS
MAKE BEGINNERS BIG PROFITS

Many men and women making big money on imports by mail order from home. No investment in merchandise or ads. We tell you where to get low cost products from abroad and supply list of magazines that run no-cost ads. Write for Free details. MELLINGER CO. Dept. G258, 1717 Westwood, Los Angeles 24, Calif.



... Swiss or American

Unique Sweeney System starts you making repairs right away. Develops your skill step-by-step. Teaches modern methods... professional short cuts. Learn by personal attendance or spare time home study. Free Sample Lesson. No obligation. Write today!

CHICAGO SCHOOL OF WATCHMAKING

2330 Milwaukee, Dept. 187, Chicago 47, Ill.

DRAFTING—DESIGN—MATH—TECH ILLUSTRATION

Aircraft. Mech'l. Electr'l. Arch'l. Struct. Bldg Est'g. Survey'g. Accel. 6-Mos. Day Course, prep for pas Engr-Architect office State Licensed. Vet approved. Start any Monday. Days, Evns.
MONDELL INSTITUTE, 230 West 41st St., New York 36, N.Y.
48 yrs Placing Thousands Drafting, Design, Engineer Positions.

RUPTURED

BE FREE FROM TRUSS SLAVERY

Now there is a new modern Non-Surgical treatment designed to permanently correct rupture. These Non-Surgical treatments are so certain, that a Lifetime Certificate of Assurance is given.

Write today for our New FREE Book that gives facts that may save you painful and expensive surgery, and tells how non-surgically you may again work, live, play and love and enjoy life in the manner you desire. There is no obligation. Excelsior Hernia Clinic, Dept. 8305, Excelsior Spgs., Mo.

MAKE UP TO \$20 A DAY WITH



EASISHARP

Big profits in your spare time sharpening scissors. We show you how to start making money immediately. This is your chance now to have your own business and a steady income. Sharpen a pair of scissors in less than two minutes. A child can operate it. Weighs only 10 lbs. Every home, barber, tailor, dressmaker—everybody uses scissors and all need sharpening two to four times a year. Don't let some one else beat you to this opportunity. Write immediately to

SERR-EDGE MACHINE CO., 9731 Lorain Ave., Cleveland, Ohio

RCA offers you the finest training at home in Radio-TV electronics TV servicing Color TV



SEND FOR THIS FREE BOOK NOW!

Pay-as-you-learn. You need pay for only one study group at a time. Practical work with very first lesson. All text material and equipment is yours to keep. Courses for the beginner and advanced student.



RCA INSTITUTES, INC.

A SERVICE OF RADIO CORPORATION OF AMERICA

350 WEST FOURTH STREET, NEW YORK 14, N.Y.

In Canada — RCA Victor Company, Ltd.

5001 Cote de Liesse Rd., Montreal 9, Que.

RCA Institutes, Inc., Home Study Dept. PM-87
350 West Fourth Street, New York 14, N.Y.

Without obligation, send me FREE 52 page CATALOG on Home Study Courses in Radio, TV & Color TV. No Salesman will call. To save time, paste coupon on postcard.

Name.....
Please Print

Address.....

City..... Zone..... State.....

KOREAN VETS! Enter discharge date.....



100X Area Magnifying Projector

— Enlarges Pictures, Printing, & Objects! — Full Color!

NEW! Electric Magna-Vue Optical Instrument projects & enlarges clippings, pictures, sketches, objects in full natural color, correctly & readable. Project on wall, screen or table. **MAGNIFIES 100 AREAS.** Enlarges any material up to 2 1/2x4-in. to 22x40 in. For home, school, class, business, shop use. Also make signs, sketches easy from any copy. Enamelled steel, 10x7 1/2-in. high. Quality 2" focusing lens. Operates on standard 110 volt current. Money back guarantee. Price Postpaid. **\$4.98**

JOHNSON SMITH CO., Dept. 569, Detroit 7, Mich.

New! TINY POCKET SIZE RADIO

\$2.98



Listen at work, play, in bed. Fits shirt pocket. No tubes. No batteries. No electric plug-ins. No expense. Plays day & night forever. New self-powered diode rectifier replaces tubes. No building. Use short aerial for local stations. Complete broadcast band. Red plastic case only 3 x 3 1/4 x 1-inches. Lifetime guarantee. Radio (without phone) **\$2.98.** Hearing Aid Phone (plugs in ear, flesh-colored, almost invisible) **\$1.98.** Regular phone **\$1.25.**

JOHNSON SMITH & COMPANY Dept. 569 Detroit 7, Mich.

Catalog of 3100 Novelties 10c

Send 10c for amazing catalog of novelties, live animals, scientific supplies, hobbies, funmakers, planes & boats, soaps, magic tricks, joke articles, unusual seeds, gadgets, time-savers, cameras, optical goods, projectors, movies, lucky jewelry, religious novelties, disguises, musical instruments, stamps, coins, puzzles, fortune tellers, radios, auto & bike accessories, telescopes, magnifiers, compasses, banks, smokers' gadgets, artists' supplies, printing sets, engines, motors, shockers, knives, billfolds, guns, rifles, sports, books, games, plants, etc. Send 10c (3 for 25c—get for friends!).

JOHNSON SMITH & CO. Dept. 569 Detroit 7, Michigan

12-Foot BULL WHIP



HARD HITTING! LOUD CRACKING! Experts knock ashes off cigarettes. Yank people off feet. Used by trainers, ranchmen. Loud cracker like shot-gun blast. 4-ply hand plaited all leather. With loop handle.

6-ft. \$1.98. 8-ft. \$2.69. 10-ft. \$3.29. 12-ft. \$5.45. Johnson Smith Company, Dept. 569, Detroit 7, Mich.

HEY KIDS! Here's Your Chance to Drive!

"Buckboardin' Buggy" will give you loads of fun until you reach car-driving age. Good training for your future driving.

Coasts down hill like a dream, or can be safely powered with old lawn mower motor. Complete, crated, ready to unpack and run for only **\$59.50** f.o.b. Fairport (with-out motor); or get complete "Build-yourself" kit and instructions for **\$49.50** f.o.b. (Includes all parts, wheels, bolts, steering wheel, clutch, beautifully painted, easy to assemble in a few hours.) Or build it from our original plans and instructions, \$5. postpaid. Best quality materials, ruggedly built to last years, weighs 60 lbs! Order today, send check or money order. We guarantee satisfaction. Free circular.



MAYO BROTHERS Dept. P FAIRPORT, N. Y.

High School at Home

MANY FINISH IN 2 YEARS

No classes. No time wasted going to and from school. Progress as fast as your time and abilities permit. Standard H. S. texts supplied. Thousands enroll each year in this 60-year-old school. Send for FREE descriptive booklet.

AMERICAN SCHOOL, Dept. HC45
Drexel at 58th St., Chicago 37, Ill.

Without obligation, please send FREE descriptive booklet.

Name.....

Address.....

Complete Canadian Courses available. Write American School, Dept. HC45, 6083 Sherbrooke St. W., Montreal

Build a Better Garage for One Half the Cost!

Get New Popular Mechanics Book Before You Build, Buy or Plan Any Garage

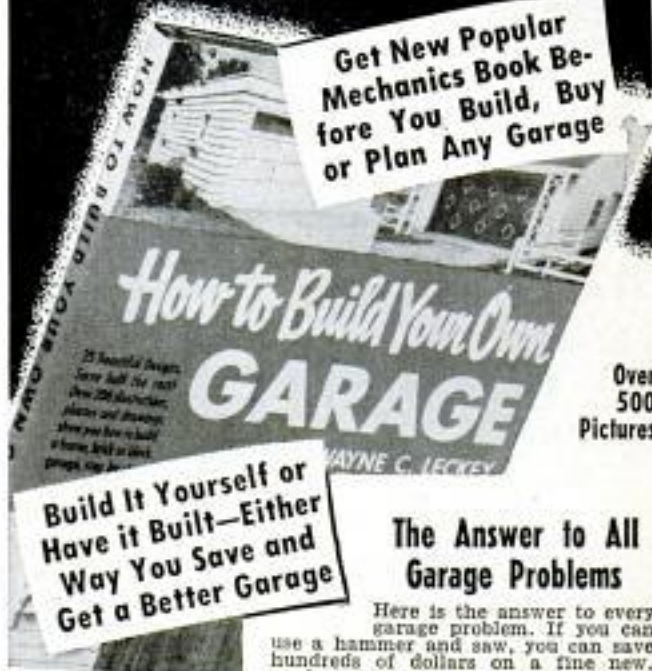

Over 500 Pictures

Build It Yourself or Have it Built—Either Way You Save and Get a Better Garage

The Answer to All Garage Problems

Here is the answer to every garage problem. If you can use a hammer and saw, you can save hundreds of dollars on a fine new, modern garage. Get "How to Build Your Own Garage," Popular Mechanics' simplified How-to-Do-It book for the amateur builder and follow the pictures and instructions. If you prefer to have your garage built by others, get this book first for it can solve any garage problem you may have.

Car Ports, Garages—Brick, Block, Frame—They're All Here!

Also valuable information on attractive garage doors; how to dress up a garage; space for storage, workshop, recreation, automatic door operators, planning and making your own driveway—plus pictures and instruction for every construction detail if you want to build your garage yourself.

Prepared especially for the inexperienced builder by Wayne C. Leckey, associate crafts editor of Popular Mechanics, with the assistance of many builders, manufacturers and associations in the building, lumber and hardware fields. It TELLS HOW in simplified, step-by-step instructions—SHOWS HOW with hundreds of plans, diagrams and actual photographs.

Money Back Guarantee

Mail the coupon for "How to Build Your Own Garage" today. Use the book for 7 days and return it for full refund if it does not please you. You can't lose under the P. M. guarantee of satisfaction or your money back.

25 Designs to Choose From

Every type—every style—every size. All shown in actual photographs to help you make your own choice. Actual building plans available for many of the garages shown.



Two-car frame garage amateur can build and getting garage under cover with large sheets of plywood. Both illustrations from the book.

Use This Money Back Coupon

POPULAR MECHANICS PRESS, Dept. 857
200 E. Ontario St., Chicago 11, Ill.

Send at once, "How to Build Your Own Garage" under your 7 day trial, money-back guarantee. Remittance for \$3.50 enclosed. Send postpaid. Send C.O.D. (U.S.A. only). I will pay postman \$3.50 plus charges.

Name.....

Address.....

City..... Zone..... State.....

HOW TO EARN UP TO \$15 HOUR SPARE TIME

Amazing Opportunity for Men or Women who want a Spare or Full Time Home-Business!



New Printing Discovery!

PRINT WITHOUT A PRINTING PRESS...NO BIG INVESTMENT. Now, right in your own home - right in your own kitchen, spare room, garage - anyplace you can go into the amazing Screen-Printing business. Print beautiful SIGNS, POSTERS, BANNERS, FABRICS - anything in fabulous new "glowing" FLUORESCENT COLORS - can be seen for miles. No art ability. It's easy! We supply everything. **PRINT YOUR OWN MONEY.** Things you print literally turn into money. \$100.00 jobs cost you less than \$10. Tremendous Profit opportunities - Huge demand! Mr. J. T. Anderson, who prints GREETING CARDS exclusively, earns over \$400.00 a week with this New Discovery. **REPRESENTATIVES WANTED** all over the U.S. Write for FREE revealing BOOK-LET and ACTUAL SAMPLES. **SCREEN-PRINT CO., Dept. 28**
15127 S. Broadway, Los Angeles 61, Calif.

BOTH Sent Free!



SANTA MARIA MODEL KIT!

Flagship of Columbus, faithfully reproduced—sails, guns, shields, lifeboat with oars. Precision plastic parts, cement, plans. 11 1/4". For catalog send 10c to Dept. M-8 4223 Glencoe, Venice, Calif.

wherever hobby kits are sold



Enjoy the Fascinating Story of the Horseless Carriage in

It's thrilling, fascinating, informative. From the very first gasoline-propelled buggy to the cars of today and the atomic auto of the future. The first cars—the men who made them—the scrambled start and development of the fabulous auto industry—the story of auto racing. 166 thrilling action pictures—old-time cars—racing cars—early auto advertising—automotive oddities. Listing of 2000 U. S. autos included. Ideal gift book. Cloth bound, only \$5.00 by mail. Money back if not pleased.



POPULAR MECHANICS PRESS, Dept. PM857, 200 E. Ontario St., Chicago 11

FREE "How To Start Your Own MAIL ORDER BUSINESS"

Earn from \$10,000 to \$20,000 spare time. We'll put you in business and furnish you with everything needed. Exclusive new catalogs every three months... Offer your customers one item free for every two they buy! Free advertising and no stock for you to buy. We ship for you under your own name. No experience required. Write today for free booklet and franchise data.

MAIL ORDER ASSOCIATES, ROCHELLE PARK 12, NEW JERSEY

RUPTURED? Write for New Relief FACTS FREE!

ENJOY NEW FREEDOM of action, peace of mind and comfort at work or play. Proven, patented MILLET holds your ruptured back Day & Night—will bring you lasting relief! Has helped thousands of others!
For FREE facts in plain wrapper—Send Name and Address to **FRED B. MILLER, DEPT. 1-M**
Manufacturer, HAGERSTOWN, MARYLAND



SAM HANKS, 1957 "INDY 500" winner says: "I'd like a NATIONAL SCHOOLS trained mechanic on my crew... any employer would!"

Sam Hanks holds American Closed Course record (182.5 M.P.H.); also many state and national racing titles. At Indianapolis he was 2nd last year, 3rd in '52 and '53.



MASTER ALL ENGINES AT HOME IN YOUR SPARE TIME NATIONAL SCHOOLS AUTO MECHANICS & DIESEL COURSE INCLUDING FUEL INJECTION

YOU GET AND KEEP ALL THIS EQUIPMENT



Complete set of professional tools and All-Metal Tool Box. Same top-quality equipment used by expert mechanics everywhere. Use them, display them proudly.



"Motor Analyzing Set" contains Standard Engine Vacuum Fuel Pump Tester, Remote Starter Switch, Modern Timing Light, Standard Compression Tester. Plus compact carrying case & instructions.



Top-quality Socket Wrench with fittings. Real professional tools you'll use during your lifetime career in repairing all types of engines, from foreign cars to big diesel jobs.

"I've worked alongside National Schools-trained mechanics," reports Sam Hanks. "They're tops, because they get all-around training, and they know how to repair fast and right the first time. No wonder National Schools graduates command top pay."

Earn as you learn men! We'll show you how. Streamlined lessons, diagrams, manuals, latest equipment, practical methods prepare you for hundreds of jobs in scores of industries. Free Placement Assistance.

Approved for GI Training

FREE! VALUABLE BOOK & SAMPLE LESSON JUST SEND COUPON



Resident Training at Los Angeles
If you wish to take your Auto-Diesel training in our famous Resident School at Los Angeles, check special box in coupon for full information.

NATIONAL SCHOOLS
Los Angeles 37, California

NATIONAL SCHOOLS

TECHNICAL TRADE TRAINING SINCE 1905
LOS ANGELES 37, CALIFORNIA

MAIL NOW

NATIONAL SCHOOLS, Dept. DB-87

4000 S. FIGUEROA ST.
LOS ANGELES 37, CALIF.

Send for FREE Auto-Diesel Opportunity Book and Sample Lesson.

NAME _____ AGE _____

ADDRESS _____

CITY _____ ZONE _____ STATE _____

Check if interested ONLY in Resident School Training at Los Angeles

VETERANS: Give date of discharge _____

FREE! U.S. STAMPS plus COMPLETE U.S. CATALOG!



Sensational Get-Acquainted Offer—from the world's largest stamp firm! FREE . . . scarce genuine postage stamp, as illustrated, picturing first U.S.A. (issued in 1847)! PLUS big collection of 30 all-different United States—19th century, valuable \$1 stamp, etc. PLUS collection beautiful Commemoratives including American Revolution, Wild West, 1893 Columbian, many others. EXTRA: other exciting offers; Collectors' Guide; Big 64-page Bargain Catalog including all U. S. Postage Issues. Send 10c to help cover mailing expenses. Supplies limited.

Send Coupon Today!

H. E. HARRIS & CO., 3020 Transit Bldg., Boston 17, Mass.

Rush my United States stamps and other offers. I enclose 10c for mailing expenses.

NAME _____

ADDRESS _____

CITY & STATE _____

MANUFACTURE THIS BEAUTIFUL CONCRETE OUTDOOR FIREPLACE

Right In Your
Own Backyard

\$4.00 Worth of
Sand & Cement
produces this
Attractive
Fireplace.



Sells on Sight
from \$60. to \$80.
Easy to start your
own Profitable
Business.

The General Fireplace
Molds and Process are the most
amazing and foolproof ever invented.
Simple to operate. Two men can produce five fireplaces a day.

BIG DEMAND!!

Sell all you produce to Department Stores, Homeowners, Parks, Nurseries and Picnic Groves. Fireplaces sell on sight. No experience necessary. We supply full operating instructions and equipment plus the know-how that spells BIG PROFITS. This is an outstanding opportunity for men of vision and small capital to get into a busy rich paying field. Don't delay, be the only exclusive manufacturer in your own home town. Mail coupon at once for full details as to how you can reserve your territory. Molds sold only on exclusive franchise.

GENERAL ENGINES CO., Inc., Dept. MF-87
ROUTE 130, THOROFARE, N. J.

Mr. Tor of Philadelphia writes:
Sold 250 in first 4 months. Selling to Sears Roebuck, John Wanamaker, and Gimbel Bros. in Philadelphia area.

Name _____
Address _____
City _____ Zone _____
State _____

INVENTORS

PROTECT YOUR INVENTION BY A U. S. PATENT. SEND FOR FREE "INVENTION RECORD" FORM AND "PATENT INFORMATION EVERY INVENTOR SHOULD HAVE."

CARL MILLER
REGISTERED PATENT ATTORNEY
WOOLWORTH BLDG., 36th FLOOR, 87A
NEW YORK CITY

INVENTORS

Whether an invention is patentable can be substantially determined by a search of the U. S. Patent records. Without obligation, write for information explaining the steps you should take to secure a patent.

JOHN N. RANDOLPH
Registered Patent Attorney
201 Columbian Building, Washington 1, D. C.



INVENTORS

U. S. Patents protect your inventions. Our free book of "Instructions on Patent Procedure for Inventors," also "Certificate of Invention" form sent without obligation.

C. A. SNOW & CO.
REGISTERED PATENT ATTORNEYS
428 SNOW BUILDING WASHINGTON 1, D. C.

INVENTORS

Send for
PATENT INFORMATION REGISTERED PATENT
Book and ATTORNEY
INVENTOR'S RECORD ASSOCIATE EXAMINER
without obligation U. S. PAT. OFF. 1922-1929
GUSTAVE MILLER Patent Attorney & Advisor
87-PM WARNER BUILDING U. S. NAVY DEPT. 1930-1947
WASHINGTON 4, D. C. PATENT LAWYER

INVENTIONS WANTED

If you want to market, or sell, your invention for cash or royalties. Write for our Free Booklet. Send no drawings. We also welcome hearing from firms, or private capital, wishing to review inventions in any field. We will be glad to send notice of our clients' inventions.

GLOBAL MARKETING SERVICE
2420 77th Ave. Dept. PD Oakland 5, Calif.

FREE AMAZING NEW BOOK "HOW TO ANSWER ADS"



Never before have you seen anything like this. Tells you in simple language the correct way to answer ads. Gets you quicker replies—better results, and greater satisfaction. Will save you time and money and it's ABSOLUTELY FREE. No obligation whatever. Every reader of advertising should have this booklet. Send a postcard for your copy NOW. F. W. JOHNSON, Popular Mechanics Magazine, Room 800-A, 204 East Ontario Street, Chicago 11, Ill.

INVENTORS

I shall be pleased to furnish you, upon request, with full information relative to patent procedure—without any obligation on your part.

PATRICK D. BEAVERS
Registered Patent Attorney
934 Columbian Building Washington 1, D. C.

Draw this car

You may win a \$375.00 Scholarship
in Professional Art

Winner gets a complete art course—free training for advertising art, illustrating or cartooning. You are taught, individually, by professional artists on the staff of world's largest home study art school. Many top artists today have studied with this school, founded over 40 years ago. As winner you also get a drawing outfit and valuable art textbooks. Try for this free art course!



Make copy of car
7 inches long. Use pencil.
Drawings for September
1957 contest must be re-
ceived by September 30
... none returned. Winner
notified. Amateurs only. Our
students not eligible. Mail
drawing today.

ART INSTRUCTION, INC., STUDIO 8137
500 South 4th Street, Minneapolis 15, Minnesota

Please enter my drawing in your contest. (PLEASE PRINT)

Name _____ AGE _____
Address _____ County _____
City _____ Zone _____ State _____
Occupation _____ Phone _____

MEN WANTED

Master a trade with a future—learn Auto-Diesel mechanics in our shops. You learn with tools on real equipment. Earn while you learn. Many of our graduates earn \$100 per week and up. No previous experience necessary. Day and night courses. Approved for veterans. Write for free bulletin.

NASHVILLE AUTO-DIESEL COLLEGE
226 7th Ave., N., Dept. 75 Nashville 3, Tenn.

Earn \$100 Per
Week and up
**AUTO DIESEL
MECHANICS**

ONLY \$399
Freight included. FREE FOLDERS

NEW 18 ft. OFFSHORE CRUISER KIT

17 Models as low as \$42.00 (freight included). Fiberglass boat covering kits, marine supplies, etc.



Tops and side curtains available!

TAFT MARINE WOODCRAFT
Dept. PM-857 • 636 39th Ave. N.E. • Minneapolis 21, Minn.

Do a Real Professional-Like Job
Yourself and SAVE

HOW to PAINT

With Brush and Spray

Covers All Painting Methods and Materials

You can do professional-like painting and finishing jobs yourself and save about two-thirds of the cost. Sam Brown, noted craft authority, makes it so easy for you in his book, **HOW TO PAINT WITH BRUSH AND SPRAY**. Order your copy now and enjoy this tremendous saving. It covers exterior painting, wall and interior decorating, furniture finishing, concrete painting — every type of painting with brush, spray gun, roller and other methods. Tells what finish is best; what materials to use, etc. No previous experience needed. Fully illustrated. Order by mail. Only \$2.50. Money back if not pleased.

POPULAR MECHANICS PRESS, Dept. PM857
200 E. ONTARIO ST., CHICAGO 11, ILL.



LEARN
Television
RADIO-COLOR-TV
In the great shops of COYNE

Great opportunity for a good job or your own business in one of America's fastest growing industries! New stations . . . new sets by the millions . . . Color TV . . . all means greater opportunities.

Veterans and Non-Veterans—Get practical shop work plus technical training in TELEVISION—RADIO at Coyne in Chicago—old established school—training background nearly 60 years. Learn on real equipment—no advanced education or previous experience needed. Lifetime employment service to graduates.

Finance Plan—New liberalized credit terms. Enroll now, pay most of tuition later. Part time employment help to students.

BIG FREE BOOK Mail coupon. No obligation. No salesman will call. Act NOW.

COYNE CHARTERED NOT FOR PROFIT.
ELECTRICAL SCHOOL Established 1899
500 S. Paulina, Chicago, Dept. C7-3H

COYNE Electrical School
500 S. Paulina St., Chicago 12, Ill., Dept. C7-3H

Send FREE BOOK and details of your training in TV-RADIO

Name _____
Address _____
City _____ State _____

Train at Home or in the Big Allied Shops

AIR CONDITIONING

HEATING & REFRIGERATION

Get into this high paying field. Learn easily and quickly in your spare time AT HOME or in 100 HOURS OF SUPERVISED SERVICING IN OUR CHICAGO SCHOOL. Tools and equipment supplied. Mail coupon today for free book and sample lesson—no obligation.



ALLIED SCHOOL OF MECHANICAL TRADES
ALLIED INSTITUTE OF TECHNOLOGY
 1338-82 So. Michigan Ave., Dept. PM-8A, Chicago 5, Ill.

Gentlemen: Mail me FREE BOOKS explaining ALLIED'S training program in AIR CONDITIONING, HEATING, and REFRIGERATION.

I am interested in residential training Home study

Name _____ Age _____

Address _____

City _____ County _____ State _____

NEW MAGIC RADIO WALKIE TALKIE!

YOUR OWN POCKET SIZE RADIO STATION!

BROADCASTS TO ANY HOME OR CAR RADIO WITHOUT WIRES OR JACKPLUGS! Wt. only 5 oz. Size, 1 1/2 x 2 1/2 x 4 1/2". Built-in telescoping antenna. Powerful Transistor-sensitive microphone. Frequency setter, break-in switch! Tunes for weeks on self-contained flashlight batteries. Durable plastic case. With this Radio Talkie you CAN TALK TO YOUR FRIENDS UP TO A BLOCK OR MORE AWAY! Talk up to 1 mile or more between two automobiles. INSTANT OPERATION! Just push button to talk! No license needed. Uses inductive field magnetic radiation. Useful and real fun in a million ways. **GUARANTEED TO WORK. 1 YEAR SERVICE GUARANTEE.**

SEND ONLY \$2.00. (cash, ck. mo) and pay postman \$9.38 COD postage or send \$11.38 for prepaid delivery. COMPLETE READY TO OPERATE with instructions and hundreds of ways and tricks for broadcasts thru any radio you desire. Price may go up soon, so get your NEW MAGIC WALKIE TALKIE NOW. Available only from: **WESTERN RADIO, Dept. RPM-8, KEARNEY, NEBR.**



Learn To **MOUNT BIRDS**

Here's Best Hobby for Fun & Profit

TAN SKINS, MAKE UP FURS

Be a Taxidermist. We teach you at Home. Mount Birds, Animals, Pets, common specimens. Save your hunting trophies. Decorate home and den. Make genuine **KROME LEATHER**, tax and make up furs for sparetime profit. **INVESTIGATE TODAY** 48 pages-tells all about it. Hunters, get your copy. It's Now Free. Send post card. State your AGE.

FREE BOOK

N. W. SCHOOL OF TAXIDERMISTRY, DEPT. 2508, Omaha, Nebr.

I'll Set You Up For Life In Your Own BIG PAY SHOE BUSINESS

ONLY 8 ORDERS A DAY CAN MAKE YOU UP TO \$32.00 A DAY—

\$180.00 a week—\$600.00 a month

It's no trick at all to make big money FULL OR SPARE TIME with America's most comfortable shoes. Amazing new "Spring-Step" cushion design proves it by actual demonstration. Only **ORTHO-VENT** has it. No other shoe in the world like it. Profits are **BIG**—repeat orders sure and easy with amazing 2-minute demonstration. No experience needed. No investment to make. Everything furnished free, including finest sales outfit and actual demonstrators! Be the big pay **ORTHO-VENT** man in your territory. Mail coupon TODAY for free outfit.

MAIL TODAY!

AMAZING 2-MINUTE DEMONSTRATION
 Does Your Selling Job for You—Fast!

I GIVE PRODUCERS THEIR OWN SHOES AS A BONUS!

ORTHO-VENT SHOE CO.,
 1178 Brand Road, Salem, Virginia

I want to sell Spring Step Shoes and make **BIG MONEY**. Rush me the complete **ORTHO-VENT LINE** and Special Salesman's Proposition.

Name _____
 Address _____
 City _____ State _____



General Electric Co., Appliance Park, Louisville, Ky.

Freezer-Oven Unit

Prepares Food Automatically

Home freezer and electronic oven have been combined by General Electric Co., coupled by an automatic conveying system that transfers foods from freezer to oven for cooking. Fourteen foods can be stored in the five-cubic-foot freezer. Any six foods can be selected by push button for time-regulated meal preparation. The experimental unit operates on 220 volts. Freezer racks can be loaded three dishes deep.

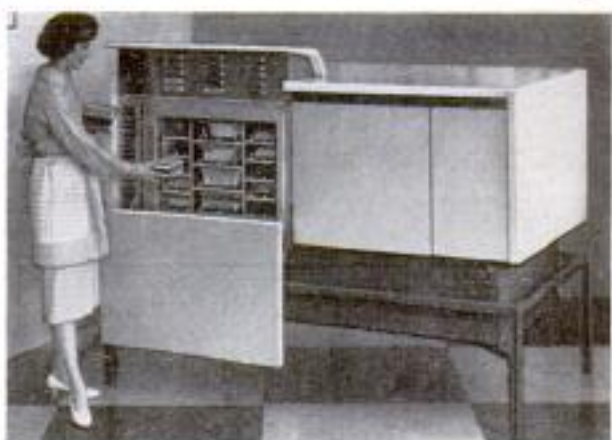

Hose Attachment Treats Lawn

Bulletlike cartridges of fertilizer, weed killer and insecticide are inserted in a chamber attachment for a garden hose. When the hose is turned on, the attachment automatically fertilizes the soil, kills weeds and crab grass, kills injurious soil insects.

Leeds Chemical Products Co., 112 E. Walton St., Chicago



GUNSMITH TO YOU \$19.95



**POWERIZED,
ACCURIZED
.30 CAL. BIG GAME SPORTER**

The most amazing high powered rifle buy of all time! Starting with a beautiful surplus Swiss army rifle in absolute excellent condition, our own gunsmith machines and precision crowns barrel to 22" sporter length, removes zeroes in sights, alters the hard mountain (red) walnut stock to sporter contours, reheads barreled action perfectly, checks headspace, trigger pull (sur. light, crisp). The Swiss love guns and make the finest in the world, but, as everyone knows, they have not been in a war for 200 years. They oil and polish their rifles every day but seldom fire them. We beg you to return this gun if it is not astounding in every respect. This gun gives you a sporter for all big game—would cost you \$79 to do it yourself. Purchase price includes magazine. The Ellner .30 Cal. Sporter is 12-shot bolt action repeater. Ammo: target, 48 rds., \$5; softnose hunting, 24 rds., \$3.89. **ORDER ON FREE TRIAL!** Send check, cash or money order. \$7 deposit for C.O.D. Test, shoot, return in 10 days for full refund if not perfect in every respect. Calif. resid. add 4% state tax.

THE ELLNER COMPANY
Dept. 20, 1206 Maple Street, Los Angeles 15, Calif.

PUMP WATER FAST!

Drains Wash Tubs, Cellars, Cisterns. Famous #7 pumps 2800 gph. 420 gph. at 75' high or 1600 gph. from 25' well. Sturdy rustproof alloy metal. Six blade impeller. 3/4" inlet, 1/2" outlet. Standard pipe threaded. Uses any 1/2 to 1/4 H.P. Motor. Will not leak or clog. Iron clad guarantee. Send check, M.O., or sent C.O.D. **\$795** IN U.S.

Irrigate, Fill Tanks, Draw Well Water. Heavy duty #8 pumps 7000 gph. 1000 gph. 75' high 3000 gph. from 25' well. Rustproof alloy metal. 8 blade impeller. 1" inlet, 1" outlet. Standard pipe threaded. Will not leak or clog. Iron clad guarantee. Send check, M.O., or sent C.O.D. **\$1195** IN U.S.

Free Catalogue—Gear Pumps, Large Centrifugal Pumps, Deep and Shallow Well Pumps, Sump Pumps.

MOORE MANUFACTURING CO.
SWEDESBORO 1, NEW JERSEY

GROW ORCHIDS AT HOME

**BIG PROFITS
SPARE OR
FULL TIME**

World's most thrilling hobby—profitable home business.

Hundreds of Families Raising Orchids At Home With Our Help

Send for **FREE** information on temperature, light & humidity Orchids need in the home. Purple Orchids, white, yellow, every rainbow color. Many grow without soil, getting food from the air. Successful home grower offers complete growing instructions—tells how to market Orchid flowers & plants to neighbors, hotels, florists for good profits. Also Mail Order from big city, small town or farm. Instructions include Blooming-size Orchid plant. Send name and address for real ORCHID SEEDS, full details & "Quick-Profit" Plan—**ALL FREE.**

TROPICAL FLOWERLAND, Dept. 318, 100 So. Vermont, Los Angeles 4, Calif.

Finish HIGH SCHOOL AT HOME

Complete 4 Yrs. in 12 Months

Learn More! Earn More! Enter professional or technical schools. Advance Socially. Live a Happier, Fuller Life. Individual Courses or complete schedule. **WRITE FOR SCHOOL BULLETIN.**

ACADEMY FOR ADULTS

30 W. Washington, Dept. PM-87, Chicago, Ill.

BUILD YOUR OWN

Walks · Driveway · Outdoor Fireplace, etc.

At very little cost, you can lay foundations, sidewalks and driveways, build steps, outdoor fireplaces, sandboxes, tennis courts, pools—all concrete work. And it's easy to do! Just follow this PM book that tells and shows all: how to make the right mixture, plan and apply. Contains 50 professional short cuts, hundreds of pictures. Only \$2.50 post-paid. Money back if not pleased. Order today!

POPULAR MECHANICS PRESS
Dept. 857, 200 E. Ontario
Chicago 11, Illinois

The terrific high costs of even little concrete jobs are mostly for labor. Now save all the labor costs with . . .



I WILL TRAIN YOU FOR RADIO-TELEVISION

**ON MY EXCLUSIVE
NO-OBLIGATION
NO-RISK TRAINING PLAN**



Frank L. Sprayberry, President

Let me prove to you . . . without cost or obligation . . . that I can prepare you to be a Radio-Television Serviceman in 10 Months or Less

Let the true facts speak for themselves! That's why I want you to have my big new catalog and an actual sample lesson of Sprayberry Training . . . both **FREE!** Read, then make up your own mind! Train on my exclusive **NO OBLIGATION PLAN . . .** which means you **DO NOT sign any kind of time payment contract.** You pay for and accept your training as fast or as slowly as you wish. Prepare now for big paying jobs in Radio-TV or your own business. I will help you earn while you learn . . . in spare hours at home.



Get Practical Experience with 25 Kits of Radio-TV Parts

Practical experience counts most. In addition to modern lessons, you train with actual parts and equipment. Build the famous Sprayberry Training Television Set, Multi-Range Tester, 2-Band Radio, other Test Equipment—all yours to keep. Get latest training

on Color TV, Transistors, Hi-Fi and UHF Conversions . . . included to make your training more valuable.

You owe it to yourself to get all the facts . . . Mail coupon for catalog and sample lesson—**FREE**

See for yourself . . . in actual pictures and descriptions . . . why Sprayberry Radio-Television Training offers more. Backed by almost 25 years of training experience. Three training plans to suit your exact needs. Rush coupon today for big new catalog and sample lesson. No obligation; no salesman will call.

SPRAYBERRY ACADEMY OF RADIO
Dept. 10-P, 1512 Jarvis Ave., Chicago 26, Illinois

**TWO
BIG
FREE
BOOKS**

Mail Coupon Today!

JOIN TO MAKE MONEY IN
Radio Television
TRAINING PLAN

SPRAYBERRY ACADEMY OF RADIO
Dept. 10-P, 1512 Jarvis Ave.,
Chicago 26, Illinois

Mail for **FREE**
Facts and
Sample Lesson

Please rush catalog on your **ALL-NEW** Radio-Television Training Plans. I understand this does not obligate me and that no salesman will call. Include Sample Lesson **FREE.**

Name _____ Age _____

Address _____

City _____ Zone _____ State _____

PREPARE FOR THE BEST JOBS IN INDUSTRY

**TRAIN
at HOME**
in Your Spare Time
or at
ALLIED INSTITUTE
in Chicago

- MECH. ENGINEER
- DRAFTSMAN
- TOOL DESIGNER
- TOOL ENGINEER
- MASTER MACHINIST
- AIR CONDITIONING
HEAT & REFRIGERATION

MORE JOBS THAN GRADUATES

Shortages of Draftsmen, Designers, Tool Engineers, Machinists, Air Conditioning technicians are so widespread that you can pick a highly paid key job and look forward to Achievement and Security. You can begin your training in Short Courses at home or at Allied Institute, and continue progressively toward an Engineering Degree in 31 months. Allied is approved by Industry, National Home Study Council, Central Schools Association, Dept. of Education, Office of Public Instruction, State of Illinois, U. S. Veterans Admin., U. S. Dept. of Justice.

SEND FOR
**FREE
BOOKS**

ALLIED SCHOOL OF MECHANICAL TRADES
1338-42 South Michigan Ave., Dept. PM-8, Chicago 5, Ill.

Send me without obligation information on your courses:

- HOME STUDY RESIDENT VETERAN NON VETERAN
 DRAFTING ENGINEERING AIR CONDITIONING

NAME _____

ADDRESS _____

CITY _____ COUNTY _____ STATE _____

LET 10 MAIL ORDER EXPERTS HELP YOU Start a Profitable Mail Order Business! AT A COST OF JUST 50c PER MONTH!!

Get into the exciting and fabulous Mail Order Business! Operate from your home. Get nice fat cash orders every day by mail! Let our staff of 10 mail order authorities show you how to operate a business—What to sell—How to start—How to sell it—How to actually MAKE MONEY IN MAIL ORDER! Get personal answers to many of your questions. AT A RIDICULOUS COST TO YOU OF JUST 50c PER MONTH! Free information.

MAIL ORDER BUSINESS, Box 591, Lynn 600, Mass.



MAKE BIG PAY!

Make big pay in the construction industry as an operator of Bulldozers, Draglines, Back Hoes, Scrapers, and Motor Graders. Learn these skills NOW! Contractors need operators of earthmoving machines and pay high wages to our graduates. Don't be satisfied with just a job . . . learn a career!

Write TODAY for FREE School Catalog,
no obligation, to either address

**National School
of Heavy Equipment
Operation**

P.O. Box 8243, Dept. D-16
Charlotte, N. C.

**Western National School
of Heavy Equipment
Operation**

P.O. Box 527, Dept. D-16
Weiser, Idaho

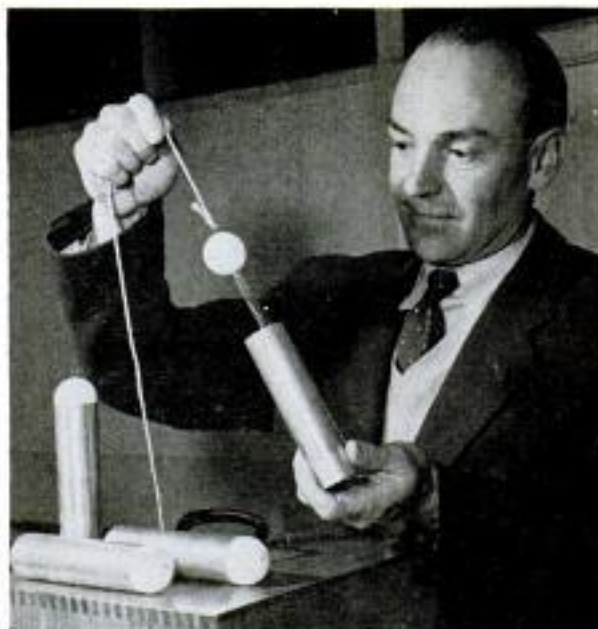

Cosmic-Ray Balloon Valve Made With Table-Tennis Ball

Australian scientists have replaced expensive valves for cosmic-ray research balloons with a simple device made from an aluminum tube, a spring and a table-tennis ball. The "homemade" valve permits a balloon to reach altitudes as high as 21 miles above the earth. The valve prevents the balloon from bursting by permitting hydrogen to escape when pressure inside the balloon becomes greater than outside pressure during the balloon's rise. Dr. V. Hopper, physicist at the University of Melbourne, invented the valve, which costs 35 cents to make instead of the usual cost of about \$500 per valve. These balloons carry photographic plates to record patterns of cosmic-ray activity.

Slow Down! You're Driving Faster Than You're Able

Experts at the Iowa State College driving laboratory have scientific evidence to show that most drivers are not qualified physically and mentally to drive more than 50 miles per hour. According to their research, at least 95 percent of the drivers should keep their car speed down to 50 miles per hour even on dry highways. Statistics in Iowa show that an increase in average highway speed from 50 miles per hour to 58 miles per hour resulted in about 25 percent more deaths.

Two physicians report that daily doses of the antibiotic terramycin have been used successfully over a six-month period to correct growth failure due to poor diets among Haitian school children.

NEW INVENTION **REPLATES** **AUTO CHROME**

with PERMANENT PLATING
MAKE MONEY! SAVE MONEY!

FACTORY-NEW BRILLIANCE FOR CAR CHROME

Here at last is the car-owner's answer to all chrome problems . . . a dramatic new invention—**SPEEDPLATER**. It actually plates **NEW METAL** as you brush. And the plating you apply becomes an **INDESTRUCTIBLE** part of the bumper, grille or trim itself. How your car will shine! You'll be mighty proud when you remove ugly rust spots and replat metal to a **NEW SPARKLE** . . . when you bring new, gleaming beauty to worn, dull, even blistered chrome areas of your car. This fast sensational method of brush-plating gives **FACTORY-NEW BRILLIANCE** that bonds itself onto your car. It forms a hard, sparkling surface that defies all elements!



Quickly Builds-up a Thick, New, Plating With Each Application

SPEED PLATES YOUR CAR!

BUMPERS—GRILLWORK—ALL CAR TRIM RESTORED TO NEW BRILLIANCE!

Here is how easily you replat your car . . . You simply attach **SPEEDPLATER'S** clamps to your car's battery, then dip **SPEEDPLATE** Brush into miracle solution. You **PLATE WITHOUT REMOVING PARTS FROM YOUR CAR**. Works Fast — yet uses less battery juice than the tiniest light on your car.

CAR DEALERS & SERVICE STATIONS— Make BIG Profits with Special HEAVY-DUTY OUTFIT!

FACTORY RESULTS and Big Volume Business can make **Terrific Profits** For You with this **Heavy-Duty Outfit**. Do your own replating without removing bumpers or grillwork! Increase the value of used cars! **Heavy-Duty Outfit Electroplates** on current from standard 12 volt storage battery. **ENTIRE KIT COMPLETE**—Only \$34.95 with enough material to plate dozens of cars! You quickly make back cost on your very first job! Re-order solutions always available from us at rock-bottom cost to you. **MONEY-BACK GUARANTEE**. Order Now—If C.O.D. send \$5 deposit.

TRY AT OUR RISK

If you want to put a new permanent gleam on **YOUR CAR'S CHROME**—you can do it right away and not risk a dime. If you are not satisfied with great results it doesn't cost you a penny! Just mail coupon with only \$1 deposit—then pay postman \$13.95 plus postage when your kit arrives. If you send \$14.95 we ship prepaid. Either way you must be **COMPLETELY SATISFIED** or you may return all in 10 days for **FULL CASH REFUND, ACT NOW!** Here's What You Get: **SPEED-PLATER** Brush with Permanent Anode; Wires and Clamps for battery hook-up; Special Buffs and Buffing Compound; Special Metal Polish; Full, Simple Instructions.

EMPIRE MERCHANDISING CO.,
4 North 3rd Ave., Mt. Vernon, N. Y. Dept. P-87

Please rush the electroplating kit I have checked

Regular Kit, \$14.95 (If C.O.D. send \$1 deposit)

Heavy-Duty Service Station Outfit, \$34.95 (If C.O.D. send \$5 deposit)

I enclose full price, send postpaid.

I understand that I must be **COMPLETELY SATISFIED** or I may return kit in 10 days for immediate **CASH REFUND**.

Name _____

Address _____

City _____ State _____



Enough Solution to plate 3 entire cars

Make Big Money Plating Other Cars!

Now you can add to your income during spare time . . . because 8 out of 10 cars on the road today **NEED REPLATING**. You can charge from \$5 for touch-up to \$50 for replating an entire car. It's easy and there's good money in it for you. When your neighbors see the brilliant plating on your car, they'll surely want you to do the job for them! Replate other things for profit too—faucets, tools, home appliances, cutlery, doctor's and dentist's instruments.

PRODUCT DIRECTORY

Popular Mechanics publishes more tool, equipment and materials advertising than any other magazine. It is your guide to better quality.



LEARN MEAT CUTTING AT NATIONAL

Pay After Graduation



The steady dependable trade of Meat Cutting taught easily in 8 short weeks. **YOU LEARN BY DOING** under actual meat market conditions in big modern school at Toledo.

For beginners or men with experience. Get a profitable store of your own. Remember, **PEOPLE MUST EAT!** Big pay jobs. Free employment help. Thousands of successful graduates.

Buying, cutting, percentage, pricing, advertising, selling, etc. A complete retail meat education. National School established 35 years. Get National training **NOW**. Pay your tuition in easy weekly payments

after you graduate. Send coupon for **FREE 52 page school catalog** — TODAY. G.I. approved.

National School of Meat Cutting, Inc., Dept. 50-U, Toledo 4, Ohio

Send me your **FREE** school catalog on National Training at Toledo in Meat Cutting, Meat Merchandising and Self Service Meats. No obligation. No salesman will call.

Name _____ Age _____

Address _____

City _____ State _____

Approved for training Korean Veterans

WORLD'S
BEST
WANT-AD
MEDIUM

CLASSIFIED ADVERTISEMENTS



Advertisements in this section \$1.25 per word, each insertion, minimum 10 words, payable in advance.

To be inserted under proper classification, copy must be in our office the

20th of the second month preceding date of issue

F. W. Johnson, Manager, Classified Advertising

Popular Mechanics Magazine, 200 East Ontario Street, Chicago 11, Illinois

YOU'LL PROFIT

By reading and answering the classified ads in this section. Hundreds of opportunities for you to make and save money

AUTOMOBILES, MIDGET CARS

AUTOMOBILE: 1957 Superignition, starting, pep, mileage \$4.95. Varitypers, IBMs, barbells, 1951 Kaisers. EG, Elmsford, N. Y.

HUNDREDS of automobile catalogs—Old, new and foreign; glossy photographs, shop manuals; dealer books; free motor magazines listed by non-profit corporation. Write to get on free mailing list. Auto Maniacs, Stockbridge, Mich.

MIDGET Race car. Building plans, parts price list \$2.00. Box 404, Big Bear City, California.

AUTO SUPPLIES AND EQUIPMENT

REBUILT Exchange on transmissions, any car, truck. Standard, overdrive parts, service. Dealers wanted. Douglas, 2634 N. 50th, Milwaukee, Wis.

POLICE-Type auto radio booster. Beautiful, chromed, tubular; fits auto antenna. Fabulous reception boost claimed by owners. \$4.95 postpaid U.S.A. Formco, Box 252, Rossville, Ga.

IGNITION Fuel pump trouble shooting emergency bypass. Free details. Williams Industries, 1349 Bryden Rd., Columbus 5, Ohio.

NO Scratched fenders when you work on your car. King size 5x6 multicolored car-work blanket \$2.99. Cartoons-of-the-Month, Roslyn 4, New York.

RING-Valve job while you drive, \$8.00. World's only product of its kind. Safe! Proven! Guaranteed! Free details. Mot-aloy, Grantham, Penna.

JEEPS And four wheel drive trucks need hubs that free wheel for two wheel drive and locking for four wheel drive. Guaranteed satisfaction. Willy's Jeeps \$39.95. Dodge Power Wagon, GMC 150 Series, 1 HCS Series, \$46.50. See nearest tractor supply store, or order direct from Tractor Supply Co., 2700 North Halsted, Chicago 14, Illinois.

TURNPIKE Automatic foot throttle \$2.49. Real driving comfort. Money back if returned within sixty days. No c.o.d. The Dow Mechanical Corporation, Thompsonville, Connecticut.

AUTOMOTIVE Accessories Repair Guide \$1.00. Marnel, Box 7642, Denver 15, Colo.

1909-1932 FORD New parts catalog 25¢. Mark, 15 Emerson, Clifton, New Jersey.

AUTO Accessory and parts catalog. 1957 edition, all new! 228 pages. Save up to 50%. 75,000 items, including Hollywood accessories, hi-speed equipment, rebuilt engines, all parts and accessories for all cars and trucks! Hard-to-get parts! Send 25¢, refundable. J. C. Whitney, 1919 PM Archer, Chicago 16, Ill.

SAVE Money on Jeep and army truck parts. Large inventory. Catalogs for Jeep or G.M.C. owners. American Auto Parts Co., 1830 Locust, Kansas City, Mo.

FREE! New catalog. Speed, power, mileage increasing equipment. Discounts! Almqvist Engineering, Milford PM5, Penna.

NEW And used parts at savings. Complete guaranteed parts service for all models cars and trucks—1924 and later. Largest in the West. Army parts specialists. No catalog. Submit your needs for quotations. Fast mail order service. Pioneer Auto and Truck Parts Co., 734 W. 13th Ave., Denver 17, Colorado.

AUTO Airconditioner. Easy "do it yourself" booklet \$1 postpaid. Auto airconditioning kit \$279, complete. Highway Airconditioning Co., Inc., 217-7th Ave., New York City.

OFFENHAUSER—1957 Catalog available on all items manufactured and distributed. Only 35¢. Offenhauser Equipment Corp., 5196 Alhambra Ave., Los Angeles 32, California.

SAVE 75% Of your car washing expense and drive a glistening car all the time. Kimball Kleener, the miracle chemically treated cloth, will do it. Good for forty or more waterless washes. Send no money; just ask for ten day free trial. If satisfied, it's one dollar. Kimball Products, 26970 Princeton, Inkster, Michigan.

STOP Burning oil! Save gas! 10,000 mile overhaul treatment, \$3.95. Guaranteed! Details. Brooks, 288 W. 34th, New York City 1.

JEEP Tops, good, \$7.50. Curtains \$2.00 each. P.O.B. Jacksonville, Texas. Surplus Sales.

AUTOMOTIVE Books. Free catalog. Popular Mechanics Press, 631 N. St. Clair St., Chicago 11.

CATCHDRIP Ends messy driveway oil smears. Simple car attachment. \$3.50. R. J. Sales, 6001 Jaymills, Long Beach, Calif.

ADJUSTMENT Tires, 670x15, 710x15, 760x15, 800x15, \$4.95 each. Reconditioned truck tires, 750x20, 8 ply, \$12.50. 825x20, 900x20, 1000x20, \$19.50 each. We pay freight on 4 or more tires. Send check or money order, sizes wanted to Bordeaux Tire Sales, 4037 Clarksville Highway, Nashville 8, Tennessee.

SPARK-O-Matic power plugs. More power plus more miles per gallon. Life guarantee. Salesmen wanted. R. J. Catherman, Windsor, Mass.

AUTO TRAILERS

BUILD Expanding eight foot trailer. Accommodates five. Literature 10¢. Fra-Mar Company, Wilmington, Mass.

TRAILER Manual. Over 200 pages, 250 pictures. Tells how to buy, tow, travel, build, live-in, repair. \$1.98. Trail-R-Club of America, Dept. PM1A, Box 1376, Beverly Hills, Calif.

BLUEPRINTS Vacation trailers. Supplies, literature 10¢. Comstock Trailers, Parsons, Kansas.

MOTORCYCLES, BICYCLES, MOTORSCOOTERS AND SUPPLIES

HARLEY - Davidsons — Used bargains. New, used parts, accessories for all models. Bulletin, catalog 25¢. Knuth's (Factory Dealer), 1733 Muskego, Milwaukee, Wis.

PARTS, New, used. List 10¢. Ballak, 811 N. 9th, St. Louis 1, Mo.

WHIZZER Motors, \$20.00; midget race car reasonable; motorscooter \$8.00;ushman two-speed \$20.00. Send 25¢ (35¢ first class mail) for catalog #30 jammed with sensational bargains in wheels, motors, motorscooters, midget cars, motorbikes, construction plans, etc. Gail, 1313 Jefferson, Toledo, Ohio.

RECONDITIONED Motorcycles and motors. Chromium accessories. Complete stock Indian parts. Expert rebuilding. Fast service. Indian Motorcycle Sales, Kansas City 27, Missouri.

MICROMIDGET Racer \$15, Whizzer \$7.50, Allstate motorscooter \$20, less engines. Johnson engine \$3, Maytag \$3, Servicycle \$8. Five Briggs engines \$15 for all. (Mailorder only). Send 25¢ (35¢ for first class mailing) for 32-page directory catalogue Number 78, just out, listing the above and hundreds of other bargains in new and used midget cars, motorscooters, home builders parts, plans, etc. Midget Motors Directory, Athens, Ohio.

AVIATION

PROPELLERS, Plans, supplies for airboats and snowplanes. Latest designs, prompt delivery. Catalog 25¢. Banks-Maxwell, Box 3301E, Ft. Worth 5, Texas.

AVIATION Surplus bargain catalogue. One dime. Box 22PM9, Thomasville, Penna.

BATTERIES, GENERATORS

EDISON Nickel storage batteries. Any voltage, any amperage. Unconditionally guaranteed. Power plants, generators, motors. Literature. Hawley Smith Co., Croton Falls 1, N. Y.

ELECTRICAL SUPPLIES

LAMP, Electrical parts, wholesale. Thousands of items for repairing, converting. Catalog 25¢. Brown Lamp, Box 303, Clayton 5, Mo.

DC Power supplies. Laboratory, test units. DC motor controls. Complete line selenium rectifiers, meters, transformers and other replacement parts. Ramyr, Dept. D-1, 1824 East First Street, Los Angeles 33, California.

LAMPS—Parts catalog containing wiring instructions. 25¢. Gyro Lamps, 3438P N.W. 54 Street, Miami, Fla.

WELDING, SOLDERING, PLATING

ACETYLENE Welding outfits new \$54.50; used \$34.50; arcwelders \$56.50. Eagle Welding, Dept. PM, 5055 Broadway, Chicago 40, Ill.

BUY Welding supplies direct from manufacturer. Cable, welding rods, helmets, etc. Portable arc-welders and kits at tremendous savings. Free factory catalog! Le-Jay Mfg. Co., 2927 Emerson Ave. So., Minneapolis, Minn.

ELECTROPLATING Equipment, anodes, solutions. All types, including new electrodeless nickel. Baby shoe metallizing equipment, supplies. Free catalog. Hollywood Bronze Supply, Dept. B-4, 1624 East First, Los Angeles 33, California.

A.C. Welders, 4 sizes, lowest prices. Free literature. Holgerson's Service, Canton, Kansas.

WELDERS, 110/220, \$39.50. Morris, 1070 Inner Drive, Schenectady 3, New York.

NEW, Timesaving oxy-acetylene outfit welds, cuts, heats, brazes. Just change tips. Light, compact, portable. Thrifty to operate, ruggedly built. Complete outfit and instructions, only \$84.50. Special economy plan for supplying gas cylinders. Write for free literature: Dept. M, Linde Company, 30 East 42nd Street, New York 17, New York.

BUILD-Your-Own welder or welder and power combination. Low cost unit connected to used engine lets you weld anywhere. Free booklet tells how. Get into profitable welding business. Write Hobart-weld, Box M-872, Troy, Ohio.

MACHINERY, TOOLS, SUPPLIES

POWER Tools, not toys. Discounts. Factory catalogs. World Tool Supply, Box 4404, Joyfield Station, Detroit 28, Mich.

RENT Electric drills, saws, sanders, catalog 10¢. Rent-It, 510 Queen, Westbury, N. Y.

ENGINES, MOTORS, DYNAMOS

REWIND Motors yourself. Complete instructions \$1.00. Lewis Mfg., Howell, Michigan.

WINDING Data, 275 motors, single and three phase, \$1.10. Data Company, Box 7631, Kansas City 28, Mo.

SMALL Electric motors. Accessories, Kiteo, Dept. 14, Box 212, Monroe, Wis.

DIESEL Injector parts wanted. GMT-110. Bares, 7120 Carnegie, Cleveland 3, Ohio.

1/2 HORSEPOWER Electric motors, a.e. 110, used, good \$5.00 each, f.o.b. Plant Machinery Corp., Richmond & Norris Sts., Philadelphia 25, Penna.

BOATS, OUTBOARD MOTORS

FIBERGLAS Boat coating. Plexiglas boat windshields—Clear, blue, green tints. Wholesale-retail. Instructive information catalog free! Gem-O-Lite, 5329 Cahuenga, North Hollywood, California.

MARINE Conversions for Ford and Jeep engines. Catalog 25¢. Lehman Manufacturing Company, 972D Broad Street, Newark 2, New Jersey.

BOAT Plans. Full size patterns. Frame kits. Modern inboards and outboards for amateur builders. Complete new catalog 50¢ or specify requirements. Glen Designs, Box 568, Compton, Calif.

NEW, Used, rebuilt marine motors. Marine conversions, fittings. Free catalog. Stokes Marine Supply, Dept. 24, Coldwater, Michigan.

FIBERGLAS Boat cloth \$1.20 yd. Resin \$5.95 gal. 3/16 plexiglas \$1.20 sq. ft. Send 10¢ for literature. United Plastics, Dept. 4, Roebling, N. J.

FREE Catalog! Boat kits, trailers, fiberglass, marine hardware. Lager Industries, Dept. M3, 3404 Lyndale South, Minneapolis, Minnesota.

FIBERGLAS Permanent boat waterproofing. Special 25% discount. Complete kits, \$9.45 up. Guaranteed materials. Easy application. Full instructions. Free literature. Ajax Plastics, Dept. PM, P.O. Box 1323, Fort Worth, Texas.

FORDS And Jeeps 100% marine engines with famous Convo-Kits. Deluxe catalogue 25¢ coin. Oscomotors, 3627B Lawrence, Philadelphia 40, Penna.

FIBERGLAS Your boat! Complete kits including color resin. Low as \$8.50. Aqua-Glas, Box 99, Altadena, Calif.

BUILD Small boats. Booklet 25¢. Catalog free. Popular Mechanics Press, 633 N. St. Clair St., Chicago 11.

ATHLETIC EQUIPMENT, BODY BUILDING COURSES

YOURS—A body like a Greek god! Startling, amazingly quick new method explained in free literature. Send name and address to: DeVel-O-Flex, 3607 W. Magnolia Blvd., Burbank, Calif.

BE Taller! ABC system \$1.00. Guaranteed! ABC, Box 849-PM, San Francisco 1, California.

BARBELLS, Dumbbells. Courses. Free catalogue. Good Barbell Co., Reading, Penna.

STRENGTH, Health, muscles. Gain, reduce. All you need is a rope! Valuable booklet free. Roperice, 4634-A Art St., San Diego 15, California.

100 TRICK Knockouts for self-defense \$1.—1c each. Priest, Box 251, Evanston 1, Illinois.

BE Taller! Coach's "Inch-At-A-Time" system. New edition, \$1 complete. Marty Snyder, Box 193-MO, Union City, New Jersey.

SPORTING GOODS, GUNS, FISHING TACKLE, ARCHERY, TRAPPING

FREE Below wholesale fishing catalog. Fishing Tackle Mart, Dept. 57, Box 6737, Chicago 80, Ill.

ANTIQU Guns, swords, weapons! Huge illustrated monthly catalog. Hundreds items each issue. \$1.00 year. 12 fabulous catalogs. N. Flayderman, Kennebunk, Maine.

180 PROFUSELY illustrated pages antique pistols, swords, daggers, armor, etc. 50¢. Robert Abels, M360 Lexington Ave., New York City 21.

RIFLES, Shotguns, pistols, scopes, ammunition. Dealers prices. Berkshire Gun Rack, Six Lakes, Michigan.

BIG Money raising crickets and 12 inch African fishworms. Free literature. Carter Ranch, Plains, Georgia.

5000 BARGAINS, Firearms, binoculars, war relics. Catalog 50¢. Smith Firearms, Runnede, N. J.

SAMPLE: 25¢ Copy of "The Archers' Magazine." Send 10¢. 1200 Walnut Street, Philadelphia 7, Pennsylvania.

FREE Sporting goods catalogs! Save 70%. Econ-O-Mart, Whippany 2, New Jersey.

MOLDS For fisherman's sinkers, jigs, squids, casting and spinning lures. Free catalog. Sweet's Molds, Tonawanda 1, New York.

FREE Catalog! Camping, hunting, diving. Write: McCanna Company, Tarrytown, N. Y.

JAP Rifle altering to 30-06, \$6.00. Japshells, \$3.95. Catalog 5¢. T. P. Shop, West Branch 11, Mich.

FREE 152 Page fishing catalog. Includes latest "do it yourself" kits. Netcraft Company, Dept. B8, Toledo 13, Ohio.

MINNOW Motels make money. Trap minnows. Build your own traps. Plans, instructions, \$1.00. Minnow Motels, Box 537-P, Park Ridge, Ill.

LEARN To swim in water three feet deep. Details 50¢. Box 452, Port Byron, New York.

MONTHLY Gun magazine. Antique, modern guns, ammunition, accessories. Photographs, articles, offerings. 12 free 25 word ads to subscribers. \$2 yearly. Sample 20¢. Gun Collector, East Ellsworth, Wisconsin.

COLTS, Remingtons, Winchesters, Lugers, P-38's, Kentuckies, Springfield. Antique—Modern guns and gun accessory values. Big bargain catalog 50¢. Agramonte's, Yonkers 2G, N. Y.

BUILD Barbecue. Complete plans. Booklet 25¢. Free catalog. Popular Mechanics Press, 633 N. St. Clair St., Chicago 11.

EARTHWORMS

FREE Folder, "43,000 Yearly Sparetime. Backyard, Raising Earthworms!" Oakhaven-56, Cedar Hill, Texas.

BEGINNERS—250 Hybrids, instruction book, \$3. Lucky Strike Earthworms, Duberly, La.

RAISE Earth worms. Profitable, easy instructions 25¢. Lairs Hatchery, Box 84, Virden, Ill.

HULA-HULA wigglers are better! Inquiry, information free. Kean, Ladonia, Texas.

BIG Money raising crickets, hybrid red wigglers and 12 inch African fishworms. Free literature. Bedrun hybrid red wigglers, 3000, \$6.50; 10,000, \$19.95, postpaid with raising instructions. Carter Redworms, Plains, Georgia.

GIANTS, Six inches, 100—\$2.00. Postpaid. Brandts Wormery, Century Apartments, Davenport, Iowa.

BINOCULARS, TELESCOPES, MICROSCOPES, MAGNIFIERS

DYNASCOPE—Sensational new reflector telescope. Send for details. Criterion Co., Dept. DP-35, Hartford, Conn.

OPTICAL Square, only \$2.95. Box 33, Grove City, Ohio.

MICROSCOPE Slides. Anatomical. Free list. Bay, 409 Roosevelt, San Francisco 14, California.

300 POWER Reflector telescopes complete with finder scope and tripod, \$24.95. 400X telescopes easily made. Kit includes focusing tube, erector, five finished lenses, building instructions, \$3.75. Free telescope booklet. Suffolk Science, Mattituck 4, New York.

BINOCULARS, Telescopes, microscopes. Terrific values \$3.98 up. Request free money-saving catalog. Criterion, Dept. P-57, Hartford, Conn.

WAR Surplus bargains: Millions of lenses, instruments, telescopes, binoculars, components and complete line of astronomical telescope items. World's greatest optical market place! Send only \$1.00 for beginner's 10-lens kit and big instruction booklet Stock 2-CH. Write for catalog CH, free! Edmund Scientific Co., Barrington, New Jersey.

REFLECTING Telescope, 60X, completely assembled \$29.75. Guaranteed observatory clearness. Free information. Skyscope, 475 Fifth Avenue, New York City 17.

REFLECTOR Telescope kits \$7.25 (3") to \$175 (12"). Mirrors, cells, focusing mounts, tripods, eye systems. Anything, everything in telescopes. Free catalog. Also ready to use telescopes from \$25. Esco Products, Oakridge, N. J.

MICROSCOPE Catalog free. Research Scientific Supplies, 128 W. 23rd, New York City 11.

AMAZING Prices, precision binoculars. Folder, "Binocular Selecting" catalog free. Dealers write. Prentiss Importers, Mercury Bldg., West Los Angeles 25, Calif.

BUILD Your own reflector telescope. Complete kit. Mirrors, eyepieces, tripod, all other accessories. Request free illustrated literature. Criterion Manufacturing, Dept. DPM-32, Hartford, Conn.

PLANTS, SEEDS, BULBS, NURSERY AND GARDEN SUPPLIES

GET Approximately \$100.00 a bushel for some corn. No expensive processing. Instructions \$1.00. Moneyback guarantee. Charles Eichhorst, Dakota City, Nebraska.

WORLD'S Greatest cash crop. Free information. Write Ginseng Gardens, Asheville, N. C.

PETS—DOGS, BIRDS, RABBITS, HAMSTERS, ETC.

HAMSTERS—Golden: young \$3.00 pair. Fully developed \$4.00 pair. Adirondack Hamsters, Prospect 10-H, N. Y.

BEAUTIFUL, Pure white pedigreed police puppies. Ansonia Kennels, McHenry, N. Dak.

RAISE Rabbits on \$500 month plan. Plenty markets. Free details. White's Rabbitry, Delaware, Ohio.

STRAIGHT Cooners! World's oldest kennel. Combination hounds, rabbit, fox, beagles, deerhounds, bird dogs. Puppies of all breeds. Prices reasonable. Trial. Free catalogue. Raccoon Mountain Kennels, Box 464, Boaz, Alabama.

CATALOG Rabbitry supplies and guide to rabbit raising. Glick, 2720 Mt. View, El Monte, Calif.

LIVE Texas horned toads, \$1.25 each. Pair, \$2.00. Postpaid, guaranteed. Tex's, Box 253, Brownwood, Texas.

RAISE Rabbits, nutria. Choice breeders. Bob Madsen, Lyndon 2, Illinois.

WE Buy all varieties, snakes, lizards, turtles, toads, frogs. Details 254. Biological Exchange, Dept. 16b, 1211 Wagner Way, El Paso, Texas.

SPORTSMEN: World's largest kennels offers 500 bird dogs, straight cooners, combination hounds, beagle hounds, rabbit hounds, small squirrel dogs, fox and deer hounds. Catalogue free. Smokey Mountain Kennels, Cleveland, Tennessee.

WE Pay \$3.50 lb. Grow mushrooms. Cellar, shed and outdoors. Spare, full time, year round. We have over 25,000 customers. Free book. Washington Mushroom Ind., Dept. 171, 2954 Admiral Way, Seattle, Wash.

RAISE Rabbits successfully by knowing facts. 48 page illustrated book describing 25 breeds. Housing, feeding, breeding, marketing, etc. Plus bulletin, 25 cents. American Rabbit Association, 38 Arba Building, Pittsburgh, Penna.

MAKE Money raising chinchillas, mink, nutria, rabbits, cavies for us. Free catalogue. Keeney Brothers, New Freedom 2, Penna.

HAMSTERS—Young Golden pairs, \$2.95. Breeders \$3.95. Free booklet. Jer-Pre's Hamstery, 2425 Hoyt, Muskegon Heights 13, Mich.

FUR BEARING ANIMALS

MINK Raising information free. Complete. Lake Superior Mink Farm, Superior, E.E.I., Wisconsin.

CHINCHILLAS into fabulous furs. Pedigreed stock reasonably priced. Care directions. Stewart Chinchilla Ranch, Washingtonville, N. Y.

FARMS, FARM LANDS, REAL ESTATE

TWO Acres, home, highway location near lake \$6,950. Other properties, Roscow, Realtor, Inverness, Florida.

TEXAS Resort property. Ideal climate. Near Mammoth Lake. 4 roomy lots adjoining total cost \$500.00, \$10.00 down and \$15.00 monthly. Write for photos, maps, etc. Hugh Matlock, Dept. 243, Pipe Creek, Texas.

SAVE! Free government land, inexpensive farms, homes. Aurepa, Central Valley, New York.

\$5.00 MONTHLY Buys 40 acres productive land. Near town. Price \$250.00. Free list. Box 425-P, Carthage, Mo.

OZARKS! 89 Acre. Listings, information free. Write: Armstrongs, Shook, Missouri.

FLORIDA. Nice homesites, \$345 at \$10 monthly. Folder free. Howard Vernor, DeLand, Florida.

GENUINE Opportunities! Government land, U. S., Alaska, Canada. Write Sledge Surveys, Macon, Mississippi.

200 ACRE Dairy farm fully equipped with stock. Heavy farm machine repair shop. John J. Marshalek, Conrath, Wis.

FREE Strout catalog! Farms, homes, businesses, resorts, retirement properties. Over 2900 values in 34 states. 57 years' service. World's largest! Write Strout Realty, 7-MP So. Dearborn, Chicago 3, Ill.

PROFITABLE OCCUPATIONS

SAVE Money! Buy wholesale! Free catalogue general merchandise. Norris, 487-M Broadway, New York City.

WE Pay \$3.50 lb. Grow mushrooms. Cellar, shed and outdoors. Spare, full time, year round. We have over 25,000 customers. Free book. Washington Mushroom Ind., Dept. 99, 2954 Admiral Way, Seattle, Wash.

SPARETIME Repeat profits taking magazine subscriptions. Special offers. Cassell Agency, Boynton Beach, Florida.

FREE Folio "\$5,000-\$45,000: Unlimited Vacations." No merchandise. Unknown! Work home, sparetime! Haylings, Carlsbad, Calif.

BE The Popular Mechanics representative in your neighborhood and earn big profits in your spare time. Write Popular Mechanics Magazine, Room 305M, 200 E. Ontario St., Chicago 11.

BIG Money raising fishworms and crickets. Free literature. Carter Wormery, Plains, Georgia.

BAKE New greaseless doughnuts in kitchen. Sell stores. Free recipes. Michael Ray, 3905 South 15th, Minneapolis 7, Minn.

HOME Mailorder beginner's manual, sources, methods, opportunities, 25¢. Carahan Bros., 2610 Acacia, Fontana, Calif.

RAISE Pheasants on \$100 week plan. Little capital and space can make you independent. Free details. Great Central System, Columbus 1, Kansas.

FREE Book "505 Odd, Successful Businesses." Work home. Pacific, Oceanside, Calif.

MAKE Flexible molds. Cast plaques, figurines. Free sample. Tooker, 1043-M Fairview, Hamilton, Ohio.

VENDING Machines—No selling. Operate a route of coin machines and earn amazing profits. 32-page catalog free. Parkway Machine Corporation, Dept. 25, 715 Ensor Street, Baltimore 2, Maryland.

AUCTIONEERING—Home study course. Diploma granted. Auction School, Ft. Smith, Ark.

TAPE Recording—Fabulous new business! \$100.00 weekly spare time! Uncrowded field. Entire country wide-open! Facts free! Dixieland Publishers, Ashboro 5, N. C.

BUY Wholesale thousands nationally advertised products at big discount. Free "Wholesale Plan." American Buyers', Hertel Station, Buffalo 16-B1, N. Y.

BIG Profits in welding. Easy to learn. Low cost training in completely equipped non-profit school. GI approved. Write for free booklet. Hobart Trade School, Box M-873, Troy, Ohio.

MAGAZINE Subscriptions—Largest commissions, bonus. Qualified Agency, 451XA Kingston, Brooklyn 25, N. Y.

BUY Wholesale! Over 10,000 nationally advertised products. Appliances, cameras, sporting goods, housewares, watches, typewriters, tools, clothing, etc. Send postcard today. Buy-Rite, Box 258, Hawthorne 3, New Jersey.

TREE—Mushroom pioneers! Top profit. Grow, monopolize China Town necessities! Spawn, instructions, \$1.00. Ohga, PM95, Sigakenkusatu, Japan.

WE Establish you in your own mail order discount business. Supply catalogs, letters, envelopes printed with your name and ship your orders. Sell gifts, appliances, watches, housewares, silverware, etc., at discounts to 75%. Catalog and details free. Topval Corp., Lindenhurst 517, N. Y.

THEY Hand him \$100! Free packet. "Secret Journal." 919 secrets-plans! Work home. Publicco, Oceanside, Calif.

SAVE Bottle caps. Make attractive wall plaques. Instructions 50¢. Campbell, 87 Poplar Ave., Bronx 65, N. Y.

\$60.00 WEEKLY Sparetime. Start home Venetian blind laundry. Protected territory. Interesting information free. Burt, 2434ES, Wichita 13, Kansas.

WANT To make big money at home? \$10.00 profit in an hour possible with invisible mending. Make tears, holes, disappear from clothing, fabrics. Steady year-round demand from cleaners, laundries, homes. Details free. Fabricon, 6236 Broadway, Chicago 40, Illinois.

BOOKS, PERIODICALS, PICTURES, POSTCARDS

FREE: Illustrated catalogue. Treasure-Site Book Company, 279 South Alden, Philadelphia 39.

BRITISH Book bargains. Any subject. Catalog free. Transbooks, Box 22-PMN, Brooklyn 26, N. Y.

BOOKS Located. All kinds. Send your lists. Mrs. Frank L. Myers, 4115 N. Lawler, Chicago 41.

OUT-Of-Print books at lowest prices! You name it—we find it! Fast service. No obligation. International Bookfinders, Box 3003-PM, Beverly Hills, Calif.

NATIONAL Geographic Magazine, 1888-1954. Periodical Service, Box 463-PM, Wilmington, Delaware.

"HOME Improvement Guide." New, amazing 192 page volume. Packed with ideas, plans for remodeling, decorating, landscaping, built-in projects. \$2.50 pre-paid. Popular Mechanics Press, 200-HG East Ontario St., Chicago 11.

BARGAIN! Send for copy of Alaska magazine, map, Cheechako certificate with your name inscribed: Deed to Goodenough mine and pocket guide to Alaska all for \$1. Alaska Sportsman, Ketchikan, Alaska.

RARE Magazines, catalog 10¢. Nationwide Exchange, Box 1373-P, San Antonio 6, Texas.

BOOKFINDERS! All subjects. Send wants! Jaher Book Service, 183 Hazelwood Drive, Westbury, N. Y.

"SCIENCE Milestones." Records march of science starting 400 years before Christ, right up to date. Amazing facts revealed. 312 pages packed with startling information that will thrill you. A real history of science. \$3.00. Literature free. Popular Mechanics Press, 200-SM East Ontario St., Chicago 11, Ill.

BOOKHUNTERS! Scarce, rare, miscellaneous books. Atlantic Book Service, Cedar Street, Charlestown 29, Mass.

JOHN Friend, bookfinder, can get the book you want. Free search service. Box 197PM, Cardiff, Calif.

SAMPLE: 30¢ copy of "The Aquarium." Send 10¢ to 12th and Cherry Sts., Philadelphia 7, Penna.

BARGAIN, Exciting Little Library booklets. 25¢ each. How to use tools, painting, welding, home improvement, games, models, plastics, lamp making, glass blowing, boats, photographs. Free catalog. Popular Mechanics Press, 200-LB East Ontario St., Chicago 11.

FREE: Exciting catalog packed with books covering most everything. Think of it—From cover to cover you will find described and illustrated hundreds of books telling how to fix and how to build almost anything. How to remodel your home; do your own decorating, plumbing, electrical work. Simplified books covering concrete work, carpentry, painting, furniture making and refinishing. How to build your own boat, home workshop tools. Best books on photography, welding, hobbies, homecraft. How to make a home freezer. Send for your free copy now. Popular Mechanics Press, 200-BC East Ontario St., Chicago 11, Ill.

GAMES, TOYS, NOVELTIES

"SINK The Battleships." A fascinating, copyrighted game including 100 money-making commission circulars \$1.00. O. M. Pace, 133B Lake Avenue, Piedmont 11, California.

MAGIC TRICKS, PUZZLES, JOKER NOVELTIES

WORLD'S Finest professional magic, Joker novelties. Giant illustrated catalog 10¢. Top Hat, Evanston 12, Illinois.

500 TRICKS, Douglas famous 120-page catalog, only 10¢. Fastest service to magicians for 30 years. Send 10¢ today. Douglas Magician, Dept. 1, Dallas, Texas.

BE A magician! Large professional catalogue of latest tricks. 35¢. Ireland, O-109 North Dearborn, Chicago 2, Illinois.

PROFESSIONAL Catalog, 175 pages, 25¢. Williams, 900 Plymouth, Ellwood City, Penna.

VENTRILOQUISM, easiest method. Details free. Smith, 2125 No. Bigelow, Peoria, Ill.

STINK Bombs. Disgustingly potent. 12/\$1. Kits, Drake Way, San Pablo 10, California.

YROW! Heat treat friends with pepper toothpicks. 25¢. Box 212, Wood Dale, Illinois.

3100 NOVELTIES, Jokes, tricks, gadgets, funmakers, hobbies. Big catalog 10¢. Johnson-Smith, D-424, Detroit 7.

COINS, TOKENS, CURRENCY

BARGAINS, U.S. coins: 1893 Columbian world's fair half dollar, \$1.00. Ten different Indian pennies, 75¢. Two-cent piece, and 3-cent piece, \$1.00. Gold 1/4 eagle, \$9.00. Gold 1/2 eagle, \$12.50. Beautiful coin bracelet, \$1.00. Many coins available. What do you need? Rare Coin Company, 31 North Clark, Chicago 2.

44 DIFFERENT Uncirculated coins, \$1.00. Oddehon, Box 482, St. Louis, Mo.

10 DIFFERENT Indian cents and 5 Lincoln cents before 1931 \$1.00. Price list free. Joray's, Box 38C, Shouns, Tenn.

SILVER Dollars: Uncirculated. 1879p through 1891p, 1897p \$2.00 each. 1893cc \$15.00. Retail lists 10¢. Holden's, Garwin, Iowa.

LARGEST Coin magazine, 180 pages, 35¢. Scrapbook, 7320-J Milwaukee, Chicago 81.

SAN Francisco mint closed! Made only cents and dimes in 1955. In short supply and great demand. One each, brilliant uncirculated, for 25¢. Free coin lists with order. Bryson Stamp & Coin Company, 612 White, Toledo 5, Ohio.

12 DIFFERENT Indian cents, coin list, \$1.00. Pounds, North Wales, Penna.

MORGAN, Dollars: 1878-87-90-91-92s, \$2.00 ea. Coin catalogue, 25¢. Shultz, Salt Lake 18, Utah.

FREE! Foreign coin, banknote and coin collectors illustrated catalog to approval service applicants. Send 3¢ postage. Tatham Coinco, Springfield 30, Mass.

COINS From Formosa, Vatican, etc., plus foreign banknote, 10¢ with coin approvals. Littleton Coin Co., Littleton 81, New Hampshire.

BARGAIN Lists, Indianhead cent, 10¢. Economy Sales, 156-A Dean, Mansfield, Mass.

U. S. large cent and coin bargain lists, only \$1. Delmaco Products, Box 1123, Wilmington, Del.

ANCIENT Roman coin over 1500 years old. Guaranteed genuine. Only 50¢. Approvals accompany. Sommers, PMS, Jenkins Arcade, Pittsburgh, Pennsylvania.

CANADIAN Silver dollars, \$1.75. Three different \$3.00. Preston, Box 192, Station E, Toronto, Canada.

\$50.00 CALIFORNIA Souvenir slug, \$3.75. Frank Sprinkle, Box 809, Bluefield, W. Va.

U.S. Coins on approval. Reasonable. Hutchinson, Box 4747, Philadelphia 34, Pennsylvania.

GET Profit and pleasure in collecting old coins. Send 10¢ for 56-page illustrated coin catalog. You'll be delighted with it. Send for it now. B. Max Mehl, 370 Mehl Building, Fort Worth, Texas. Largest rare coin establishment in U. S. Established 40 years.

10 INDIAN Head cents plus price lists, 5¢ postpaid. Louis Bell, Masonic Building, Decatur, Alabama.

BARGAINS—\$5 Gold \$11.95; \$10 gold \$21.95; \$20 gold \$42.95. Also paying highest prices all gold coins, any quantity. Bebee's, 4514 North 30th, Omaha 11, Neb.

OLD Money wanted. Do you know that coin collectors pay up to \$100.00 for certain U. S. cents? And high premiums for all rare coins? We buy all kinds. Send 5¢ for large coin folder. May mean much profit to you. Numismatic Co., Dept. 20, Fort Worth, Texas.

LINCOLN Cents 1910-S, 1913-S, 1921-S, 1923-S, 1924-S, all for \$2. Gasser's, Box 34615, Los Angeles 34, California.

10 MIXED Foreign coins—bills: 10¢. Dwight Musser, Dunbar, West Virginia.

LINCOLN, Indian cents, all dates. Indian cent and complete pricelist 25¢. Penny Mart, PL-4, Box 629, Chicago 90.

COINS From distant Africa and Asia. Unusual, 20 different \$1.00. Alfred Szego, Box 187, Jackson Heights 72, New York.

12 DIFFERENT Indian cents \$1.00. Coins, Box 6184, Albuquerque, New Mexico.

HONDURAS, Switzerland, Austria, Finland's coins—All 10¢. Jolise, Roslyn Heights, N. Y.

UNITED States wooden nickel, Minnesota medal, American Canadian flag medal, 3 army chevrons. All for \$1.00. Acecoin, 314 South Clark, Chicago 4.

STAMP COLLECTING

STAMP Collecting outfit, includes packet worldwide stamps, package hinges, watermark detector, millimeter gauge. Everything 10¢ with approvals. Lorain Brown, Marlon, Michigan.

WOW! 135 All different Germany 10¢. Zeppelins, semi-postals, airmails, high values. Big bargain lists and approvals included. Jamestown Stamp, Dept. ASPMC, Jamestown, N. Y.

COLORFUL Pictorial assortment free with approvals. Variety Stamps, 57-M Circuit, Newton Highlands 61, Mass.

PENNY Approvals. Thousands. Bargains for pennies. Gifts with purchases. Penny Stamps, Orange 1, California.

U. S. stamps, Giant bargain catalog—10¢. Raymax, 35-VZ Maidenlane, New York City 38.

100 DIFFERENT U. S. — 50¢ approvals. Utechs, 1143 North Keeler, Chicago 61.

TOPS! Free book, "How to Collect Stamps." Send for your copy today! Approvals. Littleton Stamp Co., Littleton 81, N. H.

SEND Two dimes for large illustrated U. S. catalogue. New-Way Stamp, Lawrence, Mass.

GIGANTIC Collection free. Includes triangles, early United States, animals, commemoratives, British Colonies, high value pictorials, etc. Complete collection plus big illustrated magazine all free. Send 5¢ for postage. Gray Stamp Company, Dept. PM, Toronto, Canada.

LIBERIA Beautiful set of four native flowers, priced at 60¢ in standard catalog, only 10¢. Approvals. Goliath Company, Bethlehem 71, New Hampshire.

FREE! Giant catalog offering thousands of bargains. Sent with beautiful approvals. Jamestown Stamp Co., Dept. ESPMC, Jamestown, N. Y.

EARN Scott's albums, catalogues, perf gauges, hinges, watermark detectors, etc., while buying from our foreign approvals. True Value, Box 2098, Santa Ana, Calif.

300 WORLDWIDE 25¢ Plus surprise packet. Packet list free. Econopackets, Box 168, Riverside 9, Calif.

FREE! 25 Different India. Wilbur Craig, 302 State, Camden 2, N. J.

FREE—50 World with approvals. Mercury, 1205 Mildred, Andalusia, Penna.

U. S. approvals. Low prices. Eagle Stamps, Romine Ave., Pittsburgh 26, Penna.

300 DIFFERENT Given free with approvals. Particulars. Windsor Stamps, 8834 Cornell Ave., Chicago 17.

150 WORLD Wide all different, 25¢. Ted's Stamp Mart, Box 96, Northlake, Ill.

FOREIGN Stamps, 1 to 5 cent approvals. Barr, 467 Oneida, Pittsburgh 11, Penna.

KENYA—Queen set to 1/- free with approvals. Lee Hoover, Box 3594, Portland 8, Oregon.

LUXEMBOURG, 25 Different 5¢. approvals. Neal, 5930 Tower, Riverside, California.

MOUNT Stamps with P.M.'s. Samples. Lee's, Box 798, Rockford, Illinois.

START Your own stamp business. Send for free circular. Donald Shepard, Box 1147, Chicago.

SENSATIONAL U.S. U.N. illustrated catalog free. Stone, 192 Washington, Boston 8, Mass.

GIANT Diamond, midget triangle, Timor, 26 others, 3¢. Approvals. Carpenter, P.O. Box 310, Claremont, Calif.

FREE Ten mint British colonies with approval request. Tropicana, Box 624, Oakland Park, Fla.

UNBELIEVABLE! Old U.S., famous Americans, flags, presidents, airmails, commemoratives plus premium with approvals for 10¢ handling. Metropolitan Stamps, Box 312 GG, Jackson Heights, N. Y.

FREE—25 Different Bavaria, plus world's only octagon stamp and Abyssinia Red Cross set with approvals. C. P. Cleaveland, Jr., 806 North Humphrey Ave., Oak Park, Illinois.

PENNY Approvals regardless catalogue. Kloster, 4164 52nd St., San Diego 5, Calif.

QUEEN Elizabeth mint sets! Dominica, Virgins, Barbados, Gibraltar, Tristan, Malta, 21 bicolors, 25¢! Approvals. Gannon Stamps, Box 931, Canton 1, Ohio.

GOOD Foreign stamps 1-3¢ each. Perry Mayers, 37 Dawson, Belleville 9, New Jersey.

NO Approvals, Pitcairn Islands, Elizabeth, Complete—\$1.35. Bargain. Almar, 18 Third Avenue, Huntington Manor, N. Y.

6 LOCOMOTIVE Stamps and stamp wallet, 5¢ with approvals. Ambergs, 537E 35th, Union City, New Jersey.

WORLDWIDE, 50 All different, absolutely free, just to introduce our incomparable approvals. Kent Stamp Company, G.P.O. Box 87, Brooklyn, N. Y.

5 MINT British colonies and 100 others 10¢ with approvals. Miller, 219 Fowler Ave., Jersey City 5, N. J.

FIRST U. N. set. Among world's prettiest. Only 10¢. Approvals. Welles, Box 1246-R, New York City 8.

PICTORIAL Packet from Antigua, Barbados, British Guiana, British Honduras, Burma, Curacao, Leewards, Rhodesia, Trinidad, Tobago, and many other hard to get countries, 84-colors, topicals. Tremendous value. Each stamp a beauty. Free if willing to buy from our attractive approvals. Roseland Stamps, Spring Lake 2, Michigan.

200 DIFFERENT Including F.D.R. triangle also scarce war ration stamps. 10¢ to approval applicants. Avalon Stamp Co., Dept. M, Springfield, Mass.

GIANT Stamp 200 free! Snakes, leopards, rhinoceros, zebu, koalabear and other fierce jungle beasts. Approvals. Send 10¢ for handling. Free stamp magazine. Lincoln Stamp Co., St. Catherine's 518, Ontario.

ECONOMICAL, 1/4-3¢ Approvals. 33,000 varieties. Dresel, Box 128-N, West Englewood, New Jersey.

FREE! Amazing list! Two feet long! All countries! Stampmart Company, Hartford 1, Connecticut.

FREE! 107 British Colony stamps. All different, from Britain's farflung colonial empire. Catalog value \$2.50. Free stamp magazine, approvals. Send 10¢ for handling. Act now! Niagara Stamp Co., St. Catherine's 71, Ontario.

UNITED States commemorative collection containing 33 different—10¢. Approvals. White, 518-A Avenue L, Brooklyn 30, New York.

TWO \$5.00 U.S. stamps plus 20 different, 10¢ with U.S. approvals. Irwin, Box 1105, Brooklyn 30, N. Y.

SELL Your surplus good grade stamps. Write, describing fully what you have. Vanroy Shirk, Lebanon, Pennsylvania.

50 DIFFERENT Argentine 10¢. Approvals. Reuter, 611 W. 40th Pl., Los Angeles 37.

AMAZING Offer! 200 United States stamps—including commemoratives, airmails, high denominations to \$1.00. Only 10¢ to approval applicants! Illustrated bargain lists free. Mystic Stamp Co., Dept. 80, Camden, New York.

U. S. Classics. Over 50 yrs. old. 15 selected old-timers. Missing in biggest collections. All 15 at less than 1¢ each. 10¢ with approvals. Jaro, Box 246-T, New York City 8.

100 STAMPS, 10¢ With approvals. Smith, 508A Brooks, College Station, Texas.

OLD Scarce U.S. seconds on approvals. Slight imperfections, lowest prices. Herfield, Clintonhill Sta., Newark 8, N. J.

100 OLD United States between 1861 and 1935, \$1.00. Roush Stamps, 51 Chestnut, Mansfield, Ohio.

UNITED States approvals. Select copies, used—mint. Kingsbury, Fairfax, Vermont.

ICELAND 10 Different beautiful stamps for only 10 cents to applicants for our good old fashioned approvals. Old Colony Stamp Co., Dept. A, Milford, Connecticut.

1-3¢ EACH! Thousands of exciting worldwide stamps. Free examination. Cole, Box 223-A, Buffalo 21, N. Y.

225 STAMPS For only 10¢! This mammoth value includes airmails, pictorials; stamps from strange countries, cataloging up to 25¢ each! Also approvals. Mystic Stamp Company, Camden 80, New York.

SELL Stamps to our readers. Your ad in this space will be read by thousands of stamp buyers. I'll prove that to you. Write now for Folder "S." F. W. Johnson, Classified Advertising Manager, Popular Mechanics, 200 E. Ontario St., Chicago 11, Ill.

100 DIFFERENT Austria. 10¢. Approvals. Aronson, Box F, Newton Centre 99, Mass.

FREE Stamp collection! 100 different stamps from Europe, Africa, Asia, Scandinavia, Balkans, etc. 3¢ to approval applicants. Tatham Stamp Co., Springfield 30, Mass.

WEIRD Diamond shape coffee stamps. Lovely flower triangle! First American big commemorative. Greenland, idol dancer, etc. Free with approvals. Capital Stamp Co., Ferrysburg 2, Mich.

FIVE Different sets French Colonies, 10¢ with approvals. Banner, Box 65, Park Forest, Illinois.

25 DIFFERENT Commemoratives 1893 up 10¢. U. S. approvals. K&B, Box 70, Brooklyn 23, N. Y.

100 DIFFERENT China 10¢. Approvals. Coast, P.O. 2187H, Santa Ana, California.

14,000 DIFFERENT! Fascinating new club plan systematically builds your collection. Only 50¢ weekly. Details free. L. G. Ware, Stepany 73, Conn.

FREE! Coronations, triangles, sports, animals, Monaco Pipe; given approval applicants. Exotic, Box 482-M, Coral Gables 34, Fla.

FREE—Multicolor scenic set with bargain bulletin. 10¢ handling. McQueston, 13544 Woodward, Highland Park 3, Mich.

MINT U. S. at face! Older commemoratives only in 2¢ packet. Limit one with request for mint U. S. approvals. Western, Box 1689P, Salinas, California.

BULGARIA: Fifty different exciting pictorials. Animals, flowers, trucks. This valuable collection, only 15 cents with approvals. Boger, Box 152, North Wales, Penna.

HOBBIES AND COLLECTIONS

ANTIQUE Automobile decals. Send \$1.00 for set of 12. Discounts to jobbers on quantity orders. Grafco Decalcomania, Inc., 59 East Illinois Street, Chicago 11, Illinois.

PENCIL Collectors. 200 different advertising pencils, 20 unused pencils, \$1.00. Price list included. Hobbies Inc., Box 744, Sterling, Colo.

COLLECTORS Matchbook covers. 100 different unused, \$1.00. Catalog 25¢. Album \$3.00. Charles Edelman, 1311-C East 84, Cleveland 3, Ohio.

MILITARY Miniatures. Civil War. Custer's Cavalry, American Revolution and U. S. Marines. Illustrated catalog 35¢. Bussler Miniatures, Dept. Z, 40 Howe St., Quincy 69, Mass.

INVENTING Can be an interesting and profitable hobby. Write for complete particulars. Institute of American Inventors, Dept. 40-E, 635-F St., N.W., Washington 4, D. C.

NAZI Insignia. 12 different \$1.00. Medals, patches, armbands, flags, daggers. Illustrated lists, 15 cents. Hobbyland, 1307 1st St., W., Calgary, Canada.

PRECIOUS STONES, MINERALS

SAPPHIRE, Topaz, tourmaline, garnet, peridot. Five uncut gem specimens, \$1.00. Ten polished gems, baroque shaped, \$1.00. Free bargain list jewelry, gems. Profitable, easy "do-it-yourself" projects. O'Brien's, 1116M Wilcox, Hollywood 38, Calif.

CUT Gems, make jewelry—For profit or fun. 100 page magazine tells how: where to get supplies. Sample 25¢ or request free literature. Lapidary Journal, Del Mar 2, Calif.

GENUINE Alaska Jade suitable for polishing; piece 3/4-inch square thin slab with description. Send \$1.25 to Alaska Specialties Company, Box 81, Ketchikan, Alaska.

RUBY, Topaz, tourmaline, others. 10 genuine gem crystals, \$1.00. Ten polished baroque gems. All different, \$1.00. Edward Helsenstell, 1429 Sandpiper Dr., Bellaire, Texas.

15 CLASSIFIED Fossils, \$2.00. 50 classified \$7.50. Pioneer Museum, Burnet, Texas.

25 SAMPLES, Unpolished \$2.00 postpaid. Nye Optical, 2100 Cherry, Long Beach 6, Calif.

EARTH Science. Rockhounds' National Magazine, subscription \$2.00. Sample 25¢. Box 1357PM, Chicago 90.

AGATE. Buy direct. Polished sample 25¢. Price list included. Roberts, Box 744, Sterling, Colo.

ANTIQUES, RELICS, INDIAN GOODS, CURIOS

GENUINE Eskimo-carved ivory whale-tooth billikins; \$4, \$5 or \$6. Alaska Specialties Company, Box 81, Ketchikan, Alaska.

ANCIENT Grooved stone tomahawk \$3.00. Indian relic list free. Lear's, Glenwood, Arkansas.

CAMERAS, PHOTO SUPPLIES

BUY Wholesale nationally advertised cameras, photo supplies, thousands other products at big discount. Free "Wholesale Plan." American Buyers, Hertel Station, Buffalo 16-E1, N. Y.

PIC-KWICK Exposure dial instantly gives best camera settings for any film, any scene, any light: Daylight, flash, floods, moonlight, city lights, television. Only \$2 postpaid, guaranteed. Russell Love, 24 California St., San Francisco 11.

KODAK, Bell-Howell, others. Discounts to 40%. Free photo catalog. Mailers Mart, Box 135-PM, Pelham, New York.

PHOTOGRAPHY For pleasure or profit. Learn at home. Practical basic training. Long established school. Free booklet. American School of Photography, 835 Diversey Parkway, Dept. 3442, Chicago 14.

REVERE Camera equipment, 1/2 off. Write. Morgan-Brownell, Inc., Dept. M, Box 108, St. Joseph, Michigan.

PHOTOGRAPHERS—Enlarge your negatives on pre-sensitized China dishes. Easy as projection paper. Beautiful gifts, tremendous profits. Rush \$1.00 for sample. Free particulars. Zed Gwartney, 65-301 Acoma, Desert Hot Springs, Calif.

PHOTO FINISHING

12 JUMBOS From any size roll developed 39¢, with this ad only. P. Skrudian, Lake Geneva, Wis.

JUMBO Prints in album 8-exposure 60¢, 12 or 16, 50¢. 2 jumbo each 75¢. Johannes Photo, Box 875X, Livingston, Mont.

COLOR Processing—High quality, fast service and low prices. Kodacolor developing 85¢; prints 27¢. Kodachrome: 35mm. processing, 20 exposures, \$1.45; 36 exposures, \$2.25. Send for complete price list and free mailers. Photo-Mail, Box 216M, Madison Square Station, New York City 10.

ENLARGEMENTS, High quality. Dull or glossy heavy weight paper. Four 5x7's or three 8x10's, \$1.00. Selwin, Box 231, Santa Monica, California.

FREE! Color snapshot folder. Offers, lists, mailers. Houghton's, Erving, Mass.

DO it yourself booklets, 24 subjects. Free catalog. Popular Mechanics Press, 631 N. St. Clair St., Chicago 11.

PARTICULAR? 8 Jumbos—35¢, 12—50¢. Special; 35mm., 36 exposures \$1.10. Flash-Photo, Box 36M, Brooklyn 4, N. Y.

12 EXPOSURE Rolls, 39¢, Jumbo prints. Guaranteed work, one day service. Lincoln Studios, Dept. K, Box 13, Lincoln, Nebraska.

TWO Beautiful prints from each picture on roll. 8 exposure 40¢; 12 exposure 50¢. Thirty-six years of satisfied customers. Quick service. Lensphotos, Dept. J-4, Janesville, Wisconsin.

8-HOUR Service on deluxe Jumbo prints. 8-exposure roll developed and 8 Jumbo prints 40¢, 12 exposure 55¢, 16 exposure 70¢; 35mm. 20 exposure 75¢, 36 exposure \$1.25. Jumbo deckle reprints 4¢ each. Contact prints made if specified. Bay Photo Service, P.O. Box 210, Oakland, California.

SUPERIOR Quality. Prompt service. 8 Jumbo in album 40¢. 16 contacts 50¢. Jumbo reprints 5¢. Satisfaction guaranteed. Also complete color film finishing service. Write for free circulars and mailers. Fast-X-Photo, Box A, Jersey City, N. J.

TRIAL Offer—8 Jumbos 25¢, 12—35¢. Limit two rolls. Thrifty Photo, PM87, Box 273, San Francisco 1, Calif.

ENLARGEMENTS, Heavyweight seven 5x7's or four 8x10's \$1.00. Jack Koons, Huntington Mills, Luzerne County, Penna.

KODACOLOR Prints 25¢ each, roll developed free with 12 prints \$3.45. Free mailer, price lists on other color services. All Color Lab, Dept. 81, Box 24, Saint Louis, Missouri.

MOTION PICTURES AND SOUND EQUIPMENT

RECORDERS, Hi-Fi. Free catalogue. Carlsan, 215 E. 88 St., New York City 28.

5,000 8-16MM. Movie films. Free catalogue. International, Greenvale, N. Y.

TAPE Recorders, tape. Unusual values. Free catalog. Dressner, 69-02M 174 St., Flushing 65, N. Y.

FREE Catalog. Save dollars. Fresh 8mm., 16mm. b&w and color film. Home processing equipment. Superior Bulk Film Company, 448 No. Wells, Chicago 10.

MOVIE Camera film: 8mm. roll \$1.50. 16mm. 100' \$3.00. Free processing. Better Films, 742 New Lots, Brooklyn, N. Y.

8-16MM. Films. Free catalogue, with sample film 10¢. Garden, 690 Howard Avenue, Brooklyn, N. Y.

SAVE 50%! Guaranteed-fresh color. b.&w. movie film! 8mm., 16mm. Free catalog! Esc-R, 47th Holly, Kansas City 12, Missouri.

RENT 16MM sound features. Major productions. Low rates. Catalogue free. Earn \$10.00 daily with your projector. Minot Films, Inc., Milbridge, Maine.

BULLFIGHT Movies. 8, 16mm. Literature. A Ruotolo, Box 1305, Greenwich, Conn.

MUSIC AND MUSICAL INSTRUMENTS

WRITE Songs. Big money and reputation. Write for information. J. Gordon Pub. Co., 4700 South California Avenue, Chicago.

SONGPOEMS And lyrics wanted. Mail to: TinPan Alley, Inc., 1650 Broadway, New York 19, N. Y.

SONGS Into dollars. Share \$29 million dollars yearly for new songwriters, song-poets. Songs composed, published, promoted by famous firm. Information, appraisal free. Send to Nordyke Publishing, 6000 Sunset, Hollywood 28PM, California.

POEMS Wanted for new songs. Send poems. Free examination. Immediate consideration. Songcrafters, 2724 Arcade Station, Nashville, Tenn.

SONG Poems wanted. Five Star Music Masters, 630 Beacon Building, Boston.

POEMS Wanted for new songs. Send poems. Immediate consideration. Crown Music Company, 49-C West 32 Street, New York City.

ELECTRIC Guitars, amplifiers, wholesale. Free catalog. Carvin P.M.M. Covina, California.

POEMS, Songs wanted! Rhymer \$1. Bengol, 93 Jefferson, Chelsea 50, Mass.

RECORDS Hi-Fi by mail. Big discounts. Noelson, Box 211, Wall Street, New York City 5.

DISCOUNTS Instruments, accessories, national brands. Tempo Music, 37 Cutler, New London, Connecticut.

COMPLETE Music service for amateur songwriters. Write: Colonna, Box 888, Burbank, Calif.

ACCORDIONS Wholesale—10 day trial. Free catalog. American Accordion Center, 5329-PM-8 Belmont, Chicago.

SONG Poems wanted for musical setting and recording. U. S. Music Studios, Box 222B, Belmont, Mass.

ACCORDIONS—Direct from importer. Save 50% and more! Free trial. Lifetime guarantee. Trades accepted. Free catalog. Write Accordion Manufacturers Outlet, Dept. 8TR, 2003 Chicago, Chicago 22, Ill.

PHONOGRAPH Records cheap, postpaid. Catalogue. Paramount, Box 242-M, Williamsport, Penna.

SONGWRITERS: Are you trying to get your song published? Our members achieving success. National Songwriters Guild, 16th Ocean Shore Dr., Ormond Beach, Fla.

Let Me start you on a songwriting career! Free details: Johnnie Martinelli, 1182 Broadway, New York City, Dept. 7.

RADIO, TELEVISION AND ELECTRONICS

PLAY Battery radios on electric. Battery eliminator and charger replaces 45, 67½, 75 volt batteries. \$4.95. Clifford Sales Co., Inc., 172 Greenwich St., New York 7, N. Y.

EXPERIMENTERS' Circuit-catalog 25¢. Refundable. Laboratories, 326-C Fuller, Redwood City, California.

SIX-Transistor pocket radio \$34.95 postpaid. Alco Electronics, Lawrence, Mass.

ATOMOTRON, Model atom smasher, \$14.95. 3-in-1 electromagnet, \$14.95. Cloud chamber, \$32.50; plans, \$1. Send 25¢ for literature. AtomLab, Box 343, Berkeley, California.

TRANSISTOR Kit operates loudspeaker. Everything furnished. No soldering. Builds ten circuits. Easy instructions. \$10.95. Send \$3.00 with order, balance c.o.d. Be satisfied or return in ten days for \$10.95 refund. Logan Electronic Products, 1718 E. Broadway, Logansport, Ind.

WECOR Tape recorders, ½ off. Write. Morgan-Brownell, Inc., Dept. M, Box 108, St. Joseph, Michigan.

ELECTRIC Guitars, amplifiers, wholesale. Free catalog. Carvin PMR, Covina, California.

DO It yourself. What? Repair TV, build furniture, make barbecue, plumbing repairs, build boats, do house wiring, remodel home, lay tile, modernize kitchen, repair home, and scores of other things you can do yourself. Books covering each subject, only 25¢. Send for descriptive list. It's free. Popular Mechanics Press, 200-LB East Ontario St., Chicago 11, Ill.

BUSINESS OPPORTUNITIES

MOTEL-Resort management—Qualify for hundreds fascinating, leisurely, well-paid executive openings. Learn at home. Free booklet. Motel Managers Training School N148C, 612 S. Serrano, Los Angeles 5.

MAKE Money growing miniature trees on your window sill. Free seed and plan. Miniature Nurseries, Dept. AT, Gardena, Calif.

JUST Published! The "Idea" Guide, by author of "Strike It Rich." Gives spanking new money-making ideas, tips, plans, etc., never before revealed! Also gives the amazing "method" that makes all fortunes! Literature free. Write: Home Industries, 1430-M W. Monroe, Chicago 7, Ill.

START Home business, sparetime. Literature, sample free. Hoffman, Box 355, Park Ridge, Illinois.

BRUSH Plating outfits for plating articles in the home and shop. No tanks necessary, silvering mirrors, spare or full time. Free particulars. Gunmetal Co., Ave. H, Decatur, Illinois.

PAINT Suede on dashboards, signs, radios, toys, figurines—anything! Amazing new discovery finish with beautiful touch and eye appeal. \$10 per hour possible for spare time effort at home. Help fill the huge growing demand. Free actual sample and "150 Home-Business Ideas" booklet. Coast Industries, Dept. AT, Los Angeles 61, Calif.

AGENTS, Salesmen—Complete line plastic foam products. Hanger covers, slippers, bath mats, ironing board pads, 40-65% discounts. Foamade Industries, Dept. B32, Oak Park 37, Michigan.

MAIL Order catalogs with own name imprinted put you in business this fall and Christmas. All merchandise drop-shipped from one source. Giftline, Dept. PM, 919 Walnut, Philadelphia 7, Penna.

LEARN T.V. servicing new simplified way at home. Save \$200 on training. Free sample lesson! Write, Electronic Engineering, Dept. AC-178, 1038 S. LaBrea, Los Angeles 19, California.

BUY Wholesale! Over 10,000 nationally advertised products. Appliances, cameras, sporting goods, housewares, watches, typewriters, tools, clothing, etc. Send postcard today. Buy-Rite, Box 238, Hawthorne 1, New Jersey.

EXCLUSIVE Distributorship available in most areas for world-famous Cadmium battery guaranteed to outlast your car. Tremendous profit opportunity. Investment for merchandise only. Free franchise. Cadmium Battery Corporation, Dept. 102, El Segundo, California.

HOME-Import mail order business—Import profitable items below wholesale. Experience and product investment unnecessary. Full, spare time. Famous world trader guides you. Free list "157 Imports," details. Mellinger, G708, Los Angeles 24.

MAILORDER. Learn to sell by mail. Complete course. Low cost. Ranse, Box 1719-A, Richmond 14, Virginia.

SELL Typewriters \$1.00 weekly. Earn yours. No collecting. McWeney Co., Drawer 87, West Haven, Conn.

START Your own business on credit. Your own boss. 1527 dealers sold \$3,000 to \$32,000 in 1956. We supply stocks, equipment on credit. 200 home necessities. Sales experience unnecessary. Pleasant profitable business backed by world-wide industry. Write Rawleigh's, Dept. H-U-PPM, Freeport, Ill.

START Your own business with our sample kits. Newest idea in selling. Re-order merchandise as you need it. Write today for full particulars. Division Sales, 3341 W. Roosevelt Rd., Chicago 24, Illinois, Dept. K.

OPERATE Profitable mail order business. Write Walter Service, 4159A East 112th, Cleveland 5, Ohio.

"HOW To Start a Business" booklet sent free! If you know any trade, go into business for yourself! Learn the 9 easy steps to follow. We've guided 5,000 others to success. Revealing free booklet yours for the asking! Write! National Business Consultants. Office AT, Los Angeles 61, Calif.

PRINT Without a printing press! Amazing new method! Print colorful signs, banners, cards, posters, glassware; anything at home. Big profits. Money-making opportunity! We supply everything. Beautiful sample, home-business plan free! Write Screen-Print Company, AT, Los Angeles 61, California.

GROW Expensive herbs for us! Big profits home-business of your own. Year around profitability! We supply everything necessary! Send for free rare seeds and revealing plan. National Herb Exchange, Dept. AT, Gardena, Calif.

MAKE Extra money. Cash or commissions. Everybody buys easy-to-sell advertising book matches, Union label. All sizes. Cuts for all businesses. Powerhouse selling kit free. Steady repeat business. No experience necessary. Superior Match Co., Dept. MX-857, 7528 S. Greenwood, Chicago 19.

MAIL Order advertising agency executive reveals sensational no-risk advertising and merchandise methods. Start in office or home; minimum capital; positive profits. Free details: Impact! 3407 Prospect Avenue, Dept. 11-8, Cleveland 15, Ohio.

UNUSUAL Bank account business building opportunities. Dahle, Box 7-PM1, Omaha 10, Nebraska.

START A buying service, buy wholesale thousands nationally advertised products. Make big profits selling at sizable discounts. Postcard brings details. American Buyers, Hertel Station, Buffalo 16-C1, New York.

SELL And repair vacuum cleaners. Write for new free catalog. Easy to read, all cleaners and parts. Eder Vacuum Cleaner Co., Dept. 15K, 13345 Livernois, Detroit 38, Mich.

DRYCLEANS Clothing for only 10¢ per garment. Lightning seller. Saves dry-cleaning bills. Samples sent on trial. Kristee 110, Akron, Ohio.

HIGHEST Profits all magazines. Sure success plan. Free catalogue, supplies, prizes. Subscription Service Co., Box 2070, Birmingham, Ala.

BE Your own boss. 234 pages of amazing opportunities. Free details. Leclair, P.O. Box 63, Brownsburg, Quebec, Canada.

WORK Home, pleasant, profitable. Own hours. Hundreds of ideas. Information free. Master's, 5145 Norwood, Arlington, Calif.

UNUSUAL Opportunity. Free literature. Quill Industries, 3607-09 So. Hamilton, Chicago 8, Illinois.

PROFITABLE Hobby. Free details. 2 samples \$1.00. Handmade Glass Figurines, 18724-A Martha, Saratoga, California.

FREE Information! Reweaving course \$2.00. Harris, Box 7112, New Orleans 19, Louisiana.

YOU Can earn up to \$600.00 mailing only 100 of our catalogs, unusual profits. Write Manufacturers, 370 Alabama Ave., Brooklyn 7, N. Y.

WANTED: Home producers, to be subcontractors. Cast plastic products for manufacturers in our clearing house service. Thousands of easily made items required. Cash in at home, without previous experience. Plastic Service Associates, Dept. 8-PM, East Boston 28, Massachusetts.

FREE Folder, "\$3,000 Yearly, Sparetime, Backyard, Raising Earthworms!" Oakhaven-38, Cedar Hill, Texas.

SELL Merlin electronic garage door operators. Make from \$50 to \$75 on every sale. Operate from your home. M. J. Fitzgerald Co., 2815 West Vilet Street, Milwaukee 8, Wisconsin.

WE Establish you in your own mail order discount business. Catalogs, sales letters, etc., printed your name can cost you nothing. No stock investment. We ship orders. Sell gifts, appliances, housewares, cookware, cutlery, dinnerware, silverware, jewelry, watches, etc., at big discounts. Catalog, details free. Topval Corp., Lindenhurst 718, N. Y.

PROFITS For you from the sea. Material for one pair of beautiful Squilla claw earrings, plus fast selling designs, instructions and jewelry supply catalog, 50¢. Modern Shellcraft, Station A, Box 22, St. Petersburg 2, Florida.

THEY Hand him \$100! Free packet. "Secret Journal." 919 secrets-plans! Work home. Publicco, Oceanside, Calif.

NOW Buy in small lots direct from importer. Below wholesale. Everything for everybody. Current illustrated bulletin 25¢. Young Company, Pleasantburg, 3102, Greenville, S. C.

DOLLARS Every day! Sensational mail item. Make 200 per hour, kitchen table. Angora House, 1058-2, Springfield, Illinois.

SPARETIME Income: Prepare confidential reports for nationally known bureaus. Send \$1.00 for instructions and addresses. Post Service, Box 16, Rice Lake, Wis.

MEN—Women! Work at home spare-time. Big money. Number of companies will buy all you produce. Easy work. \$5.00-\$15.00 hour possible. Start now. Send only \$1.00 for copyrighted money-maker. Lynn Publishers, Lynn 3, Mass.

START Home business. Absolutely new. Never before offered. Amazing money making opportunity. Physical handicap no obstacle. Unlimited opportunities. Free samples and information. Peter J. Hahn & Sons Co., 4445 W. Belmont Ave., Chicago 41, Illinois.

BUILD Fascinating hobby-business engraving plastics! Make colorful titleplates, bas-reliefs, pendants. Sample engraving, details 25¢. Desco Distr's., 5262-B Van Nuys, Van Nuys, California.

OPERATE Easy-to-start, profitable home mailorder business! B. Mann, Woodcliff Lake, N. J.

MAKE Attractive, durable, building plastic, easily, 800% profit. Exclusive district. Bays Laboratory, Cedaredge, Colo.

CANDIED Popcorn and potato chip equipment.—Eakins, Box 933-AT, Springfield, Ohio.

EARN To \$100.00 per hour snow-flocking Xmas trees, centerpieces, etc. Flocking, 7061 Belmont Avenue, Chicago 34, Illinois.

\$80.00 WEEKLY Sparetime. Start home Venetian blind laundry. Protected territory. Interesting information free. Burt, 2434EP, Wichita 13, Kansas.

WANT To make big money at home? \$10.00 profit in an hour possible with invisible mending. Make tears, holes, disappear from clothing, fabrics. Steady year-round demand from cleaners, laundries, homes. Details free. Fabricon, 6234 Broadway, Chicago 40, Illinois.

TURN Bottle caps into cash. Learn how 50¢. Specimens included \$1.00. Metro, Dept. G, Box 151, Oak Park, Illinois.

I Got rich in the dry cleaning business—so can you. Write for free details. Imperial School of Dry Cleaning, 1700 Touhy Ave., Chicago 36, Ill.

NEW Snow cone machines. All prices. P.O. Box 7803, Dallas, Texas.

IMPORTING—Exporting. Modern dropship method. Profitable. Details free. The Hazen Company, 6601-8th Ave. N., St. Petersburg, Fla.

WHOLESALE—Thousands nationally advertised products. Buy, sell. Amazing profits. New, free plan. Associated Wholesalers, 1016-D Starr, Burlington, Iowa.

PROFITABLE Future in your own mail order business. Free details. Zed Gwartney, Desert Hot Springs, Calif.

\$200.00 WEEKLY Reported! No selling. Free booklet. Franklin Credit, Roanoke, Virginia.

OPERATE Mailorder folio business! Free details. Ballard's, 425 East Catherine, Louisville 3, Ky.

MAKE Flexible molds. Cast plaques, figurines. Free sample. Tooker, 1045-B Fairview, Hamilton, Ohio.

NATURAL Molding rubber, extra thick. Free sample. W. Wooley, 1016-A Donald, Peoria, Illinois.

INTERNATIONAL Mailorder business. Complete setup service—Not just instructions. Hermes, 152 West 42, New York City 36.

BIG Money raising fishworms and crickets. Free literature. Carter Farms, Plains, Georgia.

START Home business making statuary, plaques, novelties, garden furniture, artificial marble flooring, liquid marble. Make your own flexible molds. Amazing profits. Only \$1.98. Free literature. Popular Mechanics Press, 631 No. St. Clair St., Chicago 11.

UNUSUAL Mailorder opportunity. Tested. We supply everything. Girard's, Azusa, Calif.

WANT More business? Here's an amazing opportunity to increase your sales. Talk to thousands of interested readers of "Mecanica Popular." Our Spanish Edition covers the Latin American countries like a blanket. They're real mailorder buyers. Classified rate 75¢ per word. Try an ad in our next issue. Classified Advertising Department, Popular Mechanics Magazine, 200 East Ontario Street, Chicago 11, Ill.

VENDING Machines—No selling. Operate a route of coin machines and earn amazing profits. 32-page catalog free. Parkway Machine Corporation, Dept. 26, 715 Ensor Street, Baltimore 2, Maryland.

HOME Workshop books. Free catalog. Popular Mechanics Press, 631 N. St. Clair St., Chicago 11.

MONEY In saw and lawnmower sharpening sparetime at home. Free book. Virgil Foley Company, Columbia Heights, Minnesota.

FREE Folio "\$5,000-\$45,000. Unlimited Vacations." No merchandise. equipment. Unknown! Work home, sparetime! Haylings, Carlsbad, Calif.

\$70 WEEKLY—Home, spare time. Simplified mail bookkeeping. Immediate income—easy! Auditax, 34757A, Los Angeles 34.

TO \$100.00 Weekly. Sparetime, home operated mailorder business. Successful beginner's plan. Everything supplied. Lynn, 10420-M National, Los Angeles 34.

FREE Book "505 Odd, Successful Businesses." Work home. Expect something odd! Pacific, Oceanside, Calif.

BREED Rare tropical fish at home. Earn big money! Learn secrets! Help fill huge demand. Amazing opportunity! Free plan. Tropical Fish Breeders, Los Angeles 61, Calif.

MINK Raising information free. Complete. Lake Superior Mink Farm. Superior, EEL, Wisconsin.

COPUBLISH Mail Sale Advertiser, leading mail order paper. Details, latest copy, dime. Vanroy Shirk, Lebanon, Penna.

LEARN Real estate by listening to records. Lee Institute, Brookline 46, Mass.

I Want to send you proof of the wonderful pulling power of Popular Mechanics classified pages. What's your proposition? Write me today. Include literature if possible. F. W. Johnson, Manager Classified Advertising, Popular Mechanics Magazine, 200 E. Ontario St., Chicago 11, Ill.

FREE "Franchise Profit Letter" describes nationwide opportunities. Exclusive distributorships, dealerships, agency operations. Write today. National Franchise Reports, 333 North Michigan, Chicago 1.

LEARN Photo-negative portrait retouching. Men, women. \$5 hour possible spare or full time at home. Easy, glamorous. Work for photographers by mail order. Full details sent free. Duval, 100 So. Vermont, Los Angeles 4.

YOUR Own name brand business. No investment; no inventory. Part time or full time. Sell famous brands of appliances, housewares, silverware, radios, vacuum cleaners, lamps, tools, clocks, watches, jewelry, etc., over 1000 items. Join thousands of successful independent dealers. Send for free catalog and dealer price list. H. B. Davis Corp., Dept. 11, 145 W. 15 St., New York City.

11,000 NEW Prospects daily. Baby record books, shoes, albums. Sell mailorder. Use our literature. Write: No-Co-Ro, Capitola, California.

COLORGLAZED Concrete pottery made without molds. Patented method. Cemetery products, novelties, tiles. Basement leak-sealing. Money-making projects. Booklet, details free. Men only. National Potteries Company, Grand Rapids, Minnesota.

OPERATE Profitable mailorder business! Splendid opportunity. For details write: Thomas Bond, 1637H West Vernon, Phoenix, Arizona.

COLOR Concrete with chemicals. Marble-glass cement benches, pottery. Home-shop. Hundred beautiful designs, made without molds. Birdbaths to waterfalls. Your chance for fame, fortune, 10¢ brings sample, pictures. Hollywood Cementcraft, 8527-R Wonderland, Hollywood 46, Calif.

CASH From sawdust, seventy methods. Tin-cans, thirty methods. Newspapers, eighteen methods. Instructions 50¢ each. All three \$1.00. Charles Company, 12-DXT, Norwood, Ohio.

BE Appointed state notary public now. Write, Stationers, Boerne, Texas.

WE Love our mailman—He leaves over \$1000.00 monthly in our rural mailbox. My college professor husband drafted a scientific home mailorder method. We bought a Texas ranch, live as we always wanted. Now we sell the Ranch Mailorder Method. Operates anywhere. Inquire: Eveningshade Ranch, Boerne, Texas.

BAKE New greaseless doughnuts in kitchen. Sell stores. Free recipes. M. Ray, 3605 South 15th, Minneapolis 7, Minnesota.

FIX Typewriters. Inexpensive home course teaches factory secrets. Free booklet. Athey, Tarentum, Penna.

MONEY For you! Big profits! Cast plaster figurines, bookends, plaques at home with XL rubber molds. No experience needed! Write for illustrated, 40-page catalog, only 25¢! Plastic Arts Studios, 3463 So. Madison Street, Department 5, Muncie, Indiana.

GROW Orchids at home. Profitable, fascinating. Year 'round, Maine to California. No greenhouse. Successful home grower shows you how to provide proper temperature and air conditions in any well lighted room. Full details and real orchid seeds free. Orchidland, 100 So. Vermont, Los Angeles 4.

PLATE Baby shoes, jewelry, gifts, bronze and colored pearl. Free booklet. Platex, 11029 South Vermont, Los Angeles 44.

START Your own subscription service. Every family buys magazines. No capital needed. We tell you how, furnish all supplies free. Liberal commissions. Write McGregor Magazine Agency, Dept. 110, Mount Morris, Illinois.

SELL By mail. Tested methods. Alfano, 19 Pine Street, Closter 2, New Jersey.

AMAZING Earnings operating home sharpening service. Write George Page, 1820 Cleveland Ave., Niagara Falls 2, N. Y.

INDUSTRIAL And institutional mail-order business. New, unexploited opportunity. Hermes Advertising, 152-C West 42, New York City 36.

WE Pay \$3.50 lb. Grow mushrooms. Cellar, shed and outdoors. Spare, full time, year round. We have over 25,000 customers. Free book. Washington Mushroom Ind., Dept. 172, 2954 Admiral Way, Seattle, Wash.

EARN \$10,000 Yearly raising Angora rabbit wool for us. Information 25¢ coin. American Angora Company, Malta 12, Montana.

FREE Catalog. Contains hundreds of businesses, farms and income properties throughout U.S., Canada. Specify type and location desired. Deal direct with owners. U. I. Buyers Digest, 1608 Hillhurst, Dept. PM-3, Los Angeles 27, Calif.

MAKE \$6 To \$10 per hour sharpening saws and lawnmowers. Our Acme equipment used by thousands of successful shops throughout United States and Canada. Free literature. No obligation. Max Mfg. Co., 138 Stockton Ave., San Jose 26, Calif.

MAKE Chipped glass nameplates. Resilvering mirrors. Electroplating. Outfits furnished. John Sprinkle V60, Marion, Indiana.

MAKE \$46 From square foot plywood; jigsaw necessary. Free information. Woodart, Bridgewater, Mass.

LIQUID Rubber. Make flexible molds. Free sample. Chaney, 1907-A East Road, Jacksonville 11, Florida.

"MAILORDER Laws and Regulations," explains necessary licenses, different taxes, legal requirements, etc., \$1.00. Tasker, 1603 Peach Street, Alexandria, Virginia.

MONEYMAKING OPPORTUNITIES

AGENTS, Salesmen—Complete line plastic foam products. Hanger covers, slippers, bath mats, ironing board pads, 40-65% discounts. Foamade Industries, Dept. B32, Oak Park 37, Michigan.

EMBOSS Your handwriting. Gold or silver. Free sample. Agents wanted. Modern Printing, 1710 N. Third, Milwaukee 12, Wisconsin.

HOME-Business pays big! Start spare time and grow with our help! We guide you every step of the way in any business you may choose. Free details, write National Business Consultants, Office P6C, Los Angeles 61, Calif.

PRINT Without printing press—At home! New miracle discovery lets you change cents materials into dollar profits. No selling. Customers come to you. Tremendous demand in every area. Possible \$250.00 week profit to you. Free revealing secrets plan, actual valuable samples, confidential facts. Hurry, supply limited! Screen-Print Company, 28C, Los Angeles 51.

MAKE Money writing short paragraphs! No tedious study. I tell you what to write, where and how to sell; and supply list of editors buying from beginners. Many small checks add up quickly. Write to sell, right away. Send for free facts. Benson Barrett, Dept. C-27-H, 7464 Clark, Chicago 26.

START Big-pay business at home in spare time. No experience needed to operate little table-top machine for bronzing baby shoes. Make \$5.46 profit on every pair. Full particulars free. Send postcard to Mason, 1512 Jarvis, Room CM-3-J, Chicago 26, Ill.

\$100.00 WEEKLY Spare time with a tape recorder! Proven facts free! Dixieland Publishers, Asheboro 4, N. C.

START A buying service, buy wholesale thousands nationally advertised products. Make big profits selling at sizable discounts. Postcard brings details. American Buyers, Hertel Station, Buffalo 16-D1, New York.

"50 NEW Home-Business Ideas" booklet free. Coast Industries, B8C, Los Angeles 61.

\$100.00 WEEKLY Spare room. Raise redworms soilless way. Odorless. Charles Morgan, Box 116E, Bushnell, Florida.

MEN And women wanted to start home business in spare time with little table-top rubber stamp machine. Easy to earn up to \$9.80 an hour without previous experience. Full particulars free by mail. Send postcard to Roberts, 1512 Jarvis, Room CR-2-S, Chicago 26, Ill.

ATTENTION Typewriter owners. Make handsome profits. Write today. Groves Company, 682, Hastings 3, Nebraska.

12 MAIL-Order plans—\$1. CWR, Box 4903, Philadelphia 19, Penn.

PRINTING Wholesale—Save 50%. Start brokerage. Elicha, 3035 Marvin(B), Toledo, Ohio.

DO It yourself. What? Repair TV, build furniture, make barbecue, plumbing repairs, build boats, do house wiring, remodel home, lay tile, modernize kitchen, repair home, and scores of other things you can do yourself. Books covering each subject, only 25¢. Send for descriptive list. It's free. Popular Mechanics Press, 200-LB East Ontario St., Chicago 11, Ill.

BUY Wholesale! 30-80% discounts! Appliances, gifts, typewriters, tools, watches, sporting goods, jewelry, cameras, housewares, etc. Consolidated Distributors, Clifton 28, New Jersey.

HOTTEST Mail order plan ever! Sell photos, films, art novelties. Huge proven profits! Free details! Ampro, 429 South Western Ave., Dept. 1, Los Angeles 5, California.

ADS Running under this heading sell printing. Ask me for proof. I'll gladly send you amazing facts. Ask for Folder "P." F. W. Johnson, 200 E. Ontario St., Chicago 11, Ill.

AMAZING Successes through franchises! Become exclusive franchise holder your territory. Information rushed. National Franchise Reports, 333 North Michigan, Chicago 1.

FREE Folio "\$5,000-\$45,000. Unlimited Vacations." No merchandise. Unknown! Work home, sparetime! Haylings, Carlsbad, Calif.

GENERAL Contest Bulletin. Lists contests monthly. Sample, 25¢. 1609 1/2 East 5th, Duluth, Minn.

READ Progressive Mailtrade, the magazine that tells how to make money by mail. Dime brings sample and special offer. Progressive Mailtrade, Box 357, Sheboygan, Wisconsin.

BIG Money raising, fishworms and crickets. Free literature. Carter Hatchery, Plains, Georgia.

EARN Money evenings copying and duplicating comic cartoons for advertisers. Adservice, Argyle 1, Wisconsin.

SELL Titania gems. Far more brilliant than diamonds. Catalog 10¢. Dismonte, 2420-M 77th, Oakland 5, California.

VENDING Machines—No selling. Operate a route of coin machines and earn amazing profits. 32-page catalog free. Parkway Machine Corporation, Dept. 27, 715 Ensor Street, Baltimore 2, Maryland.

FREE Book "565 Odd, Successful Businesses." Work home. Pacific, Oceanside, Calif.

PRIZE Contests provide fabulous and confidential home income opportunities! Here's how and where to win your share! Send stamp! National Contest Bulletin, Box 2685-P, Miami 16, Florida.

MAKE \$5,000 Yearly sparetime raising mink, chinchillas, nutria, etc. Free booklet reveals proved plans. Write Pura, 348 Mt. Pleasant Road, Toronto 1, Canada.

WE Pay \$3.50 lb. Grow mushrooms. Cellar, shed and outdoors. Spare, full time, year round. We have over 25,000 customers. Free book. Washington Mushroom Ind., Dept. 173, 2954 Admiral Way, Seattle, Wash.

DOLLARS Every day! It's magical—You keep all the dollars. Setup free. Otto Miller, Box 584-W, Oshkosh, Wis.

JOIN The prosperity parade with a mail order bookshop in your own home. Valuable information free. Practical Publications, 3974-F Milwaukee, Chicago 41, Ill.

MAKE Money, mailing sample business cards. Vosacek Printing, 4444PT Ute, San Diego 17, Calif.

MEN — Women! Start money-making plastic laminating business at home in spare time. Material that costs 11¢ brings back \$2.58. No canvassing or selling but mail orders bring in \$20 a day. Write for full particulars free. Rush name on postcard to Warner, Room CL-2-S, 1512 Jarvis, Chicago 26, Ill.

TURN Pennies into dollars at home! Free details! ABC, Box 849, San Francisco 1-C, California.

HOMEWORKER Supplies, profitable items. Lists free. Schulthies, Box 449, Irwin, Penna.

HUNDREDS Of plans, ideas, businesses. Executives income. Work home. Information free. Masters, 5145 Norwood, Arlington, Calif.

CRICKETS And brooder, stocked for big hatch, \$25.00 or booklet 25¢. Kean, Ladonia, Texas.

EARN Money. Lucky-Star-Plan. Details. Strine Sales, Thurmont, Maryland.

THEY Hand him \$100! Free packet. "Secret Journal." 919 secrets-plans! Work home. Publicos, Oceanside, Calif.

DOLLARS For you in mailorder. Dime brings magazines, information. Palm, Box 1321, Baton Rouge, La.

\$50.00 WEEKLY Sparetime. Start home Venetian blind laundry. Protected territory. Interesting information free. Burt, 2424ER, Wichita 13, Kansas.

REPEAT Income for life. New ideas for established product. \$1,000,000 a day market. New plan makes \$1,000 a month possible with small investment. Sells on sight! Hot reorder item! Collect royalties for life! Travel-Pak, 2151 American Ave., Long Beach 6, Calif.

TYPISTS! Make money at home! Mailers, 2 Madison, Greencastle, Indiana.

EARN Money in spare time at home. No selling. Send \$1.00 for complete information. Satisfaction guaranteed. Catalina Enterprises, 1219 N. 6 Ave., Tucson, Ariz.

SELL Merchandise by mail using four color catalogs! Fifty fast selling items! Orders filled for you! Sample, plans free! NMMA, 618 Washington, Boston 24-A, Massachusetts.

YOU'LL Like goat milk! Profit and health with dairy goats. Booklet plus year's subscription monthly magazine: Special \$1. Dairy Goat Journal, Columbia, H-32, Missouri.

FORMULAS, PLANS, ETC.

FREE Formula catalog. Anything analyzed. Reasonable. Western Chemical, Salem, Oregon.

FORMULAS; All kinds, latest, best. Literature free. Kemixal, Park Ridge, Ill.

PRACTICAL Formulas. Lists free. Cummings, Chemist, Gordon Ave., Syracuse 4, N. Y.

LATE, Modern manufacturing formulas. List free. Moon Chemical, Martville, New York.

FORMULAS For latest money-making discoveries. New! Good! Valuable literature free! Miller, Chemist, 1517-D, Tampa, Florida.

CHEMISTRY

CHEMICALS And apparatus for industrial, analytical, and private laboratories. Catalog 25¢. Dept. M-50. Biological Supply Co., 1176 Mt. Hope Ave., Rochester 20, N. Y.

ILLUSTRATED Catalog: Chemistry, mineralogy, biology 30¢. Tracey Laboratories, Evanston, Illinois.

AMAZING New Book of Science. Experiments, formulas, and catalogue of laboratory supplies. Only 25¢. National Scientific Co., Dept. PM-8, 500 West Road, Lombard, Illinois.

PLASTICS

NEW Liquid casting plastic, clear, colors. Embed real flowers, coins, photos. New manual shows fine things you can make at home and sell at big profit. Send 25¢. Castolite, Dept. J-101, Woodstock, Illinois.

PLASTIC Casting, laminating, embedding supplies; formulas, manufacturing methods for hundreds of profitable items. Catalog 25¢. Oel, Box 261, Union, N. J.

COLORED Plastic storage bags. Send \$1.00 to Lo Ray Co., 2025 Charleston, Chicago 47, Ill.

FIBERGLASS Patio sheets 58¢ sq. ft. Plexiglas 95¢ sq. ft. Liquid casting plastic \$1.90 qt. Send 10¢ for literature. United Plastics Products Co., Dept. 7, Roebling, N. J.

LEARN Plastics fabrication for spare time income. Low cost home training now available. Write for free booklet. Interstate Training Service, Dept. D-3, Portland 13, Ore.

LAMINATING Supplies. Free price list. Solomonson, 46 Cornhill, Boston 6, Mass.

PLEXIGLAS, Fiberglass, polyester, epoxy, acetate, vinylite, styrofoam, acrylicite. Instructive wholesale-retail catalog, free. Gem-O'-Lite, 5529 Cahuenga, North Hollywood, Calif.

BOXES, Plastic. Free list. Althor, 170 Bay 23 Street, Brooklyn, N.Y.

AGENTS WANTED

NEED Money? \$50 yours. Sell only 100 boxes new Christmas cards. Other amazing offers. Free samples imprinted cards. Feature box assortments on approval; free catalog. 100 profitable items. Work with a national leader. Write today. Pen-'N-Brush, Dept. PM8, 139 Duane Street, New York City 13.

60% PROFIT On cosmetics — Famous nationally advertised Hollywood cosmetics pay 60%. Make \$25 day up. Hire others. For free samples, details, write Studio Girl, Glendale, Calif., Dept. 1276G.

AGENTS Sell fur-like cape stoles. Large profits. Free photos. J. A. Mfg. Co., 174C Westwood Avenue, Long Branch, N. J.

MAKE \$50-\$300 Extra money fast. Show big value \$1.00-\$1.25 Christmas, everyday greeting card assortments, gift wrappings, costume jewelry, gifts, stationery. Profits to 100%. Cash bonus. Write for newest assortments on approval, free gift offer, free album name imprinted Christmas cards, catalog, details. Hedenkamp, 361 Broadway, Dept. PM-51, New York City.

IF You want to earn money fast, I'll send you free sample stocking of newest stretch DuPont nylons to sell at only \$1 a pair. American Mills, Dept. 620, Indianapolis 7, Ind.

EARN \$10,000 Yearly — Only two sales daily. World's best seller. The Holy Bible (illustrated). Protestant or Catholic. Margareta's, P.O. Box 92, Hazelton 7, Penna.

MAKE Your spare time profit time! Over 600 beautiful, unusual gifts, greeting cards, household gadgets, toys, jewelry, baby items, and gift wraps you can sell to friends, neighbors, relatives. Write at once for big, colorful free catalog just off the press. Samples on approval. Hurry. Get details on sensational money-makers! Greetings Unlimited, 7-41 Park Square, St. Paul, Minnesota.

BEAUTIFUL Feather pictures, 200% profit! Free details; sample 20¢ stamps. PM, Apartado 9036, Mexico City.

BUY Wholesale thousands nationally advertised products at big discount. Free "Wholesale Plan." American Buyers, Hertel Station, Buffalo 16-A1, N. Y.

\$1,000.00 A Month for making dramatic 3-second demonstration of amazing lightweight Presto fire extinguisher. New chemical used by airforce snuffs out fires instantly. Only \$4.95. Terrific commissions. Millions want it. Free kit. Merlite, 114 E. 32nd, Dept. P-552, New York City 16.

SHINE Shoes without polish. New invention. Lightning seller. Shoes gleam like mirror. Sample sent on trial. Kristee 67, Akron, Ohio.

AMAZING Greeting card assortment pays 53¢ cash profit on \$1.25. Make \$85.00 fast! Gift bonuses besides. Outstanding new Christmas cards, novelties, free imprint album. Samples on approval. Act fast, get golden egg banks free. Creative, 4401 Cermak, Dept. 512-G, Chicago 23.

RUN Spare-time greeting card and gift shop at home. Show friends samples of our new 1957 Christmas and all occasion greeting cards and gifts. Take their orders and earn to 100% profit. No experience necessary. Costs nothing to try. Write today for samples on approval. Regal Greetings, Dept. 70, Ferndale, Michigan.

NEW Bathroom deodorizer. Hangs on wall. Banishes odors bathroom, kitchen. Lightning seller. Samples sent on trial. Kristee 66, Akron, Ohio.

200% PROFIT. No-Kro stops battery and cable corrosion. Guaranteed. Whirlwind seller. Protected territories. Write No-Kro Company, Chanute, Kansas.

EXCLUSIVE Line of personal initialed buckles, belts, cap badges, 3,000 emblems, uniforms, shirts, caps, etc. Hook-Fast, Dept. PM, Roanoke, Virginia.

WHOLESALE Catalog! Clothing, linens, housewares. Write Bostonian, 14 Dock Sq., Boston 8, Mass.

AGENTS — 300% Profit selling genuine gold window letters; stores and offices. Free samples. Metallic Sign Letter Co., 1217-D West Newport, Chicago.

YOUR Ad in this space will get some good agents for you. Yes, I'll prove it. Write for Folder "A" right now. F. W. Johnson, Classified Advertising Manager, Popular Mechanics Magazine, 200 E. Ontario St., Chicago 11, Ill.

GOLDMINE Of 600 money makers. Copy free. Specialty Salesman Magazine, Desk 5-B, 307 N. Michigan, Chicago 1.

GOLD Or silver letters, numbers. Windows, doors, trucks. 1" to 6". 500% profits. Free samples. Atlas-T, 544 West 79th, Chicago 20.

PRINTING. Advertising salesmen—Excellent moneymaking sideline selling decalcomania name plates, small quantities. Automobile initials, sign letters. Free samples. Ralco, XL, Boston 19, Mass.

YOUR Own business—Used suits \$1.50, overcoats 65c, mackinaws 35c, shoes 12½c, ladies coats 30c, dresses 15c. Enormous profits. Catalog free. Nathan Portnoy Associates, 605-AA West 12th Place, Chicago 7.

EASY Handwork makes fast-selling articles. Sample free. Sunmade Company, Brockton 64, Massachusetts.

SELL Famous \$3 fire extinguishers. Fast sales, liberal profits. Write Fire-Killer, Box 182, Hazleton, Penna.

CHRISTMAS Cards—Impressive albums of deluxe and popular-priced greetings with customer's name imprinted. 150 lavish designs for business and personal use. Wide selection for every taste and budget. You can earn \$300 to \$500 commissions, even in spare time, between now and Christmas. Sales experience unnecessary. We furnish free fully equipped sales kit complete with albums and easy-to-follow selling instructions. Dependable service guaranteed by old established manufacturer. Write Process Corp., 1952 S. Troy, Dept. FA, Chicago 23, Illinois.

MAKE Money quick, easy, taking subscriptions from every family in your community. Liberal commissions. We tell you how, furnish all supplies free. Write McGregor Magazine Agency, Dept. 100, Mount Morris, Illinois.

TERRIFIC Way to earn extra cash the year round! Sell sensational line of gifts, household items, toys, collector's items and greeting cards. Ideal for starting a gift shop in your own home with no big investment! No experience needed. Send for big free illustrated catalog. Samples on approval. No obligation. North Star, 7-527 Finch Bldg., St. Paul 1, Minnesota.

SELL Hawaiian macadamia candy. Maier Products, 1120 Koko Hd., Honolulu.

YOUR Photo on stamps. No investment. No stock. Big profits. Free samples. Miniature Photostamps, Box 44-D, New York City 67.

START A home greeting card-gift shop. Show friends new idea Christmas, all occasion boxed assortments, gift wrappings. Profits to \$1.00 per box. Write for feature boxes on approval, 64 free personal Christmas card, stationery samples, free catalog, sensational free offer. New England Art Publishers, North Abington M-65, Mass.

TOOLS And fishing kits. Big profits. Literature free. Imperial, 2324 North 3rd Street, Milwaukee, Wisconsin.

TREMENDOUS Profits! Every man, woman and child a customer. Used suits \$1.50, pants 35c, dresses 20c, shoes 20c. Operate from store, home, car. Free catalog. Superior, 1250-A Jefferson, Chicago 7.

EARN \$3 Hour spare time writing orders for appliances, dinnerware, watches, etc. Free catalog. Beauchamp Company, 856 East 156 St., Bronx 55, N. Y.

300% PROFIT. Nu-Marvel products. Whirlwind sellers. Service stations, auto owners, homes. Sample. Alden's, 2515 E. 4th, Reno, Nev.

SCRIPTURE—Text personalized Christmas cards. Exclusive assortments, big profits. Free information. Cicero Bible Press, 2301-X Roosevelt Road, Broadview, Illinois.

GUARANTEED — Moneymaking. 10¢. Charles R. Williams, Route 2, Clarksville, Tennessee.

PRIVATE Eye door lookout. You see intruders. They can't see you. Sells like wildfire. Big profit. Free literature. Michael Broudo, Box 231, Duluth, Minn.

\$2.00 PAYS \$56.00. Capitalize on new discovery of metallurgical chemists. Perfect business for life. Write—Miracle Products, P.O.B. 1344, Oakland, California.

EXCELLENT Propositions. High earnings. Arno Art, 175 Fifth Avenue, New York City 10.

BEAUTIFUL Feather pictures! Free details, sample 20¢ stamps. Apartado 1643, Mexico 1, D. F.

BUY IT WHOLESALE

BUY Wholesale! Over 10,000 nationally advertised products. Appliances, cameras, sporting goods, housewares, watches, typewriters, tools, clothing, etc. Send postcard today. Buy-Rite, Box 258, Hawthorne 4, New Jersey.

TERRIFIC Discounts. Catalogue \$1.00 (refundable). Billera, 38 Circle, Hicksville, New York.

BIG Multicolor wholesale catalog! Housewares, appliances, clothing, silverware, cookware, luggage, binoculars, radios, phonographs, cameras, recorders, projectors, typewriters, shavers, sporting goods, toys, tools, sewing machines, watches, jewelry. Name brands. Huge discounts. Postcard: Selbyco, Decatur 159, Illinois.

FREE Wholesale catalog. Gifts, appliances, housewares, cookware, cutlery, watches, dinnerware, silverware, jewelry, etc. Discounts to 80%. Topval Corp., Lindenhurst 524, N. Y.

WHOLESALE Catalog! Discounts to 80%! Clothing, appliances, tools, housewares, jewelry, etc.! Midwest, IMP-136, Pontiac, Illinois.

ELECTRIC Guitars, amplifiers, wholesale. Free catalog. Carvin PMW, Covina, Calif.

USED And new watches \$2 up. Free list. Southern Watches, Gray, Georgia.

NAME Brand products. Huge discounts. Catalog free. Boynton, 836 W. 75th St., Los Angeles 44, Calif.

AUTOMOBILES! Discounts to 40% guaranteed! Jaktela, 2644 No. Western, Chicago 47.

SALESMEN—DISTRIBUTORS

ANYONE Can sell famous Hoover uniforms for beauty shops, waitresses, nurses, doctors, others. All popular miracle fabrics—Nylon, dacron, orlon. Exclusive styles, top quality. Big cash income now, real future. Equipment free. Hoover, Dept. H-100, New York 11, N. Y.

EXCLUSIVE "Trade-in sale" of old shoes sells new Air Cushion Shoes for you! Highest commission, bonus. Paid vacation. Samples supplied. Charles Chester Shoes, 842 Brockton, Massachusetts.

\$1,000.00 A Month for making dramatic 3-second demonstration of amazing lightweight Presto fire extinguisher. New chemical used by Airforce snuffs out fires instantly. Only \$4.95. Terrific commissions. Millions want it. Free kit. Merlite, 114 E. 52nd, Dept. P552, New York City 16.

AD Matches! Sell amazing designs—10, 20, 30, 40 and 240-light book matches. Bigger spot cash commissions; every business a prospect. Low prices for high quality. Repeats. Start without experience: men, women; full, part time. Buy nothing! Sales kit furnished. Match Corp., Dept. PM-92, Chicago 32, Illinois.

DISTRIBUTORS: Exciting earnings yours daily, plus monthly bonus. Write: Prestige, Box 1263, Huntington Park, Calif.

EXTRA Cash for employed man. Up to \$3.25 hourly. Commission, bonus. No experience. Demonstrate patented Air Cushion Shoes. Samples supplied. Charles Chester Shoes, 843 Brockton, Mass.

WILL You wear new suits and topcoats without one penny cost and agree to show them to friends? You can make up to \$30.00 in a day even in spare time, without canvassing. Progress Tailoring Co., 500 South Throop St., Dept. L-326, Chicago 7, Illinois.

MAKE Extra money. Cash commissions. Everybody buys easy-to-sell advertising book matches. Union label. All sizes. Cuts for all businesses. Powerhouse selling kit free. Steady repeat business. No experience necessary. Superior Match Co., Dept. M-857, 7528 S. Greenwood, Chicago 19.

IF You're interested in making money in selling, see the hundreds of exceptional opportunities in Salesmen's Opportunity Magazine. Send name for your copy, absolutely free. Tell us what you're selling now. Opportunity, 848 N. Dearborn, Dept. 17, Chicago 10, Illinois.

AMAZING Insecticide line. Safe indoors, outdoors. Sells fast. Demonstrates. Great repeater. Wonderful profits. Distributors opportunity. Write Sayer Associates, 426P2 Portland Bldg., NW, Washington 5, D. C.

NEW, Exclusive, fast-selling car gadget gives you profits up to \$300 a day! Write now for details. Eldon Mfg. & Eng. Co., Box 235, Milwaukee 13, Wis.

BUY Or be representatives for Hongkong men's tailored suits. Big profit at full/spare time. For details write P.O. Box 1560, Hongkong.

SENSATIONAL New product guarantees immediate sale with amazing 3 minute demonstration. Every retail business a customer for "Strip-Off window sign paint." Low cost. Paint on, strip off. Waterproof, all colors. Protected territory. High profit. Repeat business. Sample kit and details \$2.00 refundable. Strip-Off, 429 So. Western, Los Angeles 5, Calif.

EMPLOYMENT INFORMATION

COMING To California? Choice listings of jobs, housing, business opportunities, etc. 15 page booklet + free gift \$1.00. Chesley, 3977½ Texas Street, San Diego 4, California.

FOREIGN, Alaskan, U.S.A., jobs! To \$1500.00 monthly! Million Americans employed overseas. Copyrighted reports. Who to contact for highest paying jobs. Laborers, trades, truck drivers, office, engineers, many others. 52 countries—St. Lawrence project, Spain, Latin America, Northern project, Europe. Year registration-advisory service. Application forms. Unconditional money-back guarantee! \$2.00 (airmailed \$2.25). C.O.D.'s accepted. International Reporter, St. Louis 1-PY, Missouri.

FLORIDA'S Booming! Hundreds of jobs. Special statewide analysis airmailed \$2.00. Sun-Glo Service Bureau, Perry 1, Florida.

AMERICAN, Overseas jobs, high pay, men, women, transportation paid. Free information. Write Transworld, 200-M West 34 St., New York 1, N. Y.

UNLIMITED Job opportunities. Details free. Personnel Associates, Box 1618, Edinburg, Texas.

NEW York City, Philadelphia classifieds \$1.00 each. Joseph Dawinka, 83 Kentucky Lane, Levittown, Penna.

JOBS On ships! Experience unnecessary. Transoceanic, Box 494, Baltimore 3, Md.

COPYRIGHTED Reports on best paying jobs with travel, adventure, promotions. Construction, aviation, shipping, laborers, clerical, trades, supervisory, factory, unusual opportunities. Many types of work. Skilled and unskilled. Foreign and state-side openings for men and women. Only \$2.00 (\$2.25 airmail), including registration-advisory service. Satisfaction guaranteed. Included absolutely free: Special reports on Alaska, Spanish airbase construction, South American opportunities and husband-wife foreign jobs. Research Services, Suite 514-PMT Meramec Building, St. Louis 5, Missouri.

EARN High pay: Jobs in South America, the Islands, U.S.A., Europe, Canada, other foreign countries. All trades, mechanics, truck drivers, laborers, office workers, engineers, etc. Chance to travel. Fare paid if hired. Application forms. Free information. Write Dept. 108, National Employment Information, 1020 Broad, Newark, New Jersey.

FLORIDA. Job information, central and southern. Housing and food prices. \$1.00. W. E. English, 2068 Milton, Lakeland, Fla.

EDUCATIONAL AND INSTRUCTION

REFRIGERATION, Air conditioning. Extension course. Free booklet. Mechanics School, 11029-PX South Vermont, Los Angeles 44.

NOW! You can write dynamic job-application letters! Copyrighted step-by-step instructions, \$2.00. Resume form 50c. Both \$2.25. Consultant, Box 101-K, Santa Ynez, Calif.

LEARN Mineralogy at home. Diploma course. Fortunes being made in minerals. Free catalogue. Mineral Science Institute, Desk 2, 159 East Ontario, Chicago 11.

CHRISTIANS—Udenominational Bible study. Ministers licensed and ordained. Write. Christian, 181 Bank, Newark, New Jersey.

SWEDISH Massage, learn at home. Diploma. Dr. Swanson School Swedish Massage, Illinois licensed vocational school, 3809 Alta Vista Terrace, Chicago, Ill.

BE A real estate broker. Study at home. Send for free catalogue. Midwest School of Real Estate, 68 North Chicago Street, Joliet, Illinois.

WE Pay \$3.50 lb. Grow mushrooms. Cellar, shed and outdoors. Spare, full time, year round. We have over 25,000 customers. Free book. Washington Mushroom Ind., Dept. 174, 2964 Admiral Way, Seattle, Wash.

TIMESTUDY—Your key to positive personal profits. Associated Techniques, Box 235, Hollidaysburg, Penna.

EARN Degree. Free bulletin. Home-study only. Midwestern Bible School, 1060 Broadripple, Indianapolis.

PIANO Tuning pays. Big money in spare time. Learn at home in 30 days. No musical knowledge necessary. Phonograph, records, tools and instructions furnished. Personal instructions available. Free catalog. Capital Tuning School, 16 Southwest Second, Fort Lauderdale, Fla.

EARN College degrees, correspondence. Metropolitan University, Box 86, Glendale 5, California.

BOOKS. Free 1967 catalog. 100 pages. Text, vocational, educational, instructional subjects. Millions of volumes, new and used. Bargain prices. Books bought. Est. 1902. Long's College Book Co., Dept. PM, Columbus 1, Ohio.

LEARN Appliance service and repair. Motors, washers, refrigeration, cleaners, everything. Free booklet. Armstrong, 11027-A South Vermont, Los Angeles 44.

STUDY For Doctor's degree of psychology, metaphysics and divinity. Correspondence courses only. College of Divine Metaphysics, Dept. P-M, 2811 North Illinois, Indianapolis 8, Indiana.

HIGH School diploma at home. Licensed teachers—Approved materials. Southern States Academy, Box 144-MX, Station E, Atlanta, Georgia.

BE A real estate broker. Study at home. Write for free book today. GI approved. Weaver School of Real Estate, 2018P Grand, Kansas City, Missouri.

USED Correspondence courses and books sold and rented. Money back guarantee. Catalog free. (Courses bought.) Lee Mountain, Pisgah, Alabama.

EARN While you learn. Auto and diesel mechanics master this top paying trade. Many graduates earn \$100 a week and up. Approved for Korean veterans. For free information write Dept. No. 256, Nashville Auto-Diesel College, Nashville 3, Tenn.

HELP Yourself to abundant living. Our courses have aided students to richer fuller lives. Learn secret of contentment, happiness. Earn degrees P.D., M.S.D. Write for free book. College of Universal Truth Correspondence School, 23-C E. Jackson, Chicago.

LEARN While asleep! Details free. Research Association, Box 610-MC, Omaha, Nebraska.

BOOKKEEPERS! Increase your earnings! Operate your own simplified "Dollar-A-Week" bookkeeping and tax service. Full or spare time. Details free. No obligation. Ellis, Box 200, Cedar Grove, North Carolina.

WANT A diesel job? New opportunities to increase income. Higher pay. More money. We can help you qualify. Tools. Shop method home training. Write today! Diesel, Tractor, Heavy Equipment Division, Interstate Training Service, Dept. B-3, Portland 13, Oregon.

I Want to send you proof of the wonderful pulling power of Popular Mechanics classified pages. What's your proposition? Write me today. Include literature if possible. F. W. Johnson, Manager Classified Advertising, Popular Mechanics Magazine, 200 E. Ontario St., Chicago 11, Ill.

INVESTIGATOR Training. Phillips Secret Service System, 1917-B North Kenneth, Chicago 39.

USED Correspondence courses and educational books bought, sold, rented. Free catalog. Educational Exchange, Menlo, Georgia.

MIDLAND Linotype School. Charles City, Iowa. Civilian and veteran courses. Free placement. Established 1909.

BE An investigator. Write for free details. State age. National Detective Academy, 535 East 4th Street, Scottsdale, Ariz.

PHYSICAL Therapy and massage. We train you at home. Earn big profits from your own private practice or work with hospitals and doctors. Free catalogue. National Institute, Desk 4, 159 E. Ontario, Chicago, Ill.

MEMORIZE 100 Phone numbers in five minutes. Extract cube roots mentally. Trick method. \$1. Dr. Lott, 28915 Louisiana, Leisure City, Florida.

DRAFTING—Design. Architectural, Mechanical, Electrical, Structural, Aircraft, Mathematics, Physics, Estimating, Surveying, Technical illustration. Veteran approved. Mondel Institute, 230 West 41st, New York City.

\$1,000 MONTHLY Possible in collection agency business. Free details. Write Cole Associates, Syracuse 2, N. Y.

EARN While you learn, professional cake decorating. Qualified instructor. Write free details. Marie's School Artistic Cake Decorating, P.O. Box 448, Denver 1, Colo.

LEARN Civil and criminal investigation at home. Earn steady good pay. Institute Applied Science, 1920 Sunnyside, Dept. 16C, Chicago 40, Ill.

LEARN By ear with Dormiphone. While you sleep, amazing new scientific invention works for you. Revolutionary Dormiphone tools give you a shortcut to learning languages, correct speech; memorizing facts, figures; ideal for self-improvement, relaxation, habit training. Saves time, effort. So simple children benefit. Used by educators, psychologists. Write today for fascinating free book. No obligation. Modernophone, Inc., 320-087 Mezz., Radio City, New York City 20.

DRAFTING—Building or mechanical. Learn at home in spare time, at low cost, from 60-year-old school. Information free. Write American School, Dept. DC43, Drexel at 58th, Chicago 37, Illinois.

DRAFTING, Design, blueprint reading. Good paying. Easy to learn at home. Minimum age 17. Write Utilities Engineering Institute, Dept. TC-6, 2525 Sheffield, Chicago 14.

FINISH High school at home, spare time. No classes. Diploma awarded. Write for free catalog. Wayne School, Catalog HF-77, 2527 Sheffield, Chicago 14.

LEARN Locksmithing from licensed experts at home in spare time. High pay. Free booklet. Locksmithing, Rutherford 2, N. J.

BLUEPRINT Reading—Train at home. Learn to read blueprints with confidence in 10 easy lessons. Write today Belton School, 1059-Q North Lawndale, Chicago 31.

WELDERS Earn big money. Easy to learn arc, gas, automatic welding. New equipment, low cost training in non-profit school. GI approved, free booklet. Hebart Welding School, Box M-871, Troy, Ohio.

COMPLETE Your high school at home in spare time with 60-year-old school. Texts furnished. No classes. Diploma. Information booklet free. American School, Dept. XC45, Drexel at 58th, Chicago 37, Illinois.

LEARN Another language at home, easily, quickly, naturally with Lingaphone. The world's standard conversational method. You learn to speak French, Spanish, German, Japanese, Modern Greek. Any of 34 modern languages available on life-like conversational recordings. It's like living in another country. Complete language course available on free trial. Send for free book and details of free trial. No obligation. Lingaphone Institute, T-83-087 Radio City, New York City 20.

PLAYS, STORIES, MANUSCRIPTS

WANTED: Book manuscripts, all subjects considered. Greenwich Book Pub., Atten. Mr. Zealand, 489 Fifth Ave., New York City.

WANT Your book published? Learn how we publish, advertise, promote, distribute. Many successes. Free booklet PM. Vantage, 120 West 31, New York City.

CARTOONING, COMMERCIAL ART, SHOWCARD & SIGN PAINTING, TATTOOING

PAINT Signs, cartoons. Quickest way to learn. Trace letters. Learn to draw. \$2.00. Sign Instruction, 4304 Virginia, Kansas City 10, Mo.

"HOW To Make Money With Simple Cartoons"—A book everyone who likes to draw should have. It is free; no obligation. Simply address Cartoonists' Exchange, Dept. 98, Pleasant Hill, Ohio.

CARTOON Your way to fame. Minimum age seventeen. Write Director, Cartoons-of-the-Month, Roslyn, New York.

LEARN Sign painting at home. Free talent test. Ben Kerns, Box 812-PM, Greenville, S.C.

TATTOOING Outfits, licensed course. Brochures 25c. Zeis, 728 Leslie, Rockford, Illinois.

AMAZING Sign system. Earn while learning. Straley, 410 S. Western, Springfield, Ohio.

DRAW Men, women, children in any pose. Simple anatomy instructions and my amazing artists' anatomical figure, \$1.00. Free literature. Don Davidson, 2653 Ravenswood, Chicago 13.

PAINT Signs—Master die cut, outline letter patterns. Complete assortment 1½" to 12" high, prepaid \$2.00. Eyerly, 583, Newton, Iowa.

ADVERTISING AGENCIES, LETTER WRITERS, FOR ADVERTISERS

ADVERTISING, Result-getting ads prepared, placed newspapers, magazines, radio, anywhere! Lowest rates. Catalogue free. Baker Advertising Agency, 189 W. Madison, Chicago 2.

MAILING Lists most any classification \$5.00 1000. Your circulars mailed with ours \$4.00 1000. Write for our literature. Dixie Mailers, King, N. C.

BEFORE Advertising—Get instructive Ad-Guide and newspaper-magazine rate-book, free. Chicago Advertising Agency, Chicago 4.

WANT More business? Here's an amazing opportunity to increase your sales. Talk to thousands of interested readers of "Mechanics Popular." Our Spanish Edition covers the Latin American countries like a blanket. They're real mailorder buyers. Classified rate 75¢ per word. Try an ad in our next issue. Classified Advertising Department, Popular Mechanics Magazine, 200 East Ontario Street, Chicago 11, Ill.

RUBBER STAMPS AND OFFICE SUPPLIES

3 LINE, Cushion base, indexed, \$1.00. Brover Specialties, Box 11, Sandwich, Ill.

8 HOUR Service, 3 lines \$1.00. Guaranteed. Bassler, Ludlow, Mass.

RUBBER Stamps, 3 lines \$1.00. Each additional line 25¢. Quality Rubber Stamps, R.R. #1, Wenona, Ill.

RUBBER Stamps. All kinds. Literature free. Capital Stamp Works, Box 187, Lincoln, Nebraska.

SPECIAL, August only, 3 lines, 75¢. Cushioned. Seeburgers Rubber Stamps, Palmyra, Michigan.

TYPEWRITERS, DUPLICATORS, OFFICE DEVICES

RECONDITIONED Typewriters, duplicating, printing devices, \$25.00 up. Supplies. Appliances. DixieGraph, King, N. C.

DUPLICATORS, inexpensive, free information. Harold Osterhoudt, Poughkeepsie, R.D. 2, N. Y.

PORTABLE Mimeograph! Weight 15 pounds. Smallest, cheapest, spirits duplicator. DuPont Distributors, Box 695, New York 1, N. Y.

PRINTING, MULTIGRAPHING, MIMEOGRAPHING, GUMMED LABELS

PRINTING By mail—Send 10¢ for catalog and samples. United Mail Order Service, Box 646, Elyria, Ohio.

TOP Quality printing, mimeographing. Free literature. Carrier, PM, New Lebanon Center, N. Y.

MIMEOGRAPHING—Letters, pricelists, formulas, instructions. Lowest prices. Lem's Letter Shop, 5710 Stanton, Detroit 8.

OFFSET Printing — \$6.50 1000, 8½x11, 16 lb. National Letter, 251 W. 42 St., New York City 35.

BUSINESS Printing, rubber stamps. Free catalog. Brose, 106 Clerk Street, Jersey City 5, N. J.

AMAZING Value, 1,000 "raised letters" business cards, \$3.50. Samples. Pioneer, Island Park 19, New York.

BUSINESS, Personal printing, W. Simons, 1027 Madison Street, Henderson, Kentucky.

100 BUSINESS Cards \$1.00. Printers, 1418 Broadway, Rockford, Illinois.

ATTRACTIVE Business cards. 100 postpaid \$1.00. Quality Printing, Belen, New Mexico.

1000 EMBOSSED Business cards \$3.50. Samples. Hickman Company, Coalgate, Oklahoma.

200 TWO Color letterheads, envelopes \$4.50. Compass Press, Box 613, Gainesville, Texas.

100 BUSINESS Cards \$1.00. Samples. Edson's, 421 W. 18th St., Jacksonville, Fla.

1000 EMBOSSED Business cards, two-color, \$6.50 postpaid. Free case. Color Press, Sacred Heart, Minnesota.

FREE Catalog. Post paid printing. D. M. Press, Sebastopol, Calif.

100 LETTERHEADS, 8½x11. Watermarked, and 100 6½ envelopes, carefully printed. \$2.00. Postpaid. Race Printers, Hudson, New York.

BUSINESS Printing prices free. Woods Print Shop, R. #2, Plainwell, Mich.

PERSONAL And small business stationery. 60, 6x9 letterheads; 40 envelopes \$1.50. Perry Printer, Dayton, Indiana.

PRINTING OUTFITS AND SUPPLIES

DO Your own printing. Save money. Simple rules. We supply everything. Print for others; good profit. Raised printing like engraving too. Have home shop. Details free. Kelsey Presses, V-11, Meriden, Connecticut.

PRINTING Presses, type, supplies, lists 3¢. Turnbaugh Service, Mechanicsburg, Penna.

MAKE Your own self-molding rubber stamps and printing cuts. Plexirubber, Argyle 1, Wisconsin.

TYPE Case specialists. Buy from manufacturer. Free catalog. King McKay Company, 23179 Telegraph Rd., Detroit 19, Michigan.

PATENT ATTORNEYS

REGISTERED Patent attorney offers services. Sanders, 6430 Evans, Chicago 37, Illinois.

INVENTORS: Without obligation, write for information explaining the steps you should take to secure a patent. John Randolph, Registered Patent Attorney, 203 Columbian Bldg., Washington 1, D. C.

INVENTION Record form free and "Patent Information Every Inventor Should Have." Carl Miller, Registered Patent Attorney, Woolworth Building, New York.

INVENTORS: When you are satisfied that you have invented something of value, write me, without obligation, for information as to what steps you should take to secure a patent. Write Patrick D. Beavers, Registered Patent Atty., 935 Columbian Bldg., Washington 1, D. C.

C. A. Snow & Co.—M427, Snow Building, Washington 1, D. C. Registered Patent Attorneys. Write for information.

PATENTS. "Proof of Invention" free. E. E. Vrooman, Registered Patent Attorney, 507 McKim Building, Washington 5, D. C.

"INVENTOR'S Guide" and "Record of Invention" free on request. Frank P. Ledermann, Registered Patent Attorney, 154 Nassau Street, New York City.

INVENTORS: Learn how to protect your invention. Unless the inventor is familiar with patent matters, he should engage a competent registered patent attorney or agent to represent him. We are registered to practice before the U. S. patent office and prepared to serve you in handling your patent matters. "Patent Guide for the Inventor" containing detailed information concerning patent protection and procedure with "Record of Invention" form will be forwarded to you upon request—without obligation. Clarence A. O'Brien & Harvey Jacobson, Registered Patent Attorneys, 718-G District National Building, Washington, D. C.

INVENTORS—Take these preliminary steps toward patent protection. Sketch and describe your invention. Sign, date and have this disclosure witnessed by two people who understand your invention. Have us make a preliminary search among U.S. patents already granted for similar types of invention. We report on the probable patentability of your invention and recommend your further course of action. Write for our instructive booklet, "Patent Protection for Inventors" and convenient "Evidence of Invention" disclosure form. Victor J. Evans & Co., 331-J Merlin Building, Washington 6, D. C.

INVENTORS—If you believe you have an invention, you should find out how to protect it. The firm of McMorow, Berman & Davidson with offices in Washington, D. C., is qualified to take the necessary steps for you. Send for copy of our patent booklet "How to Protect Your Invention." We will also send you an "Invention Record" form. No obligation. They are yours for the asking. McMorow, Berman & Davidson, Registered Patent Attorneys, 1342 Victor Building, Washington 1, D. C.

FOR INVENTORS

INVENTORS—If you believe you have an invention, you should find out how to protect it. The firm of McMorow, Berman & Davidson with offices in Washington, D. C., is qualified to take the necessary steps for you. Send for copy of our patent booklet "How to Protect Your Invention." We will also send you an "Invention Record" form. No obligation. They are yours for the asking. McMorow, Berman & Davidson, Registered Patent Attorneys, 1341 Victor Building, Washington 1, D. C.

INVENTORS—This firm is registered to practice before the United States Patent Office and available to assist you in the preparation and prosecution of your patent application. "Patent Protection for Inventors" booklet containing detailed information and steps to take toward patent protection sent promptly upon request. No obligation. Victor J. Evans & Co., 332-J Merlin Building, Washington 6, D. C.

INVENTIONS Wanted now by my manufacturer-clients. Patented. Unpatented. Write Gilbert Adams, Patent Broker, 80-A Wall Street, Financial District, New York City.

I Found a sure way to sell my invention for big royalties. My experience may help you. Full report \$1.00. Harold Kahm, Eola Plaza, Orlando, Fla.

INVENTORS—Send for free Patent Information book and Inventor's Record. Registered Patent Attorney, Associate Examiner. Patent Office 1923-29, Patent Attorney & Advisor, Navy Department 1930-47. Gustave Miller, 87A Warner Building, Washington 4, D. C.

INVENTORS: Test the commercial value of your patented or unpatented inventions, quickly and inexpensively. Write for free information. Institute of American Inventors, Dept. 40-B, 635-F St., N.W., Washington 4, D. C.

INVENTORS. Don't sell your invention patented or unpatented until you receive our offer. Write Cowgill, Box 298, Marion, Ohio.

PATENT Searches \$5.00. 48-hour airmail service. Invention protection forms free. Write Patent Engineering Service, 711 14th Street N. W., Washington 5, D. C.

INVENTION Record form free and "Patent Information Every Inventor Should Have." Carl Miller, Registered Patent Attorney, Woolworth Building, New York.

PATENT Searches \$5.00. 48-hour service. Free invention protection forms. Write Raymond L. Smith, Patent Searcher, 620 Sheraton Building, Washington 5, D. C.

SEARCHES—Put your patent searches in the hands of a registered patent attorney or agent, as he qualifies to give a worthwhile patentability report. Record of invention form upon request and information on patent protection. Patrick D. Beavers, Registered Patent Attorney, 935 Columbian Bldg., Washington 1, D. C.

INVENTORS: Information on patent procedure furnished on request, without obligation. John Randolph, Registered Patent Attorney, 202 Columbian Building, Washington 1, D. C.

PATENT Searches, including copies of nearest patents, \$6.00. Reports airmailed within 48 hours. More than 100 registered patent attorneys use my service. For free invention protection forms, write Miss Ann Hastings, P.O. Box 176, Washington 4, D. C.

INVENTORS: Learn how to protect your invention. Unless the inventor is familiar with patent matters, he should engage a competent registered patent attorney or agent to represent him. We are registered to practice before the U. S. patent office and prepared to serve you in handling your patent matters. "Patent Guide for the Inventor" containing detailed information concerning patent protection and procedure with "Record of Invention" form will be forwarded to you upon request—without obligation. Clarence A. O'Brien & Harvey Jacobson, Registered Patent Attorneys, 718-G District National Building, Washington, D. C.

INVENTIONS And ideas designed for your profit and patented for your best protection at low definite fees. Thirty years experience in developing and patenting inventions in U.S. and foreign countries. Patent searches with valuable report \$15.00. Joseph O'Brien, 132 Nassau Street, New York 38, N. Y.

INVENTIONS WANTED

WANTED Inventions of all kinds. Write Winsco Services, 6720 S. Figueroa, Los Angeles 3.

INVENTORS: Hundreds of manufacturers have requested our assistance in locating marketable new products. Complete information free. Institute of American Inventors, Dept. 40-D, 635-F St. N.W., Washington 4, D. C.

INVENTORS, Don't sell your invention patented or unpatented until you receive our offer. Write Cowgill, Box 298, Marion, Ohio.

INVENTIONS Wanted. Patented or patent pending. 26 years experience promoting inventions. National Service Bureau, 3120 Meramec, St. Louis 18, Mo.

INVENTIONS Wanted. Patented; unpatented. Tremendous manufacturers lists. Global Marketing Service, 2420 77th, Oakland 5, California.

SUPERIOR Promotions. Patented; unpatented inventions. Information booklet, free. Superior, 333-344 North Rodeo, Beverly Hills, Calif.

INVENTIONS Needed immediately for manufacturers. For additional information write Kessler Corporation, 58-1W, Fremont, Ohio.

INVENTIONS Wanted now by my manufacturer-clients. Patented, unpatented. Write Gilbert Adams, Patent Broker, 80-B Wall Street, Financial District, New York City.

PATENTS FOR SALE

DOUBLE Acting slip form jack. U. S. patent. For building silos, grain elevators, cement plants, rock crushing plants. Free circular. Jacks, 66 So. Terry, Dayton 3, Ohio.

MODELS, MODEL SUPPLIES

BALSA Wood and model aircraft. 40-page catalog 25¢. Sig Co., Montezuma, Iowa.

SHIP Model kits and fittings including clippers, trawler, fishermen, frigates, privateer, radio control tug, etc. Send 25¢ for 1957 catalog. Model Shipways, Box 85, Bogota, N. J.

SHIP And yacht model fittings; blueprints. Send 35¢ for illustrated catalog listing hundreds of items. A. J. Fisher, 1002-1 Etowah Ave., Royal Oak, Mich.

SHIP Models. Most complete line in New England. Kits, fittings, plans, books, tools, engines, motors. Illustrated catalog 30¢. James Bliss & Co., Inc., Dept. 8M, 342 Atlantic Ave., Boston 10, Mass.

SHIP Models and yacht supplies complete. Large 68 page catalogue 50¢. Bill Wild's, 510 East 11 St., New York City 9.

POWER Models. Unusual steam gas-line and traction engines, fittings, metals. Comprehensive catalog \$1.00. Chas. Cole, Ventura, Calif.

MANUFACTURING

WOOD Products and parts, toys, models, kits, knobs, handles, etc. Small orders accepted. Buckingham, 533 Putnam St., Sandusky, Ohio.

DESIGNING. Tools, dies, models, manufacturing. Pro Devco, Box 983, Cincinnati 1, Ohio.

MODELS—Small lot manufacturing. Metals, plastics, etc. Milburn, Burlington, Kentucky.

HOME CRAFTSMEN

LEARN Art metalcraft and jewelry making. Complete, inexpensive, home training course now available. Special tools and materials furnished. Write for free booklet. Interstate Training Service, Dept. L-3, Portland 13, Oregon.

LEATHERCRAFT. Copper enameling, mosaic tile, shellcraft, metal tooling, beadcraft, many more crafts. Free big catalog. Kit Kraft, Dept. 228, Studio City 1, Calif.

FREE. New catalog, 1,658 patterns, designs. Craftplans, 1322-A S. Wabash Avenue, Chicago 5.

LEATHERCRAFT. Complete illustrated catalog, leathercraft kits, tools, supplies, books. Send 10¢ today to J. C. Larson Co., 820 S. Tripp, Dept. 7327-L, Chicago 24.

FINISHING Kits for furniture. Free pamphlet with how to finish pictures. Show-Off, Inc., 253 Main St., Jamestown, N. Y.

89 FULL Size 1/8 saw patterns of beautiful shelves, ornaments, toys, novelties. Plus "How, Where to Sell." Only \$1.00. Mastercraft 84M, 7041 Olcott, Chicago 31, Illinois.

LEATHERCRAFT. Send 10¢ for new 76-page catalog of tools, supplies, kits, including metalcrafts, enameling, ceramics, all other crafts. Complete stock. Reasonable. Since 1910. Sax Bros., Dept. FM-8, 1111 N. 3rd, Milwaukee, Wis.

BUY Wholesale nationally advertised power, hand tools, thousands other products at big discounts. Free "Wholesale Plan." American Buyers', Hertel Station, Buffalo 16-F1, N. Y.

FREE Shellworkers catalog, instruction book 35¢. Secor's, Bradenton, Florida P.M.

GRANDFATHER Clock copyrighted photopack shop tested plans, dollar. Weight movements from \$39. Kuempel Clocks, Minneapolis 16.

FREE 6" Rule, decimal-equivalent table, tool price list. Unique gift offer! Enclose stamp. Laircraft, Box E-5008, Detroit 35, Michigan.

KNOCKDOWN Cedar chests, Lumber and veneers. Free price list. Giles & Kendall Company, Huntsville, Ala.

FREE "Do-it-yourself" leathercraft catalogue. Tandy Leather Company, Box 791-T22, Fort Worth, Texas.

KNOCKDOWN Cedar chests and lumber. Free price list. Bedford Lumber Company, Shelbyville, Tennessee.

I want to send you proof of the wonderful pulling power of Popular Mechanics classified pages. What's your proposition? Write me today. Include literature if possible. F. W. Johnson, Manager Classified Advertising, Popular Mechanics Magazine, 200 E. Ontario St., Chicago 11, Ill.

WOODWORKING And cabinetmaking course for beginning and advanced home craftsmen. Only complete low-cost home training program available. Write for free booklet. Interstate Training Service, Dept. G-3, Portland 13, Ore.

DO-IT-YOURSELF booklets 25¢. 24 subjects. Free catalog. Popular Mechanics Press, 631 N. St. Clair St., Chicago 11.

ALL Crafts, supplies. Large free catalog. National Handicraft, 109 William Street, New York City 38.

STYLECRAFT "Pretraced" leather kits. Handbags, billfolds, filigree belts. Patterns on leather. Just carve, assemble and lace. "Pretraced" kits also available. Send 25¢ for catalog, free folder. Refunded first order. Apache Leather Company, 2804 E. Washington St., Phoenix, Arizona.

SHELLCRAFTERS Send \$1. Terrific secret information. Buy simulated jewelry, seashells, coral, shell clay 2¢ pound. Unlimited. Shellcraft Economy, 602 East Market, Taylorville, Illinois.

BOOKS: Hundreds of subjects. Big catalog free. Popular Mechanics Press, 200-DC East Ontario St., Chicago 11.

CHAIR Caning. Send 25¢ for complete instructions and price list of materials. King & Walters, 27 Perry Street, New York 38, N. Y.

DO IT YOURSELF

FREE—Material for molds. Make concrete products "molds from household waste" know-how, plans, blueprints \$2.00 profitable hobby. \$100.00 weekly possible our concrete step molds simplified, efficient. Aepco, Box 8313, Houston 4, Texas.

OIL Drum cement mixer assembly kit. Circular. Nu-Way-Do Co., Newaygo, Mich.

HOUSE Wiring—Electrical repairs. 32-page booklet 25¢. Popular Mechanics Press, 633 N. St. Clair St., Chicago 11.

AIR Conditioners, homes, automobile. See Kool Engineering ad page 16.

\$2,500.00 BUILDS Modern \$10,000.00 home. Details \$1.00. Savage-Contractors, (Established 1927), 103 Riverside, Scranton 9, Pennsylvania.

SENSATIONAL Offer. Build at home your own water well drilling rig out of wood. Construction cost approximately \$35.00. Complete blueprints and drilling instruction. Send \$3.00. Roy Vulgamore, Route #7, Chillicothe, Ohio.

MOWER Kits and parts. Also complete mowers. Write for free plans and literature. Triangle, Dept. M-7, Fort Scott, Kansas.

MELT Cast iron, brass, aluminum. Make castings for profit. Free literature. Ursutz Burner Co., Box 586-M, Tempe, Arizona.

HOW To read blueprints. Amazing booklet 25¢. Free catalog. Popular Mechanics Press, 631 N. St. Clair St., Chicago 11.

18 FULL-Size patterns. Save money with easy-to-use, professionally designed full-size patterns. Make money selling beautiful, useful furniture. Make modern step and cocktail tables; metal lamps; cupola; 12-foot outdoor. All patterns test-built; sold with money-back guarantee. Get your free list of these convenient, economical patterns today. Popular Mechanics Press, 200-HH E. Ontario Street, Chicago 11, Ill.

WATCHES, OLD GOLD, JEWELRY

HIGHEST Cash for old gold, broken jewelry, gold teeth, watches, diamonds, silverware, spectacles, platinum, mercury. Free information. Rose Refiners, Heyworth Building, Chicago 2.

WATCHMAKERS'—Jewelers', machinists' tools. Watchmaking course. Catalog 25¢. Bengale, Culver City, California.

GOLD, Silver, platinum, diamonds wanted. Cash immediately, highest prices; appraisals made. Wilmo's, 1067 Bridge, N.W., Grand Rapids 4, Mich.

RHINESTONES, Pearls, costume jewelry supplies. Catalog 10¢. Rhinestone kit and catalog \$1.00. J & M Novelties, Dept. CJ-3, Box 173, Broadview, Illinois.

WATCH And clock repairing books. Free catalog. North American, 2320-AH Milwaukee, Chicago 47, Ill.

10 WATCHES \$18.00. Catalog 20¢. Chronograph repair specialist. Berkwit, 1150 Castlehill, New York 62.

COSTUME Jewelry supplies, settings, rhinestones, etc. 88 page illustrated catalog. 25¢. Milady, Box 1328, G.P.O., New York City.

RAZORS, BLADES, SHARPENING

RAZOR Blades, very good double edge blades, send \$1.00 for 100. Chic Sales, Dept. H, Box 274, Alameda, California.

FOR THE HOME

FOAM Rubber furniture cushions. Factory seconds. 50% discount. Free catalog. Perma-Foam, 390-C Nye Avenue, Irvington, N. J.

"**HOME** Improvement Guide." New, amazing 192 page volume. Packed with ideas, plans for remodeling, decorating, landscaping, built-in projects. \$2.50 pre-paid. Popular Mechanics Press, 200-HG East Ontario St., Chicago 11.

RITE-Timer time switch saves money. Turns off attic fans, lights, electric heaters, or motors at any preselected time (15 minutes to 12 hours). Replaces regular wall switch. Installed in a few minutes. Guaranteed. \$1.95 postpaid. Literature on request. Precision Products, Inc., 532 So. Quaker, Tulsa, Oklahoma.

REVEALING After 40 years. Old Southern barbecue sauce recipe. \$1.00. Southern, 406 S. Union Ave., Los Angeles 17, Calif.

BE Your own plumber. You can. Few inexpensive tools and our instructive book, "Home Plumbing Guide," shows and tells you how. Hundreds of photographs and diagrams. Easy to follow. 160 pages. \$1.50. Catalog free. Popular Mechanics Press, 200PG East Ontario St., Chicago 11, Ill.

OF INTEREST TO WOMEN

FREE—Big new wholesale catalog! Up to 50% saving for you, family, friends on nationally-known gifts, jewelry, toys, appliances, Christmas cards, etc. Also make money selling part time! Write: Evergreen Studios, Box 846-D, Chicago 42, Ill.

60% PROFIT On cosmetics—Famous nationally advertised Hollywood cosmetics pay 60%. Make \$25 day up. Hire others. For free samples, details, write Studio Girl, Glendale, Calif. Dept. 1278G.

WE Pay \$3.50 lb. Grow mushrooms. Cellular, shed and outdoors. Spare, full time, year round. We have over 25,000 customers. Free book, Washington Mushroom Ind., Dept. 176, 2854 Admiral Way, Seattle, Wash.

SELL Fine fabrics. Get yours wholesale. Box 883, Norwalk, Conn.

MAKE New greaseless doughnuts in kitchen. Sell stores. Free recipes. Morgan Ray, 3695 South 15th, Minneapolis 7, Minn.

BOOKS: Hundreds of subjects. Big catalog free. Popular Mechanics Press, 200-BC East Ontario St., Chicago 11.

BOBBY PINS. Black, brown, 18 on card, 10¢. King, 330 Alexander, Kamloops, B.C., Canada.

RE-WEAVING Instructions, \$1.00. Fabulous earnings. Servicecraft, 1412M Adams, Toledo, Ohio.

PERSONAL

BORROW Money—By mail. \$100 to \$600 from Postal Finance. Employed men, women easily obtain \$100 to \$600 fast, entirely by mail. Repay in small monthly payments. Friends, relatives, employer, tradespeople will not know you are applying for loan. Advise occupation, amount wanted. Postal Finance Company, 200 Keeline Bldg., Dept. 7-P, Omaha, Nebr.

START Your party with a bang. "Trobet 'en Wury Bag," 2 1/2 dozen \$1.00. Print-A-Product, 232-34th Ave. No., St. Petersburg 1, Florida.

BIBLE Questions answered. Stamped envelope. Bylon, 17187 Bentler, Detroit 19, Michigan.

ENJOY Health. Free booklet. Ruth's Nutrition, 152 Kearny, PM, San Francisco, Calif.

"**HOW** Can I find out?" You can! Information confidentially developed. Any matter, person, problem. Worldwide. Officially licensed. Established 1922. William Herman, 170 Broadway, New York City.

BOOKS: Hundreds of subjects. Big catalog free. Popular Mechanics Press, 200-BC East Ontario St., Chicago 11.

YOUR Letter remailed from fabulous San Francisco 25¢. Fairburn, 1513 Taylor St., San Francisco 11, California.

AMAZING Health plan! Tested diet and simple instructions. Send \$1.00. Dr. Leland, Jamestown, Kansas.

REMAILING SERVICE

COLUMBUS Mail forwarding-receiving address for rent. Details free. William McLaughlin, 809 Stewart, Columbus 6, Ohio.

ASIATIC Remailing. Confidential. Send \$1.00 airmail. Frank Short, JDP Boite Postale 464, Saigon Sud Vietnam.

HAWAIIAN Remails 25¢. Business information 50¢. Mailings, contacts made. Kinoh, Waiānāe, Oahu, T.H.

DENVER Remails 25¢. Sanchez, 7012 E. 4th Ave., Denver 20, Colorado.

LETTERS Remaild 25¢. J. Love, 1419 E. 83, Los Angeles 1, Calif.

SECRET Mail receiving, forwarding system. \$3 month. Hedgpath, Box 830, Alhambra 23, California.

LAS Vegas: Letters remailed pronto 25¢. Emel, 1115 Ogden, Las Vegas, Nevada.

JACKSONVILLE, Fla. remailing 25 cents. Edson's, 421 W. 18th St., Jacksonville, Fla.

AIR Remails 35¢. I buy Canadian stamps. Ross Hancock, 63 Bellhaven Rd., Toronto 8, Canada.

REMAILS, 25¢. Receiving, forwarding, \$3.00 month. Hale, Box 1, Glenmont, N. Y.

TREASURE FINDERS

FREE, 16-Page manual from world's largest manufacturer of prospecting equipment. Detectron Corp., 5528 Vineland Ave., North Hollywood, Calif.

TREASURE. Metal, mineral detectors. M-Scope. Used worldwide for treasure hunting. Mineralights, Geiger, scintillation counters. Prices from \$14.75. Fully guaranteed. Use our time payment plan. Free booklets on treasure hunting, uranium prospecting. Free catalog. Fisher Research Lab. Inc., Dept. PM-C1, Palo Alto, Calif.

LITHIUM. The wonder metal. Free booklet describes prospecting information, uses, etc. Nu Age, Box 142, North Battleford, Sask., Canada.

FREE Literature—Light weight, guaranteed metal detectors, Geiger counters and mineralights. Kits and assembled models, electronic applications. Dept. M, Box 3, Arlington 10, Virginia.

FIND Buried treasure, gold and silver, with Goldak's sensational 3 1/2 lb. "find-it" locator, only \$84.50. Write for free literature on complete line of mineral, metal locators; Geiger and scintillation counters. Goldak, 1341 W. Glenoaks Blvd., Glendale, Calif.

FOR SALE—MISCELLANEOUS

EVERYONE Needs a permanent social security card. Send name, number and \$1.00 for our beautiful, modern, billfold size, bronze card. Catalog Sales, Box 34-M, Princeton, Florida.

SMOKERS. Free literature on Missouri Meerschmum pipes. Ed. Locke, Lac du Flambeau, Wisconsin.

HEARING Aid batteries, wholesale. Free list. Habs, Box 51, York, Penna.

HURRICANE Charts—Printed on metal. Movable magnetic markers. Gyco, Palm Beach.

WANTED—MISCELLANEOUS

OLD And broken jewelry, any condition. Wicker, 564 Hooper Road, Johnson City, N. Y.

WRENCHES And accessories wanted for auto, industrial use. Will sell and invoice. International Sales Organization, Established 1919, Box 818, Cleveland 22, Ohio.

CASH For Indian bird stones; antique northwest coast totem, masks, carvings. Send photos. Robert Stolper, 8552 Cynthia Street, Los Angeles, California.

QUICKSILVER. Sterling, silver solders, precious metals. Wholesale Terminal, Norwood, Massachusetts.

SCRAP Mercury (quicksilver) containers supplied — Tantalum, tungsten, silver, platinum. Metallurgical Products Company, Established 1909, 35th & Moore Sts., Philadelphia 45, Penna.

HAVE You any old phonograph records? Some of them may be worth \$5.00 to \$125.00 each as collectors items! For list of over 2,000 such records, approximate values, and other information, send \$1.00 to: Rare Records, P.O. Box 3053, Temple, Texas.

WANTED Old phonograph record catalogs, records. George Moran, Lodi, Wis.

MISCELLANEOUS

TAX Free souvenirs postpaid. Tropical fruit candies, 8 pound variety \$8.00. Mango, pineapple, papaya, coconut, guava, wild orange. Bolo knife or 2 1/2" machete \$4.00. Hand painted earrings \$1.00. Letters remailed 3 for \$1.00. Allan Shaw, Rio Piedras, Puerto Rico.

BUILD Wall framing for your future home in your present basement or garage. Layout and instructions \$5 prepaid. W-M-B Sales & Service, 1606 Tenth Avenue, Menominee, Michigan.

NAMES Latest births, etc. Reasonable. Kloeffer, 184 N. Miami, Gary, Indiana.

"**MAN** Shall not live by bread alone, but by every word of God"—Holy Bible. Information free. S. L. Bigford, P.O. Box 11, Solvay, N. Y.

SKYSCRAPER—Heel shoes! Photo catalogue, \$1.00. Finecraft, Box 442-R, Hollywood 28, Calif.

FREE Details. Air-condition one or more rooms \$34.50. Weather Merchants, 2913 Gaston, Dallas, Texas.

CIGARETTES—Improved roller makes 20 for 8¢. Facts free. Moberly, Box 820, Owensboro, Kentucky.

JAPAN: Mail-order, gifts, novelties, kimono, jackets, jewels, etc., 24 page catalogue, business information. \$1.00. Clarence Yamagata, Room 202, Naka 7 Bldg., Marunouchi, Tokyo.

WE Pay \$3.50 lb. Grew mushrooms. Cellar, shed and outdoors. Spare, full time, year round. We have over 25,000 customers. Free book. Washington Mushroom Ind., Dept. 175, 2954 Admiral Way, Seattle, Wash.

LEARN While asleep! Details free. Research Association, Box 610-MC, Omaha, Nebraska.

BOOKS: Hundreds of subjects. Big catalog free. Popular Mechanics Press, 200-BC East Ontario St., Chicago 11.

HOW To remodel, basement, attic. Booklet 25¢. Free catalog. Popular Mechanics Press, 633 N. St. Clair St., Chicago 11.

RECEIVE Magazine samples, mails, catalogues, offers from everywhere. Get listed 25¢. Rorick, Cincinnati 26, Ohio.

YOUR Name wanted. We'll send 1000 publishers, mailers, wholesalers your name, on our list one year 25¢. Dixie Mailers, King, N. C.

"**MAGIC** For everybody." 25¢. Free catalog. Popular Mechanics Press, 631 N. St. Clair St., Chicago 11.

CARPENTERS: Most revolutionary rafter framing instrument known. Write Eastern Enterprises, 1310 Lincoln, Watsonville, Calif.

18 FULL-SIZE patterns. Save money with easy-to-use, professionally designed full-size patterns. Make money selling beautiful, useful furniture. Make modern step and cocktail tables; metal lamps; cupola; 12-foot outdoor. All patterns test-built; sold with money-back guarantee. Get your free list of these convenient, economical patterns today. Popular Mechanics Press, 200-HH E. Ontario Street, Chicago 11, Illinois.

BOOKS On antiques and their prices. Free circular! P. Warman Publishers, Uniontown, Penna.

WOMEN'S Leather handbags from Mexico. Beautifully hand-tooled, \$5.00 each. Stratton, 2637 E. 6 St., Highland, Calif.

I want to send you proof of the wonderful pulling power of Popular Mechanics classified pages. What's your proposition? Write me today. Include literature if possible. F. W. Johnson, Manager Classified Advertising, Popular Mechanics Magazine, 200 E. Ontario St., Chicago 11, Ill.

10¢ COMIC Books 5¢. Details free. Box 1647, Uniontown, Penna.

HAND-Carved leather belts \$7.50. Catalogue available. Lillard's Leathercraft, Friona, Texas.

WHOLESALE Catalog! Discounts to 80%! Clothing, appliances, tools, housewares, jewelry, etc.! Midwest, 2P-158, Pontiac, Illinois.

REMODEL Your own home. Save hundreds of dollars. New, amazing book shows you how. Written so you can understand it. Step by step instructions make it easy. Fully illustrated, 460 photographs, hundreds of diagrams, 160 pages, \$2.95. Literature free. Popular Mechanics Press, 200-RH East Ontario St., Chicago 11, Ill.

CLOGGED Drains, cesspools and septic tanks cleaned by new powerful chemical. Surasolvent removes grease, soap, tree roots, etc., without expensive digging and electric rodding machines. No pumping necessary. Mix with water and pour down drain. Free details. Export trade invited. Electric Drain Cleaning Co., Boston 34, Mass.

BUY Wholesale! Over 10,000 nationally advertised products. Appliances, cameras, sporting goods, housewares, watches, typewriters, tools, clothing, etc. Send postcard today. Buy-Rite, Box 258, Hawthorne 2, New Jersey.

WANT More business? Here's an amazing opportunity to increase your sales. Talk to thousands of interested readers of "Mechanics Popular." Our Spanish Edition covers the Latin American countries like a blanket. They're real mailorder buyers. Classified rate 75¢ per word. Try an ad in our next issue. Classified Advertising Department, Popular Mechanics Magazine, 200 East Ontario Street, Chicago 11, Ill.

FREE Details. Air-condition one or more rooms \$34.50. Weather Merchants, 2913 Gaston, Dallas, Texas.

CIGARETTES—Improved roller makes 20 for 8¢. Facts free. Moberly, Box 820, Owensboro, Kentucky.

JAPAN: Mail-order, gifts, novelties, kimono, jackets, jewels, etc., 24 page catalogue, business information. \$1.00. Clarence Yamagata, Room 202, Naka 7 Bldg., Marunouchi, Tokyo.

Superior's New Model 70 UTILITY TESTER®
FOR REPAIRING ALL ELECTRICAL APPLIANCES
MOTORS • AUTOMOBILES • TV TUBES

As an electrical trouble shooter the Model 70:



- Measures A.C. and D.C. Volts, A.C. and D.C. Current, Resistances, Leakage, etc.
- Will measure current consumption while the appliance under test is in operation.
- Incorporates a sensitive direct-reading resistance range which will measure all resistances commonly used in electrical appliances, motors, etc.
- Leakage detecting circuit will indicate continuity from zero ohms to 5 megohms (5,000,000 ohms).
- Will test toasters, irons, broilers, Heating Pads, Clocks, Fans, Vacuum Cleaners, Refrigerators, Lamps, Fluorescents, Fans, Switches, Thermostats, etc.
- Will test all TV tubes for open filaments, inter-element shorts, burned out tubes, etc.

As an Automotive Tester the Model 70 will test:

- Both 6 Volt and 12 Volt Storage Batteries • Generators • Starters • Distributors • Ignition Coils • Regulators • Relays • Circuit Breakers • Cigarette Lighters • Stop Lights • Condensers • Directional Signal Systems • All Lamps and Bulbs • Fuses • Heating Systems • Horns • Also will locate poor grounds, breaks in wiring, poor connections, etc.

Model 70 comes complete with 44 page book written in plain easy-to-understand language. Explains laws of electricity, how to proceed with repairs of appliances and automobile circuits, how to test TV tubes, etc. Only **15⁸⁵**

SHIPPED ON APPROVAL
NO MONEY WITH ORDER — NO C. O. D.

Try it for 10 days before you buy. If completely satisfied then send \$3.85 and pay balance at rate of \$4.00 per month for 3 months — No interest or Finance Charges. **Added!** If not completely satisfied, return to us, no explanation necessary.

MOSS ELECTRONIC DIST. CO., Inc.

Dept. D-368, 3849 Tenth Ave., N.Y. 34, N.Y.

Please rush me one Model 70. If satisfactory I agree to pay \$5.85 within 10 days and balance at rate of \$4 per month with total price of \$17.85 plus postage in cash. If not satisfactory, I may return for cancellation of account.

Name _____
 Address _____
 City _____ State _____



BARBELLS

140-Pound, CHROME DELUXE Barbell-Dumbbell set only **\$18.80**. This is our feature set and is the finest ever manufactured.

Training with adjustable weight is the **BEST** way to keep fit; the **ONLY** way to develop great strength and a perfect body. As the oldest and best equipped barbell company, BUR gives value and prices no one can equal.

SEND FOR FREE CATALOG.
BUR BARBELL CO.
 Lyndhurst 9, New Jersey

ENGINEERING

DEGREE IN 27 MONTHS

B. S. DEGREE IN

Aeronautical, Chemical, Civil, Electrical, Mechanical and Electronic Engineering (inc. Radio and TV)

Also B.S. DEGREE in 36 mo. in Mathematics, Chemistry, Physics (inc. Nuclear Physics) Engineering Science prep. courses. Thorough, practical program. Individualized instruction emphasized. Government approved for G.I.'s.

Keeping pace with progress in science and engineering

Spacious campus. 20 bldgs.; dorms, gym, Playing field, Modern, well-equipped labs including new physics lab and wind tunnel. Low tuition. New terms start quarterly. Enter September, December, March or June. Big demand for graduates. Students from 48 states and 40 foreign countries. Many earn a major part of their college expenses in this large industrial center. Send coupon for free catalog and full information. Enroll now!

INDIANA TECHNICAL COLLEGE

587 E. Washington Boulevard, Fort Wayne 2, Indiana

Please send me free information on 27 MO. B.S. DEGREES in:

Aeronautical Chemical Civil Electrical
 Mechanical Electronics

on 36 MONTH B.S. DEGREES in:
 Mathematics Chemistry Physics

Name _____

Address _____

How Much Oil Has Russia?

AT MOSCOW last February Russia's Supreme Soviet was told that the current Five Year Plan would have to be cut back. Somewhat later an 11 percent reduction in military production was announced. Why?

A major reason is insufficient oil to fuel the modern machinery of peace and war.

Just how is the Soviet empire faring in the world quest for oil? Konrad Kellen sums up the situation in the American Petroleum Institute *Quarterly*. Mr. Kellen was for five years chief of Radio Free Europe's information service, specializing in affairs behind the Iron Curtain, and now is head of its Broadcast Review Staff.

Here are some significant excerpts from his report:

Both in quality and quantity, the Soviet petroleum industry seems now inadequate to sustain *prolonged* wartime operations.

Although total Soviet oil production (1956) increased by 20 percent over the previous year, progress in refining and transportation was not proportionate. Refined products are in short supply, while there is an excess of crude oil in storage.

The Communists will continue their subversive activity in the Middle East, where the next best thing to Soviet possession of the world's largest oil pool is to deny this vital oil to the West.

One area in which the Soviets have made considerable progress is exploration. Russia has only 5.3 percent of the world's proven oil reserves. However, despite unusual difficulties caused mostly by the top-heavy Kremlin bureaucracy, Soviet geologists have in the last few years discovered large fields, including some in the frozen wastes of the Arctic. As a result, Soviet air bases and Red Army installations in this region have been made independent.

The Baku fields still remain one of the largest single producing areas. The quality of Baku oil is high and most Soviet aviation and motor fuel is produced in this area. Refining methods, however, remain in general inferior to those in the West. The octane rating of Soviet gasoline is generally low. Baku, moreover, is showing signs of exhaustion. Production from the old field there has been level since 1951 despite enormous drilling and exploration efforts.

Offshore Caspian Sea operation, begun last year, has proven so successful that the Soviets have erected hundreds of rigs south of Baku.

One of the world's largest oil regions, in the Ural-Volga area, is now reaching peak productivity . . . exceeds in size the East Texas field. This area accounted for 62 percent of Russia's total oil output during the second half of 1956.

Other promising districts being explored: Surrounding the Black Sea, the Donetz Basin, the Kuibyshev region, the Bashkir and Tatar "republics" and the Ukraine. The only major producing area in the Soviet Far East is on Sakhalin Island.

The average Russian cannot readily afford to purchase a single gallon of gasoline for his personal use. There are relatively few privately owned automobiles, and petroleum products are even scarcer than other consumer goods.

Though refining has not been able to keep up with production increases, improved refining methods are being steadily introduced.

One of the major bottlenecks is transportation. The Soviet oil-tanker fleet, which operates principally in the Caspian and Black Seas, is still very meager. Plans call for a considerable increase in tanker construction: 460,000 tons over the next five years. But even with the use of tankers from Poland and Rumania, the Soviet Union still has less than two percent of the world's tanker fleet at its disposal.

A notable feature of the transport system is the constant need for transshipment from pipeline to tanker, tanker to rail, rail to barge, etc. Pipeline construction is also being increased.

Today the Russian petroleum industry stands at a crossroads. Its production of 1,640,000 barrels of oil daily compares very unfavorably with U. S. production, which last year averaged 7,151,000 barrels daily. Yet during 1956 Soviet oil production increased by 18 to 20 percent, a larger increase than any other oil-producing area. New explorations and production methods can make the difference. ★ ★ ★

Chemical Kills Metal Fires

"TMB," the liquid chemical trimethoxyboroxine, extinguishes metal fires, such as those occurring after aircraft crashes. Easily applied to vertical surfaces to exclude air from the fire, TMB has virtually non-toxic combustion products. Wide use is expected for this extinguishing fluid in fires involving the reactive metals magnesium, titanium and zirconium.

DIESEL MECHANICS IN DEMAND

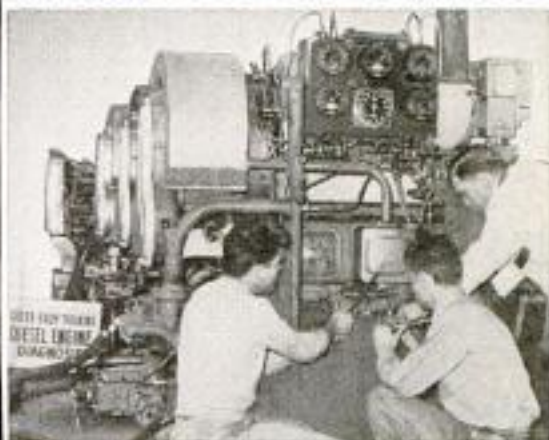

Learn to earn big pay in DIESEL in our large, modern equipped Chicago school and shop. No previous experience or training necessary. We help you find living quarters and part time job while in school. Complete, practical courses taught in the following trades, under the supervision of experienced, expert technicians.

APPROVED FOR CIVILIANS OR GI'S

— CHOOSE YOUR TRADE —

CHECK HERE	WEEKS
<input type="checkbox"/> DIESEL MECHANICS	20
<input type="checkbox"/> AUTO MECHANICS	20
<input type="checkbox"/> BODY & FENDER	16½
<input type="checkbox"/> GAS-ARC WELDING	4-12
<input type="checkbox"/> REFRIGERATION	13½
<input type="checkbox"/> AIR CONDITIONING	8½
<input type="checkbox"/> MACHINIST TRADE	30
<input type="checkbox"/> ADVANCED MACHINIST (includes tool & die)	32½
<input type="checkbox"/> PIANO TUNING & REPAIR	36

CHOOSE YOUR ENGINEERING COURSE

These courses are intended as terminal education for men who wish to enter the Diesel-Automotive and Refrigeration-Air Conditioning fields as technicians. These courses are designed to prepare men for supervisory positions. Students with a high school education, or equivalent, will be accepted.

<input type="checkbox"/> DIESEL AUTOMOTIVE ENGINEERING.....	2 years
<input type="checkbox"/> REFRIGERATION & AIR COND. ENGINEERING.....	18 months

HEAVY CONSTRUCTION EQUIPMENT OPERATORS TRAINING SCHOOL FOR CIVILIANS—Road Building, Terracing, Land Clearing, etc. Reservations accepted now!

FREE EMPLOYMENT HELP

Start your career with Greer by checking your interest above and mail coupon for complete information at no obligation.

NAME _____ AGE _____

STREET _____

TOWN _____ ZONE _____ STATE _____

Established 1902 — Over 50,000 Graduates.
55 years of continuous trade school experience
to guide your training.

GREER SHOP TRAINING
Box H, 2236 S. Michigan Ave.
Chicago 16, Illinois

COOL... COOL As An ICE GUBE



Try New MENTHOL AERO SHAVE

...and save 20¢

Imparts a bracing tingle to even sensitive skin. 3 beard softeners plus gentle, soothing lanolin. Try new Menthol AERO SHAVE.

Not ~~79¢~~ Not ~~69¢~~ Only **59¢**

Help science find CAUSE and CURE of MS*

HELP FILL

MS HOPE CHEST



- RESEARCH
- CLINICS
- PATIENT AID

* MULTIPLE SCLEROSIS—crippling disease of young adults
National Multiple Sclerosis Society
National Headquarters
257 Fourth Ave., New York 10, N. Y.

WHERE-TO-BUY-IT INDEX

Source of supply appears after items commercially available

AUTOMOTIVE

Accordion-pleated bus bends for corners (Continental Trailways Bus System, 711 Interurban Bldg., Dallas 1, Tex.)	71
Iron Curtain cars	78
Two-in-one lantern (Cable Electric Products, Inc., 234 Daboll St., Providence 7, R. I.)	97
Trailer porch is storage box (North Welding Co., Arnold, Kans.)	104
Converted weapons carrier travels mountain roads	105
Pint-size trucks handle many jobs (Getman Bros., South Haven, Mich.)	117
Truck with hoppers hauls dry cement and aggregate (Bates Body and Equipment Co., Schofield, Wis.)	117
Drive-in phone used from car	136

AVIATION

New alloys mean faster, longer flights (Dow Chemical Co., Midland, Mich.; Westinghouse Electric Corp., Merchandise Mart, Chicago 54)	4
Guided-missile cruiser gets super "eyes"	81
Experimental tilt-wing VTOL plane given flight exams (Vertol Aircraft Corp., Morton, Pa.)	87
The balloon men land hard!	88
Long-range interceptor missile heads ground-to-air defense	93
Trapeze take-off for Ryan Vertijet	95
British aircrews use escape chute	98
Homemade tri-winger built to sow seeds and dust crops	111
Guided-missile plane flies for Royal Navy	136
"Pod" of strange plane transports ton of chemicals	140

CONSTRUCTION

Grounded church steeple	4
Rubber tires move 3500-seat stadium to new site	116
Rubber balls and food tins make acoustic ceiling	125
Concrete carport roof seems to defy gravity (Concrete Engineering Co., Tacoma, Wash.)	130
Spiral shopping center to cover Caracas mountain	137

FISHING, BOATING AND SWIMMING

Fisherman's crimpers install "dialed" shot (South Bend Tackle Co., Inc., 1108 South High St., South Bend 23, Ind.)	87
Wide-beamed steel boat is almost unsinkable	89
Swimmer changes clothes in portable tent	89
Round boats keep fish guessing	112
Tulip-headed tool removes hook from fish (A & H Tackle Co., 902 N. Los Angeles St., Anaheim, Calif.)	124

MISCELLANEOUS

Caddy cart has dial to select club (M. R. Watson, 11681 Foot-hill Blvd., San Fernando, Calif.)	71
Italian ship carries 1000 cars	77
Quick-starting charcoal package burns 90 minutes (Diamond Match Co., 122 E. 42nd St., New York City 17)	77
"Freeze dry" foods may be stored in cupboard (Raytheon Mfg. Co., Pittsburgh, Pa.)	79
"Shuttle darts" game tests catching skill	79
Railroad laboratory cuts operating costs	80
Hydraulic lift alters motor height (Texas Apparatus Co., 2300 Congress, Houston, Tex.)	87
Weather gun fires pellets to measure wind velocity	89
Electric-power growth	93
Plastic swimming pool bolted at site (U. S. Swimming Pool Co., Route 22, Scotch Plains, N. J.)	93
Table-model facsimile unit sends or receives printed items	93
Power shovel has 80-ton bite (Bucyrus-Erie Co., South Milwaukee, Wis.)	96
Sculpturing with newspapers	98
Clothesline tightener (Ever-Tite Mfg. Co., 4209 S. W. Gaines Rd., Roseburg, Ore.)	99
Huge drill bores holes of almost any size or angle (Ward Lindbeck, 15-B Morrell St., San Francisco, Calif.)	99
Portable magnetometer (Radiac Co., 489 Fifth Ave., New York City 17)	99
Electronic flash unit plugs into wall outlet	103
Floor-tile remover cleans 14-inch swath (American Floor Machine Co., Toledo 3, Ohio)	103
Fractional thickness of film measured (General Motors Corp., General Motors Bldg., Detroit 2, Mich.)	103
Liquids are shipped in plastic holders (E. I. Du Pont de Nemours & Co., P. R. Dept., Wilmington, Del.)	103
Thirsty dogs serve themselves (The Harwood Co., Farmingdale, N. J.)	104
"Quadricycle" saves gasoline	104
Giant steel cutter	105
Language students see, hear, read new words on machine (Elamac, Inc., 686 N. Lake Shore Dr., Chicago)	111
Huge cylinder takes three weeks for 800-mile trip	112
Portable diamond drill cuts six-inch cores (Wink Corp., 1518 N. 117th St., Milwaukee 13, Wis.)	116
Elevator file—going up! (Diebold, Inc., Systems Div., 818 Mulberry Rd., S.E., Canton 2, Ohio)	124

(Continued on page 69)

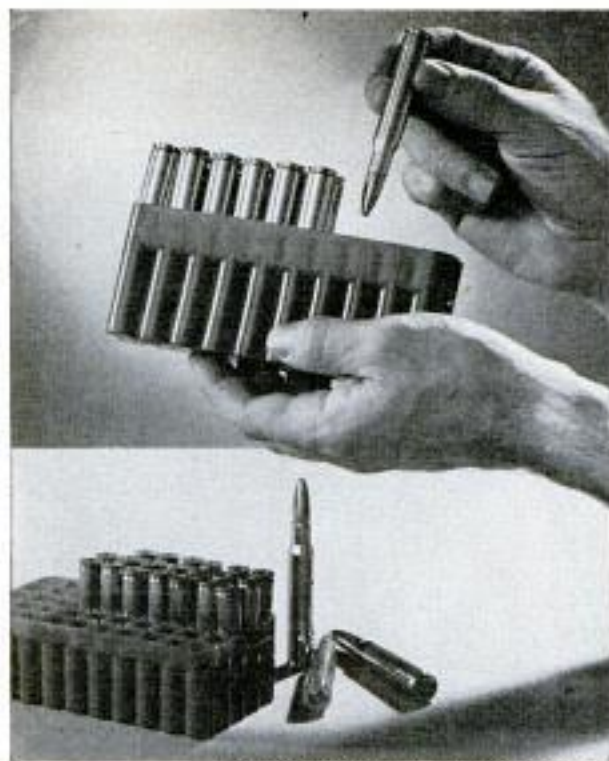

FITA, Box 49702, Los Angeles 49, Calif.

Plastic Boxes Hold Cartridges

Plastic cartridge boxes hold shells clean and dry, eliminating the problem of torn containers. Each box has a slip-on plastic cover. The containers are available in three sizes to fit most rifle and pistol ammunition.

Aborigines Immune to Cold

Reduced sensitivity is the reason Australian aborigine natives can survive drastic temperature drops without the protection of clothing. A study reveals that although the tropical temperature falls from 90 degrees Fahrenheit during the day to 10 degrees above freezing at night, the natives don't feel it and there is no change in their body metabolism.

"Talk" 1000 Words Per Minute

Business machines can now ^{SEE AUG. 58, 94} "talk" to each other 1000 words per minute. This is possible with a new experimental device called data subset that has been developed by Bell Telephone Laboratories. Letters, numbers or symbols are put on magnetic tape in the form of "spots." Machines code these spots, the data is transmitted automatically over telephone lines and a receiving machine such as an electric typewriter decodes the message 16 times faster than other similar methods.

Combined length of railroad bridges in the U. S. is almost 4000 miles—a distance greater than the width of this continent.

\$3 to \$5 an hour
IN SPARE TIME

WITH NEW FOLEY PRECISION GRINDER

Make \$3 to \$5 an hour in your own spare time business. Low cost machine sharpens circular saws, rotary mower blades, ice skates, does sanding, polishing, buffing. Easy to operate—no experience needed. Send coupon today for Free Circular. No salesman will call.

FOLEY MFG. COMPANY
873-7 Foley Bldg.
Minneapolis 18, Minn.

Send Free Circular on Foley Precision Grinder.



Name _____
Address _____



SAVE \$200.00
and more—
IMMEDIATE
PROFITS

BOTH FREE!
Write!



This FREE Lesson Proves You Can

Learn TV Repair in one short week!

Why pay up to \$250 for training—study months or years? My new SIMPLIFIED TV REPAIR METHOD lets you make \$10 to \$20 the first day! No confusing electronic "double talk"—but a wealth of practical "know how." 1000's have already proved that if you can replace a lightbulb, you can make good money immediately, repairing all makes of sets. It's amazing—and, it's true! For proof send for FREE Simple Lesson and Business Plan now! No salesman will call. **ELECTRONIC ENGINEERING**, Dept. A-178, 1038 So. LaBrea, L. A., California

PREPARE FOR BETTER JOB, BIGGER PAY IN SPARE TIME AT HOME

Today, choose the job you want—and prepare for it in time you might otherwise waste. Or if you are already in the work you like best, start training now for quicker promotion and increased pay. During the past 60 years AMERICAN SCHOOL has helped ambitious people to reach higher goals. Check subject that interests you and mail coupon for full information.

AMERICAN SCHOOL, Dept. GC45, Drexel at 58th, Chicago 37, Ill.

Without obligation, please send FREE and postpaid, full particulars about the subject checked below.

<input type="checkbox"/> Accounting	<input type="checkbox"/> Contracting	<input type="checkbox"/> Mechanical Engineering
<input type="checkbox"/> Apprenticeship Courses	<input type="checkbox"/> Diesel Technician	<input type="checkbox"/> Mechanical Technology
<input type="checkbox"/> Architecture & Building	<input type="checkbox"/> Drafting—Building	<input type="checkbox"/> Metalworking Courses
<input type="checkbox"/> Automotive Technician	<input type="checkbox"/> Drafting—Machines	<input type="checkbox"/> Plumbing—Practical
<input type="checkbox"/> Better Foremanship	<input type="checkbox"/> Electrical Engineering	<input type="checkbox"/> Private Secretary
<input type="checkbox"/> Blueprint Reading	<input type="checkbox"/> Electricity—Practical	<input type="checkbox"/> Retail Merchandising
<input type="checkbox"/> Bookkeeping	<input type="checkbox"/> Electronics—Industrial	<input type="checkbox"/> Salesmanship—Outside
<input type="checkbox"/> Business Management	<input type="checkbox"/> HIGH SCHOOL COURSES	<input type="checkbox"/> Sheet Metal Work
<input type="checkbox"/> Civil Engineering	<input type="checkbox"/> Machinists	<input type="checkbox"/> Tool Making

NAME _____ OCCUPATION _____

HOME ADDRESS _____ AGR _____

CITY _____ STATE _____

Canadian: Write American School, Dept. GC45, 6083 Sherbrooke St. W., Montreal

MAIL COUPON NOW



TRAINED MEN NEEDED!

**IN INDUSTRY - ARMED FORCES
BIG PAY! - GOOD FUTURE!**

- DIESEL ELECTRONICS
 AUTO AUTOMATION

NEVER BEFORE has the opportunity been so good for the properly trained mechanic and technician to step into BIG PAY POSITIONS with rapid advancement and future security virtually assured.

YOUR SUCCESS depends on the quality of training you receive... and the reputation of the school you attend.

YOUR GUARANTEE we are giving the best in mechanical and technical training is proved by the fact... High pay jobs in Industry, and ratings in the Armed Forces now waiting for our graduates.

RESIDENT SHOP TRAINING is easier and costs less than you may think! We provide you with housing and part-time jobs while in school, plus free nation-wide placement service for graduates.

Check subject above in which you are interested and mail for

FREE BOOKLET

BAILEY
Technical Schools

Veteran Approved

1634 S. Grand, St. Louis 4, Mo.

Name _____ Age _____
Street _____
Town _____ Zone _____ State _____

Your Future
IN
ELECTRONICS
AND
AUTOMATION

Your Future
IN
DIESEL and
AUTO
MECHANICS

(Continued from page 58)

- Rock 'n' roll pumps boat dry (Rockin' Pump Co., 755 Luton Dr., Glendale, Calif.).....124
- Hydraulic lift pivots truck van on railroad flatcar.....125
- Direct-dial system for mobile phones (Richmond Radiotelephone, Inc., Richmond, Ind.).....129
- Pressed cornstaks make wall panels.....129
- Tape recorder is versatile toy.....129
- Duplex table has tilting top.....130
- Egg beaten in shell by electric whipper (Egg Master Corp., Dunbar, W. Va.).....130
- Pivot control turns mower (Winpower Mfg. Co., Newton, Iowa).....136
- Four-way pencil sharpener stops at sharpest point (Silver Bells, Ltd., 600 16th St., Oakland, Calif.).....137
- Converted submarine carries liquid rubber.....140
- Light lures bugs into electric-fan trap (Reed Blackman's Bug Fan, Stover, Mo.).....140
- Swedish baby carriage "walks" on feet.....140

SCIENCE

- Mountain models locate oil pools..... 81
- Life-size glass horse..... 97
- Vacuum in air sampler caused by gas jet (E. I. Du Pont de Nemours & Co., Wilmington, Del.).....105
- Mobile unit aids arthritis victims (A. & R. Foundation, 23 W. 49th St., New York City 36).....116
- Special reactor tank for chromium recovery.....117
- Rattlesnake-poison antidote.....214
- Glass fiber takes a lot of heat.....216
- Insects grow to death.....216
- Iodine in drinking water.....220

WHAT'S NEW FOR YOUR HOME

- Ceiling diffuser.....138
- Electric heating mat.....138
- Shelves come in sections.....138
- Wall lamp can be moved up or down.....138
- Plastic sink.....139
- Redwood picnic table.....139
- Shelf fixtures.....139
- Vertical meat grinder.....139

Radio-Television, Electronics

- In the interest of higher fi (Stereophonic listening chair (Stereo Products Co., Severna Park, Md.; Kophonon Radio Craftsmen, Inc., 4223 W. Jefferson Blvd., Los Angeles 14, Calif.).....141
- Companion phono plays records anywhere.....142

Craftsman and Shop Notes Index

AUTOMOTIVE

- Your car should be waxed.....155
- Carry luggage on top.....165
- New auto horns are better.....162
- Undercoating tank completely eliminates condensation.....192

HOUSE AND HOME

- Asphaltum "gaskets" under posts stop water leaks in metal roof.....154
- Safe tests for finding cause of blown fuse.....154
- Wax-base floor cleaner used on wall paneling.....157
- Solving Home Problems—
- Clothesline can be taken down or put up in moments.....158
- Mildew stains can be removed.....158
- Prevent glasses and tumblers from sticking together.....158
- S-shaped "brush" for painting window edge.....158
- Waxing metal curtain rods.....158
- Cleansing tissue may be used as blotter.....159
- Extra needles held safely.....159
- How to remove cotton from small pill bottle.....159
- Driving small screw eyes.....159
- To prevent stamps sticking together when mailing.....159
- Wallpaper paste applied with paint roller.....159
- When an ice bag is needed in a hurry.....159
- Positive pin stop for drawer fits vertical hole in back.....160
- Wick-type room cooler is quickly improvised.....164
- Rings lost in bathtub drain retrieved through trap.....171
- Handy toolkit for small jobs made from large juice can.....172
- Jig permits uniform spacing of fence pickets.....172
- File card stretches screening.....178
- Root irrigator made from pipe and fittings.....181
- Screw eye prevents hook damage.....181

HOUSEHOLD HINTS

- Ladder stored on closet door is readily accessible.....155
- Stains removed from porcelain.....155
- Garment-airing rack hangs on clothesline.....157
- Towel rack capacity enlarged to accommodate extra guests.....178

(Continued on page 62)

FREE WHOLESALE CATALOG

MAKE MONEY!! SAVE MONEY!!
Buy Tools, Hardware, appliances, photo equipment, sporting goods, power tools, paints and thousands of other nationally advertised products at WHOLESALE COST TO YOU.

get up to
50%
off

"SEND FOR FREE 1957 WHOLESALE CATALOG TODAY"

SILVO HARDWARE COMPANY

Dept. PM 8, P. O. Box 266, Philadelphia 5, Pa.

KEEP YOUR... EYE ON BENJAMIN "First in POWER and ACCURACY"
for HIGH H.C. COMP
AIR GUNS & CO. GAS GUNS—Top Quality at LOWEST PRICES!

BB BB or 177 or 22

BENJAMIN SUPER
CO₂ Gas Carbine **\$14.95**
with Reg. Stock as low as
Deluxe Model with Custom Stock (Shown) as low as \$17.95

Benjamin Air Rifles and Benjamin Air Pistols are Recognized All Over the World for Finest Workmanship and Highest Quality at Lowest Prices. Adjustable Power with Amazing Optimum Force. Fully Guaranteed—Safe—Accurate—Economical. Easy to Use anywhere—12 Models for Target and Small Game BB or 177 or 22.
All Models Benjamin CO₂ Carbine Gas Rifles and Benjamin CO₂ Rocket Gas Pistols Use Standard Size CO₂ Cartridges (available everywhere). 2-Stage Hi-Lo Jet Power—High for Small Game—Low for Target—Up to 90 Shots from each Cartridge. No Pumping—Safe—Accurate—Economical—Non Toxic—12 Models BB or 177 or 22.

FREE! Catalog All Models Benjamin Air Guns & CO₂ Guns & Supplies. Also, Money-Saving Offer on Hunting & Fishing Accessories.

Send Free Gun Catalog and Special Offer!

BENJAMIN AIR RIFLE CO., MAIL TODAY!
896 MANION ST., ST. LOUIS 4, MO., U.S.A.
Name _____
Address _____
City _____ State _____

BUILD THIS HOUSE Yourself

The Famous Popular Mechanics House

The picture below is from an actual photograph of the Build-It-Yourself House with breezeway and garage, as built by Jack Brownson, 23-year-old veteran, in Aurora, Illinois.



Designed by Popular Mechanics and Famous Architects. Every Detail Simplified and Explained. No Previous Experience Needed!

Can you use everyday tools as well as the average Popular Mechanics reader? Then you, too, can easily build this modern house in any of its five designs, doing every part of the job yourself. The new Popular Mechanics Book, "Your Home—How to Build It Yourself" will show you how.

Space for Living and Family Growth

This beautiful, modern house is 1½ stories, with basement, living room, kitchen, dining nook, two bedrooms, bath, plenty of closets and space for two additional bedrooms on second floor. The house itself is 35' 9"x28' 11"; breezeway 20' 10"x8'; garage 20' 10"x12'.

The House That Has Everything

Designed for easy construction and the most living space for the least cost, the Build-It-Yourself House is also most attractive and suitable for any community and most income groups. The basic plan is adaptable to four other exterior designs.

Get Book and Plans Now—Build When You Can

You may never have thought about actually building a house yourself, but now that building restrictions have been lifted, it is easier than you think. So order book and plans today. Even if you engage a contractor to build for you, you will need the plans. And you certainly will want the book which can easily save you hundreds of dollars, whether you build this or any other house.

Mail Coupon for New Book and Plans!

Build It Yourself or Have It Built—Save Hundreds of Dollars!

PLANS YOU CAN READ AND FOLLOW

Plans consist of ten working-size blueprints—floor plans, elevations, construction notes, framing, joints, lumber and mill list, specifications, plumbing and wiring diagrams. Every measurement is marked—every detail made clear as ABC. Book has 100 pages—three-fifths are photographs and drawings. Some sections in colors, showing just how your house will look when finished.

BIG BOOK
8½x11 inches



MAIL COUPON FOR BOOK AND PLANS

POPULAR MECHANICS PRESS, Dept. 857
200 E. Ontario St., Chicago 11

I enclose \$_____ Send me the items checked at once.

- Your Home and How to Build It Yourself..... \$ 3.00
 Complete set of plans for Popular Mechanics Home... 12.50
 Book and plans at reduced price..... 14.00
 Duplicate sets of plans..... 5.00

Name _____

Address _____

City _____ Zone _____ State _____

BUILD THE BEST FOR LESS!

BUILD ALLIED'S OWN ELECTRONIC knight-kits

IT'S EASY
IT'S FUN—
and you save!

You'll marvel at how easy it is to build KNIGHT-KITS (with "step-and-check" instructions, it's like having a good instructor at your side). You'll be thrilled by KNIGHT-KIT performance—you'll be proud of your work—and you'll save money!

2-Transistor Pocket Radio Kit

Build this pocket-size, two-transistor radio—enjoy loud, clear broadcast-band reception wherever you go! Completely self-contained with built-in ferrite loop antenna—no external antenna needed. Printed-circuit board for easiest assembly. Efficient reflex-type circuit operates for months and months on long-life alkaline battery supplied. Super-sensitive miniature earpiece gives remarkably good tone. With all parts, including simulated leather case, earpiece and transistors. 4 x 3¼ x 1¼". Shpg. wt., 1 ½ lbs.

83 Y 262, Pocket Radio Kit..... \$14.65



Transistorized Electronic 10-in-1 Lab Kit

Sensational—work with transistors! Assemble the basic parts, then complete project after exciting project (10 of them in all) just by plugging leads into proper jacks on printed-circuit board—no wiring changes needed. Make the following: AM radio, amplifier, wireless broadcaster, code practice oscillator, electronic timer, switch, or flasher, or any of 3 other electronic relays. Includes all parts, 7 transistors, battery, headphones and instructions, for each project. 3 lbs.

83 Y 299, Electronic Lab Kit..... \$15.45



Famous 2-Band "Space-Scanner"

Thrilling new bandswitching receiver. Selects exciting short wave on 6 to 18 mc (foreign, amateur, aircraft, police, marine); and full standard broadcast. Sensitive regenerative circuit; 4" PM speaker; beam-power output. Easy to build. All parts supplied (less cabinet). 4½ lbs.

83 Y 243, "Space-Scanner" Kit.... \$15.95

83 Y 247, Cabinet for above..... \$2.90



2-Way Intercom Kit

It's easy and inexpensive to build your own 2-station intercom! Use it in home or office. Makes ideal "baby sitter". Extra high gain—delivers full output from only a whisper. Complete with 50 ft. cable (up to 200 ft. may be added), antique-white cases, tubes and all parts. For AC-DC. 7 lbs.

83 Y 295, 2-Way Intercom Kit.... \$14.75



FREE ALLIED SUPPLEMENT

Send for our special Supplement No. 165 featuring the complete line of KNIGHT-KIT Hobby, Hi-Fi, Amateur and Test Instrument Kits. See hundreds of special values in Hi-Fi systems and equipment, recorders, Amateur gear, test instruments, parts, tubes and tools. FREE—send for it today.



ALLIED RADIO

World's Largest
Electronic
Supply House
Our 36th Year

ALLIED RADIO CORP., Dept. 05-H7
100 N. Western Ave., Chicago 80, Ill.

Send FREE ALLIED Supplement No. 165

Send the following KNIGHT-KITS:

83 Y 262. 83 Y 243. 83 Y 295.

83 Y 299. 83 Y 247. \$_____ encl.

(All prices Net F. O. B. Chicago)

Name _____

Address _____

City _____ Zone _____ State _____

MANUFACTURER'S CLOSEOUT GOLDE' SLIDE PROJECTORS

ONLY \$19.95

prepaid



Selling entire stock of brand-new, direct-from-factory Golde' Coronet 2 x 2 slide projectors. Blower cooled, 300 watt lamp, 4" f3.5 anastigmat 2 element ground lens, 3 polished condensers. Heavy-duty cast aluminum housing (no pressed metal). Finger-tip focusing and tilt adjustment. Nationally sold for \$49.95. Our price direct to you only \$19.95 prepaid. Can be completely assembled with screw driver in 10 minutes. Money-back guarantee if not completely satisfied.

Send \$19.95 check or money order (no stamps). Your brand-new Golde' 300 watt Coronet 2 x 2 slide projector will be sent you prepaid.

GOLDEN SALES COMPANY
P. O. Box 529
Brooklyn 1, New York

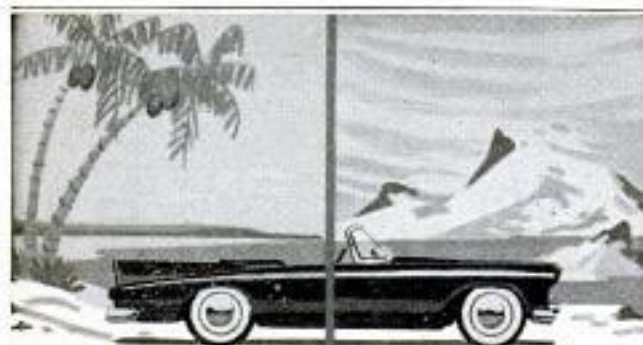

TROPIC HEAT OR ARCTIC COLD YOU'LL START AND YOU'LL GO!

When a fuel pump has been tested under strict government supervision and found to work perfectly at 114 degrees above zero and at 76 degrees below zero, we think it has proved itself the best on the market. That's what the Bendix* Electric Fuel Pump did. Positively eliminates vapor lock. No other pump even close to its price class could match it. Better get one for your car. (Send for free illustrated folder.)

*REG. U.S. PAT. OFF.



Bendix
ELECTRIC FUEL PUMP

BENDIX AVIATION CORP. • (Eclipse Machine Div.), Elmira, N. Y.

(Continued from page 60)

MISCELLANEOUS

Easel-type "clipboard" holds without clamps.....	148
Holder suspended from table keeps ink bottle level.....	148
Ordinary table salt can be made to serve many purposes.....	148
Cabin lock.....	148
Boiling water on propane tank determines gas level.....	154
Easier removal of stamps.....	154
Magnet on typewriter frame holds eraser at hand.....	154
Featherweight tent for two.....	156
Washing-machine barbecue has motorized spit.....	157
Book carton provides dust-free storage.....	160
Fountain-pen point protected by lead shot in cap.....	160
Plaster figures are strengthened when treated with plastic.....	160
Hoist eases boat cleaning.....	161
Can you name 'em?.....	162
Build a "moon watch" telescope.....	170
Adhesive tape on thumbnail aids in "starting" pen.....	172
Back-yard Ferris wheel has three speeds.....	179
Envelope catches pencil dust.....	180
Models displayed on "wall" made of perforated hardboard.....	180
Wood shaving floats lure to extend casting range.....	184
Horse-drawn cultivator is mailbox support.....	188
Drive through differential steps up feed-grinder speed.....	192
Barrel feeder reduces waste.....	192
Removing corroded fittings.....	192

PHOTOGRAPHY

Darkroom graduates and funnels stored on dowel hangers.....	147
Kelvin photo lamps marked for easy identification.....	149
Talcum-coated window glass used to check focusing.....	154
Portable retouching outfit made from photo-paper box.....	157
Enlarger provides ample light for photo retouching.....	160
Sectional wooden platform for bathroom darkroom.....	172
Correcting for parallax.....	173
Color transparencies checked with aid of white paper.....	177
Detergent photoprint solution permits spot-free drying.....	177
Glass block is developing tank.....	177
Two simple methods for storing films hangers in the dark-room.....	177
Photographs attached to wall by thumbtacks hidden on back.....	177

TOOLS

A good wood scraper.....	180
Accurate tapping with lathe.....	188
Wood-turning tools from used files.....	188
Handling lathe chuck safely.....	192
Shopping for Tools—	
Masonry fastener.....	198
Pneumatic screwdriver.....	198
Small-parts bin.....	198
Universal work holder.....	198
Chain-drive tightener.....	199
Dust collector.....	199
Form clamp eliminates problems.....	199
Portable jigsaw.....	199

WORKSHOP HINTS

Wooden miter box for cutting compound miters.....	155
Ladder rails curve-braced for maximum rigidity.....	164
Tilting shavings bin fits under workbench.....	164
Finishing fabricated panels made of plywood scraps.....	169
Tape is gauge on circular saw.....	178
Guard for glass-cutter tip.....	181
Applicator for liquid asphalt is plastic squeeze bottle.....	184
Hooks bent from wire solder used to hold paintbrushes.....	184
Block aids toenailing.....	187
Saber-blade "broach" squares hole corners.....	187
Bending S-hooks in improvised jig.....	193
Threaded tallstock arbor takes lathe faceplate.....	193
V-belt jig holds dowels for cutting on bandsaw.....	193
Drilling hole through exact center of small steel ball.....	196
Easy removal of tack welds assured with steel blocks.....	196
Shop sander makes quick work of polishing power tools.....	196
End-drilling long stock accurately.....	197
Leak in water pipe closed by welding.....	197
Rotary knife cuts perfect disks.....	197

NOTICE—It is the intention of this magazine to provide its readers with information regarding the latest developments in the mechanical arts. Except where otherwise indicated, this magazine has no information as to any unexpired patents in respect of the developments reported herein. In the event that commercial use is to be made of any of the developments reported herein, it is suggested that legal counsel be consulted to avoid liability for patent infringement. It is not the purpose of this magazine to encourage patent infringement but, as indicated, it is the intention of this magazine to report on the latest developments in the mechanical arts.

User reports **COOLER ROOMS** under **GLO-TALLIC ALUMINUM PAINT**

This residence roof in Atlanta, Georgia, was weatherproofed in one hour with a coat of bright, reflective Glo-Tallic, made with ALCOA® Aluminum Pigment. And the user reported that it cooled off the interior almost immediately—so much that the air conditioner in the rooms was no longer needed. Because aluminum paint turns back 70 per cent of the sun's heat, inside summer temperatures can be lowered as much as 15 degrees.

ALCOA Aluminum Pigments consist of minute, highly polished flakes—not granules, as in ordinary pigments. These flakes "leaf"—that is, arrange themselves in parallel layers five to ten deep. The top layer forms an almost continuous film of aluminum, an effective moisture barrier on weather-exposed wood, or sure defense against rust and corrosion on metal.

A high-quality aluminum paint like Boat-

wright's Glo-Tallic is easy to apply, indoors or out, and coverage is remarkable—500 to 800 sq ft per gallon. One coat hides any surface—metal, wood, brick, concrete—makes dingy walls clean, dark rooms bright, hot roofs cool.

ALCOA does not make paint, but ALCOA Aluminum Pigments are used in more aluminum paints than any other brand. Special formulas have been developed by paint manufacturers to solve individual problems. Paints made to these formulas actually cost less, last longer, give utmost protection against heat, cold, sun, rain, smoke and fumes.

Write today for our two **FREE** booklets, *Painting With Aluminum* and *Aluminum Asphalt Roof Coatings Make Time Stand Still*. They contain valuable, up-to-date information on all types of aluminum paint and aluminum asphalt roof coatings. Use the coupon.



It took one man only one hour to protect this roof with bright, reflective Glo-Tallic aluminum paint. Glo-Tallic aluminum paint, a quality product of

Boatwright Paint & Varnish Works, Norcross, Georgia, is so easy to apply—one coat covers any surface—stays bright and new-looking for years.



Aluminum Company of America, 1718-H Alcoa Building, Pittsburgh 19, Pa.

Please send me your **FREE** booklets:

- Painting With Aluminum*
 Aluminum Asphalt Roof Coatings Make Time Stand Still

I am interested in protecting _____

Name _____

Address _____

City _____ Zone _____ State _____

Does
your
engine
feel only
half-there?



Then see your

DOCTOR OF MOTORS

If the years and the miles have taken the power and punch out of your engine's horsepower—your Doctor of Motors knows how to make your engine feel *all* there—alert, responsive and fun to command!

Skilled mechanics everywhere restore that New Car Feel by installing Perfect Circle 2-in-1 Chrome piston rings. Here's why: Perfect Circles are plated with thick, solid chrome that resists wear—more than doubles

the life of cylinders, pistons and rings, and assures thousands of extra miles of driving pleasure and satisfaction.

For long life and responsive power with positive oil control, ask your mechanic to install Perfect Circle 2-in-1 Chrome piston rings in your engine. Perfect Circle Corporation, Hagerstown, Indiana; The Perfect Circle Co., Ltd., 888 Don Mills Road, Don Mills, Ontario, Canada.



You'll be surprised how quickly and economically your dependable Doctor of Motors can bring back a New Car Feel to your car.



PERFECT CIRCLE

2-IN-1 CHROME PISTON RINGS *restore that New Car Feel*

POPULAR AUGUST 1957 MECHANICS

WRITTEN SO YOU CAN UNDERSTAND IT
VOL. 108 NO. 2

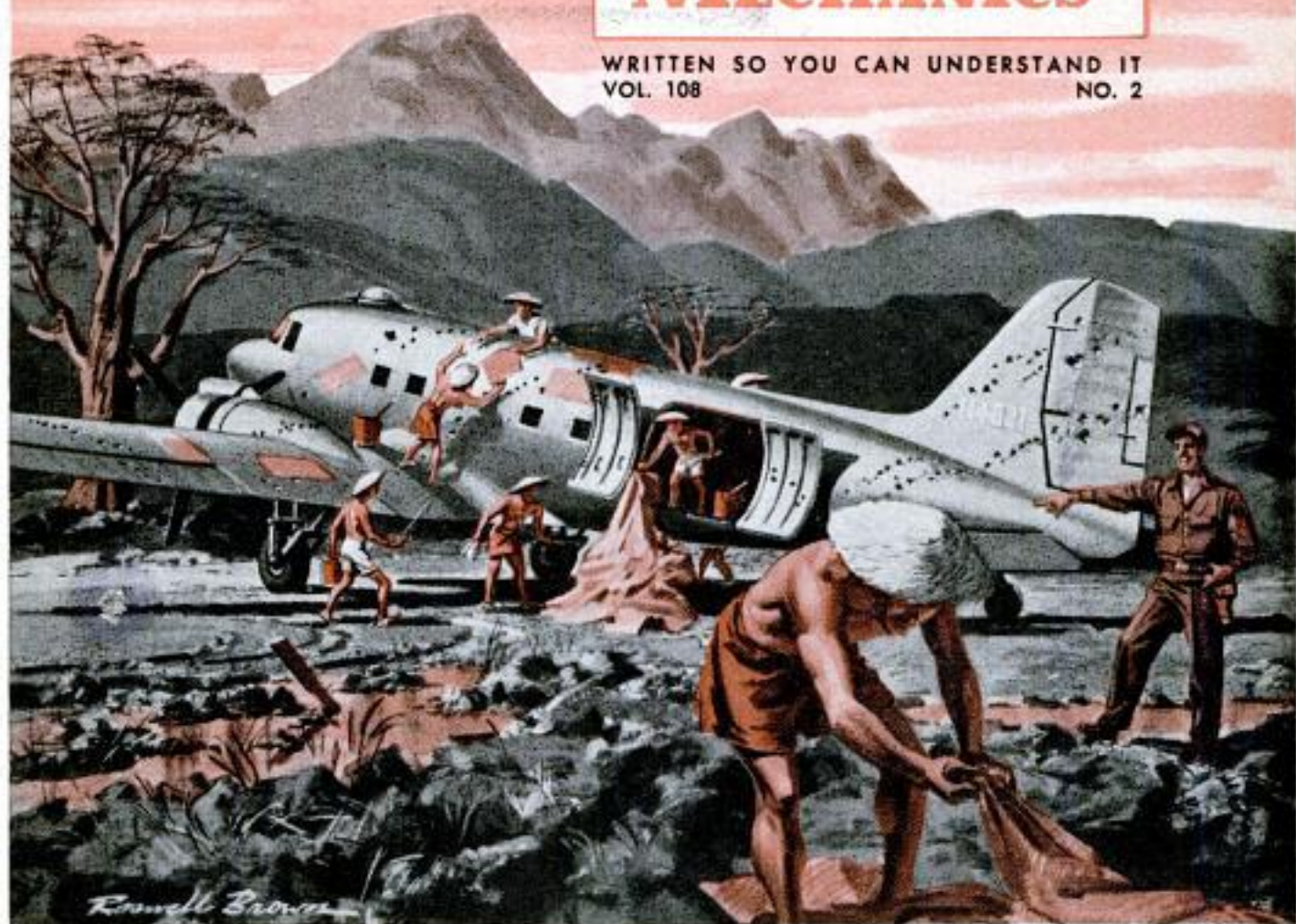

Coolies patched 1000 holes in the DC-3, but what happened to it in a storm shouldn't happen to a sieve

The Saga of the DC-3

By Joseph Stocker

Reprinted "FM Highlights"

THEY CALLED the airplane "Whistling Willie, the Flying Sieve." It happened in China during World War II when Jap strafers caught a DC-3 on the ground and riddled it with machine-gun fire. Coolies patched up about 1000 holes with pieces of canvas.

Then it took off for India with 61 refugees aboard, a plane that was intended—under normal circumstances—to carry 21 passengers and a crew of three.

En route the plane ran into a tropical storm. Rain loosened the canvas patches and wind passing over the holes caused a variety of shrill whistles which increased until the ship sounded like a thousand screaming banshees.

For two hours the intrepid airplane lumbered through hostile skies. Finally it landed. As its weary pilot swung to the ground, an Army major on the base came up to him and growled, "Why did you bother to radio ahead? We could hear you 50 miles away!"

To old-time pilots familiar with the DC-3 and its Herculean capabilities, this incident probably won't seem unusual. They've long since regarded the "gooney bird," one of their affectionate nicknames for the DC-3, as the world's toughest, longest-lived and most unconquerable airplane—an airplane that refuses to die.

It was in 1936—more than two decades ago—that the DC-3 was born. As the most



DC-2½, a Chinese "gooney bird" with its right wing blasted off, flew back to its base using a 10-foot shorter DC-2 wing



Snow almost engulfed an abandoned Air Force DC-3, but some young Icelanders waited for the right moment and flew it out

Gooney birds have been everywhere, done everything—they were even made amphibious with wheels attached to pontoons



efficient and economical transport produced up to that time, it revolutionized air travel.

Then came the Martins, Convoirs, DC-4s, 6s and 7s, the "Connies" and "Super Connies," the "Stratocruisers" and the Viscount jet-props and, more recently, the first of the jet transports. By all the rules of a fast-moving business, the DC-3 should have been obsolete and gone from the skies long ago. After all, how many 1936-model automobiles are still operating today?

But the old gooney bird isn't about to vanish. Of the 10,926 DC-3s manufactured by the Douglas Aircraft Co., some 4500 are still flying throughout the world. Thirty-four scheduled airlines in the U.S. and 113 foreign airlines are still using them. Additional hundreds are in use by non-scheduled carriers, private operators and the military of many nations. In both hemispheres, over countries civilized and not-so-civilized, gooney birds fly every day, carrying cargoes that range from coal to cattle and fish to flowers, not to mention, of course, people. And in Russia, where just about everything is claimed to have been invented, the plane most generally used for commercial travel is the Ilyushin LI-2, the Soviet version of the DC-3.

Accomplishments Immortalized

However, it's right here in the gooney bird's own native country that its accomplishments have become immortalized in aviation history. During World War II, despite the fact that it was already outdated, it proved to be both a hero and an almost indestructible workhorse. Even in the first desperate days of Korea, it flew tons of supplies to enable a thin line of defenders to check the unexpected Communist thrust. And during the peace years it carried America into the Air Age, spawned the cut-rate aircoach and airfreight era and gave more people their first ride in an airplane than anything else on wings.

Indestructible? Well, consider the DC-3 airliner over Arizona that was caught in a violent downdraft. More than 10 feet of its 95-foot wingspan was sheared off in flight when it struck the ground.



Air Force DC-3s (C47s) dropped thousands of paratroopers, tons of supplies on every front in World War II

But the pilot brought his storm-buffed plane and passengers in for a safe landing.

It seems that other extreme weather conditions can't keep this airplane from flying, either. The Air Force abandoned one on a high glacier in Iceland when huge snow drifts almost swallowed it up. But some young Icelanders, operators of a small airline, bought it as salvage for \$1600. The next spring they found that the snow, as it dried and froze, had shrunk away from the DC-3, leaving it as well-preserved as if it had been "mothballed." So they simply tracted a runway across the snow, climbed aboard, started and warmed the engines and took off. As far as the Air Force knows, that bird is still flying.

Then there was the gooney bird in Burma that was rammed at tree-top altitude by a pursuing Jap Zero. The Zero crashed, but the DC-3, with almost all of its rudder chewed away, flew on to its base. And it emerged from the war as the only transport plane officially credited with downing an enemy fighter!

DC-3 Restaurant Roof

Another DC-3 was used by a South African roadside restaurant owner who bought it as war surplus to serve as a roof for his building. It perched there for 12 years until an enterprising firm bought it, restored it and as far as is known it's still flying today.

Still, an airplane can't last forever—or so it seemed to the U. S. government's Civil Aeronautics Board. Hence, shortly after World War II, the CAB set a deadline when the DC-3 would not be certificated for airline use. Somehow, though, the gooney bird persisted in flying, and safely so. Three times the CAB extended its dead-

line. Finally, in 1951, it washed its hands of the whole troublesome business by decreeing that the plane could continue in service "indefinitely." And, as if to confirm its judgment, the Air Force shortly afterward gave Douglas an Exceptional Service Award, proclaiming the DC-3 as "the best single airplane ever built."

The gooney bird, or "Dizzy Three," as it's sometimes called, had its origin in a letter. It was a brief, two-paragraph note written in 1932 by Jack Frye, then vice-president of Transcontinental and Western Airlines, to Donald Douglas in Santa Monica, Calif. Would Douglas be interested in designing an air transport capable of carrying 12 passengers? Although occupied mainly with military airplanes, he decided to give it a whirl, resulting in the DC-1 (the letters stood for Douglas Commercial).

The DC-1 was a success. It flew from Winslow, Ariz., to Albuquerque, N. Mex., on one engine and broke 19 world's records. But only a single prototype was built. Even while it was being tested, Douglas went to work refining and enlarging it, and the result was the DC-2, a 14-passenger ship.

It, too, was a success. Don Douglas built 138 of them and might have kept right on building them except American Airlines thought he could do even better. What they wanted was a larger and more luxurious airliner.

Thus was born the DC-3, a 21-seater. "That figure 21," says a Douglas official, "was one of the happiest, luckiest figures we ever hit on."

Safe, Easy to Fly

Powered by two 900-horsepower Wright Cyclone engines, the plane was safer and

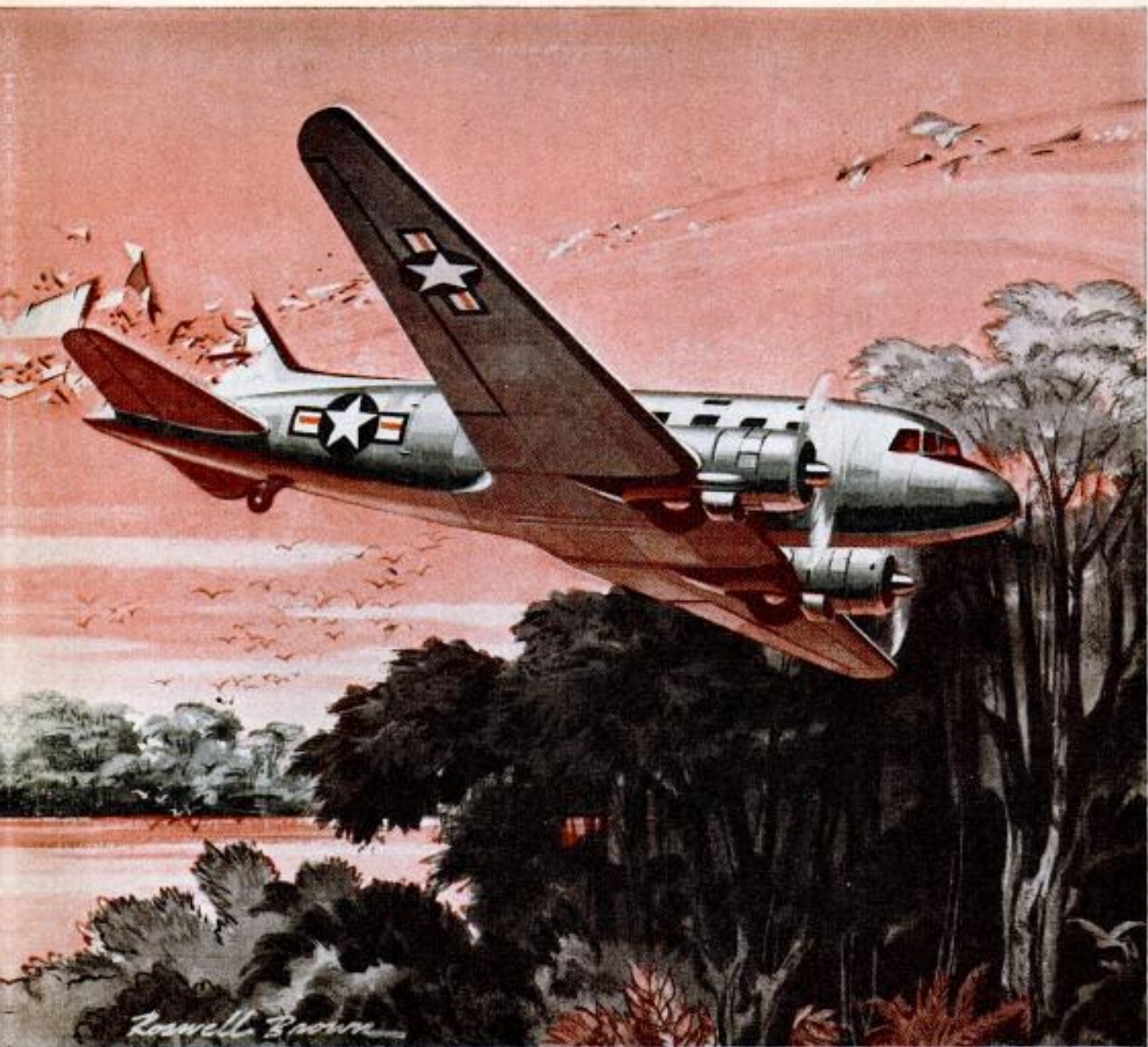

Invincible DC-3, rammed by a Jap Zero, made it back to base with its rudder gone . . . the Zero crashed

easier to fly than any other transport then in existence, and its pay load was one third greater. It cruised at 185 miles per hour and could clip off 210 in a pinch. Where other transports had to fly through storms, the DC-3 could fly over them. It had two separate sets of instruments in the cockpit, each independent of the other in case one failed. And, best of all, it had "George," the brand-new automatic pilot developed by the Sperry Gyroscope Co.

An eccentricity of the gooney bird, however, disturbed the pilots. The plane's wings had a slight but clearly visible tendency to flap while in flight. Accordingly, the pilots gave it another nickname, the "Flying Vagrant" (no means of support).

But their apprehension was soon relieved when they learned that the Douglas engineers had built this into the plane to relieve structural wing tension. In fact, one of the early DC-3s was flown into what appeared to be an innocent accumulation of clouds. But inside was a freak downdraft so severe that passenger seats tore bolts from the floor. Yet the plane made it and afterwards no structural defects could be found.

This wing tension feature proved to be a major reason for the plane's extraordinary durability.

Eccentric or not, the DC-3 was an immediate success. Airline after airline, here and overseas, converted to it—and just in



time, too. For the wolf was clawing at the collective door of commercial aviation. Transports then in use were slow, uneconomical and unreliable. Timetables were a joke. And crashes frightened the public away from flying.

But thanks to the DC-3, public confidence soared, and so did the airlines' profits.

Don Douglas originally thought he would produce only 50 gooney birds. Then, when airline presidents began lining up at his office door, he revised his estimate and calculated that he might be able to sell 500. He doubted then if the market would absorb much more.

But he didn't figure on a second world war.

When it broke out, the Allies desperately needed air transports. Manufacturers were already making four-engine planes, but they weren't far enough along yet. The DC-3, on the other hand, was in business. Its "bugs" had long since been ironed out. And so orders poured in at Douglas, and DC-3s poured off the assembly lines, hastily donned their wartime coats of olive drab and flew off to the war.

Dressed in this uniform, with its familiar "bucket" seats, the DC-3 was known variously as the "Three," "Old Fatso," the "Doug," the C-47 (Air Force version), R4D (Navy) and the Dakota (British). Years later a well-known general named Eisenhower called it something else. He said it had been one of the most valuable weapons of the war.

It was truly that. It hauled men and supplies to every battle front and brought back litters of wounded. It re-opened the life line into China by hurdling the Hump in some of the worst weather on the face of

For 12 years a war surplus gooney bird served as the roof of a restaurant, and then it flew again





Crash-landed DC-3 is salvaged with the help of New Guinea natives who dragged it out of heavy jungle

the globe. It dumped paratroopers behind enemy lines and pulled gliders full of troops. It was shot at and shot up, and still it flew.

One gooney bird set some kind of a record by taking off from Burma with 74 people aboard, including Jimmy Doolittle, on his way home after bombing Tokyo. The ship had been airborne just a few minutes when Doolittle poked his head into the cockpit. "If I'd known you were crazy enough to try to fly this thing with this many people aboard," he said, "I'd have walked home."

DC-2½ Flies

But perhaps the most valiant gooney bird of all was one belonging to the China National Aviation Corp. Jap bombers spotted it on the ground and blasted a wing off. The pilot radioed Hong Kong and requested a new one. But Hong Kong had only a DC-2 wing—10 feet shorter and designed to carry a load several thousand pounds less than a DC-3 wing. "Okay," said the pilot, "bring that."

The wing arrived and was attached to the DC-3. The plane looked weirdly lopsided, but when its pilot leaned forward on the throttles, it took off and flew like a charm.

What did they call it? Why, the DC-2½, of course!

The exigencies of wartime forced fliers to do quite a number of things with the gooney bird that would have given Douglas engineers the willies if they'd known. The ship had been designed, for instance, to carry a maximum load of 25,000 pounds. But pilots couldn't always afford this luxury. For example, when 27 DC-3s crossed the South Atlantic in 1942, bound for the Hump in history's first mass ocean flight, they lurched off the runway with 35,000 pounds each.

On at least one occasion the gooney bird was used as a bomber. Some Air Force pilots, tired of being sitting ducks for Japanese anti-aircraft fire over the Hump, loaded up one night with old carbide and gasoline drums, plus a few fortifying fingers of alcoholic "jungle juice." Then they flew over a Jap airfield in Burma, unloaded their homemade bombs, fired Tommy guns and carbines through the cockpit windows and flew merrily home. They were court-martialed for unauthorized use of government equipment and really didn't care.

When the war ended, four-engine airplanes were the vogue. Douglas produced its last DC-3 in 1946 for a Brazilian airline, and figured that was about the end of the old gooney bird.

But they figured wrong again. For, instead of going to the junk heaps, war-surplus DC-3s were snatched up by the thousands, at bargain prices, and put back into operation. Feeder lines bought many of them and opened up rural America to air travel. They've been in operation ever since.

This is explained to some extent by the fact that the gooney bird can get into and out of short landing strips. And these predominate in many remote parts of the world, especially South America, Asia and Africa. Thus, the DC-3 is—and, for a long time will continue to be—the backbone of air travel in those regions. As one pilot put it: "Millions of people in South America were familiar with the DC-3 before they ever saw an automobile. Two thirds of the people in Central America have had their traveling eyeteeth cut on the DC-3, but have never ridden on a train nor seen one."

Every now and then there's talk of some new twin-engine transport which, it is confidently said, will supplant the DC-3. But so far it hasn't been replaced.

(Continued to page 232)



Accordion-Pleated Bus Bends for Corners

Buses with accordion pleats in the middle are being used in Colorado. Built in Germany of steel and aluminum, the buses are 60 feet long, carry 64 passengers and are powered by horizontal-type diesel engines. A central turntable enables the rear section of a bus to follow the front section. The turning radius is less than 40 feet, compared to the 60-foot turning radius of most buses. Ten wheels support the chassis, which has a conventionally steered front axle and a "self steering" rear axle.



Bus hostess prepares light refreshments for the passengers

Caddy Cart Has Dial to Select Club

Dialing to obtain the desired golf club from an aluminum container is the latest caddy-cart innovation. Turning the dial indicator to the club number exposes the club for removal through a slot in the container. It holds 10 irons and four woods in separate clips on a rack inside the protective housing which is rainproof and detachable from the wheels for storage. The cart also features a permanent score card etched in the metal top of the container and a built-in shock-absorber spring.

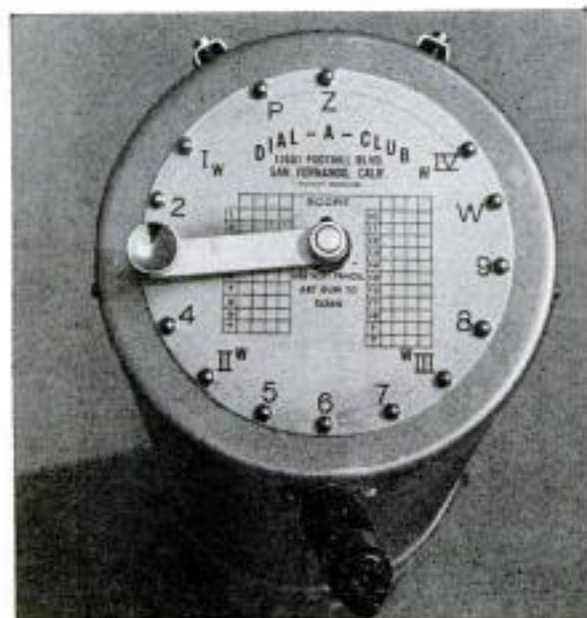

How You Can

To calculate little moon's orbit, place globe so hoop makes angle of 35 degrees with equator. Photos show earth's movement for every two satellite revolutions

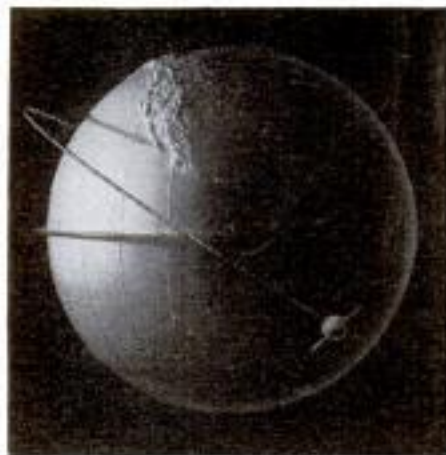

Lower photos show how the satellite's orbit wobbles as it revolves around the earth. Fifty days after satellite starts on its journey, the orbit will be back on its original plane again

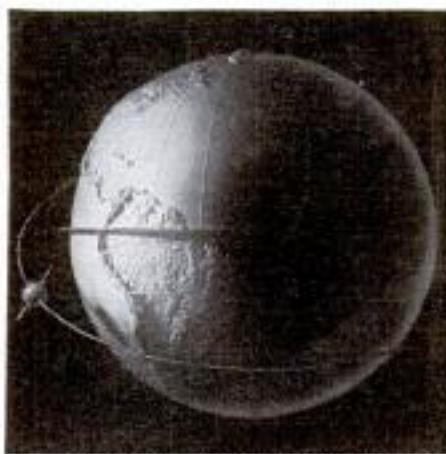
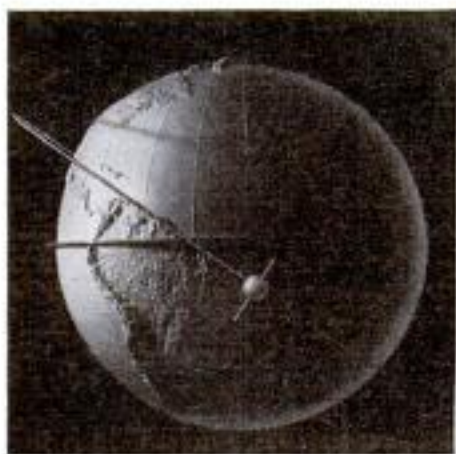

Globe by Geophysical Map Company, Inc.

DURING THE NEXT 18 months, half a dozen 72-foot three-stage Vanguard rockets will roar skyward. If scientists are lucky, at least one of those mammoth vehicles will soar 300 miles up, reach a speed of 25,000 feet per second and fling into space a 21-inch gold-plated magnesium manmade moon weighing 21½ pounds.

Within minutes after the first successful rocket stands on its tail above a column of fire at Cape Canaveral, Fla., the satellite will be orbiting. The job of finding it and plotting its course will be a tough one—about the same, in fact, as trying to locate a golf ball spanning the sky in 45 minutes at 60,000 feet.

Solution of this problem will be met by two radio and two optical programs. The Minitrack radio system and big Baker, Nunn telescope cameras will provide official ears and eyes. The other two programs

will be carried out entirely by amateurs, assisting International Geophysical Year scientists by providing additional sky coverage.

Plans are being made available for a radio receiver which "hams" can use to pick up signals from the satellite.

Diagrams and directions for an official "moon watch" telescope you can build yourself are detailed on page 170. Qualifications for official moon watchers, the amateur visual observers of the program, are described below. They are necessarily rigid. But even if you don't qualify for an official team in your area, the telescope will provide a fascinating sky instrument. With it you can track the satellite for your own satisfaction and go on to discover the fascination of stargazing long after the satellite has disappeared.

To bring interested readers all available

POPULAR MECHANICS

Naval Research Laboratory
Washington, D. C.

Spot the Satellite



By Richard F. Dempewolff



information regarding amateur participation in the satellite visual-observation program, *Popular Mechanics* asked the project directors to answer a series of pertinent questions regarding who can join, how to join and how to moon watch for the program—or just for fun.

Who will be able to see the satellite?

In the United States, anyone south of an imaginary line running from New York City to a point on the West Coast about 150 miles north of San Francisco should be within view of the planned orbit on several occasions during the satellite's life. Present plans call for the sphere to orbit between the two fortieth latitudes. People slightly beyond the fortieth latitudes may spot it during twilight hours in good weather.

Can the satellite actually be seen with the naked eye?

The sphere's gold-plated magnesium skin

will be highly polished to reflect the sun's rays. However, it is so small that at 300 miles it will have a magnitude of only six or seven, the same as the faintest star that can be seen by the naked eye under ideal weather conditions. Since the orbit will be elliptical, carrying the satellite on a course between 300 and 800 miles from the earth's surface, it is highly doubtful that many people will see it without optical aid. At 800 miles it will be as faint as a 9th or 10th-magnitude star, and virtually invisible. However, an inexpensive pair of six-power binoculars, or a small homemade telescope such as the one shown in this issue of *Popular Mechanics*, is all you'd need to bring the sphere into visibility.

What will be the best time to see the satellite?

The satellite can only be observed visually during evening or morning twilight,

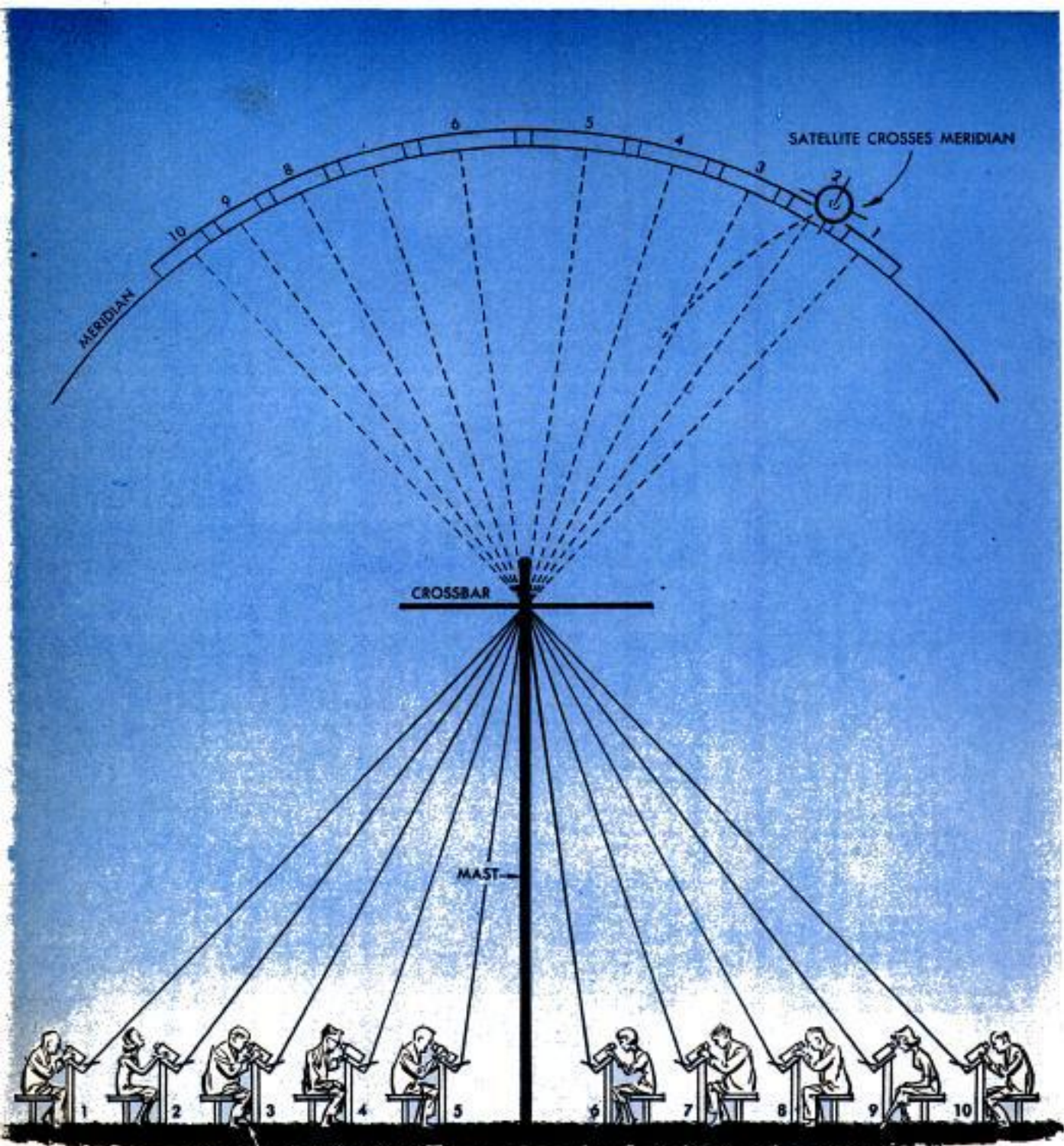

THIS MAN SEES SATELLITE FIRST

Drawing shows a typical setup for a "moon watch" team. Each watcher covers an assigned sector of the sky

when the observer is in the shadow of earth's rim, while the sphere, above the shadow, is illuminated by bright sun. Appearance of the satellite during these twilight periods is not always guaranteed. Motion of the sphere's orbital plane, plus rotation of the earth, and the earth's own movement around the sun, present a complex pattern of constant change. You can do your own predicting of the satellite's probable location from day to day with a

globe, a wire hoop from a lampshade (about six or eight inches larger in diameter than the globe) and a flashlight to simulate the sun. With the light fixed a few feet away to shine on the globe from one side, here's what you do:

1. Fasten a clamp on the hoop so it stands on a table as shown in the illustration on page 75.
2. Cut "legs" in a coffee can that has had its top and bottom removed so that it fits over hoop and clamp.

3. Trim the top of the can so that when the globe is placed on it, the globe rests approximately in the center of the hoop.
4. Place the globe on the can so the equator lines up with the hoop, then twist the globe slightly until the equator makes an angle of about 35 degrees with the line of the hoop. Daub white paint on the wire hoop at the two spots, top and bottom, where it crosses the equator.
5. The hoop represents the satellite's orbit. Now, since the satellite starts from Florida, mold a little ball of clay or putty on the hoop above this point on the globe.
6. You're ready to start projecting the satellite's day-to-day orbit. In a darkened room, the light shining on the globe's left side will create detectable "twilight" zones, between lighted side and dark side, where the satellite should be visible on its rounds.
7. During one revolution of the satellite, the earth will rotate 1700 miles eastward. Make believe the satellite has completed one orbit. Don't move the hoop yet. Instead, rotate the globe 1700 miles (about 25 degrees in longitude lines at the equator) eastward. Note how the twilight zone, where the satellite is visible from earth, has moved westward.
8. But another change occurs, too. The entire tilted orbit of the satellite swings around the earth like the wobble of a coin settling to a table top. For every revolution of the earth, you must turn the hoop so the white markers move about $6\frac{1}{2}$ degrees westward along the equator. The area beneath the hoop where it crosses the twilight zone is where the satellite will be visible after one revolution. By continuing this procedure, you will get a graphic picture of where, from earth, the satellite will be visible during successive revolutions, provided it is on the course planned for it.

The picture sequences at the beginning of this article show how successive motions of satellite, earth and orbit create a constantly changing pattern. When twilight occurs under the satellite's perigee (300 miles above the earth), the earth's shadow will not miss it by much. So there will be only 40 minutes to watch for it before darkness sets in and shadow consumes it. Morning twilight under perigee will also last only 40 minutes before the earth's surface speeds eastward into full daylight. By the same token, at apogee (800 miles above earth), the satellite will be high above the earth's shadow across a wide arc of sky, and there will be at least 100 minutes of observing time, during which a lucky spotter may see the sphere pass overhead twice.

How long will the satellite stay aloft?

Nobody can be sure. Several months is a safe guess. The answer to this question depends partly on the density of earth's outer atmosphere that will act on the satellite to slow it and eventually bring it

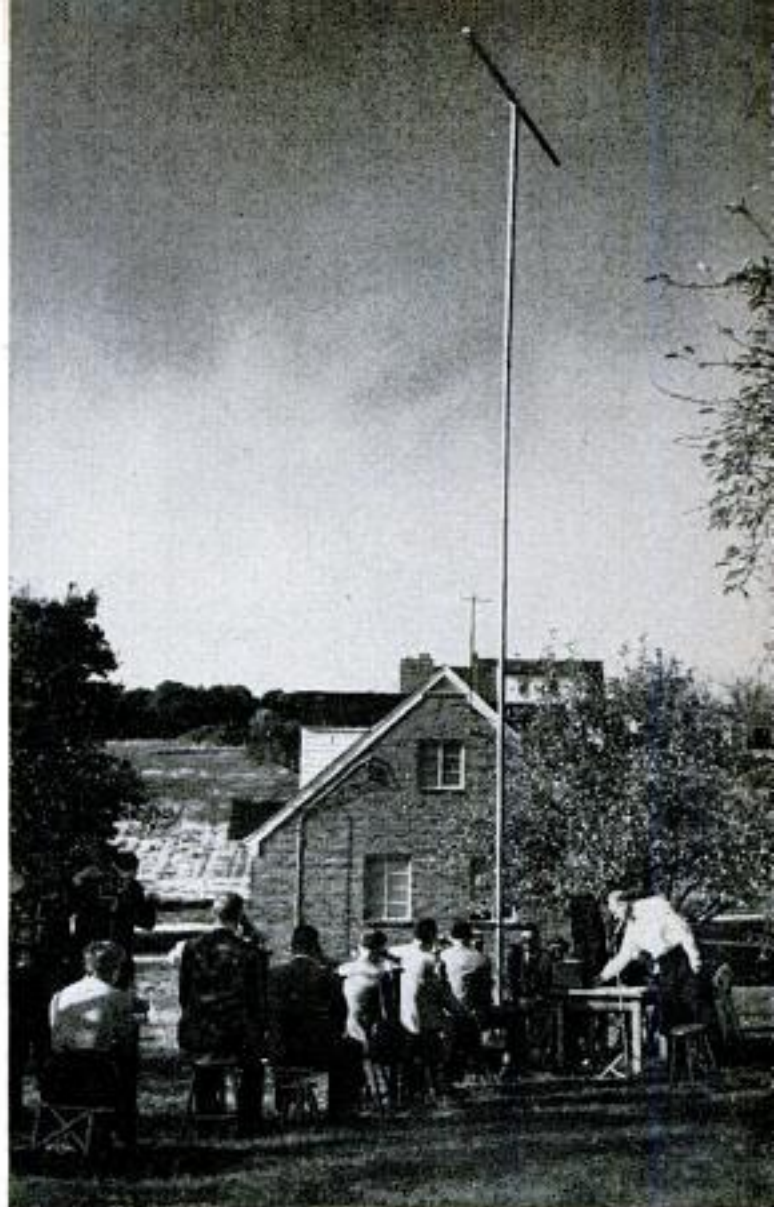

Rehearsal for moon watch. The reflecting telescopes are aimed at the intersection of crossbar and mast

Coffee can, wire hoop from a lamp shade and a school globe can be used to calculate satellite's orbit and predict places on earth where little moon can be seen



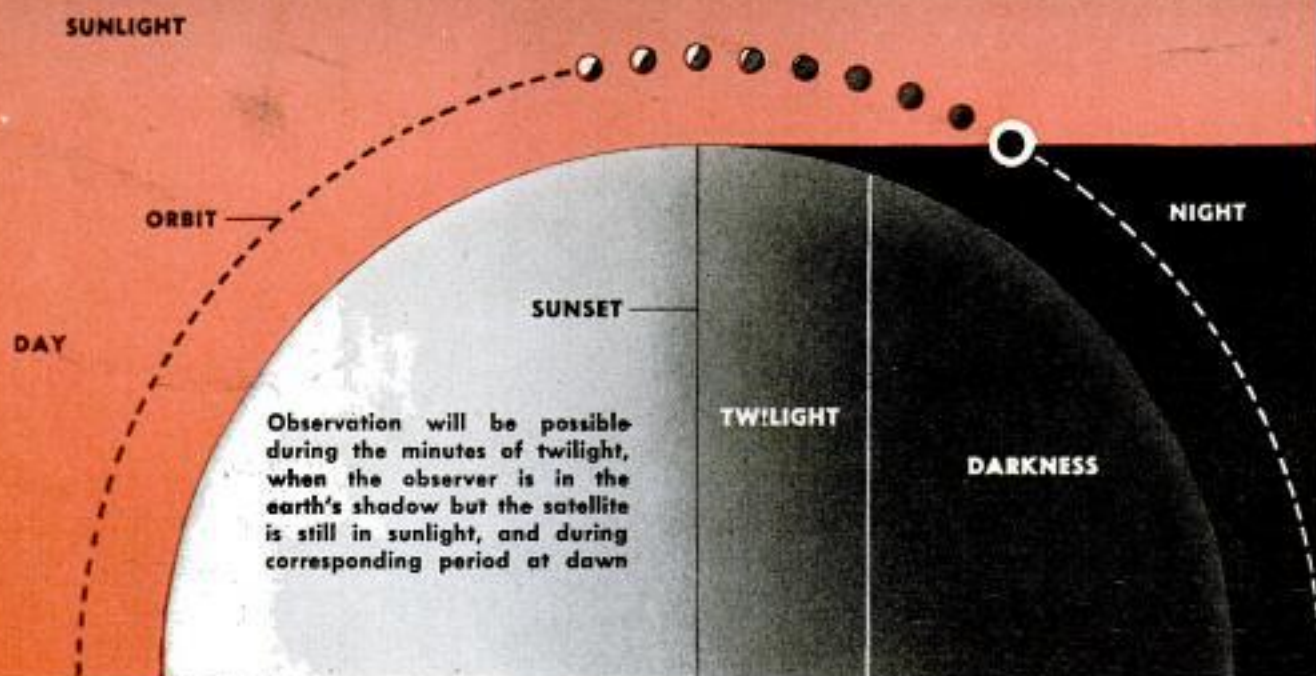

plummeting downward. This is something we know little about, and one of the things that the satellite will tell us by the way it behaves.

Can any interested amateur sign up for work on a moon-watch team?

Dr. Armand Spitz, coordinator of visual operations for the program, has invited interested amateur astronomers to participate in operation moon watch. Due to the

satellite's life will depend upon altitude achieved. Recent calculations indicate outer atmosphere may be much thinner than previously believed, so estimated lifetimes shown here may be considered conservative

technical aspects of the work, only truly competent stargazers should apply.

How is operation moon watch set up?

Since a precise observation of the satellite's position is useless unless the observer's exact geographical position is known, it has been necessary to organize "fences" of volunteer observers along certain meridians on the earth's surface. These observers, sitting in a north-south line are arranged so that they cover a single arc of sky by aiming their telescopes through a point on a 35-foot mast, as shown on page 74. Each man covers only 12 degrees of sky along the line, with little overlap. Hence, only one or two men on any team will see the orb cross his scope. When a man sees the tiny pin point of light enter his rim of vision, he calls "I see it." When it passes out of view, 10 to 20 seconds later, he shouts "I saw it." Recorded on tape, via lapel microphone, along with continuous radio time signals from a short-wave set beside the observer, the shouted signal will enable experts to compute the position and course of the orb in space, since the exact position of every moon-watch telescope is known. The "see" and "saw" code, incidentally, has given this phase of the project the nickname "operation see-saw."

Can anyone with a telescope send in position reports to help?

Because of the precision required, the central computing bureau can only accept observations sent in by the leader of a moon-watch team. Hence, no "lone wolf" can contribute usefully. Moon-watch alerts will be held during twilight hours. Planes equipped with a small light approximating

(Continued to page 234)

LIFETIME OF SATELLITE

300 miles: almost one year

200 miles: about 15 days

100 miles: less than one hour



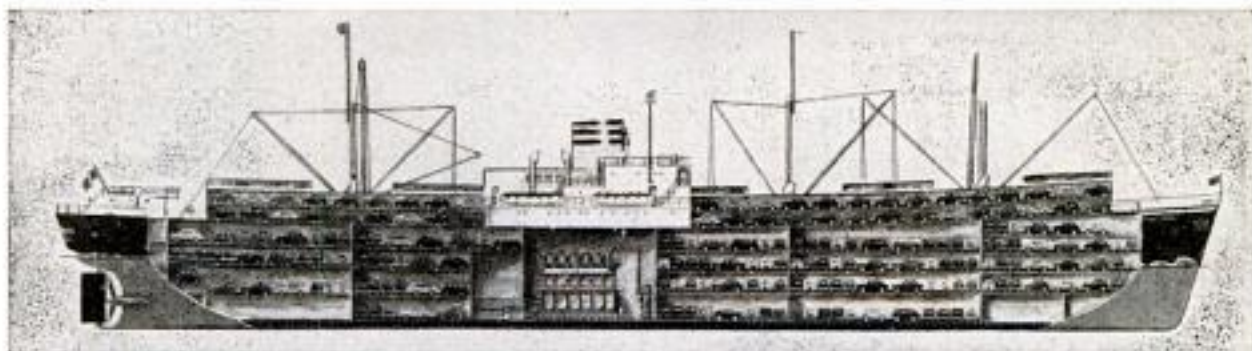

Italian Ship Carries 1000 Cars

Italterra, a 7155-ton Italian freight vessel, now is being converted at Genoa into a ship that will carry only cars — 1000 of them. With this capacity, the *Italterra* is said to be the world's largest car carrier. The craft will be used in the exporting of Italian-made cars, and is expected to cut shipping costs.



Quick-Starting Charcoal Package Burns 90 Minutes

Completely sealed and dustproof box of charcoal briquets, below, needs only a lighted match to start a glowing barbecue fire that lasts an hour and a half. The molded pulp package has vent channels on the bottom, plus a center chimney. After

five minutes, the box has burned away. But the back-yard chef should wait until the briquets are covered with grey ash before spreading them into a bed of glowing coals. The package contains enough charcoal to barbecue two big steaks.





From East Germany comes the P-70 coupe with a plastic body, steel roof

IRON CURTAIN CARS



Below, the Wartburg convertible combines a folding roof with a transparent hardtop

Two toning gives the Wartburg station wagon a stylish look. It has a three-cylinder engine



Below, sleek and small, this sports roadster has a top speed of 85 miles per hour. None of these cars is sold in the U. S.



CARS from behind the Iron Curtain are beginning to show signs of luxury and style. Here are some examples:

The P-70 coupe has an all-plastic body with a steel roof supported by slender steel pillars. Its water-cooled 42-cubic-inch engine develops 22 horsepower. Top speed is about 60 miles per hour. It has front-wheel drive.

The Wartburg wagon has wrap-around side windows at the rear and a folding panel in the roof. The seats recline and lie flat to form a double bed. The body is designed to appeal to campers and sportsmen. The three-cylinder two-stroke engine has a power rating of 37 horsepower.

The Wartburg Bellevue combines the convertible with the hardtop. The forward-hardtop portion of the roof is transparent. It is claimed that you can light a cigarette in the back seat with the roof down at 60 miles per hour.

An East German sports roadster looks like a version of the Mercedes 190SL. It, too, is a three-cylinder front-wheel-drive design rated at 50 horsepower. Top speed of this sporty car is said to be about 85 miles per hour.



"Shuttle Darts" Game Tests Catching Skill

Two hand-held dart boards and a shuttlecock with a rubber suction cup are used in a new Australian game called "shuttle darts." Each player holds one of the target boards. Standing from 20 to 60 feet apart, the players alternately throw the shuttlecock at the target held by their opponent,

above right. The catcher tries to land the shuttlecock on the bull's-eye of the target, above left, for a score of three points. Less accurate catches count two and one points. Each player must throw the shuttlecock within the other person's "reasonable reach."

"Freeze Dry" Foods May Be Stored in Cupboard

Laboratory "freeze dry" methods soon may provide spoilage-free foods and medical supplies. Raytheon Manufacturing Co., Pittsburgh, Pa., is testing electronic processing equipment (below) which preserves fresh and cooked foods for storage at room temperatures without refrigera-

tion (below right). The freeze-dry method is similar to what happens to laundry drying outdoors in freezing weather; moisture changes from the frozen state to vapor, which is removed. Immersed in water, the "re-hydrated" foods can be cooked without loss of flavor, texture or nutrients.





Scientists, above, check samples at railroad laboratory. Weatherometer, below, reproduces entire summer of heat and rain within a few hours to test the quality of paint

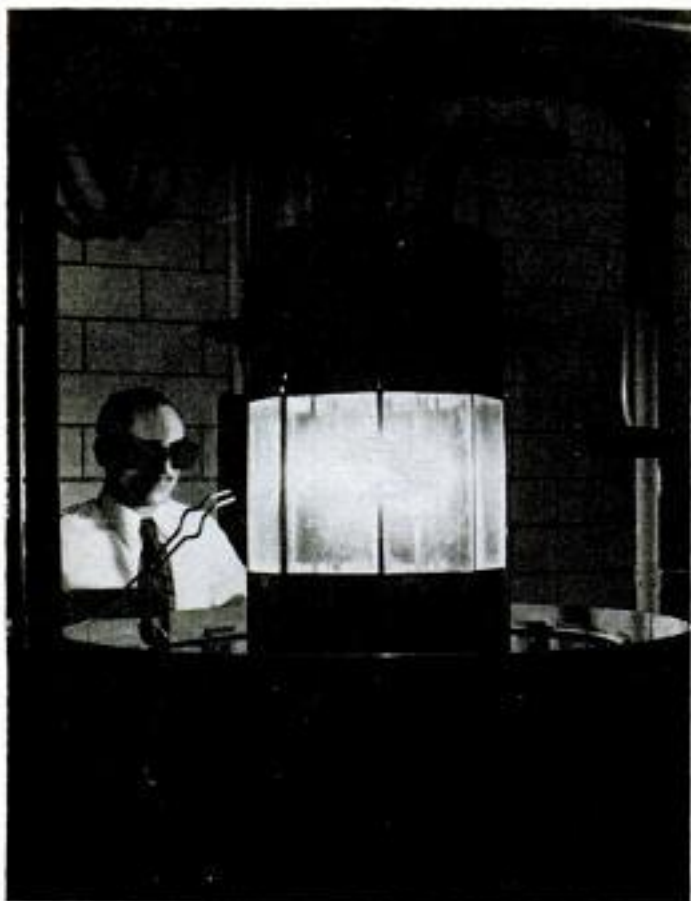

Railroad Laboratory Cuts Operating Costs

HOW DOES A RAILROAD know when it's time to overhaul a big diesel locomotive? Scientists at the New York Central lab find the answer by burning a sample of lubricating oil in an electronic spectrometer. The instrument automatically records the presence of any of 16 chemical elements. If the device indicates even a trace of copper, the research workers know there is a worn bearing. Silicon in the oil usually means a faulty air filter is letting dust from the road bed into the wearing parts. Boron indicates that water is leaking into the oil. The technicians also analyze samples of diesel fuel to determine what organic material is in it which, in turn, indicates how well it will burn. A typical day's collection of samples of fuel and lubricating oils, as well as worn parts, is shown in the photo, above left. The New York Central estimates that chemical analysis of lubricating oils saves \$16,000,000 a year in the cost of locomotive overhauls. Analyzing fuel oil permits the railroad to burn non-premium fuels at one to two cents a gallon below the price of premium diesel oil. Since the railroad consumes about 22 million gallons a month, the savings in fuel costs also amount to millions of dollars a year. The laboratory also is testing a new-type gas turbine that burns inexpensive powdered coal.

Research technician, below, experiments with track switches to be used in automatic yards

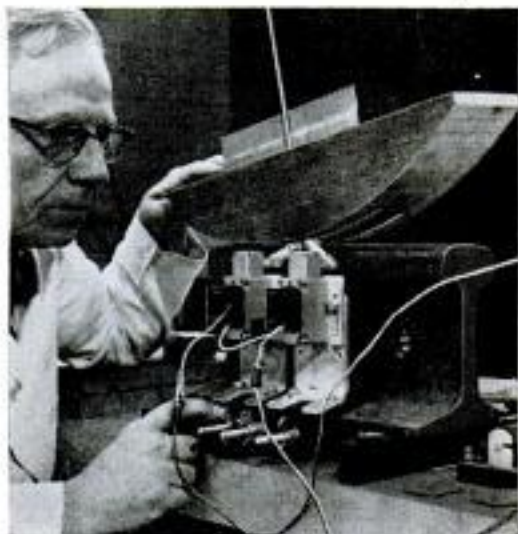



Guided-Missile Cruiser Gets Super "Eyes"

Two super-radar units, able to scan the air many miles beyond the horizon, have been installed aboard the guided-missile cruiser USS *Canberra*. They will be used in the detection of potential enemy supersonic aircraft, and in the guidance of ship-to-aircraft Terrier missiles, four of which are shown in their launching position in the photograph above. In the photograph at right, one radar is facing the camera, while the other is directed up in the air. The radars can track different targets simultaneously and control missiles fired singly or in salvos.

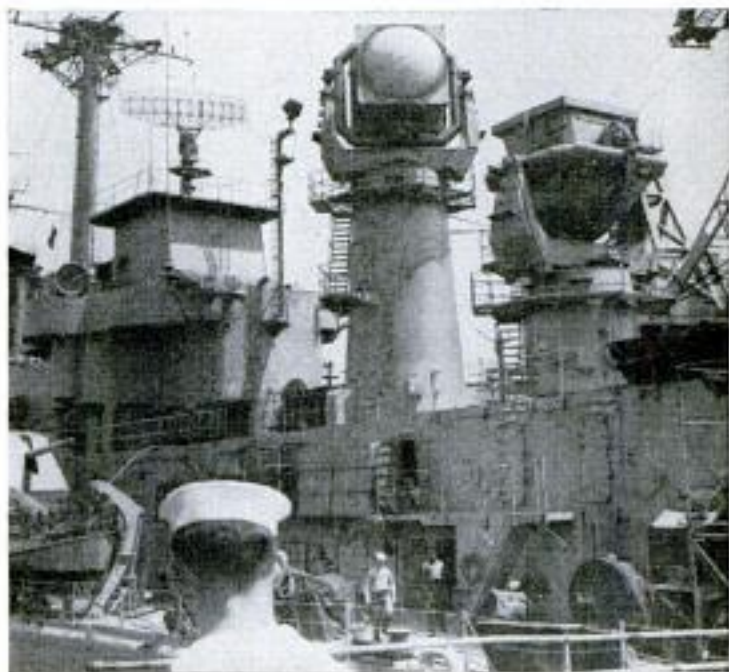

Mountain Models Locate Oil Pools

Forces that wrinkled the surface of the earth to produce mountains can be simulated by a machine developed by scientists at the Gulf Oil Research Center in Pittsburgh, Pa. The machine-built miniature mountains help oilmen study the types of mountainous structures likely to conceal oil pools. Sheets of clay compounded to represent the strength, density and other qualities of rock strata are deposited in the machine. Pressures are applied against the sides of the box and mold the earth model into folds representing hills and mountains. The process can be stopped at any stage of "mountain building" while scientists study cross-sections of the "underground" strata.





Miss Thriftway, 1956 Gold Cup winner, paces Hawaii Kai III by length at Lake Mead

Gold Cup Racers Aim at 200 Miles per Hour

By Kent Hitchcock

Honorary Vice-President, American Power Boat Association

Salvage equipment and skin divers work fast to recover expensive boats that capsize at races and regattas

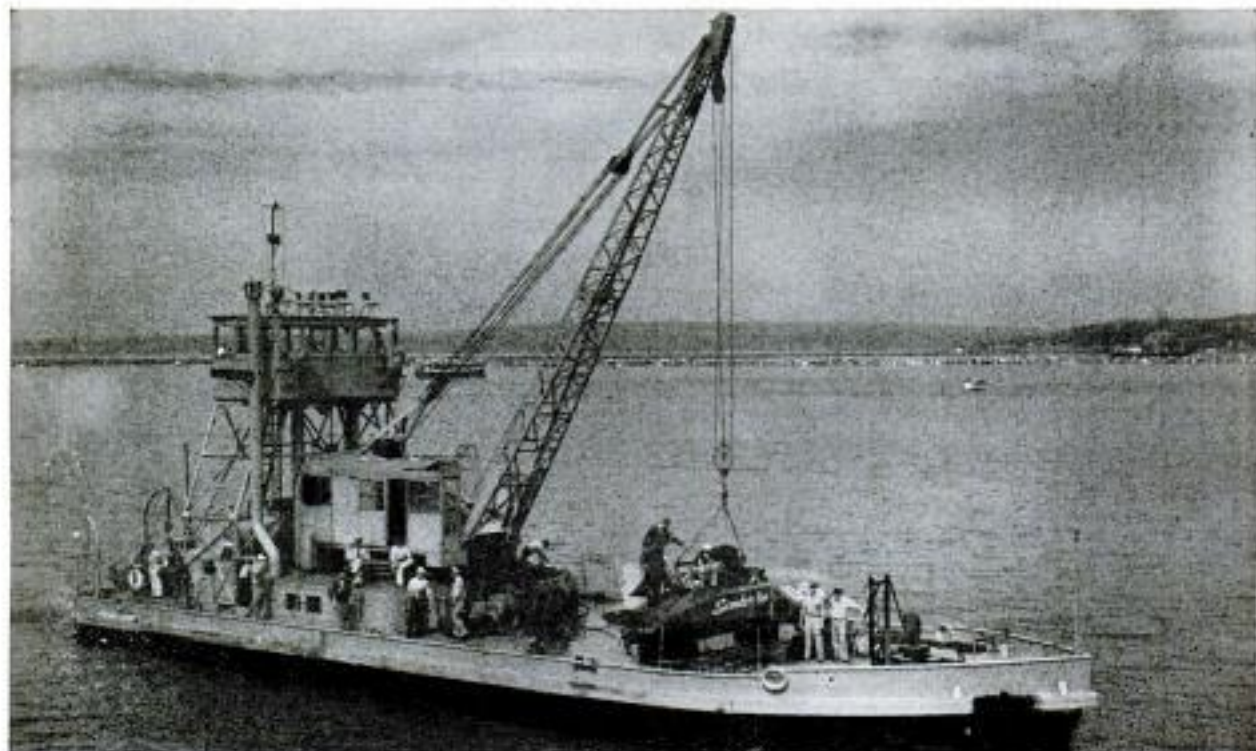



Fabulous *Slo-Mo-Shun IV* had big air fin to help boat track straight at high speed. Ted Jones is at wheel

THRILLS and excitement—the roar of powerful motors—the flying “rooster tails” and the terrific speeds—these are the ingredients that have skyrocketed unlimited hydroplane racing as a spectator sport. Two million people will watch the big jobs race before the end of this season and a vaster audience will watch and listen over TV and radio.

The unlimiteds, often called the Gold Cuppers, are shoving the 190-mile mark on straightaway runs. Experts think a new world record of around 200 miles per hour for propeller-driven boats will be set this year.

The annual contest for the Gold Cup is the big race. Unlike any other trophy in speedboat racing, the Gold Cup is defended on the home waters of the winner of last year's race. *Miss Thriftway* of Seattle won the cup in Detroit in 1956, so this year Seattle plays host. Half a million frenzied spectators will jam the shore line adjacent to the course and hundreds of private boats will be tied rail-to-rail in every available location.

After Seattle the unlimiteds will race in Detroit August 31 for the Silver Cup, an event that annually draws some 350,000 spectators. The race for the President's Cup on the Potomac is next, followed by the International Cup race at Elizabeth City, N. J., with the



Hawaii Kai III carries big Rolls-Royce engine for power. Below, Allison aircraft engine is power plant of most unlimited hydroplanes. The engine has 1700-cubic-inch displacement and develops a whopping 2500 horsepower when “souped up” for racing

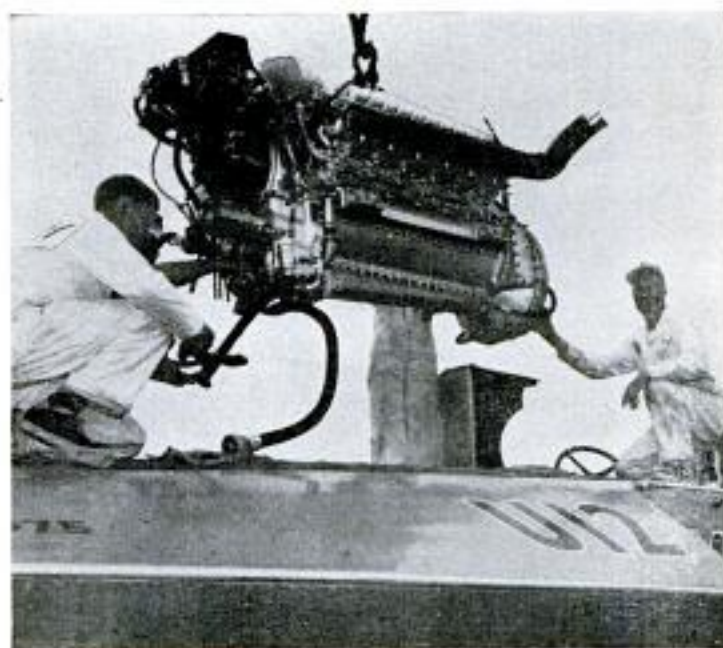

TRIM TAB PREVENTS
"PROP WALKING" TENDENCY

HORIZONTAL STABILIZER
PROVIDES LIFT TO HELP
KEEP BOAT IN
"PROP RIDING" ATTITUDE

STABILIZING FIN

SHAFT BEARINGS
LUBRICATED WITH WATER
PUMPED UNDER PRESSURE
FROM ENGINE

WATER-SPEED
INDICATOR CABLE

SIDES ARE 3/8-INCH
FIVE-PLY MAHOGANY

RÜDDER IS OFFSET LEFT
— UNLIMITED HYDROS
ALWAYS TURN LEFT

BOTTOM IS 1/4-INCH
FIVE-PLY MAHOGANY
WITH SHEETING
BONDED TO IT

"CHOPPER" TYPE PROPELLER
TURNS 12,000 REVOLUTIONS
PER MINUTE

"VENTILATED" SPONSON

SPONSON FIN
HELPS PIVOT BOAT
WHEN TURNING

V-SHAPED SPOILER
UNDER BOW

THRIFTWAY, TOO



Above, Miss Thriftway, 1956 Gold Cup winner, carried driver in "conventional" place aft of the engine. Below, Thriftway, Too showing driver in the cockpit at forward end of the boat



season winding up at Lake Mead, Nev., with the Sahara Cup race October 12 and 13.

All this is a far cry from the dreary unlimited picture of 10 years ago. The fastest heat in the 1947 Gold Cup race was turned at an average of 56.8 miles per hour by a boat powered by a 1500-horsepower engine. Meanwhile the little 135-cubic-inch hydros were averaging 70.5 miles per hour with tiny Ford V-8 "60" engines. Spectators stayed away from unlimited racing.

Curiously, the boat that changed the whole Gold Cup picture and that set phenomenal records on the water was conceived as a pleasure boat. In fact, it was used strictly for pleasure until its owner, Stanley Sayres of Seattle, found he was breaking the world record every time he took a friend out for a spin.

The extraordinary craft was designed by Ted O. Jones, who was working at Boeing at the time and who applied aircraft engineering principles to the three-point hydroplane design. The boats are called three-pointers because at high speed they ride on the trailing edges of their two outboard

sponsons and on one blade of the propeller.

The hydros are tricky. If the bottom of the hull isn't shaped exactly right the boat will not get up off the water. On the other hand, too much air under the hull makes the boat kite and possibly flip backward.

Slo-Mo-Shun IV, the boat Jones designed for Sayres, looked much like the other hydros but there were some important differences. *Slo-Mo* trimmed out in perfect balance at high speed. It had a "spoiler" under the bow to break up the flow of air and keep the bow from rising too high. There was a big air fin to help the boat track straight at high speed, offsetting the sidewise thrust of the propeller.

The unlimited hydros had a tendency to break apart in rough water even though their speeds were not sensational. They were heavy, but poorly reinforced. Jones used aircraft principles of construction to produce a light boat that could take a beating and not fall apart. Tanks and instrument installations were other sources of failure, and again Jones went to aircraft procedures.

At high speeds a floating pop bottle or a small piece of drift will smash right through the bottom of a racing hydroplane. Jones sheathed the sponson runners and the bottom of the hull with dural plate. He put in a special gearbox to reduce the chance of mechanical failure. He installed hydraulic steering and placed the rudder to the left of the centerline to get it out of the prop wash.

After a number of trials and adjustments, *Slo-Mo* got up and literally flew across the water. Sayres found that the needle of his water speedometer was banging against the pin on every run, and the speedometer was calibrated to 150 miles per hour. The boat rode so smoothly that it seemed impossible to Sayres that he could be going faster than the world speed record of 141 miles per hour, set by the late Sir Malcolm Campbell in 1939. And he was using a stock Allison aircraft engine.

The speedometer was checked and found accurate. A special 200-mile-per-hour speedometer was built for the boat, the first ever designed. *Slo-Mo* went on to set a world speed record of 160.323 miles per hour and later won the Gold Cup and Harmsworth Trophy races.

Today, unlimited hydroplanes designed by Ted Jones hold every unlimited record in the book and most of the important cups and championships. Even the boats designed by others show the Jones influence. The annual battle for the Gold Cup has become a feud between Seattle and Detroit, home of many of the fastest Eastern boats.

In the past you virtually needed to be a

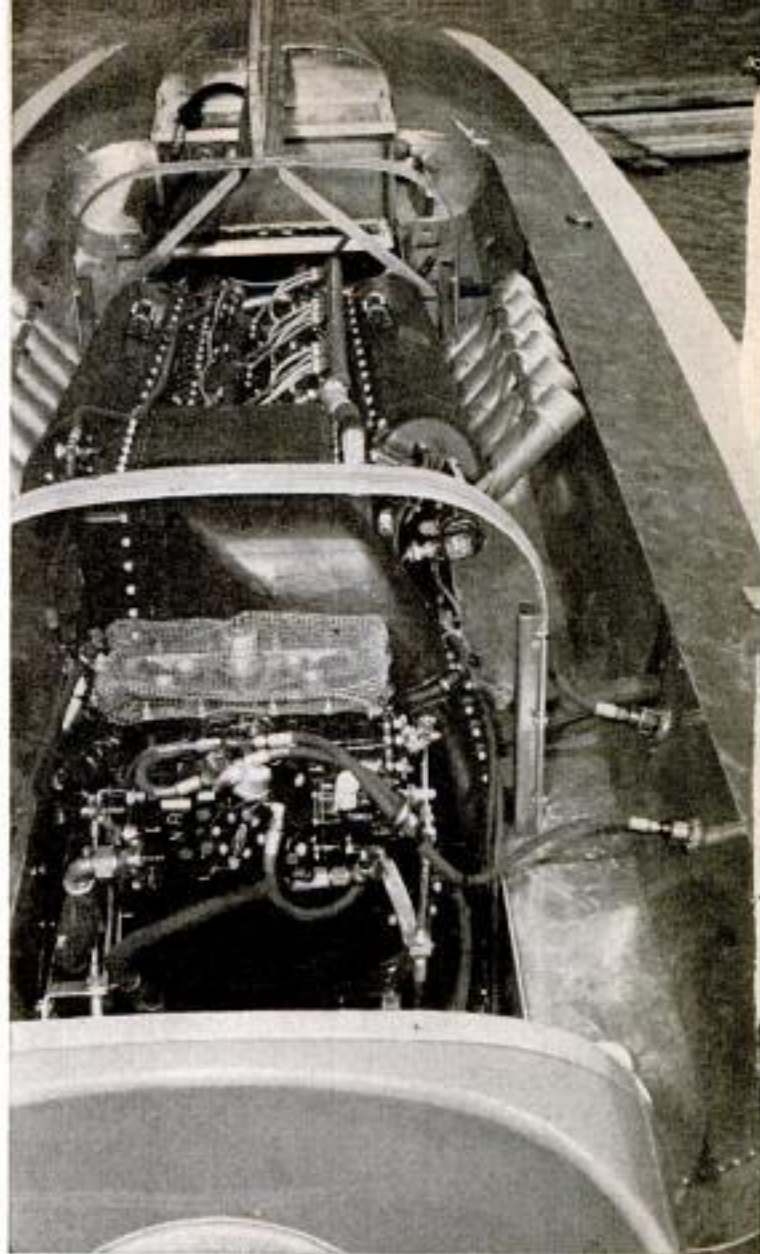

Big Rolls in engine compartment of *Thriftway, Too*. Note quick connections of various lines and cables

millionaire to own and race one of the big boats. It's by no means a cheap sport today. You can spend \$50,000 on a boat and its equipment. A single propeller, for instance, costs \$500 and if you want real quality you can buy a propeller machined from a forging for \$1000. Different water conditions and different courses demand different propellers for peak performance. Counting spares, an owner may invest \$4000 to \$8000 in propellers alone.

An owner wants spare engines, too. A blown engine used to mean a boat was out of the race. Now the owners with the necessary cash carry spare engines, each complete with its own gearbox, all ready to drop into the hull. A trained crew can change an engine in 40 minutes.

Ted Jones has an improved design of boat on the water this year and the unlimited-hydroplane fraternity is looking it over with a critical eye. Jones has retained all the principles of the airfoil hull and the tunnel between the sponsons in the new



Side view of *Thriftway, Too* being hoisted from trailer. Exhaust ports of left engine bank are aft of intake

boat, *Thriftway, Too* and has added new features. One of them is that the driver sits ahead of the engine instead of behind it. Riding in front, he isn't cooked by the heat of the big engine and he isn't deafened by the thunder of its exhaust. He gets a smoother ride in rough water, has better visibility and is in less danger in case of fire, explosion or shaft failure. The quiet cockpit allows the use of a short-wave radio to the pit.

The new *Thriftway, Too* weighs 6552 pounds, more than most hydroplanes, and is 34 feet long, four to six feet longer than most. Beam is 13 feet. The hull is of a special 5-ply mahogany plywood, a quarter inch thick on the bottom. For extra protection a dural plate is bonded to the bottom of the hull.

Six fuel tanks of 44 gallons capacity each are placed so that the trim of the boat does not change as the supply of fuel diminishes. The tanks are of stainless steel covered with glass fiber.

The boat's vertical stabilizing fin is larger than in previous boats and has the usual trim tab on its trailing edge that helps offset propeller torque. A new feature is a pair of small horizontal fins near the top of the vertical fin. These small airfoils help lift the stern of the boat up off the water at high speed.

Thriftway, Too has a large engine compartment that at present contains a supercharged Rolls-Royce aircraft engine delivering about 2500 horsepower souped up for racing. Jones wanted the compartment large enough to install two engines if necessary but the boat proved so fast in

early season trials that he may not need a second power plant. Instead, he may install a small engine ahead of the main power plant simply to drive the blower. This would relieve the main engine of a drag of at least 500 horsepower and would allow the supercharger to be driven at constant speed, materially reducing the chances of blower failure.

Propeller shaft of the new boat is $1\frac{3}{4}$ inches in diameter, of tough "K" Monel, and the propeller is $13\frac{1}{2}$ inches in diameter. The selection of propellers made up for the boat ranges from 20 to 24 inches in pitch.

Jones hopes that *Thriftway, Too* will start a new era in unlimited hydroplanes, with a corresponding upward jump in the world record for propeller-driven boats. But already he is looking ahead to something else. He has a jet hydroplane in mind, and has done some preliminary planning. In appearance the jet boat would look very much like *Thriftway, Too* with the same over-all dimensions but with a higher, fatter cowling to hold the jet engine. The vertical fin would be taller. The hull would be entirely of dural, glass-fiber covered.

These plans are based on using the J-47 jet engine, a power plant that develops 6200 pounds of thrust. This is a bigger engine than the jet used by Donald Campbell in setting his world water record of 225.63 miles per hour in the *Bluebird*, and Jones sees no problem in getting the speed up to 300 miles per hour. A pure jet boat would be strictly for setting records; eventually we may have competition racing between boats powered with gas turbines hooked to the propeller shaft. ★ ★ ★



Experimental Tilt-Wing VTOL Plane Given Flight Exams

Flight testing of the first tilt-wing VTOL (Vertical Take-off, Landing) aircraft readied for such trials is under way. The

Vertol 76, powered by gas-turbine engine aft of the cockpit, has wings that can be adjusted for vertical or horizontal flight.

Fisherman's Crimpers Install "Dialed" Shot

"Dial type" mechanical crimpers permit fishermen to attach split lead shot to their lines without wasting time, teeth or tackle. A disk, holding shot, is inserted in the crimper and the line laid over the split in the shot. Pressure on handles of the crimper pinches the shot on the line. To remove closed shot without harming the line, the crimper also has a steel blade that splits open the shot. The kit includes the crimper, of rust-proof alloy, and three cartridges of popular-size split shot.

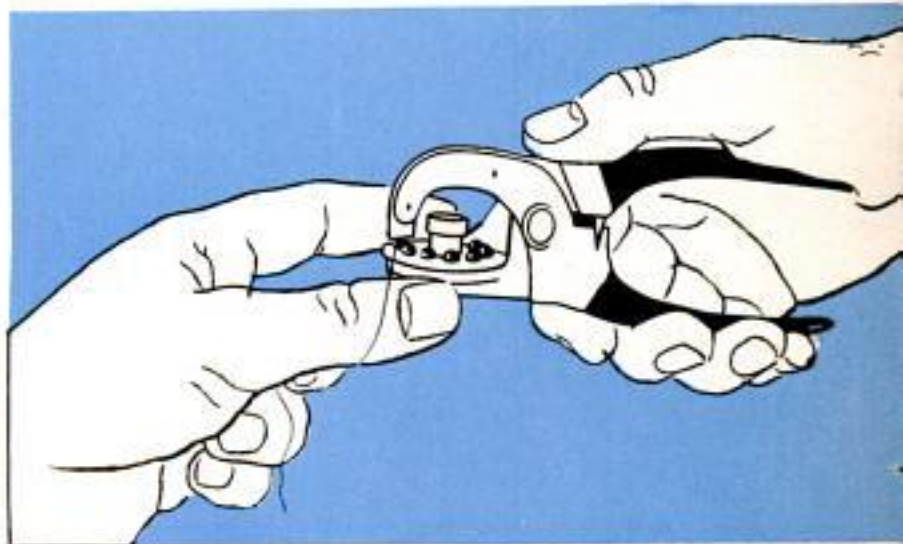

Hydraulic Lift Alters Motor Height

Boaters can control the depth of outboard-motor propellers with a new hydraulic lift. Two cylinders containing pistons raise or lower the motor as much as seven inches. The lift is controlled by a pump handle which can be installed on the transom or dashboard. By altering the depth of the propeller the boater can travel faster in deep water and avoid obstacles in shallow water.





PUSH-OFF



FLOATING

The Balloon Men Land Hard!

AIR FORCE OFFICERS are "parachuting" with balloons near Holloman Field, N. Mex. They are simulating and studying the shock effects of a pilot hitting the ground with a parachute attached to his ejection seat. The buoyancy of a helium-filled balloon allows the officer to be "thrown" up in the air about 100 feet. He descends the same speed that he would by parachute. The answer to shock-free landings may be a cushion of collapsible material on the bottom of the ejection seat.



LANDING



Swimmer Changes Clothes In Portable Tent

Changing clothes on the beach is no problem with an opaque tent that assures complete privacy. It is opened and closed with a zipper. Designed by a Melbourne, Australia, handbag maker, the tent can be folded into a package with a handle for carrying.

Wide-Beamed Steel Boat Is Almost Unsinkable

Two airtight compartments, plus an overflow device in the stern to drain excess water automatically make a "rocket" boat almost unsinkable. This 425-pound craft is 14 feet long, 6½ feet wide, and 3 feet high. Built of 16-gauge, cold-rolled steel, the vessel has rust-preventive primer and enamel applied inside and out. The boat seats four and uses a 25-horsepower or larger outboard motor.



Weather Gun Fires Pellet To Measure Wind Velocity

Measurement of low-altitude wind velocity—necessary for more accurate launching of missiles—is achieved with an experimental U. S. Army weather gun that fires a small steel ball up into the wind. Nicknamed "Breeze Buster," the gun fires its pellet at an angle calculated to make it fall back close to the gun's muzzle. The greater the wind, the greater the angle. When the steel ball falls back and hits close to the gun, the tilt of the gun is checked with a calibration chart to obtain reading of the wind velocity. This method is faster than using weather balloons, less expensive, and in time of war could not be observed by the enemy as would the balloons.





Trailer Home Folds For Travel

Seven piano hinges make this home ready to roll in 30 minutes.

By Kenneth Anderson

BUYING A TRAILER HOME presents a dilemma to families who want either a temporary lake-front cottage or a semi-permanent house. If they choose a mobile unit with a lot of living space it may be too large to move on all highways. If they select a trailer that conforms to all state laws, it's too small for active family life.

In Ohio, for example, a trailer home more than eight feet wide can cross the state only on the toll road. In Indiana, the state collects a fee of 75 cents a mile for moving a

Ready for visitors just a few hours after selecting homesite—price of this mobile home is about \$5000



Plenty of room for other vehicles to pass, even on a two-lane country road. This mobile home is designed to move over all highways without restrictions



Above, the 35-foot wall section is being raised by turning winch to shorten the length of steel cable





2 Steel bipods at corners help support the roof and 35-foot wall section while trailer is being folded or unfolded. Bipods are furnished with the trailer



3 Two people are needed to operate the winches at the front and rear of the trailer. Here, the floor and outside wall are being lowered after raising the roof



5 Photo above, from rear end of trailer, shows same stage of erecting the wall section as photo at left



6 Now, above, the end walls and two interior walls swing into position, as indicated by the arrows

mobile home wider than eight feet. The solution must be a trailer that's only eight feet wide on the road, but containing all the conveniences of a conventional house.

The Schult Corporation has designed such a mobile home, with over 500 square feet of living space in a package that's only eight feet wide and 35 feet long when it travels. Schult solved the problem by putting piano hinges in the walls, roof and floor. To pull up stakes, you simply move all the furniture to one side of the trailer and fold up the other side.

For a semipermanent stay, it takes a total of six man-hours to set up housekeeping. There are weather-tight cap strips and moldings to apply, plumbing connections and other minor tasks. At the end of that time, however, you have a two-bedroom ranch-style house for approximately \$5000.

Folding or unfolding the trailer requires a pair of steel bipods, a set of jacks, which are furnished with the mobile home, and a stepladder. A steel tube at the top of each

Adding finishing touches, below, makes the trailer home weather-tight. Caps and moldings are furnished



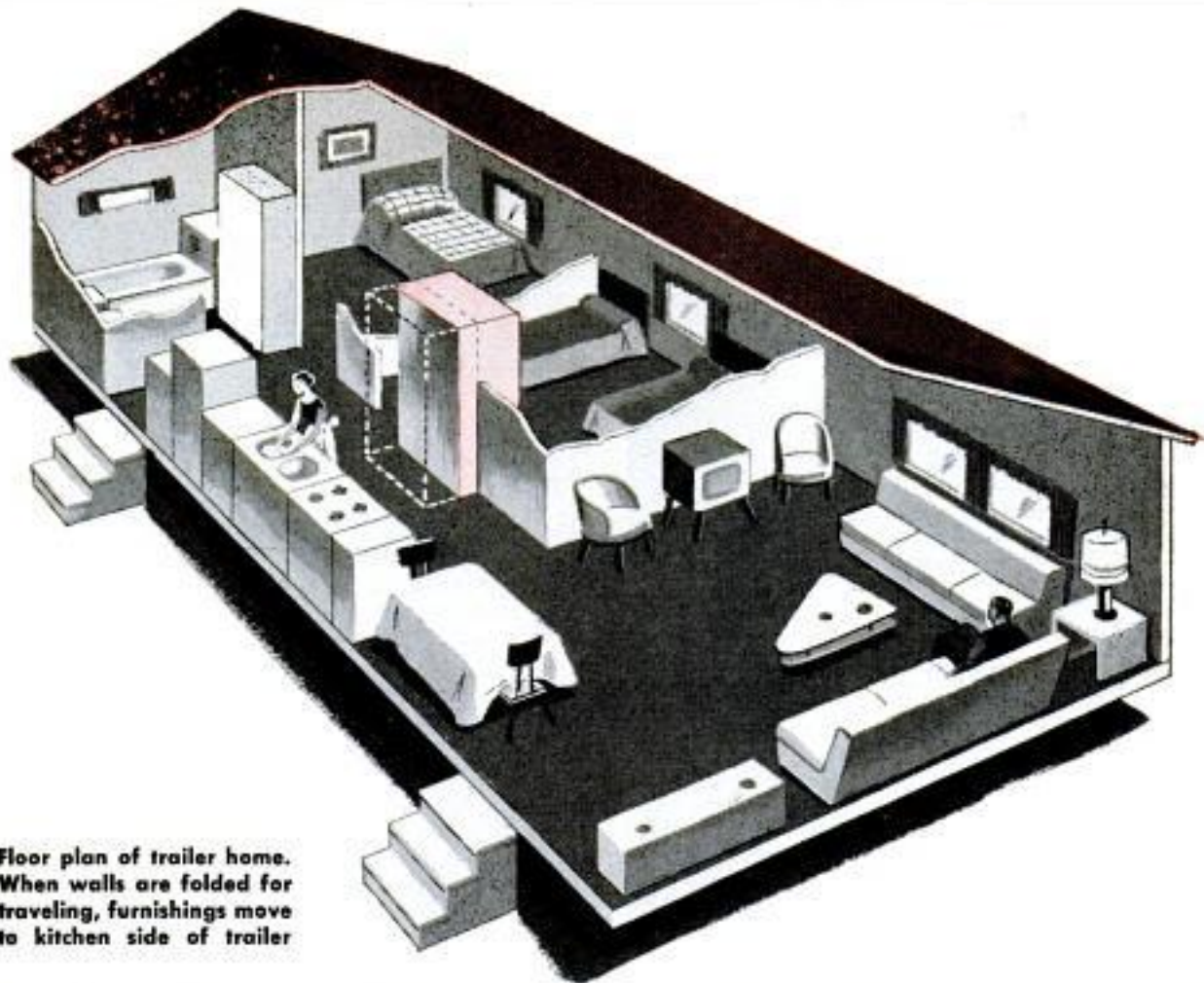

Floor plan of trailer home. When walls are folded for traveling, furnishings move to kitchen side of trailer

bipod slips into a socket at the peak of the roof, making a temporary steel scaffolding that bears the weight of the roof, floor and wall sections as they are raised or lowered. Raising or lowering the sections is done by turning winches that shorten or lengthen steel cables which are hooked to corners of the house segments. Folding or unfolding becomes just a matter of hooking the cables to the proper section and turning the

As semipermanent home, the trailer can be equipped with all the conveniences of a conventional house



winch. The end and interior walls swing into position with a gentle push and are fastened with screws.

This trailer has marine-varnished redwood exterior walls and is mounted on a steel frame. It weighs around 12,000 pounds, but it can be moved with a medium-to-heavy car equipped to tow that much weight. For hauls in hilly country, a truck or tractor is recommended. ★ ★ ★

As indicated in drawing at top of page, this bedroom closet moves into kitchen when trailer travels





Plastic Swimming Pool Bolted at Site

Resembling an oversize boat, a plastic swimming pool is bolted together at the site. The shell is then lowered into a hole and backfilled. Young William Kovacs (above) of Ft. Myers, Fla., is ready with trunks and towel for the big day when the pool is finished.

Long-Range Interceptor Missile Heads Ground-to-Air Defense

Twin ramjet engines and a rocket motor enable the Bomarc IM-99 interceptor missile to shoot down enemy aircraft at a far greater distance than any missile presently used in air defense, according to the Air Force. This ground-to-air missile is designed to operate at extreme altitudes at supersonic speeds. It is launched vertically by a liquid-fuel rocket motor. When the missile reaches a certain speed, the rocket cuts out and twin ramjet engines take over. The 47-foot missile is built by Boeing.

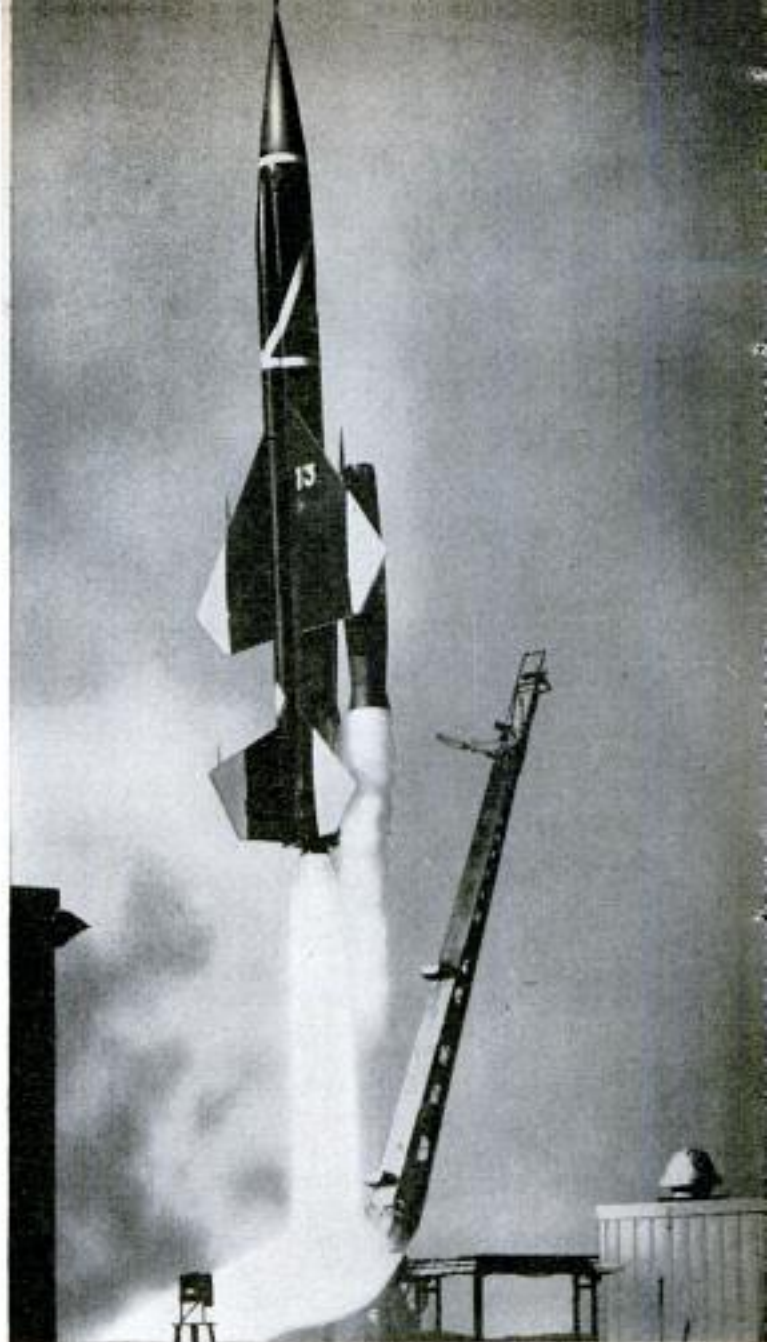

Table-Model Facsimile Unit Sends or Receives Printed Items

Even untrained workers can use a table-model, 37-pound facsimile unit to send or receive line drawings, printed documents or written messages over an ordinary telephone circuit. The transmitter-receiver scans the original item on a rotating drum with a photoelectric cell and prints a one-color duplicate on plain paper with an inked wheel.

Electric-Power Growth

By 1977 the U. S. will be using enough electricity to light a 100-watt bulb in every 114-foot square throughout the one-billion, 900-million acres of the country, according to a General Electric Company scientist. This represents the 625-million-kilowatt capacity of electricity-producing equipment to be built in the next 20 years, compared to more than 120 million now in existence for present needs.



Detroit Listening Post

By Art Railton



THEY'LL SOON be here—the 1958 models, that is. And then the merry-go-round will start again. New models, new beauty, new temptations to buy. Every one bigger and handsomer than its predecessor.

Before the shouting and tumult begin, let's take a quiet look at the industry's plans for your future.

This reporter has been asking Detroit planners questions like these:

"Where are you going? What's ahead? Will cars continue to be bigger, lower, faster and more luxurious? More expensive to buy and operate?"

The answers were simple and straightforward: "We are going forward. We shall never go backward. Tomorrow's cars will be like today's only more so. That's progress and America thrives on progress."

But, we asked, is there no room for a workaday car that can be driven with ease, parked handily, paid for quickly? Perhaps something different from the main line of luxury vehicles? Maybe a second car?

Detroit sees nothing in its immediate future like this. If America wants a second car (and it apparently does), it can get a good used car for less than it costs to buy a simple, utility machine and it will be a full-size car at that.

But, we asked, what about repair bills, operating costs, sheet-metal costs? Aren't these apt to be too high on tired cars with four-barrel carburetors, power accessories, big displacements as well as automatic transmissions?

The answer: Americans never have been concerned about operating costs. Americans want luxury, size and the satisfaction that comes with today's cars. They will never accept a small, underpowered, uncomfortable, austerity vehicle.

We walked away wondering why so much of our mail is from Americans who complain about poor fuel economy, excessive overhang, too much power, unnecessary ostentation.

We wondered about the 125,000 Americans who are buying foreign cars this year.

Detroit Not Worried

But Detroit is not concerned. It believes in progress and progress means bigger, thirstier, more expensive cars. It means thicker carpets, softer tires, lower roofs, more power assists, more expensive fabrics.

Detroit feels this way not because it's ornery, but because the public wants it that way. You get more basic transportation for the dollar in Detroit than any place in the world, if you buy the so-called standard models. But nobody buys them! Buyers want extras, deluxe trim, more power. You can't blame Detroit for that.

But this column is aware of a small minority (which is becoming larger every year) that is demanding more sensible cars. This group feels that a car is a device to make walking unnecessary. It is simply a convenience, not a social symbol. And this group, this minority, has no visible future except in foreign cars. But Detroit cagily covers its bet: Ford is pushing its small British-made cars and now General Motors announces Buick dealers will sell the German built Opel, Pontiac dealers will sell the British-built Vauxhall Victor, both small family cars. How long American labor will stand by while Europeans build "American" cars is unknown.

Edsel First Out

It's hard to keep the secret, but we will. We have seen, photographed and driven the Edsel. Look for the full details next month. It will be out late in August.

Other new models will be out in September and October with, perhaps, a straggler holding out until November.

Buick will come roaring back after an admittedly quiet year. It is expected to offer aluminum brake drums, a new transmission, air suspension. Its new deluxe Roadmaster 75 will be even bigger than this year's Cadillac (which will be bigger next year).

Ford will have the same body as this year with some identification changes. There is expected to be a four-passenger Thunderbird and it probably will offer air suspension at extra cost. Ford has apparently decided it's gone as far as it can with the wagon-wheel taillight. The 1958 cars are rumored to have six small lights on the back arranged horizontally.

Chevrolet is ready to take off after Ford and it is betting it will finish the year in first place. But, it frankly admits, it is out of the fin business. It has not been happy that the 1957 Chevrolet tail looked like an imitation of Chrysler's fins.

Lincoln's lines are square. There will be no upflying fin here either despite a move in that direction in the 1957 model.



Trapeze Take-off For Ryan Vertijet

Drawing shows how exhaust gases are piped to wing tips for control

SUPERSONIC FIGHTERS and fighter-bombers that take off straight up are on the drawing boards. They will be able to hover like helicopters, climb like rockets and nose over in a horizontal attitude to travel faster than the speed of sound.

These developments are based on the successful testing of Ryan Aeronautical's X-13 Vertijet, an experimental aircraft that uses a jet engine for propulsion and pipes some of its exhaust gases to its wing tips for precise control while hovering or maneuvering at slow speeds.

The Vertijet has no conventional landing gear, saves the 10 percent of the gross weight usually devoted to landing wheels, struts, flaps and actuators. Instead, it has a single hook under its nose. The hook engages a trapezoidal mechanism on the bed of the ground trailer on which the plane is carried to any convenient launching site. The bed of the trailer is hydraulically tilted to the vertical, after which the pilot starts his engine and rises off the "trapeze." To land, the pilot puts the plane in a vertical position again, close to the ground, and slowly moves toward the raised trailer bed until his hook engages the trapeze, after which he shuts off the engine.

With its nose pointed to the sky the Vertijet can remain motionless a few feet off the ground or it can travel sideways faster than a man can walk. The plane can climb straight up to 10,000-foot altitude faster than any conventional aircraft and it has a forward speed in excess of 330 miles per hour. The pilot's seat automatically tilts for either vertical or horizontal flight.

Ryan officials predict that in the future a Vertijet may take off and land from a one-inch nylon rope stretched between two trees or buildings.

Pilot's seat tilts automatically as craft is raised to vertical take-off position. Plane is held by hook under nose. This type of landing gear cuts weight 10 percent, allows greater fuel and armament capacity

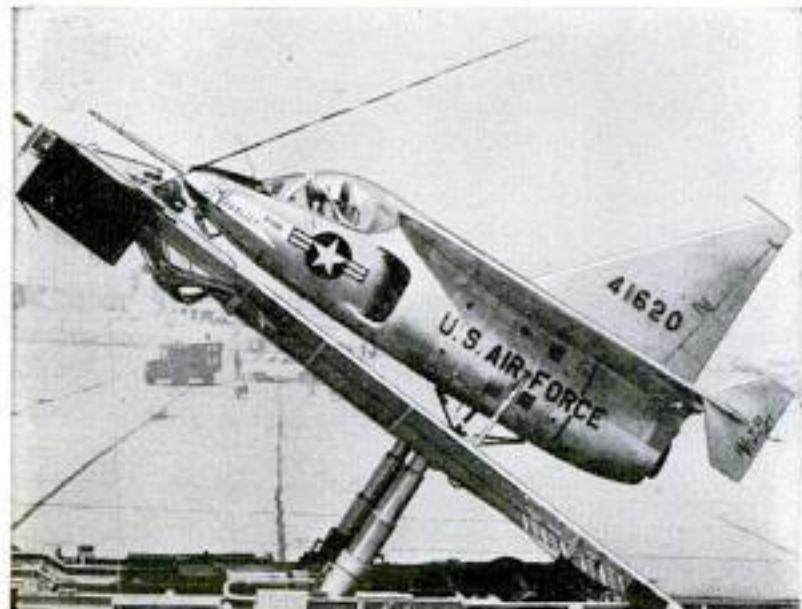

Vertijet can remain motionless few feet above ground. Rolls-Royce Avon jet engine develops 10,000-lb. thrust

Diagram below illustrates path of Vertijet taking off from trailer, changing to a horizontal position



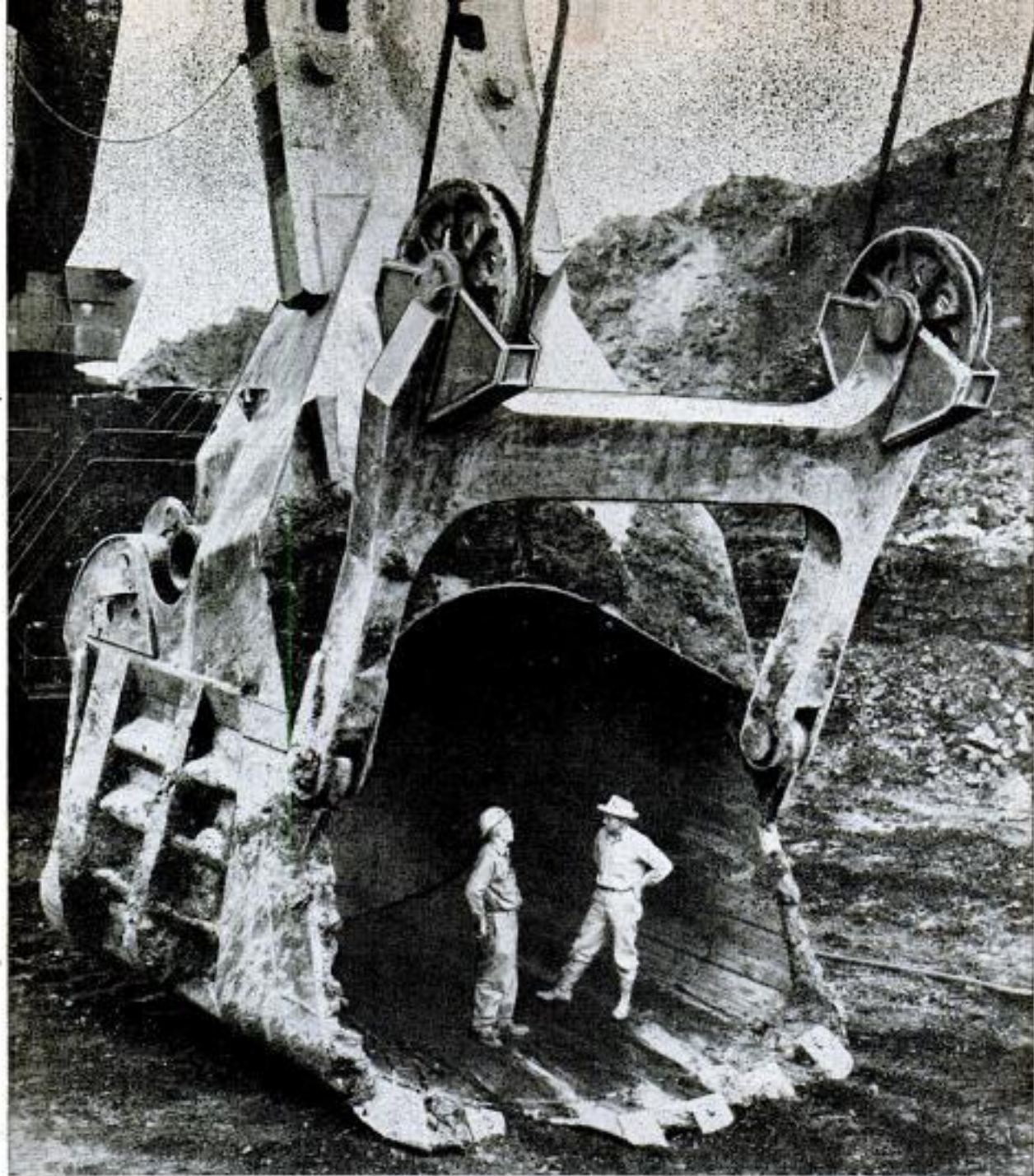

Two men are dwarfed by the River Queen's mammoth dipper, which can dig 100,000 tons of earth in 24 hours



Power Shovel Has 80-Ton Bite

MORE THAN 80 TONS of earth per scoop is the capacity of a monstrous power shovel now operating in western Kentucky. Named the River Queen, it is higher than a 13-story building—140 feet to the top of its boom—and at 2400 tons it weighs more than most naval destroyers. The 55-cubic-yard dipper can dump its load nearly 300 feet from the digging point and pile it up more than 100 feet high. At a rate of one digging-dumping cycle per minute, the River Queen could excavate 100,000 tons of earth in 24 hours. Despite its size, the shovel is operated by one man in a glass-enclosed cab 30 feet above the ground. An eight-foot wiper keeps the windshield clean. Fifteen motors power the shovel, including two 1500-horsepower synchronous units. The River Queen is mobile, and designed to uncover seams in an open-pit coal mine.

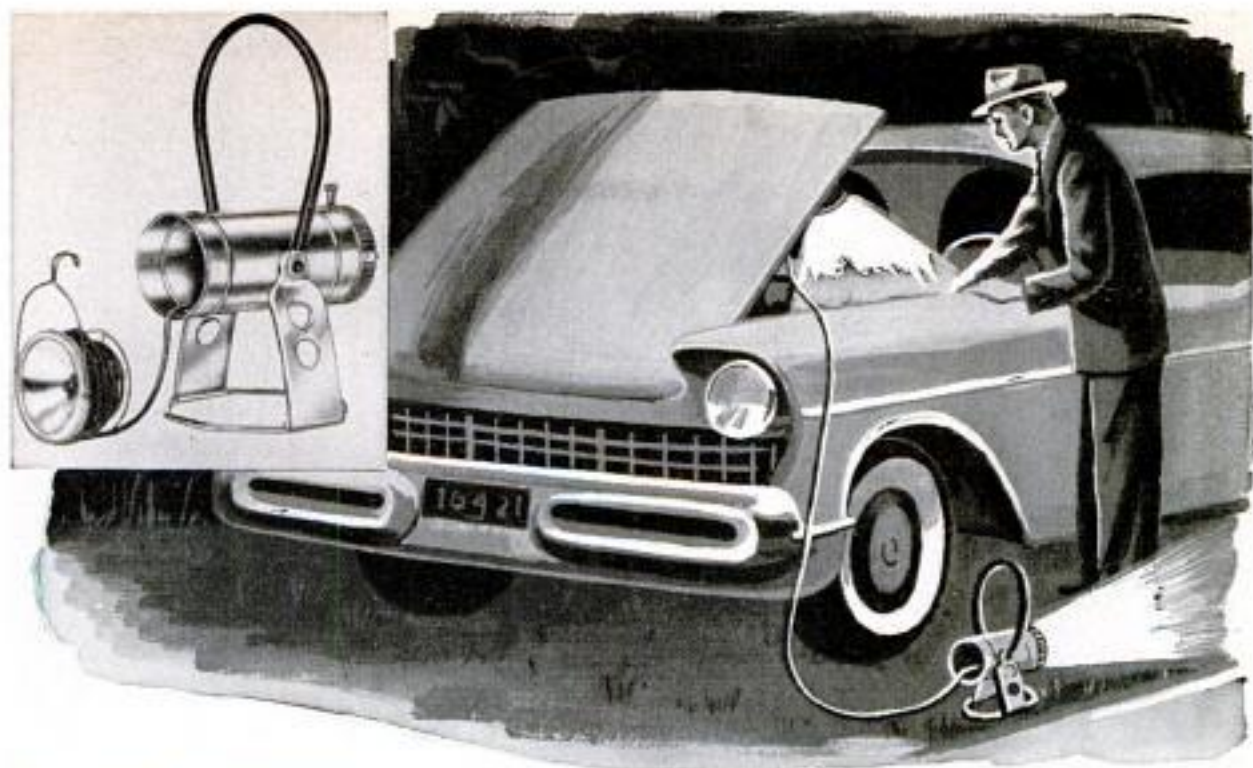

Two-in-One Lantern

Motorists with engine trouble at night can use a two-in-one lantern (above). They can set a red-flashing warning light in the road and, at the same time, work on the car with a clear-beam light on the end of a 25-foot extension cord.

Life-Size Glass Horse

Visitors to the Museum of Hygiene, Dresden, Germany, look through a 6¼ by 8-foot glass horse (below). Sixty-three bulbs light up its organs. A tape-recording explains anatomy and functions.

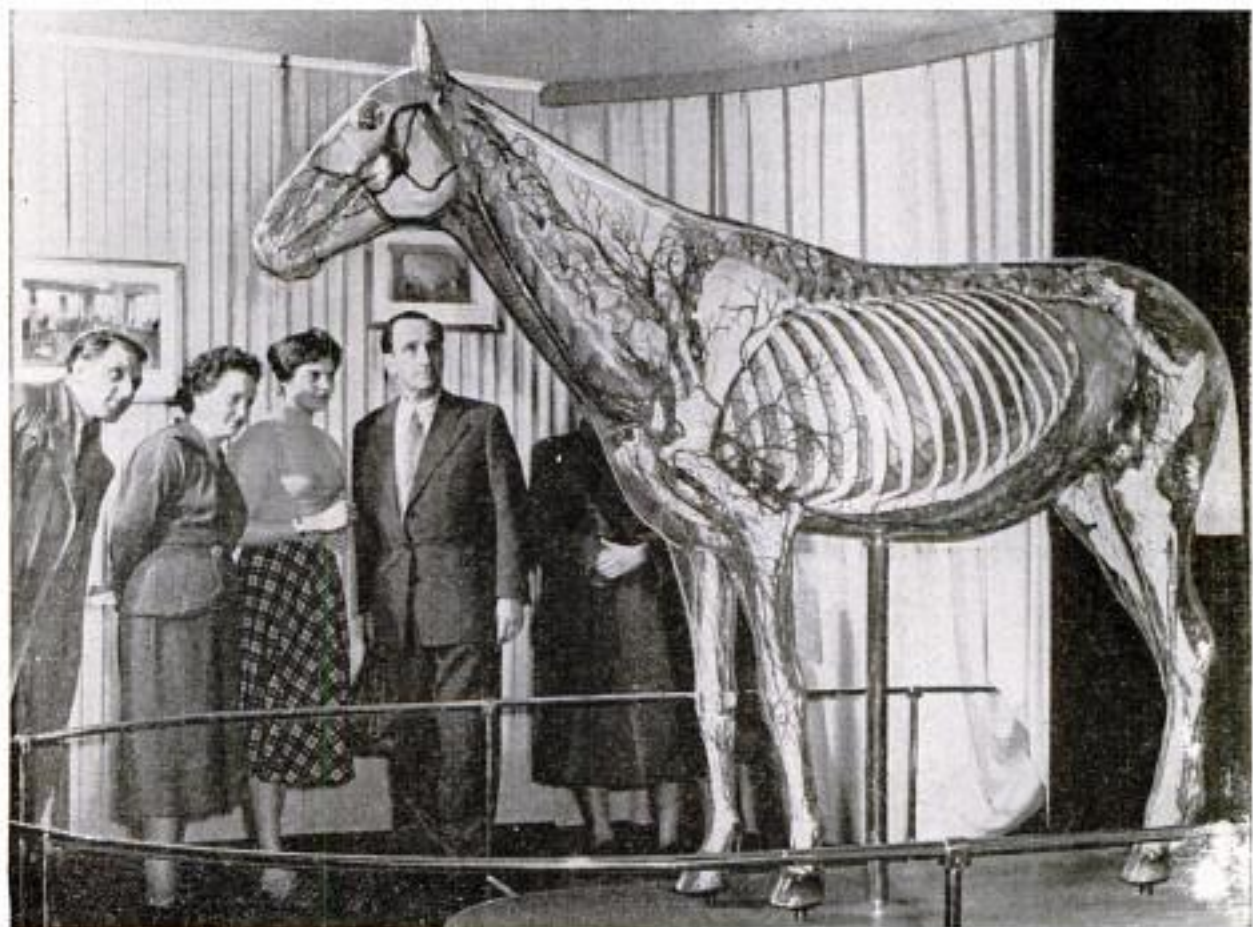



Sculpturing With Newspapers

What can you do with old newspapers? Mrs. Winifred McPherson of Cape Town, South Africa, sculpts with them. Differing from papier-maché work, the method used by Mrs. McPherson is to crumple paper into a rough shape. Then she glues on small pieces of paper to give the statue form. When dry, the sculpture is painted.



British Aircrews Use Escape Chute

Nicknamed "Beverley's Tongue," the curved object in the picture is an inflatable chute anchored to the floor of a British Air Force Blackburn Beverley transport plane. It was developed so that aircrew members could slide out of the plane in a hurry if an emergency occurred while the aircraft was on the ground. The chute can be stowed in a valise in the rear compartment and can be inflated in 15 seconds.

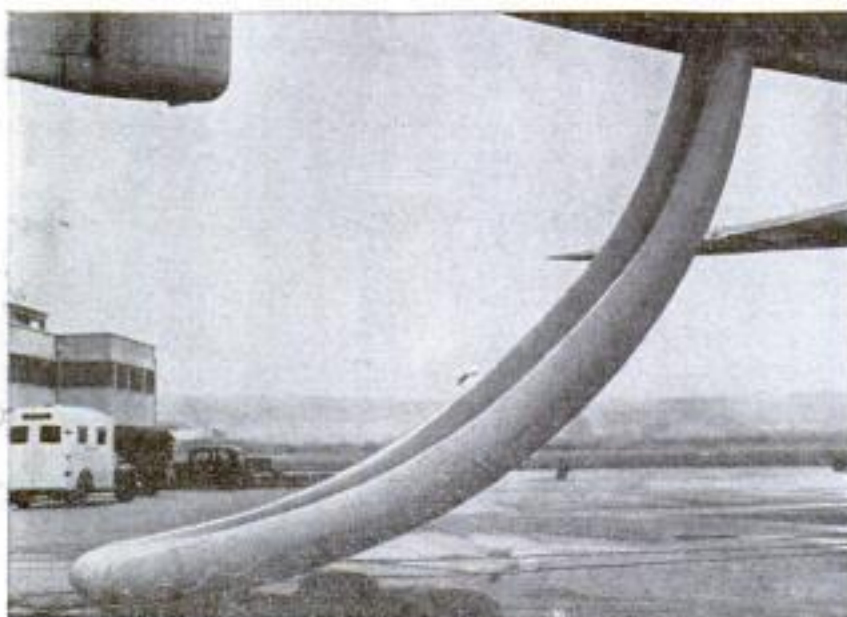



Huge Drill Bores Holes of Almost Any Size or Angle

With a few quick adjustments, a versatile drilling machine can cut into the ground at angles up to 45 degrees. It also can drill holes up to 75 feet deep without the use of extensions. By changing augers, the ma-

chine can cut holes from 20 inches up to 10 feet 6 inches in diameter. A control allows the operator to pull the auger from the hole and move it aside before he spins the dirt from the cutting edges.

Clothesline Tightener

As much as 16 inches of slack wire, rope or plastic clothesline can be wound on a new line tightener. Line tension holds the 4½-inch pipe firmly to the crossarm against the pressure of a coiled spring. No nails or bolts are needed for installation. A nail in the pipe serves as a lever.

Portable Magnetometer

Prospectors can carry along a new portable magnetometer used for the location of minerals and oil-bearing formations. Weighing only 12 pounds, the instrument can be operated over bog, snow and water where conventional magnetometers of larger size cannot easily be handled.

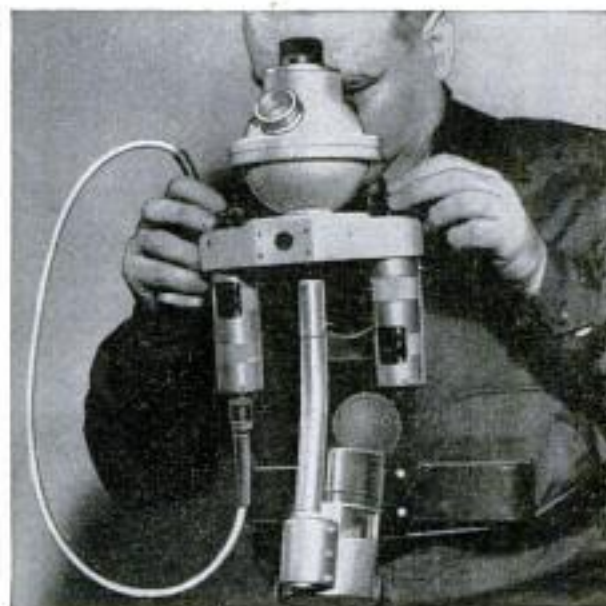
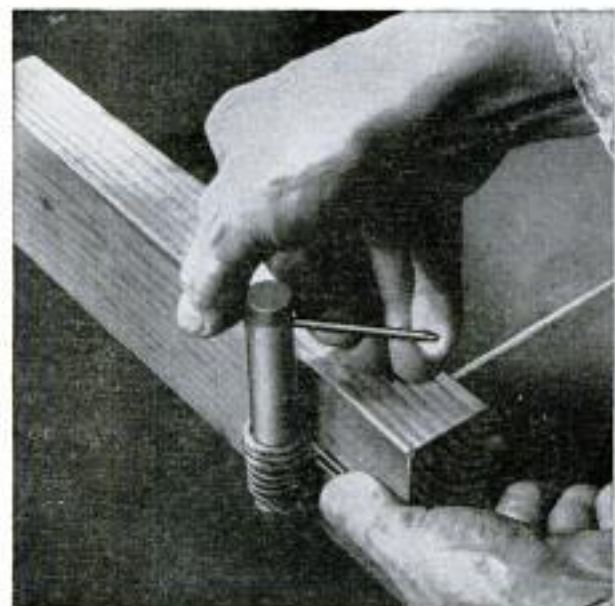

HERE'S THE PM TEST RESULT

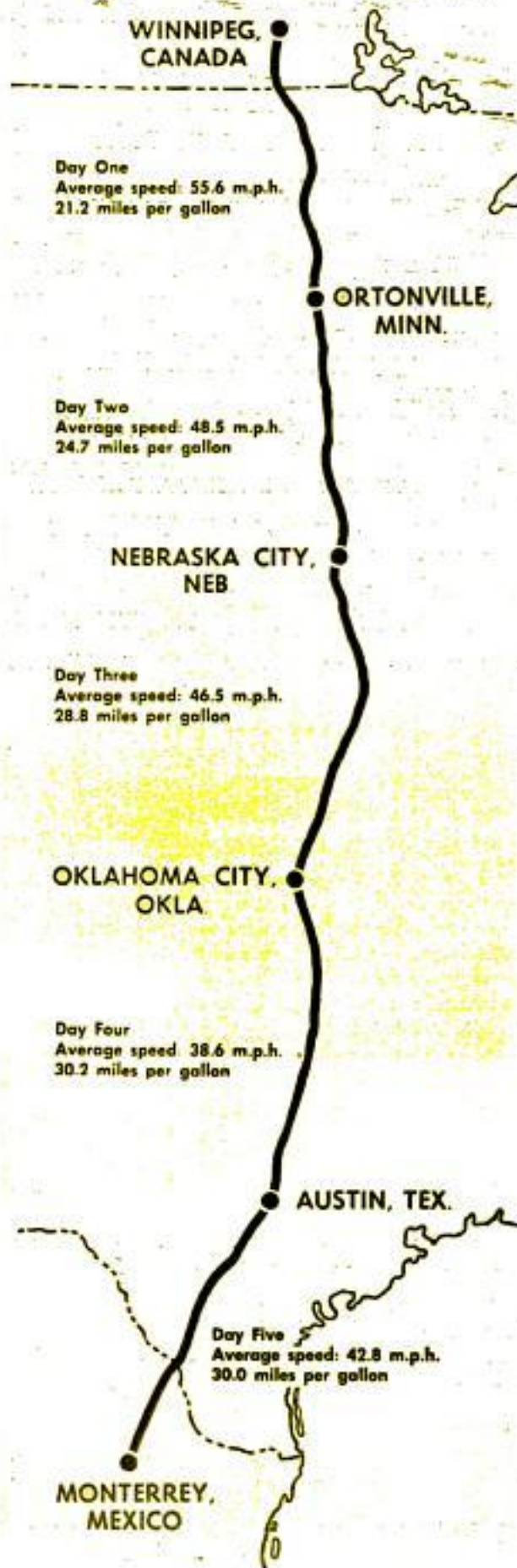

Gas was precisely weighed before it went into tank

What You Can

By Arthur R. Railton

ECONOMY RUNS have never impressed me very much. Not that they are dishonest, but they involve such precise tuning and such tender-toed driving that they don't come close to being typical of ordinary motoring.

There wasn't one car in the 1957 Mobilgas Economy Run that averaged less than 18.5 miles per gallon and that included all sizes from Imperial down.

Let's face it. You're bound for disappointment if you buy a 1957 car and expect that kind of gas mileage. To get such economy you'll have to drive with radio dead, with windows up. You'll worry through stoplights and turn what should be a pleasure trip into a nerve-wracking endurance contest.

So when American Motors invited me to go on its economy run from Canada to Mexico, I accepted, but on one condition: That I be given a duplicate of the official test car to drive as I wished so I could compare my mileage with what the experts got. American Motors agreed.

Here's what happened: My gasoline economy ranged from a low of 21.2 miles per gallon the first day to a high of 30.2 miles per gallon on the fourth day, depending on how I drove. The most the experts

←Economy went up as speed went down, except on fifth day when a special driving technique was used



Official test Rambler stops briefly for customs check at Canadian border on first day of the Mexican run

Learn on an Economy Run

beat me by was 18.8 miles per gallon, the least was only 2.2 miles per gallon.

The car I drove was a stock 1957 Rambler four-door sedan with a six-cylinder engine and overdrive. It had an economy rear axle (4.1 to 1), a lean metering rod in the carburetor and a 180-degree thermostat. You can order a duplicate of it from any American Motors dealer. The official test car was identical. It was driven by two American Motors engineers, Les Viland and Carl Chakmakian.

DAY ONE: Winnipeg, Canada, to Ortonville, Minn., 345.4 miles.

I drove as I would drive my own car on a long trip, with utter disregard for economy. We often hit 90 on the speedometer, once ran it up to 100. I accelerated fast and usually dropped out of overdrive for passing other cars.

We had the advantage of a strong tail wind and the disadvantage of temperatures around 32 degrees.

Like the usual tourist, we stopped for coffee on occasion. Our average speed for the day was 55.6 miles per hour (the test car averaged 45.7 miles per hour). Our gasoline economy was 21.2 miles per gallon (the test car averaged 39.96 miles per gallon).

We finished the day's run about 20 minutes ahead of the test car. That's how much time we saved by hurrying (of course, we did stop to relax which the test

car did not). To save that much time, we used about eight gallons more gasoline than the test car.

DAY TWO: Ortonville to Nebraska City, Neb., 365.2 miles.

At the start we had a moderate tail wind. Temperatures were cool, but warmer than the first day. Roads were good, traffic light.

I drove more carefully this second day. Instead of cowboying it, I drove with an eye on the speedometer. I held it between 65 and 70 all morning.

Heavy rains made it necessary to drive

Art Railton, *PM's* automotive editor, gets back into car after clearing customs at the Mexican border





In Texas the Rambler inched through flood waters like these, which certainly did not help gas mileage any!

slower (and at one time to stop briefly) during the afternoon.

Economy was better, proving the merits of sensible driving. I averaged 48.5 miles per hour (the test car averaged 41.0). My gasoline economy jumped to 24.7 miles per gallon (the official test car averaged 34.0 miles per gallon).

My mileage was up 3.5 miles per gallon and the test car's was down about 6 miles per gallon. There was now only a 10-mile-per-gallon spread.

DAY THREE: Nebraska City to Oklahoma City, Okla., 418.5 miles.

I borrowed another trick from the test car. I inflated the tires to 34 pounds (I had

End of the test was Governor's Palace at Monterrey. On this final day, Railton's car averaged 30 m.p.g.



been carrying 27 pounds) just like the test car. I reduced my speed still more, holding it steady between 55 and 60 where possible. We were on the Kansas Turnpike much of the day and that made it easy to maintain a constant speed.

Thanks to the hard tires (which, by the way, caused no discomfort on smooth highways) and the lower speed, my gasoline mileage went up again. Our average was 28.8 miles per gallon (the test car averaged 31.78 miles per gallon. The gap was now only 3 miles per gallon. Our average speed was 46.5 miles per hour (the test car was only slightly slower, 45.9 miles per hour).

DAY FOUR: Oklahoma City to Austin, Tex., 434.6 miles.

This was the day we hoped to prove that an average driver, after a little practice, can match the experts. We drove even more slowly, holding speed down to a top of 50 and running between 45 and 50 most of the time. We accelerated very, very gingerly, making a real fetish of economy.

Then came the flood. We were forced by torrential rains to stop several times. Creeks washed across the highway. At times we had to forget economy as we inched through deep water in low gear.

We arrived at Austin very, very late indeed. And tired, too. Our average speed, discounting stops for rain and lunch, was 38.6 miles per hour (the test car went faster than we did, averaging 40.6 miles per hour). Our gasoline economy was a miserly 30.2 miles per gallon (the test car's was 32.4 miles per gallon).

What had originally been a 19-mile-per-hour spread between our mileage and the test car's was now only 2.2 miles per gallon.

(Continued to page 228)



Floor-Tile Remover Cleans 14-Inch Swath

Four 3½-inch-wide steel cutter blades on a new electric floor-tile remover make a 14-inch swath. This portable machine weighs 155 pounds and is powered by a ½-horsepower electric motor for 115 and 230-volt current. The remover has a built-in blade-grinding attachment.

Liquids Are Shipped In Plastic Holders

Housed inside a paperboard shell, a polyethylene-resin container with molded-on spout may become useful in shipping, storing and dispensing liquids. The cutout handle in the box facilitates handling and pouring. The spout can be snapped open.



AUGUST 1957



Fractional Thickness Of Film Measured

As little as 1/10,000 inch of paint film, electroplating or metal overlay can be measured by a new quality-control instrument. Portable, it is plugged into a 110-volt outlet. When the instrument's probing coil touches a product, the thickness of paint or overlay is registered on a dial.

Electronic Flash Unit Plugs Into Wall Outlet

Made in East Germany for export, the electronic flash unit, below, weighs less than a pound. It requires no batteries but plugs into an alternating-current outlet. The unit has a built-in transformer and charges in five seconds.



103

"Quadricycle" Saves Gasoline



Confronted with the European gasoline shortage, Ruiz Luciarte of Paris invented this pedal-operated "quadricycle." The vehicle has four wheels, weighs 35 pounds, has 18 speeds and is reported to be highly maneuverable.

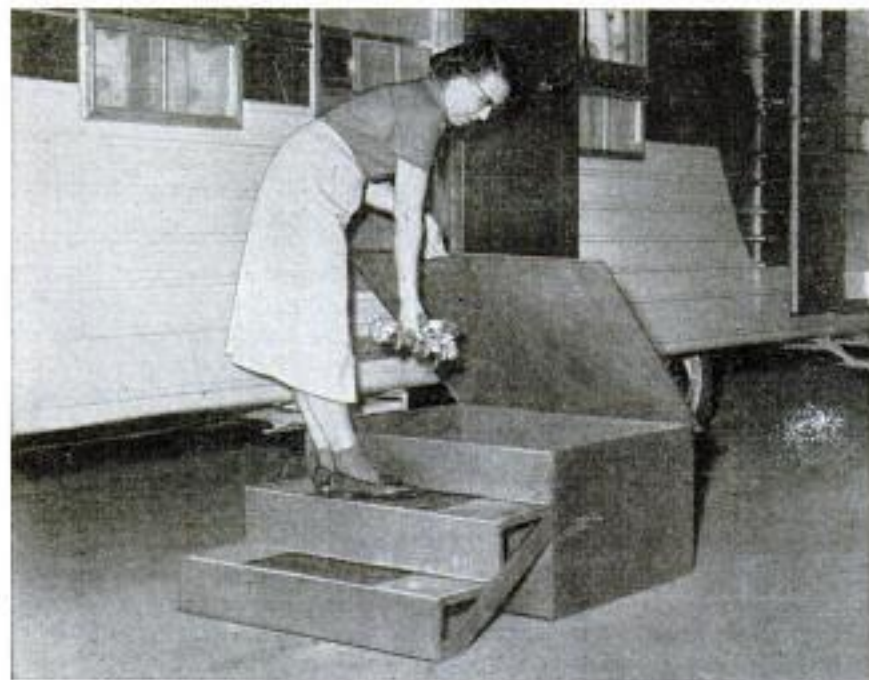

Trailer Porch Is Storage Box

Mobile-home owners who need outside storage space for such items as children's toys can now buy a steel porch that doubles as a storage box. The box is 18 inches high, the proper height for most mobile homes, and the top surface is about nine square feet. The steps, which are 11 inches wide with six-inch risers, can be detached from the box for easier handling if the trailer is moved. The storage porch weighs about 100 pounds.



Thirsty Dogs Serve Themselves

Here's one trick any dog can perform—turn on the water for a cool drink on a warm day. A float keeps the water at canine-drinking level. As the dog drinks, the dish refills itself automatically. The pan and float come with four feet of hose and coupling. The float arm bends to change the drinking level.

2588

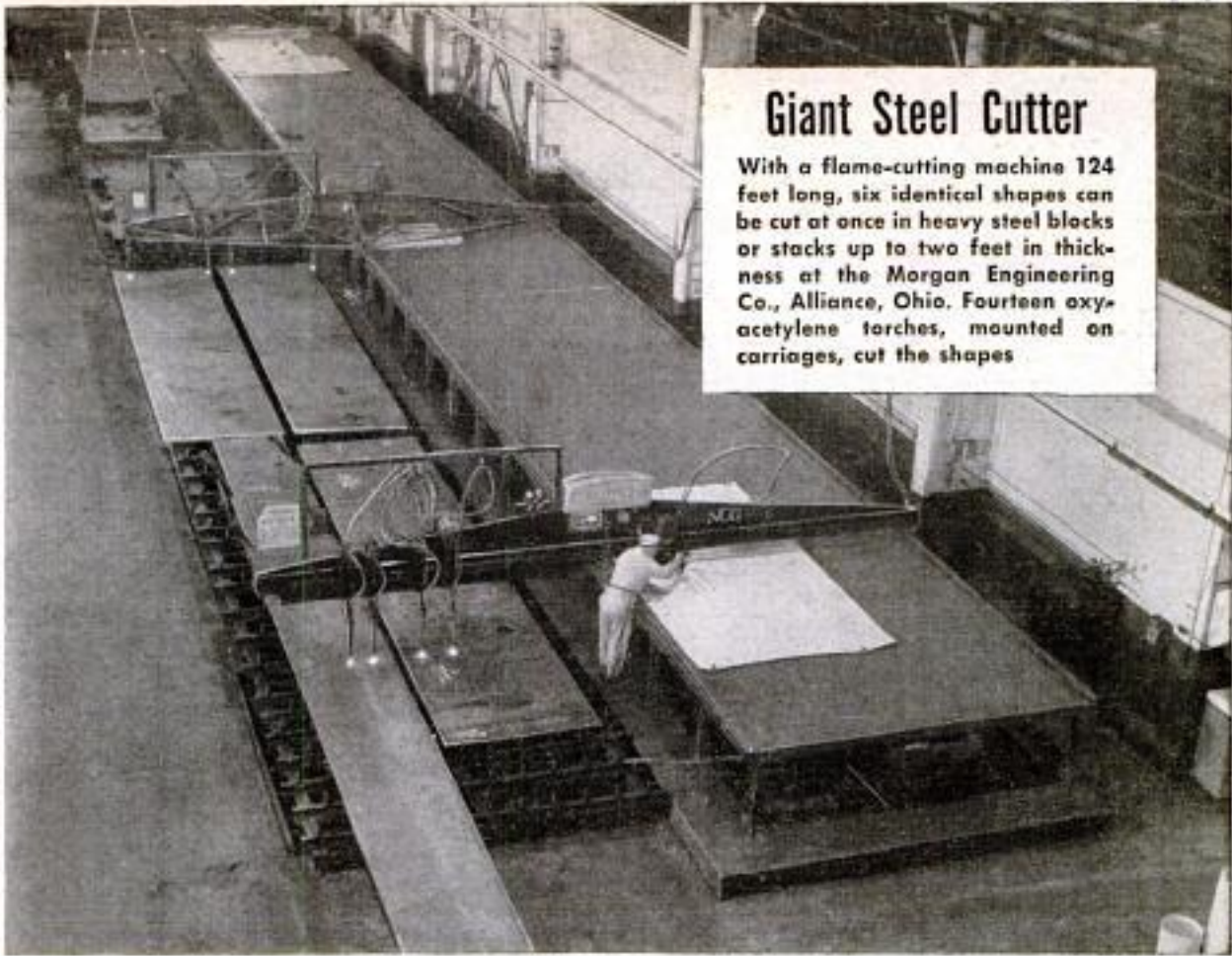

Giant Steel Cutter

With a flame-cutting machine 124 feet long, six identical shapes can be cut at once in heavy steel blocks or stacks up to two feet in thickness at the Morgan Engineering Co., Alliance, Ohio. Fourteen oxy-acetylene torches, mounted on carriages, cut the shapes

Converted Weapons Carrier Travels Mountain Roads

Once a wrecked three-quarter ton Dodge GI weapons carrier, the vehicle below was rebuilt as a "super Jeep" for covering rugged mountain terrain. C. W. Arrowwood of Oakland, Calif., had the controls moved 12 inches to the left and installed a cab from a 1949 Hudson coupe. A convertible-top motor was added to lower or lift the 200-pound spare tire and rack.



AUGUST 1957

Vacuum in Air Sampler Caused by Gas Jet

Pollution experts now obtain samples of air with a vacuum-operated instrument that fits in the hand. The explosionproof sampler is a miniature jet engine powered by low-pressure liquefied gas. A valve to control the gas is the only moving part. Gas in motion creates a vacuum which draws air into the instrument. The sampler replaces bulky pumps used in the past.



105

X322



Which Grass for YOUR Lawn?

By Clifford B. Hicks

WHAT CROP is the most valuable in the United States? Corn? Wheat? Cotton? In terms of investment, surprisingly enough, it is turf—grass for your lawn and parkway, grass for landscaping public buildings, grass for garden paths and golf courses. More money is spent on grass than on any other single crop. It costs us annually about \$15 per person to keep the green grass growing in the United States. Multiply that figure by the number in your family and you'll find you have a significant investment in turf.

The information on these pages can help you get a good return on your investment in your own lawn. Much of this information was provided by Dr. F. V. Juska, Turf Research Agronomist, U. S. Department of Agriculture.

The map at the top of the opposite page shows the grasses which are well adapted to the various regions of the country. Find your own region and you'll find the grasses

suitable to your locality. Naturally, the lines on the map are arbitrary, and a grass suited to an area along one side of a line may be equally well adapted to the adjacent area just across the line.

At the bottom of the opposite page, and continuing in the color panel, is a list of the various grasses, with some of the characteristics of each. By comparing these characteristics you can decide which grasses you can use to good advantage in establishing a new lawn.

In the listing of each grass type on the opposite page also appears information on whether the grass is established by seed or vegetatively (by planting sprigs, stolons or plugs which spread to form the turf); when to seed or plant it; the seeding rate or manner of planting, and essential information on maintaining that type of lawn.

Also, beginning on the opposite page is general information on establishing and maintaining almost any type of lawn.

Region 1A—Northern (Cool, Humid)

Bluegrass strains: Kentucky, Merion, pos trivialis. Bent grasses: Colonial (Astoria, Highland); Velvet. Fescues: Creeping red; chewings, Pennlawn. Grasses for southern transition zone: Meyer zoysia; zoysia japonica; U-3 Bermuda.

Region 1B—Northern (Cool, Humid), Pacific Northwest

Same grasses as region 1A.

Region 2—Southern (Warm, Humid)

Bermuda grasses (Tiflawn, Tiffine, Ormond, and Tifgreen); Emerald zoysia, St. Augustine, carpet grass, centipede grass. Grasses for northern transition zone: bent grasses, Meyer zoysia, U-3 Bermuda.

Region 3—Southwest (Irrigated)

Zoysia matrella, Bermuda, carpet grass, St. Augustine, Meyer zoysia, zoysia japonica.

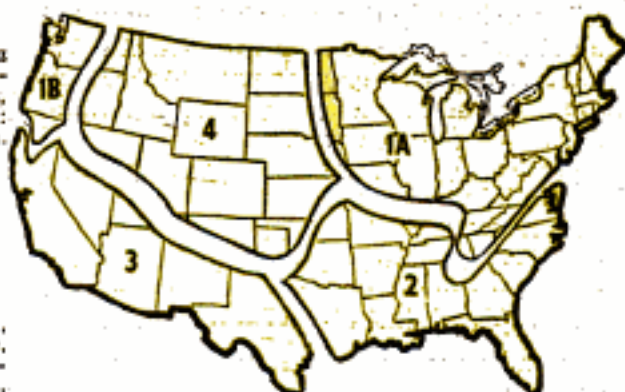

Region 4—West Central

Crested wheat grass, blue grama, buffalo grass, red fescues.

Where irrigation is possible: Kentucky bluegrass, bent grass.

TIPS ON ESTABLISHING AND MAINTAINING A LAWN



When to Establish a Lawn

Depends on where you live and what type of grass you select. In general, if you live in regions 1A, 1B or 4 as shown on the map, seed in early fall. This gives the cool-season grasses a chance to establish themselves during the fall rains, before they go dormant for the winter. There is less competition from weeds, and the grass plants have time to develop a good root system before they are subject to the heat and drought of summer.

In general, if you live in regions 2 or 3 on the map, you'll do best to plant your lawn in the spring, as most of the grasses adapted to these regions thrive and spread

out in hot weather and may go dormant during winter.

Another rule of thumb: Establish Bermuda, carpet grass, blue grama, centipede grass, buffalo grass, St. Augustine grass and the zoysias in the spring, the bent grasses, bluegrasses, fescues and crested wheat grass in the fall.

Does Your Lawn Need Lime?

High soil acidity can ruin many lawn grasses. The only way you can be sure of the acid content of your own soil is to send a sample to your county agent, state agricultural college or state department of agriculture for testing. The presence of moss suggests too much soil acidity, but it may also indicate low fertility, too much water or too much shade. The accompanying map



TYPES OF GRASSES

BENT GRASSES

Bent grasses should be used only if the homeowner is willing to spend considerable time, care and money on maintenance. They are especially adapted to the New England states and the Pacific Northwest. All bent grasses survive in the shade but prefer the sun. They are fine textured and spread to form a dense turf. Establish a new lawn in September, sowing at a rate of four ounces of seed per 1000 square feet. Seedbed must be well fertilized, and bent grass should be fertilized once a month during growing season. It must be watered regularly during hot, dry

periods. Disease is the biggest problem; in some localities fungicides may have to be applied every seven to ten days during periods favorable to the development of disease. All bent grasses should be mowed below $\frac{3}{4}$ inch, some below $\frac{1}{2}$ inch, with a reel-type mower. Many mowers will not cut this low. Varieties of bent grass include: Creeping bent grass, which is not generally recommended for lawns. Velvet bent grass has the finest texture but is not as aggressive in spreading and is slow to recover from injury. Colonial is best adapted for lawn use. Strains of Colonial include Highland, Astoria and Rhode Island.

shows, on the left, the so-called "lime line," an arbitrary line dividing the country into acid and neutral or near-neutral soils. If you live anywhere in the area covered by the map, your soil may well require lime, but only a soil test can tell you for sure.

If you need lime, apply 75 to 100 pounds of ground limestone per 1000 square feet. Apply it before you spread the topsoil. Usually a similar application repeated every six to eight years will be sufficient. You can spread lime on an established lawn any time of the year, but fall is somewhat preferred.



Preparing the Seedbed

Remove the topsoil. Then remove all building debris and spade, plow or Rototill the subsoil. Establish the grade of the lawn. For good drainage you need a drop of at

least one foot in 50 linear feet. Apply lime and fertilizer as required. Then spread the topsoil evenly, working out any large lumps to provide a smooth, fine seedbed. If you haul in additional topsoil, it may require fertilizer, too. For best results you should have at least four inches of topsoil.

Pregerminating The Seed

Some types of grass, such as Merion blue, have long germinating periods, up to a month or more. You can appreciably shorten this time by pregermination treatment. Put the seed in a cloth bag and soak it in cold water overnight. Then wash the bag under a faucet until the water runs clear. Spread the seed in sunlight, let it dry thoroughly, turning it occasionally. Then sow it. In some cases this will cut germination time in half, speeding the establishment of a new lawn.



BERMUDA GRASSES

Also known as wire grass, Bermuda is a persistent, long-lived perennial. It is very aggressive, spreading vigorously so that it may become a pest in gardens adjoining the lawn. Very drought-tolerant, it stays green during long dry periods. Dense turf with excellent wear resistance. Requires bright sunlight, will not tolerate shade. Almost all Bermuda grass is established vegetatively, usually by planting stolons or plugs one foot apart from spring until early August. Should be well-fertilized while it is spreading, then fertilized four times each growing season.

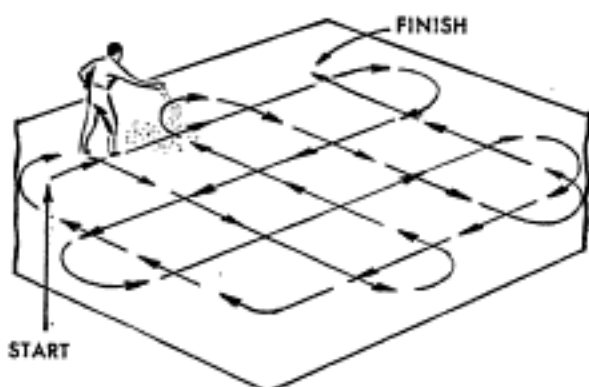

Sowing the Seed

Measure off a test plot of around 500 square feet. You then can weigh out the amount of seed recommended for a plot of this size and sow it. If you find you have the wrong setting on the seeder or are applying too much or too little by hand, you can change the rate before spreading the rest of your seed. It may help you distribute the seed if you mix it with sand or fine soil.

For any given area, divide the seed into two equal parts. Sow one part by working up and down the length of the plot, the other by working crosswise.

Cover the seed lightly by hand raking, then firm the soil by rolling it.

Planting Plugs or Stolons

Many grasses yield seed that is not true to type, or no seed at all. Such grasses must be established vegetatively by planting round plugs of sod or stolons (rooted runners). This is especially true of the zoysias,



Should be mowed below $\frac{3}{4}$ inch. Varieties include: Ormond, with a medium-fine texture; Tiffine, with a very fine, very dense texture and excellent disease resistance; Tiflawn, with a medium-fine texture and very rapid growth; Tifgreen, a new and improved variety; and U-3 Bermuda, with excellent wear resistance, the most cold-tolerant strain of the Bermudas.

BLUEGRASSES

These are the old stand-bys for cooler regions. Most of them have medium-fine leaves and form a dense turf. Shade-tolerant in the South. If not watered, bluegrasses may go

centipede, St. Augustine and the hybrid strains of the Bermudas.

Prepare the seedbed as for seeding. Plugging tools are available which will cut the sod into plugs two inches in diameter, and also dig holes of exactly the same size in the seedbed. Plant the plugs at measured intervals, no more than a foot apart, closer for more rapid coverage. Use a taut string as a guide in spacing the plugs. Tamp them firmly into place. One square foot of sod will provide about 36 plugs.

Plant stolons or sprigs in a shallow trench, spacing them only six inches apart. At this rate, 15 to 20 pounds of stolons will cover 1000 square feet.

Watering Your Lawn



It is most important that the surface of a newly seeded lawn be kept damp. Seed that has once been exposed to moisture in contact with the soil, and then permitted to dry out, very likely will not germinate.

Sprinkle a newly seeded lawn at least once a day and oftener if needed. Only the surface needs to be moist at this time, but it must never be permitted to dry out completely. Sprinkle with a fine mist to avoid dislodging the individual seeds. In general, less frequent sprinkling is permissible if you are establishing a lawn planted with plugs or stolons. However, more water should be applied at any one time to ensure moisture throughout the root zone.

Once the lawn has been established, it is important that the roots obtain water. Don't sprinkle lightly and frequently, as the roots will tend to be shallow, reaching toward the surface for water. Never sprinkle less than an inch of water on an established lawn. You can easily determine how much water you are applying by plac-

dormant during hot, dry spells and lose much of their color, but resume growth in the fall. They require watering, as long, dry spells may cause permanent injury. Establish in August or early September, seeding at a rate of two pounds per 1000 square feet. Fertilize the seedbed well and apply a high-nitrogen fertilizer fall and spring. Mow at 1½ inches or higher. Kentucky is the best-known strain of bluegrass, and has a medium-fine leaf and vigorous rootstock. *Poa trivialis* will withstand shade and dampness but suffers damage in heat and drought. It is good for shady lawns. No creeping rootstocks. Merion is superior to other bluegrasses in disease tolerance,

ing two or three coffee cans or other straight-side containers at various distances from the sprinkler. An inch of water in the bottom of the can, of course, indicates an inch of water on the lawn. In many localities, sprinkling for a given period of time is not a true indication of the amount of water you are applying; water pressure fluctuates in some residential areas and, unless you check, you may be applying much less water than you think.

On the other hand, too much water can harm creeping fescues and some other grasses, and is a waste of a critical natural resource.

In general, water lawns only when they need water. Wilting and browning of grass are your cues. Then apply water to wet the soil to a depth of six inches or more.

Mowing

Start mowing in the spring as soon as the grass reaches the recommended mowing height. There is one important rule to observe if you are to avoid damage to the grass: *Don't remove more than half the leaf at one time.*

Guided by this rule, you can leave clippings to add organic matter to the soil.

Bluegrasses and fescues should be mowed at 1½ to 2 inches; bent grasses, zoysias and Bermudas at ¾ inch, though some bent-grass strains should be mowed as low as ⅜ inch. Close clipping, especially during hot weather, will weaken or kill the bluegrasses. Centipede, St. Augustine and carpet grass are best maintained at a clipping height of one inch. Always keep a mower sharp, no matter what type it is. A dull mower will crush the leaves as it cuts, and such damage will move down the leaf. It encourages disease and may cause the grass plant to die. The crushed cut of a dull mower gives a lawn a brown cast.



drought tolerance, appearance and vigor, although susceptible to rust in some areas. It is extremely slow to germinate. Requires high-fertility soil, should be heavily fertilized spring and fall, lightly several times during summer. One drawback: It is more expensive than other bluegrasses.

BUFFALO GRASS

A native grass, good for lawns in the West Central states. Fine-leaved, it spreads rapidly by surface runners to form a dense, matted turf. Begins growing in late spring and continues until frost. Highly wear-resistant. Grayish green in color, turning to light straw

Fertilizing

Each type of "complete" plant food (a mixture of chemicals) is labeled with three numbers. Examples are 10-6-4, 5-10-5 and 10-10-10. There are other combinations. In each, the first number indicates *nitrogen*, the second *phosphorus*, the third *potassium*. Each of these elements is essential to plant growth. Any one of the numbers indicates



the percentage of that particular element in the analysis. By adding up the numbers, you can determine the percentage of *actual* plant food. For example, a 10-6-4 formula actually has 20 percent plant food; the remainder is inert material to make it easier to spread.

By simple calculation from the formula on the bag you can determine how much *actual nitrogen* you are applying. Apply no more than two pounds of actual nitrogen per 1000 square feet at one time. For example, 1000 square feet can take 20 pounds of a 10-6-4 formula, 40 pounds of a 5-10-5 formula or 50 pounds of a 4-12-4 formula.

For most lawns you can't go wrong applying this much fertilizer in the spring and again in early fall. However, there are several exceptions to this general rule. Merion blue, for example, requires high-nitrogen fertility, and should be fertilized several times each year with a high-nitrogen fertilizer. Bermudas, zoysias, St. Augustine and other warm-season grasses should be fertilized frequently through the summer.

Liquid fertilizer should be applied only as a quick booster. Rely on solids for longer lasting effects.

Organic fertilizers (made from sewage sludge, tankage and other waste products)

(Continued to page 218)

after frost. Can be established vegetatively or by seed. Sow 12 ounces of seed per 1000 square feet. Get treated seed for faster germination. Fertilize in the spring. Mow at 1½ inches or higher. Little watering required.

BLUE GRAMA GRASS

Another drought-resistant grass for the West Central states, it thrives in heavy soils. Medium-fine leaves, low growing. Growth ceases during drought but resumes when water is available. Readily established from seed. Seeding rate is one pound per 1000 square feet. Fertilize at least each spring. Mow at 1½ inches or higher.

CARPET GRASS

A low-growing perennial that spreads above ground by creeping stems which root at every joint. Can be established vegetatively, but the simplest method is by seed, which is abundant and cheap. Produces a dense, compact turf under close clipping. Grows best in sandy to sandy-loam soils. Tolerant to heavy trampling. Grows in partial shade if soil is moist. Resistant to insect and disease damage, but is not tolerant of salt-water spray. Thrives under limited fertilization on poor soils, but is sensitive to lack of iron. Mowing frequently to height of one inch with a rotary mower is recommended.

CENTPEDE GRASS

A low-growing grass which spreads by stolons to form a very dense mat. Requires little maintenance and is good for recreational areas. May spread to become a pest in flower beds. Will survive without fertilization, but produces dense turf upon application of high-nitrogen fertilizer. Establish vegetatively. Plant plugs or stolons six inches apart. Five to ten square feet of sod will establish about 1000 square feet of lawn. For best results, fertilize fairly heavily in spring, then lightly every month or six weeks during growing season. Inexpensive. Mow at ½ to 1 inch. Water when turf begins to show signs of drought.

CRESTED WHEAT GRASS

Excellent for cool, dry areas. Coarse leaves, somewhat hairy in appearance. A deep root system sustains the grass through long, dry spells, even though grass may go dormant. Establishment largely depends upon available moisture, and it can be seeded in fall or spring over much of its region of adaptation. Seeding rate is two pounds per 1000 square feet. Fertilize both spring and fall. Cut at 1½ inches or higher. Little watering required.

FESCUES

Hardy and robust, they are especially adapted to shady, dry areas. There are many strains that vary widely in texture and growth. Creeping red fescue has bright green leaves, creeps by underground stems. It is frequently mixed with bluegrass in prepared lawn seed. Chewings fescue is similar but does not creep. Pennlawn fescue is a new and improved strain of creeping red fescue. It has greater tolerance to leaf spot, better foliage density, faster rate of spread and greater ability to withstand close clipping. Establish fescues by seed, sowing at a rate of two to three pounds per 1000 square feet. Mow at 1½ inches or higher. Less fertilizer required than for most lawn grasses. One light application fall and spring will usually do the job.

ST. AUGUSTINE GRASS

A creeping, coarse grass that thrives in shaded areas and will withstand salt spray. Dense, wear-resistant sod. Establish vegetatively. Should be well fertilized with nitrogen, especially in sandy soils. Fertilize at least once each year, preferably at start of growing season.

ZOYSIAS

Excellent turf, but adapted mainly to the South and the "twilight zone" between South

(Continued to page 220)



Language Students See, Hear, Read New Words on Machine

Electronic language machines, operating on the tape-recording principle, present spoken and printed words and pictures in teaching vocabulary and grammar to students. A card is inserted manually in the machine and is moved mechanically until the lesson is completed. On this card students read the words under study, hear the same words pronounced and see illustrations explaining these words. The machine works from a 110-120-volt, 60-cycle, alternating-current outlet. The tone-control knob on the front panel starts the card carrier and amplifier. Headphones or an external speaker can be plugged in, disconnecting the internal speaker.

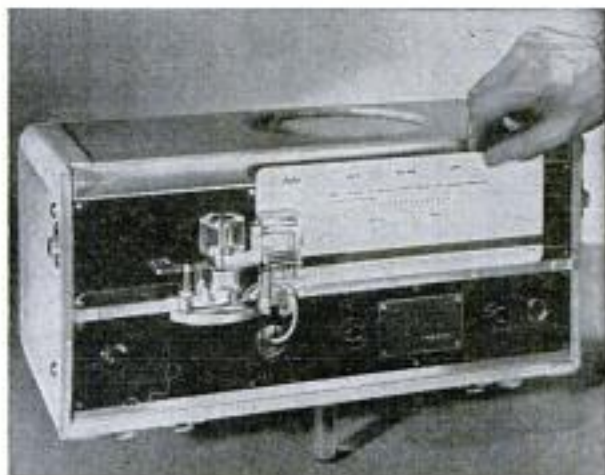

Homemade Tri-Winger Built to Sow Seeds and Dust Crops

Tom DeKellis, olive rancher of Oroville, Calif., is flight-testing his triple-wing plane. He made it from spare parts to use for sowing seeds and dusting crops. A 450-horsepower Pratt and Whitney engine powers the aircraft as it carries a 3000-pound pay load. Its fuselage can hold a Jeep. Wingspan is 36½ feet. Length is about 27 feet. Over a fixed, four-wheel landing gear, twin booms carry a pair of fins and rudders with trim tabs worked by a bicycle chain. It cruises at 70, can fly 90 and lands at 25 miles per hour.





Round Boats Keep Fish Guessing

Two circular craft, designed for fishermen, may overshadow futuristic "flying saucers" in appearance. One angler-bearing boat (see top photo) is a \$14,000, custom-made model that seats eight, is powered by two motors on opposite sides of the vessel, and has an electronically operated, underwater color TV camera and screen. The second craft (see photo at left) looks like the USS *Monitor* of Civil War fame and is the third such boat built by 85-year-old Bert Ross of Ottawa, Kans.



Huge Cylinder Takes Three Weeks for 800-Mile Trip

Towed three miles per hour by two tractors, a 110-ton cylinder required three weeks for transfer from a Parisian plant, where it was built, to atomic facilities at Marcoule, France—a distance of 350 miles.

The colossal tube is 100 feet long and 17 feet high. These dimensions added 450 miles of detours to the trip in avoiding bridges. Engineers tore down three houses and built a special road for this move.





At almost 40 miles per hour the 63-foot *Marlin* outruns most craft in its area. This boat carries crew of four

SEAGOING GAME WARDENS

By Jack B. Kemmerer

THE SLEEK, 63-foot *Marlin* wallowed in a choppy sea off the west coast of Catalina Island, 24 miles from the California mainland. A dense fog had settled down in the area, grounding even the sea gulls.

An expectant hush hung over the crew, as the short-wave radio crackled out a terse message. "This is it, boys. Let's go," the captain said grimly. He switched on the vessel's radar and eased the throttles ahead



Fish shipped to canneries by truck are checked by a warden at the cleaning table. Tonnage of fish processed is taxed by State of California



On 28 miles of Los Angeles docks, a warden sees that no undersized fish are unloaded from tuna boats to processing plants

Marine Patrol radios Coast Guard to send out a towboat for disabled fishermen who had a radio receiver but no transmitter



to nose the *Marlin* carefully along in the sticky fog hugging the island's rocky coastline.

In a few minutes a tiny pip on the radar screen revealed a boat, close inshore, getting nearer and nearer as the *Marlin* closed in. Suddenly, the captain turned on his craft's two powerful searchlights, outlining the strange boat a few yards dead ahead.

What's going on? An enemy vessel mining a harbor—or a narcotic smuggler with a fortune in dope headed for the mainland?

Neither one! The searchlights also revealed a huge fish net being hoisted aboard the unidentified craft—a purse seiner—with sardines still enmeshed in the net. Again, the Marine Patrol of California's Department of Fish and Game had convinced another fish poacher that it was unwise to operate illegally in restricted waters covered by vigilant, seagoing game wardens.

Jack London Served as Deputy

The Marine Patrol is not a new service in California. The state's fish commission appointed a game warden in 1870 to patrol and enforce the laws concerning salmon and other fish along the coastal rivers of central California and also in the San Francisco Bay and Delta areas. Assignment of this man—using a small sailboat to carry out his duties—was the beginning of today's modern Marine Patrol Service. It was during this period that Jack London served as a deputy game warden with the hazardous Marine Patrol which was the basis of his book, *Tales of the Fish Patrol*.

The real beginning of the patrol fleet took place in 1897 with the launching of a 40-foot, gasoline-powered launch, the *Quinnat*. The new patrol boat boasted a top speed of seven knots and soon made quite a name for itself among lawless fishermen operating in the Sacramento-San Joaquin Delta area. The peak of its long colorful career was reached when two game wardens were killed during a pitched battle with an organized gang of fish poachers.

Contrast between present-day patrol boats and the *Quinnat* is as great as contrast between the California of 1897 and that of 1957.

The department presently operates the 83-foot *Albacore*, based at Sausalito and assigned to the patrol of the rough waters between the Golden Gate and the Oregon line. The *Bonito*, a 63-footer, is based at San Francisco, covering the San Francisco area south to Morro Bay.

Electronically Equipped Boats

A pair of 63-foot vessels, *Marlin* and *Bluefin*, are based at Los Angeles' Terminal Island. Their patrol assignments take them from Morro Bay south to the Mexican border and include all of the numerous offshore islands, such as Catalina. All of the vessels are radar-equipped and also carry depth finders and short-wave radio in addition to their own private communication system.

Besides these large, well-equipped boats, the Marine Patrol operates eight smaller vessels, ranging in size from the 21-foot *Minnow* to the 45-foot *Tuna*.

(Continued to page 222)



Marlin's Capt. William Plett checks Catalina fishing



Warden sits in small skiff to write citation for fishing without a license. This is a very frequent violation. Short-wave radio at Terminal Island headquarters links office to patrol boats and land-based wardens.



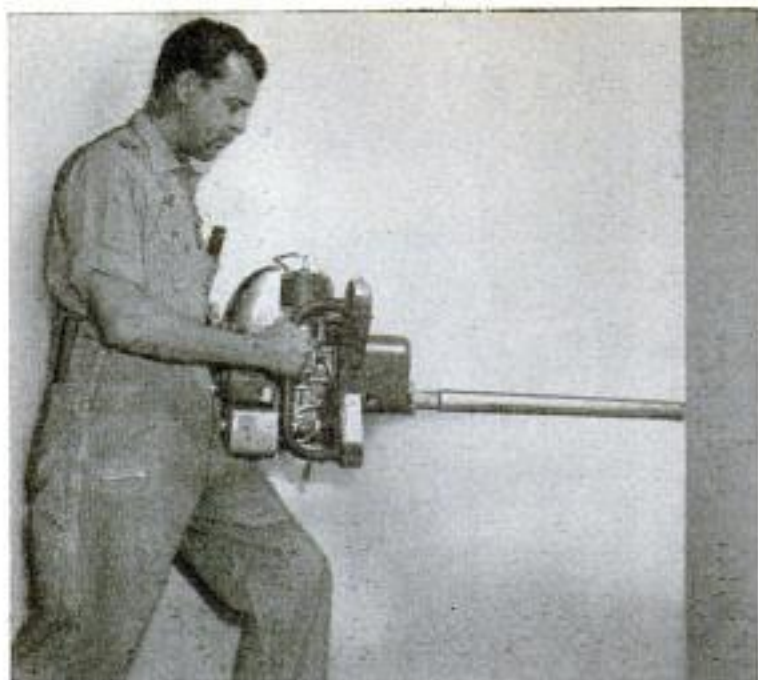

Portable Diamond Drill Cuts Six-Inch Cores

One man can handle the rotary drilling machine, above left, which weighs 47 pounds with a gasoline engine. A smaller 37-pound model uses an air-driven motor.

Diamond or tungsten-carbide bits and cores, above right, ranging from $\frac{7}{8}$ inch to 6 inches in diameter, can be used on the drill to cut through almost any material.

Special Reactor Tank For Chromium Recovery

Pure chromium metal can now be produced electrolytically for use in superalloys for jet engines. The U. S. Bureau of Mines said the key to the long-sought process is a special cell, or reactor tank, in which the metal is deposited. The cell is charged with an aluminum complex which aids recovery of chromium from its ores.

Mobile Unit Aids Arthritis Victims

Mobile physical-therapy units which visit the homes of arthritis victims are operated in 16 states by chapters of the Arthritis and Rheumatism Foundation. Manned by registered therapists, the units are station wagons or light panel trucks fitted with heat lamps, pulleys and other physical-therapy devices.

Rubber Tires Move 2500-Seat Stadium to New Site

Workmen in Flagstaff, Ariz., put a 200-ton stadium on 22 sets of rubber-tired dollies to move the steel structure to a new athletic field two blocks away. The 2500-

seat stadium was cut loose from the old concrete floor and raised by jacks to position over the dollies. Winch trucks moved the stadium, 100 feet at a time.

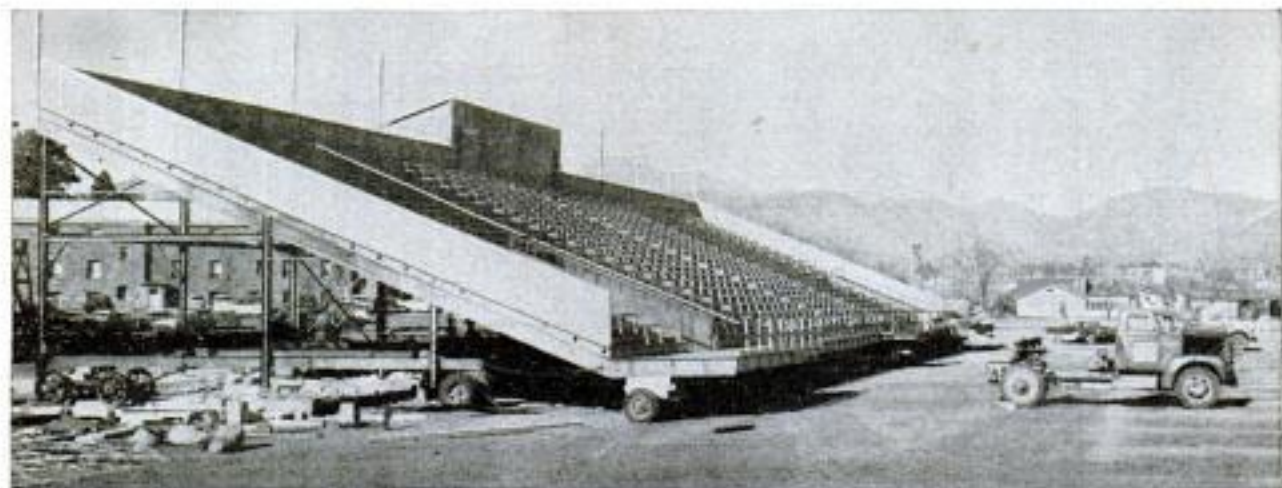

Pint-Size Trucks Handle Many Jobs

Miniature dump trucks weighing only 800 to 1400 pounds can carry loads up to 3500 pounds at speeds ranging from 1 to 20 miles per hour. One man can load, drive and dump a truck, available in a variety of body styles. With caster steering, the vehicle can be turned in its own length. Drive wheels are located directly under the load and can carry the truck up a 25-percent grade, if necessary. A locking brake can be set to hold the little truck immobile. Concrete can be hauled in one model, and another can be used for underground construction in tunnels. The trucks are available with either an air-cooled gasoline or a diesel engine. Over-all length varies with the model from 70 to 103 inches. Over-all widths range from 31 to 51 inches, and the trucks' wheel-bases range from 43½ to 58 inches.



Truck With Hoppers Hauls Dry Cement and Aggregate

Dry concrete aggregate now is hauled long distances by truck for mixing with water at the construction site. This procedure avoids dangers of overmixing, seepage and other long-haul losses brought on by wet mixes. Five 14-cubic-foot steel hoppers

are placed in the truck bed to hold the dry cement. The hoppers themselves separate the bed into five compartments for concrete aggregate. When the truck is dumped at the site, the aggregate and cement automatically mix and are ready for the water.





OWNERS REPORT:

Best-Liked

What Do They Like About
Mercury's Distinctive Look?

Least-Liked

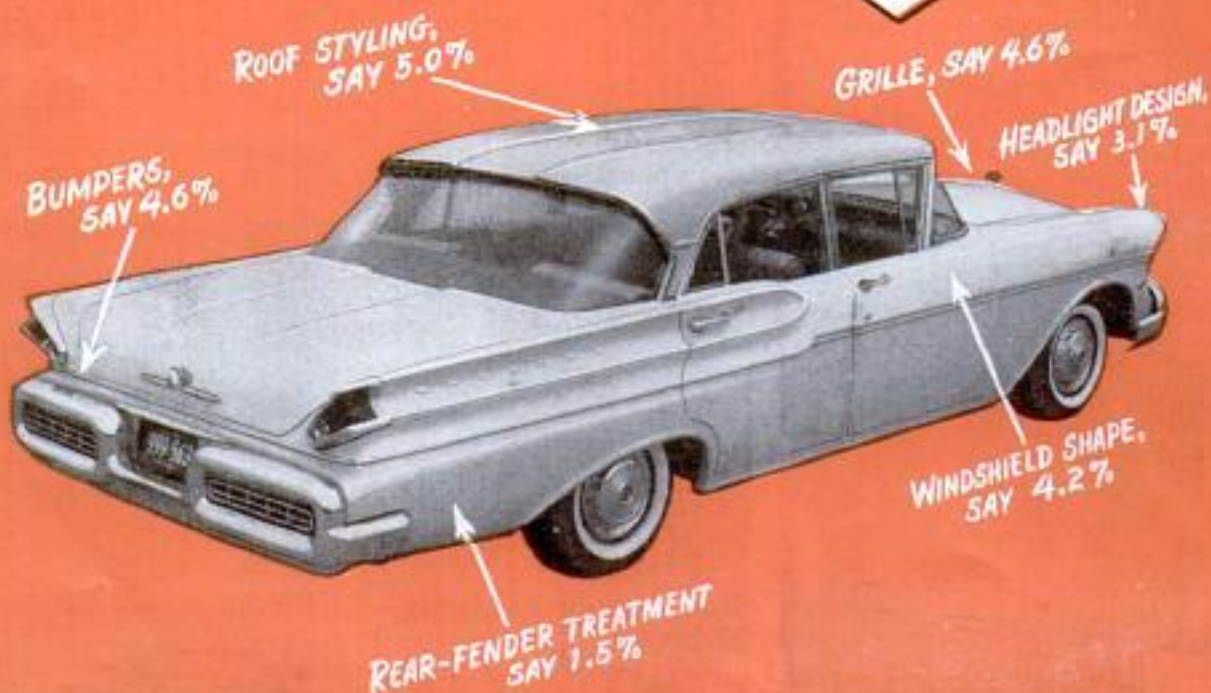

You have no difficulty identifying Mercury's distinctive rear styling



MERCURY STYLING MAKES BIG HIT WITH OWNERS



Opinions of Mercury owners in 42 states are summarized in this PM Owners Report

By Mercury Owners

STYLING IS TOPS—that's what owners of the 1957 Mercury say about their new cars.

Never in a *PM Owners Report* has there been such emphasis on styling as among Mercury owners. They are excited about the Mercury look and nearly 50 percent give styling as the one feature that most convinced them to buy. Styling also topped the best-liked list with 52.7 percent mentioning it.

"I like the square, sculptured look as opposed to the Buck Rogers styling of the Chrysler cars and the rounded look of the GM cars."—Michigan lineman.

"I was impressed with the beauty. The sleek bumpers, free of exhaust vents, torpedoes and other items. The beautiful grille. The taillights blended into the body lines."—California carpenter.

"The car is different from all the rest. The only car on the road that has a beautiful body style all its own."—Illinois claim adjuster.

"Receive many complimentary comments. Many say, 'Didn't like design at first, but it grows on you.'"—Ohio architect.

"Best looking. Plain straight lines. No frills."—Michigan retired owner.

What Is an Owners Report?

Popular Mechanics sends questionnaires to 1000 owners of a different make of car each month. These owners are picked at random from state registration lists by an independent organization. Owners' replies are tabulated and quoted to provide you with a summary of what owners think of their new cars.

Next month: The 1957 Dodge



You'll have no difficulty getting into the back seat. Mercury's wide-opening door gives 16-inch foot room



However, long-legged front-seat passengers may find their knees are tight against the padded dashboard

Second on the list of best-liked features is handling ease, mentioned by 38.1 percent of the Mercury owners.

"Car has balance. Ease of handling."—Michigan foreman.

"An exceptionally easy car for my wife to drive."—Nebraska telephone executive.

"Handles well in a cross wind."—South Dakota parts manager.

Third of the best-liked features is riding quality with 35.8 percent mentioning it.

"Smooth on rough roads. Takes bumps smooth."—West Virginia news dealer.

"Very comfortable even on long trips and I have taken two of over 2000 miles each already."—Michigan nurse.

What Are Complaints?

There's no doubt about it—owners seem to be getting more conscious of gasoline economy. *PM Owners Reports* show that Mercury owners are no exception. The most frequently mentioned complaint is poor gasoline economy with 25.4 percent of the owners mentioning it.

"I have had five Mercurys before and got from 16 to 21 miles to the gallon. Now

with this 1957 Mercury I get 10 miles to the gallon. Costs too much for a common man to drive."—Minnesota owner.

"I know a heavy car takes more gas, but this one seems to overdo it. It's too expensive for me."—New Jersey inspector.

"Just finished a 5000-mile trip. Actual gas-and-oil check made. Car used no oil. Averaged 11 miles per gallon of gasoline."—California oil worker.

"Much work was done on the carburetor even to get it up to 13 miles per gallon."—California retail sales driver.

Second most frequent complaint is poor workmanship (18.8 percent).

"This is our fifth new car since 1949 and we never before had any complaints about the car or dealer. There is nothing seriously wrong with the car, but there is always something not in working order. The signal lights did not work properly, the heater and defroster didn't work. The speedometer wasn't connected. They worked on the heater for several hours. It ran fine for one day. It's been repaired twice since and again it's not working. The radio is not

(Continued to page 210)

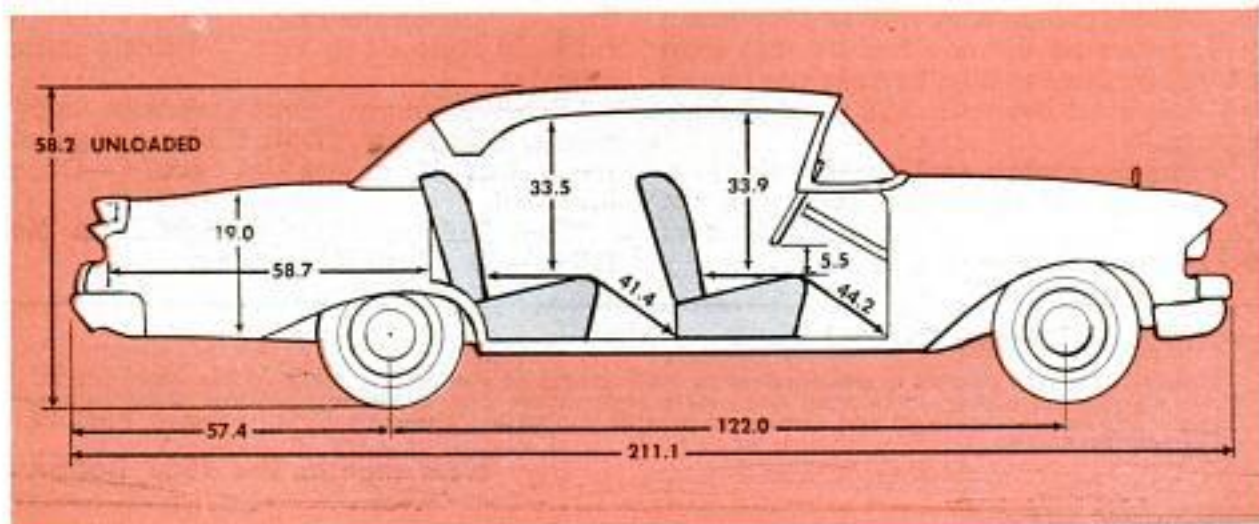

THE OWNERS' OPINION OF THE '57 MERCURY

Had trouble with engine?

No trouble	69.3%
Some trouble	21.5%
Considerable trouble	9.2%

What was engine trouble?

Carburetor	9.6%
Valves	2.7%
Water leaks	1.5%
Oil leaks	1.5%
Camshaft	1.2%

Performance

Would like faster acceleration?

Yes, would	33.8%
No, would not	55.8%
Undecided, no answer	10.4%

Would like more top speed?

Yes, would	14.8%
No, would not	55.5%
Undecided, no answer	29.7%

What is car's horsepower?

Knew correct hp.	66.9%
Did not know hp.	33.1%

Have checked gas mileage?

Yes, have checked it	72.1%
No, have not	21.2%
Don't care about mileage	6.7%

Styling

Best-liked exterior feature?

Rear-fender shape	19.2%
Lowness	18.5%
Taillight design	12.3%
Bumpers	6.5%
Length	6.5%
Roof treatment	4.6%
Grille	4.6%

Least-liked exterior feature?

Roof treatment	5.0%
Bumpers	4.6%
Grille	4.6%
Windshield	4.2%
Headlight design	3.1%
Rear-fender shape	1.5%

Best-liked interior feature?

Dashboard design	25.8%
Upholstery	13.1%

OVER-ALL RATING

Excellent	Average	Poor
61.4%	25.4%	13.2%

Least-liked interior feature?

Floor hump, wells	8.1%
Front ash tray	6.2%
Floor carpeting	4.6%
Glove compartment	4.2%

Miscellaneous

Push-button shift convenient?

Yes, more convenient	64.6%
No, less convenient	19.8%
Makes no difference	15.6%

Power-boost fan worthwhile?

Yes, it is	43.2%
No, it is not	6.3%
Can't tell difference	50.5%

Front seat comfortable for 3?

Yes, it is	70.8%
No, it is not	29.2%

What car will buy next?

Mercury	53.5%
Other Ford product	4.2%
General Motors car	9.2%
Chrysler Corp. car	6.5%
Some other car	1.9%
Don't know yet	24.7%

How is dealer service?

Excellent	43.5%
Average	32.4%
Poor	24.1%

Would buy from him again?

Yes, would	36.9%
No, would not	25.8%
Undecided, no answer	37.3%

What make car was traded?

Mercury	50.8%
Other Ford product	17.7%
General motors make	12.7%

Chrysler Corp. make..... 3.5%

Some other make..... 5.4%

No trade, no answer..... 9.9%

Why did they buy Mercury?

Exterior styling	49.2%
Previous ownership	15.8%
Trade, deal	2.3%

What should be changed?

Nothing at all	35.4%
More gasoline economy	11.9%
Improve performance	7.7%
Push-button shift	6.9%
Better workmanship	6.5%
Ash tray	4.2%

Best-Liked Features

Exterior styling	52.7%
Handling ease	38.1%
Riding comfort	35.8%
Roominess	16.3%
Performance	16.2%
Roadability	13.1%
Visibility	7.7%

Most-Frequent Complaints

None at all	21.9%
Poor gas economy	25.4%
Poor workmanship	18.8%
Body rattles, squeaks	16.3%
Push-button shift	13.5%
Not enough power	9.6%
Door fits	8.5%
Speedometer	6.9%
No "Park" on trans.	5.8%

Mercury is very low

Like this lowness	88.1%
Don't like it	9.2%
No answer	2.7%

Mercury is very long

Like this length	80.4%
Don't like it	13.1%
No answer	6.5%

Mercury is very fast

Like this speed	72.7%
Don't like it	3.1%
It's not so fast	11.1%
No answer	13.1%

What Do Owners Think of Industry Trend in Design?

Approve	88.5%
Disapprove	7.3%
No answer	4.2%

Being left-handed will help a Mercury owner. There are plenty of jobs for the left hand and foot to do

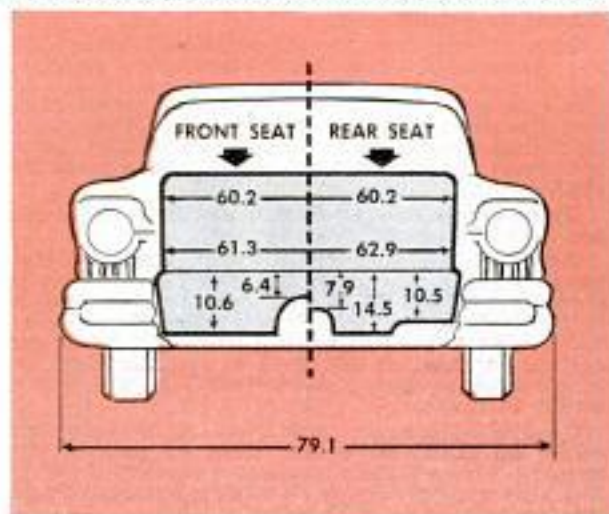

AN ENGINEER ANALYZES '57 MERCURY

By Dale Kelly SAE, Registered Professional Engineer

MODEL TESTED: Montclair four-door sedan with the extra-cost 368-cubic-inch engine. Also on the test car were a four-barrel carburetor, dual exhausts, Merc-O-Matic transmission, power steering and power brakes.

Rear-axle ratio: 3.22 to 1. Wheelbase: 122 inches.

Tires: 8.00 by 14. Weight: 4238 pounds with gas tank half-full (55 percent on the front wheels, 45 percent on the rear).

Mileage on car at time of test: 2900 miles. Barometer: 28.96 inches. Temperature: 78 degrees F. Pay load: 200 pounds.



ACCELERATION TIME FROM STANDING START, IN SECONDS

	0 to 20	0 to 40	0 to 60	0 to 80	1/4 MILE
Ignition timed for regular gas (90 octane Research)	2.8	5.9	10.6	18.0	18.2
Ignition timed for premium gas (97 octane Research)	2.1	5.3	10.0	18.0	17.8
Ignition timed for super fuel (105 octane Research)	No improvement noted				

(All tests in "Drive" range, using first, second and third gears.)



FUEL ECONOMY IN MILES PER GALLON

	Steady 30 m.p.h.	Steady 50 m.p.h.	Steady 70 m.p.h.	Traffic Route
Ignition timed for regular gasoline (90 octane Research)	18.5	16.2	13.2	10.3
Ignition timed for premium gasoline (97 octane Research)	18.8	16.5	13.1	10.5

On the traffic route the car makes 10 full stops per mile and is driven fast enough to average 15 miles per hour.

ESTIMATED AVERAGE ANNUAL GASOLINE BILL: \$194 for 10,000 miles.

Based on the exclusive use of premium gasoline. It is felt that almost all owners will prefer the improved performance that the use of premium fuel provides in this car.



SPEEDOMETER ERROR (miles per hour)

Speedometer speed	20	30	40	50	60	70	80
True speed	19	28	37	45	54	63	73

ODOMETER ERROR

Distance registered when car covered an actual 100 miles: 104 miles.



DRIVER'S VISION (for an average driver—5 feet 9 inches tall)

Distance at which part of road in front of car could be seen (A in sketch)	18.5 feet
Distance at which full width of road in front of car could be seen (B in sketch)	26 feet



GROUND CLEARANCE (unloaded car)

Radius of worst dip that could be crossed (solid line)	29.5 feet
Radius of worst hump that could be crossed (dotted line)	20 feet
Deepest rut car could be driven in	6.9 inches
Curb clearance for door opening	12 inches

MISCELLANEOUS

STEERING

Wheel turns from straight ahead to steer outside front wheel in a 100-foot-diameter circle: 0.85 turns

Diameter of smallest circle within which the wheels could complete a circle (curb-to-curb): 43 feet

Diameter of smallest walled circle within which the entire car could complete a circle (wall-to-wall): 45.5 feet

Steering-wheel turns, lock-to-lock: 4.2 turns

Steering-wheel diameter: 17 inches

TRUNK CAPACITY

Number of standard cartons (1 cubic foot each) that could be packed into trunk: 17 cartons

CENTER OF GRAVITY (unloaded car):

22.8 inches

WATER RESISTANCE

Fair. In the splash-pan test the brakes and ignition were not affected and no water entered the car. In the high-pressure car wash both front ventilator panes leaked; no water entered the trunk.

OBSERVATIONS

Instruments: Because the glass that covers the speedometer is tilted, there is absolutely no glare or reflection on it. Unfortunately, there are no five-mile-per-hour graduation marks on the scale and the scale itself is rather short. The signal light that shows when the parking brake is on is not very conspicuous at night and almost invisible in daylight.

Glove compartment: Rather small. But you can see into it without bending over.

Transmission: Accelerating wide open in Drive range from a standstill, it shifted from first to second at about 35 m.p.h. and from second to third at about 65 m.p.h. Accelerating from standstill with a light throttle, it started in second and shifted to third at about 20 m.p.h. Flooring the accelerator produced a downshift at any speed under 60 m.p.h.

General: Gasoline tank held 20 gallons and could be filled at better than 14 gallons per minute. Power-brake reserve provided four to five full applications with engine stopped. Parking brake held on a 14-percent grade.



It takes two hands to get into Mercury's glovebox

I DROVE THE Mercury Montclair four-door hardtop nearly 1000 miles in California and Nevada. It was powered by the 290-horsepower, 368-cubic-inch engine with a 10-to-1 compression ratio. This engine is optional on the Montclair at extra cost. The 255-horsepower, 312-cubic-inch engine is standard equipment.

Mercury has a carburetor air intake that automatically selects and delivers either cool outside-the-hood air (which is denser and gives more power) or heated under-the-hood air, or a mixture of both for top engine efficiency.

With the big engine, performance was fantastic. On a dry lake bed, the speedometer registered the maximum reading (120 miles per hour). It checked out fast, like most others, by about seven percent.

The lower center of gravity has greatly improved ride and stability on curves. There is a minimum of frame twist. The front suspension is improved with a swept-back design. The front wheels are pulled over, rather than pushed into, the bumps. This is definitely an improvement. The car has an extremely soft ride, in fact softer than I like. There is a noticeable, but not excessive, front-end dip when braking fast. However, the big surprise is that the car has little front-end roll or mushiness when cornering at high speed, despite soft front suspension. The driver has the feeling that the car is heavier than it really is. When cruising at any speed, there is a minimum of engine vibration, although there is considerable fender-tip vibration at above-average speed on rough roads.

Brakes are better than average for a car of Mercury's weight. Fade was less than average for an American car.

I wouldn't rate its economy as tops. If the people who buy cars insist on more horsepower, more speed and performance, they must continue to pay more money for the fuel. High speed and high performance certainly do not contribute to economy. The gas tank now holds 20 gallons (up from 18 gallons), but the owner won't get any

Driving the Mercury Montclair

By Floyd Clymer

more miles from a full 20-gallon tank with this high-performance engine than he did with a full 18-gallon tank last year.

The hood hinges in front, opening from the rear. It is counterbalanced to open and close easily. The front hinges permit an inside-the-car latch, something that has become unusual on a new automobile. This latch should help reduce petty thievery of under-hood accessories.

Vision is good. Due to the flat roof line, rear headroom is more than first appearances indicate. The inside rear-view mirror is too small. However, the outside rear-view mirror is the best I have used. It is easily seen through the windshield corner. Rear-fender tips serve as good guides for parking. The taillights are of a wrap-around design. They give good rear-end protection and also extend four inches along the sides of the fenders for added safety.

The doors feel solid, opening and closing easily. I do not care much for the door locks. Key operation could be lighter and smoother. The body also seems solid although a couple of rattles developed in the test. In a heavy rain, some water came in around one front window.

The instrument panel is well located and visibility is excellent. The horizontal-ribbon speedometer is steady and easy to read, but the spaces between its 10-mile-per-hour calibrations are too small. The face is shrouded for reflection-free visibility.

Although conveniently located in the center of the dash, the glove compartment is not good. Its lid is hinged at the top and requires two hands to open. There is little room inside.

Mercury's power-seat control is fun to use. Atop the dashboard is a dual control. One control selects any of five seat heights, the other selects any of seven fore-and-aft positions. Code numbers designate the particular seat position so you can easily set it to suit you. When the engine is turned off, the seat automatically moves back for ease of entry and exit. When the ignition is

(Continued to page 216)

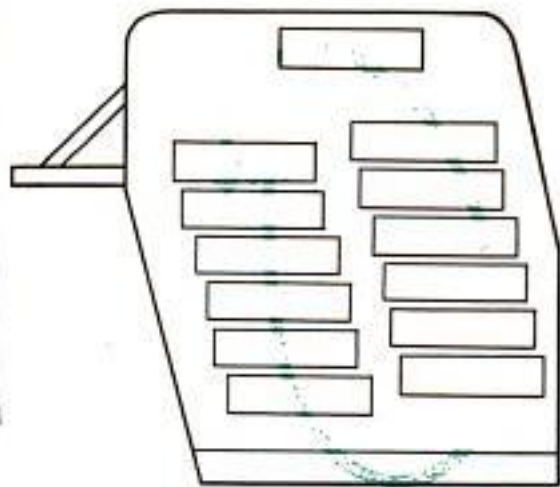

Elevator File—Going Up!

File records are no more than three seconds away from an operator using a new elevator-type filing machine. Depressing a latch-type button automatically delivers the desired file tray to correct working position for a sitting or standing person, who does not have to wait until the machine completes a rotational cycle of the files. The file holds 200,000 three-by-five-inch records in 13-inch-deep trays.



Tulip-Headed Tool Removes Hook From Fish

Resembling a closed tulip, a seven-inch-long plastic fishhook remover is guided along the line into the fish's mouth. The shaft of the hook slips into a slot and the barb slides into one of the grooves on one head of the remover. A push dislodges the hook, and the remover is taken from the fish's mouth. One end of this device is sized for pan fish, and the other end is adapted for larger fish.

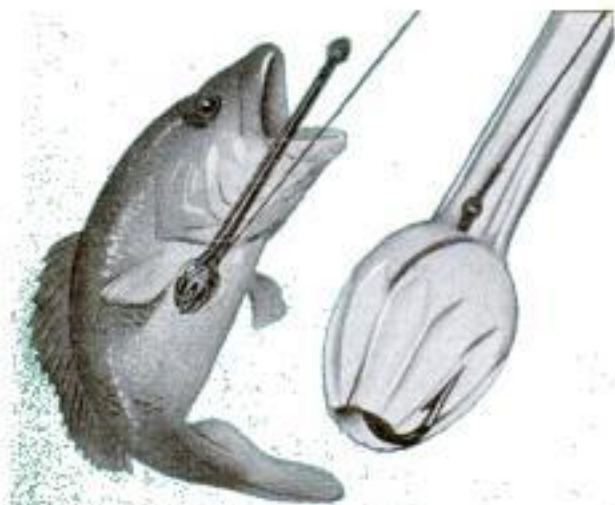

Rock 'n' Roll Pumps Boat Dry

Wave motion provides the energy to operate a new bilge pump. The pump, which requires no motor, no priming and no attention, is designed for pleasure yachts and fishing craft. When the boat rocks, a pendulum operates a double-end piston which draws water from two suction hoses running to the bilge. The water is discharged through one of two hoses at the top of the pump.

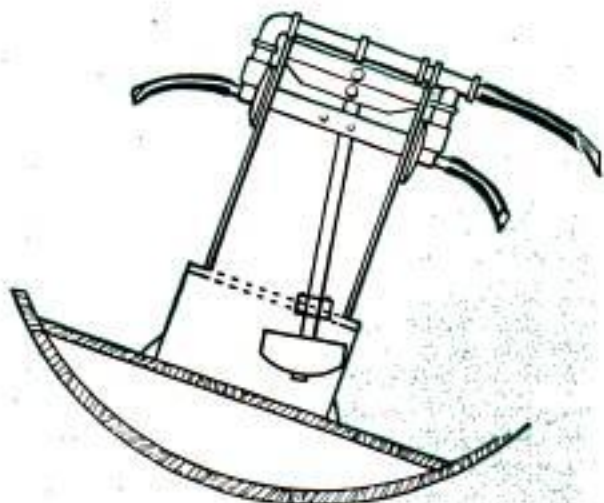



Rubber Balls and Food Tins Make Acoustic Ceiling

Fifteen thousand sponge-rubber balls and 30,000 baby-food cans solved the problem of how to dampen low-frequency sounds in the new ballroom of the Hotel Chase in St. Louis. The contractor cut the balls in half and nailed the halves, flat side down, on top of the roof form. The cans were placed over the rubber hemispheres and a three-inch layer of concrete was poured around them. When the form was dismantled, the balls were removed. The tops of the cans were cut off and the metal interiors were rustproofed.



Workman places empty baby-food tins over rubber balls cut in half and nailed to concrete form. Two-by-fours held cans in place while concrete was poured

Hydraulic Lift Pivots Truck Van on Railroad Flatcar

One semitrailer-truck driver can back a van onto a railroad flatcar from the side and, using a hydraulic lift, line up the van with the car. Using the new equipment, the driver completes the operation in four minutes. The lift permits the van to be separated from its wheel assembly and fastened to the flatcar for a more stable

ride. Several flatcars can be loaded simultaneously with this technique, as compared to the standard system requiring each semitrailer van and wheels to be loaded from the end of an individual flatcar. Only minor modifications are necessary in adapting this loading system to currently used flatcars and semitrailers.





Old-time station is built approximately to scale. Below, Buchmann fires up the vertical-boiler locomotive

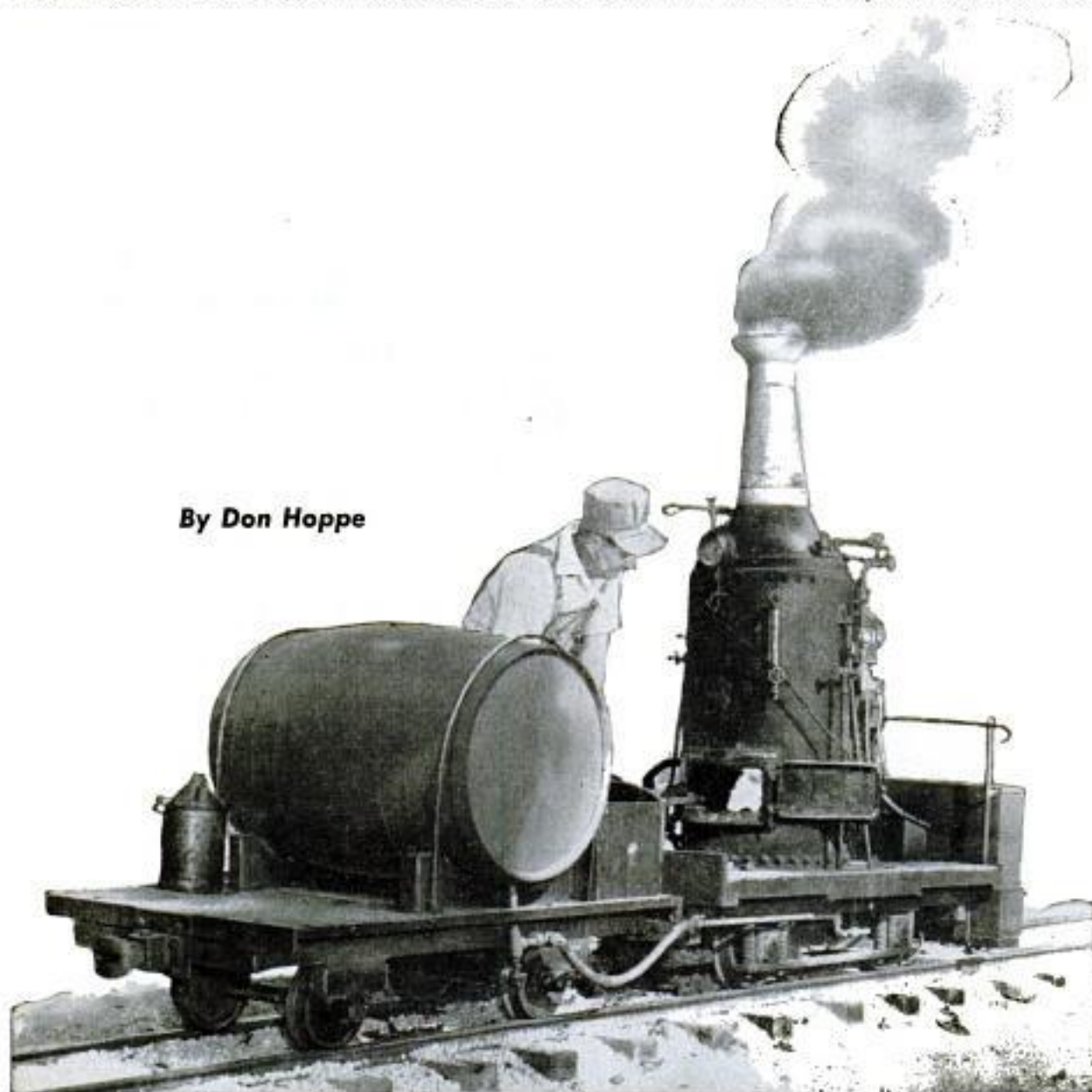

By Don Hoppe



Eastbound train, right on time, steams across the main trestle, which is 40 feet long, 16 feet high

DID YOU EVER dream of owning and operating your own passenger-carrying steam railroad? Bob Buchmann of Elgin, Ill., did, and then made his dream come true.

A former O-gauge model-railroad fan and a collector of railroad lore, Buchmann first thought seriously of building a real live-steam railroad about 10 years ago. And for 10 years, the H. T. & W. remained a persistent idea while Bob enjoyed a successful career in the hardware business.

Finally, in 1955, the Buchmanns decided that the time had come to turn their dream into reality. By this time, Mrs. Buchmann had also become a railroad enthusiast. For six months they searched for just the right piece of property. Then they found their present site: a 16-acre tract of beautiful rolling woodland covered with white oak and hickory trees and abounding in small game. The location was nearby, just three miles east of Elgin and 29 miles from Chicago.

Small System, Big Problems

Buchmann soon found that building the H. T. & W. presented all the problems found in building a full-size railroad. A regular railroad surveyor had to be employed to establish the correct grades and alignment for the 1¼ miles of track that wind through the woods.

Bob chose the 15-inch gauge for the H. T. & W., which stands for Hoot, Toot and Whistle. Incidentally, there really was an H. T. & W., the old Hoosiac Tunnel and Wilmington, which operated in Maine for many years. The 15-inch gauge is equal to a scale of three inches to the foot, or one-

quarter the size of the prototype. The system uses 12-pound rail.

Being partial to the old-time steamers, Buchmann decided on the 1860s for his prototype and contracted with Norman Sandley of the Sandley Light Railway Equipment Works to build four circa-1860 passenger coaches and a steam locomotive. Sandley painstakingly duplicated every detail of an 1860-style coach. Each of these eight-passenger cars has authentic hardware including link-and-pin couplers, clerestory windows, handbrake wheels and fully sprung trucks. The color scheme is dark green with orange trim—a popular motif of the '60s.

Sandley was able to supply an upright boiler-type engine immediately while another, a duplicate of the old "General" of Civil War fame, is still under construction. Although vertical-boiler types were not built after the 1840s, they were very reliable engines and were often kept in service for many years. The B. & O. for instance did not retire its last upright-boiler engine until 1893, so old "No. 1" is not out of place on an 1860 line. The H. T. & W.'s "mud digger," as they were sometimes called, is also unique in that the cylinders and driving mechanism were taken from an old Stanley Steamer automobile.

Problems With Right-of-Way

The rolling stock was only a small part of Buchmann's problems however. The real challenge was in the right-of-way construction. That beautiful rolling woodland, which makes the H. T. & W.'s route so unique, presented some first-class engineering difficulties. On the lower side of



H. T. & W.'s ornate eight-passenger cars are one quarter actual size, have authentic link-and-pin couplers

the property a 16-foot fill was needed and over 6000 yards of earth had to be trucked in. A 40-foot trestle had to be built to span an entrance road to the parking area. This trestle is constructed entirely of eight by eight-inch white-oak timbers, which weigh about 500 pounds apiece. During construction a severe rainstorm caused a washout of about 1500 yards on the big fill, which

Maintenance is a continuing job. Engineer Buchmann oils journals while his wife cleans the marker lights



had to be replaced. It took about a year to complete the entire construction job. At one time 15 people were employed, but for the most part the work was done by Bob and one or two assistants.

With the grading completed, a limestone ballast was applied, and over 5000 creosoted ties were laid. The rail was fastened with miniature railroad spikes. Two switches and sidings and a high-banked horseshoe curve are also included in the system.

Complete 1860 Station

A railroad needs buildings, too, so Buchmann built a replica of an 1860 station which is complete with rest rooms, refreshment bar and ticket office. He also constructed a train shed and loading platform, and then decided that no better spot could be found for his own home than the center of his growing railroad empire. Now his house is located in a clearing in the woods. A spur track from the main line runs to the garage under his house and here the rolling stock can be stored and repaired during bad weather.

Throughout most of the year the H. T. & W. operates on a seven-day-a-week schedule. During the winter months the road operates on Sundays whenever weather conditions permit.

The H. T. & W. is a growing system and new construction is always under way. A water tower and a turntable have been completed. Old No. 1 alternates with the only non-1860 piece of equipment the line owns, a gasoline work engine to keep traffic open. All aboard! ★ ★ ★

Tape Recorder Is Versatile Toy

Invented in Germany is a toy tape recorder as versatile as a regular machine. Operated by transistors and two flashlight batteries, it features both forward and rewind action. The tapes can be played back through any radio or through earphones. The recorder was introduced at a recent trade fair, and costs about \$22.



Pressed Cornstalks Make Wall Panels

Building materials can be produced from old cornstalks by a heat-and-pressure method developed at Purdue University. An example of the use of cornstalk building panels is shown in the photograph, above left. The treated stalks are covered with a wood veneer while an outer aluminum coating protects the panels against weather and fire. The panels need no studing but are connected at the eaves by

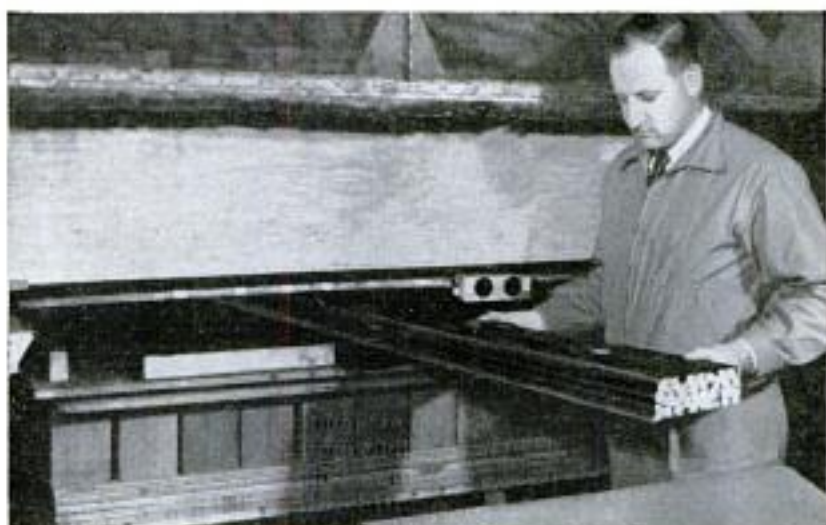

gusset plates. The pith of the stalks reportedly has excellent soundproofing and insulating qualities. The stalks are processed, above right, by removing the leaves and wax, spraying them with insect and rodent repellents, and applying a plastic binder. Heat sets the plastic while the stalks are in a pneumatic press.

Direct-Dial System For Mobile Phones

Owners of automobile and truck two-way radio-telephones in Richmond, Ind., may now make or receive calls by a dial system instead of having them go through an operator. This is possible with a transmitter-receiver station connected with the local telephone company. It automatically transfers radio calls to the telephone system and vice versa. The system is used by physicians, salesmen and others.



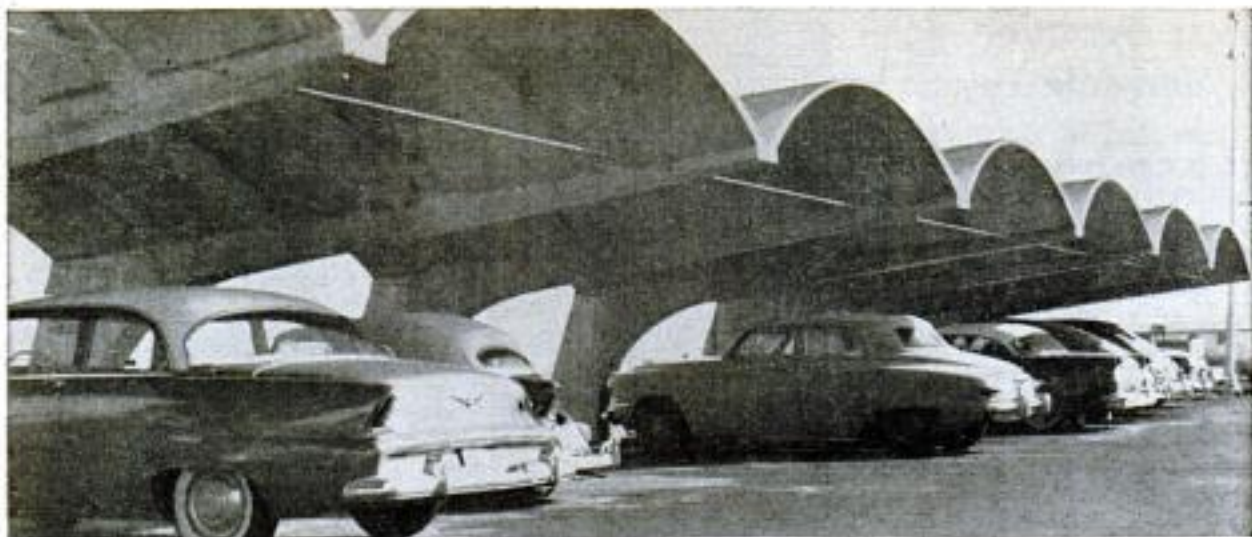

Concrete Carport Roof Seems to Defy Gravity

At first glance, drivers hesitate to park under an all-concrete carport roof that is supported on one side only and seems certain to crash to earth. The weight of the roof is supported by the cantilever principle. Two half-inch steel wires run from one end of the roof to the other to increase its strength. Added strength is provided by the multiple arches that form the roof.



Duplex Table Has Tilting Top

Two table tops, supported by a steel-tube upright on an adjustable horizontal base, serve as one double or two single tables. The tops are raised or lowered together. The larger top tilts and moves out or in on an arm.



Egg Beaten in Shell By Electric Whipper

Egg beating in the shell is accomplished by this new electric appliance. When the tilting head is lowered, the curved wire enters the egg and whips it inside by rotary action.

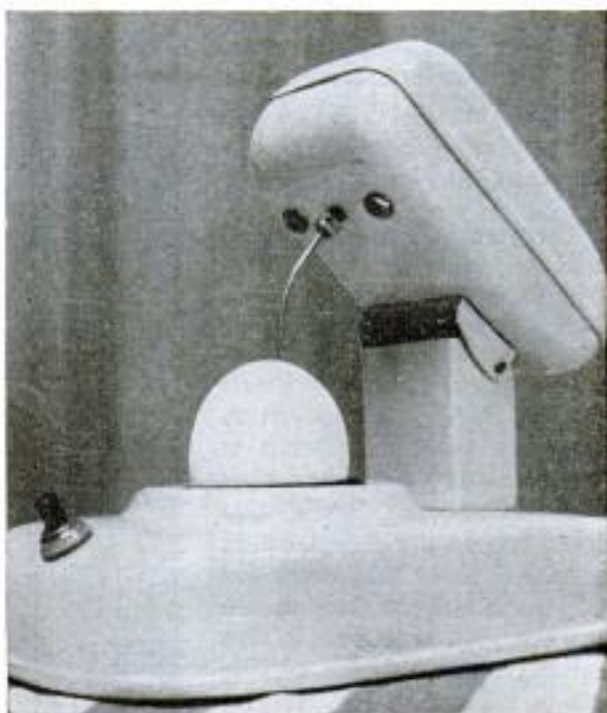

THEY FIND WATER ON THE DESERT



Jeep truck and trailer bearing generator are important field equipment in new technique for finding water

THE WATER PROSPECTOR was going over his findings with the owner of a large ranch in New Mexico.

"Drill your new well inside the circle I've marked on this map," he advised. "That's where you'll find the greatest volume of water that's fit to drink.

"There's water to the west of the circle, to be sure, but not in as large amounts. And don't waste any money in the south where you had planned to drill. The water there is loaded with salts."

This information, vital to the ranch, came from a new kind of prospecting technique known as induced polarization. It is an electrical method of searching for water developed by the New Mexico Institute of Mining and Technology.

With it a trained geophysicist can decide whether or not water exists underground. If there is water, he can give its approximate depth or depths. He can determine where the best water from the standpoint of quality will be found, and he can indicate the locations that will deliver the greatest yields.

This is big news to cities, towns and ranches in arid areas in all parts of the world. To some communities that have been outgrowing their water supplies it means the possibility that new underground reservoirs can be located and tapped. To other towns now using water with an objectionable taste it offers the chance of finding and tapping new supplies which have a lower mineral content.

Many barren valleys in the Southwest are completely deserted even though there may be plenty of water underground. In some valleys you can dig for water with the toe of your shoe. The water is there but it isn't fit to drink. It's not good for irrigation; it won't even support "browse" for cattle. Yet in the same area there may be enough good, fresh water to irrigate

By

Thomas E. Stimson, Jr.

Pickup electrodes used in tests are buried in ground at selected intervals



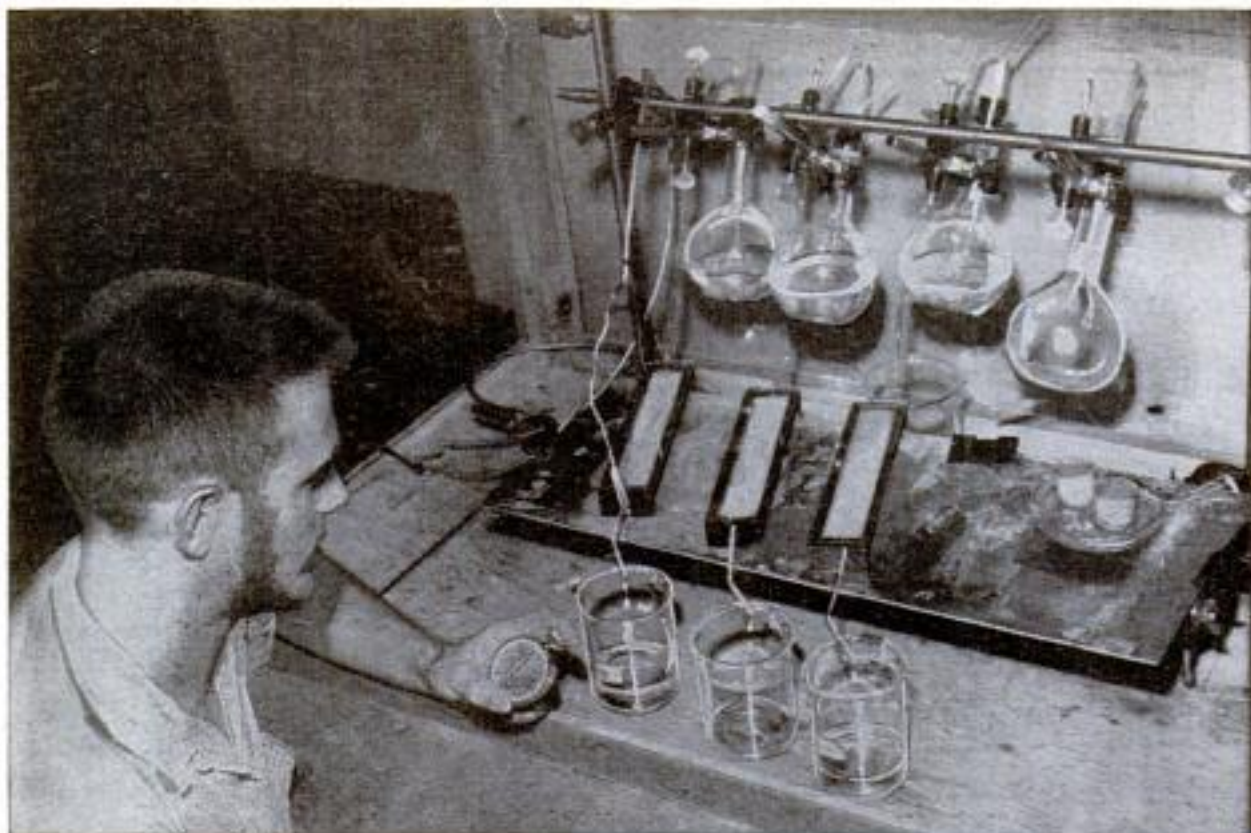

Effect of underground formations on electrical responses is studied by running water through soil mixtures



several sections of land or to supply all the needs of a small town. The new prospecting method offers the chance of locating the good water.

Arid areas such as New Mexico and Arizona don't receive very much rain to begin with, and only a small fraction of the rain that does fall from the clouds ever reaches the underground reservoirs. Half the rain over the lowlands evaporates in the dry air before it reaches the ground. Much of the rest is absorbed by vegetation or evaporates from the surface.

The underground reservoirs are recharged mainly by moisture that falls on the mountain ranges and then percolates underground. Here it follows porous channels downhill and then finally drains into the reservoir

During "charging" of ground, sign beside high-voltage electrode warns of danger. Deep probes require 1000-foot spacing

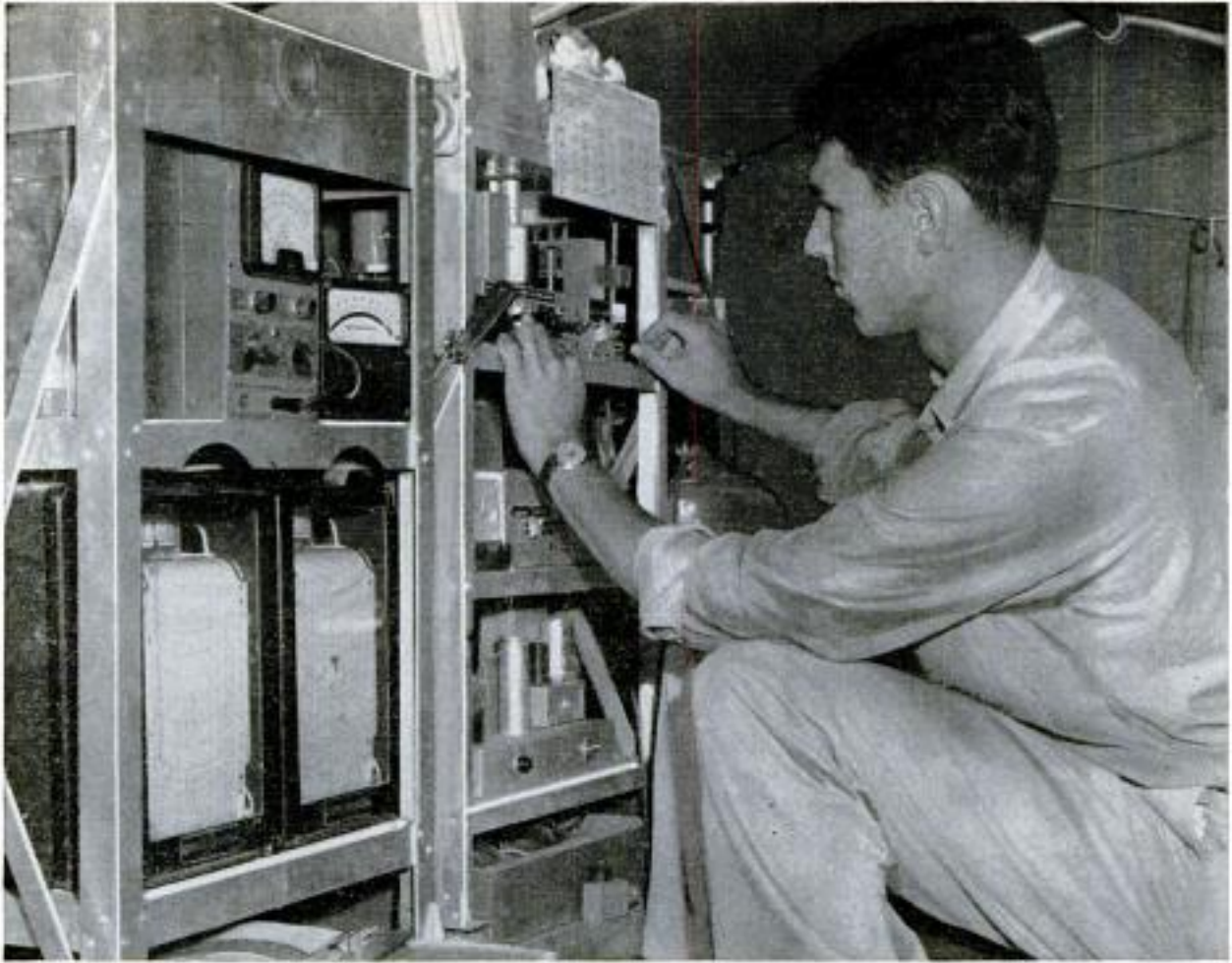

Recording apparatus in field truck makes a record of fading current in ground which helps to locate water

areas under the valley floors. But the reservoirs may be loaded with natural minerals including chlorides and sulphates. The water becomes unpalatable or even laxative. It is too hard for use in boilers (mineralization may run 1500 parts per million) and may not even be fit for irrigation purposes.

Hard water can be demineralized, of course, but this is too expensive a process for agricultural water or even for most domestic uses. The best trick is to intercept the water on its way downhill, before it becomes contaminated with minerals.

Much of the water draining out of a mountain range percolates down under the alluvial fans at the entrances of canyons, following old, buried channels that give no indication of their presence on the surface. Locating these channels is one of the jobs that the new prospecting technique can do.

In this method, the ground is energized for a short time by feeding 600 volts of direct current through it by means of electrodes spaced several hundred feet apart. Then, as soon as the current is shut off, the rate of decay of the induced field voltage in the ground is measured. This is something like charging a very inefficient storage battery and then measuring the rate

at which it discharges itself. The analogy is not quite accurate but it conveys the idea.

The decay rate of the current in the ground is measured in millivolts. By means of amplifiers this current is made to operate a pen that draws an inked curve on the paper of an automatic recorder. The length and shape of this curve, plus other information, tell a great deal about the subsurface conditions.

If the curve is flat it means that no water exists in the area examined. A steep rise in the curve indicates that water is present. Changes in the slope of the curve may indicate water at more than one depth. The degree of polarization, indicated by this curve, is an indication of the purity of the water. The speed of decay, also indicated by the curve, is related to the grain size of the underground structure. Slow decay indicates coarse grains, from which water can be pumped more rapidly than from a fine-grained structure.

There are other geophysical methods of prospecting for water. Shallow seismic refraction is one. Here small charges of explosives are detonated just below ground level, creating vibrations that bounce back from buried strata. By this method the

(Continued to page 206)

HOT SHIP AND LAND



Children can climb, crawl, hide, slide or jump into sand from "The Thing," above

Left: It's a bird, it's a plane, it's anything your imagination wants it to be

Carefully balanced swing ride, below, whirls or stops as children shift weight

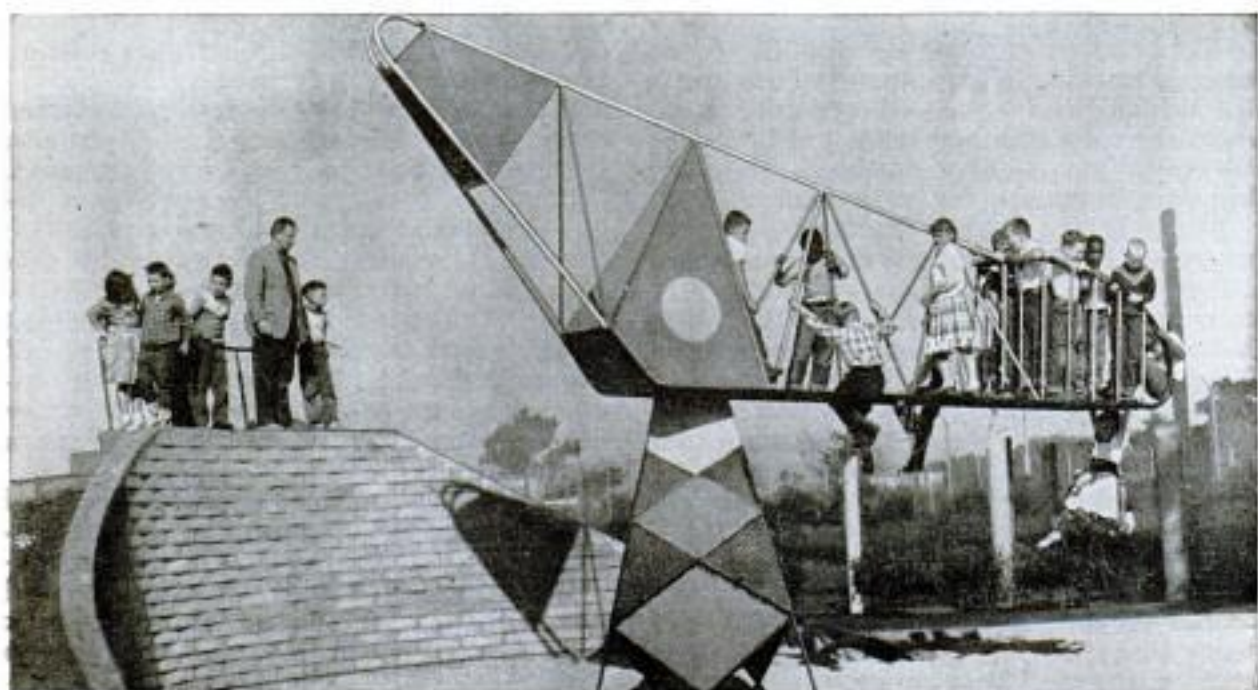

BASIC PLAY URGES of children—running, sliding, jumping, hiding, swinging or floating things on water—were the focal point of design of a new playground in Monterey, Calif.

The playground was conceived by Hank Ketcham, who draws the "Dennis the Menace" cartoons. Sculptor-artist Arch Garner helped bring the play equipment into being.

The only things the kids have to furnish are their apparently boundless imagination and limitless energy. Some of the units of equipment, like the 30 by 40-foot free-form conglomeration of steel rods and sheets called "The Thing," give vent to many play urges. Kids can climb on it, slide on it, crawl on it or jump from it. They can pretend it's an airplane or spaceship, a fish, a bird or perhaps a prehistoric monster.

For youngsters who prefer to play in water, there's a plastic-foam island, 12 feet in diameter, floating in a shallow lake. Nearby is a 30-foot-long winding brook in which kids can float boats or twigs.

Children also can ride their tricycles or coaster wagons on a miniature highway marked with such appropriate road signs as "No Left Turn," "Watch for Slow Moving Vehicles," and "Speed Limit 5 miles."

The playground was designed with safety in mind. Each unit is mounted in concrete so it will not pull loose under stress of play.

The Monterey Junior Chamber of Commerce is making the playground plans available to other Jaycee groups and recreation authorities. ★ ★ ★



"Umbrella Tree," above, has 12 ladders which children climb to a steel framework. They slide down on "fireman" sliding poles



Like a giant bedspring, this 12-foot-high spiral of steel pipe satisfies the urge of children to jump on something that will bounce up and down





Guided-Missile Plane Flies for Royal Navy

Great Britain's de Havilland Sea Vixen, an all-weather fighter, will carry guided missiles for the Royal Navy. Powered by two Rolls-Royce Avon engines, the Sea Vixen has power-folded, sweptback wings, steerable nose-wheel and air brakes for carrier operation. This plane will replace the de Havilland Sea Venom as the Royal Navy's chief all-weather fighter.



Pivot Control Turns Mower

Touch the right or left turn button of the control box for this electric-power lawn mower and a lever drops to the ground. The lever lifts the wheel on one side, allowing the mower to pivot in the direction you want it to move. The controls limit the turn to a fraction of an inch or allow a complete circle. When the mower pivots, the carrying arm at the rear elevates the electric cord, keeping it out of the path of the mower blades. The mower cuts easily and accurately under bushes and low-hanging limbs.



Drive-in Phone Used From Car

Weatherproof, curbside telephone service now is available at three locations in Chicago. If a driver in that city wants to call a friend, he just pulls his car over to one of the curbside booths and places the call without having to get out of his car. The Illinois Bell Telephone Company has installed the three units as an experiment to determine public acceptance of this unusual service.

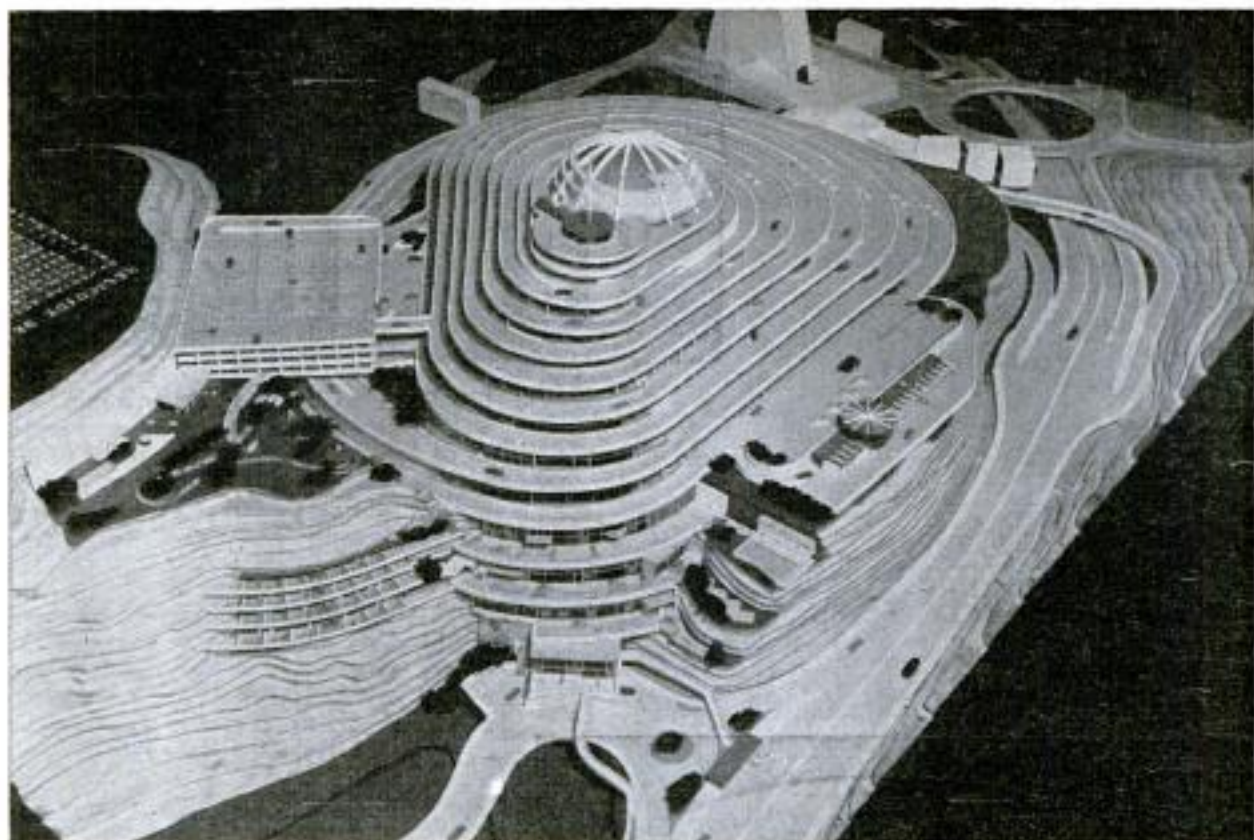

Spiral Shopping Center To Cover Caracas Mountain

Brain child of Venezuelan architect Jorge Romero Gutierrez, a 25-story business and commercial center, shown in the model above, is being erected on the contours of a mountain which overlooks the city of Caracas. The helicoid structure, when completed in 1960, will contain 320 stores, a hotel, swimming pool, industrial showrooms, business offices and garages. Cost will be about \$25,000,000. A spiral ramp will allow cars to drive to any level, right, where shoppers can park. There will be Escalators and elevators for pedestrians.

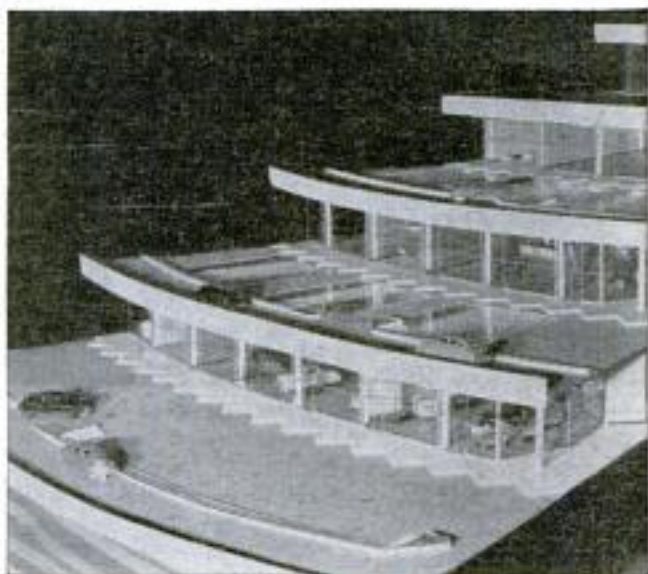

Four-Way Pencil Sharpener Stops at Sharpest Point

With a new type of pencil sharpener manufactured in West Germany, you can shave either the lead or the wood casing separately. As illustrated in the drawing, right, the No. 1 blade shaves only the wood casing and it automatically stops cutting before the lead touches the blade. The No. 2 blade cuts only the lead and stops when the sharpest point is reached. Two cutters on the sides sharpen mechanical-pencil leads. One takes up to standard size, the other sharpens heavier than standard leads.

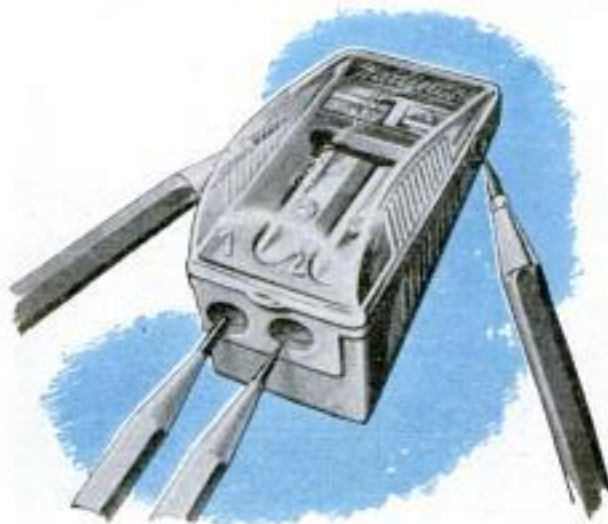

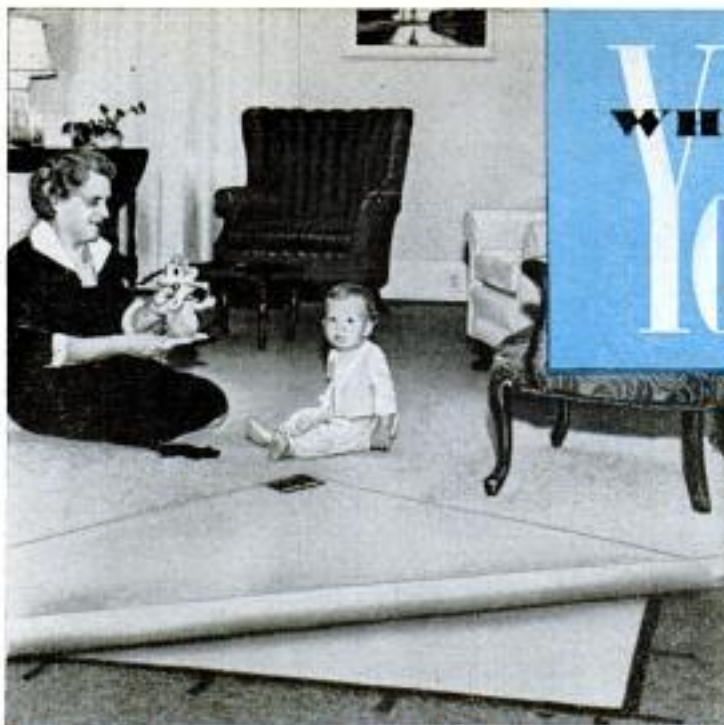

WHAT'S NEW FOR Your Home

ELECTRIC HEATING MAT under a rug, left, will keep the chill away when people sit or play on the floor. The mat is available in five sizes and designed to protect against electrical contact or overheating

Radiant Products, Inc., Monroe, N. C.

CEILING DIFFUSER, left center, improves overhead air distribution by controlling a room's air motion below 50 feet per minute, the standard draft-free condition. Built-in rings help eliminate dirt smudges

Conzor Engineering Corp., Danbury, Conn.



SHELVES, left below, can be added and sections made into different combinations with frames of steel tubing. The shelves hook into holes, which are three inches apart. Suction cups on legs anchor the units

Shelfmaker Products Corp.,
319 Jefferson St., Newark 5, N. J.

WALL LAMP, below, can be moved up or down without the aid of pulleys or counterweights and the cord is always enclosed. Made of aluminum, it can easily be changed to different locations where the extra wall brackets have been installed

Maypole Clamp Lamp Co.,
727 Delaware Ave., Youngstown, Ohio



PLASTIC SINK, right, with separate dish-washing and rinsing compartments makes the chore easier and saves water. Available in four different colors, it fits in a standard-size kitchen sink. Ribs on the bottom keep the drain open. The dish-washing compartment has a capacity of 11 quarts of water, while the rinsing section holds approximately two quarts

Federal Tool Corp.,
3000 W. Pratt Blvd., Chicago 54

REDWOOD PICNIC TABLE, right center, is portable and collapsible. It can be folded to only 13 inches in width, and rolls on four-inch rubber casters. Unfolded, it can be moved on steel "sled runner" supports. The table is six feet long, the top is four feet, five inches wide and it is made of 1¼-in.-thick vertical-grain redwood planks

Magma Mfg. Co.,
5217 Eden Ave. S., Minneapolis 24, Minn.

VERTICAL MEAT GRINDER, right below, has several advantages. It makes feeding almost automatic and prevents splattering. A new cutting action slices the meat and doesn't mash it through. The parts are made of lightweight cast aluminum, simple to disassemble and clean. The grinder is available built-in or in a table-top model

Nutone, Inc., Cincinnati 27, Ohio

SHELF FIXTURES, below, are brass-plated, adjustable and easy to install. The bolt-less brackets fasten to the standard's slots with a new, patented friction grip. The standards are available in three, four, five and six-foot lengths, with slots spaced one inch apart, and the brackets in six, eight, ten and twelve-inch lengths. Both of the fixtures have a lacquered finish

Knape & Vogt Mfg. Co., Grand Rapids, Mich.

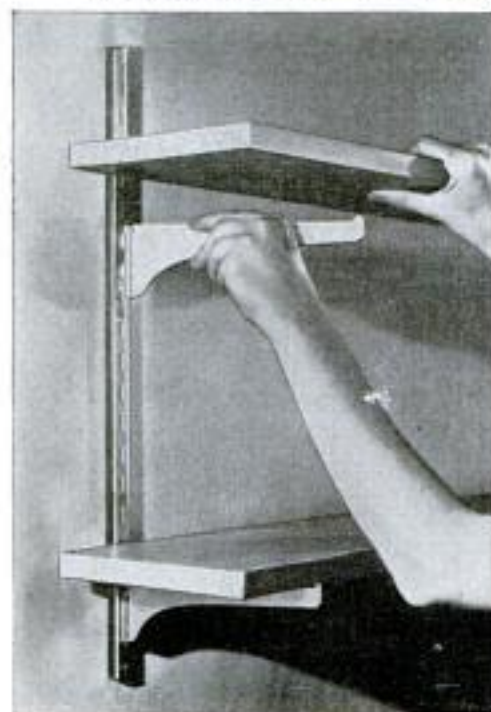



Converted Submarine Carries Liquid Rubber

Like beating swords into plowshares, an Italian industrialist is converting wartime submarines into tankers to transport liquid rubber to ports near rubber-goods factories.



Swedish Baby Carriage "Walks" on Feet

Instead of wheels, a Swedish baby buggy has 20 metallic feet fixed to its axle like spokes of a wheel. The carriage "walks" up and down stairs in a rocking motion.



"Pod" of Strange Plane Transports Ton of Chemicals

Improved weight distribution determined the lines of this oddly built airplane. With the cockpit in the rear, it carries a ton of crop-spraying chemicals in its podlike fuselage. Metal tubes support the unique tail. The plane was built in Australia by the Kingsford Smith Aviation Service, Ltd.

Light Lures Bugs into Electric-Fan Trap

Bugs attracted by the lights on electric fans are caught in the air currents and hurled inside a mesh bag. The bag is re-

moved and dipped in hot water to kill the insects. Large-size traps can be used in orchards and gardens.

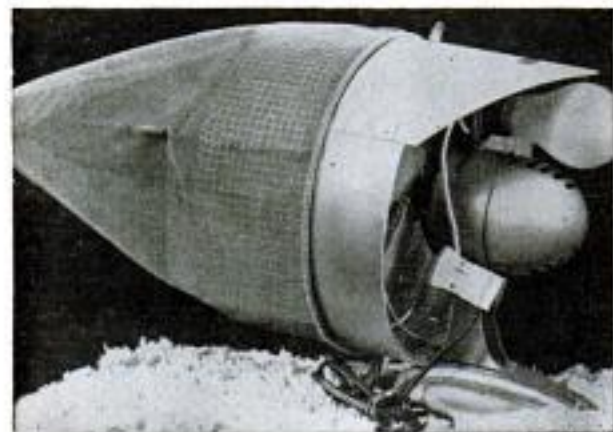

RADIO TELEVISION ELECTRONICS

THE SEARCH for high fidelity continues. Today, moderately priced electronic components are capable of reproducing almost all sounds within the limits of human hearing. Higher-priced units can duplicate the loudness level of complete symphony orchestras with so little distortion or alteration of sound, that even a trained ear can barely detect the difference between the original presentation and the recorded reproduction. Still, the quest goes on, and some recent developments attest the fact that the ultimate has not yet been achieved.

For the true hi-fi enthusiast, faithful reproduction of recorded music is not enough. He must capture the "feel" of the concert hall, the presence of the orchestra, to gain optimum enjoyment. To meet this demand, stereophonic playback equipment and prerecorded stereo tapes have appeared on the hi-fi scene in ever-increasing numbers. Such systems are relatively expensive because they require duplicates of all components used in the normal set—two pickups, two amplifiers, two speakers—but the change from monaural to stereo playback is as striking as the difference between ordinary phono reproduction and real high fidelity.

Stereo recordings are made by positioning two (or more) microphones so that each one picks up the sounds from a particular section of the orchestra. The output from each microphone is recorded on a separate tape track. During playback, the two tape tracks are separately reproduced so that a listener seated between two correctly positioned speakers is effectively placed in the very center of the orchestra. So lifelike is the reproduction that one can almost discern the exact location of the various instruments.

An interesting new development in the stereo field is the listening chair shown in the drawing, above. The chair, designed by the Stereo Products Company for personalized listening in the home, for stereo demonstrations at exhibitions and in stores, and for possible theater use, contains a concealed loudspeaker and volume control in each of its wings. The sound, therefore, is brought directly to the listener's ears for a true binaural effect previously available only through the use of special earphones.

At present, stereo recordings are avail-



In the Interest of Higher Fi

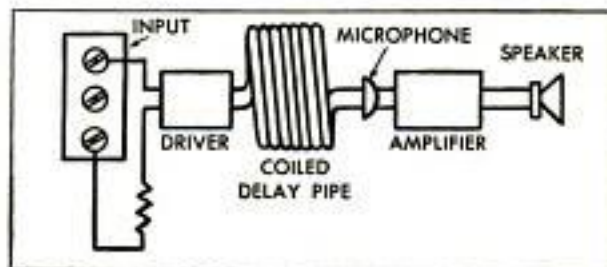

able only on tape, since a foolproof method for reproducing two individually recorded sound tracks from a conventional disk remains to be developed. Yet, there are thousands of phonographs whose output could be measurably improved through the addition of concert-hall realism. This is accomplished quite effectively with the

(Continued to page 224)

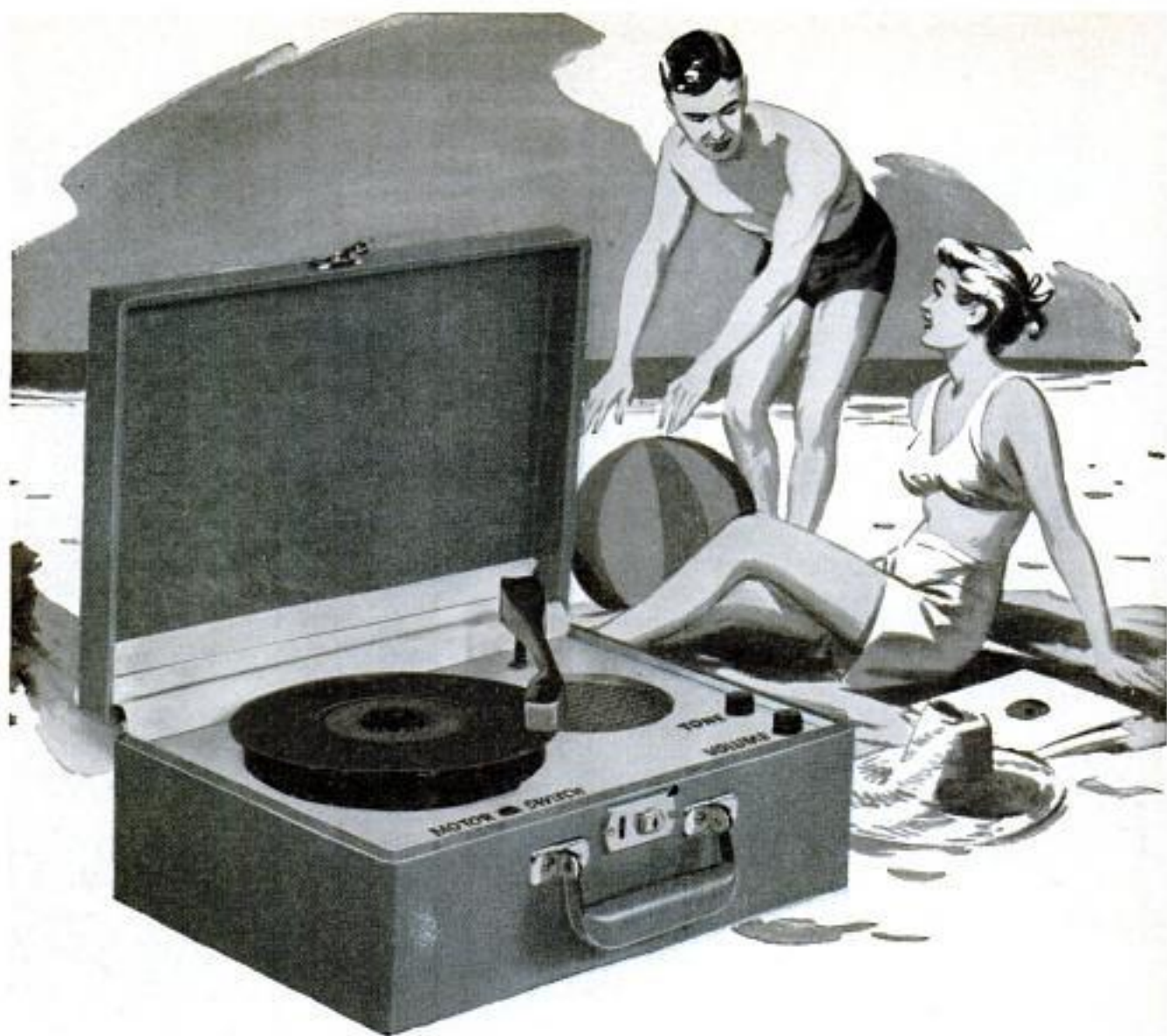

Companion Phono Plays Records Anywhere

By Samuel Sosenko

HERE IS an easy-to-build phonograph which will permit you to enjoy your favorite platters even during those hot summer months when most record collections are neglected in favor of picnics, beach parties and other outdoor activities. This unique little unit can accompany you everywhere and will play at the flick of a switch with never a thought as to the location of the nearest electrical outlet. Built around a newly developed 6-volt phono motor and a fully transistorized amplifier, it operates on a set of self-contained batteries which are good for several hundred hours of use.

Performance-wise this portable phonograph leaves little to be desired. The amplifier delivers up to 250 milliwatts of power, enough to provide comfortable listening

volume even in noisy locations and relatively large rooms. A 5-in. speaker, adequately baffled, gives far better tone quality than is usually associated with portable equipment and an effective tone control permits treble-frequency attenuation to suit your own listening preference.

Building the Amplifier

Layout and construction of the amplifier are shown in the three illustrations of Fig. 1. To prevent undue cluttering of the chassis-layout diagram, illustration A, only the most important dimensions are specified. The dimensions not given can easily be determined by placing the actual parts on the chassis, as shown in illustration B.

Slots A are for the transistor sockets which are fastened in place with retainer

clips furnished with these units. Those labeled B are used for mounting transformers T1 and T2. These transformers have mounting tabs which are inserted through the slots and bent underneath the chassis. Holes E are centered on opposite sides of each transformer to permit transformer-lead feed through from the top to the bottom of the chassis. The purpose of the other holes can be determined by a careful comparison of the three illustrations.

Short lengths of spaghetti (insulating-fiber tubing) should be used to cover the transformer leads at the point of chassis feed through to prevent damage to these fragile wires.

Be sure to mount the transistor sockets exactly as shown in the pictorial diagram, Fig. 1C. Note the close spacing between the emitter pin (E) and base pin (B), and a somewhat wider separation between the base and the collector (C) pins. The transistor leads are similarly spaced for easy identification, so that these can be properly inserted in the sockets. This should be done only after all wiring has been completed.

Since some of the miniature components, particularly the small electrolytic capacitors are easily damaged by excessive heat, a solder gun or small-tipped iron should be used for all wiring. The iron should be applied to the component leads just long enough to permit the solder to flow and make a good electrical connection.

After the wiring is completed, check it against the schematic diagram, Fig. 3, to make sure that no wiring errors have been made. Then, cut the transistor leads to a length of approximately $\frac{1}{4}$ in. and plug these into the sockets. Make sure that the transistor leads coincide with the pin spacing of the sockets. Incorrect insertion of the transistors will prevent the amplifier from operating and may cause the transistor to be damaged.

Choice of Phono Motor

The choice of phono motor depends entirely on the type of records included in your collection. Because the small 45-r.p.m. records take up little space and are easily carried about, a single-speed 45-r.p.m. motor, General Industries Model BX-45, was

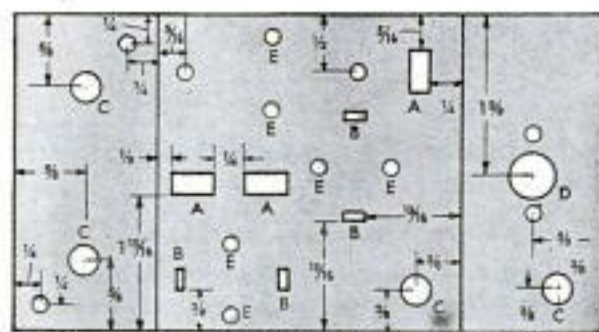

CHASSIS—TOP VIEW

- A— $\frac{1}{8} \times \frac{1}{8}$ -IN. SLOTS
- B— $\frac{3}{16} \times \frac{1}{8}$ -IN. SLOTS
- C— $\frac{1}{4}$ -IN. DIA.
- D— $\frac{3}{8}$ -IN. DIA.
- E— $\frac{1}{8}$ -IN. DIA.

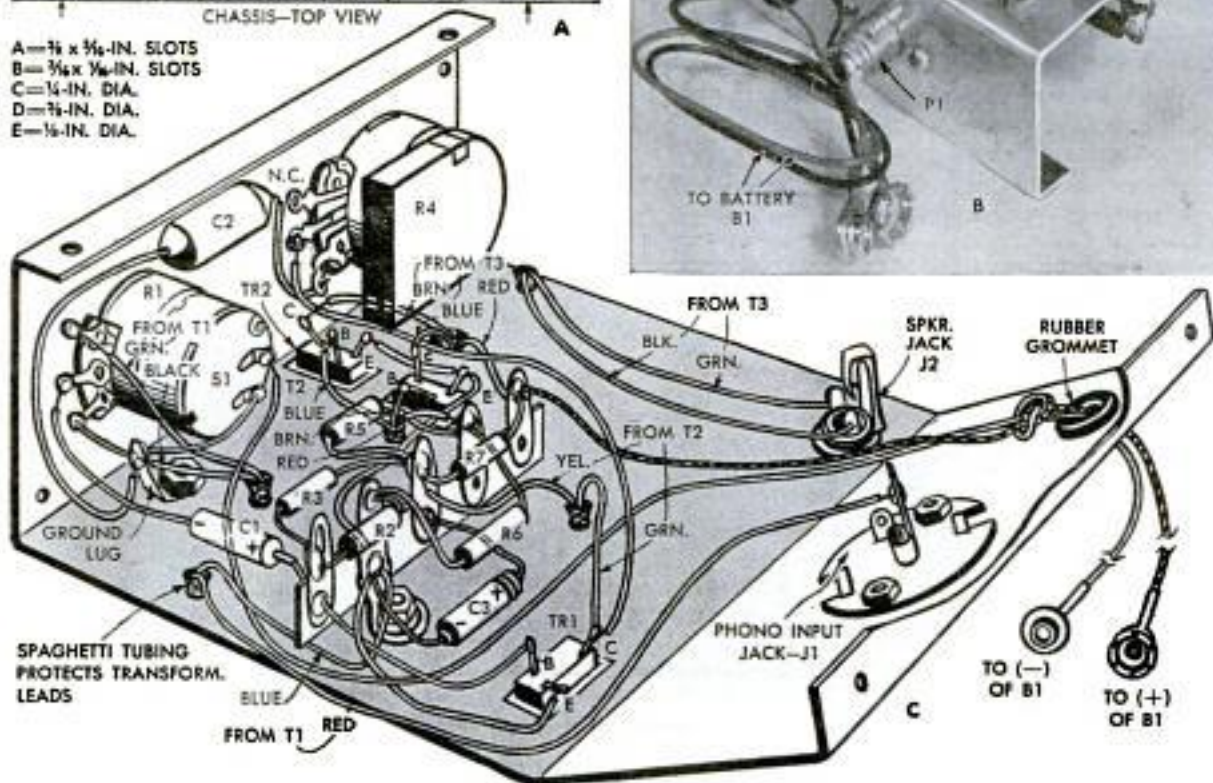
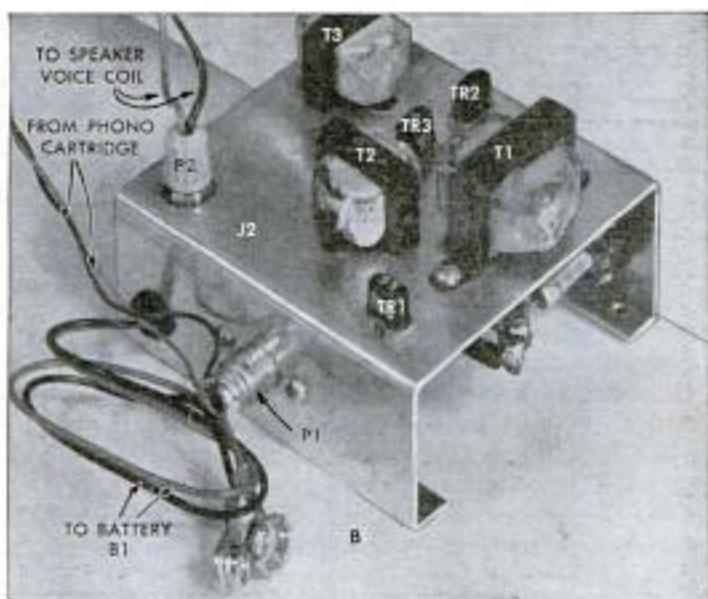

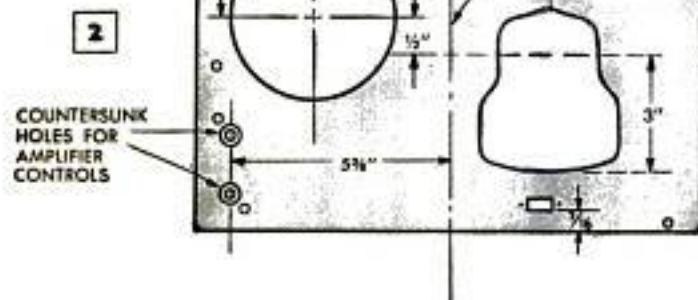
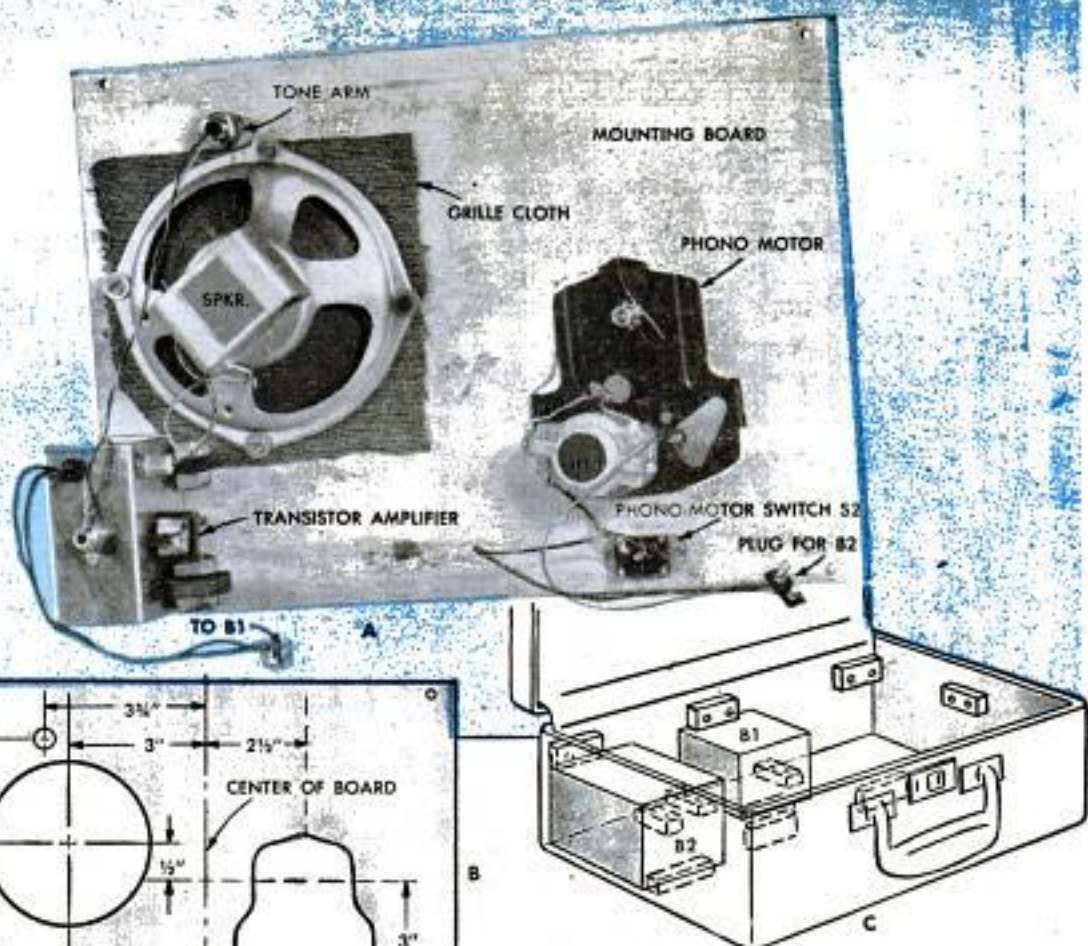

dividual styli for standard and microgroove records.

Tone Arm and Cartridge

used in the original unit. If desired, more versatile three-speed motors such as the General Industries Model BX (16 $\frac{1}{2}$, 33 $\frac{1}{2}$ and 45-r.p.m.) or the Trans-Aire Model T-240 (33 $\frac{1}{2}$, 45 and 78-r.p.m.) may be substituted. The latter requires a phono cartridge with a compromise 2-mil stylus or, preferably, a turnover-type cartridge with in-

The transistor amplifier has ample gain to permit the use of any crystal or ceramic phono cartridge. Since the instrument was not designed for high-fidelity reproduction, there is little point in employing an expensive unit. Just about any general replacement-type pickup arm and cartridge will fit the bill. A number of good quality units of this kind are listed in

(Continued to page 226)

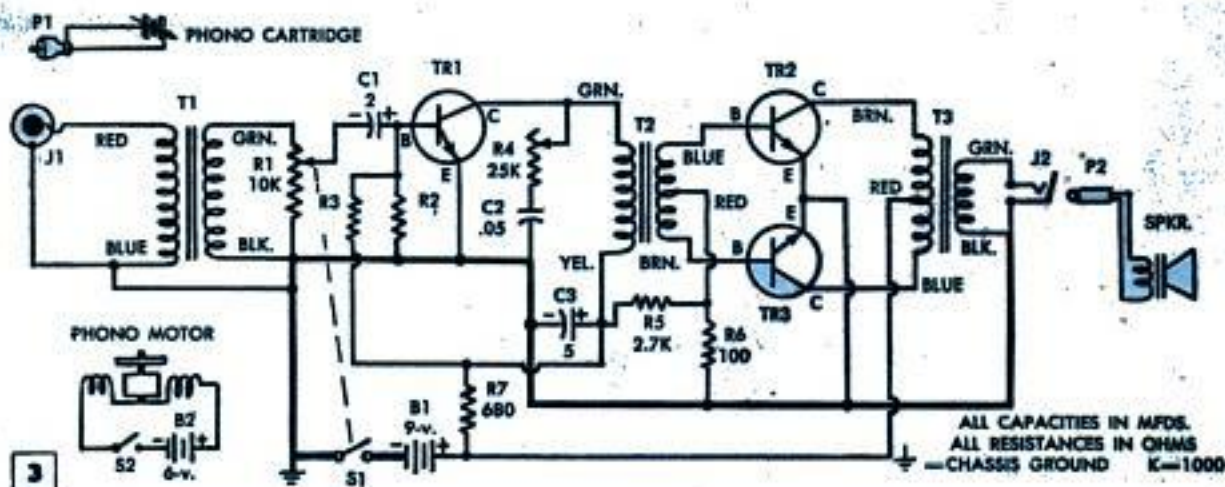

X728

THE



WTM 59

CRAFTSMAN

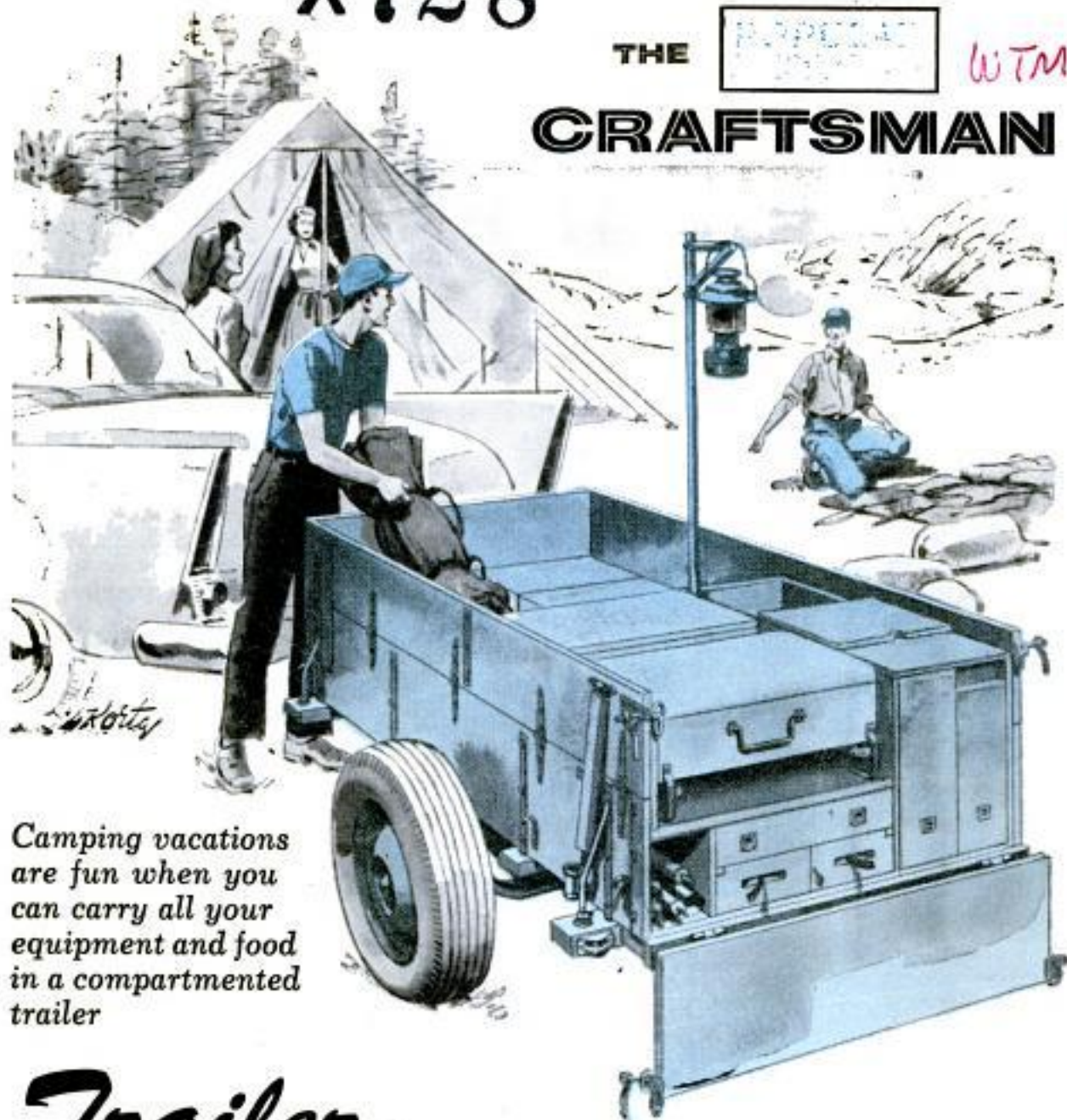

Camping vacations are fun when you can carry all your equipment and food in a compartmented trailer

Trailer

By George Laycock

FOR CAMPERS

THIS TWO-WHEELED TRAILER with removable "kitchen" unit and clothing and equipment lockers is used by one family of outdoor enthusiasts for carrying all the items needed for camping on week-end trips, or when vacationing in the country. When not in use for camping, the kitchen and locker units can be removed in a few minutes to permit using the trailer for other purposes. The self-contained units can be stacked in the garage in winter with all the camping gear conveniently stored in the compartments ready for the next camping trip.

The dimensions and arrangement of shelves, cabinets and drawers as given in the drawings, may be changed so that the units can be accommodated in a trailer you now have or in a suitable trailer that can be rented locally. The only disadvantage of using a rented trailer is doing without the hinged sideboards. The latter afford handy work and serving tables when opened and supported by two wooden braces attached to each, as shown in the illustration and Fig. 1. The braces pivot on hinges that are screwed to one end of the braces and to the sideboards near the top.

Kitchen Unit

Made of 1-in. pine lumber, $\frac{1}{4}$ -in. exterior-grade plywood and $\frac{1}{8}$ -in. tempered hardboard, the kitchen unit, Fig. 5, detail A (blue area), has shelves and drawers for waist-high storage of canned and boxed foods, a platform with adequate space for a two or three-burner kerosene or gasoline stove, and a pot-and-pan compartment as shown in Figs. 1 and 3. Also, there is a covered bin for such staples as flour and sugar. A $6\frac{1}{2} \times 9\frac{1}{2}$ -in. space under the left side of the kitchen unit is used for carrying tent poles, pegs, shovel, ax, lantern pole and other long pieces of equipment that can be accommodated. Plywood is used for the bottoms of the drawers and shelves and the bottoms of all units to reduce their net weight. If you prefer, $\frac{1}{4}$ -in. hardboard can be used instead of plywood.

Clothing and Equipment Lockers

Two large lockers that fit in the forward part of the trailer provide convenient storage for camping apparel and miscellaneous equipment. The uncomparted space

in the trailer, Fig. 5B, is ideal for bulky objects such as tent, sleeping bags, luggage and other large pieces of equipment. The only camping equipment that need be carried in the car is the box containing the gasoline lantern, Fig. 2, which is carried in the trunk. This leaves the interior of the car uncluttered for the exclusive use of the passengers.

When en route, the sideboards and two-piece endgates are closed and secured at the corners with fasteners of the type shown. These are simply standard endgate fasteners, complete with tail nuts, which make it easy to tighten and release both endgates and sideboards quickly. Chain links attached to the eyes of the fasteners are designed to slip over hooks located at the sides of the upper tailgate. The fastener for the lower endgate, or tailgate, fastens to a hook bolted to the side of the trailer. A custom-fitted tarpaulin with heavy-duty rubber bands cut from an inner tube used as tie-downs (not shown), permits quick removal and replacing of the tarpaulin to assure complete dust and rain protection.

Lockers and "kitchen" are constructed as self-contained units so they can be removed quickly to permit use of trailer for other purposes. Also, units provide handy storage place for camping equipment in winter

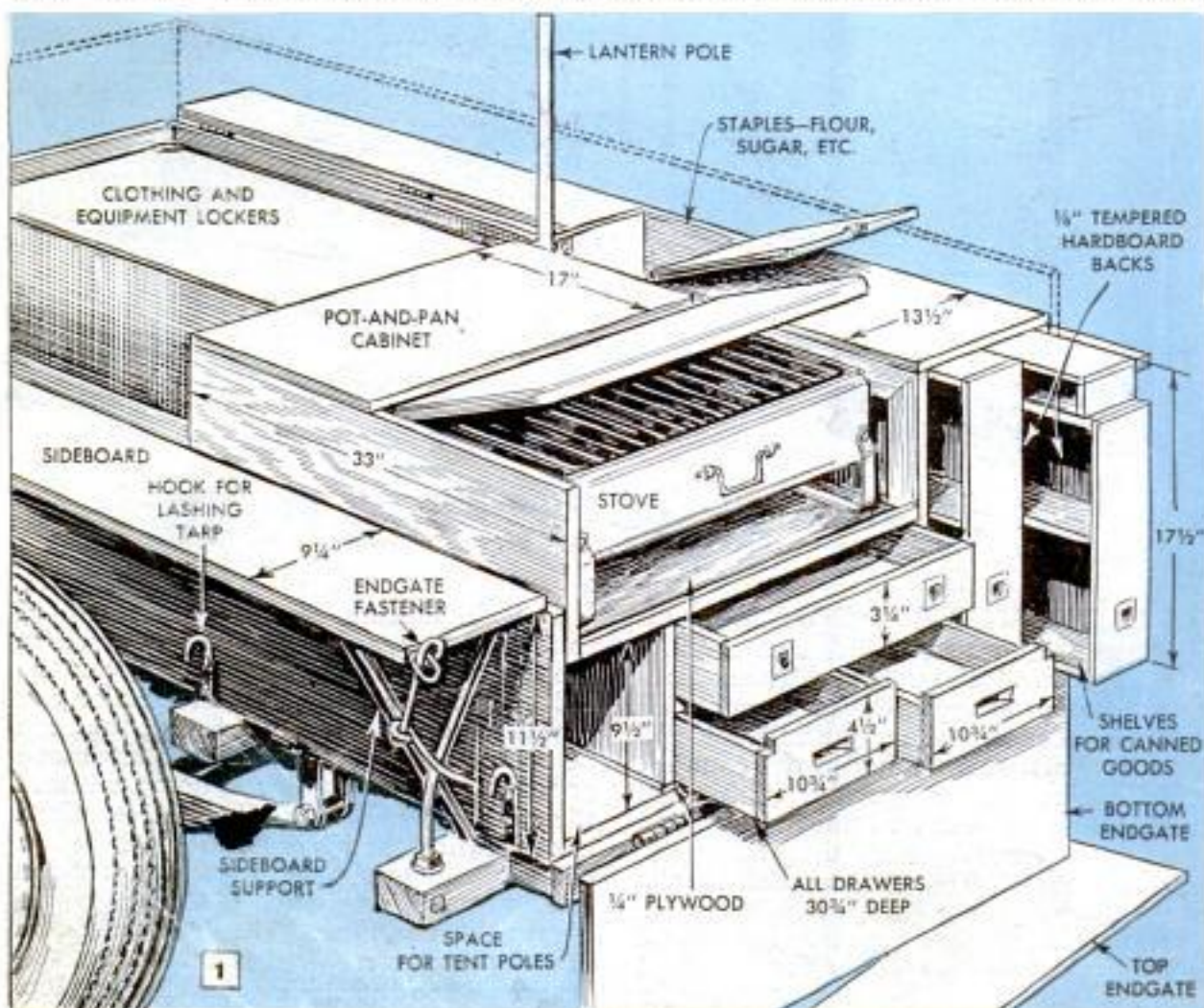



2



3

Fig. 2, gasoline lantern is carried in plywood box and has plywood cutout fitted over top of lantern to protect it from damage when traveling. Fig. 3, hinged sideboards are handy work and serving tables

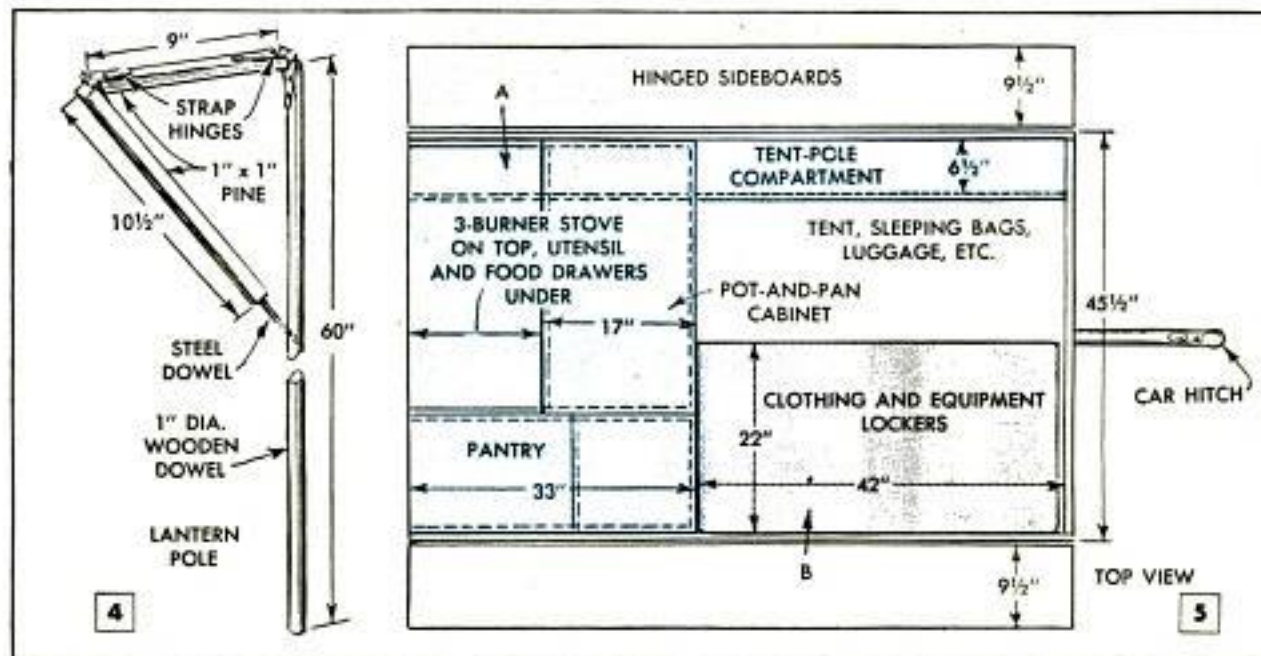

4

5

The lantern pole is made of two lengths of pine and a 1-in.-dia. dowel hinged as shown in Fig. 4, so that it can be stowed in the tent-pole compartment. When in use,

the pole is held upright by two pipe clamps screwed to one of the inside corners of the staples bin. Finish all units inside and out with paint or varnish. ★ ★ ★

Darkroom Graduates and Funnels Stored on Dowel Hangers

Dowels in a darkroom wall provide a convenient way to store glass graduates, funnels and similar items. Supported upside down, such items will drip dry. Drill the holes for the dowels at a 45-deg. angle and make them slightly undersize so they can be driven snugly in place. In the case of funnels, use dowels small enough to pass readily through the spouts.

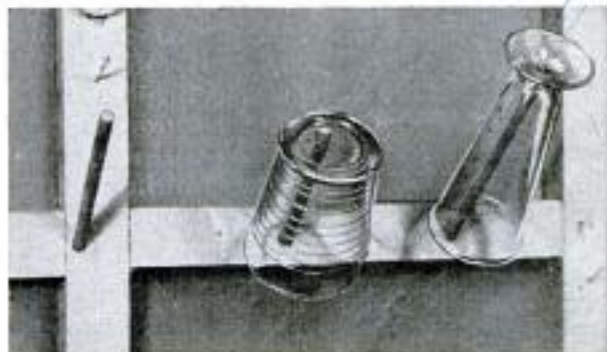



Holder Suspended From Table Keeps Ink Bottle Level

Suspended from the edge of a drafting table with a single screw so that it can swing, this bottleholder assumes a level position no matter at what angle the table is set. The wood base of the holder either is routed out to take the ink bottle, or several brads are driven into the base to retain it. A metal or plastic ring that slips over the bottle neck, and two rubber bands, assembled as shown, hold the bottle securely. If desired, a hole can be drilled through the base to hold the stopper.



Easel-Type "Clipboard" Holds Without Clamps

Neither tacks nor clamps are required to hold sheets of paper flat and smooth for writing on this practical "clipboard" that is made from two pieces of hardboard of equal size. One piece is cut to form a frame as indicated. This is hinged to the solid piece of hardboard with strips of adhesive tape. Sheets of paper then are sandwiched in the assembly. A rubber band can be used to hold the free ends of the board together. Before assembling, sand all the edges, rounding the corners slightly.

Ordinary Table Salt Can Be Made to Serve Many Purposes

In addition to seasoning food, common table salt has many other uses. Silver spoons tarnished by eggs are easily cleaned by rubbing them with damp salt. To prevent food from sticking to a griddle or omelet pan, clean them with salt instead of washing. Deep vases may be cleaned by allowing a solution of salt and vinegar to stand in them for an hour. Shake well, then wash and rinse. To hasten the thawing of frozen meat, season it with salt when it is taken from the freezer. If salt is used in the bottom part of a double boiler, the cooking time will be shortened. Cracked eggs can be boiled without the whites running from them when a tablespoon of salt is added to the water. When milk has been accidentally scorched, place the pan in cold water and add a pinch of salt to remove the scorched taste. For a faster job and fluffier egg white, add a pinch of salt when whipping them. To be assured of whole nut kernels for special recipes, soak the nuts in salt water 12 hours before cracking them.

A salt-water bath will kill chiggers, or ease the itching caused by mosquito and other insect bites. Fruit stains are removed from the hands by rubbing lemon juice and salt on the stains followed by a clear-water rinse. A pinch of salt slowly swallowed will often stop an annoying tickling in the throat. Salt eaten before taking bitter-tasting medicine will render it tasteless. Salt can be used for removing mildew from linen. Mix salt, starch and lemon juice into a paste and apply to both sides of the fabric. Then lay it out in the sun until the stain disappears and wash in the usual way. To keep bluing from streaking clothes, add a cup of salt to the rinse water. Perspiration stains are more easily removed from cotton clothing if soaked in salt water a few hours before washing. To brighten the colors in an old carpet or rug, sprinkle it with salt before sweeping or vacuuming. When a felt hat becomes soiled with soot, cover the soiled part with dry salt and then brush it off.

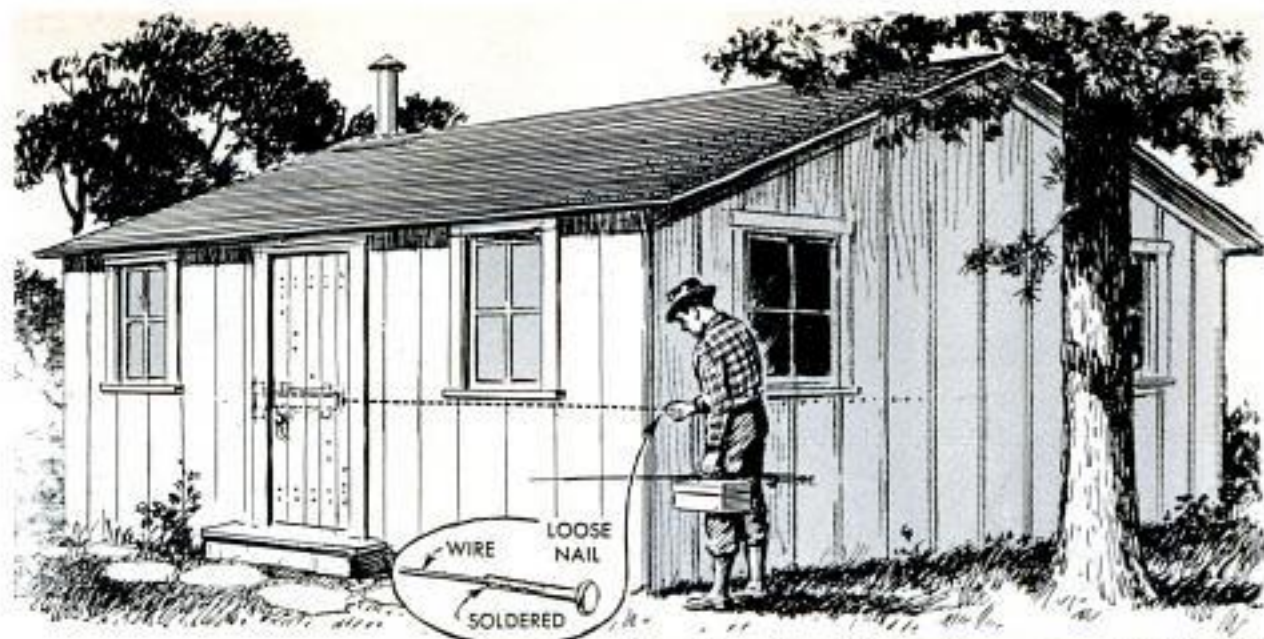

CABIN LOCK

You can't lose the key to this lock. There isn't any, for the lock is a sliding bolt actuated by a trick latchstring. You'll have to make the whole thing yourself so you'll always know how to unlock it. The latchstring is a length of light wire long enough to reach from the rear end of the bolt to a point just outside the wall of the cabin. The free end of the wire passes through a small hole drilled through the siding near a corner of the structure. Solder a roofing nail to the free end of the wire. Then make and assemble the bolt on the door as detailed at the right. Fit a false knob, with an escutcheon on the outside of the door. Now you're ready for two-man operation, one to swing the door closed while you retract the bolt. The door is opened simply by pulling out on the nail-head as pictured above. This retracts the bolt and swings the door inward. For one-man operation you will need to add an extra part, not shown in the details. To do this, retract the bolt and wedge it in posi-

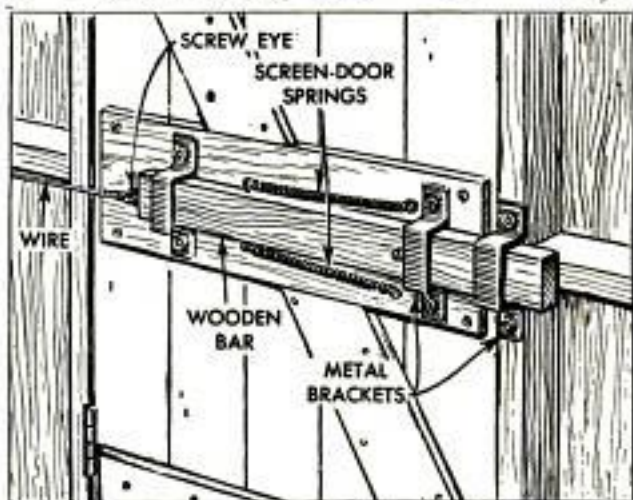

tion. Then drill a hole through from the outside of the door. The hole should center through the bolt and be of a size to take a 16d spike loosely. Then as you go out, retract the bolt and insert the spike to hold it retracted and permit the door to close. Hold the door in the closed position and pull out the spike, permitting the bolt to slide forward to the locked position.

Austin H. Phelps, Omaha, Neb.

Kelvin Photo Lamps Marked For Easy Identification

When using standard 3200-deg. Kelvin floodlamps for indoor color photography, mark a large "K" on the ends of the lamps with India ink to identify them. Unmarked Kelvin lamps can be confused with regular photoflood lamps, which are the same size. Use of the regular lamps would upset color balance and result in poor transparencies.

Henry Hanscom, Elmhurst, Ill.

☛ To lift corners of linoleum, use a plumber's force cup. Rub soap on the edges of the cup for a tight grip.

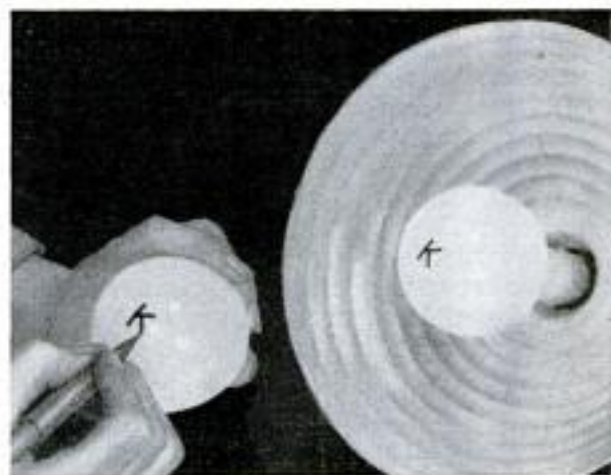

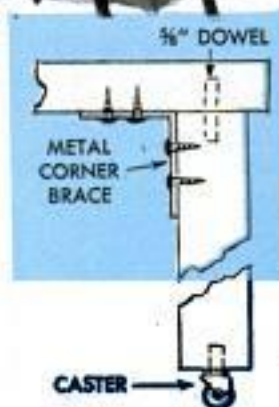

THE SWING IS TO DOOR FURNITURE

By Tom Riley

THERE WAS A TIME when a door was just a door. Now it can be anything from a bed headboard to a patio screen. These thick, smooth panels, called flush doors, are making craftsmen out of everyone since in many cases they require merely finishing the edges and the job's practically done. The suggestions given here are but a few of the many ways that standard flush doors can be utilized to produce modern pieces of furniture that are both inexpensive and practical.

Types of Doors

Flush doors are available with solid or hollow cores. If they are to be used as is,

hollow-core doors, which are lighter and cheaper than the solid-core type, will do. However, where it is necessary to cut the door in several sections, it is best to select a solid-core door. When a hollow core is cut crosswise, other than at the center, it exposes a series of core strips which must be cut back and a strip of solid wood inserted, as in Fig. 12, to fill in the open end. Rather than rip a door lengthwise, it is best to select a door of the approximate width desired. You'll find that most flush doors are available in widths ranging from 18 in. to 36 in. wide in 2-in. multiples. The average interior-type door measures 1 $\frac{3}{8}$ in. thick and 80 in. long. And, of course, you can get them faced in either common or fancy wood grains.



2

To stretch the budget on a sofa, purchase two cushions with matching bolsters and a flush door of the right width. Attach ready-made legs to the door and center the cushions as shown. Let the ends of the door serve as end tables. You'll wind up with a smart sofa for a song

Right, a 30-in. flush door with the edges taped makes a simple Hollywood headboard for a double bed. The space at the projecting ends can serve to support small shelves or an attractive pedestal storage cabinet as shown below



3

Above, a 30 x 80-in. hollow-core door cut in half will make headboards for twin beds. Black in sawed ends and trim exposed edges with wood tape



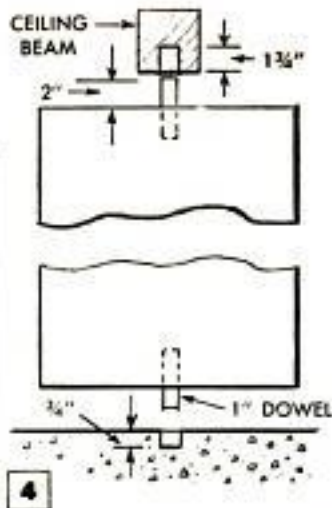

4
Blind holes in floor and ceiling for dowel pivot pins allow doors to be removed by lifting up to free lower pin at the bottom

Two or more doors pivoted at top and bottom can be used like a vertical Venetian blind to keep out sun

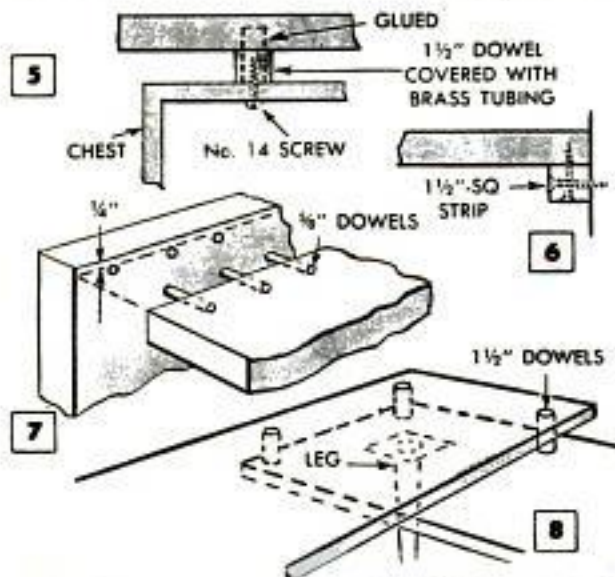

The edges of flush doors vary considerably. Some have softwood showing, others have hardwood. Some are quite rough, others very smooth. Often you can cull a stack and find a door with edges that need only to be varnished or lacquered. The new hardwood tape in ribbon form offers an easy way to conceal the edges and make them match the surface. The tape is applied with contact cement, which bonds instantly and without clamping. Another way of treating the edges is to rip 3/4-in. strips of matching stock and use as trim to form a rim around the door as in Fig. 9.

Novel Applications

The pass-through table idea shown in Fig. 1 is a novel and practical answer to the "Tudor" corner desk is two doors resting on two-drawer file cabinets. New handles and paint camouflage files, leg supports doors at the corner

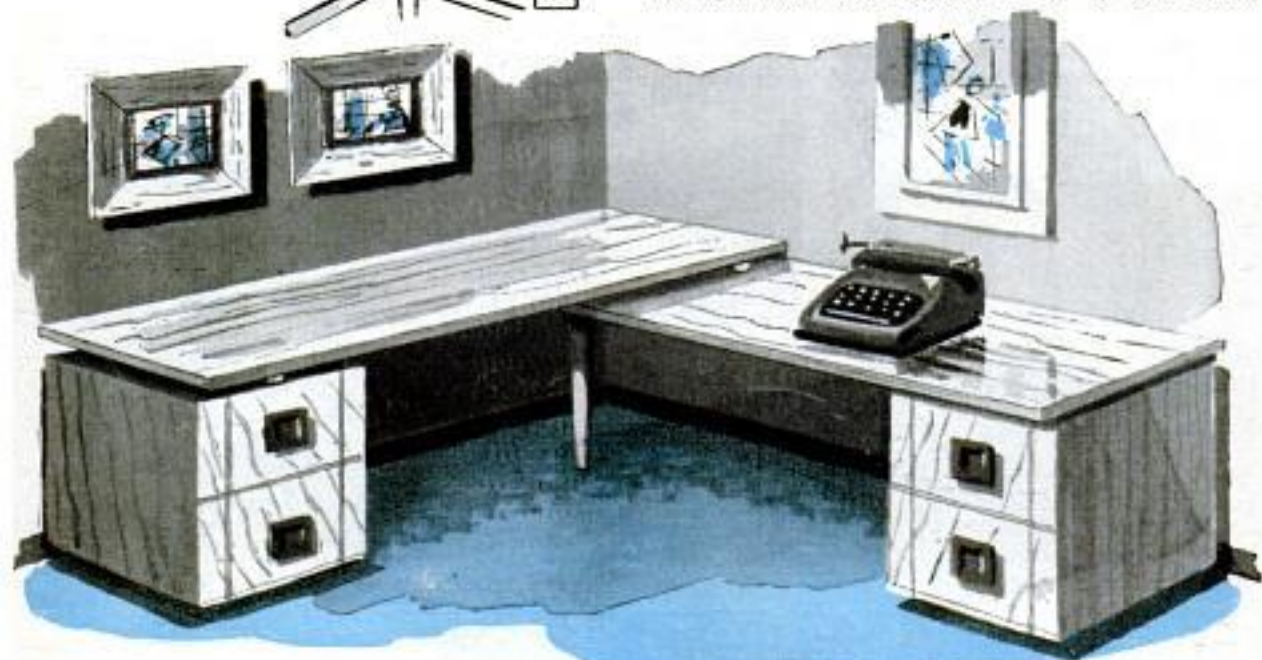

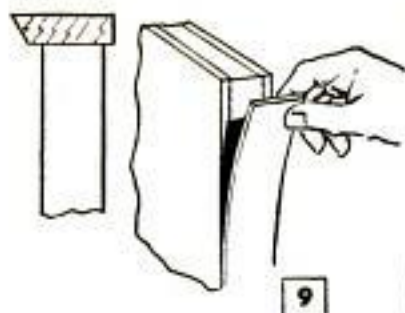

9

problem of space. Here a table of doors fitted with casters and extended through an opening between the kitchen and a dinette permits one table to serve both rooms by pulling it from one to the other. A simple two-piece screen that raises and lowers like a window can be used to close off the opening.

Another novel use for flush doors is pictured in Fig. 4. A series of doors pivoted vertically on a porch or roofed patio so they may be adjusted make a vertical "Venetian blind" that affords both privacy and ventilation.

The "tudor" king-size desk, pictured and detailed in Figs. 5, 6, 7 and 8, shows how a double desk can be arranged in a corner of a room without undue crowding.

Twin two-drawer cabinets support the door tops at the ends and a tapered leg supports them at the corner. Short dowels raise one door above the other to bring it to regulation desk height. The other should be 24 to 26 in. to provide the best working height for a typewriter. Cleats screwed to the wall can be used instead of the leg to support



10

A 24-in. closet door supported at the ends 29 to 30 in. off the floor and equipped with several padded stools makes a quickie breakfast bar



11

Infinite variety of coffee tables can be made from flush doors, king-size and otherwise. Add custom or ready-made legs

the doors at the corner. Fig. 7 shows how door stock can be joined together with dowels to form a simple desk that is supported at the opposite end with a cleat attached to the wall. ★ ★ ★

When hollow-core doors are cut, open-core end is filled with hardwood strip glued and clamped

Solid-core door requires no filling of edge after cutting. This is true of hollow door when cut at center

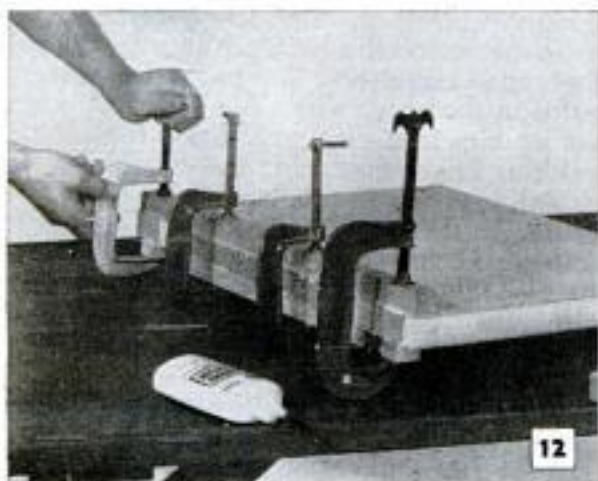

12



13



Magnet on Typewriter Frame Holds Eraser at Hand

A permanent magnet located at any convenient place on the typewriter frame holds your eraser always within easy reach. A small machine screw or stove bolt is inserted in the center hole in the eraser and held in place with a washer and nut. File the end of the screw flush with the nut.

Boiling Water on Propane Tank Determines Gas Level

To determine approximately how much propane gas is left in a storage tank, one man pours boiling water over the container. When his bare hand is passed down the tank immediately afterward, the metal will feel warm where the tank is empty. Near the gas level the tank will feel cold since the liquefied gas will absorb the heat.

E. J. Hannigan, New York City.

← Easier Removal of Stamps

Stamps removed from envelopes will receive minimum damage if the usual method of removal is reversed. Instead of pulling the stamp from the envelope, peel the envelope away from the stamp. Hold the stamp in the center as indicated so it is slightly curved, then pull the envelope down away from the stamp at each corner.

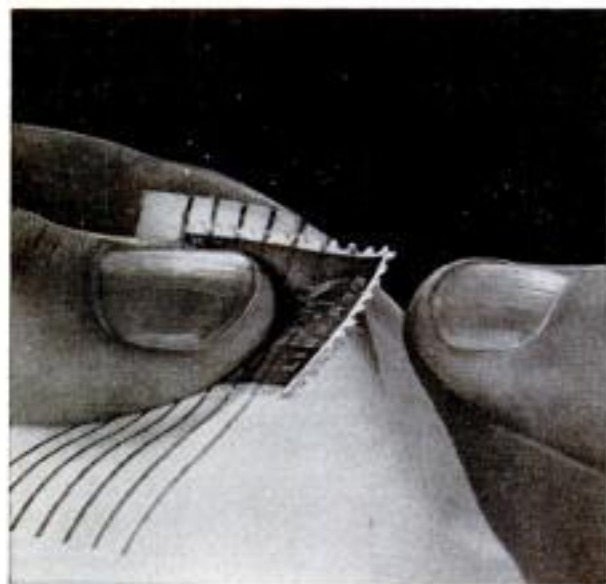

Talcum-Coated Window Glass Used to Check Focusing

When a ground glass is not at hand for checking the focus on a camera, ordinary glass can be adapted for temporary use by coating it with talcum powder. First, wipe a thin coating of petroleum jelly on the glass, then sprinkle on the powder.

Safe Tests for Finding Cause of Blown Fuse

Should a fuse blow in your switch box, do not replace it with a piece of wire, metal foil or a penny. A fuse is a protection and the fact that it blows indicates that there is either an overload or a short circuit in the line. Shut off the main switch, remove the blown fuse and replace it with a 25 or 60-watt lamp bulb. An overloaded circuit is indicated if the bulb burns dimly. Some appliances or lights must be disconnected permanently and new circuits added to provide the increased current necessary. To determine which appliance is causing the overload, have someone stand by the switch box and watch the bulb while you disconnect various appliances. When you remove the appliance or appliances causing the overload, the bulb brightens. When

a blown fuse is replaced with a bulb and it burns brightly, it indicates that there is a short circuit in that line. Again have someone watch the bulb while you disconnect appliances and lamps and unscrew bulbs in fixtures. When the test bulb goes out or becomes dim, you have found the trouble. The remedy for the trouble is, of course, to repair the item in which the short exists. Now remove the bulb, replace it with a new fuse and turn on the switch. If the fuse again blows, there is trouble somewhere inside the walls. Turn off the switch and call an electrician. As an added safety precaution, always keep a flashlight handy near the switch box. Never attempt to change fuses in the dark.

Thomas E. Moyer, Long Beach, Calif.

not to be reprinted
— per Shop Notes

WTM 59

Ladder Stored on Closet Door Is Readily Accessible

When a small stepladder is kept in a closet and used to reach a trap door in the ceiling, it will be more accessible and take less space if it is stored on hooks on the inside of the closet door. This is done by means of four screw eyes driven into the sides of the ladder as shown, and four L-hooks driven into the closet door at corresponding points. A narrow wooden cleat nailed horizontally near the bottom of the door will support the ladder and relieve the hooks of the ladder's weight. A length of felt weather stripping or other similar material nailed on the back edge of the top step of the ladder will prevent it from damaging the finish on the door.

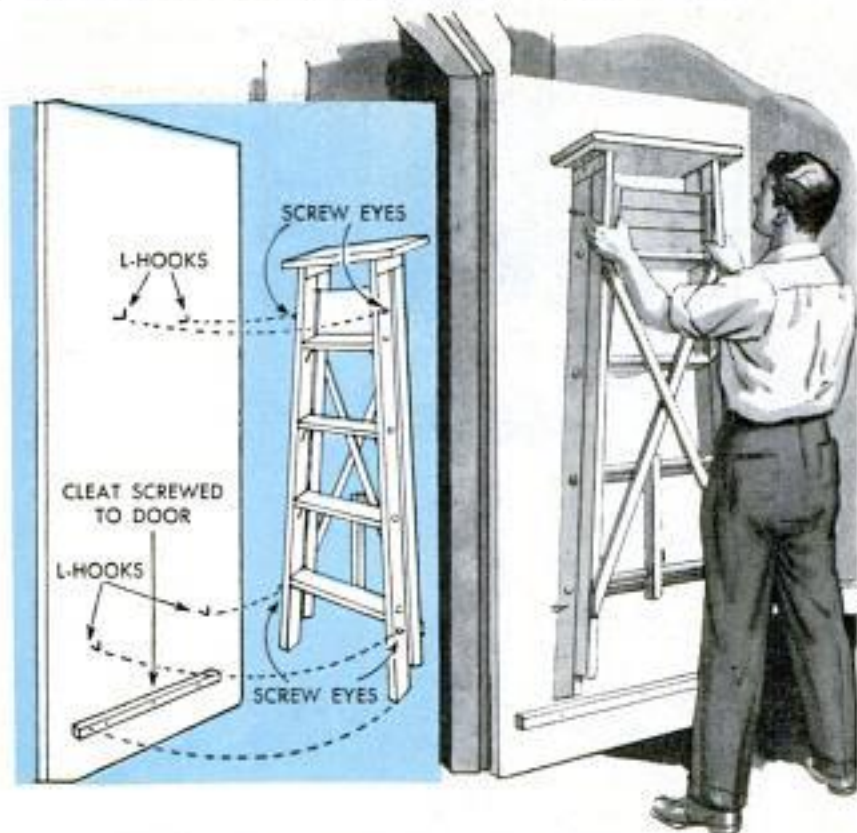

Stains Removed From Porcelain

Most stains can be removed from porcelain fixtures in a bathroom or kitchen by scrubbing the stained areas with a mixture of powdered chalk wetted slightly with small amounts of ammonia and water.

Arlene E. Schulz, Cicero, Ill.

Your Car Should Be Waxed when water no longer rolls off in beads, but spreads into a smooth, shiny layer. This condition indicates that the finish is open to the elements and should be protected with a coating of wax immediately. Always apply wax with the car parked in the shade.

Roger Darling, Revere, Mass.

Wooden Miter Box for Cutting Compound Miters

With this miter box, compound miters for that occasional picture frame or small molding can be cut accurately and easily. Make the box as shown in the detail, using hardwood for the sliding stop blocks, the position of which determines one angle of the compound cut. Screw the upright to the base before making the saw kerfs, being careful to space the screws to hold each section in place after the kerfs are made. Stock to be cut is positioned in the box by first using a cardboard template to determine the correct angle for the joint.

—George A. Chiddie, Winston-Salem, N. C.

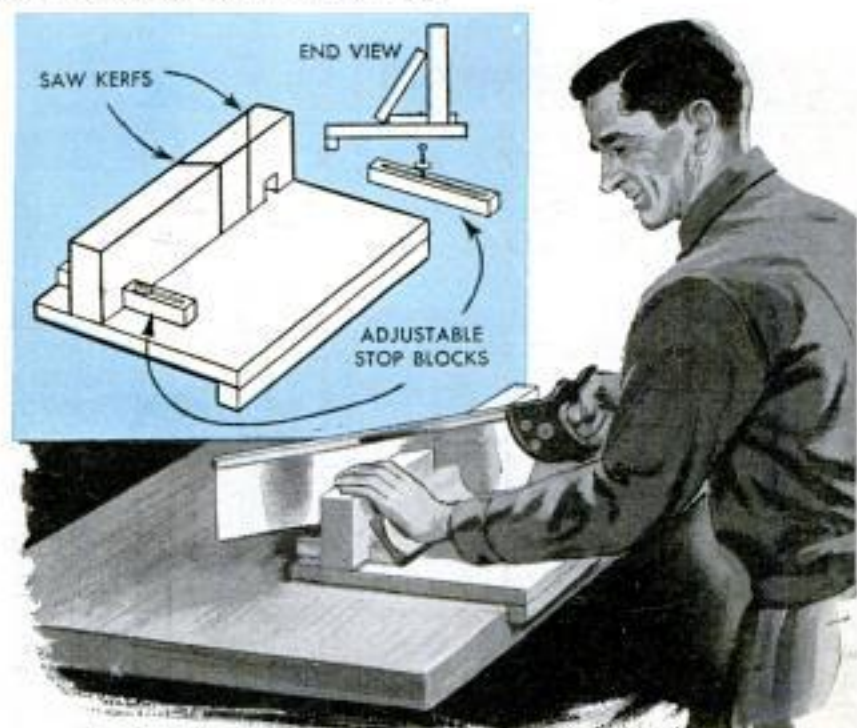



WTM 59

Featherweight Tent for Two

By Austin H. Phelps

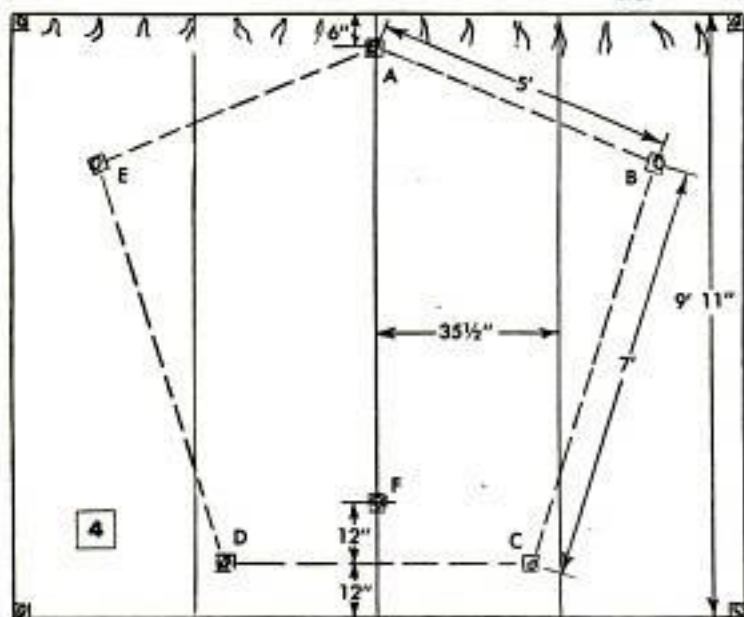
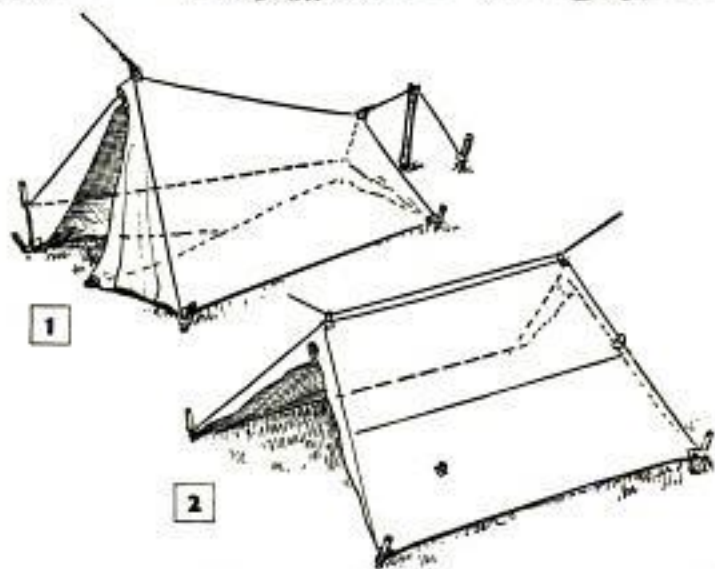

A VERY PRACTICAL TENT that is light enough to be carried in a knapsack yet will provide shelter for two adults, was made by one outdoorsman simply by sewing together four 36 x 120-in. lengths of treated 6-oz. canvas as shown. After the lengths of canvas are sewed together, $\frac{1}{2}$ in. of the border is folded under and stitched.

Reinforcement patches are sewed on the corners as shown in Fig. 3. Then, rope grommets are made as in the detail and sewed to the patches. Also, reinforcement patches for attaching the peak and guy ropes are sewed to the canvas as indicated in Fig. 4. Patches are positioned at the points shown by first locating A and F on the tent. Then, C and D are found by measuring 30 in. to the right and left of the seam that passes through F as shown. E and B are located by striking arcs with a 7-ft. radius from C and D and intersecting them with an arc of 5-ft. radius drawn from A.

For wet weather, the tent is set up as in Fig. 1, with the peak rope at A, guy rope at F, the back secured to stakes at C and D and the front at B and E. For more floor space, the tent can be erected as in Fig. 2, with peak ropes at A and F and stakes at each of the four corners.

Garment-Airing Rack Hangs on Clothesline

Numerous garments on hangers may be equally spaced for airing on a clothesline by hanging them from this rack slung from the line. It is merely a length of 1 x 2 wood with two or three screw hooks to suspend it from the line, and several screw eyes spaced 12 in. apart on which to hang the garments.

Wax-Base Floor Cleaner Used on Wall Paneling

Wax-base cleaners, such as used on wooden floors, can be used to clean wooden wall paneling. When the paneling is extremely soiled, go over the surface with fine steel wool to loosen the grime, then apply the cleaner again.

Portable Retouching Outfit Made From Photo-Paper Box

Self-contained and portable, this retouching outfit is made from an empty photographic-paper box. Cut a hole in the lid of the box to accommodate a 4 x 5-in. sheet of glass that is taped in place. A short length of dowel is used to hold the lid up at an angle. Facing the opened box towards a window or light will provide sufficient illumination, since the white surface of the inside of the box will reflect the light through the glass. Retouching materials and other accessories are stored inside the box when not being used.

Ken Murray, Colon, Mich.

Washing-Machine Barbecue Has Motorized Spit

What was once the family washer is now the family barbecue grill and a mighty efficient one which contains a built-in motorized spit. John Kostick of Binghamton, N. Y., shows what you can do with a little ingenuity and a discarded wringer-type washing machine. The wringer mechanism which operates the spit was slowed down by fitting it with a larger gear and pulley, and a drill chuck was fitted to the wringer end to hold a stainless-steel spit rod. The agitator was removed, of course, and the tub lined so charcoal could be used. A hood, or windbreak, made the grill complete.

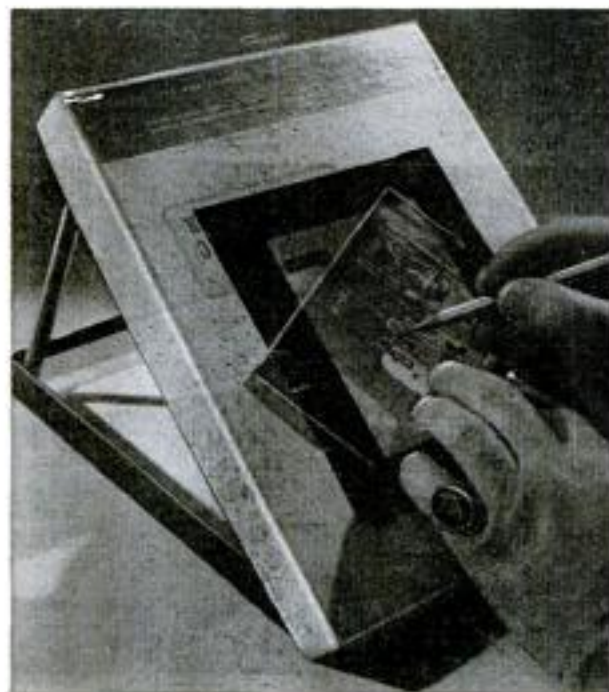

Solving HOME PROBLEMS



MILDEW STAINS on a shower curtain can be removed by first washing the curtain in hot suds, then rubbing the stains with a lemon. Allow the curtain to dry in the sun. Iodine stains can be removed by using the same method



WAXING METAL CURTAIN RODS not only assures that curtains or draperies will slide easier, but also minimizes the chances of stains caused by rust spots forming on metal of the rods

AN S-SHAPED "BRUSH" bent from flat iron is ideal for job of painting inner edge of check rail of top half of double-hung sash that cannot be lowered. Wool pad on brush holds paint



PREVENT GLASSES AND TUMBLERS FROM STICKING together when stored in stacks by fitting a paper muffin-tin liner on the bottom of each glass tumbler



CLOTHESLINE CAN BE TAKEN DOWN or put up in moments when ends of line are gripped by wedging effect of cam levers made and attached to poles

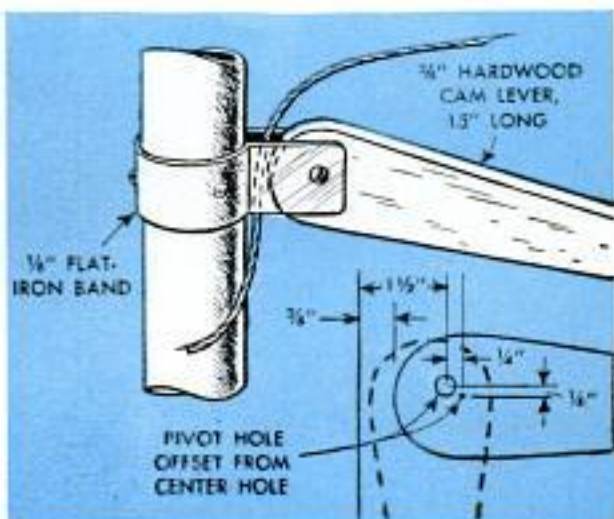



IF A BLOTTER IS NOT AT HAND to blot an ink spot, try using cleansing tissues. The highly absorbent tissues will soak up the ink as quickly as a blotter and there will be less chance of smearing the ink



WHEN AN ICE BAG IS NEEDED IN A HURRY and none is available, one can be improvised from a large plastic bowl cover. Fill the cover with ice cubes, tie the opening securely and it is ready for use



NEED A WRENCH for driving small screw eyes, cup hooks and the like? Do the job easily and with a minimum of finger strain by slipping an ordinary wooden clothespin over the loops and using it as a wrench



EXTRA NEEDLES ARE HELD safely in a receptacle made by plugging one end of an empty spool with modeling clay. Needles are held securely by the clay, but project enough for easy removal



REMOVING THE COTTON from the neck of a small pill bottle is no problem when a moistened wooden matchstick is used. Insert the moistened stick in the cotton, twist once or twice; lift out the cotton

WHEN A SUITABLE BRUSH for applying wallpaper paste is not available, you can use a paint roller with equal or better results. The roller will apply the paste evenly and with much less chance of splashing



WHEN MAILING A NUMBER OF STAMPS in a letter, place them between the folds of a piece of waxed paper. This prevents them from sticking to the letter, even though the mucilage becomes dampened

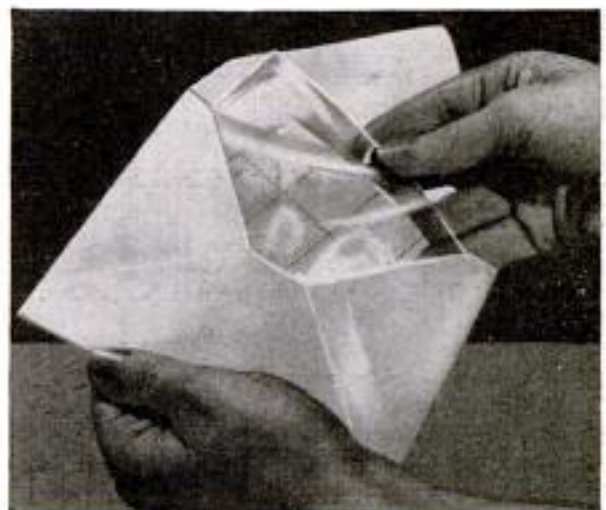



Positive Pin Stop for Drawer Fits Vertical Hole in Back

Because this simple drawer stop does not project inside the drawer, it does not interfere with the contents, nor do the contents interfere with the operation of the stop. It consists of a short dowel or finishing nail slipped into a blind hole drilled vertically in the drawer back so that the stop projects about $\frac{1}{2}$ in. The stop should fit the hole so that it can be lifted out readily with the fingers when it is necessary to remove the drawer.

Enlarger Provides Ample Light For Photo Retouching

A photographic enlarger is an excellent light source when retouching prints in a darkroom. Place the print on an inclined surface, such as a masking easel, on the enlarger base and turn on the light, with the lens diaphragm wide open. The enlarger can also be used as a floodlight for studio work. Simply remove the enlarger lamp house, which contains the reflector and bulb, replace the bulb with a flood-type bulb and use as a reflector.

Edward L. Fisher, Milwaukee, Wis.

Plaster Figures Are Strengthened When Treated With Plastic

Plastic impregnating resins now available permit the hobbyist who works with plaster to add both beauty and strength to figures cast of this material. The resins penetrate the porous surface of the plaster and combine with it to form a dense, impact-resistant finish. Color, which can vary from a brownish black to old ivory, is imparted to the plaster at the same time.

Book Carton Provides Dust-Free Storage

To keep books from gathering dust on library shelves between readings, one man alters a book-club mailing carton by simply removing the folding flaps and cutting a half-round finger slot in each edge as in details A and C. The book, B, is thus protected from dust, is easily withdrawn for reference and the back is always exposed when placed on a shelf or in the bookcase.—A. Zanelli, Tampa, Fla.

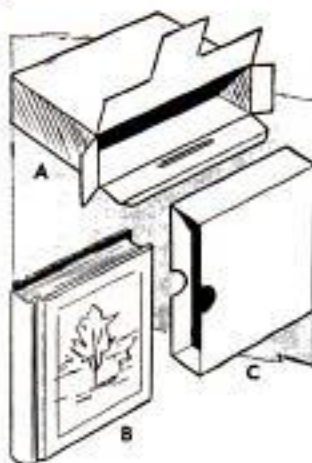

When buffed and polished with paste wax, the treated plaster will appear to be wood or ivory. The unbuffed finish provides an ideal surface for applying enamel or lacquer if an opaque finish is desired, since the plastic-impregnated plaster will not absorb paint as will ordinary plaster which is quite porous.

Thomas A. Dickson, Los Angeles, Calif.

Fountain-Pen Point Protected By Lead Shot in Cap

Reduce the chances of damaging the point of an open fountain pen when it falls to the floor by adding weight to the opposite end. This can be done by dropping a few pieces of lead shot in the cap, followed by a little melted sealing wax to keep the shot in place. Use only a small amount of wax and shot, so they do not interfere with the point when the cap is replaced on the pen.



*PLASPREG
FURANE
PLASTICS
INC
4514 Bixby St., Los Angeles 39, Calif.*

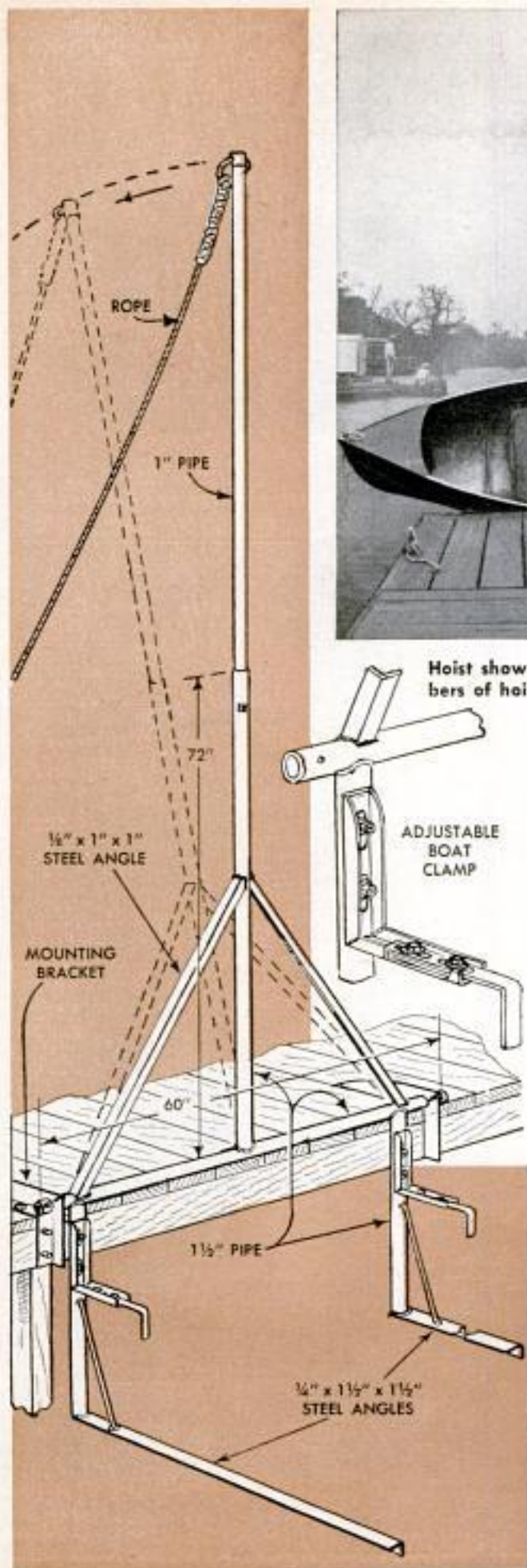

Hoist shown in photos is designed for 14-ft. boat but all members of hoist can be made longer to accommodate larger boats

HOIST EASES BOAT CLEANING

CLEANING A FLEET of small boats was a difficult and time-consuming job for one operator of a boat-rental service, until he built the hoist shown in the photos and drawing. The device is made of welded steel angles and pipe, and pivots on two brackets mounted on the dock. To remove a boat from the water for washing, the hoist is moved to a vertical position as in the drawing, and the boat is floated over the arms so that the boat clamps can be hooked on the gunwale. Then, the boat is raised out of the water as shown in the photo at the top of the page.—L. A. Wilke, Austin, Tex.

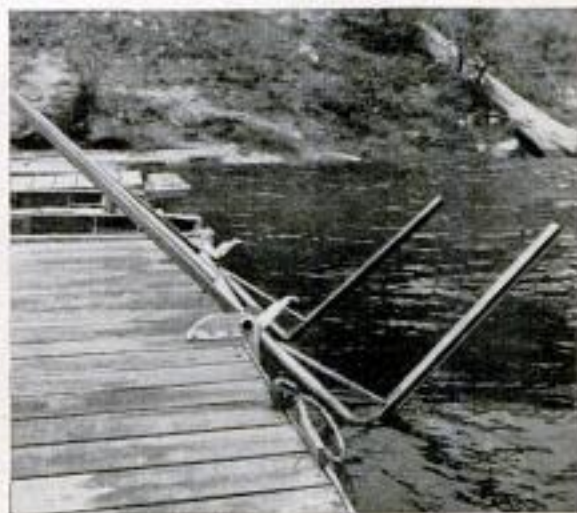

Can you NAME 'EM?

MANY of the work-saving appliances used in modern kitchens are descendants of items great-grandmother used 100 years ago. Other appliances of that era became outdated when the tasks for which they were designed were taken over by food-processing plants. By examining the appliances in the photos, part of Simmons collection on view at the Staten Island Historical Society, can you determine what they are? ★ ★ ★



1. Let's start with a tough one. Can you imagine what this giant-sized roasting pan with a slotted lid was used for in great-grandmother's kitchen?

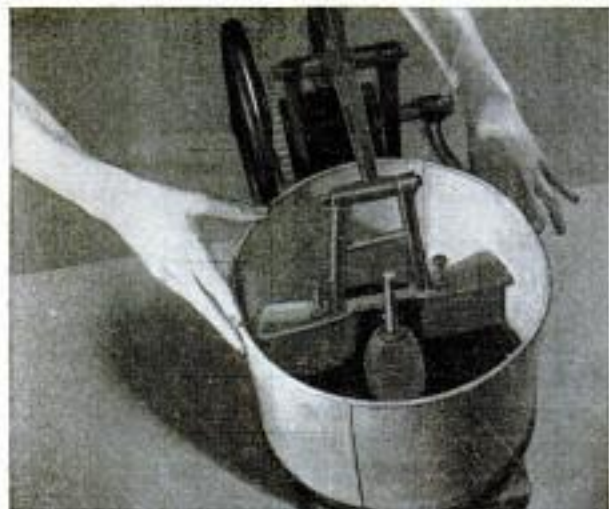

2. The electric-powered modern counterpart of this device is not a midget washing machine, despite the resemblance. What would be your guess as to its use?



3. This item was an accessory to the heating plant. Its descendant is enjoying increasing popularity in our modern society. Can you identify the appliance?

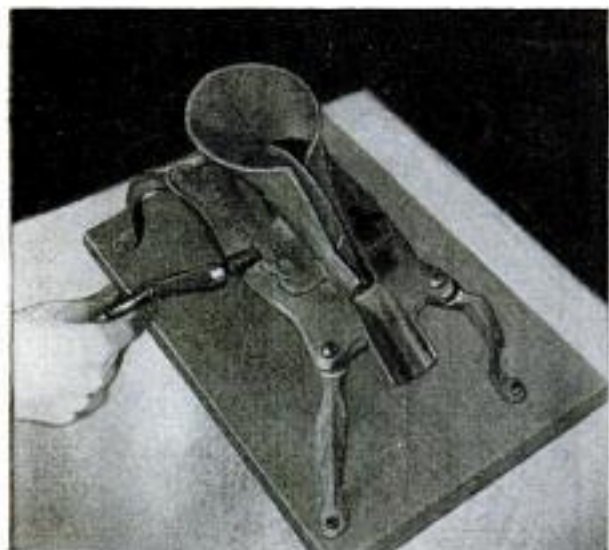

4. Once considered indispensable during the canning season, this appliance disappeared with the advent of commercial food processing. What job did it do?

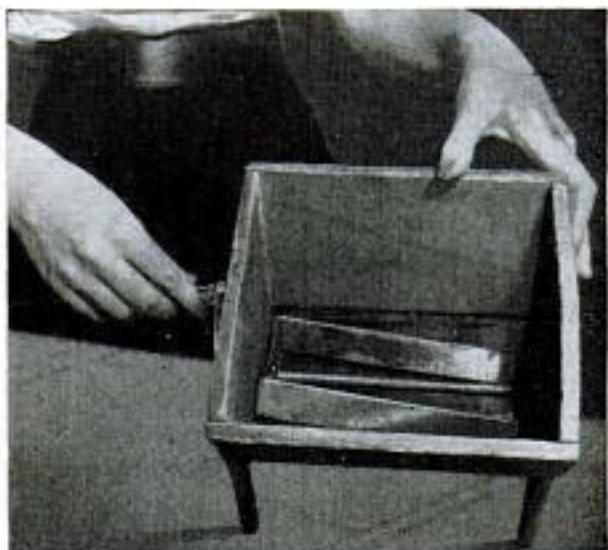

5. Necessary for making bread a century ago, this device, now redesigned, still is used in modern kitchens. Can you identify this very ordinary utensil?

(see Aug 58, 163)

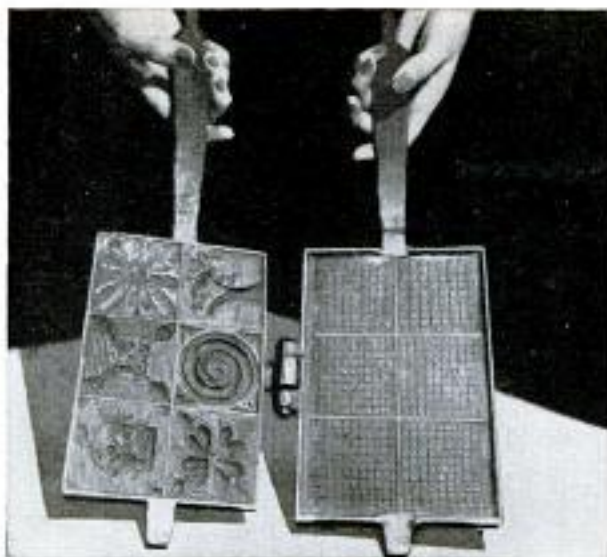

6. Not a fancy cookie press, this utensil would be more at home with breakfast bacon and eggs. Your modern-day models are simpler. But what is it?



7. Although this unit looks like a section of tubes from a steam boiler, it actually helped to make great-grandmother's housework lighter. What is it?



8. This one should not be too difficult. The modern version probably is made of aluminum instead of cast iron, but does the same job. Know what it is?



9. Not a nutcracker or curling iron, this odd-looking gadget was used for a task that no longer is performed. Do you know on what it was clamped?



10. If you remember what this corrugated roller-and-plate combination was used for, you are a real old-timer. Can any of you youngsters identify it?



Answers to
quiz will be
found on
page 164

11. Although it does not look much like a kitchen appliance, this fearsome machine helped to produce some fine food. What would you guess it to be?

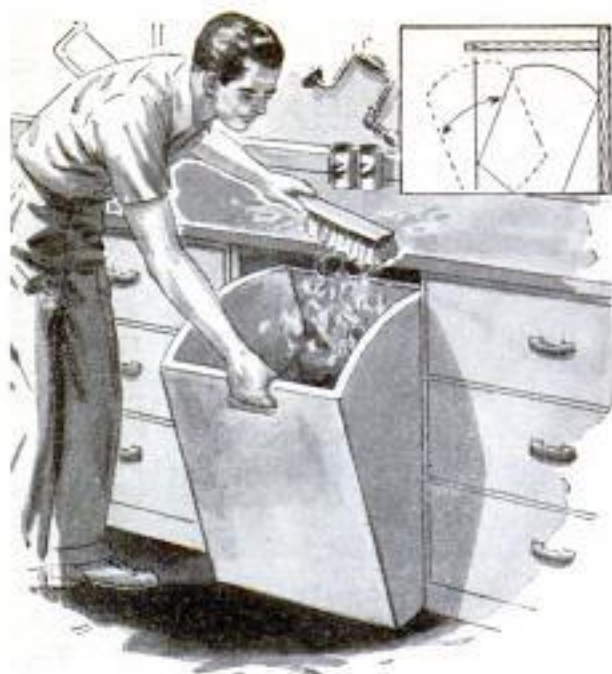

Tilting Shavings Bin Fits Under Workbench

This bin tilts outward just like the old-fashioned flour bin. But note in the detail that it is not hinged at the lower corner like its counterpart. Rather it tilts on a V-bottom. This feature permits it to be easily removed for emptying.

G. E. Hendrickson, Argyle, Wis.

Wick-Type Room Cooler Is Quickly Improvised

In localities where humidity remains at a comparatively low level for long periods of time this room cooler will prove quite efficient. It consists of a wooden box with open ends, a small electric fan, a row of wicks and a long, rectangular water tank, or trough. Upper ends of the wicks are attached to a cleat nailed inside the box near the room end. A small, metal rod passed through holes in the lower ends of the wicks keeps them taut. The fan is placed just behind the wicks. Glass, plywood or hardboard closures are placed on each side of the box.

Carl S. Bates, Chicago.

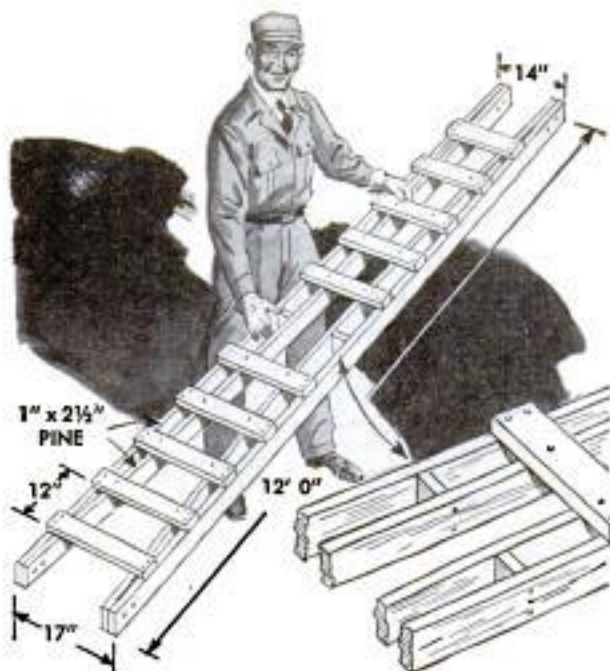
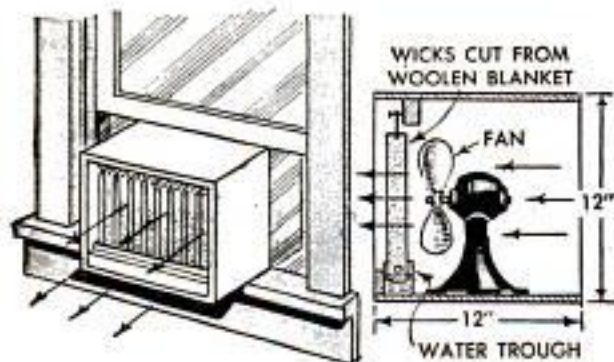

Ladder Rails Curve-Braced For Maximum Rigidity

Like a ladder that feels solid and sure? Here's one that won't tip, sway or fold, even when made a full 16 ft. long. It's lighter than any you can build using 2 x 4 rails and 1 x 4 rungs. Rails, braces and rungs are cut from 1 x 2½-in. stock. Width is given as 17 in. at the lower end and 14 in. at the top, but you can increase these dimensions if desired. The rungs are nailed to the rails and also to the curved braces. Ends of the curved braces are clinch-nailed (or bolted) to the rails.

Answers to Quiz on Page 162

1. If you didn't know this one, don't worry. Even the museum does not know its name or use.
2. A forerunner of the modern electric-powered meat grinders and food mixers, this machine chopped mincemeat.
3. This is a reflector oven, used for roasting meats in front of a fireplace. The hand-operated spit has been replaced in modern rotisseries by one that is rotated by an electric motor.
4. This is a cherry pitter, used to prepare the fruit for home canning. It was faster than hand pitting, but food-processing plants do it faster.
5. You probably knew this one. It's a flour sifter, operated by a hand crank on the side.
6. If you like waffles, you might have recognized this one, since the right-hand plate has a pattern similar to that used on modern waffle irons.
7. When great-grandmother needed light for her housework, she made her own candles with the aid of a candle mold, such as this one.
8. Muffin pan is right for this one, although it does somewhat resemble an egg poacher.
9. This device was used to compress corks that were forced into the necks of bottles.
10. A fluting iron. The plate was heated on top of the coal stove to permit ironing pleats or flutes in cloth.
11. Sausage stuffer is what this machine is called. It's not likely that you will see one in a neighborhood delicatessen.

Carry Luggage On Top



THERE'S NO NEED to crowd luggage and other vacation or camping gear inside your station wagon when everything can be carried on top in this handy luggage rack bolted to a bar-type auto-top carrier. This leaves the inside of the wagon uncluttered for comfortable riding during the day with ample sleeping space for two or three. As shown in the drawing and details, the rack is made of $\frac{3}{8}$ -in. plywood and 1-in. lumber cut to fit the space requirements of the wagon for which it is to be used. When placed in the back of the wagon as shown in the second photo from the top, the rack also can be used for carrying brick, loose sand, gravel and other material.

Tom Riley, Atherton, Calif.



Luggage rack used inside wagon as truck bed for hauling sand, gravel, etc. Below, carrier bars are bolted to bottom of rack before securing it on top of wagon

Below, plywood bottom may be nailed to strips as in detail A, or glued in grooves as shown in detail B

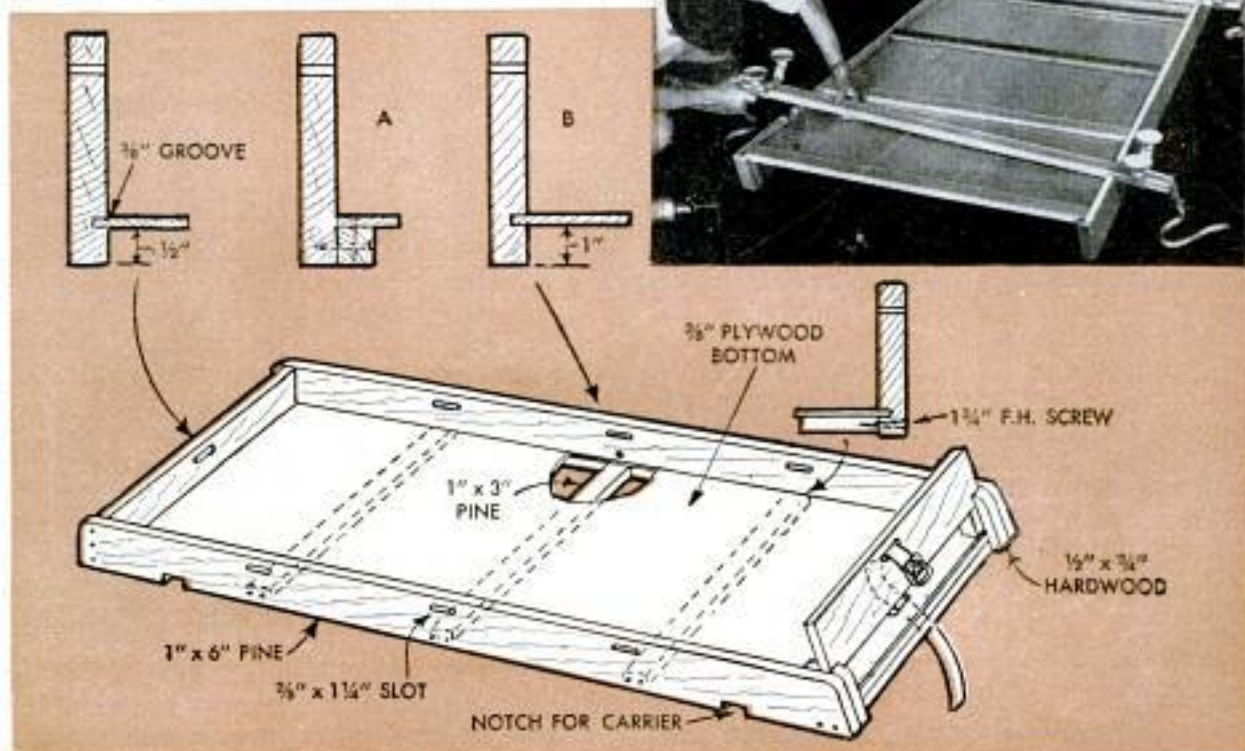
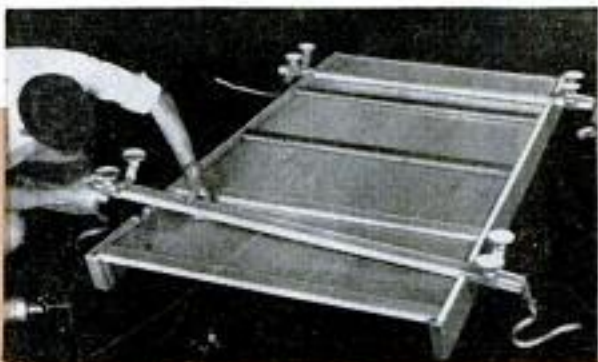

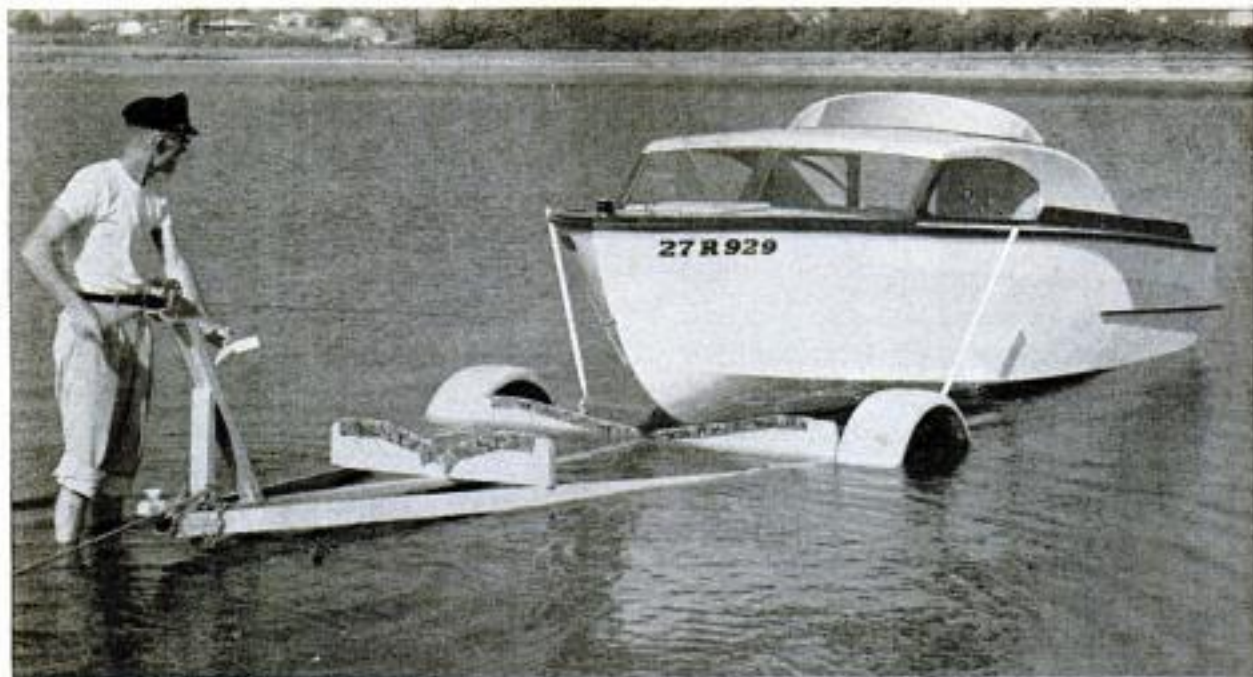

A winch, plus the upright guides, make it a comparatively easy task to get *Sea Knight* back on its trailer

SEA KNIGHT

17-Ft. Plywood Cruiser

PART IV

By Glenn L. Witt
NAVAL ARCHITECT

CONTINUING THE DISCUSSION of the motor well, the latter has a watertight tray of $\frac{1}{4}$ -in. plywood that fits flat on the 1 x 3-in. transom brace and extends at right angles to the transom and the motor-well bulkhead. The tray is supported by cleats to which it is nailed with 1-in. ring nails. Use glue or mastic on all the joints to insure watertightness and drill two 1-in. holes through the transom to drain water that may enter the storage compartments. Finally, the aft decking is fitted just under the cap rail and extended inboard to the side of the motor well. Floor battens can now be fitted in the notches provided in the frames and glued and fastened with 2-in. No. 10 screws. Notice that the 1 x 3-in. blocking on the aft side of the bulkhead acts as a ledge for the cockpit flooring. The latter is in three sections so that the center

section can be removed. This section rests on the floor battens. The outer sections of the floor are blocked to the chines at the proper height and notched around the protruding frames.

Fig. 44, Part III, shows how the hatch on the forward deck is framed with $\frac{1}{2}$ -in. strips to provide a lip for the hinged hatch cover. A standard hold-down fixture is used to secure the cover. The cabin doors are of $\frac{3}{4}$ -in. plywood and are hinged accordion-fashion to fold against the helm box. Equip the door with a barrel bolt or a rim lock if locking the cabin is important. An 18 x 18-in. opening is cut on the starboard side of the bulkhead and fitted with a hinged cover to let down and form a table.

Mahogany trim: The sheer bumper rail, bow toe rail, quarter-round trim strip and the lower bumper rail are all located as indicated. All should be bedded in mastic and securely nailed or screwed. In attaching the sheer bumper rail, which extends from the bow to the stern, sand the edge of the side-deck planking to provide a flat for the rail so it will lie as vertical as possible. The quarter-round trim strip is applied at the juncture of the cabin sides and side decking. This is bedded in mastic and nailed with $\frac{3}{4}$ -in. ring nails. The cabin roof should be covered with glass fiber completely down to the trim rail at the junction of the cabin side and mahogany coaming. The helm box is made of 1-in. mahogany following the general shape shown to accommodate the particular steerer used.

Painting: After filling all holes and giving your boat a thorough sanding, exterior surfaces to be painted are primed with a good marine primer, followed with at least

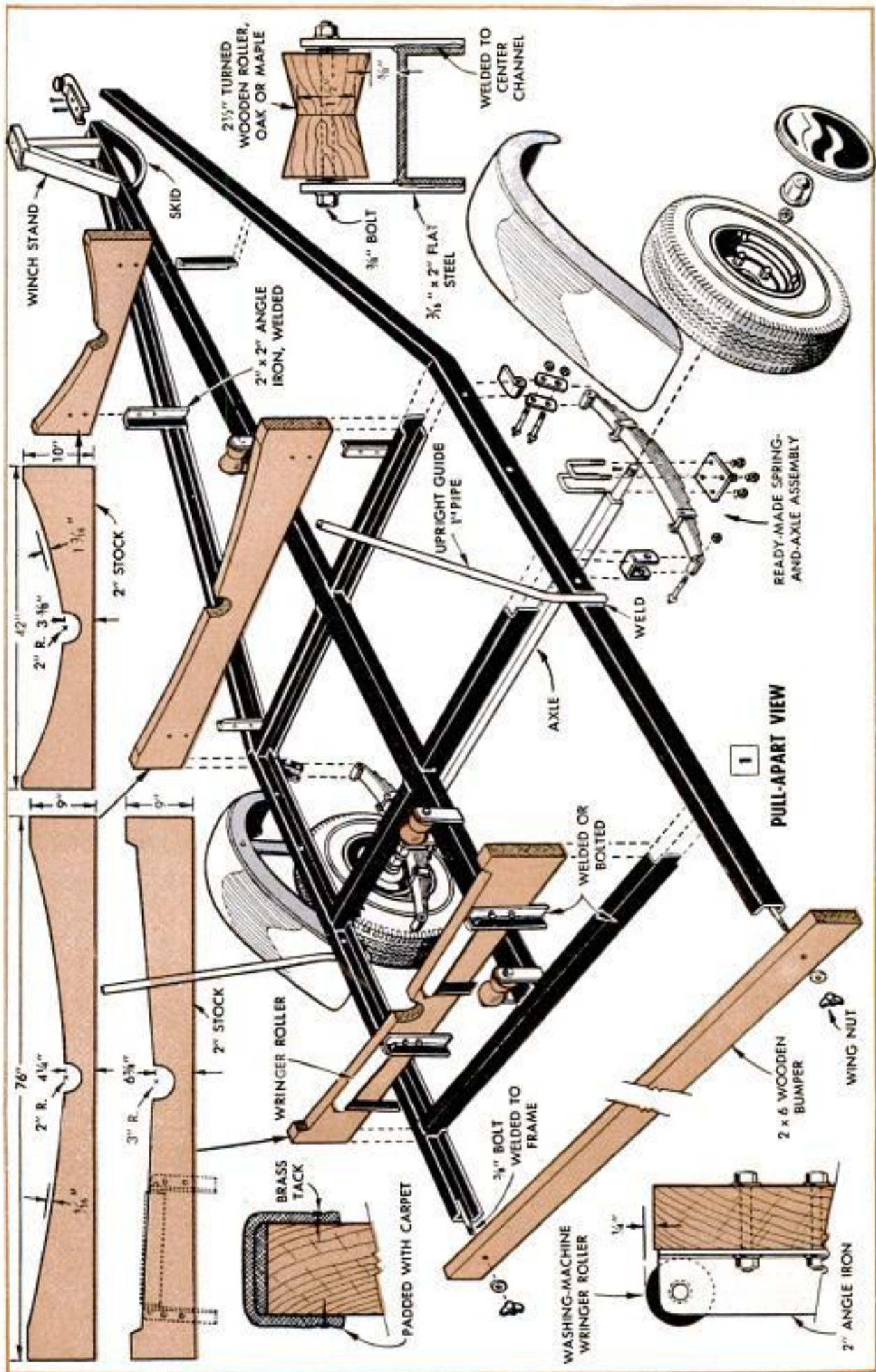

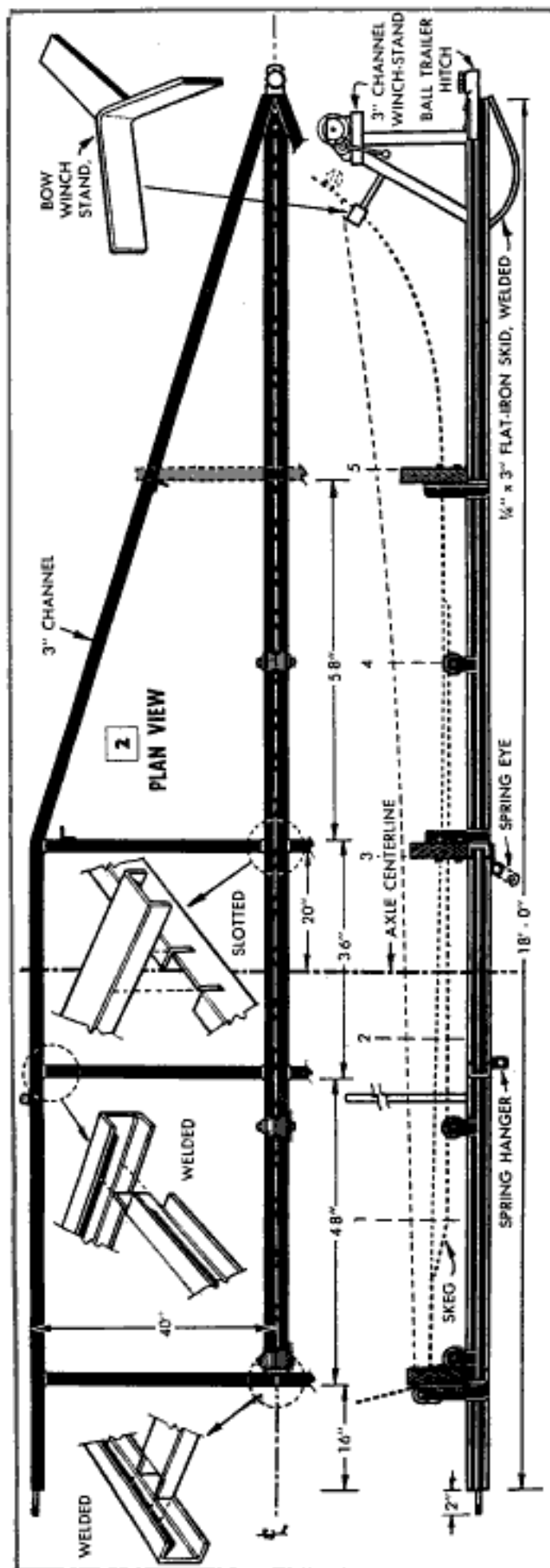

two coats of marine enamel. The interior surfaces are sealed with a clear-resin sealer before painting to suit. The decking and floor boards should be painted with a nonskid deck paint. All areas to be left natural are first filled and stained and then given at least three and preferably five coats of marine varnish.

Cabin windows and windshield: The side windows are $\frac{1}{8}$ -in. plastic. These are set in the grooves in the coaming and bedded in compound to assure watertightness. The plastic is cut large enough to lap the opening $\frac{3}{8}$ in. at the top. Use $\frac{1}{2}$ -in. No. 4 screws at the lap and space them 3 in. apart. You'll find in installing the cabin windows that the plastic will have to be flexed considerably to fit it in position. Safety glass or thicker plastic can be used in the windshield. Bed the glass in compound and hold it in place with prefinished $\frac{3}{8}$ -in.-mahogany strips nailed with brass nails. The 15-gal. water tank, detailed in Fig. 55, Part III, is located under the berth between frames Nos. 4 and 5. A 13 x 13-in. sink may be installed in the counter top and piped to drain overboard just above the water line on the starboard side. Any angle-type galley pump may be used to draw the water from the water tank. Use plastic hose for this and be sure to have a vent in the tank inlet. A portable toilet having a disposable bag is preferred to the standard marine-type water closet as no through-the-hull fittings are necessary. The berth cushions are tailored in two sections to fit the space and can be of either kapok or foam rubber, 3 in. thick. By locating the cabin light on the helm side of the bulkhead it will be convenient to connect it to the electric wiring in the event an electric motor starter is used. Up forward on the top rail a combination light should be installed, whereas, aft, a white stern light with a telescoping pole should be used. The fittings on the deck may be kept basically simple. A heavy lifting ring, or mooring bit, is bolted to the front deck with angle chocks mounted on the toe rail. Aft, streamlined towing cleats should be mounted on the side decks near the transom both port and starboard. You may desire a flying bridge which can be provided by using a fixed-type, curved plastic windshield that comes with a rubber gasket to fit the contour of the cabin roof. One 15 in. high and 62 in. long is recommended.

Building the trailer: The trailer pictured and detailed in Figs. 1 and 2 was designed expressly for your *Sea Knight*. The bed is constructed of 3-in. steel channel, while the bumper and boat-cradle forms are made of wood. The 1½-in. drop-type axle used on the original was purchased from a trailer-supply house. It has a load capacity of 2000 lb. and provides a wheel tread of 88 in. which gives a maximum trailer width of 96 in. which is allowable in most states. Select a good commercial hitch that must be bolted or welded directly to the frame of the car. Avoid a hitch that merely clamps to the bumper. Weld husky safety chains to the trailer and provide a means of bolting them to the car. The winch, stand and wheel skid are optional. The winch, if used, should be equipped with about 35 ft. of cable and a safety hook for attaching it to the boat bow eye. The cradle forms are cut from 2 x 10 material to conform to the bottom of the boat. The two rollers at the transom can be improvised from washing-machine wringer rolls. The keel rollers are located as shown in Fig. 2. The rollers under the skeg of the boat should be adjusted for height after the boat is on the trailer.

Upright guides: The pipe guides locate and guide the boat directly to the center of the trailer even during a good breeze. They should be padded and welded to the trailer so the bumper rails just touch the guides. The wooden bumper which carries the license plates and the stop and tail lights is made so it can be removed when launching. The metal parts of the trailer should be primed with zinc-chromate primer before



Blueprints Available

Those who prefer to build *Sea Knight* from plans larger than the ones presented in the magazine may purchase a set of blueprints, 22 x 34 in., by writing Blueprint Department, *Popular Mechanics Magazine*, 200 E. Ontario St., Chicago 11.

enameling wood and all to either match or contrast with the boat.

Launching: To launch your boat, tie a 100-ft. length of cable or 5/8-in. rope to the trailer and to the car. A 25-ft. length of 3/8-in. rope is coiled and left on the fore-deck within easy reach. Unhook the trailer and push it as rapidly as you can down the bank. Then, as soon as it reaches water deep enough to float, grab the line coiled on the deck and give the boat a good shove. Forget about the trailer for the moment and pay out the line until the boat drifts clear of the trailer. Then simply pull in on the bow line and moor the craft to the shore. The trailer is pulled from the water by the 5/8-in. cable attached to the car. To recradle the boat on the trailer, push the trailer, with the cable attached, into the water. Then fasten the winch line to the boat and push the boat out to align it with the trailer. The winch makes it a simple matter to draw the boat up on the cradle of the trailer, after which the latter is pulled out of the water with the car and finally hooked to the car hitch. ★ ★ ★

To Save Both Time and Work

If you wish, you can buy the patterns for the stem, frames, transom, breasthook and chine blocking already drawn full size. And, to further simplify construction, you can buy these parts in kit form accurately cut in mahogany from Glen-L Marine Designs, P.O. Box 568, Compton, Calif.

Finishing Fabricated Panels Made of Plywood Scraps

Home craftsmen probably use more plywood than any other wood and eventually accumulate a sizable stock of remnants. In many cases these leftovers can be used up in a fabricated panel and one of the best ways to hide the built-up core of such panels is with a covering of muslin. The muslin should be of good quality and free from nubs. It is glued smoothly to the surface, and when dry, the pores of the muslin are filled by rubbing in a commercial wood fill-

er. Spackle is inexpensive and quite suitable for this purpose. The filler is carefully sanded with fine paper, taking care not to roughen the threads of the cloth. Then the surface is dusted and painted. When a hard glossy enamel is used, you can build up a durable finish which resists denting, making it ideal for a desk top. If a glossy finish is not desired, it can be toned down by rubbing with pumice and oil.

William B. Rasmussen, Posser, Wash.

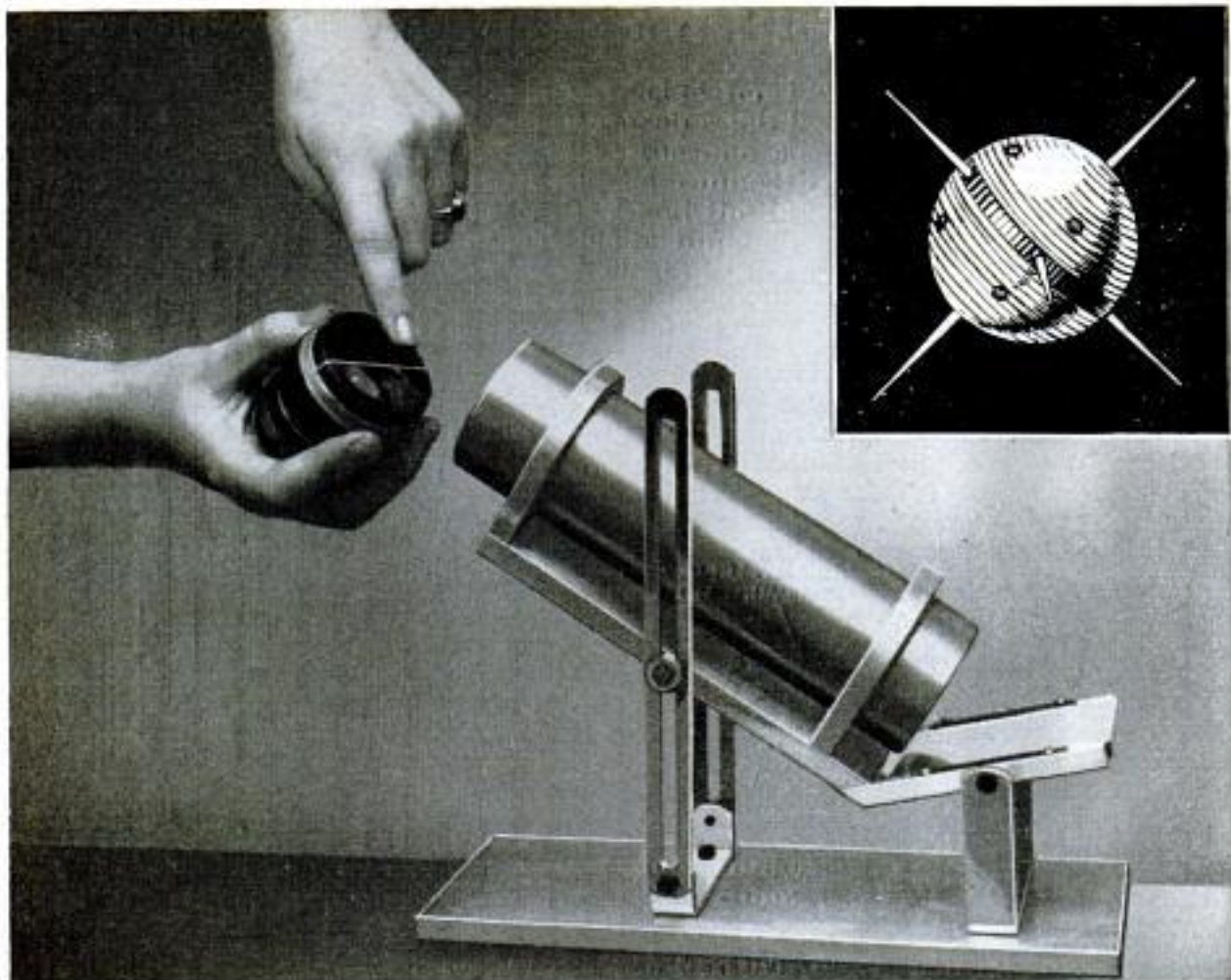

Wire across diameter of eyepiece must be in vertical position in telescope to divide star field at meridian

Build a "Moon Watch" Telescope

WHETHER OR NOT you join one of the amateur-astronomer teams of "operation moon watch" to help Smithsonian Observatory scientists track the manmade satellite, you can have plenty of fun satellite hunting on your own or just stargazing with this easy-to-build telescope. It is of a type designed for official use at moon-watch stations. The lenses give a wide-angle view ($12\frac{1}{2}$ deg.) at a magnification of $5\frac{1}{2}$ times. With it you can observe the planets in our own solar system and investigate some of the constellations in our galaxy.

Parts for the instrument, including two lenses, an aluminum tube, mirror and material for platforms and a base, cost less than \$30. For the eyepiece, a wide-angle Erfle lens with a focal length of $1\frac{1}{4}$ in. is recommended. The threaded focusing mount on this lens facilitates installing it in the lens barrel of the telescope. If the Erfle lens is not available, any lens of similar field, focal length and mount diameter can be substituted.

The second lens needed is the objective, which should be 51 mm. ($2\frac{1}{4}$ in.) in diameter, with a focal length of 180 mm. ($7\frac{1}{16}$ in.). The lens should be housed in a metal cell with an outside thread of 40 turns per inch to fit the threads in the lens tube.

The eyepiece and objective are mounted at opposite ends of an aluminum tube (machining grade) $8\frac{1}{2}$ in. long with an o.d. of $2\frac{3}{8}$ in. and i.d. of $2\frac{1}{32}$ in. The threads on the inside of the tube must be cut to match the threads on the eyepiece and objective for a good fit. If it is impossible to cut the threads yourself or to have the work done at a machine shop, the lenses can be press-fitted into the tube after the inside wall at each end has been machined to accept them. A simple spring ring will hold the objective in place. The eyepiece should be fitted snugly so that friction prevents it from turning, since the wire that crosses the diameter of the lens shown in the photo and drawing must remain in a vertical position when observing. The purpose of the cross wire is to divide the star field at

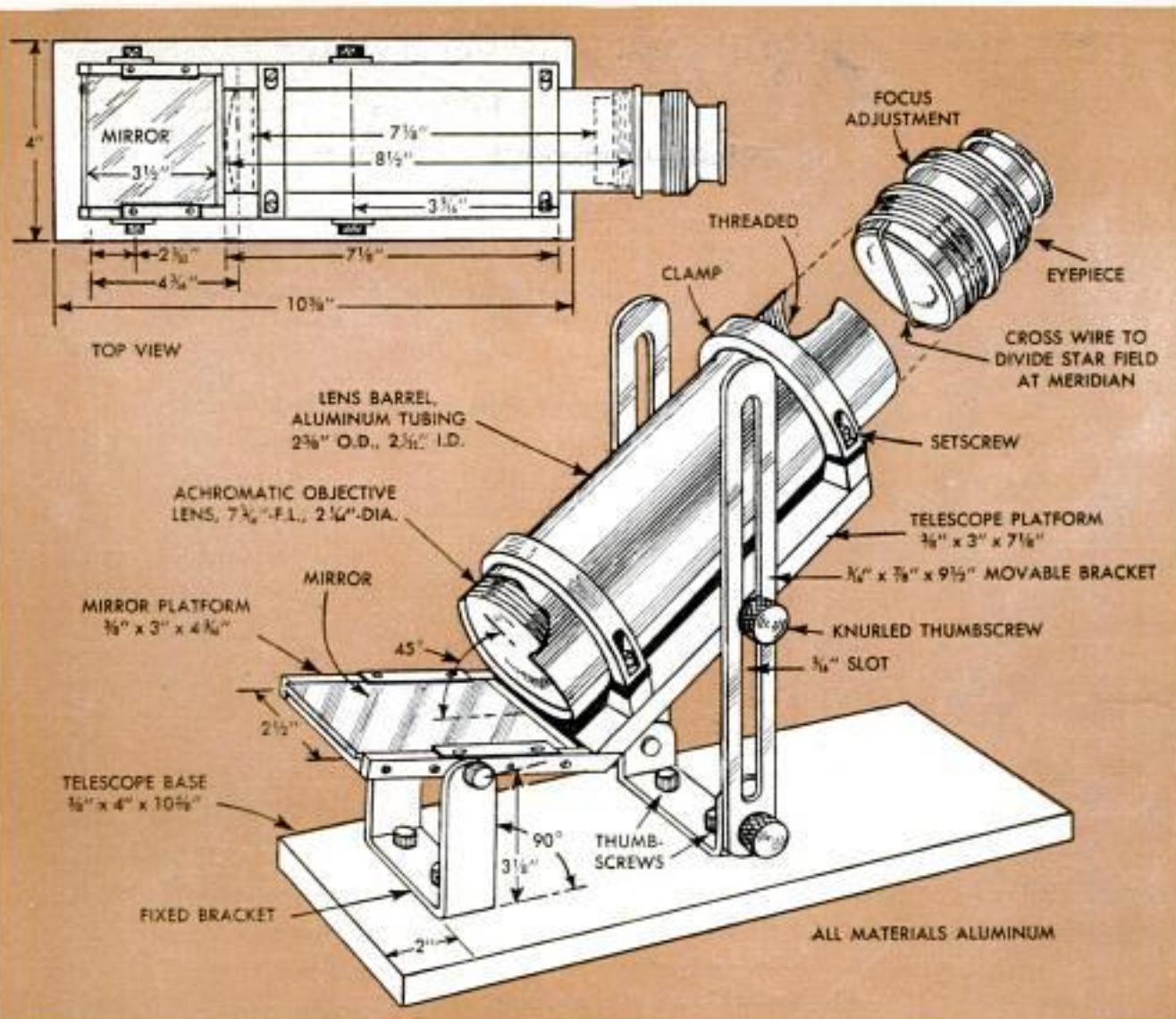

the meridian, cutting the observable sky exactly in half.

The lenses are positioned in the tube so that their facing surfaces are exactly $7\frac{1}{8}$ in. apart. If even approximate precision is achieved, this will provide a focusing range of 10 ft. to infinity.

With the lenses mounted, the basic telescope is complete. But, to enable you to have an overhead view while looking obliquely into the eyepiece, the telescope is equipped with a mirror mounted at a 45-deg. angle in front of the objective lens. This will permit you to place the telescope on a table and use it from a sitting position. The easiest way to do this, is to clamp the telescope on a $\frac{3}{8}$ -in. board

or aluminum platform as detailed. The mirror platform, made of the same material, is simply screwed to the telescope platform and the mirror is clamped in position on top of it as shown.

Almost any kind of pivot arrangement that will permit adjusting the viewing angle of the telescope can be used. The one shown consists of two slotted uprights pivoting on U-shaped brackets screwed to the base. Thumb screws turned into tapped holes in the platform permit the telescope to be tilted to the desired position and locked in place. Mirror and telescope tilt as a unit on a fixed bracket. Thumb screws at the top ends of the bracket arm provide a lock for the mirror platform. ★★★

Rings Lost In Bathtub Drain Retrieved Through Trap

Small articles like rings and beads that pass through the drain of a bathtub can be retrieved usually from the bathtub trap. The trap cover is visible generally, coming slightly above the floor. It is threaded on the trap and has a square or hexagon boss

to which a wrench can be applied to loosen it. When a trap cover cannot be turned with a wrench, you cut two small notches in the edge on opposite sides of the cover, so that the cover can be tapped loose. Apply cup grease to cover when replacing.

Jig Permits Uniform Spacing of Fence Pickets



When building a picket fence, you can save time and do a neater job by using a wooden jig, such as the one shown. The width of the upright determines the spacing between the pickets, and the block at the top permits the jig to be hung on the upper rail of the fence. A cleat at the bottom end of the jig holds a picket in the desired position while it is being nailed to the rails.

Enno R. Haan, Evanston, Ill.

Adhesive Tape on Thumbnail Aids in "Starting" Pen

To aid in starting ink flow of a pen in intermittent use, one artist attaches a small square of adhesive tape to his left thumbnail. After dipping the pen, a quick pass of the point over the tape cleans it effectively and causes ink to flow uniformly from either a crow-quill pen or ruling pen.



and causes ink to flow uniformly from either a crow-quill pen or ruling pen.

Handy Toolkit for Small Jobs Made From Large Juice Can

Hand tools and several types of fasteners are carried in this home toolkit that is made from a large juice can. Two steel flats are screwed to the can with a length of broomstick between them to provide a handle. Four shallow tins are screwed to the flats to hold the fasteners.



Sectional Wooden Platform For Bathroom Darkroom

Converting the bathroom into a temporary darkroom is an easy matter with this sectional wooden platform which fits over the bathtub. Constructed of cypress or redwood slats, the platform serves as a convenient worktable, while the tub below is used for washing film or prints. The platform should be built in sections so it can be stored easily in a closet or corner of the bathroom when not in use.

Virginia Hanson, Venice, Calif.



ⓘ Never shake a can of varnish before using it; stir it. Shaking will cause small bubbles on the finished surface.

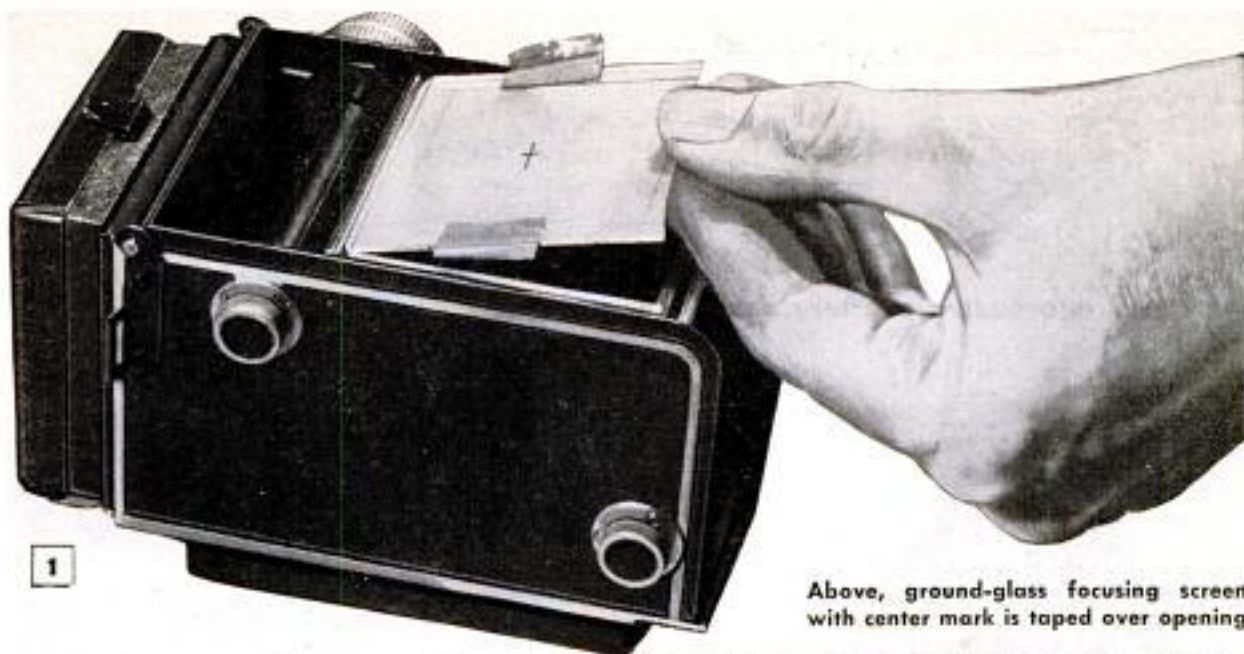

Above, ground-glass focusing screen with center mark is taped over opening

Correcting for PARALLAX

SHOOTING WHAT YOU SEE in the viewer at a range as close as 12 in. can be done with a twin-lens reflex camera if you first compensate for the difference in the fields of view of the taking lens and the viewing lens. This is known as parallax and must be corrected to avoid cutting off part of the picture. To do this, first remove the back of the camera and tape a square of ground glass over the film opening as shown in Fig. 1. Next, mark a cross, B, with a pencil on the ground glass at the exact center of the picture area. With the camera mounted on an elevator-type tripod, focus it on some distant object and then swing the camera until a prominent part of the image coincides with the mark on the ground glass.

Now, without moving the camera, make a mark on the view finder as in Fig. 2, C, to coincide with the same detail. Remove the ground glass and load the camera. Finally, measure the distance from the center of the taking lens to the center of the viewing lens, A, Fig. 2.

Compose the image on the view finder as you want it and prop a steel tape against the object as in Fig. 3 so the lens-to-lens measurement, in this case $1\frac{1}{16}$ in., coincides exactly with the mark on the viewer. Without disturbing the position of the camera, elevate it on the tripod until the dot on the viewer centers on the end of the tape. Place the proper auxiliary lens on the taking lens and shoot. You may find from test shots that the amount the camera must be raised is slightly less than the actual measurement between the lenses.

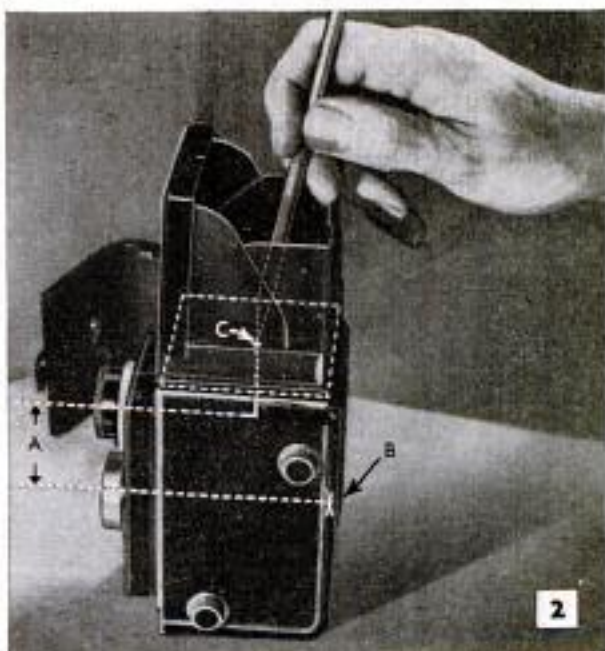

Above, camera is focused on object 200 ft distant and dot made in center of viewer, C, to coincide with prominent point in image. Below, steel tape propped against subject provides target at which to aim camera in registering lens-to-lens measurement with mark C and finding amount camera must be raised



YOU CAN HANDLE THOSE Small Concrete Jobs

X195

Photos and information courtesy Sakrete, Inc.



EXTRA-STRONG MIX



MEDIUM MIX



MIX WITH TOO MUCH WATER





Three steps in fitting block in concrete-block wall are shown above. A ribbon of mortar first is troweled along edges of top of lower block. Also, although not shown, mortar is spread along edges of end of adjacent block. Next, block is lowered into place and tapped into mortar on lower block and adjacent block

SSMALL CONCRETE REPAIRS, and even moderate-sized masonry-construction jobs, are within the scope of any homeowner now that the problem of determining the correct proportions of material in concrete and mortar has been solved for him by convenient ready-mixed products. Simply adding water to the dry mixes produces quality material that can be used with assurance for any job. The only possible error to be made with the ready-mixes is to add too much water, and if a quantity

of the dry mix is held out until the final mix is completed, such an error can be corrected by adding more of the dry material. The three photos on the opposite page demonstrate the three types of mix possible when water is added. The first two are good, the last is not, too much water having been added. The extra-strong mix should be used whenever possible; the medium mix will be used for most jobs, as it will flow more readily. Tools required for working with concrete are a shovel, hoe



Typical of many small-to-medium-sized jobs that can be done around the home with the aid of ready-mixed cement products is this one, where a concrete fillet between the wall of a concrete-block garage and a driveway has broken up. First step is to remove all loose material and wire brush the area carefully. Next, the area is soaked down thoroughly with a hose to assure that old material does not absorb water from fresh mix. Final step is to trowel on extra-strong mixture of sand-cement mix. Larger repairs would require use of sand-gravel-cement mix





First step in sidewalk repair is to remove old concrete and undercut crack to assure "keying in" repair



Old concrete then must be thoroughly wet down to prevent it absorbing water in fresh concrete mix



Crack in walk then is filled with concrete, which is tamped thoroughly to compact it into all spaces

for mixing the dry mix with water, a pointed trowel, a wooden float and a rectangular finishing trowel. A square of plywood or solid stock may come in handy for carrying small quantities of mortar or mixing small quantities of concrete.

When making repairs on concrete, certain general rules can be followed: All loose material must be removed. Cracks in concrete should be chiseled out so they are wider at the bottom than at the top. Thus, when concrete is poured into them, it is "keyed" in the old material and will not readily break loose. Before pouring concrete in such cracks or other openings, saturate the old work with water. This will prevent the old concrete from absorbing water from the fresh mix and destroying its strength. Concrete does not harden because of the evaporation of the water; a chemical action takes place that produces heat and causes the cement particles to bind themselves to the sand and gravel aggregates and to each other to form a solid



Wooden float then is used to smooth freshly poured concrete. Steel tool is used for final finishing

mass. Water is necessary for this chemical action, and its removal will result in weak, crumbling concrete that will have to be replaced almost immediately. Too much water in a mix is just as detrimental to quality. The excess water will float away the light particles of cement, leaving only the aggregates. If you pour a too-wet mixture of concrete and it seems to dry too rapidly, turning yellowish from the sand, it would be best to chop out the concrete before it sets and do the job over. The weak material will crumble and wear quickly, but there will be just enough cement left in the mix to require chiseling to remove it. Digging it out before it sets is the easier way, and will require much less time.

Mortar mixes are a boon to the homeowner who wants to build a fireplace, barbecue pit or the foundation for a small building. The correct proportions of sand, cement and lime assure consistent color and quality of work, making it possible for anyone to be a competent mason. ★ ★ ★

Photographs Attached to Wall By Thumbtacks Hidden on Back

Photographs can be hung on a darkroom wall, without a visible means of support, by pushing several thumbtacks through a strip of tape and sticking it to the back of the print with the tack points exposed. A strip at the top and bottom of the print will provide a firm anchorage and leave no puncture marks in the print.

Robert C. Florian, Chicago.

Glass Block is Developing Tank

For a sturdy and comparatively inexpensive container for processing sheet film, obtain glass building blocks of the type that are open at one end. Various sizes are available.—Jeanne Stasack, Chicago.



Detergent Photoprint Solution Permits Spot-Free Drying

One or two drops of a liquid dishwashing detergent in a quart of water makes a solution that will allow fast, spot-free drying of photoprints. After the prints have been washed, soak them for about two minutes in the solution. The treatment works on both glossy and matte papers.



Color Transparencies Checked With Aid of White Paper

When a regular viewer is not available, color transparencies can be checked with the aid of a sheet of white paper. Place the transparency on the paper and hold both up to a light with paper nearest the light. Because the light shining through the paper is diffused, the color values of the transparency are much more apparent than if the film were illuminated by direct rays from the light source. Black-and-white negatives can be checked in the same manner.

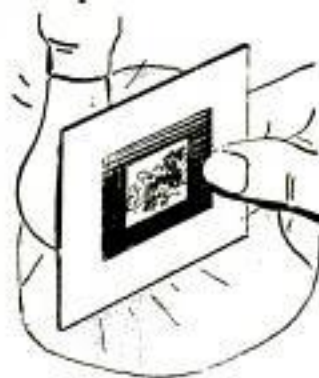

John Krill, North Lima, Ohio.

Two Simple Methods for Storing Film Hangers in the Darkroom

One simple means for storing cut-film developing hangers is to use dowel supports which are inserted in holes drilled in a wall. The dowels should be spaced from 2 to 7 in. apart, those closer together being used to support hangers upside down for drying. The second method is to support the hangers from L-shaped wooden tracks fastened to the underside of a shelf. The tracks are formed by nailing a 1/2-in. strip to the side of a piece of 1 x 2-in. stock, which in turn is screwed to the bottom of the shelf. Space the tracks

wide enough to admit the hanger crossbars, using one set for empty hangers and another for loaded ones.

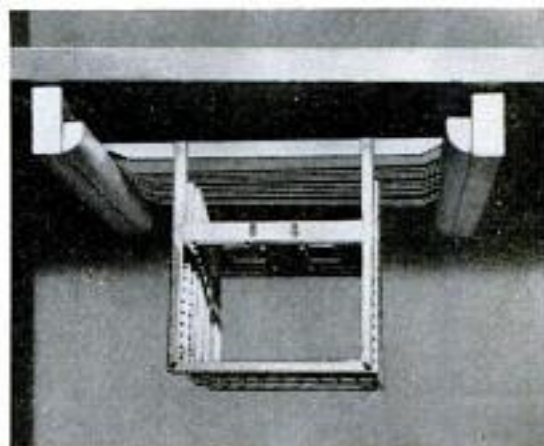

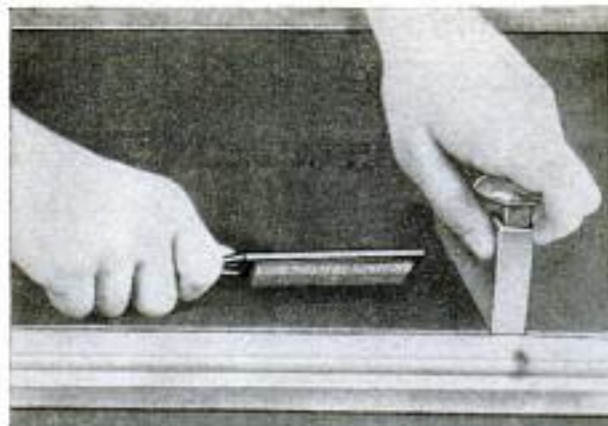

File Card Stretches Screening

Gripping screen wire to stretch it smoothly on a frame is no problem if a file-cleaning wire brush is used. Grip the brush handle and force the bristles of the brush into the mesh of the screen as shown. Because the brush grips a fairly wide area, narrow "ripples" in the finished job, caused by pulling on only a few strands of wire, are eliminated.—Ed Packer, Chicago.

Towel Rack Capacity Enlarged To Accommodate Extra Guests

When your regular towel-rack facilities are insufficient for house guests, the racks can be lengthened temporarily with pieces of dowel or broomstick. The extensions may be wrapped with colored, water-resistant tape to match or contrast with the bathroom decor. Tie or tape the extensions to the regular towel racks as shown and place a strip of tape bearing the name of each guest on the wall above each towel position. The extensions can be removed quickly and stored for future use.

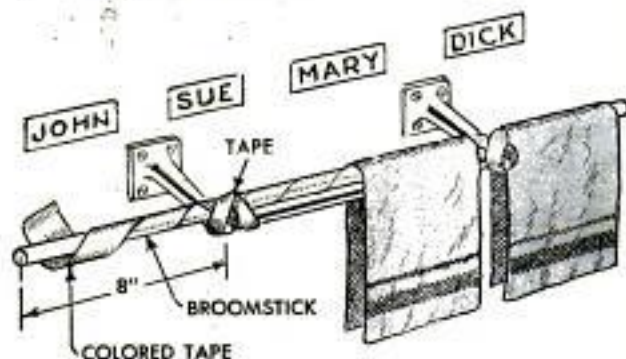

Tape Is Gauge on Circular Saw

Instead of using a crayon or pencil mark on the table of a circular saw to indicate the lengths of a number of pieces of stock to be cut, fix a piece of masking tape to the table. The tape is seen readily through a layer of sawdust and can be removed and reused several times.

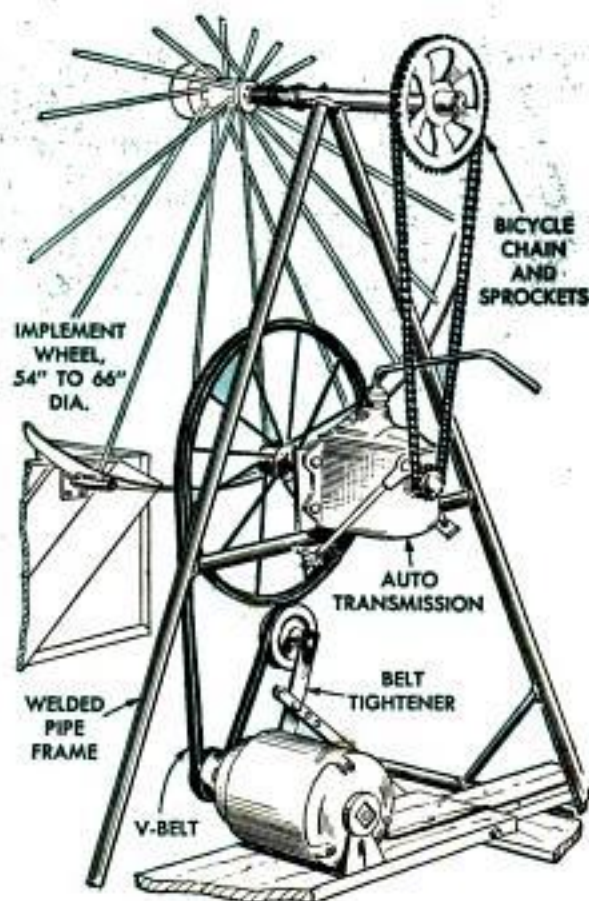
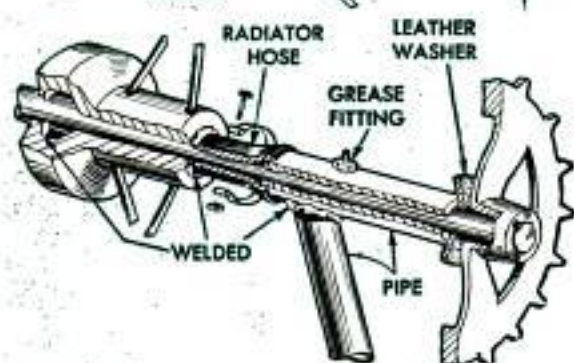
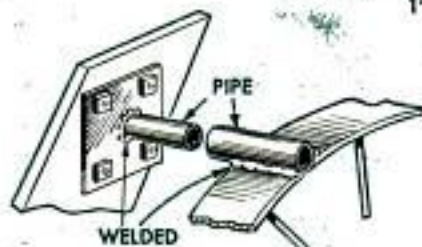

X271

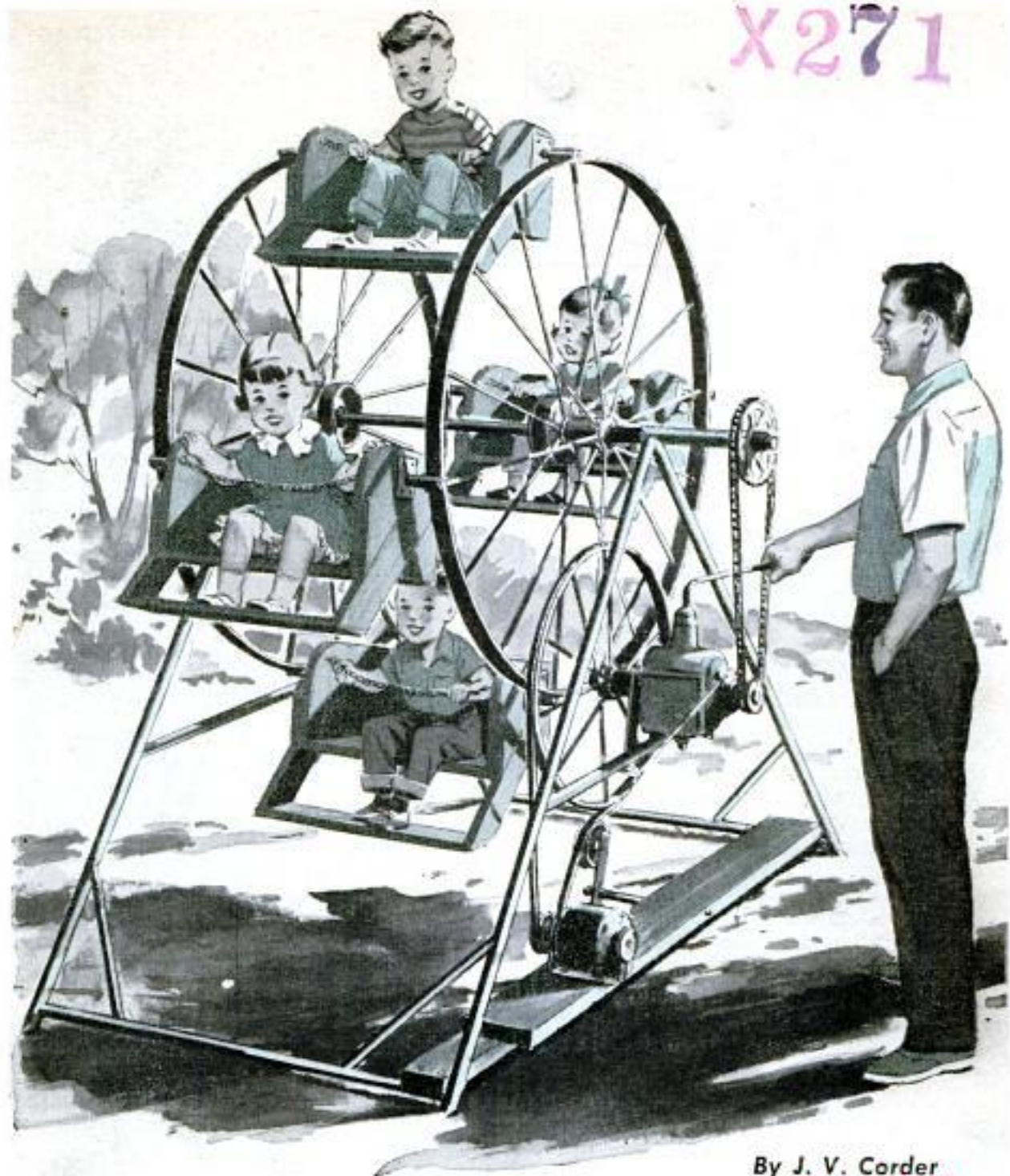

By J. V. Corder
 2517 35TH ST.
 Des Moines 10, Iowa

Back-Yard Ferris Wheel Has Three Speeds

DRIVEN through an auto transmission by a $\frac{3}{4}$ -hp. electric motor, this Ferris wheel may be operated at three different speeds by merely shifting the transmission. The frame consists of two A-frames of 2-in. pipe welded together, the two units being tied together at the lower ends by short lengths of pipe welded in place. The upper end of each A-frame terminates in a short horizontal pipe, which serves as a bearing for the wheel axle. Note in the lower center detail how a leather washer and a piece of

radiator hose serve as grease retainers.

Seats swing between two large implement wheels, such as cultivator or hayrake wheels, which are welded to the axle. The seats are pivoted as shown in the upper detail on the facing page, and fitted with safety chains. Lower detail shows the drive mechanism. Sprockets and chain used on implements may be substituted for those of a bicycle if desired. Large belt wheel is about 30 in. in diameter. Note belt tension is provided by idler pulley. ★ ★ ★

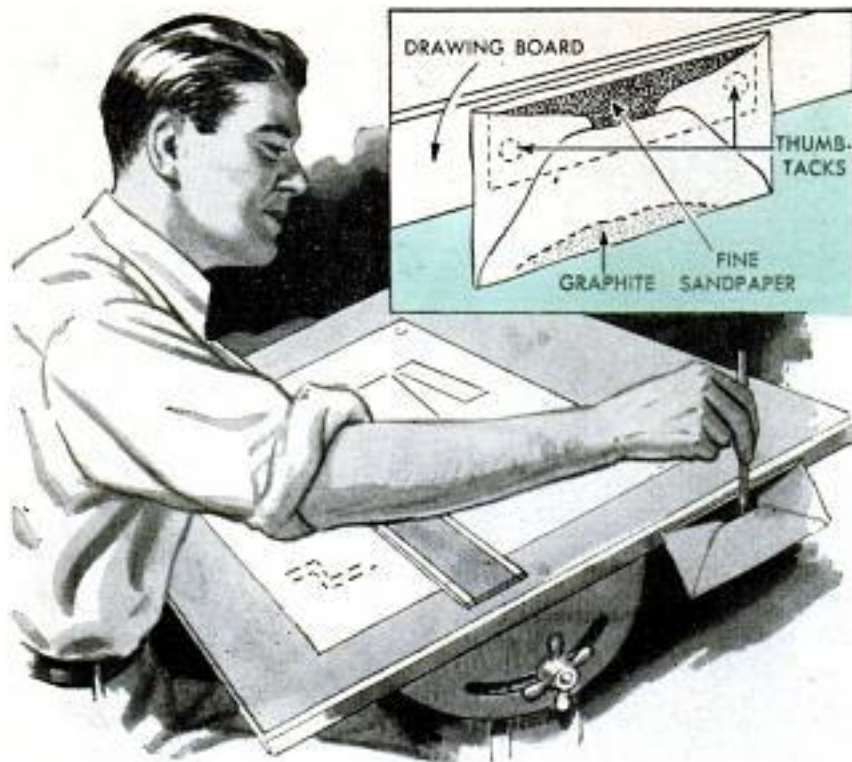

Envelope Catches Pencil Dust

Instead of keeping a piece of sandpaper on his drawing board for pointing pencils, which often soiled the drawings, one draftsman used the idea shown. A strip of sandpaper was placed inside an envelope having the flap removed, and the assembly tacked to one edge of the drawing board as indicated, locating it within easy reach. In this way, the envelope served as a pocket in which the graphite or wood dust was retained, and the sandpaper was always covered to prevent it from soiling either artwork, or hands.

A GOOD WOOD SCRAPER CAN BE MADE from a piece of hacksaw blade by grinding off the teeth and then sharpening one end to a keen scraping edge. If the characteristics of the steel permit, turning the cutting edge by burnishing or tapping with a hammer will give the tool better scraping action. Such a tool is especially handy for getting into places not accessible with the conventional scrapers. Old power-hacksaw blades are ideal for this purpose as they are heavier than those used in hand hacksaws.—Walter E. Burton, Akron, Ohio.



Models Displayed on "Wall" Made of Perforated Hardboard



Models built by one young hobbyist are made part of the decor of his room by hanging them on a display "wall" of perforated hardboard. The latter is nailed to the room wall over furring strips, which space it from the wall so that hooks can be fitted into the perforations. After giving the hardboard a prime coat and a coat of finish paint, the clouds, sky, roadway, railroad track and sea were painted on in brilliant, natural colors. Final step was to hang the models on the board with the proper hooks.

The Masonite Corp.

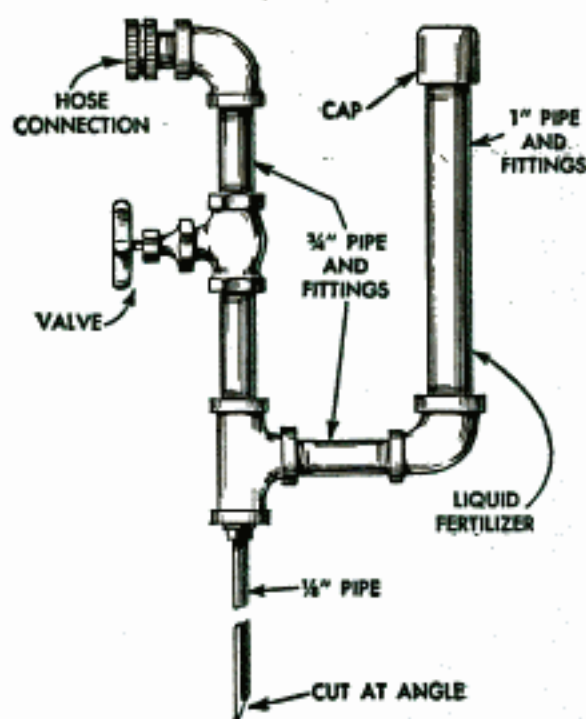

Root Irrigator Made From Pipe and Fittings

With a few short lengths of pipe and fittings you can improvise this subsurface root fertilizer and irrigator in less than an hour. Also, the device can be used for trenching under a sidewalk when installing a sprinkler system, and similar jobs. For trenching, it is only necessary to connect the device to a water supply, insert the end of the $\frac{1}{8}$ -in. pipe shaft in the soil and turn on the water at full pressure. A shaft length of 3 ft. is sufficient for most trenching jobs.

When using the device as an irrigator, its valve should remain closed until the shaft is started into the soil. The water can then be turned on with sufficient pressure to permit the shaft to dig its way into the ground. Once the shaft reaches the desired

depth, pressure should be reduced so that the water can be absorbed by the soil without washing it away. Small holes drilled into the shaft will increase the absorption rate for irrigating purposes.

When the device is used for applying liquid fertilizer to the roots of shrubs, small trees and other plants, the procedure is the same, except that the water must be turned off when the fertilizer is being poured into the 1-in. pipe reservoir. After replacing the cap on the pipe, the water is turned on and the fertilizer mixes with the water as it enters the shaft. Only enough fertilizer as is needed for a single application should be poured into the reservoir, since it has no shutoff valve.

Doug Beaton, Burbank, Calif.

Screw Eye Prevents Hook Damage

Avoid catching or tearing clothes on the hook of a screen or combination door by installing an extra screw eye on the door to take the end of the hook as shown. This also will prevent the free end of the hook from grooving the door.

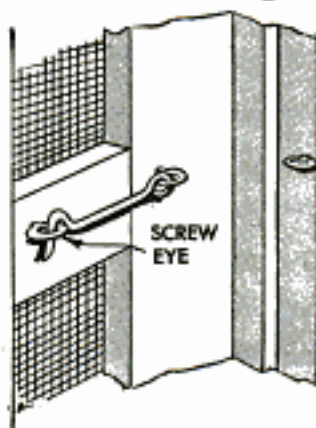

Guard for Glass-Cutter Tip

No need for a glass cutter to rattle around in a drawer or tool kit between jobs, where the cutting tip can be dulled or damaged. Protect the tip with a "bumper sheath," made from a short length of small-diameter rubber tubing.



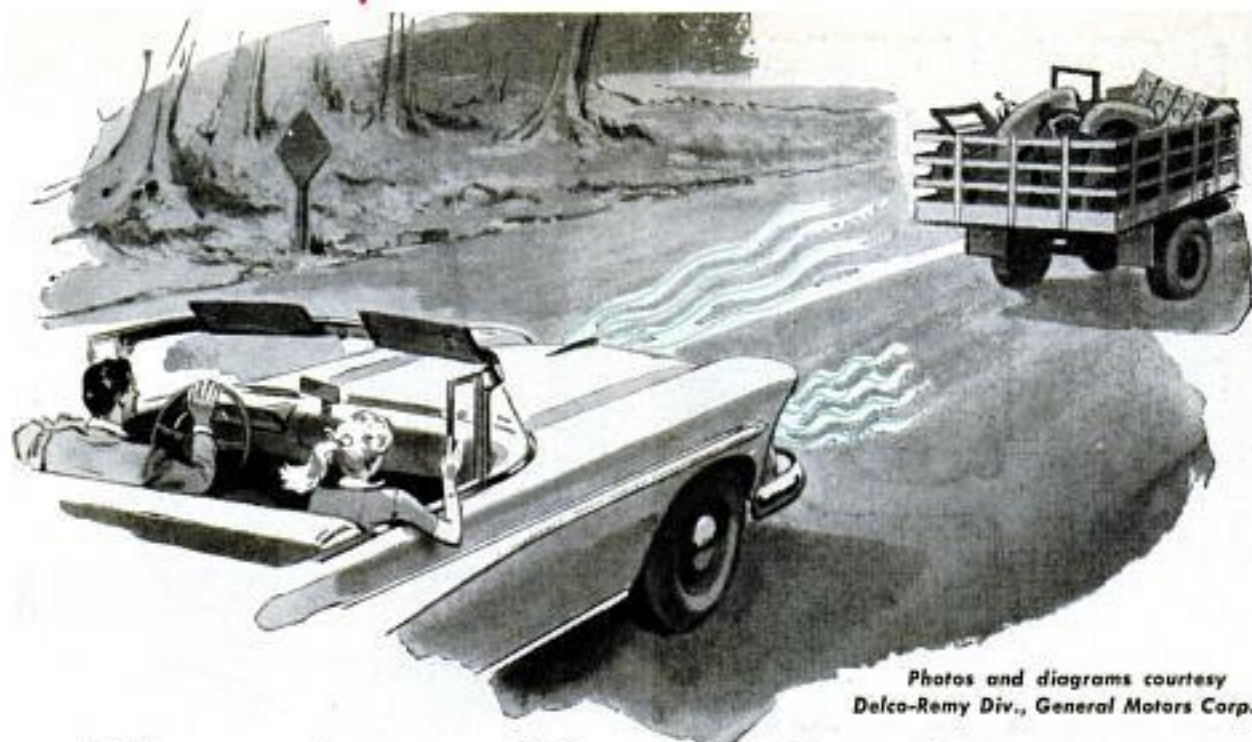

Photos and diagrams courtesy Delco-Remy Div., General Motors Corp.

New Auto Horns Are Better

By W. K. Mitchell

THREE DEVELOPMENTS in recent years have combined to make imperative the need for improving horns on modern automobiles. First is the increase in the number of cars on the streets and highways, second is the installation of more auto accessories and third is the better

soundproofing of automobile bodies. In congested traffic, motorists find it necessary to sound their horns more often, which adds to the regular din of traffic, but at the same time, soundproofed automobile bodies, plus the noises caused by radios, heaters and other accessories make it increasingly difficult for drivers to hear the horns of other cars. Therefore, while an improved horn must be one that is heard more clearly, at the same time it must not appreciably add to the sound level of traffic.

"Third tone" horn is typical seashell-type, air-tone horn. Frequency rating is higher than horns on most modern cars

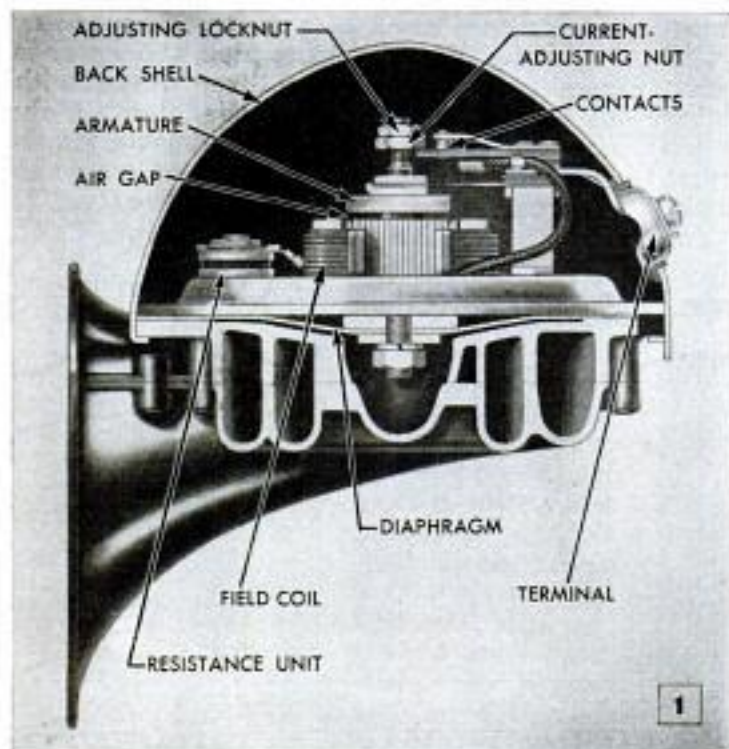

Two solutions to the problem now are available. The first is a "third tone" horn, Fig. 1, designed to produce a tone that blends harmoniously with the tones of the pairs of horns in use on most cars. The second is a high-frequency, penetrating-note horn, Fig. 6, designed for highway use.

The third-tone horn is a typical seashell-type, air-tone horn, and is tuned to B-flat, which has a frequency rating of 468 c.p.s. This is a higher note than either of the two matched horns on most cars, which are tuned to E-flat at 311 c.p.s. and G at 390 c.p.s., respectively. Blending the tones of the three horns produces a chord that is more pleasing than the two-note signal and, since it covers a wider

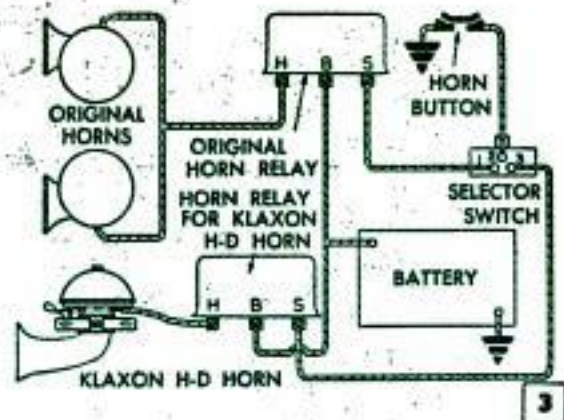
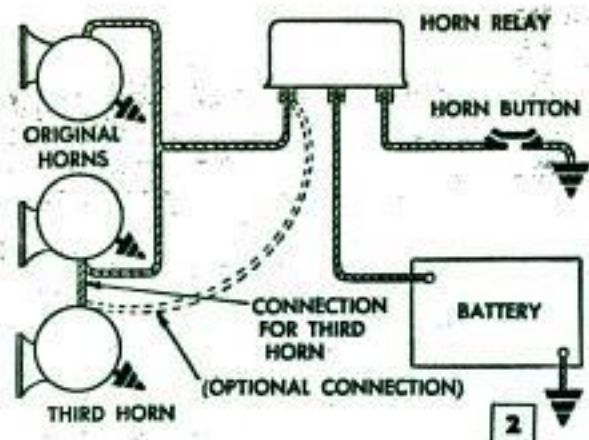

Wiring diagram shows two methods of connecting third-tone horn to present pair of horns in car

range of frequencies, is more easily heard through the noise of traffic and sounds inside the car.

The high-frequency horn is designed for maximum signal penetration on the highway, and is similar to horns in use on some highway buses. It can be mounted on any passenger car in combination with the original horns in the same manner as the third-tone horn. One recommended installation for the high-frequency horn, Fig. 3, utilizes a special switch that permits the highway horn to be cut out of the circuit when the car is being driven in the city. The highway horn has a fundamental frequency of 313 c.p.s. in combination with an overtone frequency of about 3000 c.p.s. Tests have shown that a high-frequency signal has the best chance of penetrating

High-frequency highway horn is wired so it can be switched off in city because of its strong signal

interference noises such as caused by rushing wind, heater fans and the like, that are in the low-frequency range.

As indicated in Figs. 2 and 3, either type of horn can be wired in the circuit with the original horns, or may be wired with a switch that will permit the horns to be used in three different ways. First, all three horns can be sounded simultaneously, second the original horns may be sounded alone and, third, the additional horn may be sounded alone.

Figs. 4 and 5 show the method used for attaching the high-frequency highway horn. A bracket with a rubber pad is required to prevent its sound from being transmitted through the car body. Also, a separate ground is needed to assure that the horn operates satisfactorily. ★ ★ ★

Details at left show special bracket and individual ground wire required for highway horn shown at right

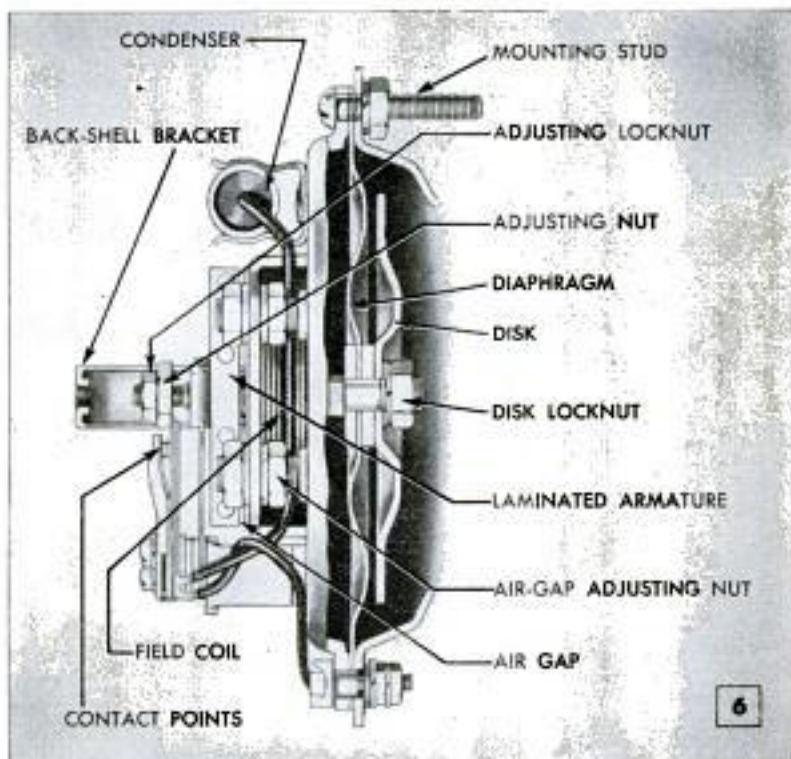
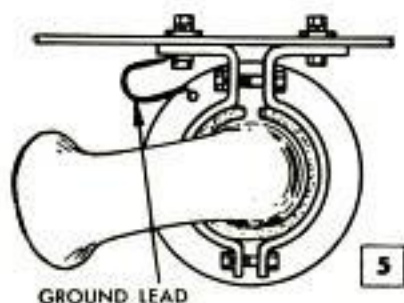
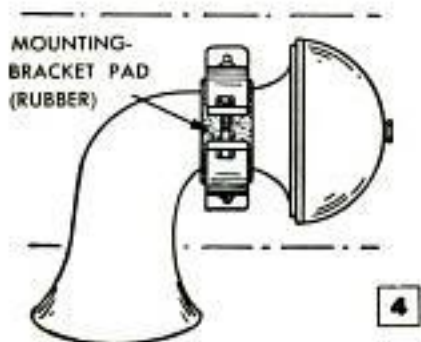



Wood Shaving Floats Lure To Extend Casting Range

Next time you clean your workshop, drop a handful of wood shavings into your fishing-tackle box. The shavings can be used to extend your casts or to drop a lure under overhanging branches where it would be impossible to reach with a cast. Drop a shaving on the water, curl side up, and place a baited hook or lure on it. Let your reel run free so wind or current will float the shaving to the "target." When the shaving is on the spot, jerk on the line to free the hook or lure. Since a shaving is lost on each cast, carry a generous supply.

Applicator for Liquid Asphalt Is Plastic Squeeze Bottle

Calking cracks in concrete with liquid asphalt, usually a messy job when a putty knife or stick is used to apply the material, has been made a cleaner, simpler operation by one homeowner who utilizes a plastic squeeze bottle fitted with a spout for dispensing catchup. Although keeping clean was the first reason for using the bottle, ease of application with the spout of the plastic bottle proved of equal advantage.

Patricia Vonderau, Bay Village, Ohio.

Hooks Bent From Wire Solder Used to Hold Paintbrushes

Instead of suspending paintbrushes on a metal rod over a container of thinner when they are being cleaned, one man uses hooks made from wire solder. The flexibility of the wire makes it easy to adjust the brushes to the proper level, regardless of the amount of thinner or the length of a brush handle. When a brush is needed, the soft wire solder is straightened easily to permit removal of the brush.

R. Mathiot, Lake Grove, Ore.

PM Books for Boys and Girls to help them advance in Science

MR. WIZARD'S SCIENCE SECRETS, by Don Herbert. The star of the famous TV program seen coast-to-coast weekly on more than 60 stations has written this educational and entertaining book that will help in school and through a whole lifetime. The book is just like his unusual program and just as intriguing. It contains more than 150 of his television experiments, in word and picture. Answers thousands of "how" and "why" questions children ask on the human body, gravity, flight, heat and radiation, electricity, etc. It's facts with fun—so fascinating and interesting children never tire of learning.

264 pages. \$3.00.

THE BOY SCIENTIST, by John Lewellen. An up-to-the-minute introduction to the exact sciences, bursting with facts every modern boy wants to know. Written and illustrated with such clarity that even complex principles are quickly grasped by the young mind. This book won for Popular Mechanics Company the 1955 award of the Thomas Alva Edison Foundation as publisher of "The Best Children's Science Book." A truly outstanding work.

264 pages. \$3.95

SCIENCE MILESTONES, from the *Science Digest* series. A record of the march of science which will fire the imagination, and inspire youngsters in their pursuit of scientific knowledge. Contains dramatic revelations of 60 important individuals whose contributions, from 400 B.C. to the present, are landmarks in the history of science. This book is as fascinating as fiction, as factual and revealing as a laboratory report. Beautifully illustrated and printed.

312 pages. \$5.00

The books above are ideal as birthday gifts, Christmas presents or for general reading for the scientific-minded youngster. Each is authoritative, clearly presented and illustrated, quality printed and bound, as you would expect from the publishers of Popular Mechanics Magazine. You and your children must be pleased or your money back. Send check or money order today for the books of your choice to—

Popular Mechanics Press, Dept. 857
200 E. ONTARIO STREET • CHICAGO 11, ILLINOIS



X633 SHOP NOTES

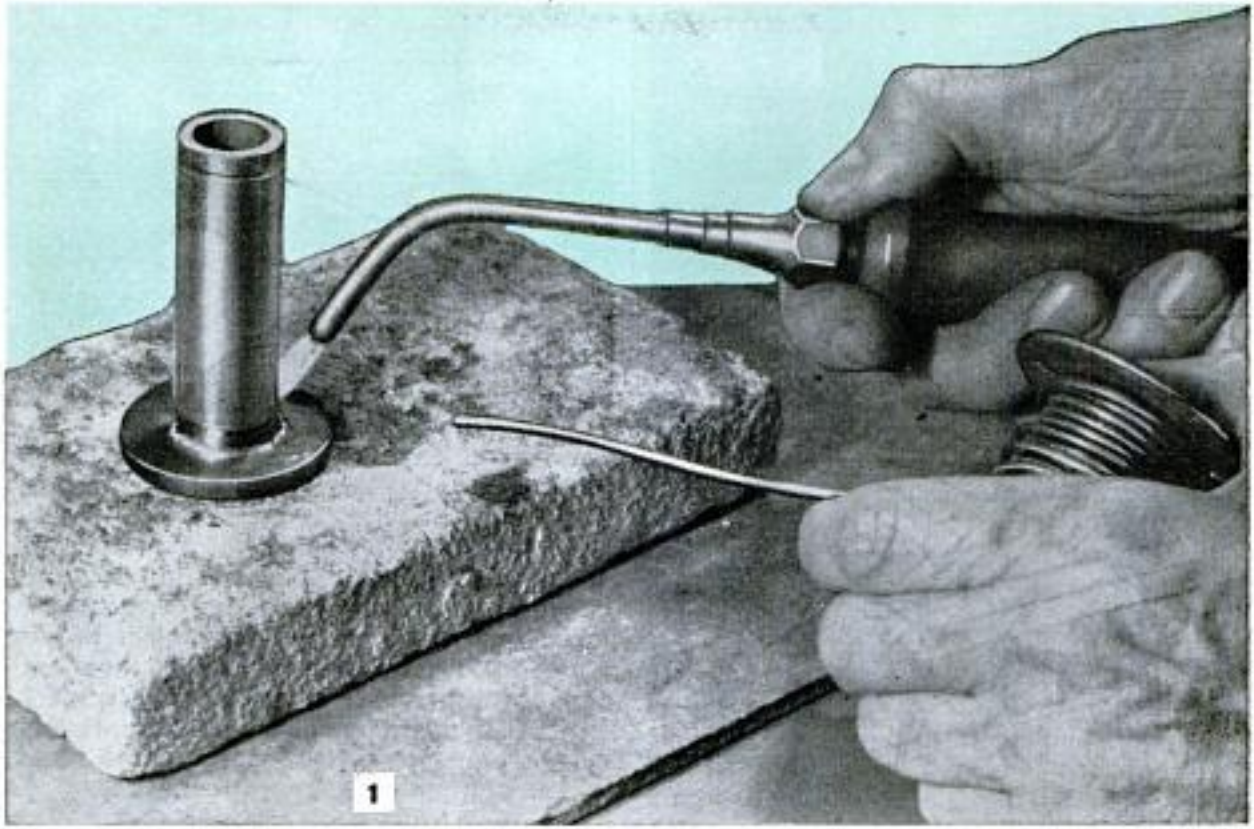

"SOLDER CLAMPING" SMALL PARTS

By Walter E. Burton

ORDINARY SOLDER can serve as a clamp in the shop. It can hold thin stock for machining in the lathe or on the milling machine, hold a number of sheets sandwich-fashion for sawing duplicate parts to pattern and hold two pieces of stock together securely while making split, or half, turnings from metal. Of course, there are other applications but these are the most common and perhaps more widely

used. After the necessary operations have been carried out on the parts which have been "solder clamped" they are released from the holder, or from one another, by the application of heat.

All metals that are easily soldered can be clamped in this manner. Usually it is necessary to sweat solder the flat surfaces of blank and holder, or the flat surfaces of duplicate blanks. To do this, the joining

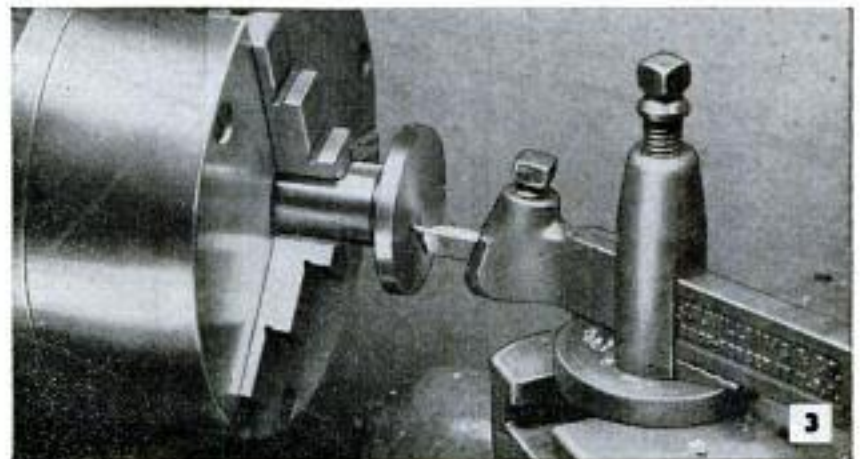
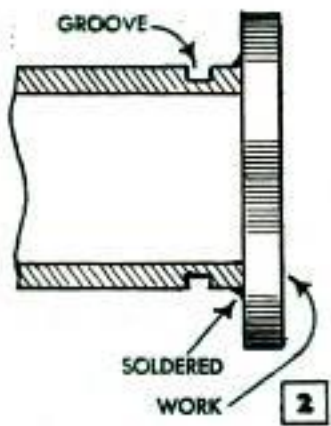

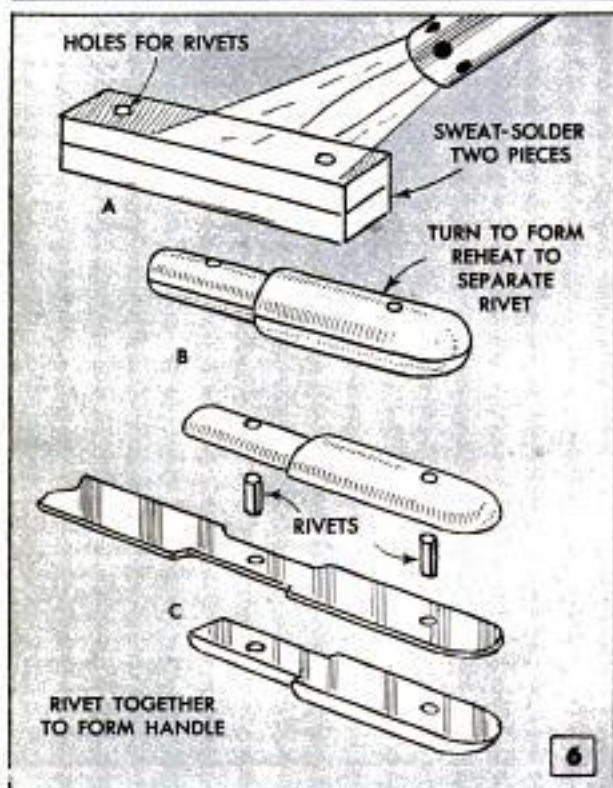
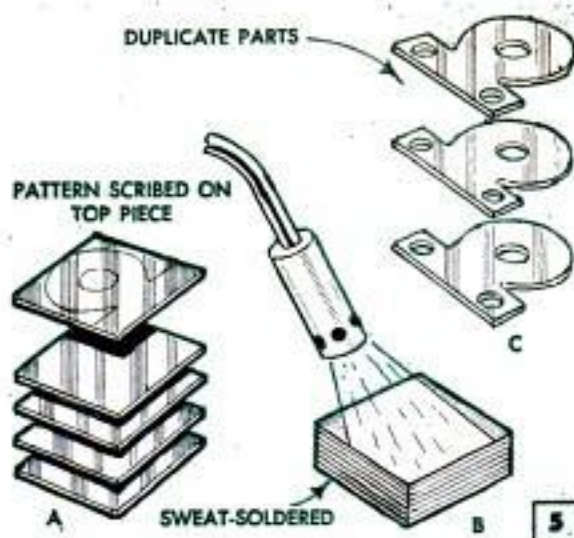

surfaces of the metal must be thoroughly cleaned and polished with a fine abrasive. This is especially important where the stacked parts will be subjected to considerable stress as in turning or milling. After cleaning, avoid touching the cleaned surfaces with the fingers. Next step is to flux and tin the joining parts on both sides, except the top and bottom pieces in a stack, which, of course, are tinned only on one side. Then, when working a stack from which duplicate parts are to be cut, mark the pattern or design on the top piece, Fig. 5, detail A, and sweat solder together as in Fig. 5, detail B. Cut to the pattern line as in Fig. 4, where the material and design are of such a nature as to permit jigsawing, and finish by filing or milling the sawed edges. Drill whatever holes are necessary to complete the duplicates, then separate by reheating, Fig. 5, detail C.

Truing a thin disk of sheet metal in a lathe is a trick seldom attempted in shops unless the work schedule is sufficiently flexible. But in some cases special require-

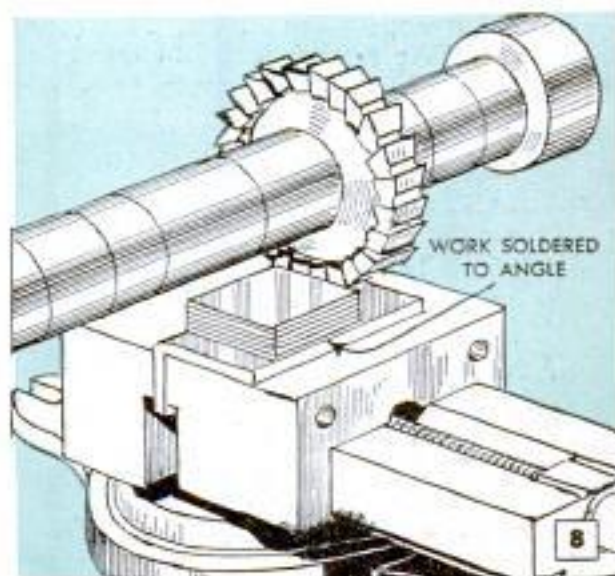
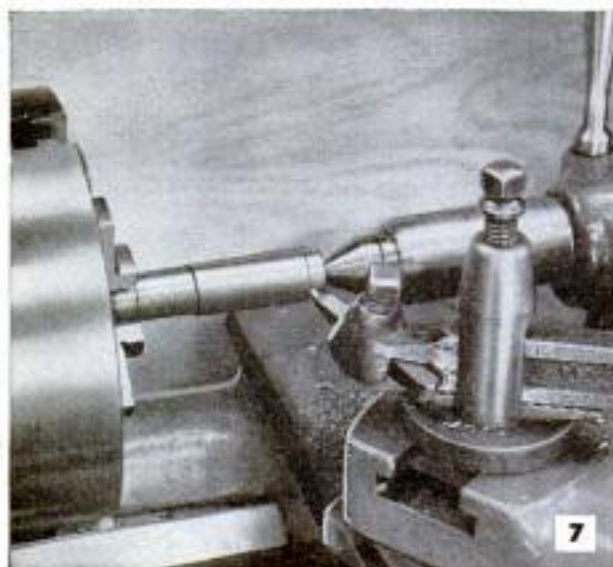

ments call for the setup to be made. Even chucking a disk as thick as $\frac{1}{8}$ in. poses a problem with conventional equipment, but the job can be set up quickly by using a "solder chuck," Figs. 1, 2 and 3. First, chuck a short length of brass tubing having a wall thickness of at least $\frac{1}{8}$ in. True both ends and cut a groove near each end, (or true and groove only one end if desired) the grooves being about $\frac{1}{8}$ in. wide and $\frac{1}{16}$ in. deep, Fig. 2. These grooves tend to retard the dissipation of heat along the length of the tube when soldering the work in place, Fig. 1. Chuck tube and work as in Fig. 3, and turn and face to the dimensions required by the job. When the specifications call for truing a disk of metal less than $\frac{1}{8}$ in. in thickness, use a solder chuck of an outside diameter about $\frac{1}{2}$ in. less than the required finish diameter of the disk. A chuck of this size will give better support to the edge of the work while turning.

If you like to make special hand tools, a comfortable handle can be made from a split turning of metal as in Fig. 6, details A, B and C. First, sweat solder two pieces together as in Fig. 6, detail A. Drill holes for rivets, then chuck and turn to desired size as in Fig. 7. Although not shown, knurling the large diameter of the handle may be worthwhile. When the turning is finished, reheat to separate the parts and attach to the tool shank with rivets.

Two applications of solder-clamping work for milling are pictured in Figs. 8 and 9. Quite accurate duplication can be accomplished as in Fig. 8 by stacking the rough-cut parts, soldering to a short length of brass angle and mounting in the milling vise. Another application is shown in Fig. 9 in which a small pinion is soldered to the angle holder and clamped in place for a slotting operation. ★ ★ ★

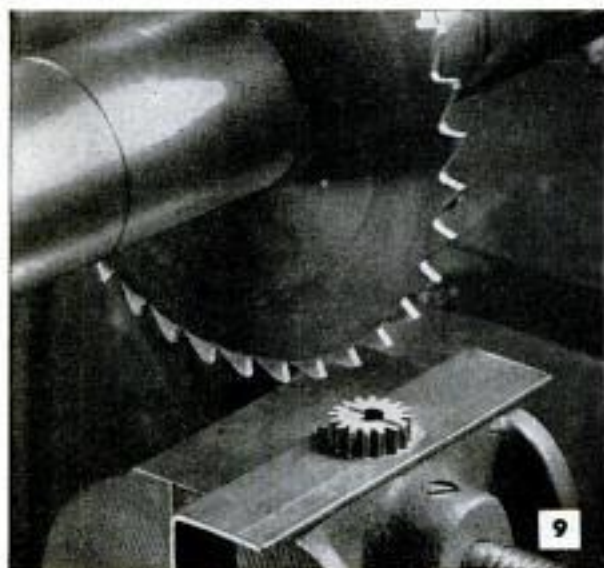

AUGUST 1957

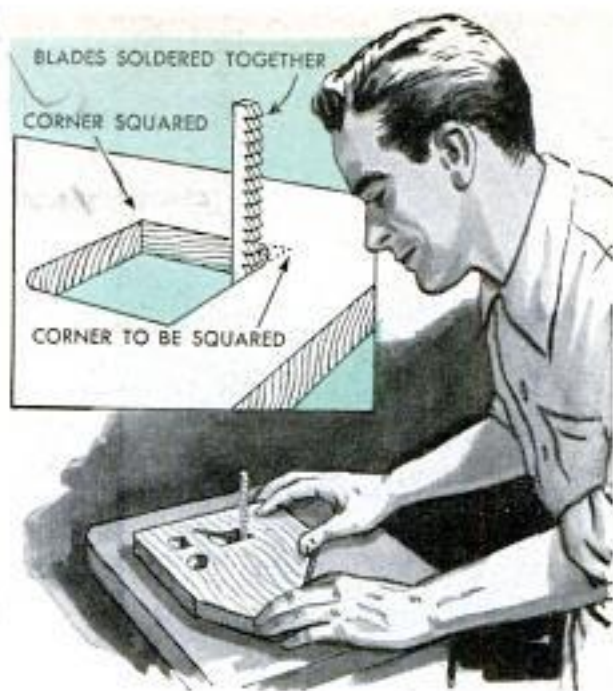

Saber-Blade "Broach" Squares Hole Corners

Confronted with the problem of quickly and accurately squaring the corners of rectangular jigsawed openings, one wood-shop foreman sweat-soldered two saber blades together and then filed the blank end slightly so it would fit into the blade chuck of the machine. The rigidity and additional cutting width of the blade thus produced handled the job quickly and with a minimum of runout per piece.

Stanley Roberts, Puente, Calif.

Block Aids Toenailing

Even a light upright that is to be toenailed will not slip sideways when the lower end is braced against this block. It is a scrap of 2 x 4 into which two headless nails are driven so the points project slightly as indicated in the photograph. To use, place the block edgewise against the upright. Tap lightly to sink nail points.

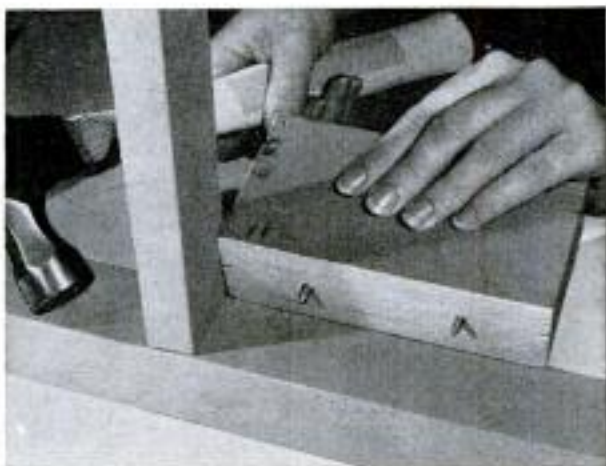

SN 59

Wood-Turning Tools From Used Files

Discarded files make excellent wood-turning tools when cutting edges are ground on the ends as shown in the drawing. After a standard file handle is installed on the tang of each tool, they are ready for use on that next turning job. When grinding the cutting edges, keep the metal cool by dipping the files in water at regular intervals. Use an oilstone to remove any featheredges and to hone the finished cutting edges.



Horse-Drawn Cultivator Is Mailbox Support

An old wooden cultivator mounted on a post by one farmer provides a colorful support for his rural mailbox as shown in the photo. The box is mounted on the end of the beam for easier access. To secure the beam to the post, a U-shaped length of flat steel is fitted over the center of the beam and fastened to the post with lag screws. Two bolts secure the mailbox to the beam. To avoid injury to children, the steel shovels on the cultivator have been replaced by wooden replicas. All metal parts and ends of the handles are painted red, with white on the other parts.

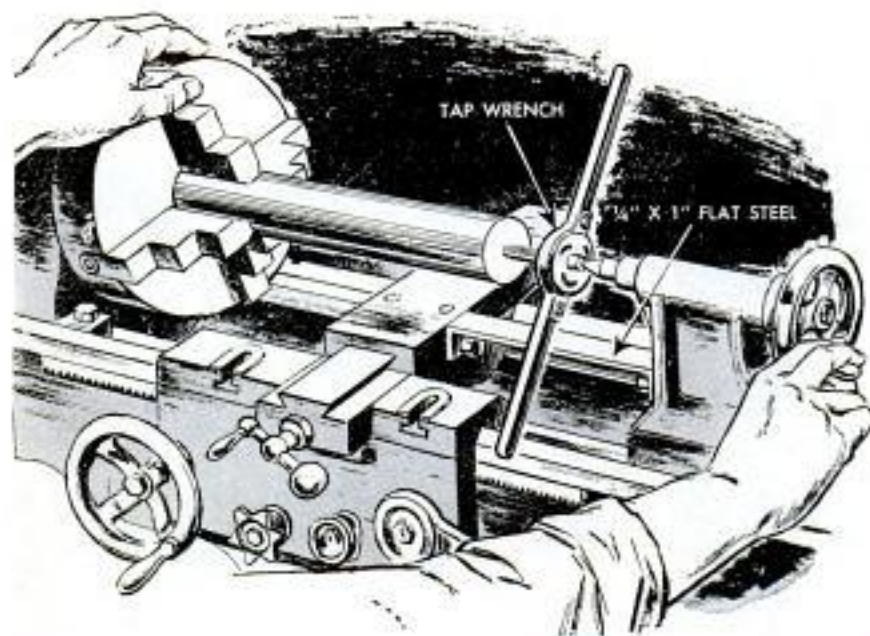
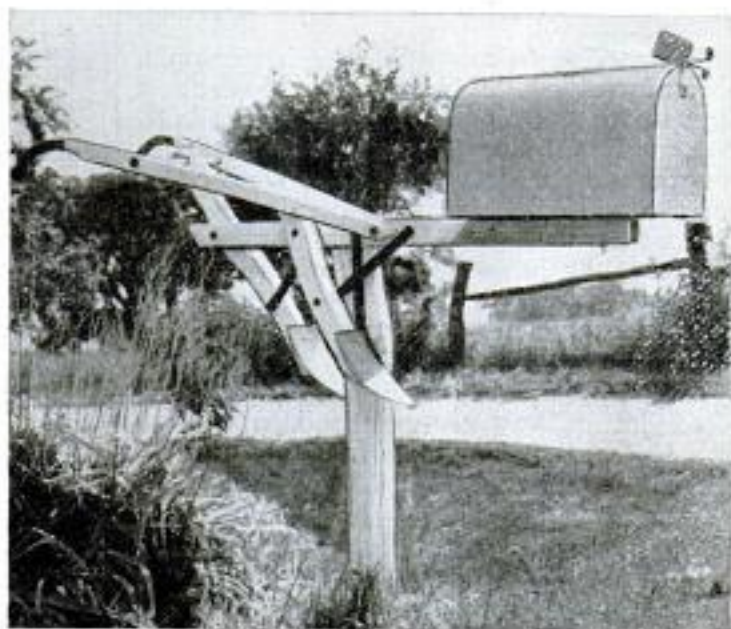

Accurate Tapping With Lathe

Holes can be threaded accurately in work in a lathe when the tailstock is connected to the carriage by a length of flat steel as shown. By loosening the clamp screw on the tailstock and allowing it to move freely on the lathe bed, the carriage handwheel can be used to move the tailstock forward and exert just the right pressure on the end of the tap. This permits the lathe center to support the tap constantly as it advances.



A — INSERT IN HOLE



B — TIGHTEN FULLY



C — REMOVE BOLT



USE THE RIGHT HANGER

WHEN YOU PLAN to hang a picture, cabinet, shelf or other fixture on the wall it's important to use the right hanger for the job. The weight to be supported, the size and shape of the object and the type of wall construction must be considered when selecting the hanger. As an example, framed pictures and small mir-

Designed for plastered walls, this hanger, or hook, will hold pictures or mirrors weighing up to 15 lb.

rors weighing up to 15 lb. can be safely hung on conventional plastered walls with the right-size hanger of the type shown in Fig. 2. But such a hanger, or hook, designed for framed pictures, won't do for a cabinet or chest like that pictured in Fig. 1. You'll need a fastener with a sectional sleeve which expands into a series of radial locking lugs when the screw or bolt is tightened, Fig. 1, A, B and C. Such hangers come in three sizes and lengths for light, medium and heavy loads. Similar hanging problems are solved by use of the hanger shown in Fig. 3, detail 1. Typical applications on plastered and hollow-tile walls are shown in details A and E. Such hangers, or toggle bolts as they are sometimes called, often are recommended for light and medium loads on plasterboard (dry-wall) walls.

Anchor plates, or "rails," that are fastened to masonry wall with a special adhesive often are used for attaching furring strips in preparation for installing solid-wood paneling. The individual fastener consists of a nail pressfitted in a perforated sheet-metal plate on which the adhesive is applied, Fig. 6. The plate is then pressed against the wall with the nail projecting outward. Ordinarily the plates are



MORTELL Co.
582 BURCH
KANKAKEE, ILL.

FEMCO MFG. CO.
12 W. QUEEN ST.
SOUTHINGTON, CONN.

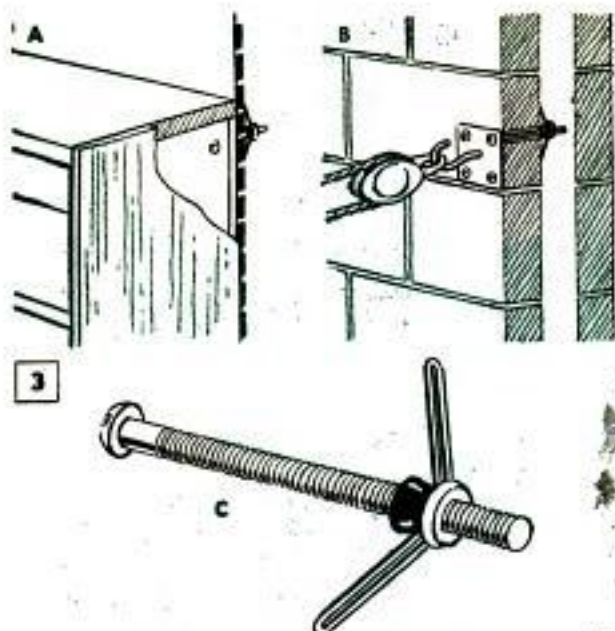

Above, fastener is similar to that pictured in Fig. 1. Suitable for light to medium loads. Below, special fastener is attached to wall with adhesive.

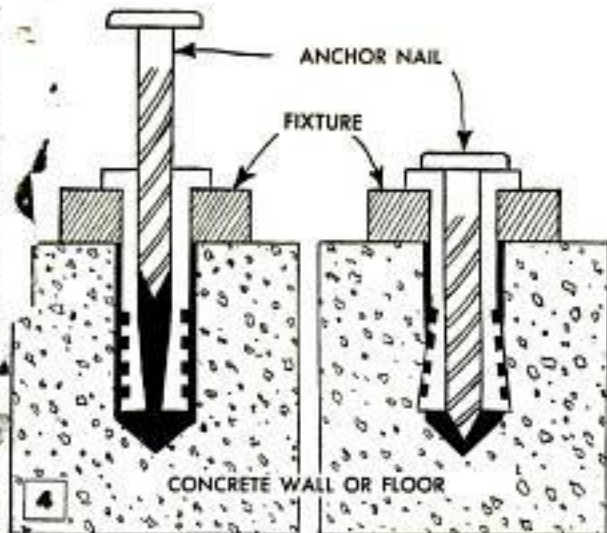

spaced horizontally about 12 to 18 in. apart. When the adhesive is thoroughly dry the wooden strips are positioned and forced down over the nail points with light blows of a hammer. Then the nail points are clinched as in the right-hand detail, Fig. 6. This method of attaching furring strips to masonry walls is somewhat faster than the usual procedure.

Figs. 4, 7 and 8 show several newer fasteners of the expanding-sleeve type designed for installation in masonry walls and floors. The type shown in Fig. 4 employs a drive nail, similar in appearance to a masonry nail, which is driven into the anchor to expand the lower end of the sleeve as detailed. The type shown in Fig. 8 is quite similar except that a headless pin serves as an expander when driven in flush. Either type makes a neat installation of motor, bench or machine pedestal on floors, also holds fairly heavy loads on

A heavy-duty fastener of the expanding type is designed for heavy loads on masonry walls and floors

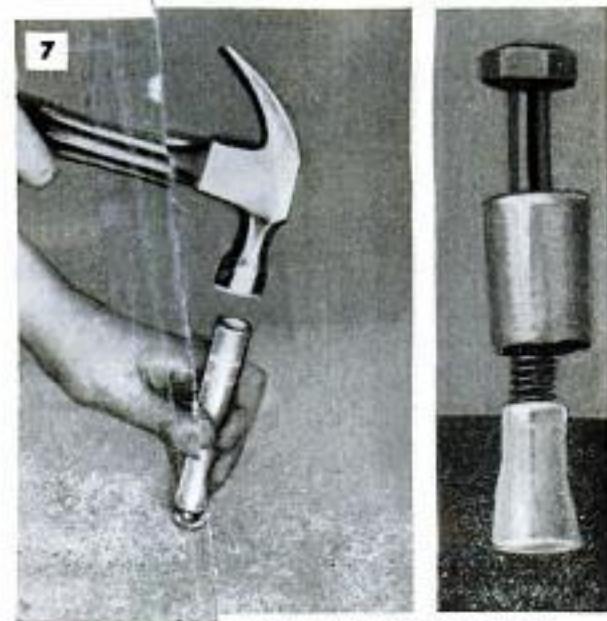

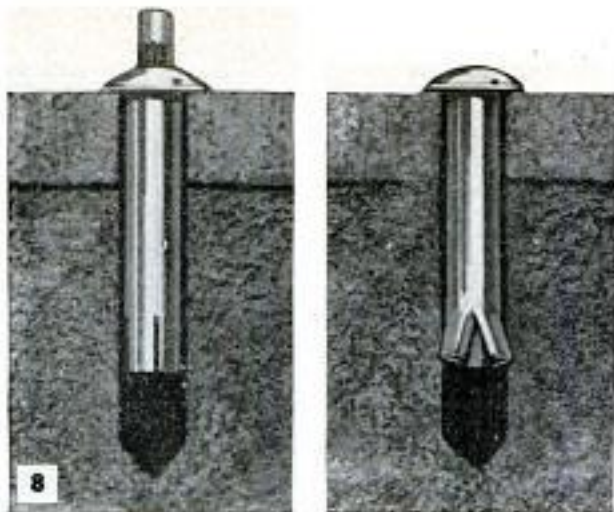

walls. The heavy-duty fastener shown in Fig. 7 is designed for heavy loads. It consists of two parts, a tapered sleeve and tapered expander into which a machine bolt is turned when making the installation. The fastener is installed with a special setting tool as in the left-hand view, Fig. 7. To install, it is necessary to drill a hole in the masonry with a carbide drill as in Fig. 9.

Small framed pictures and individual plate racks can be attached to the walls with the gummed-tape hanger shown in Fig. 10. These hangers are safe for very light loads. Also, for very light loads a prepared cement-asbestos compound pressed into a hole drilled in plastered walls makes a good anchor for a screw, Fig. 11. Another anchor, especially designed for light loads on hollow-tile, glass-block and marble walls, is shown in Fig. 12. It requires only a shallow hole. When the screw is tightened the rubber sleeve expands.

Cement-asbestos compound forced into hole provides secure anchor for wood screw which serves as hanger

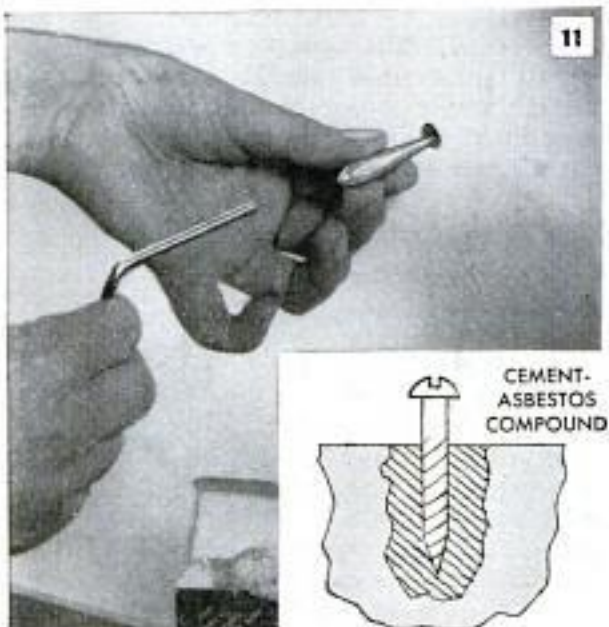

AUGUST 1957



Holes for expanding-type fasteners are drilled in masonry with a hand (star) drill or carbide drill

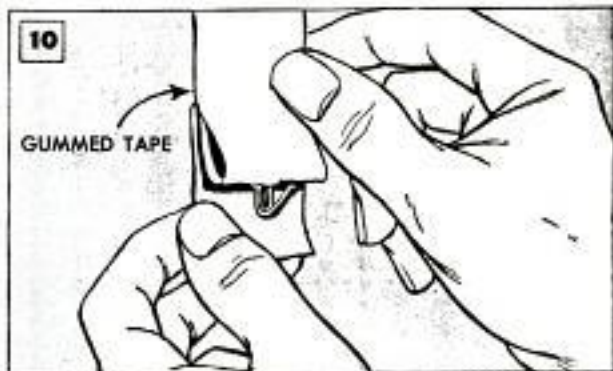

Below, this fastener is installed in a very shallow hole. Suitable for hollow-tile, glass-block, marble walls



191



Barrel Feeder Reduces Waste

Every farmer will appreciate the labor and feed-saving features of this unit at a glance. The wooden barrel and its stand are placed just outside the feed-lot fence. A short pipe nipple is screwed into a hole drilled in the bottom of the barrel. Next comes an elbow, a short nipple and tee. The rest of the pipe assembly is readily seen from the photo. Liquid feeds, such as skim milk and buttermilk, are poured into the barrel and immediately dispensed in equal amounts to two troughs placed inside the feed-lot fence. Feeder is fitted with a cover to keep out insects, snow and sleet.

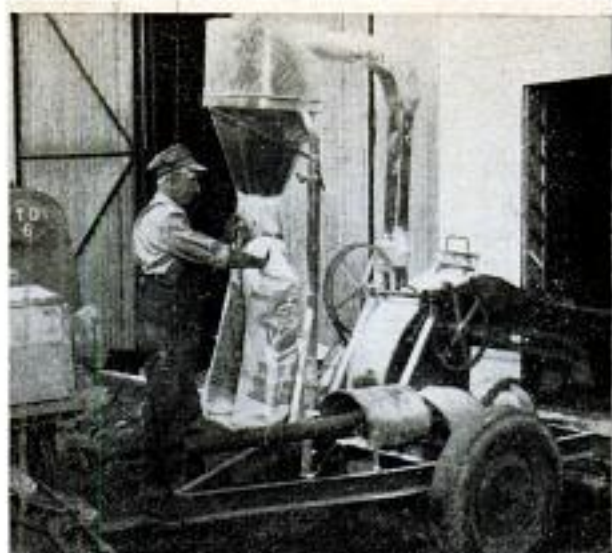

Drive Through Differential Steps up Feed-Grinder Speed

This novel grinder drive is rigged from a truck rear axle. The differential is locked with a weld, one axle and housing are removed and the opening closed dust-tight with a steel plate welded on. The other axle is connected to the tractor power take-off by means of a telescoping shaft with universals. Then the drive-shaft end of the differential is direct-connected to the grinder shaft. Thus the right-angle drive from the tractor power take-off is through the truck axle to the differential ring gear and from the ring gear to the pinion. This gives a positive drive, the speed of which can be controlled to a nicety. The grinder and drive unit are assembled on a two-wheeled trailer as pictured.

Donald K. O'Brien, Gahanna, Ohio.

Undercoating Tank Completely Eliminates Condensation

When one motorist was troubled with excessive condensation inside the gasoline tank of his new car, he solved the problem by removing the tank and covering it completely with undercoating. Although the lower surface of the tank had been sprayed when the car was undercoated, the upper

portions and filler neck of the tank had not because of their inaccessibility. The temperature differential between the coated and uncoated portions of the tank caused water vapor in the air inside the tank above the gasoline to condense against the surface of the uncoated metal.

Removing Corroded Fittings

One service man carries solder-filled brass fittings in his kit to remove corroded fittings that cannot be turned out with a wrench without crushing out of round. The solder-filled fitting prevents crushing the angle fitting even though heavy pressure is applied with the wrench.



Handling Lathe Chuck Safely

To minimize the possibility of damage to lathe chucks while handling, one shop uses knurled handles, or spindles, which are locked in the jaws at the time the chuck is removed from the lathe. Handle aids in removing chuck and facilitates storage and handling in the toolroom.

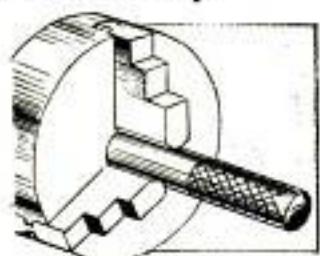

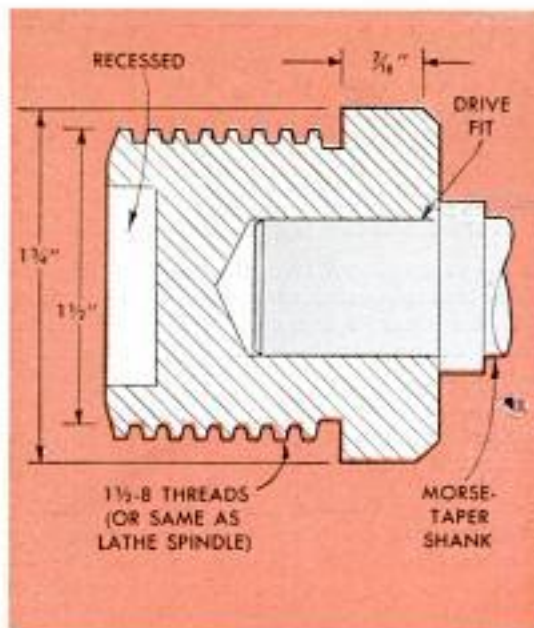

Threaded Tailstock Arbor Takes Lathe Faceplate

A threaded tailstock arbor is a useful lathe accessory, especially when the lathe must be used for widely diversified operations. The thread on this arbor is a duplicate of that on the spindle, making it possible to mount the large or small faceplate or the three or four-jaw chuck for holding work for drilling or machining. A hand-controlled feed and a scale on the tailstock quill (on later model lathes) give you a direct reading for work involving precise depths, such as drilling blind holes or boring larger diameters with an adjustable boring tool. A large faceplate turned onto

the arbor supports work of large size or irregular shape for drilling.

Dimensions given in the detail are only approximations. The unit must be proportioned to suit the lathe on which it is to be used. A suitable shank is obtained by machining a broken or discarded drill bit of the type having a tapered shank, No. 1, 2 or 3 Morse taper as the lathe requires. Cut off the drill bit, or the broken portion as the case may be, and shoulder the shank to take the threaded arbor head as in the sectional view. Then place in the headstock and cut the thread and recess as indicated.

V-Belt Jig Holds Dowels For Cutting on Bandsaw

Cutting dowel stock to length on a bandsaw calls for a jig that not only squares the dowel with the blade, but prevents it from turning. Cut two short lengths from a V-belt and nail to a piece of wide stock. Then guide with the miter gauge.

Bending S-Hooks In Improved Jig

When you need an S-hook or a repair link for a chain, here's a jig that does the trick. Place two short lengths of dowel in the vise (steel rods will do) and space them apart a distance equal to the diameter of the wire. Then make the bend as shown.

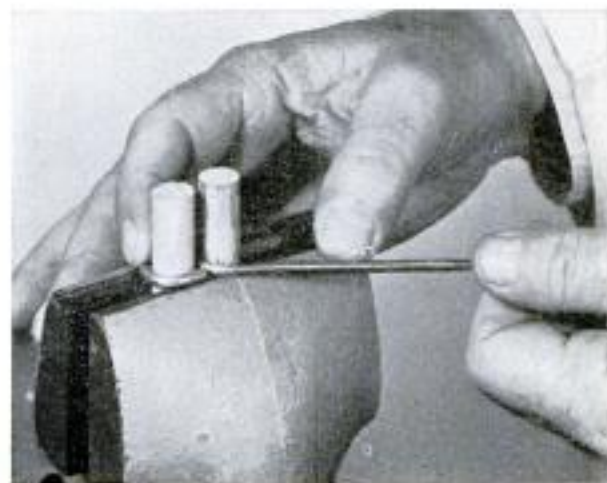
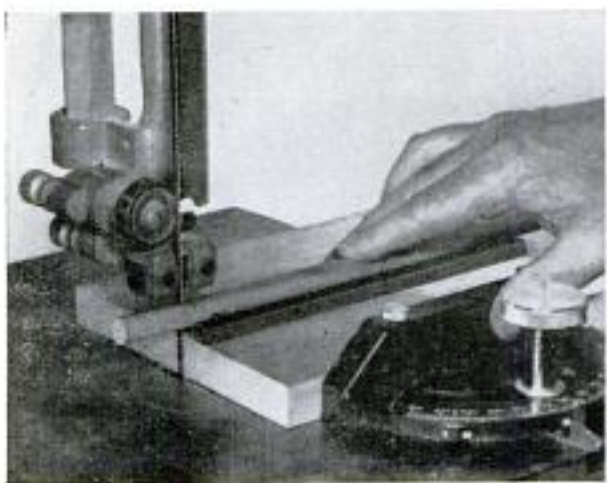

How Would You Do It?

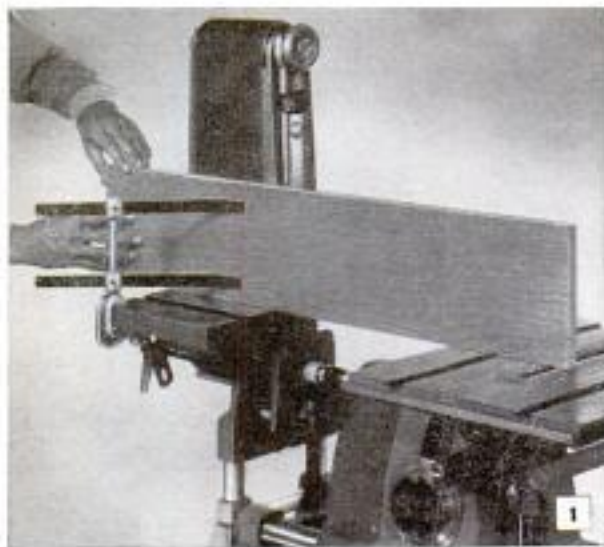

1. Q—How can you sand a very wide and very rough board when the sander is vertical?

A—Use the setup shown, with a hold-down, if one is available, to assure constant pressure on the workpiece. If the stock is long, use additional support so there is no problem in controlling the workpiece

2. Q—What motion is required for sanding end grain of stock squarely?

A—When sanding the end grain of work, hold the stock flat against the fence then slide it down to make contact with the belt. Keep the edge to be sanded parallel with the surface of the belt



3. Q—When sanding spherical shapes on a belt sander, how do you avoid making flat spots?

A—Sand spherical shapes against the rear of the sander where the lack of a backup plate allows the belt to flex. Work near the center of the belt so pressure does not cause it to shift to one side

4. Q—Which way should sander table be tilted when sanding the beveled end on stock, and why?

A—Whenever possible, tilt the table away from the belt for bevel sanding such as indicated. The open angle formed is better than a closed one, which could cause the work to jam between table and belt

5. Q—When end sanding heavy stock, such as 4 x 4s, what belt-sander setup assures squareness?

A—To assure square sanding on the ends of heavy stock, the work is supported on two sides. One method is to clamp a block or the miter gauge to the table, providing support on the second side as shown



6. Q—It sometimes is necessary to rough sand boards wider than the abrasive belt of a belt sander. How is this done?

A—Pass stock diagonally across belt, using setup shown. Extension fence bolted to table provides additional support. Final sanding is done on fine-grit belt, with fence parallel to belt. Work is turned end-for-end to sand its full surface area

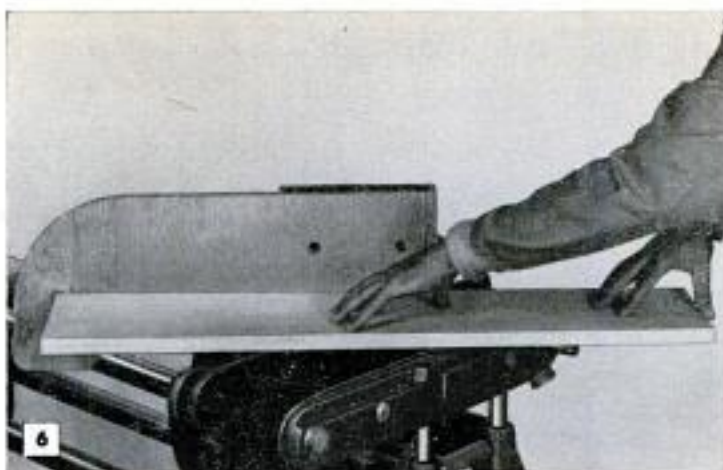

7. Q—To assure a smooth finish, in which direction should work be moved on a belt sander when surface sanding?

A—Work is always moved against rotation of belt. Keep contact with table throughout pass. Photo shows how to use spring hold-down if one is available. Position hold-down so springs do not snap down against belt after work passes under them

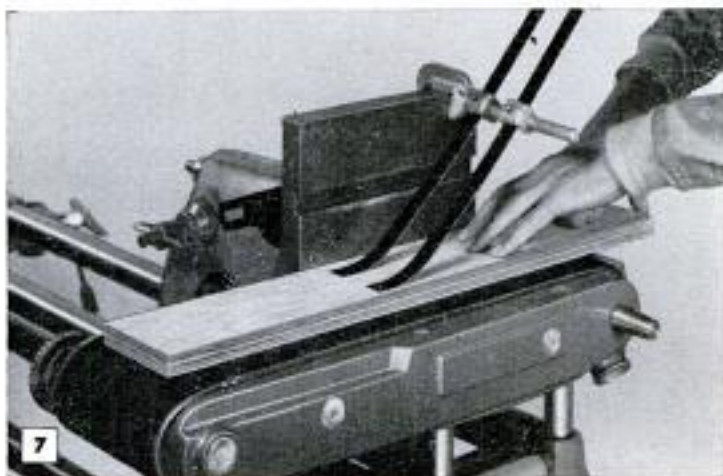

8. Q—Although not ordinarily considered for the job, a belt sander can smooth inside curves. How is this done?

A—Most curves can be sanded against the idler drum in the manner shown. If you have much of this type of work to do and the table or fence does not reach far enough to hold work square with the belt, make an auxiliary fence and bolt it on



9. Q—When edge sanding work on a belt sander, how can the table or fence be used to assure sanding square edges?

A—Set up the fence or table as shown in the photograph. When making a pass with a piece of stock, hold it firmly against the fence all the way. An auxiliary fence, needed when sanding longer pieces of stock, is simply a board bolted to the fence

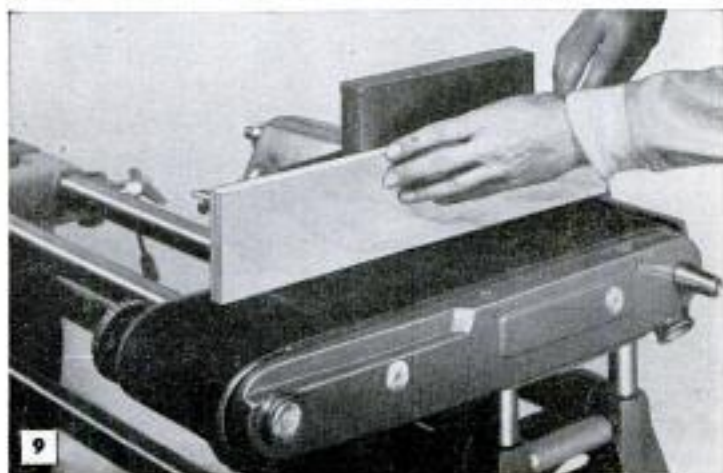

Drilling Hole Through Exact Center of Small Steel Ball

SN 59

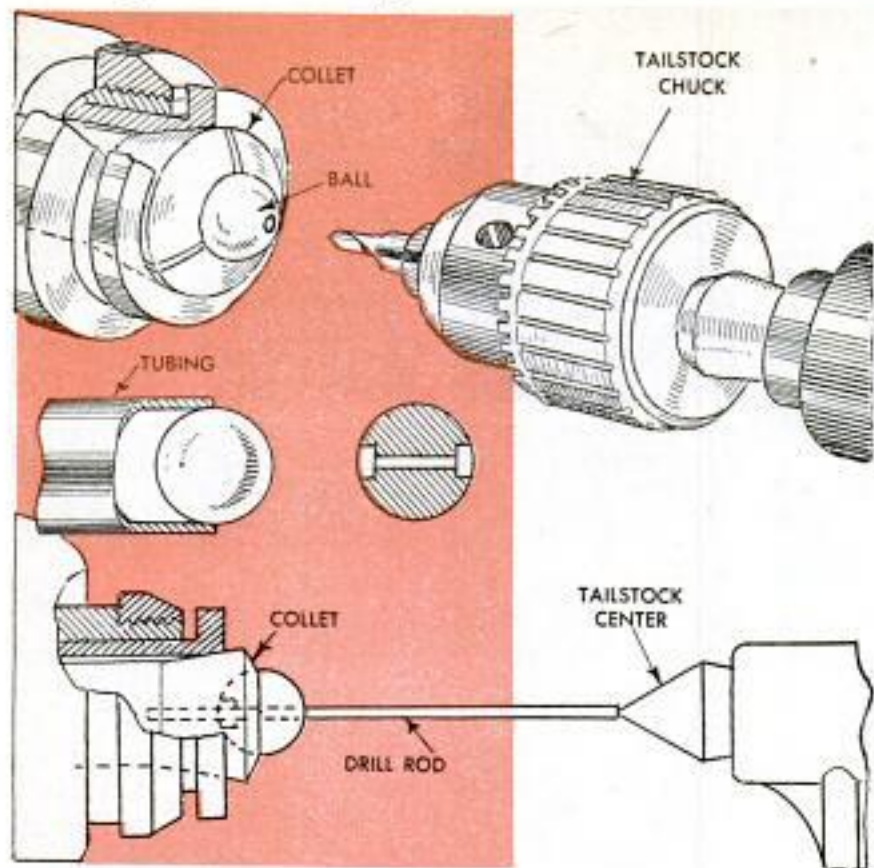

Drilling a hole through the center of a small steel ball can be done fairly easily if the ball is held in a collet chucked in a lathe as indicated. Start the hole with a center drill chucked in the tailstock, then complete the job with a twist drill of the required size. If counterboring is necessary, do it before removing the ball from the collet. Counterboring the opposite end of the hole is done by aligning the hole with a length of drill rod centered on the tailstock center as shown in the lower detail. If the ball to be drilled is of too large a diameter to be fitted in an available collet, force the ball into a length of tubing of a suitable diameter. The tubing will seat the ball perfectly and hold it securely.

Shop Sander Makes Quick Work Of Polishing Power Tools

When the precision-ground tables of workshop machines become discolored and rusted through neglect or infrequent use, an orbital-type sander does an effortless job of reconditioning them. Fitted with a fine-grade aluminum-oxide abrasive, the sander will quickly remove rust spots without scratching the metal. For an even higher polish, the sander can be fitted with a felt pad and the tables buffed with rouge.

Thor photo



196

Easy Removal of Tack Welds Assured With Steel Blocks

The disassembly of steel members tack-welded together temporarily is simplified by using steel blocks. The top of each block is tack-welded to the surface of one member and the lower edge of each block is tack-welded to the adjacent member. The latter weld is at right angles to the first. To remove the blocks, strike them on the tack-welded edge. Then grind off welds.

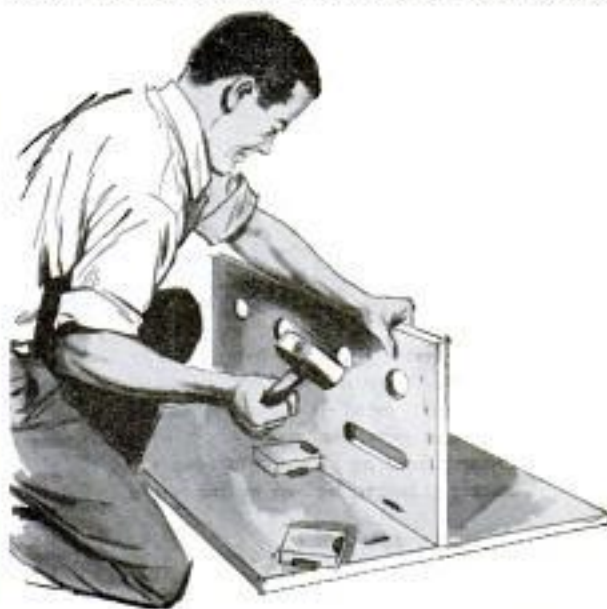

POPULAR MECHANICS



Rotary Knife Cuts Perfect Disks

SN 59

No other tool does the job of cutting disks from cardboard, leather or plastic quite as neatly as this rotary knife. It's made from a length of seamless steel tubing the inside diameter being equal to the diameter of the disk desired. One end of the tubing is shouldered, beveled and turned slightly by spinning to form a keen cutting edge. Spinning can be done with a length of drill rod flattened slightly at one end. The simple setup for cutting the disks is shown in the upper right-hand photo. Use a drill pad in the tailstock spindle, or quill, and back the work with a block of hardwood. Run the lathe at its lowest speed

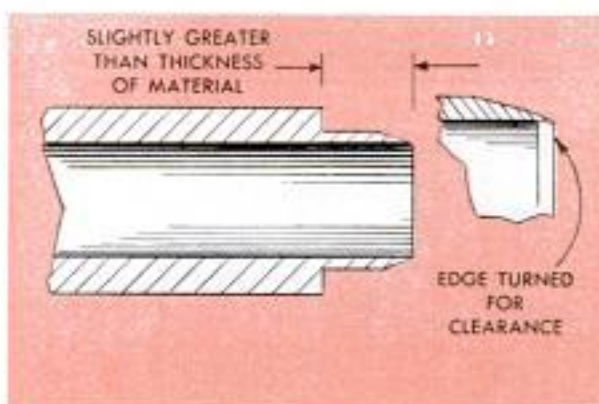
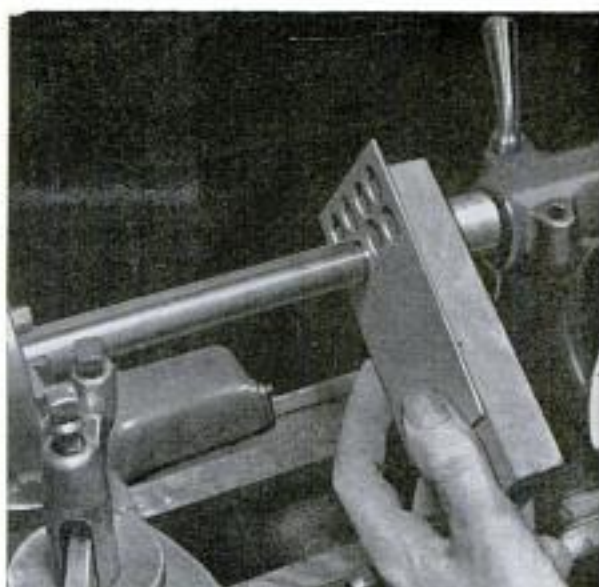

and feed the material to the knife with the tailstock handwheel. Feed the rotary knife slowly to prevent undue heating.

End-Drilling Long Stock Accurately on Floor-Type Drill Press

Using the setup pictured you can drill holes in the ends of fairly long pieces of stock. Swing the table sidewise to center the stock under the drill. If necessary lower the drill-press head and the table to bring upper end of the stock to the position shown. Clamp in place with lower end of stock bearing on the drill-press base.

Leak in Water Pipe Closed by Welding

A leak in a 6-in. water pipe rising vertically in a corner was repaired without removing the pipe. After draining the pipe, the welder simply cut out a rectangular section opposite the leak. This enabled him to reach the damaged portion with his torch. A piece of sheet asbestos placed back of the pipe protected the plastered walls against damage from heat. After closing the leak with a weld, the rectangular section of the pipe was welded in place.

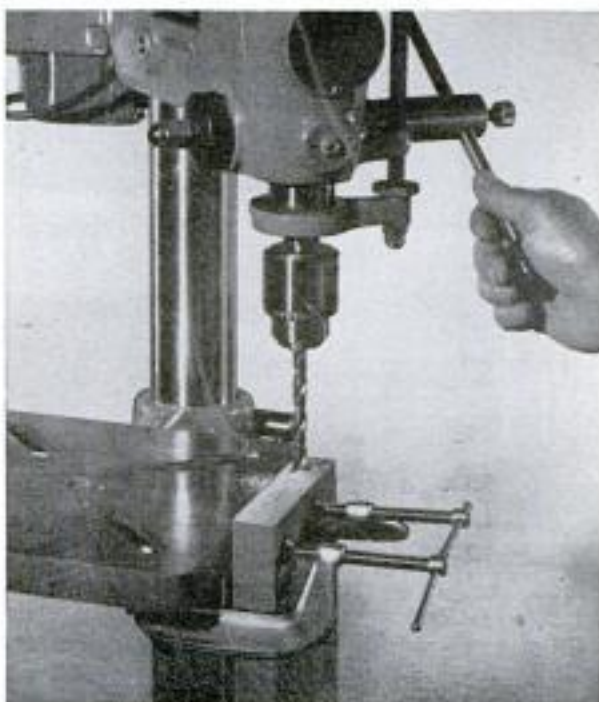

SHOPPING



1. PNEUMATIC SCREWDRIVER drives screws from a refillable cartridge. It weighs $6\frac{1}{2}$ lb., is approximately 18 in. long. Drives oval, round, flat, fillister or hex-head screws in lengths varying from $\frac{7}{16}$ to $1\frac{1}{2}$ in. long. Handles screws with regular slotted heads or Phillips heads. Driving head is so designed that it cannot score surface of work. Torque is adjustable to seat screws to any tension

Shakeproof Div., Illinois Tool Works
2501 N. Keefer Ave., Chicago 30

2. SMALL-PARTS BIN is assembled from a number of hopper-type units placed side by side and forming a semicircular assembly as pictured. Placed on bench this arrangement eases the job of assembling when a number of small parts must be handled rapidly and efficiently. Each individual bin is arranged with a sloping bottom so that parts feed into hoppers by gravity. Bins are available in various sizes

Speed Assembly Equipment Co., Box 344, Fords, N. J.

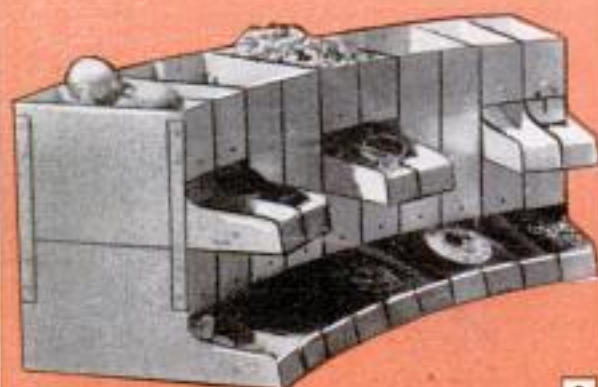

3. UNIVERSAL WORK HOLDER is a vise, clamp and fixture in one unit. Removable base plate permits jaws to open to 9 in. for use as a clamp. Add the base-plate with its special clamp for attaching to bench or machine table and you have either a vise or fixture. On the bench the jaws can be located flat, vertically or at any desired angle. On a machine, such as the drill press, unit is a universal holder

DeWalt, Inc., Lancaster, Pa.

4. MASONRY FASTENER, or anchor, drills its own hole. Comes as a kit containing several sizes of anchors with expanders and a holder-driver by means of which the anchors are installed with a hammer. In this procedure no star drill is required as anchor cuts its own hole. For power installation, using a portable impact hammer, anchors are provided with a snap-off chucking end which is held in power-tool chuck

Phillips Drill Co., Michigan City, Ind.

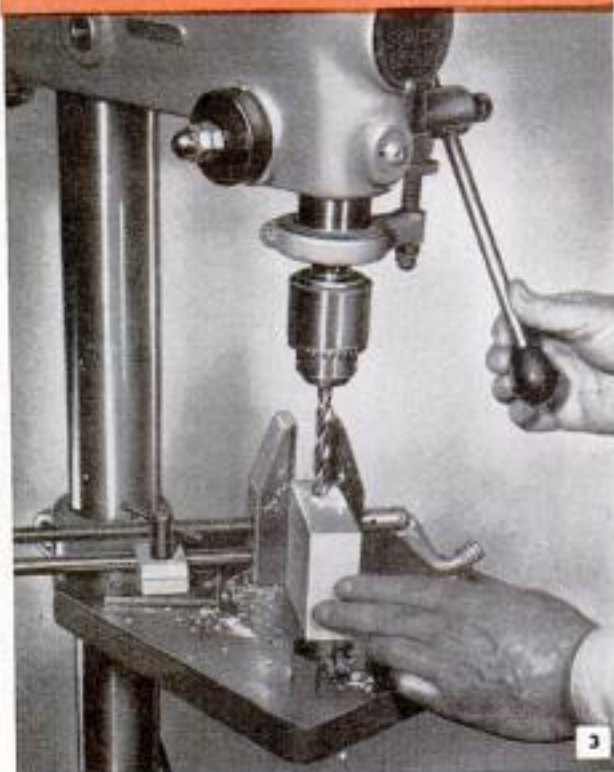

FOR TOOLS

5. DUST COLLECTOR is designed to meet the needs of the home shop. Can be connected direct to individual machines or used as a tank-type vacuum cleaner. Portable and very powerful, static lift capacity is sufficient to pick up metal chips and filings, sawdust and shavings, even nuts and bolts. Accessories include 13 swivel brushes and nozzles. Container has a capacity of 2.83 bushels of loose material

Rockwell Mfg. Co., Delta Power Tool Div.,
400 N. Lexington Ave., Pittsburgh 8, Pa.

6. PORTABLE JIGSAW cuts 2-in. stock, zips through hardwood, metals, plastic and composition materials of varying thicknesses. Makes pocket cuts in baseboards, walls and floors with a speed and precision not possible by other methods. Features a roller-type blade guide which takes the thrust of heavy cutting at a point just above the surface of the work, thus reducing blade breakage to the minimum

Skill Corp., 5033 Elston Ave., Chicago 39

7. FORM CLAMP eliminates common problems encountered by masons when setting brick window sills. The clamp, shown in the lower photo, holds form securely in place, permitting mason to give his entire attention to spacing of bricks and uniformity of mortar joints. Upper photo shows two clamps in normal position. Length of clamp screw provides sufficient range of adjustment for all applications

Gates & Sons, Inc., 80 S. Galapago, Denver, Colo.

8. CHAIN-DRIVE TIGHTENER is useful for tightening and maintaining tension on sprocket idlers carrying long lengths of flat-link chain such as that used on elevators and conveyors. Units are mounted as shown in the detail, one being attached to each end of the sprocket shaft. Grease forced into the cylinder through the fitting actuates a piston, moving the shaft in its guides and tightening the chain

Harvard Products Co., Harvard, Neb.

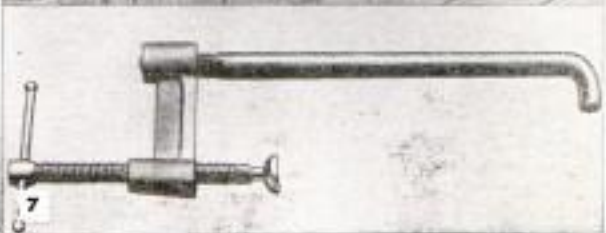
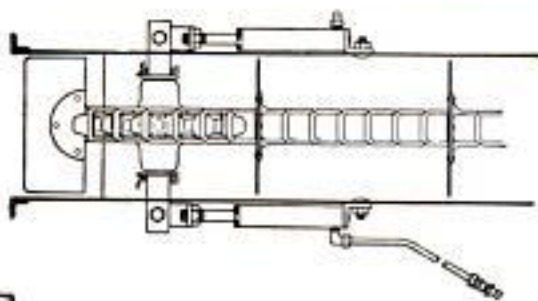
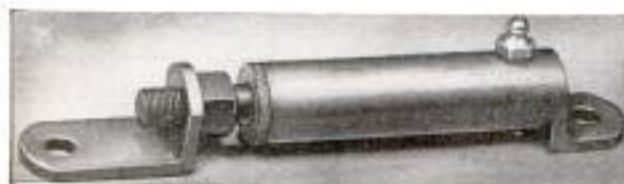
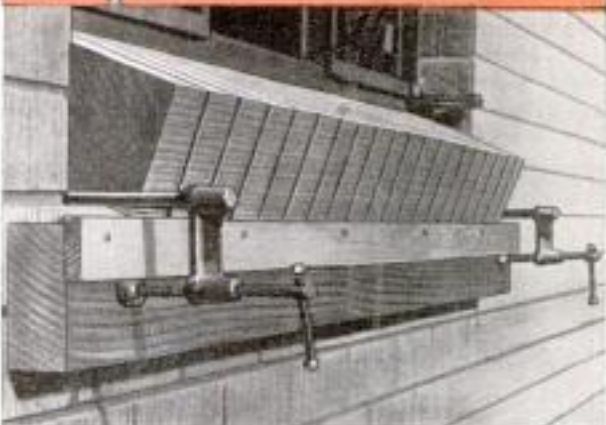

On the MARKET

for Do-It-Yourselfers

1. SHINGLE CLIP locks the butts of composition shingles securely, prevents them from being turned up or torn off by high winds. Individual clips are simple to install. Just press them into place as pictured. Made from aluminum alloy to resist corrosion.

2. METAL POLISH restores tarnished metals to their original luster. One application maintains the finish over a long period of time due to a protective film deposited on the surface by a special agent contained in the polish. Will not harm finest silverware.

Robert Mitsch Co., 631 N. Vance St., Carey, Ohio

3. SPECIAL CEMENT has been developed for anchoring ornamental-iron railing posts and porch columns in masonry. Comes in the form of a dry powder which, when mixed with water, has the special property of expanding as it dries, the effect being similar to that of a conventional expanding anchor. The material sets in 15 min., dries hard in about 2 hr.

Tennessee Fabricating Co.,
1490 Grimes St., Memphis, Tenn.

4. ALL-PURPOSE BLACK PAINT is an anticorrosive finish for metal, also is effective on wood or masonry. Can be used above or below ground. Dries quickly when applied with brush or spray. Has unusual covering power because of its easy spreading qualities.

Maintenance, Inc., Wooster, Ohio

5. FLOOR COVERING is applied with a trowel, looks like linoleum when dry. Left-hand photo below shows how material is applied to subfloor. Photo at the right pictures the finished job. Mixed color pattern develops as mixture is troweled onto subfloor.

Husley-Cox Associates, Shoreham Bldg., Washington D. C.

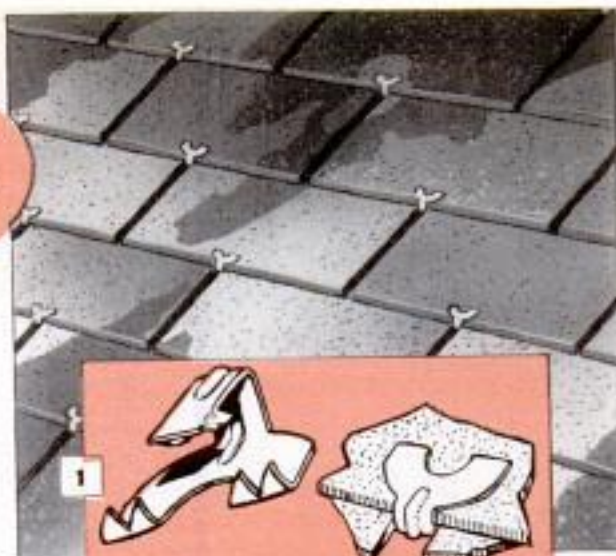

MANUFACTURER
SURFEX
FLOORING
CO.,
48 HIGH ST.,
CAMBERLEY,
SURREY,
ENGLAND.

now, in power tools, too...

if it's Remington, it's right!

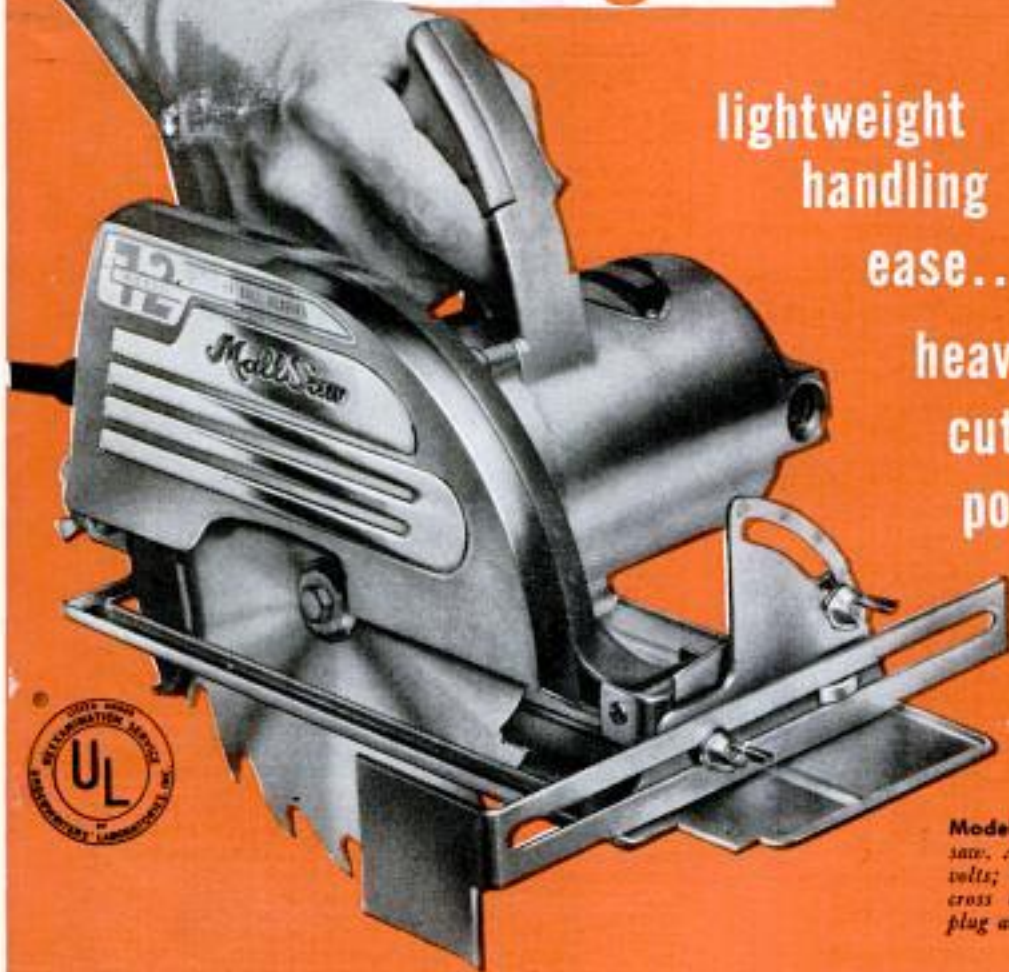

lightweight
handling
ease...

heavyweight
cutting
power!



Model 72. 7-inch blade standard saw. AC-DC, 25 to 60 cycles; 115 volts; 8 3/4 lbs. Comes with 7" rip-cross blade, wrench, 10 ft. cord, plug and ground. \$74.95*.

these great features make our Model 72 Saw right for you!

- Cutting capacity of 2 1/4 inches.
- Cuts 2 x 4 at 45° angle.
- Precision ball and needle bearings for more blade power.
- Automatic telescoping blade guard.
- Heat treated gears for longer life.



Belt and Orbital type sanders.



Electric Drills of many capacities.

*Prices and specifications subject to change without notice.

Remington

Mall®

MALL TOOL COMPANY, Division of Remington Arms Company, Inc., 25000 S. Western Ave., Park Forest, Ill.

In Canada: Mall Tool Ltd., 36 Queen Elizabeth Blvd., Toronto, Ont.

Cuts tile and metal with quick blade change!

This rugged, compact saw is the favorite of many carpenters because it has the power and performance of a heavy duty model. Yet it has the handling ease of a lightweight tool—an ideal power saw for the home workshop!

Blade changing is quick and easy for plasterboard, tile, sheet metal and other tough cutting jobs. Try it yourself! When you feel its power you'll know the Remington Model 72 Saw by Mall is no ordinary saw. It is built with the quality and precision that have made Remington famous for 141 years in sporting firearms and ammunition.



MALL TOOL COMPANY,
Division of Remington Arms Company, Inc., Dept. H6,
25000 S. Western Ave., Park Forest, Illinois.

Please send your new, fully-illustrated **FREE Power Tool** catalog.

NAME _____

ADDRESS _____

CITY _____ ZONE _____ STATE _____



How to select a paintbrush



A good brush performs better... wears longer... saves you money

In selecting a good paintbrush, the first thing to look for is (1) a full head of bristles in a firm setting.

Then, look closely at the individual bristles. They should be (2) finely tapered with slightly curled tips.



Make sure a generous portion of the bristles have tips which are (3) split—"flagged."



Your final assurance of a brush which will give excellent painting performance is bristles which (4) vary in length.



A brush with these qualities has a greater working and paint-holding capacity—eliminates excessive dipping. It will (5) release a finish smoothly and evenly on any surface. You save time, paint with ease, do a professional-looking job.



Now, better performance with improved TYNEX® nylon bristles

When buying a paintbrush, look for (6) the trademark TYNEX on the handle. Quality paintbrushes made with bristles of TYNEX nylon give you better performance. They pick up a full load of paint



at every dip and lay on a smooth, streak-free coat. And brushes bristled with TYNEX have durable bristles that (7) clean easily...rinse thoroughly...dry quickly—are always ready for re-use.

FREE—additional facts everyone should have on choosing and using a paintbrush. To get this valuable information without cost or obligation, just send your name and address to E. I. du Pont de Nemours & Co. (Inc.), Polychemicals Dept., Room 658, Du Pont Building, Wilmington 98, Del.



7

TYNEX is the registered trademark for Du Pont nylon bristles.

DU PONT **TYNEX**
NYLON BRISTLES
BETTER THINGS FOR BETTER LIVING . . . THROUGH CHEMISTRY

Clinic for Homemakers



As a service to our readers in solving the hundreds of problems pertaining to a home—inside or out—the editors of Popular Mechanics invite you to present your problems to The Clinic Editor for help and advice. Address your questions to The Clinic Editor, Popular Mechanics Magazine, 200 East Ontario Street, Chicago 11, Ill.



Waterproofing Door

Q—During hard rainstorms water comes under my garage doors. These doors are of an older type, are carried on a track and run inward along the inside of the wall when opened. There is no offset between the floor and the ramp. Is there some way to keep the water out?—M. K., Ga.

A—We assume there is no possibility of building an awning over the doors. Usually this proves quite effective where the design of the building will permit such an installation. If this is not possible then it will be necessary to install a threshold to prevent the entrance of water. One installation we know of that proved effective consisted of a length of 1-in. pipe anchored in a groove cut in the concrete to a depth of about $\frac{1}{2}$ in. The length of pipe is cut to a close fit between the doorjamb. Equally spaced holes are drilled through the pipe and countersunk to take flatheaded screws. These are turned into lead anchors driven into holes drilled in the bottom of the groove. After the pipe has been screwed in place in the groove the space on each side is filled with waterproof mastic or hot asphalt. Care must be taken to see that the pipe is located on the center line of the doors when the latter are closed. It probably will be necessary to trim the bottom ends of the doors and then adjust them to assure a smooth, sliding fit over the pipe threshold.



Paint Removal

Q—While painting my gutters and downspouts last fall I accidentally spilled gutter paint on a concrete walk near one corner of the house. Using paint thinner I managed to remove most of the paint but a discoloration still remains. The paint was a dark, red color and naturally it left a dark, unsightly stain that gives no indication of wearing off. Is it possible to remove this and if so what do I use?—L. K., Minn.

A—You should be able to eliminate the discoloration by using a paint remover of the wash-off type, although it will take several applications in

(Continued to page 204)

AUTO-LITE **POWER TIP** "fires up" winners in 1957 Mobilgas Economy Run



IMPERIAL CROWN . . . Winner in both High Price Class and Sweepstakes



CHRYSLER SARATOGA V-8... Winner in Upper-Medium Price Class



DE SOTO FIREDOME V-8 . . . 2nd Place in Upper-Medium Price Class



DODGE CORONET 500 V-8 . . . Winner in Low-Medium Price Class



PLYMOUTH BELVEDERE V-8 . . . Winner in Low Price Class



Victory sweep by Chrysler-built cars proves that Auto-Lite Spark Plugs with **POWER TIP** deliver top performance and economy at all speeds.

The 1957 Mobilgas Economy Run gives dramatic evidence of Power Tip's ability to give top performance and economy in all kinds of driving . . . at all speeds. For 1568 miles, in the mountains, on the highway, and in city traffic, Power Tip sparked the winners to victory. Here's how Auto-Lite Spark Plugs with Power Tip operate . . .

At *low speeds*, the projecting spark plug tip . . . the Power Tip . . . gets hot fast, operates hotter to burn away fouling deposits which impair engine performance in city driving. At *high speeds*, the Power Tip is actually cooled by the richer air-fuel

mixture to check costly and dangerous high-speed pre-ignition caused by overheated spark plugs.

Power Tip, first spark plug ignition-engineered for today's engines and today's driving, is designed for overhead-valve V-8 engines and for most overhead-valve 6's in all these cars: Buick, Cadillac, Chevrolet, DeSoto, Chrysler, Dodge, Plymouth, Ford, Hudson, Imperial, Lincoln, Pontiac, Mercury, Oldsmobile, Studebaker, Nash, Packard, Rambler.



Mobilgas Economy Run, sponsored annually by Socony-Mobil, is rigidly supervised by the Sports Commission of the United States Auto Club.



The protruding tip makes the big difference!

AUTO-LITE[®] RESISTOR SPARK PLUG WITH **POWER TIP**

Auto-Lite makes a complete line of spark plugs, including Standard, Resistor, Small-Engine, Transport, Aircraft, and Diesel-Starting.



in red, blue,
green, yellow & orange

KRAEUTER has done it again. Now for the first time you can secure comfort and color along with KRAEUTER quality at no increase in cost.

Every KRAEUTER solid joint plier has a cushion grip of thick vinyl to make your tough jobs easy. All KRAEUTER "CG"® cushion grips provide easy identification—easy to locate in your tool box—ideal for departmental color coding in your plant. All KRAEUTER "CG"® cushion grip pliers assure you comfort and ease on the job.

Whether you use side cutters, diagonals, lineman's or one of the other quality pliers in KRAEUTER's long line, you will find "CG"® cushion grips a standard feature at regular prices.

Ask your distributor for KRAEUTER "CG's"® today and put ease in your work.

®CG Cushion Gripped Pliers

BUY THE FINEST
BUY KRAEUTER
BUY AMERICAN

AS MODERN AS TOMORROW

kraeuter & co., inc.

FOR 100 YEARS THE FINEST IN HAND TOOLS 1860-1960 NEWARK, N. J.



(Continued from page 202)

order to accomplish a satisfactory job. Apply the remover over the whole area with one-way strokes of a paintbrush, laying the material on heavily and covering the area as quickly as possible. Allow the remover to "work" for 15 min. or more, then wash off with cold water, or as the instructions on the container direct. Working over the affected surface with a stiff-bristle scrub brush may aid in loosening the paint pigment from the porous surface of the concrete. Continue this procedure until no discoloration shows after the surface dries.



Cedar Closet Lining

Q—I want to line two clothes closets with red cedar but I have hesitated to do this as I'm told that it will not serve as a reliable moth repellent. It also is said that the wood gradually loses its characteristic odor. Is this correct?

—E. L., Pa.

A—Red-cedar closet lining is not generally considered as effective as are chemical moth repellents now available. Likely this is because the chemicals are sprayed or otherwise applied directly to the fabrics and are toxic to adult moths and larvae alike. Cedar closet lining is said to be a reasonably effective deterrent to adult moths but the volatile elements are not considered sufficiently toxic to reliably dispose of moth larvae which may be in the clothing when it is placed in the closet. However, we would not hesitate to line closets with cedar if original plans call for this type of lining. Red cedar which has been selected and milled especially for closet lining is attractive, retains its color almost indefinitely, does not readily warp or shrink and is easily installed.

Removing Paint From Tile

Q—While painting the ceiling of my bathroom I spilled some paint on the tiled wall, just a few drops, but unfortunately I did not discover these until after the paint had dried. Now it seems impossible to remove the paint without damaging the tile, which are of plastic, yellow and black in color. I am told not to use any kind of paint remover as it will dull the surface of the tile. Is there any other way to remove the paint?—F. N., Calif.

A—Your information is correct. It is not safe to use paint removers on plastic tile. Any attempt at scraping off the paint drops is likely to scratch or score the surface of the tile. However, in one instance we know of, paint spatters were removed from plastic tile with a safety-razor blade fitted in a holder such as that supplied for scraping paint spatters from glass. You might try this. It could prove successful if you use extreme care. Ammonia (household) will soften most paints, also alcohol. If you try either one, apply with an artist's brush or with a small pledget of cotton.

Shellac Does Not Harden

Q—Some time ago I refinished a workbench top with shellac. The finish went on nicely but it never dried or hardened properly, is still slightly sticky, or tacky to the touch. It gathers dust which is impossible to wipe off cleanly. I sanded the bench top thoroughly before applying the shellac. What did I do wrong?—S. D., Mich.

A—Probably nothing in preparation of the surface and application of the shellac, if we judge correctly from your description of the procedure. However, we would guess right away that you used shellac from a container which was not properly sealed after using a part of the contents in some previous application. The only permanent remedy for the condition of the present finish is to remove it by washing off with alcohol, or an application of paint-and-varnish remover. Sand the surface to expose bare wood and then refinish with fresh shellac. It's a good idea to apply a wash of shellac as the first coat. Thin to a watery consistency with alcohol, apply, and allow to dry about 1 hr. Then smooth with fine steel wool and apply a second coat of shellac as it comes from the container.

DOWN
IN BED



DOWN IN
THE MOUTH



DOWN IN
THE POCKET



A long winter's ahead . . . don't let it get you down!

Here is why it's LENNOX
for better winter living

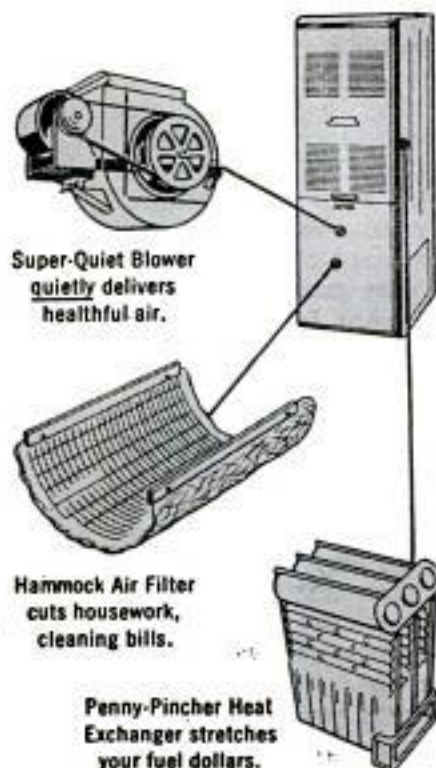

Super-Quiet Blower
quietly delivers
healthful air.

Hammock Air Filter
cuts housework,
cleaning bills.

Penny-Pincher Heat
Exchanger stretches
your fuel dollars.

Get set now for happier, healthier winter living . . . with up-to-date LENNOX WARM AIR HEATING!

This winter live in air that's always the perfect temperature, humidity-controlled, freshened and filtered-clean, gently and quietly circulated to every room. Choose the best—choose Lennox, made by the world leader in home comfort. Costs less than you may think!—and you're all set to add summer air conditioning!

FREE HEATING SURVEY! Call your Lennox Comfort Craftsman, your community's heating and air conditioning dealer-expert. He's listed in the Yellow Pages. Ask about the Lennox Easy Pay Plan.

More families buy

LENNOX



world leader in all-season air conditioning for the home

©1957 Lennox Industries Inc., Heating and Air Conditioning, founded 1895; Marshalltown and Des Moines, Iowa; Syracuse, N. Y.; Columbus, O.; Decatur, Ga.; Ft. Worth; Los Angeles; Salt Lake City. In Canada: Toronto, Montreal, Calgary, Vancouver.

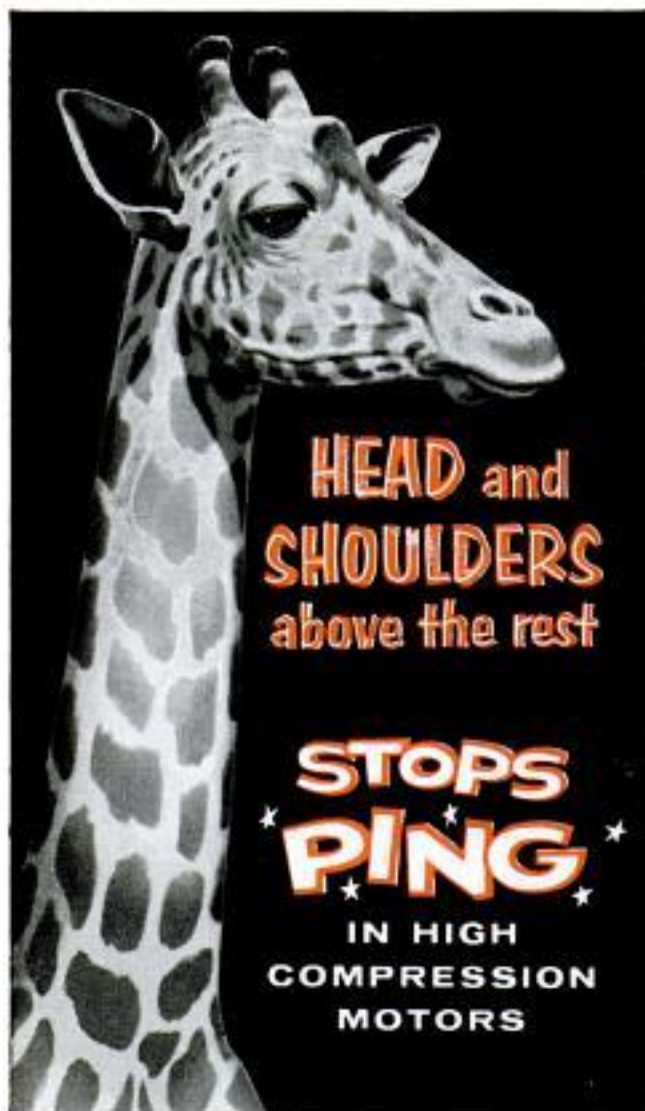

BRINGS YOU **5** OTHER ADVANTAGES, TOO



An entirely different kind of motor oil, Kendall SuperB All-Weather SAE 10W-30 completely satisfies the special lubrication needs of modern engine design. In addition to freedom from ping, Kendall SuperB brings you these advantages:

- STOPS VALVE LIFTER CLATTER
- LOWERS OIL CONSUMPTION
- REDUCES ENGINE WEAR
- PROLONGS ENGINE LIFE
- INCREASES GASOLINE MILEAGE

Refined from 100% Bradford Pennsylvania Crude Oil...

**KENDALL REFINING COMPANY,
BRADFORD, PENNA.**



They Find Water on the Desert

(Continued from page 133)

rock basin or trough under a valley can be charted. From this information it is possible to locate channels and dips in which water may collect.

Another procedure is the earth electrical-resistivity method. Electric current is introduced into the ground by a pair of electrodes spaced some distance apart and the electrical resistance of the ground is measured. As the distance between the electrodes is increased, a greater proportion of the current flows at greater depths, giving an increasingly deeper picture of the resistivity of the earth. In theory, a water-bearing stratum can be located because of its change in resistance. In practice it often happens that dense clay or dry gravel gives the same response.

About three years ago at the Socorro campus of the New Mexico Institute a student observed that clayey sand that was saturated with water could be polarized by passing a current through it, and that the decay of this polarization could be measured. Hardly anyone would consider this important, but to water-conscious New Mexico it held some promise of being adaptable to prospecting for water. A team consisting of Victor Vacquier, Paul Kintzinger, Charles R. Holmes and Richard H. Frische was formed to investigate it. The studies have been going on ever since, and today the institute feels that a valuable method of seeking water in alluvial deposits has been developed.

The phenomenon is unique because it occurs only under certain conditions. Clean sand mixed in water cannot be polarized, nor can a mixture of sand, clay and water. It is only when the clay forms a coating around the individual grains of sand that the effect takes place. Fortunately, this is the condition that exists in nature. The electrical effect seems to be based on the movement of current-carrying ions between adjoining clay membranes.

The field equipment for prospecting for water consists of a Jeep truck and trailer carrying a 10-kw. generator, recording equipment and thousands of feet of insulated wire. In making a survey a pair of high voltage wires is unreeled and strung out to be attached to electrodes that are driven into the ground at a spacing of several hundred feet. Two other electrodes that will pick up the induced current are driven at closer distances to the truck and are connected by wires to the recording equipment.

The high voltage is switched on for some

(Continued to page 208)

FREE!

4 booklets on new finishes for WESTERN PINES

24 full-color photographs, complete "how to" information
Yours for the asking! Beautiful color finishes developed especially for the 10 fine Western Pine woods, together with details on mixing, sealing, applying, sanding—all collected in 4 separate booklets entitled:

- Fine Finishes for Family Rooms
- Fine Finishes for Kitchens
- Fine Finishes for Living Rooms
- Fine Finishes for Sleeping Areas

Write for your FREE copies to: WESTERN PINE ASSOCIATION, Dept. 208-N, Yeon Building, Portland 4, Oregon.

The Western Pines

Idaho White Pine

Ponderosa Pine

Sugar Pine

and these woods from
the Western Pine mills

WHITE FIR • INCENSE CEDAR
RED CEDAR • DOUGLAS FIR
ENGELMANN SPRUCE
LODGEPOLE PINE • LARCH

are manufactured to high standards of seasoning, grading, measurement

TODAY'S WESTERN PINE TREE FARMING GUARANTEES LUMBER TOMORROW

Folding Landing Net Eases Anglers' Plight



Fishermen tired of snarling landing nets in bushes, car trunks, or on other obstacles now can carry a fold-up net on their belts or in tackle boxes. Drawn by its wooden handle from a leather case, the net's spring-steel frame instantly expands to a 14-inch diameter. Netting is heavy green nylon. The angler can replace the net in its three-inch case by detaching one end of the frame and winding the steel around his hand in a small circle, bunching the netting into the center of this circle to fit the case.

Lavender Potato Chips?

Soon you may be eating potato chips dyed lavender, peach, strawberry, lime green and other tints. Two Long Beach, Calif., men have a patent on the process.

Blower-Brush Combination

Dust and lint can be removed from sensitive equipment and lenses by applying a blower-brush device. The brush is made of sable.



NOW! CUT ALMOST ANYTHING

with **WISS** "Mighty Midget" Snips! No. V-13

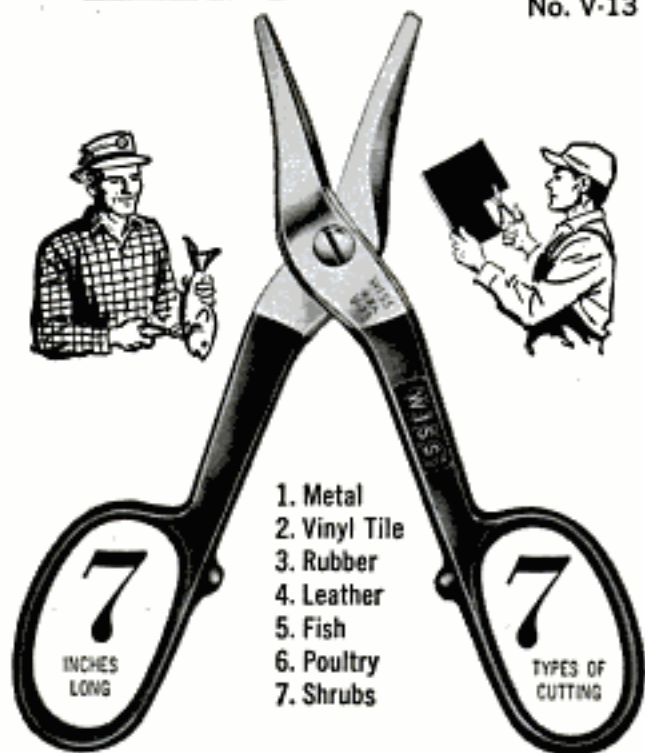

1. Metal
2. Vinyl Tile
3. Rubber
4. Leather
5. Fish
6. Poultry
7. Shrubs

ONLY \$2.10! "Mighty Midget" Solid Steel Snips fit easily into your pocket or fishing tackle box. Make straight and curved cuts. At leading hardware and tool stores. Get a pair soon!

OTHER WISS SNIPS
FOR HOME, FARM, AND
PROFESSIONAL
CRAFTSMEN

**CIRCULAR and
STRAIGHT CUT**
**\$2.80 and
\$3.80**



Versatile as "Mighty Midget" snips. 10" model cuts 24 gauge metal; 13" model cuts 21 gauge.

REGULAR
\$2.35
to
\$3.50



For powerful straight cutting. Four different sized models. Good for all sheet metal work, 25-20 gauge.

**METAL MASTER
M-3**
\$4.25*



Tremendous power! Only 10" long. Make intricate straight or curved cuts in 18 gauge metal, with half the normal effort!

* Slightly higher in Denver and West.
Vinyl handle grips optional and extra.

J. WISS & SONS CO., NEWARK 7, N. J.

WISS ... always a cut above competition

30 seconds, then switched off, and the decay rate of the induced current in the ground is automatically recorded. Then the whole operation is repeated, this time with the electrodes spaced farther apart, for a deeper probe.

Prospecting by induced polarization isn't cheap. No one could normally afford to hire a trained crew to find the best place to drill for water on a 20-acre farm. It cost possibly \$3000 to keep a three-man crew in the field for a month, during which time they can survey 30 square miles of land. They can make a spot survey in a week.

The New Mexico Institute stresses the fact that it is not in the business of prospecting for water. Rather, its interest is in developing methods for use by engineers.

At the same time that the new prospecting method has been under development, Dr. E. J. Workman, president of the institute, has been conducting long-range studies of the speed at which water percolates through the ground.

To find out, Doctor Workman is using the hydrogen bomb as an unwitting tool. One by-product of a hydrogen-bomb explosion is tritium, an isotope of hydrogen that normally is present in the atmosphere in the ratio of one atom of tritium to one million million million atoms of hydrogen.

Ever since the explosion of the first hydrogen bomb three years ago, the tritium content of the atmosphere has been about 100 times greater than normal. Thus, beginning three years ago, all the rain that has fallen has been "marked" water because of its high tritium content.

Today, in several New Mexico towns that get their water from wells, the water supplies are being monitored to learn when water with a high tritium content will appear. When found, the marked water will tell a great deal about the distance it has traveled underground, its speed of travel, the degree to which it has mixed with older water (giving an indication of the size of underground reservoirs).

Leaders in the Southwest believe that the lack of water there is going to bring important economic changes to the region. They feel that industry can make better use of the existing water than can agriculture. They base this on the estimate that an industrial community can support 60 times more people than an agricultural one on the same amount of water.

Another change they foresee is a switch from cattle to tourists. Head for head, they say, there's more money to be made from a tourist than from a cow and they add, jokingly, that eventually in the Southwest the largest herds of beef cattle will be scenery on dude ranches. ★ ★ ★

The AMERICAN BASIC SCIENCE CLUB

offers

an exciting new hobby for everyone!

A HOME SCIENCE LABORATORY

Fascinating Experiments with

LIGHT

ELECTRICITY

HEAT

ELECTRONICS

SOUND

ATOMIC ENERGY



DEVELOPED WITH WORLD FAMOUS
SOUTHWEST RESEARCH INSTITUTE
To Bring the Wonderful World of
Science into the American Home.

COMPLETE LABORATORY COMES IN 8 KITS... ONE A MONTH

SUPPLIES *All* THE EQUIPMENT FOR *All* THE FOLLOWING:

ELECTRICAL EXPERIMENTS

Educational fun with Electro-Magnets, Transformer, Galvanometer, Rheostat, Relay, and other basic electric equipment.

MICROPHONE

A sensitive instrument with which you can hear insects walk and other unsuspected noises. Also used as Detecto-Phone.

BROADCAST TRANSMITTER

Sends clear signals to nearby radios. Can be used with your microphones, record player, or code oscillator.

SOUND EXPERIMENTS

Laboratory demonstration of sound waves, resonance and pitch. Equipment includes Loud Speaker, Resonance tube and Sonometer.

PHOTOGRAPHY LAB

Complete dark room equipment including: Printer — Enlarger — Electronic Timer — Safe Light — Developing Trays and a sample supply of paper and chemicals.

RADIO RECEIVER

A sensitive three tube regenerative radio — transformer powered. Can be plugged into regular 110 a/c home circuit. Complete with head set.

ELECTRONIC EXPERIMENTS

Explore the functions of vacuum tubes and other basic electronic components. Build an Electronic Switch — Signal Amplifier and other experimental circuits.

RADIO SERVICE EQUIP.

All the parts to build your own Radio Signal Tracer and a Probe Light Continuity Tester. Both pieces invaluable in radio servicing.

CODE PRACTICE SET

Signal oscillator and key to learn the first step toward getting your "ham" license.

MICROSCOPE

Powerful, self-illuminated precision ground optical lens. High and low power. Adaptable for microphotography in connection with photo lab.

SPECTROSCOPE

Fascinating optical instrument used to identify and analyze substances by comparing the spectrum of their flame, with the included spectrum charts.

SLIDE PROJECTOR

35 mm Slide Projector throws enlargements up to 40" x 30". Sharp focusing, convection cooled. Complete including 120 watt GE Projection Lamp.

HEAT EXPERIMENTS

Laboratory studies of the nature of heat and its effect on solids, liquids and gases. Provides two Thermometers, Thermostat, Thermocouple, and Burner.

WEATHER STATION

Barometer — Humidistat — Sling Psychrometer — Anemometer — Rain Gauge — Cloud Charts — Record Charts — Weather Map.

LIGHT EXPERIMENTS

Interesting experiments with Optical Lens, Polarized Light — Ultra Violet "Black" Light, Invisible Infrared and Photometer.

PHOTOELECTRIC EYE

Photoelectric Tube, Exciter Lamp — and Electronic Relay. Everything you need to start and stop motors, bells, alarms and do other light beam experiments.

STRONG LIGHT

A variable pulse neon light that "freezes" the motion of rapidly vibrating or rotating objects for close study and checking R.P.M. and vibrational frequencies.

ATOMIC RADIATION EXPM.

Check radioactivity of mineral ores and do radiation experiments with sensitive Electro-scope. Sample of Uranium and other radioactive ores furnished.

SPINTHARISCOPE

Gives you a blown up ring-side view of the brilliant explosions of disintegrating radium atoms ejecting alpha particles at 11,000 miles per second.

ATOMIC CLOUD CHAMBER

The famous vapor chamber in which you can see the various types of illuminated paths made by the subatomic particles that bombard us from outer space.

All THE EQUIPMENT FOR *All* THE ABOVE... ONLY \$27.60

SEND ONLY \$200 WITH COUPON

PAY ONLY \$320

FOR EACH KIT YOU RECEIVE (ONE A MONTH FOR 8 MONTHS)

and you get a FREE ELECTRIC SOLDERING IRON WITH YOUR SECOND KIT.

YOUR SATISFACTION OR YOUR MONEY BACK... AND YOU MAY CANCEL AT ANY TIME! YOU'LL BE... SURPRISED! AMAZED! DELIGHTED!



SAFE!

All circuits are low voltage supplied by a step-down isolation transformer that comes with the first kit.

Free! These 6 Text Books to help you get the most from your lab!



NO EXPERIENCE NECESSARY

The 8 remarkable sets of instructions that accompany the kits are a real science course, expertly written to make every step interesting and understandable.

Illustrations are clear and effective. Without any previous experience you can do every project and acquire a valuable scientific background.

EASY! FUN! EDUCATIONAL!

"An Amazingly Complete and Versatile Lab"

"Kit a Month Idea Is Perfect Timing"

"A Real Achievement — So Much For So Little"

"The Photoelectric Unit Alone Is Worth The Total Cost Of The Lab"

AMERICAN BASIC SCIENCE CLUB, Box 524, San Antonio, Texas

Start sending me A.B.S.C.'s "Home Science Lab" in eight kits, one each month. If not satisfied on inspection of first kit I may return it for immediate refund. (I choose plan checked.)

- () I enclose \$2.00 and will pay \$3.20 plus COD postage on receipt of each kit.
() I may cancel at any time without obligation.
() I enclose \$27.60 as payment in full. POSTAGE PAID, for all eight kits.
() I may cancel at any time and get full refund on unreceived kits.

NAME

STREET

CITY.....STATE.....

MAIL COUPON TODAY

Through
the Atomic
Eye of
AccuRay®



Dunlop now
brings you

**SAFER
TIRES**



YOU'RE SAFER than ever on a matched set of Dunlops... because Dunlop now uses the latest advances in atomic control to bring you even stronger, cooler-running, better-balanced tires with extra mileage built-in.

The remarkably precise nucleonic action of AccuRay assures uniform application of an exact amount of protective rubber to every cord ply. There's no danger of premature failure due to uneven, excessive or inadequate ply coating.



You owe yourself and family the extra safety and comfort of Dunlop AccuRated Tires. Your Dunlop dealer will give you the "inside story" that makes Dunlop your best tire value today. He has a complete selection of Dunlop tires in Nylon or Super Hi-Test Rayon.

**You'll go farther,
SAFER... on tires by**

DUNLOP

They're AccuRated

DUNLOP TIRE AND RUBBER CORPORATION, BUFFALO 5, N. Y.

Mercury Styling Makes Big Hit With Owners

(Continued from page 120)

working."—New York truck driver.

Third complaint is another familiar one to readers of Owners Reports: Body noises and rattles (16.3 percent).

"Doors and dash develop squeaks and rattles that can't seem to be eliminated. Take car to local dealer an average of two or three times a month, but do not seem to get rid of rattles. They always return after a few days."—Arizona railroad conductor.

Push-Button Trouble

Mercury introduced a push-button control for its automatic transmission and apparently all was not well in the first cars built. The push-button control placed fourth on the complaint list with 13.5 percent of the owners mentioning it (another 5.8 percent of the owners complain about the absence of any "Park" bar in the push-button console—which will be discussed later).

"Keyboard transmission control continually chatters, even after a new one was installed. Service department claims it is due to the solenoid that prevents transmission going into reverse."—Tennessee sailor.

"I don't like push-button shift. Too much waste motion. Shift lever under steering wheel is more convenient."—New Jersey store manager.

"There are too many buttons to push for initial start."—California businessman.

"I like everything but the keyboard control. You have to move your eyes from the road to hunt for the key to punch."—Oklahoma teacher.

Fifth on the complaint list is a lack of power and performance.

"It doesn't take off fast enough."—California warehouseman.

"It is lazy. Won't do but 90 miles per hour. Passing gear doesn't respond as it should."—Illinois maintenance engineer.

"My car is not fast. It has 120 on the speedometer and it will hit only 96 or 97. It has been worked on by Mercury mechanics unsuccessfully."—Virginia owner.

Exterior Styling Quotes

The PM questionnaire asks owners what they like most about styling and what they like least. Here are some quotes of likes and dislikes in order of frequency of mention:

"I like the styling from the rear doors back."—Illinois sales manager.

"The lowness and straight lines."—New Jersey sailor.

(Continued to page 212)

BIG VALUES IN MOTORS AND NEW POWER APPLICATION KITS

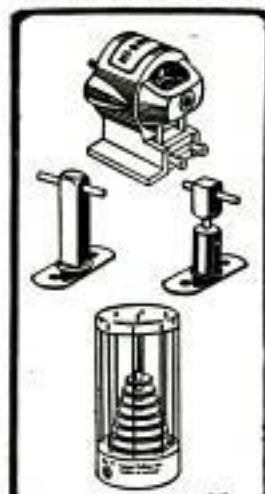

Order your choice of four miniature battery-operated motors—one for every use—from 1 1/2 to 12 volts—and today's BIGGEST VALUES IN THE HOBBY FIELD. These motors, with the accessories in kits listed below, provide all types of drives for hobby items, toys, research and industrial devices. Make wonderful gifts.

- *No. 8-100 Hi-Drive Motor, 3-6V. \$2.50
- No. 9-100 Same for 12V. \$3.00
- No. 3-100 Tiny Atom Motor, 1 1/2-3V. \$2.00
- For higher voltage. \$2.50
- No. 3113M Tiny Atom motor assembly kit with many acc. \$3.50
- No. 26 Couplings kit. \$1.50
- *No. 12 Solid shaft supports kit \$2.50
- *No. 14 Adjustable shaft supports kit. \$3.00
- *No. 79 Set of 7 large pulleys, 6 shafts and 3 belts. \$3.00
- No. 3700 Large accessories kit. \$3.00
- No. 3000 Vari-speed gear unit. \$4.00
- No. 1042 Gear train with Hi-Drive motor No. 8-100. \$5.95
- Same with No. 9-100 Motor. \$6.45
- * Item Illustrated. Ask for FREE Cat.

All Wilson's motors have Permanent Alnico Magnets.

Remit with order and we pay postage in U.S.A. No C.O.D. Add 3% Sales Tax for delivery in Ohio. Write Dept. PM.

For quick delivery see your local dealer — or order direct



WILSON'S OF CLEVELAND

425 Lakeside Ave., N.W. • Cleveland 13, Ohio

"PROJECTS FOR OUTDOOR LIVING"

NEW DELTA hard cover book features dozens of outdoor projects. Clear illustrations, complete bills-of-materials, easy-to-follow plans. Only \$1.00. Also get FREE folder on complete Delta Library; Delta Power Tool Div., Rockwell Mfg. Co., 502H North Lexington Avenue, Pittsburgh 8, Pa.

Works in seconds!



Loosens Rusted Bolts
nuts, screws, "frozen" parts!

LIQUID WRENCH

The super-penetrating rust solvent that quickly loosens rust and corrosion.

AT HARDWARE STORES, GARAGES
SERVICE STATIONS, EVERYWHERE
RADIATOR SPECIALTY CO.
Charlotte, N. C.

Protect your home against power interruptions with an...

ONAN Emergency ELECTRIC PLANT

Provides dependable stand-by electricity for heating system, pumps, freezer, lights, appliances. Keeps home safe, livable. Automatic start and stop. Find out how little it costs!

Write for Folder!

D. W. ONAN & SONS, INC.
3253 University Ave. S.E. • Minneapolis 14, Minnesota

A SIZE FOR EVERY NEED
500 to 75,000 watts.
Compact, quiet-running.
Gasoline-powered
Priced from \$269.00

FIRST CHOICE IN ADJUSTABLE WRENCHES

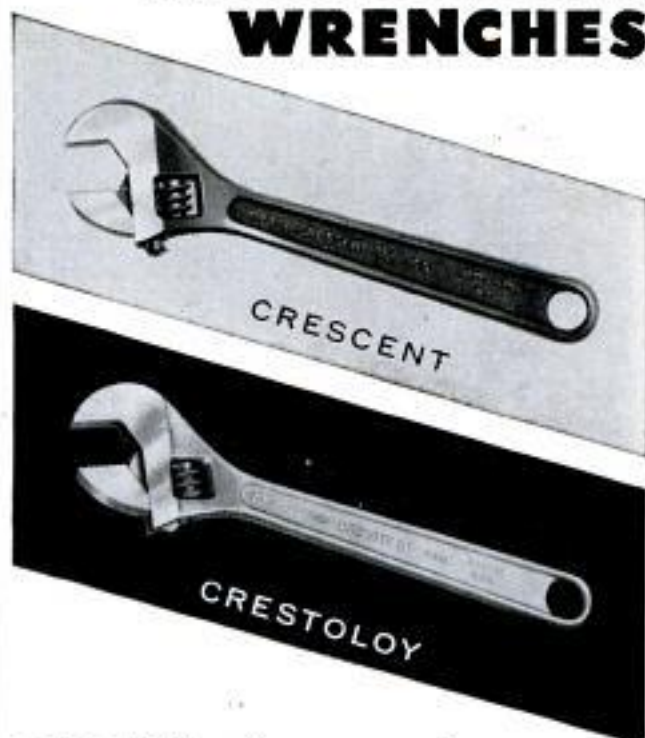

CRESCENT and **CRESTOLOY** outsell all other Adjustable Wrenches for good reason. Crescent Wrenches, forged from selected carbon steel, have been the world's favorite for 50 years and sell at popular prices. The thinner, trimmer Crestoloy Wrenches, forged from special alloy steel and chrome-plated, cost only slightly more. There is no finer or stronger adjustable wrench made. Both patterns are available in all popular sizes and are fully guaranteed. Ask your hardware dealer.

CRESCENT TOOLS
Give Wings to Work



*Sign of the Artisan
Symbol of Excellence*

Crescent is our trade-mark, registered in the United States and abroad, for wrenches and other tools. Sold by leading distributors and retailers everywhere and made only by **CRESCENT TOOL COMPANY, JAMESTOWN, N. Y.**



STOP WASTING MONEY on worn-out piston rings!

Oil-pumping is the first sign of worn-out piston rings. And worn-out piston rings mean power drop-off—costly wastage of gas and oil—expensive repairs later on.

The sooner you act, the less it will cost. See your motor specialist the minute oil-pumping warns you there's trouble ahead. When he recommends new piston rings, ask him for Hastings. They're engineered exclusively for replacement service . . . to provide the additional lubrication worn engines need . . . to stop oil-pumping, save gasoline and restore lost performance. Truly the best money you can spend on your car.

HASTINGS MANUFACTURING CO. • HASTINGS, MICH.

HASTINGS

PISTON RINGS

TOUGH on oil-pumping • **GENTLE** on cylinder walls

Buy these Hastings Products with confidence:
Piston Rings, Casite, Wear Reducer,
Oil Filters, Spark Plugs

"The V-shaped taillights."—California owner.

"Don't like trough in roof. It collects water and when brakes are applied, water spills down windshield."—Arizona owner.

"Rear bumper looks too much like the front bumper."—California teacher.

"I think the front grille should be changed."—Florida businessman.

More Best-Liked Features

Here, in order of frequency of mention, are quotations describing other best-liked features of the Mercury:

"Roomy. Plenty of legroom front and rear."—South Carolina specialist.

"The first car I ever owned that has more legroom than I need."—New Jersey crane operator.

"It has the big Turnpike Cruiser engine and that gives plenty of performance. I drag it on the local strip."—Oklahoma contractor. (*The big T.C. engine is optional at extra cost—Ed.*)

"Most of the 10,000 miles were put on delivering rural mail over all kinds of roads. More than 50 miles per day and the trouble-free performance has sold me on Mercury. I stop at more than 450 boxes every day."—California rural mail carrier.

"Has great roadability on curves."—Ohio paper hanger.

"Stability on the road."—Michigan Air Force planner.

"Excellent vision. No blind spots."—California foreman.

"Can see equally well from back or front seat."—Maryland farmer.

"Interior is well designed, beautiful."—Texas engineer.

"Plenty of trunk room."—California dairy worker.

"I like the push buttons."—California housewife.

"Trouble-free engine."—Colorado owner.

"Quick starting, hot or cold."—Ohio rubber worker.

And More Complaints

Here are additional quotations that describe more complaints in order of frequency of mention by owners:

"Doors not properly adjusted. Sometimes cannot be opened. Trunk hinges poor. Broke one."—Montana farmer.

"Speedometer cable has broken once, been fixed and is bad again."—Mississippi oil-company employee.

Eighth on the list of complaints is the lack of any Park lock in the push-button transmission control. Because the test cars PM used had this lock installed, we asked Mercury why none was installed on some

(Continued to page 214)

Paint Peeling?

GET

Handi-calk

NOW!

Seal Damage-Causing Cracks and Gaps Easily—Ugly cracks admit moisture causing unsightly damage to wood, metal, plaster, wallpaper and paint. Stop this costly damage with easy-to-use Handi-calk. Convenient nozzle-type cartridge drops in Handi-calk gun. Just pull the trigger and calk. Can be painted over.

FREE!

Send postcard today for your free copy of "Home Calk Check List" showing "Where, When and How to Calk"

HANDI-CALK DIVISION DEPT. HC-4
2386 WOODHILL RD CLEVELAND 6, OHIO

At leading paint, hardware and building supply dealers!

FREE! 44 PAGE BOOKLET ON PORTABLE POWER TOOLS

Hundreds of time and money-saving ideas for hobbyists, builders, professional wood-workers. New booklet #204 includes 150 pictures of latest tools with complete specifications on how they work and what they do. Write for your free copy now!

PORTER-CABLE MACHINE COMPANY
7148 N. Salina St., Syracuse 8, N. Y.

DRAINS cellars, cisterns, wash tubs, **\$7.95**
IRRIGATES - CIRCULATES - SPRAYS

Up to 3,000 GPH; 450 GPH 80' high; or 1800 GPH from 25' well. Use 1/8 to 3/4 HP motor. Coupling included free. 1" inlet; 3/4" outlet. Stainless steel shaft. Won't rust or clog. Type P—\$7.95. **HEAVY DUTY BALL-BEARING PUMP.** Up to 7,500 GPH; or 3,000 GPH from 25' well. 1 1/2" inlet; 1" outlet. \$12.95. Postpaid if cash with order. **MONEY BACK GUARANTEE.** Centrifugal and Gear Pumps in All Sizes. LABAWCO PUMPS, Belle Mead 7, New Jersey

Find HIDDEN TREASURES

GOLD, SILVER, PRECIOUS METALS with the Famous Model 27 Metal Detector. Lightweight, ultra-sensitive, low cost. None finer. Also GEIGER COUNTERS for uranium and the VIOLITE for tungsten. **INFORMATION FREE**

THE *Detectron* CORP.
5528 Vineland Ave., No. Hollywood, Calif.

Automatic Saw Set...

MAKE EXTRA PROFITS!

Set 400 teeth per minute on hand or band saws, 4 to 16 point, with the BeMaCo Automatic Saw Set. Fast, accurate, true hammer-anvil action sets teeth uniformly, eliminates tooth breakage. Used profitably by saw shops and manufacturers everywhere. Every machine positively guaranteed!

Write for details—today!

BEAVER MFG. CO.

PO Box 434
800 1515 AVENUE • INGLEWOOD, CALIF.

Saw
Machine
Division
29-C

ONLY \$75 DOWN

for today's best buy in
fun-filled transportation

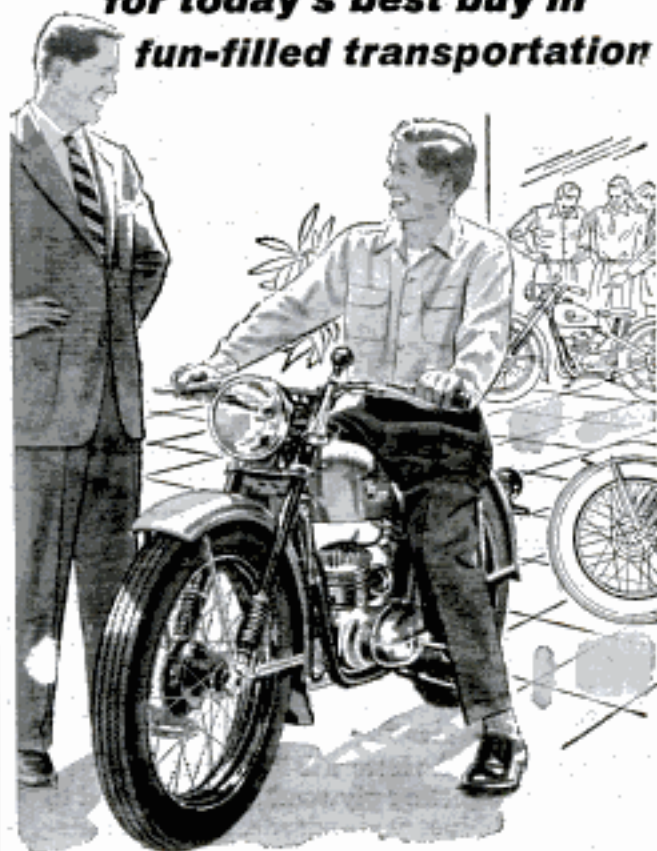

Ride to work or play on a
HARLEY-DAVIDSON
HUMMER

New liberal purchase plans — After minimum down payment, monthly instalments average only \$18.74 for vehicle, property and liability insurance and carrying charges.

Operating costs as little as 35¢ for 100 miles of travel. Maintenance and depreciation costs are negligible when compared with other forms of transportation.

Beat traffic worries — There's plenty of room to breeze between crawling or standing lanes of traffic, get up front ahead of the crowd. No parking problems either! Enjoy traveling the Harley-Davidson way — money-wise, pleasure-wise.

Good deals on other new and used models too—Visit your dealer for a trial ride and details. Or, write us for free literature.

HARLEY-DAVIDSON MOTOR CO.
DEPT. P • MILWAUKEE 1, WISCONSIN

You can build
almost anything with
FIR PLYWOOD

but
remember -



1 - LOOK FOR THE DFPA QUALITY TRADEMARK



When you see the letters DFPA on panel you know you're getting plywood quality-tested to meet rigid industry standards. DFPA trademarks attest quality, performance and value.

2 - CHOOSE THE RIGHT GRADE FOR EACH JOB

- EXT-DFPA**
Exterior plywood for outdoor & marine use
- INTERIOR-TYPE PLY PANEL**
PlyPanel® for paneling, most indoor uses
- GENUINE UNGLUED TO FIBER PLYSCORD**
PlyScord® (unsanded economy panel) for sheathing, backing

Choose Exterior-type (waterproof glue) for outdoor and marine uses; Interior-type for inside jobs. Within each type are several appearance grades (panels with one good side, two good sides, etc.). See your lumber dealer. He'll help you choose the right grade, help with ideas and plans.

SPECIALTY PANELS include 1. textured plywood with smart grooved, striated or brushed surfaces for special decorative effects; 2. overlaid plywood (smooth, durable resin-fiber surfaces) for extra quality work.



FREE: Helpful booklets that show how to buy, use and finish plywood. Also, list of available homecraft plans. Write (USA only) Douglas Fir Plywood Assoc., Tacoma 2, Wash., Dept. 9.

earlier models. Mercury's explanation is that production difficulties made it necessary to deliver about 45,000 Mercurys without the Park bar on the shift control. Mercury officials state that any owner who has not yet had this Park bar installed can have it done at no charge by going to his dealer, although some owners seem to disagree:

"When we bought our Mercury we were told that the Park lock would be installed later. Now, four months later, they tell us they may not put one on at all."—California teacher.

"Prior to delivery, the dealer removed the Park lock from the transmission control panel. My wife is unable to set the parking brake firmly enough to hold the car on a hill."—Ohio Air Force worker.

"I never feel safe parking my Mercury, especially on a hill. The foot pedal to the parking brake does not hold the car, as the cable stretches. Should have a transmission lock."—Massachusetts restaurateur.

"Transmission cannot be parked in gear. Thus if a child should hit the brake-release button, the car may roll away."—Maryland salesman.

"The parking brake has given way on me and the car rolled free. There's no way to hold the car on a steep hill when parked. I shall never again buy a car with this type of brake on it."—Massachusetts housewife.

"After delivery the Park lock was removed. New cars coming through have them. I have waited four months for this missing part which has been paid for. Are we forgotten?"—New York businessman.

"Flat roof design is weak. Slight hand pressure on inside top will move it easily."—California mechanical engineer.

"Rug on floor is an inch thick. Arizona is no place for deep-pile rugs."—Arizona retired Army officer.

"Front bumper not supported well enough on ends. I hit a dog but not hard enough to kill it and it bent bumper back and cut fender."—Georgia granite worker.

"Paint job is thin. White paint spattered on bronze."—Nebraska Air Force officer.

"Leak in top of gas tank. Dealer has tried to fix it twice."—Georgia housewife.

"Ignition switch is placed where one cannot see it."—California manufacturer.

There it is, the story of the 1957 Mercury as told by the folks who know it best—the owners themselves. ★ ★ ★

Rattlesnake-Poison Antidote

Hydrocortisone, a drug used to treat arthritis, has proved in experiments on animals to be an antidote against the poisonous bite of a rattlesnake.

HOME PAINTING TIP No. 8



PAINTING FURNITURE?

Stretchy "SCOTCH" Masking Tape hugs curves, keeps edges neat. Strips cleanly;

paint will not bleed through. Get 39¢, 69¢, 98¢, \$1.69 sizes in handy cutter-edge carton wherever paint is sold. Made by Minnesota Mining & Mfg. Co., St. Paul 6, Minn.



the finest

PUTTY KNIVES

are

Red Devil Tools.



ROAD TO RICHES

You can be the next uranium millionaire! Government guarantees huge bonus! PRI instruments from \$29.95. See your local dealer today! FREE CATALOG!

Write PRI, 4223 PM W. Jefferson, Los Angeles 16, California

DEALERS WANTED



Do a Better Job with DREMEL STRAIGHT-LINE ACTION SANDERS

Send for FREE Power Tool Catalog

DREMEL MFG. CO. RACINE, WIS.

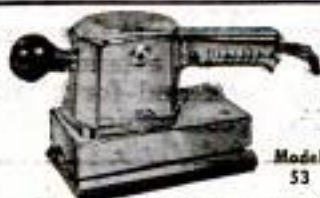

\$14.85 to \$34.85

Jiffy SAWHORSE BRACKETS

NO NAILS NO SCREWS NO BOLTS

Now a sawhorse in a jiffy! Just use Jiffy Brackets and 2x4s. Sold by hdw. and bldg. supply stores everywhere, or order direct. \$1.95 A pair. Fisher W. Coast

GRAND HAVEN STAMPED PRODUCTS CO. Grand Haven, Mich.



GENUINE ALNICO MAGNETS

AMAZING, PERMANENT, NON-ELECTRIC, HIGHLY PRACTICAL. Conduct interesting experiments. Hundreds of uses. Retrieve valuable steel items such as guns, tackle from fresh or salt water; tools from tanks & drains. GUARANTEED. Try any magnet one week. Money back if you are not well-pleased.

No. M-710 (Wt. 53-oz.) Has pull of 225 lbs. on steel block... \$16.50
 No. M-625 (Wt. 70-oz.) Has pull of 125 lbs. on steel block... \$9.50
 No. M-575 (Wt. 18-oz.) Has pull of 75 lbs. on steel block... \$6.50
 No. M-500 (Wt. 12-oz.) Has pull of 50 lbs. on steel block... \$4.50
 No. M-300 Kit of Flat Bars 5 Pairs (10 Magnets)... \$3.00
 No. M-250 Kit of Round Rods 5 Pairs (10 Magnets)... \$2.99
 No. M-47 Hot Pad Magnets, 10 for \$1.00... \$9 for \$4.97
 No. M-35 Hobbyist assortment of 8 small magnets... \$1.99

Send M.O. or check. We pay postage. Sorry no C.O.D.'s.
 MIAMI MAGNET COMPANY, 3240 N.W. 27th Ave., Miami 42, Fla.

At Last!

A "TOOTHLESS" PLIER
 THAT GRIPS
 WITHOUT GOUGING



CHANNELLOCK

No. 415 Smoothjaw PLIER

Just
 The Thing
 For Chrome
 Fixtures and
 Fittings



One of the handiest tools you'll ever use . . . the new "toothless", smooth-jaw plier that grips without gouging. Just the ticket for gripping chrome-plated fittings, plastic, wood and other smooth surfaces. Especially handy on chrome sink-fixtures and other hard-to-handle jobs. Jaws quickly adjustable to full 2" opening. Get yourself a Channellock No. 415 Smoothjaw Plier. You'll find it's "the right tool" on scores of jobs in home and shop.

Ask Your Hardware Man For A
CHANNELLOCK Smoothjaw PLIER

MADE ONLY BY

CHAMPION DEARMENT TOOL CO.
 MEADVILLE, PENNSYLVANIA

REPLACE YOUR

OLD WOOD CELLAR DOOR



WITH A MODERN ALL-STEEL BILCO DOOR

DO IT YOURSELF

IN JUST 3 TO 4 HOURS

Think of it! Only a few hours of pleasant work to replace your unsightly, troublesome wood hatchway with a lifetime, weathertight BILCO . . . the door installed on tens of thousands of new homes.

PAYS FOR ITSELF! Cost so little, yet never needs repair or replacement. Operates at a touch. Smooth, trim appearance adds amazing new beauty to your home.

Rush coupon TODAY for free folder "How to replace your wornout wood hatchway" showing sizes and prices.

Bilco®

THE BILCO CO.
DEPT. 966C
NEW HAVEN, CONN.

AMERICA'S FINEST
BASEMENT DOOR

Gentlemen: Please send me free folder and name of nearest dealer.

Name _____

Street _____

City _____ State _____

Driving the Mercury Montclair

(Continued from page 123)

turned on again, the seat comes forward to the preselected position. This, of course, is an extra-cost option.

Although it is not used on the test car's 368-cubic-inch engine, the power-booster engine fan is something I like. At speeds above 30 or 40, a fan is not needed for engine cooling. This automatic device disengages the fan when it is not needed. It makes for more quiet operation and should improve fuel economy and increase engine power somewhat at high speeds.

Mercury's bumpers are massive and afford excellent protection. There are no bulletlike projections. Being flat, they are practical in parking or when pushing another car. On some models (including the test car), large red reflectors are mounted in the rear bumper. License plates are well protected as they mount in a recessed section of the bumper.

I like the location of the push-button shift panel and also like the fact that the starter is operated by pushing the neutral button. This combines two operations in one (placing the transmission in neutral and operating the starter).

While the transmission park lock is a good feature, I don't like its method of operation. A bar located below the push-buttons applies the park lock when pushed in. When pulled out, the lock is released. Once you get used to this, it may be all right, but parking-lot attendants and drivers changing back and forth from other cars may find it confusing. ★ ★ ★

Insects Grow to Death

Growing insects to death may be the method of an insecticide still in the experimental stage. A Harvard University scientist has succeeded in isolating a hormone from male silkworm moths. When a tiny amount of this substance is applied to insect larvae, that area develops into that of an adult insect while the rest of the body remains in larval form. The creature soon dies because of this malformation. An advantage of the process is that an insect is not likely to develop an immunity to a hormone, but can become resistant to poisons such as DDT.

Glass Fiber Takes a Lot of Heat

Glass fiber is being produced that can withstand heat of 5000 degrees Fahrenheit. The material, made experimentally at the University of Pittsburgh, is intended for use in jet planes and guided missiles.

Here it is!

THE NEW 1958 ROBEL JUNIOR RACER

designed by
STAN OSBORN



Model 3075-P complete with Briggs & Stratton 2¼ h.p. gas engine, only \$199.50 FOB Berwick, Pa. AS SHOWN, completely assembled.

Hurry! Place your order now for one of these new "do-it-yourself" Father & Son Chassis! Speeds can be safety-locked at factory at 5, 10, or 15 MPH. 1957 Briggs and Stratton engine with re-wind starter. Designed and safety engineered by Stan Osborn.

- Welded channel-iron Flex-Frame design!
- Heavy-duty 12" wheels (12" x 2.50) with puncture proof tires!
- Two-wheel brakes!
- Polished aluminum steering-wheel!
- 70" long...30" wide!



Model 3075 chassis only \$99.50 FOB Berwick, Pa. AS SHOWN. (same as above less power plant)

New! ROBEL OFFICIAL ¼ MIDGET RACER

WAY OUT FRONT IN SPEED AND DRIVER SAFETY! Fully powered! Ready for the track! Equipped with exclusive ¼ midget racing tires with built up sides! Shipped complete, ready to run, Only \$495.00

- Triple strength fibre glass body!

OSBORNE WHEEL CO., DIV.,
Robel Corporation, Berwick, Pennsylvania
Gentlemen: Please rush your new catalog and price breakdown for the new 1958 ROBEL JUNIOR RACER. Enclosed find 10¢ to cover cost of mailing.

NAME _____
ADDRESS _____
CITY _____ ZONE _____ STATE _____



OSBORN WHEEL CO. • Division ROBEL Corp.
BERWICK, PA.

Remodeling?

Save Money! Save Time!

See SEARS!



One stop at SEARS
takes care of everything!

☆ PLANNING ☆ ESTIMATES ☆ FINANCING
☆ TOOLS ☆ INSTALLATION ☆ MATERIALS

At Sears you make all remodeling arrangements under one roof—at one time. No delay. No separate financing needed. Sears remodels any room—bath, kitchen, bedroom, recreation room; Sears can also arrange for adding rooms, heating, wiring, plumbing, roofing, siding, painting. Ask about Sears Modernizing Credit Plan . . . NO MONEY DOWN—up to 36 months to pay! Read all about it in Sears new 24-page booklet.

FREE 24-PAGE BOOKLET

Send Coupon Today!

Take to any Sears Store or Catalog Office or mail to Sears, Roebuck and Co., Dept. 139, 925 So. Homan Ave., Chicago 7, Ill, for free booklet. JA-97152.



Please check which improvements you are interested in:

- | | | |
|------------------------------------|--------------------------------------|-------------------------------------|
| <input type="checkbox"/> BATHROOM | <input type="checkbox"/> INSULATION | <input type="checkbox"/> FLOOR TILE |
| <input type="checkbox"/> PAINT | <input type="checkbox"/> KITCHEN | <input type="checkbox"/> HEATING |
| <input type="checkbox"/> PLUMBING | <input type="checkbox"/> WALLPAPER | <input type="checkbox"/> WIRING |
| <input type="checkbox"/> WALL TILE | <input type="checkbox"/> OTHER _____ | |

NAME _____

ADDRESS _____

CITY _____

STATE _____

NEAREST SEARS STORE _____

CATALOG SALES OFFICE _____

PH-8

Which Grass for Your Lawn?

(Continued from page 110)

have no phosphorus or potassium, although this may be mixed in by the manufacturer. If not, it should be done by the user.

Killing Weeds and Crab Grass



The best weed killer is a healthy, vigorous stand of grass. This will tend to choke out existing weeds and prevent encroachment by others.

However, chemical weed killers are a part of good lawn management. Available under several trade names

and in a variety of forms, 2,4-D will kill many broad-leaved weeds. Follow the manufacturer's directions explicitly. Such directions vary accordingly to the formulation. Do not apply when rain is forecast within the next 48 hours, as rainfall will wash off much of the chemical.

Weed killers can be used on broad-leaved weeds any time the weeds are growing actively, from spring through fall. However, best results are obtained by applying them in early fall, as turf grasses will fill in the sod prior to the emergence of crab grass the following spring. Weeds that are killed in the spring frequently are replaced by germinating crab grass, which means you have solved one problem but inherited a worse one.

Crab-grass killers, too, are effective when applied precisely according to instructions. However, where one application of 2,4-D will kill most broad-leaved weeds, crab grass must be given at least three successive treatments spaced seven to ten days apart. The crab-grass killer should be applied any time after crab grass emergence up to the two-leaf stage of growth. Another excellent measure for controlling crab grass is to rake the lawn vigorously in late summer to make the crab-grass blades stand up, mow closely, then rake up the clippings. This will reduce invasion of crab grass in subsequent years by eliminating a big share of the seed.

General Lawn Maintenance

To reseed an established lawn, rake the bare areas vigorously. Fall seeding in late August or early September gives the best results with cool-season grasses, but fair results can be obtained with spring seeding providing it is done before April 1 and kept

(Continued to page 220)

DO IT YOURSELF

It's Easy With



Soldering's really a "cinch" . . . when you use time-tested, reliable KESTER . . . available everywhere.

FREE! "Soldering Simplified" . . . 16-page how-to-solder booklet. At your dealer or write direct.

KESTER SOLDER COMPANY
4251 Wrightwood Avenue Chicago 39, Illinois

MONEY MEN ALL FREE

THE PLASTEX Industry needs manufacturers on small scale and for big production of Lamp and Clock Stands, Art Goods and Novelties in Plastex and Marble imitation. Experience unnecessary. Use material makes regular 10¢ store sellers. Rubber moulds furnished for speed production. Small investment brings good returns. We are now placing big Chain Store Orders with manufacturers. Ambitious men have chance for real prosperity. Our Free booklet will interest and benefit you.

PLASTEX INDUSTRIES, Dept. A
3400 Third Ave. New York 26, N. Y.

TOP VALUES! Surplus at Fraction of Original Cost or GROBAN'S



GENERAL ELECTRIC HIGH PRESSURE AIR COMPRESSORS

Output—1000-1500 Lbs. per Sq. In. • For filling aqua-lung tanks • For air brush work • Filling accumulator and air-oil shock struts • Cleaning and testing spark plugs • Hundreds of other uses.

Built by General Electric to exacting U.S. Air Force Standards. This two-stage air compressor rated 1000 P.S.I. output, may be modified to deliver 1500 P.S.I. Driven by 27 volt D.C. electric motor. As released from U.S.A.F. in used, serviceable condition. (Covered by our 30-day guarantee.) 14" L x 9 1/2" H, 8hp. Wt. 15 Lbs.

U. S. Gov't paid \$296.00 **OUR PRICE..... 15.00** F.O.B. Chicago
High pressure air receiver tank for G.E. Compressor, 8hp. Wt. 2 Lbs. \$4.00

A \$15.00 VALUE 37-PIECE METAL STAMPING SET

MADE TO RIGID U.S. ARMY SPECIFICATIONS
STAMPS NAMES, NUMBERS, ON WOOD OR METAL



FULL ALPHABET, A-Z, NUMBERS 1-9, "0", and PERIOD.

ITEM #300-B — PRECISION HAND TRIMMED, deep cut, hardened TOOL STEEL STAMPS — IN FITTED EASY ACCESS CARTON.

\$5.50 per Set
2 FOR 10.00 PPD.

1 1/2 H.P. HYDRAULIC SPEED REDUCER



with **FINGERTIP CONTROL**

USE FOR: • Reamer Drives • Midget Cars • Feed Mills • Canning Machines • Conveyors • Lathes • Milling Machines • Motor Boats • Cream Separators • Garden Tractors • Pumps

Variable output speeds from 0 to input speed available by moving control handle. Locking handle maintains setting. Use input power of 1/4 to 1 1/2 H.P. Shafts 3/4" diam. Input rotation counter-clockwise facing shaft. Input speed 750 R.P.M. 1 1/2" x 7 1/2" x 11 1/2". Output rotation reversible. Shipp. wt. 31 lbs. Complete with 2 qts. of oil and full instructions. F.O.B. Chicago..... **72.50**

BRAND NEW! U. S. NAVY COST \$92.00 SELF-PRIMING — BRONZE 1" GEAR PUMP

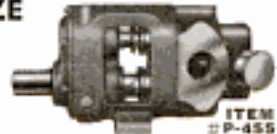

FOR — • Insecticide Spraying of DDT, 2-4D, CHLORDANE, Etc. • Sprinkling • Fuel Transfer.

BUILT TO EXACTING U. S. NAVY STANDARDS
FEATURES: • Ball bearing construction • NEOPRENE Pump Gears • Monel Shaft—1" Dia., 2" long • Sealed steel idler gears.

OUTPUT: 20 Gal. per Min. 100 lbs. per Sq. In. at 1500 R.P.M.—8 Gal. per Min. at 550 R.P.M. • Standard Base Mounting—3/8" bolt holes • Grease cup included. • 1" Pipe Thread Ports. • Dim. 11" L. x 5" H. x 4 1/4" W. Ship. Wt. 16 lbs..... **26.50 EA.**
Limited Quantity Order Direct **2 for 50.00** F.O.B. Chicago

FREE — FALL 1957 CATALOG

60 PAGES—Chuckfull of unsurpassed War Surplus and newly manufactured Equipment Bargains for farm, home, factory, workshop. Write letter today.

ORDER DIRECT FROM AD—**SATISFACTION GUARANTEED**
Send Payment Or Purchase Order Today
For Phone Orders Call **WEBSTER 9-3793**



GROBAN SUPPLY CO. DEPT. PM-8
GROBAN BUILDING
1139 S. WABASH AVE. CHICAGO 5, ILL.

New! Magna-Line Power Tools

The biggest advance in engineering since introduction of SHOPSMITH. Get your free MAGNA-LINE Catalog; get the full story on this brilliant new line of single-purpose power tools!

Write Dept. 808-M, MAGNA POWER TOOL CORPORATION
Box 2808, Ft. Wayne, Indiana, OR Menlo Park, California

WHEEL PLAN BOOK FREE

Shows portable farm, home and garden equipment built easily, economically with 6- to 12-inch Gleason ball bearing rubber tire wheels. Barrows, carts, toys, garden furniture, etc. Write —

GLEASON Corp., 340 North 12th Street • Milwaukee 3, Wisconsin

SAKRETE

Build, remodel and repair the easy way . . . with SAKRETE, dry-mixed concrete and mortar in a bag. See your building supply dealer, lumber dealer or hardware store — today!



Look for the Bag with the Yellow Diamond!

NEW 1957 CATALOG 200 MODELS—SAVE 2/3 BOAT KITS

EASY TO BUILD—Designed for the amateur. Over 200 Models. Prams to Cruisers, 8 to 21 ft. Formed hulls Semi and Custom finished. Save 50% . . . Now NEW Sea Ray Molded FIBERGLAS BOAT KITS. Truly professional results. NO upkeep. SAVE 2/3 assembly time. 12 to 16 ft. Utilities and Runabouts. SEND 35c for 64 page Boat Kit & 24 page Sea Ray Catalogs. SEND \$1.00 for both plus "Boating Handbook". Dealers inquire for franchise.

World's largest selection; over 200 plans, full-size patterns, frame-packs! Designed strictly for amateurs! All types: prams, kayaks, racers, runabouts, catamarans, houseboats, cruisers — inboard-outboard 6-40' wood-plywood-steel! Send 35c for PLAN CATALOG Catalog PLUS "Boatbuilding Handbook" \$1.00
WRITE NOW! CUSTOM CRAFT, BUFFALO 7L, N. Y.



Shock-absorbing handle won't loosen

Here's the finest hammer made. Shaft is gleaming, chrome-plated tube of boron alloy steel. Strongest ever made. Polished head is locked permanently to shaft. Tough neoprene-fiber cushion grip absorbs shock, won't slip wet or dry or in gloved hand. See ROCKET tools at your hardware store. True Temper, Cleveland 15, Ohio.



New JET ROCKET hammer, axe and hatchet, too. Bell-face design, built like the famous original ROCKET but with jet-black head and black cushion grip.

JET ROCKET HAMMER \$3⁹⁵

TRUE TEMPER®



Finest quality in Hammers, hatchets, axes • Shears
Shovels • Garden, lawn and farm tools • Fishing
tackle • Golf-club shafts • Railroad products

well-watered. To convert an established lawn to Bermuda or zoysia, plant sprigs, stolons or plugs throughout the existing turf on one-foot centers any time from May to late August. The grass will spread.



Rolling a lawn lightly in the spring will press down any plants that have been heaved by winter freezing and thawing. However, never try to use a roller as a means of leveling a lawn. Frequent rolling will compact the soil.

Aerate the turf if the soil becomes compacted.

This means spiking holes in it, a practice which permits water and fertilizer to penetrate deeply for heavy root growth. Hand tools are available to do the job, or you can rent a machine from an equipment dealer or a landscape gardener. Also you can have the work done on contract. ★ ★ ★

(Continued from page 110)

and North. In areas farther north, zoysias will live but will not spread. Zoysias need bright, hot sunlight. Most of them will spread during such days to crowd out many other lawn grasses and weeds, forming a beautiful, uniform turf. They are drought tolerant and resist disease, insects and wear. Zoysias turn a dead, unattractive brown in winter, though this may be a very short period in the Deep South. Establish them vegetatively in the spring, planting plugs one foot apart. One square foot of sod provides up to 36 two-inch plugs. Meyer zoysia is a fine-leaf strain of zoysia japonica, with a silky feel. Grows well in unfavorable soils. Unsatisfactory in heavy shade. Especially adapted to the twilight zone. Expensive. Emerald zoysia is superior to other strains in the Deep South. Tolerates shade. Slower spreading than Meyer zoysia. Zoysia japonica is not as dense as most zoysias, but has excellent winter hardiness and will survive farther north. Can be planted by seed or vegetatively. If seeded, sow two pounds per 1000 square feet. Insist on hulled seed. In general, zoysias should be fertilized in spring after last killing frost. An application of fertilizer every month or six weeks through the summer will make turf thrive. Mow below one inch.

Iodine in Drinking Water

Because chlorine tablets do not kill all the organisms in drinking water, the Army has adopted iodine as a water-purifying agent. Iodine tablets in a soldier's canteen water will kill amoeba cysts which chlorine will not. Inexpensive iodine preparations are gaining popularity in dairy, hospital and restaurant sanitation and may one day replace chlorine in purifying public-water supplies.



1 More road horsepower—Tests by independent engineers proved new Champions give cars of all makes an *immediate* boost in road horsepower—the real power actually de-

livered at the rear wheels. Most cars gained from 6% to 31%! No wonder 9 of 11 cars that broke the Indianapolis speed record this year were powered with Champion spark plugs!

If you haven't changed your plugs in about 10,000 miles—

You can make your car 4 ways newer with Champion spark plugs



2 Quicker starts—Tests with cars whose plugs had gone 10,000 miles or so show that new Champions can cut starting time by as much as 71%—with an average of 39%!

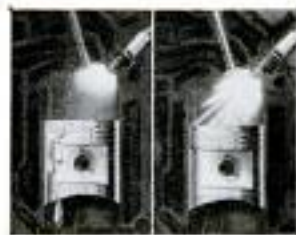

3 Less engine wear—Old, misfiring plugs (left) dilute oil with raw gas. New, full-firing Champions (right) protect the oil. *When you change oil, check your spark plugs!*



4 Lower cost-per-mile—As photo above shows, Champion's great new Powerfire electrode stands up better than ordinary types under same use. Insist on 5-rib Champions!



CHAMPION

LOOK FOR THE 5 RIBS

Seagoing Game Wardens

(Continued from page 115)

California has 1200 miles of coastline, 1500 miles of navigable inland waterways, plus an additional 500 miles surrounding the islands located off the mainland. A look at California's Fish and Game Code reveals that not one foot of this vast area is without some type of law restricting the use, possession or size of nets that may be used.

A constant patrol of the entire area at one time is impossible. In addition to the wardens who man the patrol boats, 25 marine wardens are stationed along the lengthy coastline, maintaining a patrol of fish markets, canneries, piers, landing places and beaches.

These land-based marine wardens fill an important job, and their work is tied in very closely with that of the patrol boats. With radio-equipped cars they are in constant touch with headquarters and the patrol boats operating in their areas. These wardens, experts in the intricate laws affecting commercial fishing, often spot illegal activities from their land patrol—such as fishing in restricted areas, undersize or out-of-season catches and the use of illegal nets—and in a matter of seconds they can have a fast cruiser speeding to the scene.

Foremost Fishing Port

Commercial fishing is rated as California's fourth largest industry, with 85 percent of the catch taken south of Santa Barbara. Los Angeles Harbor is cited as the world's foremost fishing port with more than one third of the entire nation's fresh and canned-fish requirements being produced in that harbor each year.

More than 1100 commercial fishing boats, manned by about 3700 fishermen, bring in approximately 419 million pounds of tuna, sardines, mackerel, anchovies and miscellaneous fish each year. In one three-month report, the Los Angeles Harbor fish canneries paid commercial fishermen over \$13,000,000 for their catches of tuna, sardines and mackerel.

With all of this activity located south of Santa Barbara, the Marine Patrol's efforts are concentrated largely on the southern coasts, with headquarters at the Harbor's Terminal Island.

In charge of this patrol district—Region V—is Chief Tom Schilling, whose main weapons are two seagoing "bloodhounds," the 63-foot *Marlin* and the *Bluefin*. Specially built and equipped for this work, each is powered with twin 630-horsepower Hall Scott engines, capable of a maximum speed of almost 35 knots, with an easy cruising

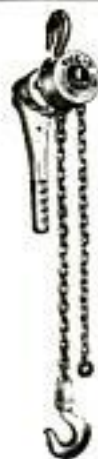

'Tugit' PULLS 'EM OUT- FAST!

There's no end to the tough jobs this handy tool makes easy for you. The smallest 'Tugit' weighs only 16½ lbs. Even a boy can safely lift a ton by tugging on the 12" handle. A mere flick of the finger control lever instantly shifts to lowering action. Operation is simple and a cinch at any angle, even in close quarters. When accurate placing is a "must," 'Tugit' moves the load as little as 1/8" at a time.

'Tugit' has long been a favorite with repair and construction workers. It is built like the finest hoist—lasts for years and years. It is safe—the handle can't kick back. Save time, trouble and expense. Get a portable 'Tugit' for your tool box, truck or car trunk. 1-ton size costs only \$63.50. See your nearby Shaw-Box Distributor or write for Bulletin 388.

- Uproots trees, posts
- Hauls cars out of mud, snow
- Moves boulders
- Stretches cable
- Erects fences
- Lays pipe
- Lifts boats, motors



578-1

MANNING, MAXWELL & MOORE, INC.
SHAW-BOX CRANE & HOIST DIVISION
 354 W. BROADWAY MUSKEGON, MICHIGAN



NEW, IMPROVED CALCULATOR FOR WOODWORKERS only 25c

Instantly gives information on lumber, nails, concrete mixes, painting materials, etc. Convenient, simple to read. Just set dial for nail specifications, to convert linear to board feet, find bit sizes for screws, compare characteristics of woods. 6" diameter heavily varnished cardboard. Send 25c, no stamps, please to Greenlee Tool Co., 2108 Columbia Avenue, Rockford, Illinois.

Build a Boat at 1/3 the Cost!

— with CLEVELAND'S full size, cut-to-shape boat patterns, detailed blueprints, and specifications. All classes and styles of modern Naval Architect-designed boats from 7½ to 38 feet. **BIG NEW 86-PAGE ILLUSTRATED CATALOG**, 50c (coin). "How to Build a Boat" booklet, \$2.50. Hardware & Equipment Catalog, \$1.50.

24 ft. Cabin Cruiser

14 ft. Runabout

CLEVELAND BOAT BLUEPRINT CO.
 Dept. B-166, Box 1651, Cleveland, Ohio



KING MIDGET

ALL NEW. First model change in six years. New bodies, new chassis, new engine. Four wheel hydraulic brakes. Still World's Lowest Priced Car. Drive it for 75c per week. Rider Agents Wanted. Earn your own car. Get the facts. Send 25c for 32 page picture book with complete details, dealers price, etc.
MIDGET MOTORS CORPORATION, Athens 1, Ohio

POPULAR MECHANICS

speed of 22 knots. Each boat carries a crew of four men: The captain, a boarding officer, deck hand and an engineer.

"These boats are sufficient," says Chief Schilling, "to catch any craft that feels guilty enough to run from us."

In this great south-coast fishery with hundreds of commercial fishing boats roaming the ocean, many regulations affecting their work must be checked and enforced. All the sea is theirs, so a law prohibits purse seining within a three-mile strip along the California coast as well as around Catalina Island, these areas being reserved for the sport-fishing boats. Here, too, is a huge industry which affords the sport fisherman an enjoyable outing along with fresh fish for his table. He buys an annual license for \$3 to fish anywhere in the state, including the ocean, and a portion of his money goes into Fish and Game funds to protect his interests.

Sport Fishing Checked

By the same token, the Marine Patrol boats check sport fishermen for licenses, and the land-based wardens keep a close watch on surf fishing, skin diving and lobster and abalone fishermen. In the past season, in addition to commercial fishermen, more than 496,000 sport fishermen tried their luck from party boats; another

half-million anglers used their own boats, ranging from small skiffs to deluxe cruisers. Region-V wardens issued 1412 citations, which brought in \$42,059 from fines and seizures.

Electronic "detectives," radar, depth finders and short-wave radio, are of immense help in commercial law-enforcement work. Major violations are few and far between, with most boat captains recognizing the necessity of the various regulations intended to preserve the fish which mean their livelihood. However, there seem to be a few fishermen willing to gamble, and these occasional violators feel the heavy hand of the Marine Patrol.

Three Repeater Stations

As most violations take place at night, the radar equipment has more than paid its own way. A large amount of information concerning possible violations is picked up by the land-based wardens, and this is immediately passed on to the patrol boats via short-wave radio. With the radio communication maintained and through the use of three repeater stations, all wardens of Region V can communicate directly with one another and also with Terminal Island headquarters from anywhere in southern California to the Mexican border. ★ ★ ★

WELD **BRAZE**
SOLDER **CUT**

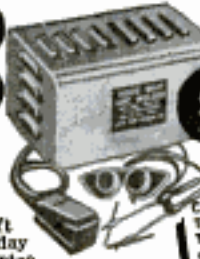

4WAY
ONLY **\$14.75**
f.o.b. factory

WELDER
Complete with
Twin Carbon Arc
Torch and ac-
cessories... to
handle all metal
craft work.

Acclaimed by thousands of Homeowners, Mechanics and Hobbyists as the welder of 1001 uses. Easily operated from properly wired 110 volt AC or DC line. The ideal gift with a life-long use... Order today on 10 day money back guarantee.

FOUR-WAY WELDER CO., Dept. F2-H
1810 S. Federal St. • Chicago 16, Ill.

HONEST CONSTRUCTION



Honest value has been built into every Gerstner Chest for 50 years. Send for Free Catalog to machinists and toolmakers.

GERSTNER TOOL CHESTS
457 Columbia St., Dayton 7, Ohio

SAVE MONEY ON YOUR COMPRESSED AIR



buy this complete SMITH 45-P air compressor

Right for spray painters, plumbers, contractors, monument shops, tire changing trucks, maintenance shops, quarries, utilities, many other users. Delivers 45 plus cu. ft. per minute; pressure up to 150 P.S.I. Powered by Wisconsin 4-cyl. air-cooled engine; uses less than 1 gal. gasoline an hour! Most compact, biggest-value compressor for its capacity anywhere! Other models to 250 cfm.

write for **FREE** brochure

GORDON SMITH & COMPANY, Inc.
411 College Street, Bowling Green, Ky.

TOUGH, DURABLE

CELO-GLASS

THE LOW-COST WAY TO MAKE

- Storm windows and doors
- Carport closures
- Your own greenhouse
- Outbuilding windows

Cel-O-Glass plastic coated screen offers protection against wind and rain, admits sun's healthful rays. Build your own storm windows and doors, that greenhouse you've wanted so long, sunshine-admitting windows for poultry houses and barns. Costs far less than glass... no sash needed... cuts with scissors. Easily tacked in place, no puttying.



"KOVER-IT" SHEET POLYETHYLENE

Now you can buy sheet polyethylene in kits... for hundreds of household uses. Make your own furniture and appliance covers, garment bags, protective hoods for expensive tools and equipment. May be sewed or heat-sealed for effective protection against moisture, oils, acids. In two sizes: 9' x 6' or 9' x 12', individually packaged. See your hardware dealer or write:



ARVEY CORPORATION R-V-LITE DIVISION
SINCE 1905  3500 N. Kimball Ave. Chicago 18, Ill.

Do it now with

DAPTM



Use DAP Kwik-Seal[®] for water-tight joints around bathtub, sink, tiling, baseboards. A wonder-white sealer. Long-lasting. Get handy tubes and free do-it-yourself booklet at hardware, paint and building supply dealers.

DICKS-ARMSTRONG-PONTIUS, Inc.
General Offices: Dayton, Ohio

Made \$900
IN SPARE TIME

"I did very well last year with my Foley equipment, about 950 saws in my spare time. About \$900 for me."—Leo H. Mix.

You can make up to \$3 or \$5 an hour in Spare Time. With a Foley Automatic Saw Filer you can file hand, band and circular saws better than the most expert hand filer. Cash business—no canvassing. No eyestrain, no experience needed.

FREE BOOK
"MONEY MAKING FACTS"

shows just how you can start at home in spare time, with small investment, no overhead—and develop into a full-time repair shop. Send coupon today for this practical plan. No salesman will call.



Send Coupon for **FREE BOOK**

FOLEY MFG. CO. 818-7 FOLEY BLDG. MINNEAPOLIS 18, MINN.

Send **FREE BOOK**—
"Money Making Facts."

Name _____

Address _____

In the Interest of Higher Fi

(Continued from page 141)

Xophonic (see photograph and diagram on page 141), a hi-fi accessory recently introduced by the Radio Craftsmen Corp.

Unlike stereo, the Xophonic does not impart the sense of location which pinpoints the positions of the instruments within an orchestra. It does, however, create a feeling of depth and spaciousness which seems to convert a small living room into a large auditorium.

In the concert hall, the sound from the performers reaches the listener directly, and also by means of reflected paths from distant walls and high ceilings. These reverberations, or echoes, which add so much to the depth of the original rendition, are lost when the recording is reproduced in the living room. The Xophonic restores these reverberations and adds a definite sense of presence to the reproduction.

How It Works

In use, the input terminals of the Xophonic are clipped to the voice-coil lugs of the speaker in an existing music system. The electrical signal at that point is converted into sound waves by a driver unit and these are forced through a coiled delay pipe. At the other end of this pipe the sound is picked up by a microphone, amplified, and then reproduced by a built-in loudspeaker.

Due to the time delay in the delay pipe, the sound from the Xophonic speaker emerges about $\frac{1}{20}$ second after it has been reproduced by the speaker of the main system. While not discernible as a direct echo, it does add considerable life and sparkle to both old and new records.

Xophonic reproduction requires no special recordings. The unit can be used with any music system, be it phono, tape, radio or television, with equal effectiveness. Furthermore, its location with respect to the main system is of little consequence for its effect will be the same whether it is placed directly on top of the main speaker or widely separated from it.

Yes, the art of recording and reproduction of sound has progressed with giant strides in the past decade. High fidelity is no longer the dream of a few, but a practical reality within the reach of almost everyone interested in good music. And so, engineers and experimenters are raising their sights to the limit in an effort to achieve "true" fidelity, the ultimate whereby even the most critical listeners and the most sensitive test instruments are unable to differentiate between the original rendition and the recorded reproduction. ★ ★ ★

For the First Time in Tool History!
SKIL'S MIRACLE LIFETIME ABRASIVES

TUNGSTEN CARBIDE GRIT BRAZED ON STEEL!

• Never Needs Replacing • Always Stays Sharp—Ready When You Need It! • Ideal for Wood, Plaster, Wallboard, Plastics, Composition Materials! • Sands Twice as Fast as Sandpaper! • Easily Cleaned With Wire Brush or Solvent! • Does Not Tear Like Sandpaper!

SKIL MIRACLE LIFETIME GRITTER | **SKIL MIRACLE LIFETIME GRIT SHAPER**

New lifetime abrasive. Miracle tungsten carbide grits brazed on steel gives a diamond-like cutting hardness. Perfectly finishes wood, plaster, plastics or composition materials. Ideal for dry wall joints, all types of wallboard. Comes complete in kit—
 1 Hand Gritter, \$3.45
 1 Medium Grit Shoe,
 1 Fine Grit Shoe.
 plus 35c pp. & hdg.

Spectacular Grit Shaper replaces any other wood rasp or file ever developed. Does any kind of wood filing in any direction. Not limited to forward cutting only. Full size 14" blade. One side 40-50 coarse grit with 80 medium grit on other side. Self-cleaning action resists loading. For stock removal, shaping, notching. \$2.25
 plus 35c pp. & hdg.

SKIL MIRACLE LIFETIME GRIT WHEEL

An amazing and unique accessory for table or radial saws. Five tools in one! Saws, sands, shapes, dados, ploughs—without changing the blade. One side of wheel has coarse 40-60 grit for stock removal. Other side has medium 80 grit. Tough 40-60 grit on edge. One 8" GRIT WHEEL—a complete workshop. \$12.95
 plus 50c pp. & hdg.

Send check or money order. If C.O.D. fees extra. Money-back Guaranteed.

SCOTT-MITCHELL HOUSE, Inc. DEPT. M-421, 611 BROADWAY
 NEW YORK 12, N. Y.

POWERFUL • LIGHTWEIGHT • PORTABLE
SELF PRIMING CENTRIFUGAL PUMP



• 1 1/2 H.P. Two-Cycle Gas Engine • Pump up to 20 GPM
 • 1" and 3/4" Connections for Inexpensive Garden Hose
 • SPRAY - DRAIN - CIRCULATE - IRRIGATE - FIRE PROTECTION
 Quality all-aluminum pump for homes, farms, cottages, resorts, boating, golf courses, industry, contractors. Working parts precision machined.

ORDER DIRECT Dept. 57
 Send Cash, Check or Money Order
 30-DAY MONEY BACK GUARANTEE
CROWN MFG. CO. WATERLOO IOWA **\$98**
 100 FACTORY

You buy better when you buy brands advertised in POPULAR MECHANICS **MP TAG of INTEGRITY**

SAVE OIL! SAVE GAS!

Sealed Power KromeX Piston Ring Sets

BEST IN NEW CARS! BEST IN OLD CARS!

ANYONE can be an EXPERT with deft

WOOD FINISH

Deft SEALS, PRIMES, FINISHES. Dries in 30 min. No thinning, nothing else to use. BAR TOP, semi-gloss interior finish.



Free Booklet

Be GOOD to your WOOD, DEFT-finish it.
 DESMONDS, 1826 W. 54, LOS ANGELES 62, CALIF.



AID TO YOUR CRAFTSMANSHIP

These three pliers—a Klein Side Cutting Plier, Long Nose Plier and Oblique Cutting Plier—belong in every workman's kit.

They put the exclamation point after your good workmanship! For a century Klein has stood for the finest in pliers and Kleins are still the standard of comparison by which other pliers are judged.

There is a type and size of Klein Plier for every job—all famous for Klein quality "since 1857."



Your hardware store has Kleins in stock or can get them for you quickly. Look for this new display board. It shows the most popular items in the Klein line.



Mathias KLEIN & Sons
 Established 1857 **Chicago, Ill., U.S.A.**
 7200 McCORMICK ROAD • CHICAGO 45, ILLINOIS



NEW! DRI-FILM
LIFETIME
LUBRICANT
PERMA-GLIDE T.M.

Gives permanent lubrication...
Makes oiling obsolete

- ★ Not Oily ★ Not Greasy
- ★ Not Grimy ★ Not Messy

ANYTHING... EVERYTHING lubricated with new PERMA-GLIDE never needs lubrication again. You just spray it on and the surface is lubricated permanently with a dry hard finish. Protects all moving parts against wear. Hundreds of uses in the home, workshop, factory, garage.

6-oz. Spray Can
ONLY 98¢

Get PERMA-GLIDE at leading hardware, paint and department stores everywhere, or, write to:

FLAMEMASTER CHEMICALS, INC.
Culver City, California

HI-FI TOOLS

by **UTICA**

Now for the Hi-Fi enthusiast, a complete set of quality hand tools designed for the assembly of Hi-Fi components.

Backed by famous full guarantee. Use UTICA, the tools the experts use.

UTICA DROP FORGE & TOOL DIVISION
Kelsey-Hayes Co., Utica 4, N.Y.

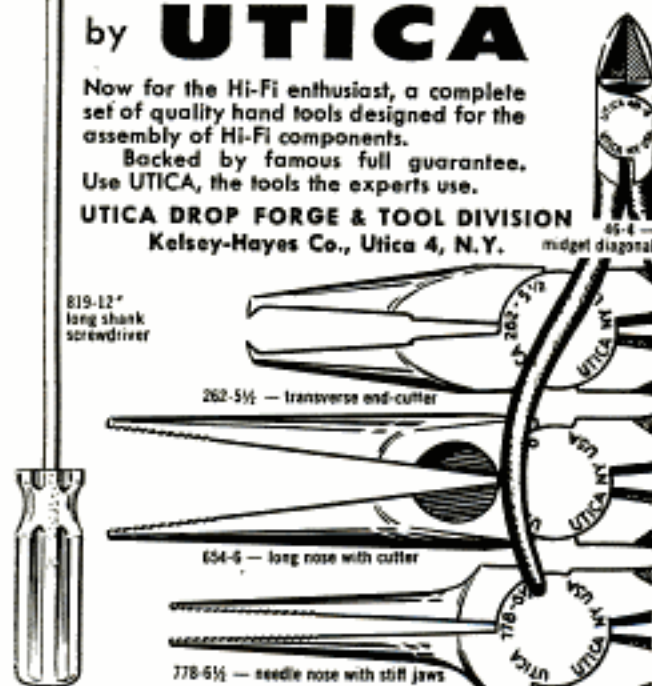

Companion Phono Plays Records Anywhere

(Continued from page 144)

distributors' catalogs for about \$3 or \$4.

A 7-in. arm was used in the model but a shorter one may be employed by slightly changing its position on the mounting board so that the arc of the stylus, when moving from one edge of the record to the other, passes through the center of the turntable.

The Carrying Case

A suitable carrying case can be purchased from most "dime" stores or luggage shops. The one originally used is 13 in. long, 9½ in. wide and 5 in. deep, but the

LIST OF MATERIALS

CONTROLS: R1=10,000-ohm miniature potentiometer with switch (S1), audio taper; R4=25,000-ohm miniature potentiometer, audio taper.

RESISTORS: (All ½-watt, carbon). R2=1000 ohms; R3=27,000 ohms; R5=2700 ohms; R6=100 ohms; R7=680 ohms.

CAPACITORS: C1=2-mfd./12-volt electrolytic; C2=.05-mfd./200-volt tubular; C3=5-mfd./12-volt electrolytic.

TRANSFORMERS: T1=200,000/1000-ohm input, Thordarson TR28; T2=5000/7500CT-ohm driver, Thordarson TR2; T3=825CT/3.4-ohm output, Thordarson TR29.

TRANSISTORS: TR1, TR2, TR3.—Sylvania 2N35, or equivalent NPN units.

MISCELLANEOUS: 5-in. PM speaker; phono motor (see text); pickup arm with cartridge (see text); carrying case (see text); s.p.s.t. slide switch (S2); veneered plywood for mounting board, to fit case; 9-volt battery (B1), Burgess D6, and snap-on connectors; 6-volt battery (B2), Burgess P4P1, and matching plug.

HARDWARE: Aluminum chassis, 2½ x 2¼ x 1¼, ICA No. 29075; transistor sockets (3); phono input jack and plug; miniature phone plug and jack, Telex No. 9240 and 9231 or equiv.; knobs for tone and volume controls; 5-lug terminal strip; ground lug; rubber grommet; assorted screws, nuts and lock washers; hookup wire; rosin-core solder.

dimensions are not particularly critical. The base portion, however, must be sufficiently deep to accommodate the parts beneath the mounting board, while the lid must be deep enough to cover the tone arm and turntable without touching these.

To prevent the lid from accidentally closing on a record, a lid support should be installed. A tone-arm latch can be fastened to the mounting board to secure the arm while the unit is being carried about.

Wood cleats are nailed to the sides of the case to hold the mounting board approximately level with the top of the case, and similar cleats at the bottom serve to hold the batteries in place.

Before soldering the B2 battery plug to the motor and switch leads, insert the bare ends of these wires in the battery-socket holes to determine the polarity required for clockwise rotation of the turntable. This simple check may prevent improper attachment of the plug which would result in reverse rotation of the motor. ★ ★ ★

AMERICA'S MOST EXCITING SPORT

MICRO-MIDGET RACING is America's fastest growing sport. Now anyone from 16 to 60 can own a real racing car and have all the thrills and excitement of SPEEDWAY RACING.

The all-new 1957 COMET is the ultimate in Micro-Midgets and has no equal. Send 25c for illustrated literature describing all details.



The HANDBOOK for SMALL RACING CARS

The ALL-NEW 5th Edition of this very popular Handbook is jam-packed with EXCITING ARTICLES, ACTION PICTURES, PLANS, SPECIFICATIONS, ENGINE INFORMATION, TRACK and RACING DATA, HOW TO START A RACING CLUB, HOW TO BUILD A TRACK, ALL RULES and REGULATIONS, etc., for 1/4 MIDGETS, MICRO-MIDGETS, 1/8 MIDGETS, 500 cc CARS, and FULL-SIZED MIDGETS. You've never seen a book filled with so much ACTION, EXCITEMENT, and VITAL INFORMATION. It also serves as a COMPLETE CATALOG telling where to buy ENGINES, WHEELS, INDIVIDUAL PARTS, SUPPLIES, and COMPLETE CARS. All for ONLY \$1.00.

COMET MANUFACTURING CORPORATION • Dept. PM 9 • Box 14821 • Los Angeles 4, Calif.

.22 MOSSBERGS

SMALL LOT OF AMERICAN MADE

MOSSBERGS issued to WWII British troops for special training. Bears British Royal Proof House marks. Ramp front sight. Walnut stock. 7-shot clip. Fires shorts, longs & L. R. ammo. Weighs 7 lbs. 20" bbl.

\$16.95

Outside condition

good, bore good.

Mechanically perfect.

Perfect for rifle teams.

TO ORDER: Send check,

cash or R.O. For C.O.D.

send \$7.50 deposit. California

residents add 4% state tax.

SEAPORT TRADERS, INC.

Dept. 38, 409 E. 12th St.,
Los Angeles 15, Cal.

Do YOU Know Your WOODS?

Take this 20-second quiz!

HANDBOOK OF
AMERICAN
WOODS

1. What wood is used chiefly for piano, organ and accordion keys? It is white and bears red berries around Christmas time.
2. What wood has a bark that can be used as a drink? It is used for fence posts and the building of small boats.
3. What wood is used in the making of axes, hammers, skis, mallets and for smoking meat?
4. What tree is given its name because of the long needles it bears?

See answers below.*

Now have at your fingertips answers to these questions and much other vital information on your wood-working projects with Popular Mechanics new book —

"HANDBOOK of AMERICAN WOODS"

This big 264-page guide describes and pictures all the commercial domestic species. It helps you select the proper woods for different projects and shows what substitutes may be used to achieve unusual effects. It can save you many hours of work and money for it contains detailed descriptions of the properties, grain, figure, color, workability and common uses of 48 softwood and 118 different hardwoods. You learn of the more interesting and outstanding characteristics of the tree, its natural growth range, a complete list of its common names and the official State trees. Written in PM's easy-to-understand style and well illustrated (over 70 actual photographs) Handbook of American Woods is a valuable addition to the library of any home craftsman or wood hobbyist. Send for your copy today. Money back if not pleased. Mail coupon below now and get your own "Lumber Yard" of beautiful Woods.

* 1. American Holly 2. Sassafras 3. Hickory 4. Long Leaf Pine

POPULAR MECHANICS PRESS, Dept. 857
200 E. Ontario St., Chicago 11, Ill.

RUSH my copy of Handbook of American Woods, in paper-bound edition for only \$2.75 in full payment.

I enclose check or money order Send COD (U.S. only)

Name _____

Address _____

City _____ Zone _____ State _____

Win a Homelite Chain Saw Every Year for Life!

You may have
3 chances to win!

- One entry makes you eligible for all the Homelite prizes!
- Just have a demonstration of the new Homelite "Power Twins"

Nothing to buy, nothing to write, no obligation. Just see your Homelite dealer to become eligible for the Grand Prize of a free Homelite Chain Saw every year for life, PLUS 25 chain saws being given free by Homelite District Offices, PLUS hundreds of chain saws awarded by Homelite dealers in their own local contests.

Register now! Contest limited to residents of the United States and subject to local, state, county and city laws.

Try both Homelite Power Twins and choose the one that's best for you! Both 6 horsepower!



**6 HORSEPOWER
19 POUNDS
DIRECT DRIVE**

Cuts down trees up to 5 feet in diameter; cuts 8" oak in 4 seconds, 18" pine in 14 seconds. Easy to handle, easy to operate, easy to carry. Ideal for cutting firewood, clearing campsites, building shelters.



**6 HORSEPOWER
22 POUNDS
GEAR DRIVE**

Built to meet the requirements of the professional woodsman, the new 6-22 cuts trees up to 7 feet in diameter, fells 20" trees in 18 seconds; makes any type of cut in any position . . . fells, bucks, limbs, notches, trims.

HOMELITE

A DIVISION OF TEXTRON INC.

9208 Riverdale Ave., Port Chester, N. Y.



Homelite builds and sells more chain saws than any other company in the world.
In Canada: Terry Machinery, Ltd.

AUGUST 1957

227

If **SUMMER DRIVING** has your car down . . .



© Wynn Oil Company 1956

**USE
AUTO-MEDIC'S
prescription —**

WYNN'S FRICTION PROOFING

Add a pint of Wynn's Friction Proofing for Auto Engine to your car's crankcase and rid your engine of hot weather sludge, gum and carbon. Frees sticking valves and rings . . . adds new pep and power.



Avoid summer-time vapor lock by adding Wynn's Friction Proofing for Upper Cylinder to every tankful of gas. Friction Proofing* decreases top ring wear and prevents sticking valves . . . increases compression.

Wynn's Friction Proofing for Automatic Transmission stops rough shifting in all automatic transmissions. Conditions and protects the plastic seals in automatic transmissions . . . prevents leaks caused by drying or shrinking of seals. Avoid costly transmission repairs with Wynn's Friction Proofing.



Also available in Canada and everywhere in the free world.

*Friction Proofing is Wynn's trademark for its exclusive metal conditioner which reduces friction between moving metals by chemically smoothing and sealing the surfaces. Manufactured by Wynn Oil Company, 1151 W. Fifth St., Azusa, California, U.S.A.

What You Can Learn on an Economy Run

(Continued from page 102)

This was the difference between the expert and the novice. Despite bad weather, we had broken the 30-miles-per-gallon figure, proving that by careful driving the average motorist can get excellent economy.

DAY FIVE: Austin to Monterrey, Mexico, 382.0 miles.

On this final day, we decided to cheat! The rules under which the official test car operated (with NASCAR sanction) stated that it could not coast in neutral. Not bound by such rules ourselves, we decided to see if coasting would help.

We accelerated quickly up to 65 miles per hour, shifted into neutral and coasted down to 45 miles per hour. Then back up to 65 for another coast down to 45 again. We took advantage of hills where possible.

We timed the periods we were under power and found that we rarely had the power on more than half the time. Often we were under power only a third of the time.

For the whole day, we averaged 42.8 miles per hour (the test car, which was driving steadily in its turtle-beating-the-hare fashion, averaged 38.9 miles per hour). Our gasoline mileage was 30.0 miles per gallon (the test car's was 33.57 miles per gallon).

The weather was hot, being 95 degrees in Mexico. This helped, but working against us (especially against our coasting technique) was a brisk headwind.

We drove this last day without regard for careful throttle action. We accelerated quickly and then coasted. We probably would have increased our economy if we had accelerated to 65 more carefully. We averaged almost four miles per hour more than the test car yet came within 3.5 miles of their economy figure. This was certainly proof that the hurry-up-and-coast technique is economical.

WHAT DID WE LEARN? Here are some principles we learned on the five- day test:

● Driving fast costs money and may not save much time. By driving fast steadily, you may be ahead if your time is worth money (as it would be if you were anxious to get somewhere on a vacation, for example). Time saved may be more valuable to you than the gasoline. If you're on a sightseeing trip, time costs nothing and you would be ahead to drive more slowly. Fast driving often makes you more tired. This

(Continued to page 230)



**MENDS
MOST ANYTHING**

"HOLDS LIKE IRON"

Used by fine furniture makers. Ideal for home and office. In 3/4 oz. or 2 1/2 oz. sizes.

**CUT EXACT CIRCLES
CURVED PATTERNS**

"ARCO JIG-SAW"

With Circle-Cutter (up to 20" dia.) & Rip Gage (fits any 1/4" drill). Has speed of \$55 saws. Cuts 2x4's, plywood, metals, etc. Incl. blade. At your dealer or try it on our 10-day trial. Send check, M.O. (ppd.) C.O.D. + post. **ARROW METAL PRODUCTS CO., Dept. PM-8, 421 W. 203 St., N.Y. 34, N.Y.**



FOR BETTER REFINISHING JOBS USE



Klean-Strip

PAINT REMOVER

- Non-inflammable
- Removes any finish
- Fast • Non-messy
- Needs no neutralizing

"Peels Off Paint"



ELECTRIC WELDER AC or DC 110 Volts

The "Little Marvel" all-metal welder, 5-year written guarantee. Welds 1/4" metal or money back. Repairs tanks, tools, fenders, machine parts, etc. Complete with everything—rods, unit, eye shield, directions. \$7.95

plus 50c postage. Flame torch accessory for soldering, cutting, brazing \$3.95 complete with carbons, brass rods, flux. \$2.00 Deposit on C.O.D. 75 amperes 1/4 inch Transformer Welder \$24.95 F.O.B.

ESSAY MFG. CO., Dept. 51, Quincy 69, Mass.

\$7.95 Complete



Get New 132 Page Catalog of WOOD AND WOODWORKING MATERIALS

WORLD'S LARGEST SELECTION—Lowest Prices
Your buying guide for finest air-dried domestic and rare imported woods, inlays, bendings, matched plywood, moldings, ornaments, etc. Suggest selection of tools and hard-to-find hardware. Packed with scroll saw patterns, projects, wood facts and money-making ideas. Enclose 25c (refunded on first order) to help pay mailing and handling costs. Write today to **CRAFTSMAN WOOD SERVICE CO.**

2729 S. Mary St., Dept. A-R, Chicago 8, Ill.

**Sharpen ALL CIRCULAR SAWS
THE QUICK-WAY** • patented

Model PG-12 Complete No extras to buy. **\$19.95** Postage Paid



Sharpens, joints, guns and retools all cross-cut, rip, standard and master combinations, miter, planer and radial saw blades to 12" diameter. Precision sharpening guaranteed by special Index Dials. New safety guide prevents tilting or gouging. Mounting block and special \$3.00 grinding wheel furnished. Fits bench, table and radial swing saws.

Thousands of satisfied users. Featured in leading publications. Order today. Send check, cash or money order. We pay postage in U.S.A. Free Booklet "How to Sharpen Circular Saws."

QUICK-WAY SAW CO.
136 Tompkins Street Cortland, N.Y.

Nicholson Tool Quiz

How many of these screwdrivers do you know?



Answers: 1. Offset. 2. Automatic return. 3. Jeweler's screwdriver.

The well-equipped shop has an assortment of screwdrivers for every job. And the well-informed craftsman keeps the business ends of his screwdrivers square and free of burrs with Nicholson or Black Diamond files. A ragged, rounded screwdriver bit chews up the heads on your screws, has a tendency to slip and damage your project. Take time out—touch up your screwdrivers with a Nicholson or Black Diamond file. And don't forget... we make a file for every sharpening or smoothing job in your shop.

FREE! "File Philosophy"—big new edition. 61 photo-packed pages on use and care of files. Send for your copy soon.



NICHOLSON FILE COMPANY
Providence, R.I.



(In Canada: Nicholson File Company of Canada Ltd., Port Hope, Ontario)

NICHOLSON FILES
A FILE FOR EVERY PURPOSE

Holt's HAVE THE ANSWER!

HOLT'S ORIGINAL
Piston Seal

it's Easy

\$4.95 Tube for most cars



does help in
6
 important ways

- 1 - reduces oil consumption
- 2 - restores compression
- 3 - stops piston slap
- 4 - increases miles per gallon
- 5 - improves performance
- 6 - makes engine quieter

20 years on the market. No one else can claim this. Effective interim treatment for worn cylinders. Forms self-lubricating seal around pistons. Lasts for thousands of miles. Get yours NOW. Delay is costly.

Send Check or Money Order.
 Mailed promptly, POSTPAID. Or...

TREGLOWN CO., Inc.

Fanwood 137, N. J.

® TRADE MARK REGD.

Write for full details

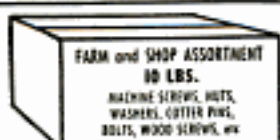

FARM and SHOP ASSORTMENT
 10 LBS.

MACHINE SCREWS, NUTS,
 WASHERS, CUTTER PINS,
 BOLTS, WOOD SCREWS, etc.

Asst. for the SHOP and FARM
 contains appr. 10 Lbs. of
 mixed hardware items.
 \$20.00 Value. Your Cost \$4.95



**HANDY ALL PLATED
 FIX-IT HARDWARE KITS**

Choice of 3 different assortments
 ... each packed in reusable clear
 plastic compartment box.

- Asst. (A) Various types of Wood
 Screws...over 400 pcs.
 (C) Machine Screws, Nuts,
 Washers...over 400 pcs.
 (D) Nails, Tacks, Brads
 ...over 1000 pcs.

Each asst. a \$5.00 Value. App.
 2¢ Each Asst. Your Cost \$1.95

Asst. Contains DELUXE Kit of
 Wood & Machine Screws, Nuts,
 Washers, Nails, Tacks, Brads,
 etc. Packed in large reusable
 plastic compartment box. \$7.50
 Value. App. 3¢. Your Cost \$2.95

Special: 24 pcs. 7" dia. Sanding
 Discs with 1/4" arbor hole.
 Package consists of 8 each 24-50
 and 80 grit discs. \$4.50 Value.
 Your Cost (24 Discs) \$1.95

SEND NO MONEY - PAY C.O.D. PLUS POSTAGE
 MONEY BACK GUARANTEE

MAELOR SALES CO., 1058 N. Damen Ave., Chicago 22, Ill.

**NEW MODEL 400 SIMPLEX
 LAWNMOWER SHARPENER**

Many Exclusive Features

The NEW SIMPLEX is the fastest, most accurate straight-line lawnmower grinder ever built... gives you all these advantages!

- Grinds all mowers—real type, rotary, hand or power, any size.
- No disassembly needed, gas and oil remain in engine, support bar returns.
- Grinding head feeds both horizontally and vertically, turns 90° for bed knives.
- Fast, positive adjustments, 4-point support on steel base with leveling screws.
- Rugged, long life construction and many other features.

Get the facts on the new SIMPLEX 400 before you buy any sharpener.

Send for free brochure today



Small investment returns big profits!

The Fete-Root-Mouth Company
 Dept. PM-8 • Plymouth, Ohio

usually leads to more frequent rest stops. These stops may cancel out the time you save by driving fast.

• Keep your throttle foot from being overactive. Accelerate gently. Plan your passing so you won't have to brake to keep from overrunning the car ahead when you cut back into line. Every time you apply the brakes you toss money out the window. On the entire run from Canada to Mexico, the brakes were rarely applied. Even in traffic, I found that I could drive without brakes if I planned my moves.

• Inflate your tires to the maximum pressure recommended (34 pounds in Rambler's case). On smooth highways you won't notice any difference in the ride and it will boost mileage about 0.6 mile per gallon.

• Coast where possible. There are some states, however, in which it is illegal to coast downhill with the transmission in neutral. This is a carryover from the days of inadequate brakes. It is doubtful if there is any need for such a law today except in mountainous terrain. Many automatic transmissions have free-wheeling characteristics in high anyway. The on-again-off-again coasting technique is a relaxing change and is fun for a while. It is an excellent way to overcome the hypnotic effects of turnpike driving. By installing a kickdown switch on the steering column you could eliminate the need to use the clutch and shift lever on overdrive-equipped cars. This technique, however, may annoy other motorists because of the irregular speeds.

• Obviously, you should have your car in good tune. But there is no economy in spending \$50 for an overhaul to save \$10 worth of gas. If your engine is in good shape, checking ignition timing, spark plugs and point setting should be enough. Be sure your car rolls freely.

• Don't buy premium gasoline unless your engine requires it to prevent knock. There are no extra miles per gallon in premium fuel if your engine doesn't need it—and it costs more.

• Finally, if you want real economy, buy a car designed for it. Order an economy rear axle and a lean carburetor metering rod. Don't overload your car or stack suitcases on a roof rack and hope for good mileage. It takes gasoline to overcome the air drag of roof loads. Last, drive carefully. One damaged fender can offset all the savings you may make on gasoline. ★ ★ ★

Ⓞ Don't drive with the windows closed if you use dry ice to cool your car on hot summer days. The evaporating carbon dioxide could asphyxiate you.

OUTDOOR KITCHEN



Written Step-by-Step For You!

Now you can have a beautiful outdoor kitchen to enjoy all summer long. Tom Riley, well-known building authority, tells and shows you how you can build your own outdoor fireplace, Chinese oven, barbecue pit or grill. There are complete building instructions included.

A Standard Piece of Equipment

Once the almost exclusive luxury of Western ranches, the outdoor barbecue now is a coast-to-coast American institution. Every year more families take to this pleasant and gracious way of outdoor dining and entertaining. Now with this book, you can join in with a minimum of expense and the utmost in results. Mr. Riley, an old hand around the barbecue ovens of Oregon, has prepared this complete book, in order that you may find the ideal outdoor fireplace for your particular back yard. He not only gives you many fireplaces from which to choose, but he also gives you money-saving short cuts in construction, hints on firing up and cooking and for extra good measure a collection of fire-tested recipes ranging from tasty frankfurters to filet of sole al fresco.

Special Section of 40 Tested Recipes!

Here are some secrets of successful barbecuing — the best fuels to use, ways to maintain proper draft, and hints on firing up and cooking that will enable you to capture the authentic barbecue flavor in the foods you serve to family and friends. So that your fare won't be confined to wieners and hamburgers, Tom Riley also tells you how to prepare and serve such barbecued delicacies as ribs, roasts, fowl, fish, special sauces, and various vegetables.



Use This Handy Order Coupon

POPULAR MECHANICS PRESS
200 E. Ontario St., Chicago 11, Illinois

Gentlemen:

Please send my copy of HOW TO BUILD AND USE YOUR OWN OUTDOOR KITCHEN, now. Enclosed is my remittance of \$2.00. If I am not completely satisfied with the book I will return it for a full refund after 7 days.

Name _____

Address _____

City _____ Zone _____ State _____

Send C.O.D. I will pay postman

No Experience or Special Tools Needed

Complete step-by-step building instructions with diagrams, photos and drawings make construction a cinch. There are designs for brick, field country stone, cement, concrete block and poured concrete, and many examples of each. With the know-how gained from this book, yours can be the most popular back yard in town and, besides you'll have lots of fun.

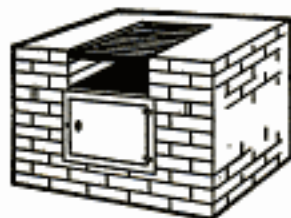

Partial Contents

Which Barbecue for you? Barbecue Fireplaces, Portable Grill, Masonry Grill, Barbecue Pits, Chinese Ovens, Infra Red Roasters, Combination Barbecues. Construction plans, Basic Fireplace Foundation, Barbecue Fireplace of poured concrete, stone construction, Firing Up! Types of Charcoal, Hardwood, Softwood, Compressed Sawdust, Cooking Temperature, Flame Tested Recipes, Charcoal Broiled Steaks, Barbecued Spareribs, special section of cooking methods employing various vegetables not usually associated with outdoor cooking, and much more.

7-Day Money Back Guarantee

Send for your copy of OUTDOOR KITCHEN, today. Read and use it for 7 days. If it isn't entirely satisfactory, return it for a full refund. We know once you have looked your copy over, and found the fireplace for your backyard, you won't part with this book under any conditions.

Can't read it?



next time,

say STANLEY!

It's not your eyes, it's those invisible markings. If you can't see 'em, you can't read 'em! Next time get a rule with markings you *can* read. Ask for a rule that lasts longer. Be precise . . . say Stanley, it's a *good* rule.



Take this Stanley 6 ft. No. 106. No comparable rule reads easier longer. It never shows early symptoms of "outside stick fadeout." The numbers are bold, black Gothic. The graduations are sharp, clear indentations. And all markings are protected with a long-wearing plastic finish. The joints are smooth working, too, and they stay that way. They have been *permanently lubricated*. Don't get your eyes checked, get a new rule, and this time say Stanley when you buy.

Have you seen the new Stanley Glide-O-Matic? This smooth acting tape rule locks blade in place, marks work with metal scribes and retracts automatically. The best in tape rules. 8, 10 and 12 ft. lengths. Try one yourself and see.



For free booklet "Measuring Tools and How To Use Them" write Stanley Tools, Division of The Stanley Works, 628 Elm Street, New Britain, Conn.

STANLEY

The Tool Box of the World



IT'S FUN
TO GET
THINGS
DONE

WITH A



FLAT SANDER

Sands Rust
Off Metal

Oscillating orbital motion produces a fine finish on all woods, metals, and fibres where hand sanding is usually employed. Better built by SIOUX, the tools the professionals use. \$49.95



write today for Free Catalog.



ALBERTSON & CO., INC.
SIOUX CITY, IOWA, U.S.A.

SANDS
WOOD
SATIN
SMOOTH



GRAVELY

New **EASE** for
Country Living!

NOW! 30 Tools

GRAVELY Gets It Done Faster! . . . Better!

New Steering Sulky, with Rotary Mower Attachment, provides the easiest, most efficient mowing ever!

With Gravely, you fit your jobs perfectly with a choice of 30 performance-proved attachments . . . Do every lawn and garden job better, faster, easier!

All-gear drive, power reverse, optional electric starter. Nation-wide sales and service . . . Easy Payment Plan.

Write today for FREE 24-page
"Power vs Drudgery" Booklet.

GRAVELY TRACTORS, INC.

BOX 863 DUNBAR, W. VA.

FIELD-TESTED SINCE 1922

The Saga of the DC-3

(Continued from page 70)

The reason is partly its stubborn sturdiness. "You can wreck one," said a pilot, "but you can't wear it out." Yet the reason is also economic. Most of the Threes now in use were picked up as surplus, for a few thousand dollars, and have been written off the books as fully depreciated. Replacements are expensive. The average operator isn't going to spend big money on new ships and sweep his DC-3s out of their hangars so long as he can keep 'em flying.

Meanwhile, Douglas has compiled some interesting statistics on them. They've flown, as nearly as can be estimated, about 87 billion passenger miles and some 75 million hours. They've carried 400 million commercial passengers, or approximately the population of India. These figures do not include military operations. And DC-3s still comprise about 35 percent of the world's air-transport fleet and do all types of other jobs, from radar-testing to pest-control forest-spraying.

Typical Old-Timer

Recently Douglas checked up on a typical old-timer among the gooney birds, belonging to a midwestern feeder line. It found the plane had piled up more than 50,000 hours and 7½ million miles. This becomes all the more remarkable when one considers that an automobile which has traveled 150,000 miles is looked upon as a mechanical Methuselah.

When will the DC-3 finally disappear? Experts at Douglas and fliers generally, having predicted before and felt foolish afterward, are no longer willing to make a prediction, except possibly this one: The DC-3, they say, probably will still be aloft long after many of the pilots and passengers now flying in it are dead and gone.

Already it has spanned almost half the history of flight itself. And this fact alone occasions a nostalgic feeling among most fliers and many passengers—a feeling that is illustrated by a recent occurrence.

A military DC-3 landed at a Chicago airport and taxied to its parking place. The pilot flipped off his switches. Then, instead of climbing out of his seat, he just sat, staring dreamily out a side window.

"Well," said the co-pilot, "are we going to get out of the airplane or aren't we?"

The pilot didn't answer. Instead he pointed to a nearby fence.

"See that spot?" he said. "That's where I saw my first DC-3. I was just a kid then, and did that plane look big. Well, here I am flying one. I feel as though I've lived a whole lifetime since that day." ★ ★ ★



Steel Tire Mask Is Blowout Guard

Constructed of $\frac{5}{16}$ -inch boiler plate, the tire mask in the photograph above is designed to protect aircraft-maintenance workers at the Miramar, Calif., Naval Air Station in the event of a blowout while inflating a tire. It's equipped with two coaster wheels and has two slits through which an air hose may be passed.

Nitrogen Helps Christmas Trees

University of Washington scientists report that applying nitrogen fertilizer to young Douglas fir trees doubles their size, speeds their growth and improves their appearance for the Christmas market.

Machine Sells Inflated Balloons

Balloons filled with air or gas and tied with a string now are dispensed by vending machines. The size of the inflated balloons can be adjusted through a gas meter in the mechanism. The vending machine makes the balloons available 24 hours a day for parties and advertising promotions.



How to get beautiful finishes for your wood or plywood projects

Painted, stained, or "natural," a good wood finish depends on how uniformly the hard and soft portions have been sealed. Firzite® controls "wild grain," prepares the surface for any type of finish.



WELDWOOD SEA SWIRL® wall paneling "pickled" with White Firzite.

NATURAL EFFECTS. To retain the natural beauty, color, and grain contrasts of all wood, use clear-as-crystal, non-yellowing Satinlac®. Easy to brush or spray on, Satinlac is its own best sealer, requires no undercoat, protects the wood thoroughly without the built-up look of conventional finishes. Quick drying.

BLOND OR PICKLED EFFECTS. White Firzite is specially adapted for Blond and Pickled effects on all woods. Easy-to-apply White Firzite wipes clean, produces clear "woody" effects without a "painty" look.

STAINED EFFECTS. For the deep, rich tones of professional looking staining, use colors-in-oil mixed with Clear or White Firzite. On softwoods, however, use Clear Firzite as a pre-sealer prior to staining. An ideal sealer, Clear Firzite assures even absorption of stain, prevents garish wild grain.

FINISHING OFF exposed lumber and plywood edges. New Weldwood Flexible Wood-Trim® is real wood veneer in handy 8' rolls. Use Weldwood Presto-Set Glue on Wood-Trim and press in position. Trim with a razor blade, sand and finish along with the rest of the job. Available in 6 woods for virtually any woodworking project.



WOOD FINISHES

by **WELDWOOD®**

Products of United States Plywood Corporation
On sale at hardware and lumber dealers



P & C SCREWDRIVER

Sure Grip... Fast Work

Fluted plastic handle fits your hand. Polished alloy steel bit gives extra long service. U.L. Approved handle. Get a professional job every time with P&C tools—"best tools money can buy."

Look for this complete P&C tool display at your favorite store.



TOOL COMPANY

Portland, Oregon and Schiller Park, Ill.
Subsidiary of Pendleton Tool Industries, Inc.

INVISIBLE GLOVE

ENDS PAINT-STAINED HANDS

Before you paint or start a dirty job in the house, garden or garage, rub Du Pont PRO-TEK hand cream on your hands and arms. It keeps sticky stains away from your skin . . . then washes off quickly, taking the grime with it. Get Du Pont PRO-TEK at drug, hardware, paint and auto supply stores.

Du Pont PRO-TEK

DUPONT Better Things for Better Living
... through Chemistry



How You Can Spot the Satellite

(Continued from page 76)

the satellite's faint glow will fly across the field of view of many moon-watch stations, to give members a dress rehearsal. To achieve such essential cooperative effort, teams must be registered and located according to prearranged plan.

What are the chances of a qualified amateur to join a team?

At last count before press time, 68 moon-watch stations had been set up. Others are being organized. A total of about 100 teams will probably be operating by the time Vanguard I soars skyward. Southern California, Arizona, New Mexico and Texas need observers most.

How does one go about signing up for a place on a moon-watch team?

An inquiry to the member of the moon watch National Advisory Committee who is nearest you is all it takes. A list of names and addresses of these committee members appears below. Don't expect an answer to anything but a specific inquiry regarding the satellite-observing program. ★ ★ ★

NATIONAL ADVISORY COMMITTEE

G. R. Wright, Chairman, 202 Piping Rock Dr., Silver Spring, Md.

Thomas A. Cragg, 246 West Beach Ave., Inglewood 3, Calif.

Walter A. Haas, 1203 N. Alameda Blvd., Las Cruces, N. Mex.

Edward A. Halbach, 2971 S. 52nd St., Milwaukee 14, Wis.

Rolland R. LaPelle, R. D. No. 3, Meadville, Pa.

Charles H. LeRoy, 621 Saxonburg Rd., Pittsburgh 38, Pa.

Russell C. Maag, 904 S. Ohio, Sedalia, Mo.

Mrs. Margaret W. Mayall, 4 Brattle St., Cambridge 38, Mass.

Miss Grace C. Scholz, 410 Mason Hall Apts., Alexandria, Va.

Steadman Thompson, 1284 Edgehill Rd., Columbus 8, Ohio.

Clyde Tombaugh, 626 E. Alameda Blvd., Las Cruces, N. Mex.

Please address all visual observing applications to any individual member of the advisory committee.

Arctic-Antarctic Radio

For the first time, arctic-to-antarctic radio contact has taken place between two Navy hams, using amateur equipment and frequencies on the 20-meter band. One operator was on the USS *Eldorado* near the North Pole. The other radioman completed the hookup from Station KC4USA near the South Pole.

GIGANTIC SURPLUS SALE!

SUMMER SPECIAL FISH & WORM SHOCKER

Powerful hand drive AC generator. Clear ponds, creeks of coarse fish (illegal for game fish.) Very effective. Also drive fish worms out of ground. Most powerful made. New. Govt. cost \$11.50. **SALE, Ppd. \$3.89**

MIDGET & GOLF CAR MOTOR

Use for child's, golf, factory cars. Power-ful, expensive ball bearing 100 to 1 gear reduction motor. Runs on 6 or 12-v storage battery. Govt. cost \$282. **SALE, \$19.46 FOB**

SPECIAL BARGAINS

- Centrifugal Blower, with motor \$21.95 FOB
- Jumpie Hammock with canopy \$6.95 Ppd.
- AC Motor, geared reduction drive, \$4.61 Ppd.

ARMY POWER PLANTS

- Amazing buys. Fully guaranteed.
- 1000-w, 115v, 60-c, \$179.50 Ppd.
 - 2000-w, 115v, 60-c, \$269.95 Ppd.
 - 3000-w, 115v, 60-c, \$299.95 Ppd.
 - 5000-w, 115v, 60-c, \$497.50 Ppd.
 - G.E. Generator 3000-w, 115v, DC. Fine for portable tools, \$49.71 FOB.
- Many other plants, generators. Get catalog.

AIR COMPRESSORS, TANKS, PUMPS

- Stainless steel tank, 12"x24". Capacity 2100 cu. in. 400 psi. 1/2" pipe thread ports. Brand new. Cost Govt. over \$40. Shipping wt. 19 lbs. **SALE, \$16.95 Ppd.**
 - Compressor, 1 cyl. 2.80 cfm \$19.95 Ppd.
 - Compressor, 2 cyl. 10.4 cfm \$49.95 Ppd.
 - Gauges 60 to 300 psi (Specify) \$1.99 Ppd.
 - Pres. Regulator 0-250 psi... \$3.29 Ppd.
 - Air Kit, complete... \$39.49 Ppd.
 - 2 1/2" Centrifugal Pump... \$39.95 Ppd.
 - 1 1/2" Centrifugal Pump... \$24.61 Ppd.
- Also guns, hose, fittings, switches. Get catalog.

ORDER FROM AD or write for big new FREE CATALOG 1000s items at tremendous savings. FOB except where shown Ppd.

BURDEN SALES COMPANY
BIO "D" ST., LINCOLN, NEBRASKA

SAW SHARPENING IS EASY

Super Filer No. 11 joints and sharpens hand and circular saws 6" to 10" with all teeth correct in height, depth, pitch, bevel. When file hits filed roller, teeth are finished. Saw runs true with no side pull. Includes B" file. **\$9.95 PPD.**

DOWEL CENTERS

Centers inscribe exact location for opposite holes. Pairs for 1/4", 3/8", 1/2" holes. **\$1.00 Ppd.**

"TRU-CIRCLE" saw set automatically sets teeth at 10° or more. **\$2.95 Ppd.**

SUPER SAW FILER No. 6

Automatically controls depth, angle, pitch for all saws. Precision made and calibrated. Use in vise or clamp. Includes file... **\$6.50 Ppd.**

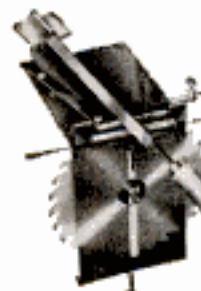

MONEY BACK GUARANTEE CATALOG FREE

A. D. McBURNEY, 5908 Hollywood Blvd., Hollywood 28, Cal., Dept. A-87

3 CU. FT. MIXER 3975 DIRECT FROM MFR.

Fills long felt need for small mixer for concrete, feed, fertilizer, seed and many other materials. Saves 1/2 cost of ready mixed concrete. Pays for itself on first job.

- 3 Cu. Ft. Drum—Mixes 2 Cu. Ft. Concrete \$33.75
- 5 Cu. Ft. Drum—Mixes 3 Cu. Ft. Concrete \$33.50

FOB Pulaski, N. Y. Cash, Check or M. O. Money back guaranteed. **UNITED STATES FORGE AND FOUNDRY CO.** CONSTRUCTION EQUIPMENT DIV. PULASKI, NEW YORK



\$1,000.00 MONTHLY FROM SMALL CLASSIFIED AD

THINK OF IT! A classified advertiser in Popular Mechanics takes a thousand dollars monthly from his mail box. You should read this amazing letter. I'll send it to you free. Write, F. W. Johnson, Class. Adv., Mgr., Popular Mechanics Magazine, Room 603, 200 E. Ontario, Chicago 11, Illinois.



In 10 years I have Given **\$495,000** to puzzle fans

Now I'm ready to pay out another \$60,000 Contest Cash to 600 other lucky puzzlers. Here's an honest-to-goodness chance to win up to \$20,000 in an exciting, enjoyable "battle of wits" different from any other puzzle contest you ever saw. It's "tops" in fun and entertainment. No 25-word essay to write... no big dictionaries to toil over... no weird pictures to trip you up. Everything needed to win a top award is supplied.

In 35 years, two million puzzle lovers have entered Gemeroy contests. In 1956, G. F. Gemeroy was nominated by a BIG Metropolitan newspaper as "World's Contest King." Thousands of puzzlers year after year, have never missed a single Gemeroy-Managed contest. If you have not had the thrill of winning a Huge Money Award, my newly devised scrabble-type puzzle is made to order for you. Mrs. G. J. Young, Long Beach, top winner in my Olympic Games contest, has just received my check for \$38,000. Among other Gemeroy Major Winners were Mrs. C. Johnson, Houston, (\$25,000), Earl Hummel, Elmhurst, N. Y., (\$21,500) and Rev. M. S. Hoffman, Abilene, Tex., (\$18,500).

SEND NO MONEY. Don't hesitate to ask for information—there's no obligation to go ahead unless you want to, after receiving my letter. If you're "yearning" to increase your "earning" power right in your own home, send postcard or letter for details about this stimulating New puzzle game. **First Prize Cannot Be Less Than \$3,000.00 and If Lucky, Your Grand Award Can Be \$20,000.00.**

G. F. GEMEROY
Suite 302, 814 Second Ave.
SEATTLE WASH.

RETAIL PRICE \$125.00 FACTORY TO YOU \$79.95

SUPERSHOP includes precision-built 8" tilting table saw, vertical and horizontal drill press, 30" lathe, sander, grinder. 100% BALL BEARING. Write for FREE catalog, full details, trial plan. Easy Pay Plan. **POWER TOOLS, INC.** 108 YATES AVENUE BELOIT, WIS.



arc welding pays BIG make more money with these easy to use arc welders

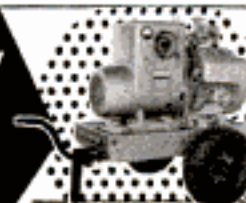

Build Your Own

Save \$200 to \$300. Lets you go after the highly profitable welding jobs. Easy portable and light weight. Welds anywhere and ready on a moment's notice. Write for Build Your Own type or details on the air cooled welder power combination for running tools, lights, motors, etc.

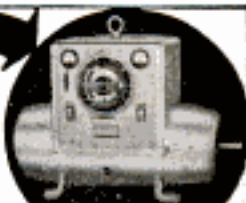

Light Weight AC Welder/AC Power

Hobart Bros. Co., Box M-87, Troy, Ohio, Phone FE-21223

Belted Type



Pilot Rides Platform Atop French VTO

Riding on an open-air platform on the top, a pilot demonstrates the vertical take-off of the French Atar Volant P-2 near Paris. The wingless and tailless VTO craft has an aluminum body and jet engine. It is maneuvered by changing position of the propulsive jet.



Carrier Corp., Syracuse 1, New York

Las Vegas Drive-in Air Conditions Cars

Air-conditioning "boots" are inserted through the window of each car stopping at the Blue Onion drive-in restaurant in Las Vegas, Nev. Each of 30 outlets comes from a central air-conditioning system in the building. The units have hand-operated volume dampers and directional vanes.

Floating Rice Harvester Operates in Canadian Swamp

Wild rice is gathered with a homemade floating rice harvester on one of central Canada's swamplike lakes. Z. Durand of Winnipeg built the outfit which consists of

long slender scoops attached to a bar across a small boat propelled by an outboard motor. Gently vibrating rods shake ripe kernels from the plants into the scoops.



MODERN

LAWN MOWER SHARPENER

Now sharpen all mowers, hand or power, reel or rotary, any size. The Original Straight Line Sharpener, copied by many but still ahead on exclusive features. Simple, accurate adjustments. Sharpens vertically or horizontally. Sharpens all bed knives. Gasoline engines remain on mower, no draining of gas or oil. Rugged 100% steel construction. Get the facts — compare before you buy. Send for free brochure # 10.



MODERN MFG. CO.
160 N. Fair Oaks
Pasadena, Calif.

BE SURE AND SPECIFY



Southern

SCREWS & BOLTS

The Quality Fastener that adds to the beauty and permanence of your projects — yet costs no more than conventional fasteners. At all good hardware and building supply dealers!

ANY SEASON . . . ANY ROAD
A HULL AUTO COMPASS
Repeatedly Earns Your Gratitude
by Eliminating

- Confusion • Wrong Turns • Lost Bearings

Beaconlite \$6.50 Streamline \$4.95
ILLUMINATED NON-ILLUMINATED



HULL MANUFACTURING CO., P. O. Box 246-D-8, Warren, Ohio

GOLF CARS
Also Ideal
for Airports,
Estates,
Factories, etc.
Write for
literature.

ESHELMAN TRACTORS

LOW AS \$99

Plows-Cultivates-Saws
Dozer-Harrows-Rolls
Hauls-Snow Plow

Eshelman Tractors,
Tillers, Riding Rotors,
Mowers for Better
Lawns and Gardens.
Advertised in GOOD
HOUSEKEEPING. Thousands of
satisfied users.
Write for Free Literature.
Dept. 225, ESHELMAN, Balto., Md. \$549.75



Shipping Points: BALTIMORE • CHICAGO • KANSAS CITY • RENO



NEW ADJUSTABLE STOP FOR POWER SAWS

Mounts on miter gauge extension rail—or back rail of radial saw—in grooves made on your own rail—cut with your own saw. No rails to buy. Renew anytime—to lengths of your choice. Works either side of blade. Need never be removed. Arm flips back for intermediate cutting without disturbing setting. Has fine adjustment screw insuring accuracy . . . Promotes safety. (Patented) POSTPAID. No COD'S.

\$3.25

THREADED EXTENSIONS DOUBLE USE OF GRINDER

Threaded extensions. Add buffers — wire wheels — polishers, etc. LEAVE YOUR EMERY WHEELS IN PLACE. For 1/2 inch — 20 thread shafts only. Measure carefully. State right or left side.

\$1.50 apiece. \$2.75 a pair POSTPAID. No COD'S
TEN DAY TRIAL MONEY BACK
GUARANTEE. Free brochure



RW Anderson Co.
1110 W. 68th Street, Los Angeles 44, Calif.



Thread That Pipe Extra Easy

with these handy

RIDDID

Drop-Head Dies

Save time and muscle on your do-it-yourself homework . . . size die head you want (1/8" to 2") snaps into ratchet drive ring from either side, can't fall out. Cuts clean accurate threads for years.

Ask for No. OOR, 1/8" to 1"—or other sizes to 2". Bolt die heads, 1/4" to 1", fit OOR ratchet handle.

Ask for it at your Hardware Store!

Famous RIDDID Pipe Wrench also gives you most service for your money!



The Ridge Tool Company, Elyria, Ohio, U. S. A.

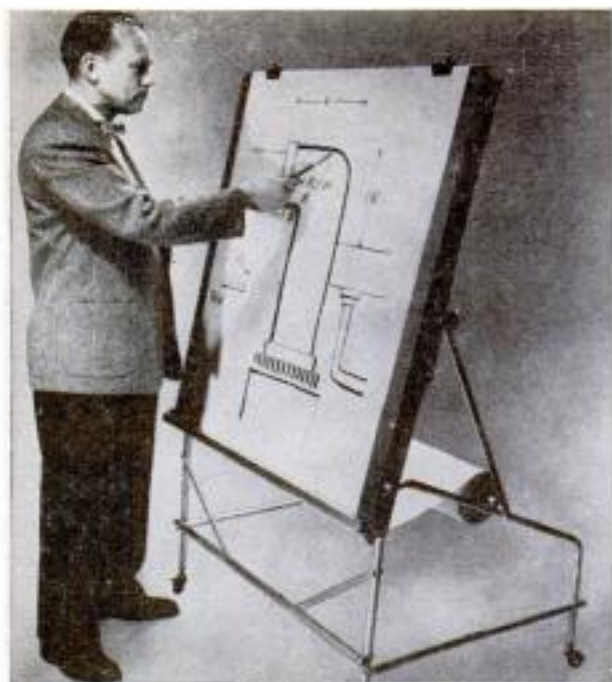

Educators Furniture & Supply Co., Inc.,
5912 K St., Sacramento, Calif.

Easel on Wheels Doubles as Table

Working surface of 1760 square inches is provided by this easel designed for teachers, artists or lecturers. The wheels can be locked and the top can be adjusted for use as a table or as a "blackboard." It holds a roll of paper 36 inches wide.



Umbrella Keeps Photo Gear Dry During Rainstorm

If you have to take pictures in the rain, you can protect photographic gear by mounting an umbrella over your outfit. One cameraman was able to do this so successfully that the umbrella kept his equipment dry, yet left both hands free for adjusting the camera controls.

Quality Electric Drills, Saws, Sanders!

Whether you're drilling holes, sawing 2 x 4's, or sanding down furniture ... you do it better with Black & Decker Tools. Each tool is built to last for years. For more information see your B&D dealer or write to: The Black & Decker Mfg. Co., Dept. M087, Towson 4, Maryland.



World's Largest Maker of Portable Electric Tools

KAY-TITE Special

MAKES BASEMENT WALLS DRY FOR ONLY 3 1/2¢ PER SQ. FT.!

Here's the most revolutionary boon to homeowners with damp, leaky walls! With KAY-TITE SPECIAL there is no need to pre-wet the surface or remove other finishes before applying. It controls water seepage on porous or non-porous surfaces. It can be brushed on walls of concrete, cinder block, brick, stucco, stone, etc. KAY-TITE SPECIAL transforms wet basements into dry, colorful rooms.

Masonry Coating Products, Inc.
790 Broad St., Dept. PM-8 / Newark, N.J.
Please ship immediately 10 lb. can of KAY-TITE SPECIAL @ \$5.00 (makes 1 gallon), postage prepaid. No C.O.D.'s. Check color desired:

Cream Spanish Buff (terracotta) Brick Red Rose Grey White

Blue Yellow Buff (tan) Light Green

Name

Address

City & State

NEW REVOLUTIONARY NEW



A Build-It-Yourself PLYWOOD CRUISER Designed Especially for PM Readers

Construct this beautiful 17-foot cabin cruiser yourself in your spare time. It's exceptionally easy to build even with little or no experience! Has cruising accommodations for two, including two full berths, complete kitchen and toilet facilities and a fast bottom for single or twin-motor installation.

Beautifully designed—roomy open cockpit, hatch in forward deck, and with two aboard it makes 26 m.p.h. with a 35-hp. motor. As a cruiser, runabout or utility boat, it will give you many hours of wonderful outdoor enjoyment for a minimum investment of time and money. Complete, fully detailed plans only \$10.00. Order below today!

POPULAR MECHANICS PRESS, Dept. 857
200 E. Ontario St., Chicago 11, Ill.

Send me complete set of seven large-size blueprints for "SEA KNIGHT" cruiser, including plans for easy-to-make boat trailer.

- I enclose \$10.00 check or money order
 Send C.O.D. (U.S.A. only)

Name

Address

City Zone State

WAR SURPLUS AND OTHER **SAVINGS** **SAVE UP TO 90%**



P1 ARC WELDER KIT \$27.95. Build your own complete make-up package consisting of 1 Aircraft DC Generator, famous mfrs. 200 to 250 Amperes, 24 Volt. RPM from 2600 up. 1 Rheostat. 1 Giant Toggle Switch. 1 Ammeter, 1 Shunt, 0 to 240 Amps. 1 Voltmeter, 0 to 30 Volts. 1 Electrode Holder. 1 Welder's Shield. 1 Voltage Regulator. Wiring diagram for hookup as welder. Wt. under 100 lbs. Approx. GOVT. COST \$475. Like new, perfect . . . \$27.95.

Complete Kit shown above less generator — \$18.75
All generators sold are pre-tested prior to shipment.

BENDIX PUMP & MOTOR

Can be used for pumping fuel, oil or where-ever hydraulic pressure is required. Pump has 1" connections, built-in relief valve, adjustable up to 1500 lbs. Max. capacity 6 GPM. 1 1/2 H.P., 24 volt motor, 4000 RPM. Can be used on 12 to 36 volts. Approx. GOVT. COST \$350. NEW — \$10.95.



140-1 REDUCTION GEAR Make your own winches, hoists, wagon unloaders, slump pullers or fence stretcher. Sturdy aircraft quality. Built-in removable 24 Volt DC motor & clutch. High torque. Low speed. 100's of uses. Wt. 42 lbs. Approx. GOVT. COST \$300. Like NEW. \$12.00
#225-1 Reduction Gear, same as above — \$13.50.



MICROMETERS Chrome plated, precision engineered, carefully tooled to give long life. All new 0-1" cap. \$2.50 ea. 1-2" cap. \$3.75.



DOUBLE ACTION HYDRAULIC CYLINDER
Will lift 7000 lbs. with 1000 P.S.I. line pressure. Can go to 3000 P.S.I. Micro-honed & all stainless steel 1 1/2" dia. piston rod. Stainless steel shaft. Flanged construction. Clevis mounting. 4" bore, 22 1/2" stroke, overall length 45". Shaft dia. 1 1/2". Weighs 14 lbs. Approx. GOVT. COST \$475. NEW. \$27.95.

FAMOUS B-16 KOLLSMAN AIRCRAFT COMPASS

Finest compass ever made. In current use on large and small planes. Ideal for boats, cars, trucks, etc. Graduated in 5° increments. Liquid filled, lighted, poly-plane compensator. Panel mounting 3 1/2" dia. face, 4 1/2" in depth. Checked & tested in our own lab. Approx. GOVT. COST \$150. Like NEW. \$13.95 ppd.



DUPONT EXPLOSIVE RIVETS! A must for the man who works with sheet metal. A hot soldering iron placed on the head of the rivet will explode and mushroom the other end of the rivet self-bucking itself. 1/8" - 5/32" - 3/16", Round and flat heads. Approx. GOVT. COST \$50.00 & 1,000. NEW, 1,000 assorted, \$5.00 ppd.

NEW! BIG CATALOG

Send 25c for your copy. Postpaid prices in U.S.A. only. Other prices P.O.R., Culver City, Calif. Send check, cash or money order. 50% deposit required for C.O.D. orders.

AIRBORNE SALES CO., INC. DEPT. PM857
8501 Stellar Drive, Culver City, Calif.



BUILD YOUR OWN HI-FI SET! MAKE A TRANSISTOR RADIO!

THIS PM BOOK SHOWS YOU HOW to make almost any electronic device

192 pages of step-by-step instructions even the electronics beginner can follow. Tells all about:

- High Fidelity—what it is
- Specifications of component parts
- What to look for in equipment
- Simplified transistor experiments
- Radio-Television—How it works
- How to do radio servicing
- What is a schematic diagram
- All about electrons and protons in simple language
- How a vacuum tube works
- What are resistors and capacitors
- How to select Hi-Fi equipment
- How to wire and solder
- Short wave reception
- Home recording procedure
- Use of hand tools
- Types of antennas

Now, as a career or hobby, step into the amazing field of electronics without any previous knowledge or experience whatever. **Electronics Made Easy** trains you by doing . . . actually shows you how to build and operate many of the newest and most useful electronic devices at amazingly low cost. If you'd like a Hi-Fi set for your home, a transistor radio no bigger than your hand, a sensitive intercom, a wireless record player—you can build these and dozens of other projects, even if you've never fixed a door bell or lamp before. This book explains in simple language exactly how radio tubes work, how signals are transmitted and received, how to convert old radios into useful equipment, how to read diagrams . . . and many other interesting and informative ideas. Contains plans for dozens of valuable electronics and radio units, with picture and schematic diagrams so clear even the beginner can do perfect work. This book can start you on a highly profitable career—in another five years there will be a shortage of more than 500,000 electronics technicians in this country. Or it can introduce you to one of the most fascinating hobbies.

Order now, under \$2.95 post-money-back guarantee. Only . . . \$2.95 post-money-back guarantee. Only . . . \$2.95 post-money-back guarantee.

Popular Mechanics Press, Dept. 657
200 E. ONTARIO ST., CHICAGO 11, ILL.



1957 CATALOG BOAT KITS WOOD and FIBERGLAS

EASY TO BUILD - DESIGNED for professional results by the amateur. World's largest selection of top performance, latest design, prams, skiffs, racers, runabouts, sailing boats, cruisers, 8 to 20 ft. Mahogany decks, frames. FREE FREIGHT. SEND FOR FREE CATALOG

Boat Plans-Patterns-Frame Kits

Includes fiberglass paints, accessories

Build over 50 modern boats from large scale plans, available with FULL-SIZE patterns, new PRE-FAB frame kits! All types: prams to cruisers, 6 to 25 ft. Best buy for Amateurs! SEND 10c for CATALOG.



Fast cutting
Top quality



SWEDISH WOOD CHISELS

Woodworking projects have that little extra professional touch when Genesco Swedish Wood Chisels are used. They're tops: hand ground, razor sharp blades, Tenite II handles are unbreakable and fire resistant . . . won't pull loose, sizes from 1/4" to 2".



Set 300-4
1/4", 1/2", 3/4" and 1"

Buy these accurate cutting, easier to use Genesco Wood Chisels at all leading hardware stores today. Available in sets of 4, 6 or 11 chisels in vinyl coated canvas rolls.



Bushman ALL-PURPOSE 21" Bow Saw

GENESCO GENESCO TOOLS
A DIVISION OF
GENERAL STEEL WAREHOUSE CO., INC.
1832 N. Kostner Ave., Chicago 39, Illinois

You buy better when you buy brands advertised in **POPULAR MECHANICS** **PM TAG of INTEGRITY**

HAVE ELECTRICITY ANYWHERE!



PORTABLE GENERATOR

Take this lightweight 110 V, 60 cycle AC generator anywhere for full 750 watts of light and power. Small, compact, completely self-contained. Weighs only 49 lbs. 2 HP engine runs up to 3 hours on single tank-full. Rewind starter; built-in muffler. Mail coupon now.



for LIGHTS TV-RADIO CAMPING TRAILERS BOATS FARM EMERGENCY

DEALER INQUIRIES INVITED

Bendix Aviation, North Hollywood, Calif.
Send literature on your 750 W Generator.
Name _____
Address _____

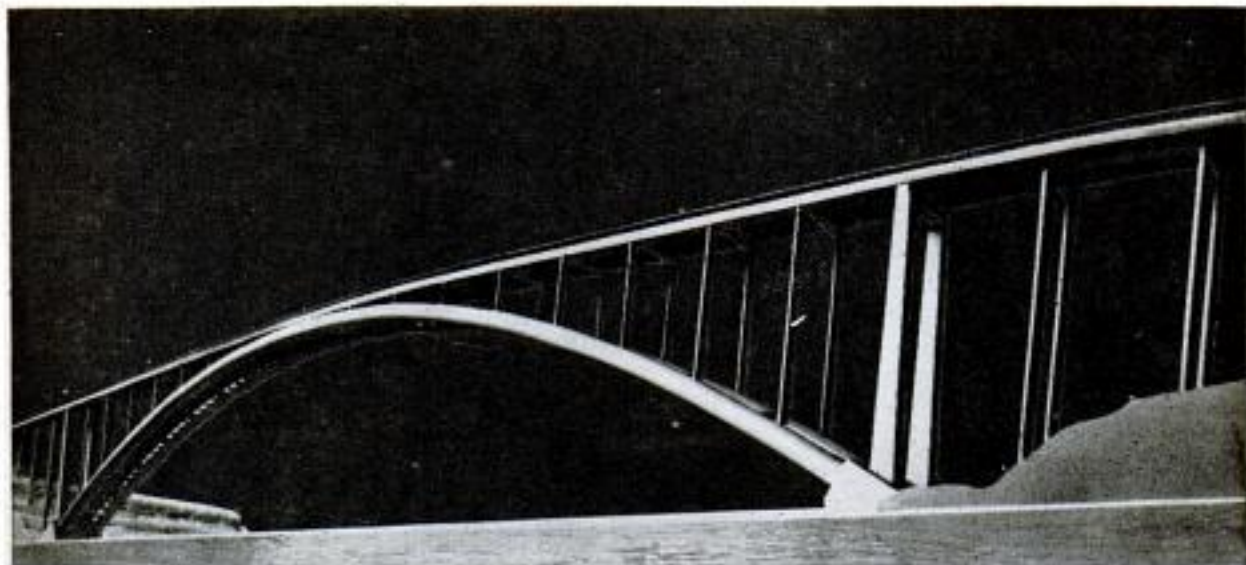

Steel Tubes Support Swedish Spans

IN THE AREA of the Skagerak, Sweden, wind gusts of 85 miles per hour are not unusual. This posed a special problem for the Swedish Royal Board of Management for Roads and Waterways when it planned a series of bridges to link the island of Tjorn with the mainland, north of Goteborg. The contract finally was awarded to a German engineering firm, which conducted wind-tunnel experiments that indicated the supporting structures of the main span should be steel tubes. The German engineers contended the cylindrical shape of the supports would offer the least wind resistance. The tubes will be anchored in rings set in concrete. The main span will be about 300 yards long and will arch approximately 120 feet above the surface of the fjord to permit the passage of ships moving to and from the harbor of Uddevalla.

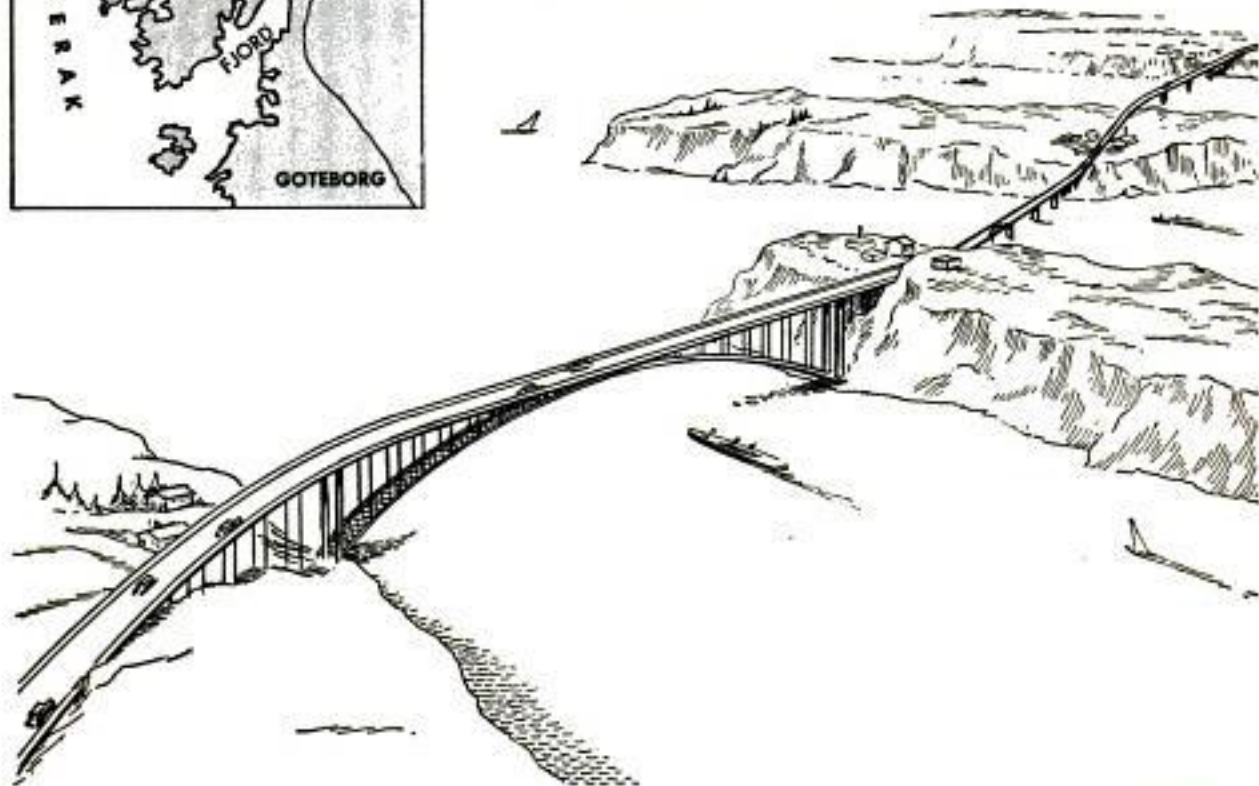
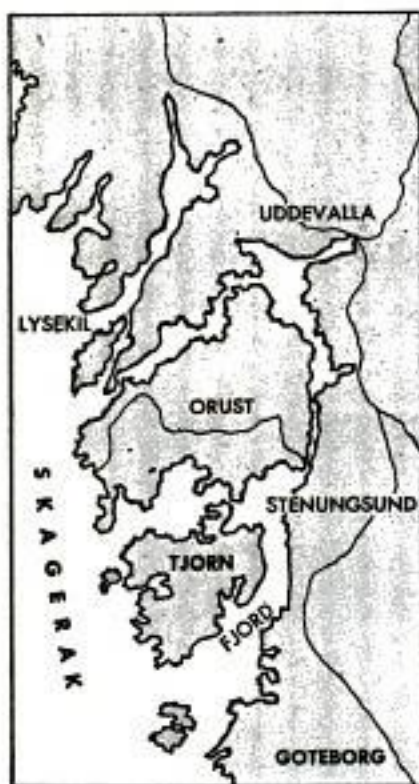

NEW!
SURPLUS

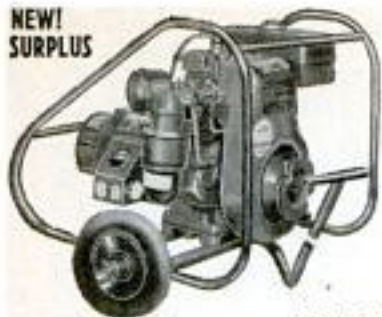

WISCONSIN 4-CYCLE Gas Engine Driven GENERATING PLANT

2500 WATT, 60 Cycle,
115 Volt, Single Phase

Only \$299.50
fob

GOV'T. COST \$500.00
FULL 1-YEAR GUARANTEE

Wheel Base Assembly
With Tow Bar—\$17.95 extra

PORTABLE!—fits easily in car trunk!
Protective carrying frame incl.

PAYS FOR ITSELF! Saves time, labor and money. Provides on-the-spot power for CONSTRUCTION, etc., where none is available or expensive to run in. Large enough for Floodlights; Saws; Pumps; and many more labor-saving heavy-duty machines. Ideal as a stand-by emergency power plant to duplicate house current. Plenty of power for lights, refrigerator, deep freezer, oil burner, radio, etc. Specifications below. CAN'T BE MATCHED anywhere at this price!

Remote Control Governor increases engine life by allowing engine to run at idle speed when load is removed from Generator.

GENERATOR 2500 Watts, 115 Volts, 17.3 Amps., 60 Cycle, single phase. Overload capacity well above its rated output. Excellent automatic voltage regulation plus Field Rheostat for even closer adjustment. Built-in Voltmeter and receptacles.

ENGINE Famous WISCONSIN 6.8 H.P. air cooled engine, 4-cycle. Weather proof high tension magneto with impulse coupling for quick easy starting in any weather. Mechanical Flyball governor. Adjustable carburetor with automatic choke release. Timken roller bearings — self cleaning.

Weights 155 lbs. Over-all dimensions: 29" long, 19" wide, 20" high
**SUPPLY LIMITED! IMMEDIATE DELIVERY! ORDER FROM AD
FREE WAR SURPLUS — WHOLESALE CATALOG**

ROBERTS ELECTRIC CO. Dept. PM-674, Phone TAYLOR 9-1365
849 W. Grand Ave., Chicago 22, Ill.

4-HR. DIVING LUNG



Send for Free
Literature
DEPT. PM-8

49.50

DIVING INDUSTRIES
813 LIBERTY AVE.
PITTSBURGH 22, PA.

HELPFUL BOOKS

Send post card asking for FREE catalog

Popular Mechanics Press, 200 E. Ontario, Dept. 601, Chicago 11



CUTTERS FOR SASH, DOORS,

kitchen cabinets, and formica. Saws, mortise chisels, planer, moulder and jointer knives, dovetail, countersink cutters, boring bits, vises, arbors, sanders. Two spindle dowel boring heads. Full line of woodworking equipment. New 100 page catalogue 107 ppd. 25c allowed on first order.

WOODWORKERS, Top Floor
222 S. Jefferson Street
Chicago 6, Illinois

Valuable new DeWalt® Manual shows

"Easy Ways to Expert Woodworking!"



Information-packed new woodworking manual shows how to get the most out of your Power Shop — how to do everything in woodworking, easily, safely, expertly! Chapter after chapter of the facts you need to know for home modernizing, hobby projects, with over 300 easy-to-follow illustrations. How to install and operate your Power Shop. Use of attachments. Special decorative cuts and shapes. Tricks of disk, belt, and drum sanding. Sharpen your own tools, make your own jigs, mix your own bleaches. How to choose woods, hardware, and finishes. Easy-to-use charts and formulas. And much more!

Just \$3.95! Send check or money order today!
DeWalt Inc., Dept. PM-708, Lancaster, Pa.

triple action...
all with one pump

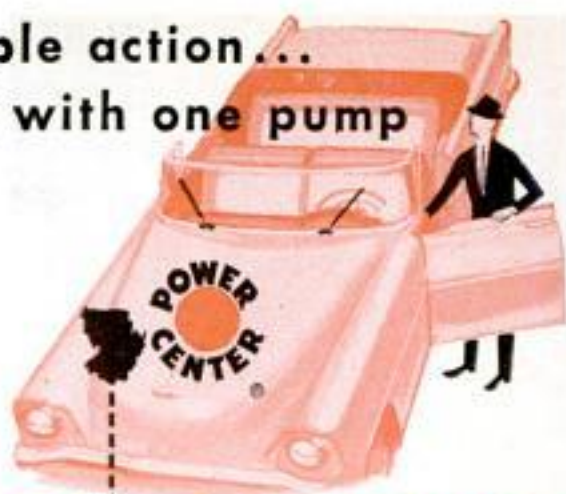

CARTER POWER CENTER



fuel and
vacuum
pump

Designed and built for America's most modern cars... the versatile Carter combination fuel pump! Here's triple duty... you get the high capacity of the famous Carter fuel pump... the amazing efficiency of the Carter Ceramic fuel filter... plus continuous vacuum for your windshield wipers! Installation is quick... and at a surprisingly low cost.

FOR COMPLETE
MODERN FUEL SYSTEMS
COUNT ON CARTER

Have your car serviced regularly wherever you see this sign... or look in the phone book yellow pages.



CARTER CARBURETOR
DIVISION OF QCF INDUSTRIES
INCORPORATED
ST. LOUIS 7, MISSOURI



Just pull the trigger...
spray paint!

The easier, better way to paint! Job's done in minutes. Finish is smooth, flawless. Speedy Sprayer is a real professional tool, favorite of craftsmen for over 35 years! At stores everywhere. 890 Outfit, including gun, hose, less motor, only \$39.95

Speedy Sprayer

Wheel it to the job!



FREE! "How to Spray" booklet and literature. Write!

WHEEL KIT \$7.50 EXTRA

W. R. BROWN CORP., 2635 N. Normandy, Chicago 35



NEW! 9.2 H.P. RIDING CRAWLER only \$895.00

OUTWORKS ANY TRACTOR ITS SIZE Ideal for clearing, grading, plowing, field or row crops, yard work. Big tractor ruggedness, quality. Anyone can operate. Borg-Warner 3-speed and reverse trans., cone clutch steering. Tractor with blade, floating drawbar, PTO, ppd. anywhere in U.S. 8805, Wt. 925 lbs. Guaranteed. Accessories available. At dealers or direct.

LAYTRAC
Power! Traction!

LAYTRAC, 25488 Airport Way, Seattle 4, Wa.

Put up shelves the easy way

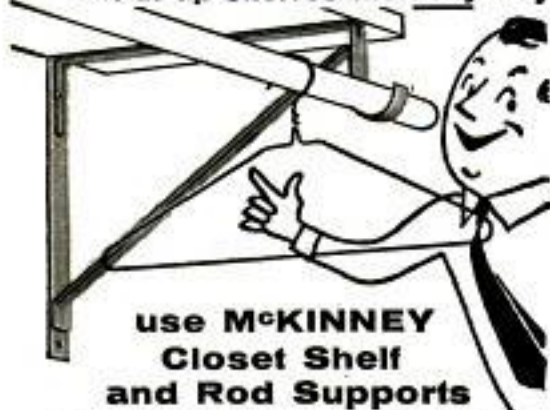

use MCKINNEY Closet Shelf and Rod Supports

These steel brackets support both closet shelf and rod. Eliminate hanging strip. A real time saver. Only \$1.15 each.

McKinney Manufacturing Company
1715 Liverpool Street, Pittsburgh 33, Penna.
Send literature on Closet Shelf and Rod Supports

Name _____
Address _____
City _____ Zone _____ State _____



Selleck WaterCycle Co., Boca Raton, Fla.

Water Cycle Built for Two Has Separate Paddle Wheels

Two independent paddle wheels operate this double water cycle. One rider can pedal forward while the other pedals backward to make the craft turn. According to the manufacturer, the water cycles are un-sinkable and require no balancing. They can operate in water only 10 inches deep. Runners beneath the pontoons protect the paddle wheels so the water cycle can be pulled onto a beach without damaging the mechanism. The water cycles are available either in kits for home assembly or as factory-finished craft.

Single Solution Develops, Stops and Fixes Film

One solution of photographic chemicals soon will develop, stop and fix film negatives and prints. This technique reduces commercial photographic processing to one tenth the time and one third the space normally required. Mixed as a dry powder, chemicals for the single solution can be stored indefinitely before being dumped into a single tray filled with water. With the new process, film can be put into the one bath and removed as a finished product in 90 seconds to three minutes. The process was recently described at a meeting of the American Chemical Society by Harry S. Keelan, research associate in Boston University's physical research laboratories.

Chemical-Element Prediction

Discovery of the next chemical element will probably be an atom at a time, according to Nobel Prize winner, Dr. Glenn T. Seaborg. The present 101 elements, both naturally in existence and artificially made, are the basic chemicals which in different combinations make up the earth and everything on and in it.

General SALE

BUILD WELDER OR LIGHT PLANT

Instruc. Incl. TYPES AMPS VOLTS PRICE
 G.E. 200 amps. 24V New \$17.50 Used \$12.95
 J. & Helms or G. E. R1 300 24 \$24.50
 G1, 150-200 amps, 80V, New \$15.50 used \$9.95

V-BELT PULLEY KIT. Fits R-1, P-1, G-1 or AC-DC Generators; has two bearing block plates, 4 bearings, triple groove V-pulley, Dr. shaft and flex. coupling \$17.50.

New G.E. #311 Generator

AC-DC WELDER KIT

Makes Ideal light plant & Battery Charger. Rated 1250 Watts, 115V. A.C. & 200 Amps. 30V D.C. Including: 1 Volt. regulator, 1 reverse c. relay, 1 Solenoid arc governor, 1 electrode holder, 1 toggle switch, 1 Helmet, 1 rheostat and instructions \$38.50. AC-DC generator if bought separate \$24.50.

Kit as above with H-1 J. & Helms or G.E. 300 amp. gen. \$38.50. Kit with 160-250 amp. gen. \$26.50. S. Kit with New G.E. 200 amp. Gen. \$34.50.

Reactor Coil Arc Stabilizer heavy duty for Kit, P-1, G-1 and AC-DC generators approx 7"x5"x4". Wt. 11 lbs. #RC700 \$10.95.

New Cooling Fan Assembly. 174 C.M.P. with motor 3/4 H.P. 20 amp 11,000 RPM. for 24-12-6 V. D.C. Fits all D.C. type welding gen. \$12.95

WATER PUMP WITH MOTOR

1 1/2 H.P. 2 1/2 V.
 D.C. runs on 6 or 12 V. D.C. Adj. press., 1" ports, 200 GPH \$12.95.
 400 GPH \$14.95. 700 GPH \$17.50.

BARGAIN HYDRAULIC MAKE UP KIT #507.
 Consists of 1 G.E. motor 24 V. D.C. .28 H.P. & hyd. pump 700 G.P.H. cap. 2 ea. hyd. D.A. cylinders 1 1/2" bore x 8" stroke; 1 ea. four way valve; 1 ea. pressure gauge 0-2000 P.S.I. dial; 1 ea. oil filter. 1 gal. hyd. fluid. \$27.50.

HYDRAULIC LIFT KIT New Weaver Hyd. Hand pump 2000 P.S.I. 20" handle with release valve, 1 D.A. cylinder 2"x2" stroke, 1 four way c. valve, 1 oil filter, tank, hose & fittings, 1 gal. fluid, c. value \$54.75. Complete \$32.50.

GEAR REDUCTION MOTOR BARGAIN
 #211 ratio, reversible 10: to 200 RPM, runs on 6- or 12V D.C. & Appl. for 110V/A.C. \$4.65. 2 for \$8.95.

(7) HYDRAULIC PUMP BARGAINS 1500 P.S.I.

MFG.	TYPE	R.P.M.	G.P.H.	Price
Pesco	Gear	1500	198	\$12.95
Pesco	Gear	4300	300	\$14.50
7	Pesco Gear	447 cu. in.	270	\$15.50

*Stratopower 450 cu. in. 3750 400 \$17.50
 * with built in pressure control & reversible
 Vickers .507 cu. in. rev. 3750 500 \$22.50

NEW FOUR WAY HYDRAULIC CONTROL VALVE has built in relief for 1 to 4 D.A. cylinders. 3/4" ports. #10080 \$14.50. No. 3500 four way with 2 handles for 1 cyl. \$8.95.

NEW HYDRAULIC CYLINDERS

Air or Oil Bore	Stroke	Short	D. Action	Price
500 1 1/2"	7 1/2"	1 1/2"		\$8.50
512 2 1/2"	4"	1 1/2"		\$8.50
127 4 1/2"	10 3/4"	1-5/16"		\$27.50
511 3 1/2"	2 1/2"	1 1/2"		\$22.50
113 3"	2"	1-3/16"		\$29.95

NEW HYDRAULIC SYSTEM KIT

#400 K. Heavy duty Power Driven. Rated 14,000 lbs. lift. Consists of 2 D.A. hyd. cylinders, 3" bore x 24" stroke, each rated 7000 lbs. with 1000 P.S.I. 1 four way hyd. control valve with built in relief #821, 1 Vickers hyd. pump, 400 G.P.H., 1500 P.S.I., 3750 RPM, 1 hyd. 2 gal. reservoir, 1 Purolator hyd. filter, 1 gauge 0-2000 P.S.I. all hose & fittings. Value \$184.10, save 800.00. Kit price \$94.10. Kit with two #311 cyl. \$79.95.

NEW HYDRAULIC POWER KIT Your complete hydraulic system. Consists of Pesco gear driven pump, 380 G.P.H. 1000 P.S.I. with 3/4 H.P. DC motor 2300 R.P.M., relief valve, unloading valve, filter, Bendix 5" accumulator, reservoir & pressure gauge to 2000 P.S.I. and all necessary hose and fittings. Complete Kit \$39.50. Same Kit minus motor \$33.50. Same Kit with Stratopower 400 GPH, 1400 P.S.I. pump \$42.50. Write for bargain list.

GENERAL SALVAGE CO CHECK OR M.O.
 2922 E. 27 St., Dept. 89, Kansas City 27, Mo.

"MFG" a lot of boat for only \$495

15'7" long . . . roomy, rugged . . . fast, easy to handle . . . smooth, dry. Seamless lapstroke hull is molded in one piece of MOLDED FIBER GLASS, one of the strongest, most durable materials known. Write for free literature.

MOLDED FIBER GLASS BOAT COMPANY
 71 Fourth Ave., Union City, Pa.

DO MORE PLANING JOBS WITH LOW COST BELSAW

LOW DOWN PAYMENT EASY TERMS

Exclusive MONEY-MAKING Features: Full 12 1/4" x 6" capacity • Power feeds at 14" to 34" a minute • Provides for Grinding Knives in the Cutter-head • Attachments for Jointing, Rabbeting, Tongue, Matching, Grooves. Convert low cost rough lumber into high priced stock. Easy to make flooring and popular patterns. Send Today for FREE Literature and Prices.

Belsaw Machinery Co., 2058 Field Bldg., K.C. 11, Mo.

BRONZE FOUNDRY

Schools • Home Workshops • Inventors

Make your own castings of aluminum, copper, bronze, silver. Foundry sets are available in three sizes including 2400 Deg. F. blast Furnaces. \$26.50; \$33.50; and \$46.00 f.a.b. Marysville or Lakewood. Free Circular.

KANSAS CITY SPECIALTIES CO. (Dept.) Box 6022, Marysville, Kans. P-8 or Box 7543, Lakewood, Colo.

Handy Nail Guide

HELPS YOU SAVE TIME AND MONEY

- Tells right nail for each job
- Tells amount of nails per pound
- Tells right hammer to use

YOURS FOR JUST 10¢ Send coin direct to Estwing

ESTWING UNBREAKABLE TOOLS

CHOICE OF CRAFTSMEN FOR 30 YEARS

ESTWING MFG. CO., DEPT. PM-5, ROCKFORD, ILLINOIS

10" TILT/ARBOR SAW BUILD-IT-YOURSELF from GIL-BILT KITS-PLANS

Sturdy wood, steel, and aluminum construction. NEW DEPARTURE ball bearings. Capacity and performance of floor saws selling for \$150.00 and up. Plans, all metal parts in kit with 10" comb. blade \$28.90, less blade \$22.95. F.O.B. St. Louis. Detail PLANS-PATTERNS only \$1.00 postpaid.

Build-it-yourself 12" and 18" Bandsaws, 6" Belt Sander, Shaper. Simplified plans, build easily with hand tools only. Advertised and sold for 10 years, over 33,000 units in use. Money back guarantee. FREE CATALOG.

GILLIOM POWER TOOLS, Dept. 80-H, Lambert Field, St. Louis 21, Mo.

YOU can build your own SUMMER CABIN or GUEST HOUSE with this natural outdoor material

For the cost of the materials alone, you can soon have a new summer cabin, guest house, garage, tool house, storage shed or many other buildings. Weatherproof Homasote Boards make them easy to build, and make them durable. These famous insulating-building panels—in sizes up to 8' x 14"—work as easily as wood—take any paint or stain.

The one-room house pictured above is built with Homasote beveled siding, subflooring, walls and ceiling. All materials and complete building instructions are listed on East-Bld® Pattern #84—available at your lumber dealer. This pattern details each step of the job, with photographs, cut-away drawings, and full-size sawcut patterns to make every inch of the job professional.

Here is a whole new world of craftsmanship and satisfaction for you. With Homasote Boards and know-how, you can make toys, furniture, cabinets, boats, buildings of many types—for the cost of the materials (only one-third normal cost!).

For other Patterns using Homasote, look for this emblem on your dealer's counter. And use the coupon today for your copy of the 68-page Homasote Handbook—your practical building manual.

*T. M. Reg. East-Bld® Pattern Company

HOMASOTE

SAVE MONEY—BUILD IT YOURSELF with our 68-page East-Bld® Patterns

HOMASOTE COMPANY, Department H-5, Trenton 3, New Jersey

Send me the 68-page Homasote Handbook, for which I enclose 10¢ for handling.

Name

Address

City..... Zone..... State.....

Windshield Washer Sprays Path for Wiper

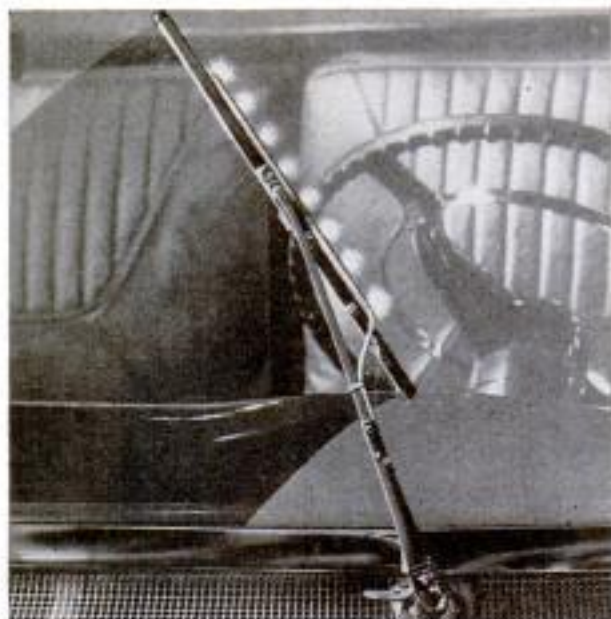

Hays Dist. Co., 410 Michigan Ave., East Lansing, Mich.

Clamp-on windshield washers will reduce frustrations of motorists used to watching the water stream blow away in the wind. This new washer makes driving safer by spraying an even flow of water in the path of the wiper blade. Water is fed through a plastic hose into an aluminum tube that has eight small jets for ejecting water on the windshield. Made in two models, the washer can be connected to nozzles installed in cowl panels or hoods.

Drugs Affect Special Brain Areas

Studies with rats indicate some drugs affect sections of the brain associated with fear and pain, while others affect the part which governs reward. The research is being conducted by Prof. Neal E. Miller of Yale University in connection with the treatment of mental illness.

Booster Tube for Radar

Radar signals will be increased from eight to fourteen times with a booster tube called "amplatron." When added to air-traffic-control radar units being built for the Civil Aeronautics Administration, their range will increase from 200 miles to 350.

Removes Photo-Chemical Stains

Photographic-chemical stains—the bane of photographers who develop their own pictures—can be removed with a liquid called Remover K-14. It will not harm clothing or skin, the manufacturer says.

Anchor Chemical Co., P.O. Box 2775, Cleveland 11, Ohio

FREE PLAN tells how to start your own business **FILING SAWS**



Here is a steady repeat CASH business you can start in your own basement or garage in your spare time and make up to \$3 or \$5 an hour. You can file hand, band and cross-cut circular saws on the Foley Saw Filer. No eye-strain—no experience needed. "The first saw I sharpened with my Foley Filer came out 100%!" —writes Clarence E. Parsons.

Every saw you sharpen with the Foley Saw Filer brings you more customers. "I rented a two-car garage and here all the work I can do." —Charles H. Smith.

FREE BOOK "Money Making Facts" shows just how you can start at home in spare time, with small investment, no overhead—and develop into a full-time repair shop. Send coupon today—no salesman will call.

SEND COUPON FOR FREE BOOK

FOLEY MFG. CO., 843-7 Foley Bldg.
Minneapolis 18, Minn.

Send for free book "Money Making Facts"

Name _____

Address _____

HELPFUL BOOKS

Send post card asking for **FREE** catalog

Popular Mechanics Press, 200 E. Ontario, Dept. 601, Chicago 11



WELD IT YOURSELF IN A JIFFY!

Weld, Cut, Braze, Solder; Iron, Steel, Brass, Bronze, Aluminum and other metals safely and easily. Make your wrought iron furniture, porch railings, fences, knock-knacks and other metal specialties. With this fine equipment anyone can do professional-like work with little practice. Tool and equipment breakdowns are annoying and costly. Don't let them bother you. The Dynamic will pay for itself quickly in both time and money and is designed to operate from any properly wired 110 volt AC line.

Order your Dynamic Industrial type transformer Arc Welder for Workshop or Industrial use today. Order from this ad.

Literature on larger equipment available on request.

DYNAMIC WELDER COMPANY, 1808 S. Federal Street, Dept. D2-H, Chicago 16, Illinois

EASY PAY PLAN

Low down-payment. Pay as you weld. Money back guarantee. Send for details. Complete outfit.

Only \$38.50

F.O.B. Factory



BUY GREAT NECK HAND TOOLS
... for long-lasting performance

**Precision Balanced
NAIL HAMMER**



One-piece, forged steel, rubber-cushioned, no-slip grip

GREAT NECK SAW MFRS., Inc.

MINEOLA, N. Y. — SEE YOUR LOCAL STORE



Popular Mechanics Book for Pleasure or Profit

23 BOATS You Can Build

Build the boat you have always wanted. Build it for fun or to sell at a profit. Get Popular Mechanics 23 BOATS YOU CAN BUILD — row boats, canoes, sail boats, power boats and other craft including a 25 foot cabin cruiser. Book includes more than 500 photos, plans, diagrams and working drawings, plus step by step instruction that anyone can follow. Only simple tools needed. Material list of lumber, hardware, fittings, etc., included. Order today under money-back guarantee. Only \$2.75 postpaid.

POPULAR MECHANICS PRESS, Dept. 857, 200 E. Ontario St., Chicago 11

Short Cuts

WILHOLD[®] CONTAX CEMENT

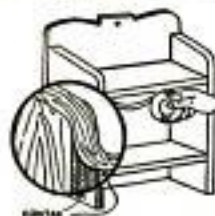

REPAIRS

SAVES
TIME

APPLY WOOD TAPES without heat or solvents

Coat edge, then one side of tape, with Contax. When dry, press tape to edge, beginning at one end. Instant bond permits immediate trim and finishing.

AD #4035

Paint, Hardware, Lumber, Variety Stores. Or write
WILHOLD PRODUCTS Los Angeles 31, Calif.; Chicago 44, Ill.

\$250,000 IN ORDERS FROM SMALL CLASSIFIED AD

Yes, you read the above statement correctly. Unbelievable? Of course—BUT IT'S TRUE. I'll gladly send you positive proof. Yes, the actual letter to prove the above statement. Write, F. W. Johnson, Class. Adv. Mgr., Popular Mechanics Magazine, Room 601, 200 E. Ontario, Chicago 11, Ill.



You know those rare days when everything's right? Air smells good. Food tastes terrific. Even the old face looks good in the mirror. Today can be that kind of day. Just do two things. Call your doctor for a thorough medical checkup for cancer. Then write out a check—a nice fat one—to the American Cancer Society, and mail it to "Cancer" in care of your local Post Office.

AMERICAN CANCER SOCIETY



2½x - 4x or 6x RIFLESCOPES



10 DAY MONEY-BACK GUARANTEE

YOUR CHOICE! SAME PRICE!

2½x - Overall lgth. 9½"
20 ft. field of view at 100 yds.
4x - Overall lgth. 9½"
20 ft. field of view at 100 yds.
6x - Overall lgth. 10½"
19 ft. field of view at 100 yds.

NEW PAL-MASTER SCOPES for TARGET • BENCH REST or HUNTING

Choice of 3 different powers **995 WITH MOUNT**
at the same LOW PRICE!

COMPARE THESE QUALITY SCOPE FEATURES:

- 1—ADJUSTMENTS Positive Internal Direct reading Windage & Elevation/Knobs
- 2—LENSES Top quality Optical Glass—precision ground, polished, color corrected, no distortions, hard coated glass-to-air surfaces.
- 3—EYE RELIEF 2½" to 4½" Safe on heavy recoil.
- 4—RETICLE Sharp, Clear Cross-Hair
- 5—FOCUS Is Lock-Tight. Won't "shoot off"
- 6—BARREL Rust-proof, Extra Durable Steel
- 7—Guaranteed to perform perfectly on ANY RIFLE.
- 8—Made by leading American Optical firm.

MOUNT INCLUDED with SCOPE

SIDE or TOP MOUNTS available with scope to fit most rifles. When ordering specify type mount, gun model number and brand.

PALLEY BARGAINS "DIVING EQUIPMENT"

PALLEY DIVING LUNG KIT

BUILD YOUR OWN! - SAVE up to \$100. Our special folder has complete instructions showing how its done. Kit includes Air Bottles, Pressure Regulator, Safety Belt, Air Hoses, Mouthpiece, Clamps, Valves, Shoulder Harness, etc. Everything needed. Price of this Kit with 2 Air Bottles (1 hour time) \$150 Value **45.95**

SEE CATALOG below for our complete stock of Diving Equip. Includes Flippers, Tanks, Goggles, Guns, Lungs, etc. in both New and Surplus types.

DIVING AIR TANKS

I.C.C. Approved to 1000 P.S.I.
22 cu. ft. cap. 5" x 19" \$10.95
38 cu. ft. cap. 7½" x 9" \$14.95

FINEST STEEL BAYONET

Genuine Infantryman's bayonet, made of the very finest tool steel. Fluted sides and precision honed edge. Blade is 8" long making it an ideal knife for skin diving use or as a hunting knife. Comes complete with a reinforced leather scabbard. **2.89**

1/6 HP. 115 VAC MOTOR

Another Palley Bargain Buy! MOTOR, HANGER MOUNT and DUAL V-BELT pulley included. An ideal shop motor. Operates on 115V., 60 cycle, 1-phase and draws 3.8 amps. Turns 1725 RPM. Pulley is 2" dia., and takes 1/2" & 1/4" V-belts. Hurry - stock limited. **Only 7.95**

NAVY WADING SUIT

Ideal for Surf or Deep Stream fishing. Also whenever necessary to protect body or clothes from mud, molasses, etc. Made of heavy duty rubberized canvas with vulcanized seams, built-in boots & gloves. Sizes: Med., Lg. **12.95**
See Catalog below for complete stock of Treading, Fishing and Camping Equipment.

16 POCKET VEST

Originally used as an Air Corps Emergency Vest. Ideal for Hunter, Riflemen, etc. Has 14 individual, outside pockets which can be used shells, glasses, etc. Also has a leather holster for pistol, 2 large (11 x 2") inner pockets. Sturdy, yet lightweight with adjustable tie straps on back for a snug fit. **3.49**

NEW ARMY CANTEEN & REISSUE CUP AND BELT

A one quart canteen and aluminum cup fit into the insulated canvas cover. Choice of web type pistol belt or cartridge belt with pockets. The canteen is new Korean War Surplus. **2.29**

AIR PRESSURE TANK

G-1 Type, Stainless Steel. Shatterproof and rustless. Built to withstand up to 400 PSI with high safety factor. Has 1/4" pipe ports. Ideal for use in Air Storage for painting, spraying, etc. Can also be used for water storage, as a buoy, etc. Size: 12½" dia. x 24" length.
NEW and UNUSED **16.95** USED **12.95**

WORLD'S MOST AMAZING BARGAIN CATALOG

1957 EDITION - 396 PAGES

NATIONALLY ADVERTISED MERCHANDISE • NEW and USED GOV'T SURPLUS • FACTORY CLOSEOUTS • EXCITING IMPORTS!

From EVERYWHERE PALLEY'S now bring you items of every description! This fabulous catalog contains Hand & Power Tools, Microscopes, Binoculars, Industrial and Building Materials, Sewing Machines, Office Equipment, Sport & Outdoor Equipment, Cameras, Photo Supplies, Hobby Kits & "Gadgets", Electrical & Radio Supplies, Motors & Generators and a HUGE selection of Surplus Hydraulic Cylinders, Pumps, Valves, etc.

We are now one of the foremost manufacturers of CUSTOM-MADE HYDRAULIC CYLINDERS. Our tremendous volume enables us to sell for LOW MASS PRODUCTION PRICES!

Send **50¢** - LIMITED EDITION! ORDER YOURS NOW!
On handling & mailing; 50¢ REFUND on your first order of \$1.00 or more.

ORDER-BY-MAIL

TERMS: Send Check, Cash or Money Order. 20% Deposit with C.O.D.s. Prices F.O.B. Los Angeles, Calif. Warehouse.

PALLEY'S 2242 EAST VERNON AVE., DEPT. PM87, LOS ANGELES 38, CALIF.



it's NEW! it's ALL IN ONE LEVEL · SQUARE · TAPE

IT'S A LEVEL!
Built-in, accurate unbreakable Level.



IT'S A TAPE!
10 ft., replaceable WYTEFACE® Tape.

IT'S A SQUARE!
Accurate Square. Easy to use.

Only \$1.98

at your hardware store

K&E KEUFFEL & ESSER CO.
Hoboken, N. J.

DID YOU EVER



**REGLAZE
A WINDOW
???**

IF YOU HAVE, you know how cumbersome it is to hammer the little triangle points into the frame to hold the glass. The FLETCHER DIAMOND POINT PUSHER illustrated will automatically sink glaziers points into the frame by simply pushing the handle. It is excellent too for framing pictures and mirrors. It costs less than a dollar.

IT'S A NEW PRODUCT BY

FLETCHER
REG. U. S. PAT. OFF.

Get one from your dealer or write to
THE FLETCHER-TERRY CO., DEPT. D, FORESTVILLE, CONN.



Oxygen Masks Aid Passengers In Decompressed Plane Cabin

When air pressure in future, high-altitude jet airliners suddenly drops below the danger point, emergency oxygen masks will lower from the ceiling into the hands of each passenger. These masks are made of porous, sponge-rubber cups connected by tubes to the plane's oxygen supply. A gas-regulator system and the porous cups will mix air and oxygen properly. The masks function automatically as the pilot guides the aircraft to low-altitude breathing levels.

Penicillin Produced Artificially

Synthetic penicillin has been produced at Massachusetts Institute of Technology. As a result, 10 new types of the substance are being tested for possible medical use. It is not expected to be inexpensive enough to compete with the fermentation process of deriving penicillin from molds, but it is hoped the material will have several new medical applications.

Faster Drill for Oil Wells Uses Percussion Hammer

Delivering 600 blows per minute, a newly developed hammer drill can bore through oil-field rock up to four times as fast as conventional twist drills. The percussion drill is suspended like a plumb bob at the bottom of the hole and is powered by the circulation of "drilling mud" which carries away the pieces of drilled rock.

PORTABLE LIGHT PLANTS

1500 WATT PLANT
115v. 60 cycle AC Push Button Start. Powered by a 3 1/2 HP. Clinton engine. Combines big output with easy portability. Provides emergency power for operating any oil burner, sump pump, freezer, television, lights, communications systems, etc. which require up to 1500 watts. (Item 22) Wt. 110 lbs. Reg. \$475. Factory price... **\$239.50**



1750 Watt Plant Powered by 4.5 Briggs engine. Electric starting & battery charging built-in! Factory price... **\$279.50**

MASTER-LITE 2500 Watt Plant
110/120 v. 60 cycle AC. A power-plant, ruggedly constructed and yet designed for easy portability. Can be started by rope or built-in 12 v. electric push button starter. Built-in winding to charge battery. Powered by a big 5.10 HP Briggs engine, complete with all accessories. Includes control box, voltmeter, and handy plug-in power receptacle. An ideal plant for permanent or stand-by service. Wt. 225 lb. Reg. price \$640.00 (Item 21) Factory Price... **\$329.50**



3500 Watt Plant Push Button Start (Item 23)
115 v. 60 cycle AC. Similar to above, but larger and 33% more capacity. Wt. 270 lbs. Reg. \$760. Factory Price... **\$379.50**

DUAL VOLTAGE 110/220 for Item 21 or 23 - \$30 additional.

1000 Watt Belt Drive AC Generator

Lightweight portable generator. Will provide 1000 watts of 115 volt 60 cycle AC power for lights, saws, drills, etc. or other appliances requiring up to 1000 watts. Operates at 3600 r.p.m. - drives with any gas engine, tractor or power take off. Can even be mounted on an automobile engine to operate off a fan belt. Complete with duplex receptacle box, safety fuse and 4" pulley. Not recommended for heavy duty. Wt. 27 lbs. (Item 825) only... **\$79.50**



750 Watt Generator, similar to above. (Item 826)... **\$59.00**

Heavy duty 1200 Watt Generator only. Wt. 50 lbs. (Item 45a)... **\$139.50**

Heavy duty 2500 Watt Generator only. Wt. 80 lbs. (Item 21a)... **\$169.50**

GIANT METAL SHEARS

"PEKTO"
Nine inch cutting blade made of special high carbon alloy steel, perfectly aligned and ground. Easily cuts steel plate up to 12 gauge or 1/4" thick. Overall length 48". Wt. 23 lbs. (Item 156) Regular \$49.50. While they last... **\$14.95**

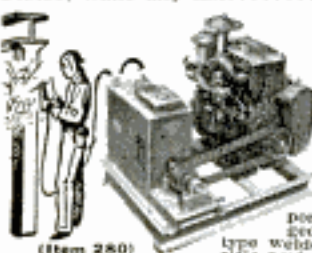

MASTER DC ARC WELDERS

Now! a portable rugged, industrial type welder with terrific performance, yet at a price hundreds of dollars less than you'd expect. Senior model made for years of trouble-free, continuous service. High capacity DC welding unit enables you to tackle any job with confidence—easily welds anything up to 2" plate using from 1/16" to 1/4" rods. Built-in stabilizer and cooling system makes arc easy to strike and hold. Dual control rheostat provides low heat soldering, brazing and welding from 30 to 300 amps. Complete with instructions, guarantee and triple V-belt or flat pulley. Easy to hook up and easy to operate. **WELDER ONLY - DUAL CONTROL MODEL.** Same as above, but drive with your tractor, jeep or gas engine of 14 HP or more. (Item 35a.) Wt. 110 lbs. \$469 value... **\$119.50**

WELDER ONLY - INDUSTRIAL MODEL same as above but with ceramic rotary type rheostat providing 74 different heat settings for all types of welding (Item 35b) \$500.00 value... **\$139.50**

COMPLETE POWER MASTER (illustrated above) powered by a 14.6 hp., air cooled Wisconsin engine. Wt. 480 lbs. (Item 280) Compares with welder costing \$1200. Factory Special... **\$449.50**

WELDING KIT Two 10 ft. leads, welding helmet, electrode holder, ground clamp. Sold only with welder at... **\$10.50**

SAVE middleman profits
get **MASTER MECHANIC'S**
direct factory prices

EXCLUSIVE! NEW! LIGHTWEIGHT WATER COOLED DIESEL GENERATOR PLANT

Never before available!
Now offered exclusively
by Master Mechanic, A low
priced, lightweight,
continuous duty,
Diesel generator set.
Powered by a
super rugged, exceptionally smooth
running, one cylinder Diesel engine.
Operates at
consistently 1750
r.p.m. and delivers full 1750-2000 watts of
power. Operates on low cost fuel oil. Wt. only
240 lbs. representing a triumph of Diesel Engineering. Complete with fuel filter, oil
pressure gauge, control box with duplex receptacle
and voltmeter. (Item 830)
Special factory price... **\$399.50**

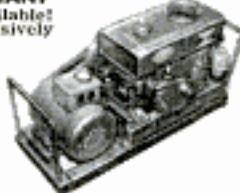

**700 WATTS
PUSH BUTTON START**
115 v. 60 cycle AC
Powered by a rugged
2.2 HP easy starting
Briggs engine. No
wiring necessary;
just plug in and operate. Plenty of current
for any oil burner,
freezer, brooder,
emergency lights,
etc. which require
up to 700 watts. Ideal for television and
radios. Complete with Voltmeter and built-in
winding to charge 6 v. auto batteries. (Item
24.) Wt. 75 lbs. Easily fits in car trunk.
Especially prepared for storm knock-out
power lines. Reg. \$275.00... **\$143.50**

1200 Watt Plant (Item 45) same as Item 24
but larger generator and engine
with 50% greater output... **\$199.50**

(Item 24)
Special factory price... **\$399.50**
3.5 HP Item 830a... **\$249.50**
Wt. 116 lbs.

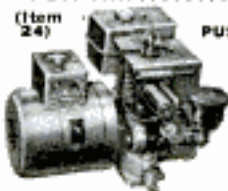

Double Acting Hydraulic Cylinder

A powerful cylinder mfr'd. by Massey Harris
which develops both a pushing and a pulling
action. Will push 2,100 lbs. with a 1000 psi
pump pressure. Cylinder in 3 1/2" O.D. with
1 1/2" stroke—standard heavy duty clevises on
both ends. Has standard 1/2" pipe thread openings.
Can be used for tilting buckets or
blades, raising or lowering implements, hydraulic
presses, etc. Can also be used as an
air cylinder. (Item 802) Wt. 17
lbs. Reg. \$68 value. Special... **\$14.95**

OTHER DOUBLE ACTING CYLINDERS

8" stroke - 3" bore... **\$34.00**
10" stroke - 3" bore... **34.80**
16" stroke - 3" bore... **43.00**
24" stroke - 3" bore... **47.50**

We have all sizes of cylinders available.

HYDRAULIC CONTROL VALVE - 4 way
open center valve with built-in
adjustable relief. Controls
1 double, or 2 single acting
cylinders. Equalizing feature
permits easy control even
under heavy loads. 3/4" pipe
thread on inlet & outlet. -
1/2" on cylinder outlets. Easily
mounted, finger tip control. Wt. 16
lbs. (Item 822)... **\$21.50**

JET STEAM MASTER

Now, a super efficient portable steam
generator that produces live steam at
100 lbs. pressure in
60 seconds from a
cold start! Produces
large volume of high
pressure steam on 2
pints of fuel oil. Instantly
cleans sticky grease,
oil, dirt, rust, old
paint, etc. off
implements and road
machinery. Pays for
itself in a few weeks.
Sterilizes soil. Sterilizes
as it cleans—milk
equipment, etc. Fully
automatic—oil fired with
new, built-in lifetime
bronze water circulating
pump. Draws water from
faucet or bucket. Simple
and safe—anyone can use
it! Equipped with safety
valve. Complete with 12 ft.
hose and new triple efficiency
steam gun that automatically
mixes in soap solution if
desired. Wt. 250 lbs. Item 463.
Special factory price... **\$349.50**

9 TON HYDRAULIC PRESS

A tremendously powerful hydraulic
press, capable of exerting 18,000
lbs. pressure. Pays for itself many
times over—straightening bent
connecting rods, king pins, crank-
shafts, axles, link pins and
nuts - or pushing out worn
bearings and bushings. Developed
pressure under precise
control and visible
at all times on accurate
gauge. Complete with both
large and small anvils and
bars to straighten any kind
of curve or bend. (Item 404)
Wt. 110 lb. Actual list price
\$365. Our special
close-out price... **\$69.50**

SCREW TYPE PRESS. Nine ton capacity. See
July Pop. Mech's. ad for details—or write.
Complete, Wt. 150 lbs. (Item 707)... **\$49.50**

Send check or M.O. Prices f.o.b. Factory. 10 day Money back guarantee. SEND 10c for... **BIG 1957 Catalog**

MASTER MECHANIC MFG. CO., DEPT. 3-R
Burlington, Wis.

LESS THAN WHOLESALE

**GIANT 2500
WATT PLANT**
110-120 v. 60 cycle
AC. Absolutely the
best made - exclusive
dynamically balanced
armature; heavy
windings develop
up to 2500 watt
overload for motor
starting. Skid
mounted - portable.
Powered by an
easy starting Briggs or Wisconsin 6 HP
engine—complete with all accessories
easily disconnected for other uses. Big outlet
box, voltmeter, no wiring necessary. Ample
current for all purposes. Factory warranty.
(Item 31) Wt. 210 lb. Reg. price \$585. Special at... **\$299.50**



Same plant with electric
self starter (Item 31a)... **\$359.50**

DUAL VOLTAGE 110-220 available on any
of above models for \$28.00 additional.
We make every type and size of light plants
—Write, giving us your requirements!

FAUCET WATER HEATER



Instant hot water from
any faucet for just
pennies—sounds unbelievable—but it's true!
You just slip **MASTER MECHANIC'S** new
Faucet Water Heater
over any water faucet,
plug it in a wall outlet
and you've got
steaming hot running
water instantly for
dishes, shaving, washing
baby's bottle, etc.

Simple and safe—operates on ordinary 110v.
house current—costs only 2 1/2 cents per hour
for hot water. Ideal for homes, barns, cabins,
trailers, etc. Easily regulated from lukewarm
to full hot. Fully guaranteed! (Item 408)
Wt. 2 lbs. Factory price f.o.b. Burlington, only... **\$4.95**

HEATING & VENTILATING FAN
(Item 10) Easily installed in
furnace pipes. Forces even heat
to all rooms. Over range re-
moves kitchen smoke and odors.
Powerful, continuous duty motor.
110-120v. AC. Mount in
wall or ceiling to ventilate any
area. Quiet, super-efficient fan moves huge
volume of air. (400 to 600 CFM.)

8" Pipe, Wt. 5 lb. **\$6.85**
9" Pipe, Wt. 6 lb. **\$7.85**
10" Pipe, Wt. 7 lb. **\$8.85**
12" Pipe, Wt. 8 lb. **\$9.85**

HEAVY DUTY FAN. Semi-enclosed motor,
suitable for spray booths, restaurant ex-
hausts, poultry houses, etc. 10" Fan, wt. 8
lbs. (Item 10E)... **\$11.95**
12" Fan, wt. 10 lbs. (Item 10D)... **\$12.95**

HIGH SPEED BARN FAN similar to above,
but larger, high speed motor moves huge
volume of air.
12" Fan (Item 10F)... **\$14.95**
14" Fan (Item 10G)... **\$17.95**

EXTENSION CORD
Heavy duty and very flex-
ible. Neoprene 14-2 cable,
25 year quality. Wt. 12
lbs. (Item 185) 100 ft.
Complete with rubber plug
and outlet. A ter-
rific buy at only **\$8.95**

No. 10-2 Power Cable. Heavy duty, very flex-
ible, 30 ft. with male and female fittings.
Wt. 4 lbs. (Item 815b)... **\$5.15**
20 ft. without fittings (Item 815a)... **\$4.15**
50 ft. (Item 892) with fittings... **\$13.45**
100 ft. (Item 135) with fittings... **\$25.95**

No. 12-2 Power Cable. Very flexible rubber
covered, special outside shield for grounding
power tools, etc. 50 ft. (Item 190) **\$6.95**,
100 ft. (Item 200)... **\$12.95**

No. 8-2 Conductor Power Cable. 30 ft. heavy
duty, very flexible rubber covered with male
& female plug (Item 817)... **\$12.95**

9 TON HYDRAULIC PRESS

A tremendously powerful hydraulic
press, capable of exerting 18,000
lbs. pressure. Pays for itself many
times over—straightening bent
connecting rods, king pins, crank-
shafts, axles, link pins and
nuts - or pushing out worn
bearings and bushings. Developed
pressure under precise
control and visible
at all times on accurate
gauge. Complete with both
large and small anvils and
bars to straighten any kind
of curve or bend. (Item 404)
Wt. 110 lb. Actual list price
\$365. Our special
close-out price... **\$69.50**

SCREW TYPE PRESS. Nine ton capacity. See
July Pop. Mech's. ad for details—or write.
Complete, Wt. 150 lbs. (Item 707)... **\$49.50**

Send check or M.O. Prices f.o.b. Factory. 10 day Money back guarantee. SEND 10c for... **BIG 1957 Catalog**

MASTER MECHANIC MFG. CO., DEPT. 3-R
Burlington, Wis.

SOUTH BEND

the VERSATILE Vertical Spindle Milling Machine

The versatility of this precision milling machine pays off in more jobs handled in less time and with less effort. The 360° vertical rotation of the machine head enables it to mill, bore, drill and ream at any angle. Its vertical design provides maximum accessibility for all types of set-ups. Write now for complete information on the rest of this machine's exceptional features.

SPECIFICATIONS

Table travel.....	.20" or 30"
Cross-feed.....	.9½"
Spindle to table.....	.20" max.
Spindle to column.....	.20" max.
Ram travel.....	.15"
Spindle speeds.....	.8
Head rotation.....	.360°

Prices start at

\$1742

f.o.b. factory

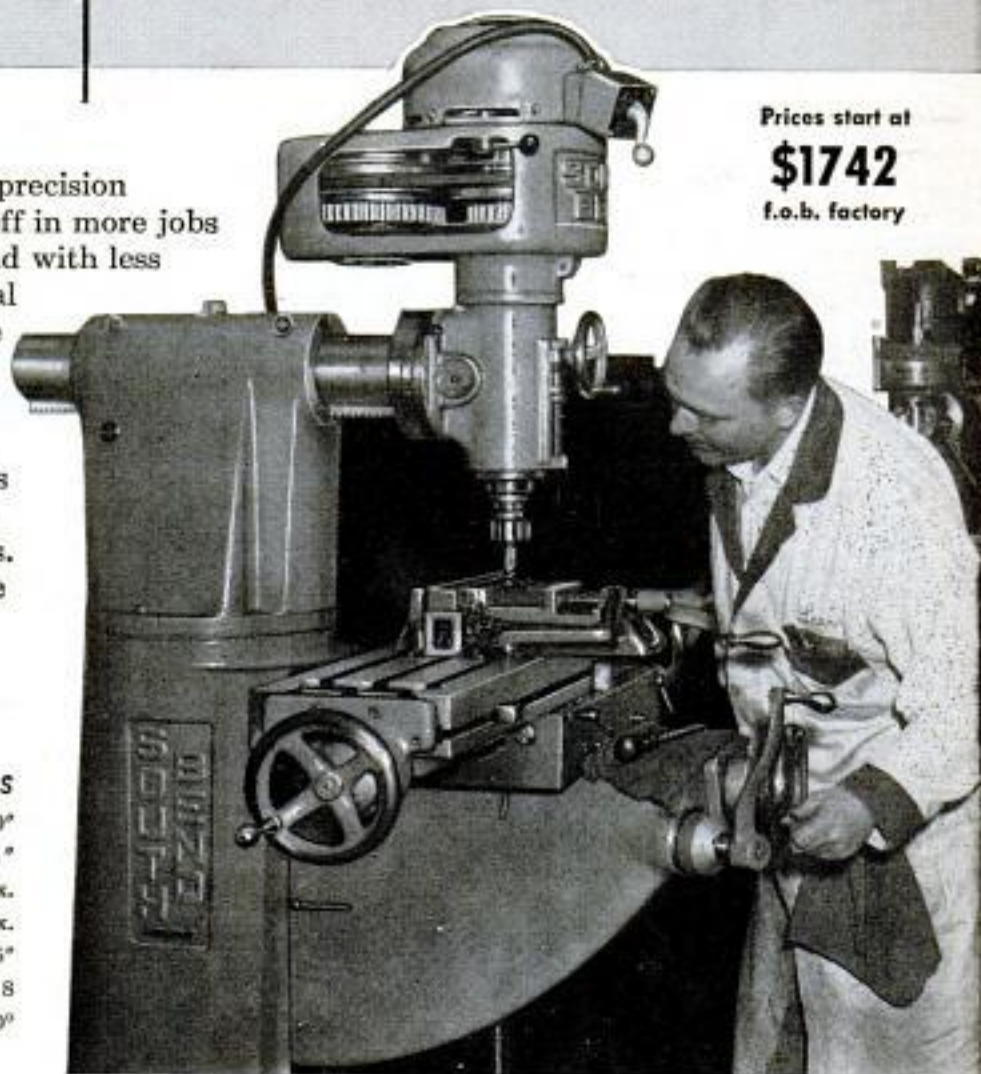

In or Out Ram Travel Without Re-setting Head Angle



This mill saves you the time and annoyance of re-setting the head angle every time the ram is transversed. The head swivels on a flange on the end of the ram. The ram has a large key sliding in a keyway fitted with an adjustable tapered gib. The head is *always* in perfect angular alignment—there's never any side play or canting when ram is moved.



SOUTH BEND LATHE

South Bend 22, Indiana
Building Better Tools Since 1906

Now available...direct to you from the Publisher

BRAND NEW EDITION OF THE WORLD FAMOUS

ENCYCLOPAEDIA BRITANNICA



On Easy...Book a Month Payment Plan

■ Yes, the latest edition of Britannica—the greatest treasure of knowledge ever published—is now being offered on a remarkable, direct-from-the-publisher plan that puts this world-renowned reference library within reach of every family. All 24 volumes will be placed in your home NOW... you pay for it later on convenient budget terms. It's as easy—and as convenient—as buying a book a month.

You may wonder how we're able to make this truly amazing offer. First, because of the great demand for this magnificent set, we have ordered a tremendous printing. Also, by offering this set *Direct from the Publisher*, we have saved many distribution costs. These savings are passed on to you.

Thousands of Subjects of Practical Value

In the brand-new edition of Britannica you will find thousands of subjects that you and your family will refer to in the course of your normal day-to-day affairs. For example, you'll find special articles on household budgets, interior decorating, medicine and health, home remodeling, child care, adolescent problems, rules and regulations for all sports, every kind of hobby... plus a treasure house of knowledge on *all* subjects. Useable information that can save you many dollars.

New Edition is Profusely Illustrated

The new Britannica almost "televizes" the information to you by means of 23,494 magnificent illustrations. But it does not merely show "attractive" pictures—it is the work of 5,565 of the world's greatest authorities on all information significant to mankind.

Britannica Often Called Key to Success
The brand-new Britannica—the biggest

Preview Booklet Offered FREE!

Simply fill in and mail the coupon today, and we will send you... without cost or obligation... a copy of our beautiful, new booklet which contains an exciting preview of the latest edition of Encyclopaedia Britannica. Send no money—not even for postage. It's yours, *absolutely free!*

In its pages, you will see the most significant scenery on the North American Continent. You'll go on a cruise to France—to the mysterious Orient—to a Pacific Island—or by rocket to the moon!

In color so beautifully etched it gives the illusion of a third dimension, you will see art treasures of famous museums, world landmarks... and scientific wonders.

Just as soon as we receive your coupon, we will send your illustrated free booklet. No obligation, of course. However, since this offer is necessarily limited, please mail the coupon today before it slips your mind.



and greatest edition in our almost 200-year publishing history—is expressly designed to help you enjoy a richer and fuller family life, aid you in achieving greater financial rewards and success in your business or trade, help your children in school, and enable you to speak factually and intelligently on the widest range of subjects.

FREE Research Service

As a Britannica owner, you would be entitled to *free* research reports on subjects of your choice. These comprehensive and authoritative reports are prepared for you by members of the world-famous Britannica Research Staff, and cover subjects of important interest to you and your family.

**Mail
Coupon
Now for
Free
Booklet**

ENCYCLOPAEDIA BRITANNICA, Dept. 3G

425 N. Michigan Avenue, Chicago 11, Illinois

Please send me, *free and without obligation*, your colorful Preview Booklet which pictures and describes the latest edition of ENCYCLOPAEDIA BRITANNICA in exciting full detail. Also include complete information on how I may obtain this magnificent set, *direct from the publisher*, on the Book a Month Payment Plan.

Name _____ (please print)

Address _____

City _____ Zone _____ State _____

In Canada, write E. B. Ltd., Terminal Bldg., Toronto, Ont.



**31 of the 33 Cars
in the Indianapolis
"500" Mile Race**

used **BOWES** **BRAKE FLUID**



When 31 out of 33 of the top race drivers in the world "Bet their life" on the same Brake Fluid—it *must be the best, the safest* brake fluid on the market.

Don't Take Chances on Your Life...

Bowes Brake Fluid is used and approved in Automobile racing, and approved by the United States Auto Club.

- 1** Have your brake fluid checked at least each time you get an oil change.
- 2** There are many dangerously inferior brake fluids on the market.
- 3** **YOU KNOW...**
BOWES BRAKE FLUID IS SAFE!

BOWES "SEAL FAST" CORP., INDIANAPOLIS 7, IND. • HAMILTON, ONTARIO, CANADA • LONDON, ENGLAND
BOWES PACIFIC CORPORATION, RIVERSIDE, CALIFORNIA