

JULY 1957

35 CENTS

POPULAR MECHANICS

MAGAZINE

WRITTEN SO YOU CAN UNDERSTAND IT

REG. U.S. PAT. OFF. TRADE MARK, GREAT BRITAIN, NO. 40428

REG. U.S. PAT. OFF.



HILLER'S AERIAL SEDAN

—your flying car for 1967—page 74

Stand by for Satellite Take-Off!

Owners Report: OLDSMOBILE

HOW TO OUTSMART HOUSEBREAKERS

Copyrighted material

Faster paste waxing!

Easier paste waxing!



Start right in waxing!
Johnson's new J-wax
does the cleaning work for you!

No extra cleaner needed
—nothing else to buy!

J-Wax has just what paste wax needed—a built-in cleaner! The exclusive J-Wax formula goes to work fast. Cleans while it waxes—saves you hours of work. J-Wax replaces grime with a glistening coat of wax. *Tough wax. Hard-finish wax* that protects your car in any weather.

J-Wax puts more wax on your car—leaves

more wax on your car than other one-step waxes. And J-Wax goes on smoothly, easily—evenly. Leaves no dull spots or streaks. You are sure of more all-around protection with J-Wax in any weather—from bumper to bumper, including the chrome!

Look for Johnson's J-Wax in this new key-opening can. Only J-Wax guarantees sealed-in freshness. It's the fastest, easiest way to genuine wax protection—*paste wax protection!*

"Johnson's Wax" and "J-Wax" are registered trademarks of S. C. Johnson & Son, Inc.

Copyrighted material

Desert Test!



Proof . . . AC Spark Plugs deliver full efficiency for recommended service life!

Location: thirty miles southeast of Phoenix, Arizona, somewhere among the Superstition Mountains. Weather: bright and clear. Temperature: a stifling 112 degrees.

This is a land of cactus, sun and swirling dust. In the heat of the summer, and in one of the most notorious heat belts within the continental limits, AC Spark Plug Division of General Motors sought out the hottest area and put AC Spark Plugs to the test . . . one of a series of tests under extreme climatic conditions to prove again that ACs are best for the kind of driving you do.

Hour after hour the desert tests went on—new ACs versus AC plugs after a normal lifetime of use. At last the tests are completed and final tabulations made. Here is one more proof that AC Spark Plugs, with normal servicing, will supply all the power you need, all the economy you could ask, right up to recommended lifetime limits.

AC SPARK PLUG  THE ELECTRONICS DIVISION OF GENERAL MOTORS

JULY 1957

- 1 **SHELL-AND-INSULATOR DESIGN**—Both insulator and shell are designed to assure rapid heat dissipation.
- 2 **CONDUCTASEAL**—Only AC uses positive metal-ceramic seal to prevent compression leakage and power loss.
- 3 **HOT TIP**—AC Hot Tip design controls tip temperatures and cuts spark plug fouling to a minimum in all climates.



This One



SYN1-5PH-ZPAF



1

Copyrighted material

You can tell a
DISSTON
 by the
**SMOOTH
 EDGE**
 you get!

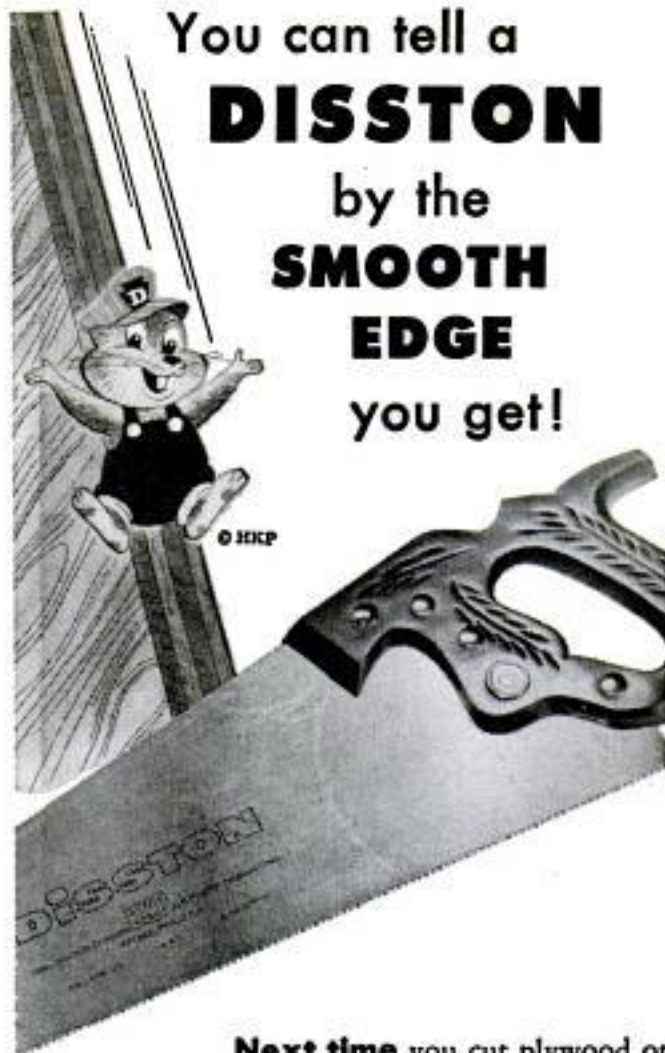

Next time you cut plywood or other well-seasoned woods, use a 10-, 11- or 12-point Disston Hand Saw. Note how easily it cuts . . . what a beautifully smooth finished edge it leaves! That's because these fine-toothed saws are specifically designed for finishing work. Made of fine tool steel, with perfectly tempered and double taper ground blade, Disston Saws give years and years of service, too.

At better hardware dealers... everywhere!



Choose a 5½-point Disston Hand Saw for cutting with the grain.

Choose a 7-, 8- or 9-point Disston Hand Saw for cutting across the grain.

FREE ILLUSTRATED BOOKLET! 64-page Disston Saw, Tool & File Manual. Tells how to choose and use tools; how to care for them. Helpful hints on wood and metal working, and selection of materials. For your free copy write today to: *Henry Disston Division, H. K. Porter Company, Inc., Philadelphia 35, Pa.*

HKP Henry DISSTON DIVISION
 H. K. PORTER COMPANY, INC.



Star-Bladed Power Trowel Speeds Plaster Finishing

Smoothing plaster with this star-bladed power tool, reportedly, is three to four times faster than hand troweling. The six blades are arranged like petals of a flower, overlapping at the base. When spinning rapidly, they produce a smooth, circled surface which is troweled evenly as the machine is moved across the wall or ceiling. Water is sprayed onto the plaster from a hole in the shaft of the blades and the flow of water from a portable pressure tank is controlled by a valve near the blades.

New Clue to Radio Stars

Some radio stars, objects in the sky which appear to emit radio signals but can not be observed with optical telescopes, may be unusually turbulent masses of gas whose atoms have been highly ionized. This conclusion was announced by Drs. B. F. Burke and Merle A. Tuve, of the Carnegie Institution of Washington, after a study of similarities between radio stars and radio sources visible to optical telescopes.

Caster Eases Jolting TV Set

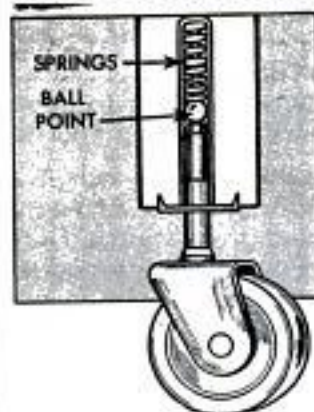

"Floating" casters ease jolts to TV sets that have to be moved. A special spring sits on a steel ball in the caster housing above the plastic wheel. This permits shock absorption and turning of wheel without marking the floor.

Popular Mechanics Magazine

Registered in U. S. Patent Office and Canada

H. H. WINDSOR, Founder

H. H. WINDSOR, JR., Editor and Publisher

FOREIGN EDITIONS: MECANIQUE POPULAIRE (French) MECANICA POPULAR (Spanish) POPULÆR MEKANIK (Danish) POPULAR MEKANIK (Swedish) POPULARE MECHANIK (German) MECCANICA POPOLARE (Italian)

Managing Editor

RODERICK M. GRANT

Assistant Managing Editor

WAYNE WHITTAKER

Shop Notes and Crafts Editor

JAMES R. WARD

Associate Editor

CLIFFORD B. HICKS

Associate Editor, Automobile

ARTHUR R. RAILTON

Associate Editor, Shop Notes and Crafts

WAYNE C. LECKEY

Associate Editor, Shop Notes

W. CLYDE LAMMEY

Associate Editor

WILLIAM D. PERKINS

Radio-Television, Electronics Editor

LOTHAR STERN

Assistant Editor, Crafts

JAY W. HEDDEN

Assistant Editor, Makeup

JOHN DALEN

Art Director, **FRANK BEATTY**

Assistant Editors

KENNETH ANDERSON **ROBERT DORSETT**
ROBERT HENDRICKSON **EARL WOBECK**

Eastern Editor

RICHARD F. DEMPEWOLFF

Empire State Bldg., Room 2906, N.Y.C. 1

Western Editor

THOMAS E. STIMSON, JR.

Suite 1010, 3460 Wilshire Blvd.,

Los Angeles 5, Calif.

London Manager

DOUGLAS W. WEDDERSPOON

Eagle House, Jermyn St.,

London S.W. 1, England

Director, Bureau of Information

ALLAN CARPENTER

200 E. Ontario St., Chicago 11

Advertising Offices

Chicago: 200 E. Ontario St., Whitehall 4-0100;

New York: Empire State Bldg., 350 Fifth Ave.,

Longacre 5-7580; Detroit: General Motors

Bldg., Room 5-118, TRINITY 5-8711; Cleveland:

Hanna Bldg., 1422 Euclid Ave., PROSPECT

1-6456; Los Angeles: 3460 Wilshire, DUNKIRK

2-8458; San Francisco: Russ Bldg., Room

468, 235 Montgomery St., YUKON 2-0823.

Sources of further information not listed in the index, starting on page 58, about articles in this issue, frequently are shown in the Where-to-Find-It List prepared for each issue. A copy may be obtained by readers, without charge, from Bureau of Information, Popular Mechanics, 200 East Ontario Street, Chicago 11, Illinois.

Published monthly by Popular Mechanics Company, 200 E. Ontario St., Chicago 11, Ill. H. H. Windsor, Jr., president; Wm. Harrison Feunings, exec. vice-pres.; Franklin S. Forsberg, operations vice-pres.; D. F. Windsor, vice-president and secretary-treasurer; H. H. Windsor III, vice-president; W. T. Windsor, vice-president; Joseph E. Buell, Jr., advertising manager; Alan M. Boyce, circulation manager. Single copy in the United States and Canada, 35 cents; subscription rates in the United States and possessions, Canada and countries of the Pan-American Postal Union, 1 year \$3.50; 2 years, \$6.00; 3 years, \$8.00. To all other countries add \$1.00 a year over United States prices for overseas postage. If you plan to move, notify us at least 30 days in advance so you will not miss an issue. Give both your old and new addresses. Entered as Second Class Matter, September 15, 1903, at the Post Office at Chicago, Illinois, under Act of March 3, 1879. Entered as Second Class Matter at Post Office Dept., Canada, Registered as Second Class Matter at the Post Office at Mexico, D.F., Mexico, June 20, 1950. Copyright 1957 by Popular Mechanics Company. Copyright under International Copyright Union. Copyright in France. All rights reserved under Pan-American Copyright Union. Printed in the United States of America.

Volume 108

JULY 1957

Number 1

Address all communications to: 200 E. Ontario St., Chicago 11, Ill.

In This Issue...

Stand By for Satellite Take-off	- - -	65
Your Aerial Sedan for 1967	- - -	74
Everybody's Going Sailing	- - -	80
After a Wreck . . . Clear the Rails!	- - -	85
How the Prefabs Got That Custom Look	- - -	91
I Shoot the Works	- - -	97
Mystery Fuels for the Missile Age	- - -	108
Our Outboard Boat Boom	- - -	116
The Owners Report on the '57 Oldsmobile	- - -	122
"Broncobusters" of the High Seas	- - -	130
Air Is the Farmer's Hired Hand	- - -	137

For the Craftsman...

"Egg Crate" Paddle Board Is Light, Strong	- - -	149
Know-How Fills the Creel	- - -	153
Build the Sea Knight — Part III	- - -	158
Outsmarting the Housebreaker	- - -	175
Index Centers	- - -	187

Regular Departments...

Detroit Listening Post	- - -	73
Keeping Up With the Atom	- - -	84
What's New for Your Home	- - -	104
Radio, TV and Electronics	- - -	145
How Would You Do It?	- - -	198
Shopping for Tools	- - -	202
On the Market for Do-It-Yourselfers	- - -	204
Clinic for Homemakers	- - -	208

Next Month...

FOR 12 YEARS a restaurant roof was a crashed, war-surplus DC-3. An enterprising firm bought it, fixed it up and it's flying again. This is one of many fascinating, true anecdotes in an August article, "The Saga of the DC-3," telling the story of the "gooney-bird" and how it refuses to die



NOW...YOU'RE "SET" FOR

SAFER TRAVEL



...thanks to **ATOMIC ENERGY**



A **MATCHED SET** of Dunlop AccuRated tires is greater-than-ever protection against premature tire failure. The precise, atomic-powered action of Accu-Ray® produces a stronger, safer tire with an exact amount of protective rubber uniformly applied to every cord ply. No dangerous ply chafing or internal heat build-up. Better balance, new stability and comfort for mile after mile of safer driving. Your Dunlop dealer will give you the "inside story" that makes Dunlop your best tire value today. He has a complete selection of Dunlop tires in Nylon or Super Hi-Test Rayon.



You'll go farther,
SAFER... on tires by

DUNLOP

They're AccuRated

DUNLOP TIRE AND RUBBER CORPORATION, BUFFALO 5, N. Y.



Vermiculite in Grill Spreads Heat Evenly

Vermiculite, a lightweight mineral used as an insulating material, now is being marketed as an aid to the back-yard chef. A layer of vermiculite is placed in the charcoal grill. It helps provide even heat for barbecuing, and absorbs grease drippings. Less fire-starting liquid is required, as the vermiculite acts as a wick. The mineral can be used repeatedly until it becomes filled with ash.

Jet Fires 114 Rockets

An Air Force F-100C Super Sabre jet fighter recently fired 114 rockets simultaneously at Eglin Air Force Base, Fla.

Power-Mower Chain Guide For Safe Grasscutting

Mowing grass on a steep terrace can be dangerous if your foot slips toward the whirling blades of a power mower. Such accidents can be averted by attaching a length of chain to the handle of the mower. A Y-shaped chain now available can be attached easily with U-clamps. On short terraces the operator can guide the mower from the top of a slope. On long terraces he can work from a safe distance.

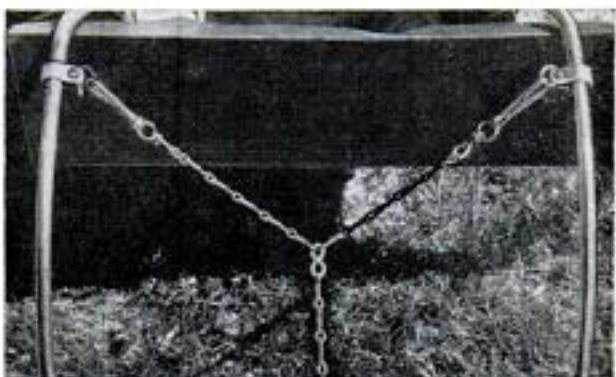

POPULAR MECHANICS



X-RAY ON CHEVROLET

Roadability begins with "silk glove" steering

Nothing—not even performance—adds as much to solid driving pleasure as roadability. And roadability has its rock-bottom beginning with the silky, surgically precise steering that is Chevrolet's hallmark.

That's Ball-Race steering—a special system of steering in which a micro-polished spiral of steel ball bearings transmits your fingertip hint into turning motion—with sports car accuracy.

Chevrolet uses ball bearings because there's much less "drag" with *rolling*

friction than with the usual *sliding* friction. And we've taken extraordinary care in designing the Ball-Race system because, basically, nothing short of power steering can make the miles seem so fatigue free. Try it and you'll know why! . . . Chevrolet Division of General Motors, Detroit 2, Michigan.





**Under this banner
the Proto Tool Company
will continue to
serve your needs...**

Founded in 1907, PROTO is the World's largest producer today of high-quality hand service tools. Leadership is attributable mainly to the professional quality of PROTO tools—resulting from intensive research, field-tested designs, special alloy steels, and superior manufacturing.

**PROTO means
PROfessional
TOols!**

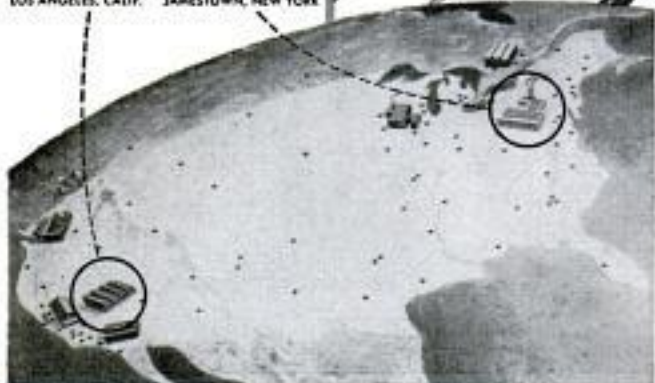

ACROSS THE DESK



To the Editor:

The remarks about American cars in the March issue are interesting. I have a '54 Buick and think that 1954 was the best style year since the war. Since then styling has been going to the dogs.

What we really need is a good "do-it-yourself" car kit. I built my own 22-foot cruiser, so why not a car, too? It would eliminate that sloppy technological abomination, the assembly line, where so much good material is fouled up and where costs skyrocket. We see many interesting custom cars built by people who labor for months on the sheet-metal work. This is too much for the average guy. But the assembly of an automobile is within reach of anybody who has built a 22-foot cruiser, provided the car kit comes as the cruiser does, with the parts formed.

Henry Hilton,
Woodbridge, N. J.

To the Editor:

In your January PM, I noticed a picture of a three-wheel car. Thought you might be interested in another one made up from



three airplanes and one jet canopy, powered by a Continental 65-horsepower aircraft engine, and running on three wheels, skis or floats. On wheels it has been clocked at 115 miles per hour, on snow at 65 so far—haven't had the nerve to hold the throttle wide open. On water it will do better than 30. As you can see, it is licensed as a car. The canopy is raised by two hydraulic cylinders. I am building one now that has, in its present condition, reached a clocked speed over a measured mile of 147 miles per hour. Oh yes, it is steered by the feet with hydraulic brakes for the two rear wheels and a booster-powered steel plate dropping between the skis. The front wheel

(Continued to page 8)



How these 18 Experts can help you

Get into a High Pay

ACCOUNTING CAREER

LaSalle's famous staff of Accounting authorities are helping thousands prepare for fast promotions and bigger pay. They can do the same for you!

If your heart is set on a larger income and all that it means . . . better home—fine car—larger bank account—more of the good things of life. . . .

If that's your ambition and you are really serious about it, then you owe it to yourself to get the REAL FACTS about LaSalle Accounting, and the many good-pay opportunities that can be YOURS through LaSalle's famous Problem Method plan.

It matters not whether you've had a single day of experience in this field—or whether you have already started but want to climb higher. LaSalle's expert training is designed to take you from where you are . . . to where you want to be . . . in higher positions and a lifetime career of security and good income.

WHY YOU CAN'T FAIL TO GAIN

You see on this page a panel of experts who know Accounting from A to Z . . . all the way from Basic Accounting, on up through Accounting Systems, Cost Accounting, Auditing, Income Tax, and training for the C.P.A. certificate. These are only part of our instruction staff. But what is most important to you . . .

...These C.P.A.'s and Expert Accountants know how to impart their knowledge to others . . . how to help you prepare quickly yet thoroughly for success in this lucrative field.

The proof? What stronger proof could there

be than that more than 4,200 Certified Public Accountants (one out of every 13 of the U.S. total) has trained with LaSalle? Or the hundreds of thousands of men and women whom LaSalle has helped qualify rapidly for more money, a brighter future, in a high-pay-lifetime career? These thousands came to us with different backgrounds of experience and varying degrees of ambition. Many have reported raises and promotions after only a few weeks of training. Thousands of them have written to say they are now earning 50% more—even double their former incomes—often in less than a year. These letters are published in book form for your inspection. They were written by real people, with real income, problems and ambitions—people who might be your next-door neighbor.

Yes, if you are really sincere in wanting to better your position—start your income climbing—enjoy a lifetime career of high standing and high reward—this friendly staff of experts can help you.

OPPORTUNITIES UNLIMITED

The demand for accountants is great—everywhere. All businesses must have trained accountants to cope with ever-growing requirements. It's a profession offering wide opportunity—always—to the man who knows.

You can fit into any business, anywhere in the country—because accounting principles are universal. Think what this means in terms of security and independence!

SEND FOR TWO FREE BOOKS

The interesting and informative book, "Accountancy, The Profession That Pays," gives all the latest facts about the new and growing opportunities in several different fields of profitable employment.

This can be an important day in your life. A coupon like the one below has started hundreds of thousands of men and women toward a bigger job, a larger income. It can do the same for you.

Member, National Home Study Council

Mail the Coupon Today!

FREE BOOK

LA SALLE EXTENSION UNIVERSITY

A Correspondence Institution

417 S. Dearborn St., Dept. 764-H, Chicago 5, Ill.

Send free books, "Accountancy, The Profession That Pays," also "Success Reports" without obligation.

FREE BOOK



Name.....Age.....

Address.....

City & Zone.....State.....

(Continued from page 6)

is replaced by a third, lighter ski which is used for steering.

William T. Rogers,
Billings, Mont.

Nylon-Lined Swimming Pool

An Indianapolis company offers a vinyl-coated nylon liner for swimming pools. Inexpensive concrete blocks frame the excavated area, the nylon liner is fitted into the pool bed, anchored at the top and filled with water—ready for swimming! The whole job can be done in about three days, says the manufacturer. A filter should be added. The liners are available in four sizes, and can be wiped clean with a cloth.

First Arctic Auto

In an old box in an abandoned Alaska cabin has just been found a remarkable photograph revealing an amazing journey of the first automobile ever to penetrate the Arctic, 57 years ago.

Its 12,000 mile journey there by steamer, rail and its own propulsion was a brilliant example of original advertising promotion by two French newspapers, the *Figaro*, and a new journal, *The Klondyke Review*.

This Arctic pioneer was a three-wheeled gasoline-driven automobile flying the French flag, and driven by E. J. de Lemare

to build up circulation of these two papers in Yukon and Alaska gold fields. The car went by steamer from Paris to New York, rail to San Francisco, steamer to Skagway.



From there it traveled several thousand miles over ice and snow.

Most difficult and thrilling moment was in April 1900 when the car was crossing Atlin Lake. The ice had commenced thawing. This placed the "burner" on the bottom of the car almost continually in water. On this record-making trip, repairs had to be made in the middle of the lake to the underside of the car. It being impossible

(Continued to page 10)

New greaseless way to keep your hair neat all day...and prevent dryness



New Vitalis keeps hair in place and prevents dryness with V-7, the greaseless grooming discovery. You never have an overslick, plastered-down look. Try it. You'll like it.



New VITALIS® Hair Tonic with V-7.

ANOTHER FINE PRODUCT
OF BRISTOL-MYERS

ARE YOU TOO OLD TO LEARN?

not at all, scientists say

New tests show that: your ability to think increases with age; your powers of deduction are greater; your judgment is better.

In the I. C. S. files are thousands of cases of men and women of every age. Their successes, their promotions, their raises prove that men and women past school age can learn!

I.C.S. GIVES YOU EXPERT GUIDANCE FREE! Do you have the feeling you're "stuck" in your job? Your trained I. C. S. counselor will appraise your abilities, help you plan for the future.

IT'S NEVER TOO LATE TO GET STARTED! You study with I. C. S. at home, in your spare time. There's no interference with business or social activity. Famous I. C. S. texts make learning easy. Don't delay. Pick your field from the coupon below. And mail it today!

3 FREE BOOKS

36-page, pocket-size guide to advancement, a gold mine of tips on "How to Succeed." Big catalog outlining opportunities in your field of interest. Also sample lesson (Mathematics).

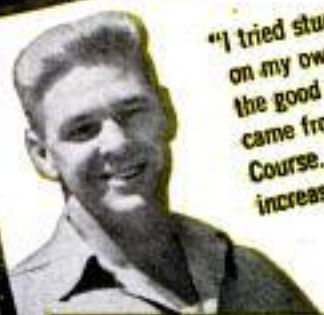

"I tried studying my work on my own, but I never got the good out of it that came from my I. C. S. Course. My salary has been increased 73.3%!"
E.L.B.
Ohio

"I am president of a small corporation. A year ago I enrolled with I. C. S. as the most practical means available to me to learn what I needed."
W.J.A.
Michigan



"It's been so long since I went to school, I've forgotten much. But now that I'm taking an I. C. S. Course, I have confidence in my ability again."
H.A.R.
New Jersey



Actual statements. Posed by models.

For Real Job Security—Get an I. C. S. Diploma!

I. C. S., Scranton 9, Penna.

Member, National Home Study Council

INTERNATIONAL CORRESPONDENCE SCHOOLS



BOX 999536, SCRANTON 9, PENNA.

(Partial list of 257 courses)

- Without cost or obligation, send me "HOW TO SUCCEED" and the opportunity booklet about the field BEFORE which I have marked X (plus sample lesson):
- | | | | | |
|--|--|--|--|--|
| <p>ARCHITECTURE and BUILDING CONSTRUCTION</p> <ul style="list-style-type: none"> <input type="checkbox"/> Air Conditioning <input type="checkbox"/> Architecture <input type="checkbox"/> Arch. Drawing and Designing <input type="checkbox"/> Building Contractor <input type="checkbox"/> Building Estimator <input type="checkbox"/> Carpentry and Millwork <input type="checkbox"/> Carpenter Foreman <input type="checkbox"/> Heating <input type="checkbox"/> Interior Decoration <input type="checkbox"/> Painting Contractor <input type="checkbox"/> Plumbing <input type="checkbox"/> Reading Arch. Blueprints <p>ART</p> <ul style="list-style-type: none"> <input type="checkbox"/> Commercial Art <input type="checkbox"/> Magazine & Book illus. <input type="checkbox"/> Show Card and Sign Lettering <input type="checkbox"/> Sketching and Painting <p>AUTOMOTIVE</p> <ul style="list-style-type: none"> <input type="checkbox"/> Automobiles <input type="checkbox"/> Auto Body Rebuilding and Refinishing <input type="checkbox"/> Auto Engine Tuneup <input type="checkbox"/> Auto Technician | <p>AVIATION</p> <ul style="list-style-type: none"> <input type="checkbox"/> Aero-Engineering Technology <input type="checkbox"/> Aircraft & Engine Mechanic <p>BUSINESS</p> <ul style="list-style-type: none"> <input type="checkbox"/> Accounting <input type="checkbox"/> Advertising <input type="checkbox"/> Business Administration <input type="checkbox"/> Business Management <input type="checkbox"/> Cost Accounting <input type="checkbox"/> Creative Salesmanship <input type="checkbox"/> Managing a Small Business <input type="checkbox"/> Professional Secretary <input type="checkbox"/> Public Accounting <input type="checkbox"/> Purchasing Agent <input type="checkbox"/> Salesmanship <input type="checkbox"/> Salesmanship and Management <input type="checkbox"/> Traffic Management <p>CHEMICAL</p> <ul style="list-style-type: none"> <input type="checkbox"/> Analytical Chemistry <input type="checkbox"/> Chemical Engineering <input type="checkbox"/> Chem. Lab. Technician <input type="checkbox"/> Elements of Nuclear Energy <input type="checkbox"/> General Chemistry <input type="checkbox"/> Natural Gas Prod. and Trans. <input type="checkbox"/> Petroleum Prod. and Engr. <input type="checkbox"/> Professional Engineer (Chem) <input type="checkbox"/> Pulp and Paper Making | <p>CIVIL ENGINEERING</p> <ul style="list-style-type: none"> <input type="checkbox"/> Civil Engineering <input type="checkbox"/> Construction Engineering <input type="checkbox"/> Highway Engineering <input type="checkbox"/> Professional Engineer (Civil) <input type="checkbox"/> Reading Struc. Blueprints <input type="checkbox"/> Structural Engineering <input type="checkbox"/> Surveying and Mapping <p>DRAFTING</p> <ul style="list-style-type: none"> <input type="checkbox"/> Aircraft Drafting <input type="checkbox"/> Architectural Drafting <input type="checkbox"/> Drafting Machine Design <input type="checkbox"/> Electrical Drafting <input type="checkbox"/> Mechanical Drafting <input type="checkbox"/> Sheet Metal Drafting <input type="checkbox"/> Structural Drafting <p>ELECTRICAL</p> <ul style="list-style-type: none"> <input type="checkbox"/> Electrical Engineering <input type="checkbox"/> Elec. Engr. Technician <input type="checkbox"/> Elec. Light and Power <input type="checkbox"/> Practical Electrician <input type="checkbox"/> Practical Lineman <input type="checkbox"/> Professional Engineer (Elec) <p>HIGH SCHOOL</p> <ul style="list-style-type: none"> <input type="checkbox"/> High School Diploma | <ul style="list-style-type: none"> <input type="checkbox"/> Good English <input type="checkbox"/> High School Mathematics <input type="checkbox"/> Short Story Writing <p>LEADERSHIP</p> <ul style="list-style-type: none"> <input type="checkbox"/> Industrial Foremanship <input type="checkbox"/> Industrial Supervision <input type="checkbox"/> Personnel-Labor Relations <input type="checkbox"/> Supervision <p>MECHANICAL and SHOP</p> <ul style="list-style-type: none"> <input type="checkbox"/> Diesel Engines <input type="checkbox"/> Gas-Elec. Welding <input type="checkbox"/> Industrial Engineering <input type="checkbox"/> Industrial Instrumentation <input type="checkbox"/> Industrial Metallurgy <input type="checkbox"/> Industrial Safety <input type="checkbox"/> Machine Design <input type="checkbox"/> Machine Shop Practice <input type="checkbox"/> Mechanical Engineering <input type="checkbox"/> Professional Engineer (Mech) <input type="checkbox"/> Quality Control <input type="checkbox"/> Reading Shop Blueprints <input type="checkbox"/> Refrigeration and Air Conditioning <input type="checkbox"/> Tool Design <input type="checkbox"/> Tool Making <p>RADIO, TELEVISION</p> <ul style="list-style-type: none"> <input type="checkbox"/> General Electronics Tech. | <ul style="list-style-type: none"> <input type="checkbox"/> Industrial Electronics <input type="checkbox"/> Practical Radio-TV Engr'g <input type="checkbox"/> Practical Telephony <input type="checkbox"/> Radio-TV Servicing <p>RAILROAD</p> <ul style="list-style-type: none"> <input type="checkbox"/> Car Inspector and Air Brake <input type="checkbox"/> Diesel Electrician <input type="checkbox"/> Diesel Engr. and Fireman <input type="checkbox"/> Diesel Locomotive <p>STEAM and DIESEL POWER</p> <ul style="list-style-type: none"> <input type="checkbox"/> Combustion Engineering <input type="checkbox"/> Power Plant Engineer <input type="checkbox"/> Stationary Diesel Engr. <input type="checkbox"/> Stationary Fireman <p>TEXTILE</p> <ul style="list-style-type: none"> <input type="checkbox"/> Carding and Spinning <input type="checkbox"/> Cotton Manufacture <input type="checkbox"/> Cotton Winding and Weaving <input type="checkbox"/> Loom Fixing Technician <input type="checkbox"/> Textile Designing <input type="checkbox"/> Textile Finishing & Dyeing <input type="checkbox"/> Throwing <input type="checkbox"/> Winding and Weaving <input type="checkbox"/> Worsted Manufacturing |
|--|--|--|--|--|

Name _____ Age _____ Home Address _____
 City _____ Zone _____ State _____ Working Hours _____ A.M. to P.M. _____
 Occupation _____
 Canadian residents send coupon to International Correspondence Schools, Canadian, Ltd., Montreal, Canada. . . . Special tuition rates to members of the U. S. Armed Forces.

**STOP
ROUGH IDLING!**



**CLEAN YOUR
CARBURETOR**
with



- Every carburetor gets dirty **INSIDE**, causing rough idling, stalling and hard starting. Clean yours with **GUMOUT** now!
- **GUMOUT** cleans carburetors easily . . . dissolves gum and varnish deposits quickly.
- Just add **GUMOUT** to your gas tank. That's all. Cleans as you drive.
- Buy **GUMOUT** at auto supply stores, or wherever automotive products are sold. There's nothing like it.

GUMOUT DIVISION

Pennsylvania Refining Company
2671 Lisbon Road, Cleveland 4, Ohio



send for **FREE**

46-page "CARBURETOR HANDBOOK"
It's loaded with helpful information
about your car's fuel system.

GUMOUT is great for power mowers and outboards, too. A clean carburetor gives you faster starts, more power.

(Continued from page 8)

to turn the machine over, a hole was cut in the thick ice the size of a man's body. The mechanic lay in this and the driver moved the car over him.

At the end of April 1900 this first car to penetrate arctic North America returned to make triumphal entry into Paris.

Francis Dickie,
Heriot Bay, B. C., Can.

To the Editor:

Henry White, high-school freshman of Phoenix, Ariz., decided he would look over the land as he rode his bicycle so he took parts of two bikes, turned over the frame of one, reversed the sprocket, welded a part of another bike on the seat section and welded a piece of bar in the front. This takes him off the ground about three or four feet and he considers it very safe and comfortable.



Henry F. Unger,
Phoenix, Ariz.

To the Editor:

I will begin this letter by stating that I have been a reader of *Popular Mechanics* since it was first published (1902) and I had the first volumes bound.

Now to my pet "peeve" . . . the story (March) of the frigate *Constitution*. In the first paragraph the *Constitution* is called a ship. Wrong, she was a frigate. The construction of the stern is far from correct and her masts were not banded, and the wheel was aft of the main mast.

When the *Constitution* was in Los Angeles harbor, I think about 1936, I had special permission from the Navy Department to photograph her from stern to stern and keel to topmast.

Now I will tell you why I was so interested. I recall that my great grandfather was a shipwright in the original construction and have in my possession a silver dollar he earned and my grandfather, my father and myself cut our first teeth on it. I was six years old and my father took me to see my first sailing ship . . . 80 years ago.

Theodore K. Hastings,
Los Angeles, Calif.

POPULAR MECHANICS

Be a Radio-TV Technician Learn at Home in Spare Time

**America's Fast Growing Industry Offers You
GOOD PAY—SECURITY—A BRIGHT FUTURE**

Training PLUS OPPORTUNITY is the ideal combination for success. Today's opportunity field is Radio-Television. Plan now to get into Radio-TV. Radio is bigger than ever. TV is growing. Color TV, Hi-Fi promise added opportunity.

Start Soon to Make \$10, \$15 a Week Extra

Soon after enrolling, many NRI students earn extra cash fixing neighbors' sets. Keep your job. NRI trains you at home in spare time. NRI is oldest and largest home-study Radio-TV school. You benefit from our 40 years experience training men.



**SAMPLE LESSON and
CATALOG—FREE**

You Learn-by-Doing

NRI sends you kits of parts to build circuits for practical experience. They "bring to life" things you study. Mail coupon today. **National Radio Institute, Dept. 7GA, Washington 16, D. C.**

NATIONAL RADIO INSTITUTE
Dept. 7GA, Washington 16, D.C.

Please send me FREE Sample Lesson and 64 Page Catalog on Radio-Television Servicing and Communications. No Salesman will call.

Name.....Age.....

Address.....

City.....Zone.....State.....

ACCREDITED MEMBER NATIONAL HOME STUDY COUNCIL



Learn to Fix Electric Appliances Turn Your Spare Time into Cash

Make Extra Money—Start Soon

To build a better future, get into a field where there is important work and opportunity for the trained man. Up to 10 million electric appliances are sold every year. Every wired home now

has an average of 8. Owners pay well to have them fixed properly, quickly. This is your opportunity for a better job, a spare time or full time business. NRI can give you the training you need, at home in your spare time.

Learn and Earn with Tester You Build

Soon after starting you will be able to earn extra cash fixing toasters, clocks, fans, vacuum cleaners for neighbors and friends. Tester you build with parts we furnish helps you locate electrical defects, correct them faster. Keep your job while learning. Turn your spare time into cash.



Train Now for Greater Security Low Price, Easy Terms

Take the first step now toward higher pay, more interesting work. No need to give up your present job. Train at home. Send coupon for actual lesson to prove NRI home training is practical. Training is low in cost. Convenient monthly payments.

NATIONAL RADIO INSTITUTE,
Dept. AG7, Washington 16, D.C.

Mail today for Lesson and Catalog—BOTH FREE

NATIONAL RADIO INSTITUTE
Dept. AG7, Washington 16, D.C.

Please send me FREE Sample Lesson and Catalog on your Electric Appliance Servicing Training. No Salesman will call.

Name.....Age.....

Address.....

City.....Zone.....State.....

ACCREDITED MEMBER NATIONAL HOME STUDY COUNCIL



Red Hot Summer Bargains



ELECTRIC MOTOR 99c

- Speeds to 5,600 RPM's
- Drives Planes, Jig Saw, etc.

Powerful, rugged, precision-built. New, never used. Fits palm of hand—gives giant performance. Speeds to 5,600 rpm's. Permanent magnetic field, bronze bushings, steel housing & mounting base. Drives model planes, toy trains, erector sets, displays, etc. Works on any flashlight battery. Built by master craftsmen. Formerly \$2.98. NO. 103 99c



Paint Kitchen in Only 55 Minutes! Famous Sprayer 1/2 Price!

Famous Hi-Speed automatic electric sprayer cuts painting time 75%. Do average kitchen in less than hour. Spray screens, doors, walls, garden furniture, etc. 101 uses. Spray insecticides on plants. Mothproof clothes. Lubricate car. New 1957 model. Cleans itself. Built-in strainer. New improved electromagnetic motor-compressor. Push button & spray. Same sprayer formerly advertised on TV for \$19.95 — now half-price. Complete kit — no extras. NO. 102 \$9.95

SAVE! BUY DIRECT FROM IMPORTER!

Sensational values! Savings up to 75% because you buy direct from importer. No needless middleman's profits or distribution costs tacked on! Buy with complete confidence. Your money back promptly if not satisfied. **GUARANTEED FAST DELIVERY.** But stock is limited on some items. Don't lose out on these red hot summer bargains. Rush coupon below today. THORESEN, Inc., Dept. 6-G, 585 Water Street, New York 2, N. Y. One of America's biggest and most respected mail order firms!



SPY CAMERA \$1.98

FREE Film & Pigskin Case!

Look high & low but you won't match this value. Not a toy or gadget but genuine import. All metal chrome plated. Coated Minus-cus lens. Speed shutter. View-finder. Instant & time settings. Sharp, clear pictures. Free film! Free pigskin case! You might expect to pay \$5.00! Thousands sold at higher price. While supply lasts . . . only \$1.98. NO. 48



Black Eagle GERMAN BINOCULARS 99c

FORMERLY \$3.95

• VIEWS UP TO 25 MILES
We've sold more than ONE MILLION binoculars—but this is our greatest value. Famous, long-range Black Eagle GERMAN binoculars—nationally advertised at \$3.95—yours for 99c. Incredible, but true! Has features found in expensive binoculars. Synchronized center focusing. Hi-fidelity views up to 25 miles away. Order several. NO. 78 99c



100 Blue Steel Blades — 1c Each

Sensational value! Genuine BLUE surgical steel blades—not 20 for 98c but 100 for 99c! Guaranteed to give same close shaves as famous brands costing 5 times more—or money back! Fits any double-edge razor perfectly. Why help pay for costly TV commercials? "Everything's the same but the name . . . and the price." Still not convinced. Then send for trial order. Use 10 blades. If not satisfied, return balance for FULL refund. NO. 131 100 for 99c



Precision-Made Wall Barometer NOW 1/2 PRICE!

\$5.98 VALUE \$2.98

Try to beat the weather man. Our lowest price ever on this handsome Wall Barometer. Same quality mechanism in weather barometers selling from \$5.98 up! Now yours at HALF PRICE. Registers weather atmospheric pressure automatically and with amazing degree of accuracy. Aids you to become your own weather man, to predict when good or bad weather is likely—HOURS IN ADVANCE! Easy to read markings—very finely calibrated from "26" to "31." You can see at a glance! Rain, Storm, Very Dry, Change and Fair. Large 5 1/2 inch diameter. Sunburst case in mahogany and gold effects. Gives that magic decorator touch to any room. Easy instructions included. Made in West Germany by fine, reputable barometer firm. Rush order now during sale. NO. 650 . . . \$2.98



WATER & SHOCK RESISTANT WATCH! Compare with Watches Costing up to \$49.95!

\$7.98
We've sold 200,000 watches—but this is our most fabulous bargain! New 1957 Geneva. Stainless steel screw back. Built-in shock protector. Anti-magnetic. Center sweep second hand. Luminous dial. Deluxe gift packaged! Precision Swiss make. Unlimited guarantee of service & repair FREE. Compares with \$49.95 watches for beauty & design. Runs under water! NO. 260 . . . \$7.98 plus 80c excise tax. Total! \$8.78

THORESEN, Inc., Dept. 6-G
585 Water Street, New York 2, N. Y.

RUSH items listed below. My money back if I am not satisfied.

- Check, cash or m.o. enclosed. Send prepaid.
- Send COD, plus postal fees (No COD's under 1.98)

NO.	QUANTITY	ARTICLE	PRICE

PRINT NAME _____
ADDRESS _____
CITY & ZONE _____ STATE _____

Canadians: Address 439 King St., W., Toronto 2B, Ont.

Solves Math Problems In Seconds Without Pencil or Paper! 10 Inches Long!

Now turn slide rule mystery into easy mastery. Solves problems in multiplication, division, proportions, squares roots IN SECONDS. Saves hours of complicated figuring, costly errors that may mean money out of your pocket. Some professional-type as used by engineers earning up to \$15,000.00 a year! 10 full inches when closed. Clear glass indicator with hairline center for pinpoint accuracy. FREE 28-page book on how to save time, work, money with this "Mr. Brain." A must for handymen, machinists, draftsmen—men on the way up!

NO. 135 99c

Does Everything \$4.00 Slide Rules Do! OUR PRICE

99c

INVENTORS

Learn how to protect your invention. The U. S. Patent Laws provide that any new and useful art, machine, article of manufacture, or composition of matter, or any new and useful improvement thereof, may be patented if the act of invention is involved. Therefore, every inventor with a valuable invention should take advantage of the Patent Laws and proceed for patent protection in order to safeguard his rights.

A patent gives the inventor the exclusive right to prevent others from making, using, or selling the invention claimed in the patent for a period of seventeen years.

The Patent Laws were enacted for the benefit of the inventor to give him protection for the features of his invention which are patentable. These features must be properly and concisely set forth and claimed in a formal application for patent, in order to comply with the requirements of the Patent Laws. For that reason, unless the inventor is familiar with patent matters, he should engage a competent registered patent attorney or agent to represent him. We are registered to practice before the U. S. Patent Office and are prepared to serve you in the handling of your patent matters.

A specially prepared booklet entitled "Patent Guide for the Inventor", containing detailed information with respect to patent protection and procedure, together with a "Record of Invention" form will be promptly forwarded to you without obligation upon request.

CLARENCE A. O'BRIEN & HARVEY JACOBSON

Registered Patent Attorneys

71-G DISTRICT NATIONAL BUILDING

WASHINGTON 5, D. C.

AUDELS Carpenters and Builders Guides

4 vols. \$8



Inside Trade Information for Carpenters, Builders, Joiners, Building Mechanics and all Woodworkers. These Guides give you the short-cut instructions that you want—including new methods, ideas, solutions, plans, systems and money saving suggestions. An easy progressive course for the apprentice... a practical daily helper and Quick Reference for the master worker. Carpenters everywhere are using these Guides as a Helping Hand to Easier Work, Better Work and Better Pay. ACT NOW... fill in and mail the FREE COUPON below.

Inside Trade Information On:

How to use the steel square—How to file and set saws—How to build furniture—How to use a mitre box—How to use the chalk line—How to use rules and scales—How to make joints—Carpenters arithmetic—Solving mensuration problems—Estimating strength of timbers—How to set girders and sills—How to frame houses and roofs—How to estimate costs—How to build houses, barns, garages, bungalows, etc.—How to read and draw plans—Drawing up specifications—How to excavate—How to use settings 12, 13 and 17 on the steel square—How to build hoists and scaffolds—skylights—How to build stairs—How to put on interior trim—How to hang doors—How to lath—lay floors—How to paint.



MAIL ORDER



AUDEL, Publishers, 49 W. 23 St., NEW YORK 10, N. Y.
Please send me for FREE EXAMINATION books marked (x) below. If I decide to keep them I agree to mail \$2 in 7 Days on each book or set ordered and further mail \$2 monthly on each book or set until I have paid price plus shipping charges. Otherwise I will return them.

Check NOW!

You Can Look Over Any Guide In Your Own Home

SAVE SHIPPING CHARGES!

Enclose Full Payment With Coupon and We Pay Shipping Charges



- HOME APPLIANCE SERVICE GUIDE, 864 Pages \$6
- AUTOMOBILE MECHANICS GUIDE, 1696 Pages. 6
- TRUCK & TRACTOR GUIDE, 1376 Pages. 5
- DIESEL ENGINE MANUAL, 640 Pages. 3
- MACHINISTS HANDY BOOK, 1728 Pages. 6
- WELDERS GUIDE, 608 Pages. 3
- BLUE PRINT READING, 448 Pages. 3
- MATHEMATICS & CALCULATIONS, 752 Pages. 3
- SHEET METAL PATTERN LAYOUTS, 1152 Pgs. 7.50
- SHEET METAL WORKERS HANDY BOOK, 448 Pgs. 2
- MECHANICAL DRAWING GUIDE, 192 Pages. 2
- MECHANICAL DRAWING & DESIGN, 480 Pages 3
- TELEVISION SERVICE MANUAL, 480 Pages. 3
- RADIONANS GUIDE, 1088 Pages. 5
- ELECTRONIC DEVICES, 304 Pages. 3
- ELECTRIC MOTOR GUIDE, 1056 Pages. 5
- WIRING DIAGRAMS (Light & Power), 304 Pgs. 2
- ELECTRICIANS EXAMINATIONS, 272 Pages. 2
- ELECTRIC POWER CALCULATIONS, 480 Pages 3
- HANDY BOOK OF ELECTRICITY, 1520 Pages. 5
- ELECTRIC DICTIONARY, 9000 Terms. 3
- ELECTRIC LIBRARY, 7000 Pages (10 Book Set) 20
- REFRIGERATION & Air Conditioning, 1360 Pgs. 6
- MILLWRIGHTS & MECHANICS GUIDE, 1248 Pgs. 5
- POWER PLANT ENGINEERS GUIDE, 1568 Pages 5
- ENGINEERS & FIREMANS EXAMS, 544 Pages. 2
- PUMPS, Hydraulic & Air Compressor, 1760 Pgs. 6
- OPERATING ENGINEERS LIBRARY (3 Books) 12
- GARDENERS & GROWERS GUIDES (4 Book Set) 6
- CARPENTERS & BUILDERS GUIDES (4 Book Set) 8
- PLUMBERS & Steamfitters Guides (4 Book Set) 8
- MASONS AND BUILDERS GUIDES (4 Book Set) 8
- PAINTERS & DECORATORS MANUAL, 464 Pgs. 2
- HOUSE HEATING GUIDE, 1008 Pages. 5
- OIL BURNER GUIDE, 416 Pages. 2

Name _____

Address _____

Occupation _____

Employed by _____ P7



college graduates get ahead faster!

You see it in your own city. They have higher incomes... advance more rapidly. Grasp your chance for a better life. Industrial growth... automation... technical advances create career opportunities for engineers, accountants, management experts. Share rewards awaiting college-trained men. Important firms visit campus regularly to employ Tri-State College graduates. Start any quarter in this world-famed college. Approved for veterans.

Bach. of Science degree in 27 months

In Mechanical, Civil, Electrical, Chemical, Aeronautical, Radio (TV-Electronics) Engineering. In 36 months a B.S. in Business Administration (General Business, Accounting, Motor Transport Management majors). Superior students may accelerate. 36-weeks course in Drafting. Intensive program: technical fundamentals stressed; comprehensive courses with more professional class hours. Small classes: personalized instruction. Enrollment limited to 1550. Preparatory courses. *Besential campus.* Well-equipped, new and modernized buildings and laboratories. Enter Sept., Jan., Mar., June. Earnest, capable students (whose time and budget require accelerated courses and modest costs) are invited to write Joan McCarthy, Director of Admissions, for catalog and book "Your Career in Engineering and Commerce."



TRI-STATE COLLEGE

477 College Avenue • • • Angola, Indiana



BIG MONEY IN YOUR OWN BUSINESS!

Earn \$8,750.00 Your First Year!
Start part time if you wish. We locally train you, furnish everything to clean and mothproof rugs, upholstery and auto interiors ON LOCATION by a world-wide process. Quickly established. No shop needed. Just 2 average jobs a day bring \$8,750.00 NET profit in year. Employ others and multiply profits. You will be only service in town to get Nat'l Advertising, Parents' Seal, 25 other regular services. Easy terms. Send now for FREE booklets. DURACLEAN CO., 7-167 Duraclean Bldg., Deerfield, Ill.

MEN WANTED

Earn \$100 Per Week and up

AUTO DIESEL MECHANICS

Master a trade with a future—learn Auto-Diesel mechanics in our shops. You learn with tools on real equipment. Earn while you learn. Many of our graduates earn \$100 per week and up. No previous experience necessary. Day and night courses. Approved for veterans. Write for free bulletin.

NASHVILLE AUTO-DIESEL COLLEGE

226 7th Ave., N., Dept. 75

Nashville 3, Tenn.

ARTHRITIS—RHEUMATISM VITAL FACTS EXPLAINED

FREE DESCRIPTIVE BOOK

How crippling deformities may be avoided. This amazing FREE BOOK explains why ordinary methods give only temporary relief—if that. Describes a drugless method of treatment successfully applied in thousands of cases. Write for this 36-page FREE BOOK today. No obligation. BALL CLINIC, DEPT. 756, EXCELSIOR SPRINGS, MO.

RAZOR BLADE PLANES



ONLY 98¢ each AT HARDWARE DEALERS
If not yet available in your area, you may order by mail. Include 25¢ additional for postage and handling.
— DEALERS WRITE FOR INFORMATION —
WILSON BROS. Dept. PM-7 SPRINGFIELD, MISSOURI

POPULAR MECHANICS

I'd like to give this to my fellow men... while I am still able to help!



I was young once, as you may be—today I am older. Not too old to enjoy the fruits of my work, but older in the sense of being wiser. And once I was poor, desperately poor. Today almost any man can stretch his income to make ends meet. Today, there are few who hunger for bread and shelter. But in my youth I knew the pinch of poverty; the emptiness of hunger; the cold stare of the creditor who would not take excuses for money. Today, all that is past. And behind my city house, my

summer home, my Cadillacs, my Winter-long vacations and my sense of independence—behind all the wealth of cash and deep inner satisfaction that I enjoy—there is one simple secret. It is this secret that I would like to impart to you. If you are satisfied with a humdrum life of service to another master, turn this page now—read no more. If you are interested in a fuller life, free from bosses, free from worries, free from fears, read further. This message may be meant for you.

By Victor B. Mason

I am printing my message in a magazine. It may come to the attention of thousands of eyes. But of all those thousands, only a few will have the vision to understand. Many may read; but of a thousand only you may have the intuition, the sensitivity, to understand that what I am writing may be intended for you—may be the tide that shapes your destiny, which, taken at the crest, carries you to levels of independence beyond the dreams of avarice.

Don't misunderstand me. There is no mysticism in this. I am not speaking of occult things; of innumerable laws of nature that will sweep you to success without effort on your part. That sort of talk is *rubbish!* And anyone who tries to tell you that you can *think* your way to riches without effort is a false friend. I am too much of a realist for that. And I hope you are.

I hope you are the kind of man—who you have read this far—who knows that anything worthwhile has to be *earned!* I hope you have learned that there is no reward without effort. If you have learned this, then you may be ready to take the next step in the development of your karma—you may be ready to learn and use the secret I have to impart.

I Have All The Money I Need

In my own life I have gone beyond the need of money. I have it. I have gone beyond the need of gain. I have two businesses that pay me an income well above any amount I have need for. And, in addition, I have the satisfaction—the deep satisfaction—of knowing that I have put more than three hundred other men in businesses of their own. Since I have no need for money, the greatest satisfaction I get from life, is sharing my secret of personal independence with others—seeing them achieve the same heights of happiness that have come into my own life.

Please don't misunderstand this statement. I am not a philanthropist. I believe that charity is something that no proud man will accept. I have never seen a man who was worth his salt who would accept

* Posing by Professional Model

something for nothing. I have never met a highly successful man whom the world respected who did not sacrifice something to gain his position. And, unless you are willing to make at least half the effort, I'm not interested in giving you a "leg up" to the achievement of your goal. Frankly, I'm going to charge you something for the secret I give you. Not a lot—but enough to make me believe that you are a little above the fellows who merely "wish" for success and are not willing to sacrifice something to get it.

A Fascinating and Peculiar Business

I have a business that is peculiar—one of my businesses. The unusual thing about it is that it is needed in every little community throughout this country. But it is a business that will never be invaded by the "big fellows". It has to be handled on a local basis. No giant octopus can ever gobble up the whole thing. No big combine is ever going to destroy it. It is essentially a "one man" business that can be operated without outside help. It is a business that is good summer and winter. It is a business that is growing each year. And, it is a business that can be started on an investment so small that it is within the reach of anyone who has a television set. But it has nothing to do with television.

This business has another peculiarity. It can be started at home in spare time. No risk to present job. No risk to present income. And no need to let anyone else know you are "on your own". It can be run as a spare time business for extra money. Or, as it grows to the point where it is paying more than your present salary, it can be expanded into a full time business—overnight. It can give you a sense of personal independence that will free you forever from the fear of lay-off, loss of job, depressions, or economic reverses.

Are You Mechanically Inclined?

While the operation of this business is partly automatic, it won't run itself. If you are to use it as a stepping stone to independence, you must be able to work with your hands, use such tools as hammer and screw driver, and enjoy getting into a pair of blue jeans and rolling up your sleeves. But two hours a day of manual work will keep your "factory" running 24 hours turn-

ing out a product that has a steady and ready sale in every community. A half dollar spent for raw materials can bring you six dollars in cash—six times a day.

In this message I'm not going to try to tell you the entire story. There is not enough space on this page. And, I am not going to ask you to spend a penny now to learn the secret. I'll send you all the information, free. If you are interested in becoming independent, in becoming your own boss, in knowing the sweet fruits of success as I know them, send me your name. That's all. Just your name. I won't ask you for a penny. I'll send you all the information about one of the most fascinating businesses you can imagine. With these facts, you will make your own investigation. You will check up on conditions in your neighborhood. You will weigh and analyze the whole proposition. Then, and then only, if you decide to take the next step, I'll allow you to invest \$15.00. And even then, if you decide that your fifteen dollars has been badly invested I'll return it to you. Don't hesitate to send your name. I have no salesmen. I will merely write you a long letter and send you complete facts about the business I have found to be so successful. After that, you make the decisions.

Does Happiness Hang on Your Decision?

Don't put this off. It may be a coincidence that you are reading these words right now. Or, it may be a matter that is more deeply connected with your destiny than either of us can say. There is only one thing certain: If you have read this far you are interested in the kind of independence I enjoy. And if that is true, then you must take the next step. No coupon on this advertisement. If you don't think enough of your future happiness and prosperity to write your name on a postcard and mail it to me, forget the whole thing. But if you think there is a destiny that shapes men's lives, send your name now. What I send you may convince you of the truth of this proverb. And what I send you will not cost a penny, now or at any other time.

VICTOR B. MASON

1512 Jarvis Avenue, Suite M-2-S

CHICAGO 26, ILLINOIS

HOW TO FIX ANY PART OF ANY CAR

QUICKLY--EASILY--RIGHT!



FREE 7-DAY TRIAL

Whether you're a beginner or an expert mechanic — now you can "breeze through" any "fix-it" job from simple carburetor adjustment to complete overhaul. Just look up job in index of MOTOR'S Brand-New Auto Repair Manual. Follow simple step-by-step directions, clear pictures. Presto—the job is done!

No guesswork! MOTOR'S MANUAL takes you from "scratch" — shows WHERE to start, WHAT tools to use, Covers EVERY job on EVERY car built from 1949 thru 1957!

Everything You Need to Know "Bolted Down" from 160 Official Shop Manuals

BIG NEW, REVISED, ENLARGED, Edition contains the "meat" from over 160 OFFICIAL shop manuals — simplified for YOU. 23,436 essential repair specifications. Over 1,000 big pages. More than 2,000 "this-is-how" pictures, 225,000 service and repair facts. Leads technicians every step of the way. Time-saving factory repair procedures for experts. Instructions and pictures so clear you CAN'T go wrong. Used by U. S. Army and Navy.

Try Book FREE 7 Days

Just mail coupon. Attach it to postcard, if you wish. Make Manual show you what it's got. Unless you agree this is the greatest time and work saver you've ever seen—return book in 7 days and pay nothing. Mail coupon today to: MOTOR—Book Dept., Desk 17, 250 W. 55th St., New York 19, N. Y.

MOTOR'S AUTO REPAIR MANUAL

Brand-New—Covers All These Makes

- | | |
|-------------|-------------|
| Buick | Jeep |
| Cadillac | Lincoln |
| Chevrolet | Mercury |
| Chrysler | Nash |
| Clipper | Oldsmobile |
| Continental | Packard |
| De Soto | Plymouth |
| Dodge | Pontiac |
| Ford | Rambler |
| Hudson | Studebaker |
| Imperial | Thunderbird |
| | Willlys |

Same FREE Offer On MOTOR'S New Truck Repair Manual

Covers EVERY job on EVERY popular make gasoline and Diesel truck made from 1949 thru 1957. FREE 7-Day Trial. Check proper box in coupon below.



MAIL COUPON NOW FOR 7-DAY FREE TRIAL (Attach to Postcard if More Convenient)

MOTOR BOOK DEPT.
Desk 17, 250 W. 55th St., New York 19, N. Y.
Rush to me at once (check box opposite book you want):

- MOTOR'S New AUTO REPAIR MANUAL. If O.K., I will remit \$2 in 7 days, \$2 monthly for 2 months and a final payment of 50c (plus 35c delivery charges) one month after that. Otherwise I will return the book postpaid in 7 days. (Foreign price, remit \$9 cash with order.)
- MOTOR'S New TRUCK REPAIR MANUAL. If O.K., I will remit \$2 in 7 days, and \$2 monthly for 2 months, plus 35c delivery charges with final payment. Otherwise I will return book postpaid in 7 days. (Foreign price, remit \$10 cash with order.)

Print Name..... Age.....

Address.....

City.....State.....

Check box and save 35c delivery charge by enclosing WITH coupon in envelope entire payment of \$8.95 for Auto Manual (or \$9 for Truck Manual.) Same return-refund privilege.



INSURED TIRE SERVICE POPULAR BRANDS

FREE INSURANCE POLICY given with each used tire sold. We guarantee the amount of service you pay for. NOWHERE CAN SUCH QUALITY BE FOUND AT SUCH LOW PRICE!

SPECIAL! Deduct 10% on orders for 2 or more used tires. **YOU CAN'T LOSE!!**

Super Quality — Rugged Performance — 6 Months Insured Service			
600x16	\$3.65	670x15	\$3.95
650x15	3.85	670x15	4.05
680x15	4.25	700x15	3.95
700x16	4.45	700x15	4.45
760x16	4.45	760x15	4.45

Supreme Quality — Nothing Finer — 12 Months Insured Service			
600x16	\$5.25	475x19	\$5.45
600x16(G)	6.75	640x15	4.25
650x15	5.75	670x15	5.35
650x15(G)	7.25	710x15	5.45
700x16	6.35	760x15	5.95
750x16(G)	8.45	800x15	6.35
550x15	4.95	820x15	6.35
550x17	4.75	550x18	5.38
650x15	5.25	670x15	5.18
700x16	8.38	700x16(G)	10.25
		725x16(G)	10.25
		725x16(G)10	12.75
		725x16(G)24	22.95

Whitewalls \$1.00 extra.
Speedy shipments on Mail Orders. F.O.B. Chicago. Insurance policy sent with each order. Deduct 10% on orders for 2 or more used tires. Send CHECK or MONEY ORDER.—No COD's.
MIDLAND TIRE SALES 3701 S. Normal, Dept. PM-60, Chicago 9, Ill.

I'll Send You This Handsome SAMPLE CASE—FREE



and Show You How to Make Up to \$30.00 in a Day

WRITE for this FREE Tailoring Sample Case packed with 100 beautiful, top-value suit and overcoat fabrics. Take orders from friends, fellow-workers, others, for fine quality, made-to-measure clothes. Pocket box cash profits in advance. Because wearing our suits and overcoats brings more orders, we make it easy for you to get your own clothes without the cost. No experience is needed. **SATISFACTION GUARANTEED! SEND NO MONEY.** Rush your name, address, and size—today!

PIONEER TAILORING COMPANY, Dept. K-1116 CONGRESS & THROOP STREETS - CHICAGO 7, ILLINOIS

LEARN MEAT CUTTING



Train quickly in 8 short weeks at Toledo for a bright future with security in the vital meat business. Big pay, full-time jobs—HAVE A PROFITABLE MARKET OF YOUR OWN! Pay after graduation. Diploma given. Job help. Thousands of successful graduates. Our 35th year! Send NOW for FREE catalog. No obligation. GI approved.

NATIONAL SCHOOL OF MEAT CUTTING, Dept. 50-T, Toledo 4, Ohio

LAW FREE BOOK **THE LAW TRAINED MAN**

Write today for a FREE copy of illustrated law book, "THE LAW TRAINED MAN," which shows how to earn the professional Bachelor of Laws (LL.B.) degree through home study of the famous Blackstone Law Course. All necessary books and lessons provided. Moderate cost; convenient monthly terms. Write for FREE law training book today.

Blackstone School of Law, 225 N. Michigan Ave. Pounded 1890 Dept. 50-B Chicago 1, Ill.

Take the ache out of **GUMS RUBBED SORE BY FALSE TEETH**

Get quick-soothing relief of sore, throbbing gums by applying medically-formulated NUM-ZIT Adult Strength. Thousands of false teeth wearers have already had this blessed relief. Pleasant-tasting NUM-ZIT eases discomfort while you break in new false teeth. Works wonders, too, for relief of toothache, neuralgic pains. Keep it handy for quick first aid. At all drug counters.

Adult NUM-ZIT
Another fine Purepac product

POPULAR MECHANICS

INVENTORS

If you believe that you have an invention, you should find out how to protect it. The first step is to have a search made of the prior pertinent U. S. patents. If a report on this search indicates that the invention appears patentable you can apply for a patent, and the specifications and claims should be prepared.

The firm of McMorrow, Berman & Davidson, with offices in Washington, D. C., is qualified to take the necessary steps for you. We can make a preliminary search on your invention, advise you whether we think it can be patented, and prepare your application for patent.

Unless you are fully familiar with the U. S. Patent Laws, we recommend that you engage the services of a Registered Patent Attorney to protect your interests. The patent laws are *your* laws. A patent gives you the right to prevent others from making, using or selling the invention claimed in your patent for a period of 17 years.

Use these patent laws for your protection. Investigate whether your invention can be patented. If you have what you believe to be an invention, we suggest that you have this firm make a search for you:

Send for a copy of our Patent Booklet entitled "How To Protect Your Invention," containing information about patent protection and patent procedure. Along with this we will also send you an "Invention Record" form, for your use in writing down and sketching details of your invention. We will mail them promptly. No obligation. They are yours for the asking.

McMORROW, BERMAN & DAVIDSON

Registered Patent Attorneys

PATENTS • COPYRIGHTS • PATENTS

135-G VICTOR BUILDING, WASHINGTON 1, D. C.

DRAFTSMEN



**CASH BIG
PAY CHECKS!**

**Train Now for
more success,
greater security**

**LEARN AT HOME IN SPARE TIME
(or at college in Chicago)**

Check the want ads in any newspaper—SEE the big-pay opportunities open to you as a draftsman. What's more, you can learn this well-paid, prestige profession at home—quickly, easily! No special talent needed. Get complete, step-by-step Chicago Tech lessons in the mail, spend a few pleasant hours studying each week. In a short time you'll be a well-trained draftsman, ready to take your pick of many good jobs. Act now!



Free Information—Mail Coupon Today!

Get **FREE TRIAL LESSON** plus information about C.T.C. practical training. Learn what successful Chicago Tech graduates say about high pay and opportunities in drafting. No charge, or obligation.

CHICAGO TECHNICAL COLLEGE

H-215 Tech Bldg., 2000 So. Michigan Ave.
Chicago 16, Illinois

Mail me **FREE** lesson with facts about big opportunities in **DRAFTING**.

Name _____ Age _____

Address _____

City _____ Zone _____ State _____

Learn To **MOUNT BIRDS**

Here's!
Best
Hobby
for
Fun &
Profit

TAN SKINS, MAKE UP FURS
Be a Taxidermist. We teach you at Home. Mount Birds, Animals, Pets, common specimens. Save your hunting trophies, decorate home and den. Make genuine **KROME LEATHER**, tan and make up furs for sparetime profit. **INVESTIGATE TODAY** 49 pages—tells all about it. Hunters, get your copy. **FREE BOOK** It's Now Free. Send post card. State your AGE. N. W. SCHOOL OF TAXIDERMISTRY, DEPT. 2507, Omaha, Neb.

NEW Self-Contained SPRAY GUN

FOR HOUSEHOLD JOBS!

**Requires NO Hoses,
Cords or Compressors**

**Completely Portable . . . Goes to
the Job Without Attachments!**

It's unique—this amazing spray gun you can carry as easily as a water pistol! Powered by inexpensive CO₂ cartridges! Container holds 21 oz., reloads in a flash. Nozzle adjusts from stream to finest spray. Sprays paints, insecticides, etc. At your dealer's or order direct. Remit in full and we'll ship postpaid. Or send \$2, pay postman balance plus COD fee.



**ONLY
\$19.95**

with 10
cartridges

SULLIVAN-BECKER CO., Dept. 117-G, Kenosha, Wis.

Shrinks Hemorrhoids New Way Without Surgery

**Science Finds Healing Substance That
Relieves Pain—Shrinks Hemorrhoids**

For the first time science has found a new healing substance with the astonishing ability to shrink hemorrhoids and to relieve pain—without surgery.

In case after case, while gently relieving pain, actual reduction (shrinkage) took place.

Most amazing of all—results were so thorough that sufferers made astonishing statements like "Piles have ceased to be a problem!"

The secret is a new healing substance (Bio-Dyne*)—discovery of a world-famous research institute.

This substance is now available in *suppository or ointment form* under the name *Preparation H.** Ask for it at all drug counters—money back guarantee. *Reg. U. S. Pat. Off.

REAL ESTATE BE A BROKER

PAYS BIG! SEND FOR FREE, BIG, ILLUSTRATED CATALOG NOW! Graduates report making substantial incomes. Start and run your own business quickly. Men, women of all ages, learn easily. Course covers Sales, Property Management, Appraising, Loans, Mortgages, and related subjects. **STUDY AT HOME** or in classrooms in leading cities. Diploma awarded. Write **TODAY** for free book! No obligation.



Approved for World War II and Korean Veterans
WEAVER SCHOOL OF REAL ESTATE (Est. 1938)
2020R Grand Avenue Kansas City, Mo.

BE A LOCKSMITH

Learn fascinating, profitable trade from experts in spare time at home! Age or physical handicap no disadvantage. Year around, steady income. Full or part time. Practical. Illustrated lessons. Make money even while learning! All materials & special tools supplied.

Learn at Home
Free Booklet
INSTITUTE OF LOCKSMITHING, Dept. P-92
15 PARK AVENUE RUTHERFORD, N. J.
Lic. by N. J. State Board of Ed. Approved for Vets

START YOUR OWN MONEY-MAKING BUSINESS

Clean rugs on customers' floors—upholstery in their homes—even painted walls—with highly efficient electric machines which are making big money for others and giving them independence. Write today for complete information. It's **FREE!**

VON SCHRADER MFG. CO., Dept. 710 "R" PL., Racine, Wis.

BIG STINKY FLY TRAP

Gracious Outdoor Living **BEGINS** with World Famous **BIG STINKY FLY TRAPS**. Now yours for only **\$3.95** postpaid in USA—3 for **\$9.95**.

Mysterious—Fascinating—Incredible—Really Works
Rush one, 3, Big Stinky Outdoor Fly Traps, standard size complete with 8 oz. fluid.

My check Money Order for \$_____ is enclosed.

BIG STINKY, P.O. Box 235, Waukesha, Wis.

WORLD'S LOWEST PRICED ADDING MACHINE

Counts up to 999,999,999
IDEAL FOR BUSINESS AND PERSONAL USE—GUARANTEED ACCURATE.
Not a toy. Operates with only a finger flick. Adds, subtracts, multiplies, divides. Counts up to one billion. Pays for itself over and over. Ideal Gift—for Business, Income Tax and School use. **MONEY BACK GUARANTEE.** Send name and address. Pay postman only \$2.95 plus postage. Beautiful rich-looking Leatherette Case included at no extra cost. Money back in 10 days if not delighted. **AGENTS WANTED.**



CALCULATOR MACHINE COMPANY
P.O. Box 126, Dept. N-57, Huntingdon Valley, Penna.

Vest Pocket
Size
FREE TRIAL
\$2.95

only
TOTAL COST
SEND NO MONEY

DeVry Tech *CAN PREPARE YOU IN SPARE TIME AT HOME...*

for a Profitable Future in

Electronics

as used in

Guided Missiles

ETC.

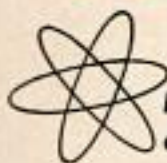

**No Previous Technical Experience
or Advanced Education Needed!**

If you think you need a "pull," advanced education or previous technical experience to prepare for a profitable career in the fast-growing, big opportunity field of Electronics—you're mistaken. The most important thing is a sincere desire to be somebody and to get somewhere.

During the past 26 years we have successfully trained farmers, store clerks, factory hands and men of practically every calling from 17 to 55. If these men can do it in their spare time, why can't you?

Regardless of your experience, we urge you to fill in coupon below for full FREE facts about our modern training that follows the same basic method used in our Chicago and Toronto Laboratories. It will cost you nothing for information that may prove to be the turning point in your career. Act now! Send coupon TODAY!

An **INDEX** to a Better Job,
a Brighter Future

Communications • Radar • Television
Micro-Waves • Radio • Computers • Industrial Electronics • Automation Electronics

Draft Age?

We have valuable information for every man of draft age; so if you are subject to military service, be sure to check the coupon.

Live-Wire Employment Service

DeVry Tech's Placement Department is in contact with some of the best-known employers in the Electronics field. The service is free to all graduates—and DeVry Tech's record in helping to place men has been outstanding.

FREE BOOKLET!

We'll give you a free copy of an interesting booklet, "Electronics and YOU." See for yourself how you may take advantage of the opportunities in this fast-growing field.



MAIL COUPON TODAY!

DeVry Technical Institute
4141 Belmont Ave., Chicago 41, Ill., Dept. PM-7-N
Please give me your FREE booklet, "Electronics and YOU," and tell me how I may prepare to enter one or more branches of Electronics as listed above.

Name _____ Age _____
Please Print

Street _____ Apt. _____

City _____ Zone _____ State _____

Check here if subject to military training.

DeVry Tech's Canadian Training Center is located at 626 Roselawn Avenue, Toronto 12, Ontario

22019

"One of North America's Foremost Electronics Training Centers"



Accredited Member
of National
Home Study Council

DEVRY TECHNICAL INSTITUTE

CHICAGO 41, ILLINOIS

FORMERLY

DIFOREST'S TRAINING, INC.





LAW TRAINING FOR BUSINESS (In spare time at home) Earn L.L.B. Degree

Thousands of men and women who never intend to practice Law are studying it in spare time at home as an aid to business advancement.

Today Law is involved in practically every business decision. In many lines of work it is almost indispensable. Law training develops keen, clear, quick, correct and decisive thinking.

You can study LaSalle's American Law and Procedure right in the privacy of your own home—progressing as rapidly as your time and ability permit. For nearly 50 years we have helped over 1,350,000 ambitious people get ahead in the business world.

A MOST UNUSUAL LAW LIBRARY
This training includes the 14-volume LaSalle Law Library—AMERICAN LAW AND PROCEDURE—that is the basis of all our instruction service. This library has been compiled by leaders in the field of Law. It covers the whole field in an orderly and simple manner that is easy to learn and understand. Collateral reading and printed lectures, furnished at regular intervals, supplement the texts. Law instructors personally supervise your program. Under the LaSalle method you learn by actually solving legal problems—not just memorizing rules.

WRITE FOR TWO FREE BOOKS

Send the coupon below TODAY and find out how you can qualify for the many fine openings available to the law-trained man. In our FREE books "Law Training for Leadership" and "Evidence" you will find answers to your questions about the study of Law and the LaSalle method.

—MAIL COUPON TODAY—
LA SALLE EXTENSION UNIVERSITY
A Correspondence Institution

417 S. Dearborn St. Dept. 764L Chicago 5, ILL.
Please send me, FREE, "Law Training for Leadership" and "Evidence."

Name.....
Address.....
City.....Zone.....State.....



MEN! Make UP TO \$1000 IN A MONTH

without "SELLING"

Sensational Demand for Low-Priced Fire Alarm
**PLUS Sure-Fire "No-Selling" Plan Offers
Ambitious Men Huge Profit Opportunities**

Even beginners are cleaning up unbelievable profits with first effective low-priced Fire Alarm. Needed in homes, stores, offices, farms. Hangs on wall like picture, no installation, no plug-in. Always on guard. HOWLS 1/5-mile blast, automatically, when fire starts, allows up to 5 minutes escape-time. \$4.95 seller with up to \$2.70 profit for you!

Nearest Thing to Automation Selling. On exciting Plan, customers sell themselves. No hard selling, no cold canvassing. We give you powerful sales tools you leave with prospects. They sell for you while you sleep!

FREE! Rush, name, address NOW for big Illustrated Sales KIT with easy "No-Selling" Plan. Learn how only 20 Fire Alarms a day pay you \$1,080.00 a month. Everything, FREE, no obligation. Write NOW to **MERLITE, Alarm Div., 114 E. 32nd St., Dept. S-15Y, N. Y. 16.** In Canada: Moga Co., Ltd., 371 Dowd St., Montreal 1, P. Q.

NOW NO ONE CAN KEEP 20x-40x-60x only \$299
A SECRET FROM YOU! TELESCOPE postpaid

Amaze your friends... See what they're doing—without being seen!

Money back guarantee. Send cash, check or money order.

Special Order now, get Free carrying case.

3-range all metal telescope magnifies up to 60 power. Watch ball games, look at the moon, stars, animals, distant buildings...up close. Bright aluminum tube, made for long use. Good on hikes, camping trips, can use either 20x, 40x, or 60x power instantly. Variable focus eyepiece. No assembling, ready-to-use, no special instructions required.

I. J. STONE, Dept. T-8-7 • 1616 Oak St. • Santa Monica, Calif.



Easy to make your own
BOWS—ARROWS—EQUIPMENT

Illustrated Hand-Book 84 pgs. \$1, tells you how! Large Colored Catalog 5c—Send for it!

Ask your dealer for "Stemmler's Archery" (Oldest Mfr. in U.S.A.)

L. E. STEMMLER CO.

Manorville (Box 1) L. I., N. Y.



Print Your Own

Cards, stationery, circulars, etc. Save money. Print for Others. Good Profit; easy rules sent. Raised Printing like engraving, too. Junior press \$14; Senior \$29 up. Sold direct from factory only. We furnish everything. Write for free details. **KELSEY PRESSES, Y-37 Meriden, Connecticut**

Free! 75 ORIENTALS

Brought to you from the farthest ends of the earth—these exotic valuable genuine **STAMPS** of the Orient! 75 all-different from Borneo, Siam, China, Japan, Hong Kong, Malaya, Sarawak, Singapore,—and other exciting mysterious lands of the Far East. **EXTRA!** Free booklet, bargain lists, fascinating offers for your free examination. Send 10c for mailing costs.

JAMESTOWN STAMP CO., DEPT. C7PM, JAMESTOWN, N. Y.



Troubled with **GETTING UP NIGHTS, Pains in BACK, HIPS, LEGS, Tiredness**

If you have these symptoms then your troubles may be traced to **Glandular Dysfunction**... a constitutional disease. Medicines that give temporary relief will not remove the cause of your trouble. Neglect of Glandular Dysfunction often leads to premature old age and sometimes incurable malignancy.

The past few years men from over 3,000 communities have been successfully treated here at the Excelsior Institute. They have found soothing relief and a new outlook in the future of life.

The Excelsior Institute, devoted to the treatment of diseases peculiar to older men by **NON-SURGICAL** methods has a **NEW FREE BOOK** that tells how Glandular Dysfunction may be corrected by proven **NON-SURGICAL** treatments. This book may prove of utmost importance in your life. Write today. There is no obligation. **Excelsior Institute, Dept. 8929, Excelsior Springs, Mo.**

HELP YOURSELF to a BETTER JOB!

I'LL TRAIN YOU AT HOME TO BE
A HIGHLY-PAID MECHANIC IN
**AIR CONDITIONING
AND REFRIGERATION**

R. C. ANDERSON
President
CTI

It has been one of America's great industries for years—but the way it's growing, you'd think it was in its infancy! That's why the air conditioning and refrigeration industry appeals so strongly to ambitious men who want better jobs, more security, higher pay.

Over 150 million refrigerating units are in use today—are in need of repair and service. Each year, 3 million refrigerators, 1 million freezers and 2 million air conditioners are produced. Not only homes, but stores, offices, restaurants, motels and transportation systems use some form of refrigeration. Even autos are being made with air conditioners. No wonder trained men are in big demand—are so well paid! Want to be a mechanic in this field? To find out how, just mail coupon for valuable free information!

AN AMAZING, NEW SHOP-METHOD TRAINING PLAN

After years of research, CTI has developed a wonderfully effective training plan. It enables you to train at home in spare time. You get 23 big kits to build an air conditioner, refrigerator, freezer or milk cooler. You keep all this equipment. You do 10 service and trouble-shooting jobs. CTI brings field training right into your home! You get practical experience as you learn.

YOU GET EXPERIENCE AS YOU TRAIN BECAUSE YOU PRACTICE WITH COMMERCIAL EQUIPMENT

You get all parts and tools to build a heavy-duty, commercial-type, 1/2 h.p. refrigeration high-side (illustrated at right.) You receive lesson material which not only makes kit assembly easy, but downright fascinating! Remember, kit training in this field is a CTI "FIRST"



Above left is photo of special tools in just one kit. In another kit (right) you get motor, fan, pulley, service tools. You get other tools, tubing, much equipment, all of finest quality. Kits are sent on a planned schedule so that you learn in easy stages. Kit training develops skill, provides experience, speeds training.



OPEN A SHOP— BE THE BOSS

The air conditioning and refrigeration industry is a good one in which to start out "on your own." Many CTI graduates have done it, and if you have the determination, you could do it, too! CTI has special information for men who want to go into business. Mail coupon for details.

COMMERCIAL TRADES INSTITUTE
1400 Greenleaf Avenue • Chicago 26, Illinois

**MAIL
TODAY
FOR
FREE BOOK
AND
SAMPLE
LESSON**

COMMERCIAL TRADES INSTITUTE

1400 GREENLEAF AVENUE DEPT. R-377
CHICAGO 26, ILLINOIS

Tell me how I can qualify for a better job or a business of my own. Send booklet, Success in Air Conditioning & Refrigeration, and Lesson Sample. Both FREE.

Name _____ Age _____

Address _____

City _____ Zone _____ State _____



**23
BIG KITS**
to build
**AIR CONDITIONER
REFRIGERATOR
FREEZER or
MILK COOLER**

HOW YOU MAY EARN CASH AS YOU TRAIN

Many students do repairing in their spare time soon after they enroll. A number get part-time jobs, others open shops. With their earnings many students not only pay their tuition, but sometimes have enough money remaining to put in the bank. The reason that students can do field work for profit is that CTI training is practical. Students get their experience as they train—not as low-paid apprentices! But get the complete story on your opportunities. Fill out and mail coupon today.

Check the Kind of Body YOU Want

- | | |
|---|--|
| <input type="checkbox"/> Slimmer Waist, Hips | <input type="checkbox"/> More Powerful Arms |
| <input type="checkbox"/> Broader Chest, Shoulders | <input type="checkbox"/> More Powerful Legs |
| <input type="checkbox"/> More Weight, Solid | <input type="checkbox"/> More Energy, More Restful Sleep |



... and I'll Show You How EASILY You Can Have It!

Just tell me, in coupon below, the kind of body you want—and I'll give it to you SO FAST your friends will be amazed! "Dynamic Tension," my easy, 15-minutes-a-day method, will make your chest and shoulders bulge . . . arms and legs surge with power . . . your whole body feel "alive!"

FREE ILLUSTRATED 32-PAGE BOOK

32 pages on how "Dynamic Tension" changed me from a 97-pound weakling into "World's Most Perfectly Developed Man"—and how it can change YOU too. Mail coupon NOW! Charles Atlas, Dept. BG, 115 E. 23rd St., N. Y. City 10.



CHARLES ATLAS, Dept. BG,
115 East 23rd St., New York 10, N. Y.

Dear Charles Atlas—Here's the Kind of Body I Want:
(Check as many as you like)

- | | |
|---|---|
| <input type="checkbox"/> Slimmer Waist, Hips | <input type="checkbox"/> More Powerful Arms |
| <input type="checkbox"/> Broader Chest, Shoulders | <input type="checkbox"/> More Powerful Legs |
| <input type="checkbox"/> More Weight, Solid | <input type="checkbox"/> Better Energy |

Send me, absolutely FREE, a copy of your famous book showing how "Dynamic Tension" can make me a new man. 32 pages, crammed with photographs, answers to vital questions, and valuable advice. No obligation.

Name _____ Age _____
Address _____ (Please print or write plainly)
City _____ State _____

NEW 1957 GEOPHYSICAL YEAR MODEL OF GENUINE 135-POWER ACHROMATIC TELESCOPE

with Achromatic Lens and 4-POWER FINDER attached

ONLY \$18.95
PREPAID

EXTRA BONUS GIFTS:

- 273 page book, "Handbook of the Heavens"
- Magic Star Finder Dial
- 220X & 400X Eyepiece lenses

5 Magnifications 18X-35X-65X-85X-135X

Never before has an ACHROMATIC 135X telescope with range finder and tripod sold for anywhere near this amazing low price. POSITIVELY SHOWS planets, stars, craters, people and all distant objects. Compound Achromatic coated lens guarantee performance. Adjustable 18X-35X-65X-85X-135X for any condition of brightness, greater range of powers, color free needle-sharp views only possible with Achromatic corrected lens. Trimmable with gleaming brass extends to 43". 4X finder scope (30MM LENS) gives brilliant clear views. Brings difficult objects on target before viewing. 5 ft. folding tripod with heavy cast iron head fitted with Criterion's famous universal 360 degree aluminum mount assures stability, locks in any position. Remote controls. This amazing 135X Achromatic telescope obtainable only from Criterion. Shipped ready for use together with 4 bonus gifts: 273 page "Handbook of Heavens," Magic Star Finder, also 220X & 400 eyepiece lenses free for experiments. Shipped complete, nothing else to buy at amazing price of \$18.95, without tripod \$14.95.

ALSO SPECIAL 40X-80X-120X TELESCOPE WITH TRIPOD \$11.95
POST PAID

5 section telescope with 5 precision lenses, opens to 36" closes to 12", 5 ft. hardwood tripod, cast head, aluminum 360 degree mount. Erect clear images. Bonus gifts: 273 page Handbook of Heavens, Star Finder. You must be completely satisfied with these instruments or money promptly refunded. Send cash, check or money order today.

Dept. PMA14, CRITERION MFG. CO., 331 Church St., Hartford, Conn.

CONVERT YOUR CAR INTO A BED

Save on Overnight Trips—Rest In Solid Comfort



QUICK, EASY CONVERSION



Works on all 2 and 4-door sedans, club coupes, convertibles, station wagons. Fits all Ford, GM, Chrysler & Studebaker products—does not affect seat structure—normal functions or appearance. GUARANTEED to work when installed by instructions. PAYS FOR ITSELF in three nights lodging. IDEAL for hunters, fishermen and travelers. Delighted users everywhere! Complete conversion kit and instructions **\$14.95**

State make, model, whether 2 or 4-door
SEND CASH, CHECK OR MONEY ORDER TO:
CAR BED CO., 600 MAGNOLIA AVE., PANAMA CITY, FLA.



SAVE \$9.00

NORELCO Men's Electric Shaver. Latest model, brand new and fully guaranteed. Complete with case, cord and cleaning brush. Regularly retails at \$24.95. Our price \$15.95 postage paid. All orders filled within 24 hours. Your money back if you are not fully satisfied. Send check or money order to: **JOHN BROOKS, Dept. 591, Box 212, St. Louis 3, Mo.**



TRICK BASEBALL 75¢

2 FOR \$1
Postpaid

YOU GET 2 FOR \$1.00 POSTPAID: A real screwball is this baseball that's as full of tricks as a practical joker. Even a Major League couldn't pitch a straight ball with it! It dips, it curves, it bounces crazily. It rolls in circles. MAIL YOUR ORDER TODAY. Medford Products, Inc., Dept. PM-5, P.O. Box 39, Bethpage, N. Y.

BRONZE FOUNDRY



Schools • Home Workshops • Inventors

Make your own castings of aluminum, copper, bronze, silver. Foundry sets are available in three sizes including 2400 Deg. F. blast Furnaces. \$26.50; \$33.50; and \$46.00 f.o.b. Marysville or Lakewood. Free Circular.

KANSAS CITY SPECIALTIES CO. (Dept. P-7) Box 6022, Marysville, Kans. or Box 7543, Lakewood, Colo.

ONE OF 1000's — PRICE RIOT!

6-PEN POCKET SECRETARY SETS. Full size secretary with memo pad and 6 automatic ball pens in different colors. Pocket protector case with flap and billfold compartment. Terrific value. A \$4.95 FLASH TO SELL FAST at \$1.50. Gross sets \$86.40.

Deposit or payment F.O.B. N.Y. Complete set & 1957 catalog \$1.00 prepaid. Dozen Sets **\$7.50**

MILLS SALES CO.

Cut-Rate WHOLESALERS Since 1916
889 BROADWAY, New York 3, N. Y.

NEW MAGIC RADIO WALKIE TALKIE!

YOUR OWN POCKET SIZE RADIO STATION! BROADCASTS TO ANY HOME OR CAR RADIO WITHOUT WIRES OR HOOKUPS! Wt. only 5 oz. Size, 1 1/2" x 2 1/2" x 4 1/2". Built-in telescoping antenna. Powerful Transistor-sensitive microphone. Frequency setter, break-in switch! Runs for weeks on self-contained flashlight batteries. Durable plastic case. With this Radio Talkie you CAN TALK TO YOUR FRIENDS UP TO A MILE OR MORE AWAY! Talk up to 1 mile or more between two automobiles. INSTANT OPERATION! Just push button to talk! No license needed. Uses inductive field magnetic radiation. Useful and real fun in a million ways! GUARANTEED TO WORK. 1 YEAR SERVICE GUARANTEE. SEND ONLY \$2.00. (cash, c.k., m.o) and pay postman \$1.98 COD postage or send \$1.98 for prepaid delivery. COMPLETE READY TO OPERATE with instructions and hundreds of ways and tricks for broadcasts thru any radio you desire. Price may go up soon, so get your NEW POWERFUL RADIO WALKIE TALKIE NOW. Available only from: **WESTERN RADIO, Dept. RPM-7, KEARNEY, NEBR.**



OUR AD HAS BEEN IN THIS MAGAZINE LONGER THAN ANY OTHER TIRE CO., NEARLY EVERYONE BUYS FROM STANDARD. 50 Years of Combined Family Experience in High Quality Tires. "We Have No Rent to Pay." That is Why We Can Under Sell All Competition.



**23 YEARS AT THIS ADDRESS
TUBE FREE WITH EVERY PASSENGER TIRE**

Our entire stock of very slightly worn EXTRA MILEAGE TOP GRADE Tires. (Written Insurance Guarantee). SEND AD

EVERYBODY MAY DEDUCT 10% off ON EVERY TIRE



FREE If you buy 2 or more Passenger 4-ply tires, WE GIVE ONE tire FREE, on each order. Does not include W.W. or Truck Tires, or Snow Tires.

12 MOS. WRITTEN GUARANTEE WITH EVERY TIRE			
600-16 \$5.52	475-14 \$4.37	700-15 \$6.72	700-20 \$9.92
600-16(G) 5.92	640-15 4.37	750-16-8 10.72	750-20-10 15.72
650-16 5.72	670-15 5.52	700-17 9.82	750-20-8 11.92
650-16(G) 6.62	710-15 5.52	750-17 10.32	825-20 18.92
750-16(G) 7.52	760-15 5.82	825-15 12.92	900-20 17.92
550-17 3.72	800-15 5.92	800-20 9.02	1000-20 17.92
650-15 5.52	820-15 5.92	850-20 9.82	1100-20 19.92
700-15 4.92	700-16-8 7.37	750-15 10.72	1100-22 18.92

"EXTRA SPECIAL" TOP QUALITY all size 4-ply pass. \$7.82
FREE TIRE with 2 or more of these also.—W.W. \$1.00
Extra Factory Tested Tube given—GIANT TIRE SALE. EA.

Thousands of tires shipped all over the U.S.A. All tires shipped F.O.B. Phila. Send Check or M.O. with this ad. Dept. 2. No C.O.D.
STANDARD 834 N. Broad St., Philadelphia 30, Pa.

"OLD IRONSIDES" MODEL KIT!

Historic U.S. Frigate. Every detail accurate—armaments, spars, longboats with oars. Precision plastic parts, cement, plans. 16 1/4". For catalog write Dept. M7, 4223 Glencoe, Venice, Calif. wherever hobby kits are sold



\$2.98

Also Eshelman TRACTORS, Riding ROTARY MOWERS, ROTARY TILLERS at amazing savings. Write for Free Literature

ESHELMAN GOLF CAR GASOLINE ENGINE
36 HOLES PER GAL. GAS UP TO 20 MILES PER HR.
Costs a fraction of most other cars. Ideal for golfers. Also 2 pass. subcompact. Write for free literature.
Dept. 346, ESHELMAN, 109 Light St., Balto. 2, Md. PATENTED

\$2.95 OR 2 FOR \$5.00!
TESTED AND GUARANTEED
Write for free list on all types of telephones. Shipments F.O.B. Simpson, Pa.
TELEPHONE ENGINEERING CO., Dept. 787, Simpson, Pa.

GET LATEST OFFICIAL AIRCRAFT PHOTOS

- SPECIAL INTRODUCTORY OFFER!**
- 4 3 1/2 x 5 photos, world's fastest jets.
 - 4 3 1/2 x 5 World War II planes.
 - 4 3 1/2 x 5 of Rockets, Missiles.
 - 1 8x10 Boeing B-52 Jet Bomber.
 - 1 8x10 Lockheed F-104A Starfighter.
- Only 25c a set. Send \$1 for all 5. (\$2 value)



Illust. CAT. with order. Money back guar.
AVIATION PHOTO EXCHANGE DEPT. PE BOX 75064 LOS ANGELES 5, CALIFORNIA

LEFAX TECHNICAL DATA BOOKS
POCKET SIZE • LOOSE LEAF
Printed on loose leaf, 6 hole, 6 3/4" x 13 1/2" bond paper, each book contains about 140 pages of technical data, condensed, accurate, essential, for engineer, technical worker, teacher, student, business man
\$1.25 each

Architecture	Surveying Tables	Machine Design	Radio
Home Heating	Highway Eng'g.	Mechanist's Data	Television & FM
Electrician's Data	General Math	Mech. of Materials	Electricity, AC
Builder's Data	Math Tables	Pwr. Trans. Mach.	Electricity, DC
Lumber Data	Physics	Thermo. Tbls. & Charts	AC Motors
Air Conditioning	Trig-Log Tables	Phys. & Thermo-dynamic Data	Conversion Tabl.
Building Constr.	Gen'l Chemistry	Metals	Steel Farms
Reinf. Concrete	Chemical Tables	Hydraulics	Welding Data
Piping Data	Analytic Chem.	Relays & Meters	Transformers
Surveying	Mech'l Drawing		

Write for FREE catalogs (2000 Editions). See how helpful LEPAX can be to you. Send \$1.25 book, or \$5 for any five books to:
LEFAX PUBLISHERS, Dept. PM-77, PHILADELPHIA 7, PA.

Make your interest in
AUTO MECHANICS & DIESEL PAY OFF!



OUR FAMOUS SHOP METHOD HOME TRAINING PREPARES YOU FOR BIG TIME PAY AT HOME IN SPARE TIME

YOU GET AND KEEP ALL THIS EQUIPMENT

Complete set of professional tools and All-Metal Tool Box. Same top-quality equipment used by expert mechanics everywhere. Use them, display them proudly.

"Motor Analyzing Set" contains Standard Engine Vacuum Fuel Pump Tester, Remote Starter Switch, Modern Timing Light, Standard Compression Tester. Plus compact carrying case & instructions.

Top-quality Socket Wrench with fittings. Real professional tools you'll use during your lifetime career in repairing all types of engines, from foreign cars to big diesel jobs.

Nearly 60 million cars and trucks on our roads! If you could talk to owners of garages, service stations and car dealerships (as we do every day), you'd realize America's DESPERATE NEED FOR TRAINED MECHANICS.

Take your choice—One modern course prepares you for Auto-Mechanic jobs, Airplane Mechanics, Farm Machinery Repair, all Diesel Jobs, Experimental Labs, Government Work, Engine Specialties, etc. A qualified, ALL-AROUND Mechanic always has a good job.

Every phase is Shop-Tested! Streamlined lessons, diagrams, manuals are easy to understand. Earn as you learn. Free Graduate Employment Service.

FREE!
VALUABLE BOOK & SAMPLE LESSON
JUST SEND COUPON

RESIDENT TRAINING AT LOS ANGELES! If you wish to take Resident Training at Los Angeles, in our big, modern Shops & Labs, check special box in coupon for full information.

APPROVED FOR GI TRAINING
NATIONAL SCHOOLS
Los Angeles 37, California

NATIONAL SCHOOLS
TECHNICAL TRADE TRAINING SINCE 1905
LOS ANGELES 37, CALIFORNIA

MAIL NOW
NATIONAL SCHOOLS, Dept. DB-77
4000 S FIGUEROA ST.
LOS ANGELES 37, CALIF.
Send for FREE Auto-Diesel Opportunity Book and Sample Lesson.

NAME _____ AGE _____
ADDRESS _____
CITY _____ ZONE _____ STATE _____
 Check if interested ONLY in Resident School Training at Los Angeles
VETERANS: Give date of discharge _____

RUSH LAST CHANCE COUPON below — YOUR NAME on it
I'll show YOU absolutely FREE

HOW to GAIN UP TO 50 LBS. of MIGHTY MUSCLES!



How to become a REAL HE-MAN like THOUSANDS of my pupils each year

Are YOU SKINNY like I was?

I'll reveal to you all my inside secrets that changed me from this 90 lb. weakling to the world's strongest man and athlete says George Jowett

WORLD'S GREATEST BUILDER OF HE-MEN



My once skinny pupil, John Sill, says:

"I gained 60 LBS. of MIGHTY MUSCLES."

WIN \$100 AND A SILVER TROPHY LIKE ME

BEFORE

Mailing Coupon I was a 125 lb. 6 ft. skinny weakling.



I added 7 inches to MY CHEST, 3 1/2 inches to EACH ARM. No, Pail You don't have to be a chicken-chested skinny weakling like I was only a few weeks ago. Mail Coupon! Says JOHN SILL.

AFTER

Mailing Coupon 185 lb. HEAD-TO-TOE HE-MAN POPULAR ATHLETE. You can be, too!



JOWETT INSTITUTE, 220 Fifth Ave., New York 1, N. Y., Dept. PM77

Send me **FREE PHOTO BOOK** of FAMOUS STRONG MEN and FREE 5 AMAZING PICTURE-PACKED COURSES

I'm enclosing 10c for postage.

- I want to gain.....lbs. (fill in)
 Add inches to ARMS CHEST SHOULDERS
 I want to lose fat, streamline my body.

Pick the kind of BODY YOU WANT

Name.....Age.....
Address.....
City..... Zone..... State.....

TELEPHONES

and ALL SUPPLIES

Room to room, house to garage, private telephone service. **HANDSET CRADLE TELEPHONES** (2) Complete outfit with 100' wire, 2 dry cells, instructions. **\$14.95**

WORM HARVESTER — Dan Mac Magneto—gathers fish-worms by electricity. Complete with instructions. **\$6.50**

Illustrated bulletin "AA-15" 10c

TELEPHONE REPAIR & SUPPLY CO.
Dept. AA-15 • 1760 Lunt Ave., Chicago 26, Ill.



KEEP YOUR... EYE ON BENJAMIN "First in POWER and ACCURACY"
for HIGH H.C. COMP
AIR GUNS & CO₂ GAS GUNS—Top Quality at LOWEST PRICES!

BB BB or 177 or 22
BENJAMIN SUPER
CO₂ Gas Carbine **\$14.95**
with Reg. Stock as low as
DeLuxe Model with Custom Stock (Shows) as Low as \$17.95

Benjamin Air Rifles and Benjamin Air Pistols are Recognized All Over the World for Finest Workmanship and Highest Quality at Lowest Prices. Adjustable Power with Amazing Optimum Force. Fully Guaranteed—Safe—Accurate—Economical. Easy to Use anywhere—12 Models for Target and Small Game BB or 177 or 22.

All Models Benjamin CO₂ Carbine Gas Rifles and Benjamin CO₂ Rocket Gas Pistols Use Standard Size CO₂ Cartridges (available everywhere). 2-Stage Hi-Lo Jet Power—High for Small Game—Low for Target—Up to 50 Shots from each Cartridge. No Pumping—Safe—Accurate—Economical—Non Toxic—12 Models BB or 177 or 22.

FREE! Catalog All Models Benjamin Air Guns & CO₂ Guns & Supplies. Also, Money-Saving Offer on Hunting & Fishing Accessories.
Send Free Gun Catalog and Special Offer!
BENJAMIN AIR RIFLE CO., MAIL TODAY!
896 MARION ST., ST. LOUIS 4, MO., U.S.A.
Name.....
Address.....
City..... State.....

DIESEL MEN WANTED

Earn \$100 per week and up
AUTO-DIESEL MECHANICS

You learn fast in our school and shops because you learn with tools on real equipment. Experienced instructors explain WHY and show you HOW, then you DO IT YOURSELF with tools on various makes and models. One of the best equipped technical schools of its kind in the United States. Thirty-seven years' experience training men. Successful graduates in 48 states and many foreign countries. Approved for veterans. Day and evening classes. Earn While You Learn. Write for free bulletin.

NASHVILLE AUTO-DIESEL COLLEGE
226 7th Ave. N., Dept. 86, Nashville, Tenn.

Be an industrial designer

Combine your design abilities with technical aptitudes in Industrial Design training at Art Center School in California. Work under practicing professionals for upper level jobs as automotive stylists, product and package designers. Design offices, stores, motels, showrooms, shopping centers. Constant demand for graduates. Recent placements with Ford, G.M., Kaiser Aluminum, G.E., Raymond Loewy and other leading design studios. 700 students. Co-ed. Accredited. B.P.A. Degree. Four-year course can be completed in 2 yrs. 8 mos. by year-round training. New terms Feb., June, Sept. Enroll early. Write Mr. Mead for new catalog. 5353 West 3rd St., Los Angeles 5, California.

ART CENTER SCHOOL

Own and Play the **ACCORDION**
for fun...for popularity...for profit!
Buy direct at amazing savings from America's biggest importer of fine Italian made accordions. **5 DAY FREE TRIAL!** Easy Terms. Free Lessons—Easy to learn. Personalized selection service. Trade-ins accepted. Write today for big Color Catalog and our low wholesale prices. **FREE!** Accordion Manufacturers & Wholesalers Outlet
2003 West Chicago Avenue • Dept. R-77 • Chicago 22, Illinois

Locksmithing AND KEY MAKING
Now Made Easy! Practical up-to-date course teaches you how to pick locks, de-code, make master keys, repair, install, service, etc. New self-instruction lessons for every handyman, homemaker, carpenter mechanic, service station operator, fix-it shop, hardware dealer, gunsmith. 50 easy illustrated lessons. Full price only \$5.95 postpaid or C.O.D. plus postage. Satisfaction or refund guaranteed.
Complete course \$5.95
... now only \$5.95
Nelson-Hall Co., Dept. GT-2
210 S. Clinton St. Chicago 6, Ill.

GIANT 6 FOOTERS 59c

Wow! Genuine Neoprene government surplus (never used) . . . giant 6 ft. across, 21 ft. around...at a fraction of original cost. Durable. Can paint on advertising message. Inflate and fly. Visible for miles. Great for attracting crowds to fairs, openings, school proms, gas stations. Fun for young and old in backyards or picnics, at the beach, etc. use as water markers & buoys. Order today — only 59c each.
Special: 2 for \$1.00; 5 for \$2.00; 13 for \$5.00. No C.O.D.

P.O. Box M-27104, Hollywood 27, Calif.
POPULAR MECHANICS



NOW IS GOOD TIME TO PLANT
 May Be Planted Summer, Fall, Winter, Spring

BLUE-GREEN
MONDO GRASS

TRADE MARK REGISTRATION APPLIED FOR U. S. PATENT OFFICE

REQUIRES NO MOWING—
MAKES WORLD'S MOST
BEAUTIFUL LAWN

View of one of the lawns surrounding the lovely \$200,000 home of Spurgeon Pickering, owner of Mondo Grass Company, on the beautiful beach of the Gulf of Mexico; the entire 7 lawns, sidewalk shoulders and neutral grounds are planted solidly in Mondo Grass, truly one of the most attractive show places of the South.

Our Blue-Green Mondo Grass is described by the U. S. Department of Agriculture as quote "Ophiopogon Japonicus, technically called ground cover (formerly called Mondo Japonicus), is native to Northern China and should withstand severe degree of freezing; drought tolerant, evergreen, commonly called Mondo Grass" unquote.

It is a grass relative to the lily with paper thin blades 1/16" wide. This sod-forming EVERGREEN, low-growing oriental genus is currently used by many owners of distinctive homes in America for lawn grass. Now we can offer this exclusive Blue-Green Mondo Grass at popular prices.

SO HARDY IT CAN BE PLANTED ANYTIME. It is recommended for beautiful lawns where mowing is not desired. Blue-Green Mondo Grass retains its color the year-round; thrives in shade or sun; extremely hardy, rarely requires watering; fantastically beautiful, drooping low to the ground in weeping style year after year. **REQUIRES NO MOWING.**

Ideal for heavy shaded areas, dry or wet. **FREE** folder of testimonials and many photos of Mondo Grass lawns sent on request.

Mondo is resistant to diseases; insects and animals will not feed on it. Stops erosion; grows compactly, crowding out other grass and weeds; multiplies rapidly, approximately 100 times (10,000%) first year. Enhances property value. So sensational we expect to revolutionize lawn-making. For good coverage first year plant 4" to 12" apart. Numerous rooted blades to sprig.

Planting and culture instructions with each order. Remittance with order. Shipped prepaid. **MONEY-BACK GUARANTEE:** If not completely delighted you may return at once for refund. Open accounts to A-1 rated firms buying 1,000 sprigs or more, FOB, Biloxi.

ORDER TODAY . . . YOU CAN'T LOSE!!
 Sprigs packed in damp moss. Guaranteed to grow or we will replace.

25 SPRIGS \$2.98

50 Sprigs \$ 5.00	1,000 Sprigs \$79.00
100 Sprigs 9.00	5,000 Sprigs or more
500 Sprigs 40.00	per 1,000 50.00

MONDO GRASS CO., Dept. PM-7, Biloxi, Miss.

I enclose \$_____ Please Ship (check one): Now _____
 send prepaid _____ Sprigs At Proper Planting Time _____
 Mondo Grass. Or When? _____

NAME _____
 ADDRESS _____
 CITY _____ STATE _____

These men are getting practical training in . . .

ELECTRICITY

ELECTRONICS

ON REAL

A.C. and D.C. Motors
 Generators
 Switchboards
 Controllers
 Appliances
 Electronic Units

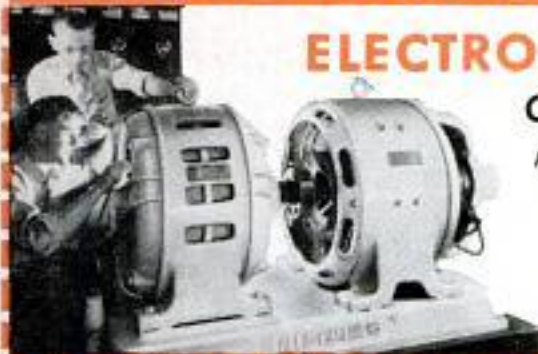

TELEVISION

COLOR-TV

ON REAL

Television
 Receivers
 Including Color TV
 AM and FM Radios
 Auto Radios
 Test Equipment



Train in Great Shops of
COYNE

in Chicago—Prepare for a better job and a real future in **TOP OPPORTUNITY FIELDS.** Train on real full-size equipment at **COYNE** where thousands of successful men have trained for nearly 60 years—*largest, oldest, best equipped school of its kind*—est. 1899. Trained instructors show you how, then do practical jobs yourself. No previous experience or advanced education needed. Employment Service to Graduates.

START NOW—PAY LATER—Liberal Finance and Payment Plans. Part-time employment help for students. **GET FREE BOOK**—"Guide to Careers in **ELECTRICITY-ELECTRONICS** and **TELEVISION-RADIO**"—no obligation; no salesmen will call. Vets and Non-Vets get vital facts now.

Coyne Electrical School 500 So. Paulina Street
 Chartered Not For Profit Chicago 12, Dept. 87-72H

MAIL COUPON TODAY!

COYNE ELECTRICAL SCHOOL
 500 S. Paulina St., Chicago 12, Ill., Dept. 87-72H

Send **BIG FREE** book and details of your training offer by return mail. I am interested in:

Electricity-Electronics Television-Radio

Name _____

Address _____

City _____ State _____



Make SURE, SAFE INSULATED ELECTRICAL CONNECTIONS

The New

SUPER **CHAMP** Hand Tool

The ONE Tool for ALL Wire Sizes used in Home Wiring, Appliances, Automobiles.

DOES ALL THESE THINGS BESIDES

CRIMPS Solderless Terminals and Connectors without solder or tape for safe connections.

STRIPS Wire sizes #22-#10. Gauges assure proper length for sure, safe crimp.

CUTS Wire, making clean, sharp cut through insulation and Conductor.

SHEARS Bolts and screws without damaging threads — no filing or hack sawing.

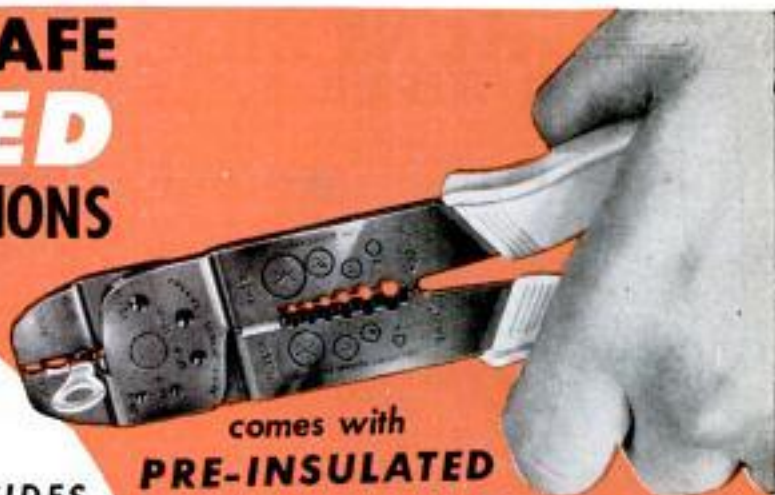

comes with
PRE-INSULATED



FREE with Each TOOL

ORDER DIRECT—USE COUPON

Only
\$3.95
Post Paid

Satisfaction guaranteed or money back. Send check or money order for \$3.95.

T. W. Berger
National Distributor
Manufactured by
AMP INCORPORATED

T. W. Berger
National Distributor Champ Tool
Dept. JY, Suite 401, 1700 Walnut St., Phila. 3, Pa.
Send me post paid the new Super Champ Hand Tool. I am enclosing \$3.95. (Incl. state sales tax where applicable)

check money order

NAME _____

ADDRESS _____

CITY _____ ZONE _____ STATE _____

SHORTHAND in 6 WEEKS

Famous SPEEDWRITING shorthand. 120 words per minute. No symbols; no machines; uses ABC's. Easiest to learn, write and transcribe. Lowest cost. For business and Civil Service. 350,000 graduates. Typing available. 34th year. Write for FREE booklet to:

© 1957

Speedwriting
Dept. 1507-7, 55 W. 42 St., New York 36 (R)

MECHANICAL DENTISTRY

A profession offering unlimited opportunities. Most modern and complete course embracing every branch from Plate to Porcelain Work, which prepares you to work for Dentists or start your own business. Individual instruction—practical training in day or night school. No books—no classes. Catalog upon request.
McARRIE SCHOOL OF MECHANICAL DENTISTRY
207 N. Broad Street Dept. 67 Philadelphia 7, Penna.

MAKE MORE \$ IN SPARE TIME HOURS!

Use "IDEAL"

Lawnmower Sharpener

New attachment makes Model 300 "Ideal" a perfect reel and rotary blade grinder—also sharpens shears, other tools! Ideal's exclusive "hook" grinding method insures quick, easy results every time. Compare all facts and you'll buy "Ideal"—leading mower sharpener for 55 years. Make more money—write for free catalog.



Sharpens All Mowers

• REEL TYPE • HAND
• ROTARY • POWER



AMAZING MUSIC DISCOVERY

PLAY ANY INSTRUMENT

—even if you don't know a single note now!

NOW it's EASY to learn ANY instrument. No boring exercises. Even if you don't know a single note now, we'll have you playing delightful pieces RIGHT AWAY—right from your FIRST lesson! And properly BY NOTE. Simple as A-B-C. Make amazing progress. No special "talent" needed. Learn at home in spare time, without a teacher. Only a few cents per lesson. Soon you can play any piece you wish. 900,000 students, including famous TV Star Lawrence Welk! (Now in our 59th successful year)

FREE 36-PAGE ILLUSTRATED BOOK

—just send this ad, with your name and address filled in below to: U. S. School of Music, Studio A307, Port Washington, N. Y. (No obligation, no salesman will call.)



Name _____

Address _____

The FATE-ROOT-HEATH Co., Dept. PM-7, Plymouth, Ohio
JULY 1957

DEER HUNTERS! ENFIELD RIFLE SALE

We have made a special low cost purchase of surplus British Lee Enfield Army rifles, one of the world's most accurate rifles and ideal without any further expense for deer, bear and any North American or African big game. Adjustable sights, 10 shot, bolt action, barrel 25", wt. approx. 8 1/2 lbs. British ordnance and proofhouse marks. Bore guaranteed good condition. .303 softnose ammo is made by Rem., Win., Western and Peters, available everywhere. We remove cosmoline and re-oil lightly before shipping. Sling included. Bayonet: \$1.95 additional. We have softnose ammo, 20 rds. for \$2.95; military target ammo, 100 rds., \$7.50. Pachmayr Lo-Swing Scope mount specially made for this rifle—\$20.00 extra.

JUST
\$19.95



TO ORDER: Send check, cash or money order. 1/2 deposit for C.O.D. Shipped express collect, Pasadena, Calif. Calif. res. add 4% state tax. 10-day unconditional money back guarantee.

THE ELLNER COMPANY
Dept. 1, 1206 Maple Ave., Los Angeles 15, Calif.

WAR SURPLUS BARGAINS

\$500,000.00 INVENTORY FOR QUICK LIQUIDATION

Surplus items—hundreds of them for home, shop, factory, farm and outdoor use. New items, used items, reconditioned items—all at tremendous savings—all priced for quick sale.

Page After Page of Values

This big catalog shows page after page of amazing money saving values. Write for your copy today. Send 10c to cover postage, mailing, etc. Write today! **SEND TODAY FOR YOUR COPY**

10c

STARK'S 212 W. Madison St.
Dept. PM-577
CHICAGO 6, ILL.

High School at Home

MANY FINISH IN 2 YEARS

No classes. No time wasted going to and from school. Progress as fast as your time and abilities permit. Standard H. S. texts supplied. Thousands enroll each year in this 60-year-old school. Send for FREE descriptive booklet.

AMERICAN SCHOOL, Dept. HB45
Drexel at 58th St., Chicago 37, Ill.
Without obligation, please send FREE descriptive booklet.

Name.....

Address.....

Complete Canadian Courses available. Write American School, Dept. HB45, 6083 Sherbrooke St. W., Montreal



BUILD and FLY Bensen HELICOPTER

Glider type 'copter—easy to build, simple to fly. Can also be mounted on floats or boat. No pilot's license required. Order 3-view drawings, specs and photo for \$1. Motor powered Gyro-Copter drawings \$2.

Ask about detailed plans and construction kits.
BENSEN AIRCRAFT CORP., Dept. PM-77
P. O. Box 2725, Raleigh, N. C.

Send
\$1
or
\$2

Name.....

Address.....

Make \$5 an Hour CASH PROFIT

THE DAY YOU START!

Start your own business at Home...
Sharpen Household, Garden and Shop Tools in Spare Time.



Turn spare time into Big Cash Profits with new Belsaw Sharp-All. No experience needed to sharpen knives, scissors, shears, ice skates, mower blades, hedge trimmers, axes, chisels and circular saws... Learn how easily you can start your own spare time business. Amazing low cost easy-payment plan. Send Postcard for **FREE BOOK.**
BELSAW SHARP-ALL CO 718 Field Bldg., Kansas City 11, Mo.

PRISMS \$1.50

Made for U. S. Govt. for tank periscopes. Fine optically ground, big precision prisms with silvered base. Terrific for all types of spectrographic work, in homemade telescopes & other optical systems for bending rays. Makes unusual paper weight (paint your name on it) or conversation piece for mantle. You'll find many other uses. **NEW, PERFECT!** Cost U. S. Govt. \$25 ea. Now—\$1.50 ea. ppd. or 4 for \$5.00 ppd. Calif. res. add sales tax.

VOLUME SALES CO., War Assets Div., Dept. M-757
3930 Sunset Blvd. Los Angeles 29, Calif.

**LEARN
EARN
MORE
MONEY**

UPHOLSTERY

YOU'RE IN BUSINESS RIGHT OFF—Complete upholsterer's tools, materials, frames, all you need to earn in sparetime while you learn **AT HOME.** Expert N. Y. State approved shop training in upholstery, slip covers, etc. Big Opportunity Field. Send for **FREE** Illust. Catalog. **FREE** Sample Lesson. Write Today. Approved for Vets.

Upholstery Trades School, Dept. FL-312, 721 Broadway, New York 3, N.Y.



A Build-It-Yourself PLYWOOD CRUISER Designed Especially for PM Readers

Construct this beautiful 17-foot cabin cruiser yourself in your spare time. It's exceptionally easy to build even with little or no experience! Has cruising accommodations for two, including two full berths, complete kitchen and toilet facilities and a fast bottom for single or twin-motor installation.

Beautifully designed—roomy open cockpit, hatch in forward deck, and with two aboard it makes 26 m.p.h. with a 35-hp. motor. As a cruiser, runabout or utility boat, it will give you many hours of wonderful outdoor enjoyment for a minimum investment of time and money. Complete, fully detailed plans only \$10.00. Order below today!

POPULAR MECHANICS PRESS, Dept. 757
200 E. Ontario St., Chicago 11, Ill.

Send me complete set of seven large-size blueprints for "SEA KNIGHT" cruiser, including plans for easy-to-make boat trailer.

- I enclose \$10.00 check or money order
 Send C.O.D. (U.S.A. only)

Name.....

Address.....

City..... Zone..... State.....

Revolutionary

NEW MECHANICAL BRAIN COMPUTER



gets you there on time.

Before the trip, set Halda Speedpilot computer to the average speed you must make. Halda shows at a glance whether you are ahead or behind schedule at any time. Pays for itself in added efficiency on trips. Now only \$86.50. Write for full information.

HAINGER CORP., 146 E. 74th St., N. Y. 21, N. Y.



Get your Auto-Valet clothes rack for your vacation trip.

Lasts a Lifetime — Fits Any Car

Nothing to install—in or out in seconds—Holds 30 to 60 garments—Occupies place of one person—Load or unload from outside.

Price \$4.95 Plus Tax — Factory to You

AUTO-VALET CO.

1480 N.E. 130th St., North Miami, Fla. PL 4-4075

BUILD YOUR OWN OPTICAL INSTRUMENT "FUN with OPTICS"



TELLS YOU HOW

Just out! 32 exciting pages! Wonderfully illustrated. Shows you how to build telephoto lenses, telescopes, microscopes, close-up camera lenses, artist drawing projectors, slide viewers, binoculars, riflescopes, etc. Plenty of diagrams—any 10-year old can easily follow the instructions. We can furnish the lenses, prisms and parts you'll need. Right now—order your copy of "FUN WITH OPTICS." Just send your name and address, along with only 50c in coin. **EDMUND SCIENTIFIC CO., Barrington 30, New Jersey.**

Learn ACCOUNTING Business Administration

Bookkeeping, secretarial and allied subjects at home in your spare time or attend nationally approved resident school. Write for FREE Success Book giving complete details on courses, plans, rates and employment opportunities. G.I. approved. Write Dept. A.



**Hills BUSINESS UNIVERSITY AND
EXTENSION SCHOOL**

829 W. MAIN ST. OKLAHOMA CITY 2, OKLAHOMA

JEEPS

**CONVERT 4 w.d. models
to 2-wheel drive**

Improve speed, save gas, eliminate drag, reduce whine — install a set of CAM CLARY FLANGES. A must for hunters, fishermen, farmers, all jeep owners. Takes minutes to install or remove. Only \$24.50 per set postpaid. Satisfaction guaranteed. Send check or money order.



CAM TOOL CO. 1038 Larkin St., San Francisco

PUMP WATER FAST!

Drains Wash Tubs, Cellars, Cisterns. Famous #7 pumps 2800 gph. 420 gph. at 75' high or 1600 gph. from 25' well. Sturdy rustproof alloy metal. Six blade impeller. 1/2" inlet, 1/2" outlet. Standard pipe threaded. Uses any 1/4 to 1/2 H.P. Motor. Will not leak or clog. Iron clad guarantee. Send check, M.O., or sent C.O.D. **\$795** IN U.S.

Irrigate, Fill Tanks, Draw Well Water. Heavy duty #8 pumps 7000 gph. —1000 gph. 75' high 3000 gph. from 25' well. Rustproof alloy metal. 8 blade impeller. 1" inlet, 1" outlet. Standard pipe threaded. Will not leak or clog. Iron clad guarantee. Send check, M.O., or sent C.O.D. **\$1195**

Free Catalogue—Gear Pumps, Large Centrifugal Pumps, Deep and Shallow Well Pumps, Sump Pumps.

MOORE MANUFACTURING CO.
SWEDESBORO 1, NEW JERSEY

Still dreaming about a good job and more pay?



WAKE UP TO YOUR OPPORTUNITIES IN

Auto Mechanics

PRACTICAL NEW WAY TO TRAIN AT HOME

Don't rely on luck to make your dreams come true! Be practical and depend on training. As a skilled man, you can step into a good, top-pay job—enjoy security—and even open a shop.

Your best bet is to become an auto mechanic. That's the big opportunity field today. Over 60 million cars and trucks are on the road, and all require maintenance. At least one-third are in the heavy-repair class. There's so much work that 50,000 mechanics are needed! It's easy to learn this trade at home. Find out how by mailing coupon below.

EARN MONEY IN SPARE TIME as you train. Many students repair cars for neighbors; others get jobs in local garages; some open shops by the time they graduate. You can learn-and-earn because CTI offers practical Shop-System training.

DIESEL MECHANICS OR BODY-FENDER REBUILDING is included at no extra cost. Only CTI offers this extra choice. Get this fully-rounded mechanic's training. Send coupon for two free books.

YOU PRACTICE WITH THIS TUNE-UP KIT
Kit includes a Compression Tester, a Vacuum Gauge and Fuel Pump Tester, an Ignition Timing Light, and a portable steel case. These professional instruments help you locate engine troubles, let you get useful practice. You keep this kit!

MECHANIC'S TOOLS TOO

You'll use these tools to get real experience. They'll increase your interest, stamp you as a "pro." You'll earn spare time cash with them. No extra cost for tools—you keep them.



MAIL COUPON TODAY!

MAIL TODAY FOR 2 FREE BOOKS

COMMERCIAL TRADES INSTITUTE
1400 Greenleaf Ave., Chicago 26
Dept. A-565

Send your new Auto Mechanics book and Sample Lesson, BOTH FREE.

Name _____ Age _____

Address _____

City _____ Zone _____ State _____





Written Especially for
the Farmer

What Every Farm Family Should Know About Taking Care of Farm Animals

NEW, ENLARGED 3rd EDITION
Bigger! Better! Even More Useful!



384 Pages • Illustrated

\$3.95

Information
You Can Use Every Day

Covers Cattle, Horses, Swine,
Sheep, Poultry

It pays you to know what diseases can strike your herd; what must be done for stricken animals; how the healthy ones in the herd can be protected; how the outbreaks can be prevented in the future. This is only part of the information you get in the VETERINARY GUIDE FOR FARMERS. Only \$3.95!

**MAIL
COUPON
TODAY!**

**Money Back
If Not Pleased**

“VETERINARY GUIDE For Farmers”

Increase profits by reducing animal losses! Now you can know many of the things the veterinarian knows. Learn for yourself how to recognize the symptoms of what is wrong with ailing meat and dairy animals and treat them yourself in emergencies. This new VETERINARY GUIDE FOR FARMERS is all you need. Completely revised, it's by far the most useful book of its kind. Tells what causes diseases of farm animals, how to recognize and treat yourself, how to prevent and control—how to make injections, castrate, etc. Even includes a full chapter on artificial breeding.

**Simplified • Non-Technical
Thoroughly Practical**

Written by G. W. Stamm. Edited by Dallas S. Burch, former executive, Bureau of Animal Industry. You would have to digest many books, bulletins and other source material to get all the information this book gives you. Presented in the most simple, non-technical terms, its 384 pages are packed with how-to-do-it instruction, pictures, charts, etc., needed on every farm. Does not require any knowledge of biology, physiology or anatomy.

**Easily Worth Many, Many Times
Its Cost**

By preventing the loss of only one animal this book can easily be worth a hundred times its cost. Today's high market value of farm animals, together with the high cost of feeding and raising them makes losses extremely expensive. Stop losses. Step up your profits. Learn how to take care of all farm animals and keep your herd healthy with the VETERINARY GUIDE FOR FARMERS.

OFFICIALLY ADOPTED IN 26 STATES

Endorsed by Vo-Ag teachers and other leaders. Adopted by "Veterans on the Farm" training classes in 26 states. More than 250 thousand copies sold.

POPULAR MECHANICS PRESS, Dept. 757
200 E. Ontario St., Chicago 11, Illinois

RUSH new, improved edition of famous Veterinary Guide for Farmers.
 I enclose \$3.95 in full payment. Send COD (U.S. only)

I understand I am protected by money-back guarantee.

Name _____

Address _____

City or Town _____ Box or Zone _____ State _____

75 POWER TELESCOPE \$3.98

25X - 45X - 75X

New 3 in one telescopes, 3 variable 25X-45X-75X magnification, Brass barrel, 25 power for ultra bright images, 45 & 75 power for long range. Guaranteed to bring distant stars, moons, objects, sports 75 times closer.



Most powerful scope sold anywhere near this amazing low price, American made, 5 sections. Opens 36" closes 1 ft.; contains 4 ground & polished lenses. Can also be used as powerful compound microscope. Directions included. Mass production enables us to offer telescope at \$3.98 postpaid complete money back guarantee. Get yours now.

CRITERION CO., 331 Church St., Hartford, Conn., Dept. PMB 47



BUILD YOURSELF A "HE-MAN" BODY In Only 6 Weeks or Money Back!

Fastest, surest method known . . . with famous

DAN LURIE BARBELLS

Special low prices . . .
50 lb. set \$ 8.98 • 100 lb. set \$14.98
150 lb. set \$21.98 • 200 lb. set \$27.98
14c per lb. F.O.B. 50% Deposit required

FREE! If you act fast. Complete exclusive body mold training course. 68 Photos with your order.

DAN LURIE BARBELL CO.
5237 Bristol St., Dept. 7596, Bklyn 12, N.Y.
AMERICA'S FAMOUS TV STRONG MAN

FREE "How To Start Your Own MAIL ORDER BUSINESS"

Earn from \$10,000 to \$20,000 spare time. We'll put you in business and furnish you with everything needed. Exclusive new catalogs every three months . . . Offer your customers one item free for every two they buy! Free advertising and no stock for you to buy. We ship for you under your own name. No experience required. Write today for free booklet and franchise data.

MAIL ORDER ASSOCIATES, ROCHELLE PARK 7, NEW JERSEY

HYDRAULIC JACK REPAIRS

Earn While You Learn at Home

Millions of jacks in gas & auto-service stations, truckers, body-shops, riggers, factories need servicing. We show you HOW—easy step by step directions—what tools to use, EARN UP TO \$3 an hour, in spare time, in your own basement or garage. Start your own business NOW. Write for pamphlet PM-7 & free bonus offer.

Institute of Hydraulic Jack Repair

P.O. Box 50, Bloomfield, N. J.



Finish HIGH SCHOOL AT HOME

Complete 4 Yrs. in 12 Months

Learn More! Earn More! Enter professional or technical schools. Advance Socially. Live a Happier, Fuller Life. Individual Courses or complete schedule. WRITE FOR SCHOOL BULLETIN.

ACADEMY FOR ADULTS

30 W. Washington, Dept. PM-77, Chicago, Ill.



DRAW The First Day! NO LESSONS! NO TALENT!

New Amazing Invention—"Magic Art Reproducer." You can draw Your Family, Friends, Anything From REAL LIFE—Like An Artist! Even If You CAN'T DRAW A Straight Line! Anything you want to draw is automatically seen on any sheet of paper thru the "Magic Art Reproducer." Then easily follow the lines of the "picture image" with a pencil for an original "professional looking" drawing. Also reduces or enlarges. SEND NO MONEY! Free Trial! Pay Postman on delivery \$1.98 plus postage. Or send only \$1.98 with order and we pay Money Back Guarantee.

NORTON PRODUCTS, Dept. 139, 296 Broadway, N. Y.

GROW ORCHIDS AT HOME

World's most thrilling hobby - profitable home business.

Hundreds of Families Raising Orchids At Home With Our Help

Successful home grower reveals his methods. Explains how to raise GORGEOUS ORCHIDS AT HOME, by following his rules. Has helped Thousands to start. Many ORCHIDS grow without soil, getting food from the air. Purple, white, yellow, green, every rainbow color.

Send for FREE information on temperature, light, humidity & general conditions ORCHIDS need in the home.

Also details on complete, illustrated instructions which include Blooming-Size Orchid Plants. Grow them for fun or profit. Orders come from friends, neighbors, hotels, clubs, florists—also Mail Orders. Operate from small town, big city, or farm. Send name & address for details. Real Orchid Seeds, and exciting "Quick-Profit Plan." ALL FREE. Send no money. TROPICAL FLOWERLAND, Dept. 317, 100 So. Vermont, Los Angeles 4, Calif.

RCA offers you the finest training

at home in

Radio-TV

electronics

TV servicing

Color TV



SEND FOR THIS FREE BOOK NOW!

Pay-as-you-learn. You need pay for only one study group at a time. Practical work with very first lesson. All text material and equipment is yours to keep. Courses for the beginner and advanced student.



RCA INSTITUTES, INC.

A SERVICE OF RADIO CORPORATION OF AMERICA

350 WEST FOURTH STREET, NEW YORK 14, N. Y.

In Canada — RCA Victor Company, Ltd.

5001 Cote de Liesse Rd., Montreal 9, Que.

RCA Institutes, Inc., Home Study Dept. PM-77
350 West Fourth Street, New York 14, N. Y.

Without obligation, send me FREE 52 page CATALOG on Home Study Courses in Radio, TV & Color TV. No Salesman will call. To save time, paste coupon on postcard.

Name.....
Please Print

Address.....

City.....Zone.....State.....

KOREAN VETS! Enter discharge date.....

WARN HUBS on your

Patented



Jeep

STOP FRONT DRIVE WEAR
in 2-Wheel Drive!



Over 100,000 now in use!

That is real proof of their many advantages and rugged dependability. Warn Hubs on 4-wheel drives make steering easier, increase power, speed in high; add life to gears, tires, because the front drive stands still in 2-wheel drive—there is no drag! Use free-wheeling 2 w.d. or tractive 4 w.d. as needed, automatically, as you shift, with Warn Lock-O-matics, through fingertip controls with Warn Locking Hubs. Factory approved. Iron-clad guarantee. Models for all 4 w.ds. to 1½ tons. See your dealer now! Write for free literature.



© 1957 WARN

WARN MFG. CO.

Riverton Box 6064-A7
Seattle 88, Wash.

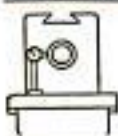

USED BY U. S. ARMED FORCES
MACHINE TOOL RECONDITIONING
& THE ART OF HAND SCRAPING (2nd printing)
SEND FOR FREE FOLDER DESCRIBING
ILLUSTRATED BOOK
MACHINE TOOL PUBLICATIONS, 382 Holly Ave., St. Paul 1, Minn.



Colorcretors are Needed Everywhere

C-9



More Colorcretors are needed to supply growing demand for the enduring, colorful beauty possible only from Colorcrete. Time-worn concrete, stucco and other old or new masonry walls are quickly transformed into clean freshness from a selection of 30 tints, tones and shades. Cementitious base—tough, tenacious, enduring. Colorcrete is applied under pneumatic air pressure by authorized Colorcretors. Machine is easy to operate and readily mobile. Opens up opportunities for men of modest capital. Broad markets with high income potentials. Write for Opportunity Book.

COLORCRETE

COLORCRETE INDUSTRIES, INC.
570 Ottawa Ave., Holland, Mich.

CANADA: 1020 Dundas Highway, Cooksville, Ont.

MAKE STRIPES with new PAINT PEN

Straight, curved, single or double
With any color paint, stripe furniture, bikes, autos, model planes, toys, linoleum, wall-board. Clean, crisp decorative lines. Can't clog or smear. Also use with glue, tempera, textile paint or underglaze... on wood, glass plastic, ceramics, metals, fabrics and paper. Ask your dealer or order direct.

DEALERS
Master paint striping tool in display carton. Write for discounts.

HOBBY
"Professional" results every time. Simple, easy to use. Order now.

MFRS
Ask about heavy duty industrial striping tools.

DOUBLE STRIPE MODEL \$325
5 COMBINATIONS...

WENDELL MFG. CO.

4234 LINCOLN AVE., Dept. 331
CHICAGO 18, ILLINOIS

Single 1/16" stripe model \$125

Other single stripe models 1/8", 1/64", 1/32", 3/64", 5/64", 3/32" & 1/8"

Complete Kit \$5.00 (all 7 tips)

Extra tips 90c ea.

Extra 1/4" tip...\$1.20

\$150⁰⁰-\$250⁰⁰ Weekly OPERATING AUTO RADIATOR SERVICE SHOP



World's largest radiator shop equipment mfr. will help you set up your own radiator shop—help you get started toward a secure, profitable future. Over 1,000 INLAND shops now operating. First year averages \$6,000 to \$10,000. Many now making much more. Garage or service station can operate as dept. As little as \$305 down for equipment starts you. We will finance balance, furnish complete factory training. Write to

INLAND MFG. CO., Dept. PM-7, 1108 Jackson St., Omaha 2, Nebr.

JEEP OWNERS

RE-POWER NOW with your choice of three famous V-8 engines
FORD • CHEVROLET • MERCURY
CONVERSION KITS now available to fit ALL 2 and 4 Wheel-Drive Jeeps. . . . Priced \$43.25 to \$64.75 . . . If you want fast action tell us which V-8 engine you wish to use . . . give us the year, 2 or 4 Wheel-Drive . . . body style of your vehicle. Send min. \$15.00 dep. and we will ship correct kit, bal. C.O.D. Send full amount for prepaid shipment. Wire, phone or write for FREE details.

HOOSIER MACHINE PRODUCTS CO.
312 S.E. 6th St. Phone 676 Pendleton, Oregon, U.S.A.



HIGH SCHOOL DIPLOMA
Earn a High School Diploma at home! Prepare for better job, more pay. Study in spare time. No classes. Materials furnished. Certified teachers. Valuable diploma awarded. Write Today for Complete Information.
SOUTHERN STATES ACADEMY
Box 144-A Sta. E Atlanta, Georgia

BUILD YOUR OWN AIR CONDITIONERS

From Junked Refrigerators for a Few Dollars
INSTRUCTION BOOKS SHOW YOU HOW . 75c EACH
"HOW TO BUILD a Low Cost Air Conditioner"
"HOW TO BUILD an Automobile Air Conditioner"
"HOW TO BUILD a Low Cost Home 'Fresher'"
"HOW TO BUILD an Electrostatic Precipitator"
"HOW TO BUILD a Low Cost Dehumidifier"
Complete "Install-It-Yourself" Air Conditioner kits for home and automobile, 2 Ton capacity, Brand New Parts—\$124.40 and up.
KOOL ENGINEERING CO., Dept. R-7, 3716 Belmont, Chicago 18, Ill.

SPECIAL OFFER
2 Books—\$1.00
3 Books—\$1.50
or all 5 for \$2.00

FREE!
Instructions and Literature on kits.

TASOPE PHOTO-ENGRAVING PLANTS



Establish your own profitable PHOTO-ENGRAVING business. Make cuts for newspapers, printers, and advertisers. Make etched name plates, plaques etc. Instructions furnished, no experience necessary. Sold direct from factory since 1931. First five hundred cuts sold locally or by mail will pay for plant and pay you well for your time. Write for FREE catalog.

Material Cost Of This Cut 34c Selling Price \$1.00 And Up

TASOPE, DEPT. PM-7, AURORA, MO.

FREE AMAZING NEW BOOK "HOW TO ANSWER ADS"



Never before have you seen anything like this. Tells you in simple language the correct way to answer ads. Gets you quicker replies—better results, and greater satisfaction. Will save you time and money and it's ABSOLUTELY FREE. No obligation whatever. Every reader of advertising should have this booklet. Send a postcard for your copy NOW. F. W. JOHNSON, Popular Mechanics Magazine, Room 600-A, 204 East Ontario Street, Chicago 11, Ill.

NORWAY'S WORLD FAMOUS MASTERPIECE

KRAG

CARBINE

on sale
\$22.50



DEER HUNTERS! This gun, easily found singly at about \$30. Our small lot imported directly from Europe by us. Selected for good bore, mechanically perfect, stocks fine Northern European walnut. Famous 5-shot Krag-Jorgensen friction-free bolt action (locks with one finger). Powerful game stopping 6.5 MM Cal. Precision calibrated adj. sights. Free leather sling. This is the most outstanding rifle offer in many a year. Do not miss it. **AMMO SPECIALS** 100 target rds., \$7.50. **SOFTNOSE HUNTING AMMO**, 20 rds., \$2.95. **TO ORDER:** Send check, cash or M.O. 1/3 deposit for C.O.D. Calif. resid. add 4% state tax. Shipped P.O. B. R.R. Ex. Coll. Pasadena. Used. 10-day money back guarantee. Dealers inquire.

GOLDEN STATE ARMS CORP.

288 W. Green Street, Pasadena 114, Calif.

SALE

20 X 50 REGULARLY \$74.50
SAVE \$44.55!

High powered, whisper-weight (27 oz.) color corrected, Achromatic binoculars. 7^{1/2}" high! EZ to hold, EZ to focus. Instant finger-tip adjustment. **SALE PRICE FOR THIS SALE ONLY** including case and strap! Made in Japan. **USE 30 DAYS. \$29.95** If not satisfied return for refund. Add \$1 postage, handling. Add 6% Tax. **UNITED BINOCULAR CO.,** 9043 S. Western, ARF-1508, Chicago 20. **DEALERS WANTED**



FIX OUTBOARD MOTORS

POWERMOWERS, AND ALL SMALL 2 & 4-CYCLE GASOLINE ENGINES

Repair your own equipment or **MAKE EXTRA MONEY** in this growing field. Fully illustrated, easy-to-understand, Home Study Course. Write for **FREE** information.

LINCOLN TECHNICAL INSTITUTE
SUITE 7 - E, 472 MARKET STREET, NEWARK 5, N. J.

RUPTURED?

NEW LASTING RELIEF

ENJOY NEW FREEDOM of action, peace of mind and comfort at work or play. Proven, patented MILLER holds your rupture back Day and Night—will bring you lasting relief. For free facts in plain wrapper, send name and address to: **FRED B. MILLER, Manufacturer,** Dept. 1-K, Hagerstown, Maryland.

Entirely
Different

FIX home & car APPLIANCES YOURSELF

NEW! EICO® REDI-TESTER
KIT \$12.95 Factory-wired \$15.95

Multi-range ac/dc voltmeter, ammeter, ohmmeter, wattmeter, leakage checker. Locates defects in appliances, air-conditioning, furnace control, TV, radio, car batteries, generators, etc. Easy step-by-step instruction book. Send Check or M.O., specify Kit or Wired. Or write for neighborhood distributor's name & FREE catalog EIC-7 describing EICO's 50 professional kits & instruments.

Electronic Instrument Co., Inc., 84 Withers St., Bklyn 11, N. Y.



MAKE BEGINNERS BIG PROFITS

Many men and women making big money on imports by mail order from home. No investment in merchandise or ads. We tell you where to get low cost products from abroad and supply list of magazines that run no-cost ads. Write for Free details. **MELLINGER CO.** Dept. G257, 1717 Westwood, Los Angeles 24, Calif

Interesting, Pictorial FREE BOOKLET

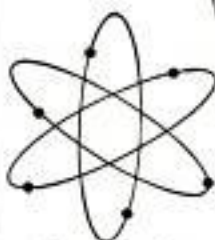

to help you decide on YOUR CAREER IN ENGINEERING

Here is a graphic story about dynamic careers as engineers and engineering technicians. Booklet covers such subjects as:

- Wide variety of job opportunities.
- The courses offered, degrees you can earn, and what you are qualified to do.
- Pictures of the Milwaukee School of Engineering, its facilities, plus Milwaukee scenes.
- Recreation, student organizations, fraternities.
- Scholarships, part-time work, admission requirements.

— and many other important and interesting facts to help you understand and decide on your career in engineering. Send for your free copy today — no obligation whatsoever.

MS-73

Milwaukee School of Engineering
— dedicated to serving young men and industry

SEND COUPON

Milwaukee School of Engineering
Dept. PM-757, 1025 N. Milwaukee St., Milwaukee, Wis.

Please send me free the new booklet
"Prepare for Your Career in Engineering"

Name _____ Age _____

Address _____

City _____ Zone _____ State _____

I'm eligible for veteran's education benefits.

Yes No Discharge date _____

HUNTERS! Powerful 7.35 mm Carbine SHOOTERS!



ONLY \$12.95

Specifications: Barrel approx. 21";
 wt. approx. 7 lbs.; Mag. cap. 6 rds.; cal. 7.35mm.
 Condition: Very good.....\$12.95
 Select Models (limited) \$5.00 Extra; Bayonets.....\$ 2.00
 Ammo: Military 130 gr. (in clips).....54 rds. \$3.40
 Sporting 135 gr.Box 20 rds. \$2.85

Hard hitting, accurate, and dependable, this powerful 7.35mm Carbine is the answer for a low-cost, reliable hunting rifle. A famous Military Carbine, lightweight and rugged; ideal for hunter or shooter!

(Use only original ammo., unlimited supply)
 C.O.D. Send \$5.00.
 Shipped Exp. chgs. coll.

WINFIELD ARMS CORPORATION

Dept. PM-7, 1006 S. Olive, Los Angeles 15, Calif.

UNUSUAL BINOCULAR SALE

Small lot of binoculars guaranteed NEW PERFECT in every respect optically and mechanically, set aside for direct sale by importer. Full size, calibrated for individual focus and interpupillary adjustment. Coated objective and ocular lenses. Dust and moisture proof. Laboratory tested and approved by Japanese Optical Assn., under rigid export restrictions. Wonderful for outdoorsmen, shooters, etc., who demand ease of operation and clarity at all distances. Superior light refraction gives crystal-clear images even under adverse light conditions.



6x30
392 feet at 1000 yards

\$15.45

Postpaid Plus 10% Fed. Tax

10x50
262 feet at 1000 yards

\$22.80

7x50 372 feet at 1000 yards

\$19.65

Postpaid Plus 10% Fed. Tax

TO ORDER: Send check, cash or M.O. \$5 deposit for C.O.D. per pair. Complete with genuine pikskin case, straps and four protective lens caps. Well packed for safe shipment. UNCONDITIONAL 10-DAY MONEY-BACK GUARANTEE. Calif. res. add 4% state tax.

SEAPORT TRADERS, INC.

Dept. 25, 609 E. 12th St., Los Angeles 15, Calif.

**ENGINEERING
 DEGREE IN
 27 MONTHS**

B.S. Degree, Aero., Chem., Civil, Elec., Mech. & Electronic Engineering (use, Radio, TV), 36 mo. B.S. degree in Math., Chem., Physics. Prep courses. Demand for grads. Spacious campus, 20 bldgs.; dorms, auditorium, gym. Low rate. Earn board. G.I. app. Enter Sept., Dec., Mar., June. Catalog.

1677 E. Washington Blvd.,
 Fort Wayne 2, Indiana
 Keeping pace with progress

INDIANA TECHNICAL COLLEGE

BUILD THIS AMAZING BOAT-RAFT IN ONE AFTERNOON



Unique simple water-tight construction. Carries in car trunk. Ideal for fishing small lakes and streams. Makes swell swimming raft—children love it. Easily carries 2 men. Displacement approx. 1/2 ton, Actual Wt. 70 lb. Can be used with small motor. Detailed plans & instructions \$2.00.

MILLS, Box 9125, Tulsa 7, Okla.

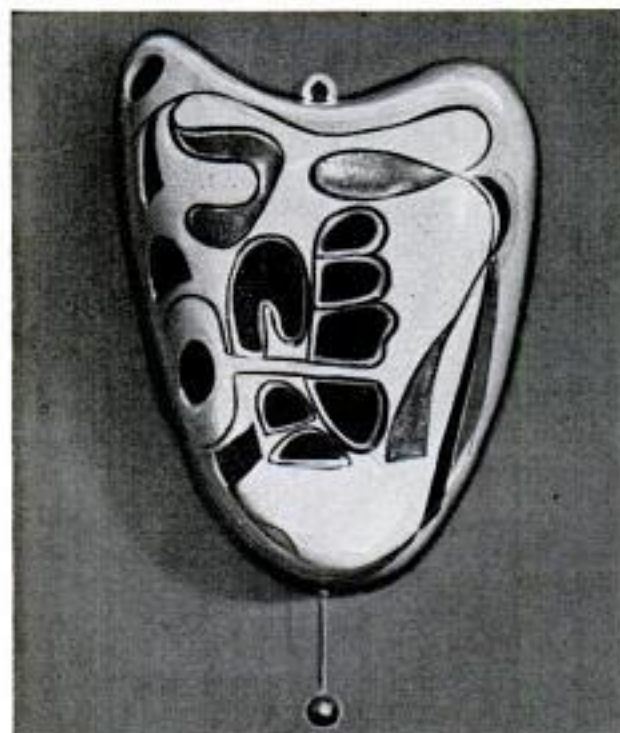

Ceramic Cases Conceal German Loudspeakers

German designer O. J. Hintze contends that reproduction of sound from a loudspeaker is clearer when the loudspeaker is enclosed in a ceramic case, rather than a case of wood or plastic. This idea also pro-

vides a new type of decorator item for homes using intercom systems. One model, above right, combines a loudspeaker with a kitchen clock. The loudspeakers have a diameter of approximately six inches.

BARGAINS

Lists Every Month Hundreds of Terrific Buys in—
 • BANKRUPT, Closeout, Surplus Goods • New and UNUSUAL ITEMS • WHOLESALE ITEMS • BELOW WHOLESALE • Sources of 100,000 items wholesale • Rare Money-Makers opportunities • HUNDREDS of TERRIFIC offers in Toys, Books, Household goods, Jewelry, Greeting cards, etc. . . . SAMPLE BARGAINS • Famous \$16.00 Perfume at 60c • 50c boxes Everyday Xmas cards, 7c box • \$1.00 toys, 20c • \$1.95 silk ties, 12 1/2c • Pencils, 99c gross • \$17.50 talking dolls at \$7.50! PLUS MANY, MANY OTHERS!

BIG SPECIAL ISSUE NOW OUT! Subscribe NOW! BARGAINS let you BUY BETTER, CHEAPER, NEWER things for yourself or for resale at THEMENDOUS PROFITS.

\$1.00 Buy 6 Big Issues—1 Yr. \$2. Reg. Price \$3 year. Spec. Limited time offer to get 10,000 new subscribers. The only magazine of its kind published!

TOWER PRESS, INC., P.O. Box 591-DDH, Lynn 804, Mass.

BE A **CAMERA CRAFTSMAN...**

Send for **FREE** book!

Many are needed in this big paying field and now you can learn to repair cameras using manufacturer's service methods at home. . . In your spare time! Instructions, tools, practice equipment + everything you need is included in this approved course! Write for big FREE illustrated booklet that tells you NOW!

national camera repair school-DEPT. V.7 ENGLEWOOD COLORADO

250 POWER

Complete Telescope Lens Kit only **\$3.49** postpaid

Conquer Space, Explore the Universe, Planets, Moon Craters, New Stars, etc. Complete Lens Kit consists of 80 inch focal length ground and polished objective lens, eyepiece lenses for 50 POWER, 100 POWER, 150 POWER, 200 POWER, 250 POWER, and all necessary lens fittings. Easy to make from simple step by step instructions. (Tripod and mount not included.) Money back guarantee.

BUSSE SALES CO., Hartford, Conn., Dept. PM 59

\$47,983 IN ORDERS

FROM 12 WORD AD

Read This Amazing Story

Sounds like a fairy tale—but it's TRUE. It happened to an advertiser in Popular Mechanics Classified Section. Write for this amazing story NOW. It's free.

F. W. JOHNSON, 202-CM E. Ontario St., Chicago 11, Ill.

RHEUMATISM

NEURITIS • SCIATICA • LUMBAGO

Why continue to suffer agonizing pains when usual remedies have failed. Learn how thousands have been successfully treated by an amazing new method which is fully explained in our New FREE Book. Don't wait. Write today. No obligation.

EXCELSIOR INSTITUTE, Dept. C9806, Excelsior Spgs., Mo.

Find HIDDEN TREASURES

GOLD, SILVER, PRECIOUS METALS with the Famous Model 27 Metal Detector. Lightweight, ultra-sensitive, low cost. None finer. Also GEIGER COUNTERS for uranium and the VIOLITE for tungsten. INFORMATION FREE

THE Detection CORP.
 5528 Vineland Ave., No. Hollywood, Calif.

ESHELMAN TRACTORS LOW AS **\$99**

Plows-Cultivates-Sows
 Doser-Harrow-Rolls
 Mauls-Snow Plow
 Eshelman Tractors, Tillers, Riding Rotary Mowers for Better Lawns and Gardens. Advertisers in 4000 HOUSEKEEPING. Thousands of satisfied users. Write for Free Literature. Dept. 205, ESHELMAN, Balto. 2, Md. 5849.75

Shipping Points: BALTIMORE - CHICAGO - DENVER

MAKE MORE MONEY get into

TELERAMA • ALL 8 BRANCHES OF TELEVISION • RADIO • IN ONE DYNAMIC, MODERN SHOP METHOD, HOME TRAINING COURSE

You get and keep ALL this modern, newest, practical equipment!

* Registration applied for



YOU COVER ALL 8 BRANCHES IN ONE MASTER COURSE, ONE LOW TUITION

1. Television-including color TV
2. Radio - FM & AM
3. Industrial electronics
4. Sound recording and Hi-Fidelity
5. Preparation for FCC License
6. Automation
7. Radar & Sonar
8. Communications

- Parts to build a modern TV set, including large screen Picture Tube.
- Parts to build a powerful Superhet Receiver, standard broadcast and short wave.
- Parts to conduct many experiments and build — • Continuity Checker • RF Oscillator • TV Circuits • Audio Oscillator • TRF Receiver • Signal Generator
- Professional Multitester
- A MUST for all technicians

FOR MEN WHO WANT TO EARN MORE MONEY! Another great advance in Home Study Training. Let National Schools, of Los Angeles, a practical Technical Resident Trade School for over 50 years, train you at home by Shop-Method, for today's unlimited opportunities in ALL 8 BRANCHES of the Television, Electronics, Radio industry.

YOU DO MANY PRACTICAL JOBS — including servicing, circuit analysis. Build a modern TV set from ground up, with equipment kits we send you, including a new large-screen picture tube and professional Multitester, at no additional charge. You receive an experiment lesson with each kit. **EARN AS YOU LEARN.** Graduate Employment Service.

SEND FOR FREE FACT-BOOK AND SAMPLE LESSON

RESIDENT TRAINING AT LOS ANGELES
 If you wish to take Resident Training at Los Angeles in our big, modern Shops, Labs, and Studios check special box in coupon for full information.

NATIONAL SCHOOLS
 4000 S FIGUEROA ST., LOS ANGELES 37, CALIF

NATIONAL SCHOOLS
 TECHNICAL TRADE TRAINING SINCE 1905
 Los Angeles, California

GET FAST SERVICE — MAIL NOW TO
 NATIONAL SCHOOLS, DEPT. RB-77
 4000 S FIGUEROA ST.
 LOS ANGELES 37, CALIF.

Rush free TV-Radio "Opportunity" Book and sample lesson. No salesman will call.

NAME _____ BIRTHDAY _____ 19____

ADDRESS _____

CITY _____ ZONE _____ STATE _____

Check if interested ONLY in Resident School Training at Los Angeles
 VETERANS: Give date of discharge.

**AT YOUR
NEWSSTAND
NOW!**



**KEEP UP-TO-DATE ON
THE MARVELOUS
WORLD OF SCIENCE
WITH THIS**

WONDERFUL MAGAZINE

Pick up a copy of SCIENCE DIGEST today . . . and become acquainted with the pocket-sized magazine that tells you "what this Changing World means to you."

Expert editors choose the finest articles on atomic science, chemistry, anthropology, medicine, electronics, etc., from the magazines and books of the world . . . and present them to you in easy-to-understand form.

You'll like this magazine. At your newsstands . . . only 35¢. One year subscription: \$3.50.

**ADDRESS: DEPT. X-21, SCIENCE DIGEST
200 East Ontario Street • Chicago 11, Illinois
36**

INVENTORS

**PROTECT YOUR INVENTION BY A
U. S. PATENT. SEND FOR FREE
"INVENTION RECORD" FORM AND
"PATENT INFORMATION
EVERY INVENTOR SHOULD HAVE."**

CARL MILLER
REGISTERED PATENT ATTORNEY
WOOLWORTH BLDG., 36th FLOOR, 77A
NEW YORK CITY

INVENTORS

Whether an invention is patentable can be substantially determined by a search of the U. S. Patent records. Without obligation, write for information explaining the steps you should take to secure a patent.

JOHN N. RANDOLPH
Registered Patent Attorney
201 Columbian Building, Washington 1, D. C.

INVENTORS

Send for **PATENT INFORMATION** **REGISTERED PATENT ATTORNEY**
Book and **INVENTOR'S RECORD** **ASSOCIATE EXAMINER**
without obligation U.S. PAT. OFF. 1922-1929
GUSTAVE MILLER Patent Attorney & Advisor
77-PM WARNER BUILDING U. S. NAVY DEPT. 1930-1947
WASHINGTON 4, D.C. **PATENT LAWYER**



INVENTORS

U. S. Patents protect your inventions. Our free book of "Instructions on Patent Procedure for Inventors," also "Certificate of Invention" form sent without obligation.

C. A. SNOW & CO.
REGISTERED PATENT ATTORNEYS
428 SNOW BUILDING WASHINGTON 1, D. C.

INVENTORS

I shall be pleased to furnish you, upon request, with full information relative to patent procedure—without any obligation on your part.

PATRICK D. BEAVERS
Registered Patent Attorney
934 Columbian Building Washington 1, D. C.

How to Build Your Own GARAGE



Save as Much as 50%
of Usual Construction Costs

Get Popular Mechanics' brand new book **How to Build Your Own Garage** by Wayne Leckey, Assistant Shop Notes Editor, and find out how you can build your own garage at savings of 50% of usual cost. Leckey tells in famous step-by-step instructions and shows in big, clear photos, drawings and diagrams how to perform every building operation from laying the concrete to installing the final trim. There are 25 designs. Brick, frame, and concrete block fully covered. Send \$3.50 for your copy. 7-day money back guarantee.

POPULAR MECHANICS PRESS, 200 E. Ontario, Chicago 11, ILL.
POPULAR MECHANICS

HOW TO EARN UP TO \$15 HOUR SPARE TIME

Amazing Opportunity for Men or Women who want a Spare or Full Time Home-Business!



New Printing Discovery!

PRINT WITHOUT A PRINTING PRESS... NO BIG INVESTMENT. Now, right in your own home - right in your own kitchen, spare room, garage - anyplace you can go into the amazing Screen-Printing business. Print beautiful SIGNS, POSTERS,

BOTH Sent Free!



BANNERS, FABRICS - anything in fabulous new "glowing" FLUORESCENT COLORS - can be seen for miles. No art ability. It's easy! We supply everything. **PRINT YOUR OWN MONEY.** Things you print literally turn into money. \$100.00 jobs cost you less than \$10. Tremendous Profit opportunities - Huge demand! Mr. J. T. Anderson, who prints GREETING CARDS exclusively, earns over \$400.00 a week with this New Discovery.

REPRESENTATIVES WANTED all over the U.S. Write for FREE revealing BOOK-LET and ACTUAL SAMPLES.

SCREEN-PRINT CO. Dept. 27
15127 S. Broadway, Los Angeles 61, Calif.

MONEY for MEN ALL DATA FREE

THE PLASTEX Industry needs manufacturers on small scale and for big production of Lamp and Clock Stands, Art Goods and Novelties in Plastex and Marble imitation. Experience unnecessary. The material makes regular 10c store sellers. Rubber moulds furnished for speed production. Small investment brings good returns. We are now placing big Chain Store Orders with manufacturers. Ambitious men have chance for real prosperity. Our Free booklet will interest and benefit you.

PLASTEX INDUSTRIES, Dept. A
3400 Third Ave. New York 56, N. Y.

make your own Gems 32.50 F.O.B.

The Gem Maker comes complete with all necessary equipment, including a super-charged diamond blade for sawing, and all wheels for grinding, shaping and polishing; also complete instructions. The complete equipment as shown, less motor and belt, for only \$32.50. F.O.B., Burlington, Wisconsin. Write today for information and literature.

B & I MANUFACTURING CO.
Dept. P, Burlington, Wis.



"MFG" a lot of boat for only \$495



15'7" long . . . roomy, rugged . . . fast, easy to handle . . . smooth, dry. Seamless lapstrake hull is molded in one piece of MOLDED FIBER GLASS, one of the strongest, most durable materials known. Write for free literature.
MOLDED FIBER GLASS BOAT COMPANY
71 Fourth Ave., Union City, Pa.

Each dollar you contribute to Crusade for Freedom sponsors a Minute of Truth over Radio Free Europe. Truth builds hope and continued resistance among Europe's captive people. Help keep Radio Free Europe on the air. Send your Truth Dollars to:

CRUSADE FOR FREEDOM

c/o Your Local Postmaster

Published as a public service in cooperation with The Advertising Council

DIESEL MECHANICS IN DEMAND

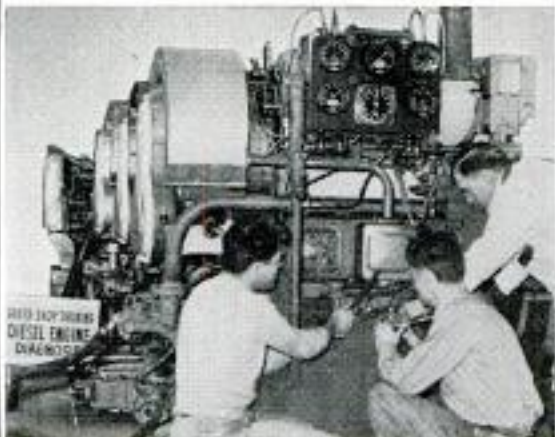

Learn to earn big pay in DIESEL in our large, modern equipped Chicago school and shop. No previous experience or training necessary. We help you find living quarters and part time job while in school. Complete, practical courses taught in the following trades, under the supervision of experienced, expert technicians.

APPROVED FOR CIVILIANS OR GI'S

— CHOOSE YOUR TRADE —

CHECK HERE	WEEKS
<input type="checkbox"/> DIESEL MECHANICS	20
<input type="checkbox"/> AUTO MECHANICS	20
<input type="checkbox"/> BODY & FENDER	16 1/2
<input type="checkbox"/> GAS-ARC WELDING	4 - 12
<input type="checkbox"/> REFRIGERATION	13 1/2
<input type="checkbox"/> AIR CONDITIONING	8 1/2
<input type="checkbox"/> MACHINIST TRADE	30
<input type="checkbox"/> ADVANCED MACHINIST (includes tool & die)	32 1/2
<input type="checkbox"/> PIANO TUNING & REPAIR	36

CHOOSE YOUR ENGINEERING COURSE

These courses are intended as terminal education for men who wish to enter the Diesel-Automotive and Refrigeration-Air Conditioning fields as technicians. These courses are designed to prepare men for supervisory positions. Students with a high school education, or equivalent, will be accepted.

<input type="checkbox"/> DIESEL AUTOMOTIVE ENGINEERING.....	2 years
<input type="checkbox"/> REFRIGERATION & AIR COND. ENGINEERING.....	18 month

HEAVY CONSTRUCTION EQUIPMENT OPERATOR TRAINING SCHOOL FOR CIVILIANS—Read Building Terracing, Land Clearing, etc. Reservations accepted now!

FREE EMPLOYMENT HELP

Start your career with Greer by checking your interest above and mail coupon for complete information at no obligation.

NAME _____ AGE _____

STREET _____

TOWN _____ ZONE _____ STATE _____

Established 1902 — Over 50,000 Graduates.
55 years of continuous trade school experience to guide your training.

GREER SHOP TRAINING

Box G, 2236 S. Michigan Ave.
Chicago 16, Illinois

MANNLICHER CARCANO CARBINE

6-SHOT
BOLT ACTION

\$12.95

HUNTERS!

Here is the hard-hitting, extremely accurate and powerful Carcano carbine, with small arm of the Italian Army, all milled parts. Built with famous Mannlicher action. Bore guaranteed good. Barrel-corn front sight, adjustable rear. Excellent saddle swagon. Compact, fast handling, deadly in big game. 7.35 MM. SPORTING AMMO, 20 cts. \$2.25. Military ammo, 54 cts. \$3.40. **TO ORDER:** Send check, cash or M.O. 1/2 deposit for C.O.D. Shipped FOB Pasadena. Calif. rec'd. add 4% state tax, 10-day money back guarantee.

THE ELLNER COMPANY

Dept. 7, 1206 Maple Av., Los Angeles 15, Cal.

2 WAY PORTABLE RADIO SET SENDS - RECEIVES UP TO 10 MILES AS SHOWN

With built-in antenna or hundreds of miles with outside antenna! 80 and 40 meter amateur radio bands (shown); also Aircraft and overseas broadcasts (1 to 8 mc.) PORTABLE SELF-CONTAINED POWERED WITH STANDARD LOW COST PORTABLE RADIO BATTERIES. NO AC PLUG-INS NEEDED! Take it with you everywhere you go—on trips, vacations, camping—keep in contact with home. 6-tubes. Has 3 watt crystal controlled transmitter—Sensitive Receptive Receiver, send receive switch. Wt. only 3 lbs. Size, only 10" x 4". TESTED—PROVEN—SIMPLIFIED—PRACTICAL—Full information given on quick easy to get license, bill, ck. mo. and pay postman \$14.95 C.O.D. postage on arrival or send \$14.95 for postpaid delivery. Complete kit includes all parts, tube, coils, plus tool cabinet, easy instructions. Set of batteries \$2.95; crystal \$1.25. COMPLETELY WIRED AND TESTED POSTPAID \$19.95. A regular \$49.95 value—Order now before price goes up. GUARANTEED - AVAILABLE ONLY FROM:



WESTERN RADIO

Dept. BNM-7

KEARNEY, NEBR.

Superior's New Streamlined Model TD-55

TUBE TESTER

QUICKLY AND EFFICIENTLY TESTS RADIO AND TV TUBES INCLUDING: SEVEN PIN MINIATURES; EIGHT PIN SUBMINIARS, OCTALS AND LOCALS; NINE PIN NOVALS

YOU CAN'T INSERT A TUBE IN THE WRONG SOCKET.

It is impossible to insert the tube in the wrong socket when using the new Model TD-55. Separate sockets are used, one for each type of tube base. If the tube fits in the socket it can be tested.

"FREE-POINT" ELEMENT SWITCHING SYSTEM.

The Model TD-55 incorporates a newly designed element selector switch system which reduces the possibility of obsolescence to an

absolute minimum. Any pin may be used as a filament pin and the voltage applied between that pin and any other pin, or even the "top-cap."

CHECKS FOR SHORTS AND LEAKAGES BETWEEN ALL ELEMENTS. The Model TD-55 provides a super sensitive method of checking for shorts and leakages up to 5 Megohms between any and all of the terminals.

ELEMENTAL SWITCHES ARE NUMBERED IN STRICT ACCORDANCE WITH R.M.A. SPECIFICATION.

One of the most important improvements, we believe, is the fact that the 4 position fast-action snap switches are all numbered in exact accordance with the standard R.M.A. numbering system.

Thus, if the element terminating in pin No. 7 of a tube is under test, button No. 7 is used for that test.

The Model TD-55 comes complete with operating instructions and charts. Use it on the bench—use it for field calls. A streamlined carrying case, included at no extra charge, accommodates the tester and book of instructions.

26⁹⁵
F.O.B.
N.Y.C.

**SHIPPED ON APPROVAL
NO MONEY WITH ORDER - NO C.O.D.**

Try it for 30 days before you buy. If completely satisfied then send \$6.95 and pay balance at rate of \$5.00 per month for 4 months - No Interest or Finance Charge Added. If not completely satisfied, return to us, no explanation necessary.

MOSS ELECTRONIC DIST. CO., INC.
Dept. D-357, 3849 Tenth Ave., New York 34, N.Y.

Please rush me Model TD-55. If satisfactory I agree to pay \$6.95 within 10 days and balance at rate of \$5 per month. If not satisfactory, I may return for cancellation of account.

Name _____
Address _____
City _____ Zone _____ State _____



Balloon-Borne Lumberjacks Pick Pine Cones in Sky

Swedish woodsmen now gather pine cones by balloon. When a timber firm needs a supply of cones, it notifies one of the company "pilots" who climbs into a portable basket attached to a pair of inflated balloons. The gatherer maneuvers his airship next to high pine-tree branches, picks a container full of cones and is hauled to earth by fellow workers.



Vacuum Pump Reseals Cans

Film which forms on the surface of paint in partly used containers can be prevented with a hand pump that expels the air. The pump punctures the lid and is held in place by a suction cup. An adhesive disk seals the hole in the lid after vacuum is restored.

B & S Co., Box 1840, New Haven, Conn.

HOW WOULD YOU LIKE TO BREAK INTO ENGINEERING STARTING NEXT MONTH?

Your start in Engineering could mean higher pay, more interesting work, a real chance for advancement. Here's how to do it—fast!

A career in Engineering may be closer than you think, whatever your age or education or present job.

You know about the tremendous demand for engineers and technicians. But do you know how easy it is to get the training that will qualify you for this vital work, and how quickly you can advance?

First Step Wins Job Consideration

The moment you enroll for a course in Engineering you're in a position to change your job. I.C.S. Engineering Courses, for example, start you off with Basic Mathematics and Drafting. Most employers are quick to accept men who start technical training.

Your Advancement Is Rapid

Your interest, your determination, your willingness to spend free hours improving your-

self all work in your favor. But your mastery of engineering subjects is what wins you the biggest boosts.

The I. C. S. method makes it possible for you to learn while you earn, to qualify yourself for upgrading step by step—from Draftsman to Detail Designer to Engineering Technician to full-fledged Engineer. It's a plan fitted to your needs, with personalized instruction and guidance, and, if you like, regular progress reports to your employer.

Mail Coupon for Free Books

If you are seriously interested in a fresh start in an opportunity-packed field, then mark and mail the coupon today. We'll send you *three* free books—(1) the 36-page career guide "How to Succeed," (2) Opportunity outlooks in your field of interest, (3) sample lesson (Math) demonstrating I. C. S. method.

For Real Job Security—Get an I. C. S. Diploma!

I. C. S., Scranton 9, Penna.

Member, National Home Study Council

INTERNATIONAL CORRESPONDENCE SCHOOLS



BOX 14953G, SCRANTON 9, PENNA.

(Partial list of 257 courses)

Without cost or obligation, send me "HOW TO SUCCEED" and the opportunity booklet about the field BEFORE which I have marked X (plus sample lesson):

- | | | | | |
|--|---|---|--|--|
| <p>ARCHITECTURE and BUILDING CONSTRUCTION</p> <ul style="list-style-type: none"> <input type="checkbox"/> Air Conditioning <input type="checkbox"/> Architecture <input type="checkbox"/> Arch. Drawing and Designing <input type="checkbox"/> Building Contractor <input type="checkbox"/> Building Estimator <input type="checkbox"/> Carpentry and Millwork <input type="checkbox"/> Carpenter Foreman <input type="checkbox"/> Heating <input type="checkbox"/> Interior Decoration <input type="checkbox"/> Painting Contractor <input type="checkbox"/> Plumbing <input type="checkbox"/> Reading Arch. Blueprints <p>ART</p> <ul style="list-style-type: none"> <input type="checkbox"/> Commercial Art <input type="checkbox"/> Magazine & Book Illus. <input type="checkbox"/> Show Card and Sign Lettering <input type="checkbox"/> Sketching and Painting <p>AUTOMOTIVE</p> <ul style="list-style-type: none"> <input type="checkbox"/> Automobiles <input type="checkbox"/> Auto Body Rebuilding and Refinishing <input type="checkbox"/> Auto Engine Tuneup <input type="checkbox"/> Auto Technician | <p>AVIATION</p> <ul style="list-style-type: none"> <input type="checkbox"/> Aero-Engineering Technology <input type="checkbox"/> Aircraft & Engine Mechanic <p>BUSINESS</p> <ul style="list-style-type: none"> <input type="checkbox"/> Accounting <input type="checkbox"/> Advertising <input type="checkbox"/> Business Administration <input type="checkbox"/> Business Management <input type="checkbox"/> Cost Accounting <input type="checkbox"/> Creative Salesmanship <input type="checkbox"/> Managing a Small Business <input type="checkbox"/> Professional Secretary <input type="checkbox"/> Public Accounting <input type="checkbox"/> Purchasing Agent <input type="checkbox"/> Salesmanship <input type="checkbox"/> Salesmanship and Management <input type="checkbox"/> Traffic Management <p>CHEMICAL</p> <ul style="list-style-type: none"> <input type="checkbox"/> Analytical Chemistry <input type="checkbox"/> Chemical Engineering <input type="checkbox"/> Chem. Lab. Technician <input type="checkbox"/> Elements of Nuclear Energy <input type="checkbox"/> General Chemistry <input type="checkbox"/> Natural Gas Prod. and Trans. <input type="checkbox"/> Petroleum Prod. and Engr. <input type="checkbox"/> Professional Engineer (Chem.) <input type="checkbox"/> Pulp and Paper Making | <p>CIVIL ENGINEERING</p> <ul style="list-style-type: none"> <input type="checkbox"/> Civil Engineering <input type="checkbox"/> Construction Engineering <input type="checkbox"/> Highway Engineering <input type="checkbox"/> Professional Engineer (Civil) <input type="checkbox"/> Reading Struc. Blueprints <input type="checkbox"/> Structural Engineering <input type="checkbox"/> Surveying and Mapping <p>DRAFTING</p> <ul style="list-style-type: none"> <input type="checkbox"/> Aircraft Drafting <input type="checkbox"/> Architectural Drafting <input type="checkbox"/> Drafting Machine Design <input type="checkbox"/> Electrical Drafting <input type="checkbox"/> Mechanical Drafting <input type="checkbox"/> Sheet Metal Drafting <input type="checkbox"/> Structural Drafting <p>ELECTRICAL</p> <ul style="list-style-type: none"> <input type="checkbox"/> Electrical Engineering <input type="checkbox"/> Elec. Engr. Technician <input type="checkbox"/> Elec. Light and Power <input type="checkbox"/> Practical Electrician <input type="checkbox"/> Practical Lineman <input type="checkbox"/> Professional Engineer (Elec.) <p>HIGH SCHOOL</p> <ul style="list-style-type: none"> <input type="checkbox"/> High School Diploma | <ul style="list-style-type: none"> <input type="checkbox"/> Good English <input type="checkbox"/> High School Mathematics <input type="checkbox"/> Short Story Writing <p>LEADERSHIP</p> <ul style="list-style-type: none"> <input type="checkbox"/> Industrial Foremanship <input type="checkbox"/> Industrial Supervision <input type="checkbox"/> Personnel-Labor Relations <input type="checkbox"/> Supervision <p>MECHANICAL and SHOP</p> <ul style="list-style-type: none"> <input type="checkbox"/> Diesel Engines <input type="checkbox"/> Gas-Elec. Welding <input type="checkbox"/> Industrial Engineering <input type="checkbox"/> Industrial Instrumentation <input type="checkbox"/> Industrial Metallurgy <input type="checkbox"/> Industrial Safety <input type="checkbox"/> Machine Design <input type="checkbox"/> Machine Shop Practice <input type="checkbox"/> Mechanical Engineering <input type="checkbox"/> Professional Engineer (Mech) <input type="checkbox"/> Quality Control <input type="checkbox"/> Reading Shop Blueprints <input type="checkbox"/> Refrigeration and Air Conditioning <input type="checkbox"/> Tool Design <input type="checkbox"/> Tool Making <p>RADIO, TELEVISION</p> <ul style="list-style-type: none"> <input type="checkbox"/> General Electronics Tech. | <ul style="list-style-type: none"> <input type="checkbox"/> Industrial Electronics <input type="checkbox"/> Practical Radio-TV Engr'g <input type="checkbox"/> Practical Telephony <input type="checkbox"/> Radio-TV Servicing <p>RAILROAD</p> <ul style="list-style-type: none"> <input type="checkbox"/> Car Inspector and Air Brake <input type="checkbox"/> Diesel Electrician <input type="checkbox"/> Diesel Engr. and Fireman <input type="checkbox"/> Diesel Locomotive <p>STEAM and DIESEL POWER</p> <ul style="list-style-type: none"> <input type="checkbox"/> Combustion Engineering <input type="checkbox"/> Power Plant Engineer <input type="checkbox"/> Stationary Diesel Engr. <input type="checkbox"/> Stationary Fireman <p>TEXTILE</p> <ul style="list-style-type: none"> <input type="checkbox"/> Carding and Spinning <input type="checkbox"/> Cotton Manufacture <input type="checkbox"/> Cotton Winding and Weaving <input type="checkbox"/> Loom Fixing Technician <input type="checkbox"/> Textile Designing <input type="checkbox"/> Textile Finishing & Dyeing <input type="checkbox"/> Throwing <input type="checkbox"/> Winding and Weaving <input type="checkbox"/> Worsted Manufacturing |
|--|---|---|--|--|

Name _____ Age _____ Home Address _____

City _____ Zone _____ State _____ Working Hours _____ A.M. to P.M. _____

Occupation _____

Canadian residents send coupon to International Correspondence Schools, Canadian, Ltd., Montreal, Canada. . . . Special tuition rates to members of the U. S. Armed Forces.

Electronic Recorder ^{ONLY} \$14.95

Make Your Own Records

On Any Phonograph. Test your voice. Talk. Sing. Play. Immediate playback. Fun at home. Practical for office & school. Send records to friends. Make records from radio or TV. Playback favorites years later. Even conceal mike in another room! Makes 33, 45 or 78 rpm records (any speed). Set includes: Recording Unit (arm & electro-magnetic cutting stylus) which operates on any turntable, electric Studio Microphone, cutting needles & blank records. No wiring. Ready to use. Independent of phono circuit. Guaranteed.



Complete Set Postpaid Only..... **\$14.95**
(Package of 5 Blank Record Discs \$1.98)
Johnson Smith Co. Dept. 558 Detroit 7, Mich.
Tiny Earphone and Microphone
Almost Invisible. Listen to radio, TV, phone in private. Secretly "Pick Up" Sounds in other rooms. Flash colored, hearing-aid style phone. Plugs in ear. Wear walking, in bed, working. Also used as microphone. Crystal element. High sensitivity. Use with any radio, TV, phone, amplifier, etc. Regularly \$7.50.
New Imported Model Only..... **\$1.98**
JOHNSON SMITH CO., Dept. 558, Detroit 7, Mich.



USED ELECTRIC GENERATOR

Cost Over \$20.00 New; While They Last, \$3.95
Generates Up to 75 Volts. Use to generate electricity, to ring bells, light up lights, as a medical battery, deliver terrific electric shock as joke, many electrical experiments, classroom uses, etc. Cost over \$20 new. Used but excellent operating condition. Hand crank or gear wheel drive. Made by leading electrical companies. Each has 3 or 4 five-inch 1-lb. bar magnets (alone worth more than total cost), generating armature, wire leads, gear crank, ready for use. Originally used in crank phones. Complete unit weighs over 3 lbs. Postpaid \$3.95.
JOHNSON SMITH COMPANY, Dept. 558, Detroit 7, Mich.



Catalog of 3100 Novelties 10c

Send 10c for amazing catalog of novelties, live animals, scientific supplies, hobbies, funmakers, planes & boats, looms, magic tricks, joke articles, unusual seeds, gadgets, time savers, cameras, optical goods, projection movies, lucky jewelry, religious novelties, diaries, musical instruments, stamps, coins, puzzles, fortune tellers, radios, auto & bike accessories, telescopes, magnifiers, compasses, banks, smokers' gadgets, artists' supplies, printing sets, engines, motors, shockers, knives, billfolds, guns, rifles, sports, books, games, plants, etc. Send 10c (3 for 25c—get for friends!).
JOHNSON SMITH & CO. Dept. 558 Detroit 7, Michigan

12-Foot BULL WHIP
HARD HITTING! LOUD CRACKING! Experts knock ashes off cigarettes. Yank people off feet. Used by trainers, ranchmen. Loud cracker like shot-gun blast. 4-ply hand plaited all leather. With loop handle.
6-ft. \$1.98. 8-ft. \$2.69. 10-ft. \$3.29. 12-ft. \$5.45.
Johnson Smith Company, Dept. 558, Detroit 7, Mich.



REPAIR ANY WATCH

... Swiss or American
Unique Smeazy System starts you making repairs right away. Develops your skill step-by-step. Teaches modern methods... professional short cuts. Learn by personal attendance or spare time home study. Free Sample Lesson. No obligation. Write today!

CHICAGO SCHOOL OF WATCHMAKING
2330 Milwaukee, Dept. 177, Chicago 47, Ill.

TURN BLACK ASPHALT INTO YELLOW GOLD!

MAKE UP TO \$100 PER DAY IN A BUSINESS OF YOUR OWN!



OUR HELPING HAND
You can call on us at any time. Our engineering department is always at your service. We show you how to enter this booming business. Whether you can work full or part time, we supply the know-how and equipment that spells big profits. Don't delay. Act now. Write for full details.

J. H. from N. Y. writes, "What a money maker this is! I'm loaded down with jobs. Working with a new housing developer — have all the driveways and patios — 140 of them!"

GENERAL ENGINES COMPANY
Dept. R-77, Route 130, Thorofare, N. J.

GIANT BALLOONS — 3 for \$1.25
Surplus US Govt. (New Overage) Neoprene Weather Target Balloons.
FOR FUN in the backyard; at parties, picnics, etc. Young & old love 'em.
FOR ADVERTISING—Attracts crowds to civic events, business openings, trade shows, fairs. Paint on sales message, seen for miles!
FOR PROMS—Makes any dance more festive. Ideal for high school or college affairs!
Approx. Inflated Sizes
3 ft. dia. 49c ea. (SPECIAL 3 for \$1.25)
5 ft. dia. 99c ea.
Postage paid on prepaid orders, Calif. res. add sales tax.
VOLUME SALES CO., War Assets Division
3930 Sunset Blvd., Dept. PM-757, Los Angeles 20, Calif.

DRAINS cellars, cisterns, wash tubs; **\$7.95**
IRRIGATES - CIRCULATES - SPRAYS

Up to 3,000 GPH; 450 GPH 80" high; or 1800 GPH from 25" well. Use 1/4 to 3/4 HP motor. Coupling included free. 1" inlet; 3/4" outlet. Stainless steel shaft. Won't rust or clog. . . . Type P—\$7.95.
HEAVY DUTY BALL-BEARING PUMP. Up to 7,500 GPH; or 3,000 GPH from 25" well. 1 1/2" inlet; 1" outlet. \$12.95
Postpaid if cash with order. **MONEY BACK GUARANTEE**
Centrifugal and Gear Pumps in All Sizes
LABAWCO PUMPS, Belle Mead 7, New Jersey

WE PAY \$3.50 lb.

GROW MUSHROOMS. Cellar, shed and outdoors. Spare or full time, year round. We have over 25,000 customers. **FREE BOOK.** Washington Mushroom Ind., Dept. 61, 2954 Admiral Way, Seattle, Wash.

SAVE 1/2 - 2/3 THE PRICE OF FACTORY-BUILT BOATS

BOAT KIT CATALOG Free!

Runabouts, cruisers, convertibles, fishing; 43 models, 8 through 18 ft. Freight paid, \$39.25 up. Assembled and finished by experienced owners, Luger boats equal factory-built in speed, handling, style, beauty; yet save you 1/2 to 2/3. Owners say: "Fastest boat on river." . . . "Pleasure to assemble." . . . "Everyone admires my Luger." Thousands in use. Send for big, free boat kit catalog; also lists fiberglass, hardware, accessories, trailers, paint. Write for catalog today.

Write: **LUGER INDUSTRIES, INC.** DEPT. 8-7 3404 Lyndale S. Minneapolis 8, Minn.

**WORLD'S
BEST
WANT-AD
MEDIUM**

CLASSIFIED ADVERTISEMENTS



Advertisements in this section \$1.25 per word, each insertion, minimum 10 words, payable in advance.

To be inserted under proper classification, copy must be in our office the
20th of the second month preceding date of issue

F. W. Johnson, Manager, Classified Advertising
Popular Mechanics Magazine, 200 East Ontario Street, Chicago 11, Illinois

YOU'LL PROFIT

By reading and answering the classified
ads in this section. Hundreds of oppor-
tunities for you to make and save money

AUTOMOBILES, MIDGET CARS

CHILDREN'S Roadster plans \$1.00. Details free. T & L Manufacturing, 4020 Linden, White Bear Lake 10, Minnesota.

DRIVERS! Cut your car expenses! Become an expert driver! Complete course with over 200 illustrations in full color. \$1. Stark, 507P Fifth Ave., New York City.

HUNDREDS Of automobile catalogs—Old, new and foreign; glossy photographs, shop manuals; dealer books; free motor magazines listed by non-profit organization. Write to get on free mailing list. Auto Maniacs, Stockbridge, Mich.

BOYS' Power-driven auto. Build your own. Plans 25 cents. Sypher Co., Sta. F., Toledo, Ohio.

FREE Factory price list. New '57 autos. Helps you buy for less. Kemp, 2015 N. E. 18th Street, Ft. Lauderdale 4, Fla.

AUTO SUPPLIES AND EQUIPMENT

TURNPIKE Automatic foot throttle \$2.49. Real driving comfort. Money back if returned within sixty days. No c.o.d. The Dow Mechanical Corporation, Thompsonville, Connecticut.

FUEL Booster injector jet. Amazing mileage increase \$4.95. Millards, 835 Iris, Boulder, Colorado.

AUTOMOTIVE Accessories Repair Guide \$1.00. Marnel, Box 7642, Denver 15, Colo.

FORD T and A parts? Try best source old car parts anywhere. Wisneski, Milwaukee 7, Wis.

SAVE 50%. Why pay more. Complete stock of automobile, hot-rod, truck and motorcycle parts and accessories. Including foreign automobiles. Motorcycles at unbelievable prices. Catalogue bulletin 35¢. Banico, 146-146, Covington, Virginia.

IGNITION, Fuelpump, trouble shooting emergency bypass. Free details. Williams Industries, 1349 Bryden Rd., Columbus 3, Ohio.

PAINT Your car complete for \$3.95. Plutone auto enamel. Guaranteed. Complete directions for spraying or brushing. Colors: onyx black, forest green. Order from United Products Co., Box 669, Ft. Collins, Colorado.

1909-1932 FORD New parts catalog 25¢. Mark, 15 Emerson, Clifton, New Jersey.

RADIATOR Cap wrench. 185% profit. Sample \$1.50. Ross Mfg. Co., 7441 Canoga, Canoga Park, Calif.

RETLIP Toilet paper filter adapters \$3.50. Zenick Products, Box 2461, Los Angeles 54, California.

RADIOS Custom for 1952-1957 Fords \$38.90. Nordic Radio, Box 582, Evanston, Illinois.

SPONGERASER Whisks bugs off windshield. Cleans car, windows. Gas stations buy quantities. Sample 50¢. Babcock, Box 551-P, Scottsdale, Arizona.

HYDRAULIC Jack repair kits. Repair your own. Send 25¢ to cover cost of price list. Jack Parts Co., 2000 South Claiborne Ave., New Orleans 13, La.

SIMPLE Gadget converts water into gas! Guaranteed! Kit, \$2.00. National, P.O. Box 606-L, Redwood City, Calif.

AUTO Accessory and parts catalog. 1957 edition, all new! 228 pages. Save up to 50%. 75,000 items, including Hollywood accessories, hi-speed equipment, rebuilt engines, all parts and accessories for all cars and trucks! Hard-to-get parts! Send 25¢, refundable. J. C. Whitney, 1919 PM Archer, Chicago 16, Ill.

RING-Valve job while you drive, \$5.00 postpaid. World's only product of its kind! Safe, proven, guaranteed. Literature. Metaloy, Grantham, Penna.

SAVE Money on Jeep and army truck parts. Large inventory. Catalogs for Jeep or G.M.C. owners. American Auto Parts Co., 1630 Locust, Kansas City, Mo.

FREE! New catalog. Speed, power, mileage increasing equipment. Discounts! Almqvist Engineering, Milford PM5, Maine.

NEW And used parts at savings. Complete guaranteed parts service for all models cars and trucks—1924 and later. Largest in the West. Army parts specialists. No catalog. Submit your needs for quotations. Fast mail order service. Pioneer Auto and Truck Parts Co., 734 W. 13th Ave., Denver 17, Colorado.

AUTO TRAILERS

TRAILER Building manual \$1.00. Booklet 30¢. Kamcraft, Box 1153, Milwaukee 1, Wis.

BLUEPRINTS For vacation trailers. Literature 10¢. Comstock Trailers, Parsons, Kansas.

BUILD Expanding eight foot trailer. Accommodates five. Literature 10¢. Framar Company, Wilmington, Mass.

TRAILER Travel Magazine. Packed with informative material. Sample copy 10¢. Mobile Home Park Directory \$1.50. Wood-all Publishers, 121PM West Wacker, Chicago 1.

NEW Boat, utility, trailer kits \$69 up, complete. Swift Trailer, 8101 Commercial, La Mesa, Calif.

MOTORCYCLES, BICYCLES, MOTORSCOOTERS AND SUPPLIES

PARTS For Cushman, Doodle-Bug, Salisbury, etc. Send make, model, 25¢ for price list. Motor Scooter Parts Co., Dept. P4, Box 7211, Indianapolis 1, Indiana.

HARLEY - Davidsons — Used bargains. New, used parts, accessories for all models. Bulletin, catalog 25¢. Knuth's (Factory Dealer), 1753 Muskego, Milwaukee, Wis.

PARTS. New, used. List 10¢. Ballak, 811 N. 9th, St. Louis 1, Mo.

RECONDITIONED Motorcycles and motors. Chromium accessories. Complete stock Indian parts. Expert rebuilding. Fast service. Indian Motorcycle Sales, Kansas City 27, Missouri.

MICROMIDGET Racer \$15. Whizzer \$7.50. Allstate motorscooter \$20, less engine. Johnson engine \$3. Maytag \$3. Servicycle \$8. Five Briggs engines \$15 for all. (Mailorder only). Send 25¢ (35¢ for first class mailing) for 32-page directory catalogue Number 74, just out, listing the above and hundreds of other bargains in new and used midget cars, motorscooters, home builders parts, plans, etc. Midget Motors Directory, Athens, Ohio.

MIDGET Auto \$25.00; 1954 Whizzer \$20.00; Cushman motorscooter \$25.00; motorcycle \$10.00. Rush 25¢ (35¢ first class mail) for new catalog #960 listing amazing bargains in motors, midget cars, motorcycles, motorbikes, construction plans. Associated, Box 534, Toledo, Ohio.

AVIATION

AVIATION Surplus bargain catalogue. One dime. Box 22PMB, Thomasville, Penna.

PROPELLERS. Plans, supplies for airboats and snowplanes. Latest designs, prompt delivery. Catalog 25¢. Banks-Maxwell, Box 3301E, Ft. Worth 5, Texas.

PARACHUTES. Pilot pullout, complete with shroud lines. Send \$1.00. Jarvis, Box 126, Bostonia, California.

SPORTPLANE Manual \$1.00. Circulars 30¢. Kamcraft, Box 1153, Milwaukee 1, Wis.

AVIATION Jobs—Names and addresses of companies to contact. \$1.00. Fitzgerald, (Chicago Division), Dept. A-4, 815 Countryside Drive, Wheaton, Illinois.

BATTERIES, GENERATORS

EDISON Nickel storage batteries. Any voltage, any amperage. Unconditionally guaranteed. Power plants, generators, motors. Literature. Hawley Smith Co., Croton Falls 1, N. Y.

ELECTRICAL SUPPLIES

DC Power supplies. Laboratory, test units. DC motor controls. Complete line selenium rectifiers, meters, transformers and other replacement parts. Ramyr, Dept. D-1, 1624 East First Street, Los Angeles 33, California.

LAMPS—Parts catalog containing wiring instructions, 25¢. Gyro Lamps, 3438P N.W. 54 Street, Miami, Fla.

LAMP. Electrical parts, wholesale. Thousands of items for repairing, converting. Catalog 25¢. Brown Lamp, Box 305, Clayton 5, Mo.

WELDING, SOLDERING, PLATING

BUILD-Your-Own welder or welder and power combination. Low cost unit connected to used engine lets you weld anywhere. Free booklet tells how. Get into profitable welding business. Write Hobart-weld, Box M-772, Troy, Ohio.

A.C. Welders, 4 sizes, lowest prices. Free literature. Holgerson's Service, Canton, Kansas.

WELDERS, 110/220, \$39.50. Morris, 1070 Inner Drive, Schenectady 3, New York.

ACETYLENE Welding outfits new \$54.50; used \$34.50; arcwelders \$56.50. Eagle Welding, Dept. PM, 5085 Broadway, Chicago 40, Ill.

BUY Welding supplies direct from manufacturer. Cable, welding rods, helmets, etc. Portable arc-welders and kits at tremendous savings. Free factory catalog! LeJay Mfg. Co., 2927 Emerson Ave. So., Minneapolis, Minn.

R-1 Generators \$29.89. Instructions one dime. Box 22PMW, Thomasville, Penna.

ELECTROPLATING Equipment, anodes, solutions. All types, including new electrodeless nickel. Baby shoe metallizing equipment, supplies. Free catalog. Hollywood Bronze Supply, Dept. B-4, 1624 East First, Los Angeles 33, California.

MACHINERY, TOOLS, SUPPLIES

BEFORE You buy a chain saw send for free copy Chain Saw Age Magazine, Portland 66, Oregon. Jim Conroy, Editor.

RENT Electric drills, saws, sanders, catalog free. Rent-It, 510 Queen, Westbury, N. Y.

POWER Tools, not toys. Discounts. Factory catalogs. World Tool Supply, Box 4494, Joyfield Station, Detroit 28, Mich.

TELESCOPING; Slot gages. Machinists or dealers. Write Campbell Tools Co., 1424 Barclay Road, Springfield, Ohio.

TOOLS For mechanics. Substantial savings. Postage paid, 25¢ for catalog. Hisco, 222-236 South Front, Memphis, Tennessee.

SURVEYING INSTRUMENTS

NEW And guaranteed factory rebuilt transits and levels, sale or rent, with purchase option. We will repair, trade or buy old instruments. Write for list M-77, Warren-Knight Co. (Manufacturers of Surveying Instruments), 136 N. 12th St., Philadelphia 7, Penna.

ENGINES, MOTORS, DYNAMOS

DIESEL Injector parts wanted, GM71-110. Bares, 7120 Carnegie, Cleveland 3, Ohio.

1/2 HORSEPOWER Electric motors, a.c. 110, used, good \$5.00 each, f.o.b. Plant Machinery Corp., Richmond & Norris Sts., Philadelphia 25, Penna.

REWIND Motors yourself. Complete instructions \$1.00. Lewis Mfg., Howell, Michigan.

WINDING Data, 275 motors, single and three phase, \$1.10. Data Company, Box 7631, Kansas City 28, Mo.

ITALIAN Manufacturer diesel injectors, elements for G.M., Caterpillar, American Bosch, Cav. engines, seeks agents in U.S., Canada, Disital, Via Lessona 13, Torino, Italy.

SMALL Electric motors, Accessories, Kitco, Dept. 14, Box 212, Monroe, Wis.

BOATS, OUTBOARD MOTORS

FIBERGLAS Permanent boat waterproofing. Special 25% discount. Complete kits, \$9.45 up. Guaranteed materials. Easy application. Full instructions. Free literature. Ajax Plastics, Dept. PM, P.O. Box 1323, Fort Worth, Texas.

FORDS And Jeeps 100% marine engines with famous Convo-Kits. Deluxe catalogue 25¢ coin. Oscomotors, 3627B Lawrence, Philadelphia 40, Penna.

MARINE Conversion, Willys to Cadillac, engines, kits and parts. Catalogue and conversion hints free. Barr Marine, 2706 Castor Avenue, Philadelphia 34, Penna.

FIBERGLASS Your boat! Complete kits including color resin. Low as \$8.50. Aquaglas, Box 99, Altadena, Calif.

FIBERGLAS Boat coating. Flexiglas boat windshields—Clear, blue, green tints. Wholesale-retail. Instructive information catalog free! Gem-O-Lite, 3529 Cahuenga, North Hollywood, California.

MARINE Conversions for Ford and Jeep engines. Catalog 23c. Lehman Manufacturing Company, 972D Broad Street, Newark 2, New Jersey.

BOAT Plans. Full size patterns. Frame kits. Modern inboards and outboards for amateur builders. Complete new catalog 50¢ or specify requirements. Glen Designs, Box 568, Compton, Calif.

NEW, Used, rebuilt marine motors. Marine conversions, fittings. Free catalog. Stokes Marine Supply, Dept. 24, Coldwater, Michigan.

FIBERGLASS Boat cloth \$1.20 yd. Resin \$5.95 gal. 3/16 plexiglas \$1.20 sq. ft. Send 10¢ for literature. United Plastics, Dept. 4, Roebling, N. J.

BUILD Small boats. Booklet 25¢. Catalog free. Popular Mechanics Press, 633 N. St. Clair St., Chicago 11.

FREE Catalog! Boat kits, trailers, fiberglass, marine hardware. Luger Industries, Dept. M7, 3404 Lyndale South, Minneapolis, Minnesota.

HYDROFOIL Type stabilizer. Bolts onto transom of boats up to 16 ft. Designed, tested and recommended by Tommy Hagood, international record holder. Stabilizer prevents porpoising, floundering and has increased speed as much as 5 m.p.h. Only \$4.98 ppd. Marine House, P. O. Box 7594, Orlando, Florida.

JUNK Auto parts make inexpensive boat! Illustrated instructions 50¢. Tharp Publications, Box 692, Muncie, Ind.

ATHLETIC EQUIPMENT, BODY BUILDING COURSES

BARBELLS Dumbbells. Courses. Free catalogue. Good Barbell Co., Reading, Penna.

STRENGTH, Health, muscles. Gain, reduce. All you need is a rope! Valuable booklet free. Roperice, 4834-A Art St., San Diego 15, California.

100 TRICK Knockouts for self-defense \$1.—1c each. Priest, Box 251, Evanston 1, Illinois.

GET Bigger arms with "The Super Arm Building Course"—Plus free Muscle Magazine! \$1.50. Melvin Margulis, 2141 Prospect Ave., Bronx 57, New York.

BE Taller! Coach's "Inch-At-A-Time" system \$1, complete. Marty Snyder, Box 195-MM Union City, New Jersey.

SPORTING GOODS, GUNS, FISHING TACKLE, ARCHERY, TRAPPING

FISHERMAN: Tents, boats, clothes lines. Hold them tight with Pul-tite line fasteners. No knots to tie. Set of two 98¢. Pul-tite Line Fastener, 232 Greenwich St., Reading, Penna.

ONE-Of-a-kind lures! Exclusively yours! Special information \$1.00 postpaid. Fisherman's, 1128 1/2 W. Dale, Muskegon, Michigan.

NEW Fishing method, bass, wall-eye, northern. Write S. R. Blackstone, 403 Powers Ave., Madison 4, Wis.

"KEEPER-Hook" catches fish. Interchangeable hook for casting, trolling, still fishing. Guaranteed. \$1.00 postpaid. Gorman's, (PMM), Box 610, Springfield, Ill.

AUTHENTIC Primitive weapon reproductions! Spears, crossbows, edged weapons, etc. Colorful. Deadly. Decorative. Catalog 10¢. Primitive Weapons, Pevely, Missouri.

FREE Below wholesale fishing catalog. Fishing Tackle Mart, Dept. 57, Box 6737, Chicago 80, Ill.

BOOMERANGS. Free instruction pamphlet, prices. Nelson, Box 25, Mission, Kansas.

ATOMIC Fishing lures. Free price list. Write: Mercier, 4223 Wilcox, Chicago 24, Illinois.

WATER Skis. Highest quality at factory prices. Write: Water Ski Enterprises, Box 395, Helena, Arkansas.

KINGFISH—The swimming, diving, flavored fish lure. Write for details. Kingfish Lures, 20405 Martin Rd., St. Clair Shores, Michigan.

CAMPING, Hunting, diving! Free catalog. Write: McCanna Company, Tarrytown, N. Y.

ANTIQUE Guns, swords, weapons! Huge illustrated monthly catalog. Hundreds items each issue. \$1.00 year. 12 fabulous catalogs. N. Flayderman, Kennebunk, Maine.

GRAY Crickets: Special advertising material free to dealers ordering crickets. Live delivery guaranteed. Write for free literature and price list. Owen Crickets, Farm 2, 2818 25th, Lubbock, Texas.

100 PROFUSELY Illustrated pages antique pistols, swords, daggers, armor, etc. 50¢. Robert Abels, M869 Lexington Ave., New York City 21.

BUILD Barbecue. Complete plans. Booklet 25¢. Free catalog. Popular Mechanics Press, 633 N. St. Clair St., Chicago 11.

RIFLES, Shotguns, pistols, scopes, ammunition. Dealers prices. Berkshire Gun Rack, Six Lakes, Michigan.

BIG Money raising crickets and 12 inch African fishworms. Free literature. Carter Ranch, Plains, Georgia.

5000 BARGAINS, Firearms, binoculars, war relics. Catalog 50¢. Smith Firearms, Runnemed, N. J.

SAMPLE: 25¢ Copy of "The Archers' Magazine." Send 10¢. 1200 Walnut Street, Philadelphia 7, Pennsylvania.

FREE Sporting goods catalogs! Save 70%. Econ-O-Mart, Whippany 2, New Jersey.

MOLDS For fisherman's sinkers, jigs, squids, casting and spinning lures. Free catalog. Sweet's Molds, Tonawanda 1, New York.

TENTS, Camping equipment; tremendous selection. Send 20¢ for 136 page tent, camping equipment catalog—handbook listing all national camping sites. Print name, address. Morsan, 10-21R 50th Ave., Long Island City 1, New York.

JAP Rifle altering to 30-06, \$6.00. Jap-shells, \$3.95. Catalog 5¢. T. P. Shop, West Branch 11, Mich.

EARTHWORMS

GIANTS, Six inches. 100—\$2.00. Postpaid. Brands Wormery, Century Apartments, Davenport, Iowa.

NIGHTCRAWLER Redworm raising easy. Profitable new soilless method. Three Oaks Ranch, Dresden, Tenn.

BIG Money raising crickets, hybrid red wigglers and 12 inch African fishworms. Free literature. Bedrun hybrid red wigglers, 3000, \$6.50; 10,000, \$19.95, postpaid with raising instructions. Carter Redworms, Plains, Georgia.

RAISE Earth worms. Profitable, easy instructions 25¢. Lairs Hatchery, Box 84, Virden, Ill.

HULA-Hula wigglers are better! Inquiry, information free. Kean, Ladonia, Texas.

BINOCULARS, TELESCOPES, MICROSCOPES, MAGNIFIERS

REFLECTING Telescope, 60X, completely assembled \$29.75. Guaranteed observatory clearness. Free information. Skyscope, 475 Fifth Avenue, New York City 17.

REFLECTOR Telescope kits \$7.25 (3") to \$175 (12"). Mirrors, cells, focusing mounts, tripods, eye systems. Anything, everything in telescopes. Free catalog. Also ready to use telescopes from \$25. Esco Products, Oakridge, N. J.

MICROSCOPE Catalog free. Research Scientific Supplies, 128 W. 23rd, New York City 11.

DYNASCOPE—Sensational new reflector telescope. Send for details. Criterion Co., Dept. DF34, Hartford, Conn.

MICROSCOPE Slides, Anatomical. Free list. Bay, 409 Roosevelt, San Francisco 14, California.

300 POWER Reflector telescopes complete with finder scope and tripod. \$24.95. 400X telescopes easily made. Kit includes focusing tube, erector, five finished lenses, building instructions, \$3.75. Free telescope booklet. Suffolk Science, Mattituck 4, New York.

WAR Surplus bargains: Millions of lenses, instruments, telescopes, binoculars, components and complete line of astronomical telescope items. World's greatest optical market place! Send only \$1.00 for beginner's 10-lens kit and big instruction booklet Stock 2-CH. Write for catalog CH, free! Edmund Scientific Co., Barrington, New Jersey.

BINOCULARS. Telescopes, microscopes. Terrific values, \$3.98 up. Request free money-saving catalog. Criterion, Dept. P54, Hartford, Conn.

AMAZING Prices, precision binoculars. Folder, "Binocular Selecting" catalog free. Dealers write. Prentiss Importers, Mercury Bldg., West Los Angeles 25, Calif.

BUILD Your own reflector telescope. Complete kit: Mirrors, eyepieces, tripod, all other accessories. Request free illustrated literature. Criterion Manufacturing, Dept. DPM31, Hartford, Conn.

BINOCULARS, Riflescopes, etc. Exclusive models! Tremendous selection. \$100,000.00 stock! Free 56 page illustrated catalog. United, 9043 S. Western, A-1308, Chicago 29. Dealers wanted.

SPECTACLE Binoculars! Wear like eyeglasses. Close-up view of all sports. \$1.00 postpaid. DuPont Distributors, Box 695, New York 1, N. Y.

PLANTS, SEEDS, BULBS, NURSERY AND GARDEN SUPPLIES

WORLD'S Greatest cash crop. Free information. Write Ginseng Gardens, Asheville, N. C.

PETS—DOGS, BIRDS, RABBITS, HAMSTERS, ETC.

RAISE Rabbits successfully by knowing facts. 42 page illustrated book describing 25 breeds, housing, feeding, breeding, marketing, etc. Plus bulletin: 25 cents. American Rabbit Association, 38 Arba Building, Pittsburgh, Penna.

STANDARD Rabbit Journal, Milton 3, Penna. Year \$1.00. Sample dime. Beginners manual 25¢.

BEAUTIFUL White pedigree police puppies. Ansonia Kennels, McHenry, N. Dak.

PETS, All kinds. Catalog \$1 (refundable). Blakey's Pets, Florida, Ala.

MAKE Money raising chinchillas, mink, nutria, rabbits, cavies for us. Free catalog. Keeney Brothers, New Freedom 2, Penna.

RAISE Rabbits on \$500 month plan. Plenty markets. Free details. White's Rabbitry, Mount Pleasant, Michigan.

HAMSTERS—Young Golden pairs, \$2.95, breeders \$3.95. Free booklet. Jer-Fre's Hamstery, 2425 Hoyt, Muskegon Heights 13, Mich.

WHITE German shepherd puppies. Theatrical dog tricks. Knoff, Nashotah, Wis.

BEAUTIFUL Black and white registered English shepherd puppies. Stock dogs. Wonderful companions. Wm. Paul Hoover, Rt. 3, Goshen, Indiana.

SPORTSMEN: World's largest kennels offers 500 bird dogs, straight cooners, combination hounds, beagle hounds, rabbit hounds, small squirrel dogs, fox and deer hounds. Catalog free. Smokey Mountain Kennels, Cleveland, Tennessee.

MONKEYS \$19.50. Baby raccoons, de-scented skunks, pigmy skunks, alligators. Animals, birds, reptiles, all kinds. Free list. Thompson Wild Animal Farm, Clewiston, Fla.

HAMSTERS—Golden: young, \$3.00 pair. Fully developed \$4.00 pair. Adirondack Hamstery, Prospect 10-G, N. Y.

WE Pay \$3.50 lb. Grow mushrooms. Cellar, shed and outdoors. Spare, full time, year round. We have over 25,000 customers. Free book. Washington Mushroom Ind., Dept. 171, 2954 Admiral Way, Seattle, Wash.

FUR BEARING ANIMALS

PALOMINO Mink, \$25.00. Free price list. Driftwood Mink Ranch, 904 E. Tipton, Seymour 3, Indiana.

CHINCHILLAS Into fabulous furs. Reasonably priced. Care directions. Stewart Chinchilla Ranch, Washingtonville, N. Y.

RAISING Fabulous nutria and luxurious mink is easy, interesting, profitable. Information free. North: Voight Fur Ranch, Lomira 8, Wisconsin. South: Voight Farms, Atlanta 2, Texas.

MINK Raising information free. Complete. Lake Superior Mink Farm, Superior, EEL, Wisconsin.

FARMS, FARM LANDS, REAL ESTATE

300 ACRE Dairy farm fully equipped with stock. Heavy farm machine repair shop. John J. Marshalek, Conrath, Wis.

FREE Strout catalog! Farms, homes, businesses, resorts, retirement properties. Over 2900 values in 34 states. 57 years' service. World's largest! Write Strout Realty, 7-MP So. Dearborn, Chicago 3, Ill.

MINNESOTA Waterfront tracts \$10 down. Norstates, Box 645-T, Houston 1, Texas.

\$5.00 MONTHLY Buys 40 acres productive land. Near town. Price \$250.00. Free list. Box 423-P, Carthage, Mo.

OZARKS! \$9 Acre. Listings, information free. Write: Armstrongs, Shook, Missouri.

FLORIDA. Nice homesites. \$345 at \$10 monthly. Folder free. Howard Vernor, DeLand, Florida.

GENUINE Opportunities! Government land, U. S., Alaska, Canada. Write Sledge Surveys, Macon, Mississippi.

PROFITABLE OCCUPATIONS

BIG Profits in welding. Easy to learn. Low cost training in completely equipped non-profit school, GI approved. Write for free booklet. Hobart Trade School, Box M-773, Troy, Ohio.

INVESTIGATE Accidents—Earn \$750 to \$1,000 month. Thousands of airlines, insurance companies, steamship lines urgently need claim investigators. We train you home spare time. Placement counsel and help. Free book, now! No obligation. Universal Schools, T-7, Box 8202, Dallas 5, Texas.

MAGAZINE Subscriptions—Largest commissions, bonus. Qualified Agency, 451WA Kingston, Brooklyn 25, N. Y.

BUY Wholesale thousands nationally advertised products at big discount. Free "Wholesale Plan." American Buyers', Hertel Station, Buffalo 16-B, N. Y.

SAVE Money! Buy wholesale! Free catalog general merchandise. Norris, 487-M Broadway, New York City.

WE Establish you in your own mail order discount business. Supply catalogs, letters, envelopes printed with your name and ship your orders. Sell gifts, appliances, watches, housewares, silverware, etc., at discounts to 75%. Catalog and details free. Topval Corp., Lindenhurst 417, N. Y.

WE Pay \$3.50 lb. Grow mushrooms. Cellar, shed and outdoors. Spare, full time, year round. We have over 25,000 customers. Free book. Washington Mushroom Ind., Dept. 99, 2954 Admiral Way, Seattle, Wash.

MAKE Attractive wall plaques from bottle caps. Instructions \$1.00. Campbell, 87 Poplar Ave., Bronx 65, N. Y.

SPARETIME Repeat profits taking magazine subscriptions. Special offers. Cassell Agency, Boynton Beach, Florida.

BE The Popular Mechanics representative in your neighborhood and earn big profits in your spare time. Write Popular Mechanics Magazine, Room 303M, 200 E. Ontario St., Chicago, Ill.

SOUVENIR Business runs to millions yearly! Tremendous profits! Season is here! No machinery required! "How to Manufacture Souvenirs," \$3.00. National, P. O. Box 696-L, Redwood City, Calif.

FREE Folio "\$5,000-\$45,000: Unlimited Vacations." No merchandise. Unknown! Work home, sparetime! Haylings, Carlsbad, Calif.

BIG Money raising fishworms and crickets. Free literature. Carter Wormery, Plains, Georgia.

BAKE New greaseless doughnuts in kitchen. Sell stores. Free recipes. Michael Ray, 3605 South 15th, Minneapolis 7, Minn.

HOME Mailorder beginner's manual, sources, methods, opportunities, 25¢. Car-nahan Bros., 9510 Acacia, Fontana, Calif.

THEY Hand him \$100! Free packet, "Secret Journal," 919 secrets-plans! Work home. Publicoe, Oceanside, Calif.

RAISE Pheasants on \$100 week plan. Little capital and space can make you independent. Free details. Great Central System, Columbus 1, Kansas.

FREE Book "505 Odd, Successful Busi- nesses." Work home. Pacific, Oceanside, Calif.

MAKE Flexible molds. Cast plaques, figurines. Free sample. Tooker, 1045-M Fairview, Hamilton, Ohio.

VENDING Machines—No selling. Operate a route of coin machines and earn amazing profits. 32-page catalog free. Parkway Machine Corporation, Dept. 25, 715 Ensor Street, Baltimore 2, Maryland.

AUCTIONEERING—Home study course. Diploma granted. Auction School, Ft. Smith, Ark.

BOOKS, PERIODICALS, PICTURES, POSTCARDS

FREE: Catalog. Many subjects. Treasure-Site Books, 279 South Alden, Philadelphia, 39.

BRITISH Book bargains. Any subject. Catalog free. Transbooks, Box 22-PMM, Brooklyn 26, N. Y.

BARGAIN! Send for copy of Alaska magazine, map, Cheechako certificate with your name inscribed: Deed to Goodenough mine and pocket guide to Alaska all for \$1. Alaska Sportsman, Ketchikan, Alaska.

BOOK Bargains. Pocket novels or magazines, 8 for \$1.00, mixed selection. Comics, 20 for \$1.00. George's, Lombard and Central, Baltimore 2, Md.

RARE Magazines, catalog 10¢. Nationwide Exchange, Box 1375-P, San Antonio 6, Texas.

BOOKFINDERS! All subjects. Send wants! Jaher Book Service, 183 Hazelwood Drive, Westbury, N. Y.

"SCIENCE Milestones." Records march of science starting 400 years before Christ, right up to date. Amazing facts revealed. 312 pages packed with startling information that will thrill you. A real history of science. \$5.00. Literature free. Popular Mechanics Press, 200-SM East Ontario St., Chicago 11, Ill.

BOOKHUNTERS! Scarce, rare, miscel- laneous books. Atlantic Book Service, Cedar Street, Charlestown 29, Mass.

JOHN Friend, bookfinder, can get the book you want. Free search service. Box 197PM, Cardiff, Calif.

SAMPLE: 30¢ copy of "The Aquarium." Send 10¢ to 12th and Cherry Sts., Philadelphia 7, Penna.

BARGAIN, Exciting Little Library book- lets. 25¢ each. How to use tools, painting, welding, home improvement, games, models, plastic, lamp making, glass blowing, boats, photographs. Free catalog. Popular Mechanics Press, 200-LB East Ontario St., Chicago 11.

OUT-Of-Print books at lowest prices! You name it—we find it! Fast service. No obligation. International Bookfinders, Box 3003-PM, Beverly Hills, Calif.

NATIONAL Geographic Magazines, 1888- 1936. Periodical Service, Box 465-PM, Wilmington, Delaware.

"HOME Improvement Guide." New, amazing 192 page volume. Packed with ideas, plans for remodeling, decorating, landscaping, built-in projects. \$2.50 pre-paid. Popular Mechanics Press, 200-HG East Ontario St., Chicago 11.

FREE: Exciting catalog packed with books covering most everything. Think of it—From cover to cover you will find described and illustrated hundreds of books telling how to fix and how to build almost anything. How to remodel your home; do your own decorating, plumbing, electrical work. Simplified books covering concrete work, carpentry, painting, furniture making and refinishing. How to build your own boat, home workshop tools. Best books on photography, welding, hobbies, homecraft. How to make a home freezer. Send for your free copy now. Popular Mechanics Press, 200-BC East Ontario St., Chicago 11, Ill.

MAGIC TRICKS, PUZZLES, JOKER NOVELTIES

FREE Illustrated catalog. Magic, Houdini escapes, jokes. Be popular. Make money. Sell tricks. Entertain. Great opportunities. Big illustrated catalog free. Great Heaney, Oshkosh, Wisconsin.

DOLLAR Magic set free with catalog 25c. 4462-PM Germantown, Philadelphia.

WORLD'S Finest professional magic, Joker novelties. Giant illustrated catalog 10¢. Top Hat, Evanston 12, Illinois.

500 TRICKS, Douglas famous 120-page catalog, only 10¢. Fastest service to magicians for 30 years. Send 10¢ today. Douglas Magician, Dept. 1, Dallas, Texas.

SMOKEBOMBS 25c. 7 For \$1.00. Terrific! 4463-PM Greene, Philadelphia 44.

STIMULATING Glad hand buzzer 50¢. Marvin's, 7956 Lee, Kansas City 15, Mo.

SENSATIONAL Magician's wand 25c. Vanishes handkerchief! Catalog included. Box 1352-PM, Philadelphia 3.

BE A magician! Large professional catalog of latest tricks. 35¢. Ireland, C-109 North Dearborn, Chicago 2, Illinois.

VENTRILLO. Professional voice-throwing instrument and catalog 25c. Box 971-PM, Philadelphia 5.

LEARN Ventriloquism, easiest method. Details free. Smith, 2125 No. Bigelow, Peoria, Ill.

WHOLESALE! Thirty 10¢ trick novelties \$1.00! Profits! 1746-W Market, Philadelphia 3.

COINS, TOKENS, CURRENCY

OLD Money wanted. Will pay fifty dollars for nickel of 1913 with liberty head (no buffalo). We pay cash premiums for all rare coins. Send 4¢ for large coin folder. May mean much profit to you. Numismatic Co., Dept. 20, Fort Worth, Texas.

CASH For all foreign coins. Harry Kelso Antiques, Pittsburg, Kansas.

GET Profit and pleasure in collecting old coins. Send 10¢ for 56-page illustrated coin catalog. You'll be delighted with it. Send for it now. B. Max Mehl, 370 Mehl Building, Fort Worth, Texas. Largest rare coin establishment in U. S. Established 40 years.

BARGAINS, U.S. coins: 1893 Columbian world's fair half dollar, \$1.00. Ten different Indian pennies, 75¢. Two-cent piece, and 3-cent piece, \$1.00. Gold 1/2 eagle, \$9.00. Gold 1/4 eagle, \$12.50. Beautiful coin bracelet, \$1.00. Many coins available. What do you need? Rare Coin Company, 31 North Clark, Chicago 2.

SILVER Dollars hand shined with quick-silver \$1.25. Loraño, Box 328, Cascade, Idaho.

44 DIFFERENT Uncirculated coins, \$1.00. Oddehon, Box 482, St. Louis, Mo.

NAZI Coin—10¢. Interesting lists included free. Approvals. Dwight Musser, Dunbar, West Virginia.

10 DIFFERENT Indian cents and 5 Lincoln cents before 1931 \$1.00. Price list free. Joray's, Box 38C, Shoups, Tenn.

SILVER Dollars: Uncirculated. 1879p through 1891p, 1897p \$2.00 each. 1893cc \$15.00. Retail lists 10¢. Holden's, Garwin, Iowa.

30 DIFFERENT Better foreign coins including some older issues and larger pieces \$1.00. Alfred Szego, Box 187, Jackson Heights, New York City.

LINCOLN, Indian cents bought, sold. Indian cent and complete pricelist 25¢. Penny Mart, PL-3, Box 629, Chicago 90.

LINCOLN Cents 1910-S, 1913-S, 1921-S, 1923-S, 1924-S, all for \$2. Gasser's, Box 34615, Los Angeles 34, California.

LARGEST Coin magazine, 180 pages, 35¢. Scrapbook, 7320-J Milwaukee, Chicago 31.

SAN Francisco mint closed! Made only cents and dimes in 1955. In short supply and great demand. One each, brilliant uncirculated, for 25¢. Free coin lists with order. Bryson Stamp & Coin Company, 612 White, Toledo 5, Ohio.

12 DIFFERENT Indian cents, coin list, \$1.00. Pounds, North Wales, Penna.

U. S. large cent and coin bargain lists, only \$1. Delmeco Products, Box 1123, Wilmington, Del.

MORGAN Dollars: 1878-87-90-91-92s. \$2.00 ea. Coin catalogue, 25¢. Shultz, Salt Lake 10, Utah.

GIANT U. S. coin catalog 25¢. Accoin, 314 So. Clark, Chicago 4.

FREE! Foreign coin, banknote and coin collectors illustrated catalog to approval service applicants. Send 3¢ postage. Tatham Coinco, Springfield 30, Mass.

U. S. Coin approvals. Reasonable. Hutchinson, 3443 "I" Street, Philadelphia 34, Pennsylvania.

COINS From Formosa, Vatican, etc., plus foreign banknote, 10¢ with coin approvals. Littleton Coin Co., Littleton 81, New Hampshire.

BARGAIN Lists, Indianhead cent, 10¢. Economy Sales, 156-A Dean, Mansfield, Mass.

STAMP COLLECTING

WOW! 135 All different Germany 10¢. Zeppelins, semi-postals, airmails, high values. Big bargain lists and approvals included. Jamestown Stamp, Dept. A7PMC, Jamestown, N. Y.

WORLDWIDE, 50 All different, absolutely free, just to introduce our incomparable approvals. Kent Stamp Company, G.P.O. Box 87, Brooklyn, N. Y.

CANADA — Newfoundland collection including early issues, commemoratives, pictorials and high values. Plus set of fascinating triangle stamps. Plus set of unused British Colonies. Plus large stamp book. All four offers free. Send 10¢ to cover postage. Empire Stamp Corp., Dept. PM, Toronto, Canada.

STAMP Finder, world map and encyclopedia of stamp issuing countries only 5¢. Approvals. Goliath Company, Bethlehem K1, New Hampshire.

FREE! French colony mint set. Approvals. Brinkman, 4241 Live Oak, Arcadia, California.

WHOLESALE Prices! Free lists. Warden, Box 68, Sierra Madre, Calif.

5 MINT British colonies and 100 others 10¢ with approvals. Miller, 219 Fowler Ave., Jersey City 5, N. J.

FOREIGN Mission mixture 75¢ per 1000 stamps. Zaporowski, 4435 Allen, Philadelphia 37, Penna.

ZEPPELIN Stamp free with approvals. Foreign. Variety Stamps, 57-V Circuit, Newton Highlands 61, Mass.

COMORRO, Hyderabad, Swaziland, Mauritania, Armenia, Nyassaland, free. Bargain approvals. Tamiami, Box 342, (Tamiami) Miami 44, Florida.

77 DIFFERENT U. S.—25¢, approvals. Utechs, 1143D North Keeler, Chicago 51.

\$5 PACKET, With high values, only \$1. R. Bernier, 555 Markham St., Toronto 4, Canada.

FIRST U. N. set. Among world's prettiest. Only 10¢. Approvals. Welles, Box 1246-R, New York City 8.

DEALERS—Wholesale list. Postage 3¢. Frank, 5031 Queensberry, Baltimore 15, Maryland.

PICTORIAL Packet from Antigua, Barbados, British Guiana, British Honduras, Burma, Curacao, Leewards, Rhodesia, Trinidad, Tobago, and many other hard to get countries. Bi-colors, topicals. Tremendous value. Each stamp a beauty. Free if willing to buy from our attractive approvals. Roseland Stamps, Spring Lake 2, Michigan.

200 DIFFERENT Including P.D.R. triangle also scarce war ration stamps. 10¢ to approval applicants. Avalon Stamp Co., Dept. M, Springfield, Mass.

40,000 VARIETIES Available on approvals. 1/4¢ upwards. Keigwin, Box 933B, Daytona, Florida.

GIANT Stamp zoo free! Snakes, leopards, rhinoceros, zebu, koalabar and other fierce jungle beasts. Approvals. Send 10¢ for handling. Free stamp magazine. Lincoln Stamp Co., St. Catherine's 518, Ontario.

2 NUDES Sets 25¢ to serious stamp approval applicants. Atlas, 1326 Vilas, Madison 5, Wisconsin.

ECONOMICAL 1/4¢-3¢ Approvals, 33,000 varieties. Dresel, Box 128-N, West Englewood, New Jersey.

FREE! Amazing list! Two feet long! All countries! Stampmart Company, Hartford 1, Connecticut.

FREE! 107 British Colony stamps. All different, from Britain's farflung colonial empire. Catalog value \$2.50. Free stamp magazine, approvals. Send 10¢ for handling. Act now! Niagara Stamp Co., St. Catherine's 71, Ontario.

UNITED States commemorative collection containing 33 different—10¢. Approvals. White, 516-A Avenue L, Brooklyn 30, New York.

TWO \$5.00 U.S. stamps plus 20 different, 10¢ with U.S. approvals. Irwin, Box 1165, Brooklyn 30, N. Y.

SELL Your surplus good grade stamps. Write, describing fully what you have. Vanroy Shirk, Lebanon, Pennsylvania.

50 DIFFERENT Argentine 10¢. Approvals. Reuter, 611 W. 40th Pl., Los Angeles 37.

AMAZING Offer! 200 United States stamps — including commemoratives, airmails, high denominations to \$1.00. Only 10¢ to approval applicants! Illustrated bargain lists free. Mystic Stamp Co., Dept. 80, Camden, New York.

U. S. Classics. Over 50 yrs. old. 15 selected old-timers. Missing in biggest collections. All 15 at less than 1¢ each. 10¢ with approvals. Jaro, Box 246-T, New York City 8.

50 DIFFERENT United States 5c with bargain approvals, lists. Bookman, Box 8245-M, Madeira Beach, Fla.

100 STAMPS, 10¢ With approvals. Smith, 508A Brooks, College Station, Texas.

OLD Scarce U.S. seconds on approvals. Slight imperfections, lowest prices. Herfield, Clintonhill Sta., Newark 8, N. J.

100 OLD United States between 1861 and 1935, \$1.00. Roush Stamps, 51 Chestnut, Mansfield, Ohio.

UNITED States approvals. Select copies, used—mint. Kingsbury, Fairfax, Vermont.

ICELAND 10 Different beautiful stamps for only 10 cents to applicants for our good old fashioned approvals. Old Colony Stamp Co., Dept. A, Milford, Connecticut.

1-3¢ EACH! Thousands of exciting worldwide stamps. Free examination. Cole, Box 223-A, Buffalo 21, N. Y.

SELL Stamps to our readers. Your ad in this space will be read by thousands of stamp buyers. I'll prove that to you. Write now for Folder "S." F. W. Johnson, Classified Advertising Manager, Popular Mechanics, 200 E. Ontario St., Chicago 11, Ill.

225 STAMPS For only 10¢! This mammoth value includes airmails, pictorials; stamps from strange countries cataloging up to 25¢ each! Also approvals. Mystic Stamp Company, Camden 80, New York.

100 DIFFERENT Austria, 10¢. Approvals. Aronson, Box F, Newton Centre 59, Mass.

FREE Stamp collection! 100 different stamps from Europe, Africa, Asia, Scandinavia, Balkans, etc. 3¢ to approval applicants. Tatham Stamp Co., Springfield 30, Mass.

GIANT Approvals, thousands different, 1¢ and 2¢ each. Wahl's Stamp Exchange, 7088P Farragut, Chicago 31, Ill.

U. S. Revenues on approval. El Jay Stamps, Box 286, New York 26, New York.

WEIRD Diamond shape coffee stamps. Lovely flower triangle! First American big commemorative. Greenland, Idol dancer, etc. Free with approvals. Capital Stamp Co., Ferrysburg 2, Mich.

FIVE Different sets French Colonies, 10¢ with approvals. Banner, Box 65, Park Forest, Illinois.

FREE Sample! Interesting, informative, illustrated. National Stamp News, Anderson, South Carolina.

FREE! Flower, sport triangles! East Indies. Others. Free gift. Approvals. Delton Page, Box 201, East Paterson, New Jersey.

U. S. \$5 Coolidge (S. D.)—25¢, approvals. Gatewood, Box 348, Winston-Salem, N. C.

QUALITY Approvals at 2¢ each. Hadrian, 13 East 31st, New York City 16.

60 PAGE U.S., U.N. illustrated catalogue free. Stone, 192 Washington, Boston 8, Mass.

FOREIGN Stamps 1¢ to 5¢. Artercraft first days approvals. Barr, 467 Onida, Pittsburg, Penna.

25 DIFFERENT Commemoratives 1893 up 10¢. U. S. approvals. K&B, Box 70, Brooklyn 23, N. Y.

100 DIFFERENT China 10¢. Approvals. Coast, P.O. 2187H, Santa Ana, California.

PICTORIALS On approval—Sets, singles, Picto, 1267 Tutwiler, Memphis 7, Tenn.

WANTED—Stamp collections, accumulations. Murray Gold, 62-95p Saunders, Rego Park 74, N. Y.

UNITED States. Fine mint airmails. #C7, #C8, #C9, #C10, Only \$1.15. Approvals accompany. Whitton Paine, Westport 11, Connecticut.

RUSSIA, 25 Exciting gems 5¢ with approvals. Belmont Stamps, Washington 13, D. C.

14,000 DIFFERENT! Fascinating new club plan systematically builds your collection. Only 50¢ weekly. Details free. L. G. Ware, Stepney 73, Conn.

MONACO New Princess Caroline issue. 5 values only 15¢ with approvals. El Montecito Stamps, 1358 Danielson Rd., Santa Barbara, Calif.

QUEEN Elizabeth mint sets! Barbados, Gibraltar, Tristan, Malta, Virgins, Dominica. 21 bicolors, 25¢! Approvals. Gannon Stamps, Box 931, Canton 1, Ohio.

OUTSTANDING, 80 Different U.S., including 25 commemoratives, 20¢, with superior approvals. Stamps, Box 37, Kennebunk, Maine.

FIRST German airport set complete. Ten cents. Approvals. Boger, Box 153, North Wales, Penna.

FREE! Coronations, triangles, sports, animals. Monaco Pipe; given approval applicants. Exotic, Box 482-M, Coral Gables 34, Fla.

SEND 25¢ For "Stamp Shopper" mailed from United Nations P.O. U.N. stamps used for postage. E. Strauss, 1414 New York Ave., Brooklyn 10, N. Y.

50 BRITISH Colonies 10¢ with approvals. Herrmann, Box 1022, Winter Park, Florida.

FREE! Fifty different stamps, plus surprise packet, approvals. Balter, Box 19464, Los Angeles 19, California.

FREE Pictorial packet to applicants for approval service. Great Plains Stamp Co., Box 266, Superior, Nebr.

MONACO Dog set plus 50 different. 10¢ with approvals. Bennett, Candor 3, N. Y.

200 WORLDWIDE 25¢ Plus surprise packet. Packet list free. Econopackets, Box 168, Riverside, Calif.

FREE—Multicolor scenic set with bargain bulletin. 10¢ handling. McQueston, 13344 Woodward, Highland Park 3, Mich.

QUEEN Elizabeth pictorials. Fiji, Montserrat, St. Kitts, Sierra Leone, etc. 20 different colonies only 10 cents. Approvals. Vulcan, Box 9053, Birmingham 9, Alabama.

20 SPORTS 25¢ With approvals. Edison Stamp Co., Edison Center Station, Box 246, Miami 51, Fla.

1 AND 2 Cent approvals in envelopes by countries. Schnoebelen, 143 North Main, Columbiana, Ohio.

ZOO Collection free approval applicants. Handling 10¢. William, Diamond, Penna.

100 STAMPS Free, Coral, Box 224, Riverside Sta., Miami, Fla.

MONACO Nudes 10¢ with approvals. Royal Stamp Company, Tamaqua, Penna.

500 FINE Mixed U. S. 15¢. Wright, 201M Mealey, Hagerstown, Maryland.

UNBELIEVABLE! Old U. S., famous Americans, flags, presidents, airmails, commemoratives with approvals for only 10¢ handling. Metropolitan Stamps, Box 312KH, Jackson Heights, N. Y.

FREE! Monaco triangles! Madagascar! Togoland! Iberia! Approvals. Keating, 2520-P Boulevard, Jersey City, New Jersey.

EXOTIC Packet 50 Orient stamps, free! Exciting, inexpensive approvals. Holiday, Box 773, Miami 35 (Riverside), Florida.

WASHINGTON Bicennials complete 15¢. Approvals. Linden, 1514 Glourie, Houston, Texas.

OLYMPIC, Sport sets. 11 colorful stamps, 10¢ with approvals. Norton, Box 926, San Antonio 6, Texas.

MINT Basutoland, St. Lucia, Swaziland, Bechuanaland, Gambia, Leeward, Norfolk, Montserrat, Aden, Antigua, all free! Superfine approvals. Tropicana, Box 624, Oakland Park, Florida.

MONACO, Latest Grace Kelly "motherhood" commemoratives, free! Approvals. William Deems, Ravenswood, W. Va.

PREMIUMS Galore with every approval selection. Free details. Stamp Farm, Oxford, Wis.

1957 UNITED States price list 25 cents. Lee's, Box 796, Rockford, Illinois.

MINT U. S. at face! Older commemoratives only in 25¢ packet. Limit one with request for mint U.S. approvals. Western, Box 1689P, Salinas, California.

FREE 55 Worldwide to introduce attractive inexpensive approvals. University Stamps, P.O. Box 95, Tamiami Station, Miami 44, Florida.

FREE Sample stamp newspaper, information on collecting, special lists. Approvals. Littleton Stamp Co., Littleton Al. New Hampshire.

FREE! Giant catalog offering thousands of bargains. Sent with beautiful approvals. Jamestown Stamp Co., Dept. ETPMC, Jamestown, N. Y.

HOBBIES AND COLLECTIONS

ARMY-Navy-Marines-A.P. 45 military insignias \$1.00, contains medals, badges, campaign ribbons, battle stars, patches, ratings, etc. Free valuable gift. Supreme Military, Dept. PM, 48 West 27 St., New York City.

MILITARY Miniatures. Civil War. Custer's Cavalry, American Revolution and U. S. Marines. Illustrated catalog 35¢. Bussler Miniatures, Dept. Z, 40 Howe St., Quincy 69, Mass.

INVENTING Can be an interesting and profitable hobby. Write for complete particulars. Institute of American Inventors, Dept. 40-E, 635-F St., N.W., Washington 4, D. C.

1956 TEXAS Auto license plates. Genuine. Unused. Wonderful collectors item. Pair, \$1.00. Willmars, 716 Hogan, Rockdale, Texas.

NAZI Insignia. 12 different \$1.00. Medals, patches, armbands, flags, daggers. Illustrated lists. 15 cents. Hobbyland, 1207 1st St., W., Calgary, Canada.

PRECIOUS STONES, MINERALS

GENUINE Alaska Jade suitable for polishing; piece 3/4-inch square thin slab with description. Send \$1.25 to Alaska Specialties Company, Box 81, Ketchikan, Alaska.

DIAMONDS. Discounted: Registered with written guarantee. Example: Genuine Marshall diamond, 1/4 carat mounted. Your price: \$77 plus tax. Write: House of Marshall, 11 Lawrence St., Lyons 5, New York.

SAPPHIRE, Topaz, tourmaline, garnet, peridot. Five uncut gem specimens, \$1.00. Ten polished gems, baroque shaped, \$1.00. Free bargain list jewelry, gems. Profitable, easy "do-it-yourself" projects. O'Brien's, 1118M Wilcox, Hollywood 38, Calif.

CUT Gems, make jewelry—For profit or fun. 100 page magazine tells how: where to get supplies. Sample 25¢ or request free literature. Lapidary Journal, Del Mar 2, Calif.

EARTH Science, the Rockhounds' national magazine. Subscription \$2.00, sample 25¢. Box 1357, Chicago 90.

ANTIQUES, RELICS, INDIAN GOODS, CURIOS

SELLING 100,000 Ancient arrowheads, spearheads, tomahawks, etc. List free. Lear's, Glenwood, Arkansas.

ANTIQUES Collecting simplified through Spinning Wheel magazine, published monthly, internationally, since 1945. \$3 year; \$5 two years. Spinning Wheel, Box 456PM, Taneytown, Maryland.

SELECTED War arrowhead \$1.00. List 5¢. H. Talburt, Calico Rock, Ark.

GENUINE Eskimo-carved ivory whale-tooth billikins; \$4, \$5 or \$6. Alaska Specialties Company, Box 81, Ketchikan, Alaska.

CAMERAS, PHOTO SUPPLIES

REVERE Camera equipment, 1/5 off. Write. Morgan-Brownell, Inc., Dept. M, Box 106, St. Joseph, Michigan.

BUY Wholesale nationally advertised cameras, photo supplies, thousands other products at big discount. Free "Wholesale Plan." American Buyers, Hertel Station, Buffalo 16-E, N. Y.

KODAK, Bell-Howell, others. Discounts to 40%. Free photo catalog. Mailers Mart, Box 135-PM, Pelham, New York.

PHOTOGRAPHY For pleasure or profit. Learn at home. Practical basic training. Long established school. Free booklet. American School of Photography, 835 Diversey Parkway, Dept. 3442, Chicago 14.

PHOTO FINISHING

ENLARGEMENTS. High quality. Dull or glossy heavy weight paper. Four 5x7's or three 8x10's. \$1.00. Selwin, Box 231, Santa Monica, California.

5x7 ENLARGEMENTS 15¢; From negative or photo. Bob Huffman, Whitesboro, Texas.

LIFETONE (Copyright) ultra fine grain prints. Custom developing plus oversize prints on heavy portrait weight paper. Salon quality, 8 exposure 70¢, 12 exposure \$1.00; 35mm—20 exposure \$1.75, 36 exposure \$2.75. Free mailers and circulars. Send to Lifetone Prints, P.O. Box 96, Chicago 17, Illinois.

COLORSLIDES From your own color-prints 50¢. Curtiophoto, 1187 Jerome Ave., New York 32.

ANY Size roll film (except 35mm.) Jumbo printed 50¢ per roll. Friendly Photos, Jacksonville, Alabama.

FREE! Color snapshot folder. Offers, lists, mailers. Houghton's, Erving, Mass.

COLOR Processing—High quality, fast service and low prices. Kodacolor developing 85¢; prints 27¢. Kodachrome: 35mm. processing, 20 exposures, \$1.45; 36 exposures, \$2.25. Send for complete price list and free mailers. Photo-Mail, Box 216M, Madison Square Station, New York City 10.

PARTICULAR? 8 Jumbos—33¢, 12—50¢. Special; 35mm., 36 exposures \$1.10. Flash-Foto, Box 36M, Brooklyn 4, N. Y.

12 JUMBOS From any size roll developed 39¢, with this ad only. P. Skrudland, Lake Geneva, Wis.

KODACHROME Processing—8mm roll or 35mm 20 exp., \$1.25. Prompt service. Write for mailer and prices. Color Pix, Dept. P, CPO Box 30, Kingston, N. Y.

12 EXPOSURE Rolls, 39¢, jumbo prints. Guaranteed work, one day service, Lincoln Studios, Dept. K, Box 13, Lincoln, Nebraska.

TWO Beautiful prints from each picture on roll. 8 exposure 40¢; 12 exposure 50¢. Thirty-six years of satisfied customers. Quick service. Lensphotos, Dept. J-4, Janesville, Wisconsin.

QUALITY Kodak finishing. 8 exposure roll 40¢; 12 exposure 60¢; 16 exposure 70¢. Reprints 5¢. Fast service. Guaranteed quality. 40 years continuous operation. Be a satisfied customer. We do color. Send for mailers. Mail Order Photo Service, Box 297, Watertown, Wisconsin.

8-HOUR Service on deluxe jumbo prints. 8-exposure roll developed and 8 jumbo prints 40¢, 12 exposure 55¢, 16 exposure 70¢; 35mm. 20 exposure 75¢, 36 exposure \$1.25. Jumbo deckledge reprints 4¢ each. Contact prints made if specified. Bay Photo Service, P.O. Box 210, Oakland, California.

SUPERIOR Quality. Prompt service. 8 jumbos in album 40¢, 16 contacts 50¢. Jumbo reprints 5¢. Satisfaction guaranteed. Also complete color film finishing service. Write for free circulars and mailers. Fast-X-Photo, Box A, Jersey City, N. J.

MOTION PICTURES AND SOUND EQUIPMENT

8MM. Subjects \$1.00. Limited quantity. Cartoon, sports, animals. Valley Film Service, 16121 Sherman Way, Van Nuys, Calif.

LOWEST Rentals. Sound features. Shorts. 204 N. Ninth St., Newark, N. J.

16 MM. Sound movies. Rented, sold. Huntoon Rental Service, Bellows Falls, Vt.

MOVIE Camera film: 8mm. roll \$1.50, 16mm. 100' \$3.00. Free processing. Better Films, 742 New Lots, Brooklyn, N. Y.

8-16MM. Films. Free catalogue, with sample film 10¢. Garden, 690 Howard Avenue, Brooklyn, N. Y.

SAVE 50%! Guaranteed-fresh color, b.&w. movie film! 8mm., 16mm. Free catalog! Eso-R, 47th Holly, Kansas City 12, Missouri.

RECORDERS, Hi-Fi. Free catalogue. Carstan, 215 E. 88 St., New York City 28.

5,000 8-16MM. Movie films. Free catalogues. International, Greenvale, N. Y.

TAPE Recorders, tape. Unusual values. Free catalog. Dressner, 69-02M 174 St., Flushing 65, N. Y.

FREE Catalog. Save dollars. Fresh 8mm., 16mm. b&w and color film. Home processing equipment. Superior Bulk Film Company, 448 No. Wells, Chicago 10.

RECORDERS, Hi-Fi. Free catalogue. Carstan, 215 E. 88 St., New York City 28.

5,000 8-16MM. Movie films. Free catalogues. International, Greenvale, N. Y.

TAPE Recorders, tape. Unusual values. Free catalog. Dressner, 69-02M 174 St., Flushing 65, N. Y.

FREE Catalog. Save dollars. Fresh 8mm., 16mm. b&w and color film. Home processing equipment. Superior Bulk Film Company, 448 No. Wells, Chicago 10.

MUSIC AND MUSICAL INSTRUMENTS

ACCORDIONS Wholesale—10 day trial. Free catalog. American Accordion Center, 5329-PM-7 Belmont, Chicago.

SONG Poems wanted for musical setting and recording. U. S. Music Studios, Box 222-A, Belmont, Mass.

ACCORDIONS—Direct from importer. Save 50% and more! Free trial. Lifetime guarantee. Trades accepted. Free catalog. Write Accordion Manufacturers Outlet, Dept. TTR, 2003 Chicago, Chicago 22, Ill.

SWISS Musical movements, \$1.90. Helax, 218 West 72nd Street, New York City 23.

POEMS Wanted for new songs. Send poems. Free examination. Immediate consideration. Songcrafters, 2724 Arcade Station, Nashville, Tenn.

SONG Poems wanted. Five Star Music Masters, 630 Beacon Building, Boston.

POEMS Wanted for new songs. Send poems. Immediate consideration. Crown Music Company, 49-C West 32 Street, New York City.

ELECTRIC Guitars, amplifiers, wholesale. Free catalog. Carvin PMM, Covina, California.

POEMS, Songs wanted! Rhymer \$1. Bengol, 93 Jefferson, Chelsea 50, Mass.

RECORDS Hi-Fi by mail, Big discounts. Noelson, Box 211, Wall Street, New York City 5.

DISCOUNTS Instruments, accessories, national brands. Tempo Music, 37 Cutler, New London, Connecticut.

VIOLINMAKERS, Repairers. Fine tone wood, and all violin supplies. Send for free wholesale price list. International Sales, 414-MPM E. Baltimore St., Baltimore 2, Maryland.

ACCORDIONS, Wholesale to everyone. Save up to 60%. All national known brands. Free catalogue. Del Principe, 29 South Cicero, Chicago 44.

WRITE Songs. Big money and reputation. Write for information. J. Gordon Pub. Co., 4700 South California Avenue, Chicago.

SONGPOEMS And lyrics wanted. Mail to: TinPan Alley, Inc., 1650 Broadway, New York 19, N. Y.

SONGS Into dollars. Share \$29 million dollars yearly for new songwriters, song-poets. Songs composed, published, promoted by famous firm. Information, appraisal free. Send to Nedyke Publishing, 6009 Sunset, Hollywood 28PM, California.

RADIO, TELEVISION AND ELECTRONICS

WEBCOR Tape recorders, 1/3 off. Write. Morgan-Brownell, Inc., Dept. M, Box 108, St. Joseph, Michigan.

CRYSTAL Radio Experimenters write to Small Radio Lab, 1331 Tyler, Topeka, Kansas.

EXPERIMENTER'S Data catalog 25¢—Refundable. Laboratories, 328-C Fuller, Redwood City, California.

ELECTRIC Guitars, amplifiers, wholesale. Free catalog. Carvin PMR, Covina, California.

FREE! Giant bargain catalog. Transistor, "Sun" radios, kits, portables, audio, electronics, photographic, optics, tools, household. Write Lektron, 131M Everett Ave., Chelsea, Mass.

DO It yourself. What? Repair TV, build furniture, make barbecue, plumbing repairs, build boats, do house wiring, remodel home, lay tile, modernize kitchen, repair home, and scores of other things you can do yourself. Books covering each subject, only 25¢. Send for descriptive list. It's free. Popular Mechanics Press, 200-LB East Ontario St., Chicago 11, Ill.

BUSINESS OPPORTUNITIES

REWEAVING Instructions, supplies \$2.00. Harris Reweavers, Box 7112, New Orleans 19, Louisiana.

NEW Snow cone machines. All prices. P.O. Box 7803, Dallas, Texas.

REPAIR Service, full or part time, no selling, free details. Servicecraft 1412M Adams, Toledo, Ohio.

IMPORTING—Exporting. Modern dropship method. Profitable. Details free. The Hazen Company, 6601-8th Ave. N., St. Petersburg, Fla.

WHOLESALE—Thousands nationally advertised products. Buy, sell. Amazing profits. New, free plan. Associated Wholesalers, 1016-D Starr, Burlington, Iowa.

HOW To obtain needed capital fully explained. Write Enterprise Bureau, SAK Bldg., Syracuse 2, N. Y.

PROFITABLE Future in your own mail order business. Free details. Zed Gwartney, Desert Hot Springs, Calif.

WANT To make big money at home? \$10.00 profit in an hour possible with invisible reweaving. Make tears, holes disappear from clothing, fabrics. Steady year-round demand from cleaners, laundries, homes. Details free. Fabricon, 8334-S Prairie, Chicago 19, Illinois.

OPERATE Mailorder folio business! Free details. Ballard's, 425 East Catherine, Louisville 3, Ky.

MAKE Flexible molds. Cast plaques, figurines. Free sample. Tooker, 1045-R Fairview, Hamilton, Ohio.

NATURAL Molding rubber, extra thick. Free sample. W. Wooley, 1016-A Donald, Peoria, Illinois.

INTERNATIONAL Mailorder business. Complete setup service—Not just instructions. Hermes, 152 West 42, New York City 36.

BIG Money raising fishworms and crickets. Free literature. Carter Farms, Plains, Georgia.

INTERESTED Mail order? Samples leading mail order magazines 10¢. Palm, Box 1221, Baton Rouge, La.

START Home business making statuary, plaques, novelties, garden furniture, artificial marble flooring, liquid marble. Make your own flexible molds. Amazing profits. Only \$1.98. Free literature. Popular Mechanics Press, 631 No. St. Clair St., Chicago 11.

UNUSUAL Mailorder opportunity. Tested. We supply everything. Girard's, Azusa, Calif.

WANT More business? Here's an amazing opportunity to increase your sales. Talk to thousands of interested readers of "Mecanica Popular." Our Spanish Edition covers the Latin American countries like a blanket. They're real mailorder buyers. Classified rate 75¢ per word. Try an ad in our next issue. Classified Advertising Department, Popular Mechanics Magazine, 200 East Ontario Street, Chicago 11, Ill.

VENDING Machines—No selling. Operate a route of coin machines and earn amazing profits. 32-page catalog free. Parkway Machine Corporation, Dept. 26, 715 Ensor Street, Baltimore 2, Maryland.

HOME Workshop books. Free catalog. Popular Mechanics Press, 631 N. St. Clair St., Chicago 11.

MONEY In saw and lawnmower sharpening sparetime at home. Free book. Virgil Foley Company, Columbia Heights, Minnesota.

FREE Folio "\$5,000-\$45,000. Unlimited Vacations." No merchandise, equipment. Unknown! Work home, sparetime! Haylings, Carlsbad, Calif.

\$70 WEEKLY—Home, spare time. Simplified mail bookkeeping. Immediate income—easy! Auditax, 34757A, Los Angeles 34.

BRUSH Plating outfits for plating articles in the home and shop. No tanks necessary. Good income spare or full time. Free particulars. Gunmetal Co., Ave. H, Decatur, Illinois.

TO \$100.00 Weekly, Sparetime, home operated mailorder business. Successful beginner's plan. Everything supplied. Lynn, 10420-M National, Los Angeles 34.

FREE Book "505 Odd, Successful Businesses." Work home. Expect something odd! Pacific, Oceanside, Calif.

PLASTERCRAFT Molds, liquid rubber, plasters, flocks, candle supplies. Catalog and manual free. Blue Rapids Supply, Blue Rapids, Kansas.

BREED Rare tropical fish at home. Earn big money! Learn secrets! Help fill huge demand. Amazing opportunity! Free plan. Tropical Fish Breeders, Los Angeles 61, Calif.

MINK Raising information free. Complete. Lake Superior Mink Farm, Superior, EEI, Wisconsin.

COPUBLISH Mail Sale Advertiser, leading mail order paper. Details. Latest copy, dime. Vanroy Shirk, Lebanon, Penna.

LEARN Real estate by listening to records. Lee Institute, Brookline 46, Mass.

I Want to send you proof of the wonderful pulling power of Popular Mechanics classified pages. What's your proposition? Write me today. Include literature if possible. P. W. Johnson, Manager Classified Advertising, Popular Mechanics Magazine, 200 E. Ontario St., Chicago 11, Ill.

FREE "Franchise Profit Letter" describes nationwide opportunities. Exclusive distributorships, dealerships, agency operations. Write today. National Franchise Reports, 333 North Michigan, Chicago 1.

LEARN Photo-negative portrait retouching. Men, women, \$5 hour possible spare or full time at home. Easy, glamorous. Work for photographers by mail order. Full details sent free. Duval, 100 So. Vermont, Los Angeles 4.

YOUR Own name brand business. No investment; no inventory. Part time or full time. Sell famous brands of appliances, housewares, silverware, radios, vacuum cleaners, lamps, tools, clocks, watches, jewelry, etc., etc., over 1000 items. Join thousands of successful independent dealers. Send for free catalog and dealer price list. H. B. Davis Corp., Dept. 11, 145 W. 15 St., New York City.

11,000 NEW Prospects daily. Baby record books, shoes, albums. Sell mailorder. Use our literature. Write: No-Co-Ro, Capitola, California.

COLORGLAZED Concrete pottery made without molds. Patented method. Cemetery products, novelties, tiles. Basement leak-sealing. Money-making projects. Booklet, details free. Men only. National Potteries Company, Grand Rapids, Minnesota.

OPERATE Profitable mailorder business! Splendid opportunity. For details write: Thomas Bond, 1657H West Vernon, Phoenix, Arizona.

COLOR Concrete with chemicals. Marble-glaze cement benches, pottery. Home-shop. Hundred beautiful designs, made without molds. Birdbaths to waterfalls. Your chance for fame, fortune. 10¢ brings sample, pictures, Hollywood Cementcraft, 8527-R Wonderland, Hollywood 46, Calif.

CASH From sawdust, seventy methods. Tin-cans, thirty methods. Newspapers, eighteen methods. Instructions 50¢ each. All three \$1.00. Charles Company, 12-DXT, Norwood, Ohio.

BE Appointed state notary public now. Write, Stationers, Boerne, Texas.

WE Love our mailman—He leaves over \$1000.00 monthly in our rural mailbox. My college professor husband drafted a scientific home mailorder method. We bought a Texas ranch, live as we always wanted. Now we sell the Ranch Mailorder Method. Operates anywhere. Inquire: Eveningshade Ranch, Boerne, Texas.

BAKE New greaseless doughnuts in kitchen. Sell stores. Free recipes. M. Ray, 3805 South 15th, Minneapolis 7, Minnesota.

FIX Typewriters. Inexpensive home course teaches factory secrets. Free booklet. Athey, Tarentum, Penna.

THEY Hand him \$100! Free plan "Secret Journal Hidden Dollars." Work home! Publicos, Oceanside, Calif.

OPERATE Your own merchandise mail-order business. Everything furnished! B. Mann, Woodcliff Lake, N. J.

MONEY For you! Big profits! Cast plaster figurines, bookends, plaques at home with XL rubber molds. No experience needed! Write for illustrated, 40-page catalog, only 25¢! Plastic Arts Studios, 3403 So. Madison Street, Department 5, Muncie, Indiana.

GROW Orchids at home. Profitable, fascinating. Year 'round, Maine to California. No greenhouse. Successful home grower shows you how to provide proper temperature and air conditions in any well lighted room. Full details and real orchid seeds free. Orchidland, 100 So. Vermont, Los Angeles 4.

PLATE Baby shoes, jewelry, gifts, bronze and colored pearl. Free booklet. Platex, 11029 South Vermont, Los Angeles 44.

LEARN Appliance service and repair. Motors, washers, refrigeration, cleaners, everything. Free booklet. Armstrong, 11027-A South Vermont, Los Angeles 44.

START Your own subscription service. Every family buys magazines. No capital needed. We tell you how, furnish all supplies free. Liberal commissions. Write McGregor Magazine Agency, Dept. 110, Mount Morris, Illinois.

BUY Direct from factories—Appliances, cameras, watches! Free details! Cam Company, 8810PM—20th Ave., Brooklyn 4, N. Y.

MAIL Order expert shows how to make money by mail, even with small starting capital. His informative course contains modern merchandising methods, not petty schemes. Write for convincing details. Seery, North Conway, New Hampshire.

IMPORT-Export! Mailorder opportunities. Details. Warner, Box 6, Fort Scott, Kansas.

SELL By mail. Tested methods. Alfano, 19 Pine Street, Closter 2, New Jersey.

MAILORDER. Free book. Shrager Advertising, 2 W. 46, New York City 38.

NEWEST Spare, full-time home business \$5 to \$10 hour possible. Paint with suede—The finish with touch and eye-appeal. Beautifully auto dashboards, signs, radios, toys, figurines, lamps—1001 others. Complete, step-by-step instructions sent for no-risk examination. Free details. Coast JY, Los Angeles 61.

MOTEL-Resort management—Qualify for hundreds fascinating, leisurely, well-paid executive openings. Learn at home. Free booklet. Motel Managers Training School N147C, 612 S. Berrano, Los Angeles 5.

AMAZING Earnings operating home sharpening service. Write George Page, 1820 Cleveland Ave., Niagara Falls 2, N. Y.

LEARN Professional TV servicing in one week! Fabulous new simplified system. No big expense. No studying. No tools or equipment. Spare, full time. Own your own big profit business! Save! Amazing but true! Free! Write, Electronic Engineering, Dept. AC-177, 1638 So. LaBrea, Los Angeles 19, California.

START A buying service, buy wholesale thousands nationally advertised products. Make big profits selling at sizable discounts. Postcard brings details. American Buyers, Hertel Station, Buffalo 16-C, New York.

START Your own business on credit. Your own boss. 1527 dealers sold \$5,000 to \$32,000 in 1936. We supply stocks, equipment on credit. 200 home necessities. Sales experience unnecessary. Pleasant profitable business backed by world-wide industry. Write Rawleigh's, Dept. G-U-PPM, Freeport, Ill.

PRINT Without a printing press! Amazing new method! Print colorful signs, banners, cards, posters, glassware; anything at home. Big profits. Money-making opportunity! We supply everything. Beautiful sample, home-business plan free! Write Screen-Print Company, JY, Los Angeles 61, California.

MAKE Extra money. Cash commissions. Everybody buys easy-to-sell advertising book matches. Union label. All sizes. Cuts for all businesses. Powerhouse selling kit free. Steady repeat business. No experience necessary. Superior Match Co., Dept. MX-787, 7528 S. Greenwood, Chicago 19.

INDUSTRIAL And institutional mail-order business. New, unexploited opportunity. Hermes Advertising, 152-C West 42, New York City 38.

GROW Expensive herbs for us! Big profits home-business of your own. Year around profitability! We supply everything necessary! Send for free rare seeds and revealing plan. National Herb Exchange, Dept. JY, Gardena, Calif.

60% PROFIT Cosmetics \$25 day up. Hire others. Samples, details. Studio Girl-Hollywood, Glendale, Calif., Dept. 1277H.

WE Establish you in your own mail order discount business. Catalogs, sales letters, etc., printed your name cost you nothing. No stock investment. We ship orders. Sell gifts, appliances, housewares, cookware, cutlery, dinnerware, silverware, jewelry, watches, etc., at big discounts. Catalog, details free. Topval Corp., Lindenhurst 618, N. Y.

WHOLESALE Catalog! Discounts to 80%! Clothing, appliances, tools, housewares, jewelry, etc.! Midwest, 2MP-136, Pontiac, Illinois.

MAKE Money growing miniature trees on your window sill. Free seed and plan. Miniature Nurseries, Dept. JY, Gardena, Calif.

HOME-Import mail order business—Import profitable items below wholesale. Experience and product investment unnecessary. Full, spare time. Famous world trader guides you. Free list "157 Imports," details. Mellinger, G707, Los Angeles 24.

"HOW To Start a Business" booklet sent free! If you know any trade, go into business for yourself! Learn the 9 easy steps to follow. We've guided 5,000 others to success. Revealing free booklet yours for the asking! Write! National Business Consultants. Office JY, Los Angeles 61, Calif.

WE Pay \$3.50 lb. Grow mushrooms. Cellar, shed and outdoors. Spare, full time, year round. We have over 25,000 customers. Free book. Washington Mushroom Ind., Dept. 172, 2954 Admiral Way, Seattle, Wash.

UNUSUAL Package of opportunities—Selling, mailorder. Magazines, catalogs, etc. \$1.00. Pickett, Mt. Airy, Maryland.

\$200.00 WEEKLY Reported! No selling. Free booklet. Franklin Credit, Roanoke, Virginia.

REVOLUTIONARY New dishwasher. Lightning seller. Ends dishwashing drudgery. Dishes gleam. Send no money. Just your name. Kristee 109, Akron, Ohio.

EARN \$10,000 Yearly raising Angora rabbit wool for us. Information 25¢ coin. American Angora Company, Malta 12, Montana.

FREE Literature of money making opportunities. Unique Trades, Box 5516, Chicago 80, Ill.

FREE! Complete mailorder business. Terrific profits! No investment. VitaMins, 4801PM Cedarvale, Wichita, Kans. 57.

CERAMIC Tile as an installer or sell to the do-it-yourself market. No investment. Order as needed. Write Norlin Co., 5515 North Ave., Chicago 39, Illinois.

FREE Catalog. Contains hundreds of businesses, farms and income properties throughout U.S., Canada. Specify type and location desired. Deal direct with owners. U. I. Buyers Digest, 1608 Hillhurst, Dept. PM-3, Los Angeles 27, Calif.

EARN \$10,000 A year and more in your spare time. For details write: Products, Box 607, Sheboygan, Wisconsin.

MANUFACTURE Thin, lightweight, concrete stone inexpensively from new, amazing, plastic mold. Exact detail and color of natural stone reproduced. Small investment, big profits. Sell homeowners, contractors, etc. Send \$1.00 for complete details, sample stone and mold. Superior, Dept. 102, 5645 Manchester, St. Louis 10, Mo.

\$200 PER DAY! Made operating stands, or concessions at fairs and carnivals. Write! Globe Sales Co., Macon, Georgia.

BOOK On culture crickets and earthworms. Excellent information free. Kean, Ladonia, Texas.

IMPORT Your own products in small lots. Start profitable mail order business using international drop shipment method. Capital unnecessary. Free details. Georgia Overseas Trading Co., Dept. W, 715 Persons Bldg., Macon, Ga.

FREE Cadillac, \$10,000 yearly. Cars, appliances wholesale. Strateway, 2114-E, Charlotte 1, N. C.

SELL And repair vacuum cleaners. Write for new free catalog. Easy to read, all cleaners and parts. Eder Vacuum Cleaner Co., Dept. 15U, 13345 Livernois, Detroit 38, Mich.

IMPORTS. List of 50 German and Japanese exporters, who will send samples of their products upon request. All correspond in English. Only \$1.00 postpaid. Henry Baasen Importer, Dept. CT-45, 328 Fullerton Ave., Chicago 14, Illinois.

YOUR Photo on stamps. No investment. No stock. Big profits. Free samples. Miniature Photostamps, Box 44-B, New York City 67.

MAKE \$6 To \$10 per hour sharpening saws and lawnmowers. Our Acme equipment used by thousands of successful shops throughout United States and Canada. Free literature. No obligation. Max Mfg. Co., 138 Stockton Ave., San Jose 26, Calif.

MAKE Chipped glass nameplates. Resilvering mirrors. Electroplating. Outfits furnished. John Sprinkle V60, Marion, Indiana.

NOW Buy in small lots direct from the importer. Gifts, purses, tools, everything for everybody. Current bulletin 25¢. Young's, Pleasantburg, 5102, Greenville, S. C.

MAKE \$46 From square foot plywood; jig saw necessary. Free information. Woodart, Bridgewater, Mass.

LIQUID Rubber. Make flexible molds. Free sample. Chaney, 1907-A East Road, Jacksonville 11, Florida.

BECOME Importer and mail order dealer. Greatest opportunity of today! Free details. International Associates, Dept. PM, Hyde Park National Bank Bldg., Chicago 13, Ill.

5000-WORD Report on opportunities in booming Mexico \$3.00. Joseph Weston, 715 Broadway, San Diego, California.

WANTED: Home producers, to be subcontractors. Cast plastic products for manufacturers in our clearing house service. Thousands of easily made items required. Cash in at home, without previous experience. Plastic Service Associates, Dept. T-PM, East Boston 28, Massachusetts.

COSTS 8¢—Retail \$1.00. Automotive product. You manufacture, distribute. Easy! Wilsons, Box 505, Princeton, W. Va.

"MAILORDER Laws and Regulations," explains necessary licenses, different taxes, legal requirements, etc., \$1.00. Tasker, 1603 Peach Street, Alexandria, Virginia.

MAIL Order advertising agency executive reveals sensational no-risk advertising and merchandise methods. Start in office or home; minimum capital; positive profits. Free details: Impact! 3407 Prospect Avenue, Dept. 11-7, Cleveland 15, Ohio.

NEW Products wholesale. Bargain close-outs. George Lucas, Bellevue 5, Wash.

MONEYMAKING OPPORTUNITIES

FREE Introduction copy to "New Horizons" for homeworkers. Shields Publication, Box 164A, Miami 38, Florida.

STEADY Income. Easy project. Tremendous demand. Yours for \$2.98. Betterworth, Vidor, Texas.

PRINTING Wholesale—Save 50%. Start brokerage. Elichs, 3035 Marvin(B), Toledo, Ohio.

"HOW To Win Prize Contests." Free information. National, 9128-P S.W. 26th, Portland 19, Oregon.

MAIL Order ideas, suggestions, methods. \$1.00. Box 4066, Wichita Falls, Texas.

DO It yourself. What? Repair TV, build furniture, make barbecue, plumbing repairs, build boats, do house wiring, remodel home, lay tile, modernize kitchen, repair home, and scores of other things you can do yourself. Books covering each subject, only 25¢. Send for descriptive list. It's free. Popular Mechanics Press, 200-LB East Ontario St., Chicago 11, Ill.

DIRECTORY! Where to obtain free merchandise, books, literature, other valuables! Directory, \$1.00. National, P.O. Box 606-L, Redwood City, Calif.

\$100.00 WEEKLY Spare time with a tape recorder! Proven facts free! Dixieland Publishers, Asheboro 2, N. C.

LEARN Technical metaphysics and insure your future. Easy, inexpensive correspondence course. Simplest method known. Diploma. Write: Premier College of Technical Metaphysics, 2532 McKenzie St., Vancouver 8, B. C., Canada.

BUY Wholesale! 30-80% discounts! Appliances, gifts, typewriters, tools, watches, sporting goods, jewelry, cameras, housewares, etc. Consolidated Distributors, Clifton 28, New Jersey.

THEY Hand him \$100! Free plan "Secret Journal Hidden Dollars." Work home! Publics, Oceanside, Calif.

HOTTEST Mail order plan ever! Sell photos, films, art novelties. Huge proven profits! Free details! Ampro, 429 South Western Ave., Dept. 1, Los Angeles 5, California.

ADS Running under this heading sell printing. Ask me for proof. I'll gladly send you amazing facts. Ask for Folder "P." F. W. Johnson, 200 E. Ontario St., Chicago 11, Ill.

AMAZING Successes through franchises! Become exclusive franchise holder your territory. Information rushed. National Franchise Reports, 333 North Michigan, Chicago 1.

FREE Folio "\$5,000-\$45,000. Unlimited Vacations." No merchandise. Unknown! Work home, sparetime! Haylings, Carlsbad, Calif.

GENERAL Contest Bulletin. Lists contests monthly. Sample, 25¢. 1609 1/2 East 5th, Duluth, Minn.

READ Progressive Mailtrade, the magazine that tells how to make money by mail. Dime brings sample and special offer. Progressive Mailtrade, Box 357, Sheboygan, Wisconsin.

RAISE Rabbits on \$500 month plan. Plenty markets. Free details. White's Rabbitry, Mount Pleasant, Michigan.

BIG Money raising, fishworms and crickets. Free literature. Carter Hatchery, Plains, Georgia.

EARN Money evenings copying and duplicating comic cartoons for advertisers. Adservice, Argyle 1, Wisconsin.

SELL Titania gems. Far more brilliant than diamonds. Catalog 10¢. Diamonite, 2420-M 77th, Oakland 5, California.

VENDING Machines—No selling. Operate a route of coin machines and earn amazing profits. 32-page catalog free. Parkway Machine Corporation, Dept. 27, 715 Ensor Street, Baltimore 2, Maryland.

FREE Book "505 Odd, Successful Businesses." Work home. Pacific, Oceanside, Calif.

PRIZE Contests provide fabulous and confidential home income opportunities! Here's how and where to win your share! Send stamp! National Contest Bulletin, Box 2685-P, Miami 16, Florida.

YOU'LL Like goat milk! Profit and health with dairy goats. Booklet plus year's subscription monthly magazine: Special \$1. Dairy Goat Journal, Columbia, G-32, Missouri.

MAKE \$5,000 Yearly sparetime raising mink, chinchillas, nutria, etc. Free booklet reveals proved plans. Write Furs, 588 Mt. Pleasant Road, Toronto 1, Canada.

MAKE Top money collecting snakes, lizards, turtles, toads, frogs. We pay guaranteed prices. Details 25¢. Biological Exchange, Dept. 15b, Box 5302, El Paso, Tex.

WE Pay \$3.50 lb. Grow mushrooms. Cellar, shed and outdoors. Spare, full time, year round. We have over 25,000 customers. Free book. Washington Mushroom Ind., Dept. 173, 2954 Admiral Way, Seattle, Wash.

DOLLARS Every day! It's magical—You keep all the dollars. Setup free. Otto Miller, Box 583-W, Oshkosh, Wis.

TRAVEL Anywhere, fast, free. Send \$1.00 for Hitch-hikers Guide, R.F.D. #1, North Lawrence, Ohio.

JOIN The prosperity parade with a mail order bookshop in your own home. Valuable information free. Practical Publications, 3974-F Milwaukee, Chicago 41, Ill.

LEARN Profitable drapery making in your home. Free literature. VZ Sales, 123 E. Poplar, San Mateo, California.

MAKE Money, mailing sample business cards. Vosacek Printing, 4444PI Ute, San Diego 17, Calif.

READ Bargain Magazine! Keeps you informed on hundreds of sensational buys every month. Breath-taking, money-saving, money-making offers of merchandise as low as 10¢ and 25¢ on the dollar! 25¢ brings sample and special offer. Glass, Ellwood City, Penna.

60% PROFIT Cosmetics \$25 day up. Hire others. Samples, details. Studio Girl-Hollywood, Glendale, Calif., Dept. 1277H.

START A buying service, buy wholesale thousands nationally advertised products. Make big profits selling at sizable discounts. Postcard brings details. American Buyers, Hertel Station, Buffalo 16-D, New York.

"50 NEW Home-Business Ideas" booklet free. Coast Industries, B7C, Los Angeles 61.

EXECUTIVE Secrets revealed! Learn about business. How to earn profits—How to operate your own business. How to better yourself and your family's income. Taught by experts. Free details write, National Business Consultants, Office P7C, Los Angeles 61, Calif.

\$250.00 WEEK Spare time profit possible. Earn at home with new fascinating printing method. \$5 starts you, send no money now. Free confidential facts and valuable samples. Screen-Print, 27C, Los Angeles 61.

MAKE Money writing short paragraphs! No tedious study. I tell you what to write, where and how to sell; and supply list of editors buying from beginners. Many small checks add up quickly. Write to sell, right away. Send for free facts. Benson Barrett, Dept. C-27-G, 7464 Clark, Chicago 26.

MEN And women wanted to start home business in spare time with little table-top rubber stamp machine. Easy to earn up to \$9.80 an hour without previous experience. Full particulars free by mail. Send postcard to Roberts, 1512 Jarvis, Room CR-2-S, Chicago 26, Ill.

MEN—Women! Start money-making plastic laminating business at home in spare time. Material that costs 11¢ brings back \$2.58. No canvassing or selling but mail orders bring in \$20 a day. Write for full particulars free. Rush name on postcard to Warner, Room CL-2-S, 1512 Jarvis, Chicago 26, Ill.

"MAKE More money with less work." Your original exclusively created Sloganeers' slogan will produce results. Write Sloganeers, 235-Fifth Ave., No., St. Petersburg 1, Fla.

FORMULAS, PLANS, ETC.

LATE, Modern manufacturing formulas. List free. Moon Chemical, Martville, New York.

FORMULAS For latest money-making discoveries. New! Good! Valuable literature free! Miller, Chemist, 1517-D, Tampa, Florida.

FREE Formula catalog. Anything analyzed. Reasonable. Western Chemical, Salem, Oregon.

FORMULAS; All kinds, latest, best. Literature free. Kemixal, Park Ridge, Ill.

PRACTICAL Formulas. Lists free. Cummings, Chemist, Gordon Ave., Syracuse 4, N. Y.

EXPORT—IMPORT

IMPORTED Merchandise. Amazing savings on German, Japanese, and Swiss cameras, photographic, and optical goods; European firearms and accessories; Swiss, German watches; hi-fi and electronic equipment; etc. All famous names supplied in any quantity. Import direct and save! Write for details. International Import Service, 22-7M Oakland Square, Pittsburgh 13, Pennsylvania.

CHEMISTRY

ATOMOTRON, Model atom smasher, \$14.95. Raybaby cloud chamber, \$3.95. 3-in-1 electromagnet, \$14.95. Send 25¢ for literature. Atomic Laboratories, Inc., P. O. Box 343, Berkeley, Calif.

CHEMICALS And apparatus for industrial, analytical, and private laboratories. Catalog 25¢. Dept. M-50, Biological Supply Co., 1176 Mt. Hope Ave., Rochester 20, N. Y.

ILLUSTRATED Catalog: Chemistry, mineralogy, biology 20¢. Tracey Laboratories, Evanston, Illinois.

60 PAGE Booklets! "Beginners Chemistry," "Chemistry," "Physics," "Relativity," "Light," "Astronomy," "Electricity," "Radio," "Useful Tables," "Scientific Oddities," 10¢ each. Franks, 3121 South Racine, Chicago 8.

CHEMICAL Curiosities! Chemical puzzles! Chemical games! Chemical novelties! All only \$1.00. National, P.O. Box 606-L, Redwood City, Calif.

AMAZING New book of science. Experiments, formulas, and catalogue of laboratory supplies. Only 25¢. National Scientific Co., Dept. PM-7, 500 West Road, Lombard, Illinois.

PLASTICS

FIBERGLASS Patio sheets 58¢ sq. ft. Plexiglas 95¢ sq. ft. Liquid casting plastic \$1.95 qt. Send 10¢ for literature. United Plastics Products Co., Dept. 7, Roebling, N. J.

PLEXIGLAS, Square foot cost, 1/16", \$1.20; 1/8", \$1.52; 3/16", \$1.86; 1/4", \$2.21; 3/8", \$3.23; 1/2", \$4.36. Colors add 10%. Send 15¢ for postage. Aristocrat Plastics, 23-25 Sussex Avenue, Newark, N. J.

LEARN Plastics fabrication for spare time income. Low cost home training now available. Write for free booklet. Interstate Training Service, Dept. D-3, Portland 13, Ore.

FAMOUS Sculptor. Internal carvings to order. Edwin E. Pinkbeiner, 1621 N. Fredrick St., Burbank, Calif.

LAMINATING Supplies. Free price list. Solomonson, 46 Cornhill, Boston 8, Mass.

PLEXIGLAS, Fiberglass, polyester, epoxy, acetate, vinylite, styrofoam, acrylic. Instructive wholesale-retail catalog, free. Gem-O'-Lite, 3529 Cahuenga, North Hollywood, Calif.

BOXES, Plastic. Free list. Althor, 170 Bay 23 Street, Brooklyn, N.Y.

NEW Liquid casting plastic, clear, colors. Embed real flowers, coins, photos. New manual shows fine things you can make at home and sell at big profit. Send 25¢. Castolite, Dept. H-101, Woodstock, Illinois.

HELP WANTED

SMALL Southwest college with excellent research facilities is seeking the services of experienced instrument makers. Beginning salary range \$5000 to \$6000 per annum depending upon qualifications. Excellent climate for health seekers, outdoor recreating including hunting, fishing, swimming, and golf. Direct letter of application to Arthur P. Stanton, Personnel Manager, Campus Station, Socorro, New Mex., describing qualifications and salary requirements. Include recent photograph.

AGENTS WANTED

IF YOU want to earn money fast, I'll send you free sample stocking of newest stretch DuPont nylons to sell at only \$1 a pair. American Mills, Dept. 618, Indianapolis 7, Ind.

SHINE Shoes without polish. New invention. Lightning seller. Shoes gleam like mirror. Sample sent on trial. Kristee 67, Akron, Ohio.

WANT Extra cash? Send your name for money-making Christmas card and gift samples. Showing them to friends pays you as much as 50¢ to \$1.25 profit per item. \$150.00 easy! Samples on approval. \$1.25 gift offered free! Midwest, 1113 Washington, Dept. 487-H, St. Louis 1, Mo.

WHOLESALE—Handmade glass figurines. 4 samples and list \$1.40. Glass Figurines, 18724 Martha, Saratoga, Calif.

60% PROFIT Cosmetics \$25 day up. Hire others. Samples, details. Studio Girl-Hollywood, Glendale, Calif., Dept. 1277H.

BUY Wholesale thousands nationally advertised products at big discount. Free "Wholesale Plan." American Buyers, Hertel Station, Buffalo 16-A, N. Y.

AMAZING Greeting card assortment pays 85¢ cash profit on \$1.25. Make \$85.00 fast! Gift bonuses besides. Outstanding new Christmas cards, novelties, free imprint album. Samples on approval. Act fast, get golden egg banks free. Creative, 4401 Cermak, Dept. 512-G, Chicago 23.

FREE! Beautiful feather pictures, 200% profit! Apartado 9038, Mexico 1, D.F.

MAKE \$50-\$75-\$100 Again and again. Show friends New Idea Christmas, all occasion boxed assortments, gift wrappings. Profits to \$1.00 per box. Write for feature boxes on approval, 54 free personal Christmas card, stationery samples. Free catalog. Sensational free offer. New England Art Publishers, North Abington M-70, Mass.

AMAZING Profits. Easy seller. Abraham Lincoln's liquor license, bond, replica. Sample \$1. Outlet, Box 336, Lindenhurst, New York.

MEN-Women agents: Sensational new moneymakers—Beautifully hand-painted, plastic personalized photo enlargements, compacts, rings, bracelets, sockets, etc. Simply take orders, pocket 40% commission. We deliver and collect. Sales outfit free. Novelco, 3343 North Avenue, Chicago 47.

NEW Bathroom deodorizer. Hangs on wall. Banishes odors bathroom, kitchen. Lightning seller. Samples sent on trial. Kristee 68, Akron, Ohio.

MAKE \$50-\$300 Extra money fast. Show big value \$1.00-\$1.25 Christmas, everyday greeting card assortments, gift wrappings, costume jewelry, gifts, stationery. Profits to 100%. Cash bonus. Write for newest assortments on approval. Free gift offer. Free album name imprinted Christmas cards, catalog, details. Hedenkamp, 361 Broadway, Dept. PM-50, New York.

RUN Spare-time greeting card and gift shop at home. Show friends samples of our new 1957 Christmas and all occasion greeting cards and gifts. Take their orders and earn to 100% profit. No experience necessary. Costs nothing to try. Write today for samples on approval. Regal Greetings, Dept. 70, Ferndale, Michigan.

\$10,000.00 AND UP yearly. Now earned by hundreds who sell heavy 3-ply stainless steel cookware, chinaware and cutlery. Opportunities for managers positions and higher earnings available. Age is no handicap. Write to: Sales Manager, P.O. Box 3038, South Bend 19, Ind.

JUMBO Profits selling slingshots to kids, stores. Buy wholesale. 50¢ for sample and information. Designed Products, P.O. Box 964-N, Concord, California.

IT'S Hot. New. Amazing miracle ash-tray. Automatically extinguishes fire. Free sample offer. Golden Gate, Box 222, Station A, Manchester, Conn.

MAKE Up to \$3.00 hourly selling cookware, appliances, dinnerware, silverware, cutlery, jewelry, watches, gifts, books, tableware, housewares. Satisfaction or money refunded. Free wholesale catalogue and details. L. G. Clark, P.O. Box 272, Greenville, Ohio.

WELL-Known importer seeks volume producing agents and distributors for fully guaranteed imported midjet radio, 3 1/4 x 5" - 4 tube superhet, weighs 14 oz. 2 1/2" speaker (interchangeable earphone), leather slipcase, strap, batteries. Sample on request. Enclose money order. \$18.50 complete. Extra set of batteries \$1.20. Albert International, 935 Broadway, New York 10, N. Y.

200% PROFIT. No-Kro stops battery and cable corrosion. Guaranteed. Whirlwind seller. Protected territories. Write No-Kro Company, Chanute, Kansas.

CALIFORNIA Sweet smelling heads. Sensational sellers. Particulars free. Mission, 2328-PM W. Pico, Los Angeles 6, California.

EXCLUSIVE Line of personal initialed buckles, belts, cap badges, 3,000 emblems, uniforms, shirts, caps, etc. Hook-Fast, Dept. PM, Roanoke, Virginia.

WHOLESALE Catalog! Clothing, linens, housewares. Write Bostonian, 14 Dock Sq., Boston 8, Mass.

AGENTS - 300% Profit selling genuine gold window letters; stores and offices. Free samples. Metallic Sign Letter Co., 1217-D West Newport, Chicago.

YOUR Ad in this space will get some good agents for you. Yes, I'll prove it. Write for Folder "A" right now P. W. Johnson, Classified Advertising Manager, Popular Mechanics Magazine, 200 E. Ontario St., Chicago 11, Ill.

GOLDMINE of 600 money makers. Copy free. Specialty Salesman Magazine, Desk 5-B, 307 N. Michigan, Chicago 1.

GOLD Or silver letters, numbers. Windows, doors, trucks. 1" to 6". 500% profits. Free samples. Atlas-T, 544 West 79th, Chicago 20.

PRINTING. Advertising salesmen—Excellent moneymaking sideline selling decalcomania name plates, small quantities. Automobile initials, sign letters. Free samples. Ralco, XL, Boston 19, Mass.

YOUR Own business—Used suits \$1.50, overcoats 65¢, maokinaws 35¢, shoes 12 1/2¢, ladies coats 30¢, dresses 15¢. Enormous profits. Catalog free. Nathan Portnoy Associates, 605-AA West 12th Place, Chicago 7.

EASY Handwork makes fast-selling articles. Sample free. Sunmade Company, Brockton 64, Massachusetts.

SELL Famous \$3 fire extinguishers. Past sales, liberal profits. Write Fire-Killer, Box 182, Hazleton, Penna.

BUY IT WHOLESALE

WHOLESALE Catalog! Discounts to 80%! Clothing, appliances, tools, housewares, jewelry, etc. Midwest, IMP-156, Pontiac, Illinois.

FREE Wholesale catalog. Gifts, appliances, housewares, cookware, cutlery, watches, dinnerware, silverware, jewelry, etc. Discounts to 80%. Topval Corp., Lindenhurst 424, N. Y.

BIG Multicolor wholesale catalog! Housewares, appliances, clothing, silverware, cookware, luggage, binoculars, radios, phonographs, cameras, recorders, projectors, typewriters, shavers, sporting goods, toys, tools, sewing machines, watches, jewelry. Name brands. Huge discounts. Just postcard: Selbyco, Decatur 153, Illinois.

BUY Your electrical supplies wholesale. Materials for any type of electrical installation. Includes fixtures. Free catalog. Bay Wholesale, P.O. Box 295, San Bruno, Calif.

BALL Pens. Full-view, liquid lead and three style retractables. Choice of 3 samples. 50¢. Quantity prices available. Nucleus, 2440 Amsterdam Ave., New York City 33.

BARGAINS, Joblots, closeouts. 2000 items. Tremendous savings, clothing, toys, gifts, jewelry, television, etc. 25¢ brings wholesale catalog, \$1.00 merchandise certificate included free. Reliable Jobbing, 311-B North Desplaines, Chicago.

ELECTRIC Guitars, amplifiers, wholesale. Free catalog. Carvin PMW, Covina, Calif.

USED And new watches \$2 up. Free list. Southern Watches, Gray, Georgia.

DIRECTORY! Where to obtain free merchandise, books, literature, other valuables! Directory, \$1.00. National, P.O. Box L-606, Redwood City, Calif.

SALESMEN—DISTRIBUTORS

AD Matches! Sell amazing designs—10, 20, 30, 40 and 240-light book matches. Bigger spot cash commissions; every business a prospect. Low prices for high quality. Repeats. Start without experience; men, women; full, part time. Buy nothing! Sales kit furnished. Match Corp., Dept. PM-91, Chicago 32, Illinois.

WILL You wear new suits and topcoats without one penny cost and agree to show them to friends? You can make up to \$30.00 in a day even in spare time, without canvassing. J. C. Field & Son, Inc., Dept. K-1826, Harrison & Throop Sts., Chicago 7, Illinois.

FABULOUS Patented sewing machine air-conditioner \$1.00. Descriptive circular. Weidner, 131 West 45th, New York City.

CALENDARS. Advertising novelties, matches. All styles, including religious, varnished, 12 sheet, girls. Hundreds of advertising novelties, book matches, etc. Fleming Calendar Co., Sales Division, 6539 Cottage Grove, Chicago 37, Ill.

HANDICAPPED People. 18-30, Travel. Permanent jobs. Excellent pay. Transportation furnished. Advancement opportunities. Help Wanted, Box 4606, Kansas City 9, Missouri.

MAKE Extra money. Cash commissions. Everybody buys easy-to-sell advertising book matches. Union label. All sizes. Cuts for all businesses. Powerhouse selling kit free. Steady repeat business. No experience necessary. Superior Match Co., Dept. M-757, 7528 S. Greenwood, Chicago 19.

SOOTHING Health giving minerals from world famous Hot Springs, Arkansas. Arko, 202 W. Turnbull, Midwest City, Oklahoma.

EXTRA Cash for employed man. Up to \$3.25 hourly. Commission, bonus. No experience. Demonstrate patented Air Cushion Shoes. Samples supplied. Charles Chester Shoes, 741 Brockton, Mass.

MULTI Pocket auto briefcase. U. S. pat. pend. Carries maps, papers, sandwiches, etc. Hooks inside window. E-Z-Reach. Big seller with millions of prospects. Sample, particulars, Vinyl \$1.95, leatherette \$2.95. Money back guarantee. Grand Novelties Mfg., Box 103, Elkton, Md.

TRADING Stamp salesman! Large discount catalog firm recently inaugurated unique stamp feature into already nationally known business. Protected territory! Top commissions! Leads! Kroboth's, W. 1118 Grace, Spokane 17, Washington.

PROMISES With profit for you. Have you promised yourself a business of your own? Better-than-average income? A secure future? Turn these promises in your spare time into a permanent, profitable business of your own. Learn the facts today! No books. Contact: Belco Products Corporation, 544 South Mariposa Avenue, Los Angeles 5, California.

100% PROFIT Selling stock rubber stamps. Send \$1.00 for sample kit refundable. Grant Stamp Co., 63 Grant St., Buffalo 13, New York.

EXCLUSIVE "Trade-in sale" of old shoes sells new Air Cushion Shoes for you! Highest commission, bonus. Paid vacation. Samples supplied. Charles Chester Shoes, 740 Brockton, Massachusetts.

AGENTS, Distributors, 200% profit sell service stations, auto lots, etc. Spinners, whirlers, streamers, etc. Free sales kit. Robbins Manufacturing, Los Angeles 18, California.

AMAZING Insecticide line. Safe indoors, outdoors. Sells fast. Demonstrates. Great repeater. Wonderful profits. Distributors opportunity. Write Sayer Associates, 426P1 Portland Bldg., NW, Washington 5, D. C.

PROFIT; Selling 3 merchandise items; repeats, too. Sterling, Corona 68, N. Y.

TERRIFIC Profits in food supplement industry with old established company. Franchise distributors wanted. Organic Sea Products, 907 Harrison Street, San Francisco 7, California.

\$200 WEEKLY Calling on businesses. Victor, Dept. 1417, Box 166, Merrill, Wis.

BIG Profit cosmetics. Hire others. Millionaire hair pomade (anti-kink) for colored people is the hottest item. Cosmetics is the big money line today. Continental Co., Box 598, Roanoke, Virginia.

NEW Jobs open in selling! Send name, address for five free issues of Opportunity Magazine's money-making guide. Listing hundreds of companies who'll pay you well, full or part-time. No experience needed. Opportunity, 850 N. Dearborn, Dept. 17, Chicago 10, Ill.

GOLF Player's delight, combination spike wrench and tee setter, light as feather, guaranteed unbreakable, sample \$1.00 postage paid. Wolfe Specialty, 350 Stanford Street, Akron 14, Ohio.

EMPLOYMENT INFORMATION

GET This: Sunday classified ads mailed from Florida, California, Arizona, New Mexico, Oregon, Washington and Texas. \$1.00 each. Satisfaction or money back. Patterson, 941 LeJeune, Miami, Florida.

AMERICAN, Overseas jobs, high pay, men, women, transportation paid. Free information. Write Transworld, 200-M West 34 St., New York 1, N. Y.

FORMOSA Jobs. Big pay, travel, house. Hundreds needed. Applications \$2. The Chinese Magazine, P.O. Box 270, Taipei, Formosa.

COPYRIGHTED Reports on best paying jobs with travel, adventure, promotions, construction, aviation, shipping, laborers, clerical, trades, supervisory, factory, unusual opportunities. Many types of work. Skilled and unskilled. Foreign and state-side openings for men and women. Only \$2.00 (\$2.25 airmail), including registration-advisory service. Satisfaction guaranteed. Included absolutely free: special reports on Alaska, Spanish airbase construction, South American opportunities and husband-wife foreign jobs. Research Services, Suite 513-PMS, Meramec Building, St. Louis 5, Missouri.

FOREIGN, Alaskan, U.S.A., jobs! To \$1500.00 monthly! Million Americans employed overseas. Copyrighted reports. Who to contact for highest paying jobs. Laborers, trades, truck drivers, office, engineers, many others. 52 countries—St. Lawrence project, Spain, Latin America, Northern project, Europe. Year registration-advisory service. Application forms. Unconditional money-back guarantee! \$2.00 (airmailed \$2.25). C.O.D.'s accepted. International Reporter, St. Louis 1-PX, Missouri.

ARIZONA. A worker's paradise. All skills, trades needed. Giant gov't project. University of Arizona reports labor shortage foreseen. Available publications: 1. "Arizona Jobs," a complete analysis \$1.00. 2. "Western Living," a cost survey \$1.00. 3. "Inside Facts," our prospectus 75¢. For all three reports, \$2.00. Limited offer. Satisfaction guaranteed. Arizona Employment Consultants, Box 10245, Phoenix, Ariz.

SOUTHERN California job opportunities. Skilled, unskilled, clerical, construction, sales, technical. Trainees also. \$3.00 (airmailed \$3.25). California Enterprises, 610 South Broadway, Suite 623, Los Angeles 14, Calif.

JOBS On ships and yachts going to foreign countries. Davenport Seamen's Service, G.P.O. Box 1354, New York 1, N. Y.

UNLIMITED Job opportunities. Details free. Personnel Associates, Box 1018, Edinburg, Texas.

NEW York City, Philadelphia classifieds \$1.00 each. Joseph Drwinka, 83 Kentucky Lane, Levittown, Penna.

TRUCK Drivers, laborers helpers, craftsmen over \$1,000 monthly for northern bases. For information South America, Spain, Europe, Alaska, etc. Foreign job listing \$1.00. Universal, 1110 Commerce Building, St. Paul, Minn.

JOBS On ships! Experience unnecessary. Transoceanic, Box 494, Baltimore 3, Md.

EDUCATIONAL AND INSTRUCTION

LEARN To earn big money in specialized automotive service! Under our proven plan we train you in our up-to-date school, help you get started in wheel alignment, balancing, tire truing, or related safety and car comfort services. Nationally advertised! Small investment brings immediate return. Equipment pays for itself out of profits. Write for full details. Address Box No. 697, Rock Island, Ill.

COMPLETE Your high school at home in spare time with 60-year-old school. Texts furnished. No classes. Diploma. Information booklet free. American School, Dept. XB45, Drexel at 58th, Chicago 37, Illinois.

SWEDISH Massage, learn at home, Diploma, Dr. Swanson School Swedish Massage, Illinois licensed vocational school, 3809 Alta Vista Terrace, Chicago, Ill.

ENGINEERING Degrees earned through home study. Residence courses also available. Pacific International University, 5719-B Santa Monica Boulevard, Hollywood 38, California.

FINISH High school at home, spare time. No classes. Diploma awarded. Write for free catalog. Wayne School, Catalog HF-76, 2527 Sheffield, Chicago 14.

BE A real estate broker. Study at home. Send for free catalogue. Midwest School of Real Estate, 68 North Chicago Street, Joliet, Illinois.

LEARN Civil and criminal investigation at home. Earn steady good pay. Institute Applied Science, 1920 Sunnyside, Dept. 168, Chicago 40, Ill.

BLUEPRINT Reading — Train at home. Learn to read blueprints with confidence in 10 easy lessons. Write today Belton School, 1059-P North Lawndale, Chicago 51.

LEARN Another language at home, easily, quickly, naturally with Lingua-Phone. The world's standard conversational method. You learn to speak French, Spanish, German, Japanese, Modern Greek — Any of 34 modern languages available on life-like conversational recordings. It's like living in another country. Complete language course available on free trial. Send for free book and details of free trial. No obligation. LinguaPhone Institute, T-83-077 Radio City, New York City 20.

LEARN Locksmithing from licensed experts at home in spare time. High pay. Free booklet. Locksmithing, Rutherford 1, N. J.

DIESEL! Learn to install, operate and maintain all type engines, spare time. Write for free book. Utilities Diesel Training, Dept. DC-66, 2521 Sheffield, Chicago 14.

WE Pay \$3.50 lb. Grow mushrooms. Cellar, shed and outdoors. Spare, full time, year round. We have over 25,000 customers. Free book. Washington Mushroom Ind., Dept. 174, 2954 Admiral Way, Seattle, Wash.

TYPING Simplified. Complete course \$1. Lutt, 319 Alabama, Brooklyn 7, N. Y.

DRAFTING — Building or mechanical. Learn at home in spare time, at low cost, from 60-year-old school. Information free. Write American School, Dept. DB45, Drexel at 58th, Chicago 37, Illinois.

TIMESTUDY—Your key to positive personal profits. Associated Techniques, Box 235, Hollidaysburg, Penna.

TRANSFORM Yourself via subconscious. Free publication. Box 847 (H-7), Ocean Park, Calif.

WELDERS Earn big money. Easy to learn arc, gas, automatic welding. New equipment, low cost training in non-profit school. GI approved, free booklet. Hobart Welding School, Box M-771, Troy, Ohio.

MACHINISTS. Get the Oldtimers tricks. Use cutoff tools without chatter. Get micro inch finishes without polishing. Turn eight foot shaft in six foot lathe. Better method for threading. Send dollar to Oldtimer, Box 207, Devon, Conn.

EARN Degree. Free bulletin. Home-study only. Midwestern Bible School, 1060 Broedripple, Indianapolis.

BECOME A newspaper printer. Study at home. Well paying business. Easily mastered. Newspaper printers in great demand. Write now for full details. Thomas Smith, P.O. Box 3987, Sarasota, Fla.

PIANO Tuning pays. Big money in spare time. Learn at home in 30 days. No musical knowledge necessary. Phonograph, records, tools and instructions furnished. Personal instructions available. Free catalog. Capital Tuning School, 16 Southwest Second, Fort Lauderdale, Fla.

EARN College degrees, correspondence. Metropolitan University, Box 86, Glendale 5, California.

BOOKS. Free 1957 catalog. 100 pages. Text, vocational, educational, instructional subjects. Millions of volumes, new and used. Bargain prices. Books bought, Est. 1902. Long's College Book Co., Dept. PM, Columbus 1, Ohio.

LEARN Appliance service and repair. Motors, washers, refrigeration, cleaners, everything. Free booklet. Armstrong, 11027-A South Vermont, Los Angeles 44.

STUDY For Doctor's degree of psychology, metaphysics and divinity. Correspondence courses only. College of Divine Metaphysics, Dept. P-M, 2811 North Illinois, Indianapolis 8, Indiana.

LEARN Mineralogy at home. Diploma course. Fortunes now being made in uranium and other minerals. Free catalog. Mineral Science Institute, Desk 2, 159 East Ontario, Chicago 11.

HIGH School diploma at home. Licensed teachers — Approved materials. Southern States Academy, Box 144-MX, Station E, Atlanta, Georgia.

BE A real estate broker. Study at home. Write for free book today. GI approved. Weaver School of Real Estate, 2018P Grand, Kansas City, Missouri.

USED Correspondence courses and books sold and rented. Money back guarantee. Catalog free. (Courses bought.) Lee Mountain, Pisgah, Alabama.

EARN While you learn. Auto and diesel mechanics master this top paying trade. Many graduates earn \$100 a week and up. Approved for Korean veterans. For free information write Dept. No. 256, Nashville Auto-Diesel College, Nashville 3, Tenn.

HELP Yourself to abundant living. Our courses have aided students to richer fuller lives. Learn secret of contentment, happiness. Earn degrees Pa.D., M.S.D. Write for free book. College of Universal Truth Correspondence School, 23-C E. Jackson, Chicago.

PIANO Tuning pays. Learned easily at home. GI approved. 59th year. Free booklet. Niles Bryant School, Dept. P, 3731 Stockton, Sacramento 20, Calif.

LEARN While asleep! Details free. Research Association, Box 610-MC, Omaha, Nebraska.

LEARN Chemistry at home! Earn diploma! First 5 lessons, supplies, \$1.00. National, P.O. Box 606-L, Redwood City, Calif.

EARN College degree. Remain employed. Sequoia University, 5625 Melrose, Los Angeles 38, Calif.

BOOKKEEPERS! Increase your earnings! Operate your own simplified "Dollar-A-Week" bookkeeping and tax service. Full or spare time. Details free. No obligation. Ellis, Box 200, Cedar Grove, North Carolina.

WANT A diesel job? New opportunities to increase income. Higher pay. More money. We can help you qualify. Tools, Shop method home training. Write today! Diesel, Tractor, Heavy Equipment Division, Interstate Training Service, Dept. B-3, Portland 13, Oregon.

I Want to send you proof of the wonderful pulling power of Popular Mechanics classified pages. What's your proposition? Write me today. Include literature if possible. F. W. Johnson, Manager Classified Advertising, Popular Mechanics Magazine, 200 E. Ontario St., Chicago 11, Ill.

INVESTIGATOR Training. Phillips Secret Service System, 1917-B North Keneth, Chicago 39.

USED Correspondence courses and educational books bought, sold, rented. Free catalog. Educational Exchange, Menlo, Georgia.

DRAFTSMEN, Shop men, students. Learn die design engineering. High pay career, or home business. Paquin system guarantees results. Details free. Northeast Technical Institute, 53 May Street, Worcester 10, Mass.

MIDLAND Linotype School. Charles City, Iowa. Civilian and veteran courses. Free placement. Established 1909.

BE An investigator. Write for free details. State age. National Detective Academy, 535 East 4th Street, Scottsdale, Ariz.

PHYSICAL Therapy and massage. We train you at home. Earn big profits from your own private practice or work with hospitals and doctors. Free catalogue. National Institute, Desk 4, 159 E. Ontario, Chicago, Ill.

PLAYS, STORIES, MANUSCRIPTS

WANT Your book published? Learn how we publish, advertise, promote, distribute. Many successes. Free booklet PM. Vantage, 120 West 31, New York City.

WANTED: Book manuscripts, all subjects considered. Greenwich Book Pub., Attn. Mr. Zealand, 439 Fifth Ave., New York City.

CARTOONING, COMMERCIAL ART, SHOWCARD & SIGN PAINTING, TATTOOING

MASONITE Cutouts—Sign letters, 6 to 20 inches. Many styles. Free catalog. Berge Co., Gonvick, Minnesota.

AMAZING Sign system. Earn while learning. Straley, 410 S. Western, Springfield, Ohio.

YOU Can entertain with chalk talks. Catalog 10c. Balda The Cartoonist, Oshkosh, Wis.

LEARN Sign painting at home. Free talent test. Ben Kerns, Box 812-PM, Greenville, S.C.

TATTOOING Outfits, licensed course. Brochures 25c. Zeis, 728 Leslie, Rockford, Illinois.

CARTOONISTS—Art students: Talented? Do you know how and where to sell your drawings? Can you pay \$28.75 for professional coaching? Write to Cartoons-of-the-Month, Roslyn, New York.

ADVERTISING AGENCIES, LETTER WRITERS, FOR ADVERTISERS

ADVERTISING Ratebook leading newspapers, magazines, free. Chicago Advertising Agency, Chicago 4.

MAILING Lists most any classification \$5.00 1000. Your circulars mailed with ours \$4.00 1000. Write for our literature. Dixie Mailers, King, N. C.

ADVERTISING, Result-getting ads prepared, placed newspapers, magazines, radio, anywhere! Lowest rates. Catalogue free. Baker Advertising Agency, 189 W. Madison, Chicago 2.

WANT More business? Here's an amazing opportunity to increase your sales. Talk to thousands of interested readers of "Mechanica Popular." Our Spanish Edition covers the Latin American countries like a blanket. They're real mailorder buyers. Classified rate 75c per word. Try an ad in our next issue. Classified Advertising Department, Popular Mechanics Magazine, 200 East Ontario Street, Chicago 11, Ill.

RUBBER STAMPS AND OFFICE SUPPLIES

3 LINES \$1.00. Pad, case, valuable gift included free! ABC Products, Box 849-P, San Francisco 1, California.

3 LINE. Cushion base, indexed, \$1.00. Brower Specialties, Box 11, Sandwich, Ill.

8 HOUR Service, 3 lines \$1.00. Guaranteed. Bassler, Ludlow, Mass.

3-LINE Business-size \$1.50. Pocket stamp \$1.00. Seeburgers, Rubber Stamps, Palmyra, Mich.

TYPEWRITERS, DUPLICATORS, OFFICE DEVICES

PORTABLE Mimeograph! Carriable. The newest, cleanest, smallest and cheapest spirits machine. Weight 15 pounds. DuPont Distributors, Box 685, New York 1, N. Y.

RECONDITIONED Typewriters, duplicating, printing devices, \$25.00 up. Supplies. Appliances. DixieGraph, King, N. C.

PRINTING, MULTIGRAPHING, MIMEOGRAPHING, GUMMED LABELS

100 WATERMARKED Letterheads $8\frac{1}{2} \times 11$ and 100 $6\frac{3}{4}$ envelopes attractively printed \$2.00 postpaid. H. Hudson, Centredale 11, R. 1.

AMAZING Value, 1,000 "raised letters" business cards, \$3.50. Samples, Pioneer, Island Park 19, New York.

FREE Business printing catalog, illustrated. D. M. Press, Sebastopol, California.

50% UNDER Book price on all printing. Free estimates. Quality Printing, Continental, Ohio.

BUSINESS, Personal printing, W. Simons, 1027 Madison Street, Henderson, Kentucky.

100 BOND $8\frac{1}{2} \times 11$ (16#) Letterheads, \$1.00 postpaid. Wilson Printers, Petroleum, W. Va.

RIPPLETONE Correspondence paper, 100 name-address \$1.49 postpaid. Kalb, Box 1228, Palm Springs, California.

100 BUSINESS Cards \$1.00. Printers, 1418 Broadway, Rockford, Illinois.

500 NAME And address printed gummed labels, 3 lines \$1.00. No c.o.d.'s. Print clearly. Addison PM-7, 1840 Addison, Chicago 13.

FREE Catalog solves every printing problem! Discount Printing, 1116-M National Press Building, Washington 4, D. C.

1000 CRAFTSMANSHIP Process embossed business cards \$5.85. Ekstrom Offset Printing, 2915 Third Ave. So., Minneapolis 8, Minnesota.

1000 PERSONALIZED Labels in rolls \$1.00— $\frac{1}{2}$ " x $1\frac{1}{4}$ ". Please print. No c.o.d.'s. Hamilton-Ward, Westfield 10, Mass.

YOUR Name and address labels 500—\$1.00. Quick. Guaranteed. Houghton's. Erving, Massachusetts.

5000 3x5 BOOKPAPER Circulars \$11.00. Estimates, anything! Lonelm, Paulding, Ohio.

100 BILLHEADS \$1.00, 500—\$2.75. $5\frac{1}{2} \times 5\frac{1}{2}$, postpaid, printed your copy. Spaulding Press, Bethel, Vermont.

PRINTING By mail—Send 10¢ for catalog and samples. United Mail Order Service, Box 646, Elyria, Ohio.

TOP Quality printing, mimeographing. Free literature. Currier, PM, New Lebanon Center, N. Y.

MIMEOGRAPHING—Letters, pricelists, formulas, instructions. Lowest prices. Lem's Letter Shop, 5710 Stanton, Detroit 8.

OFFSET Printing—\$5.50 1000, $8\frac{1}{2} \times 11$, 16 lb. National Letter, 251 W. 42 St., New York City 36.

BUSINESS Printing, rubber stamps. Free catalog. Brose, 196 Clerk Street, Jersey City 5, N. J.

PRINTING OUTFITS AND SUPPLIES

TYPE Case specialists. Buy from manufacturer. Free catalog. King McKay Company, 23179 Telegraph Rd., Detroit 19, Michigan.

PRESSES, Type cabinets, supplies. List for stamp. Lincoln Press Company, 220-G Hartwell, Fall River, Mass.

RUBBER Stamp making presses, hydraulic operated, electrically heated. Sizes 5×8 ", 8×12 ", 10×15 " starting outfits. All kinds supplies. Custom Manufacturing, 601 N. Jefferson, Springfield, Missouri.

DO Your own printing. Save money. Simple rules. We supply everything. Print for others; good profit. Raised printing like engraving too. Have home shop. Details free. Kelsey Presses, V-11, Meriden, Connecticut.

PRINTING Presses, type, supplies, lists 2¢. Turnbaugh Service, Mechanicsburg, Penna.

MAKE Your own self-molding rubber stamps and printing cuts. Flexirubber, Argyle 1, Wisconsin.

OFFSET Press! Prints 20,000 copies, in colors! Build from scrap! Instructions, \$2.00. National, P.O. Box 606-L, Redwood City, Calif.

PATENT ATTORNEYS

PATENTS. "Proof of Invention" free. E. E. Vrooman, Registered Patent Attorney, 507 McKim Building, Washington 5, D. C.

"INVENTOR'S Guide" and "Record of Invention" free on request. Frank P. Ledermann, Registered Patent Attorney, 154 Nassau Street, New York City.

PATENTS—Irving L. McCathran, 515 McLachlin Bldg., Washington 1, D. C. Registered Patent Attorney.

REGISTERED Patent attorney offers services. Sanders, 6430 Evans, Chicago 37, Illinois.

INVENTORS: Without obligation, write for information explaining the steps you should take to secure a patent. John Randolph, Registered Patent Attorney, 203 Columbian Bldg., Washington 1, D. C.

INVENTION Record form free and "Patent Information Every Inventor Should Have." Carl Miller, Registered Patent Attorney, Woolworth Building, New York.

INVENTORS: When you are satisfied that you have invented something of value, write me, without obligation, for information as to what steps you should take to secure a patent. Write Patrick D. Beavers, Registered Patent Atty., 935 Columbian Bldg., Washington 1, D. C.

C. A. Snow & Co.—M427, Snow Building, Washington 1, D. C. Registered Patent Attorneys. Write for information.

CANADA—Ramsay Company Registered, 273 Bank Street, Ottawa, Canada.

MECHANICAL Skill alone is not enough to entitle you to patent protection; your invention must clearly show your exercise of the inventive faculties. As patent attorneys we feel better qualified than the inventor to recognize patentable invention. Sketch and describe your invention. Sign, date and have this disclosure witnessed by two people who are capable of understanding your invention. Have us make a preliminary search among U. S. patents already granted for similar types of invention. We report on the probable patentability of your invention and recommend your further course of action. Write for our instructive booklet, "Patent Protection for Inventors" and convenient "Evidence of Invention" disclosure form. Victor J. Evans & Co., 331-H Merlin Building, Washington 6, D. C.

INVENTORS—If you believe you have an invention, you should find out how to protect it. The firm of McMorow, Berman & Davidson with offices in Washington, D. C., is qualified to take the necessary steps for you. Send for copy of our patent booklet "How to Protect Your Invention." We will also send you an "Invention Record" form. No obligation. They are yours for the asking. McMorow, Berman & Davidson, Registered Patent Attorneys, 134-Y Victor Building, Washington 1, D. C.

INVENTORS: Learn how to protect your invention. Unless the inventor is familiar with patent matters, he should engage a competent registered patent attorney or agent to represent him. We are registered to practice before the U. S. patent office and prepared to serve you in handling your patent matters. "Patent Guide for the Inventor" containing detailed information concerning patent protection and procedure with "Record of Invention" form will be forwarded to you upon request—without obligation. Clarence A. O'Brien & Harvey Jacobson, Registered Patent Attorneys, 71B-G District National Building, Washington, D. C.

FOR INVENTORS

INVENTORS—Send for free Patent Information book and Inventor's Record. Registered Patent Attorney, Associate Examiner, Patent Office 1922-29, Patent Attorney & Advisor, Navy Department 1930-47. Gustave Miller, 77A Warner Building, Washington 4, D. C.

INVENTORS: Test the commercial value of your patented or unpatented inventions, quickly and inexpensively. Write for free information. Institute of American Inventors, Dept. 40-B, 635-P St., N.W., Washington 4, D. C.

INVENTORS, Don't sell your invention patented or unpatented until you receive our offer. Write Cowgill, Box 298, Marion, Ohio.

INVENTORS! Have you good, patentable ideas? Write Mr. Metzler, 11 West 42nd Street, New York City.

PATENT Searches \$5.00. 48-hour airmail service. Invention protection forms free. Write Patent Engineering Service, 711 14th Street N. W., Washington 5, D. C.

INVENTION Record form free and "Patent Information Every Inventor Should Have." Carl Miller, Registered Patent Attorney, Woolworth Building, New York.

PATENT Searches \$5.00. 48-hour service. Free invention protection forms. Write Raymond L. Smith, Patent Searcher, 620 Sheraton Building, Washington 5, D. C.

SEARCHES—Put your patent searches in the hands of a registered patent attorney or agent, as he qualifies to give a worthwhile patentability report. Record of invention form upon request and information on patent protection. Patrick D. Beavers, Registered Patent Attorney, 935 Columbian Bldg., Washington 1, D. C.

INVENTORS: Information on patent procedure furnished on request, without obligation. John Randolph, Registered Patent Attorney, 203 Columbian Building, Washington 1, D. C.

PATENT Searches, including copies of nearest patents, \$6.00. Reports airmailed within 48 hours. More than 100 registered patent attorneys use my service. For free invention protection forms, write Miss Ann Hastings, P.O. Box 178, Washington 4, D. C.

INVENTIONS And ideas designed for your profit and patented for your best protection at low definite fees. Thirty years experience in developing and patenting inventions in U.S. and foreign countries. Patent searches with valuable report \$15.00. Joseph O'Brien, 132 Nassau Street, New York 38, N. Y.

PATENT Searches. Information and free forms on request. Evelyn B. Surles, P.O. Box 75, Washington, D. C.

INVENTORS: Learn how to protect your invention. Unless the inventor is familiar with patent matters, he should engage a competent registered patent attorney or agent to represent him. We are registered to practice before the U. S. patent office and prepared to serve you in handling your patent matters. "Patent Guide for the Inventor" containing detailed information concerning patent protection and procedure with "Record of Invention" form will be forwarded to you upon request—without obligation. Clarence A. O'Brien & Harvey Jacobson, Registered Patent Attorneys, 71A-G District National Building, Washington, D. C.

INVENTIONS Wanted now by my manufacturer-clients. Patented, unpatented. Write Adams, Patent Broker, 80-A Wall Street, Financial District, New York City.

INVENTORS—If you believe you have an invention, you should find out how to protect it. The firm of McMorow, Berman & Davidson with offices in Washington, D. C., is qualified to take the necessary steps for you. Send for copy of our patent booklet "How to Protect Your Invention." We will also send you an "Invention Record" form. No obligation. They are yours for the asking. McMorow, Berman & Davidson, Registered Patent Attorneys, 134-Z Victor Building, Washington 1, D. C.

INVENTORS—This firm is registered to practice before the United States Patent Office and available to assist you in the preparation and prosecution of your patent application. "Patent Protection for Inventors" booklet containing detailed information and steps to take toward patent protection sent promptly upon request. No obligation. Victor J. Evans & Co., 332-H Merlin Building, Washington 6, D. C.

INVENTIONS WANTED

FREE Publicity possible for inventions. Write for information. Salter-Lee Associates, 15 West 44 St., New York 36, N. Y.

INVENTORS—Do you want to sell or license your invention on cash or royalty basis? Write Kessler Corporation, 57-1W, Fremont, Ohio.

WANTED Inventions of all kinds. Write Winsco Services, 6720 S. Figueroa, Los Angeles 3.

INVENTIONS Needed, patented, unpatented. We process, examine for manufacturers. Details, International Development Corporation, 315 Realty Bldg., Washington, D. C.

INVENTORS: Hundreds of manufacturers have requested our assistance in locating marketable new products. Complete information free. Institute of American Inventors, Dept. 40-D, 635-P St. N.W., Washington 4, D. C.

INVENTORS, Don't sell your invention patented or unpatented until you receive our offer. Write Cowgill, Box 298, Marion, Ohio.

INVENTIONS Wanted now by my manufacturer-clients. Patented, unpatented. Write Adams, Patent Broker, 80-S Wall Street, Financial District, New York City.

INVENTIONS Wanted. Patented or patent pending. 26 years experience promoting inventions. National Service Bureau, 3120 Meramec, St. Louis 18, Mo.

INVENTIONS Wanted. Patented; unpatented. Tremendous manufacturers lists. Global Marketing Service, 2420 77th, Oakland 5, California.

SUPERIOR Promotions. Patented; unpatented inventions. Information booklet, free. Superior, 338-344 North Rodeo, Beverly Hills, Calif.

PATENTS FOR SALE

FOR Sale to an established manufacturer. Machine for stemming gooseberries and currants on cash and royalty basis. Over forty years of perfecting and now ready for the market. Patent applied for, Box 661, Topeka, Kans.

MODELS, MODEL SUPPLIES

BUILD Miniature passenger hauling live steam locomotive with file and drillpress. We do machine work, you bolt it together. Catalog 50¢. Little Engines, Lomita, Calif.

SHIP And yacht model fittings: blueprints. Send 35¢ for illustrated catalog listing hundreds of items. A. J. Fisher, 1002-1 Etowah Ave., Royal Oak, Mich.

SHIP Models. Most complete line in New England. Kits, fittings, plans, books, tools, engines, motors. Illustrated catalog 30¢. James Bliss & Co., Inc., Dept. 5M, 342 Atlantic Ave., Boston 10, Mass.

BALSA Wood and model aircraft. 40-page catalog 25¢. Sig Co., Montezuma, Iowa.

SHIP Model kits and fittings including clippers, trawler, fishermen, frigates, privateer, radio control tug, etc. Send 25¢ for 1957 catalog. Model Shipways, Box 85, Bogota, N. J.

MANUFACTURING

MODELS—Small lot manufacturing. Metals, plastics, etc. Milburn, Burlington, Kentucky.

DESIGNING. Tools, dies, models, manufacturing. Pro Devco, Box 983, Cincinnati 1, Ohio.

HOME CRAFTSMEN

20,000 **PIECES** 1/4" Tempd. Masonite cut-offs 7x12", 4¢ each and 12x13 1/2", 6¢ f.o.b. Chairmaster, 99 River Dr., Passaic, N.J.

NEW Catalog 1958 artist-drawn workshop patterns 10¢. Craftplans, 1322-A Wabash, Chicago 5.

FREE Shellworkers catalog, instruction book 35¢. Secor's, Bradenton, Florida P.M.

LEATHERCRAFT. Copper enameling, mosaic tile, shellcraft, metal tooling, beadcraft, many more crafts. Free big catalog. Kit Kraft, Dept. 227, Studio City 1, Calif.

LEATHERCRAFT. Complete illustrated catalog, leathercraft kits, tools, supplies, books. Send 10¢ today to J. C. Larson Co., 820 S. Tripp, Dept. 7227-L, Chicago 24.

MAKE Money making picture frames. Write for free catalog of all styles of moldings. International Sales, 414-PM East Baltimore St., Baltimore 2, Md.

101 **FULL-Size** patterns. Smart, new, gifts, novelties, lawn figures, shelves, action windmills, alphabets. Plus "Make Money Jig Sawing." Only \$1.00. Mastercraft 75M, 7041 Olcott, Chicago 31, Illinois.

BUY Wholesale nationally advertised power, hand tools, thousands other products at big discounts. Free "Wholesale Plan." American Buyers', Hertel Station, Buffalo 18-P, N. Y.

BUILD Different, exclusive outdoor grill—Easily, economically! Attractive book of designs, plans, instructions, plus fabulous collection outdoor cooking recipes \$1.00. Roastro Specialties, Dept. 777, Coldwater, Michigan.

LEATHERCRAFT. Send 10¢ for new 76-page catalog of tools, supplies, kits, including metalcrafts, enameling, ceramics, all other crafts. Complete stock. Reasonable. Since 1910. Sax Bros., Dept. PM-7, 1111 N. 3rd, Milwaukee, Wis.

"**OLD Whittler**" readi-cut figures make whittling fun! Send \$1.00 for set. The DAE Company, Box 219, Baraboo, Wis.

GRANDFATHER Clock copyrighted photopack shop tested plans, dollar. Weight movements from \$39. Kuempel Clocks, Minneapolis 16.

13 **WORK** Bench patterns \$1.00. Queens Dowel House, Rosedale 22, N. Y.

FREE 6" Rule, decimal-equivalent table, tool price list. Unique gift offer! Enclose stamp. Laircraft, Box E-5008, Detroit 35, Michigan.

KNOCKDOWN Cedar chests. Lumber and veneers. Free price list. Giles & Kendall Company, Huntsville, Ala.

FREE "Do-it-yourself" leathercraft catalogue. Tandy Leather Company, Box 791-T22, Fort Worth, Texas.

FREE Leathercraft catalog. Kirkpatrick Leather Co., Box 637-A6, Gainesville, Tex.

KNOCKDOWN Cedar chests and lumber. Free price list. Bedford Lumber Company, Shelbyville, Tennessee.

LEARN Art metalcraft and jewelry making. Complete, inexpensive, home training course now available. Special tools and materials furnished. Write for free booklet. Interstate Training Service, Dept. L-3, Portland 13, Oregon.

LEATHERCRAFTSMEN: Imported and domestic leather, tools, kits, copper. Complete catalog 25¢ refundable. Midas, 7703 State, Huntington Park, California.

I want to send you proof of the wonderful pulling power of Popular Mechanics classified pages. What's your proposition? Write me today. Include literature if possible. F. W. Johnson, Manager Classified Advertising, Popular Mechanics Magazine, 200 E. Ontario St., Chicago 11, Ill.

WOODWORKING And cabinetmaking course for beginning and advanced home craftsmen. Only complete low-cost home training program available. Write for free booklet. Interstate Training Service, Dept. G-3, Portland 13, Ore.

STYLECRAFT Sure fire hits. "Pre-traced" leather kits. Handbags, billfolds, filigree belts, over fifty other projects. Patterns on leather. Why trace? Just carve, assemble and lace. Large assortment "precarved" kits also available. Send 25¢ for catalog, free folder. Refunded first order. Apache Leather Company, 2804 E. Washington St., Phoenix, Arizona.

DO-It-Yourself booklets 25¢. 24 subjects. Free catalog. Popular Mechanics Press, 631 N. St. Clair St., Chicago 11.

ALL Crafts, supplies. Large free catalog. National Handicraft, 199 William Street, New York City 38.

DO IT YOURSELF

SENSATIONAL Offer. Build at home your own water well drilling rig out of wood. Construction cost approximately \$35.00. Complete blueprints and drilling instruction. Send \$8.00. Roy Vulgamore, Route #7, Chillicothe, Ohio.

YOU Can replace TV Tubes, save expensive service calls. Instructions \$1.00. Slate's Television Service, Corsicana, Texas.

MOWER Kits and parts. Also complete mowers. Write for free plans and literature. Triangle, Dept. M-7, Fort Scott, Kansas.

BUILD Your own optical instrument! New book—"Fun With Optics" tells you how! 32 exciting pages. Full diagrammed instructions on how to build telephoto lenses, telescopes, microscopes, slide viewers, artist drawing projectors, binoculars, magnifiers, riflescopes, etc. We can furnish the lenses, prisms and parts you'll need. To get this terrific book send your name and address and only 50¢, full price. Request Stock No. 9050-CY. Edmund Scientific Company, Barrington, New Jersey.

AMAZING Plastic mold enables homeowners to make beautiful, thin, lightweight replicas of natural stone. Frame or masonry buildings easily refaced. Dress up interior walls, rathskellers, fireplaces, flower boxes. Sample stone, mold and complete details, send \$1.00. Superior, Dept. 101, 5645 Manchester Ave., St. Louis 10, Mo.

NEW Boat, utility, trailer kits \$69 up, complete. Swift Trailer, 1101 Commercial, La Mesa, Calif.

AIR Conditioners, homes, automobile. See Kool Engineering ad page 32.

MELT Cast iron, brass, aluminum. Make castings for profit. Free literature. Uruts Burner Co., Box 566-M, Tempe, Arizona.

18 **FULL-Size** patterns. Save money with easy-to-use, professionally designed full-size patterns. Make money selling beautiful, useful furniture. Make modern step and cocktail tables; metal lamps; cupola; 12-foot outdoor. All patterns test-built; sold with money-back guarantee. Get your free list of these convenient, economical patterns today. Popular Mechanics Press, 200-EE E. Ontario Street, Chicago 11, Ill.

WATCHES, OLD GOLD, JEWELRY

WATCHMAKERS' Tools, materials, supplies, watches. Catalog. Gales, Box 1000, Chicago 90, Illinois.

WATCH And clock repairing books. Free catalog. North American, 2320-AG Milwaukee, Chicago 47, Ill.

RHINESTONES, Pearls, costume jewelry supplies. Catalog 10¢. Rhinestone kit and catalog \$1.00. J & M Novelties, Dept. CH-3, Box 173, Broadview, Illinois.

HIGHEST Cash for old gold, broken jewelry, gold teeth, watches, diamonds, silverware, spectacles, platinum, mercury. Free information. Rose Refiners, Heyworth Building, Chicago 2.

GOLD, Silver, platinum, diamonds wanted. Cash immediately, highest prices; appraisals made. Wilmet's, 1067 Bridge, N.W., Grand Rapids 4, Mich.

10 **WATCHES** \$18.00. Minor repairs. Catalog 20¢. Berkwit, 1150 Castle Hill, New York City 62.

WATCHMAKERS'—Jewelers', machinists' tools. Watchmaking course. Catalog 25¢. Bengale, Culver City, California.

RAZORS, BLADES, SHARPENING

RAZOR Blades, very good double edge blades, send \$1.00 for 100. Chic Sales, Dept. H, Box 274, Alameda, California.

FOR THE HOME

ARCHITECT Designed home plans. Free information. S&P Plan Service, 5553 Glenway Ave., Cincinnati 38, Ohio.

ALUMINUM Roll-up awnings. Door hoods. Prepaid, direct from distributor. Lowest prices. Installation instructions. Barry, Box 815, Manchester, New Hampshire.

BE Your own plumber. You can. Few inexpensive tools and our instructive book, "Home Plumbing Guide," shows and tells you how. Hundreds of photographs and diagrams. Easy to follow. 160 pages. \$3.50. Catalog free. Popular Mechanics Press, 200PG East Ontario St., Chicago 11, Ill.

FOAM Rubber furniture cushions. Factory seconds. 50% discount. Free catalog. Perma-Foam, 236C Rhode Island Ave., East Orange, New Jersey.

RITE-Timer time switch saves money. Turns off attic fans, lights, electric heaters, or motors at any preselected time (15 minutes to 12 hours). Replaces regular wall switch. Installed in a few minutes. Guaranteed, \$11.95 postpaid. Literature on request. Precision Products, Inc., 532 So. Quaker, Tulsa, Oklahoma.

"HOME Improvement Guide." New, amazing 192 page volume. Packed with ideas, plans for remodeling, decorating, landscaping, built-in projects. \$2.50 prepaid. Popular Mechanics Press, 200-HG East Ontario St., Chicago 11.

OF INTEREST TO WOMEN

STAMPED Linens for embroidery or painting. Buy direct from manufacturer and save. Send for free catalog. Merrilee, 16 West 19th St., Dept. 401, New York 11, N. Y.

60% PROFIT Cosmetics \$25 day up. Hire others. Samples, details. Studio Girl-Hollywood, Glendale, Calif., Dept. 1277H.

WE Pay \$3.50 lb. Grow mushrooms. Cellar, shed and outdoors. Spare, full time, year round. We have over 25,000 customers. Free book. Washington Mushroom Ind., Dept. 176, 2954 Admiral Way, Seattle, Wash.

BEAUTIFY Complexion and hair. Economical formulas 25¢. Grace Collins, 804 14th Avenue, Paterson 4, New Jersey.

NAME Brand products. Huge discounts! Catalog free. Boynton, 836 W. 79th St., Los Angeles 44, Calif.

FRENCH Perfume, 24 bottles, 12 ounces \$1.45. Information. Marlen Products, Box 227, Lewistown, Pennsylvania.

ANALYZE Handwriting. Make money. Easily learned at home. Free details. Ben Kandel, Eatonton, Georgia.

WANT To make big money at home? \$10.00 profit in an hour possible with invisible mending. Make tears, holes disappear from clothing, fabrics. Steady year-round demand from cleaners, laundries, homes. Details free. Fabricon, 8332-S Prairie, Chicago 19, Illinois.

SELL Fine fabrics. Get yours wholesale. Box 863, Norwalk, Conn.

MAKE New greasless doughnuts in kitchen. Sell stores. Free recipes. Morgan Ray, 3605 South 15th, Minneapolis 7, Minn.

BOOKS: Hundreds of subjects. Big catalog free. Popular Mechanics Press, 200-BC East Ontario St., Chicago 11.

PERSONAL

BIBLE Questions answered. Stamped envelope. Byron, 17167 Bentler, Detroit 19, Michigan.

SIMPLE Television repairs. Marvelous booklet 25¢. Free catalog. Popular Mechanics Press, 633 N. St. Clair St., Chicago 11.

ENJOY Health. Free booklet. Ruth's Nutrition, 152 Kearny, PM, San Francisco, Calif.

"**HOW** Can I find out?" You can! Information confidentially developed. Any matter, person, problem. Worldwide. Officially licensed. Established 1922. William Herman, 170 Broadway, New York City.

BOOKS: Hundreds of subjects. Big catalog free. Popular Mechanics Press, 200-BC East Ontario St., Chicago 11.

BORROW Money—By mail. \$100 to \$600 from Postal Finance. Employed men, women easily obtain \$100 to \$600 fast, entirely by mail. Repay in small monthly payments. Friends, relatives, employer, tradespeople will not know you are applying for loan. Advise occupation, amount wanted. Postal Finance Company, 200 Keeline Bldg., Dept 7-N, Omaha, Nebr.

REMAILING SERVICE

DENVER Remails 25¢. Sanchez, 7012 E. 4th Ave., Denver 20, Colorado.

AIR Remails 35¢, I affix stamps. Ross Hancock, 83 Belhaven Rd., Toronto 8, Canada.

COLUMBUS Mail forwarding-receiving address available. William McLaughlin, 800 Stewart, Columbus 6, Ohio.

REMAILING: New York City—25¢. Scenic postcard service. Bob Gillespie, 6702 Ridge Boulevard, Brooklyn 20, New York.

LETTERS Remailed 25¢. J. Love, 1419 E. 83, Los Angeles 1, Calif.

LETTERS Remailed and forwarded, 25¢. Month, \$3.00. Hale, Box 1, Glenmont, N. Y.

BARRANQUILLA, Colombia. South America—Letters remailed 25¢. Viewcards. T. P. Dann, 76-30, Carrera 51B, Barranquilla, Colombia.

CITRUS Valley remails 25¢. Forwarding. Monthly and yearly rates. All services. 1598 Sheridan Road, San Bernardino, Calif.

SECRET Mail receiving, forwarding systems. \$3 month. Hedgpeith, Box 830, Alhambra 23, California.

TREASURE FINDERS

TREASURE Map, 17x22, in color. 50 lost mines and treasures. Data and clues to their location. Ideal for framing. \$1.50. Prospector Milt, 3915 Lamont, San Diego 9, California.

FIND Buried treasure, gold and silver, with Goldak's sensational 3 1/2 lb. "Find-it" locator, only \$49.50. Write for free literature on complete line of mineral, metal locators; Geiger and scintillation counters. Goldak, 1541 W. Glenoaks Blvd., Glendale, Calif.

TREASURE Locator. Build yourself. Guaranteed plans. Free details. Howe, 811 Kansas Ave., Atchison, Kansas.

GOLD, Silver, metal detectors. Geiger counters for uranium. Violites. Sensational new fully guaranteed models. None finer. Information free. Detectron Corp., 5528 Vineland Ave., North Hollywood, Calif.

RENT Geiger counters, catalog free. Rent-It, 510 Queen, Westbury, N. Y.

TREASURE, Metal, mineral detectors. M-Scope. Used worldwide for treasure hunting. Mineralights, Geiger, scintillation counters. Prices from \$14.75. Fully guaranteed. Use our time payment plan. Free booklets on treasure hunting, uranium prospecting. Free catalog. Fisher Research Lab, Inc., Dept. PM-CI, Palo Alto, Calif.

FOR SALE—MISCELLANEOUS

MAGNETIC Hurricane charts—\$3.95; \$15.95. Free brochure. Gyco, Palm Beach 10, Florida.

SMOKERS, Free literature on Missouri Meerschaum pipes. Ed. Locke, Lac du Flambeau, Wisconsin.

HEARING Aid batteries, wholesale. Free list. Habs, Box 51, York, Penna.

WANTED—MISCELLANEOUS

CASH For Indian bird stones; antique northwest coast totem, masks, carvings. Send photos. Robert Stolper, 8852 Cynthia Street, Los Angeles, California.

WANTED—Used automatic screw machine. Miller, 3151 E. Colorado, Pasadena, Calif.

QUICKSILVER, Sterling, silver solders, precious metals. Wholesale Terminal, Norwood, Massachusetts.

SCRAP Mercury (quicksilver) containers supplied—Tantalum, tungsten, silver, platinum. Metallurgical Products Company, Established 1909, 35th & Moore Sts., Philadelphia 45, Penna.

MISCELLANEOUS

CIGARETTES—Improved roller makes 20 for 9¢. Facts free. Moberly, Box 820, Owensboro, Kentucky.

AIR—Condition up to three rooms \$34.50. Free details. Weather Merchants, 2913 Gaston, Dallas, Texas.

JAPAN: Mail-order, gifts, novelties, kimono, jackets, jewels, etc., 24 page catalogue, business information. \$1.00. Clarence Yamagata, Room 202, Naka 7 Bldg., Marunouchi, Tokyo.

LIMITED Supply—Gold-plated solid metal key chains and charm bracelets, each with lucky "Ike" charm big as half-dollar. \$1 each complete including postage. Oleet, 305 East 47, New York City 17.

WE Pay \$3.50 lb. Grow mushrooms. Cellar, shed and outdoors. Spare, full time, year round. We have over 25,000 customers. Free book. Washington Mushroom Ind., Dept. 175, 2954 Admiral Way, Seattle, Wash.

70 BIBLE Lessons, 25¢. Bulletin, Box 87, Cathedral Station, New York City 25.

YOU Can teach your child to swim. Instruction booklet \$1.00. Swimming, Box 1222, Memphis, 1, Tenn.

LEARN While asleep! Details free. Research Association, Box 610-MC, Omaha, Nebraska.

BOOKS: Hundreds of subjects. Big catalog free. Popular Mechanics Press, 200-BC East Ontario St., Chicago 11.

I Want to send you proof of the wonderful pulling power of Popular Mechanics classified pages. What's your proposition? Write me today. Include literature if possible. F. W. Johnson, Manager Classified Advertising, Popular Mechanics Magazine, 200 E. Ontario St., Chicago 11, Ill.

CLOGGED Drains, cesspools and septic tanks cleaned by new powerful chemical. Sursolvent removes grease, soap, tree roots, etc., without expensive digging and electric rodding machines. No pumping necessary. Mix with water and pour down drain. Free details. Electric Drain Cleaning Co., Boston 34, Mass.

REMODEL Your own home. Save hundreds of dollars. New, amazing book shows you how. Written so you can understand it. Step by step instructions make it easy. Fully illustrated, 400 photographs, hundreds of diagrams, 160 pages. \$2.95. Literature free. Popular Mechanics Press, 200-HH East Ontario St., Chicago 11, Ill.

HOW To remodel, basement, attic. Booklet 25¢. Free catalog. Popular Mechanics Press, 633 N. St. Clair St., Chicago 11.

RECEIVE Magazine samples, mails, catalogues, offers from everywhere. Get listed 25¢. Rorick, Cincinnati 26, Ohio.

YOUR Name wanted. We'll send 1000 publishers, mailers, wholesalers your name, on our list one year 25¢. Dixie Mailers, King, N. C.

18 FULL-Size patterns. Save money with easy-to-use, professionally designed full-size patterns. Make money selling beautiful, useful furniture. Make modern step and cocktail tables; metal lamps; cupola; 12-foot outboard. All patterns test-built; sold with money-back guarantee. Get your free list of these convenient, economical patterns today. Popular Mechanics Press, 200-HH E. Ontario Street, Chicago 11, Illinois.

WANT More business? Here's an amazing opportunity to increase your sales. Talk to thousands of interested readers of "Mechanics Popular." Our Spanish Edition covers the Latin American countries like a blanket. They're real mailorder buyers. Classified rate 75¢ per word. Try an ad in our next issue. Classified Advertising Department, Popular Mechanics Magazine, 200 East Ontario Street, Chicago 11, Ill.

CARPENTERS: Most revolutionary raft-er framing instrument known. Write Easterly Enterprises, 1310 Lincoln, Watsonville, Calif.

MEN—Save money. Swap three ties for \$1.00. Send three ties and \$1.00. Money refunded or the exchanged if not satisfied. Kansas City Tie Exchange, Box 420, N.W. Sta., Kansas City 4, Kansas.

SAVE 40-50% On vitamins—Buy direct. Write for free catalogue listing all brands, formulas, prices. For example, food supplements selling for \$19.50, our price \$5.75. Enclose label of vitamins now using for free example. Vitamin Specialties, Box 4435B, Philadelphia 40, Penna.

BOOKS On antiques and their prices. Free circular! P. Warman Publishers, Uniontown, Penna.

AFRICAN Primitive wood carvings specially carved for you by the Wakamba craftsmen. Salad sets, figure of warrior, 2 paper knives. All roughly 12" long. Or wall plaque (6"-10"). Each \$3. Freight included. Genuine, wonderful offer. Further inquiries invited. Write direct to Irene Smith, Standard Bank of South Africa, Kilindini Road, Mombasa, Kenya. Cash with order—international postal order or cheque.

WOMEN'S Leather handbags from Mexico. Beautifully hand-tooled, \$5.00 each. Stratton, 26537 E. 6 St., Highland, Calif.



Radiant Screen Corp., 2627 W. Roosevelt Rd., Chicago 8, Ill.

Portable Transparent Plastic Garage

English car owners can check on the whereabouts of their family vehicles merely by glancing through the walls of plastic garages. These portable garages are made

of transparent plastic sheeting over a tubular framework. No foundation is needed, the units can be disassembled quickly, and they may be used also as greenhouses.

Fog-Free Engine Developed for Use in the Arctic

Arctic ice fog, resulting from internal-combustion-engine exhaust and flue gases from power-plant chimneys, can be eliminated by a fog-free engine. Developed by Armour Research Foundation of Chicago,

the engine cools, condenses, mixes and reheats the exhaust, passing it off with a moisture content that is below maximum for producing fog. The manmade fog has been a problem to the Army in arctic areas.

Cheaper Air Conditioning Available With Compressed Air?

If you send compressed air up the stem of a T-shaped tube, hot air emerges from one tip and cold air from the other.

This puzzling phenomenon holds promise of providing inexpensive air conditioning for homes and cars. In one demonstration by physicists of the Southwest Research

Institute, air compressed to 100 pounds per square inch and with a temperature of 80 degrees is forced up the tee. A thermometer at one end of the cross tube shows that the air emerging there has a temperature of 116 degrees. Air emerging from the other end registers only 20 degrees.

Even the physicists don't know what happens inside the tube. They suggest that the incoming air sets up a vortex when it enters the cross tube, and the whirling action somehow creates the streams of hot and cold air.

At present the device is not as efficient as other ways of heating or cooling because of the cost of compressed air. However, physicists of the institute hope to learn the cause of the phenomenon. Once they find a satisfactory explanation, they reason, they may be able to increase the efficiency. Then you could cool or heat your car with a small air compressor.

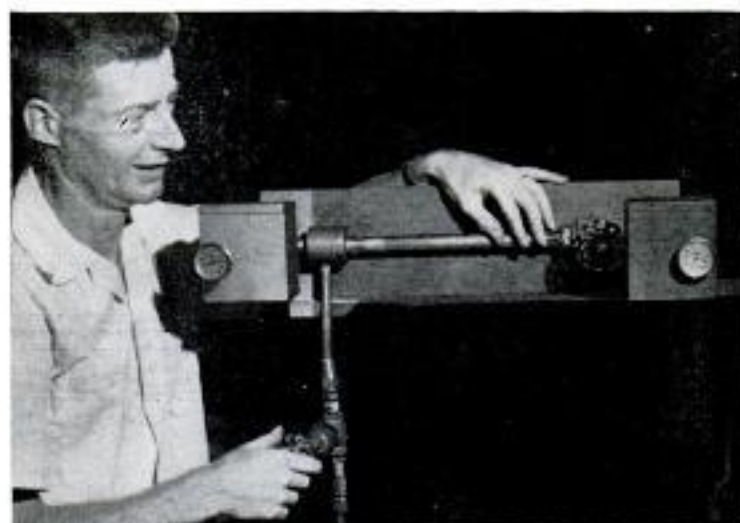

Get into..

PLASTIC LAMINATING AT HOME!

Make \$20 to \$30 a Day by..
MAGIC MAIL PLAN!

Get **ORDERS** and **CASH** from your mailman—do work in **SPARE TIME** at home—or expand into **FULL TIME** business. Send coupon for Free facts about the newest and most fascinating of all home operated businesses. For the first time a simplified machine brings the fabulous profits of **Plastic Sealing and Plastic Laminating** within the reach of the small operator. Anyone can learn to operate the machine with a few minutes practice—then with our **Magic Mail Plan** can get mail orders pouring in daily with cash in every envelope. **No canvassing—no selling.** We even

supply the circulars you mail to bring back cash and orders. Don't waste a minute. Rush your name. We'll send you **FREE** and postpaid, pictures, prices, details, and all the facts you need to start. Mail coupon or send name on postcard. No charge. Warner Electric Co., 1512 Jarvis Av., Dept. L-2-S, Chicago 26, Ill.

THIS MAN... is taking out of the machine a Plastic Sealing Job—ordered by mail—only 11c in material cost brings back \$2.58 in cash by mail. Capacity of machine: **\$25.00 profit per hour of operation.**

Make Thousands of Beautiful Art Creations

COSTUME JEWELRY • CIGARETTE BOXES TRAYS • CANDLESTICKS • COASTERS LAMP BASES • BOOK ENDS...ALL IN SPARKLING COLORED PLASTIC



WARNER ELECTRIC CO., 1512 Jarvis Av.

Dept. L-2-S, Chicago 26, Ill.

At no cost to me, please rush complete details postage prepaid. I am under no obligation.

Name.....

Address.....

City.....Zone.....State.....

Also Eshelman Gasoline Engine GOLF CARS Write for Free Literature

ESHELMAN ROCKET BOAT



NEW JET PLANE DESIGN

- Airtight compartments prevent sinking.
 - 14 Ft.—Holds 4 Adults.
 - Leakproof. 16-gauge all-steel construction.
- Write for Free Literature. Dept. 357, ESHELMAN, Balto. 2, Md.

Pat. Pend. Operates With Any Suitable Outboard Motor

Shipping Points: BALTIMORE • CHICAGO • MEMPHIS

AMAZING NEW "LIFETIME" RADIO

GUARANTEED TO WORK FOR YOUR LIFETIME! USES NO TUBES, BATTERIES OR ELECTRICAL PLUG-INS. Never runs down! SMALLER THAN A PACK OF CIGARETTES! RECEIVES LOCAL RADIO STATIONS—MOST ANYTIME, ANYWHERE WITHOUT EXTRA ANTENNA. Uses crystal diode 10-4 Tuner. Beautiful black gold speaker-phone grill—plastic cabinet.



SEND ONLY \$2.00 (bill, ck, mo) and pay postman \$4.00 COD on arrival or send \$6.00 for postpaid delivery. **SENT COMPLETE READY TO LISTEN**—NOTHING EXTRA TO BUY EVER! Aerial kit included free for distant stations. Available only from: **MIDWAY COMPANY, Dept. GPM-7, Kearney, Nebraska**

Help science find CAUSE and CURE of MS*

HELP FILL

MS HOPE CHEST



- RESEARCH
- CLINICS
- PATIENT AID

* **MULTIPLE SCLEROSIS—crippling disease of young adults**
National Multiple Sclerosis Society
National Headquarters
257 Fourth Ave., New York 10, N. Y.

PREPARE FOR BETTER JOB, BIGGER PAY IN SPARE TIME AT HOME

Today, choose the job you want—and prepare for it in time you might otherwise waste. Or if you are already in the work you like best, start training now for quicker promotion and increased pay. During the past 60 years AMERICAN SCHOOL has helped ambitious people to reach higher goals. Check subject that interests you and mail coupon for full information.

AMERICAN SCHOOL, Dept. GB45, Drexel at 58th, Chicago 37, Ill.

Without obligation, please send **FREE** and postpaid, full particulars about the subject checked below.

- | | | |
|--|---|---|
| <input type="checkbox"/> Accounting | <input type="checkbox"/> Contracting | <input type="checkbox"/> Mechanical Engineering |
| <input type="checkbox"/> Apprenticeship Courses | <input type="checkbox"/> Diesel Technician | <input type="checkbox"/> Mechanical Technology |
| <input type="checkbox"/> Architecture & Building | <input type="checkbox"/> Drafting—Building Trades | <input type="checkbox"/> Metalworking Courses |
| <input type="checkbox"/> Automotive Technician | <input type="checkbox"/> Drafting—Machine Trades | <input type="checkbox"/> Plumbing—Practical |
| <input type="checkbox"/> Better Foremanship | <input type="checkbox"/> Electrical Engineering | <input type="checkbox"/> Private Secretary |
| <input type="checkbox"/> Blueprints Reading | <input type="checkbox"/> Electricity—Practical | <input type="checkbox"/> Retail Merchandising |
| <input type="checkbox"/> Bookkeeping | <input type="checkbox"/> Electronics—Industrial | <input type="checkbox"/> Salesmanship—Outside |
| <input type="checkbox"/> Business Management | <input type="checkbox"/> HIGH SCHOOL COURSES | <input type="checkbox"/> Sheet Metal Work |
| <input type="checkbox"/> Civil Engineering | <input type="checkbox"/> Machinists | <input type="checkbox"/> Tool Making |

NAME.....
HOME ADDRESS.....
CITY.....STATE.....
Occupation.....AGE.....
Conditions: Write American School, Dept. GB45, 6083 Sherbrooke St. W, Montreal

MAIL COUPON NOW



COMING SOON!

WHAT TO MAKE 1958. This book will give you many hours of pleasant enjoyment creating practical, useful articles for your home and family. Contains scores of projects for the amateur handyman, complete with fully detailed build-it-yourself plans. You'll find projects for the household, the sportsman, children's playthings, lawn and garden suggestions and many other ideas you can quickly execute. 192 pages, paper bound.....75c

HOW TO REMODEL BASEMENTS AND ATTICS. More people every day are discovering more room and better living in their attic and basement. This book reveals how much beauty and convenience can really be had in remodeling "top and bottom," and how to do it. Contains many B & A projects you can adapt to your home, planned by top designers for the do-it-yourselfer, with a complete materials list for each job. Use it as an "idea book" or a practical guide for your own remodeling. There's no finer book on the subject. 192 pages, paper bound.....75c

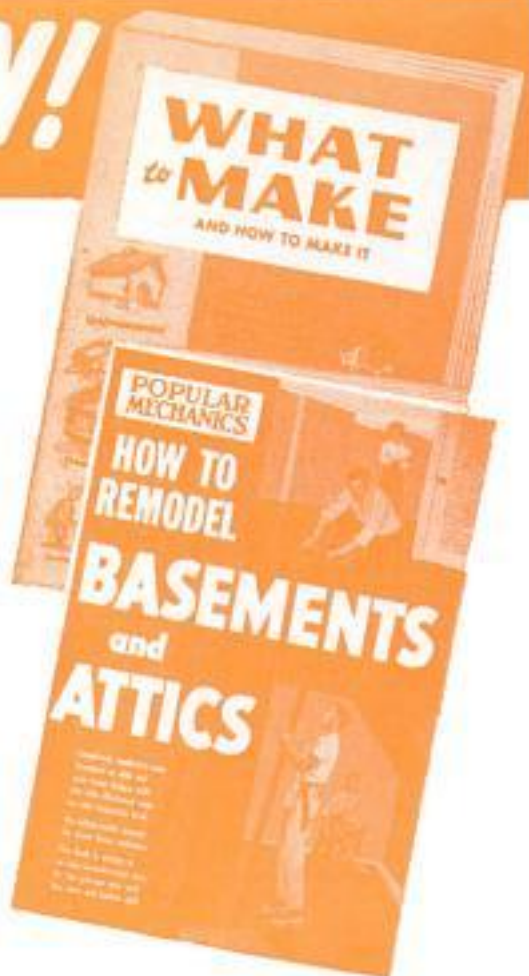

OTHER PM BOOKS FOR YOUR HOME LIBRARY



Electronics Made Easy. Enables you to build your own hi-fi, transistor radios, intercoms, many other electronic devices. Non-technical language; hundreds of illustrations. 196 pages, paper bound.....75c.



Getting Started with Power Tools. Explains the function of every power tool, identifies all parts, suggests how to buy for full satisfaction. Has valuable short cuts, operating hints, safety tips. 160 pages, paper bound.....75c.



Television Manual. Make 9 out of 10 TV repairs yourself! This book shows by actual photographs, dozens of typical TV maladjustment and repair problems... then exactly how to cure them. 168 pages, paper bound.....75c.



Home Improvement Guide. One of the finest funds of helpful money-saving ideas for home repairs and remodeling ever published. Packed with pictures and diagrams on every room of the home. 196 pages, paper bound.....75c.



How to Tempt a Fish. Must reading for all anglers, whether you're an expert or just beginning. Authorities describe all forms of fishing, best techniques and equipment, where to fish. 148 pages, paper bound.....75c.



Lawn and Garden Book. Answers every question about lawn and garden care, including preparing soil for lawn, planting, etc. Guides you through each step leading to a well landscaped plot of land. 196 pages, paper bound.....75c.

ONLY 75c

AT YOUR NEWSSTAND, LEADING HARDWARE STORE AND BUILDING SUPPLY DEALER

(or mail your order today!)

Add 10c for postage

POPULAR MECHANICS PRESS, Dept. 757
200 E. Ontario St., Chicago 11, Ill.

I am enclosing \$_____ @ 85c each (to cover postage, etc.). Please send me the following books as indicated:

- WHAT TO MAKE TV MANUAL POWER TOOLS
 BSM'TS-ATTICS TEMPT A FISH HOME IMPROVEMENT
 ELECTRONICS LAWN & GARDEN

Name _____

Address _____

City _____ Zone _____ State _____

THE MIGHTY-MARAN

- Unsinkable pontoons!
- Weighs only 87 pounds! 9 ft. long, 5 ft. 4 in. wide.
- Life-time aluminum frame requires no maintenance.
- FUN FOR EVERYONE . . . Children love it. Fish in comfort. Has a motor mount for outboard motor.
- Dismantles for easy transportation and storage. (Beach chairs optional.)

DISTRIBUTORS WANTED

Place your order today. Send check or Money Order. No C.O.D.
Mighty-Maran is shipped knocked down, cartoned, via motor freight, collect.

BARNARD COMPANY, 4623 Dodge Street, Omaha, Nebraska



\$199.95

CHROME VANADIUM 29 Pc. DRILL SET

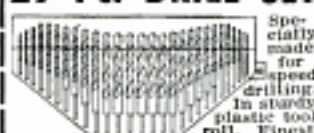

Specially made for speed drilling in sturdy plastic tool roll. Finest alloy steel drills hardened and precision ground to the sharpest, longest lasting cutting edge obtainable; will easily and cleanly bite through hardwoods, plastics, aluminum, iron and the toughest steels. Unconditionally guaranteed for thousands of drillings. Full jobber length. Sizes by 64ths from 1/16" to 1/2". NOW **\$6.49** ppd. Also available with Turned Down Shanks to fit all 3/4" drills. In individual pocket roll. **\$8.95** ppd.

60 Pc. Set WIRE GAUGE CHROME VANADIUM DRILLS



Top quality German import high test Chrome Vanadium Drills designed for speed drilling through toughest steels, woods, plastic, iron and aluminum. Precision ground, long-lasting cutting edges. Guaranteed to give years of satisfaction. A full 60 pc. set, Nos. 1 through 60. A \$14.95 value— **\$5.40** NOW ONLY PLUS 35c PP. & HDLG. Same set above with Hicut Metal Index. **\$6.65** PLUS 35c PP. & HDLG. Also Available 20 Pc. Set — Nos. 61-80 **WIRE GAUGE DRILLS** in plastic kit with marked pocket for each drill. ONLY **\$2.50** ppd.

Send Check or M.O. C.O.D. fee extra. MONEY BACK GUARANTEE

SCOTT-MITCHELL HOUSE, INC. DEPT. M-401, 611 BROADWAY NEW YORK 12, N. Y.

NEW! FOR FINISHING WOOD EDGES



WELDWOOD FLEXIBLE WOOD TRIM

Real wood veneer, paper-backed, in handy rolls, for edging plywood, lumber. Many decorative uses. Apply with Contact Cement, or Presto-Set Glue. Oak, birch, African mahogany, walnut, fir, Sonora.® At your lumber dealer's. **SAVE!** Get 89¢ sample roll, 8" x 1", specify wood. Send this ad with 50¢ to: United States Plywood Corp., Dept. PM7, 55 W. 44th St., N.Y. 36, N.Y.

TWO WAYS TO BUY BETTER

Your dealer knows the right products for your needs—quality products that are nationally advertised. POPULAR MECHANICS brings you a monthly roundup of valuable "how to" information and product advertising. Read POPULAR MECHANICS every month—then talk to your dealer.



JULY 1957

115 Volt, A. C., ELECTRIC GENERATORS

60 Cycle, Single Phase, Continuous Duty



750 Watt Cost \$115.00 **\$59.50** fob
1000 Watt Cost \$130.00 **\$79.50** fob
2000 Watt Cost \$235.00 **\$115** fob

BRAND NEW SURPLUS FULLY GUARANTEED

Ideal as a permanent or stand-by unit for electricity IDENTICAL to house current. Perfect for farms, camps, aboard ship, oil fields, mines, etc. Easily handles lights, refrigerator, deep freeze, oil burner, radio; power for saws, floodlights, drills, pumps, etc.

All ball bearing. Operates at 3600 R.P.M. Drive with 2 HP to 3 1/2 HP or larger engine—or use power take-off. Voltage self regulating. Standard base mounting. Two outlets. Modern, compact design. Tremendous overload capacity. Operates in either direction!

SUPPLY LIMITED! WE PAY SHIPPING! ORDER FROM AD FREE CATALOG OF OTHER SURPLUS, HYDRAULICS

Phone TAYLOR 9-1365

ROBERTS ELECTRIC CO., Dept. PM-668, 849 W. Grand, Chicago 22, Ill.

4-HR. DIVING LUNG



Send for Free Literature
DEPT. PM-7

49.50

**DIVING INDUSTRIES
813 LIBERTY AVE.
PITTSBURGH 22, PA.**

ENGINEERING DEGREE IN 27 MONTHS

B. S. DEGREE IN

Aeronautical, Chemical, Civil, Electrical, Mechanical and Electronic Engineering (inc. Radio and TV)

Also B.S. DEGREE in 36 mo. in Mathematics, Chemistry, Physics (inc. Nuclear Physics) Engineering Science prep. courses. Thorough, practical program. Individualized instruction emphasized. Government approved for G.I.'s.

Keeping pace with progress in science and engineering

Spacious campus, 20 bldgs.; dorms, gym, playing field. Modern, well-equipped labs including new physics lab and wind tunnel. Low tuition. New terms start quarterly. Enter September, December, March or June. Big demand for graduates. Students from 48 states and 40 foreign countries. Many earn a major part of their college expenses in this large industrial center. Send coupon for free catalog and full information. Enroll now!

INDIANA TECHNICAL COLLEGE

577 E. Washington Boulevard, Fort Wayne 2, Indiana

Please send me free information on 27 MO. B.S. DEGREES in:

Aeronautical Chemical Civil Electrical

Mechanical Electronics

on 36 MONTH B.S. DEGREES in:

Mathematics Chemistry Physics

Name _____

Address _____

PREPARE FOR THE BEST JOBS IN INDUSTRY

TRAIN at HOME
In Your Spare Time
or at
ALLIED INSTITUTE
in Chicago

- MECH. ENGINEER
- DRAFTSMAN
- TOOL DESIGNER
- TOOL ENGINEER
- MASTER MACHINIST
- AIR CONDITIONING HEAT & REFRIGERATION

MORE JOBS THAN GRADUATES

Shortages of Draftsmen, Designers, Tool Engineers, Machinists, Air Conditioning technicians are so widespread that you can pick a highly paid key job and look forward to Achievement and Security. You can begin your training in Short Courses at home or at Allied Institute, and continue progressively toward an Engineering Degree in 26 months. Allied is approved by Industry, National Home Study Council, Central Schools Association, Dept. of Education, Office of Public Instruction, State of Illinois, U. S. Veterans Admin., U. S. Dept. of Justice.

SEND FOR
FREE BOOKS

ALLIED SCHOOL OF MECHANICAL TRADES
1338-42 South Michigan Ave., Dept. PM-7, Chicago 5, Ill.

Send me without obligation information on your courses:

- HOME STUDY RESIDENT VETERAN NON VETERAN
 DRAFTING ENGINEERING AIR CONDITIONING

NAME _____

ADDRESS _____

CITY _____ COUNTY _____ STATE _____

TOUGH, DURABLE
CELO-O-GLASS
THE LOW-COST WAY TO MAKE

- Storm windows and doors • Carport closures
- Your own greenhouse • Outbuilding windows

Cel-O-Glass plastic coated screen offers protection against wind and rain, admits sun's healthful rays. Build your own storm windows and doors, that greenhouse you've wanted so long, sunshine-admitting windows for poultry houses and barns. Costs far less than glass... no sash needed... cuts with scissors. Easily tacked in place, no puttying.



"KOVER-IT" SHEET POLYETHYLENE



Now you can buy sheet polyethylene in kits... for hundreds of household uses. Make your own furniture and appliance covers, garment bags, protective hoods for expensive tools and equipment. May be sewed or heat-sealed for effective protection against moisture, oils, acids. In two sizes: 9' x 6' or 9' x 12', individually packaged. See your hardware dealer or write:

ARVEY CORPORATION R-V-LITE DIVISION
SINCE 1905 3500 N. Kimball Ave. Chicago 18, Ill.

WHERE-TO-BUY-IT INDEX

Source of supply appears after items commercially available

AUTOMOTIVE

Metal roof rack has key lock (Stemun Mfg. Co., 3919 W. National Rd., Springfield 11, Ohio).....	71
Radiator water cools the brakes.....	72
Detroit Listening Post.....	73
Studebaker Scotsman is stingy with gas.....	79
Aluminum truck bodies reduce dead weight (Aluminum Co. of America, 1501 Alcoa Bldg., Pittsburgh 19, Pa.).....	103
Power take-off on tractor drives trailer wheels.....	103
Utility generator for car (E. F. Lindsay, North Prairie, Wis.).....	107
You can have a refrigerator in your car trunk (Stanley Campbell, 6241 Penrose, Dallas, Tex.).....	113
Economy sports car: the \$1600 Berkeley (Berkeley of America, Inc., 566 Whalley Ave., New Haven, Conn.).....	121
Free-piston turbine powers unique tractor (Tractor and Implement Div., Ford Motor Co., Birmingham, Mich.).....	134
British GM's Vauxhall Victor is all new but smaller.....	135

AVIATION

Flying salvage craft works on land or sea.....	106
Just drive your plane downtown.....	106
Two-seat jet interceptor gets first test flight (McDonnell Aircraft Corp., St. Louis 3, Mo.).....	113
Aerial platforms drop heavy gear.....	114
Regular motors off, jets fly "boxcar".....	114
Rocket missile can catch jet.....	114
Fighter-bomber can carry A-bomb at supersonic speed (Republic Aviation Corp., Farmingdale, Long Island, N. Y.).....	115
First German plane since World War II.....	115
"Saucer top" plane to warn fleet.....	115
Engines and landing gear bring home test missile.....	128
Navigation ship guides missiles.....	128
Pistol gives wave-off signal.....	129

MISCELLANEOUS

Caster eases jolting TV set.....	2
Star-bladed power trowel speeds plaster finishing (E-Z-On Corp., 1725 W. Pershing Rd., Chicago 9).....	2
Power-mower chain guide for safe grasscutting (General Products Co., P.O. Box 36, Overland 14, Mo.).....	4
Vermiculite in grill spreads heat evenly (Zonolite Co., 135 S. La Salle St., Chicago 3).....	4
Portable hoist is self-erecting (Buck Equip. Corp., 720 Anderson Fer., Cincinnati, Ohio).....	62
Pint-sized runabout.....	71
Shoulder mount steadies fast photos.....	79
Television and radio team up to operate Swedish power plant.....	79
Boat-trailer has twin hulls.....	83
Carver shapes burl into huge salad bowl.....	90
"Dog tag" sales checks aid drive-in operation (Bill First, 1316 N. Elm, Spokane 62, Wash.).....	90
Ultrasonic gauge tests thickness (Branson Instruments, Inc., 37 Brown House Rd., Stamford, Conn.).....	103
Swimmers use hands to paddle beach "boats" (Selbeck Factory, Boca Raton, Fla.).....	113
Shell cost soars.....	115
Homemade "vacuum sweeper" collects millions of aphid enemy.....	120
Portable baby crib easily handled by one person.....	120
Heavy boot holds prisoner.....	129
Powered roller packs evenly (Lawn-All Corp., Johnstown, Pa.).....	129
German Hercules flexes mighty muscles to "defeat" two Jeeps.....	133
"Sardine can" transmitter provides emergency communications (Fairchild Camera and Instrument Corp., Robbins Lane, Syosset, Long Island, N. Y.).....	133
Electronic assembly uses belt feeder.....	134
Plastic plant protector has adjustable heat vent (Aldon Product Co., Duncannon, Pa.).....	134
Monorail transports materials.....	136
Spring retrieves lure (Russell's Retriever, 1754 E. 71st Pl., Chicago 40).....	136
Weedless lure (Barbee Bait Co., 252 Farmers' Trust Bldg., Fort Wayne 2, Ind.).....	136
Attachments increase versatility of implements (John Deere Co., Moline, Ill.).....	142
How to split a bullet.....	143
Miniature generator has diesel engine (Lynn Engineering Co., Russ Bldg., San Francisco 4, Calif.).....	144
Scooter motor powers mechanized hoe.....	144
Swinging wall lamp has wide radius (IEZ, 1880 Broadway, New York City 23).....	222
"Envelope" keeps out rain.....	226
Plastic "air pocket" bag serves as pump (Davis Products, Inc., Santa Monica, Calif.).....	236

SCIENCE

New clue to radio stars.....	2
Dial on microscope selects magnification (American Optical Co., Instrument Div., Buffalo 15, N. Y.).....	90
Surgical sniffer developed.....	136
Tetraethyl lead synthesized in new method.....	232

(Continued to page 60)



Hedge-trimmer attachment operates smoothly with power supplied by vacuum cleaner via rotating unit



Above, floor-accessory set includes 6 $\frac{3}{4}$ -pound polishing base, waxing and polishing brushes, buffing pad

Power Unit Uses Vacuum Cleaner to Run Tools

AIR POWER may make the vacuum cleaner an indispensable aid to the do-it-yourselfer. One two-pound power unit goes onto the cleaner's suction air hose to become a portable rotating device. Attachments are available to adapt the cleaner as a tool for drilling holes, polishing the car, sawing and sanding wood, cleaning and waxing floors, trimming hedges, driving screws and doing many other household chores. For scrubbing the kitchen floor a 6 $\frac{3}{4}$ -pound, cast-iron polishing base, heavy enough to give the necessary push to clean or polish hard surfaces, fits over the new power unit. Brushes snap onto the base. Waxing and polishing brushes and a buffing pad are included in this particular floor-accessory set.



Attached to cleaner power unit, saw rips through plank. Kit includes drilling, sandpapering, buffing unit

Air from vacuum cleaner operates $\frac{1}{8}$ -inch drill on standard drill chuck (above), sands boat bow (below)
Electrolux Corp., 500 Fifth Ave., New York City

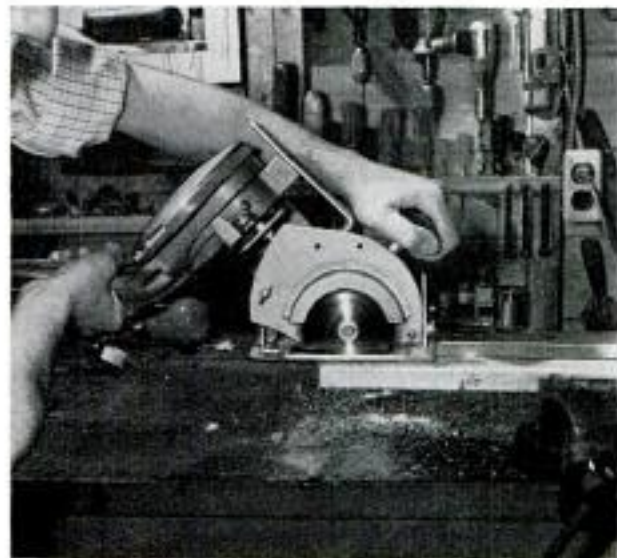

BUILD THE BEST FOR LESS!

BUILD ALLIED'S OWN ELECTRONIC

knight-kits

IT'S EASY
IT'S FUN—
and you save!

You'll marvel at how easy it is to build KNIGHT-KITS (with "step-and-check" instructions, it's like having a good instructor at your side). You'll be thrilled by KNIGHT-KIT performance—you'll be proud of your work—and you'll save money!



2-Transistor Pocket Radio Kit

Build this pocket-size, two-transistor radio—enjoy loud, clear broadcast-band reception wherever you go! Completely self-contained with built-in ferrite loop antenna—no external antenna needed. Printed-circuit board for easiest assembly. Efficient reflex-type circuit operates for months and months on long-life alkaline battery supplied. Super-sensitive miniature earpiece gives remarkably good tone. With all parts, including simulated leather case, earpiece and transistors, 4 x 3 1/4 x 1 1/4". Shpg. wt., 1 1/2 lbs.

83 Y 262. Pocket Radio Kit..... \$14.65



Transistorized Electronic 10-in-1 Lab Kit

Sensational—work with transistors! Assemble the basic parts, then complete project after exciting project (10 of them in all) just by plugging leads into proper jacks on printed-circuit board—no wiring changes needed. Make the following: AM radio, amplifier, wireless broadcaster, code practice oscillator, electronic timer, switch, or flasher, or any of 3 other electronic relays. Includes all parts, 2 transistors, battery, headphones and instructions, for each project, 3 lbs.

83 Y 299. Electronic Lab Kit..... \$15.45



Famous 2-Band "Space-Spanner"

Thrilling new bandswitching receiver. Selects exciting short wave on 6 to 18 mc (foreign, amateur, aircraft, police, marine); and full standard broadcast. Sensitive regenerative circuit; 4" PM speaker; beam-power output. Easy to build. All parts supplied (less cabinet). 4 1/2 lbs.

83 Y 243. "Space-Spanner" Kit.... \$15.95

83 Y 247. Cabinet for above..... \$2.90



2-Way Intercom Kit

It's easy and inexpensive to build your own 2-station intercom! Use it in home or office. Makes ideal "baby sitter". Extra high gain—delivers full output from only a whisper. Complete with 50 ft. cable (up to 200 ft. may be added), antique-white cases, tubes and all parts. For AC-DC. 7 lbs.

83 Y 295. 2-Way Intercom Kit.... \$14.75

FREE

ALLIED SUPPLEMENT

Send for our special Supplement No. 165 featuring the complete line of KNIGHT-KIT Hobby, Hi-Fi, Amateur and Test Instrument Kits. See hundreds of special values in Hi-Fi systems and equipment, recorders, Amateur gear, test instruments, parts, tubes and tools. FREE—send for it today.



ALLIED RADIO

World's Largest
Electronic
Supply House
Our 36th Year

ALLIED RADIO CORP., Dept. 05-G7
100 N. Western Ave., Chicago 80, Ill.

Send FREE ALLIED Supplement No. 165

Send the following KNIGHT-KITS:

83 Y 262. 83 Y 243. 83 Y 295.

83 Y 299. 83 Y 247. \$_____encl.

(All prices Net F. O. B. Chicago)

Name _____

Address _____

City _____ Zone _____ State _____

(Continued from page 58)

WHAT'S NEW FOR THE HOME

Aluminum handle for milk cartons.....	104
Chalk marker.....	104
Decorator fabric front for air conditioner.....	104
Food mincer.....	104
Table tennis.....	104
Chair lift.....	105
Cord shortener.....	105
Electronic air cleaner.....	105
Lawn shuffleboard.....	105
Round-ice-cube tray.....	105

Radio-Television, Electronics

Transistor radios you can build.....	145
Novel TV-antenna suspension.....	148
Record-it-yourself TV.....	148

Craftsman and Shop Notes Index

HOUSE AND HOME

Hose mounted on masonry wall of garage protects car doors.....	170
Picket fence with steel posts easy to move and lasts longer.....	170
Guide strips on sides of roof help amateur shingler.....	180

HOUSEHOLD HINTS

Candleholder adds charm.....	164
Inexpensive birdbath made from household items.....	168
Small flower vase from test tube fitted in candleholder.....	179
"Antique" rack to display your show dishes.....	181

LAWN AND GARDEN

Soaker hose rolled into position with reel.....	169
Rubber bumper on lawn mower protects trees and shrubs.....	174
Broken tiles prevent erosion on sloping lawn.....	186

MISCELLANEOUS

Car battery illuminates trailer in absence of park facilities.....	157
Enlarging drawings the easy way.....	157
Midget barbecue from water tank.....	157
Coffee can used as toaster.....	165
This folding grill is outdoor cook's delight.....	165
You can steer your twin outboards like a pro.....	166
Mirror and magnifying glass help find particle in eye.....	168
Egg slicer used for cutting flat pieces of ceramic clay.....	169
Altering worn eraser to use it effectively.....	174
"Ferrules" for furniture legs made from thread.....	174
Tape guide on level vial speeds setting sidewalk forms.....	174
Locking screw in eyeglasses.....	180
Notched shelf holds fishing rods.....	180
Checkers strung on needle stored in mailing tube.....	181
Support for heavy parade flag improvised from work rubber.....	181
Plywood pontoons.....	182
Bag with plywood in bottom keeps fish alive longer.....	184
Plant-lined creel preserves freshly caught fish.....	184
Handy insulated food bag.....	185
Blowgun of metal tubing fires harmless "darts".....	186
Concrete poured from mixer directly into forms.....	196
Correct distributor installation.....	196
Roadside stock-loading chute helpful during spring thaw.....	196

ON THE MARKET

Liquid rubber.....	204
Mender contains a new ingredient.....	204
Penetrating concrete stain.....	204
Simulated ceramic tile.....	204

PHOTOGRAPHY

Photo solutions protected against damage by air.....	157
Low-contrast film adapted for line-copy work.....	168
Clean darkroom equipment assures higher quality work.....	186

SHOPPING FOR TOOLS

Pneumatic nailer.....	202
Screwdriver gives extra power.....	202
Torque wrench.....	202
Drill-press attachment.....	203
Dual-purpose wrench.....	203
Electrostatic flocking kit.....	203
Magnetic driver.....	203
Self-energizing centrifugal clutch combines level action.....	203
Spiral nail holds better than common nail.....	203

WORKSHOP HINTS

Rotary knife scores plasterboard.....	165
Parallel lines drawn accurately by scribing arcs with compass.....	168
Saw fitted in slotted step kept handy on ladder.....	168
Coarse sandpaper "smoothed" for use on fine work.....	169
Cotter pin in door-latch bolt serves as locking device.....	170
Magnet hung over edge of tumbler holds small brushes off bottom.....	170
Modified mechanical pencil is miniature grease gun.....	174

(Continued to page 62)

Air-Conditioned Sidewalk Makes Shopping More Pleasant

Air-conditioned sidewalks keep prospective customers comfortable while they browse in North Towne Plaza, San Antonio, Tex. A glassed-in, roofed-over mall with year-round weather control eliminates the discomfort for buyers of going out into heat or cold to get from store to store. In this shopping center a terrazzo-tile walk 16 feet wide is closed in on the parking-area side with 3 by 10-foot glass panels in removable aluminum frames. The walk is roofed over with prefabricated decking, insulated with two inches of Pearlite and one half inch of white marble chips. Additional roof overhang holds down heat of the afternoon sun. Three sets of electric-eye doors open automatically at the approach of shoppers. Instead of traditional doors in shop fronts, large plate-glass panels slide open on tracks in the morning and are closed at the end of the day.



Carrier Corp., Syracuse, New York

Low Temperature Recorded

Scientists have recorded the lowest temperature ever observed at the South Pole—89 degrees below zero F. It is within one degree of the all-time world's record, recorded in northeastern Siberia in 1933, and exceeds by eight degrees the lowest in North America observed in the Yukon Territory of Canada in 1947.

Changing Molecules Fireproofs Fabrics

Flame-resistant cloth can now be produced by substituting bromine or iodine for some of the oxygen-hydrogen fragments in the cellulose molecules of rayon and cotton. The previous method of making fabrics fire-resistant required a chemical coating on the fibers. Scientists at the Textile Research Institute, Princeton, N. J., report that fabrics also can be made to resist afterglow by adding phosphorus to the cellulose molecules. Tests indicate the treated fabrics show no appreciable loss of strength and weigh only 10 to 12 percent more. Research workers plan to apply the technique of changing the molecule structure to cellulose building materials.

Fastest-Firing Machine Gun for Jet Aircraft

Considered the world's fastest-firing machine gun, the Vulcan borrows the principle of one of the oldest machine guns, the Gatling. The electrically operated 20-mm. cannon will be installed aboard jet aircraft. It has six barrels that rotate to multiply its firepower. In 20 seconds the Vulcan can fire more shells than 400 riflemen can shoot in one minute.



Amazing do-it-yourself discovery!

Metaltone

T.M.

...the new spray finish
paint with a
hammered metal look.

An amazing spray finish that gives a hammered metal look to most any surface...wood, leather, metal, etc.

PROTECTS as it beautifies with a flexible coating resistant to acids, alkali, water, corrosion.

QUICK, EASY TO USE! Sprays on with no muss or fuss...no brush marks. Ideal for home, workshop, anywhere.

ECONOMICAL, BIG 16-OZ. SPRAY CAN...Assorted metallic colors including copper and clear plastic.

ONLY
\$1.79

Available at hardware, paint, hobby and department stores or write:

FLAMEMASTER CHEMICALS, INC.
Culver City, California



BUILD YOUR OWN WINDOW FAN

Save 1/2 or More
Enjoy Cool Comfort

ORDER TODAY—A factory-packed fan kit containing fan blade, self-contained bearing and shaft assembly, two pulleys, and belt, plus easy assembly instructions. You use your own 1/8 HP or larger motor and lumber for frame. Iowa Residents add 2 1/2% Sales Tax. If cash with order, we prepay shipment. If C.O.D., send 25% deposit.

Size	RPM	Approx. CFM	Price
20"	852	3090	\$12.90
24"	662	4890	\$14.90
30"	430	5880	\$17.90



Send for **FREE** complete Fan and Parts Catalog.

KLOPPENBORG FOUNDRY & FAN CO.

211 MARQUETTE STREET DEPT. PM57 DAVENPORT, IOWA

Burnishes as it flares! IMPERIAL no. 500-F flaring tool

Rolls flares in air above die block
Automatic burnishing
Long-life hard chrome finished cone



Smoothest, strongest 45° precision flares you've ever seen! For copper, aluminum, brass tubing—3/16" to 5/8" O.D. Sold by leading industrial, refrigeration, plumbing and automotive supply houses everywhere. Also 37° and double flaring tools.

SEND 10c for VALUABLE HANDBOOK and CATALOG

THE IMPERIAL BRASS MFG. CO.
1212 W. Harrison St. Chicago 7, Ill.
Send 36-page Imperial Tube Working Handbook and Catalog. Also name of nearest dealer.

Name.....
Address.....
City..... Zone..... State.....



Circle of Quality

(Continued from page 60)

Wooden strips dampen flutter when sawing wallboard.....	174
Paper cup for mixing paint held in plastic container.....	179
Tin-can rack provides storage for garden tools.....	180
Circle-cutting attachment improvised for roaster.....	186
Metal spool provides storage for several extension cords.....	189
Piece of hardboard under paper increases sander efficiency.....	189
Carriage bolt used as rasp.....	192
Drill lubricated by paintbrush.....	192
Jig space holes uniformly when drilling half rounds.....	192
Workpieces held with dowels when being cut on jigsaw.....	192
Bench plate.....	193
Wedge with long taper aids in removing piston rings.....	193
Brush cleans T-slots in table.....	194
Strips modify "drive block" for more efficient use.....	194
Lumber racked between joists in basement workshop.....	196
Adapters fit standard collets.....	197

NOTICE—It is the intention of this magazine to provide its readers with information regarding the latest developments in the mechanical arts. Except where otherwise indicated, this magazine has no information as to any unexpired patents in respect of the developments reported herein. In the event that commercial use is to be made of any of the developments reported herein, it is suggested that legal counsel be consulted to avoid liability for patent infringement. It is not the purpose of this magazine to encourage patent infringement but, as indicated, it is the intention of this magazine to report on the latest developments in the mechanical arts.

Portable Hoist Is Self-Erecting

Push a button and this 45-foot hoist tower raises itself into position like an opening carpenter's rule. As the tower, powered by gasoline engine or electricity, is being raised, the wheels of the platform retract to give the device solid footing. When the hoist is lowered, the wheels of the platform pop into towing position. Another model of the hoist, which opens to a height of 42 feet, is built into the body of a truck. It also can be adapted to trucks already owned by contractors.

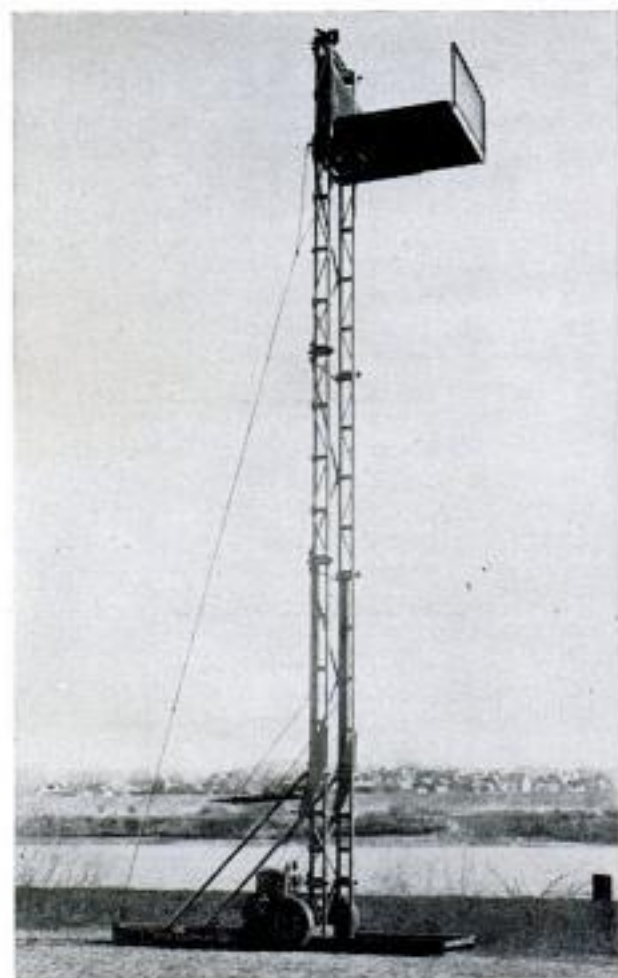

the inside story of
PATENT NO. 2,442,945*

ALDOR SPARK PLUGS
 THERMO-REACTOR

The ONLY FULLY AUTOMATIC spark plug in the world! Engineered especially for today's new car HI-COMPRESSION engine!

You get MORE miles per gallon, GREATER horsepower, under any and every driving condition—INSTANTLY—AUTOMATICALLY! Millions in daily use in the U.S. and in over 30 foreign countries! GUARANTEED TO OUTLAST & OUTPERFORM ANY OTHER PLUG!

Aldor's specially designed D-H* ELECTRODE insures peak resistance to pitting and burning and assures INSTANT STARTING!

ALDOR Thermo-Reactor Spark Plugs are on sale at most better Auto Accessory Stores, Garages and Service Stations—Ask for them by name! If not available locally, send check or money order, or C.O.D. (stating year, make and model of car or type of engine) to:

A. L. DOERING SPARK PLUG CORP.
 2 STATION PLAZA, BAYSIDE 61, N. Y.
 Manufacturers of the
 world famous OIL FIRING Spark Plug since 1914!

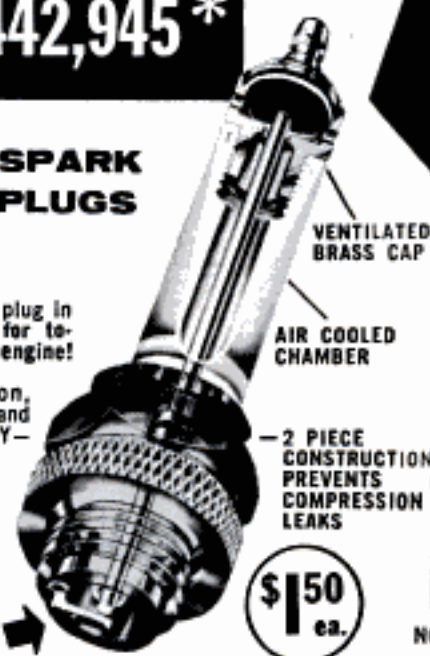

The ONLY spark plug in the world with the
PATENTED AUTOMATIC "BUILT-IN-BRAIN"*

* The PATENTED THERMOSTATIC REACTOR DISK is an engineering marvel that gives you AUTOMATIC spark adjustment for both high and low speeds—SOMETHING NO OTHER PLUG CAN DO! Power response is faster and smoother than ever—from a standing start, easing along in traffic, or passing at cruising speeds!



At low speed, stop & go city driving, the Thermostatic Reactor Disk AUTOMATICALLY snaps away from the electrode causing a voltage buildup. This produces the HOT spark that burns away ALL carbon deposits and PREVENTS FOULING!



At high speed driving, the Thermostatic Reactor Disk AUTOMATICALLY snaps back to the electrode reducing voltage flow and producing the COLD plug that PREVENTS PRE-IGNITION and compression loss!

NO FOULING in stop and go city driving ...
NO PRE-IGNITION at high speed open road driving ...
AUTOMATICALLY!

The Patented Thermo-Reactor is also built into the World Famous ALDOR OIL-FIRING non-fouling spark plug for older engines and worn engines using excessive amounts of oil! SELF-CLEANING, WILL NOT FOUL! Actually FIRES IN OIL!



ALDOR Thermo-Reactor plugs also sold under the following trade names: DOERING; LLOYD; WHITE; PRECISION BILT.

BUILD A BOAT AT 1/3 THE COST!



with CLEVELAND'S full size, cut-to-shape boat patterns, detailed blueprints, and specifications. All classes and styles of modern Naval Architect-designed boats from 7 1/2

to 38 ft. **BIG NEW 86-PAGE ILLUSTRATED CATALOG.** See (contn). "How to Build a Boat" Booklet, \$2.50. Hardware & Equipment catalog, \$1.50.

CLEVELAND BOAT BLUEPRINT CO.

Dept. A-165 Box 1651 Cleveland, Ohio

"MINIATURE MACHINE SHOP

No Bigger Than A Typewriter, Outperforms Machines Many Times Its Size!



That's what a popular publication says about UNIMAT in their 3 page feature story in the May issue. If you want a reprint of this story plus complete information about this amazing 10 in 1 combination precision tool write to:

AMERICAN EDELSTAAL, INC., UNIMAT DIV., Dept. 377, 350 B'way., N.Y. 13

NEW REMOTE CONTROL TARGLITE®

...for faster, safer shooting

Exclusive Crosman "portable, lighted shooting range." Recessed light spots hits. Simple pulley changes target from behind firing line. Traps pellet and BB ammo. See it at your dealer's.



FREE 32-page Gun Book with Targlite data
 CROSMAN ARMS CO., INC., Dept. PM-7, Fairport, New York

Jet King
 POCKET-SIZE
BUTANE BLOW TORCH

ONLY
\$1.95
 WITH CHARGER

**SOLDERS!
 BRAZES!
 FIXES LEAKS!**



Every do-it-yourself and hobby fan needs this Kidde JET KING butane Blow Torch. Just the tool you've been looking for to do dozens of jobs in home or hobby...TV, appliance, lamp, radio or plumbing repairs...precision soldering, brazing or metal craft. Useful, too, for starting charcoal fires. A tiny, clean, safe charger does the job.

Each charger gives 30 minutes of intense 3500° pinpoint flame; turns on and off. Extra chargers, 39¢ per box of 2. Money back guarantee. At leading hardware and hobby stores...or send check or money order, we pay postage.

Kidde KIDDE MANUFACTURING CO., INC.
 Dept. PM-7
 42 Farrand Street, Bloomfield, N. J.

Please send me _____ JET KING BLOW TORCHES plus: _____ boxes extra chargers (limit 2 boxes per torch).
 My check money order for \$_____ is enclosed.

Name _____
 Street _____
 City _____ State _____

"How to Think Ahead of Your Car and Save Gas Dollars!"

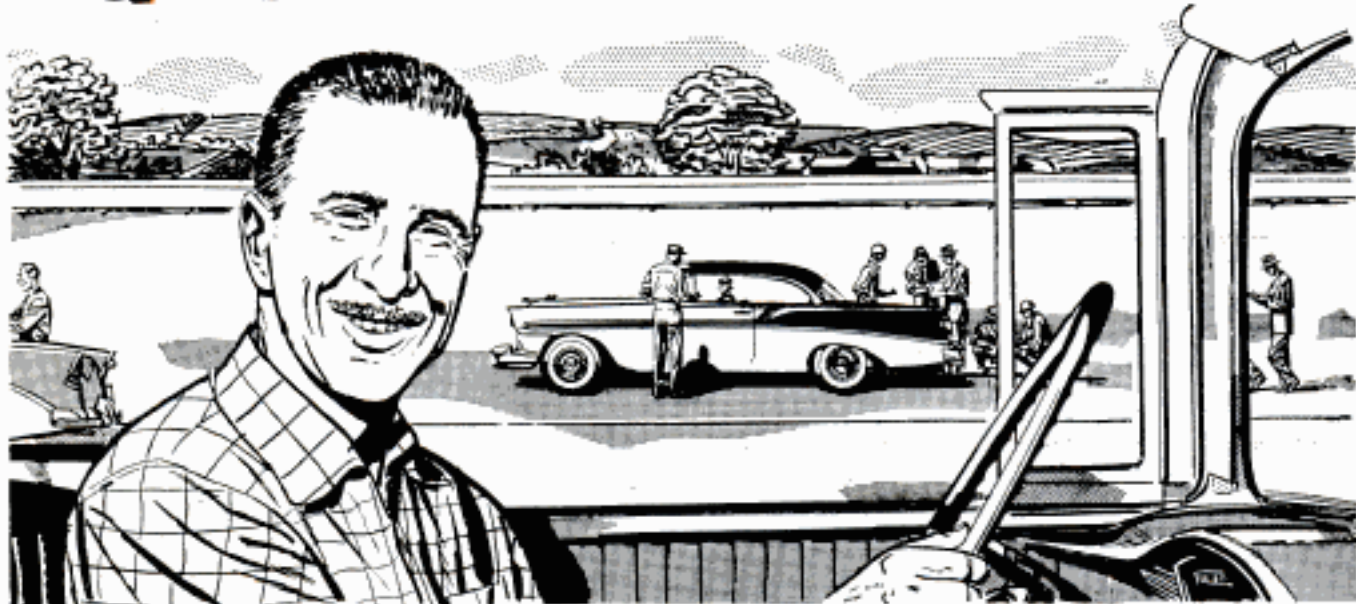

"Professional drivers think ahead of their cars... avoid needless stops and starts... save fuel that many drivers waste..."

Maurice Rose

One of America's top professional drivers for over 25 years, three-time Indianapolis 500-mile winner.

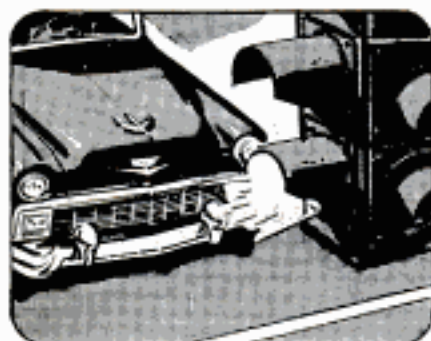

"Most drivers waste gas at stop lights. The smart driver goes at a steady pace, slowing down well back of a red light... avoiding the stop if possible."



"A professional driver always keeps well back of the car ahead. This way, he avoids gas-consuming 'panic' stops... possible rear-end collisions."



"A pro never speeds over a hill or into any 'blind' situation. It's dangerous... and even if you can stop in time, it's a stop and start that consumes extra gas."

You can think ahead of your car in more ways than one. Make sure you're getting all the performance you paid for... see your Rochester Carburetor specialist. He'll give your car the kind of care that only a factory-trained mechanic can. And he knows that Rochester Carburetors are precision-built for top performance on today's high-compression engines... they're rugged and reliable! They'll help you save on gas by delivering just the right mixture, at just the right time, to squeeze extra mileage out of every gallon.

Standard equipment on Cadillac, Buick, Oldsmobile, Pontiac and Chevrolet

R **ROCHESTER**
CARBURETORS

ROCHESTER PRODUCTS DIVISION
GENERAL MOTORS CORP., ROCHESTER, N. Y.



"A stop every good driver considers necessary is at his factory-trained mechanic's for regular checks on the carburetor and vital engine parts whose condition affects performance and economy."



POPULAR JULY 1957 MECHANICS

WRITTEN SO YOU CAN UNDERSTAND IT
VOL. 108 NO. 1

Stand By for Satellite Take-off

By **Fred L. Whipple**,
Director, Smithsonian Astrophysical Observatory
and
J. Allen Hynek,
Associate Director,
Smithsonian Astrophysical Observatory

IF A MAN COULD shrink to fly size and ride with the first artificial satellite, he'd have quite a view. Far below he'd see the earth—its plains, mountains and seas—through blue sky between the great cloud banks encasing our solar system's most beautiful planet.

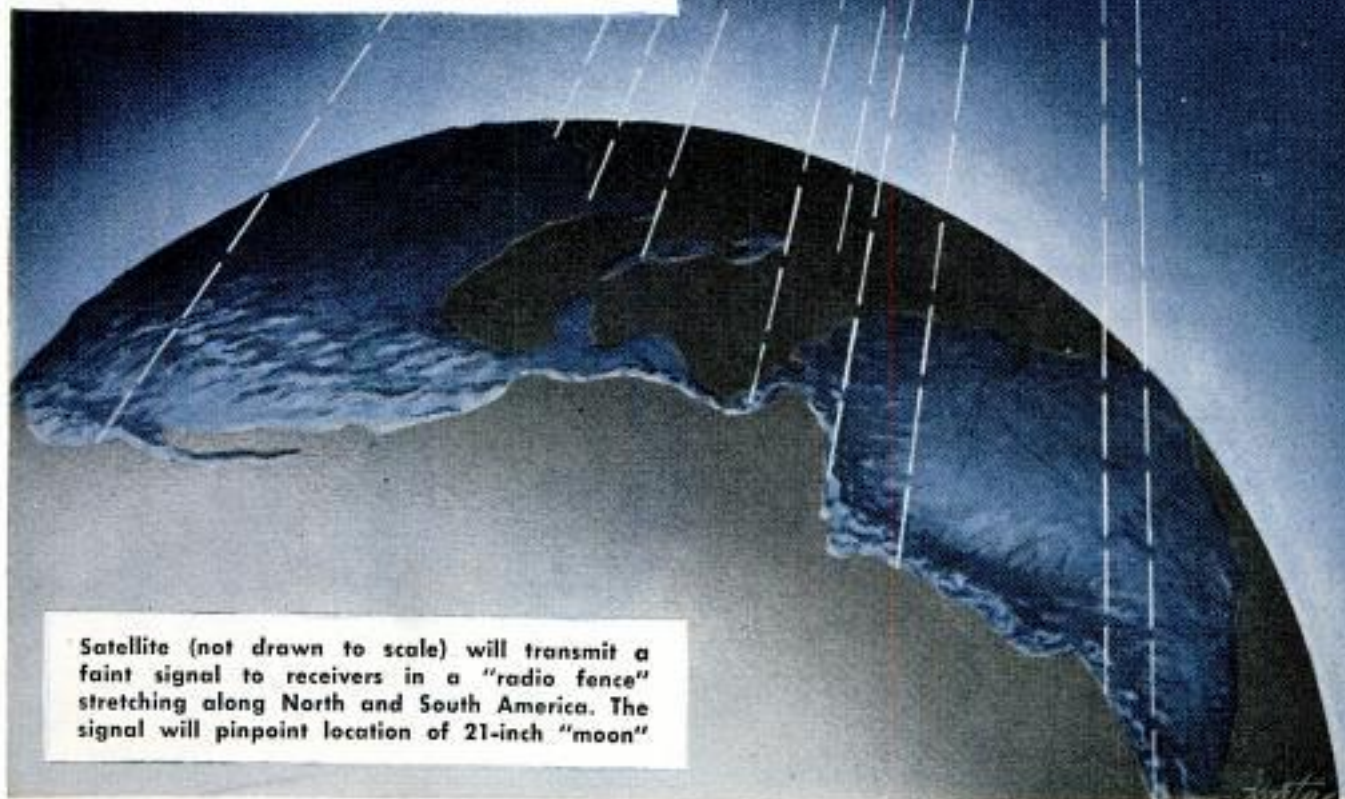

Satellite (not drawn to scale) will transmit a faint signal to receivers in a "radio fence" stretching along North and South America. The signal will pinpoint location of 21-inch "moon"

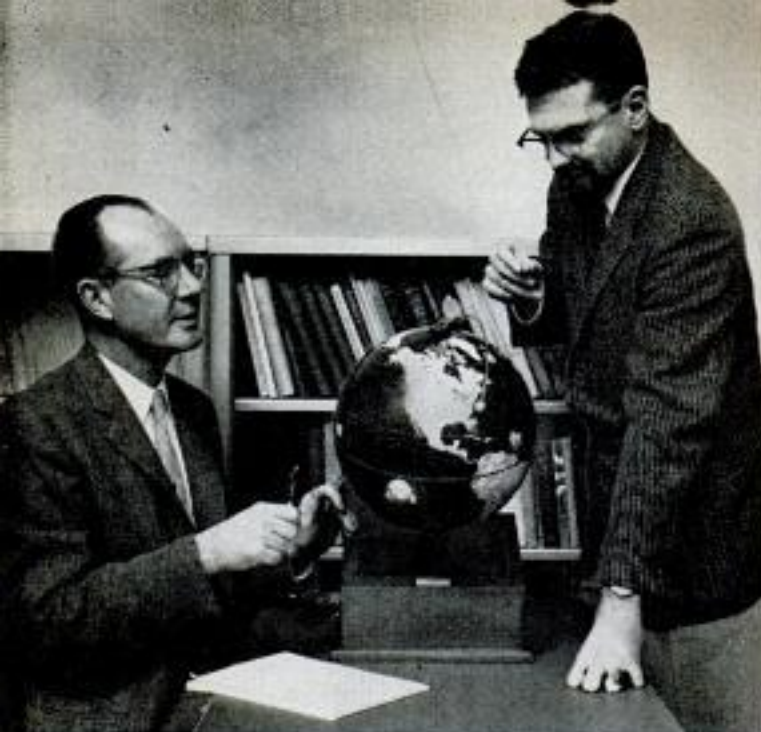

Co-authors Dr. Fred L. Whipple, left, and Dr. J. Allen Hynek discuss satellite's anticipated orbit

Earth's blue sky, making it unique and by far the most colorful of our planets, reaches only 10 or 20 miles above its surface. At 300 miles the air is so rare it shows no trace of blue scattered sunlight. The satellite rides in a paradox of night sky with its pattern of stars, planets and Milky Way—all in full daylight.

Originally, the target date for launching the 21-inch "moon" was September of this year. It is now believed that the satellite, part of the participation of the United States in the International Geophysical Year, will not be launched until next spring at the earliest.

Whenever it is launched, the dramatic

Engineer adjusts tiny gear in instrument which will collect information on outer limits of atmosphere

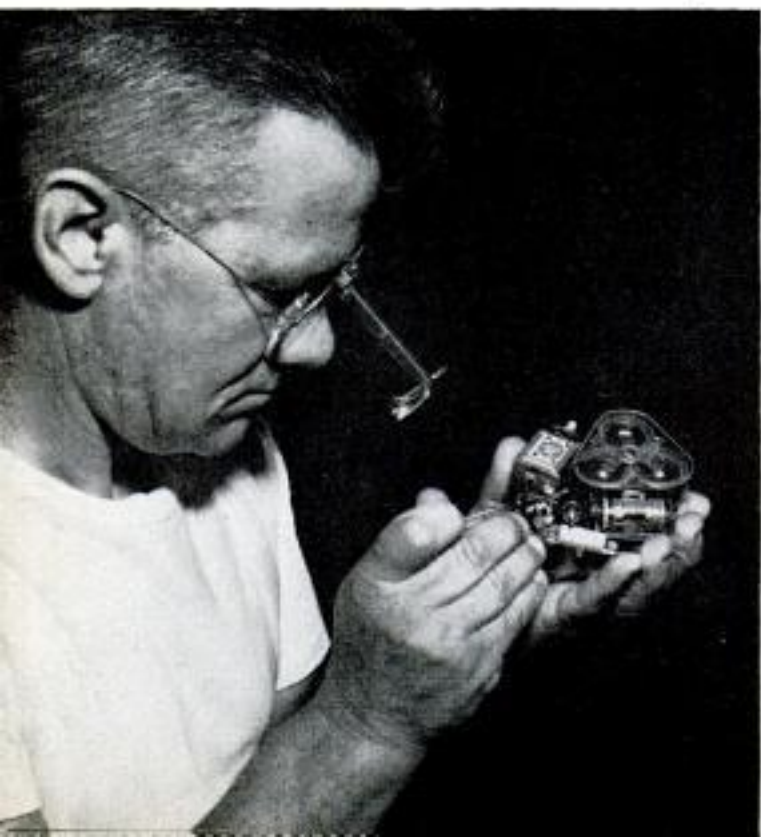

journey of the satellite will start with the firing of the rocket that takes it into space. To visualize the trip, you'll have to imagine riding in the cramped nose of an 11-ton, three-stage rocket, leaving the earth from Patrick Air Force Base at Cape Canaveral, Fla. In post-sunset darkness, the huge, pencil-like rocket stands 72 feet high against a star-studded sky, poised on a strange launching platform. Its ponderous first stage, almost four feet in diameter, appears graceful because of its incredible length. At "X minus one" every man will have disappeared into squat blockhouses. Then, with an unearthly roar, fire from the tail of the biggest rocket in history bends through a deflection tunnel beneath the platform and shoots across scorched ground. Along with it goes a hurricane of hissing steam from torrents of water drenching the lining of the steel tunnel to keep it from melting under the blast. For a moment, as though gathering itself for the Gargantuan effort, the monster seems to stand still, trembling atop its roaring exhaust. Then with indescribable power it moves upward, gathering speed. In seconds, it is a pin point of light disappearing in the sky.

Motor Pivots for Steering

No fins are needed to guide this epoch-making rocket. They were removed to reduce drag. Instead its big motor is mounted in gimbals, allowing it to pivot and direct its thrust for steering. Second and third stages are similarly rigged. Rising vertically under the powerful thrust of exploding liquid oxygen, ethyl alcohol, gasoline

Electronic package, heart of the satellite, is encased in plastic foam and slipped into the sphere



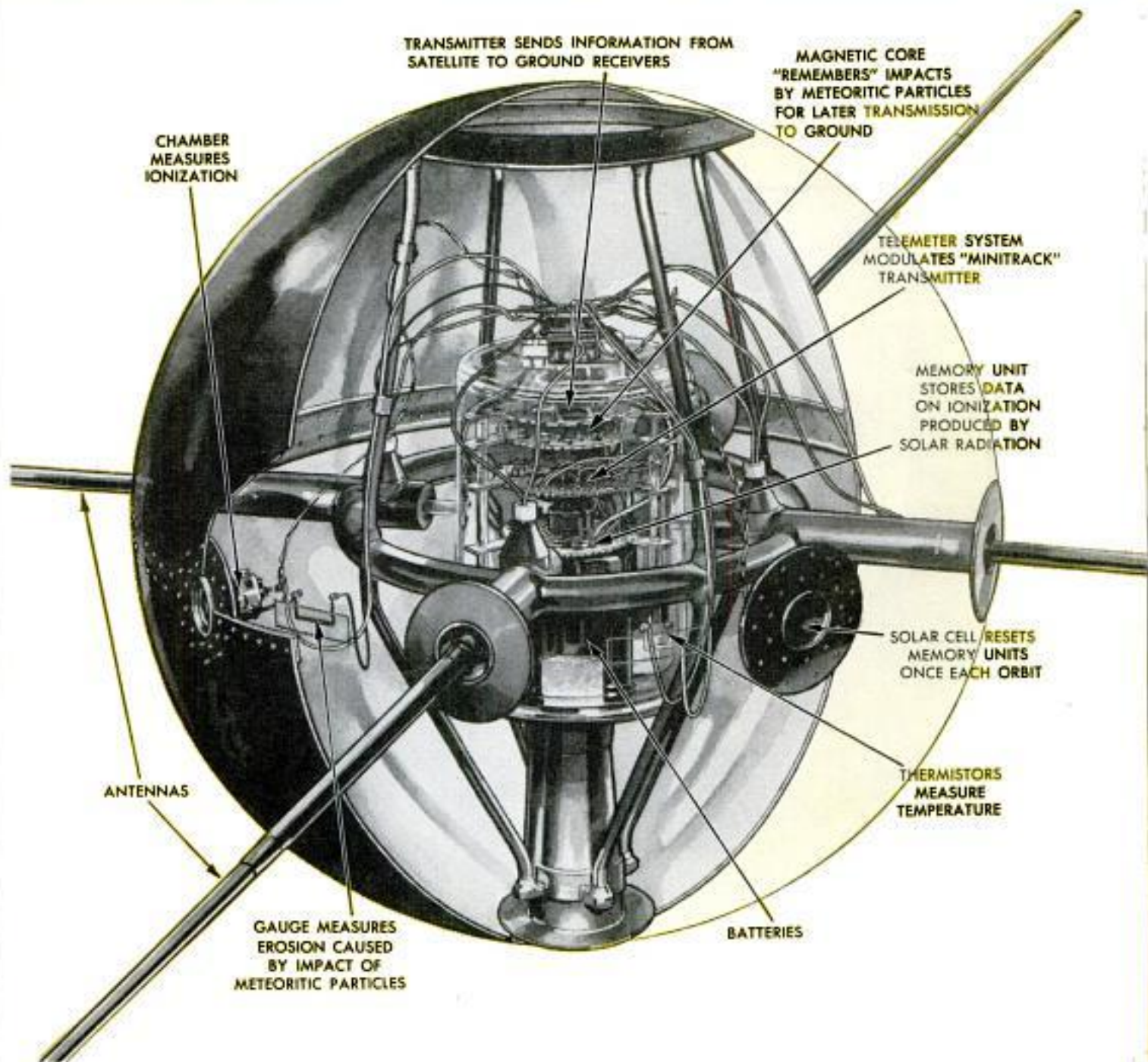

Drawing of the little manmade moon shows the parts and their functions. Radio will transmit data to the earth

and silicone oil, the massive first stage catapults the vehicle to 4000 miles per hour, lifting it 30 miles through the denser layers of atmosphere in 130 seconds. At this point, nitric acid and unsymmetrical dimethyl hydrazine burst into flaming reaction in the motor of stage two, carrying it up and away from the burned-out hulk of stage-one motor and tanks.

By the time the second stage burns its fuel, our satellite has risen more than 150 miles above the earth and is traveling nearly 10,000 miles per hour. The flight path is no longer vertical; it has been programmed into a more horizontal course by a gyroscopic guiding device in the second stage. We coast for about 40 seconds, the second-stage motor and fuel tanks still with us until an altitude of 300 miles is reached

and speed drops to 9000 miles per hour.

At this point the third stage takes over to provide spin and the final boost, shoving stage three horizontally into orbit at 18,000 miles per hour. Disengaging gently from the third-stage rocket by spring or small explosive charge, the tiny sphere slowly drifts away from this empty hulk, which tags along behind—a brother satellite.

The 18,000 miles per hour is significant. At this speed the satellite falls toward earth at the same rate earth's surface curves away from it. Consequently, the satellite's distance from the earth remains about the same.

About 35 minutes after take-off the satellite is in orbit, approaching South Africa and dawn. From its height above the earth you would see the sun rise, illuminating

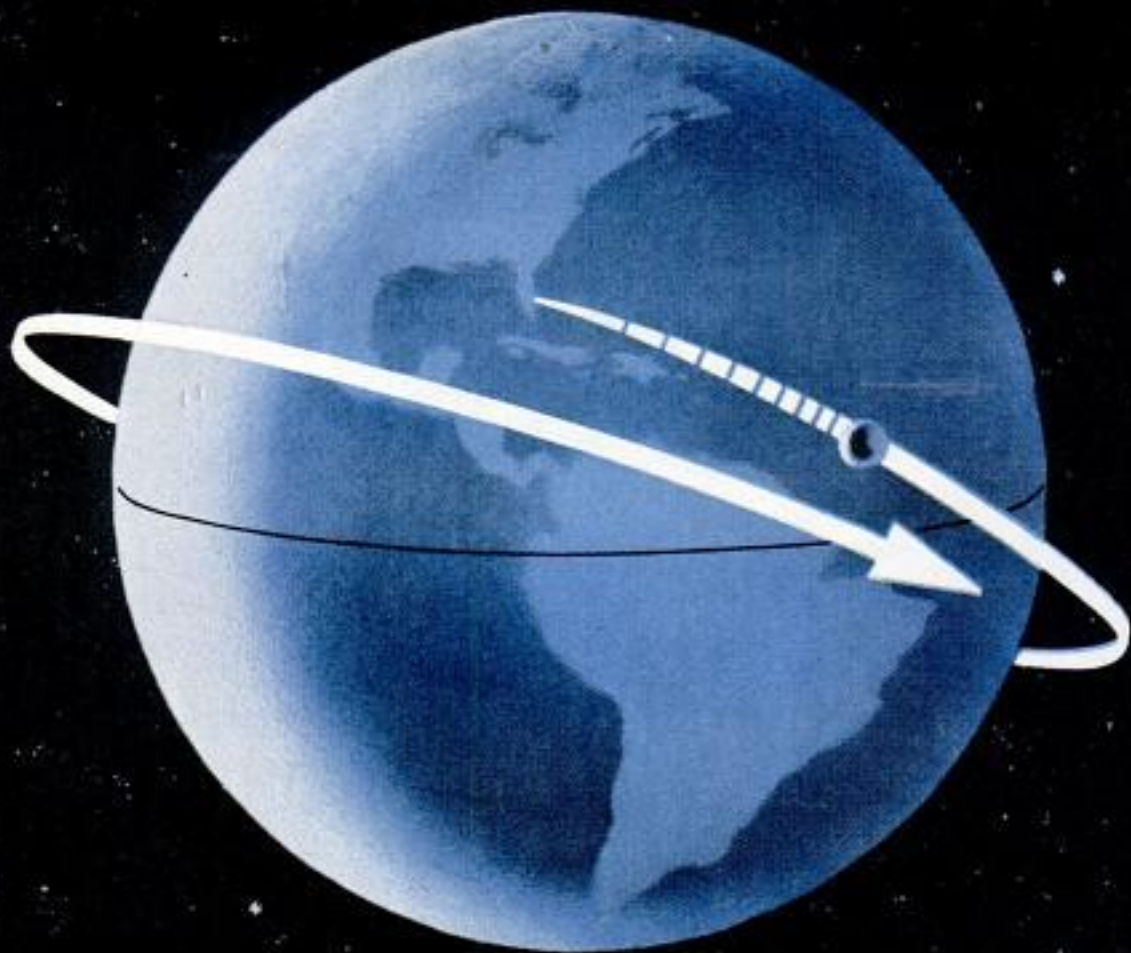

In relation to the earth, the satellite will not follow the same path on succeeding revolutions because the earth is turning inside the orbit. Also, its height above earth will vary from 300 to 800 miles

Drawing below shows size of the huge rocket in relation to the size of a man. Bottom, critical tracking job will occur during initial stages of launching, to determine its precise course for future observations

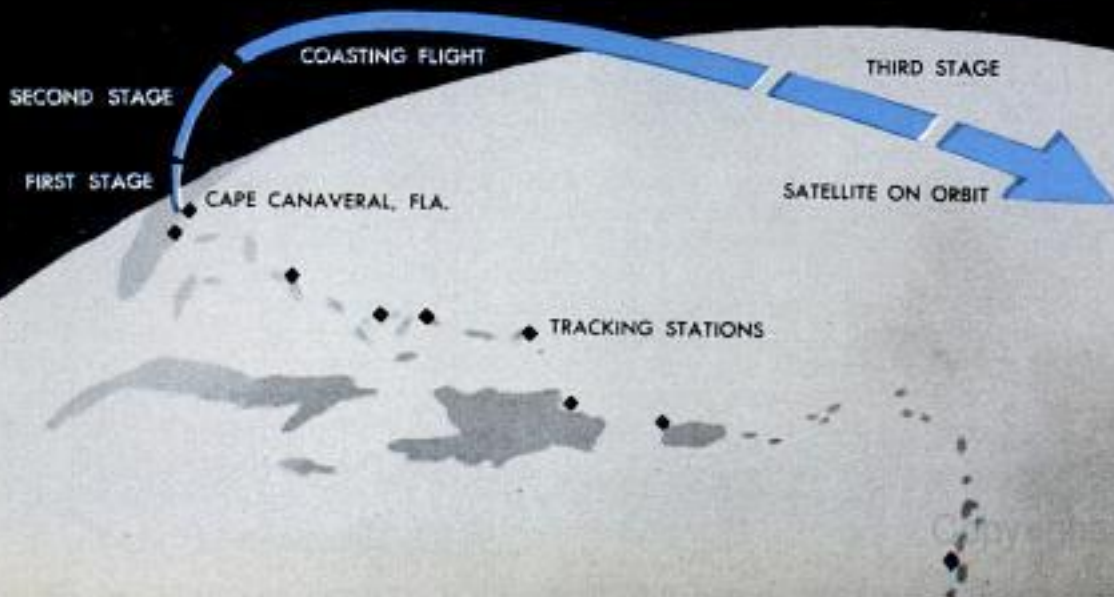

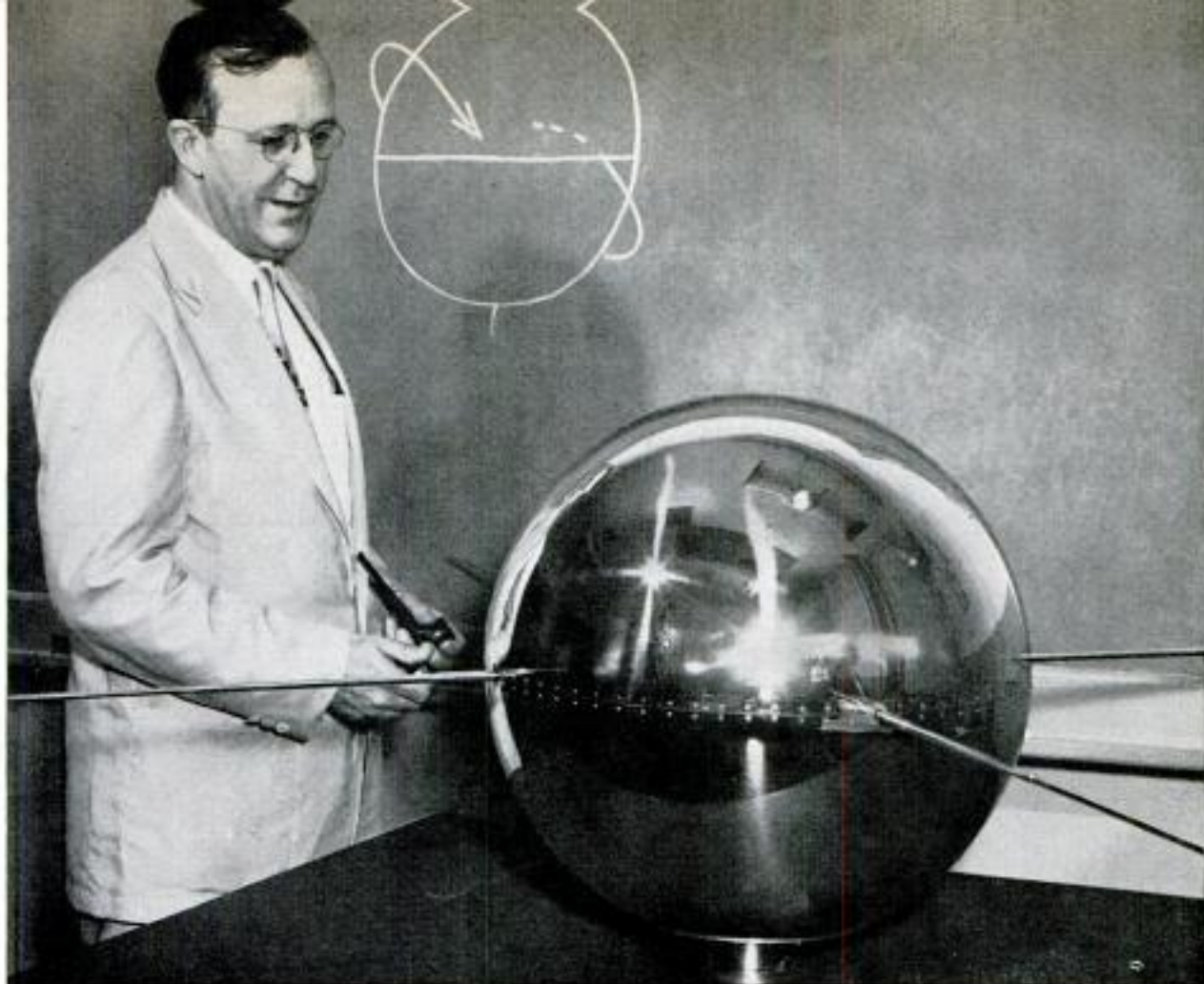

Dr. Hagen of Naval Research Laboratory examines full-scale model of satellite, complete with gold plating

the metal sphere and allowing watchers on the tip of South Africa to get first view of the tiny orb. Soaring over Madagascar, you'd see earth brightened by morning sun. During the next 50 minutes the baby moon will cross the Indian Ocean, Indonesia, then the far Pacific.

A "satellite day" is short. Slightly more than one hour after launching, the sphere circles most of the globe, passing sunset between Hawaii and San Francisco.

It approaches America near San Diego. From its vantage point, you'd see a broad expanse of the Pacific with the Canadian Rockies to the north. Southward lies Lower California and a sizable portion of Mexico. Toward the east glow the lights of Salt Lake City and Denver.

Visible Only at Twilight

Since the satellite shines only by reflected sunlight, it is visible to watchers on earth only at twilight. At night, shadowed by earth, it is invisible. In daytime it is lost in the glare of skylight. In 10 minutes the orb crosses the country.

Because the earth has turned during the first trip around, the satellite does not pass over its launching site, but considerably south of it—across Nicaragua. Although it is still launching night in Florida, it is the "second night" for the satellite. Aboard this

moon a full day is 100 minutes long; night less than 50 minutes.

During its ensuing trips, the satellite shows best at sunrise in Australia on its 11th, 12th and 13th revolutions. At sunset it shines over Tokyo on its 6th revolution, Hankow on the 7th, Tibet on the 8th, over Iran on the 9th, Syria on the 10th, Tripoli on the 11th, Spain on the 12th and the Azores on the 13th.

On the 14th revolution it arrives over the United States at sunset in Arkansas and above the eastern part of the country in late twilight. This is the first evening after the launching!

As twilight moves across the country, the orb's glitter is observed in the Midwest and Southwest areas—Arizona, New Mexico and California during revolutions 15, 16 and 17. With the 18th circling of the earth, night has fallen over the United States and the satellite will be invisible until next evening.

Evening appearance of our artificial moon over the United States does not last for many days, however, because the earth gyrates slowly around inside the baby moon's orbit, completing one gyration in about 60 days. Because of this, the zone of visibility at twilight slowly shifts southward, while the zone of morning visibility moves north. About 30 days after the launching, United States observers will see

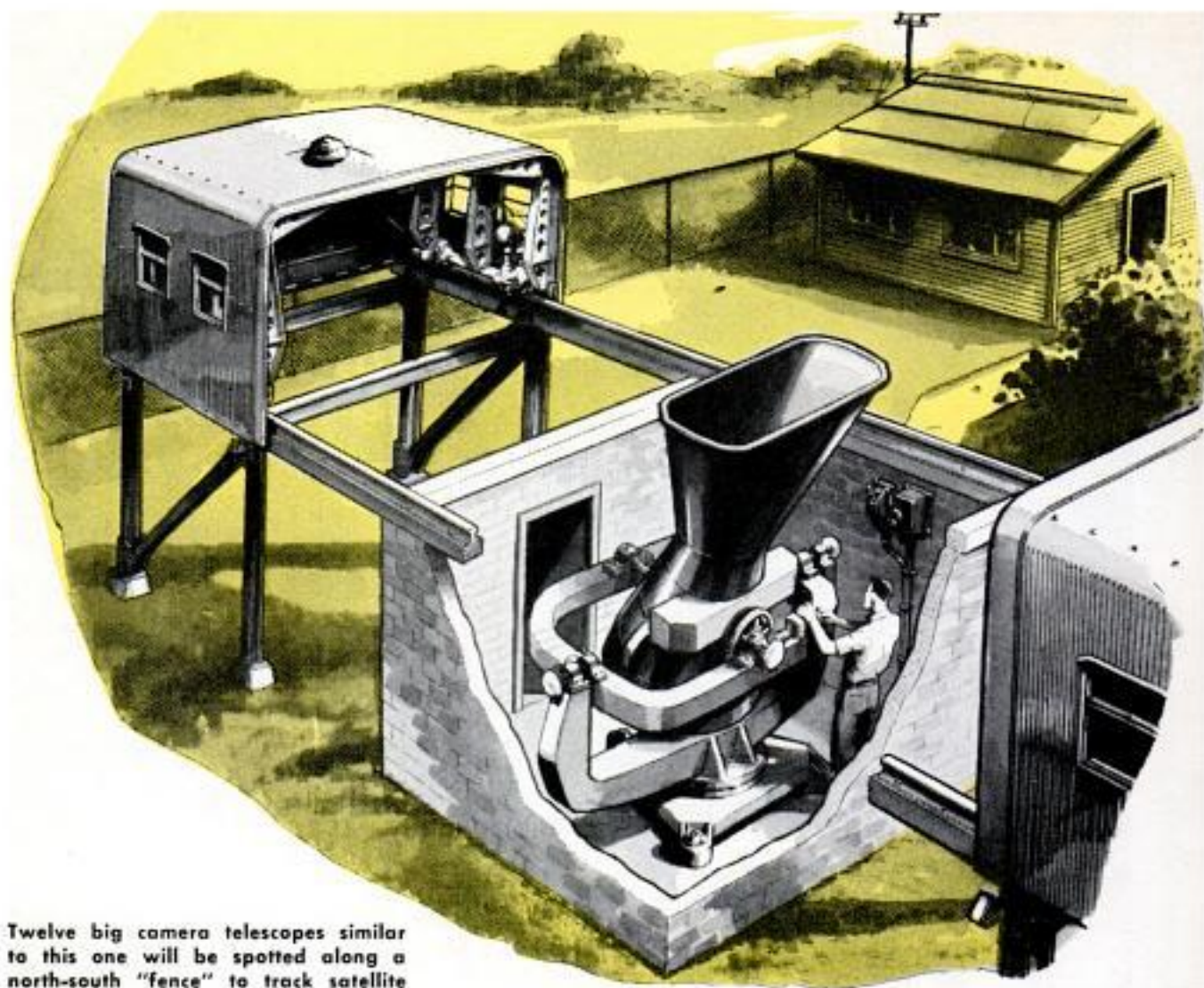

Twelve big camera telescopes similar to this one will be spotted along a north-south "fence" to track satellite

the satellite in morning twilight, but it will be some 60 days before they see it in evening twilight again.

Elliptical Orbit

The satellite's orbit is elliptical, because launching speed must be made a little more than necessary for a circular path. As a result, the altitude of the satellite varies from 300 to about 800 miles.

At perigee (nearest point) over St. Louis, for instance, the view from the satellite would extend from Canada to the Gulf of Mexico and from the Rocky Mountains to the Atlantic Coast.

Many revolutions later when apogee (farthest point) occurs over St. Louis, the view would encompass the North American continent—from Hudson Bay nearly to Panama and from Pacific to Atlantic—if Earth's atmosphere were cloud-free. From the vantage point of the satellite there is an unparalleled view of the world's weather. In the 14 globe-girdling trips each day, the progress of storms could be easily noted in a manner impossible to chart on ordinary weather maps.

What data of scientific value can be obtained from observing the satellite from the earth?

First, we know that the earth is not spherical, but has a pronounced bulge around the equator. Such irregularities will cause the orbit to "regress," or gradually return to earth. By carefully observing the rate of regression, we can make a more accurate determination of the size and shape of our planet than has been possible heretofore. Similarly, the minute quantity of air at the satellite's altitude, though less than you'd find in the best manmade vacuum, is enough to produce a minute drag which will cause the orbit to change, and eventually lead the satellite down to earth. Observations of these orbital changes will give scientists a good determination of atmospheric density at such heights—something we don't yet know.

Challenge to Trackers

For the satellite to constitute a truly scientific vehicle, its orbit must be plotted with extreme care. Since it is a celestial

(Continued to page 216)

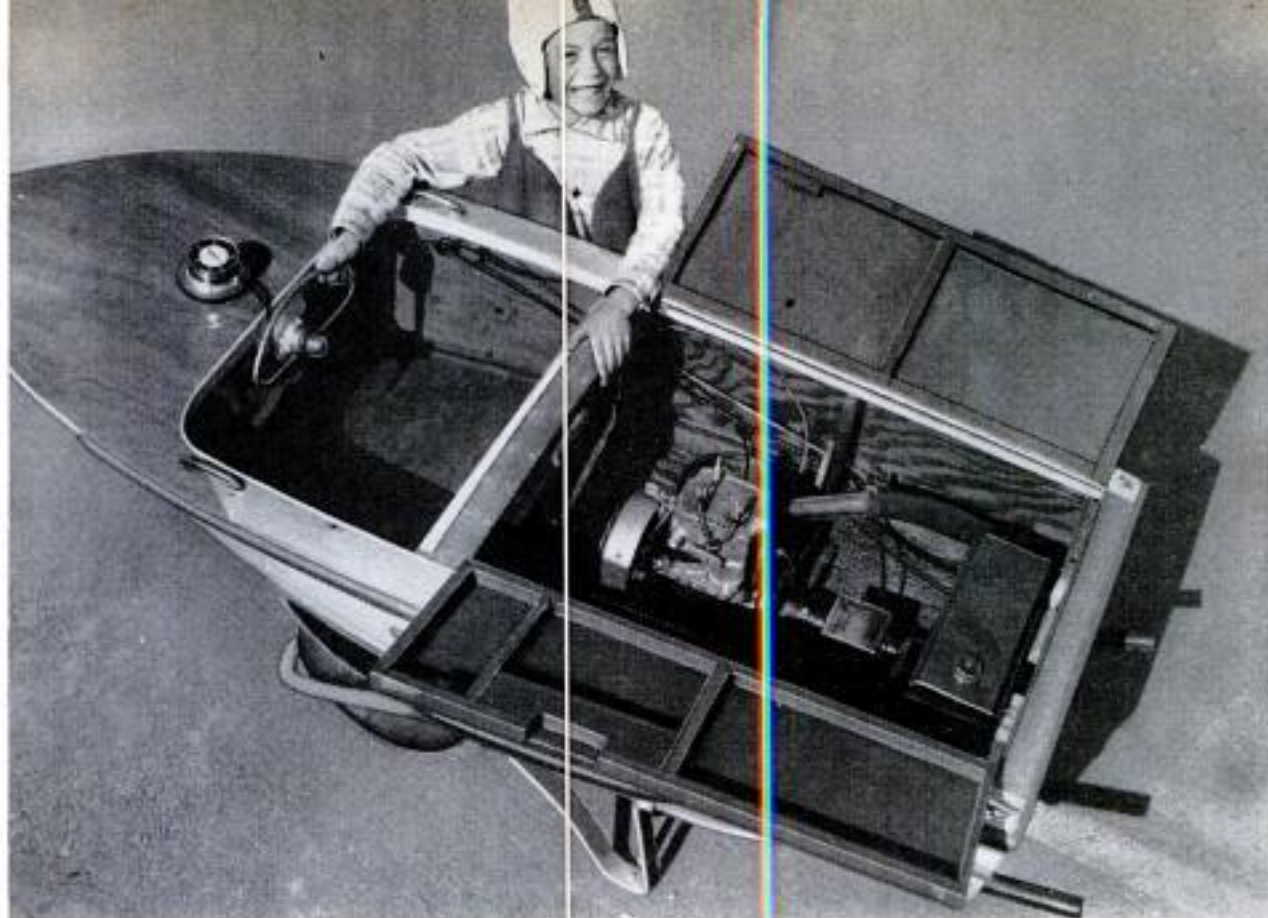

Pint-Sized Runabout

Proudest sailor afloat is a nine-year-old boy of Lakewood, Calif. The lad's father, H. R. Brakensiek, an aircraft worker, built his son a pint-sized inboard runabout that zips along at 30 miles per hour. The little craft is powered by a converted 7½-horsepower bilge pump. Weighing only 140 pounds, it is so small it can be moved on a wheelbarrow.

Metal Roof Rack Has Key Lock

Locked with a key, a metal roof carrier for cars keeps luggage and equipment secure from weather and thieves. Joints are rubber-sealed for complete water and dust protection. The frame of the carrier is steel, the panels are aluminum. Providing about 14 cubic feet of storage, it weighs 47 pounds. Only 16 inches high, it is designed for minimum wind resistance. The side-opening swing-up door permits convenient packing and unpacking.

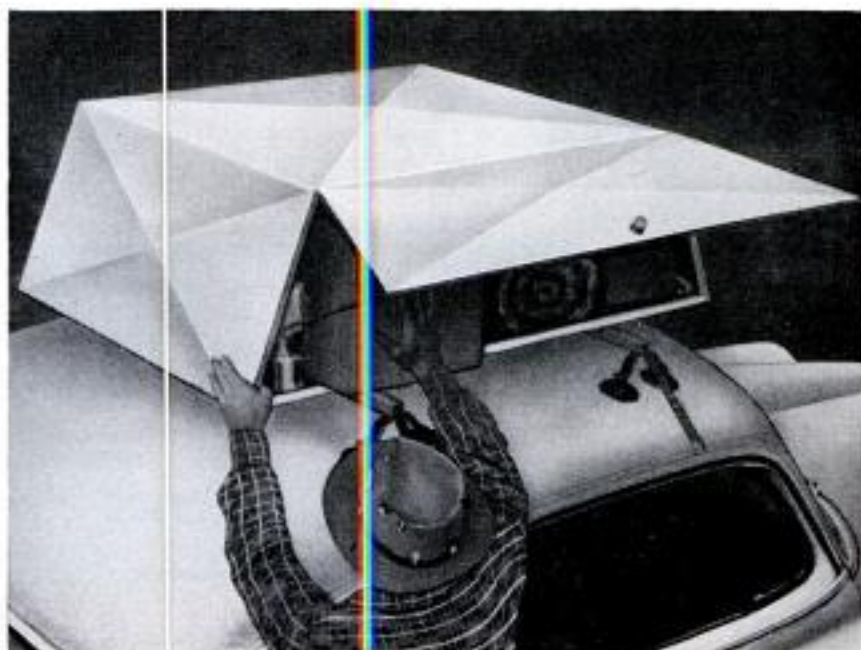



Each shoe has a shiny copper lining fused to it. Frictional lining is bonded to the inside of the drum

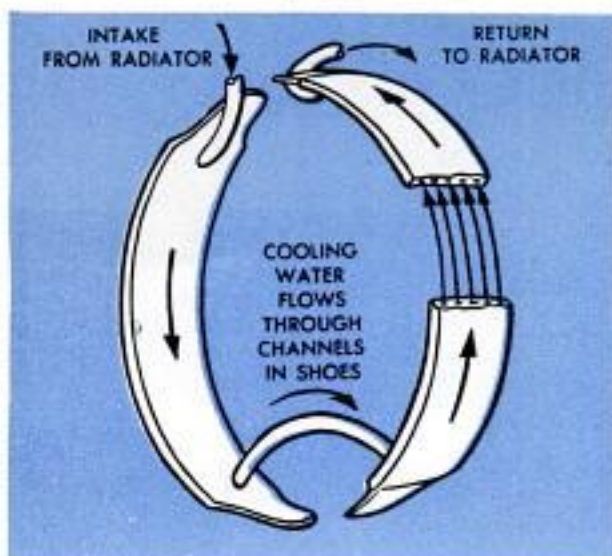

Arrows show flow of cooling water through the shoes. Below, pipe at right extends through backing plate



RADIATOR WATER COOLS THE BRAKES

BRAKE FADE may be a worry of the past if a new water-cooled brake becomes standard on autos. The brake, developed by Raybestos, is cooled by radiator water.

Stopping a vehicle is principally a matter of getting rid of heat. Brakes convert the energy of the moving car into heat by the frictional action of the lining. As wheels get smaller and cars get heavier, heat dissipation becomes a serious problem.

Raybestos says it has the solution. Its system (which is said to cost about \$20 more than present systems) is three times as effective as conventional brakes in stopping cars from high speeds.

The cooling action also makes the linings last longer, says Raybestos. Tests indicate that the linings will be good for more than 100,000 miles or about three times the normal mileage.

Water is piped through a series of channels in the brake shoes. The heat is removed as fast as it develops. There is no frictional lining on the shoes themselves. Instead, a thin copper lining (an excellent heat conductor) is fused to the shoes and the frictional lining is bonded to the inner diameter of the drum.

Tubing, not unlike the tubing used in hydraulic-brake systems, carries the water from the radiator to each wheel.

ECONOMY IS in the air. More and more owners are watching the numbers on the gas pump spin around and asking: "How can I get more mileage?"

PM Owners Reports show that interest in gas economy has jumped sharply in recent months. This could mean that future buyers will demand more miles per gallon. If they do, what happens to industry plans?

Right now, everything points the opposite way—1958 engines will be bigger and thirstier in more luxurious cars. The public, Detroit feels, will not take an economy car. It insists on more car each year.

So small cars get bigger and more expensive to own and operate. This continuous upgrading inevitably leaves a void at the bottom—a void being filled today by imported cars.

Studebaker now hopes its Scotsman (a de-chromed Champion with an austerity rear end) will capitalize on the economy mood. Rambler's Canada-to-Mexico economy run was aimed at the same target. The big sales pitch for these two cars is miles per gallon, not ton-miles. (If you want to win an economy run based on ton miles just enter a heavily loaded truck—you'll win every time.)

Additional evidence of the economy mood is the fact that American Motors' Metropolitan is selling far more than expected. Sales of British economy cars are up 200 percent over last year. These are family cars, not sports cars.

In any case, some imported-car experts claim Detroit has itself in a squeeze. It couldn't make a living selling cars for \$1600 because it is set up for a \$3000 average sale. There is a tremendous overhead in this business that would have to go if sales dollars were cut in half.

Sculpture Versus Fins

Edsel is getting into the news more and more as announcement date nears. It will be out around September 1. Its two top lines will have only pillarless four-door sedans. Conventional four-door sedans will be available in its two lower-price models. Pushbuttons for the transmission are rumored to be in the steering-wheel hub.

Edsel's side treatment will feature some marked sculpturing, not unlike the Mercury treatment. It appears that both Ford and General Motors are going to let Chrysler ride the tailfins alone. Sculpturing seems to be the Big Two's answer, the theory being that you can only go so far with fins and Chrysler is there already!

The low car is here to stay although owners complain about the problems that result, especially the absence of legroom in the center of the front seat. Guesses are that 52 inches is about as low as cars will

Detroit Listening Post



By Art Railton

go. Lowest production cars for 1957 are about 54 inches high, so there is room for more lowering. Cars are now about as long as they will get, readers who are running out of garage will be glad to know.

We might as well correct a couple of errors. Now it appears that Chrysler will not have the Bendix fuel-injection system as reported here months back. Plans were set at that time, but it later developed that Bendix couldn't deliver in necessary volume. Chrysler is now turning to other injection suppliers, probably nonelectronic.

Metro Wagon?

The Metropolitan station wagon is back on the uncertain list again. The problem seems to be finances. There is little doubt that it would sell if American Motors could arrange suitable financing.

Electric door locks will be available on Chryslers for 1958. This is not an industry first as Packard had them just before the big switch to South Bend. All doors will lock from the driver's seat. For this convenience and safety you'll pay about \$45. No economy trend developing here!

Chrysler's trouble is all the other way. It is having difficulty selling its "economy" models. The expensive, luxurious lines are going great. Biggest gains of all are with Imperial. Plymouth's big sales are in the two top lines. Dodge alone is having difficulty with its most expensive models. And the low-price Windsor is not doing well at all compared with New Yorker gains.

All these facts seem to bear out Detroit's repeated claims that America will never settle for an austerity vehicle.

Yet how do you explain the striking success of the economy-type foreign cars which double sales each year? It can't be (or can it?) that what Detroit calls the "lunatic fringe" is increasing that fast!

If you'd like to bet on a long shot, watch the tiny bubble cars like the Isetta. Once their unbelievable convenience has been proved to American housewives there will be one in every suburban driveway.



YOUR

By
**Thomas E.
Stimson, Jr.**

A NEW KIND of flying machine is being designed that sounds like the answer to your desires for a personal aerial vehicle.

It is almost like a flying carpet. A good name for it might be the "flying fan." It uses the principle of the ducted fan, the same idea that is used by the flying platform.

Superficially this new machine, now being developed by Hiller Helicopters, will resemble an automobile although it will rest on short stilts. You'll be able to order a four-door model, a sports job or even a light-truck configuration.

To fly it, open the door and sit down behind the wheel. That button on the instrument panel operates the starter, and there's a faint whine and hum while you get the turbines up to speed.

See those two levers? The one on the left is the climb control. Push it up and leave it there. Now we are

Principle of "flying fan" vehicles of future is same as that of flying platform, left, which gets lift from air forced through duct

FLIGHT ANGLE



FAN-POWERED CAR WILL FLY WITH NOSE SLIGHTLY TILTED DOWNWARD

CHROME GRILLES OVER FANS

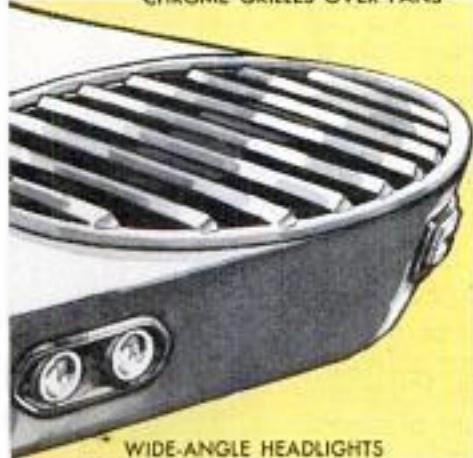

WIDE-ANGLE HEADLIGHTS

MILITARY USES



ABLE TO LAND ON ROUGH TERRAIN, ARMY VEHICLE COULD BE "RECON" CAR OR FLYING GUN PLATFORM

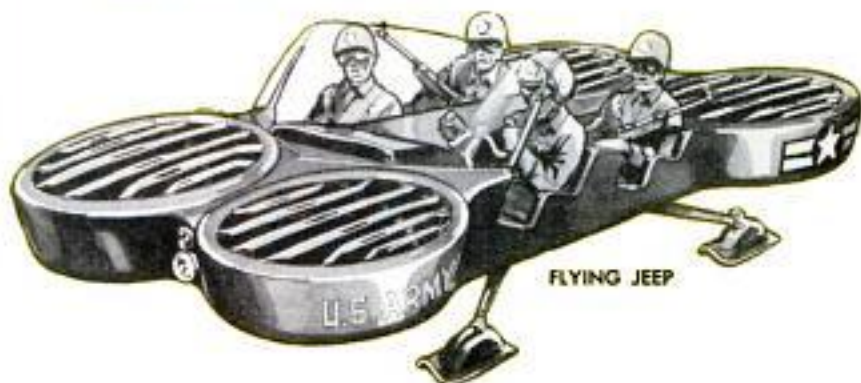

FLYING JEEP

AERIAL SEDAN FOR 1967

rising. Easy, isn't it? There's no big thrashing rotor overhead, no churning propellers. We just ascend with no apparent effort.

We are higher than the roof-tops now, so let's head across town. Turn the wheel to the right, in the direction we want to go. Now that second lever, push it ahead. Sure our nose dropped a bit. That's what the lever's for. It took some of the power off the front fans and tilted the machine. That's the way this thing flies. Air speed is up to 50 miles per hour already. If you want to stop in mid-air, just move the lever back again.

All this sounds too easy to be true, but the designers say this description is about right. They say the fans have most of the advantages and few of the disadvantages of ordinary helicopters. The fans will be easier to fly and should cost a lot less. It's too early to quote prices or delivery dates now: A rough guess is that in about 10 years you'll be able to buy a four-place fan for the price of a good car.

How can engineers be so sure about something that hasn't been flown yet, or even built?

For one thing, the flying fan is nothing more than four ducted fans that are held together by a framework that supports the

engines and cabin. A ducted fan is a shroud or duct that is placed around a propeller. This duct has a wide flange or lip around its upper edge. When the propeller forces air downward through the duct, pressure above the lipped surface is reduced. An extraordinary amount of lift is obtained as compared to an unducted helicopter rotor.

The Hiller flying platform was the first practical vehicle to use the ducted-fan principle, and the platform has made scores of flights. Some of the early bugs have been worked out of it. A new and advanced model is under construction.

A multifan vehicle is an obvious improvement over a simple flying platform. The platform is maneuvered by the body movements of its operator. He leans in the direction he wants to travel. He depends on his sense of balance, something that could be unreliable at night or in a dense fog.

With four fans, controllability is materially increased. The vehicle is maneuvered by varying the revolutions per minute of the front or rear fans. With twin power plants, possibly automotive gas turbines of the type that has been demonstrated by Chrysler, there's little chance of a complete power failure. If one turbine fails, the other

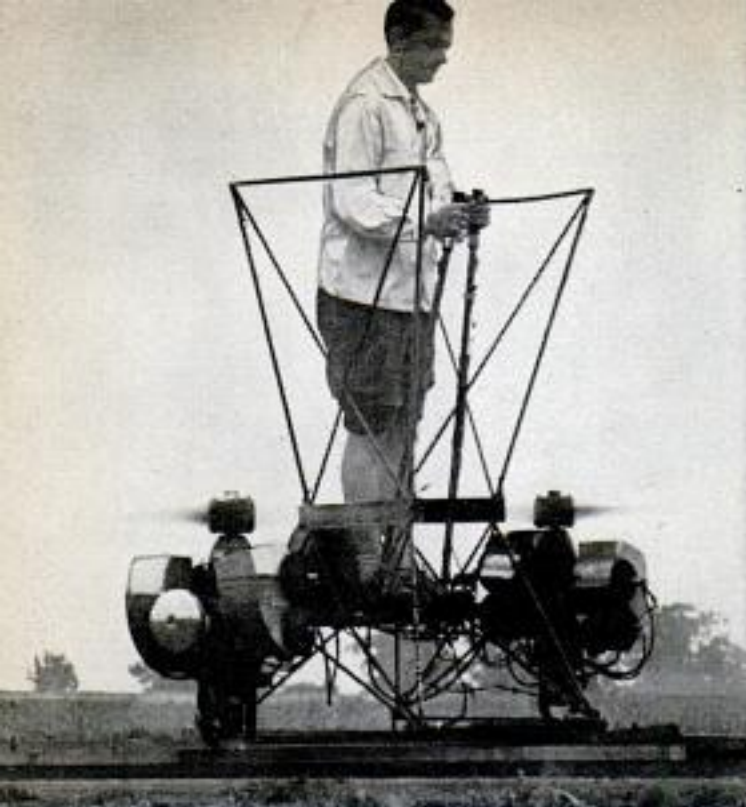

Original flying platform was this device which had two propellers to force air downward. This in turn led to concept of the shrouded or ducted platform



Close-up of first flying platform, above, shows it was something like two small helicopters. Putting duct around blades proved to be much more efficient

Hiller proposal for a "flying Jeep," below, would have four seats and cruising speed of 60 miles per hour

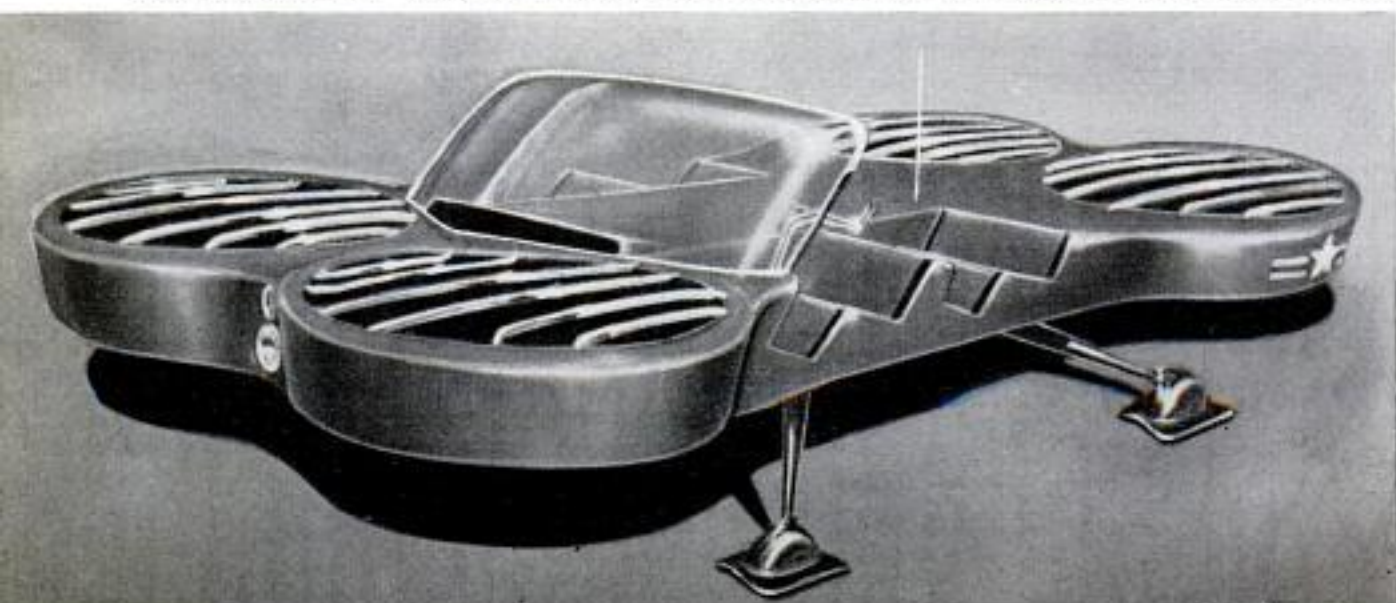

one would keep the vehicle sufficiently stable to permit an easy emergency landing.

Probably the first flying fan will be in the form of an aerial Jeep, an aircraft in which the Army is greatly interested. Hiller Helicopters has submitted a proposal for a four-fan Jeep. Basic engineering studies have been completed. Performance and costs have been closely estimated.

This Jeep-of-the-air would be capable of every job that an ordinary Jeep can do, with the advantage that it could travel across country with no need for roads. It would be able to land and take off from fairly steep hillsides. It could carry men and supplies, be used as an ambulance, or serve as a recon vehicle or even a flying gun platform.

Advantages Over a Copter

For this kind of service the flying fan has several major advantages over an ordinary helicopter. It can operate close to buildings or other obstructions. A helicopter taking off from alongside a building gets a rebound of air from the building that makes it very hard to control. And the flying fan can be operated around people in safety, with no chance that someone might accidentally walk into the whirling overhead rotor.

The Hiller engineers expect that eventually the ducted fan will become the basis for a whole family of special-purpose aircraft, the largest of which would be a "flying crane" that could lift enormous loads over short distances. The ducted fans look better for this job than do the huge helicopters that have been tried out in the past.

One of the Hiller proposals is a flying crane that would consist of four large fans, each about 15 feet in diameter. They would be bolted together in the form of a rough square to provide great lifting capacity. The gas-turbine power plant would be located in the center, with a bubblelike control cabin placed in front. Standing off the ground

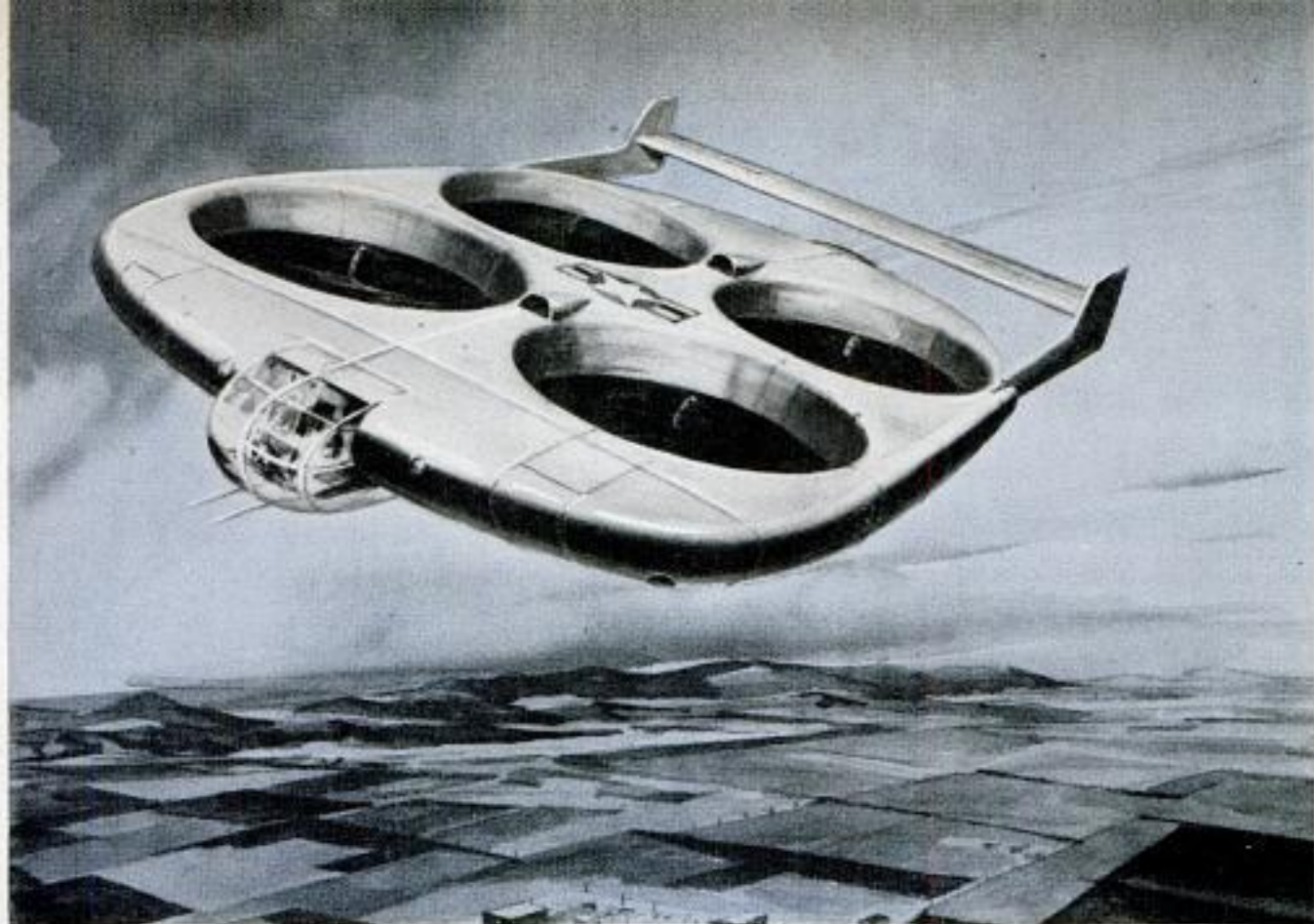

Four large fans in a streamlined airfoil could be combined with jet engines for swift forward propulsion

on tall, stiltlike legs, there would be plenty of room below the crane for moving into place below it a heavy tractor, large truck or loaded cargo box.

Basically the ducted fan is not a very fast vehicle. In its present stage of development it is good for approximately 50 miles per hour. One hundred miles per hour may become possible in the future.

Possible Airborne Sentries

There's a chance that this kind of platform could be used for aerial sentry duty to guard national boundaries against intruding bombers. One suggestion is to install early warning radar equipment on one

big platform, with the second platform of the team loaded to capacity with guided missiles. Hovering at medium altitudes, such a team would be able to detect and destroy hostile aircraft while they were still a long way off.

The ducted fan is not the only new idea that is being investigated for vertical-rising aircraft. One study Hiller has made is for a combination helicopter and airplane. This craft looks like an ordinary plane but has a large rotor overhead. The craft would use its rotor for taking off straight up, then as it began to use its main power plants to achieve forward speed, the rotor blades would fold and retract into the wing.

"Flying crane," below, has been proposed to U. S. Army for lifting trucks and tractors across rough terrain

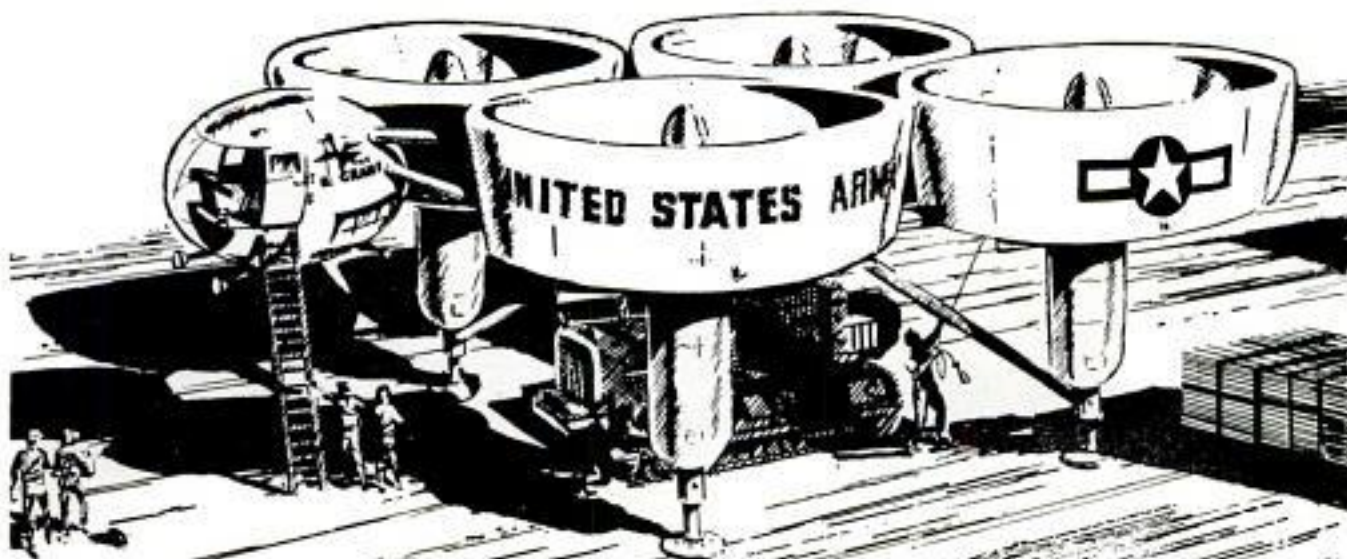

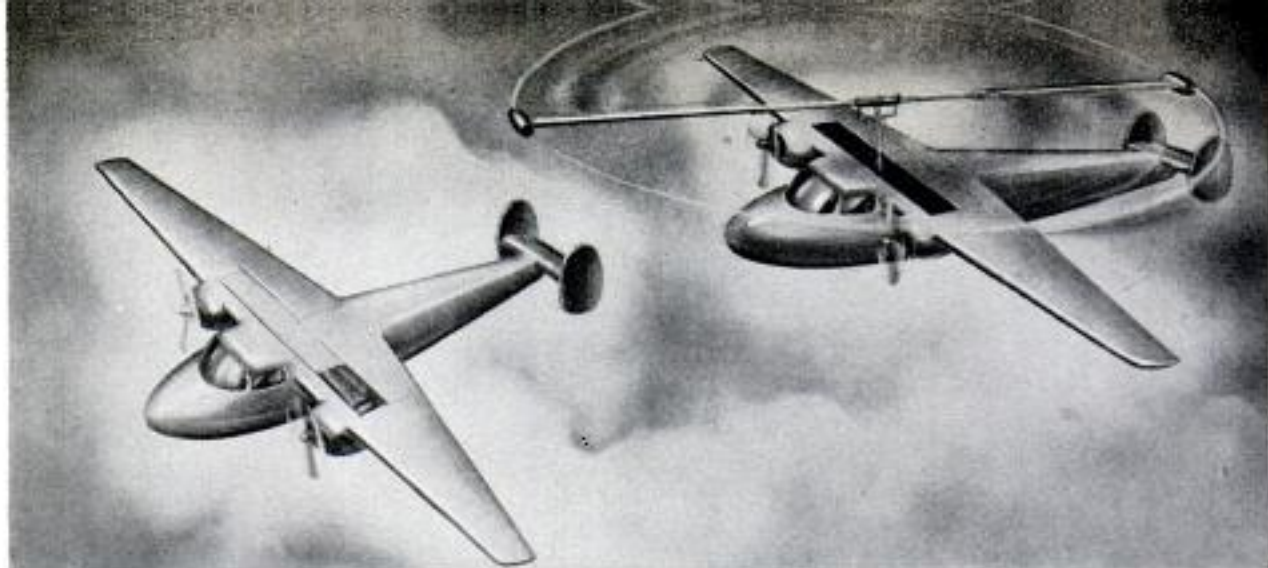

Retractable rotor systems, above, are being studied as aid for vertical landing of conventional aircraft

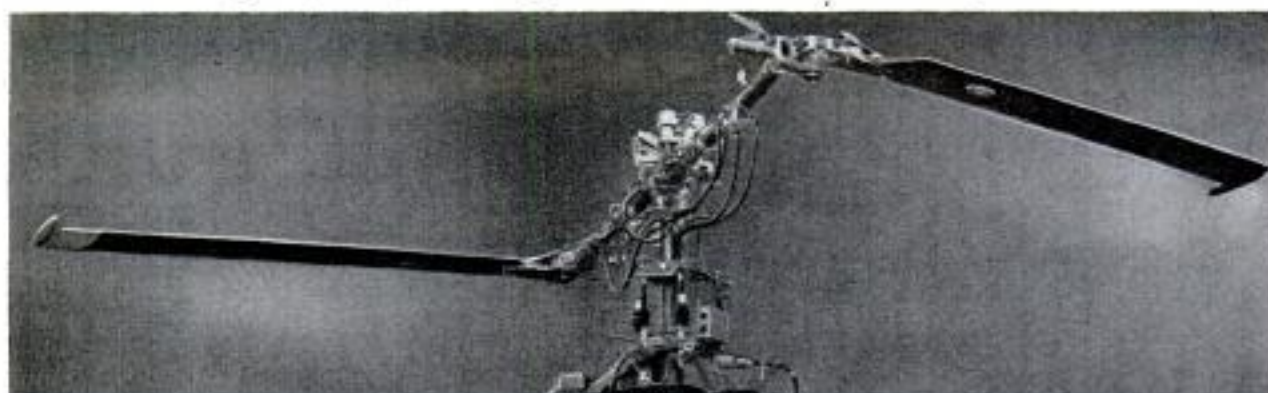

Folding rotor assembly being tested in the Hiller factory. Rotor-tip pods would hold ramjet engines

Now under construction at the Hiller factory in Palo Alto, Calif., is a transport plane with a tilting wing. For vertical take-offs the wing is rotated to a vertical position so that its twin turboprop power plants exert their thrust straight down. After take-off the pilot rotates the wing toward its normal angle, reducing the rate of climb and at the same time acquiring forward speed. Eventually, with its wing locked in the standard horizontal position, the plane flies just like any other airplane.

Vertical take-offs are not always necessary, and one of the advantages of the tilting-wing transport is that it can take off or land at any angle desired, depending on the length of the landing strip and the load that the plane is carrying. With a long runway, the plane would take off just like any other airplane. With a very short runway, the pilot would tilt the wing to get just the amount of lift he needed, and then take off in the short distance that was available to him. ★ ★ ★

Now under construction is a tilting-wing transport. For take-off, wing will turn to vertical position

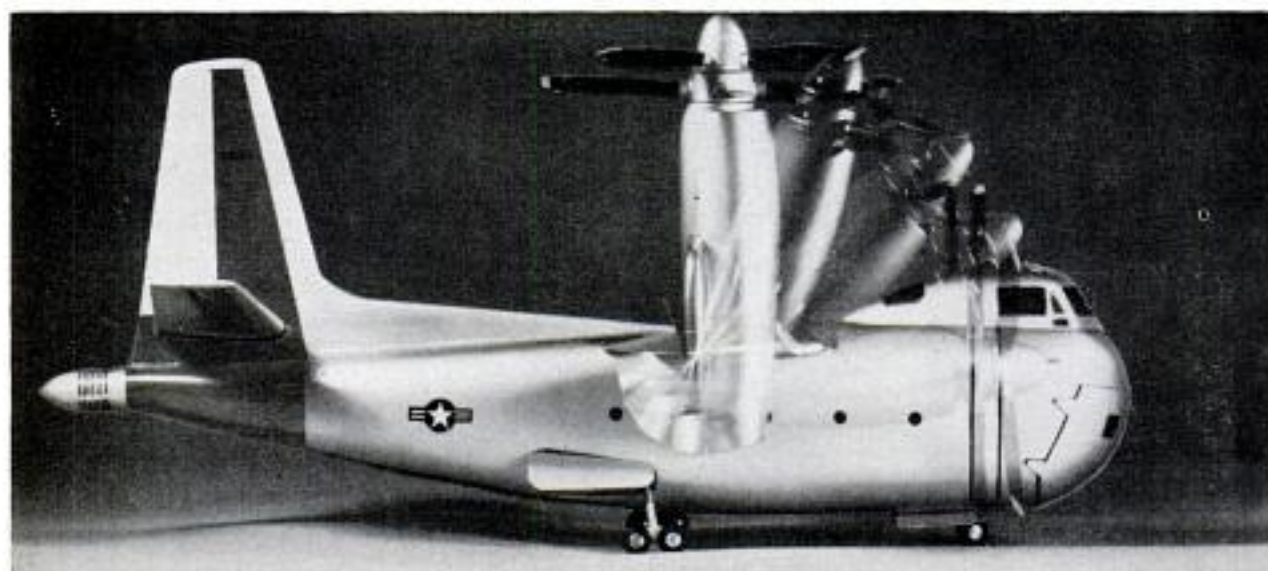



Studebaker Scotsman Offers Gas Economy

Carrying a price tag of \$1776, the Studebaker Scotsman two-door sedan is aimed at the growing economy-car market. Basically a Champion, the Scotsman is devoid of chrome or brightwork and comes in three colors: gray, green or blue. Also available is a four-door sedan for \$1826 and a two-door station wagon for \$1995. These prices include federal taxes, dealer-handling

charges, heater, defroster and turn signals. The only extras are shipping charges to your city and local taxes, if any. The engine in all three models is the Champion six of 101 horsepower. The 3.54-to-1 rear axle is said to make possible as much as 29 miles per gallon of gas. Station wagons have a 4.10-to-1 rear axle. Scotsman models weigh 80 pounds less than Champions.

Television and Radio Team up to Operate Swedish Power Plant

Television's "eye" and radio's ability to trip switches are being teamed up in Sweden to operate an electric generating station by remote control. With the equipment, the hydroelectric plant will be com-

pletely operated from a station 11 miles away. The unusual feature of the installation is the control by radio, to direct a TV camera's field of view, change lenses and even start a windshield-wiper mechanism.

Shoulder Mount Steadies Fast Photos

Held and triggered like a submachine gun, a new high-speed movie camera enables Navy photographers to take steady slow-motion pictures of high-velocity operations. The sturdy shoulder mount eliminates the "jumpy" effect of former high-speed photos. The camera has a 400-foot film capacity and is equipped with through-the-lens sighting for both photography and tracking scope. Operating from battery or alternating current, the camera accommodates either 6 or 12-inch telephoto lenses.





Everybody's Going Sailing

TO THE AMATEUR SAILOR, life is at its peak when he can hear the wind pop open a gleaming sail, sniff the tang of pure air and feel the sudden spray as the lee rail dips into the water. Troubles are forgotten in the always new, always exciting game of taming wind and wave. It's a world of pure delight. To the landlubber, too, there's something infinitely appealing in the sight of a sleek boat gliding gracefully, silently through the water. *Why don't I try it sometime?* he thinks. And landlubbers by the thousands are trying it each

year. The boom on the mast is not the only boom in sail-boating. Today there are an estimated 575,000 sailboats in American waters. A majority are class boats; all boats in a class are built on the same lines. In a class-boat race, because the lines of the boats are the same (though finish and rigging may vary somewhat), victory usually belongs to the skillful skipper. Here we present details on four of the most popular of all classes. They're proven craft, found on waters throughout the world. Take your pick. See you offshore! ★★★



THE PENGUIN, a little sailing dinghy, is perhaps the best boat of all for the beginner, and the least expensive. She's easy to build, and kits of pre-cut parts are available. Despite her simplicity, the Penguin will give the novice sailor training in meeting most of the problems he'll encounter in larger boats. The Penguin weighs 200 pounds and can be carried atop a car. She'll carry three children or two adults. She has a hinged centerboard for stability, which can be retracted for greater speed when running with the wind. Small investment, lots of fun



THE SNIPE, shown running for home before an impending storm, has been called the world's most popular sailboat. Races for the world championship are held every two years. The Snipe is a sloop; that is, she has a jib in addition to her mainsail. Snipes, too, are available in kit form, or you can buy blue-printed plans. Three types of hulls are recognized: Planked, plywood and glass-fiber. The Snipe has either a hinged centerboard, or a dagger board that can be pulled up into the boat. Total sail area is 103 square feet. She's fast, easy to rig, easily transported on a trailer, a fine boat for sailors of any age

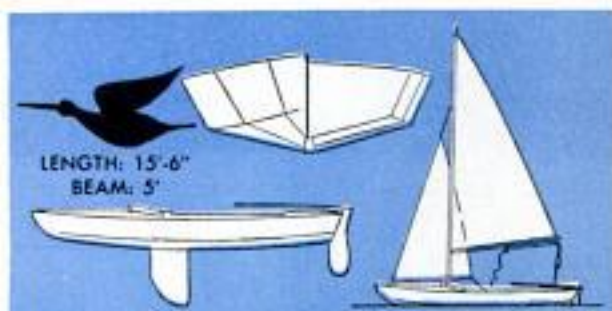

THE LIGHTNING is a top-notch sloop for both family sailing and racing. Her cockpit is large and protected by a coaming, making her a comfortable boat for just loafing along in the water. In addition to her regular sail area of 177.5 square feet, she carries a parachute spinnaker (shown in use below) for added speed downwind. An estimated 25 percent of the Lightnings are built by amateurs, but she's a fairly large boat for the beginner to tackle. Wide of beam, she's a stable boat especially good for family sailing. Trailer required. Carries up to eight

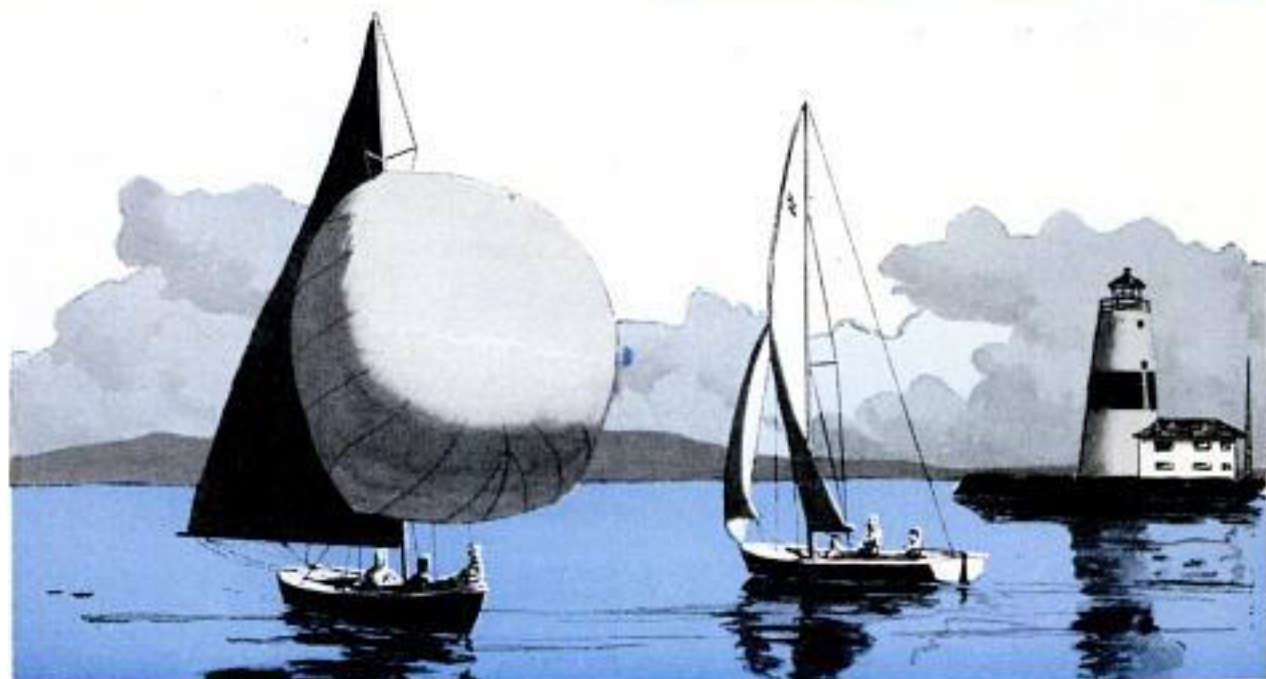



THE STAR, a fin-keel boat, is one of the oldest of the class boats and can be found throughout the world. Because of her beauty and exciting handling characteristics, she is preferred by some of the best of racing skippers over larger boats. Many sailors start out with smaller craft but end up with a Star as they become more adept. The Star has a total sail area of 281 square feet. Her fin is made of cast iron and weighs 890 pounds, so she is more difficult to transport than the other boats shown here. In heavy weather you'll be hiking over the lee rail, sailing's top thrill



Boat-Trailer Has Twin Hulls

FOR A REAL HYBRID, take a look at a craft which combines elements of a boat, a catamaran and a trailer. Basically the craft consists of two watertight pontoons fastened together and surmounted by a body. The two hulls are built of marine plywood covered with glass fiber. Two trailer wheels are installed on arms projecting downward from the sides of the boat. Up to 400 pounds of gear can be carried in the boat when it is rolling along the highway as a trailer. Once the boat is in the water, the wheels are pivoted up against the sides of the craft. Powered by a 30-horsepower motor, the boat will skim along on its twin hulls at 23 miles per hour. As a result of its unique hull design, the boat will virtually turn in its own length, 12 feet 9 inches. If the boat ships water, the water runs out two drain holes in the hulls. Thus bailing is eliminated and the boat can be washed by splashing water inside with a bucket or a hose. Also the boat is virtually impossible to sink. If one pontoon is punctured, the other will keep the craft afloat. If both hulls are punctured on the underside, air still will remain trapped inside the pontoons to support the craft. The total weight of the boat is 520 pounds. The boat seats five comfortably in its roomy cockpit.

Twin-hulled boat will virtually turn in its own length. Any water it ships automatically runs out drain holes in pontoons

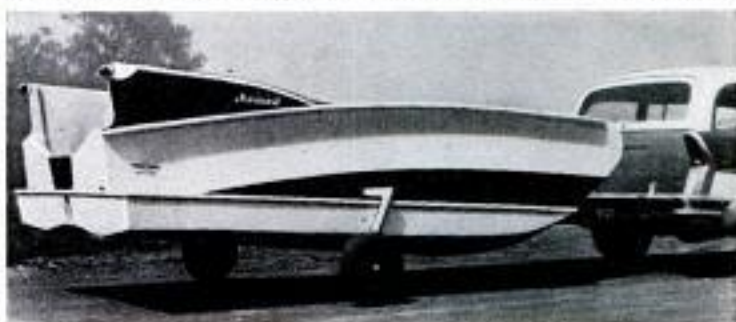

Ashore, the boat becomes a trailer, with wheels pivoted down from the sides. Below, seats in cockpit will accommodate five



KEEPING UP WITH THE ATOM

TASTERS ARE TESTING tomorrow's food today in the booths shown at right. Constant though slow progress is being made in research to preserve food by irradiation. In the process, gamma rays are used to kill the bacteria which cause the spoilage of food.

However, irradiation may also affect the flavor of food. In this part of the research, expert taste testers take over. The ones shown here are members of a panel at American Can Company. Selected for their exceptionally good flavor perception, they have no strong food likes or dislikes.

Foods to be tested are unmarked, and it's up to the expert to rate the flavors of several samples, or to determine whether a sample has an off-flavor.

Want a job tasting these atomic-age foods? You must be in good health, free from worry, with a fast "taste recovery" and good "flavor memory." Which leaves one question unanswered: Who tests the taste-testers' tastes?

☆☆☆

SOVIET SCIENTISTS have tested the world's most powerful atom smasher. It is a huge synchrotron designed to achieve 10 billion electron volts of energy. In tests, it has accelerated protons to 8.3 billion electron volts, according to official announcements.

Prior to these tests, the world's largest



atom smasher was the six-billion-volt bevatron at the University of California.

According to a Soviet spokesman, the new machine will be used in studies of the atomic nucleus.

☆☆☆

ARE WE RECEIVING too much X-ray energy from our television sets? A statement in Britain that viewers are receiving harmful amounts of radiation has created much controversy.

In this country, research by various agencies seems to indicate that viewers are not receiving harmful doses from well-constructed standard sets. A Massachusetts

Institute of Technology physicist points out that considerable X-ray energy is generated in a picture tube, but the set housing, the thickness of the picture tube and the protective glass reduce the intensity. He warns servicemen, however, that tubes tested outside their cabinets produce considerable amounts of X-ray energy.

☆☆☆

THE CORE STRUCTURE of the Army Package Power Reactor is shown at left. Fuel elements and control rods were slipped into the grid recently and the reactor went critical. Tests of the APPR are being watched with interest because the reactor is designed to provide electrical energy in remote areas.

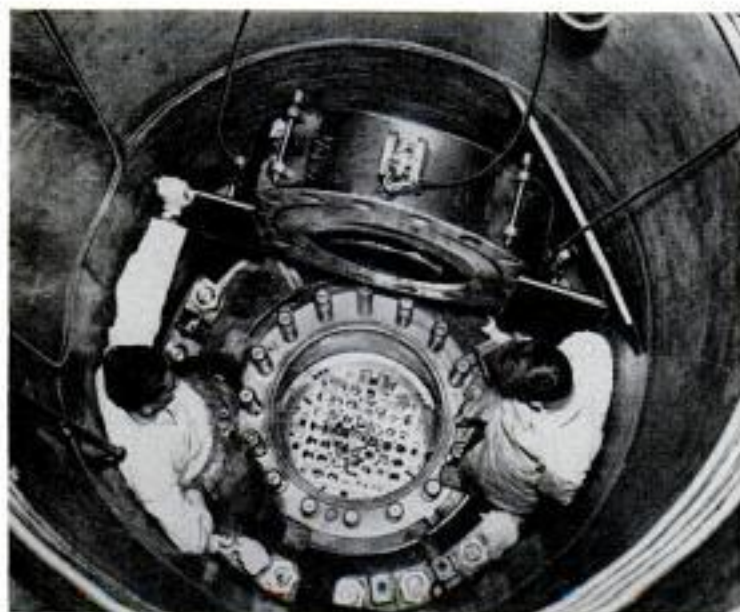

After a wreck there's a big job to be done fast . . .

THE TRAIN THAT leaves its tracks plows up a lot of trouble. Tangled steel, demolished cars, upset engine, twisted and torn rails may mark the scene. The wreck is a giant jigsaw puzzle that apparently defies solution. But order comes to the scene fast, thanks to the experienced men and modern machinery that are always ready to move out on short notice to clean up after a wreck.

Some months ago a saboteur broke the switch lock off a small siding in central Ohio. The first train through opened the switch and seven cars slammed onto the siding, left the tracks and landed in soft earth.

Within a short time a wreck crew was on its way to the scene from Columbus.

One of first jobs is rigging a field telephone. The trainmaster reports immediately and keeps his headquarters posted

CLEAR THE RAILS!

By
George
Laycock

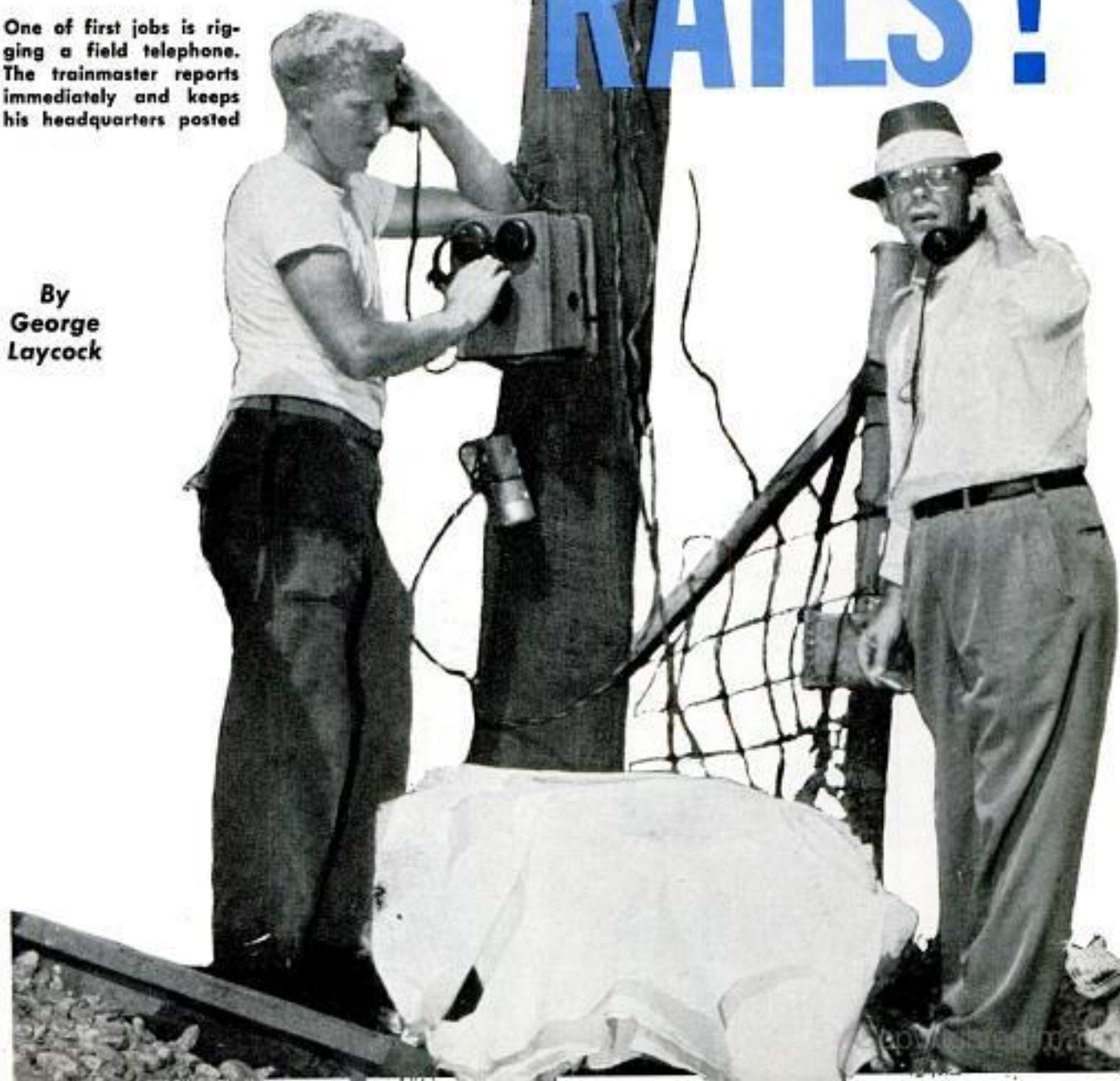

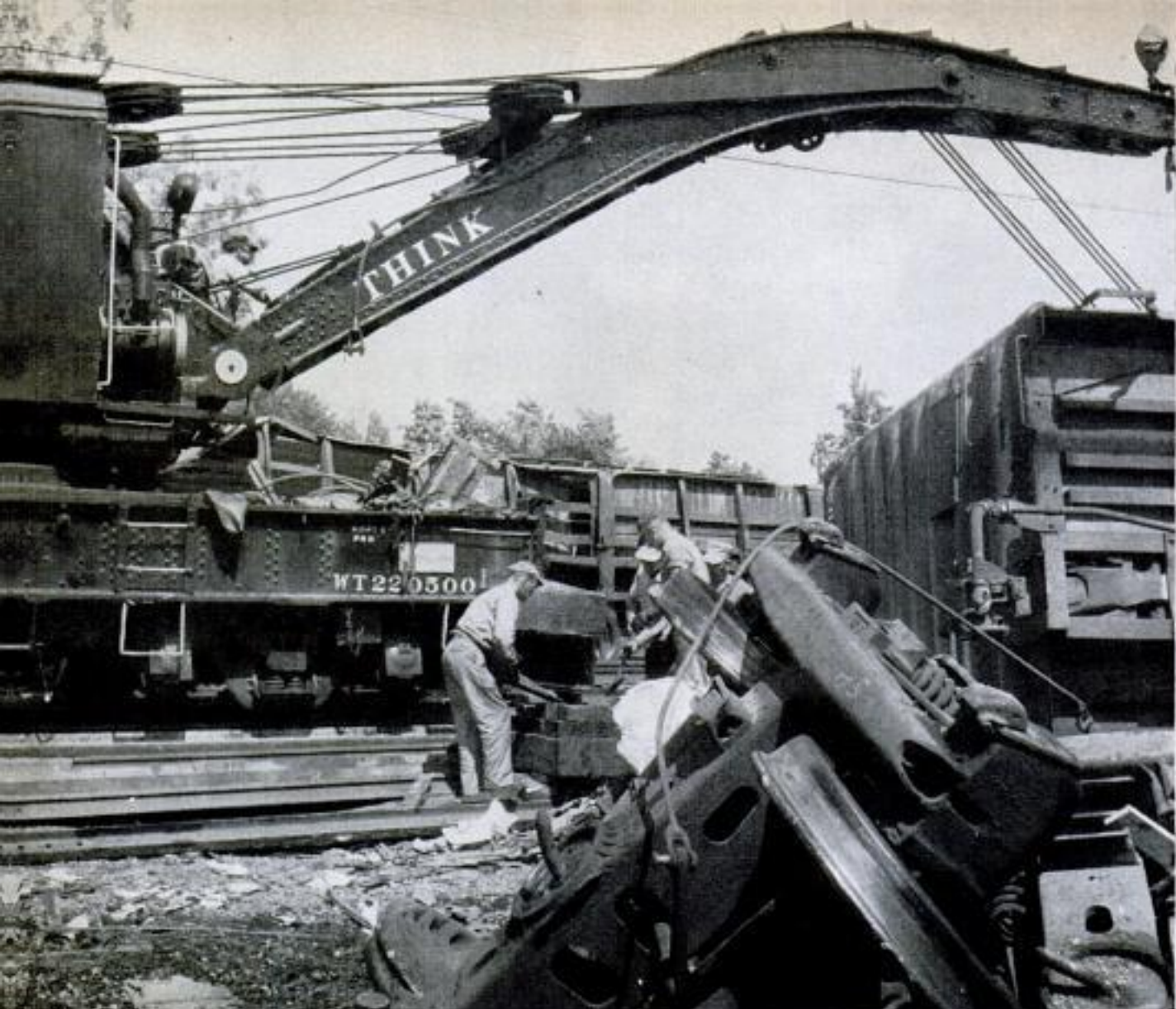

Crane's boom dips into the tangled wreckage. It is the key tool, lifting the equipment piece by piece

Track-repair crew replaces the bent and broken rails as fast as the crane moves wreckage out of the way

Telephone pole, sheared off by a grain combine in the wreck, is snubbed back out of workmen's way



The tracks had been twisted and torn beneath the cars. The problem was what to do with the cars while the crews repaired the track. Here was added evidence of what wreck-crew superintendents mean when they say, "Every wreck has its own problems. Each wreck is a custom job."

The foreman solved this one in an unusual fashion. He instructed the crane operator to lift the cars one at a time, and while the cars were held off the ground the track crews laid new track. Then the cars were gently lowered onto the new rails.

Signals Flash a Warning

At the instant the wreck occurs and metal falls across the rails, the system's induction signals flash the danger warning up and down the track. All traffic from both directions stops.

Then a crew member from the wrecked train calls the nearest dispatcher either from a telephone on the train or from one of the phones spotted along the right of way. He describes the wreck thoroughly to the dispatcher.

The dispatcher sends out the nearest wreck crew. Then, if more men are needed, he begins to call in other wreck crews from more distant points. Other railroads may send crews to the scene, for railroads cooperate in clearing up after a serious train wreck. A supervisor gets to the scene as fast as possible. He sizes up the situation and begins to direct the clean-up operations. He keeps in constant contact with system headquarters, often on a field telephone set up at the scene.

The wreck train consists of engine, crane

and a few cars for men and equipment. The dispatcher sends out the first train crew available to take the wreck train to the scene.

On one of the larger Eastern railways a wreck crew consists of a wreck foreman, the train engineer, a power inspector and 10 ground crewmen. Usually these are shop workers who are also on call at any time for wreck-clearing duty. If the emergency comes during the work day it's fairly simple to gather up the crew and head for the scene. If the call comes at night the crewmen are called at their homes and they're expected to be at the shop ready to leave within a half hour.

Meanwhile the dispatcher has sent out the "maintenance of way" people who have the job of repairing tracks.

If the wrecked train was carrying passengers, other plans have been put into action as fast as possible. The railroad calls surrounding cities. Ambulances and doctors are dispatched to the scene. Police and firemen may be called out.

But more often the wrecked train is a freight and there are no serious injuries to anything but equipment. Here the big problem that faces the railroad men immediately is clearing the tracks. Regardless of how serious the wreck, other trains must go through with their freight, passengers and mail.

Mighty Muscles

One major piece of equipment for clearing the tracks is the crane. A modern crane is capable of lifting 250 tons; a machine with such muscles can simplify many a job. The first step often involves dragging

Crewmen quickly repair crossing sign. It must be ready for auto traffic when crossing is cleared





Track crew quickly lays brand-new ties and rails so other trains won't be bottled up by wreckage of this one

the wreckage aside so other trains will have clearance. The crane and perhaps a bulldozer accomplish this.

Howard Long, an executive in the traffic section of the Pennsylvania Railroad, in his long career has been out on so many wreck jobs that he no longer recalls the number.

"Some places are worse than others for clearing up a wreck," he says. "If you get a wreck in town or where there are many overhead power lines, you often have trouble moving your crane the way you want to." Usually the power company men are

There's nothing tidy about the way the wreckage is cleared. Trucks are simply pushed out of the way

standing by to see that the wreck foreman doesn't hit one of the wires or stretch it too much.

Mountainside train wrecks present special problems. Cars and even engines may leave the track and roll down steep grades. There is always a risk when you start snaking a car back up a mountainside that instead of pulling the wrecked car up you'll send the crane downhill.

To prevent tipping over, the cranes are equipped with outriggers, steel arms that extend from the base of the crane. Each

Volunteers wash out the eyes of two workers. Chemical from a tank car irritated eyes in this wreck



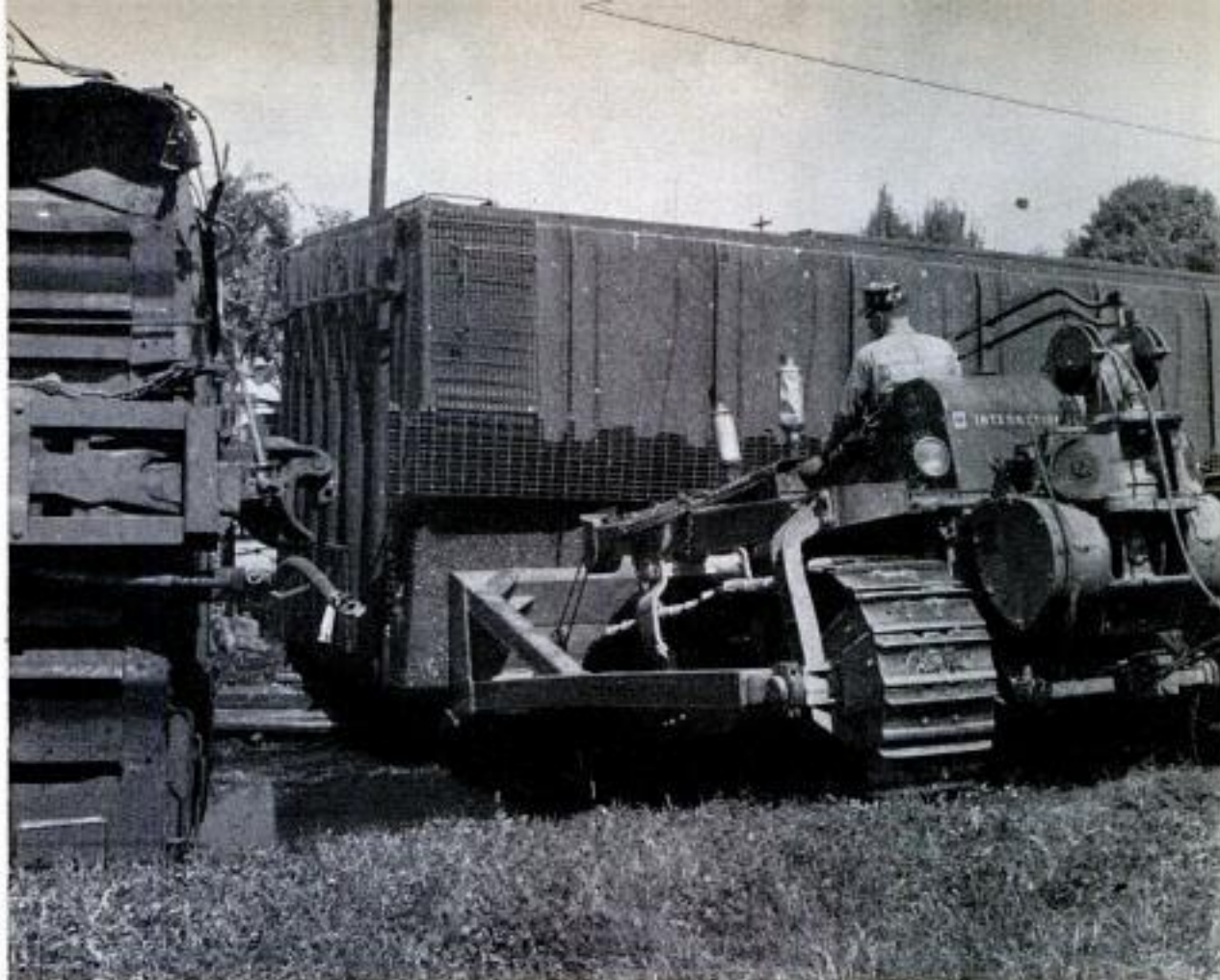

Bulldozer shoves a wrecked freight car out of line of cars. Crane then will lift it free of the tracks

is blocked and wedged to broaden the crane's base.

Tunnels are a nightmare to the wreck crew. Workmen in cramped quarters must struggle to clear the tracks as fast as possible, for more often than not the tunnel is a vital link in the system.

Always after a wreck the railroad supervisors want to determine the cause of the accident. If the accident resulted from a collision it is almost always charged to human negligence. But the hotbox on the axle of a freight car still causes many

an accident. All railroad people working along the right of way are instructed to report smoking or flaming hotboxes on passing trains. If the hotbox trouble isn't caught in time the wheel may cut the end off the axle. The axle drops on the track, and shortly there's another call for the wreck crews.

You may seldom hear of the wreck crews. But every major railroad has them, well equipped and highly organized. Their assignment is to make order out of chaos—
★ ★ ★

Local fire department hauled water for the steam boiler of the crane at this wreck. In such emergencies, nearby towns or cities cooperate by sending medical care, fire-fighting equipment and police protection





Carver Shapes Burl Into Huge Salad Bowl

Rodney D. Woodard, New Hampshire woodworking artisan, carved for 100 hours on a 200-pound birch burl to make the world's largest birch-burl salad bowl. A multi-grained growth on the trunk of a tree in northwestern Maine, the burl was 40 inches in diameter at the time he started to carve on it. Woodard shaped the wood into a bowl 33 inches in diameter, 9 inches in depth and 1½ inches thick. He also carved a bas-relief on the bowl's bottom to show a woodsman at work driving logs down the Androscoggin River in New England.

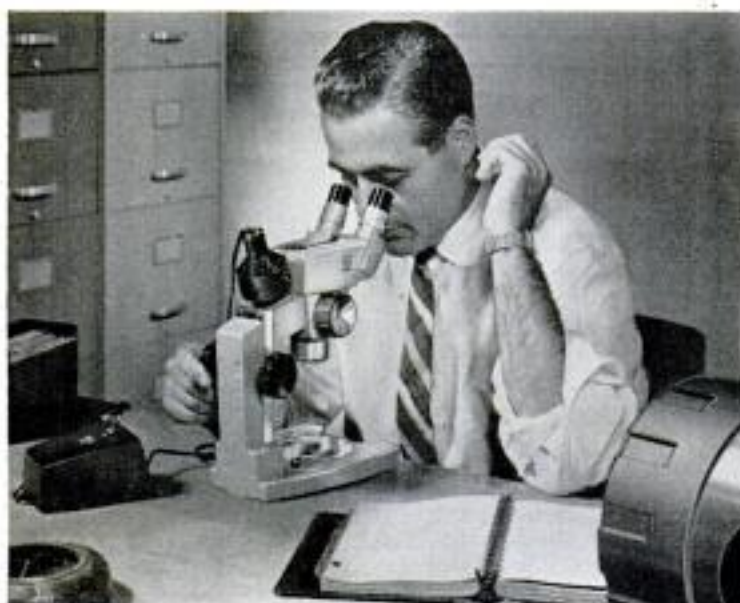

Dial on Microscope Selects Magnification

With this stereoscopic microscope, you can dial the desired magnification by rotating a chamber containing 16 corrected lenses. The microscope provides magnification from 3.5X to 80X and a three-dimensional view through dual eyepieces.



"Dog Tag" Sales Checks Aid Drive-In Operation

Metal sales checks, about the size of a serviceman's "dog tag," are used instead of paper slips at a Spokane, Wash., drive-in restaurant. The metal tabs cut costs, simplify handling and can't be blown off drive-in serving trays, according to M. J. Baker, operator of the eating place. The checks are made of pure nickel in five-cent denominations from five cents to five dollars and each check lists the sales tax on its surface. The sales checks are arranged on a wall rack near the cash register.

Not many years ago the prefabricated house was scorned in polite building-trade circles, as well as by zoning boards and the general public. After an uphill fight, the prefabs have won a place in the sun. Here's

How the Prefabs Got That **Custom Look**

By Wayne Whittaker



Courtesy of the Masonite Corporation

Frank Lloyd Wright, noted architect, gives his stamp of approval to the prefab idea with this new design

WHEN FRANK LLOYD WRIGHT, the unofficial dean of American architects, designed a house recently for a prefabricated home manufacturer it was big news to every builder in the country. To the prefabbers, this prestige plum was a highly important event.

Only a decade ago many an architect, noted or otherwise, would have scorned the job of designing a prefabricated house. Now in 1957, the man who has had the greatest influence on architecture for the last half century has lent his distinguished name and talent to the field of prefabri-

cated homes. The design is low and smart.

The Wright house and all it implies is a far cry from the days when hostile zoning boards relegated the prefab builders to undesirable locations outside city limits. The most that could be said for the prefab of 15 and 20 years ago was that it was cheap and a lot of house for the money. These low-cost houses seemed to be slapped together overnight. The public, unused to prefabricated techniques, leaped to the wrong conclusion that the houses were poorly constructed. Stylewise, the homes were miserable boxes strung in drab and

Donald Scholz calls this glass-walled home with pool his "Contemporary" model. It is a big prefab seller





Hodgson Houses, Inc., Dover, Mass.

This three-bedroom split level has 1074 square feet of floor area. The recreation room is in the basement

lookalike rows. "Tomorrow's slums," said the zoning board members.

Surprisingly enough, some of the early prefabs look better today than when they were built. The sturdy homes have been individualized with shutters, trellises, porches, garages, carports and good paint jobs of careful color selection. These early houses, largely, have upheld the promises of the builders in regard to durability. However, the complete lack of architectural style, poor site planning and the connotation of the word "cheap" with the early prefabs gave the industry an uphill problem with regard to public acceptance.

The prefab industry was a "depression child," the first company being organized in 1933. By 1946, only 37,500 prefabs were sold—most of them still nondescript in appearance. Last year, 94,791 of the homes were sold for a whopping \$1,098,010,414, according to the Prefabricated Home Manufacturers' Institute. One house out of every 10 single-family dwellings built in 1957 was a prefab. The prefabricated homes ranged in price from a few thousand dollars to \$100,000. Many were sold in the \$40,000 to \$50,000 bracket. Some of the houses won national mention for design and some of the mass projects won awards

for site planning, surprising the old-timers.

The prefab manufacturers confidently expect greater recognition this year. In addition to their low-cost homes, they are offering rambling ranch houses with open plan, family rooms, multiple baths, intriguing patios and outdoor-living areas. They are offering contemporary designs (modified modern) with low-pitched roofs and glass walls, wall-type ovens, air conditioning and swimming pools. They are offering two-story homes of traditional New England saltbox style and nostalgic colonial designs with modern interiors that include utility rooms and perimeter heating.

This year one of the big prefabbers proudly proclaims: "Our Luxury Line homes—\$15,000 to \$100,000—can be individualized in every luxurious detail. A special architectural service is available to help you fit the house to its natural setting and landscape it beautifully. Our low-cost homes—\$7500—can be built in 4½ days."

The ugly duckling of the housing industry was not transformed to a glamorous swan over night. Right after World War II there were many people who still didn't know what a prefabricated house was.

"We had to teach the public that a prefabricated house is made of parts assembled

The L-shape, Roman brick and vertical siding lend individuality to this five-room home. Kitchen is at front

Barnschfeger Homes, Inc., Port Washington, Wis.





Scholz Homes, Inc., Toledo, Ohio.

This ranch home with colonial detail is built with variable floor plans (basic floor plan is at left). The owner of this house made a recreation room with big window out of garage

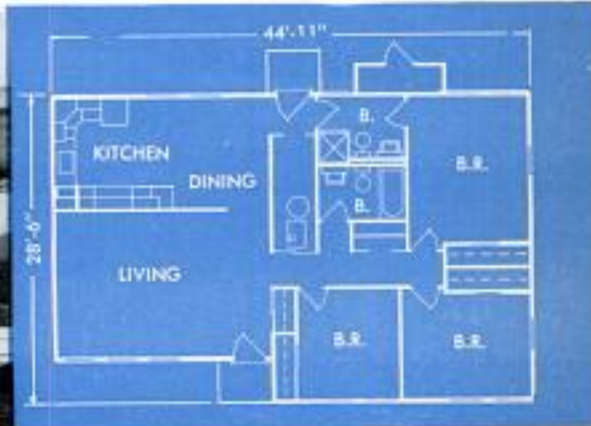
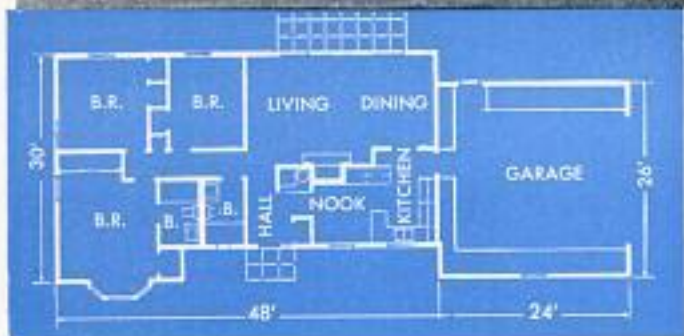

United States Steel Homes

Above, something new in prefabs is offered with this model which has steel roof trusses and steel-framed panels. Big windows and the low-pitched roof help give it a custom look

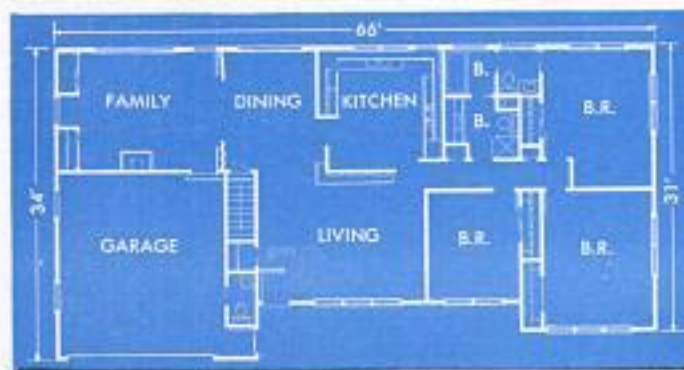

The home below won an award for both quality and design in competition with conventionally built houses. Custom features include stone trim, family room and an open plan within

W. G. Best Homes Co., Effingham, Ill

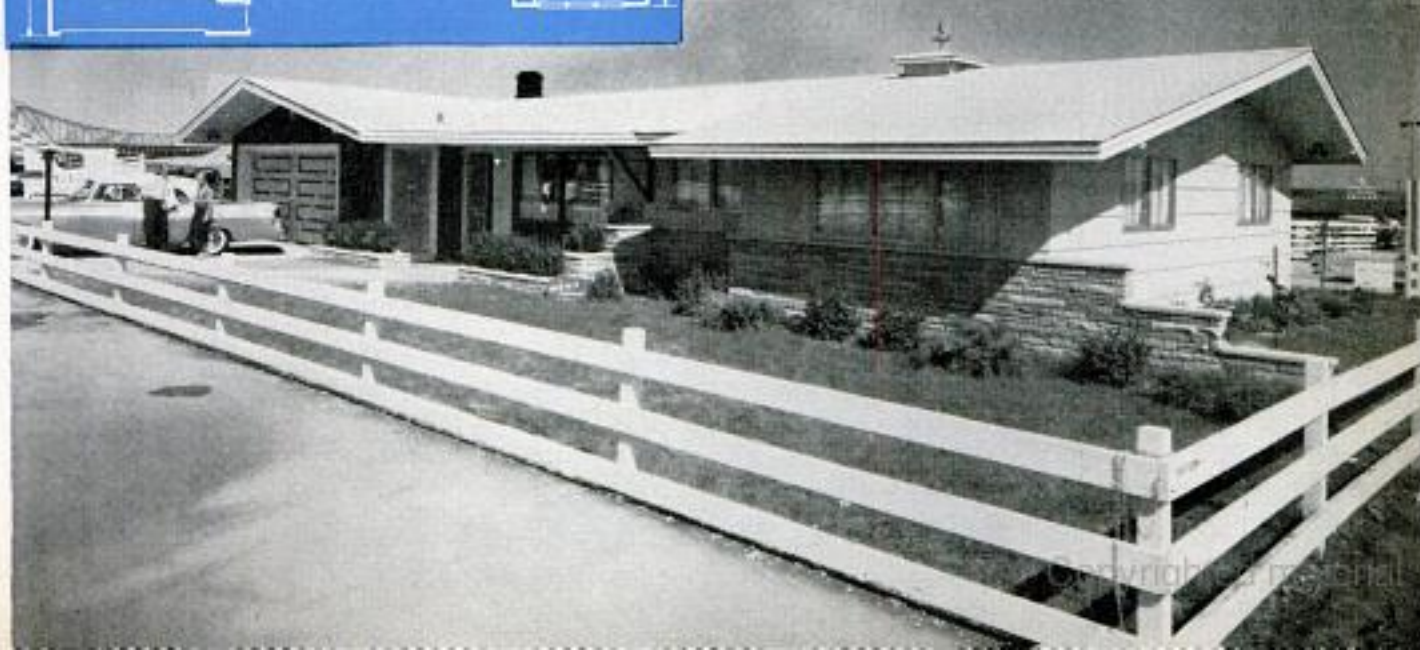



Modular Homes, Inc., Kirkwood, Mo.

This interior of attractive home at top of page shows effect of front window wall. It sells for \$15,000 without the lot. Below, two treatments of the same basic three-bedroom plan

Knox Corporation, Thomson, Ga.



at a factory for quick construction at the site," says one of the pioneers in the business. "These parts include wall panels, floors, roof trusses—in fact, all the main carpentry. Nowadays many prefabricators also supply the plumbing plus fixtures, heating and air-conditioning equipment, all sorts of built-ins including kitchen cabinets, also lighting fixtures, wallpaper, paint and rugs. Brick and stone are not included in the 'packages,' nor is the landscaping."

The prefab package (which fills a huge and scientifically packed truck) is transported to the waiting foundation of the building site at night so when the construction crew arrives in the morning there will be no delay. Some small houses are enclosed in a day and a half. There is no lost motion or costly delay waiting for some vital bit of material or job to be performed either at the prefab site or in the factory. A prefabricated house is said to save from 5 to 15 percent of the cost of an identical structure put up by conventional means. Fifteen percent of a \$20,000 house—\$3000—is a sum large enough to impress any family planning a home.

From the beginning, the prefabricators have stressed labor-saving in the assembly and construction of their houses. If you have any doubts on this score, all you have to do is visit a prefab factory or the site where a house is going up. Everything moves with speed and precision. In the factory, wall panels complete with insulation seem to be put together like magic. The place hums with the sound of busy power saws, nailing machines and every aid to mass production that engineers can devise.

The prefab manufacturers like to compare their product to the mass-produced automobile.

"Who has enough money to buy a custom-built car in this day and



age?" they ask. "The prefab house makes just as much sense as the mass-produced prefabricated car."

Before they could make this argument convincing, the prefabers had to do something about the design of their houses. Soon after World War II, one of the big prefabricators hired a well-known architect to tackle the problem. This architect came up with clean contemporary designs. Business boomed. Then the prefabber hired a color expert to plan color harmony, not only for the individual home but entire building projects. Sales zoomed even higher. Soon the prefab manufacturers were in a scramble—and still are—to lure some of the best names in the roster of the American Institute of Architects to their payrolls. Frank Lloyd Wright was preceded by Charles Goodman, Yamasaki, A. Quincy Jones, Frederick E. Emmons and others. Of the 300 firms now producing prefab homes, 75 percent employ registered architects. Donald J. Scholz, however, designs most of his own houses. The manufacturers give the public a choice of over 3000 models. These models are sold by 7000 builder-dealers.

Cuts Cost of Luxury Homes

Recently, the prefabricators have found that their methods are as adaptable to luxury homes as to low-cost models. After all, it is only reasonable that the economy of the basic units remains the same whether a house is 24 or 80 feet long. An Ohio doctor was on the verge of giving up the plan for his dream home when he discovered the cost by conventional building methods was prohibitive. Then he looked into prefabrication. He got his dream house for exactly \$52,000—far less than it would have cost with custom building. This doctor's acceptance of prefabrication—construction methods, styling and quality—is complete.

One of the biggest builder-deal-



National Homes Corporation, Lafayette, Ind.

Open plan of this house presents vista with fireplace in the background. Windows over fireplace add unusual custom look

ers in the Chicago area points with pride to the caliber of his buyers. They include many engineers, numerous architects and four mortgage officials. He points to the latter with special pride because there was a time when mortgage money for prefab buyers was hard to get.

One of the interesting results in the development of the prefabricated house is its impact on the entire housing field. This small segment of home building has forced many mass builders to adopt prefab money-saving ideas. These include the precutting of material in sheds right at the building

New England "saltbox" is the flavor of this house which has three bedrooms upstairs and a big family room on first floor

Midwest Houses, Inc., Mansfield, Ohio.





Scholz Homes, Inc.

High priced and colonial in design, this prestige prefab called "Monticello" is in \$35,000-\$50,000 range

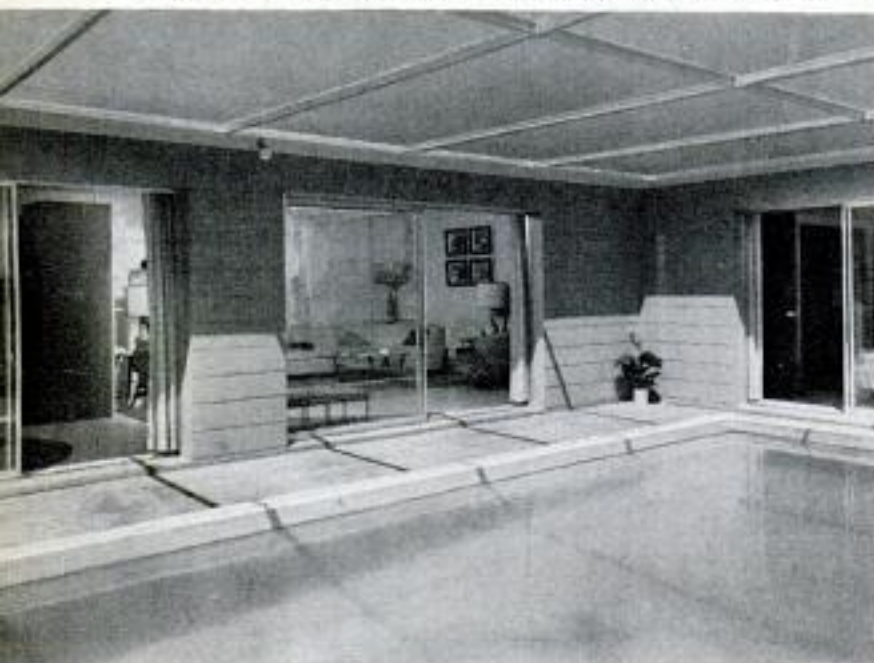

site and the use of prefabricated components.

The prefabricators say "you ain't seen nothin' yet" when it comes to impact on housing in general. They freely predict that by 1970 half of the houses built will be prefabricated. Meanwhile, they are enlarging the scope of activities beyond the luxury house to motels, college dormitories and laboratories, churches, schools and public buildings long associated with conservative architecture and building methods.

"Prefabrication will play an increasingly important part in the fulfillment of the undiminished need for homes in this country," says George Price, veteran prefabricator and president of the Prefabricated Home Manufacturers' Institute. "This is because prefabrication has proved itself to be the most effective bulwark against constantly rising building costs that otherwise threaten to push the prices of new homes beyond the ability of a vast number of families."

To this, Conrad "Pat" Harness, executive vice-president of the institute, adds: "Prefab methods are a 20th century way of producing a 20th century house." ★ ★ ★

Screened pool is featured with this Florida prefab. The house is built of concrete blocks with two terrazzo floors. Price including the lot plus extras is \$12,950

Florida Builders, St. Petersburg.

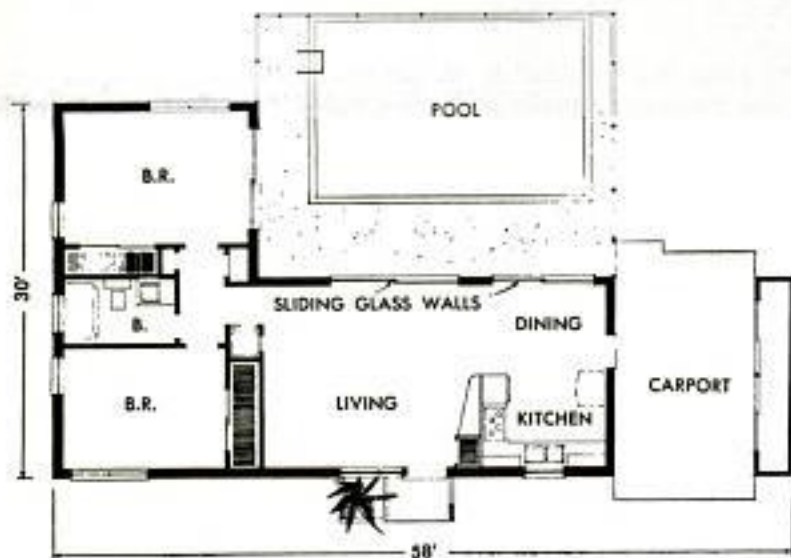

I SHOOT THE WORKS

By Hugo Lizza

As told to James Joseph

A SBESTOS-SUITED, heart working hard, I brace behind the sandbagged control bunker, conscious as always of the crowd—the 85,000 jamming the black stands of Los Angeles' Coliseum. Or it might be any of a thousand stadiums and arenas scattered across country. Suddenly a voice pounds out of the night:

"You're on, Mr. Lizza!"

For the next 60 minutes I'm ringmaster, a pyromaniac with a license to play with fire.

Sweaty-fisted, I press the walkie-talkie's "speak" button.

"Firing captains . . . ready?"

From across three acres of sets and high explosives, from the mortar entrenchments and rocket stations, crackles confirmation . . . "Ready to fire" . . . "Okay" . . . "Set and ready!"

Spread over the arena's vast blackness are 2000 blunt-nosed mortars, buried two thirds of their six-foot lengths in dirt, barricaded by 20 tons of sand and all within easy reloading of the powder magazines.

Behind the mortars loom two dozen sets—huge, building-high frameworks crafted from



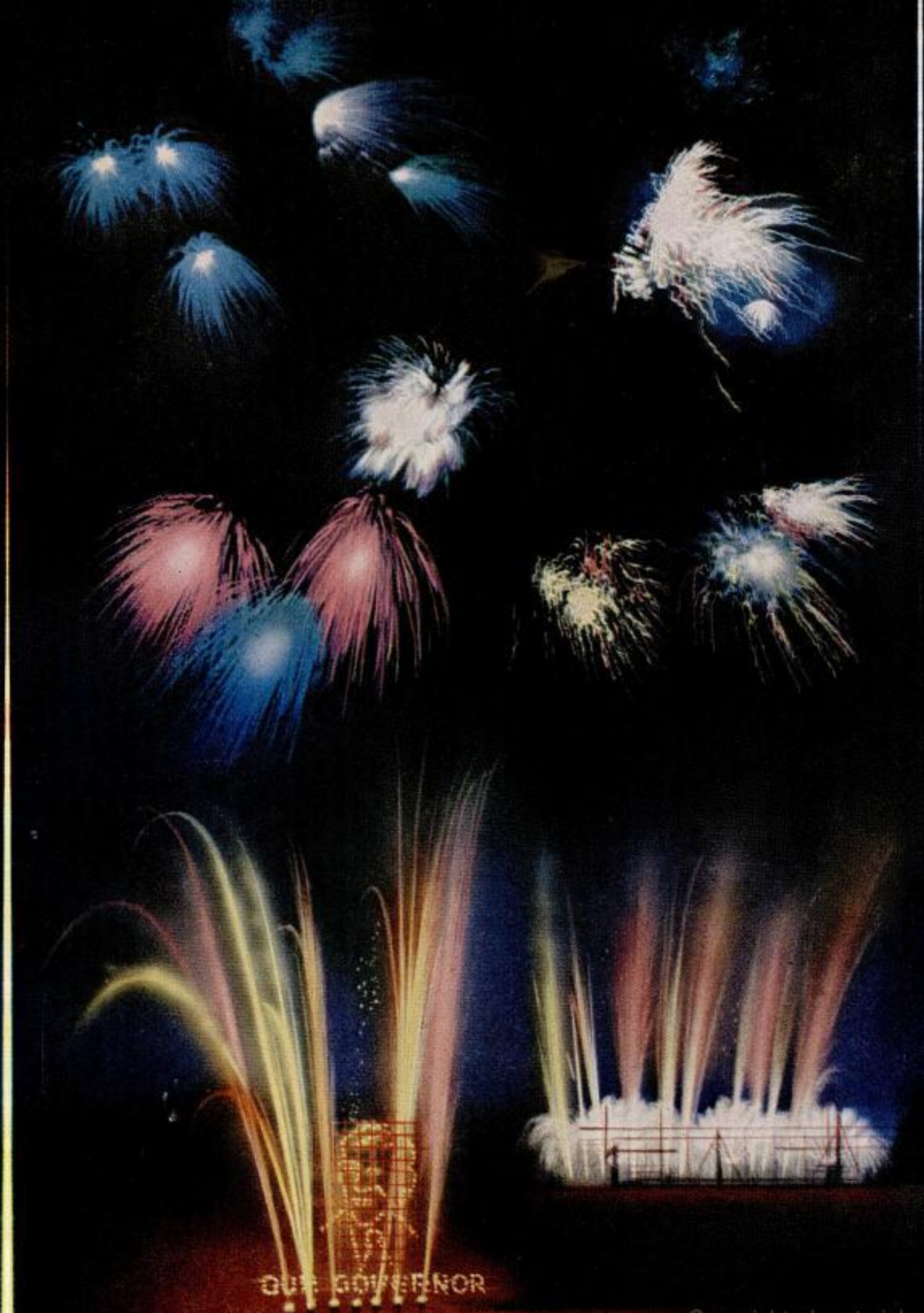

OUR GOVERNOR



Surpassing colors of the rainbow, skyrocket and big aerial "bursts" light up the Fourth of July night sky (top of opposite page). Bombs are launched from mortar installations and a single bomb may contain 150 bursts released at split-second intervals. Beneath the aerial pyrotechnics is an incendiary portrait of "Our Governor" and the dazzling show opener. On this page is a panel of grand-finale color effects—fountains of flame which are reflected in a lake

20,000 feet of lumber and strengthened by steel. They're intricately fused and primed, their 30 miles of wrapped fuses run to remote firing stations. At each station crouches a triggerman, a rheostat at his finger tips, earphones snugged beneath his safety helmet.

An acre beyond, hidden by the stadium's lofty peristyles, waits the rocket crew, a dozen hand-picked men, each sheathed in asbestos. They're bossed by a firing chief, his back slung with a walkie-talkie. Close by my control post stands an observer, eyes probing the night, intent upon the mortars. His job: Spotting misfires.

Twenty tons of explosives await detonation, their colors and intensities as carefully compounded as those of a masterpiece. The artist paints with pigments; the fireworks designer with chemicals—dry pigments instead of wet. From grayish strontium-nitrate pellets come pyrotechnic reds; from barium and potassium chlorates, flaming greens; from slow-burning aluminum powder, the waterfall brilliance of Niagara. Modern firemakers, like their forefathers, keep secret their formulas. The chemicals? They're standard. The secret lies in the compounding, how one chemical's mixed with another and when.

Lingo of Pyrotechnics

There's also a nomenclature grown up around big-time fireworks. *Powders*, the explosive color etching every display; *fuses*, the intricate self-timers regulating a hundred different bursts; *boosters*, charges which keep pin wheels spinning; *lances*, the colored flares outlining the sets, literally drawing incendiary portraits. There are *parachutes*, too, which suspend explosives in mid-air.

During the next 60 minutes, \$20,000, perhaps \$30,000 worth of high explosives will go up in an artistic holocaust of flame and beauty. To the crowd, expectant in the stands, each flaming spectacle has a name . . . *Aerial Ballet* . . . *Devil Wheels* . . . *Battle of Midway* . . . *Niagara Falls*. And all etched in brilliant color against night's backdrop. To me they're just numbers . . . Set No. 1 . . . Set No. 2 . . . Numbers and seconds. Every shot's scheduled, timed to the second, regimented by radio and electrical impulse. Behind this pending holocaust stand four generations of craftsmanship—not to mention three hectic months of preparation and a half dozen dry-run rehearsals.

It's the spectacle that holds the crowd's attention. Aerial bursts. Thundering bombshells. Salvos of sky-rockets. It's a spectacular, all right, as breath-catching as a barrage along no man's land and almost as costly.

Few will notice, or even be aware of the three dozen men sweating over switches and fuses. For all eyes will be on the sky, on this, America's fieriest night of the year—Fourth of July.

As the last firing captain reports "set and ready," I tense.

Flashlight held close, I scan the firing order, the "sheet music" of big-time pyrotechnics. It's a score that's sometimes fast-paced, sometimes slow, as carefully composed as a ballad, as precisely arranged as any opera. As controller I'm a kind of symphony



Months of hard work precede the big show—here staple guns speed work of fusing elaborate set pieces

conductor. Fire and fantasy are my musicians. The mike is my baton.

The time watch's hand edges to 9 p.m. One second to go . . . half a second. . . .

"Fire aerials!" I rasp into the mike dangling from my neck. And the show is screaming skyward.

Three hundred feet to the south, the mortar chief slams his rheostat to first posi-

tion. Inside a steel-walled tube, a resistance wire bedded in black powder flares suddenly, igniting 1000 feet of tightly wrapped fuse. Fire races toward the mortar pits at 500 feet per second.

"Salooompp!" Two thousand lifting charges simultaneously explode in their tubes, hurling their bombs skyward, end-over-end. In quick succession come the

Below left, mortar chief in asbestos suit checks an aerial bomb. Right, Lizza with bombs and big set piece





Lizza checks wiring which will detonate this barrage of "candles." They are triggered from firing station

"breaks"—the dozen or more fountains of flames erupting from every bombshell, one break following the next at split-second intervals.

"Reload!" I bark. A dozen mortar men heft aerial bombs from the magazines, ram them down the still-hot throats of the firing tubes. They reach quickly—carefully—over

the sandbag barricades, barricades designed so that only a man's forearm lies exposed in the loading.

Quickening pace, I call, "Ready Set No. 1 . . . fire!" An acre away, across the thundering night, a set captain triggers his rheostat. "Sheesshh!" A half dozen fireworks destroyers flame against the night,

Colored flares called "lances" fastened to giant sets draw pictures in fire to form old and new favorites

FAVORITE DISPLAYS



OLD GLORY



NIAGARA FALLS



OUR PRESIDENT



MILITARY HERO



NAVAL BATTLE



CARTOON

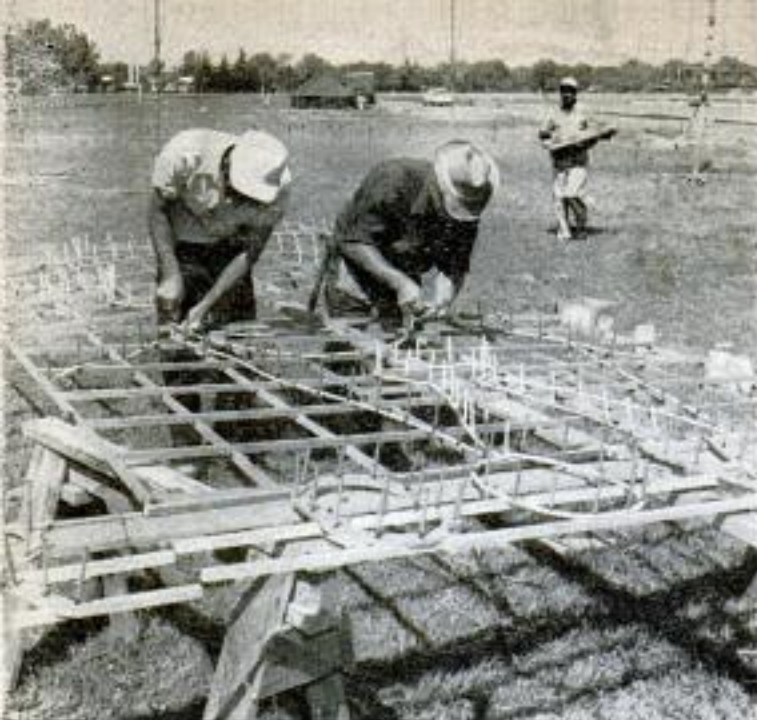

Elaborate set piece takes shape in an open field. Black-powder fuses link hundreds of flares in set

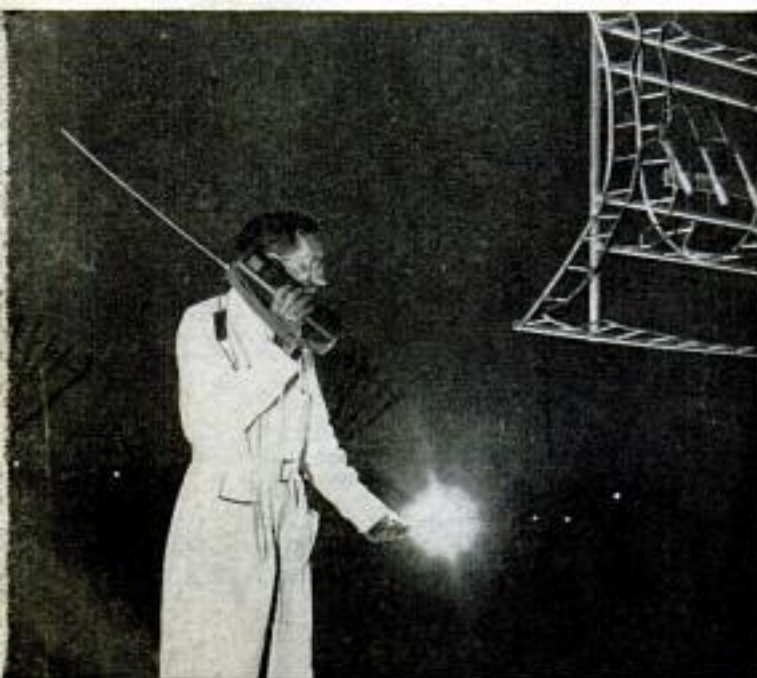

Mortar chief gets walkie-talkie orders from Lizza and signals his assistants with a special flare. Below, workmen behind set pieces attend rocket emplacements controlled from the main firing station



their cannon ranging on the Japanese fleet. For three minutes the Battle of Midway rages—precisely three minutes, not 10 seconds longer. Suddenly, the enemy armada sinks into a sea of fireworks as the Americans hoist a triumphant Stars and Stripes.

"Skyrockets!" I order. The pace changes. Fast pace, slow, fast again. That's the controller's job—the showmanship which is his for 60 earsplitting minutes. It's the gasps he's after, the startled "oohhhs" drifting down from the stands. "Keep them on seat's edge," is the credo of big-time pyrotechnicians.

An hour later it's over, the last flare pot spent. My throat's raw from fumes and directing. My ears ring to the crescendo of aerial bombs. Vaguely, I'm conscious of engines straining as a hoist truck lifts mortar tubes free of their holes. A dozer Jeep follows behind, filling the craters. At the arena's far end a crane's at work, its riggers hauling down steel cables which but half an hour before supported two tons of explosives, the 5000 "candles" which had fountained into a stadiumwide Niagara Falls. The arena's earthen floor is strewn with bits of paper and dabs of twine—all that remains of \$30,000 worth of high explosives.

Plant Has 80 Buildings

Only three months before, the holocaust had begun to take shape among the 80 buildings snugged into a canyoned 1400 acres near Saugus, Calif. Here, closely guarded and engineered for safety, are the Golden State Fireworks Co., founded by my father, and its big brother, Bermite Powder Co. My father, Patrick Lizza, is probably the world's most successful and energetic pyromaniac. Four generations of Lizzas have, literally, been shooting the works. But the spectaculars we engineer today would have left great-grandfather Antonio Lizza gasping like any ordinary Fourth of July celebrant.

Grandfather Lizza never foresaw the bombshell—the aerial bursts which are the staple of today's big-time displays. Electrical firing devices were unheard of a century ago. The walkie-talkie, coordinating two dozen men at a half dozen firing stations? It hadn't been invented. Nor had special lead-in fuses which, with one igniting, simultaneously fire a whole set piece. Nor had engineering climaxed to the point where detonation was both positive and a veritable chain reaction—built-in time-delay fuses triggering upwards of 150 bursts from a single bombshell as it arcs through the night. And there weren't "moving" sets, their animated characters "walking"

(Continued to page 212)



Aluminum Truck Bodies Reduce Dead Weight

Pay-load capacity is increased 10 to 15 percent with aluminum-alloy truck bodies, according to manufacturers. This dump-

body combination has a legal pay load of 51,470 pounds. Each body weighs 1400 pounds; aluminum wheels also cut weight.

Ultrasonic Gauge Tests Thickness

Changes in the thickness of metal and plastics as small as .05 percent can be detected by ultrasonic test equipment recently developed. The automatic thickness gauge can be wired to ring an alarm, flash a signal light or activate various kinds of compensating controls. Other circuits wired to the equipment convert the ultrasonic signals to readings on a strip-chart recorder, or make it possible to set high and low tolerances so material will be sorted as small, large or the correct size.

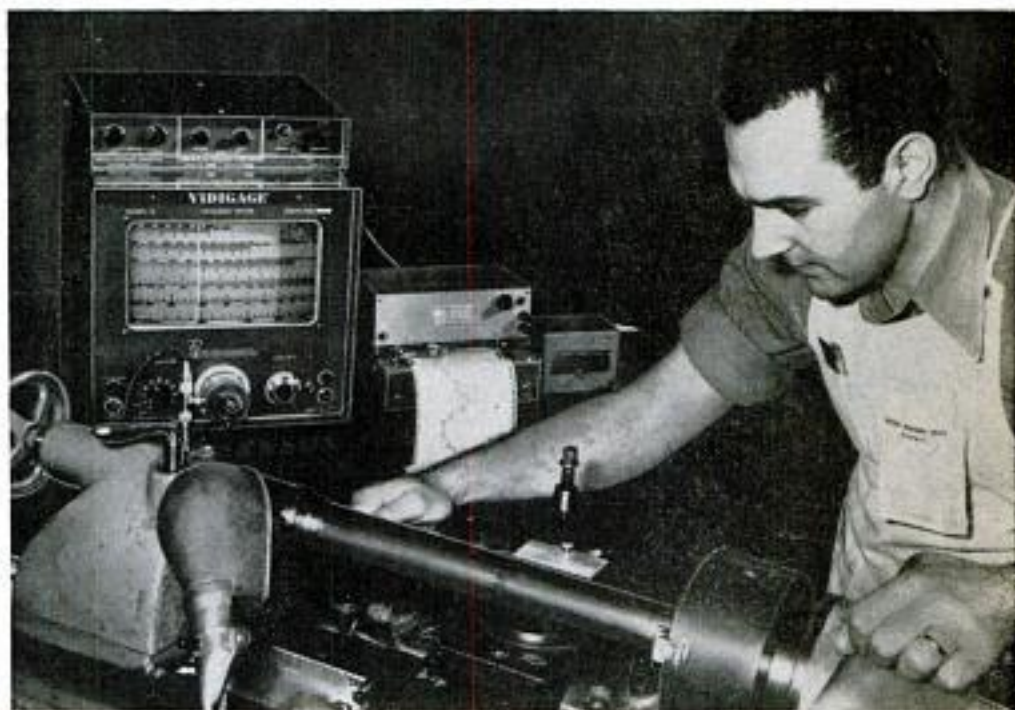

Power Take-off on Tractor Drives Trailer Wheels

It's almost impossible to bog down a German trailer that has its wheels powered from the power take-off of the tractor. A

two-jointed drive shaft connects the tractor and trailer to provide power to the trailer axle which is differential-equipped.

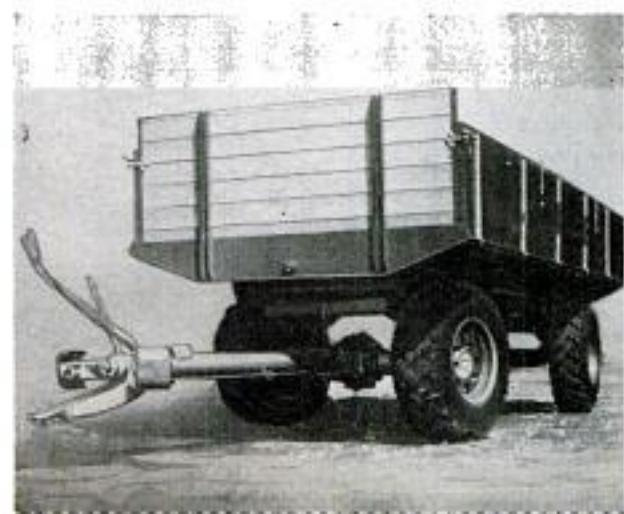



WHAT'S NEW FOR Your Home

TABLE TENNIS, anyone? This 5 by 9-foot table, left, folds in half for easy storage and rolls away on a set of four built-in ball-bearing casters. The top is five-ply, three-quarter-inch plywood with the court lines accurately striped on the playing surface

Brinktum, Inc., 710 N. Fourth St., Minneapolis, Minn.



FOOD MINCER uses five disk-shaped cutting blades which revolve and slice through meats, fish, fruits or vegetables. The palm-shaped holder also protects the fingers. The blades can be removed for cleaning

Competition Chemicals, Box 141, Iowa Falls, Iowa



CHALK MARKER for tacking dress material makes it easy to transfer pattern markings to the fabric. Built somewhat like a scissors, the tips are fitted with a device that automatically sharpens the chalk

Berwalt Co., 812 Huron Rd., Cleveland, Ohio

ALUMINUM HANDLE for milk carton will convert a conventional half-gallon container into an easy-to-handle pitcher. When not being used, the lightweight kitchen helper folds into a small space for storage

Specialty Sales Co., 801 1/2 Houston St., Arlington, Tex.



DECORATOR FABRIC FRONT for room air conditioners blends with the decor of the room and also conceals the control panel. You can replace the fabric with matching or contrasting material if you redecorate

Amana Refrigeration, Inc., Amana, Iowa



LAWN SHUFFLEBOARD game can be converted to conventional sliding deck shuffleboard in seconds. Puck is balanced to roll 75 feet for lawn games. Move peg, and puck slides for games on hard-surfaced courts. Set includes scoring courts, colored pucks, hardwood cues

Wamo Manufacturing Co.,
Dept. B, 835 El Monte St.,
San Gabriel, Calif.

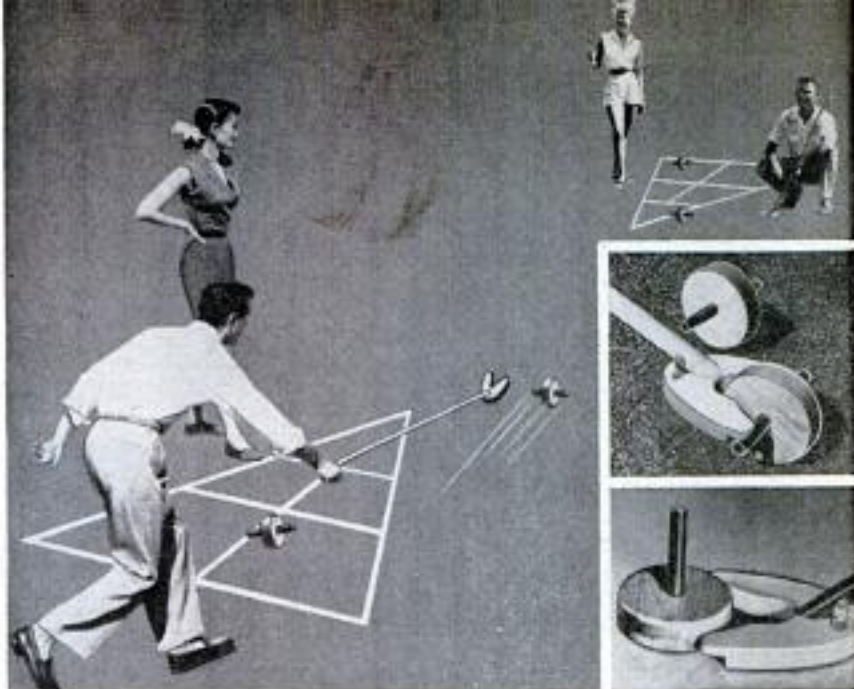

ELECTRONIC AIR CLEANER removes germ-laden dirt, dust, pollen and smoke by attracting airborne particles to grounded plates. Some models can be connected to furnaces or to central air-conditioning units

Trion, Inc., Pittsburgh, Pa.

CHAIR LIFT can be installed in most multilevel homes without structural changes. Suitable for persons who cannot or prefer not to climb stairs, the lift does not interfere with ordinary use of the stairs

Sedgwick, 84 Eighth Ave., New York City



JULY 1957



ROUND ICE CUBES? Yes, this rubber tray is designed to freeze ice in either clear or colored balls, with or without fruit flavoring. For freezing lollipops, sticks can be inserted through the holes in the trays

Ena's Mailbox Shopper, Box 7005 DU, Denver 8, Colo.

CORD SHORTENER takes up the slack in long telephone or appliance cords. The excess cord is simply wrapped around the holder which can be tacked to the baseboard for semipermanent room installation

Robert Fales Co., 34F Talcott Ave., West Springfield, Mass.



105

Copyrighted material



Just Drive Your Plane Downtown

If police don't have any objections, this amphibious aircraft—made by a manufacturer in Genoa, Italy—can also travel busy city streets. Cars and other types of vehicles merely move under the plane's wings



Flying Salvage Craft Works on Land or Sea

Tests conducted at the U. S. Naval Amphibious Base at San Diego, Calif., prove that the versatile helicopter can be used as a highly mobile salvage vehicle during amphibious landings. In the top photograph, a powerless, tracked LVT is hauled over loose sand and into the sea by a tandem-rotor H-21 helicopter. In the simulated-invasion problem, it was assumed that ordinary salvage vessels would be barred by reefs and shallow water. In another mock-invasion problem, left, the H-21 serves as a flying tugboat by towing a 3000-ton, 382-foot LST through the water at a speed of five knots. The helicopter's performance was reported better in many ways than that of a water-borne tug.

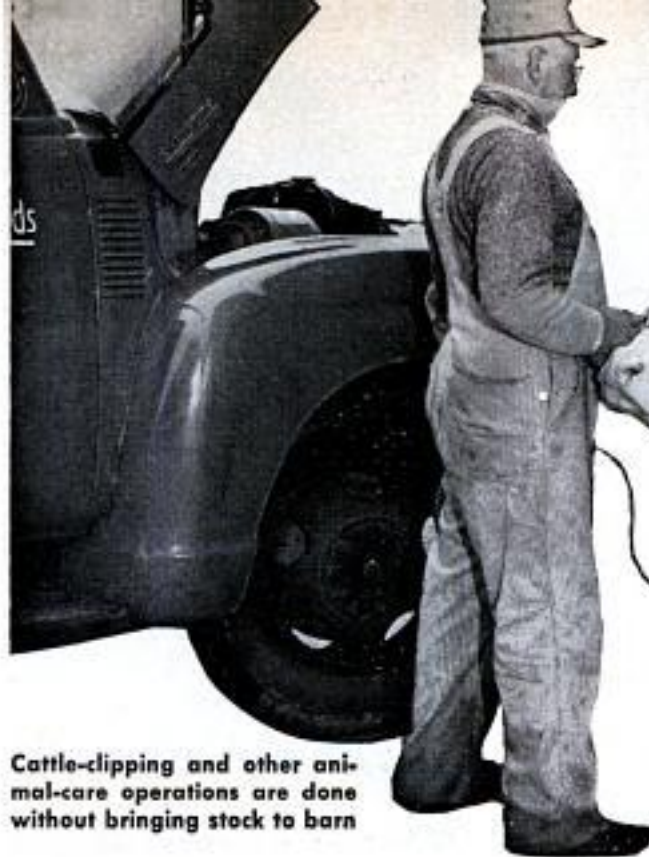

Cattle-clipping and other animal-care operations are done without bringing stock to barn



Utility Generator for Car

POWER TOOLS, appliances or emergency equipment operate from a 110-volt, alternating-current generator that hooks up to the engine of any truck or car. Called GenerAC, this generator and a small control box with hand throttle, on-off switch and voltmeter can be mounted with ease. A steady 3500 watts, or a temporary 6000 watts, are available; this power source also can start a two-horsepower motor. Outlets for 110, 220 or combination voltages may be installed in accessible locations. An electrical clutch prevents the generator from being run while the vehicle is driven.

Handy man can use portable generator to power chain saw, below, or drive Sanders, drills, other tools



Above, on emergency vehicles this power source operates lights, rescue equipment, medical refrigerators



JULY 1957

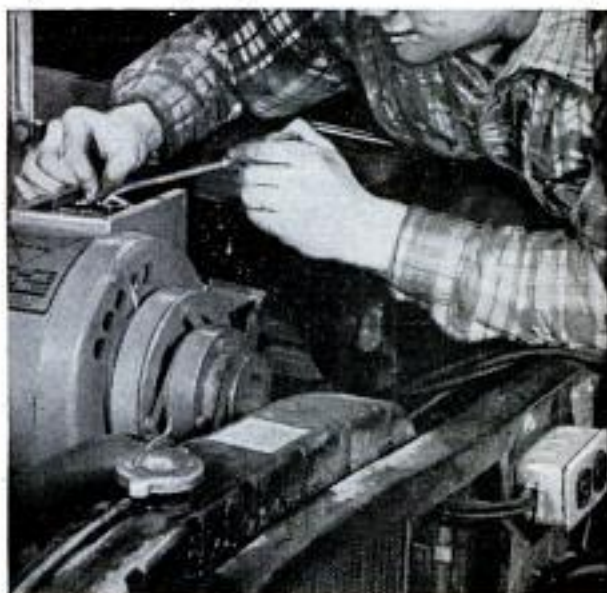

Below, generator mounts under hood without removing crankshaft pulley or radiator. Outlet is at right

107

Mystery Fuels for the Missile Age



We're turning to metals and chemicals for the high-energy fuels essential to supersonic warplanes and missiles and the space vehicles of tomorrow

By
Thomas E. Stimson, Jr.

Courtesy of Aircraft Industries Association

Chart shows comparative thrust of piston engines versus turbojet-engine thrust up to 1957. With metal-chemical fuels, the curve of turbojet-engine thrust will rise in the next several years (see dotted line at right)

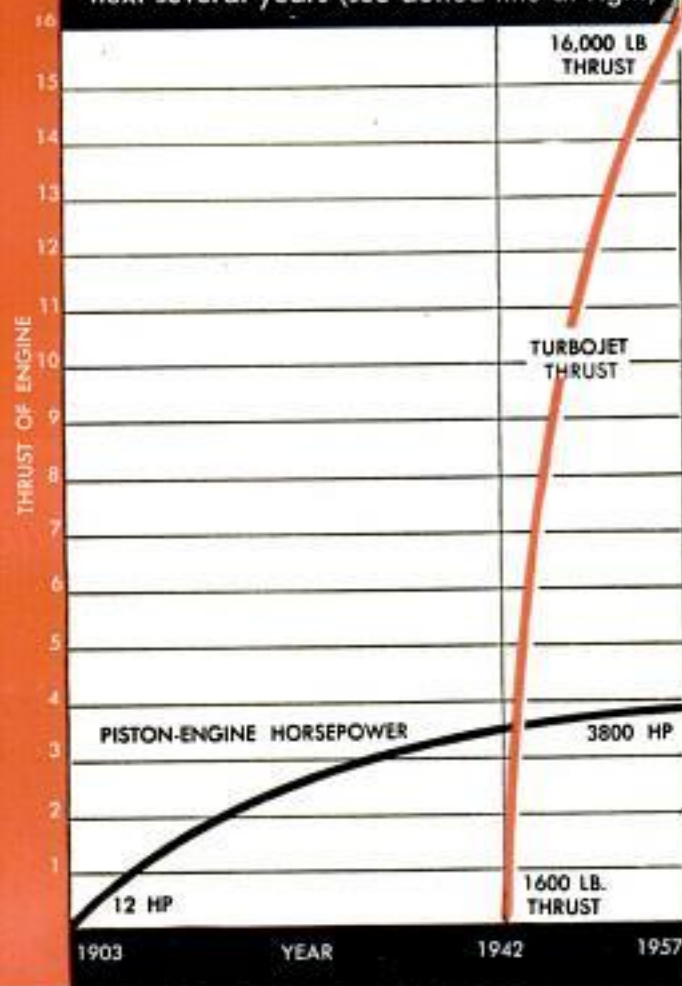

MILITARY AVIATION has turned to the chemistry books to find ways of making aircraft fly faster and farther.

Specifically, new fuels are being compounded that give an airplane the same superperformance that a tankful of nitromethane gives a hot-

rodger's car.

"Some very remarkable propellants are being tested," a power-plant engineer says. "Some are metals. Others are so poisonous that a few whiffs of their vapor would kill you. A number are highly corrosive. Of course, fuels like these aren't practical unless we find ways of taming them. All of them are more potent than ordinary hydrocarbon fuels."

Curiously, the most satisfactory "zip" fuel found so far comes from the material from which borax is produced. Boron is one of the lightest elements. It is the basis of borax and boric acid and is widely used in enamels, in the glass industry and for producing a shiny surface on paper. Most of the world's supply is in the Death Valley region in California where it has been mined since the days of the 20-mule teams.

One group of boron chemicals known as boranes contains tremendous amounts of power in relation to its weight and bulk. A borane is a boron-hydrogen combination, and hydrogen burns with a greater heat of combustion per pound than any other pure material.

In a hydrocarbon, the hydrogen, a gas, is locked up with carbon, a solid. The resulting liquid contains around 18,000 BTUs per pound.

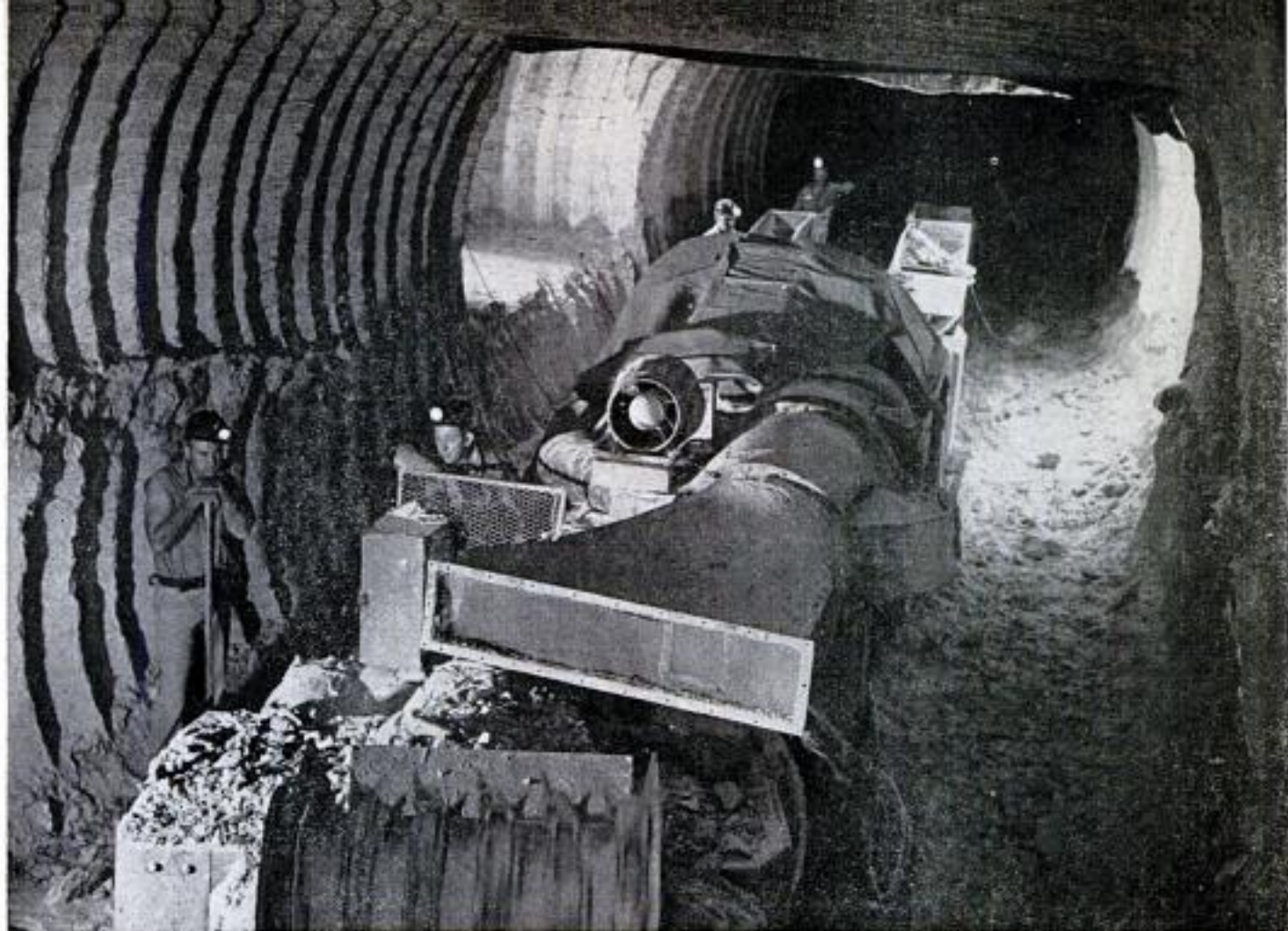

"Continuous miner" machine digs and loads borate ore, basis for a high-energy fuel, under California desert

In a borane, the hydrogen atoms are tied to boron atoms. This combination, also a liquid, contains something like 30,000 BTUs per pound, about a third more heat units (or power) than gasoline or kerosene.

This means that in an airplane a borane can deliver a third more thrust than the same amount of JP-4 jet fuel. The ratio is actually better than that although the exact figure is a military secret.

With the extra power an airplane can fly faster at the same fuel-consumption rate or it can fly farther on the same amount of fuel. "These fuels literally deliver many more miles per gallon," a research chemist says. A borane burns efficiently at high altitudes where the air is so thin that ordinary fuels sputter and flame out.

Nevertheless, your service station isn't going to stock up on "superzip." These fuels would do more harm than good in present automobile engines. Their cost is many times that of gasoline. Besides, their products of combustion are poisonous to vegetation and possibly to humans and animals as well.

But their advantages for military aircraft and some missiles are so great that huge plants are being rushed to completion to produce them in vast quantities. This past spring ground was broken near Muskogee, Okla., for a \$38,000,000 plant in which Callery Chemical Company will produce "HiCal" for the Navy. This fuel is a combination of boron and hydrogen plus carbon. The carbon is added as a stabilizer. It

Honest John solid-propellant missile makes visible shock waves in supersonic flight at White Sands, N. Mex.

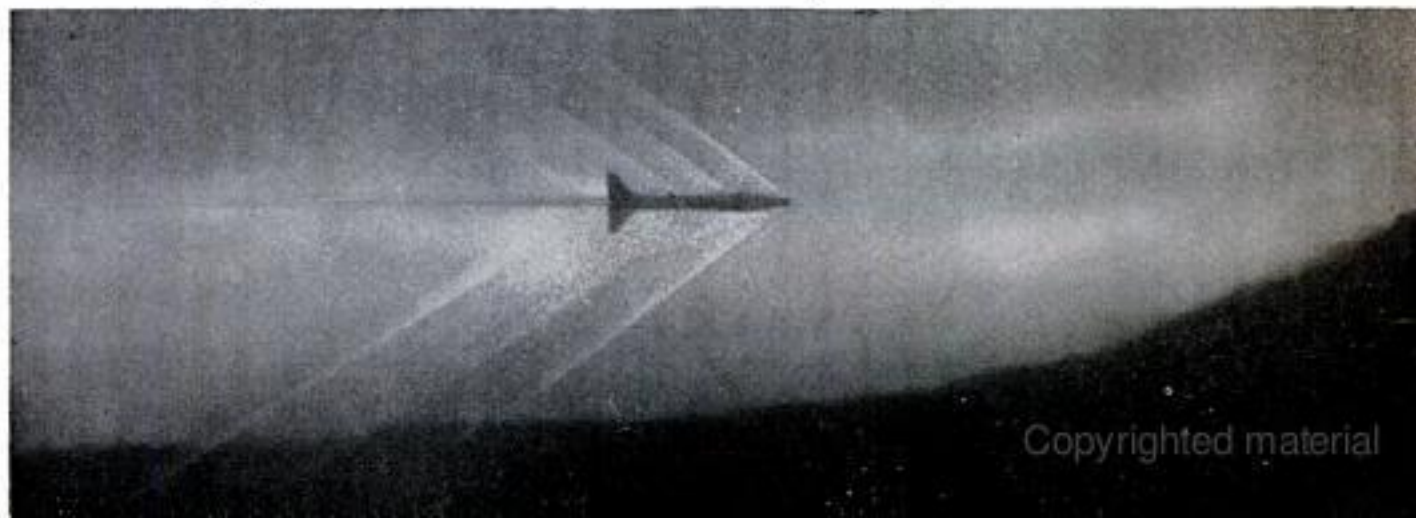



F-100 Super Sabre afterburner generates big exhaust flame on take-off. Chemical fuels will give more power

also contributes to the heat of combustion. A similar fuel is to be manufactured for the Air Force by Olin Mathieson at a \$26,000,000 plant now under construction at Niagara Falls.

It's an open secret that a borane will be used to power the world's first bomber designed from the start to operate on a chemical fuel. This plane, the WS-110, is intended to fly at 75,000-foot altitude and at three times the speed of sound. (WS means "weapons system" and may be replaced by the more conventional B for bomber when construction starts.) It is

understood that the WS-110 will have a delta wing and that titanium will be used for 40 percent of its structure. North American and Boeing are making preliminary studies of the project. Long before the WS-110 is built, the present B-58 supersonic bomber and a number of other military aircraft may be re-engined to use the new exotic fuels.

The boranes are not the only compounds being studied. Lithium is another light element and has some possibilities when hooked to hydrogen. Beryllium could be the basis of an excellent high-energy fuel

New high-performance exotic fuels are used in such missile engines as illustrated by this cutaway drawing

Courtesy of Ryan Aeronautical Co.

TYPICAL SUPERSONIC RAMJET ENGINE

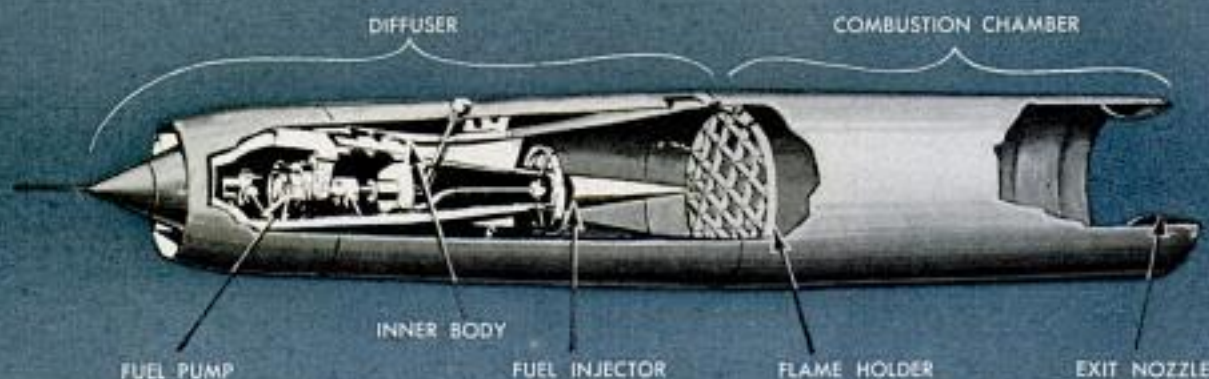

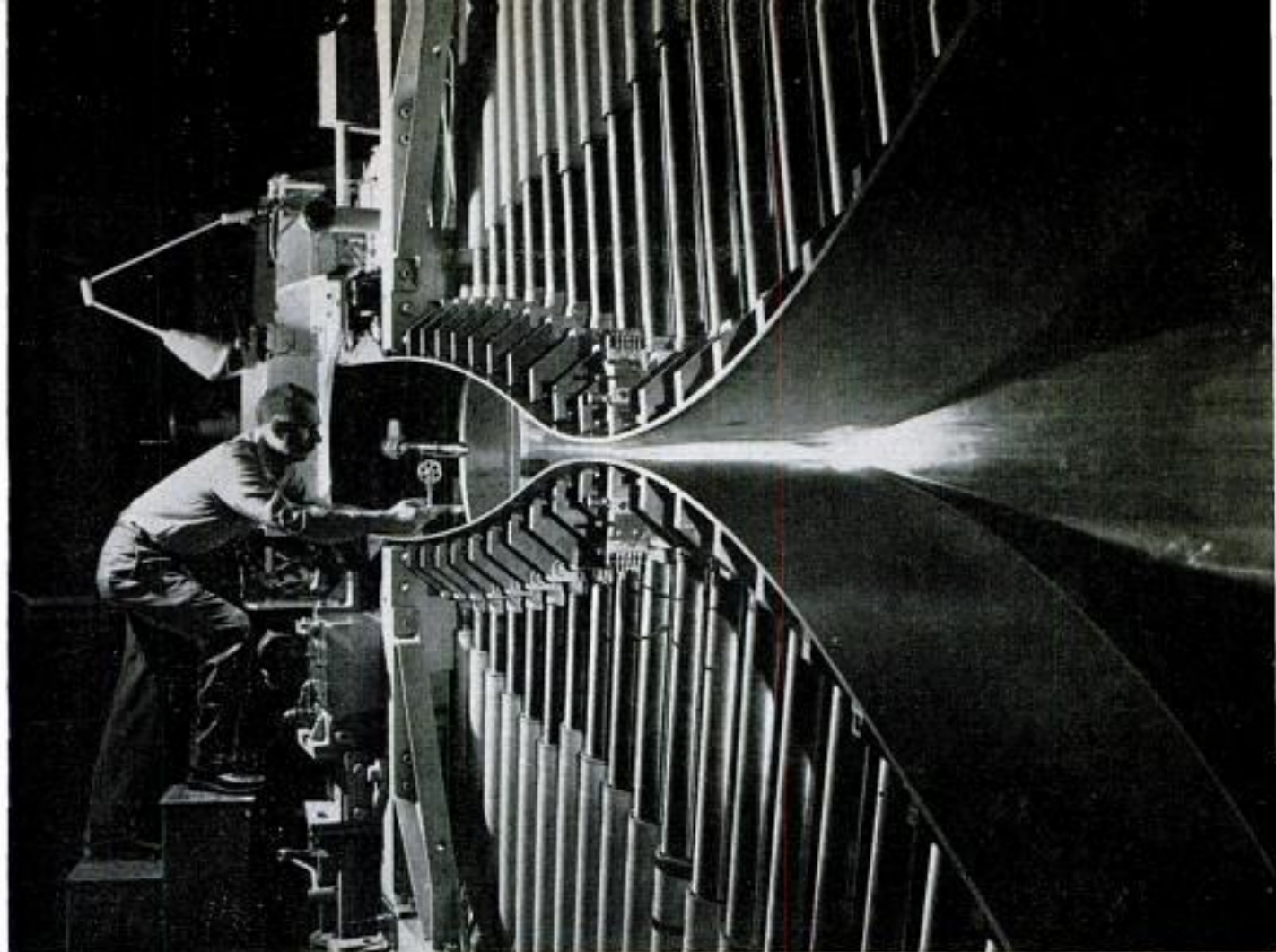

Experimental model of missile at Caltech is rigged in 20-inch supersonic wind tunnel with variable throat

except that it doesn't exist in the vast tonnages needed. Nitromethane, the chemical that turns an automobile into a "bomb," can't compete with the other chemicals as an aircraft fuel. Its heat content is too low on a bulk basis.

One way of using a metal as fuel is to grind it into a fine powder, then mix it with ordinary jet kerosene on a fifty-fifty basis. Such a suspension is known as a slurry. The mixture contains more BTUs than a hydrocarbon fuel and can produce as much as 50 percent more thrust.

Powdered magnesium in JP-4 is one such slurry. Like many of the other exotic fuels it needs relatively little oxygen for combustion and is ideal for high-altitude flight. Aluminum slurry is another mixture with good characteristics. Boron is a poor slurry material because one of the products of its combustion is boron oxide. This forms a glasslike coating on the walls of the exhaust chamber and reduces thrust.

The slurries have one big handicap. They must be kept in constant agitation to prevent the metal particles from settling to the bottom. This calls for powerful stirring devices in the fuel tanks. Stronger fuel lines and pumps also are necessary. Abrasion is a big problem. There may be a way of eliminating some of this trouble: The

men who are studying slurries are seeking an additive which, when poured into a fuel, would keep heavy particles in suspension.

Some of the other new chemicals being studied are highly unstable; some are dangerously explosive. Thus, in the new gas-turbine-propellants laboratory that General Electric has just opened near Cincinnati, many of the tests are performed by remote control and are watched via explosionproof windows or closed-circuit TV.

Chart gives combustion-chamber temperatures for oxidizer-fuel combinations used or possible for rocket

Courtesy of Rocketdyne

COMBUSTION-CHAMBER TEMPERATURES FOR ROCKET MOTORS		
PROPELLANT COMBINATION	DEG. F.	ROCKET MOTOR
NITRIC ACID	AMMONIA	4220
OXYGEN	HYDROGEN	4500
HYDROGEN PEROXIDE	HYDRAZINE	4690
HYDROGEN PEROXIDE	GASOLINE	4830
NITRIC ACID	ANILINE	5100
FLUORINE	HYDROGEN	5100
NITRIC ACID	GASOLINE	5150
OXYGEN	HYDRAZINE	5370
OXYGEN	ALCOHOL	5560
OXYGEN	GASOLINE	5770
FLUORINE	AMMONIA	7224
FLUORINE	HYDRAZINE	7940

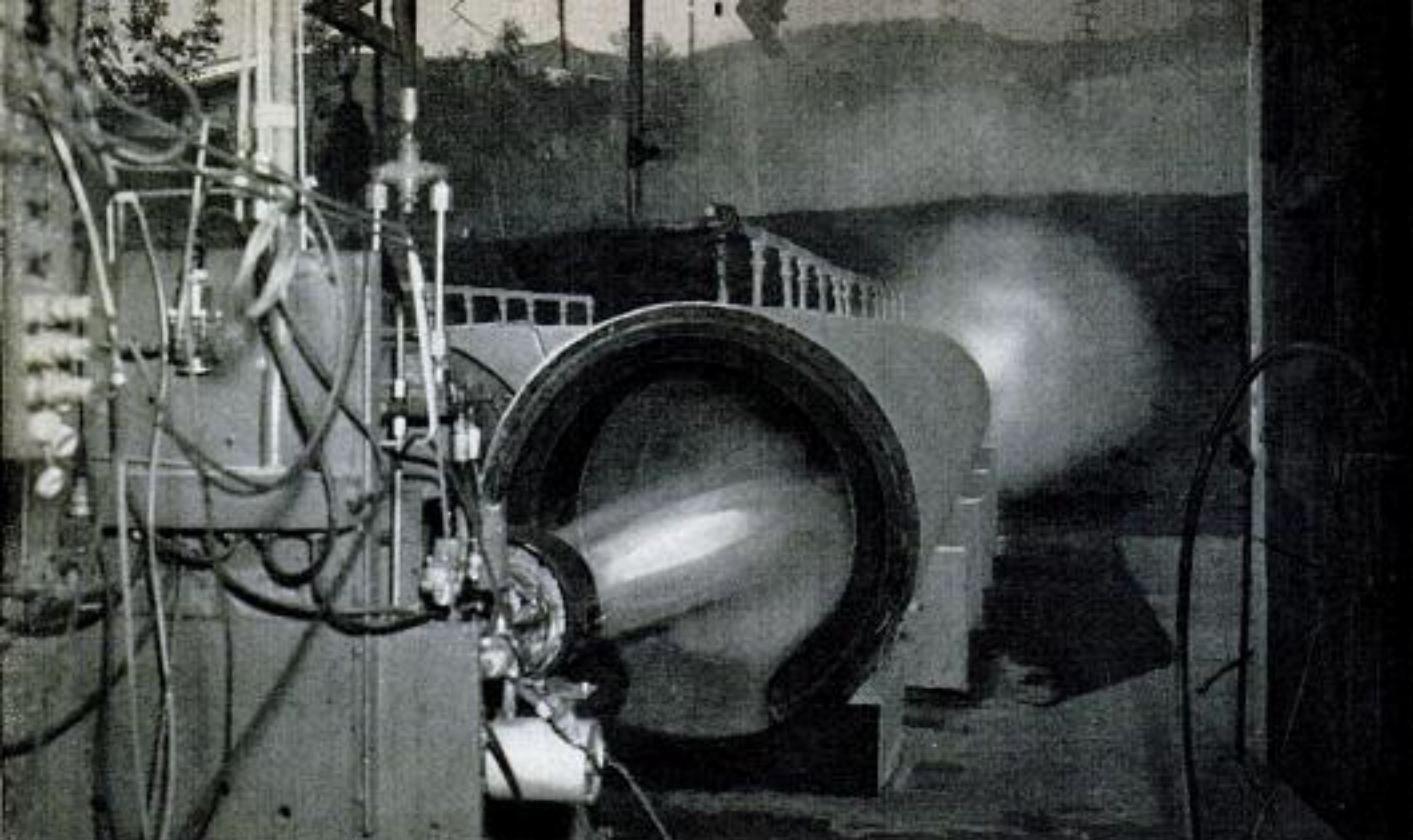

High-energy-propellant flame in experimental rocket motor is released into noise-suppression unit at Caltech

FUEL COMPARISONS

FUEL	BTU _s PER POUND
HYDROGEN	51,571
DIBORANE	31,370
BERYLLIUM	29,140
PENTABORANE	29,127
BORON	25,100
GASOLINE	18,800
KEROSENE	18,490
LITHIUM	18,460
CARBON	14,087
ALUMINUM	13,309
MAGNESIUM	10,639
TITANIUM	8,187

Above list shows heat content of fuels. Below, air-sensitive fuel is transferred to "bomb" for testing

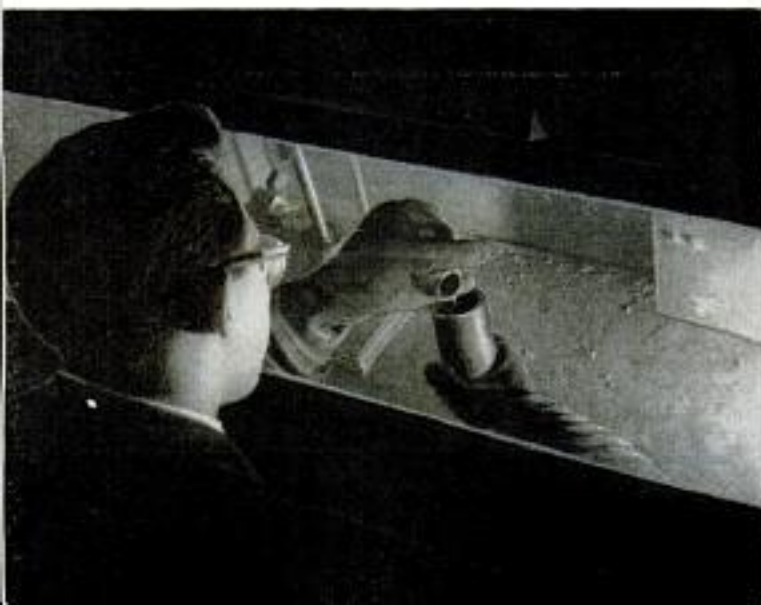

Similarly, New York University has moved its jet and rocket-fuels laboratory to a fire and explosionproof building. Among other jet fuels being investigated at NYU is a group of monopropellants that formerly were considered suitable for rockets alone. Monopropellants contain their own oxidizer and don't need to take oxygen from the atmosphere for combustion. Some of the compounds under study include hydrazine, hydrogen peroxide and propyl nitrate.

Using a high-energy fuel is one way of getting around the basic inefficiency of present turbojet engines. Ordinary jet fuel burns at 2500 degrees F., a temperature that would soon turn an engine into junk except that the heat is dissipated rapidly. The jets operate on an air-rich mixture, an excess of air, simply to keep their temperatures down. In spite of all the research on new metal alloys and cermets, it isn't possible yet to operate a jet engine at higher and more efficient temperatures.

Until better metals are available, engineers are trying such engine refinements as "variable-geometry inlets," "convergent-divergent nozzles" and "Coke-bottle configurations" in efforts to produce more velocity at the tail pipe, thereby obtaining more thrust.

The new high-energy fuels suggest other engine modifications. The new propellants have better flame-holding characteristics; hence, combustion chambers can be shorter. This leads to other changes and the net result is a shorter, lighter engine. Not all

(Continued to page 226)



Two-Seat Jet Interceptor Gets First Test Flight

F-101B Voodoo, a long-range, supersonic jet plane designed for fast climb and high-altitude interception, has successfully completed its first test flight. Built by McDon-

nell Aircraft Corp., the plane has two Pratt and Whitney J-57 jet engines and carries pilot and radar observer. The F-101B is one of three in the Voodoo series.



You Can Have a Refrigerator in Your Car Trunk

Soon they'll put running water in cars and we won't need houses—that is, if the current trend keeps up. The newest auto convenience is an ice-making refrigerator

that is part of an air conditioner that mounts in the trunk. Another unit made by the same company fits neatly under the dash and is easily installed.

Swimmers Use Hands to Paddle Beach "Boats"

Fun for adults as well as children, a new small watercraft combines swimming and boating. The rider steps into a cockpit hole, picks up the craft and wades into the water.

He then sits down on a seat suspended beneath the cockpit and uses his hands as paddles. The child's version of the boat is four feet long, and will support 100 pounds.



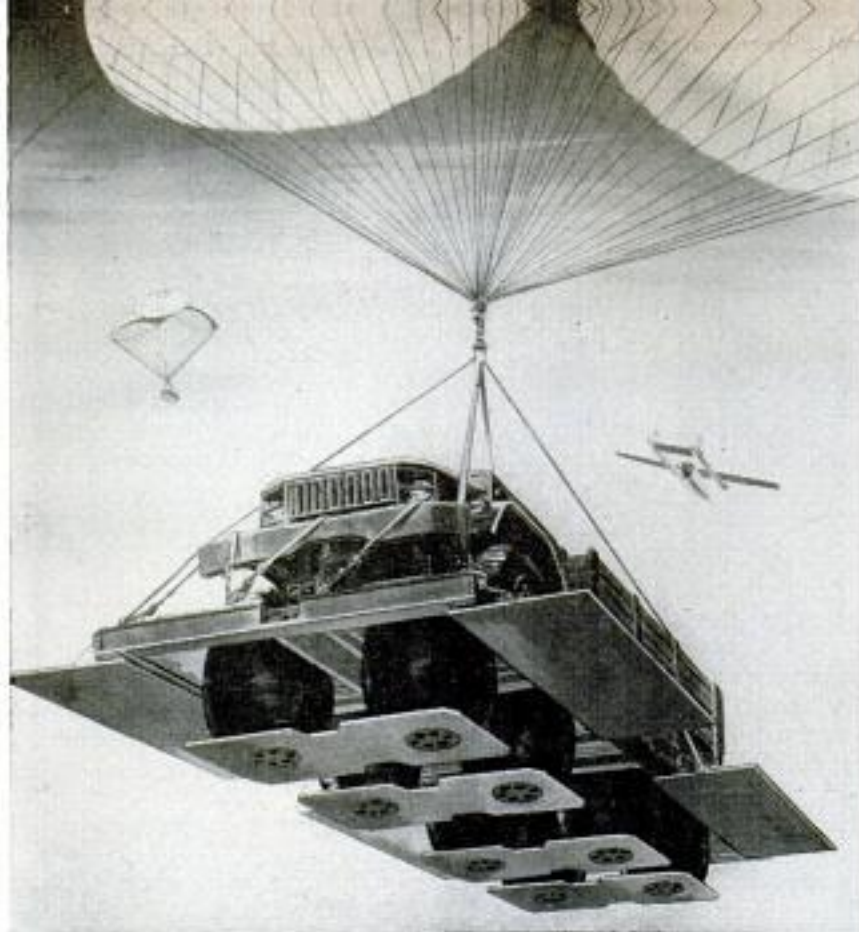

Aerial Platforms Drop Heavy Gear

Heavy fighting equipment—trucks, tanks and artillery—can be parachuted to troops on huge air-cushioned platforms. Each platform, made of magnesium, has a series of barrel-shaped nylon-and-rubber bags on its underside. When the platform is loaded into the transport plane, the bags are collapsed. As soon as the platform is ejected, uprushing air inflates them. Upon impact, the air is forced through diaphragms easing the load to the ground. The platforms are made in three sizes, the largest one 24 feet long.



Regular Motors Off, Jets Fly "Boxcar"

With both piston motors stopped, this Flying Boxcar flies 150 miles per hour powered by the two turbojet engines mounted on top of its fuselage. The jets were designed as auxiliary power if one piston engine should fail. When this was tried, their performance was so outstanding that the pilot turned off the other piston engine and the big 54,000-pound C-82 maintained its altitude and speed on the supplementary jet engines.

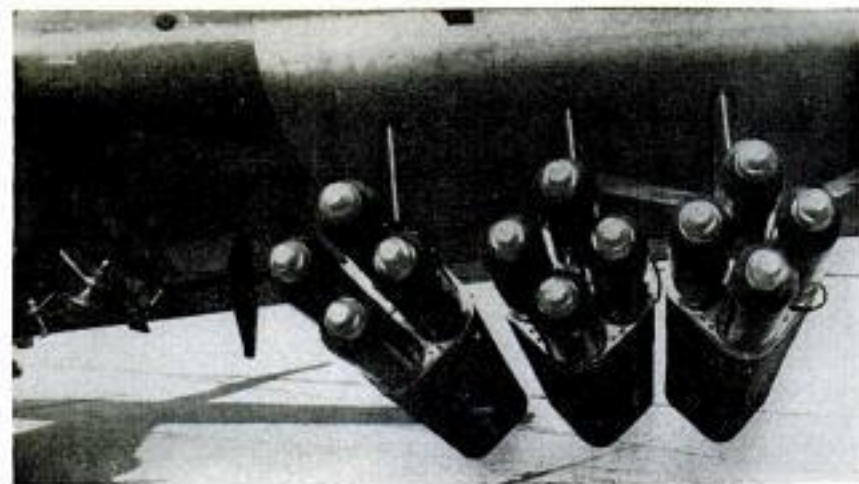

Rocket Missile Can Catch Jet

Newest rocket-propelled missile for the Navy is Zuni, an economical air-to-air or air-to-ground five-inch weapon that can overtake a jet plane. Costing only \$150 each, four of the folding-fin Zunis are carried in a detachable launching pod under an airplane's wing. They can be fired singly or in "ripples."



Fighter-Bomber Can Carry A-Bomb at Supersonic Speed

Nuclear bombs can be carried at supersonic speeds by the Republic F-105 Thunderchief, new fighter-bomber slated for peak production in late 1958. Powered

by the Pratt and Whitney J-75 engine, the F-105 features a cylindrical fuselage, sweptback wings, needle nose and a fin on the bottom of the fuselage near the tail.

First German Plane Since World War II

Short take-off and landing-space requirements are features of the first postwar German plane to be built. Designed by the German aviation pioneer, Claude Dornier, the four-place plane can take off in less than 300 feet, has a maximum and minimum speed of 158 and 37 miles per hour, and can climb an average of 1000 feet per minute to its top altitude of 20,000 feet.



"Saucer Top" Plane To Warn Fleet

Long-range radar, its antenna housed in a saucer-shaped radome atop the carrier-based WF-2, will warn U.S. fleets of impending attacks by enemy air and sea forces. The Grumman plane also will control friendly task-force defense fighters.

Shell Cost Soars

Five-inch-caliber shells fired in World War II cost about \$100 per projectile. Today, one Navy Terrier guided missile, a modern substitute for a five-inch antiaircraft shell, costs about \$60,000 without its launcher.

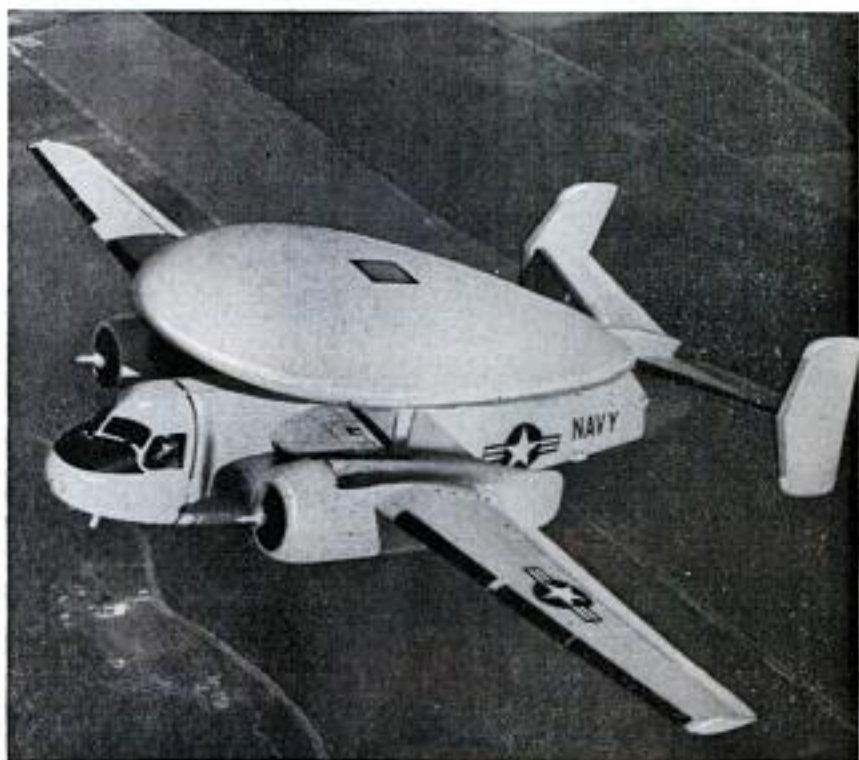

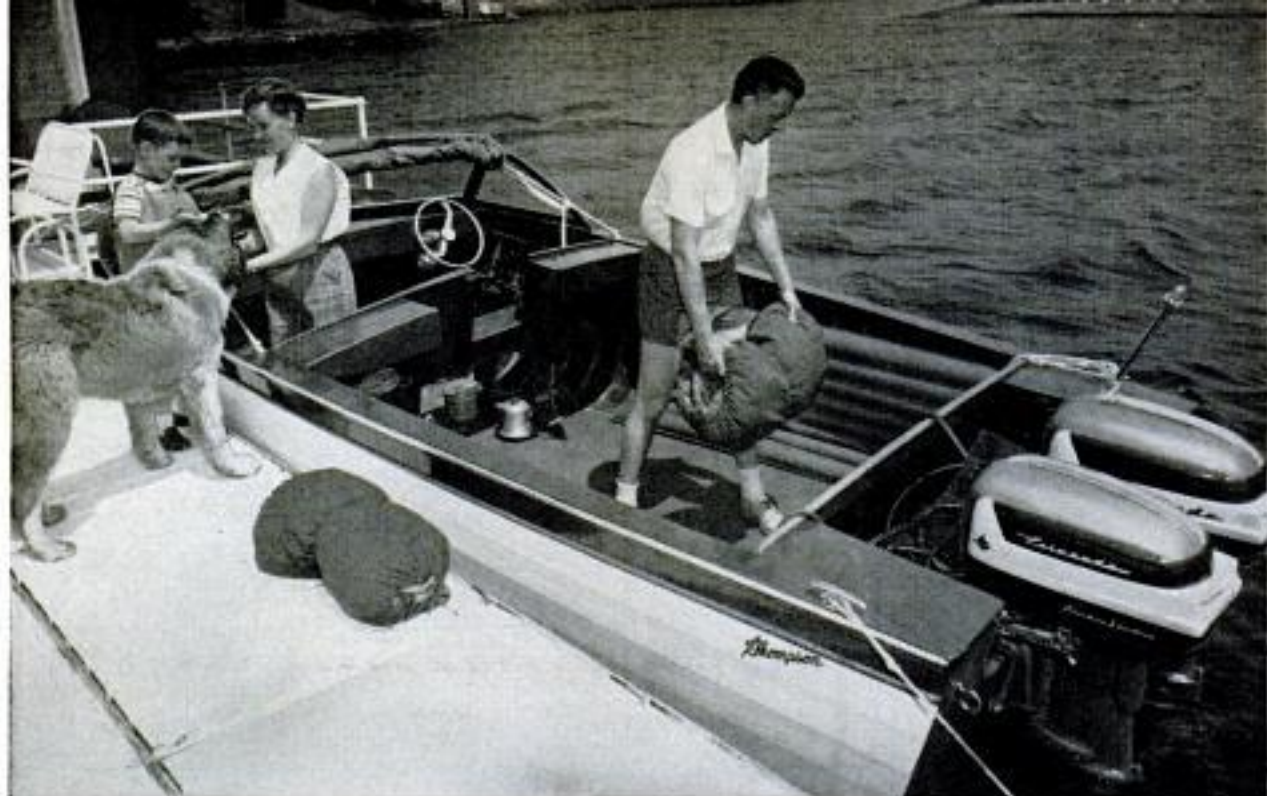

Day cruising, increasingly popular family pastime, helps account for current boom in outboard boating

Our Outboard-Boat Boom

By Don Wharton

*24 Gramercy Park
New York City*

LAST YEAR Americans spent \$1,250,000,000 on boating—more than on any other recreation. They bought 275,000 boats and 600,000 outboard motors. When the war ended this country had two million pleasure craft; now it has more than six million. About half a million are sailboats, the rest powerboats—nine out of ten powered by the outboard motor. Last Labor Day the Coast Guard estimated that in the New York naval district alone a million persons

were on the water in their boats—mainly family boating. A financial publication estimates that every summer week end "... one in every eight families in the nation now goes down to the sea."

Trailers have come in for hauling boats overland, popularizing boating among families 50 to 100 miles from navigable water. Yacht clubs have been formed in such places as Wichita Falls, Tex., right in the dust bowl. Denver people are now trailing boats up to mountain lakes, Phoenix families trailing them down to the Gulf of California. In 1947, boat-trailer sales totaled only 3800. Last year they added up to 154,000.

The heart of the whole boating boom is the outboard motor—the old put-put which for years was the scorned, noisy, little wretch of the marine world. Its manufacture is the only industry I've encountered which was founded by a man and wife. The man was Ole Evinrude, born in Norway, brought to America when he was only five, raised on a small Wisconsin farm. His wife was Bess Cary, a little Milwaukee girl who on the death of her parents had to go to work at 15. Ole left the farm at 16, walked 20 miles to Madison, got a 50-cents-a-day job in an agricultural-implement plant. Later he worked in a Pittsburgh rolling mill and a Chicago toolworks. Then, moving to Milwaukee, he began making

The late Ole Evinrude, left, and S. F. Briggs, a business associate, examine a 1914-model motor



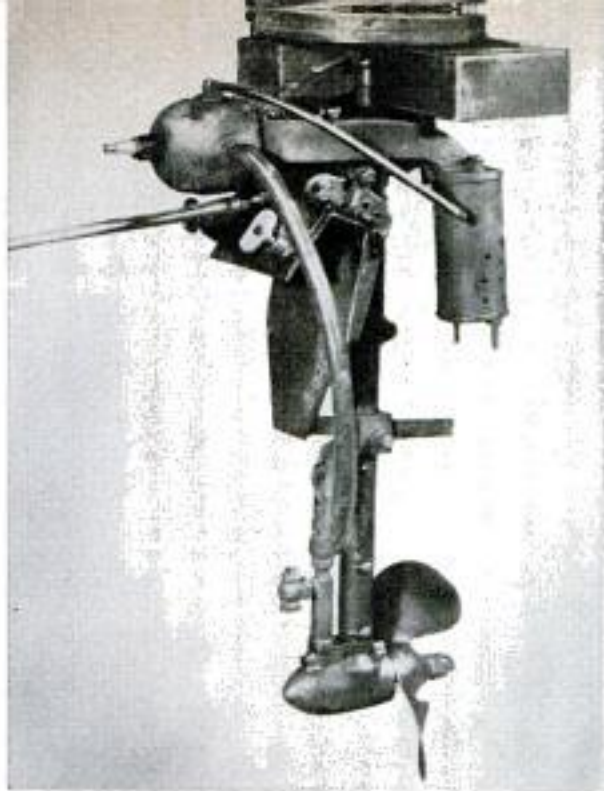

This is a 1909-model Evinrude motor. It developed one half horsepower, weighed 62 pounds, cost \$62

wood patterns for manufacturers to use in forming molds for iron castings.

Machinery fascinated him, particularly engines. He built a car around 1900, using four Harley-Davidson engines mounted on a frame he constructed of oak. But he couldn't get backers for his machine. Later he designed a gasoline engine, found a partner, went into the engine business. In six months the partnership broke up. Ole then figured that the budding automobile

First gearshift for outboard motors was pioneered on this 14-horsepower 1950-model Fastwin engine



JULY 1957



By 1929 outboard motors had come into their own. This four-cylinder Super Elto had 25 horsepower

industry needed a standard motor that could be installed in any horseless carriage. He teamed up with a retired furniture dealer, formed the Motor Car Power Equipment Company. It too failed—and again Ole went back to patternmaking in a shabby one-room rented shop heated by a potbellied stove. He was working there when he and Bess married in 1906.

Then, in spare time, in the basement of a rooming house, Ole began working on a

This Mercury Mark 75, rated at 60 horsepower, is the industry's first six-cylinder in-line outboard motor

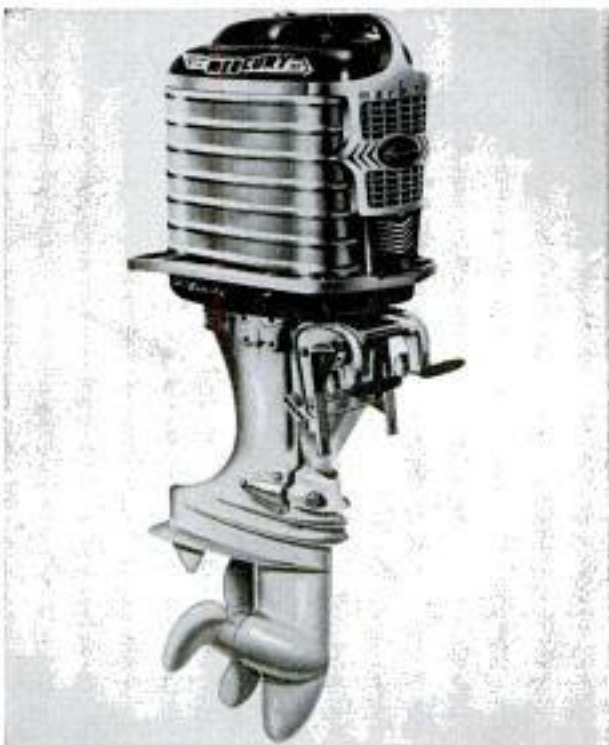

117



The rakish-styled Meteor has a glass-fiber hull, radio, leather bucket-seats, headlights and taillights

contraption destined to carry the Evinrude name around the world—a motor to be attached to the stern of a rowboat. There's a legend that Ole got the idea on a picnic when he had to row miles to get ice cream for Bess. Some say he got tired of rowing, some that the ice cream melted. Anyway, the idea wasn't new and his wasn't the first outboard motor. A Long Island firm had produced a few in 1896 and a French company had patented one as early as 1864. In 1907 a Detroit firm marketed a motor called the Waterman Porto. But Ole liked to build

Fifty-horsepower outboard motors moved storm boats of Allies across the Rhine River in World War II



for himself. He worked nights, swapped pattern jobs for parts, and in April, 1909, tested his first motor on the Kinnickinnic River, in a rented rowboat. While deck hands watched from big coal boats, the crude Evinrude motor pushed the rowboat along at five miles per hour. Ole made an improved model, loaned it to a friend one Sunday and soon had orders for 10 which he turned out when and as he could.

It would have all ended there, a spare-time operation, but for Bess Evinrude. She was only 24, frail, had her hands full with a two-year-old baby. Her only business experience was stenography and a little bookkeeping. But she was convinced that outboard motors could be developed into a real business, and for months she argued that with easygoing Ole. Then Bess wrote an ad, placed it in a Milwaukee paper, paid for it with money saved from her household funds. "Don't Row!" it said. "Throw the Oars Away!" She hoarded the replies until they made a big stack, then one evening showed the whole bunch to Ole.

Next, Bess set out to help him get capital. Banks, investment houses, businessmen weren't interested. But Bess found a tugboat owner, Christopher Meyer, who put up \$5000 for half interest in a new firm. Space was rented in a shabby red-brick factory building, secondhand machinery secured. While Ole handled production, Bess managed distribution, sales, advertising, bookkeeping. Bess had a keen business mind, much imagination. She hid her sex by signing all business letters "B. Evinrude." When she found orders dwindling in wintertime she began a hunt for new markets. She lined up an export company which introduced outboards to Scandinavia, shortly had enough orders to keep the factory busy the year 'round.

By 1913 there were 300 employees, Evinrude was an international word and Theo-



Scott-Atwater photo

Even youngsters can learn how to handle small boats properly with today's easy-to-operate outboard motors

dore Roosevelt was taking the outboards with him to Brazil for exploration of the River of Doubt. The Evinrudes sold out to Meyer for \$140,000 and began roaming the country, but Ole couldn't keep his mind off motors. In 1921 he came back with new designs: A two-cylinder outboard with less weight, more power. He tried to sell it to his old company but Meyer turned him down flatly. So he and Bess, with most of their money gone, again went into business together—"the perfect partners," someone called them.

They named the new motor Elto, coining the name from the first letters of the words Evinrude's Light Twin Outboard. The first year they lost \$10,500, then the Elto caught on, began outselling the Evinrude. By 1928, profits were nearly \$1000 a day. The next year Elto and Evinrude were merged in a firm ultimately called Outboard Marine, with Ole president and largest stockholder. Bess died in 1933 and Ole 14 months later.

Switch From Bikes to Boats

The second biggest push to the outboard industry came from three Johnson brothers, Lou, Harry and Clarence, who in 1921 found that their business—making a motor for bicycles—was flopping. They switched to an outboard motor, helped spark the drive for more power, and for outboard racing. The depression hit the Johnson company hard. In 1936 it, too, was taken over by Outboard Marine which today has three motor plants in the United States, one in Canada, another starting this year in Europe.

Outboard Marine is the "General Motors" of the industry, accounting for over half the total American volume. It has 7500 employees, makes both the Johnson and Evinrude motors, and has a third division producing outboards for mail-order houses and other firms. There are half-a-dozen well-known American makes now, includ-

ing Mercury, Scott-Atwater, West Bend, Champion and Oliver.

During the war, Johnson and Evinrude built 18,000 special outboards for the armed forces: Rugged, 50-horsepower units that saw service on most fighting fronts. Engineers used them to push pontoons into place quickly for bridges; the Navy dropped them from the air, along with rubber lifeboats, to bomber crews adrift at sea. The most spectacular employment came in Montgomery's massive crossing of the Rhine, when the first assault waves were carried in hundreds of storm boats powered by these outboards. Before the 9th Army moved up into position for the river crossing it checked personnel-record cards, found which men had given motorboating as a hobby, selected hundreds for special training at a German officers' swimming club near Maastricht. These men, for days before H-hour, were observed working over outboards in barns and under trees. The engineers even secured 1000 electric heating pads—to warm the motors for quick starting.

Longer Week Ends Boost Boating

After the war, social and economic changes in America began boosting outboard boating. Rising living standards were an influence, more and longer vacations, the five-day week and the whole trend from spectator to participation sports. Another big factor: Highways, parks and playgrounds were getting too crowded. Families turned to the water as the last frontier and outboards were changed to lure them. Electric starters became available, eliminating the business of pulling a cord, thus enabling wives and children to use the family boat when the husband was away. Gearshifts came in, boats could be started in neutral, reversed, more easily maneuvered. Separate fuel tanks made longer

(Continued to page 240)



Portable Baby Crib Easily Handled by One Person

Traveling on casters, a plywood baby crib can be handled by one person. The casters are on the ends of the legs, which

slide out. Then the two ends separate and the mattress, hinged bottom and safety guard all unfold to form the bed.

Homemade "Vacuum Sweeper" Collects Millions of Aphid Enemy

Fifty million parasite enemies of the spotted alfalfa aphid in California are "vacuumed" in a half hour by biologists

for redistribution to aphid-hit fields. A fan, mounted behind a truck, sucks parasites into canvas sacks through a wide scoop.



Moisture-Repellent Chemical Protects Clothing

Pouring oil on a sleeve (instead of the salad) without staining the cloth is now possible if the coat has been impregnated with a new fluoro-chemical. Fabric fibers coated with the chemical resist oil or water and the staining ingredients they carry. Because the treated fibers can't absorb oil or water, they form in beads on the cloth, as in the lower right photograph. The beads can easily be blotted. Even suede leather's natural "oil hunger" is made resistant by the chemical (see photograph below). Upholstery can be treated with it, too. A cleaning solvent such as carbon tetrachloride can be used to help remove stains without leaving a ring. The chemical is being used by some manufacturers of clothing, suede leather and furniture upholstery, and products treated with it will be available late this summer.

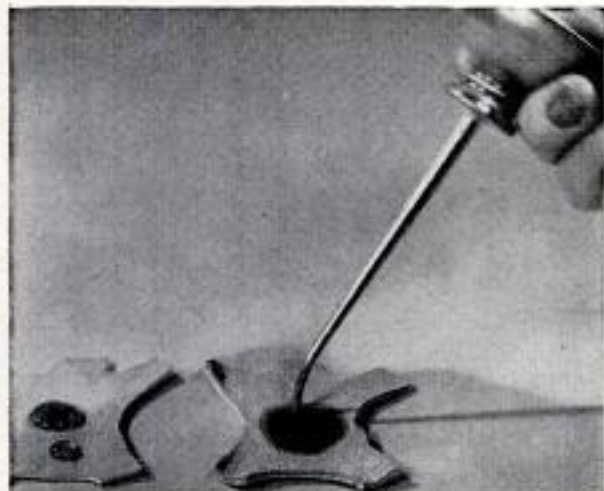

Economy Sports Car: The \$1600 Berkeley

Weighing 700 pounds (less than half as much as an MG or a Triumph), the British Berkeley sports car is sold in this country for about \$1600. The body is plastic. The engine, a two-cycle, two-cylinder air-cooled job, drives through the front wheels and,

thanks to the light weight, is said to yield as many as 70 miles on a gallon of gasoline. Cruising speed is about 70 miles per hour. Only 130 inches long and 42 inches high, the automobile has a surprising amount of headroom and luggage space.



OWNERS REPORT:



Here's What Oldsmobile Owners Like:

They like most its power and performance. Most of them bought Oldsmobile because of previous ownership, in fact 62.6 percent of them traded in Oldsmobiles when buying this 1957 model. An even higher percentage (69.4 percent) expect to buy Oldsmobile next time they buy a new car.

Here's What They Don't Like:

Their biggest complaint is that the Olds uses too much gasoline. Although Oldsmobile is certainly not sold as an economy car, only 6.9 percent of the owners say that they do not care about gas economy. Apparently, most owners, regardless of price class, are seriously concerned about economy.

What Is an Owners Report?

Each month *Popular Mechanics* sends questionnaires to 1000 owners, asking for frank and informed opinions of their cars. The Owners Report is a digest of their opinions and summarizes the experiences of hundreds of owners during millions of miles of driving.

NEXT MONTH: The 1957 Mercury

Owners in 39 states from coast to coast (shaded on map) tell you about their Oldsmobiles





Power to accelerate is what Oldsmobile owners like most. Some complain about the three-piece rear window

Power Is Oldsmobile's Top Feature, Say Owners From Coast to Coast

By Oldsmobile Owners

OLDSMOBILE IS STILL a "rocket," the PM survey shows. Owners of the 1957 Oldsmobile place power and performance at the top of the best-liked list.

Second best-liked feature is handling ease, followed by riding comfort and exterior styling in that order. Fifth on the list is roadability.

"Has tremendous power from a dead stop and a wonderful pickup at high speeds."—Indiana attorney.

"It has plenty of power. I believe the Rocket engine is responsible for the rise in Oldsmobile popularity. I like the speed, but I don't abuse it. It could have less speed and I would like it just as well."—Illinois salesman.

"It's a big car, yet it handles as well if not better than a smaller car."—New York owner.

"I like its ease of handling and its feeling of balance."—Wisconsin attorney.

"Olds is as easy riding as anyone could want."—Nebraska businessman.

"Just returned from a trip to Florida. Traveled about 500 miles a day. Car rode wonderfully, never tired from riding."—New York superintendent.

"It has eye appeal. Oldsmobile has not gone overboard in body styling."—Ohio elevator manager.

"Looks nice. Modern lines, but avoids extremes in fins."—Florida store owner.

"Holds the road well. Exceptionally good in cornering."—Washington foreman.

"When driving fast, the car is under my control at all times, even around curves. I have tried this at 70, so I should know."—Massachusetts electrical worker.

But They Complain, Too

Although Oldsmobile has the highest "Excellent" rating of any 1957 car to date (and, incidentally, the second lowest

Lowness is stylish, say owners, but at times like this, it is an accomplishment to get in or out gracefully





In a year of smallish glove boxes, Olds has one that is two feet long, but height and depth are restricted



Rare indeed is this example of poor assembly, but it did occur on the test car: incorrectly spelled name

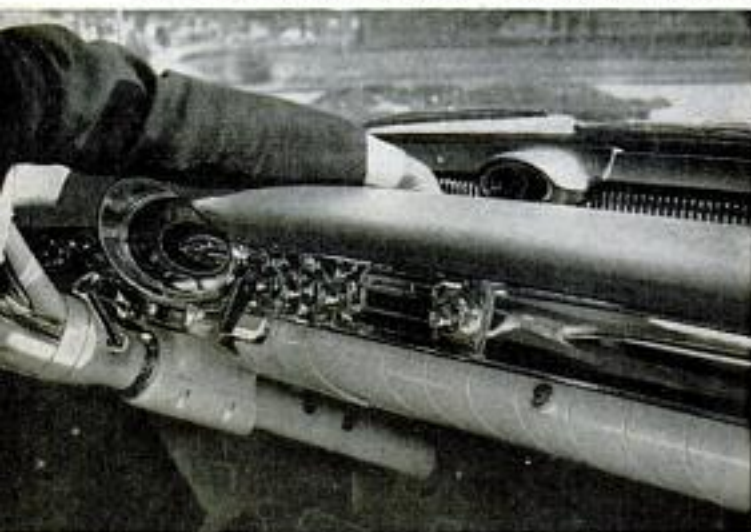

Above, hand reaches into opening between dash and windshield. Some owners like this feature, others do not. Below, miniature jet planes on front fenders make it more difficult to wash and polish the car



"Poor" rating), it does have owners who complain. In fact, only 23.6 percent of the owners make no complaints at all and this is a comparatively small percentage.

What do Olds owners complain about? Tops on the list is poor gasoline economy. The owners like the fast, exciting performance, but they don't seem to like the lowered fuel economy that goes with it.

Second on the complaint list is poor assembly work; third is poor paint or chrome; fourth, body noises and rattles.

"When I first purchased the car it was getting only five to seven miles per gallon so they changed the rear end which did help a bit. It still uses too much."—Illinois radio engineer.

"I and many like me who travel 20,000 miles a year must pay through the nose for a comfortable ride. With gas more than 32 cents a gallon, I average about 9½ miles over-all."—California sales representative.

"Cars are not inspected properly. There were at least 25 faults. We are still trying to get corrected such faults as defective places in paint, car higher on one side than the other, one shock missing, and others. When one pays over \$5000 for a car I think he is entitled to a perfect machine."—California sales manager.

"Of the three Oldsmobiles I have owned,

(Continued to page 220)

Drawings show how the 88 and 98 differ. Virtually all the added length of the 98 is in rear overhang

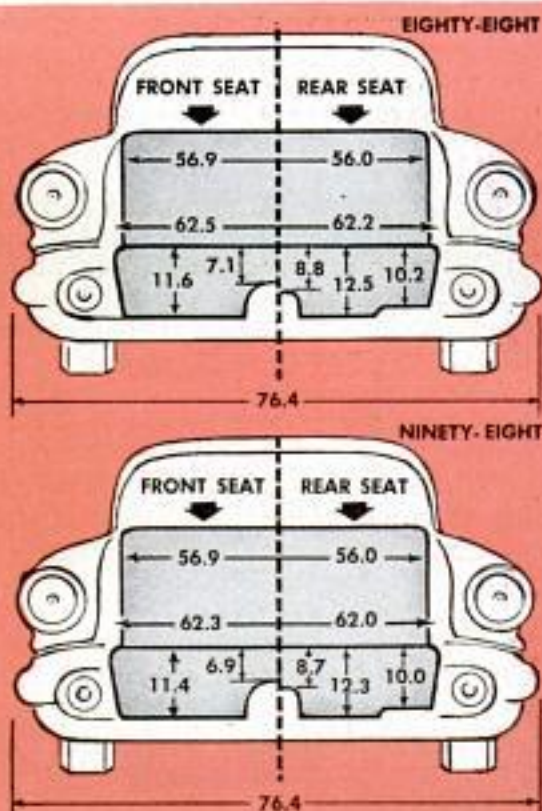

THE OWNERS' OPINION OF THE OLDSMOBILE

Had trouble with engine?

No trouble	82.2%
Some trouble	14.7%
Considerable trouble	3.1%

What was engine trouble?

Carburetor	4.9%
Transmission	2.2%
Valve troubles	1.8%
Power steering	1.3%
Poor idle	1.3%

Performance

Would like faster acceleration?

Yes, would	14.4%
No, would not	74.0%
Undecided, no answer	11.6%

Would like more top speed?

Yes, would	5.1%
No, would not	88.4%
Undecided, no answer	26.5%

What is car's horsepower?

Knew horsepower	61.7%
Did not know it	38.3%

Have checked gasoline mileage?

Yes, have checked it	75.3%
No, have not	17.8%
Don't care about it	6.9%

Styling

Best-liked exterior feature?

Simple lines	18.1%
Grille, front bumper	16.7%
Low body	12.8%
Side trim	10.1%

Least-liked exterior feature?

3-piece rear window	15.4%
Front grille and bumper	7.0%
Wrap windshield	4.4%
Fender ornaments	4.0%

Best-liked interior feature?

Dash and instruments	23.8%
Upholstery	17.2%
Colors	6.2%

OVER-ALL RATING

Excellent Average Poor

75.0% 22.1% 2.9%

Least-liked interior feature?

Dashboard design	5.3%
Glove box	4.8%
Floor mats	4.8%

Miscellaneous

What car will buy next time?

Oldsmobile	69.6%
Other GM make	4.0%
Ford Motor make	1.8%
Chrysler Corp. make	5.7%
Other make	0.4%
Undecided	18.5%

How is dealer service?

Excellent	51.7%
Average	37.9%
Poor	10.4%

Would buy from him again?

Yes, would	41.4%
No, would not	13.5%
Undecided, no answer	45.1%

What make of car was traded?

Oldsmobile	62.6%
Other GM make	19.4%
Ford Motor make	7.5%
Chrysler Corp. make	2.2%
Other make	1.8%
No trade, no answer	6.5%

What about "strut" dashboard?

Like the design	69.9%
Don't like it	6.4%
See no advantage	23.7%

What about power-heater controls?

Like the controls	77.2%
Don't like them	9.1%
Undecided, no answer	13.7%
Had trouble with them	19.2%
Have had no trouble	80.8%

Why did they buy Olds?

Previous ownership	27.2%
Exterior styling	20.9%
Resale value	4.7%
Performance	5.2%

What should be changed?

Nothing at all	33.5%
Improve gas mileage	12.0%
Better heating system	5.8%
Easier to get in, out	5.8%
Front grille	4.7%
Rear-view mirror	4.7%

Best-Liked Features

Power, performance	44.0%
Handling ease	34.6%
Riding comfort	34.0%
Exterior styling	31.4%
Roadability, cornering	12.6%
Rocket engine	7.9%
Sturdy body	7.3%

Most-Frequent Complaints

No complaints at all	23.6%
Poor gasoline economy	23.6%
Poor assembly work	14.1%
Poor paint, chrome	12.6%
Body noises	9.4%
Hard to get in, out	8.4%
Heater operation	6.3%
Hydra-Matic	5.8%

Olds is very low

Like this lowness	81.4%
Don't like it	15.8%
No answer	2.8%

Olds is very long

Like this length	87.1%
Don't like it	6.2%
No answer	6.7%

Olds is very fast

Like this speed	87.4%
Don't like it	5.6%
It's not fast	0.9%
No answer	6.1%

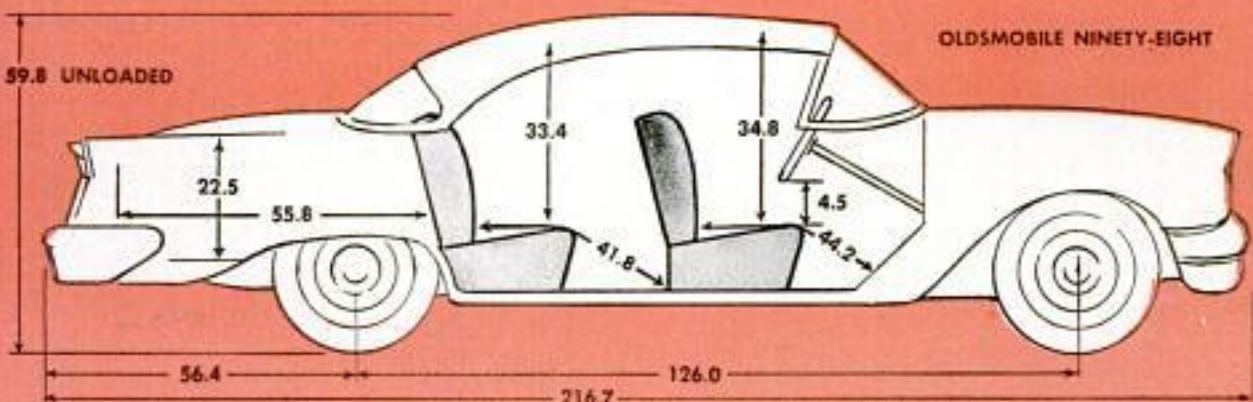
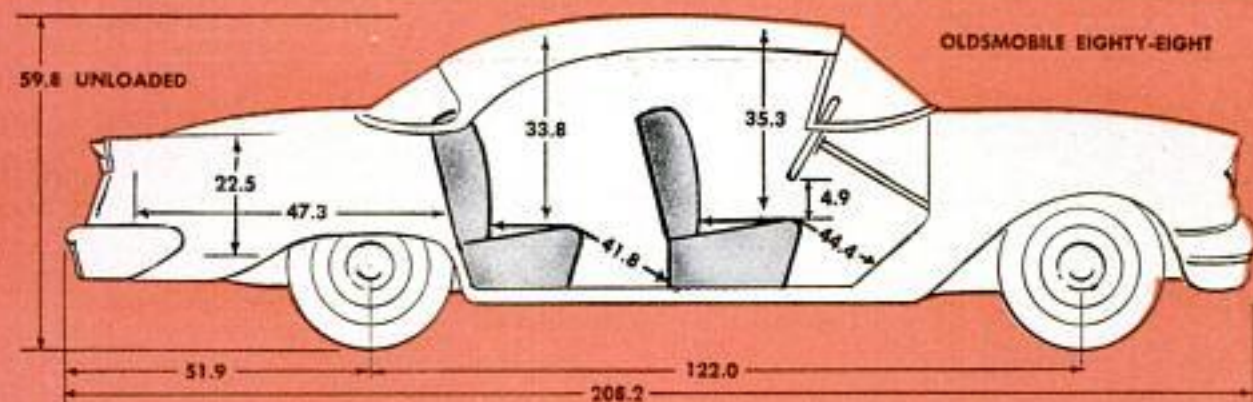

An Engineer Analyzes the 1957 Oldsmobile

By Dale Kelly, SAE, Registered Professional Engineer

MODEL TESTED: Super 88 four-door sedan with J-2 carburetion (three two-barrel carburetors, two of which open at three-quarter throttle or beyond), dual exhausts, automatic transmission, power steering and power brakes.
Rear-axle ratio: 3.42 to 1. Wheelbase: 122.5

inches. Tires: 8.50 by 14. Weight: 4335 pounds with gas tank half full (57 percent on the front wheels, 43 percent on the rear).
Mileage on car at time of test: 400 miles.
Barometer: 29.10 inches. Temperature: 55 degrees F. Payload: 200 pounds.



ACCELERATION TIME FROM STANDING START IN SECONDS

	0 to 20	0 to 40	0 to 60	0 to 80	1/4 mile
Ignition timed for regular gasoline, 90 octane (Research)	2.7	6.6	10.7	18.5	18.6
Ignition timed for premium gasoline, 97 octane (Research)	2.4	6.1	10.2	17.5	18.2
Ignition timed for super fuel, 105 octane (Research)		5.9	10.0		

All acceleration runs made with transmission in "Drive" range.



FUEL ECONOMY IN MILES PER GALLON

	Steady 30 m.p.h.	Steady 50 m.p.h.	Steady 70 m.p.h.	Traffic Route
Ignition timed for regular gasoline, 90 octane (Research)	21.6	14.8	13.6	9.6
Ignition timed for premium gasoline, 97 octane (Research)	21.6	14.8	13.4	10.1

On the traffic route the car makes 10 full stops per mile and is driven fast enough to average 15 miles per hour.
Estimated average ANNUAL GASOLINE BILL: \$202 for 10,000 miles.



SPEEDOMETER ERROR (miles per hour)

Speedometer speed	20	30	40	50	60	70	80
True speed	22	31	39	48	58	69	80

ODOMETER ERROR

Odometer registered 104 miles when car traveled an actual 100 miles.



DRIVER'S VISION (for an average driver—5 feet 9 inches tall)

Distance at which part of road in front of car could be seen (A in sketch)	16 feet
Distance at which full width of road in front of car could be seen (B in sketch)	21 feet



GROUND CLEARANCE (unloaded car)

Radius of worst dip that could be crossed (solid line)	24 feet
Radius of worst hump that could be crossed (dotted line)	21 feet
Deepest rut car could be driven in	6.5 inches
Curb clearance for door opening	12.5 inches

MISCELLANEOUS

STEERING

Steering-wheel turns from straight ahead to steer outside front wheel in a circle with a 100-foot diameter: **0.85 turns.**

Diameter of the smallest circle in which the wheels could complete a circle (curb-to-curb): **43.25 feet.**

Diameter of the smallest circle in which the entire car could complete a circle (wall-to-wall): **45.5 feet.**

Steering-wheel turns, lock-to-lock: **4.4 turns.**
Steering-wheel diameter: **17.0 inches.**

TRUNK CAPACITY

Number of standard cartons (1 cubic foot each) that could be packed into trunk: **10 cartons.**

CENTER OF GRAVITY (unloaded car): **23.6 inches.**

WATER RESISTANCE

Fair. In the splash-pan test, brakes and ignition were not affected and no water entered the body. In high-pressure car wash, water came in around the right ventilator pane.

OBSERVATIONS

Instruments: Excessive chrome on instrument panel makes instruments hard to read. Worst offender is the chrome in the center of speedometer. Because the speedometer (and clock,

also) is elliptical instead of round, every five-mile-per-hour interval between 30 and 90 is compressed into 1/4 inch or less, further reducing readability. On the clock, 6:30 is easily misread as 7:30. The water-temperature gauge, like the ammeter and oil-pressure gauges, has been replaced by signal lights. A green "cold" light is supposed to go out when the water reaches 113 degrees F., and a red "hot" light comes on if the water reaches 232 degrees F. The 113-degree mark is too low for good engine life and the 232-degree mark is higher than is normal or safe.

Transmission: Hydra-Matic has a simple fluid coupling instead of a torque converter and torque multiplication is obtained with planetary gears, four ratios being available. Shifts from first to second and from third to fourth are made by filling an auxiliary fluid coupling and were almost imperceptible in the test car, but shifts from second to third are by mechanical clutch and were quite noticeable.

Headroom: Good in front, poor in rear.

General: Gas tank holds 20 gallons and could be filled at more than 15 gallons per minute when empty. Brake vacuum-reserve tank provided four to five full applications with engine dead. Parking brake held on a 14-percent grade.



Driving the 1957 Olds Super 88 Holiday

By Floyd Clymer

THE TEST CAR was a Super 88 four-door hardtop fitted with a 277-horsepower J-2 engine fed by the three two-barrel carburetors.

This car loafs along at 90 miles per hour without strain. Top speed by the speedometer was about 120 miles per hour which was about 10 percent on the high side (slightly more than the usual error).

There is the feel of a really heavy car. It might even be considered a little on the cumbersome side for certain kinds of driving. You cannot throw it into slides or corners as fast as some previous Oldsmobiles. The front end is extremely soft. It gives a very comfortable ride in normal straight-away driving and at moderate cornering speeds. In fast cornering, the car has good stability despite considerable roll.

The rear-seat ride is good. However, on sharp bumps or dips the rear end sometimes bottoms with a full passenger load. The front suspension has a considerably reduced front-end dive during braking.

The car is free of vibration and gives a smoother-than-average ride. There is a flexible coupling mounted in the base of the steering column to absorb road shocks before they reach the steering wheel. A constant slight drag on the steering wheel gives a simulated "feel of the road."

Few cars can touch the Super 88 when it comes to hill climbing or acceleration. Economy is not high, but it is not expected to be with a high-performance engine. All cars with high-performance equipment seem to be getting less mileage than in former years.

Brakes are probably satisfactory for normal driving, but they certainly could be improved for the hard driver or for regular driving in mountainous territory. The effective braking area of 191.7 square inches is not enough for such high performance and weight and is less than most other cars of about the same weight. I found considerable brake fading, especially when slowing down from high speeds or descending steep mountain curves.

The Hydra-Matic transmission (Olds calls its new version the Jetaway) has four forward speeds. A good feature is the downshift, available at any speed below 65 miles per hour by depressing the throttle part way (about halfway down). The "Super"

position ("S" on the quadrant) is good for city driving or in hills as it uses only three of the four speeds, locking out the top. Low can be used for braking on hills.

No squeaks or rattles developed in the solid-feeling body. The doors sound solid and tight. They open and close easily. Body rumble and wind noise at high speed are quite low. Olds is again using two metal strips to divide its rear window.

The driving position is comfortable. Cushions are well padded and have good springs. Nicely located armrests are built into each door and not merely bolted on. The interior of the body is luxuriously finished.

The relative locations of the throttle and brake pedals are good. The parking brake is operated by the left foot and is easily released by pulling on a small lever with the left hand. This parking-brake pedal is too high and seems to require more foot pressure than should be necessary. There are no ratchet graduations on the pedal travel and it must be pushed down as hard as possible before you feel it is in a securely locked position.

Several innovations have been designed into the new instrument panel. Power-assisted operation of both heating and ventilating systems is by push buttons. There is no need to move levers long distances to open and close vents. You merely press a button and engine vacuum does the work for you.

Warning lights are used instead of needles for generator, oil pressure and water temperature. I prefer the needles. One unusual feature is a green light that indicates that the engine is cold. This serves no purpose as the engine warms up so quickly that the light goes off in a minute or so after starting the engine.

Sun reflections are reduced by the padding atop the instrument panel. At the base of the windshield on top of the dash there is a wide slot which may be ornamental, but is a trap for small objects.

Bumpers are massive. The front one is too big and too low, being less than nine inches from the ground—even lower than bumpers on low sports cars. The rear bumper affords excellent protection and its lowest point is 14 inches above ground, which is ample clearance. ★ ★ ★

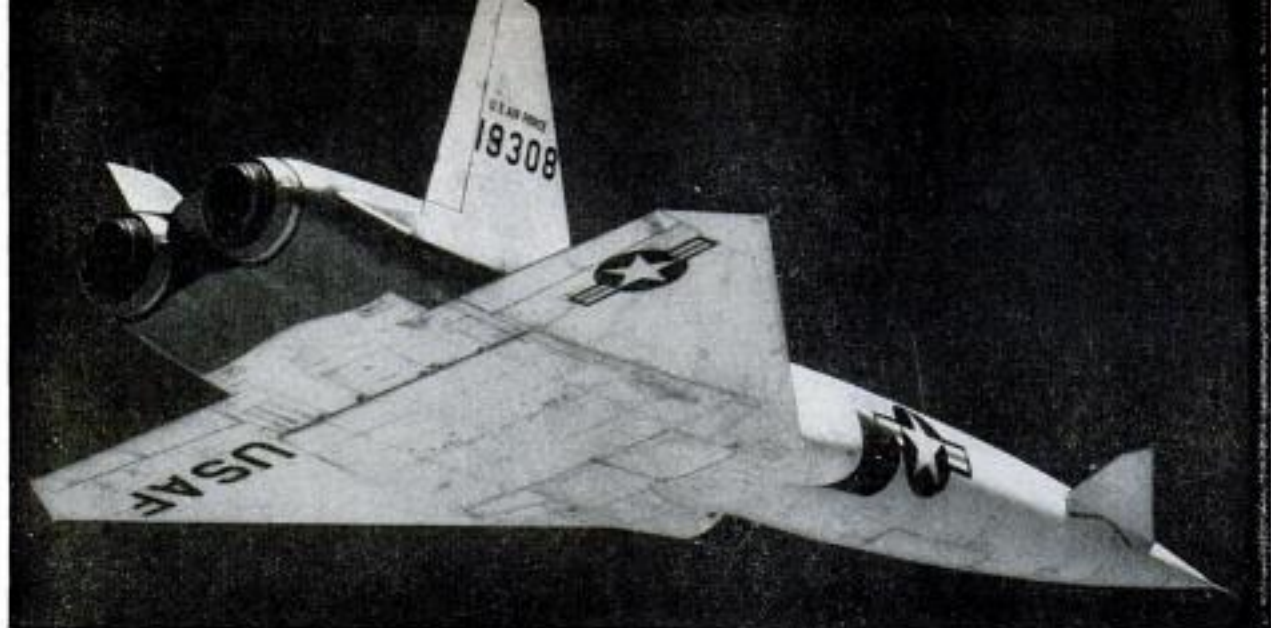

Engines and Landing Gear Bring Home Test Missile

Recovery of the U.S. Air Force X-10 unmanned test missile has been made possible by two turbojet engines and landing gear on the missile. At completion of a test, turbojets carry the craft to an airfield to alight on the landing gear. X-10 is test vehicle for the SM-64 Navaho surface-to-surface intercontinental missile



Navigation Ship Guides Missiles

Converted from a cargo craft, a new Navy vessel is being equipped with "the most fantastic array of navigation instruments ever assembled in a ship," according to the Navy. The vessel will provide navigational information for testing 1500-mile-range guided missiles. Precise navigation instruments determine the ship's position, true north, and the speed over the ground. A telescope equipped with a photo-electric cell is so sensitive that stars become visible in daylight. The telescope, regardless of rolling and pitching, will automatically align itself on a star. Instruments to be installed will be able to see the sun, moon and certain stars by detecting the radio signals they give off, making celestial navigation possible even when clouds cover the sky. Eventually the ship will locate position by radar.



"Star tracker" checks navigation even in daylight. Below, an officer inspects a graph recorded automatically by instruments



Powered Roller Packs Evenly

Power for these lawn rollers comes from a 2½-hp. engine. Biggest roller (below) weighs 1000 pounds loaded



Self-propelled, water-filled lawn rollers are easing tasks for the home gardener. A 2½-horsepower engine moves the roller at a constant speed forward or reverse to provide even packing. Forward-reverse engine transmission is controlled by one lever for instantaneous response under full load. The standard roller unit has a wide rear roller for balance and weighs 265 pounds empty and 610 pounds filled with ballast. Another model is equipped with an easy-turning rear caster, instead of the wide roller, for maneuverability; this roller assembly weighs 250 pounds empty and 595 pounds filled. The third model can be used from lawns to "hot top" paving and has two rollers and a seat for the operator; empty weight is 425 pounds; filled weight is 1000 pounds.

Heavy Boot Holds Prisoner

Prisoners hoping to run away while en route to another jail or to court may change their minds after wearing an 18-pound, lead-weighted boot. The device is used only on one foot and is locked with a chain around the small of the prisoner's leg to thwart removal.

Pistol Gives Wave-off Signal

Pilots flying faulty aircraft or making wrong approaches to landing strips can be waved off by a shot from remote-controlled Very pistol. Fired downfield in the flier's range of vision, this signal makes it possible to wave off a pilot in the final moments of his letdown, even after the control tower can no longer communicate with him. The device, developed by a noncommissioned Navy air officer, has been granted a United States patent.





Queen Margaret, a ferry, battled mountainous seas for nine days in epic voyage around northern Scotland

"Broncobusters" of the High Seas

By John Kerr



Numbered routes on map show voyages of the craft shown in these photos. Below, the side-paddle steamer Yamuna, in a trip that lasted 81 days, was delivered to India where she is now at work on the River Ganges

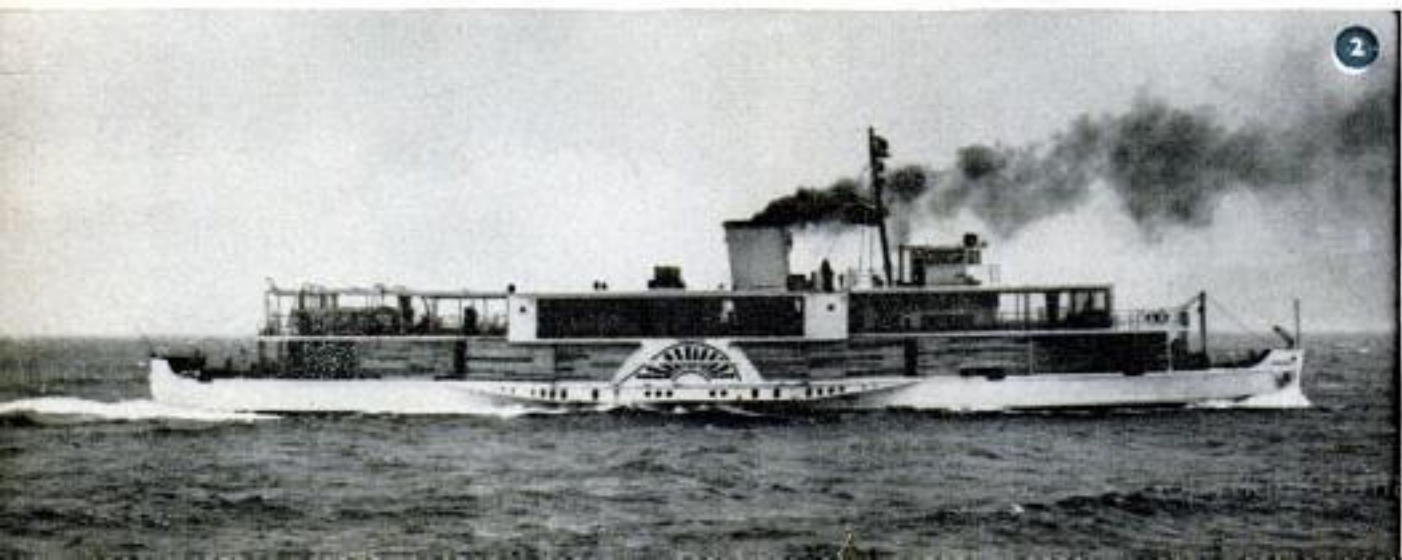



Ferry leaves the River Clyde bound for Quebec. Intrepid "runners" will deliver almost anything that floats

FOR THREE HOURS the 289-ton diesel-electric auto-and-passenger ferry *Queen Margaret* had battled against the vicious tidal race of Scotland's notorious Pentland Firth, that rough and narrow channel which divides the mainland from the Orkney Islands to the north.

Captain MacDonald, master for the 700-mile delivery voyage from the Clyde on the west to the Firth of Forth on the east coast—only 40 miles as the sea gull flies—peered anxiously at the nearby rocky coastline, graveyard of many fine ships.

His sturdy eight-knot ferry, built by Denny's of Dumbarton, should do well in the Forth waters, he reflected. But exposed to deep-sea hazards she was a nautical nightmare. Her shallow draft of four feet gave little "grip" of turbulent waters, and the wind resistance offered by her suspended bridge and relatively high superstructure made accurate steering impossible.

Old Iron Becomes Ballast

Some 50 tons of old iron and rubble served as ballast to steady the *Queen Margaret* a little. But the 11-foot paddle sponsions which overlapped the hull to give her a 50-foot beam produced a bucking motion that was impossible to eliminate

even in a moderately rough seaway.

With the wind freshening from the north, she plowed through the 12-mile-long Pentland Firth, where the tidal stream runs at 7½ knots. Often she seemed to be making no headway at all. When MacDonald took another bearing of Dunnet Head, he found to his dismay that though he'd had the engines opened full out, he'd made exactly one mile in three hours.

Disaster Looms

As the tidal race slackened at last, Captain MacDonald relaxed for a moment. His relief was short-lived. Almost instantly, disaster loomed for the ferry. Duncansby Head was now abeam and the Pentland Firth astern. Ahead lay a leg of open sea. The wind was rapidly rising to gale force. Soon tremendous seas buffeted the laboring vessel. Plunging and rearing like a bronco trying to unseat its rider, she refused to answer her helm and wallowed helplessly. Snowstorms laced the gale and sea spume froze on the bucking decks.

Slowly, determinedly, MacDonald edged her south.

At last, six days out from the Clyde, a trawler appeared out of the turmoil. Sensing salvage, the skipper came close.

Small passenger vessel sailed from the River Clyde across the Atlantic, through Panama Canal, to Vancouver





Runners find life difficult aboard craft such as this, a ferry bound for river service in British Guiana

"Need any help?" he shouted across the heaving waters.

"Going the Forth way?" MacDonald queried back.

"Yes," came the answer. Gratefully, the *Queen Margaret* accepted the offer of a towline.

It was not to be so simple. All efforts to get a line aboard failed. Then darkness intervened.

When dawn broke the trawler was still standing by. Both vessels were 30 miles off course.

Success on Fifth Try

Again they tried to heave a line, and on the fifth attempt a rope was made fast between them and they headed into the gale. Twelve hours later they reached Aberdeen. This was the trawler's home port, but it lay 100 miles north of the Forth, the agreed destination, so the rescuer's subsequent claim for salvage failed.

It was 36 hours later, favored by calm weather, when the ferryboat finally berthed at her base—under her own power and in good shape, but nine days after she had chugged out of the Clyde.

That epic voyage took place 23 years ago, and the *Queen Margaret* is still in operation. In March of last year she was joined by a sister ferry, the *Sir William Wallace*.

Skipper for this voyage was another Captain MacDonald—Dugald MacDonald—who'd been mate on the *Queen Margaret's* delivery voyage in 1934.

This MacDonald comes from Tiree, one of Scotland's Hebridean islands, and knows the island-studded route around Scotland

like the back of his hand. Even so, he approached a voyage in such a "nautical conundrum" with trepidation and true Highland caution.

They had hardly left the Clyde before bad weather forced them to seek shelter for three days at Campbelton.

One Glimmer of Light

Then, sailing through the Sound of Islay on a Sunday evening, a combined seaway and tidal race made shelter imperative. Port Askaig, dark and deserted on a Sabbath, was their only hope. The black and rocky coast showed only one glimmer of light—which MacDonald figured came from a telephone booth perched on the cliff—and towards this he steered his vessel.

But for MacDonald's knowledge of the isles and islesmen the *Sir William* would have been lost then, for there was no light to pick a channel through the rocks and no sign of life ashore. Two blasts on the siren, however, brought quick assistance. The headlights of an automobile came jolting down the hillside towards the unlit jetty, and soon three men were dropping lighted matches to pinpoint a berth.

Yet another stop had to be made at Tobermory, on the Island of Mull; then fog patches appeared to cause some anxious moments as the ferry approached the sharp headlands of the Pentland Firth. There MacDonald was stopped by the tidal race inside the firth, and found shelter in slack-water under the lee of Stroma.

Fortunately, that was the end of the difficulties. The weather improved, and the *Sir William* reached port after a voyage of

(Continued to page 218)



German Hercules Flexes Mighty Muscles to "Defeat" Two Jeeps

With canvas straps and bath towels, Max Hartmann of Heidelberg, Germany, stood between two regulation Army Jeeps facing different directions and kept them from

moving until he had released them. Drivers of both vehicles jammed accelerators to the floor in low gear without dislodging Hartmann or the vehicles from position.

"Sardine Can" Transmitter Provides Emergency Communications

Transistors and printed circuits are the chief components of an ultra-high-frequency beacon transmitter built in a standard-size sardine can. This transmitter is capable of sending radio signals 25 miles

continuously for 24 hours. Designed for military emergency signaling and communications, the transmitter can be modified for voice or code operation at frequencies other than its present range.

Below, two transistors and compact power transformer make up the power supply. Battery pack is separate unit. Below right, self-erecting, three-foot antenna

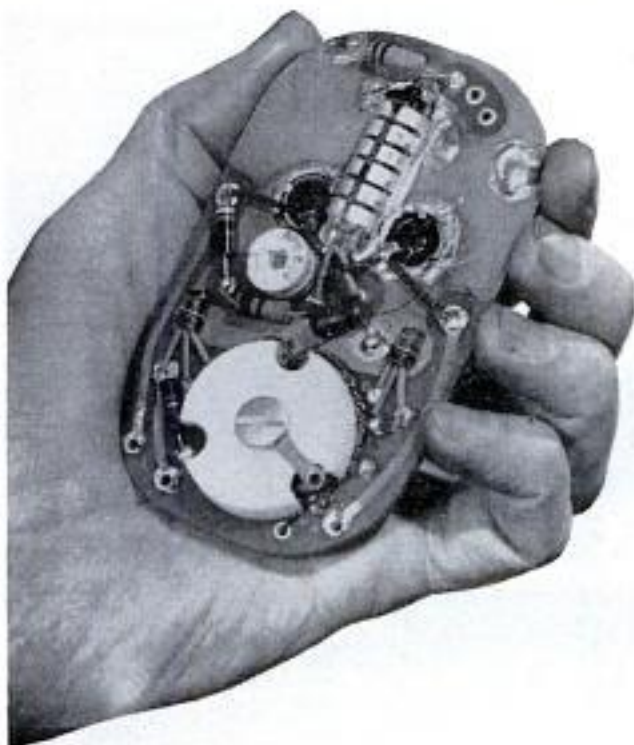

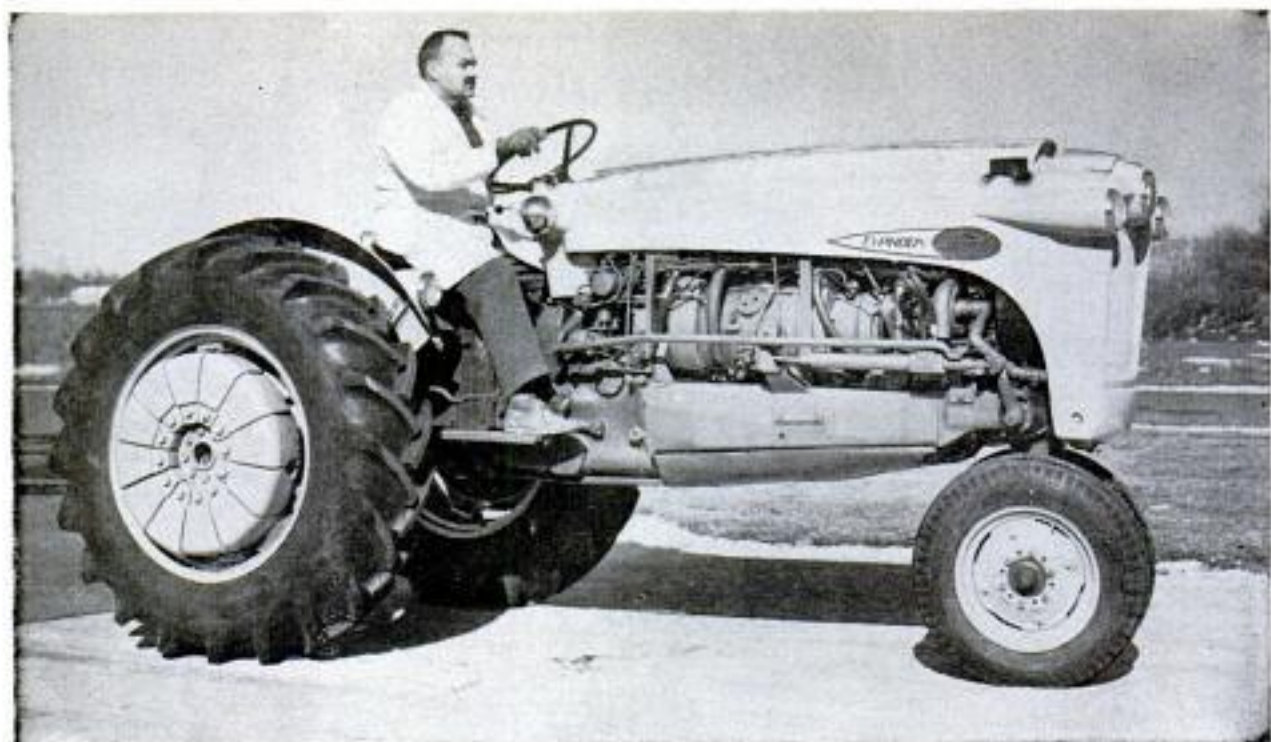

Free-Piston Turbine Powers Unique Tractor

Under test by the Ford Motor Company is an experimental tractor powered by a free-piston turbine engine. This is the first known installation of such an engine in a tractor. The engine will operate on a wide variety of inexpensive hydrocarbon fuels, and eliminates many of the moving parts of a conventional engine. The diagram at left shows a stroke of the two free-moving pistons. Forced outward by the burning gases, they compress air in the "bounce" cylinders (indicated at "b"). Air is drawn into the compression cylinders ("c") and mixes with the discharged gases to drive a turbine wheel.

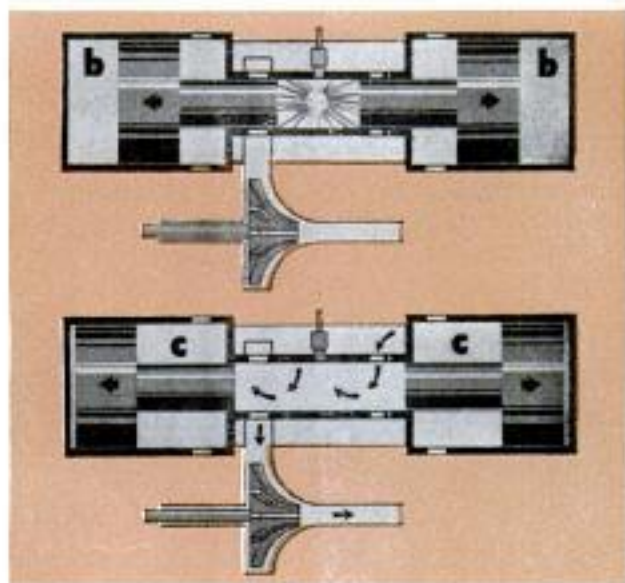

Electronics Assembly Uses Belt Feeder

The machine at right is expected to boost the use of semiconductors in the electronics industry. Semiconductors, devices about the size of grains of rice that do the work of large vacuum tubes, previously had to be built into electronic circuits by laborious hand-assembly methods. Now the tiny electronic devices can be carried by the thousand in flexible belts, somewhat like belts of machine-gun bullets. The belts of precisely spaced semiconductors are fed into stapling machines that tack them into place in electronic circuits. With the production bottleneck eliminated, manufacturers say the use of semiconductors will be much more economical.



POPULAR MECHANICS



Plastic Plant Protector Has Adjustable Heat Vent

Polyethylene plant protectors, highly resistant to moisture, will maintain the high level of humidity required by young plants. Opaque white sides shade the plants from strong sunrays while the transparent surface permits the home gardener to watch the progress of growth. A vent on top can be closed when frost threatens, or opened to prevent an excessive buildup of heat. Large-size plant covers are available to protect broad-leaved evergreens against strong winds and snow, as well as low-level humidity during the winter months.

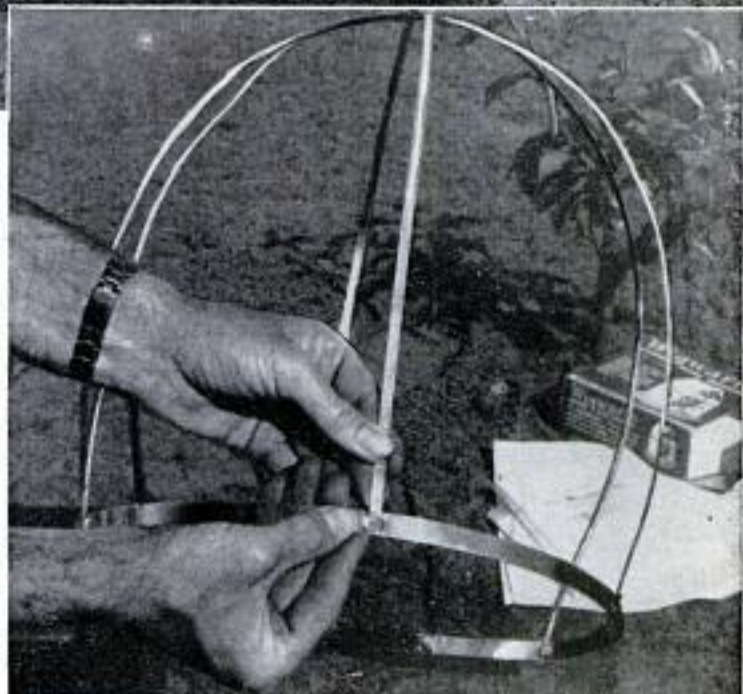

The polyethylene film is held in place by series of three aluminum ribs which lock into the sides of a base ring

British GM's Vauxhall Victor Is All New but Smaller

In America, General Motors cars get bigger, but the Vauxhall, GM's British-built car, is smaller this year. The new Victor is a four-seater powered by an economical (30 to 40 miles per gallon) four-cylinder overhead-valve engine of 92 cubic inches. But the new Victor is no midget, having a 98-inch wheelbase, only 17 inches less than the Chevrolet. Over-all length is 166½ inches—about 34 inches less than the Chevrolet. The American influence in styling is evident, including a wrap-around windshield, the first in England.





Spring Retrieves Lure

Snagged fishing lures can be dislodged by a new weighted spring. The coil spring is turned around the fishing line until the line is in the center. Then the dislodger is lowered on another line and bounced against the snagged lure to dislodge it.

Monorail Transports Materials

Standing in an electric-monorail lift bucket to demonstrate its size, a pretty German model shows how heavy construction materials are transported over long distances up a steep incline.



136



Surgical Sniffer Developed

Aided by a resuscitator-anesthetizer that automatically adjusts to an animal's lung capacity, veterinarians perform singlehanded operations. The new instrument provides the precise respiration for pets that humans receive in surgery.

Weedless Lure

When a new fishing lure strikes weeds, the hooks are pushed upward to make the lure weedless. There are no guards and the hooks are always open, ready to receive a strike. The lures are available in two sizes.



POPULAR MECHANICS

Like giant vacuum cleaner, this clover-seed harvester sucks up 900 pounds of seed per acre, misses less than three pounds per acre

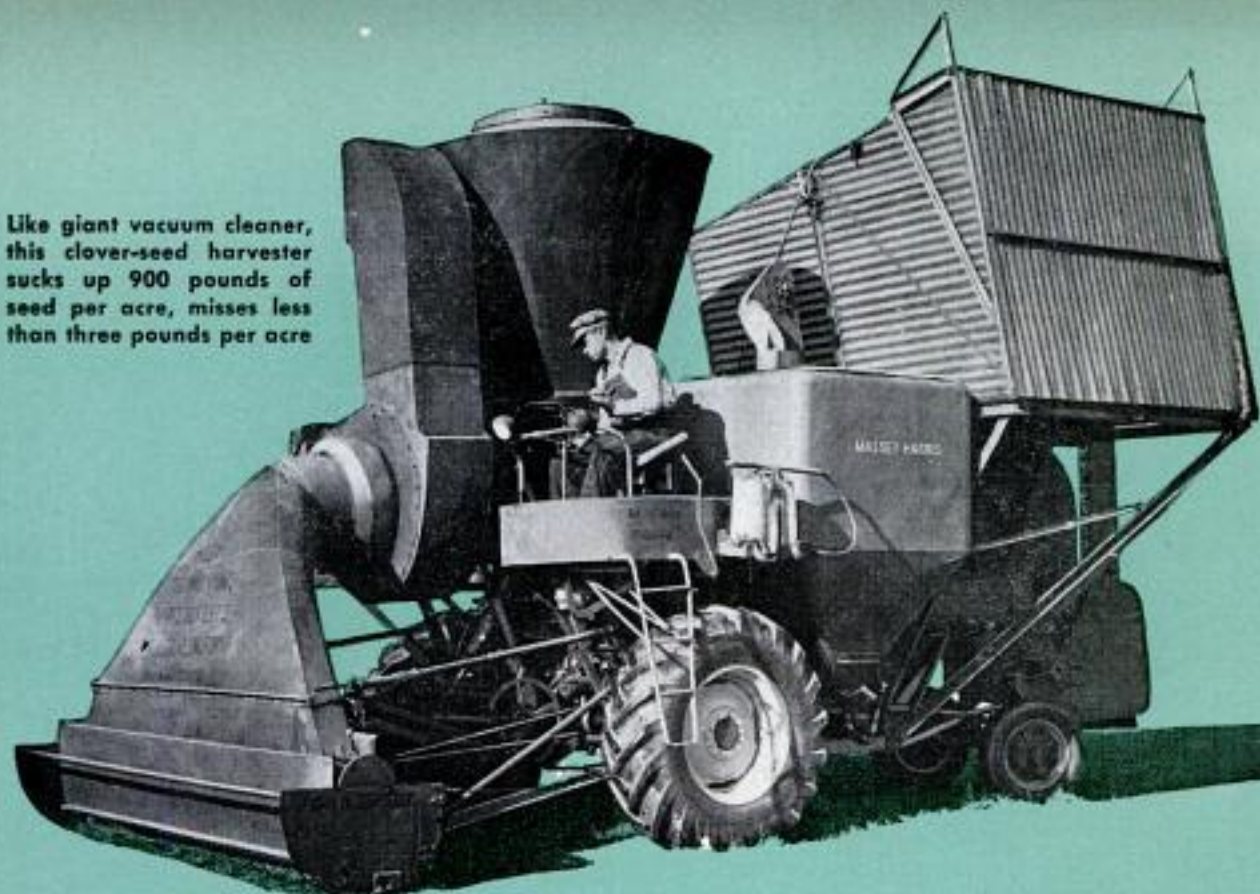

Air Is the Farmer's Hired Hand

By F. Leland Elam

ABOUT 100 YEARS AGO it took one person on a farm to provide food and fiber for one person in a city. Thirty years ago, that ratio had been reduced to one to seven, and in 1955 it required only one farm hand to sustain 18 city dwellers.

The introduction of extensive mechanization has brought into the hands of farmers many "chore boys" that make it possible for them to plant, grow, harvest, store, feed and market their crops, livestock and poultry faster, and with less labor. This has been the major contributing factor in bringing about the spectacular change in the ratio.

Air is one of the chore boys the farmer has been able to harness and put into use in just about every conceivable phase of farm mechanization.

Portable electric fan blows dry air into chopped hay on the Wesley Sawyer farm at Waterford, Calif.

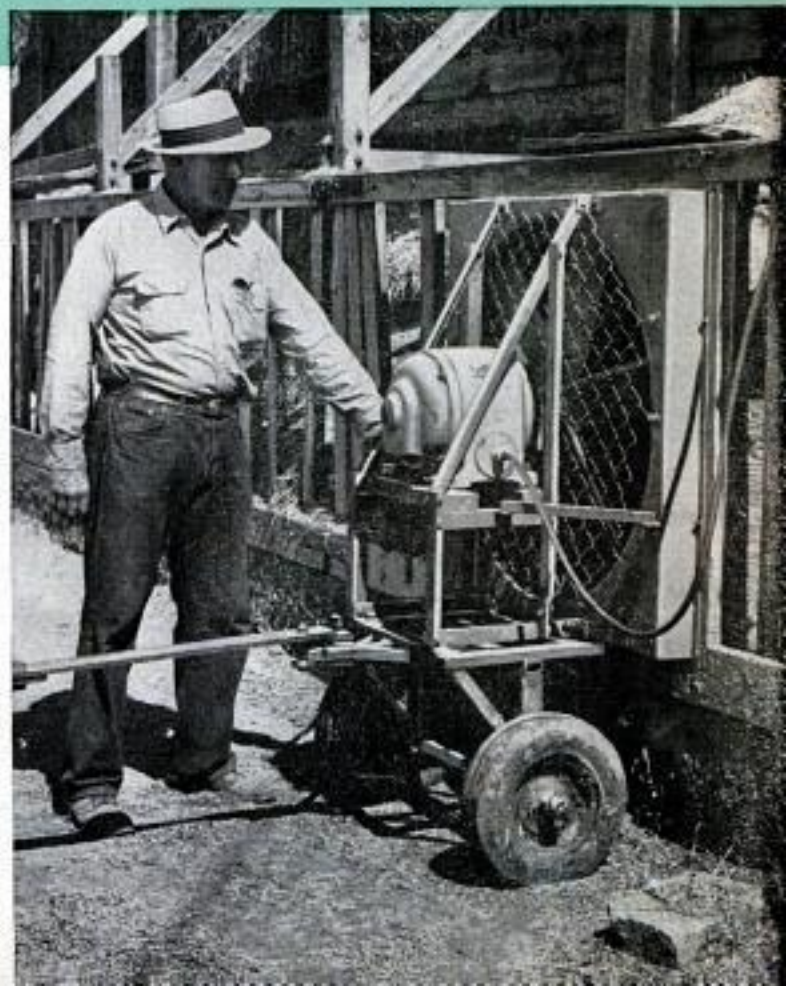

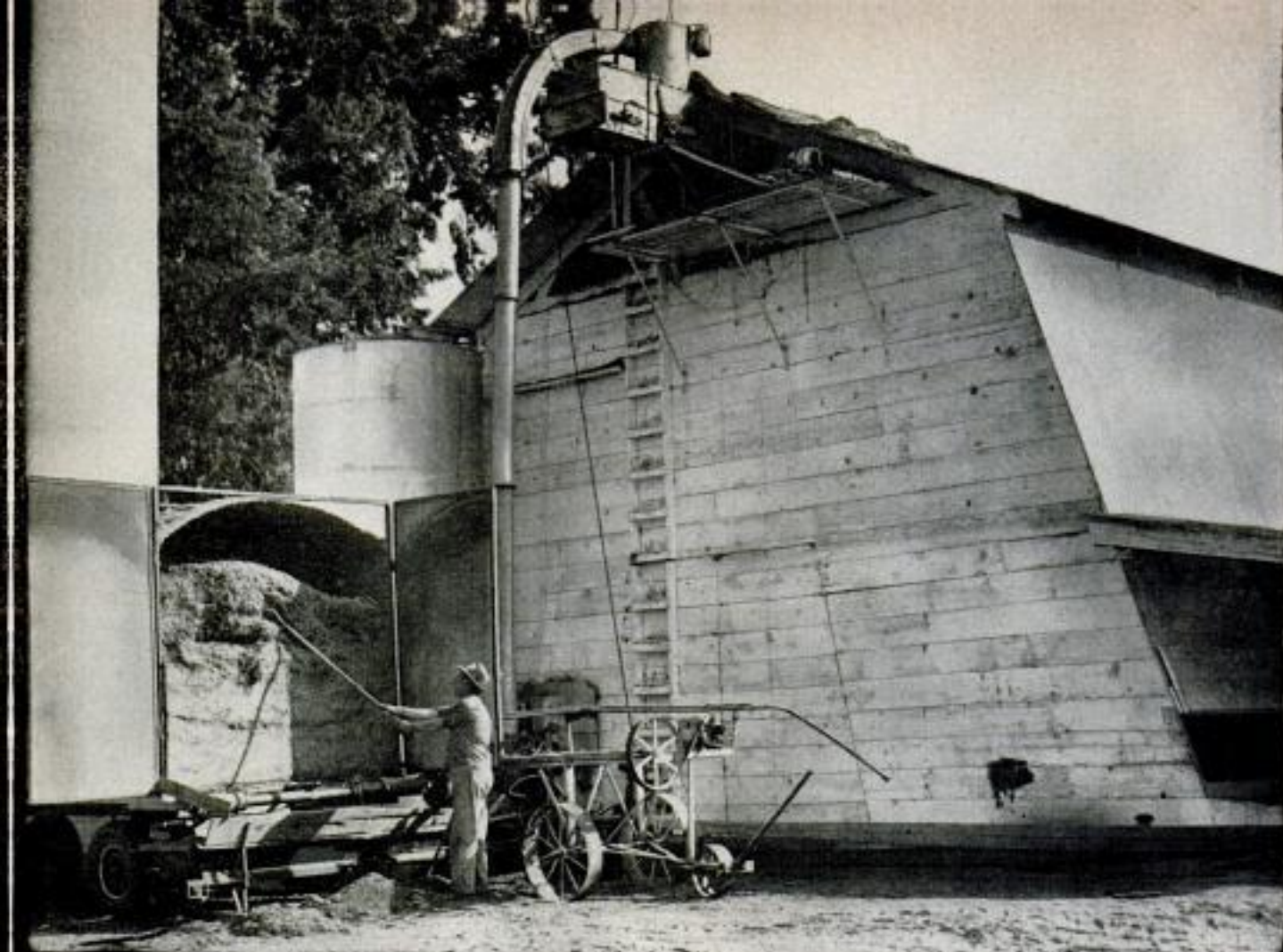

Blower system on Wesley Clark farm, at Hanford, Calif., automatically mixes chopped hay with molasses spray

He uses it under pressure, blows it with great force in a definitely directed manner or sets it to work on a suction or "airlift" basis. All three control methods are used to do a multitude of work tasks.

Air is a cheap means of power. It does away with expensive machinery. In many tasks it takes the place of equipment such as augers, elevators and hydraulic rams.

In California, a giant vacuum cleaner that uses a 32-inch fan to form the suction power, airlifts clover-seed plants into a harvest-

ing unit as a sickle bar cuts them loose from their roots, spits the seed onto a cleaning table and at the same time blows the dirt and plants away from the seed. So thorough is its action that its owner, Jack Brinkley of Elk Grove, finds it leaves only two to three pounds of seed on the ground while harvesting up to 900 pounds per acre.

"When it comes to handling chopped hay, even a big fork doesn't help much," Ward Watson, a Santa Rosa, Calif., dairyman comments. "It's just a disagreeable job to

Ray Fisher, of Lathrop, Calif., saves thousands of dollars with forced hot air in his turkey brooders



A 32-inch fan distributes dry air to six grain bins on Vinson Vanderford ranch at Yuba City, Calif.



handle chopped hay by hand." But he, as well as Harold Bontrager of Winfield, Iowa, have put air to work on their farms to eliminate the disagreeable job.

Watson solved his problem by rigging up a suction fan and hose that picks up hay like a giant vacuum cleaner. With this unit he mixes 500 pounds of chopped hay with 20 percent molasses in just 15 minutes. He can reach any area of the haymow with a six-inch pipe and hose, through which the hay is moved by an 18-inch centrifugal blower operated by a five-horsepower electric motor.

"I handle 18 tons of hay per hour," Bontrager says, "when taking it directly from the wagon and delivering it to the mow. The blower that forms the suction to lift the hay from the truck also blows it into the barn. It is operated by a belt from a tractor."

This forced flow of air has also been put to work moving concentrate feeds from a bulk-feed bin and delivering it to individual feed mangers at each stallion in the Elwin V. Gordon dairy barn at Marysville, Calif.

"It works like this," Gordon explains. "There is an electric-powered fan mounted above a feed receiving box on top of the bulk bin. It does all the lifting and distribution of the feed. Its first task is to lift the feed out of a delivery truck via a flexible hose and deposit it in the bin. When feeding time arrives, it's turned on. The action causes the air to be drawn through a four-inch pipeline that passes from the top of the tank through the barn to a controlled-flow outlet at the bottom of the tank. As the feed is airlifted along the pipe it drops into hoppers over the individual feeding mangers. Any feed that bypasses the hoppers drops back into the bulk bin via the feed receiving box under the fan."

Feed is released from

Harry Lechner, of Kirkwood, Wash., uses an old vacuum cleaner to clean out the watering troughs in his chicken house. The debris is collected in the milk can





Vacuum cleaner, above, pulls packaging bags tight against turkeys. Fans, below, keep eggs fresh by forcing air chilled to 50 degrees through baskets



each small manger hopper by turning a crank to deposit the desired amount in the manger. It takes only 40 minutes to fill 12 hoppers and the farmer goes on about other chores while this is being done.

The use of air in moving milk in the bulk operation at his Pocatello, Idaho, dairy has resulted in easier handling and less mechanical trouble for Thomas Rowland. The system is one in which a vacuum draws milk from the cows, carries it to the bulk tank and provides circulation. An air-pressure unit forces the milk from the tank to the truck that calls for it every day. The system eliminates the vacuum releaser found on most bulk systems. Vacuum from the milking machine works through the tank and milk can flow directly into it. It eliminates also a mechanical agitator inside the tank and milk pump mounted on the tanker truck. Milk has been held inside the sealed refrigerated unit five days without collecting oxidized flavor.

Ray Fisher, Lathrop, Calif., turkeyman, had to cut costs to stay in business. Hot-air brooding was his answer to the problem. Hot air flowing into brooding cages has taken the place of the usual gas or electric hover brooders. Air is heated by a gas burner. A blower distributes it through overhead pipes and ducts to 23 cages, each holding 300 turkeys. It comes out through a hover where the birds can find the heat they desire. The system has saved Fisher an average of \$500 on the cost of brooding each flock of 6900 birds—in medicine bills, labor and other operational costs.

Portable Air Supply

No task is too small for air to be used as the farmer's chore boy when it means the saving of labor and other expenses. Dairyman Wesley Clark, Hanford, Calif., has converted a small war-surplus oxygen tank into a unit that has multiple uses. He brazed an automobile-tube air stem and valve in one end of the tank. In the other he brazed an outlet onto which he could fasten a six-foot length of air hose. Air is forced into the tank from an air compressor via the auto tire valve. The tank holds 150 pounds of air pressure with safety.

"Being easy to carry, it offers excellent service in putting air into equipment tires which may go flat in the field," Clark explains. "Air from the tank induces air cushions into any of the three pressure systems on the ranch and saves time in blowing dirt from machinery that is to be repaired. It cost me less than \$5.00."

Glenn Culbertson of Acampo, Calif., has an easy way of getting oil out of a drum. Air from his shop compressor is forced into the drum through a small priming cock fitted into a small plug on top of the drum.

Five pounds' pressure is sufficient. The oil flows out through a long pipe curved at the top with a small valve near the mouth.

Air under pressure cleans dust and cobwebs out of the fryer-rearing houses of John Hamilton of Fresno, Calif., after each flock of chickens is sent to market. He built his own portable compressor and takes it to every corner of each room and forces air over the wall and ceiling surfaces, thus getting dirt out of the wood pores and cracks. This is a major sanitation procedure. He also uses it to produce air for spray painting.

The lives of newborn lambs are saved by forced air at the Allyn Tedmon ranch in Colorado. The lamb is placed in a wire-mesh cage. A fan drives air from an electric heater through the mesh and the lamb is soon dry and able to withstand chill winter temperatures.

It takes just five pounds of air pressure to force fuel from a field-service

(Continued to page 230)



Time and labor-saving system on the Elwin V. Gordon ranch, at Marysville, Calif., distributes feed from this bulk tank to hoppers in barn

"Airlift" fills the individual hoppers over each stallion in 40 minutes while Gordon does other chores

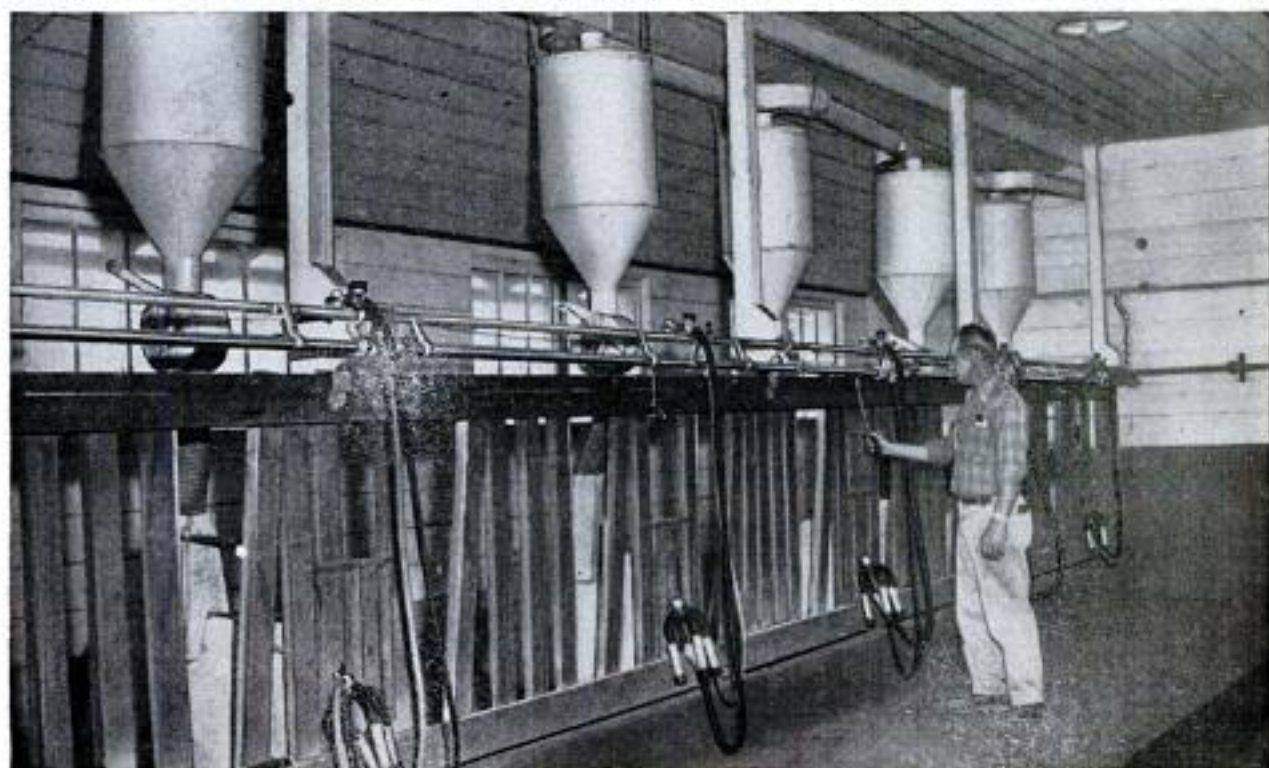



Self-driven drills can be clamped on any square tool bar, permitting flexibility in the spacing of crop rows

Attachments Increase Versatility of Implements

FLEXIBILITY is the feature of two new farm implements. Individual drills, shown above, can be clamped to a tool bar to form a planter for both narrow and wide-row crops. Each drill is self-contained and self-driven, so it can be used on a front-mounted cultivator frame as well as a rear tool bar. Rows can be spaced as narrow as 13 inches. The individual John Deere drills will plant

sugar beets, edible beans, soybeans, corn, sorghum and many vegetable seeds.

With the new attachment shown below, all John Deere corn planters can serve as liquid-fertilizer spreaders. The twin carrying tanks are mounted directly over the planter's wheels, and each tank holds enough fertilizer to apply approximately 250 pounds per row.

Twin-tank attachment is mounted on a corn planter, converting it into a liquid-fertilizer applicator



How to Split a Bullet

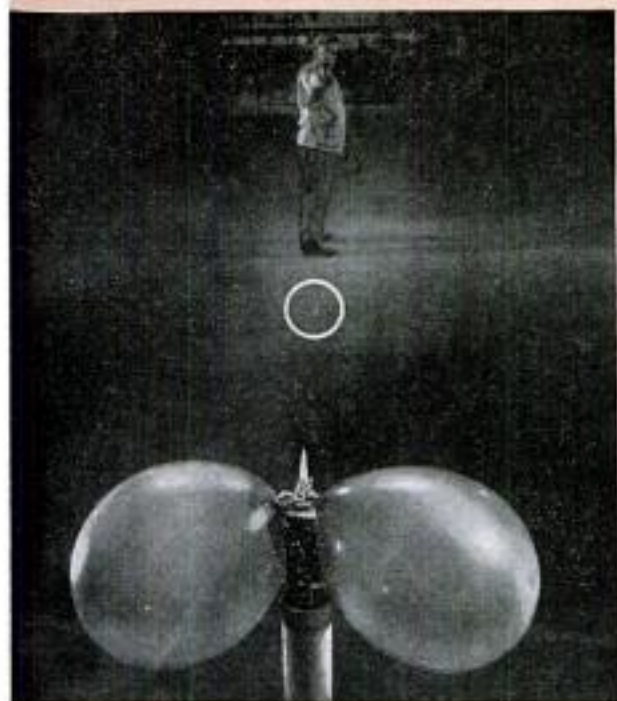

WITH ONE PISTOL SHOT M/Sgt. Huelet Benner can split a fired bullet in half and puncture two inflated balloons with the pieces. An ax blade is fixed with its edge pointed at Benner. Two filled balloons, one on each side, are placed by the blade. From 30 feet away Benner fires a shot from a .45-caliber pistol into the blade. The bullet splits. Each sliver of metal pierces and bursts a balloon. Benner is now an Army instructor at the United States Military Academy, West Point, N. Y.



JULY 1957

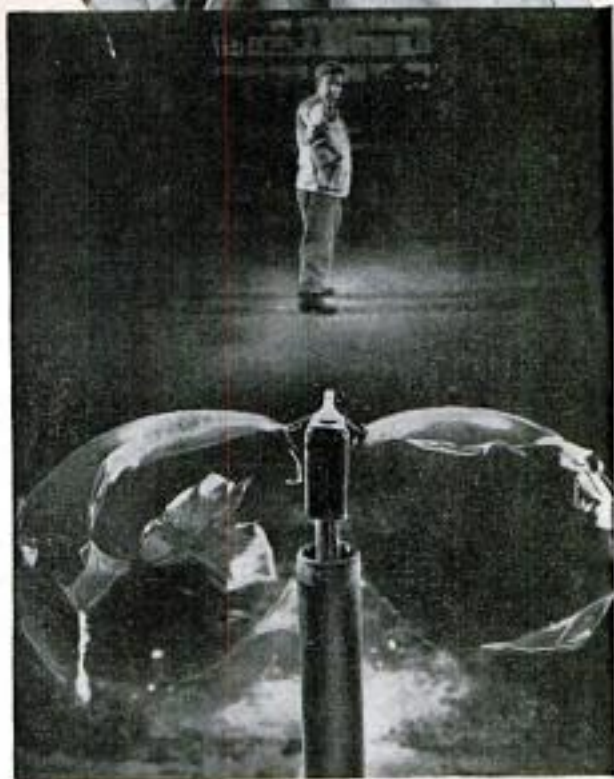

Top left above, bullet (in white circle) speeds toward ax blade. Camera, set up behind balloons to catch action at 1/10,000 second, was triggered electronically by the sound of the gun firing

Center right above, balloons burst simultaneously, as bullet hits ax blade and splits in half. Each half hits a balloon. Benner uses a soft-nosed bullet for this demonstration

Left, before performing stunt Benner ties inflated balloons on each side of an ax blade. See camera above balloons. Benner, 39, is a former American and Olympic pistol titlist

143

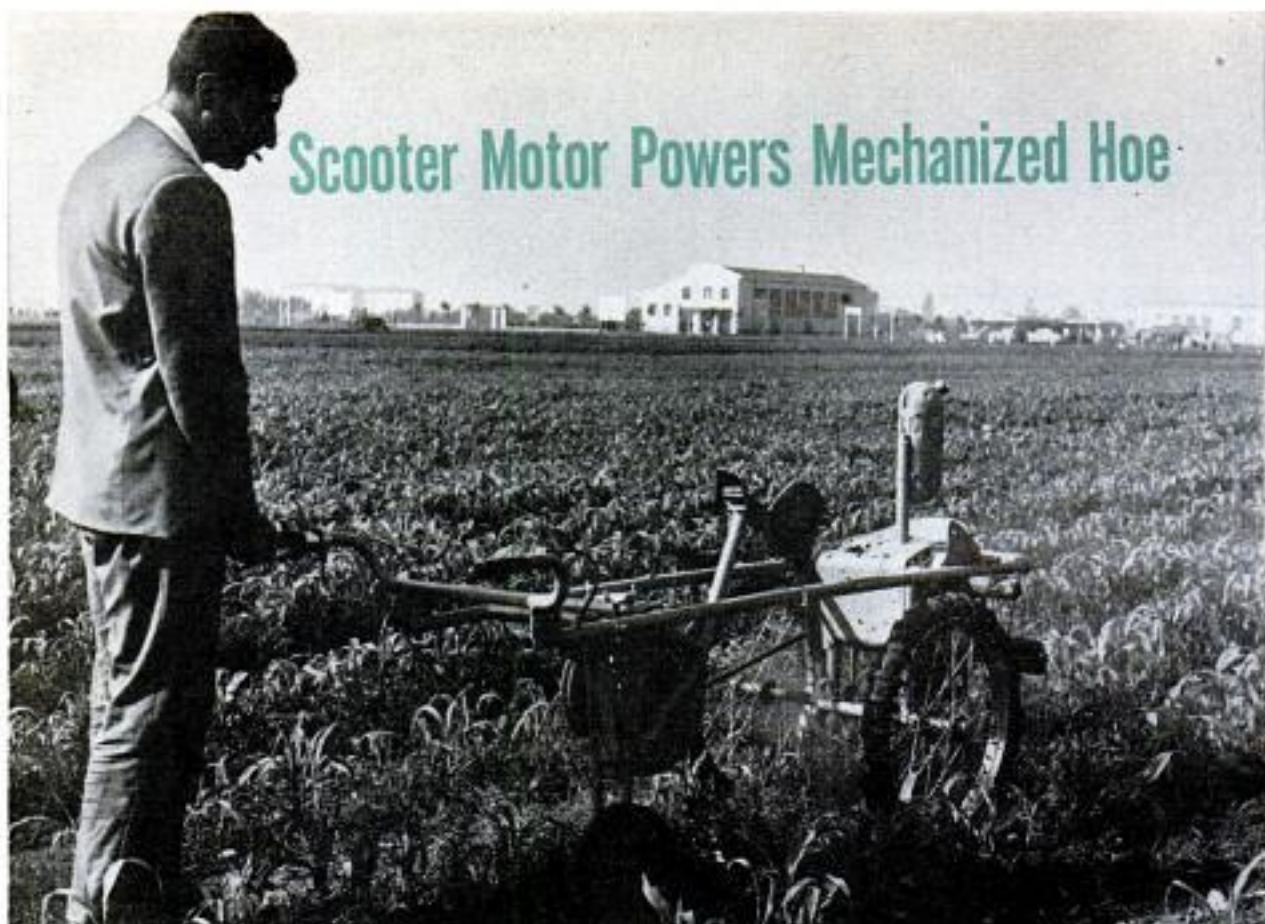

Scooter Motor Powers Mechanized Hoe

Bicycle and motor-scooter parts have been combined into a power tiller by an Italian manufacturer. The same engine that powers a popular brand of Italian motor

scooter not only powers the wheels of the little farm machine, but also the tilling blades. The mechanized hoe may replace horse-drawn plows on small Italian farms.

Miniature Generator Has Diesel Engine

Fuel costs are low in a miniature generator because the engine is a small diesel. Rated at six horsepower, the engine has an

unusual cooling system. The heat of the engine forms steam, which expands into the flywheel, where fins dissipate the heat.

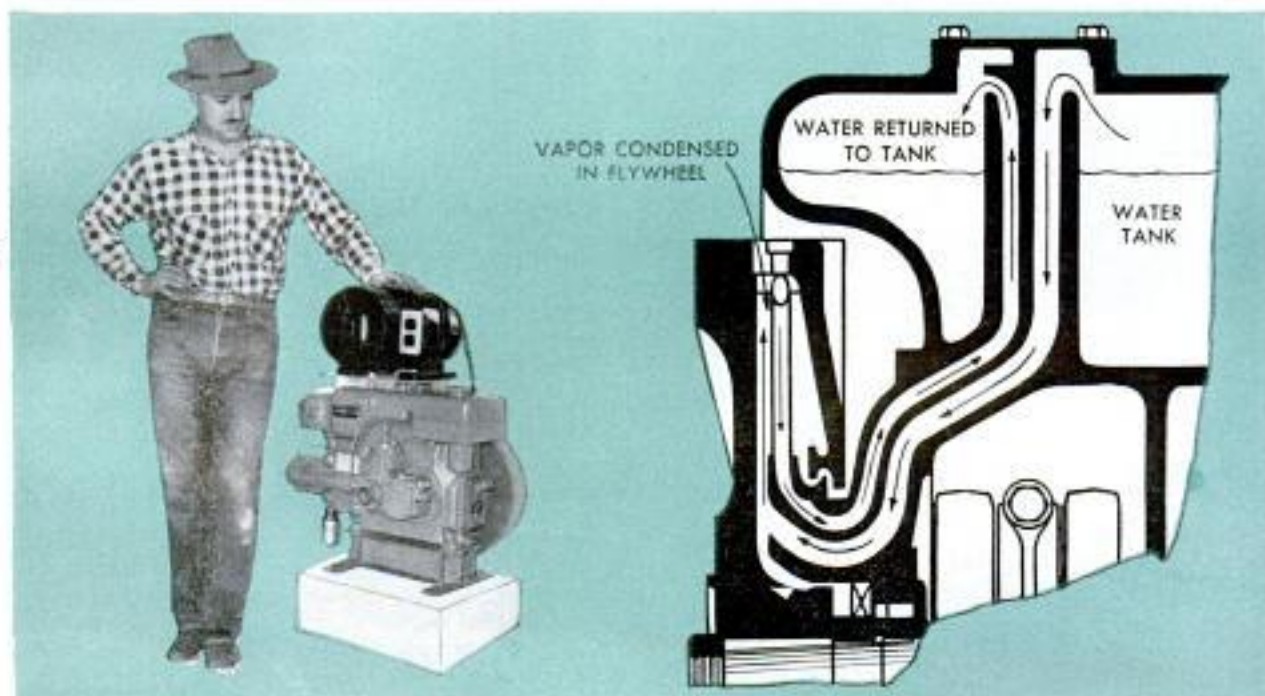



TRANSISTOR RADIOS YOU CAN BUILD

By Lothar Stern

THOSE AMAZING little transistor radios are literally "busting out all over." Not only in parks and on beaches where you would normally expect to see them, but also in railroad cars, automobiles and even in the home these little midgets are taking over from their larger vacuum-tube counterparts. Housewives carry them from room to room as they do their daily chores, children mount them on bicycles or take them along on hikes and camping trips and sports-minded individuals use them to tune in their favorite ball game while shoveling the snow or mowing the lawn. They fit into pocket or purse, use so little current that a single battery may last over a hundred hours and are rugged enough to withstand severe shock and vibrations.

But transistorization and miniaturization run high, and many attracted to the neat

appearance and small size of these little marvels are discouraged by the high price tags. Most radio hobbyists and experimenters, however, are lopping sizable chunks off these prices by devoting a few evenings toward putting together their own transistor portables.

Transistor-radio kits are available today from most leading radio-parts distributors. They range all the way from simple one-transistor sets to the more elaborate six-transistor units which compare favorably in performance and appearance to some of the best factory-assembled receivers. And construction is not difficult. The instruction manuals supplied with the kits give not only elaborate pictorial diagrams but also step-by-step assembly procedures which virtually eliminate the possibility of wiring errors by the careful builder.

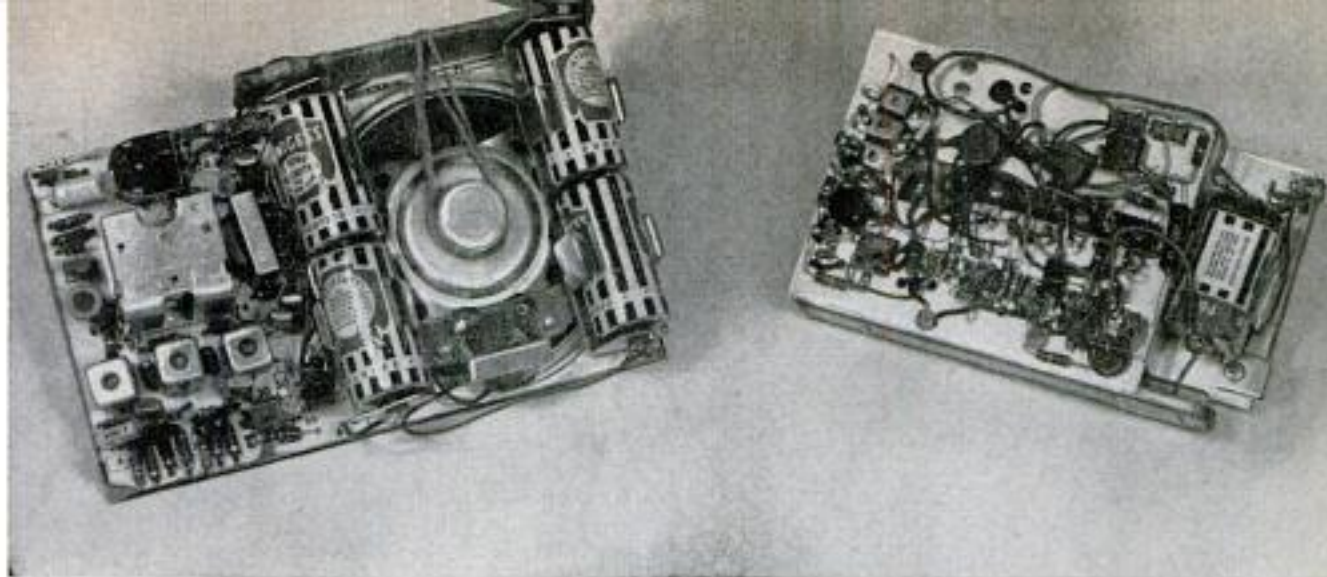

Comparison of small-parts layout between printed circuit, left, and conventionally wired six-transistor radio

Some transistor-radio kits are supplied with printed-circuit chassis boards in which most of the actual wiring is already done. Others must be wired in the conventional manner, using hookup wire to interconnect the various parts. From the standpoint of final performance there is little difference between the two types. The printed-circuit units, however, require considerably less assembly time, while the more conventional ones are somewhat easier to service in the event of a possible wiring mistake or defective part. For either type, the only tools needed are a solder gun or pencil-type soldering iron, a pair of long-nose pliers, diagonal cutters and a set of screwdrivers.

Transistor Circuits

While transistors have been widely publicized as 20th-century electronic miracles and have, indeed, certain unique characteristics which make them far superior to vacuum tubes for special applications, the mere transistorization of a radio does not guarantee better performance than can be obtained with a vacuum-tube model. In fact, from the standpoint of sensitivity (the ability to pick up weak signals), selectivity (the ability to separate stations close together in the frequency band) and undistorted volume, it takes more transistors than tubes for comparable results. What, then, are transistor's special advantages?

Primarily, transistors require very little current, and only a low operating voltage, for proper performance. The sets illustrated schematically on page 146 all operate from inexpensive 9-volt batteries. Compare this with the battery packs of vacuum-tube portables* and it is evident that transistor radios cost far less to operate, particularly since a single set of transistor

* Vacuum-tube portables use two sets of batteries; the A-batteries ranging from 1.5 to 9 volts and the B-battery which usually has between 45 and 90 volts.

batteries will outlast several of the more expensive units used in vacuum-tube portable radios.

Secondly, transistor radios will give exceptionally long periods of trouble-free service. Transistors themselves do not wear out or burn out, and the low current and voltage requirements of transistor circuits greatly increase the life expectancy of the associated parts.

And, finally, the tiny physical size of transistors permits the design of receivers which are considerably smaller and lighter than conventional models.

Cost vs. Performance

Since transistors, particularly those suitable for r.f. circuits, are still relatively expensive, the cost of transistor radios rises rapidly as the number of transistors is increased. Simple one-transistor receivers are hardly capable of providing the type of performance to which we have become accustomed. Usually consisting of a diode detector followed by a stage of transistor amplification (in some cases the diode is omitted and the transistor serves as a combination detector-amplifier) these units require a long external antenna for satisfactory headphone reception, even on local stations. Yet their performance is much

(Continued to page 236)

Bottom of printed-circuit chassis is neat and clean but small iron and great care are needed to prevent solder shorts between closely spaced printed wires

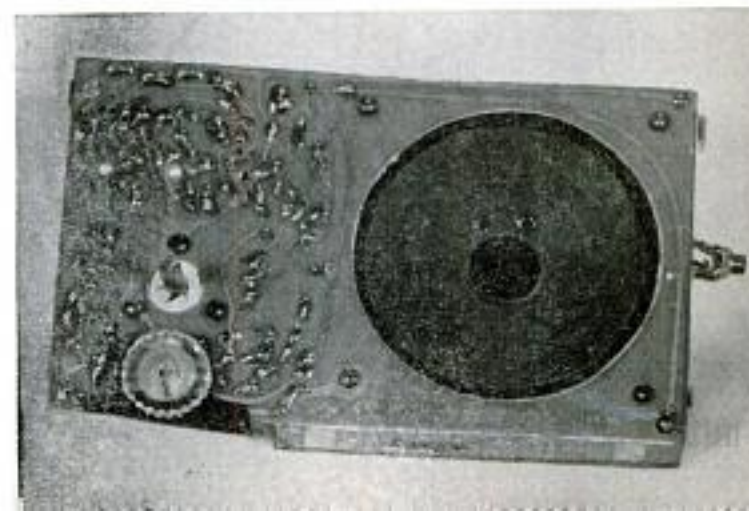



Novel TV-Antenna Suspension

Balloon suspension of television antennas eliminates expensive towers and can greatly improve reception in extreme fringe areas. The balloon shown here, a target-type purchased from Army surplus, has a maximum diameter of 13 ft. It is inflated approximately half-size and is moored at an elevation of 100 ft. A four-way bridle of nylon secures the antenna to the balloon and the mooring line to the antenna. Nylon is also used for the mooring line and for the three guy lines which are fastened to the antenna extremities. The lead-in wire is tied to the mooring line



By Paul D. Smith
GRANITE FALLS,
WASH.

with nylon loops at 10-ft. intervals. Helium is recommended as an inflating gas wherever it is available. Though heavier than hydrogen, it is nonflammable and can be used with greater safety. The light Neoprene balloons must be handled with great care to avoid tearing. It is well to use a balloon size large enough so that it need be inflated only one half to two thirds its maximum size. To determine how much inflation is necessary, weigh the antenna assembly, including lead-in, guy and mooring lines before inflating the balloon. Then, with the balloon about half inflated, determine its lifting power with a spring scale. Continue the inflation process until the lift is about two or three pounds greater than the weight of the antenna system. Once aloft, the antenna is oriented by proper positioning of the guy lines. These should be spread about 120 degrees apart, thus guying the installation in every direction.



Record-It-Yourself TV

Playing back a previously recorded TV program, Antonio Rubbiani of Modena, Italy, tests his homemade device which reproduces both picture and sound. The invention records photographically the scanning lines of a TV picture on a Plexiglas disk which is then revolved under a powerful light by a turntable. A photocell gathers the light and transmits it to the set, producing the image. Rubbiani says the distortion apparent on the screen is caused by imperfect functioning of the electric motor that powers the turntable.

X-666

THE POPULAR MECHANICS

CRAFTSMAN

IF YOU WANT THRILLS and excitement on the water, this paddle board is for you. It will carry you along on the rushing crest of a breaker or let you skip through the wake of a speedboat towing you at full throttle. The board is equally good if you just want to paddle lazily around in a lake and sun-bathe. Safety, light weight and minimum maintenance are designed into the board to assure more fun and less work and worry. "Egg crate" construction is used to produce a board weighing one third less than a conventional type, with the added advantages of much greater strength and a one-third increase in weight-carrying capacity. A glass-fiber covering assures complete watertightness and minimum finishing problems.

Tempered hardboard $\frac{1}{8}$ in. thick is used for all construction except the bow, which is made from solid stock and $\frac{1}{4}$ -in. plywood, and the stern block that also is solid stock. Mahogany is suggested for some

pieces made from solid stock, but since the finished paddle board is entirely covered, any good hardwood will do. Two 4 x 10-ft. sheets of hardboard are required in the construction of the board. Start by drawing the 29 ribs required on one sheet, using the dimensions shown in Fig. 1. Cut them out oversize with a handsaw, then trim to exact size on a table saw. Because of the need for accuracy when cutting the components of an egg-crate structure, a table saw is almost a necessity. However, an experienced craftsman, with much care, could do the job with a handsaw. Number each of the ribs, starting with No. 2. No. 1 is cut from wood. Cut a notch for the keel

WTM 59

"EGG CRATE" PADDLE BOARD *Is Light and Strong*

By Newell W. Tune

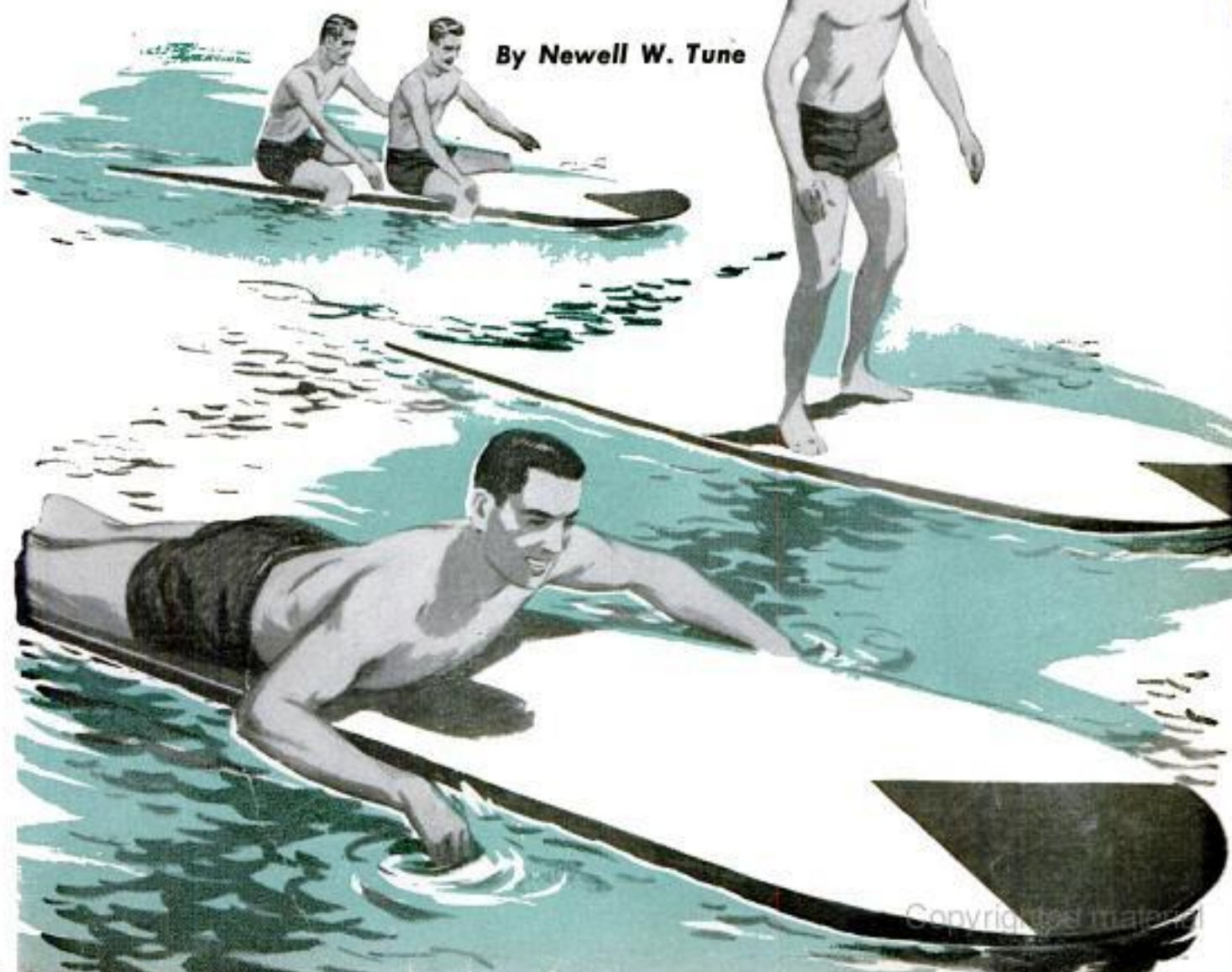

Copyrighted material

FRESH-WATER PADDLE BOARD

ALL MEASUREMENTS REFER TO SKELETON BEFORE ADDING EXTERIOR PLANKING, EXCEPT BOW AND STERN

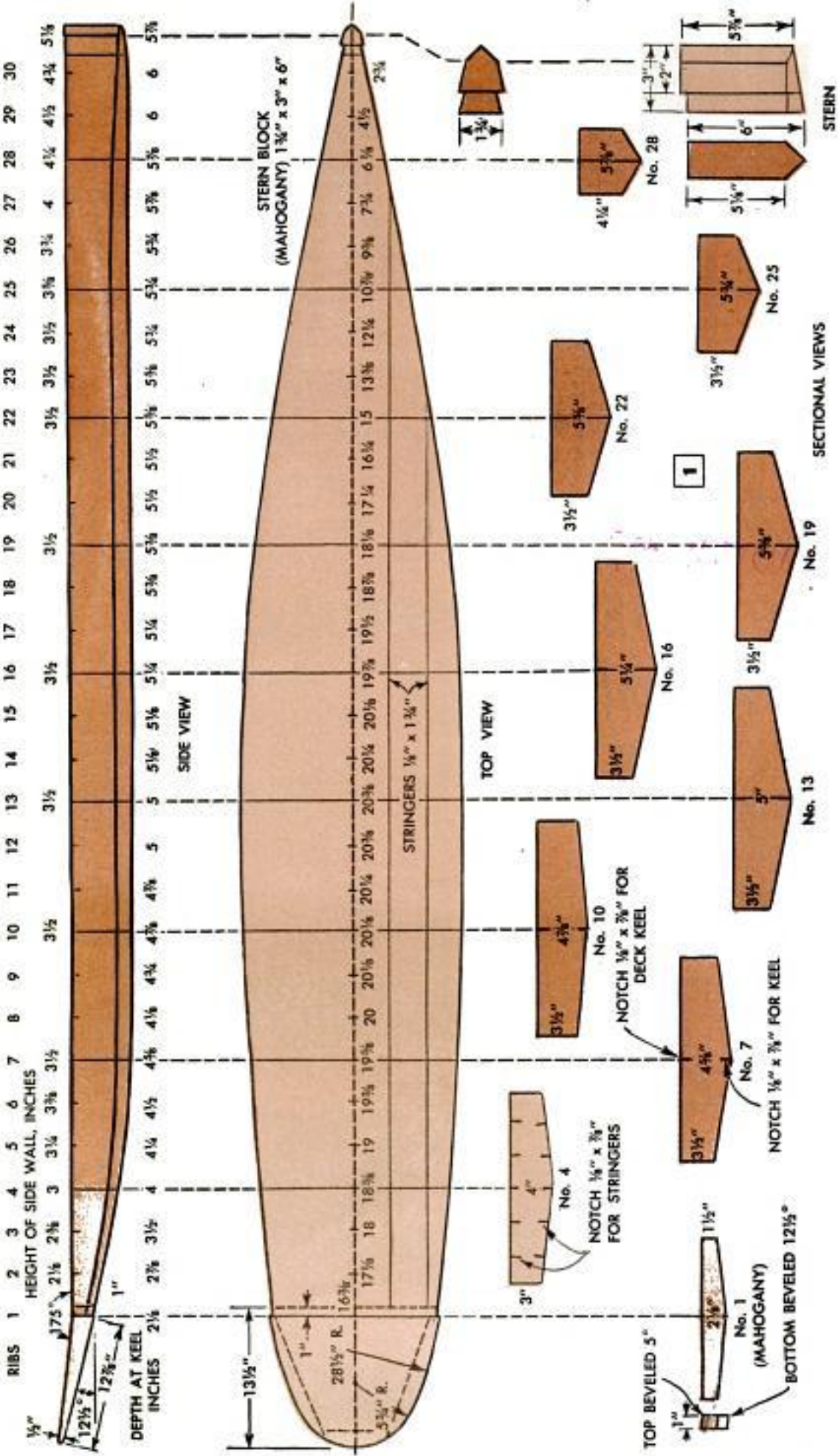

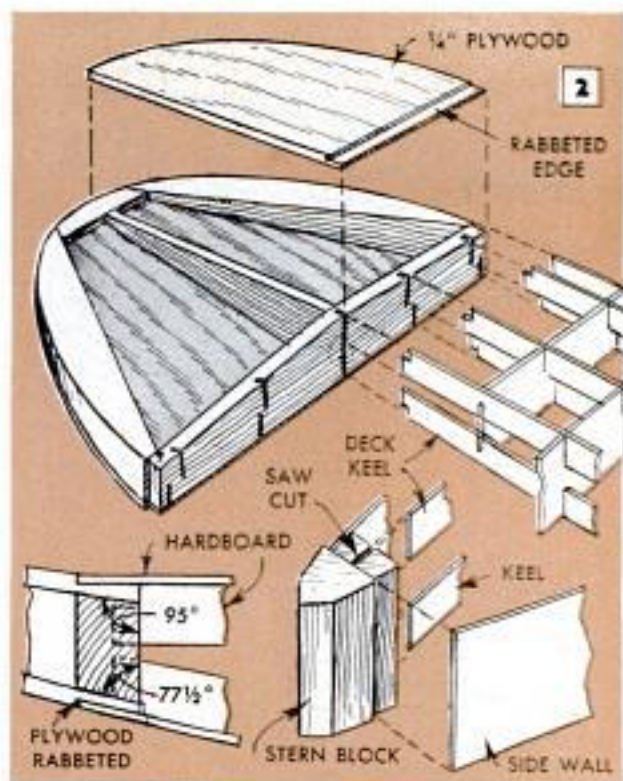

and deck keel in each rib, then stack the ribs and fit a strip of hardboard in both keel slots to keep the ribs aligned. Figs. 4 and 5 show the appearance of the stack from both bow and stern ends when it is clamped together. With the clamps in the position shown, cut slots for the bottom stringers. Because the ribs vary in height, cut the slots slightly deeper than $\frac{7}{8}$ in. so the cuts in the narrower ribs will be closer to the right depth, even though slots in the deeper ribs will be too deep. On most of the shallow ribs, the slots later will have to be deepened still further to provide a correct fit. Because of the irregular shape of the stacked ribs, a jig of some kind will have to be used to support the work squarely and permit sawing. Note, too, that the slats for the stringers are offset slightly to let them bypass at rib No. 1. Next, fit two clamps over the opposite edges of the ribs, remove the other two clamps, then saw the stringer slots in the top edges of the ribs. These slots can be cut to the correct depth, as the top of the paddle board is flat.

Now, cut all stringers and both keels $1\frac{3}{4}$ in. wide and make the keels $\frac{1}{4}$ in. longer. Clamp them in a stack and notch them every 4 in. to a depth of $\frac{7}{8}$ in. The keels and stringers can be test-fitted to make sure all notches are the correct depth, Fig. 6, before gluing is started. Use a good grade of waterproof glue and wipe the inside edges of all slots when assembling the egg crate. Install the deck keel and stringers first, then clamp in the stern block, detailed in Figs. 1 and 2. Turn the assembly upside down on a flat surface

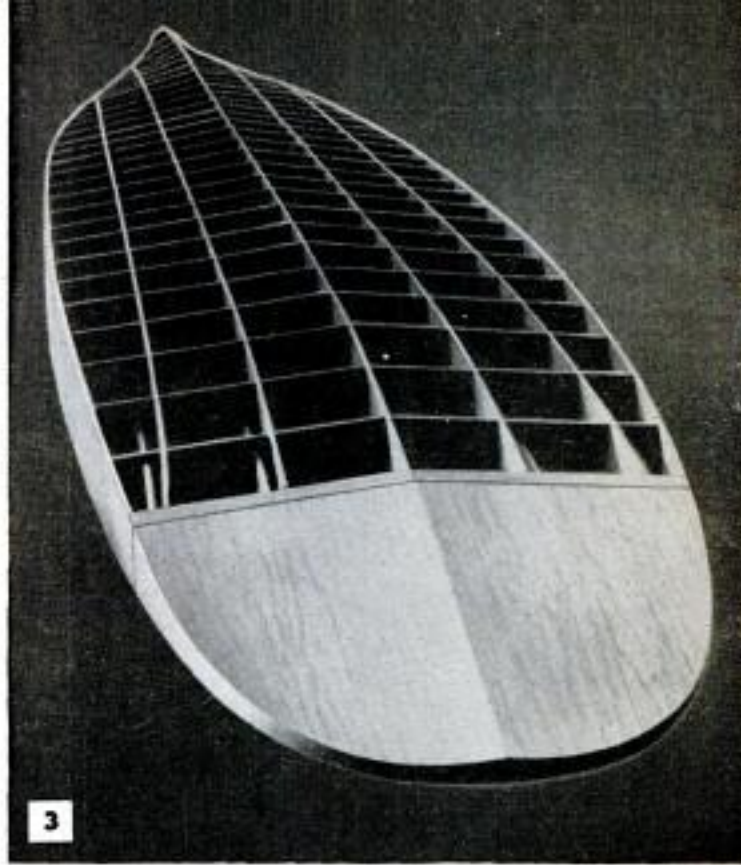

Above, bottom view of partly assembled hull shows bow, stern block, side walls and top deck in place

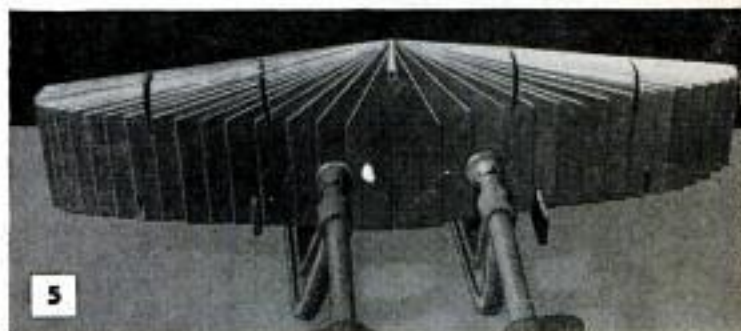

Above, top and bottom views of stacked and clamped ribs. Note strips of hardboard in keel slots to keep ribs aligned. Below, slotted ribs and stringers are trial-fitted to assure proper fit before gluing

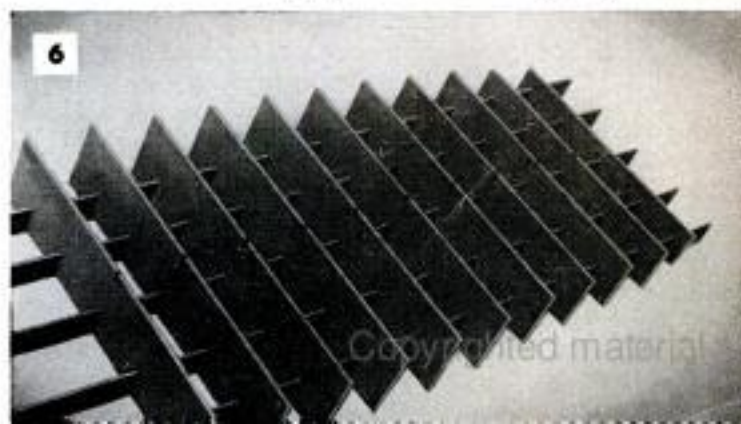

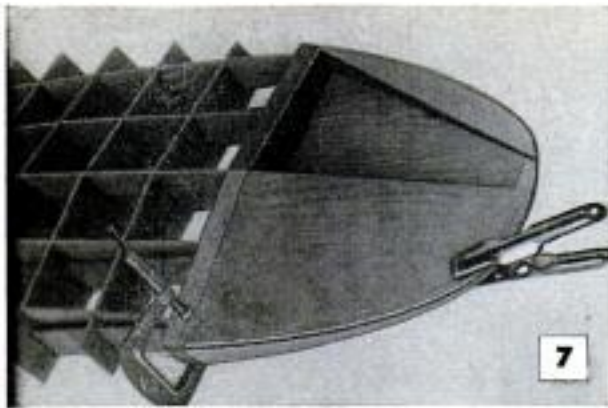

Rib No. 1 is cut from hardwood, slotted to accept ends of keels and stringers, then glued in place

and place weights on it to keep all pieces in proper alignment and contact. Make certain that the top edge of each stringer and the keel are flush with the tops of all ribs. After the glue has completely set, glue in the bottom stringers and keel, also placing weights on them to hold them in place until the glue sets.

Construction of the bow section of the paddle board, Fig. 2, starts with the making of rib No. 1, which is cut from hardwood. Note that the 2½-in. height of the rib is ¼ in. less than required at this point, to allow for the difference in the thickness of the ¼-in. plywood used to cover the bow, and the ⅛-in. hardboard used on the rest of the hull. A rabbet is cut in the plywood, as indicated, to accept the ends of the deck and bottom. The curved pieces of the bow frame are made according to the bow details in Figs. 1 and 2. Note that the bow frame is ¼ in. wider than No. 1 rib, where it attaches to the rib. This offset on each side allows for the ⅛-in.-hardboard sides and provides a flush joint at this point. As indicated in Fig. 2, a triangular-shaped center brace also is included in the bow section. The lower surface of this brace is beveled along each edge so that it will meet squarely with the two bottom pieces of plywood. Notches are cut in No. 1 rib to receive the top and bottom stringers and keels and it is glued in place. The bow pieces then are assembled and glued and the plywood top piece is glued and clamped in place, Fig. 8. When the glue has set, the bottom pieces of plywood are glued to the bow and clamped until the glue sets, Fig. 7.

The deck planking is next. Cut the deck from hardboard, making it ¼ in. oversize. Place the deck planking, bottom side up, on a flat surface, coat the top edges of all ribs and stringers with glue and invert the egg-crate assembly on the planking. Place weights on the assembly, making sure that all ribs and stringers contact the deck planking at all points. When the glue has set, cut two side pieces, making them ⅛ in.

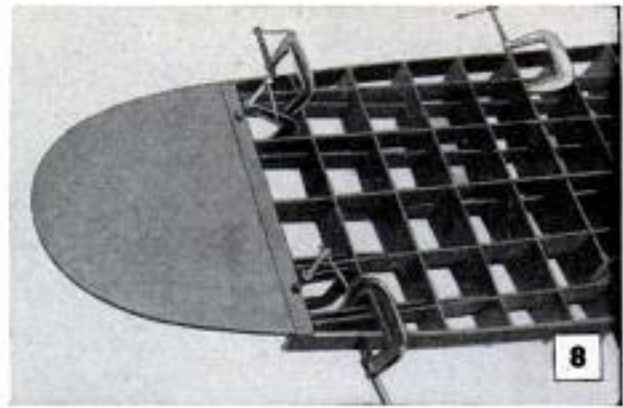

Curved blocks for bow next are glued in place. Finally, plywood top and bottom are glued to assembly

too wide. Coat the edges of the rib ends with glue and clamp the side pieces in place, allowing the ⅛ in. extra material to project below the bottoms of the ribs. When the glue has set, plane the edges of the deck so they are flush with the sides as in Fig. 3. Now, cut the two halves of the bottom planking and coat the inner surfaces of the planking and all inside surfaces of the partially completed paddle board with marine spar varnish or a vapor-barrier sealer. The bottom planks now are glued on, one at a time. Clamp them tightly to the sides and use weights to assure that they contact all ribs and stringers. When the glue has set, drill holes in the ends of the deck, sides and bottom planking and drive wood screws through these pieces into the stern block and No. 1 rib. Plane and sand all corners of the paddle board so they are smooth and rounded.

Application of the glass-fiber cloth is the final step. Place the paddle board with the deck side up, fitting wedges under the bottom to keep the board steady. Cut a piece of glass-fiber cloth large enough to fit over the deck and down the sides. Paint the deck with polyester resin, leaving a dry strip ⅜ in. wide along both edges. Start at the bow with the cloth and press it into the resin on the deck. Immediately paint both sides of the paddle board with resin, as well as the untouched ⅜-in. strip on the edges of the deck. Pull the cloth down over the edges and press it into the resin on the sides. The cloth folds readily over the edges as it contacts the resin, something it would not do if it had been saturated with resin before being folded. The resin sets up so rapidly that the cloth would have become semirigid by now if the ⅜-in. strip had not been left dry along the deck edges.

After the resin has completely set, invert the paddle board and apply resin and glass cloth to the bottom, allowing it to overlap the sides, bow and stern. This provides a double thickness of cloth at bow and stern for added strength. ★ ★ ★

Know-How Fills the Creel



By Claude M. Kreider

HAVING A FULL CREEL at the end of a day of fishing often depends on the angler's skill with rod and reel. The skill, in turn, depends in large degree on the correct combination of rod, reel and line. If there is an organized casting club in your area, contact them for aid in increasing your casting skill. They usually have access to a park lake or swimming pool, and seeing the splash of the lure as it hits the water adds realism to casting practice which is

missing when you have to cast on dry land. Also, members of such a club can give you the benefit of their experience in choosing tackle best suited to your particular needs. And because they have a large variety of tackle, Fig. 1, you can learn for yourself the importance of using the correct line with a particular rod and reel.

However, if no club is available to you, a back-yard lawn will substitute for a body of water and an old bicycle tire can be

An organized casting club will have the tackle and facilities to aid in improving your casting skill

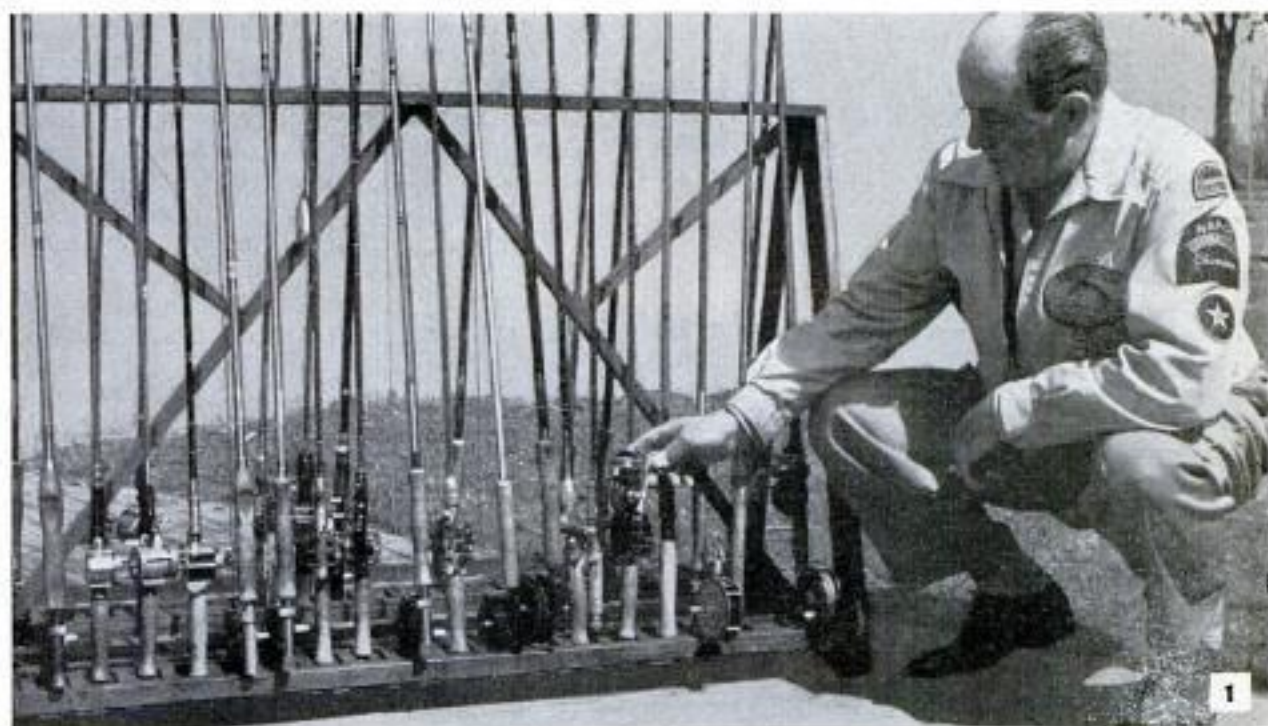



Upper reel is spinning type, the lower is for plug casting. When plug casting, thumb is held on reel spool as indicated to control accuracy of cast. No control is used on spinning reel, once line is released when forward cast is made

ROD POSITIONS WHEN PLUG CASTING

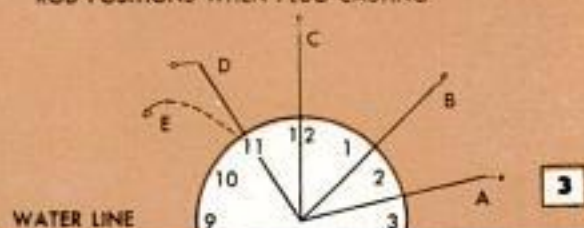

Above, rod positions for plug casting are indicated over a watch face to demonstrate various angles through which rod passes during back cast to D at 11:00 where rod flexes to E at 10:30, then picks up momentum for cast and follow-through

ROD POSITIONS WHEN FLY CASTING

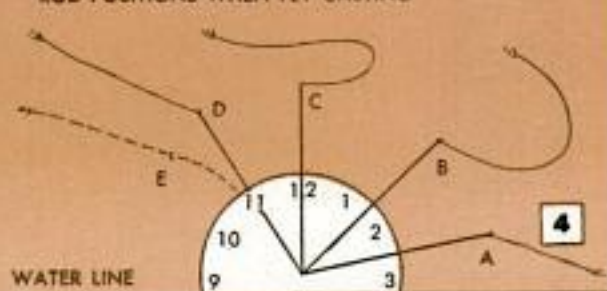

The rod positions for fly casting are similar to those used in plug casting. Main difference lies in the fact that the weight of the extended line flexes fly rod to provide momentum for forward cast, while weight of lure flexes casting rod



The upper two reels are types of spinning reels, lower reels are two types used for plug casting

your target. The table, Fig. 8, will aid you in selecting the right line for your fishing rod.

Fly Casting and Tackle

Your fly rod can have a 7½ or 8-ft. length for small-stream trout fishing or a 9-ft. length for larger streams and lakes. For large trout and bass, when using fly or bug lures, a 9½-ft. rod weighing 6 oz. is best. A rod with just the right amount of backbone permits greater distance and better control when casting a fly, but only if the line matches the rod action. Most beginners use a line too light, and of the wrong type. In fly casting, the heavy mid-length of the line is always in the air beyond the rod, and its weight flexes the rod on the back cast to provide power on the forward cast. Tapered lines, Fig. 8, are recommended because they permit more accurate casting than constant-diameter lines. Line sizes vary .005 in. with each letter size. Thus, a double-taper line designated HDH will have a diameter of .025 in. at each end, tapering up to a mid-length diameter of .045 in. Torpedo-taper line in GBF size will have about 85 ft. of F running line, tapering up quickly to 15 or 20 ft. of B size, then down to a G tip to which a leader is attached.

The double-taper line is best for dry-fly casting; the torpedo for long casts, or where wet flies, bass bugs and small spinners are used. Use a large, bright fly for practice, with the point of the hook removed for safety. Start with about 30 ft. of line extended from the rod. Pick it up for a back cast by imparting a quick snap to the rod from a position about 2:30 on a watch dial, Fig. 4. Apply full power back through B and C and decrease to D. At this point you will feel a distinct pull on the line as the back cast straightens. Start the forward cast with a powerful snap to build momentum

in the line quickly. Apply power through C and B, at which point the rod speed is diminished to follow through to point A as the fly alights. After mastering the 30-ft. length of line, increase the length, pausing slightly longer at the finish of the back cast to permit the longer line to straighten. At about 50 ft. you will reach the practical limit of an ordinary cast. But where there is need for greater distance you still can shoot the line 12 to 15 ft. farther. Strip several coils of line from the reel and hold them in your left hand. Execute the pickup and back cast with the maximum amount of line you can handle in the air. Then, as the line straightens, add extra force to the forward drive. Release the coils just as the line straightens on the forward cast. This trick will send the fly under overhanging branches or ahead of you into water you cannot reach in waders.

Plug Casting

The weight of the plug or other lure flexes the rod in plug casting and thus permits the rod to develop its driving power. In this type of casting, careful thumbing of the reel is important, Figs. 2 and 6, as this is the only method of controlling the cast both for distance and accuracy. The casting rod can be glass fiber, bamboo or steel, and 5½ to 6 ft. is the best length. It should be fairly stiff through the lower two thirds of its length, with a rather flexible tip. The line may be silk or nylon, testing from 6 to 15 lb., depending on the size of the fish you expect to catch. The reel need not be expensive, but should have a free-running spool of the lightest weight to eliminate any possibility of a "flywheel" effect, which can cause overrunning and backlash. Also, the reel should be of the level-wind type to spool the line evenly when you retrieve, lower two reels, Fig. 5 and Fig. 7. Start with a target 35 to 40 ft. away. Grasp the rod easily with the hand in a natural position that puts the reel handle almost on top. Let your thumb



Photo illustrates how thumb is placed on the crossbar of casting reel so it can be used as brake on line. Thumb is used to slow unreeling line, then stop it when plug is above target. A calloused thumb is a definite aid for this



Illustrated above are three types of fly-rod reels of the nonautomatic type. Fly-rod reels are larger than plug-casting reels and are located below rod at rear of handle instead of on top of rod ahead of handle, as are plug-casting reels. Below, double-taper and torpedo-taper fly lines have varying diameters in over-all length



Rod Length	Rod Weight	Double Taper	Torpedo Taper
7½ ft.	3 to 3½ oz.	HEH	HOG
8 ft.	4 to 4½ oz.	HEH OR HDH	HCF
8½ ft.	4¾ to 5 oz.	HDH OR HCH	HCF OR GBF
9 ft.	5½ to 6 oz.	HCH OR GBG	GBF OR GAF
9½ ft.	6½ to 6¾ oz.	GBG	GAF

rest lightly over a crossbar on the reel, lightly touching the spool, Fig. 6. Start the cast with the plug about 3 in. from the rod tip. Keep your eyes on the target and slowly raise the rod tip to the "aiming position" A, about 2:30, Fig. 3. Increase rod speed lightly to B at 1:30, then snap back smartly to D where you will feel the pull of the plug, the rod tip flexing to E. Apply forward drive at once, carrying through to one o'clock, then diminish rod speed through B and follow through until the plug lands. Thumb pressure on the spool is lightened—but not entirely released—when the rod tip reaches vertical, then gradually applied to stop the plug at your point of aim. With an hour's practice you should be able to place half your casts within a 30-in. circle at 40 ft., and in another hour or two attain a smooth delivery up to 80 ft.

Spin Casting

Of the three types of casting, plug, fly and spin casting, the latter is the easiest to master. The spinning rod is light and whippy, permitting the use of many light lures too heavy for a fly rod and too light to develop the action of a conventional plug-casting rod. Also, the spinning reel releases its line spirally off a fixed spool, so there is no problem of backlash. Seven feet is a good length for a spinning rod, and the reel should hold about 100 yd. of line testing from 6 to 12 lb. for most fresh-water fish. For salt-water fishing, and larger fresh-water fish, the rod may be of the two-hand type with a long cork handle. In this case the reel will hold up to 200 yd. of heavier line.

The conventional spinning reel has a pickup bail, or finger, which you "cock" (set at the casting position) with the forefinger at the start of the cast, upper reels, Fig. 2 and Fig. 5. The cast is executed with the same motion as plug casting, but more slowly, due to the longer and more flexible rod. Your forefinger is used to hold the line against the rod grip until the moment of release when the rod is at a one o'clock position.

As with any sport, skill at casting requires practice. An hour or so several evenings a week, or on week ends when you cannot go fishing, can be well spent in improving your ability with rod and reel. The full creel of fish you bring home will be ample reward for your time. ★ ★ ★



Hypodermic Needle Altered To One-Drop Oiler

For applying a trace of light oil to action parts of guns one gunsmith uses a hypodermic needle altered to suit his purpose. He buys needle units in various sizes, the smallest for light oil and the larger sizes for gun grease or cleaning fluid such as carbon tetrachloride. The sharp point of each needle is ground square across so that small drops of oil will be formed when the plunger is slightly depressed.

Colorful Accessories for Toys Made From Plastic Caps

Toys for toddlers can be made even more colorful by the addition of plastic-cap accessories. The cap from a hand-lotion bottle provided the smokestack for the locomotive pictured, while caps from other bottles provided boiler domes. Pill-bottle caps are cemented to the front of the boiler and toothpaste-tube caps hide the heads of the screws used for wheel axles.

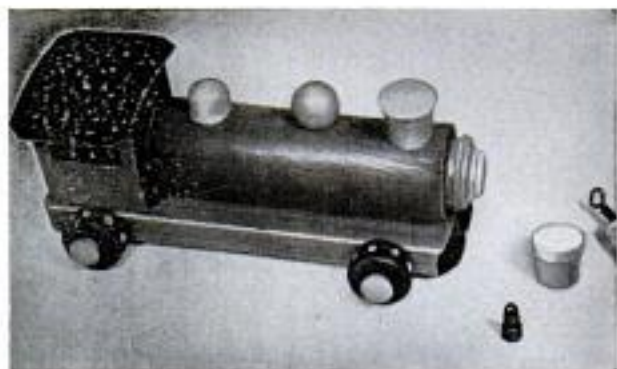

Wet Cloth Refrigerates Fish

To prevent fresh trout from spoiling when cleaned and placed in the creel, one fisherman wraps each fish in a wet dish towel. Air entering through the porous sides of the creel evaporates the water, which cools the fish.

Thomas P. Ramirez, Fond du Lac, Wis.

Enlarging Drawings The Easy Way

Here is a simplified method of enlarging a drawing by laying it out in squares or rectangles. First, draw lines on all four sides to touch the outer extremities of the sketch. Then draw two diagonal lines within the box thus formed, and draw a vertical and horizontal line to bisect these lines where they cross, thus forming four divisions. If required, each of these divisions may be divided into four parts, and so on, depending on the detail of the sketch to be reproduced. Mark copy the same way.—Henning Nelms, Washington, D. C.

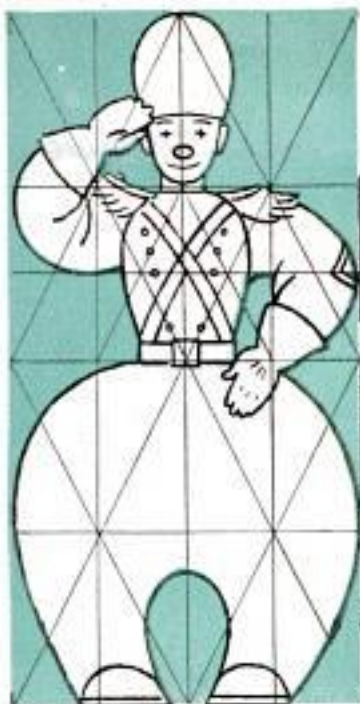

Photo Solutions Protected Against Damage by Air

Home photographers can use one of the two following methods to prevent spoilage of developing solution that is caused by the presence of air inside the bottle. The first method is to replace the liquid that is removed each time by dropping clean glass marbles into the bottle until the level of the solution is raised up into the neck, thus eliminating most of the air. A second method of protecting the solution is to distribute the liquid in a number of equal-size small bottles, each holding just enough solution for one session of print developing. By this latter method a gallon (128 fl. oz.) of stock solution will fill thirty-two 4-oz. bottles.

Car Battery Illuminates Trailer In Absence of Park Facilities

If you find it necessary to park your trailer where 110-volt electrical service is not available, your car battery may be used to operate one bulb inside the trailer. To do this, wire an extension-cord type of receptacle into the car-battery circuit, running one heavily insulated wire from the starter terminal where the battery terminal connects. Run a second wire from the receptacle to a bolt on the car frame. Mount the receptacle on the underside of the car trunk or bumper. This will enable you to plug the trailer circuit into the car-battery circuit easily. Use one 25-watt bulb of 6 or 12 volts, depending on your battery.

Clinton R. Hull, Santa Ana, Calif.

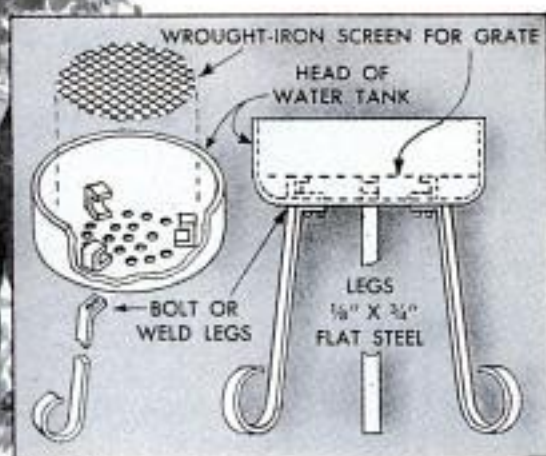

Midget Barbecue From Water Tank

When fired with charcoal this midget barbecue will cook as well as the larger ones. The fire bowl is the top of a hot-water tank. Three flat-steel legs support the unit. The grate is a wrought-iron screen supported on steel brackets. Several small holes drilled in the bottom of the fire bowl assure adequate draft. A welded-wire shelf provides a cooking surface.



SEA KNIGHT

PART III

By **Glen L. Witt**,
Naval Architect

AT THIS STAGE of construction *Sea Knight* is completed right side up which means that before continuing, the hull and building form are turned over. This is done with the form in place as in Fig. 39, for the simple reason that it continues to brace the hull during the topsy-turvy operation. After the hull is right side up, the form is dismantled piece by piece and removed. Your boat should look like

Here is what your hull should look like when turned right side up and building form removed. Note frame deck beam

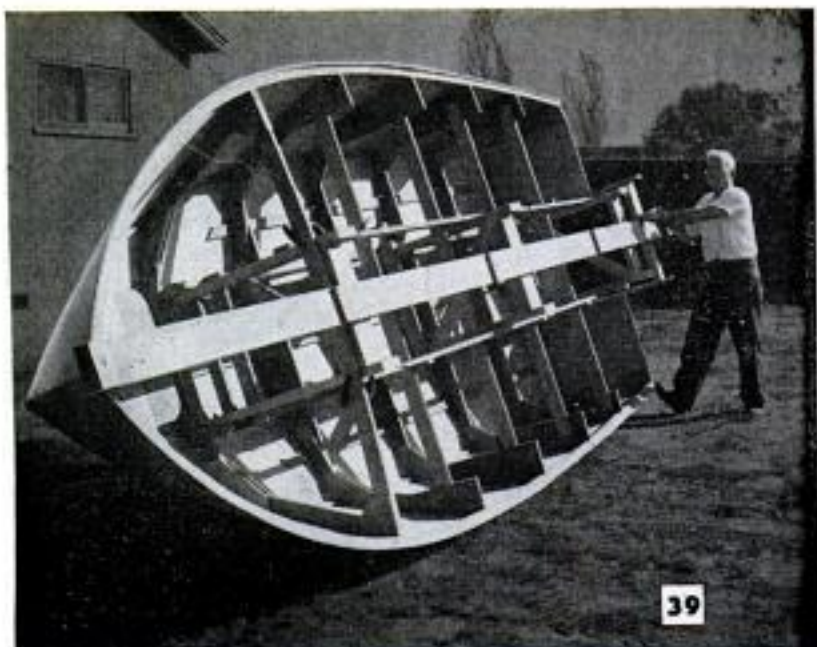
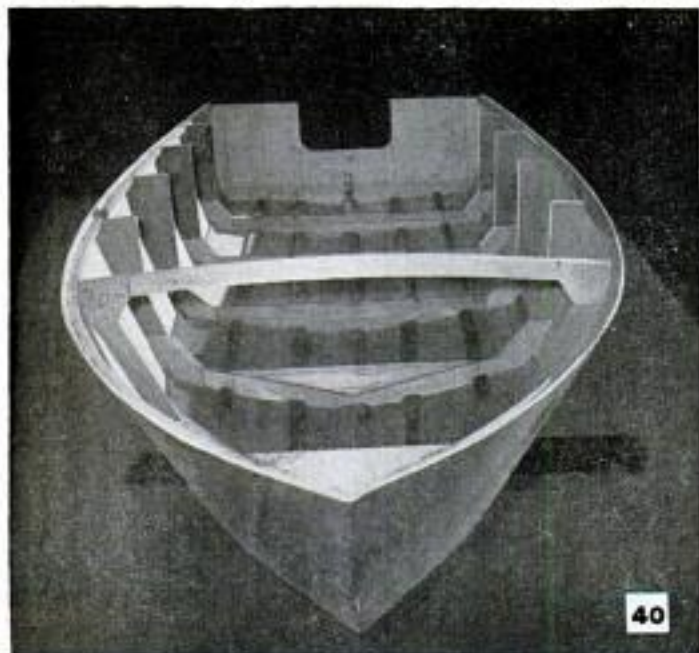

Hull is rolled over with building form in place so it remains braced during the operation. Use a pad to protect the planking

Fig. 40, with one deck beam in place. Since the lines of the hull are curved and thereby offer no reference plane from which to work in plumbing and squaring the cabin and interior fixtures, it is important that the hull be chocked and braced securely so that the setup level is again level both fore and aft, as well as athwartship. Use a level on the frames.

Carlings: The carlings are trim pieces that line both sides of the cockpit. They measure about 13 ft. long and fit between the transom and the deck beam on frame No. 5. Fig. 41 shows the carlings installed. They are ripped about 4 in. wide from 1-in. mahogany or oak and are screwed to the edges of the frames so the lower edges of the pieces are 2½ in. down from the top at the transom and the deck beam. In referring to the sectional frame drawings in Part II, you'll see that the carlings are even with the tops of the frames. This means that the tops of the carlings must be arched to match the deck contour. A long batten resting on the tops of the side frame members is used to mark them. You may find it necessary to either trim or shim the frames so the carlings are straight. Fasten with 2-in. No. 10 screws.

Intermediate deck beam: This beam is installed at a point 27 in. from beam No. 5 and serves to frame the forward end of the hatch. It assumes the same crown as the other beam and is cut from 1 x 3-in. oak or mahogany. You'll notice in the profile view, Fig. 46, that it rests on

Here you see the carlings, deck beams and battens, and hatch framing installed ready for plywood decking

blocks at the sheer clamps and is fastened with 2-in. No. 10 screws.

Strongback: This member extends from beam No. 5 to the breasthook and is tapered at the forward end to lie flat against the slanting breasthook. It is applied in one length to assure trimness and is housed in notches cut in both deck beams. It serves as a backing for the deck-planking joint and is later cut away where it bridges the hatch opening. Fasten in place with glue and 2-in. No. 10 screws. Notches in both beams, 22 in. each side of the centerline, house two deck battens.

Hatch frame: The hatch is formed by separate framing members installed between the deck beams. These are crowned to coincide with the curvature of the beams, as well as the deck curvature fore to aft. The deck-framing plan shows the spacing of these members to form a 15 x 18-in. hatch.

Decking: The edges of the side planking, sheer clamps, carlings, battens and strongback must be faired so the deck planking will lie flat on these members. The decking should be $\frac{3}{8}$ -in. exterior plywood, either AA or AB grade. The forward decking is

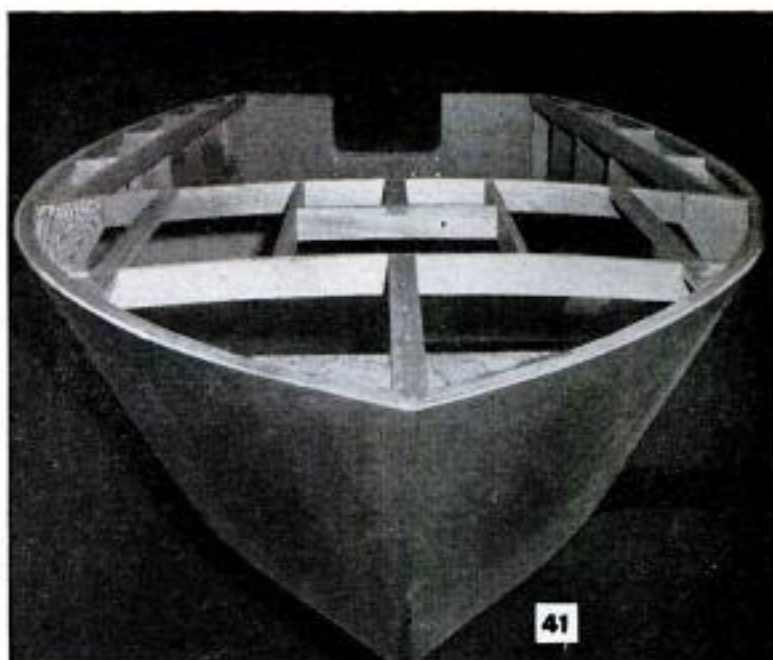

applied in two pieces with the joint falling on the center of the strongback. The side decking is applied in lengths as long as possible. Where joints must be made, the plywood is butted and backed with blocking. All decking is nailed at the outer edges with $1\frac{1}{4}$ -in. ring-type nails spaced 3 in. apart, whereas 1-in. nails are used in fastening it to the battens, beams and strongback. After fastening, the decking is planed to bring it flush with the side planking.

Cabin interior: The forward rope-locker shelf is positioned to suit the builder, keeping in mind that you'll need foot clearance

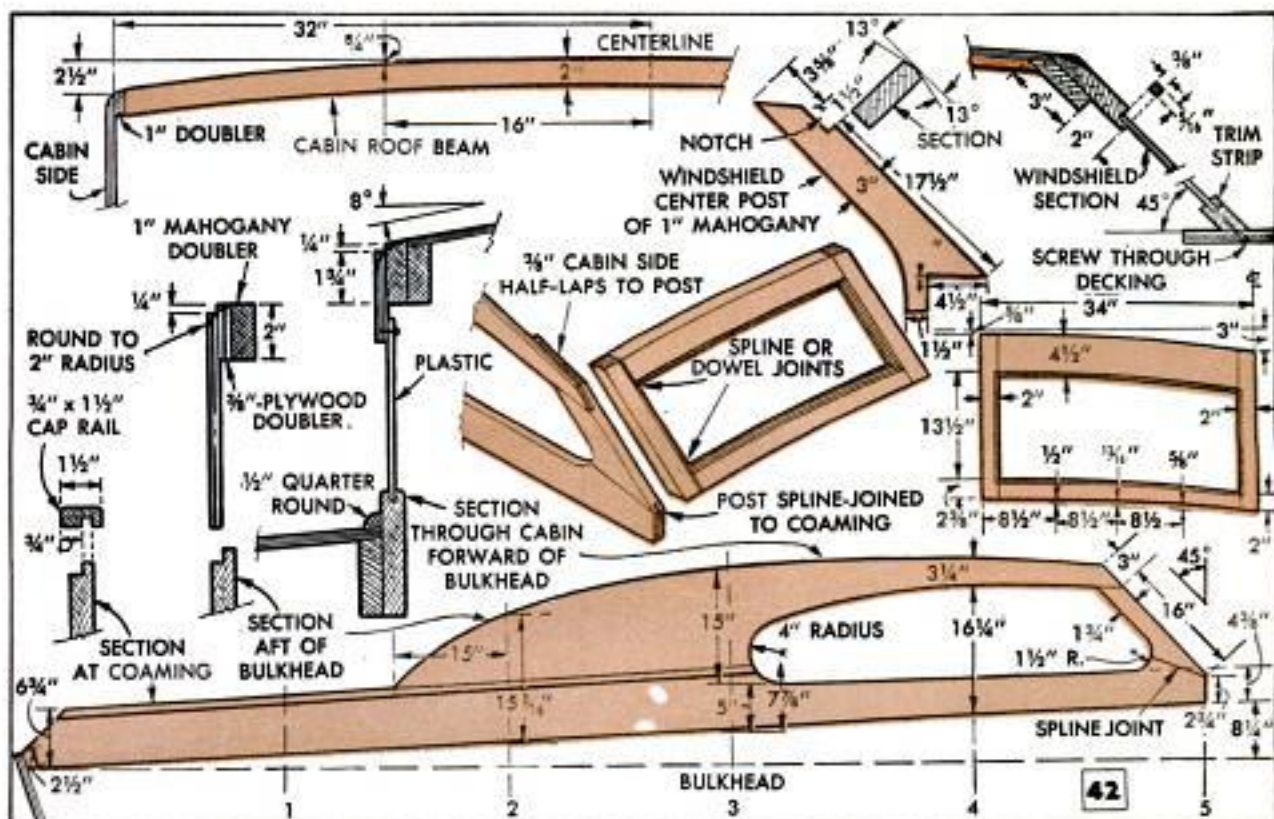

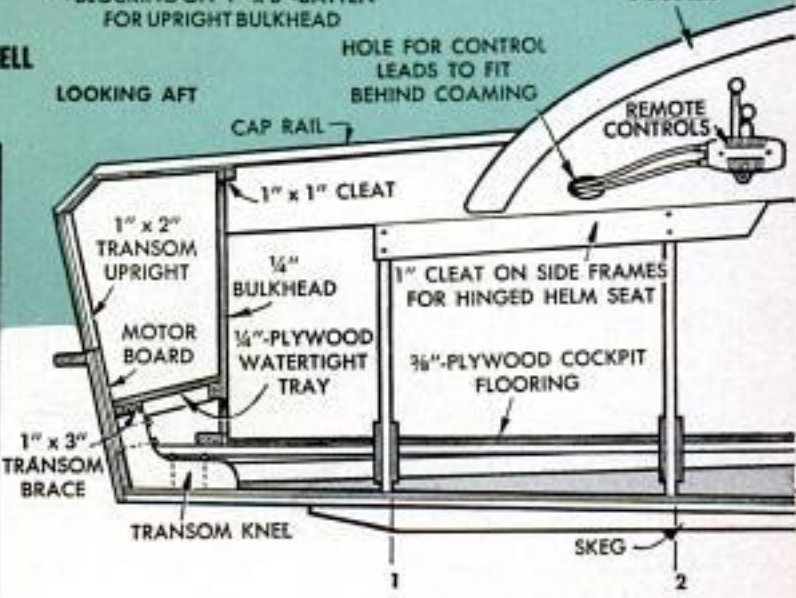
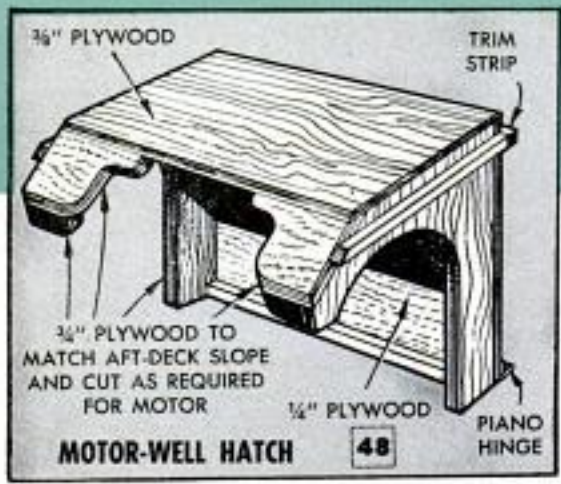
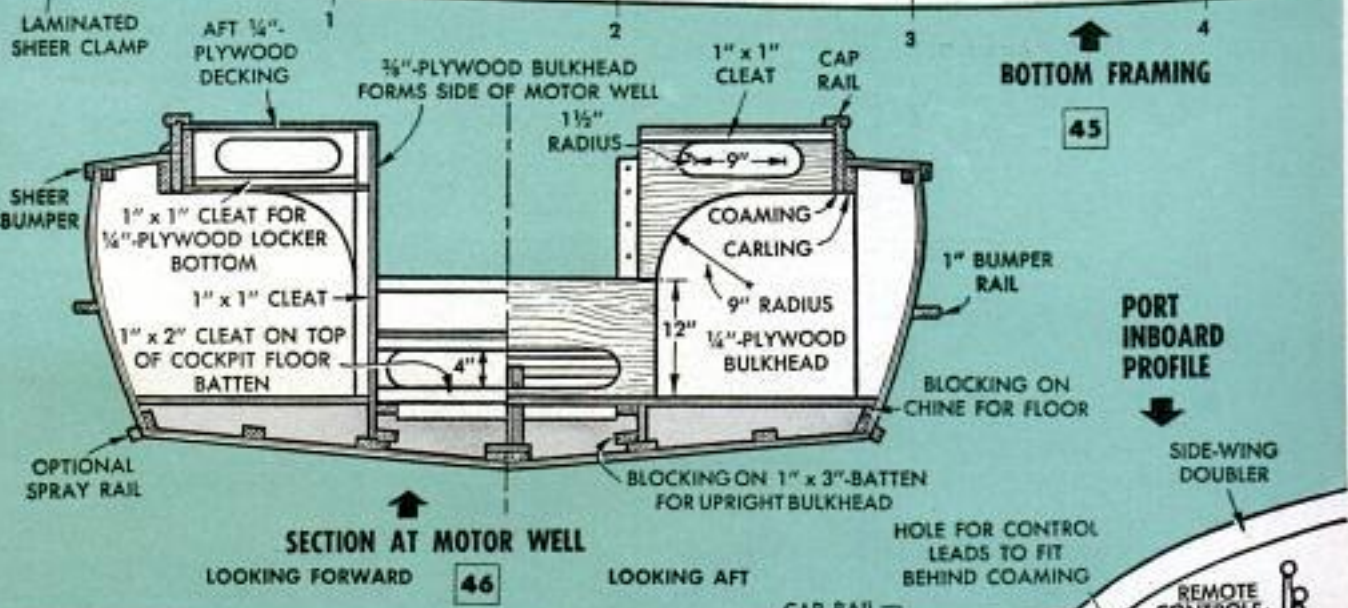
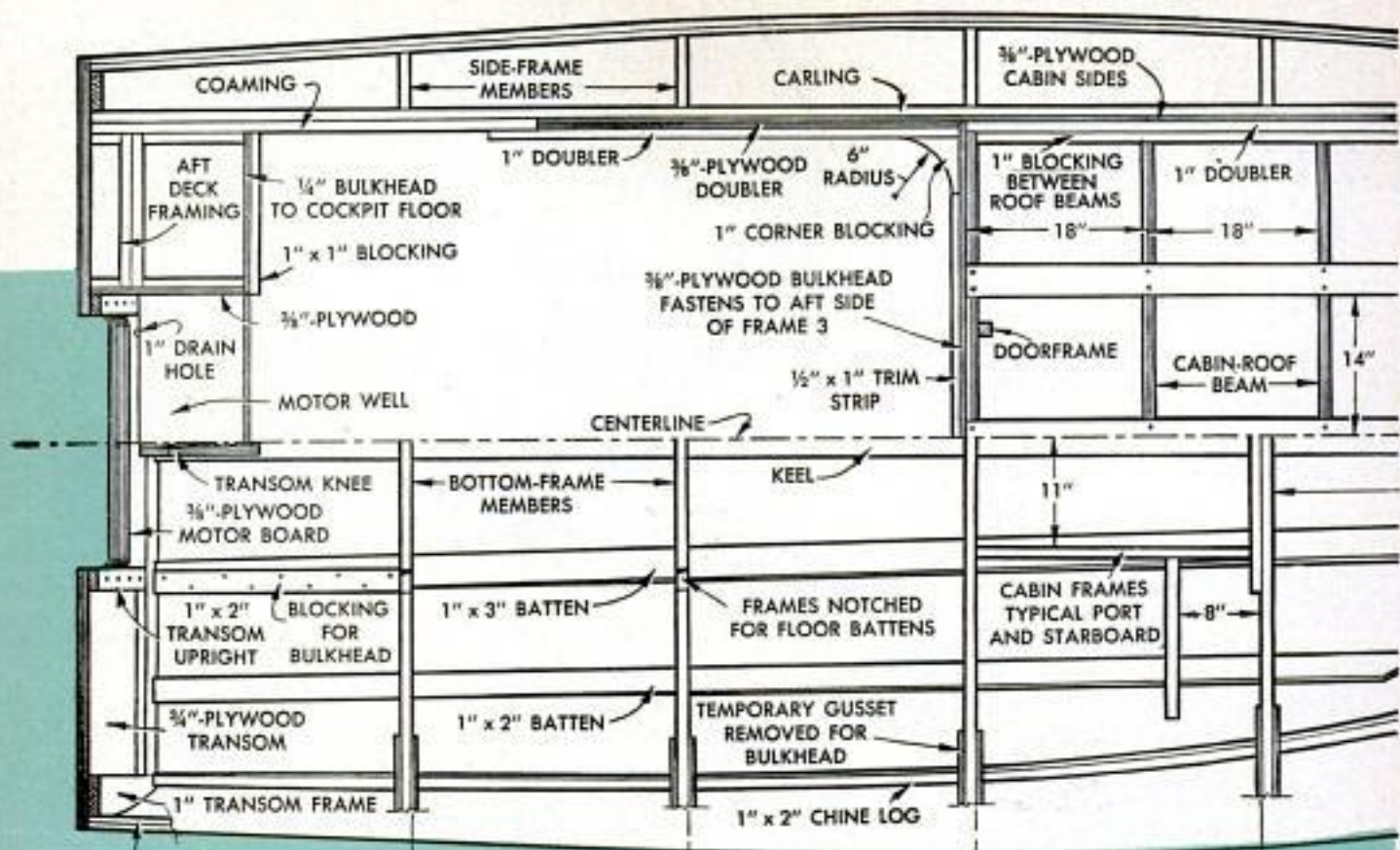

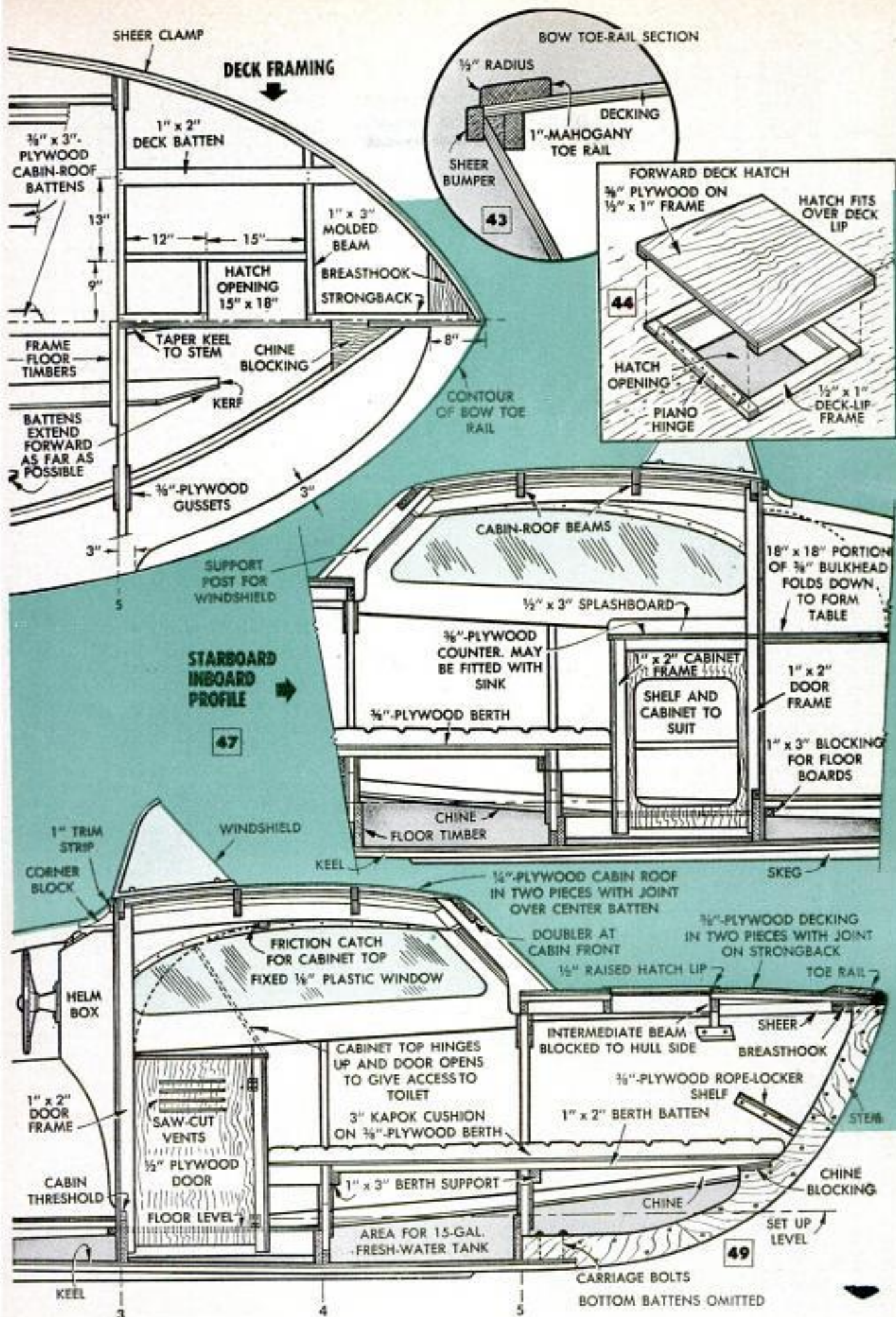

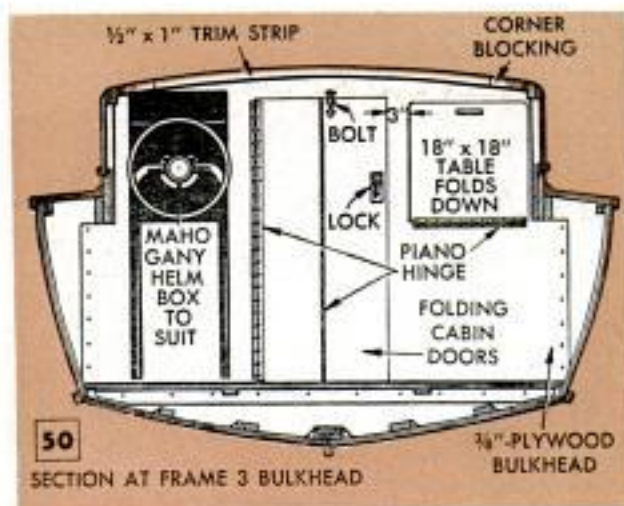

50

SECTION AT FRAME 3 BULKHEAD

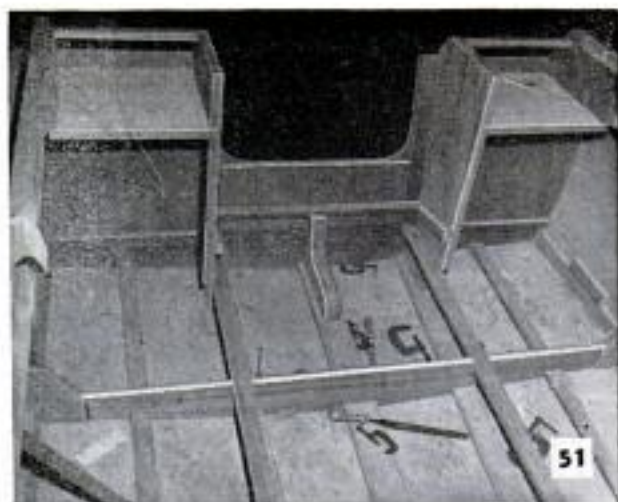

51

below it for sleeping comfort. In Fig. 49 you can see that it is merely supported at a slant by cleats. The port and starboard cabinets are supported on members installed between frames Nos. 3 and 4 and are kept at the same height as the floor timber of frame No. 4. By studying the bottom-framing plan, Fig. 45, you'll see where these members are placed in relation to the centerline of the keel and frame No. 4. The pieces that are 8 in. from the frame extend outward as far as possible at the same height as the floor timber. The plywood sides of the cabinets, both port and starboard, are fastened to this member. Since the cabinet tops are 24 in. above the setup level, these sides must be fitted to this level. Where the cabinet sides join the side planking, they are fastened to 1 x 2-in. cleats which extend from the carlings down to the chines. On the forward side of the cabinet sides, 1 x 3-in. cleats are added 7½ in. above the setup level to support the aft ends of the plywood berth. Berth supports also are screwed to the forward sides of frames 4 and 5 at the 7½-in. level. See Figs. 31 and 35 in Part II. Both of these supports are notched at the center-

You can use a commercial helm seat or make one of plywood and pad it. Note motor-starter control

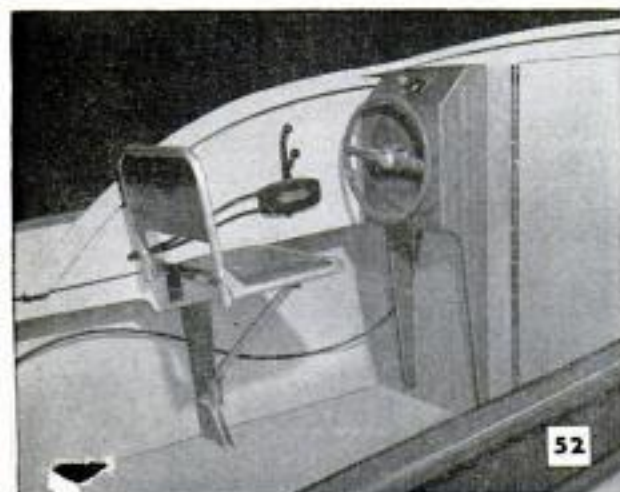

52

View looking aft toward transom shows partial completion of motor well and stern storage compartments

line to house a 1 x 2-in. batten that extends from frame No. 4 to the chine blocking at the stem. Additional blocking is installed between the frames at the juncture of the side planking to support the berth plywood at the outer edges, and two more 1 x 3-in. support blocks are installed parallel to the keel between the support at frame No. 4 and the cabinet sides. The ¾-in.-plywood berth covering is installed in two sections, letting the joint come on top of the 1 x 2-in. batten.

Cabin sides: The lower portion of the cabin sides, which actually is the coaming, is ¾-in. mahogany, while the upper part is ¾-in. exterior-grade fir plywood. A full-size paper pattern of the side, Fig. 42, over which each cabin side is assembled, will be needed before you start. The windshield end posts are doweled or splined to the coaming part and notched at the top to receive the plywood portion flush. The lower edge of the plywood fits a ¾-in. rabbet cut in the outside edge of the coaming. You'll notice that a ¼-in. groove is cut in the edge of the coaming, as well as the corner post, to receive a ¼-in.-plastic window. The assembled cabin sides are installed with the lower edges even with carlings. Use plenty of mastic between the cabin sides and the carlings and fasten with 1½-in. No. 8 screws, well staggered and 6 in. apart.

Bulkhead at frame No. 3: Now the temporary gussets can be removed from the aft side of frame No. 3 and a ¾-in. plywood

To Save Both Time and Work

If you wish, you can buy the patterns for the stem, frames, transom, breasthook and chine blocking already drawn full size. And, to further simplify construction, you can buy these parts in kit form accurately cut in mahogany from Glen-L, Marine Designs, P.O. Box 568, Compton, Calif.



Cabin sides and windshield have been added and beams installed to support plywood roof which is added next

bulkhead glued and nailed to the frame with $1\frac{1}{4}$ -in. ring nails spaced 4 in. apart. The top of this bulkhead is crowned to conform with the cabin roof and, as a doorway must be made in it, it is more practical to install the bulkhead in two sections. See Fig. 50. Two doublers are added to the top edges of the cabin sides aft of the bulkhead to help strengthen it. One is of $\frac{3}{8}$ -in. plywood, 2 in. wide, which is beveled 8 deg. and allowed to project $\frac{1}{4}$ in. above. The other is 1-in. mahogany which is applied over the other. The latter one sweeps down across the inside face of the coaming to serve as a brace. This you can see in the profile view in Fig. 49. Glue and then screw the doublers with $1\frac{1}{8}$ -in. No. 8 screws.

Cabin beams: The cabin-roof beams are cut from $\frac{3}{4}$ -in. plywood and kept 2 in. wide. Three of these are required and their exact lengths should be taken from the boat. Three $\frac{3}{8}$ x 3-in. notches are cut in each beam for plywood roof battens. Before the beams are installed, a 1-in. doubler of mahogany is added to the cabin sides forward of the bulkhead. This too, is beveled 8 deg. and allowed to project $\frac{1}{4}$ in. In gluing and screwing the doublers in place, keep the screws as low as possible so they will not interfere later when rounding the edges. The cabin beam at the bulkhead is installed first, gluing and nailing it directly to the plywood with 1-in. ring nails spaced 4 in. apart. A ledge cleat to support the cabin roof is applied to the face of each doubler in three sections. Like the doubler, it is cut to match the curvature of the cabin roof line and beveled 8 deg. After

the first beam is installed, a section of ledge is added. Then the second beam is butted against the end of the ledge piece and fastened to it with screws. Then another section of ledge is added and another beam and so on.

Doorframe: The cabin doorway is framed on the forward side of the bulkhead with 1 x 2-in. mahogany strips that extend from the beam to the floor member. The strip on the starboard side of the doorway also serves as one frame for the door of the toilet enclosure. On the galley side, the $\frac{1}{4}$ -in.-plywood cabinet front is sandwiched between the 1 x 2-in. frame member and a 1 x 2-in. cabinet upright. Study Fig. 47.

Galley cabinet: The shelves in this cabinet are positioned to suit the builder. Cleats are used to support the plywood top and then a splashboard is fitted across the back to fill the gap between the cabin side and the cabinet. The cabinet top should be covered with linoleum or counter plastic. Like the galley cabinet, you already have two sides of the head (toilet compartment) completed. The front is merely a hinged panel of $\frac{1}{2}$ -in. plywood with saw-cut vents in the face. The hinged top of the head is $\frac{3}{8}$ -in. plywood and is held open with a friction catch attached to the cabin side.

Blueprints Available

Those who prefer to build *Sea Knight* from plans larger than the ones presented in the magazine may purchase a set of blueprints, 22 x 34 in., by writing Blueprint Department, *Popular Mechanics Magazine*, 200 E. Ontario St., Chicago 11.

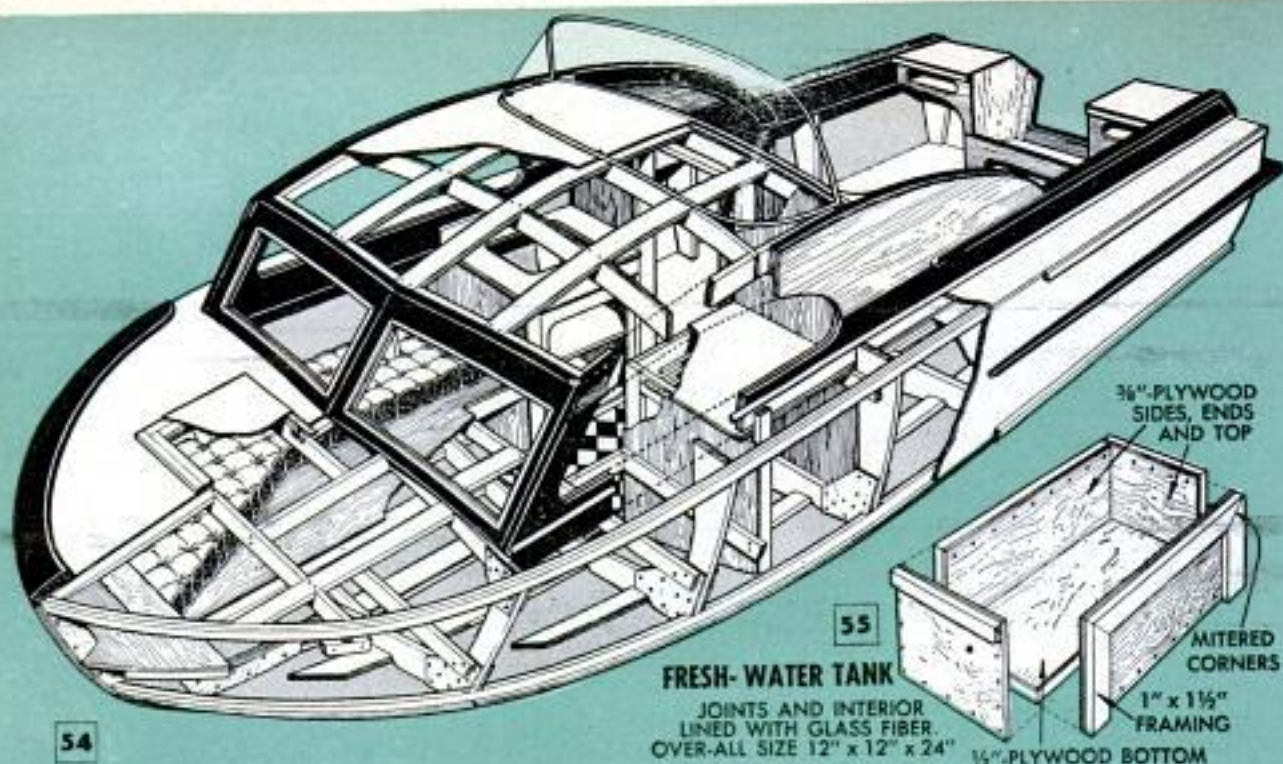

54

55

FRESH-WATER TANK

JOINTS AND INTERIOR
LINED WITH GLASS FIBER.
OVER-ALL SIZE 12" x 12" x 24"

3/8" PLYWOOD
SIDES, ENDS
AND TOP

MITERED
CORNERS1" x 1 1/2"
FRAMING

1/2" PLYWOOD BOTTOM

The bottom of the head should be covered with linoleum for ease in cleaning.

The cabin floor is sprung between the two inner battens and rests on the keel. It can be in one or two parts, and should be covered with linoleum or painted with a nonskid deck paint.

Front-windshield frame: Fig. 42 details the frame which is made up in two parts and supported at the center with a 1-in. mahogany post. This requires a certain amount of handwork to make it fit the curvature of the deck. It is best to make each half oversize so you will have extra stock for fitting, and to bevel the top edges after the framework is in place. A rabbet is run all around for the glass. Cover the screwheads with mahogany wood plugs. A ledge piece across the inside of the windshield at the top forms a rabbet for the cabin-roof plywood. The latter is both nailed and screwed in place after the roof battens are installed. Coat all contacting surfaces with glue and drive 1-in. ring nails around the edges of the roof. Then fasten it to the battens with 5/8-in. No. 5 screws, staggering and spacing them 4 in. apart.

Cap rail: This is a grooved member that caps the rabbeted edge of the coaming and continues past the juncture of the cabin side to cover the joint. The cap rails are not permanently fastened until ready for the final trim. Then it is screwed down to the coaming with 1-in. No. 8 screws, spaced 12 in. apart, and to the cabin side with 3/4-in. ring nails 6 in. apart. A short cap rail is used to cover the slanting part of the

coaming at the transom. At the top corners of the open cockpit, corner blocking is fastened to the cabin sides and bulkhead with glue and two 2-in. No. 10 screws in each leg of the blocking.

Aft deck and motor well: This part of your cruiser will vary slightly with the motor used. As detailed, it worked out very satisfactorily for the 35-hp. Evinrude motor that was used. In studying the transom drawings in Figs. 46 and 51 you will see that 1 x 2-in. uprights are glued and screwed to the transom at each side of the motor cutout. The 1 x 3-in. transom brace which lies flat on top of the transom knee extends to the outside of the 1 x 2-in. uprights. This is glued and fastened to the knee with 2-in. No. 10 screws, as well as to the transom with screws from the outside. A 1 x 2-in. block on top of each 1 x 3-in. batten is installed between the transom and frame No. 1 to support the 3/8-in. motor-well side. The sides of the motor well fasten to the 1 x 2-in. uprights at the transom, to the 1 x 2-in. floor battens and to the blocking on the batten just described.

Motor-well bulkhead: This is cut from 1/4-in. plywood and is held by cleats fastened to the coaming and floor battens. Elongated openings to provide access to glove-compartment-type storage lockers are made both port and starboard and below the motor well for bilge inspection.

In a concluding article next month, the completion of the construction will be described and plans will be presented for building a winch-fitted trailer to transport your *Sea Knight*.

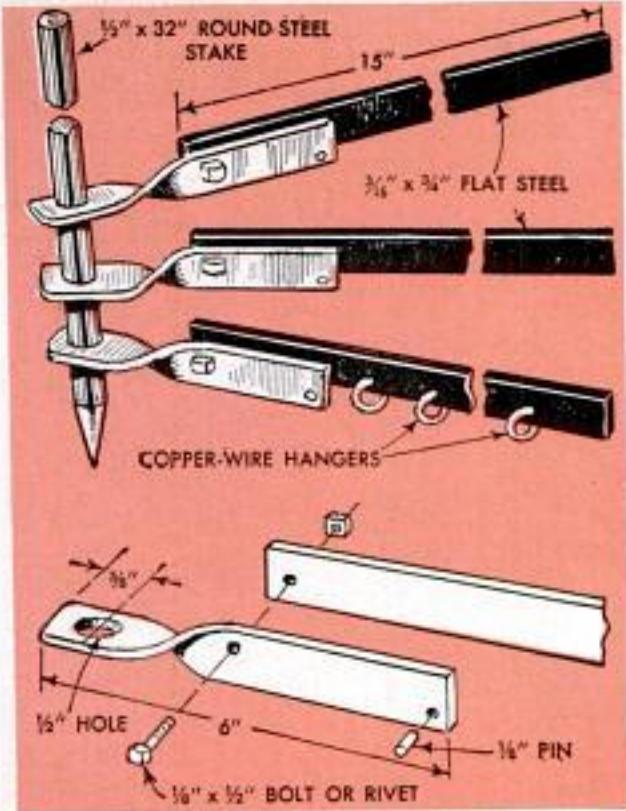

This Folding Grill Is Outdoor Cook's Delight

Outdoor enthusiasts who like food cooked over an open fire will find this collapsible stake-type grill a handy camping or picnicking accessory that can be set up in a few minutes and stowed compactly in a pack or car trunk. The unit consists of only four members—three flat steel arms and a round steel stake on which the arms pivot.

When using the grill, you need only drive the steel stake into the ground next to a fire and arrange the arms to accommodate the cooking utensils used, as shown in the photo. The lower arm is equipped with wire hangers for attaching steaks, bacon,

fish and other foods to be broiled. The large hole at the end of each arm, through which the stake is passed, should be made slightly larger than the diameter of the stake to permit positive jamming of the arm at any elevation desired. The 6-in. sections of the arms are twisted 90 deg. as shown in the detail above, and joined to the 15-in. sections by bolts or rivets that permit the latter sections to be folded against the stake when the unit is carried. A steel pin on the outer end of each short piece, serves as a stop when the arm is extended.—J. G. Wing, Santa Fe, N. Mex.

Coffee Can Used as Toaster

For a toaster that can be used with a portable gasoline stove, punch 25 to 30 small holes in the bottom of a 1-lb. coffee can and wrap two lengths of wire around the can as shown. When using the toaster, simply invert it over a lighted burner and place a slice of bread on the crossed wires.

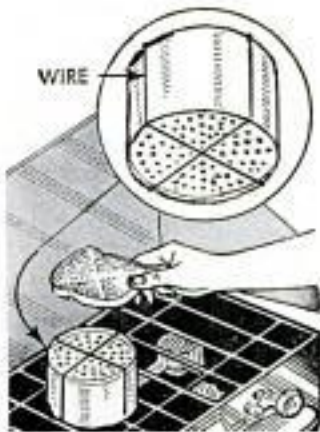

Clinton R. Hull, Santa Ana, Calif.

Rotary Knife Scores Plasterboard

You'll find a serrated rotary knife of the type used for trimming wall-paper better than an ordinary knife for scoring plasterboard prior to breaking it. Use of a rotary knife requires much less effort, since it "punches" through the paper overlay and avoids the friction against the blade when a straightedged knife cuts the plaster core.

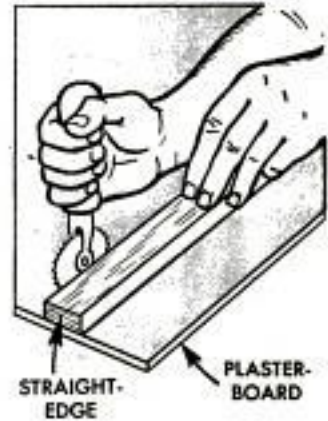

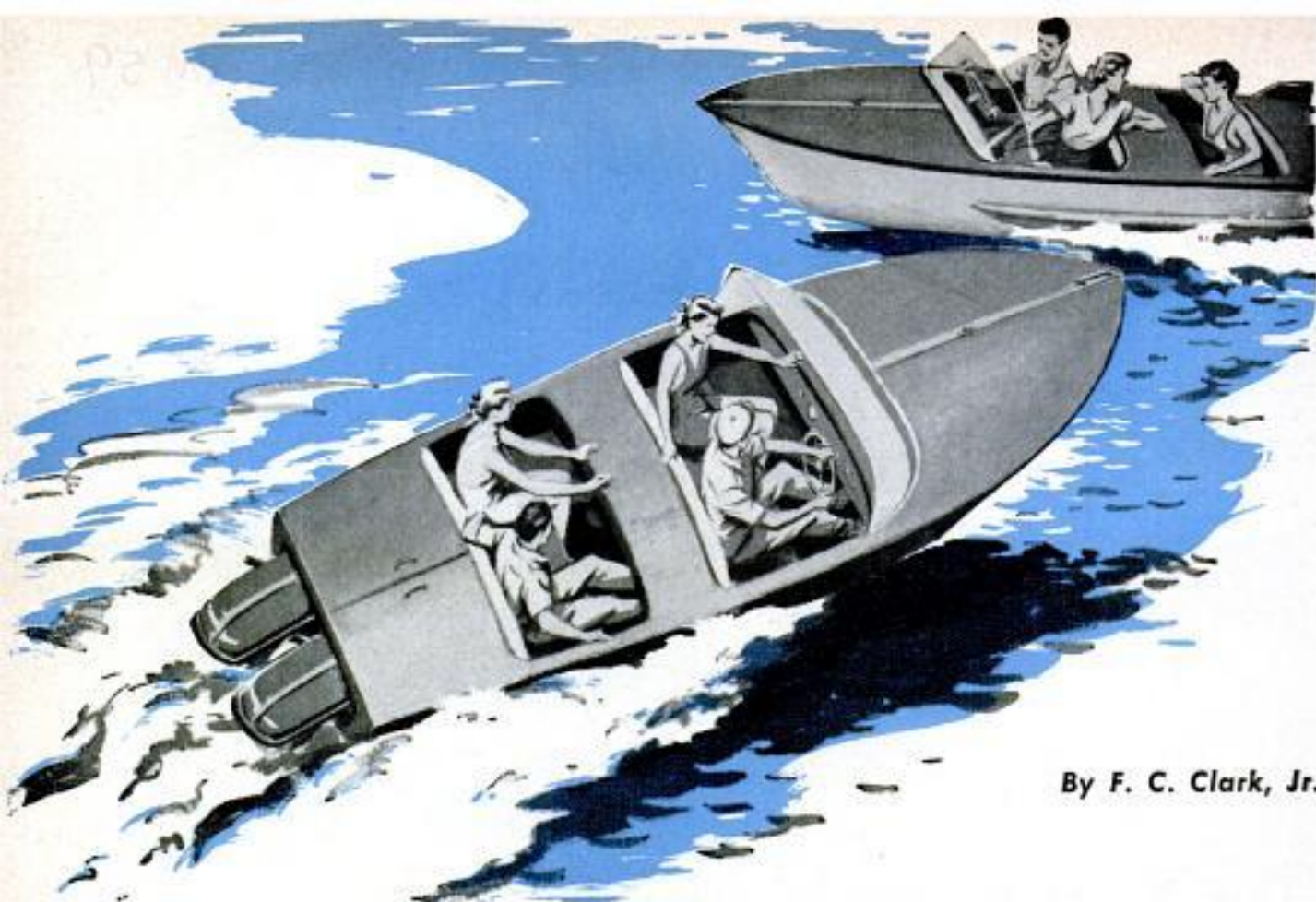

By F. C. Clark, Jr.

You Can Steer Your Twin Outboards Like a Pro—

with this remote-control steering system, which has a tie-rod assembly that permits both motors to pivot as a unit, and a sprocket-and-chain assembly that responds instantly to the slightest turn of the wheel

HERE IS A REMOTE-CONTROL steering unit for twin outboards that you can adapt to your own boat for instant rudder response and a solid feel of the wheel when making tight turns in a race or to avoid a collision. The tie-rod assembly provides positive steering control similar to the type used on cars. The bicycle-sprocket-and-chain assembly is optional and is connected to the steering-wheel and tie-rod assembly as shown in the drawing and details. Conventional steering cables and pulleys may be used with the tiller-bar and tie-rod assemblies, but this non-rigid-type cable system may introduce lag or "soft" steering response, when cables stretch and clamps and other fittings vibrate loose as a result of use.

Using the sizes of sprockets shown, effortless steering, lock to lock, is assured with about $2\frac{1}{2}$ turns of the wheel. Any combination of sprocket sizes that will afford a favorable steering ratio may be used. The length of the tiller bar, cut from $\frac{1}{4}$ x $1\frac{1}{2}$ -in. flat steel, is determined by the dis-

tance from the transom to the bulkhead on which assemblies 1, 2 and 5 are mounted. Also, the lengths of the chains, the two shafts for the sprocket assemblies shown in details 1 and 2, and the steering drive shaft will depend upon the size and design of the hull in which the unit is installed.

For proper operation of the tiller-bar and tie-rod assemblies, it is necessary that the tiller bar pivot at a point that is in line with the pivot points of the motors and be equidistant from them as shown in details 3 and 4. Four complete ball joints installed on two lengths of $\frac{1}{4}$ -in. steel rod threaded on both ends, make up the tie-rod assembly, which is bolted to the tiller bar and to steering clamps on the steering brackets of the motors as shown in the photo. The slide, detail 2, is made of two $2\frac{1}{2}$ -in. lengths of steel angle welded together, with a bolt welded on the underside and three holes drilled and tapped in the top piece for screwing the bicycle chain to it. The 36-in. length of $\frac{1}{4}$ x $1\frac{1}{4}$ x $1\frac{1}{4}$ -in. steel angle used as a track for the slide, is of sufficient

length for most boats and is mounted on the forward side of the motor-compartment bulkhead. Also, the track, slide and sprocket assemblies may be mounted on the inside of the latter bulkhead, if there is room, or on either side of any other transverse member that is suitable.

After mounting the tie-rod, tiller-bar and sprocket assemblies, the tiller bar is marked for cutting the slot that receives the bolt on the slide. This is done by moving the bar from port to starboard and outlining the position of the bolt on the bar at the ends of its swing in each direction.

Since the steering drive shaft turns quite slowly, it can be mounted in maple or oak bearing blocks drilled and cut to fit snugly over the shaft and with or without metal linings. The blocks can be screwed to the frames under the floor boards. Any type of steering wheel can be used, simply by mounting it on a shaft and attaching a sprocket as shown in the drawing. ★ ★ ★



Steering clamps of type shown permit secure attachment of tie-rod assembly to steering bars of motors and quick disconnecting when motors are removed

Except for tie-rod assembly, dimensions of structural members, shafts and chains are determined by design and size of boat in which steering gear is installed

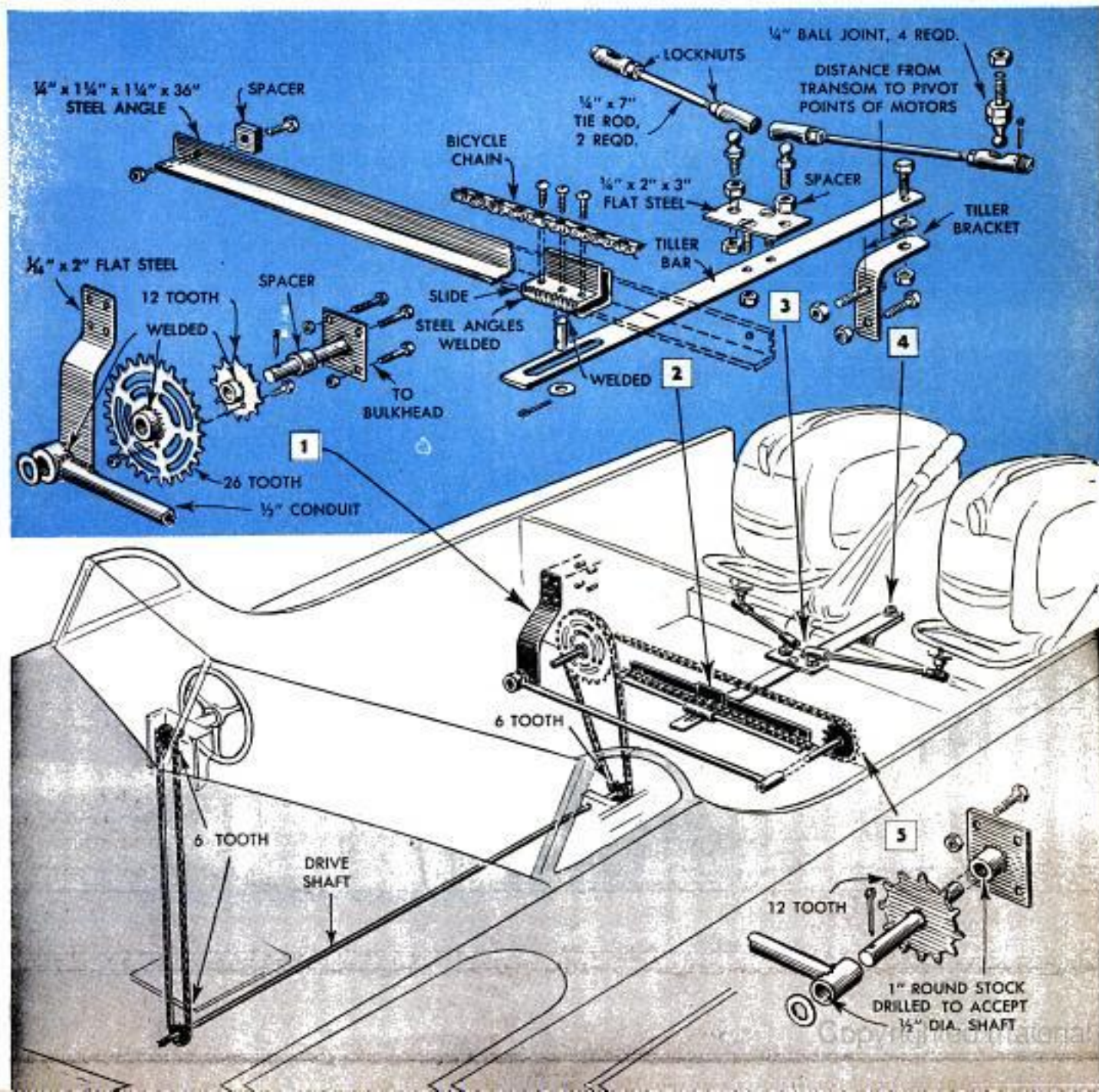



Saw Fitted in Slotted Step Kept Handy on Ladder

To keep a handsaw close at hand, yet out of the way, when working from a step-ladder, fit the saw in a slot cut in the top step as indicated. The slot is made by boring two holes, then cutting between them with a keyhole saw.



Mirror and Magnifying Glass Help Find Particle in Eye

Simplify finding that bit of foreign matter in your eye by holding a magnifying glass between the eye and a mirror as shown. Rest your hand against the mirror to steady the magnifying glass, which still can be moved slightly for proper focus.

Low-Contrast Film Adapted for Line-Copy Work

When a contrasty negative for a line-copy job was needed by one photographer, and there was no process film available, he used panchromatic film and exposed it one stop under the indicated exposure for the shot. Next, the film was developed for twice the recommended time in DK60 de-

veloper, immersed in a stop bath, fixed and washed thoroughly. The film then was agitated in a dilute solution of rapid selenium toner for five min., after which it was washed in running tap water for 30 min. and hung up to dry.

Earle V. Leavitt, Knoxville, Tenn.

Inexpensive Birdbath Made From Household Items

This easily made birdbath consists of an aluminum pie plate, or a pot cover, that is nailed or screwed to one end of a length of broomstick or dowel, the lower end of which is sharpened to a point. Force the point of the stick into the ground and your birdbath is ready.



Parallel Lines Drawn Accurately By Scribing Arcs With Compass

Use a compass to assure that two lines are parallel to each other. Set the points of the compass at the distance required between the two lines, then place one leg on the original line and scribe two or more arcs. A line tangent to two or more arcs is parallel to first line.

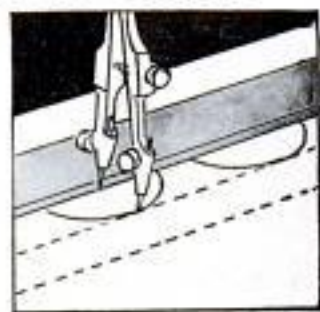

Soaker Hose Rolled Into Position With Reel

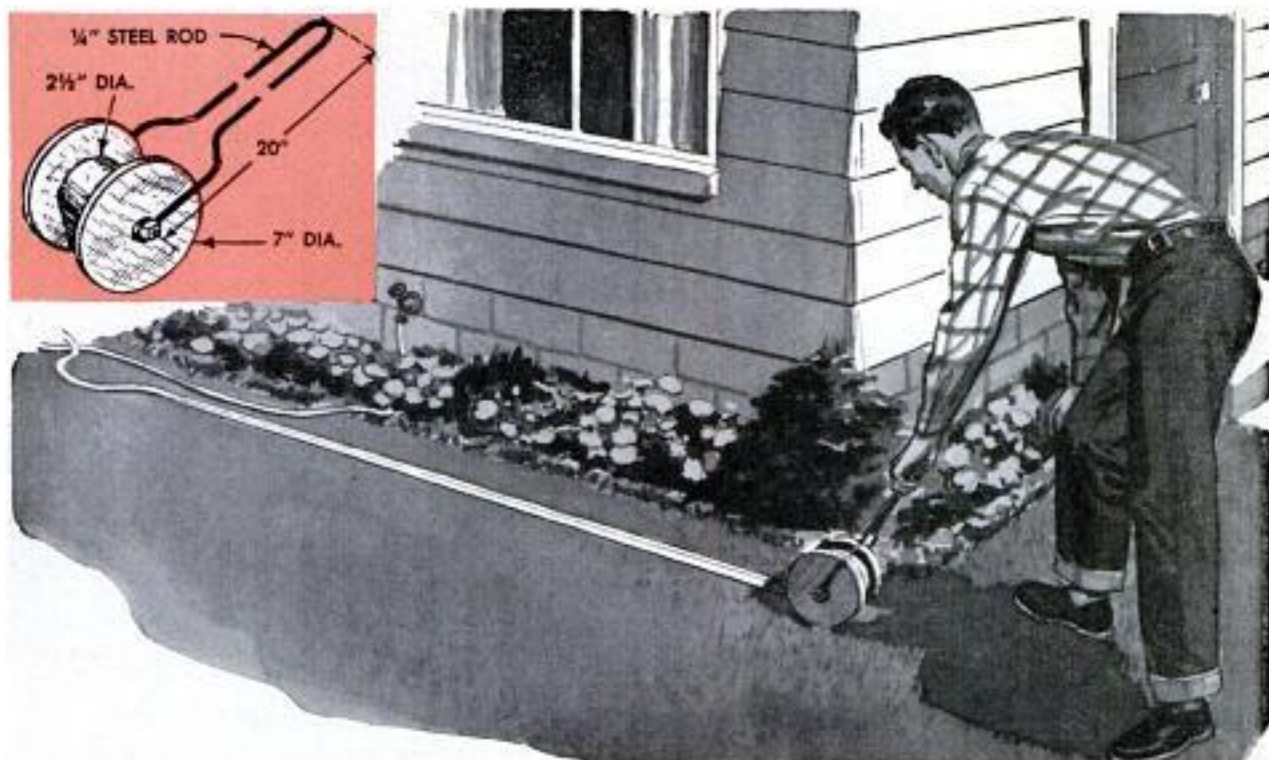

No tangled soaker hose with this handy wooden reel that will pay out the hose just where you want it with little effort. Made of rot-resistant redwood, with a U-shaped steel handle mounted on the axle as shown in the detail, this reel can accommodate 25-ft. of hose and is easily pulled across the lawn or garden. Also, the handle permits convenient storage on a hook. If a hose

longer than 25 ft. is used, it is only necessary to install larger end pieces on the reel. Wood other than redwood may be used for the reel, but it should be well painted or treated with wood preservative. For convenient unrolling and rolling of the hose, the closed end is secured to the drum of the reel permanently.

W. G. Waggoner, Sacramento, Calif.

Egg Slicer Used for Cutting Flat Pieces of Ceramic Clay

An egg slicer of the type shown is an excellent tool for cutting balls of clay into flat pieces of uniform thickness from which small articles such as buttons and brooches are made. When forming round objects, a length of thin-wall tubing is used like a cookie cutter. Cut surfaces are smoothed with a wet spatula.

Walter E. Burton, Akron, Ohio.



Coarse Sandpaper "Smoothed" For Use on Fine Work

When a fine grade of sandpaper is needed and only coarse is available, pass a mill file over the paper a few times. The file will knock off the points of the coarse abrasive grains so that the paper can be used for finer work. A piece of coarse paper that has been well used also will be dulled enough so that it can be used for finer work.—Ken Murray, Colon, Mich.

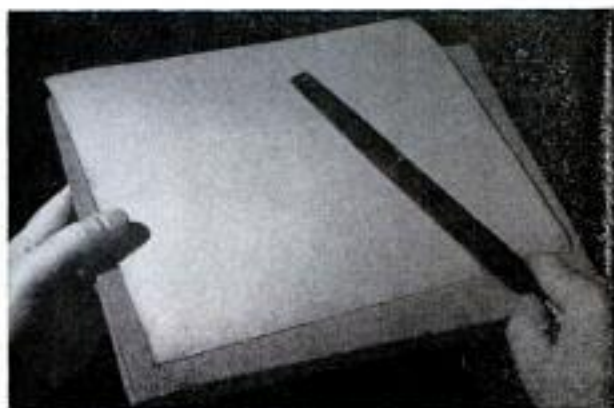



Hose Mounted on Masonry Wall Of Garage Protects Car Doors

To avoid damaging the finish on his car doors when opening them in a narrow garage with unfinished masonry walls, one homeowner screwed a length of garden hose to a strip of wood anchored on the wall as shown. The protective strip is located at door-handle height and extends about 1 ft. in front and 1 ft. in the rear of the points of contact with the doors. Heads of the screws are inside the hose.

Magnet Hung Over Edge of Tumbler Holds Small Brushes off Bottom

To prevent damage to the bristles of small brushes, a small but strong magnet can be used to hold the brushes having steel ferrules off the bottom of tumbler filled with a solvent as shown. A number of brushes can be held in this manner merely by placing the steel ferrule in contact with the magnet at the desired height. Hook the magnet over the rim of the glass.



☐ A pillow case provides a good cover for a drawing while carrying it, especially if such a cover is needed only occasionally.

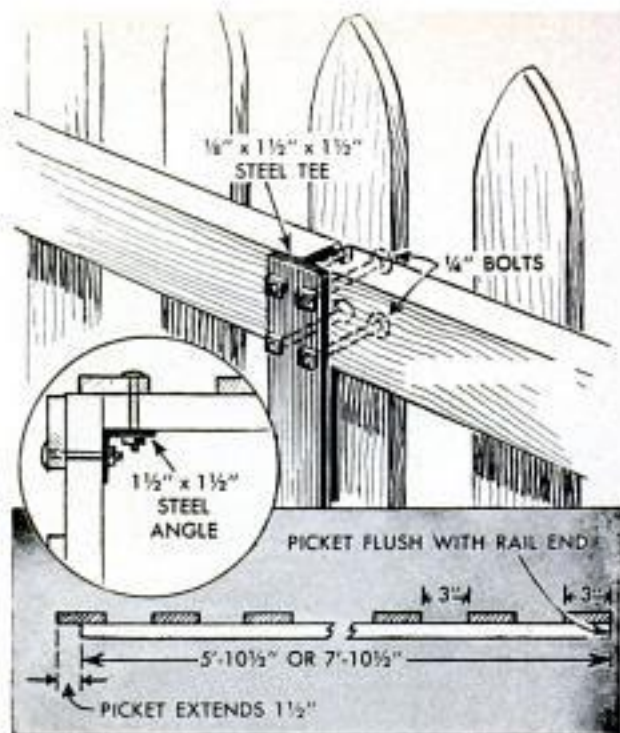

Picket Fence With Steel Posts Easy to Move and Lasts Longer

Picket fences with steel tees used as posts as shown, last longer and can be easily moved to new locations when changing the landscaping. A fence is made of sections 6 or 8 ft. long, consisting of 3-in. pickets nailed 3 in. apart on two 2 x 4 rails. Beginning and corner sections are constructed as shown in the top view and detail. All other sections are the same except that the picket on the right end, top view, is omitted.

Cotter Pin in Door-Latch Bolt Serves as Locking Device

A rim-type door latch not equipped with a pin that locks the latch, can be provided with a locking device in a somewhat similar manner by means of a cotter pin. To do this, a pin is slipped into a blind hole drilled in the bolt as shown. The legs of the cotter pin should be spread a little so that they will have to be forced together when inserting, which prevents the pin from working out.

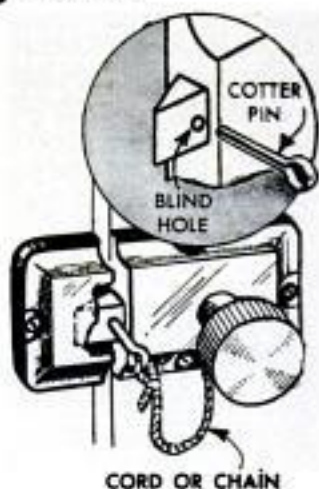

☐ Before mixing cold shortening with an electric mixer, heat the blades in hot water and they are less likely to clog.

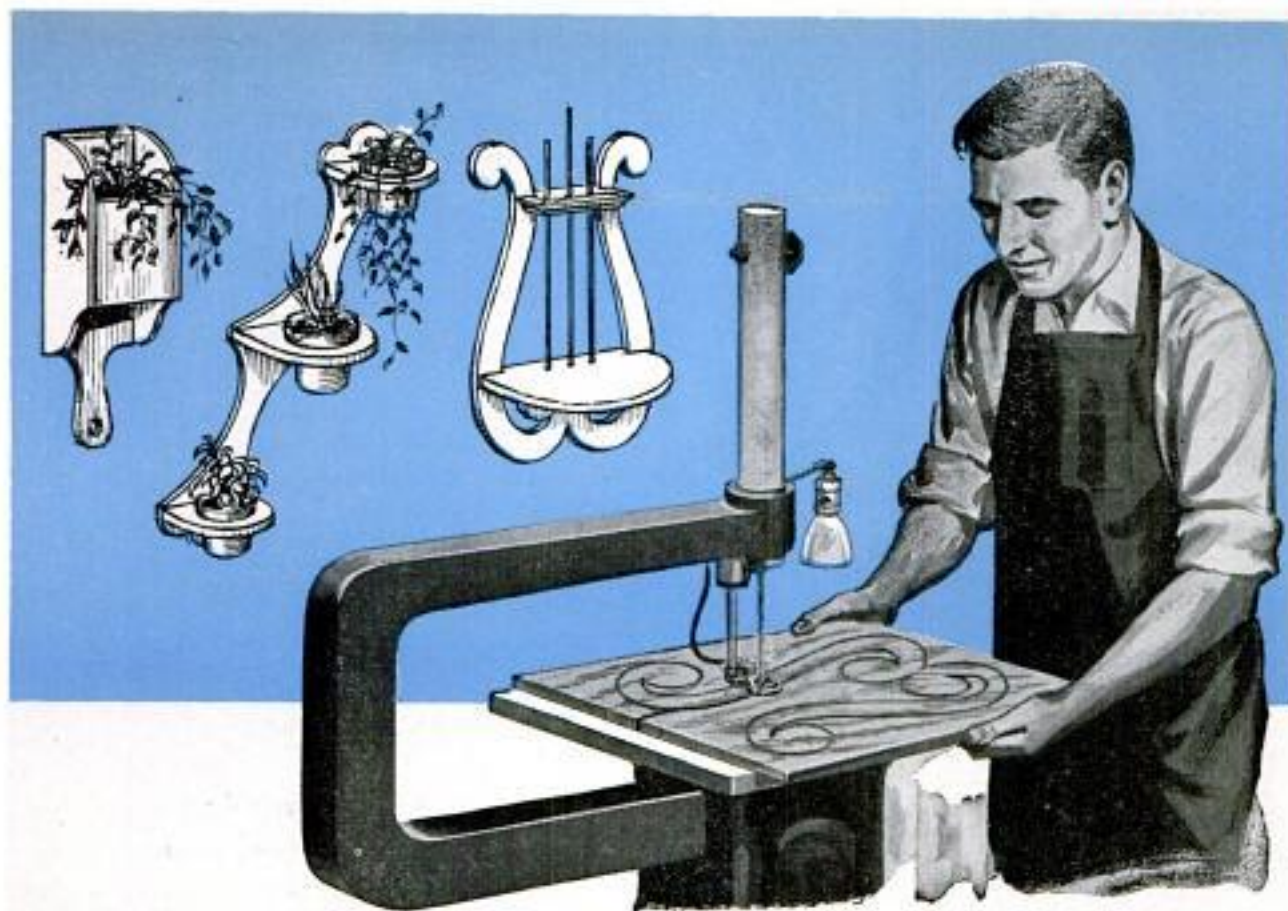

FOUR WALL PLANTERS for attractive display of your plants

POTTED PLANTS grown indoors always are more attractive and more easily tended when they have their own special racks or shelves. And whether your taste and decor run to colonial, modern, classic or conventional, you will find a style of shelf or rack described in this article that will meet your needs. As with any job, power tools will reduce both the time and labor required to make the plant holders, but hand tools are entirely adequate.

Classic Lyre

The classic lyre shape of the shelf detailed on this page can be jigsawed from a single piece of plywood or cut from two pieces of solid stock. In the latter case, one half of the pattern is drawn on one piece of stock, which is placed over another and both pieces are jigsawed at one time. A dowel glued and fitted in blind holes at the point where the side scrolls join will hold the lyre together at the lower end, and the decorative cross piece near the top will hold the upper ends of the lyre in position. Adding the shelf and the vertical members, which can be $\frac{1}{4}$ -in. dowels or brass rods, will give rigidity and strength to the

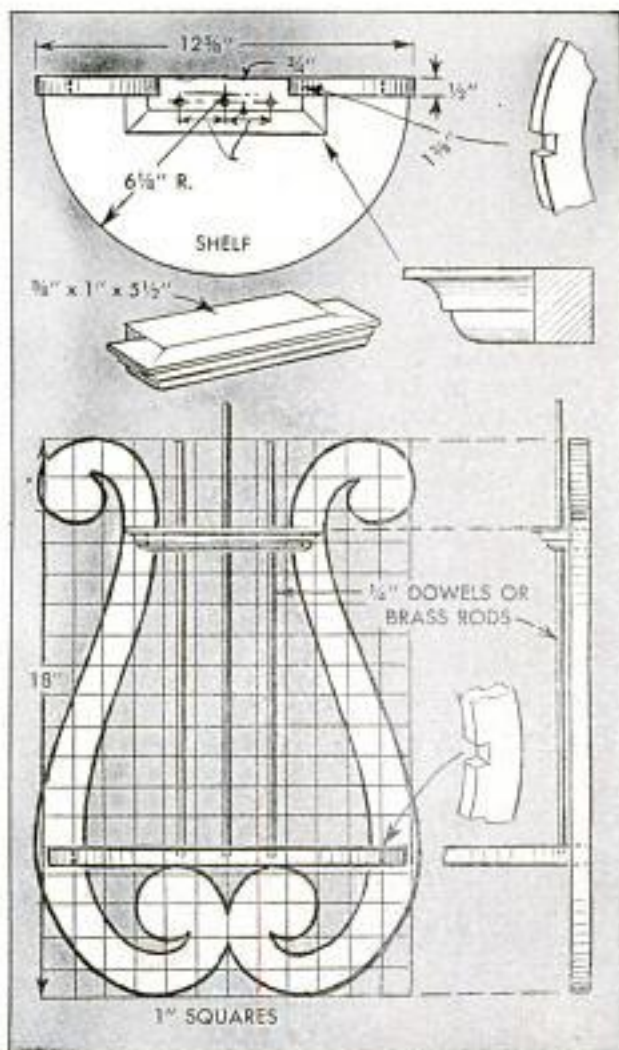

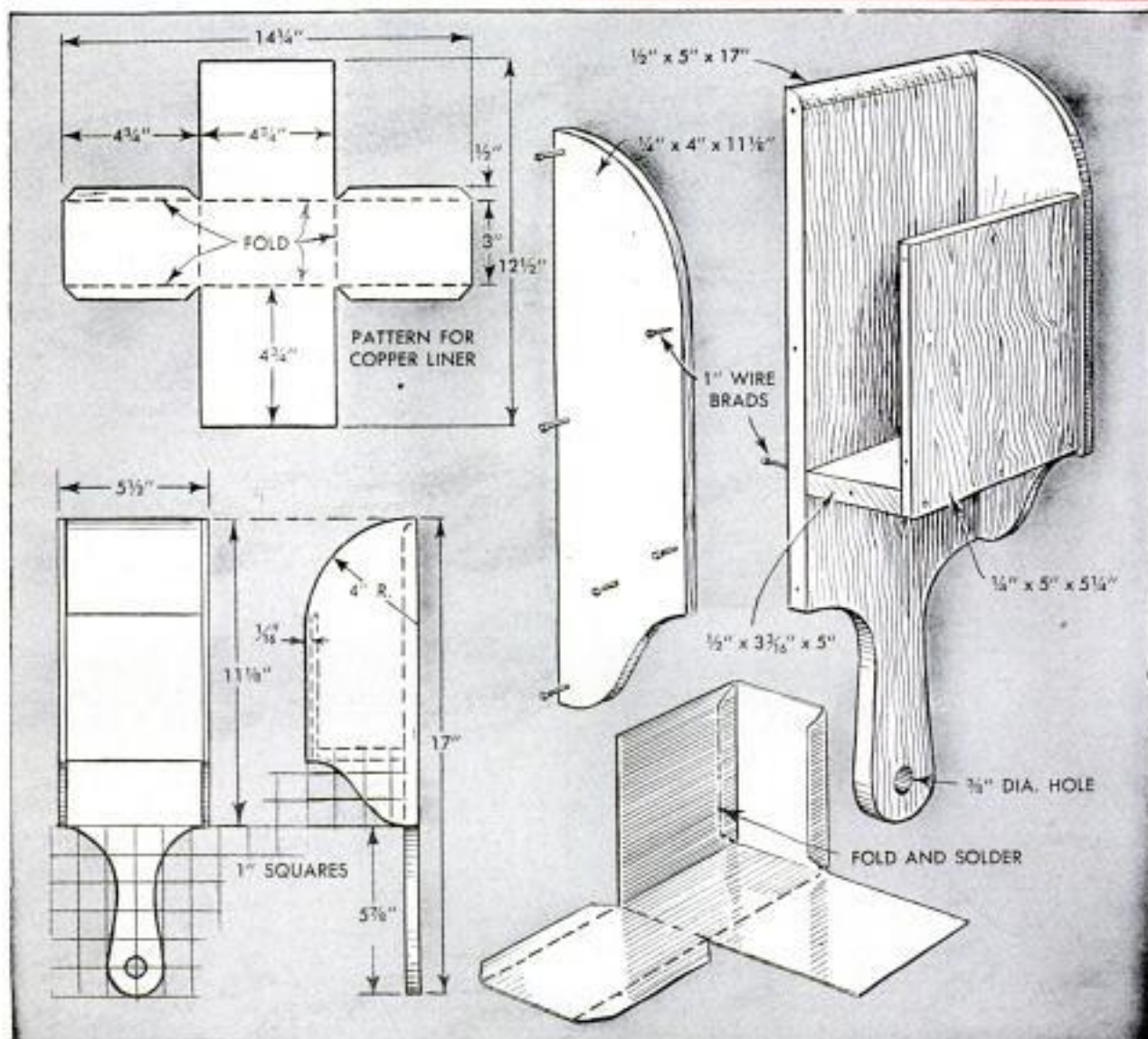
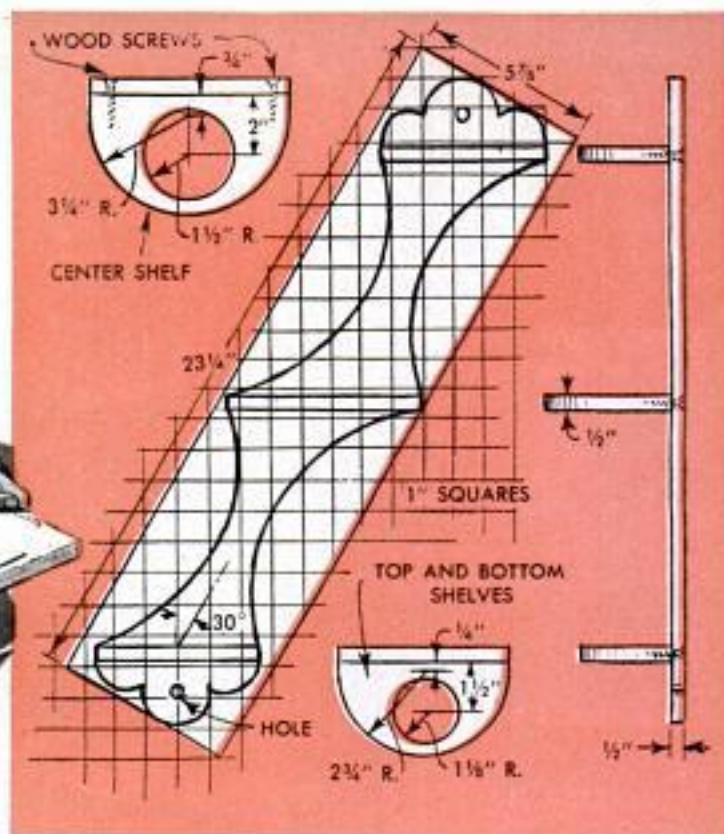

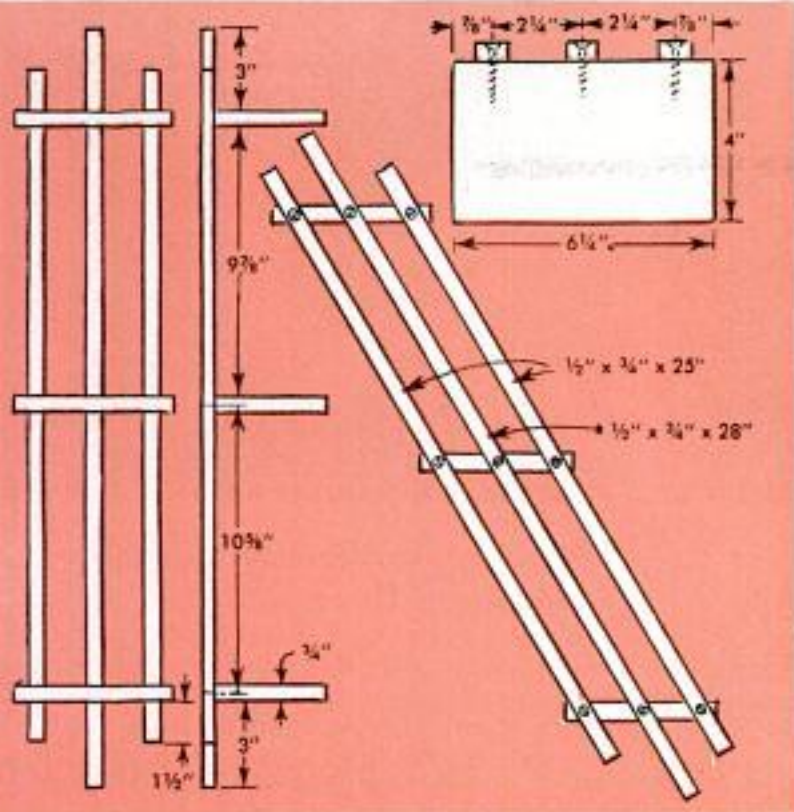

finished shelf. Note that inside edges of the lyre scrolls are notched to accept the shelf and top cross piece, which adds both strength and neater appearance to the finished assembly.

Modern Design

Modern design is featured in the next shelf, which actually consists of three brackets arranged in steps. A hole is bored in each shelf to accommodate flowerpots, as indicated. The top and bottom shelves have a 2 1/4-in.-dia. hole, the center shelf has a 3-in.-dia. hole, so that the larger pot is located on the center shelf.

Again either plywood or solid stock can be used. If solid stock is used, a 2-ft. length of 1/2 x 6 is adequate for the back piece. For greater strength, 1-in. stock could be used. The three bracket shelves are butted against the back piece and fastened with glue and wood screws.

Early American or Colonial

Maple furniture and shining brass provide the decor which goes best with the "flour scoop" planter, but it will look well even in a modern kitchen. Extremely simple in design, only a few curves are required and these are shown on a pattern of 1-in. squares. The curves can be varied from the original for individuality, and both sides of the paddle-shaped back of the planter made identical by first drawing one half of the pattern on a folded sheet of paper and cutting it out to form a full

pattern. The unfolded pattern then can be traced on the stock with a pencil. The two curved sides of the scoop are clamped or nailed together temporarily and jigsawed at one time, to assure that they are the same size and shape. The scoop is designed to have flowers planted directly in it without need for a flowerpot, so a waterproof liner is required. Copper is the best metal to use for the liner, as it is bent easily as well as being rust-resistant. However, both brass and galvanized steel also can be used. Cut out the liner according to the detail, fold as indicated and solder it. The wooden portion of the planter may be made of maple, or pine can be used and stained maple. To blend with more modern decor, the planter might be enameled and a decal added for the final touch. Two holes must be drilled near the upper edge of the planter back to permit hanging or fastening it to the wall. They are not shown on the detail. The 3/8-in. hole in the handle is a touch of realism, but can be used to screw the handle to the wall, if that is necessary.

Trellis-Type Shelf

The last shelf is of more conventional design and is simple to make. It consists of two 25-in. lengths of 1/2 x 3/4-in. stock and one 28-in. length of the same material, that are used to form a vertical trellis to which three shelves are screwed. To provide an alternate design, the screws may be loosened and the back tipped at an angle, as indicated. ★ ★ ★

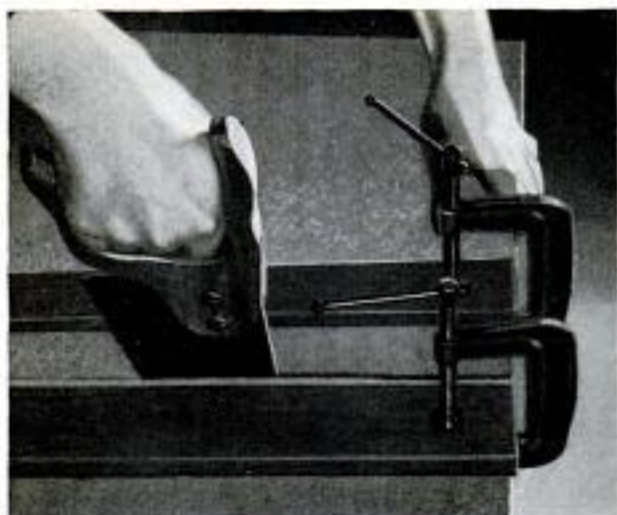

Wooden Strips Dampen Flutter When Sawing Wallboard

The tendency of wallboard to flutter when cutting it with a handsaw can be avoided by clamping two wooden strips at each side of the cut. Apply clamps at both ends of the strips. This stiffens the wallboard so that it cannot flutter with each stroke of the saw. Strips of 1 x 4 will do.

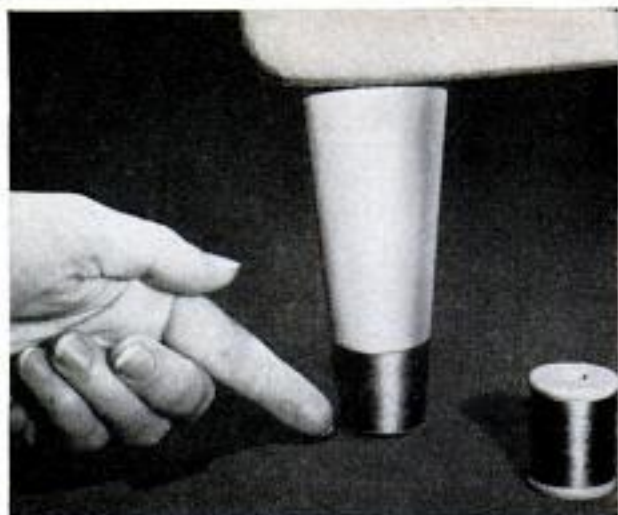

"Ferrules" for Furniture Legs Made From Thread

If you want to add something to the short, plain, round legs on furniture, try providing each with a thread "ferrule" at the bottom. Thread such as used on fishing rods is ideal and comes in many colors. Wind it tightly and closely and then coat it with clear shellac or lacquer.

Tape Guide on Level Vial Speeds Setting Sidewalk Forms

The job of setting sidewalk forms can be speeded up by using tape as a guide on the level vial. Position the tape so it centers the bubble when the forms are at correct pitch.

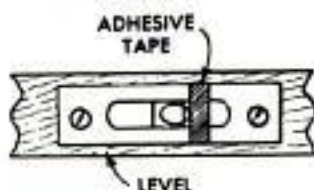

Altering Worn Eraser to Use It Effectively

Difficulty in using a circular-type eraser after it becomes worn on one side may be overcome by pinching the metal frame to grip the eraser. This holds the unworn part in place.



Rubber Bumper on Lawn Mower Protects Trees and Shrubs

By cutting a length of garden hose spirally, it can be "threaded" onto the crossbar of a lawn mower to serve as a bumper to protect trees and shrubs when mowing around them. The hose can be cut easily if a dowel is inserted in it.

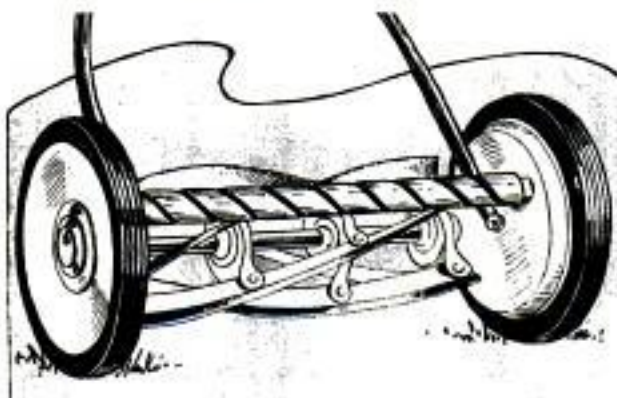

Modified Mechanical Pencil Is Miniature Grease Gun

If you need a miniature grease gun for lubricating small mechanisms, one can be made from a mechanical pencil. Remove the mechanism, fill the barrel with grease, then make a plunger from a tightly packed ball of cotton and a length of dowel.

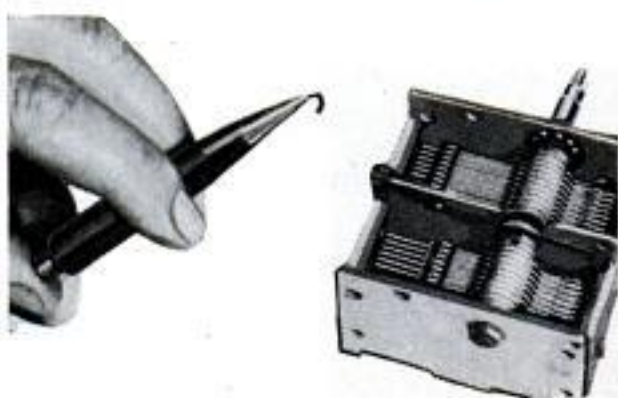



Avoid letting newspapers, magazines, handbills and mail accumulate at your entrance during an extended absence. Such "advertising" practically invites prowlers inside to strip the premises at their leisure

Outsmarting the Housebreaker

By Enno R. Haan

RETURNING TO FIND your home ransacked can take all the enjoyment out of a vacation or an evening out. Unfortunately, many persons actually invite such theft by advertising their absence without realizing it. The chances of having your home burglarized can be minimized by a few common-sense precautions.

First: Avoid telltale clues that advertise your absence and thus invite housebreakers, who usually prefer to work when occupants are gone. Second: Make provisions to mislead and confuse would-be intruders as they usually try to avoid needless complications, trouble and risk. Third: Lock all doors and windows whenever you leave and install additional fastening devices as may be necessary. The average housebreaker prefers places that are easy to enter. Fourth: Inform the police of your vacation absence so they can check up daily. Also ask neighbors to keep an eye on the place for any signs of activity. Fifth:

Leave your jewelry and other valuables in a bank safety-deposit box, in a burglar-proof safe or with trusted relatives or friends. Although these measures, or any others, do not make a home burglarproof, they are nevertheless effective deterrents. A burglar-alarm system may be installed also as an added preventive measure.

Lights, Shades and Radio

A dark house having the front entrance or porch light on as in Fig. 8 is a dead giveaway that the occupants are absent for the evening. A dimly lighted front hall or living room does not fool a smart prowler. A lighted bathroom is much more effective, but it's even better to have the house illuminated as usual. Most of the window shades and drapes should be open so that neighbors can notice the presence of an intruder. **Leaving your radio turned on during a few hours' absence does not cost much and suggests that someone is home,**

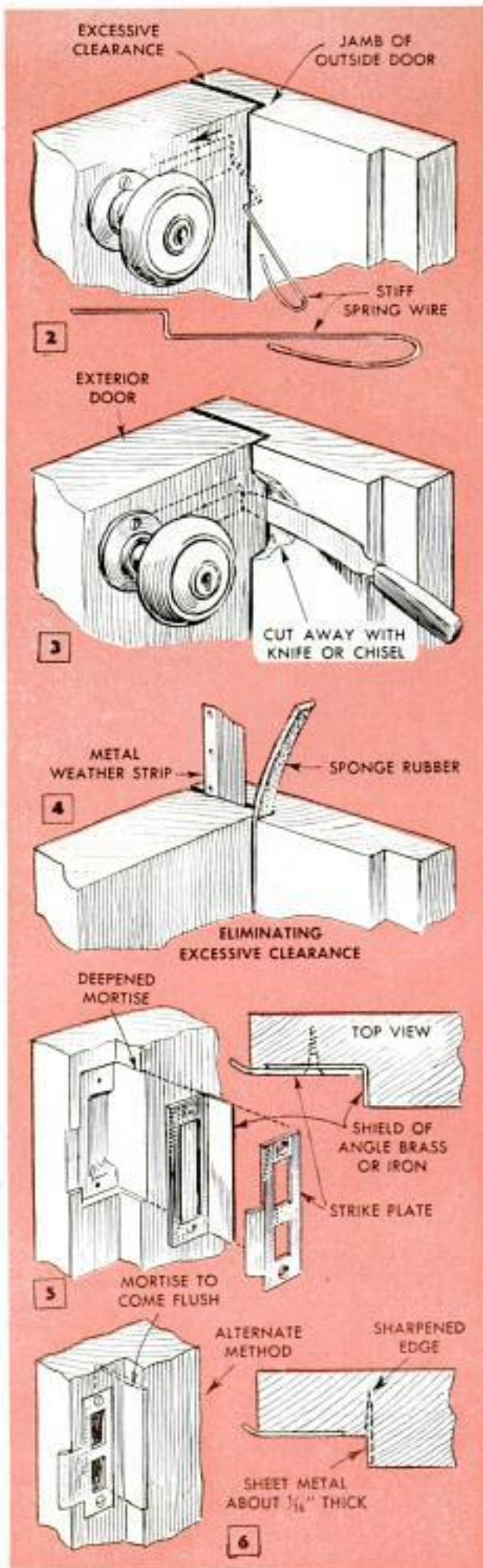

Old-time naive habit of "hiding" key under mat or in mailbox is like handing it to a burglar as he habitually checks these places first for easy entry

provided that the prowler cannot look into rooms completely. However, some rooms should not be entirely visible from the outside as this enables a prowler to check whether the house is unoccupied.

Clues of Absence at Doors

Accumulated newspapers, magazines, circulars, etc., at your front door and stuffed in the mailbox, Fig. 1, betray absence. Thus alerted, a prowler can move in with comparative safety. To prevent such evidence, have your newspaper deliveries discontinued during your absence and have the mail held at the post office or forwarded to you. Then ask a neighbor to pick up circulars and packages and remove "have called" signs sometimes hung on doorknobs.

An array of milk bottles at a back door is another urgent invitation to a prospective prowler. A note left for a milkman to discontinue milk may be read by someone else first. Use the telephone to cancel milk deliveries. Also avoid newspaper comments on a pending trip; no one will read this with greater personal interest than a housebreaker. Don't leave door keys under mats, Fig. 7, in mailboxes or other hiding spots for the convenience of other members of the family. These are the first places that prowlers investigate for easy entry. Have each member of the family carry a separate key without any address attached.

Making Door Latches Hard to Open

Many door latches can be opened easily by using a length of spring wire, as in Fig. 2, a thin knife blade or a screw driver. This will be more difficult to do if excessive clearance between the door and jamb is eliminated by installing weather stripping as shown in Fig. 4. However, leave the normal $\frac{1}{16}$ -in. clearance between the door and jamb to allow for expansion. Most outside doors have rabbeted doorjamb but it's easy to cut away some of the wood with a jackknife or chisel to permit inserting a thin blade as in Fig. 3, to pry the latch



8 Leaving an entrance lamp lighted, but the rest of the house dark and quiet when you're out for the evening, is another "polite" invitation to prowlers

loose. To prevent such jimmying, you can install a piece of angle brass or steel as in Fig. 5, or a piece of flat steel sharpened at one edge and driven into the jamb as in Fig. 6.

Interior doors sometimes serve as entrances to dwellings as, for example, the doors in the hallway of an apartment building that give access to the apartments; also the doors between houses and attached garages that are left open or unlocked. Inside doors generally have stop strips nailed or screwed to the jambs and these can be pried up to get at the door latch. To make such doors more foolproof, eliminate excessive clearance between the stop and door by relocating the stop strips. Then attach them more securely with ring-type drive nails, two or three of which should be located near the lock. You can also install shields as shown in Figs. 5 and 6.

A crude but effective method of jimmying a door open is to insert the end of a crowbar, or similar tool, between the door and the jamb and apply brute force to disengage the latch from the striker plate. This method of entry can be made difficult by providing additional holding devices that do not respond to this action.

Install Locks Having Dead Bolts

Entrance doors should have foolproof cylinder locks equipped with dead bolts or dead latches. These cannot be pried open with a wire or knife like an ordinary latch. A dead bolt on a cylinder lock, such as the mortise-type entrance lock shown in Fig. 9, works independently of the doorknobs. The dead bolt can be opened or closed from the inside with a turn button and from the outside by means of the door key. Tubular-lock sets, such as shown in Fig. 10, have a latch only but this can be deadlocked to give the same security as a dead bolt.

Adding Auxiliary Fasteners

In many homes only the front entrance is provided with a tamperproof lock and

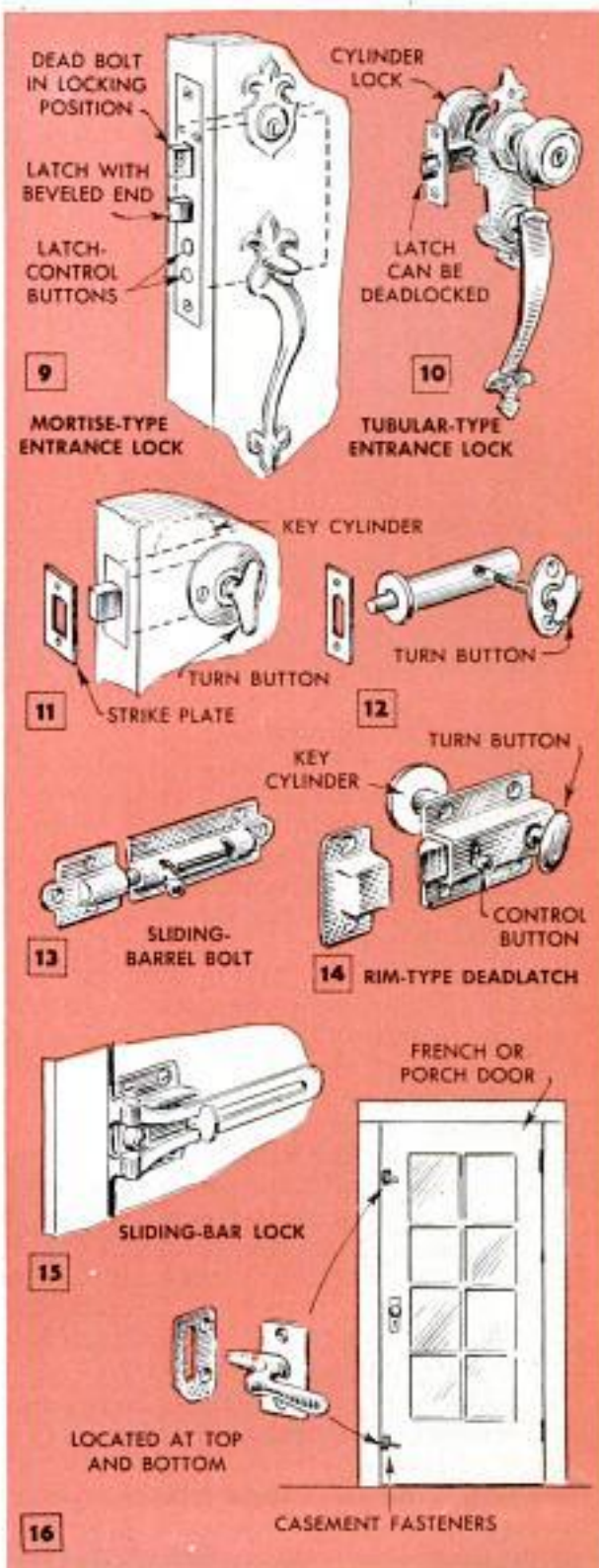

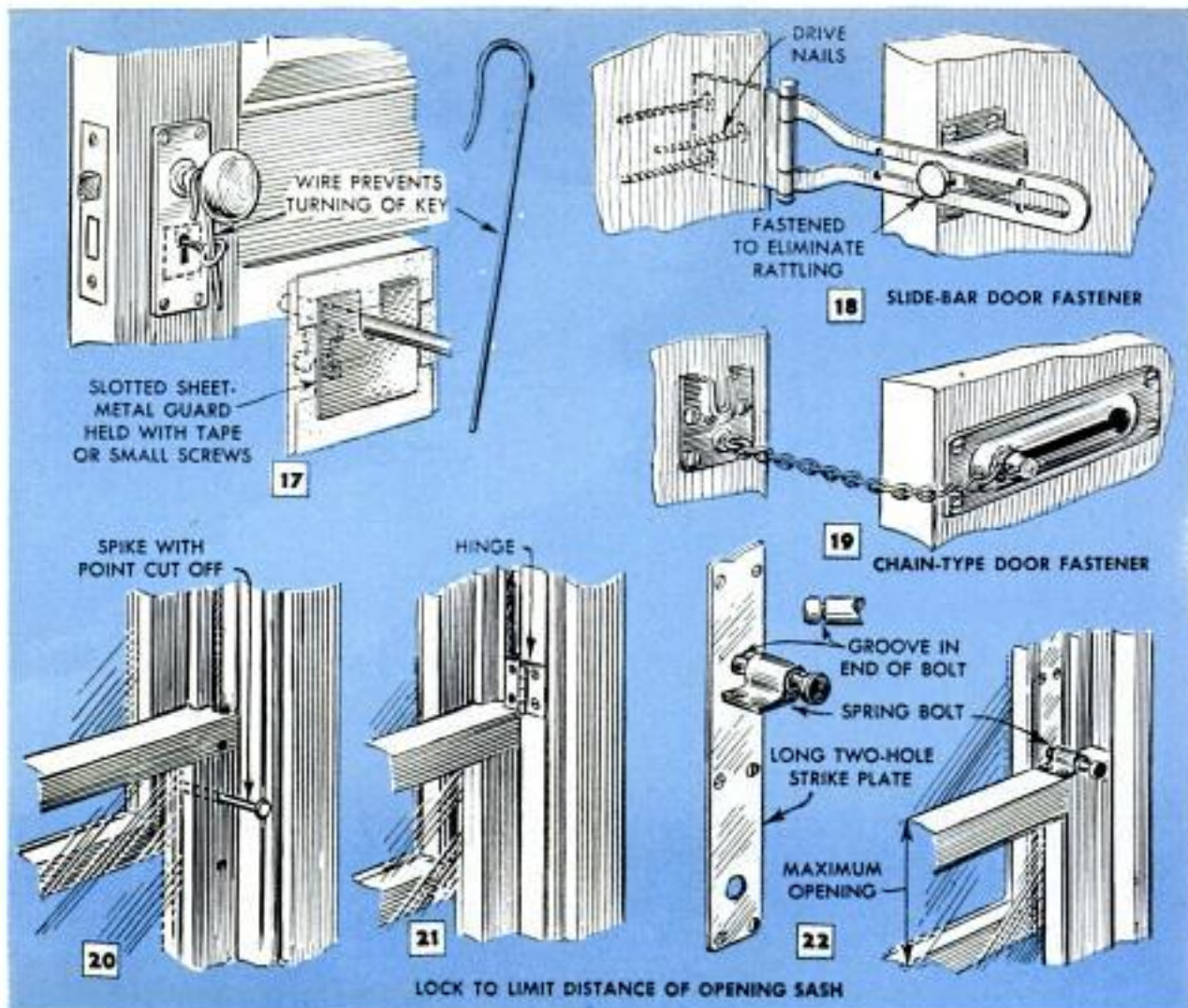

the other doors have locks of little or no security value. These doors should be provided with separate bolts or dead locks, or other auxiliary locking devices of equal effectiveness. A sliding bolt of the tubular type is least conspicuous as it is housed inside the door. It may be operated from the inside with a turn button and from the outside with a key, as the one shown in Fig. 11. A simpler style that is operated from the inside only is shown in Fig. 12. A barrel bolt, Fig. 13, or a rim-type latch may be operated from the inside and outside as the one shown in Fig. 14, or from the inside only. The kind that can be dead-locked offers maximum protection.

An alternate arrangement consists of a bar fastener of the kind shown in Fig. 15. For doors that open onto screened porches, patios or decks, extra security is gained by installing casement fasteners, Fig. 16, at both top and bottom of the doors.

Built-in milk and package boxes near kitchen-entrance doors may provide a means of intrusion even though they are themselves too small to permit entry. When not equipped with an adequate lock on the inside door, they can be opened and then

may permit manipulation of a wire hook to open the door. In some cases it is even possible to extend an arm through an open milk box and reach the lock of the door.

Practically no security whatever is offered by bit-key locks that are often found on back doors. Leaving the key in the lock on the inside offers no protection as it can be pushed out or gripped by a special tool and turned. About the only way to prevent the key from being turned is to hold it with a stiff-wire hook as shown in Fig. 17. To prevent the key from being pushed out, you can insert a slotted, sheet-metal guard under the keyhole escutcheon, or plate, as is also indicated in Fig. 17. Screen door hooks are no deterrent to a prowler as he simply slashes the screen to loosen the hook.

Locking Partly Opened Doors

Bar fasteners and chain fasteners, Figs. 19 and 20 that are commonly used to keep out intruders when a door is partly open, are installed so that a person outside cannot loosen them by reaching inside. Spirally grooved drive nails should be used to fasten parts that attach to the jamb. Or,

SHOULD READ 18 and 19

flat-headed wood screws can be used, the slots being filled with solder after installation, which prevents their easy removal with a screwdriver.

Secure Window Fasteners

When doors are hard to open, prowlers turn to windows that are not easily observed by neighbors. Double-hung windows—those having an upper and lower sash—can be locked effectively by means of the usual crescent-type sash locks installed at the parting rails. However, they provide no security when the sash are left partly open for ventilation. Therefore, it is advisable to fit windows with supplementary locks that limit the distance that the sash can be opened. Some of these locks can be opened easily from the outside with a length of wire or a flat blade. The homemade arrangement shown in Fig. 22 consists of a spring bolt which engages holes in a strike plate. The latter is screwed to the upright of the upper sash. It is difficult to open from the outside, particularly if the bolt has a groove at the end as shown in the detail. The groove should engage the edge of the strike plate automatically when either sash is opened the maximum distance. The reason for a long strike plate extending to the top of the sash is to prevent the sash from being marred by the bolt sliding over its surface. The bolt also enters the lower hole automatically when the window is closed, and thus assures a locked window even though the center lock may be forgotten. Figs. 20 and 21 show two other methods of locking partially opened windows.

Outswinging casement windows having crank-type adjusters cannot be opened easily when they are closed or slightly open—not far enough to permit inserting a heavy-wire tool or an arm to reach in and turn the crank. Casement windows that swing inward can be held by means of regular casement fasteners like doors as shown in Fig. 16, or by means of bar fasteners. The latter will hold the windows locked when they are completely closed or slightly open. Using chain locks or hooks and eyes for this purpose does not eliminate movement and rattle.

Hooked screens in front of windows offer no protection at all as it is so easy to slit them and then open the window. Basement windows are likely to be inadequately locked. Second-story windows often are accessible from the low roof or deck of a porch or garage, or by means of a ladder conveniently acquired by the prowler on the premises. With this in view, it's best to keep a ladder inside the house or in another locked building. ★ ★ ★



Small Flower Vase From Test Tube Fitted in Candleholder

For an attractive bud vase or holder for water-grown plants, such as philodendron, simply insert a test tube in a candleholder as shown. Also, the glass tube some brands of cigars are individually sealed in can be used for this purpose. If necessary, a rubber ring may be used to secure the bottom of the tube in the holder.

H. T. Gunderman, New York City.

Paper Cup for Mixing Paint Held in Plastic Container

A paper cup held in a small plastic container used for cheese spread provides a convenient paint-mix can for small paint jobs. The disposable paper cup eliminates some of the work of cleaning up and avoids having messy paint cans around the shop.



☞ Place a few pennies in a goldfish bowl to keep the green scum from forming.

Guide Strips on Sides of Roof Help Amateur Shingler



If you have trouble keeping the sides and lower edge of a roof straight and neat when applying shingles, try the following kink. Flush with one edge of a 1 x 2, nail a $\frac{3}{8}$ -in. lath or other wood strip, and then nail this assembly to the edge of the roof as indicated, allowing the 1 x 2 to project above the roof a distance at least equal to the thickness of the shingles to be applied. Apply the strips to both sides and the lower edge of the roof. The strips provide guides to keep the roof line straight and uniform, and the lath assures the correct overhang of shingles. Guide strips are later removed when the shingling is completed.

Walter L. White, Indianapolis, Ind.

Notched Shelf Holds Fishing Rods

To provide a handy place for storing casting rods in a cabin, just cut some notches in an existing shelf in the cabin. Height of the shelf is immaterial as the rods are supported against the line guides and can be set in the shelf at any height necessary to keep the lower end off the floor.—G. E. Hendrickson, Argyle, Wis.

Tin-Can Rack Provides Storage For Garden Tools

Two large tin cans having both ends removed and nailed to a stud in the garage or tool shed will provide a good rack for storing handled garden tools. Such a rack also is ideal for storing rod and pipe. Ideal, too, for clothesline props.

Stanley Clark, East Bradenton, Fla.



Locking Screw in Eyeglasses

Loss of tiny screws from a pair of eyeglasses with possible breakage of the lens, may be avoided by locking the screws in place. This can be done with a drop of auto-windshield sealer, which is available at most auto-supply stores. Be sure that the frame adjacent to the screw is clean and then apply a drop of the sealer with a toothpick. Contacting both the screw-head and the frame, the sealer prevents the screw from turning. This idea may also be used to hold small screws in assemblies where vibration has a tendency to loosen them.—Andy Vena, Philadelphia, Pa.

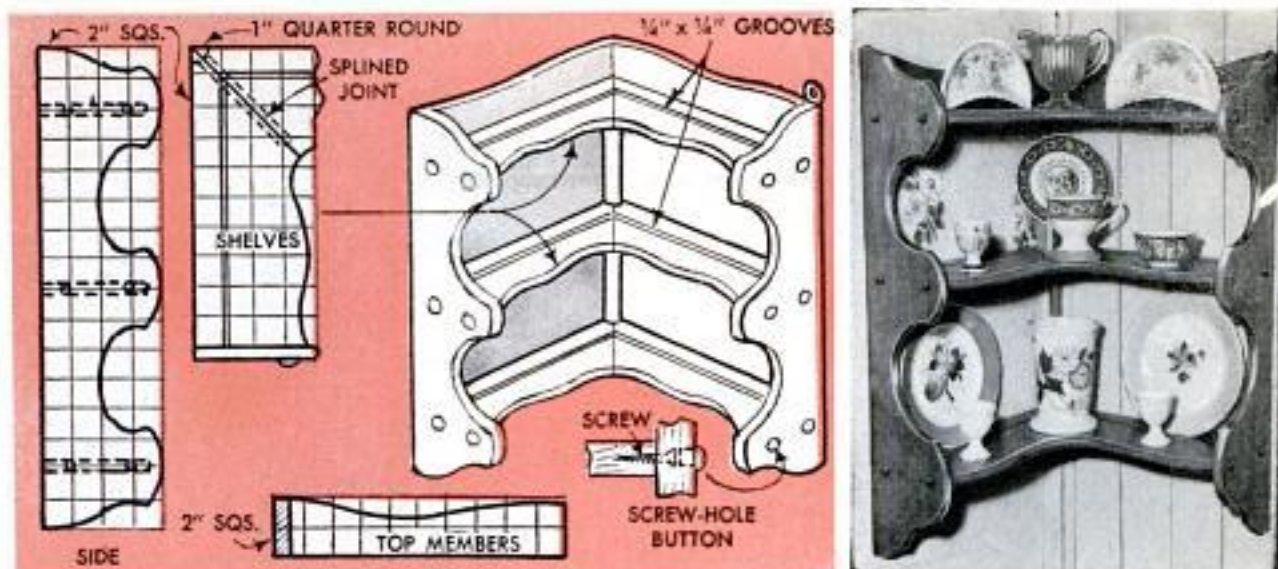

"Antique" Rack to Display Your Show Dishes

Antique dishes and bric-a-brac will be shown to better advantage if the display rack also is of antique design. This corner rack is ideal for the purpose. Made of $\frac{3}{4}$ -in. birch, the rack may be used without a back as shown in the photo, or it may be provided with one of $\frac{1}{4}$ -in. birch-faced plywood as indicated in the detail. If power tools are not available, $\frac{1}{4} \times \frac{1}{4}$ -in. cleats

may be substituted for the plate grooves in the shelves, and the splined center joints of the shelves can be assembled with corrugated fasteners driven in from the underside. Hangers at the outside corners are made of flat steel and mortised flush into the edges of the side pieces. Screw-hole buttons used to hide screw heads in these pieces are available at most lumberyards.



Support for Heavy Parade Flag Improved From Work Rubber

When his troop was called on to parade and there was only a minimum of equipment, one scoutmaster used a heavy work rubber to improvise a support for carrying a heavy flagstaff. The heel section of the rubber was cut away and the sole slotted to accept a belt. The toe of the rubber then provided a socket for the flagstaff.

Checkers Strung on Needle Stored in Mailing Tube

To prevent checkers from being mislaid when they are stored, drill a hole through the center of each and slip it over a knitting needle. Press a cork over the point of the needle to keep the checkers in place and then slip the assembly into a mailing tube, using another cork in the opposite end.

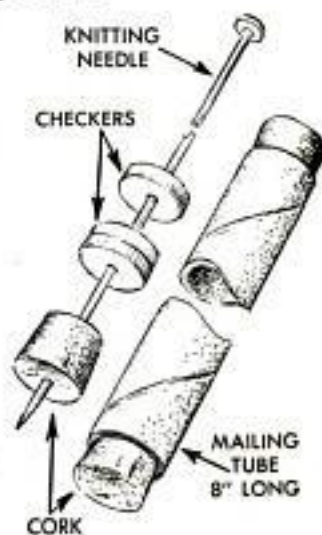

X501



DIVING FLOAT

For more enjoyable water sports, build your dock, diving float, launching ramp or boathouse on—

PLYWOOD PONTOONS

INEXPENSIVE, EASY-TO-BUILD pontoons are the answer to your problem if there is need to frequently rebuild a dock or other pile-supported marine facility because changes in the water level have made it unusable. A pontoon, such as the one

shown in the drawing, can be used as the basic unit upon which to float the structure desired, such as the ones illustrated.

Two of these pontoons with a platform nailed on top of them provide a diving float. A diving board and other equipment

Basic unit for floating ramp, boathouse, deck and diving float is plywood pontoon 8 ft. long and 4 ft. wide

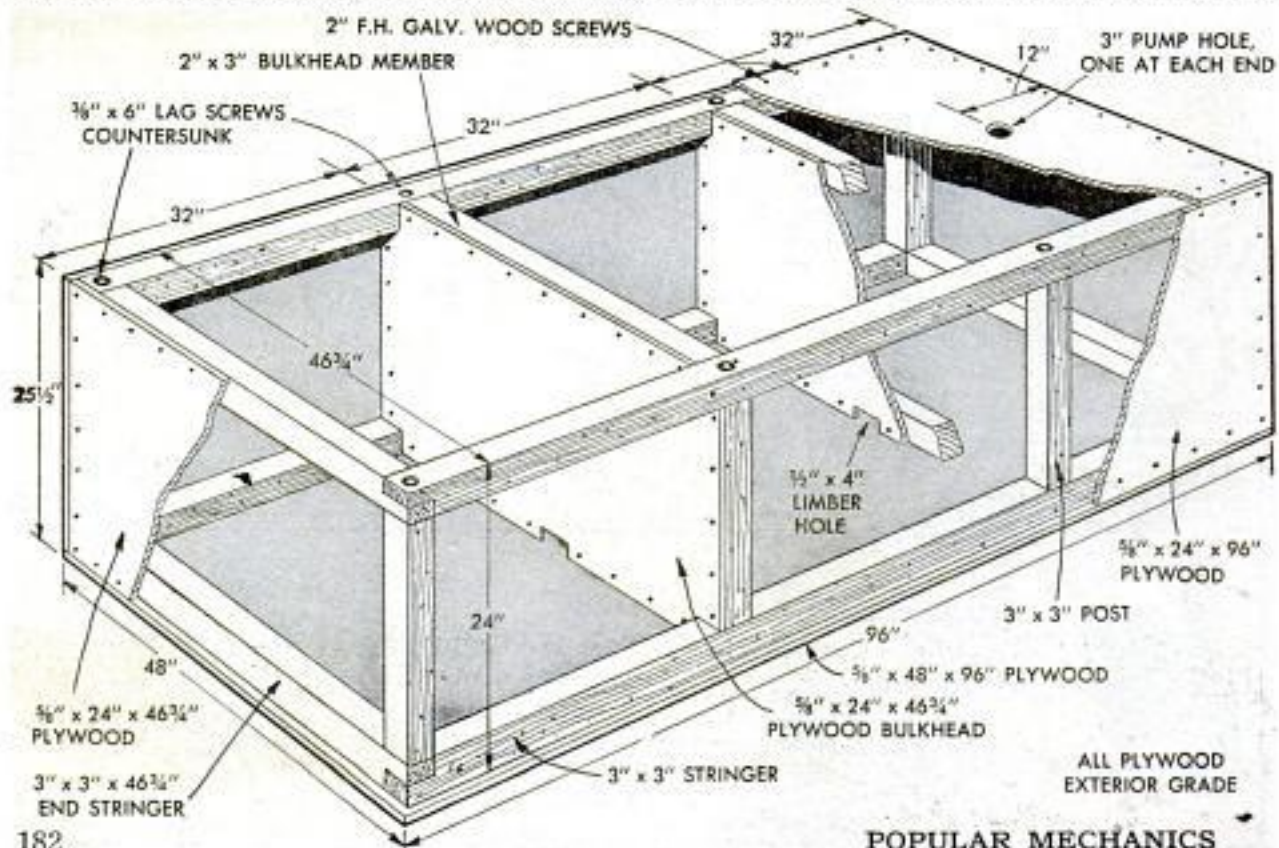

can be added as necessary. In some cases, as when the pontoons are used for a dock or boat-launching ramp, the $\frac{5}{8}$ -in.-thick plywood tops serve as a dock. Additional decking is unnecessary.

Maximum buoyancy of one pontoon is 3650 lb. initially, but it can be ballasted with water to gain the desired depth. Only exterior-type fir plywood should be used for the pontoons. Three types of protection may be used to prevent deterioration of the plywood. Pontoons may be pressure-treated with creosote if a pressure-treating plant is located in the vicinity, or they may be covered with glass fiber, although the latter does not give the protection against decay that creosote treatment provides. The third type of protection involves painting the pontoons as you would the hull of a boat, using a good grade of marine paint. A final coat or two of anti-fouling paint below the water line will discourage marine growths.

A 3-in.-dia. hole cut in the top of each pontoon permits inserting a hand-operated bilge pump, obtainable at most marine-supply stores, for removing water should the pontoon leak. Although some taking on of water is to be expected at first, a well-constructed pontoon will stop leaking soon after it is launched. It is a good idea to paint the inside of the pontoons to reduce water absorption by the plywood. ★ ★ ★

Top of page, launching ramp is automatically raised or lowered as water level changes. It is secured to sea wall and two piles

Center, floating boathouse anchored offshore because water is too shallow at landing. Overhead door permits easy entry of boat

Below, 2 x 4s bolted to pontoons permit dock held by unattached piles to rise and fall freely with changing water level

Information courtesy Douglas Fir Plywood Assn.



BOAT-LAUNCHING RAMP

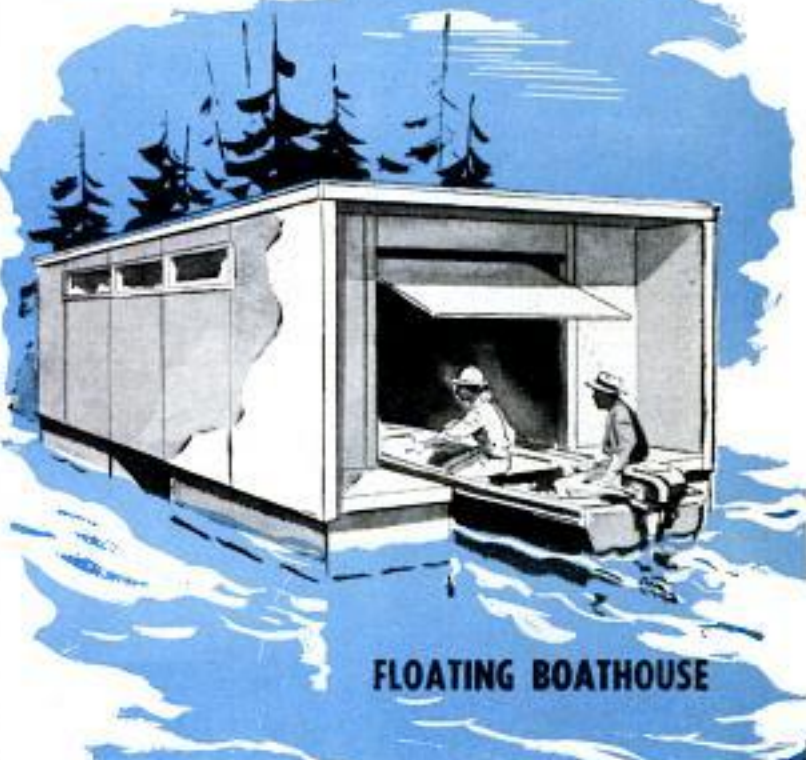

FLOATING BOATHOUSE



PONTOON DOCK



Bag With Plywood in Bottom Keeps Fish Alive Longer

Burlap bags were found to do a better job of keeping the catch alive by one fisherman, when he inserted one bag within another and fastened a short length of marine plywood in the bottom of the inside bag. Without provision for keeping the sides of the bags extended when lifting them out of the water, the burlap tends to bind the gills of the fish and suffocate them. A 1 x 2-in. strip of wood nailed over the bottom seams of the bags, as shown in photo, holds the plywood in position. The plywood is slightly smaller than the bottom of the bag and the corners rounded to prevent tearing the burlap. Nails holding the two strips are clinched on the bottom.

Plant-Lined Creel Preserves Freshly Caught Fish

One method of keeping a catch fresh during a day's fishing is to drop the fish in a woven creel that has been lined with grass or other available plants and submerged in a cool area of a stream, or dropped over the side of a boat. Water-lily leaves, grass and stems or swamp moss are used to line the creel, and a few clean pebbles in the bottom keep the creel submerged, but with the top above the surface of the water. At

the end of the day's fishing, the catch should be cleaned, then repacked in the creel with fresh, moistened plants. The fish can be transported for a short distance when packed in this manner, but for longer trips the fish should be packed in ice or placed under refrigeration in a portable icebox of the type that can be stowed easily in the trunk of a car.

Ben C. Robinson, Newcomerstown, Ohio.



ADD THOUSANDS OF DOLLARS TO THE VALUE OF YOUR HOME...

New PM Book tells and shows how to handle power tools like an expert—and make valuable property improvements

A thorough knowledge of power tools and how to use them will enable you to perform hundreds of major and small projects around your home at *tremendous savings*, and *increase its value* significantly. Now, with the aid of a new Popular Mechanics book, "Getting Started with Power Tools", it's easy, fun, safe . . . and with no previous experience you'll be able to do more home remodeling and repair jobs, make beautiful furniture, toys and boats, or execute many other projects you may have wanted to do, but never could.

This remarkable book, in 160 pages of easy-to-understand text and scores of illustrations, shows you all about the interesting and profitable avocation of working with power tools. Special attention is given to the type of learning problems encountered by the novice, and each major type of power tool is clearly illustrated with captions showing all of its components. But this book is written for the skilled craftsman as well. It contains many helpful hints that will save time and money. It tells what you should look for in planning a power tool shop, and how to lay it out for greatest efficiency. It stresses safety procedures that will benefit even the practiced workman. And various attachments are shown that will convert one tool to multiple duty, thus saving on the total investment. Never before has a book on power tools been written for the home craftsman that provides as much basic information for the novice, and as many down-to-earth work hints for the expert, as "Getting Started with Power Tools". Order your copy today, with a money-back guarantee if not pleased. Send your check or money order to the address below in the amount of only..... **\$2.50**

CONTENTS

- Ch. 1—Selecting power tools
- Ch. 2—Installing power tools
- Ch. 3—Portable power tools
- Ch. 4—Operating the circular saw
- Ch. 5—Dado-head techniques
- Ch. 6—Drill-press operations
- Ch. 7—Operating the bandsaw
- Ch. 8—How to use the jigsaw
- Ch. 9—Working with the wood lathe
- Ch. 10—Wood-shaper techniques
- Ch. 11—Fundamentals of the jointer

POPULAR MECHANICS PRESS, Dept. 757
200 EAST ONTARIO ST. CHICAGO 11, ILLINOIS



HANDY INSULATED FOOD BAG

WHEN TAKING ALONG food for a picnic or beach party, you can wrap steaks and other frozen foods in this glass-fiber insulated bag where they will remain frozen for hours. Also, the bag affords protection for photo supplies from extreme heat or cold, and glassware and other fragile objects wrapped in it are protected when carried in a truck or car.

The bag consists of a layer of glass-fiber insulation sandwiched between a plastic lining and a medium-weight fabric cover as shown in the drawing. When making the bag, the plastic lining is sewed first into the hem of the fabric leaving one end open so that the insulating material can be in-

serted. After inserting the insulation, the open end of the bag is sewed shut and the plastic flaps are stitched to the lining as shown in the detail. The flaps, when folded over articles being wrapped in the bag, hold them in place. Two cloth tapes, each 36 in. long, riveted to the back of the bag as shown in the photo at lower left, provide a means of tying the bag.

Two 36-in. lengths of $\frac{3}{8}$ -in. cloth tape are riveted to fabric cover on food bag to prevent ties from slipping off when rolled or folded bag is secured

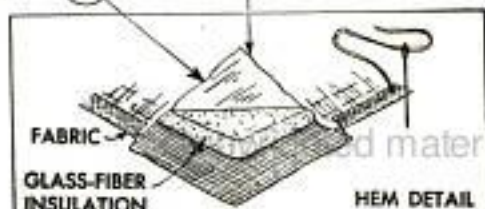
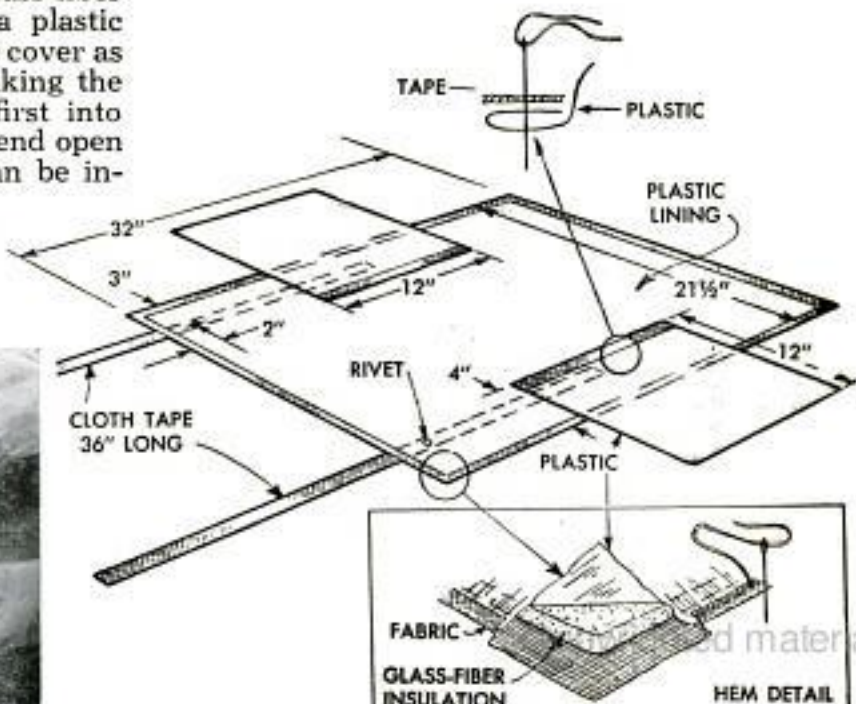



Broken Tiles Prevent Erosion On Sloping Lawn

Pieces of broken draitile were found by one homeowner to be excellent for holding the soil on sloping ground. The porous tile also serves as a "mulch" to retain moisture, which aids in the rapid growth of ivy and other ground cover suitable for binding the soil and preventing it from eroding. The curved pieces of tile are not moved easily and provide stepping stones when the ground is muddy. When soil is worked in around them, the tiles are not unsightly, and soon are covered with plants that conceal them completely. If desired, the tile pieces may be worked into a design.



Blowgun of Metal Tubing Fires Harmless "Darts"

Here is a blowgun any youngster can make that expels "darts" that are harmless. The gun itself is a 3-ft. length of $\frac{3}{4}$ -in. tubing. Steel, brass or aluminum can be used, although the latter is preferred because of its light weight. File and sand the ends of the tubing smooth, and clean the inside thoroughly. Darts for the gun are made by rolling cones of paper, obtained by tearing pages from a magazine that uses a slick, coated stock. Cellulose tape can be used to hold the cones together. Coat a small weight with glue and drop it inside the tip of the cone as indicated.—Perry and Brian Barnard, Los Angeles, Calif.

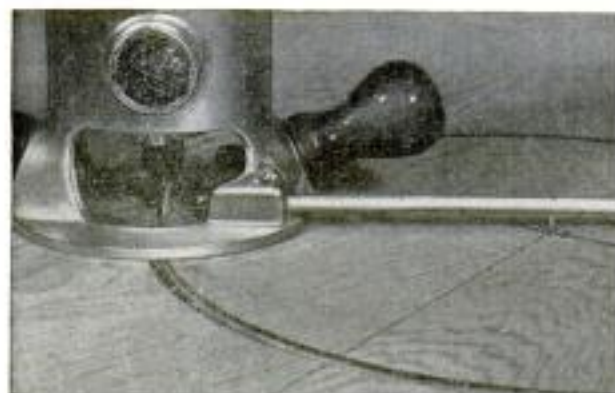

Circle-Cutting Attachment Improvised for Router

If the regular accessory is not available, a circle-cutting attachment for a portable router can be improvised from a length of $\frac{1}{4}$ -in. dowel slightly longer than the radius of the required circle. A nail is driven into the dowel near one end, and the other end is fitted into the accessory opening in the router base. The nail fits into a hole drilled in the center of the circle to be cut.

R. J. De Cristoforo, Los Altos, Calif.

Clean Darkroom Equipment Assures Higher Quality Work

Thorough cleaning of darkroom equipment at regular intervals will assure improved quality of work and help prolong the useful life of the equipment. To keep film-developing tanks free of residue, first empty them, and then place 1 oz. of hypo in the bottom, sprinkle a little potassium ferrocyanide over the chemicals and add hot water. Allow time for the solution to loosen the residue in the tank, then rinse with warm water. Acetic acid,

or specially prepared cleaners, also can be used for this job. Film tanks may be cleaned with a solution of equal parts of hydrochloric acid and water. Apply it with a brush, then rinse the tanks thoroughly. Film hangers are cleaned in a developing tank containing acetic acid in a 28 percent solution, allowing them to soak for about 15 min. Rinse the hangers with water and place them in a solution of sodium carbonate and warm water for 10 min.

THE **POPULAR MECHANICS**
SHOP NOTES

SN 59

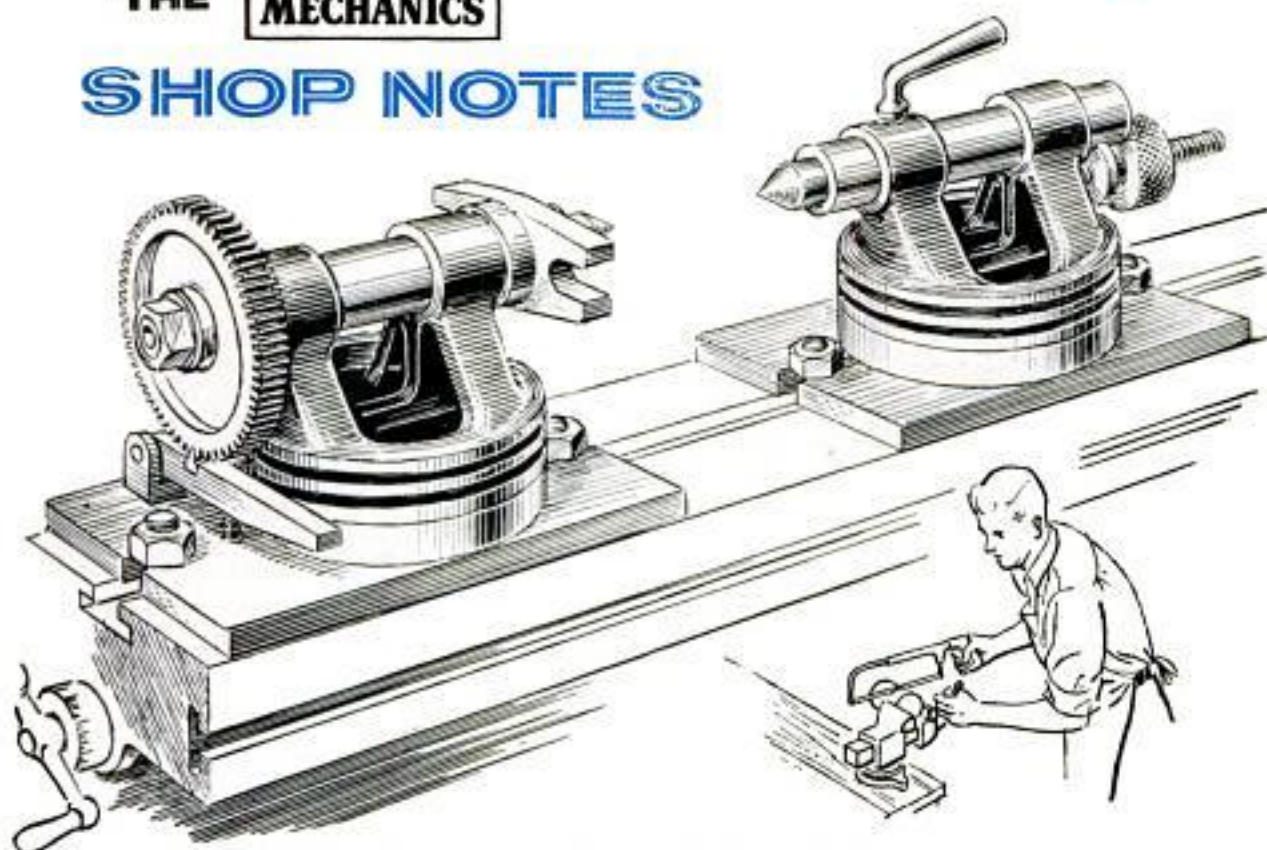

INDEX CENTERS—

accurately space gear teeth and splines, and locate flats when squaring ends of round work

By C. W. Woodson

TWO DISCARDED PISTONS from a Buick auto engine serve as the head and tailstock of these shop-made indexing centers. As designed, the centers are intended for use on a milling machine, but of course they can be mounted on a special base for bench work. The first step is to face off the heads of the pistons so they will

seat on round subbases turned from $\frac{1}{2}$ -in. steel, Figs. 4 and 6. Mounted as in Fig. 4, the centers have a swing of about 5 in. After facing off, cut away the piston skirts, leaving only the wrist-pin bearings to serve as bearings for the spindles which carry the 60-deg. centers and indexing gear.

Figs. 1 and 2 detail the headstock and

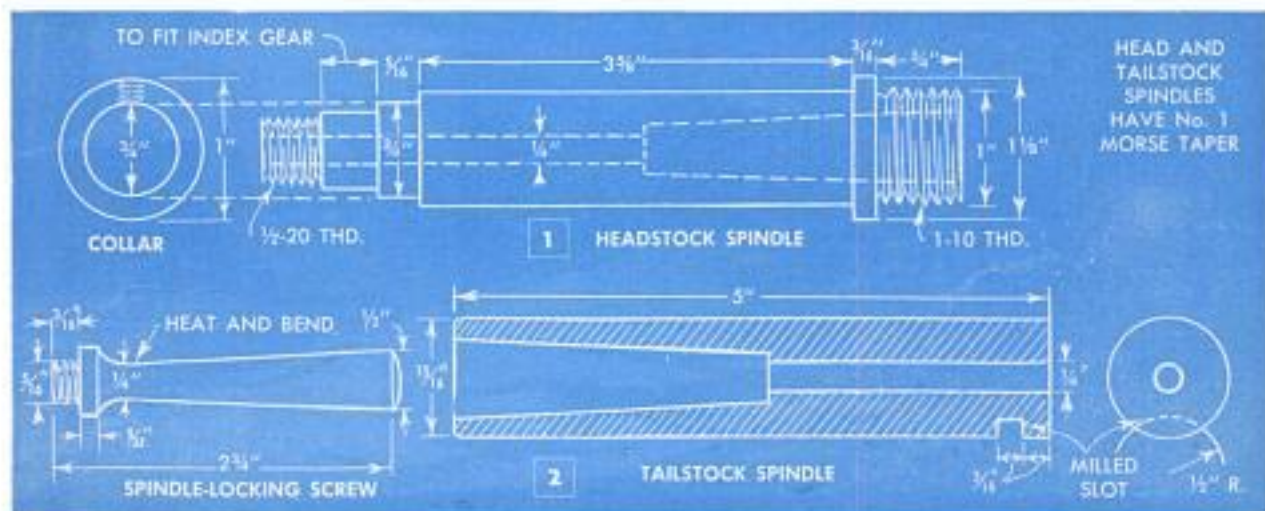

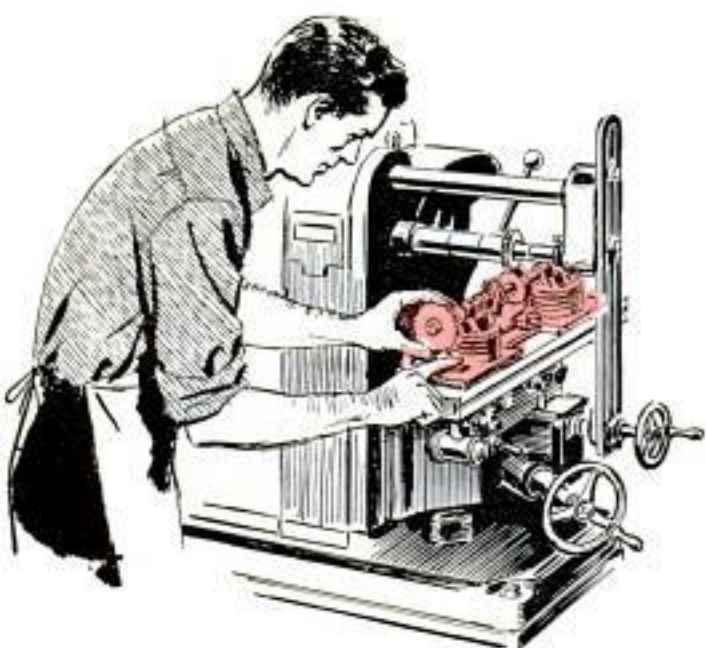

tail spindles. Note that these are machined with No. 1 Morse tapers and are drilled through longitudinally for $\frac{3}{16}$ -in. knockout rods. Both spindles normally are turned to $\frac{15}{16}$ in. in diameter, but check the inside diameters of the wrist-pin bearings before turning to final specification as there may be some variation. Head and tailstock bases are cut from $\frac{3}{8}$ -in. flat steel, Fig. 3. Both are the same width but note that the headstock base is $\frac{5}{8}$ in. longer to permit mounting the spring-latch indexing unit, Fig. 5. The guide bars, Figs. 3, 6 and 7, slide in the T-slots in the machine table. The width is given as $\frac{3}{4}$ in. but this may have to be varied. Registering holes are drilled through the guide bars, bases, subbases and into the pistons for $\frac{1}{4}$ -in. fillister-head screws, Fig. 7. The holes must be drilled in precise alignment with the axis of each spindle. Make a jig for this purpose.

The headstock is designed to utilize a standard 48-tooth gear wheel in place of a

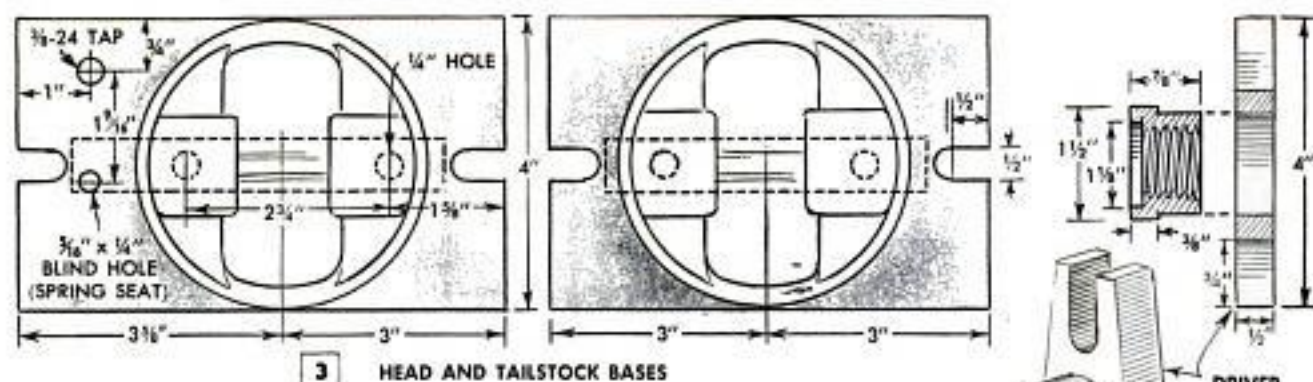

3 HEAD AND TAILSTOCK BASES

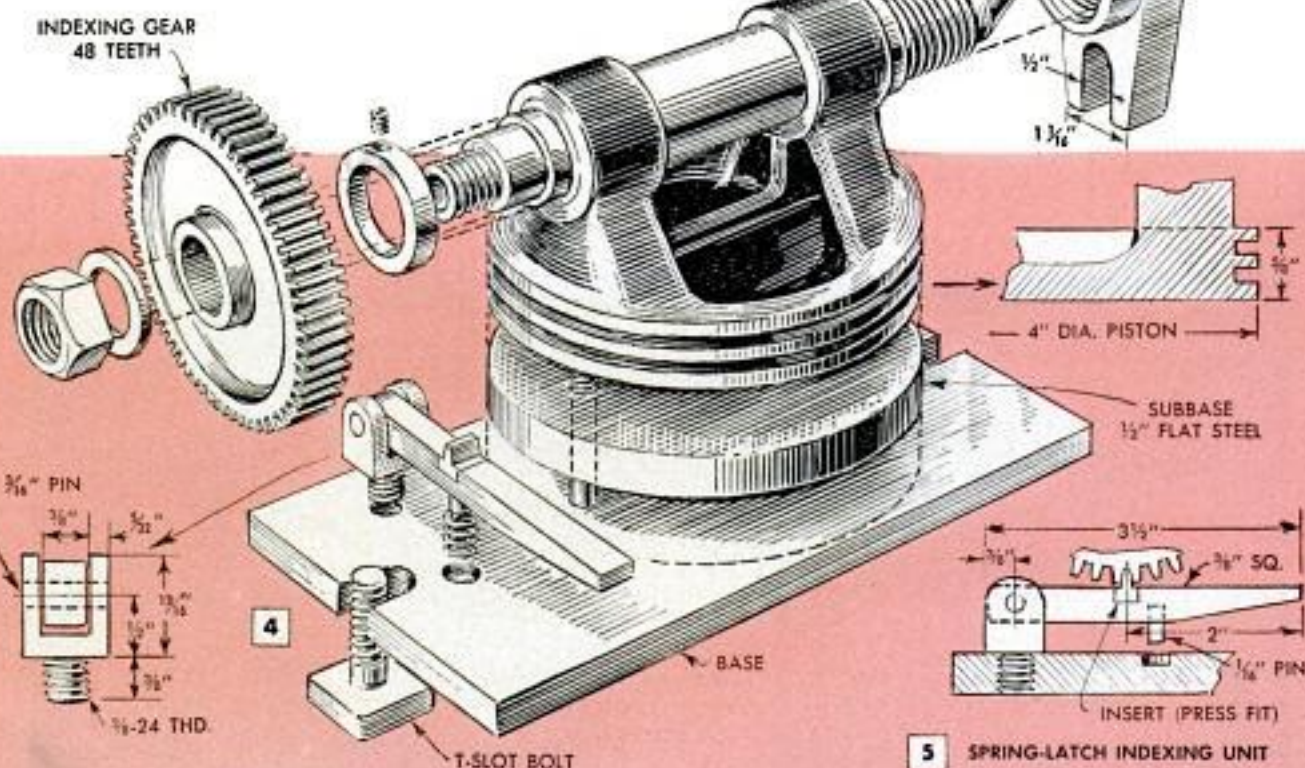

5 SPRING-LATCH INDEXING UNIT

regular indexing plate. The arm of the spring latch is fitted with an insert on which a matching gear tooth is filed, Fig. 5. This should engage to the full depth.

Note that the driver, Fig. 4, is fitted to a machined hub which is shouldered, recessed and threaded to fit the headstock spindle. This construction is not essential but it does save stock, as otherwise it would be necessary to machine the hub projection from the solid. In the best practice, the adjusting screw for the tailstock spindle, Figs. 6 and 7, would be turned from brass or a machining aluminum. In any case, the flange should be a close fit in the slot milled in the spindle, Fig. 2. The stud, Fig. 7, gives slightly more than an inch of spindle travel. It can, of course, be made longer if desired. After the units have been assembled, place them on the machine table, bolt down and check the centers for vertical and horizontal alignment. ★ ★ ★

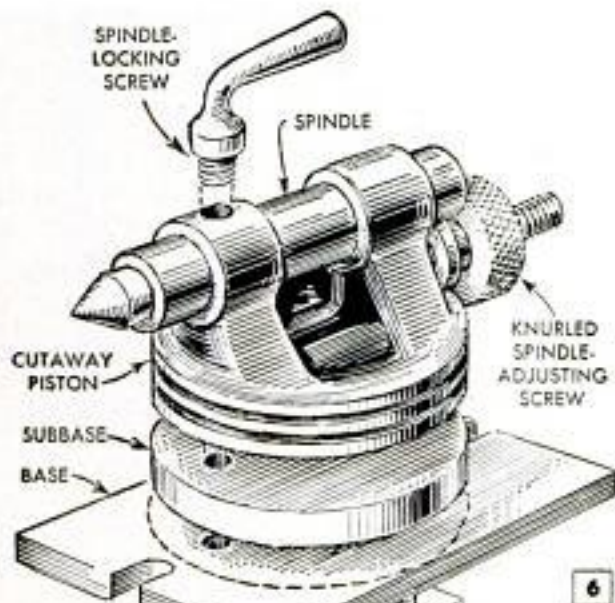

6

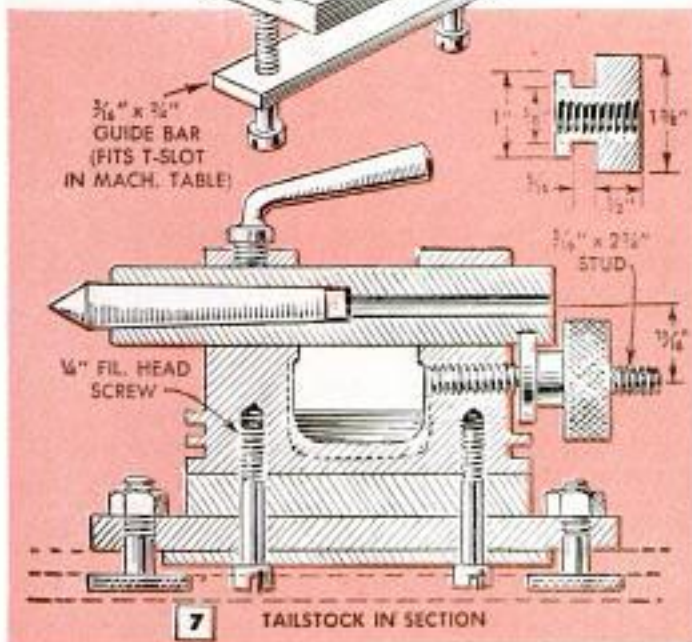

7 TAILSTOCK IN SECTION

Piece of Hardboard Under Paper Increases Sander Efficiency

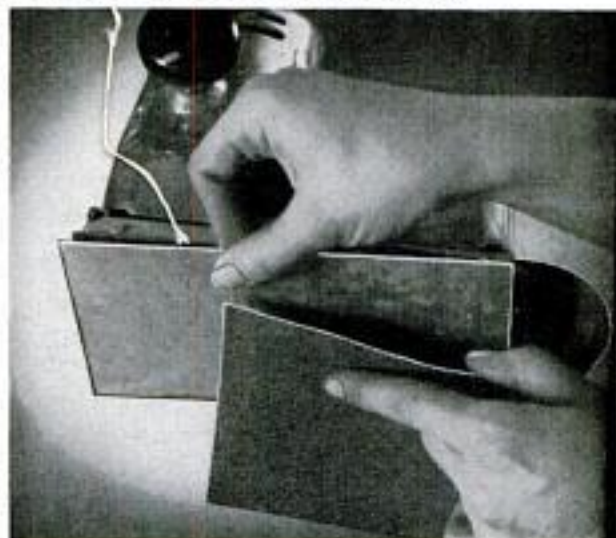

When sanding rough surfaces with an orbital sander you can speed up the job by covering the soft pad of the sander with a firm material. A piece of sheet metal or hardboard fitted over the pad under the sandpaper as indicated will hold the paper flat so that it sands only the high spots, quickly cutting them down.

Henry V. Lucas, Inglewood, Calif.

Metal Spool Provides Storage For Several Extension Cords

Ask your hardware dealer to save one of the metal spools on which is wound the electric cord he purchases. Nailed or screwed to the wall of a workshop in a handy spot, the spool will provide storage for several extension cords.



Midget Electric Furnaces



1



Disassembled socket is shown with required strip of asbestos paper, resistance wire and connector wire

After wet asbestos paper, over which resistance wire is wound, is completely dry, socket is reassembled



WHETHER YOU HAVE a home workshop or a home laboratory, one of these two midget electric furnaces will prove invaluable where small amounts of clean, dependable heat are required. The first furnace, Fig. 1, actually is an "electric Bunsen burner," being designed primarily for heating test tubes, while the second, Fig. 7, is a crucible for melting metals, such as solder, for tinning the ends of wires.

A transformer is required to modify current delivered to the furnaces, and on the original furnaces, the transformer is of the type provided with solder guns. Filament-type transformers, such as used in radio work, also can be used. Transformer output should be 8 to 10 amp. at 5 to 7 volts.

Heating elements for the furnaces are made from resistance wire of the type used in electric toasters and portable heaters. Replacement elements, consisting of coils of this wire, are available at electrical-supply stores. In the original furnaces, .020-in.-dia. wire was used.

The Bunsen burner, which develops about 250 deg. F., is made from a surface-mounted porcelain lamp socket. First, an 18-in. length of wire is connected between the transformer output terminals and the current is turned on to the transformer. If the wire will scorch paper after a 20-sec. contact, it is producing the correct



4 Lower end of wire is fastened to screw holding shell in socket. Upper end of wire connects to lead running to strip that is center contact of porcelain socket

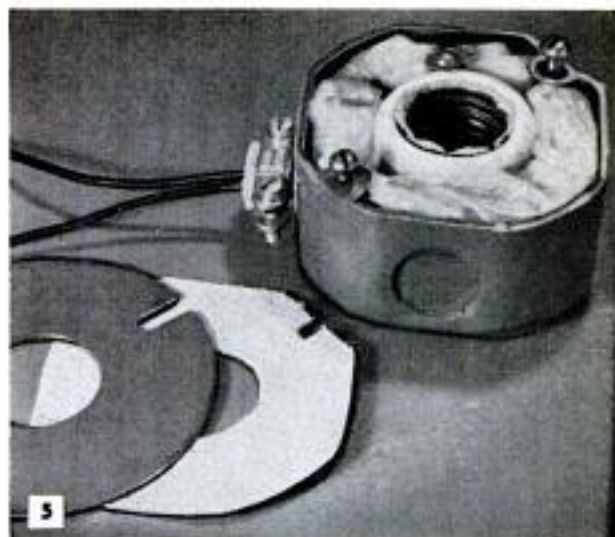

5 Porcelain socket is installed in 3-in. junction box, leads are run through connector and socket is packed with glass-fiber or asbestos insulation as indicated

heat. If not hot enough, shorten it 1 in. at a time until it does produce the right heat. Next, chip the sealing wax from the screw holes in the bottom of the porcelain socket, remove the screws and disassemble the socket, Fig. 2. Wrap a layer of wet asbestos paper around the threaded shell and wind the resistance wire over it, Fig. 3. Bend a hook in the starting end of the wire to fit the screw in the bottom of the shell. Bend a loop in the other end of the wire and connect it to a short piece of 14-ga. copper wire. Run the wire down the side of the socket and loop it under the screw in the metal strip that provides the center contact of the socket, Fig. 4. After the asbestos paper is dry, reassemble the socket and attach a pair of flexible leads to the socket terminals. Now, fit the socket in a 3-in. junction box, run the leads out through a connector and pack glass-fiber or asbestos insulation around the socket, Fig. 5. Finally, fit a standard cover, in which a $1\frac{1}{8}$ -in. hole has been cut, on the box.

The "solder melting" furnace, Fig. 7, is similar to the test-tube heater in construction. In the original unit, a 9-in. length of resistance wire was correct. The heat chamber of the furnace consists of a $3\frac{3}{8}$ -in. length of $\frac{3}{8}$ -in. tubing, one end of which is squeezed shut in a vise. Two thicknesses of sheet mica $1\frac{1}{4}$ in. wide are wrapped around the tube and the resistance wire is wound over it. The ends of the resistance wire are connected to 2-in. lengths of 14-ga. copper wire that are screwed to a $2\frac{1}{2}$ x $3\frac{5}{8}$ -in. sheet of $\frac{1}{8}$ -in. asbestos. The asbestos is nailed to the end of a $\frac{3}{4}$ x $2\frac{1}{2}$ x $3\frac{1}{2}$ -in. wooden block, the top of which is covered with asbestos paper. The heat chamber is supported on a $\frac{1}{2}$ x $\frac{3}{4}$ x $\frac{3}{4}$ -in. block of asbestos. A guard of hardware cloth is stapled to the base block, Fig. 7. ★ ★ ★



6 Above, crucible without hardware-cloth guard and asbestos top. Below, solder being melted in unit

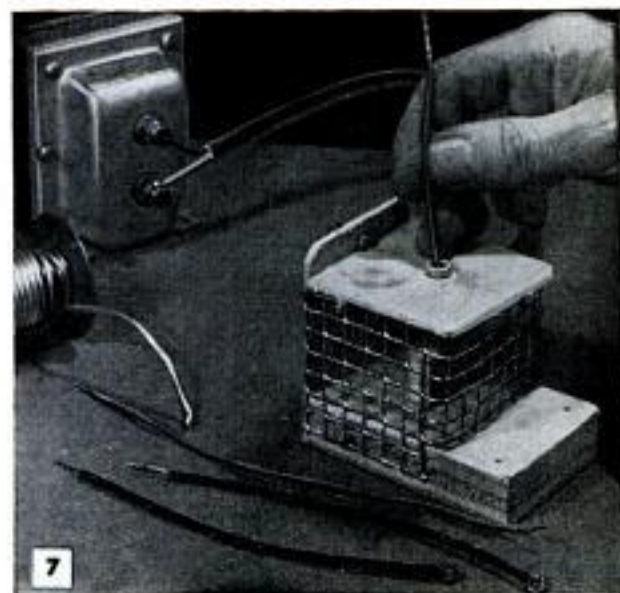



Workpieces Held With Dowels When Being Cut on Jigsaw

To hold a number of thin pieces of stock in alignment when sawing through to duplicate a pattern, stack the pieces and drill a small hole near each corner. Drive a short length of dowel into each hole. Lay out the pattern on the top piece. Pinned together in this way the stack can be sawed without any possibility of the pieces shifting. Always plan the pattern so the holes can be drilled and pinned in the waste area of the work.

Carriage Bolt Used as Rasp

When a wood rasp or round file is not at hand, a carriage bolt makes a good emergency substitute. Can be used for enlarging holes in hardwood, rounding corners or reducing thickness of small pieces. Threads cut freely with or across the grain.

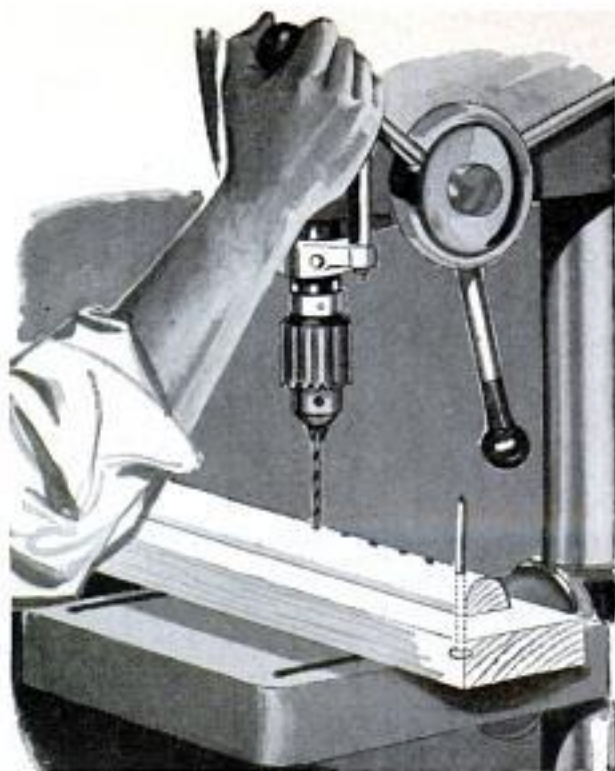
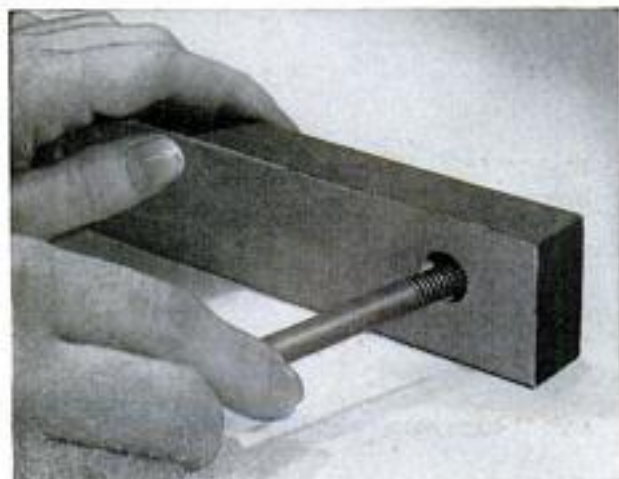

Jig Spaces Holes Uniformly When Drilling Half Rounds

Keeping a number of holes equally spaced when drilling dowels or half-rounds is no problem when this jig is used. It consists of a nail of the correct diameter driven into a board and allowed to project. Mark a center line on the stock and also mark location of the holes. Drill the first hole, then fit the workpiece over the nail. Then, advance the work one hole as each additional hole is drilled, slipping the work over the nail each time.

Drill Lubricated by Paintbrush

The time involved in the frequent use of an oil can when drilling metal can be saved by nailing a paintbrush to a block of wood and positioning it next to the drill as shown. The brush, saturated with oil, presses against the drill.

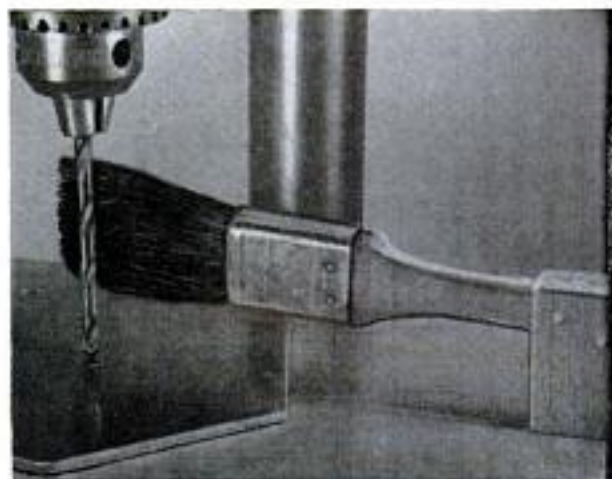

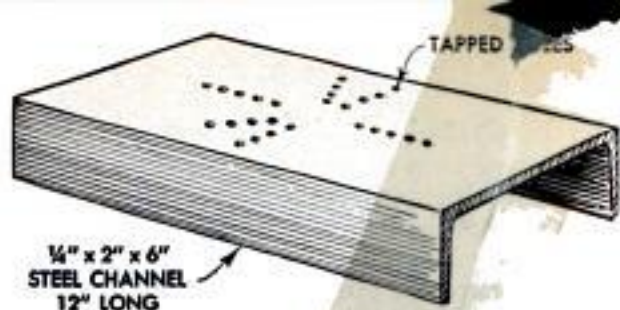

BENCH PLATE

holds work for filing, drilling, punch marking, layout and tapping

A bench plate is handy for holding work rigidly in position when several separate operations are to be carried out. This portable plate, made from a length of steel channel, will serve the purpose well where a high degree of accuracy is not required. Open ends make the plate easy to handle and permit the placement of C-clamps. A pattern of holes drilled and tapped in the web of the channel provides a means of fastening a vise to the plate or of clamping work directly to the web with strap clamps. A piece of channel of the length and sectional size given weighs about 9 lb. This weight is sufficient to give stability for light filing, layout and punching without the necessity of clamping the plate to the bench. An angle vise bolted to the plate facilitates handling work which calls for angular drilling or similar operations. Although the original plate pictured was used without finishing either the web or flanges, greater accuracy will be achieved by surface grinding the edges of the flanges and the web. This will better adapt the plate for use as a fixture on machine tables.

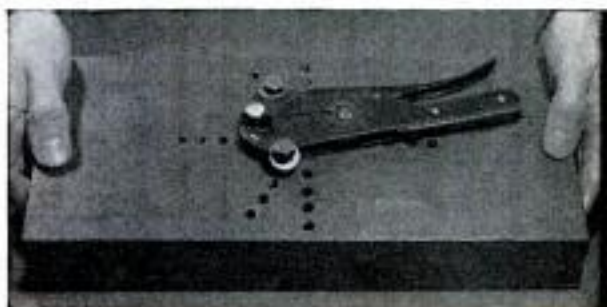

Above, top of plate showing hole pattern and clamping pliers held in place with capscrews. Below, plate and vise in use as holding fixture on drill press

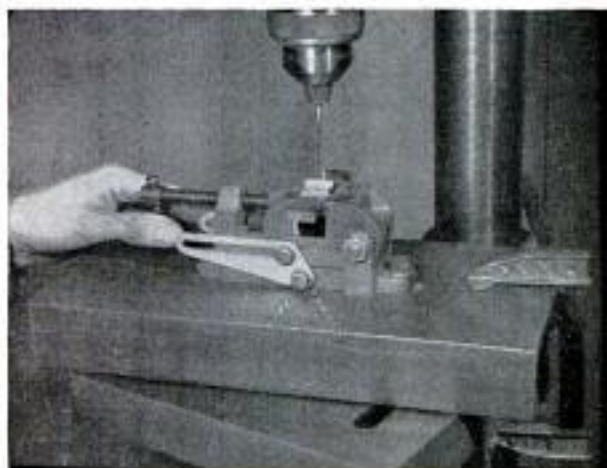

Wedge With Long Taper Aids in Removing Piston Rings

When no conventional ring expander is at hand, piston rings can be removed by forcing the ends of each ring apart with a tapered wedge. The latter is improvised by filing long tapers on a length of flat steel. Press the ring into the groove at a point opposite the ends. While holding it in this position, force the wedge between the ends to expand the ring sufficiently to clear the groove. Then insert a feeler gauge and lift the ring clear.

Wood sheathing acts as a structural part of the wall of a home and provides maximum bracing when applied diagonally.

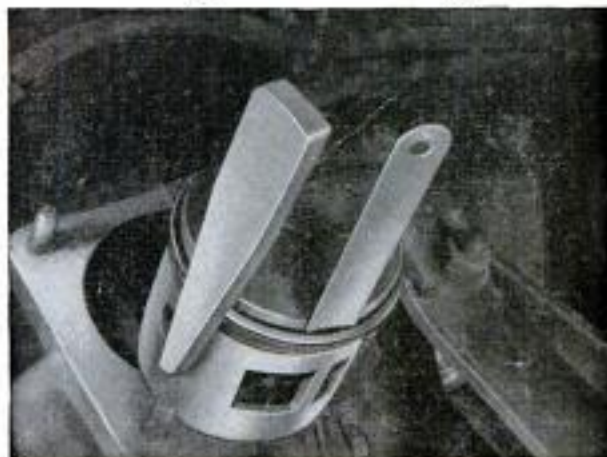

Make This

THIS CHEST OFFERS maximum tool storage in a minimum of space. It was originally designed to accommodate sets of wrenches and pliers assembled for special purposes. Constructed entirely of plywood with all exposed corners protected by aluminum angle it will withstand hard usage. The $\frac{1}{4}$ -in.-plywood sides are joined to end pieces of $\frac{1}{2}$ -in. plywood with staggered rows of screws driven through holes drilled in the aluminum angles. Note in the sectional view that the bottom panel fits inside the frame formed by the ends and side panels. Although $\frac{1}{4}$ -in. plywood is specified for the top panel, $\frac{1}{2}$ -in. plywood can be used. This will give somewhat greater strength, also prevent any possibility of breakage should the chest be used as an emergency support for a heavy weight or as a stool. Spacing of the sliding tool panels, shown in the sectional view, is optional. Perhaps the best way to determine spacings to suit the toolkit at hand is to lay the individual tools on a flat surface and measure the space required for those to be racked on each side of the individual panels. Special hangers for each tool are easily made from sheet metal and attached with screws or stove bolts. Finish in the natural color with spar varnish. ★ ★ ★



Strips Modify "Drive Block" For More Efficient Use

When applying tongue-and-groove flooring or drop siding to studding, it often is necessary to use a block and hammer to drive warped boards into place. The "drive block" can be made even more effective by nailing wooden pieces to each side to form a channel at the lower edge of the block. Besides making it easier to position the block on the edge of a board more quickly, the channel also permits the block to be left on the edge of a board while nailing is completed, so it is close at hand when next needed.

Brush Cleans T-Slots in Table

Cleaning metal chips from the T-slots of machine-tool tables is a simple job when a round bottle brush is used. Moderate pressure is used to force the brush down into the slot undercuts as indicated and pull out the chips.

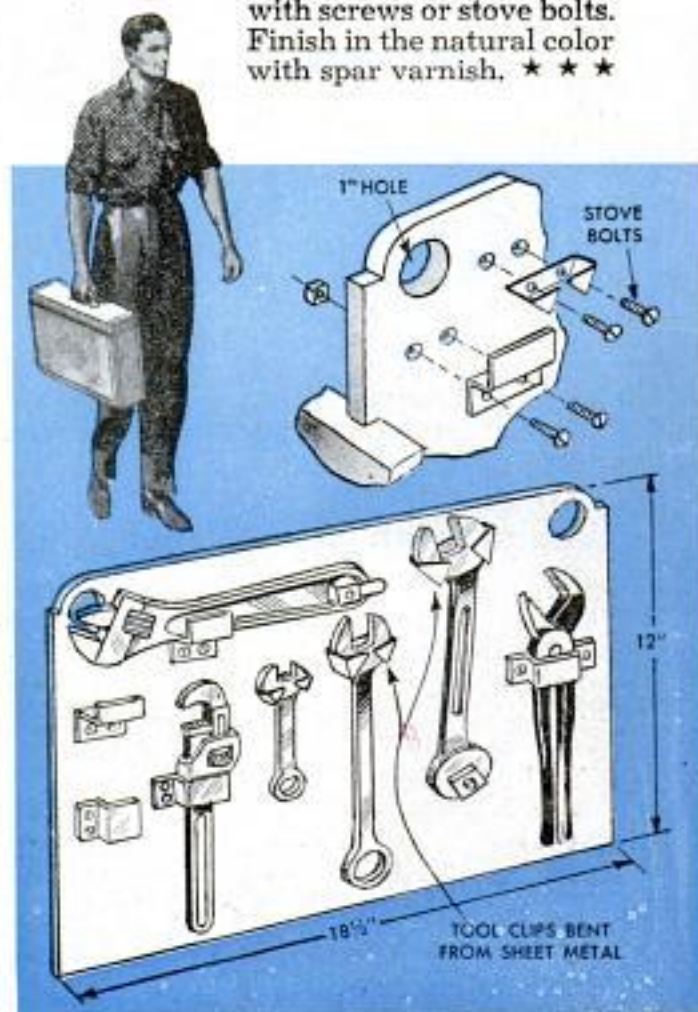

POPULAR MECHANICS

HANDY TOOL CHEST

Its sliding storage panels can be removed and taken to the job



Auto mechanics and men who service household appliances will find this tool chest a handy size to carry. Tool panels slide out for quick selection of the wrenches and pliers needed for the job. Regular toolbox locks can be substituted for the luggage catches specified. Smooth all exposed metal edges

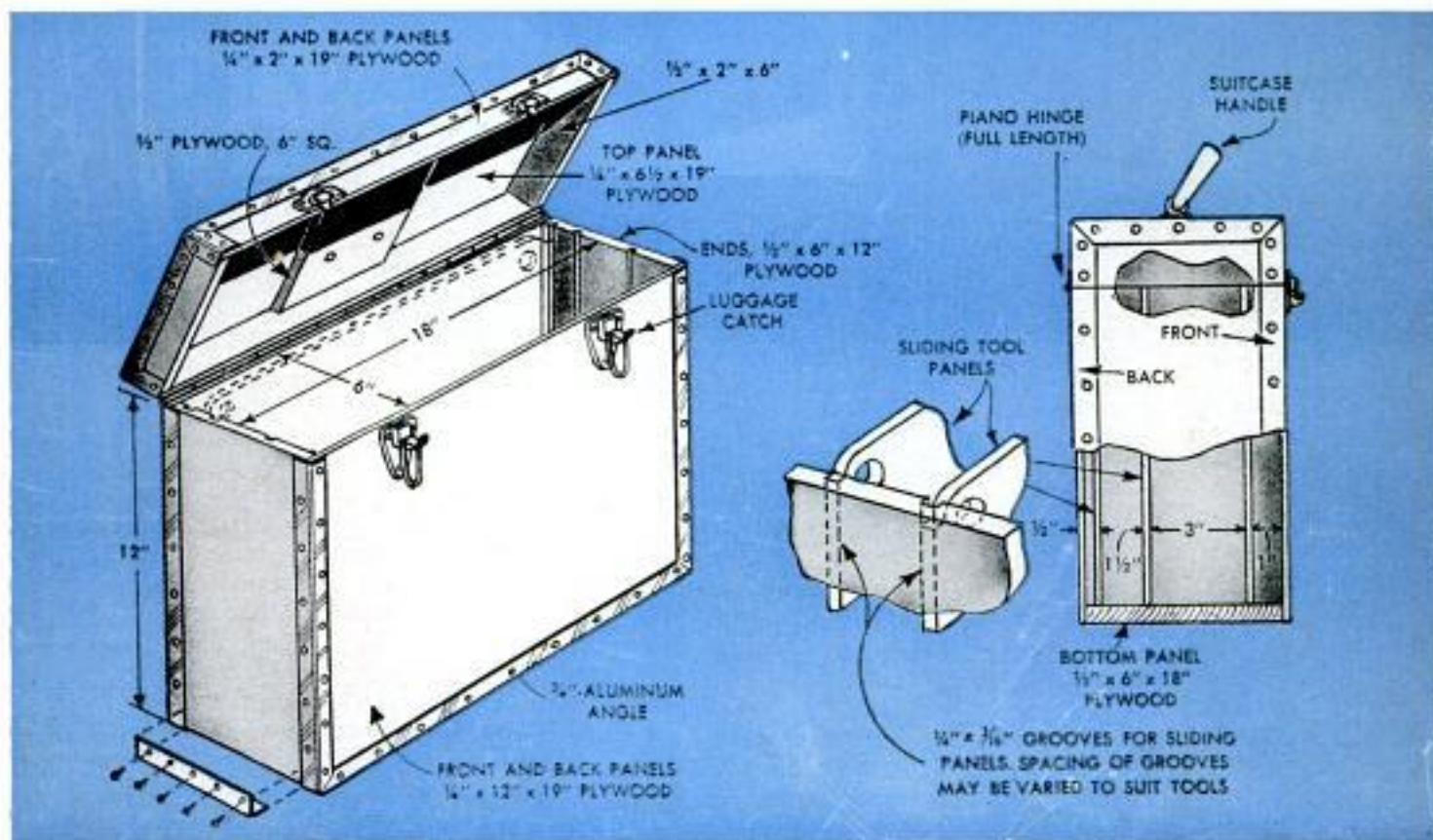

Lumber Racked Between Joists in Basement Workshop



One solution to the space problem in the average basement workshop is an overhead lumber rack made by screwing hardwood cleats to the bottom edges of a pair of floor joists. When cutting the cleats to length, allow for equal projection of the ends beyond the pair of joists to which the cleats are attached. Then you can rack long strips, such as moldings, on the extended ends of the cleats without the necessity of sliding each piece into position endwise. Spacing of cleats should be about 36 in.

Roadside Stock-Loading Chute Helpful During Spring Thaw

Shipments for the spring markets are never delayed by soft ground or stubborn cattle on the farm of Millen F. Sandersfeld of Williamsburg, Iowa. In fact, cattle are practically in the truck before they know it with this special chute that allows loading from the road—just the thing for big semis during spring thaws. Wing gates lead the cattle into the chute which makes a slight bend so they cannot see the truck until they start up the ramp. If they try to turn or backtrack, a 2 x 4 is slipped through the chute behind them. A 2 x 8 on edge provides a "catwalk" up the outside of the chute.

Concrete Poured From Mixer Directly Into Forms

To save one handling of concrete when pouring foundations and feed-lot slabs, one farmer mounted the mixer and a water tank on a trailer bed. With these two units there is room on the bed for bags of cement and $\frac{1}{2}$ yd. or more of aggregate. When pouring a foundation the trailer is backed into a position to bring the mixer directly over the form. When pouring a slab, concrete is dumped from the mixer into a chute, which carries the concrete to the desired point. The trailer is easily moved when one section of the wall or slab is finished.—C. F. Marley, Nokomis, Ill.



Correct Distributor Installation

Correctly reinstalling a distributor in an automobile engine is no problem if the distributor is pictured as the face of a clock. Before removing the distributor, choose a point, preferably where the primary wire enters the distributor, as the 12 o'clock position. Note at what hour the clock "hand"—the rotor—points, and reposition it at the same hour when replacing the distributor in the engine.

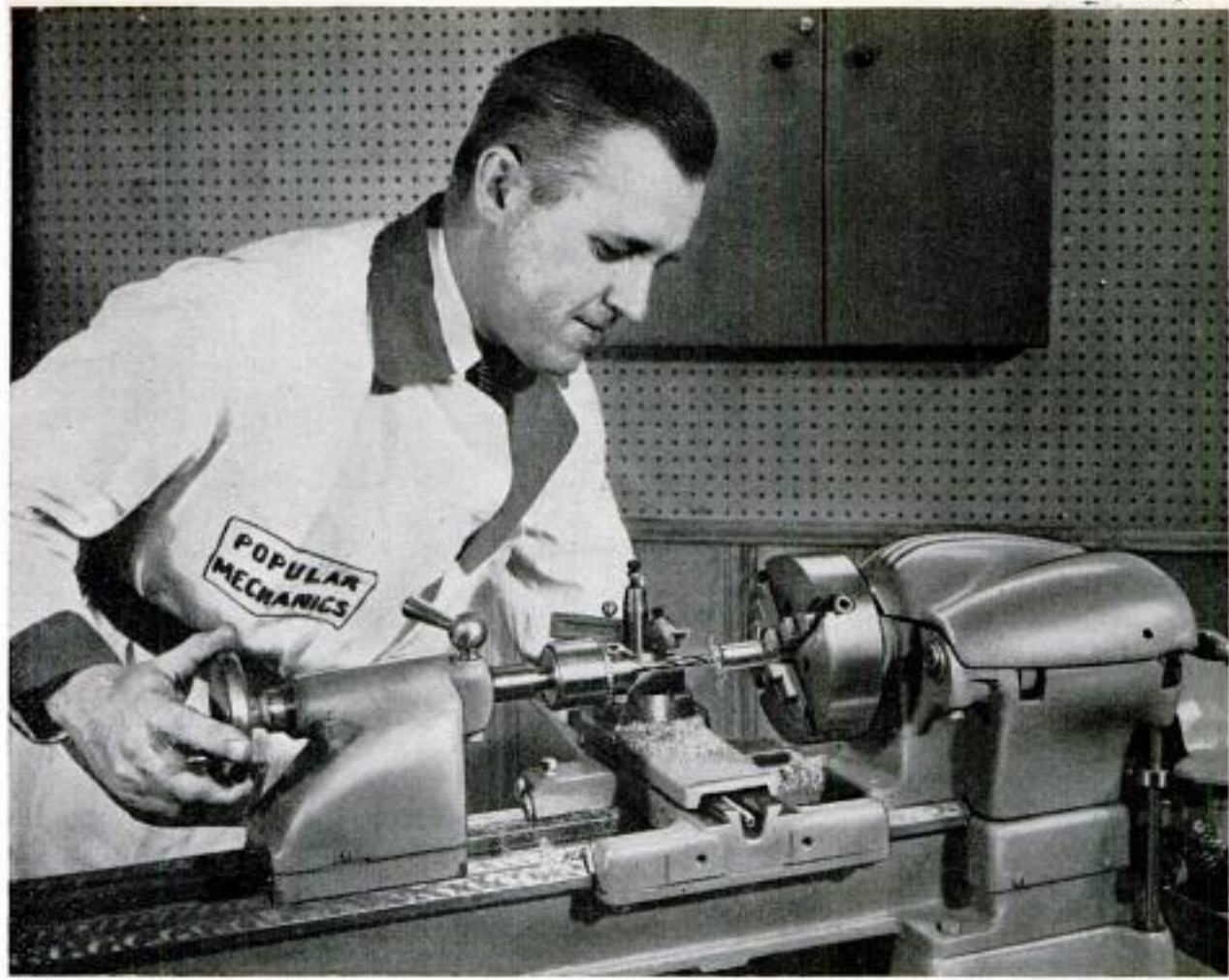

Adapters Fit Standard Collets

WHEN ACCESSORY EQUIPMENT does not include a full set of collets the work range of those at hand can be extended with adapters. As an example, a 1/2-in. standard collet can be fitted with 3/8, 1/4 and 1/8-in. adapters, or bushings. This increases its range to four sizes. Carefully made, the accuracy of the adapters should very nearly equal that of the collet in which they are used. Adapters can be made from brass, bronze or machining aluminum. Drill and ream the center hole and finish all over. Machine the groove for the retainer, then cut through lengthwise on the center line. Slide the retainer in place in the groove, open the collet and insert the adapter. Then place the collet in the lathe spindle and tighten on a short length of drill rod of the same diameter as the hole reamed in the adapter. In some instances the retainer may prevent the adapter from closing fully. Should this occur, remove the adapter and file the ends of the retainer ring. Dimensions given are only approximations. Check the collet before machining the adapter to final dimensions.

C. W. Woodson, Chicago.

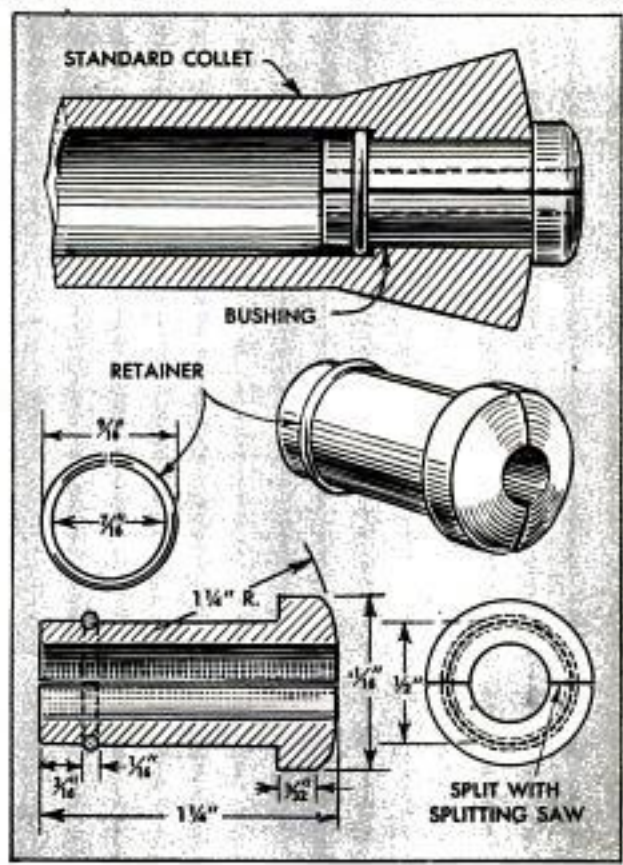

X226

SN 59
P. 109

How Would You Do It?

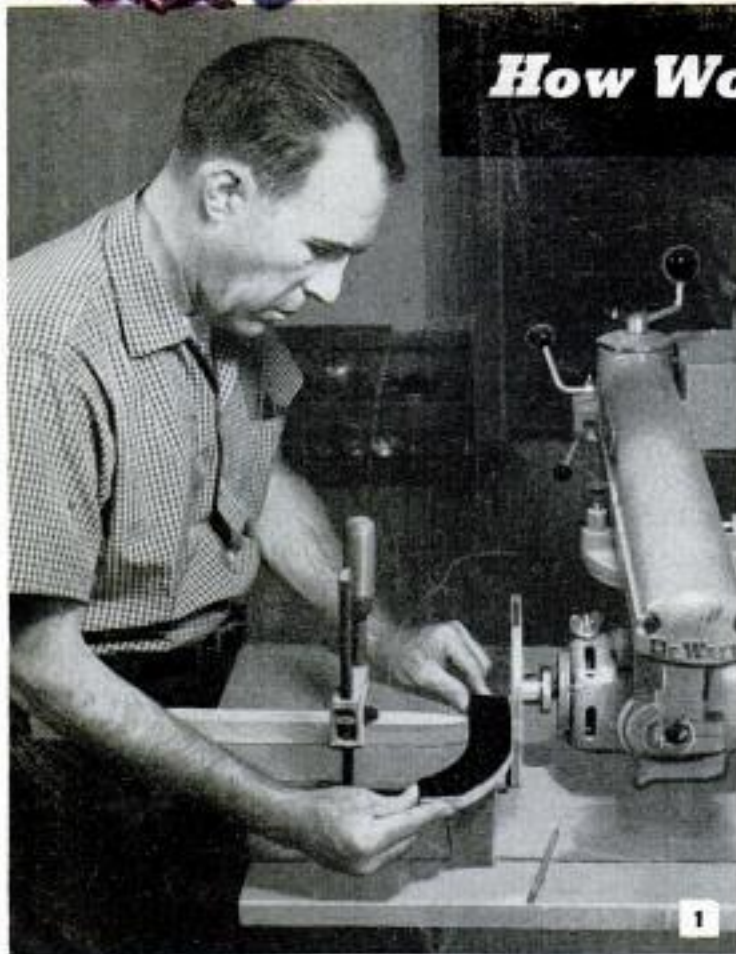

1

1. Q—What jig assures that curved work is disk-sanded to uniform width?

A—Clamp a pointed jig block to the sander table at the required distance from the disk and pass the work between the block and the disk. The inside surface of the curve must be sanded beforehand, using a drum sander, or on the drum of a belt sander, if these tools are available

2. Q—How is sandpaper applied to the disk when using liquid adhesives?

A—Liquid adhesive must be applied to both disk and paper. When using a contact adhesive, locate the paper properly the first time, as it cannot be moved once it is in place. When using any adhesive, apply pressure to the full surface of the paper to assure complete adhesion



2

3. Q—Can a disk sander be used to "joint" the edge of stock to be glued?

A—Yes. Set the rip fence at a slight angle as shown in the photograph, so the stock is forced against the edge of disk when it is passed between the fence and the disk. Make several passes with the stock to make sure that the edge of the wood is absolutely true and smooth for gluing

4. Q—Stick adhesive requires that the disk be warmed. How is this done?

A—The use of friction is the easiest way to warm the disk. Simply hold a wooden block against the disk for a few moments to warm it, then apply the stick adhesive as shown. Using the block as indicated prevents the stick from becoming jammed between the rotating disk and the table

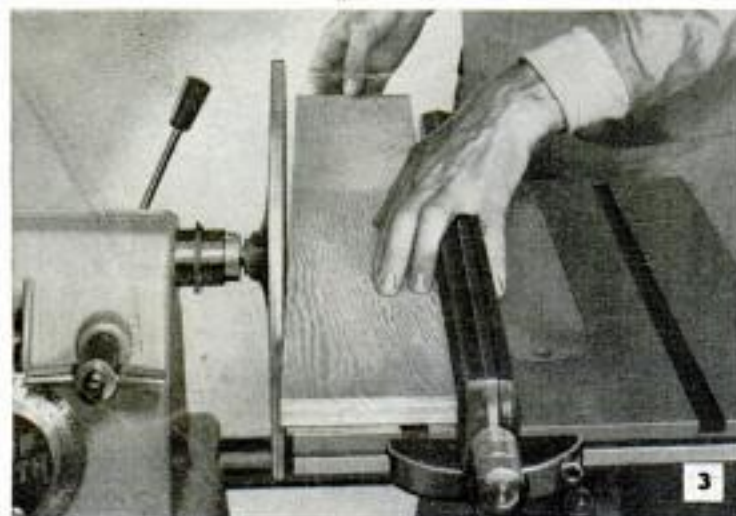

3



4

5. Q—How are wheels "turned" on sander without a jigsaw or bandsaw?

A—Use jig consisting of pivot pin in wood block. Draw wheel on stock, center-drill it and rough cut to shape with saw. Fit wheel on jig clamped to sander table and rotate it against sander, moving jig closer until wheel is correct diameter

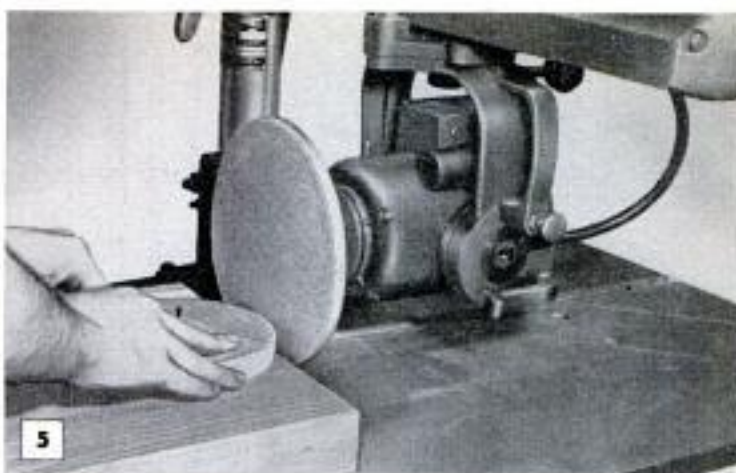

6. Q—What method is used for making an accurate chamfer on a wheel or disk?

A—On a conventional-type disk sander, use a jig such as described in the preceding answer, with the sander table tilted at correct angle. On some combination tools, a threaded pin can be screwed into the bar of the miter gauge to provide a pivot

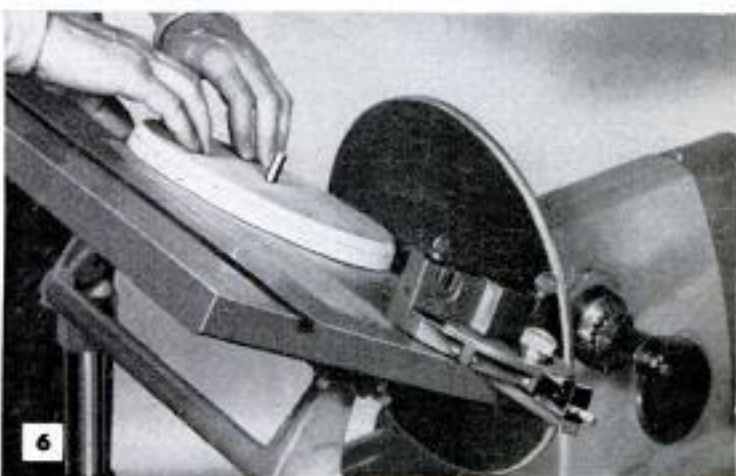

7. Q—What is the quickest way to sand uniform points on a number of dowels?

A—Hold the dowels against a miter gauge to assure maintaining a uniform angle. If your sander is not equipped with a miter gauge, clamp a block of wood on the table instead. Push end of the dowel against the disk and rotate it slowly

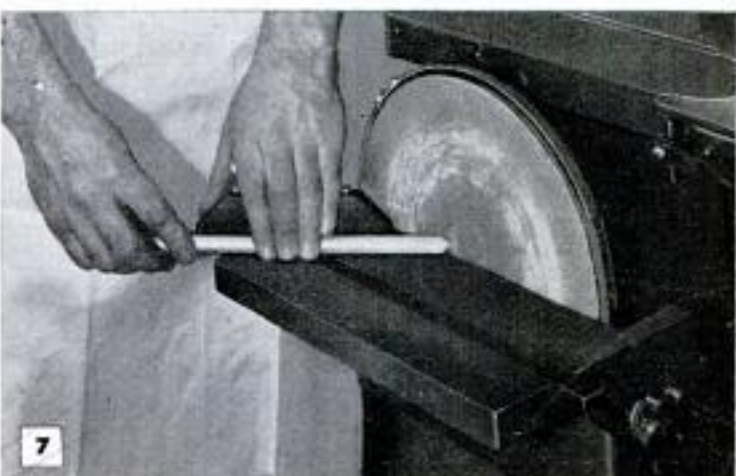

8. Q—How can a disk sander be used to smooth the edges of an inside corner?

A—To sand the long edge of an inside corner, move the work across the face of the disk, stopping it just short of the disk rim. Next, slide the long edge directly into the disk, using either a clamped block or a miter gauge as shown

9. Q—What method is used to sand duplicate round corners on several pieces?

A—First, cut the corners of workpieces at a 45-deg. angle, making all cuts of uniform size. Then, sand angles into curves freehand. When several workpieces have been sanded, stack them and resand slightly to assure that curves are duplicated



SN 59
P. 73

4 SHOP KINKS

By C. W. Woodson

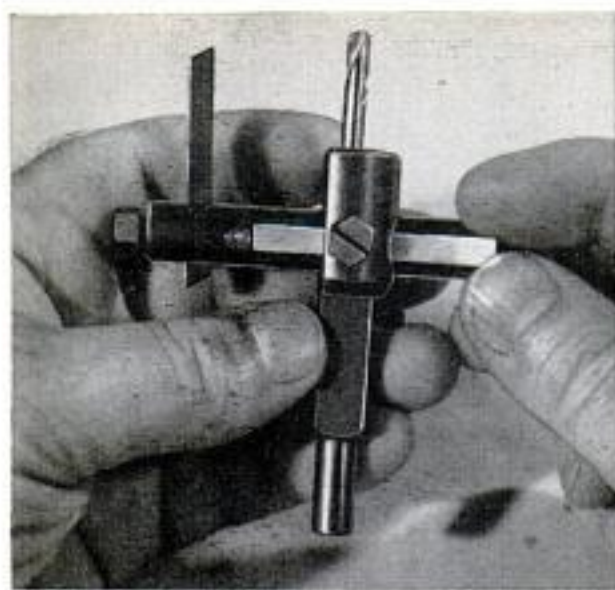

Metal Shim Under Setscrew Maintains Accuracy of Cutter

After a circle cutter has been in use for some time it may slip out of adjustment while a cut is being made because of damage to the extension bar by the setscrew. Avoid this by slipping a narrow strip of thin sheet metal under the setscrew as shown. Move the shim to a different position each time the setting is changed and replace it when it becomes deeply scored along its length by the screw.

Ken Murray, Colon, Mich.

Simple Clamp for Saw Filing

If you have only an occasional job of saw filing, try using a length of beveled siding, or any molding that reduces to a relatively thin edge, as a clamp. This can be screwed to the edge of the workbench or other suitable surface with the saw blade between as indicated. In most cases it is best to remove the saw handle and, of course, the blade is mounted so that the teeth project above the clamp. If some vibration persists, place a strip of felt, such as weather stripping, between the saw and clamp.

Michael Ligocki, Gary, Ind.

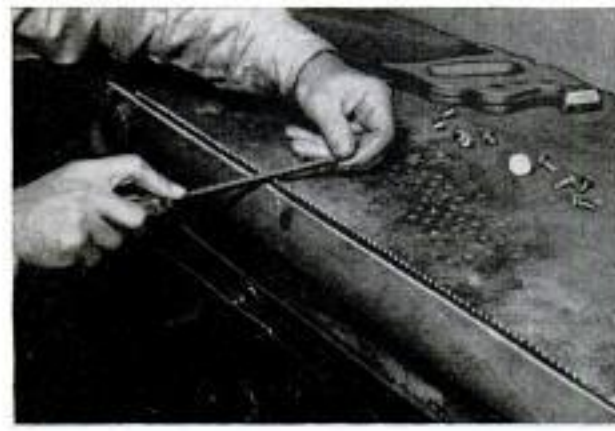

FIRST ONE, shown in the photo on the opposite page, is a test bar for checking alignment of lathe centers before setting up a job in the toolroom or school shop. Turn the bar from solid stock in a lathe with centers known to be in alignment. Mount in the lathe to be checked and run a light cut across both disks without moving the cross slide. Then mike the disks. If both show the same reading the centers are in line.

One way of laying out the job of squaring the end of a shaft is shown in steps 1, 2 and 3 in the left-hand detail, opposite page. It's fast and reasonably accurate.

A shop gadget handy for scribing center lines on bar stock of rectangular cross section is shown in the right-hand details 1, 2 and 3 on the opposite page. Construction is clearly shown and you can make it to suit your own requirements.

The lower details, opposite page, show inside and outside chucks for holding thin metal disks. The outside chuck, details 1 and 2, holds the disk for facing only. Contracting jaws grip the outside of the disk. The inside chuck, details 3 and 4, has expanding jaws and permits work to be both trued and faced. ★ ★ ★

Roadside Weed Sprayer

Novel feature of this highway spray rig is the outrigger crow's-nest which carries the man handling the spray head directly over the road shoulder. This arrangement permits the truck to travel in the outside lane at a steady pace and still give the spray man ample time to cover the entire shoulder effectively.



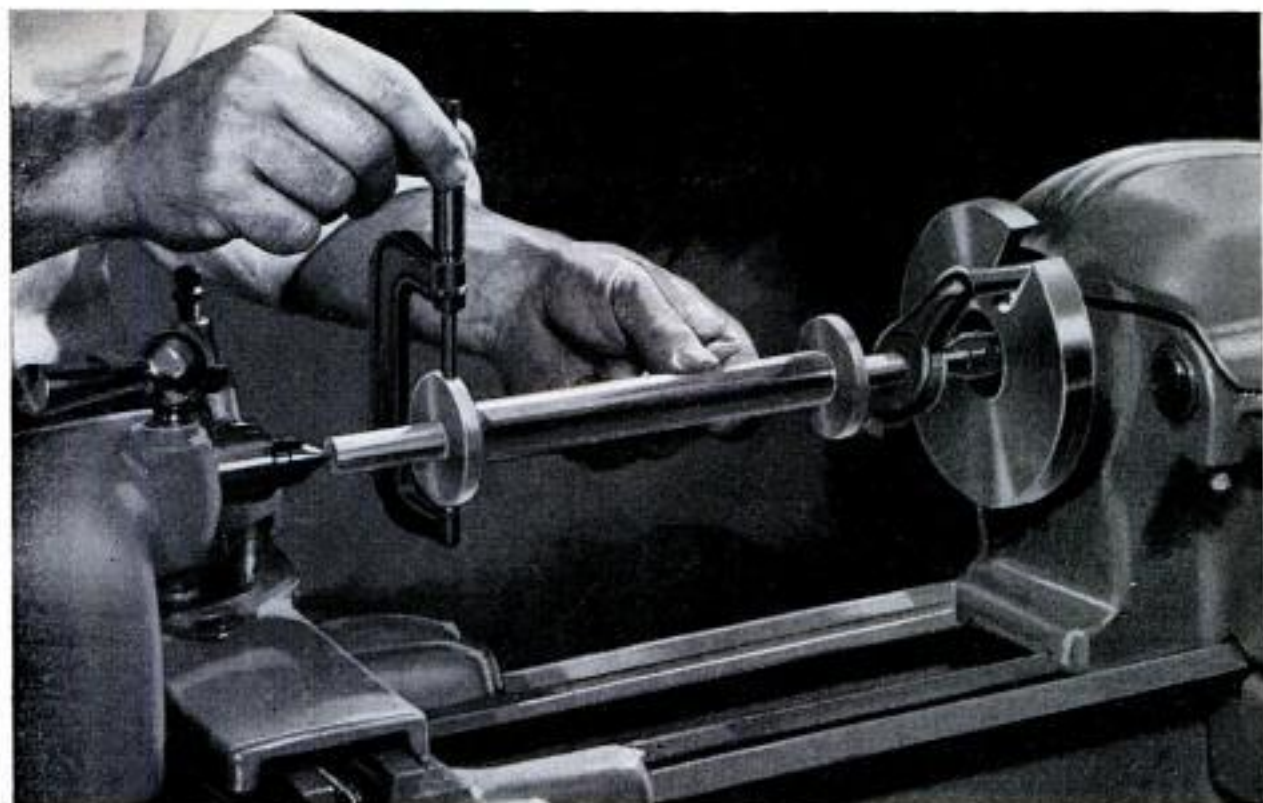

To check alignment of lathe centers, turn a test bar, run a light cut across disks. Then mike as pictured

Layout for squaring the end of shaft can be made with scriber after establishing center of shaft. Cuts are run tangent to the scribed lines as indicated

This handy gadget scores an accurate center line on bar stock in one stroke. Adjusts automatically for different widths of stock, either wood or metal

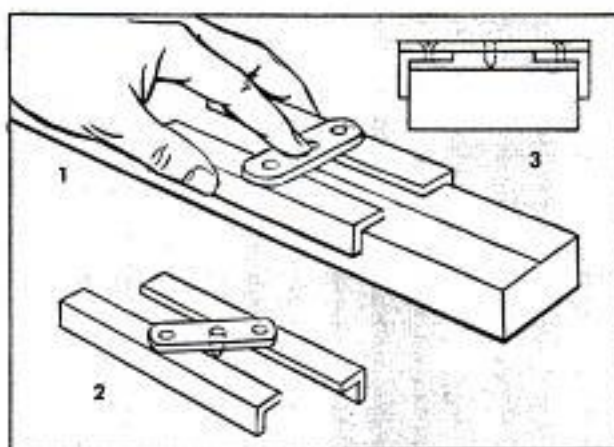
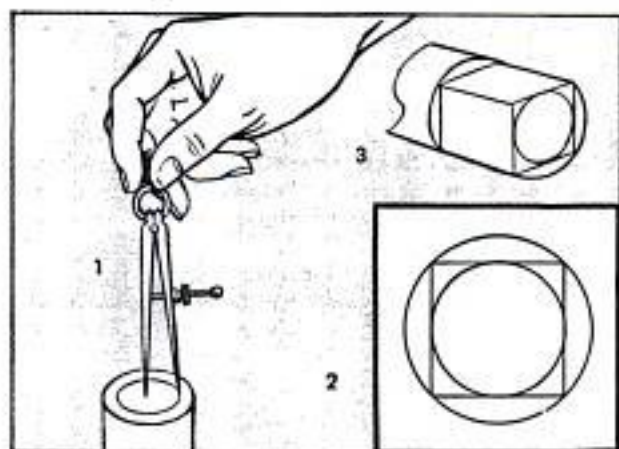

Inside and outside chucks for turning and facing thin metal disks are handy to have among the lathe accessories. To cover a wide range of work both inside and outside chucks should be made in several sizes

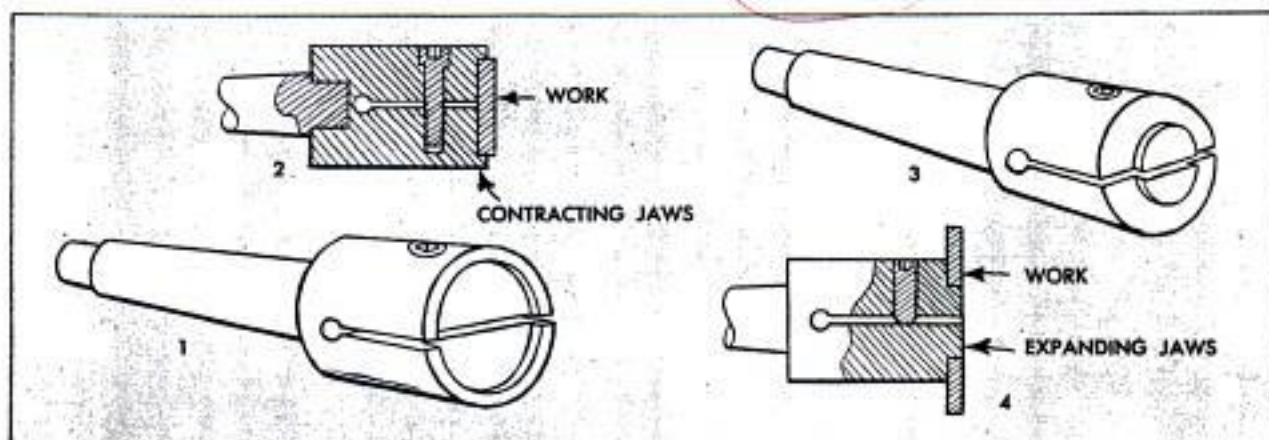

SHOPPING FOR TOOLS

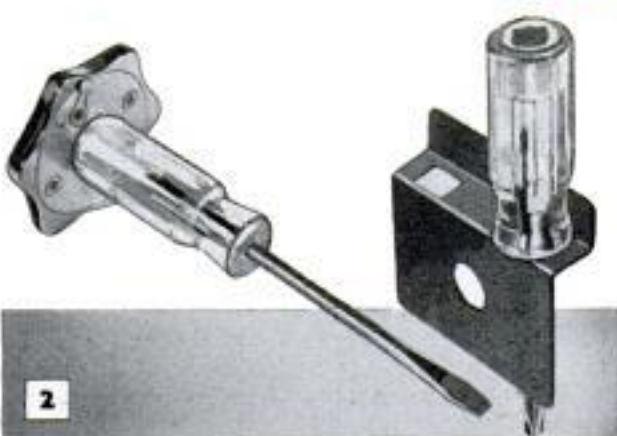

1. PNEUMATIC NAILER can drive 60 nails per minute in sheathing, subflooring and roof boards. Also seats nails through sheet metal without predrilling. Takes cement-coated nails, box nails or common nails from 4 to 8d. Adapters are available for clinching nails or driving at an angle. Driving unit works within a radius of 15 ft. from the separate feeding unit Morgan Machine Co., Inc., 1230 University Ave., Rochester 7, N.Y.



2. SCREWDRIVER has detachable palm-type ratchet driving unit which gives extra power for tightening or loosening wood or machine screws. Available as individual drivers or as a kit consisting of two drivers and a storage rack as pictured. Each driver is fitted with a special square socket to take the ratchet driving unit which is reversible for turning in or out

Kipton Industries, Box 21, Royersford, Pa.

3. TORQUE WRENCH performs as a precision nut runner with a smooth, constant torque having an accuracy range of 1 percent. Comes in three drive types giving precision, nonimpact torque from 6 to 300 in.-lb. Weight of the three drive types ranges from 5 $\frac{3}{4}$ to 6 $\frac{1}{4}$ lb. with a side-to-center distance of 1 $\frac{1}{4}$ in., this distance permitting use in hard-to-reach places

Swift Tools Corp., 3201 S. Prairie, Sioux Falls, S.D.

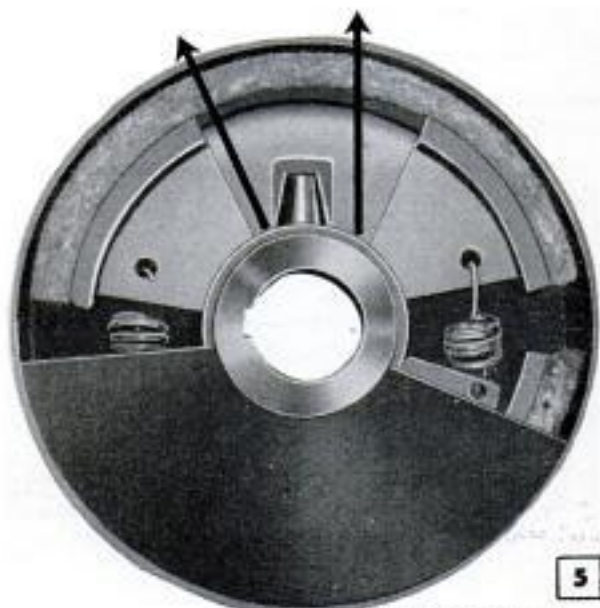
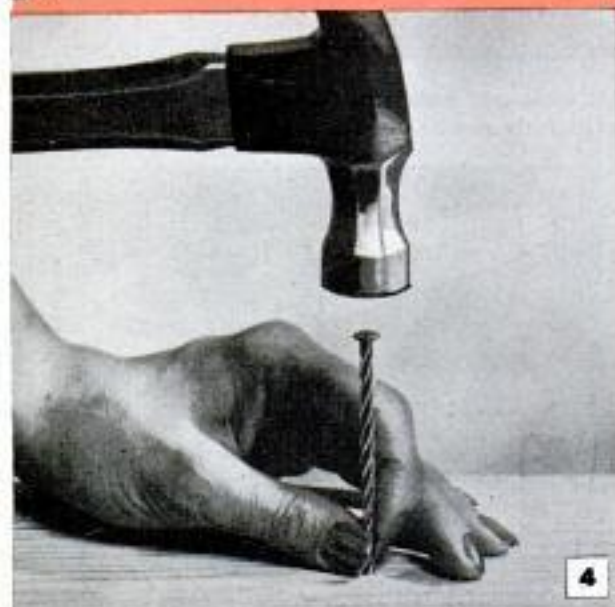

POPULAR MECHANICS



4. SPIRAL NAIL is said to cost less and hold better than the common wire nail. Shank, or body, of nail is deeply threaded, or fluted, throughout its full length. This gives it increased holding power, reduces splitting of wood, especially hardwood, and makes the nail easier to drive. Crest of thread is rounded, does not cut wood fibers when nail is driven
 Jones & Laughlin Steel Corp., 3 Gateway Center, Pittsburgh 30, Pa.

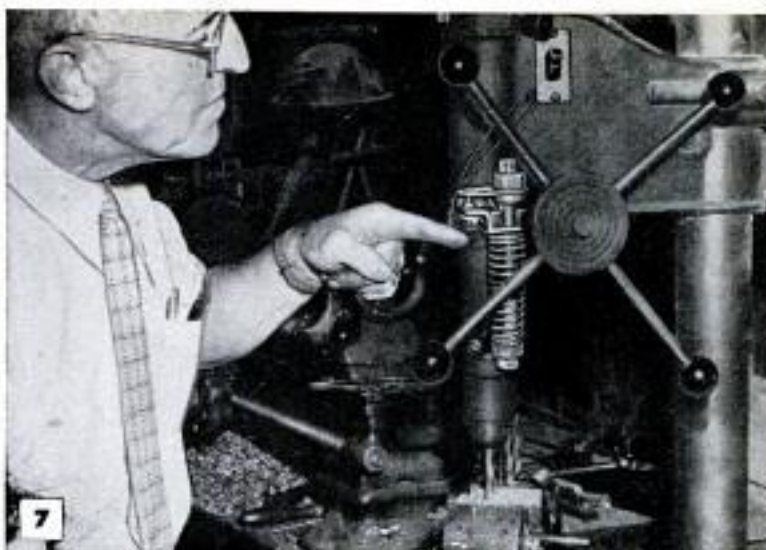

7. DRILL-PRESS ATTACHMENT provides automatic down-feed and shutoff in repetitive drilling operations. Adjustable depth stop automatically limits travel of the drill bit making it possible to drill blind holes of dependable uniformity in depth. Pressure is decreased as drill nears the end of the down-stroke, a feature that prevents burring through holes
 Diamond Tool Co., Box 32, South Haven, Mich.

5. SELF-ENERGIZING CENTRIFUGAL CLUTCH combines centrifugal and lever action to force shoes against drum. This utilization of two forces gives smooth, positive engagement under heavy torque requirements. Shoes rest on a taper pin which exerts lever action. Floating shoes permit adjustment for misalignment. Used on chain saws, air conditioners, etc.
 E-Z Machine & Tool Wks., Beloit, Wis.

8. MAGNETIC DRIVER seats small nails and brads right where you want them. Body of tool houses a plunger with magnetic tip. Nail or brad is held in tapered tip, which is similar to drill chuck in shape, and is guided into wood as pressure is applied to handle. Fine for bradding glass-retaining strips in small doors, also in picture and mirror frames
 Carol Beatty Co., 7410 Santa Monica Blvd., Los Angeles 46, Calif.

6. ELECTROSTATIC FLOCKING KIT comes with generator, adhesive, stencil of alphabet letters, four colors of flock and an applicator. Makes a quick job of flocking the bases of ash trays, ceramic vases and figurines. Also is used to flock-embroider designs, monograms or initials on fabrics, such as sportswear, drapes, handkerchiefs, pillow cases, napkins
 Dennis E. Radford Co., 5620 Maywood Ave., Hammond, Ind.

9. DUAL-PURPOSE WRENCH features a novel sliding jaw having one side notched, the other smooth. Moving the sliding jaw forward against fixed jaw exposes smooth side, providing a quick-acting wrench for nut running. Sliding jaw back to original position gives the equivalent of two pipe jaws for a firm grip on pipe or thin-walled tubing
 St. L. Zak, Oberpfaffenhofen/Post, Weasling (Bavaria), South Germany, American Zone

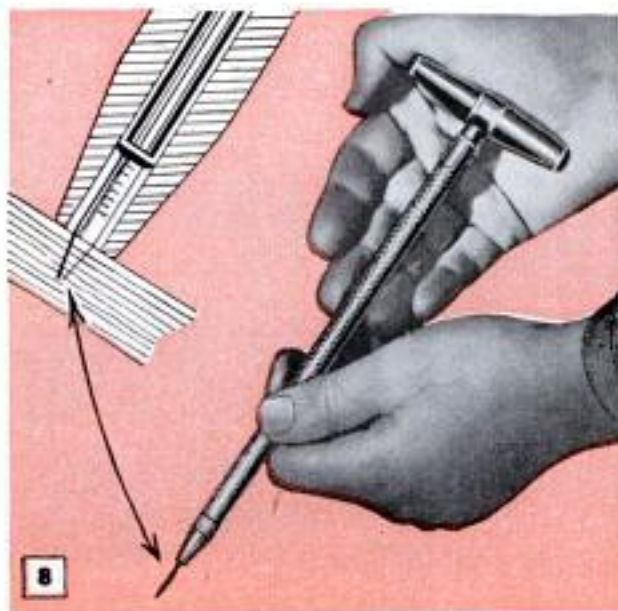

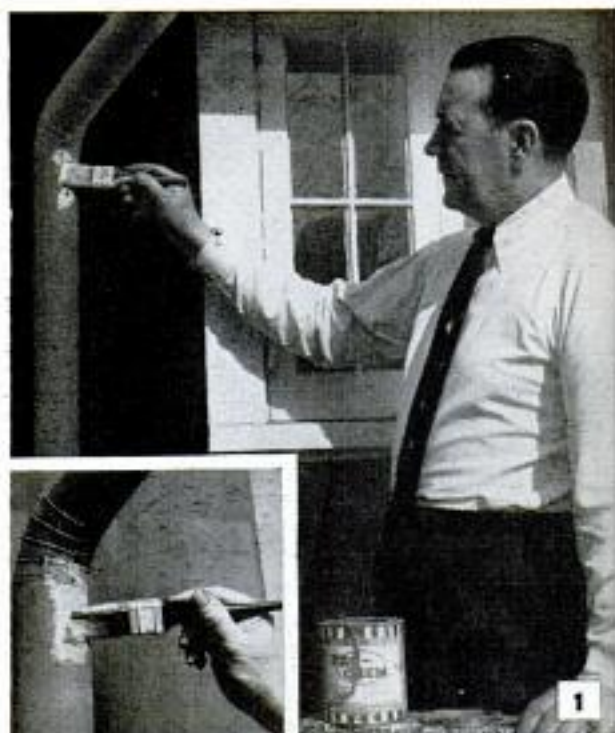

On the
MARKET
for Do-It-Yourselfers

1. LIQUID RUBBER can be applied with a brush, roller or spray gun. Forms protective coating on almost any material—metals, masonry, wood and fabrics. Withstands heat to 200 deg. F., cold to -35 deg. F. Second coat can be applied within 1 hr., and material can be built up to any desired thickness by successive applications. Surfaces must be clean and dry

The Pro-Chem Co., Inc., 51 E. 42nd St., New York City 17

2. MENDER contains a new ingredient which gives fast-hardening properties and unusual strength for bonding unlike materials—metal to wood, wood to glass, also metal to metal, porcelain, pottery, fabrics and leather. Not affected by heat, moisture, oil or common acids. Clamps or weights are not required to obtain strongly bonded joints

Merimart, 2615 W. 21st St., Erie, Pa.



3. PENETRATING CONCRETE STAIN can be applied with a brush in the same manner as a penetrating wood stain. Complete concrete-staining kit contains the stain, an undercoater or toner and a final finish of wax. Two coats of stain usually are required. The other materials are one-coat applications. Comes in choice of nine colors with full instructions

Bohloff & Co., 918 N. Western Ave., Hollywood 29, Calif.

4. SIMULATED CERAMIC TILE are made from resilient plastic and can be installed in any outside area where ceramic or concrete tile ordinarily are laid. Not affected by ordinary weather conditions and colors will not fade. Tile come in six attractive colors and can be laid in various combinations to achieve unusual effects. Be sure surface is clean

Robbins Floor Products, Inc., Tuscumbia (Muscle Shoals), Ala.



5. MULTICOLORED LACQUER is a new lacquer emulsion composed of white, gray and brown flecks, or particles. When applied by spraying, the three colors remain separated during the spraying process. This characteristic produces the attractive multicolor or spatter finish pictured. By varying the base color it is possible to obtain a variety of finishes

Pittsburgh Plate Glass Co., 632 Fort Duquesne Blvd., Pittsburgh 22, Pa.



**GET TOP
PROTECTION**

**WITH MOPAR
HEAVY-DUTY
BRAKE FLUID!**



Today's high speeds, heavier cars and more congested traffic conditions call for a heavy-duty brake fluid... Mopar's Heavy-Duty Brake Fluid:

Surpasses S.A.E. heavy-duty standards
Is safe for all hydraulic brake systems
Protects rubber parts against softening, swelling

Lubricates and protects metal parts against corrosion
Is chemically balanced
Won't vaporize at high temperatures
Won't freeze, form sludge in sub-zero cold

Order from your local Plymouth, Dodge, De Soto, Chrysler or Imperial dealer now.

It's Smart to Be Right in Brake Repair, Too!



Chrysler Corporation  Parts Division
Detroit 31; Michigan



Mopar Cyclebond Brake Linings are safety-engineered... 15% more braking area, 35% longer life, more efficient braking, higher heat resistance—at no extra cost.



Mopar Brake Hose, with rugged four-layer construction, is always your best bet at replacement time. Superior in efficiency and safety; easier and simpler to install.



Mopar Cyclebond Brake Shoe and Lining Exchange Axle Sets... individual Assemblies... and Riveted Lining Car Sets... for all post-war Chrysler Corporation cars.

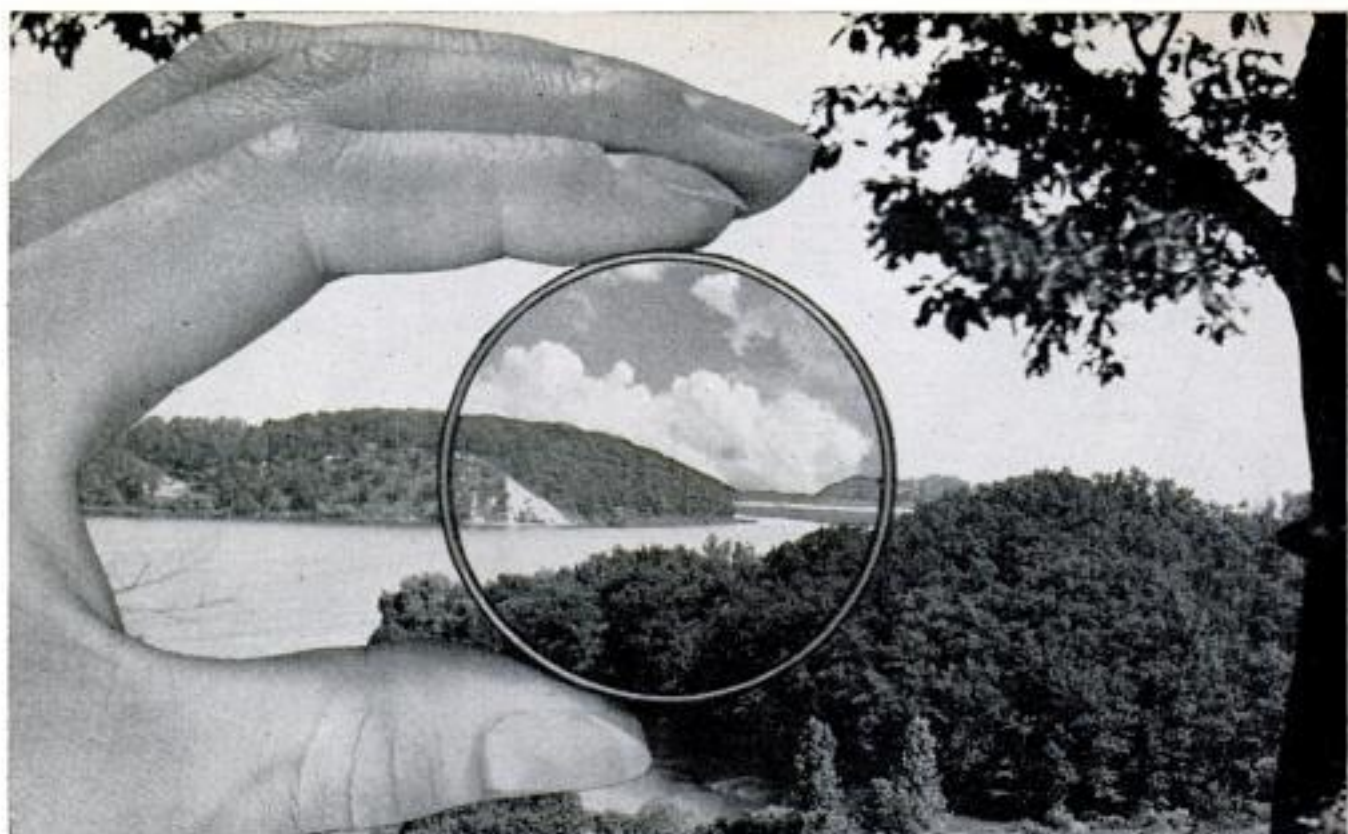

From Kodak—32 ways to

Now's the time to choose the photo aids that will make your picture taking easier . . . more satisfying . . . this summer. Your photo dealer will be glad to help you decide *which* Kodak filters and photo aids *exactly suit* your picture-taking needs. See him soon!

Use these filters for color pictures . . .

Kodak Skylight Filter (No. 1A)—The most popular outdoor filter for color. Reduces excess bluish light on hazy days, in open shade. Gives warmer tones to distant shots, aerial photographs.

Kodak Daylight Filter for Type A Color Films (No. 85)—Adapts Type A (indoor) Kodachrome Film (8mm and 16mm movie size) for outdoor use.

Kodak Daylight Filter for Type F Color Films (No. 85C)—Adapts Type F (indoor) Kodachrome and Ektachrome Films for outdoor use.

Kodak Photoflood Filter, No. 80B (for Kodak Daylight Type Color Films)—Adapts Daylight Type Kodachrome and Ektachrome Films for use with photoflood lights.

Kodak Photoflash Filter, No. 80C (for Daylight Type Color Film)—Adapts Daylight Type Kodachrome and Ektachrome Films for indoor use with clear flash lamps.

Use these filters for black-and-white pictures . . .

Kodak Wratten K-2 Filter (and Kodak Yellow Pictorial Filter)—Most popular outdoor filters for black-and-white films. Brings out clouds in blue sky, enhances tone values in any scene.

Kodak Wratten G Filter—Darkens sky and water . . . reduces atmospheric haze in landscape shots.

Kodak Wratten A Filter (and Kodak Red Pictorial Filter)—Produces dramatically dark skies. Creates moonlight effects on daytime scenes.

For both black-and-white and color pictures . . .

Kodak Pola-Screen—The only filter that will darken the sky for color film without changing other colors. Controls glare on glass or water.

Kodak Porra Lenses—Use over your regular lens for "close-ups" of small objects. Available in sizes and magnifying strengths to fit most any camera.

New . . . Handy Kodak Filter Kit comes complete with the basic filters for the kind of pictures you want to take. Available for most any still or movie camera, from \$6



EASTMAN KODAK COMPANY, Rochester 4, N. Y.



Kodak Field Cases—Your camera is fully protected and instantly ready for use. There's a handsome field case to fit almost every Kodak camera. From **\$2.65**



Kodak Flashholders—Enjoy picture taking indoors! Kodak B-C Midget, or Standard Flashholders fit most cameras. Prices start at only **\$3.50**



Kodak Rotary Flashholder—Takes 6 flash shots without reloading. Fits most cameras, **\$9.95** and **\$11.95**



Kodak Flexiclamp—Clamps in place to hold your camera or extension lights rock-steady. **\$5.95**



Kodak Auto-Release—Lets you get in your own pictures, **\$4.50** (Attaches by cable release, **\$1.25**)



Kodaslide Pocket Viewer—Magnifies your color slides 4 times! **\$1.95**. **Kodaslide Dial-Lite Viewer**—Plugs into wall receptacle for bright, internal illumination. Completely adjustable for top-quality viewing. **\$8.95**

increase summer picture fun



Kodak Photo-Hobby Outfits—Everything needed to develop black-and-white films and prints, from **\$9.95**. **Kodak Ektachrome Processing Outfit**, 35mm—For processing—mounting 35mm Ektachrome color slides, **\$26.50**



Brownie Movie Titrer Outfit—Makes all kinds of home movie titles. Fits all Brownie Movie Cameras, **\$14.95**



Cine-Kodak Duo Splicer Outfit—Everything needed to cut, rejoin your home movies, **\$9.95**



Kodak Telephotos—Low-cost telephoto and wide-angle converters for Brownie and Medallion Cameras, **\$16.95** each. Telephoto Lenses to fit most cameras, from **\$49.50**



Kodak Reels and Cans—Help protect your films from scratches, dust and curl. From **50¢**

Prices are list and subject to change without notice

Kodak
TRADE MARK



Are you an
"add-a-quart"
car owner?

Sealed Power KromeX Piston Ring Sets Save oil immediately!

If you're adding oil every time you buy gas... if your car's performance is sluggish, it's time you had a Sealed Power Ring job.

RESTORE POWER! SAVE OIL!

Sealed Power KromeX Piston Rings put new car zip and surge back in your engine's performance. Right away you save money you've been spending for oil. Ask for Sealed Power KromeX Piston Rings by name. They'll prove themselves in reduced maintenance costs, longer engine life.



GUIDE TO CAR MAINTENANCE

FREE—an illustrated manual on engine maintenance. "Care and Feeding of Engines" is informative, written in understandable language. Yours for the asking, it may save you money. Write Sealed Power, Dept. G-7, Muskegon, Michigan.

Sealed Power PISTON RINGS

BEST IN NEW CARS! • BEST IN OLD CARS!

Clinic for Homemakers



As a service to our readers in solving the hundreds of problems pertaining to a home—inside or out—the editors of *Popular Mechanics* invite you to present your problems to The Clinic Editor for help and advice. Address your questions to The Clinic Editor, *Popular Mechanics Magazine*, 200 East Ontario Street, Chicago 11, Ill.



Crack Filler

Q—Before painting plastered walls I've tried all kinds of crack fillers without much satisfaction, as you can always see the filler through the paint, which spoils the job entirely. Even two or three coats of a lighter color won't cover it. And how does one get crack filler into a corner to fill a fine crack? I've tried every tool I could think of. Any suggestions?—P. R., Ga.

A—Have you ever tried mixing the paint you are using with whiting (precipitated chalk) and using this mixture as a crack filler? However, most all crack fillers, patching plasters and the like which are made for the purpose work satisfactorily if handled correctly. It's the usual practice to clean out the crack, removing all loose material, then undercut the edges slightly so the new plaster, or filler, will key securely in place. When it is dry, sand it flush and coat with shellac to prevent absorption of the paint. Cracks having the edges offset should be sanded flush with the surface of the wall before filling. For filling fine cracks you can use a mixture of paint, of the same color as that used on the wall, and sufficient whiting to make a stiff, puttylike paste. Apply with a putty knife dipped in turpentine or any suitable paint solvent to prevent the mixture from sticking to the blade. Sand smooth after drying. To fill cracks in corners use the same mixture and apply with the index finger, which makes a perfect fillet.

Restoring Chairs

Q—I recently acquired several chairs to complete an old dining set. These apparently have been exposed to dampness for a long period of time which has caused the joints to loosen. Otherwise the chairs seem to be in fairly good condition and I'd like to put them back in first-class shape. But how does one go about it?

H. R., N. J.

A—You say the chairs are in good condition and from this we assume that no refinishing is involved. For a permanent repair the joints should be



(Continued to page 210)

Black & Decker® U-3

—packs more power—does more jobs!



GEARED CHUCK same as used by industry for extra holding power and accuracy.

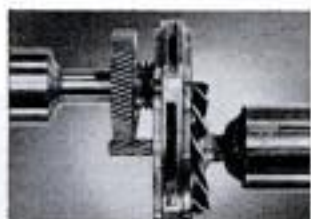

HIGH-QUALITY HELICAL GEARS give quieter, smoother flow of power from motor.



FAMOUS B&D-BUILT MOTOR has 45% more power, 100% greater torque (turning force).



SLIM, TRIM HANDLE is shaped to fit the hand for better control. Bright, highly polished housing stays new looking.

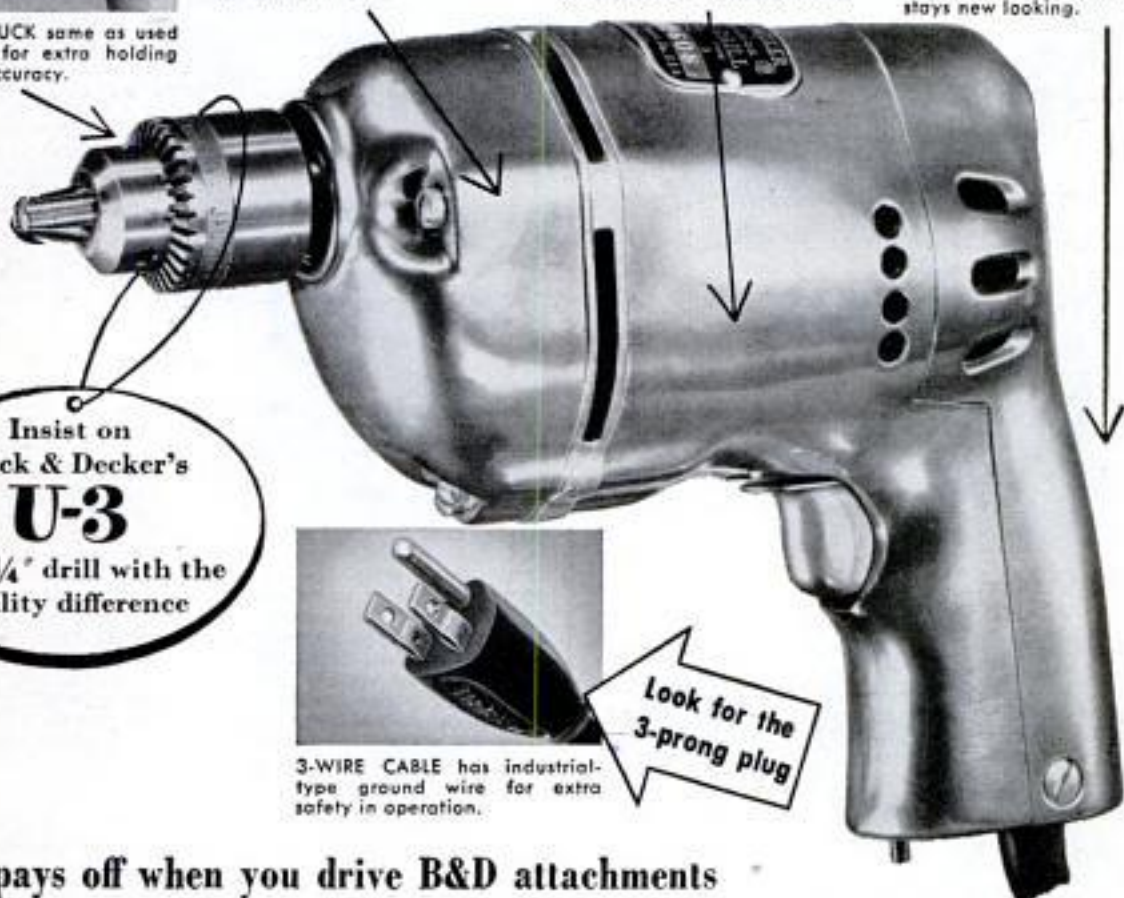

Insist on
Black & Decker's
U-3

—the 1/4" drill with the
quality difference



3-WIRE CABLE has industrial-type ground wire for extra safety in operation.

Look for the
3-prong plug

Power pays off when you drive B&D attachments

- Trims hedges
- Drives screws
- Polishes any material...and DRILLS!
- Saws wood
- Sands any surface

Most drills can bore holes without trouble. But driving attachments really separates the tools from the toys. That's why we gave the

Black & Decker U-3 Drill extra power, extra torque, extra quality. Insist on the U-3 Drill and B&D attachments by name at your dealer's —don't accept less than the best!

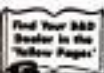

Look under "Tools-Electric"



Black & Decker®

World's largest maker of Portable Electric Tools



SEND COUPON FOR HANDY IDEA BOOK!

THE BLACK & DECKER MFG. CO.

Dept. M077, Towson 4, Md.

Please send me a copy of your "Handy Tips" booklet. I enclose 25c to cover cost of handling and mailing.

Name.....

Address.....

City..... State.....

your best buy...



- stretches the years between painting ...
- right paint for every type of surface ...
- endorsed by leading painters ...



FREE! Beautiful 44-page "Home Decorator" book. At your dealer, or write The Sherwin-Williams Co., 1237 Midland Building, Cleveland 1, Ohio.

SHERWIN-WILLIAMS HOUSE PAINT

(Continued from page 208)

opened and thoroughly cleaned to remove old glue and accumulated dust and grime. Usually it is possible to invert the chair, unscrew the corner braces and seat, if removable type, and then work the tenons out of the mortises by tapping the legs just below the rails and stretchers with a wooden mallet. Work carefully or you may split the wood at the mortises. Do a thorough job of cleaning away old glue but be careful not to enlarge the mortises or reduce the size of the tenons. Then "paint" the joining surfaces of the mortises and tenons with glue and reassemble with clamps. Another method which makes it unnecessary to disassemble the chair is to drill small holes through the back edges of the legs into the mortises and then force glue into the joints with a small glue gun made especially for the purpose. This method is satisfactory provided the joints are still in reasonably good condition. After forcing glue into the joints in the manner described, draw the joints tight with bar clamps or a band clamp and allow to dry thoroughly.



Summer Lawn Care

Q—When does one apply plant food to a lawn during the summer months to prevent "burning" the grass? I've been told that the best time is late in the evening after the dew falls, also that it is not advisable to apply any kind of fertilizer during July and August, but begin the applications again in September and continue at intervals until cold weather sets in. What is the correct procedure? — L. S., Ind.

A—A good lawn is the result of a regular maintenance schedule, just as is a golf green. Spring and fall applications of recommended fertilizers are good, but the spring applications do not as a rule furnish sufficient plant food to sustain growth at a high level during the summer months. Ordinarily the feeding schedule should begin early in the spring and carry through consistently until well along into the fall. This calls for regular applications of approved fertilizers at two, three or four-week intervals, whatever appears necessary to maintain growth at the desired level. Lawns on thin soils low in plant food and humus content may require steady applications on a two-week schedule, while lawns on heavier soils of greater moisture retentivity and higher fertility levels may be maintained throughout the season by 30-day applications.

Replacing Wood-Shingle Roof

Q—My home is roofed with wooden shingles. I do not know how old the roof is, but it's beginning to deteriorate as several small leaks have developed. My problem is whether to replace the old roof with new wooden shingles or reroof with composition shingles. I like the wooden shingles but I am afraid replacing them is going to be expensive. What is best?—J. P., N. Y.

A—You do not describe the condition of the roof other than saying that it is beginning to deteriorate and that small leaks have developed. It would hardly seem, from this description, that the entire roof is in a condition requiring immediate replacement. If the wooden shingles still lie reasonably flat, not turned up at the butts or cracked over large areas, they should give service for several years longer if repaired and further protected with a preservative. A good time to locate leaks is during a rainstorm. Remember that from the attic side, wooden shingles usually appear wet during a heavy rain but water does not drip from them unless there is an opening. Locate the points where the leaks occur and drive a small nail through the shingles so you can locate these points when you get up on the roof. Repair with new shingles. Then coat the roof with a creosote-base stain which is prepared for the purpose.

CALK THE EASY WAY

STOP

- Roof Leaks • Paint Peel
- Drafts • Wood Rot
- Soot Stain • Insects

Handi-calk

Seal ugly cracks and gaps, inside and outside, with this easy-to-use Handi-calk cartridge. Just drop it in the Handi-calk gun and pull the trigger. Will not sag or stain. Seals cracks and gaps tight and can be painted over.

Glazing? It's Easy with Handi-glaze!

HANDI-CALK DIVISION DEPT. HC 3
2366 Woodhill Rd. Cleveland 6, Ohio

FREE! Home Calk Check List. "Where and How to Calk". Send for it today.

Only SHOPSMITH lets you complete the job!

Let us send you our free Catalog! It gives you the full story on SHOPSMITH, the original complete home workshop in one unit, five major power tools in one!

Write Dept. 507-M, MAGNA POWER TOOL CORPORATION
Box 2808, Ft. Wayne, Indiana, OR Menlo Park, California

NEW 1957 CATALOG 200 MODELS—SAVE 2/3
BOAT KITS

EASY TO BUILD—Designed for the amateur. Over 200 Models. Prams to Cruisers, 8 to 21 ft. Formed hulls Semi and Custom finished. Save 50%... Now NEW Sea Ray Molded FIBERGLAS BOAT KITS. Truly professional results, NO upkeep. SAVE 2/3 assembly time. 12 to 16 ft. Utilities and Runabouts. SEND 35c for 64 page Boat Kit & 24 page Sea Ray Catalogs. SEND \$1.00 for both plus "Boating Handbook". Dealers inquire for franchise.

BOAT PLANS & PATTERNS
Frame-Pac Kits
World's largest selection; over 200 plans, full-size patterns, frame-pac kits! Designed strictly for amateurs! All types: prams, kayaks, racers, runabouts, catamarans, houseboats, cruisers - inboard-outboard 6-40' wood-plywood-steel!
Send 35c for PLAN CATALOG
Catalog PLUS "Boatbuilding Handbook" \$1.00
WRITE NOW! CUSTOM CRAFT, BUFFALO 7L, N. Y.



SOLVE YOUR STORAGE PROBLEM

With TURNBUCKLES Perforated Board fixtures you can easily end space-wasting clutter and keep everything neatly in place until needed.

TURNBUCKLES do-it-yourself fixtures come in a wide variety of shapes and sizes... fit easily into any wall-hung perforated board... and hold everything from clothing and kitchen utensils to hand tools and garden equipment.

TURNBUCKLES, INC.
BOX 333, MICHIGAN CITY, IND.

Send for your free copy of space saving suggestions for home, farm and workshop.

65

the plier you'll reach for
9 times
out of 10*



CHANNEL LOCK

No. 420

*because no other plier does so many jobs so well

GRIPS LIKE A PIPE WRENCH

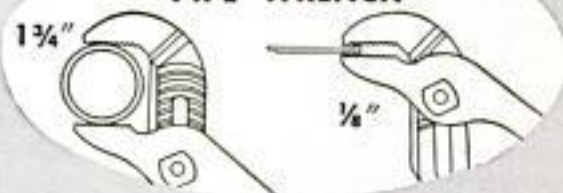

Mechanics tell us that our Channellock No. 420 is the handiest plier of them all... the plier they reach for more often than any other. They like its all 'round usefulness... its pipe-wrench grip... its big jaw-opening... its streamlined design for hard-to-get-at jobs. And you'll like Channellock for the same reasons. Ask your hardware man for a Channellock 420.

BE SURE IT'S A GENUINE CHANNELLOCK



CHAMPION DEPARTMENT TOOL Co. MEADVILLE, PA.

I Shoot the Works

(Continued from page 102)

across stage, life-like as their blood-and-bone counterparts.

This is the new science of pyrotechnics and nothing better illustrates it than the bombshell.

Consider the intricacy of a single big aerial bomb, packed with 60 or more small breaks, in a dozen colors following the main burst. Biggest mortar bombs are 48 inches long, 12 inches in diameter. To hurl them skyward you need a lifting charge—three or four pounds of black powder. The lifter packed beneath the bomb ignites first. The aerial shell, handmade as are all such complex explosives, is built up from tightly wrapped layers of sawdust, paper and powder, with as many as a dozen breaks to the layer. And each break is a different color, each mushrooming a different shape. As the bomb clears the mortar tube, the breaks must successively detach themselves from the mother bomb, and explode seconds later. Roughly, the biggest aeriels break every 200 milliseconds.

A Matter of Engineering

Visualize the engineering: The bomb's got to be hefty enough to withstand the terrific ballistic pressures of the lifting charge (so great that mortar tubes are welded from $\frac{3}{4}$ -inch steel). Each segment and every break must in turn survive the explosive "break away" of the next, igniting precisely in planned sequence.

The secret lies partly in the packing (compaction of sawdust and powder), partly in the delicate fusing (the fuse's length and density). What if something goes wrong, the slower-fused breaks igniting before the lifting charge?

This doesn't happen often, perhaps not once in a thousand displays. But it has happened while I've been ringmastering things.

We'd set up at the California State Fair, had laid out the mortars in a single line, the tubes 10 feet apart, as always.

Just before firing, I'd briefed the mortar chief.

"Soon as the swabbers have cleaned out the bores, reload. And if a bombshell hangs up in its tube," I'd cautioned, "get word to me fast. We'll isolate the tube, keep a hose on it until after the show."

That'd been our technique: Isolate the mortar, wet down around it, fill the tube with water and wait things out. A couple of hours later we'd remove the bomb, douse it with a fire hose as we cut it open. We'd wet the powder and bury what was left.

I'd called "Fire aeriels!" and watched as the mortars let go. Even with 2000 mortars coughing up bombs, you develop a sixth sense about misfires. Besides, bombshells trail a fuse as they go up. They're easily spotted, though not from the stands.

Suddenly I sensed that a tube close by hadn't let go. At the same moment the firing chief's voice crackled in my ear-phones, "Misfire! Tube No. 10!"

From the control point I saw the chief motioning the loaders away with hand signals because there's no hearing yourself think when bombshells let go. He'd no more than turned back to the magazine when one of the guys, confused I suppose, rammed a shell down the misfire and torched the fuse (we were lighting them manually that show).

I ducked, expecting the tube to blow to bits.

"Zoommmp!" With a deafening explosion both shells skittled skyward, blossoming with bursts as if nothing was wrong. Ever since then we've gotten rid of misfires—the smaller, four to six-inch-diameter ones—that way.

Maybe when the stadium lights flick on, you've noticed an unfired set standing among the debris. A misfire? Perhaps. But there's a much better explanation: Somebody missed a cue. Slip-ups happen occasionally during the frenzy of firing. If a piece isn't fired in its turn, we seldom get back to it.

Fireworks Are Fragile

What most people don't appreciate is the fragility of fireworks. It seems incredible that a flimsy package of paper and powder can rock a huge stadium and set onlookers to holding their ears.

The "gerondole," or "spin around," is both my father's most fragile creation and his most spectacular. Its one-million-candlepower burst is enough to bring daylight to the darkest stadium. Yet the gerondole's feather-light bamboo frame, hand-tied and shaped like a piepan, is so fragile it can scarcely support the weight of the 72 pushers ranged around its rim. Can't support them, that is, until its lifting charge hurls it into the night, simultaneously firing the pushers. That's when centrifugal force takes over. Spinning more than 500 revolutions per second, the gerondole's flimsy frame tauts like steel. And the spin around, fiery as a flying saucer, soars high above the crowd—one of the most spectacular and expensive of man-made meteors. About \$250 worth of powder and patience burn during its scant 15 seconds of life.

(Continued to page 214)

AUTO-LITE **POWER TIP** "fires up" winners in 1957 Mobilgas Economy Run



IMPERIAL CROWN . . . Winner in both High Price Class and Sweepstakes



CHRYSLER SARATOGA V-8 . . . Winner in Upper-Medium Price Class



DE SOTO FIREDOME V-8 . . . 2nd Place in Upper-Medium Price Class



DODGE CORONET 500 V-8 . . . Winner in Low-Medium Price Class



PLYMOUTH BELVEDERE V-8 . . . Winner in Low Price Class



Victory sweep by Chrysler-built cars proves that Auto-Lite Spark Plugs with **POWER TIP** deliver top performance and economy at all speeds.

The 1957 Mobilgas Economy Run gives dramatic evidence of Power Tip's ability to give top performance and economy in all kinds of driving . . . at all speeds. For 1568 miles, in the mountains, on the highway, and in city traffic, Power Tip sparked the winners to victory. Here's how Auto-Lite Spark Plugs with Power Tip operate . . .

At *low speeds*, the projecting spark plug tip . . . the Power Tip . . . gets hot fast, operates hotter to burn away fouling deposits which impair engine performance in city driving. At *high speeds*, the Power Tip is actually cooled by the richer air-fuel

mixture to check costly and dangerous high-speed pre-ignition caused by overheated spark plugs.

Power Tip, first spark plug ignition-engineered for today's engines and today's driving, is designed for overhead-valve V-8 engines and for most overhead-valve 6's in all these cars: Buick, Cadillac, Chevrolet, DeSoto, Chrysler, Dodge, Plymouth, Ford, Hudson, Imperial, Lincoln, Pontiac, Mercury, Oldsmobile, Studebaker, Nash, Packard, Rambler.



Mobilgas Economy Run, sponsored annually by Socony-Mobil, is rigidly supervised by the Sports Commission of the United States Auto Club.



The protruding tip makes the big difference!

AUTO-LITE[®] RESISTOR SPARK PLUG WITH **POWER TIP**

Auto-Lite makes a complete line of spark plugs, including Standard, Resistor, Small-Engine, Transport, Aircraft, and Diesel-Starting.

Try the **NEW...ALL NEW**
HOMELITE
6 HORSEPOWER
CHAIN SAWS

**"POWER
 THE
 TWINS"**



Take your pick! Both have 6 full horsepower. Both have light weight. They make every type of cut fast. They're the newest chain saws for every woodcutting operation.

HOMELITE EZ-6

6
 HORSEPOWER
19
 POUNDS



**DIRECT
 DRIVE**

Gives you the perfect combination of fast cutting and light weight... 6 full horsepower and only 19 pounds. It's the fastest, easiest-to-handle saw you can use for cutting firewood, clearing campsites or woodlots. Cuts in any position.

HOMELITE 6-22

6
 HORSEPOWER
22 POUNDS



**GEAR
 DRIVE**

A real "pro" when it comes to cutting wood. Packed with 6 full horsepower and weighs only 22 pounds. Powerful enough to bring down trees up to 7 feet in diameter. Zips through 20" trees in 18 seconds.

WIN A FREE CHAIN SAW EVERY YEAR FOR LIFE — IT'S EASY

No obligation! Just have a free demonstration. You may win:
 1. A free Homelite chain saw of your choice every year for life.
 2. One of 25 Homelite chain saws given by Homelite District Offices.
 3. Plus hundreds of chain saws given by Homelite dealers in local contests. This promotion is limited to residents of the United States and is subject to local state, city and county laws.

Homelite builds and sells more chain saws than any other company in the world

HOMELITE

A DIVISION OF TEXTRON INC.

9107 Riverdale Ave., Port Chester, N. Y.
 In Canada: Terry Machinery, Ltd.

Costliest and showiest of aerial bombardments short of war was a Lizza creation. VJ Day was but a week old and Los Angelesans wanted something big. They got it. That night we rocketed 3000 bombshells into the night in just 180 seconds, fired the four and eight-inch-diameter aerals from steel barrels, fused one to the other. That three minutes of pyrotechnics cost \$10,000. Those who watched gasped for breath. You'd have had to be there to get the impact.

A show like that requires miles of fragile fuses. Fuses are really timing devices. Their burning rate depends upon compaction—how tightly the explosive ingredients are packed—and upon the fuse's length and diameter. Basic ingredients are black powder blended with a binder—a high-melting-point wax which needs about 200 degrees F. to melt. The wax is the firemaker's "glue." It solidifies the millions of tiny grains of powder. Electronics can trigger a fuse, set it to burning. But only powder—and craftsmanship—can make it behave.

Fuses triggering elaborate set pieces are breathtakingly fast. A big bomb's fuses may burn a paltry half inch per second. In that same second, fire races along 500 feet of set fuses. Watching from the stands, it seems that a stadiumwide set fires instantaneously. It doesn't. Your eyes simply aren't fast enough to catch the igniting.

Set fuses look like coils of rope. Upwards of seven plies of cotton twine, 75 to 500 feet long, are dipped into a solution of black powder, allowed to dry, then threaded through light Manila tubing (typical diameters: 1/8 to 1/4 inch). It's "rope"—the lethal variety. Thousands of feet of the flammable stuff may go into a single set piece, crisscrossing thousands of lances—so the whole set seems to flare at once.

As controller, I worry about fuses, about electronic igniters, about the maze of sets and the blunt-nosed mortars spread before me across the arena.

Then, as my stop watch nudges 9 p.m., I brace behind the sandbagged control bunker, conscious always of the crowd—of you—huddling in the black stands.

Suddenly a voice sledges out of the night. "You're on, Mr. Lizza!"

I rasp into the mike dangling from my neck: "Fire aerals!"

And the show's screaming skyward—on this, America's fieriest night of the year, Fourth of July. ★ ★ ★

Submarines operating in World War II cost from \$5,000,000 to \$7,000,000 each. Today, nuclear-powered submarines require an outlay of \$45,000,000 to \$60,000,000 each.

Be Your Own Boss in the Profitable Excavating Business!

Custom Operators of Sherman Power Diggers Earn Up to \$1,000 and More Per Month

Wherever you live, you'll find plenty of profitable work the whole year 'round for this versatile outfit . . . not just a "trencher" but an all-purpose excavating machine! Custom operators everywhere are making big money with Sherman Power Diggers. One bought a farm with just 3 years' profits! Work for builders, contractors, utilities, and municipalities on such jobs as • SEPTIC TANKS and DRAINFIELDS • SEWER LINES • FUEL TANK INSTALLATIONS • FOUNDATIONS and FOOTINGS • GAS and WATER LINES • FIELD TILLING and many others. The Sherman Power Digger travels quickly from job to job, digs at a fraction of the cost of manual labor. It's simple to operate, easy to maintain, built to last.



Send now for complete information about the easy-to-get jobs for your Sherman Power Digger. Let us tell you—without obligation—how you can go into business for yourself with an investment of less than \$5000. Or make a small down payment and pay the balance from your earnings.

SHERMAN PRODUCTS, Inc.
Dept. 1736 Royal Oak, Michigan

SAKRETE



Dry-mixed concrete and mortar in a bag. No mess . . . no guess . . . just add water, stir and use. See your building supply dealer, lumber dealer or hardware store—today! © 1957

Look for the Bag with the Yellow Diamond!

"PROJECTS FOR OUTDOOR LIVING"

NEW DELTA hard cover book features dozens of outdoor projects. Clear illustrations, complete bills-of-materials, easy-to-follow plans. Only \$1.00. Also get FREE folder on complete Delta Library: Delta Power Tool Div., Rockwell Mfg. Co., 502G North Lexington Avenue, Pittsburgh 8, Pa.

Protect your home against power interruptions with an . . .

ONAN Emergency ELECTRIC PLANT



Provides dependable stand-by electricity for heating system, pumps, freezer, lights, appliances. Keeps home safe, livable. Automatic start and stop. Find out how little it costs!

Write for Folder!

A SIZE FOR EVERY NEED
500 to 75,000 watts.
Compact, quiet-running.
Gasoline-powered
Priced from \$269.00

D. W. ONAN & SONS, INC.
3251 University Ave. S.E. • Minneapolis 14, Minnesota

it's NEW! it's ALL IN ONE LEVEL · SQUARE · TAPE

IT'S A LEVEL!
Built-in, accurate unbreakable Level.

IT'S A SQUARE!
Accurate Square. Easy to use.

IT'S A TAPE!
10 ft., replaceable WYTEFACE® Tape.

ADD 2 INCHES

Only \$1.98
at your hardware store



KEUFFEL & ESSER CO.
Hoboken, N. J.

JULY 1957

215

Use 'em
together

No. 10
only \$1.89

the **STAR** Hack Saw Blade
& the **STAR** "Lever-Lock" Frame ...

Get Better Metal Cutting Results
Change Blades Faster



Exclusive!

One-piece solid Heat-Treated Back



Exclusive!

"Lever-Lock"...change Blades
Instantly.

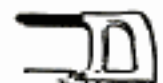

Exclusive!

Tenite handle molded around steel
back for greatest strength...perfect
balance!

AT ALL LEADING HARDWARE STORES



It's Yours!

...Info-packed booklet on metal cutting.
Send 10¢ in coin.

Clemson Bros., Inc., Middletown, N. Y., U. S. A.

HANG FIXTURES SECURELY



USE **MOLLY**
SCREW ANCHORS

THE PERFECT FASTENER to hold anything
in walls, floors, ceilings

With Molly you can install fixtures exactly where you want... not just where studs are. Won't pull through. Spider backing reinforces area in which used. Fixtures can be removed and replaced in same anchor. Easy to install without disfiguring wall. Inexpensive, guaranteed. Ask your hardware dealer for genuine Molly... the name is stamped on the cap.

150,000,000
IN USE

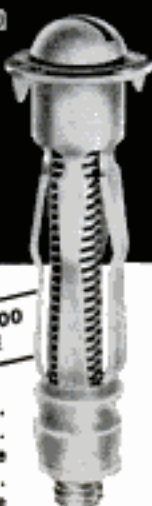

SEND
\$1.00 FOR
SAMPLE BOX
OF 12



200 N. 5th ST. • READING, PA.

Enclosed is \$1.00 for which please send
me a sample box of 12 Mollys postpaid.

NAME _____

ADDRESS _____

CITY _____

ZONE _____ STATE _____

Stand By for Satellite Take-off

(Continued from page 70)

body while aloft, standard astronomical methods can be used to observe it. But the tracking job will be a challenge because never have astronomers had to chart the position of such a rapidly changing celestial object.

Before precise observations can be made, the satellite's exact path on its first few revolutions must be quickly charted. This will be done in two interesting ways.

First, the sphere will carry its own transmitter, radiating a fraction of a watt. The miniature radio was designed and built by Naval Research Laboratory as a part of Project Vanguard headed by Dr. John Hagen. Its batteries will last two or three weeks. Nonetheless, NRL and the Army Engineers have designed special Minitrack receivers to form a "radio fence," extending from North America down into South America. If the satellite's radio operates, observers will have data to predict the orbit in its early stages.

Second, the satellite will be visible during twilight hours as a rapidly moving star of almost naked-eye magnitude, and can be picked up by simple optical instruments manned by amateur and semiprofessional sky watchers all over the world.

Satellite spying should become a popular sport, as well as an important scientific endeavor. Should the radio fail, these observers will prevent loss of the satellite to science. When the miniature radio batteries die and when the sphere's orbit grows erratic due to the forces working on it, visual observers will be the only ones who can chart its route. There is rich potential scientific information in these final stages.

Computers Will Calculate Orbit

As various teams across the country spot the satellite on successive revolutions through the creeping twilight zone, the time and location data from each will be telephoned to the Smithsonian Observatory's Satellite Computing Center in Cambridge, Mass. In minutes, electronic computers will plot the preliminary orbit. Before the satellite has completed many revolutions, its path will be sufficiently well-known to enable special photographic telescopes to be aimed accurately at succeeding orbital paths.

These photo observatories, especially established by the Smithsonian Astrophysical Observatory, will be in Florida, New Mexico, Hawaii, Japan, Australia, Dutch West Indies, Peru, Argentina, South Africa, Spain, Iran and India.

(Continued to page 224)

**Easy-to-Read
EMPIRE Levels**
Make Your Jobs Easier to Do

Exclusive Magnified Crystal Vision, free of shadows and reflections, makes Empire three times easier to read than other levels. Shock-absorbing mounts prevent damage by accidental fall. Unmovable adjustment guarantees accuracy. It's today's big buy in levels . . .

ACT NOW!

No. 152M, magnesium, 78" . . . **\$24**
No. 152M, magnesium, 48" . . . **\$14**
No. 152M, magnesium, 28" . . . **\$9**
No. 152M, magnesium, 24" . . . **\$8**

ORDER DIRECT
Send check or money order!



EMPIRE LEVEL MFG. CO. 10932 W. Fetter Road
Milwaukee 13, Wis.

FOR BETTER REFINISHING JOBS USE



Klean-Strip
PAINT REMOVER

"Peels Off Paint"

- Non-inflammable
- Removes any finish
- Fast • Non-messy
- Needs no neutralizing

Do a Better Job
with **DREMEL**
STRAIGHT-LINE ACTION SANDERS

Send for **FREE**
Power Tool Catalog

DREMEL MFG. CO.
RACINE, WIS.



Model 53
\$14.85 to \$34.85

MAKE \$10-\$20 AN HOUR
Full or part time, work anywhere.

Berrate and sharpen table, steak knives. Every restaurant, hotel, etc., repeat customers. Write today for proven daily profit plan. Guaranteed.

CUTTER-CRAFT



58-B So. Raymond
Pasadena, Calif.

"DO IT YOURSELF"
IT'S EASY WITH
KESTER SOLDER



Soldering's really a "cinch" . . . when you use time-tested, reliable KESTER . . . available everywhere.

FREE! "Soldering Simplified" . . . 16-page how-to-solder booklet. At your dealer or write direct.

KESTER SOLDER COMPANY
4251 Wrightwood Avenue Chicago 39, Illinois

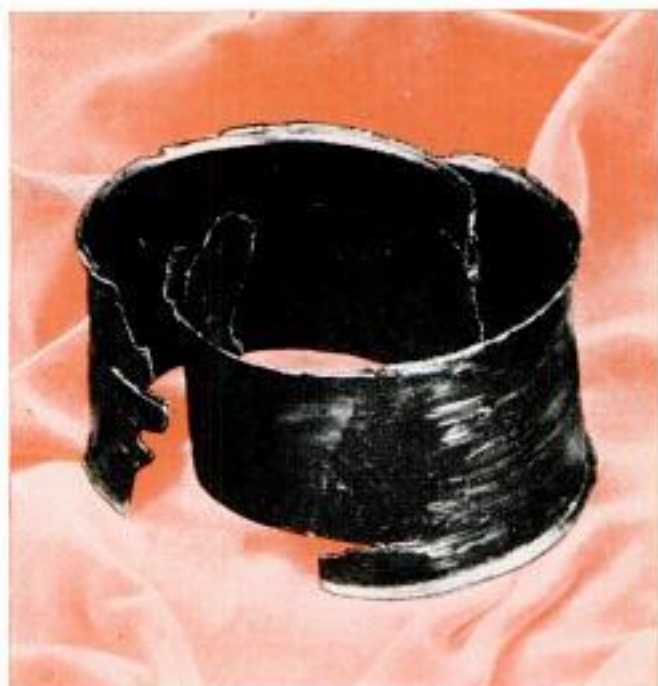

What happens when you wait too long to replace engine bearings?

In addition to power and pick-up loss and carbon fouling the engine's "insides," driving with excessively worn bearings can cause costly crank-shaft damage—perhaps even replacement! When engine sluggishness and increased gas and oil bills signal worn bearings, to protect the shaft and to restore power, pep and economy, replace with Federal-Mogul main and con rod bearings—they are *engineered* for the job! *Ask your mechanic!*

FEDERAL-MOGUL SERVICE
Division of
Federal-Mogul-Bower Bearings, Inc.

Mechanics Know . . .

that the black and red Federal-Mogul box identifies the service bearing line as modern as today's engines.

RESEARCH • DESIGN
METALLURGY • PRECISION
MANUFACTURING • SERVICE



"Broncobusters" of the High Seas

(Continued from page 132)

seven days. She went into service the following day.

Delivery of vessels of all types, from their port of launching to their new owners, is the responsibility of the "runners" or contracting firms.

One of the oldest of these is Abram's of Glasgow, the company which delivered both ferries. It was Henry Abram, son of the founder, who waited so anxiously for news of the *Queen Margaret*; it was his son, another Henry, who fretted until the *Sir William Wallace* docked safely. Between them, the three generations of Abrams have managed to deliver hundreds of ships, hulks, floating docks and other seaborne objects to all parts of the world.

"Weather is the taskmaster in this business," Henry Abram explains, "but each commission presents its own problems. It might be, for instance, the question of how to deliver a harbor tug with a 36-ton bunker capacity, burning eight tons of coal daily, across 6000 miles of ocean with bunkering ports 10 days and more apart."

Extra Bags of Coal

Abram, who is himself a Naval Reserve officer, was faced with this very problem recently, when he was charged with delivering three 113-ton, 90-foot-long tugs built in Britain to Cape Town, South Africa. He managed it by stowing extra bags of coal wherever possible aboard, and making arrangements to bunker at obscure points on the African coast which seldom see a ship.

One of Abram's longest voyages was that of the British-built 85-foot-long motor lighter *Meealong*. This was delivered at Palembang, Dutch East Indies, 8750 miles away, in 81 days. It traveled via Gibraltar, the Suez Canal, Aden and Colombo. Bad weather played havoc with the original schedule.

Dredgers Difficult to Deliver

Hoppers and dredgers of all types, whether self-propelled or towed out, are always difficult delivery assignments. Trawlers, on the other hand, being sturdy craft built to stand up to storm and stress, present few delivery difficulties. In 1952, the 133-ton *Dauntless Star*, built in Britain and sold to the Booth Fisheries Corporation, Chicago, was delivered at Halifax, Nova Scotia, in 25 days' steaming time.

The 625-ton pilot ship *Jean Mentelet*, built on the Clyde for the Suez Canal Company, was taken out to Port Said, via Malta, by Abram's in 14 days. Recently

a coaster sailed from Rotterdam for the West Indies completely bunkered, stored and manned by an Abram crew of runners six days after the delivery price was quoted.

Last Voyage

Delivery of ships on the last sad voyage to the shipbreaker's yard takes place frequently. Some must be taken even as far as Japan. In 1953 Abram's arranged for the towage of the burned-out hulk of the 20,000-ton *Empress of Canada*, submerged for 20 months in a Liverpool dock and raised after an epic salvage feat, to a breaker's yard in Spezia, Italy.

Yachts, powered by their own tall canvas, are occasionally delivered overseas. The auxiliary Bermudan cutter *Gulvain*, 55 feet long and with 1135 square feet of sail, was delivered to a Greek shipping tycoon in Bermuda after a splendid 30 days' Atlantic crossing, sailing by way of the Canary Islands.

The successful delivery of any ship depends greatly on the crew of runners engaged. Abram's draws on a pool of qualified officers and efficient crewmen, all prepared at a moment's notice to sail anywhere in anything that floats.

Good food and comfortable berths, the modern sailor's birthright, are not always possible in small craft doing a deep-sea safari. Canned and dehydrated foods and meat without bones are invaluable space savers.

Bread wrapped in waxed paper keeps fresh for about 10 days. Fresh water is always a problem in small ships on long voyages. Barricoes (wooden casks) of water are stowed away to augment limited tank capacities and canvas is stretched to catch the rains.

Small ships can now be equipped temporarily with short-wave radiotelephones capable of transmitting arrival messages or, in an emergency, the "Mayday" distress signal.

Cabled news of arrival is immediately phoned to waiting clients. Then, as a goodwill gesture, the crew's next of kin are informed.

Ship delivery is certainly a risky business requiring a high degree of skill. It gets few publicity fanfares. Yet, where small craft are concerned, it is as essential to shipbuilders as the mail service is to industry ashore. There are very few executives in this ulcer-provoking job—Mr. Abram hasn't had a holiday for three years—but fortunately there's always a good pool of runners ready to deliver anything that floats.

YES . . . Paint furniture, fence etc. — spray away the insects for outdoor living — these and scores of other jobs actually are fun with the portable Johnson **Red Head** Air Compressor. It's a powerful piece of equipment—not a play-thing. You can do a "professional" job with the Johnson **Red Head** Can pay for itself many times over.

It's Fun
with a
"Red Head"



HERE'S HOW TO USE AND ENJOY YOUR JOHNSON "RED HEAD"

Do-it-Yourselfers . . . the "Red Head" puts the professional touch to all refinishing jobs, painting work and odd jobs around the house.

Boat Owners . . . the "Red Head" is the best spray machine made for hull painting, deck and cabin refinishing, handling insect spray.

Home Painters . . . the "Red Head" spray gun gives a flawless, smooth finish to exterior home surfaces and professional finishes on furniture.

Charcoal Chefs . . . A fast spraying with insecticides virtually eliminates annoying bugs and pests . . . means truly enjoyable outdoor meals and living.

Farmers . . . the "Red Head" used properly for barn fogging, machinery maintenance and painting saves you time, money and cost of extra personnel.

Gardeners . . . "Red Head" spraying is a most effective way to control insect pests.

Equestrians and Kennel Enthusiasts . . . the "Red Head" barn fogging process and sanitary spraying will insure the health and comfort of your animals.



\$44
LESS MOTOR

"Red Head" Compressor Kit includes: gun, 15 ft. air hose, tire chuck, fittings, 4" pulley on compressor, 26" V-belt, 3 1/2" pulley for mounting on 1/4 to 1/3 h.p. motor . . . weight less than 30 lbs. — easily portable.

CHECK THESE "RED HEAD" FEATURES

100% BALL BEARING and needle roller bearing construction.

PISTON-TYPE UNIT. Provides oil-free air. Built-in surge tank eliminates pulsations.

NYLON THRUST WASHER keeps shaft in alignment. Neoprene seal tested through thousands of hours of trouble-free operation.

LIGHTWEIGHT AND COMPACT. 14" long, 8" wide, 10" high. Weighs less than 30 lbs. with motor. Easy to carry to any location.

NO STORAGE TANK NEEDED. Delivers 3 1/2 cfm of free air and 50 psi pressure.

FORCED AIR INTERNAL COOLING. Aluminum die cast housing ribbed and reinforced for greater strength and maximum cooling.

GUARANTEED PERFORMANCE. Quality materials and advanced engineering. Simple, oilless, efficient.

• **FOR USE WITH** any 1725 rpm 1/4 h.p. or larger fractional horsepower electric motor. Power take-off or gas engine can also be used.

JOHNSON SERVICE COMPANY

Compressor Division, Milwaukee 1, Wisconsin

Please send **FREE** literature and name of dealer for "Red Head" Compressor — information and prices for complete Johnson Compressor line .

Name.....

Street.....

City..... Zone..... State.....

Made by **JOHNSON SERVICE CO.**

FOR 75 YEARS

MANUFACTURERS OF PNEUMATIC TEMPERATURE AND AIR CONDITIONING CONTROL SYSTEMS.

Power Is Oldsmobile's Top Feature, Say Owners From Coast to Coast

(Continued from page 124)

this is by far the least mechanically perfect. Many bugs were apparent in the car after only a few weeks of driving, such as poor printed circuit in the dash, poor shocks and an inadequately strengthened radiator for the high pressures involved."—Indiana Air Force man.

"I paid \$65 extra for my special paint. It is more metallic. It is showing through on the roof struts and not from polishing as it has not been polished, only washed."—Ohio union representative.

"Door glasses rattle."—Texas pastor.

"Has more rattles and squeaks than any car I've had and I've had 10 new cars since 1949."—Michigan attorney.

What About Styling?

Because Oldsmobile has been completely restyled for 1957 and because it retains much of the general appearance of previous years, we asked several specific questions about styling.

Oldsmobile has developed a reputation for clean, simple styling with a minimum of frills and it is not surprising that owners rank this characteristic tops on the list. On the don't-like list, the feature most frequently mentioned is the three-piece rear window. Here are quotations to illustrate the likes and dislikes in order of frequency of mention by the owners:

"I like its simplicity, its clean lines."—Illinois diemaker.

"The simple, but well-built design with no exaggerated fins."—Michigan sales manager.

"Modern front bumper and grille design."—Tennessee service manager.

"Low, streamlined."—Indiana salesman.

"I like the red stripe on the chrome side trim."—Wisconsin owner.

"Rear-window dividers cut down the vision through rear-view mirror."—Michigan state policeman.

"Front grille too hard to wash and polish."—Indiana plasterer.

"Wrap-around windshield makes it too hard to get in and out."—Oklahoma dentist.

"Chrome airplanes on front fenders collect extra dirt."—New York salesman.

Interior Likes, Dislikes

Strangely enough, the best-liked interior feature and the least-liked interior feature are the same: the dashboard. Oldsmobile has an unusual dashboard design this year. It is called a "strut mounted" dashboard. There is an opening between the base of

the windshield and the top of the dashboard. Here are the good and bad features of this design, as seen by the owners:

"Strut dash adds strength and gives good radio sound quality."—Missouri retailer.

"The design keeps the sun's rays from hitting me in the eye."—Texas farmer.

"Strut-mounted dash looks good but is a catchall. Everything goes over behind it."—Virginia contractor.

"Opening behind dash is strictly a dust catcher."—Mississippi businessman.

Here are more opinions on Oldsmobile interior design:

"Headlining is made so it can be washed."—New York clerk.

"Colors of interior are subdued. This is a safety factor."—Florida retailer.

"Glove pocket is long, but poor in depth. Should be deeper."—New Jersey university student.

"Floor mats are too hard to sweep."—Kansas night-club operator.

"Floor mat should be something you could wash."—California stage-property man.

More Best-Liked Features

"I like most the fine, quiet, durable and outstanding performance of its engine."—Illinois corporation executive.

"Sturdy construction."—New Jersey salesman.

"Hydra-Matic changes from first gear to second quickly and smoothly. Has a quick getaway."—Maryland well driller.

"Large window area."—Wisconsin retailer.

"Lots of vision."—Michigan farmer.

"I like the dual exhausts below the bumper, throwing fumes down instead of through bumper."—Nebraska contractor.

"As an auto mechanic, I prefer Olds to any other make due to its general accessibility."—New York mechanic.

"I like the heater controls—no levers to pull or knobs to turn. Just push the buttons."—Maryland foreman.

"My dealer service could not be beat."—New York fire chief.

More Complaints

"When you open the rear door, space is too narrow to get your feet out of the door."—Illinois retired farmer.

"Too low. Hurt my back getting in and out, as I am six feet tall."—Colorado salesman.

"Heater control does not work right. When not on Hot, it throws all cold air. No way to get warm air."—California owner.

"Heater vents vibrate at over 60 miles per hour."—California Navy man.

(Continued to page 222)

Here's a sound-conditioned fun room you can build yourself!



Kids should have a room where they can make all the noise they want. Parents should have a room, too — for their parties or hobbies. Even if you've never driven a nail before, you can build a sound-conditioned fun room for your family. It's easy to do, and costs less than you think.

On the ceiling, use Gold Bond Acoustamatic Tiles. They make rooms pleasantly quieter, are attractive and inexpensive. Both Regular and Random patterns (see above) have hundreds of perforations that literally soak up noise. Nail or staple tiles to wood strips applied right on your old ceiling. Their rich ivory-white finish beautifies any basement.

On the walls, use Gold Bond Gypsum Wallboard and Insulation Tiles. Tiles come in ivory-white and a random assortment of four lovely pastels, have interlocking edges that hide nails or staples. Wallboard goes up fast. Saw panels like wood, or

score with a knife, and snap. Finish with quick-drying Gold Bond Velvet Latex Paint. Job's done!

Want plans so you can start building? Write for free illustrated folder, "How to Remodel Your Basement," to National Gypsum Company, Dept. PM 77, Box 73, Buffalo 13, N. Y. Then see your local Gold Bond® dealer. He'll supply everything you need — including helpful advice.



NATIONAL GYPSUM COMPANY



"Jetaway is not as fast from a standing start as plain Hydra-Matic."—California steel worker.

"Some road ice struck the rod which operates the transmission control and I could not shift. The car could not even be towed. This important rod should be in a more protected location if the car is to be given such low clearance."—New Jersey dentist.

"When driving fast in rain, wipers fail to hold against the windshield."—Indiana farmer.

"Windshield-wiper mechanism uses cables that are too loose and result in poor window coverage."—California executive.

"Front fenders overlap front bumper and the wheels throw all the mud and road dirt over the chrome."—Illinois merchant.

"Window cranks are too low and work too hard."—New York distributor.

"Have to slam trunk lid almost through the rear end to close it."—Connecticut owner.

"Should move dimmer button two inches to the right as emergency-brake pedal is in the way."—New York engineer.

"Too much of the underside of the front fenders shows."—Ohio housewife.

General Comments on Industry

We ask the owners who take part in our Owners Reports to tell us what they think about the current trends in the automobile industry. Many of their comments are of unusual interest. While they do not necessarily apply to Oldsmobile, they are interesting enough, we feel, to be quoted. Here are some of them:

"Why have all cars gone overboard in horsepower? Power, power, power. Laws don't begin to allow the use of all the power so we use more gas for power we can't use. I'm not an engineer, but it all sounds pretty silly to me."—Massachusetts housewife.

"They have lowered the cars too much. It isn't as convenient getting in and out as the 1956 models."—Michigan assembler.

"My reaction to body styling of several of the 1957 cars is that changes are too drastic. I like more conservative styling. Also I think extreme fins and such add to the cost."—Texas business manager.

"I don't mind the lowness, but I do not like the windshield protruding in the way of getting into the car. It is also dangerous as to getting fingers caught in the door."—Michigan owner.

"I sell direct to homeowners. I would have bought another make which is more stylish, but it looks too much like a 'brag' car. Some people resent obvious prosperity and the big-shot appearance. The conserv-

ative lines of the Oldsmobile are the main reason for my buying it."—Missouri salesman.

"This car is air-conditioned which I have not used to date. There is some question in my mind as to the value of this in this part of the country. It may turn out to be more of an expense to maintain and operate than the advantage it offers."—Michigan salesman.

"If speedometers were more nearly correct, the highways would not be cluttered up with slow drivers. Also gas mileage would be different."—California retired owner.

And that is the assembled opinion of the Oldsmobile owners who took part in this month's Owners Report. For the engineering analysis of the car turn back to page 126. For a report of the way the car drives see page 127. ***

Swinging Wall Lamp Has Wide Radius

Blind workers are manufacturing a product they can never use. It's a suspension wall lamp with a swinging radius of eight feet. The frame is made of tubular aluminum with a black, gold or silver finish. One type of shade is triangular and the unit's cost is \$11.50 including parcel post and handling. The other model is a Japanese-parasol type costing \$12.50.



❑ Paper of synthetics such as nylon is planned for manufacture within a year.



MENDS MOST ANYTHING

"HOLDS LIKE IRON"

Used by fine furniture makers. Ideal for home and office. In 3/4 oz. or 2 1/2 oz. sizes.

BUY GREAT NECK HAND TOOLS

... for long-lasting performance



CHROME PLATED ADJUSTABLE TUBULAR HACK SAW

GREAT NECK SAW MFRS., Inc.

MINEOLA, N. Y. — SEE YOUR LOCAL STORE

8,000 STOCK GEARS, SPROCKETS

1/8" to 168". Worms, Chains, etc.



Change Gears, Bevel Gears, Miller Gears, Spur Gears, steel or Formica, Worms and Worm Gears, Sprockets, all types, Roller Chain, single or double, Flexible Chain Couplings, Shaft Collars, Universal Joints, Worm Gear Speed Reducers, Surface Plates, Straight Edges, Cubes, Angles, Right Angles, Drill Presses, Coolant Pump Systems, Dust Collectors, Motors, Low Prices. Send 25c for 206-page catalog.

UNIVERSAL GEAR & MACHINE CO.
1299 E. McNichols Road Detroit 3, Mich.

"ARCO-SAW" CUTS GROOVES AND 2x4's!

Exclusive "Dado-Arbor" swivels blade to cut grooves up to 1 1/2" wide x 1" deep in 1 cut. Rips, Crosscuts, cuts angles with tapes. Fits any 1/4" drill. Incl. 5" blade. . . . **\$12.95**

At your Dealer or order direct (ppd.) C.O.D. + post. Money Back Guarantee.

ARROW METAL PRODUCTS CO.
Dept. PM-7, 421 West 203rd St., New York 34, N. Y.



STOP WASTING MONEY
on worn-out piston rings

Get **HASTINGS** STEEL-VENT

Earn Big Money Arc

180 AMP. UTILITY AC ARC WELDER

LOW IN COST, a Hobart Arc Welder will immediately set you up in a highly profitable business. Quickly you can capitalize on the great demand for emergency repairs and construction jobs. Be sure to write today for complete details. No obligation.

HOBART BROTHERS CO., BOX M-77, TROY, OHIO



Welding

BUILD YOUR OWN

This low cost unit is easy to connect to a good auto engine



Solved at Last

the Mystery of **WHEN TO CHANGE YOUR CRANKCASE OIL SOLVED BY THE NEW REVOLUTIONARY DETECT-O-TUBE OIL TESTER**



... Only **\$1.00** ppd

- So simple, so easy, you do it yourself... in minutes... Shows you how to:
1. Cut down on oil changes, repair bills... save yourself money.
 2. Lengthen the life of your engine... reduce wear and tear.
 3. Help eliminate exhaust smoking.
 4. Reduce loss of oil.

Kit contains four finger-shaped, finger-long test tubes, filled with chemical fluid. Just take one tube, pull out the dipstick from your car while the engine is hot, drop some 15 to 20 drops of oil from the dipstick into the tube. Shake and allow time for tell-tale ring to form so the amount of contamination is visible. Then, using the chart that comes with the kit, you can tell at a glance whether your oil or filter needs to be changed.

All car owners should use the Detect-O-Tube Oil Tester and all power boat owners should have a kit aboard.

All you do is send \$1.00 in cash, check or money order (no C.O.D.'s please) and your Detect-O-Tube Oil Tester, enough for 1 year's supply, will be shipped postpaid at once.

CHECK YOUR OIL... CUT ENGINE TOIL
THE MILLER CO. Marblehead 10, Mass.

An Amazing Bargain! 100% NYLON COVERALLS (BRAND NEW)

Made to Rigid Govt. Specifications for the Air Force

Now for **MOTORISTS, MECHANICS, AVIATORS, SPORTSMEN, HANDYMEN AROUND THE HOME OR FARM**



These **NYLON COVERALLS** prevent your clothes from getting dirty or soiled. They cover you from head to foot. In a short time **COVERALLS** save their cost many times over. No motorist should be without one. When anything goes wrong, that's when a **COVERALL** is needed most.

This **NYLON COVERALL** is a cleverly made one-piece garment. On and off in a jiffy, yet affords complete protection.

2-way zipper front. Nine extra large, roomy pockets, four with zippers, for holding everything needed. The **COVERALL** itself is extra roomy, yet lightweight, durable and very comfortable. Easily washed; dries in minutes. Olive drab color.

SIZES: 36, 38, 40, 42, 44, 46; short, regular or long.

These are Air Force Surplus **COVERALLS**, so you get wonderful value for only

\$6.95
POST PAID

SATISFACTION GUARANTEED

Send Check or Money Order . . . **NOW.**

AMERICAN JOBBING CO., Inc.
Dept. M, 164 Canal St., New York 13, N. Y.

NO MORE VAPOR LOCK!

Got vapor lock troubles with your car, Mister? Pretty aggravating, isn't it? And it can be mighty expensive! But there's a simple answer. Install a Bendix® Electric Fuel Pump and you'll positively eliminate vapor lock. Good idea, don't you think? Get a Bendix Electric Fuel Pump at any independent garage or service station. (If you wish, write us first for illustrated folder.)

*REG. U.S. PAT. OFF.



Bendix ELECTRIC FUEL PUMP

BENDIX AVIATION CORP.
(Eclipse Machine Div.), Elmira, N.Y.

FREE PLAN tells how to start your own business FILING SAWS

Here is a steady repeat CASH business you can start in your own basement or garage in your spare time and make up to \$3 or \$5 an hour. You can file hand, band and cross-cut circular saws on the Foley Saw Filer. No eyestrain—no experience needed. "The first



saw I sharpened with my Foley Filer came out 100%."—writes Clarence E. Parsons.

Every saw you sharpen with the Foley Saw Filer brings you more customers. "I rented a two-car garage and have all the work I can do"—Charles H. Smith.

FREE BOOK

Shows How To Start
Send coupon today.
No salesman will call.

SEND COUPON FOR FREE BOOK

FOLEY MFG. CO., 743-7 Foley Bldg.
Minneapolis 18, Minn.

Send me free book "Money Making Facts"

Name _____

Address _____



The heart of these stations is the Baker-Nunn Satellite Schmidt telescope. Basically the telescope is a Schmidt type, modified optically and mechanically for this tracking problem. It employs a 31-inch spherical mirror and three corrector plates, providing a 30-degree field of view, and stellar images of high quality. Continuous photographic film in the telescope mechanism records the path of the satellite across the sky in a series of pictures that may be as frequent as one per second.

Film Records Background Stars

Merely to photograph the satellite without respect to background stars would be interesting but meaningless. An ingenious drive mechanism enables the new telescope to track the satellite for a short time, then on the same film to record the star field, which acts as a celestial frame of reference for the satellite motion.

Clock timing, also recorded on film, pinpoints the passage of the sphere to an accuracy of $\frac{1}{1000}$ second. Radio time signals broadcast to all 12 stations simultaneously, for accurate calibration of the telescope clocks, make this remarkable tracking program possible.

As soon as the satellite has passed over a given station, the film will be processed on location, rough measurements made and transmitted to the computing center in Cambridge. This will serve as a rough check on orbit computations. Precise measurements will not be made until the film is received in Cambridge for analysis.

The scientific value of such records, besides furnishing data for predicting satellite positions, will yield a complete history of the satellite's changing orbit on successive journeys around the earth. These changes will enable scientists to determine the size and shape of the earth, to link the geodetic networks from continent to continent, and to measure the variation in density of the upper atmosphere of the earth.

The satellite will also carry instruments for measuring such things as cosmic rays, ultraviolet light from the sun, and the magnetic field of the earth.

It is intriguing to reflect that this tiny body will give us information about the upper atmosphere as well as conditions inside the earth, since its motion will be controlled by conditions in both places. Such information is not obtainable any other way. Our satellite may well be the forerunner of a new astronomical tool, as important in its unique role as was the telescope of Galileo in its role. It is fitting that this effort be an international cooperative effort.

What about future satellites? It seems

(Continued to page 228)



Works in seconds!
Loosens Rusted Bolts
 nuts, screws, "frozen" parts!

LIQUID WRENCH

The super-penetrating rust solvent that quickly loosens rust and corrosion.

AT HARDWARE STORES, GARAGES
 SERVICE STATIONS, EVERYWHERE
RADIATOR SPECIALTY CO.
 Charlotte, N. C.



NEW, IMPROVED CALCULATOR FOR WOODWORKERS only 25c

Instantly gives information on lumber, nails, concrete mixes, painting materials, etc. Convenient, simple to read. Just set dial for nail specifications, to convert linear to board feet, find bit sizes for screws, compare characteristics of woods. 6" diameter heavily varnished cardboard. Send 25c, no stamps, please to Greenlee Tool Co., 2107 Columbia Avenue, Rockford, Illinois.

FREE WHOLESALE CATALOG

MAKE MONEY!! SAVE MONEY!! Buy Tools, Hardware, appliances, photo equipment, sporting goods, power tools, paints and thousands of other nationally advertised products at WHOLESALE COST TO YOU.

SEND FOR FREE 1957 WHOLESALE CATALOG TODAY!

SILVO HARDWARE COMPANY
 Dept. PM 7, P. O. Box 266, Philadelphia 5, Pa.

get up to 50% off

NEW! Completely UP-TO-DATE!

Manual for PLYMOUTH OWNERS



COVERS ALL MODELS 1941 to 1957. Gives you more from your Plymouth for less. So accurate mechanics can use it... so simple a woman can understand it

Now fix it yourself and save money on Plymouth repairs. With this Popular Mechanics book you prevent trouble... enjoy care-free driving... increase trade-in value... get sparkling performance... and avoid major repairs by fixing minor troubles before they get serious. Not just a re-hash of service manuals, but a completely updated version of the famous 1950 PM book written by automotive expert Ed Packer, with the assistance of the Chrysler Corporation. Covers latest Plymouth features: power brakes, torque bar suspension, automatic transmission, tubeless tires, air conditioning, etc. Motor specifications are given for all models 1941-57. Contains 272 pages, more than 350 photos, diagrams, tables, charts, breakdown drawings, plus clear, non-technical directions that make all repairs as simple as ABC. Shows you how to diagnose troubles by feel, sound, sight, smell and performance.



MONEY BACK IF IT DOESN'T SAVE MORE THAN IT COSTS!

One minor repair will save the cost ten times over. Read it. Then you decide. If you don't see that you'll save more than the cost, send it back for refund. SEND NO MONEY. Send postcard. Ask for PLYMOUTH Manual. Postman will deliver C.O.D. for \$3.50 plus postage. Or, save postage by sending \$3.50 with order. Save its cost on your next repair. Send today.

POPULAR MECHANICS PRESS, Dept. 757
 200 E. Ontario St. • Chicago 11, Illinois

GIGANTIC SURPLUS SALE!

TYPICAL BARGAINS

- \$1300 AC Power Plant... Sale, \$497.50
- \$275 Electric (6-12v) Truck Winch 46.75
- \$62 Finest 1 1/2" Centrifugal Pump 24.61
- \$145 Weed Spray 5-row outfit... 97.65
- \$46 Hydraulic Cylinder 24" stroke 27.95
- \$35 Stainless Stl Portbl Air Tank 16.95
- \$195 DC 110-v 3 KW Generator... 49.50
- \$35 Air Comprsr, piston type 150 lb 27.00
- \$11 Fish and Worm AC Shocker, Ppd. 3.89
- \$300 AC (115-v) DC (30-v) Generator 13.91
- \$21 New Govt. Jungle Hammock, Ppd. 7.95
- \$95 220-110-v 1500-w Transformer 27.95
- \$42B Hydraulic Speed Clutch, Reducer 47.81
- \$12 El. Timer Clock 110-v 60-c Ppd. 5.79
- \$64 El. Sump or Bilge Pump 6-12-v 10.87
- \$66 Gear Reduction Unit 80-1 Ppd. 7.49
- \$27.50 Air Compressor, 1 cyl. Ppd. 19.95
- \$62.50 Air Compressor, 2 cyl. Ppd. 49.95
- \$51.50 Air Kit, complete... 39.49



ORDER FROM AD or write for big new FREE CATALOG 1000s items at tremendous savings. FOB except where shown Ppd.

BURDEN SALES COMPANY
 809 "O" St., LINCOLN, NEBRASKA

SPECIAL BUY!

COMMERCIAL-INDUSTRIAL BATTERY CHARGER



6-volt, 6-E, multi-110-v 60-c charger. Rate 2 to 12 amps. Charges up to 8 six-volt batteries. Many industrial, laboratory applications. Start battery service station, etc. Size 12 7/8 x 9 1/2 x 2 1/2. Wt. 8 1/2 lbs. Govt. cost \$325. Sale \$48.27 FOB.

MIDGET & GOLF CAR MOTOR



Use for child's, golf, factory cars. Power full, expensive ball bearing 100 for 1 year reduction motor. Runs on 6 or 12-v storage battery. Govt. cost \$282. SALE \$19.46

YOU SHOULD EQUIP YOUR TRAILER WITH



BULL DOG

- AXLE ASSEMBLIES
- JACKS • COUPLERS

Straight or drop axles in single or tandem—capacity up to 10,000 lbs.—any width. Also Torq-Less Axles for all types of trailers.

JACKS—Bull Dog Jacks make hitching and parking a one-man job.

COUPLERS—Bull Dog Couplers hitch or unhitch to trailer in a moment.

Write today for FREE Descriptive folder 13J.



HAMMER BLOW TOOL COMPANY

WAUSAU, WISCONSIN

WELD BRAZE SOLDER CUT 4WAY ONLY \$14.75 f.o.b. factory



Acclaimed by thousands of Homeowners, Mechanics and Hobbyists as the welder of 1001 uses. Easily operated from properly wired 110 volt AC or DC line. The ideal gift with a life-long use... Order today on 10 day money back guarantee.

FOUR-WAY WELDER CO., Dept. F2-G
 1810 S. Federal St. • Chicago 16, Ill.

TILT ARBOR SAW \$16.95 SOLD DIRECT FACTORY TO YOU

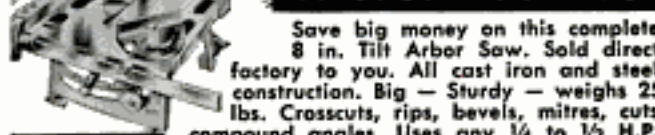

Save big money on this complete 8 in. Tilt Arbor Saw. Sold direct factory to you. All cast iron and steel construction. Big — Sturdy — weighs 25 lbs. Crosscuts, rips, bevels, mitres, cuts compound angles. Uses any 1/4 to 1/2 H.P. motor. Reg. \$4.95 — 8 in. Simonds Blade included. Try 10 days. If you are not satisfied FOR ANY REASON, return saw for absolute money back refund. Ship express collect. Send check, M.O. or sent C.O.D.

AMERICAN MACHINE & TOOL CO.
 ROYERSFORD 23, PA.

Write For FREE CATALOG Big Bargain On Power Tools

Mystery Fuels for the Missile Age

(Continued from page 112)

the new fuels, incidentally, are suitable for turbojet use. Some are best when used in the afterburner; some are best in supersonic ramjet engines.

Other studies are being made to improve the operation of afterburners and ramjets. An afterburner requires a flame holder (usually a pair of V-shapes) to prevent the flame from being blown out by the hot gases rushing past. When the afterburner isn't in use, its flame holder is an obstacle that cuts down thrust. Recently, Stanford Research Institute came up with a solution: Turn the afterburner fuel nozzle around so that it faces forward. The nozzle sprays its fuel just as efficiently in the new position, serves as the flame holder and causes little turbulence.

"Screeching combustion" is another afterburner malady and this has been studied intensively at Caltech's Jet Propulsion Laboratory. In this phenomenon the usual low-pitched roar of an afterburner suddenly changes to a piercing whistle or screech. The screech is accompanied by a build-up of heat so intense that the afterburner can be destroyed. Schlieren spark photographs were made of the condition and the screech was found to be an oscillation of the flame, an instability produced by some air-fuel ratios in combination with certain flow rates and afterburner shapes. With this information it became possible to modify the afterburners so that screech doesn't occur.

Rocket Carries Own Oxidizer

The hunt for new jet fuels springs in part from a similar search that has been going on in the rocket field. A rocket carries its own oxidizer as well as fuel. One fairly reliable combination, used in the V-2s and the early Vikings, was liquid oxygen as the oxidizer and alcohol as the fuel. Since then many other combinations of propellants have been tried, including nitric acid and aniline, hydrogen peroxide and hydrazine, and nitric acid and ammonia.

As an indication of the present state of the art, the rocket that will loft the Vanguard satellite will use liquid oxygen and water-alcohol in its first stage, nitric acid and a special kind of hydrazine in its second stage, and a solid monopropellant in its third stage. Hydrazine is a nitrogen-hydrogen compound that is made by the reaction of chlorine with ammonia. The Vanguard hydrazine is called "unsymmetrical dimethyl-hydrazine and contains extra amounts of hydrogen plus some carbon atoms.

The theoretically best combination for rocket propulsion would be hydrogen as the fuel and fluorine as the oxidizer. This yields the highest heat of combustion, some 8100 degrees, producing more thrust than other propellants. But so far, engineers haven't been able to find a way of using the combination. Hydrogen gas has to be compressed into a liquid and requires heavy tankage. The liquid fluorine is so corrosive that it rapidly eats through all metals and most other substances. And the flame that this combination produces is so hot that no one has been able to design a rocket engine that could handle it.

John F. Tormey, chief of research for Rocketdyne, the rocket motor division of North American Aviation, estimates that present rocket fuels give 25 percent better performance than did earlier fuels. He adds that another 25 percent boost in power is possible before the energy barrier is reached, as far as chemical fuels are concerned. ★ ★ ★

"Envelope" Keeps Out Rain

Full protection against rain is provided by an umbrella with a clear-plastic "envelope" attached, which can be lowered or raised by a drawstring. The invention was displayed at the first International Gadget Show in New York City.



ORDER DIRECT FROM AD

SURPLUS AT FRACTION OF GOV'T COST

TOP VALUE SPECIALS

SHOP BY MAIL AND SAVE AT GROBAN'S

SATISFACTION GUARANTEED

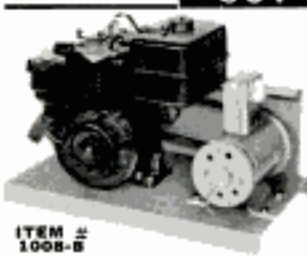

PORTABLE 1000 WATT A.C. LIGHT PLANT
Electricity for Your Comfort
COMPACT—
Fits in the trunk of your car
FAST STARTING

ITEM # 1008-B

ENGINE: BRIGGS-STRATTON 2 1/2 H.P. — Equipped with recoil Starter.

GENERATOR: Ball bearing construction 1000 Watts. 115 Volts A.C. 60 cycles. Automatic self-regulating. **SAME AS HOUSEHOLD CURRENT**

SIZE: 20 1/2" x 12" x 16"

PRICE: Shipping Weight 100 lbs. boxed. Save \$100.00 from \$259.50 list price. **159.50**

Now! F.O.B. Chicago.....NET

BRAND NEW WALKER 5-TON HYDRAULIC LIFT KIT



FOR — • SNOW PLOWS • TO DUMP FARM WAGONS • ADJUST DEPTH OF PLOWS • HYDRAULIC PRESS • HYDRAULIC JACK.

THE COMPLETE KIT CONSISTS OF: 1—Walker Hydraulic Hand Pump—Rated 1500 lbs. per sq. inch with 2 gal. hydraulic reservoir • Release valve • Filter plug and air vent

ITEM # KW-116

• 28" steel handle. Fine for hydraulic presses; snow plows, jacks. Dimensions: 6" Diameter, 29" long with 3/8" pipe thread port. Pump Assembly Item #P449..... **23.50**

1—6 Ft. length double wire beaded rubber covered hydraulic hose—tested to 20,000 lbs. Item #27B4... **3.95**

1—Hydraulic Cylinder, 3" bore, 6" stroke. Husky 3/4" solid steel shaft. Will lift 10,000 lbs. using 1500 lbs. of pump pressure. Clevis mountings that take 3/4" diameter pins. May be used for single or double action service. Overall length 17 1/4"—retracted. Item #C419..... **12.50**

1-Gallon hydraulic fluid furnished free with each kit. Plus all necessary hydraulic fittings. Total ship. wt.—40 lbs.

COMPLETE KIT PRICE 38.95 F.O.B. CHICAGO

(ALL OF ABOVE INCLUDED)

Send Payment Or Purchase Order Today For Phone Orders Call Webster 9-3793

FREE — NEW, FALL 1957 CATALOG

60 PAGES—Chockfull of unsurpassed War Surplus and newly manufactured Equipment Bargains for farm, home, factory, workshop. Write letter today.

HIGGINS BRONZE CENTRIFUGAL PUMP

PUMPS ALMOST ANYTHING

ITEM #414

Fine for: — • Irrigation • Sump Pumping • Sewer Drainage • 75 gallons per minute @ 2400 R. P. M.

Higgins Type PNB, Model R, marine bilge pump. Open Impeller design for handling muddy water. Delivers 75 gallons per minute, 30 foot head with 3/4 H.P. motor.

Pump body and impeller are made of solid bronze, with alloy steel 1/2" diameter shaft, 1 1/4" long. Rotation of the pump is clockwise. Inlet has 1 1/2" pipe thread. Plain 1 1/2" outlet for hose connection. Dimensions 12"x7"x8". Shipping weight 23 lbs. F.O.B. Chicago..... **23.50**



37-PIECE METAL STAMPING SET

STAMPS NAMES, NUMBERS, ON WOOD OR METAL FULL ALPHABET, A-Z, NUMBERS 1-9, "6", and PERIOD.

ITEM #390-B—PRECISION HAND TRIMMED, deep cut, hardened TOOL STEEL STAMPS—IN FITTED EASY ACCESS CARTON.

\$5.50 per Set 2 FOR 10.00 PPD.

MADE TO RIGID U.S. ARMY SPECIFICATIONS

GENERAL ELECTRIC HIGH PRESSURE AIR COMPRESSORS

OUTPUT — 1000-1500 Lbs. per Sq. In.

• For filling aqua-lung tanks • For Air brush work • Filling accumulator and air-oil shock struts • Cleaning and testing spark plugs • Hundreds of other uses.

Built by General Electric to exacting U. S. Air Force standards. This two cylinder, two stage air compressor . . . rated 1000 P.S.I. output, may be modified to deliver 1500 P.S.I. Driven by 27 Volt D.C. electric motor. As released from U.S.A.F. in used, serviceable condition. (Covered by our 30-day guarantee.) 14" L. x 9 1/2" H. — Ship. Wt. 15 lbs.

U. S. Gov't OUR PRICE..... **15.00** F.O.B. Chicago

paid \$296.00 High pressure air receiver tank for G.E. Compressor, Ship. Wt. 2 lbs. \$4.00

ITEM #461



GROBAN SUPPLY CO. DEPT. PM-7

1139 S. WABASH AVE. CHICAGO 5, ILL.

the finest **WOOD SCRAPERS** are **Red Devil Tools.**



5-BOX Drawer RACK STACK WITHOUT SLIPPING OR FASTEN TO WALL The newest, cleverest, most convenient method of keeping your screws and bolts handy for quick use!

stock your SHOP SCREWS • BOLTS • NUTS



59c PER BOX

Look in your hardware store for the revolving display rack that contains all 40 of the most-wanted types and sizes of screws, bolts, and nuts. You get generous quantities in clear plastic boxes, brilliantly labeled for fast, accurate selection. Start to "Stock your Shop" today!

ELCO TOOL & SCREW CORP., Rockford, Ill.

MODERN

LAWN MOWER SHARPENER

Now sharpen all mowers, hand or power, reel or rotary, any size. The Original Straight Line Sharpener, copied by many but still ahead on exclusive features. Simple, accurate adjustments. Sharpens vertically or horizontally. Sharpens all bed knives. Gasoline engines remain on mower, no draining of gas or oil. Rugged 100% steel construction. Get the facts — compare before you buy. Send for free brochure # 10.



MODERN MFG. CO. 160 N. Fair Oaks Pasadena, Calif.

Small investment big profits!

WOLVERINE GLOVES

**FULL
FINGER
GRIP
FREEDOM**

*you can feel
the softness*

Choose Finger-Freedom that only Wolverine pigskins give. Made super-soft by triple tanning. Dry out soft and flexible after soaking. Money saving extra wear plus doe-skin softness.

feel that tanned-in softness

rockford, michigan



almost certain that man's inventiveness and curiosity will demand that larger and better-equipped satellites be placed in orbit. These would be true satellites in that they would orbit the earth at altitudes up to 1000 miles, where lack of atmospheric drag would allow them to circle the earth for thousands of years.

TV Cameras in the Sky

Future satellites may have instrumentation undreamed of today. An era of satellites with radio powered by a nuclear power plant or solar batteries can be visualized in the foreseeable future. Such large satellites might carry television cameras aimed not only at the earth but at the skies, transmitting to permanent satellite observatories around the world a constant flow of cosmic information.

At the beginning of our article we whimsically anticipated the manned satellite by imagining ourselves in the 21-inch sphere during its initial revolutions. The end of such an imaginary junket would be little less spectacular than the beginning. After a few months to a year, the resistance of even rare atmosphere will exert a telling drag on the sphere. Slowly its orbit will shrink, carrying it closer to Earth, where air is more dense. The rate of spiraling will increase rapidly until at last the satellite plummets downward in a long arc at 18,000 miles per hour.

At this stage, you'd better get off—preferably with an asbestos parachute. Friction will heat the skin of the satellite rapidly above the melting point of any materials we can use. The tiny moon will glow like a shooting star and finally plunge to earth, a mangled handful of partially melted junk.

But its memory will persist through all history. Telemeter receivers, tracking cameras and visual observers will have preserved the scientific story of its record-breaking adventure. ★ ★ ★

Process Reduces Lines on TV

Those black horizontal lines across a television screen may soon be eliminated, according to scientists at the Westinghouse Research Laboratories. They have developed an experimental method of "wobbling" the electron beam vertically about 15,000,000 times per second as it scans the picture tube. This broadens the white lines which carry the picture information and narrows the distracting black lines between them. The improvement is possible through a slight change in the construction of picture tubes.

BOAT PLANS PATTERNS—FRAME KITS

BY THE DESIGNERS OF
"SEA KNIGHT"
CURRENTLY FEATURED IN
POPULAR MECHANICS

We have a complete selection of designs INBOARDS and OUTBOARDS especially for the amateur builder. Send for our COMPLETE CATALOG. 50¢.



marine designs BOX 568T COMPTON, CALIF.



LARGE SCALE PLANS, INSTRUCTIONS, AND PHOTOS... \$10.00
FULL SIZE PATTERNS FOR THE STEM, KNEE, BRESTHOOK, CHINE, BLOCKING, AND HALF SECTIONS OF EACH FRAME AND TRANSON... \$10.00
PLANS AND PATTERNS... \$20.00
MAILED POSTPAID IN U.S.A.
AND CANADA

HOW TO USE GLUE **ROGERS** BE SURE IT'S

Then the secret of getting permanent glueing is easy... apply a thin film of Rogers Glue to both surfaces, first having warmed parts. Next, eliminate all air from the glued surfaces by applying pressure to the joints by tying or clamping. (This is absolutely essential for dovetail, tenons, and other joints.) Finally, allow plenty of time for drying so that the adhesion will take care of any shrinkage or expansion in the wood and give sure strength. SPECIAL OFFER: Get other valuable tips on the use of glue and woodworking, plus a set of woodworking project plans, and a full-size jar of Rogers Glue. Send only 15 cents with your name and address to Rogers Glue, Gloucester, Mass. Ask for Rogers Glue at Your Local Hardware Store.



Over 3.885 lbs. Actual Tensile Strength per Square Inch.

ROGERS

the best LIQUID FISH GLUE
GLOUCESTER, MASS.





Glenn Culbertson, Acampo, Calif., runs forced-air hose into oil drums and gets an even flow of oil

Air Is the Farmer's Hired Hand

(Continued from page 141)

rig to the tractor on the Raymond Morris ranch at Garden City, Kans. Air comes from a small tank which is filled by a shop compressor.

A hoverless brooding system gets chicks off to a good start with air bringing heat into the building from an oil-fired, home-type furnace and metal heating ducts on the Roy Heckenluber poultry ranch at Biglerville, Pa. Vertical heat ducts 10 inches above the floor supply an even flow and plenty of hot air at any desired temperature, thermostatically controlled.

"The handling of silage has always been a tremendous chore when no mechanical means has been available," Albert Helbig, an Illinois farmer reports. "I just couldn't put up with the tremendous amount of work I had to give out when unloading corn silage from the field chop wagon, so I mounted an auger in the bottom of a wagon. This auger moves the silage to a blower set on the outside of the wagon and airlifts it up a pipe and into the silo."

Air also comes into its own when chores are to be done around the hog ranch. There's no hand-carrying in the hog-feeding system of Bob Lynch, Marshall County, Ill. Air from a blower does all the feed handling, taking corn and supplement from a hammer mill and sending it as far as 80 feet to both indoor and outdoor feed pens.

Time control permits the rancher to do other chores while feeders are being filled.

Air Removes Water

Air is one of the principal means of drying hay, grains, and any other crops which must have moisture drawn from them. Ways and means of sending or drawing the air through the crops are many and quite varied.

One of the latest developments is the use of a Quonset-type building set on a concrete floor. Grains are piled in the building over tunnels made of steel mesh and covered with window screen so air can pass through but grain cannot fall into the tunnel.

John Wheeler of Courtland, Calif., in his building of this type has divided it into four sections with a powerful electric fan blowing air into a tunnel in each section and sending the air up through the corn.

Another method used in Quonset buildings is to run two tunnels the length of the building and connect them to a giant fan at one end. Air is fed through a series of air ducts that runs the length of the galvanized-iron walls, vents in each end of the building and in the uppermost part of the roof.

Circular steel tanks also have become quite important as drying units during the last two years, with thousands of them being put to that purpose. Tanks are set on a 20-inch-high wall of concrete blocks. Flooring is perforated so that when air is forced in under the floor it passes up through the grain and out a vent in the top of the tank. One fan takes care of six 1000-sack tanks, with air delivered via a main tunnel to ducts leading to each tank.

Joe Gruenthal of Live Oak, Calif., sets up each of his circular tanks as an individual drying unit, and has portable squirrel-cage-type fans, which he runs up to the opening under the tank floor. Each fan is equipped with a gas heater unit.

Cold Air for Small Grain

"Only cold air is used in drying small grains," Gruenthal explains. "If hot air is used it only moves the moisture into the top two feet of the tank where it condenses and refuses to move out. Cold air will take moisture on out without condensation. Hot air is used when corn is dried because the kernels of corn are large enough to let air pass around them without condensation."

Corn drying by air receives attention wherever corn is grown. In some sections of the United States, column-type air driers, such as the one on the Clarence Ragland farm in Ohio, are used extensively.

(Continued to page 232)

WEIGHT ONLY 37 lbs. **POWERFUL • LIGHTWEIGHT • PORTABLE**
SELF PRIMING CENTRIFUGAL PUMP

• 1 1/2 H.P. Two-Cycle Gas Engine • Pump cap. up to 35 GPM
 • 1" and 1/2" Connections for Inexpensive Garden Hose
 • SPRAY - BRUSH - CIRCULATE - IRRIGATE - FINE PROTECTION

Quality all-aluminum pump for homes, farms, cottages, resorts, boating, golf courses, industry, contractors. Working parts precision machined.

ORDER DIRECT Dept. 57
 Send Cash, Check or Money Order
 30-DAY MONEY BACK GUARANTEE

\$98 FOR FACTORY

DISTRIBUTORS & DEALERS WANTED **CROWN MFG. CO.** WAUKESHA IOWA

ONLY \$399 Freight included FREE FOLDERS

NEW 18 ft. OFFSHORE CRUISER KIT

17 Models as low as \$42.00 (freight included). Fiberglass boat covering kits, marine supplies, etc.

TAFT MARINE WOODCRAFT
 Dept. PM-757 • 636 39th Ave. N.E. • Minneapolis 21, Minn.

Top and side curbtains available!

Buy nationally advertised products. Ask with confidence for the brands advertised in **POPULAR MECHANICS**

PM TAG of INTEGRITY

3 CU. FT. MIXER 3975 DIRECT FROM MFR.

Fills long felt need for small mixer for concrete, feed, fertilizer, seed and many other materials. Saves 1/2 cost of ready mixed concrete. Pays for itself on first job.

3 Cu. Ft. Drum—Mixes 2 Cu. Ft. Concrete \$39.75
 5 Cu. Ft. Drum—Mixes 3 Cu. Ft. Concrete \$49.50

FOR PALASKI, N. Y. Cash, Check or M. O. Money back guarantee.

UNITED STATES FORGE AND FOUNDRY CO.
 CONSTRUCTION EQUIPMENT DIV. PULASKI, NEW YORK

AMERICA'S MOST EXCITING SPORT

1957 COMET MICRO-MIDGET



MICRO-MIDGET RACING is America's fastest growing sport. Now anyone from 18 to 60 can own a real racing car and have all the thrills and excitement of speedway racing. You can't imagine how much downright actual fun it is to drive a Micro until you try it for yourself. There's a thrill to driving a Micro-midget that nothing else can equal. The new 1957 COMET is the ultimate in Micro-Midgets and has no equal. Breath-taking acceleration, precision control plus outstanding body styling and workmanship all combine to make it the best performing and most beautiful small racing car ever built.

SEND 25c FOR ILLUSTRATED LITERATURE DESCRIBING ALL DETAILS OF THE 1957 COMET

COMET MANUFACTURING CORPORATION - Dept. PM-1 - P.O. Box 14631 - Los Angeles 4, Calif.

10" TILT/ARBOR SAW
BUILD-IT-YOURSELF
 from GIL-BILT KITS-PLANS



Sturdy wood, steel, and aluminum construction. NEW DEPARTURE ball bearings. Capable and performance of floor saws selling for \$150.00 and up. Plans, all metal parts in kit with 10" comb. blade \$25.90, less blade \$22.95. P.O.B. St. Louis. Detail PLANS-PATTERNS only \$1.00 postpaid.

Build-it-yourself 12" and 18" Bandsaws, 6" Belt Sander, Shaper. Simplified plans, build easily with hand tools only. Advertised and sold for 10 years, over 33,000 units in use. Money back guarantee. FREE CATALOG.

GILLIOM POWER TOOLS, Dept. 80-G, Lambert Field, St. Louis 21, Mo.

FREE CATALOG



Choose your genuine Gerstner Chest from our Free Catalog to machinists and toolmakers.

GERSTNER TOOL CHESTS
 457 Columbia St., Dayton 7, Ohio

Do-It-Yourself... Better... Easier... With the Right Materials!



Better Home Workshop Job Skills

- Contains All This Helpful Information**
- Improvements around the house
 - How to select and how to use lumber, millwork, plywood and hardboard
 - Exterior wall and roof materials
 - Hardwood floors and floor coverings
 - Wall and ceiling materials
 - Doors, windows, screens and weather stripping
 - Glass, the material of tomorrow
 - Plumbing, pipes and fittings
 - Electrical equipment
 - Nails, screws, bolts, etc.
 - Hinges, locks and other hardware
 - Paints and miscellaneous products
 - Index



160 Pages
667 Pictures

For Better Home Repairs and Improvements

What materials to use—how to use them. More than 50 pages of vital home shop information.

New ceilings over old. From walls and ceilings section with 21 pages and 91 pictures. One of 12 big, fat sections in the book.

You Need the New Popular Mechanics DO-IT-YOURSELF Materials Guide

The Key to Buying and Using Lumber, Hardware and Other Home and Home Workshop Materials

The right lumber. The right grade. The right fastenings, nails, screws, glue and other hardware. These are all just as important as the right design and the right kind of workmanship. It's true, whether you are fixing up the house, making a fine piece of furniture or just knocking out a time-killing gadget. Get Popular Mechanics Materials Guide. Fills a long-felt need of home owners and home workshop fans, who frequently are stumped over what is the best or most suitable material. You get expert information quick in this book. You get too, the best information on how to use the materials recommended.

Order on 5 Days' Trial Mail Coupon

Send only \$2.95 for postpaid delivery. Sent COD if you prefer. Money back if you are not pleased and you return book within 5 days. Mail coupon today.



Use This Coupon for Quick Book Service

POPULAR MECHANICS PRESS Dept. 757
 200 East Ontario Street, Chicago 11, Illinois

Send me the Do-It-Yourself Materials Guide. If I return the book in 5 days you will refund the full purchase price,
 I enclose \$2.95 Send COD

Name _____
 Address _____
 City _____ Zone _____ State _____

LONGER-LASTING EASIER APPLIED!

IDEAL FOR ALL CAR FINISHES,
INCLUDING NEW ACRYLIC
LACQUER FINISHES

FAST

45 to 60 minutes to
clean, glaze, polish
most cars! One easy
application!

EASY

Rub on, let dry and
wipe off! No harsh
abrasives!



MAC'S SUPER GLOSS CO., INC.

Los Angeles 42, Calif.
Cincinnati 26, Ohio

DON'T WAX IT—MAC'S IT!

Enjoy Breezy Cool Comfort this Summer!

Window or Attic

FANS at amazingly

SAVE LOW COST!

up to **75%**
WITH FAMOUS

**FAN
KITS**

No special tools or skill
required. Absolute **MON-
EY-BACK GUARANTEE**.
Only a few pieces of
lumber and new or used
1/2 HP 1750 RPM motor
required to complete.
Thousands in use.



Also highly recommended
for poultry houses, farm
buildings, Greenhouses,
Factories, etc.

20" Fan cools average home, 6,000 CFM \$14.95
24" Fan cools larger home, 8,000 CFM 17.95
24" Fan cools smaller homes, 4,500 CFM 13.95
20" Fan cools apt., offices, etc., 2,800 CFM 12.95
Money order or check with order shipped postpaid, \$3.00 de-
posit on C.O.D. orders. Circular free.

Satisfaction Guaranteed

FAN KIT Company

154-P No. Belvedere

• Memphis, Tenn.

ANYONE
CAN DO IT!



COMPLETE KIT includes:
Aluminum fan spider,
masonite blades, Shaft,
Oilite bronze bearings, col-
lars, pulleys, belt and bolts.
Step-by-step instructions

For window or attic, vertical
or horizontal installation.

Corn goes into two steel drying columns with an air space in between and air holes in the columns next to the air space. Hot air from a furnace is forced between the two drying columns, and moisture in a 180-bushel truckload of corn is reduced from 35 to 13 percent in eight hours. Such a batch drier can be eight feet high, 12 feet long, 54 inches wide. Drying chambers are 14 inches wide.

The tunnel system is also used for drying hay, either in the barn or in the outdoors. Such a unit is used by dairyman Wesley Sawyer, Waterford, Calif. The system calls for placing a four-foot-square tunnel made of wood the length of the building or outside stack, with laths covering the top and sides. Chimneylike plugs extend up from the tunnel. A fan is set at one end. As the hay is placed around the plugs they are moved upward leaving an opening in the hay through which air, forced from the tunnel, spreads out through the hay. Air also goes upward from the slat walls of the tunnel. Moisture content of hay is brought down to a safe level in less than 12 hours.

Hay Driers on Wheels

Portable hay-drying systems are common in some areas, such as the one on the University of Wisconsin farm. In this wagon drier, a duct spreads heated air beneath a slatted false bottom, quickly reducing moisture content. Heat comes from a portable heating unit that is attached to one end of the wagon. When the hay is dry a chain unloader dumps it into a unit which blows it to storage. This system cuts fire danger and there's no need to install a duct system.

How do you remove loose husks, silks and trash from corn when it is being placed for drying? With air of course. An air blast from a fan removes them on the R. J. Tweedy ranch at Mt. Pleasant, Iowa. On the William F. Renk and Sons ranch at Sun Prairie, Wis., forced air rips the husks off corn as the ears pass through corn-shredder rolls.

"Now," one farmer mused, "if someone will just invent a system that will harvest crops by air power when we push a button while sitting at home enjoying its many comforts..." ★★★

Tetraethyl Lead Synthesized In New Method

Tetraethyl lead, the chemical antiknock additive used in gasoline to raise its octane count, now can be synthesized from a combination of organometallic compounds and lead sulfide, lead oxide and lead dioxide.

New! VISE-GRIP with **EASY** Release!

Model 10WR, 10"
Only \$2.95



PRESS HERE
... and Jaws
CLICK open!

EASY does it! Now, world-famous Ton-Grip instantly released. Makes Vise-Grip better than ever as the quickest, easiest tool for every gripping job. 7" and 10", cutter optional, \$2.15 to \$2.95. Get the new Vise-Grip—you'll love it!

MADE ONLY BY PETERSEN MFG. COMPANY, DEPT. M-7, DE WITT, NEBR.

DINSMORE Compasses

Beautiful, precision made. Designed and styled for modern cars. Dinsmore compasses save you time and money by showing you the right way—the short cuts. An ideal gift for every one who drives.

ONLY COMPASSES APPROVED BY AUTO MAKERS!

WRITE FOR COMPASS HISTORY FOLDER

DINSMORE INSTRUMENT CO., 1802-33 Kelleo St., Flint 1, Mich.



FUN-WORK YARD TRACTOR WHEEL-HORSE RIDE-AWAY



SENSATIONAL
LOW PRICE

Turn work into FUN! Do a dozen back-breaking jobs in a jiffy. Yard-size tractor with 5 forward speeds and 1 reverse. 3½ hp (or 2½ hp) engine. Heavy channel steel chassis. Mow 5-foot swath at 5 mph. Plow snow, cultivate, haul compost, pull any of 22 attaching tools for yard and garden. Write for details, and name of dealer.

WHEEL-HORSE PRODUCTS

2644-F Dixieway North

South Bend, Indiana

Do-It-Yourself WHEELS



For Homecraft, Replacement, Repair 6-, 8-, 10- and 12-inch dia. wheels to build and repair mowers, barrows, carts, toys, garden and home eqpt. Sturdy steel hubs, rubber tires, ball bearings. Write for Free Plan Book.



GLEASON CORP. • 286 North 12th Street., Milwaukee 3, Wis.

Exclusive Double-Bearing HEAVY-DUTY PUMPS

IRRIGATE • DRAIN • CIRCULATE • SPRAY
Up to 7,500 GPH, 3,000 GPH from 25' well. Use ¼ to 1 HP motor, 1¼" inlet; 1" outlet. Stainless shaft. Won't rust.

TYPE X—2 oilless bronze bearings. \$10.95

TYPE XB—Ball bearing model. \$12.95

Postpaid if cash with order. Rush your order today

MONEY BACK GUARANTEE

Centrifugal and Gear Pumps in All Sizes

LABAWCO PUMPS, Belle Mead 2, N. J.

If quality is a part of your project, specify Southern fasteners, made in U.S.A. under strictest quality controls. . . . Costs no more than ordinary fasteners.

Southern SCREWS & BOLTS

At leading Hardware & Building Supply Dealers



The Modern PLASTIC
for lasting Home Repairs

PERMANENTLY mends cracks or holes in wood, tile, stone or plaster. Sticks and stays put—Does not chip, shrink or fall out. Easy to use. Economical. Mold it, chisel it, polish or paint it. The big 4-lb. can is obtainable from your lumber, paint or hardware dealer at \$1.25; or will be shipped direct postpaid (in U. S.) for \$1.50. Complete satisfaction guaranteed or your money refunded.

DONALD DURHAM CO.

Box 804-T Des Moines, Iowa

Make \$20 to \$30 a Week EXTRA MONEY!

With the high prices of food, clothing and everything else, just think what you could do with extra money every week! Turn your spare time into CASH—sharpening saws with a Foley Automatic Saw Filer pays up to \$3 or \$5 an hour. Start in your basement or garage—no experience necessary. "The first saw I sharpened with my Foley Filer came out 100%"—writes Clarence E. Parsons. No canvassing—"I advertised in our local paper and got in 93 saws"—says M. L. Thompson. With a Foley you can file all hand saws, also band and cross-cut circular saws.

FREE BOOK

Shows How to Start

It explains how you can get business from home owners, farmers, carpenters, schools, factories, etc. "I get work from 20 to 30 miles away"—says Charles H. Smith. Free Book, "Money Making Facts," tells how to start. Send coupon today—no salesman will call.



Send Coupon for **FREE BOOK**

FOLEY MFG. CO. 716-7 FOLEY BLDG. MINNEAPOLIS 18, MINN.

Send me free book
"MONEY MAKING FACTS"

Name _____

Address _____

NOW YOU CAN DO YOUR OWN REGLAZING



DO IT PROFESSIONALLY

The new FLETCHER "Do-It-Yourself" Reglazing Kit contains all the necessary tools for any home owner to do a professional reglazing job. Included are a glass cutter, an electric putty softener for removing the old putty, an automatic driver for inserting glaziers points, a can of glazing compound, a putty knife and an excellent window paint scraper. Complete simple instructions are furnished with this inexpensive kit.

Ask your dealer for the FLETCHER Reglazing Kit or write

THE FLETCHER-TERRY CO., Dept. D, FORESTVILLE, CONN.

INVISIBLE GLOVE

ENDS PAINT-STAINED HANDS

Before you paint or start a dirty job in the house, garden or garage, rub Du Pont PRO-TEK hand cream on your hands and arms. It keeps sticky stains away from your skin . . . then washes off quickly, taking the grime with it. Get Du Pont PRO-TEK at drug, hardware, paint and auto supply stores.

Du Pont PRO-TEK



Better Things for Better Living
... through Chemistry



Tin-Can Artist

Equipped with pairs of tin snips and needlenosed pliers, Lt. Thomas A. Shall-better of the Seattle, Wash., Army Terminal folds and curls tin cans into six-pointed stars. He then bolts together four or five layers, plus several lacerated lids, into a three-dimensional "sunburst" in the center of which he attaches a colorful piece of costume jewelry.

At least 10 tons daily are added to the earth's mass by the 200 million naked-eye meteors smashing into the earth's atmosphere, two Canadian scientists estimate.

Household and Auto Items Make Portable Trouble Light

Plumber's helper, bicycle-handle grip, and sealed-beam bulb form a trouble light that plugs into a cigarette lighter. Developed by Junior Achievement workers in Waukegan, Ill., the light has a 16-foot cord and uses either 12 or 6-volt bulbs.



*Make
your dealer
your*

PROJECT PARTNER

His years of experience in recommending quality products will save time and money.

YOUR DEALER has the experience and know-how to help you get the job done better and more economically.

He knows, for example, that you buy better when you buy quality. That is why he recommends nationally-advertised tools, equipment and materials. He can recommend them with full confidence because they are backed by manufacturers who stand behind their products—who furnish full product information in their advertising.

Whenever you buy tools, equipment or materials, make it a point to consult your quality dealer. He knows the products that will fit your needs best.

You will find hundreds of helpful suggestions in every issue of Popular Mechanics—suggestions for making your job easier, the results better. Popular Mechanics publishes more product information than any magazine of its kind. And you can be sure products advertised in Popular Mechanics are tops in quality. You can decide better what you need for any job when you read Popular Mechanics. Read it regularly, your dealer does.

**HOME IS WHAT YOU MAKE IT—
AND YOUR DEALER CAN HELP**



Transistor Radios You Can Build

(Continued from page 147)

better than that of ordinary crystal sets, and their low cost (between \$5 and \$7 including phones) and extreme simplicity make them ideally suited as first projects for the beginner.

Surprising improvement results from the use of two transistors in a reflex-type circuit which eliminates the need for an external antenna for local reception. Both the earphone and loudspeaker sets shown in the photograph employ a circuit similar to the one diagrammed at the top of page 146. The r.f. signal picked up by the antenna is amplified by the first transistor and detected by a crystal diode. The resulting audio is then fed back through a 5-mfd. capacitor and amplified by both the first and the second transistor before being applied to the earphone or speaker. In effect, therefore, these two-transistor sets provide three-transistor performance.

In most locations these simple receivers, which sell for about \$12 to \$15, give very satisfactory performance. Tone quality and volume of the speaker set are as good as or better than that of some more elaborate units, due to the large speaker and relatively large case. Selectivity, however, is somewhat limited with the result that a strong station may leak through and provide a slight amount of interference when the set is tuned to a weak station.

The center schematic is that of a modern superheterodyne radio circuit which is used in the pocket-sized three-transistor receiver shown in the photograph. The kit, which sells for about \$17, includes two high-frequency transistors, one used as an oscillator-mixer, the other as an i.f. amplifier, and an inexpensive low-frequency unit employed as an audio amplifier. The circuit, while lacking some refinements such as automatic volume control, is capable of excellent sensitivity and selectivity and provides more than adequate earphone volume on most stations.

Four-transistor circuits usually include an additional audio-amplifier stage for greater volume on weak stations. Prices range from about \$22 to \$30 including an optional, matching Leatherette case which may be omitted if you build your own.

The last schematic on page 146 is that of a representative six-transistor radio circuit, including the usual oscillator-mixer, two i.f. amplifiers, a diode detector, an audio amplifier and a push-pull output stage. While seemingly complex, even these sets are easy to put together by anyone possessing normal proficiency in the use of

a soldering iron and in the handling of miniature parts. Prealigned i.f. transformers simplify final adjustment to the point where little or no previous radio experience is needed to obtain proper operation.

But don't expect high-fidelity tone quality. Modern science still hasn't learned how to pull bass notes out of a midget speaker in a pocket-sized enclosure and any claims of "big-set performance" are not likely to be realized. Yet, all other characteristics are entirely adequate and, at a cost of about \$33 (plus Leatherette case), these six-transistor kits are good values.

So thorough are the instruction manuals supplied with transistor-radio kits that most distributors offer a written guarantee to repair any nonoperating receiver for a very nominal service charge. The charges usually vary from \$1 to \$3, depending on the complexity of the kit, but to validate the guarantee the builder has the responsibility of completely wiring the set and using due care in following the manual. By working slowly and carefully checking each step, however, even a newcomer to the radio field is not likely to encounter any undue construction difficulties. ★ ★ ★

Plastic "Air Pocket" Bag Serves as Pump

Body pressure on a plastic "air pocket" bag that has a special valve in its bottom may replace effort now needed to inflate air mattresses, wading pools and similar products. The bag is folded at the top, trapping enclosed air for transfer to the product being inflated.



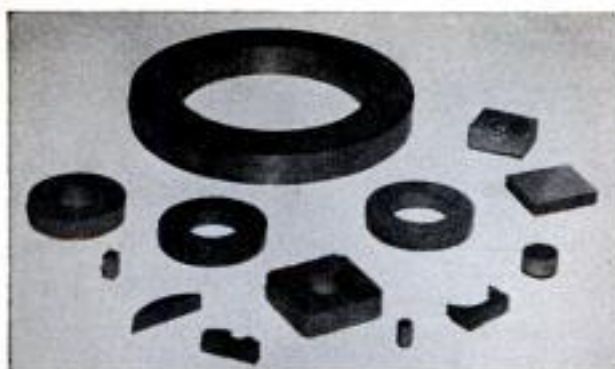

North American Philips Company, Inc.,
100 E. 42nd St., New York City

Above, made from Ferroxdure, newly patented ceramic material which is readily molded, these parts will replace industrial use of nickel and cobalt-alloy magnets. Right, Dr. Frank Brockman of North American Philips Company, Inc., studies the repelling power of magnetized Ferroxdure rings

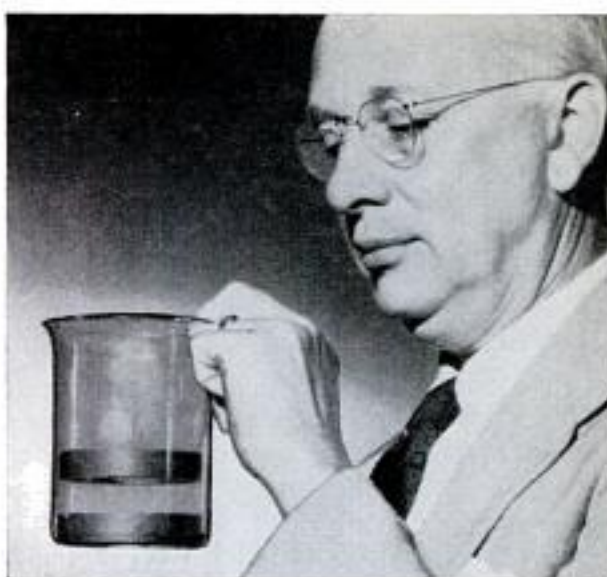

Ceramic Magnets Keep Doors Closed

Ceramic magnets—nonmetallic, electrically nonconductive and yet permanently magnetized—have been patented. Applications include use in refrigerator and cabinet-door latches, in loudspeaker and television yoke-focusing, in motors and generators, oil filters, rotating mechanical couplings, cushion-

ing devices and toys. Made without crucial materials, ceramic magnets are unaffected by external fields and are difficult to demagnetize. Compared with metal magnets, this substance is smaller, lighter, has longer effective life and gives improved performance and cost savings, its developers say.

RETAIL PRICE \$125.00
FACTORY TO YOU \$79.95

SUPERSHOP includes precision-built 8" tilting table saw, vertical and horizontal drill press, 30" lathe, sander, grinder. 100% BALL BEARING. Write for FREE catalog, full details, trial plan. Easy Pay Plan.

POWER TOOLS, INC.

197 YATES AVENUE
BELOIT, WIS.



EXTENDING HACK SAW
10" to 12" IN SECONDS

- Cast alloy "pistol-grip" handle
- Tubular steel extending frame
- Blade position allows closer work

LM MFG. CO., 1425 Washington St. N.E. • Minneapolis, Minn.

Short Cuts with WILHOLD* CONTAX CEMENT



AD NO. 1036

Paint, Hardware, Lumber, Variety Stores. Or write
WILHOLD PRODUCTS Los Angeles 31, Calif.; Chicago 44, Ill.

W.L.M.M.

SAVES TIME

ERECT WALL PANELS Without Nails or Clamps

Contax cement spreads easily, bonds immediately... holds permanently. Saves time.

HAVE ELECTRICITY ANYWHERE!

Bendix

PORTABLE GENERATOR

Take this lightweight 110 V, 60 cycle AC generator anywhere for full 750 watts of light and power. Small, compact, completely self-contained. Weighs only 49 lbs. 2 HP engine runs up to 3 hours on single tank-full. Rewind starter; built-in muffler. Mail coupon now.



for LIGHTS
TV-RADIO
CAMPING
TRAILERS
BOATS
FARM
EMERGENCY

DEALER INQUIRIES INVITED

- Bendix Aviation, North Hollywood, Calif.
- Send literature on your 750 W Generator.

Name _____

Address _____

JULY 1957

237



Get New 132 Page Catalog of
WOOD AND WOODWORKING MATERIALS

WORLD'S LARGEST SELECTION—Lowest Prices
Your buying guide for finest kiln dried domestic and rare imported woods, inlays, bendings, matched plywood, moldings, ornaments, etc. Biggest selection of tools and hard-to-find hardware. Packed with scroll saw patterns, projects, wood facts and money making ideas. Enclose 25c (refunded on first order) to help pay mailing and handling costs. Write today to
CRAFTSMAN WOOD SERVICE CO.

2720 S. Mary St., Dept. A-7, Chicago 8, Ill.

24" ATTIC FAN KIT



Easy to assemble. Belt-driven. Blade, shaft, 2 self-aligning bearings, 2 pulleys, 2 collars, and V-belt. Everything you need, except frame and 1/4-hp motor, to make your own house cooler. Send for complete list of fan parts.

ONLY
\$9.95
SAVE
\$46.00

PENNA. WHOLESALE DISTRIBUTORS
104 N. 6th St., Phila. 6, Pa.



Who Invented the Electric Clock?

ELECTRIC CLOCKS (alarm, mantel and kitchen) have become a household necessity. Very few American homes are without these accurate and convenient instruments. In recent years they have become a domestic fixture. Apparently it has occurred to very few to wonder who gave us this dependable and entirely automatic timekeeping machine. A recent letter in a Chicago newspaper asking that question drew a surprising number of replies and surmises. That prompted the writer to investigate, by inquiry to various authorities.

On account of a number of opinions expressed that the first practical electric clock was made by a Frenchman, an inquiry was addressed to the Institut de Chronométrie at Besancon, France. The Institut promptly handed the inquiry to Marius Lavet, ingénieur, of Paris, and apparently, in their opinion, the supreme French authority on the subject.

Mr. Lavet replied:

"To my knowledge, this invention (the electric clock) is due to the Swiss engineer Thury, from Geneva, who realized in 1890 the first hours distribution through three-phase current transmitted by a special line of three conductors. The current was distributed by a little swivel engine (change-over switch) which transferred the power driven by a storage battery to a three-phase current of constant frequency. The Thury Swiss system is described . . . in a book written by A Favarger, *Electricity and Its Application to the Chronometrie*, published in 1924 by the Journal d'Horlogerie de Bijouterie à Neuchatel, Switzerland. Mr. H. E. Warren (from the General Electric Co., Telechron Department) stated at the International Convention of Electricity in Paris in 1932, that the first clock using alternating current had been done in 1916 in the Boston area by the Edison Electric Illuminating Co. The arms were controlled by a single-phase engine with automatic starter."

M. Lavet enclosed a short description of the Thury clock. From Mr. Jean-Pierre Savary of the Watchmakers of Switzerland Information Center, New York City, came the following:

"In 1830 the physicist Zamboni of Verona, Italy, constructed the first electric clock. This clock was presented in 1832 to the Art Society of Geneva, Switzerland. In Switzerland in 1860 a watchmaker called Hipp built one of the first electric clocks which could be used for practical purposes. Engineer Thury, of Geneva, built the first electric clock with a synchronous motor in 1899. In 1917 the American engineer, Warren, built the first electric clock with a synchronous motor in the U.S.A."

Other electric-clock experimenters mentioned by correspondents included Huygens, 1854; Farcot, also 1854 (reputed to have developed the Thury clock); Paul Lacour, 1846-1908, of Denmark, who was given a U. S. patent on an electric clock in 1878. There was also an electrical time-keeping device called the Bulle clock which, it is said, was operated by alternating current.

There are at least 12 books in English about clocks in general. They all discuss the electric clock but are inclined to be hazy about credit for origin. The following from Mr. Donald E. Stewart, an editor of the Encyclopedia Britannica, is definite, however. He said:

"The consensus seems to be that Henry E. Warren should be given credit for developing the first practical modern domestic (electric) clock. As early as 1878, however, Paul Lacour, who was born in Denmark, was awarded a U.S. patent for a synchronous clock motor on principles later applied by other inventors."

Now here is the American viewpoint on the subject, as presented by Mr. John W. Babb of the Clock and Timer Department, General Electric Telechron, Ashland, Mass.:

"The synchronous electric clock was not invented by a Frenchman, but by an American by the name of Henry E. Warren in 1916. The Warren Master Clock is used by electric utility companies to regulate the current. He (Warren) conceived the idea that a synchronous motor that follows the changing direction of alternating current could keep accurate time if the speed of the current were regulated. The term 'electric clock' must be broken down to include two basic types. First, there is the original type used since the advent of electricity, the simple magnet used to wind a spring-powered clock. This type has been replaced by the 'synchronous-motor clock.' Up to the time of the master clock, no synchronous motor could keep time. Synchronous timekeeping was suggested to Mr. Warren by an article in a technical journal describing a synchronous-motor clock exhibited at the Leipzig Fair in Germany in 1914, with the comment that 'of course, it did not keep time correctly because the frequency of the current was not controlled.' As a result of this, Mr. Warren developed his own self-starting synchronous motor and then the master clock so the motor could keep correct time."

Mr. Babb added that "the electric clock may be termed 'the fourth estate of electricity.' Previous to its development, electric power companies were able to furnish three services—heat, light and power—and now electric time has rapidly become a prominent fourth."

From the foregoing it may be gathered that invention, in this case, was definitely important, but that development of the invention to the point of making it practical for human use was equally vital. So, when that musical chime interrupts your slumber in the morning you can, whether you like to get up or not, thank Mr. Henry Warren for the service. And you might add a subdued cheer for Messrs. Thury and Lacour.

Charles Grant, Evanston, Ill.

WAR SURPLUS AND OTHER BARGAINS SAVE UP TO 90%

R1 ARC WELDER KIT \$39.95. Build your own complete make-up package consisting of 1 Aircraft DC Generator, famous mfrs. 300 to 350 Amps, 24 Volt, RPM from 4000 up, 1 Rheostat, 1 Giant Toggle Switch, 1 Ammeter, 1 Shunt, 0 to 300 Amps, 1 Voltmeter, 0 to 30 Volts, 1 Electrode Holder, 1 Welder's Shield, 1 Voltage Regulator, Wiring Diagram for hookup as welder, Wt. under 100 lbs. Approx. GOVT. COST \$475. Like new, perfect... \$39.95.
Complete kit shown above less generator—\$18.75. All Generators sold are pre-tested prior to shipment.

HEAVY-DUTY RHEOSTAT Designed for heavy-duty use with Air Force heated suits. Ideal for regulating voltage on electric welders, model trains, lights, generators; controls soldering irons, etc. Rated 5.75 ohms, 100 watts with double windings and dual female 25 amp, 125 volt receptacles. Size: 7" H x 5 1/4" W x 1 1/4" D. Shpg. Wt. 2 1/2 lbs. Approx. GOVT. COST \$25. Brand new, only \$1.95.

140-1 REDUCTION GEAR Make your own winches, hoists, wagon unloaders, stump pullers or fence stretcher. Sturdy aircraft quality. Built-in (removable) 24 Volt DC motor & clutch. High torque, Low speed. 100's of uses. Wt. 42 lbs. Approx. GOVT. COST \$300. Like NEW. \$12.00.
#225-1 Reduction Gear, same as above — \$13.50.

DUPONT EXPLOSIVE RIVETS! A must for the man who works with sheet metal. A hot soldering iron placed on the head of the rivet will explode and mushroom the other end of the rivet self-bucking itself. 1/8" - 5/32" - 3/16". Round and flat heads. Approx. GOVT. COST \$50.00 a 1,000. NEW, 1,000 assorted, \$5.00 ppd.

DOUBLE ACTION HYDRAULIC CYLINDER
Will lift 7000 lbs. with 1000 P.S.I. line pressure. Can go to 3000 P.S.I. Micro-honed & all stainless steel 1 1/4" dia. piston rod. Stainless steel shaft. Rugged construction. Clevis mounting. 4" bore, 2 1/2" stroke, overall length 45", shaft dia. 1 1/4". Weighs 14 lbs. Approx. GOVT. COST \$475. NEW. \$32.95.

MICROMETERS Chrome plated, precision engineered, carefully tooling to give long life. All new 0-1" cap. \$2.50 ea. 1-2" cap. \$3.75.

FAMOUS B-16 KOLLSMAN AIRCRAFT COMPASS Finest compass ever made. In current use on large and small planes. Ideal for boats, cars, trucks, etc. Graduated in 5° increments. Liquid filled, lighted, poly-plane compensator. Panel mounted 3 1/2" dia. face, 4 1/2" in depth. Checked & tested in our own lab. Approx. GOVT. COST \$150. Like NEW. \$12.95 ppd.

BENDIX PUMP & MOTOR
Can be used for pumping fuel, oil or where-ever hydraulic pressure is required. Pump has 1" connections, built-in relief valve, adjustable up to 1500 lbs. Max. capacity 6 GPM. 1 1/2 H.P., 24 volt motor, 4000 RPM. Can be used on 12 to 36 volts. Approx. GOVT. COST \$350. NEW — \$10.95.

NEW! BIG CATALOG Send 25c for your copy. Postpaid prices in U.S.A. only. Other prices F.O.B., Culver City, Calif. Send check, cash or money order. 50% deposit required for C.O.D. orders.

AIRBORNE SALES CO., INC. DEPT. PM 757
8501 Stellar Drive, Culver City, Calif.

GENUINE ALNICO MAGNETS

AMAZING, PERMANENT, NON-ELECTRIC, HIGHLY PRACTICAL. Conduct interesting experiments. Hundreds of uses. Retrieve valuable steel items such as guns, tackle from fresh or salt water; tools from tanks & drains. **GUARANTEED.** Try any magnet one week. Money back if you are not well-pleased.

No. M-710 (Wt. 53 oz.) Has pull of 225 lbs. on steel block... \$16.50
No. M-625 (Wt. 70 oz.) Has pull of 125 lbs. on steel block... \$9.50
No. M-575 (Wt. 18 oz.) Has pull of 75 lbs. on steel block... \$6.50
No. M-500 (Wt. 13 oz.) Has pull of 50 lbs. on steel block... \$4.50
No. M-100 Kit of Flat Bars 5 Pairs (10 Magnets)... \$3.00
No. M-250 Kit of Round Rods 5 Pairs (10 Magnets)... \$2.50
No. M-47 Hot Pad Magnets, 10 for \$1.00... \$0 for \$4.87
No. M-35 Hobbyist assortment of 8 small magnets... \$1.50

Send M.O. or check. We pay postage. Sorry no C.O.D.'s.
MIAMI MAGNET COMPANY, 3240 N.W. 27th Ave., Miami 42, Fla.

SAW SHARPENING IS EASY
Super Filer No. 11 joints and sharpens hand and circular saws 6" to 10" with all teeth correct in height, depth, pitch, bevel. When file hits steel restor teeth are finished. Saw runs true with no side pull. Includes 8" file. PPD. \$9.95

DOWEL CENTERS
Centers inscribe exact location for opposite holes. Pairs for 1/4", 3/8", 1/2" holes. \$1.00 ppd.

TRU-CIRCLE saw set automatically sets teeth at 10° or more. \$2.95 ppd.

SUPER SAW FILER No. 6
Automatically controls depth, angle, pitch for all saws. Precision made and calibrated. Use in vice or clamp. Includes file... \$6.50 ppd.

MONEY BACK GUARANTEE CATALOG FREE
A. D. MCBURNEY, 5908 Hollywood Blvd., Hollywood 28, Cal., Dept. A-77



KING MIDGET

ALL NEW. First model change in six years. New bodies, new chassis, new engine. Four wheel hydraulic brakes. Still World's Lowest Priced Car. Drive it for 75c per week. Rider Agents Wanted. Earn your own car. Get the facts. Send 25c for 22 page picture book with complete details, dealers price, etc.
MIDGET MOTORS CORPORATION, Athens 1, Ohio

FREE! 44 PAGE BOOKLET ON PORTABLE POWER TOOLS
Hundreds of time and money-saving ideas for hobbyists, builders, professional wood-workers. New booklet #204 includes 150 pictures of latest tools with complete specifications on how they work and what they do. Write for your free copy now!
PORTER-CABLE MACHINE COMPANY
7147 N. Salina St., Syracuse 8, N. Y.

REMODEL YOUR KITCHEN OR BATH WITH A TRADE-WIND VENTILATOR

ELIMINATES HEAT, ODORS, GREASE... ADDS LASTING BEAUTY

It's easy to install a Trade-Wind Ventilator in a cabinet over the stove or in the ceiling in the kitchen or bath. Highest rated dual centrifugal blowers whisk away fumes and odors — you can even slice onions without crying! Choice of 3 hoods in copper and stainless steel, pre-wired with switch and light, ready to install in your kitchen. Also 6 top performance ventilators for kitchen, bath, laundry, workroom. Complete instructions with each unit.

MAIL COUPON NOW FOR FULL INFORMATION

Trade-Wind Motorfans, Inc.
7755 Paramount Blvd., Dept. PM, Rivera, Calif.

Please send full color brochure on Trade-Wind equipment.

Name _____
Address _____



Typical family pose, taken 30 years ago, shows the late Ole Evinrude with son Ralph and Mrs. Evinrude

Our Outboard-Boat Boom

(Continued from page 119)

cruising possible and ended for many the dangerous practice of refilling the engine tank in open water.

Also, bigger motors were put on the market—25 horsepower, then 30, 35, 40—and even a 60-horsepower Mercury marketed by the growing Kiekhaefer company in Fond du Lac, Wis. The step-up in horsepower is startling. Outboards are now powering 21-foot cruisers with two bunks, and even some 25-foot outboard cruisers with four bunks. Many boatmen use outboards in pairs—clamping two on the stern of their boat. They get more power, also a second engine to come home on if one fails.

Meanwhile, three new kinds of boats have emerged: Glass-fiber boats which don't have to be painted, molded-plywood boats which are cheaper to make, and aluminum boats whose lightness makes them easily carried on car tops. More and more banks began financing boat and motor purchases. Kits, including knocked-down boat components, are on the market for people who want to build for themselves—everything from an eight-foot pram to a twenty-foot cabin cruiser. The result was over three million outboard sales in the past seven years. Last year's sales figure of 600,000 was more than twice all outboards marketed during Ole Evinrude's lifetime.

They Get Away From the Highway

Thousands of people own outboard motors without owning a boat—they put their motor in their trunk compartment, drive

along until they find a place they want to fish, rent a rowboat and clamp the motor on. Many families are buying an outboard boat instead of a second car. Others, instead of renting a cottage for week ends and vacations, put their money into a boat, spend spare time on cruising-camping trips. Often they discover a whole new world: solitude, islands they didn't know existed, little coves for swims and picnics, spectacular views never seen from highways. Some find their fun in short-haul runs, others take 1000 and 2000-mile cruises—for instance, Chicago to New York via lakes, rivers and canals, or all the way down the Mississippi.

Boating clubs have been organized in over 800 communities. They sponsor weekend and vacation cruises, with family boats traveling in company, tying up together at night. For instance, each July 30, members of a Bay City, Ore., club take a week's cruise together in the San Juan Islands. The nation's largest mass cruise is the Kissimmee Boat-a-Cade in Florida each October—321 boats last year. They start at Kissimmee Lake, go down the Kissimmee River and through other lakes to Lake Okeechobee. Participants from as many as 17 states bring in their boats by trailer.

Today, outboards enable families to take to the water in whatever style they can afford. You can get an eight-foot pram for \$90, attach a 3-horsepower outboard costing \$150, and make up to 12 miles per hour—good for teaching youngsters small-boat handling. A 16-foot runabout costing \$600 with an 18-horsepower outboard at \$400 is fine for fishing and family fun; if you want water skiing—one of the world's fastest-growing sports—with this runabout you can get a 30-horsepower outboard for \$550 and speed along at 25 miles per hour. Then, a 21-foot cruiser, complete with two bunks, toilet and a galley with sink and ice chest, costs around \$2500, plus \$500 to \$650 for a 30 to 40-horsepower outboard. With a pair of these you can cruise at 22 miles per hour.

Top Outboard Speeds

Incidentally, the fastest speed ever recorded by an outboard boat is 100.36 miles per hour. This record was set in 1954 on Italy's Lake Idrocalo by Massimo Leto di Prioli—one of three brothers who built their own motor. The fastest time of a boat powered by a stock outboard is 75.402 miles per hour—set in 1954 at DeLake, Ore., by Burt C. Ross, Jr. He used a hydroplane and a 40-horsepower Mercury. Last year there was outboard racing at 353 sanctioned regattas, plus informal racing at hundreds of boat clubs. By far the biggest race is the

(Continued to page 242)

Handy Nail Guide

HELPS YOU

SAVE TIME AND MONEY

- Tells right nail for each job
- Tells amount of nails per pound
- Tells right hammer to use



YOURS FOR JUST 10¢ Send coin direct to Estwing

Estwing

UNBREAKABLE TOOLS

CHOICE OF
CRAFTSMEN
FOR 30 YEARS



ESTWING MFG. CO., DEPT. PM-4, ROCKFORD, ILLINOIS

Metal Turning Lathe for Model Makers



SEND FOR FREE FOLDER describing the new Lathe for Model Makers, 15 1/4" bed with 4 1/2" swing; 7" between centers. Guaranteed. Only \$35.00

f.o.b. Lansing.
Rosemoor Manufacturing Co.,
2501 Bernice Rd., Lansing, Ill.

GIVES YOU YOUR BEST ANSWERS ON
WHERE TO GO ON VACATION
HULL AUTO COMPASS

Most compass drivers use Hull. A favorite also for boats, private planes. \$4.95 and \$6.50.

See your Hull Dealer or write for literature

HULL MANUFACTURING CO., P.O. BOX 246-D7, Warren, O.



ROAD TO RICHES

You can be the next uranium millionaire! Government guarantees huge bonus! PRI instruments from \$29.95. See your local dealer today! FREE CATALOG!

Write PRI, 4223 PM W. Jefferson
Los Angeles 16, California

DEALERS WANTED



ELECTRIC WELDER AC or DC 110 Volts

The "Little Marvel" all-metal welder, 5-year written guarantee. Welds 1/8" metal or money back. Repairs tanks, tools, fenders, machine parts, etc. Complete with everything—rods, unit, eye shield, directions. \$7.95

plus 50¢ postage. Flame torch necessary for soldering, cutting, brazing \$8.95 complete with carbons, brass rods, flux. \$2.00 Deposit on C.O.D. 7.5 ampere 1/4 inch Transformer Welder \$24.95 F.O.B.

ESSAY MFG. CO., Dept. 51, Quincy 69, Mass.

\$7.95
Complete

AUTOMATIC TRANSMISSION at LOW, LOW COST!



Here's the way to get low-cost, truly automatic transmission on your midget racer, power mower, garden tractor or any gas driven machine. There's no load on your engine when starting—no stalling possible. Step on the gas and this Mercury Automatic Clutch picks up the load smooth as silk. Engines do bigger jobs on less gas. Easily installed with 1 screw. 1/2", 5/8", 3/4" bores—standard 3" x AB pulley assembly. For engines to 3 1/2 HP. Send check or MO, specifying bore. MONEY-BACK GUARANTEE!

MERCURY CLUTCH DIVISION
1201 Camden Ave., S.W., Canton 6, Ohio

ONLY
\$7.95

SAVE! BUILD-YOUR-OWN CARPORT OR PATIO

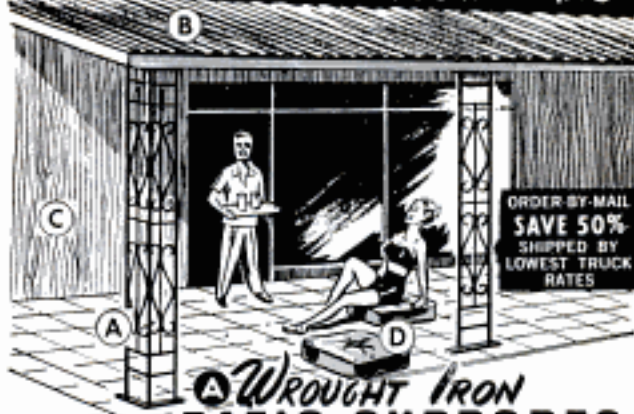

ORDER BY-MAIL
SAVE 50%
SHIPPED BY
LOWEST TRUCK
RATES

WROUGHT IRON PATIO SUPPORTS

A NEW, DECORATIVE, Do-It-Yourself item that has hundreds of uses IN and OUT of your home. Use them for patio reel supports, room dividers, etc. Sturdy 1 1/2" diameter, black tubular supports with a beautiful wrought iron filigree between. 12" wide by 8 ft. high (can be cut to 7 ft.) with mounting flanges. Flat or Corner style.

TRANSLUCENT FIBERGLAS PANELS

Finest quality. Available in many widths and lengths. An excellent color selection in present stock. Ideal for use in the home or office. FREE SAMPLE and instructions booklet on request. 85¢ Val. for 49¢ ft.

SAVE ON PHILIPPINE MAHOGANY PLYWOOD

Selected LUAN MAHOGANY Plywood at prices LESS THAN WHOLESALE! Rotary cut for beauty of grain. Both sides sanded with face side unjointed. Bonded with finest resin adhesive. Weather & Water resistant. Shipped by LOW truck rates. Minimum order accepted 100 lbs. (4) 1/4" or (8) 1/8" sheets.

3 ft. x 6 ft. x 3/8" (1/8") 179 4 ft. x 8 ft. x 1/4" thick 4.49
18 sq. ft. = \$5.00 Value PER SHEET 32 sq. ft. = \$9.50 Value PER SHEET

6" x 17" x 18" NAUGAHYDE COVERED PILLOWS

Wondrous Naugahyde cover—Looks, Feels & Wears like leather. Reg. \$9.80 a yard. 100% cotton filler. Solid colors flame orange, pink, lavender, med. blue. Give 1st & 2nd choice. 3.99 EA

3400 RPM 1/2 HP POWER SAW

RIPS - CROSSCUTS
CUTS A FINISHED 2x4 LIKE A KNIFE THROUGH BUTTER

COMPARES TO SAWS SELLING UP TO \$49.50 1998 Complete with 5-1/2" Blade

A rugged, professional type, adjustable saw. Will cut any angle from 0 to 45°. Has an adjustable (0 to 6") rip fence. Safety-trigger switch on handle. Full 1/2 HP Universal AC DC, 110-120 Volt, 60 cycle motor. Weighs only 8 1/2 lbs.

EXTRA SAW BLADES—Available in Rip, Crosscut or Combination. Please Specify ONLY 2.25 EA

PORTABLE SNOWEL ARMY FIELD SHOES

G.I. Surplus. 20" handle. Blade folds to form pick. 179 Carry in car for emergency.

JUST ARRIVED! 10,000 PAIR — ALL SIZES! High Blucher style. Natural Cowhide & composition soles

22" Vanadium steel blade & wood handle. Sheath included. 198

ARMY MACHETE 198

4.49

WORLD'S MOST AMAZING BARGAIN CATALOG

1957 EDITION — 396 PAGES NOW! THE LARGEST COLLECTION OF BARGAINS EVER ASSEMBLED IN ONE CATALOG!

NATIONALLY ADVERTISED MERCHANDISE — NEW and USED GOV'T. SURPLUS — FACTORY CLOSEOUTS — EXCITING IMPORTS! From EVERYWHERE PALLEY'S now bring you items of every description! This fabulous catalog contains Hand & Power Tools, Microscopes, Binoculars, Industrial and Building Materials, Housewares, Office Equipment, Sport & Outdoor Equipment, Cameras, Photo Supplies, Hobby Kits & "Gadgets", Electrical & Radio Supplies, Motors & Generators and a HUGE selection of Surplus Hydraulic Cylinders, Pumps, Valves, etc.

We are now one of the foremost manufacturers of CUSTOM-MADE HYDRAULIC CYLINDERS. Our tremendous volume enables us to sell for BELOW MASS PRODUCTION PRICES!

Send 50¢ LIMITED EDITION! ORDER YOURS NOW! 50¢ REFUND on your first order of \$1.00 or more.

PRICE F.O.B. Los Angeles, Calif. Send 50¢ Deposit with all C.O.D.'s.

Palley's 2263 E. VERNON AVE., DEPT. PH-77 LOS ANGELES 18, CALIF





GRAVELLY Gets It Done Faster! . . . Better!

New Steering Sulky, with Rotary Mower Attachment, provides the easiest, most efficient mowing ever!

With Gravely, you fit your jobs perfectly with a choice of 30 performance-proved attachments . . . Do every lawn and garden job better, faster, easier!

All-gear drive, power reverse, optional electric starter. Nation-wide sales and service . . . Easy Payment Plan.

Write today for FREE 24-page "Power vs Drudgery" Booklet.

GRAVELLY TRACTORS, INC.

BOX 763 DUNBAR, W. VA.

FIELD-TESTED SINCE 1922



HANDLE OUTBOARDS SAFELY

Lifting today's high horsepower outboards or handling hundreds of tough hoisting jobs around marine basins, stores and repair shops, farms and construction projects — is easy with a 'Budget' Aluminum Chain Block. The ½-ton size weighs just 29 lbs. but lifts 500 lbs. with a hand chain pull of only 25 lbs.

The lightweight 'Budget' Aluminum Chain Block is a rugged one-man hoist, built to save time and money. Sealed housing protects mechanism from dirt and sand. Anti-friction bearings assure easy operation. "Full-jeweled" automatic brake provides positive load control. Sizes from ¼ to 10 tons. Priced \$199. Spark-resistant models available. Get details from your "Shaw-Box" Distributor or write us for Bulletins 405 and 415.



B7C-3



MANNING, MAXWELL & MOORE, INC.

SHAW-BOX CRANE & HOIST DIVISION

354 W. BROADWAY MUSKEGON, MICHIGAN

88-mile run on Lake Winnebago, Wis. It drew 223 starters last year, but high winds whipped the lake into a froth and only 22 boats finished.

In the United States today, eight out of ten outboards are used for pleasure. But they do a lot of useful work around the globe. Fishermen were the first commercial users here, the first to buy exports to Scandinavia. In the past few years the outboard has revolutionized the fishing industry in some regions. In the Philippines and East Indies, fishermen who formerly couldn't venture far offshore now go out 20 miles. Some are bringing in two or three catches a day instead of one.

Filipinos use outboards on outrigger fishing boats. In South Panama, the Choco Indian clamps the motor to a large dugout canoe to transport bananas down jungle streams. Missionaries use outboards on the Amazon, Congo and scores of other rivers. Explorers have used them—from Roosevelt in Brazil in 1913 to a Spitzbergen expedition in 1956. Thirty medical and health teams in Colombia are equipped with outboards in order to reach roadless sections of the interior.

Even Newsboys Use Boats

On the Klamath River in California, outboards pull rafts of logs 250 feet long. In Ontario, huge rafts are assembled on some lakes, a piece of lumber nailed to a rear log, then an outboard clamped on—to push the raft to a paper mill. A steel company in Peru uses outboards on Lake Titicaca to move steam-shovel barges into position. On the open Honduras coast they have been employed for years as power for unloading freighters—the outboards bring the barges through the surf to the beach. One outboard made in England is standard equipment on many lifeboats.

Paris uses wooden barges propelled by outboards to clean its huge underground sewers. Last year the newspaper *France-Soir* began employing outboard boats to rush the latest edition to Saint-Cloud, Charenton and other suburbs. Four boats carry 80,000 papers a day, reducing costs and cutting delivery time in half.

Finland has more outboards per capita than any other European country. At Helsinki, every summer afternoon around four you can see hordes of business and professional men leaving the city in outboard boats for islands where they have family cottages. Docks, empty at night, are jammed each morning with several hundred boats apiece—a thrilling sight 75 years after Ole Evinrude, the emigrant boy, left Scandinavia for America. ★ ★ ★

PORTABLE LIGHT PLANTS

GIANT 2500 WATT PLANT

110-120 v. 60 cyc. AC. Absolutely the best made — exclusive dynamically balanced armature; heavy windings develop up to 5000 watt overload for motor starting. Skid mounted — portable. Powered by an easy starting Briggs or Wisconsin 6 HP engine—complete with all accessories; engine easily disconnected for other uses. Big outlet box, voltmeter, no wiring necessary. Ample current for all purposes. Factory warranty. (Item 311) Wt. 210 lbs. Reg. price \$585. Special at..... **\$299.50**

Same plant with electric self starter (Item 312)..... **\$359.50**

Generator only and control box..... **\$169.50**

DUAL VOLTAGE 110-220 available on any of above models for \$28.00 additional.

We make every type and size of light plants — Write, giving us your requirements!

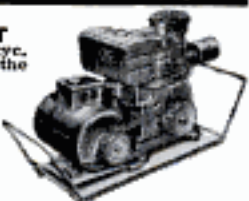

1000 Watt Belt Drive AC Generator

Lightweight portable generator. Will provide 1000 watts of 115 volt 60 cycle AC power for lights, saws, drills, etc. or other appliances requiring up to 1000 Watts. Operates at 3600 r.p.m.—drive with any gas engine, tractor or power take off. Can even be mounted on an automobile engine to operate off a fan belt. Complete with duplex receptacle, safety fuse and 4" pulley. Not recommended for heavy duty. Wt. 27 lbs. (Item 825) only... **\$79.50**

750 Watt Generator, similar to above. (Item 826)..... **\$59.00**

Heavy duty 1200 Watt Generator only. Wt. 50 lbs. (Item 45a).... **\$139.50**

Heavy duty 2500 Watt Generator only. Wt. 80 lbs. (Item 21a)..... **\$169.50**



Double Acting Hydraulic Cylinder

A powerful cylinder mfr'd. by Massey Harris which develops both a pushing and a pulling force. Will push 8,100 lbs. with a 1000 P.S.I. pump pressure. Cylinder is 3 3/4" O.D. with 6 1/2" stroke—standard heavy duty clevises on both ends. Has standard 1/2" pipe thread openings. Can be used for tilting buckets or blades, raising or lowering implements, hydraulic presses, etc. Can also be used as an air cylinder. (Item 802) Wt. 17 lbs. Reg. \$88. Special..... **\$14.95**

OTHER DOUBLE ACTING CYLINDERS

8" stroke — 3" bore..... **\$34.00**

10" stroke — 3" bore..... **\$4.00**

16" stroke — 3" bore..... **\$3.00**

24" stroke — 3" bore..... **\$7.50**

HYDRAULIC CONTROL VALVE — 4 way open center valve with built-in adjustable relief. Controls a double or 2 single acting cylinders. Equalizing feature permits easy control even under heavy loads. 3/4" pipe thread on inlet & outlet. 1/2" on cylinder outlets. Easily mounted. Finger tip control. Wt. 16 lbs. (Item 822)..... **\$21.50**

MASTER AIR COMPRESSOR

COMPARE! This is the only compressor built with a **NO RUST** stainless steel tank. Safe up to 500 lbs. (Item 209) High pressure type (4 c.f.m.) Large type 2" bore compressor with built-in air filter. Master built with high strength alloys and precision bearings. Tank, 12"x24", 2100 cu. in. cap. Equipped with automatic switch that starts and stops motor to maintain desired pressure (up to 50 lbs.) and check valve, safety valve, gauge, shut-off valve, 20 ft. air hose and tire chuck. Beautifully balanced on ball bearing wheels and rubber tires. Don't take chances with used or surplus equipment. Our compressors are factory new and are guaranteed **SAFE**. Low factory prices. 1 1/2 HP Model (cap. 30 lbs.)..... **\$109.50**

Reg. \$175. (Item 209)..... **\$129.50**

1 1/2 HP heavy duty model, Reg. Ind. motor & unloader switch (Item 209a)



MASTER MECHANIC'S BEDROCK FACTORY PRICES

700 WATTS PUSH BUTTON START
115 v. 60 cyc. AC. Powered by a rugged 2 1/2 HP easy starting Briggs engine. No wiring necessary; just plug in and operate. Plenty of current for any oil burner, refrigerator, brooder, emergency lights, etc. which require up to 500 watts. Ideal for television and radios. Complete with Voltmeter and built-in winding to charge 6 v. auto batteries. (Item 24.) Wt. 75 lbs. Easily fits in car trunk. He prepared to storm knock-out power lines. Reg. \$475 value... **\$143.50**

1200 Watt Plant (Item 45) same as Item 24 but larger generator and engine with 50% greater output..... **\$199.50**

Stainless Steel Pressure Tanks

Stainless steel tanks tested to 1000 P.S.I. Working pressure 500 P.S.I. Absolutely corrosion proof — will last indefinitely! Ideal for air, gases, chemicals, boozys, etc. 1/4" pipe thread openings each end.

2100 cubic inches (21 1/2" x 24")..... **\$16.95**

Wt. 20 lbs. (Item G-1)..... **\$12.95**

1000 cubic inches (8" x 18")..... **\$12.95**

Wt. 10 lbs. (Item F-1)..... **\$12.95**



SCREW-TYPE PRESS
A tremendously powerful press capable of exerting pine tons of pressure. Pays for itself straightening bent parts, or pushing out bearings and bushings. Ideal for manufacturing and assembly operations because of precise control. Massive 1 1/2" screw permits precise control over vertical travel. Extra heavy ribbed yoke has a throat 2 1/2" high; depth capacity for working to the center of an 1 1/2" diameter. Includes 8" x 15 1/2" vise-type table and two pushing arbors. Wt. 150 lbs. (Item 797). Reg. \$49.50. Special..... **\$149.50**

HYDRAULIC PRESS. Nine ton capacity. See June Pop. Mech's. ad for details on write Complete. Wt. 110 lbs. (Item 404)..... **\$68.50**

JET STEAM MASTER

Now, a super efficient portable steam generator that produces live steam at 100 lbs. pressure in 60 seconds from a cold start! Produces large volume of high pressure steam on 2 pints of fuel oil. Instantly cleans sticky grease, dirt, rust, old paint, etc. off implements and road machinery. Pays for itself in a few weeks. Sterilizes soil. Sterilizes as it cleans—kills equipment, etc. Fully automatic—oil fired with new, built-in lifetime bronze water circulating pump. Draws water from faucet or bucket. Simple and safe — anyone can use it; built-in safety valve. Complete with 12 ft. of hi-pressure steam hose and hose fitting efficiency steam gun that automatically mixes in soap solution if desired. Special factory price..... **\$349.50**

Rugged, ball bearing WINCH

Sturdy ball bearing winch—super tough aluminum alloy construction. Powered by an easy starting 2 1/2 HP Briggs gas engine thru gear reduction drive — it exerts up to 3000 lbs. of terrific force for hoisting materials or pulling. Combination gear and pulley reduction results in tremendous multiplication of engine power. Later pulley clutch arrangement and built-in drum brake (with ratchet hand lever) enables operator to back loads down gently and lock at any point desired. Drum handles 400 ft. of 3/8" cable or 600 ft. of 1/4" cable. Ideal for contractors, farm implement trailers and unlimited other uses! (Item 703) Wt. 125 lbs. Only..... **\$149.50**

HAND WINCH—Same winch with large crank handle for extra leverage and 2 speed drive. (Item 704) Wt. 80 lbs..... **\$59.50**



LESS THAN WHOLESALE

1500 WATT PLANT
115v. 60 cyc. AC Push Button Start. Powered by a 3 1/2 HP. Clinton engine. Combines big output with easy starting. Provides emergency power for operating any oil burner, sump pump, freezer, television, lights, communications systems, etc. which require up to 1500 watts. (Item 23). Wt. 110 lbs. Reg. \$475 value. Factory price... **\$239.50**



1750 Watt Plant Powered by 4.5 Briggs engine. Electric starting & battery charging built-in. Factory price... **\$279.50**

MASTER-LITE 2500 Watt Plant
110/120 v. 60 cyc. AC. A power plant, ruggedly constructed and yet designed for easy portability. Can be started by rope or built-in 12 v. electric push button starter. Built-in winding to charge battery. Possesses a big 5.0 HP Briggs engine, etc. complete with all accessories. Includes control box, voltmeter, and handy plug-in power receptacle. An ideal plant for permanent or stand-by service. Wt. 225 lbs. Reg. \$665.00 (Item 21) Factory Price..... **\$329.50**



3500 Watt Plant Push Button Start (Item 23) 115 v. 60 cyc. AC. Similar to above, but larger and 33% more capacity. Wt. 270 lbs. Reg. \$780. Factory Price..... **\$379.50**

DUAL VOLTAGE 110/220 for Item 21 or 23 —\$30 additional.

EXTENSION CORD

Heavy duty and very flexible. Neoprene 14-2 cable. 20 year quality. Wt. 12 lbs. (Item 185) 100 ft. Complete with rubber plug and outlet. A terrific buy at only **\$8.95**

No. 10-2 Power Cable. Heavy duty, very flexible, 20 ft. with male and female fittings. Wt. 4 lbs. (Item 818b)..... **\$5.15**

20 ft. without fittings (818a)..... **\$4.15**

50 ft. (Item 592) with fittings..... **\$13.45**

100 ft. (Item 135) with fittings..... **\$28.95**

No. 12-2 Power Cable. Very flexible rubber covered, special outside shield for grounding power tools, etc. 50 ft. (Item 199)..... **\$6.95**

100 ft. (Item 200)..... **\$12.95**

No. 8-2 Conductor Power Cable. 30 ft. heavy duty, very flexible rubber covered with male & female plug (Item 817)..... **\$12.95**



Variable Speed Selector

Heavy duty, made by S. F. GOOBICH for industrial use. Provides instant speed changes for any drive. For machine tools, dryers, printing, conveyors, production lines, hoists—any operation requiring variable speed. Employs reliable "trochoid" planetary system. No hydraulic power losses. Infinite range, smooth operation, easy installation. 3 sizes: 1/2-1 hp, 36 lbs.; 1-2 hp, wt. 55 lbs.; 2-3 hp, wt. 105 lbs.; Reg. list \$228, \$252 and \$352. Our prices **\$79.50, \$89.50 and \$114.50**



MASTER DC ARC WELDERS

Now! a portable rugged, industrial type welder with terrific performance, yet at a price hundreds of dollars less than you'd expect. Senior model made for years of trouble-free, continuous service. High capacity DC welding unit enables you to tackle any job with confidence—easily welds anything up to 2" plate using from 1/16" to 1/4" rods. Built-in stabilizer and cooling system makes arc easy to strike and hold. Dual control rheostat provides for heat soldering, brazing and welding from 30 to 500 amps. Complete with instructions, guarantee and brake V-belt or flat pulley. Easy to hook up and easy to operate.

WELDER ONLY — DUAL CONTROL MODEL. Same as above, but drive with your tractor, jeep or gas engine of 14 HP or more. (Item 35a) Wt. 110 lbs. \$450 value..... **\$119.50**

WELDER ONLY — INDUSTRIAL MODEL same as above but with ceramic rotary type rheostat providing 74 different heat settings for all types of welding (Item 35b)..... **\$139.50**

\$500.00 value..... **\$139.50**

COMPLETE POWER MASTER (Illustrated above) powered by a 14.6 hp., air cooled Wisconsin engine. Wt. 480 lbs. (Item 280) Complete with welder costing \$1200. Factory Special..... **\$449.50**



Send check or M.O. Prices f.o.b. Factory. 10 day Money back guarantee. SEND 10c for... **BIG 1957 Catalog**

MASTER MECHANIC MFG. CO., DEPT. E4-D Burlington, Wis.

Top Value FOR THOSE WHO WANT THE BEST

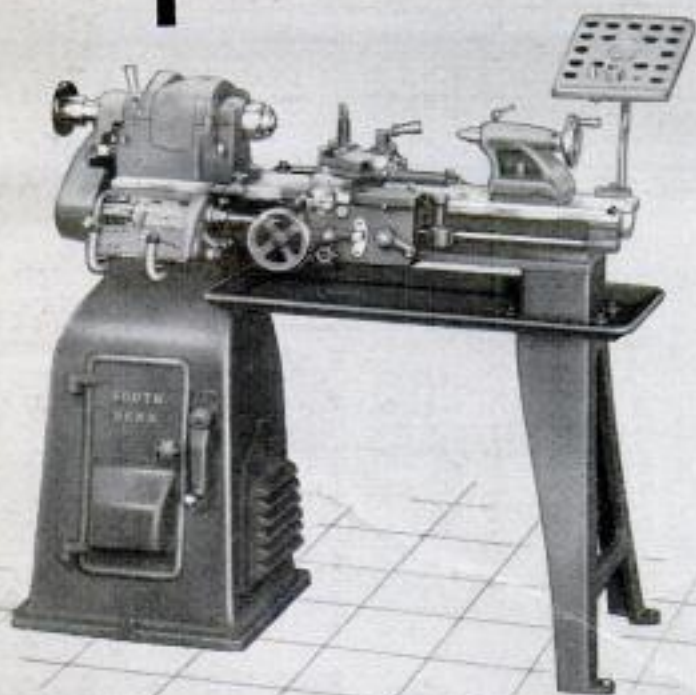

SOUTH BEND 10"-1" COLLET LATHE

When you measure the value of a lathe by its accuracy, dependability and versatility, South Bend 10"-1" Collet Lathes stand out as top values. You'll find them a match for toolroom demands—efficient and trouble-free on production—and ready for any kind of work. Find out about them now—they'll give you more value for your money. Prices start at \$1221.



Send FOR THIS HELPFUL BOOK



How to Run a Lathe is needed by every lathe operator—128 pages, over 365 illustrations. 50c postpaid.

PLEASE SEND INFORMATION CHECKED:



9" and 10" BENCH LATHES



10" to 14-24" FLOOR LATHES



DRILL PRESSES



1/2" & 1" Collet TURRET LATHES



TOOL GRINDERS



7" BENCH SHAPERS



MILLING MACHINES

Name _____ Street _____

City _____ State _____



Building Better Tools Since 1906 • SOUTH BEND LATHE • South Bend 22, Indiana

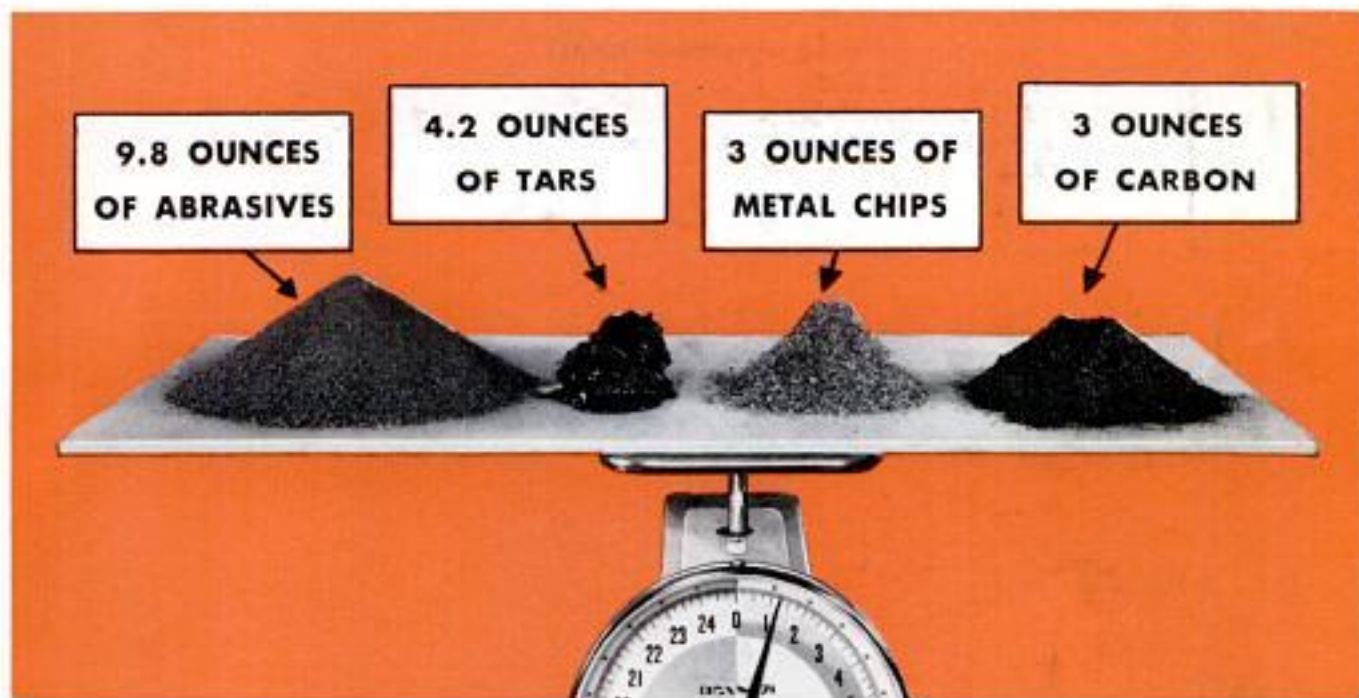

FRAM FILTERS

trap over a pound of these engine-killers every 10,000 miles!

No car owner would *deliberately* pour a pound of dust, dirt, metal chips, tar and carbon into his engine. Yet, the motorist who assumes his filter cartridge never needs changing does just that! Every filter cartridge—regardless of make—can hold just so much engine dirt. Like a waste basket, it must be emptied from time to time or it overflows. When your filter cartridge *overflows* it permits dirt to return to the engine.

Smart motorists change their filter cartridge when they change their oil. And, they insist on a FRAM Cartridge. They know FRAM Filters are individually engineered to car factory specifications. They know that FRAM Filters will remove engine debris as small as 39/1,000,000ths of an inch in size. They know their oil will always be clean—able to keep their engines clean. See your FRAM dealer soon!

FRAM Corporation, Providence 16, R. I.
Fram Canada Ltd., Stratford, Ontario



FRAM Oil Filter Replacement Cartridge. Over 30,000,000 vehicles—FRAM equipped.

271 manufacturers of precision engines specify FRAM as original equipment . . . proof of FRAM engineering leadership. Make sure *all* your filter equipment is FRAM.



Revolutionary new FRAM Easy Change Oil Filter—changes in minutes—no mess. Original Equipment on many 1957 cars.

Drilling for oil in the Gulf of Mexico.

The Offshore Company's Rig No. 54 sinks pipe 50 miles out at sea. Rig Supt. Hank Matthews is a Camel smoker. He says: "Camel's a *real* cigarette — lots of good flavor all the way."

Hank Matthews

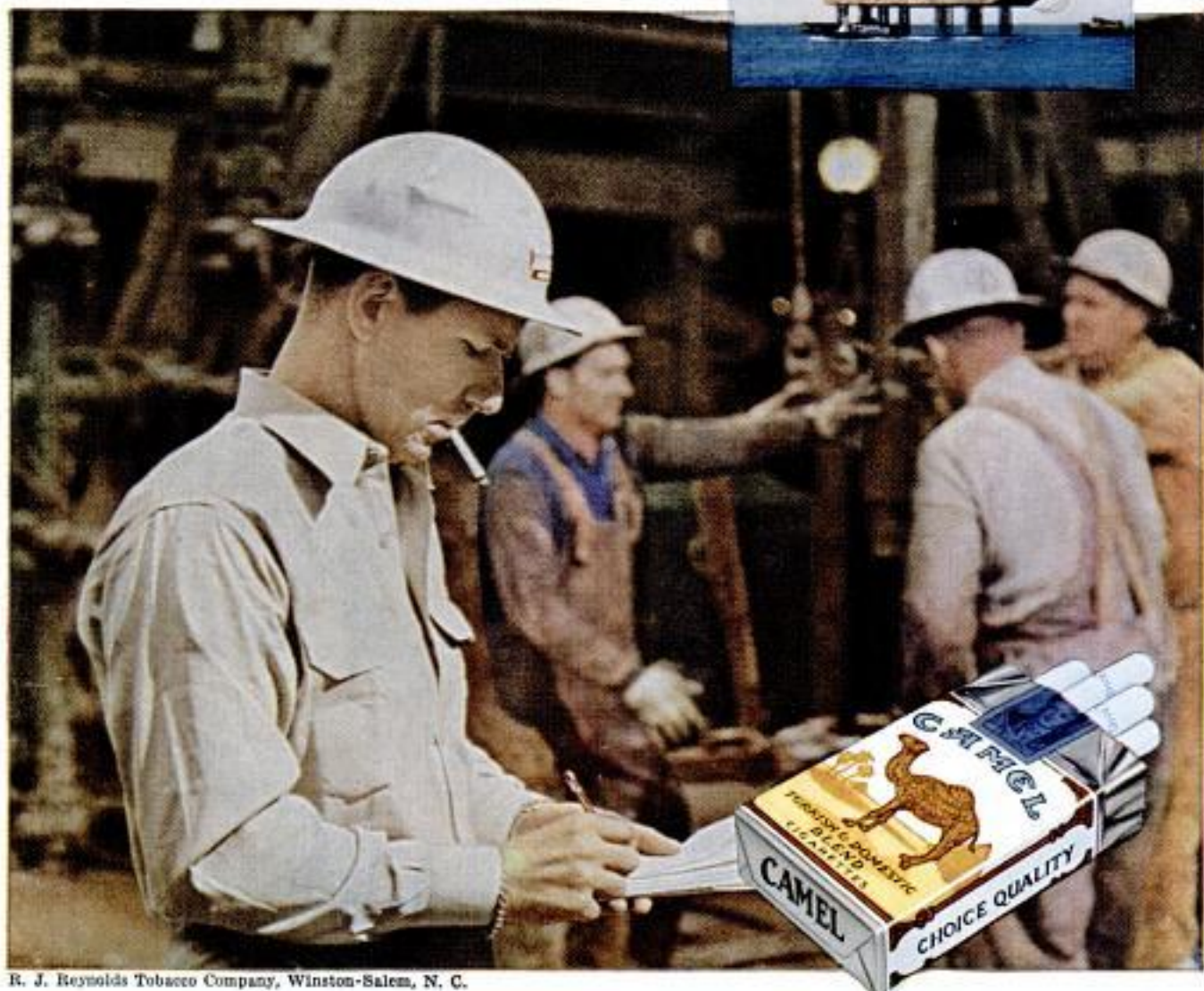

R. J. Reynolds Tobacco Company, Winston-Salem, N. C.

HAVE A REAL CIGARETTE— HAVE A **Camel**

Discover the difference between "just smoking"...and Camels!

Taste the difference! Camel's good, rich flavor is deeply satisfying. No fads, no frills, no fancy stuff—simply the finest taste in smoking.

Feel the difference! The exclusive Camel blend of costly tobaccos has not been equalled for *smooth* smoking. Camels are easy to get along with.

Enjoy the difference! Try Camels. See for yourself why they're the largest-selling cigarette in America today. They've really got it!