

WHAT OWNERS SAY ABOUT THE '57 BUICK

POPULAR MECHANICS

MAGAZINE

JUNE 1957
35 CENTS

HOW TO GUARD YOUR HOME
FROM WINDSTORMS

Read
"We Chase the Jets on Film"
—Page 91



Faster paste waxing!

Easier paste waxing!



Start right in waxing!
Johnson's new J-wax
does the cleaning work for you!

No extra cleaner needed
—nothing else to buy!

J-Wax has just what paste wax needed—a built-in cleaner! The exclusive J-Wax formula goes to work fast. Cleans while it waxes—saves you hours of work. J-Wax replaces grime with a glistening coat of wax. *Tough wax. Hard-finish wax* that protects your car in any weather.

J-Wax puts more wax on your car—leaves

more wax on your car than other one-step waxes. And J-Wax goes on smoothly, easily—evenly. Leaves no dull spots or streaks. You are sure of more all-around protection with J-Wax in any weather—from bumper to bumper, including the chrome!

Look for Johnson's J-Wax in this new key-opening can. Only J-Wax guarantees sealed-in freshness. It's the fastest, easiest way to genuine wax protection—*paste wax protection!*

"Johnson's Wax" and "J-Wax" are registered trademarks of S. C. Johnson & Son, Inc.

**FREE booklet shows
how and where to use**



MASONITE
PEG-BOARD
PANELS AND FIXTURES

When you send for Masonite's colorful, illustrated booklet, you'll get dozens of ideas for putting these sturdy, easy-to-paint panels to work for you. It has ideas for organizing tools by your workbench ...for ending "closet clutter"—for bringing more efficiency to the kitchen... ideas for every room in your home.

More than 70 specially designed metal fixtures and Masonite® Peg-Board® panels (including heavy duty panels for garage and tool shed) are on sale at your lumber dealer's.

AS SEEN ON **HOME** WITH ARLENE FRANCIS



MASONITE CORPORATION
Dept. PM-6, Box 777, Chicago 90, Ill.
In Canada: Masonite Corporation, Gatineau, Quebec
Please send me your free 16-page booklet with ideas for using Peg-Board panels and fixtures

Name.... **This One**

Address..

City.....

Zone.....



HYN9-D69-7YT7

*Masonite Corporation—manufacturer of quality panel products.

The new Torsion-Aire suspension system,* only on Chrysler Corporation cars, is the riding advance of the year. It isolates road shock—takes curves flat—eliminates jolting dive on stops. This is engineering leadership. Plymouth, Dodge, De Soto, Chrysler and Imperial.

**Another big reason why The Switch is On to the cars of The Forward Look*

Popular Mechanics Magazine

Registered in U. S. Patent Office and Canada

H. H. WINDSOR, Founder

H. H. WINDSOR, JR., Editor and Publisher

FOREIGN EDITIONS: MECANIQUE POPULAIRE (French) MECANICA POPULAR (Spanish) POPULAE MEKANIK (Danish) POPULAR MEKANIK (Swedish) POPULARE MECHANIK (German) MECCANICA POPOLARE (Italian)

Managing Editor
RODERICK M. GRANT
Assistant Managing Editor
WAYNE WHITTAKER
Shop Notes and Crafts Editor
JAMES R. WARD
Associate Editor
CLIFFORD B. HICKS
Associate Editor, Automotive
ARTHUR R. RAILTON
Associate Editor,
Shop Notes and Crafts
WAYNE C. LECKEY
Associate Editor, Shop Notes
W. CLYDE LAMMEY
Associate Editor
WILLIAM D. PERKINS
Radio-Television, Electronics Editor
LOTHAR STERN
Assistant Editor, Crafts
JAY W. HEDDEN
Assistant Editor, Makeup
JOHN DALEN
Art Director
FRANK BEATTY
Assistant Editors
KENNETH ANDERSON **ROBERT DORSETT**
ROBERT HENDRICKSON **EARL WOBECK**
Eastern Editor
RICHARD P. DEMPEWOLFF
Empire State Bldg., Room 2000, N.Y.C. 1
Western Editor
THOMAS E. STIMSON, JR.
Suite 1010, 3460 Wilshire Blvd.,
Los Angeles 5, Calif.
London Manager
DOUGLAS W. WEDDERSPOON
Eagle House, Jermyn St.,
London S.W. 1, England
Director, Bureau of Information
ALLAN CARPENTER
200 E. Ontario St., Chicago 11

Advertising Offices

Chicago: 200 E. Ontario St., Whitehall 4-0100;
New York: Empire State Bldg., 350 Fifth Ave.,
LONGacre 5-7580; Detroit: General Motors
Bldg., Room 5-118, TRINITY 5-8711; Cleveland:
Hanna Bldg., 1422 Euclid Ave., PROspect
1-0456; Los Angeles: 3460 Wilshire, DUNKirk
2-8458; San Francisco: Russ Bldg., Room
468, 235 Montgomery St., YUKon 2-0823.

Sources of further information not listed
in the index, starting on page 58, about
articles in this issue, frequently are shown
in the Where-to-Find-It List prepared for
each issue. A copy may be obtained by
readers, without charge, from Bureau of
Information, Popular Mechanics, 200 East
Ontario Street, Chicago 11, Illinois.

Published monthly by Popular Mechanics Company,
200 E. Ontario St., Chicago 11, Ill. H. H. Wind-
sor, Jr., president; Wm. Harrison Ferguson, exec.
vice-pres.; Franklin S. Forsberg, operations vice-
pres.; D. F. Windsor, vice-president and secretary-
treasurer; H. H. Windsor III, vice-president; W. T.
Windsor, vice-president; Joseph R. Buell, Jr., ad-
vertising manager; Alan M. Dwyer, circulation
manager. Single copy in the United States and
Canada, 35 cents; subscription rates in the United
States and possessions, Canada and countries of
the Pan-American Postal Union, 1 year \$3.50; 2
years, \$6.00; 3 years, \$8.00. To all other coun-
tries add \$1.00 a year over United States prices
for overseas. If you plan to move, notify us
at least 30 days in advance so you will not
miss an issue. Give both your old and new addresses.
Entered as Second Class Matter, September 15,
1903, at the Post Office at Chicago, Illinois, under
Act of March 3, 1879. Entered as Second Class
Matter at Post Office Dept., Canada. Registered
as Second Class Matter at the Post Office at
Mexico, D.F., Mexico, June 20, 1950.
Copyright 1957 by Popular Mechanics Company.
Copyright under International Copyright Union.
Copyright in France. All rights reserved under
Pan-American Copyright Act. Printed in the
United States of America.

Volume 107 JUNE 1957 Number 6

Address all communications to: 200 E. Ontario St., Chicago 11, Ill.

In This Issue...

His Cameras Spy on Life's Secrets	-	-	65
France Is Harnessing the Tides	-	-	85
We Chase the Jets on Film	-	-	91
The Owners Report on the '57 Buick	-	-	98
Musical Museum	-	-	110
Professor of the Outdoors	-	-	118
Push-Button Bakery	-	-	133

For the Craftsman...

"Field Kitchen" for Week-End Campers	-	145
Install a Through-the-Wall Air Conditioner	-	153
Oil-Barrel Oven	-	161
Decorate With Mosaics	-	163
Build the Sea Knight — Part II	-	166
Protect Yourself Against Windstorm Damage	-	174
Boat Camping for the Sportsman	-	185
Machining Metal Tubing	-	192

Regular Departments...

Detroit Listening Post	-	76
Keeping Up With the Atom	-	139
Solving Home Problems	-	158
How Would You Do It?	-	198
Shopping for Tools	-	200
On the Market for Do-It-Yourselfers	-	202
Clinic for Homemakers	-	208

Next Month...

Nowadays you can buy a prefabricated home complete with swimming pool, patio and outdoor-living area, in smart, modern design or colonial style, ranch type or two story. One of the most exciting developments in housing is revealed in a July article on "How the Prefabs Got That Custom Look"



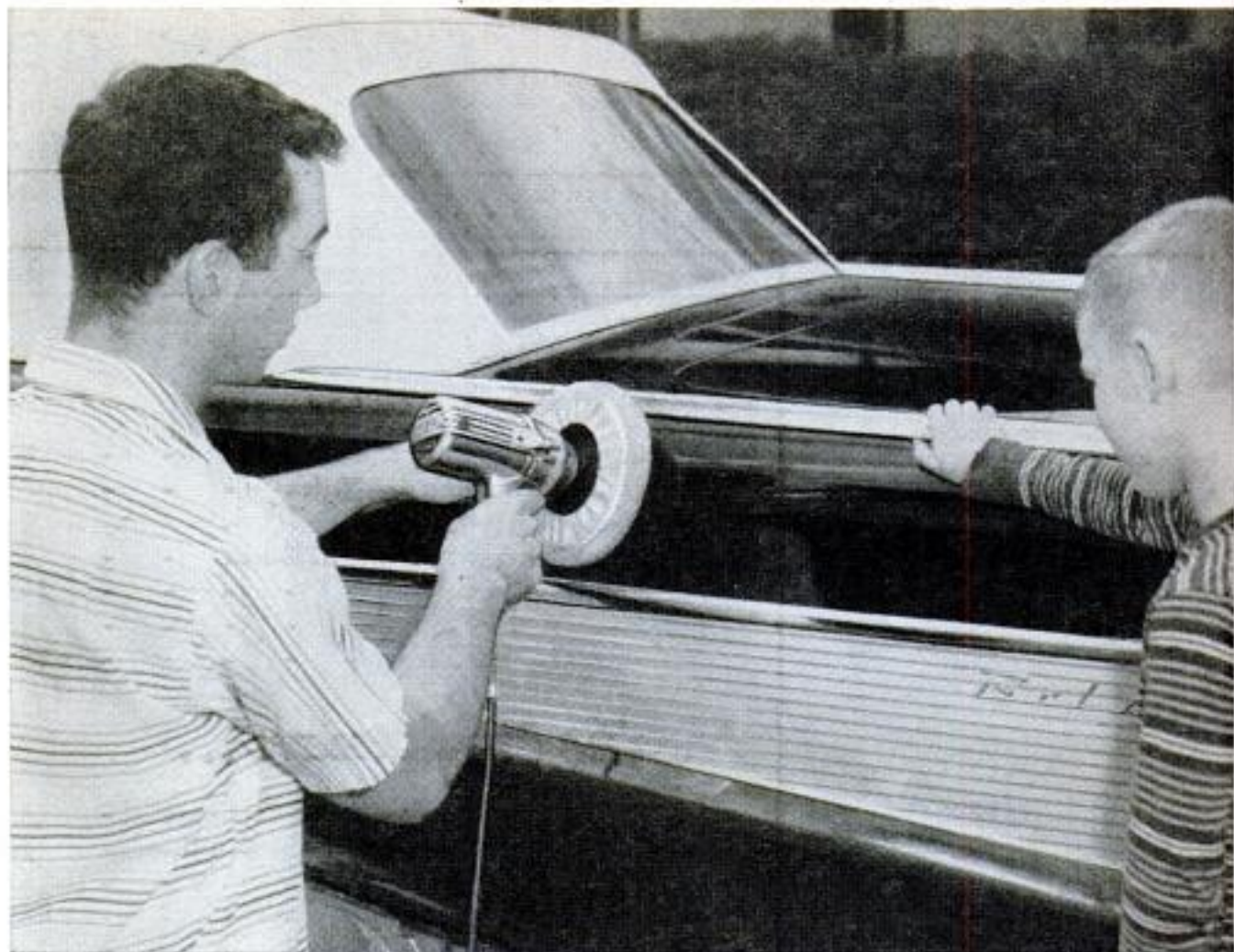

Give your car, your furniture a professional polish with Thor's model 36 car and home polisher—only \$39.95.

Thor car and home polisher

Shines things brighter, makes work lighter

Now you can brighten up the old bus (or that new one) and not wear yourself out in the process. All you need is Thor's popular model 36 car and home polisher.

This Thor SpeedPolisher is light (only 4½ lbs.) and easy to handle. Lets even an amateur turn in a professional polish job and save money.

Thor's model 36 is useful inside the house, too. Perfect for polishing furniture: Give your car and your furniture a professional polish job with this durable,

quality-built Thor SpeedPolisher. Just \$39.95. For complete versatility around the home workshop, be sure to see the complete kit at \$49.95. The kit includes accessories so that the basic power unit becomes a drill, a sander, a paint stirrer and a wire brushing machine.

See these and the complete line of Thor SpeedTools at your nearest hardware dealer. SpeedWay Manufacturing Co., division of Thor Power Tool Company, Prudential Plaza, Chicago 1, Illinois.



THOR POWER TOOL COMPANY, CHICAGO

Branches in all principal cities

World's largest exclusive manufacturer of portable air and electric tools



TRIPS WITHOUT SLIPS...

WEEK ENDS . . . vacations . . . plan your family motor trips . . . *without slips.*

Item: Be sure you take your car jack, lug wrench, other tools. You could miss them a lot . . . later. Flashlight, paper towels, etc., can come in handy.

Start early: Ask "Mr. Service" . . . your nearby Texaco Dealer . . . for a special Texaco Touring Service routing for best routes . . . to avoid detours. Have him check your car . . . tires,

battery, filters, fan belt and other potential trouble spots. His Marfak chassis lubrication will give you smoother, quieter riding, easier handling.

Invitation: Stop where you see those green and white Texaco Registered Rest Room signs . . . *you're always welcome.*

And, on the road, let Texaco Dealers give you their famous "Circle Service" for clear vision and safer driving.

Here's "slip" that safeguards...

It's Marfak chassis lubricant! Lubricates perfectly yet clings to vital points. Seals itself in to protect against road dirt, dust and water. Lasts longer for "cushiony" riding, easier handling, bearing wear protection. Get Marfak. See your Texaco Dealer . . . *the best friend your car has ever had.*

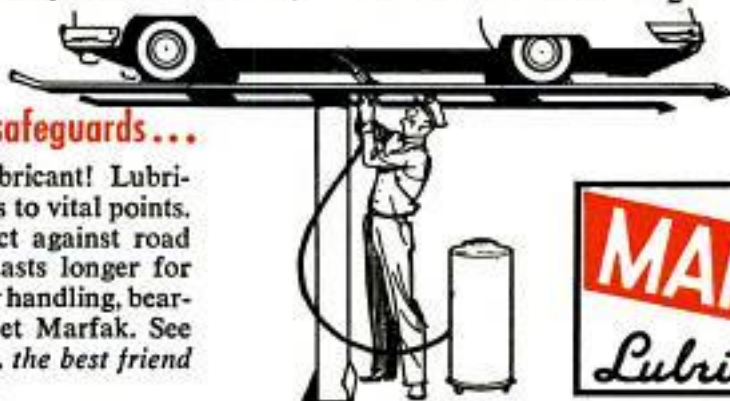

TEXACO DEALERS

IN ALL 48 STATES

Texaco Products are also distributed in Canada, Latin America, and Africa

THE TEXAS COMPANY



New!



strobomite

by **GRAFLEX®**

Big Performance-Low Price!

Here is a brand new Graflex product specifically designed and priced for YOU. It offers important, exclusive features never before obtainable in low priced electronic flash units. Look them over . . . compare . . . and you'll choose STROBOMITE.

1. Four D-cell batteries cut cost to 1c a flash.
2. 60 cycle, 110-120 volt AC operation with accessory 15-foot cord.
3. Exclusive adjustable reflector.
4. Exclusive accessory wired shoe adapter permits use of 35mm. cameras having internally wired flash shoe.
5. Ready light indicates when Strobomite is ready to flash.
6. Push button on lamphead permits "off camera" operation.
7. Modern, gray plastic covering with aluminum trim; extremely light and compact.
8. For color use guide number 25-30 with Kodachrome; 50-55 with Ektachrome and Anscochrome.
9. Specifications: Rated Energy Storage—50 watt sec. Flash Duration: 1/1100 sec. Recycling Time: 6 sec. AC; 10 sec. battery.
10. PRICE: Strobomite Power Pack and Lamphead (less batteries) \$64.50.

See it at your Graflex dealer listed in the "yellow pages" or write Dept. PM-67, Graflex, Inc., Rochester 8, N.Y. Prices include federal tax where applicable and are subject to change without notice.

70th Anniversary—1887-1957

GRAFLEX®

A SUBSIDIARY OF



ACROSS THE DESK



To the Editor:

I have just read your article, "Build Your Own Swimming Pool," in the March issue.

I am enclosing photographs of the swimming pool we built in our back yard.



Pertinent facts:

- Size, 12 by 20 by 7 feet deep.
- Kiddy pool, 4 by 12 by 3 feet deep.
- Cinder-block construction (reinforcing rods and concrete in block cavities).

(Continued to page 8)

5 reasons why ACCOUNTING



offers you MORE MONEY... and SUCCESS!

REASON #1. If you were an expert accountant right now, chances are you would find yourself among the highest-paid of all professional men and women. Even back in "depression years," accountants earned more than many men in other major professions.

REASON #2. The demand for accountants is great—everywhere. All businesses must have trained accountants to cope with ever-growing requirements. It's a profession offering wide opportunity—always—to the man who knows.

REASON #3. You can fit into any business, anywhere in the country—because accounting principles are universal. Think what this means in terms of security and independence!

REASON #4. Accounting is open to all. Any man or woman of good intelligence, who enjoys figure work and is willing to follow LaSalle's systematic "problem method" plan, can rapidly qualify for a highly profitable, enjoyable lifetime career... and he doesn't have to finish his training before beginning to "cash in."

REASON #5. Without losing a day from your present work, you can prepare in spare hours at home, at low cost, under LaSalle's step-by-step "Problem Method" of "learning by doing." This famous plan accounts for LaSalle's remarkable record of having trained one out of every 13 of all Certified Public Accountants in the U. S. . . . and of having put many thousands of others into high-paying careers.

Send today for Free Sample Lesson and "Accountancy, the Profession That Pays." Learn about the several great fields of opportunity . . . and LaSalle's time-tested plan for helping men and women to rapid advancement, higher income, greater prestige and professional standing. The coupon below will bring this information to you—without cost or obligation.

MAIL THE COUPON—NOW
Member, National Home Study Council

GET FREE SAMPLE LESSON

LaSalle Extension University
— A Correspondence Institution —
Dept. 664H, 417 S. Dearborn St., Chicago 5, Ill.

Please send me, free of all cost or obligation, a sample lesson in Accounting . . . also, your latest illustrated book, "Accountancy, the Profession That Pays."

Name.....Age.....
Address.....
City, Zone, State.....

LASALLE
417 S. Dearborn St.,
CHICAGO 5, ILL.
JUNE 1957



NOW...YOU'RE "SET" FOR
**SAFER
 TRAVEL**

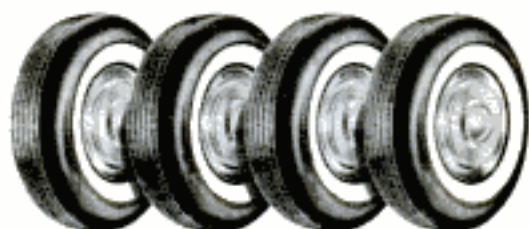

...thanks to **ATOMIC ENERGY**



A MATCHED SET of Dunlop AccuRated tires is greater-than-ever protection against premature tire failure. The precise, atomic-powered action of Accu-Ray® produces a stronger, safer tire with an exact amount of protective rubber uniformly applied to every cord ply. No dangerous ply chafing or internal heat build-up. Better balance, new stability and comfort for mile after mile of safer driving. Your Dunlop dealer will give you the "inside story" that makes Dunlop your best tire value today. He has a complete selection of Dunlop tires in Nylon or Super Hi-Test Rayon.



You'll go farther,
 SAFER... on tires by

DUNLOP
 They're AccuRated

DUNLOP TIRE AND RUBBER CORPORATION, BUFFALO 5, N. Y.

(Continued from page 6)

Floor of pool, 6-inch-thick reinforced concrete.

Wood-slat rustic fence 6 feet high obtained from sawmill nearby.

Blue morning glories cover fence.

Wire-mesh safety fence and gate around pool.

Flagstone border.

Water obtained from deep well.

The kids and I dug the pool with the shovel-and-wheelbarrow method. Tough work — two months digging — but a lot of fun. Help from mason contractor in laying blocks and cement work. Total cost approximately \$750 and worth every penny.

Joseph W. Scheld,
 Ansonia, Conn.

To the Editor (From "Down Under"):

Re Mr. Burggraf's article, "The World's Toughest Car Test," in February. Congratulations on a most interesting story, the like of which we Aussies would like to see more.

However, some of Mr. Burggraf's statements regarding our "roos," as we call them [kangaroos], would stand correction. For some eight years I worked as a ringer, the same as your cowboy, on New South Wales and Queensland sheep and cattle stations and I have seen thousands of these marsupials but never, as stated on page 188, 10 feet in height. One seven-foot red buck was quite a legend in his district.

Five hundred pounds in weight? Very doubtful.

But the statement "... frequent the center of the continent in packs numbering hundreds of thousands" is entirely incorrect. Under certain conditions mobs of 500 may be seen in the semiarid belt, but this would not happen once in 10 years.

J. Inall,
 Regentville, N. S. W.,
 Australia

Editor's Note:

Looks like we may have to go to Australia ourselves for the answer. Roland Burggraf, author of the article questioned, is with the Sydney, N. S. W., Sun.

To the Editor:

In the March issue of PM I read the letters from the people concerning the 1957 automobiles. It seems to me that most of these are aimed at Chrysler Corp., and as there is no answer to this in the book, I want to put in my two bits.

I think the Chrysler cars are distinctive and beautiful. They are different from those of the past and I predict the '58 Chevy

(Continued to page 10)



Picture yourself going places

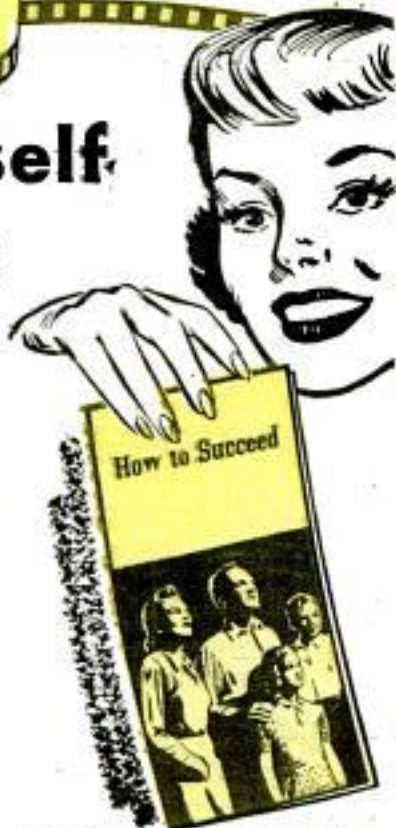

You've done it often. Call it day-dreaming if you like, but you've seen yourself in a bigger job - giving orders and making decisions - driving off in a smart new car - buying your family a fine home.

There's nothing wrong with dreams. But how about making them come true? *You can do it*, if you're willing to try!

Look around you. The men who are going places are the *trained* men. They've learned

special skills that bring them better jobs and higher pay. It's the men *without* training whose dreams never come true.

What are you going to do about it? Just wait and wish? If you really *want to succeed*, you can get the training you need by studying at home in your spare time. International Correspondence Schools offer you a course in just about any field you choose, giving you the practical plus the bedrock facts and theory. No skimming or skimping! And you'll be earning while you learn. Students report better jobs and more pay within a few months.

Look over the list of subjects in the coupon below. Pick out the one that interests you most - the one that holds the greatest future for you. Then mark the coupon, and mail it today. *Find out* what I. C. S. can do for you. It costs only a stamp or postcard, but it's the first step if you want to go places!



SMARTEST THING HE EVER DID

"I noticed that the trained men held the better jobs. That's when I decided to take an I. C. S. course. Enrolling with I. C. S. was one of the smartest things I ever did. The position as Plant Engineer I hold today is largely due to the 'know-how' derived from my I. C. S. texts. I. C. S. can help any man who will study."

L. P. S., Elkhart, Ind.

FREE BOOKS

1. Thirty-six page pocket-size guide to advancement, "How to Succeed."
2. Big catalog on career that interests you.
3. Free sample lesson (Math).

For Real Job Security - Get an I. C. S. Diploma!

I. C. S., Scranton 9, Penna.

Member, National Home Study Council

INTERNATIONAL CORRESPONDENCE SCHOOLS



BOX 54953F, SCRANTON 9, PENNA.

(Partial list of 257 courses)

- WITHOUT cost or obligation, send me "HOW TO SUCCEED" and the opportunity booklet about the field BEFORE which I have marked X (plus sample lesson):
- | | | | | |
|--|--|--|--|---|
| <p>ARCHITECTURE and BUILDING CONSTRUCTION</p> <ul style="list-style-type: none"> <input type="checkbox"/> Air Conditioning <input type="checkbox"/> Architecture <input type="checkbox"/> Arch. Drawing and Designing <input type="checkbox"/> Building Contractor <input type="checkbox"/> Building Estimator <input type="checkbox"/> Carpentry and Millwork <input type="checkbox"/> Carpenter Foreman <input type="checkbox"/> Heating <input type="checkbox"/> Interior Decoration <input type="checkbox"/> Painting Contractor <input type="checkbox"/> Plumbing <input type="checkbox"/> Reading Arch. Blueprints <p>ART</p> <ul style="list-style-type: none"> <input type="checkbox"/> Commercial Art <input type="checkbox"/> Magazine & Book Illus. <input type="checkbox"/> Show Card and Sign Lettering <input type="checkbox"/> Sketching and Painting <p>AUTOMOTIVE</p> <ul style="list-style-type: none"> <input type="checkbox"/> Automobiles <input type="checkbox"/> Auto Body Rebuilding and Refinishing <input type="checkbox"/> Auto Engine Tuneup <input type="checkbox"/> Auto Technician | <p>AVIATION</p> <ul style="list-style-type: none"> <input type="checkbox"/> Aero-Engineering Technology <input type="checkbox"/> Aircraft & Engine Mechanic <p>BUSINESS</p> <ul style="list-style-type: none"> <input type="checkbox"/> Accounting <input type="checkbox"/> Advertising <input type="checkbox"/> Business Administration <input type="checkbox"/> Business Management <input type="checkbox"/> Cost Accounting <input type="checkbox"/> Creative Salesmanship <input type="checkbox"/> Managing a Small Business <input type="checkbox"/> Professional Secretary <input type="checkbox"/> Public Accounting <input type="checkbox"/> Purchasing Agent <input type="checkbox"/> Salesmanship <input type="checkbox"/> Salesmanship and Management <input type="checkbox"/> Traffic Management <p>CHEMICAL</p> <ul style="list-style-type: none"> <input type="checkbox"/> Analytical Chemistry <input type="checkbox"/> Chemical Engineering <input type="checkbox"/> Chem. Lab. Technician <input type="checkbox"/> Elements of Nuclear Energy <input type="checkbox"/> General Chemistry <input type="checkbox"/> Natural Gas Prod. and Trans. <input type="checkbox"/> Petroleum Prod. and Engr. <input type="checkbox"/> Professional Engineer (Chem) <input type="checkbox"/> Pulp and Paper Making | <p>CIVIL ENGINEERING</p> <ul style="list-style-type: none"> <input type="checkbox"/> Civil Engineering <input type="checkbox"/> Construction Engineering <input type="checkbox"/> Highway Engineering <input type="checkbox"/> Professional Engineer (Civil) <input type="checkbox"/> Reading Struc. Blueprints <input type="checkbox"/> Structural Engineering <input type="checkbox"/> Surveying and Mapping <p>DRAFTING</p> <ul style="list-style-type: none"> <input type="checkbox"/> Aircraft Drafting <input type="checkbox"/> Architectural Drafting <input type="checkbox"/> Drafting Machine Design <input type="checkbox"/> Electrical Drafting <input type="checkbox"/> Mechanical Drafting <input type="checkbox"/> Sheet Metal Drafting <input type="checkbox"/> Structural Drafting <p>ELECTRICAL</p> <ul style="list-style-type: none"> <input type="checkbox"/> Electrical Engineering <input type="checkbox"/> Elec. Engr. Technician <input type="checkbox"/> Elec. Light and Power <input type="checkbox"/> Practical Electrician <input type="checkbox"/> Practical Lineman <input type="checkbox"/> Professional Engineer (Elec) <p>HIGH SCHOOL</p> <ul style="list-style-type: none"> <input type="checkbox"/> High School Diploma | <ul style="list-style-type: none"> <input type="checkbox"/> Good English <input type="checkbox"/> High School Mathematics <input type="checkbox"/> Short Story Writing <p>LEADERSHIP</p> <ul style="list-style-type: none"> <input type="checkbox"/> Industrial Foremanship <input type="checkbox"/> Industrial Supervision <input type="checkbox"/> Personnel-Labor Relations <input type="checkbox"/> Supervision <p>MECHANICAL and SHOP</p> <ul style="list-style-type: none"> <input type="checkbox"/> Diesel Engines <input type="checkbox"/> Gas-Elec. Welding <input type="checkbox"/> Industrial Engineering <input type="checkbox"/> Industrial Instrumentation <input type="checkbox"/> Industrial Metallurgy <input type="checkbox"/> Industrial Safety <input type="checkbox"/> Machine Design <input type="checkbox"/> Machine Shop Practice <input type="checkbox"/> Mechanical Engineering <input type="checkbox"/> Professional Engineer (Mech) <input type="checkbox"/> Quality Control <input type="checkbox"/> Reading Shop Blueprints <input type="checkbox"/> Refrigeration and Air Conditioning <input type="checkbox"/> Tool Design <input type="checkbox"/> Tool Making <p>RADIO, TELEVISION</p> <ul style="list-style-type: none"> <input type="checkbox"/> General Electronics Tech. | <ul style="list-style-type: none"> <input type="checkbox"/> Industrial Electronics <input type="checkbox"/> Practical Radio-TV Eng'g <input type="checkbox"/> Practical Telephony <input type="checkbox"/> Radio-TV Servicing <p>RAILROAD</p> <ul style="list-style-type: none"> <input type="checkbox"/> Car Inspector and Air Brake <input type="checkbox"/> Diesel Electrician <input type="checkbox"/> Diesel Engr. and Fireman <input type="checkbox"/> Diesel Locomotive <p>STEAM and DIESEL POWER</p> <ul style="list-style-type: none"> <input type="checkbox"/> Combustion Engineering <input type="checkbox"/> Power Plant Engineer <input type="checkbox"/> Stationary Diesel Engr. <input type="checkbox"/> Stationary Fireman <p>TEXTILE</p> <ul style="list-style-type: none"> <input type="checkbox"/> Carding and Spinning <input type="checkbox"/> Cotton Manufacture <input type="checkbox"/> Cotton Winding and Weaving <input type="checkbox"/> Loom Fixing Technician <input type="checkbox"/> Textile Designing <input type="checkbox"/> Textile Finishing & Dyeing <input type="checkbox"/> Throwing <input type="checkbox"/> Winding and Weaving <input type="checkbox"/> Worsted Manufacturing |
|--|--|--|--|---|

Name _____ Age _____ Home Address _____

City _____ Zone _____ State _____ Working Hours _____ A.M. to P.M. _____

Occupation _____

Canadian residents send coupon to International Correspondence Schools, Canadian, Ltd., Montreal, Canada. . . . Special tuition rates to members of the U. S. Armed Forces.

Superior's New Model 70 UTILITY TESTER®

FOR REPAIRING ALL ELECTRICAL APPLIANCES MOTORS · AUTOMOBILES · TV TUBES



AS AN ELECTRICAL TROUBLE SHOOTER THE MODEL 70:

- Measures A.C. and D.C. Voltages, A.C. and D.C. Current, Resistances, Leakage, etc.
- Will measure current consumption while the appliance under test is in operation
- Incorporates a sensitive direct-reading resistance range which will measure all resistances commonly used in electrical appliances, motors, etc.
- Leakage detecting circuit will indicate continuity from zero ohms to 5 megohms (5,000,000 ohms)
- Will test Toasters, Irons, Broilers, Heating Pads, Clocks, Fans, Vacuum Cleaners, Refrigerators, Lamps, Fluorescents, Fans, Switches, Thermostats, etc.
- Will test all TV tubes for open filaments, inter-element shorts, burned out tubes, etc.

AS AN AUTOMOTIVE TESTER THE MODEL 70:

- Tests both 6 Volt and 12 Volt Storage Batteries
- Generators
- Starters
- Distributors
- Ignition Coils
- Regulators
- Relays
- Circuit Breakers
- Cigarette Lighters
- Stop Lights
- Condensers
- Directional Signal Systems
- All Lamps and Bulbs
- Fuses
- Heating Systems
- Horns
- Also will locate poor grounds, breaks in wiring, poor connections, etc.

Handsome round-cornered molded bakelite case, 3 1/2" x 5 1/2" x 2 1/4". Complete with all test leads. Also included is a 64 page book giving detailed instructions, for testing all electrical appliances, automotive equipment, TV tubes, etc. Only

15⁸⁵

MOST EXCITING INVENTION SINCE THE HAMMER & NAIL

NEW Heavy Duty AUTOMATIC GUN TACKER KIT

SHOOTS A STAPLE WHEREVER YOU'D DRIVE A NAIL
ONE SQUEEZE AND YOU'VE NAILED IT!!

LITERALLY 1001 USES...



- Wood Veneer
- Wire Screening
- Ceiling Tile
- Electric and TV Wire
- Upholstering
- Venetian Blind Tapes
- Felt Stripping
- Metal Lath
- Roofing Felt
- Shingles
- Wood Siding
- Cornices
- Insulation
- Weatherstripping
- Linoleum Flooring
- Carpeting

10 TIMES FASTER THAN HAMMER AND NAILS!



Automatic Gun Tacker Kit comes complete. Includes Automatic Staple Gun, 5,000 assorted size staples from 1/4" to 9/16", Staple Remover and directions. Only

16⁵⁰

SHIPPED ON APPROVAL

NO MONEY WITH ORDER - NO C.O.D.

Try either of the above units for 10 days before you buy. If completely satisfied then send down payment and pay balance as indicated on coupon. No Interest or Finance Charges Added! If not completely satisfied, return unit to us, no explanation necessary.

MOSS ELECTRONIC DIST. CO., INC.
Dept. D-352, 3849 Tenth Ave., New York 34, N. Y.

Please rush the unit(s) checked. If satisfied, I agree to remit the down payment within 10 days and to pay the monthly indicated rate. If not satisfactory, I will return within 10 days for cancellation of account.

Model 70... Total Price \$15.85
—\$3.85 within 10 days. Balance
\$4.00 monthly for 3 months.

Gun Tacker Kit
Total price \$16.50
\$6.00 within 10 days. Balance
\$3.50 per month for 3 months.

Name.....

Address.....

City.....Zone.....State.....

All prices net, F.O.B., N.Y.C.

(Continued from page 8)

and Pontiac will fall in with the same type of design. I think the design of these cars is far advanced to the present Buick and Olds. These cars haven't changed in the last five years stylewise. I say let all companies go their own way in design, but let's get them to put them together better.

David Welch,
Sacramento, Calif.

Album of Chevies

Ed Cole's office in Detroit is uncluttered and businesslike, as befits the office of the

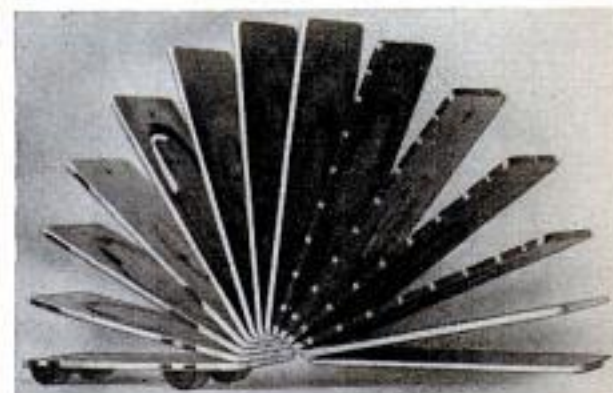

sharp-thinking, young engineer who is General Manager of Chevrolet Division. Obviously out of place is the bright yellow-and-red toy bus that stands on a table looking, at first glance, like any other toy bus. But, Ed quickly points out, it is not at all like any other toy bus.

The bus is made up of 14 thin slices of
(Continued to page 20)

For Good Pay—A Job with a Future Be a Skilled Technician

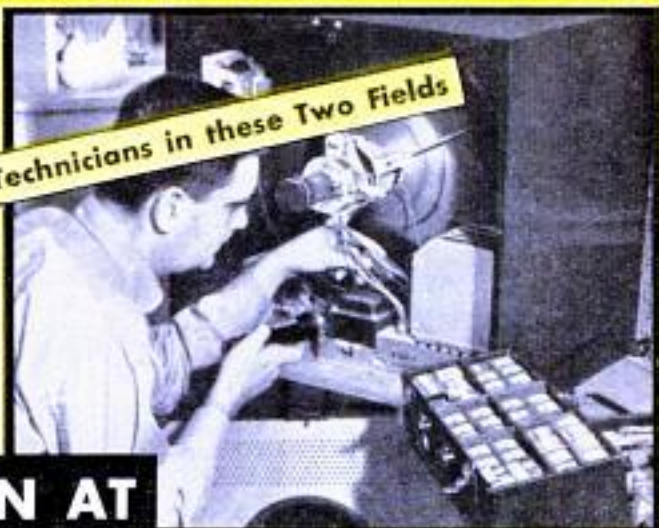

Growing Need for Trained Technicians in these Two Fields

Electric Appliances

Get into a field where there is important work and opportunity for the trained man. Millions of electric appliances are sold every year. Every wired home now has an average of 8. Many of them need service and repair. Owners pay well to have them fixed quickly, properly. This is your opportunity for a better job, your own part time or full time business. N.R.I. can give you the training you need, at home, in your spare time.

Learn and Earn with Tester N.R.I. Sends Soon after starting you will be able to earn extra cash fixing toasters, clocks, fans, vacuum cleaners, etc., for neighbors and friends. Keep your job while learning and earning. Put spare time to work for you. Work in your basement, garage, spare room. You'll be amazed how easily, quickly you, too, can start earning many extra dollars. N.R.I. shows you how. Even before you finish training your spare time earnings may pay for the course and equipment. You need proper training to service today's automatic appliances. With this course you get parts to build professional type, multi-use Appliance Tester. Takes guess work out of servicing. Mail coupon for FREE Catalog and Sample Lesson. See how easy it is to learn. . . . Find out about N.R.I.—a school that for more than 40 years has been training men, through home study, for success, good pay jobs.

**LEARN AT HOME
In Spare Time**

**Add to Your Income
Starting Soon**

**\$10, \$15 WEEK EXTRA
IN SPARE TIME**



"Before enrolling I was a laborer. Now have good service job, profitable spare time business." — E. M. DUDEK, Chicago, Ill.



"I have a job working on Radar. Also do spare time Radio-TV servicing." — F. ZAWAKE, Scranton, Pa.

Television—Radio

Bigger than ever and still growing fast. That's why Television-Radio has special appeal to ambitious men not satisfied with their jobs, their present earnings. More than 4,000 Radio and TV stations now on the air. More than 150 million home and auto Radios, 40 million Television sets. Color TV promises added opportunities. For trained men, there are good jobs, bright futures, security and prosperity in Television-Radio Servicing or Broadcasting. Soon after enrolling, many N.R.I. students start to earn \$10, \$15 a week extra in spare time fixing sets. Some make enough extra to start their own TV-Radio shops. N.R.I. training is practical—gets quick results. N.R.I. lessons are easy to understand, well illustrated, teach you basic principles. And you also LEARN-BY-DOING by practicing with kits of equipment which "bring to life" things you read about in the lessons.

Find Out What TV-Radio Offers You

N.R.I. is the oldest and largest home study TV-Radio school with thousands of successful graduates. N.R.I. instructors—specialists in home study training—devote full time to providing you with effective training. You get personal attention, helpful advice, from experts. Mail coupon for Catalog and Sample Lesson FREE. Cost of N.R.I. courses now available on easy terms. Address: NATIONAL RADIO INSTITUTE, Dept. 7FA, Washington 16, D. C.

N.R.I. Supplies Kits to Learn by Doing You Get Practical Experience

Enroll with N.R.I. and LEARN-BY-DOING. Training includes kits of parts to build actual equipment. Use it to practice what you learn from our easy to read, well illustrated lessons. Shows equipment you get, how you use it to learn quickly, become a trained technician.

**40 Years Experience
Backs N.R.I. Training**

SAMPLE LESSON AND CATALOG FREE
MAIL NOW—NO OBLIGATION

NATIONAL RADIO INSTITUTE
Dept. 7FA, Washington 16, D.C.

- Send FREE Sample Lesson and Catalog on TV-Radio Training.
- Send FREE Sample Lesson and Catalog on Electric Appliance Servicing Course. (No salesman will call. Please write plainly).

Name _____ Age _____

Address _____

City _____ Zone _____ State _____

Accredited Member, National Home Study Council

Handsome New 1957 GENOVA WATER & SHOCK RESISTANT WATCH

**Challenges Comparison
with Watches that Cost
up to \$49.95!***

**WHILE
SUPPLY
LASTS!** **\$898**
PLUS TAX

OUR greatest watch bargain since 1947! Handsome, rugged 1957 Genova water and shock resistant timepiece—engineered to rigid Swiss precision standards—yours at a money-saving bargain price. Not an ordinary watch . . . as radically different from other low cost watches as night and day! Bang it! Jolt it! Wet it!

RUNS UNDER WATER!

MULTI-PROTECTED! Resists shocks at work or play. Sealed-in safeguard gasket resists water, grime, dust. Yes! It actually runs under water!

We Challenge You to Compare It with Expensive Watches!

* Yes . . . compare the Genova with watches selling for \$49.95 for its elegant, very thin design, its modern applique dial, its smart, distinctive looks, its truly durable construction! Don't let our low price confuse you. The Genova is precision-made and electronically time-checked for satisfying performance. Even if we were to charge you TWICE the price, we couldn't give you a more accurate timepiece!

ONLY 25,000 AVAILABLE!

This ad will appear in over 100 magazines and newspapers reaching 60,000,000 people. Better order yours NOW—before they are sold out! **LIMIT**—one watch per family so we can please as many new customers as possible. Mail coupon for 10-day trial. **YOUR MONEY REFUNDED** promptly if not completely satisfied. And remember, you receive the famous THORESEN watch guarantee of FREE service, FREE oiling, FREE adjusting, FREE labor. See unlimited Guarantee Certificate above. This guarantee comes to you **IN WRITING** and is good not only for one year or five years — but for the lifetime of this firm. We stand behind our product!

THORESEN, Inc., Dept. 6-F-261

585 Water Street, New York 2, N. Y.

RUSH handsome, rugged 1957 Genova Deluxe—at only \$8.98 plus 90c excise tax: Total: \$9.88. My money refunded promptly if I am not satisfied. Include your famous Unlimited Guarantee Certificate.

- Check or money order enclosed. Send prepaid.
 Send COD, plus postal fees. I enclose \$1 deposit.

PRINT NAME _____

ADDRESS _____

CITY & _____

ZONE _____

STATE _____

Check here for Genova with metal expansion band. Only \$1.12 more. Total: \$11 tax paid. (No. 262)



We've sold more than 200,000 watches in recent years—but this is our greatest value! We will be swamped with orders. Don't lose out. Order your watch NOW! Remember, we have a full-time Jewelry & Watch Repair Department to service your watch—not for 90 days—but for the lifetime of this firm! **WE STAND BEHIND EVERY WATCH WE SELL!** Mail coupon.

UNLIMITED GUARANTEE

exclusive of parts

Repairs on watch, if ever needed, absolutely FREE. Never a charge for labor, handling, adjusting, etc. for the LIFETIME of this firm! Guarantee given in WRITING!

Make daring water test at our risk!

If, at any time in 5 years, the Genova watch fails to function properly after immersing in water for ONE HOUR, we will replace it with a watch of equal value.

THORESEN, Inc.,
585 Water St., N. Y. 2, N. Y.



- Precision-Made in Switzerland by Craftsmen Famed for Their High Standards of Workmanship!
- Water and Shock Resistant!
- Built-In Shock Protector!
- Anti-Magnetic! ● Luminous Dial!
- Stainless Steel Screw-Back!
- Center Sweep Second Hand!
- Built to Take Rugged Abuse!



INVENTORS

Learn how to protect your invention. The U. S. Patent Laws provide that any new and useful art, machine, article of manufacture, or composition of matter, or any new and useful improvement thereof, may be patented if the act of invention is involved. Therefore, every inventor with a valuable invention should take advantage of the Patent Laws and proceed for patent protection in order to safeguard his rights.

A patent gives the inventor the exclusive right to prevent others from making, using, or selling the invention claimed in the patent for a period of seventeen years.

The Patent Laws were enacted for the benefit of the inventor to give him protection for the features of his invention which are patentable. These features must be properly and concisely set forth and claimed in a formal application for patent, in order to comply with the requirements of the Patent Laws. For that reason, unless the inventor is familiar with patent matters, he should engage a competent registered patent attorney or agent to represent him. We are registered to practice before the U. S. Patent Office and are prepared to serve you in the handling of your patent matters.

A specially prepared booklet entitled "Patent Guide for the Inventor", containing detailed information with respect to patent protection and procedure, together with a "Record of Invention" form will be promptly forwarded to you without obligation upon request.

CLARENCE A. O'BRIEN & HARVEY JACOBSON

Registered Patent Attorneys

71-F DISTRICT NATIONAL BUILDING

WASHINGTON 5, D. C.

BUILD THE BEST FOR LESS!

BUILD ALLIED'S
OWN ELECTRONIC

knight®-kits

IT'S EASY
IT'S FUN—
and you save!

You'll marvel at how easy it is to build KNIGHT-KITS (with "step-and-check" instructions, it's like having a good instructor at your side). You'll be thrilled by KNIGHT-KIT performance—you'll be proud of your work—and you'll save money!

2-Transistor Pocket Radio Kit

Build this pocket-size, two-transistor radio—enjoy loud, clear broadcast-band reception wherever you go! Completely self-contained with built-in ferrite loop antenna—no external antenna needed. Printed-circuit board for easiest assembly. Efficient reflex-type circuit operates for months and months on long-life alkaline battery supplied. Super-sensitive miniature earpiece gives remarkably good tone. With all parts, including simulated leather case, earpiece and transistors. 4 x 3 3/4 x 1 3/4". Shpg. wt., 1 1/4 lbs.

83 Y 262, Pocket Radio Kit..... \$14.65



Transistorized Electronic 10-in-1 Lab Kit

Sensational—work with transistor! Assemble the basic parts, then complete project after exciting project (10 of them in all) just by plugging leads into proper jacks on printed-circuit board—no wiring changes needed. Make the following: AM radio, amplifier, wireless broadcaster, code practice oscillator, electronic timer, switch, or flasher, or any of 3 other electronic relays. Includes all parts, 2 transistors, battery, headphones and instructions, for each project. 3 lbs.

83 Y 299, Electronic Lab Kit..... \$15.45



Famous 2-Band "Space-Spanner"

Thrilling new bandswitching receiver. Selects exciting short wave on 6 to 18 mc (foreign, amateur, aircraft, police, marine); and full standard broadcast. Sensitive regenerative circuit; 4" PM speaker; beam-power output. Easy to build. All parts supplied (less cabinet), 4 1/4 lbs.

83 Y 242, "Space-Spanner" Kit.... \$15.95

83 Y 247, Cabinet for above..... \$2.90



2-Way Intercom Kit

It's easy and inexpensive to build your own 2-station intercom! Use it in home or office. Makes ideal "baby sitter". Extra high gain—delivers full output from only a whisper. Complete with 50 ft. cable (up to 200 ft. may be added), antique-white cases, tubes and all parts. For AC-DC. 7 lbs.

83 Y 295, 2-Way Intercom Kit... \$14.75

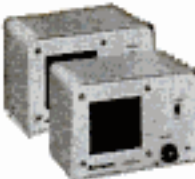

FREE ALLIED SUPPLEMENT

Send for our special Supplement No. 165 featuring the complete line of KNIGHT-KIT Hobby, Hi-Fi, Amateur and Test Instrument Kits. See hundreds of special values in Hi-Fi systems and equipment, recorders, Amateur gear, test instruments, parts, tubes and tools. FREE—send for it today.



ALLIED RADIO

ALLIED RADIO CORP., Dept. 05F-7
100 N. Western Ave., Chicago 80, Ill.

Send FREE ALLIED Supplement No. 165

Send the following KNIGHT-KITS:

83 Y 262. 83 Y 243. 83 Y 295.

83 Y 299. 83 Y 247. \$_____encl.

(All prices Net F. O. B. Chicago)

Name _____

Address _____

City _____ Zone _____ State _____

World's Largest
Electronic
Supply House
Our 36th Year

Tense, Nervous Headaches Need This Relief

A survey shows 3 out of 4 doctors recommend the famous ingredients of Anacin to relieve pain. Here's why Anacin® gives better total effect in pain relief than aspirin or any buffered aspirin:

- ➔ ACTS INSTANTLY: Anacin goes to work instantly. Brings fast relief to source of your pain.
- ➔ MORE EFFECTIVE: Anacin is like a doctor's prescription. That is, Anacin contains not one, but a combination of medically proven ingredients.
- ➔ SAFER: Anacin simply can not upset your stomach.
- ➔ LESSENS TENSION: Anacin also reduces nervous tension, leaves you relaxed, feeling fine after pain goes. Buy Anacin Tablets today!

I'll Send You This Handsome SAMPLE CASE—FREE



and Show You How to Make
Up to \$30.00 in a Day

WRITE for this FREE Tailoring Sample Case packed with 100 beautiful, big-value suit and overcoat fabrics. Take orders from friends, fellow-workers, others, for fine quality, made-to-measure clothes. Pocket big cash profits in advance. Because wearing our suits and overcoats brings more orders, we make it easy

for you to get your own clothes without 1c cost. No experience is needed. SATISFACTION GUARANTEED. SEND NO MONEY. Rush your name, address, and age—today!
J. C. FIELD & SON, INC., Harrison & Throop Sts.
DEPT. J-1716 CHICAGO 7, ILLINOIS

SHORTHAND IN

Famous SPEEDWRITING shorthand. 120 words per minute. No symbols; no machines; uses ABC's. Easiest to learn, write and transcribe. Low cost. For business and Civil Service. Over 350,000 graduates. Typing available. 34th Year. Schools in over 400 cities. Write for FREE booklet to:

Speedwriting
Dept. 1806-7
55 W. 42 St., N.Y. 36, N.Y.

6
WEEKS

REAL ESTATE BE A BROKER

PAYS BIG! SEND FOR FREE, BIG, ILLUSTRATED CATALOG NOW! Graduates report making substantial incomes. Start and run your own business quickly. Men, women of all ages, learn easily. Course covers Sales, Property Management, Appraising, Loans, Mortgages, and related subjects. STUDY AT HOME or in classrooms in leading cities. Diploma awarded. Write TODAY for free book! No obligation.

FREE
BOOK
TELLS
HOW

Approved for World War II and Korean Veterans
WEAVER SCHOOL OF REAL ESTATE (Est. 1938)
2020R Grand Avenue Kansas City, Mo.

Million Dollar Inventory — All Famous Brands



AT LESS THAN WHOLESALE!

SAVINGS NEVER LESS THAN 50% UP TO 70% OFF REGULAR PRICES

➔ SEND FOR YOUR FREE CATALOG! ➔

RELIABLE TIRE CO. • 728 MORGAN BLVD. CAMDEN 4, N. J.

DON'T JUST SIT THERE!



Ever see a man get to first base in his job and then "die"?

He camps there, waiting for something or someone else to advance him. And all too often, he just waits... and waits... and waits.

In the competitive game of business and industry, it's every man for himself. You advance on your own. And the best way to get ahead is to make yourself better qualified than the next guy.

But how? For the man with a family to support, a job to hold down, there's no more sensible method than spare-time training with I.C.S.

It's convenient! It's fast! It's low in cost! *And it works!*

Give us the chance to prove this and we'll send you three helpful and valuable books—*free!* We'll demonstrate the I.C.S. method with a sample lesson—we'll show you in an illustrated catalog how quickly and thoroughly you can master any of 257 courses. And you'll get the rewarding career guidebook, "How to Succeed."

Don't just sit there! Mark and mail the coupon!

For Real Job Security—Get an I. C. S. Diploma! I. C. S., Scranton 9, Penna. Member, National Home Study Council

INTERNATIONAL CORRESPONDENCE SCHOOLS



BOX 18953F, SCRANTON 9, PENNA.

(Partial list of 257 courses)

Without cost or obligation, send me "HOW TO SUCCEED" and the opportunity booklet about the field BEFORE which I have marked X (plus sample lesson):

- | | | | | |
|--|--|--|--|---|
| <p>ARCHITECTURE and BUILDING CONSTRUCTION</p> <ul style="list-style-type: none"> <input type="checkbox"/> Air Conditioning <input type="checkbox"/> Architecture <input type="checkbox"/> Arch. Drawing and Designing <input type="checkbox"/> Building Contractor <input type="checkbox"/> Building Estimator <input type="checkbox"/> Carpenter and Millwork <input type="checkbox"/> Carpenter Foreman <input type="checkbox"/> Heating <input type="checkbox"/> Interior Decoration <input type="checkbox"/> Painting Contractor <input type="checkbox"/> Plumbing <input type="checkbox"/> Reading Arch. Blueprints <p>ART</p> <ul style="list-style-type: none"> <input type="checkbox"/> Commercial Art <input type="checkbox"/> Magazine & Book Illus. <input type="checkbox"/> Show Card and Sign Lettering <input type="checkbox"/> Sketching and Painting <p>AUTOMOTIVE</p> <ul style="list-style-type: none"> <input type="checkbox"/> Automobiles <input type="checkbox"/> Auto Body Rebuilding and Refinishing <input type="checkbox"/> Auto Engine Tuneup <input type="checkbox"/> Auto Technician | <p>AVIATION</p> <ul style="list-style-type: none"> <input type="checkbox"/> Aero-Engineering Technology <input type="checkbox"/> Aircraft & Engine Mechanic <p>BUSINESS</p> <ul style="list-style-type: none"> <input type="checkbox"/> Accounting <input type="checkbox"/> Advertising <input type="checkbox"/> Business Administration <input type="checkbox"/> Business Management <input type="checkbox"/> Cost Accounting <input type="checkbox"/> Creative Salesmanship <input type="checkbox"/> Managing a Small Business <input type="checkbox"/> Professional Secretary <input type="checkbox"/> Public Accounting <input type="checkbox"/> Purchasing Agent <input type="checkbox"/> Salesmanship <input type="checkbox"/> Salesmanship and Management <input type="checkbox"/> Traffic Management <p>CHEMICAL</p> <ul style="list-style-type: none"> <input type="checkbox"/> Analytical Chemistry <input type="checkbox"/> Chemical Engineering <input type="checkbox"/> Chem. Lab. Technician <input type="checkbox"/> Elements of Nuclear Energy <input type="checkbox"/> General Chemistry <input type="checkbox"/> Natural Gas Prod. and Trans. <input type="checkbox"/> Petroleum Prod. and Engr. <input type="checkbox"/> Professional Engineer (Chem) <input type="checkbox"/> Pulp and Paper Making | <p>CIVIL ENGINEERING</p> <ul style="list-style-type: none"> <input type="checkbox"/> Civil Engineering <input type="checkbox"/> Construction Engineering <input type="checkbox"/> Highway Engineering <input type="checkbox"/> Professional Engineer (Civil) <input type="checkbox"/> Reading Struc. Blueprints <input type="checkbox"/> Structural Engineering <input type="checkbox"/> Surveying and Mapping <p>DRAFTING</p> <ul style="list-style-type: none"> <input type="checkbox"/> Aircraft Drafting <input type="checkbox"/> Architectural Drafting <input type="checkbox"/> Drafting Machine Design <input type="checkbox"/> Electrical Drafting <input type="checkbox"/> Mechanical Drafting <input type="checkbox"/> Sheet Metal Drafting <input type="checkbox"/> Structural Drafting <p>ELECTRICAL</p> <ul style="list-style-type: none"> <input type="checkbox"/> Electrical Engineering <input type="checkbox"/> Elec. Engr. Technician <input type="checkbox"/> Elec. Light and Power <input type="checkbox"/> Practical Electrician <input type="checkbox"/> Practical Lineman <input type="checkbox"/> Professional Engineer (Elec) <p>HIGH SCHOOL</p> <ul style="list-style-type: none"> <input type="checkbox"/> High School Diploma | <ul style="list-style-type: none"> <input type="checkbox"/> Good English <input type="checkbox"/> High School Mathematics <input type="checkbox"/> Short Story Writing <p>LEADERSHIP</p> <ul style="list-style-type: none"> <input type="checkbox"/> Industrial Foremanship <input type="checkbox"/> Industrial Supervision <input type="checkbox"/> Personnel-Labor Relations <input type="checkbox"/> Supervision <p>MECHANICAL and SHOP</p> <ul style="list-style-type: none"> <input type="checkbox"/> Diesel Engines <input type="checkbox"/> Gas-Elec. Welding <input type="checkbox"/> Industrial Engineering <input type="checkbox"/> Industrial Instrumentation <input type="checkbox"/> Industrial Metallurgy <input type="checkbox"/> Industrial Safety <input type="checkbox"/> Machine Design <input type="checkbox"/> Machine Shop Practice <input type="checkbox"/> Mechanical Engineering <input type="checkbox"/> Professional Engineer (Mech) <input type="checkbox"/> Quality Control <input type="checkbox"/> Reading Shop Blueprints <input type="checkbox"/> Refrigeration and Air Conditioning <input type="checkbox"/> Tool Design <input type="checkbox"/> Tool Making <p>RADIO, TELEVISION</p> <ul style="list-style-type: none"> <input type="checkbox"/> General Electronics Tech. | <ul style="list-style-type: none"> <input type="checkbox"/> Industrial Electronics <input type="checkbox"/> Practical Radio-TV Eng'g <input type="checkbox"/> Practical Telephony <input type="checkbox"/> Radio-TV Servicing <p>RAILROAD</p> <ul style="list-style-type: none"> <input type="checkbox"/> Car Inspector and Air Brake <input type="checkbox"/> Diesel Electrician <input type="checkbox"/> Diesel Engr. and Fireman <input type="checkbox"/> Diesel Locomotive <p>STEAM and DIESEL POWER</p> <ul style="list-style-type: none"> <input type="checkbox"/> Combustion Engineering <input type="checkbox"/> Power Plant Engineer <input type="checkbox"/> Stationary Diesel Engr. <input type="checkbox"/> Stationary Fireman <p>TEXTILE</p> <ul style="list-style-type: none"> <input type="checkbox"/> Carding and Spinning <input type="checkbox"/> Cotton Manufacture <input type="checkbox"/> Cotton Warping and Weaving <input type="checkbox"/> Loom Fixing Technician <input type="checkbox"/> Textile Designing <input type="checkbox"/> Textile Finishing & Dyeing <input type="checkbox"/> Throwing <input type="checkbox"/> Warping and Weaving <input type="checkbox"/> Worsted Manufacturing |
|--|--|--|--|---|

Name _____ Age _____ Home Address _____

City _____ Zone _____ State _____ Working Hours _____ A.M. to P.M. _____

Occupation _____ Canadian residents send coupon to International Correspondence Schools, Canadian, Ltd., Montreal, Canada. . . . Special tuition rates to members of the U. S. Armed Forces.

Let AUDEL Guides Help You Earn A BIGGER INCOME!



Read AUDEL MECHANICS GUIDES for profit



Every Mechanic can Step Up his Skill with AUDEL'S GUIDES. Containing Practical Inside Information in a Handy Form. Covers facts and figures of your Trade. All illustrated and explained. Books sent to you for 7 DAYS FREE EXAMINATION. Send No Money. Nothing to Pay Postman. Check Books Wanted - Mail Today.

MAIL ORDER

AUDEL, Publishers, 49 W. 23 St., New York 10, N.Y.



Check NOW!

You Can Look Over Any Guide In Your Own Home

Start the Easy Payments If Satisfied

MAIL THIS TODAY

Please send me for FREE EXAMINATION books marked (x) below. If I decide to keep them I agree to mail \$2 in 7 Days on each book or set ordered and further mail \$2 monthly on each book or set until I have paid price plus shipping charges. Otherwise, I will return them.

- HOME APPLIANCE SERVICE GUIDE, 864 Pages \$6
- AUTOMOBILE MECHANICS GUIDE, 1696 Pages. 6
- TRUCK & TRACTOR GUIDE, 1376 Pages. 5
- DIESEL ENGINE MANUAL, 640 Pages. 3
- MACHINISTS HANDY BOOK, 1728 Pages. 6
- WELDERS GUIDE, 608 Pages. 3
- BLUE PRINT READING, 448 Pages. 3
- MATHEMATICS & CALCULATIONS, 752 Pages. 3
- SHEET METAL PATTERN LAYOUTS, 1152 Pgs. 7.50
- SHEET METAL WORKERS HANDY BOOK, 448 Pgs. 2
- MECHANICAL DRAWING GUIDE, 192 Pages. 2
- MECHANICAL DRAWING & DESIGN, 480 Pages 3
- TELEVISION SERVICE MANUAL, 480 Pages. 3
- RADIONOMANS GUIDE, 1088 Pages. 8
- ELECTRONIC DEVICES, 304 Pages. 3
- ELECTRIC MOTOR GUIDE, 1056 Pages. 5
- WIRING DIAGRAMS (Light & Power), 304 Pgs. 2
- ELECTRICIANS EXAMINATIONS, 272 Pages. 2
- ELECTRIC POWER CALCULATIONS, 480 Pages. 3
- HANDY BOOK OF ELECTRICITY, 1520 Pages. 5
- ELECTRIC DICTIONARY, 9000 Terms. 3
- ELECTRIC LIBRARY, 7000 Pages (10 Book Set) 20
- REFRIGERATION & Air Conditioning, 1360 Pgs. 6
- MILLWRIGHTS & MECHANICS GUIDE, 1248 Pgs. 5
- POWER PLANT ENGINEERS GUIDE, 1568 Pages 5
- ENGINEERS & FIREMANS EXAMS, 544 Pages. 2
- PUMPS, Hydraulic & Air Compressor, 1760 Pgs. 6
- OPERATING ENGINEERS LIBRARY (3 Books) 12
- GARDENERS & GROWERS GUIDES (4 Book Set) 6
- CARPENTERS & BUILDERS GUIDES (4 Book Set) 8
- PLUMBERS & Steamfitters Guides (4 Book Set) 8
- MASONS AND BUILDERS GUIDES (4 Book Set) 8
- PAINTERS & DECORATORS MANUAL, 464 Pgs. 2
- HOUSE HEATING GUIDE, 1008 Pages. 5
- OIL BURNER GUIDE, 416 Pages. 2

Name _____

Address _____

Occupation _____

Employed by _____ PG

SAVE SHIPPING CHARGES! Enclose Full Payment With Coupon and We Pay Shipping Charges.

RAZOR BLADE PLANES



ONLY 98¢ each AT HARDWARE DEALERS
If not yet available in your area, you may order by mail. Include 25¢ additional for postage and handling.
- DEALERS WRITE FOR INFORMATION -
WILSON BROS. Dept. PM-6 SPRINGFIELD, MISSOURI

\$6,000-\$10,000 YEARLY OPERATING AUTO RADIATOR SERVICE SHOP



World's largest radiator shop equipment mfr. will assist responsible individuals in setting up radiator shops. Opportunity to own secure profitable business. First year averages \$6,000 to \$10,000. Garage or service station can operate as dept. Over 1,000 INLAND shops now operating. As little as \$295 down for equipment starts you. INLAND will finance balance and furnish training. Write to

INLAND MFG. CO., Dept. PM-6, 1108 Jackson St., Omaha 2, Nebr.

LEARN PLASTICS



COMPLETE LOW COST SHOP METHOD HOME TRAINING NOW AVAILABLE

Get in on Big Money opportunities in Plastic molding, casting, forming, carving, etc. Earn as you learn with Interstate's professionally prepared course. All plastic materials furnished.

WRITE FOR FREE BOOKLET

INTERSTATE TRAINING SERVICE
DEPT. C-3, PORTLAND 13, OREGON

ENGINEERING DEGREE IN 27 MONTHS

B. S. Degree, Aero., Chem., Civil, Elec., Mech., & Electronic Eng. (inc. Radio & TV). B.S. degree in 36 mo. in Math., Chem., Physics. Prep. courses. Low rate. Earn board. Large industrial center. Students from 48 states, 21 countries. Demand for grads. G.I. app. Enter June, Sept., Dec., March. Catalog. 1667 E. Washington Boulevard Fort Wayne 2, Indiana

INDIANA TECHNICAL COLLEGE

MAKE MONEY AS A LOCKSMITH

A RESPECTED, PROFITABLE TRADE FULL OR PART TIME. AGE OR HANDICAP IS NO RESTRICTION. UNCROWDED FIELD. EASY TO LEARN!



LEARN AT HOME FROM LICENSED SCHOOL EVERYTHING SUPPLIED BY US.

Send For

FREE BOOKLET NOW!

Licensed by N. J. State Board of Education. Approved by V.A.

INSTITUTE OF LOCKSMITHING, Dept. P91
15 PARK AVENUE, RUTHERFORD, NEW JERSEY

How To Hold FALSE TEETH More Firmly in Place

Do your false teeth annoy and embarrass by slipping, dropping or wobbling when you eat, laugh or talk? Just sprinkle a little FASTEETH on your plates. This alkaline (non-acid) powder holds false teeth more firmly and more comfortably. No gummy, goeey, pasty taste or feeling. Does not sour. Checks "plate odor" (denture breath). Get FASTEETH today, at any drug counter.

POPULAR MECHANICS

INVENTORS

If you believe that you have an invention, you should find out how to protect it. The first step is to have a search made of the prior pertinent U. S. patents. If a report on this search indicates that the invention appears patentable you can apply for a patent, and the specifications and claims should be prepared.

The firm of McMorrow, Berman & Davidson, with offices in Washington, D. C., is qualified to take the necessary steps for you. We can make a preliminary search on your invention, advise you whether we think it can be patented, and prepare your application for patent.

Unless you are fully familiar with the U. S. Patent Laws, we recommend that you engage the services of a Registered Patent Attorney to protect your interests. The patent laws are *your* laws. A patent gives you the right to prevent others from making, using or selling the invention claimed in your patent for a period of 17 years.

Use these patent laws for your protection. Investigate whether your invention can be patented. If you have what you believe to be an invention, we suggest that you have this firm make a search for you:

Send for a copy of our Patent Booklet entitled "How To Protect Your Invention," containing information about patent protection and patent procedure. Along with this we will also send you an "Invention Record" form, for your use in writing down and sketching details of your invention. We will mail them promptly. No obligation. They are yours for the asking.

McMORROW, BERMAN & DAVIDSON

Registered Patent Attorneys

PATENTS • COPYRIGHTS • PATENTS

135-F VICTOR BUILDING, WASHINGTON 1, D. C.

HOW TO FIX ANY CAR

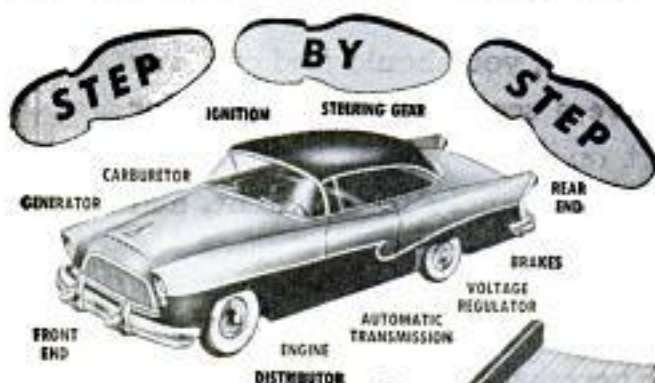

FREE 7-DAY TRIAL

ANY tune-up, service or repair job on ANY car can be as easy as A-B-C when factory experts show you how-to-do-it one step at a time. That's why no job's too tough to handle when you've got MOTOR'S brand-new AUTO REPAIR MANUAL at your elbow!

Book "starts from scratch" — tells you WHERE to start, what TOOLS to use. Whether you're a beginner or an expert mechanic—you can "breeze through" ANY repair on ANY make of model car built from 1949 through 1957!

Everything You Need to Know in 1000 Big ILLUSTRATED Pages!
NEW, REVISED, 1000-Page Edition contains the "meat" from over 160 OFFICIAL shop manuals—simplified for YOU. 23,436 essential repair specifications on 23 different makes. More than 2,900 "this-is-how" pictures. 225,000 service and repair facts. Leads beginners every step of the way. Time-saving factory repair procedures for experts. Instructions and pictures so clear you CAN'T go wrong. Used by U. S. Army and Navy. 2,500,000 COPIES SOLD!

Try Book FREE 7 Days

SEND NO MONEY! Pay postman nothing. Make Manual PROVE to you what it's got. Unless you agree this is the greatest time and work saver you've ever seen—return book in 7 days and pay nothing. Mail coupon today to: MOTOR Book Dept., Desk 16, 250 W. 55th St., N.Y. 19

Same FREE offer on MOTOR'S New Truck Repair Manual

Brand new! Covers EVERY job on EVERY popular make gasoline and Diesel truck made from 1949 thru 1957. FREE 7-Day Trial. Check proper box in coupon.

**MOTOR'S
AUTO
REPAIR
MANUAL**

Covers All Models —1949 thru 1957

Buick	Jeep
Cadillac	Lincoln
Chevrolet	Mercury
Chrysler	Nash
Clipper	Oldsmobile
Continental	Packard
De Soto	Plymouth
Dodge	Pontiac
Ford	Rambler
Hudson	Studebaker
Imperial	Thunderbird
	Willys



MEN! Make UP TO \$1000 A MONTH

without "SELLING"

Sensational Demand for Low-Priced Fire Alarm PLUS Sure-Fire "No-Selling" Plan Offers Ambitious Men Huge Profit Opportunities

Even beginners are cleaning up unbelievable profits with first effective low-priced Fire Alarm. Needed in homes, stores, offices, farms. Hangs on wall like picture, no installation, no plug-in. Always on guard. HOWLS 1 1/2-mile blast, automatically, when fire starts, allows up to 5 minutes escape-time. \$4.95 seller with up to \$2.70 profit for you!

Nearest Thing to Automation Selling. On exciting Plan, customers sell themselves. No hard selling, no cold canvassing. We give you powerful sales tools you leave with prospects. They sell for you while you sleep!

FREE! Rush, name, address NOW for big Illustrated Sales Kit, with easy "No-Selling" Plan. Learn how only 20 Fire Alarms a day pay you \$1,000.00 a month. Everything, FREE, no obligation. Write NOW to: MERLITE, Alarm Div., 114 E. 32nd St., Dept. 3-15X, N. Y. 16. In Canada: Moga Co., Ltd., 373 Doved St., Montreal 1, P. Q.



**WORLD'S LOWEST PRICED
ADDING MACHINE**

Counts up to 999,999,999 IDEAL FOR BUSINESS AND PERSONAL USE—GUARANTEED ACCURATE. Not a toy. Operates with only a finger flick. Adds, subtracts, multiplies, divides. Counts up to one billion. Pays for itself over and over. Ideal Gift—for Business, Income Tax and School use. **MONEY BACK GUARANTEE.** Send name and address. Postman only \$2.95 plus postage. Beautiful rich-looking Leatherette Case included at no extra cost. Money back in 10 days if not delighted. AGENTS WANTED.

CALCULATOR MACHINE COMPANY, P.O. Box 126, Dept. M-57, Huntingdon Valley, Penna.



FREE! New Issues

PLUS NEW, RARE BONUS OFFER!
Big collection, just released, New Issue British Empire Stamps. All genuine, all different, hard to get. Mini, used, topical, pictorials, bi-colors, others. More! New, valuable free "British Empire Bonus Packet", seldom-seen stamps: Coronations, Jubilees, Royal Visits, Commemoratives. One per person. Other offers for inspection, free "Stamp Collector's Guide." RUSH name, 10c for mailing. GARCELON STAMP CO., DEPT. PM6N, Calais, Maine.



**Easy to make your own
BOWS—ARROWS—EQUIPMENT**

Illustrated Hand-Book 84 pgs. \$1, tells you how! Large Colored Catalog 5c—Send for it!

Ask your dealer for "Stemmler's Archery" (Oldest Mfr. in U.S.A.)

L. E. STEMMLER CO.
Manorville (Box 1) L. I., N. Y.

**TERMITES
IN YOUR HOUSE?**

**GET RID OF
THEM YOURSELF!**

DON'T PAY \$300.00 AND UP TO ERADICATE TERMITES FROM YOUR HOME OR PREVENT INFESTATION. DO IT YOURSELF IN ONE AFTER-NOON. EASILY! QUICKLY! INEXPENSIVELY WITH "TERM-OUT"! SEND STAMP FOR HANDBOOK.

COMPASS RESEARCH
4700-A CLAIRTON BLVD., PITTSBURGH 36, PA.



RUPTURED?

**Write for New
Relief
FACTS FREE!**

ENJOY NEW FREEDOM

of action, peace of mind and comfort at work or play. Proven, patented MILLER holds your rupture back Day & Night—will bring you lasting relief! Has helped thousands of others!

For FREE facts in plain wrapper—Send Name and Address to

FRED B. MILLER, DEPT. 1-H
Manufacturer, HAGERSTOWN, MARYLAND



ENTIRELY DIFFERENT

DeVry Tech Specializes in Training Men

IN THEIR SPARE TIME AT HOME TO BECOME Electronic Technicians

Did you ever stop to think how much your happiness depends on having the right job? Getting your bills paid, living the life you want, doing the kind of work you like . . . ?

The right job (a promotion) with your present employer, or a good job with a new employer, would help solve such problems for you, wouldn't it?

DeVry Tech, with a successful 26-year record of training men for industry, offers you a real opportunity for a better job or your own profitable service shop . . . in one or more branches of the fast-growing field of Electronics.

We can show you a way to a more interesting and brighter future without interfering with your present job. We can give you all of this in your spare time at home . . . or in our well-equipped Chicago or Toronto training centers.

Find out how Electronics may give you a brighter and more profitable tomorrow. It will cost you nothing to get the facts. Fill in coupon below. We think this information is worth a postage stamp, don't you?

ELECTRONICS AT WORK AT DEVRY TECH

Jack Dempsey, T. J. Lafeber, President, watch student Joe Skala solve a problem with the Electronic Analog Computer in DeVry Tech's Chicago training center.



AN INDEX TO A BETTER JOB, BRIGHTER FUTURE

**NO PREVIOUS TECHNICAL EXPERIENCE,
NO ADVANCED EDUCATION REQUIRED**

Live-Wire Employment Service

DeVry Tech's Placement Department is in contact with some of the best-known employers in the Electronics field. The service is free to all graduates — and DeVry Tech's record in helping to place men has been outstanding.



DRAFT AGE?

We have valuable information for every man of draft age; so if you are subject to military service, be sure to check the coupon.

A SAMPLE LESSON FREE!

See for yourself how DeVry Tech trains you for real opportunities in Electronics. We'll also give you a free copy of an interesting booklet, "Electronics and YOU."

"One of North America's Foremost Electronics Training Centers"

Accredited Member of
National Home Study Council



DEVRY TECHNICAL INSTITUTE

CHICAGO 41, ILLINOIS

FORMERLY

DEFORREST'S TRAINING, INC.



Radar	Industrial Electronics
Automation Electronics	Computers
Guided Missiles	Radio
Television	Remote Control Systems
Communications	Broadcasting
Micro-Waves	Your Own Service Shop

MAIL COUPON TODAY

DeVry Technical Institute
4141 Belmont Avenue, Chicago 41, Ill., Dept. PM-6-N

Please give me a FREE Sample Lesson and your booklet, "ELECTRONICS AND YOU," and tell me how I may prepare to enter one or more branches of Electronics as listed above.

Name _____ Age _____

Street _____ Please Print _____ Apt. _____

City _____ Zone _____ State _____

Check here if subject to military training

1092 DeVry Tech's Canadian Training Center is located at
626 Roselawn Avenue, Toronto 12, Ontario

DRAFTSMEN



CASH BIG PAY CHECKS!

Train Now for more success, greater security

LEARN AT HOME IN SPARE TIME (or at college in Chicago)

Check the want ads in any newspaper—SEE the big-pay opportunities open to you as a draftsman. What's more, you can learn this well-paid, prestige profession at home—quickly, easily! No special talent needed. Get complete, step-by-step Chicago Tech lessons in the mail, spend a few pleasant hours studying each week. In a short time you'll be a well-trained draftsman, ready to take your pick of many good jobs. Act now!



Free Information—Mail Coupon Today!

Get FREE TRIAL LESSON plus information about C.T.C. practical training. Learn what successful Chicago Tech graduates say about high pay and opportunities in drafting. No charge, or obligation.

CHICAGO TECHNICAL COLLEGE

G-215 Tech Bldg., 2000 So. Michigan Ave. Chicago 16, Illinois

Mail me FREE lesson with facts about big opportunities in DRAFTING.

Name _____ Age _____

Address _____

City _____ Zone _____ State _____

Here's Best Hobby for Fun & Profit

Learn To MOUNT BIRDS

TAN SKINS, MAKE UP FURS

Be a Taxidermist. We teach you at Home. Mount Birds, Animals, Pets, common specimens. Save your hunting trophies, decorate home and den. Make genuine KROME LEATHER, tan and make up furs for sparetime profit. INVESTIGATE TODAY! 48 pages—tells all about it. Hunters, get your copy. It's Now Free. Send post card. State your AGE. IN. W. SCHOOL OF TAXIDERMY, DEPT. 2506, Omaha, Nebr.



SAVE 1/2 - 2/3 THE PRICE OF FACTORY-BUILT BOATS

BOAT KIT CATALOG Free!

Write:



LUGER INDUSTRIES, INC. DEPT. B-6 3404 Lyndale S. Minneapolis 8, Minn.

(Continued from page 10)

African wood, all hinged together at the back so they open like a family album.

And that's what it is—a family album of Chevrolets. Precisely carved into each page is a faithful representation of one Chevy body style, faithful down to name plates and upholstery design.

Creator of this most unusual catalogue of cars is a young Dane, Sven Hojberg of Copenhagen (home city of PM's two Scandinavian editions, by the way). Hojberg, a wood carver by hobby only, used a sharp knife, some sandpaper and an obviously well-trained talent to make this display which he sent to Cole as a gift. It took about 500 hours of spare time to make it.

To the Editor:

Your article, "Beachcombers of the Woods," in the March issue has motivated numerous requests for additional information. We welcome this interest but to those of us who had to read and answer these letters it was obvious that the readers were overoptimistic of the possibilities. . . .

These many by-products of the forests should not be compared to drift material which comes to rest on the beach and is considered free for the taking by beachcombers. Minor forest products, such as decorative greens, cones, medicinal material and the like, are just as much a crop to the forest landowner as timber which is grown and harvested for saw logs, pulpwood, firewood and poles. Therefore, persons collecting or harvesting by-products of the forest must recognize ownership, abide by Federal, state and local requirements, and must obtain permission or negotiate for a price with the owner.

Another important item which is of direct concern to the novice collector is markets and harvesting know-how. Too often the beginner, lacking business ability and collection know-how, gets into trouble with the landowner or has no sale for the product. Believe it or not, this is generally a highly competitive business and unless the beginner is correctly advised, disappointment, heartaches and hard feelings may be the result. For example, the article mentions conk at \$2 per pound (presume this is quinine conk). This was probably one of the all-time highs during the war years. This past summer the price was about 25c per pound in the vicinity of Portland. We have been advised that there is no market for quinine conk at the present time. Demand and price vary.

Thomas H. Burgess,
Assistant Regional Forester,
U. S. Forest Service,
Portland, Ore.

GOOD NEWS for men who need GOOD JOBS!

R. C. ANDERSON
President
COMMERCIAL TRADES
INSTITUTE

BE A TRAINED MECHANIC IN AIR CONDITIONING AND REFRIGERATION

Why let the high cost of living get you down when there's such good money to be made in the Air Conditioning and Refrigeration field! Yes, this old, established, but fast-growing industry needs thousands of trained mechanics to install, repair and service the 150 million refrigeration units in use today. And the industry is growing! Last year, over 3 million refrigerators, 1 million freezers and 2 million air conditioners were sold. Small wonder there's a shortage of trained men! And those who are in the field earn top wages, work steady, put money in the bank!

Train at home in spare time for a better job in this uncrowded industry. For complete information, fill out and mail coupon. Do this today.

23
BIG KITS
to build
AIR CONDITIONER
REFRIGERATOR
FREEZER or
MILK COOLER

**Great new way to learn
by practicing at home
with real equipment!**

At left, Mr. Anderson demonstrates the commercial type, heavy-duty, 1/4 h.p. refrigeration high-side which you build as part of your training.



You get sound experience by training with CTI kits

Why leave home or give up your job to attend a resident school? Train at home in spare time! CTI sends you easy-to-understand instruction and 23 training kits. You get all parts and tools to build a 1/4 h.p. refrigeration condenser. You do 10 service and trouble-shooting jobs—build a freezer, refrigerator, air conditioner or milk cooler. You get practical training—intensive experience. (Two of the 23 kits are shown at left.) Act now! Mail coupon! No obligation.



Many students earn cash as they train

Many students, soon after they start training, do repairing in spare time. They work with local dealers evenings and week-ends. Others go "on their own." They earn extra cash, get added experience. Some land full-time jobs while students, and quite a number open shops. All this is possible because CTI training is so practical.

An opportunity for a business of your own!

Students often build up a list of customers which includes not just homes, but office buildings, shops, food stores and industrial plants. They contract to do servicing on a fee basis, or simply answer calls. The Air Conditioning and Refrigeration field offers plenty of opportunity for independence. Own a shop—Be the boss!



MAIL COUPON TODAY FOR 2 FREE BOOKS

COMMERCIAL TRADES INSTITUTE

1400 GREENLEAF AVENUE
CHICAGO 26, ILLINOIS

DEPT. R-366

Send me your booklet, Success in Air Conditioning & Refrigeration, and Sample Lesson. Both FREE.

Name _____ Age _____

Address _____

City _____ Zone _____ State _____



"TRAINING YOU CAN TRUST"



YOU
can
acquire

LAW NIGHTS AT HOME!
L. L. B. DEGREE

LaSalle's famous Law Library—used as reference in many Law libraries and Law offices—has enabled thousands to master Law surprisingly fast, in spare hours at home, for business and professional advancement.

These 14 remarkable volumes, compiled by leading professors and lawyers, cover the whole basic field of Law in condensed, orderly, simplified manner.

You advance rapidly with this great library, plus special lectures furnished. We guide you step-by-step with personalized Problem Method of instruction . . . you learn by doing—handling legal problems—not by memorizing rules.

Send for two FREE booklets, "Law Training for Leadership," and "Evidence," answering questions about Law and its value to you, and telling how LaSalle Law graduates are winning rapid advancement in business and public life. Mail coupon below. No obligation.

LA SALLE EXTENSION UNIVERSITY
A Correspondence Institution

417 S. Dearborn St. Dept. 664L Chicago 5, Ill.

Send me your two FREE booklets described above, without obligation.

Name.....Age.....

Street.....

City, Zone & State.....

ENGINEERING DEGREE IN 27 MONTHS

B. S. DEGREE IN

Aeronautical, Chemical, Civil, Electrical, Mechanical and Electronic Engineering (inc. Radio and TV)
Big Demand for Graduates

Hundreds of young men are earning B. S. ENGINEERING DEGREES annually in this recognized institution—year around classes optional. Also B.S. in 36 mo. in Mathematics, Chemistry, Physics. New terms start quarterly. Many students earn a major part of their college expenses in this large industrial center. Low tuition. Competent instruction.

Thorough, intense practical program. Modern, well-equipped laboratories including new physics laboratory and modern wind tunnel. Individualized instruction emphasized. Government approved for G.I.'s. Engineering Science preparatory courses.

Students from 48 states and 21 foreign countries. Enter June, September, December and March. Send coupon for free catalog and full information. Enroll now.

INDIANA TECHNICAL COLLEGE

567 E. Washington Boulevard, Fort Wayne 2, Indiana

Please send me free information on 27 MO. B.S. DEGREES in:

Aeronautical Chemical Civil Electrical
Mechanical Electronics

on 36 MONTH B.S. DEGREES in:
Mathematics Chemistry Physics

Name.....

Address.....

INSURED TIRE SERVICE
POPULAR BRANDS

FREE INSURANCE POLICY given with each used tire sold. We guarantee the amount of service you pay for.

YOU CAN'T LOSE!!

NOWHERE CAN SUCH QUALITY BE FOUND AT SUCH LOW PRICE!

Super Quality — Rugged Performance — 6 Months Insured Service	Supreme Quality — Nothing Finer — 12 Months Insured Service
600x16 \$3.85 670x15 \$3.95 700x16 \$4.45 760x16 \$4.75	600x16 (6) 6.75 640x15 4.95 750x16 (8) 15.95 750x20 (8) 15.50
650x15 3.85 670x16 4.05 710x15 4.35 820x15 4.95	650x16 5.75 670x15 5.35 700x17 11.95 750x20 (10) 17.50
650x16 4.25 700x15 3.95 760x15 4.45 550x17 4.65	650x16 (6) 7.25 710x15 5.45 750x17 16.45 825x20 21.50
	700x16 4.35 760x15 5.95 750x17 10.95 900x20 19.95
	750x16 (6) 8.45 800x15 6.35 30x8 11.25 1000x20 20.45
	850x15 4.95 820x15 6.35 600x20 10.95 1100x20 21.25
	850x17 4.75 850x15 5.35 650x20 11.75 1000x22 21.95
	850x15 5.25 670x16 5.15 32x8 (8) 11.95 1100x22 22.75
	700x15 5.35 700x16 (6) 10.25 32x8 (10) 12.75 1100x24 25.95

Whitewalls \$1.00 extra.

Speedy shipments on Mail Orders. F.O.B. Chicago. Insurance policy sent with each order. Deduct 10% on orders for 2 or more used tires. Send CHECK or MONEY ORDER.—No COD's.

MIDLAND TIRE SALES
3701 S. Normal, Dept. PM-59, Chicago 9, Ill.

GIANT BALLOONS — 3 for \$1.25

Surplus US Govt. (New Coverage) Neoprene Weather Target Balloons.

FOR FUN in the backyard; at parties, picnics, etc.! Young & old love 'em.

FOR ADVERTISING—Attracts crowds to civic events, business openings, trade shows, fairs. Paint on sales message, seen for miles!

FOR PROMS—Makes any dance more festive. Ideal for high school or college affair!

Approx. Inflated Sizes

3 ft. dia. 49c ea. (SPECIAL! 3 for \$1.25)

Postage paid on prepaid orders. Calif. res. add sales tax.

VOLUME SALES CO., War Assets Division
3930 Sunset Blvd., Dept. PM-657, Los Angeles 29, Calif.

NOW NO ONE CAN KEEP A SECRET FROM YOU! TELESCOPE only \$299 postpaid

Amaze your friends... See what they're doing—without being seen!

Special Order now, get free carrying case.

3-range all metal telescope magnifies up to 60 power. Watch ball games, look at the moon, stars, animals, distant buildings... up close.

Bright aluminum tube, made for long use. Good on hikes, camping trips, can use either 20x, 40x, or 60x power instantly. Variable focus eyepiece. No assembling, ready-to-use, no special instructions required.

I. J. STONE, Dept. T-B-6 • 1818 Oak St. • Santa Monica, Calif.

BUILD YOUR OWN AIR CONDITIONERS

From Junked Refrigerators for a Few Dollars INSTRUCTION BOOKS SHOW YOU HOW... 75c EACH

SPECIAL OFFER
2 Books—\$1.00
3 Books—\$1.50
or all 5 for \$2.00

FREE! Instructions and Literature on kits.

Complete "Install-It-Yourself" Air Conditioner kits for home and automobile, 2 Ton capacity, Brand New Parts—\$124.40 and up.

KOOL ENGINEERING CO., Dept. R-6, 3716 Belmont, Chicago 18, Ill.

SAVE THOUSANDS OF DOLLARS "HOME-A-MINUTE" KIT

Not Something To Fool Around With!

Let's be frank. Isn't it ridiculous for you to pay thousands of dollars in excess profits when you build or buy a New Home, simply because you do not know the actual cost of building it? WHY NOT design and build your New Home, Attic Flat, Extra Bedrooms or Remodeling—IN MINUTES—with dozens of fiber partitions, Doors, Windows, Kitchen Cabinets, made to 1/4 inch scale same as blueprints. THEN, BELIEVE IT OR NOT, YOU, THE LAYMAN, who knows nothing about building, can estimate your own costs—IN MINUTES—after you adjust charts to local prices.

Don't build anything until you get this "KIT." If you want to save money, Handbook tells you how. Also financing. This information should not pass you by. Complete "KIT"—\$3.95 ppd. Money back guarantee. Return in 10 days.

B. D. HALL & CO. MILWAUKEE 10, WIS.



Ask Ray Tollefson. He knows the art field is a good one. Former student of Art Instruction, Inc., home study art

school. Now heads a big staff at Artists, Inc., Minneapolis—one of largest commercial art studios in Upper Midwest.

How To Get Into Commercial Art

by Walter J. Wilwerding

Do you like to draw? If you do, you may have talent enough for a money-making career in commercial art or illustrating.

Trained artists are wanted. Openings have increased about 50% in the last five years, according to a large employment agency. Earnings? Up, even for beginners. Limited only by skill, training, experience.

You must have talent, of course. Secondly, you should have special schooling—in the fundamentals of art and the requirements of the commercial art field itself.

Special Training Available

You won't have to move from where you live, or spend full time, to get the education you need for a career in commercial art. *Art Instruction, Inc.*—a school with

over 40 years' experience teaching commercial art—will tutor you right in your own home, by mail.

Over the years, more than two hundred thousand men and women have enrolled with this home study art school. Many former students are now earning from \$150 a week to over \$50,000 a year.

Ray Tollefson, shown here, is a former Art Instruction student. He heads up a large and successful commercial art studio.

Over 40 years of Art Teaching

Art Instruction, Inc. has been teaching art for over 40 years. It's now the world's largest home study art school. The teachers are professional artists with experience in advertising art, illustrating and cartooning. As a student you

get lesson assignments based on the illustrated art textbooks that come with your course, together with drawing supplies.

You do your lesson work at home, in your spare time. You go as fast as you like, or take all the time you need.

Your work is reviewed by professional artists; then returned to you with corrections and suggestions. You get individual attention, personal guidance.

You study basics, then specialize

You start by sketching in outline to study shape. You go on to proportions and shading, basic figure drawing, composition. Training in the fundamentals of art is followed by specialized work.

A Way to Test Your Talent Free

First you need to decide whether you have enough natural talent to be as successful as you'd like in the commercial art field. I suggest you take our *Art Talent Test*. This was devised by professional artists as a test of natural talent. A copy will be mailed you free and without obligating you in any way.

You take the Test at home. It's simple, yet it will tell the professionals whether you have the necessary talent for commercial art.

To Help You Decide

Take this Test at home and we will send you a free estimate of your talent at no obligation to you. This will help you decide whether to consider further training for a career in commercial art.

Clip the coupon below and send today for this free Art Talent Test. It could be your start towards a fascinating and profitable career.

ART INSTRUCTION, INC. STUDIO 6137
500 S. 4th St., Minneapolis 15, Minn.

Please send me your Talent Test, without cost or obligation. (Please Print)

Name _____ AGE _____

Address _____ Phone _____

City _____ Zone _____ County _____

State _____ Occupation _____

Check the Kind of Body You Want



Charles Atlas

... and I'll Show You How EASILY You Can Have It!

Just tell me, in coupon below, the kind of body you want—and I'll give it to you SO FAST your friends will be amazed! "Dynamic Tension," my easy, 15-minutes-a-day method, will make your chest and shoulders bulge... arms and legs surge with power... your whole body feel "alive!"

FREE BOOK Learn how I became "World's Most Perfectly Developed Man"—Mail coupon! CHARLES ATLAS, Dept. 8F, 115 East 23 Street, New York City 10, N. Y.

CHARLES ATLAS, Dept. 8F, 115 East 23rd St., New York 10, N. Y.

Dear Charles Atlas: Here's the Kind of Body I want: (Check as many as you like)

- More Weight—Solid—in The Right Places
 Broader Chest, Shoulders
 Powerful Arms, Legs, Grip
 Slimmer Waist, Hips
 Better Sleep. More Energy

Send me absolutely FREE a copy of your famous book showing how "Dynamic Tension" can make me a new man—32 pages, crisscrossed with photographs, answers to vital questions, and valuable advice. No obligation.

NAME _____ AGE _____
 (please print or write plainly)
 ADDRESS _____
 CITY _____ STATE _____

NEW 1957 GEOPHYSICAL YEAR MODEL OF GENUINE 135-POWER ACHROMATIC TELESCOPE

with Achromatic Lens and 4-POWER FINDER attached

ONLY \$18.95 PREPAID

EXTRA BONUS GIFTS:

- 273 page book, "Handbook of the Heavens"
- Magic Star Finder Dial
- 220X & 400X Eyepiece lenses

5 Magnifications 18X—35X—65X—85X—135X

Never before has an ACHROMATIC 135X telescope with range finder and tripod sold for anywhere near this amazing low price. POSITIVELY SHOWS planets, stars, craters, people and all distant objects. Compound Achromatic coated lens guarantee performance. Adjustable 18X—35X—65X—85X—135X for any condition of brightness, greater range of powers, color free needle-sharp views only possible with Achromatic corrected lens. Trimmed with gleaming brass extends to 43". 4X finder scope (30MM LENS) gives brilliant clear views. Brings difficult objects on target before viewing. 5 ft. folding tripod with heavy cast iron head fitted with Criterion's famous universal 360 degree aluminum mount assures stability, locks in any position. Remote controls. This amazing 135X Achromatic obtainable only from Criterion. Shipped ready for use together with 4 bonus gifts: 273 page "Handbook of Heavens," Magic Star Finder, also 220X & 400 eyepiece lenses free for experiments. Shipped complete, nothing else to buy at amazing price of \$18.95, without tripod \$14.95.

ALSO SPECIAL 40X—80X—120X TELESCOPE WITH TRIPOD \$11.95 POST PAID

5 section telescope with 5 precision lenses, opens to 36" closes to 12". 5 ft. hardwood tripod, cast head, aluminum 360 degree mount. Erect clear images. Bonus gifts: 273 page Handbook of Heavens, Star Finder. You must be completely satisfied with these instruments or money promptly refunded. Send cash, check or money order today.

Dept. PMA13, CRITERION MFG. CO., 331 Church St., Hartford, Conn.

DIESEL MEN WANTED

Earn \$100 per week and up AUTO-DIESEL MECHANICS

You learn fast in our school and shops because you learn with tools on real equipment. Experienced instructors explain WHY and show you HOW, then you DO IT YOURSELF with tools on various makes and models. One of the best equipped technical schools of its kind in the United States. Thirty-seven years' experience training men. Successful graduates in 48 states and many foreign countries. Approved for veterans. Day and evening classes. Earn While You Learn. Write for free bulletin.

NASHVILLE AUTO-DIESEL COLLEGE
 226 7th Ave. N., Dept. 86, Nashville, Tenn.

FREE! Inside Story on Publishing Your Book

If you are the talented author of an unpublished manuscript, let us help gain the recognition you deserve. We will publish your BOOK—we will edit, design, print, promote, advertise and sell it! Good royalties.

Write for FREE copy of How To Publish Your Book
 COMET PRESS BOOKS, Dept. PM6
 200 Varick St., N. Y. 14



Exclusive Double-Bearing HEAVY-DUTY PUMPS

IRRIGATE • DRAIN • CIRCULATE • SPRAY
 Up to 7,500 GPH, 3,000 GPH from 25" well. Use 1/4 to 1 HP motor. 1 1/4" inlet; 1" outlet. Stainless shaft.

TYPE X—2 oilless bronze bearings. \$10.95

Won't rust. \$12.95

TYPE XB—Ball bearing model. \$12.95

Postpaid if cash with order. Rush your order today

MONEY BACK GUARANTEE

Centrifugal and Gear Pumps in All Sizes

LABAWCO PUMPS, Belle Mead 2, N. J.

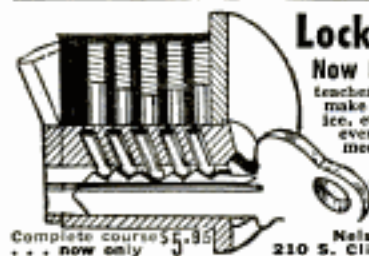

Locksmithing AND KEY MAKING

Now Made Easy! Practical up-to-date course

teaches you how to pick locks, de-code, make master keys, repair, install, service, etc. New self-instruction lessons for every handyman, homeowner, carpenter, mechanic, service station operator, fix-it shop, hardware dealer, gunsmith. 53 easy illustrated lessons. Full price only \$5.95 postpaid; or C.O.D. plus postage. Satisfaction or refund guaranteed.

Complete course \$5.95 . . . now only \$3.95 Nelson-Hall Co., Dept. FT-2, 210 S. Clinton St., Chicago 6, Ill.

MAKE STRIPES with new PAINT PEN

Straight, curved, single or double With any color paint, stripe furniture, bikes, autos, model planes, toys, linoleum, wall-board. Clean, crisp decorative lines. Can't clog or smear. Also use with glue, tempera, textile paint or underglaze . . . on wood, glass, plastic, ceramics, metals, fabrics and paper. Ask your dealer or order direct.

DEALERS Master paint striping tool in display carton. Write for discounts. Order now.
 HOBBY "Professional" results every time. Simple, easy to use.
 MFRS Ask about heavy duty industrial striping tools.

DOUBLE STRIPE MODEL \$3.25
 5 COMBINATIONS.

Single 1/16" stripe model \$1.25

Other single stripe models \$1.75 ea. 1/64", 1/32", 3/64", 5/64", 3/32" & 1/8"

Complete Kit \$5.00 (all 7 tips)

Extra tips 90c ea.

Extra 1/4" tip—\$1.20

WENDELL MFG. CO. 4234 LINCOLN AVE., Dept. 330 CHICAGO 18, ILLINOIS

RCA offers you the
 finest training
 at home in
Radio-TV
 electronics,
TV servicing,
Color TV

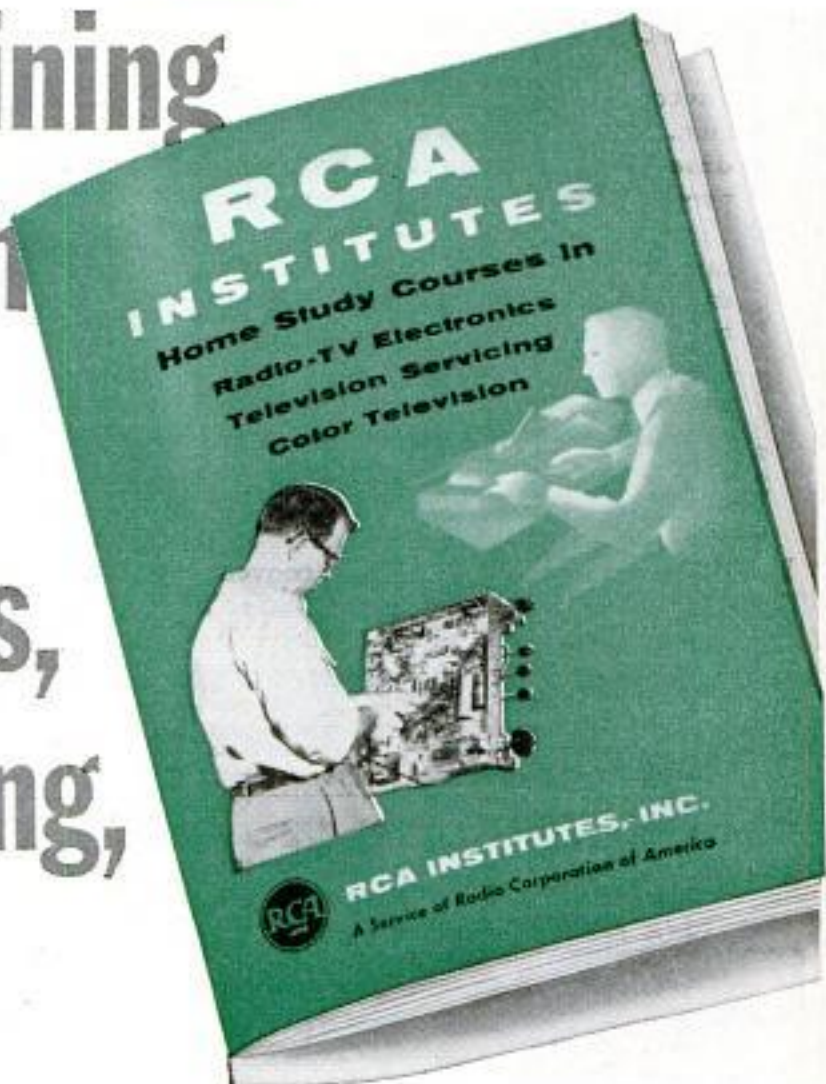

**SEND FOR THIS FREE
 BOOK NOW!**

The instruction you receive and equipment you get (and keep) will start you on your way. Pay-as-you-learn. You pay for only one study group at a time. This 52 page book contains complete information on Home Study Courses for the beginner and the advanced student.



RCA INSTITUTES, INC.
 A SERVICE OF RADIO CORPORATION OF AMERICA
 350 WEST FOURTH STREET, NEW YORK 14, N.Y.

In Canada—RCA Victor Company, Ltd.,
 5001 Cote de Liesse Rd., Montreal 9, Que.

RCA Institutes, Inc., Home Study PM-67
 350 West Fourth Street New York 14, N. Y.
 Without obligation, send me FREE CATALOG
 on Home Study Courses in Radio, Television
 and Color TV. No salesman will call.

Name.....
 Please Print

Address.....

City..... Zone..... State.....

VETERANS
 KOREAN G. I.
 P. L. 550
 CHECK HERE
 ()

Inventors

Take these necessary preliminary steps promptly to protect your invention by applying for a United States patent—

Sketch and describe your invention. Sign, date and have this disclosure witnessed by two people who understand your invention. Have us make a preliminary search among U. S. patents already granted for similar types of invention. We then report to you on the probable patentability of your invention and recommend your further course of action.

Write for our instructive booklet, "Patent Protection for Inventors" and our convenient "Evidence of Invention" disclosure form. No obligation.

VICTOR J. EVANS & Co. *Merlin M. Evans*
REGISTERED PATENT ATTORNEY

330-G MERLIN BUILDING, WASHINGTON 6, D. C.

Make \$500 an Hour CASH PROFIT THE DAY YOU START!



START YOUR OWN BUSINESS AT HOME . . . SHARPEN HOUSEHOLD, GARDEN AND SHOP TOOLS IN SPARE TIME

Now you can turn spare time into Big Cash Profits with new Belsaw Sharp-All. Sharpen knives, scissors, shears, snips, ice skates, mower blades, hedge trimmers, grass whips, axes, chisels, screw drivers, scrapers and saws . . . just about any household, garden and shop tool. Your own CASH business with no inventory. No calls to make. No experience needed.

Learn how easily you can start your own spare time business. Amazing low cost easy-payment plan. Send postcard for FREE BOOK.

BELSAW SHARP-ALL CO

717 Field Bldg. Kansas City 11, Missouri

**FREE
BOOK**

TELEPHONES

and ALL SUPPLIES

Room to room, house to garage, private telephone service. **HANDESET CRADLE TELEPHONES** (2) Complete outfit with 100' wire, 2 dry cells, instructions. **\$14.95**

WORM HARVESTER—Dan Mac Magneto—gathers fish-worms by electricity. Complete with instructions. **\$6.50**

Free illustrated bulletin "AA-14"



TELEPHONE REPAIR & SUPPLY CO.
Dept. AA-14 • 1760 Lunt Ave., Chicago 26, Ill.

FIX OUTBOARD MOTORS

POWERMOWERS, AND ALL SMALL 2 & 4-CYCLE GASOLINE ENGINES

Repair your own equipment or **MAKE EXTRA MONEY** in this growing field. Fully illustrated, easy-to-understand, Home Study Course. Write for **FREE** information.

LINCOLN TECHNICAL INSTITUTE
SUITE 6-E, 472 MARKET STREET, NEWARK 5, N. J.

BUILD YOUR OWN OPTICAL INSTRUMENT "FUN with OPTICS"



TELLS YOU HOW

Just out! 32 exciting pages! Wonderfully illustrated. Shows you how to build telephoto lenses, telescopes, microscopes, close-up camera lenses, artist drawing projectors, slide viewers, binoculars, riflescopes, etc. Plenty of diagrams—any 10-year old can easily follow the instructions. We can furnish the lenses, prisms and parts you'll need. Right now—order your copy of "FUN WITH OPTICS." Just send your name and address, along with only 50c in coin. **EDMUND SCIENTIFIC CO.**, Barrington 30, New Jersey.

**SAVE
MONEY**

**HAVE
FUN
WITH
THESE
PM
BOOKS**

1/2 PRICE SALE!

First come, first served! 50% off during the month of June only on most of the Popular Mechanics books listed below. These are books that actually never go out of date. They contain useful ideas, home kinks and shop notes that are as time- and money-saving as when they were first presented. **Circle the books you want.** They will be sent prepaid. We will refund correct amount if short of any titles.

No. of Copies	TITLE (Please circle)	Regular Price	Sale Price
525	Useful Ideas 1950	\$0.35	17c
120	Useful Ideas 1953	0.30	25
750	Useful Ideas 1954	0.50	25
105	How To Remodel Your Home	0.75	37
100	Home Kinks 1952	0.35	17
100	Home Kinks 1953	0.50	25
275	Quizzeroo Word-Game	1.00	50
840	Shop Notes 1947	0.50	25
70	Shop Notes 1950	1.00	50
30	Shop Notes 1951	1.00	50
10	Shop Notes 1952	1.00	50
10,000	Shop Notes 1957	0.75	37
1,350	Summer Jobs	0.75	37
3,550	Farm Manual	0.75	37
300	Auto Racing—5th ed.	0.50	29
2,400	Auto Racing—6th ed.	0.50	29

**WRITE
IN
TOTAL
AMOUNT
OF
ORDER
HERE**

\$

IMPORTANT: MINIMUM ORDER \$1.00

Clip and mail this ad with check or money order to—
POPULAR MECHANICS PRESS, Dept. 657
200 E. Ontario St. • Chicago 11, Ill.

POPULAR MECHANICS

Copyrighted material

Pyroil "B" add to oil 12 oz. can 85c ... \$1.00 in Canada at your service station



GET NEW CAR PEP . . . NOW!

Cars Need A Tonic Tool

Pyroil flushes out dirty gum and goo from your engine. Frees Hydraulic Valves fast, then protects the surfaces with a film of heat proof lubrication. Allows your engine to perform better and last longer. Write for trial offer, Pyroil Company, Inc., Dept. PM-67, La Crosse, Wisconsin—Toronto, Can.



Manufacturers of
Super Lubricants • Flex-O-Fix
Champ and Silver Bullet Oil Filter Cartridges
World Famous Since 1929

Make your interest in AUTO MECHANICS & DIESEL PAY OFF!



OUR FAMOUS
SHOP METHOD
HOME TRAINING
PREPARES YOU
FOR BIG TIME
PAY AT HOME
IN SPARE TIME

YOU GET AND KEEP ALL THIS EQUIPMENT



Complete set of professional tools and All-Metal Tool Box. Same top-quality equipment used by expert mechanics everywhere. Use them, display them proudly.



"Motor Analyzing Set" contains Standard Engine Vacuum Fuel Pump Tester, Remote Starter Switch, Modern Timing Light, Standard Compression Tester. Plus compact carrying case & instructions.



Top - quality Socket Wrench with Fittings. Real professional tools you'll use during your lifetime career in repairing all types of engines, from foreign cars to big diesel jobs.

Nearly 60 million cars and trucks on our roads! If you could talk to owners of garages, service stations and car dealerships (as we do every day), you'd realize America's DESPERATE NEED FOR TRAINED MECHANICS.

Take your choice—One modern course prepares you for Auto-Mechanic jobs, Airplane Mechanics, Farm Machinery Repair, all Diesel Jobs, Experimental Labs, Government Work, Engine Specialties, etc. A qualified, ALL-AROUND Mechanic always has a good job.

Every phase is Shop-Tested! Streamlined lessons, diagrams, manuals are easy to understand. Earn as you learn. Free Graduate Employment Service.

FREE!
VALUABLE BOOK
& SAMPLE LESSON
JUST SEND COUPON

RESIDENT TRAINING AT LOS ANGELES! If you wish to take Resident Training at Los Angeles, in our big, modern Shops & Labs, check special box in coupon for full information.

APPROVED FOR GI TRAINING
NATIONAL SCHOOLS
Los Angeles 37, California

NATIONAL SCHOOLS
TECHNICAL TRADE TRAINING SINCE 1905
LOS ANGELES 37, CALIFORNIA

MAIL NOW

NATIONAL SCHOOLS, Dept. DB-67

4000 S. FIGUEROA ST.
LOS ANGELES 37, CALIF.

Send for FREE Auto-Diesel Opportunity Book and Sample Lesson.

NAME _____ AGE _____

ADDRESS _____

CITY _____ ZONE _____ STATE _____

Check if interested ONLY in Resident School Training at Los Angeles

VETERANS: Give date of discharge _____

SHEET METAL BRAKES

Forms angles, locks, pans, etc. Quick eccentric clamp. All steel construction.

15"-16 gauge steel	\$20.00
30"-32 gauge steel	\$37.00
48"-24 gauge steel	\$52.00
Floor stand	\$ 8.00
15"-24 gauge Folder	\$16.50
36" Pan and Box brake	\$60.00
3/4 x 3 Adjustable Bender	\$11.50
16 gauge 7" Bench Shear 3 adj. gauge	\$16.50
30"-20 gauge Curve Former	\$11.50

ORDER DIRECT OR SEND FOR FREE CATALOG

YVKE MFG. CO., P-4158 Jason St., Denver 11, Colo.



Free! 153 GERMANY

Giant and midget-sized STAMPS; hated Hitler heads; blood-red swastikas; inflation issues with pre-war face of millions of dollars; Allied and Russian Occupation issues; birds, animals, air-mail stamps—153 all-different, guaranteed worth 32.6¢ at Catalog prices. EXTRA! Free booklet, bargain lists, and other fascinating offers for your free consideration. Send 10¢ for mailing expenses, Jamestown Stamp Co., Dept. AGPM Jamestown, N.Y.

RUPTURED

BE FREE FROM TRUSS SLAVERY

Now there is a new modern Non-Surgical treatment designed to permanently correct rupture. These Non-Surgical treatments are so certain, that a Lifetime Certificate of Assurance is given.

Write today for our New FREE Book that gives facts that may save you painful and expensive surgery, and tells how non-surgically you may again work, live, play and love and enjoy life in the manner you desire. There is no obligation. Excelsior Hernia Clinic, Dept. 8305, Excelsior Spgs., Mo.

OUR AD HAS BEEN IN THIS MAGAZINE LONGER THAN ANY OTHER TIRE CO., NEARLY EVERYONE BUYS FROM STANDARD. 50 Years of Combined family experience in High Quality tires. "We Have No Rest to Pay." That is Why We Can Under Sell All Competition.

23 YEARS AT THIS ADDRESS
TUBE FREE WITH EVERY PASSENGER TIRE

Our entire stock of very slightly worn EXTRA MILEAGE TOP GRADE TIRES. (Written Insurance Guarantee). SEND AD

EVERYBODY MAY DEDUCT 10% off ON EVERY TIRE

FREE If you buy 2 or more Passenger 4-ply tires, WE GIVE ONE tire FREE, on each order. Does not include W/W or Truck Tires, or Snow Tires.

12 MOS. WRITTEN GUARANTEE WITH EVERY TIRE					
600-16	\$5.52	475-15	\$4.82	700-15 (6)	\$7.52
600-16 (6)	5.92	640-15	4.22	750-16 (8)	10.72
650-16	5.72	670-15	5.52	700-17	9.82
650-16 (6)	6.62	710-15	5.52	750-17	10.32
750-16 (6)	7.52	760-15	5.82	825-15	12.92
550-17	3.72	800-15	5.92	600-20	9.02
650-15	5.82	850-15	5.92	650-20	9.82
700-15	6.92	700-16 (6)	7.32	750-15	10.72
				1100-20	19.92
				1100-22	18.92

EXTRA SPECIAL! TOP QUALITY all size 4-ply pass. \$7.82 FREE TIRE with 2 or more of these also—W/W. \$1.00 Extra Factory Tested Tube given—GIANT TIRE SALE. EA.

Thousands of tires shipped all over the U.S.A. All tires shipped F.O.B. Phila. Send Check or M.O. with this ad. Dept. 2, No. C.O.D. **STANDARD** 834 N. Broad St., Philadelphia 30, Pa.

Home Operators Take Over Huge Rubber Stamp Profits

Men and Women Everywhere Now Can Start in a Big-Pay Business at Home in Spare Time

The multi-million dollar Rubber Stamp business is now being taken over by small, home operators throughout the U.S. Men and Women who operate this inexpensive machine can turn out large numbers of Rubber Stamps with special wording of all kinds. Material costing only 27¢ makes a stamp that sells for \$1.80. The machine is easy for anyone to operate. It molds as many as six Rubber Stamps at a time, each with different wording such as names, addresses, notices, stock numbers, prices and other "copy" needed by offices, factories and individuals. At full capacity, it can earn as much as **\$9.20 an hour for the operator!** You don't need experience to get into this big profit business at home. We supply everything, including complete instructions and eight ways to get orders for stamps coming in fast. Start making up to \$9.20 in one hour right away. We'll mail full particulars **FREE** and no salesman will call. Be first in your locality. Rush coupon today to **Rubber Stamp Div., 1512 Jarvis Ave., Dept. R-2-H, Chicago 26, Ill.**

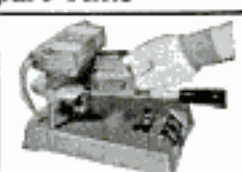

This Little Table Top Machine pays Home Workers up to \$9.20 AN HOUR.

Rubber Stamp Div., Dept. R-2-H FREE!
1512 Jarvis, Chicago 26, Ill.

Please rush full particulars about the little machine that can get me started in the profitable Rubber Stamp business at home in spare time. Everything you send me is **FREE** and no salesman will call.

Name _____
Address _____
City _____ Zone _____ State _____

WARN HUBS on your



Jeep

STOP FRONT DRIVE WEAR
in 2-Wheel Drive!



Over 100,000 now in use!

That is real proof of their many advantages and rugged dependability. Warn Hubs on 4-wheel drives make steering easier, increase power, speed in high; add life to gears, tires, because the front drive stands still in 2-wheel drive—there is no drag! Use free-wheeling 2 w.d. or tractive 4 w.d. as needed, automatically,

as you shift, with Warn Lock-O-matics, through fingertip controls with Warn Locking Hubs. Factory approved. Iron-clad guarantee. Models for all 4 w.ds. to 1½ tons. See your dealer now! Write for free literature.

WARN MFG. CO.

Riverton Box 6064-A6
Seattle 88, Wash.

WAR SURPLUS BARGAINS

WAR SURPLUS BARGAINS

\$500,000.00 INVENTORY for QUICK LIQUIDATION

Surplus items—hundreds of them for home, shop, factory, farm and outdoor use. New items, used items, reconditioned items—all at tremendous savings—all priced for quick sale.

Page After Page of Values

This big catalog shows page after page of amazing money saving values. Write for your copy today. Send 10¢ to cover postage, mailing, etc. Write today! **SEND TODAY FOR YOUR COPY**

10c

STARK'S 212 W. Madison St.
Dept. PM-576
CHICAGO 6, ILL.

THE FINEST AUTHENTIC SCALE MODELS 1957 AUTOMOBILES

For Mini Sized Drivers and Adult Collectors

Faithful reproductions. Sturdy plastic body, non-chip, two-tone paint, metal chassis, plated trim, rubber tires, authentic interiors. Buick R. M., Ford Fairlane, Thunderbird, Sunliner, Continental Mark II, Pontiac Catalina, Chevrolet Sports Coupe.

\$7.25 ea. or \$2.10 ea. for 2 or more ppd. Order Today.

PRODUCTS INTERNATIONAL, Box 123, Canton, O.

\$10,000 REWARD

if correct use of my new body building course fails to build you a "HE-MAN" BODY

The secret is in my revolutionary, exclusive Body Mould system. Yours **FREE** with famous

DAN LURIE BARBELLS

Scientific! Fastest, surest method known—beats all other training methods. Results guaranteed. Special low prices.

50 lb. set \$ 8.98 • 100 lb. set \$14.98
150 lb. set \$21.98 • 200 lb. set \$27.98
14¢ per lb. P.O.B. 50% Deposit required

DAN LURIE BARBELL CO.
52MG Bristol St., Dept. 759F, B'klyn 12, N. Y.

JEEP OWNERS

RE-POWER NOW with your choice of three famous V-8 engines

FORD • CHEVROLET • MERCURY

CONVERSION KITS now available to fit ALL 2 and 4 Wheel-Drive Willys Jeeps. . . . Priced \$43.25 to \$64.75 . . . If you want fast action tell us which V-8 engine you wish to use . . . give us the year . . . 2 or 4 Wheel-Drive . . . body style of your vehicle. Send min. \$15.00 dep. and we will ship correct kit, bat. C.O.D. Send full amount for prepaid shipment. Wire, phone or write for **FREE** details.

HOOSIER MACHINE PRODUCTS CO.
312 S.E. 6th St. Phone 676 Pendleton, Oregon, U.S.A.

BIG STINKY FLY TRAP

Gracious Outdoor Living BEGINS with World Famous **BIG STINKY FLY TRAPS**. Now yours for only **\$3.95** postpaid in USA — 3 for \$9.95.

Mysterious — Fascinating — Incredible — Really Works

Rush one, 3, Big Stinky Outdoor Fly Traps, standard size complete with 8 oz. fluid.

My check Money Order for \$_____ is enclosed.

BIG STINKY, P.O. Box 235, Waukesha, Wis.

MAKE UP TO \$20 A DAY WITH

EASISHARP

Big profits in your spare time sharpening scissors. We show you how to start making money immediately. This is your chance now to have your own business and a steady income. Sharpen a pair of scissors in less than two minutes. A child can operate it. Weighs only 10 lbs. Every home, barber, tailor, dressmaker—everybody uses scissors and all need sharpening two to four times a year. Don't let some one else beat you to this opportunity. Write immediately to

SERR-EDGE MACHINE CO., 9731 Lorain Ave., Cleveland, Ohio

MONEY MAKING SALES PLAN FREE

AMAZING! Secret Spy CAMERA



It's a
CAMERA!
It's a
LIGHTER!
ONLY

\$2.98

Complete
with roll film

TAKE PICTURES UNDETECTED!! Now you can take pictures while lighting your own or someone else's cigarette—WITHOUT BEING SUSPECTED! Others think you're just using the lighter, BUT ACTUALLY YOU'RE TAKING PICTURES WITHOUT THEIR KNOWLEDGE! Patterened after the long-secret spy camera used by secret agents, it's a dependable lighter in addition to being a precision-made camera that takes 20 clear, detailed pictures at a moment's notice. Same size as an ordinary cigarette lighter; fits vest pocket.

SATISFACTION GUARANTEED OR MONEY BACK
High quality lens takes close-ups or distance photos that enlarge beautifully. Allows you to get natural, unposed pictures at parties, home or out-of-door. No complicated adjustment necessary; easy to operate camera takes 20 photos per roll, that can be developed anywhere. Comes to you complete, ready to operate. Send check, money-order or cash. Add only 20c to each order for postage and handling. No C.O.D.'s please. **\$1.00 SPECIAL** — Extra Film, 4 rolls for only.....
DOBBS PRODUCTS CO., 1255 So. Wabash Ave., Dept. 474, Chicago 5, Ill.

75c ea. for Finest Imported PRECISION PLIERS!

• Flat Nose • Combination • Diagonal Cutter • End Cutting Nippers • Round Nose • One Side Flat—One Side Round • Snipe

FOR JEWELERS, OPTICAL WORKERS, HOBBYISTS, CRAFTSMEN OF ALL KINDS! These superb German instruments are of deep-forged, heat-treated high quality tool steel, fabricated to most exacting specifications. All-over ground and polished to smooth hard surfaces. Smooth working joints with just the right tension. Jaws meet perfectly to safely and securely hold even the most delicate objects in the hard-to-reach corners and angles. Each plier is 4" long and a veritable gem of precision and strength.

75c each . . . ALL 7 for \$5.00 ppd.

AUTOMATIC SIPHON PUMP
Now — siphon any liquid automatically, safely, WITHOUT putting tube to mouth! Squeeze bulb of this all new type siphon, liquid starts to flow immediately! Transparent valves let you see liquid flowing! Siphons, pumps gasoline, water, any liquid. Even acids, corrosives! For cars, boats, power mowers, campers, plumbers, doctors, chemists, factories! Acid resistant. Over 7 ft. long overall!

**SENSATIONAL
LOW PRICE
\$1.98 ppd.**

Minimum order \$1.00. Send Check or M.O. C.O.D. plus fee. Money Back Guarantee.

SCOTT-MITCHELL HOUSE, INC. Dept. M-391, 611 Broadway New York 12, N. Y.

NEW PROFESSIONAL PLASTIC LAMINATING HYDRAULIC PRESS

- 40-ton pressure, cast steel, table press for home use.
- Electrically heated, thermostatically controlled and water cooled platens.
- 3 10" x 12" laminations at one time.



The finest home press offered... unequalled for performance and profits! One heating-cooling operation under constant hydraulic pressure assures perfect results. Larger laminations than ever before! Liberal trade-in on small presses. Write for details.

start your own
BUSINESS AT HOME
EARN UP TO
\$20 - \$30 a DAY
laminating plaques,
book covers, signs,
cards, etc.
FREE Scale for computing laminating charges sent on request.

WILLSON & GEVERT HYDRAULIC PRESS CO., INC.
Dept. 119 1369 Lawrence Road, Haverlown, Pa.

GIANT 6 FOOTERS 59c



Wow! Genuine Neoprene government surplus (never used) . . . giant 6 ft. across, 21 ft. around . . . at a fraction of original cost. Durable. Can paint on advertising message, inflate and fly. Visible for miles. Great for attracting crowds to fairs, openings, school proms, gas stations. Fun for young and old in backyards or picnics, at the beach, etc. use as water markers & buoys. Order today — only 59c each.

Special: 2 for \$1.00; 5 for \$2.00; 13 for \$5.00. No C.O.D.

P.O. Box 27104, Dept. PM-657, Hollywood 27, Calif.



STOP BREAKING THERMOS BOTTLES
New handy carrying harness fits any size thermos. Handy to carry in your hands or over your arm. Made of tan braid with nickel plated fasteners. YOU CAN'T AFFORD TO BE WITHOUT THIS HANDY DEVICE.

PRICE \$1.00 POSTPAID

WENNEL PRODUCTS CO.
139-3 Rd. St. Barberton, Ohio

BRONZE FOUNDRY



Schools • Home Workshops • Inventors

Make your own castings of aluminum, copper, bronze, silver. Foundry sets are available in three sizes including 2400 Deg. F. blast Furnaces. \$26.50; \$33.50; and \$46.00 f.o.b. Marysville or Lakewood. Free Circular.

KANSAS CITY SPECIALTIES CO. Dept. Box 6022, Marysville, Kans. P-6 or Box 7543, Lakewood, Colo.

PLEASE SEND ME



for the
time checked.
I am enclosing . . .

- 1 year \$3.50
 2 years \$6.00

name _____

address _____

city _____

zone _____

state _____

Hand this order to your newsdealer or send it to
POPULAR MECHANICS
200 East Ontario St. Chicago 11, Ill.

FOR OLDER MEN

Troubled with GETTING UP NIGHTS, Pains in BACK, HIPS, LEGS, Tiredness

If you have these symptoms then your troubles may be traced to Glandular Dysfunction . . . a constitutional disease. Medicines that give temporary relief will not remove the cause of your trouble. Neglect of Glandular Dysfunction often leads to premature old age and sometimes incurable malignancy.

The past few years men from over 3,000 communities have been successfully treated here at the Excelsior Institute. They have found soothing relief and a new outlook in the future of life.

The Excelsior Institute, devoted to the treatment of diseases peculiar to older men by NON-SURGICAL methods has a NEW FREE BOOK that tells how Glandular Dysfunction may be corrected by proven NON-SURGICAL treatments. This book may prove of utmost importance in your life. Write today. There is no obligation.

Excelsior Institute, Dept. B929, Excelsior Springs, Mo.

1957 CATALOG BOAT KITS WOOD and FIBERGLAS

EASY TO BUILD - DESIGNED for professional results by the amateur. World's largest selection of top performance, latest design, prams, skiffs, racers, runabouts, sailing boats, cruisers. 8 to 20 ft. Mahogany decks, frames. **FREE FREIGHT. SEND FOR FREE CATALOG**

Boat Plans-Patterns-Frame Kits Includes fiberglass points, accessories

Build over 50 modern boats from large scale plans, available with FULL-SIZE patterns, new PRE-FAB frame kits! All types: prams to cruisers, 6 to 25 ft. Best buy for Amateurs! SEND 10¢ for CATALOG.

Craig Craft
Tonawanda, N. Y.

IT'S EASY... MAKE MONEY IN PHOTOGRAPHY

If you are over 17—good pay and fascinating work await you in photography! Start making money quickly in sparetime—step into your own studio or exciting career job. **LEARN-BY-DOING** method trains you at home! Write TODAY for FREE catalog. Also Resident Training. Co-ed. 47th Year. Approved for Veterans.

NEW YORK INSTITUTE OF PHOTOGRAPHY
Dept. 49, 10 West 33 Street, New York 1, New York
47th YEAR

Laurel MECHANICAL DENTISTRY

To make Crowns, Plates, Bridgework, etc., for Dentists. Easy practical way to learn mechanical dentistry at home in spare time. **FULL EQUIPMENT OF TOOLS AND MATERIALS INCLUDED WITH COURSE.** Low tuition. Easy terms. Write for FREE BOOK about this money making profession that is not affected by machine age.

MCGARRIE SCHOOL OF MECHANICAL DENTISTRY
207 N. Broad St., Dept. 66, Philadelphia 7, Pa.

Also Eshelman TRACTORS, Riding ROTARY MOWERS, ROTARY TILLERS

ESHELMAN GOLF CAR **GASOLINE ENGINE** Shipping Points: BALTIMORE • NEW ORLEANS • CHICAGO • MEMPHIS

36 HOLES PER GAL. GAS UP TO 20 MILES PER HR.

Costs a fraction of most other cars. Ideal for golfers. Also 2 pass. adult Sportabout. Write for free literature.

Dept. 194, **ESHELMAN**, 109 Light St., Balto. 2, Md. **PATENTED**

High School Course at Home

Many Finish in 2 Years

If you did not or cannot finish high school, here is your opportunity. Study in spare time at home. Go as rapidly as your time and abilities permit. Course equivalent to residential school—prepares for college exams. Standard texts supplied. Credit for subjects already completed. Single subjects if desired. Diploma awarded. Be a High School graduate. Start studies now. Free Bulletin. Write today.

AMERICAN SCHOOL, Dept. HA45
Drexel at 58th, Chicago 37, Illinois

I EARN CASH DOING REPAIR JOBS WHILE I TRAIN!



CTI training in Auto Mechanics is so practical that many students do repairing in spare time, earn up to \$15 a week and more. *CTI training pays its own way!*

AUTO MECHANICS

EARN GOOD PAY ENJOY SECURITY

A Trade You Can Learn at Home

Now hear this: if you want to earn big money or open a shop of your own! The auto industry is America's greatest. No wonder! There are over 60 million cars and trucks on the road, and a third are in the "heavy repair" classification. Each year, over 7 million new vehicles are produced. As a result, there's a severe shortage of skilled mechanics—and too few are training to fill the vacancies. What an opportunity for you! Yes, you can have one of those high-pay, steady, life-long jobs. How? *By training at home in spare time!*

The CTI Shop-Method Home Training Plan gets you ready for success in months—not years. You get easy-to-understand picture lessons, as well as valuable tools and a tune-up kit (see below). You learn to repair engines, transmissions, brakes, and the various systems—cooling, lubricating and electric. And that isn't all: *If you want additional training in Diesel Mechanics or Body-Fender Rebuilding, you get it (without extra cost).* Why not get all the facts? You can, by just filling out and mailing the coupon. We'll send two **FREE BOOKS** that show how you can fit into America's No. 1 industry.

You Practice with Tune-Up Kit and Tools

Only CTI sends this professional Tune-Up Kit. It includes a Compression Tester, a Vacuum Gauge and Fuel Pump Tester, an Ignition Timing Light, and a portable steel case. Instruments locate engine troubles quickly, help you get valuable practice.

You get this top quality set of mechanic's tools. You'll need tools to practice and for experience, and to earn money spare time. Tools increase your interest, stamp you as a "pro." *You get both the Tune-Up Kit and the set of tools as part of your training—no extra cost.*

MAIL COUPON TODAY!

COMMERCIAL TRADES INSTITUTE

1400 Greenleaf Ave. Dept. A-553
Chicago 26, Ill.

Send your Auto Mechanics book and Sample Lesson. Both FREE.

Name _____ Age _____
Address _____
City _____ Zone _____ State _____

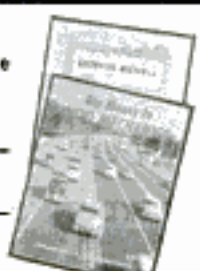

RUSH LAST CHANCE COUPON below — YOUR NAME on it
I'll show YOU absolutely FREE



HOW TO GAIN UP TO 50 LBS. OF MIGHTY MUSCLES!

How to become a REAL HE-MAN like THOUSANDS of my pupils each year

Are YOU SKINNY like I was?

I'll reveal to you all my inside secrets that changed me from this 90 lb. weakling to the world's strongest man and athlete says George Jowett

WORLD'S GREATEST BUILDER OF HE-MEN

My once skinny pupil, John Sill, says:
"I gained 60 LBS. of MIGHTY MUSCLES."

WIN \$100 AND A SILVER TROPHY LIKE ME

BEFORE

Mailing Coupon I was a 125 lb. 6 ft. skinny weakling.



I added 7 inches to MY CHEST, 3 1/4 inches to EACH ARM. No, Pal! You don't have to be a chicken-chested skinny weakling like I was only a few weeks ago. Mail Coupon! Says JOHN SILL.

AFTER

Mailing Coupon 185 lb. HEAD-TO-TOE HE-MAN POPULAR ATHLETE. You can be, too!



JOWETT INSTITUTE, 220 Fifth Ave., New York 1, N. Y., Dept. PM76

Send me **FREE PHOTO BOOK** of FAMOUS STRONG MEN and FREE 5 AMAZING PICTURE-PACKED COURSES

I'm enclosing 10c for postage.

- I want to gain.....lbs. (fill in)
 Add inches to ARMS CHEST SHOULDERS
 I want to lose fat, streamline my body.

Pick the kind of BODY YOU WANT

Name..... Age.....
Address.....
City..... Zone..... State.....



HIGH SCHOOL DIPLOMA

Earn a High School Diploma at home! Prepare for better job, more pay. Study in spare time. No classes. Materials furnished. Certified teachers. Valuable diploma awarded. Write Today for Complete Information

SOUTHERN STATES ACADEMY
Box 144-A Sta. E Atlanta, Georgia

You Can Be a Local Manufacturer of CAVITEX

SUPERFINE MASONRY

Local production explains why Cavitex can offer so much in quality for so little money, yet is so generous in profit potentials. It's a case of streamlined manufacturing—processing local materials for local building—cutting out the high costs of freight and distribution.

Cavitex creates new standards of beauty—in size, proportion and color. "Puts emphasis on the horizontal." Cored-out design for lighter weight and greater insulation values. Available in 8-inch and 4-inch.

Hundreds of territories are available to men looking for a local manufacturing enterprise. Franchise privileges. Responsible operators can obtain basic equipment on attractive rental terms. The Cavitex industry is sponsored by a million-dollar company backgrounded by fifty years of experience and reputation. Write or wire at once for "Opportunity, Unlimited" and tentative reservation of territory.



W. E. DUNN MFG. CO.
409 W. 24 St., Holland, Mich.
In Canada
Dunn Masonry Machinery, Ltd.
844 Dundas Highway
Cooksville, Ont.

X-6

NEW SIMPLEX MODEL 400 LAWNMOWER SHARPENER

Many Exclusive Features

The NEW SIMPLEX is the fastest, most accurate straight-line lawnmower grinder ever built... gives you all these advantages:

- Grinds all mowers—real type, rotary, hand or power, any size.
- No disassembly needed, gas and oil remain in engine, support bar rotated.
- Grinding head feeds both horizontally and vertically, turns 90° for bed knives.
- Fast, positive adjustments. Apatel support on steel base with leveling screws.
- Rugged, long life construction and many other features.

Get the facts on the new SIMPLEX 400 before you buy any sharpener.

Send for free brochure today

Small investment returns big profits!

The Fate-Root-Heath Company
Dept. PM-6 • Plymouth, Ohio



See Stars Close Up!

3" "PALOMAR, JR." TELESCOPE 60 & 120 Power—An Unusual Buy!

Assembled—ready to use! You'll see the Rings of Saturn, fascinating planet Mars, huge craters on Moon, Star Clusters. Mounts of Jupiter in detail. Aluminized and overcoated 3" diameter high-speed f/10 ventilated mirror. An Optical Finder Telescope is also included. Sturdy, hardwood, portable tripod. Order by Stock No.—Send check or M.O. —Money-back guarantee! \$29.50 f.o.b. Stock No. 85,650-H. (Shipping Wt. 10 lbs.) Barrington, N.J.

Ask for FREE catalog M EDMUND SCIENTIFIC CO., Barrington, N. J., U. S. A.



EXPLORE FOR TREASURE!

Find gold, silver, coins, jewelry, battle relics! Treasure-Metal-Mineral Detectors. M-SCOPE. Used worldwide for Treasure Hunting. Mineralights. Geiger. Scintillation Counters. Prices from \$14.75. Fully GUARANTEED. Time Payment Plan. FREE Treasure and Uranium booklets. New outfitting catalog. FISHER RESEARCH LAB., INC., Dept. PM-1, Palo Alto, Calif.



BE A CAMERA CRAFTSMAN...

Send for FREE book! Many are needed in this big paying field and now... YOU can learn to repair cameras using manufacturer's service methods of repair... In your spare time! Test your skills, tools, practice equipment—everything you need included in this approved course! Write for Big FREE illustrated booklet that tells you HOW!

national camera repair school - DEPT. V-6 ENGLEWOOD COLORADO

make your own Gems 32.50 F.O.B.

The Gem Maker comes complete with all necessary equipment, including a super-charged diamond blade for sawing, and all wheels for grinding, shaping and polishing; also complete instructions. The complete equipment as shown, less motor and belt, for only \$32.50, f.o.b., Burlington, Wisconsin. Write today for information and literature.

B & I MANUFACTURING CO.
Dept. P, Burlington, Wis.

PUMP WATER FAST!

Drains Wash Tubs, Cellars, Cisterns. Famous #7 pumps 2800 gph. 420 gph. at 75' high or 1600 gph. from 25' well. Sturdy rustproof alloy metal. Six blade impeller. 3/4" inlet, 1/2" outlet. Standard pipe threaded. Uses any 1/2 to 3/4 H.P. Motor. Will not leak or clog. Iron clad guarantee. Send check, M.O., or sent C.O.D. \$795 U.S.

Brigate, Fill Tanks, Draw Well Water. Heavy duty #8 pumps 7000 gph. —1000 gph. 75' high 3000 gph. from 25' well. Rustproof alloy metal. 8 blade impeller. 1" inlet, 1" outlet. Standard pipe threaded. Will not leak or clog. Iron clad guarantee. Send check, M.O., or sent C.O.D. \$1195

Free Catalogue—Gear Pumps, Large Centrifugal 1/2 U.S. Pumps, Deep and Shallow Well Pumps, Sump Pumps.

MOORE MANUFACTURING CO.
SWEDSBORO 1, NEW JERSEY

Train in Great Shops of COYNE for better jobs in

ELECTRICITY - TELEVISION

ELECTRONICS

RADIO—COLOR TV



TWO TOP OPPORTUNITY FIELDS

Whether 17 or up to 45 years of age, train the Coyne way for a better job and a real future in **ELECTRICITY-ELECTRONICS** or **TELEVISION-RADIO**, fields that offer a world of opportunities. Train on real, full-size equipment at COYNE where thousands of successful men have trained for nearly 60 years—largest, oldest, best equipped school of its kind—established 1899. No advanced education or previous experience needed. Employment service to graduates. **START NOW—PAY LATER**—Liberal Finance Plans and Easy Payment Plans. Also part-time employment help for students. Training in Refrigeration and Electric Appliances can be included.

B. W. COOKE Jr., President

COYNE
ELECTRICAL SCHOOL

FOUNDED 1899

A Technical Trade Institute Operated Not For Profit
500 S. Paulina Street, Chicago, Dept. A7-72H

ELECTRICITY • RADIO • TELEVISION • REFRIGERATION • ELECTRONICS

MAIL COUPON FOR FREE BOOK

Send coupon for 48-page illustrated book "Guide to Careers in Electricity-Electronics and Television-Radio." No cost; no obligation; no salesman will call. Vets and Non-Vets get vital facts now!



B. W. COOKE Jr., President
COYNE ELECTRICAL SCHOOL
500 S. Paulina St., Chicago 12, Ill., Dept. A7-72H

Send BIG FREE book and details of your training offer. This does not obligate me and no salesman will call. I am interested in:

() Electricity-Electronics () Television-Radio

Name _____

Address _____

City _____

State _____

NEW 18 ft. OFFSHORE CRUISER KIT

17 Models as low as \$42.00 (freight included). Fiberglass boat covering kits, marine supplies, etc.

Top and side curtains available!

TAFT MARINE WOODCRAFT
Dept. PM-657 • 626 29th Ave. N.E. • Minneapolis 21, Minn.

NEW MAGIC RADIO WALKIE TALKIE!

YOUR OWN POCKET SIZE RADIO STATION!
BROADCASTS TO ANY HOME OR CAR RADIO WITHOUT WIRES OR HOOKUPS! Wt. only 6 oz. Size: 3 1/2 x 2 1/2 x 4 1/2". Built-in telescoping antenna. Powerful Translator—sensitive microphone, frequency selector, break-in switch! Runs for weeks on self-contained flashlight batteries. Durable plastic case. With this Radio Talkie you CAN TALK TO YOUR FRIENDS UP TO A BLOCK OR MORE AWAY! Talk up to 1 mile or more between two automobiles. INSTANT OPERATION! Just push button to talk! No license needed. Uses indetective field magnetic radiation. Useful and real fun in a million ways! **GUARANTEED TO WORK. 1 YEAR SERVICE GUARANTEE.**

SEND ONLY \$2.00. (cash, ck. mo) and pay postman 80.00 COD postage or send \$11.98 for prepaid delivery. COMPLETE READY TO OPERATE with instructions and hundreds of ways and tricks for broadcasts thru any radio you desire. Price may go up soon, so get your NEW INDIVISIBL RADIO-WALKIE TALKIE NOW. Available only from **WESTERN RADIO, Dept. RPM-6, KEARNEY, NEBR.**

MONEY in WORMS

Big money made raising crickets, hybrid red wigglers and 12 inch African fishworms—sell by mail—We teach you how to raise and where to sell. Free Literature. Hybrid breeder red wigglers—1000—\$4, 5000—\$17.50, postpaid. **CARTER WORM RANCH, PLAINS, GEORGIA.**

Get info.. PLASTIC LAMINATING AT HOME!

Make \$20 to \$30 a Day by.. MAGIC MAIL PLAN!

Get **ORDERS** and **CASH** from your mailman—do work in **SPARE TIME** at home—or expand into **FULL TIME** business. Send coupon for Free Facts about the newest and most fascinating of all home operated businesses. For the first time a simplified machine brings the fabulous profits of **Plastic Sealing** and **Plastic Laminating** within the reach of the small operator. Anyone can learn to operate the machine with a few minutes practice—then with our **Magic Mail Plan** can get mail orders pouring in daily with cash in every envelope. **No canvassing—no selling.** We even

supply the circulars you mail to bring back cash and orders. Don't waste a minute. Rush your name. We'll send you **FREE** and postpaid, pictures, prices, details, and all the facts you need to start. Mail coupon or send name on postcard. No charge.

Warner Electric Co., 1512 Jarvis Av., Dept. L-10 H, Chicago 26, Ill.

Make Thousands of Beautiful Art Creations
COSTUME JEWELRY • CIGARETTE BOXES
TRAYS • CANDLESTICKS • COASTERS
LAMP BASES • BOOK ENDS...ALL IN
SPARKLING COLORED PLASTIC

WARNER ELECTRIC CO., 1512 Jarvis Av. Dept. L-10-H, Chicago 26, Ill.
At no cost to me, please rush complete details postage prepaid. I am under no obligation.

Name _____
Address _____
City _____ Zone _____ State _____

THIS MAN...
...is taking out of the machine a Plastic Sealing Job—ordered by mail—only 11¢ in material cost brings back \$2.68 in cash by mail. Capacity of machine: \$25.00 profit per hour of operation.

PREPARE FOR THE BEST JOBS IN INDUSTRY

TRAIN at HOME
in Your Spare Time or at
ALLIED INSTITUTE
in Chicago

- MECH. ENGINEER
- DRAFTSMAN
- TOOL DESIGNER
- TOOL ENGINEER
- MASTER MACHINIST
- AIR CONDITIONING
- HEAT & REFRIGERATION

MORE JOBS THAN GRADUATES

Shortages of Draftsmen, Designers, Tool Engineers, Machinists, Air Conditioning technicians are so widespread that you can pick a highly paid key job and look forward to Achievement and Security. You can begin your training in Short Courses at home or at Allied Institute, and continue progressively toward an Engineering Degree in 26 months. Allied is approved by Industry, National Home Study Council, Central Schools Association, Dept. of Education, Office of Public Instruction, State of Illinois, U. S. Veterans Admin., U. S. Dept. of Justice.

SEND FOR
FREE BOOKS

ALLIED SCHOOL OF MECHANICAL TRADES
1338-42 South Michigan Ave., Dept. PM-6, Chicago 5, Ill.

Send me without obligation information on your courses:

- HOME STUDY RESIDENT VETERAN NON VETERAN
 DRAFTING ENGINEERING AIR CONDITIONING

NAME _____

ADDRESS _____

CITY _____ COUNTY _____ STATE _____

Write Like This **Complete OUTLINE FREE!**

MIRACULOUS IMPROVEMENT in your Penmanship in six hours practice with Grooved Letters. No failures. Inexpensive. No charges unless you're satisfied after 6 hours practice.

WRITE **OZMENT** BOX 665
34-P, ST. LOUIS, MISSOURI

WE PAY \$3.50 lb.

GROW MUSHROOMS. Cellar, shed and outdoors. Spare or full time, year round. We have over 25,000 customers. **FREE BOOK.** Washington Mushroom Ind., Dept. 61, 2954 Admiral Way, Seattle, Wash.

KEEP YOUR... EYE ON BENJAMIN "First in POWER and ACCURACY"

for HIGH H.C. COMP

AIR GUNS & CO₂ GAS GUNS—Top Quality at LOWEST PRICES!

BB or 177 or 22



BENJAMIN SUPER
CO₂ Gas Carbine
with Reg. Stock as low as **\$14.95**
DeLuxe Model with Custom Stock (Shown) as low as \$17.95

Benjamin Air Rifles and Benjamin Air Pistols are Recognized All Over the World for Finest Workmanship and Highest Quality at Lowest Prices. Adjustable Power with Amazing Optimum Force. Fully Guaranteed—Safe—Accurate—Economical. Easy to Use anywhere—12 Models for Target and Small Game BB or 177 or 22.

All Models Benjamin CO₂ Carbine Gas Rifles and Benjamin CO₂ Rocket Gas Pistols Use Standard Size CO₂ Cartridges (available everywhere). 2-Stage Hi-LO Jet Power—High for Small Game—Low for Target—Up to 50 Shots from each Cartridge. No Pumping—Safe—Accurate—Economical—Non Toxic—12 Models BB or 177 or 22.

FREE! Catalog All Models Benjamin Air Guns & CO₂ Guns & Supplies. Also, Money-Saving Offer on Hunting & Fishing Accessories.

Send Free Gas Catalog and Special Offer!

BENJAMIN AIR RIFLE CO., MAIL TODAY!
896 MARION ST., ST. LOUIS 4, MO., U.S.A.

Name _____
Address _____
City _____ State _____

CONVERT YOUR CAR INTO A BED



Save on Overnight Trips—Rest In Solid Comfort

QUICK, EASY CONVERSION



Works on all 2 and 4-door sedans, club coupes, convertibles, station wagons. Fits all Ford, GM, Chrysler & Studebaker products—does not affect seat structure—normal functions or appearance. **GUARANTEED** to work when installed by instructions. **PAYS FOR ITSELF** in three nights lodging. **IDEAL** for hunters, fishermen and travelers. Delighted users everywhere! Complete conversion kit and instructions **\$14.95**

State make, model, whether 2 or 4-door
SEND CASH, CHECK OR MONEY ORDER TO:
CAR BED CO., 600 MAGNOLIA AVE., PANAMA CITY, FLA.

Finish HIGH SCHOOL AT HOME

Complete 4 Yrs. in 12 Months

Learn More! Earn More! Enter professional or technical schools. Advance Socially. Live a Mapper, Fuller Life. Individual Courses or complete schedule. **WRITE FOR SCHOOL BULLETIN.**

ACADEMY FOR ADULTS

30 W. Washington, Dept. PM-67, Chicago, Ill.

YOU BUILD 'EM — WE SELL 'EM EARN UP TO \$50.00 A DAY AT HOME

Participate in our national sales and sub-contract plan—spare time—full time. You assemble special luggage and cases for photographers, musicians, salesmen, and all types of portables. We supply complete instructions—materials—tools—everything. No previous experience necessary. Free details. Abaris Casecraft, Dept. AG, 807 W. Sunset Blvd., Los Angeles 12, Calif.

"SEA KNIGHT"



A Build-It-Yourself PLYWOOD CRUISER Designed Especially for PM Readers

Construct this beautiful 17-foot cabin cruiser yourself in your spare time. It's exceptionally easy to build even with little or no experience! Has cruising accommodations for two, including two full berths, complete kitchen and toilet facilities and a fast bottom for single or twin-motor installation.

Beautifully designed—roomy open cockpit, hatch in forward deck, and with two aboard it makes 26 m.p.h. with a 35-hp. motor. As a cruiser, runabout or utility boat, it will give you many hours of wonderful outdoor enjoyment for a minimum investment of time and money. Complete, fully detailed plans only \$10.00. Order below today!

POPULAR MECHANICS PRESS, Dept. 657
200 E. Ontario St., Chicago 11, Ill.

Send me complete set of seven large-size blueprints for "SEA KNIGHT" cruiser, including plans for easy-to-make boat trailer.

- I enclose \$10.00 check or money order
 Send C.O.D. (U.S.A. only)

Name _____

Address _____

City _____ Zone _____ State _____

"WONDERFUL" SAYS AUTO DEALER! "Your Speed Plater is wonderful. Instructions are easy and clear. We had excellent results. Thank you from all of us here at Faubert BUICK, Inc." Malone, N. Y.

NEW INVENTION AUTO CHROME

REPLATES with PERMANENT PLATING

MAKE MONEY! SAVE MONEY!

FACTORY-NEW BRILLIANCE FOR CAR CHROME

Here at last is the car-owner's answer to all chrome problems... a dramatic new invention—SPEEDPLATER. It actually plates NEW METAL as you brush. And the plating you apply becomes an INDESTRUCTIBLE part of the bumper, grille or trim itself. How your car will shine! You'll be mighty proud when you remove ugly rust spots and replat metal to a NEW SPARKLE... when you being new, gleaming beauty to worn, dull, even blistered chrome areas of your car. This fast sensational method of brush-plating gives FACTORY-NEW BRILLIANCE that bonds itself onto your car. It forms a hard, sparkling surface that defies all elements!

BUMPERS—GRILLWORK—ALL CAR TRIM RESTORED TO NEW BRILLIANCE!

Here is how easily you replat your car... You simply attach SPEEDPLATER'S clamps to your car's battery, then dip SPEEDPLATE Brush into miracle solution. You PLATE WITHOUT REMOVING PARTS FROM YOUR CAR. Works Fast—yet uses less battery juice than the tiniest light on your car.

CAR DEALERS & SERVICE STATIONS— Make BIG Profits with Special HEAVY-DUTY OUTFIT!

FACTORY RESULTS and Big Volume Business can make Terrific Profits For You with this Heavy-Duty Outfit. Do your own replating without removing bumpers or grillwork! Increase the value of used cars! Heavy-Duty Outfit Electroplates an current from standard 12 volt storage battery. ENTIRE KIT COMPLETE—Only \$34.95 with enough material to plate dozens of cars! You quickly make back cost on your very first job! Re-order solutions always available from us at rock-bottom cost to you. MONEY-BACK GUARANTEE. Order Now—If C.O.D. send \$5 deposit.



TRY AT OUR RISK

If you want to put a new permanent gleam on YOUR CAR'S CHROME—you can do it right away and not risk a dime. If you are not satisfied with great results it doesn't cost you a penny! Just mail coupon with only \$1 deposit—EVEN pay postman \$13.95 plus postage when your kit arrives. If you send \$4.95 we ship prepaid. Either way you must be COMPLETELY SATISFIED or you may return all in 10 days for FULL CASH REFUND. ACT NOW—Here's What You Get: SPEED-PLATE Brush with Permanent Anodes, Wires and Clamps for battery hook-up; Special Buffs and Buffing Compound; Special Metal Polish; Full, Simple Instructions.

EMPIRE MERCHANDISING CO.,
4 North 3rd Ave., Mt. Vernon, N. Y. Dept. P-67

- Please rush the electroplating kit I have checked:
- Regular Kit, \$14.95 (If C.O.D. send \$1 deposit)
 - Heavy-Duty Service Station Outfit, \$34.95 (If C.O.D. send \$5 deposit)
 - I enclose full price, send postpaid.
- I understand that I must be COMPLETELY SATISFIED or I may return kit in 10 days for immediate CASH REFUND.

Name _____

Address _____

City _____



Quickly Builds-up a Thick, New, Plating With Each Application

SPEED PLATES YOUR CAR!

Enough Solution to plate 3 entire cars

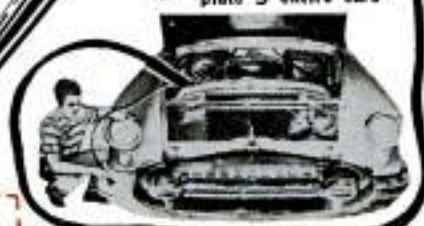

Make Big Money Plating Other Cars!

Now you can add to your income during spare time... because 8 out of 10 cars on the road today NEED REPLATING. You can charge from \$5 for touch-up to \$50 for replating an entire car. It's easy and there's good money in it for you. When your neighbors see the brilliant plating on your car, they'll surely want you to do the job for them! Replate other things for profit too—faucets, tools, home appliances, cutlery, doctor's and dentist's instruments.

Learn ACCOUNTING Business Administration

Bookkeeping, secretarial and allied subjects at home in your spare time or attend nationally approved resident school. Write for FREE Success Book giving complete details on courses, plans, rates and employment opportunities. G.I. approved. Write Dept. A.

Hills BUSINESS UNIVERSITY AND EXTENSION SCHOOL
619 W. MAIN ST. OKLAHOMA CITY 2, OKLAHOMA

Catalog of 3100 Novelties 10c

Send 10c for amazing catalog of novelties, live animals, scientific supplies, hobbies, funmakers, planes & boats, looms, magic tricks, joke articles, unusual seeds, gadget time-savers, cameras, optical goods, projectors, movies, lucky jewelry, religious novelties, disguises, musical instruments, stamps, coins, puzzles, fortune tellers, radios, auto & bike accessories, telescopes, magnifiers, compasses, banks, smokers' gadgets, artists' supplies, printing sets, engines, motors, shockers, knives, billfolds, guns, rifles, sports, books, games, plants, etc. Send 10c (3 for 25c—get for friends!). JOHNSON SMITH & CO. Dept. 418 Detroit 7, Michigan

YEAR AFTER YEAR, SINCE 1915 — THE BLATT FAMILY PROVED: A Million words couldn't SAVE YOU MORE \$ (Not recaps or retreads). Don't be misled by "Free Offers," Discounts & "Rent" stories.

FINER TIRES

88 to \$12 Value Worn Slightly 12 MO. \$5 any car WW \$1 Ext.

Heavy Duty Truck Tires, Guar., Longer Wearing, 30,000 Mile Type

600-16(6) \$6.77 700-15(6) \$8.27 750-20 \$14.27 1000-20 \$21.37
650-16(6) 7.77 700-17 11.67 825-20 18.87
700-16(6) 8.27 700-20 12.87 900-20 19.37 900-16 \$15.38

"I'll Never Ship a Tire I Wouldn't Use Myself!"—Marvin Blatt

MARVIN BLATT 6th & Spring Gardens Philadelphia, Pa.
Send Ck. or Money Order for Rush Shipment. FOB Phila.

BIG SUPER-VALUE WHOLESALE TOOL CATALOG

Tremendous Discounts 50% and more

Hand & Power Tools for HOME, FARM, WORKSHOP, BUSINESS

Before you buy—check our big, clearly illustrated catalog. You can save hundreds of dollars a year. Over 14,000 items in stock. All nationally known makes. Finest quality. Lowest cost. Every tool unconditionally guaranteed. Your money back without question.

Make extra money selling to friends, neighbors, fellow workers. NO STOCK TO CARRY—NO MONEY TO INVEST. Just show the catalog and take orders. Your cost is known only to you.

SEND TODAY for your TOOL CATALOG — Just pin \$1 to this ad—DO IT NOW!

U. S. GEN. SUPPLY, Dept. M1, 149 Church St., N.Y.C. 7



MAKE BIG PAY!

Make big pay in the construction industry as an operator of Bulldozers, Draglines, Back Hoes, Scrapers, and Motor Graders. Learn these skills NOW! Contractors need operators of earthmoving machines and pay high wages to our graduates. Don't be satisfied with just a job . . . learn a career!

Write TODAY for FREE School Catalog, no obligation, to either address

National School
of Heavy Equipment
Operation

Western National School
of Heavy Equipment
Operation

P.O. Box 8243, Dept. D-15
Charlotte, N. C.

P.O. Box 527, Dept. D-15
Weiser, Idaho

BE A CLAIM INVESTIGATOR



INVESTIGATE ACCIDENTS! Many earning \$750 to \$1000 a month. Thousands of insurance companies, airlines, steamship lines and Government Offices need Claim Investigators. Also big opportunities for your own spare time business. We train you at home. National Placement Service FREE of extra charge. Bill King writes: "Your course has paid off for me with large earnings. You can quote me—your Adjuster Training Course is worth many times the cost." Write TODAY for FREE book.

UNIVERSAL SCHOOLS

University Park, Dept. PM-6, Box 8202, Dallas 5, Texas

CONCRETE BLOCK HOME PLANS

\$2500 RANCH HOME



Build your own 28'x48' Ranch Home, complete for \$2500. No block cutting necessary. Under slab forced air heating. Contains 12'x20' living-dining room, 10'x10' and 11'x12' bedrooms, 12'x12' den with fireplace, 11'x12' kitchen, bath, six closets, utility room, carport or garage. Genuine blueprints scale 1/4"=1', instructions, and material cost list \$2.00.

paid. Money back guarantee. \$1900 DUPLEX, 24'x36'. Each side contains 11'x17' liv. room and kitchenette, 10'x11' bedroom, bath, five closets. Plans \$2.00. \$1150 GARAGE APARTMENT, 22'x24', liv. room, kit., two bedrooms, bath. Double garage below. Plans \$1.00.

MEMBER ARKANSAS HOME BUILDERS ASSOC.

BAILEY BUILDERS, 7608 Harmon Drive, Little Rock, Ark.

I MADE \$1,622.00 FIRST MONTH WITH YOUR LONG-NEEDED INVENTION



CYCLO Wonder Tool Pays You Big Initial Profit... Plus Repeat Supply Sales

Every filling station, garage "goes wild" over amazing new patented, portable CYCLO Wonder Tool! World's first and only practical car polisher, with genuine "human hand action," but 800 times more efficient! Automatically makes professional out of unskilled man at once! Your customers make double profit with Cyclo . . . they get more polishing jobs, handle them faster, and they rent Cyclo to public for big plus profits. Many customers order 2 . . . one to use, one to rent.

YOU Get Big Double Profit, Tool Make huge profit on each Cyclo, and even more on continuous repeat business! Only 30 Cyclos a month can hand you \$30,000 business first year, and much more each following year. Bilger of Indiana made \$1,622.00 first month, predicts he'll make \$50,000.00 this year. Many Cyclo Exclusive Distributor Franchises still open. **FREE!** Send name, address TODAY for free facts of Cyclo Wonder Tool, tremendous double-profit Distributor Plan, and special Guaranteed Demonstrator Offer.

CYCLO, 3816 Dahlia St., Dept. W5-K, Denver 1, Colo.

INVENTORS

PROTECT YOUR INVENTION BY A U. S. PATENT. SEND FOR FREE "INVENTION RECORD" FORM AND "PATENT INFORMATION EVERY INVENTOR SHOULD HAVE."

CARL MILLER

REGISTERED PATENT ATTORNEY

WOOLWORTH BLDG., 36th FLOOR, 67A
NEW YORK CITY



INVENTORS

U. S. Patents protect your inventions. Our free book of "Instructions on Patent Procedure for Inventors," also "Certificate of Invention" form sent without obligation.

C. A. SNOW & CO.

REGISTERED PATENT ATTORNEYS

428 SNOW BUILDING WASHINGTON 1, D. C.

INVENTORS

Send for PATENT INFORMATION Book and INVENTOR'S RECORD without obligation

GUSTAVE MILLER
67-PM WARNER BUILDING
WASHINGTON 4, D. C.

REGISTERED PATENT ATTORNEY

ASSOCIATE EXAMINER
U. S. PAT. OFF. 1922-1929

Patent Attorney & Advisor
U. S. NAVY DEPT. 1930-1947
PATENT LAWYER

INVENTORS

Whether an invention is patentable can be substantially determined by a search of the U. S. Patent records. Without obligation, write for information explaining the steps you should take to secure a patent.

JOHN N. RANDOLPH

Registered Patent Attorney

201 Columbian Building, Washington 1, D. C.

Whatever the job, you'll do it better with nationally advertised products. Ask for products advertised in POPULAR MECHANICS



INVENTIONS WANTED

If you want to market, or sell, your invention for cash or royalties. Write for our Free Booklet. Send no drawings. We also welcome hearing from firms, or private capital, wishing to review inventions in any field. We will be glad to send notice of our clients' inventions.

GLOBAL MARKETING SERVICE

2420 77th Ave. Dept. PD Oakland 5, Calif.

INVENTORS

I shall be pleased to furnish you, upon request, with full information relative to patent procedure—without any obligation on your part.

PATRICK D. BEAVERS

Registered Patent Attorney

934 Columbian Building Washington 1, D. C.

Shrinks Hemorrhoids New Way Without Surgery

Science Finds Healing Substance That Relieves Pain—Shrinks Hemorrhoids

For the first time science has found a new healing substance with the astonishing ability to shrink hemorrhoids and to relieve pain—without surgery.

In case after case, while gently relieving pain, actual reduction (shrinkage) took place.

Most amazing of all—results were so thorough that sufferers made astonishing statements like "Piles have ceased to be a problem!"

The secret is a new healing substance (Bio-Dyne*)—discovery of a world-famous research institute.

This substance is now available in suppository or ointment form under the name Preparation H.* Ask for it at all drug counters—money back guarantee. *Reg. U. S. Pat. Off.

\$8,750 FIRST YEAR... IN YOUR OWN BUSINESS

Start part time if you wish. We locally train you, furnish everything to clean and mothproof rugs, auto interiors, upholstery on location by world-wide process. Quickly established. No shop needed. Just 2 average jobs a day bring \$8,750 net profit in year. Employ others and multiply profits. You will be only service in town receiving National Advertising, Parents' Seal, 25 other regular services. Easy terms. Send now for free booklets.

DURACLEAN CO., 7-166 Duraclean Bldg., Deerfield, Ill.



FREE "How To Start Your Own MAIL ORDER BUSINESS"

Earn from \$10,000 to \$20,000 spare time. We'll put you in business and furnish you with everything needed. Exclusive new catalogs every three months... Offer your customers one item free for every two they buy! Free advertising and no stock for you to buy. We ship for you under your own name. No experience required. Write today for free booklet and franchise data.

MAIL ORDER ASSOCIATES, ROCHELLE PARK 3, NEW JERSEY

TESTS BLOOD PRESSURE



at home with guaranteed results. Check yourself daily with a simple mercury gauge. It's not as elaborate as a doctor's, but it does the job accurately. An illustrated manual tells how to test and what to do to avoid or reduce the damaging effects of high blood pressure. There are years of dependable service in this apparatus, which now includes a professional stethoscope for accurate testing. Complete new tester just \$9.75 plus 25c postage, or C.O.D. plus charges.

RESEARCH SPECIALTY CO.

2025-A N. Western Ave., Chicago 47, Illinois

LAW FREE BOOK THE LAW TRAINED MAN

Write today for a FREE copy of illustrated law book, "THE LAW TRAINED MAN," which shows how to earn the professional Bachelor of Laws (LL.B.) degree through home study of the famous Blackstone Law Course. All necessary books and lessons provided. Moderate cost; convenient monthly terms. Write for FREE law training book today.

Blackstone School of Law, 225 N. Michigan Ave.

Founded 1890

Dept. 50-A Chicago 1, Ill.

75 POWER TELESCOPE \$3.98

VARIABLE EYEPIECE 25X-45X-75X — BRASS BOUND

NEW! Three telescopes in one. 3 different magnifications. 25 power for ultra-bright images with 45 and 75 power for extra long range. Guaranteed to bring distant objects, people, sports events, ships, moon, stars, etc. 75 times as close.

Most powerful for any-where near the moon. 5 sections. Closes to 1 ft. long. Contains 4 ground and polished lenses. Also used as a powerful compound microscope. Directions included. Mass production enables us to offer this instrument at amazing price of \$3.98 complete. Money back guarantee. We pay postage. Get yours now.

CRITERION CO., 331 Church St., Hartford, Conn., Dept. PMB 46

DIESEL MECHANICS IN DEMAND

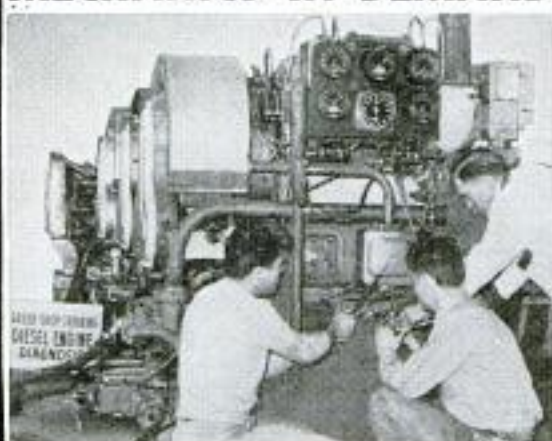

Learn to earn big pay in DIESEL in our large, modern equipped Chicago school and shop. No previous experience or training necessary. We help you find living quarters and part time job while in school. Complete, practical courses taught in the following trades, under the supervision of experienced, expert technicians.

APPROVED FOR CIVILIANS OR GI'S

— CHOOSE YOUR TRADE —

CHECK HERE	WEEKS
<input type="checkbox"/> DIESEL MECHANICS	20
<input type="checkbox"/> AUTO MECHANICS	20
<input type="checkbox"/> BODY & FENDER	16 1/2
<input type="checkbox"/> GAS-ARC WELDING	4 - 12
<input type="checkbox"/> REFRIGERATION	13 1/2
<input type="checkbox"/> AIR CONDITIONING	8 1/2
<input type="checkbox"/> MACHINIST TRADE	30
<input type="checkbox"/> ADVANCED MACHINIST	32 1/2
(includes tool & die)	
<input type="checkbox"/> PIANO TUNING & REPAIR	36

CHOOSE YOUR ENGINEERING COURSE

These courses are intended as terminal education for men who wish to enter the Diesel-Automotive and Refrigeration-Air Conditioning fields as technicians. These courses are designed to prepare men for supervisory positions. Students with a high school education, or equivalent, will be accepted.

<input type="checkbox"/> DIESEL AUTOMOTIVE ENGINEERING.....	2 years
<input type="checkbox"/> REFRIGERATION & AIR COND. ENGINEERING.....	18 months

HEAVY CONSTRUCTION EQUIPMENT OPERATORS TRAINING SCHOOL FOR CIVILIANS—Road Building, Terracing, Land Clearing, etc. Reservations accepted now!

FREE EMPLOYMENT HELP

Start your career with Greer by checking your interest above and mail coupon for complete information at no obligation.

NAME _____ AGE _____

STREET _____

TOWN _____ ZONE _____ STATE _____

Established 1902 — Over 50,000 Graduates.
55 years of continuous trade school experience to guide your training.

GREER SHOP TRAINING
Box F, 2236 S. Michigan Ave.
Chicago 16, Illinois

BUY BELOW WHOLESALE



START YOUR OWN HOME-IMPORT BUSINESS

Make big profits on thousands of exotic imports. No experience or investment in products needed. Famous world trader guides men and women—shows you how to pocket profits before ordering, how to get free ads, how to start full or spare time home mail-order business or take volume orders from stores. Export opportunities also. Full details, booklet and list of 157 imports showing amazing low foreign prices—**ALL FREE.** Air mail reaches us overnight. Write **MELLINGER CO., Dept. G256** 1717 Westwood, Los Angeles 24, Calif.

Be an industrial designer

Combine your design abilities with technical aptitudes in Industrial Design training at Art Center School in California. Work under practicing professionals for upper level jobs as automotive stylist, product and package designers. Design offices, stores, motels, showrooms, shopping centers. Constant demand for graduates. Recent placements with Ford, G.M., Kaiser Aluminum, G.E., Raymond Loewy and other leading design studios. 700 students. Co-ed. Accredited, B.P.A. Degree. Four-year course can be completed in 2 yrs. 8 mos. by year-round training. New terms Feb., June, Sept. Enroll early. Write Mr. Mead for new catalog. 5353 West 3rd St., Los Angeles 5, California.

ART CENTER SCHOOL

MEN WANTED

Earn \$100 Per Week and up
AUTO DIESEL MECHANICS

Master a trade with a future—learn Auto-Diesel mechanics in our shops. You learn with tools on real equipment. Earn while you learn. Many of our graduates earn \$100 per week and up. No previous experience necessary. Day and night courses. Approved for veterans. Write for free bulletin.

NASHVILLE AUTO-DIESEL COLLEGE

226 7th Ave., N., Dept. 73 Nashville 3, Tenn.

FREE AMAZING NEW BOOK "HOW TO ANSWER ADS"

Never before have you seen anything like this. Tells you in simple language the correct way to answer ads. Gets you quicker replies—better results, and greater satisfaction. Will save you time and money and it's **ABSOLUTELY FREE.** No obligation whatever. Every reader of advertising should have this booklet. Send a postcard for your copy NOW. F. W. JOHNSON, Popular Mechanics Magazine, Room 600-A, 204 East Ontario Street, Chicago 11, Ill.



LEARN UPHOLSTERY

EARN MORE MONEY YOU'RE IN BUSINESS RIGHT OFF—Complete upholsterer's tools, materials, frames, all you need to earn in sparetime while you learn **AT HOME.** Expert N. Y. State approved shop training in upholstery, slip covers, etc. Big Opportunity Field. Send for **FREE** Illust. Catalog, **FREE** Sample Lesson. Write Today. Approved for Vets.

Upholstery Trades School, Dept. FH-312, 721 Broadway, New York 3, N.Y.

URANIUM ORE GOOD LUCK AND HEALTH CHARM

Uranium for wealth, atomic energy for power and gamma rays for health. Uranium ore imbedded in plastic can be carried in pocket or purse, on key or watch chains. Charm is as big as a silver dollar, is beautiful, makes an attractive gift. Send \$1.00 to: **LAFAVE-LEE CHARMS, P.O. Box 413, Mar Vista 66, Calif.**

GROW ORCHIDS AT HOME

World's most thrilling hobby—profitable home business.

Successful home grower shows you how to start—how to provide proper temperature & air conditions in any well lighted room—how to market orchid flowers and plants for fine profits to friends, neighbors, hotels, florists. Also MAIL ORDER from big city, small town, or farm. **FILE YOUR HOME.** WITH NATURE'S MOST FABULOUS FLOWER. Many grow without soil, getting food from the air. Purple, white, yellow, green, every rainbow color. Illustrated instructions include blooming-size orchid plant—Everything you need to start. Hundreds of home growers Coast to Coast using our plan successfully. Send name & address on postcard for real **ORCHID SEEDS** & full details, including "Quick-Plant" Plan all **FREE.** Tropical Flowerland, Dept. 314, 100 So. Vermont, Los Angeles 4, Calif.

SHOWN ON TV

SENSATIONAL NEW GIBBERELLIN

Makes Flowers Grow Bigger, More Beautiful, Faster

STIMUCEL (Gibberellins-Plus) Contains GIBREL Mfg. By MERCK & CO.

Now you may grow the garden of your dreams without even dirtying your hands . . . for just pennies a day! Sensational gibberellin is astounding plant scientists with exciting results: ornamentals, turf grasses, tree seedlings show unusual growth . . . Rose bushes develop up to three times bigger . . . Geraniums grow into 3 foot plants . . . African Violets grow bigger, more erect . . . Gloxinia blossoms actually double in size and triple in number. Order **STIMUCEL** with **GIBREL** today . . . so that this Spring and this Summer you may grow flowers and plants so big, so lush, so fast they dazzle your imagination.



Now Only **\$1.00!**

SPECIAL OFFER

Send \$1 for special **TRY-It** size containing four big 500 mg packets of high-speed fertility . . . enough to treat an entire flower bed. See amazing results in a matter of days or your money back. Limited Offer. Large economy size (25 packets) with **FREE** \$1 value plastic squeeze sprayer only \$5.98 C.O.D. plus slight postage charges. Or save C.O.D charges and mail \$5.98 in cash, check or money order with name and address.

Dept. S-3, Garden Research Laboratories, 31 West 47th St., N. Y. 36, N. Y. In Canada, send to 64 Front St. West, Toronto, Ontario

Sig Spaeth Says:

My Amazing New Easy Method Shows You HOW TO PLAY THE HOHNER HARMONICA The Very First Day!



Here's the magic key to popularity! Following Dr. Spaeth's simple diagrams anyone can play popular tunes on a Hohner Marine Band Harmonica right off. No knowledge of music is required. If you can read this ad you can play!

This 35¢ Book **FREE** for a limited time

M. HOHNER, INC., Dept. M-67
351 Fourth Avenue, New York 10, N. Y.
Please send me New Easy Method Book.

Name _____
Address _____
City _____ Zone _____ State _____

MAKE MORE MONEY
get into

TELERAMA • ALL 8 BRANCHES OF TELEVISION ELECTRONICS • RADIO •
IN ONE DYNAMIC, MODERN SHOP METHOD, HOME TRAINING COURSE

You get and keep ALL this modern, newest, practical equipment!

* Registration applied for



YOU COVER ALL 8 BRANCHES IN ONE MASTER COURSE, ONE LOW TUITION

1. Television-including color TV
2. Radio — FM & AM
3. Industrial electronics
4. Sound recording and Hi-Fidelity
5. Preparation for FCC License
6. Automation
7. Radar & Sonar
8. Communications

- Parts to build a modern TV set, including large screen Picture Tube.
- Parts to build a powerful Superhet Receiver, standard broadcast and short wave.
- Parts to conduct many experiments and build — • Continuity Checker • RF Oscillator • TV Circuits • Audio Oscillator • TRF Receiver • Signal Generator
- Professional Multitester
- A MUST for all technicians

FOR MEN WHO WANT TO EARN MORE MONEY! Another great advance in Home Study Training. Let National Schools, of Los Angeles, a practical Technical Resident

Trade School for over 50 years, train you at home by Shop-Method, for today's unlimited opportunities in ALL 8 BRANCHES of the Television, Electronics, Radio industry.

YOU DO MANY PRACTICAL JOBS — including servicing, circuit analysis. Build a modern TV set from ground up, with equipment kits we send you, including a new large-screen picture tube and professional Multitester, at no additional charge. You receive an experiment lesson with each kit. **EARN AS YOU LEARN.** Graduate Employment Service.

SEND FOR FREE FACT-BOOK AND SAMPLE LESSON



RESIDENT TRAINING AT LOS ANGELES
If you wish to take Resident Training at Los Angeles in our big, modern Shops, Labs, and Studios check special box in coupon for full information.



NATIONAL SCHOOLS
4000 S. FIGUEROA ST., LOS ANGELES 37, CALIF.

NATIONAL SCHOOLS
TECHNICAL TRADE TRAINING SINCE 1905
Los Angeles, California

GET FAST SERVICE — MAIL NOW TO
NATIONAL SCHOOLS, DEPT. RB-67
4000 S. FIGUEROA ST.,
LOS ANGELES 37, CALIF.

Rush free TV-Radio "Opportunity" Book and sample lesson. No salesman will call.

NAME _____ BIRTHDAY _____ 19__

ADDRESS _____

CITY _____ ZONE _____ STATE _____

Check if interested ONLY in Resident School Training at Los Angeles
VETERANS: Give date of discharge.

AMMUNITION

for a fraction of regular cost



Reload a whole carton for the cost of a few rounds of factory ammunition. Shotgun shells, rifle and pistol cartridges can be reloaded safely and easily with an inexpensive set of famous IDEAL Reloading Tools. 164 page IDEAL Reloaders Handbook ... \$1.00, post-paid. Free folder on request.

THE LYMAN GUN SIGHT CORP.
MIDDLEFIELD, CONN.

AMAZING NEW "LIFETIME" RADIO

GUARANTEED TO WORK FOR YOUR LIFETIME! USES NO TUBES. BATTERIES DO ELECTRICAL PLUG-INS. Never runs down! SMALLER THAN A PACK OF CIGARETTES! RECEIVES LOCAL RADIO STATIONS MOST ANYTIME, ANYWHERE WITHOUT EXTRA ANTENNA. Uses crystal diode Hi-Q Tuner. Beautiful black gold speaker-phone grill-plastic cabinet.



SEND ONLY \$2.00 (bill, ok, mo) and pay post-man \$4.99 COD on arrival or send \$6.99 for postpaid delivery. SENT COMPLETE READY TO LISTEN—NOTHING EXTRA TO BUY EVER! Aerial kit included free for distant stations. Available only from:

MIDWAY COMPANY, Dept. GPM-6, Kearney, Nebraska

BECOME AN EXPERT IN

TRAFFIC and TRANSPORTATION

Traffic men earn \$4,000 to \$10,000 and up. Thousands of firms need experts on rates, tariffs, regulations. We train you thoroughly in spare time at home for executive traffic jobs. Personal training under traffic authorities. Write for free book "Traffic and Transportation."

LASALLE Extension University, 417 So. Dearborn St.
A Correspondence Institution Dept. 664-T, Chicago 5, Ill.

NEW! HMS BOUNTY MODEL KIT!

Famed mutiny ship. Every detail accurate—cannon, launch, rigging. Precision plastic parts, cement, plans, 14 3/8". \$2.98. For catalog, write Dept. M6, 4223 Glencoe, Venice, Cal.

\$2.98



wherever hobby kits are sold



NEW DISCOVERY!

GLOW-PRINTING

AMAZING NEW HOME-BUSINESS OPPORTUNITY **EARN BIG MONEY**

NO PRESS NEEDED—SUPPLIES COST PENNIES

Tremendous opportunity to earn up to \$10 per hour in your own home in spare time only. Learn to print signs, banners, posters—anything in amazing RADIANT GLOWING COLORS you can see for miles. Earn up to 300% profit filling orders to meet huge demands in every area. Some earning over \$1,000 per month already. No art experience needed.

FREE SAMPLES & HOME-PROFIT DETAILS

Send name and address and we'll rush samples revealing details to you. Don't delay!

SCREEN-PRINT CO. Dept. 26

15127 S. Broadway, Los Angeles 61, Calif.



POPULAR MECHANICS

WORLD'S
BEST
WANT-AD
MEDIUM

CLASSIFIED ADVERTISEMENTS



Advertisements in this section \$1.25 per word, each insertion, minimum 10 words, payable in advance.

To be inserted under proper classification, copy must be in our office the

20th of the second month preceding date of issue

F. W. Johnson, Manager, Classified Advertising

Popular Mechanics Magazine, 200 East Ontario Street, Chicago 11, Illinois

YOU'LL PROFIT

By reading and answering the classified ads in this section. Hundreds of opportunities for you to make and save money

AUTOMOBILES, MIDGET CARS

BOYS' Power-driven auto. Build your own. Plans 25 cents. Sypher Co., Sta. F., Toledo, Ohio.

FREE Factory price list. New '57 autos. Helps you buy for less. Kemp, 2015 N. E. 18th Street, Ft. Lauderdale 4, Fla.

CHILDREN'S Roadster plans \$1.00. Details free. T & L Manufacturing, 4020 Linden, White Bear Lake, Minnesota.

SERVICE Manager? Garage owner? Service station? Motorists put cash in your pocket, by this tested, accurate, service. You benefit! \$1.00. Satisfaction guaranteed. Green Co., Dept. GSP, 8332 Sagamore, Kansas City 13, Mo.

1957 SUPERIGNITIONITER. Starting, pep, mileage. \$4.95. Varsitytype, 1951 Kaisers, Barbelis, EG, Elmsford, N. Y.

HUNDREDS Of automobile catalogs—Old, new and foreign; glossy photographs, shop manuals; dealer books; free motor magazines listed by non-profit organization. Write to get on free mailing list. Auto Maniacs, Stockbridge, Mich.

AUTO SUPPLIES AND EQUIPMENT

AUTO Accessory and parts catalog. 1957 edition, all new! 228 pages. Save up to 50%. 75,000 items, including Hollywood accessories, hi-speed equipment, rebuilt engines, all parts and accessories for all cars and trucks! Hard-to-get parts! Send 25¢, refundable. J. C. Whitney, 1919 PM Archer, Chicago 16, Ill.

RING-Valve job while you drive. \$6.00 postpaid. World's only product of its kind! Safe, proven, guaranteed. Literature. Metalay, Grantham, Penna.

AUTOMOBILE Safety strap. Metal to metal buckle. Nylon webbing in all standard colors; \$7.00 plus 50¢ handling and postage. Breen's, Rutherford Ave., Charlestown, Mass.

TIRES. Save up to 50%. Goodyear, etc. Guaranteed not seconds. First line only. Write free price sheet. Busser Tire Co., 1730 Broadway, Lorain, Ohio.

"NO-Kro" stops battery and cable corrosion. Lasts years. Liberal supply \$1.00. Guaranteed. 200% profits. Protected territories. No-Kro Company, Chanute, Kans.

SAVE Money on Jeep and army truck parts. Large inventory. Catalogs for Jeep or G.M.C. owners. American Auto Parts Co., 1830 Locust, Kansas City, Mo.

FREE! New catalog. Speed, power, mileage increasing equipment. Discounts! Almqvist Engineering, Milford PM3, Penna.

NEW And used parts at savings. Complete guaranteed parts service for all models cars and trucks—1924 and later. Largest in the West. Army parts specialists. No catalog. Submit your needs for quotations. Fast mail order service. Pioneer Auto and Truck Parts Co., 734 W. 13th Ave., Denver 17, Colorado.

JEEPS And four wheel drive trucks need hubs that free wheel for two wheel drive and locking for four wheel drive. Guaranteed satisfaction. Willy's Jeeps \$39.95. Dodge Power Wagon, GMC 150 Series, 1 HCS Series, \$45.50. See nearest tractor supply store, or order direct from Tractor Supply Co., 2700 North Halsted, Chicago 14, Illinois.

AUTO Air-conditioner, easy "make it yourself" booklet. \$1 postpaid. Highway Air Conditioning, 167PM West 22, New York City.

CYLINDER Grinding in your car for new oversize pistons. Send for booklet telling how to do it yourself. Send \$1.00 for booklet tried and true. Charles Helsel, 115-49—118 Street, Ozone Park, N. Y.

RETLIF Toilet paper filter adapters \$3.50. Zenick Products, Box 2461, Los Angeles 54, California.

RING-Valve job in minutes. \$3.95 postpaid. Safe, proven, guaranteed. Literature. Helm Sales Company, Odon, Ind.

RADIOS Custom for 1952-1957 Fords \$38.90. Nordic Radio, Box 582, Evanston, Illinois.

THIEVES, Vandals run from automobile equipped with police auto alarm. Salesman's sample \$4.00 postpaid. Retail \$6.95. Guaranteed. Not a gadget. Gregory Sales Company, 316 Marion Building, Cleveland 13, Ohio.

SPONGERASER Whisks bugs off windshield. Cleans car, windows. Gas stations buy quantities. Sample 50¢. Babcock, Box 551-P, Scottsdale, Arizona.

DO-It-Yourself ring and valve job in seconds. Only \$6.00. Information free. James Products, 1625—50th Avenue, Cicero 50, Ill.

SPEED Parts. Save 25%. Free catalogue. Bell Auto Parts, San Antonio 10, Tex.

HYDRAULIC Jack repair kits. Repair your own. Send 25¢ to cover cost of price list. Jack Parts Co., 2600 South Claiborne Ave., New Orleans 13, La.

SIMPLE Gadget converts water into gas! Guaranteed! Kit, \$3.00. National, P.O. Box 606-L, Redwood City, Calif.

AUTO TRAILERS

SEE America! Rent travel trailer, \$100 deposit, \$40 weekly. Send 10¢ for Twin Lakes Times. Tells how you can travel U. S. at 7¢ per mile. See Miami! Rent mobilehome before buying. \$50 deposit, \$40 and up weekly. Make capital gains investment. Purchase Miami land, \$2500 lot share units of Mobilehome Park. Established 10 years. Leased with income 6% yearly. Taxes paid. \$35 options 30 days. Miami's Twin Lakes, 9674 N. W. 10th Ave., Miami 50, Florida.

TRAILER Building manual \$1.00. Booklet 30¢. Kamcraft, Box 1153, Milwaukee 1, Wis.

BUILD Expanding eight foot trailer. Accommodates five. Literature 10¢. Pru-Mar Company, Wilmington, Mass.

MARATHON Mobile homes are your answer to that vacation cottage, second family home, new tenant house. Models include King Size (10 ft. wide) 41, 45 and 49 ft. long. Other models 29 to 49 ft. 1, 2 and 3 bedroom—luxury at a price. Details free. Write Dept. 100, Har-Mac, Inc., Stratford, Wisconsin.

TRAILER Life in Arizona? Send 50¢ for Arizona Trailer Guide, 4110½ E. Van Buren, Phoenix, Arizona.

TRAILER Travel Magazine. Packed with informative material. Sample copy 10¢. Mobile Home Park Directory \$1.50. Wood-all Publishers, 121PM West Wacker, Chicago 1.

PICKUP Coach. Trailer blueprints. Literature 10¢. Comstock Trailers, Parsons, Kansas.

TRAILER Parts catalog. Largest in mid-west. Send 25¢. Refundable. Hanna Trailer Supply, 615 West Layton, Milwaukee, Wisconsin.

MOTORCYCLES, BICYCLES, MOTORSCOOTERS AND SUPPLIES

WHIZZER Motors, \$20.00; midget race car reasonable; motorscooter \$6.00; Cushman two-speed \$20.00. Send 25¢ (35¢ first class mail) for catalog #30 jammed with sensational bargains in wheels, motors, motorscooters, midget cars, motorbikes, construction plans, etc. Gail, 1313 Jefferson, Toledo, Ohio.

CUSHMAN Motorscooter \$30. Doodlebug \$30, James motorcycle \$35. Indian less engine \$30; Whizzer engine \$7.50. Briggs \$5, Maytag \$3, outboard engine \$6. (Mail-order only.) Send 25¢ (35¢ for first class mailing) for new Directory-Catalogue Number 77, listing these and hundreds of other bargains, homebuilders' midget car parts, plans, etc. Midget Motor Directory, Athens, Ohio.

MOTORCYCLES And supplies, all makes, new and used. Factory dealer. Tell us your needs. Wichita Cycle Co., 813 Ohio, Wichita Falls, Texas. Our 32nd year.

BANKRUPT Motorcycle, \$35 up. Bicycles \$12.50 up. Gasoline motors, \$4.00 up. Catalogue bulletin 25¢. Bunico, 146-C, Covington, Virginia.

PARTS For Cushman, Doodle-Bug, Salsbury, etc. Send make, model, 25¢ for price list. Motor Scooter Parts Co., Dept. P4, Box 7211, Indianapolis 1, Indiana.

HARLEY - Davidsons — Used bargains. New, used parts, accessories for all models. Bulletin, catalog 25¢. Knuth's (Factory Dealer), 1753 Muskego, Milwaukee, Wis.

PARTS, New, used. List 10¢. Ballak, 811 N. 9th, St. Louis 1, Mo.

RECONDITIONED Motorcycles and motors. Chromium accessories. Complete stock Indian parts. Expert rebuilding. Fast service. Indian Motorcycle Sales, Kansas City 27, Missouri.

AVIATION

TREMENDOUS Government sales now on. Buy direct from Uncle Sam. Surplus aircrafts; fuselages; accessories; engines; instruments; electronics; radiotelephones. Government depot list and procedure \$1.00. Brody, Box 8-PMM, Sunnyside 4, New York.

NEW Lightplane circulars, illustrated 30¢. Kamcraft, Box 1153, Milwaukee 1, Wis.

AVIATION Surplus bargain catalogue. One dime. Box 22PMB, Thomasville, Penna.

PROPELLERS, Plans, supplies for airboats and snowplanes. Latest designs, prompt delivery. Catalog 25¢. Banks-Maxwell, Box 3301E, Ft. Worth 5, Texas.

BATTERIES, GENERATORS

EDISON Nickel storage batteries. Any voltage, any amperage. Unconditionally guaranteed. Power plants, generators, motors. Literature. Hawley Smith Co., Croton Falls 1, N. Y.

ELECTRICAL SUPPLIES

LAMP, Electrical parts, wholesale. Thousands of items for repairing, converting. Catalog 25¢. Brown Lamp, Box 305, Clayton 3, Mo.

BOOK 200 Electric stunts \$1.00. Kutting, 26278 Arastradero, Los Altos, Calif.

GENERATORS 120 Volt a.c. and 28 volt d.c. both voltages same generator at same time. Industrial, home, marine use. New surplus \$29.50. Hutchinson Co., 4646 Melbourne, Los Angeles, Calif.

WELDING, SOLDERING, PLATING

ACETYLENE Welding outfits new \$54.50; used \$34.50; arcwelders \$54.50. Eagle Welding, Dept. PM, 5085 Broadway, Chicago 40, Ill.

BUY Welding supplies direct from manufacturer. Cable, welding rods, helmets, etc. Portable arc-welders and kits at tremendous savings. Free factory catalog! LeJay Mfg. Co., 2927 Emerson Ave. So., Minneapolis, Minn.

R-1 Generators \$29.89. Instructions one dime. Box 22PMW, Thomasville, Penna.

ELECTROPLATING Equipment, anodes, solutions. All types, including new electrodeless nickel. Baby shoe metallizing equipment, supplies. Free catalog. Hollywood Bronze Supply, Dept. B-4, 1624 East First, Los Angeles 33, California.

"BUILD-UR-OWN" a.c. welder and a.c. power plant with a good used engine and low cost Hobart generator. Welds anywhere and supplies 5KW stand-by power for any emergency. Write Hobartweld, Box M-673, Troy, Ohio.

A.C. Welders, 4 sizes, lowest prices. Free literature. Holgeron's Service, Canton, Kansas.

WELDERS, 110/220, \$39.50. Morris, 1070 Inner Drive, Schenectady 3, New York.

MACHINERY, TOOLS, SUPPLIES

NEW—Saw handle. Fits any hand saw. Only one bolt holds it. Priced at \$1.75. Reliable Tite-Lock Handles Co., 217 So. Williams, Westmont, Ill.

BEFORE You buy a chain saw send for free copy Chain Saw Age Magazine. Portland 66, Oregon. Jim Conroy, Editor.

BORING Bar and holder for your small lathe. We think it's the finest. Write House of Henderson, 1252 North Union St., Kokomo, Indiana.

MACHINISTS' Gages, Telescoping; slot. Write Campbell Tools Co., 1424 Barclay Road, Springfield, Ohio.

SURVEYING INSTRUMENTS

SEND Dollar, stamped self-addressed (8 x 3½) envelope for plans and instructions for self-leveling water level. Used with rod like surveyor's level. Originally made to stake irrigation ditches. Fast, accurate. M. Mercier, 74—3rd St., San Francisco 3, Calif.

ENGINES, MOTORS, DYNAMOS

REBUILT Motors. State requirements. 30-60% new motor prices. Richardson Electric, Monroe, Wisconsin.

NEW And used Diesel engines, generators, all capacities, 30 years experience. Glenmoore Diesel Mfg. Company, Glenmoore, Pennsylvania.

DIESEL Injector parts wanted. GM71-110. Bares, 7120 Carnegie, Cleveland 3, Ohio.

AIR Compressors half price. Free folder. IMSCO, 1829 South State, Chicago 16.

1/2 HORSEPOWER Electric motors, a.c. 110, used, good \$5.00 each. f.o.b. Plant Machinery Corp., Richmond & Norris Sts., Philadelphia 25, Penna.

SMALL Electric motors. Accessories. Kitco, Dept. 13, Box 212, Monroe, Wis.

GAS Engines wanted. Up to 8 h.p. New. Closeouts, quantities. Cash. Northern, 172 Merrimac Street, Boston 14, Mass.

REWIND Motors yourself. Complete instructions \$1.00. Lewis Mfg., Howell, Michigan.

WINDING Data. 275 motors, single and three phase, \$1.10. Data Company, Box 7631, Kansas City 28, Mo.

BOATS, OUTBOARD MOTORS

BARGAINS Galore — Boat kits, custom hardware, steerer \$9.95, plex-shield \$12.95, skis \$14.95. Save dollars folder. Box 681, Mendota, Minnesota.

FIBERGLASS Boat cloth \$1.20 yd. Resin \$5.95 gal. 3/16 plexiglas \$1.20 sq. ft. Send 10¢ for literature. United Plastics, Dept. 4, Roebling, N. J.

BUILD Small boats. Booklet 25¢. Catalog free. Popular Mechanics Press, 633 N. St. Clair St., Chicago 11.

ALUMINUM Boats and canoes. Quality aircraft-type design and construction. Safe, durable, beautiful. No maintenance. 100% boating pleasure. New 1957 catalog free. Grumman Boats, Inc., 3767 South. Marathon, N. Y.

NEW! "How to Build Your Own Fiberglass Boats" and "How to Make Old Boats New with Fiberglass." Send 10¢. Castolite, Marine Division, Dept. GM-101, Woodstock, Illinois.

FREE Catalog! Boat kits, trailers, fiberglass, marine hardware. Luger Industries, Dept. M6, 3404 Lyndale South, Minneapolis, Minnesota.

BOAT Covers and tops, free catalog. Barker Manufacturing Co., 66 Main St., Honeoye Falls, N. Y.

FIBERGLASS For boats and repairs. Top marine grade. Direct prices and free literature. Lukas, 17W286 Karban, Villa Park, Illinois.

WATER Skis \$21.95. Kits \$11.50 up. Finest quality. Enterprise Products, 28400 Gilchrist, Willoughby, Ohio.

FIBERGLAS Permanent boat waterproofing. Special 25% discount. Complete kits, \$9.45 up. Guaranteed materials. Easy application. Full instructions. Free literature. Ajax Plastics, Dept. PM, P.O. Box 1323, Fort Worth, Texas.

FORDS And Jeeps 100% marine engines with famous Convo-Kits. Deluxe catalogue 25¢ coin. Oscomotors, 3627B Lawrence, Philadelphia 40, Penna.

MARINE Conversion, Willys to Cadillac, engines, kits and parts. Catalogue and conversion hints free. Barr Marine, 2706 Castor Avenue, Philadelphia 34, Penna.

FIBERGLAS Boat coating. Plexiglas boat windshields—Clear, blue, green tints. Wholesale-retail. Instructive information catalog free! Gem-O-Lite, 5529 Cahuenga, North Hollywood, California.

MARINE Conversions for Ford and Jeep engines. Catalog 25¢. Lehman Manufacturing Company, 972D Broad Street, Newark 2, New Jersey.

SAVE Money. New, used outboard motor parts. Send wants. Stamp appreciated. Outboard Motor Mart, 229-M State, Boston 9, Mass.

FIBERGLASS Your boat! Complete kits including color resin. Low at \$8.50. Aquaglas, Box 99, Altadena, Calif.

BOAT Plans. Full size patterns. Frame kits. Modern inboards and outboards for amateur builders. Complete new catalog 50¢ or specify requirements. Glen Designs, Box 568, Compton, Calif.

NEW, Used, rebuilt marine motors. Marine conversions, fittings. Free catalog. Stokes Marine Supply, Dept. 24, Coldwater, Michigan.

ATHLETIC EQUIPMENT, BODY BUILDING COURSES

BARBELLS. Complete line quality equipment. Catalogue. Jackson Barbells, Springfield, N. J.

100 TRICK Knockouts for self-defense \$1.—1c each. Priest, Box 251, Evanston 1, Illinois.

DISABLE Any bully, with two fingers. Secrets, Ju-Jitsu, 96 pages, illustrations, \$1.50. Special chapter for women. Seico, Box 38, Cooper Station, New York 3, N. Y.

BE Taller! Coach's "Inch-At-A-Time" system \$1, complete. Marty Snyder, Box 195-ML Union City, New Jersey.

JUDO—Defeat bullies, 23 complete lessons, \$1.00, Box 1475, E.T.S.C., Johnson City, Tenn.

PUSHED Around? Don't take nonsense from bullies. Give them the shock of their lives. Easy when you know Police Jiu Jitsu. Complete fully illustrated course in one volume as taught police and armed forces. Send \$1 now. Money back guarantee. Books Publishing Co., Amityville 3, N. Y.

FEET, Leg muscles hurt? We can help you! Famous Ferrins method rebuilds and renews tired muscles. Activates and normalizes circulation. Intensifies nervous forces. No electricity. No internal medication. No massage. No special or expensive equipment. No continuing treatment. Increase your efficiency and complete health. Results are lasting. Write for free information. No obligation. Ornin Company, 1017 13th Street, Des Moines, Iowa.

BARBELLS. Dumbbells. Courses. Free catalogue. Good Barbell Co., Reading, Penna.

4 MUSCLE Courses 25¢. Fully guaranteed. Sid's System, Southgate, California.

STRENGTH, Health, muscles. Gain, reduce. All you need is a rope! Valuable booklet free. Ropercise, 4834-A Art St., San Diego 15, California.

SPORTING GOODS, GUNS, FISHING TACKLE, ARCHERY, TRAPPING

180 PROFUSELY Illustrated pages antique pistols, swords, daggers, armor, etc. 50¢. Robert Abels, M860 Lexington Ave., New York City 21.

BUILD Barbecue. Complete plans. Booklet 25¢. Free catalog. Popular Mechanics Press, 633 N. St. Clair St., Chicago 11.

RIFLES, Shotguns, pistols, scopes, ammunition. Dealers prices. Berkshire Gun Rack, Six Lakes, Michigan.

GUNSMITH—400 Page illustrated course \$4. Pioneer Press, Harriman, Tennessee.

17,000,000 GUN Parts stocked—Modern, obsolete, foreign. Send tracing, description for quotation, 44/40 instant gun-blue, takes second, largest selling, absolutely guaranteed, \$2.00 bottle. Junked guns wanted for parts, \$1-\$5 each plus postage, any kind, condition. Ship off-check airmailed. Numrich Arms, West Hurley 16, N. Y.

BIG Money raising crickets and 12 inch African fishworms. Free literature. Carter Ranch, Plains, Georgia.

5000 BARGAINS, Firearms, binoculars, war relics. Catalog 50¢. Smith Firearms, Runnemed, N. J.

SAMPLE: 25¢ Copy of "The Archers' Magazine." Send 10¢. 1200 Walnut Street, Philadelphia 7, Pennsylvania.

GRAY Crickets: Special advertising material (limited offer) free to fishbait dealers ordering crickets. Use material for your advertising. Crickets shipped immediately, any quantity. Live delivery guaranteed. Scientifically raised. Write for free literature and price list. Owen Crickets, Farm 2, 2818 25th, Lubbock, Texas.

FREE Sporting goods catalogs! Save 70%. Econ-O-Mart, Whippany 2, New Jersey.

MOLDS For fisherman's sinkers, ligs, squids, casting and spinning lures. Free catalog. Sweet's Molds, Tonawanda 1, New York.

FREE Fishing scent secrets. Johnston's, 312 Lake Avenue, Ithaca, New York.

FREE. Below wholesale fishing catalog. Fishing Tackle Mart, Dept. 55, Box 6737, Chicago, Ill.

TENTS. Camping equipment: tremendous selection. Send 20¢ for 136 page tent, camping equipment catalog-handbook listing all national camping sites. Print name, address. Morsan, 10-21R 50th Ave., Long Island City 1, New York.

AUTHENTIC Primitive weapon reproductions! Spears, crossbows, edged weapons, etc. Colorful. Deadly. Decorative. Catalog 10¢. Primitive Weapons, Pevely MB, Missouri.

JAP Rifle altering to 30-06, \$6.00. Jap shells, \$3.95. Catalog 5¢. T. P. Shop, West Branch 11, Mich.

BAIT Stolen? Bait thief detector! Tiny, adjustable featherweight, shows when thief is nibbling, \$1.00. Satisfaction guaranteed. Bite Lite, 8332 Sagamore, Kansas City 15, Missouri.

FREE 132 Page fishing catalog. Includes latest "do it yourself" kits. Netcraft Company, Dept. B5, Toledo 13, Ohio.

FREE — Giant 1957 wholesale sporting goods catalog. Lowest wholesale prices. Complete line of cameras, sporting goods, appliances, outdoor items. Write today. Santa Fe Distributing Co., 1321 Main Street, Dept. PM, Kansas City, Mo.

BOOMERANGS — Guaranteed return. \$2.50. Art Nelson, Box 25, Mission, Kans.

SPORTSMEN. Waterproof sta-dry suits. Adjustable sizes. Tough, durable. \$3.95 prepaid. Details free. Raygens Company, 1713A Victoria Ave., Arnold, Penna.

COLTS, Remingtons, Winchester, Lugers, P-38's, Kentuckies, Springfields. Antique-modern guns and gunnery values. Big bargain catalog 50¢. Agramonte's, Yonkers 2G, N. Y.

10 GAUGE Magnum 32" double barrels, full choke, new \$125.00. Virginia Pawnbrokers, Danville, Virginia.

POCKET Reel, casts, retrieves without pole. \$2.98 guaranteed. Reddi-Reel, Box 91A, North Brunswick, New Jersey.

CATCH Fish anytime! Secret Indian bait scent guaranteed makes fish bite! \$1.00 bottle. King Company, Ashville, New York.

MOSQUITO Headnets, two for \$1.00. Insect bar, large, \$3.00. Jungle hammock, insect and waterproof, \$6.00. Army, new, postpaid, except c.o.d.s. Surplus Sales, Jacksonville, Texas.

HUGE illustrated catalog monthly! Hundreds antique guns, swords, weapons each issue. \$1.00 year—12 fabulous catalogs. Norm Flayderman, Kennebunk, Maine.

CAMPING, Hunting, diving! Free equipment catalog. McCanna Company, Tarrytown, N. Y.

EARTHWORMS

BIG Money raising crickets, hybrid red wigglers and 12 inch African fishworms. Free literature. Bedrun hybrid red wigglers. 3000, \$6.50; 10,000, \$19.95, postpaid with raising instructions. Carter Redworms, Plains, Georgia.

RAISE Fish bait, worms and crickets for pleasure and profit. New illustrated booklet \$1.00. E. P. Green, Aliceville, Ala.

GIANTS—Six inches. 100—\$2.00. Postpaid. Brandt's Wormery, Century Apartments, Davenport, Iowa.

RAISE Earth worms. Profitable, easy instructions 25¢. Lairs Hatchery, Box 64, Virden, Ill.

HULA-HULA wigglers are better! Inquiry, information free. Kean, Ladonia, Texas.

PROFITS in worms. Yes, get your library on raising-selling and distribution. Write: H. G. Jackson, R-4, Stillwater, Okla.

FREE! "\$3,000 Yearly Sparetime. Backyard, Raising Earthworms!" Oakhaven-56, Cedar Hill, Texas.

BIG Profits raising earthworms. Literature free. Lund's Hatchery, Olathe, Kansas.

BINOCULARS, TELESCOPES, MICROSCOPES, MAGNIFIERS

AMAZING Prices, precision binoculars. Folder, "Binocular Selecting" catalog free. Dealers write. Prentiss Importers, Mercury Bldg., West Los Angeles 25, Calif.

BINOCULARS, Telescopes, microscopes, terrific values \$3.98 up. Request free money-saving catalog. Criterion, Dept. P-55, Hartford, Conn.

MICROSCOPE Slides, Anatomical. Free list. Bay, 409 Roosevelt, San Francisco 14, California.

SPECTACLE Binoculars! Wear like eyeglasses. Close-up view of all sports events. \$1.00 postpaid. DuPont Distributors, Box 695, New York 1, N. Y.

300 POWER Reflector telescopes complete with finder scope and tripod. \$24.95. 400X telescopes easily made. Kit includes focusing tube, erector, five finished lenses, building instructions, \$3.75. Free telescope booklet. Suffolk Science, Mattituck 4, New York.

BUILD Your own reflector telescope. Complete kit; mirrors, eyepieces, tripod, all other accessories. Request free illustrated literature. Criterion Manufacturing, Dept. DPM-30, Hartford, Conn.

WAR Surplus bargains! Millions of lenses, instruments, telescopes, binoculars, components and complete line of astronomical telescope items. World's greatest optical market place! Send only \$1.00 for beginner's 10-lens kit and big instruction booklet Stock 2-CH. Write for catalog CH, free! Edmund Scientific Co., Barrington, New Jersey.

REFLECTING Telescope, 60X, completely assembled \$29.75. Guaranteed observatory clearness. Free information. Skyscope, 475 Fifth Avenue, New York City 17.

REFLECTOR Telescope kits \$7.25 (3") to \$175 (12"). Mirrors, cells, focusing mounts, tripods, eye systems. Anything, everything in telescopes. Free catalog. Also ready to use telescopes from \$25. Esco Products, Oakridge, N. J.

DYNASCOPE—Sensational new reflector telescope. Send for details. Criterion Co., Dept. DP-33, Hartford, Conn.

FREE Catalog astronomical, scientific optics. Nye Optical, 2100 Cherry, Long Beach 6, California.

MICROSCOPE Catalog free. Research Scientific Supplies, 126 W. 23rd, New York City 11.

PLANTS, SEEDS, BULBS, NURSERY AND GARDEN SUPPLIES

TRAIN, Protect plants. 100—12" covered copper plant ties, \$1.00. Plant-Tie Company, 344 Norton Street, New Haven, Connecticut.

GROW Dwarf trees! Pot. sell. Instructions and seeds, 25¢. Mail Order Specialties, 1459PM Sabraton Ave., Morgantown, W. Va.

WORLD'S Greatest cash crop. Free information. Write Ginseng Gardens, Ashville, N. C.

PETS—DOGS, BIRDS, RABBITS, HAMSTERS, ETC.

BEAUTIFUL White pedigreed police puppies. Ansonia Kennels, McHenry, N. Dak.

HAMSTERS—Golden: young, \$3.00 pair. Fully developed \$4.00 pair. Adirondack Hamstery, Prospect 10-F, N. Y.

PETS, All kinds. Catalog \$1 (refundable). Blakey's Pets, Florida, Ala.

ANGORAS, Chinchillas — World's most profitable rabbits! Particulars free. Grinsteeds, Edwardsville, Illinois.

TAME Baby fox squirrels, raccoons, skunks, \$20.00. Others, information \$1.00. Refundable. Pets, 3704 South Pecan, Fort Worth 10, Texas.

STOP! Investigate earthworm raising first! Money making details free! Oakhaven-4, Cedar Hill, Texas.

MAKE Money raising chinchillas, mink, nutria, rabbits, cavies for us. Free catalog. Keeney Brothers, New Freedom 2, Penna.

RAISE Rabbits on \$500 month plan. Plenty markets. Free details. White's Rabbitry, Mount Pleasant, Michigan.

HAMSTERS—Young Golden pairs, \$2.95, breeders \$3.95. Free booklet. Jer-Pre's Hamstery, 2425 Hoyt, Muskegon Heights 13, Mich.

GROW Mushrooms. Cellar, shed, spare, full time, year round. We pay \$3.50 lb. We have over 25,000 customers. Free book. Mushrooms, Dept. 171, 2954 Admiral Way, Seattle, Wash.

AQUATIC Life—Oldest aquarium magazine. \$2.00 yearly, 12 issues. Copy 20¢. Baltimore 6, Maryland.

BEAUTIFUL Golden collies. Greatest child's pet. Barnes, M., Collyer, Kans.

RAISE Rabbits successfully by knowing facts. 48 page illustrated book describing 25 breeds. Housing, feeding, breeding, marketing, etc. Plus bulletin, 23 cents. American Rabbit Association, 36 Arba Building, Pittsburgh, Penna.

STANDARD Rabbit Journal, Milton 3, Penna. Year \$1.00. Sample dime. Beginners manual 25¢.

FUR BEARING ANIMALS

RAISING Fabulous nutria and luxurious mink is easy, interesting, profitable. Information free. North: Voight Fur Ranch, Lomira 8, Wisconsin. South: Voight Farms, Atlanta 2, Texas.

MINK Raising information free. Complete. Lake Superior Mink Farm, Superior, EE1, Wisconsin.

FARMS, FARM LANDS, REAL ESTATE

CANADIAN Tax sale lands for three dollars an acre and up. Small monthly payments. Farms, timber, hunting and fishing camps, minerals. Limited number of properties. Write at once for free catalogue. Tax Sale Service, Room 105, 120 Bloor St., W., Toronto 5, Canada.

OZARKS! \$9 Acre. Listings, information free. Write: Armstrongs, Shook, Missouri.

FLORIDA, Nice homesites, \$345 at \$10 monthly. Folder free. Howard Verner, DeLand, Florida.

GENUINE Opportunities! Government land. U. S., Alaska, Canada. Write Sledge Surveys, Macon, Mississippi.

FREE Strout catalog! Farms, homes, businesses, resorts, retirement properties. Over 2900 values in 34 states. 37 years' service. World's largest! Write Strout Realty, 7-MF So. Dearborn, Chicago 3, Ill.

MINNESOTA Waterfront tracts \$10 down. Norstates, Box 645-T, Houston 1, Texas.

\$5.00 MONTHLY Buys 40 acres productive land. Near town. Price \$250.00. Free list. Box 425-F, Carthage, Mo.

FLORIDA'S Most desirable wooded homesites, 80 by 135 feet only \$240 at \$10 monthly. Extra large Bear Creek waterfront tracts at \$25 monthly. Near famous Panama City gulf resort, unsurpassed fishing, boating, bathing, hunting. Also 10-acre garden farms and bearing tung groves. Booklet free. Wendell Wood, Fountain, Florida.

FLORIDA—50'x125' Homesites; \$10 down, \$10 monthly; full price \$395. Outskirts Bushnell, Highway 391. City conveniences, no city taxes. High elevation. Free information. Austin and Dawson Realty, Brooksville, Florida, Dept. PM-3.

POULTRY, FARM SUPPLIES

GUARANTEED. Surplus chicks, also pullets, wholesale, retail. C.o.d. Claude Caple, Newfield, N. J.

PROFITABLE OCCUPATIONS

NOW Grow mushrooms with standard commercial fertilizers. Marketing "how-to" free facts. Luxur, 641 South 19th, Newark 3, N. J.

FREE! "\$3,000 Yearly Sparetime. Backyard, Raising Earthworms!" Oakhaven-39, Cedar Hill, Texas.

FREE Folio "\$5,000-\$45,000: Unlimited Vacations." No merchandise. Unknown! Work home, sparetime! Haylings, Carlsbad, Calif.

BIG Money raising fishworms and crickets. Free literature. Carter Wormery, Plains, Georgia.

YOUR Own wholesale business without investment. Bargain catalog. Send 25¢. \$1.00 refunded with first order. Norria, 487-M Broadway, New York City.

BUY Wholesale! Discounts to 80%! Appliances, cameras, sporting goods, housewares, watches, tools, clothing, etc. Buy-Rite, Hawthorne 3, New Jersey.

BAKE New greaseless doughnuts in kitchen. Sell stores. Free recipes. Michael Ray, 3605 South 15th, Minneapolis 7, Minn.

HOME Mailorder beginner's manual, sources, methods, opportunities. 25¢. Carnahan Bros., 9610 Acacia, Fontana, Calif.

GROW Mushrooms. Cellar, shed. Spare. full time, year round. We pay \$3.50 lb. We have over 25,000 customers. Free book. Mushrooms, Dept. 99, 2954 Admiral Way, Seattle, Wash.

THEY Hand him \$100! Free packet. "Secret Journal." 919 secrets-plans! Work home. Publicco, Oceanside, Calif.

LEARN Locksmithing from licensed experts at home in your spare time. High pay. Earn as you learn. Locksmithing Institute, Rutherford 13, N. J.

RAISE Pheasants on \$100 week plan. Little capital and space can make you independent. Free details. Great Central System, Columbus 1, Kansas.

FREE Book "505 Odd, Successful Businesses." Work home. Pacific, Oceanside, Calif.

MAKE Flexible molds. Cast plaques, figurines. Free sample. Tooker, 1045-M Fairview, Hamilton, Ohio.

VENDING Machines—No selling. Operate a route of coin machines and earn amazing profits. 32-page catalog free. Parkway Machine Corporation, Dept. 25, 715 Ensor Street, Baltimore 2, Maryland.

AUCTIONEERING—Home study course. Diploma granted. Auction School, Ft. Smith, Ark.

EASY Street is right down our alley! You'll be set for life in this highly profitable type of automotive service. We train you in our modern, accredited school to become an expert in this specialized service. Thousands of jobs open, millions of car owners need this service! Write today for facts. No obligation. Strictest confidence. Address P.O. Box 607, Rock Island, Illinois.

AMAZING Earnings, sharpening shears and knives. Especially designed home service grinder. Free descriptive circular. George Page, 1820 Cleveland Ave., Niagara Falls 2, N. Y.

MAKE Attractive wall plaques from bottle caps. Instructions \$1.00. Campbell, 87 Poplar Ave., Bronx 65, N. Y.

BUY Wholesale thousands nationally advertised products at big discount. Free "Wholesale Plan." American Buyers', Hertel Station, Buffalo 18-B1, N. Y.

HANDICAPPED People, 18-30. Travel. Permanent jobs. Excellent pay. Transportation furnished. Advancement opportunities. Help Wanted, Box 4806, Kansas City 9, Missouri.

SPARETIME Repeat profits taking magazine subscriptions. Special offers. Cassell Agency, Boynton Beach, Florida.

BE The Popular Mechanics representative in your neighborhood and earn big profits in your spare time. Write Popular Mechanics Magazine, Room 305M, 200 E. Ontario St., Chicago, Ill.

WELDING Pays big money. Learn easily at best equipped school in country. Non-profit school with low cost training. G.I. approved. Write Hobart Trade School, Box M-872, Troy, Ohio.

WE Establish you in your own mail order discount business. Supply catalogs, letters, envelopes printed with your name and ship your orders. Sell gifts, appliances, watches, housewares, silverware, etc., at discounts to 75%. Catalog and details free. Topval Corp., Lindenhurst 317, N. Y.

MAGAZINE Subscriptions—Largest commissions, bonus. Qualified Agency, 431VA Kingston, Brooklyn 25, N. Y.

SOUVENIR Business runs to millions yearly! Tremendous profits! Season is here! No machinery required! "How To Manufacture Souvenirs," \$3.00. National, P. O. Box 606-L, Redwood City, Calif.

BOOKS, PERIODICALS, PICTURES, POSTCARDS

ACE Book finder—Please send me lists of books you want. No obligation. Charles Wells, Box 2378, Santa Monica, Calif.

BRITISH Book bargains. Any subject. Catalog free. Transbooks, Box 22-PML, Brooklyn 28, N. Y.

CUBAN Beautiful views, colorful photographs, 15 for \$1.00. R. Lloret, Box 431, Havana, Cuba.

PICTURE Post cards made from your photograph. 1000, \$12.00. Raum's, 4154 Fifth Street, Philadelphia 40.

BARGAIN, Exciting Little Library booklets. 25¢ each. How to use tools, painting, welding, home improvement, games, models, plastics, lamp making, glass blowing, boats, photographs. Free catalog. Popular Mechanics Press, 200-LB East Ontario St., Chicago 11.

OUT-Of-Print books at lowest prices! You name it—we find it! Fast service. No obligation. International Bookfinders, Box 3003-PM, Beverly Hills, Calif.

FREE Catalog. Many titles. Treasure-Site Books, 279 South Alden, Philadelphia 39.

NATIONAL Geographic Magazines, 1888-1956. Periodical Service, Box 465-PM, Wilmington, Delaware.

"HOME Improvement Guide." New, amazing 192 page volume. Packed with ideas, plans for remodeling, decorating, landscaping, built-in projects. \$2.50 prepaid. Popular Mechanics Press, 200-HG East Ontario St., Chicago 11.

RARE Magazines, catalog 10¢. Nationwide Exchange, Box 1375-P, San Antonio 6, Texas.

BOOKFINDERS! All subjects. Send wants! Jaher Book Service, 165 Hazelwood Drive, Westbury, N. Y.

"SCIENCE Milestones." Records march of science starting 400 years before Christ, right up to date. Amazing facts revealed. 312 pages packed with startling information that will thrill you. A real history of science. \$5.00. Literature free. Popular Mechanics Press, 200-8M East Ontario St., Chicago 11, Ill.

BOOKHUNTERS! Scarce, rare, miscellaneous books. Atlantic Book Service, Cedar Street, Charlestown 29, Mass.

JOHN Friend, bookfinder, can get the book you want. Free search service. Box 197PM, Cardiff, Calif.

SAMPLE 30¢ copy of "The Aquarium." Send 10¢ to 12th and Cherry Sts., Philadelphia 7, Penna.

FREE: Exciting catalog packed with books covering most everything. Think of it—From cover to cover you will find described and illustrated hundreds of books telling how to fix and how to build almost anything. How to remodel your home; do your own decorating, plumbing, electrical work. Simplified books covering concrete work, carpentry, painting, furniture making and refinishing. How to build your own boat, home workshop tools. Best books on photography, welding, hobbies, homecraft. How to make a home freezer. Send for your free copy now. Popular Mechanics Press, 200-BC East Ontario St., Chicago 11, Ill.

MAGIC TRICKS, PUZZLES, JOKER NOVELTIES

LEARN Ventriloquism, easiest method. Details free. Smith, 2125 No. Bigelow, Peoria, Ill.

STINKBOMBS 12/\$1. Smells utterly appalling. Kits, 1452 Drake, San Pablo 10, Calif.

BACK Seat driver's license. 15¢, four, 50¢. Wholesale. Gent, Box 484, Tremonton, Utah.

PARTY Fun plate lifter 25¢. Marvin's, 7956 Lee, Kansas City 15, Mo.

FREE Magic catalog! Entertain! Be popular! Write! Great Heaney, Oshkosh, Wisconsin.

VENTRILOQUIAL Course \$1.00. Figure catalog 35¢. Magic catalog 50¢. Finis, 624 West Third, Waterloo, Iowa.

DOLLAR Magic set free with catalog 25¢. 4462-PM Germantown, Philadelphia.

WORLD'S Finest professional magic. Joker novelties. Giant illustrated catalog 10¢. Top Hat, Evanston 12, Illinois.

500 TRICKS, Douglas famous 120-page catalog, only 10¢. Fastest service to magicians for 30 years. Send 10¢ today. Douglas Magicland, Dept. 1, Dallas, Texas.

SMOKEBOMBS 25¢, 7 For \$1.00. Terrific! 4463-PM Greene, Philadelphia 44.

PROFESSIONAL Catalog, 175 pages, 25¢. Williams, 900 Plymouth, Ellwood City, Penna.

SENSATIONAL Magician's wand 25¢. Vanishes handkerchief! Catalog included. Box 1352-PM, Philadelphia 5.

BE A magician! Large professional catalog of latest tricks. 35¢. Ireland, C-109 North Dearborn, Chicago 2, Illinois.

VENTRILLO, Professional voice-throwing instrument and catalog 25¢. Box 871-PM, Philadelphia 5.

WHOLESALE! Thirty 10¢ trick novelties \$1.00! Profits! 1746-W Market, Philadelphia 3.

COINS, TOKENS, CURRENCY

LINCOLN Cents 1910-S, 1913-S, 1921-S, 1923-S, 1924-S, all for \$2. Gasser's, Box 34615, Los Angeles 34, California.

LARGEST Coin magazine, 130 pages, 35¢. Scrapbook, 7320-J Milwaukee, Chicago 31.

SAN Francisco mint closed! Made only cents and dimes in 1955. In short supply and great demand. One each, brilliant uncirculated, for 25¢. Free coin lists with order. Bryson Stamp & Coin Company, 612 White, Toledo 5, Ohio.

12 DIFFERENT Indian cents, coin list, \$1.00. Pounds, North Wales, Penna.

U. S. large cent and coin bargain lists, only \$1. Delmaco Products, Box 1123, Wilmington, Del.

MORGAN Dollars; 1878-87-90-81-87¢, \$2.00 ea. Coin catalogue, 25¢. Shultz, Salt Lake 10, Utah.

GIANT U. S. coin catalog 25¢. Acecoin, 314 So. Clark, Chicago 4.

FREE! Foreign coin, banknote and coin collectors illustrated catalog to approval service applicants. Send 3¢ postage. Tatham Coinco, Springfield 30, Mass.

U. S. Coin approvals. Reasonable. Hutchinson, 3463 "I" Street, Philadelphia 34, Pennsylvania.

COINS From Formosa, Vatican, etc., plus foreign banknote, 10¢ with coin approvals. Littleton Coin Co., Littleton 81, New Hampshire.

BARGAIN Lists, Indianhead cent, 10¢. Economy Sales, 156-A Dean, Mansfield, Mass.

GET Profit and pleasure in collecting old coins. Send 10¢ for 56-page illustrated coin catalog. You'll be delighted with it. Send for it now. B. Max Mehl, 370 Mehl Building, Fort Worth, Texas. Largest rare coin establishment in U. S. Established 40 years.

BARGAINS, U.S. coins: 1893 Columbian world's fair half dollar, \$1.00. Ten different Indian pennies, 75¢. Two-cent piece, and 3-cent piece, \$1.00. Gold ¼ eagle, \$8.00. Gold ½ eagle, \$12.50. Beautiful coin bracelet, \$1.00. Many coins available. What do you need? Rare Coin Company, 31 North Clark, Chicago 2.

OLD Money wanted. Will pay \$100.00 for 1894 dime, S mint, \$50.00 for 1913 Liberty head nickel (not buffalo). Big premiums paid for all rare coins. Send 4¢ for large coin folder. May mean much profit to you. Numismatic Co., Dept. 20, Fort Worth, Texas.

COIN Collectors! Magazine with price list 25¢. Free gift with subscription, \$2 year. Eaglet, 229 So. 11th St., Newark 7, N. J.

SILVER Dollars hand shined with quick-silver \$1.25. Lorado, Box 328, Cascade, Idaho.

44 DIFFERENT Uncirculated coins, \$1.00. Oddehon, Box 482, St. Louis, Mo.

TAKEN Any wooden nickels lately? Send 25¢. Satisfaction guaranteed. Bill's, 8332 Sngamore, Kansas City 15, Missouri.

INDIAN Cent, liberty nickel, barber dime and 13 different foreign coins \$1.00. Alfred Szego, Box 187, Jackson Heights 72, New York City.

1956 PROOF Set, mint sealed \$4.25. 1955 mint set, pds 11 pieces, select, brilliant, uncirculated, in art display holders, \$2.95. Thomas Lavin, 6751 Paschall Ave., Philadelphia 42, Penna.

BUY And sell U.S. coins. Paul Thome, 1786 Montrose, Concord, Calif.

NAZI Coin—10¢. Interesting lists included free. Approvals. Dwight Musser, Dunbar, West Virginia.

BARGAINS—\$5 Gold \$10.95; Ireland animal set \$2.50; gigantic 80-page bargain catalogue (only one like it in America) \$1.00. Bebee's, 4514 North 30th, Omaha 11, Nebraska.

10 DIFFERENT Indian cents and 5 Lincoln cents before 1931 \$1.00. Price list free. Joray's, Box 38C, Shouns, Tenn.

STAMP COLLECTING

FREE! Gigantic collection. Interesting approvals. Thurman, 10522 Ashbrook, St. Louis 15, Missouri.

40,000 VARIETIES Available on approvals. 1/2¢ upwards. Kelgin, Box 933B, Daytona, Florida.

BETTER British Colonies on approval. Brand, 425 E. 63rd St., New York 21, N. Y.

CANADIAN Commemoratives 35 different \$1.00. Canadian Stamps, 139 Danforth Ave., Toronto 6, Canada.

DAHOMY, Gabon, Guadeloupe, Mauritania, Soudan, Oubangi. Free! Excellent approvals. Holiday, Box 773, Miami 35 (Riverside), Florida.

OUTSTANDING Special! Stamp wallet, 105 stamps 10¢, approvals. Shoaps, 7304 Briarcliff, Cleveland 30, Ohio.

GIANT Stamp zoo free! Snakes, leopards, rhinoceros, zebu, koalabear and other fierce jungle beasts. Approvals. Send 10¢ for handling. Free stamp magazine. Lincoln Stamp Co., St. Catherine's 518, Ontario.

LIBERIA Beautiful set of four native flowers, priced at 60¢ in standard catalog, only 10¢. Approvals. Goliath Company, Bethlehem Pl., New Hampshire.

COLLECTION Monaco stamps featuring wedding of Princess Grace Kelly; also Presidents Eisenhower, Lincoln, Washington, Roosevelt and others. Only 10¢ to introduce approvals. Littleton Stamp Co., Littleton Bl., New Hampshire.

FREE U. S. price list, to approval customers only. New-Way Stamp, Lawrence, Massachusetts.

MOUNT Stamps with P.M.'s. Samples. Lee's, Box 796, Rockford, Illinois.

FRENCH Colonies. Approvals. Leon Keeton, 1121 S. Hill, Los Angeles 15, Calif.

2 NUDES Sets 25¢ to serious stamp approval applicants. Atlas, 1526 Vilas, Madison 5, Wisconsin.

FREE! Giant catalog offering thousands of bargains. Sent with beautiful approvals. Jamestown Stamp Co., Dept. E6PMC, Jamestown, N. Y.

AUSTRALIA, Fifty different, 10¢ with approvals. Molzan, 720 Pomona, El Cerrito 8, California.

U. S. Stamps, Giant bargain catalog, 10¢. Raymax, 35-VZ Maidenlane, New York City 38.

QUEEN Elizabeth mint sets! Barbados, Caymans, Dominica, Tristan, Grenada, Gibraltar. 21 bicolors—25¢! Approvals. Gannon Stamps, Box 931, Canton 1, Ohio.

NOW! 200 Different stamps including F.D.R. triangle also scarce war ration stamps. Only 10¢ to approval applicants. Avalon Stamp Co., Dept. M, Springfield, Mass.

ECONOMICAL 1/2¢-3¢ Approvals. 33,000 varieties. Dressel, Box 128-N, West Englewood, New Jersey.

100 LATIN America 25¢. Plus surprise packet. Packet list free. Econopackets, Box 168, Riverside 9, Calif.

FREE! Amazing list! Two feet long! All countries! Stampart Company, Hartford 1, Connecticut.

FREE! 107 British Colony stamps. All different, from Britain's farflung colonial empire. Catalog value \$2.50. Free stamp magazine, approvals. Send 10¢ for handling. Act now! Niagara Stamp Co., St. Catherine's 71, Ontario.

FREE! 50 British Colonies. 5¢ handling. Approvals included. Kensington Stamps, Buffalo 15, N. Y.

UNITED States commemorative collection containing 33 different—10¢. Approvals. White, 516-A Avenue L, Brooklyn 30, New York.

TWO \$5.00 U.S. stamps plus 20 different, 10¢ with U.S. approvals. Irwin, Box 1105, Brooklyn 30, N. Y.

SELL Your surplus good grade stamps. Write, describing fully what you have. Vanroy Shirk, Lebanon, Pennsylvania.

50 DIFFERENT Argentine 10¢. Approvals. Reuter, 611 W. 40th Pl., Los Angeles 37.

AMAZING Offer! 200 United States stamps—including commemoratives, airmails, high denominations to \$1.00. Only 10¢ to approval applicants! Illustrated bargain lists free. Mystic Stamp Co., Dept. 80, Camden, New York.

U. S. Classics. Over 50 yrs. old. 15 selected old-timers. Missing in biggest collections. All 15 at less than 1¢ each. 10¢ with approvals. Jaro, Box 246-T, New York City 8.

50 DIFFERENT United States 5¢ with bargain approvals, lists. Bookman, Box 8245-M, Madeira Beach, Fla.

100 STAMPS, 10¢ With approvals. Smith, 508A Brooks, College Station, Texas.

OLD Scarce U.S. seconds on approvals. Slight imperfections, lowest prices. Hernefield, Clintonhill Sta., Newark 8, N. J.

100 OLD United States between 1861 and 1925. \$1.00. Roush Stamps, 51 Chestnut, Mansfield, Ohio.

UNITED States approvals. Select copies, used—mint. Kingsbury, Fairfax, Vermont.

ICELAND 10 Different beautiful stamps for only 10 cents to applicants for our good old fashioned approvals. Old Colony Stamp Co., Dept. A, Milford, Connecticut.

1-2¢ EACH! Thousands of exciting worldwide stamps. Free examination. Cole, Box 223-A, Buffalo 21, N. Y.

SELL Stamps to our readers. Your ad in this space will be read by thousands of stamp buyers. I'll prove that to you. Write now for Folder "S." F. W. Johnson, Classified Advertising Manager, Popular Mechanics, 200 E. Ontario St., Chicago 11, Ill.

225 STAMPS For only 10¢! This mammoth value includes airmails, pictorials; stamps from strange countries cataloging up to 25¢ each! Also approvals. Mystic Stamp Company, Camden 80, New York.

PICTORIAL Packet from Antigua, Barbados, British Guiana, British Honduras, Burma, Curacao, Leewards, Rhodesia, Trinidad, Tobago, and many other hard to get countries. Bicolors, topicals. Tremendous value. Each stamp a beauty, 10¢ with inexpensive, attractive approvals. Roseland Stamps, Spring Lake 2, Michigan.

100 DIFFERENT Austria, 10¢. Approvals. Aronson, Box P, Newton Centre 59, Mass.

FREE Stamp collection! 100 different stamps from Europe, Africa, Asia, Scandinavia, Balkans, etc. 3¢ to approval applicants. Tatham Stamp Co., Springfield 30, Mass.

GIANT Approvals, thousands different, 1¢ and 2¢ each. Wahl's Stamp Exchange, 708P Farragut, Chicago 31, Ill.

MINT U. S. at face value! All different older commemoratives! Send 25¢ for yours with first selection mint U. S. approvals. Western, Box 1689P, Salinas, California.

U. S. Revenues on approval. El Jay Stamps, Box 286, New York 36, New York.

WEIRD Diamond shape coffee stamps. Lovely flower triangle! First American big commemorative. Greenland, idol dancer, etc. Free with approvals. Capital Stamp Co., Ferrysburg 2, Mich.

WANT Lists filled, 100,000 varieties available. References. Downey Stamp Service, Box 70A, Bell, California.

FIVE Different sets French Colonies, 10¢ with approvals. Banner, Box 65, Park Forest, Illinois.

FREE Sample! Interesting, informative, illustrated. National Stamp News, Anderson, South Carolina.

FREE! Flower, sport triangles! East Indies. Others. Free gift. Approvals. Delton Page, Box 201, East Paterson, New Jersey.

FREE! Eight sided stamp, triangle, diamond, midget, mammoth; to approval buyers. Plymouth, Dept. 80, Bell, California.

U. S. \$5 Coolidge (S. D.)—25¢, approvals. Gatewood, Box 346, Winston-Salem, N. C.

FREE! New sensational picture frame stamp mounts. Plus 51 different stamps, plus stock album, 10¢ handling. Approvals. Surf Stamps, Box 443-P Wildwood, New Jersey.

QUALITY Approvals at 2¢ each. Hadrian, 12 East 31st, New York City 16.

EXTRAORDINARY Antarctic set free with approvals. Variety Stamps, 57-A Circuit, Newton Highlands 61, Mass.

CANADA—10 Large pictorials and 100 world wide, free with approvals. Rand A, 10524 St. Charles, Montreal, Que., Can.

U. S. Mint specials! 13 different commemoratives, 25¢; flags, #909-21, \$1.00; four different souvenir sheets, \$1.00. Free price list. Brooks, 2352-C East 23rd Street, Brooklyn 29, New York.

60 PAGE U.S., U.N. illustrated catalogue free. Stone, 192 Washington, Boston 8, Mass.

FOREIGN Stamps 1¢ to 5¢. Artcraft first days approvals. Barr, 467 Oneida, Pittsburgh, Penna.

25 DIFFERENT Commemoratives 1893 up 10¢. U. S. approvals. K&B, Box 70, Brooklyn 23, N. Y.

GIFT With foreign approvals. Smith, 504 Water Street, Warren, Penna.

MEXICO, Twenty different 5¢. Approvals. Stampcraft, Box 935A, Brownsville, Texas.

100 DIFFERENT China 10¢. Approvals. Coast, P.O. 2187H, Santa Ana, California.

SENSATIONAL Offer 75 year old U. S., Famous Americans, flags, presidents, commemoratives with approvals for 10¢ handling. Metropolitan Stamps, Box 312EN, Jackson Heights, N. Y.

MIXTURES—Canadian or worldwide, \$1.00 1/2 pound; 125 different large U.S. commemoratives \$1.00; 125 large, colorful foreign \$1.00. Sauerwald, 136 North Lakewood, Baltimore 24, Maryland.

MINT! Cayman, Borneo, Fiji, Honduras, Somaliland, all free! Superfine approvals. Tropicana, Box 624, Oakland Park, Florida.

REASONABLY Priced sets on approval. Iray, Box 114, Allston 34, Mass.

PICTORIALS On approval—Sets, singles, Picto, 1267 Tutwiler, Memphis 7, Tenn.

50 BRITISH Colonies free! Inexpensive approvals. Pan-American, Box 24, Coconut Grove, Miami 33, Florida.

BUTTERFLY Set, Madagascar set plus Monaco Washington, 10¢ with approvals. Bennett, Candor 3, N. Y.

FREE! Monaco triangles! Madagascar! Togoland! Iberia! Approvals. Keating, 2520-P Boulevard, Jersey City, New Jersey.

ANGOLA Latest bicolor native costumes—Free! Approvals. William Deems, Ravenswood, West Virginia.

BEAUTIFUL Stamps, 100 different, \$1.00; 10, 10¢. Guaranteed. Alfred Darrow, Camden, Maine.

RUSSIA, 25 Exciting gems 5¢ with approvals. Belmont Stamps, Washington 15, D. C.

IRAQ, Iran, Syria, Lebanon, Egypt, Israel, free! Popular approvals. Panorama, Box 229, Miami 2, Florida.

LUXEMBOURG, 25 Different 5¢. Approvals. Neal, 5950 Tower, Riverside, Calif.

125 DIFFERENT United States—\$1.00 approvals. Utecht, 1143J North Keeler, Chicago 51.

ISRAEL, 10 Different free. Approvals. Chippewa, Box 65M, Doylestown, Ohio.

FREE Mint collection! Ascension, Pitcairn, Mauritius, Norfolk, Montserrat, Virgin, Fascinating approvals. Lincoln, Box 157, Wood River, Illinois.

WANTED—Stamp collections, accumulations. Murray Gold, 62-89p Saunders, Rego Park 74, N. Y.

EIGHT Beautiful Barbados Queens 25¢; 4—10¢, approvals. Levin Otis, Lewiston, Calif.

UNITED States. Fine mint airmails, #C7, #C8, #C9, #C10. Only \$1.15. Approvals accompany. Whiton Paine, Westport 11, Connecticut.

50 DIFFERENT Latin Americans, just 10¢. Approvals included. Fred Pittsley, South Montgomery, Napa, Calif.

14,000 DIFFERENT! Fascinating new club plan systematically builds your collection. Only 5¢ weekly. Details free. L. G. Ware, Stepmey 73, Conn.

BIG Stamp collecting outfit 10¢. Approvals. Popular Adventure, Buckland, Conn.

FREE 100 All different China, approvals. Sevel, 12317 Brackland, Cleveland 8, Ohio.

ADEN To Zanzibar. A special collection of over 200 different stamps from Aden, Barbados, Cyprus, Dahomey, Egypt, Falkland Is., Guadeloupe, Hejaz, Israel, etc., to Zanzibar. Very unusual collection. Some really scarce ones included. Free to those willing to buy from our attractive, low priced approvals. You will also receive free Eisenhower, Grace Kelly and George Washington stamps from Monaco. Lyle Clark, Muskegon 2, Michigan.

GIGANTIC Collection free. Includes triangles, early United States, animals, commemoratives, British Colonies, high value pictorials, etc. Complete collection plus big illustrated magazine all free. Send 5¢ for postage. Gray Stamp Company, Dept. PM, Toronto, Canada.

WOW! 135 All different Germany 10¢. Zeppelins, semi-postals, airmails, high values. Big bargain lists and approvals included. Jamestown Stamp, Dept. A6PMC, Jamestown, N. Y.

FREE United States illustrated catalog. Bailey, 45 Bromfield, Boston, Mass.

HOBBIES AND COLLECTIONS

130 NEW American military campaign ribbons, shoulder patches. Includes purple heart ribbons. Sterling silver air corps wing insignia free with order. Twenty-five extra ribbons free with two or more orders. \$2.25 postpaid. Money-back guarantee. Victory, 8211 South Alameda Street, Los Angeles 1, California.

COLLECTORS Exotic woods samples. Five \$1.00. Free catalog. Alfredo Otero, Box 431, Havana, Cuba.

ARMY-Navy-Marines-A.F. 45 military insignias \$1.00, contains medals, badges, campaign ribbons, battle stars, patches, ratings, etc. Free valuable gift. Supreme Military, Dept. PM, 48 West 27 St., New York City.

WANTED—Cigarette, tobacco cards. Write Charles Bray, East Bangor, Penna.

NAZI Insignia, 13 different \$1.00. Medals, patches, armbands, flags, daggers. Illustrated lists, 15 cents. Medcrafts, Box 532, Victoria, B. C. 2, Canada.

MILITARY Miniatures. Civil War. Custer's Cavalry, American Revolution and U. S. Marines. Illustrated catalog 35¢. Bussler Miniatures, Dept. Z, 40 Howe St., Quincy 69, Mass.

COLLECTORS Matchbook covers. 100 different unused, \$1.00. Catalog 25¢. Album \$3.00. Charles Edelman, 1311-C East 84, Cleveland 3, Ohio.

INVENTING Can be an interesting and profitable hobby. Write for complete particulars. Institute of American Inventors, Dept. 40-E, 635-F St., N.W., Washington 4, D. C.

PRECIOUS STONES, MINERALS

SAPPHIRE, Topaz, tourmaline, garnet, peridot. Five uncut gem specimens, \$1.00. Ten polished gems, baroque shaped, \$1.00. Free bargain list jewelry, gems. Profitable, easy "do-it-yourself" projects. O'Brien's, 1116M Wilcox, Hollywood 38, Calif.

CUT Gems, make jewelry—For profit or fun. 100 page magazine tells how; where to get supplies. Sample 25¢ or request free literature. Lapidary Journal, Del Mar 2, Calif.

EARTH Science, the Rockhounds' national magazine. Subscription \$2.00, sample 25¢. Box 1357, Chicago 90.

MAPS And handbooks for rockhounds, treasure hunters, prospectors. Catalog, 25¢ (refunded). Simpson Publishing Company, 6629 Ridgeview Place, Spokane 16, Wash.

FIND Uranium, tungsten, mercury, hundreds of other minerals with Mineralight. Free information kit on fun and profit in fluorescent minerals; hobby set. Write Dept. PM8, Ultra-Violet Products, San Gabriel, California.

FREE List. "Minerals of Economic Interest." Minerals Unlimited, 1724 University, Berkeley 3, California.

ANTIQUES, RELICS, INDIAN GOODS, CURIOS

SCALPING Knife, spearhead, thunderbird \$4.00. Catalog free. Arrowhead, Glenwood, Arkansas.

SELECTED War arrowhead \$1.00. List 5¢. H. Talburt, Calico Rock, Ark.

SELLING 100,000 Ancient arrowheads, spearheads, tomahawks, etc. List free. Lear's, Glenwood, Arkansas.

CAMERAS, PHOTO SUPPLIES

REPAIR All cameras, binoculars. Free estimate. Modern Technical Supply PM, 55 West 42nd Street, New York City 36.

PHOTOGRAPHY For pleasure or profit. Learn at home. Practical basic training. Long established school. Free booklet. American School of Photography, 835 Diversey Parkway, Dept. 3442, Chicago 14.

BELL & Howell, Kodak, Graflex, discounts to 40%. Photo equipment, appliances. Free catalog. Mailers Mart, Box 135-KG, Pelham, New York.

FREE New bargain book. Big savings. Central Camera Company. Since 1899 mid-west's most complete mail order headquarters. Central Camera Company, Dept. 141, 230 South Wabash Avenue, Chicago 4, Illinois.

BUY Wholesale nationally advertised cameras, photo supplies, thousands other products at big discount. Free "Wholesale Plan." American Buyers, Hertel Station, Buffalo 16-E1, N. Y.

NEEDED Amateur or professional photographers, full or part time. Any age. No special equipment required. Apply now. International Press Assn., Inc., Dept. PM6, 30 North La Salle, Chicago 2.

PHOTO FINISHING

12 JUMBOS From any size roll developed 39¢, with this ad only. P. Skrudland, Lake Geneva, Wis.

KODACHROME Processing—8mm roll or 35mm 20 exp., \$1.25. Prompt service. Write for mailer and prices. Color Pix, Dept. P, CPO Box 30, Kingston, N. Y.

TRIAL Offer—8 jumbos 25¢, 12—35¢. Limit two rolls. Thrifty Photo, PM67, Box 275, San Francisco 1, Calif.

12 EXPOSURE Rolls, 39¢, jumbo prints. Guaranteed work, one day service. Lincoln Studios, Dept. K, Box 13, Lincoln, Nebraska.

TWO Beautiful prints from each picture on roll, 8 exposure 40¢; 12 exposure 50¢. Thirty-six years of satisfied customers. Quick service. Lensphotos, Dept. J-4, Janesville, Wisconsin.

WE Custom develop and print your films. Get the most from your photographic effort. Kradwells Photo Service, Greenlake, Wisconsin.

QUALITY Kodak finishing. 8 exposure roll 40¢; 12 exposure 60¢; 16 exposure 70¢. Reprints 5¢. Fast service. Guaranteed quality. 40 years continuous operation. Be a satisfied customer. We do color. Send for mailers. Mail Order Photo Service, Box 297, Watertown, Wisconsin.

8-HOUR Service on deluxe jumbo prints. 8-exposure roll developed and 8 jumbo prints 40¢, 12 exposure 55¢, 16 exposure 70¢; 35mm, 20 exposure 75¢, 36 exposure \$1.25. Jumbo deckle reprints 4¢ each. Contact prints made if specified. Bay Photo Service, P.O. Box 210, Oakland, California.

SUPERIOR Quality. Prompt service. 8 jumbos in album 40¢, 16 contacts 50¢. Jumbo reprints 5¢. Satisfaction guaranteed. Also complete color film finishing service. Write for free circulars and mailers. Fast-X-Photo, Box A, Jersey City, N. J.

30 WALLET Fotos for \$1.00 from one pose, portrait or negative. Add 10¢ for mailing. No copy negative charge. Send ad. Scout Wallet Fotos, P.O. Box 37, Athens, Tenn.

FAST—One day service. 8 brilliant over-size prints 45¢. 12—60¢. Reprints 5¢. Speed, satisfaction guaranteed. PicSure, Box 899-M, Philadelphia, Penna.

ANY Size roll film (except 35mm.) jumbo printed 50¢ per roll. Friendly Photos, Jacksonville, Alabama.

ENLARGEMENTS, Heavyweight seven 5x7's or four 8x10's \$1.00. Jack Koons, Huntington Mills, Luzerne County, Penna.

FREE! Color snapshot folder. Offers, lists, mailers. Houghton's, Irving, Mass.

FREE Roll film with your first order. Send 50¢ and 1 roll of exposed film or 10 negatives for reprints and you will receive one roll of guaranteed camera film free your size with your pictures. Send ad. Cher-O-Ke Scout, Athens, Tenn.

COLOR Processing—High quality, fast service and low prices. Kodacolor developing 85¢; prints 27¢. Kodachrome: 35mm. processing, 20 exposures, \$1.45; 36 exposures, \$2.25. Send for complete price list and free mailers. Photo-Mail, Box 216M, Madison Square Station, New York City 10.

PARTICULAR? 8 Jumbos—35¢, 12—50¢. Special: 35mm., 36 exposures \$1.10. Flash-Photo, Box 36M, Brooklyn 4, N. Y.

MOTION PICTURES AND SOUND EQUIPMENT

5,000 8-16MM. Movie films. Free catalogues. International, Greenvale, N. Y.

TAPE Recorders, tape. Unusual values. Free catalog. Dressner, 69-02M 174 St., Flushing 65, N. Y.

FREE Catalog. Save dollars. Fresh 8mm., 16mm. b&w and color film. Home processing equipment. Superior Bulk Film Company, 448 No. Wells, Chicago 10.

MOVIE Camera film: 8mm. roll \$1.50, 16mm. 100' \$3.00. Free processing. Better Films, 742 New Lots, Brooklyn, N. Y.

8-16MM. Films. Free catalogue, with sample film 10¢. Garden, 690 Howard Avenue, Brooklyn, N. Y.

SAVE 50%! Guaranteed-fresh color, b&w. movie film! 8mm., 16mm. Free catalog! Eno-R, 47th Holly, Kansas City 12, Missouri.

RECORDERS, Hi-Fi. Free catalogue. Carstan, 215 E. 88 St., New York City 28.

MUSIC AND MUSICAL INSTRUMENTS

DISCOUNTS Instruments, accessories, national brands. Tempo Music, 37 Cutler, New London, Connecticut.

VIOLINMAKERS. Repairers. Fine tone wood, and all violin supplies. Send for free wholesale price list. International Sales, 414-MPM E. Baltimore St., Baltimore 2, Maryland.

ACCORDIONS. Wholesale to everyone. Save up to 60%. All national known brands. Free catalogue. Del Principe, 29 South Cicero, Chicago 44.

WRITE Songs. Big money and reputation. Write for information. J. Gordon Pub. Co., 4700 South California Avenue, Chicago.

SONGPOEMS And lyrics wanted. Mail to: TinPan Alley, Inc., 1650 Broadway, New York 19, N. Y.

SONGS Into dollars. Share \$29 million dollars yearly for new songwriters, song-poets. Songs composed, published, promoted by famous firm. Information, appraisal free. Send to Nordyke Publishing, 6090 Sunset, Hollywood 28PM, California.

POEMS Wanted for new songs. Send poems. Free examination. Immediate consideration. Songcrafters, 2724 Arcade Station, Nashville, Tenn.

SONG Poems wanted. Five Star Music Masters, 630 Beacon Building, Boston.

POEMS Wanted for new songs. Send poems. Immediate consideration. Crown Music Company, 49-C West 32 Street, New York City.

ELECTRIC Guitars, amplifiers, wholesale. Free catalog. Carvin P.M.M. Covina, California.

ACCORDIONS Wholesale—10 day trial. Free catalog. American Accordion Center, 3329-PM-6 Belmont, Chicago.

GUITARS—Wholesale. Photographic catalog. 38 page book "How to Play Any Instrument," sample lesson, free. Ed Sale, 88M6, Bradley Beach, N. J.

ACCORDIONS. Direct from importer. Save 50% and more! Free trial. Lifetime guarantee. Trades accepted. Free catalog. Write Accordion Manufacturers Outlet, Dept. 67R, 2903 Chicago, Chicago 22, Ill.

POEMS, Songs wanted! Rhymer \$1. Ben-gol, 93 Jefferson, Chelsea 50, Mass.

RECORDS Hi-Fi by mail. Big discounts. Noelson, Box 211, Wall Street, New York City 5.

RADIO, TELEVISION AND ELECTRONICS

CRYSTAL Radio experimenters write to Hulet, 305 Hope, Lakewood, N. J.

ELECTRIC Guitars, amplifiers, wholesale. Free catalog. Carvin P.M.R. Covina, California.

ANYONE Can replace TV tubes, save expensive service calls. Instructions \$1.00. Slate's Television Service, Corsicana, Texas.

FREE! Giant bargain catalog. Transistor, "Sun" radios, kits, portables, audio, electronics, photographic, optics, tools, household. Write Lektron, 131M Everett Ave., Chelsea, Mass.

XTAL Radio kit, blueprints, \$1.00. Electrocraft, 7820 Volk, Dayton 5, Ohio.

REMOTE Control capacitance switcher \$29.95. Starts window display action electronically. Marketing Devices, 1170 Broadway, New York 1, N. Y.

TRANSISTORIZED Pocket broadcast transmitter kit, \$9.95. Wired \$11.95. Literature. Amerlabs, 471 Clifton Avenue, Newark 4, N. J.

SIX Transistor pocket radio \$42.95. Electronic Outlet, Wolcott Ave., Lawrence, Mass.

DO It yourself. What? Repair TV, build furniture, make barbecue, plumbing repairs, build boats, do house wiring, remodel home, lay tile, modernize kitchen, repair home, and scores of other things you can do yourself. Books covering each subject, only 25¢. Send for descriptive list. It's free. Popular Mechanics Press, 200-LB East Ontario St., Chicago 11, Ill.

BUSINESS OPPORTUNITIES

START Profitable lawn mower business. Book "1001 Tricks of Trade" including sharpening instructions all mowers—\$7.50. Book free with purchase of Grindrite lawn mower sharpener. Grindrite, 2639½ Durfee, El Monte, Calif.

\$200 PER DAY! Made operating stands or concessions at fairs and carnivals. Write! Globe Sales Co., Macon, Georgia.

FREE!—"How to Turn Rags Into Riches!" Metro, Dept. F, Box 151, Oak Park, Illinois.

BUY New, unusual products wholesale! George Lucas, Bellevue 5, Wash.

\$10.00 PER HOUR net profit in monument cleaning business. Free details. X-Pert Monument Cleaning Company, 456 Potomac, P.M.5, Buffalo 13, New York.

SELL And also manufacture, new sensational item. We need you for nationwide coverage. Address: Windsor, 438 No. Roosevelt, Wichita 8, Kansas.

HIGH Quality imports at low low prices bring big profits to mailorder. \$1 enlists our honest effort to help you succeed. Rogers-Hansen, Salem 5, West Virginia.

COSTS \$4—Retail \$1.00. Automotive product. You manufacture, distribute. Easy! Willson, Box 505, Princeton, W. Va.

MANUFACTURE And distribute newly developed windshield and glass cleaner. Your own label. \$1.00 brings \$4.00 worth material and complete plans. Lu-Co Products, Box 53, Caribou, Maine.

IMPORT Your own fast selling products in small lots. Also, start highly profitable mail order business using international drop-shipment method. Capital unnecessary. Free details. Georgia Overseas Trading Company, Dept. W, 715 Persons Building, Macon, Georgia.

EARN To \$90.00 up weekly sparetime. Mailorder operated. This business works! Test proves profits. Free plan. Bariskill, 1715 Julian, El Cerrito, California.

REWEAVING Instructions, supplies \$2.00. Harris Reweavers, Box 7112, New Orleans 19, Louisiana.

NEW Snow cone machines. All prices. P.O. Box 7803, Dallas, Texas.

SELL And repair vacuum cleaners. Write for new free catalog. Easy to read, all cleaners and parts. Eder Vacuum Cleaner Co., Dept. 15H, 13345 Livernois, Detroit 38, Mich.

REPAIR Service, full or part time, no selling, free details. Servicecraft 1412M Adams, Toledo, Ohio.

PROTECTED Territories. 200% profit. "No-Kro" protection lasts. Stops battery and cable corrosion. Liberal supply \$1.00. No-Kro Company, Chanute, Kansas.

FREE Catalogs. Each contains hundreds of businesses, farms and income properties throughout the U.S. Specify type and location desired. Deal direct with owners. U. I. Buyers Digest, 1808 Hillhurst Ave., Dept. PM-2, Los Angeles 27, Calif.

HOME-Import mail order business—Import profitable items below wholesale. Experience and product investment unnecessary. Full, spare time. Famous world trader guides you. Free list "157 imports," details. Mellinger, G706, Los Angeles 24.

CATALOG 1000 Bargains. Time payment. 25¢ week, up. 50¢ deposit refunded. Warner Farm Supply, 1985 Bridgeport, Conn.

IMPORTING—Exporting. Modern drop-ship method. Profitable. Details free. The Hazen Company, 6691-8th Ave. N., St. Petersburg, Fla.

WHOLESALE—Thousands nationally advertised products. Buy, sell. Amazing profits. New, free plan. Associated Wholesalers, 1016-D Starr, Burlington, Iowa.

MOTELS. Free bulletin describing 70 motels. Continental, 804 Grand, Kansas City, Missouri.

LIQUID Rubber. Make flexible molds. Free sample. Chaney, 1907 East Rd., Jacksonville 11, Fla.

START Your own business for \$20.00. We send you 15 samples of our best selling items. Reorder only the numbers you can sell. Money back if not completely satisfied. Division Sales, 3341 W. Roosevelt Rd., Chicago 24, Illinois, Dept. K.

HOW To obtain needed capital fully explained. Write Enterprise Bureau, SAK Bldg., Syracuse 2, N. Y.

CANDIED Popcorn and potato chip equipment. Eakins, Box 933-A7, Springfield, Ohio.

PROFITABLE Future in your own mail order business. Free details. Zed Gwartz, Desert Hot Springs, Calif.

WANT To make big money at home? \$10.00 profit in an hour possible with invisible reweaving. Make tears, holes disappear from clothing, fabrics. Steady year-round demand from cleaners, laundries, homes. Details free. Fabricon, 8334-S Prairie, Chicago 19, Illinois.

RELIABLE Men, women wanted for profitable mail order work. Wabash Products, Box 105, Cayuga, Indiana.

WHOLESALE Catalog! Discounts to 80%! Clothing, appliances, tools, housewares, jewelry, etc.! Midwest, 156-MM2, Pontiac, Illinois.

OPERATE Mailorder folio business! Free details. Ballard's, 425 East Catherine, Louisville 3, Ky.

MAKE Flexible molds. Cast plaques, figurines. Free sample. Tooker, 1045-R Fairview, Hamilton, Ohio.

NATURAL Molding rubber, extra thick. Free sample. W. Wooley, 1018-A Donald, Peoria, Illinois.

INTERNATIONAL Mailorder business. Complete setup service—Not just instructions. Hermes, 152 West 42, New York City 36.

BIG Money raising fishworms and crickets. Free literature. Carter Farms, Plains, Georgia.

INTERESTED Mail order? Samples leading mail order magazines 10¢. Palm, Box 1221, Baton Rouge, La.

START Home business making statuary, plaques, novelties, garden furniture, artificial marble flooring, liquid marble. Make your own flexible molds. Amazing profits. Only \$1.98. Free literature. Popular Mechanics Press, 631 N. St. Clair St., Chicago 11.

UNUSUAL Mailorder opportunity. Tested. We supply everything. Girard's, Azusa, Calif.

WANT More business? Here's an amazing opportunity to increase your sales. Talk to thousands of interested readers of "Mechanica Popular." Our Spanish Edition covers the Latin American countries like a blanket. They're real mailorder buyers. Classified rate 75¢ per word. Try an ad in our next issue. Classified Advertising Department, Popular Mechanics Magazine, 200 East Ontario Street, Chicago 11, Ill.

VENDING Machines—No selling. Operate a route of coin machines and earn amazing profits. 32-page catalog free. Parkway Machine Corporation, Dept. 26, 715 Ensor Street, Baltimore 2, Maryland.

HOME Workshop books. Free catalog. Popular Mechanics Press, 631 N. St. Clair St., Chicago 11.

MONEY In saw and lawnmower sharpening sparetime at home. Free book. Virgil Foley Company, Columbia Heights, Minnesota.

FREE Folio "45,000-445,000. Unlimited Vacations." No merchandise, equipment. Unknown! Work home, sparetime! Haylings, Carlsbad, Calif.

\$250 WEEK Cleaning venetian blinds. Patented machinery. Free literature. Robinson, 7213B, Indianapolis 1, Indiana.

\$70 WEEKLY—Home, spare time. Simplified mail bookkeeping. Immediate income—easy! Auditax, 34757A, Los Angeles 34.

BRUSH Plating outfits for plating articles in the home and shop. No tanks necessary. Good income spare or full time. Free particulars. Gunmetal Co., Ave. H, Decatur, Illinois.

\$1,000 MONTHLY Possible in collection agency business. Free details. Write Cole Associates, Syracuse 2, N. Y.

TO \$100.00 Weekly. Sparetime, home operated mailorder business. Successful beginner's plan. Everything supplied. Lynn, 10420-M National, Los Angeles 34.

FREE Book "505 Odd, Successful Businesses." Work home. Expect something odd! Pacific, Oceanside, Calif.

PLASTERCRAFT Molds, liquid rubber, plasters, flocks, candle supplies. Catalog and manual free. Blue Rapids Supply, Blue Rapids, Kansas.

BRED Rare tropical fish at home. Earn big money! Learn secrets! Help fill huge demand. Amazing opportunity! Free plan. Tropical Fish Breeders, Los Angeles 61, Calif.

MINK Raising information free. Complete. Lake Superior Mink Farm, Superior, Eel, Wisconsin.

COPUBLISH Mail Sale Advertiser, leading mail order paper. Details, latest copy, dime. Vanroy Shirk, Lebanon, Penna.

LEARN Real estate by listening to records. Lee Institute, Brookline 46, Mass.

I want to send you proof of the wonderful pulling power of Popular Mechanics classified pages. What's your proposition? Write me today. Include literature if possible. F. W. Johnson, Manager Classified Advertising, Popular Mechanics Magazine, 200 E. Ontario St., Chicago 11, Ill.

FREE "Franchise Profit Letter" describes nationwide opportunities. Exclusive distributorships, dealerships, agency operations. Write today. National Franchise Reports, 333 North Michigan, Chicago 1.

LEARN Photo-negative portrait retouching. Men, women. \$5 hour possible spare or full time at home. Easy, glamorous. Work for photographers by mail order. Full details sent free. Duval, 100 So. Vermont, Los Angeles 4.

YOUR Own name brand business. No investment; no inventory. Part time or full time. Sell famous brands of appliances, housewares, silverware, radios, vacuum cleaners, lamps, tools, clocks, watches, jewelry, etc., etc., over 1000 items. Join thousands of successful independent dealers. Send for free catalog and dealer price list. H. B. Davis Corp., Dept. 11, 145 W. 15 St., New York City.

11,000 NEW Prospects daily. Baby record books, shoes, albums. Sell mailorder. Use our literature. Write: No-Co-Ro, Capitola, California.

COLORGLAZED Concrete pottery made without molds. Patented method. Cemetery products, novelties, tiles. Basement leak-sealing. Money-making projects. Booklet, details free. Men only. National Potteries Company, Grand Rapids, Minnesota.

FREE Cadillac \$10,000 yearly. Cars, appliances wholesale. Strateway, 6228E, Charlotte 7, N. C.

OPERATE Profitable mailorder business! Splendid opportunity. For details write: Thomas Bond, 1637H West Vernon, Phoenix, Arizona.

COLOR Concrete with chemicals. Marble-glaze cement benches, pottery. Home-shop. Hundred beautiful designs, made without molds. Birdbaths to waterfalls. Your chance for fame, fortune, 10¢ brings sample, pictures. Hollywood Cementcraft, 8527-R Wonderland, Hollywood 46, Calif.

CASH From sawdust, seventy methods. Tin-cans, thirty methods. Newspapers, eighteen methods. Instructions 50¢ each. All three \$1.00. Charles Company, 12-DXT, Norwood, Ohio.

BE Appointed state notary public now. Write, Stationers, Boerne, Texas.

GROW Mushrooms. Cellar, shed. Spare, full time, year round. We pay \$3.50 lb. We have over 25,000 customers. Free book. Mushrooms, Dept. 172, 2954 Admiral Way, Seattle, Wash.

WE Love our mailman—He leaves over \$1000.00 monthly in our rural mailbox. My college professor husband drafted a scientific home mailorder method. We bought a Texas ranch, live as we always wanted. Now we sell the Ranch Mailorder Method. Operates anywhere. Inquire: Eveningshade Ranch, Boerne, Texas.

BAKE New greaseless doughnuts in kitchen. Sell stores. Free recipes. M. Ray, 3605 South 15th, Minneapolis 7, Minnesota.

BUY Wholesale! Discounts to 80%! Appliances, cameras, sporting goods, housewares, watches, tools, clothing, etc. Buy-Rite, Hawthorne 1, New Jersey.

FIX Typewriters. Inexpensive home course teaches factory secrets. Free booklet. Athey, Tarentum, Penna.

TOP Flight mailorder business opportunity. Modest capital. Request convincing details. Stav, 147 Victoria Street, Kamloops 18, B. C., Canada.

THEY Hand him \$100! Free plan "Secret Journal Hidden Dollars." Work home! Publicos, OceanSIDE, Calif.

MAKE \$48 From square foot plywood; jig saw necessary. Free information. Woodarts, X-7, Bridgewater, Mass.

\$5,000 YEARLY. Spare time at home. Nothing to buy. No local selling. Dignified. Guaranteed. Home Harvest, Rt. 3, Box 3491-A, Albuquerque, New Mexico.

"MAILORDER Laws and Regulations," \$1.00. Explains necessary licenses, different taxes, legal requirements, etc. "Mailorder Rules for Beginners," \$1.00 additional. Tasker, 1603 Peach Street, Alexandria, Virginia.

MIMEOGRAPHING Pays sensational local profits. Exclusive secret plans exposed! Start free. Mosele Mimeo Shoppe, Bonham, Texas.

PLASTIC Laminating. Pleasure and profit. Self-sealing. No machines. Complete home kit, \$1.00. Mountainside 1, Springwater, New York.

OPERATE Your own merchandise mail-order business. Everything furnished! B. Mann, Woodcliff Lake, N. J.

PIANO Tuning learned quickly at home. Tremendous field! Musical knowledge unnecessary. Free information. Empire School of Piano Tuning, Champaign, Ill.

MONEY For you! Big profits! Cast plaster figurines, bookends, plaques at home with XL rubber molds. No experience needed! Write for illustrated, 40-page catalog, only 25¢! Plastic Arts Studios, 3463 So. Madison Street, Department 5, Muncie, Indiana.

EXCLUSIVE Distributorship available in most areas for world-famous Cadmium battery guaranteed to outlast your car. Tremendous profit opportunity. Investment for merchandise only. Free franchise. Cadmium Battery Corporation, Dept. 102, El Segundo, California.

GROW Orchids at home. Profitable, fascinating. Year 'round. Maine to California. No greenhouse. Successful home grower shows you how to provide proper temperature and air conditions in any well lighted room. Full details and real orchid seeds free. Orchidland, 100 So. Vermont, Los Angeles 4.

PLATE Baby shoes, jewelry, gifts, bronze and colored pearl. Free booklet. Platex, 11029 South Vermont, Los Angeles 44.

LEARN Appliance service and repair. Motors, washers, refrigeration, cleaners, everything. Free booklet. Armstrong, 11027-A South Vermont, Los Angeles 44.

START Your own subscription service. Every family buys magazines. No capital needed. We tell you how, furnish all supplies free. Liberal commissions. Write McGregor Magazine Agency, Dept. 110, Mount Morris, Illinois.

NOW Grow mushrooms with standard commercial fertilizers. Marketing "how-to," free facts. Luxur, 641 South 19th, Newark 3, N. J.

BOOK On culture crickets and earthworms. Excellent information. \$1.00. Kean, Ladonia, Texas.

BUY Direct from factories—Appliances, cameras, watches! Free details! Cam Company, 6810PM—20th Ave., Brooklyn 4, N. Y.

FREE! "\$3,000 Yearly Sparetime. Backyard. Raising Earthworms!" Oakhaven-38, Cedar Hill, Texas.

MILLIONS Of saws and lawnmowers need sharpening regularly. Get in on this profitable business now! Spare time or full time there's good money to be made; \$6.00 to \$10.00 per hour not unusual. For details write Max Mig. Co., 138 Stockton Ave., San Jose 26, Calif. No obligation.

MAKE Money growing miniature trees on your window sill. Free seed and plan. Miniature Nurseries, Dept. JE, Gardena, Calif.

LEARN Professional TV servicing in one week! Fabulous new simplified system. No big expense. No studying. No tools or equipment. Spare full time. Own your own big profit business! Save! Amazing but true! Free! Write, Electronic Engineering, Dept. AC-176, 1038 So. LaBrea, Los Angeles 19, California.

PRINT Without a printing press! Amazing new method! Print colorful signs, banners, cards, posters, glassware; anything at home. Big profits. Money-making opportunity! We supply everything. Beautiful sample, home-business plan free! Write Screen-Print Company, JE, Los Angeles 61, California.

MAKE Extra money. Cash commissions. Everybody buys easy-to-sell advertising book matches. Union label. All sizes. Cuts for all businesses. Powerhouse selling kit free. Steady repeat business. No experience necessary. Superior Match Co., Dept. MX-687, 7328 S. Greenwood, Chicago 19.

START Your own business on credit. Your own boss. 1527 dealers sold \$5,000 to \$32,000 in 1966. We supply stocks, equipment on credit. 200 home necessities. Sales experience unnecessary. Pleasant profitable business backed by world-wide industry. Write Rawleigh's, Dept. F-U-PPM, Freeport, Ill.

WANTED! Home workers to assemble luggage and cases for ready market. Instructions, materials, tools, everything supplied. Free details. Abarsi, 807-BG Sunset, Los Angeles 12.

NEWEST Spare, full-time home business \$5 to \$10 hour possible. Paint with suede—The finish with touch and eye-appeal. Beautifully auto dashboards, signs, radios, toys, figurines, lamps—1001 others. Complete, step-by-step instructions sent for no-risk examination. Free details. Coast JE, Los Angeles 61.

MAIL Order expert shows how to make money by mail, even with small starting capital. His informative course contains modern merchandising methods, not petty schemes. Write for convincing details. Seery, North Conway, New Hampshire.

START A buying service, buy wholesale thousands nationally advertised products. Make big profits selling at sizable discounts. Postcard brings details. American Buyers, Hertel Station, Buffalo 16-C1, New York.

FLEXIBLE Rubber molds for plaster and Marble figurines. Sample and large illustrated catalog 25¢, refunded on first order. K-C Novelties, Dept. 56, Southampton, Massachusetts.

GROW Expensive herbs for us! Big profits home-business of your own. Year around profitability! We supply everything necessary! Send for free rare seeds and revealing plan. National Herb Exchange, Dept. JE, Gardena, Calif.

MAILORDER. Free book, Shrager Advertising, 2 W. 46, New York City 36.

"HOW To Start a Business" booklet sent free! If you know any trade, go into business for yourself! Learn the 9 easy steps to follow. We've guided 5,000 others to success. Revealing free booklet yours for the asking! Write! National Business Consultants, Office JE, Los Angeles 61, Calif.

IMPORT-Export! Mailorder opportunities. Details. Warner, Box 6, Fort Scott, Kansas.

SELL By mail. Tested methods. Alfano, 19 Pine Street, Closter 2, New Jersey.

MAIL Order advertising agency executive reveals sensational no-risk advertising and merchandise methods. Start in office or home; minimum capital; positive profits. Free details: Impact! 3407 Prospect Avenue, Dept. 11-6, Cleveland 15, Ohio.

OPERATE Profitable mail order business. Write Walter Service, 4159A East 112th, Cleveland 5, Ohio.

FREE Copy, Home Business Digest, full of home business information, send post card, Hofstede's, 928 Belmont Ave., Pater-son 2, N. J.

HIGHEST Profits all magazines. Sure success plan. Free catalogue, supplies, prizes. Subscription Service Co., Box 2070, Birmingham, Ala.

100% PROFIT. No investment. Stamp brings details, samples. Miller, Box 384, Brooklyn 1, New York.

60% PROFIT Cosmetics \$25 day up. Hire others. Samples, details. Studio Girl-Hollywood, Glendale, Calif., Dept. 1276H.

WANTED! Home producers, to be subcontractors. Cast plastic products for manufacturers in our clearing house service. Thousands of easily made items required. Cash in at home, without previous experience. Plastic Service Associates, Dept. 6PM, East Boston 28, Massachusetts.

VENDING Machines—Every description. New or used. Lowest prices. Start a route or sell outright. Established 29 years. Mack Postal, 2932-C Milwaukee Ave., Chicago 18.

\$75 WEEKLY In spare time. Repairing watches and clocks. Full information 50¢. Stewart's, 5315 Wells, St. Louis 12, Mo.

LIQUID Marble—Brushed! Sprayed! Mold novelties, tile! Particulars free. Marbleizing Service, Edwardsville, Illinois.

OPPORTUNITY In mail order. Free literature. McFall Enterprises, 5075 Niagara, San Diego 7, Calif.

FREE! Profitable home mailorder plans. Townsend, 1018A Woodland, Sharon Hill, Penna.

WE Establish you in your own mail order discount business. Catalogs, sales letters, etc., printed your name can cost you nothing. No stock investment. We ship orders. Sell gifts, appliances, housewares, cookware, cutlery, dinnerware, silverware, jewelry, watches, etc., at big discounts. Catalog, details free. Topval Corp., Lindenhurst 818, N. Y.

MONEYMAKING OPPORTUNITIES

YOUR Own wholesale buying service. Buy for clients, the "best" at the "lowest" America's biggest money making deal. Free details. Associated Wholesalers, 1016-DX Starr, Burlington, Iowa.

HOME-Business pays big! Start spare time and grow with our help! We guide you every step of the way in any business you may choose. Free details, write National Business Consultants, Office P6C, Los Angeles 61, Calif.

MEN And women wanted to start home business in spare time with little table-top rubber stamp machine. Easy to earn up to \$9.80 an hour without previous experience. Full particulars free by mail. Send postcard to Roberts, 1512 Jarvis, Room 7-H, Chicago 26, Ill.

MAKE Money writing short paragraphs! No tedious study. I tell you what to write, where and how to sell; and supply list of editors buying from beginners. Many small checks add up quickly. Write to sell, right away. Send for free facts. Benson Barrett, Dept. C-27-F, 7464 Clark, Chicago 28.

"50 NEW Home-Business Ideas" booklet free. Coast Industries, B6C, Los Angeles 61.

START A buying service, buy wholesale thousands nationally advertised products. Make big profits selling at sizable discounts. Postcard brings details. American Buyers, Hertel Station, Buffalo 16-D1, New York.

MAKE Top money collecting snakes, lizards, turtles, toads, frogs. We pay guaranteed prices. Details 25¢. Biological Exchange, Dept. 14b, Box 5302, El Paso, Tex.

MEN—Women! Start money-making plastic laminating business at home in spare time. Material that costs 11¢ brings back \$2.58. No canvassing or selling but mail orders bring in \$20 a day. Write for full particulars free. Rush name on postcard to Warner, Room 7-H, 1512 Jarvis, Chicago 26, Ill.

SELL Books by mail. 400% profit. Royal, Box 368-X, Cleveland 27, Ohio.

PRINT Without printing press—At home! New miracle discovery lets you change cents materials into dollar profits. No selling. Customers come to you. Tremendous demand in every area. Possible \$250.00 week profit to you. Free revealing secrets plan, actual valuable samples, confidential facts. Hurry, supply limited! Screen-Print Company, 26C, Los Angeles 61.

60% PROFIT Cosmetics \$25 day up. Hire others. Samples, details. Studio Girl-Hollywood, Glendale, Calif., Dept. 1276H.

START Big-pay business at home in spare time. No experience needed to operate little table-top machine for bronzing baby shoes. Make \$5.46 profit on every pair. Full particulars free. Send postcard to Mason, 1512 Jarvis, Room 7-H, Chicago 26, Ill.

FREE Introduction copy to "New Horizons" for homeworkers. Shields Publication, Box 164A, Miami 38, Florida.

STEADY Income. Easy project. Tremendous demand. Yours for \$2.98. Betterworth, Vidor, Texas.

PRINTING Wholesale—Save 50%. Start brokerage. Elichs, 3035 Marvin(B), Toledo, Ohio.

"HOW To Win Prize Contests." Free information. National, 9128-P S.W. 26th, Portland 19, Oregon.

BIG Money making professional draperies. Complete instructions plus paper model, only \$2.50. V Z Sales, 123 E. Poplar, San Mateo, Calif.

MAIL Order ideas, suggestions, methods. \$1.00. Box 4066, Wichita Falls, Texas.

YOU Can double your income. No selling. Complete details \$1. Business Consultants, 615 East Smith, Medina, Ohio.

DO It yourself. What? Repair TV, build furniture, make barbecue, plumbing repairs, build boats, do house wiring, remodel home, lay tile, modernize kitchen, repair home, and scores of other things you can do yourself. Books covering each subject, only 25c. Send for descriptive list. It's free. Popular Mechanics Press, 200-LB East Ontario St., Chicago 11, Ill.

DIRECTORY! Where to obtain free merchandise, books, literature, other valuable! Directory, \$1.00. National, P.O. Box 606-L, Redwood City, Calif.

FREE: "Retirement \$68,700.00 Investor's Dream!" Zinke, 315 Lincoln, Mount Morris, Illinois.

BUY Wholesale! Save 66%! 100,000 name brand appliances, housewares, clothing, furniture, tools, sporting goods. Everything! Free catalog offer. National Buyers Service, Box 3338EB, San Francisco.

NYLONS 12½ Cents. Write: Allsheer, 636 E. State Fair, Detroit, Mich.

\$100.00 WEEKLY Spare time with a tape recorder! Proven facts free! Dixieland Publishers, Asheboro 2, N. C.

OPENINGS: Spare-time. Work home. Coleman's, 1350 Carol, Aurora, Illinois.

START Your worm project with the best. Free literature. Dewey's Worm Ranch, Henderson, Colorado.

NOW Grow mushrooms with standard commercial fertilizers. Marketing "how-to," free facts. Luxur, 641 South 19th, Newark 3, N. J.

FREE! "\$3,000 Yearly Sparetime. Backyard. Raising Earthworms!" Oakhaven-48, Cedar Hill, Texas.

REFLECTIVE Sign letters, ornaments. Free samples. E-Z-On Sign Letters, Pell Lake, Wis.

LEARN Technical metaphysics and insure your future. Easy, inexpensive correspondence course. Simplest method known. Diploma. Write: Premier College of Technical Metaphysics, 2532 McKenzie St., Vancouver 8, B. C., Canada.

BUY Wholesale! 30-80% discounts! Appliances, gifts, typewriters, tools, watches, sporting goods, jewelry, cameras, housewares, etc. Consolidated Distributors, Clifton 28, New Jersey.

THEY Hand him \$100! Free plan "Secret Journal Hidden Dollars." Work home! Publica, Oceanside, Calif.

HOTTEST Mail order plan ever! Sell photos, films, art novelties. Huge proven profits! Free details! Ampro, 429 South Western Ave., Dept. 1, Los Angeles 5, California.

ADS Running under this heading sell printing. Ask me for proof. I'll gladly send you amazing facts. Ask for Folder "P." P. W. Johnson, 200 E. Ontario St., Chicago 11, Ill.

AMAZING Successes through franchises! Become exclusive franchise holder your territory. Information rushed. National Franchise Reports, 333 North Michigan, Chicago 1.

FREE Folio "\$5,000-\$45,000. Unlimited Vacations." No merchandise. Unknown! Work home, sparetime! Haylings, Carlsbad, Calif.

OROW Mushrooms. Cellar, shed. Spare, full time, year round. We pay \$3.50 lb. We have over 25,000 customers. Free book. Mushrooms, Dept. 173, 2954 Admiral Way, Seattle, Wash.

"HOME Business Digest" has money-making opportunities galore. Sample 25c. Donovan, 79-PM Greenbelt, Levittown, New York.

EARN \$50.00 Daily making mats, shoes and mud guards from old tires. S and S Patents Inc., 1307 North Clark St., Chicago 10, Ill.

DOLLARS Every day! Amazing new magic mail plan. Set-up free. Miller, Box 588X, Oshkosh, Wis.

GENERAL Contest Bulletin. Lists contests monthly. Sample, 25c. 1609½ East 5th, Duluth, Minn.

READ Progressive Mailtrade, the magazine that tells how to make money by mail. Dime brings sample and special offer. Progressive Mailtrade, Box 357, Sheboygan, Wisconsin.

RAISE Rabbits on \$500 month plan. Plenty markets. Free details. White's Rabbitry, Mount Pleasant, Michigan.

BIG Money raising. fishworms and crickets. Free literature. Carter Hatchery, Plains, Georgia.

EARN Money evenings copying and duplicating comic cartoons for advertisers. Adservice, Argyle 1, Wisconsin.

SELL Titania gems. Far more brilliant than diamonds. Catalog 10c. Diamondite, 2420-M 77th, Oakland 5, California.

VENDING Machines—No selling. Operate a route of coin machines and earn amazing profits. 32-page catalog free. Parkway Machine Corporation, Dept. 27, 715 Ensor Street, Baltimore 2, Maryland.

FREE Book "505 Odd, Successful Businesses." Work home. Pacific, Oceanside, Calif.

PRIZE Contests provide fabulous and confidential home income opportunities! Here's how and where to win your share! Send stamp! National Contest Bulletin, Box 2685-P, Miami 16, Florida.

FORMULAS, PLANS, ETC.

BEAUTIFY Complexion and hair. Economical formulas 25c. Grace Collins, 804 14th Avenue, Paterson 4, New Jersey.

FORMULAS; All kinds, latest, best. Literature free. Kemixal, Park Ridge, Ill.

PRACTICAL Formulas. Lists free. Cummings, Chemist, Gordon Ave., Syracuse 4, N. Y.

LATE. Modern manufacturing formulas. List free. Moon Chemical, Martville, New York.

FORMULAS For latest money-making discoveries. New! Good! Valuable literature free! Miller, Chemist, 1517-D, Tampa, Florida.

FREE Formula catalog. Anything analyzed. Reasonable. Western Chemical, Salem, Oregon.

EXPORT — IMPORT

1957 BUYERS' Guide to imported German products. First complete directory of German products, marketed in U. S. by category, manufacturer, importer. Plus 110 pages market facts on Germany. 370 pages, 10,000 listings, \$3.40. Nordeman Publishing Co., Inc., 14 E. 62nd St., New York 21, N. Y.

FREE Catalog — Rare imported gifts. Empire Imports, 2514 Genesee Street, Utica 4, New York, Dept. M.

CHEMISTRY

AMAZING New book of science. Experiments, formulas, and catalogue of laboratory supplies. Only 25c National Scientific Co., Dept. PM-6, 500 West Road, Lombard, Illinois.

CHEMICAL Curiosities! Chemical puzzles! Chemical games! Chemical novelties! All, only \$1.00. National, P.O. Box 806-L, Redwood City, Calif.

STUDENTS — Amateur experimenters. Five unusual dazzling chemical experiments 25c. Chemtron Company, 114 East 28 Street, New York City.

ATOMOTRON. Model atom smasher. \$14.95. Raybaby cloud chamber. \$3.95. 3-in-1 electromagnet, \$14.95. Send 25c for literature. Atomic Laboratories, Inc., P. O. Box 343, Berkeley, Calif.

CHEMICALS And apparatus for industrial, analytical, and private laboratories. Catalog 25c. Dept. M-50, Biological Supply Co., 1176 Mt. Hope Ave., Rochester 20, N. Y.

ILLUSTRATED Catalog: Chemistry, mineralogy, biology 20c. Tracey Laboratories, Evanston, Illinois.

60 PAGE Booklets! "Beginners Chemistry," "Chemistry," "Physics," "Relativity," "Light," "Astronomy," "Electricity," "Radio," "Useful Tables," "Scientific Oddities." 10c each. Franks, 3121 South Racine, Chicago 8.

PLASTICS

NEW Liquid casting plastic, clear, colors. Embed real flowers, coins, photos. New manual shows fine things you can make at home and sell at big profit. Send 25c. Castolite, Dept. G-101, Woodstock, Illinois.

PLEXIGLAS, Fiberglass, polyester, epoxy, acetate, vinylite, styrofoam, acrylite. Instructive wholesale-retail catalog, free. Gem-O-Lite, 3529 Cahuenga, North Hollywood, Calif.

BOXES, Plastic. Free list. Althor, 170 Bay 23 Street, Brooklyn, N.Y.

LAMINATING Supplies. Free price list. Solomson, 46 Cornhill, Boston 3, Mass.

REPAIR Kit welds broken plastic. Restores original finish. Standard kit \$2.00. Special trial kit \$1.00. Rayther Co., Box 271, Station B, Toledo, Ohio.

FIBERGLASS Patio sheets 58c sq. ft. Plexiglas 95c sq. ft. Liquid casting plastic \$1.95 qt. Send 10c for literature. United Plastics Products Co., Dept. 7, Roebling, N. J.

PLEXIGLAS. Square foot cost. 1/16", \$1.20; 1/8", \$1.52; 3/16", \$1.86; 1/4", \$2.21; 3/8", \$3.23; 1/2", \$4.36. Colors add 10%. Send 15c for postage. Aristocrat Plastics, 23-25 Sussex Avenue, Newark, N. J.

AGENTS WANTED

AGENTS — 300% Profit selling genuine gold window letters; stores and offices. Free samples. Metallic Sign Letter Co., 1217-D West Newport, Chicago.

YOUR Ad in this space will get some good agents for you. Yes, I'll prove it. Write for Folder "A" right now. P. W. Johnson, Classified Advertising Manager, Popular Mechanics Magazine, 200 E. Ontario St., Chicago 11, Ill.

GOLDMINE Of 600 money makers. Copy free. Specialty Salesman Magazine, Desk 5-B, 307 N. Michigan, Chicago 1.

GOLD Or silver letters, numbers. Windows, doors, trucks. 1" to 6". 500% profits. Free samples. Atlas-T, 544 West 79th, Chicago 20.

PRINTING, Advertising salesmen—Excellent moneymaking sideline selling decalcomania name plates, small quantities. Automobile initials, sign letters. Free samples. Ralco, XL, Boston 19, Mass.

YOUR Own business—Used suits \$1.50, overcoats 65c, mackinaws 35c, shoes 12½c, ladies coats 30c, dresses 15c. Enormous profits. Catalog free. Nathan Portnow Associates, 605-AA West 12th Place, Chicago 7.

EASY Handwork makes fast-selling articles. Sample free. Sunmade Company, Brockton 64, Massachusetts.

SELL Famous \$3 fire extinguishers. Fast sales, liberal profits. Write Fire-Killer, Box 182, Hazleton, Penna.

EARN An extra \$100 a week demonstrating the latest hit games Teeko, I.Q. Solitaire and Scar-Ne. Nationally advertised, millions seeking them. Terrific opportunity. John Scarne Games, Fairview, N. J.

BIG Profits! Fragrant cedar chips blended with certain tested ingredients freshens foul air, repels insects. Sell homes, stores, offices. Attractively packaged. Sample offered. Plinson, 706-PM, East 19th, Kansas City 8, Missouri.

SELL Hawaiian macadamia candy. Maier Products, 1120 Koko Hd, Honolulu.

AFRICAN Hand carved hard wood statuettes, wall plaques, book ends, warriors, big game animals, supplies limited, send for free list. Agents wanted. Apply J. A. Matthews, 3363 Queens Park West, Bulawayo, Southern Rhodesia, Central African Federation.

MAKE \$50-\$300 Extra money fast. Show big value \$1.00-\$1.25 Christmas, everyday greeting card assortments, gift wrappings, costume jewelry, gifts, stationery. Profits to 100%. Cash bonus. Write for newest assortments on approval, free gift offer, free album name imprinted Christmas cards, catalog, details. Hedenkamp, 361 Broadway, Dept. PM-49, New York City.

CALIFORNIA Sweet smelling beads. Sensational sellers. Particulars free. Mission, 2328-PM W. Pico, Los Angeles 6, California.

60% PROFIT Cosmetics \$25 day up. Hire others. Samples, details. Studio Girl-Hollywood, Glendale, Calif., Dept. 1276H.

EXCLUSIVE Line of personal initialed buckles, belts, cap badges, 3,000 emblems, uniforms, shirts, caps, etc. Hook-Fast, Dept. PM, Roanoke, Virginia.

BUY Wholesale thousands nationally advertised products at big discount. Free "Wholesale Plan." American Buyers, Hertz Station, Buffalo 16-A1, N. Y.

ROUTE Men—New terrific item sell bartenders. Send name. Ransom Sherman Enterprises, P.O. Box 3190, Hollywood 28, California.

MEN, Women, make money spare time plus new car as bonus for encouragement. Amazing hosiery guaranteed to wear without holes, snags, and runs, or replaced free. For example, lovely 60 gauge nylons guaranteed for as long as 1 1/2 years or replaced free. Write Wilknit, 1776 Wash., Greenfield, Ohio.

EARN \$10,000.00 Yearly—Only two sales daily. World's best seller, the Holy Bible (illustrated). Protestant or Catholic. Margaret's P.O. Box 92, Hazelton 6, Penna.

NAMEPLATES For homes, desks, etc. Free samples, Whitneys, West Springfield, Mass.

COULD You sell first quality nylon stockings at 39¢? That's all they cost if they run within 3 months because new slashed prices only 79¢ prepaid (including your commission and bonus). If free replacements needed, customer has two pairs for 79¢! Fantastic opportunity for fabulous earnings. Just write order, we deliver and collect. Free sample stocking and outfit. Dept. 33, Kendex, 108 Lawrence St., Brooklyn 1, N. Y.

HIGH Dealer and jobber profits on Magic-Mist. Attractive, all-purpose unit for vaporizing or bug killing. Many other practical uses. Proven consumer acceptance. Repeat sales of fuel crystals. Inquire Magic Mist, 1824 Spring St., Houston, Texas.

FABULOUS Patented sewing machine air-conditioner. Sells for \$1. Write for descriptive circular. Weidner, 131 West 45, New York City.

WANTED. Man sell fire stopper. Out-O-Matic, 1737A E. 31st, Denver, Colorado.

DAMASCENE Earrings! Gold plated. One pair, \$1.00, twelve pairs, \$6.00. Ohga, Pm88, Sigakenkusatu, Japan.

WHOLESALE Religious merchandise. Free catalog. Big profits! Gospel, 538 S. Dearborn, Chicago, Illinois.

\$1 PUTS You in business! Green Magic liquid hand cleaner in plastic squeeze bottle is easy, fast, repeat, big income, necessity item. Auto workers, painters, printers, mechanics, plumbers, say "It's the greatest!" Details free. Mr. Pope, The Lanyan Co., 401 Seneca Ave., Mt. Vernon, New York.

WHOLESALE Catalog! Clothing, linens, housewares. Write Bostonian, 14 Dock Sq., Boston 8, Mass.

CALIFORNIA Sweet smelling beads. Sensational sellers. Particulars free. Mission, 2328-PM W. Pico, Los Angeles 6, California.

SELL By mail or locally. African wall decorations. 57% profit! Clements, M-1345 Third, New York City 21.

TRADING Stamp salesman! Large discount catalog firm recently inaugurated unique stamp feature into already nationally known business. Protected territory! Top commissions! Leads! Kroboth's, W. 1118 Grace, Spokane 17, Washington.

JUMBO Profits selling slingshots to kids, stores. Buy wholesale. 50¢ for sample and information. Designed Products, P.O. Box 964-M, Concord, California.

BUY IT WHOLESALE

PLUMBING Goods—Faucets, valves, fittings. Buy brand names direct. Save to 60%. Send your requirements. Free list. Allied Mfg., Box 509, Morgantown, W. Va.

FREE. New wholesale catalog. Name brand products. Sell two items, get one free. Write: S. Smith, 1938 Pine Street, Beaumont, Texas.

MONEYMAKING Gifts, wholesale. J. J. Davis Co., Englewood Ave., Englewood, New Jersey.

BARGAINS. Joblots, closeouts. 2000 items. Tremendous savings, clothing, toys, gifts, jewelry, television, etc. 25¢ brings wholesale catalog. \$1.00 merchandise certificate included free. Reliable Jobbing, 311-B North Desplaines, Chicago.

ELECTRIC Guitars, amplifiers, wholesale. Free catalog. Carvin PMW, Covina, Calif.

USED And new watches \$2 up. Free list. Southern Watches, Gray, Georgia.

BUY Wholesale! Discounts to 80%! Appliances, cameras, sporting goods, housewares, watches, tools, clothing, etc. Buy-Rite, Hawthorne 4, New Jersey.

SAVE Up to \$39.75 on each order name brand products. Free gift plus \$10 discounts! Literature free. Boynton, 636 W. 75th St., Los Angeles 44, Calif.

FREE Wholesale catalog. Gifts, appliances, housewares, cookware, cutlery, watches, dinnerware, silverware, jewelry, etc. Discounts to 80%. Topral Corp., Lindenhurst 324, N. Y.

DIRECTORY! Where to obtain free merchandise, books, literature, other valuables! Directory, \$1.00. National, P.O. Box L-606, Redwood City, Calif.

BIG Multicolor wholesale catalog! Housewares, appliances, clothing, silverware, cookware, luggage, binoculars, radios, phonographs, cameras, recorders, projectors, typewriters, shavers, sporting goods, toys, tools, sewing machines, watches, jewelry. Name brands. Huge discounts. Just postcard: Selbyco, Decatur 157, Illinois.

AUTOMOBILES—New, used! Discounts to 33 1/2%! Jakiela, 2644 N. Western, Chicago 47-P.

SAVE 50%! Nationally advertised portable water softeners. Lifetime mineral. Regular \$29.95. Special \$14.95 prepaid. No c.o.d. Satisfaction guaranteed. Age Products, 1027 Atkinson, Milwaukee 6, Wis.

WHOLESALE Catalog! Discounts to 80%! Clothing, appliances, tools, housewares, jewelry, etc.! Midwest, 156-MM1, Pontiac, Illinois.

FREE Wholesale catalog. Watches, cameras, luggage, appliances, fans, power mowers, sporting goods, graduation-wedding gifts. Housewares, 924-P West 79th St., Chicago.

BIG Wholesale catalog. 20 to 75% discount. \$1.00. Refundable on first order. R & R Sales, Dept. B, 833 Westover Drive, Danville, Va.

SALESMEN—DISTRIBUTORS

NEW Jobs open in selling! Send name, address for five free issues of Opportunity Magazine's money-making guide, listing hundreds of companies who'll pay you well, full or part-time. No experience needed. Opportunity, 850 N. Dearborn, Dept. 17, Chicago 10, Ill.

MAKE Extra money. Cash commissions. Everybody buys easy-to-sell advertising book matches. Union label. All sizes. Cuts for all businesses. Powerhouse selling kit free. Steady repeat business. No experience necessary. Superior Match Co., Dept. M-657, 7528 S. Greenwood, Chicago 19.

CALLING On businessmen? Double your profits with exclusive advertising-embroidered uniforms, jackets, pants, shirts, coveralls, sportswear. Every business big-order prospect! Free outfit. Master Co., B-26 Water, Ligonier, Indiana.

IF You can sell or canvass any building specialty product, you can make more money selling Perma-Stone. During 1957, Perma-Stone dealers will be backed by the largest national advertising program in our history. There are over 300 active Perma-Stone dealers located in every state in the union. Get on the band wagon now. In 1957, sell Perma-Stone—America's most profitable, least competitive item. The season is here, don't delay, write at once for the name, address and phone number of the exclusive Perma-Stone dealer in your area. He is anxious and willing to discuss a sales arrangement with you. Perma-Stone Company, Dept. 3, 719 East Hudson St., Columbus, Ohio.

NEW Unique miniature Christmas lights, beautiful items. Guaranteed. Ferrari Importing, 2438 Hawkins, Royal Oak 2, Mich.

ADVERTISING Specialty selling profitable? Write Magid, Box 5226, Chicago 80, Ill.

SELL The perfect tie for sport shirts. Every man a prospect. Cost you \$7.00 doz. Double your money. Sample tie and swatches cost you 75¢. Los Wigwam Weavers, Desk 6, 1517 Arapahoe St., Denver 2, Colo.

CALLING On business men? Make \$50 extra weekly showing Merit business greeting letters, cards, etc. New idea saves time, effort, cash. Ideal sideline. No extra calls. Just 7 minutes with your present customers. Powerful sample outfit free! M. P. Brown, 452 N. 3rd, Burlington, Iowa.

AD Matches! Sell amazing designs—10, 20, 30, 40 and 240-light book matches. Bigger spot cash commissions; every business a prospect. Low prices for high quality. Repeats. Start without experience; men, women; full, part time. Buy nothing! Sales kit furnished. Match Corp., Dept. PM-90, Chicago 32, Illinois.

WILL You wear new suits and topcoats without one penny cost and agree to show them to friends? You can make up to \$30.00 in a day even in spare time, without canvassing. J. C. Field & Son, Inc., Dept. J-1826, Harrison & Throop Sts., Chicago 7, Illinois.

"HOW To Increase Your Selling Power." This new, revised book will show you how the experts sell. Also includes memory training and public speaking techniques. \$1.50 prepaid in U.S.A. Money refunded if you are not thrilled with results. Johnson Consultants, P.O. Box 451, Nampa, Idaho.

SENSATIONAL Value in elegant cigarette lighter yields fast profits. \$1 brings sample, sales plans, plus information other quality imports. Full refund on first order! Rogers-Hansen, Salem 4, West Virginia.

GOLF Player's delight, combination spike wrench and tee setter, light as feather, guaranteed unbreakable, sample \$1.00 postage paid. Wolfe Specialty, 250 Stanford Street, Akron 14, Ohio.

EMPLOYMENT INFORMATION

FOREIGN, Alaskan, U.S.A., jobs! To \$1500.00 monthly! Million Americans employed overseas. Copyrighted reports. Who to contact for highest paying jobs. Laborers, trades, truck drivers, office, engineers, many others. 52 countries—St. Lawrence project, Spain, Latin America, Northern project, Europe. Year registration-advisory service. Application forms. Unconditional money-back guarantee! \$2.00 (airmailed \$3.25). C.O.D.'s accepted. International Reporter, St. Louis 1-PW, Missouri.

COPYRIGHTED Reports on best paying jobs with travel, adventure, promotions. Construction, aviation, shipping, laborers, clerical, trades, supervisors, factory, unusual opportunities. Many types of work. Skilled and unskilled. Foreign and state-side openings for men and women. Only \$2.00 (\$3.25 airmail), including registration-advisory service. Satisfaction guaranteed. Included absolutely free: special reports on Alaska, Spanish airbase construction, South American opportunities and husband-wife foreign jobs. Research Services, Suite 207-PMR Brown Building, St. Louis 5, Missouri.

UNLIMITED Job opportunities. Details free. Personnel Associates, Box 889, Wheeling, W. Va.

ALASKA Jobs, information, opportunities, conditions, true facts on last frontier \$1.00. Alaska Reports, Rt. #1, Box 253, Ketchikan, Alaska.

TRUCK Drivers, laborers helpers, craftsmen over \$1,000 monthly for northern bases. For information South America, Spain, Europe, Alaska, etc. Foreign job listing \$1.00. Universal, 1110 Commerce Building, St. Paul, Minn.

HIGH Dollar jobs in Detroit. Send \$1.00 to Griffin, Box 225, Farmington, Mich.

EMPLOYMENT, Housing, business opportunities. Southern California's largest classified ads. Airmail \$1.00. W. Nelson, 235 Colia, Compton, Calif.

FROM \$60.00 To \$82.50 per week per diem, plus top hourly wages plus locations of your choice. Listings in all states, unconditional guarantee on all listings or money refunded, send one dollar for registration fee and additional information to Allstate Service, 828 Jefferson, Chula Vista, California.

CONTACTS Construction firms. U. S., Alaska, Canada. Plus largest St. Louis classified help wanted. See job data. Application information. Airmail \$2. Satisfaction guaranteed. Model Service, St. Louis 1-P. O., Mo.

FLORIDA Jobhunters aid. New statewide survey contains over 350 names, addresses, types businesses Florida's leading firms. Send \$2.00. Florida Employment Journal, 66 Treasury St., St. Augustine, Fla.

JOBS On ships. Men 16 to 55 wanted. High pay while traveling. Experience not necessary. Write for free information. World Wide Seamens Service, 309-PM West 42nd, New York City 36.

JOBS On ships! Experience unnecessary. Transoceanic, Box 494, Baltimore 3, Md.

SPECIAL SERVICES

INFORMATION On anything. Ferguson Research Specialists, 116-14 141 St., South Ozone Park 36, N.Y.

START Profitable imports business. Select suppliers from 25 countries—\$5.00. Specialty Imports Co., M5814, Philadelphia 28, Penna.

EDUCATIONAL AND INSTRUCTION

PIANO Tuning pays. Big money in spare time. Learn at home in 30 days. No musical knowledge necessary. Phonograph, records, tools and instructions furnished. Personal instructions available. Free catalog. Capital Tuning School, 16 Southwest Second, Fort Lauderdale, Fla.

EARN College degrees, correspondence. Metropolitan University, Box 86, Glendale 5, California.

BOOKS. Free 1957 catalog, 100 pages. Text, vocational, educational, instructional subjects. Millions of volumes, new and used. Bargain prices. Books bought. Est. 1902. Long's College Book Co., Dept. PM, Columbus 1, Ohio.

LEARN Appliance service and repair. Motors, washers, refrigeration, cleaners, everything. Free booklet. Armstrong, 11027-A South Vermont, Los Angeles 44.

STUDY For Doctor's degree of psychology, metaphysics and divinity. Correspondence courses only. College of Divine Metaphysics, Dept. P-M, 2611 North Illinois, Indianapolis 8, Indiana.

LEARN Mineralogy at home. Diploma course. Fortunes now being made in uranium and other minerals. Free catalog. Mineral Science Institute, Desk 2, 159 East Ontario, Chicago 11.

HIGH School diploma at home. Licensed teachers—Approved materials. Southern States Academy, Box 144-MX, Station E, Atlanta, Georgia.

BE A real estate broker. Study at home. Write for free book today. GI approved. Weaver School of Real Estate, 2018P Grand, Kansas City, Missouri.

USED Correspondence courses and books sold and rented. Money back guarantee. Catalog free. (Courses bought.) Lee Mountain, Pisgah, Alabama.

EARN While you learn. Auto and diesel mechanics master this top paying trade. Many graduates earn \$100 a week and up. Approved for Korean veterans. For free information write Dept. No. 256, Nashville Auto-Diesel College, Nashville 3, Tenn.

HELP Yourself to abundant living. Our courses have aided students to richer fuller lives. Learn secret of contentment, happiness. Earn degrees Ph.D., M.S.D. Write for free book. College of Universal Truth Correspondence School, 23-C E. Jackson, Chicago.

SECRET Investigation. Experience unnecessary. Investigators particulars free. George Wagner, M125 West 86th, New York 24.

BOOKKEEPERS! Increase your earnings! Operate your own simplified "Dollar-A-Week" bookkeeping and tax service. Full or spare time. Details free. No obligation. Ellis, Box 200, Cedar Grove, North Carolina.

WANT A diesel job? New opportunities to increase income. Higher pay. More money. We can help you qualify. Tools. Shop method home training. Write today! Diesel, Tractor, Heavy Equipment Division, Interstate Training Service, Dept. B-3, Portland 13, Oregon.

I Want to send you proof of the wonderful pulling power of Popular Mechanics classified pages. What's your proposition? Write me today. Include literature if possible. F. W. Johnson, Manager Classified Advertising, Popular Mechanics Magazine, 209 E. Ontario St., Chicago 11, Ill.

INVESTIGATOR Training. Phillips Secret Service System, 1917-B North Kenneth, Chicago 39.

PHYSICAL Therapy and massage. We train you at home. Earn big profits from your own private practice or work with hospitals and doctors. Free catalogue. National Institute, Desk 4, 159 E. Ontario, Chicago, Ill.

STUDENTS—The Maxwell Simplified Method of Study will help you get better grades. Simple, efficient, proven. Only one dollar. Study Methods, Box 419, Pacific Grove, California.

SIMPLIFIED Analytics teach algebra clearly. \$1; guaranteed. Ziembra, H-6123 Orchard, Dearborn, Mich.

GROW Mushrooms. Cellar, shed. Spare, full time, year round. We pay \$3.50 lb. We have over 25,000 customers. Free book. Mushrooms, Dept. 174, 2954 Admiral Way, Seattle, Wash.

\$200.00 WEEKLY Reported! No selling. Free booklet. Franklin Credit, Roanoke, Virginia.

DRAFTSMEN. Shop men, students. Learn die design engineering. High pay career, or home business. Paquin system guarantees results. Details free. Northeast Technical Institute, 53 May Street, Worcester 10, Mass.

MIDLAND Linotype School. Charles City, Iowa. Civilian and veteran courses. Free placement. Established 1909.

WELDING Training pays at Hobart Welding School, Box M-671, Troy, Ohio. VA contract. Best equipment. Catalog free.

USED Correspondence courses and educational books bought, sold, rented. Free catalog. Educational Exchange, Menlo, Georgia.

THINK Clearly. Avoid mistakes. Learn the seven easy steps. Read "Magic of Clear Thought." Send \$1.00. Martin Dale Research, Box 293, Jackson, Mich.

BE An investigator. Write for free details. State age. National Detective Academy, 335 East 4th Street, Scottsdale, Ariz.

LEARN Another language at home with Linguaphone, the world's standard conversational method on fine, life-like recordings. You learn to speak French, Spanish, German, Japanese. Modern Greek—any of 34 modern languages easily, quickly, naturally. It's like living in another country. Complete language courses available for free trial. Send for free book and details of free trial. No obligation. Linguaphone Institute, T-83-067 Radio City, New York 20.

MEMORY Problems? Educated memory means additional mental power. Free, first lesson of Memorology. Memorology Studio, 2016-M Sunnyside, Chicago 25, Illinois.

WANTED: More new writers for TV-radio, magazines, business publications, motion pictures. Learn at home for extra income or exciting full time career. Many students earn while learning. Professional instruction. Send today for free lesson and book. Palmer Institute of Authorship, Desk TM-67, 1680 N. Sycamore, Hollywood 28, Calif.

COMPLETE Year high school at home in spare time with 60-year-old school. Texts furnished. No classes. Diploma. Information booklet free. American School, Dept. XA45, Drexel at 58th, Chicago 37, Illinois.

LEARN Camera repair. Easy, complete, approved home-study course. Free illustrated booklet. National Camera Repair School, Dept. L-5, Englewood, Colo.

U. S. Civil service tests! Training until appointed. Men-women, 18-55. Start high as \$340.00 month. Experience often unnecessary. Get free 36-page book showing jobs, salaries, requirements, sample tests, benefits. Write today: Franklin Institute, Dept. H-24, Rochester, N. Y.

FINISH High school at home, spare time. No classes. Diploma awarded. Write for free catalog. Wayne School, Catalog HF-75, 2527 Sheffield, Chicago 14.

BLUEPRINT Reading—Train at home. Learn to read blueprints with confidence in 10 easy lessons. Write today Belton School, 1059-N North Lawndale, Chicago 51.

RENOWNED Memory expert shows you how to improve your memory to remarkable degree at home. Amazing new method of memory training developed by Dr. Bruno Furst. You can remember names, faces, telephone numbers, this whole page if you wish. The course featured in Reader's Digest. Write today for free details: Dr. Bruno Furst Course in Memory and Concentration, Dept. A4, 365 West End Avenue, New York 24, New York.

LEARN By ear with Dormiphone. While you sleep, amazing new scientific invention works for you. Revolutionary Dormiphonic tools give you a shortcut to learning languages, correct speech; memorizing facts, figures; ideal for self-improvement, relaxation, habit training. Saves time, effort. So simple children benefit. Used by educators, psychologists. Write today for fascinating free book. No obligation. Modernophone, Inc., 320-067 Mezz., Radio City, New York 20.

DRAFTING, Design, blueprint reading. Good paying. Easy to learn at home. Minimum age 17. Write Utilities Engineering Institute, Dept. TC-5, 2525 Sheffield, Chicago 14.

PIANO Tuning pays. Learned easily at home. GI approved, 50th year. Free booklet. Miles Bryant School, Dept. P, 3731 Stockton, Sacramento 20, Calif.

LEARN While asleep! Details free. Research Association, Box 610-MC, Omaha, Nebraska.

LEARN Civil and criminal investigation at home. Earn steady good pay. Institute Applied Science, 1920 Sunnyside, Dept. 16A, Chicago 40, Ill.

LESSONS To suit individual needs. Woodworth, Box 4867, Detroit 19, Mich.

PROFESSIONAL Books. Medical, psychology, nursing, etc. Free list. National Books, Box 11564, Dallas 18, Texas.

HANDWRITING Character analysis self-taught. Free brochure. Lucas, 2419 Sunset Boulevard, Los Angeles 26, Calif.

USED Correspondence courses, educational books. Catalog ten cents. Bayles, 211 Essex, Hackensack, New Jersey.

LEARN Chemistry at home! Earn diploma! First 5 lessons, supplies, \$1.00. National, P.O. Box 606-L, Redwood City, Calif.

TRANSFORM Yourself via subconscious. Free publication. Box 847 (H-6), Ocean Park, Calif.

EARN College degree. Remain employed. Sequoia University, 5625 Melrose, Los Angeles 38, Calif.

ENGINEERING Degrees, EE option electronics earned through home study. Residence classes also available. Pacific International University, 5719-B Santa Monica Boulevard, Hollywood 38, California.

DIPLOMA, Degree correspondence courses, nursing, psychology, science. Aureba, Central Valley, New York.

TEST Preparation for Civil Service careers. Write: N.T.S., Box 873, Greenwich, Connecticut.

LEARN To swim. Teach children. Safety precautions. Reduce and develop body. Exercises included. \$2.00. Swimming, Del Mar 1, Calif.

USED Correspondence courses, books, music bought, sold. Gibbs, 312-B W. 11th, Amarillo, Texas.

PLAYS, STORIES, MANUSCRIPTS

WANTED: Book manuscripts, all subjects considered. Greenwich Book Pub., Attn. Mr. Zealand, 489 Fifth Ave., New York City.

WANT Your book published? Learn how we publish, advertise, promote, distribute. Many successes. Free booklet PM. Vantage, 120 West 31, New York City.

CARTOONING, COMMERCIAL ART, SHOWCARD & SIGN PAINTING, TATTOOING

CARTOONISTS—Art students: Talented? Do you know how and where to sell your drawings? Can you pay \$26.75 for professional coaching? Write to Cartoons-of-the-Month, Roslyn, New York.

NEW YORK Cartoon News complete cartooning course. Twelve lessons, one each month. Gagwriter's markets. Features galore. Three months \$1.00. Sample copy free. 123-35 82 Road, Kew Gardens 13, New York.

"HOW To Make Money With Simple Cartoons." A book everyone who likes to draw should have. It is free; no obligation. Simply address Cartoonists' Exchange, Dept. 95, Pleasant Hill, Ohio.

AMAZING Sign system. Earn while learning. Straley, 410 S. Western, Springfield, Ohio.

YOU Can entertain with chalk talks. Catalog 16¢. Balda The Cartoonist, Oskosh, Wis.

LEARN Sign painting at home. Free talent test. Ben Kerns, Box 812-PM, Greenville, S.C.

TATTOOING Outfits, licensed course. Brochures 25¢. Zeis, 728 Leslie, Rockford, Illinois.

BASIC Art training at home. New plan. Free talent test. Students' Art Club, Kennebunkport, Maine.

ADVERTISING AGENCIES, LETTER WRITERS, FOR ADVERTISERS

ADVERTISING. Result-getting ads prepared, placed newspapers, magazines, radio, anywhere! Lowest rates. Catalogue free. Baker Advertising Agency, 189 W. Madison, Chicago 2.

MAILING Lists most any classification \$5.00 1000. Your circulars mailed with ours \$4.00 1000. Write for our literature. Dixie Mailers, King, N. C.

BEFORE Advertising—Get instructive Ad-Guide and newspaper-magazine rate-book, free. Chicago Advertising Agency, Chicago 4.

WANT More business? Here's an amazing opportunity to increase your sales. Talk to thousands of interested readers of "Mechanica Popular." Our Spanish Edition covers the Latin American countries like a blanket. They're real mailorder buyers. Classified rate 75¢ per word. Try an ad in our next issue. Classified Advertising Department, Popular Mechanics Magazine, 200 East Ontario Street, Chicago 11, Ill.

RUBBER STAMPS AND OFFICE SUPPLIES

3-LINE Business-size \$1.50. Pocket stamp \$1.00. Seeburgers, Rubber Stamps, Palmyra, Mich.

FOUR Lines \$1.00 postpaid. Self-inking pocket stamp. Fast service. California Jack, 965 Weber, Pomona, California.

3 LINE, Cushion base, indexed, \$1.00. Brower Specialties, Box 11, Sandwich, Ill.

8 HOUR Service. 3 lines \$1.00. Guaranteed. Bassler, Ludlow, Mass.

QUALITY Rubber stamps! Distinctive lettering. 3 lines \$1.00. Prompt service. Money-back guarantee. Campfeld, 14 Beaufort Circle, Springfield 4, Mass.

THREE Lines, pocket case, pad \$1.00. Colford, 1610 Rucker, Everett, Wash.

RUBBER Stamps. Complete line. Free catalog. Weymouth Rubber Stamp Co., North Weymouth 91, Mass.

TYPEWRITERS, DUPLICATORS, OFFICE DEVICES

RECONDITIONED Typewriters. duplicating, printing devices. \$25.00 up. Supplies. Appliances. DixieGraph, King, N. C.

EARN \$10.00 Recommending purchasers. Remington typewriters. Payable \$1.00 weekly. Sax, #200 Allen, New York City.

PORTABLE Mimeograph! Carriable. The newest, cleanest, smallest and cheapest spirit machine. Weight 15 pounds. DuPont Distributors, Box 695, New York 1, N. Y.

PRINTING, MULTIGRAPHING, MIMEOGRAPHING, GUMMED LABELS

TOP Quality printing, mimeographing. Free literature. Currier, PM, New Lebanon Center, N. Y.

CATALOG Free. Distinctive printing. Reasonable prices. Vosacek Printing, 4444 Ute, San Diego 17, Calif.

ECONOMICAL Printing of books, catalogs, publications. Catalog free. Adams Printery, 30 West Washington, Chicago 2, Illinois.

MIMEOGRAPHING—Letters, pricelists, formulas, instructions. Lowest prices. Lem's Letter Shop, 5710 Stanton, Detroit 8.

FREE Catalog business, personal printing. D.M. Press, Sebastopol, California.

OFFSET Printing—\$6.50 1000, 8 1/2 x 11, 16 lb. National Letter, 251 W. 42 St., New York City 36.

100 BUSINESS Cards \$1.00. Print Shop, 1418 Broadway, Rockford, Illinois.

BUSINESS Printing, rubber stamps. Free catalog. Brose, 196 Clerk Street, Jersey City 5, N. J.

MIMEOGRAPHING. Reasonable rates, prompt service. Free pricelist, samples. Mimeo, Box 40-B, Adelaide Street Station, Toronto 1, Canada.

1000 NAME And address gummed labels, quality printed, 3 lines \$1.00. Guaranteed. No c.o.d. Print clearly. Castle Company, 10509 Voltaire Ave., Oakland 5, Calif.

1000 CARDS—\$2.95. Booklet, circular printing. Samples. Morey's B94, Redwood City, Calif.

YOUR Name and address labels 500—\$1.00. Quick. Guaranteed. Houghton's, Irving, Massachusetts.

GOOD Printing, offset, engraving, quality letterheads, envelopes, circulars. Low prices. Pleased customers everywhere. Investigate! Bryce Service, 903D Griswold, Port Huron, Michigan.

BEAUTIFUL Luxury printing. Different. Free samples. Aladdin, 6735 Del Rio, Houston, Texas.

PRINTING, Advertising. Small budgets invited. Moore, 5735 Market, Philadelphia 39, Penna.

PERSONALIZED Name and address stickers. Roll of 500 1/2" x 1 1/4", \$1.00. Airmailed immediately \$1.25. Alexander, Box 474, Pomona, California.

1000 RAISED Letters business cards \$3.50. Samples. Pioneer, Island Park 17, New York.

500 3-COLOR Printed name-address labels, 5/8 x 1 1/2. Light blue, dark blue, gold. Plastic case. Send \$1.00. Schuster, Box 1419, Dept. PM, Springfield, Ill.

5000 3x6 BOOKPAPER Circulars \$11.00. Estimates, anything! Lonelm, Paulding, Ohio.

SPECIALIZING Letterheads, typewritten form letters, bulletins. Samples: Chelsea, Box 4211 North, Winston-Salem, N. C.

AMERICA'S First discount printing catalog free! Better-looking business cards, free case, 1000 postpaid \$3.49. No c.o.d.s. Discount Printing Center, 1116-F National Press Building, Washington 4, D. C.

1,000 NAME-Address labels \$1.00. ABC, Box 849, San Francisco 1, California.

1000 BUSINESS Cards with free card case, raised printing on new white thin-plate stock, black or blue ink, \$5; combination of red and black or red and blue ink, \$7.50. Postage paid anywhere in U. S. Check or money order to King's Press, 567 Weybosset St., Providence, R. I.

100 BILLHEADS \$1.00, 500—\$2.75, 5 1/2 x 5 1/2, postpaid, printed your copy. Spaulding Press, Bethel, Vermont.

PRINTING By mail—Send 10¢ for catalog and samples. United Mail Order Service, Box 646, Elyria, Ohio.

500 NAME And address printed gummed labels, 3 lines \$1.00. No c.o.d.s. Print clearly. Addison PM-6, 1840 Addison, Chicago 13.

DISPLAY Circulars, postcards. Free samples. Golden Rule Press, Woodbridge, Va.

100 NOTEHEADS (5 1/2 x 8 1/2) 60¢. Postpaid. Samples? Wong, 966 Hoc, New York City 59.

150 LETTERHEADS 8 1/2 x 11 Bond. 150 envelopes 6 3/4 postpaid \$3.00. Farlie, Box 2501, San Antonio, Texas.

100 LETTERHEADS, 8 1/2 x 11. Water-marked, and 100 6 3/4 envelopes, carefully printed. \$2.00. Postpaid. Race Printers, Hudson, New York.

PRINTING OUTFITS AND SUPPLIES

PRINTING Presses, type, supplies, lists 3¢. Turnbaugh Service, Mechanicsburg, Penna.

MAKE Your own self-molding rubber stamps and printing cuts. Pixirubber, Argyle 1, Wisconsin.

OFFSET Press! Prints 20,000 copies, in colors! Build from scrap! Instructions, \$2.00. National, P.O. Box 606-L, Redwood City, Calif.

RUBBER Stamp making presses, hydraulic operated, electrically heated. Sizes 5"x3", 8"x12", 10"x15" starting outfits. All kinds supplies. Custom Manufacturing, 601 N. Jefferson, Springfield, Missouri.

DO Your own printing. Save money. Simple rules. We supply everything. Print for others; good profit. Raised printing like engraving too. Have home shop. Details free. Kelsey Presses, V-11, Meriden, Connecticut.

PRESSES, Type cabinets, supplies. List for stamp. Lincoln Press Company, 220-F Hartwell, Fall River, Mass.

PATENT ATTORNEYS

MECHANICAL Skill alone is not enough to entitle you to patent protection; your invention must clearly show your exercise of the inventive faculties. As patent attorneys we feel better qualified than the inventor to recognize patentable invention. Sketch and describe your invention. Sign, date and have this disclosure witnessed by two people who are capable of understanding your invention. Have us make a preliminary search among U. S. patents already granted for similar types of invention. We report on the probable patentability of your invention and recommend your further course of action. Write for our instructive booklet, "Patent Protection for Inventors" and convenient "Evidence of Invention" disclosure form. Victor J. Evans & Co., 331-G Merline Building, Washington 6, D. C.

PATENTS—Irving L. McCathran, 515 McLachlan Bldg., Washington 1, D. C. Registered Patent Attorney.

INVENTORS—If you believe you have an invention, you should find out how to protect it. The firm of McMorro, Berman & Davidson with offices in Washington, D. C., is qualified to take the necessary steps for you. Send for copy of our patent booklet "How to Protect Your Invention." We will also send you an "Invention Record" form. No obligation. They are yours for the asking. McMorro, Berman & Davidson, Registered Patent Attorneys, 134-X Victor Building, Washington 1, D. C.

INVENTORS: Learn how to protect your invention. Unless the inventor is familiar with patent matters, he should engage a competent registered patent attorney or agent to represent him. We are registered to practice before the U. S. patent office and prepared to serve you in handling your patent matters. "Patent Guide for the Inventor" containing detailed information concerning patent protection and procedure with "Record of Invention" form will be forwarded to you upon request—without obligation. Clarence A. O'Brien & Harvey Jacobson, Registered Patent Attorneys, 715-D District National Building, Washington, D. C.

INVENTORS: Without obligation, write for information explaining the steps you should take to secure a patent. John Randolph, Registered Patent Attorney, 203 Columbian Bldg., Washington 1, D. C.

INVENTION Record form free and "Patent Information Every Inventor Should Have." Carl Miller, Registered Patent Attorney, Woolworth Building, New York.

INVENTORS: When you are satisfied that you have invented something of value, write me, without obligation, for information as to what steps you should take to secure a patent. Write Patrick D. Beavers, Registered Patent Atty., 935 Columbian Bldg., Washington 1, D. C.

C. A. Snow & Co.—M427, Snow Building. Washington 1, D. C. Registered Patent Attorneys. Write for information.

REGISTERED Patent attorney offers services. Sanders, 6430 Evans, Chicago 37, Illinois.

PATENTS. "Proof of Invention" free. E. E. Vrooman, Registered Patent Attorney, 507 McKim Building, Washington 5, D. C.

"INVENTOR'S Guide" and "Record of Invention" free on request. Frank P. Ledermann, Registered Patent Attorney, 154 Nassau Street, New York City.

FOR INVENTORS

INVENTORS—If you believe you have an invention, you should find out how to protect it. The firm of McMorrow, Berman & Davidson with offices in Washington, D. C., is qualified to take the necessary steps for you. Send for copy of our patent booklet "How to Protect Your Invention." We will also send you an "Invention Record" form. No obligation. They are yours for the asking. McMorrow, Berman & Davidson, Registered Patent Attorneys, 134-W Victor Building, Washington 1, D. C.

INVENTORS—This firm is registered to practice before the United States Patent Office and available to assist you in the preparation and prosecution of your patent application. "Patent Protection for Inventors" booklet containing detailed information and steps to take toward patent protection sent promptly upon request. No obligation. Victor J. Evans & Co., 332-G Merlin Building, Washington 8, D. C.

IDEAS. You develop. Illustration \$1.00. Inventions, Box 64, Buena Park, California.

"INVENTOR'S Guide" tells what you need to know before going to expense of patents. Send \$2.00 for helpful book. How to protect, profit from inventions. Manufacturers contact us. Inventors Creative Service, 354 So. Spring St., Los Angeles 13, Calif.

INVENTORS Assistance. forty years service. Write American Commercial Men's Association, Box 642, Evanston, Illinois.

INVENTORS—Send for free patent information book and inventor's record. Registered Patent Attorney, Associate Examiner. Patent Office 1922-29, Patent Attorney & Advisor, Navy Department 1930-47. Gustave Miller, 67A Warner Building, Washington 4, D. C.

INVENTORS: Test the commercial value of your patented or unpatented inventions, quickly and inexpensively. Write for free information. Institute of American Inventors, Dept. 40-B, 635-F St., N.W., Washington 4, D. C.

INVENTORS. Don't sell your invention patented or unpatented until you receive our offer. Write Cowgill, Box 298, Marion, Ohio.

INVENTORS! Have you good, patentable ideas? Write Mr. Metzler, 11 West 42nd Street, New York City.

PATENT Searches \$5.00. 48-hour airmail service. Invention protection forms free. Write Patent Engineering Service, 711 14th Street N. W., Washington 5, D. C.

INVENTION Record form free and "Patent Information Every Inventor Should Have." Carl Miller, Registered Patent Attorney, Woolworth Building, New York.

PATENT Searches \$5.00. 48-hour service. Free invention protection forms. Write Raymond L. Smith, Patent Searcher, 620 Sheraton Building, Washington 5, D. C.

SEARCHES—Put your patent searches in the hands of a registered patent attorney or agent, as he qualifies to give a worthwhile patentability report. Record of invention form upon request and information on patent protection. Patrick D. Beavers, Registered Patent Attorney, 836 Columbian Bldg., Washington 1, D. C.

INVENTORS: Information on patent procedure furnished on request, without obligation. John Randolph, Registered Patent Attorney, 202 Columbian Building, Washington 1, D. C.

PATENT Searches. including copies of nearest patents, \$5.00. Reports airmailed within 48 hours. More than 100 registered patent attorneys use my service. For free invention protection forms, write Miss Ann Hastings, P.O. Box 178, Washington 4, D. C.

INVENTIONS And ideas designed for your profit and patented for your best protection at low definite fees. Thirty years experience in developing and patenting inventions in U.S. and foreign countries. Patent searches with valuable report \$15.00. Joseph O'Brien, 132 Nassau Street, New York 38, N. Y.

INVENTORS: Learn how to protect your invention. Unless the inventor is familiar with patent matters, he should engage a competent registered patent attorney or agent to represent him. We are registered to practice before the U. S. patent office and prepared to serve you in handling your patent matters. "Patent Guide for the Inventor" containing detailed information concerning patent protection and procedure with "Record of Invention" form will be forwarded to you upon request—without obligation. Clarence A. O'Brien & Harvey Jacobson, Registered Patent Attorneys, 71A-D District National Building, Washington, D. C.

PATENT Searches. Information and free forms on request. Evelyn B. Surles, P.O. Box 75, Washington, D. C.

INVENTIONS WANTED

MANUFACTURER Wants inventions. Mechanical, electrical, or electronic. Write direct. Laystrom Mfg. Co., 2001 N. Parkside, Chicago 39.

INVENTIONS Wanted immediately for promoting on cash or royalty. Patented, unpatented. Free booklet outlines royalty rates, requirements. Write Kessler Corporation, 561W, Fremont, Ohio.

INVENTIONS Wanted. Patented or patent pending. 26 years experience promoting inventions. National Service Bureau, 3129 Meramec, St. Louis 18, Mo.

INVENTIONS Wanted. Patented; unpatented. Tremendous manufacturers lists. Global Marketing Service, 2420 77th, Oakland 5, California.

SUPERIOR Promotions. Patented; unpatented inventions. Information booklet, free. Superior, 338-344 North Rodeo, Beverly Hills, Calif.

CASH Buyers for inventions. Write National Inventors Institute, Box 7007, Cleveland 28, Ohio.

INVENTORS: Hundreds of manufacturers have requested our assistance in locating marketable new products. Complete information free. Institute of American Inventors, Dept. 40-D, 635-F St. N.W., Washington 4, D. C.

INVENTORS. Don't sell your invention patented or unpatented until you receive our offer. Write Cowgill, Box 298, Marion, Ohio.

INVENTIONS Wanted now by my manufacturer-clients. Patented, unpatented. Write Adams, Patent Broker, 80-B Wall Street, Financial District, New York City.

PATENTS FOR SALE

FOR Sale to an established manufacturer. Machine for stemming gooseberries and currants on cash and royalty basis. Over forty years of perfecting and now ready for the market. Patent applied for. Box 661, Topeka, Kans.

MODELS. MODEL SUPPLIES

BUILD A live steam locomotive! Plans instructions \$5.50. Details free. David Bair, 725 Walden, Winnetka, Illinois.

SHIP Models. Most complete line in New England. Kits, fittings, plans, books, tools, engines, motors. Illustrated catalog 30¢. James Bliss & Co., Inc., Dept. SM, 342 Atlantic Ave., Boston 10, Mass.

BALSA Wood and model aircraft. 40-page catalog 25¢. Sig Co., Montezuma, Iowa.

SHIP Model kits and fittings including clippers, trawler, fishermen, frigates, privateer, radio control tug, etc. Send 25¢ for 1957 catalog. Model Shipways, Box 85, Bogota, N. J.

SHIP Models and yacht supplies complete. Large 68 page catalogue 50¢. Bill Wild's, 510 East 11 St., New York City 9.

POWER Models. Unusual steam gasoline and traction engines, fittings, metals. Comprehensive catalog \$1.00. Chas. Cole, Ventura, Calif.

BUILD Miniature passenger hauling live steam locomotive with file and drillpress. We do machine work, you bolt it together. Catalog 50¢. Little Engines, Lomita, Calif.

SHIP And yacht model fittings: blueprints. Send 35¢ for illustrated catalog listing hundreds of items. A. J. Fisher, 1602-1 Etowah Ave., Royal Oak, Mich.

MANUFACTURING

DESIGNING. Tools, dies, manufacturing. Pro Devco, Box 983, Cincinnati 1, Ohio.

MODELS—Small lot manufacturing. Metals, plastics, etc. Milburn, Burlington, Kentucky.

HOME CRAFTSMEN

STYLECRAFT Sure fire hits. "Pre-traced" leather kits. Handbags, billfolds, filigree belts, over fifty other projects. Patterns on leather. Why trace? Just carve, assemble and lace. Large assortment "precarved" kits also available. Send 25¢ for catalog, free folder. Refunded first order. Apache Leather Company, 3804 E. Washington St., Phoenix, Arizona.

DO-It-Yourself booklets 25¢. 24 subjects. Free catalog. Popular Mechanics Press, 631 N. St. Clair St., Chicago 11.

ALL Crafts, supplies. Large free catalog. National Handicraft, 199 William Street, New York City 38.

WOODWORKING And cabinetmaking course for beginning and advanced home craftsmen. Only complete low-cost home training program available. Write for free booklet. Interstate Training Service, Dept. G-3, Portland 13, Ore.

NEW Catalog 1958 artist-drawn workshop patterns 10¢. Craftplans, 1322 Wabash, Chicago 5.

BUILD Different, exclusive outdoor grill—Easily, economically! Attractive book of designs, plans, instructions, plus fabulous collection outdoor cooking recipes \$1.00. Rostro Specialties, Dept. 677, Coldwater, Michigan.

QUALITY Leathercraft and 16 other crafts at big savings. Send 10¢ for large catalog. Russo Handicrafts, Box 29-D, Los Angeles, California.

LEATHERCRAFT. Send 10¢ for new 76-page catalog of tools, supplies, kits, including metalcrafts, enameling, ceramics, all other crafts. Complete stock. Reasonable. Since 1910. Sax Bros., Dept. PM-4, 1111 N. 3rd, Milwaukee, Wis.

FREE "Do-it-yourself" leathercraft catalog. Tandy Leather Company, Box 791-019, Fort Worth, Texas.

KNOCKDOWN Cedar chests and lumber. Free price list. Bedford Lumber Company, Shelbyville, Tennessee.

LEARN Art metalcraft and jewelry making. Complete, inexpensive, home training course now available. Special tools and materials furnished. Write for free booklet. Interstate Training Service, Dept. L-3, Portland 13, Oregon.

PATTERNS Flying ducks, man sawing wood. Dutch maid churning butter, and 30 lawn ornaments, only \$1.00. Lincoln Studio, Columbia, Conn.

LEATHERCRAFT. Complete illustrated catalog, leathercraft kits, tools, supplies, books. Send 10¢ today to J. C. Larson Co., 820 S. Tripp, Dept. 7127-L, Chicago 24.

LAMP Size cypress knee with nipple installed \$2.00. Cy Products, Dept. 2-L, Lafayette, La.

GRANDFATHER Clock plans, shop tested patterns, dollar. Thousands built. Sturdy weight movements \$39. Order today. Kuempel Clocks, Minneapolis 16, Minn.

LEATHERCRAFTSMEN: Imported and domestic leather, tools, kits, copper. Complete catalog 25¢ refundable. Midas, 7705 State, Huntington Park, California.

I want to send you proof of the wonderful pulling power of Popular Mechanics classified pages. What's your profession? Write me today. Include literature if possible. P. W. Johnson, Manager Classified Advertising, Popular Mechanics Magazine, 200 E. Ontario St., Chicago 11, Ill.

LEATHERCRAFT. Copper enameling, mosaic tile, shellcraft, metal tooling, beadercraft, many more crafts. Free big catalog. Kit Kraft, Dept. 226, Studio City 1, Calif.

89 FULL Size jig saw patterns of beautiful shelves, ornaments, toys, novelties. Plus "How, Where to Sell." Only \$1.00. Mastercraft 64M, 7041 Olcott, Chicago 31, Illinois.

LOUISIANA Cypress knees. Make lamps, etc. \$2.00 each. Cypress, Box 52, Ponchartraine, Louisiana.

KNOCKDOWN Aluminum screen door. You put together and install; only \$15.95. Details write Box 1003, Laguna Beach, California.

BUY Wholesale nationally advertised power, hand tools, thousands other products at big discounts. Free "Wholesale Plan." American Buyers', Hertel Station, Buffalo 18-P1, N. Y.

DO IT YOURSELF

BUILD Your own room, attic fans. Parts list, instructions. Jack's Refrigeration, Letart, W. Va.

MELT Cast iron, brass, aluminum. Make castings for profit. Free literature. Ursutz Burner Co., Box 366-M, Tempe, Arizona.

ROTATE Your own T.V. roof antenna 360°. Simple construction under \$6. Plans \$1. Norig Co., P.O. Box 117, San Francisco 1, Calif.

BUILD Your own hi-fidelity kits. Details. Arkay Dist. Co., P.O. Box 381, Church St. Sta., New York 6, N. Y.

GRANDFATHER Clock movements, blueprints, kits. Wholesale catalog 25¢. Mason-Sullivan, Noroton, Conn.

18 FULL-Size patterns. Save money with easy-to-use, professionally designed full-size patterns. Make money selling beautiful, useful furniture. Make modern step and cocktail tables; metal lamps; cupola; 12-foot outboard. All patterns test-built; sold with money-back guarantee. Get your free list of these convenient, economical patterns today. Popular Mechanics Press, 300-HH E. Ontario Street, Chicago 11, Ill.

BUILD Your own optical instrument! New book—"Fun With Optics" tells you how! 32 exciting pages. Full diagrammed instructions on how to build telephoto lenses, telescopes, microscopes, slide viewers, artist drawing projectors, binoculars, magnifiers, riflescopes, etc. We can furnish the lenses, prisms and parts you'll need. To get this terrific book send your name and address and only 50¢, full price. Request Stock No. 9050-CY, Edmund Scientific Company, Barrington, New Jersey.

MOWER Kits and parts. Also complete mowers. Write for free plans and literature. Triangle Mfg. Co., Dept. M-7, Fort Scott, Kansas.

PICTURES For framing. List 25¢. Foxcrafts, Box 143, Jackson 39, Michigan.

AIR Conditioners, homes, automobile. See Kool Engineering ad page 22.

SEE Yourself as others see you. Record your meals in Queen's dietary diary, "Do-it yourself analysis", 10¢. Recommended by patients of dentists and physicians. Dietary Surveys, 9546 N.W. 12th Ave., Miami 50, Florida.

WATCHES, OLD GOLD, JEWELRY

GOLD, Silver, platinum, diamonds wanted. Cash immediately, highest prices; appraisals made. Wilmot's, 1067 Bridge, N.W., Grand Rapids 4, Mich.

10 WATCHES \$18.00. Minor repairs. Catalog 25¢. Berkwit, 1150 Castle Hill, New York City 62.

WATCHMAKERS'—Jewelers', machinists' tools. Watchmaking course. Catalog 25¢. Bengale, Culver City, California.

HIGHEST Cash for old gold, broken jewelry, gold teeth, watches, diamonds, silverware, spectacles, platinum, mercury, gold coins. Free information. Rose Refiners, Heyworth Building, Chicago 2.

HELBROS Watches, jewelry 70% discount. Catalog 25¢. Dorinda, Huntington Station 7, N. Y.

RHINESTONES, Pearls, costume jewelry supplies. Catalog 10¢. J & M Novelties, Dept. CG-3, Box 173, Broadview, Illinois.

WATCH And clock repairing books. Free catalog. North American, 2320-AP Milwaukee, Chicago 47, Ill.

OLD Gold purchased. Information free. Shonback, 2137 Clement, San Francisco 21, California.

TOBACCO, SMOKERS' SUPPLIES

TRY Tomills tobacco pouch. \$1.00 postpaid. Box 3086, St. Louis 5, Mo.

RAZORS, BLADES, SHARPENING

RAZOR Blades, very good double edge blades, send \$1.00 for 100. Chic Sales, Dept. H, Box 274, Alameda, California.

FOR THE HOME

FOAM Rubber furniture cushions. Factory seconds, 50% discount. Free catalog. Perma-Foam, 236C Rhode Island Ave., East Orange, New Jersey.

ARCHITECT Designed home plans. Free literature. S.&P. Plan Service, 5353 Glenway Ave., Cincinnati 38, Ohio.

RITE—Timer time switch saves money. Turns off attic fans, lights, electric heaters, or motors at any preselected time (15 minutes to 12 hours). Replaces regular wall switch. Installed in a few minutes. Guaranteed. \$11.95 postpaid. Literature on request. Precision Products, Inc., 532 So. Quaker, Tulsa, Oklahoma.

"HOME Improvement Guide." New, amazing 192 page volume. Packed with ideas, plans for remodeling, decorating, landscaping, built-in projects. \$2.50 prepaid. Popular Mechanics Press, 200-HG East Ontario St., Chicago 11.

BEAUTIFY Rugs, upholstery. Guaranteed professional shampoo, 50¢ size does couch, car. Agents wanted. Fab-Rex, 532 Desplaines, Forest Park, Illinois.

SAVE 80% Soap—30% coffee. Enjoy soft water with Century portable water softener. Nationally advertised at \$29.95. Now \$14.95 prepaid. No c.o.d. Satisfaction guaranteed. Age Products, 1027 Atkinson, Milwaukee 6, Wisconsin.

ALUMINUM Roll-up awnings. Door hoods. Prepaid, direct from distributor. Lowest prices. Installation instructions. Barry, Box 815, Manchester, New Hampshire.

BE Your own plumber. You can. Few inexpensive tools and our instructive book, "Home Plumbing Guide," shows and tells you how. Hundreds of photographs and diagrams. Easy to follow. 160 pages. \$3.50. Catalog free. Popular Mechanics Press, 200PG East Ontario St., Chicago 11, Ill.

OF INTEREST TO WOMEN

SELL Fine fabrics. Get yours wholesale. Box 863, Norwalk, Conn.

MAKE New greaseless doughnuts in kitchen. Sell stores. Free recipes. Morgan Ray, 3605 South 15th, Minneapolis 7, Minn.

50% PROFIT Cosmetics \$25 day up. Hire others. Samples, details. Studio Girl-Hollywood, Glendale, Calif., Dept. 1276H.

GROW Mushrooms. Cellar, shed. Spare, full time, year round. We pay \$3.50 lb. We have over 25,000 customers. Free book. Mushrooms, Dept. 138, 2954 Admiral Way, Seattle, Wash.

WANT To make big money at home? \$10.00 profit in an hour possible with invisible mending. Make tears, holes, disappear from clothing, fabrics. Steady year-round demand from cleaners, laundries, homes. Details free. Fabricon, 8352-8 Prairie, Chicago 19, Illinois.

BOOKS: Hundreds of subjects. Big catalog free. Popular Mechanics Press, 200-BC East Ontario St., Chicago 11.

PERSONAL

"RUMPLESTILTSKIN." Papers to sign at Aunt Sallies. Write Mother there.

BORROW Money—By mail. \$100 to \$600 from Postal Finance. Employed men, women easily obtain \$100 to \$600 fast, entirely by mail. Repay in small monthly payments. Friends, relatives, employer, tradespeople will not know you are applying for loan. Advise occupation, amount wanted. Postal Finance Company, 200 Keeline Bldg., Dept. 7-K, Omaha, Nebr.

MAKE Money selling our graphology charts. Carnivals—Mailorder. Details, sample 25¢. Ben Kandel, Eatonton, Georgia.

BARTENDER? Great new item. More, bigger tips first day. Send name. Ransom Sherman Enterprises, P.O. Box 3190, Hollywood 28, California.

BIBLE Questions answered. Stamped envelope. Bylon, 17167 Bentler, Detroit 19, Michigan.

SIMPLE Television repairs. Marvelous booklet 25¢. Free catalog. Popular Mechanics Press, 633 N. St. Clair St., Chicago 11.

ENJOY Health. Free booklet. Ruth's Nutrition, 152 Kearny, PM, San Francisco, Calif.

"HOW Can I find out?" You can! Information confidentially developed. Any matter, person, problem. Worldwide. Officially licensed. Established 1922. William Herman, 170 Broadway, New York City.

BOOKS: Hundreds of subjects. Big catalog free. Popular Mechanics Press, 200-BC East Ontario St., Chicago 11.

PHOTOSTAMPS—Your photo on stamps, 100 for \$2.00. Samples free. Alcor's, 2005 Bergenline, Union City, N. J.

REMAILING SERVICE

REMAINS Air 35¢. Confidential monthly \$3. Walter, 3916 St. Zotique, Apartment One, Montreal, Canada.

SECRET Mail receiving, forwarding system. \$3 month. Hedgpeh, Box 830, Alhambra 23, California.

REMAILING: 25¢ Regular, 35¢ air mail. Surprise your neighbor! Bobbie Johnson, Chatham Apts. #9-O, Savannah, Georgia.

AIR Remails 35¢. I affix stamps. Confidential mailing \$3 monthly. This is permanent address. Ross Hancock, 83 Belhaven Rd., Toronto 6, Canada.

CALIFORNIA'S Favorite vacationland! Remails 25¢. 6 for \$1.00. Box 400, Santa Cruz, California.

COLUMBUS Mail forwarding-receiving address for rent. Details free. William McLaughlin, 800 Stewart, Columbus 6, Ohio.

BARRANQUILLA, Colombia. South America—Letters remailed 25¢. Viewcards. T. P. Dann, 78-30, Carrera 51B, Barranquilla, Colombia.

NEW Zealand remails. Thermal and fishing Eidorado. Re-airmails \$1.00. Hope, Box 3267, Auckland, New Zealand.

NORTH Bay, Canada, sportsmen paradise. Remail 35¢. Worthwhile fishing, hunting information \$1.00. Walter, 159 1st Ave. W., North Bay, Ont., Canada.

LETTERS Remailed 25¢. Monthly rates. Korsi, Box 7852, Kansas City 28, Mo.

HOLLYWOOD Remails 25¢. Forwarding \$2.00 monthly. Dictor, 1234 N. Hayworth, Hollywood 46, California.

MIAMI Address \$3.60. Information, Box 122, Miami 51, Florida.

HONOLULU Remailing 25¢. Receiving-forwarding available! Write: Fobel, 3132-J George Street, Honolulu.

LAS Vegas: Remails 25¢. Postcards only 10¢ each. William Post, 1479 South Seventh, Las Vegas, Nevada.

TREASURE FINDERS

URANIUM Finding made easy! High efficiency, low cost transistorized geiger counters. Extremely sensitive and lightweight. Scientifically engineered. Unconditionally guaranteed. Free information. Universal Atomics, Dept. PM37, 143 East 49th Street, New York City.

INDICATOR, Locates uranium, buried money, minerals. Price \$25.00. Dirt samples tested free for oil. Horton's Surface Oil Survey, Belle Rive, Illinois.

TREASURE Locator plans, \$1.00. Art Howe, 811 Kansas, Atchison, Kansas.

FORTUNES For the taking. Gold, silver treasures. Light weight, guaranteed, power-packed metal detectors. Kits and assembled models from \$39.90. Geiger counters and mineralights. Free literature. Electronic Applications, Dept. M, Box 8, Arlington 10, Virginia.

FREE—16-Page manual from world's largest mfr. of prospecting equipment. Detector Corp., 3528 Vineland Ave., North Hollywood, California.

FIND Buried treasure, gold and silver, with Goldak's sensational 3½ lb. "find-it" locator, only \$49.50. Write for free literature on complete line of mineral, metal locators; Geiger and scintillation counters. Goldak, 1541 W. Glenoaks Blvd., Glendale, Calif.

TREASURE Map, 17x22, in color. 50 lost mines and treasures. Data and clues to their location. Ideal for framing. \$1.50. Prospector Milt, 3915 Lamont, San Diego 9, California.

FOR Treasure locators, geiger, scintillation counters, mineralights, M-Scope. Fisher Research Laboratory. See advertisement page 32.

FOR SALE—MISCELLANEOUS

SMOKERS. Free literature on Missouri Meerscham pipes. Ed. Locke, Lac du Flambeau, Wisconsin.

HEARING Aid batteries, wholesale. Free list. Haba, Box 51, York, Penna.

WANTED—MISCELLANEOUS

OLD Cabinetmakers tools, before 1875, any condition. Arthur Cantor, 1264 Rhineland Avenue, Bronx 61, N. Y.

SCRAP Mercury (quicksilver) containers supplied — Tantalum, tungsten, silver, platinum. Metallurgical Products Company, Established 1909, 35th & Moore Sts., Philadelphia 45, Penna.

QUICKSILVER. Sterling, silver solders, precious metals. Wholesale Terminal, Norwood, Massachusetts.

OLD Wireless gear, radio sets, radio tubes. Geo. Delaplaine, Box 861, New Brunswick, N. J.

MISCELLANEOUS

LEATHER Jackets refinished like new. Choice of colors, Nero brown, cordovan, black. Write E. P. Dotson, 5 School St., Peabody, Mass.

YOUR Name wanted for huge mailing list of imported products. Send 25¢. Import Co., Sta. A, Box 284, Bakersfield, California.

FREE Stubborn drawers, doors and windows with amazing new discovery. Last indefinitely. Satisfaction guaranteed. \$1.00 postpaid. Magic-Slide, 2349 N. W. 62nd St., Miami, Florida.

SAMPLES—Magazines, catalogs, opportunities. Year 25¢. American Directory, Leming, Texas.

MAKE-UR-Own-exterminator. Gets flies, moths, mosquitoes, all flying insects. Instructions—\$1.00. G. F. Dennler, Juliaetta, Idaho.

CIGARETTES—Improved roller makes 20 for 9¢. Facts free. Moberly, Box 820, Owensboro, Kentucky.

70 BIBLE Lessons, 25¢. Bulletin, Box 87, Cathedral Station, New York City 25.

YOU Can teach your child to swim. Instruction booklet \$1.00. Swimming, Box 1222, Memphis, 1, Tenn.

10¢ COMIC Books 5¢. Details free. Box 1647, Uniontown, Penna.

LEARN While asleep! Details free. Research Association, Box 610-MC, Omaha, Nebraska.

BOOKS: Hundreds of subjects. Big catalog free. Popular Mechanics Press, 200-BC East Ontario St., Chicago 11.

FRESH Kodak Film, 3 rolls \$1.00. Sizes 620, 120, 127. Guaranteed. PicSure, Box 299-M, Philadelphia, Penna.

GROW Mushrooms. Cellar, shed. Spare, full time, year round. We pay \$3.50 lb. We have over 25,000 customers. Free book. Mushrooms, Dept. 173, 2954 Admiral Way, Seattle, Wash.

I Want to send you proof of the wonderful pulling power of Popular Mechanics classified pages. What's your proposition? Write me today. Include literature if possible. F. W. Johnson, Manager Classified Advertising, Popular Mechanics Magazine, 200 E. Ontario St., Chicago 11, Ill.

JAPAN: Gifts by mail. Kimonoes, lighters, pictures, jackets, toys, novelties, etc. Business information, \$1.00. Send money orders. Clarence Yamaguchi, Room 202, Naka 7, Bldg., Marunouchi, Tokyo.

CLOGGED Drains, cesspools and septic tanks cleaned by new powerful chemical. Sursolvent removes grease, soap, tree roots, etc., without expensive digging and electric rodding machines. No pumping necessary. Mix with water and pour down drain. Free details. Electric Drain Cleaning Co., Boston 34, Mass.

10 BALL Pens, full-view, \$1.00, retractable pen 25¢. Nucleus, 2440 Amsterdam Ave., New York City 33.

CYPRESS Knees, \$5.00 dozen up. Details. Gipple's Giftwares, DeLeon Springs, Florida.

INTRODUCTORY Offer: "Vitamins 22" \$2.00 size—\$1.00. Donte Chemical, Great Neck 17, N. Y.

STUPENDOUS Mental power. Adults. Details—3¢. Wisdom, 846 Sunnyside, Chicago 46.

GERMAN Address lists! Anything manufactured, 25¢. Burke Associates, Manchester, Mass.

REMODEL Your own home. Save hundreds of dollars. New, amazing book shows you how. Written so you can understand it. Step by step instructions make it easy. Fully illustrated, 400 photographs, hundreds of diagrams, 160 pages. \$2.95. Literature free. Popular Mechanics Press, 200-RH East Ontario St., Chicago 11, Ill.

PUZZLE Hobbyists: Legitimate contest helps. Allowable in all contests. Unique treatise \$1.00. Refundable. Unique, Box 99, Mt. Vernon, Ill.

FREE! "\$3,000 Yearly Sparetime. Backyard, Raising Earthworms!" Oakhaven-49, Cedar Hill, Texas.

HOW To remodel, basement, attic. Booklet 25¢. Free catalog. Popular Mechanics Press, 635 N. St. Clair St., Chicago 11.

RECEIVE Magazine samples, mails, catalogues, offers from everywhere. Get listed 25¢. Rorick, Cincinnati 26, Ohio.

YOUR Name wanted. We'll send 1000 publishers, mailers, wholesalers your name, on our list one year 25¢. Dixie Mailers, King, N. C.

18 FULL-Size patterns. Save money with easy-to-use, professionally designed full-size patterns. Make money selling beautiful, useful furniture. Make modern step and cocktail tables; metal lamps; cupola; 12-foot outdoor. All patterns test-built; sold with money-back guarantee. Get your free list of these convenient, economical patterns today. Popular Mechanics Press, 200-HH E. Ontario Street, Chicago 11, Illinois.

BEAUTIFUL Portraits done in oils from photographs. Very reasonably priced. Free particulars. Elmer Brunow, 2452A No. 17 St., Milwaukee 6, Wisconsin.

WANT More business? Here's an amazing opportunity to increase your sales. Talk to thousands of interested readers of "Mechanica Popular." Our Spanish Edition covers the Latin American countries like a blanket. They're real mailorder buyers. Classified rate 75¢ per word. Try an ad in our next issue. Classified Advertising Department, Popular Mechanics Magazine, 200 East Ontario Street, Chicago 11, Ill.

250 POWER



Complete Telescope Lens Kit only \$3.49 postpaid

Conquer Space, Explore the Universe, Planets, Moon Craters, New Stars, etc. Complete Lens Kit consists of 80 inch focal length ground and polished objective lens, eyepiece lenses for 50 POWER, 100 POWER, 150 POWER, 200 POWER, 250 POWER, and all necessary lens fittings. Easy to make from simple step by step instructions. (Trim and mount not included.) Money back guarantee.

BUSSE SALES CO., Hartford, Conn., Dept. PM 58

FRANCHISES Learn about the big profit field! Opportunities everywhere for distributors, dealers, agency operators. Write today for interesting letter giving free details.

NATIONAL FRANCHISE REPORTS, C-528, 333 N. Michigan, Chicago 1

college graduates get ahead faster!

You see it in your own city. They have higher incomes . . . advance more rapidly. Grasp your chance for a better life. Industrial growth . . . automation . . . technical advances create career opportunities for engineers, accountants, management experts. Share rewards awaiting college-trained men. Important firms visit campus regularly to employ Tri-State College graduates. Start any quarter in this world-famed college. Approved for veterans.

Bach. of Science degree in 27 months

In Mechanical, Civil, Electrical, Chemical, Aeronautical, Radio (TV-Electronics) Engineering. In 26 months a B.S. in Business Administration (General Business, Accounting, Motor Transport Management majors). Superior students may accelerate, 36-week course in Drafting. *Intrinsic* program: technical fundamentals stressed; comprehensive course with more professional class hours. Small classes; personalized instruction. Enrollment limited to 1500. Preparatory courses. Beautiful campus. Well-equipped, new and modernized buildings and laboratories. Enter June, Sept., Jan., Mar. Earnest, capable students (whose time and budget require accelerated courses and modest costs) are invited to write Jean McCarthy, Director of Admissions, for catalog and book "Your Career in Engineering and Commerce."

TRI-STATE COLLEGE

467 College Avenue . . . Angola, Indiana

LAWRENCE WELK says:

"I Got My Start in MUSIC This 'TEACH-YOURSELF' Way"

NOW it's easy to learn to play ANY instrument the same way famous TV Star Lawrence Welk did! No boring exercises. Even if you don't know a single note now, we'll have you playing delightful pieces **RIGHT AWAY**—right from your **FIRST** lesson! Simple as A-B-C. Make amazing progress. No special "Talent" needed. Learn at home in spare time, without a teacher. Only few cents per lesson. Soon you can play any piece you wish. 900,000 students. (59th successful year.)

WRITE FOR 36-PAGE ILLUSTRATED FREE BOOK—Just send this ad, with your name and address filled in below to **U. S. School of Music, Studio A306, Port Washington, N. Y.** (No obligation; no salesman will call.)

Name _____

Address _____

Get these **BIG NEW** **POPULAR MECHANICS** **BOOKS** at your newsstand

**WORTH MANY TIMES
THEIR PRICE... in fun...
...in money-saving ideas!**

LAWN AND GARDEN BOOK. Give your home a beautiful setting. This new PM book makes it easy! Features many valuable ideas and tips on landscaping, grading, drainage, soil testing and conditioning, lawns, flowers, vegetables, maintenance. Well illustrated, with a unique 32-page Buyer's Guide of Garden Tools and Power Mowers. 192 pages, 75¢.

HOW TO TEMPT A FISH. Must reading for every angler, whether you're an expert or just beginning. Contains scores of action shots, 16 pages in glorious 4-color and instructions from eminent authorities in the field on all forms of fishing and their best techniques. You'll read, too, of what equipment to use and where to fish. 144 pages, 75¢.

HOT ROD HANDBOOK. All about this popular sport and hobby. Gives you eyewitness, inside accounts of leading drag races; championship hot rods; how to build your own dragsters; how to hop-up 1957 engines; and—for the first time anywhere—a complete directory of U.S. speed shops. 160 pages, 75¢.

HOW TO MODERNIZE HARDWOOD FLOORS. Renovation of scuffed, soiled, old hardwood floors is made easy with this new PM booklet. 32 pages, 25¢.
HOW TO MODERNIZE WALLS AND CEILINGS. Ideas and instructions for modern treatments of walls and ceilings in PM's famous tell-and-show style. 32 pages, 25¢.

ASK FOR THEM TODAY!

BARGAINS

Lists Every Month Hundreds of Terrific Buys in—

• BANKRUPT, Closeout, Surplus Goods • New and UNUSUAL items • WHOLESALE SALE ITEMS • BELOW WHOLESALE •



Sources of 100,000 items wholesale • Bare Money-Makers opportunities • HUNDREDS of TERRIFIC offers in Toys, Books, Household Goods, Jewelry, Greeting cards, etc. • SAMPLE BARGAINS • Famous \$10.00 Perfume at 60¢ • 50¢ boxes Everyday, Xmas cards, 7¢ box • \$1.00 toys, 20¢ • \$1.05 silk ties, 12¢pc • Pencils, 99¢ gross • \$17.50 talking dolls at \$7.50! PLUS MANY, MANY OTHERS!!

\$1.00 Buys 6 Big Issues—1 Yr. \$2. Reg. Price \$3 year. Spec. Limited time offer to get 10,000 new subscribers. The only magazine of its kind published!

FREE! FREE! With every 1 year Sub. to "Bargains" you get the new 1957 "BUY IT WHOLESALE" Buying Guide—practically gives you sources of 100,000 items wholesale! Scores of Wholesale Bargains, closeout offers, jobbers lists, etc. Many helpful articles on making money. Thousands of copies being sold at \$1.00 each. Yours FREE with every 1 year subscription to Bargains! (No free copies with 6 mo. subscription—just 1 year subscriptions.)

TOWER PRESS, INC., Box 591 DDX, Lynn, Mass.

TASOPE PHOTO-ENGRAVING PLANTS



Material Cost of This Cut 3/4¢ Selling Price \$1.00 And Up

Establish your own profitable **PHOTO-ENGRAVING** business. Make cuts for newspapers, printers, and advertisers. Make etched name plates, plaques etc. Instructions furnished, no experience necessary. Sold direct from factory since 1931. First five hundred cuts sold locally or by mail will pay for plant and pay you well for your time. Write for FREE catalog.

TASOPE, DEPT. PM-6, AURORA, MO.

Own and Play the ACCORDION

for fun...for popularity...for profit!

5 DAY FREE TRIAL

SAVE UP TO 50% on famous ITALIAN MAKES

Buy direct at amazing savings from America's biggest importer of fine Italian made accordions. **5 DAY FREE TRIAL!** Easy Terms. Free Lessons—Easy to learn. Personalized selection service. Trade-ins accepted. Write today for big Color Catalog and our low wholesale prices. FREE! Accordion Manufacturers & Wholesale Outlet

2003 West Chicago Avenue • Dept. R-67 • Chicago 22, Illinois

100 BEST Woodworking Projects



SELECTED FOR YOU BY POPULAR MECHANICS EDITORS Enjoy the fun—the pride—of making things. Get 100 BEST WOODWORKING PROJECTS, complete with simplified instruction, plans, diagrams and more than 400 how-to-do-it pictures. Make all kinds of furniture, baby carriages, cradles, lamps, book shelves, fireplaces and other useful articles at little or no cost. Send only \$2.00 with name and address. Money back if not pleased.

POPULAR MECHANICS PRESS, Dept. 657, 200 E. Ontario St., Chicago 11

DRAINS cellars, cisterns, wash tubs; \$7.95



Up to 2,000 GPH; 450 GPH 80' high; or 1800 GPH from 25' well. Use 1/6 to 3/4 HP motor. Coupling included free. 1/2" inlet; 3/4" outlet. Stainless steel shaft. Won't rust or clog. Type P—\$7.95.

CELLAR DRAINER KITS (less motor)
"Low Boy"—15" high, 1500 GPH.....\$12.95
"High Boy"—32" high, 3,000 GPH.....\$8.95
Postpaid if cash with order. **MONEY BACK GUARANTEE**
LABAWCO PUMPS, Belle Mead 7A, N. J.

Secrets of VENTRILOQUISM Now Revealed!



Easy to learn in 60 to 90 days with our Home Study Course. **RESULTS GUARANTEED.** Make Money! Be Popular! Have Fun! Big Opportunity! Radio, Television, Stage, Appearance! For FREE information regarding price and terms WRITE: You must state your age. Dummy Catalog 25¢.
MAHER HOME COURSE OF VENTRILOQUISM
Box 36, Studio E, PM-6, Kensington Station
Detroit 24, Michigan

ARTHRITIS—RHEUMATISM VITAL FACTS EXPLAINED

FREE DESCRIPTIVE BOOK

How crippling deformities may be avoided. This amazing FREE BOOK explains why ordinary methods give only temporary relief—if that. Describes a drugless method of treatment successfully applied in thousands of cases. Write for this 30-page FREE BOOK today. No obligation.
BALL CLINIC, DEPT. 756, EXCELSIOR SPRINGS, MO.

NEW SURPLUS

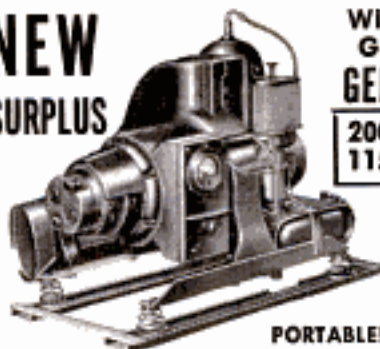

WISCONSIN 4-CYCLE Gas Engine Driven GENERATING PLANT

2000 WATT, 60 Cycle, 115 Volt, Single Phase

Only \$219.50 fob

GOV'T. COST \$500.00

FULL 1-YEAR GUARANTEE

PORTABLE!—fits easily in car trunk!

PAYS FOR ITSELF! Saves time, labor and money. Provides on-the-spot power for CONSTRUCTION, etc., where none is available or expensive to run in. Large enough for Floodlights! Saws; Pumps; and many more labor-saving heavy-duty machines. Ideal as a stand-by emergency power plant to duplicate house current. Plenty of power for lights, refrigerator, deep freeze, oil burner, radio, etc. Specifications below. CAN'T BE MATCHED anywhere at this price!

GENERATOR 2000 Watts, 115 Volts, 17.3 AMPs., 60 Cycle, single phase. Overload capacity well above its rated output. Excellent automatic voltage regulation plus Field Rheostat for even closer adjustment. Built-in Voltmeter and receptacles.

ENGINE Famous WISCONSIN 5.6 H.P. air cooled engine, 4-cycle. Weather proof high tension magnets with impulse coupling for quick easy starting in any weather. Mechanical Flyball governor. Adjustable carburetor with automatic choke release. Timken roller bearings—self cleaning.

Weights 155 lbs. Over-all dimensions: 29" long, 19" wide, 20" high

SUPPLY LIMITED! IMMEDIATE DELIVERY! ORDER FROM AD

FREE WAR SURPLUS—WHOLESALE CATALOG

ROBERTS ELECTRIC CO. Dept. PM-615 849 W. Grand Ave., Chicago 22, Ill.



... MAKE BIG MONEY WITH RAINBOW ROCK

... world's most beautiful slump brick. Cuts building costs by one-third. Sell all you make to contractors, supply houses, others. Needs no special skill. Operates indoors or out from common electric socket. Protected franchise. We help you start. Write for FREE facts.

Praised by architects, builders. Makes inside, outside walls, fences, porches, fireplaces.

GENERAL ENGINES CO., INC.

Dept. MR-67 Route 130, Thornfare, N. J.

PREPARE FOR BETTER JOB, BIGGER PAY IN SPARE TIME AT HOME

Today, choose the job you want—and prepare for it in time you might otherwise waste. Or if you are already in the work you like best, start training now for quicker promotion and increased pay. During the past 60 years AMERICAN SCHOOL has helped ambitious people to reach higher goals. Check subject that interests you and mail coupon for full information.

AMERICAN SCHOOL, Dept. GA45, Drexel at 58th, Chicago 37, Ill.

Without obligation, please send FREE and postpaid, full particulars about the subject checked below.

Accounting	Contracting	Mechanical Engineering
Apprenticeship Courses	Diesel Technician	Mechanical Technology
Architecture & Building	Drafting—Building	Metalworking Courses
Automotive Technician	Drafting—Machine	Plumbing—Practical
Better Foremanship	Electrical Engineering	Private Secretary
Blueprint Reading	Electricity—Practical	Retail Merchandising
Bookkeeping	Electronics—Industrial	Salesmanship—Outside
Business Management	HIGH SCHOOL COURSES	Sheet Metal Work
Civil Engineering	Machinists	Tool Making

NAME _____ OCCUPATION _____
 HOME ADDRESS _____ AGE _____
 CITY _____ STATE _____
 Canadians: Write American School, Dept. GA45, 6083 Sherbrooke St. W, Montreal

MAIL COUPON NOW



MEN! THERE'S BIG MONEY IN NEW ALUMINUM ROOF COATING



For exclusive territory; booming full or part-time business use coupon to get FREE SAMPLE. full details on today's newest

sales sensation for factories, farms, schools, trailers, buildings of all kinds.

Users love all-weather defying Storm King Aluminum Roof Coating and Mobile Home Aluminum Trailer Coating. Ready-mixed. Easy-to-apply. No thinning. No heating. Leaves coating that's firm on top, pliable below; won't sag, run, or crack. Makes interiors 15-30% cooler! A natural for enormous, still-growing do-it-yourself market. A rapidly recognized *must* for thousands and thousands of roofs everywhere! Market only *now* being tapped, but there's no time to lose!

WARREN REFINING & CHEMICAL CO. (Est. 1901)
5151 Denison Ave., Cleveland 2, Ohio

Please send FREE SAMPLE and full details as outlined above.

Name _____

Address _____

City _____ Zone _____ State _____



... Swiss or American

Unique Sweeney System starts you making repairs right away. Develops your skill step-by-step. Teaches modern methods... professional short cuts. Learn by personal attendance or spare time home study. Free Sample Lesson. No obligation. Write today!

CHICAGO SCHOOL OF WATCHMAKING

2330 Milwaukee, Dept. 167, Chicago 47, Ill.

HOW TO MAKE PAINTING AND RIGGING FLAGPOLES—IT'S EASY!

PAINTING AND RIGGING FLAGPOLES—IT'S EASY!

A safe, sure glamorous business is yours for only a small investment. Men are needed everywhere to paint, repair and rig flagpoles. Without any previous training you can make BIG MONEY and travel to the four corners of the earth. We provide the know-how and proper rigging. Our low cost starts you quickly, easily. The rigging is spliced by an expert of best Plymouth manila rope — ready for you to use.



\$50 TO \$100 A DAY

COMPLETE RIGGING & FULLY ILLUSTRATED COPYRIGHTED BOOKLET ONLY \$15 POSTPAID

Start to earn now in your spare time. Live the "life of Reilly" in financial independence — be your own boss.

Send check or money order today (save C.O.D. charges). Money back in 10 Days if not completely satisfied.

UNITED RIGGING CO., 18 Field Point Road, Greenwich, Conn.

WHERE-TO-BUY-IT INDEX

Source of supply appears after items commercially available

AUTOMOTIVE

Detroit Listening Post.....	76
Jalopy graveyard grows in New York.....	79
Tiny bus carries five (California Texas Oil Co., Ltd., 380 Madison Ave., New York City 17).....	91
14-ton truck can expand to five times road size (Gerstenlager Co., Wooster, Ohio).....	96

AVIATION

Huge "docks" shelter B-52 bombers undergoing repairs.....	84
Mockup B-47 nose "flies" around world.....	89
Bomber carries detachable pod to provide for various missions.....	105
British 1000-mile-per-hour jet fighter has two powerful engines.....	109
Hercules transport "flies" underwater (Lockheed Aircraft Corp., Marietta, Ga.).....	116
Experimental missile fired "backward" (Cornell Aeronautical Laboratory, Buffalo 21, N. Y.).....	116
F-51 becomes museum piece.....	117
Flight suit with built-in gear developed for Skyhawk pilots (Douglas Aircraft Co., Inc., Santa Monica, Calif.).....	117
Ten-story mobile tower aids missile maintenance.....	117
Templates 30 feet long from giant printer (Miller-Trojan Mfg. Co., Troy, Ohio).....	140

CONSTRUCTION

Special carriers move huge girders.....	83
Dome design for Oklahoma City's "church of tomorrow".....	138
UNESCO headquarters in Paris to have two acres of glass.....	138
Seats for 150,000—none behind a post.....	200

FISHING

Depth regulator for trolling (Marine Research, Inc., P. O. Box 723, Fort Worth, Tex.).....	72
Shot dispenser (Varco Products Co., 1015 Juniper Ave., Boulder, Colo.).....	72
"Armchair" fishing dock (L. A. Wilke, P. O. Box 9003, Austin 17, Tex.).....	77
He fishes in comfort.....	83

MISCELLANEOUS

Nylon ship propeller has longer life.....	70
Power saw has flexible shaft.....	70
"Vertical mulching".....	70
Bowmen collect cones to "breed" better trees.....	71
Push of button pulls boat onto trailer (Tee-Nee Trailer Co., Youngstown, Ohio).....	72
High-speed TV office duplicator (Stanford Research Institute, Menlo Park, Calif.).....	73
"Village smithy" travels highways (Gordon L'Allemand, Box 323, Ranch Station, Los Angeles 84, Calif.).....	73
Floor drainer covers wider area (Haynes Equipment Co., 62 Voorhis Lane, Hackensack, N. J.).....	78
Two-way fan eliminates drafts.....	78
"Flying" bananas start to market (United Fruit Co., 321 N. Charles Ave., New Orleans, La.).....	79
Train of equipment harvests forage on cattle ranches.....	82
Homemade flame thrower thaws rail switches.....	84
Chair becomes table.....	90
"Flattop" haircut measured mechanically.....	90
Machine opens, stuffs, counts, seals, imprints, stacks mail (Pitney-Bowes, Inc., Stamford, Conn.).....	96
Designed for the handicapped.....	97
Zoo vacuum cleaner.....	104
Hearing aid helps surgeons.....	105
Reel-and-rotary power lawn mower introduced (La Grange and Garrison Inc., 30 E. Georgia St., Indianapolis, Ind.).....	108
Lightweight passenger car has plastic interior (The Budd Co., 2450 Hunting Park Ave., Philadelphia 32, Pa.).....	108

(Continued to page 60)

FREE New FAN—Shutter—Motor—Catalogue



Packed with the Largest Selection of Fan equipment
ATTIC FANS & DIRECT DRIVES
BUY FROM MFR. and SAVE 50%

• Attic Fans • Exhaust Fans • Pedestal Fans • Shutters • Motors • Tub Enclosures • Sewing Machines • IBM Electric & Manual Typewriters • Awnings • Attic or Window Fans • Fan Kit includes: Steel Blade—2 Pulleys—2 Bearings—2 Collars—Shaft—Instructions—Easy assembly. VISIT US OR SEND FOR FREE COPY TODAY

Enclose postage with check or money order. Dealers invited.

Fanlex & Torrington Fans & Kits

FANLEX BLADE SIZES	WT.	LIST PRICE	SALE PRICE
16"	7 lbs.	\$15.90	\$7.95
20"	8 lbs.	17.90	8.95
24"	10 lbs.	19.90	9.95
TORRINGTON BLADE SIZES	WT.	LIST PRICE	SALE PRICE
22"	17 lbs.	\$28.90	\$12.95
24"	20 lbs.	30.70	15.35
28"	22 lbs.	31.90	15.95
30"	25 lbs.	31.40	16.70
36"	30 lbs.	42.56	21.27

ALBIN MACHINE

Dent. M. N. Y.
423 Broome St., N. Y. 13

ROOF FRAMING MADE EASY

WITH THE NEW SWANSON SPEED SQUARE
ALL PURPOSE

RAFTER BOOK

Simplified precision made tool

Frame your roof as easily as your job or study. Send 50¢ in coin, and you will receive rafter lengths booklet giving all length rafters for any size building, with construction folder. Framing a roof with The Swanson Speed Square and its many other uses in framing. Indispensable for inside trim work and home work shop. No carpenter, homeowner, farmer or handyman should be without this modern tool. Send today.

SWANSON TOOL CO., 9113 So. 53rd, Oak Lawn, Ill.

"MINIATURE MACHINE SHOP

No Bigger Than A Typewriter, Outperforms Machines Many Times Its Size!



That's what a popular publication says about UNIMAT in their 3 page feature story in the May issue. If you want a reprint of this story plus complete information about this amazing 10 in 1 combination precision tool write to:

AMERICAN EDELSTAAL, INC., UNIMAT DIV., Dept. 367, 350 E'way., N.Y. 13

RHEUMATISM

NEURITIS • SCIATICA • LUMBAGO

Why continue to suffer agonizing pains when usual remedies have failed. Learn how thousands have been successfully treated by an amazing new method which is fully explained in our New FREE Book. Don't wait. Write today. No obligation.

EXCELSIOR INSTITUTE, Dept. C9806, Excelsior Spgs., Mo.

SEE YOUR DEALER

Two steps to professional results in your workshop: (1) check POPULAR MECHANICS for helpful "how to" suggestions; (2) discuss your project with your dealer. He knows the importance of working with quality products. They're advertised in POPULAR MECHANICS



JUNE 1957

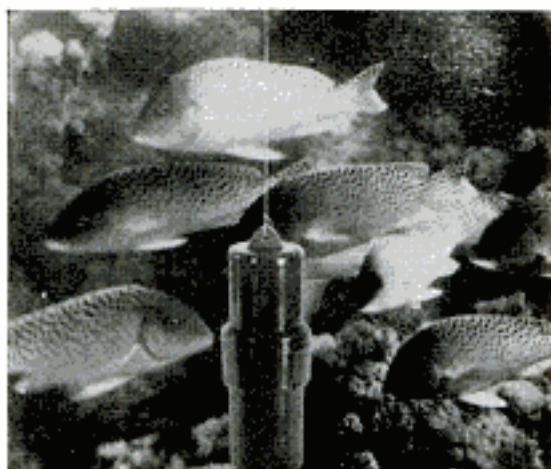

U. S. Patents and Patents Pending
Photographed at Islamorada, Florida, Proving Ground

Amazing new Krafty Fish Caller

draws fish like crazy with its insect buzzing sound! One twist of leak-proof Eastman plastic case (4" long)—hermetically sealed buzzer starts. Lower your Krafty—and here come the fish—big fish chasing small ones away. Krafty lasts for years (replace only small flashlight battery.)

Fishermen everywhere are wild about Krafty—like Walter J. Kessler, Director of Special Services, Pabst Brewing Co.: "Does all you claim for it...caught more fish...had more fun!" For the biggest catches of your lifetime get Krafty and get fish. Makes a wonderful gift!

Only \$9.95 Postpaid

(For C.O.D. pay postman \$9.95 plus C.O.D. fee)

Order now from

BIRCHKRAFT, Inc., Dept. PM
1696 North Astor St. • Milwaukee 2, Wis.

New PRECISION MAGNIFIER

FEATURING 3
DIFFERENT STRENGTH
OPTICAL LENSES

Quick interchangeable, snap-in lens sets of increasing strength (1½, 2¼ and 3½ power). The lenses are unbreakable, scientifically accurate, and molded together for permanent focal alignment. ROCKET is light in weight and is adjustable to any head size. Both hands are free for work. Additional lens sets of greater strength will be available at \$3 a set. Squinting is eliminated as both eyes are used. Can be worn over your own eye glasses. Guaranteed. Full refund if not completely satisfied.



Only \$12.50

ORDER YOURS TODAY

USEFUL FOR
Photographers
Hobbyists
Machinist
Philatelists
Tool & Die-makers
Jewelers
Artists
Coin Collectors
Cartographers

STANDARD UNBREAKABLE WATCH CRYSTALS, INC.
123 East 144th Street, New York, New York

Please send me

Rocket Viewers with 3 interchangeable lens @ \$12.50
 Money Order enclosed C.O.D.
 Send Literature

Name _____

Address _____

City _____ Zone _____ State _____

59

Copyrighted material

FREE BOOKLET!

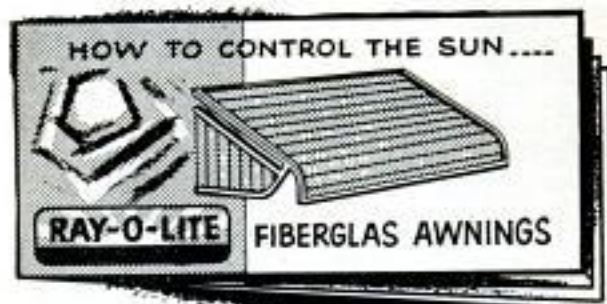

How can you eliminate heat and glare in your home, yet actually add usable light? What are the things to look for and demand when buying awnings? This new free booklet gives you all the answers!

RAY-O-LITE

TRANSLUCENT FIBERGLAS AWNINGS

RAY-O-LITE CORPORATION OF AMERICA
Dept. P-6 • 316 Peachtree St. N.E., Atlanta, Ga.
Send me free booklet on controlling sunlight.

NAME _____
ADDRESS _____
CITY _____ STATE _____

FISHERMEN... OUTBOARD FANS



**You're actually afloat
in 60 seconds
with the amazing new
GLENCREFT STOWBOAT!**

In the water in 60 seconds... that's all it takes to unfold and launch the amazing Stowboat. So light you can carry it by hand... so easy to pack on top of a car. Durable, sea-worthy,

it folds flat; sturdily constructed of marine plywood, vinyl coated, guaranteed leak-proof.
8 ft. model \$225 • 10 ft. model \$250
Includes ringbolt and oarlocks.
F.O.B. Bronx, New York



HIGGS MARINE SERVICE, National Sales Agent

300 Zerega Avenue, Bronx 72, New York

Send 8' model express collect 10' model express collect
 Send free literature. I enclose check money order

Name _____

Address _____

City _____ Zone _____ State _____

MONEY BACK GUARANTEE within 1 year of purchase date

(Continued from page 58)

Telephone receiver amplifier can be carried in pocket (Remler Co., 2101 Bryant St., San Francisco 10, Calif.).....	109
Homemade automatic sprinkler stops when rain falls (Specialty Sales Co., 801½ Houston St., Arlington, Tex.).....	109
New tools for grooming your lawn.....	114
Experimental missile fired "backward" (Cornell Aeronautical Laboratory, Buffalo 21, N. Y.).....	116
Seagoing trucks for Alaska.....	126
Globemaster hauls two 36-foot trailer homes to Greenland....	128
Slotted surfboard gives "feel" of water skis (Fun Craft, Winamac, Ind.)	129
Weight "heard" on scales for blind (Lighthouse for the Blind, 4306 Capitol Ave., Dallas 4, Tex.).....	129
Submarine lumberman	130
Pocket calculator easy to operate (Controller Calculators, Silver Bells, Ltd., 600 16th St., Oakland, Calif.).....	132
Streamlined cycle looks like scooter.....	132
Getting cold feet?.....	140
"Pony express" by motor scooter.....	140

SCIENCE

Superstrong magnet "defies" microscope (General Electric Co., Schenectady, N. Y.).....	78
TV aids study of cancer cells.....	78
U. S. bomber air-to-surface missile is "Rascal".....	79
"Iron lung" on wheelchair goes with patient (J. J. Monaghan, 500 Alcott St., Denver, Colo.).....	82
Fight atomic fires with special gear.....	84
Antibiotic aids crops (American Chemical Society, 2 Park Ave., New York City 16).....	90
Portable detector speeds up prospecting.....	90
Battleship guns become test chambers.....	96
Lowly cactus starts industry.....	104
Will borazon replace diamonds?.....	104
Two-million-volt X ray.....	105
Ultrasonics rip cells.....	105
Fuel source in pond algae.....	108
Basis of life created in test tube.....	117
Tailor-made antibiotics	129
Insects due for fatal surprise (Hercules Powder Co., Wilmington, Del.)	216

Radio-Television, Electronics

New horizons in electronics—

Ionovac, a new loudspeaker (Dukane Corp., St. Charles, Ill.)	141
Small, high-voltage battery (General Electric Co., West Genesee St., Auburn, N. Y.).....	141
A four-speaker bass-reflex enclosure.....	142

Craftsman and Shop Notes Index

FARM AND FARMING

Egg-eating hens discouraged by linoleum swinging doors.....	204
Grain hopper set on legs dispenses ground feeds.....	204
Hot-water tank converted to stock-watering trough.....	204
Old iron wagon-wheel rims support farmyard feed rack.....	204

HOUSE AND HOME

Decor boards in free form.....	148
Light-radiating ceiling illuminates bathroom.....	149
Wax paper keeps tile from sticking to mastic.....	152
Cork strips prevent buckling of hardwood block floor.....	156
Solving Home Problems—	
Paint-roller tray is container for storing brushes.....	158
Masking tape applied to book jackets.....	158
Sticky tape holds thread on bobbins.....	158
Paper drinking cups used as molds.....	158
Plants removed from pots with slotted paddle.....	158
Lifting tab on milk-bottle cap replaced.....	158
Folded Turkish towel makes padded ironing surface.....	159
Coat hooks mounted over plastic coasters.....	159
Avoid shine on ribbon after washing.....	159

(Continued to page 62)

STOPS VAPOR LOCK...GIVES INSTANT STARTS in any weather!

STEWART-WARNER

electric fuel pump for cars, trucks, and busses!

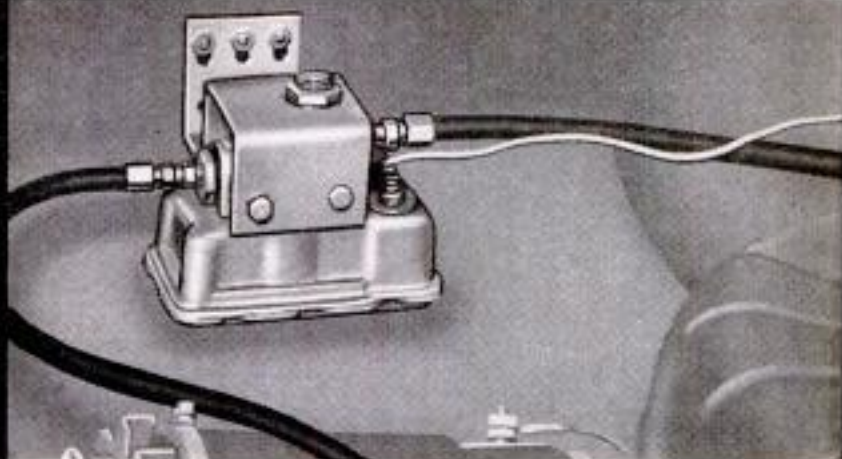

- Delivers a steady, uninterrupted flow of gas to your engine, from the moment you turn your key!
- Operates independently of engine!
- No bellows or rocker arms to wear!

- Heavy-duty construction. Weatherized finish, in bright green baked enamel!
- Models with single or dual pumps!
- Pump may be mounted under hood, on fire wall or fender panel, or on frame near gas tank.

Ask about a
Stewart-Warner Electric
Fuel Pump at your
garage or car
dealer today!



Dept. AM-67
1840 Diversey Parkway
Chicago 14, Illinois

STEWART-WARNER

Instrument Division

24" ATTIC FAN KIT



Easy to assemble. Belt-driven. Blade, shaft, 2 self-aligning bearings, 2 pulleys, 2 collars, and V-belt. Everything you need, except frame and 1/4-hp motor, to make your own house cooler.

Send for complete list of fan parts.

ONLY
\$9.95
SAVE
\$46.00

PENNA. WHOLESALE DISTRIBUTORS
104 N. 6th St., Phila. 6, Pa.



BUILD YOUR OWN HI-FI SET! MAKE A TRANSISTOR RADIO!

THIS PM BOOK SHOWS YOU HOW
to make almost any electronic device

192 pages of step-by-step instructions even the electronics beginner can follow. Tells all about:

- High Fidelity—what it is
- Specifications of component parts
- What to look for in equipment
- Simplified transistor experiments
- Radio-Television—How it works
- How to do radio servicing
- What is a schematic diagram
- All about electrons and problems in simple language
- How a vacuum tube works
- What are resistors and capacitors
- How to select Hi-Fi equipment
- How to wire and solder
- Short wave reception
- Home recording procedure
- Use of hand tools
- Types of antennas

Now, as a career or hobby, step into the amazing field of electronics without any previous knowledge or experience whatever. **Electronics Made Easy** trains you by doing . . . actually shows you how to build and operate many of the newest and most useful electronic devices at amazingly low cost. If you'd like a Hi-Fi set for your home, a transistor radio no bigger than your hand, a sensitive intercom, a wireless record player—you can build these and dozens of other projects, even if you've never fixed a door bell or lamp before. This book explains in simple language exactly how radio tubes work, how signals are transmitted and received, how to convert old radios into useful equipment, how to read diagrams . . . and many other interesting and informative ideas. Contains plans for dozens of valuable electronics and radio units, with picture and schematic diagrams so clear even the beginner can do perfect work. This book can start you on a highly profitable career—in another five years there will be a shortage of more than 500,000 electronics technicians in this country. Or it can introduce you to one of the most fascinating hobbies of today. Order now, under **\$2.95** post-paid money-back guarantee. Only . . .

Popular Mechanics Press, Dept. 657
200 E. ONTARIO ST., CHICAGO 11, ILL.

FIX BROKEN WOODEN OR
METAL FURNITURE WITH

Plastic Steel®

80% STEEL — 20% PLASTIC

A DEVCON PRODUCT



AS EASY TO USE AS MODELING CLAY

A completely new way to make permanent repairs to furniture, toys, tools, models. Fixes leaking pipes, tanks, radiators, cracked engine blocks.

Bonds to metals, wood, porcelain, glass, concrete and other surfaces . . . becomes hard and tough as steel in 2 hours . . . can be machined.

NEW HANDY HOME KIT 98c

Also \$1.89 and \$3.95 sizes at leading hardware and hobby stores. WRITE FOR FREE BOOKLET.

DEVCON CORPORATION
175 Endicott Street, Danvers, Mass.

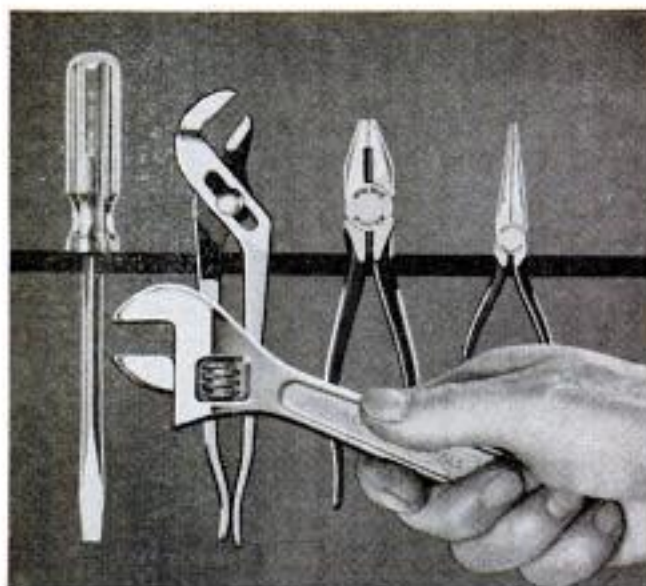

Home Hobbyist Tools by **UTICA**

Wherever you see the most useful of all modern hand tools at work you'll find Utica pliers, wrenches, screw drivers, etc. Hallmark of quality in hand tools since 1895! Precision made. Unconditionally guaranteed. At leading hardware stores everywhere!

UTICA DROP FORGE AND TOOL DIVISION
Kelsey-Hayes Co., Utica 4, N.Y.

"Use Utica . . . the tools the experts use"

TRAINED MEN NEEDED!

BIG PAY!—GOOD FUTURE!

- DIESEL ELECTRONICS
 AUTO AUTOMATION

NEVER BEFORE has the opportunity been so good for the properly trained mechanic and technician to step into **BIG PAY POSITIONS** with rapid advancement and future security virtually assured.

YOUR SUCCESS depends on the quality of training you receive . . . and the reputation of the school you attend.

YOUR GUARANTEE we are giving the best in mechanical and technical training is proved by the fact . . . we have a waiting list of good pay positions for our graduates, with leading companies throughout the United States.

RESIDENT SHOP TRAINING is easier and costs less than you may think! We provide you with housing and part-time jobs while in school, plus free nation-wide placement service for graduates.

Check subject above in which you are interested and mail for

FREE BOOKLET

BAILEY
Technical Schools

Veteran Approved

1634 S. Grand, St. Louis 4, Mo.

Your Future
in
ELECTRONICS
AND
AUTOMATION

Your Future
in
DIESEL and
AUTO
MECHANICS

Name _____ Age _____
Street _____
Town _____ Zone _____ State _____

(Continued from page 60)

Bowl won't rock and roll.....	159
Closing joint between crossrail and stile of paneled door.....	159
Recipe holder.....	159
Screen door held at any angle by rubber-tipped prop.....	160
Shelving conceals chimney for attic conversion.....	160
Lavatory "step" for small children.....	184
Warm water for washing car.....	184
Year-round uses for shellac in the home.....	188

PHOTOGRAPHY

Index card in negative file identifies cut-film type.....	157
Two light-tight ventilators for cooling photo enlargers.....	160
Adapter for cut-film holder handles off-size film.....	188

TOOLS

Hinged tool tightens flooring before nailing in place.....	152
Hand grinder fitted to lathe.....	189
Shopping for Tools—	
Builder's level.....	200
Setting tool.....	200
Bandsaw and belt sander.....	200
Builder's square.....	200
Service kit.....	201
Masonry drill.....	201
Special chuck.....	201
Screwdriver.....	201
Lawn-mower sharpener.....	201

MISCELLANEOUS

Bug catcher on car radiator gathers fish bait en route.....	148
Boat-equipment locker.....	150
Cool grip for hot cup.....	152
Truck-size insecticide sprayer utilizes exhaust manifold.....	152
Removable "rumble seat" makes two-passenger tricycle.....	157
Rowlock horns tied to gunwale can't be dropped overboard.....	157
New fence-post-treating method stops decay and termite damage.....	171
Rubber-stamp impressions tinted with metal powder.....	171
Section of wooden snow fence provides slipproof walk.....	180
Water-ski jump.....	180
Protect art-brush bristles with drinking straw.....	188
Razor blade used for cutting stored safely in clip.....	188
Altered boxes save work, time.....	196
Simple rack for C-clamps.....	196
Simple ball-turning tool bit.....	196
Torch carrier for flame cutting.....	197

WORKSHOP HINTS

Plane itself is fixture for honing blade.....	149
Subduing appearance of screws on cabinet hardware.....	149
T-base fitted with clips holds hand grinder in vise.....	160
Magnet serves as cutoff stop.....	171
Wood jig starts tap square in plastic.....	171
Pulling headless nail.....	180
Rubber band cut from inner tube chipproofs sharpening stone.....	184
Solder gun and stick shellac speed furniture refinishing.....	184
Damper quiets circular saw.....	190
Hold-down for running moldings.....	191
Post shelves add shop space.....	191
Sanding-block lock.....	191
Simple rack for C-clamps.....	196
Wire solder on tape spool protected against dirt.....	196

NOTICE—It is the intention of this magazine to provide its readers with information regarding the latest developments in the mechanical arts. Except where otherwise indicated, this magazine has no information as to any unexpired patents in respect of the developments reported herein. In the event that commercial use is to be made of any of the developments reported herein, it is suggested that legal counsel be consulted to avoid liability for patent infringement. It is not the purpose of this magazine to encourage patent infringement but, as indicated, it is the intention of this magazine to report on the latest developments in the mechanical arts.

How Is Your Science IQ?

Try the Quiz,

"ARE YOU SCIENCE MINDED?"

Starts on Page 242

mobile homeowners say:

KOOL-SEAL ALUMINUM ROOF COATING WEATHERPROOFS WITH ONE APPLICATION

Insulates... Beautifies... Lasts for years

For worry-free, all-climate roof protection, mobile homeowners tell us they are applying aluminum roof coatings like Kool-Seal, made with ALCOA® Aluminum Pigments.

DEFIES WEATHER

This roof coating is made with a tough asphalt base and has as its pigment brightly polished ALCOA Aluminum flakes. It remains firm on top, but soft and pliable beneath its protective shield of aluminum. It will not sag or run under tropic sun, or alter under frigid cold. It provides waterproof shelter, protects against surface deterioration.

TURNS BACK HEAT

Because aluminum turns back 70 percent of the sun's heat, your mobile home can be as much as 15 degrees cooler this summer . . . warmer in winter, too. Because of aluminum's low heat radiating power, it acts like insulation, reduces interior heat loss.

EASY TO APPLY

Aluminum coatings like Kool-Seal come ready mixed . . . require no thinning or heating . . . are easy to apply with either brush or spray gun . . . adhere to any metal or composition roof.

LASTS LONGER

Aluminum flakes "leaf" to produce a brilliant metallic surface—literally a metal shield that protects the underlying asphalt vehicle from deterioration. This means long life and years of service for your roof.

STAYS BEAUTIFUL FOR YEARS

The soft, silvery finish is highly reflective . . . sets off any mobile home . . . lends a clean, prosperous appearance that lasts for years.

ALCOA does not make aluminum roof coatings. But we will gladly refer you to reputable manufacturers who do. Write today for our two free booklets, *Painting With Aluminum* and *Aluminum Asphalt Roof Coatings Make Time Stand Still*. Use the coupon.



Look at the aluminum-coated roofs in this community, a typical sight in the more than 4,000 mobile parks in the United States. Inset

shows how easily Kool-Seal goes on. Kool-Seal is a product of Electric Paint & Varnish Company, Cleveland, Ohio.



THE ALCOA HOUR
TELEVISION'S FINEST LIVE DRAMA
ALTERNATE SUNDAY EVENINGS

Aluminum Company of America, Paint Service Bureau
1718-F Alcoa Building, Pittsburgh 19, Pennsylvania

Please send me your FREE booklets:

- Painting With Aluminum*
 Aluminum Asphalt Roof Coatings Make Time Stand Still

I am interested in protecting _____

Name _____

Address _____

City _____ Zone _____ State _____

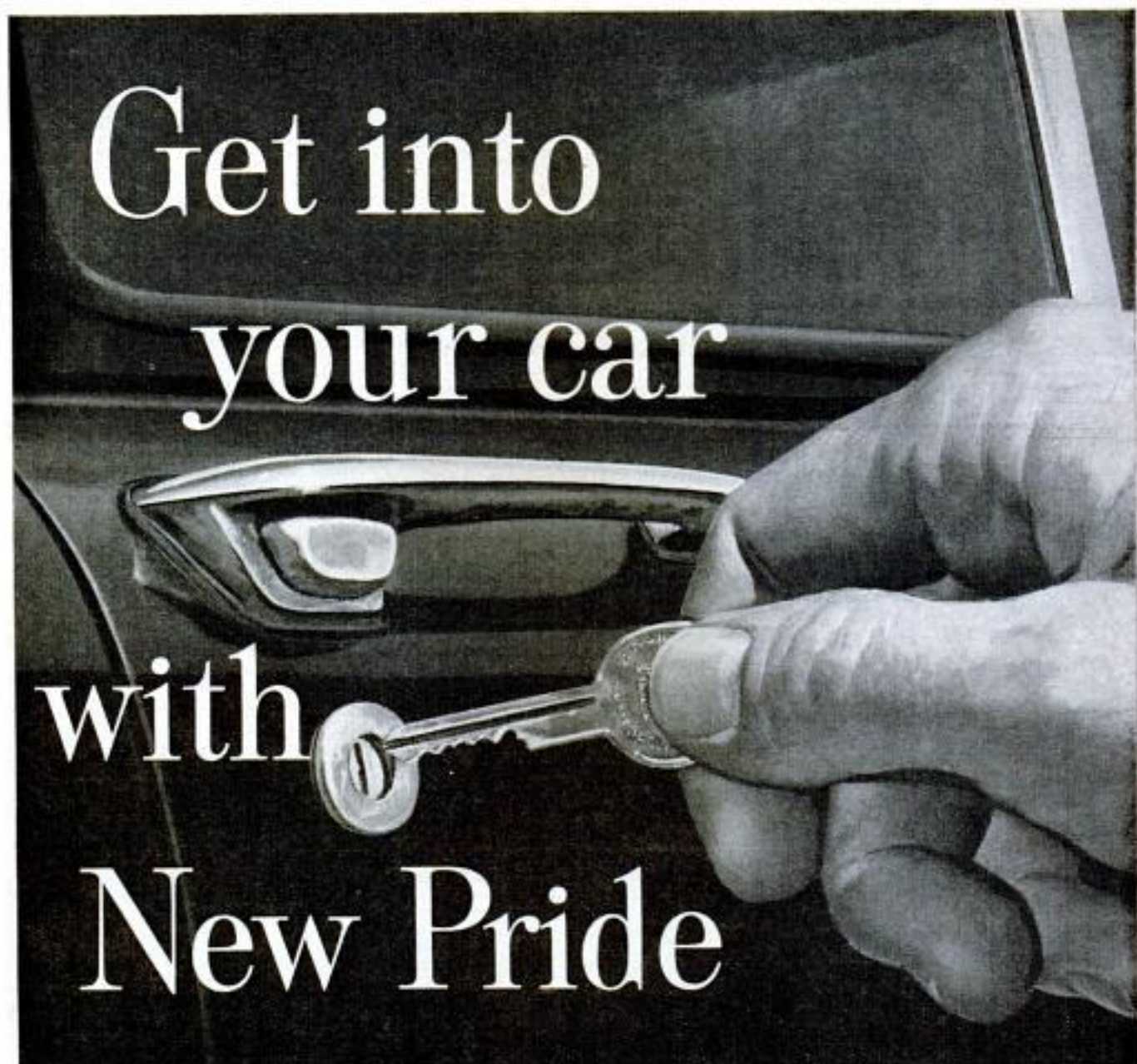

Restore that **NEW CAR FEEL** with

Why drive a car that just "gets you there"—when it's so easy to have a car that's a thrill to handle... full of pep, performance and GO! Your Doctor of Motors—your skilled mechanic—knows how to bring back that satisfying "new car feel."

Doctors of Motors everywhere install Perfect Circle 2-in-1 Chrome piston rings to assure top performance. Perfect Circles are plated

with thick, solid chrome that resists wear—more than doubles the life of cylinders, pistons and rings.

For long life and responsive power with positive oil control, ask your mechanic to install Perfect Circle 2-in-1 Chrome piston rings in your engine! Perfect Circle Corporation, Hagerstown, Indiana; The Perfect Circle Co., Ltd., 888 Don Mills Road, Don Mills, Ontario.

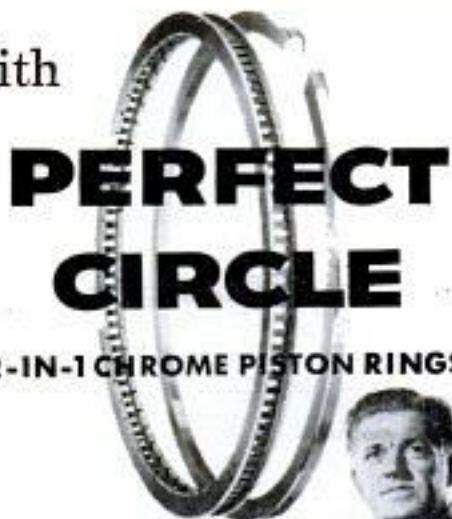

2-IN-1 CHROME PISTON RINGS

You'll be surprised how quickly and economically your Doctor of Motors can bring back a "New Car Feel" to your car!



POPULAR MECHANICS

POPULAR MECHANICS

JUNE
1957

WRITTEN SO YOU CAN UNDERSTAND IT
VOL. 107 NO. 6



For a time-lapse study of pollen, Ott focused 25 cameras on ragweed, some looking through microscopes

John Ott, who cast aside his career as a Chicago banker to pioneer time-lapse movies of flowers bursting into bloom, has crossed another frontier. Now cancer cells visibly multiply and ragweed pollen touches off hay fever under his microscope.

Reprinted "PM Highlights"

His Cameras Spy on Life's Secrets

By Clifford B. Hicks

MILLIONS OF TELEVIEWERS look on John Ott as an old friend, always on hand to help them tackle their gardening problems. Millions of movie fans look on John Ott as a magician with a camera.

A few men—biologists, pathologists, chemists and other scientists—look on John Ott as a founder of a new scientific

technique. And only this handful has seen his most significant work.

These scientists, usually unemotional in their approach, have gasped at the sights he has shown them. Vital life processes which occur over a period of days, weeks or months unfold on a movie screen in seconds. They watch cancer cells divide and

Ragweed pollen, exposed to nasal secretion of hay-fever sufferer, starts emitting tiny drops of liquid



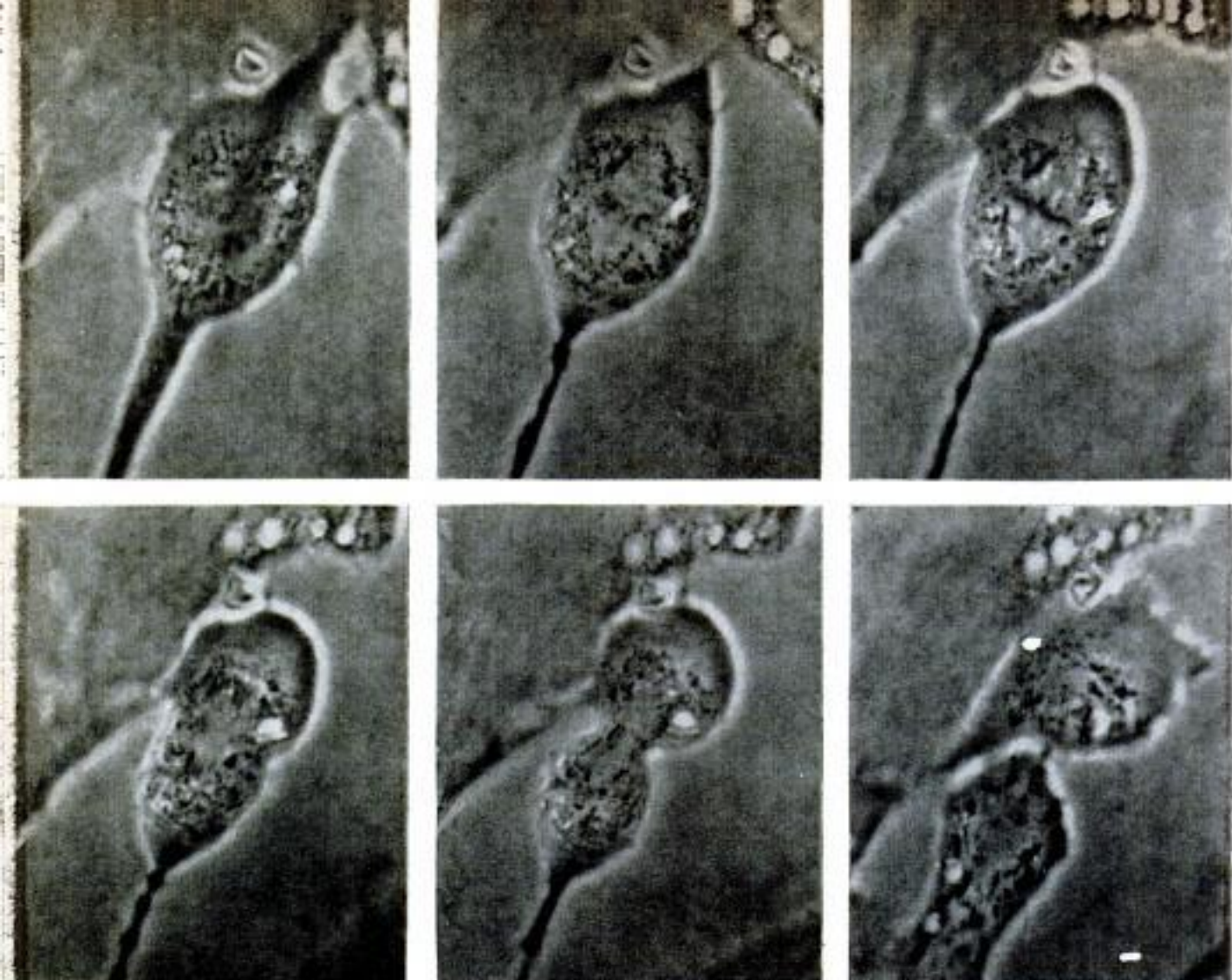

Scientists are excited about Ott's films which show (upper left to lower right) cancer cell reproducing

redive, ragweed pollen react in the nasal secretion of a hay-fever victim. They watch light of certain wavelengths determine the sex of various plants.

They watch these spectacular sights through the magic of time-lapse motion pictures, taken through a high-power microscope.

John Ott is a pioneer of time-lapse photography. Today his time-lapse cameras are spying on living cells. In his basement laboratory at Winnetka, Ill., he speeds the

Ott's wife felt he spent too much time in basement lab, suggested he edit film upstairs, as shown here. He tried it two days, then moved back downstairs



passage of time a hundred-thousandfold.

Back in 1927 a 17-year-old lad bought a movie camera. First off, he decided he'd photograph the unfolding of apple blossoms on the tree in the front yard. To do the job, he figured he'd have to expose one frame of film every few minutes. Then when he projected the film the blossom would unfold before his eyes. This was to be just the opposite of slow-motion photography. He was going to speed things up.

His first try showed blossoms appearing and disappearing so fast he scarcely could see them. After several false starts he produced his first successful time-lapse sequence. On the screen, buds appeared, swelled and burst into spectacular bloom.

That was 30 years ago. The boy grew to be John Ott, Chicago banker, who puttered around taking films of his garden as a hobby. Because the time-lapse technique was new, he had to devise his own equipment, and finally succeeded in making it automatic. After any desired interval, timers would close the shutters in his greenhouse, snap on floodlights, expose one frame of film, turn off the lights and open the shutters again.

Shortly after World War II, Ott found himself with a series of time-lapse garden

films so spectacular they'd make anyone gasp. Trouble was, few people had seen them. In 1949 one of the Chicago TV stations heard of the films and asked him to put them on the air. The reaction was immediate. So many viewers wrote letters that the station persuaded Ott to start the program, *How Does Your Garden Grow?*

The program has been televised over as many as 40 stations throughout the country.

Soon Walt Disney became interested in Ott's time-lapse films. As a result the films have appeared in the Disney movies *Secrets of Life* and *Nature's Half Acre*, and on the Disneyland television show. (Recently Ott rephotographed the blossoming of an apple tree in his yard, this time for Disney. A lad appeared in this film, too—Ott's nine-year-old boy.) Ott also has shown his films on such TV shows as *Zoo Parade*, *Today*, *The Home Show* and *Out on the Farm*.

He is a man of incredible patience. When he wanted to show the formation of a bunch of bananas on the screen, he trained 10 cameras on a banana tree for 18 months. In a recent study of ragweed he had 25 cameras focused on the ragweed plants, some of them watching the formation of pollen through microscopes.

This quiet, scholarly man puttering

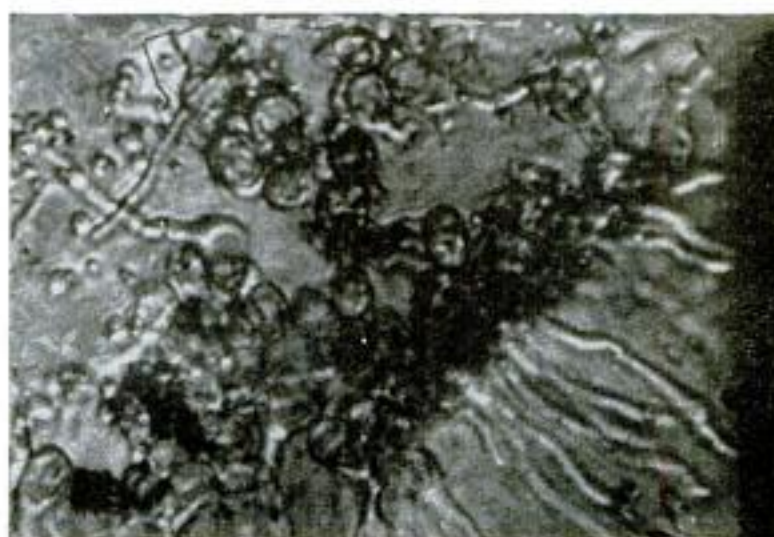

Miniature air-conditioned laboratory holds cameras and microscopes for taking films of life processes

Photos were taken from movie study of spore which causes black spot on roses. Note growth from spores

CAMERA-MICROSCOPE SETUP IS SIMILAR TO ONE ON RIGHT.

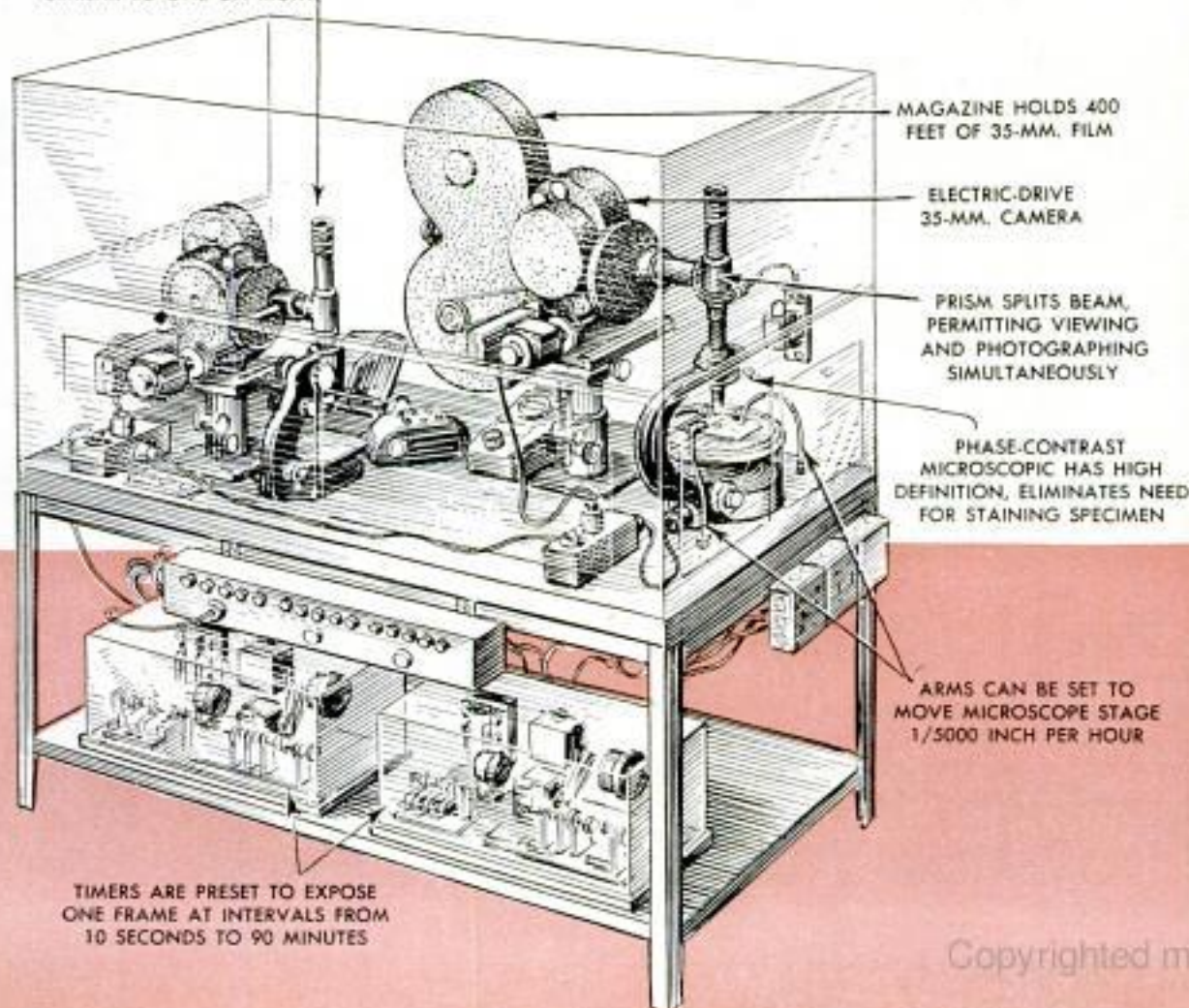

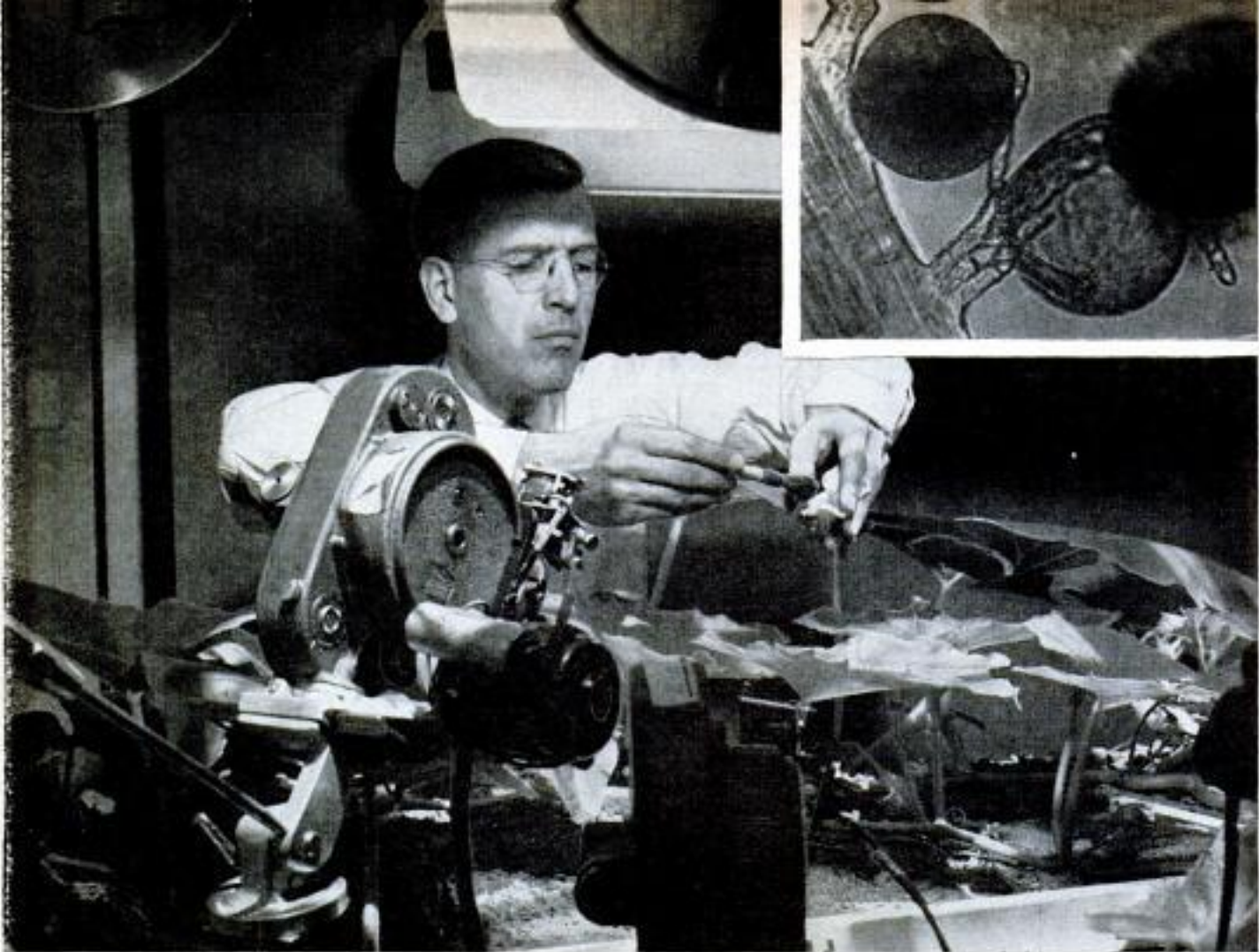

Ott dusts pollen on pumpkin flower. Inset, taken through microscope, shows tubes growing from pollen grain

around his greenhouse appears the exact opposite of a television star or an eminently successful movie producer. Instead, he might be a soft-spoken scientist indulging in his hobby. This last impression strikes close to the mark, for Ott's latest field is science. He is a man driven by the idea that time-lapse motion pictures, taken through a high-power microscope, can reveal the secrets of vital life processes hitherto hidden from man's prying eyes.

Scientists peering through microscopes always have had difficulty in observing certain phenomena. Some activities, such as the splitting of cells, occur at unpredictable moments. Others gradually take place over a period of hours or days.

"It's like watching the hour hand of a clock," explains Ott. "You know it's moving but you can't see it move. Glance away for even five minutes, and you can observe that some movement has taken place. Yet if you watch constantly, your eye can't detect it.

"Similarly, a biologist trying to observe a vital life process often is frustrated because he can't actually watch it occur. The change is just too slow. In such a situation,

Typical time-lapse film of the type that made Ott famous shows the gradual unfolding of orchid blossom

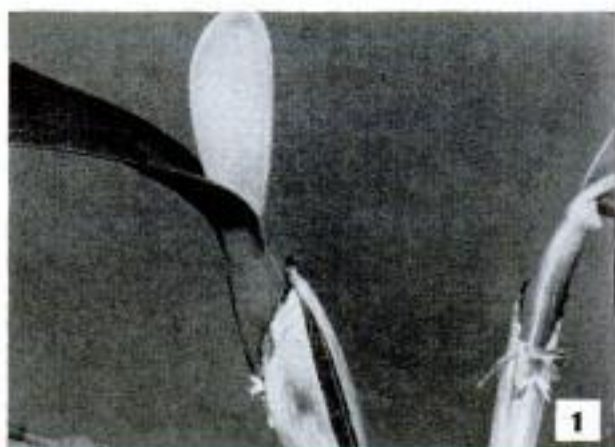

a time-lapse movie is ideal. In minutes we can show a life process from beginning to end. We simply speed it up."

Ott has designed his own equipment to speed up life. In his miniature laboratory for science studies, a high-intensity light is focused through the microscope slide. The microscope itself is a new phase-contrast type that splits the light beam, retarding part of the light. The result is much finer definition (important to photographic work) and no need for staining the specimen. The staining process frequently kills living specimens.

A special eyepiece on the microscope permits Ott to watch the specimen at the same time a frame of the film is being exposed. The camera is a rebuilt 35-mm. Bell & Howell with electric drive. The magazine holds 400 feet of film. Whenever Ott refocuses the microscope, the camera automatically moves too. He also has installed miniature motors which will move the microscope slide at the infinitesimal speed of $\frac{1}{5000}$ inch per hour.

Heart of the time-lapse system, of course, is the timer, which can be preset to expose one frame of film automatically at any interval from 10 seconds to 90 minutes.

Perhaps the most spectacular of Ott's new scientific films shows individual grains of pollen fertilizing flowers. Before your eyes the grain of pollen produces a tube and

through it the contents of the pollen are discharged into the stigma. Ordinary time-lapse movies go on from there to show a pollinated pumpkin flower developing into a full-size pumpkin in 30 seconds, changing from green to bright orange.

Another time-lapse study shows the effects of ragweed pollen on humans. Across the screen move spheres of pollen. They are swimming through the nasal secretion of a person who is not allergic. Nothing happens. Then similar pollen grains appear, this time in a culture taken from a sniffing hay-fever victim. Almost immediately the pollen starts emitting tiny drops of liquid. Until this film was available there was some doubt as to whether the pollen itself changed, or whether the only change occurred in the nasal passage of the hay-fever victim. The time-lapse films prove that the ragweed pollen emits some substance. It's a film of profound significance in the study of such allergies.

Ott has become intrigued with the effect of certain wavelengths of light on plants. Light in a particular band will cause certain plants to produce flowers of only one sex. For example, a pumpkin exposed to a certain wavelength will produce all female flowers. The same plant, exposed to another wavelength, will produce all male flowers. Ott now is analyzing the effects of bands

(Continued to page 234)

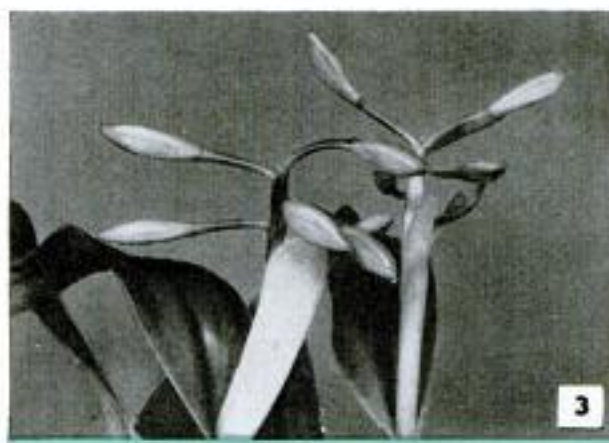
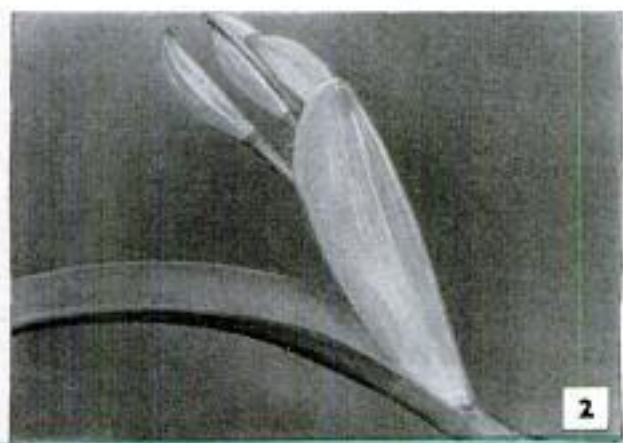

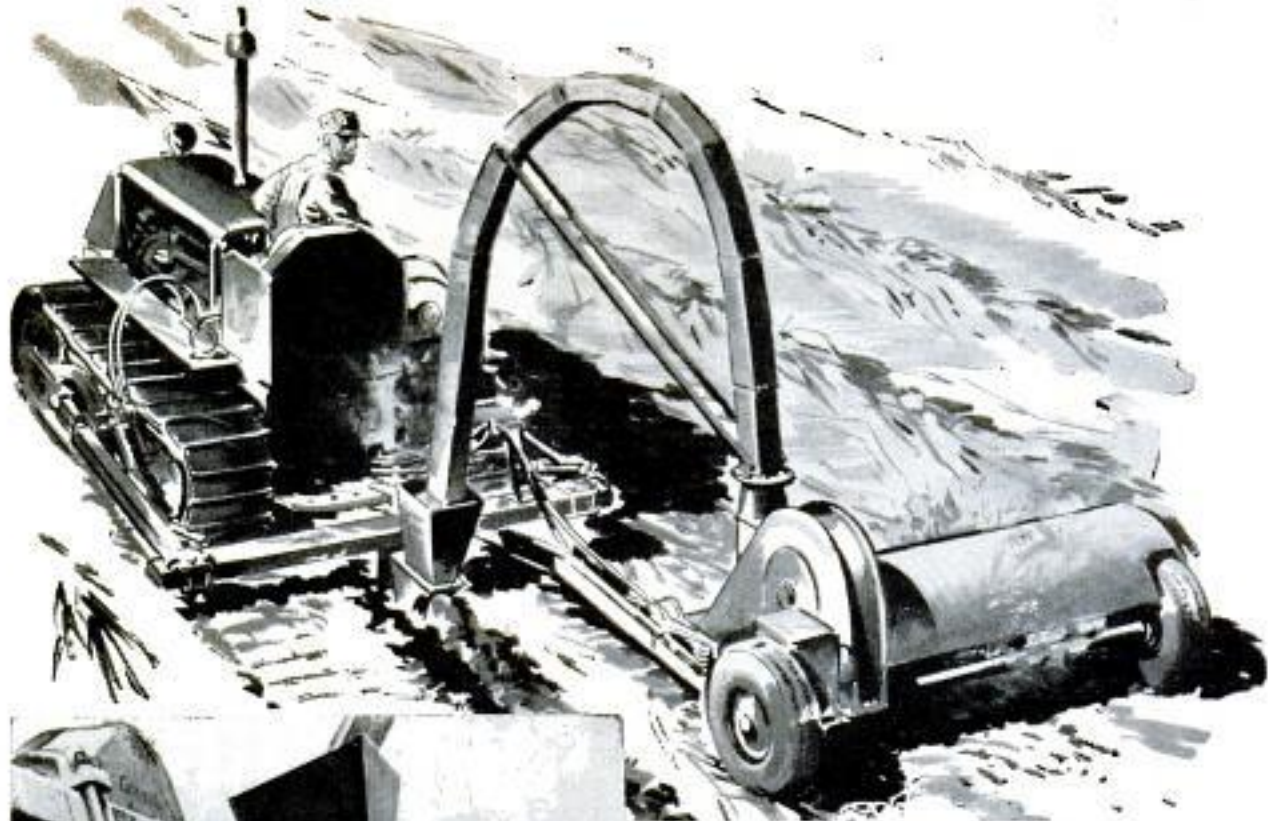

"Vertical Mulching"

"Vertical mulching," a new technique in soil conservation, shows promise of increasing the water-storage capacity of the soil. In the technique, developed at Purdue University, a subsoiler opens up a channel in the soil 18 inches deep and 6½ inches wide at the surface. At the time the channel is opened, a forage harvester behind the tractor chops crop residue and blows it into the channel. Studies show that the crop residue holds the channel open to moisture penetration and prevents soil compaction for three to five years.



Power Saw Has Flexible Shaft

German woodcutters use a portable circular power saw that works at the end of a flexible shaft connected to an electric or gasoline engine on the cutter's back. Safety guides on the saw frame grip the timber, which can be five to seven inches in diameter for one cut. Two handles give the worker greater leverage.

Nylon Ship Propeller Has Longer Life

Air bubbles which develop when the screw propeller of a ship churns through the water can have a damaging effect on the mechanism. A Danish factory hopes to eliminate this problem by developing a nylon screw propeller. One of the nylon propellers is now being tested in the waters near Greenland. Besides resisting the wear of air bubbles, it is much lighter in weight.

Bowmen Collect Cones To 'Breed' Better Trees

IT'S APPROPRIATE that foresters on a large British estate use bows and arrows to help grow better trees. After all, Robin Hood's Nottingham Forest is nearby.

The longbows are a means of pulling ladders and rope nets high into the trees so cones can be picked for controlled plantings.

Sharpshooting foresters, anxious to improve timber quality, collect the cones from the known superior trees. If they wait until the cones fall it is difficult to tell from which tree each cone dropped.

With his bow, a forester shoots an arrow so it carries a trailing fishline over a branch high up the towering trunk. With the line as a starter, he pulls a rope over the limb and follows this with a ladder and netting. The crew then clambers around the netting, picking the cones which are cultivated to provide superior-quality seedlings.



Forester aims arrow while helper holds spinning reel to pay out the line that will pull the light rope over the branch. The rope then hauls up the ladder, shown in lower-left photo

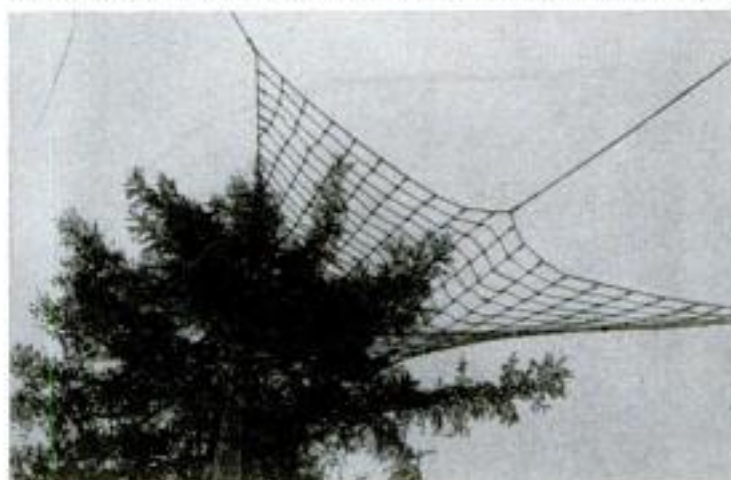

Above, with the help of the ladder, a forester rigs the rope netting in position. Below, clambering over the net 100 feet in the air, the crew picks cones for future cultivation. The project is developing trees that produce top-quality timber





Push of Button Pulls Boat Onto Trailer

All the boater has to do to load his craft on a new trailer is push a button. The boat then glides out of the water and onto the trailer, pulled by an electric winch. The winch is powered by a low-amperage motor which connects to the electrical system of

the car. Available on one new make of trailer, the winch also can be installed on any other make or model and uses either a six or twelve-volt system. The winch is available in three capacities, to handle boats up to 1000, 1600 and 2000 pounds.

Shot Dispenser

Shot can quickly be installed on a fishline with the aid of a new plastic dispenser. The case holds a supply of 3/0 split shot. The fisherman simply dials a shot into position in a feeder slot, inserts the line and presses a plunger.



Depth Regulator for Trolling

Anglers can troll at any level with a new depth regulator on the line a few feet ahead of the lure. Fins on the regulator cause the lure to run deep or shallow, depending upon how the line is attached. The regulator floats when it is not in motion.

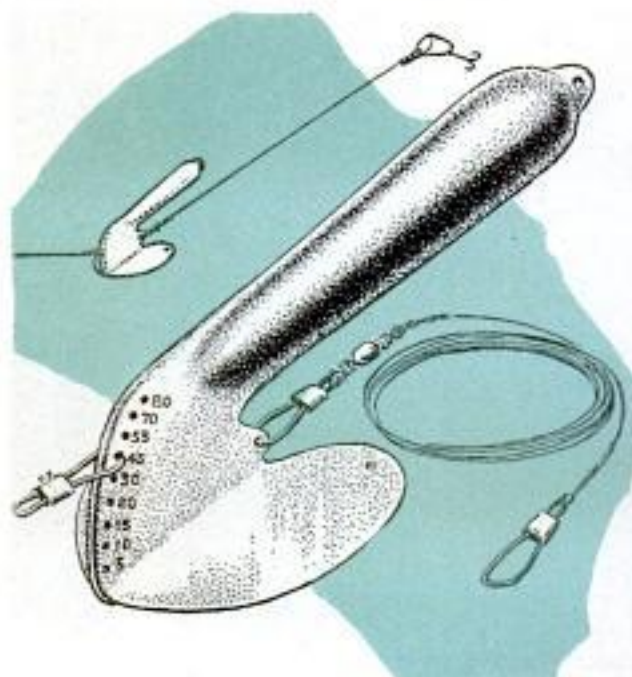

"Village Smithy" Travels Highways

Working out of a well-equipped, $\frac{3}{4}$ -ton truck, traveling blacksmith J. W. Burton and his helper, Jerry Kardas, have shod hundreds of horses in southern California in the past four years. These men use stock shoes for ordinary jobs and make special shoes for saddle, gaited and harness horses and polo ponies. Horse-shoes weigh from $2\frac{1}{2}$ ounces each for a thoroughbred to four pounds per shoe for a Tennessee walking horse. The "firm's" equipment includes a 25-pound trip-hammer for roughing out shoes; a forge that can be manually or electrically driven, burning blacksmithing coal, to heat a shoe red-hot in two minutes, drill press and anvil. A portable emery wheel folds out over one side of the truck to grind and polish shoes and to make nippers for trimming hooves. A portable acetylene-welding outfit is used to braze shoes and puts borium facing on parade shoes to prevent slipping.



High-Speed TV Office Duplicator

Closed-circuit TV may become standard in office equipment used for high-speed, multiple duplication of communications. Test models now can reproduce 17,000 characters of elite type per second—equal to three $8\frac{1}{2}$ by 11-inch sheets of paper. This electronic system consists of a transmitter-printer unit designed to occupy the same amount of office space as do current duplicating machines. Copies are printed directly from original documents (see photo right).

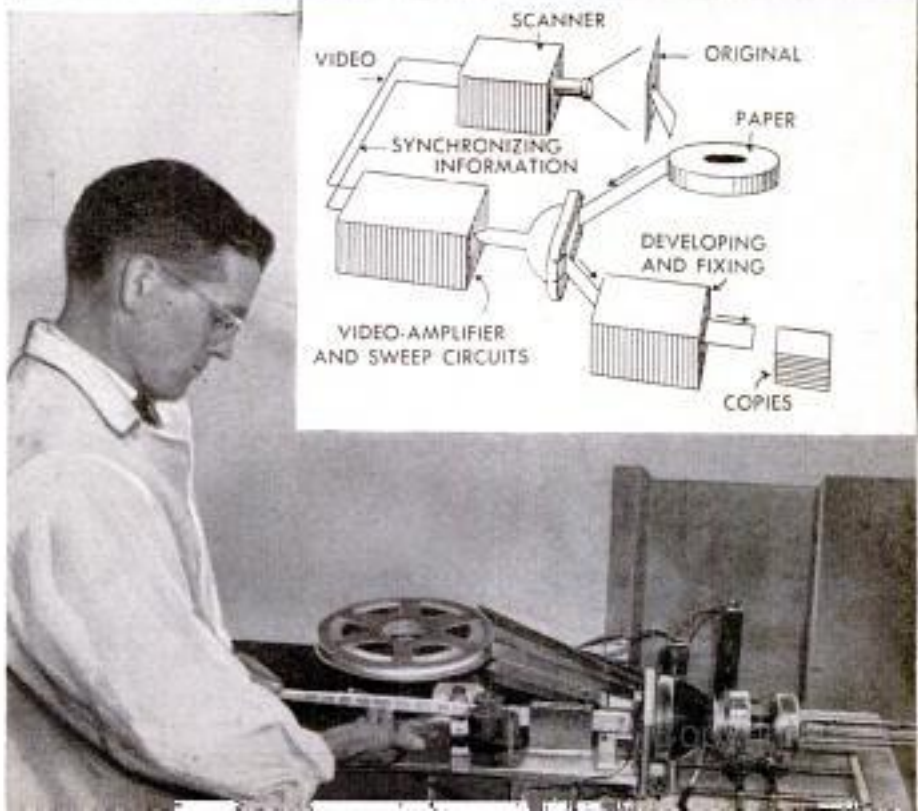
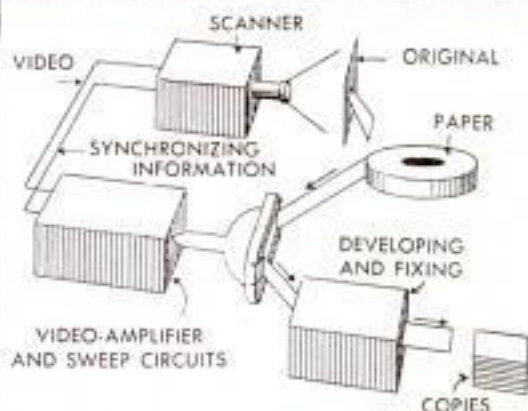

The Bus that Grew Into a Fire Truck

By Joe Van Wormer



Members of Bend, Ore., fire department used their spare time to convert a bus into this fire truck

WHEN THE FIRE DEPARTMENT of Bend, Ore., needed a new emergency unit, city officials decided to shop around for the best bargain they could get for their tax dollars. They heard that Pacific Trailways, an intercity bus company, planned to sell a 25-passenger bus that had seen more than a million miles of travel but had been completely overhauled. The city made a deal at a nominal figure and acquired a bus which grew into a full-fledged fire-fighting unit.

The Bend fire department has 16 paid employees and 35 volunteer firemen. The paid firemen did the conversion work in their spare time and within two months had the unit, known as the "City Service Truck," in operation. The exterior of the

All this fits neatly inside the former bus: 1. 24-foot ladder; 2. 12-foot roof ladder; 3. 35-foot ladder; 4. Resuscitator and inhalator; 5. Smoke masks; 6. Light plants; 7. Salvage kit; 8. Sawdust; 9. Exhaust fans; 10. Salvage tubs; 11. 45-foot ladder; 12. Electric cords; 13. Picks and axes; 14. Mops; 15. Cellar nozzle; 16. Power saw; 17. Tarpaulins; 18. Hand tools; 19. Life belts; 20. Lights



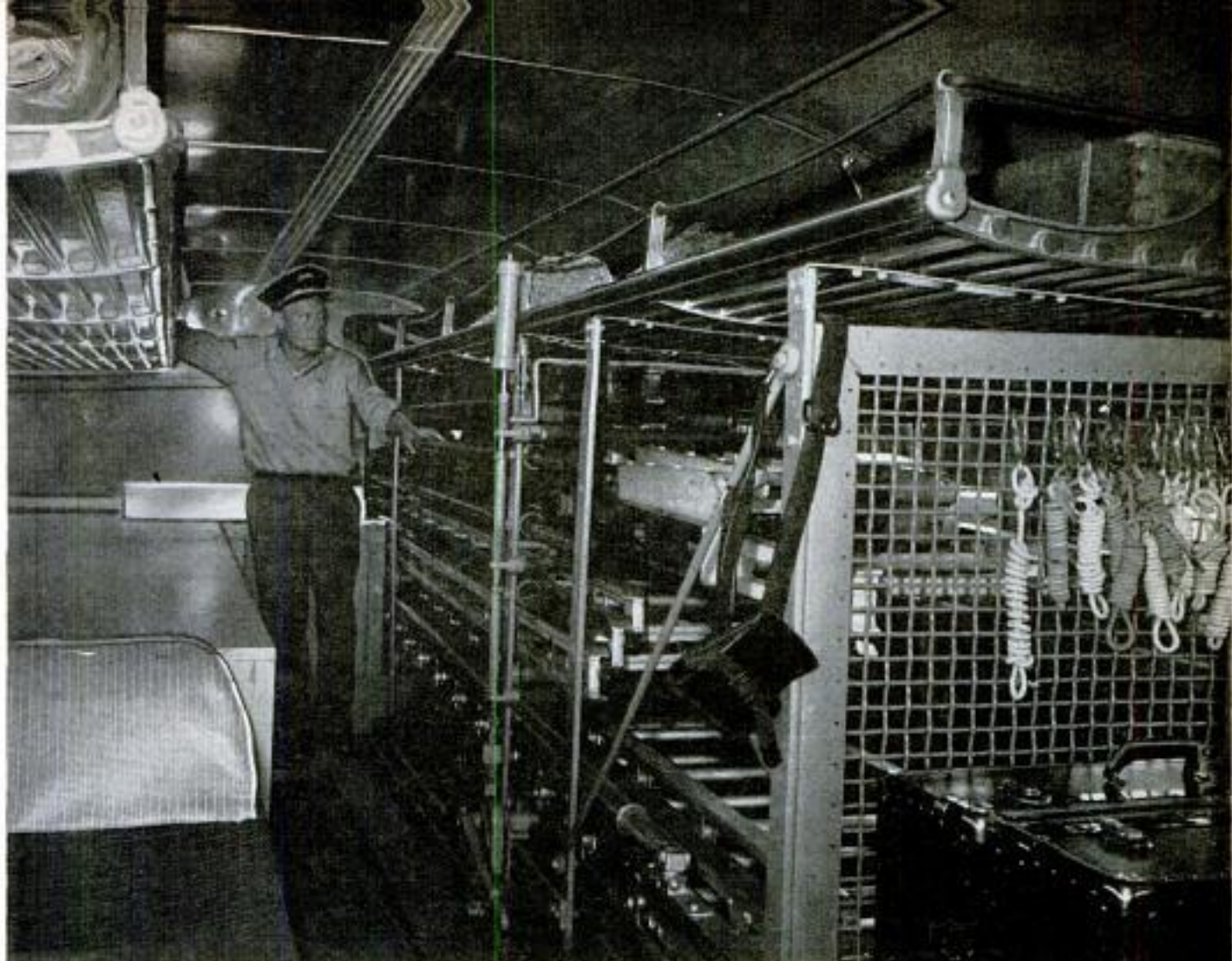

Seven ladders, ranging from 45-foot extension set down to 12-foot roofer, can be rolled out back door

bus was given a coat of bright-red paint. Ladder racks were built along the left side of the interior so the ladders could be unloaded through a rear door. Toughest part of the project was making new doors where the thin metal skin of the bus had to be framed and braced. The conversion was planned so that nearly all the equipment would be accessible from the outside of the unit.

Visiting firemen are startled by the amazing amount of equipment regularly carried in the former bus. All of it is vital in modern fire-fighting techniques. Seven ladders on roller racks range from a small, 12-foot roofer to a 45-foot aluminum extension set. Two gasoline-powered electric plants with enough wire and floodlights to illuminate a sizable area are carried in the luggage compartment. Also included as standard equipment are smoke blowers, self-contained air masks, resuscitator and inhalator, first-aid kit, tarpaulin salvage covers, axes, shovels, saws, mops, brooms, buckets, tubs and other salvage equipment.

Except for a public-address speaker, siren and flashing red light on the front, the outside of the vehicle still looks like a bus. But inside, it's as well-equipped as a modern emergency unit can be. ★ ★ ★

Once a luggage compartment, now storage space for two portable electric generators, wires and lights



Detroit Listening Post



By Art Railton

IF YOU HAVE ONE, don't sell it. It will soon be a collector's item.

The proud, dignified, undeniably handsome Continental Mark II is gone to wherever fine cars go when they die. And those that remain will, no doubt, be much sought after by the car collectors of tomorrow.

It just didn't come off. Why? That is a question certain to be pondered for years.

Death was not due to any lack of publicity. No car was given more lavish press notices. It couldn't be the price, because many buyers spend \$4000 for medium-price cars these days. And when workers buy \$4000 cars, certainly top executives can afford \$10,000.

Perhaps the error was in too much emphasis on "dignity" and not enough on "sell." Or maybe it was in looking backward, not forward.

So now the 1958 Lincoln (which will be all-new and beautiful) is to have a Continental series as its top line. There will be enough of the Mark II in the new design so you can tell it is a legitimate descendant, but the custom-built Continental concept is gone. The 1958 Continental will be just another Lincoln, and fine as that is, it's no hand-rubbed Mark II.

The Continental will have a four-door hardtop among several body styles. It will be of unit construction as will all Lincolns. Rumor has it that the Continental series will be made to look different from other Lincolns by lengthening the hood. With unit construction, it is said to be possible to vary the relative proportion of the hood-to-greenhouse-to-rear-deck without great expense or complication. This may be the basis of a combined Lincoln-Continental design. Incidentally, it would seem that the "Mark" designation would have to go also. From 1958 on, it will probably be designated by the model year like more earthy machinery.

For Transportation Only

Studebaker-Packard (or is it Curtiss-Wright?) says it will soon have an "econ-

omy" car for under \$1800, including heater and turn signals. This car will be out much earlier than the regular 1958 line (in fact, it might even be out by the time you read this). But it will not be the all-new small car that early reports suggested. There isn't time or money enough for that.

It appears likely that this economy car will be a modified Studebaker Champion with certain cost-reducing differences. It may be that S-P hopes to build it for years without annual changes. It would become a car sold strictly for transportation—something a loud minority has been demanding. It will be interesting to see if the loud minority will back up its demands with money.

It would seem that the car will have to use the current Studebaker frame and shell and much of the current sheet metal. There are to be three body styles: A two-door, a four-door and a station wagon (the wagon, presumably a two-door, will sell for just under \$2000).

The theory may be that if the car sells steadily in small volume, it will be possible to cut the price to attract even more buyers in the years ahead. This, then, would put it in direct competition with the small foreign cars like Volkswagen and Renault which sell for around \$1600. All this activity, of course, would be separate from the main line of Studebaker-Packard cars which will continue with annual style changes.

Stretch It, Please

This year's Caddy owners are a bit unhappy about the shorter look of the 1957 car (although they are still lining up to buy it). The division senses this, of course, and is expected to stretch out the 1958 trunk. After all, when you buy the most expensive car, you want it to look big!

Cadillac and all GM cars are expected to offer air suspension in 1958. The corporation is going with it all the way, even down to the Chevy, rumors say. The experience with the air suspension on the Eldorado has been most encouraging.

Ford, too, is expected to have air suspension in all its divisions. American Motors may have it as an option. Chrysler seems certain to stick with torsion bars.

American Motors reportedly is in good shape for air suspension because its high-level pockets for the present four coil springs are ready-made to take air springs.

Nonslip rear axles will be common in the industry in 1958. They, plus fuel injection, will give companies like Chrysler something to shout about in a year of minor styling changes.

The British Ford is going after the U.S. market in a big way. It plans to sell 20,000 cars here this year. Look out, VW! ★ ★ ★

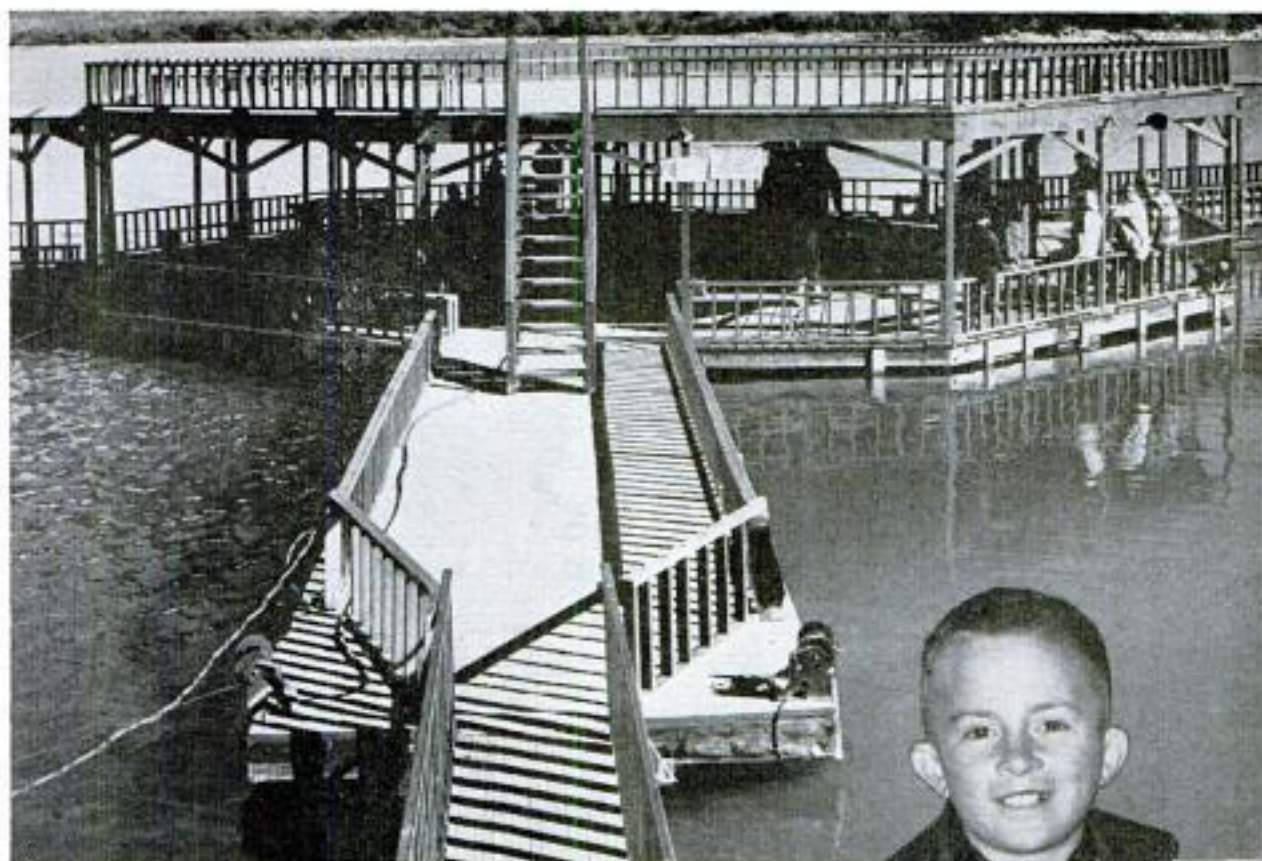

“Armchair” Fishing Dock

MANY FISHERMEN on Lake Buchanan, Tex., angle from an eight-sided, 100-foot-wide covered platform that floats in waters 10 to 25 feet deep. “Wells” are cut into the platform to accommodate several fishermen at a time. Anglers may fish from the sides or from one of two covered piers extending from the central “dock.” The owner baits the waters with alfalfa, corn and fish entrails from the cleaning block on the platform.

Entrails of cleaned fish are swept from cleaning block to water



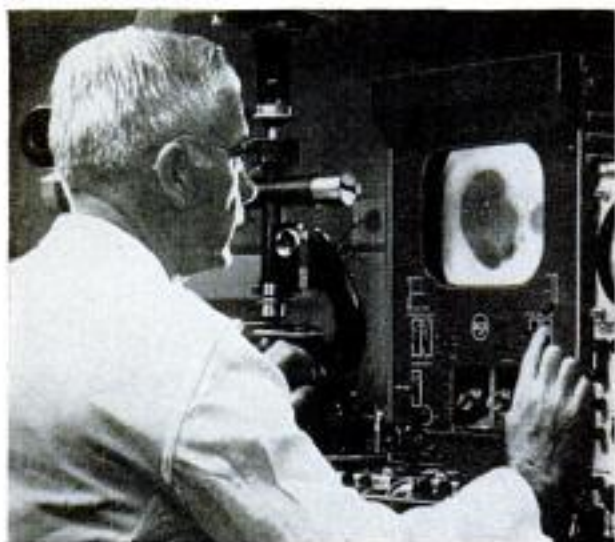

TV Aids Study of Cancer Cells

Closed-circuit TV enables cancer researchers to observe and take motion pictures simultaneously of chemical activity in living cells, making rapid diagnosis possible. Ultraviolet light is focused on a specimen under a microscope. A TV camera transmits the cell image to a TV monitor unit and an oscilloscope. Scientists then photograph internal cell activity.

Superstrong Magnet "Defies" Microscope

Iron particles small enough to be invisible under a conventional microscope are basic elements in a new superstrong magnet. By controlling size and shape of individual particles, this magnet can be made 10 times stronger than existing magnets. It can be molded in unusual shapes (see Christmas tree below) for various uses ranging from toys to aircraft instruments.

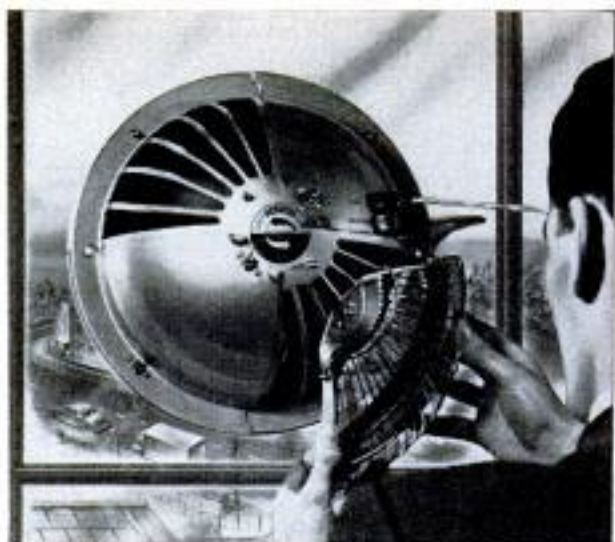

Two-Way Fan Eliminates Drafts

Drawing out stale air and blowing in fresh air in equal volumes, a new two-way ventilating fan eliminates drafts. Air change is 4140 cubic feet per hour. To warm fresh air, a one-kilowatt heater can be attached to the fan grille. A glass-fiber pad can be inserted to filter incoming air. An inner horizontal baffle separates pairs of inlet and outlet quadrants on the fan.

Floor Drainer Covers Wider Area

Through slits designed to draw water from a wide surface area, a new drainer is able to pick up liquid waste missed by conventional drainers. This drainer prevents an air cavity from forming. Pumping continues until all water is removed from flooded sections. Weighing five pounds, the drainer is heavy cast aluminum and can be attached to 1½ or 2-inch suction hose.

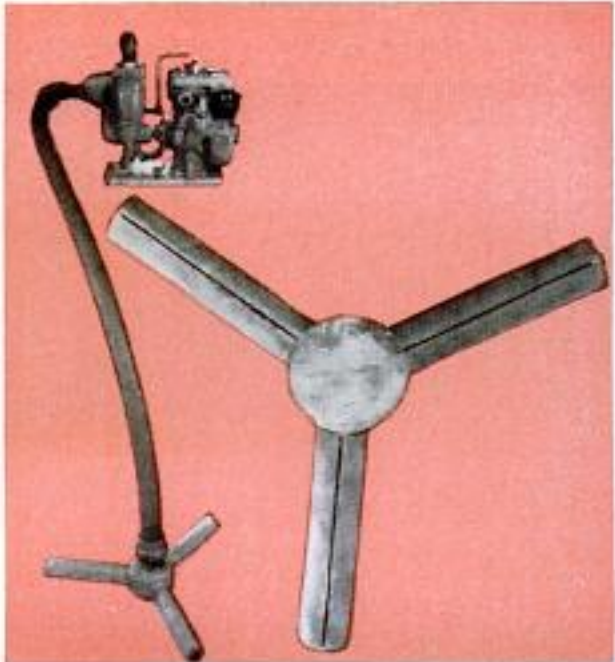

"Flying" Bananas Start to Market

"Airborne" cable systems enable Costa Rican plantation workers to move bananas to railroad shipping centers before shipment of the fruit to U.S. markets. Length of these conveyor assemblies varies from 5000 to 28,000 feet. Depending on terrain, the bunches move at 180 to 200 feet per minute along systems involving 51 to 191 towers which extend 16 to 80 feet in height. Cable carriers, in addition to moving fruit, are also used in the washing of bananas.

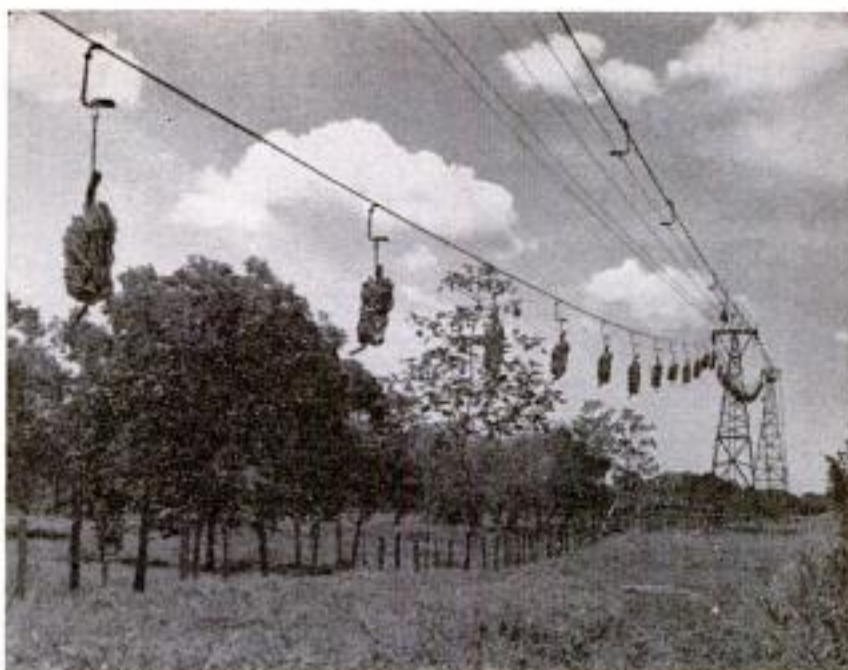

U.S. Bomber Air-to-Surface Missile Is "Rascal"



GAM-63 Rascal air-to-surface guided missile is supersonic rocket weapon used by long-range U.S. bombers. It could be used as a nuclear weapon

Jalopy Graveyard Grows in New York

Scrap-iron output for the U.S. will increase several thousand tons as a result of New York State's compulsory insurance laws. This legislation has driven many worn-out cars from the highways to the junk heap of Academy Auto Wreckers, a private firm. Stripped of radios, heaters and other usable gear, the car bodies wait for shipment to a smelter, where they are melted into scrap iron. Eventually, this iron may find its way into the chassis and other parts of new cars.





Closed-circuit television shows traveler Pullman space available when clerk dials train's code number

Buy Your Railroad Tickets by TV

By Creighton Peet

RAIL TRAVELERS are selecting Pullman space from television screens in New York's Pennsylvania Station. Batteries of electronic brains sort information about available space and transmit it with lightning speed to the customer via closed-circuit TV.

The Pennsylvania's \$900,000 system uses a dazzling array of humming instruments—105 television cameras and 101 receivers, 41 automatic ticket printers, 65 facsimile machines and 72 Telautograph units. Many of the TV receivers are on the ticket-selling

counters where the prospective passenger can see for himself what Pullman or coach space on a particular train has already been sold. With 5183 seats available on cross-country trains leaving the station each day, it's expected that this installation will save vast amounts of time.

Here's how it works. Suppose you want a lower berth on a train leaving tomorrow evening for Chicago. You tell a clerk at a zigzag counter that fills most of one side of the concourse. He dials a couple of numbers on a spin dial in front of him. Immediately,

Here's how electronic circuits in New York's Pennsylvania Station transmit information and speed sales

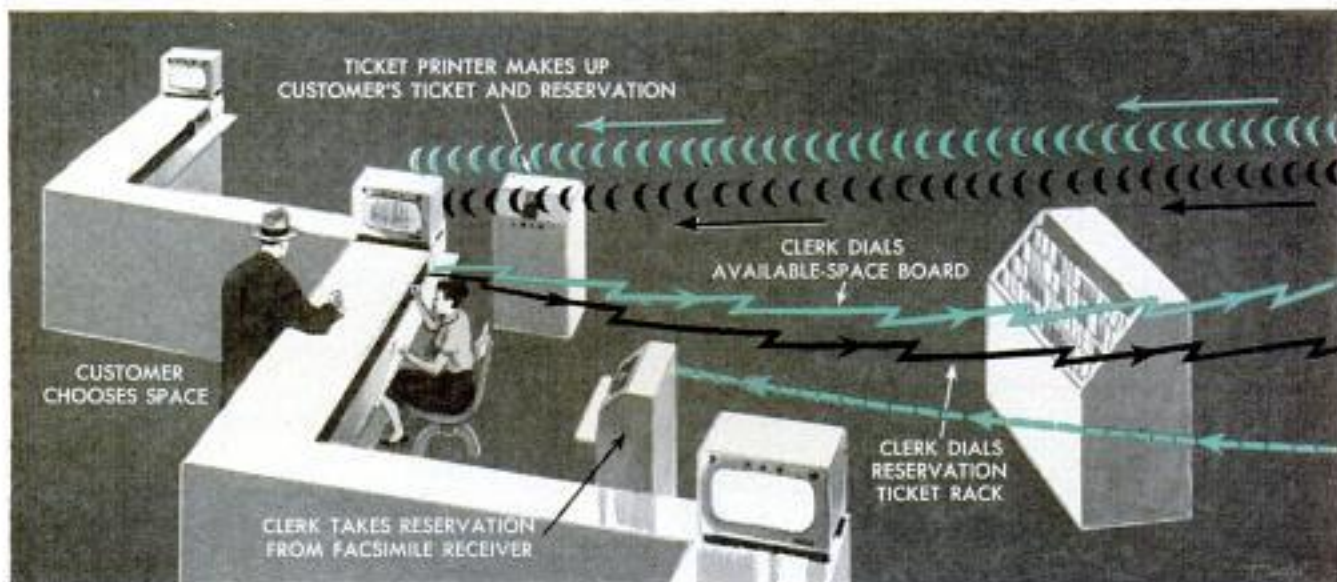

the TV screen on the counter flashes a view (from camera A in diagram) of the "availability board." It looks like a timetable. The clerk runs his fingers along one column and reports, "Sorry, no more lowers on that train . . . but there are still some on the train an hour earlier . . . and the train following." In some cases, availability boards may be consulted as much as 16 weeks in advance.

When you have selected a train with the space you want, the clerk dials another two-digit number. Now the TV screen shows the rack (camera B in diagram) where coupons for the reserved space on the train are stored in slots, like theater tickets. In this TV picture, you also see the clerk servicing the coupon rack. He can talk to the ticket seller by a two-way intercom system. The proper coupon is pulled from its slot in the rack and placed in a facsimile machine.

In about seven seconds, a reproduction of this coupon is transmitted to another machine, a few feet from where you are waiting. The slip of gray paper on which all the reservation data has been "burned" electronically is now your ticket for the space you ordered.

Meanwhile, the ticket seller has pulled a 10-inch-long matrix—something like an Addressograph plate fastened to a long strip of metal—out of a nearby rack. It is inserted in a ticket-printing machine which instantly prints the required transportation ticket and

(Continued to page 226)



Battery of telephone sales clerks uses same TV facilities to handle orders of travelers calling from their home or office



Desk-on-wheels unit keeps clerk within reach of thousands of coupons representing space sold and reservations canceled

Facsimile machine, below, transmits reservation to ticket counter in seven seconds. Rack holds 500,000 space coupons

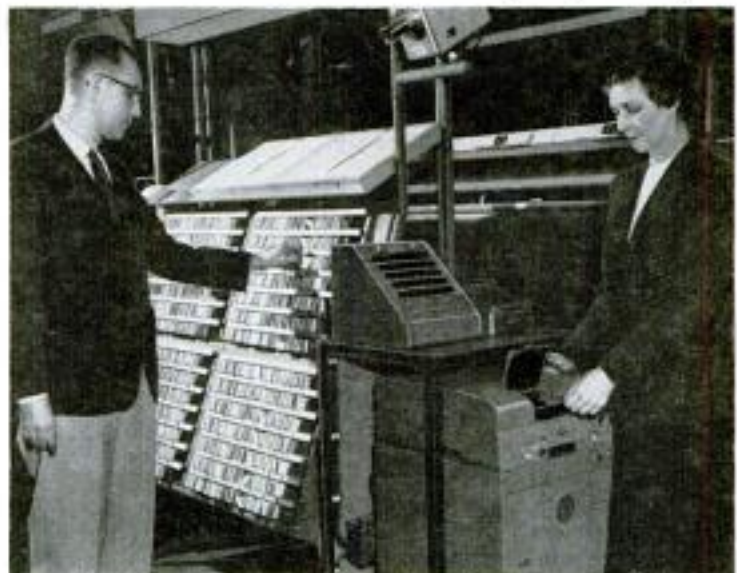
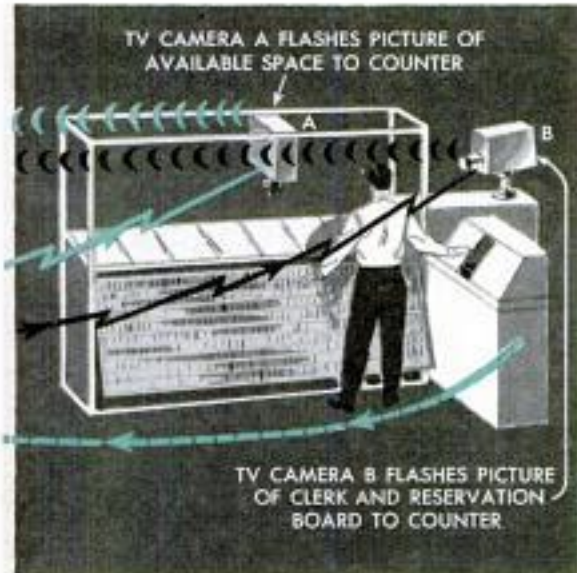



Harvesting unit moves through field until trailer is filled. Below, conveyor then unloads trailer into truck



Train of Equipment Harvests Forage on Cattle Ranches

Western ranchers are using a train of equipment as a unit to harvest green chopped forage and grass silage. First comes a self-powered, pusher-type mower, then a chopper and blower and finally a self-unloading grass trailer. The operator sits high beside the engine that furnishes

power for the entire rig. The trailer has slanting sides which tend to deposit grass in the center. When a truck draws up behind the trailer, a chain and bar conveyor moves the grass up and out of the trailer and transfers it to the truck. The trailer has a capacity of four tons.



"Iron Lung" on Wheelchair Goes With Patient

Thanks to a new portable "lung," some polio victims and other patients who require mechanical respirators now can attend the theater or go shopping. The patient sits in a wheelchair wearing the respirator, which fits snugly around the chest. The mechanism, which is battery-operated and about the size of a small suitcase, is installed beneath the seat of the wheelchair. The apparatus replaces an "iron lung" about the size of a large home freezer. With the aid of a nurse or attendant, the patient can leave the hospital or home and once more go on shopping trips or visit theaters and other places of entertainment.



Special Carriers Move Huge Girders

Prestressed concrete girders about 102 feet long, 11 feet high and each weighing 72 tons will be carried 30 miles to a building site. Master beam carriers have been designed to move them. Each girder is supported at either end above the carrier. Forty-two tires at each end help support the load.

He Fishes in Comfort

Ice fishing causes no hardships to Forest Throe of Burlington, Wis. Throe bought an old car and cut two holes under the back seat. When he arrives at the lake he chops holes in the ice, backs the car over them, removes the seat and fishes in comfort.

Tiny Bus Carries Five

Four children and a driver travel 20 miles per hour in a miniature bus, made by oil-company employees in the Persian Gulf. The vehicle has a 150-cubic-centimeter Piaggio engine and a four-speed gearbox with chain drive. The brake is hydraulic.





Huge "Docks" Shelter B-52 Bombers Undergoing Repairs

Portable "docks," costing \$170,000 each, now are being used at Castle Air Force Base, Calif., to cover B-52 intercontinental bombers on which repairs are made. Individual docks are 190 feet long and 60 feet

wide. The electrical power available at a dock is sufficient to light one full city block. Each dock weighs 350,000 pounds and can be broken into seven numbered sections for relocation.

Fight Atomic Fires With Special Gear

Firemen in Detroit, which has 55 plants and labs using atomic materials, now have special gear for fires involving radioactive materials: Geiger counter, self-contained oxygen mask, ionization tester, dosimeter and a transistorized Handie-Talkie set.

Homemade Flame Thrower Thaws Rail Switches

Frozen switches on a German railway are thawed with a flame thrower made from an insecticide sprayer, two-horse-power motor and ignited diesel oil. Fire spurts four feet at 950 degrees C. The unit uses $3\frac{1}{4}$ gallons of fuel hourly.





Sluice gates in proposed dam allow waters of rising tide to rush into river basin. Dam is 2100 feet long

France Is Harnessing the Tides

By R. N. Hadden

Drawings by G. H. Davis

WITHIN THE NEXT DECADE, the world's first tidal-power station will start to supply electrical power to the people of France, thus realizing one of man's oldest dreams—harnessing the sea.

Plans for this huge power station are well advanced. It will be built on the estuary of the river Rance, where twice every day the tide rises and falls between 7 and 41 feet. When this power station is completed it will produce about 800,000,000 kilowatt hours a year, according to the French engineers who have been working on the project.

How will this power station derive its energy from the tides? Simply by capturing the water behind the dam at high tide and then releasing it to turn the turbines. However, this is not quite as simple as it sounds as is evidenced by the diagrams on page 88.

The dam will be constructed across the estuary at a point where the distance from shore to shore is 700 yards. Turbines and generators will be located within the dam which will be 150 feet wide at the base. Giant sluice gates will be about 27,000 square feet in area.

JUNE 1957

BUILT BY:
ELECTRICITE DE FRANCE
65 RUE DU FAUBOURG — ST. MARC
PARIS SE, FRANCE

85

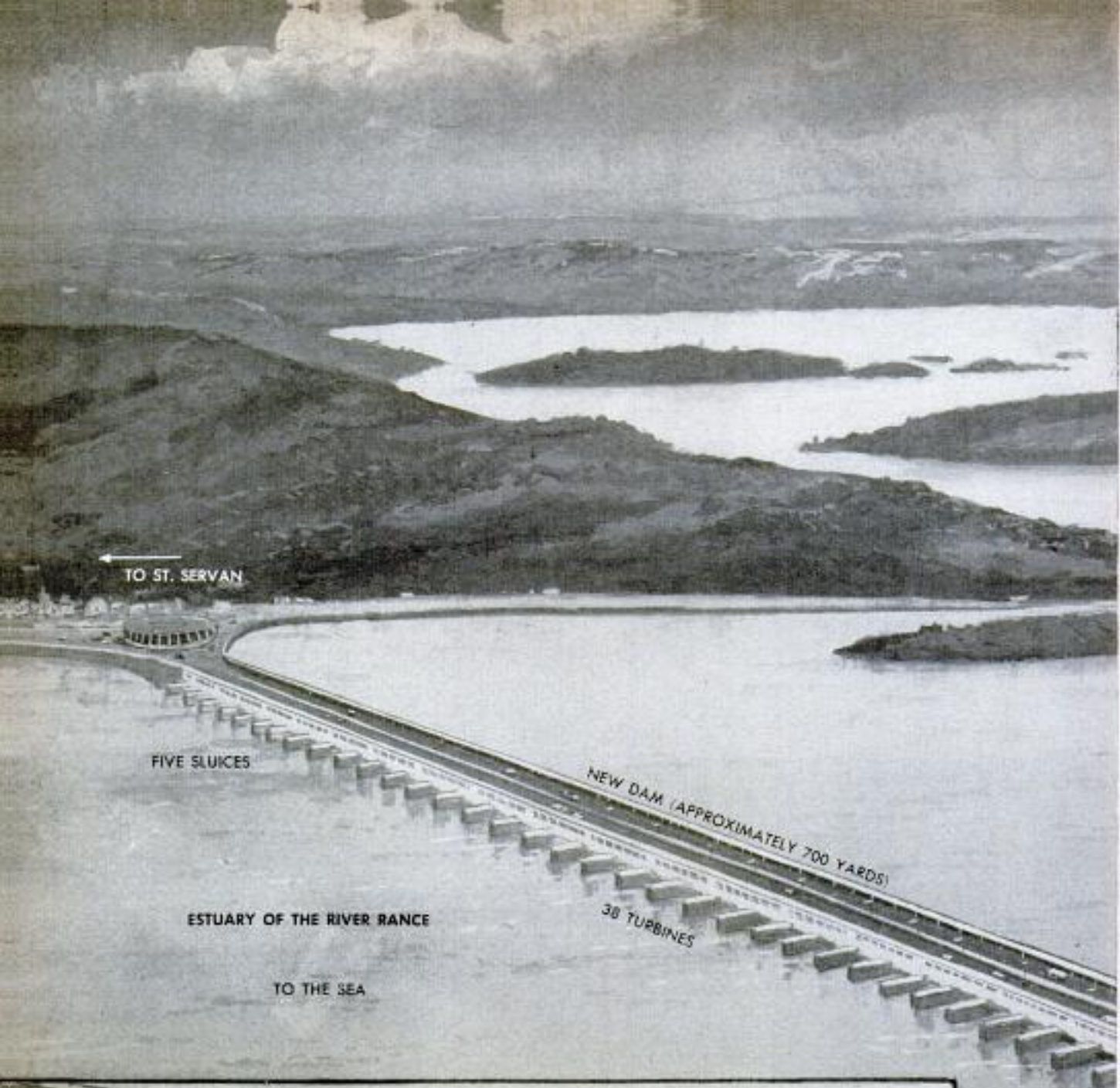

TO ST. SERVAN

FIVE SLUICES

ESTUARY OF THE RIVER RANCE

TO THE SEA

NEW DAM (APPROXIMATELY 700 YARDS)

38 TURBINES

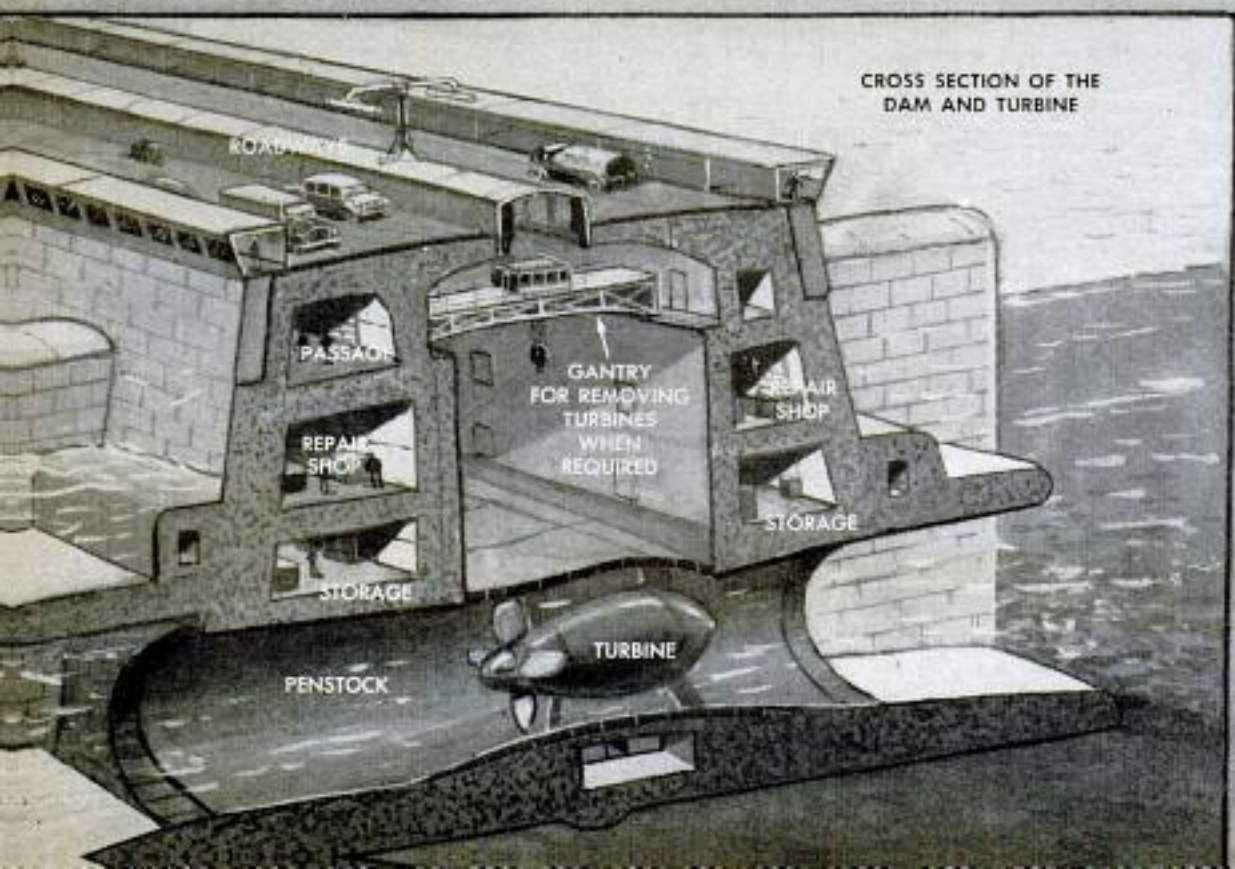

CROSS SECTION OF THE DAM AND TURBINE

ROADWAY

PASSAGE

REPAIR SHOP

STORAGE

PENSTOCK

GANTRY FOR REMOVING TURBINES WHEN REQUIRED

TURBINE

STORAGE

REPAIR SHOP



RIVER RANCE

RIVER RANCE
(SERVING AS BASIN)

FIVE SLICES

RAISING
BRIDGE

LOCK ARRANGED
TO ALLOW SMALL
VESSELS AND FISHING
CRAFT TO PASS AT
CERTAIN PERIODS

NEW ROAD

G. JAMES
FRANCO
1837

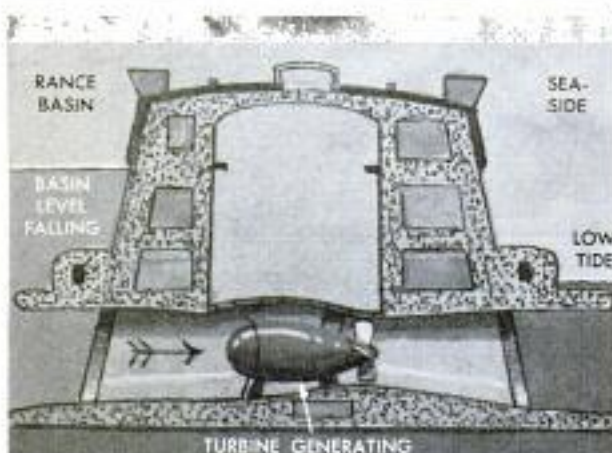
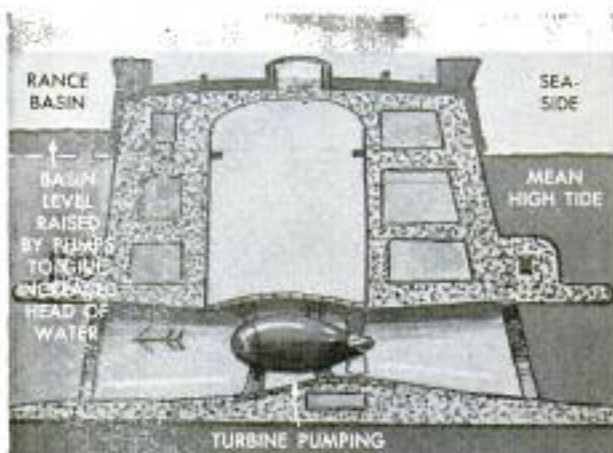
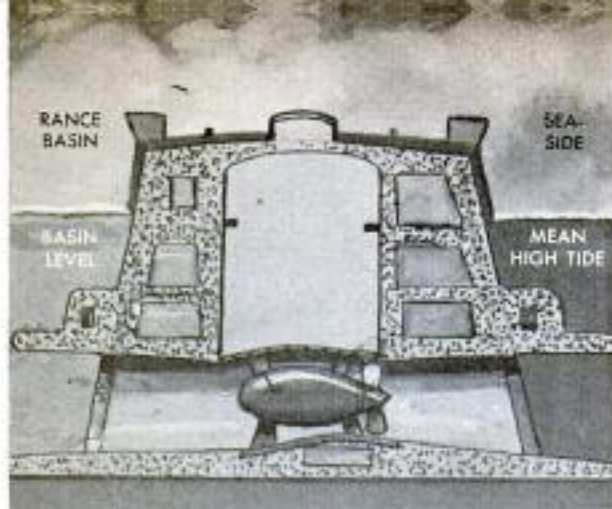
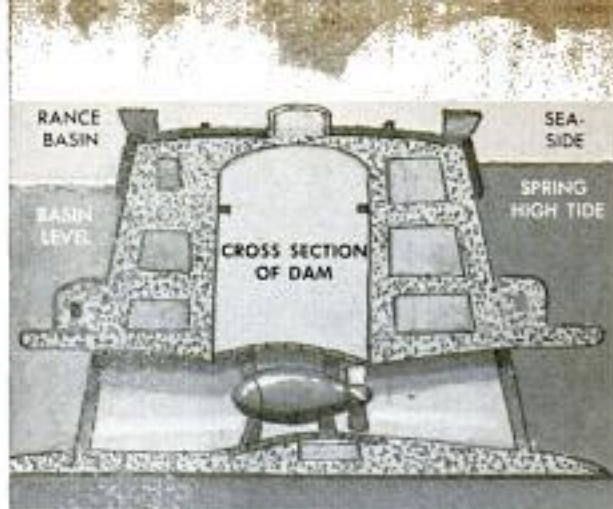

Drawings show how the dam operates with respect to river and seaside water levels. Turbine also pumps

This is how the tidal "harness" will operate: Shortly after low water the sluice gates will be opened. When the tide rises, water will rush through the gates and fill the channel above the dam. When the channel has been filled the sluice gates will be shut. The turbines will then be started up in reverse to act as pumps, the generators serving as motors. The power taken for this operation will be obtained from France's existing electrical network. More water will be pumped from the sea into the channel above the dam.

When the difference in level between the water behind the dam and the falling tide has increased to four feet, the pumping will be stopped. Three hours after high tide the turbines will again be started up, but this time to run as turbines. Electricity will then be fed into the country's power network. The turbines will continue to run until just after low tide when the levels below and above the dam will again be equal. The cycle will then be repeated, electricity being produced for 10 hours in every day.

The reason for the pumping operation may not be quite obvious at first. It has, however, been found from model tests, that the small amount of power absorbed in pumping, when the difference in water level is small, produces a much greater quantity of power when the same water flows through the turbines under a higher head caused by the falling tide. In other

words, a small investment brings big dividends.

There is one apparent drawback to a tidal-power station if operated in this manner—its intermittent operation. This will not be a great difficulty in connection with the Rance plant because it will run in conjunction with a hydroelectric station. While the tidal station is shut down, the hydrostation will be running at a rate that would exhaust its water reservoir if its operation were to be continuous. When the tidal station is running, the hydrostation will be shut down—thus allowing water to accumulate in its reservoir.

The power station itself will be housed in a tunnel inside the dam. In order to preserve the beauty of the Breton vacation area, the top of the dam will be only a few feet above level of highest tides.

Several complex plans for the type and arrangement of turbines best suited to the situation have been considered and discarded by France's National Electricity Company. The present approved scheme calls for horizontal-axis turbines. This type permits using the units either as turbines or pumps. This offers many opportunities for choosing the best levels for greatest efficiency in operation.

The big advantage of a tidal-power station is that come what may, drought or fuel shortage, it will never lack water for its operation. Engineers say it will take about eight years to build the dam. ★ ★ ★



Mockup B-47 Nose "Flies" Around World

STUDENT NAVIGATORS in a mockup B-47 nose at Mather Air Force Base in California use a moving aerial photograph and an ultrasonic trainer to check their navigation on simulated flights around the world. They visually check the unrolling strip photograph of the ground until artificial weather obscures vision. Then they switch to a radar scanner. This ultrasonic trainer is electrically connected to a sound transceiver touching the surface of a nearby 38 by 11-foot tank of water. On the tank's floor is a relief model of the western coast of the United States. An ultrasonic sound head gives off high-frequency waves and echoes reflected to it from the underwater model are translated electrically into a typical radar picture, guaranteeing radar navigation for 1000 miles. The sound head moves across the tank with directional and speed settings made by the student to flight instruments.



Top left, student navigators use radar scanner, while "bug" on aerial photo at top right moves with speed and course of the simulated aircraft. Above, the instructor creates problems on radar navigational trainer operated by student. Below, in water tank with relief model of coastline, the ultrasonic transceiver picks up radar image for training navigation students

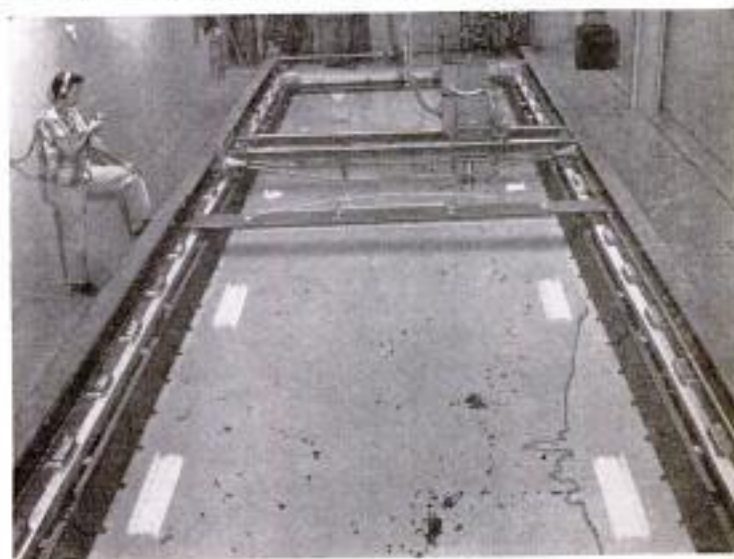



Portable Detector Speeds Up Prospecting

Powered by flashlight batteries, a portable electromagnetometer for prospecting metals is operated by two men simultaneously who can cover up to a five-mile line per day.

It was developed by Vaino Ronka of Toronto, Ontario, Can., patterned after the wartime mine detector.

Hunting for lead, zinc or copper, one man carries a receiver coil and equipment and the other a transmitter. They are connected by a 200-foot cable stretched taut between transmitter coil and receiver coil. In this way an electromagnetic field is set up between the coils and induces voltage to inform the prospectors when they pass over a metallic deposit.



"Flattop" Haircut Measured Mechanically

Thomas Siemons of Wenatchee, Wash., is a barber who guarantees a perfectly level "flattop" cut. He uses a horizontal, swinging iron bracket equipped with two swivel-arms that hold a slanted clipper blade in level position. An adjustable vertical sleeve places the blade in the exact plane for a "flattop" haircut. With clipper attached to the blade, Siemons moves the apparatus in sweeping arcs to produce a haircut in five minutes less time than for the usual trim.



Chair Becomes Table

With a convertible backrest, a British tubular-steel chair has a dual function. Normally a lightweight straight chair, it becomes a chair-table combination when its plastic-covered backrest is flipped into a horizontal position.

Antibiotic Aids Crops

Duramycin is a new antibiotic compound to be used against diseases hampering bean, wheat and bluegrass crops. Named Duramycin because of its stability when subjected to heat, this antibiotic curbs growth of certain organisms and combats several yeasts and fungi, according to the U. S. Department of Agriculture.

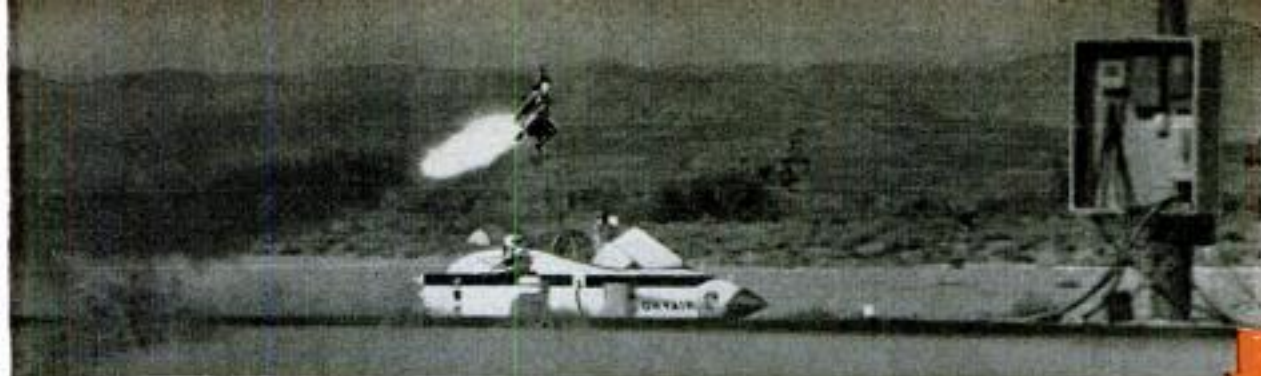

Two dummies are rocket-ejected from a simulated-airplane sled traveling faster than the speed of sound

We Chase the Jets on Film

By Willis E. Harrison

Chief, Photographic Branch, Air Force Flight Test Center, Air Research and Development Command

As told to Thomas E. Stimson, Jr.

EMERGENCY LANDING! Emergency landing in 15 minutes! Get those cameras on the flight-line in a hurry!"

With this urgent command ringing in their ears, the four cameramen barely reached their stations at the edge of the runway when the crippled plane began its approach. It was an F-100 on a ferry flight and the pilot decided to land here at Edwards Air Force Base, Calif., upon dis-

covering the nose wheel of his plane had not fully retracted.

We thought he would land on his main gear and roll out most of his momentum, then slowly settle onto the nose wheel.

But this didn't happen. The pilot suddenly poured on full power, his nose pointed up, a wing hit the ground and the plane slammed over on its back, exploding in flames. He didn't have a chance.

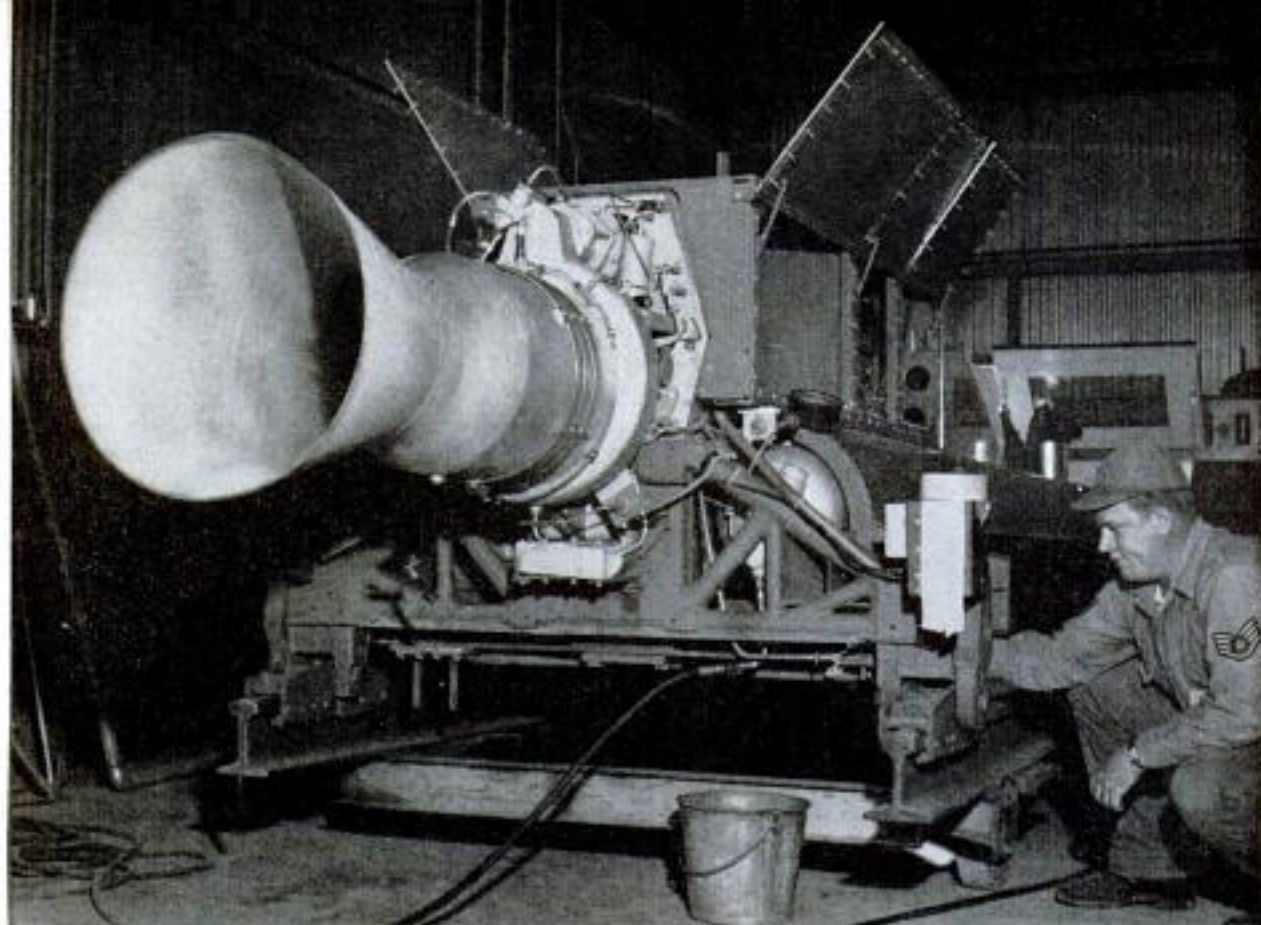

Rocket engine powers the supersonic sled. "Slippers" on each side grip the track rails during the run



Aerial photographer's 30-lb. camera weighs the equivalent of 200 lb. in his lap during a 7-G pull-out

It happened so fast, to the human eye there was no telling what went wrong. But the movies would show us what happened. In addition to the four flight-line 16-mm. cameras shooting color at 700 frames per second, the accident was also covered by two space-position cameras on a hilltop four miles away. Projected at normal speed, these movies would stretch one second of time into half a minute on the screen. The accident could be analyzed foot by foot.

Films Tell Story

This is what they showed: The pilot made a normal approach and flare-out but at the last moment he decided to go around again. He snapped his throttle into afterburner for more power, then immediately cut it. He did this three times.

These enormous surges of thrust pushed

As these rockets burn out, ones on other end of sled fire up and reverse it suddenly to test fuel tank



his nose so high that the normal flow of air into the engine intake was reduced. A compressor stall occurred, causing a reverse flow of the flame. That ended it. In the motion pictures we could actually see the afterburner go into action three times, could see flame shooting from the intake when the engine lost its air.

It was apparent the pilot delayed too long his decision to go around again. We made extra prints of the film and sent them to all tactical units using the airplane so pilots would learn the importance of completing a landing once they were committed.

One of the main jobs of our photographic branch at Edwards is to make high-speed movies of routine events merely on the chance that something might go wrong. If nothing happens, hardly anyone bothers to view the film. But if there is an accident the experts gather in the projection room and run the film over and over. Often there is no other way of taking an accident apart and learning how it developed. Because of this photography designers are learning how to build better airplanes.

That's the reason we record every run made on our rocket-sled track. As many as 42 cameras have been used on a single test. Some are high-speed 16-mm. movie cameras shooting up to 8000 frames per second, others are 70-mm. outfits that make 50 sequence stills per second. Most of them are located on "camera row," 360 feet away from the track. The rest are mounted beside the track. They are tripped electrically by a cutter bar mounted on the sled.

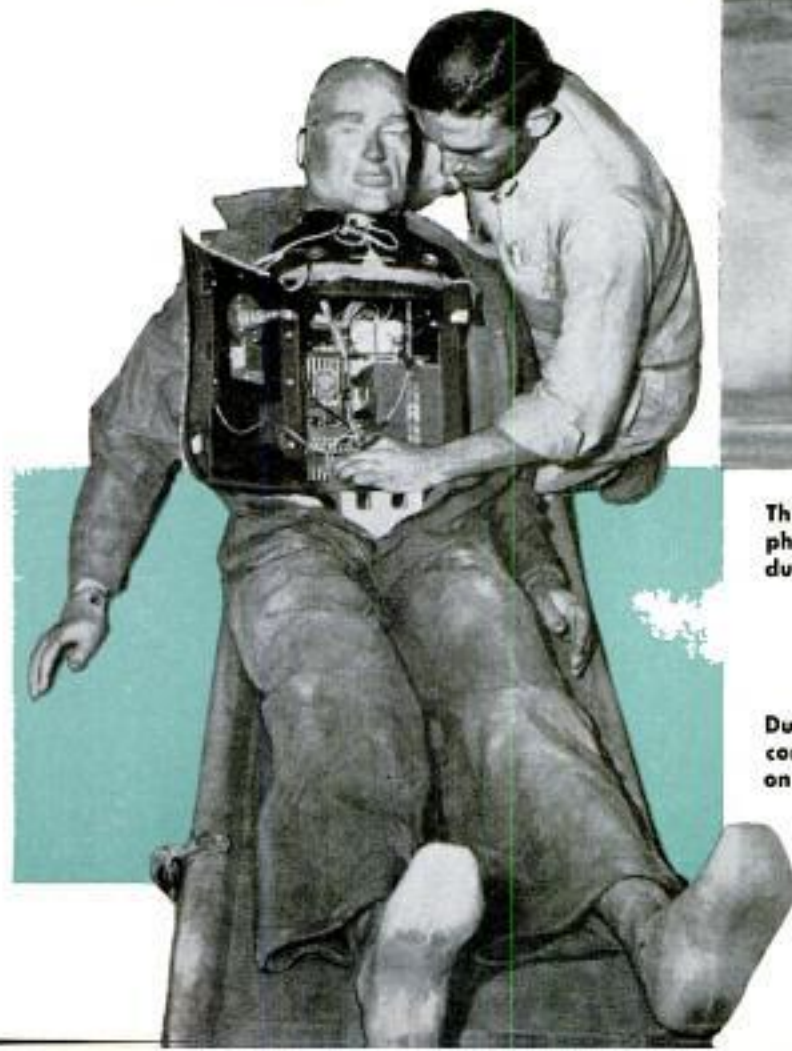

This might have been disaster! High-speed photo catches rocket breaking from ejected dummy, helps analyze cause of the accident

Dummy's "brains" are in its chest, where complicated instruments relay information on what would happen to a man in the tests



Billows of rocket smoke indicate the supersonic speed of this test sled in a sequence of front-view photos showing how a rocket attached to the ejection seat of lifelike dummy propels it from the sled's cockpit

Any piece of gear, any part of an aircraft that needs testing can be mounted on a rocket sled and fired down the 10,000-foot track at speeds up to Mach 2, about 1500 miles per hour. Fantastic things happen at this brutal speed.

Once, a complete rocket sled broke away from the rails and became airborne. Observers said it flew like an airplane, but the high-speed movies revealed that it made a complete flip. The action happened so fast that no one could see it with the naked eye.

We've seen big rocket bottles rip loose from their mountings on a sled and take off in erratic, tumbling flight. They behave like a toy balloon that you blow up and release. There's no telling where they will go. One bounced across the ground three times and then roared over the head of a photographer.

To give you an idea of the speed of a rocket sled, if we place a camera at trackside one mile from the start and operate it at normal speed, only three feet of film will be

exposed by the time the sled goes past.

Watching one of these supersonic runs is a unique experience. The rocket motor makes a tremendous roar. But it's absolutely silent approaching, for the sled is moving faster than Mach 1. There's a big crash when it goes by, a "close up" of the sonic boom you get from a supersonic airplane. The shock wave has a real punch and an inexperienced photographer is apt to duck.

The trackside cameras would be demolished if we left them unprotected. Each is encased in a box built of thick aluminum plates, with a glass port for the lens. Even this protection isn't always enough. The shock wave from a fast sled sometimes rips a camera box from its mounting and tosses it 30 feet away, popping all its rivets. We are now designing small armored block-houses for the cameras.

None of the photo staff has been hit by objects flying off a sled, although there have been a lot of near misses. Thick chunks of

Plexiglas from shattered canopies and portions of ejection seats have slammed into the ground close by. Usually the photographers crouch in a ditch when a sled roars past, but on some occasions they must be stationed in the open.

They are top men, with split-second reflexes. Recently I assigned six of them to cover every aspect of a multiple-seat ejection from a sled that simulated the nose of a bomber. Three canopies would be jettisoned from the sled and three dummy pilots in ejection seats would shoot up into the air. At a safe altitude the seats would drop away and the dummies would descend by parachutes. The sled would be traveling 650 miles per hour.

One photographer was assigned to the first canopy, the next to the first dummy, and so on. Each would pick his own object as it left the sled and pan his camera to follow it to the ground. What made the assignment difficult is that at the moment of ejection, the air is suddenly filled with all kinds of debris. Shoes and helmets may be ripped off the dummies, and anything loose in the cockpit is whipped up into the air. It's hard to single out the object to be tracked. Nevertheless, each photographer did a perfect job.

Testing an experimental ejection apparatus is always spectacular. Quite often the test is a failure as far as the dummy is concerned. That's why sleds and dummies are used for studying a new idea and that's why high-speed pictures are made.

Most of the ejection studies today are concerned with escape from aircraft traveling 1000 miles per hour or faster. Eject a pilot traveling at these speeds and it's like

(Continued to page 228)

Right, high-speed-sequence still camera catches the launching of an airplane by rocket booster. Below, photographer is almost hit by flaming piece of solid propellant (see dotted lines under tripod) in filming of a rocket's effect on the pilot's vision



Sled's shock wave sometimes tosses trackside cameras 30 ft. although they're bolted down in metal boxes

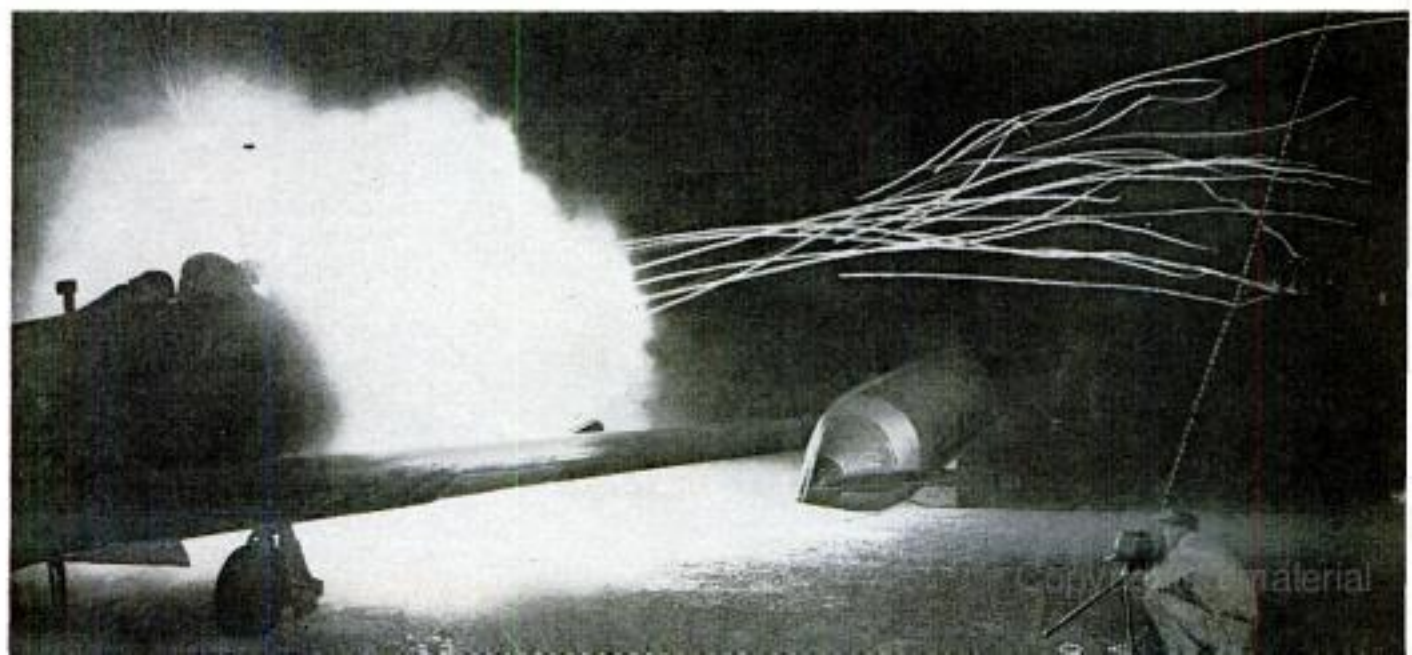

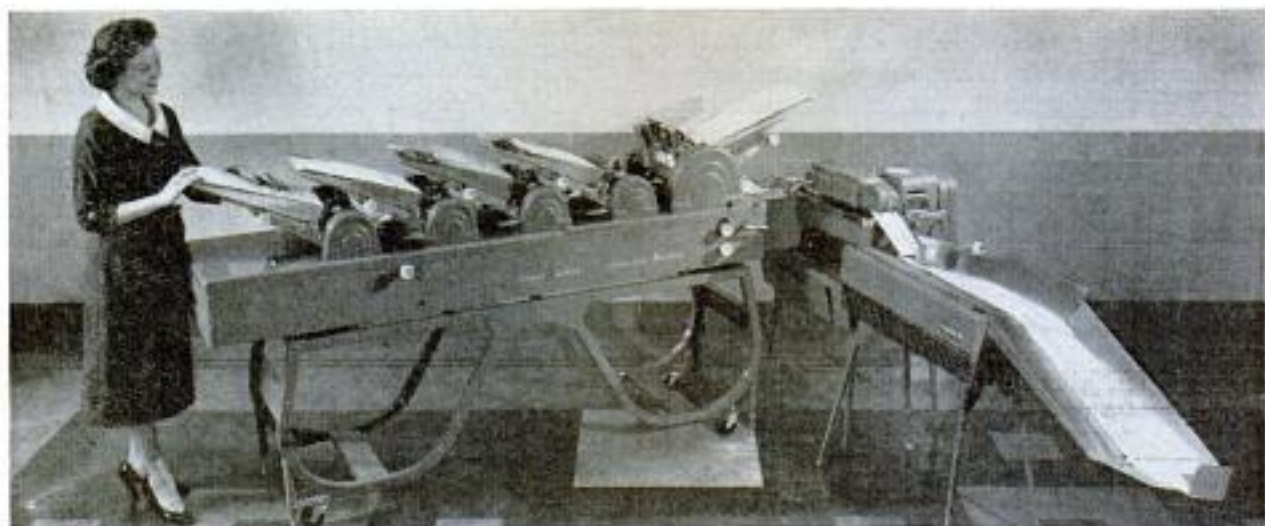

Machine Opens, Stuffs, Counts, Seals, Imprints, Stacks Mail

Handling 6000 mailing pieces hourly, a new machine can open and stuff envelopes, count, seal, imprint postage and stack mailings in a continuous operation. One worker can set up a job in minutes without a mechanic or toolkit. Minor adjustments are made by turning knobs, and a straight-line, self-centering feed eliminates align-

ment problems. Automatic signals prevent misfeeding. A detector forestalls jams, faulty insertions and mutilation of enclosures. Variable speed control makes difficult jobs possible through dialing of slower cycles. This machine can accommodate most envelopes, end-folded telephone and utility bills and items of different shapes.



14-Ton Truck Can Expand to Five Times Road Size

Starting with an inside area of 150 square feet, a 14-ton truck made of aluminum can expand in five minutes to 780 square feet—five times its on-the-road size. When a button is pushed, the truck's sides move outward, while accordion-folded aluminum floors drop into place until an area large enough to seat 125 persons is available. With a trailer that can be drawn by any standard-truck power source, this vehicle's potential uses range from a service vehicle for the armed forces to a mobile home.



Battleship Guns Become Test Chambers

Two United States battleship guns have been converted into high-pressure test chambers at the Navy Electronics Laboratory, San Diego, Calif. Sonar equipment, diving apparatus, and devices destined for deep-sea use will be tested. The guns are of 12 and 16-inch caliber. One third of each gun barrel was sawed off and a solid-fitting, watertight, airtight plug was machined for the "muzzle" end. The breech mechanism is reported ideal for insuring the chamber against leaks. An object to be tested is inserted in the gun barrel; the breech is closed and water pumped into the barrel to simulate a desired depth, controlled by gauges on the gun's exterior.





Above, completely immobile patient rests on a three-in-one unit, which consists of a combination wheelchair, armchair and bed

Designed for the Handicapped



Right, young spastic patient finds her "walker" fun to use. This equipment provides support and allows leg movement



Above, legs weak, a girl works at a play table with an attachment on the reverse side to keep her erect

Below, "walking skis" promote normal gait in persons who have suffered the loss of leg functions



TO THOUSANDS OF DISABLED or partially disabled persons in Great Britain, the name of Emil A. Andre is synonymous with hope. Many of these people are polio patients, victims of accidents in the first stages of postoperative recovery or patients suffering from old-age ailments. Their common denominator is that each of these persons has limited use of the arms or legs. In his small plant at Tottenham near London, Andre makes devices to help these people eat, walk, exercise, play and meet everyday needs. Hospitals, such as St. Bartholomews in London and the Bristol Royal Infirmary, refer "problem cases" to Andre. For individual patients, he fashions working scale models, which he tests before completing the final product. A member of the British Red Cross Society, Andre has made a glassholder for the weak-in-arm, a "walker," "walking skis" and a play table for the weak-in-leg.

Below, her hands still too weak to grasp a glass, this young girl gets her water by using an Andre-designed "glassholder"



OWNERS REPORT:



HOW GOOD IS THE BUICK?

Owners say its best feature is its handling ease (47.0%), next comes its riding comfort (38.9%), third its styling (33.3%).

Owners complain most about poor gas mileage (20.1%), poor workmanship (14.5%), and body rattles (13.7%).

WHAT DO OWNERS THINK ABOUT INDUSTRY TRENDS?

Most of them approve. Only 12.3% register disapproval. Specifically, here's how they feel about Buick's design: 84.3% like its lowness; 79.7% like its length; 76.6% like its speed.

**FOR MORE OF WHAT OWNERS SAY
ABOUT BUICK READ THIS ARTICLE** 

Buick owners in 40 states (shaded on map at top of page) complain of poor gas mileage, praise handling



Owners Praise Handling, "Conservative" Styling

By Buick Owners

BUICK IS ALL NEW for 1957, but it's unmistakably Buick. You have no difficulty identifying it because it retains much of its character from previous years.

Whether this is desirable or not is a matter for argument. There are things to be said on both sides.

Among the Buick owners, there seems to be a strong feeling that certain makes have gone too far in styling. Of the Buick owners who rate exterior styling as the best-liked feature, 25 percent describe it as being "conservative" or "dignified" or use some similar term.

"I like the styling. Other cars look like rockets to me. I want a car that's down to earth."—Connecticut retired owner.

"It looks like an automobile and not like something that came from Mars."—New York sales manager.

"I like straight-line styling. No fantastic fins."—Ohio cafeteria worker.

"I like the nonradical style change. It keeps resale value up."—California pilot.

Owners also like the Buick's lowness, its front grille and open rear wheels.

"Car is built close to the road."—Ohio builder.

"I like the neat grille."—California telephone worker.

"Full-exposed rear wheels."—Colorado architect.

Among the least-liked exterior styling features are the three-piece rear window, the windshield shape, the front bumper and the rear-deck design.

"The three-piece rear window has good styling possibilities, but this is not the best that could be done with it. It leaks, too."—California pilot.

WHAT IS AN OWNERS REPORT?

Popular Mechanics sends questionnaires to 1000 owners of a different make of car each month. These owners are picked for us at random from coast to coast by an independent organization. The replies from owners are tabulated and compiled to provide readers with a summary of what the owners think of their new cars.

Next month's Owners Report will be on the 1957 Oldsmobile.



Irving Seligmann photos

Power and performance rate fourth with the owners, following the top-rated handling, ride and styling



Extending far into the door opening, the big wrap-around windshield makes entry and exit awkward, say 11.6 percent of owners. Below, the long glove box is handy and its lid is designed to use as a snack tray



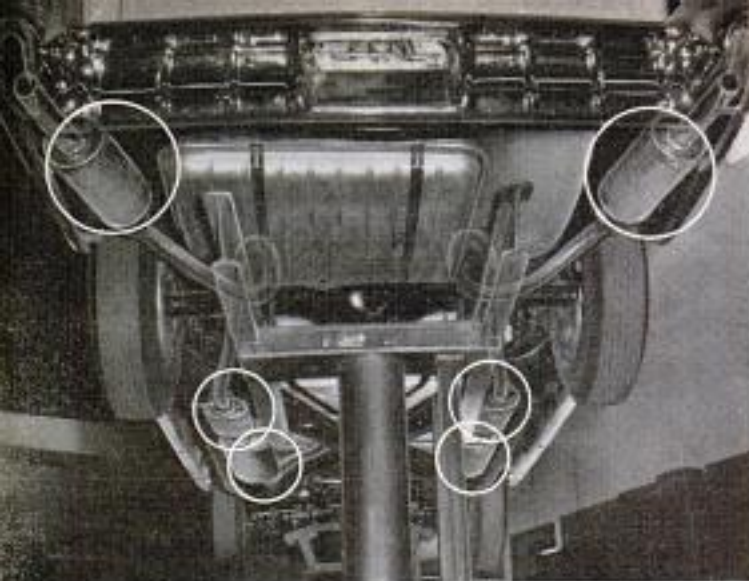

Evidence of why cars cost so much is Buick's huge muffler system, shown in phantom. Cost of all parts of system: \$100. Labor for installation is extra

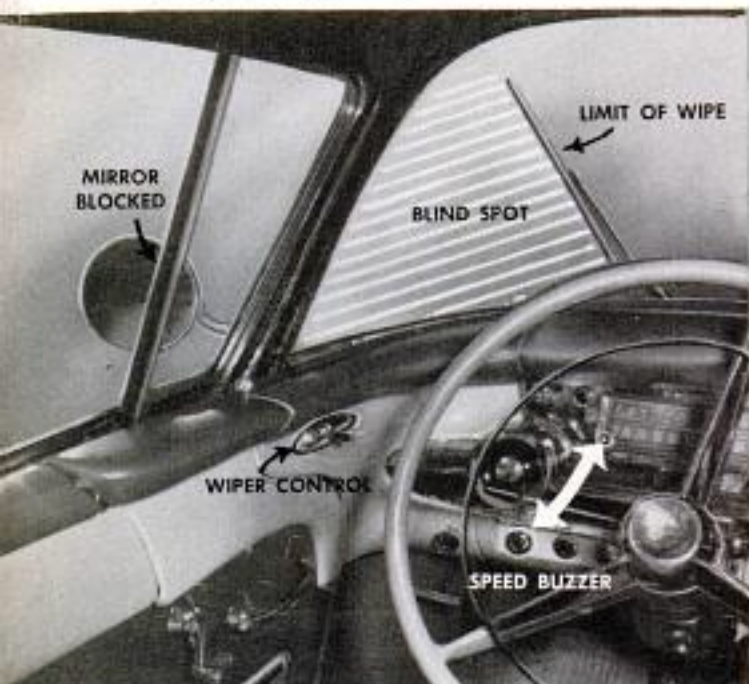

Photo shows some good and bad features as noted by owners. Buzzer adjusts to go off at any preset speed

Below, owners describe this styling as conservative and say they prefer it to more radical fin treatment



"Windshield curves too much, making it hard to get in and out the front seat."—Missouri sheet-metal worker.

"Front-bumper guards offer no protection."—California supervisor.

"Don't like the lopped-off trunk."—Illinois technician.

Best-Liked Features

Topping the list of best-liked features among Buick owners is its handling ease. Second is riding comfort, third is exterior styling.

"I drive four miles to work each morning, back home at noon for lunch, back to work and home at night again. All in heavy city traffic. My Buick is a dream to handle. No stalling at stop lights, no sluggish starts."—Indiana drill-press operator.

"In rainy weather I have about a half mile of mud roads to drive over. It handles good on mud."—Oklahoma aircraft worker.

"Easy to handle in traffic."—Michigan engineer.

"The car is heavy enough for comfort on long trips."—Missouri superintendent.

"I am 71 years old and drive about 40,000 miles a year. I must have comfort and I find Buick affords it."—Maryland engineer.

"I like its dignified styling."—Connecticut salesman.

(Continued to page 218)

Special and Super dimensions are given on diagrams. The other models differ only by fractions of an inch

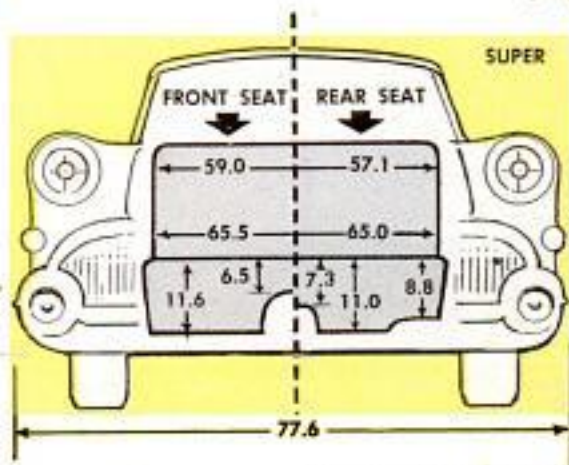
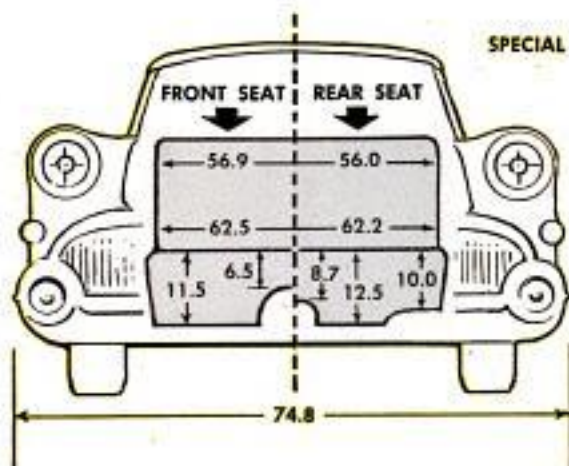

The OWNERS' OPINION of the '57 BUICK

Had trouble with engine?

No trouble	66.4%
Some trouble	25.7%
Considerable	7.9%

What was engine trouble?

Carburetor	9.8%
Valves, lifters	2.3%
Oil pump	2.3%
Water pump	2.3%
Timing	2.3%

Performance

Would like faster acceleration?

Yes, would	24.9%
No, would not	67.4%
Undecided, no answer	7.7%

Would like more top speed?

Yes, would	3.4%
No, would not	73.6%
Undecided, no answer	23.0%

What is the car's horsepower?

Knew correct hp	75.5%
Did not know hp	24.5%

Styling

Best-liked exterior feature?

Lowness of body	14.9%
Conservative styling	12.4%
Front grille	5.2%
Open wheel housings	4.0%

Least-liked exterior feature?

3-piece rear window	11.2%
Windshield shape	6.0%
Front bumper	3.2%
Short, stubby trunk	3.2%

Best-liked interior feature?

Dashboard design	30.5%
Glove box	7.6%
Upholstery	6.0%
Color treatment	5.2%

Least-liked interior feature?

Ash trays	8.0%
Floor covering	3.6%
Window-crank location	3.2%
Floor hump	3.2%

OVER-ALL RATING

Excellent	Average	Poor
60.9%	31.4%	7.7%

Miscellaneous

Have Safety Minder buzzer?

Yes, have it	91.4%
No, do not	8.6%

Is it used?

Yes, all the time	48.5%
Some of the time	45.4%
No, none of the time	6.1%

What car will buy next time?

Buick again	62.3%
Another GM make	6.8%
Chrysler Corp. make	7.9%
Ford Motor Co. make	4.1%
Some other make	0.4%
Don't know, no answer	18.5%

Why Buick this time?

Previous ownership	27.3%
Exterior styling	17.3%
Dynaflo	11.2%
Riding comfort	6.0%

What make car was traded?

Buick	58.9%
Another GM make	18.5%
Ford Motor Co. make	9.1%
Chrysler Corp. make	5.3%
Some other make	1.9%
No trade, no answer	6.4%

How is dealer service?

Excellent	50.4%
Average	31.9%
Poor	17.7%

Would buy from him again?

Yes, would	47.9%
No, would not	19.2%
Undecided, no answer	32.9%

What should be changed?

Nothing at all	33.7%
Improve gas economy	9.2%
Better workmanship	9.2%
Easier to get in, out	6.0%
Better brakes	4.4%
Less horsepower	4.4%
3-piece rear window	4.0%

Best-Liked Features

Handling ease	47.0%
Riding comfort	38.9%
Exterior styling	33.3%
Power, performance	27.3%
Dynaflo	16.9%
Roadability	6.8%
Roominess	6.0%

Most-Frequent Complaints

No complaints at all	22.9%
Poor gas mileage	20.1%
Poor body assembly	14.5%
Body noises, rattles	13.7%
Hard to get in, out	11.6%
Brake troubles	9.2%
Carburetor trouble	7.6%
Window fit, operation	7.2%

Buick is very low

Like this lowness	84.3%
Don't like it	10.7%
Undecided, no opinion	5.0%

Buick is very long

Like this length	79.7%
Don't like it	6.1%
Undecided, no opinion	14.2%

Buick is very fast

Like this speed	76.6%
Don't like it	7.3%
Undecided, no opinion	16.1%

What Do Owners Think of Industry Trend in Auto Design?

Like current trend.....83.1% Don't like trend.....12.3% No answer.....4.6%

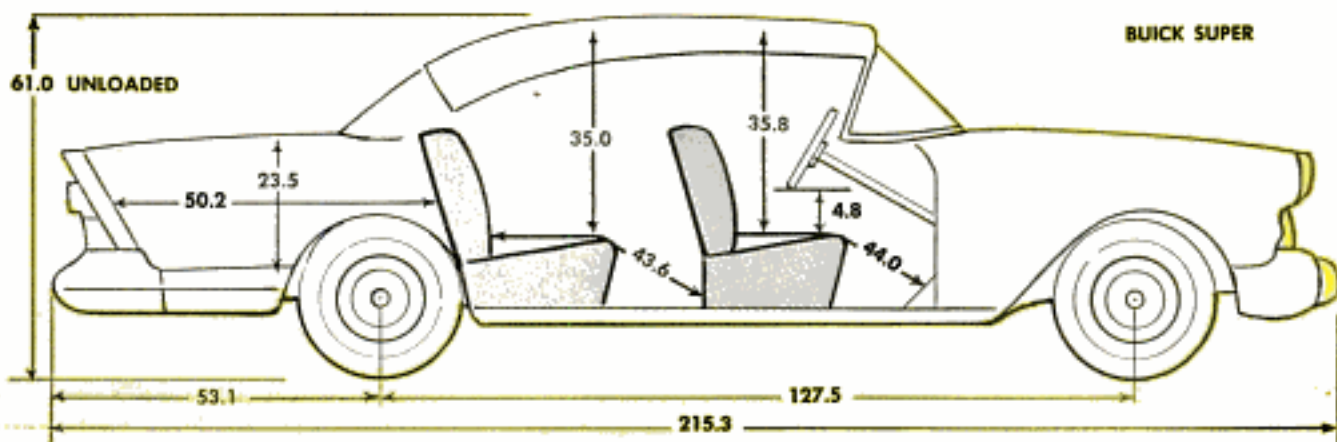
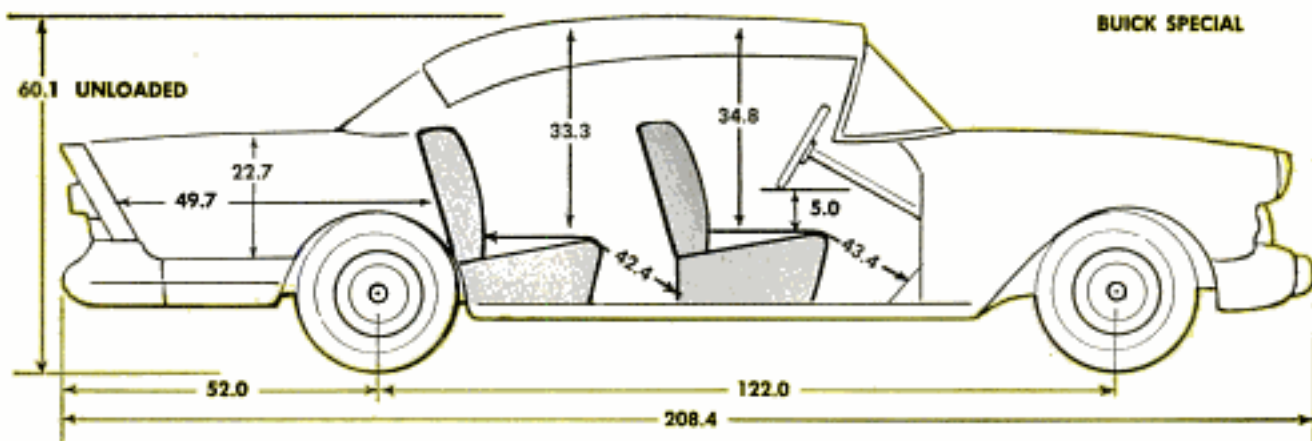

An Engineer Analyzes the 1957 Buick

By Dale Kelly SAE, Registered Professional Engineer

MODEL TESTED: Special four-door hardtop with two-barrel carburetor, dual exhausts, Dynaflo transmission, power steering and power brakes.

Wheel base: 122 inches. Tires: 7.60 by 15. Weight: 4410 pounds with gas tank half full (55 percent

of this weight is on the front wheels, 45 percent on the rear).

Mileage on car at time of test: 1800 miles. Barometer: 29.25 inches. Temperature: 62 degrees F. Payload: 200 pounds.



ACCELERATION TIME FROM STANDING START IN SECONDS

	0 to 20	0 to 40	0 to 60	0 to 80	¼ mile
Ignition timed for regular gas (90 octane Research)	3.1	6.9	11.8	24.5	19.2
Ignition timed for premium gas (97 octane Research)	3.0	6.7	11.6	24.5	19.0
Ignition timed for super fuel (105 octane Research)	No improvement noted				



FUEL ECONOMY IN MILES PER GALLON

	Steady 30 m.p.h.	Steady 50 m.p.h.	Steady 70 m.p.h.	Traffic Route
Ignition timed for regular gasoline (90 octane Research)	18.1	17.4	14.9	9.4
Ignition timed for premium gasoline (97 octane Research)	18.2	17.0	14.8	9.4

On the traffic route the car makes 10 full stops per mile and is driven fast enough to average 15 miles per hour.

ESTIMATED AVERAGE ANNUAL GASOLINE BILL: \$189 for 10,000 miles.



SPEEDOMETER ERROR (Miles per hour)

Speedometer speed	20.0	30.0	40.0	50.0	60.0	70.0	80.0
True speed	18.5	27.5	36.0	45.0	54.0	63.0	73.0

ODOMETER ERROR

Odometer showed correct mileage within ½ of 1 percent.

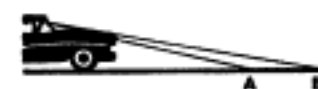

DRIVER'S VISION (for an average driver—5 feet 9 inches tall)

Distance at which part of road in front of car could be seen (A in sketch)	20 feet
Distance at which full width of road in front of car could be seen (B in sketch)	25 feet



GROUND CLEARANCE (unloaded car)

Radius of worst dip that could be crossed (solid line)	23.5 feet
Radius of worst hump that could be crossed (dotted line)	20.0 feet
Deepest rut car could be driven in	6.9 inches
Curb clearance for door opening	12.6 inches

MISCELLANEOUS

STEERING

Wheel turns from straight ahead to steer outside front wheel in a 100-foot-diameter circle: 0.65 turn
 Diameter of smallest circle within which wheels could complete a circle (curb-to-curb): 42 feet
 Diameter of smallest walled circle within which the entire car could complete a circle: 44.5 feet
 Steering-wheel turns, lock-to-lock: 4.0 turns
 Steering-wheel diameter: 17.5 inches

TRUNK CAPACITY

Number of standard cartons (1 cubic foot each) that could be packed into trunk: 11 cartons

CENTER OF GRAVITY (unloaded car)

Height of center of gravity: 21.5 inches

WATER RESISTANCE

Good. In splash-pan test, brakes and ignition were not affected and no water entered the body. In high-pressure car-wash test there was slight leakage at each of the doors, none in the trunk

OVER-ALL DIMENSIONS

Length: 208 in. Width: 75 in. Height: 60 in.

OBSERVATIONS

Buick has a full set of pointer-type gauges, preferred over warning lights by many motorists. However, only the speedometer has a proper numerical scale. Oil-pressure gauge, temperature indicator, and ammeter do not have any numbers at all. With engine running and battery low, the ammeter pointer, moving to extreme charge position, went completely out of sight. It indicated a slight charge when no current was flowing and read zero when radio alone was turned on

Straight-line speedometer is novel, but because red line ends at an angle there is a three-miles-per-hour ambiguity, depending on whether it is read at the bottom, where the graduations are, or at the top, where the numbers are

Buick is to be commended for providing an excellent jack and for building special jack points on the frame

Gas-tank fill rate satisfactory. Brakes good. Parking brake held on a 14-percent grade. Power-brake reserve vacuum sufficient for five applications with engine dead

Test Driving the '57 Buick Special

By Floyd Clymer

THE TEST ROUTE was from Los Angeles to Yuma, Ariz., via San Diego, then along the U. S.-Mexican border, the Salton Sea (346 feet below sea level) over El Cajon Pass (4301-foot altitude) and back to Los Angeles—a total of 815 miles.

The two-door Special hardtop has the 250-horsepower engine of 364 cubic inches, the displacement used in all '57 Buicks.

There is minimum engine vibration. It has fast acceleration and pulling power. The speedometer hit 116 miles per hour on long open stretches, but it was optimistic by about eight percent.

The car is several inches lower than previous models. There is a solid feel to the body and stability has been improved. The center of weight has been lowered, which has improved the handling qualities. Wind noise at high speeds and body rumble have been reduced to a minimum.

There is, however, the same steering-wheel vibration that was noticeable in previous Buicks at above-average speeds over rough roads or pavement. This is caused by the rear-end unsprung weight of the torque-tube drive. The torque-tube drive does combine the rear axle and drive shaft into a rigid unit, which assures better rear-end alignment than Hotchkiss drive.

The car has an extremely soft ride but front-end "floating" is noticeable, with some roll on sharp corners. Nevertheless, the car is a good roadholder. I found roadability to be better than in previous Buicks tested. Coil springs on the rear give a soft ride but, with a loaded car or over sharp dips, there is a tendency to "bottom." However, rebound control is good.

Dynaflow no longer has the slippage or mushiness so evident on early models. The

drive is positive enough to spin wheels on a dry pavement. The downshift is smooth and Low range provides excellent braking when descending steep hills. It has less "creep" than any transmission I have used.

I abused the brakes, both at high speeds and in the mountains. I have always felt that Buick brakes could be improved, and I haven't changed my mind, as there was some fading at high speeds.

The massive bumpers offer excellent protection. The rear bumper has openings at each end for the exhaust. This makes for dirty bumper ends—a no-good feature in my book. The gas-tank fill location is under a hinged lid in the center of the bumper, fine for fueling from either side.

Interior appointments are of high quality. Doors open and close easily. The instrument panel is new. Instruments are well arranged and located below a dull-finish cowl that has minimum reflection. The speedometer indicator is a horizontal ribbon in place of the customary needle. It has very little fluctuation. The new Safety Minder can, by means of a knob, be set to buzz when the car reaches any desired speed.

The heater is one of the best that I have ever used and heats quickly. The glove compartment is larger than average, with a lid that opens flat with indentations for four glasses—handy for drive-in eating.

Even though a full-circle horn ring is used, the speedometer view is unobstructed. I especially like the needle gauges for temperature, oil pressure and voltage. To me these are better than warning lights.

Another excellent feature is the location of the windshield-wiper control on the left side of the cowl ahead of the door. ★ ★ ★

Clymer praises Buick's soft ride, but says steering-wheel vibrations are noticeable on rough pavements

All Buicks have same displacement. Horsepower differences are due to carburetion, compression ratios





Lowly Cactus Starts Industry

Mescal cactus, once an unwanted plant, now is being processed into stuffing for car seats, cushions and carpet underpads by 85 workers in a modern factory at tiny Punto Colnett, Mexico. The workers at this \$100,000 factory place severed cactus leaves on an endless belt (see photo at left) which carries them to a sorter for sizing, pressing between rollers and shredding. Fibers extracted are dried on racks (top photo), packed and shipped.



← Zoo Vacuum Cleaner

Attendants use special vacuum cleaners to spruce up animals (left) at the zoo in Rome, Italy. Each cleaner has a suction brush that sucks dirt, dust and fleas from the fur of such beasts as the tapir at left.

Will Borazon Replace Diamonds?

Borazon crystals scratch diamonds and stay hard in temperatures at which diamonds burn. Officially named "cubic boron nitride," each colored grain is about as hard as a diamond and withstands 3500 degrees F., while a diamond burns at 1600 degrees F. Borazon's resistance to oxidation will make possible superior methods of mounting stones in industrial tools and may allow bits and wheels to be operated at higher speeds, according to General Electric Co., developer of borazon. Methods similar to those used in producing manmade diamonds were employed to make borazon.



Powered by four turbojet engines, the delta-wing Hustler carries pointed pod behind the nose wheel

Bomber Carries Detachable Pod to Provide for Various Missions

Detachable pods carried under the fuselage of the B-58 Hustler, America's first supersonic bomber, will enable this plane to perform a greater variety of missions,

U. S. Air Force officials report. The Hustler has been designed to carry such pods, which are kept off the runway by the aircraft's stilt-like landing gear.

Ultrasonics Rip Cells

Sound waves, made to vibrate at 400,000 cycles per second, break apart disease-causing microbes in making vaccines. Dr. Giulio Bosco, University of Chicago scientist, isolates internal-cell material by operating a 2000-volt generator. The exposed cell body is processed for vaccines.

Hearing Aid Helps Surgeons

Transistorized hearing aids now are saving the lives of surgical patients. A microphone from the hearing-aid amplifier is placed inside the anesthesia breathing circuit. The sound of the patient's breathing then goes to an earphone, and the surgeon has a check on the patient's respiration.

Two-Million-Volt X Ray

Navy Ordnance engineers use a two-million-volt X-ray machine at Port Chicago, Calif., to inspect defense materiel. The machine, the largest west of the Alleghenies, is housed in a huge concrete building with a 66-ton door to shield radiation "scatter."



JUNE 1957

105

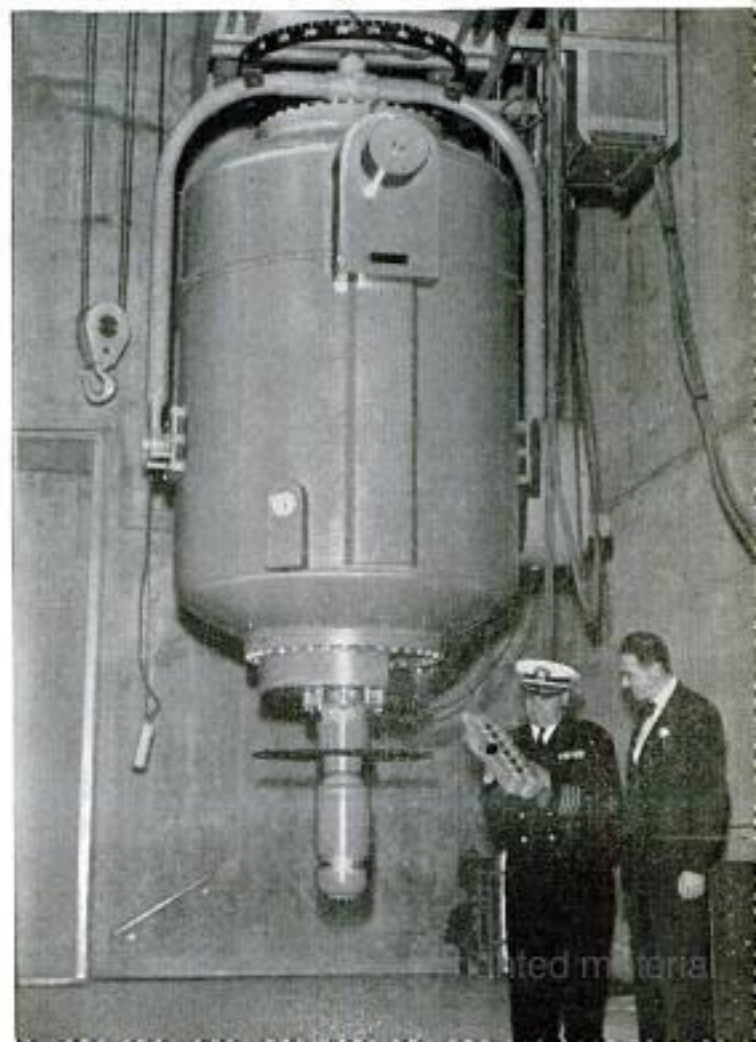

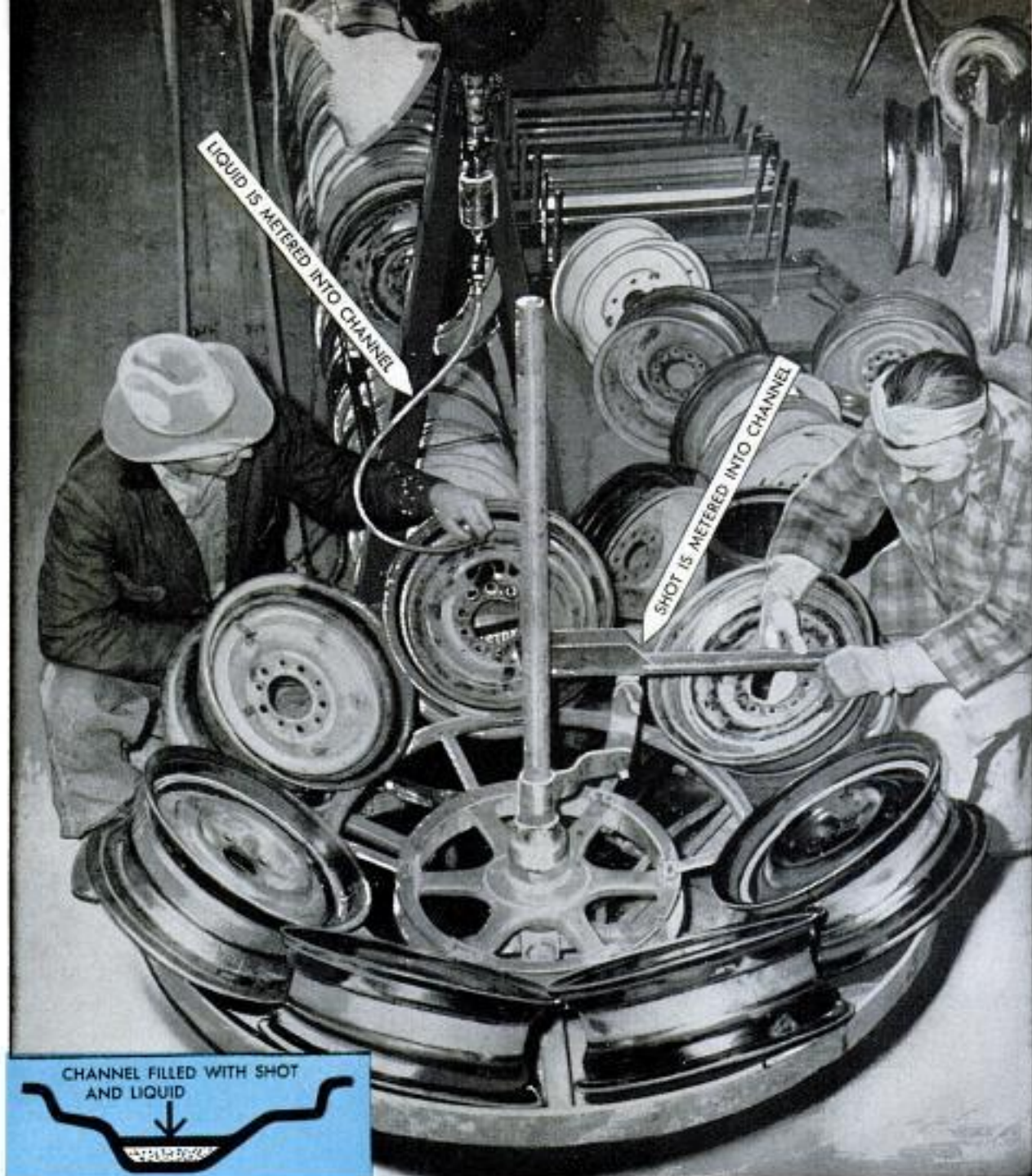

Shot and liquid are metered into channel (see drawing at left) in the wheel and the opening is then sealed

"Shot in the Arm" ***Balances Wheels***

By Martin McAfee

HOW DO YOU make a wheel balance itself? It's a problem that has plagued the auto industry for years.

Now a Texas company claims to have solved the problem. It makes any wheel self-balancing simply by adding about 13 ounces of steel shot and some ethylene

glycol to form an automatic balancer.

The shot and the liquid in which it is suspended is retained in a welded channel around the drop center of the wheel. When a heavy spot develops in the tire or wheel putting the wheel out of balance, some of the shot is automatically thrown to the

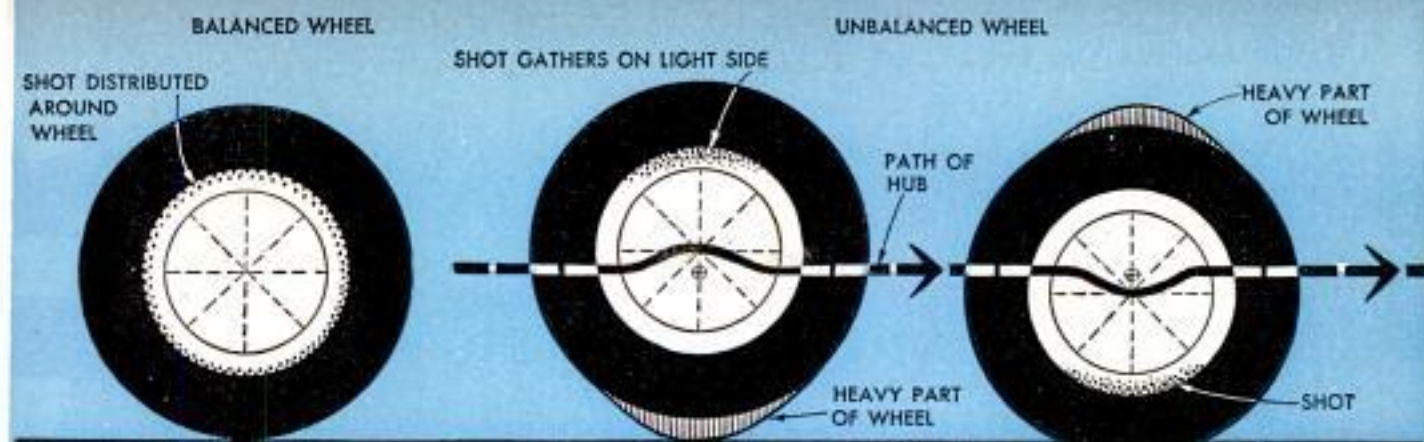

As center of rotation (small circle near hub) moves, the shot is spun outward to counterbalance heaviness

lighter side, counterbalancing the heaviness. Centrifugal force does the work and the driver is unaware that the operation is taking place.

It's as simple as that, say the officials of the Self-Balancing Wheel Corporation, Perryton, Tex.

Only enough shot to counterbalance the heaviness moves to the lighter side. The remainder of this shot stays scattered around the channel awaiting a chance to correct subsequent imbalance.

The principle of the self-balancing wheel is not something new. But previous designs have usually involved circular tubes containing shot. These often became troublesome because they were easily damaged or knocked out of round. The channel must remain exactly centered around the wheel hub. Otherwise, the shot contributes to the imbalance.

For this reason the first and most important step in the production is the cutting of a precise groove a quarter inch above the bottom of the drop center. The loss of this small amount of drop-center depth interferes only slightly with mounting tires.

Major problem in mass-producing such a wheel is the accurate placement and welding of the steel band that forms the top side of the channel. This is done on a machine especially designed for the job. Then the liquid and shot are metered into the channel and the opening sealed.

The ethylene-glycol liquid is used to dampen noise and reduce wear on the shot. At speeds of under five miles per hour, there is a slight rustle as the shot moves around in the channel. Above that speed the shot is held to the outer surface of the channel.



Above, three steps in forming the shot channel in the wheel. Below, automatic machine welds band to wheel in three minutes

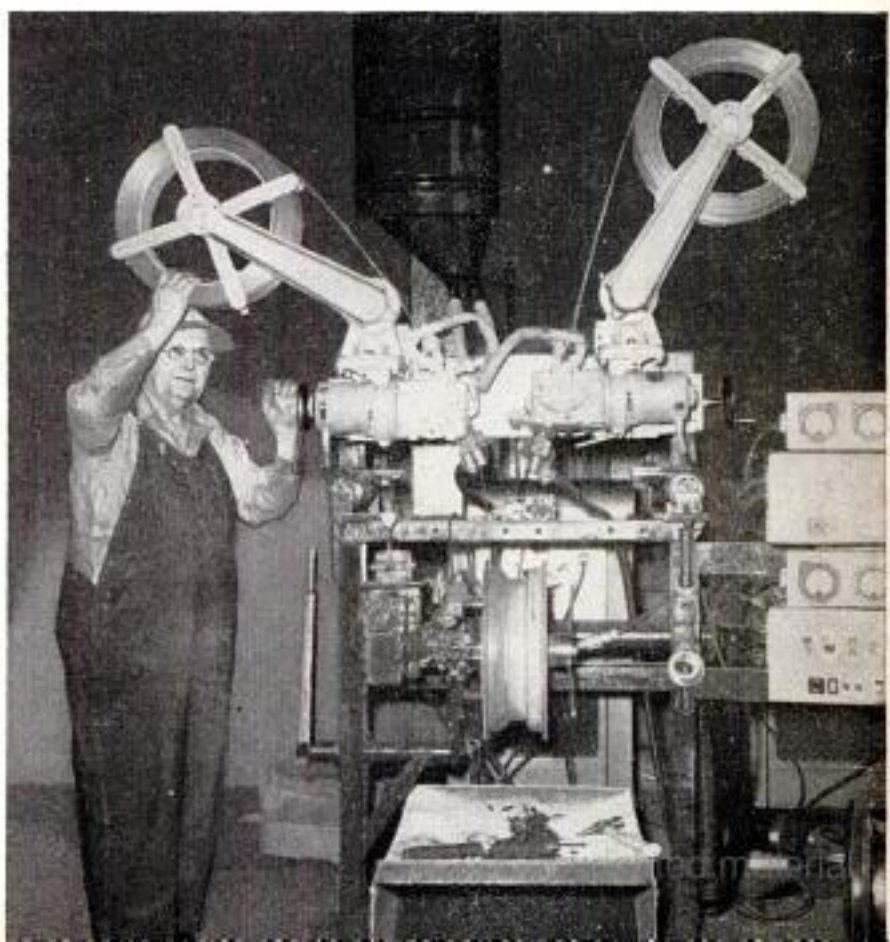

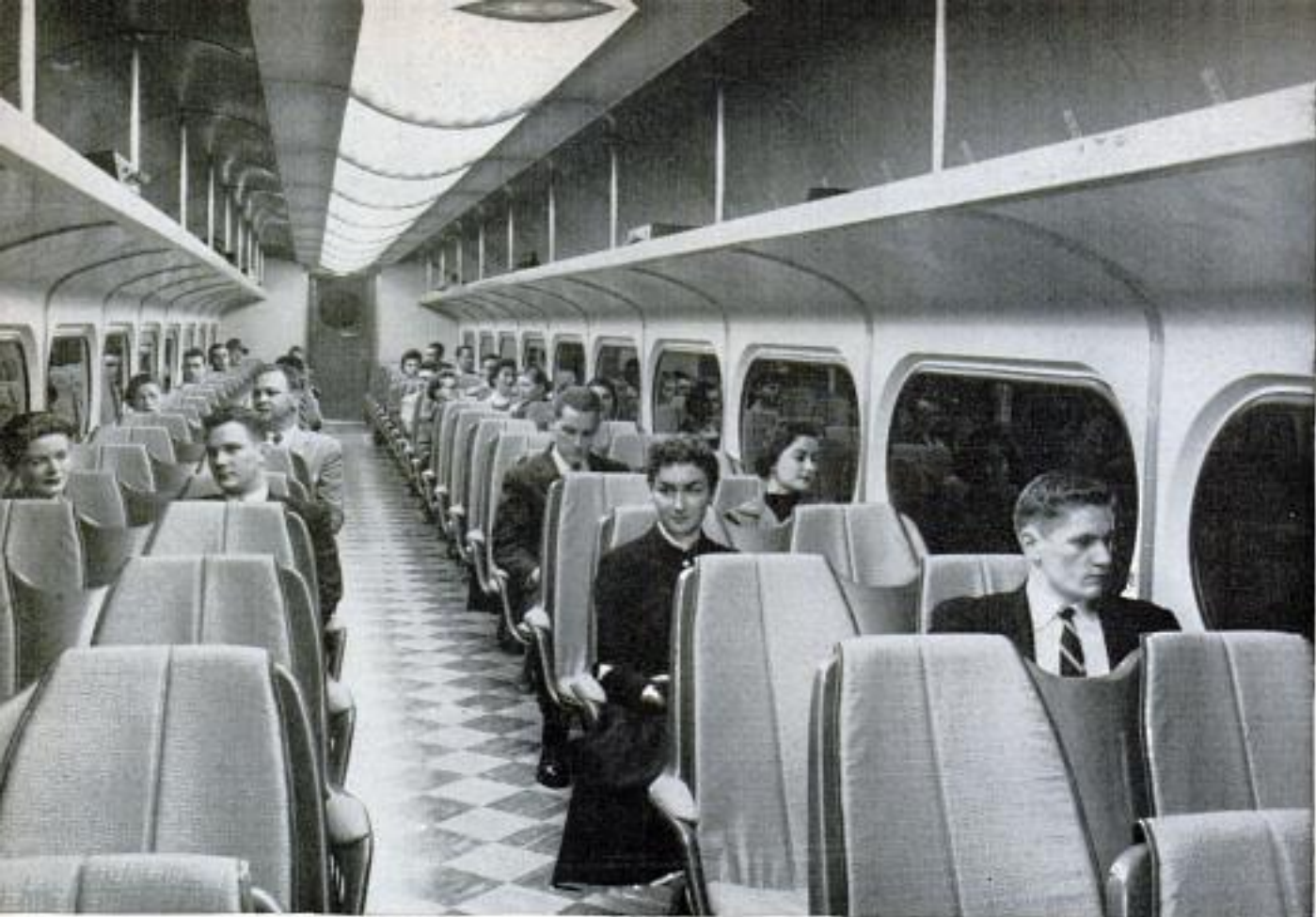

Lightweight Passenger Car Has Plastic Interior



With a gleaming skin of stainless steel, a new railway car has the lightest weight per passenger of any car ever built in this country. The car, built by Budd, meets all the strength and safety requirements of the Association of American Railroads. It weighs only 595 pounds for each of the 88 passengers it will accommodate, compared with 1678 pounds per passenger for a conventional car. Virtually the entire interior is plastic, including plastic seats, wall panels, ceiling and baggage racks.

Fuel Source in Pond Algae

Converting energy from the sun into methane gas has been achieved on a small scale by University of California scientists. The gas, a basic component of motor fuels, is formed when bacteria attack dead pond algae in the absence of oxygen. The plants store energy from the sun while growing.

Reel-and-Rotary Power Lawn Mower Introduced

Features of rotary and reel-type lawn mowers are now in one unit. Powered by a 2 $\frac{3}{4}$ -horsepower gasoline engine, the mower cuts down rough growth in a 20-inch rotary swath, after which the 18-inch reel smooths and shapes the lawn. Cutting-height controls are on the mower wheels to vary the degree of cutting. Clutching is automatic through throttle control on the handle. The rotary attachment is removed by pulling out two pins and slipping off the V-belt blade drive.

Homemade Automatic Sprinkler Stops When Rain Falls

When there's insufficient rainfall for Bert Scriver's lawn in Ft. Lauderdale, Fla., his homemade automatic sprinkling system takes over. He made a rainfall gauge out of a tin can. If rainfall is more than one quarter inch, the weight of the water in the tin tilts a control arm to disconnect the system. Otherwise, a time clock activates a solenoid valve inside a $\frac{1}{8}$ -inch water line, and triggers a hydraulic valve in the main water line from which the sprinkler system operates. Normal evaporation of water from the tin-can gauge resets the system.



Telephone Receiver Amplifier Can Be Carried in Pocket

Voice volume received by telephone can be amplified for the hard of hearing, for persons working in a noisy location and for those making rural or long-distance calls. A new portable amplifier clips over the receiver. With a plastic housing that has much the same contour as the telephone receiver it covers, this amplifier weighs only three ounces and can be carried in the pocket. This apparatus has been designed with printed circuits, transistor amplifier and tiny batteries which may be conserved by turning off a volume-control switch when the amplifier is not in use. Volume can be adjusted by finger-tip control. The amplifier also cuts out room noise.



British 1000-Mile-Per-Hour Jet Fighter Has Two Powerful Engines

Britain's Electric P1A prototype fighter plane has flown 1000 miles per hour in level flight and can fly 1500 miles per hour. Razor-thin, sweptback wings and tail have ailerons on trailing edges. The production

model will stack two Rolls-Royce Avon jet engines vertically in the fuselage with an air intake in the nose. They will replace the Hunter and Javelin as all-weather fighters for squadron duty with the RAF.



Like to try your hand at voodoo, jazz or chamber music on an assortment of antique instruments?

Drop in on this

Musical Museum

By John Franchey

Photos by George W. Walter



Arthur Sanders, son of museum's founder, inspects an orchestrion which duplicates a 12-piece band

Visitor tries out a tune on a dulcimer, built in 1860. Instrument is an ancestor of the present-day piano



EVER VISIT a museum and wish you could touch or get a better look at the rare objects on display?

There's one in New York State where visitors can do just that and more. They not only can see over 500 antique musical instruments and player devices of every description, all in working order, but they can play them as well.

The museum is a hobby turned full-time activity for a retired automobile mechanic, Hardie Sanders of Deansboro, N. Y., which is about 14 miles south of Utica. In a building near his home where he formerly operated his own business, Sanders has collected a fabulous assortment of priceless old instruments, from harmoniums to melodeons to all types of mechanical marvels.

Visitor Has Wide Choice

Depending on his whim of the moment, the visitor can try a tune on a 17th Century virginal, which is a small spinet, have a go with mallets at an 1860 dulcimer, an ancestor of the piano, or tap out a roundelay on a harpsichord built in 1547.

If he's percussion-minded, he can do a solo stint on such diverse instruments as African voodoo drums, Chinese gongs,

Javanese bells, Malayan cymbals or American tambourines dating back to the California gold-rush days of 1849.

Or if his tastes are on the loud and rugged side, the visitor can blast out a chorus on a pre-World War I pipe organ once used at spiritualist meetings, or make the neighborhood dogs howl by a brief turn on a calliophone that can be heard two miles away.

Automatic Musicmakers

There are scores of other manual instruments in Sanders' museum. And while they are popular, the center of interest is an array of automatic musicmakers that were ingenious in their day—and still are.

Typical of these is a 1915 Seeburg nickelodeon, the grandfather of today's jukebox. It plays tunes using bass and snare drums, cymbals and castanets, to name a few.

Another is the Mills Violano Virtuoso, probably the first mechanical musicmaker to be powered by electricity and once called "The Eighth Wonder of the World." Originally costing \$6000 around 1912, it plays piano and violin duets with steel fingers plucking out the melody on the violin. The museum has five of these rare collector's items, including two with a pair of violins.

Among the dozens of other mechanical marvels is a Deegan Una-Fon which is powered by a storage battery and plays tunes on 32 bells, and a Wurlitzer military-band organ complete with rows of cornets and drums. The museum also features several foreign street pianos from such countries as Italy, France and Turkey.



This is a DuKleist military-band organ used on a merry-go-round about 1898. It has to be hand-cranked. Note array of horns in the front opening

A pair of youthful instrumentalists try a duet with an old-fashioned slide trumpet, shown at left, and an unusual Italian serpentine horn





Hardie Sanders' Musical Museum features several foreign street pianos, including this one from France



Girl discovers how her grandmother listened to music with a 1904 phonograph and cylinder record

Remarkable Violano Virtuoso plays violin-piano duets with steel fingers plucking melody on violin



Sanders' curious hobby started 20 years ago when he bought a music box that wouldn't work. Being a master mechanic, he tinkered with it in his spare time until he fixed it. This interested him so much that, for a man who worked all day tuning motors, he turned to collecting and tuning old musical instruments and player devices as a relaxing hobby.

Since then Sanders has gradually added to his collection, all requiring repairs and some, particularly the self-playing type, needing extensive work.

Couldn't Get Parts

The manufacturers of these marvels of music automation have either gone out of business or changed to other lines of products, making it impossible to obtain vitally needed parts. So Sanders has to make his own parts and often special tools as well. Some of this work turned out better than the originals, Sanders claims with a true craftsman's pride.

At first Sanders kept his collection in his home. But then his son, Arthur, joined him in his hobby and it wasn't long before they had music boxes and melodeons under all the beds, harps and pipe organs stacked in the hallways, and assorted pianos, melo-harps and nickelodeons strewn all over the living room.

By 1951 the restored musical antiques were so numerous that they were crowding the family out of house and home. So, Mrs. Sanders made a suggestion.

Museum in Garage

Since the doctor had ordered Sanders to retire anyway, why not convert the automobile-repair garage into a musical museum and open it to the public? This was done and it has been a tremendous success ever since.

Sanders travels throughout the country seeking additions to his collection, which has increased from its original 150 instruments to more than 500 today. And he has obtained them in the most unusual places and often in terrible condition.

For example, his orchestrion, an extremely versatile and complicated automatic that duplicates a 12-piece band, was located in a small Pennsylvania coal-mining town. The cabinet had been chopped up for firewood and the innards were a maze and filled with dust. Three months of intensive work were required to restore it.

And what are Sanders' plans for the future of his museum?

Nothing more, he says than to keep it the kind of a place where both children and grandparents can have fun exploring musical instruments of a bygone era that are a part of our cultural heritage. ★ ★ ★

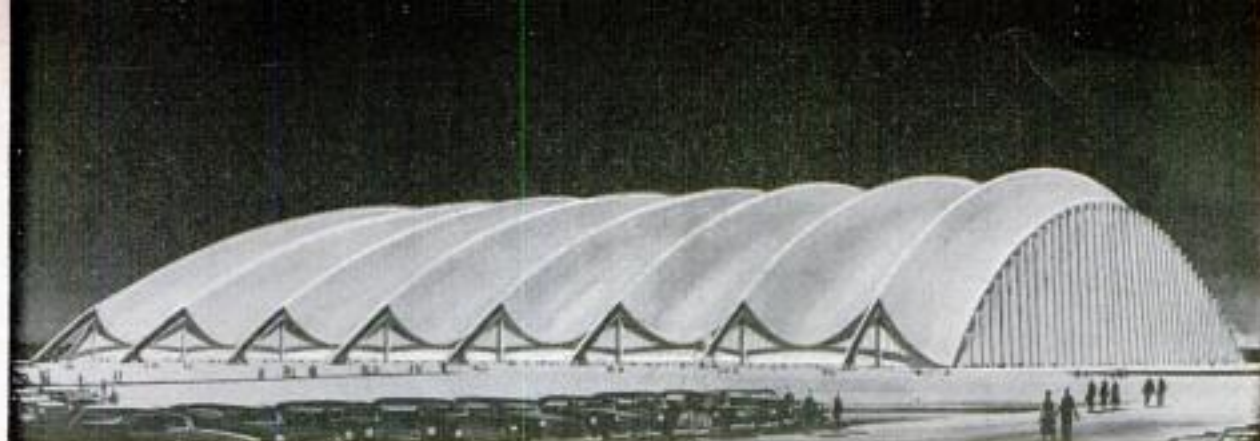

Olympic City will be world's largest enclosed arena. Eight ridges will support aluminum roof over 35 acres

Seats for 150,000— None Behind a Post

FOUR FOOTBALL GAMES could be played at the same time in the arena of Olympic City, \$57,000,000 aluminum-canopied sports and convention palace planned for the New York City area.

Dubbed the "world's largest room," its 250-foot-high ceiling will span 34.7 acres without a single supporting post to block a spectator's view. The building will contain an estimated 228,312,000 cubic feet of space. Seating capacity will be 150,000.

Architects designed the roof as a "series of hyperbolic paraboids," using plates of aluminum welded together and stiffened at the connecting ridges with extrusions. This design is expected to give the strength needed to span a width of 1080 feet and to withstand the usual snow and wind loads.

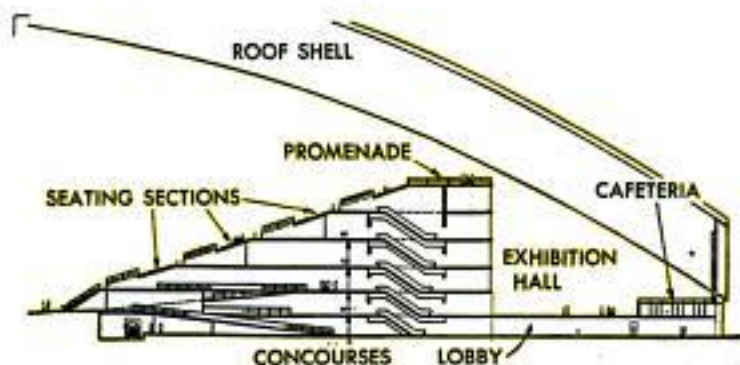
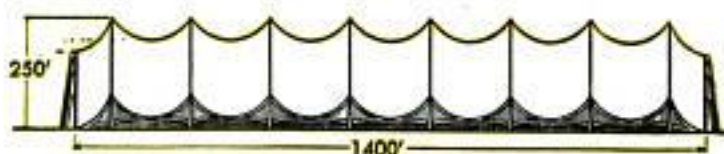

Roof of structure will reach height of a 25-story building. Weight load will be directed to foundation via walls at edge

At uppermost level of Olympic City clubhouse will be a promenade-restaurant with accommodations for 1000

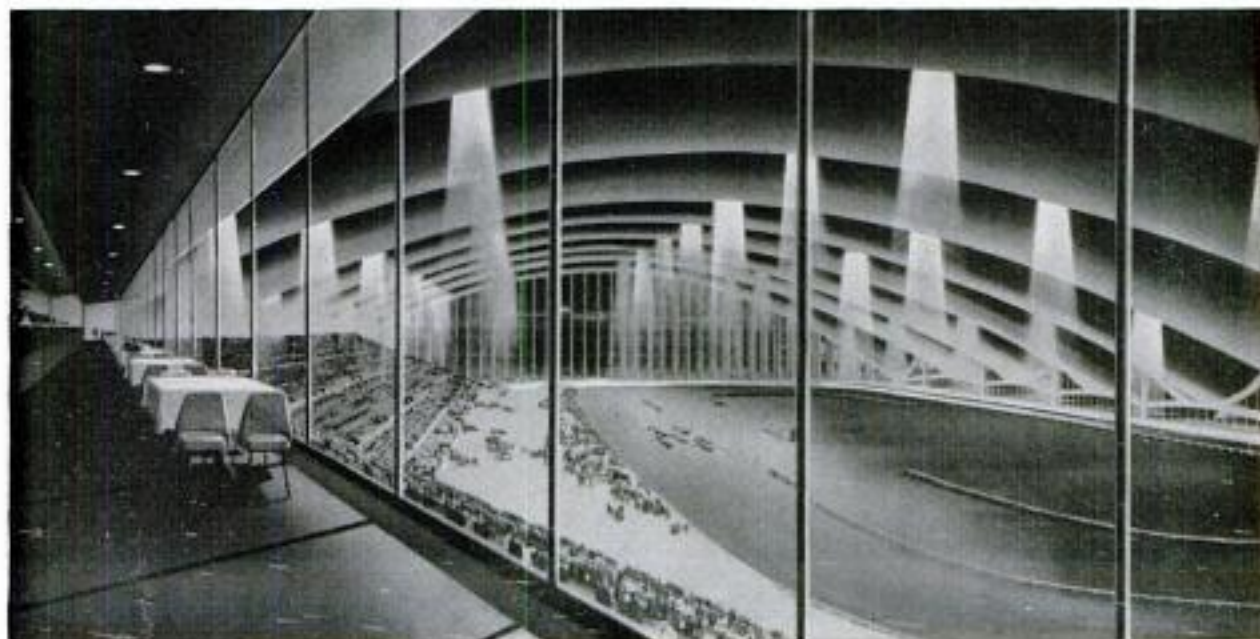

New Tools for Grooming Your Lawn



ROTARY POWER MOWER with a 32-inch cut and a motor of only $2\frac{1}{2}$ horsepower is made possible by using three individual overlapping blades (see bottom-view diagram). The two smaller blades are belt-driven by the direct-drive center blade.

Goodall Mfg. Corp., Warrensburg, Mo.

SPRINKLER CADDY attaches to a garden hose and provides mobility, controlled watering and may be changed without getting shoes or clothing wet. It can also be used as a sprinkler for children. The entire unit folds flat for storage.

Clark Metals Co., Denver 2, Colo.

RIDING POWER MOWER will grade and seed a lawn, cut the grass, pull loads up to 1000 pounds and do a variety of other chores. Pneumatic rear tires provide maximum traction, while an automotive-type differential reduces lawn gouging.

Porter-Cable Machine Co.,
Syracuse 8, N. Y.



CUTTING HEIGHT is changed on this power mower by a simple lever that adjusts all four wheels simultaneously. Squeezing the lever releases it for a new setting in a matter of seconds, and when released it locks into place again.

Huffman Mfg. Co.,
Dayton 1, Ohio



DISPOSABLE ROTO-FERTILIZER is an easy way to feed the lawn. Slip the outer cover off, attach the metal handle and roll the perforated cylinder which releases the right amount of fertilizer evenly over the grass. And, the fertilizer is mint scented.

Forward House Div., Olin Mathieson Chemical Corp.,
745 Fifth Ave., New York City 22



LIQUID SPRAYER assures an even distribution of lawn chemicals. The hose pump operates on a one-wheel drive. As the wheel turns, rollers move along the hose and forces the solution out in a fine constant spray through a clogproof nozzle.

O. E. Linck Co.,
Clifton, N. J.



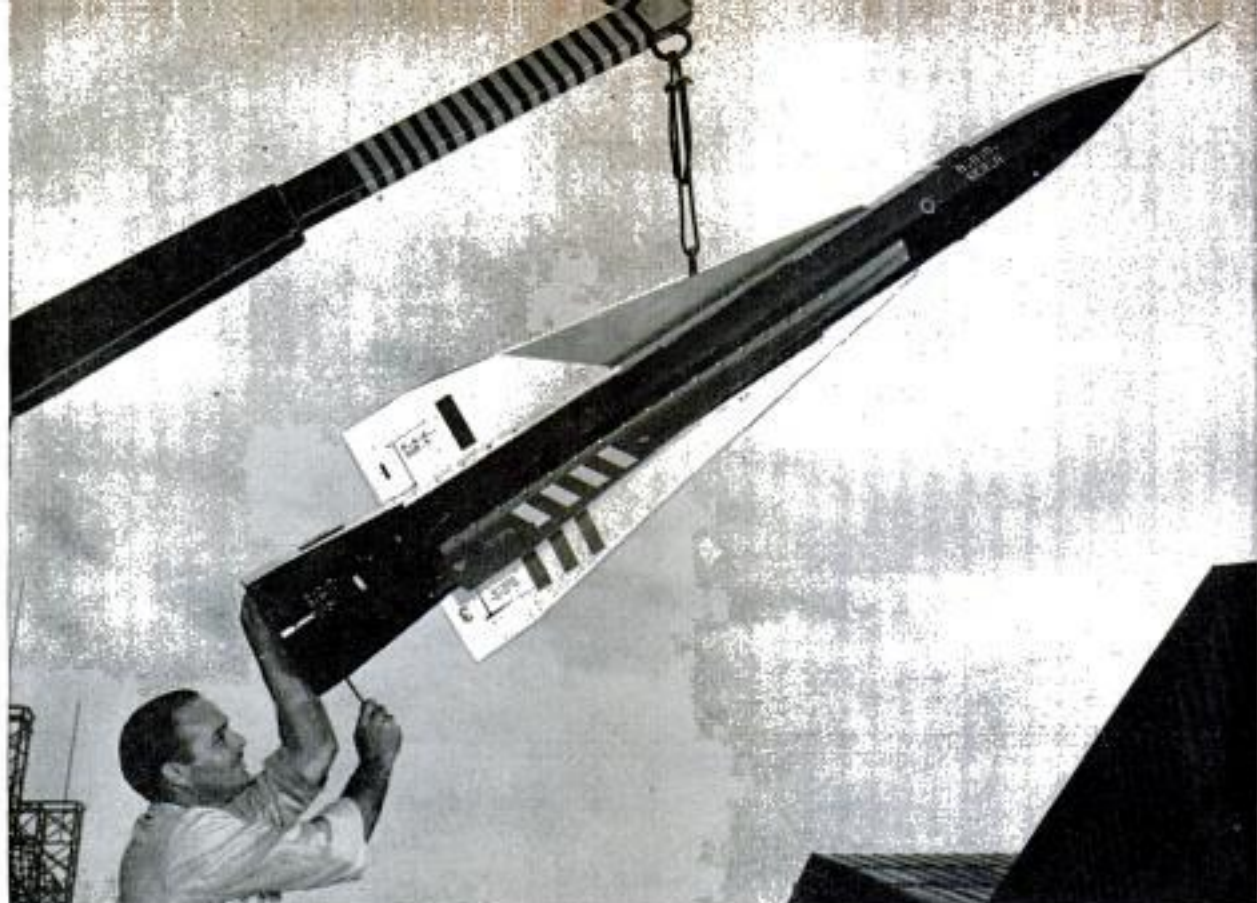

Experimental Missile Fired "Backward"

Rearward-launched guided missiles can be fired by high-speed U. S. bombers at attacking interceptor aircraft. This missile system, first developed for the U. S. Air Force by Cornell Aeronautical Laboratory, Buffalo, N. Y., has been tested successfully on rocket-propelled sleds at the Holloman Air Force Base, N. Mex.

Hercules Transport "Flies" Underwater

Skin divers are helping aeronautical engineers, equipped with TV cameras, fatigue-test an aircraft submerged in a 270,000-gallon tank of water at Marietta, Ga. The 62-ton C-130 military propjet plane will make 20,000 pressurized underwater "flights."

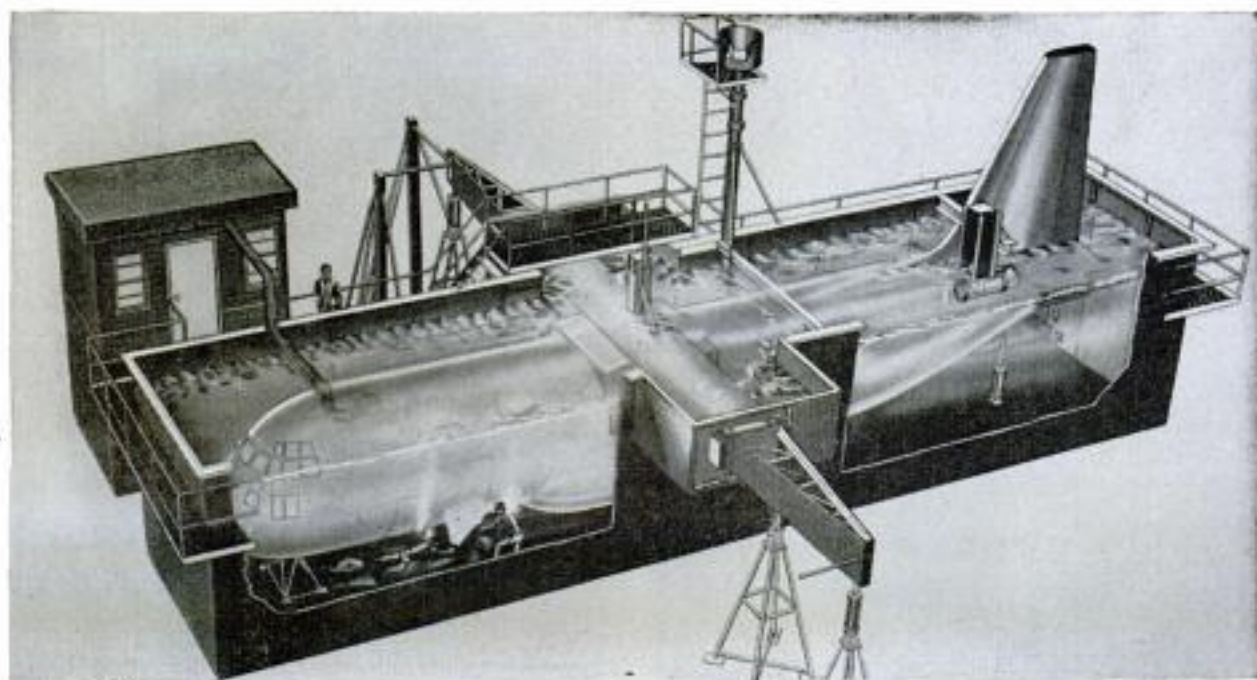

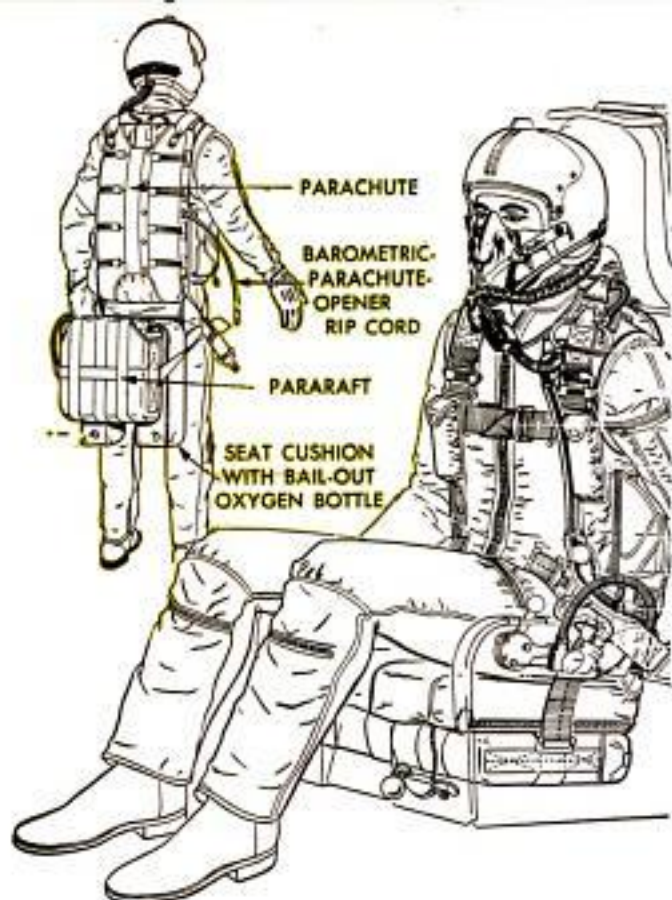

Flight Suit With Built-in Gear Developed for Skyhawk Pilots

Pilots for the Navy's A4D Skyhawk midget attack bomber wear a new lightweight flight suit. In one garment are: A

life jacket, parachute harness, seat belt, shoulder strap and oxygen gear. On ejection, a timing device opens the chute.

Ten-Story Mobile Tower Aids Missile Maintenance



Servicing of guided missiles prior to firing at Patrick Air Force Base, Orlando, Fla., is to be made easier by a 120-foot tower that moves under its own power along railroad tracks. The tower weighs 340,000 pounds, has a base span of 24 feet and can be lowered on a giant hinge in order to escape hurricane winds.

Basis of Life Created in Test Tube

Scientists have taken an important step toward the creation of life in a test tube. An international group of scientists has synthesized ribonucleic acid, the energy-packed cell material that manufactures protein. The laboratory-created molecules appear to be identical to natural ones, or at least very similar, and to behave in much the same way in laboratory tests.

F-51 Becomes Museum Piece

Retirement recently of the last North American F-51 Mustang to the Air Force Central Museum at Wright-Patterson Air Force Base, Ohio, marked the end of propeller-driven fighter aircraft in the U.S. Air Force.





Ross McKenney, center, shows students split sapling which he bent over knee and will form into snowshoe

Graduate of the Maine woods, Ross McKenney learned enough from the Indians and from his battles with Nature to become Dartmouth's

Professor of the

By William Gilman

Photos by Eleanor Gilman

Rabbit snare is wire loop on the end of a heavy pole balanced over forked stick and under peg in tree



Copyrighted material

TO THE ORDINARY PERSON lost and hungry in the woods, perhaps facing starvation, a rabbit bounding safely away among the trees can be sadly frustrating. That's where Ross McKenney, expert in getting out of trouble in the forest, is different. He'd get that rabbit for his supper.

Where fancier sports gear fails, the do-it-yourself survival technique of this master woodsman takes over. He'd have the rabbit come back. And he'd snare it with whatever he had handy—shoelace or threads unraveled from his sweater or a piece of tree bark.

Such are the tricks which McKenney teaches at Dartmouth, where he is America's only college coach in bait and bullet, cabin and trail. One of our few remaining woodsmen of the genuine old school, his university was the deep Maine woods.

Tenderfeet Get into Trouble

Forests have much to teach in these outdoor-living days of camping and hunting, when the tenderfoot can stray into serious trouble. But where the tenderfoot feels only lonely wilderness around him, McKenney's alert eyes see a supply house filled with the simplest materials imaginable for easing an ordeal or saving a life.

For example, tree bark can meet one emergency after another. It will kindle a warming fire and tie poles for a night's shelter. Lapped sheets will give a "shingled" roof against rain. Bark will wrap

leaves or moss around a wound, bind sapling splints about a broken leg, tie improvised snowshoes or make an emergency stretcher for transporting an injured companion. Bark binds sticks into a cage-like fish trap or can be made into a cup for heating water.

This kind of education may seem remote from Latin, literature and logarithms, but along with being in the Ivy League, Dartmouth has a strong North Country flavor. That is why 16 years ago it created a new job called "outdoor technician" and asked McKenney to take it.

His main duty is coaching woods-and-stream activities of the famed Dartmouth Outing Club at this New Hampshire school whose students attend our only college with an arctic research center. Dartmouth owns summits such as Mount Washington and a 26,000-acre wilderness for use as a proving ground by budding geologists and explorers. DOC rescue teams, frequently called on to hunt crashed airplanes and lost persons, are made up of two first-aid men, two rock-climbers and two woodsmen.

"Workshop" Is the Outdoors

On campus McKenney has a basement workshop, where the only power tool is a motorized grindstone for sharpening such favorite instruments as his trail ax or his unusual "whittling tool" made from an old hayrake tooth. In this basement,

Outdoors

For emergency cup to get drinking water, McKenney cuts out circle of birch bark, folds it (below) and inserts it in split-stick handle

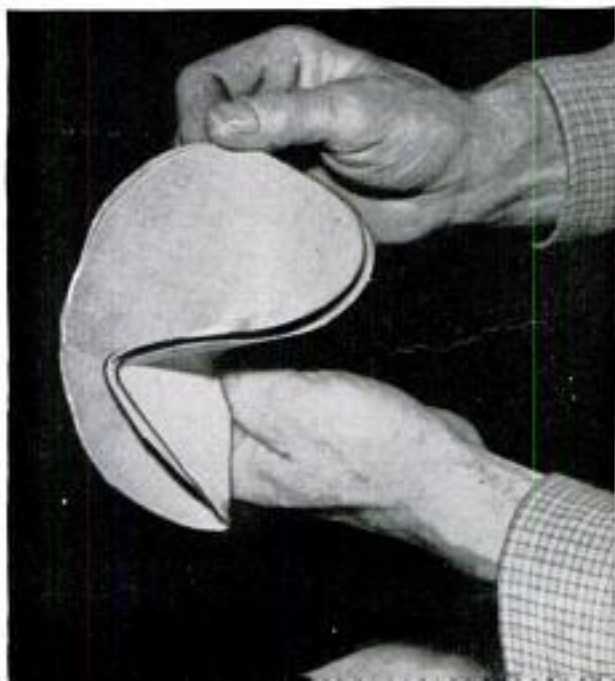

he builds skis, snowshoes, canoe paddles and the like. His main workshop is the outdoors where he teaches the "little things" that make a crafty woodsman. His young trailmates look on him as somewhat of a cross between Deerslayer and Hiawatha.

Incidentally, it was from serious Johnny Neptune, a Penobscot Indian chieftain, that McKenney learned many of his stock of survival tricks like getting that rabbit if you've missed him with your gun, or if you don't have a gun. In a few minutes you can rig up a snare. It's easiest if you have in your pocket a coil of copper wire. With wire a slip-knot loop can be made quickly. Otherwise, a bootlace or strand of tree bark or sweater threads will do the trick just as effectively.

Keep off the Rabbit's Tracks

Choose a tree alongside the route which the rabbit took, but keep off the hare's tracks. A heavy pole is poised across a forked stick. The lightweight end of the pole is held down by a peg driven in several feet up the tree trunk. The snare's

loop dangles from the pole tip. When the rabbit runs into the loop, dislodging the pole tip from the peg, the heavyweight pole end drops and the snared animal is raised.

McKenney "Outfoxes" Rabbit

Without bait the snare might stay empty a long time, but McKenney knows a rabbit habit. In flight, it halts at the nearest thicket. By circling around, then hollering, you can start the rabbit running again. But this time it bolts straight down its previous tracks and runs its head into the loop suspended there, even if someone stands only several feet off to one side of the rabbit trail.

Besides this tip-up snare, there are various deadfall traps using bait. Here, a pole's heavy end or a rock drops on the animal after it has dislodged a trigger pin whittled out of wood. This trap can be set up in a tree to catch climbers or in water to get animals such as the muskrat.

Drinking water also can be an emergency

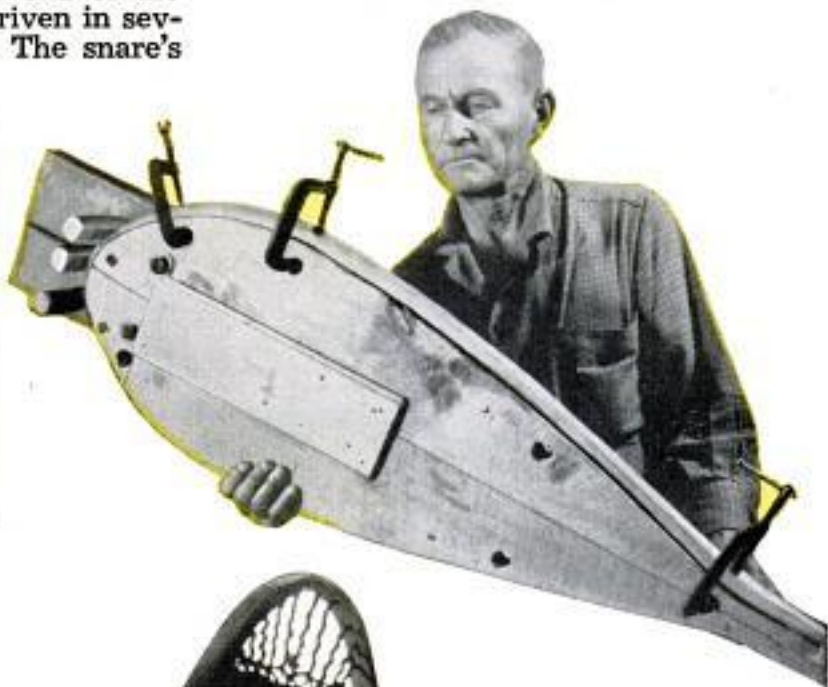
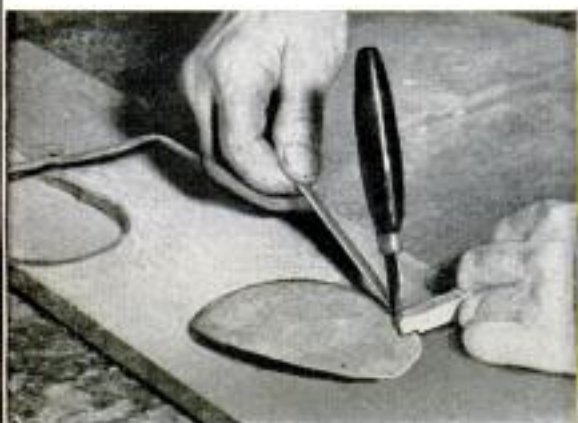

Top left, McKenney makes leather thongs by pulling circle of leather, cut from boot, against knife beside whittled wood block. Left and top right, he builds snowshoes in campus shop



The "professor" shows how to make a two-section lean-to out of boughs and bark with fire in the center

item, especially if it happens to be tantalizingly out of reach in a stream or pool; or perhaps you're too exhausted or have had an accident and can't get down to the water.

Bark on the common white birch tree peels easily. Cut a round sheet of it six inches in diameter. Fold this in half; then fold the bark again. Open the bark like a chemist's filter paper and you have a conical drinking cup. Split the tip of a stick and insert the cup's folded side in the slit, and you have a handy dipper the handle of which can be several feet long. Additional layers of bark make the cup sturdier. Two handles prevent its getting limp; when warmed carefully over a fire, you can boil water in this container. Yet, McKenney will show you there's no better emergency kindling for a fire; a match flame applied strongly to "green" birch bark causes a quick flare-up.

Shelter and Warmth

A big survival item is providing yourself with night shelter and warmth to restore your energy and avoid dangerous wandering in the dark. "A nice overhanging ledge is fine," says McKenney, "but they don't often come when you want one. I've seen too many victims of walking too late. When a fellow knows he's lost, an hour before sundown is none too soon to start putting up that shelter and dragging in windfall stuff for an all-night fire."

McKenney's experienced eyes can spot a

suitable shelter site almost anywhere. The lean-to structure can be a pair of forked uprights with crossbar over the forks to support the leaning roof poles which are then covered with tree boughs or birch bark to keep out rain.

You can pull down the top of a young tree, lash it to a ground post and have a fine arch against which to set poles. A lodged tree fallen against another is also ideal "backbone" for a lean-to. A log lying on the ground or an ordinary standing tree will do when poles are poised at an angle on them. For the tree you whittle wooden pegs which you pound into its trunk; driven slightly downward with the grain, the pegs penetrate. Poles leaned against these pegs form a wigwam-shaped shelter.

Heating Tips

Heatingwise, if your fire is built at the base of a tree, a natural draft will pull smoke up. If there are several persons, rather than making a wide sleeping shelter, erect two narrower ones face to face; fire between them makes for easier heating. In winter dig down to ground level for your fire and shelter; walls of the snow trench will make you more snug.

One *must* item is waterproof matches, either the purchased kind or the type made by wrapping ordinary matches in paper and dipping the package in melted paraffin. The other *must* is your cutting tool—a belt ax preferably, but at least a jackknife.



Fish trap made of sticks and tree bark is placed in stream below pool. Dammed stream steers fish to trap

Survival also means finding your way back to civilization. In case of a deep snowstorm McKenney builds his own snowshoes to carry him lightly over icy surfaces. For material his first choice is the ash tree—a lightweight wood, easy to work. He cuts a four-inch sapling and splits it lengthways into four quarters. To prevent warping he removes most of the heartwood. He now has lumber for the snowshoe frame.

Remaining work consists of slowly bending such a strip over your knee to give it

McKenney shows Tony Ryan fish trap made of sticks and tree bark. Fish enter inner edge of snare through the small end

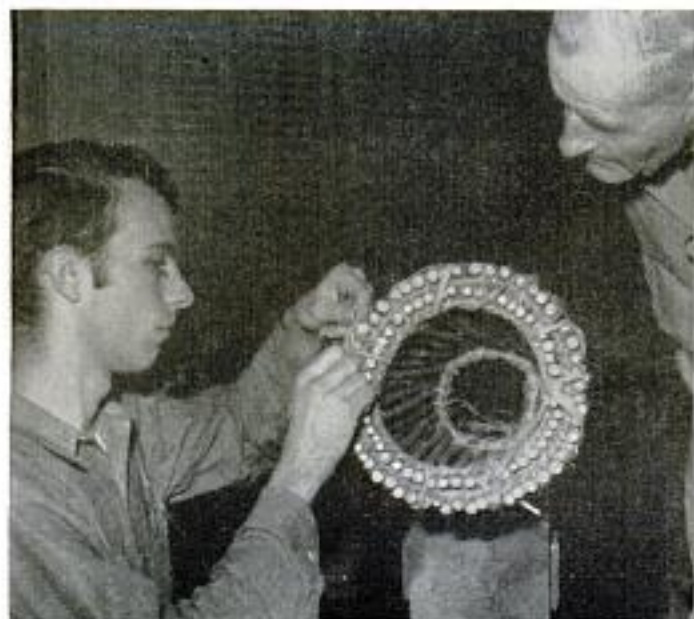

snowshoe shape; if soaked in water first, the wood will bend more readily. It is slotted toward front and back; in the slots a wooden toe and heel bar are inserted; then the tail end is tied together permanently. Netting is now strung across with a basket weave, as in darning. For this filling, thongs would be fine, but tree bark will do. Use tough, inner bark that has been cut into strips and braided for extra strength.

Trees such as elm, basswood and ash are best for bark removal. In spring's sap-run time the bark peels off easily in big sheets. Later, when the bark is tighter, you peel more carefully, as you pry with your knife. When bark is very tight in winter, first pound the tree with a club or simply whittle strips of bark from the trunk.

Thongs From Animal Skin

An expert woodsman isn't limited to tree bark, when he needs material for rope. From the skin of an animal, McKenney easily makes rawhide thongs. After scraping the hide, he slices it into thong strips. Drawing them through a $\frac{1}{8}$ -inch hole shapes them nicely.

McKenney's neatest trick for making emergency thong involves his leather boot. First, he cuts off a circular strip. Then, he whittles a notch at the end of a small piece of wood. The notch is as deep as the leather's

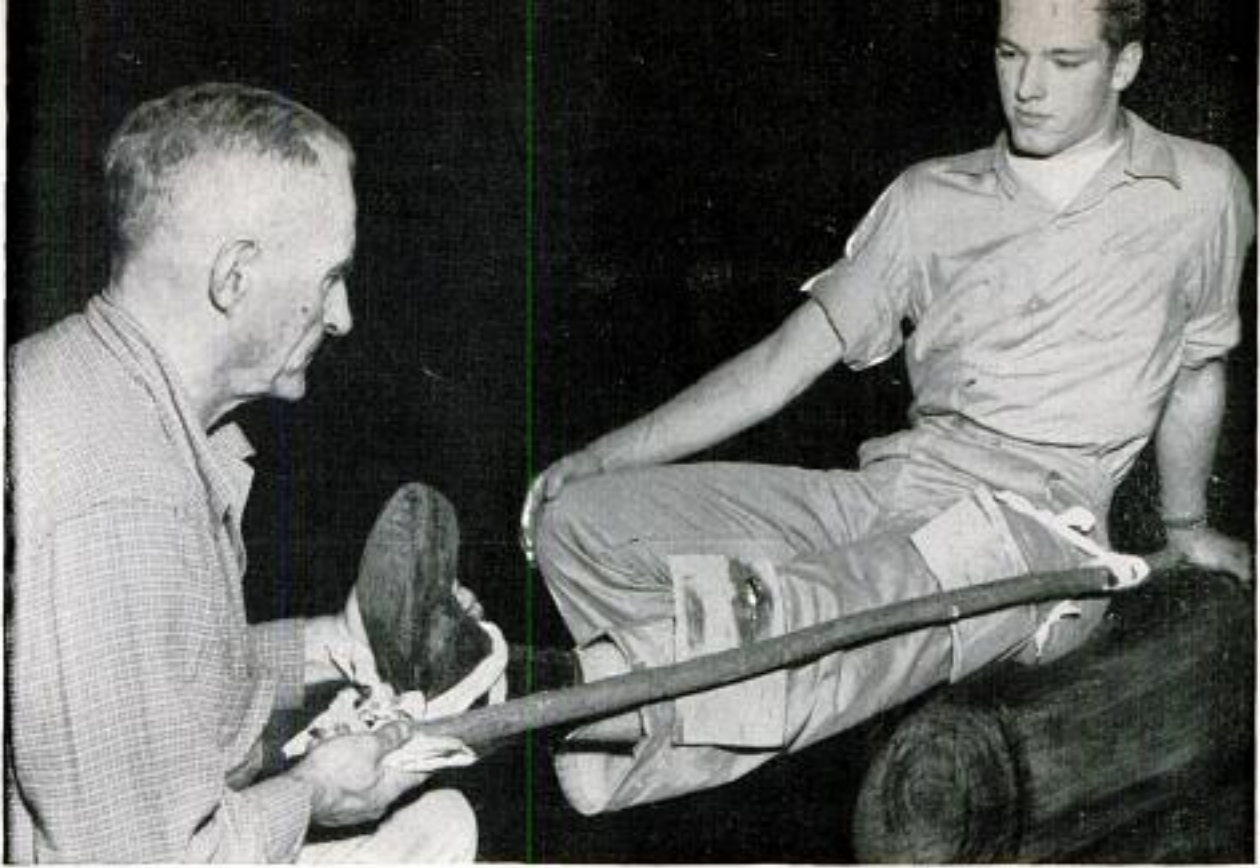

Above, chopped sapling serves as splint with padding of birch-bark sheets for "injured" Dartmouth student

thickness and as long as the thong is to be wide. The leather is laid on a flat piece of wood with the notch held firmly over its edge and the point of a jackknife jabbed into the wood at a slight slant. Simply by pulling on the leather's end—as in ripping a ribbon of cloth—the leather unwinds into a long thong.

With such a selection of emergency binding materials, McKenney points out that it's easy to create equipment in the woods in case your companion is injured.

"Of course, if he's big and you're a little
(Continued to page 216)

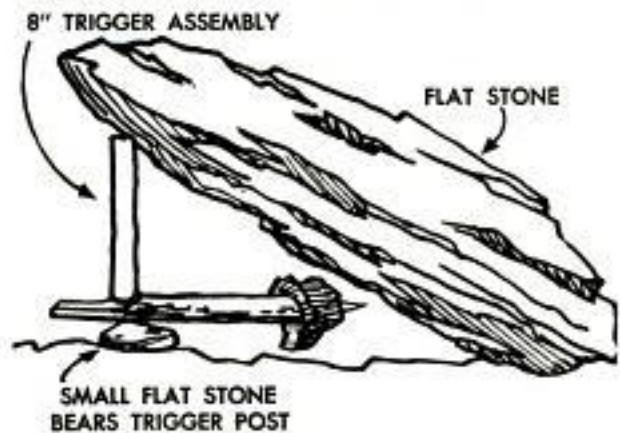

Rock deadfall trap, above, and tree deadfall, below, both operate on principle of animal dislodging trigger

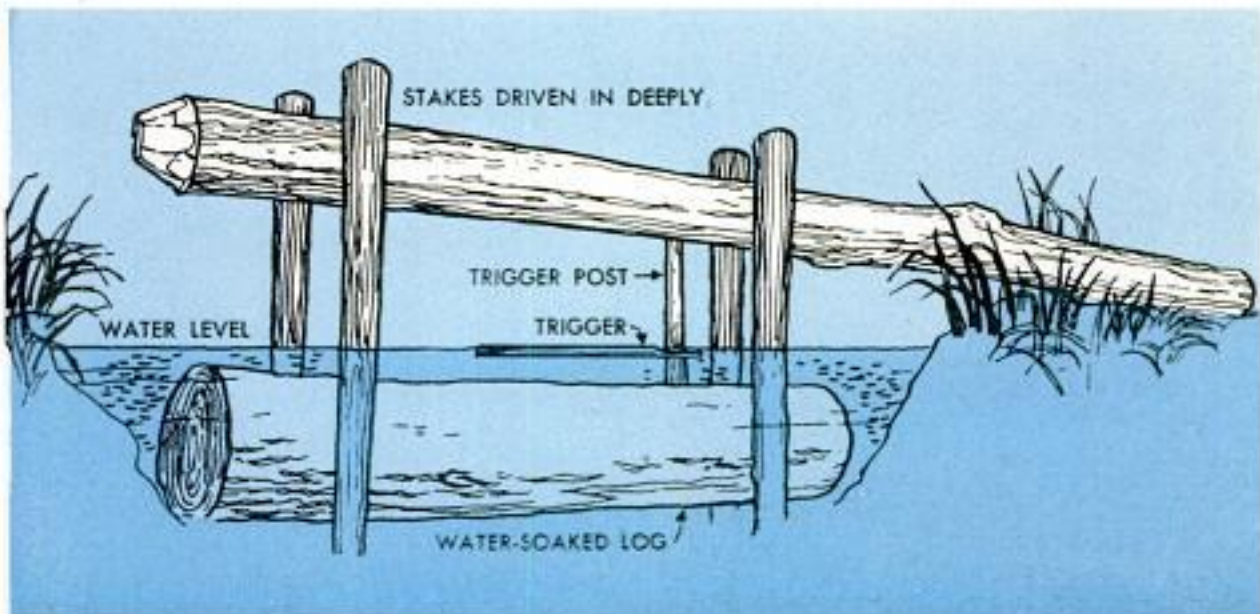



WIRE-ART KIT contains 40 feet of wire of various colors. The hobbyist, using simple jigs and other tools, bends the easily worked wire into a variety of shapes to make miniatures, ornaments and gifts. A complete chess set made of wire figures is shown below. Other hobbycraft materials such as pipe cleaners and raffia are fastened to wire with special glue

X-Acto, Inc., 48-41 Van Dam St., Long Island City 1, N.Y.



FOR THE HOBBYIST...

BUILD A CITY in your spare time. Prefabricated parts of skyscrapers and bridges interlock to form strong, realistic models. The set consists of plastic sections of various shapes which can be combined to form models of real buildings such as New York's Empire State Building and Chicago's Tribune Tower

Halsam Products Co., 3610 Touhy Ave., Chicago 45

TILE KIT duplicates appearance of ceramic tile but actually consists of small squares of vinyl tile. Odd-shaped tiles are easily made by trimming with scissors. Tile cement is spread over object such as a wooden bowl, and tiles pressed into place. Tile mortar then is used to fill and seal cracks

Hobby-Time Mfg. Co., 14401 Meyers Rd., Detroit 27, Mich.



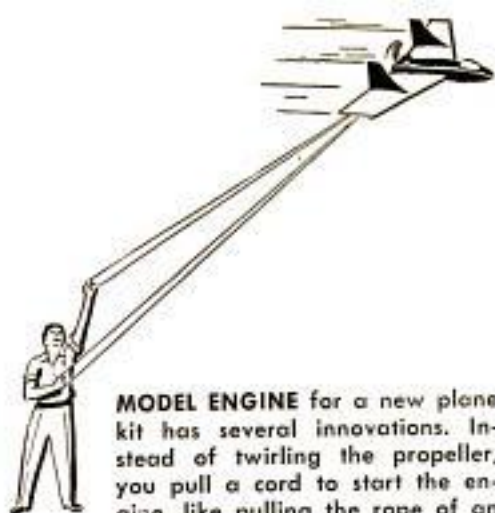

MODEL ENGINE for a new plane kit has several innovations. Instead of twirling the propeller, you pull a cord to start the engine, like pulling the rope of an outboard motor. The plane has two sets of controls (above). One set makes model climb or dive, the other is connected to a new control on engine which enables the young aviator to slow it down or speed it up. Previously, such model planes flew at constant speed

Wen-Mac Corp., 11511 Tennessee Ave.,
Los Angeles 63, Calif.

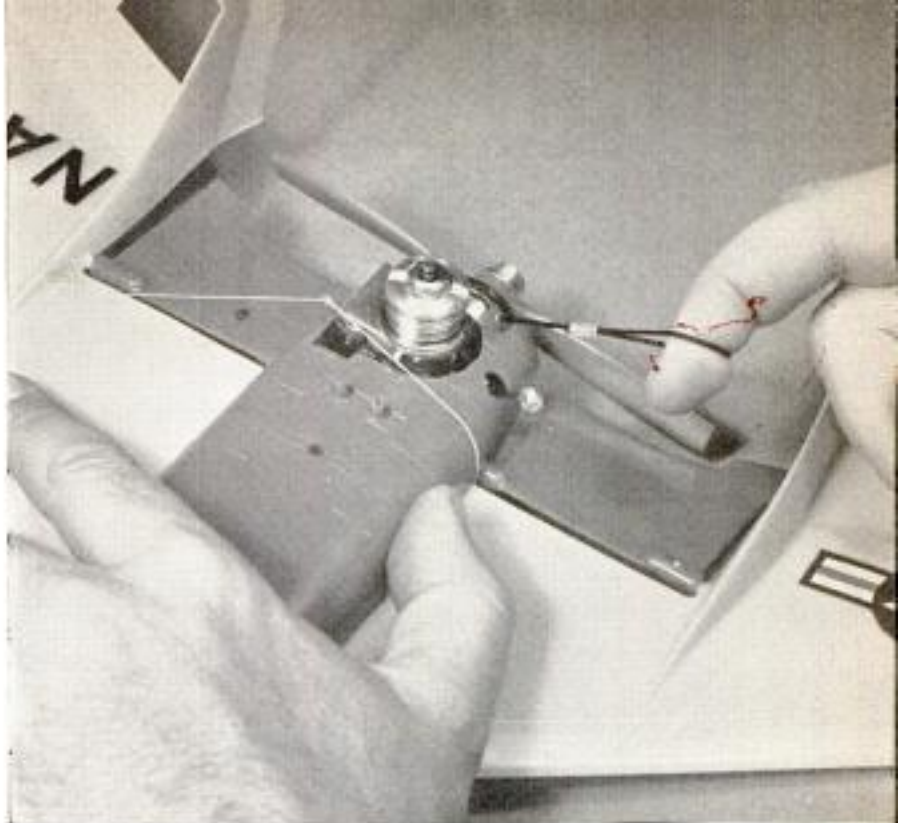

FURRY SQUIRREL, approximately full size, comes to life in another kit. The kit has 12 preshaped plastic parts which are cemented together to form the animal. Flocking then is applied to give the squirrel a furry appearance. Whiskers and green-tinted eyes complete the project

Revell, Inc., 4223 Glencoe Ave., Venice, Calif.



PORTABLE RADIO complete with six transistors can be built from another kit. Small battery no larger than a flashlight battery powers the transistorized circuit. Instructions include easily understood diagrams so even a novice can assemble the radio. Kits are also available for building smaller transistorized radios. Hearing-aid plug takes place of speaker

Lafayette Radio, 165-08 Liberty Ave.,
Jamaica 33, N.Y.

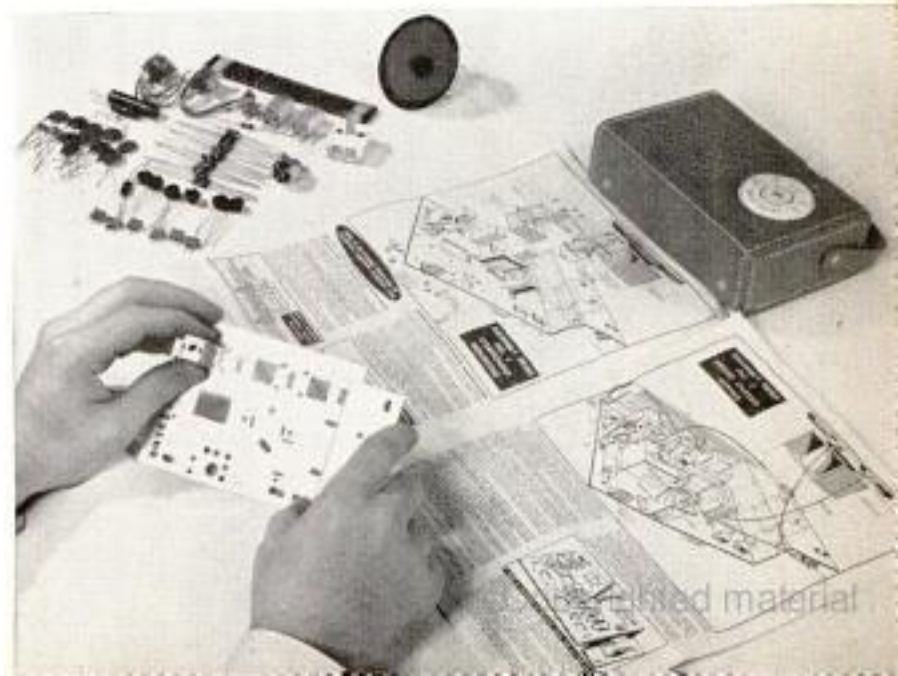

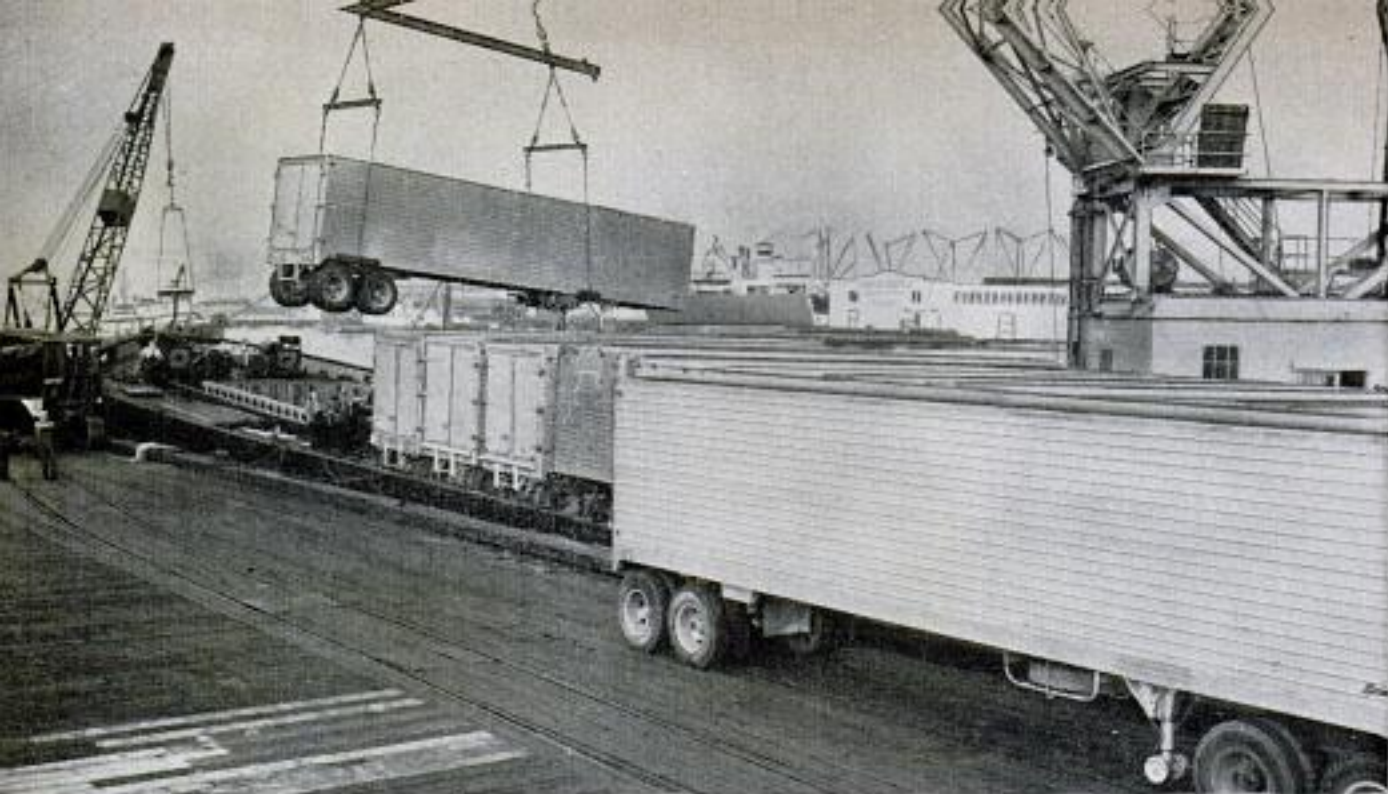

Loaded van is stowed aboard a barge and fastened securely for the five-day voyage to an Alaskan port

Seagoing Trucks for Alaska

By Edward A. Herron

CONVEYING SUPPLIES to Alaska quickly and safely has been a problem since gold-rush days almost 60 years ago. Seagoing "truck convoys" may be the answer. These consist of a fleet of ocean-going tugs that move in a perpetual circle between Seattle and Anchorage; behind each tug is a 204-foot barge crowded with

refrigerated trailer units. At Alaska Freight Lines' pier in Seattle, cranes lift loaded vans aboard barges for the 10.7-mile-per-hour, 5-day voyage. Self-contained generator units on each barge continuously refrigerate perishables. Arriving at Anchorage or Seward, vans are hauled by diesel trucks to destinations. ★ ★ ★

Bargeload of trailer units is towed through Puget Sound toward Port of Anchorage 2000 miles away

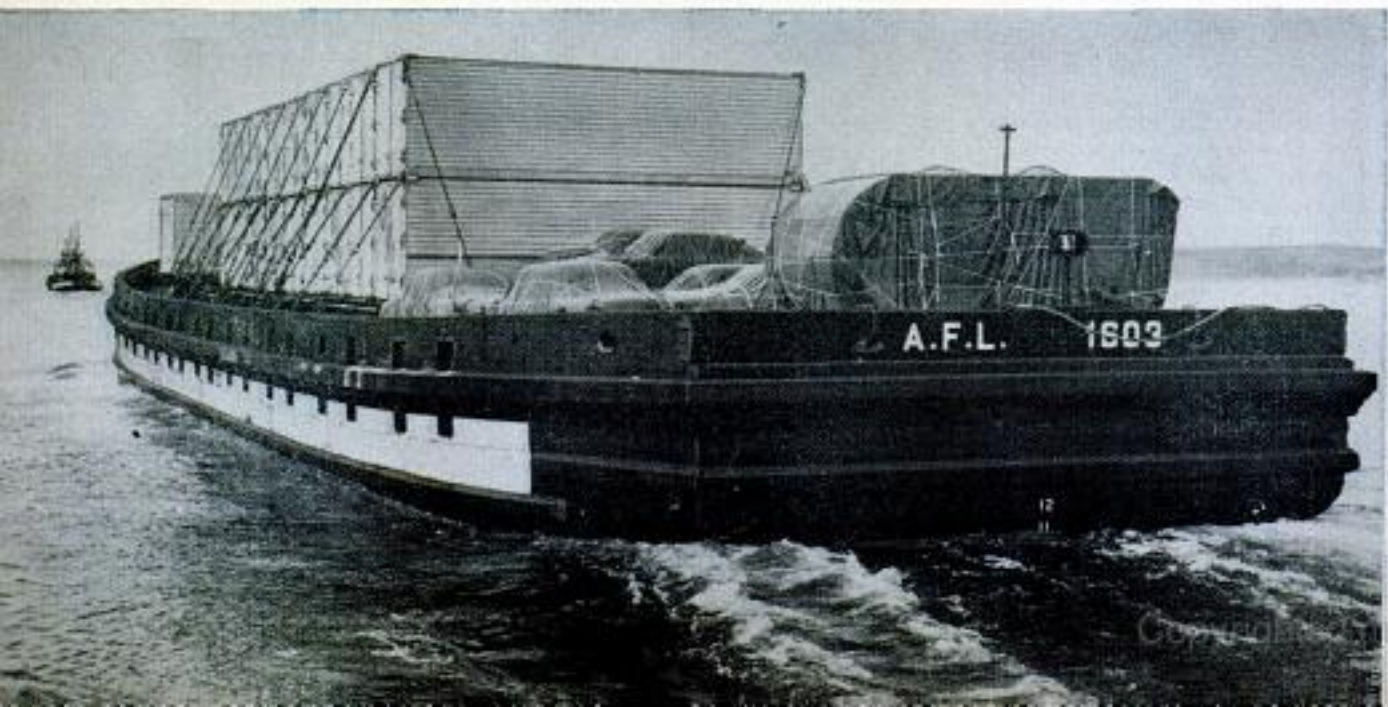

Most of the tugs and barges are able to make the trip between Seattle and Anchorage (at 10.7 m.p.h.) in less than a week



Below, dock facilities are maintained at Anchorage in the summer and at Seward to the south for wintertime barge deliveries



Right, 60 heavy-duty, diesel-powered trucks haul cargoes in vans to docks at Seattle and from docks at Seward and Anchorage





Globemaster Hauls Two 36-Foot Trailer Homes to Greenland

Two special 36-foot-long cold-weather trailers are loaded into a C-124 Globemaster for delivery in Greenland. The trailers will be office and home for the men who operate one of the Air Force's distant early-

warning line of radar sites which stretch across the frozen regions of North America. They are specially insulated against cold weather and equipped with vaporproof lights.

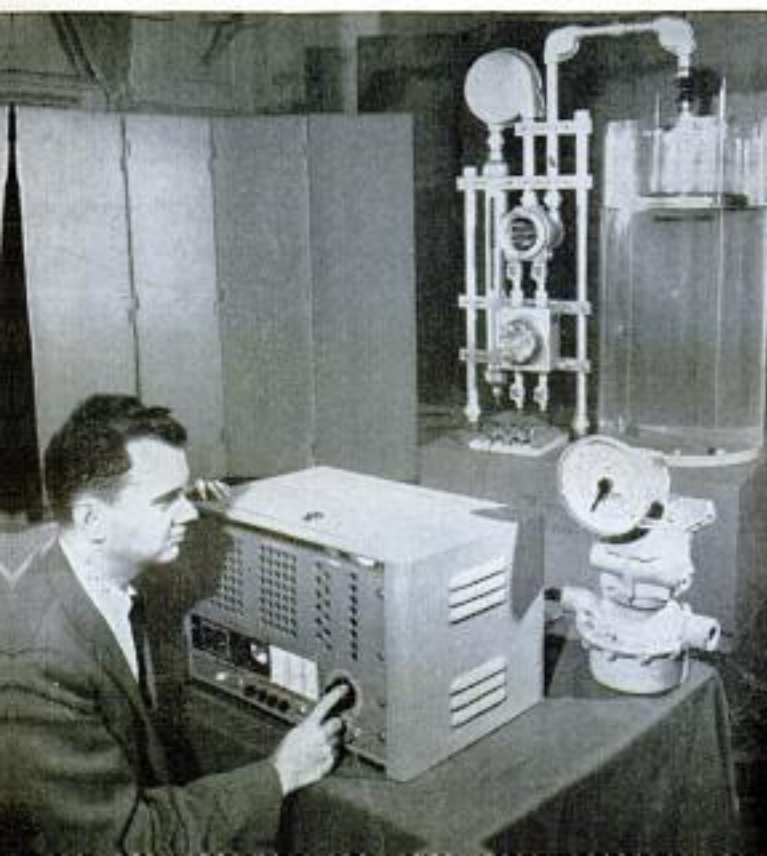

Push-Button Control Operates Distant Factory

Industrial processes can be measured and monitored by remote-control apparatus hundreds of miles from the actual production site. When requested by a supervisor at the control point, the temperatures, pressures or other data necessary in storage tanks and manufacturing techniques are adjusted and reported. A receiver indicator, remotely operated by a supervisor, "calls" the tank or work site with signals over ordinary telegraph circuits, telephone lines, VHF and microwave radio bands. Apparatus at the production area converts data requested into a return signal for the receiver indicator.

Left, supervisor operates remote-control receiver indicator in "calling" for position of tank float. Device by tank's side converts data into return signal

Slotted Surfboard Gives "Feel" of Water Skis

There's a new thrill in water sports—a board that combines the features of a surfboard and water skis. The board, shaped much like a surfboard, has a U-shaped slot in the rear, leaving two sections about the width of water skis. The flexibility of these sections gives the "feel" of water skis, yet the board is easier for a beginner to master than a pair of skis.

Tailor-Made Antibiotics

Can microorganisms be crossbred? That is the hope of scientists at Rutgers Institute of Microbiology. They are studying microorganisms' reproduction methods in the hope that tailor-made antibiotics can be developed.

Weight "Heard" On Scales for Blind

Electronic scales enable blind workers to "hear" the weight of small-lot items to be packaged. Wired to a three-tone speaker, a two-arm scale produces one sound for underweight, another tone for overweight, and a third sound for correct weight. A blind worker places a container with the exact number of items to be packaged on one scale arm; into an empty container on the other scale arm, he drops items until the scale tone tells him the arms are balanced and the container has enough units.

Russian Jet Race Car Hits 185 Miles Per Hour

Strictly experimental, a jet racing car built by the Gorky Motor Works in Russia has been successfully tested, according to press stories. The jet car is driven by jet thrust alone, there being no linkage between the wheels and the kerosene-burning jet engine. Thus no gearbox is needed.

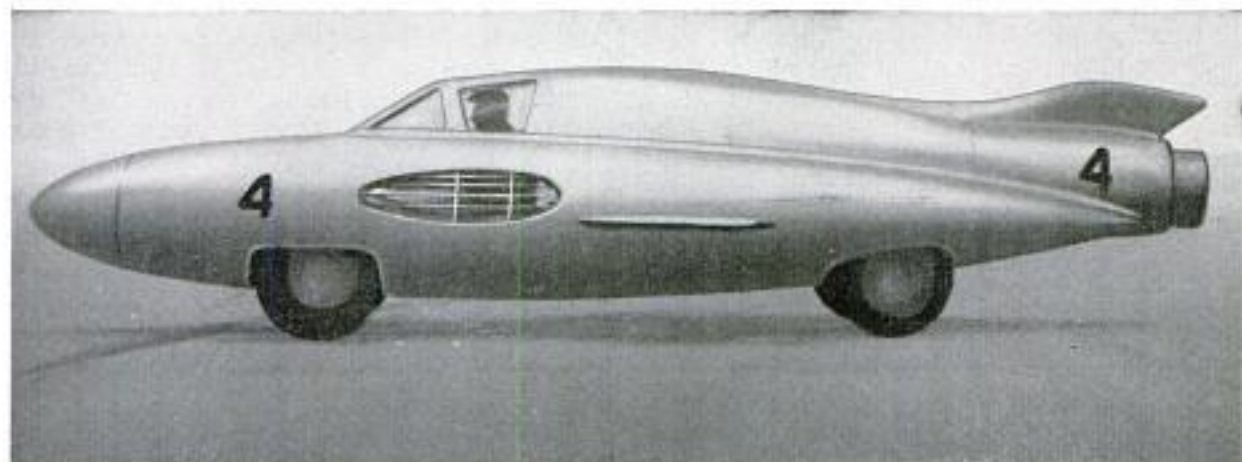

SUBMARINE LUMBERMAN

By Ken Metzler

DEE McVAY, ex-Navy diver, heard that Oregon's State Game Commission was seeking an economical way to clear the mountainous stacks of logs and stumps that cluttered the shores of a tiny lake on the coast.

If so much wood clogged the shores, McVay reasoned, there must be wood on the bottom, too.

As a result of this curiosity, today he's in business diving for logs to help fill the high demand for lumber.

Back in 1954 McVay slipped beneath the waves of Eel Lake in the first of a series of underwater explorations. There, in jumbled abandon, he found hundreds of logs representing 10 million board feet of lumber.

This began one of the most unusual logging operations in the annals of American forestry. So far, McVay and his five-man crew have raised a million board feet of submerged logs from the depths of the lake.

The logs are an accumulation of timber cast off from reckless logging operations of 20 to 45 years ago. These loggers literally stripped the coastal foothills of old-growth timber. The logs were shoved into the lake, where they eventually sank to the bottom.

Storms Also Contributed

To a lesser extent, gales whipping landward from the Pacific contributed to this massive collection. Through many centuries, giant Douglas firs, cedars and spruces succumbed to the ravages of coastal weather and toppled into the lake.

From the murky, muddy lake bottom, McVay brings up logs he estimates blew into the water about the time the *Mayflower* was being rigged to sail westward with the Pilgrims. The water has preserved them remarkably well, according to McVay, and the lumber is as sound as if the trees had been chopped down only yesterday. He said the lumber goes to market with that of recent vintage, and no one can tell any difference between the two.

The techniques used by these deep-water lumberjacks would probably astound some of their traditional ax-and-power-saw



Canvas-bag buoys, when inflated with air, bring logs to surface

contemporaries. Working from a raft, McVay or one of his divers descends into the inky blackness of water 40 to 50 feet deep. He "fells" a log by attaching a large deflated canvas bag or buoy at each end.

Air is then pumped into the bags and, as the diver cries "Timber!" over the two-way telephone, the log begins rising to the surface. Inflated, these canvas bags can bring up logs weighing as much as two tons.

Logs thus "harvested" are towed to shore, sawed into convenient lengths for handling and fed into an adjacent sawmill. The rough-cut lumber from this mill is trucked to another mill for finishing.

In this highly specialized type of logging, no one worries about falling trees or forest fires. Logs rising out of control, however, are a serious threat to both the diver and the men on the raft above. And there are probably no other woodsmen who have to worry about getting their air lines fouled.

Project Aids Conservation

Despite these differences, both accomplish the same basic purpose of providing lumber for a construction-hungry nation. But equally important in McVay's project are the conservation aspects.

Eel Lake rests placidly beneath the foothills of the Western coastal mountains in



Diver emerges from the bottom of Eel Lake, Ore., the scene of unusual underwater-logging operation

a setting of young trees. Oregon's Game Commission, anxious to revive it as a fishing and recreation lake, gave McVay underwater-salvage rights in return for clearing the shores.

Not Getting Rich

McVay admits he isn't exactly getting rich from his underwater logging operation, but he finds the task very interesting and he is familiar with the work since he's been diving for years.

His previous salvage-diving work sent him to the bottoms of sawmill storage ponds to recover sunken logs. He also has helped remove automobiles from torrential streams.

Once he spent many nerve-racking hours beneath the surface of a raging flood in Iowa, patching up dikes that threatened to wash out at a moment's notice.

Spider Shares Helmet

But his most hectic time in a diving suit occurred the day a spider somehow got inside his helmet.

"The darned thing started building his web," McVay recalled, "from my nose to my eyebrows and there wasn't a thing I could do about it. He was still at it when I came up two hours later. It was the worst time I've ever had." ★ ★ ★

Below, McVay saws a log into sections. Water has eroded log's surface, but wood inside is usable





Russian Volga Is Clutchless

Ruggedly built for the rough roads of Russia, the new Volga has that country's first automatic transmission. It is a conventional torque converter with a three-speed gearbox. The 150-cubic-inch engine is a four-cylinder model of 70 horsepower. Top speed of the Volga is said to be about 80 miles per hour.

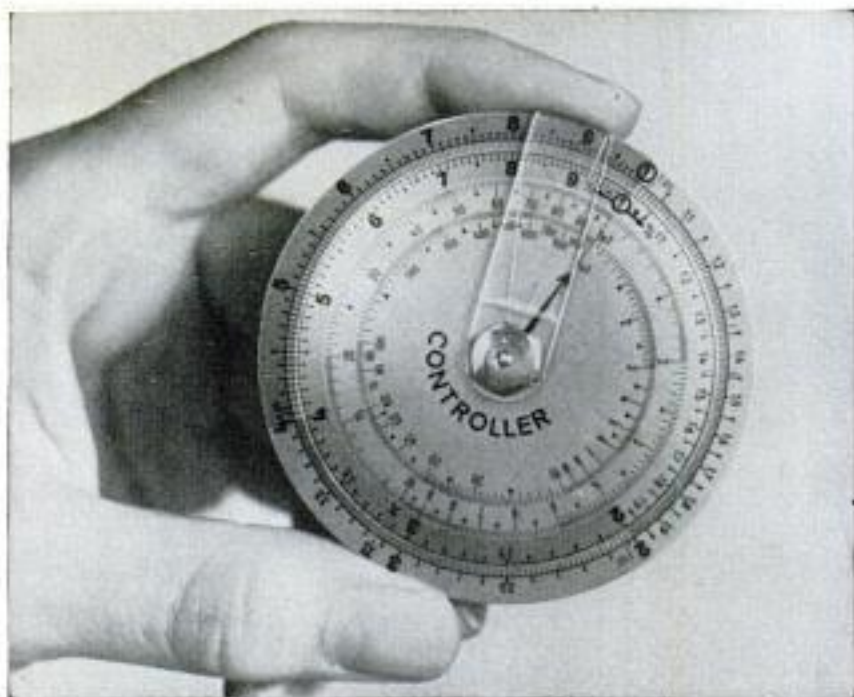

Pocket Calculator Easy to Operate

You can write with one hand, while the other is operating an automatic calculating device. Made of aluminum, this instrument is three inches in diameter and weighs one ounce with case. The circular calculator does multiplication, division, exchange rates, currency calculations, percentages, squares, cubes and other problems. The device is said to have the performance of a 10-inch slide rule. Instructions accompanying the device furnish all knowledge necessary to operate the unit.



Streamlined Cycle Looks Like Scooter

It looks like a motor scooter, but it's really a streamlined body shell that can be clipped to any motorcycle. Made of plastic, the shell was designed as a prototype by staff members of the British magazine *The Motor Cycle*. Tests show that a motorcycle equipped with the body gets up to 35 percent more mileage per gallon and 10 percent more speed. The 45-pound body shell, including 20 pounds of accessories, is attached by thumbscrews at only three points on the motorcycle frame.

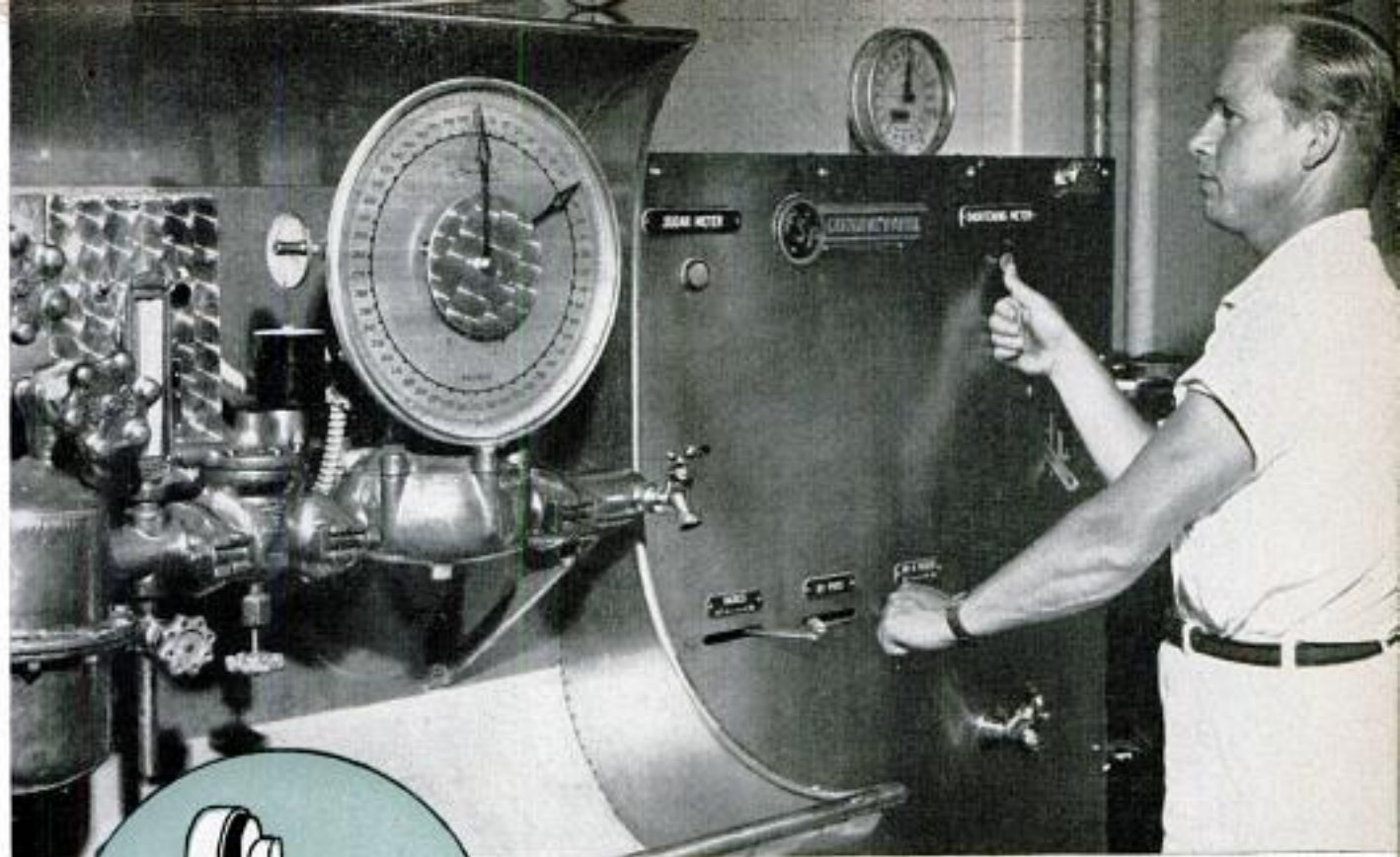

Activated by button, the control panel meters proper amounts of sugar, shortening and other additives to the mixing machine

By Thomas E. Stimson, Jr.

Bakery

URNS OUT 10,000 LOAVES PER HOUR

ANYONE WHO HAS WATCHED a housewife struggle through the chore of baking half a dozen loaves of bread will marvel at a mammoth bakery near Los Angeles. It has a capacity of 10,000 loaves per hour. The new Langendorf bread plant, costing \$2,500,000, turns out loaves of bread in much the same manner that Detroit manufactures automobiles.

Automatic equipment sifts flour, meters ingredients and mixes dough. Other machinery cuts dough to size, shapes loaves and places them in pans that travel on conveyor lines through a giant baking oven and finally to slicing and wrapping machines.

Not only does the robot bakery perform all the work that once was done by hand, its machines have been taught to think for themselves. The molder-panner refuses to drop a lump of dough onto its conveyor line until an empty pan arrives and then

Final mixer discharges 1600 pounds of dough after all ingredients have been mixed for about 10 minutes. From here, the dough goes to the loaf divider

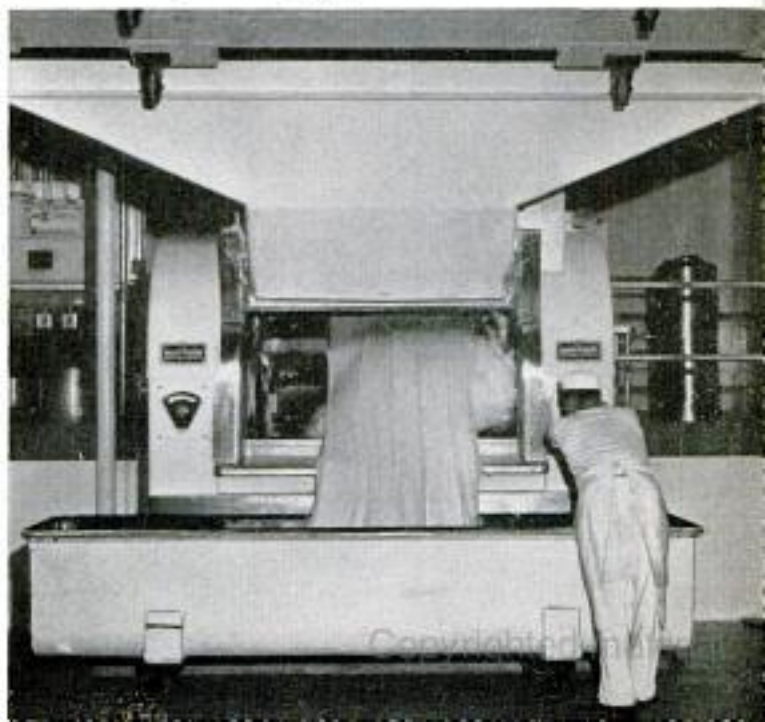

ABOVE, BASIC INGREDIENTS ARE MIXED INTO SPONGE AND DISCHARGED INTO A WHEELED TROUGH

ABOVE, SPONGE FERMENTS 4½ HOURS AT 80 DEGREES F.

ABOVE, IN FINAL MIXER INGREDIENTS ARE ADDED TO SPONGE TO MAKE UP 1600 POUNDS OF DOUGH

LEFT, DOUGH IS CUT IN DESIRED SIZE AND SHAPE IN LOAF DIVIDER BEFORE GOING TO LOAF ROUNDER

BELOW, LOAVES MATURE FOR 12 MINUTES WHILE PASSING THROUGH PROOFER

LEFT, TRAVELING BELT CARRIES LOAVES TO ROUNDER FOR KNEADING AND ROUNDING

BELOW LEFT, IN FINAL PROOFER LOAVES RISE 65 MINUTES AT 110 DEGREES F. HEAT

BELOW, LOAVES ARE FLATTENED TO ELIMINATE GASES

RIGHT, LOAVES ARE RE-ROLLED AND DROPPED IN SINGLE PANS

LEFT, IN 120-FOOT OVEN AT 400 DEGREES F., LOAVES BAKE 22 MINUTES

ABOVE, AIR JETS LOOSEN LOAVES, WHICH ARE DROPPED ON TRAVELING BELT

ABOVE, BREAD SPENDS 1½ HOURS IN COOLER AND COMES OUT AT 95 DEGREES F. FOR SLICING, WRAPPING, SHIPPING

R. P. GILLES

ed material

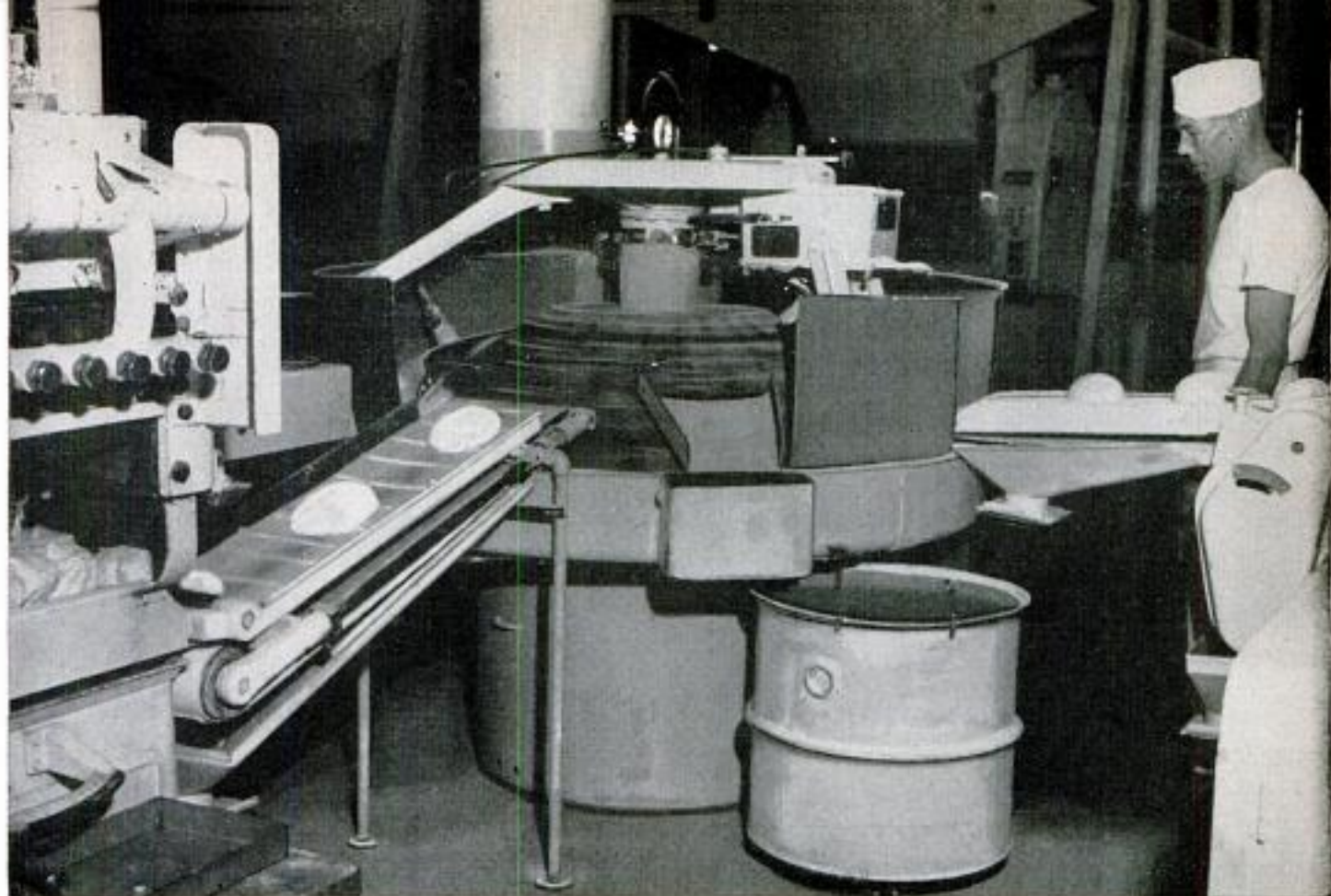

Loaf divider, at left, cuts dough to correct weight and shape. Dough then moves to loaf rounder, at center

drops the dough in the center of the pan. Again, when pans from several machines are arriving simultaneously at the main conveyor line, pans from one machine are held up until other pans have moved along and the way is clear. Otherwise, there would be a traffic jam. There are still white-shirted bakers present, but they are there only to oversee the machines. The entire process operates on an electronically controlled timetable.

In this bakery, quantities are measured by the ton instead of in ounces or pounds. There is enough flour in four big tanks for 136,000 large loaves; even more flour remains in an adjacent seasoning room. Blended and sifted, flour in the tanks is blown by air pressure through stainless-steel tubes to the mixing department when needed.

8000-Gallon Sugar Tank

A housewife keeps a few pounds of sugar in a bin; at the Langendorf plant as much as 8000 gallons of liquid sugar are stored in a huge plastic-lined tank, kept sterile by ultraviolet lamps. A pair of 4000-gallon tanks contain shortening that is heated to 115 degrees F. so it can be pumped as a liquid through insulated pipes to the mixing department. Milk, salt and

other ingredients are kept in stainless-steel receptacles.

It isn't even necessary here for the master baker to look at the ingredients he is mixing. Almost everything he does is by remote control. His recipe for a certain kind of bread might read like this: "Set the flour dial and press the discharge button. Next, press the shortening and sugar buttons. Set the water meter to deliver the desired number of pounds and press that button. . . ." Each substance is electronically

After leaving the proofer, each loaf is squeezed flat by rollers to eliminate gases. Here a flattened loaf, shaped like a tortilla, is moving along from one endless belt to another

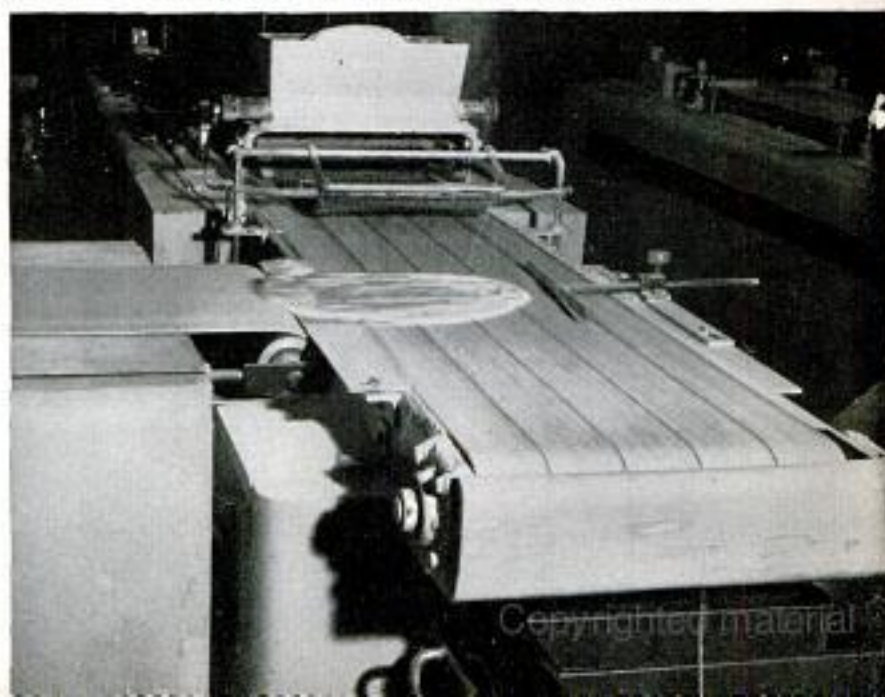

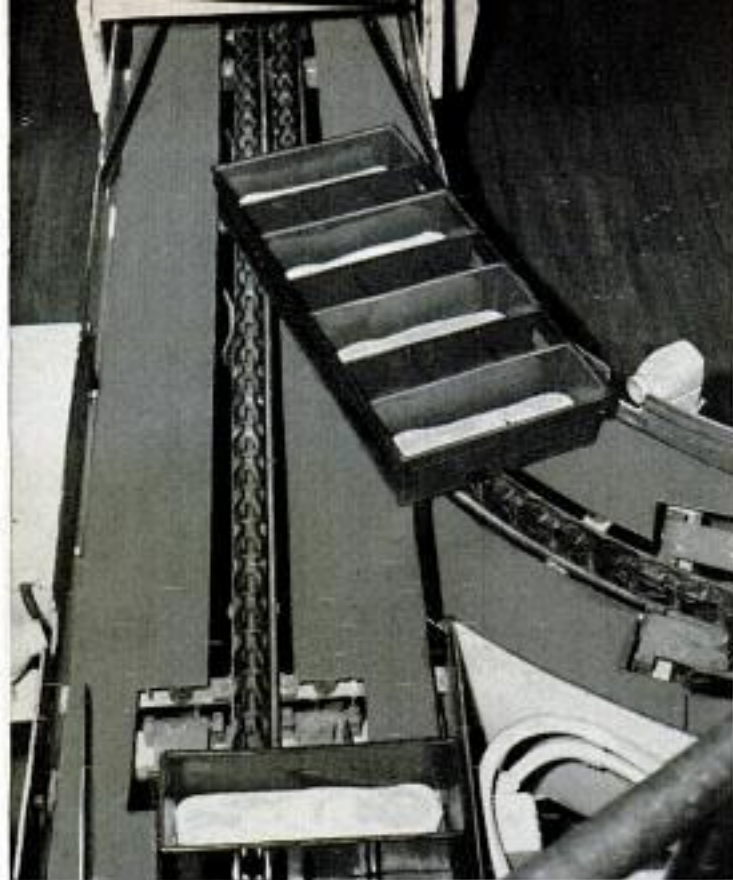

Above, four pans with loaves are connected to form a moving "train." Electric eye spaces trains and prevents pile ups

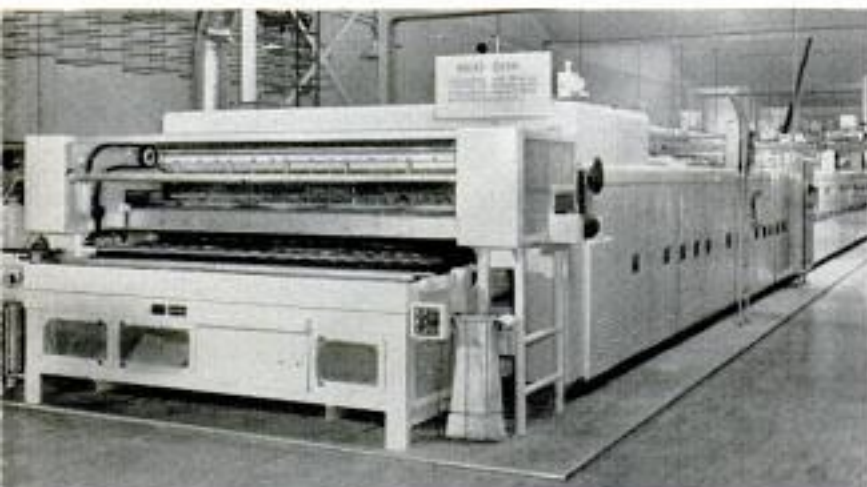

Above, this is a general view of the 120-foot traveling oven. Next, loaves are depanned, cooled, wrapped and shipped

Below, inspection doors spaced along the oven allow attendant to check the bread as it cooks its way along to the other end

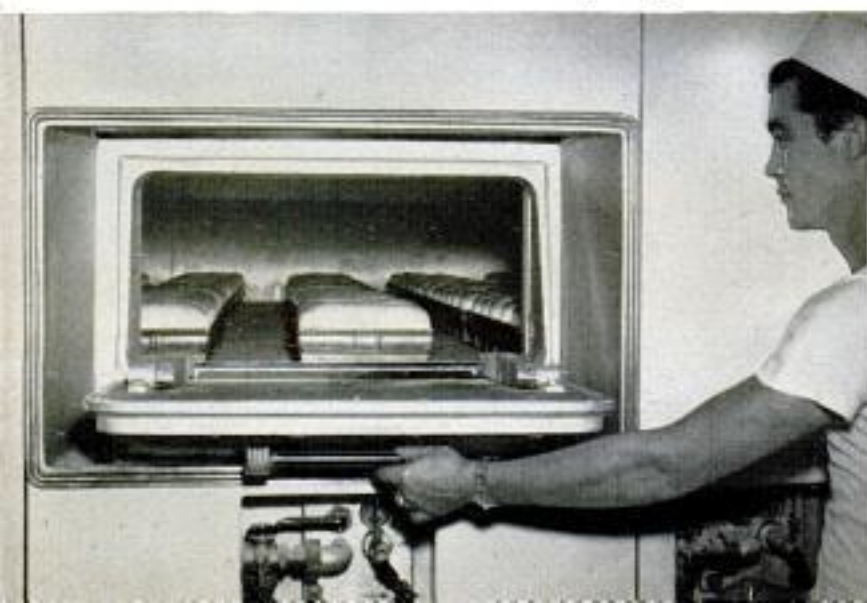

measured to the correct amount when its button is pushed, then is automatically delivered through pipes or tubes to the proper mixing machine.

Step-by-step, the process of baking bread scientifically follows this pattern: Metered amounts of flour, yeast, yeast foods and water are stirred together in a giant mixer, then poured into a trough which is wheeled into a fermentation room for a 4½-hour period. During this time, under controlled heat and humidity, the yeast converts the basic ingredients into a "sponge." From the fermentation room the sponge goes to another mixer where the final ingredients are added. These consist of more water and flour, milk, malt, sugar, shortening, salt and enrichment substances (such as minerals and vitamins).

Dough Goes to Loaf Divider

Next the thoroughly mixed batch of dough, now weighing 1600 pounds, is delivered to the loaf divider, a machine that automatically weighs and cuts the dough into the pieces that eventually will become loaves of bread. Each piece of dough falls onto an endless belt that carries it to the next machine, a loaf rounder, that kneads and rolls the lump of dough into a ball. A belt carries the loaves slowly through a "proofer room" where fermentation continues.

Gases produced by the yeast must now be removed, so the loaves are squeezed flat like pancakes in a series of rollers, then carried by endless belts to the molder-panner where the flat pieces of dough are rerolled into shape and are dropped one at a time into the baking pans traveling on a conveyor line below the machine.

The conveyor line transports the pans to the final proofer room where the dough rises and assumes its final loaflike shape. The slowly moving pans spend 65 minutes here in a temperature of 110 degrees F., then are switched to a conveyor that carries them into one end of the 120-foot-long baking oven. This oven is a continuous traveling hearth, with its heat automatically controlled so that loaves enter one end as dough,

emerge from the other end at the precise moment when they have been beautifully baked.

Air Jets Loosen Loaves

Now each loaf must be loosened from its pan; this is done by a jet of air directed down one side of the loaf. Next, loaves must be removed from their pans. This was a hot chore that no one wanted in the days of baking by hand. In the new bakery, it's done via machine by a depanner that clamps onto 20 pans at a time and tips them over, dropping the loaves onto a traveling belt. On this the loaves move to a cooler where they are transferred to slowly moving trays for an hour of cooling off.

By the time their temperature has dropped to 95 degrees F. they leave the cooler and ride one after another along a belt to the slicing machine, where a row of bandsaws slices an entire loaf at once.

The final operation is the wrapping of each loaf, a task that a machine can do more quickly and neatly than human hands. In the wrapping machine a length of plastic is cut from a thick roll, wrapped and folded around the loaf, then sealed with heat. There are several slicing and wrapping machines side by side; each handles 60 loaves per minute.

Process Takes 10 Hours

There's only one thing that mechanization cannot do without lowering the quality of the product, and that is the speeding up of the fermentation, rising and cooling processes. Each of these steps takes time. The only thing science can do about it is to provide the temperatures and humidities at each step that produce the best results. It still takes 10 hours from the time the first ingredients are mixed together until the freshly baked loaf is sliced and wrapped.

On merits of home-baked bread as compared to bread made in a commercial bakery, master bakers flatly say that from the standpoint of quality control, the bread made by machines wins hands down. The reason: Each loaf contains precisely the same amounts of the same scientifically selected ingredients, baked exactly the correct length of time at exactly the same temperature. ★ ★ ★



Above, baked loaves emerge from oven to conveyor system that takes them past air jet which loosens loaves for depanner

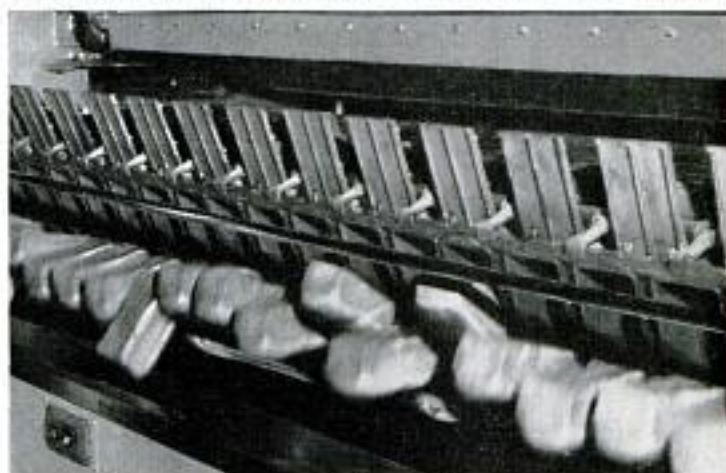

Above, in the depanner, hot loaves tumble from their pans to traveling belt that carries them quickly to the cooler room

Below, after a trip through wrapping machine, which automatically slices, wraps and seals them in cellophane, the finished loaves are taken by conveyor system to the shipping room





UNESCO Headquarters in Paris to Have Two Acres of Glass

Ideas of some of the world's greatest architects went into the planning of the massive, Y-shaped UNESCO headquarters building in Paris. The seven-story concrete-and-glass structure was designed by Pier Nervi of Italy, Bernhard Zehrffuss of France and Marcel Breuer of the United States. They were assisted by Lucio Costa, Walter Gropius, Charles Le Corbusier, Ernesto Rogers, Sven Markelius and Eero Saarinen, whose buildings dominate the capitals of the world.

As indicated by the models above, the Secretariat will be faced with nearly 100,000 square feet of glass. The futuristic structure in the foreground will be used for conferences and committee meetings. Approximately 1000 scientists, educators and technical experts will have offices in the Secretariat Building. The basement will have facilities for five radio and television studios, a theater, printing plants for UNESCO publications and an emergency electric plant.

Dome Design for Oklahoma City's "Church of Tomorrow"

Wide sweeping curves are emphasized in the design of the First Christian Church of Oklahoma City, Okla. The steep hemispherical roof of the modern sanctuary

rises to a height of four stories and has a glistening cover of white-chip marble. The front of the egg-shaped structure features a towering arch of glass.





KEEPING UP WITH THE ATOM



QUESTION: How do you photograph the interior of a vast underground tank made "hot" by the storage of millions of gallons of radioactive waste?

ANSWER: By rigging a camera on a "fish pole." That, in effect, is what General Electric photographers did at the Hanford plant. The tank had to be checked by photograph after the wastes were removed. An additional problem was that the tank's top entrance was only nine inches in diameter.

The photographers rigged an old copy camera on one end of a 12-foot metal pole. A flash unit was fitted in place with a spring hinge so it would fold back behind the camera as it entered the tank. Once inside, it flopped into firing position.

The fish pole was a success and engineers now have a composite picture of the inside of the entire tank.

☆☆☆

RESEMBLING a guided missile, a gleaming new electrostatic generator (lower right) has been put into operation at Aldermaston, England. Capable of building up to six million volts of electricity, the instrument hurls atomic "bullets" at various materials in a target area. The instrument will serve as a tool for basic nuclear research.

☆☆☆

TOMORROW'S leading nuclear scientists may be trained in a new nuclear-engineering center under construction at the Massachusetts Institute of Technology.

Physics students of a few years ago would be amazed at some of the facilities that will be available at the new center: A \$2,225,000 research reactor, a nuclear instrumentation laboratory, a subcritical reactor and a graphite-moderated pile.

☆☆☆

THE ATOM powers a new airport-marker lamp that has no bulbs, batteries or electric supply and will operate for as long as 10 years without maintenance.

The lamp operates by exposing phosphorus to a radioactive gas. It is available in a variety of shapes and sizes.

☆☆☆

URANIUM mining in the United States now has moved east of the Colorado plateau for the first time.

Just 50 miles northwest of New York City, at Warwick, N. Y., a uranium mine now is producing ore and high-grade uranium concentrates.



Camera on a "fish pole" is lowered into a "hot" tank at Hanford. Strange rig had to be devised because the tank was intensely radioactive and there was only a small opening at the top. Below, a new electrostatic generator strikingly resembles a guided missile



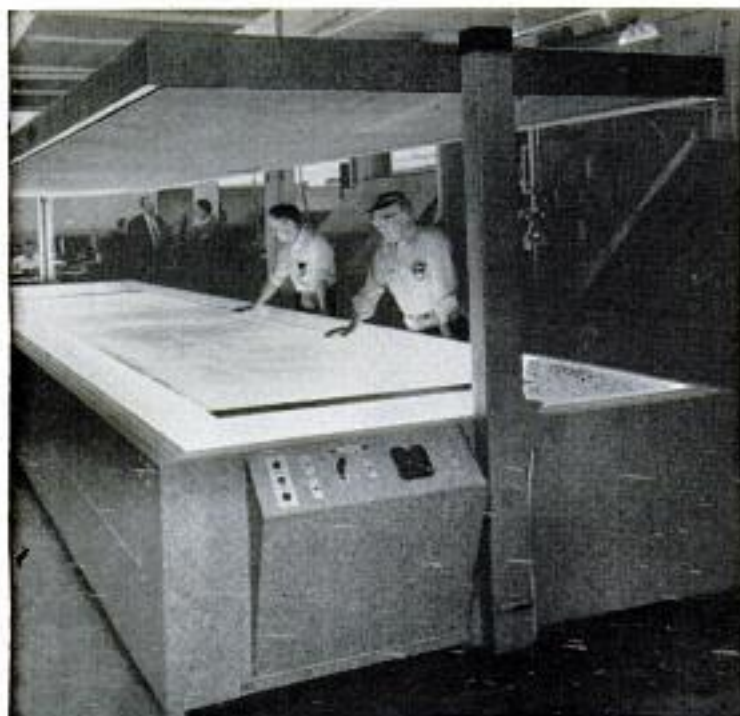

Templates 30 Feet Long From Giant Printer

A contact printer which reproduces templates 30 feet long has been developed for the aircraft industry.

The first machine, installed at the Columbus, Ohio, plant of North American Aviation, Inc., is actually two units mounted end to end. They can be operated separately or simultaneously from either of two control panels.

A unique feature is the raising and lowering of the lid with a powered ball-bearing unit. This replaces the "clam shell" or "removable blanket" type of lid found on the usual contact printer.

Average cycling time of the machine is three minutes.



Getting Cold Feet?

No more cold sheets! A new bed warmer, developed in Germany, takes the chill off the bed quickly. The warmer is plugged into an electrical outlet and slipped between the sheets. A wire frame around the heating element holds up the top sheet and permits the warm air to spread throughout the bed.



"Pony Express" By Motor Scooter

Mailmen in residential areas are sitting down in comfortable, weatherproof motor scooters as they deliver mail. A large cargo space behind the cab enables the mailman to carry his entire day's mail instead of having to be supplied from storage boxes. The Post Office Department has ordered 1500 of the "Mailsters" from the Cushman Motor Works, makers of the well-known motor scooter.

□ A British firm has developed a glass-fiber diesel-powered lifeboat that holds 144 persons.

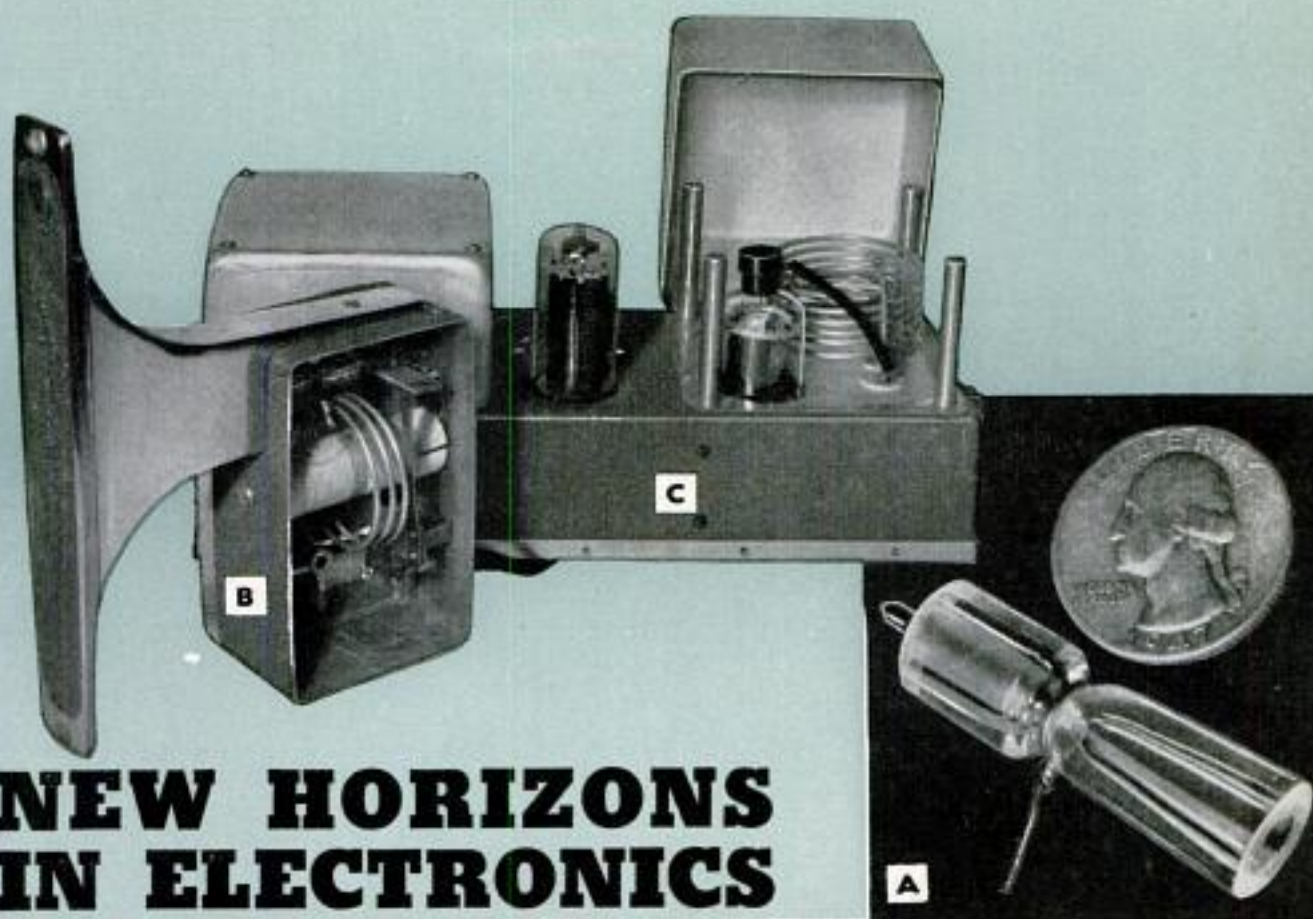

NEW HORIZONS IN ELECTRONICS

By Lothar Stern

THE YEAR 1957 is likely to go down in history as another milestone in the field of electronics. Some developments already announced promise to open entire new vistas for experimentation and may provide the solutions to some very vexing problems.

Sound Waves Unlimited

One of the most startling achievements is the development of the Ionovac, a loud-

speaker capable of changing high-frequency audio waves into equivalent sound waves with amazing fidelity. The operating principle of this unit, though not new, differs radically from that of any speaker in common use. Rather than employing a moving voice coil and diaphragm, it utilizes the motion of ionized air to change electrical energy into sound. The complete

(Continued to page 212)

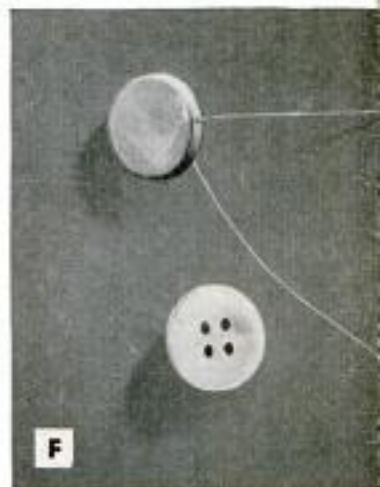
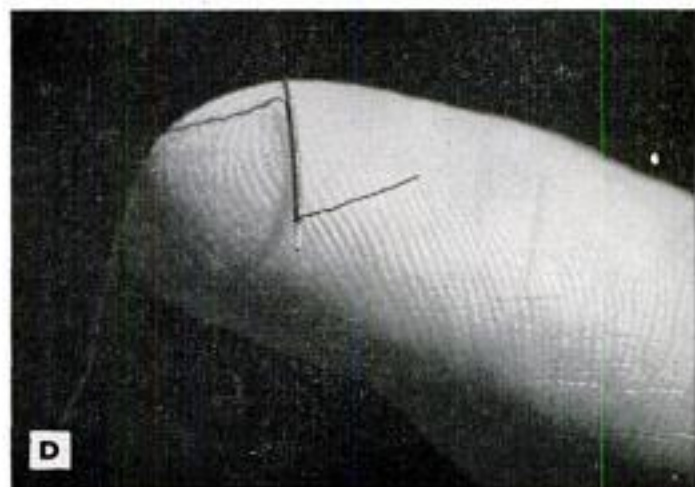

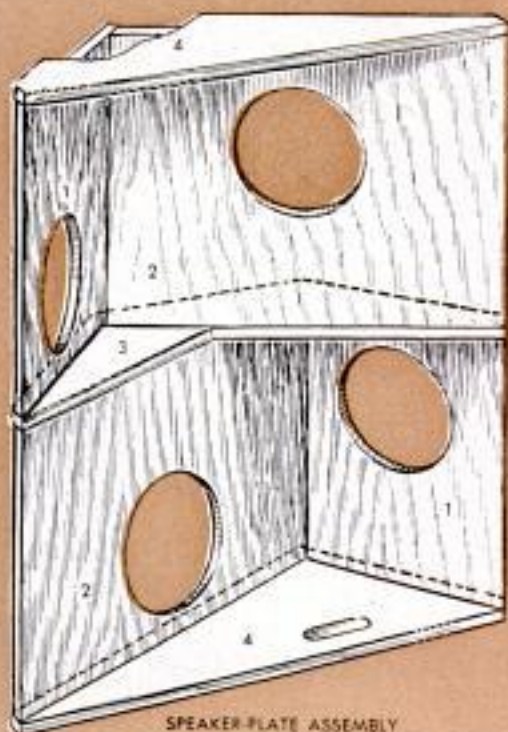

SPEAKER-PLATE ASSEMBLY

Fig. 1, above. Initial assembly consists of numbered parts shown at right. Tip of V-shaped cutout in board No. 3 is located midway between outer edges and $1\frac{1}{2}$ in. from back edge

Fig. 2, lower right. Cabinet details. Cutout in front of bottom plate permits entry of leads

Fig. 3, below. Install glass-fiber insulation, and mount and phase speakers before fastening speaker-plate assembly to cabinet cleats

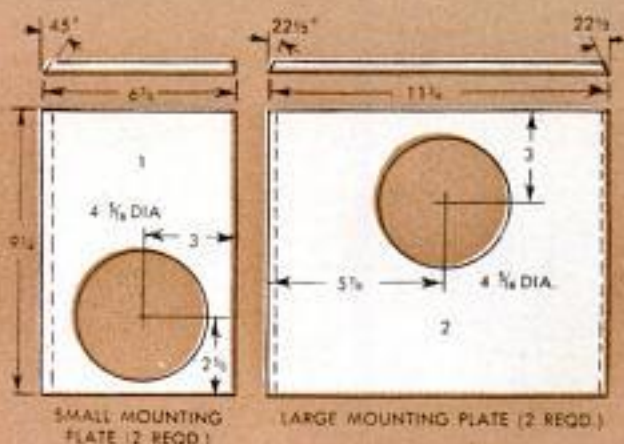

SMALL MOUNTING PLATE (2 REQD)

LARGE MOUNTING PLATE (2 REQD)

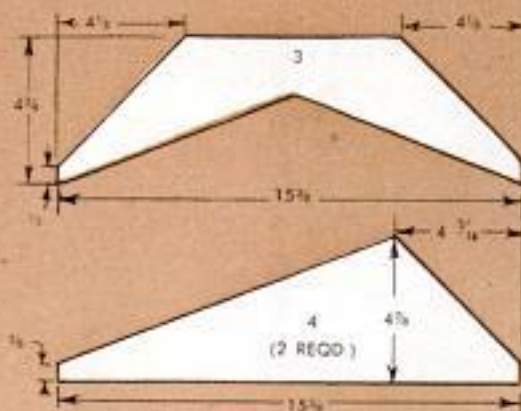

SPEAKER-MOUNTING PLATES TIGHT AGAINST UNDERSIDE OF TOP

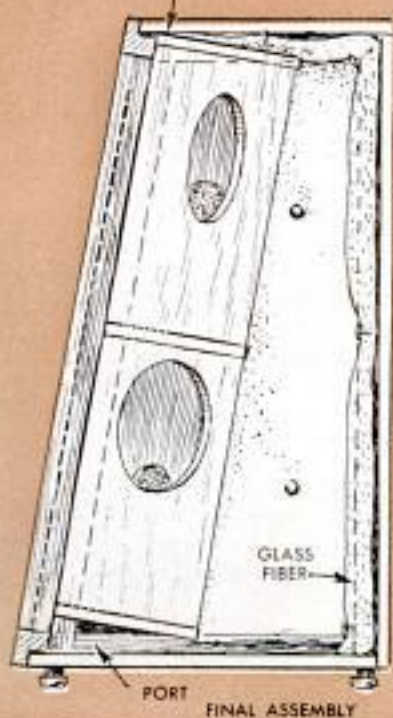

FINAL ASSEMBLY

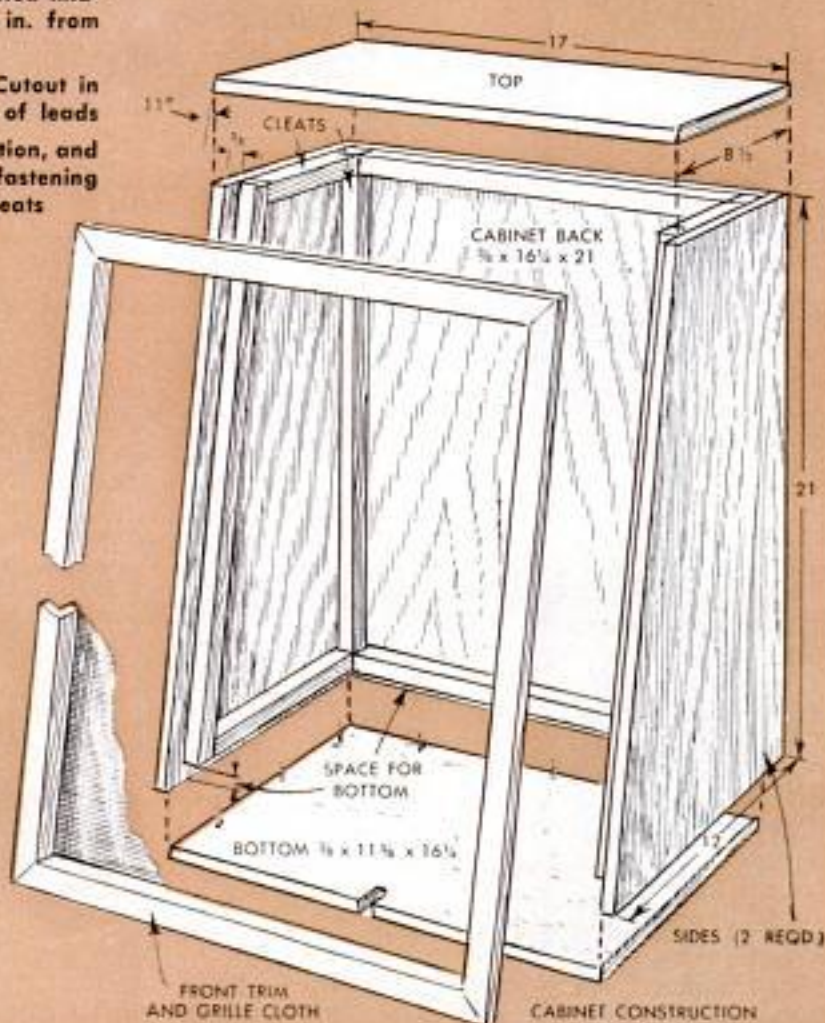

FRONT TRIM AND GRILLE CLOTH

CABINET CONSTRUCTION



A Four-Speaker Bass-Reflex Enclosure

By Dr. Richard C. Hitchcock

HERE'S A LOUDSPEAKER system that's fun to build and a pleasure to listen to. It is specially designed for improving the sound quality of console radios and television receivers, but will also do full justice to low-cost hi-fi systems.

The system consists of four identical 5-in. speakers mounted in a bass-reflex cabinet of unusual design. Each speaker is mounted at an angle so that the high-frequency sound beams cover an angle of 120 deg. as compared to the 30-deg. dispersion angle of single speakers. Vertical spacing between the four units prevents interference between individual beams.

At low frequencies, the four small cones, acting in unison, can push around plenty of air, and the bass-reflex cabinet design provides efficient speaker-to-air coupling which makes even a low-power amplifier sound mighty impressive. Rigid construction provides a vibrationless enclosure with a remarkably smooth response. Don't use cheap surplus speakers and expect to get a wide frequency range. But good extended-range units, such as the Jensen P5TX models used in the original enclosure, will give you an upper limit in excess of 15,000 c.p.s. and good efficiency down to about 80 c.p.s. (measurable response down to 60 c.p.s.).

Cut out the required pieces in accordance with the dimensions given in Figs. 1 and 2. If you don't have a power saw, better

hunt up someone who has, because the dimensions are rather critical if a tight-fitting final assembly is to be obtained.

Inexpensive $\frac{3}{8}$ -in. fir or white-pine plywood can be used for the speaker-plate assembly and for the back and bottom of the cabinet. Birch plywood, $\frac{3}{8}$ in. thick, is recommended for the top and sides, since this will take a good finish. The cleats fastened to the inside of the cabinet pieces should be $\frac{7}{16}$ in. square and can be made from scrap lumber (not plywood).

Begin the construction with the speaker-plate assembly shown in Fig. 1. If all dimensions and angles have been cut correctly, the outside edges of the speaker plates should line up evenly with those of the top and bottom plates and of the center spacer. This is important because these surfaces will be fastened to the cleats in the cabinet during the final assembly. The cutout in the bottom piece is for the terminal strip to which the speaker and amplifier leads will be connected.

All panels must be securely joined with glue and nails. Any good wood glue and $\frac{3}{4}$ -in. brads are satisfactory.

Assembly of the cabinet is illustrated in Fig. 2. The cleats are so placed that all nailing can be done from the inside of the cabinet. If the cleats are $\frac{7}{16}$ in. square, $\frac{3}{4}$ -in. brads will get a firm grip without emerging from the $\frac{3}{8}$ -in. facing plywood used for the top and sides.

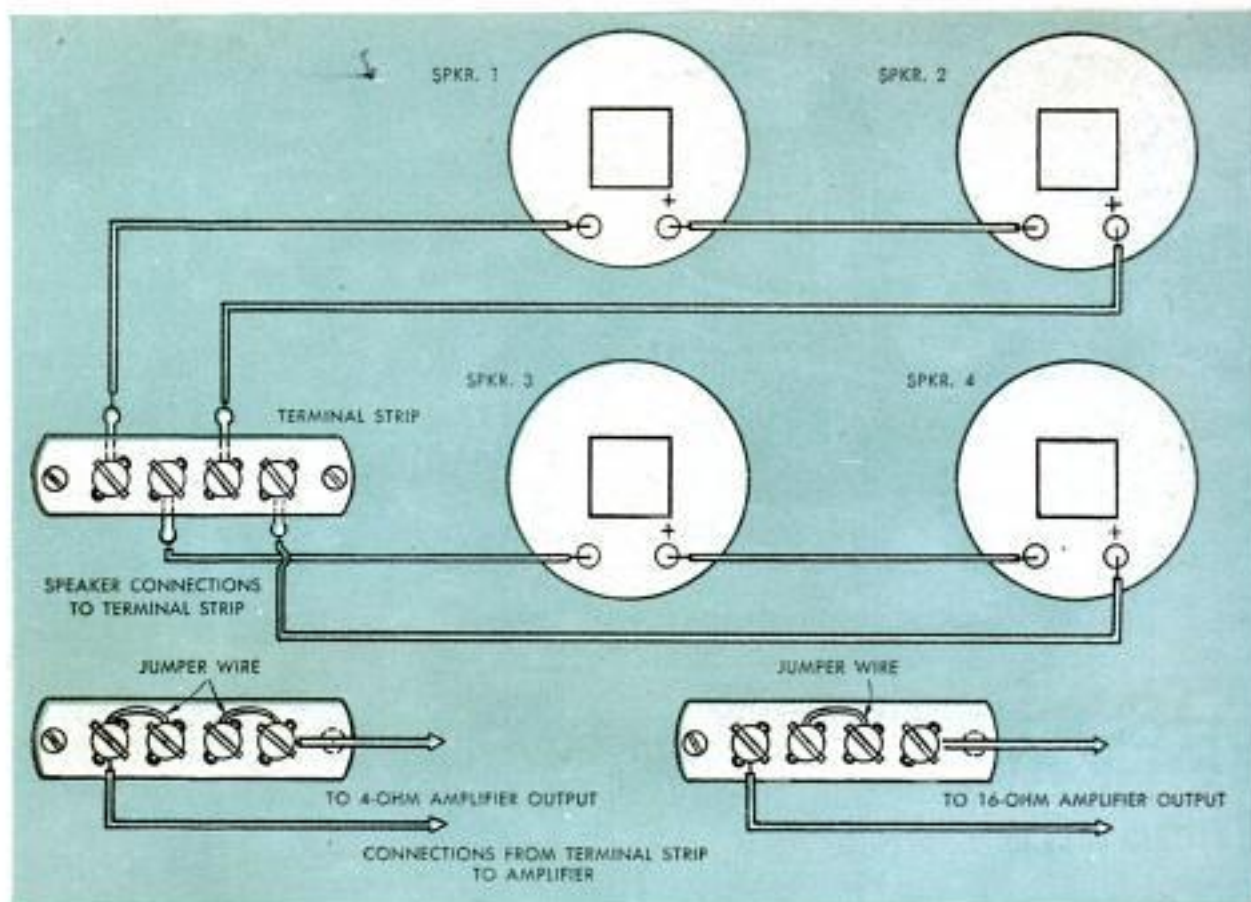

Fig. 4. Proper connections between speakers and terminal strip for matching 4-ohm or 16-ohm amplifier output

All panels are glued and nailed except the bottom which is screwed on with No. 4 flatheaded screws, $\frac{3}{4}$ in. long.

The inside of the cabinet must be thoroughly padded with glass-fiber or similar acoustical insulating material. Use a double thickness (1 in.) and cut it as shown in Fig. 5. Cover the back and both sides, and use several thicknesses for the top. The bottom remains uninsulated. Use large-headed tacks to hold insulation in place.

Install the speakers by front-mounting them to the panels with wood screws. It is essential that the speakers be properly phased so that their respective cones move in and out in unison. To do this, solder a

wire lead to each pole of a 1.5-volt battery and momentarily touch the voice-coil lugs of a speaker with the opposite ends of these wires (one wire to each lug). As contact is made, the speaker cone will move either out or in. If it moves out, label the lug going to the positive side of the battery with a + sign. If the cone moves backward, label the lug connected to the negative side of the battery with a + sign. Repeat this with all speakers and then interconnect the speakers and terminal strip as shown in Fig. 4.

Now glue and nail the speaker-plate assembly to the diagonally mounted cleats on the cabinet sides. (See Fig. 3.)

Some front angle trim, cut and assembled to fit the front of the cabinet and backed up with grille cloth, completes the enclosure.

Operation

Fig. 4 shows two methods of connecting the speaker system to the output of an amplifier. Television sets, radios, tape recorders and the like usually have 4-ohm output impedances, and the corresponding 4-ohm connection should be used. For hi-fi amplifiers having only an 8-ohm and a 16-ohm output, use the 16-ohm connection.

Caution: Do not play this speaker system at full volume (preferably not at all) until the glued joints have had a chance to dry completely. ★ ★ ★

Fig. 5. Pattern of insulating material to fit cabinet

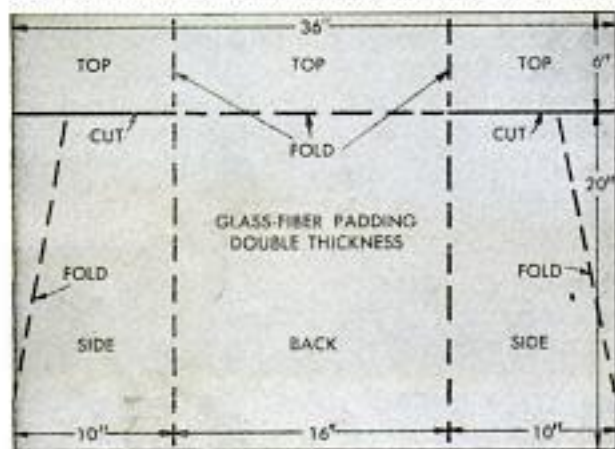

X131 also → 365

THE

POPULAR
MECHANICS

WTM 59

CRAFTSMAN



"FIELD KITCHEN" FOR WEEK-END CAMPERS

By Clinton R. Hull

ON YOUR NEXT family picnic you can "take along the kitchen sink." All you have to do is build these two plywood cabinets, which have storage space for all the necessary pots and pans, dishes, cutlery, packaged foods, a two-burner stove and even a self-draining sink built into the top unit.

A removable end table and a second table attached to the back of the upper unit provide seating space for four adults. Additional tables can be attached to the front and opposite end if desired, doubling the seating capacity. The tables are joined to the upper unit by hooks and screw eyes,

and can be supported at the outer end by a brace or by a leg inserted in a floor flange screwed to the underside. The end table shown in the illustration above is supported by a wooden bar hidden from view, similar to the type used on a drop-leaf table.

The sides, ends, bottoms and tops of both units are cut from $\frac{1}{4}$ -in. exterior-grade fir plywood and glued and nailed to a frame of 1 x 1-in.-pine stock as shown in the drawing. Runners cut from 1 x $1\frac{1}{2}$ -in. stock and nailed to the bottom of the lower unit permit easy moving of the stacked units at a camp site. Rope handles at both

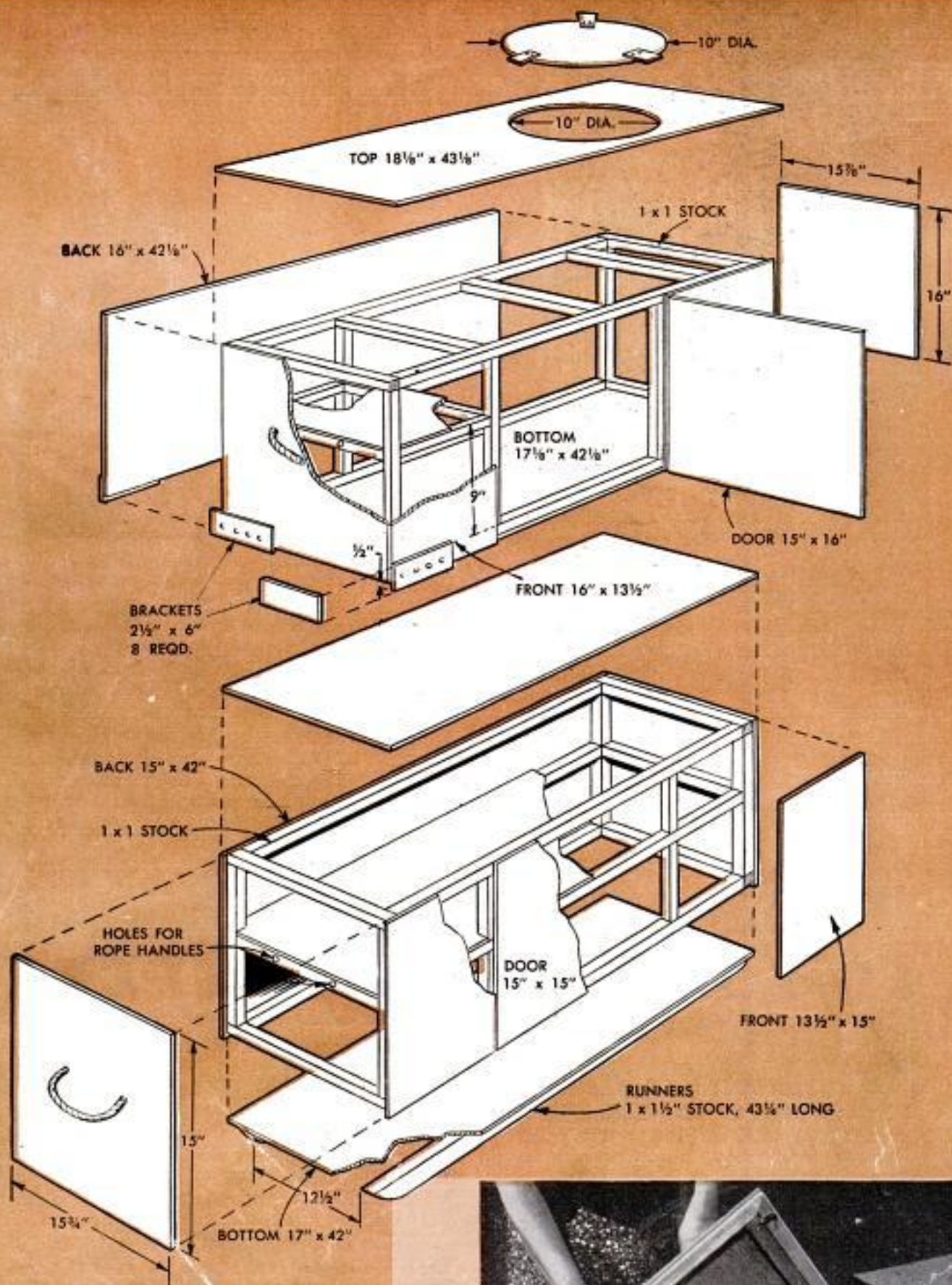

Right, hooks made from flat steel and screwed to underside of end tube, engage screw eyes on cabinet



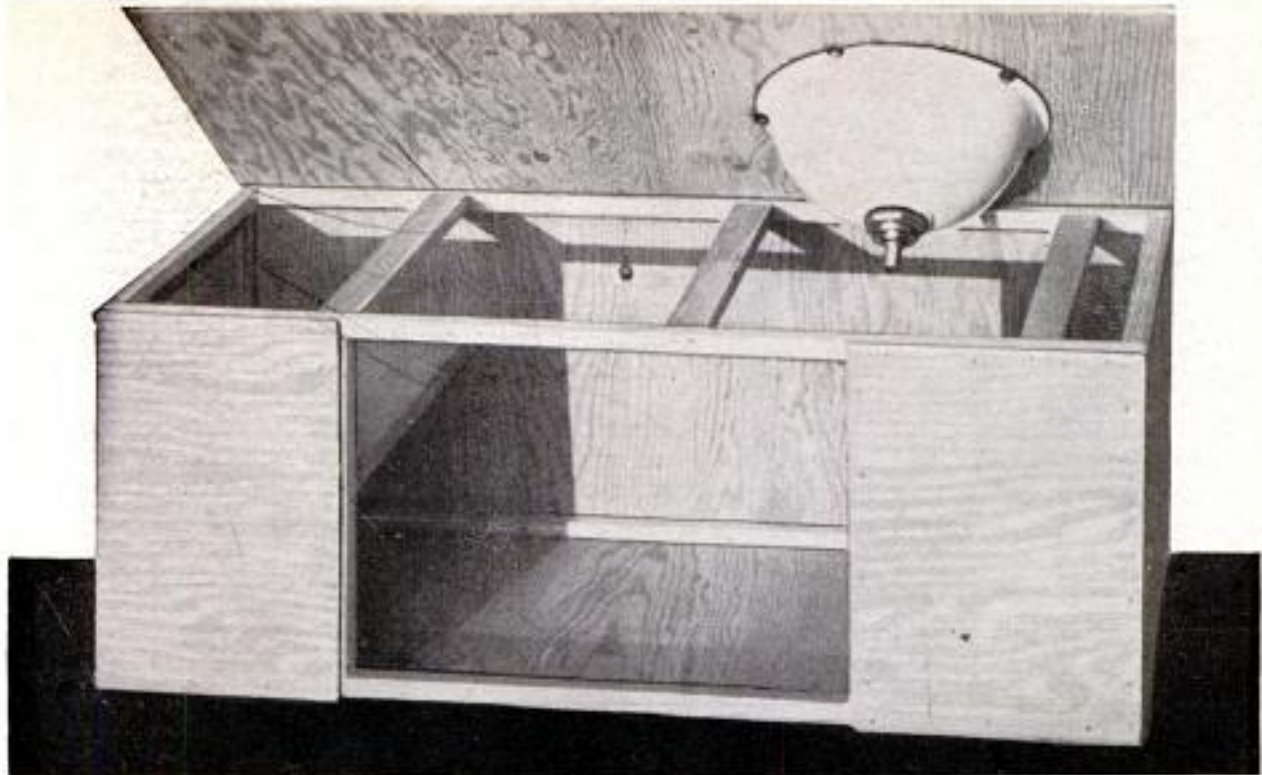

Marine-type seam compound, applied between sink lip and underside of cabinet top, assures watertight seal around sink. Garden hose is clamped over sink outlet to carry waste water to trench near camp site

ends of each unit provide a comfortable and safe grip when carrying them.

The top on the lower unit should be flush with the sides and ends with the edges sanded round, so that the corner brackets on the upper unit slide over the top without splintering the edges when stacking the units for use. A thick coating of marine-type seam compound applied between the rim of the sink and the underside of the cabinet top before mounting the sink, assures a watertight seal. The completed cabinets can be painted or varnished and

Cleats on plywood sink cover hold it flush with surface of top when unit is used as bunk or seat

plain or fancy hardware installed on the doors and tables as desired. A plastic-laminate top installed on the top of the upper unit provides a good work surface and improves the appearance.

A length of plastic garden hose attached to the sink outlet and passed through a hole drilled in the end of the cabinet provides for convenient disposal of dishwater and other liquids. Liquid refuse should be allowed to empty directly into a shallow trench and covered with fresh earth daily for sanitary purposes. ★ ★ ★

Leg on table attached to cabinet is inserted in floor flange screwed to underside of table top

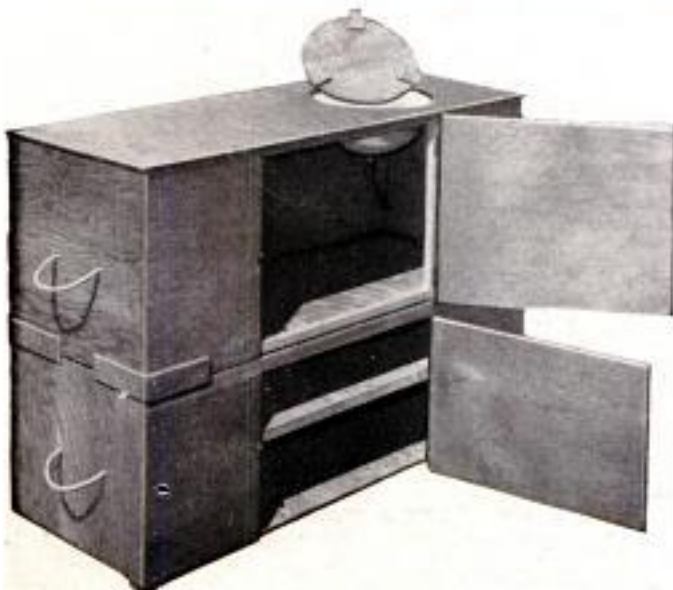

WIM 59

DECOR BOARDS IN FREE FORM

In addition to being conversation pieces in themselves, decor boards are the answer to the problem of displaying small pictures, curios and other knickknacks in a room of modern furnishings. Besides adding a sharp contrasting background, these "bulletin boards" save the wall from numerous nail holes as they hang like pictures. Insulation board tacked to a plywood base provides a soft, thumbtack surface which is covered with a fabric of your choice. The decor board in the photo was covered with black burlap to contrast against a salmon-pink wall.

Jeanne and Emil Frey, Trumbull, Conn.

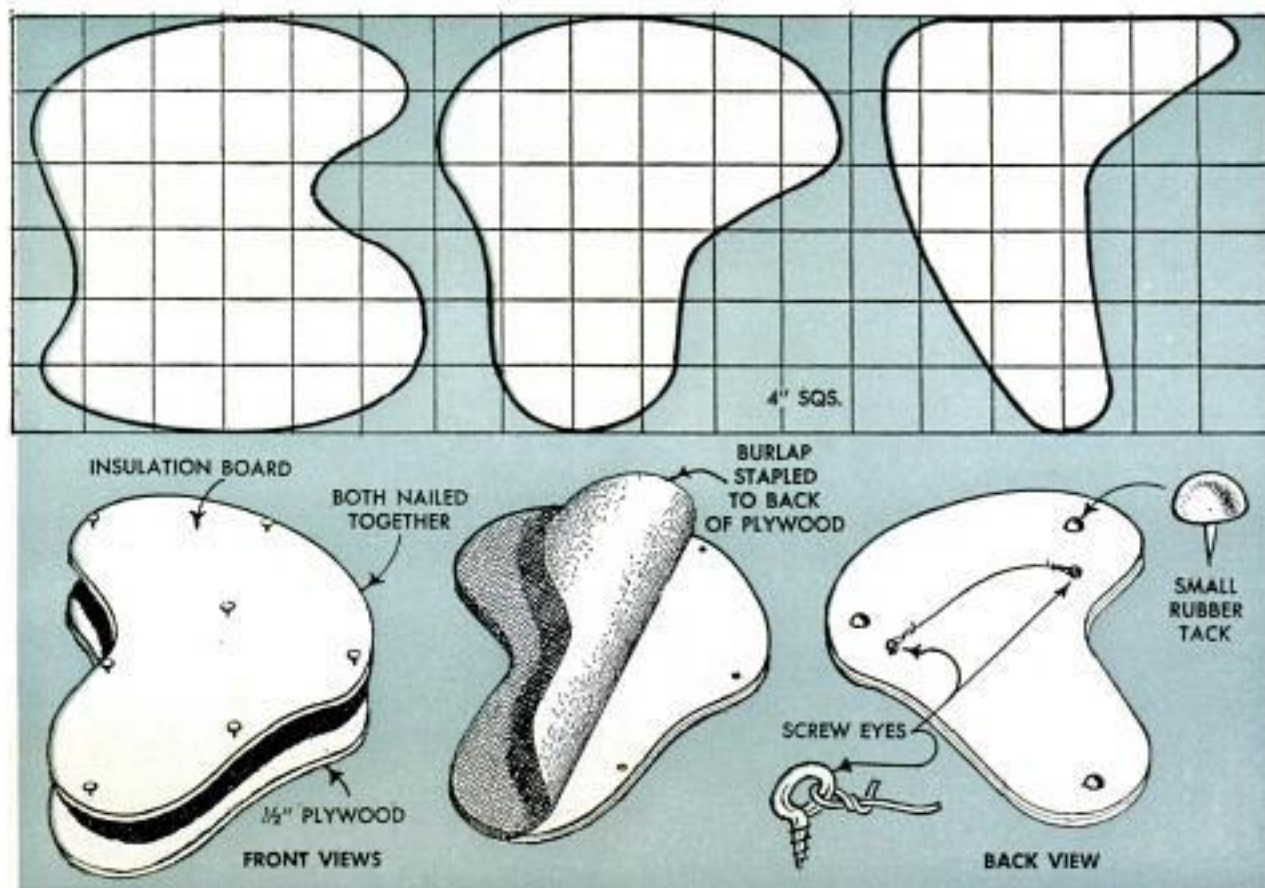

Bug Catcher on Car Radiator Gathers Fish Bait En Route

Using your car to trap fish bait may sound a bit ridiculous but it proved a worthwhile stunt to one fisherman in traveling from one lake to another on a vacation trip. Like every motorist, he was plagued with bugs clogging the radiator of his car. The thought occurred to him that the bugs would make excellent bait if there were some way of collecting them as he drove along. This was accomplished by attaching a piece of screen wire to the radiator and curling up the lower edge to form

a trough to catch the bugs that fell to the bottom. Each day a handful of bugs was collected in this manner which made it particularly convenient when bait was not always readily available.

Lyle Sovay, Toledo, Ohio.

When preparing vegetables for cooking, peel and cut the onions before you peel and cut the potatoes. Handling the potatoes after the onions will kill the onion odor on your hands.

Light-Radiating Ceiling Illuminates Bathroom

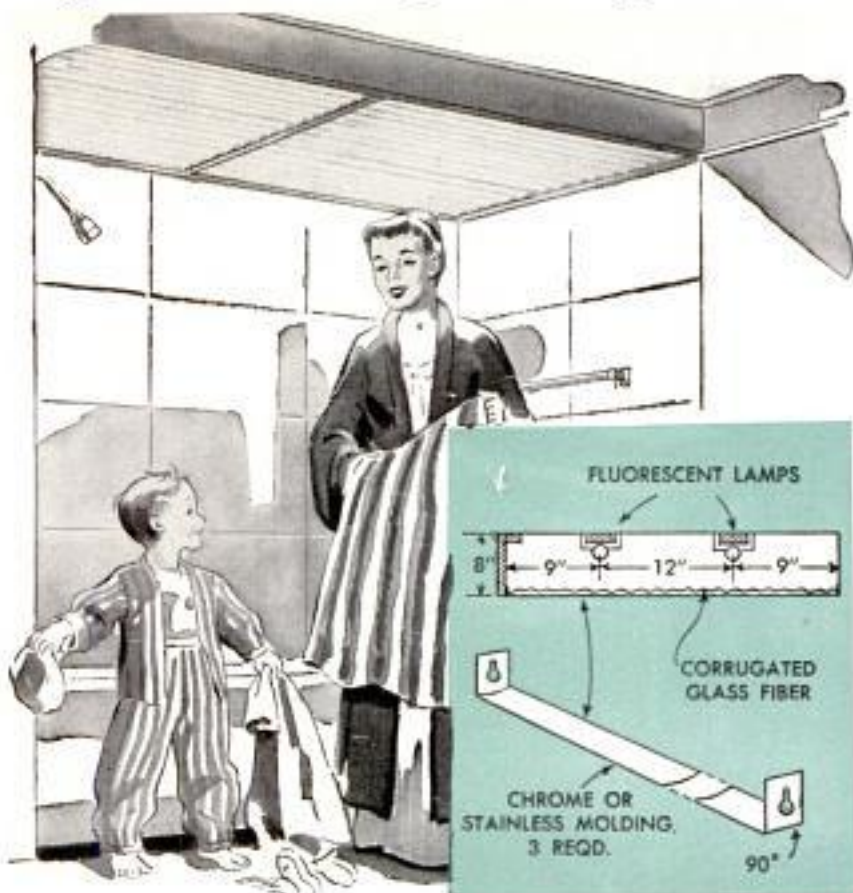

Soft, shadowless illumination that approaches the effect of daylight is produced in this bathroom by fluorescent lamps mounted above a false ceiling of corrugated glass fiber as shown in the illustration. Line-type fluorescent lamps are installed 12 in. apart and wired to a wall switch that is located out of reach from the tub as a safety precaution. A single strip of plywood 8 in. wide, nailed to a cleat fastened to the ceiling, forms one side of the light enclosure. Three pieces of stainless-steel molding bent at the ends and provided with T-slots so they can be hung between opposite sides of the enclosure, support a panel of corrugated glass fiber as shown. The latter is mounted 8 in. below the fluorescent lamps.

Subduing Appearance of Screws On Cabinet Hardware

Often the appearance of a cabinet may be improved by making the screws or bolts that attach the hardware as inconspicuous as possible. This can be done by filling the screwhead slots with crack filler, sanding them smooth and painting them to match the hardware. In the case of a bolt head, just paint the exposed part or replace the bolt with a screw, if it is possible.

Walter E. Burton, Akron, Ohio.



Plane Itself Is Fixture For Honing Blade

When the plane iron of your block plane needs honing you can put a perfect edge on it without removing it from the plane. First extend the length of the oilstone with a piece of wood of the same thickness as the stone to serve as a rest for the rear end of the plane. Then advance the plane iron through the adjustable throat a distance sufficient to hone a 25 to 30-deg. bevel and simply move it back and forth over the stone, keeping the end of the plane on the wooden block. If the plane iron cannot be clamped in the plane, hold it in place with the fingers, using a slight pressure on each forward stroke over the oilstone.

Ken Murray, Colon, Mich.

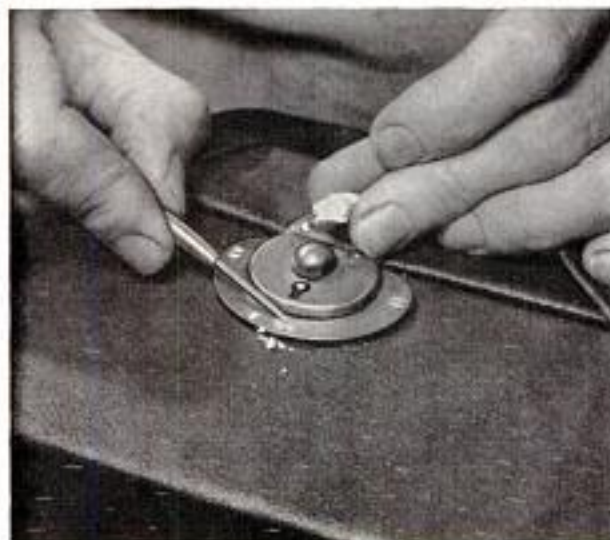

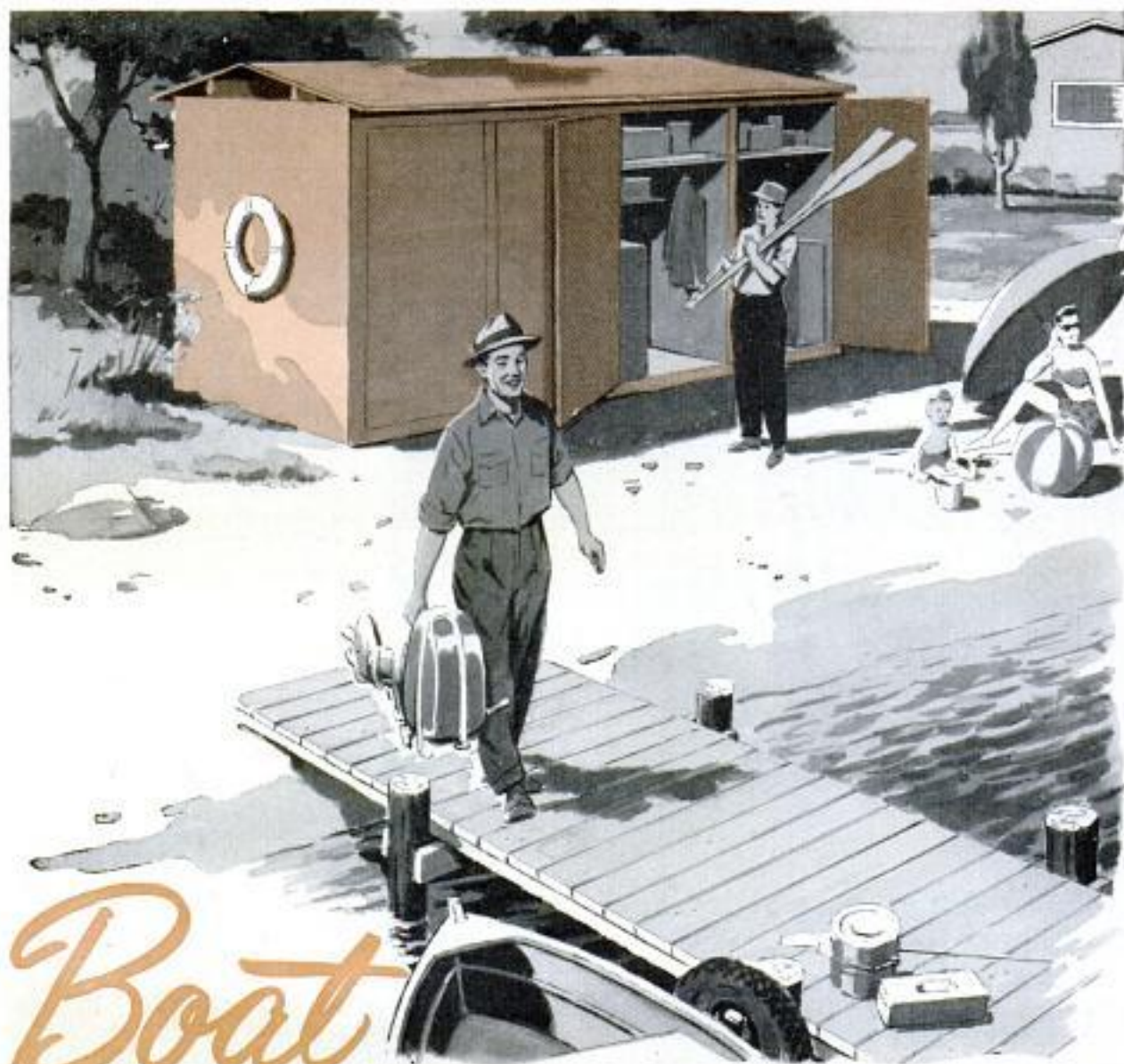

Boat EQUIPMENT LOCKER

THERE'S ROOM for shipshape stowage of all your valuable boat gear in this locker. The structure, which can be built in single or multiple units, is framed in 2 x 4-in. stock and sheathed and roofed with exterior-type plywood bonded with a waterproof adhesive. Doors and storage shelves also are of plywood. Details on the opposite page suggest shelf arrangements, but of course both the arrangement and number of shelves are optional with the builder. There will be material left over from cutting the plywood panels to make shelves of average size for each unit. In this way waste is reduced to the minimum.

A single unit of the locker measures 7 ft. from the bottom of the sole plate to the top plate. It is 6 ft., 1½ in. wide and 3 ft., 7 in. long. The multiple unit as pictured on the opposite page provides four lockers

and is approximately 13 ft., 4 in. long. The multiple unit also can consist of only two single units, making the structure very nearly square. This can be an advantage in some locations.

As originally planned, the structure can be placed on the dock or along the water front as pictured above. Note that the plan view on the opposite page provides for framing the structure on the dock, the sole plates, which in this case are 2 x 4s, being nailed directly to the dock boards. In this construction the dock forms the floor. When the structure is located elsewhere, as along the water front, a foundation and floor must be built. The upper right-hand details on the opposite page suggest two methods. If you decide to build a single-unit locker it may be advantageous to frame the floor on skids so that the locker can be moved.

In this case, 2 x 4-in. joists are nailed to two 4 x 6-in. skids. Then a plywood floor goes down over the joists and the studs are toenailed to sole plates nailed in turn to the floor. Use nails of sufficient length to reach through the plywood floor into the joists. Where a multiple-unit structure is to be located permanently on the beach, the floor can be framed as in the upper

right-hand detail below, the framing bearing on concrete blocks as suggested in the illustration. Flat stones also can be used as a foundation. When blocks or stones are used in this manner they should be bedded level on reasonably stable soil. Stones or blocks should be placed at the corners and also at a minimum of three points along the length in order to support a four-unit structure adequately. As a foundation for a two-unit structure, stones or blocks should be placed at the corners and at the mid-point. In any case, the structure must be above grade level a sufficient distance to assure ample air circulation under the floor.

Note from the details that the roof is supported on two 2 x 4-in. beams running lengthwise. Note also the construction at section D-D and in details A, B and C. Materials required for construction of one unit only are given in the material list. ★★★

BILL OF MATERIALS FOR SINGLE UNIT	
PLYWOOD	
1—4'x8' 3/4" ext. fir plywood (roof)	
2—4'x8' 3/4" ext. fir plywood (doors; waste for shelves)	
4—4'x8' 1/2" ext. fir plywood (sides, doors and dividers)	
LUMBER	
8—2"x4"x8' No. 2 and better, S4S (studs)	
8—2"x4"x6' No. 2 and better, S4S (plates, beams and headers)	
3—1"x2"x10' white pine, S4S (door stiffeners)	
6—1"x2"x8' white pine, S4S (shelf cleats)	
4—1"x3"x8' No. 2 white pine (door trim)	
HARDWARE	
4 1/2 pr. 4" lightweight T-hinges (doors)	
3—3/4" safety hasp (doors)	
4d galv. casing nails (door stiffeners)	
6d galv. box nails (plywood to frame)	
8d and 16d common nails (framing)	
MISCELLANEOUS	
Roll roofing and finishing materials (Follow recommendations of manufacturers)	

Construction details courtesy Douglas Fir Plywood Association and Socony Mobil Oil Co., Inc.

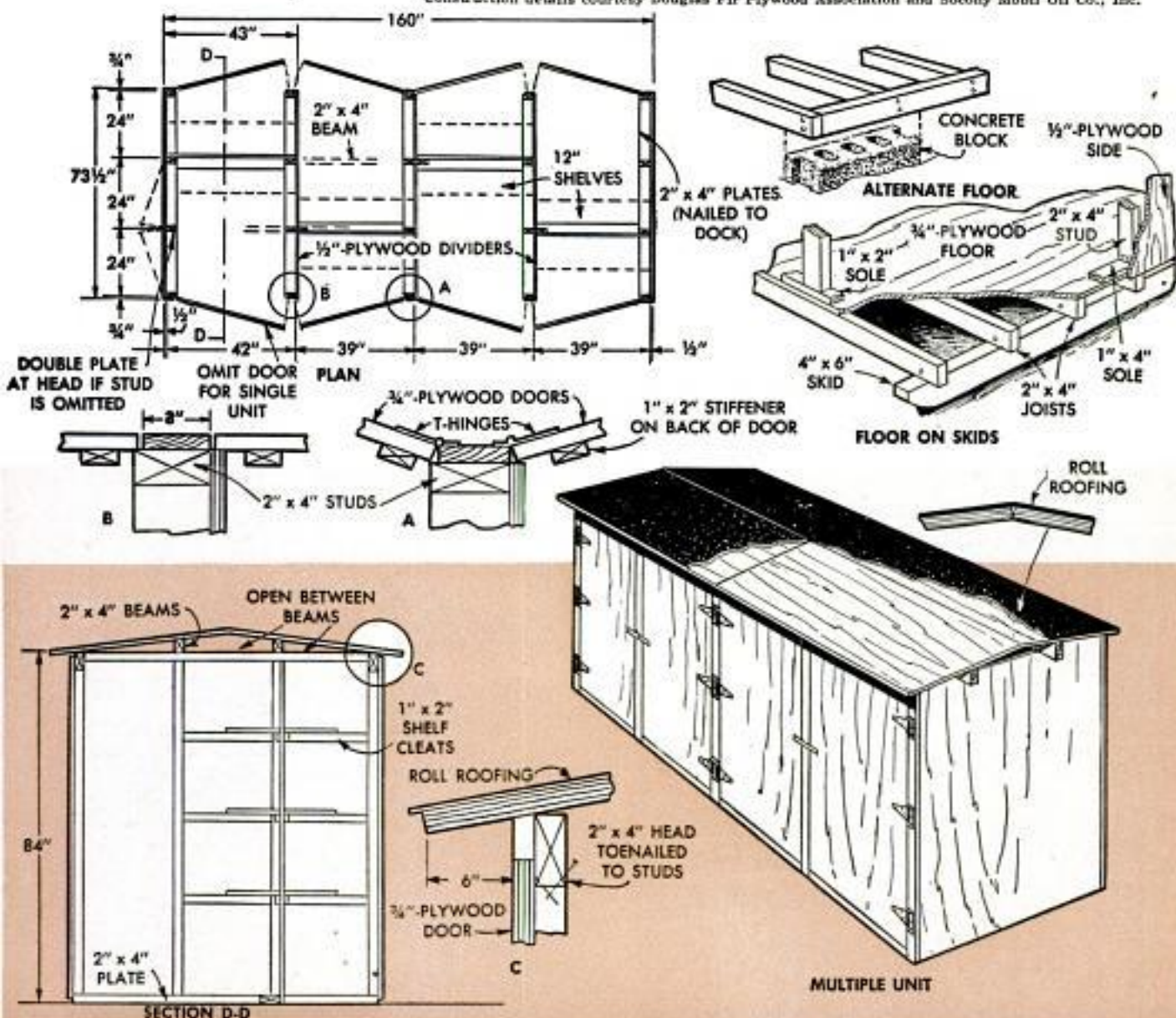



Hinged Tool Tightens Flooring Before Nailing in Place

To avoid damaging the tongue of a flooring board while tightening it for nailing, one carpenter uses the tool shown. It is made of two wooden blocks hinged together, one end being grooved to fit over the flooring tongue, the other having three or four large screws driven at an angle to project about $\frac{1}{2}$ in. Placing the notched end over the tongue of the flooring and pressing the tool down with the foot drives the projecting screw points into the sub-floor and forces the finish floor into place.

Wax Paper Keeps Tile From Sticking to Mastic

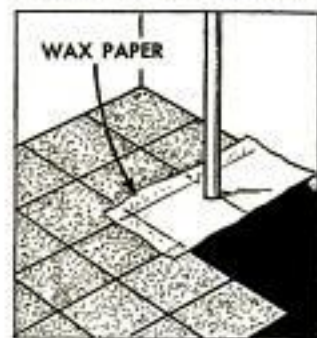

Fitting floor tile individually around pipes, door casings and other obstructions can be a messy job when the floor has been coated with mastic. A stunt worth remembering is to first lay a piece of wax paper over the sticky mastic. This will permit you to cut and try the tile for fit without getting it smeared with cement. Since the mastic will not cling to the wax paper, it can be removed easily.

John Krill, N. Lima, Ohio.

Cool Grip for Hot Cup

Slipped over a paper or aluminum cup, a sleeve of corrugated cardboard will provide a cool grip when serving hot coffee. Several sleeves can be made in a few minutes by cutting the sleeves from



single-faced corrugated cardboard. Be sure to make the sleeves small enough that they will not slip over the tops of the cups.

Truck-Size Insecticide Sprayer Utilizes Exhaust Manifold

Eliminating insects from an outdoor picnic grounds is done by one grounds keeper with a minimum of time and labor by using the exhaust system of a pickup truck as a portable sprayer. A pump-equipped gallon tank from a kerosene heater is clamped under the instrument panel of the truck and connected to the exhaust manifold by a length of tubing. After the tank is filled with insecticide it is pumped to 10-lb. pressure, which assures that the insecticide will be forced into the manifold against exhaust pressure. A valve on the tubing line controls flow of the insecticide into the manifold where the heat and pressure cause an insect-killing fog to be discharged from the exhaust pipe.

DENNER HORNE
3500 S. OSPREY AVE
SARASOTA, Fla.



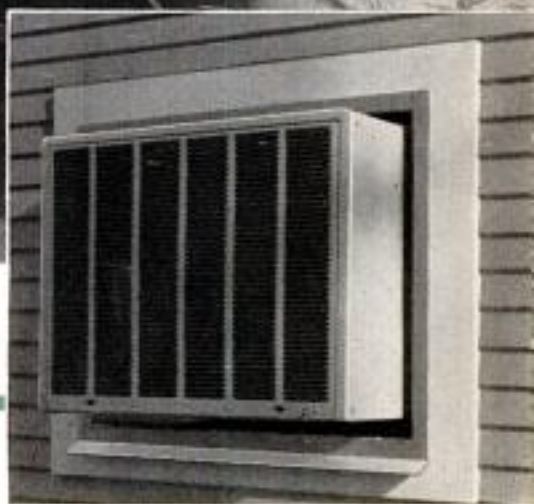

HOW TO INSTALL A THROUGH-THE-WALL AIR CONDITIONER

IF YOU DISLIKE the idea of having to mount a room air conditioner in a window, you'll be interested to know that through-the-wall models now permit the do-it-yourselfer to mount them right in the wall where they won't rob the room of daylight or hinder the cleaning of the window.

Through-the-wall opening is located on inner side of wall first. Here cutting line is drawn on masking tape

Being thinner in cross section than the conventional window types, they take up less room both inside and out. As an example, General Electric's Thinline model, which was used in this installation, projects into the room less than 3 in. and permits a novel camouflage treatment when the unit is not

Sawing through tape helps prevent chipping of plaster. Note starting hole at corner for keyhole saw

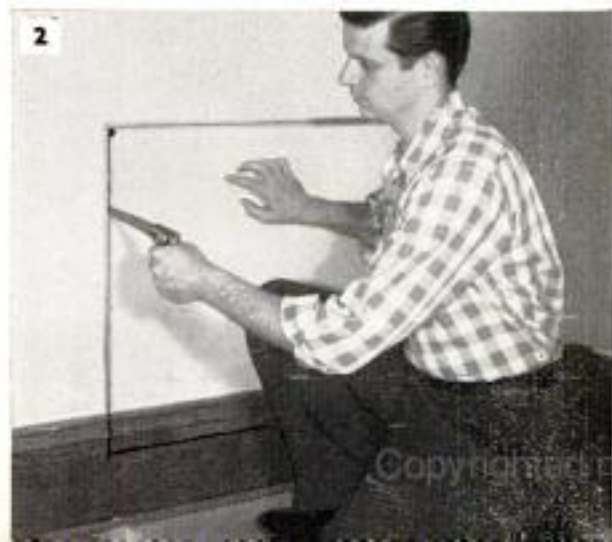



After marking through-the-wall opening on outside, plus the cutting line for the surround casing, a portable saw makes quick work of cutting the opening



When siding and sheathing have been ripped off rough-cut opening, a handsaw is used to saw off the studs flush. Notice how siding has been cut back



Above, this part you make yourself. It is called a surround and is nailed securely in the opening



Above, metal sleeve assembly is installed next and is screwed solidly to the surround at top and sides

Below, with mounting flanges in place, unit is set in opening and bolted securely to the metal sleeve

Below, unit installed. Preassembled "picture frame" fits snugly around case to cover rough plaster

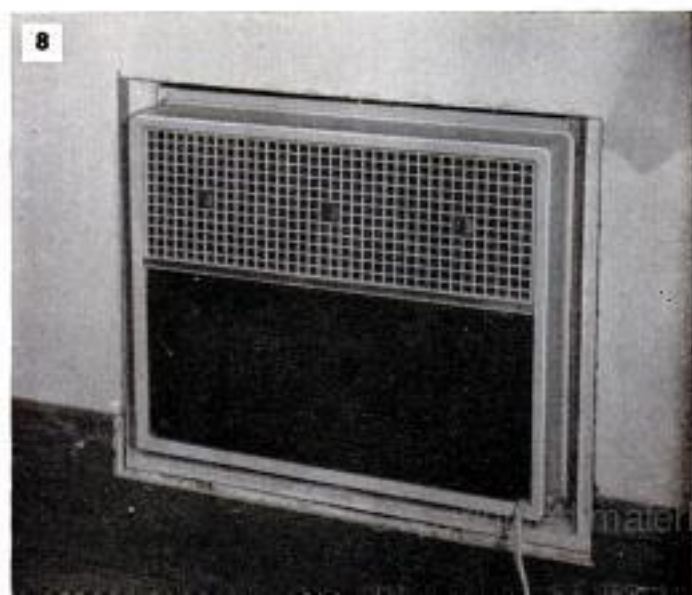
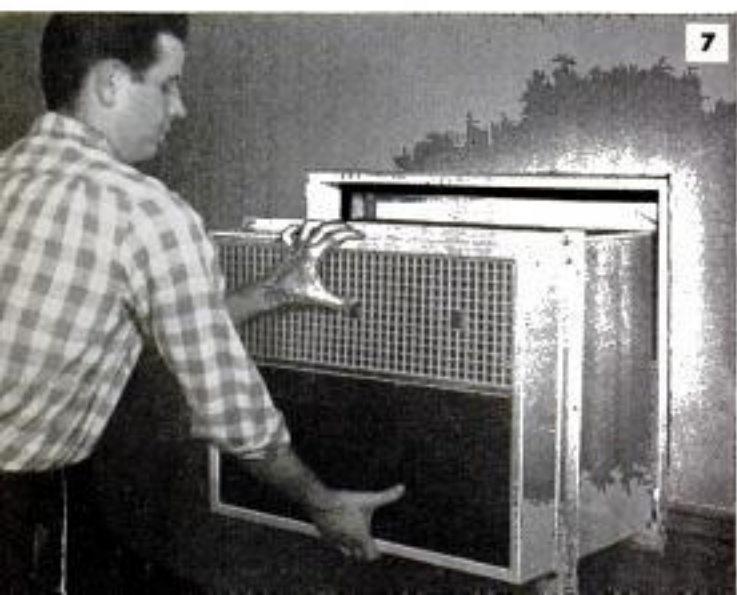

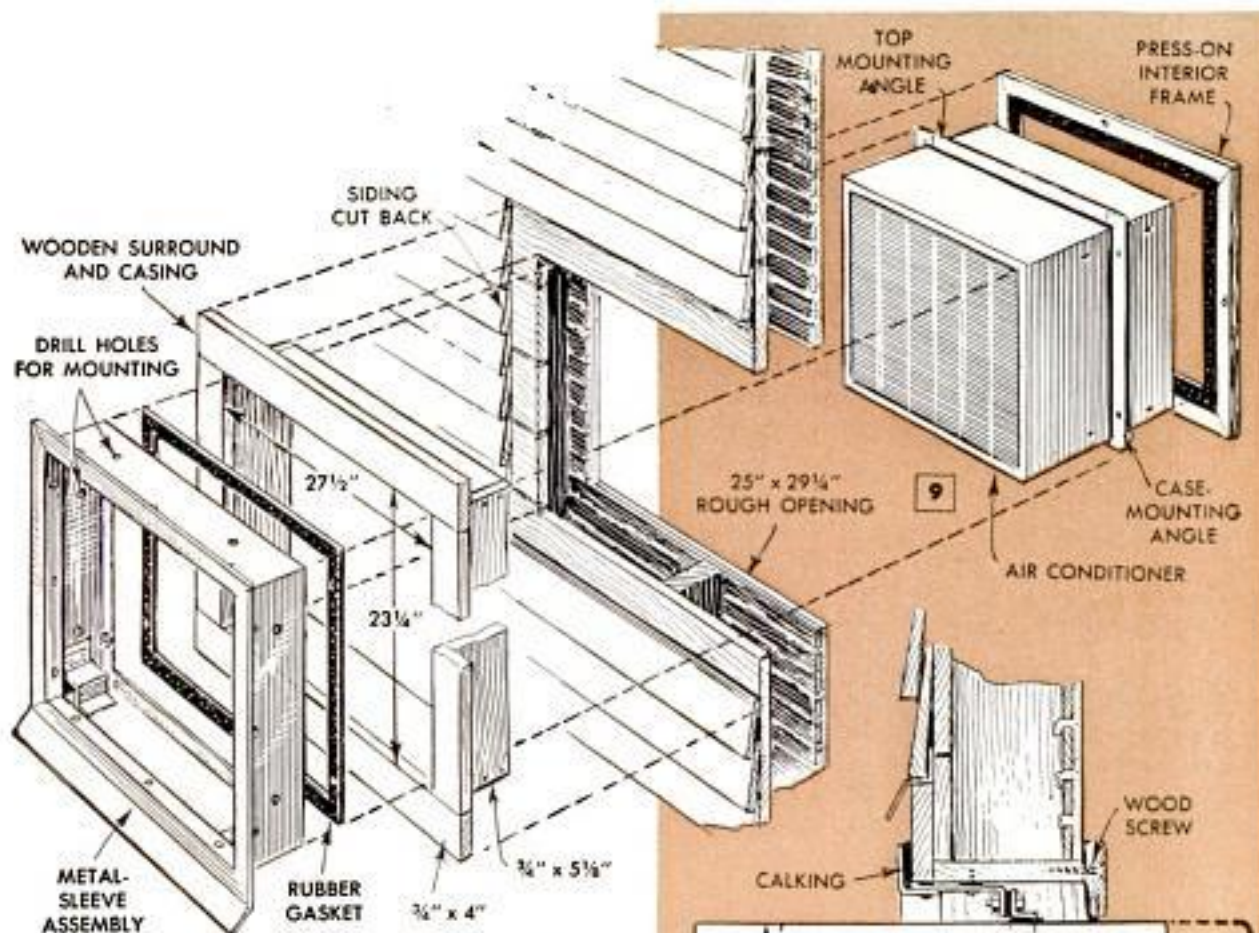

being used. A large wall picture can be hung over the grille in cases where it presents a decorator problem appearancewise.

The unit pictured comes as a kit and all you need do to install it is to cut a rough opening in an exterior wall and make a wooden surround and casing to fit the opening. The air conditioner can be installed in both brick-veneer and frame construction. The manner in which it is supported in each case is shown in Figs. 10 and 11. In frame construction it can be easily installed by any handy homeowner.

Roughing-in the Opening

It is best to make the surround and casing beforehand so as to have it ready to slip in place when the rough opening is cut. This is made similar to a regular window frame, using $\frac{3}{4}$ -in. material for the surround part and $1\frac{1}{8}$ -in. stock for the casing. Fig. 9 shows how it is nailed together. The important thing is to see that the inside opening measures $23\frac{1}{4}$ x $27\frac{1}{2}$ in. You should give it a priming coat of paint at this time.

Actual location of the air conditioner is governed by individual requirements and preferences. You may wish to mount it low, such as under a picture window, or up higher on the wall. From the standpoint of maximum efficiency and the fact that cool air falls, a head-high installation is perhaps best. The design of the room itself will

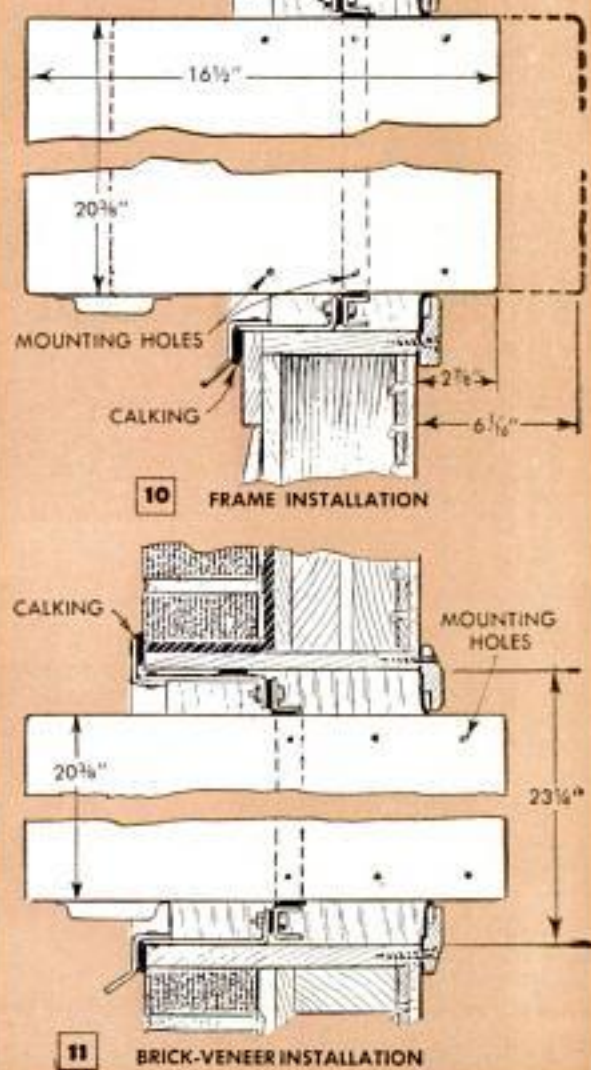



Caulking space between the metal sleeve and surround is filled all around to make it water and air-tight

dictate where it will work out the best.

Make the opening in the inside wall first, marking it as in Fig. 1, and sawing through the plaster and lath with a keyhole saw as in Fig. 2. The rough opening must measure 25 x 29 $\frac{1}{4}$ in. to allow for the thickness of the wooden surround that lines the opening. Your next step is to align the position of the opening in the outside surface with the one just cut. Perhaps the best way to do this is to spot the four corners of the opening by marks on the sheathing, doing this as accurately as you can, and then drawing lines diagonally from these points. A small hole is drilled through to the outside at the point where the lines intersect and this hole is used as a central point in marking the outline of the siding. You have a little leeway here if you do not get this just perfect. With a level and square you'll be able to come close.

Electric Saw Speeds Job

A portable electric saw makes quick work of cutting through both the siding and sheathing as shown in Fig. 3. It is partic-

ularly useful in cutting back the siding all around to let in the casing of the surround. From here on it is a case of sawing off with a handsaw studs that fall in the opening, as in Fig. 4, and then inserting the surround as in Fig. 5. You'll notice in Fig. 10 that the surround, when in place, must not protrude beyond the plaster. A width of 5 $\frac{1}{4}$ in. for the surround only is about right for all typical frame-wall construction. The surround is nailed securely in the opening.

The hardest part of the job is done and from here it is a case of inserting a metal sleeve assembly in the surround as in Fig. 6. This comes preassembled with a sponge-rubber seal around the rear face. The sleeve is fastened to the surround with two screws on each side, inserting them in holes that you must drill yourself. Additional screws may be used in the top to anchor the sleeve, but do not use any in the bottom. Water could leak through if you did.

Placing the Air Conditioner

Mounting angles must be screwed to the case of the air conditioner before it is shoved in the opening. You have a choice of two mounting positions which depend upon the thickness of the wall. In frame construction, the No. 2 mounting position is generally used. Complete instructions show just how these angles are attached. The air conditioner is placed in the opening from the inside and is anchored securely to tapped holes in the sleeve with six hexhead bolts that permit you to draw the case tightly against the sponge-rubber gasket provided. Where it is mounted high on the wall, you'll need help as it is fairly heavy. After this, the opening remaining around the case on the inside is covered by a preassembled picture-frame trim piece held with four screws. The final step before plugging it in is caulking all around the metal sleeve on the outside, as in Fig. 12, to make it weathertight. A caulking gun does the job in a jiffy. ★ ★ ★

Cork Strips Prevent Buckling of Hardwood Block Floor



To prevent a hardwood block-type floor from buckling at doorways and other places where a small gap for expansion is not practical, one homeowner cemented a cork strip in a gap provided between the outer edge of the flooring and adjoining construction. At interior doorways, a cork strip the width of the threshold is used, and next to the threshold piece of exterior doors and other places where an expansion gap is needed, a strip $\frac{1}{2}$ in. wide is sufficient. The strips can be cut from $\frac{3}{16}$ -in.-thick squares of cork tile, or from a sheet of cork gasket material obtainable in most auto-supply stores.

Removable "Rumble Seat" Makes Two-Passenger Tricycle

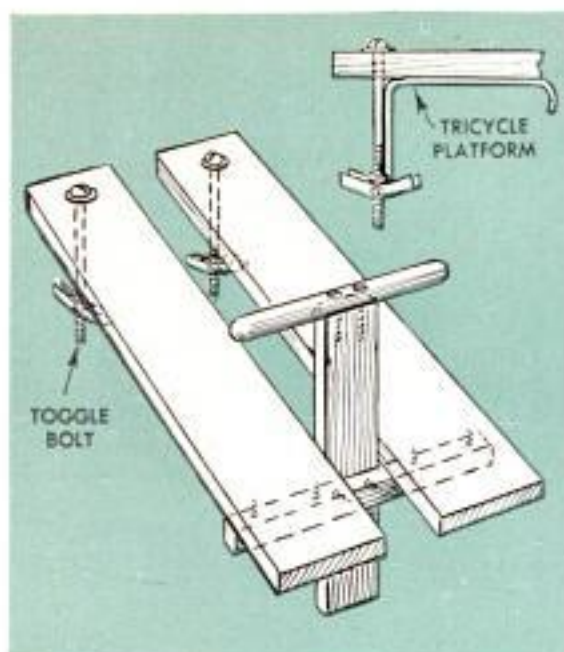

Just a few scraps of lumber and a couple of toggle or J-bolts are all the materials required to build this tricycle "rumble seat," which is bolted to the step plate. Dimensions are determined by the size of the tricycle, but the seat should not extend too far or the rider's weight may raise the

front wheel off the ground. Mounting a heavy-duty caster on the lower end of the handle-bar support of the rumble seat may be necessary, if the step plate at the rear of the tricycle is too narrow to provide sufficient support for the seat.

John D'Avella, Lindenhurst, N. Y.

Index Card in Negative File Identifies Cut-Film Type

A method employed by one photographer enables him to quickly identify cut-film type by referring to an index card filed with the specific negatives. Printed notching codes cut from the film boxes are pasted on the cards, as shown, identifying the film type used, so that the same type can be used in making a similar shot.



☞ To prevent marring freshly painted drawer pulls, leave the screws in the pulls and "hang" them from a magnet. Screws must be steel to be attracted by a magnet.

Rowlock Horns Tied to Gunwale Can't Be Dropped Overboard

Rowlock horns can be prevented from being accidentally dropped overboard from a rowboat if a short length of fishing line, tied to the shaft of each, is secured to a screw eye fastened to the underside of the gunwale as shown. As a safety precaution, the horns should be removed from their sockets when passengers are boarding.



☞ It is easier to finish wood paneling before installing it. Be careful when nailing or gluing so that no marks will be left on the finished panels.

SOLVING Home Problems



YOUR PAINT-ROLLER TRAY provides an ideal container for storing brushes overnight. Lying flat in the tray, there is no chance of the bristles losing their shape

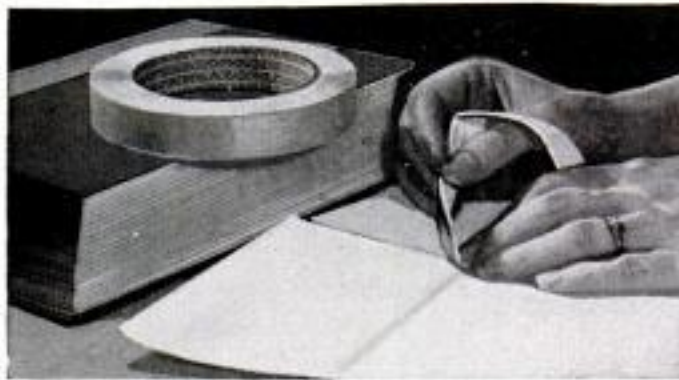

MASKING TAPE applied to the reverse side of book jackets at the top and bottom edges prevents wear and tear

THREAD ON YOUR BOBBINS won't come unwound and tangled in your sewing box if held with bit of sticky tape



158



PAPER DRINKING CUPS serve as perfect molds for making frozen fruit-juice suckers. Punched paper strip placed across cup will hold stick upright in cup while the liquid freezes



PLANTS ARE REMOVED from their pots without disturbing the roots with a slotted paddle. Slip slot around plant stem, turn over and dislodge by tapping paddle on table edge

WHEN THE LIFTING TAB on a milk-bottle cap tears off, a handle can be formed by wrapping the cap in plastic wrap and then twisting the ends as shown. Cap will still fit the bottle



POPULAR MECHANICS

Copyrighted material



FOLDED TURKISH TOWEL makes a good padded surface for ironing any material that has snap fasteners. Fold the towel in several layers and place fasteners face down on it. Then press from backside

COAT HOOKS are less of an eyesore when mounted over plastic coasters. Here you can see what eye appeal a leaf-design coaster adds to a plain hook on hall door. Holes are punched in coaster for screws



WHEN A JOINT OPENS between the crossrail and the stile of a paneled door, two long screws driven in counterbored holes as shown below will draw it up tight again. Hold it first with a clamp if you can

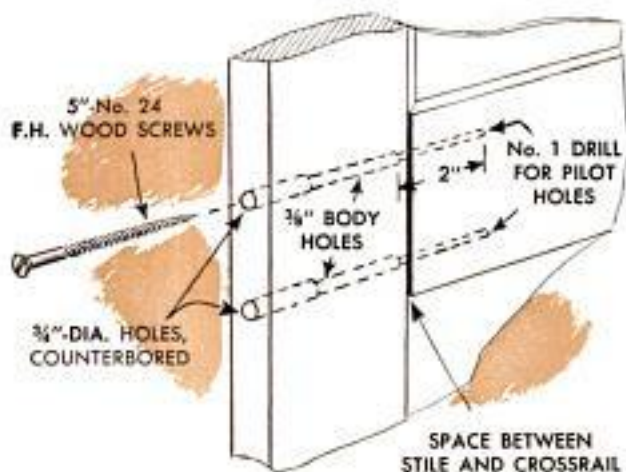

JUNE 1957



TO AVOID THE SHINE on ribbon after washing, don't iron it. Instead, wind it tightly around a clean bottle and let dry. A couple of rubber bands may be used to hold the ribbon in place on the bottle

BOWL WON'T ROCK AND ROLL when chopping vegetables for salads if you rest it on the open end of a pan. This will cradle the bowl so it won't rock. Any kitchen pan that is smaller than the bowl will do



RECIPE HOLDER becomes a new use for a spring-type paper clamp when attached to the file box. Use a small clamp for this and attach it to the front of the lid with a tiny bolt placed in hole provided



159

Copyrighted material

T-Base Fitted With Clips Holds Hand Grinder in Vise

Next time you want to hold your hand grinder horizontally in a stationary position so both hands are free, don't risk damaging the tool by squeezing it between the jaws of a bench vise. Instead, take a few moments' time to make this simple holder which is nothing more than two blocks nailed together T-fashion and fitted with two spring-type tool clips. Adjust the clips so they grip the grinder firmly yet allow it to be removed easily.

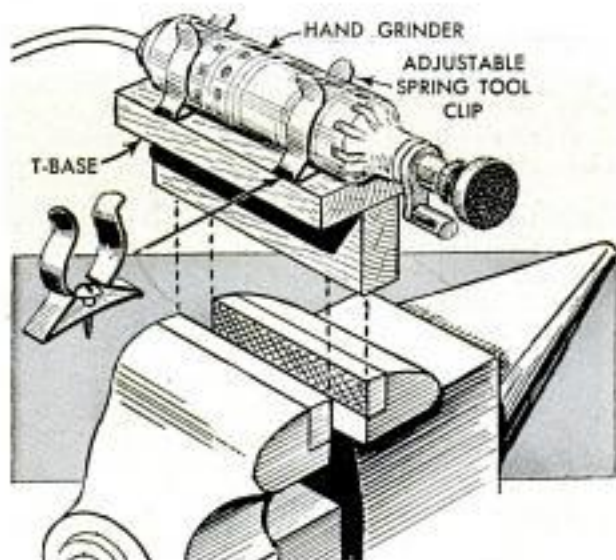

Shelving Conceals Chimney For Attic Conversion

In attic conversions, where chimneys cannot be included in corners or concealed between walls, they can be made less conspicuous behind removable shelving. When installing the shelving, allow a 2-in. clearance between the chimney and combustible material such as wall framing. Four sections of shelving, extending from floor to ceiling, can be arranged around a chimney, forming a rigid assembly when bolted or screwed together as indicated.

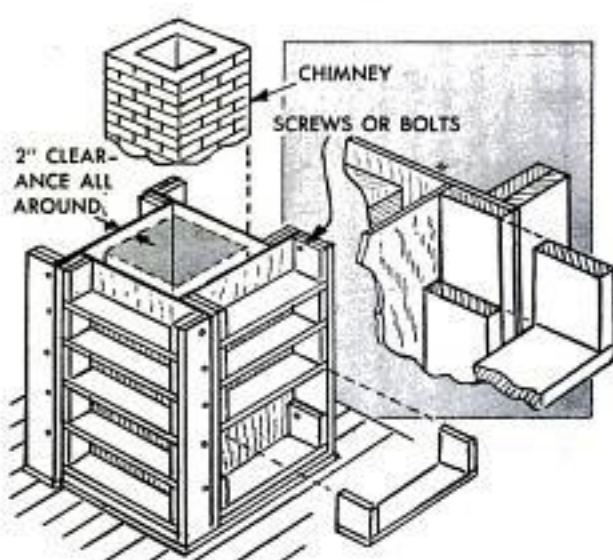

Two Light-Tight Ventilators For Cooling Photo Enlargers

One of these two light-tight ventilators can be used to prevent a homemade photo enlarger from overheating. The vertical ventilator consists of a 1-gal. metal can in which disk baffles are fastened. Trimming one edge of each disk provides a zigzag path for the escaping air. The horizontal ventilator is made of wood and contains a spiral passage from inlet to outlet for the heated air.

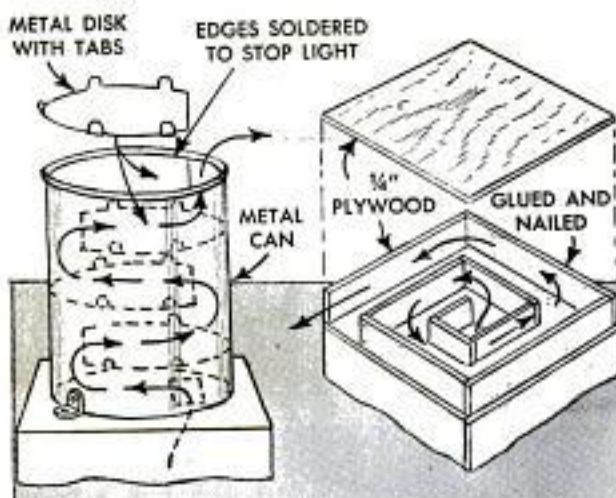

Screen Door Held at Any Angle By Rubber-Tipped Prop

Holding open a screen door at any angle is no problem when this door prop is used. It consists of a 2½-ft. length of ½-in. dowel that is attached to the doorframe by means of a screw eye in both dowel and frame. A rubber crutch tip on the lower end of the dowel prevents it from slipping. When not in use, the prop is swung out of the way and fitted into a screw hook driven into the lower part of the door.

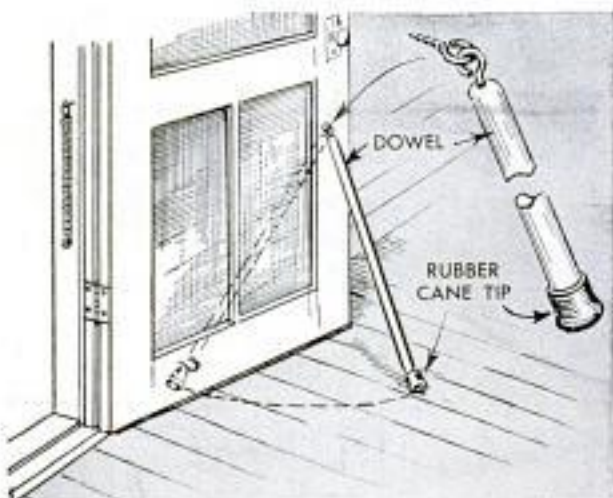



Oil-Barrel Oven

By Gene Segerblom

SMOKE ROASTING, now so popular, can be done by anyone without expensive oven equipment. All that is needed to make this close cousin to a Chinese oven is a 35 or 55-gal. oil drum, some small wheels or large casters to provide mobility, and an asbestos-lined box of heavy sheet metal to serve as a firebox. Necessary adjuncts are a thermometer and a heavy-gauge wire grill.

If making the firebox is beyond your tools and skill, have your local sheet-

metal man do it. Have him provide a hinged lid and a draft door as indicated. Then, while the box is being made, remove one end of the drum, which will be hinged in place later to serve as a lid, and clean the barrel thoroughly inside and out.

Now, rivet the firebox over an opening cut in the side of the drum near the bottom and line the box with asbestos. The lining may be held in place with sheet-metal screws, driving them through the asbestos and into the metal. The projecting ends of

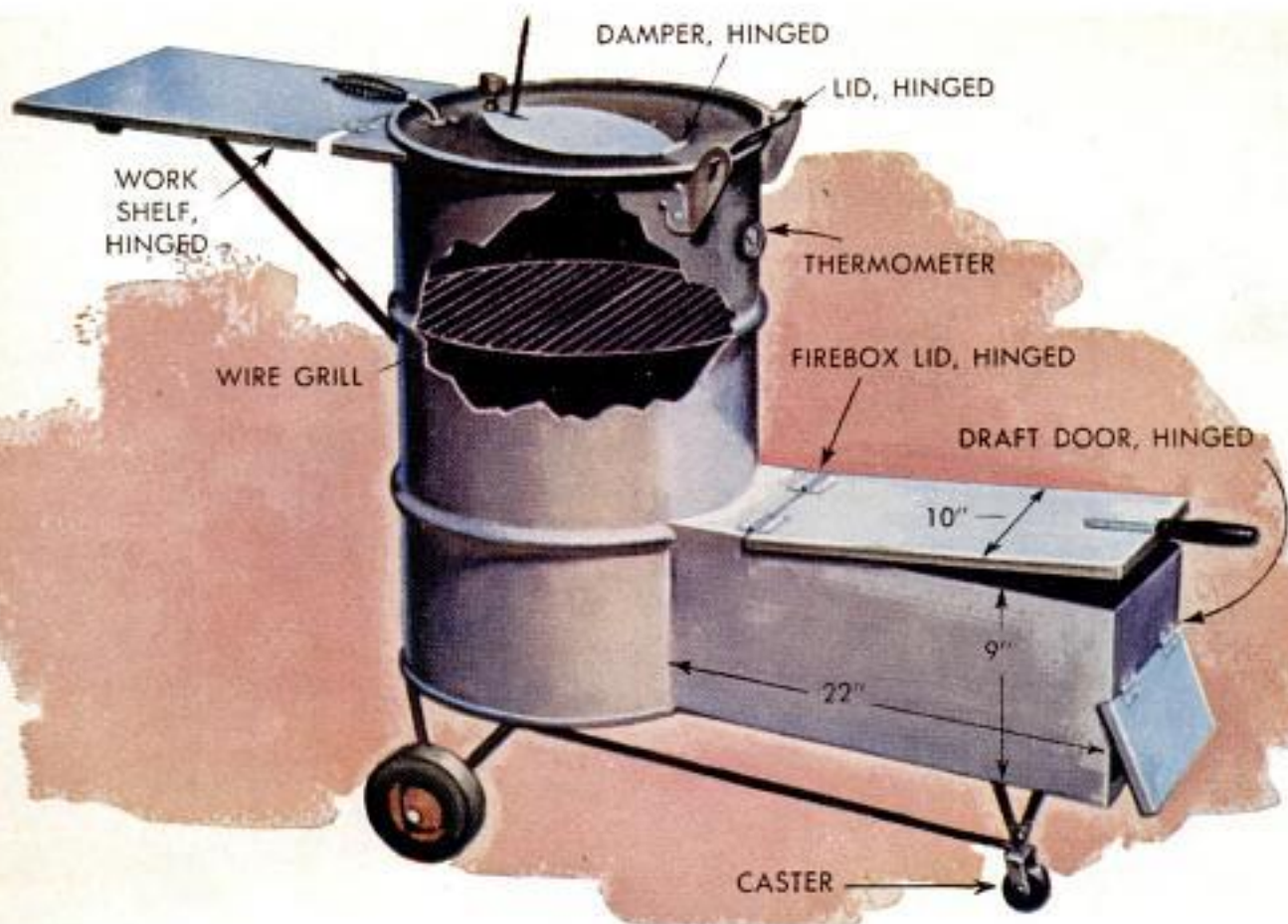

the screws should be cut off almost flush with the sides of the firebox.

Mounting the wheels or casters is next. This may be done in any way desired. The method shown is only a suggestion. Next comes the wire grill. Mount it inside the barrel in the position shown. Three small angle brackets, spaced equally and riveted or bolted to the side of the barrel, will support it.

You are now ready for the lid. Cut a damper opening in the lid, hinge a cover over it and provide some means of supporting the cover at different heights. Some kind of a cool lifting handle will be required for the lid. This may be an old cooking-utensil handle, stove-lid handle or something similar. The handle should be installed before hinging the lid to the barrel.

Installing the thermometer is next. This should be the type that can be inserted in the barrel with the dial on the outside and have a reading up to at least 350 deg. F. If this type is not available, an oven thermometer may be installed inside the barrel, but will be difficult to read.

The work shelf is a handy accessory, but not absolutely necessary if you prefer to get along without it. It is made of heavy sheet metal flanged along both sides and one end to provide rigidity. The other end is hinged to another piece of sheet metal, which also is flanged at the sides, and has

one end cut to the contour of the drum. This piece is attached to the drum with small metal brackets. A folding bracket supports the shelf in the raised position.

Painting is a matter of choice, but be sure to use a heat-resistant paint. Before cooking in the oven, preheat it to a high temperature to burn off any residue that might cause an unsavory odor in the food. In use, charcoal is burned in the firebox, the draft door and damper being adjusted to maintain the desired temperature inside the oven.

Since every outdoor chef considers accessories as necessary to his hobby as an oven or grill, every neophyte chef should have a supply. Basic are a chef's hat, cotton gloves to handle charcoal, a pair of tongs to handle meat without puncturing it and a folding wire grill to handle crumbly hamburgers. There are others not necessary, but convenient if you wish them. But more important is a knowledge of fuels. In most stores you will find two types of charcoal, lump and briquettes. Which one to buy is mostly a matter of choice. There is a third type of briquette that contains partially burned hickory that imparts a hickory flavor to the foods. And, of course, small pieces of hardwood can be applied to the fire to produce smoke and impart their flavor to the foods. Hickory and cherry are the woods most used. ★ ★ ★



Larry Argiro, Associate Professor of Art, State Teachers College, New Paltz, N. Y., saw his first mosaics as a boy in southern Italy while playing in the ruins of Pythagoras' temple. Struck by the intricate designs on ancient floors and walls, he decided then to revive the nearly forgotten art. Although Professor Argiro worked in many art forms in this country, it wasn't until five years ago that he discovered a successful way to inlay mosaics on metal, wood and other substances used in modern buildings and furnishings. Now, mosaic can be applied to almost any surface in or on your house



DECORATE WITH

MOSAICS

By Larry Argiro

THE ANCIENT ART of mosaicking (inlaying surfaces with ceramic or glass-like tiles now available in many colors) is well within the ability of almost anyone. Applied with special adhesives, mosaic tile may be used to modernize and beautify old surfaces, or to inlay new pieces, such as free-form tables designed and built to your liking. Lamps, book ends, jewelry and cigarette boxes, glittering bowls and ash trays can be made with base materials that depend entirely on your own ingenuity. Or, you can tile counter tops, walls around sinks, lavatories and bathtubs and, if desired, even work out beautiful designs on other walls.

Most mosaic tiles are approximately $\frac{3}{4}$ in. square and are available in a rainbow of colors. There are three basic types, the cost of the tile depending on the type. The tiles may be "cut" to various sizes and shapes with carpenter's pincers. In doing

Tray and table above are two good examples of using mosaic tile to produce modern-appearing objects. Below, large cardboard tube is mosaicked to produce an unusual, but beautiful, base for a modern lamp





The beginning of an attractive, easy-to-clean splashboard above the work counter in a kitchen

this, there will be some waste as a tile does not always break as desired. But in most cases, the waste material can be used in working out other designs.

To apply mosaics, first work out the design full size on paper, Fig. 1, coloring it to match the tiles being used. Then transfer the design to the base or object to be covered, Fig. 2, first thoroughly cleaning the surface. Next, apply adhesive to the



A plywood top mosaicked and edged with brass and fitted with screw-on legs produced this table

Right, an old metal tray takes on a crisp, new look when mosaicked in a pleasing design of suitable colors

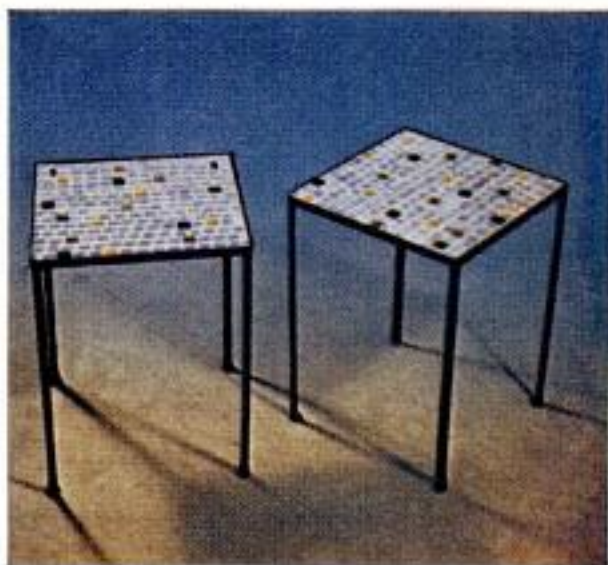

Modern metal tables lend themselves nicely to mosaic tops. Final appearance depends on the design used

surface and place the tiles, following the design and color previously worked out. It is best to coat only a few square inches of surface at a time as the adhesive may set before the tiles can be placed.

It is easier to work out any central designs or themes first, Fig. 4, and fill in the background afterward. Leave spaces of $\frac{1}{16}$ in. or more between the tiles for grouting.

After all tiles have been applied, mix a grout as in Fig. 3. It consists of white tile cement and water, mixed to a consistency slightly thinner than patching plaster. This is spread over the mosaic by hand to fill in the joints between the tiles. While the grout is still wet, wipe the face of the mosaic with a damp sponge to remove excess grout.

In case of a table or other flat surface, metal or wood edging may be used to cover the edges and produce a finished appearance. The basic forms on which you can cement the tile to make different objects are endless. For example, a section of cardboard carpet roll provides an excellent cylindrical lamp base. Each end is plugged with a wooden disk, glued in place. Rec-



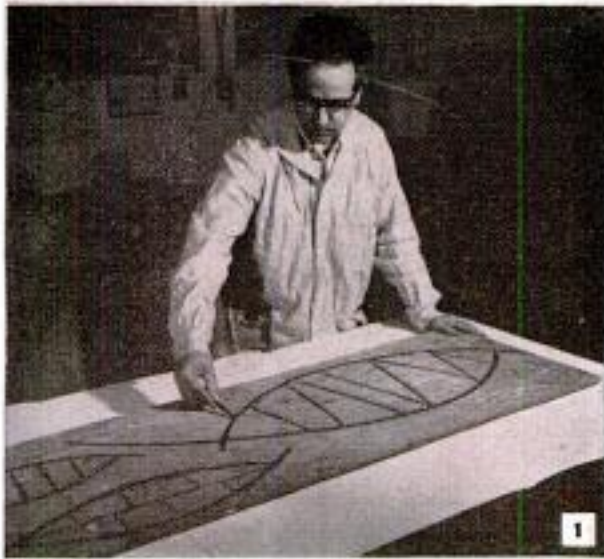

First step in mosaic work is to lay out the design on paper full size and color it to suit your desire

tangular lamps can be produced by assembling suitable forms from plywood. A hole bored in the top before the tiles are applied will accommodate the lamp fittings, which are available in any hardware store.

Blocks of wood provide excellent bases for mosaic book ends. They may be used in rectangular shapes, or sawed diagonally to make interesting pyramidal forms.

Old cigar boxes provide good foundations for jewelry and cigarette boxes. Interesting effects can be achieved by setting the tiles close together with no grouting. Almost any battered old tray or bowl can be made to look like a collector's item with simple application of mosaic. Steel mixing dishes used by chefs in restaurant kitchens are good, as are wooden salad bowls. Cheap metal or paper trays and bowls from the dime store do equally well. Much depends on the mosaic design.

A mosaic-surfaced table is a piece you

After tile has been placed and adhesive set, grout is mixed in bowl and applied to the tile joints



JUNE 1957



The design then is transferred to the surface to be mosaicked and the tiles laid according to pattern

will be proud of forever. If you make your own in free form or in rectangular shape, nothing lighter than $\frac{3}{4}$ -in. plywood should be used. Shellac both sides to prevent warping. Sets of flange-base, screw-on legs in walnut, mahogany, birch or metal may be purchased inexpensively. These legs come with mounting plates for setting them either vertically or at an angle, depending on the period design of the table.

Mosaic may be applied directly to walls to make interesting splashboards above sinks, bathtubs and lavatories, much in the same manner as applying plastic tile. To assure neat, straight rows of tile, draw pencil lines on the wall for each row, leaving joint spaces for grouting. Apply the grout as for other types of work and wipe off the surplus. Here, as for other jobs, work out the design on paper first and then transfer it to the wall. Be sure to use appropriate designs for kitchen and bathroom. ★ ★ ★

Remember, it's easier to work in central design first and then fill in the various backgrounds afterward



165



Pivoted hood swings down to provide convenient access to outboard motor. Evinrude 35 sent *Sea Knight* skimming along at 26 m.p.h. during the trial runs

SEA KNIGHT

PART II

By *Glen L. Witt*

Naval Architect

HAVING REACHED THE POINT described in Part I, you are ready to plank the hull. The importance of careful fairing cannot be stressed too much and you should double check with a straight-edge to make sure that the planking will lie flat against all contacting members. This not only includes the sheer and chine log and the edges of the frames but the keel and bottom battens as well. You'll notice in Fig. 21 that the keel is faired from a centerline. As there is a slight arc to the bottom members of the frames, you may find it necessary to fair the outer edges of the bottom battens a little. A strip of plywood placed across the members as in Fig. 22 will determine the amount that must be removed.

Side planking: Sectional views in Figs.

To Save Both Time and Work

If you wish, you can buy the patterns for the stem, frames, transom, breasthook and chine blocking already drawn full size. And, to further simplify construction, you can buy these parts in kit form accurately cut in mahogany from Glen-L Marine Designs, P.O. Box 566, Compton, Calif.

24, 25, 26, 31, 34 and 35 detail the planking. It is preferred that the hull be side-planked with single panels of $\frac{3}{8}$ -in. marine-grade (AA) plywood. However, if you cannot obtain plywood long enough, two panels can be joined in the manner shown in Fig. 27.

If working alone, perhaps the best way to determine the shape of the plywood planking is to make a template by stretching wrapping or building paper around one side of the hull and marking it accordingly. This is then cut out and traced on the plywood as in Fig. 32. If extra help is available, you can forget the paper pattern and mark the shape directly on the plywood by holding it against the hull and running a pencil along the sheer and chine log. After the plywood is cut slightly oversize, it is clamped and temporarily screwed in place at several points for the final fitting, Fig. 23. The fitting at the transition joint, Fig. 28, from frame 5 forward, must be made at the very edge of the chine log and is the most important joint in the planking. The planking at the sheer, transom, stem and chine aft of frame 5, may be left $\frac{1}{4}$ in. or so long for final fitting after the planking is permanently fastened in place. When the

trial fitting meets your satisfaction, the planking is removed and used as a master pattern to mark the plywood planking for the opposite side. If the hull is to be coated with glass fiber, you can use a hard-setting glue in applying the planking. Where it is not to be treated with glass fiber, a soft-setting or mastic-type glue should be used.

All contacting surfaces are coated with glue and the plywood planking is relocated by the trial screw holes and fastened permanently. Screw the planking to the sheer clamp with 1-in. No. 8 screws spaced 4 in. apart. Space them 3 in. apart at the chine and stagger them as much as possible. Space 1¼-in. screws 2 in. apart at the stem and transom. It is not necessary to screw the plywood to the frames unless you wish. The plywood planking is applied to the opposite side of the hull in the same manner. You will notice in Fig. 30 that it is first necessary to fair off the planking at the stem to allow the planking to lap at this point. The planking on both sides is now trimmed even with the chine-log member. Go about this carefully and check as you proceed with a straightedge as you did in fairing. Here, the fairing is done only aft of a point at frame 5. Fig. 28 shows that from this point forward, the bottom planking and the side planking butt together.

Bottom planking: The bottom planking

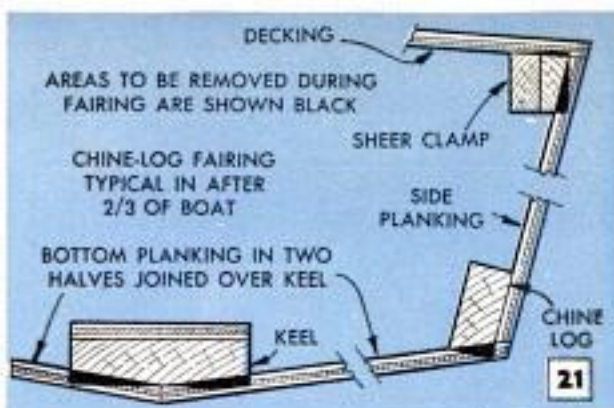

is ¾-in. marine plywood also and, like the side planking, it is preferred that it be full-length panels. It is applied in two sections with the joint falling on the centerline of the keel. Fitting the butt joint with the side planking from frame 5 forward will require a little doing. Your best bet is to rough-mark, cut and keep trimming until you get a good fit. The rough scribing along the stem is, of course, a simple matter. In springing-in the bottom planking up forward, you will find the panel fairly stiff. To help make it conform, cover the area with a few burlap bags and saturate them with boiling water. This is necessary also when actually fastening the panel in place. After one panel of the bottom is fitted, it may be used to mark the other half. Coat all contacting surfaces with glue as before

Fairing of keel, battens and chines is checked for unevenness with plywood strip placed across members

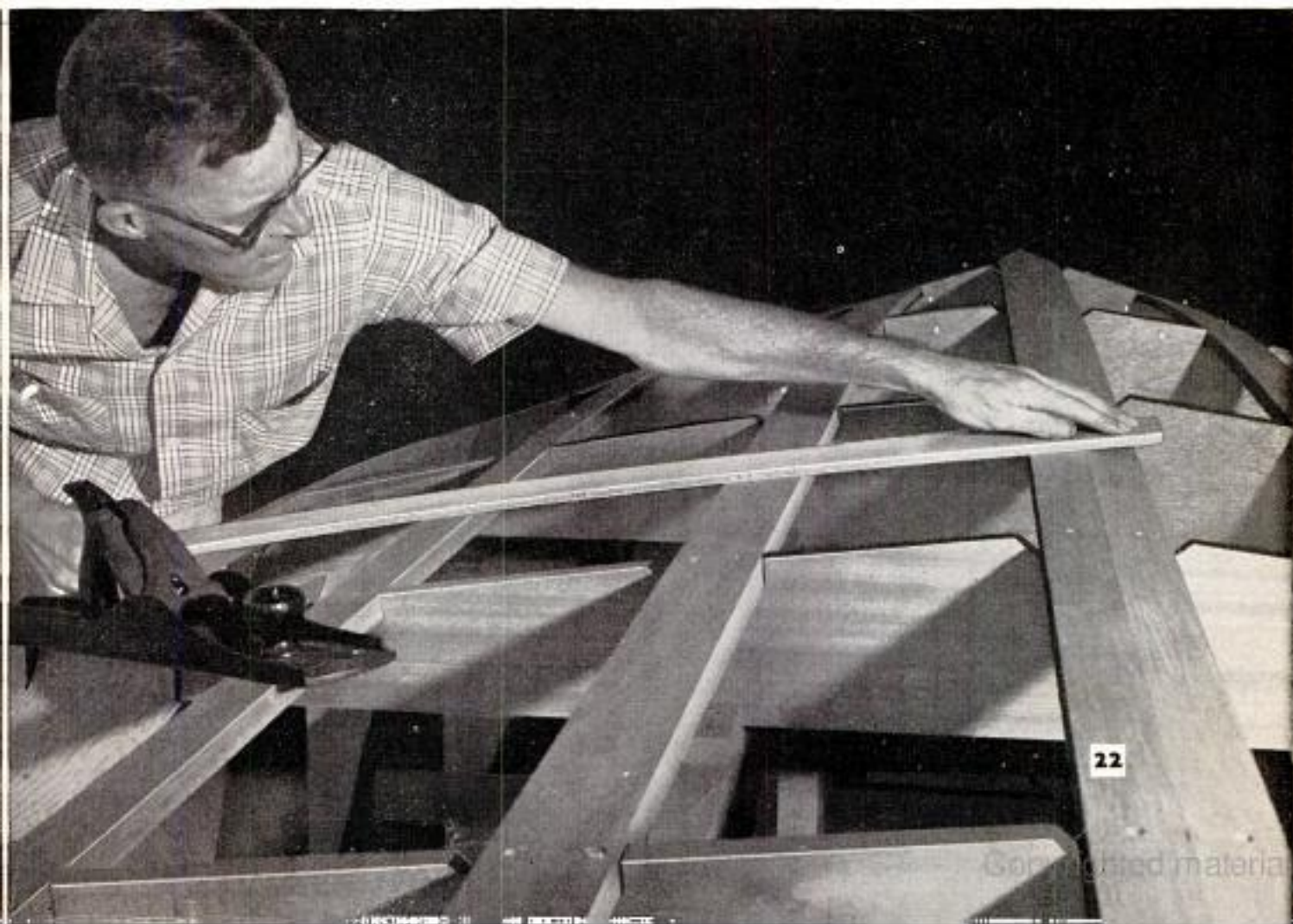

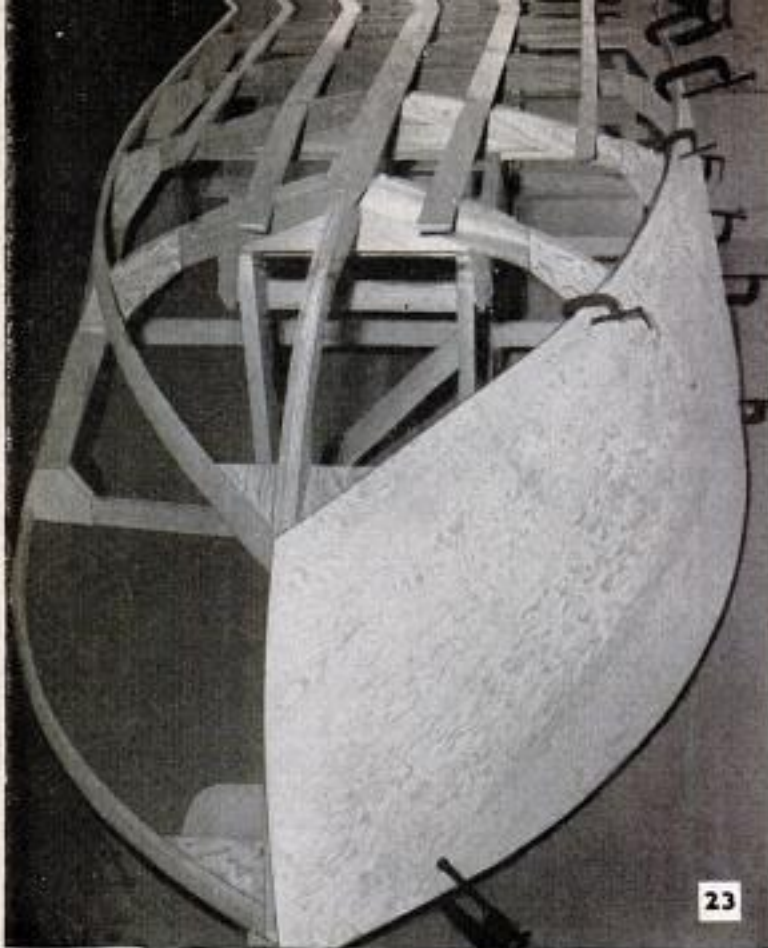

Left, plywood side planking is temporarily clamped in position and then roughly marked for over-all size

and begin driving the screws, working forward from the transom. Use 1-in. No. 8 screws 3 in. apart along the chine and keel and 4 in. apart at the battens and stagger them as much as possible. After the first half is trimmed at the stem, the other half is applied. After both halves are in place, final trimming is done.

Skeg: The skeg covers the joint in the bottom planking at the keel, Fig. 38. It is cut from 1¼-in. oak or fir, following Fig. 38 and is set in a bed of mastic before being fastened to the keel with 2-in. No. 10 screws spaced about 6 in. apart. If the hull is to be glass-fibered, the skeg, of course, is added afterward.

If the hull is not to be covered with glass fiber, a stem band is used to cap the exposed edges of the plywood planking. This oak strip, which measures ½ x 1 in., extends from the deck line to the end of the skeg. Screw this to the stem and keel with 1½-in. No. 8 screws spaced 12 in. apart. In addition to the stem band, a spray rail should be added to cover the joint of the side and bottom planking at the chine, Fig. 33. A single piece of oak or mahogany is used for this and is ripped to measure 1 x 1¼ in. in section. It too is embedded in mastic before being attached with 2-in. No. 10 screws, 12 in. apart.

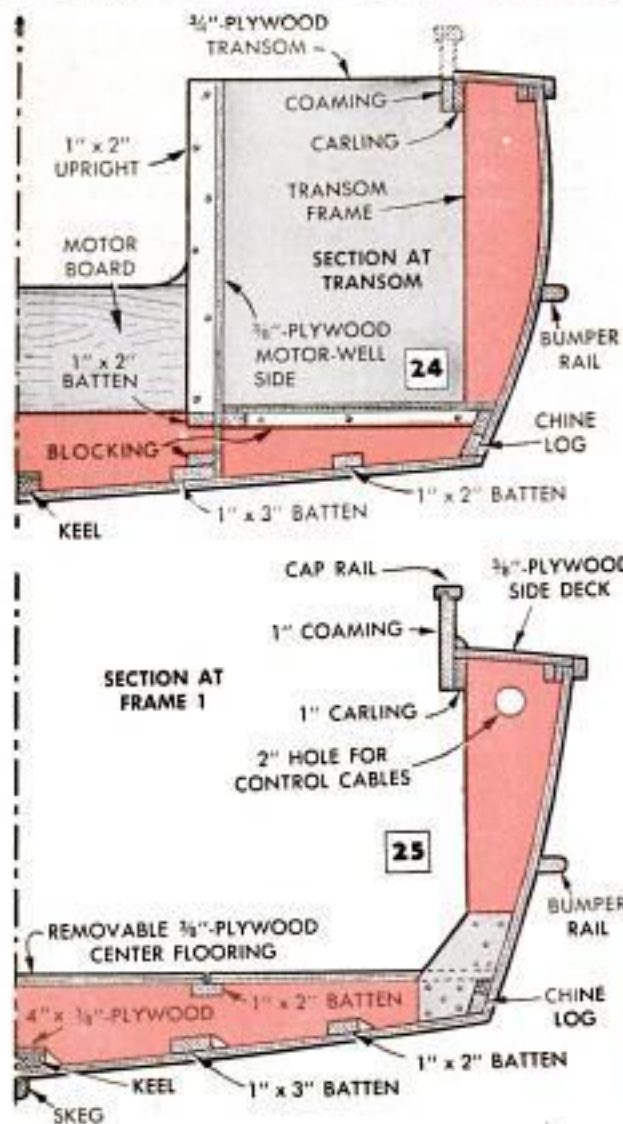

Blueprints Available

Those who prefer to build *Sea Knight* from plans larger than the ones presented in the magazine may purchase a set of blueprints, 17 x 34 in., by writing Blueprint Department, *Popular Mechanics Magazine*, 200 E. Ontario St., Chicago 11.

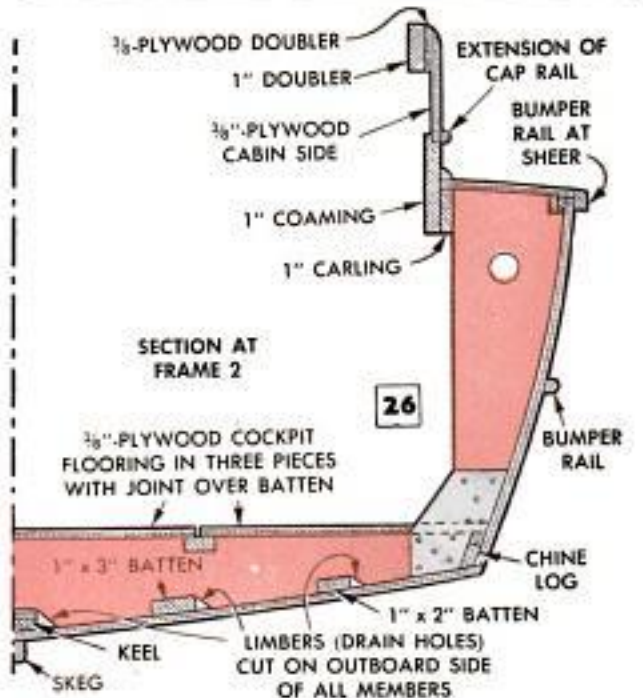

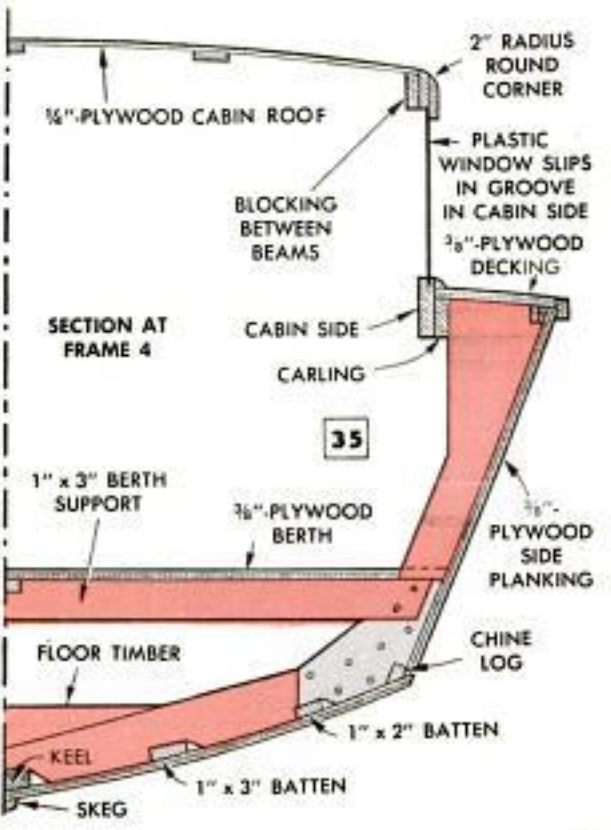
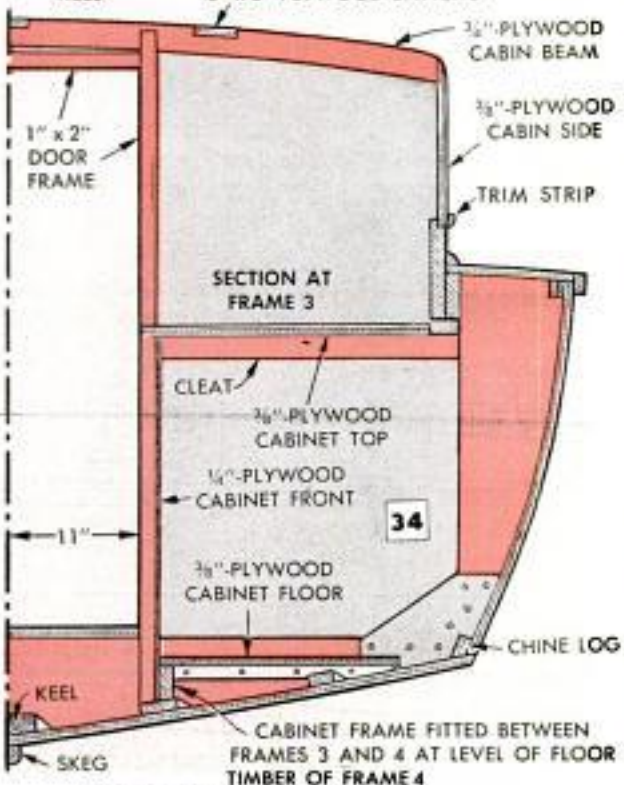
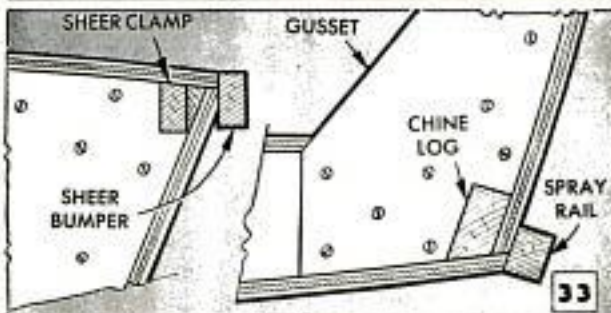
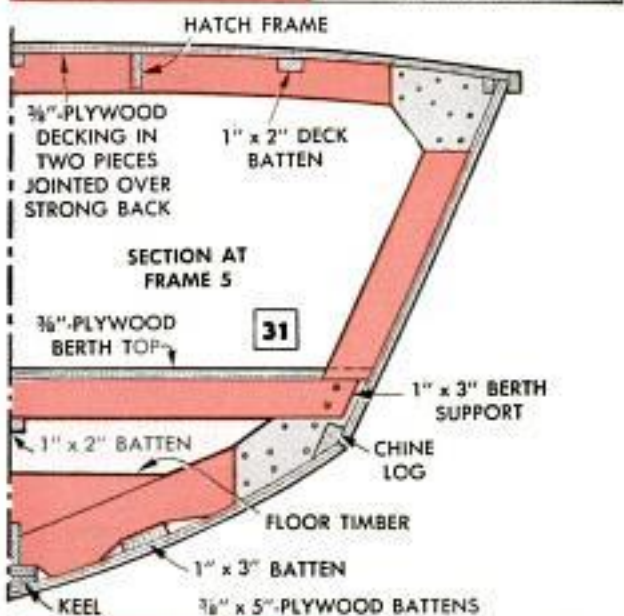
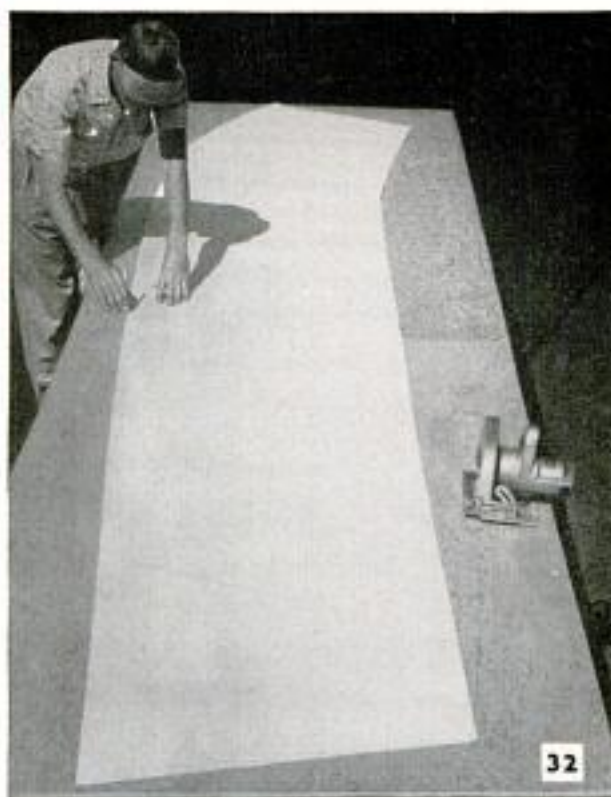
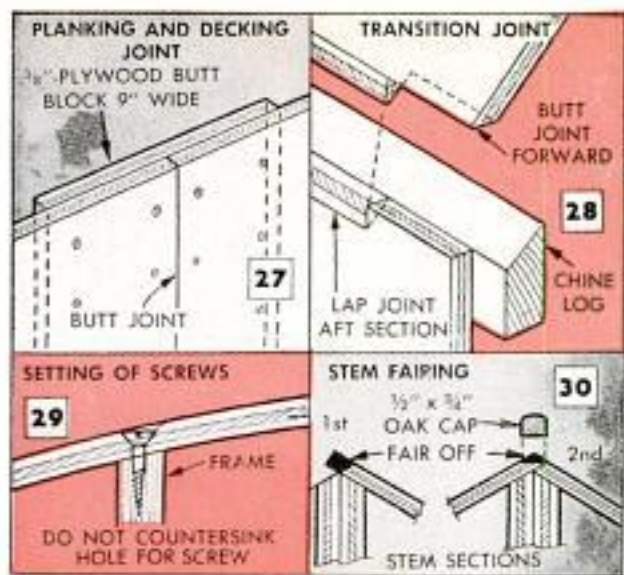

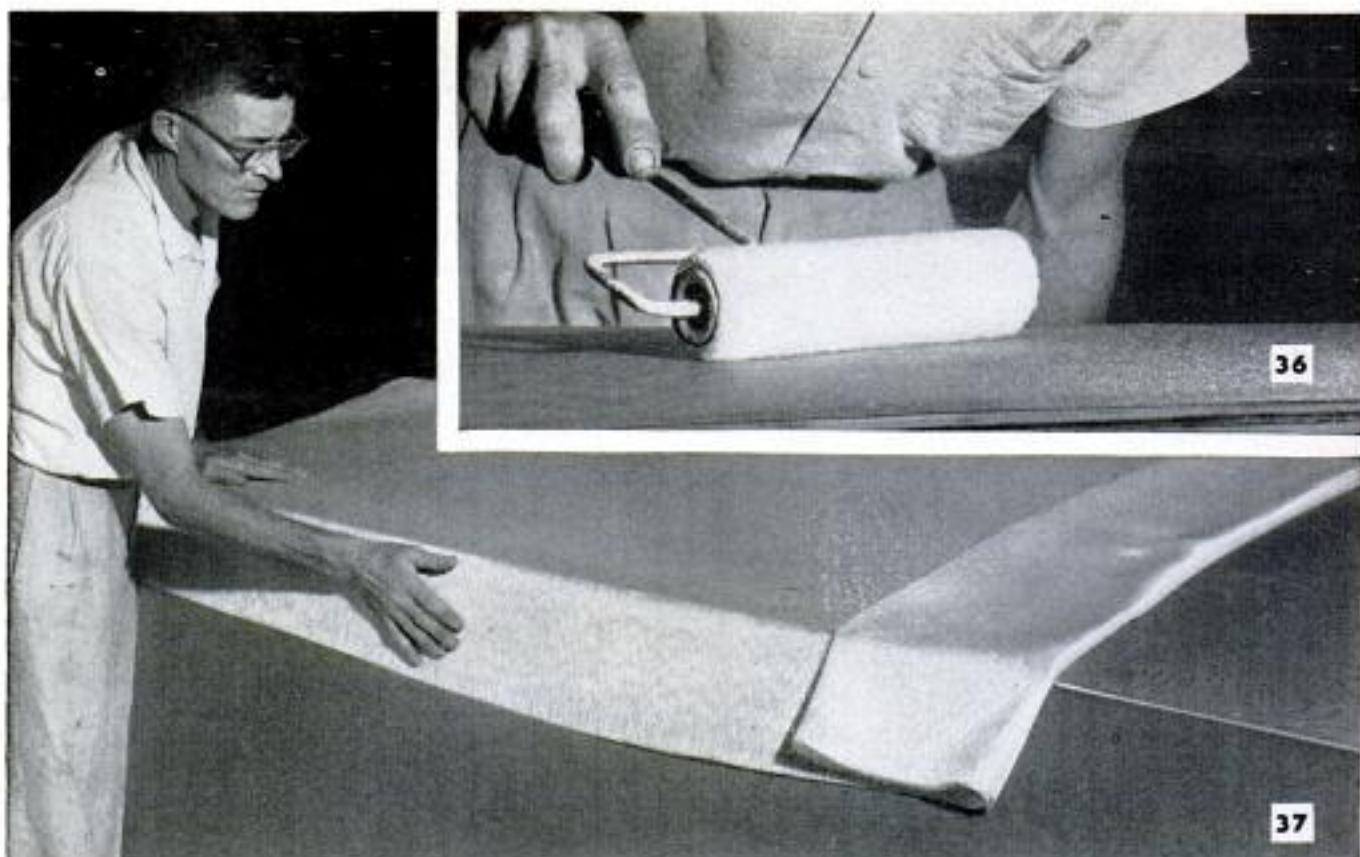

Glass-fiber cloth is applied to bottom of hull and brought about 4 in. up side planking and trimmed

Glass fiber: Covering the hull with glass fiber is a sure way of preventing checking of fir plywood, a common fault. There is nothing particularly difficult about applying glass fiber but it is important that the manufacturer's instructions be followed carefully. Proper proportions in mixing the resin catalyst are most important as is the correct temperature for applying. Essentially, it is a case of applying the bonding agent to the wood with a roller as in Fig. 36 and then laying glass-fiber cloth in it while wet, Fig. 37, and finally applying a second application of the resin-catalyst mixture. Before actual painting, the hull should be sanded lightly and any screw holes or imperfections filled with wood putty.

Painting: While the hull is upside down, the primer may be applied to the bottom. If the hull has been covered with glass fiber, be sure that the primer is recommended for use on glass fiber. If the hull is fir, use a resin-type plywood primer as a base. Flat primer should be applied, sanded when dry and then given a second application and so on until the surface is smooth. Follow the primer with two coats of marine enamel applied to the bottom only. If the hull is to remain in water, the bottom should be painted with an antifouling paint applied according to manufacturer's instructions. This is generally applied to an unprimed surface shortly before the hull is launched.

(To be continued)

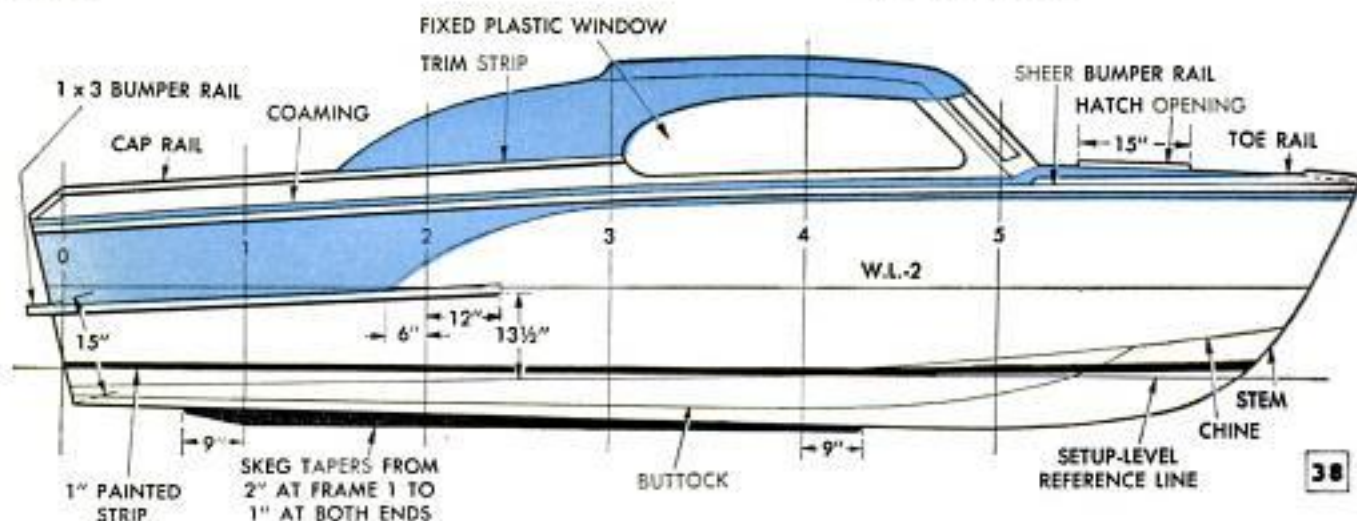

Magnet Serves as Cutoff Stop

When using the saw fence as a cutoff stop for repetitive work, a strong horseshoe magnet stuck to the fence provides a "self clamping" clearance "block." A block like this, or one of wood, is always required in cutoff work and never should the work be butted directly against the fence. If done, the work will catch between the blade and fence and be thrown with force.



Wood Jig Starts Tap Square in Plastic

The difficulty of starting a tap square in plastic, without damaging the surface of the material, is avoided when a block of wood is drilled and tapped and then held in position over the work. In addition to eliminating damage to the plastic, this jig will enable you to make the holes tap true and with greater precision.

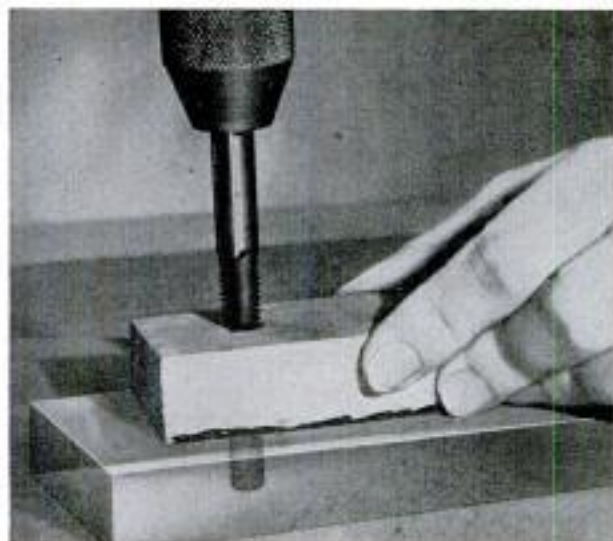

Rubber-Stamp Impressions Tinted With Metal Powder

Metallic powders are easily applied to fresh rubber-stamp impressions, giving them the appearance of having been imprinted with metal. Regular stamp ink can be used in any color on absorbent materials. After covering the impression with the powder, allow it to dry a minute or two. Then gently shake off the excess.



New Fence-Post-Treating Method Stops Decay and Termite Damage

A simple soaking process, developed by the Forest Service of the U. S. Department of Agriculture, has been devised whereby homeowners and farmers can treat their own fence posts against decay and termite damage. It entails soaking the ends of the posts in two successive solutions, the first being copper sulphate, available in crystal form, which is diluted at a ratio of 18 lb. to 24 gal. of water. Allow a day for the crystals to dissolve, otherwise extensive stirring will be necessary. The large ends of the posts, preferably freshly cut, are immersed in the liquid which should be of a sufficient depth to cover the entire section of the post that is later to be buried in the ground. After two days the posts are transferred to a second solution of sodium chromate, purchased in powdered form, which is dissolved in water at a ratio of 18 lb. to 26

gal. Posts are soaked with the wide end down for one day and are then inverted to permit saturation of the narrow end for another day. Upon removal, they should be piled and allowed to dry for several weeks to allow the chemicals to become more evenly distributed. If necessity demands that they be used immediately, rinse the posts in clear water to remove surface deposits. Rubber gloves are required for handling the solutions and care must be taken as these chemicals cause irritation if brought in contact with the skin and are harmful if taken internally. Residue should be disposed of in a hole dug in the ground at a sufficient distance from wells and livestock ponds to prevent contamination. The liquids should be allowed to seep away before refilling the hole. If retained, the solutions must be fortified before reusing.

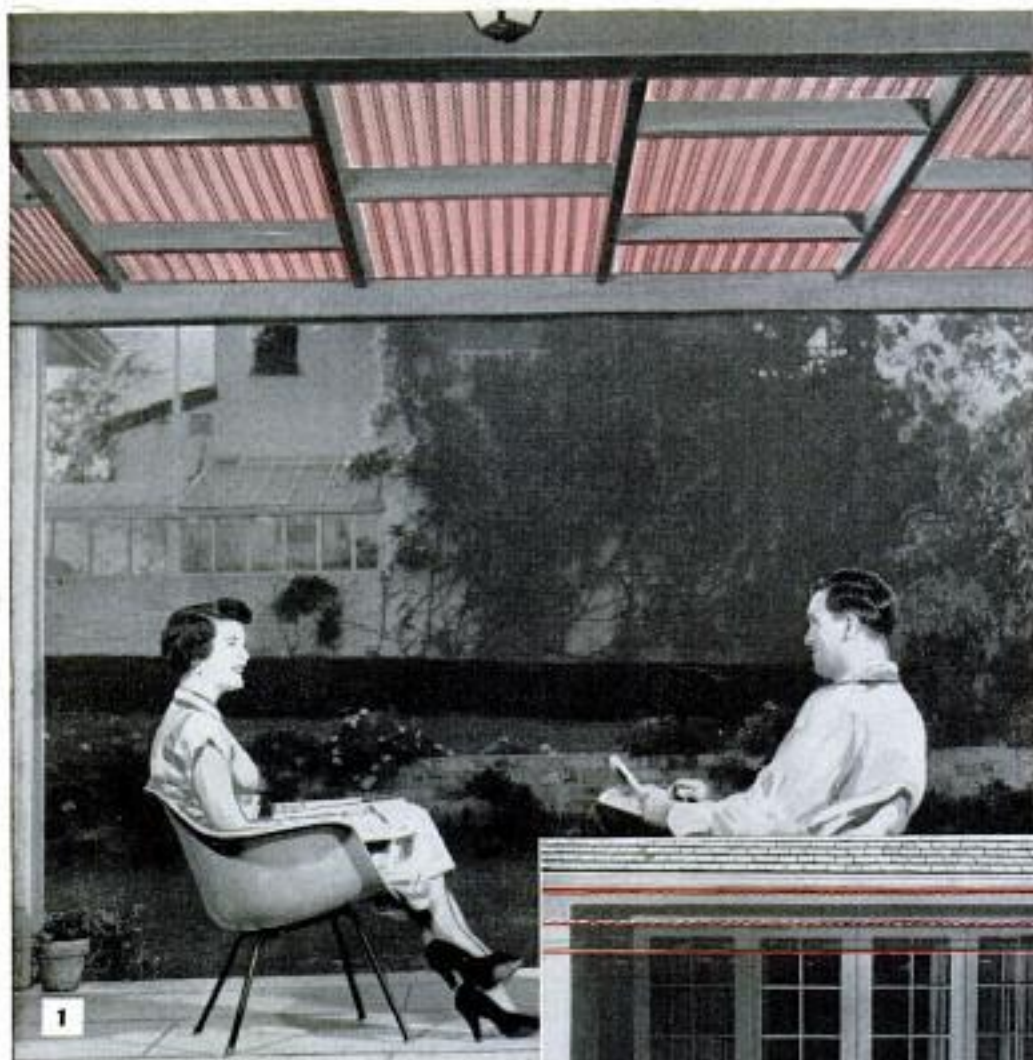

Above, patio roof of corrugated glass fiber nailed on framework of 2 x 4s attached to house and supported by posts as outlined in Fig. 2, affords protection from rain and direct rays of the sun. A second post, not shown in the outline, supports the other end of the roof

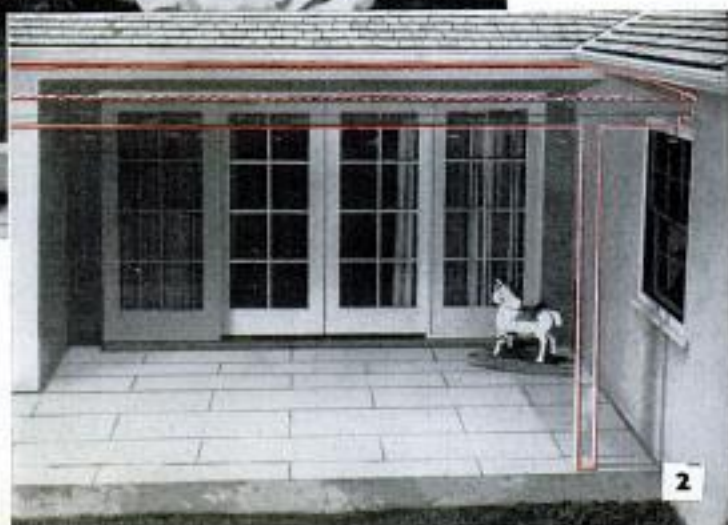

KEEP YOUR PATIO COOL WITH A GLASS-FIBER ROOF

By Raymond Schuessler

HERE IS A COLORFUL glass-fiber patio roof that you can start building in the morning and have completed before sundown. After measuring the area to be covered, the members for the framework are cut from 2 x 4s and the supporting posts positioned as indicated in the red outline in Fig. 2. Each post is anchored to the floor by a ½-in. steel rod, which is inserted in the bottom of the post and in a ½-in.

hole drilled in the concrete floor. Then the framework is nailed to the house and to a 4 x 6-in. beam nailed on top of the posts, Figs. 3 and 4, after which the glass-fiber panels, Fig. 1, are cut and fastened to the 2 x 4s with aluminum nails. The panels should overlap one corrugation for sealing with clear mastic. Predrilling of nail holes is recommended prior to fastening the panels to the rafters. ★★★



Above, cross pieces are staggered to break dominant lines of corrugated roof. Fig. 4, pre-painted 2 x 4 nailed directly to house supports upper end of roof. Fig. 5, glass fiber is easy to cut with fine-tooth saw



Leather Punch Improvised by Grinding Nail End Flat

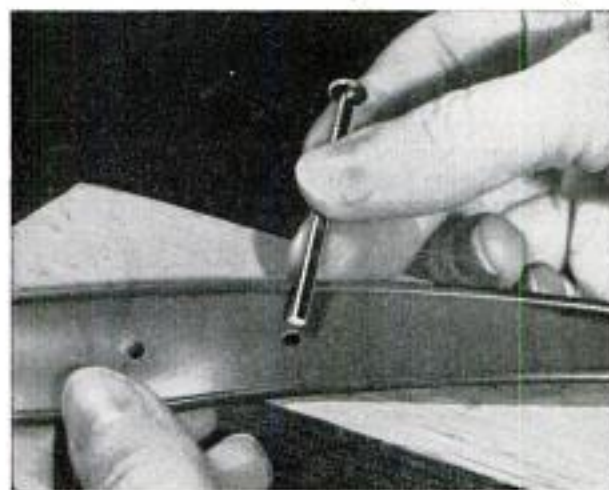

When it is necessary to provide an extra hole in a leather belt and no punch is available, try grinding the end of a nail flat as shown. Then, hold the nail in position on the belt, using a wooden block as backing, and strike it a sharp blow with a hammer. A neat, clean-cut hole will result.

☐ When you reupholster or slipcover furniture, pin some of the fabric scraps to the underside of the chair or sofa. There they will be handy in case you need them for small patches. They will have faded about the same degree and be just about as soiled, making a better match than a piece of fabric stored where it kept perfectly clean.



Board of Fire Underwriters photo

Protect Yourself Against

Simple, practical suggestions that any homeowner can take to family as well as reduce possible damage by wind to his home

YOUR CHANCES of becoming part of the statistics compiled each year on the loss of life by windstorm can be reduced greatly by taking precautions to safeguard yourself and family. This is especially important if you live in a region where severe windstorms may be expected.

Although it is not practical at present to build houses that will withstand the full impact of tornadoes, they can be reinforced to resist the strong winds along the fringe of tornadoes, or most winds of hurricane force. Personal safety in such storms is best assured by substantial shelters below grade level. Much property damage can be

prevented by taking some simple precautions before a storm strikes.

Effects of Severe Winds

A wind blowing from one prevailing direction exerts a positive pressure on the windward side of a building, and a negative pressure or suction on its leeward side. The amount of pressure on the windward side of a roof depends mostly upon its angle. There is practically no pressure from a horizontal wind if the roof slope is less than 30 deg., but the roof covering still may be susceptible to damage. Fig. 1 shows the distribution of pressure and suction on

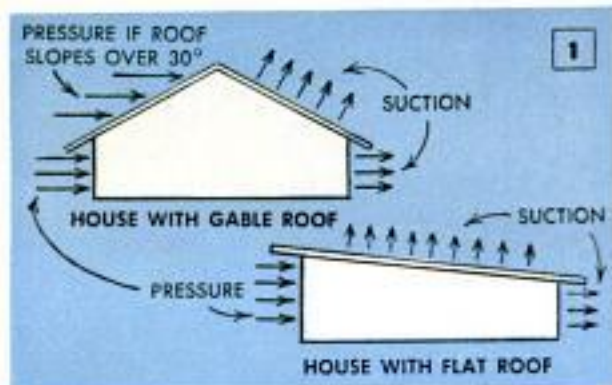

WIND-VELOCITY PRESSURES			
M.P.H.	Lb. Per Sq. Ft.	M.P.H.	Lb. Per Sq. Ft.
Wind Speed		Wind Speed	
2 30	2.30	120	36.8
40	4.09	130	43.3
50	6.39	140	50.2
60	9.21	150	57.8
70	12.5	160	65.8
80	16.4	170	74.2
90	20.7	180	83.0
100	25.6	190	92.6
110	30.9	200	102.4



Board of Fire Underwriters photo

Windstorm Damage

By E. R. Haan

*help assure safety to himself and
and other personal property*

various parts of two types of buildings, one having a gable roof and the other a flat or shed-type roof. While a 50-m.p.h. wind produces a pressure of about $6\frac{1}{2}$ lb. per sq. ft., a 70-m.p.h. wind almost doubles, a 100-m.p.h. wind quadruples this pressure as shown in Fig. 2. Sometimes the suction force exceeds the pressure force. Openings like broken windows on the windward side of a building permit pressure to be built up inside of it.

Fig. 3 shows how buildings are affected by strong winds. Pressure against the windward side tends to lift and overturn a building not firmly anchored to a founda-

tion or one not having a substantial foundation. As the suction force increases, a building tends to shear and slide off a foundation. Suction on the roof, aided by pressure under it, tends to raise it unless firmly anchored to the walls. A building tends to collapse under wind pressure if it does not have properly braced walls and roof, or if the structural members are weakened by decay or deterioration. Momentary gusts of wind from varying directions, generally of greater force than that of the prevailing wind, weaken a building.

Windstorm-Resistant Construction

New buildings erected in a region where severe windstorms can be expected should have windstorm-resistant construction. Details of such construction are contained in

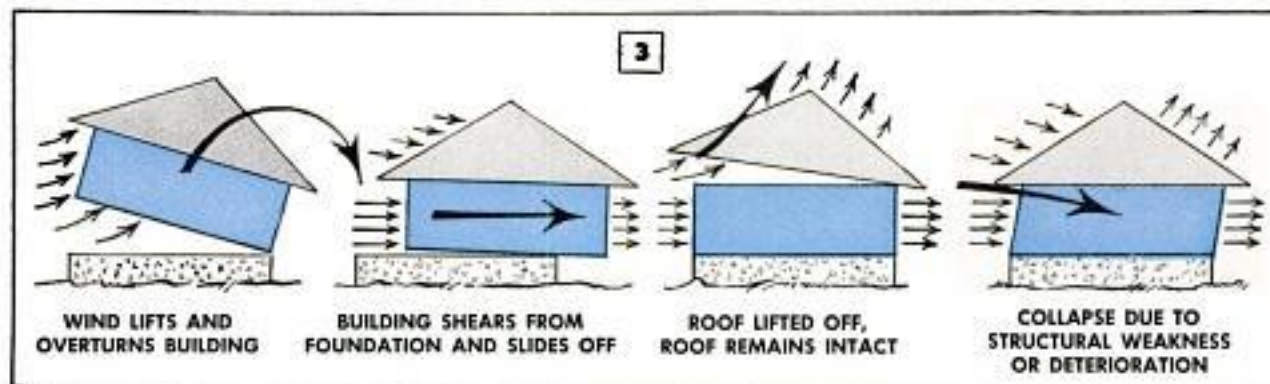

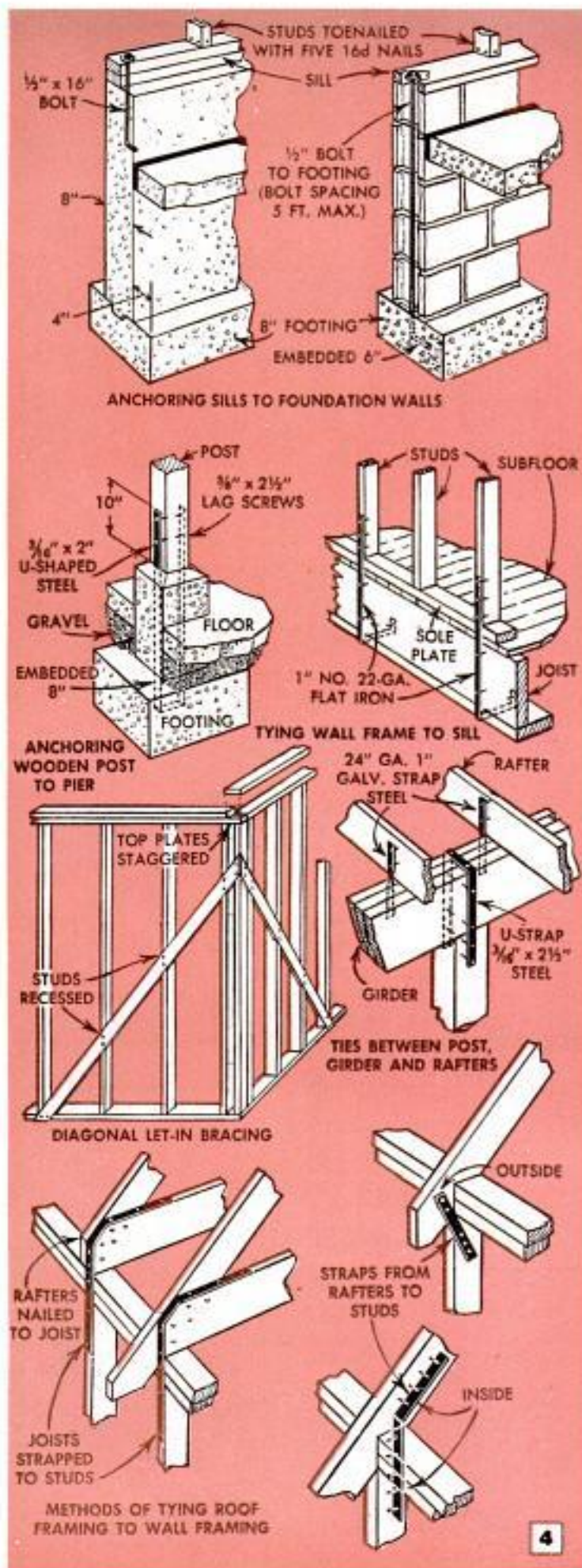

the National Building Code. Information on how to build wind-resistant farm buildings is also contained in Bulletin No. 144 of the U. S. Dept. of Agriculture. Fig. 4 shows a number of important features. Sills are fastened to a poured-concrete foundation wall with $\frac{1}{2}$ x 16-in. anchor bolts of which the ends to be embedded are bent at right angles. For concrete-block foundations, the anchor bolts extend through the blocks and are embedded in the footing. In both cases, the spacing of anchor bolts should not exceed 5 ft. Studs are each toenailed to sills with five 10d nails. Wooden posts on piers are fastened to them with U-shaped straps of $\frac{3}{16}$ x 2-in. steel. These are embedded in both the pier and the footing, and fastened to the post with $\frac{1}{2}$ x $3\frac{1}{2}$ -in. lag screws. Diagonal bracing let into the frame members of walls at corners will add considerable rigidity. Girders resting on posts are bolted or strapped together with $\frac{3}{16}$ x $2\frac{1}{2}$ -in. steel straps. Rafters and joists resting on top plates of wall framing are attached to them and to the studs with 24-ga. steel straps about 1 in. wide, as in the lower three details of Fig. 4.

As roof damage is the most frequent result of windstorms, particular attention should be given to strong roof construction and wind-resistant covering. Roof coverings should be applied strictly in accordance with manufacturers' instructions. Inadequate nailing is usually the cause of failure of some composition shingles in breaking off when subjected to strong wind. Fastening each tab with a spot of quick-setting asphalt cement, not less than 1 in. in diameter, Fig. 5, will hold the tabs down securely.

Protective Measures

Existing buildings are less susceptible to windstorm damage if kept in good repair. Any loosened projections of portions of a house, such as trim, cornices, shutters, gutters and downspouts, should be kept properly secured, in good sound condition, or replaced as necessary. Tabs of composition shingles should be cemented down as already noted. Trees should be kept pruned to eliminate dead branches and minimize breakage



DABS OF QUICK-SETTING ASPHALT CEMENT (1" MIN. DIA.) TO HOLD COMPOSITION SHINGLES

5

of live ones. Loose objects like trash cans, lawn furniture, lumber and children's play equipment, should be located in spots sheltered from prevailing winds, or gathered and put in the basement before a severe storm strikes. This will prevent them from being blown about and causing damage. Some of the loose objects may have to be anchored securely.

Window Protection

In areas subject to hurricanes, strong panels of 1-in. wood or $\frac{5}{8}$ -in. exterior-type plywood should be kept at hand to board up windows as in Fig. 6. Provisions for securely fastening such panels should be made in advance, instead of nailing them down at the time of an emergency. In some cases the panels may be held in place like storm sash or screens, using hangers at the top and hooks or turn buttons at the bottom. The inset in Fig. 6 shows the use of hanger bolts, which are left in place permanently. The panels should not touch the glass of a window, especially when under wind pressure. For windows that are larger than a single panel, you can join several panels together, reinforcing the abutting edges with lengths of $\frac{3}{16}$ -in. T-iron as shown in Fig. 7.

Picture windows in houses, and display windows in stores can withstand considerable wind pressure if braced as shown in Fig. 8. A straight piece of 2 x 10-in. stock is set vertically against the center of the windowpane by means of adjustable holders at the top and bottom. A slight cushioning effect is provided between the glass and the brace by applying a length of self-adhering sponge-rubber weather stripping to the edge of the brace as indicated. Large garage doors also should be braced.

If, during a severe windstorm, the wind blows into the house through broken windows, doors or other openings, dangerous pressure may be built-up inside. This can be relieved by providing openings of equivalent size on the leeward side. This precaution may be enough to save a building.

Warnings are radioed in areas that are likely to be subjected to severe storms like tornadoes and hurricanes. As tornadoes form suddenly, and therefore cannot be



6

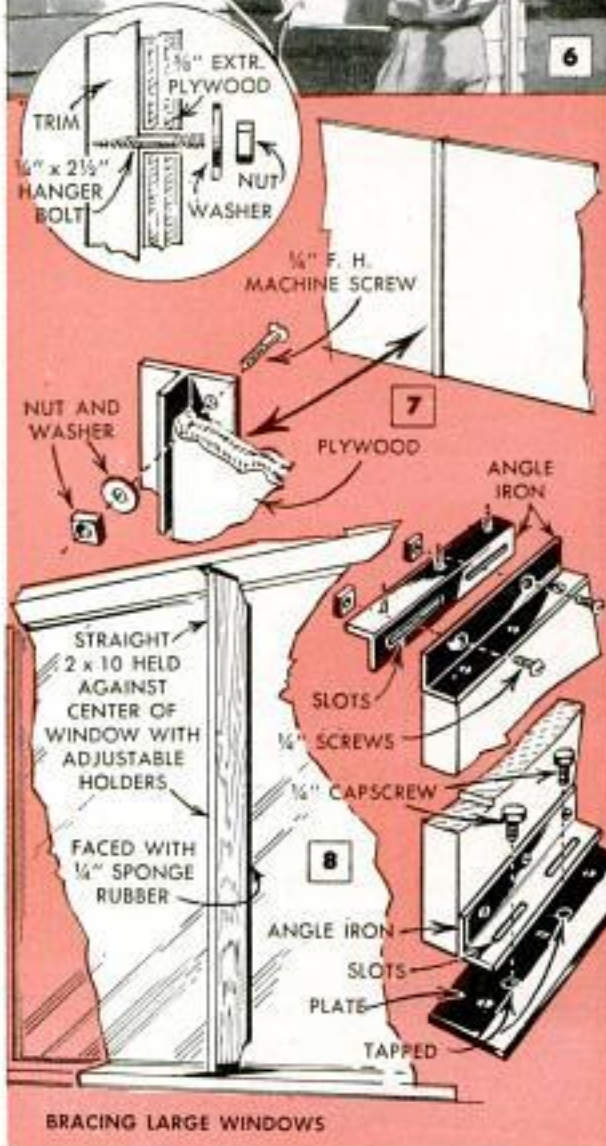

BRACING LARGE WINDOWS

forecast, tornado alerts are issued in areas where weather conditions are likely to cause them. After one has been observed, its general direction and progress can be broadcast. The general path of a hurricane can be predicted with reasonable accuracy and warnings issued many hours in advance. Knowing what kind of a windstorm to expect enables a person to take

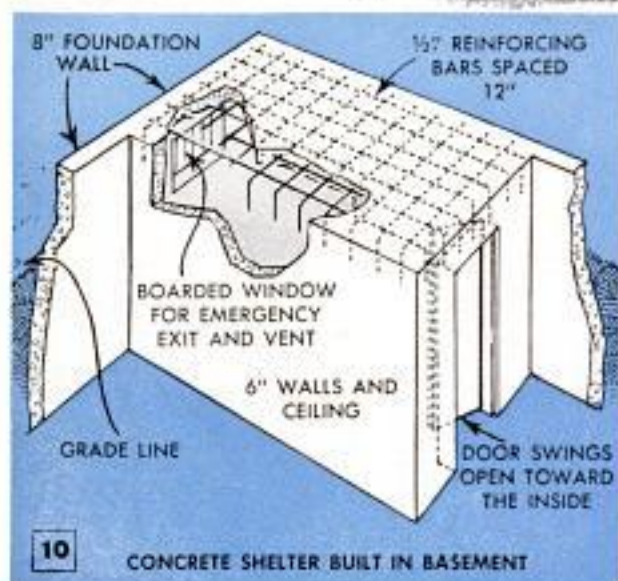

specific precautions besides the general measures that apply to all windstorms.

Recognizing a Tornado

Persons who are frequently in open country and may be out of touch with communications temporarily, should be able to recognize the funnel-shaped cloud formation that is characteristic of a tornado. Extending downward from storm clouds, this columnar cloud may look like a thick rope that is only a dozen or so feet in diameter. Or, it may be a V or U-shaped cloud of much greater diameter, occasionally as much as a mile or two, although the average diameter is about $\frac{1}{4}$ mile. This cloud whirls around in counterclockwise direction at speeds estimated as high as 500 m.p.h., accompanied by a deafening roar. When the lower end of the cloud touches the earth, which it may do intermittently, continuously or not at all, structures in its path usually are instantly demolished.

In central U. S., tornadoes generally

move toward the northeast and tend to swing northward at the end of their path. The forward speed is generally 25 to 40 m.p.h., although over 65 m.p.h. has been recorded. A tornado may remain stationary at one spot for several minutes, or it may follow erratic U-shaped or circular paths occasionally. While the average path is only 15 miles long in midwestern U. S., some have traveled over 200 miles. They may occur in any month of the year, but their greatest frequency is during the early months in the southern states, and during May and June in locations farther north. The center of a tornado is an area of greatly diminished pressure. When this passes over buildings that are not vented to equalize air pressure inside and out, the structures practically "explode." The difference in pressure may be equal to several hundred tons.

Surviving a Tornado

Quick decision and action are essential to survive an approaching tornado. Often people in autos can get out of the way. If such escape is impossible, the best place outdoors is a ditch or depression in which a person should lie flat. The greatest protection is afforded by a reinforced-concrete shelter built below grade level, Fig. 9. It should be about 5 x 8 ft. in size, preferably about 7 ft. deep. It should have a vent and a strong door that can be fastened securely.

A reinforced-concrete shelter located in one corner of a basement, as in Fig. 10, will be accessible quickly to persons in the house. This shelter should have a window opening, provided with a solid panel of plywood instead of glass, as an emergency exit should the doorway become blocked with debris. The door should swing inward so it cannot be held shut by debris.

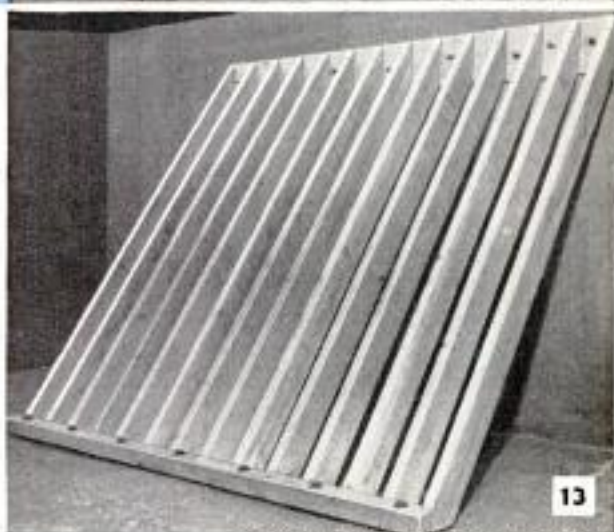
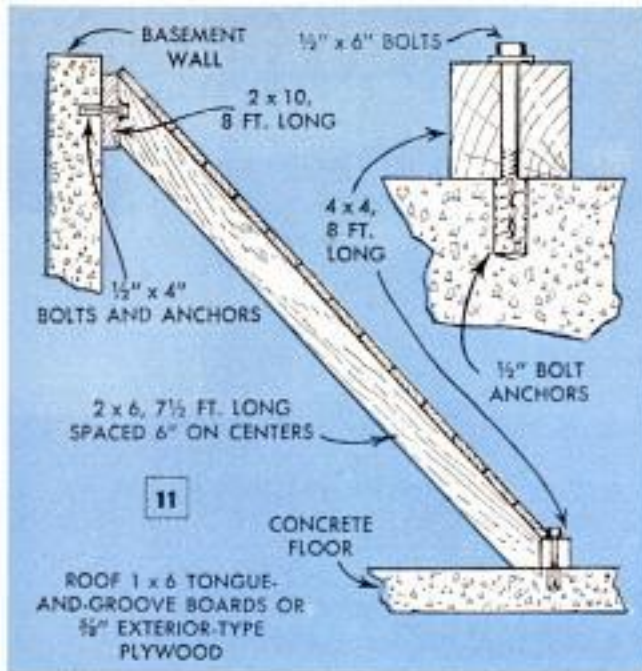

U. S. Civil Defense Administration photos

A lean-to type of basement shelter that will accommodate two or three persons, and has an exit at either end, can be built of wood as shown in Figs. 11 to 13 inclusive. This shelter was especially designed by the U. S. Civil Defense Administration to provide protection against bomb blast. Being highly resistant to falling debris, largely because of its strongly reinforced roof that slopes at a 45-deg. angle, this shelter offers considerable safety in a tornado. The roof of 1-in. yellow pine or $\frac{5}{8}$ -in. exterior-type plywood is nailed to a framework of 2 x 6-in. "rafters" spaced about 6 in. on centers. These are nailed to top and bottom plates or cross pieces which in turn are securely bolted to the wall and floor of a basement.

In a frame house, the part of a basement that is closest to an approaching tornado is the safest spot to be if a separate storm shelter is not available. Very little rubble tends to fall into the basement of a frame house at this point. However, just the opposite is true in case of a brick, stone or concrete-block house. Such a house tends to disintegrate quickly when struck by a tornado, and debris may bury persons in a basement. Such a house should have a separate storm shelter. Reinforced-concrete buildings or those that have a steel-frame construction offer a high degree of safety when occupants keep away from windows and doorways.

Hurricanes

A hurricane is a rotating windstorm that may be several hundred miles in diameter. The center or "eye" is a calm area of low atmospheric pressure averaging about 14 miles in diameter. Around this center the wind travels in counterclockwise direction,

at speeds of 75 to 150 m.p.h. The greatest force is just outside the eye. The storm center advances at a relatively slow speed. A spot that lies in the path of the eye is first subjected to winds from one direction, after which there is a period of absolute calm, and then the wind blows with equal fury from the opposite direction.

Many hurricanes lose most of their violence after traveling inland, but cause torrential rainfall, often resulting in severe floods. In the U. S., hurricanes are seasonal from June to November, reaching a peak of frequency at the beginning of September but they can occur at other times also.

In view of the changing wind direction that may be experienced in a hurricane, the vent openings on the leeward side of buildings during the early part of the storm may have to be closed, and other vents provided on the opposite side. Occupants of waterfront homes should evacuate them and move to higher and safer locations farther inland before the storm strikes. ★ ★ ★

Water-Ski Jump



Section of Wooden Snow Fence Provides Slipproof Walk

Instead of slipping and sliding around when climbing a sloping beach, lay a section of wooden snow fence on the sand. The slats provide a slipproof surface on which to walk with little possibility of the fence settling too deeply into the sand.

Pulling Headless Nail

Pulling a headless nail is no problem if you grip the nail with a pair of pliers and slip the hammer claws under the pliers. If a nail is especially hard to remove, and a pair of regular pliers slips, grip the nail lightly with a pair of cutting pliers.



SKI-JUMPING THRILLS are not restricted to winter snow when you have this floating ski-jump ramp to lift you into the air on water skis. The 20-ft. ramp lifts the skier 5 ft. into the air, and only speed and natural caution determine how high and how long will be the jump.

Designed for simplicity of construction and quick disassembly for winter storage, the ramp has a 2 x 4 frame that is assembled with galvanized bolts, nuts and washers. For the surface of the floating ramp, a new, high-density-resin overlaid fir plywood is recommended. The surface of this type of plywood is glass-smooth and flint-hard, ideal for water skiing, as it requires no waxing or finishing and withstands the abuse of water skis sliding over it. However, regular exterior-grade plywood can be used for the ramp surface. Its upper surface should be prepared by flowing on two coats of heated carnauba wax. The underside of the plywood, as well as all framing of the ramp, should be given a heavy prime coat, then finished with a good grade of exterior or marine-grade paint. As indicated in the details, the framework under the plywood ramp consists of cross members between the outer frame members, and staggered shorter members between the cross members. This construction assures a rigid surface for the skier. The lower frame, in which oil-barrel floats are strapped, also is made as one unit.

When the ramp is to be assembled, float the lower frame with all diagonal braces loosely connected to it. Then, float the plywood ramp over it and slip bolts through the upper ends of the diagonals while lifting the ramp into position. Next, install the two side gussets and tighten all bolts. Now, strap the oil drums in place, with the bungs facing upward, and fill them with water, as required, to balance the ramp and adjust its height. Heavy screw eyes on the four corners of the lower frame of the ramp are used to attach anchor cables that lead to anchors made by filling pails with concrete and inserting large screw eyes in the wet mix. These anchors are necessary to keep the ramp from shifting with the wind and from the wake of a passing boat.

As indicated on the detail, the forward member of the ramp frame is a length of 2 x 6 to provide added strength at this point. To finish the edge of the plywood ramp, $\frac{5}{8}$ -in. half round is glued and nailed to it as indicated in the detail.

Douglas Fir Plywood Association



Add a new dimension of thrills to the sport of water skiing by taking to the air via this floating ramp. Details below show that upper frame, to which plywood ramp is screwed, consists of staggered short

members fitted between cross pieces of outside frame. Lower frame supports four standard 55-gal. oil drums that act as floats. All openings in the drums should be sealed except those on the sides of the drums

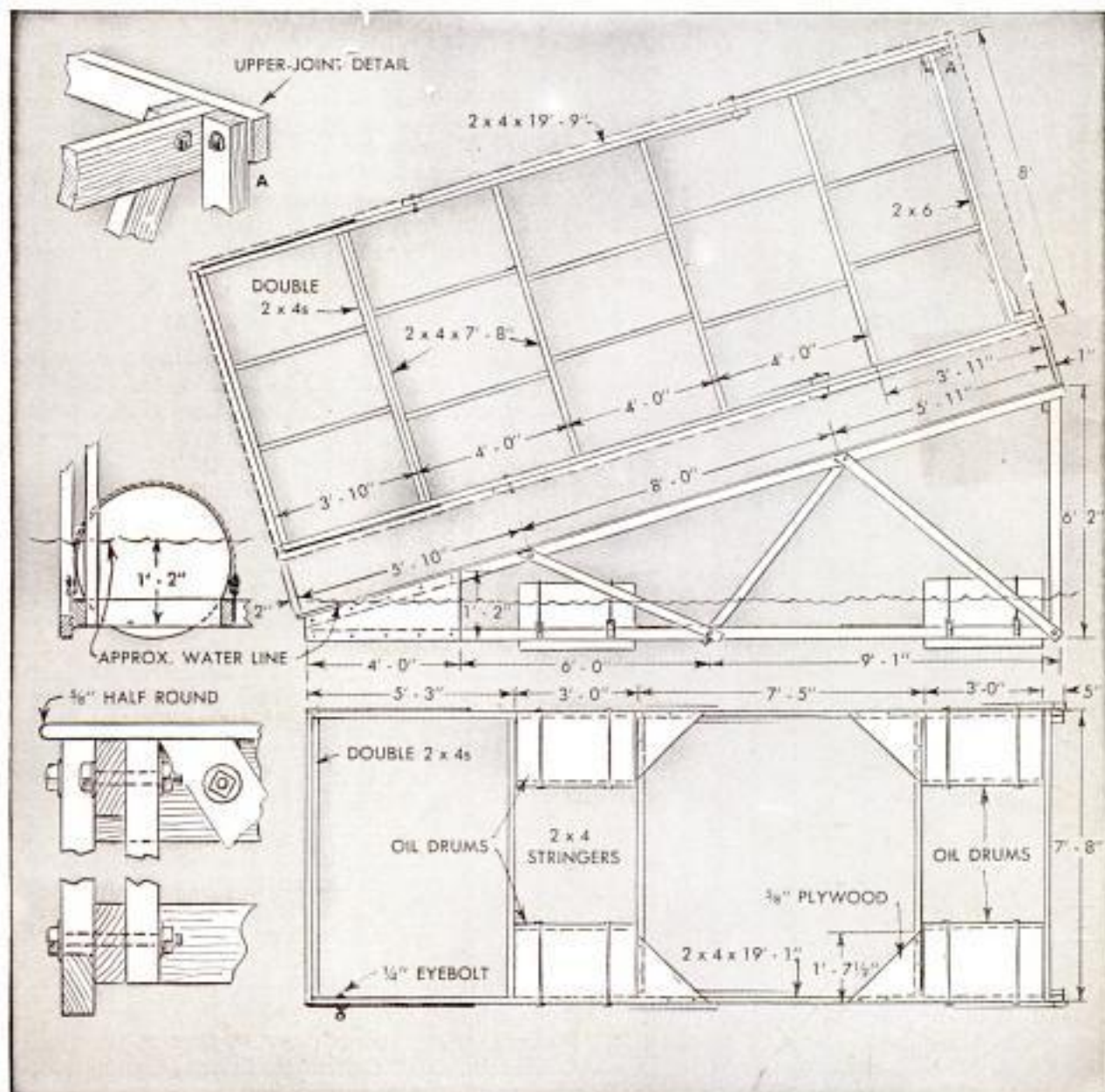

How to make

Fishing Jigs

By Vlad Evanoff



ONE OF THE MOST effective lures used in salt-water fishing, and which now is finding increasing favor with fresh-water anglers, is the "jig." This lure consists of a metal "head" in which a single hook is embedded, and a "body" of bucktail hair, feathers or nylon. The most attractive feature of jigs is that any fishing enthusiast who ties his own flies or makes his own lures can cast the jigs with a minimum of tools and equipment.

Making the Molds

First step in making jigs is to have a model, or pattern. The pattern can be a jig on hand from which the feathers have been stripped and the hook and eyelet removed, or it can be carved from softwood, Fig. 1. Next, a mold is made by pouring plaster of paris or water putty into a cardboard box. As indicated in Fig. 2, the box should be a size that permits a space of $\frac{3}{8}$ in. between the body end of the jig and the box side, and $1\frac{1}{2}$ in. from the opposite end of the jig and the box side. First, pour the box half full of plaster, coat the jig pattern with petroleum jelly and press it halfway into the wet plaster. Two nails then are sunk into the plaster near diagonally opposite corners and allowed to project about $\frac{1}{4}$ in., Fig. 3. They will act as locating pins when reassembling jig halves for casting.

After the first half of the mold has hardened, brush its entire surface with heavy oil, then fill the box with plaster. When the plaster sets, which usually requires about $\frac{1}{2}$ hr., break the box away from the mold. Use a knife blade to separate the mold halves, Figs. 5 and 6. Pry out the pattern, which will remain in one of the mold halves, and set the mold aside to season at room temperature for about two weeks.

POPULAR MECHANICS

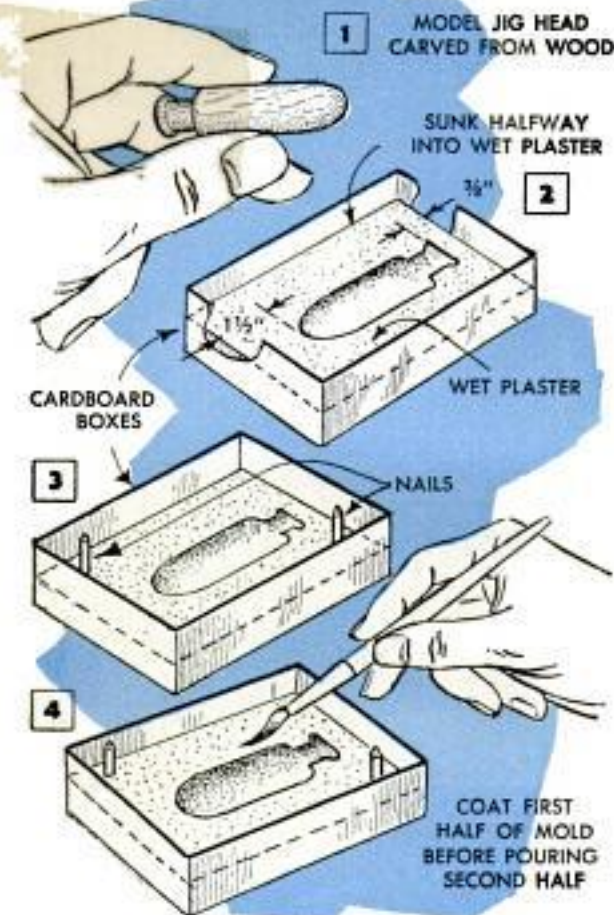

When the plaster mold has thoroughly seasoned, use the point of a knife to cut eyelet grooves and hook slots, Fig. 8, which are determined by placing hooks and eyelets on the mold and tracing around them with a pencil. Eyelets, Fig. 7, are formed from brass or copper wire. Also carve a funnel-shaped pouring hole in each mold half.

Casting the Jigs

Metal for casting the jigs should be lead or tin, which often can be purchased as scrap metal. A combination of the two metals, such as bar solder, also is good. The greater the proportion of tin, the lighter the jig will be. Melt the metal in a ladle and pour some into each half of the mold, both to warm it and to remove any moisture. Next, place the hook and eyelet in position, Fig. 9, hold the mold halves together and quickly pour the mold full of metal, Fig. 10. When the surface of the metal indicates that it is hardening, lay the mold on its side until the metal has cooled completely. Wear heavy gloves for this operation, as the mold quickly becomes too hot to hold, and there is the risk of splashing molten metal on the hands.

In a minute or two the mold halves can be separated and the jig removed. Cut off the excess metal, Fig. 11, and drop it back into the ladle. A mold made as described will permit casting up to two dozen jigs. Chips or holes in the mold can be patched, but when the mold gets rough it should be remade. For a permanent mold, take a freshly cast plaster mold to a foundry and have it cast in bronze or aluminum. The cost should not be more than a few dollars, and the mold can be used for a lifetime.

Finishing the Jigs

After a number of jigs have been cast, file them smooth, then polish with sandpaper or emery cloth. Feathers or hair now are applied in several steps. First, wrap a few turns of heavy thread around the jig where the feathers will be attached, and cover this wrapping with quick-drying cement. Place a pinch of feathers against the cement, then wrap a few more turns of thread over them. Again apply the cement and a few more feathers. Repeat this operation until the hook is well concealed. Finally, wrap a few extra turns of thread around the assembly and coat them with cement. If the metal used for casting the jig had a high tin content, it probably will stay shiny. Metal containing more lead will quickly oxidize and turn dark, so it should be painted in colors that are compatible with the colors of the feathers used. Eyes may be painted on the jig to give it a more professional look. ★ ★ ★

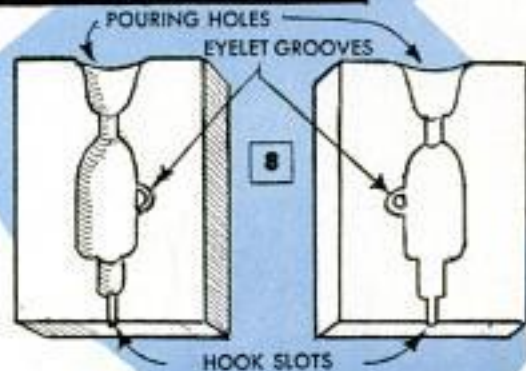
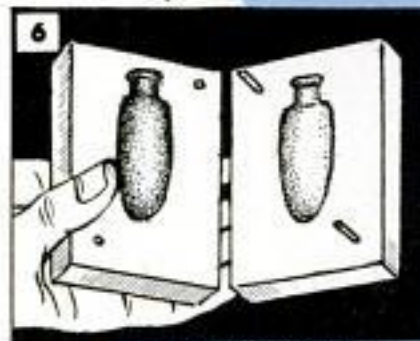



Rubber Band Cut From Inner Tube Chipproofs Sharpening Stone

The edges of your sharpening stones will not become chipped when stored in a tool drawer if a wide band cut from an inner tube is stretched around each of them as shown. Also, dirt is prevented from working into the surface of the stones in contact with the bottom of the drawer.

Lavatory "Step" for Small Children

This plywood step or platform built into a lavatory cabinet permits a small child to reach the lavatory. Made of $\frac{3}{4}$ -in. plywood, the step is fitted in a slot cut in the front of the cabinet as shown, and slides between cleats nailed to the inside of the cabinet. A wooden strip nailed to the front and extending slightly from the sides of the platform prevents it from being pushed in too far.

Robert Taylor, Cuyahoga Falls, Ohio.



Warm Water for Washing Car

Warm running water was made available outdoors for car washing by this homeowner who installed a hot-water tap next to the cold-water outlet on the side of his house and then connected both to a garden hose with a laundry-tub mixer, which is available at most hardware stores. Temperature of the water is controlled by adjusting the tap faucets.



Solder Gun and Stick Shellac Speed Furniture Refinishing

One fast and efficient way to fill deep scratches when refinishing furniture is to use a soldering gun and stick shellac. Use just enough heat to melt the shellac and flow it into the cracks. Overheating will char the wood. Smooth the shellac as well as possible with the heated gun, then sand when cool.—H. Y. Moon, Orient, N. Y.

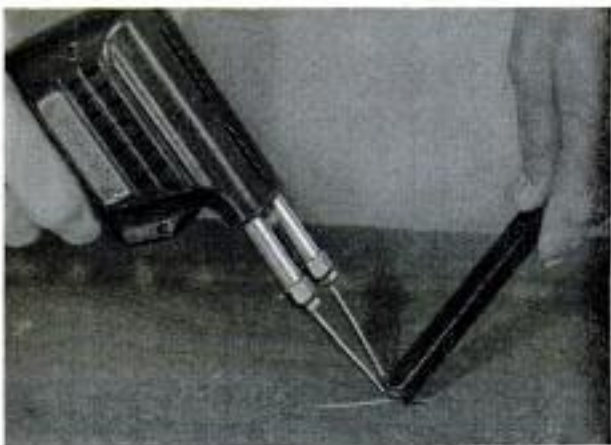



Boat Camping for the Sportsman

By Clinton R. Hull

IF YOU USE A BOAT to reach your favorite hunting or fishing grounds, and would like to spend more time at these spots, boat camping may be the answer to your problem. When fishing a lake or stream, instead of heading back to a lodge or seeking a camp site in late afternoon to avoid traveling in strange waters after dark, just drop anchor and stay aboard.

Boat camping does not require a large craft outfitted with bunks and deluxe equipment. Ordinary outboard-powered runabouts from 12 to 16 ft., if fairly broad-beamed and seaworthy, can be fitted for boat camping. Two persons can sleep aboard most 12 to 14-ft. boats, and there will be room for food, fuel and equipment for a two or three-day trip. If the boat is 15 or 16 ft. long, three adults can be accommodated under the same circumstances.

Fuel and oil consumption will limit the distance that it is possible to run a boat, if there are no fuel or supply stations along the route you plan to take. For an ordinary runabout the maximum round-trip distance usually is from 150 to 200 miles. After a test run of a fully loaded boat to determine

fuel consumption, the practical range of operations can be estimated fairly closely. Keep in mind that some extra fuel should be carried to permit operating the boat while on the hunting or fishing grounds. Because 20 gal. of gasoline and 4 qt. of oil equal the weight of an average adult, and require as much or more space, rate of fuel consumption may dictate that one less person can be carried in a boat when longer trips are made.

Boat camping permits you to drop the fishing pole and pick up the mess kit without walking a step



Framework of lightweight tubing fitted on boat supports canvas cover that provides excellent weather protection for boat camper



Each boat will have to be considered a separate problem, but fundamentally, boat camping requires that a boat have weather protection and sleeping space. In some instances, removable hinged plywood seat backs can be lowered to a horizontal position so the backs and seats form a sleeping platform. Where this is not possible, two or more pieces of plywood placed lengthwise of the boat across the seats will provide a sleeping platform. When the platform is not in use, the plywood pieces are placed in the bottom of the boat for floorboards. For maximum sleeping comfort, sleeping bags are recommended over a blanket-mattress combination. Sleeping bags are weatherproof, and can be rolled up and stowed away in a small space.

For protection against the weather, a folding canvas cover can be either pur-

chased or made. For the do-it-yourself top, $\frac{1}{2}$ -in. thin-wall conduit is bent to form the ribs and the cover itself is cut and sewn from 8-oz. canvas. As shown in the photographs, the lower portion of the cover is designed to stay in place when the upper portion is removed, forming a windscreen.

Cooking can be done aboard on a small camp stove. Because gasoline and oil for the engine, as well as fuel for the stove, are carried aboard, a dependable portable fire extinguisher should be considered standard equipment when a stove is used. In addition, keep the stove as far as possible from engine and fuel supplies. Flashlights or battery-powered electric lanterns should be used rather than lamps requiring fuel.

Because you must be self-sufficient when boat camping, a spare propeller and nut should be clamped under one of the seats

Lower portion of cover stays on boat permanently, provides a windscreen and protection against spray

Plywood and boat seats form spacious platform for sleeping bags and canvas cover completes "bedroom"

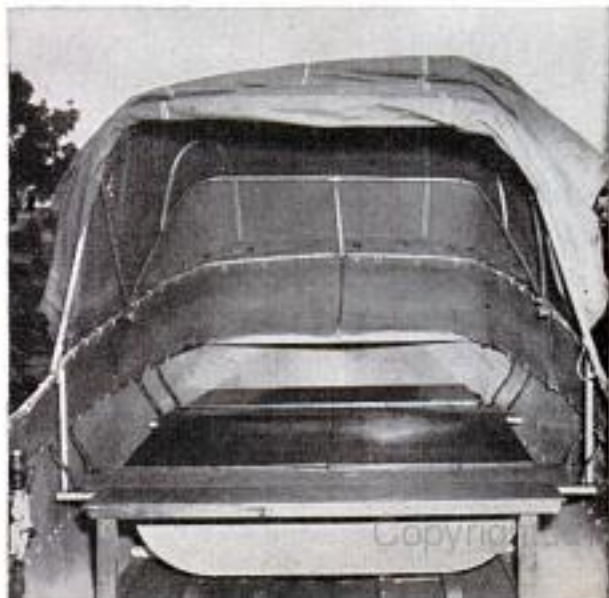

Weather seal between removable upper portion of canvas top and permanent lower portion is provided by flap extension on upper portion as shown



or under the foredeck out of the way. A lightweight folding anchor and about 100 ft. of anchor line also are necessary. A small kit of tools, spare ignition points and spark plugs should be included in the equipment. If your boat is subject to puncture or snag damage, buy a repair kit, available at most boat dealers, which consists of glass-fiber cloth patches and resin. Materials in these kits can be used on either wood or metal hulls. Shear pins for the propeller are another necessity, as is a pair of lightweight oars, just in case a pin is sheared in midstream and the boat must be rowed to shore.

Foodstuffs carried aboard should be as light as practicable, and can include pancake flour, dried fruits and the like. Carry a minimum of canned goods, since their weight may be considerable. A first-aid kit is an indispensable piece of equipment for boat camping or any outdoor trips. If you anchor your boat in a stream where there is a possibility of flash floods, put out plenty of anchor line and face the bow upstream. In country where there are snakes anchor at least several feet off shore, with the bow toward open water so the boat will ride well in case of a sudden storm. Where the banks are rocky, wedge several smooth dead branches vertically against the bank to keep the boat off the rocks. Tie bow and stern lines well above water, in case the stream should rise while you are sleeping.

When you have had enough of hunting or fishing, no time need be spent in breaking camp. Just take in the anchor, start the motor and head for home. ★ ★ ★



Above, with sleeping bags unrolled on platform, comfortable sleeping accommodations are ready. Below, dead limbs keep boat way from rocky bank



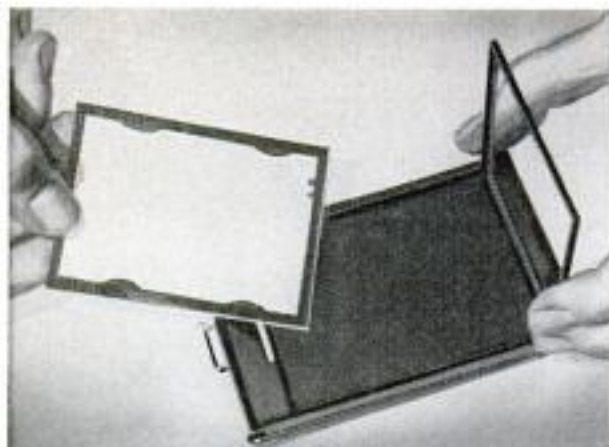

Adapter for Cut-Film Holder Handles Off-Size Film

Sheet film that is smaller than the holder at hand can be used in an emergency by making a simple adapter to hold it. Select a discarded negative that will fit the holder and cut four tabs in it under which the edges of the unexposed film can be inserted as shown in the photo. Then load the adapter and insert it in the holder in the regular manner. A fifth tab cut at the upper end of the adapter will allow you to center the film when loading in the dark.

Richard Hanscom, Elmhurst, Ill.

Razor Blade Used for Cutting Stored Safely in Clip

A single-edge razor blade is a useful cutting tool for many odd jobs around the home, but when not in use it is a real hazard unless the sharp edge is covered. After slipping the blade in the clip, hang it in a convenient place out of reach of children, or keep it in a drawer.

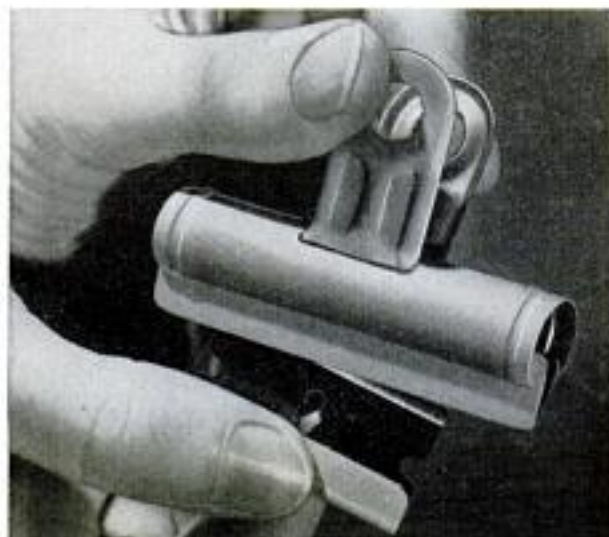

Protect Art-Brush Bristles With Drinking Straw

The bristles on a small art brush can be protected from damage when not in use if a short length of drinking straw is slipped over the ferrule as shown. For a long period of storage, the bristles can be completely sealed in the straw by closing the open end with cellulose tape.



Year-Round Uses for Shellac in the Home

From garden markers to winter bouquets is the range of uses for shellac around the home. For the garden, shellac empty seed packets to row markers and then shellac the outside surfaces of the packets. The packets will stay in place and be legible all summer. In your home, holes worn in linoleum can be repaired by filling them with a paste made of shellac and finely ground cork. When the mixture has dried, sand smooth and paint to match the linoleum pattern. Repair cracked wooden salad bowls by cleaning the cracks as well as possible and then filling them with shellac. Use only enough to come flush with the surface and wipe off any excess. You can restore the appearance of a mirror

when breaks appear in the silver backing by applying smooth aluminum foil and shellacking it in place. Polished-brass fixtures and utensils will not darken if two thin coats of shellac are applied. Denatured alcohol will remove shellac should that become necessary. Old lamp shades can be given new life by stripping off the covering and replacing it with a colored map or decorative paper. For durability, apply two thin coats of shellac to the paper. Shellac can be used to preserve the beauty of autumn foliage for winter bouquets. Lay the leaves as flat as possible on a newspaper and apply shellac to one side, covering stems as well as leaves. When the shellac is dry, turn the leaves over and repeat.

WFM 59
SN

THE POPULAR MECHANICS SHOP NOTES

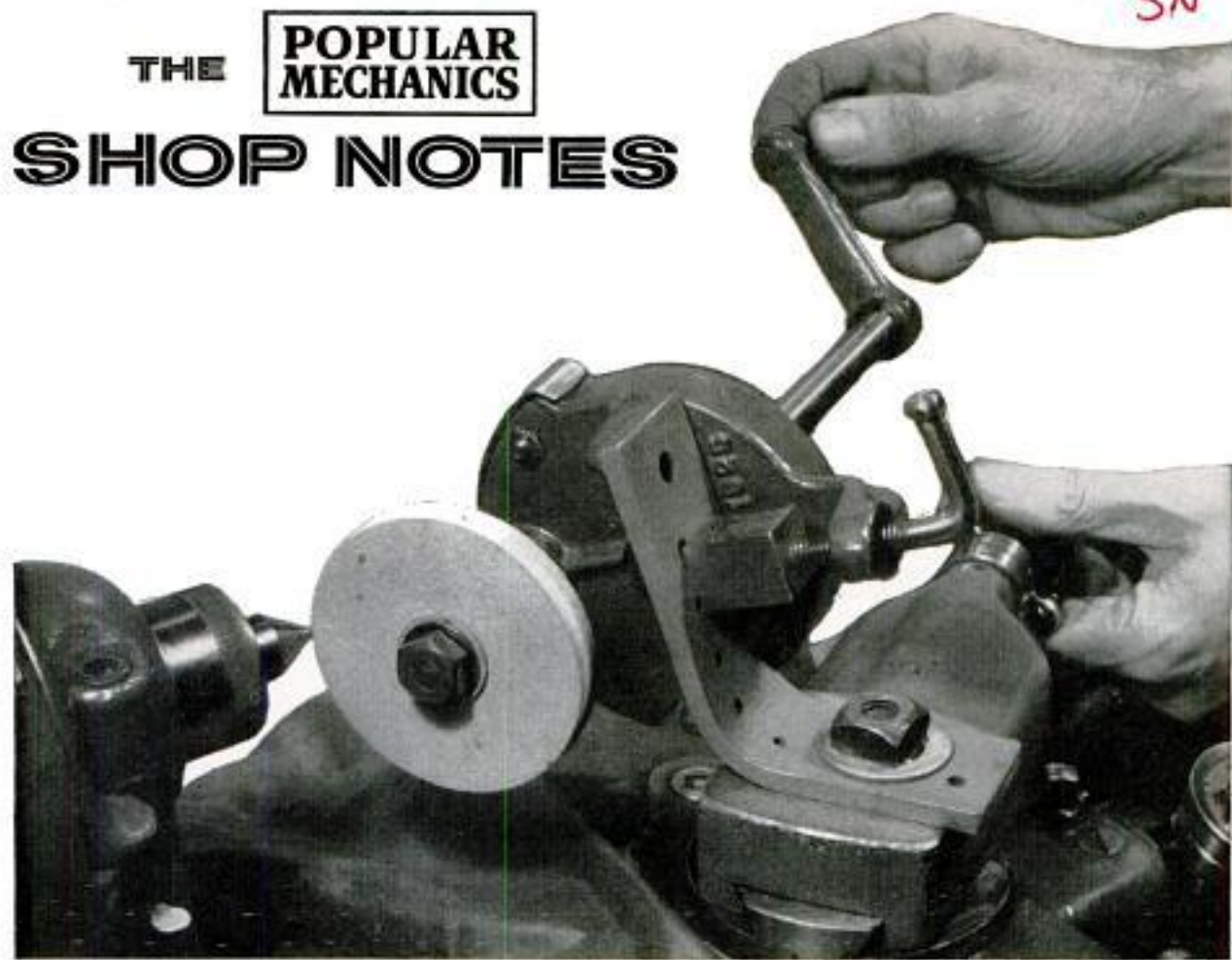

Hand Grinder Fitted to Lathe

By Walter E. Burton

S SMALL SHOPS will find practical use for this simple adaptation of a hand grinder of the type that clamps to a workbench. Common light grinding jobs ordinarily done on the lathe with a motor-driven tool-post grinder can be carried out with an accuracy very nearly equalling that of

standard tool-post-grinder setups. The hand grinder used must be in good condition with tight bearings and without excessive backlash in the gear.

As pictured above and below, the grinder is clamped to a bracket bolted to the tool-post mounting pad. On some small lathes,

Here the hand grinder is set up with wheel guard and crank extension for refinishing lathe center

Axis of grinding wheel must be in same horizontal plane as lathe centers. Note position of bracket

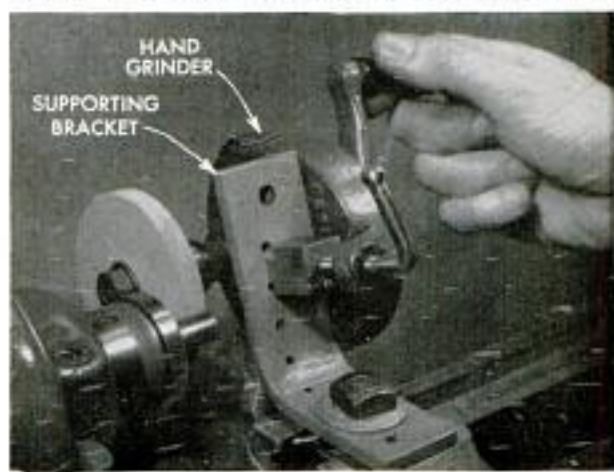
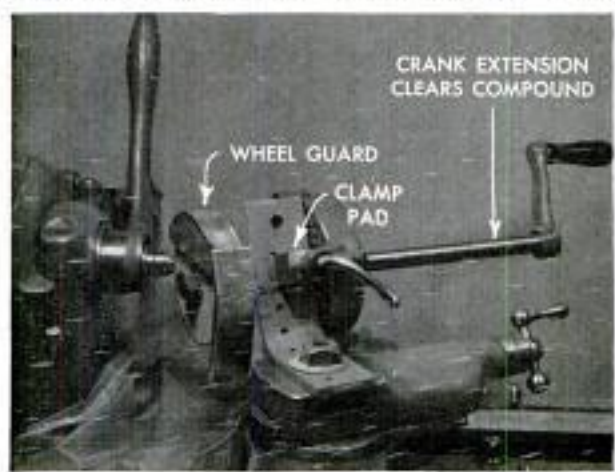

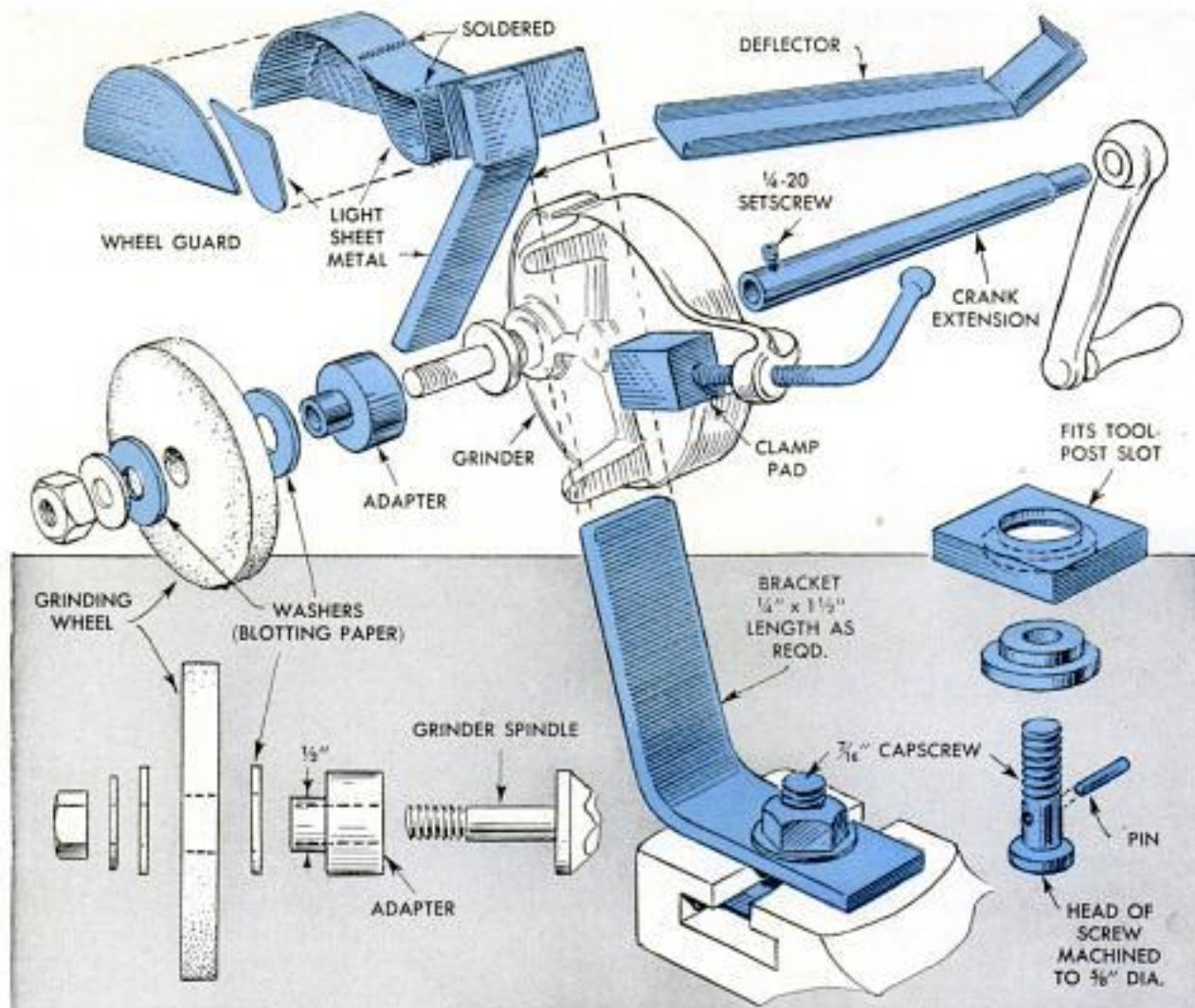

a standard $\frac{1}{2}$ -in. machine bolt will serve to hold the bracket. On other lathes you may find it necessary to make a special clamping plate and alter a cap screw to suit as in the lower-right-hand detail above. The pin detailed is usually necessary to prevent the screw from turning in the T-slot when tightening or loosening. In some cases the standard tool-post clamping plate will serve as a clamp for the grinder bracket. If this assembly can be utilized, then all that will be needed is a cap screw altered to suit. The bracket must be bent at the correct angle to bring the axis of the grinding wheel in the same horizontal plane as that of the lathe centers when the grinder is clamped in place.

In addition to the bracket and clamping-plate assembly, the parts shown above in color were added to the original grinder. These are the crank extension which is necessary when the grinder is aligned with the compound, the deflector and wheel guard which are optional, the special clamping screw and pad, and the adapter. The adapter is needed only when wheels having center holes larger than the grinder spindle are used. Ready-made adapters

also are available. If the original clamp screw and pad are long enough to clamp tightly onto the bracket, then the special clamp screw and pad pictured will not be required. None of the parts shown is fully dimensioned as each must be made to fit the grinder and lathe used.

Before grinding work mounted in a chuck or between centers, dress the grinding-wheel face square-across. When grinding work mounted between centers, set the compound at an angle of 1 to 2 deg. so that only the corner of the wheel contacts the work. Set the lathe carriage for a slow longitudinal advance and turn the grinder crank uniformly at a moderate speed. If you do not wear eyeglasses regularly, protect the eyes either with goggles or a suitable eyeshield. ★ ★ ★

Damper Quiets Circular Saw

To reduce the "sing" of a circular-saw blade one craftsman improvised a damper. The damper consists of a piece of sole leather positioned to contact the blade below the arbor. It is supported by a length of spring wire bolted to the dust chute.

Hold-Down for Running Moldings

To run uniform moldings on a saw, one craftsman uses this adjustable hold-down, which clamps to the rip fence. A piece of thin spring steel bent as shown and mounted in a recess in the lower edge exerts a downward pressure on the stock. Elongated screw holes at one end permit limited flexing. Additional tension is applied by a compression spring inserted in a hole drilled edgewise through the hold-down at the center of the recess. The screws in the plate which retains the spring are adjusted in or out for the desired tension.

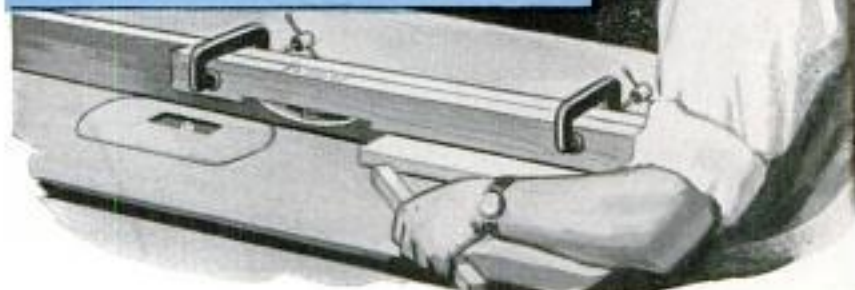
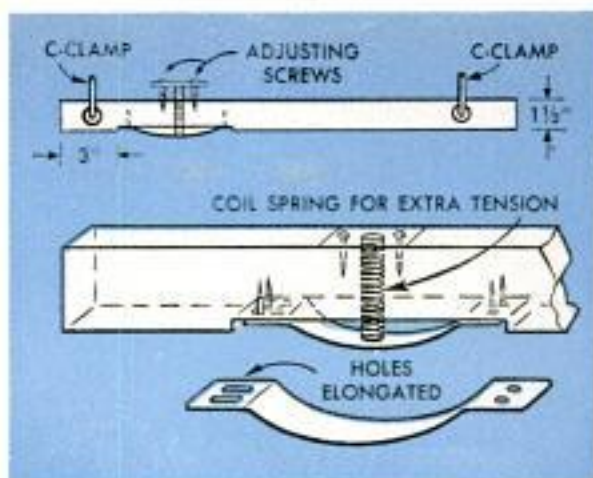

Sanding-Block Lock

Cloth or paper abrasives may be locked to a flat, curved or round sanding block by means of a bar which snaps into a slot cut lengthwise in the block. The bar is hinged at one end and equipped with a spring clip on the opposite end. When depressed in the slot the bar does not interfere with the sanding operation. Another means of fastening strips of abrasive to a flat holder is with a flexible piece of wood wedged against undercut shoulders at each end to clamp the ends of the abrasive.

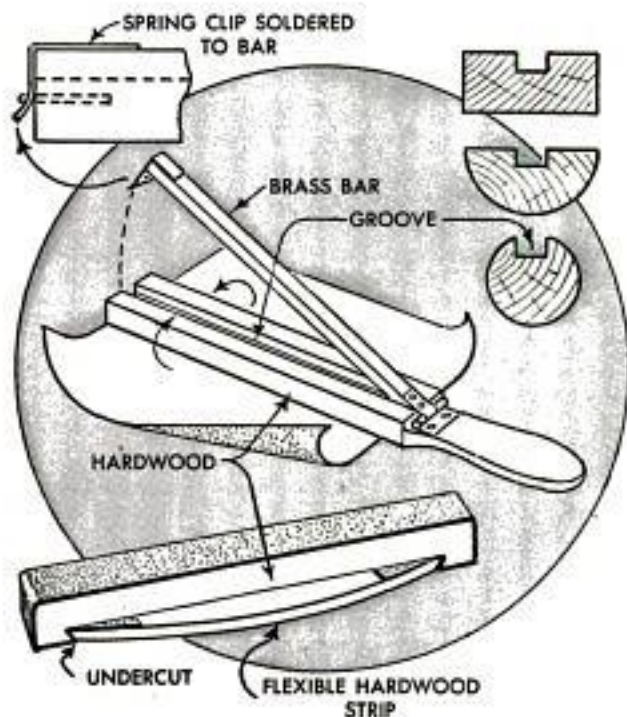

Post Shelves Add Shop Space

A metal support column located in your basement workshop can be used to good advantage when equipped with shelves as shown. Each shelf is made from two pieces of 2 x 8 clamped together edgewise around the post, the hole for the post being cut half in each piece. Long bolts running through both pieces clamp them to the post. Thin wood strips nailed to the shelf edges, to project above them slightly, keep small parts and tools from rolling off and being damaged on a concrete floor.

Mrs. Doris F. Wiley, Maywood, Ill.

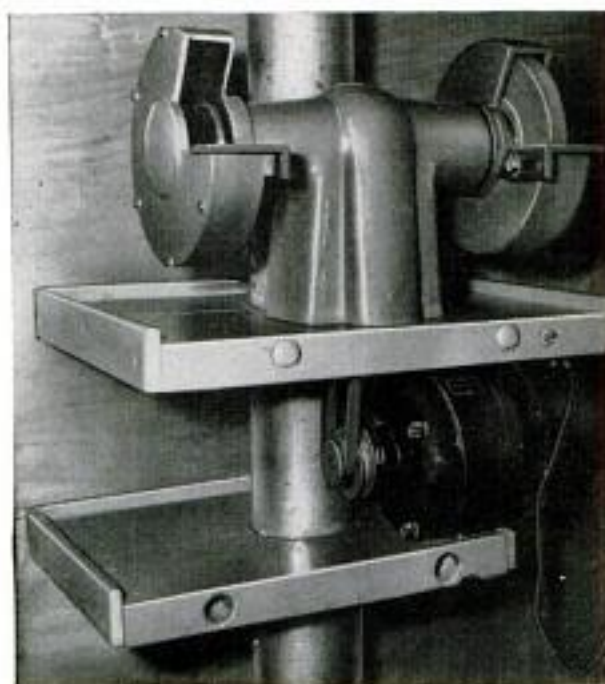

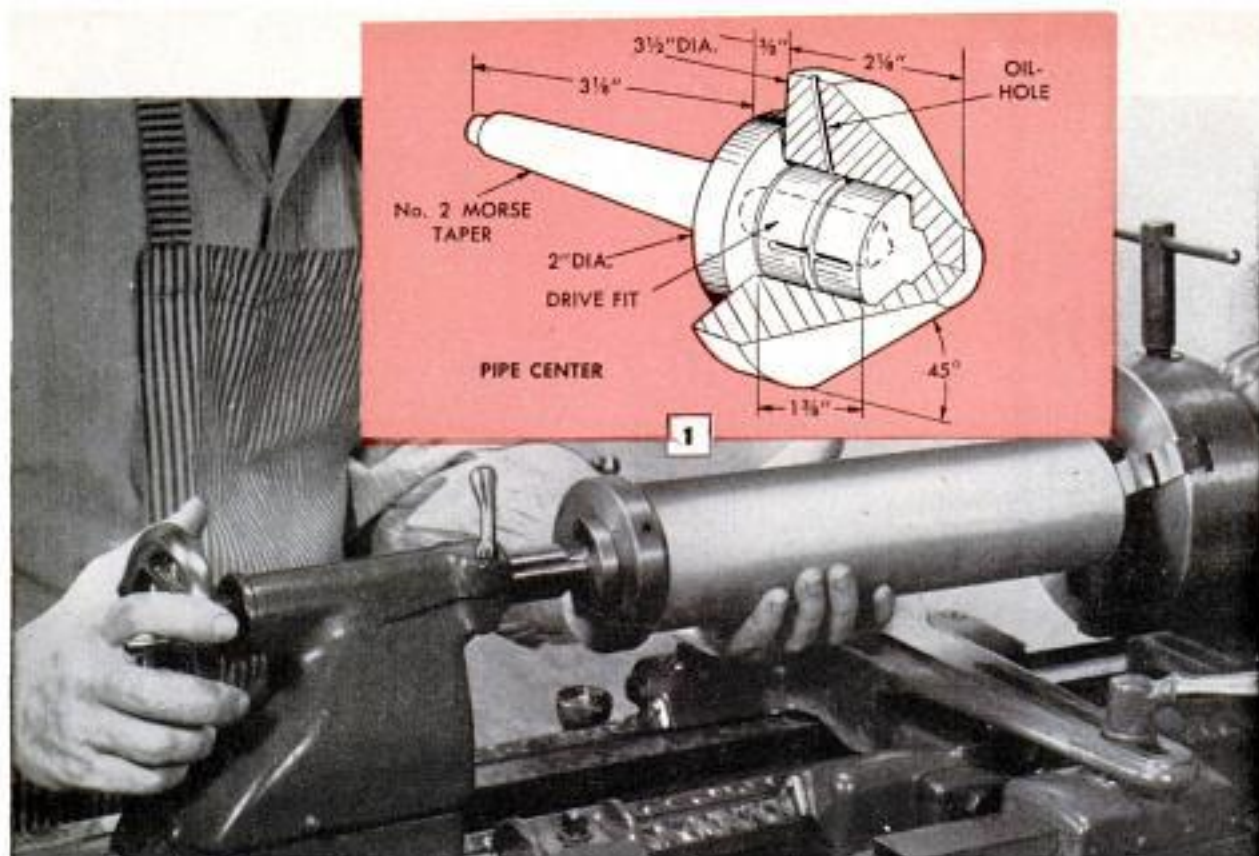

MACHINING METAL TUBING

By Sam Brown

SN 59

MACHINING METAL TUBING in the lathe often poses a problem in mounting between centers and also in chucking. Some operations may require that internal cuts be made to precise dimensions, or that both ends of the tube be faced-off true. When chucking tubing having a wall thickness of $\frac{1}{8}$ in. or under, special care must be taken to prevent crushing the tubing out of round or, if chucked internally, of distorting it and affecting the accuracy of the machining cuts. Although it requires more time and care to center the work accurately in the 4-jaw chuck, some operators prefer

the latter rather than the 3-jaw scroll, or self-centering, chuck. Each individual jaw of the 4-jaw chuck will require less pressure to hold the work securely, whether it is gripping the tubing internally or externally. The four jaws also more nearly equalize distribution of the pressure.

As a rule, when machining externally or internally, it is advisable to remove stock from tubing in a series of light cuts rather than attempt to bring the work to dimension in one heavy cut. Aluminum, brass and plastic tubing are easiest to work, as the average cuts can be made without a

Many lathe operators prefer expansion center for supporting tubing. Center does not score outside surface

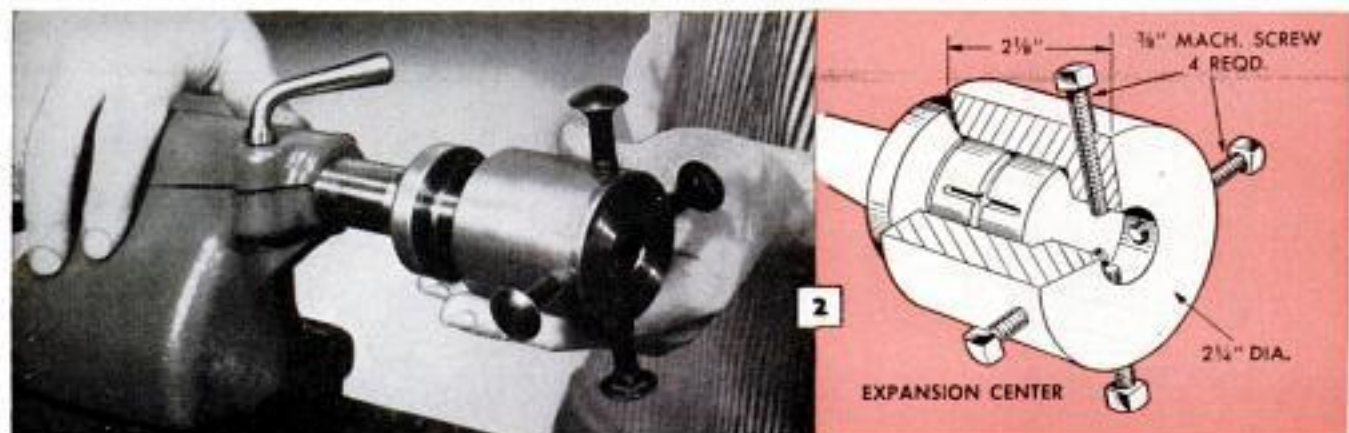

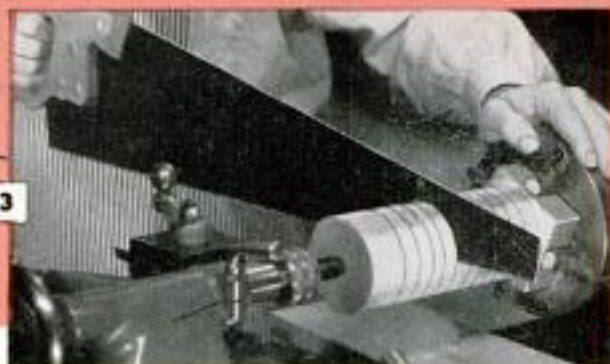
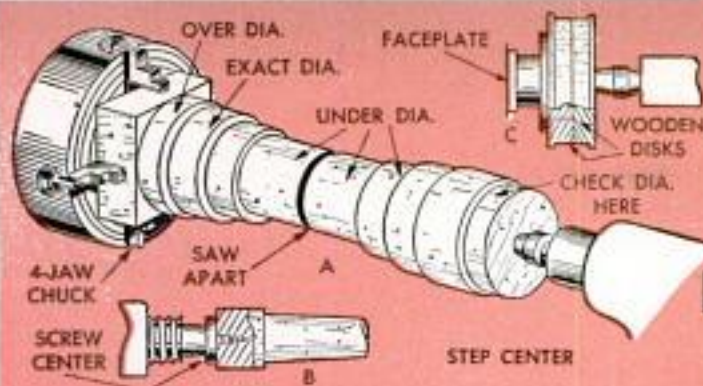

Above, hardwood turning is sawed apart to make two step centers. Below, tube mounted on step centers



lubricant. Smooth work on steel tubing will require a lubricant.

Turning: Perhaps the easiest of all methods of chucking a large tube for turning is to grip it internally with a 4-jaw chuck and then support the tailstock end with a pipe center, as shown in Fig. 1. The pipe center can be purchased ready-made or can be turned in the lathe. Pipe centers with plain bearings are suitable for average work. The center detailed has a plain bearing with oil grooves. It has a capacity of up to 3½-in. inside diameter of tubing. Another method of handling tubes over 3 in. in diameter is by means of an expansion center, Fig. 2, which works on the same shank as the pipe center. The expansion center is fitted over the shank, which is placed in the tailstock, and is then adjusted to the inside diameter of the work by turn-



Above, end of long tube is supported in steady rest. Below, improvised rest supports large-diameter tubing

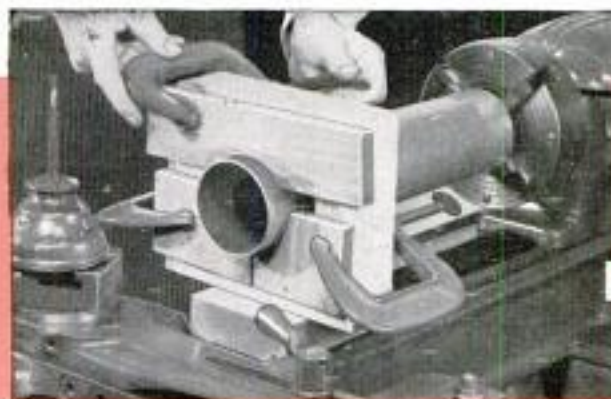

ing the four bolts or screws in or out as needed. Either carriage bolts or machine screws can be used.

The one disadvantage in using a pipe center is that the end of the work must be faced-off square to assure accurate centering. However, if the work is mounted on a cone center having a slow taper, reasonably accurate centering will be more or less automatic. A metal pipe center is sometimes made up with a slow taper to accommodate a limited range of work diameters. Often the required slow taper is worked on a length of hardwood to the requirements of the job at hand. For making wooden-plug chucks, or centers, B in Fig. 3, use maple or birch, either one of which will hold its shape and turn well at slow speed. Instead of cutting the plug chuck to a slow taper, it can be step cut, A in Fig. 3, to the exact work size on one step. By turning

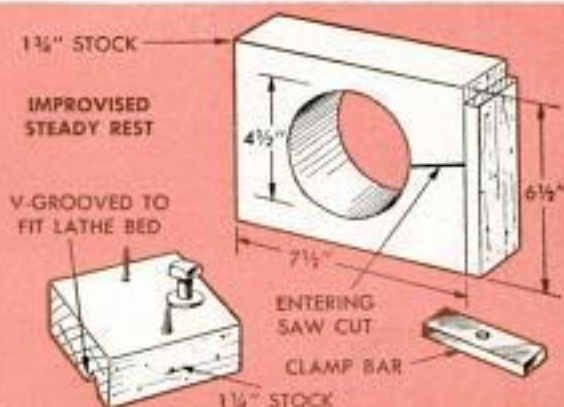

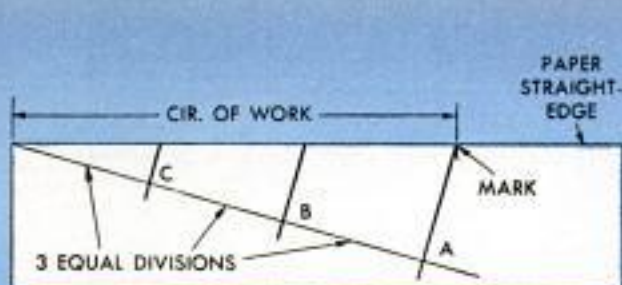

9

three steps on each piece the center can be used for three work diameters. After turning the chuck and before removing it from the 4-jaw chuck, it is sawed apart, Fig. 3, to provide a mounting for both ends of the tube. Fig. 4 shows a tube mounted on plug chucks made in this manner.

A standard piece of equipment for supporting the outboard end of a chucked piece of tubing is the lathe steady rest. On small lathes this will have a capacity of about 3 in. Both the steady-rest jaws and the work at the point of contact should be coated with lubricant to minimize scoring. If it is desired to completely eliminate scoring on a piece of smooth tubing, the simple trick of wrapping the work with gummed paper tape will give the needed protection. The tape should wrap around and slightly overlap, with the lap so made that the edge of the paper will not catch and tear as it passes under the steady-rest jaws. Coat the paper with polishing wax or paraffin and then apply light grease.

When centering work with the lathe steady rest, run the work at slow speed with the jaws set to clear. Then, with the work rotating, advance any one jaw of the rest until the tube appears to run true. Center with a stop, or a dial indicator if a high degree of accuracy is specified. Note in Fig. 5 that work longer than the lathe

can be handled by using the steady rest. Fig. 5 shows the headstock end being threaded, the mounting being a plug chuck on a screw center, B in Fig. 3. This type of chuck is often used for tubes under 2 in. in diameter. For very large work, two disks of wood, C in Fig. 3, are most practical. One disk is first turned to the required diameter and flanged slightly as detailed. The second disk is then placed against the first and supported by the cup center. This setup will give enough friction to hold the second disk in place and permit turning it to duplicate form.

A large steady rest is often useful. A simple improvised type is shown in Fig. 6. It is suitable for work up to 4¼ in. in diameter. Jaws for this rest are made up as required for each job. An example is pictured in the photo, Fig. 6, the special jaws being held in place with C-clamps.

Drilling: When holes are to be drilled in tubing it must be mounted in a vise or held securely by other means. A milling vise of the type pictured in Fig. 7 is useful as it allows the work to be moved directly under the drill bit. Holes should be accurately located and the locations center-punched before drilling. A simple method of locating a straight line around a tube is to use a single wrapping of paper, Figs. 8 and 9. The paper can be taped in place or used as a straight-edge for pencil marking, Fig. 8. The paper may also be used to determine hole spacing. Do this by first marking the circumference of the work. Then, for example, if the work is to have three holes, set off three equal spaces on any line drawn on the paper, Fig. 9. Connect point A with the circumference mark and then draw lines from B and C parallel with the line from A. This will divide the circumference into three equal spaces, and the marks can be transferred by wrapping the paper around the work.

In most cases it is not worthwhile to fit a backing behind a drilled hole to prevent burring. On most jobs, slight burring on the inside of the tube is not objectionable. Burring can be minimized by using a drill

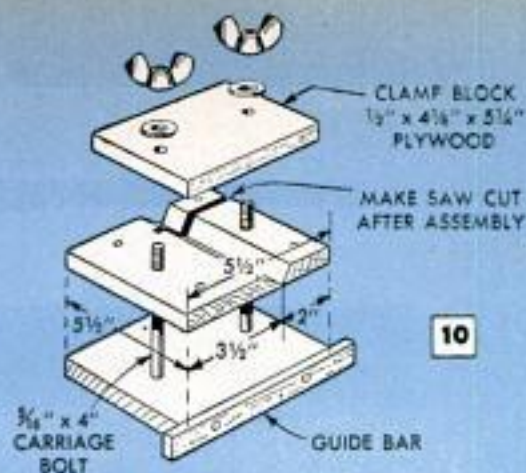

10

with a point angle of about 135 deg. instead of the usual 118 deg.

Sawing: Aluminum is easily cut on the bandsaw, using an ordinary woodcutting blade running at the speed normally used for wood. Of course, tubing also can be cut with a hacksaw if a bandsaw is not available. The tubing is very likely to slip and turn if you try to cut it freehand by either method. It is always best to use some kind of clamping device in order to get an accurate cut. One simple mounting is the drill-press vise, Fig. 11. A shop-made V-block, Figs. 10 and 12, will take tubing up to 2 in. in diameter. The use of a drill vise in an inverted position, Fig. 15, is often useful. Two other practical methods of holding tubing for bandsawing are pictured in Figs. 13 and 14, the hand screw providing both clamp and handle for moving the work to the blade. Note that the clamp detailed in Fig. 10 and shown in use in Fig. 12 has a guide bar which slides in the groove in the machine table. This device gives a very accurate cut. Brass and steel tubing also can be bandsawed, but the machine must be fitted with a reduction drive and special metal-cutting blades. Some small bandsaws are available with a built-in reduction gear which reduces the speed of the band wheels for metal cutting. Machines without this special drive can be driven at reduced speeds through an improvised countershaft. Always use a blade with the correct number of teeth. ★ ★ ★

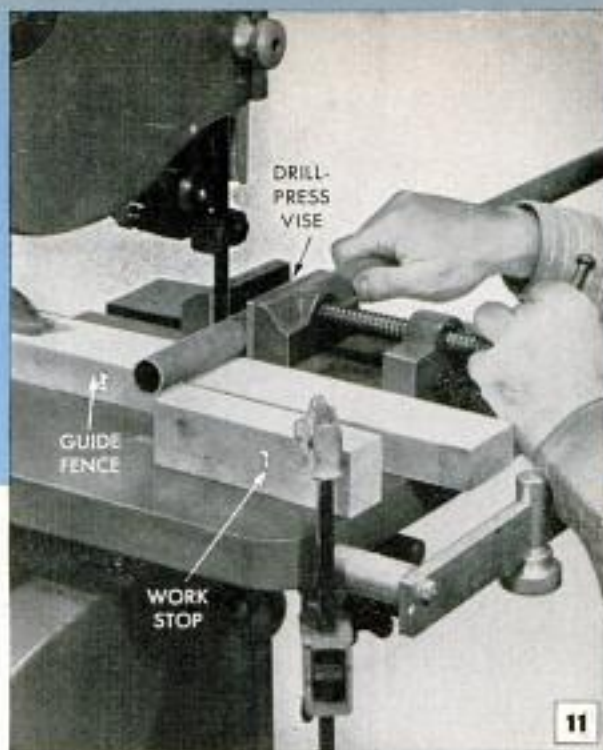

Drill-press vise holds tubing securely for cutting with bandsaw. Setup produces accurate, smooth cut

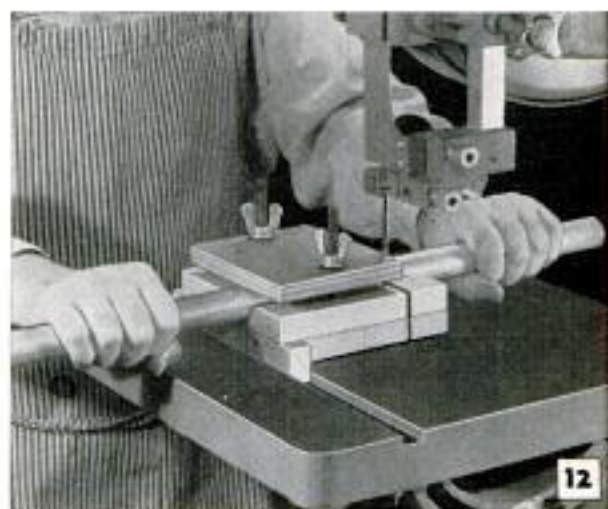

Above, work up to 2 in. in dia. can be held in this V-block with improvised clamp and a guide bar which rides in table groove. Below, three views picturing use of hand screw and drill-press vise as holders for tubing of large and small diameters. Fig. 13 shows handscrew used as clamp with sliding guide. Figs. 14 and 15 show hand screw and drill vise used freehand

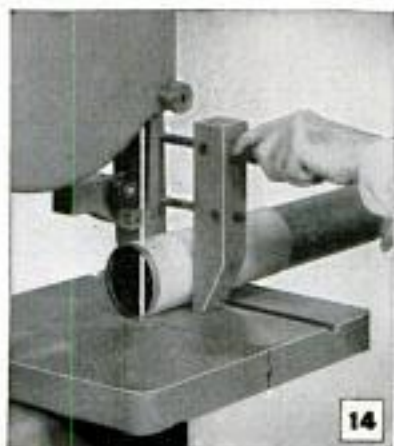

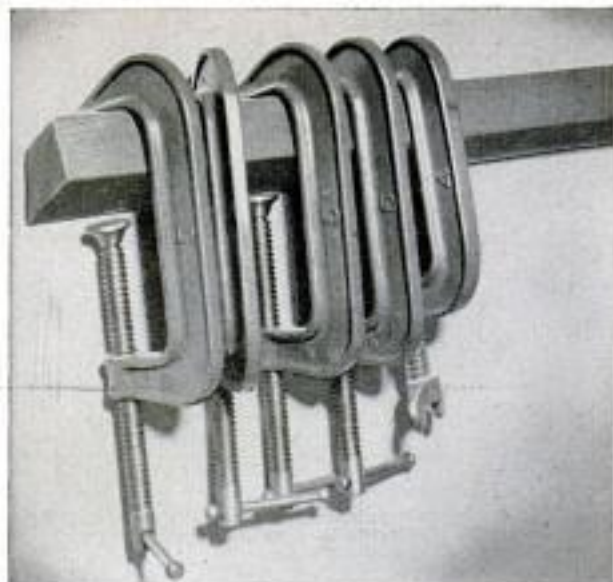

Simple Rack for C-Clamps

If you are tired of dragging several C-clamps hooked together out of a drawer, or unscrewing them from the edge of the bench top each time one is needed, try the simple rack shown. It consists of a length of 2 x 4, beveled on one edge so it tilts up slightly when screwed to a wall. The clamps are hooked over the 2 x 4 with the clamp screws down.

M. C. Anderson, San Lorenzo, Calif.

Altered Boxes Save Work, Time

Many of the stacked paper boxes on store shelves need not be lifted off to get at items in the lower ones if the box fronts are altered as shown. This applies particularly to boxes containing such items as envelopes and other thin, flat stock in boxes that have slipover covers of equal length. First, the end of the box is removed, then the lower half of the end of the cover is "hinged" with transparent tape to provide easy access.

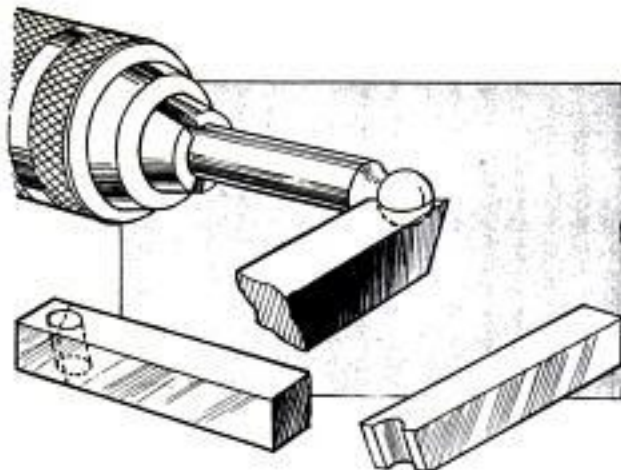
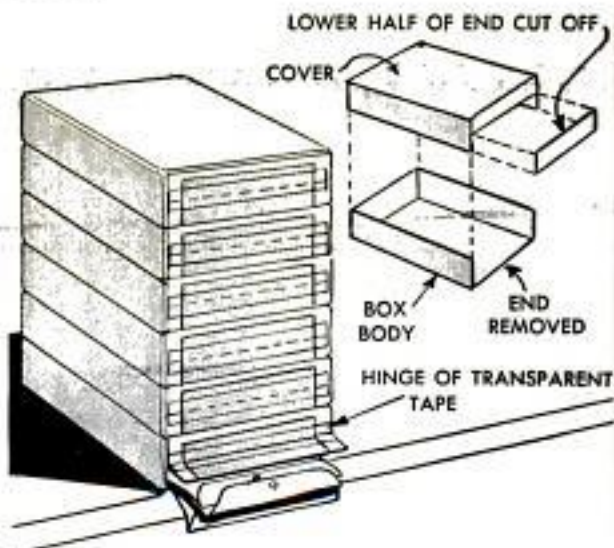

Simple Ball-Turning Tool Bit

The tool bit shown in the detail permits fast, accurate turning of small metal balls on a lathe without a special ball-turning attachment. To make the bit, use a blank turning bit or a piece of tool steel. Anneal it and at a slight angle drill a hole of the same diameter as the desired diameter of the ball through the bit near one end. Mark a diagonal line around the tool, bisecting the center of the hole at the top and bottom. Then grind away the end to this mark. The bit is then hardened and the ends honed to provide keen cutting edges.

C. W. Woodson, Chicago.

Wire Solder on Tape Spool Protected Against Dirt

Wire solder will stay dirt-free and grease-free whether carried in a toolbox or stored on a shelf in the workshop when it is rolled onto an empty adhesive-tape spool. Snapping the cover onto the spool as indicated will effectively seal the solder against dirt. The tape spool also is ideal for carrying small amounts of solder in a toolbox when the solder is removed from a large roll.



SN 59

TORCH CARRIER for flame cutting

THIS TORCH CARRIER, or burning machine, was developed to handle a special flame-cutting job, the specifications of which called for cutting heavy steel plate to a tolerance of plus $\frac{1}{16}$ in. The unit consists of a carriage sliding on $1\frac{3}{16}$ -in. rods in a manner similar to that of a lathe carriage. The carriage is advanced at a uniform speed by means of a lead screw, which is power-driven through a double-reduction, V-belt drive as detailed below. A vacuum-cleaner motor controlled by a rheostat supplies power. On the original machine a three-step sliding pulley was used on the lead screw. Matching four-step pulleys also can be used. Only a few general dimensions are given as the drive unit must be built to suit the job. Ordinarily, the machine is mounted on a large welding table so that the torch can be positioned for straight cuts. For cutting off heavy tubing as pictured at the right, the torch is held stationary and the work rotated.—Phillipo Vallini, Kenosha, Wis.

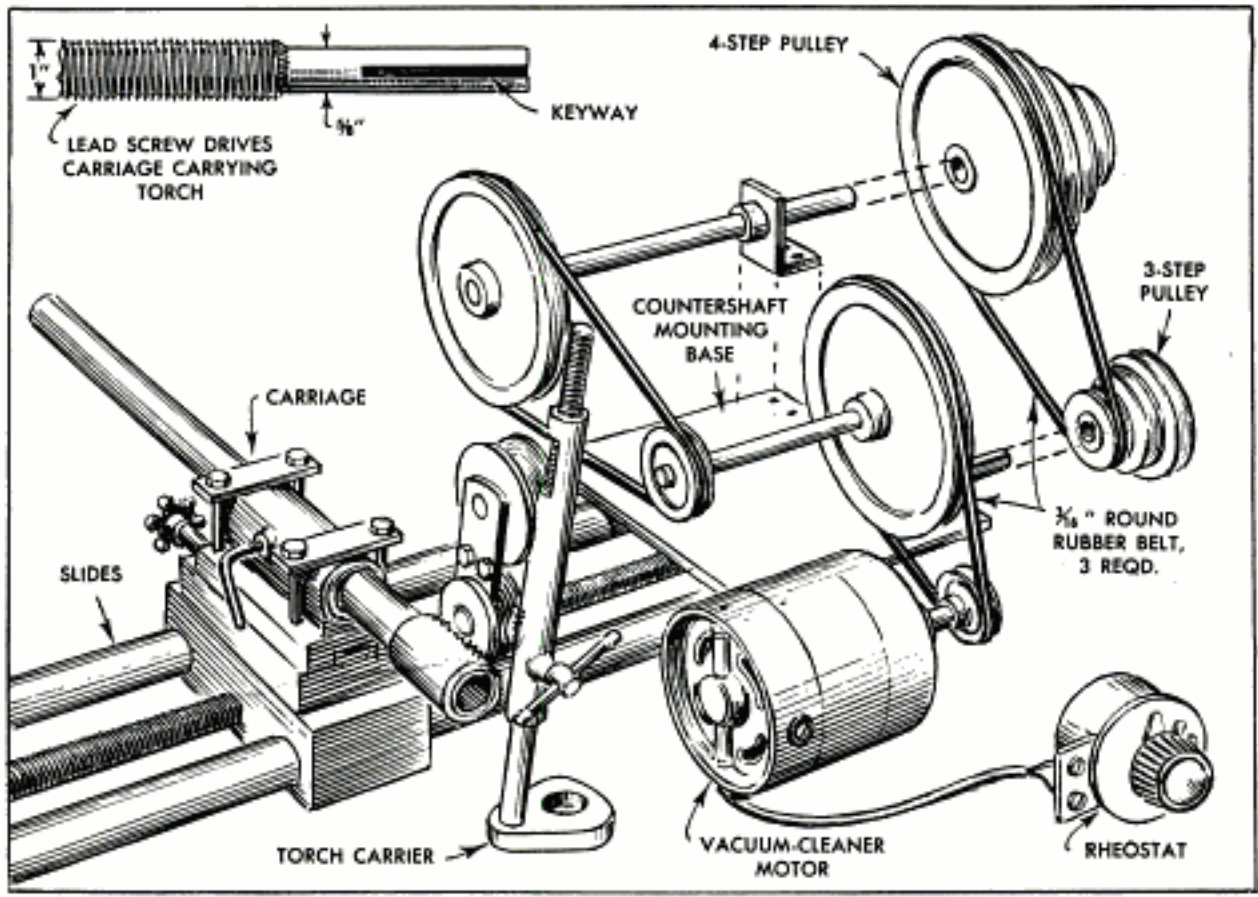

HOW WOULD

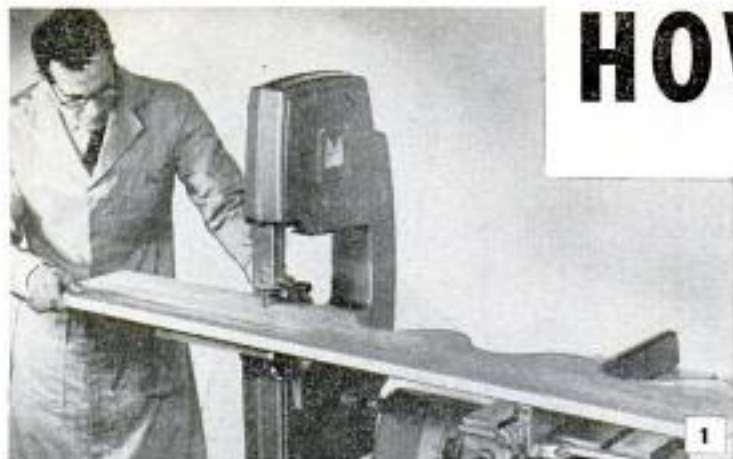

Q—When cutting long stock, what should be done to minimize blade breakage and assure accurate cutting on a bandsaw?

A—Provide an extra support for extremely long work. The support can be an extension of the saw table, a special, separate supporting table, a stand or sawhorse of the correct height. On some combination tools, such as shown, the saw table and rip fence can be combined to provide a low-friction supporting surface in a matter of moments

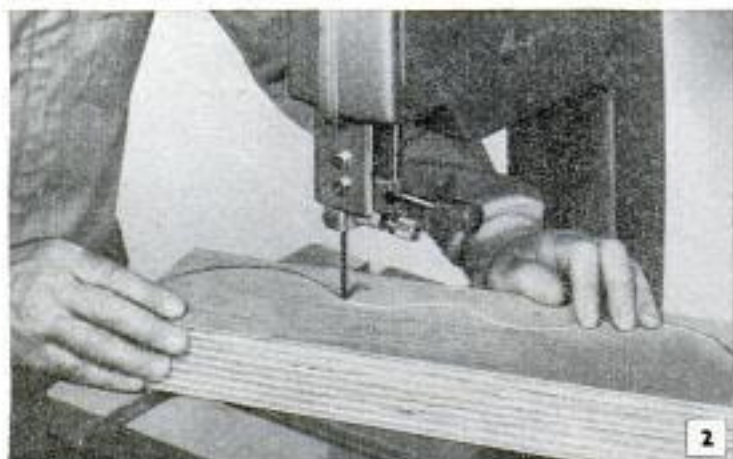

Q—What is "pad sawing" and how can it be a big timesaver when many duplicate pieces of stock are cut on a bandsaw?

A—"Pad sawing" simply means that a number of pieces of stock are made into a "pad" or stack that is held together by driving nails through the waste portions of the work. The pattern to be cut out on the saw is drawn on the top piece of stock and the cut is made as though the stack of wood were a single piece of material



Q—Cutting a small number of pieces of the same width in which there are reverse curves will require what bandsaw setup?

A—A pointed guide block is clamped to the table as shown in the photograph. After drawing the curve on the stock and making the first cut freehand, the guide block is clamped to the table directly opposite the center of saw blade so the space between the blade and the end of block is equal to the width of the workpiece to be cut

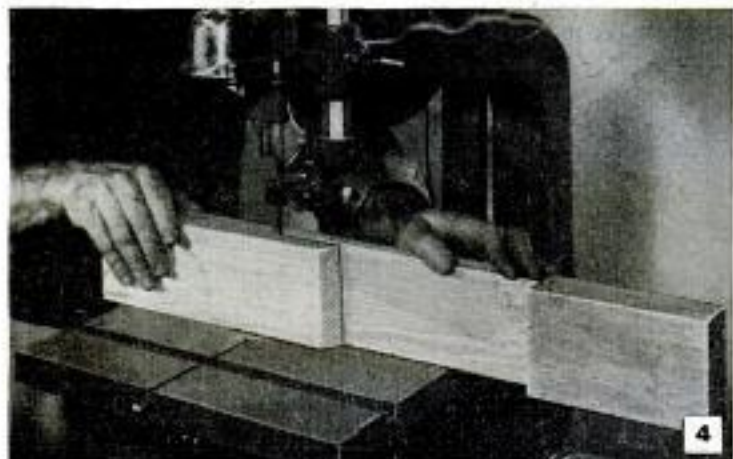

Q—Stock to be bent in a curve must be reduced in thickness on the area of the curve. How is this done on a bandsaw?

A—On one edge of the stock, mark section to be reduced in thickness, making its length about 1 in. more than the required length of the curve. Make one end cut first, then saw into the line and to the end cut. Reverse the workpiece and saw along the line to the opposite end of the scribed line as shown in the photo

YOU DO IT?

Q—You need a number of thin pieces of wood cut in a curved pattern for trim. How can they be cut from thicker stock?

A—Lay out the pattern on a piece of fairly thick stock and cut it out on the bandsaw. Next, turn the shaped stock on edge and rip it into thin sections as shown in the photograph, to produce pieces of trim of the desired thickness. Stock to be cut in this manner must be clear, straight-grained and free of large knots

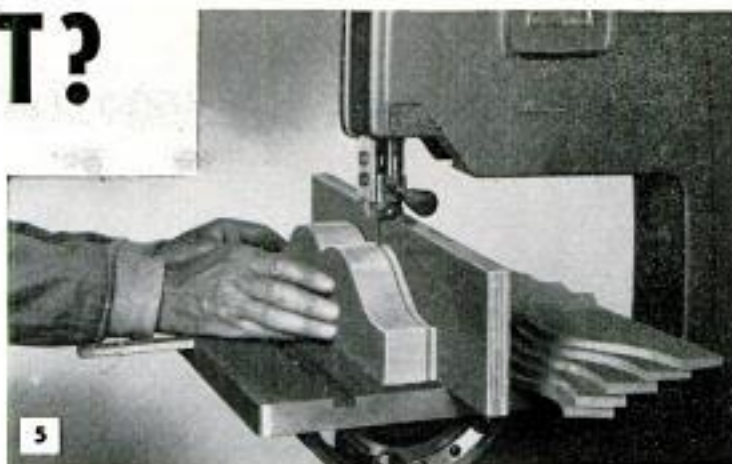

Q—What two rules should be followed when ripping thick stock on a bandsaw to produce accurately dimensioned thinner stock?

A—Because even the widest bandsaw blade is comparatively narrow, it is important that the work be held rigidly and at right angles to the saw table. Even if your saw has a rip fence, attach a wide auxiliary fence to it as shown in the photo. This will assure that the stock being ripped has support its full height and length

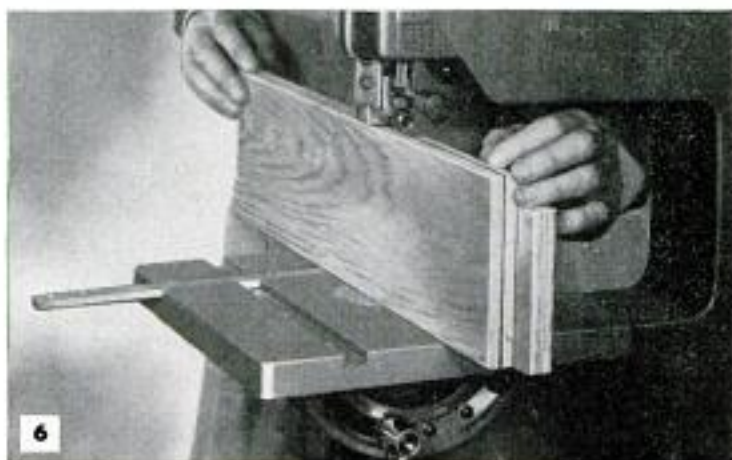

Q—In compound cutting, as when making a shaped part, why should the waste pieces be kept until bandsawing is completed?

A—Because the waste pieces can be replaced temporarily on the workpiece to permit easier handling while other cuts are made. To make pieces like the ones shown in the photo, make cuts on opposite sides first. Then tack or tape the waste pieces back onto the surfaces from which they have just been bandsawed

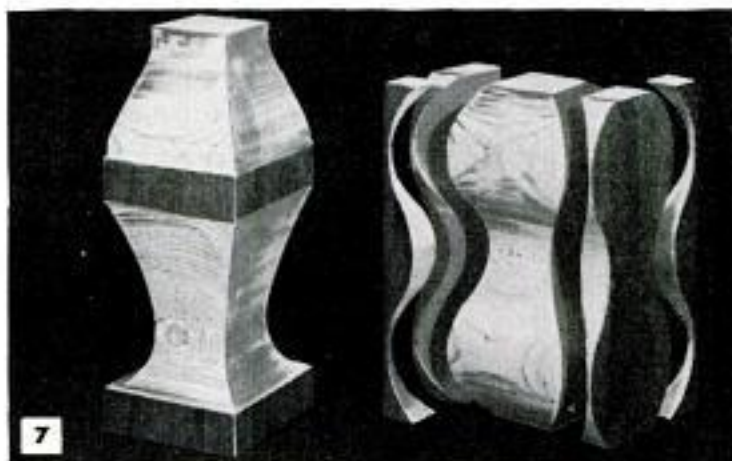

Q—When cutting pieces of stock to a simple curve and uniform width, what setup can be used on a bandsaw?

A—Place the rip fence on the table so the distance between it and the blade is the width of the stock to be cut. Then, cut the curve on one edge of the stock freehand. Place this edge against the rip fence and make the opposite cut by keeping the curve at a constant tangent to the rip fence to make a parallel cut



SHOPPING FOR TOOLS



1. BUILDER'S LEVEL works on the principle that water always seeks its own level. Consists of two transparent tubes with valves and clamps. One of the gauges is screwed to each end of a garden hose filled with water. Gauges are clamped to that part of structure to be level-checked as pictured. Lengths of hose can be coupled to give accurate level checks of 100 ft. or more

Level-Rite, Granby, Conn.

2. SETTING TOOL is made especially for expanding masonry anchors in bottomless holes, and also in walls where hammer blows may break or shatter masonry such as tile and cinder-block construction. In use, the anchor is attached to expandable holder and pressed into hole in masonry. Turning the handle sets the anchor tightly in the hole. Comes in a wide range of sizes

Arro Expansion Bolt Co., Marion, Ohio



3. BANDSAW AND BELT SANDER mounted on a single stand provide the small shop with an efficient combination tool that conserves space. Comes complete ready to set up and operate. Includes 10-in. bandsaw, 6-in. belt sander, 1/2-hp. motor, motor mount and floor stand. Tools located to permit full-capacity use without interference. Mount designed for easy belt change

Power Tools, Inc., Beloit, Wis.

4. BUILDER'S SQUARE has body 48 in. long and tongue 16 in. in length. Made especially for work on wallboards of all kinds, also plywood panels 48 in. in width. Tongue is graduated through 8 in. of its length and outer end is provided with a lip which prevents the tongue from dropping below the edge of stack when laying off dimensions across width or along length

Fairgate Rule Co., Cold Spring, N. Y.



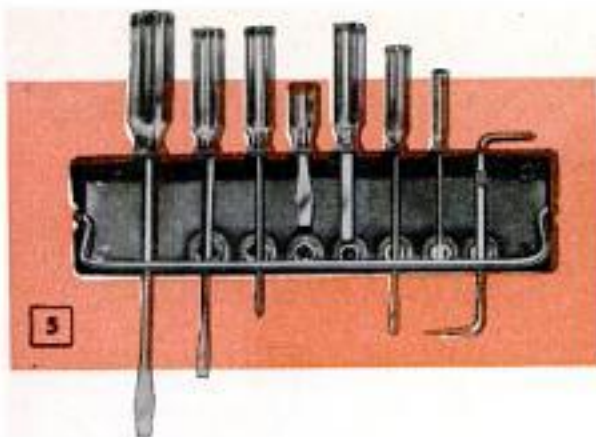

5. SERVICE KIT is a 16-piece screwdriver and socket set packed in a metal tote tray which also serves as a wall rack. Set contains seven screwdrivers in assorted sizes, seven sockets, one socket-drive handle and metal tray. Drivers have plastic handles

Falber Sales Co., 1842 Merilbrook Rd., Philadelphia 31, Pa.

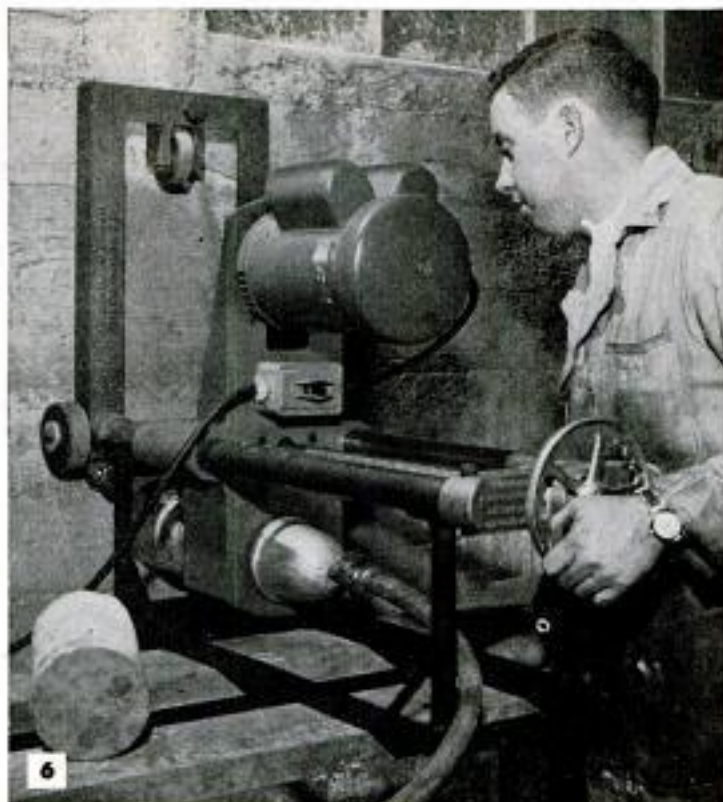

6. MASONRY DRILL is power-driven, cores a hole through reinforced concrete at an average rate of 1 in. per min. Can be positioned for vertical operation as pictured, or for operation on floors. Maintains a constant cutting speed in either position

General Electric Co., Schenectady 5, N. Y.

7. SPECIAL CHUCK holds drills and reamers with broken shanks. Chuck features a driving plate designed to fit over the flutes of the drill and hold it in correct axial alignment when chuck is tightened. Three-jaw collet grips the drill body uniformly

Paul H. Moynihan & Co., 4206 N. Wilson Dr., Milwaukee 11, Wis.



8. SCREWDRIVER has wire stripper in plastic handle. Strips insulation from solid or stranded wires, 14 to 20 ga. inclusive, without tearing insulation at point of cut or scoring the wire. Driver blade is nickel-plated. Comes in 4, 5 and 6-in. lengths

Wire Stripper Tools, Inc., Glen Head, N. Y.

9. LAWN-MOWER SHARPENER handles both reel and rotary-type mowers. Fast, accurate adjustments for positioning mower, hollow or flat grinding of bed knife and for horizontal and vertical feed of grinding carriage. For hand and power mowers

The Fate-Root-Heath Co., Plymouth, Ohio

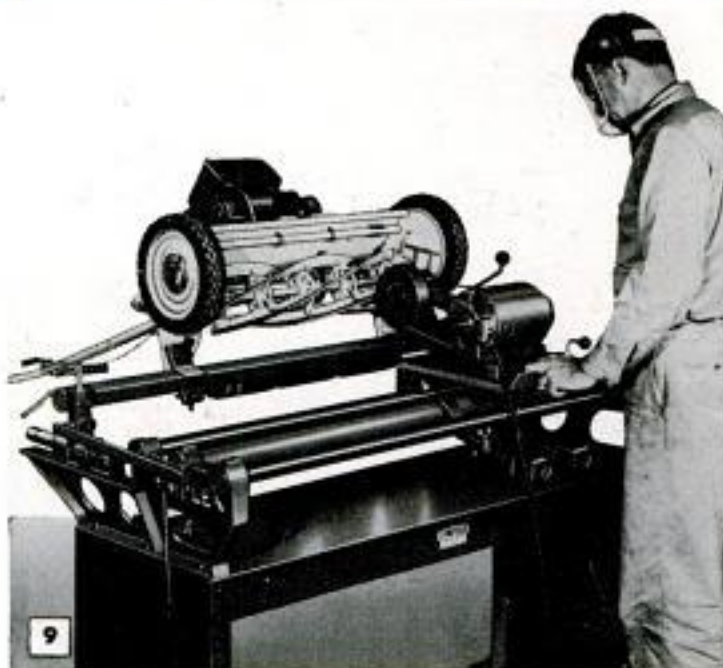
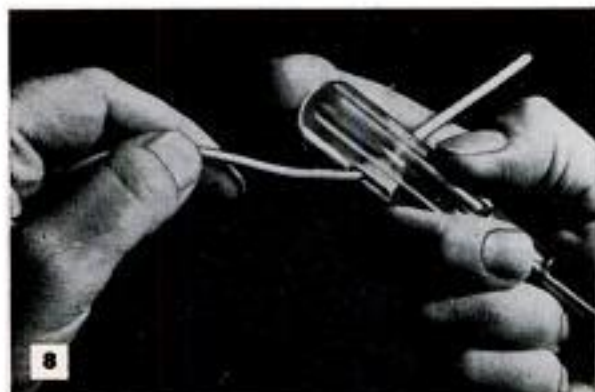

On the MARKET

for Do-It-Yourselfers



1

1. ALUMINUM SLIDES modernize and beautify old windows. To install, remove the wooden stops, cords and weights. When removing the stops, care must be taken not to splinter the sides of the grooves in which they are installed. Then insert metal strips according to instructions furnished with the kit. Due to tension which holds strips in place, they also act as weather stripping. Wimsal Mfg. Co., 727 Allegheny Ave., Oakmont, Pa.



2. TWO-COLOR DRAWER PULLS combine velvety black and colors with polished brass, bronze or copper. Come in choice of two sizes of conical knobs and two sizes of rectangular pulls as pictured. The parts are interchangeable, making a range of color combinations possible. Round pulls can be used either as doorknobs or drawer pulls in colors to match counter surfaces. Washington Steel Products, Inc., Tacoma 2, Wash.

3. LOCK GUARD attached to the strike plate of a door lock prevents forcing of the striker with a strip of metal or a hacksaw blade. Is installed simply by loosening the striker plate with a screwdriver and then sliding the guard into place. Requires no alteration of the lock or striker plate. Will not cause the door to bind. Available in 3/32, 1/8 and 5/32-in. sizes. Cellulock Corp., 299 Madison Ave., New York City 17

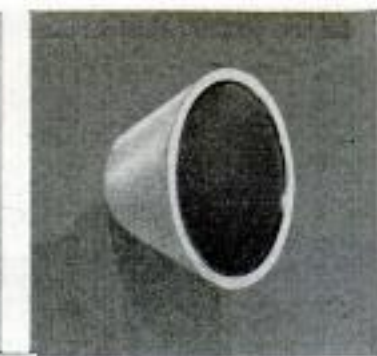

2

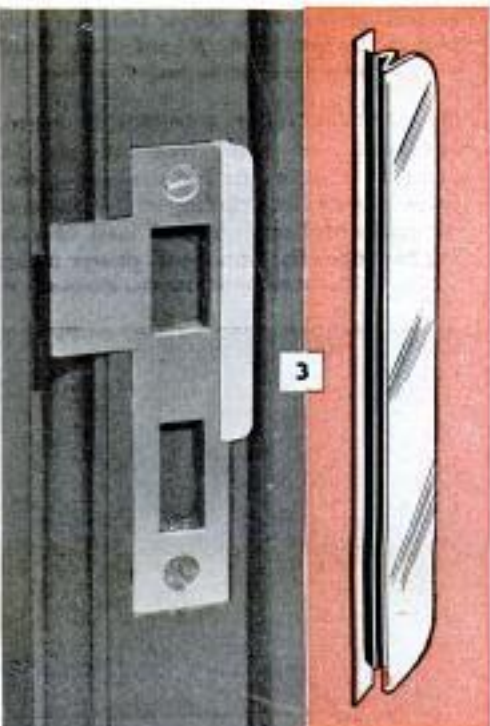
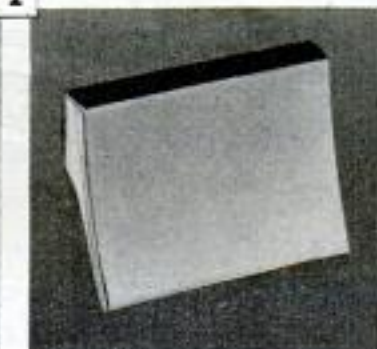
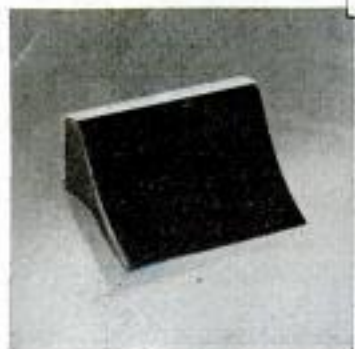

3

4. ALUMINUM INSULATION is said to reflect up to 95 percent of radiant heat that reaches its surface. Keeps homes warmer in winter and cooler in summer. Comes in easily handled rolls 36 in. wide, each roll covering an area of 250 sq. ft. Installed with a staple gun or with a hammer and ordinary tacks or screen staples. Foil is bonded to two sides of heavy paper

Reynolds Metals Co., 2500 N. Third St.,
Louisville, Ky.

5. SPECIAL PAINT-CAN LID is fitted with a tubular holder designed to support the brush upright in the can when the lid is pressed down into the closed position. Eliminates the time and bother of cleaning the brush at the end of the day, a feature that will be fully appreciated by do-it-yourself painters and decorators. Also prevents film forming over paint in can

R. S. Hansbury, 300 Marshall Ave.,
Collingdale, Pa.

6. WEATHERPROOF COATING can be used inside or out for added protection for exposed surfaces such as window sills, porch columns and exterior doors. Applied over a glass fabric it seals cracks in plaster, woodwork and masonry, gutters and flashings. Can be colored and used as a primer for paint or as a finish coat on walls. Can be applied with gun or applicator

Tuff-Kote Co., Woodstock, Ill.

7. FOLDING UTILITY TABLE also can serve as a sturdy workbench. Top is 1½ in. thick, 24 in. wide and 60 in. long. It is supported on folding brackets of steel finished in baked enamel. Brackets lock automatically when table is raised to horizontal position. Folding feature aids in solving space problems in laundry and utility rooms, kitchens and garage workshops

Sturdy-Bilt Steel Products, Inc.,
2501 W. Peterson, Chicago 45



4



5



6

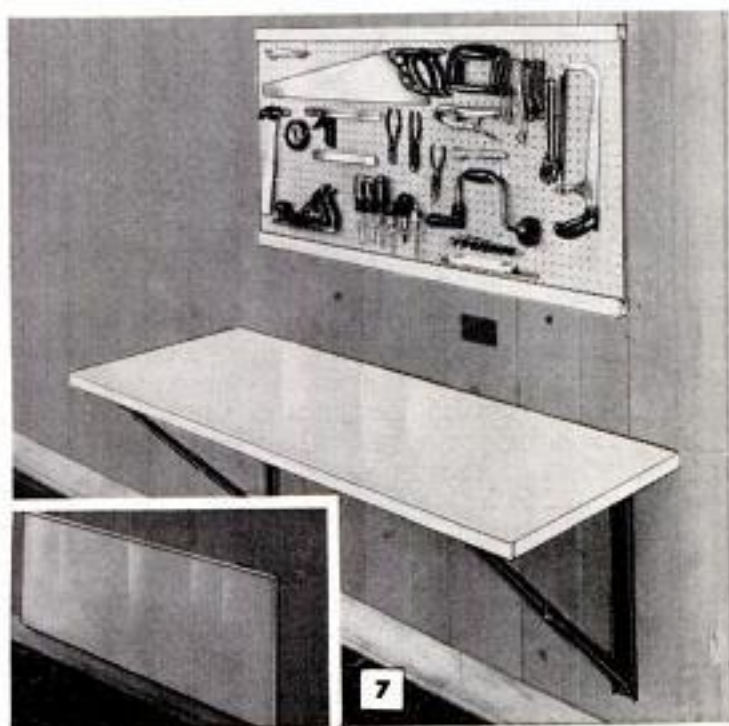

7

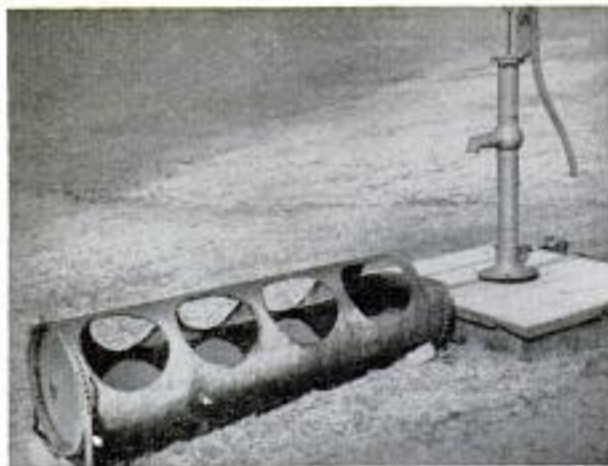

Hot-Water Tank Converted To Stock-Watering Trough

A discarded hot-water-heater tank with four holes cut on one side and three staggered on the opposite side allows hogs or sheep to drink without crowding or getting into the water. A cutting and welding torch is the only tool required to cut the holes and weld the tank to its base.

Egg-Eating Hens Discouraged By Linoleum Swinging Doors

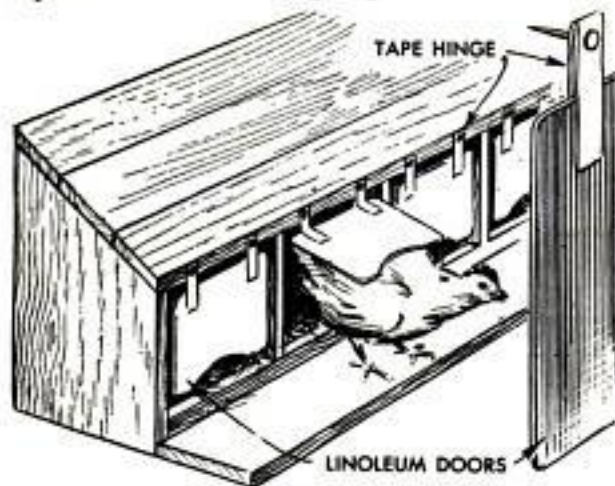

When the problem of hens eating their eggs must be eliminated by attaching swinging doors to darken the nests, linoleum doors hinged with friction tape will do the job. Cut the doors to the shape shown and fold the tape so it adheres to both sides. Tack the free ends of the tape hinges to the upper edge of the nest opening. Leather or canvas also could be used as hinges. The latter materials would require riveting to the linoleum doors.

When selecting a paint color remember that the sample should be a little lighter than the finish desired since paint dries darker, and the larger the wall surface to be covered, the darker it will appear.

Grain Hopper Set on Legs Dispenses Ground Feeds

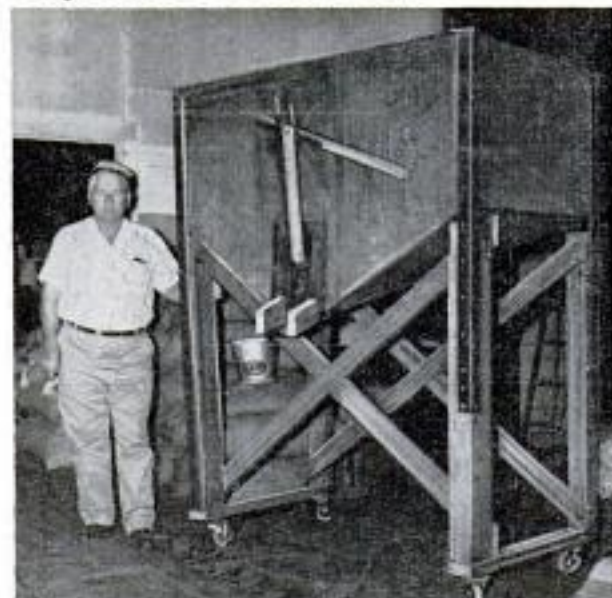

The grain hopper from an old combine was salvaged by a feed dealer and mounted on legs with casters for use in dispensing ground feeds in small quantities. The legs, made from 4 x 4-in. stock, are fastened to the hopper with angle iron at the corners and steadied with diagonal braces of 2 x 4-in. lumber. Bed rails for the casters are also made from lengths of 2 x 4s. A vertical sliding door on the side of the hopper, operated by a lever, controls the flow of feed.

C. F. Marley, Nokomis, Ill.

Old Iron Wagon-Wheel Rims Support Farmyard Feed Rack

Iron-wheel rims from old wagons and farm implements were used by one farmer to support feed troughs at the proper height. Two wheels cut in half with the spokes removed furnish the four supports necessary for one trough. Flat-steel cleats are welded to the cut ends of each rim and drilled to accommodate bolts which fasten them to the bottom of the trough. Serving as runners, the rims permit skidding the trough to a new location when necessary.





FORD

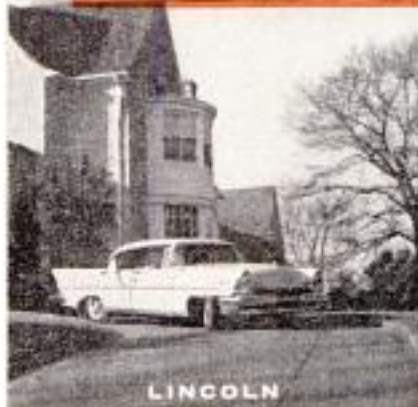

LINCOLN



CONTINENTAL



MERCURY



THUNDERBIRD

Some spark plugs are designed for high speeds, some spark plugs are designed for low speeds, but . . .

AUTO-LITE **POWER TIP** "fires up" Ford Motor Company cars at all speeds!

The first spark plug ignition-engineered
for today's engines* and today's driving

Today's higher-horsepower, higher-compression engines and today's driving demand *more* from spark plugs, and Power Tip *gives* more! Performance tests prove Power Tip "fires up" engines of Ford Motor Company cars for top performance and economy at *all speeds!* Here's why...

At *low* speeds, the projecting Power Tip gets hot *fast*, operates hotter to burn away fouling deposits which impair engine performance in city driving. At *high* speeds, the Power Tip is actually cooled by the richer air-fuel mixture to check dangerous pre-ignition caused by over-heated spark plugs.

Ask your dealer to install a set of Auto-Lite Resistor Spark Plugs with Power Tip in your car *today!*

*Power Tip is ignition-engineered for overhead-valve V-8's and for most overhead-valve 6's in all these cars: Buick, Cadillac, Chevrolet, Chrysler, De Soto, Dodge, Ford, Hudson, Imperial, Lincoln, Mercury, Nash, Oldsmobile, Packard, Plymouth, Pontiac, Rambler, Studebaker.

THE PROTRUDING TIP
MAKES THE
BIG DIFFERENCE!



Ordinary Tip Power Tip

AUTO-LITE® RESISTOR SPARK PLUG WITH **POWER TIP**

Auto-Lite makes a complete line of spark plugs, including Standard, Resistor, Small-Engine, Transport, Aircraft, and Diesel-Starting.

New!

Kodak



ACTUAL SIZE
AVAILABLE IN TWO
TYPES TO FIT MOST
FLASH-SYNCHRONIZED
CAMERAS
\$9.95-\$11.95
(AS LITTLE AS \$1 DOWN)

F-A-S-T MAGAZINE LOADING WITH
CARRIER DISCS THAT HOLD
6 FLASHBULBS EACH

Rotary Flashholder

permits 6 flash shots without reloading!

Ever miss a prize flash shot because you were changing bulbs when the action took place? Not much chance of that happening when you own a new Kodak Rotary Flashholder! It holds six M2 bulbs per loading, changes bulbs instantly by revolving the magazine turret, ejects all spent bulbs simultaneously . . . and can be completely reloaded in split seconds!

Ask your photo dealer to demonstrate the

Kodak Rotary Flashholder. You'll like the simplified exposure calculator which tells at a glance which lens opening to use. And with its B-C (battery condenser) power, you'll get top flash dependability. Available in two models to fit most synchronized-shutter cameras. Complete with a Midget B-C Flashpack, flashbulb carrier discs. (Batteries extra.) List prices only \$9.95 and \$11.95 . . . or as little as \$1 down.

HERE'S HOW THE KODAK ROTARY FLASHHOLDER WORKS...



FAST, EASY LOADING. Six M2 flashbulbs are slipped into each of the two carrier discs that come with the Kodak Rotary Flashholder.



LOADED DISC OF BULBS is placed in magazine on the back of the flashholder. Bulbs are changed by simply rotating the magazine turret.



DIAL WINDOW on flash exposure calculator frames name of film in use — provides direct reading of correct exposures to be used.



BATTERY COMPARTMENT easily accessible. Rotary Flashholder operates on either B-C or penlight battery power. Midget B-C Flashpack provided.



TYPE I KODAK ROTARY FLASHHOLDERS attach directly to the bodies of cameras provided with the Kodalite-type of built-in contacts. Type II Kodak Rotary Flashholders fit cameras with an accessory shoe, or those that require a bracket mount. Bracket, cord, and connectors supplied.

(Prices are list and are subject to change without notice)

EASTMAN KODAK COMPANY, Rochester 4, N.Y.

Kodak
TRADE MARK



Snappy Performance!

Sealed Power

KromeX Piston Ring Sets

Snappy! This describes your engine's performance when you re-ring with Sealed Power KromeX Piston Ring Sets. New car zip has been built back in.

Designed for your car

Sealed Power manufactures piston rings specifically designed for every American make of car.

Save Oil

A KromeX ring job saves you oil money *immediately*, also pays off in longer piston and cylinder life. Install a Sealed Power KromeX Ring Set and you will prove to yourself that no finer piston rings can be had.



From us to you. An illustrated manual on engine care—free, yours for the asking. "Care and Feeding of Engines" is highly informative, could save you a lot of maintenance expense. For your free copy, write Sealed Power, Dept. G-6, Muskegon, Mich.

Sealed Power

PISTON RINGS

BEST IN NEW CARS! • BEST IN OLD CARS!

Clinic for Homemakers



As a service to our readers in solving the hundreds of problems pertaining to a home—inside or out—the editors of *Popular Mechanics* invite you to present your problems to The Clinic Editor for help and advice. Address your questions to The Clinic Editor, *Popular Mechanics Magazine*, 200 East Ontario Street, Chicago 11, Ill.



Water in Basement

Q—During exceptionally heavy rains water comes into my basement through the floor drains. Several times it has reached a depth of 2 in. or more, even at the highest points of the floor. My neighbor says he thinks this water comes from the downspouts which empty into tiles at the corners of the house. Is this possible? If so, how do I correct it?
R. A., Mo.

A—It's possible your neighbor is right. We're guessing, of course, without knowing the layout and direction of the drain, or drains, from the downspouts. Assuming that these lead to a common drain, which in turn leads to the storm sewer, it is possible that the common drain has become partially clogged, either with debris or by tree roots. If this assumption is correct and the common drain is clogged to the point where it will not take the full flow from the gutters, then the excess water will back into the basement through the floor drains. Assuming that this deduction is correct, then the thing to do is have the drain rodded to clear the obstruction. However, another and more common cause of basement flooding should not be overlooked. That is the possibility that water may be backing from an overloaded or partially clogged storm sewer directly into the basement through the floor drains. In this case it may be necessary to install a sump pump or "standpipes" of the type which screw into special threaded fittings installed in the floor drains. Also it's a good idea to notify your street department. Cleaning the sewer may remedy the trouble.

Buckling Roof Shingles

Q—My home is less than a year old and already the roof shingles are buckled in places on both sides of the ridge. What has caused this and what should I do to correct it?—B. S., Chicago.

A—Usually, shrinkage of the roof boards is the reason shingles buckle as you describe. Either the roof boards were wet by rain before the shingles were applied, or the lumber already contained too much moisture. In either case, as the boards dry they shrink in sectional size and any course of shingles nailed to one board will buckle as shrinkage of the board lessens the distance between the nails. It also should be noted that buckling can

(Continued to page 210)

ROCKWELL-BUILT

DELTA "900" radial saw

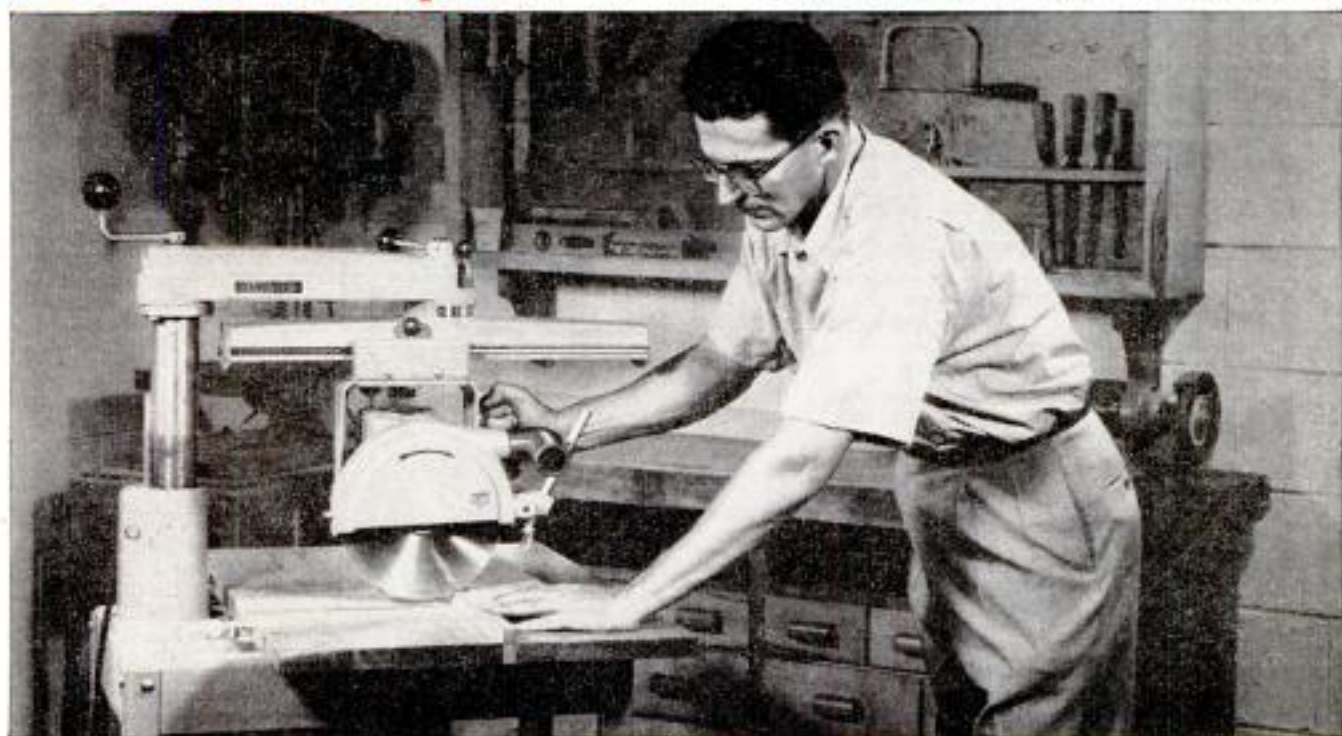

.. "industrial saw" power, home workshop price

The Delta "900" is the most powerful 9" home workshop radial saw ever built. And it's the most useful all-purpose radial saw ever made for use outside of industry. Here's why:

TRUE 3/4 H.P. MOTOR—Actually exceeds NEMA power specifications. Guaranteed for one full year! You make heavy cuts faster, easier—and the motor runs cooler.

EXCLUSIVE "TURRET ARM" ACTION—Swing, spin and tilt the head with Delta's double overarm construction. You get full blade travel and full table capacity at any angle, including left hand miters.

EXTREME VERSATILITY—It does almost every workshop job you want to do—rip, drill,

rout, sand, grind, shape, cut mouldings and many others. Saves you the cost of extra, specialized tools in your workshop.

SELECT EDGE GRAIN FIR TABLE—Only the finest grade prime wood is used to guarantee freedom from warpage and distortion.

TAKE UP TO 24 MONTHS TO PAY on terms to suit you! The Delta Budget Plan offers easy terms—as little as 10% down—and you can start enjoying Delta tools right away.

GET ALL THE FACTS ABOUT THE DELTA "900" RADIAL SAW—Compare—then make up your own mind. Your Delta Dealer is listed under "TOOLS" in the Yellow Pages of your phone book.

Send Coupon for all the facts



another product by
ROCKWELL



Delta Power Tool Division
Rockwell Manufacturing Co.
502F N. Lexington Ave., Pittsburgh 8, Pa.

- Please send me complete information on the Delta "900" Radial Saw.
 Please send me names of Delta Dealers near me.

Name _____

Address _____

City _____ County _____ State _____

Aluminum Living

is maintenance-FREE

with
nichols
NEVER-STAIN



ALUMINUM trellis

to accent the Beauty of your Flowers

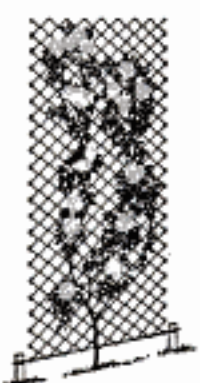

- RUSTPROOF — lasts indefinitely
- Never requires painting — maintenance-free
- Attractive "LUSTRE-BRITE" silver-like finish accents beauty of flowers and vines
- Reflects sun's heat and provides numerous surfaces for vines to grip
- Easy to put up — complete instructions in each package
- Ideal for interior treatments such as room dividers, etc.
- Available in 10 ft. and 25 ft. packages complete with hardware. Look for the red-white-blue displays at your favorite store.



ALUMINUM grass stop

for the neatest lawn in your neighborhood



- RUSTPROOF—lasts for years and years
- NEW "safety edge" makes installation easy — no sharp edges. No joints or clips.
- Ideal for use around trees, shrubs, sidewalks and driveways
- Substantially reduces tedious lawn work
- Won't interfere with mowing
- Available in 40 ft. coils in 4" and 8" girth



ALUMINUM clothesline



- RUSTPROOF — lasts indefinitely
- Once up — always up, summer and winter
- Will not rot, rust, chip or crack
- Solid or stranded in 50 ft. and 100 ft. coils

nichols WIRE & ALUMINUM COMPANY
DAVENPORT, IOWA

RECOMMENDED BY A LEADER OF OPINION
Guaranteed by Good Housekeeping
AS SHOWN AT ADVERTISED PRICES

(Continued from page 208)

be caused by the swelling of the roof boards due to absorption of excess moisture in the attic. If this is the case, buckling will occur where the shingle course happens to be nailed to adjacent boards, one of which may be of high resin content and, therefore, less absorptive than the other. One board swells (expands) and this has the effect of shortening the distance between the nails. Usually buckling caused by shrinkage of roof boards will correct itself if excessive moisture is eliminated from the attic by adequate ventilation. However, when buckling is caused by shrinkage of the roof boards, it can be corrected only by carefully removing the nails holding the buckled shingles, flattening the shingles and then re-nailing. After re-nailing in this manner, the old nail holes in the shingles should be filled with asphalt roofing cement to prevent leakage.



Relocating Trim

Q—The walls in my home are in bad condition, the plaster having deteriorated to the point where it will be necessary to cover walls and ceilings with plasterboard. The trim is old style and I'm wondering what to do about it, that is, how does one relocate it to compensate for the added thickness of the plasterboard?—O.R., Nebr.

A—Perhaps you have thought of removing the old plaster. We hesitate to recommend this procedure as a first step. It's a tedious, disagreeable task, but in some cases it may be advisable to assure a permanent job. Removing the plaster saves a lot of extra work in relocating the wiring, outlets and the trim. If you decide not to remove the plaster you have two or three choices of procedure. You can remove the trim and nail 1/2-in. filler strips to the door and window casings. These strips should be about three fourths the width of the trim piece so that when the latter is reinstalled it will cover the edge of the plasterboard. Another method is to remove the trim entirely and install a metal molding, or edging, especially made to finish off edges of the plasterboard at openings. In some cases old types of trim have square edges and the pieces are thick enough to permit rabbeting the edges to take the plasterboard. Of course, this job requires power equipment.



Restyling Exterior

Q—I have a postwar brick home, square, two-story with hip roof. "Modified Georgian" I suppose it's called. The door opens onto a concrete stoop and there's a picture window. It's livable but unattractive. Can you suggest improvements? E. D., N. Y.

A—If, as you say, the house affords a livable interior plan, then we would not make any major changes in the structure. Your local architect or builder is in a much better position to advise than are we at such long range. All that we can offer are suggestions for your consideration. We would think about adding a porch, extending perhaps across the front but lacking a foot or so of being the full width of the structure. This could be built with concrete floor over a suitable fill, the roof being supported on corner columns of ornamental iron. We also would consider adding a screened porch at the back, or an open porch if desired, with access from the service door or the kitchen.

GM GENERAL MOTORS GUIDE

goes one step further to give you
the big difference in headlamps

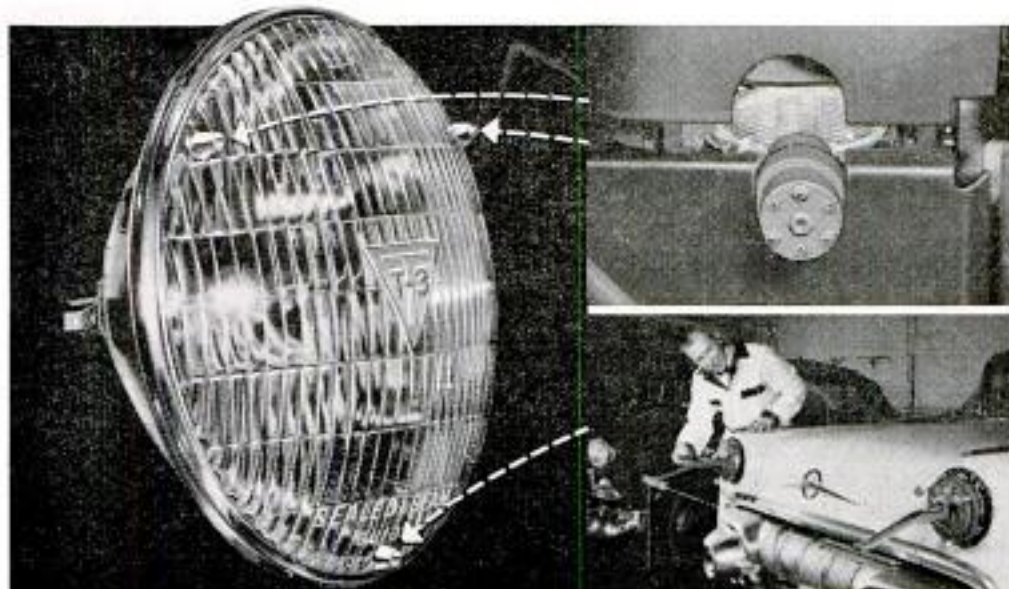

In this Guide-developed machine each Guide T-3 Headlamp completes its assembly as follows. The light is turned on and when the exact beam center is automatically located, the machine electronically computes, memorizes and performs the necessary degree of "Guide Point" grinding to establish a perfect plane for Safety-Aiming.

Here, with only an ordinary screw driver, Guide T-3 Headlamps are being accurately aimed with T-3 Safety-Aimers that fit over the accurately placed and ground "Guide Points". This can be done in a few minutes in broad daylight —insures your really getting all the benefits built into these new Guide T-3 Headlamps.

*Exclusive electronically controlled process
is secret of Guide's extra aiming accuracy!*

Now, your car can have 20/20 vision for nighttime driving. With new Guide T-3 Safety-Aim Headlamps you get more light aimed right . . . on the right side of the highway, where you need it most!

A Guide-developed process permits Guide to gem-grind three precisely located aiming points on the lens of every headlamp. These "Guide Points" are accurate within one ten-thousandth of an inch—providing the most accurate aiming plane in the industry.

You get safer, more relaxed, pleasanter motoring every night you drive with Guide! It's a proven fact that nighttime driving is the most tiring and dangerous. So, give yourself and fellow motorists all the benefits of more light aimed right from a new pair of Guide T-3 Safety-Aim Headlamps. Your nearby AC dealers can install and aim them in a matter of minutes, day or night.

Relax . . . go Guide . . . tonight!

AC SPARK PLUG  THE ELECTRONICS DIVISION OF GENERAL MOTORS

GUIDE

T-3

Safety-Aim

HEADLAMPS

BUY IN PAIRS
WHERE YOU SEE



Don't call
a doctor...



This rule has loose joints . . . they're weak and worn. It's ready to fold up forever. Don't call a doctor. Get a new one. This time, be precise . . . say Stanley, it's a good rule.

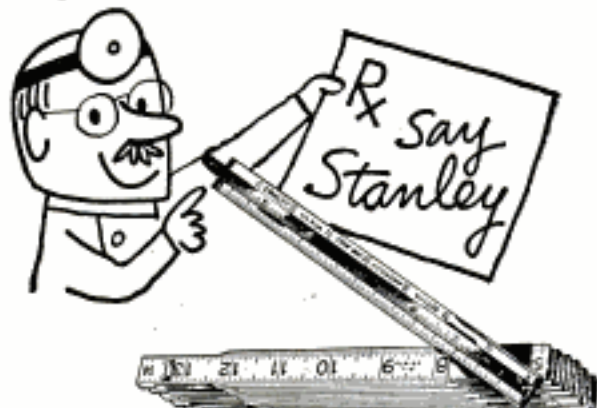

Take this new Stanley "100 PLUS" No. X226 6 ft. Extension Rule for example. No comparable rule lasts longer. It never gets "rule arthritis." Its joints have been permanently lubricated. They're young and springy. They can take it. The black, deep-cut markings with their protective plastic finish wear four times longer than those on thin-skinned rules that may suffer from "tired ink." Buy No. X226, and make a note of how long it measures up for you. You'll agree that Stanley Rules are your best buy.

Have you seen the new Stanley Glide-O-Matic? This smooth acting tape rule locks blade in place, marks work with metal scribes and retracts automatically. The best in tape rules. 8, 10 and 12 ft. lengths. Try one yourself and see.

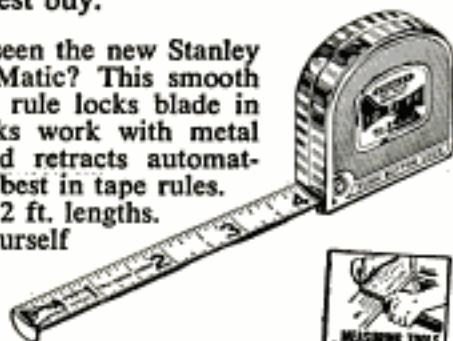

For free booklet "Measuring Tools and How To Use Them" write Stanley Tools, Division of The Stanley Works, 626 Elm Street, New Britain, Conn.



STANLEY

The Tool Box of the World

New Horizons in Electronics

(Continued from page 141)

absence of any moving mass other than air contributes to its phenomenal high-frequency response, said to be well over 50,000 c.p.s.

The heart of the Ionovac is a small quartz cell, Fig. A, which is divided in two sections by a narrow aperture. Air cupped within this aperture is ionized by the application of a high r.f. voltage which literally tears billions of electrons out of their atomic orbit and forms an electron cloud. Under the influence of an audio signal, this cloud expands and contracts, thus creating sound waves which faithfully follow any modulating electrical signal.

As a hi-fi "tweeter" the Ionovac is mounted in a horn, Fig. B, which also houses a transformer required for coupling the signal from the modulator-oscillator chassis, Fig. C, to the quartz cell.

Although the Ionovac's first application is in the field of high fidelity, its more significant potential lies in its ability to create supersonic (silent sound) waves of almost any power and frequency. These frequencies above the range of human hearing are already being used for numerous industrial and medical purposes, but research is still in its infancy. It is here that the Ionovac's unique characteristics may prove to be of vital importance.

Introducing the Cryotron

Three years of research have resulted in the development of the Cryotron, Fig. D, a tiny electronic switch destined to trim giant computers down to size. The Cryotron represents the first practical application of superconductivity, a phenomenon discovered nearly 50 years ago.

(All materials, even the best conductors, have some electrical resistance at normal temperatures. At extremely low temperatures, however, below -240 deg. F., the resistance of certain metals is reduced almost to zero and such metals become superconductive.)

The Cryotron, in its simplest form, consists of a straight piece of wire with another wire, fine as a human hair, wound around it as a control winding. Below the critical temperature, the resistance of the straight wire drops almost to zero, permitting the flow of a large amount of current through this wire. Any current flow through the control winding sets up a magnetic field which destroys superconductivity in the straight wire, causing its resistance to return. Thus current in the control winding can cut off the current in the straight wire.

(Continued to page 214)

POPULAR MECHANICS



X-RAY ON CHEVROLET

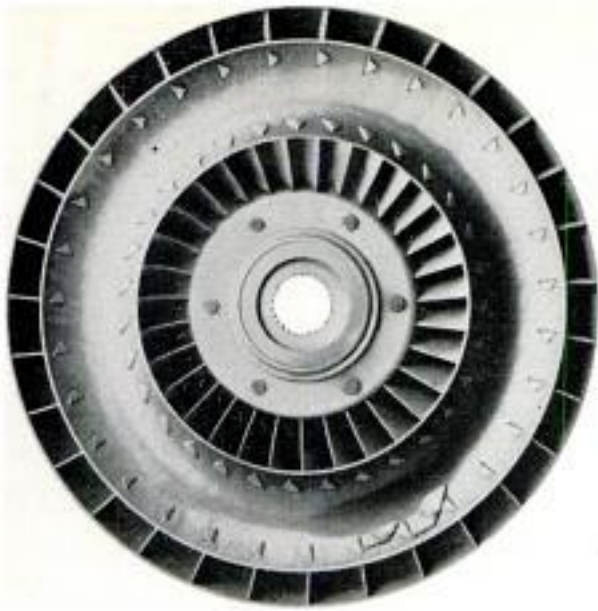

TURBOGLIDE: forecast of the future

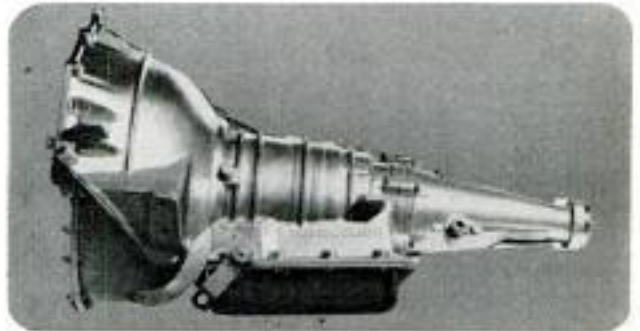

You don't have to look on the drawing boards—the answer is plain in any Turboglide-equipped 1957 Chevrolet. Here is tomorrow's drive, with an absolutely shift-free sweep of power, smooth as a plume of steam. Here is a quadrant that doesn't say "LO"—because there is *no* auxiliary planetary gear system needed. Here are *three* turbines for full-torque take-off, brilliant passing power and ultra-thrifty cruising. Here is the finger-flick Hill Retarder for safer slowing on grades . . . all this in a transmission that weighs 30 percent less than any other automatic drive (thanks to the largest production aluminum die casting in the world), with fewer parts, far fewer external openings and absolutely no delicate automatic shift valves. It's an engineering triumph—because it moves without a hint of mechanism. Try it and see! . . . *Chevrolet Division of General Motors, Detroit 2, Michigan.*



Switches such as these form the basis of electronic computers, and many thousands of them are used in a single instrument. To date, fragile vacuum tubes and expensive transistors have been used, but the Cryotron's basic simplicity which permits rapid, low-cost manufacture, coupled with its small size, may bring about a revolution in computers.

New Batteries Show Promise

With the invention of transistors less than 10 years ago came the demand for smaller, lighter batteries with longer life. Two recently announced units give promise of some real progress. The small battery in Fig. E packs a potential of 95 volts into a cylinder only about $\frac{3}{8}$ inch in diameter and less than 1 inch long. But its real asset is its phenomenal shelf-life expectancy—predicted to be more than 20 years. Though currently produced only for special applications requiring high voltage at little or no current, such as monitoring instruments, one-shot triggering devices and the like, continued research may soon produce a similar unit for more popular and universal applications.

Departing from the conventional method of generating electricity by chemical action, the button-sized battery in Fig. F actually converts atomic energy into elec-

tric power. Operation of the battery depends on a two-step conversion of energy: from atomic action to light and from light to electricity. The light source consists of a mixture of phosphorus and an oxide of promethium-147, once considered a waste product of nuclear fission. Beta particles emitted by the promethium are absorbed by the phosphorus and converted into red and infrared light. This light is picked up by two or more photocells and converted to electric current.

The atomic battery has a nominal power output of 20 microwatts and will provide usable current for about five years. It is the first such device to be completely safe for personal use and requires no special precautions.

Although not yet commercially available, the battery will eventually be used for hearing aids and radios, and even an atomic-powered wrist watch is currently under consideration.

The principles involved in these new products represent drastic departures from accepted procedures. While designated, at present, for specific and special applications, engineers are already engaged in research and experiments intended to broaden their scope. Results of those experiments may have a far-reaching influence on electronic developments. ★ ★ ★

**WHAT A DREAMBOAT!
MY IDEAL HERO!**

**WHAT A DATE!
I'M BATTING ZERO!**

**SMELLS GRAND!
PACKS RIGHT!
SMOKES SWEET!
CAN'T BITE!**

**WHY YOU
SMOKE A PIPE
TOO! MM-MM!
YOU'RE FOR
ME!**

VARSAITY THEATER

IT'S
SIR WALTER
RALEIGH—
NATURALLY!

SIR WALTER RALEIGH'S BLEND OF CHOICE
KENTUCKY BURLEYS IS EXTRA-AGED
TO GUARD AGAINST TONGUE BITE.

FREE!

24-PAGE BOOKLET ON
PIPE CARE. JUST WRITE
TO: SIR WALTER RALEIGH
DEPT. 126-F
LOUISVILLE, KY.

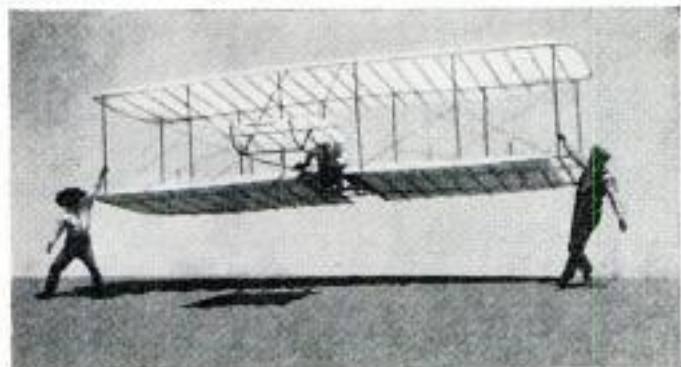

A great heritage

A great future



50

YEARS OF
AIR POWER

GO

U. S. AIR FORCE

For complete information on your opportunities as an Airman in the U.S. Air Force, write, giving your age, to: Airman Information, A-103, P.O. Box 7608, Washington 4, D.C.

Looking for Something?

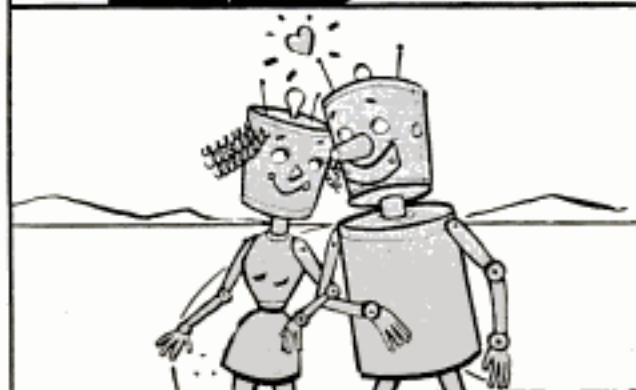
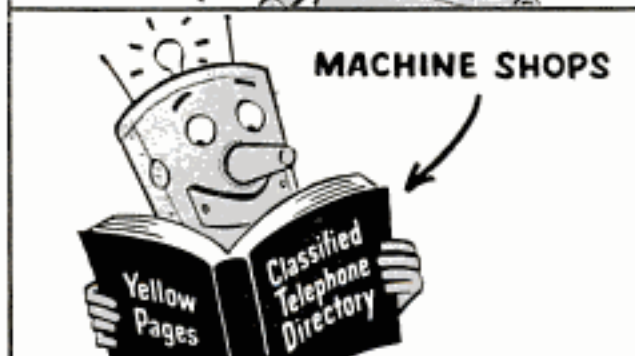

**FROM MACHINE SHOPS TO
STEEL FABRICATORS**
whatever you need-

Find It Fast
In The
Yellow Pages



Ads with this emblem make your shopping easier

Professor of the Outdoors

(Continued from page 123)

guy, it might be best to leave him comfortable in a shelter with fire and fuel, and hike out for help," says McKenney. "But even so, if he's badly hurt, you can carry him out on a travois."

First, if the injury is a fracture like a broken leg, saplings bound with thong or bark will keep the leg straight. "Don't try to set the bone. The main thing is to keep it straight so the tendons won't contract," McKenney says. Then, assemble a travois, which is a pair of poles for dragging your burden. Upper ends of the poles are tied around your chest. Below, the poles are cross-framed with notched saplings tied to the poles. Bark is woven across this frame to support the victim and is used to lash him to the travois for the journey. If there are two or more persons available for the carrying job, an ordinary stretcher can be put together in similar fashion.

Campus Workshop

Back in his campus workshop with a choice of drawknives, clamps and other gear, this woodsman turns out homemade products. In five minutes he blocks out an ax handle from a flat plank or tree limb; in 15 minutes more he has it whittled to exactly what he wants.

His favorite carving tool—his "crooked knife"—is a hayrake tooth of quality steel. This, McKenney heated and pounded to shape to give it an upturned and slight backward curve. The resulting tool doesn't tear wood but slices in a quartering motion; swiveling the wrists adjusts the depth of cut.

Of his profession McKenney concludes: "I wouldn't sell my forest knowledge for all the paper money in Wall Street, but I'm happiest when I'm giving it away to real sportsmen who are able to laugh when the going gets rough." ★ ★ ★

Insects Due for Fatal Surprise

New contender for the championship among insect repellents is diethyltoluamide for use on skin or clothing against mosquitoes, chiggers, ticks, fleas and biting flies. Resisting rubbing and wearing, this substance is a pleasant lotion that reportedly is superior to other repellents against the yellow fever, salt marsh, irrigation water, snow water, subarctic and malaria mosquitoes, in addition to the stable, deer and sand flies. Diethyltoluamide is said to be the best available repellent against ticks and chigger mites.

If your headlamps look like these—

**YOU NEED A PAIR OF NEW G-E *All-Weather* HEADLAMPS
YOU'LL GET LOTS MORE LIGHT!**

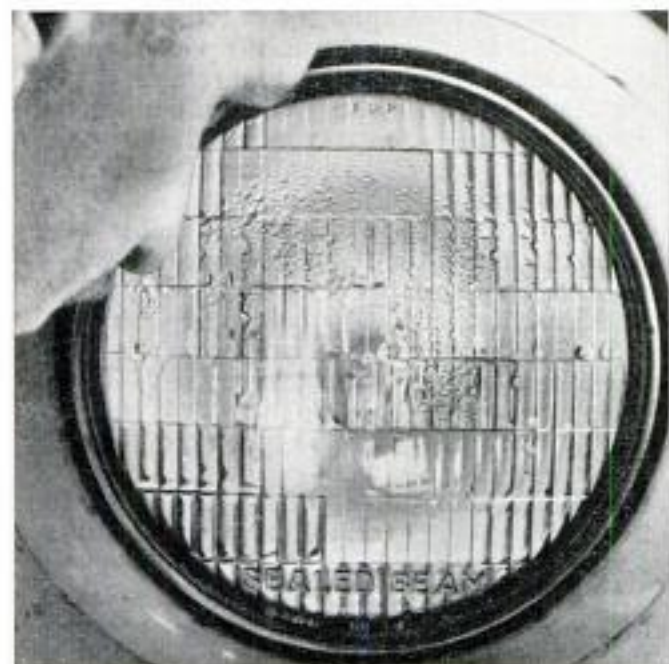

WATER DROPLETS inside the lens not only scatter the light, but they also help discolor metal reflectors. This can't happen with G-E *All-Weather* Headlamps—moisture can't possibly get inside.

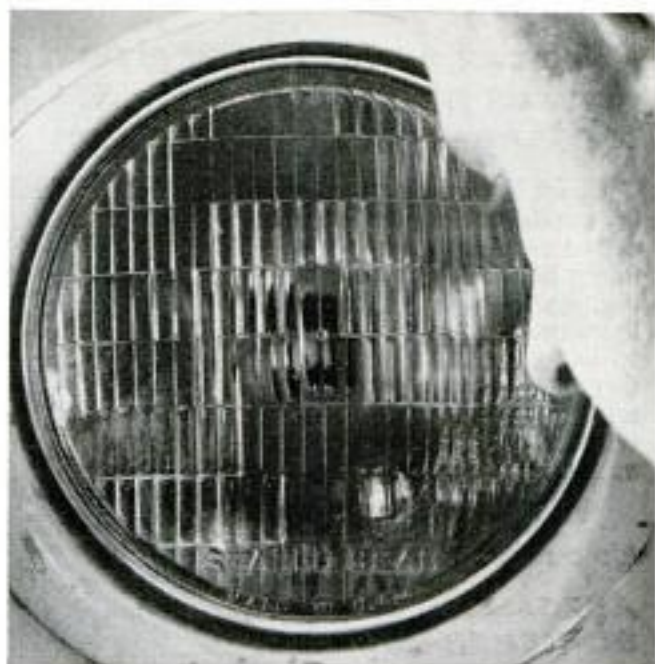

DISCOLORED REFLECTORS absorb light rather than reflect it, causing a loss of up to 50% of the original light output. Dirt and moisture can never enter G-E *All-Weather* Headlamps so the reflectors always stay shiny.

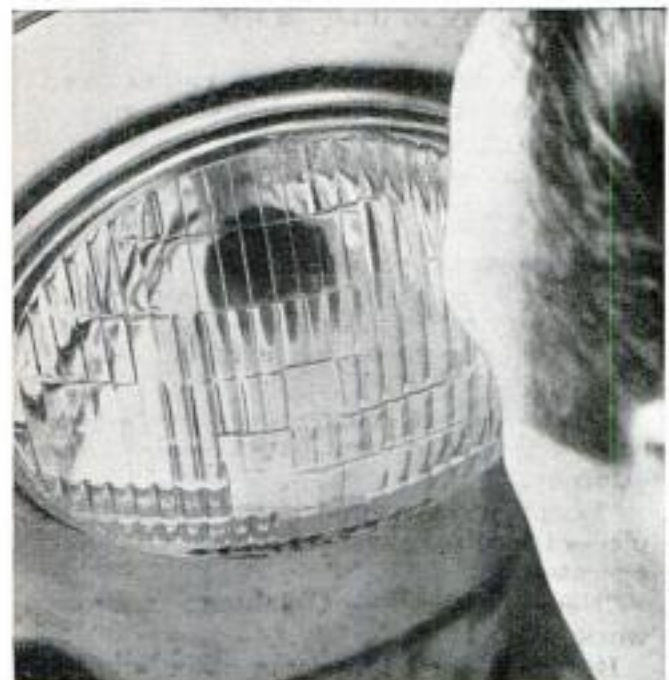

BLACKENED BULBS in old-style headlamps block out the light from the filament and cause a dangerous drop in light output. This can't happen with G-E *All-Weather* Headlamps because *there are no inner bulbs!*

G-E *All-Weather* HEADLAMPS NOT ONLY GIVE YOU LOTS MORE LIGHT... BUT YOU ALSO GET:

Better seeing in fog, rain, snow—The lower beam filament has a special shield that cuts down reflected glare and lets you see better in any weather.

Lower beam puts twice the light 300 feet ahead at the curb—You can see much better against the glare of oncoming traffic.

Upper beam that reaches far and wide—For open road driving, the upper beam filament is left unshielded to let you see curves, dips—even side roads.

So, for safer night driving, get a pair of new G-E *All-Weather* Headlamps today — and have your dealer aim them when he puts them in. You'll see the difference tonight. General Electric Co., Miniature Lamp Dept., Nela Park, Cleveland 12, Ohio.



GENERAL  ELECTRIC

Soft water can save every home owner \$100 a year

Reduces water heating costs, saves plumbing, adds 33% longer wear to clothes

Clear, filtered soft water is more efficient, more economical for every water-using need: photo developing, car washing, bathing, laundry, dishes. Saves up to 60% on soaps and detergents, keeps drains open and trouble-free. No hard water scale in plumbing, appliances, utensils.

New Culligan®
AUTOMATIC WATER SOFTENER—provides an unlimited supply of hot and cold soft water regardless of family size or water usage.

Completely automatic! Electronic Regen-a-rator quickly, quietly, automatically regenerates at night, while you sleep. Compact! Softener is 57 in. high x 10½ in. square. Low operating cost; salt supply lasts 6 to 12 months. 10-year Warranty.

About **\$330** plus installation
Slightly higher west of Rockies and in Canada

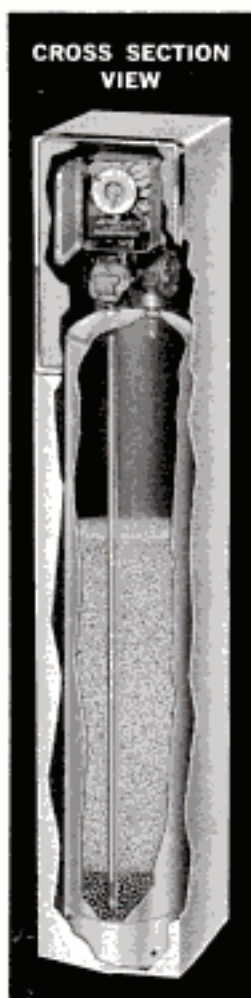

3,000 page, 12-volume \$20 Popular Mechanics DO-IT-YOURSELF ENCYCLOPEDIA SET. Send coupon for certificate which your Culligan dealer will redeem for \$20 Popular Mechanics Encyclopedia Set with your purchase of Culligan Automatic.

CULLIGAN, INC., NORTHBROOK, ILLINOIS
Gentlemen: Please send free Popular Mechanics Do-it-yourself Encyclopedia Certificate.

Name _____

Address _____

City _____ State _____

(This offer void wherever taxed or otherwise restricted. Offer may be withdrawn or modified at any time.)

Owners Praise Handling, "Conservative" Styling

(Continued from page 100)

Most-Frequent Complaints

While 22.9 percent of the Buick owners make no complaints at all, others have some unkind things to say.

First on the complaint list is the excessive use of gasoline. Second is poor assembly and third, body noises and rattles.

"The car is fine, but it takes a banker to drive it at the mileage it gets. My two-ton truck gets better gas mileage."—Texas lumberman.

"Very poor gas mileage: 7.5 miles per gallon in city and 10 on highway."—Missouri telephone worker.

"I must use the very best premium gas. It won't run properly on some brands that are advertised as premium grade."—Ohio telephone assigner.

"My complaints are in the assembly. I think there is good material used in Buick, but it is put together poorly. Doors don't fit, windows don't roll all the way up, bulbs are missing or don't light."—Iowa inspector.

"Most of my trouble has been minor, but annoying: Faulty ignition switch, oil pumps, speedometers, leak in power steering, window alignment, door locks, horn ring not operating, and others. When we get all the parts working properly, it will most likely turn out to be a good car."—California accountant.

"I have had it at the dealer's for service approximately 40 times in five months."—California surgeon.

"Dealer unable to stop rattles and squeaks in body."—Texas branch manager.

"Rattles like a cheap car, not like a \$4000 automobile."—Tennessee advertising man.

What About Interior?

Buick owners place the neat instrument panel high on their list of interior likes. Other interior features they commend include the large glove compartment and the upholstery.

"I like the arrangement and workmanship of the instrument panel."—Maryland attorney.

"Large glove-compartment door with places for coffee cups."—Indiana telephone operator.

"New fabrics."—Oklahoma railroad worker.

But they don't like some other interior features. And, as seems to be common in the industry, the chief complaint is the location and design of the ash trays. Other complaints involve floor mats, location of

(Continued to page 220)

BIG VALUES in TINY MOTORS and POWER APPLICATION KITS

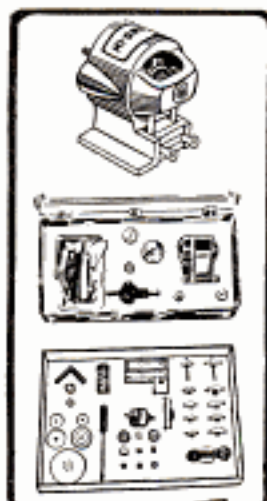

Order your choice of four miniature battery-operated motors—one for every use—from 1½ to 12 volts—and today's BIGGEST VALUES IN THE HOBBY FIELD. These motors, with the accessories in kits listed below, provide all types of drives for hobby items, toys, research and industrial devices. Make wonderful gifts.

- *No. 8-100 Hi-Drive Motor, 3-6V. \$2.50
- No. 9-100 Same for 12V. \$3.00
- No. 3-100 Tiny Atom Motor, 1½-3V. \$2.00
- For higher voltage. \$2.50
- *No. 3113N Tiny Atom motor assembly kit with many acc. . . \$3.50
- No. 1300N Small accessories kit. \$1.00
- No. 3700 Large accessories kit \$3.00
- No. 4000 Deluxe accessories kit with motor. \$5.00
- *No. 700 Super-Power kit with motor, speed reducer, all accessories. \$10.00
- No. 88 Kit of 8 pulleys—2 leads \$2.00
- No. 3000 Vari-speed gear unit. \$4.00
- No. 1049 Gear train with Hi-Drive motor No. 8-100. . . \$5.95
- Same with No. 9-100 Motor. . . \$6.45
- * Item illustrated. Ask for FREE Cat.

All Wilson's motors have Permanent Alnico Magnets.

Remit with order and we pay postage in U.S.A. No C.O.D. Add 3% Sales Tax for delivery in Ohio. Write Dept. PM.

For quick delivery see your local dealer — or order direct

WILSON'S OF CLEVELAND

425 Lakeside Ave., N.W. • Cleveland 13, Ohio



GENUINE ALNICO MAGNETS

AMAZING, PERMANENT, NON-ELECTRIC, HIGHLY PRACTICAL. Conduct interesting experiments. Hundreds of uses. Retrieve valuable steel items such as guns, tackle from fresh or salt water; tools from tanks & drains. **GUARANTEED.** Try any magnet one week. Money back if you are not well-pleased.

- No. M-710 (Wt. 5½ oz.) Has pull of 225 lbs. on steel block. . . \$16.50
- No. M-625 (Wt. 7½ oz.) Has pull of 125 lbs. on steel block. . . \$9.50
- No. M-775 (Wt. 1½ oz.) Has pull of 75 lbs. on steel block. . . \$6.50
- No. M-500 (Wt. 13 oz.) Has pull of 50 lbs. on steel block. . . \$4.50
- No. M-300 Kit of Flat Bars 5 Pairs (10 Magnets). \$3.00
- No. M-250 Kit of Round Rods 5 Pairs (10 Magnets). \$2.50
- No. M-47 Hot Pad Magnets. 10 for \$1.00. \$0 for \$4.87
- No. M-35 Hobbyist assortment of 8 small magnets. \$1.50

Send N.O. or check. We pay postage. Sorry no C.O.D.'s.

MIAMI MAGNET COMPANY, 3240 N.W. 27th Ave., Miami 42, Fla.

MONEY FOR MEN ALL FREE

DATA

THE PLASTEX Industry needs manufacturers on small scale and for big production of Lamp and Clock Stands, Art Goods and Novelties in Plastic and Marble imitation. Experience unnecessary. The material makes regular 10c store sellers. Rubber moulds furnished for speed production. Small investment brings good returns. We are now placing big Chain Store orders with manufacturers. Ambitious men have chance for real prosperity. Our Free booklet will interest and benefit you.

PLASTEX INDUSTRIES, Dept. A
3400 Third Ave. New York 56, N. Y.

Automatic Saw Set...

MAKE EXTRA PROFITS!

Set 400 teeth per minute on hand or band saws, 4 to 16 point, with the BeMaCo Automatic Saw Set. Fast, accurate, true hammer-anvil action sets teeth uniformly, eliminates tooth breakage. Used profitably by saw shops and manufacturers everywhere. Every machine positively guaranteed!

Write for details—today!

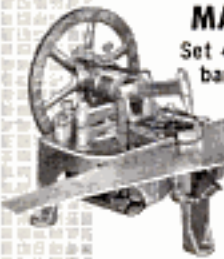

Saw Machine Division 28-C

BEAVER MFG. CO.

800 ISIS AVENUE • INGLEWOOD, CALIF.

MAKE MINE KLEINS



Your skill—the quality of work you do—is controlled in no small measure by the quality of the tools you use.

That's why electricians and good workmen everywhere insist on Klein Pliers—standard of quality by which others are judged "since 1857."

In the complete Klein line you will find pliers exactly suited for every job you do. See your hardware store or Klein distributor for the Klein Pliers you need.



Your hardware store has Kleins in stock or can get them for you quickly. Look for this new display board. It shows the most popular items in the Klein line.

Mathias KLEIN & Sons
Established 1857 Chicago, Ill., U.S.A.
7200 McCORMICK ROAD • CHICAGO 45, ILLINOIS



solves woodworking problems in seconds!

Speed your jobs, get answers to countless building and woodworking questions immediately! Improved GREENLEE Woodworking Calculator converts linear to board feet, gives nail specifications, tool sharpening tips. Compares woods, gives bit sizes for screws, concrete mixes, painting information, etc. Convenient . . . simple to read. 6" diameter . . . heavily varnished cardboard. Special offer by the makers of famous GREENLEE tools . . . **Only 25c** (no stamps please)

TOOLS FOR CRAFTSMEN

GREENLEE

The GREENLEE line of fine tools includes auger bits, electric drill bits, chisels, gouges, spiral screw drivers, drawknives, and many more. At leading hardware and building supply dealers.

GREENLEE TOOL CO.,
2106 Columbia Ave., Rockford, Ill.

the window cranks and the floor humps. "Must close ash trays to get out of the car. I have two skinned knees to prove it. The trays are too low and too small."—Anonymous owner.

"Ash tray is too small and dangerous. Have to look every time it's used. That takes my eyes off the road too much."—Kansas salesman.

"Don't like long-nap floor mat."—New York retired Army officer.

"Carpeting shows all footprints."—Ohio housewife.

"Front-window crank not in right place. Too hard to work."—Mississippi farmer.

"Don't like hump in front where transmission is located."—Maryland dentist.

More Best-Liked Features

The following quotations from owners describe additional best-liked features. For a listing of the features and the percentage of owners mentioning them, turn to the percentage table on page 101.

"When you tromp down on the accelerator, the variable pitch comes in and you are gone."—Texas lineman.

"Performance is superb. It has speed if I need it and very often I need it."—Ohio salesman.

"I like Dynaflo, especially in the mountains in snow and ice. You keep moving. We have passed dozens of stalled cars, but the Buick just keeps on going."—Ohio businessman.

"Dynaflo is smooth. You feel no change in going from stop to high speeds."—Kansas secretary.

"Holds the road good at top speed."—California serviceman.

"Has the weight to keep it from whipping every time the winds are strong."—Oklahoma retired policeman.

"Holds the road. You feel solid and secure."—Nebraska cattle feeder.

"This four-door hardtop has legroom, front and rear."—Virginia salesman.

"Visibility good. Lower hood means all four fenders are visible."—California scrap dealer.

"Interior trim is in good condition. Nothing is misfit. No rough edges."—Michigan carpenter.

"Low without sacrifice of seat height and headroom in my Super."—Nebraska retired farmer.

"Like the windshield washer and find the new location of the control button an excellent safety feature."—California owner.

"I find the Safety Minder buzzer useful. It would have saved me \$10 if I had used it all the time."—California aircraft worker.

"I like the elimination of portholes on

(Continued to page 222)

New Pine Plywood helps you add storage space to your home

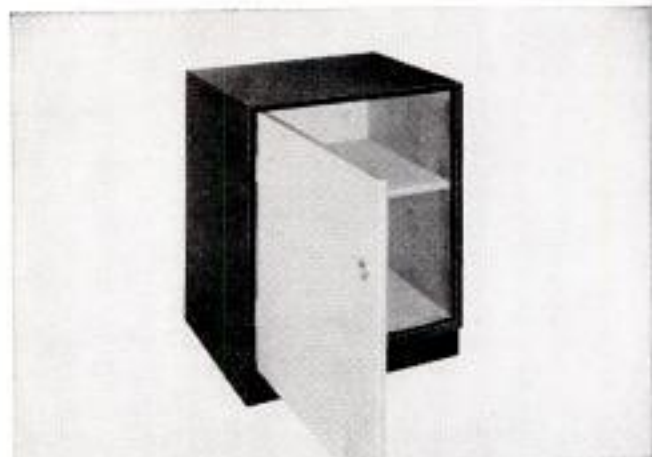

STORAGE CABINET only 29" high—but with over 5 cubic feet of storage space! Has an adjustable shelf. Ideal for records, linens or as a base for desk or dressing table. See coupon for easy-to-follow plans.



SLIDING-DOOR CABINET is 4' long, 2' deep, has adjustable shelves. Ideal for linen, china, clothing, etc. Complete plans and step-by-step photos in new booklet. See coupon for your copy.



EARLY AMERICAN HUTCH gives you plentiful storage space in a handsome, conversation-provoking cabinet. Has drawer, handsome planter box, over 6 cubic feet of storage space. See coupon.

Weldwood Old Craftsman makes the job easy because it's the easiest working, easiest painting plywood ever!

Cramped for storage space? Here are four ways you can get it—easily. And although these projects are really "pro"-looking, they're not hard to build. The reason: they're made with Weldwood Old Craftsman Pine Plywood according to easy plans (see coupon). Old Craftsman Pine combines all the advantages of top grade pine lumber with all the advantages of rugged plywood construction.

Old Craftsman Pine Plywood paints better, saws cleaner, machines more quickly and sands smoother. Comes already factory-sanded! Available in panel sizes from 3' x 6' to 4' x 10'. Thicknesses from 1/4" to 1-13/16". See Old Craftsman at your lumber dealer's soon.

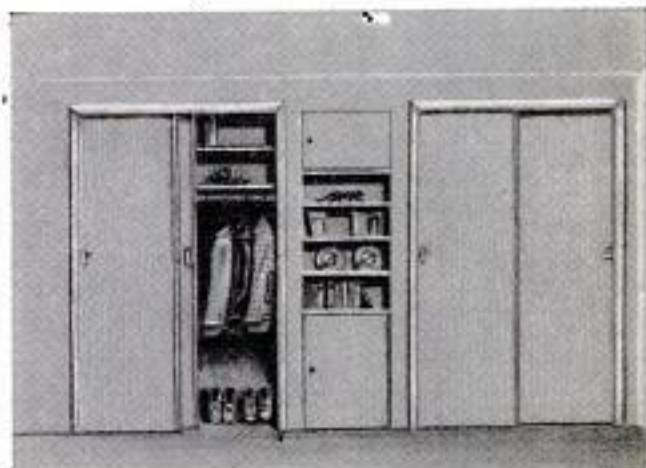

BUILT-IN CLOSET converts the wall at one end of your room into two 6' x 30" closets plus four open shelves and two swinging-door cabinets. See coupon for plans.



PINE PROJECT BOOK

UNITED STATES PLYWOOD CORPORATION
Box 61, New York 46, N. Y.

Please send me your book "Projects You Can Build With Weldwood Old Craftsman Pine Plywood." I understand it contains the 4 projects shown on this page plus 14 others. I enclose 25¢. PM6-57

NAME.....

ADDRESS.....

CITY.....STATE.....

STILL FULL AND SAFE

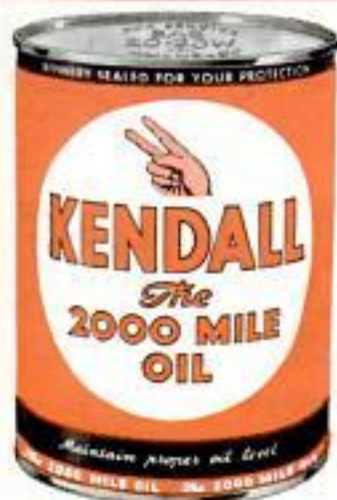

Refined from 100% Bradford Pennsylvania Crude Oil — world's richest — by special Kendall processes and an exclusive additive formula.

STOPS VALVE LIFTER STICKING, TOO

Kendall quality means economy for you. Specially formulated to provide full protection and superior lubrication for the engine in your car. Kendall, the 2000 Mile Oil has been performance-proven by millions of motorists. Ask for it at your favorite dealer's now.

BY THE REFINER OF
KENDALL SUPERB MOTOR OIL
KENDALL REFINING COMPANY
BRADFORD, PENNA.

the front fenders."—Massachusetts field representative.

"Have had very good service from my dealer."—Texas medical doctor.

And Other Complaints

Here, in order of frequency of mention, are quotations that describe the other complaints of Buick owners:

"Not enough entrance headroom. I don't like hitting my head every time I get in."—Iowa assistant manager.

"Difficult to enter and leave from curb side, although plenty roomy when inside."—Illinois businessman.

"Brakes wear out too fast."—California physician.

"I have had five sets of brake linings put on this Roadmaster in 5000 miles."—North Carolina radio serviceman.

"Brakes always grabbing on windy days due, so experts say, to sand blowing into the brake drums."—Wisconsin owner.

"Bad carburetion, but a special carburetor kit is coming in to correct it."—Kansas engineer.

"Am having trouble with stalling. Dealer blames it on carburetor. GM is sending a kit to correct it."—New York pharmacist.

"Windows are hard to move up or down."—New Jersey merchant.

"Glass in windows does not fit properly."—Kentucky salesman.

"Windshield wipers are jerky if windshield isn't real wet."—Indiana farmer.

"Wipers do not give enough coverage in heavy rain and snow at high speed."—Iowa salesman.

"Car is only two months old and chrome is pitted and rusted."—Michigan plumber.

"Paint poor. It's flaking."—Georgia Army officer.

"Dealer service particularly poor."—California secretary.

"Does not have good rear springs. They bottom easily when loaded."—Ohio railroad engineer.

"With any grade of gasoline there is a sufficiently vicious engine knock on fast acceleration to cause one to let up."—Illinois electrical engineer.

"They should put better tires on the car. In 5000 miles I have had three of them replaced."—Texas welder.

"Should put some kind of a handle on trunk of Special."—New York attorney.

"When new, oil consumption was very heavy—five quarts first 1000 miles. Now it burns none. I don't like fact that I must buy premium gas for normal driving."—Connecticut park superintendent.

"Rear window fogs up. It is a definite safety hazard. Someone forgot to compute

(Continued to page 224)

SAVE MONEY THREE WAYS WITH A SILENTONE MUFFLER!

The moment you install a Silentone on your car, you start saving money in three ways. Look at this!—

1. LONGER MUFFLER LIFE—Silentone is a heavier muffler, with double-wrapped, up to $\frac{1}{2}$ heavier shell, heavier outer heads and tubes; this gives you thousands of extra driving miles.

2. BETTER MILEAGE—Silentone's scientific design lets your car run quieter—more efficiently, too, reducing exhaust back pressure to give more pickup and smooth acceleration. And with improved performance you get real savings on gas.

3. LOWER FIRST COST—Despite their extra performance and longer life, Silentones actually cost you less. Many stores will install a Silentone for you at big savings. Ask about one today. They're individually engineered for your car.



1 Double shell—26 gauge inner shell, 22 gauge outer shell—lasts longer

2 Nonlogging extruded holes—no whistling, no restriction

3 16 gauge spun locked, blowout-proof steel heads

4 Crimped seams eliminate weak points

5 High and low frequency tuning chambers

SOLD ONLY BY AMERICA'S LEADING AUTOMOTIVE CHAIN STORES

SILENTONE MUFFLERS · DYNATONE · GLASS-PACKED
Dept. 2F, Toledo 1, Ohio

FOR BETTER REFINISHING JOBS USE



Klean-Strip
PAINT REMOVER

- Non-inflammable
- Removes any finish
- Fast • Non-messy
- Needs no neutralizing

"Peels Off Paint"

**FREE! 44 PAGE BOOKLET
ON PORTABLE POWER TOOLS**

Hundreds of time and money-saving ideas for hobbyists, builders, professional wood-workers. New booklet #204 includes 150 pictures of latest tools with complete specifications on how they work and what they do. Write for your free copy now!
PORTER-CABLE MACHINE COMPANY
7146 N. Salina St., Syracuse 8, N. Y.

**SAVE MONEY ON YOUR
COMPRESSED AIR**



buy this complete
SMITH 45-P air compressor

Right for spray painters, plumbers, contractors, monument shops, tire changing trucks, maintenance shops, quarries, utilities, many other uses. Delivers 45 plus cu. ft. per minute; pressure up to 150 P.S.I. Powered by Wisconsin 4-cyl. air-cooled engine; uses less than 1 gal. gasoline an hour! Most compact, biggest-value compressor for its capacity anywhere! Other models to 230 cfm.

write for
FREE
brochure

GORDON SMITH & COMPANY, Inc.
411 College Street, Bowling Green, Ky.

JUNE 1957

**'Budget' HOIST
LIFTS 2 TONS**



**HANDLES ALL KINDS
OF LOADS EASILY:**
Farm Implements
Autos, Trucks
Wheels, Tires
Boats, Motors
Crates, Bags, Bundles
Structural Units
Baled Hay
Oil Drums, Ash Cans
Machinery, Dies
Appliances
Concrete Pipe



Save your back and money. To lift a tractor or deep freeze, a propeller or side of beef, a 2-ton machine or 250 lb. tank—use a 'Budget' Electric Hoist. It's fast— $\frac{1}{4}$ ton can be lifted 1 ft. in less than 2 seconds. It's safe—the two brakes act "quick as a wink". Each brake can hold the full load. It is easy to "inch" loads into place. All parts of the hoist are extra tough for years of work. Garages, farmers, institutions, machine shops, big and little plants—all prefer portable 'Budget' Electric Hoists. $\frac{1}{8}$ to 2-ton sizes. AC and DC models. For truck service or where there is no electricity, choose a 12-volt battery-operated model. Ask your "Shaw-Box" Distributor for details or write us for Bulletins 402 and 404.



57A-6

MANNING, MAXWELL & MOORE, INC.
SHAW-BOX CRANE & HOIST DIVISION
354 W. BROADWAY
MUSKEGON, MICHIGAN

223

Copyrighted material

At Last!

**A "TOOTHLESS" PLIER
THAT GRIPS
WITHOUT GOUGING**



CHANNELLOCK

No. 415 Smoothjaw PLIER

Just
The Thing
For Chrome
Fixtures and
Fittings



One of the handiest tools you'll ever use . . . the new "toothless", smooth-jaw plier that grips without gouging. Just the ticket for gripping chrome-plated fittings, plastic, wood and other smooth surfaces. Especially handy on chrome sink-fixtures and other hard-to-handle jobs. Jaws quickly adjustable to full 2" opening. Get yourself a Channellock No. 415 Smoothjaw Plier. You'll find it's "the right tool" on scores of jobs in home and shop.

**Ask Your Hardware Man For A
CHANNELLOCK Smoothjaw PLIER**

MADE ONLY BY

**CHAMPION DEPARTMENT TOOL CO.
MEADVILLE, PENNSYLVANIA**

the air circulation."—New Jersey marketing analyst.

"Don't like plastic lining in glove compartment. Everything in it rattles."—New Mexico farmer.

Other Comments

PM asked the owners for their opinions on the trends in the industry. The great majority state that they agree with the trend (83 percent). Many made interesting criticisms of the trends. Some of the most interesting are quoted below.

"I am disappointed in the trend toward lower, faster cars. The lowness makes it awkward to get in and out. You have to push harder on the seat and this ruins the seat eventually. No other durable item appears to get into the consumer's hands needing so many adjustments as a new automobile. At the price we have to pay we should receive quality merchandise."—Massachusetts comptroller.

"I would like to be able to see a little farther by having my eyes a little higher. They put prison guards up in towers so they can see farther and at the same time they drop us lower in these cars and claim better visibility. Just who are they trying to kid?"—Colorado trader.

"I wish the car builders would listen more to these PM questionnaires and build the cars the people want."—Ohio salesman.

"It is my opinion, having had eight new cars in the past 10 years, that you are now trading in a better car fundamentally than you get."—New York clergyman.

"If I had it to do over, I would have kept my 1955 Buick. It had only 12,000 miles on it. I got 18 miles per gallon, it rode better and I believe it was faster."—Indiana service attendant.

"This Buick is as low as it should ever get. Fourteen-inch wheels would be foolish as would the addition of fins."—Massachusetts product specialist.

"If I had wanted exceptional gas mileage I would have bought a smaller, lighter one."—California mechanic.

These are the opinions of a cross section of 1957 Buick owners from coast to coast. They live with the car and know it best. Turn to pages 102 and 103 for additional opinions and performance data on the Buick Special. ★ ★ ★

Closed-Circuit TV for Trains

British Railways have put into service the first train to be equipped with closed-circuit television for passenger entertainment, with a coach fitted as a studio and a receiver in each passenger coach.

Handi-calk saves on
HOME REPAIRS



**SO EASY
YOU CAN
Do-It-Yourself**

Handi-calk

Ugly cracks and gaps in your home due to settling, admit dirt, dust, soot, moisture and cold and lead to costly repairs, inside and out. Seal them the easy way with Handi-calk. Will not sag or stain. Can be painted over. So easy to do yourself with the Handi-calk gun.

FREE!

Home Calk Check List "Where and How to Calk". Get your copy now!

Glazing? Try **EASY HANDI-GLAZE!**
HANDI-CALK DIVISION DEPT. HC2
2366 Woodhill Rd. Cleveland 6, Ohio

**Beauty... Power
... Adventure!**



**YOURS
with the fabulous new
HARLEY-DAVIDSON
SPORTSTER**

★ BEAUTY...

Magnificently sleek styling, flashing chrome and striking two-tone color combinations command immediate attention wherever you go.

★ POWER...

Get "raring to go," instantly responsive speed and acceleration with the 1957 Sportster's pace-setting new 55 cubic inch overhead valve engine.

★ ADVENTURE...

Whether you're off on a lark or off to work, each mile is an adventure on a Sportster. You're on your own, happy and carefree as the wind.

Easy Monthly Terms

Your Harley-Davidson dealer will be pleased to show you how easy it is to own a fabulous new Sportster... arrange for a convincing test ride. Call him now or write for free literature.

HARLEY-DAVIDSON MOTOR CO.

Dept. P, Milwaukee 1, Wis.

NEW 1957 CATALOG 200 MODELS—SAVE 2/3

BOAT KITS

EASY TO BUILD—Designed for the amateur. Over 200

Models. Plans to Cruisers, 8 to 21 ft. Formed hulls. Semi and Custom finished. Save 50%... Now **NEW** Sea Ray Molded FIBERGLAS BOAT KITS. Truly professional results. NO upkeep. **SAVE 2/3** assembly time. 12 to 16 ft. Utilities and Runabouts. **SEND 35c** for 64 page Boat Kit & 24 page Sea Ray Catalogs. **SEND \$1.00** for both plus "Boating Handbook". Dealers inquire for franchise.

**BOAT PLANS
& PATTERNS
Frame-Pac Kits**

World's largest selection: over 200 plans, full-size patterns, frame-pac kits! Designed strictly for amateurs! All types: prams, kayaks, racers, runabouts, catamarans, houseboats, cruisers - inboard-outboard 6-40' wood-plywood-steel! **Send 35c for PLAN CATALOG** Catalog PLUS "Boatbuilding Handbook" \$1.00

WRITE NOW! CUSTOM CRAFT, BUFFALO 7A, N. Y.

the finest
FLOOR POLISHERS
are
Red Devil Tools.

Protect your home against
power interruptions
with an...

**ONAN Emergency
ELECTRIC PLANT**

Provides dependable stand-by electricity for heating system, pumps, freezer, lights, appliances. Keeps home safe, livable. Automatic start and stop. *Find out how little it costs!*

Write for Folder!

D. W. ONAN & SONS, INC.
3249 University Ave. S.E. Minneapolis 14, Minnesota

A SIZE FOR EVERY NEED
500 to 75,000 watts.
Compact, quiet-running.
Gasoline-powered
Priced from \$269.00

Make \$20 to
\$30 a Week

**EXTRA
MONEY**



MACHINE SAW FILING PAYS UP to \$3 or \$5 an HOUR

• Turn your spare time into CASH—sharpening saws with a Foley Automatic Saw Filer pays up to \$3 or \$5 an hour. You will find you can make \$20 to \$30 a week in your spare time as a starter.

You can work in your basement or garage—no experience necessary. "The first saw I sharpened with my Foley Filer came out 100%"—writes Clarence E. Parsons. No canvassing—"I advertised in our local paper and got in 93 saws"—says M. L. Thompson. The Foley is the only machine with which you can file all hand saws, also band saws and cross-cut circular saws.

SEND FOR FREE BOOK "MONEY MAKING FACTS"

Shows how you can get business from home owners, farmers, carpenters, schools, factories, etc. With a small investment, no overhead, no stock of goods to carry, you can get right into a cash business,—and possibly later on develop into a full-time repair shop. Send coupon today for Free Book. No salesman will call.

"Each saw I filed got me 5 more and business has been picking up that way since a year ago. If it keeps up I will have to buy another Foley Saw Filer."
William C. Baldwin

"I have done 4 or 5 thousand saws in my spare time in the 4 1/2 years since I got the outfit, and they are all coming back." Len Crego

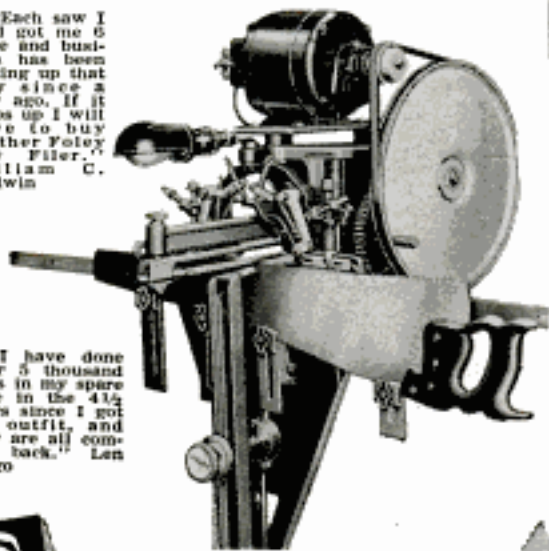

Send Coupon for **FREE BOOK**

FOLEY MFG. CO., 616-7 Foley Bldg.
Minneapolis 18, Minnesota
Send **FREE BOOK** —
"Money Making Facts"



Name _____

Address _____

Buy Your Railroad Tickets by TV

(Continued from page 81)

staples it to the space coupon. The transaction is ended and you pay your money.

The original coupon listing the space sold is forwarded by pneumatic tube to the filing area where it will be quickly available until the moment the train departs. If there is a cancellation, it will be returned to its original slot in the rack.

The ticket machine not only prints the price, the tax and the total cost of the ticket, but makes a detailed record of every transaction on a four-inch-wide strip of tape. At the end of the day, this tape will show the total cash intake, eliminating many hours of tedious bookkeeping.

Telephone orders for reserved space are taken by one of the Pennsylvania Station's 72 information clerks. Each has a television receiver, dial system and Telautograph machine. The customer's name and the location at which he wishes to pick up the ticket are flashed to the coupon clerk via Telautograph so the ticket and reservation coupon can be forwarded instantly by facsimile to the ticket designated.

Still another innovation of the electronic ticket-selling system is the use of Intrafax machines in hotels and offices of large industrial firms. A clerk in the hotel or office merely puts an order on the Intrafax cylinder. A few minutes later, on the same machine, out comes a facsimile railroad ticket and space-reservation ticket on a single sheet of paper. This service was purchased by 25 firms before it went into operation, but facilities for 100 more firms, including banks and other railroad ticket offices, are being added. The service eliminates the need for messengers and bypasses the problem of congested city traffic. Intrafax customers are billed later by mail.

Although some availability boards list space on trains for several months in advance of their departure, most display only the available space on trains departing for a two-week period. When all the space of a certain type or for a given date is sold, the area on the availability board appears blacked out on the television screen.

Parlor-car reserved seats are handled at a different set of counters in another part of Pennsylvania Station. For parlor-car customers, the actual space coupon is sold when the ticket is purchased. Since these are sold without regard to location, and all are identical in price, they are simply handed out from a pack as they are needed. Only in the case of telephone orders are facsimile slips prepared for parlor-car seats. These are usually forwarded to a distant location. ★ ★ ★

Let fast, easy Strypeeze remove paint!



BEFORE

AFTER

Get right down to bare wood fast with the *guaranteed* paint remover—Strypeeze—the fastest selling paint remover in America.



Kwikleeze cleans all brushes fast! Even the hardest brush softens in a jiffy with KWIKLEEZE. No rinsing, no mess. Perfect for all bristles.



- ✓ Stays wet—stays put
- ✓ Removes all finishes
- ✓ Harmless to hands or wood
- ✓ Cuts every layer

Available at paint and hardware stores everywhere

Just off the press! SAVOGRAN'S booklet, "How to Remove and Restore All Finishes". Write SAVOGRAN, Dept. 604, 25 Huntington Ave., Boston, Mass., enclosing 25¢.

SAVOGRAN

The Remover Corporation of America



BUY GREAT NECK HAND TOOLS

... for long-lasting performance



GREAT NECK SAW MFRS., Inc.

MINEOLA, N. Y. — SEE YOUR LOCAL STORE

Cadillac trim-tough-
TERRIFIC!



Light, all-aluminum Cadillacs are *care-free*, give you extra hours on the water, extra speed per h.p. Extremely strong, they handle like silk, won't skid or trip on turns, can't sink. Buy Cadillac—you'll get more boat for your money! Write for free catalog—aluminum and molded plywood models for every sport.

CADILLAC MARINE & BOAT CO.
390 Seventh Avenue • Cadillac, Michigan

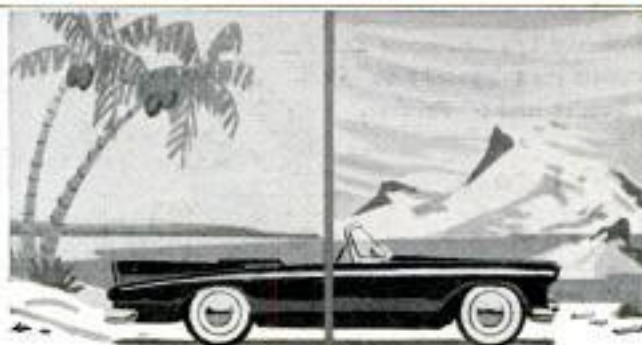

**TROPIC HEAT OR ARCTIC COLD
YOU'LL START AND YOU'LL GO!**

When a fuel pump has been tested under strict government supervision and found to work perfectly at 114 degrees above zero and at 76 degrees below zero, we think it has proved itself the best on the market. That's what the Bendix* Electric Fuel Pump did. Positively eliminates vapor lock. No other pump even close to its price class could match it. Better get one for your car. (Send for free illustrated folder.)

*REG. U.S. PAT. OFF.



Bendix

ELECTRIC FUEL PUMP

BENDIX AVIATION CORP. • (Eclipse Machine Div.), Elmira, N. Y.

SAVE \$10

**DURING THIS
SAWBUCK SALE**

**You Get 4 Rugged Power Tools In One-
DRILL, SANDER,
POLISHER, SAW**

the
Versatile
"888"



DYNO-MITE

POWER TOOL

with husky 1/3 h.p. motor and completely equipped as 3/8" Drill, 6" Sander and 6" Polisher.

PLUS



**6" Circular
SAW ATTACHMENT**

Complete with 6" combination blade, ripping guide, telescoping saw guard. Quick, easy adjustments for depth and angle of cut.

Regular Price \$63.90
For limited time only \$53.90

Start with this money-saving offer — then add the many other inexpensive attachments available to build up a complete power workshop. If your dealer can't supply you, write us direct —



MILLERS FALLS COMPANY
Dept. PM-18
Greenfield, Mass.

This offer expires June 30, 1957

We Chase the Jets on Film

(Continued from page 95)

slamming him against a brick wall. Earlier methods of escape aren't good enough.

One current idea is to power the pilot with his own personal rocket. If his aircraft gets into trouble, the rocket can shoot him up from the cockpit and ahead at the same time. He doesn't get hit by the tail of his own plane, and deceleration is less violent. On one early test the dummy was shot out of the plane as planned, but then the rocket tore away and ran wild. On the basis of our high-speed pictures, the engineers designed a stronger bracket for the rocket.

Our photographic branch handles every kind of assignment. Seven of the staff are qualified as aerial cameramen and they have done extensive photographic work while flying supersonic. Two-place versions of such aircraft as the F-100 are used as camera ships.

There's not much routine in their work. One man may be assigned to track a bomb after it's been released at high altitude. His camera ship may follow the bomb drop for thousands of feet and then level off in what amounts to a 7-G pull-out. At that time the 30-pound hand-held movie camera weighs the equivalent of 200 pounds pressing down in the photographer's lap.

Meanwhile, another cameraman may be filming spin tests of a new plane and a third

(Continued to page 230)

Photo officer adjusts the camera which shoots through a hole in the tail of the drag parachute sled





Drawer-cabinet easy to build with economical Western Pines

Just the thing to rid a room of clutter.

And it's easy to build with clean-cutting, straight-grained Western Pine woods. Soft-textured and carefully dried, these fine woods take any paint, stain or enamel. Left natural, they can be waxed and rubbed to a smooth satiny glow.

Almost any building or remodeling project can be done more easily and economically with versatile Western Pines. See your lumber dealer for complete details.



FREE! New edition of bright ideas!

"FRIENDLY HOME IDEAS"—85 photographs, many in color, feature traditional and contemporary ideas for building, decorating and remodeling using cheerful Western Pines. Write for your free copy to WESTERN PINE ASSOCIATION, Dept. 204-N, Yeon Bldg., Portland 4, Oregon.

The Western Pines

Idaho White Pine

Ponderosa Pine

Sugar Pine

and these woods from the Western Pine mills

**WHITE FIR • INCENSE CEDAR
RED CEDAR • DOUGLAS FIR
ENGELMANN SPRUCE
LODGEPOLE PINE • LARCH**

are manufactured to high standards of seasoning, grading, measurement

TODAY'S WESTERN PINE TREE FARMING GUARANTEES LUMBER TOMORROW

PRI **ROAD TO RICHES**

You can be the next uranium millionaire! Government guarantees huge bonus! PRI instruments from \$29.95. See your local dealer today! FREE CATALOG!

Write PRI, 4223 PM W. Jefferson Los Angeles 16, California

DEALERS WANTED

ELECTRIC WELDER AC or DC 110 Volts

The "Little Marvel" all-metal welder, 5-year written guarantee. Welds 1/4" metal or money bark. Repairs tanks, tools, fenders, machine parts, etc. Complete with everything—rods, unit, eye shield, directions. \$7.95 plus 50¢ postage. Flame torch accessory for soldering, cutting, brazing \$3.95 complete with carbons, brass rods, flux. \$2.00 deposit on C.O.D. 75 ampere 1/4 inch Transformer Welder \$24.95 P.O.B.

ESSAY MFG. CO., Dept. 51, Quincy 69, Mass.

\$795 Complete Unit

MENDS MOST ANYTHING

"HOLDS LIKE IRON"

Used by fine furniture makers. Ideal for home and office. In 1/4 oz. or 2 1/2 oz. sizes.

GRAVELY

New **EASE** for Country Living!

NOW! 30 Tools

GRAVELY Gets It Done Faster! . . . Better!

New Steering Sulky, with Rotary Mower Attachment, provides the easiest, most efficient mowing ever!

With Gravely, you fit your jobs perfectly with a choice of 30 performance-proved attachments . . . Do every lawn and garden job better, faster, easier!

All-gear drive, power reverse, optional electric starter. Nation-wide sales and service . . . Easy Payment Plan.

Write today for FREE 24-page "Power vs Drudgery" Booklet.

GRAVELY TRACTORS, INC.
BOX 663 DUNBAR, W. VA.

FIELD-TESTED SINCE 1922



CRESCENT PIPE WRENCH

Now, Crescent quality in a really heavy duty wrench. Jaws of special analysis steel, alloy handle... great strength with less weight. Also a normal duty (Stillson) pattern with forged steel handle and jaws. Both in 6" to 24" sizes.

AT YOUR
HARDWARE
DEALERS

ARTISAN'S TIE CLASP

For the craftsman or hobbyist who is proud of his skill, a handsome gold-plated clasp designed by a leading jewelry manufacturer. A \$2.00 value... yours for 75¢, postpaid. Use the coupon.



To Crescent Tool Co., Jamestown, N. Y.

Enclosed find 75¢ for Artisan's Tie Clasp.

NAME _____

ADDRESS _____

M

CRESCENT TOOLS

Give Wings to Work

*Sign of the Artisan
Symbol of Excellence*



Crescent is our trade-mark, registered in the United States and abroad, for wrenches and other tools. Sold by leading distributors and retailers everywhere and made only by

CRESCENT TOOL COMPANY, JAMESTOWN, N. Y.

may be making air identification pictures of a new bomber.

Planning the camera layout for some jobs is complicated and we have a photo engineering unit for that purpose. The engineers lay out the locations of the cameras and how they will be triggered. One typical assignment was to make high-speed motion pictures of an aircraft taking off by the system known as "Zelmal" (zero launch, mat landing). For take-off, the plane is held in a launching position and becomes airborne with the help of a huge rocket booster under the fuselage.

One camera was to be focused on the launching frame, one on the rocket bottle, and others were to track the bottle to the point where it dropped from the aircraft. In addition, a number of theodolite cameras were positioned to supply the following information: Altitude versus time, down-range distance versus time, flight-path deviation versus time and pitch angle versus time. Accuracy had to be within one foot of actual position at all times. Such an assignment had to be planned with care.

Another tough problem was how to make close-up pictures of raindrops smashing against a radome at Mach 2. A radome is an exposed nonmetallic housing where the radar antenna is located. Purpose of the pictures was to learn more about rain erosion of a radome surface at high speed.

It would have been simple to mount the camera on the rocket sled carrying the radome, but this would disturb the normal flow of air around it. The camera had to be

(Continued to page 232)

Big liquid-fueled rocket engine fires up before take-off on a high-speed test of drag parachutes

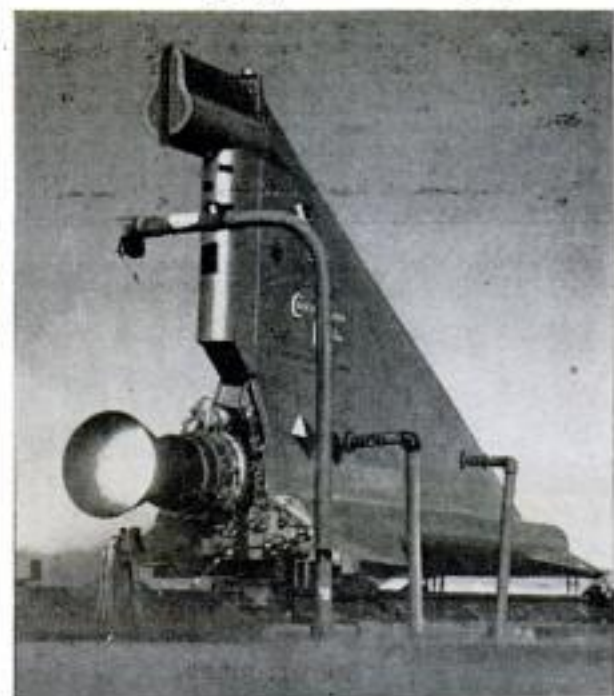

SURPLUS AT FRACTION OF GOV'T COST **TOP VALUE SPECIALS** **SHOP BY MAIL AND SAVE AT GROBAN'S**

MASTER & SLAVE HYDRAULIC REMOTE CONTROL SET

ITEM #415—Designed for remote operation of controls on engines, boats, special machinery, etc. Eliminates complicated mechanical linkages, cables, pulleys, etc. The master unit connects to the slave unit with a single 1/4" tube.

When master control lever is moved, slave lever follows exactly. Light, compact, aluminum alloy construction. Dim. of both units: 5 1/4" W, 9" H, 1 3/4" D. (exclusive of handle) Ship. Wt. 8 lbs. P.O.B. Chicago. . . . **27.50** pair (Note — Tubing not supplied)

GROBAN FOUR-WAY OPEN CENTER HYDRAULIC CONTROL VALVE

ITEM #126 — Four-way open center control valve, with built-in adjustable relief valve factory set at 1000 P.S.I. Spring loaded neutral position. For use with one double acting cylinder. In neutral position cylinder is locked and pump unloaded. Can be used as single unit or mounted in series. Has 3/4" pipe thread inlet and outlet. 1/2" pipe thread cylinder ports. Finger grip handle. Ship. wt. 10 1/2 lbs.

AN OUTSTANDING BUY!
P.O.B. Chicago **23.50**

VICKERS HYDRAULIC PUMP PISTON TYPE COMPACT — POWERFUL

For direct or pulley drive. Rated 8 Gal. per min. at 3750 R. P. M. Delivers 1000 lbs. per sq. in. Ball bearing construction. Standard foot mounting. 1/2" shaft. 1/2" pipe thread ports. U. S. Air Force cost \$136.00 Our low price Postpaid. . . . **24.95**

BELT DRIVEN A. C. GENERATORS

Ideal for powering electric tools, oil burner, refrigerator, lights, or other appliances requiring up to 1000 watts of power. **1000 WATTS**, 115 Volts, 60 cycles A.C. 3600 R.P.M. Compact, self-regulating generator with V Belt pulley and double outlet receptacle. Rotation counterclockwise. May be driven by tractor or auxiliary gasoline engine. Requires 2 1/2 HP minimum. Dimensions: 10" long x 8" high x 6" wide, Shipping wt. 27 lbs. F.O.B. Chicago. . . . **79.50**

MODEL 700 — 750 WATTS A.C. 59.50
Model 2000 — 2000 WATT A.C. Generator. 133.00

U.S. NAVY ALL BRONZE CENTRIFUGAL PUMP

These all bronze Centrifugal Pumps are ideal for use as marine bilge pumps, circulating pumps, fire protection or irrigation, car-washing, dewatering, basement sump pumping, lawn sprinkling. Will pump water, oil, brine, gasoline, DDT and sulphur compounds. Equipped with 6" adjustable 'V' pulley, 2" dia. inlet and outlet, 180 GPM capacity. Inlet and outlet take hose with 2 1/4" inside diameter. Dimensions: 11" x 8" x 11".

Total head-feet	Speed	H.P.	GPM
25	3600 RPM	3	180
15	3000 RPM	1 1/2	90
20	2400 RPM	1 1/2	75

Back plate may be rotated for most convenient inlet position. Gov't acquisition cost \$96.00. Shipping weight 31 lbs. P.O.B. Chicago. . . . **29.50**

1 1/2 H.P. HYDRAULIC SPEED REDUCER with FINGERTIP CONTROL

USE FOR: Reamer Drives • Midget Cars • Feed Mills • Canning Machines • Conveyors • Lathes • Milling Machines • Motor Boats • Cream Output Separators • Garden Tractor Shafts • Pumps.

Variable output speeds from 0 to input speed available by moving control handle. Locking handle maintains setting. Use input power of 1/4 to 1 1/2 H.P. Shafts 5/8" diam. Input rotation counter-clockwise facing shaft. Input speed 750 R.P.M. 7 1/2" x 7 1/2" x 11 1/2". Output rotation reversible. Ship. wt. 31 lbs. Complete with 2 eqs. of oil and full instructions. P.O.B. Chicago. . . . **72.50**

DOUBLE ACTION HYDRAULIC CYLINDERS

ITEM #31C — 3 1/2" bore, 11" stroke. Alloy steel cylinder wall. Micro-Honed and all steel 1 1/2" diameter piston rod. 19 1/2" overall length closed. Clevis mounting at base and shaft. Will lift 9625 lbs. with 1000 PSI Pump Pressure. Uses 3/4" tubing fittings. (Fittings to pipe thread: two 3/8" MPT @ 35c.) A \$102.00 value. Shipping weight 11 lbs. POB Chicago. . . . **25.00**

ITEM #16-C — 1 1/2" bore, 26" stroke. Will lift 1760 lbs. with 1000 lbs. pump pressure. Great for hay loaders, etc. 1" stainless steel piston rod. Postpaid. . . . **16.95**

16-TON "SIMPLEX" SCREW JACKS

BRAND NEW
ITEM #505 • For house movers, railroads • Construction Equipment • Machinery, rigging. 16-Ton Simplex screw jacks, 1 3/4" x 16", 4-way head type, with malleable iron base, and heat-treated steel handle. Shipping Wt. 35 lbs. P.O.B. Chicago, EA. . . **9.50**

Set of 4 — 35.00
P.O.B. Chicago

BRAND NEW 1 H.P. 12 Volt Electric Motor

For electric wheel chairs (Pop. Mech. Digest—Mar., 1957)
For electric golf carts
For self-propelled scooters, children's mid-let cars.

ITEM #308
Rated 1 H.P., —100 amps., 5000 R.P.M., 12 volts, D.C.—This double shaft motor of ball-bearing construction may be run on 6 volts for lower horsepower requirements.—Standard 3/8" shafts, flange mountings.—Dimensions: 3" x 4 1/2" x 4 1/2" Ship. wt. 19 lbs. A real **12.50** P.O.B. Chicago

2 H.P. ELECTRIC MOTOR

24 Volts, 90 Amps., 4000 RPM, Split shaft both ends. Style similar to above. Mfgd. by Hobart or Diehl. **ITEM #315** P.O.B. Chicago. . . . **13.00**

FREE — 1957 CATALOG JUST OUT!

60 PAGES—Chuckful of unsurpassed War Surplus and newly manufactured Equipment Bargains for farm, home, factory, workshop. Write letter today.

ORDER DIRECT FROM AD— SATISFACTION GUARANTEED
Send Payment Or Purchase Order Today
For Phone Orders Call WEBster 9-3793

GROBAN SUPPLY CO. DEPT. PM-6
GROBAN BUILDING
1139 S. WABASH AVE. CHICAGO 5, ILL.

DO-IT-YOURSELF . . . WITH SAKRETE

Perfectly balanced, dry-mixed concrete and mortar in a bag. Just add water, mix and use! See your building supply dealer, lumber dealer or hardware store—today!

Look for the Bag with the Yellow Diamond!



10" TILT/ARBOR SAW BUILD-IT-YOURSELF from GIL-BILT KITS-PLANS

Sturdy wood, steel, and aluminum construction. NEW DEPARTURE ball bearings. Capacity and performance of floor saws selling for \$150.00 and up. Plans, all metal parts in kit with 10" comb. blade **\$25.90**, less blade **\$22.95**. P.O.B. St. Louis. Detail PLANS-PATTERNS only \$1.00 postpaid.

Build-it-yourself 12" and 18" Bandsaws, 6" Belt Sander, Shaper. Simplified plans. Build easily with hand tools only. Advertised and sold for 10 years, over 22,000 units in use. Money back guarantee. **FREE CATALOG.**

GILLIOM POWER TOOLS, Dept. 80-F, Lambert Field, St. Louis 21, Mo.



New Steering Assist

gives you more positive control over your car at all times!



When you hit the shoulder of a road... or a hole... or railroad tracks...

Your car lurches... and for a split-second is out of control! Then...?

Now you can minimize this danger to yourself and family. Moog Ball-Bearing Idler Arm Kit gives you positive steering control... helps you return your car to the road smoothly. Even improves cars with power steering!

See how this new Moog Kit *adjusts out steering play*... makes steering easier, safer, quieter. Find out how it maintains wheel alignment... prolongs life of tires and front-end parts... *saves you money*. Mail coupon now!

Moog Industries, Inc., St. Louis 14, Mo.

Please send me information on the Moog Ball-Bearing Idler Arm Kit and name of my nearest dealer.

Name.....

Address.....

City.....State.....

installed beside the track, together with the sprinkler heads supplying the "rain."

Here again careful planning was necessary. At 3000 frames per second, the 100 feet of film in the camera would last just 1 1/3 second. But one third of the film would be run off while the camera was accelerating up to speed, so we actually had less than one second of shooting time. And the long lens we were using had only an 18-inch field of view at the selected distance. This meant we had to catch the radome as it raced past a particular 18 inches of track at 1500 miles per hour.

All we got on the first run was a cloud of fog. The camera was late. On the third run we hit it on the nose and got sharp, clear pictures of what happens to an object when hit by raindrops at 1500 m.p.h.

We were asked recently if a camera, aimed to film bombs as they leave the bomb bay, could be attached to the wing tip of a B-47. It isn't as easy as it sounds. The flexible wing of a B-47 droops when on the ground, but straightens out in flight. You can calculate the angle at which the camera should be aimed, but there's another factor. The instant a B-47 is relieved of its bombs, the plane rises. The wings deflect momentarily and your camera misses its aim.

A problem like that is exasperating. We have others that are worse. For example: How would you mount a wing camera on a supersonic aircraft? You can't hang it outboard, as on a B-47. Turbulence would smash the camera and possibly the wing. Our solution was to have a small hole cut in the leading edge of the wing, with a mirror attached at an angle just inside the hole. The camera was placed inside the wing and aimed at the mirror.

That wing was ready for the scrap heap after its first flight. We hadn't anticipated the tremendous forces existing at Mach 1 and above. The small hole had disturbed the normal flow of air so violently that the wing was pounded out of shape in some places, ripped open in others. It looked as if it had been hit by flak. We had to try a different scheme for our pictures.

Sometime soon our rocket-sled track at Edwards will be lengthened to about four miles. Faster sled speeds will be possible, and a start will be made in full-scale studies of aerodynamic heating right on the ground. Surface temperatures may rise to 650 degrees. A whole structure won't have time to heat up, of course, but the skin will be too hot to touch. We're wondering what'll happen to our cameras mounted on these "hot" sleds.

We'll find out in time, and there'll be a whole new set of problems to solve in putting supersonic experiments on film. ★★

FREEZER TIPS...



SAVE by buying day-old bread for freezer—thaws out completely fresh! Wrap in freezer paper, seal tight with "Scorch" Brand Freezer Tape. Moisture-resistant

tape sticks tight in freezing cold to foil, film, Saran or other wraps—and you can write on it! Get "Scorch" Freezer Tape in cutter-edge carton, 35¢ or 98¢ rolls at stores everywhere. © 1957, Minnesota Mining & Mfg. Co., St. Paul 6, Minn.



Get New 132 Page Catalog of WOOD AND WOODWORKING MATERIALS

WORLD'S LARGEST SELECTION—Lowest Prices
Your buying guide for finest kiln dried domestic and rare imported woods, inlays, bendings, matched plywood, moldings, ornaments, etc. Biggest selection of tools and hard-to-find hardware. Packed with scroll saw patterns, projects, wood facts and money making ideas. Enclose 25¢ (refunded on first order) to help pay mailing and handling costs. Write today to CRAFTSMAN WOOD SERVICE CO.
2729 S. Mary St., Dept. A-6, Chicago 8, Ill.

QUALITY FASTENERS

Low-cost, high-quality Southern fasteners give your project Quality and Permanence! Buy 'em by the box — and save!



COST NO MORE

Wood Screws • Tapping Screws • Machine Screws • Drive Screws • Dowel Screws • Stove Bolts • Hanger Bolts • Carriage Bolts

Southern
SCREWS & BOLTS

"ARCO HOLE-SAW"

with Exclusive "SLUG-EJECTOR"

Pops out chips automatically.

7 blades cut 1", 1 1/4", 1 1/2", 2", 2 1/4" & 2 1/2" holes thru stock—wood, plastics, metals. Fits drills, lathe, motors. Incl. 1/2" bit.

At your dealer or order direct (imp.)

C.O.D. + post. Money Back Guarantee.

ARROW METAL PRODUCTS CO.

Dept. PM-6, 421 West 203rd St., N.Y. 34, N.Y.



"MOLDED FIBER GLASS" BOAT



Write for free literature.
MOLDED FIBER GLASS BOAT COMPANY
71 Fourth Ave., Union City, Pa.

... only boat in the world with popular lapstrake design molded right into one-piece seamless hull, with matched metal dies. Tough, fast, smooth, beautiful. Mahogany-trimmed. Three 15' 7" models, priced from \$495.

Fast cutting
Top quality

GENSCO



SWEDISH WOOD CHISELS

Woodworking projects have that little extra professional touch when Gensco Swedish Wood Chisels are used. They're tops: hand ground, razor sharp blades, Tenite II handles are unbreakable and fire resistant... won't pull loose, sizes from 1/4" to 2".

Buy these accurate cutting, easier to use Gensco Wood Chisels at all leading hardware stores today. Available in sets of 4, 6 or 11 chisels in vinyl coated canvas rolls.



Set 300-4

1/4", 1/2", 3/4" and 1"



Bushman
ALL-PURPOSE 21"
Bow Saw

GENSCO

GENSCO TOOLS

A DIVISION OF

GENERAL STEEL WAREHOUSE CO., INC.

1832 N. Kostner Ave., Chicago 39, Illinois



WINCO ENGINE GENERATORS

PORTABLE POWER FOR ELECTRIC TOOLS

Electric hedge clippers, lawn mowers, power saws, spray guns, lights run smoothly wherever you need them with dependable Winco Portable Plants. Full range of sizes, 1,500 to 10,000 watts. Includes models for emergency power when electricity is cut off. Write today for facts and free booklet "How to choose a Generator." Dent. PM-67.

WINCHARGER CORPORATION

SIOUX CITY, IOWA

Subsidiary of Zenith Radio Corporation

NEW HONEYWELL DECORATOR LIGHT SWITCH!



Change it
any way,
any time



to match
your room's
decor!



THE TRANSPARENT decorator plate on the new Honeywell Tap-Lite* snaps off for easy decorating, cleans easily. Just wipe with a damp cloth. Simple to install. Tap-Lite has screwless terminals. Easy to operate. Tap, it's on. Tap, it's off! Switch and plate \$1.95 at hardware stores.

MINNEAPOLIS
Honeywell



*Trademark

First in Controls

Copyrighted material

Versatile, Powerful, easy to use . . . Black & Decker Tools!



Powerful Black & Decker No. 44 Sander! Does ten hours sanding in an hour. Will not track, score or burn surfaces. Even beginners get satin-smooth finishes on wood, metal or plastics. Perfect for almost any sanding job you can think of—antiques, boats, home maintenance, etc. Try it yourself, and *feel* the finish.



Versatile, easy to use B&D Jig Saw! U-10 does the work of a jig saw, sabre saw, key hole saw, plus most band saw operations. Pays for itself fast. Great for making pocket cuts without lead holes. It follows intricate pattern lines perfectly in wood, metal, plastics, leather, composition materials. Five different blades cut almost any material in your workshop.

Both of these famous tools are built to last for years. For more information see your dealer or write to: **THE BLACK & DECKER MFG. Co., Dept. M067, Towson 4, Md.**



Look under "Tools-Electric"



Black & Decker®

World's Largest Maker of Portable Electric Tools

His Cameras Spy on Life's Secrets

(Continued from page 69)

of light on the sex of fish, and there is some evidence that certain wavelengths have a strong effect. Biologists are so interested they already are asking him to make similar studies on poultry and cattle. The implications are obvious.

Another time-lapse study shows cancer cells dividing. One of the principal characteristics of malignant cells is that they reproduce wildly. Ott's films, of great interest to scientists studying the cause or causes of cancer, actually show the division of cancer cells in such detail you can even see the chromosomes ("threads" which carry the hereditary genes) lining up in orderly fashion prior to the division.

Cancer in a Glass Cage

For Northwestern University, Ott set his cameras to spying on the life secrets of cancer cells for a full year. He imprisoned malignant-tumor cells inside a glass cage, and rigged pipes to the prison which fed nourishment in the form of plasma and saline solution to the vigorously growing cells. His cameras took one exposure every 30 seconds, day and night, for a year. In that year he obtained 1,041,200 separate pictures on 65,075 feet of film, certainly the most intensive study ever made of cancer.

Occasionally Ott is so wound up in his scientific studies that he can't sleep at night. "Then something compels me to get up and head for the laboratory to see if anything has happened," he says.

Sometimes things happen that aren't anticipated. When Ott screened a microscopic study of pollen, he saw what he hoped to catch, but something else stole the show. In one corner of the screen, a cell-like body appeared to be going crazy, trembling violently and changing shape so fast he scarcely could trace its movements. This strange "thing" which crept onto the stage is still a mystery to biologists.

Ott makes no pretense of being a specialist in this microscopic world, and makes it clear that he leaves the interpretation of his films to qualified scientists. There is a universal desire on their part to lay their hands on more of his work. In the short time he has been showing his microscopic studies, he has been besieged by universities and medical laboratories to tackle specific assignments. Right now he's at the crossroads, and can turn down any number of paths he wants to investigate.

Chill and Warm Cycles

He has turned up one interesting theory

(Continued to page 236)

Tyler SPYRAL BLADE

SAWS
ANY MATERIAL

metal, wood,
linoleum, plastic,
rubber, etc.

SAWS IN
ANY DIRECTION

up or down
right or left
even in circles!



WORLD'S SAFEST SAW BLADE!

First important improvement in blades since the invention of the saw. Does what no other blade can do. Fits standard coping saw or hacksaw frames without special adapters. Fun to use...cuts fast and easy without chipping or tearing...leaves clean, smooth edge.

Ask for **TYLER SPYRAL BLADES**
at Hardware, Lumber, Auto & Variety Stores Everywhere

TYLER MANUFACTURING CO. 1000 W. Arbor Vista Ave.
Inglewood, Calif.

GIVES YOU YOUR BEST ANSWERS ON WHERE TO GO ON VACATION HULL AUTO COMPASS



Most compass drivers use Hull.
A favorite also for boats, pri-
vate planes. \$4.95 and \$6.50.

See your Hull Dealer or
write for literature



HULL MANUFACTURING CO., P.O. BOX 246-D6, Warren, O.

Metal Turning Lathe for Model Makers



SEND FOR FREE FOLDER
describing the new Lathe for
Model Makers. 15 1/4" bed
with 4 1/2" swing; 7" between
centers. Guaranteed. **\$35.00**
Only.....
f.o.b. Lansing.

Rosemoor Manufacturing Co.,
2501 Bernice Rd., Lansing, Ill.

Jiffy SAWHORSE BRACKETS

NO NAILS NO SCREWS NO BOLTS

Now a sawhorse in a jiffy! Just
use Jiffy Brackets and 2x4s.
Sold by hdw. and bldg. supply
stores everywhere, or order
direct. \$1.95 A pair. Higher W. Coast

GRAND HAVEN STAMPED PRODUCTS CO.
Grand Haven, Mich.



ANYONE can be an EXPERT with **deft**

WOOD FINISH

Deft SEALS, PRIMES,
FINISHES. Dries in 30
min. No thinning, noth-
ing else to use. BAR
TOP, semi-gloss interior
finish.

Free Booklet

Be GOOD to your WOOD, DEFT-finish it.
DESMONDS, 1826 W. 54, LOS ANGELES 62, CALIF.



T-BIRD

owners swear by

AJUSTOMATIC

shock absorbers

More and more owners of high-
performance automobiles are
demanding what only Gabriel
"AjustOmatic" shocks offer:

- A choice of *three* positive
settings—soft, normal or firm—
to be made in installation.

Gabriel
SHOCK ABSORBERS



WONDER-PASTE makes paint removing easy

Finish comes off, not coat by coat,
but in one easy scraping

Before refinishing furniture, woodwork, etc., remove all cracked or peeling finish with Wonder-Paste. Softens up the toughest paint, varnish or enamel. Adheres to uprights. Use indoors or out.

At paint and hardware stores.



The painter's favorite

● Write for free Wonder-Paste folder

or send 25¢ for Illustrated Manual on Refinishing.

Wilson-Imperial Co., 119 Chestnut St., Newark 5, N. J.

New "PULL-GEAR" SPEED-REDUCING PULLEY

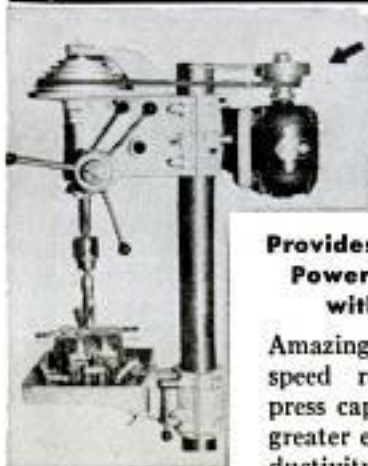

Provides Correct Speed and
Power to Drill Up to 1 3/8"
with 1/2 H.P. Motor

Amazing new internally geared speed reducer doubles drill press capacity. Greater power, greater efficiency, greater productivity.

Provides the correct speed and power for larger drilling, reaming, tapping and boring on light presses. Easily installed in five minutes. Adaptable to all type machines. Spindle speed range approx. 45 to 3000 RPM. Made in 3 motor shaft sizes: 1/2" — 5/8" — 3/4". Write for literature.

WRITE FOR LITERATURE

THE PULL-GEAR CO.

25427 Mound Road
Center Line, Mich.

that he wants to pursue. A gardener by inclination, he has long been aware that certain plants (tulips are a common example) require a chilling period—winter—then a warming period before they will germinate. Ott suddenly observed that this phenomenon carried over to his medical studies. For some time, cancer specimens had been brought to him in heated containers from a university, and he had observed them in their heated stage. For long weeks he could see no activity. One day the lid fell off the heated container during the trip to the laboratory. Ott was tempted to throw the specimen away, but decided to put it under a microscope anyway. To his surprise, the sample showed intense activity. Subsequently, he found that many living specimens which were chilled and warmed again behaved spectacularly.

In a study of black spot on roses (caused by a microscopic spore) he couldn't force any black spot to appear, although he knew the spore was present. One day he discovered that the laboratory's night thermostat was failing to function. As a result, the heat wasn't turned down at night and the laboratory was maintained at the same temperature continually. When the thermostat was repaired, black spot immediately began to develop on the rose leaves. Subsequent experiments proved that the spore had to go through a chill-warm cycle before it would do its damage.

Similarly, he has observed insects going through the pupa stage in winter. He is convinced this is not merely a protective stage, but that the chill-warm cycle is vital to their existence. He further is convinced this chill-warm phenomenon is more important to many life processes than is generally believed. Most medical authorities agree that chilling plays an important part in the common cold, infantile paralysis and other illnesses. Ott feels that the complete cycle, chilling and warming, is essential. In one study he made of the secretions of common-cold victims, long tentaclelike growths attacked the body cells. Chilling and warming speeded up this activity.

Ott also is excited about the prospect of industrial uses of time-lapse movies taken through a microscope. In metallurgy, such films would be of great value in the study of corrosion and molecular change.

John Ott is a modest man. He speaks in soft terms of his accomplishments, but he speaks enthusiastically of the time-lapse technique that makes them possible. Scientists are even more enthusiastic about this new research tool. It's quite possible that this technique may play an important part in the solution of some of our greatest medical mysteries. ★ ★ ★

NEED A TRAILER ?

GOV. COST \$128.00
YOUR COST



FOR MOVING



FOR BOATS



FOR STOCK

Dear Handyman:
Imagine a galvanized, welded, factory made utility trailer frame complete with: (1) a 2000* Acme hitch and ball—(2) Heavy reinforced hitch support—(3) & (6) Heavy 12 ga. galvanized steel frame with gussets at all corners—(4) Two heavy galvanized steel fenders—(5) (9) (10) 2000* heavy duty axle assembly including bearings, 15" wheels and chrome hubcaps—(7) One steel b/c ding jack—(8) One Ratchet hand wrench with 15 ft. aircraft cable—all this for \$49.00—a price you would normally pay for the axle assembly alone. Numerous uses as boat trailer, utility trailer, etc.

You'll never match this close-out value with a money back guarantee — number limited — send your check today

\$49.00
F.O.B.
MINERAL WELLS, TEX.

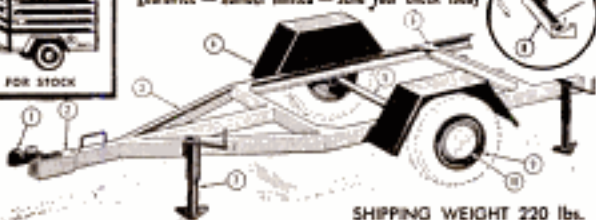

SHIPPING WEIGHT 220 lbs.

ALUMINUM PRODUCTS CO. DEPT. S
MINERAL WELLS, TEXAS

Free book on home workshops!

"What To Look For When You Buy Power Tools" gives you up-to-the-minute information on how to select and buy power tools, tells you how to set up ideal workshop at home. **FREE!**

Write Dept. 505-M, MAGNA POWER TOOL CORPORATION
Menlo Park, California, OR Box 2808, Ft. Wayne, Indiana

DO MORE PLANING JOBS WITH LOW COST BELSAW



Exclusive MONEY-MAKING Features: Full 12 1/4" x 6" capacity • Power feeds at 14" to 34" a minute • Provides for Grinding Knives in the Cutter-head • Attachments for Jointing, Rabbing, Tongue, Matching, Groove. Convert low cost rough lumber into high priced stock. Easy to make flooring and popular patterns. Send Today for FREE Literature and Prices.

LOW DOWN
PAYMENT
EASY TERMS

Belshaw Machinery Co., 2057 Field Bldg., K.C. 11, Mo.

KADET 4-WHEEL TRACTOR

LOW IN COST - HIGH IN QUALITY

Tillers, Mowers, Tractors
low as **79.50**

This tractor is ideal for Farms, Estates, Schools, Nurseries, Parks, etc. 12 quick-hitch attachments available, including Snow Plow, Sickle Mower, Trailer, Turning Plow, etc.

FREE catalog write Dept. '21'
NATIONAL FARM EQUIPMENT CO., INC.
142 GREENE STREET • NEW YORK 12, N. Y.

DO IT YOURSELF

It's Easy With ...



Soldering's really a "clinch" ... when you use time-tested, reliable KESTER ... available everywhere.

FREE! "Soldering Simplified" ... 16-page how-to-solder booklet. At your dealer or write direct.

KESTER SOLDER COMPANY
4251 Wrightwood Avenue Chicago 39, Illinois



THE REACH IS RIGHT AND TIGHT

with KRAEUTER

LONG NOSE PLIERS



#1781-7"

You can depend on reachability and cutting power with Kraeuter's #1781 Long Chain Nose Pliers. And your reach will be tight and sure for those hard-to-get-at jobs with the extra long milled jaws of these pliers.

Buy the right line. It's the Kraeuter line. Kraeuter tools are unreservedly guaranteed.

Send for catalog #25 illustrating complete Kraeuter line.

BUY THE FINEST
BUY KRAEUTER
BUY AMERICAN

MODERN AS TOMORROW
kraeuter & co., inc

FOR 100 YEARS THE FINEST IN HAND TOOLS 1860-1960 • NEWARK, N. J.





Hiller Helicopters to Develop X-18 Tilt-Wing Plane

Propeller-driven, tilt-wing transport aircraft, capable of vertical take-off and landing, are now under development. They have

less hovering ability but greater forward speed than copters. Illustration shows phases of vertical to forward flight.



British Machine Is Versatile

Back-yard gardeners will find plenty of use for a small British power tool that can weed, dig, hoe, cut grass, trim hedges or, if you wish, polish your car. A universal coupler fits to the end of the drive shaft and powers a variety of tools. The air-cooled engine develops one horsepower. The entire machine weighs only 58 pounds and can cultivate between rows.

CAA Controls More Airspace

All airspace above 24,000 feet has been taken under the control of the Civil Aeronautics Administration. This more than triples the amount of airspace controlled by the CAA. Under the old system the CAA controlled traffic only when it was moving along the 90,000 miles of designated airways, or in the control zones of airports. The new system controls all airspace above 24,000 feet regardless of whether it has been designated an airway. Eventually the CAA plans to provide positive separation of all aircraft at the upper levels.



In just
10 minutes
your dealer
can prove...

The AMF DeWalt® Power Shop makes woodworking easy for you



SEE Safer, easier
top-side cutting



Direct-drive power,
no belts, no pulleys



DeWalt's exclusive
safety features



Layout marks visible
every cut, no mistakes



Work moves straight —
saves 75% floor space



DeWalt becomes 12
professional tools in 1

See for yourself why DeWalt's original radial arm design, big capacity, and unsurpassed accuracy make it the finest, most valuable all-purpose power tool you can own.

Your dealer will quickly show you how a DeWalt saves the cost of a shop full of tools — makes all home woodworking fast, easy, safe... fun! How you can make furniture, build in cabinets, finish off the attic or basement, make home repairs... do all those things you've always wanted, *even if you've never used a power tool before!*

See your Franchised DeWalt Dealer for a Free, convincing demonstration today! Easi-Budget Terms — 10% down, 2 years to pay!

Send the coupon for
free booklet and name
of nearest DeWalt dealer.

Another **AmF** Product

DeWalt Inc., Dept. PM-706, Lancaster, Pennsylvania
Subsidiary of AMERICAN MACHINE & FOUNDRY COMPANY



Send FREE colorful 20-page Booklet and name of dealer.

Name _____

Address _____

City _____ Zone _____ State _____

Five-Stage Rocket Exceeds Mach 10

FIVE STAGES of rockets propelled this missile faster than Mach 10.4, 6864 miles per hour, which was the speed record set previously by a four-stage rocket. Since this time, another missile has reportedly exceeded the five-stage rocket's speed by flying more than 9000 miles per hour.

Final checking of the five-stage rocket was accomplished by technical personnel with the help of a giant crane at the National Advisory Committee for Aeronautics' Station, Wallops Island, Va. The first two rocket stages attained the missile's maximum altitude, while the other three were fired during its horizontal flight. Performance information was automatically transmitted to scientists on the ground.

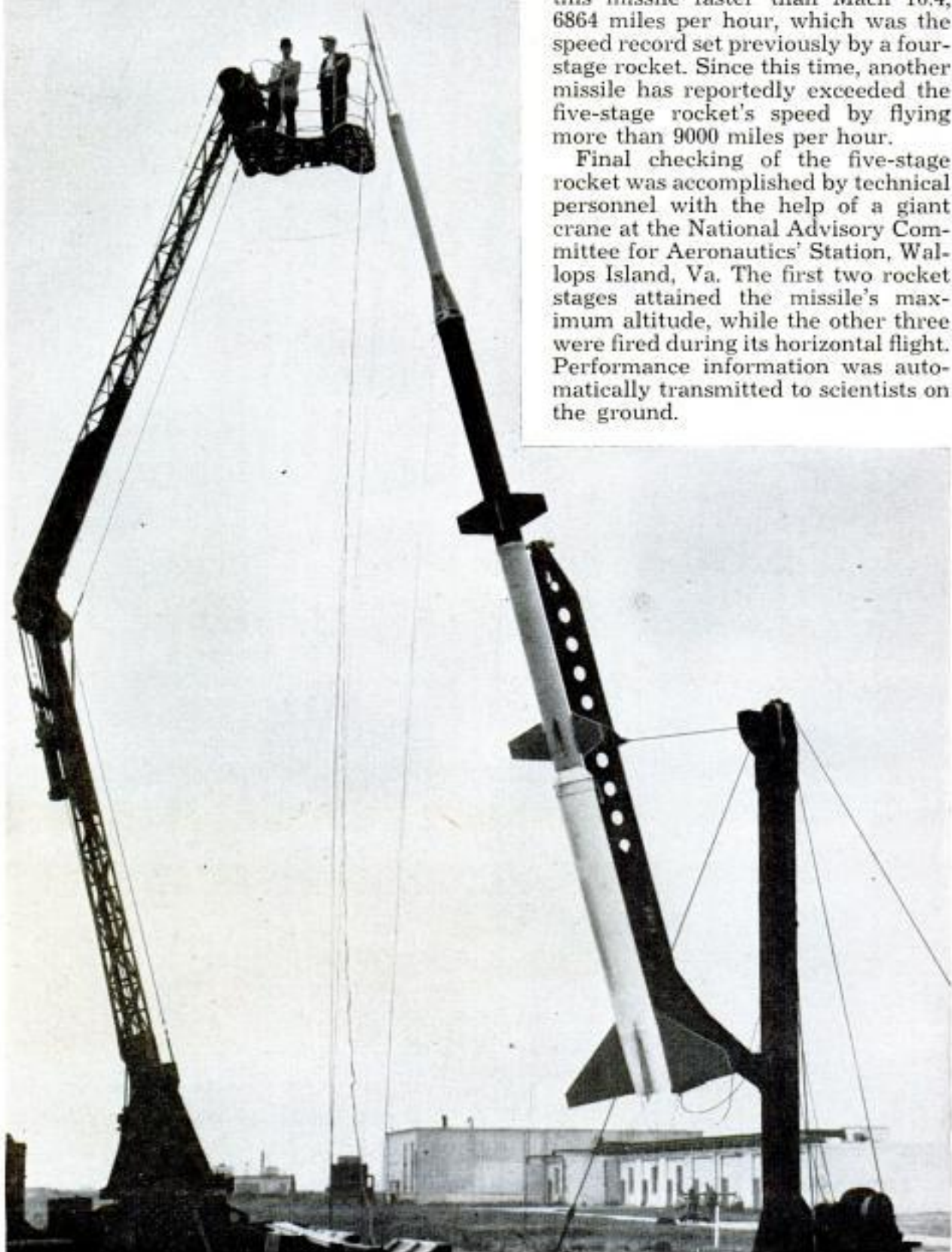

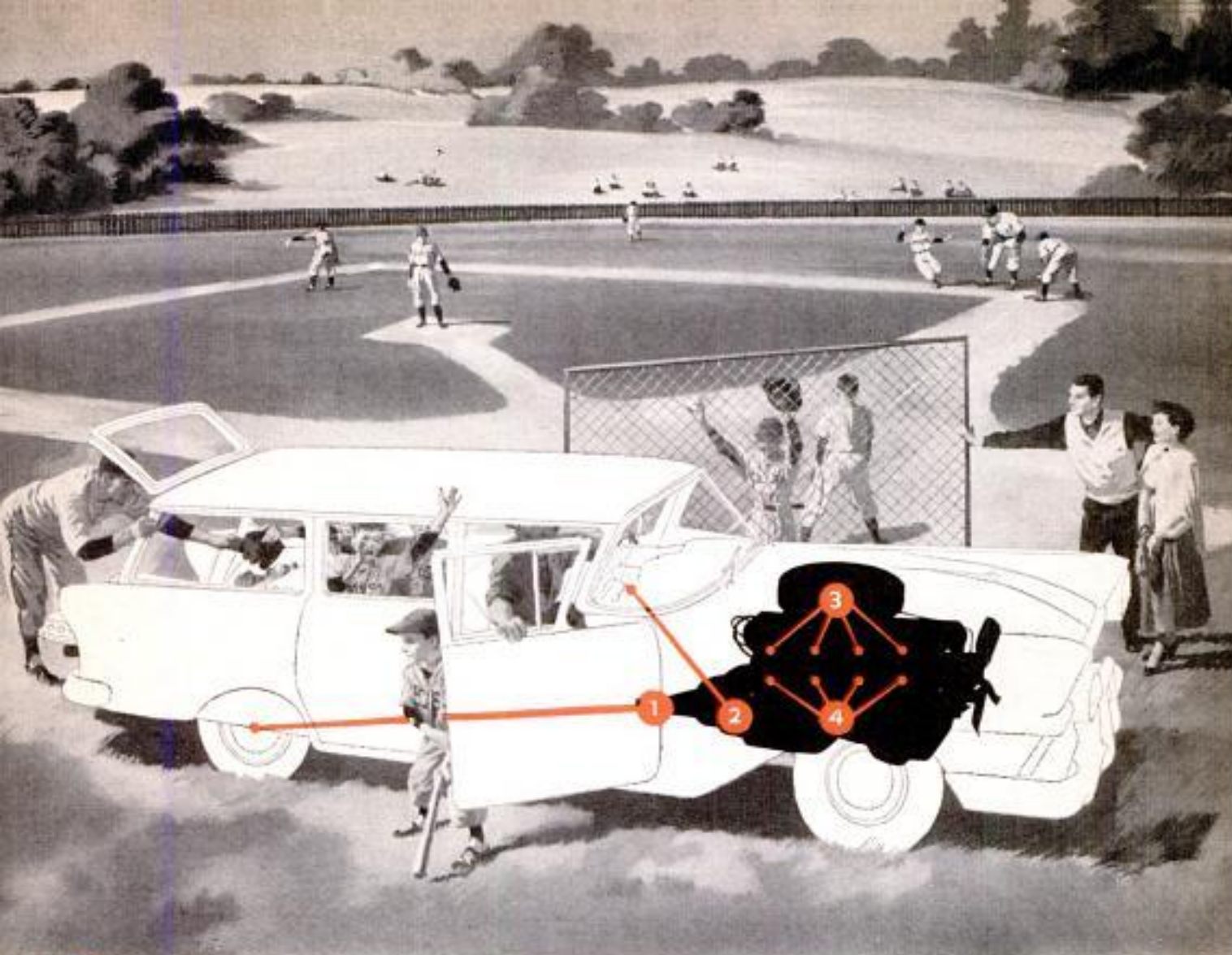

1 More road horsepower— Your car will act young again when you put in 5-rib Champion spark plugs! Independent engi-

neers proved new Champions give cars of all makes an *immediate* boost in the real power actually delivered at the rear wheels. Most

cars gained 6% to 31%—for better hill climb and safer passing. No wonder 9 out of 10 racing drivers insist on Champion spark plugs.

If you haven't changed your plugs in about 10,000 miles—

You can make your car 4 ways newer with Champion spark plugs



2 Quicker starts—Your engine will start quicker, too...save time and battery wear. Tests with cars whose plugs had gone about 10,000 miles show that new Champions cut starting time as much as 71%—with an average of 39%!

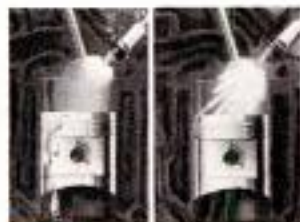

3 Less engine wear—You'll save costly repairs! Old misfiring plugs (left) dilute oil with raw gas. New full-firing Champions (right) burn the gas...protect oil from dilution. *When changing oil—be sure to check your spark plugs!*



4 Lower cost-per-mile—You get top power and gas economy for life of the plug. Champion's great new Powerfire electrode stands up better than ordinary types—as photo above shows. Always insist on 5-rib Champion spark plugs!



it's NEW! it's ALL IN ONE LEVEL · SQUARE · TAPE

IT'S A LEVEL!
Built-in, accurate unbreakable Level.

IT'S A TAPE!
10 ft., replaceable WYTEFACE® Tape.

IT'S A SQUARE!
Accurate Square. Easy to use.

Only \$1.98
at your hardware store

K+E KEUFFEL & ESSER CO.
Hoboken, N. J.

Holt's WORLD FAMOUS "Do-It-Yourself" PRODUCTS

HOLT'S ORIGINAL Piston Seal

20 years on the market. No one else can claim this. Effective interim treatment for worn cylinders. Forms self-lubricating seal around pistons. Lasts for thousands of miles. Get yours NOW. Delay is costly.

Only \$4.95 a Tube

- 1 - reduces oil consumption
- 2 - restores compression
- 3 - stops piston slap
- 4 - increases miles per gallon
- 5 - improves performance
- 6 - makes engine quieter

REPAIR MUFFLER AND EXHAUST LEAKS in 10 min.

The plastic gas-tight seal sets hard, withstands heat and vibration. Prevents carbon monoxide gas poisoning.

SETS LIKE A WELD—NO TOOLS NEEDED

Holt's GUN-GUM MUFFLER SEAL

\$1.69 Per Can

Ask for Piston Seal and GUN GUM at nearest garage or auto store . . . or

TREGLOWN CO., Inc.
Fanwood 130, N. J.
© TRADE MARK REGD.

Write for full details

are you SCIENCE MINDED?

DO YOU HAVE a natural aptitude for science? The following quiz will give you a clue. It's a shortened version of a 2½-hour examination given by the Science Clubs of America in a search for tomorrow's research scientists.

Don't be discouraged if the questions look tough. They are tough. The test isn't designed to test your over-all knowledge or reasoning ability, but only your aptitude toward science.

There are 17 questions with 28 different answers to be provided. Give yourself one point for each correct answer (a perfect score would be 28). Based on a random sample of high-school seniors who have taken the test, a high score is 18 or better; average, 10 to 17; and low, 9 or less. You'll find the answers on page 252.

1. One kilowatt is equivalent to 2,654,200 foot-pounds per hour. One horsepower is equivalent to 33,000 foot-pounds per minute. How many kilowatts are equal to one horsepower?

1. $\frac{33,000}{2,654,200}$
2. $\frac{33,000 \times 60}{2,654,200}$
3. $\frac{33,000 \times 2,654,200}{60}$
4. $\frac{2,654,200}{60 \times 33,000}$

Should be #2 not #4 as shown on p 252

2. Which one of the following terms or concepts does not apply to lichens?

1. Fungus 2. Perennial
3. Seeds 4. Symbiosis

3. Leprosy is caused by a

1. Bacillus 2. Chemical irritant
3. Protozoan 4. Virus

4. The diagram shows the relative size of the earth and another celestial body. On the basis of relative size, which of the following is the most likely identity of the larger body?

- 1. Jupiter
- 2. Mars
- 3. Polaris
- 4. Sun



5. Androgens have been made from

- 1. Ascorbic acid
- 2. Cholesterol
- 3. Insulin
- 4. Trypsin

6. Hyperon refers to

- 1. Unit of measurement
- 2. Guided missiles
- 3. Hormones
- 4. Subatomic particles

7. If a sphere of 10-inch radius represented the earth (sea level), about how far would a projection representing a mountain range with a height of 15,000 feet project from the surface of the sphere if the scale were the same?

- 1. .0025 inches
- 2. .0075 inches
- 3. .0250 inches
- 4. .1000 inches

8. The first successful separation of rare-earth elements as free ions, reported in 1955, made use of what method?

- 1. Chromatography
- 2. Ion-exchange resins
- 3. Magnetic centrifuging
- 4. Successive precipitation

9. A special type of temperature-sensing element which can transmit a strong signal from a very tiny temperature change is a

- 1. Thermion
- 2. Thermistor
- 3. Thermocouple
- 4. Thermophile

10. According to Charles Darwin, "A struggle for existence inevitably follows from the high rate at which all organic beings tend to increase. Every being, which during its natural lifetime produces several eggs or seeds, must suffer destruction during some period of its life, and during some season or occasional year, otherwise, on the principle of geometrical increase, its members would quickly become so inordinately great that no country could support the product. Hence, as more individuals are produced than can possibly survive, there must in every case be a struggle for existence, either one individual with another of the same species, or with the individuals of distinct species, or with the physical con-

(Continued to page 244)

new
Fir Plywood
8 BOAT PLANS
only 25¢ each

PERFORMANCE TESTED
 Fir Plywood Fleet
 ACCURATELY DESIGNED

See your lumber dealer or use coupon below.



No. 30. 7' 9" Pram Dinghy



No. 35. 11' 3" Outboard



No. 40. 13' 4" Outboard



No. 45. 13' 9" Punt



No. 50. 15' Outboard



No. 55. 15' 11" Runabout



No. 60. 18' Day Cruiser



No. 65. 20' Cabin Cruiser

***Use Only Exterior Fir Plywood For All Marine Construction**

(EXT-DFPA® Means 100% Waterproof Glue!)

Douglas Fir Plywood Association, Dept. 9, Tacoma, 2, Wash.

Please send plans checked below. I enclose 25c for each. (Good in U.S.A. only)

No. 30 No. 35 No. 40 No. 45 No. 50 No. 55 No. 60 No. 65

Name _____

Address _____

City _____ Zone _____ State _____

(Continued from page 243)

ditions of life. It is the doctrine of Malthus applied with manifold force to the whole animal and vegetable kingdoms; for in this case there can be no artificial increase of food, and no prudential restraint from marriage. Although some species may be now increasing, more or less rapidly in numbers, all cannot do so, for the world would not hold them."

It can best be inferred from this paragraph that:

- 1. The natural laws of reproduction serve to keep all organic beings in check;
- 2. The principle of geometric increase serves to keep all organic beings in check;
- 3. There is always a struggle for survival, keeping organic beings in check;
- 4. When environment is limited, a struggle for survival must occur.

11. In Darwin's statement the doctrine of Malthus evidently refers to

- 1. Manifold force;
- 2. The fact that natural limits cannot be overcome, even by living organisms;
- 3. The fact that organic beings, if allowed, will overgrow the capacity of their surroundings;
- 4. The fact that the animal and vegetable kingdoms are in constant strife.

12. According to Darwin, the constant battle which each organic being wages against the other is due, first of all, to

- 1. Food problems
- 2. High reproductive rate
- 3. Natural enmity
- 4. The animal-vegetable cycle

(Graph below applies to questions 13, 14 and 15.)

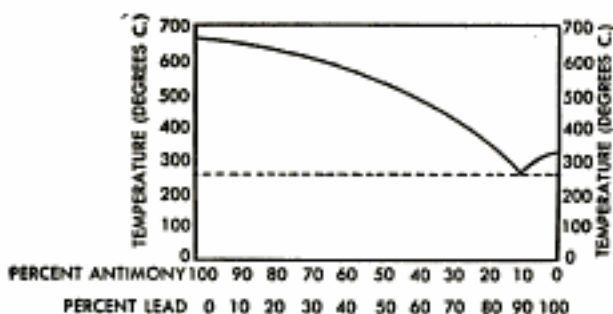

13. This graph shows the relationship between melting temperature and composition of antimony-lead alloys.



Head
won't loosen
Handle
won't break

Here's the finest hammer made. Shaft is gleaming, chrome-plated tube of boron alloy steel. Won't bend or break. Polished head is locked permanently to shaft. Tough neoprene-fiber cushion grip absorbs shock, won't slip wet or dry or in gloved hand. See ROCKET hammers at your hardware store. True Temper, 1623 Euclid Ave., Cleveland 15, Ohio.



New JET ROCKET hammer, axe and hatchet, too. Bell-face design. Built like the famous original ROCKET but with jet-black head and black cushion grip. From \$3.95.

BOH

B16

TRUE TEMPER®



Finest quality in Hammers, axes, hatchets
Shears • Shovels • Garden, lawn and farm
tools • Fishing tackle • Golf-club shafts

The graph clearly shows that

- 1. Antimony decomposes lead
- 2. Lead and antimony are insoluble
- 3. Lead has a lower melting point than antimony
- 4. Lead is softer than antimony

14. As the percentage of antimony increases from 0 to 100, the melting temperature of the alloy

- 1. Decreases
- 2. First decreases, then increases
- 3. Increases
- 4. Remains constant

15. A mixture of lead and antimony with the lowest melting point consists of

- 1. 10% lead and 90% antimony
- 2. 50% antimony and 50% lead
- 3. 90% lead and 10% antimony
- 4. None of the mixtures listed in the other three answers

16. Underscore the correct chemical name for each of the following substances

1. Hypo (sodium hypochlorite) (sodium thiosulfate)
2. Marsh gas (methane) (methanol) (trichlormethane)
3. Rare earths (actinide series) (lanthanide series)
4. Saltpeter (potassium nitrate) (sodium nitrate)
5. TNT (trinitrophenol) (trinitrotoluene)

17. Column I lists enzymes and hormones. Column II lists the glands that secrete them. Place the number of the gland from column II in the parentheses in front of the appropriate name in column I.

- | | |
|---------------------|-----------------------|
| () 1. ACTH | 1. Adrenal cortex |
| () 2. Erepsin | 2. Adrenal medulla |
| () 3. Insulin | 3. Gastric glands |
| () 4. Parathormone | 4. Intestinal glands |
| () 5. Pepsin | 5. Liver |
| () 6. Ptyalin | 6. Pancreas |
| () 7. Rennin | 7. Parathyroid glands |
| () 8. Thyroxine | 8. Pituitary gland |
| | 9. Salivary glands |
| | 10. Thyroid gland |

For answers to quiz see page 252



STOP WASTING MONEY on worn-out piston rings!

Oil-pumping is the first sign of worn-out piston rings. And worn-out piston rings mean power drop-off—costly wastage of gas and oil—expensive repairs.

The sooner you act, the less it will cost. See your motor specialist the minute oil-pumping warns you there's trouble ahead. When he recommends new piston rings, ask him for Hastings. They're engineered exclusively for replacement service . . . to provide the additional lubrication worn engines need . . . to stop oil-pumping, save gasoline and restore lost performance. Truly the best money you can spend on your car.

HASTINGS MANUFACTURING CO. • HASTINGS, MICH.

HASTINGS

PISTON RINGS

TOUGH on oil-pumping • GENTLE on cylinder walls

Buy these Hastings Products with confidence:
Piston Rings, Casite, Wear Reducer,
Oil Filters, Spark Plugs

Enjoy Breezy Cool Comfort this Summer!

Window or Attic

ANYONE
CAN DO IT!

FANS at amazingly
SAVE LOW COST!

up to 75%
WITH FAMOUS

FAN
KITS

No special tools or skill required. Absolute MONEY-BACK GUARANTEE. Only a few pieces of lumber and one or used 1/4 HP 1750 RPM motor required to complete. Thousands in use.



Also highly recommended for poultry houses, farm buildings, Greenhouses, Factories, etc.

COMPLETE KIT includes: Aluminum fan spider, masonite blades, Shaft, Oilite bronze bearings, collars, pulleys, belt and bolts. Step-by-step instructions

For window or attic, vertical or horizontal installation.

- | | |
|--|---------|
| 30" Fan cools average home, 6,000 CFM | \$14.95 |
| 36" Fan cools larger home, 8,000 CFM | 17.95 |
| 24" Fan cools smaller homes, 4,500 CFM | 13.95 |
| 20" Fan cools apt., offices, etc., 2,800 CFM | 12.95 |
- Money order or check with order shipped postpaid, \$3.00 deposit on C.O.D. orders. Circular free.

Satisfaction Guaranteed

FAN KIT Company

154-M No. Belvedere

Memphis, Tenn.

Here is your
new garage ...

Completely
MODERN

Completely
"DO-IT-YOURSELF"

Easi-Bild[®] Patterns—for dozens of home projects
—save you two-thirds the cost

With Easi-Bild Patterns you build valuable improvements for your home—and the results are professional. Here is a whole new world of fun, satisfaction, and possession. For example, this modern garage—complete with tool house and swing-up door—is made with Pattern #113 and Pattern #86. Or, with Pattern #86 you can put a swing-up door on your present garage. The lumber dealer sells you and delivers the materials listed on each pattern. Step by step, you follow plans for choosing a site, laying out the foundation, and building the frame. Homasote Insulating-Building Boards form the sheathing and interior surfaces.

Easi-Bild Patterns thus give you the know-how to build things for yourself for the cost of materials alone—reducing your outlay two-thirds. With Homasote Boards (in sizes up to 8' x 14') and Homasote know-how, you build everything from a cabinet to a complete house—even furniture and toys. The newly-revised Homasote Handbook is a 68-page building manual, written for you in practical language and with detailed illustrations. Look for the Easi-Bild emblem on your lumber dealer's counter and use the coupon to secure your free copy of the Homasote Handbook.

*T. M. Reur, Easi-Bild Pattern Company



HOMASOTE COMPANY, Department F-4, Trenton 3, N. J.
Send me the 68-page Homasote Handbook.

Name
Address
City Zone State

246



Flash-bulb photography with a flat-face reflector may be the winning combination for amateur camera fans. These reflectors deliver a different, distinct amount of light from each of three conventional types of bulbs. "Spill over" from this reflector provides softlighting. A readable, easy-to-set lamp-exposure dial simplifies camera settings. The deluxe reflector model has a push-button handle and universal bracket

Helland Division of Minneapolis-Honeywell

New for

Sound and picture are recorded simultaneously on magnetically stripped film in a hand-held, single-system magnetic-sound camera. Film processing does not harm the sound. One third the weight and size of existing single-system sound cameras, the unit includes a portable power supply

Magnetic Sound Camera Corp.,
1732 N. California Ave., Chicago 8



POPULAR MECHANICS

Copyrighted material



Newborn babies can be photographed by their mothers or members of the hospital's nursery staff. A private firm installs an automatic camera in the hospital on a rental basis. The baby is placed on a tray beneath the prefocused camera

Hospital Picture Service,
800 Boylston St., Boston 15, Mass.

Film Fans

Ten slides of any style stereo mounting are accommodated in the magazine of a hand-held viewer. This saves handling of each slide. With matched, precision-ground lenses, the viewer has batteries capable of conversion to 110-volt a.c. rheostat control. The viewer is used without magazine

Arrow Photographic Products, Inc.,
108-128 N. Jefferson St., Chicago



JUNE 1957

Stop Rust

DUE TO DAMPNESS



in TOOL CHESTS,
LOCKERS, GUN CASES, WORKSHOPS,
CAR TRUNKS, FISHING GEAR, GOLF BAGS, ETC.

Safe, easy way to keep your expensive equipment rust-free! Just place or hang De-Moist wherever needed. Won't drip! Proved twice as effective as any other dehumidifiers.

for only
\$1.39



De-Moist

G. N. Coughlan Co., West Orange, N. J.

AT ALL HARDWARE AND DEPARTMENT STORES

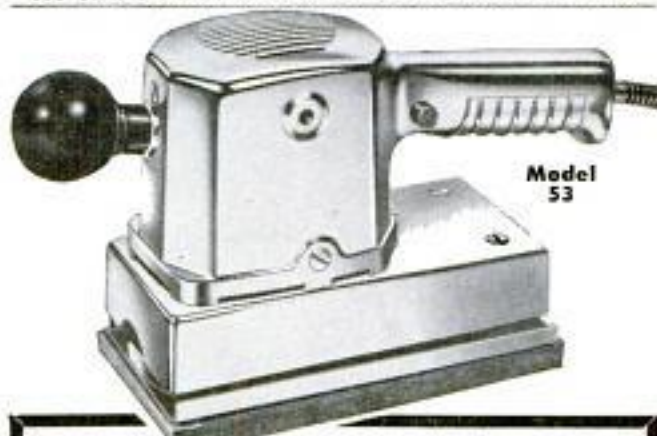

Model
53

The Secret of Scratch-free Sanding!

Ask any expert—the secret of a perfect finish is to sand with the wood grain! The old-time craftsman did when he sanded by hand. And so do you, when you use a Dremel Straight-Line Action Sander—except that a powerful motor does all the work. With Dremel Straight-Line Action, you leave no cross-grain scratches or orbital swirl marks to mar the finish of your project. Three models to choose from.

Get a Dremel from your local power tool dealer. If he can't supply you, order direct from factory on 5-DAY TRIAL, money back guarantee. We ship postpaid.

Dremel Straight-Line Action
Power Sanders — 3 popular models — \$14.85 to \$34.85

FREE Power Tool catalog.
Write today!

DREMEL MFG. CO.

DEPT. 117F

RACINE, WIS.



247

Copyrighted material

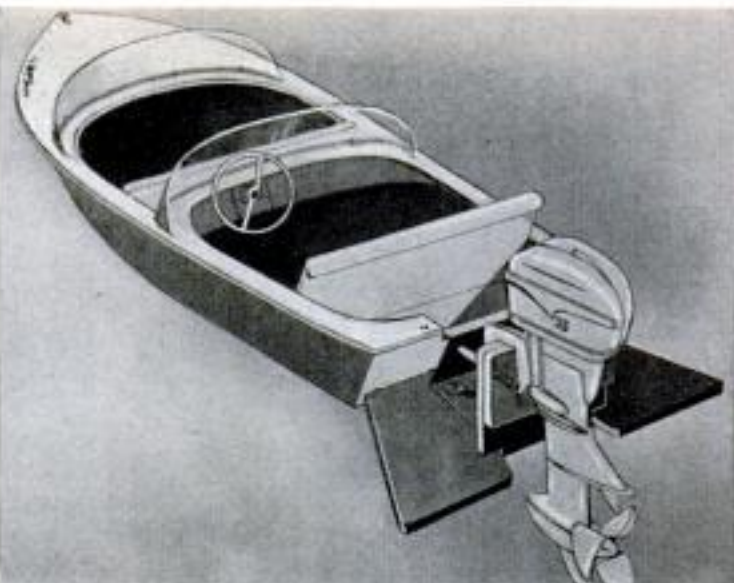
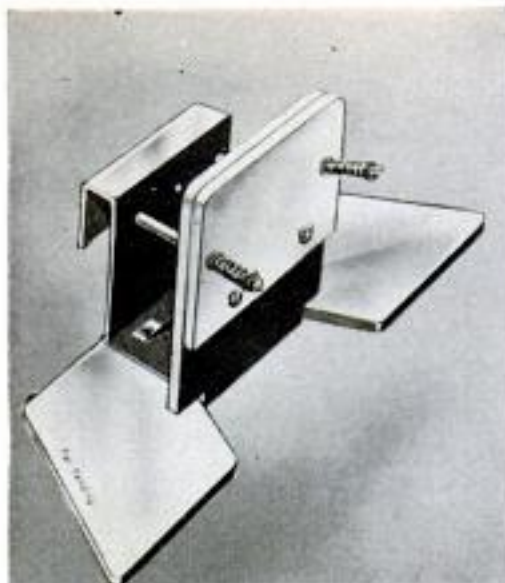

Outboard Boats Can Ride Faster, More Safely With Stern Fin

Stabilizing-fin units attached to the transoms of small craft permit these boats to plane smoothly within seconds after getting under way. Outboard vessels as large as 18 feet in length report speeds up to 20 per cent faster and fuel savings of about 30 per cent as a result of installing this device. A torsion plate on the fin assembly allows

easier remote steering. An outboard motor clamps to a vertical section of the fin unit, which is secured to the craft's transom to eliminate drag and vibration. About nine more inches of storage space are available in the stern of the boat. Safer loading and unloading of passengers are possible, and capsizing while under power is minimized.

Handy Nail Guide

HELPS YOU
SAVE TIME AND MONEY

- Tells right nail for each job
- Tells amount of nails per pound
- Tells right hammer to use



YOURS FOR JUST 10¢ Send coin direct to Estwing

Estwing

UNBREAKABLE TOOLS

CHOICE OF
CRAFTSMEN
FOR 30 YEARS



ESTWING MFG. CO., DEPT. PM-3, ROCKFORD, ILLINOIS

Do a Real Professional-Like Job
Yourself and SAVE

HOW to PAINT

With Brush and Spray

Covers All Painting Methods and
Materials

You can do professional-like painting and finishing jobs yourself and save about two-thirds of the cost. Sam Brown, noted craft authority, makes it so easy for you in his book, **HOW TO PAINT WITH BRUSH AND SPRAY**. Order your copy now and enjoy this tremendous saving. It covers exterior painting, wall and interior decorating, furniture finishing, concrete painting — every type of painting with brush, spray gun, roller and other methods. Tells what finish is best; what materials to use, etc. No previous experience needed. Fully illustrated. Order by mail. Only \$2.50. Money back if not pleased.

POPULAR MECHANICS PRESS, Dept. PM657
200 E. ONTARIO ST., CHICAGO 11, ILL.



MODERN

IMPROVED LAWN MOWER SHARPENER AND BED KNIFE GRINDER



\$275.00
FOB
PASADENA,
CALIF.

Grinds any reel type mower. Hollow grinds or flat grinds bed knives. New micro feed grinding head. Sharpens hand and power mowers. No disassembly of wheels, roller, handle or gasoline engine. No draining of gasoline or oil. Precision sharpens more mowers per hour. Costs less. Compare before you buy. If it isn't a MODERN it can't be MODERN.

WRITE FOR FREE BOOKLET 10A

The Modern Lapping Machine is designed to fit the needs of any large user of mowers and the lawn mower shops. Laps any reel type mower. 1/2 H.P. motor, \$67.95 fob, Pasadena, Calif.



MODERN MFG. CO., 160 N. FAIR OAKS, PASADENA, CALIFORNIA

POPULAR MECHANICS



BURBANK TEST PILOT says:

"Experimenting is my business, but when I shop I don't take risks..."

FPG

**I'm always satisfied most with
a BRAND that's made a NAME for itself!"**

MANUFACTURER



"I MADE IT . . . and I know it's top quality . . . in materials and workmanship. It has to be to satisfy people today. And satisfied people are the only reason my business is successful."

DEALER



"I SOLD IT . . . and I recommend it, because I know the brand has made a name for itself. Well-known brands offer the widest choice and latest improvements . . . and keep my customers satisfied."

CUSTOMER



"I BOUGHT IT . . . by brand because that's the best way of getting just what I want. I can't risk wasting time and money on hit-or-miss buying. Brand names give me the best and safest buy."

THE BRANDS YOU SEE ADVERTISED IN THIS NEWSPAPER ARE NAMES YOU CAN TRUST!

They stand firmly behind every product and claim they make.

BRAND NAMES FOUNDATION, INC • 437 FIFTH AVENUE, NEW YORK 16, N. Y.



RIPS THROUGH WEEDS 18 INCHES THICK! Nobody thought an outboard could cut a path through the matted water weeds in Florida's Lake Kissimmee. But Mark 75 made it where even air boats tried and failed! Whatever the going, Mercury can get you there. No other outboard is so reliable because no other even approaches Mercury in engineering features. Ask your dealer for a demonstration today.

MIGHTIEST OUTBOARD SHOWS ITS MUSCLES

60 WORKHORSE-POWER STRONG

New 6 cylinder Mercury Mark 75 has power for every kind of family boating fun! It's the leader of a new line of outboards with a new kind of power, stamina and handling ease.



PULLS FOURTEEN WATER SKIERS! Want *big* power for every purpose? Mark 75 is ideal for water skiing, cruising . . . fishing, too! Full Jeweled Power* protects moving parts. Aircraft-type engine mounts hush noise and vibration. Special clutch eliminates shear pins. *Anti-friction ball and roller bearings.

STANDS RUGGED SAND BAR TEST! A multi-cylinder Mercury was slammed over a sand bar time after time. No damage! Exclusive drop-forged clamp brackets, Uni-Cast 1-Piece Gear Housing and prop were intact. Mercurys are made for *extra* safety! (Note: Don't try this with any other outboard.)



PLANES FAMILY-SIZE CRUISERS! Mark 75 is far more powerful, far smoother than "over-sized twins." Exclusive multi-cylinder in-line design, chosen after all others were tried and rejected, gives the power flow of a fine car engine.



SINGLE LEVER CONTROL! Puts 60 hp in the palm of your hand. To start, push the lever forward and press thumb-button. To reverse (above), pull back and press button again. Crankshaft reverses direction and motor runs backward!



BALANCED TO FEATHER TOUCH! Center of gravity is so low (see photo) Mark 75 minimizes strain on the boat. See Mercury's 12 models, 6 to 60 hp. Or write for catalog to Kiekhaefer Corp., Box M-2, Fond du Lac, Wis. ©1957.

MERCURY OUTBOARDS for 1957



As low as 10%
down, up to 24
months to pay

introducing a new kind of performance >> power, stamina, handling ease

THE CHOICE OF TOP CRAFTSMEN

LUFKIN WHITE CLAD MEZURALL TAPE RULES

467

SAW SHARPENING IS EASY

Super Filer No. 11 joints and sharpens hand and circular saws 6" to 10" with all teeth correct in height, depth, pitch, bevel. When file hits steel roller, teeth are finished. Saw runs true with no side pull. Includes 8" file. **\$9.95 PPD.**

"TRU-CIRCLE" saw set automatically sets teeth at 10° or more. **\$2.95 PPD.**

SUPER SAW FILER No. 6 Automatically controls depth, angle, pitch for all saws. Precision made and calibrated. Use in any vise or clamp. Includes 8" file. **\$6.50 PPD.**

DOWEL CENTERS Centers inscribe exact location for square holes. Pairs for 1/2", 3/4", 1" holes. **\$1.00 PPD.**

MONEY BACK GUARANTEE—CATALOG FREE

A. D. McBURNEY, 5908 Hollywood Blvd., Hollywood 28, Cal., Dept. A-67

BALANCE YOUR OWN WHEELS

A precision DO-IT-YOURSELF wheel balancer designed for high-speed driving... Avoid high balancing costs... drive safely on balanced wheels—carry in your car. **GUARANTEED**

Balances with 1/4 oz.—absolutely reliable. Same unit formerly sold to garages at higher costs—Order direct, check or money order—prepaid in U.S. **\$21.95**

WHEEL BALANCER CORBIN, KANSAS

NEW HOUSEHOLD HUMIDIFIER

WAND-A-MATIC! New type humidifier that works better but costs less. Eliminates ill effects of dry atmosphere on health, house plants, furniture, etc. Extra large evaporating surface provides greater humidifying capacity. Adjustable to humidity desired. Easy to install in (hot-air) furnace. (Patent Applied For) Money-back guarantee. Complete. **\$13.95** postpaid, only.

WAND-A-MATIC HUMIDIFIER CO.
20631 Moross Rd. Detroit 36, Mich.

ONE-BAG MIXER THAT TRANSPORTS

Universal Transmix® transports, mixes and dumps cement, silage, dirt, etc. P. T. O. driven—no gears or chains. Can be installed or removed in 15 minutes. Fits Ford, Ferguson, AC-WD, IHC Super C, H&M, Case VAC, J.D.-40, Oliver 55, and other 2- and 3-plow tractors. Unconditionally guaranteed. See your dealer or write, giving tractor model, to

UNIVERSAL PULLEYS COMPANY
377 NORTH MOSLEY • WICHITA, KANSAS

Print Your Own

Cards, Stationery, Advertising, Circulars, labels, photo and movie titles, church work, tags, etc. Save money. Sold direct from factory only. Rivalled printing like engraving, too.

Own a Printing Business

Print for Others, Good Profit. Have home shop. Junior press \$15; Senior \$29 up. We supply everything. Easy rules. Pays for self in short time. Write for free catalog of outfits and all details.

KELSEY PRESSES, C-37 Meriden, Conn.

Get your free copy now!

HOW TO PROTECT THE NATURAL BEAUTY OF EXTERIOR REDWOOD

An informative, factual guide to applying finishes to all redwood and other types of exterior woodwork. Written by experts at McCloskey's—one of the nation's oldest varnish manufacturers.

McCloskey Lumber Life—a lasting, natural exterior finish that shields against fading and weathering. One of the few finishes approved by leading lumber associations after testing more than 260 exterior finishing systems.

McCLOSKEY VARNISH CO.
7600 State Road, Philadelphia 36, Pa.

Name _____
Street & No. _____
City and State _____

(I buy my paint from this store)

(store is located at this address)

MAIL THIS COUPON

ANSWERS

(Give yourself one point for each correct answer)

1-4; 2-3; 3-1; 4-1; 5-2; 6-4; 7-2; 8-1; 9-5; 10-4; 11-3; 12-2; 13-3; 14-2; 15-3; 16. 1—Sodium thiosulfate; 16. 2—Methane; 16. 3—Lanthanide series; 16. 4—Potassium nitrate; 16. 5—Trinitrotoluene; 17. 1-(8); 17. 2-(4); 17. 3-(6); 17. 4-(7); 17. 5-(3); 17. 6-(9); 17. 7-(3); 17. 8-(10).

Should be #2

WAR SURPLUS AND OTHER BARGAINS SAVE UP TO 90%

BUILD YOUR OWN ARC WELDER, LIGHT PLANT OR BATTERY CHARGER

Complete Kit \$38.00

Kit consists of: 1 Famous Navy NEA-5 Generator, New Combination AC-DC Type, AC voltage—115 V, DC voltage—24 V, 200-300 Amps. 2 complete generators in 1 . . . 2 separate fields & 2 separate armatures on same shaft yet no larger than regular generator. Ideal for home, farm & shop lighting plants by hooking wires to AC side which will give 1200 watts. DC side can be used for charging batteries, welding & operating war surplus low voltage hobby motors & equipment. Also in kit: 1 Voltage Regulator DC, 1 Voltage Regulator AC, 1 Reverse Current Relay, 1 Ammeter and Shunt, 1 Voltmeter, 0 to 30 Volts, 1 Rheostat, 1 Electrode Holder, 1 Giant Toggle Switch, Welder's Shield. Wiring diagram for hookup as welder. Wt. under 100 lbs. Approx. GOVT. COST \$600. KIT, \$38.00 Navy NEA-5 Generator (only) — same as above . . . if purchased separately: \$27.50

R1 GENERATOR KIT Jack & Heintz or GE. Rated 300 Amps. 24-32 Volts. With same items as above incl. 300 Amp Ammeter. Approx. GOVT. COST for kit \$600. Complete kit only \$39.95. Wt. 60 lbs.

MICROMETERS Black crackle finish frame. Easy-to-read graduations in .001. NEW. 0-1" cap. \$2.69 ppd. 1-2" cap. \$3.79 ppd.

FAMOUS B-16 KOLLSMAN AIRCRAFT COMPASS

Finest compass ever made. For use on planes, boats, cars, trucks. In current use on small & large aircraft. Can be hung carried on expeditions, weighs 1 1/2 lbs. Graduated in 5° increments. Liquid filled, lighted, poly-plane compensator. Panel mounting, 3 1/4" dia. face, 4 1/2" in depth. Like NEW. Approx. GOVT. COST \$150. Only \$13.95 ppd.

ASTRO COMPASS MARK II A standard instrument used by U. S. Air Force & Navy & commercial airline navigators for obtaining true heading, checking & adjusting magnetic compasses, taking bearings of celestial & terrestrial objects & identifying stars. Makes a satisfactory pelorus & azimuth circle for either air or marine navigators. Perfect for amateur astronomers. Complete with carrying case. Approx. GOVT. COST \$400. NEW \$12.95 ppd.

BENDIX PUMP & MOTOR

Can be used for pumping fuel, oil or where-ever hydraulic pressure is required. Pump has 1" connections, built-in relief valve, adjustable up to 1500 lbs. Max. capacity 6 GPM. 1 1/2 H.P., 24 volt motor, 4000 RPM. Can be used on 12 to 36 volts. Approx. GOVT. COST \$350. NEW — \$16.95.

HEAVY-DUTY RHEOSTAT Designed for heavy-duty use with Air Force heated suits. Ideal for regulating voltage on electric welders, model trains, lights, generators; controls soldering irons, etc. Rated 3.75 ohms, 100 watts with double windings and dual female 25 amp. 125 volt receptacles. Size: 7" H x 5 1/4" W x 1 3/4" D. SHPG. Wt. 2 1/2 lbs. Approx. GOVT. COST \$25. Brand new, only \$1.95.

"HELIOS" ORIGINAL TOOLMAKERS VERNIER CALIPERS

ULTRAPRECISION — Imported. Used by machinists at Lockheed, Douglas, Bendix, GM, RCA, GE. Model 51/2E. Genuine Helios. Hardened lapped precision surfaces. 1/1000" and 1/128" graduations. Handy slide roll and thumb lock. Quick, accurate depth. A \$35 value. De Luxe finish. ALL NEW. Just \$4.95. Leather carrying case, \$1 extra.

DUPONT EXPLOSIVE RIVETS!

A must for the man who works with sheet metal. A hot soldering iron placed on the head of the rivet will explode and mushroom the other end of the rivet self-bucking itself. 1/8" x 5/32" - 3/16". Round and flat heads. Approx. GOVT. COST \$50.00 a 1,000. NEW. 1,000 assorted, \$5.00 ppd.

225-1 REDUCTION GEAR. Make your own winches, hoists, wagon unloaders, stump pullers or fence stretcher. Sturdy aircraft quality. Built-in (removable) 24 Volt DC motor & clutch. High torque. Low speed. 100's of uses. Wt. 42 lbs. Approx. GOVT. COST \$300. Like NEW. Only \$12.

NEW! BIG CATALOG Send 25c for your copy. Postpaid prices in U.S.A. only. Other prices F.O.B. Culver City, Calif. Send check, cash or money order. 50% deposit required for C.O.D. orders.

AIRBORNE SALES CO., INC. DEPT. PM657
8501 Stellar Drive, Culver City, Calif.

Whatever the job, you'll do it better with nationally advertised products. Ask for products advertised in POPULAR MECHANICS

PM TAG of INTEGRITY

NOW! It's EASY TO REMOVE STUMPS With "MAGIC" STUMP REMOVER

All you do is pour "Magic" Stump Remover—a new, quick-acting chemical compound—into hole drilled in center of stump. Wood fibres soon decompose, all way to root tips, making removal easy . . . even for women and youngsters! **SPECIAL TRIAL OFFER:** 8-oz. Can enough for one stump—\$1.50; 16-oz. — \$2.50; 3 lbs. \$5.00. Send no money! Pay postman's bill, plus postage. (We send full amount with order for postpaid delivery.) Satisfaction Guaranteed or Money Refunded!

FREE! Generous sample of "GRO-GREEN," new liquid lawn fertilizer, with each Stump Remover order. H. D. CAMPBELL CO. Rochelle 43, Ill.



**No Digging! No Chopping!
No Blasting!**

EASY TO USE! Saves Time, Money!

NEW! 9.2 H. P. RIDING CRAWLER only \$895.00

OUTWORKS ANY TRACTOR ITS SIZE Ideal for clearing, grading, plowing, field or row crops, yard work. Big tractor ruggedness, quality. Anyone can operate. Borg-Warner 3-speed and reverse trans., cone clutch steering. Tractor with blade, floating drawbar, PTO, ppd. anywhere in U.S. \$895. Wt. 925 lbs. Guaranteed. Accessories available. At dealers or direct.

LAYTRAC
Power! Traction!

LAYTRAC, 25488 Airport Way, Seattle 4, Wn.

Drawers float like a feather—with

AMAZING NYLON BEARING DRAWER ROLLERS

Now, in minutes, give a lift instead of a drag to drawers in your home, office, trailer, etc., with amazing "Tiny Tots." Lifetime nylon rollers give finger tip float-action to even the heaviest, stubborn drawers. Stops sawdust from sifting down in drawers, too. Midget in size, but giant in strength! Use 2 on average drawers; 3 or 4 on heavier types. Simple to attach; directions included. 8 rollers \$1. SPECIAL, 30 for only \$2.98 ppd. No C.O.D.'s. Order NOW!



EDSCO PRODUCTS 2319J West Washington Blvd. Los Angeles 18, California



"I'VE USED A LOT OF ELECTRIC DRILLS BUT THERE AREN'T ANY AROUND THAT CAN BEAT SIOUX!"

"With the Sioux No. 1495 ALL-ANGLE Drill you can get into the tightest places that you can put your fist into. You can put oversize drills into it and it won't die on you. It's the most compact, most rugged piece of equipment I've used. I give your drill a lot of credit for our prize winning cars."

JOHN SHARRIGAN, Watertown, Mass.



LOOK UNDER ELECTRIC TOOLS



ALBERTSON & CO. INC.
SIOUX CITY, IOWA, U. S. A.

Experts do it THIS WAY...



The simple steps in this easy-to-read booklet tell how to do a professional finishing job. Thirty-two pages of information on sanding and surfacing wood and metal, for only 25¢ at your paint dealer's or sent with the coupon below. For best results, start with this booklet and finish with...

BEHR-MANNING

Sandpaper, sanding discs, and belts. Also, Behr-cat masking and electrical tapes... Norton sharpening stones.



BEHR-MANNING CO.
Troy, N.Y.



BEHR-MANNING CO., Troy, N. Y.
Enclosed is 25¢. Please send "Finishing School" book.

Name _____
Address _____
City _____ Zone _____ State _____

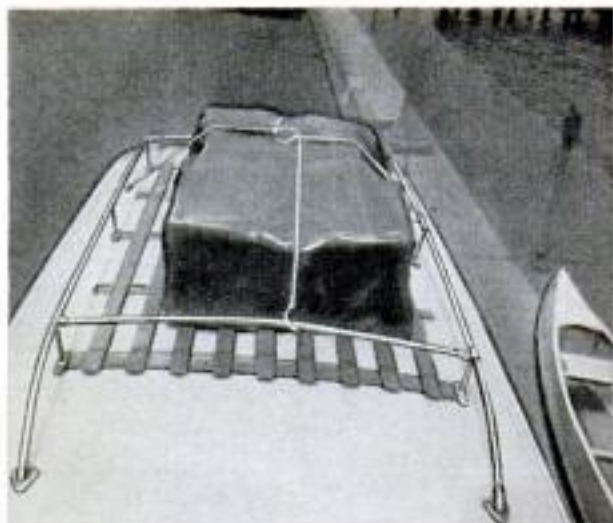

Attaching luggage to the top of the family car is simplified by a holding device which consists of tough cord, a metal loop and spring steel hooks. Placed on top of luggage with the steel ring at the center, double-cord strands are pulled to front, back and sides for fastening to existing framework. These ropes maintain tension while stretching 100 percent under 20 to 30 pounds' pull or receiving shocks of 200 pounds' pull

Holtite Mfg. Co., 210 S. Clinton St., Chicago 6

Miscellany for

Motorists with clothes-carrying problems may find a solution in a new hook that holds four hangers. This unit springs up out of the rear-seat passengers' way when not in use. The old screw and screw hole are used in installation

Spencer Specialties, 3305 Wilshire Blvd.,
Los Angeles 9, Calif.

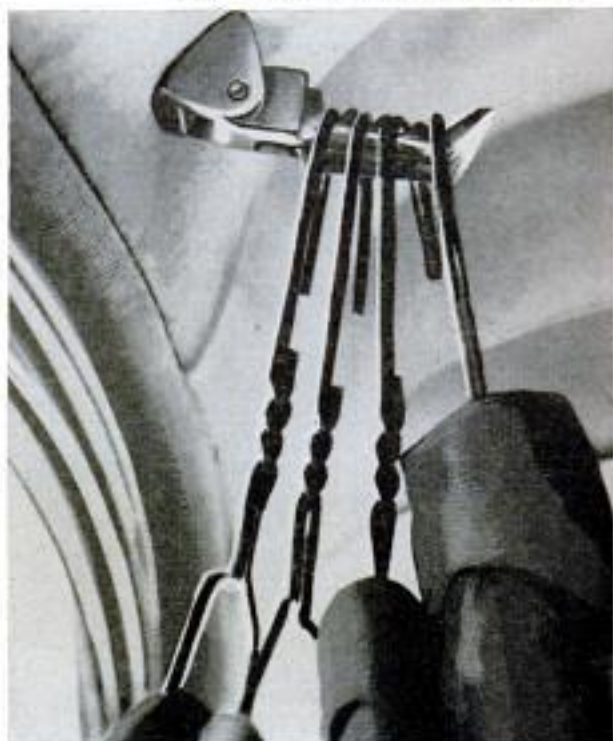



HELP, spelled in bright-yellow letters on a 12 by 12-inch red flag, now summons aid to motorists in distress. Visible day or night, this signal can be attached to the car window, while vehicle doors and windows remain securely locked

Westwin Co., 170 Highland Ave., Kearny, N. J.

Motorists

Radio-controlled garage doors, contacting an obstruction, will stop and reverse without coasting. Based on limit switches and a reversing brake motor, a new apparatus is attached to a garage door driven by a sprocket engaging notches in a track. The power element is a heavy-duty, 1/4-horsepower capacitor-type electric motor, working through a sealed gear unit plugged into a 110-volt outlet

Safe-Way Motor Door Co.,
18430 Nottingham Rd., Cleveland, Ohio

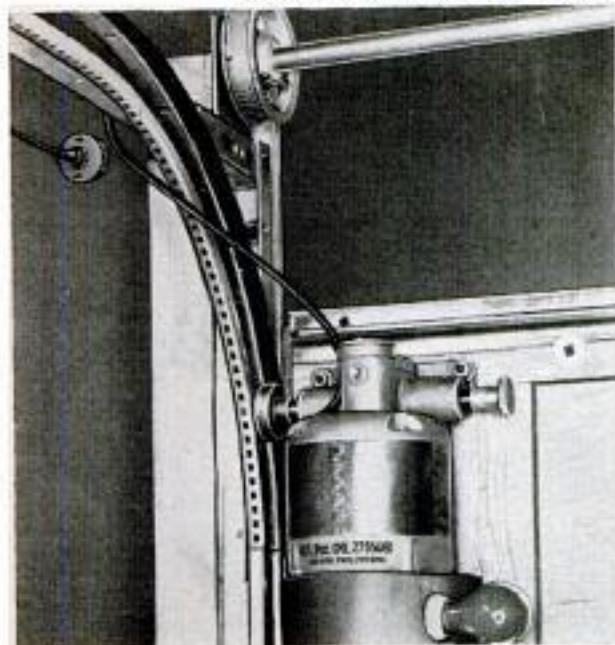

wherever modern cars go...



they go with modern

CARTER POWER CENTER FUEL SYSTEMS



CARBURETERS

Look to CARTER... leading manufacturer of complete automotive fuel systems... for advanced engineering developments that make up the Power Center of America's most modern cars!



FUEL PUMPS



FUEL FILTERS

For Complete
MODERN FUEL SYSTEMS
Count on **CARTER**

Have your car serviced regularly wherever you see this sign... or look in the phone book yellow pages.



CARTER CARBURETOR
DIVISION OF **ACF** INDUSTRIES
INCORPORATED
ST. LOUIS 7, MISSOURI



Beat traffic and parking problems with the ALL NEW Cushman ROAD KING

You'll be proud to ride it anywhere, everywhere. Years-ahead body design, two-tone colors. Greater comfort, riding ease. Ruggedly built. Cushman Husky 4-cycle engine. Up to 50 miles per hour, 100 miles per gallon. Operating cost just 3/4 cent per mile.

- Sold and serviced nationally; replacement parts available immediately
- Ask your Cushman dealer for FREE demonstration
- Dealer inquiries invited.

Write for new FREE booklet today.
CUSHMAN MOTOR WORKS, INC.
 910 No. 21st, Lincoln, Nebraska

ONLY \$239 (10 FT.)

MEASURES UP! the Evans KING-SIZE TAPE

IT STANDS UP STRAIGHT
 6-8-10-12 FOOT LENGTHS

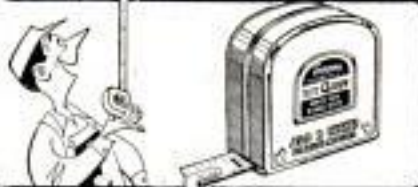

Long upright measuring jobs are easy with Evans King Size. Blade is a full 3/4" wide . . . 33% wider than ordinary tapes. Stands straight up or lays down flat—won't bend or buckle. Easier to read, too. Free belt clip. Tenite utility case. Sliding end hook—for 100% accurate inside-outside measuring.

Exclusive! NO FIGURING!

Work in feet & inches? Read here → 

Work in inches? Read here → 

ALSO . . . get Evans Regular White-Tapes

- 6 Ft. only 98¢ 50 Ft. only \$4.98
- FREE Tenite utility case • All Evans quality features • 6-8-10-12-50-100 foot lengths

Ask your hardware dealer—Today!

Evans RULE CO.

Elizabeth, N. J. Montreal, Que.

GIGANTIC SURPLUS SALE!

SUMMER SPECIAL FISH & WORM SHOCKER

Powerful hand drive AC generator. Clear ponds, creeks of coarse fish—ideal for game fish. Very effective. Also drive fish worms out of ground. Most powerful made. New. Govt. cost \$11.50. S.A.L.E. Ppd. \$3.89

MIDGET & GOLF CAR MOTOR

Use for child's, golf, factory cars, lawnmowers, etc. Expensive ball bearing 100 to 1 gear reduction motor. Runs on 6 or 12-v storage battery. Govt. cost \$282. S.A.L.E. \$19.46 FOB

SPECIAL BARGAINS

- Centrifugal Blower, with motor \$24.95 FOB
- Sportsman's Hammock with canopy \$7.95 Ppd.
- AC Motor, geared reduction drive, \$4.61 Ppd.

ARMY POWER PLANTS

Amazing buys. Fully guaranteed.
 • 1000-w, 115v, 60-c, \$179.50 Ppd.
 • 2000-w, 115v, 60-c, \$269.95 Ppd.
 • 3000-w, 115v, 60-c, \$299.95 Ppd.
 • 5000-w, 115v, 60-c, \$497.50 Ppd.
 • G.E. Generator 3000-w, 115v, DC. Fine for portable tools, \$49.71 FOB.
 Many other plants, generators. Get catalog.

AIR COMPRESSORS, TANKS, PUMPS

• Stainless steel tank, 12"x24". Capacity 2100 cu. in. 480 psi. 1/2" pipe thread ports. Brand new. Cost Govt. over \$40. Shipping wt. 19 lbs. S.A.L.E. . . . \$16.95 Ppd.
 • Compressor, 1 cyl. 2.80 cfm \$19.95 Ppd.
 • Compressor, 2 cyl. 10.4 cfm \$49.95 Ppd.
 • Gauges 60 to 300 psi (Specify) \$1.89 Ppd.
 • Pres. Regulator 0-250 psi. . . . \$3.29 Ppd.
 • Air Kit, complete. . . . \$39.49 FOB.
 • 2 1/2" Centrifugal Pump. . . . \$39.95 Ppd.
 • 1 1/2" Centrifugal Pump. . . . \$24.41 FOB
 Also guns, hose, fittings, switches. Get catalog.

ORDER FROM AD or write for big new FREE CATALOG 1000s Items at tremendous savings. We pay fri. except where FOB.

BURDEN SALES COMPANY
 808 "O" St., LINCOLN, NEBRASKA

STOP DON'T THROW ME OUT

IMPERIAL Rapid Brush Cleaner
 cleans hard-caked paint brushes in a jiffy. No long soaking. Bristles stay springy—never flabby. At paint and hardware stores.



Wilson-Imperial Co., 119 Chestnut St., Newark 5, N.J.

ESHELMAN TRACTORS LOW AS \$99

For Better Lawns and Gardens investigate Eshelman Riding Rotary Mowers, Tillers, Tractors. Advertised in GOOD HOUSEKEEPING. Thousands of Satisfied Users. Write for Free Literature.

Dept. 173, ESHELMAN, Balto. 2, Md.

New 1957 SPORTABOUT CARS and GOLF CARS. Write for literature.

Riding Mower \$187.50

Shipping Points: BALTIMORE - CHICAGO - BENO

Enjoy RUNNING WATER at LOW COST
 Buy Water System Direct from Factory & SAVE

LABAWCO PUMPS

Duralbrone System costs little, gives "city water" service. No more hand pumping! Only minutes to install. Pumps 275 GPM. Draws from 25' well. Fully automatic, 20-40 lbs. Bronze pump, plastic-lined galv. tank, pressure switch, air volume control, pressure gauge, bronze foot valve, bronze relief valve. Fitted for 1/2" pipe. 1/2 HP. Only \$65.95 complete, or \$49.95 less motor.

Postpaid. If cash with order. 3 Year Guarantee. Water supply and drainage pumps for over 40 years.

LABAWCO PUMPS, Belle Mead 8, New Jersey

Find HIDDEN TREASURES

GOLD, SILVER, PRECIOUS METALS with the Famous Model 27 Metal Detector. Lightweight, ultra-sensitive, low cost. None finer. Also GEIGER COUNTERS for uranium and the VIOLITE for tungsten. INFORMATION FREE

THE **Detector** CORP.
 5528 Vineland Ave., No. Hollywood, Calif.



WELD BRAZE SOLDER CUT

4WAY WELDER ONLY \$14.75 f.o.b. factory

Acclaimed by thousands of Homeowners, Mechanics and Hobbyists as the welder of 1001 uses. Easily operated from properly wired 110 volt AC or DC line. The ideal gift with a life-long use. . . . Order today on 10 day money back guarantee.

FOUR-WAY WELDER CO., Dept. F2-F
 1810 S. Federal St. • Chicago 16, Ill.

Complete with Twin Carbon Arc Torch and accessories . . . to handle all metal-craft work.



Antenna Tracks Moon, Missiles

"Dish" antennas, 61 feet in diameter and designed by Stanford Research Institute, are being installed near Palo Alto, Calif., and Fairbanks, Alaska. The two antennas will measure radio and radar reflections from the moon, "northern lights," meteors, and possibly intercontinental ballistic missiles and earth satellites. Each antenna is built of aluminum tubing. The Palo Alto unit will use a 100-megacycle transmitter, while the Alaskan site is to have a 200 to 400-megacycle klystron transmitter.

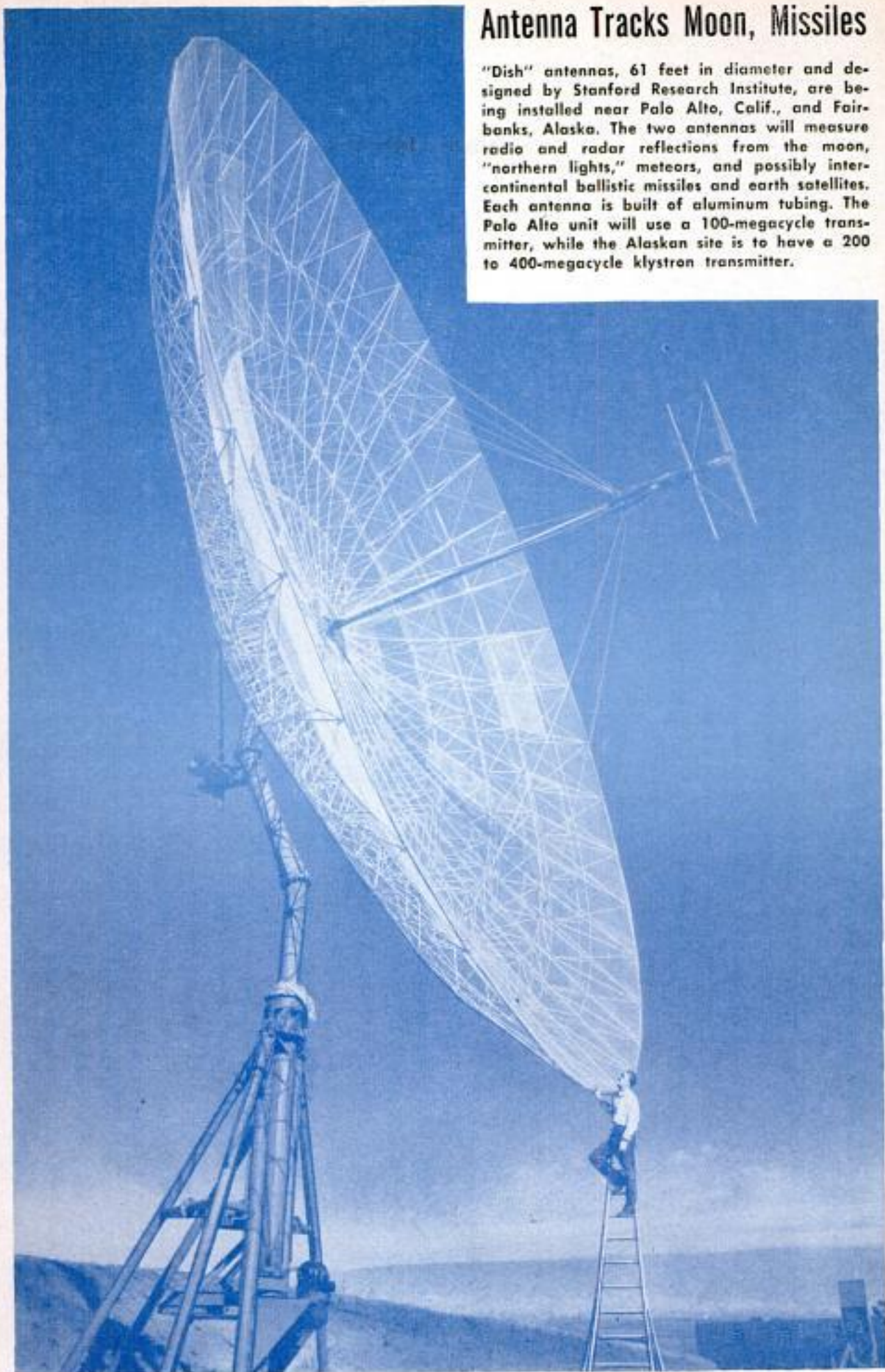



This Tool Finds Out When an Oil Well Is Really an Oil Well

Fluid samples from prospective oil-bearing rock formations can be obtained for analysis with a tool that is lowered on an electric cable into position opposite the suspected formation. Discharged electrically, a hollow bullet attached to an alumi-

One in every ten persons in Sweden today owns an automobile.

num tube is fired into the rock. Formation fluid flows through the bullet's open nose, along the tube and into a small reservoir.

A valve seals the reservoir when full and a slight pull frees the tool. Five tests can be made each time the tool is lowered.

Wiggling "Worm" of Mercury Inside Lure May Out-Fox Fish



Mercury, wobbling around like a worm in a transparent, tubular fishing lure, provides continuous wiggle, dive and dart enticing to fish. With a red head and tail, this 1/4-ounce plastic lure pulls a treble hook and appears to be a real worm moving deep through the water, or just under the surface during trolling. When a retrieve is halted briefly, the lure goes into a wiggling "dive."

2 WAY PORTABLE RADIO SET SENDS - RECEIVES UP TO 10 MILES AS SHOWN

with built-in antenna or hundreds of miles with outside antenna! 80 and 40 meter amateur radio bands (novice) also Aircraft and Overseas broadcasts (3 to 8 mc.) PORTABLE SELF-CONTAINED POWERED WITH STANDARD LOW COST PORTABLE RADIO BATTERIES. NO AC PLUG-INS NEEDED! Take it with you everywhere you go—on trips, vacations, camping—keep in contact with home, friends. Has 5 watt crystal controlled transmitter—Sensitive Regenerative Receiver. Send receive switch. Wt. only 3 lbs. Size, only 4" x 4" x 4". TESTED—PROVEN—SIMPLIFIED—PRACTICAL—Full information given on quick easy to get license. SEND ONLY \$3.00 (incl. ck. mo) and pay postman \$11.95 COD postage on arrival or send \$14.05 for postpaid delivery. Complete kit includes all parts, tube, coils, plastic cabinet, easy instructions. Set of batteries—\$2.75; crystal \$1.25. COMPLETELY WIRED AND TESTED POSTPAID \$10.95. A regular \$49.95 value—Order now before price goes up. GUARANTEED — AVAILABLE ONLY FROM:

WESTERN RADIO Dept. BNM-6 KEARNEY, NEBR.

FREE WHOLESALE CATALOG *get up to 50% off*

MAKE MONEY!! SAVE MONEY!! Buy Tools, Hardware, appliances, photo equipment, sporting goods, power tools, paints and thousands of other nationally advertised products at WHOLESALE COST TO YOU.

SEND FOR FREE 1957 WHOLESALE CATALOG TODAY!

SILVO HARDWARE COMPANY
Dept. PM 6, P. O. Box 266, Philadelphia 5, Pa.

Build a Boat at 1/3 the Cost!

— with CLEVELAND'S full size, cut-to-shape boat patterns, detailed blueprints, and specifications. All classes and styles of modern Naval Architect-designed boats from 7 1/2 to 38 feet. **BIG NEW 86-PAGE ILLUSTRATED CATALOG**, 50c (coin). "How to Build a Boat" booklet, \$2.50. Hardware & Equipment Catalog, \$1.50.

CLEVELAND BOAT BLUEPRINT CO.
Dept. B-166, Box 1651, Cleveland, Ohio

14 ft. Runabout
24 ft. Cabin Cruiser

How to Build Your Own GARAGE

Save as Much as 50% of Usual Construction Costs

Get Popular Mechanics' brand new book **How to Build Your Own Garage** by Wayne Leckey, Assistant Shop Notes Editor, and find out how you can build your own garage at savings of 50% of usual cost. Leckey tells in famous step-by-step instructions and shows in big, clear photos, drawings and diagrams how to perform every building operation from laying the concrete to installing the final trim. There are 25 designs. Brick, frame, and concrete block fully covered. Send \$3.50 for your copy. 7-day money back guarantee.

POPULAR MECHANICS PRESS, 200 E. Ontario, Chicago 11, Ill.

NOW... get that wonderful inimitable, tempting, delectable flavor known as

CHARCOAL FLAVOR

every time you broil meat or fish. It's easy, it's foolproof with the NEW

LAZY-MAN Open Fire Charcoal Type Gas Broiler



The secret is in our "Permanent Coals," which never need replacing and which enhance, even and screen heat from the fire. Nothing else like it: nothing anywhere near as good. Saves time; eliminates all soot, dust and ashes. No preheating necessary. Always ready for instant use. Never disappoints. Inexpensive, too. Can be used all 12 months of the year. Thousands already in use. Highly praised. Our "Permanent Coals" are made of compounded ceramics, about the size of walnuts. You heat them with piped city gas or bottled gas.

Broiling capacity—4 to 6 steaks or a dozen hamburgers at one time. Broiling grate 16 1/4" square. Overall dimensions: 17" x 21" x 7 1/2". Made of heavy gauge welded steel. Weight 45 lbs.

Order NOW... by mail. Complete satisfaction guaranteed. Basic Unit for "Do-It-Yourself" installation..... **\$59.50**

Shipped promptly. Express Collect.
Or Write for FREE Folder "Broiling Over Permanent Coals."
CHICAGO COMBUSTION CO.
318 Cliff Lane, Cliffside Park, N. J.

OUTDOOR KITCHEN



Written Step-by-Step For You!

Now you can have a beautiful outdoor kitchen to enjoy all summer long. Tom Riley, well-known building authority, tells and shows you how you can build your own outdoor fireplace, Chinese oven, barbecue pit or grill. There are complete building instructions included.

A Standard Piece of Equipment

Once the almost exclusive luxury of Western ranches, the outdoor barbecue now is a coast-to-coast American institution. Every year more families take to this pleasant and gracious way of outdoor dining and entertaining. Now with this book, you can join in with a minimum of expense and the utmost in results. Mr. Riley, an old hand around the barbecue ovens of Oregon, has prepared this complete book, in order that you may find the ideal outdoor fireplace for your particular back yard. He not only gives you many fireplaces from which to choose, but he also gives you money-saving short cuts in construction, hints on firing up and cooking and for extra good measure a collection of fire-tested recipes ranging from tasty frankfurters to filet of sole al fresco.

Special Section of 40 Tested Recipes!

Here are some secrets of successful barbecuing—the best fuels to use, ways to maintain proper draft, and hints on firing up and cooking that will enable you to capture the authentic barbecue flavor in the foods you serve to family and friends. So that your fare won't be confined to wieners and hamburgers, Tom Riley also tells you how to prepare and serve such barbecued delicacies as ribs, roasts, fowl, fish, special sauces, and various vegetables.

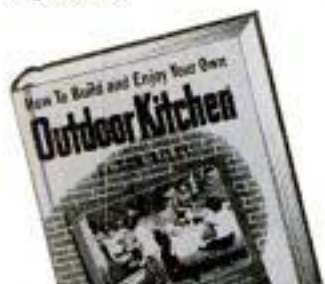

Use This Handy Order Coupon

POPULAR MECHANICS PRESS
200 E. Ontario St., Chicago 11, Illinois

Gentlemen:

Please send my copy of HOW TO BUILD AND USE YOUR OWN OUTDOOR KITCHEN, now. Enclosed is my remittance of \$2.00. If I am not completely satisfied with the book I will return it for a full refund after 7 days.

Name _____

Address _____

City _____ Zone _____ State _____

Send C.O.D. I will pay postman

No Experience or Special Tools Needed

Complete step-by-step building instructions with diagrams, photos and drawings make construction a cinch. There are designs for brick, field country stone, cement, concrete block and poured concrete, and many examples of each. With the know-how gained from this book, yours can be the most popular back yard in town and, besides you'll have lots of fun.



Partial Contents

Which Barbecue for you? Barbecue Fireplaces, Portable Grill, Masonry Grill, Barbecue Pits, Chinese Ovens, Infra Red Roasters, Combination Barbecues, Construction plans, Basic Fireplace Foundation, Barbecue Fireplace of poured concrete, stone construction, Firing Up! Types of Charcoal, Hardwood, Softwood, Compressed Sawdust, Cooking Temperature, Flame Tested Recipes, Charcoal Broiled Steaks, Barbecued Spare ribs, special section of cooking methods employing various vegetables not usually associated with outdoor cooking, and much more.

7-Day Money Back Guarantee

Send for your copy of OUTDOOR KITCHEN, today. Read and use it for 7 days. If it isn't entirely satisfactory, return it for a full refund. We know once you have looked your copy over, and found the fireplace for your backyard, you won't part with this book under any conditions.

Need A Pipe Vise?

get one that does more than just hold pipe

RIGGID
Bench Vise
8 sizes, capacities
1/8" to 6".

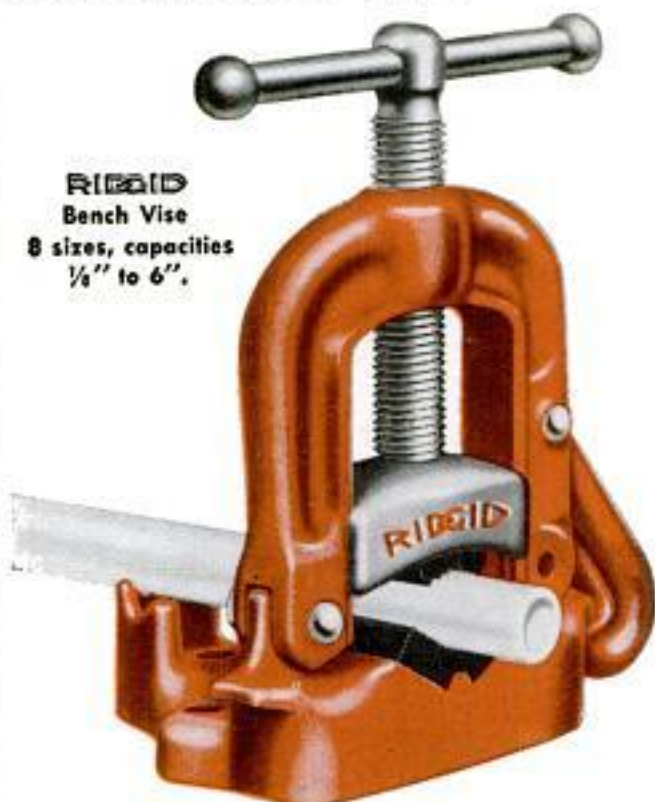

RIGGID

extra-service pipe vise

It has a handy built-in pipe bender . . . and pipe rest—for accurate threading. Exclusive LonGrip jaws hold pipe extra firmly, don't chew it up. Yoke and base of lifetime malleable. Most for your money—buy RIGGID Vises at your Hardware Store.



Make your next pipe wrench the famous RIGGID!



The Ridge Tool Company, Elyria, Ohio, U. S. A.

**AT YOUR
NEWSSTAND
NOW!**



**KEEP UP-TO-DATE ON
THE MARVELOUS
WORLD OF SCIENCE
WITH THIS
WONDERFUL MAGAZINE**

Pick up a copy of SCIENCE DIGEST today . . . and become acquainted with the pocket-sized magazine that tells you "what this Changing World means to you."

Expert editors choose the finest articles on atomic science, chemistry, anthropology, medicine, electronics, etc., from the magazines and books of the world . . . and present them to you in easy-to-understand form.

You'll like this magazine. At your newsstands . . . only 35¢. One year subscription: \$3.50.

**ADDRESS: DEPT. X-21, SCIENCE DIGEST
200 East Ontario Street • Chicago 11, Illinois**



Cardboard Cathedral Model

Cardboard church models are the hobby of Franz Boehm, formerly of Prague, Czechoslovakia, and now living in Wiesbaden, Germany. Working with scissors in his home, Boehm recently built a scale model of the cathedral at Cologne. The model's towers are four feet high.

**Fight
CEREBRAL PALSY**



**GOLDEN DEED
CRUSADE**

**Send Your Gift to Your Local
United Cerebral Palsy Affiliate**

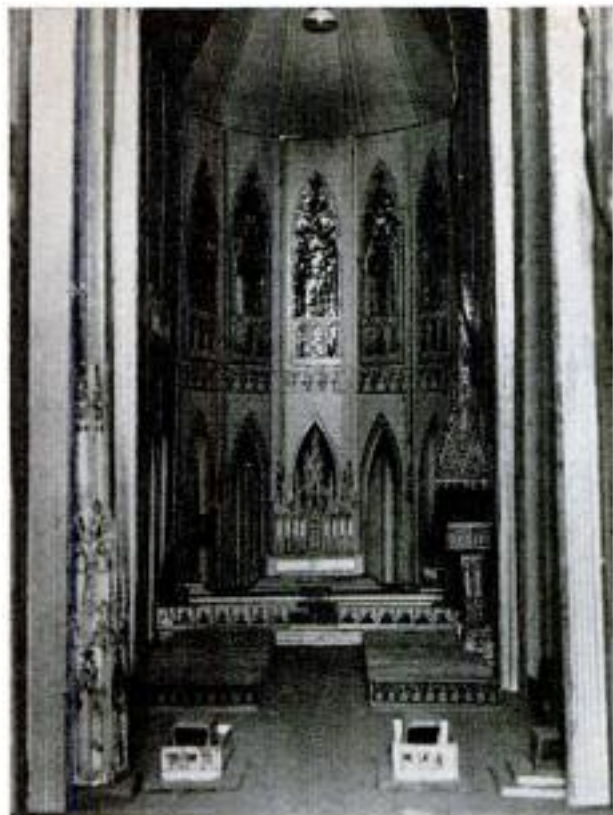

Each part of this cardboard model of the cathedral at Cologne, Germany, has been scissored out

TWO WAYS TO BUY BETTER

Your dealer knows the right products for your needs—quality products that are nationally advertised. POPULAR MECHANICS brings you a monthly roundup of valuable "how to" information and product advertising. Read POPULAR MECHANICS every month—then talk to your dealer.





Arc Welding PAYS BIG!

Build Your Own

LOW COST GENERATORS for building your own arc welder

Cash in on the many opportunities that exist in the ever expanding arc welding field. With a minimum investment you can start your own profitable business with the big demand for emergency repair work and construction projects. Hobart gives high efficiency at low cost, and a selection from the most complete line of welders. Phone FE 2-1223.

HOBART BROS. CO., Box M-67, Troy, Ohio

"One of the world's largest builders of arc welding equipment."

Write Today for Complete Catalog

NEW!

SHAW

RM 24 MOWER WITH AMAZING MAGIC DRIVE



Three Speeds forward neutral & reverse

Wide range of speeds, complete gear selection gives you outstanding mowing control for any type terrain, any type mowing. Low cost!

3 sizes, cut 24, 32 and 36"

Riding Mowers 2½ to 8 H.P. low as.....\$199.00

Riding Tractors 3 to 14 H.P. low as.....\$299.00

Walking Type Tractors 2 to 5 H.P. low as..... \$99.00

Kit, 2½ H.P. 21" Cut Rotary Mower Shown Below \$59.00

Bargains in Rotary Pulverizers also.

See your Shaw dealer or write for free literature.

Dealer inquiries invited.



SHAW Mfg. Company

4506 Front Street, Galesburg, Kansas
668-06 N. 4th Street, Columbus, Ohio

• BUILD YOUR OWN FANS •

Motor & Fan Blade Combinations For Stand Fans, Room Coolers—Windows, Evaporative Coolers, Etc. Motors all 110 V. 50/60 cy. 1500 rpm. Fan Duty.
10 in. 600 cfm Blade & Motor . . . FREE GUARD . . . \$5.50; 12 in. 900 cfm Blade & Motor . . . FREE GUARD . . . \$7.50; 16 in. 1700 cfm Blade & Motor, \$11.50. Guard \$3.50; 20 in. 2500 cfm Blade & Motor, \$13.50. Guard \$4.50.

ALL ITEMS SHIPPED PREPAID
FREE FAN CIRCULAR listing Fan Kits, Motors, Timers, Thermostats, Shutters, etc., etc.

C. MARSHALL SALES, 3546 Fullerton Ave., Dept. P-6, CHICAGO 47



WHATEVER YOU'RE MAKING

save hours of time with



WILHOLD WHITE GLUE

with Oriflexal

Quicker to work; less clamping. Colorless, permanent. Leaves the work clean, the shop clean and your hands clean.

Paint, Hardware, Lumber, Variety Stores. Or write WILHOLD PRODUCTS Los Angeles 31, Calif.; Chicago 44, Ill.

Write Today for Complete Catalog

**Stop Drips Quick
with**  **PIPE
WRENCHES!**



You do it fast and easily with tough, special analysis steel P&C Pipe Wrenches. Deeply milled, oil tempered gripping teeth give you real gripping power, prevent slipping, knuckle busting. Shop from colorful P&C Merchandisers, in 12,000 stores. Send 10c for catalog.

 **TOOL CO.**

Box 5926, Portland 22, Oregon

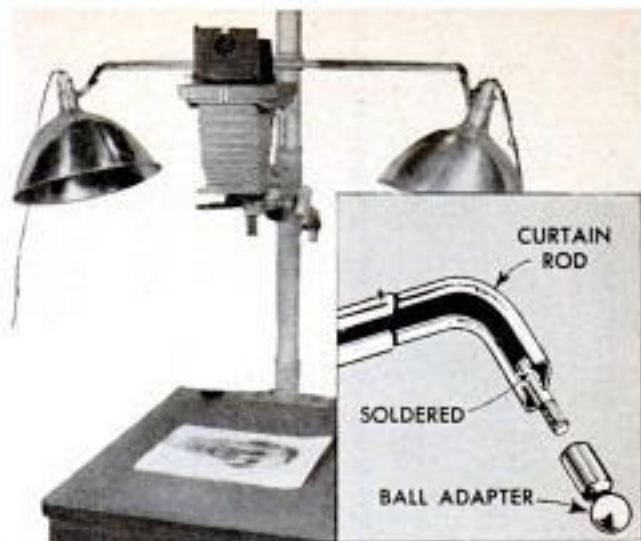

Adjustable Copy-Light Brackets From Curtain Rods

Extension-type curtain rods are used to support the copy lights shown. A straight section 18 in. long is centered on the column and fastened so that it can be raised or lowered. Two sections, with a right-angle bend at one end, are cut 7 in. long and fitted into opposite ends of the longer section. Ball-joint swivels are soldered to ends of the rod assembly and the lights attached to them.—H. Klien, Pittsburgh, Pa.

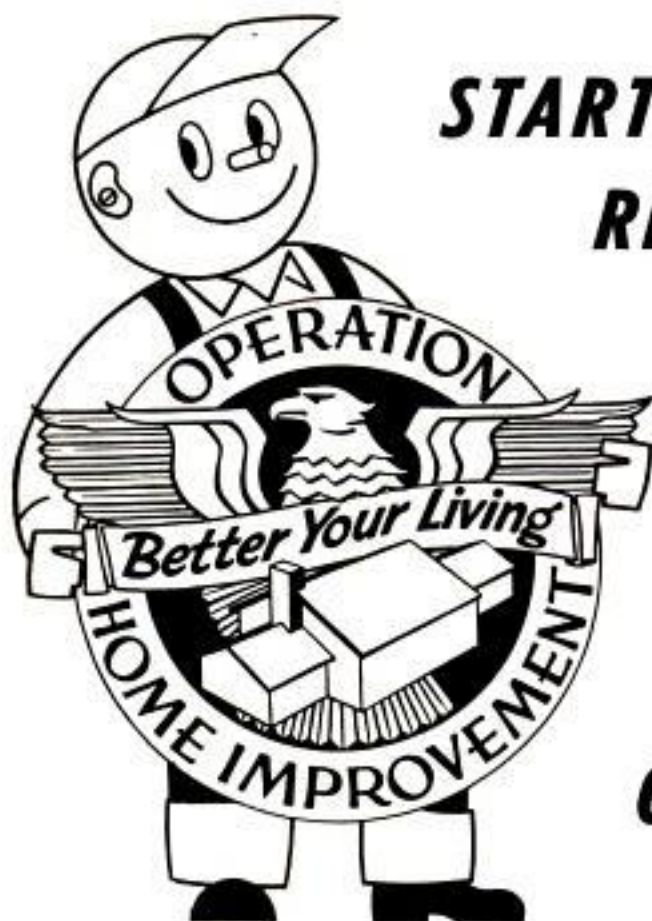

**START NECESSARY HOME
REPAIRS TODAY!**

**CONSULT YOUR LOCAL
HARDWARE AND BUILDING
SUPPLY DEALERS FOR
QUALITY PRODUCTS**

BUILD WELDER OR LIGHT PLANT

Instruc. incl. **TYPES AMPS VOLTS PRICE**
 G.E. 200 amps, 24V New \$17.50 Used \$12.95
 J. & Heints on G. E. RI 300 24 \$24.50
 G.I. 100-200 amps, 30V, New \$15.50 used \$9.95

V-BELT PULLEY KIT. Fits R-1, P-1, G-1 or AC-DC Generators; has two bearing block plates, 4 bearings, triple groove V-pulley, Dr. shaft and flex. coupling \$17.50.

AC-DC WELDER KIT G. E. #511. New Generators. Makes ideal light plant & Battery Charger. Rated 1250 Watts, 115V. A.C. & 200 Amps. 30V. D.C. including 1 Volt. regulator, 1 reverse c. relay, 1 H.P.M. indicator, 1 electrode holder, 1 toggle switch, 1 Welders Helmet, 1 rheostat and instructions \$36.50. AC-DC generator if bought separate \$24.50.

Same Kit as above with R-1 J. & Heints on G.E. 300 amp. gen. \$36.50. Same Kit with Autolite 100-250 amps. gen. \$26.50. 8. Kit with New G.E. 200 amp. Gen. \$34.50.

General SALE

WATER PUMP WITH MOTOR 1 1/2 H.P. 2 1/2 V. D.C. runs on 6 or 12 V. D.C. Adj. press., 1" ports, 200 GPH \$12.95. 400 GPH \$14.95. 700 GPH \$17.50.

BARGAIN HYDRAULIC MAKE UP KIT #507. Consists of 1 G.E. motor 24 V. D.C. .28 H.P. & hyd. pump 700 G.P.H. cap. 2 ea. hyd. D.A. cylinders 1 1/2" bore x 6" stroke; 1 ea. four way valve; 1 ea. pressure gauge 0-2000 P.S.I. dial; 1 ea. Purolator oil filter. Gov't. cost \$350.00. \$27.50. Write for bargain list.

HYDRAULIC LIFT KIT New Weaver Hyd. hand pump 2000 P.S.I. 20" handle & release valve, 1 D.A. cylinder, 3 1/2" bore x 2 1/2" stroke cylinder output 7000 lbs. with 1000 P.S.I. tank, filter, 6 hose & 1 gal. fluid \$34.95.

DRAINS BASEMENTS. Pump water with rotary pump #107 400 G. P. H. 3/4" ports adj. to 100 P.S.I. reversible, 3 1/2" x 3 1/2" x 7". Incl. mt. base. \$12.95.

GEAR REDUCTION MOTOR BARGAIN 42:1 ratio, reversible 10- to 200 RPM, runs on 6- or 12V D.C. & Appl. for 110V/A.C. \$4.69. 2 for \$8.50.

NEW HYDRAULIC CYLINDERS

Air or Oil Bore	Stroke	Shaft D.	Action
#500 1 1/2"	7 1/2"	5/8"	\$8.50
#512 2 1/2"	4"	3/4"	\$6.50
#127 4 1/2"	10 1/2"	1-5/16"	\$27.50
#311 3 1/2"	2 1/2"	1 1/4"	\$22.50

HYDRAULIC PUMP BARGAINS 1500 P.S.I. MFG. TYPE R.P.M. G.P.H. NEW
 7 Pesco Gear - 1500 108 \$12.95
 7 Pesco Gear - 4300 300 \$14.50

*Stratopower -450 cu. in. 3750 400 \$17.50
 Vickers -410 cu. in. rev. 3750 RPM \$17.50

NEW FOUR WAY HYDRAULIC CONTROL VALVE has built in relief for 1 to 4 D.A. cylinders, 3/4" ports, ±10060 \$14.50. No. 3500 four way with 2 handles for 1 D.A. cyl. \$8.95.

NEW HYDRAULIC SYSTEM KIT = 4 0 0 0 K. Heavy duty Power Drive. em. Rated 14,000 lbs. lift. Consists of 2 D.A. hyd. cylinders, 3" bore x 2 1/2" stroke, each rated 7000 lbs. with 1000 P.S.I., 1 four way hyd. control valve with built in relief = \$21. 1 Vickers hyd. pump, 400 G.P.H., 1500 P.S.I., 3750 RPM, 1 hyd. 2 gal. reservoir, 1 Purolator hyd. filter, 1 gauge 0-2000 P.S.I. & 9 hose, C. Value \$184.10, save \$100.00. Kit price \$94.10. Kit & 2 = 111 cyl. \$74.95.

GENERAL SALVAGE CO. CHECK OR M.O. 2922 E. 27 St., Dept. 87, Kansas City 27, Mo.

3 CU. FT. MIXER 3975

DIRECT FROM MFR.

Fills long felt need for small mixer for concrete, feed, fertilizer, seed and many other materials. Saves 3/4 cost of ready mixed concrete. Pays for itself on first job.

3 Cu. Ft. Drum—Mixes 2 Cu. Ft. Concrete \$39.75
 5 Cu. Ft. Drum—Mixes 3 Cu. Ft. Concrete \$69.50

FOR PALASKI, N. Y. Cash, Check or M. O. Money back guarantee.

UNITED STATES FORGE AND FOUNDRY CO.
 CONSTRUCTION EQUIPMENT DIV. PALASKI, NEW YORK

ESHELMAN TRACTORS

LOW AS \$99

Plows-Cultivates-Saws Dzer-Harrow-Rolls Hauls-Snow Plow

Eshelman Tractors, Tillers, Riding Rotary Mowers for Better Lawns and Gardens. Advertis. in GOVERNMENT HOUSEKEEPING. Thousands of satisfied users. Write for Free Literature. Dept. 171, ESHELMAN, Balto. 2, Md. \$491.25

Shipping Points: BALTIMORE - CHICAGO - RIND

POPULAR MECHANICS BUILD IT YOURSELF BOOK-BOYS

Every Boy Should Have This Build-It-Yourself Book for Boys!

It's natural for boys to want to make things—to fuss with tools—to fashion the kind of things "kids" want. So give boys the Build-It-Yourself Book for Boys. Encourage a youngster to express himself through the sensational new Popular Mechanics book that shows how to make 56 different things every boy dreams about. It covers science, mechanics, electricity, modeling and other fields. 192 pages of easy-to-follow instruction and 469 how-to-do-it pictures.

56 Toys, Games, Gadgets, Models, Boats, Electrical Devices, Cars and Other Things Boys Can Make at Home

How to make—Airplane Models, Aquaplane, Archery Kit, Bird Houses and Shelter, Boats, Bobsleds, Boomerangs, Cannon Toy, Electric game, Electric Motors, Garage Toy, Helicopter Toy, Hunting Knife, Hydroplane Model, Kites, Log Cabins, Marble Game, Microscope, Printing Press, Radio Sets, Rafts, Railroad Modeling, Shooter, Scooter, Sidewalk Cars, Sprinkler

Truck, Squirt Gun, SS United States Model, Surfboard, Tank Toy, Taxidermy, Telegraph Set, Telephone, Tree House, Water Skis, Weather Instruments, Toboggan, Worktable.

Build-It-Yourself for Boys sent postpaid for \$2.50 or COD, charges additional. Money refunded if you are not pleased after 5 days' use. Mail order to address below.

Toy motors

Boomerangs

"Ju-be"—the punt

POPULAR MECHANICS PRESS
 Dept. 657, 200 E. Ontario St., Chicago 11

BENDS HARD OR SOFT TUBING!

Any angle up to 180°!

No. 364-FH — for 3/8" to 3/4" O.D. tubing

IMPERIAL TUBE BENDERS Make neat, accurate bends. Choice of lever, gear and spring types—sizes to 1 1/8" O.D.

SEND 10c for VALUABLE HANDBOOK and CATALOG

THE IMPERIAL BRASS MFG. CO.
 1212 W. Harrison St. Chicago 7, Ill.

Send 36-page Imperial Tube Working Handbook and Catalog. Also name of nearest dealer.

Name: _____
 Address: _____
 City: _____ Zone: _____ State: _____

IT'S EASY BUILD OR REMODEL FURNITURE

TAPERED Hardwood LEGS

KITS OF 4 IN ALL LENGTHS

for making:
 Sofas • Cocktail or Coffee Tables
 Benches • Lounges
 Chairs • Cabinets, etc.

Create your own designs. Build your own furniture at a fraction of ordinary cost. Legs come complete with 2-way bracket, screws, hanger bolt, 1 1/2" polished brass ferrule and metal glide. Install straight or at slanting angle in minutes. Paint any color.

Length	Set of Four here	Check here
5"	\$3.39	<input type="checkbox"/>
7"	3.59	<input type="checkbox"/>
12"	4.29	<input type="checkbox"/>
22"	5.49	<input type="checkbox"/>
28"	6.49	<input type="checkbox"/>

Special offer: Finest Quality Genuine HICKORY Hammer Handle 75c

Renew your tool at small cost.

IXL Manufacturing Co., Bernie, Mo.
 Rush Tapered legs checked above and/or Deluxe Hammer Handle.

Check enclosed Ship C.O.D.

NAME _____
 ADDRESS _____
 City _____ State _____

MAD FOR LADS

who use
AERO SHAVE!



Save 20¢ a Can!

So, go man! Get rich, creamy AERO SHAVE . . . the smoothest, slickest lather bomb of all! Three beard softeners *plus* gentle Lanolin! Feel—save the difference! Only 59¢.

59¢ AERO SHAVE

successor  to sandpaper

steelie Handy Sander

with **STEEL UNIBRASIVE SHEETS**



- outlasts hundreds of sheets of sandpaper
- cuts wood, plastic—faster
- no scars—leaves smooth polished surface

HERE'S THE SECRET:

Magnified Unibrasive looks like this—every tooth same depth—can't scratch—graze—clog

Steelie + 2 sheets stainless steel Unibrasive—1 case, 1 fee

postpaid
\$1.95

BUCKBEE HEARS CO.
Tool Building - Saint Paul 1, Minnesota

SUPERIOR PERFORMANCE



You can rely on Gerstner Chests to provide proper care for your precision tools. Free Catalog to machinists and toolmakers.

GERSTNER TOOL CHESTS
457 Columbia St., Dayton 7, Ohio

JEEP & 4-WHEEL DRIVE OWNERS

FRONT DRIVE WITH
FREE-LOCK HUBS

LOW OPERATING COSTS
ALL PARTS STOP
ONLY WHEELS MOVE!

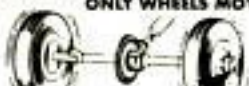

IN 2-WHEEL DRIVE
NO PARTS MOVING
STOPS GEAR WHINE



Stop front drive wear
Reduce engine wear
Save gasoline
UNCONDITIONALLY GUARANTEED!
Benefit now from this money-returning investment.

FRONT DRIVE—NO
FREE-LOCK HUBS

HIGH OPERATING COSTS
ALL THESE PARTS MOVE
WHEELS MOVE

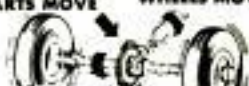

IN 2-WHEEL DRIVE
OVER 100 PARTS MOVING
—WEARING!

Increase power
Tires last longer
Easier steering

© FLC Ask dealer to order yours now Write for **FREE FOLDER**

FREE-LOCK CORPORATION
6301 NORTH FEDERAL BLVD., DENVER 11, COLORADO

Diving Sled Permits Two-Man

TWO MEN, riding an underwater sled adapted from an Air Force mesh ambulance litter, inspect trawls, fishing nets and other marine gear for the U.S. Fish and Wildlife Service. The sled has controllable fins for steering up, down and to either side by the man in front. The rear man photographs and observes, while the sled moves up to four miles per hour at depths down to 60 feet. A Lucite "water shield" protects the team from the towing vessel's wake. Oxygen bottles provide buoyancy for the sled. The team wears breathing gear, life preservers, knives, depth meters and shark repellent.



LEAKING FAUCETS? Fix Them Yourself!

This simple test hones and polishes faucet valve seat smooth so rubber compression washer will work. Grinds out corrosion pits and damage caused by chattering metal resonant. Save money, stop water waste!

MONEY BACK GUARANTEE
Don't delay—send for yours today!

Test, complete with 2 grinding wheels, only \$4.00. Postpaid with Check, Cash or Money Order or C.O.D. plus postage.

Additional Grinding Wheels Available
HONE TOOL CO., P. O. BOX 1477, TULSA 1, OKLA.

POWERFUL • LIGHTWEIGHT • PORTABLE
SELF PRIMING **CENTRIFUGAL PUMP**

• 1 1/2 H.P. Two-Cycle Gas Engine • Pump cap. up to 35 GPM
• 3" and 1/2" Connections for Inexpensive Garden Hose
• SPRAY - BRAIN - CIRCULATE - IRRIGATE - FIRE PROTECTION

Quality all-aluminum pump for homes, farms, cottages, resorts, boating, golf courses, industry, contractors. Working parts precision machined.

ORDER DIRECT Dept. 57
Send Cash, Check or Money Order
30-DAY MONEY BACK GUARANTEE
\$98
CROWN MFG. CO. WATERLOO, IOWA
FOR FACTORY

Works in seconds!

Loosens Rusted Bolts
nuts, screws, "frozen" parts!

LIQUID WRENCH

The super-penetrating rust solvent that quickly loosens rust and corrosion.

AT HARDWARE STORES, GARAGES SERVICE STATIONS, EVERYWHERE

RADIATOR SPECIALTY CO.
Charlotte, N. C.

3 oz. CAN
30c

Team to Observe Marine Gear

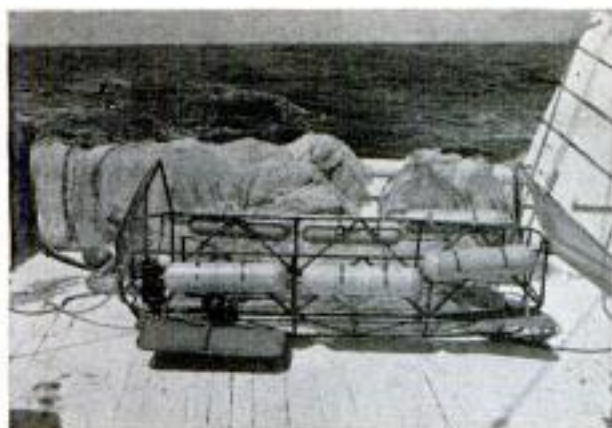

3400 RPM 1/2 HP POWER SAW
RIPS - CROSSCUTS
CUTS A FINISHED 2x4 LIKE A KNIFE THROUGH BUTTER
 COMPARES TO SAWS SELLING UP TO \$49.50 **1998** Complete with 5-1/2" Blade
 A rugged, professional type, adjustable saw. Will cut any angle from 0 to 45°. Has an adjustable 0 to 6" rip fence. Safety trigger switch on handle. Full 1/2 HP Universal AC DC, 110-120 Volt, 60 cycle motor. Weighs only 8 1/2 lbs.

EXTRA SAW BLADES - Available in Rip, Crosscut or Combination. Please Specify **225 EA.**

NEW POWER SAW BENCH TABLE
 This sturdy precision made benchtop table converts our famous Power Saw (above) to a handy, versatile table-saw. Comes with a rip fence and miter guide that permits accurate rip, cross, angle or bevel cuts. Saw is easily and quickly installed. Table size 14" x 16" x 6" high. **Now Only 9.95**

SAVE 50%
PHILIPPINE MAHOGANY PLYWOOD
 For Paneling Dens, Offices, etc. Use in Cabinets, Furniture, etc. Rotary cut. Both sides sanded. Bonded with the finest resin adhesive. Face side unjointed. Shipped at lowest truck rates.

3MM (1/8") x 3 FT. x 6 FT. \$5.00 VALUE 179 PER SHEET
FREE SAMPLE ON REQUEST
1/4" x 4 FT. x 8 FT. 950 VAL. 449 PER SHEET
 MINIMUM ORDER 4 SHEETS

SAVE 50% ON TRANSLUCENT FIBERGLAS PANELS
 Finest quality. Available in many colors and lengths. Excellent color selection. Ideal for home, office, etc. **FREE sample and booklet.** **49.50 850 VAL.**

SPECIAL CATALOG BARGAIN!
NEW! DECORATIVE! HEAVY WROUGHT IRON TRELLIS
 FOR PATIO ROOF SUPPORTS-DIVIDERS, etc.
 Use them INDOORS or OUTDOORS! Heavy 1-1/8" black tubular supports with a beautiful wrought iron filigree between them. 8 ft. high, 12" wide. Height can be cut to 7 ft. Available either flat or corner type. Mounting flanges included.
FLAT TYPE 9.95
CORNER TYPE 17.95

AUTOMATIC PILOT SERVO UNIT ADAPTS TO
 AUTOMATIC HOIST SYSTEMS
 IN A BEAR DRIVING SYSTEM
 AUTOMATIC DOOR OPENERS
 REMOTE MACHINERY CONTROL
 Has 1/20HP, 2.4V DC, 2270 RPM, continuous duty motor. Gear box reduction is 133-1. Take-off speed 17 rpm. **\$22.50**

2500 LB. LIFT HOIST
 Ideal for garage, boat, jeep, truck, shop, etc. Has bronze worm gear drive with 24 to 1 ratio and 3-speed crank. Comes with 18 ft. of 3/16" high tensile steel cable and crank and free-spool, pull-out clutch. **34.95**

HOIST MOUNTING FRAME - Ideal for above hoist. **4.50**
PORTABLE SHOVELCASE
 G.I. Surplus. 20" handle. Blade folds to form pick. Carry it out for emergency **ONLY 1.79**

SPECIAL AIR PRESSURE TANKS
 G-1 Type. Stainless Steel. Shatterproof and rustless. Built to withstand up to 400 PSI with high safety factor. Has 1/4" pipe ports. Ideal for use in Air Storage for painting, spraying, etc. Can also be used for water storage, as a bubbler, etc. Size: 12 1/2" diam. x 24" length. **NEW and UNUSED 16.95 USED 12.95**

LARGE VOLUME Stainless Steel AIR or CHEMICAL STORAGE TANK
 J-1 Type. 18,000 cu. in. capacity or 77 gallons. 24" diam. x 48" length. Modified for use with air. Will stand pressure up to 400 PSI. **9.95**

TARMY PICMATTOCK
 Has 12" steel head with burrow on one side pick on the other. 16 1/2" hardwood handle. **1.29**

WORLD'S MOST AMAZING CATALOG
396 PAGES OF BARGAINS
NEW 1957 ISSUE
 NOW! The Largest Collection of Bargains ever assembled in one Catalog! **NATIONALLY ADV. MERCHANDISE** - New and Used **GOV'T SURPLUS** - **FACTORY CLOSEOUTS** and **EXCITING IMPORTS!** From all these sources Palley's now bring you items of every description - **ALL at Bargain prices.** This fabulous catalog contains Hand & Power Tools for industry as well as Home Medicine, Industrial & Building materials and supplies, Sport & Camp Equip., Housewares & Appliances, Cameras, Microscopes, Electric Motors of all types - a huge stock of New and Surplus Hydraulic Cylinders, Pumps, Valves, Fittings, etc. plus so many more items we can't list them all!
SEND 50¢ LIMITED EDITION! ORDER YOURS NOW!
 50¢ REFUND on your first Order of \$1.00 or more.
Palley's TERMS: Order from this ad. Pay by M.O. or check. P.O.'s accepted from D&B firms. 1/2 deposit with C.O.D.'s. All prices are F.O.B. Los Angeles. All sales are final.
 2263 E. VERNON AVE., DEPT. PM-6, LOS ANGELES 38, CALIF.

CLEANS IN SECONDS
PROCESS 33
PAINT BRUSH AND ROLLER CLEANER
 Cleans in seconds - keeps 'em like new. Switch from one color to another in 33 seconds. Re-usable - keeps original strength! **ONLY 69¢ FT.**
AT HARDWARE & DEPARTMENT STORES

WHEEL PLAN BOOK FREE
 Shows portable farm, home and garden equipment built easily, economically with 4- to 12-inch Gleason ball bearing rubber tire wheels. Barrows, carts, toys, garden furniture, etc. **Waste - PLAN BOOK**
GLEASON Corp., 340 North 13th Street • Milwaukee 3, Wisconsin



KING MIDGET
ALL NEW. First model change in six years. New bodies, new chassis, new engine. Four wheel hydraulic brakes. Still World's Lowest Priced Car. Drive it for 75¢ per week. Rider Agents Wanted. Earn your own car. Get the facts. Send 25¢ for 32 page picture book with complete details, dealers price, etc.
MIDGET MOTORS CORPORATION, Athens 1, Ohio

One Person Folds and Rolls Banquet-Type Table



Two steel wheels, built into the underframe on one side of a folded, banquet-type table, enable one person to transfer the table from one place to another with little effort. Made of all-steel "girder" frame construction, this table has legs that are rigidly locked in place between toggle-action end brackets and a one-piece center-support member, when the table is in use. All bracing members are pivot-attached to the underframe. When folded, the table top and legs are locked into the underframe, leaving a profile of $1\frac{3}{16}$ inches in total thickness. Tread-rubber shoes lock on over legs to prevent slipping and marring of floors. Top working surface of the table is hard plastic with simulated birch grain and a perimeter edge of anodized aluminum. The two sizes made are 30 by 72 inches and 30 by 96 inches in area; both sizes are 29 inches in height. Use is suggested for schools, churches, hotels, lodges, clubs and cafeterias.

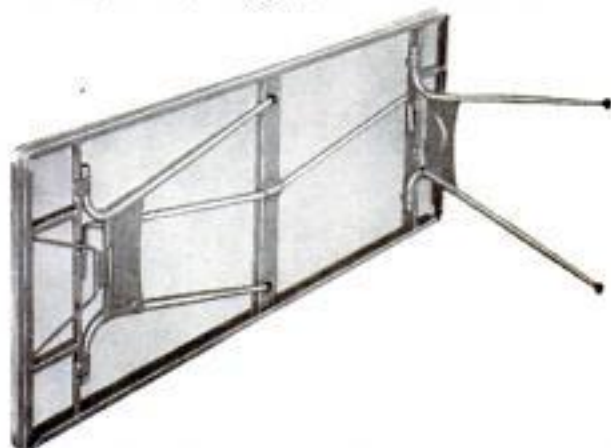

Just pull the trigger...
spray paint!

The easier, better way to paint! Job's done in minutes. Finish is smooth, flawless. Speedy Sprayer is a real professional tool, favorite of craftsmen for over 35 years! At stores everywhere. 890 Outfit, including gun, hose, less motor, only \$39.95



FREE! "How to Spray" booklet and literature. Write!

WHEEL KIT \$7.50 EXTRA

W. R. BROWN CORP., 2635 N. Normandy, Chicago 35

RETAIL PRICE \$125.00
FACTORY TO YOU \$79.95

SUPERSHOP includes precision-built 8" tilting table saw, vertical and horizontal drill press, 30" lathe, sander, grinder. 100% BALL BEARING. Write for FREE catalog, full details, trial plan. Easy Pay Plan.

POWER TOOLS, INC.

106 YATES AVENUE
BELOIT, WIS.



FREE AMAZING NEW BOOK "HOW TO ANSWER ADS"



Never before have you seen anything like this. Tells you in simple language the correct way to answer ads, gets you quicker replies—better results, and greater satisfaction. Will save you time and money and it's **ABSOLUTELY FREE**. No obligation whatever. Every reader of advertising should have this booklet. Send a postcard for your copy **NOW**. F. W. JOHNSON, Popular Mechanics Magazine, Room 600-A, 204 East Ontario Street, Chicago 11, Ill.

NOW—THE QUICK-WAY TO SHARPEN ALL CIRCULAR SAWS

NEW

Model PG-12 Complete No extras to buy. \$16.50 Postage Paid



Model PG-12 sharpens, joints, gums, and retoots all cross cut, rip, combination, miter, and planer blades up to 12" in diameter. Two precision index plates give versatile, accurate sharpening. Guarantees precise spacing of teeth. New safety rest prevents tilting and gouging of blade. Save time and money. Special \$3.00 grinding wheel also included for use on your own power table. Fits regular or radial swing tables.

Order today. Send check, cash, or money order. We pay postage. **FREE** Booklet—"How To Sharpen Saws."

QUICK-WAY SAW CO.

136 TOMPKINS ST.

CORTLAND, N. Y.

PORTABLE LIGHT PLANTS

1500 WATT PLANT

115 v. 60 cyc. AC Push Button Start. Powered by a 3 1/2 HP. Clinton engine. Combines big output with easy portability. Provides emergency power for operating any oil burner, sump pump, freezer, television, lights, communications systems, etc. Which require up to 1500 watts. (Item 22). Wt. 110 lbs. Reg. \$475 value. Factory price... **\$239.50**



1750 Watt Plant Powered by 4.5 Briggs engine. Electric starting & battery charging built-in. Factory price... **\$279.50**

MASTER-LITE 2500 Watt Plant

110/120 v. 60 cyc. AC. A powerful plant, ruggedly constructed and yet designed for easy portability. Can be started by rope or built-in 12 v. electric push button starter. Built-in winding to charge battery. Powered by a big 5.10 HP Briggs engine, complete with all accessories. Includes control box, voltmeter, and handy plug-in power receptacle. An ideal plant for permanent or stand-by service. Wt. 225 lb. Reg. price \$645.00 (Item 23) Factory Price... **\$329.50**



3500 Watt Plant Push Button Start (Item 23) 115 v. 60 cyc. AC. Similar to above, but larger and 33% more capacity. Wt. 270 lbs. Reg. \$700. Factory Price... **\$379.50**
DUAL VOLTAGE 110/220 for Item 21 or 23 —\$80 additional.

JET STEAM MASTER

Now, a super efficient portable steam generator that produces live steam at 100 lbs. pressure in 40 seconds from a cold start! Produces large volume of high pressure steam on 2 pints of fuel oil. Instantly cleans sticky grease, dirt, rust, old paint, etc. off implements and road machinery. Pays for itself in a few weeks. Sterilizes soil. Sterilizes as it cleans—milk equipment, etc. Fully automatic—all fired with new, built-in lifetime bronze water circulating pump. Draws water from faucet or bucket. Simple and safe—anyone can use it; built-in safety valve. Complete with 12 ft. of hi-pressure steam hose and new triple efficiency steam gun that automatically mixes in soap solution if desired. Wt. 250 lbs. Item 463. **\$349.50**
Special factory price...



GIANT METAL SHEARS

"PEKTO"
Nine inch cutting blade made of special high carbon alloy steel, perfectly aligned and rounded. Easily cuts steel plate up to 12 gauge or 1/4" thick. Overall length 48". Wt. 23 lbs. (Item 156) Regular \$49.50, While they last... **\$14.95**



MASTER DC ARC WELDERS

Now! a portable rugged, industrial type welder with terrific performance, yet at a price hundreds of dollars less than you'd expect. Senior model made for years of trouble-free, continuous service. High capacity DC welding unit enables you to tackle any job with confidence—easily welds anything up to 2" plate using from 1/16" to 1/2" rods. Built-in stabilizer and cooling system makes arc easy to strike and hold. Dual control rheostat provides low heat soldering, brazing and welding from 30 to 300 amps. Complete with instructions, guarantee and triple V-belt or flat pulley. Easy to hook up and easy to operate.
WELDER ONLY — DUAL CONTROL MODEL. Same as above, but drive with your tractor, jeep or gas engine of 14 HP or more. (Item 285.) Wt. 110 lbs. \$450 value... **\$119.50**
WELDER ONLY—INDUSTRIAL MODEL same as above but with ceramic rotary type rheostat providing 74 different heat settings for all types of welding (Item 286) \$500.00 value... **\$139.50**
COMPLETE POWER MASTER (Illustrated above) powered by a 14.6 hp., air cooled Wisconsin engine. Wt. 480 lbs. (Item 280) Complete with welder costing \$1200. **\$449.50**
Welding Special...



WELDING KIT Two 10 ft. leads, welding helmet, electrode holder, ground clamp. Sold only with welder at... **\$10.50**

TERRIFIC VALUES

direct to you from
MASTER MECHANIC'S FACTORY



700 WATTS PUSH BUTTON START
115 v. 60 cyc. AC Powered by a rugged 2.2 HP easy starting Briggs engine. No wiring necessary—just plug in and operate. Plenty of current for any oil burner, freezer, heater, emergency lights, etc. which require up to 700 watts. Ideal for television and radios. Complete with Voltmeter and built-in winding to charge 6 v. auto batteries. (Item 24.) Wt. 75 lbs. Easily fits in car trunk. Be prepared if storm knocks out power lines. Reg. \$275 value... **\$143.50**
1200 Watt Plant (Item 45) same as Item 24 but larger generator and engine with 50% greater output... **\$199.50**

MASTER AIR COMPRESSOR
COMPARE! This is the only compressor built with a NO RUST stainless steel tank. Safe up to 500 lbs. (Item 209) High pressure type 14 c.f.m. Large volume of air for heavy duty service. For paint spraying, inflating truck & auto tires, greasing, sand blasting, etc. Piston type 2" bore compressor with built-in air filter. Master built with high strength alloy and precision bearings. Tank, 12"x24", 2100 cu. in. cap. Equipped with automatic switch that starts and stops motor to maintain desired pressure (up to 150 lbs.) and check valve, safety valve, gauge, shut-off valve, 20 ft. air hose and tire chuck. Beautifully balanced on ball bearing wheels and rubber tires. Don't take chances with used or surplus equipment. Our compressors are factory new and are guaranteed SAFE. Low factory prices. 1 1/2 HP Model (cap. 85 lbs.)... **\$109.50**
Reg. \$175. (Item 209)
1 1/2 HP heavy duty model, Reg. \$150. **\$129.50**
motor & unloader switch (Item 209a)



Double Acting Hydraulic Cylinder

A powerful cylinder mfr'd. by Massey Harris which develops both a pushing and a pulling action. Will push 8,100 lbs., with a 1000 PSI pump pressure. Cylinder is 3 3/4" O.D. with 6 1/2" stroke—standard heavy duty clevis on both ends. Has standard 1/2" pipe thread openings. Can be used for lifting buckets or blades, raising or lowering implements, hydraulic presses, etc. Can also be used as an air cylinder. (Item 802) Wt. 17 lbs. Reg. \$68 value, Special... **\$14.95**
OTHER DOUBLE ACTING CYLINDERS
8" stroke — 3" bore... **\$34.00**
10" stroke — 3" bore... **34.80**
16" stroke — 3" bore... **43.00**
24" stroke — 3" bore... **47.50**
HYDRAULIC CONTROL VALVE — 4 way open center valve with built-in adjustable relief. Controls 1 double, or 2 single acting cylinders. Equalizing feature permits easy control even under heavy loads. 3/4" pipe thread on inlet & outlet. 1 1/2" on cylinder outlets. Easily finger tip control. Wt. 16 lbs. (Item 822)... **\$21.50**



LESS THAN WHOLESALE

GIANT 2500 WATT PLANT

110-120 v. 60 cyc. AC, absolutely the best made — exclusive dynamically balanced armature; heavy windings develop up to 5000 watt overload for motor starting. Skid mounted — portable. Powered by 30 easy starting Briggs or Wisconsin 6 HP engine—complete with all accessories; engine easily disconnected for other uses. Big outlet box, voltmeter, no wiring necessary. Ample current for all purposes. Factory warranty. (Item 31) Wt. 210 lbs. **\$299.50**
Reg. price \$585. Special at...
Same plant with electric self starter (Item 31a)... **\$359.50**
Generator only and control box... **\$160.50**
DUAL VOLTAGE 110/220 available on any of above models for \$28.00 additional.
We make every type and size of light plants —Write, giving us your requirements!



FAUCET WATER HEATER

Instant hot water from any faucet—super hotness—seconds unobtainable—but it's true! You just slip MASTER MECHANIC'S new Faucet Water Heater over any water faucet, plug it in a wall outlet and you've got steaming hot running water instantly for dishes, shaving, washing baby's bottle, etc. Simple and safe—operates on ordinary 115 v. house current—costs only 2 1/2 cents per hour for hot water. Ideal for house trailers, cabins, trailers, etc. Easily regulated from lukewarm to full boil. Fully guaranteed! (Item 408) Wt. 2 lbs. Factory price F.O.B. Burlington, only... **\$4.95**



Rugged, ball bearing WINCH

sturdy ball bearing winch—super tough minimum alloy construction. Powered by an easy starting 2 1/2 HP Briggs gas engine thru gear reduction drive — it exerts up to 3000 lbs. of terrific force for hoisting materials or pulling. Combination gear and pulley reduction results in tremendous multiplication of engine power. Toller pulley clutch arrangement and built-in drum brake (withatchet hand lever) enables operator to ease loads down gently and lock at any point desired. Drum handles 400 ft. of 5/8" cable or 600 ft. of 3/4" cable. Ideal for contractors, farm implement trailers and unlimited other uses! (Item 795) Wt. 125 lbs. Only... **\$149.50**
HAND WINCH—Same winch with large crank handle for extra leverage and 2 speed drive. (Item 794) Wt. 60 lbs... **\$59.50**



EXTENSION CORD

Heavy duty and very flexible. Neoprene 14-2 cable. 20 year quality. Wt. 12 lbs. (Item 185) 100 ft. Complete with rubber plug and outlet. A big price... **\$8.95**
No. 10-2 Power Cable. Heavy duty, very flexible, 20 ft. with male and female fittings. Wt. 4 lbs. (Item 818)... **\$5.15**
20 ft. without fittings (818a)... **\$4.15**
50 ft. (Item 592) with fittings... **\$13.45**
100 ft. (Item 135) with fittings... **\$23.95**
No. 12-2 Power Cable. Very flexible rubber covered, special outside shield for grounding power tools, etc. 50 ft. (Item 199) **\$6.95**
100 ft. (Item 200)... **\$12.95**
No. 8-2 Conductor Power Cable, 30 ft. heavy duty, very flexible rubber covered with male & female plug (Item 817)... **\$12.95**



9 TON HYDRAULIC PRESS

A tremendously powerful hydraulic press, capable of exerting 18,000 lbs. pressure. Pays for itself many times over—straightening bent connecting rods, king pins, crankshafts, axles, link pins and bars — or pushing out frozen bearings and bushings. Develops pressure under precise control and visible at all times on accurate gauge. Complete with both large and small anvils and jigs to straighten any kind of curve or bend. (Item 464) Wt. 110 lbs. Actual list price \$365. Our special... **\$69.50**
close-out price...
SCREW TYPE PRESS. Nine ton capacity. See May Pop. Mech's. ad for details... **\$49.50**
Complete, Wt. 150 lbs. (Item 707)...



Send check or M.O. Prices L.o.b. Factory. 10 day Money back guarantee. SEND 10c for... **BIG 1957 Catalog**
MASTER MECHANIC MFG. CO., DEPT. 69-Q Burlington, Wis.



KEEP CLOSE-TOLERANCE MACHINING EFFICIENT!

South Bend PRECISION TURRET LATHES

South Bend 2-H Precision Turret Lathe—1" collet capacity, 16 1/4" swing, 96 power turret feeds, 48 cross slide feeds, 48 carriage feeds, 48 thread cutting feeds.

Base Price \$3484

South Bend Precision Turret Lathes keep efficient the machining of small duplicate parts. Their remarkable accuracy and positive controls simplify the holding of close tolerances with only normal machine handling care. Finishes are commonly produced that otherwise would require additional operations. Simplicity of tooling makes job changes quick and economical. Wide ranges of power feeds and thread cutting feeds assure maximum efficiency on every job. They are particularly suited for second operations. Sizes available include: 1" collet—16" swing; 1" collet—13" swing; 1" collet—10" swing. Priced from \$1665.



TURRET ATTACHMENTS

South Bend Turret Attachments are available for tooling 9", 10", 13" and 16" swing South Bend Lathes for repetitive operations. Precision built for precision work, their rigidity and accuracy permit maximum feeds and speeds. Prices of hexagon bed turrets range from \$284.00 to \$726.00. Square Turret Tool Blocks are priced from \$43.25 to \$94.50. Write for Catalog giving full information on South Bend Turrets and the complete line of South Bend Attachments and Accessories.



PLEASE SEND INFORMATION CHECKED:

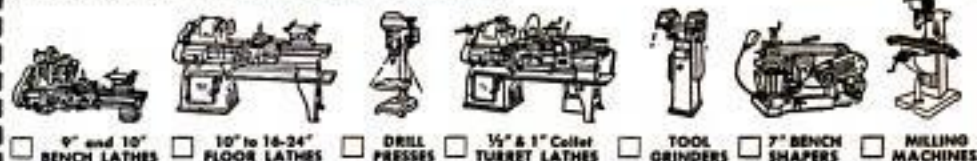

9" and 10" BENCH LATHES 10" to 16-24" FLOOR LATHES DRILL PRESSES 1/2" & 1" Collet TURRET LATHES TOOL GRINDERS 7" BENCH SHAPERS MILLING MACHINES

Name _____ Street _____
City _____ State _____

Building Better Tools Since 1906 • SOUTH BEND LATHE • South Bend 22, Indiana



The **NEW**

F-57 HAMMER with *IMPROVED light-weight CONSTRUCTION*

**NON-BREAKABLE
FIBER-GLASS
HANDLE**

*Stronger than Steel
-with the Hickory feel*

You'll marvel at the free and easy swing of the most perfectly balanced hand tools ever made. These are two of the 28 tools with non-breakable fiber-glass handles in the new Plumb line.

At last. Here's the only handle that won't bend out of shape or collapse — can't rust, rot or corrode. Guaranteed non-breakable in normal use.

**BALL PEIN
MACHINISTS' HAMMER**

FM24. 24 oz. head —

\$5.00

Advised
Consumer
Price



New Functional head design gives added driving power.

**NEOPRENE
COVERED
GRIP**

Shock absorbent and Slip-Proof. Resists grease, oil and sweat.

Handle withstands overstriking without breaking. Also available in 16, 20, 32, and 40 oz. head weights.

\$4.95
Advised
Consumer Price

PLUMB®

Available at your local
retail hardware stores.

FAYETTE R. PLUMB, INC., PHILADELPHIA 37, PA.



hitch your wagon to a holiday
...go with an Evinrude in tow!

Where to this week end . . . a placid pine-fringed lake? A river hidden in the hills? Down to the sparkling sea? You name it . . . and it's yours!

Join the thousands who go with an Evinrude in tow! One look at the new '57 Evinrudes will tell you why there's *more* fun ahead with an Evinrude behind.

First, they're beauties to behold . . . brilliantly styled to complement the smartest craft. Next, they're power-packed for great performance. Two new "18's" and three new "35's" with new, high-compression engines that deliver solid big-load driving power. New 12-volt electric starting or easy manual starting. New fuel economy that extends your cruising range. New high capacity generator (optional). Wonderfully smooth, *whisper quiet* power that wins you a welcome wherever you go!

Name your fun . . . fishing, cruising, skiing, or just plain boating . . . there's an Evinrude to match it with today's most advanced features.

Why let another week end slip away? See your Evinrude dealer today. Ask him for a "Revelation Ride." Catalog free, **EVINRUDE MOTORS**, 4467 North 27th Street, Milwaukee 16, Wisconsin.

A Division of Outboard Marine Corporation
 In Canada: Mid, by Evinrude Motors, Peterborough



 **Evinrude**
quiet outboard motors



Copyrighted material