

# POPULAR MECHANICS

## MAGAZINE

BOATTEL

EN 50 M

REG. TRADE MARK, GREAT BRITAIN, NO. 4042



*Build the SEA KNIGHT — a 17-Foot cabin cruiser — page 164*

**TAKE YOUR VACATION BY BOAT**  
**What Does It Cost to Own a Boat?**  
**OWNERS REPORT** on the Long, Low Look—  
**the '57 PLYMOUTH**

Printed in

BOAT IN THIS AD MANUFACTURED BY:

FIBER CRAFT CO.

1820 N.E. 146th ST., NORTH MIAMI, FLORIDA

# smart fishermen



have all  
the luck!



Talk about the girl... the string of fish... the motor... it fits 'em all! Especially it fits the new '57 Evinrudes. Talk about *quiet* smooth-running power from slowest trolling to full throttle... these new Evinrudes have really got it! Talk about easy starting, easy handling, good looks, sure reliability... you can't beat 'em!

New high compression engines in the "18's" and "35's" offer unsurpassed load handling power. New starting ease... manual or 12-volt electric starting. New fuel economy. New high output generator (optional).

One look at these '57 Evinrudes and you'll see why more families are going boating... why more of them buy Evinrudes. See the nine new models... 3 to 35 hp... at your Evinrude dealer. Ask for a "Revelation Ride." Full color catalog free. Write EVINRUDE MOTORS, 4450 N. 27th St., Milwaukee 16, Wis.

Find Your  
Nearest Dealer  
in the  
"Yellow Pages"

A Division of Outboard Marine Corporation  
In Canada: Mfd. by Evinrude Motors, Peterborough

 **Evinrude**  
quiet outboard motors

Copyrighted material

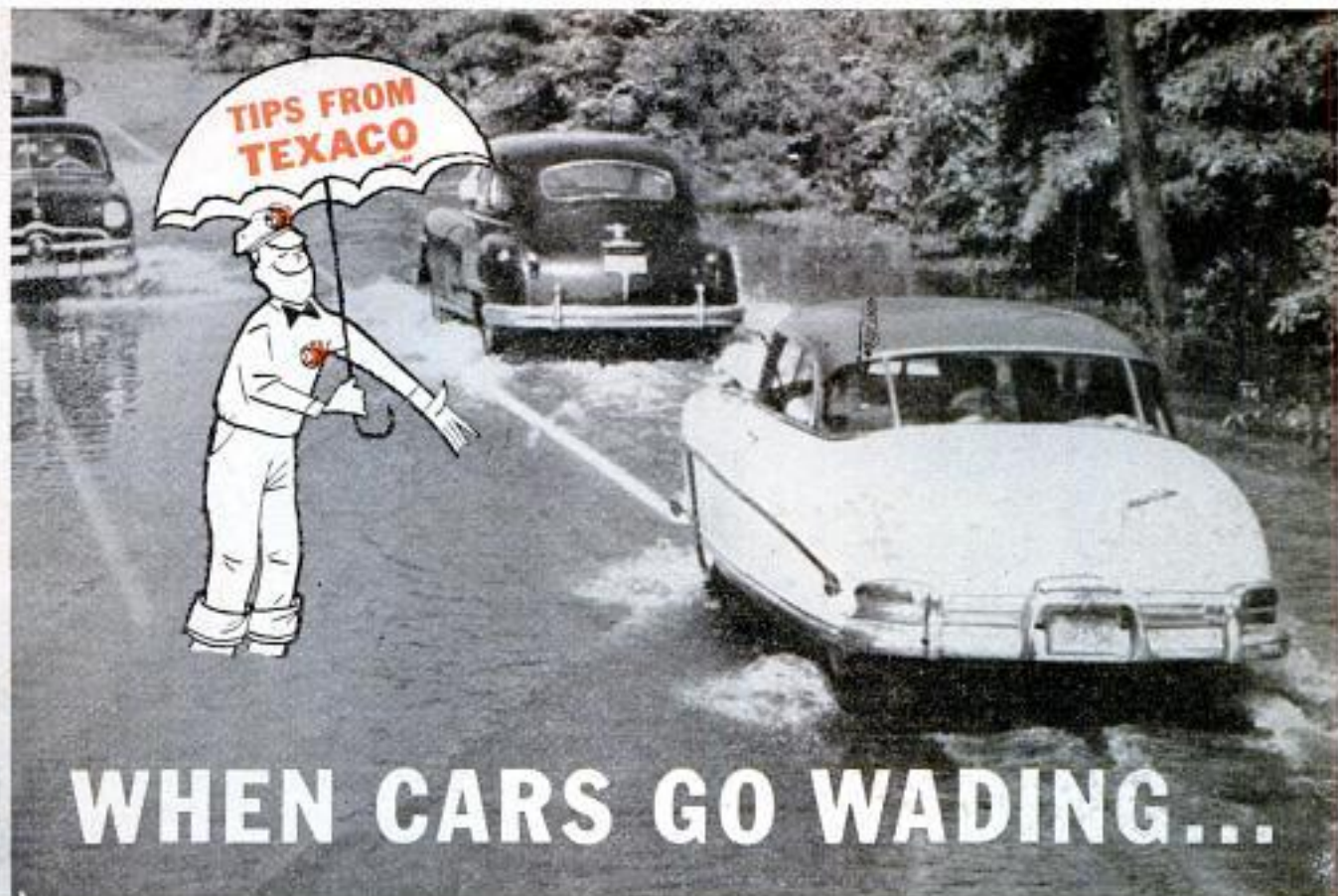

## WHEN CARS GO WADING...

SOMETIMES your car has to *navigate*... on flooded roads... crossing deep puddles after heavy rain... fording a small stream.

*Resist that impulse*... don't rush! Water resents being "pushed" around. The sudden shock of hitting it *fast* may stall your engine. Splashed water, sucked in by the fan, can give your engine a shower bath and short circuit the plugs

and maybe the distributor. Result — you may have a *dead engine*.

Instead, do wade *slowly* in low gear. If your engine *does* get splashed, you can hope the heat will dry it. If not, and your engine sputters, dry the spark plugs and the distributor with a cloth.

*Another warning:* when water covers the exhaust pipe, engines stop. It can mean a tow job to get you out.



### PROTECT your car's lifeline

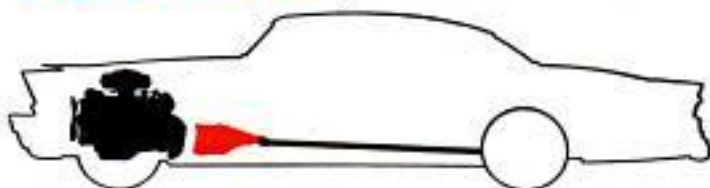

Automatic transmissions need careful servicing. Texaco Dealers are specially trained to service them... use only Texaco *Texamatic* automatic transmission fluid, the one which has been most widely used for original filling. See your Texaco Dealer — *the best friend your car has ever had.*

THE TEXAS COMPANY

# TEXACO DEALERS

IN ALL 48 STATES

Texaco Products are also distributed in Canada, Latin America, and Africa



# If your headlamps look like these—

YOU NEED A PAIR OF NEW G-E *All-Weather* HEADLAMPS  
YOU'LL GET LOTS MORE LIGHT!

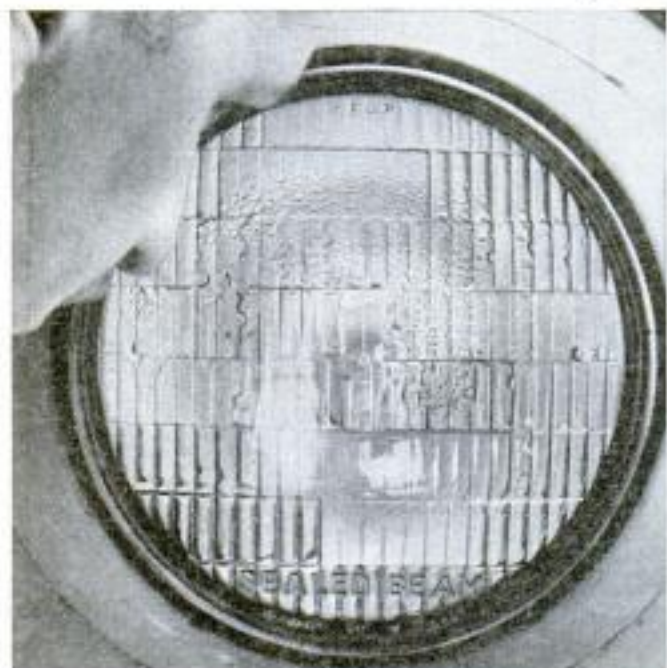

**WATER DROPLETS** inside the lens not only scatter the light, but they also help discolor metal reflectors. This can't happen with G-E *All-Weather* Headlamps—moisture can't possibly get inside.

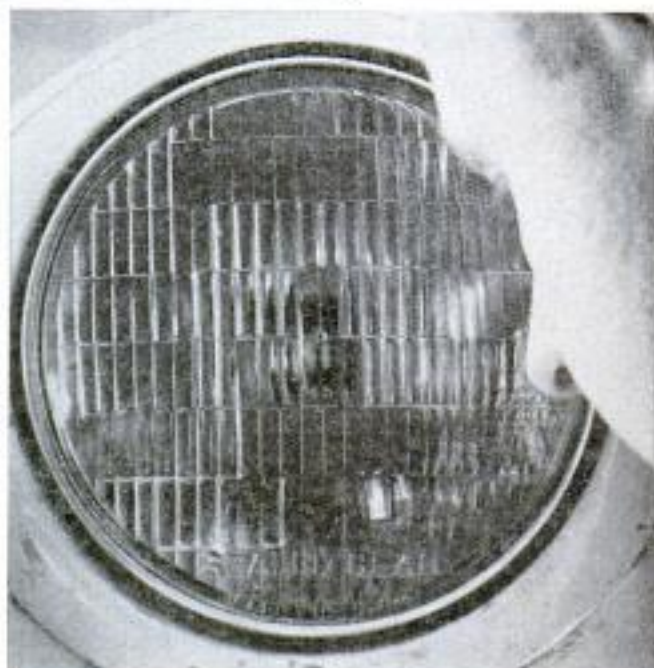

**DISCOLORED REFLECTORS** absorb light rather than reflect it, causing a loss of up to 50% of the original light output. Dirt and moisture can never enter G-E *All-Weather* Headlamps so the reflectors always stay shiny.

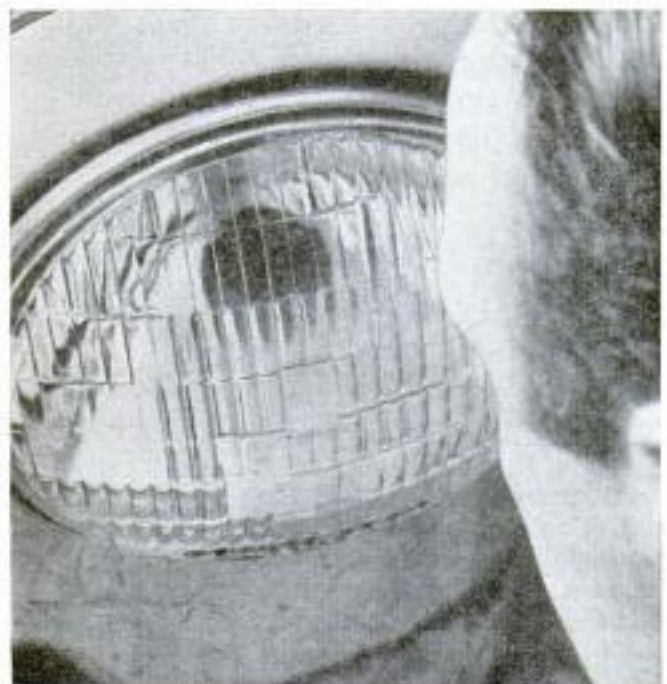

**BLACKENED BULBS** in old-style headlamps block out the light from the filament and cause a dangerous drop in light output. This can't happen with G-E *All-Weather* Headlamps because *there are no inner bulbs!*

G-E *All-Weather* HEADLAMPS NOT ONLY GIVE YOU LOTS MORE LIGHT... BUT YOU ALSO GET:

**Better seeing in fog, rain, snow**—The lower beam filament has a special shield that cuts down reflected glare and lets you see better in any weather.

**Lower beam puts twice the light 300 feet ahead at the curb**—You can see much better against the glare of oncoming traffic.

**Upper beam that reaches far and wide**—For open road driving, the upper beam filament is left unshielded to let you see curves, dips—even side roads.

So, for safer night driving, get a pair of new G-E *All-Weather* Headlamps today — and have your dealer aim them when he puts them in. You'll see the difference tonight. General Electric Co., Miniature Lamp Dept., Nela Park, Cleveland 12, Ohio.



GENERAL  ELECTRIC



Why cool  
just  
one room?



New Lennox  
air conditioner  
(installs anywhere)



Cools your  
whole house  
(every room of it)



## Now...from Lennox...a whole-house air conditioner for cigarette money

Available for custom-installation by your  
local Lennox Comfort Craftsman

Developed by Lennox, world leader in the science of conditioning air—here is a remarkable new air-cooled whole-house air conditioner that's surprisingly economical to install, operate and maintain. *It costs no more over the years you enjoy it than you spend on cigarettes—even if your family smokes as little as two packs a day!*

### ECONOMICAL TO INSTALL

Called the Lennox Stowaway, this new air conditioner has been specially designed for low-cost installation in any home—no matter how it's designed or heated. It requires no plumbing, no water tower, no expensive wiring; can be neatly "stowed away" in an attic, basement or crawl space, or outside on a roof or concrete slab. If you have a warm air heating system of any make, you're really lucky, of course, because you can then use your furnace ducts and registers. But since the Lennox Stowaway air conditioner requires only the simplest type of ductwork, it can also be economically installed in homes with any type heating.

### COSTS LESS TO OPERATE

And what about operating costs? To cool and de-

humidify the air throughout your house, the Stowaway uses substantially less electricity than many other air-cooled air conditioners of similar capacity. Lennox Stowaway units of 2-ton, 3¼-ton and 5-ton capacities are now available for custom-installation by your Lennox Comfort Craftsman.

### BUY NOW ON EASY PAY PLAN

Call your Lennox Comfort Craftsman, listed in the yellow pages of your phone book. He's factory-trained, deals directly with Lennox. He'll be glad to give you a free air conditioning estimate.

### CAN YOU QUALIFY AS A LENNOX COMFORT CRAFTSMAN?

Opportunities are open in some localities to heating and air conditioning specialists who can meet our high standards. Write: Lennox, Dept. CC, Marshalltown, Iowa.

More families buy

**LENNOX**



world leader in all-season

air conditioning for the home

© 1957 Lennox Industries Inc., Heating and Air Conditioning, founded 1895; Marshalltown and Des Moines, Ia.; Syracuse, N.Y.; Columbus, O.; Decatur, Ga.; Ft. Worth; Los Angeles; Salt Lake City. In Canada: Toronto, Montreal, Calgary, Vancouver.

POPULAR MECHANICS

# LONG ON ACTION!

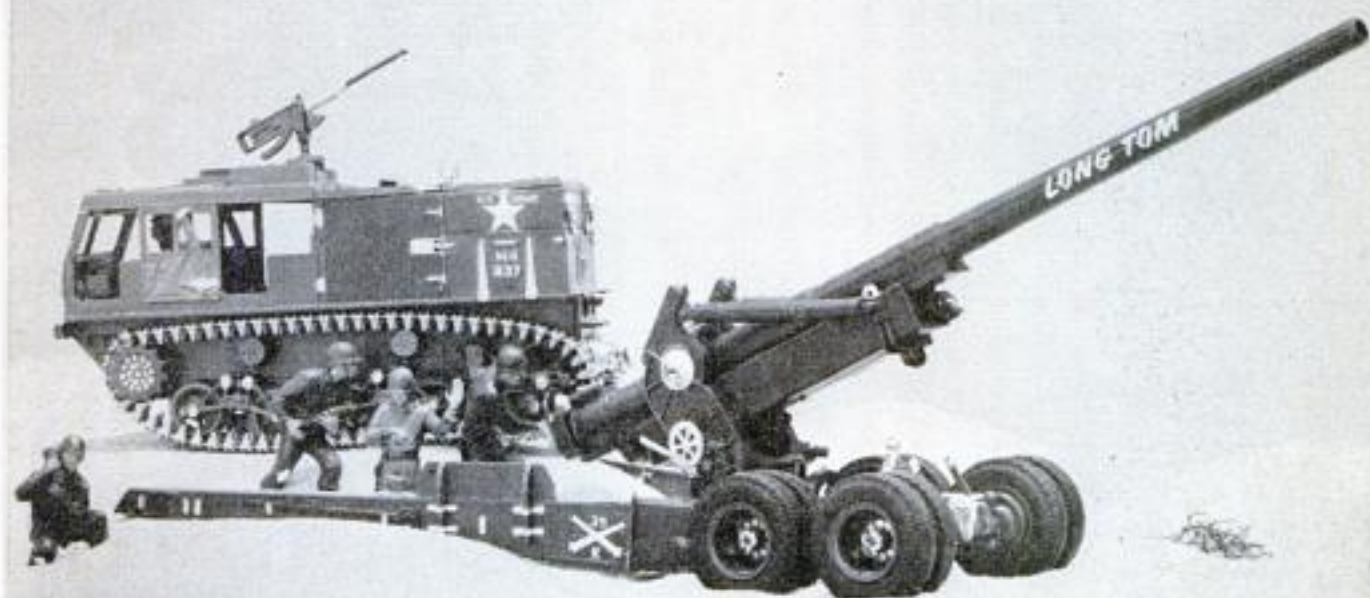

**"LONG TOM" GUN WITH TRACTOR AND 5-MAN CREW \$1.98**

155 mm. gun, towing limber, high-speed tractor all move—in new model Revell Authentic Kit scaled from Army blueprints!

This new Revell model not only looks real—it almost acts real: Build it yourself and see. You can pivot and swivel the 155 mm. gun barrel, roll it along on wheels, move the split trail on the gun carriage from towing to battle-ready position. Gun even has recoil action. M-4 tractor has real moving treads. It's all there—detail for detail like the heavy artillery unit that saw action on every World War II front. You put it together from precision-plastic parts with step-by-step instructions. Complete Revell Authentic Kit. **\$1.98**

Copyright 1957. Revell, Inc.



**OLD IRONSIDES**—Historic U. S. Frigate Constitution, reproduced in museum-perfect scale. Accurate to last details of rigging, cannon, long boats. Comes with display stand, cement, 16 $\frac{3}{4}$ ". **\$2.98**



**CONTINENTAL MARK II**—Aristocrat of the auto world, scaled down from 218" to 61 $\frac{3}{16}$ ". Exact detailing, even to overhead valve V8 engine, movable hood, under-chassis. Includes 2 figures. **98¢**



Wherever hobby kits are sold.

MAY 1957

NOW! See all the other models you can send this coupon to get big 32-page (Stamps or Cuts)

Packed with photos, real-life details planes, sportcars, trucks, guns, dozens Revell Authentic Kits.

Please rush by return mail the 32-pag

NAME \_\_\_\_\_

STREET ADDRESS \_\_\_\_\_

CITY \_\_\_\_\_ ZONE \_\_\_\_\_ STATE \_\_\_\_\_

Send COUPON AND 25¢ to Revell, Inc., Dept. PT, 4223 Glencoe, Venice, Calif.

This One



XY55-SYX-3J2L

Kit before.

My age is \_\_\_\_\_

# Do Your Work Easily with PROTO's New, Improved Flat Wrenches



## CHECK THESE FEATURES!

Balance... Proportion... Design •  
PROTOLLOY Steels • Good Obstruction  
Clearance • Tough, Non-Slip Finish •  
Plainly Marked Openings.

PROTO Flat Wrenches are truly "professional quality" tools, made of specially forged alloy steel, carefully heat treated. Designs are based on scientific study to make them as slim as possible for convenience in tight places, yet reinforced properly where it counts to eliminate breakage. See your nearby PROTO dealer today. Send 10¢ for catalog of entire line to

**PROTO TOOLS**  
2217 Santa Fe Ave., Los Angeles 54, Calif.  
Eastern Factory, Jamestown, N.Y. • Canadian Factory, London, Ont.

**A. NEW!** Whitworth Combination Box & Open End Wrenches. Four sizes commonly used on foreign automobiles and motorcycles. Whitworth openings,  $\frac{3}{16}$ " to  $\frac{3}{8}$ ". Lengths,  $5\frac{1}{4}$ " to  $8\frac{1}{4}$ ". Satin chrome plated.

**B. NEW!** Long 6-Point Box & Open End Wrenches. Provide greater gripping area for heavier torque loads.  $\frac{3}{16}$ " to  $\frac{3}{8}$ " openings.  $5\frac{3}{4}$ " to  $9\frac{1}{8}$ " lengths. Satin chrome plated.

**C. NEW!** Ratcheting 12-point Box Wrench. For oil filter work on new cars.  $\frac{3}{8}$ " x  $\frac{3}{4}$ " openings.  $8\frac{1}{16}$ " long. PROTO line now includes 6 tools in this series.

**D. NEW!** Double Head 12-Point 15° Box Wrench. Meets Mil. Spec. Designed for use on elastic stop nuts. Openings,  $\frac{3}{16}$ " x  $\frac{1}{32}$ ". Length,  $5\frac{1}{4}$ ". Satin chrome plated.



A5000

## ACROSS THE DESK



### 136-M.P.H. Grandfather

The mere fact that a New Zealand motorcyclist roared down a well-paved strip of country road over a measured half mile at 136 miles per hour would not stir any excitement among racers around the world. But look at the man and his mount. The racer was H. A. "Dad" Munro, age 52, of Invercargill and his motorcycle was also old enough to be a "grandfather." It was a

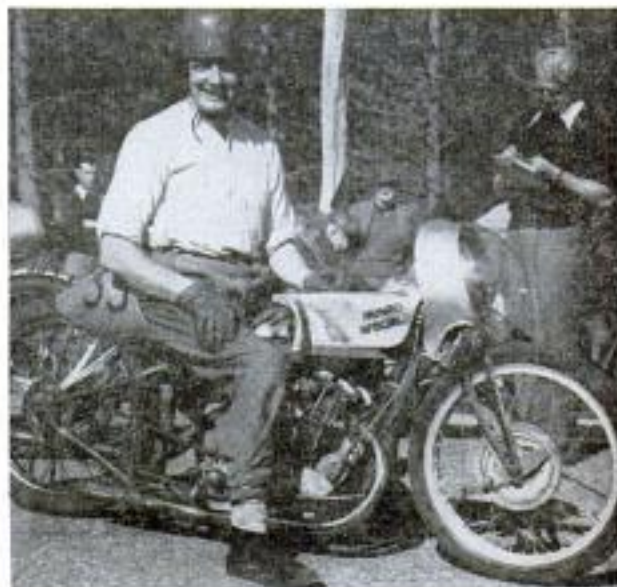

1920 Indian Scout, claimed by its builders to be good for 55 miles per hour.

Munro has 13 grandchildren and at his age most cyclists are no longer trying for speed records. But Munro, a prosperous building contractor who drives a modern car, has made a hobby of his ancient Indian. From 1940 to 1952 he held the New Zealand and Australia record of 120.8 miles per hour for a machine of his engine class, and in 1954 got the speed above 130 m.p.h. Unfortunately his more recent time of 136 m.p.h. cannot be claimed as a record as the timers had not been certified.

Leslie Hobbs,  
Christchurch, N. Z.

### To the Editor:

Thank you for the copy of the February annual auto issue. I particularly enjoyed your feature, "Eight Memorable Days in the History of Speed." I wish you could have been able to start with the remarkable feat of Emile Levassor in his Panhard in

(Continued to page 8)

POPULAR MECHANICS





How these 18 Experts can help you

Get into a High Pay

## ACCOUNTING CAREER

LaSalle's famous staff of Accounting authorities are helping thousands prepare for fast promotions and bigger pay. They can do the same for you!

If your heart is set on a larger income and all that it means . . . better home—fine car—larger bank account—more of the good things of life. . . .

If that's your ambition and you are really serious about it, then you owe it to yourself to get the REAL FACTS about LaSalle Accounting, and the many good-pay opportunities that can be YOURS through LaSalle's famous Problem Method plan.

It matters not whether you've had a single day of experience in this field—or whether you have already started but want to climb higher. LaSalle's expert training is designed to take you from where you are . . . to where you want to be . . . in higher positions and a lifetime career of security and good income.

### WHY YOU CAN'T FAIL TO GAIN

You see on this page a panel of experts who know Accounting from A to Z . . . all the way from Basic Accounting, on up through Accounting Systems, Cost Accounting, Auditing, Income Tax, and training for the C.P.A. certificate. These are only part of our instruction staff. But what is most important to you . . .

. . . These C.P.A.'s and Expert Accountants know how to impart their knowledge to others . . . how to help you prepare quickly yet thoroughly for success in this lucrative field.

The proof? What stronger proof could there

be than that more than 4,200 Certified Public Accountants (one out of every 13 of the U.S. total) has trained with LaSalle? Or the hundreds of thousands of men and women whom LaSalle has helped qualify rapidly for more money, a brighter future, in a high-pay-lifetime career? These thousands came to us with different backgrounds of experience and varying degrees of ambition. Many have reported raises and promotions after only a few weeks of training. Thousands of them have written to say they are now earning 50% more—even double their former incomes—often in less than a year. These letters are published in book form for your inspection. They were written by real people, with real income, problems and ambitions—people who might be your next-door neighbor.

Yes, if you are really sincere in wanting to better your position—start your income climbing—enjoy a lifetime career of high standing and high reward—this friendly staff of experts can help you.

### OPPORTUNITIES UNLIMITED

The demand for accountants is great—everywhere. All businesses must have trained accountants to cope with ever-growing requirements. It's a profession offering wide opportunity—always—to the man who knows.

You can fit into any business, anywhere in the country—because accounting principles are universal. Think what this means in terms of security and independence!

### SEND FOR TWO FREE BOOKS

The interesting and informative book, "Accountancy, The Profession That Pays," gives all the latest facts about the new and growing opportunities in several different fields of profitable employment.

This can be an important day in your life. A coupon like the one below has started hundreds of thousands of men and women toward a bigger job, a larger income. It can do the same for you.

Member, National Home Study Council

Mail the Coupon Today!

FREE BOOK

LA SALLE

FREE BOOK

EXTENSION UNIVERSITY

A Correspondence Institution

417 S. Dearborn St., Dept. 564H, Chicago 5, Ill.

Send free books, "Accountancy, The Profession That Pays," also "Success Reports" without obligation.

Name.....Age.....

Address.....

City & Zone.....State.....



(Continued from page 6)

the Paris-Bordeaux Race of June 1895. His speed was only an average of 15 miles per hour, but that was a world-shaking sensation in view of the fact that it was an average for a total of 366 miles which he drove all alone, without relief, in a continuous run that took 58 hours and 47 minutes to complete. Moreover, he was not a young man (he was 51), and the tiny four-horsepower, 600-kilogram gasoline buggy was a tiller-steered boneshaker with solid tires, and with only kerosene carriage lamps for illumination.

One critical comment on your piece which have undoubtedly heard about: Lake St. Clair is not in Wisconsin.

Christy Borth,  
Automobile Manufacturers Assn.,  
Detroit 2, Mich.

*Congratulations on the February color section, depicting "Eight Memorable Days in the History of Speed," come also from the Indianapolis Motor Speedway Corporation, which has been loaned the original paintings for exhibit at its museum during the "500" race, May 30.—Editor's note.*

#### To the Editor:

Just fifty years ago, in 1907, this Ford tractor was just starting the crusade to make things easier on old Dobbin. It



wouldn't plow very deep, or pull a startling load, but Henry Ford didn't give up. He improved each new model and predicted the present era of modern-tractor farming.

Actually, the machine was called an "automobile plow." The storage battery to which the Minnesota farm youth is point-

(Continued to page 10)

## New greaseless way to keep your hair neat all day

Billy Pierce took a shower... ..then he used Vitalis



White Sox lefthander Billy Pierce rarely goes to the shower before the game ends.

Want the pitch on a greaseless hair tonic?

New Vitalis keeps hair in place and prevents dryness with V-7, the greaseless grooming discovery. You never have an over-slick, plastered-down look. Try it. You'll like it.



ANOTHER FINE PRODUCT  
OF BRISTOL-MYERS

### New VITALIS® Hair Tonic with V-7®

POPULAR MECHANICS

Cast your ballot for a successful future!

# 256 I. C. S. COURSES



Whether you stand at a machine or sit at a desk . . . whether you're making \$75 a week or \$75 hundred a year . . . whether your interest is Power Plants or Paper Pulp, Advertising or Electronics . . . chances are I. C. S. has exactly the course you need to get ahead.

I. C. S. is not only the oldest and largest correspondence school. It also offers the most courses, 256 in all. Each one success-proved by graduates who rose to top technical and administrative positions. Chief engineers. Superintendents. Foremen. Managers. Executive assistants.

I. C. S. Courses cover bedrock facts and theory plus practical, on-the-job applications. No skimming. Texts

are prepared by leading business and industrial authorities working with I. C. S. editors and educators. They are constantly being reviewed and revised in line with current developments.

As an I. C. S. student, you study in your spare time, set your own pace. No time lost getting to class or waiting for slower students to catch up. If you wish, I. C. S. will make progress reports to your employer. You win recognition as a "comer," one who is ready to move ahead. Thousands of students report pay increases and promotions within a few months of enrollment. All graduates win the coveted, approved I. C. S. diploma.

**3 FREE BOOKS!** Check the subject that interests you in the coupon below. I. C. S. will rush you (1) a special book outlining your opportunities in this field, (2) the 32-page gold mine of career tips, "How to Succeed," (3) a sample I. C. S. lesson (Math.) demonstrating the famous "I. C. S. Method." "X" MARKS OPPORTUNITY.



For Real Job Security—Get an I. C. S. Diploma! I. C. S., Scranton 9, Penna. Member, National Home Study Council

## INTERNATIONAL CORRESPONDENCE SCHOOLS



BOX 23953E, SCRANTON 9, PENNA.

(Partial list of 257 courses)

Without cost or obligation, send me "HOW TO SUCCEED" and the opportunity booklet about the field BEFORE which I have marked X (plus sample lesson):

- |  |   |   |   |  |
|--|---|---|---|--|
| <p><b>ARCHITECTURE and BUILDING CONSTRUCTION</b></p> <ul style="list-style-type: none"> <li><input type="checkbox"/> Air Conditioning—Refrig.</li> <li><input type="checkbox"/> Architecture</li> <li><input type="checkbox"/> Architectural Interiors</li> <li><input type="checkbox"/> Building Contractor</li> <li><input type="checkbox"/> Building Estimator</li> <li><input type="checkbox"/> Building Maintenance</li> <li><input type="checkbox"/> Carpentry and Mill Work</li> <li><input type="checkbox"/> Heating</li> <li><input type="checkbox"/> Painting Contractor</li> <li><input type="checkbox"/> Plumbing</li> <li><input type="checkbox"/> Reading Arch. Blueprints</li> </ul> <p><b>ART</b></p> <ul style="list-style-type: none"> <li><input type="checkbox"/> Cartooning</li> <li><input type="checkbox"/> Commercial Art</li> <li><input type="checkbox"/> Fashion Illustrating</li> <li><input type="checkbox"/> Magazine Illustrating</li> <li><input type="checkbox"/> Show Card and Sign Lettering</li> <li><input type="checkbox"/> Sketching and Painting</li> </ul> <p><b>AUTOMOTIVE</b></p> <ul style="list-style-type: none"> <li><input type="checkbox"/> Auto Body Rebuilding</li> <li><input type="checkbox"/> Auto Elec. Technician</li> <li><input type="checkbox"/> Auto-Engine Tune Up</li> <li><input type="checkbox"/> Automobile Mechanic</li> </ul> | <p><b>AVIATION</b></p> <ul style="list-style-type: none"> <li><input type="checkbox"/> Aeronautical Engineering Jr.</li> <li><input type="checkbox"/> Aircraft &amp; Engine Mechanic</li> </ul> <p><b>BUSINESS</b></p> <ul style="list-style-type: none"> <li><input type="checkbox"/> Advertising</li> <li><input type="checkbox"/> Bookkeeping and Accounting</li> <li><input type="checkbox"/> Business Administration</li> <li><input type="checkbox"/> Business Correspondence</li> <li><input type="checkbox"/> Public Accounting</li> <li><input type="checkbox"/> Creative Salesmanship</li> <li><input type="checkbox"/> Federal Tax</li> <li><input type="checkbox"/> Letter-writing Improvement</li> <li><input type="checkbox"/> Office Management</li> <li><input type="checkbox"/> Professional Secretary</li> <li><input type="checkbox"/> Retail Business Management</li> <li><input type="checkbox"/> Sales Management</li> <li><input type="checkbox"/> Stenographic-Secretarial</li> <li><input type="checkbox"/> Traffic Management</li> </ul> <p><b>CHEMISTRY</b></p> <ul style="list-style-type: none"> <li><input type="checkbox"/> Analytical Chemistry</li> <li><input type="checkbox"/> Chemical Engineering</li> <li><input type="checkbox"/> Chem. Lab. Technician</li> <li><input type="checkbox"/> General Chemistry</li> <li><input type="checkbox"/> Natural Gas Prod. &amp; Trans.</li> <li><input type="checkbox"/> Petroleum Engineering</li> <li><input type="checkbox"/> Plastics</li> <li><input type="checkbox"/> Pulp and Paper Making</li> </ul> | <p><b>CIVIL, STRUCTURAL ENGINEERING</b></p> <ul style="list-style-type: none"> <li><input type="checkbox"/> Civil Engineering</li> <li><input type="checkbox"/> Construction Engineering</li> <li><input type="checkbox"/> Highway Engineering</li> <li><input type="checkbox"/> Reading Struct. Blueprints</li> <li><input type="checkbox"/> Sanitary Engineering</li> <li><input type="checkbox"/> Structural Engineering</li> <li><input type="checkbox"/> Surveying and Mapping</li> </ul> <p><b>DRAFTING</b></p> <ul style="list-style-type: none"> <li><input type="checkbox"/> Aircraft Drafting</li> <li><input type="checkbox"/> Architectural Drafting</li> <li><input type="checkbox"/> Electrical Drafting</li> <li><input type="checkbox"/> Mechanical Drafting</li> <li><input type="checkbox"/> Mine Surveying and Mapping</li> <li><input type="checkbox"/> Plumbing Drawing and Estimating</li> <li><input type="checkbox"/> Structural Drafting</li> </ul> <p><b>ELECTRICAL</b></p> <ul style="list-style-type: none"> <li><input type="checkbox"/> Electrical Engineering</li> <li><input type="checkbox"/> Electrical Maintenance</li> <li><input type="checkbox"/> Electricians <input type="checkbox"/> Contracting</li> <li><input type="checkbox"/> Lineman</li> </ul> <p><b>HIGH SCHOOL</b></p> <ul style="list-style-type: none"> <li><input type="checkbox"/> Commercial <input type="checkbox"/> Good English</li> <li><input type="checkbox"/> High School Subjects</li> <li><input type="checkbox"/> Mathematics</li> </ul> | <p><b>LEADERSHIP</b></p> <ul style="list-style-type: none"> <li><input type="checkbox"/> Foremanship</li> <li><input type="checkbox"/> Industrial Supervision</li> <li><input type="checkbox"/> Leadership and Organization</li> <li><input type="checkbox"/> Personnel-Labor Relations</li> </ul> <p><b>MECHANICAL AND SHOP</b></p> <ul style="list-style-type: none"> <li><input type="checkbox"/> Gas-Electric Welding</li> <li><input type="checkbox"/> Heat Treatment <input type="checkbox"/> Metallurgy</li> <li><input type="checkbox"/> Industrial Engineering</li> <li><input type="checkbox"/> Industrial Instrumentation</li> <li><input type="checkbox"/> Industrial Supervision</li> <li><input type="checkbox"/> Internal Combustion Engines</li> <li><input type="checkbox"/> Machine Design-Drafting</li> <li><input type="checkbox"/> Machine Shop Inspection</li> <li><input type="checkbox"/> Machine Shop Practice</li> <li><input type="checkbox"/> Mechanical Engineering</li> <li><input type="checkbox"/> Quality Control</li> <li><input type="checkbox"/> Reading Shop Blueprints</li> <li><input type="checkbox"/> Refrigeration</li> <li><input type="checkbox"/> Sheet Metal Worker</li> <li><input type="checkbox"/> Tool Design <input type="checkbox"/> Toolmaking</li> </ul> <p><b>RADIO, TELEVISION</b></p> <ul style="list-style-type: none"> <li><input type="checkbox"/> Industrial Electronics</li> <li><input type="checkbox"/> Practical Radio TV Eng'ng</li> <li><input type="checkbox"/> Radio and TV Servicing</li> <li><input type="checkbox"/> Radio Operating</li> </ul> | <ul style="list-style-type: none"> <li><input type="checkbox"/> Television Technician</li> </ul> <p><b>RAILROAD</b></p> <ul style="list-style-type: none"> <li><input type="checkbox"/> Air Brake Equipment</li> <li><input type="checkbox"/> Car Inspector</li> <li><input type="checkbox"/> Diesel Engineer &amp; Fireman</li> <li><input type="checkbox"/> Section Foreman</li> </ul> <p><b>STEAM AND DIESEL POWER</b></p> <ul style="list-style-type: none"> <li><input type="checkbox"/> Combustion Engineering</li> <li><input type="checkbox"/> Diesel-Elec. <input type="checkbox"/> Diesel Eng's</li> <li><input type="checkbox"/> Electric Light and Power</li> <li><input type="checkbox"/> Stationary Fireman</li> <li><input type="checkbox"/> Stationary Steam Engineering</li> </ul> <p><b>TEXTILE</b></p> <ul style="list-style-type: none"> <li><input type="checkbox"/> Carding and Spinning</li> <li><input type="checkbox"/> Cotton, Rayon, Woolen Mfg.</li> <li><input type="checkbox"/> Finishing and Dyeing</li> <li><input type="checkbox"/> Loom Fix'g <input type="checkbox"/> Textile Des'ing</li> <li><input type="checkbox"/> Textile Eng'g <input type="checkbox"/> Throwing</li> <li><input type="checkbox"/> Winding and Weaving</li> </ul> <p><b>MISCELLANEOUS</b></p> <ul style="list-style-type: none"> <li><input type="checkbox"/> Domestic Refrigeration</li> <li><input type="checkbox"/> Marine Engineering</li> <li><input type="checkbox"/> Ocean Navigation</li> <li><input type="checkbox"/> Professional Engineering</li> <li><input type="checkbox"/> Short Story Writing</li> <li><input type="checkbox"/> Telephony</li> </ul> |
|--|---|---|---|--|

Name \_\_\_\_\_ Age \_\_\_\_\_ Home Address \_\_\_\_\_

City \_\_\_\_\_ Zone \_\_\_\_\_ State \_\_\_\_\_ Working Hours \_\_\_\_\_ A.M. to P.M. \_\_\_\_\_

Occupation \_\_\_\_\_ Canadian residents send coupon to International Correspondence Schools, Canadian, Ltd., Montreal, Canada. . . . Special tuition rates to members of the U. S. Armed Forces.

**START FASTER!!!**



**CLEAN YOUR  
CARBURETOR**  
with

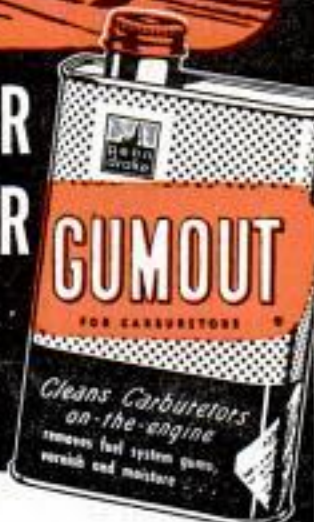

- There's gasoline gum in your carburetor, and it's cutting down on your power, increasing your gas consumption. Your car needs GUMOUT—now!
- GUMOUT cleans your carburetor fast . . . without fuss. Gives you faster starts, more power, smoother idling.
- Just add GUMOUT to your gas tank. Cleans as you drive.
- Buy GUMOUT at auto supply stores, or wherever automotive products are sold. There's nothing like it.

**GUMOUT DIVISION**

Pennsylvania Refining Company  
2671 Lisbon Road, Cleveland 4, Ohio



send for **FREE**

46-page "CARBURETOR HANDBOOK"  
It's loaded with helpful information  
about your car's fuel system.

GUMOUT is great for power mowers and outboards, too. A clean carburetor gives you faster starts, more power.

(Continued from page 8)

ing is a modern touch added to eliminate the hand crank used to start the two-cylinder engine. Note rear wheels, all steel and cleated. Front wheels had wooden spokes. The machine appeared at a farm show.

Wilbert N. Savage,  
Connellsville, Pa.

**To the Editor:**

I just finished reading an article "I Race in the Big Leagues" (Feb. 1957) in your magazine. Let me tell you this article certainly brought back memories and I enjoyed it immensely. I come from the fair country of India and Grand Prix racing, though in its infancy, has stirred up a lot of interest in India. I am here studying and it is a pity that though Americans go for sports cars, racing has not caught on widely.

Sam S. Carone,  
New York City

**To the Editor:**

I make the following comments in connection with your very interesting article: ("Do Small Cars Make Cents?" Feb. 1957):

1. You forgot to mention that the driver has to get used to driving one of these smaller cars. [But now] I rarely take my new Buick unless I am really going to go 25 miles or more.

2. You can park them in the parking spaces which remain because the man in the front or rear of you wasn't careful and which the man with the average car can't get into except with a lot of trouble.

3. You have a feeling that the car doesn't need to be babied, washed and polished since you have a smaller amount invested and the car is not so luxurious.

4. I should like to know something regarding the experience in accidents. Are persons more likely to be seriously hurt in an accident in cars of this type than in a larger American car? I still think that any convertible carries with it potential danger which the average motorist does not fully understand.

Leonard F. Markel,  
Norristown, Pa.

**To the Editor:**

Two photos of a molded glass-fiber swimming pool are shown on page 85 of your March issue, with no credit line to indicate the manufacturer.

We are the manufacturers of this pool and all inquiries in regard to it should be forwarded to us.

Dr. Dave Richman,  
Paradise Pools, Inc.,  
12955 Biscayne Blvd.,  
North Miami, Fla.

POPULAR MECHANICS

# Make More Money Soon

**LEARN RADIO-TELEVISION or ELECTRIC APPLIANCE SERVICING at Home in Your Spare Time with NRI**

**NRI Trained these Men and Thousands More for Positions of Prestige**



NRI Graduate Zimmerman



NRI Graduate Kline



NRI Graduate Peters



NRI Graduate Searcy



NRI Graduate Travers



NRI Graduate Meline

## NRI Trained these Men

"My success is the result of my NRI training." J. L. ZIMMERMAN, Miami, Fla. JOE TRAVERS, Asbury Park, N. J. and W. F. KLINE, Cincinnati, Ohio have Radio-TV businesses of their own. "Am Radio Operator for State Highway Patrol and do spare time Servicing" says D. H. PETERS, Newton Falls, Ohio. E. RUIZ, Santa Clara, Cal., Electric Appliance graduate, says: "It enabled me to make extra money and plan a business of my own." "As a Marine Radio Operator I am able to take a 2 month vacation each year." W. P. SEARCY, New Orleans, La. Graduate J. F. MELINE had no Radio training before he enrolled, now is Master Control Supervisor, WRCA-TV, N. Y.



## Make \$10, \$15 a Week Extra in Your Spare Time While Learning

Keep your job until you're ready for a better one. Train at home in your spare time. No experience needed. Soon after enrolling many NRI students start earning extra money fixing neighbors' radios or electrical appliances. To build a better future, get into a field where there's important

work, security. The skilled technician enjoys prestige, interesting work, high pay. Choose your career, Radio-TV or Electric Appliance Repair, and train for it. NRI can supply the training you need, quickly. Benefit from NRI's experience as the world's oldest and largest home study Radio-TV school.

### NRI Sends You Kits for Practical Experience

NRI training is "learn-by-doing." As part of NRI training you get kits to build equipment for practical experience. If you choose the Electric Appliance Course, you build an Appliance Tester. Use equipment to earn extra money.

### Find Out What NRI Offers

NRI has trained thousands of men for success. Find out about this tested way to better pay. Mail coupon today, check the course that interests you. Get Actual Sample Lesson that shows how easily you learn at home. Catalog that tells things you study, equipment you get. NATIONAL RADIO INSTITUTE, Dept. 7EA, Washington 9, D.C.

## Sample Lesson & Catalog FREE

NATIONAL RADIO INSTITUTE, Dept. 7EA, Washington 9, D.C.  
(CHECK ONE PLEASE—NO SALESMAN WILL CALL)

Radio-Television—Please send me FREE Sample Lesson and 64 Page Catalog on Radio-Television Servicing and Communications.

Electric Appliance—Please send me FREE Sample Lesson and Catalog on your Electric Appliance Servicing Training.

Name.....Age.....

Address.....

City.....Zone.....State.....

ACCREDITED MEMBER, NATIONAL HOME STUDY COUNCIL

# ANNIVERSARY SALE!

## Black Eagle GERMAN BINOCULARS



Formerly  
\$3.95

**99c**

Thousands sold at \$3.95—now 99c during our 25th Anniversary celebration. Hi-fidelity views up to 25 MILES AWAY! Clear, sharp images. No distortion. Synchronized center focusing. Sturdy—yet lightweight. No arm fatigue. Imported direct from West Germany. Limit: one to customer.  
NO. 78.....99c

## 100 Blue Surgical Steel Razor Blades

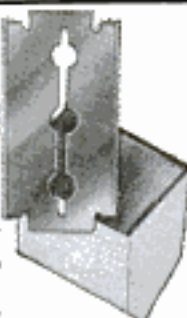

New, first-quality double-edged blades. Fit any razor perfectly. GUARANTEED to give same close shaves as famous-name blades costing 5 times the price! Why help pay for TV commercials when "everything's the same but the name... and the price." Others get 20 blades for 98c. You get 100 for 99c. Send for trial order now! NO. 131...99c

**1c**  
ea.

## 5 BALL POINT PENS

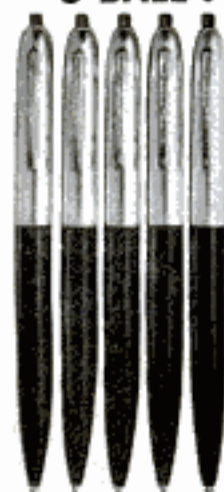

**20c**  
each

**\$1.69 Quality!**

All brand-new, first-quality. Manufacturer's surplus. Guaranteed to write like famous \$1.69 pen—you pay only 20c each (in lots of 5 only). Leak-proof! Smudge-proof! Smear-proof! Accepted by banks, schools, offices, etc. Long-life cartridge. Writes 1/2 million words. Refills available anywhere. Press-clip type. Deluxe look. Blue ink. Fantastic value!  
NO. 133.....5 for \$1

## NEW, AMAZING, HEAVY-DUTY MATS AND RUNNERS!

**17c**

50  
FT. IN  
12 FT. ROLL



**Thick 24-Gauge Poly...Tough as Rubber!**  
**Buy it in ROLL -- Cut to Any Size or Shape!**

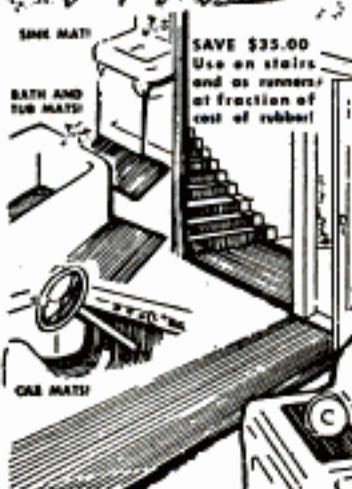

- WATERPROOF!
- GREASE, STAIN RESISTANT!
- WASHABLE!
- LAYS FLAT!
- 5 YEAR WRITTEN GUARANTEE!
- SKID-PROOF!
- DRIES FAST!
- 101 USES!

All-purpose TRANS-KLEER MATS & RUNNERS—scientific new discovery for home, shop, office, factory, outdoors. Already in use by thousands of people! You buy in ROLL, like wholesaler. You cut with shears to size and shape desired. 101 practical uses! Place over rugs to protect costly carpeting on rainy, muddy days. Use as floor runners, bath & sink mats, stair treads & risers, door mats, car mats, shelf protectors, back-of-stove wall protectors, etc.

Trans-Kleer has advantages of thick rubber—at a fraction of the cost of rubber! Constructed of first-quality, heavy-duty THICK 24-gauge semi-translucent polyethylene with 96 strong-gripping, rubber-like, non-skid ribs every foot. 240 RIBS EVERY 2 1/2 FEET! So durable, so long-lasting we give you 5-Year Replacement Guarantee IN WRITING!

### ENJOY TREMENDOUS SAVINGS!

- Others pay \$4.98 for door mat. 3-foot roll of Trans-Kleer costs \$1.49. **SAVE \$3.49!**
  - Others pay \$25.00 for carpet runners. 12-foot roll of Trans-Kleer costs \$4.98. **SAVE \$20.02!**
- We've advertised these amazing plastic mats & runners twice—and twice we've sold out! All our customers can't be wrong. They MUST be good! Avoid thin, inferior imitations. This is thick, 24-gauge miracle polyethylene—washable, dirt & grease resistant, waterproof—with 240 NON-skid ribs!

### ALL ROLLS 2 1/2 FEET WIDE:

3 ft. roll—\$1.49, 6 ft. roll—\$2.98, 12 ft. roll—\$4.98  
18 ft. roll—\$7.50, 24 ft. roll—\$9.95, 50 ft. roll—\$17.95

THORESEN, Inc., Dept. 6-E, 585 Water St., N.Y. 2, N.Y.

**10-DAY TRIAL!  
MONEY-BACK  
GUARANTEE!**

THORESEN, Inc., Dept. 6-E, 585 Water Street, New York 2, N. Y.

RUSH items checked on 10-day home trial. My money refunded promptly—no questions asked—if I am not satisfied.

- Check, cash, money order enclosed. Send prepaid.  
 Send G.O.D., plus postal charges.  
 No. 78 Black Eagle 99c       No. 133 Five Ball Point Pens  
 No. 131 100 Blades 99c       No. 139 Slide Rule 99c  
 No. 136 Trans-Kleer Heavy-Duty Mats & Runners  
 3 ft. roll—\$1.49       6 ft.—\$2.98       12 ft.—\$4.98  
 18 ft.—\$7.50       24 ft.—\$9.95       50 ft.—\$17.95

PRINT NAME \_\_\_\_\_

ADDRESS \_\_\_\_\_

CITY & \_\_\_\_\_

ZONE \_\_\_\_\_

STATE \_\_\_\_\_

Canadians:  
Address  
439 King St.,  
W., Toronto

## SOLVES MATH PROBLEMS FAST!

Without Pen or Paper!

Meet "Mr. Brain"—smart little non-human who solves mathematical problems in seconds—without pencil or paper! Turn slide rule mystery into easy mastery! Let "Mr. Brain" help you solve multiplication, division, higher math problems fast and easy. Save costly mistakes—complicated figuring! Compare with \$3.95 models.

NO. 139.....99c



**99c**

POPULAR MECHANICS

Copyrighted material

# INVENTORS

**L**earn how to protect your invention. The U. S. Patent Laws provide that any new and useful art, machine, article of manufacture, or composition of matter, or any new and useful improvement thereof, may be patented if the act of invention is involved. Therefore, every inventor with a valuable invention should take advantage of the Patent Laws and proceed for patent protection in order to safeguard his rights.

A patent gives the inventor the exclusive right to prevent others from making, using, or selling the invention claimed in the patent for a period of seventeen years.

The Patent Laws were enacted for the benefit of the inventor to give him protection for the features of his invention which are patentable. These features must be properly and concisely set forth and claimed in a formal application for patent, in order to comply with the requirements of the Patent Laws. For that reason, unless the inventor is familiar with patent matters, he should engage a competent registered patent attorney or agent to represent him. We are registered to practice before the U. S. Patent Office and are prepared to serve you in the handling of your patent matters.

A specially prepared booklet entitled "Patent Guide for the Inventor", containing detailed information with respect to patent protection and procedure, together with a "Record of Invention" form will be promptly forwarded to you without obligation upon request.

---

## CLARENCE A. O'BRIEN & HARVEY JACOBSON

*Registered Patent Attorneys*

71-E DISTRICT NATIONAL BUILDING

WASHINGTON 5, D. C.



## LAW TRAINING FOR BUSINESS

(In spare time at home)

### Earn L.L.B. Degree

Thousands of men and women who never intend to practice Law are studying it in spare time at home as an aid to business advancement.

Today Law is involved in practically every business decision. In many lines of work it is almost indispensable. Law training develops keen, clear, quick, correct and decisive thinking.

You can study LaSalle's American Law and Procedure right in the privacy of your own home—progressing as rapidly as your time and ability permit. For nearly 50 years we have helped over 1,350,000 ambitious people get ahead in the business world.

### A MOST UNUSUAL LAW LIBRARY

This training includes the 14-volume LaSalle Law Library—AMERICAN LAW AND PROCEDURE—that is the basis of all our instruction service. This library has been compiled by leaders in the field of Law. It covers the whole field in an orderly and simple manner that is easy to learn and understand. Collateral reading and printed lectures, furnished at regular intervals, supplement the texts. Law instructors personally supervise your program. Under the LaSalle method you learn by actually solving legal problems—not just memorizing rules.

### WRITE FOR TWO FREE BOOKS

Send the coupon below TODAY and find out how you can qualify for the many fine openings available to the law-trained man. In our FREE books "Law Training for Leadership" and "Evidence" you will find answers to your questions about the study of Law and the LaSalle method.

—MAIL COUPON TODAY—

LA SALLE EXTENSION UNIVERSITY

A Correspondence Institution

417 S. Dearborn St. Dept. 564L Chicago 5, ILL.  
Please send me, FREE, "Law Training for Leadership" and "Evidence."

Name.....

Address.....

City.....Zone.....State.....

## What Do 3 Out of 4 Doctors Recommend to Relieve Pain?

A survey shows 3 out of 4 doctors recommend the famous ingredients of Anacin Tablets to relieve pain of headache, neuritis and neuralgia. Here's why Anacin® gives you better *total* effect in relieving pain than aspirin or any buffered aspirin:

- ➔ **ACTS INSTANTLY:** Anacin goes to work *instantly*. Brings fast relief to source of your pain.
- ➔ **MORE EFFECTIVE:** Anacin is like a doctor's prescription. That is, Anacin contains not one but a combination of effective, medically proven ingredients.
- ➔ **SAFER:** Anacin simply can not upset your stomach.
- ➔ **LESSENS TENSION:** Anacin also reduces nervous tension, leaves you relaxed, feeling fine after pain goes. Buy Anacin today.



## \$6,000-\$10,000 YEARLY OPERATING AUTO RADIATOR SERVICE SHOP

World's largest radiator shop equipment mfr. will assist responsible individuals in setting up radiator shops. Opportunity to own secure profitable business. First year averages \$6,000 to \$10,000. Garage or service station can operate as dept. Over 1,000 INLAND shops now operating. As little as \$295 down for equipment starts you. INLAND will finance balance and furnish training. Write to

INLAND MFG. CO., Dept. PM-5, 1108 Jackson St., Omaha 2, Nebr.

## STUDY TO BE A DOCTOR of Psychology or Metaphysics

Obtain a Ps.D., Ms.D., or Ph.D. Be a Teacher, Lecturer or Accredited Practitioner. Teach others how to achieve Health, Happiness and Contentment. Chartered by State. Correspondence Courses only. Write for FREE book telling how.

THE NEOTARIAN FELLOWSHIP  
Desk 8, Pickwick Building Kansas City 6, Missouri

## BUILD YOUR OWN OPTICAL INSTRUMENT "FUN with OPTICS"



### TELLS YOU HOW

Just out! 32 exciting pages! Wonderfully illustrated. Shows you how to build telephoto lenses, telescopes, microscopes, close-up camera lenses, artist drawing projectors, slide viewers, binoculars, riflescopes, etc. Plenty of diagrams—any 10-year old can easily follow the instructions. We can furnish the lenses, prisms and parts you'll need. Right now—order your copy of "FUN WITH OPTICS." Just send your name and address, along with only 50c in coin. EDMUND SCIENTIFIC CO., Barrington 30, New Jersey.

you can be

# TALLER

too, in

FREE BOOKLET write

"ELEVATORS" do so many wonderful things for you. You slip on a pair and grow almost 2 inches taller at once. It's amazing . . . because they look and feel just like any other fine quality shoes you've ever worn. 31 styles for street, sport, dress.

THE ORIGINAL AND GENUINE

## ELEVATORS

RIGHT-INCREASING SHOES  
"YOUR PERSONAL PEDISTAL"

IN THESE MAKE UP YOUR MIND TODAY

STONE-TARLOW SALES CORP., Dept. PM557, Brockton 68, Mass.



**DEVRY TECH CAN PREPARE YOU  
IN SPARE TIME AT HOME AS AN**

# ELECTRONICS TECHNICIAN!



## No Previous Technical Experience or Advanced Education Needed!

Laborers and bookkeepers, store clerks, farmers, salesmen — men of nearly every calling — have taken the DeVry program and today have good jobs or service shops of their own in Electronics.

Here's proof positive that it can be done — done by men like yourself — men who had no previous technical experience, no advanced education.

If you are 17 to 55, we will tell you free how you may prepare for exciting, interesting jobs in Automation Electronics, Radar, Guided Missiles, Communications, Industrial Electronics and many others shown at right. Here is a chance of a lifetime to prepare to cash in on one of today's fastest growing fields. Mail the coupon for details.

DeVry Tech's amazingly practical home method enables you to spend minimum time to get maximum knowledge. In fact, you get exactly the same type of basic training equipment used in our Chicago and Toronto training laboratories — among the finest!

**Send coupon for free facts NOW!**

### Live-Wire Employment Service

DeVry Tech's Placement Department is in contact with some of the best-known employers in the Electronics field. The service is free to all graduates—and DeVry Tech's record in helping to place men has been outstanding.



### Draft Age?

We have valuable information for every man of draft age; so if you are subject to military service, be sure to check the coupon.

### What a DeVry Tech Diploma Meant to These Men!



G. F. Beane, W. Virginia, was a truck driver. He took the DeVry Tech Training Program, and is now a technical electronics sales representative.



Edward Hahn, Illinois. Was a laborer, now an electronics project engineer with Televiso, Inc. DeVry Tech training helped him prepare for his present position.



Nick Barton, Illinois, came directly from high school to DeVry Tech. Now has his own service shop and tells us he is "literally snowed with work."



George D. Crouch, California, was a retail store clerk. He took the DeVry Program, and today is in the servicing field for himself.

"One of North America's Foremost Electronics Training Centers"



Accredited Member of  
National Home Study Council

## DEVRY TECHNICAL INSTITUTE

CHICAGO 41, ILLINOIS

FORMERLY

DEFOREST'S TRAINING, INC.



**AN  
INDEX  
To a  
BETTER JOB,  
A BRIGHTER  
FUTURE**

- COMMUNICATIONS
- RADAR
- GUIDED MISSILES
- TELEVISION
- MICRO-WAVES
- RADIO
- INDUSTRIAL ELECTRONICS
- COMPUTERS
- AUTOMATION ELECTRONICS

### Sample Lesson **FREE!**

See for yourself how DeVry Tech trains you for real opportunities in Electronics. We'll also give you a free copy of an interesting booklet, "Electronics and YOU."

### Mail Coupon Today!

DeVry Technical Institute  
4141 Belmont Ave., Chicago 41, Ill., Dept. PM-5-N

Please give me FREE Sample Lesson and your booklet, "Electronics and YOU," and tell me how I may prepare to enter one or more branches of Electronics as listed above.

Name \_\_\_\_\_ Age \_\_\_\_\_  
Street \_\_\_\_\_ Apt. \_\_\_\_\_  
City \_\_\_\_\_ Zone \_\_\_\_\_ State \_\_\_\_\_

Check here if subject to military training.  
DeVry Tech's Canadian Training Center is located  
at 626 Roselawn Avenue, Toronto 12, Ontario  
2004

# WHAT ALL AUTO MECHANICS WANT TO KNOW

1696 PAGES

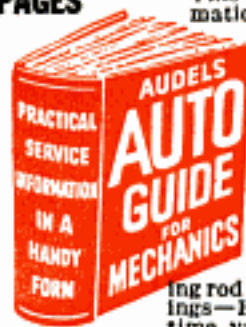

This Big Practical Book gives full information with working diagrams covering the principles, construction, ignition, service and repair of modern cars, trucks and buses.

### Diesel Engines, Hydramatic & Fluid Drives Fully Explained.

A complete Guide of 1696 Pages, with over 1500 illustrations showing inside views of working parts, with instructions for service jobs.

### IT PAYS TO KNOW

How to fit pistons—How to locate engine knocks, How to fit connecting rod bearings—How to service main bearings—How to recondition valves—How to time valves—How to adjust fan belts—How to adjust carburetors and chokes, How to rebuild a clutch—How to service automatic transmissions—How to service brakes—How to adjust steering gear—How to cope with ignition troubles—How to service distributors—How to time ignition—How to "tune up" an engine.



**\$6 COMPLETE - PAY \$2 A MO.** TO GET THIS ASSISTANCE FOR YOURSELF SIMPLY FILL IN AND MAIL COUPON TODAY.

Step up your own skill with the facts and figures of your trade. Audels Mechanics Guides contain Practical Inside Trade Information in a Handy Form. Fully illustrated and Easy to Understand. Highly Endorsed. Check the book you want for 7 DAYS FREE EXAMINATION. Send No Money. Nothing to pay postman.

## MAIL ORDER



**Check NOW!**

You Can Look Over Any Guide In Your Own Home

SAVE SHIPPING CHARGES!

Enclose Full Payment With Coupon and We Pay Shipping Charges

Name \_\_\_\_\_  
 Address \_\_\_\_\_  
 Occupation \_\_\_\_\_  
 Employed by \_\_\_\_\_

- AUDEL, Publishers, 49 W. 23 St., NEW YORK 10, N. Y.**
- Please send me for FREE EXAMINATION books marked (x) below. If I decide to keep them I agree to mail \$2 in 7 Days on each book or set ordered and further mail \$2 monthly on each book or set until I have paid price plus shipping charges. Otherwise I will return them.
- HOME APPLIANCE SERVICE GUIDE, 864 Pages \$6
  - AUTOMOBILE MECHANICS GUIDE, 1696 Pages. 6
  - TRUCK & TRACTOR GUIDE, 1376 Pages. 5
  - DIESEL ENGINE MANUAL, 640 Pages. 3
  - MACHINISTS HANDY BOOK, 1728 Pages. 6
  - WELDERS GUIDE, 608 Pages. 3
  - BLUE PRINT READING, 448 Pages. 3
  - MATHEMATICS & CALCULATIONS, 752 Pages. 3
  - SHEET METAL PATTERN LAYOUTS, 1152 Pgs. 7.50
  - SHEET METAL WORKERS HANDY BOOK, 448 Pgs. 2
  - MECHANICAL DRAWING GUIDE, 192 Pages. 2
  - MECHANICAL DRAWING & DESIGN, 480 Pages 3
  - TELEVISION SERVICE MANUAL, 480 Pages... 3
  - RADIOMANS GUIDE, 1088 Pages. 5
  - ELECTRONIC DEVICES, 304 Pages. 3
  - ELECTRIC MOTOR GUIDE, 1056 Pages. 5
  - WIRING DIAGRAMS (Light & Power), 304 Pgs. 2
  - ELECTRICIANS EXAMINATIONS, 272 Pages. 2
  - ELECTRIC POWER CALCULATIONS, 480 Pages 3
  - HANDY BOOK OF ELECTRICITY, 1520 Pages. 5
  - ELECTRIC DICTIONARY, 9000 Terms. 3
  - ELECTRIC LIBRARY, 7000 Pages (10 Book Set) 20
  - REFRIGERATION & Air Conditioning, 1360 Pgs. 6
  - MILLWRIGHTS & MECHANICS GUIDE, 1248 Pgs. 5
  - POWER PLANT ENGINEERS GUIDE, 1568 Pages 5
  - ENGINEERS & FIREARMS EXAMS, 544 Pages. 2
  - PUMPS, Hydraulic & Air Compressor, 1760 Pgs. 6
  - OPERATING ENGINEERS LIBRARY (3 Books) 12
  - GARDENERS & GROWERS GUIDES (4 Book Set) 6
  - CARPENTERS & BUILDERS GUIDES (4 Book Set) 8
  - PLUMBERS & Steamfitters Guides (4 Book Set) 8
  - MASONS AND BUILDERS GUIDES (4 Book Set) 8
  - PAINTERS & DECORATORS MANUAL, 464 Pgs. 2
  - HOUSE HEATING GUIDE, 1008 Pages. 5
  - OIL BURNER GUIDE, 416 Pages. 2

# DIESEL MEN WANTED

Earn \$100 per week and up  
**AUTO-DIESEL MECHANICS**

You learn fast in our school and shops because you learn with tools on real equipment. Experienced instructors explain WHY and show you HOW, then you DO IT YOURSELF with tools on various makes and models. One of the best equipped technical schools of its kind in the United States. Thirty-seven years' experience training men. Successful graduates in 48 states and many foreign countries. Approved for veterans. Day and evening classes. Earn While You Learn. Write for free bulletin.

**NASHVILLE AUTO-DIESEL COLLEGE**  
 226 7th Ave. N., Dept. 86, Nashville, Tenn.

# REAL ESTATE BE A BROKER

**PAYS BIG! SEND FOR FREE, BIG, ILLUSTRATED CATALOG NOW!** Graduates report making substantial incomes. Start and run your own business quickly. Men, women of all ages, learn easily. Course covers Sales, Property Management, Appraising, Loans, Mortgages, and related subjects. **STUDY AT HOME** or in classrooms in leading cities. Diploma awarded. Write TODAY for free book! No obligation. Approved for World War II and Korean Veterans  
**WEAVER SCHOOL OF REAL ESTATE (Est. 1936)**  
 2020R Grand Avenue Kansas City, Mo.



# MONEY in WORMS

Big money made raising fishworms and crickets. Billions used yearly—unlimited market—Sell by mail—We teach you how to raise and where to sell. Learn about our new, tremendous 6 to 12 inch African Redworms—in demand everywhere. Free Literature. **CARTER WORM RANCH, PLAINS, GEORGIA**

## MAKE MONEY AS A LOCKSMITH

A RESPECTED, PROFITABLE TRADE FULL OR PART TIME. AGE OR HANDICAP IS NO RESTRICTION. UNCROWDED FIELD. EASY TO LEARN!



LEARN AT HOME FROM LICENSED SCHOOL. EVERYTHING SUPPLIED BY US.

Send For **FREE BOOKLET NOW!**

Licensed by N. J. State Board of Education. Approved by V.A.  
**INSTITUTE OF LOCKSMITHING, Dept. P90**  
 15 PARK AVENUE, RUTHERFORD, NEW JERSEY

**INSURED TIRE SERVICE**  
**POPULAR BRANDS**

**SPECIAL!**  
 Deduct 10% on orders for two or more tires

FREE

INSURANCE POLICY given with each used tire sold. We guarantee the amount of service you pay for.  
 NOWHERE CAN SUCH QUALITY BE FOUND AT SUCH LOW PRICES!

YOU CAN'T LOSE!!

Supreme Quality — Rugged Performance — 6 Months Insured Service	
600x16 \$3.65 670x15 \$3.95 700x15 \$4.45 760x16 \$4.75	
650x15 3.85 670x16 4.05 710x15 4.35 820x15 4.95	
650x16 4.25 700x15 3.95 760x15 4.45 850x17 4.95	
Supreme Quality — Nothing Finer — 12 Months Insured Service	
600x16 \$5.25 475x15 \$5.45 700x15(6) \$10.45 700x20 \$12.50	
600x16(6) 6.75 640x15 4.95 750x16(8) 15.95 750x20(8) 15.50	
650x16 5.75 670x15 5.35 700x17 11.95 750x20(10) 17.50	
650x16(6) 7.25 710x15 5.45 750x17 16.45 825x20 21.50	
700x16 6.35 780x15 6.95 750x15 10.35 900x20 19.95	
780x16(6) 8.45 800x15 6.35 30x5 11.35 1000x20 29.45	
650x17 4.75 550x15 6.35 600x20 10.95 1100x20 21.25	
650x17 4.75 550x15 6.35 680x20 11.75 1000x22 21.95	
650x15 5.25 670x16 5.15 32x6(8) 11.95 1100x22 22.75	
700x15 5.35 700x16(6) 10.25 32x6(10) 12.75 1100x24 25.95	

Whitewalls \$1.00 extra.

MIDLAND

Speedy shipments on Mail Orders. F.O.B. Chicago. Insurance policy sent with each order. Deduct 10% on orders for 2 or more used tires. Send CHECK or MONEY ORDER—No COD's.

TIRE SALES

3701 S. Normal, Dept. PM-58, Chicago 9, Ill.

# INVENTORS

If you believe that you have an invention, you should find out how to protect it. The first step is to have a search made of the prior pertinent U. S. patents. If a report on this search indicates that the invention appears patentable you can apply for a patent, and the specifications and claims should be prepared.

The firm of McMorrow, Berman & Davidson, with offices in Washington, D. C., is qualified to take the necessary steps for you. We can make a preliminary search on your invention, advise you whether we think it can be patented, and prepare your application for patent.

Unless you are fully familiar with the U. S. Patent Laws, we recommend that you engage the services of a Registered Patent Attorney to protect your interests. The patent laws are *your* laws. A patent gives you the right to prevent others from making, using or selling the invention claimed in your patent for a period of 17 years.

Use these patent laws for your protection. Investigate whether your invention can be patented. If you have what you believe to be an invention, we suggest that you have this firm make a search for you.

*Send for a copy of our Patent Booklet entitled "How To Protect Your Invention," containing information about patent protection and patent procedure. Along with this we will also send you an "Invention Record" form, for your use in writing down and sketching details of your invention. We will mail them promptly. No obligation. They are yours for the asking.*

**McMORROW, BERMAN & DAVIDSON**

*Registered Patent Attorneys*

**PATENTS • COPYRIGHTS • PATENTS**

**135-E VICTOR BUILDING, WASHINGTON 1, D. C.**

# DRAFTSMEN



**CASH BIG  
PAY CHECKS!**

**Train Now for  
more success,  
greater security**

**LEARN AT HOME IN SPARE TIME  
(or at college in Chicago)**

Check the want ads in any newspaper—SEE the big-pay opportunities open to you as a draftsman. What's more, you can learn this well-paid, prestige profession at home—quickly, easily! No special talent needed. Get complete, step-by-step Chicago Tech lessons in the mail, spend a few pleasant hours studying each week. In a short time you'll be a well-trained draftsman, ready to take your pick of many good jobs. Act now!



**Free Information—Mail Coupon Today!**

Get FREE TRIAL LESSON plus information about C.T.C. practical training. Learn what successful Chicago Tech graduates say about high pay and opportunities in drafting. No charge, or obligation.

## CHICAGO TECHNICAL COLLEGE

E-215 Tech Bldg., 2000 So. Michigan Ave.  
Chicago 16, Illinois

Mail me FREE lesson with facts about big opportunities in DRAFTING.

Name \_\_\_\_\_ Age \_\_\_\_\_  
Address \_\_\_\_\_  
City \_\_\_\_\_ Zone \_\_\_\_\_ State \_\_\_\_\_

## BE YOUR OWN BOSS

**Earn \$7,500.00 to  
\$15,000.00  
a Year**



### OWN A **tastee-freez** STORE

Join America's most exciting and fastest growing chain of soft ice cream DRIVE-INS. Enjoy good income, permanent security. TASTEE-FREEZ Stores are individually owned, nationally advertised and merchandised. Over 1,800 stores coast-to-coast. Locations available throughout U.S. and Canada. Minimum capital \$3500. (Higher in Metropolitan areas and Canada.) Information FREE. Write: Tastee-Freez, 2518 Montrose, Dept. Q-57, Chicago 18, Ill.



# LEFAX

## TECHNICAL DATA BOOKS

### POCKET SIZE • LOOSE LEAF

Printed on loose leaf, 6 hole, 6 1/4"x3 3/4" bond paper, each book contains about 140 pages of technical data, condensed, accurate, essential, for engineer, technical worker, teacher, student, business man. **\$1.25 each**

Architecture	Surveying Tables	Machine Design	Radio
Home Heating	Highway Eng'g.	Machinist's Data	Television & FM
Electrician's Data	General Math	Mech. of Materials	Electricity, AC
Builder's Data	Math Tables	Per. Trans. Mash.	Electricity, DC
Lumber Data	Physics	Thermo. Tbls. &	AC Motors
Air Conditioning	Trig-Log Tables	Charts	Conversion Tabl.
Building Constr.	Gen'l Chemistry	Phys. & Thermo-	Steel Forams
Reinf. Concrete	Chemical Tables	dynamic Data	Welding Data
Piping Data	Analytic Chem.	Metals	Transformers.
Surveying	Mech'l Drawing	Hydraulics	Relays & Meters

Write for FREE catalogs (2000 listings). See how helpful LEFAX can be to you. Send \$1.25 book, or \$6 for any five books to

**LEFAX PUBLISHERS, Dept. PM-57, PHILADELPHIA 7, PA.**

## I'll Send You This Handsome SAMPLE CASE—FREE



**and Show You How to Make  
Up to \$30.00 in a Day**

WRITE for this FREE Tailoring Sample Case packed with 100 beautiful, big-value suits and overcoat fabrics. Take orders from friends, fellow-workers, others, for fine quality, made-to-measure clothes. Pocket big cash profits in advance. Because wearing our suits and overcoats brings more orders, we make it easy for you to get your own clothes without cost. No experience is needed. **SATISFACTION GUARANTEED. SEND NO MONEY.** Rush your name, address, and age—today!

**J. C. FIELD & SON, INC., Harrison & Throop Sts.  
DEPT. H-1716 CHICAGO 7, ILLINOIS**

## LEARN

## MEAT CUTTING



Train quickly in 8 short weeks at Toledo for a bright future with security in the vital meat business. Big pay, full-time jobs—HAVE A PROFITABLE MARKET OF YOUR OWN! Pay after graduation. Diploma given. Job help. Thousands of successful graduates. Our 35th year! Send NOW for FREE catalog. No obligation. GI approved.

**NATIONAL SCHOOL OF MEAT CUTTING, Dept. 50-R, Toledo 4, Ohio**

**Exclusive Double-Bearing HEAVY-DUTY PUMPS**  
IRRIGATE • DRAIN • CIRCULATE • SPRAY  
Up to 7,500 GPH, 3,000 GPH from 2 1/2" well. Use 1/2 to 1 HP motor, 1 1/4" inlet; 1" outlet. Stainless shaft. TYPE X—2 oilless bronze bearings. **\$10.95**  
Won't rust. . . . .  
TYPE XB—Ball bearing model. . . . . **\$12.95**  
Postpaid if cash with order. Rush your order today  
**MONEY BACK GUARANTEE**  
Centrifugal and Gear Pumps in All Sizes  
**LABAWCO PUMPS, Belle Mead 2, N. J.**

**Now! TEST YOUR OWN  
TV — RADIO TUBES!**  
EVEN THE PICTURE TUBE  
Checks fuses, appliances, etc. Easy, safe to use. Insert tube in socket. Pilot light instantly indicates if tube needs replacement. Rugged metal case (not plastic). AC or DC. One service call saved pays for tester. Only \$3.95 post. or C.O.D. plus charges. Deluxe Model \$4.95. Instructions. 5-yr. guarantee.  
**GEIGER ENGINEERING CORP., Dept. AS-102, 6349 N. Western Ave., Chicago, Ill.**

## Worry of FALSE TEETH Slipping or Irritating?

Don't be embarrassed by loose false teeth slipping, dropping or wobbling when you eat, talk or laugh. Just sprinkle a little FASTEETH on your plates. This pleasant powder gives a remarkable sense of added comfort and security by holding plates more firmly. No gummy, gooey, pasty taste or feeling. It's **alkaline** (non-acid). Get FASTEETH at any drug counter.

# Get "The Most" in Pay and Job Security— LEARN AIR CONDITIONING

## MAKE HOME YOUR TRAINING SHOP

## & REFRIGERATION



BUILD A REFRIGERATOR,  
AIR CONDITIONER,  
FREEZER or  
MILK COOLER

### A GOOD JOB, MORE MONEY, BRIGHT FUTURE

—all three can be yours in the Air Conditioning & Refrigeration field! *Thousands of mechanics are needed to repair and service the 150 million units in use—and the six million air conditioners, freezers and refrigerators that are produced each year. You can earn more money in a better job—if you are trained. For information on how to get this training, just fill out and mail coupon below. No obligation!*



R. C. Anderson  
President CTI

### A New, Easy Way to Learn in Months

CTI training is quick and effective because it is *practical*. You learn by doing. During the course of your training, you receive 23 big kits, including tools. You practice with these kits, get valuable experience. For instance, you do 10 complete service and trouble-shooting jobs with CTI kits. You assemble a heavy-duty, commercial type, ¼ h.p. high side (illustrated at left). You build an air conditioner, refrigerator, freezer or milk cooler—and you keep and use this valuable unit! Only CTI sends you these fine tools and kits—helps you get real *on-the-job* training! And all this fine equipment is yours at *no extra cost!* With CTI training you can *start out* as a mechanic and avoid years of work as a lower-paid apprentice.

### You Practice with 23 Kits

You learn fast because CTI sends you 23 kits. Illustration shows heavy-duty ¼ h.p. refrigeration high-side which you will build—and keep. *Only CTI sends these kits.*



### Earn Good Income as You Train, too

CTI training is so practical that students often work in spare time repairing air conditioners and refrigerators. *They add to their income this way.* Some get jobs with local dealers; others work on their own. Many students go in business on graduation. A number get full-time jobs while they're students.

### A Wonderful Opportunity to Be the Boss

If you want to own a business, Refrigeration offers you opportunity for success. Since most jobs are service calls, you can build up a list of potential customers. Very little capital is needed to start.



### Mail Coupon For Two FREE Books

Mail coupon below for two books which give you complete information. One is entitled *Success in Air Conditioning and Refrigeration*. The other is a *Lesson Sample*. Both FREE.

### You Get Professional Tools

Here are tools included in just one kit. You get other tools, tubing, much equipment. Tools develop your interest and skill, speed up training.



### You Learn in Easy Stages

Another kit, which includes motor, fan, pulley, service tools. Kits are sent on a planned schedule to help you learn in easy stages. There's no other training like this!

### DO NOT DELAY—MAIL THIS TODAY

Mr. R. C. Anderson, President Dept. R-362  
COMMERCIAL TRADES INSTITUTE  
1400 Greenleaf Ave., Chicago 26, Ill.

Mail me SUCCESS BOOK and LESSON SAMPLE. No cost or obligation.

Name \_\_\_\_\_ Age \_\_\_\_\_

Address \_\_\_\_\_

City \_\_\_\_\_ Zone \_\_\_\_\_ State \_\_\_\_\_



# Mental Poisoning!

## Thoughts that Enslave Minds

Tortured souls. Human beings whose self-confidence and peace of mind have been torn to shreds by invisible darts — the evil thoughts of others. Can envy, hate and jealousy be projected through space from the mind of another? Do poisoned thoughts, like mysterious rays, reach through the ethereal realms to claim innocent victims? All of us, from day to day and hour to hour, in every walk of life, in every circumstance, are possible victims of mental poisoning, unless we understand its nature, and can quickly recognize its infectious inoculation.

### This FREE Sealed Book

Do you know the strangest of all laws in man's body? Man's life, happiness, health, and enjoyment of the things of life depend on his understanding of the working of the human mind. Let the Rosicrucians explain how you may acquire an age-old method for mind development and the proper use of your latent inner powers. If sincere, write for the free sealed book.

Address: Scribe Z.P.A.

**The ROSICRUCIANS**  
(A M O R O)  
San Jose, California



C-10

**Beauty by  
Colorcrete  
Can Earn  
High Incomes**



Beautifying buildings by Colorcrete is a business opportunity awaiting men of modest capital everywhere. Owners of homes, stores, motels, schools — almost any type of construction — are looking for means to give lifetime eye-appeal to drab or dirty concrete, stucco and similar masonry surfaces. Colorcretors can do such jobs, in little time and at little cost, and pocket generous profits. Colorcrete is a cementitious material, applied by air pressure. Tough, tenacious, enduring; 30 colors. Investigate this low-investment enterprise by writing for the Opportunity Book.

COLORCRETE INDUSTRIES, INC.  
570 Ottawa Ave., Holland, Mich.

**COLORCRETE**

CANADA: 2020 Dundas Highway, Cooksville, Ont.

## MAKE STRIPES with new PAINT PEN

**Straight, curved, single or double**  
With any color paint, stripe furniture, bikes, autos, model planes, toys, linoleum, wall-board. Clean, crisp decorative lines. Can't clog or smear. Also use with glue, tempera, textile paint or underglaze... on wood, glass, plastic, ceramics, metals, fabrics and paper.

Ask your dealer or order direct.

DEALERS	HOBBY	MFRS
Master paint stripping tool in display carton. Write for discounts.	"Professional" results every time. Simple, easy to use. Order now.	Ask about heavy duty industrial stripping tools.

**DOUBLE STRIPE MODEL \$3.25**  
5 COMBINATIONS.

**WENDELL MFG. CO.**

4234 LINCOLN AVE., Dept. 329  
CHICAGO 18, ILLINOIS

Single 1/16" stripe model \$1.25

Other single stripe models 1 ea.  
1/64", 1/32", 3/64", 5/64", 3/32" & 1/8"

Complete Kit \$5.00 (all 7 tips)

Extra tips 90c ea.

Extra 1/4" tip...\$1.20

## IT'S EASY... MAKE MONEY IN PHOTOGRAPHY

If you are over 17—good pay and fascinating work await you in photography! Start making money quickly in sparetime—step into your own studio or exciting career job. LEARN-BY-DOING method trains you at home! Write TODAY for FREE catalog. Also President Training. Co-ed. 4th Year. Approved for Veterans.

**NEW YORK INSTITUTE OF PHOTOGRAPHY**  
Dept. 49, 10 West 33 Street, New York 1, New York  
47th YEAR

### Locksmithing AND KEY MAKING

Now Made Easy! Practical up-to-date course teaches you how to pick locks, de-code, make master keys, repair, install, service, etc. New self-instruction lessons for every handyman, homeowner, carpenter, mechanic, service station operator, fix-it shop, hardware dealer, gunsmith. 23 easy illustrated lessons. Full price only \$6.95 postpaid or C.O.D. plus postage. Satisfaction or refund guaranteed.

Complete course \$5.95... now only \$5.95

Nelson-Hall Co., Dept. 57-2  
210 S. Clinton St. Chicago 6, Ill.

## Learn MECHANICAL DENTISTRY

A profession offering unlimited opportunities. Most modern and complete course embracing every branch from Plate to Porcelain Work, which prepares you to work for Dentists or start your own business. Individual instruction—practical training in day or night school. No books—no classes. Catalog upon request.

**MCCARRIE SCHOOL OF MECHANICAL DENTISTRY**  
207 N. Broad Street Dept. 65 Philadelphia 7, Penna.

## LAW FREE BOOK THE LAW TRAINED MAN

Write today for a FREE copy of illustrated law book, "THE LAW TRAINED MAN," which shows how to earn the professional Bachelor of Laws (LL.B.) degree through home study of the famous Blackstone Law Course. All necessary books and lessons provided. Moderate cost; convenient monthly terms. Write for FREE law training book today.

**Blackstone School of Law, 225 N. Michigan Ave.**  
Founded 1890 Dept. 55 Chicago 1, Ill.

Enjoy the Fascinating Story of the Horseless Carriage in

## Popular Mechanics 166 Illustrations AUTO ALBUM

The most intriguing book about the automobile ever printed. It's thrilling, fascinating and informative. 166 thrilling action pictures—old-time cars—racing cars—early auto advertising—automotive oddities. Roll call of names of more than 2000 autos made in the U.S. included. Ideal gift book. Cloth bound, only \$3.00 by mail. Money back if not pleased.

POPULAR MECHANICS PRESS, Dept. PM-557  
200 East Ontario Street Chicago 11, Illinois

OUR AD HAS BEEN IN THIS MAGAZINE LONGER THAN ANY OTHER TIRE CO. NEARLY EVERYONE BUYS FROM STANDARD. 50 Years of Combined family experience in High Quality Tires.

"We Have No Rent to Pay." That is Why We Can Undersell All Competition.

23 YEARS AT THIS ADDRESS  
TUBE FREE WITH EVERY PASSENGER TIRE

Our entire stock of very slightly worn EXTRA MILEAGE TOP GRADE Tires, (Written Insurance Guarantee). SEND AD

EVERYBODY MAY DEDUCT 10% off ON EVERY TIRE

**FREE** If you buy 2 or more Passenger 4-ply tires, WE GIVE ONE tire FREE, on each order. Does not include W.W. or Truck Tires, or Snow Tires.

12 MOS. WRITTEN GUARANTEE WITH EVERY TIRE							
600-16	\$5.82	475-19	\$4.82	700-15(6)	57.52	700-20	\$9.92
600-16(8)	5.92	640-15	4.22	750-16(8)	10.72	750-20(10)	15.72
650-16	5.72	670-15	5.52	700-17	9.82	750-20(8)	11.92
650-16(8)	6.02	710-15	5.52	750-17	10.32	825-20	18.92
750-16(8)	7.52	760-15	5.82	825-15	17.92	900-20	17.92
850-17	3.72	800-15	5.92	600-20	9.02	1000-20	17.92
650-16	5.52	820-15	5.92	650-20	9.82	1100-20	19.92
700-15	4.92	700-16(8)	7.32	750-15	10.72	1100-22	18.92

"EXTRA SPECIAL" TOP QUALITY all size 4-ply pass. FREE TIRE with 2 or more of these also.—W.W. \$1.00 Extra Factory Tested Tube given—GIANT TIRE SALE. EA.

Thousands of tires shipped all over the U.S.A. All tires shipped F.O.B. Phila. Send Check or M.O. with this ad Dept. 2, No. C.O.D. **STANDARD** 834 N. Broad St., Philadelphia 30, Pa.



### GIANT BALLOONS — 3 for \$1.25

Surplus US Govt. (New Overage) Neoprene Weather Target Balloons.

FOR FUN in the backyard: at parties, picnics, etc. Young & old love 'em.

FOR ADVERTISING—Attracts crowds to civic events, business openings, trade shows, fairs. Paint on sales message, seen for miles!

FOR PROMS—Makes any dance more festive. Ideal for high school or college affair! Approx. Inflated Sizes

3 ft. dia. 49c ea. (SPECIAL! 3 for \$1.25)

5 ft. dia. 99c ea. (SAVE! 3 for \$2.75)

Postage paid on prepaid orders. Calif. res. add sales tax.

**VOLUME SALES CO., War Assets Division**

3930 Sunset Blvd., Dept. PM-557, Los Angeles 29, Calif.

## 75 POWER TELESCOPE \$3.98

New 3 in one telescopes, 3 variable 25X-45X-75X magnification. Brass bound, 25 power for ultra bright images 45 & 75 power for long range. Guaranteed to bring distant stars, moons, objects, sports 75 times closer.



Most powerful scope sold anywhere near this amazing low price. American made, 5 sections. Opens 36" class 1 1/2". contains 4 ground & polished lenses. Also powerful compound microscope. Directions included. Mass production enables us to offer telescope at \$3.98 postpaid complete money back guarantee. Get yours now.

**CRITERION CO., 331 Church St., Hartford, Conn., Dept. PMB 45**

## STUDY FOR THE DEGREE

of Lit. D. in short story writing now available to qualified graduates in our writing course. Constructive criticism and personal assistance to students. Our course endorsed by Jack London. Write for FREE BOOKLET, The Art of Story Writing.

**HOOSIER INSTITUTE, Inc.**  
Desk 8, Pickwick Bldg. Kansas City, Mo.

## HOW TO FIX ANY AIR COOLED ENGINE!

Save time and money servicing small engines on power lawn mowers, small tractors, industrial applications, etc. SMALL ENGINES SERVICE MANUAL shows how to make expert repairs, tune-up, overhaul or troubleshoot on 200 makes and models. Edited by engineers and professional mechanics. Covers any job on popular 2 or 4-cycle engines. Includes 1, 2 and 4 cylinder models, light weight and heavy duty, 1 to 35 HP. Contains 25,000 procedures, easy-to-follow instructions, time-saving shortcuts, 6,000 specifications. Parts information on 1,700 items. Only manual of its kind. Order NOW at \$3.45 introductory price. Send check or M.O. Money refunded if you're not satisfied. Clip this.

**SMALL ENGINES SERVICE MANUAL** 646 Graphic Arts Bldg. Kansas City 5, Mo.

# Make your interest in AUTO MECHANICS & DIESEL PAY OFF!



OUR FAMOUS SHOP METHOD HOME TRAINING PREPARES YOU FOR BIG TIME PAY AT HOME IN SPARE TIME

## YOU GET AND KEEP ALL THIS EQUIPMENT



Complete set of professional tools and All-Metal Tool Box. Same top-quality equipment used by expert mechanics everywhere. Use them, display them proudly.



"Motor Analyzing Set" contains Standard Engine Vacuum Fuel Pump Tester, Revolve Starter Switch, Modern Timing Light, Standard Compression Tester. Plus compact carrying case & instructions.



Top-quality Socket Wrench with Fittings. Real professional tools you'll use during your lifetime career in repairing all types of engines, from foreign cars to big diesel jobs.

Nearly 60 million cars and trucks on our roads! If you could talk to owners of garages, service stations and car dealerships (as we do every day), you'd realize America's DESPERATE NEED FOR TRAINED MECHANICS.

Take your choice—One modern course prepares you for Auto-Mechanic jobs, Airplane Mechanics, Farm Machinery Repair, all Diesel Jobs, Experimental Labs, Government Work, Engine Specialties, etc. A qualified, ALL-AROUND Mechanic always has a good job.

Every phase is Shop-Tested! Streamlined lessons, diagrams, manuals are easy to understand. Earn as you learn. Free Graduate Employment Service.

FREE! VALUABLE BOOK & SAMPLE LESSON JUST SEND COUPON

RESIDENT TRAINING AT LOS ANGELES! If you wish to take Resident Training at Los Angeles, in our big, modern Shops & Labs, check special box in coupon for full information.



APPROVED FOR GI TRAINING **NATIONAL SCHOOLS** Los Angeles 37, California

## NATIONAL SCHOOLS TECHNICAL TRADE TRAINING SINCE 1905 LOS ANGELES 37, CALIFORNIA

MAIL NOW  
NATIONAL SCHOOLS, Dept. DB-57  
4000 S. FIGUEROA ST. LOS ANGELES 37, CALIF.  
Send for FREE Auto-Diesel Opportunity Book and Sample Lesson.

NAME \_\_\_\_\_ AGE \_\_\_\_\_  
ADDRESS \_\_\_\_\_  
CITY \_\_\_\_\_ ZONE \_\_\_\_\_ STATE \_\_\_\_\_  
 Check if interested ONLY in Resident School Training at Los Angeles  
VETERANS: Give date of discharge \_\_\_\_\_

**You can start a  
\$40<sup>00</sup> a Day Business  
IN YOUR SPARE TIME**



**MAKE BIG CASH PROFITS IN YOUR OWN HOME  
SHARPENING HOUSEHOLD, GARDEN, SHOP TOOLS**

Now you can turn spare time into Big Cash Profits with new Belsaw Sharp-All. Sharpen knives, scissors, shears, snips, ice skates, hedge trimmers, mower blades, grass whips, axes, chisels, screw drivers, scrapers and saws. Your own CASH business with no inventory. No calls to make. No experience needed.

Learn how easily you can start your own spare-time business. Amazing low-cost, easy payment plan. Send postcard for FREE BOOK.



**BELSAW SHARP-ALL CO**

717 Field Building • Kansas City 11, Missouri

looking for the shortest route?

... find it in a moment with

**MILE-O-GRAPH**

measures mileage ... without arithmetic



Find the fastest, shortest route yourself, on any scaled map, with this amazing, patented mileage measurer. Easy as 1-2-3—no figuring.

Precision MILE-O-GRAPH adjusts to any map scale, fits into pocket or purse. Saves time, tires, temper. A welcome gift, perfect for motorists. MILE-O-GRAPH also adaptable for measuring air and sea charts and blueprints.

SETS TO ANY SCALE ON ANY SCALED MAP

**ONLY \$2 EACH OR 3 FOR \$5** gift boxed  
**MONEY-BACK GUARANTEE.**  
we pay postage on prepaid orders

MILE-O-GRAPH, INC., Dept. PM-5, 117 Liberty St., N.Y. 6  
Please send . . . Mile-O-Graphs at \$2 each or 3 for \$5.  
Enclose find \$..... or send C.O.D. I will pay postman.

NAME .....

ADDRESS .....

CITY & STATE .....

**RAZOR BLADE PLANES**

3-WAY CURVE PLANE

LITTLE GIANT

FLAT PLANE



**JUST USE  
A  
DOUBLE-EDGE  
RAZOR  
BLADE**



FOR JOBS OTHER  
PLANES CAN'T DO  
For Short Curves  
and Shaping  
For Long Curves  
and Flat Surfaces



ADJUSTS  
INSTANTLY  
FOR  
DESIRED  
DEPTH  
OF CUT

**ONLY 98¢ each AT HARDWARE DEALERS**  
If not yet available in your area, you may order by mail. Include 25¢ additional for postage and handling.  
- DEALERS WRITE FOR INFORMATION -  
**WILSON BROS. Dept. PM-5 SPRINGFIELD, MISSOURI**

NOW NO ONE CAN KEEP  
A SECRET FROM YOU!

20x-40x-60x only \$2.99  
TELESCOPE postpaid

Amaze your friends... See what they're doing—without being seen!

Special: Order now, get free carrying case.

Money back guarantee. Send cash, check or money order.

20x, 40x, or 60x power instantly. Variable focus eyepiece. No assembling, ready-to-use, no special instructions required.

3-range all metal telescope magnifies up to 60 power. Watch ball games, look at the moon, stars, animals, distant buildings... up close. Bright aluminum tube, made for long use. Good on hikes, camping trips, can use either side.

**I. J. STONE, Dept. T-B-5 • 1816 Oak St. • Santa Monica, Calif.**



**Easy to make your own  
BOWS—ARROWS—EQUIPMENT**

Illustrated Hand-Book 84 pgs. \$1, tells you how! Large Colored Catalog 5c—Send for it!

Ask your dealer for "Stemmler's Archery" (Oldest Mfr. in U.S.A.)

**L. E. STEMMLER CO.**

Manorville (Box 1) L. I., N. Y.

**GROW WITHOUT SOIL**

You can grow vegetables, flowers, or rare plants without soil (HYDROPONICS) every day of the year. Start this fast, clean, EASY way to grow any plant for fun or PROFIT. Big returns from small space. Wonderful and also amazing. Big surprise to neighbors. Send \$5.00 to-day at our risk for generous trial supply, also copy of Modern Hydroponics Course with Wick Fed Flower Pot, the growing substance Vermiculite and seeds. You will be pleased or money refunded. **GILBERT CO., Box 608, 525 Spruce St., San Diego 3, Calif.**

**BUY IT WHOLESALE!**

**GET UP TO 40% OFF**  
★ Agents-Start Buying Service at Home. Get big-name merchandise for clients up to 40% off. Sales easy as you can give sizeable discounts, still make fat commissions. Postcard brings FREE COPY "The Wholesale Plan."  
**FREE! "THE WHOLESALE PLAN"**

**American Buyers Service**  
HERTEL STATION, DEPT. R, BUFFALO 16, N. Y.

**RUPTURED**

**BE FREE FROM TRUSS SLAVERY**

Now there is a new modern Non-Surgical treatment designed to permanently correct rupture. These Non-Surgical treatments are so certain, that a Lifetime Certificate of Assurance is given. Write today for our New FREE Book that gives facts that may save you painful and expensive surgery, and tells how non-surgically you may again work, live, play and love and enjoy life in the manner you desire. There is no obligation. **Excelsior Hernia Clinic, Dept. 8305, Excelsior Spgs., Mo.**





## college graduates get ahead faster!

You see it in your own city. They have higher incomes . . . advance more rapidly. Grasp your chance for a better life. Industrial growth . . . automation . . . technical advances create career opportunities for engineers, accountants, management experts. Share rewards awaiting college-trained men. Important firms visit campus regularly to employ Tri-State College graduates. Start any quarter in this world-famed college. Approved for veterans.

### Bach. of Science degree in 27 months

In Mechanical, Civil, Electrical, Chemical, Aeronautical, Radio (TV-Electronics) Engineering. In 36 months a B.S. in Business Administration (General Business, Accounting, Motor Transport Management majors). Superior students may accelerate. 36-weeks course in Drafting. Intensive program: technical fundamentals stressed; comprehensive courses with more professional class hours. Small classes; personalized instruction. Enrollment limited to 1050. Preparatory courses. Beautiful campus. Well-equipped, new and modernized buildings and laboratories. Enter June, Sept., Jan., Mar. Earnest, capable students (whose time and budget require accelerated courses and modest costs) are invited to write Jean McCarthy, Director of Admissions, for catalog and book "Your Career in Engineering and Commerce."



## TRI-STATE COLLEGE

457 College Avenue • • • Angola, Indiana



## WORLD'S LOWEST PRICED ADDING MACHINE

Counts up to 999,999,999. IDEAL FOR BUSINESS AND PERSONAL USE—GUARANTEED ACCURATE. Not a toy. Operates with only a finger flick. Adds, subtracts, multiplies, divides. Counts up to one billion. Pays for itself over and over. Ideal gift—for Business, Income Tax and School Use. MONEY BACK GUARANTEE. Send name and address. Pay postman only \$2.95 plus postage. Beautiful rich-looking Leatherette Case included at no extra cost. Money back in 10 days if not delighted. AGENTS WANTED.

CALCULATOR MACHINE COMPANY  
P.O. Box 126, Dept. K-57, Huntingdon Valley, Penna.

## FREE-U.S. STAMPS

U. S. 1943 Bi-Colored Flag of Occupied Nations (as illustrated) Airmails. Commemoratives. Regular Issues. Included in this collection of 25 selected, all different, genuine U. S. stamps. PLUS VALUABLE U. S. \$5.00 STAMP. Everything for 10c to cover mailing expenses. Approvals included. Act at once.

WILLETT CO., P.O. Box 390, Dept. 707, Mount Kisco, N. Y.

## LEARN METALCRAFT and JEWELRY MAKING



### Low Cost Home Training Now Available

Make money. Learn profitable skills and arts of decorative metal and jewelry crafts. Course is complete. Professionally prepared. Easy to master. Special tools and materials furnished.

Write for Free Booklet INTERSTATE TRAINING SERVICE  
DEPT. K-3 PORTLAND 13, OREGON

New Table Top Invention Puts You In...

## PROFITABLE RUBBER STAMP BUSINESS

Home Operators now make \$9.40 AN HOUR in business once monopolized by a few big companies

Special rubber stamps bring high prices—cost only pennies to make on new, low-cost table top machine. Take 27 cents worth of material, make perfect stamps, the kind businesses and offices now buy by the dozen at \$1.80 each. Make up to \$9.40 an hour. Start in spare time in your own home. Run machine on kitchen table using ordinary electrical outlet. Make any kind of stamp. We'll send you free information without obligation about this established, highly profitable business, now open to individuals for the first time. For free information send name today on a post card to

Rubber Stamp Div., 1512 Jarvis Ave., Dept. R-2-E, Chicago 26, Ill.



## LET CAR EXPERTS

# GUIDE YOUR HANDS THROUGH ANY AUTO REPAIR



QUICKLY--EASILY--RIGHT!

FREE 7-DAY TRIAL



SUPPOSE you had an automobile factory engineer standing right beside you . . . guiding your hands through every step of even the toughest car repair job! Think how you'd "whiz through" every job! No wonder, then, 2,500,000 MOTOR'S Auto Manuals have been sold. No wonder so many thousands of beginners and expert mechanics alike are already using MOTOR'S brand-new AUTO REPAIR MANUAL. It shows you, in step-by-step words and pictures, factory-approved repair procedures for fixing ANY part of ANY car, 1949 through 1957!

No guesswork! MOTOR'S Manual "starts from scratch" — leads you through entire job with easy step-by-step directions, clear "how-to" pictures. Tells WHERE to start, what TOOLS to use, how to remove, repair and replace parts. You CAN'T go wrong.

1000 Big ILLUSTRATED Pages NEW, REVISED, ENLARGED Edition contains the "meat" from over 160 OFFICIAL shop manuals—simplified for YOU in Over 1,000 big pages, 23,400 essential repair specifications. More than 2,500 "this-is-how" pictures, 225,000 service and repair facts. Leads beginners every step of the way. Time-saving factory repair procedures for experts. Used by U. S. Army and Navy.

Try Book FREE 7 Days SEND NO MONEY! Pay postman nothing. Make Manual PROVE to you what it's got. Unless you agree this is the greatest time and work saver you've ever seen—return book in 7 days and pay nothing. Mail coupon today to MOTOR Book Dept., Desk 15, 250 W. 55th St., New York 19, N.Y.

### Brand New--Covers All These Makes

- |             |             |
|-------------|-------------|
| Buick       | Jeep        |
| Cadillac    | Lincoln     |
| Chevrolet   | Mercury     |
| Chrysler    | Nash        |
| Climax      | Oldsmobile  |
| Continental | Packard     |
| De Soto     | Plymouth    |
| Dodge       | Pontiac     |
| Ford        | Rambler     |
| Hudson      | Studebaker  |
| Imperial    | Thunderbird |
|             | Willys      |

### Same FREE Offer On MOTOR'S Brand-New Truck Repair Manual

Covers EVERY Job on EVERY popular make gasoline and Diesel truck made from 1949 thru 1957. For FREE 7-Day Trial, check the proper box in coupon.



## MAIL COUPON NOW FOR 7-DAY FREE TRIAL

MOTOR BOOK DEPT.  
Desk 15, 250 W. 55th St., New York 19, N. Y.

Rush to me at once (check box opposite book you want):

MOTOR'S New AUTO REPAIR MANUAL. If O.K., I will remit \$2 in 7 days, \$2 monthly for 2 months and a final payment of \$56 (plus 35c delivery charges) one month after that. Otherwise I will return the book postpaid in 7 days. (Foreign price, remit \$9 in cash with order.)

MOTOR'S New TRUCK REPAIR MANUAL. If O.K., I will remit \$2 in 7 days, and \$2 monthly for 3 months, plus 35c delivery charges with final payment. Otherwise I will return books postpaid in 7 days. (Foreign price, remit \$10 cash with order.)

Print Name..... Age.....

Address.....

City..... State.....

Check box and save 35c delivery charge by enclosing WITH coupon entire payment of \$6.95 for Auto Repair Manual (or \$8 for Truck Repair Manual.) Same return-refund privilege.

# Check the Kind of Body You Want

...and I'll Prove How EASILY You Can Have It!

Charles Atlas



Just tell me, in coupon below, the kind of body you want—and I'll give it to you SO FAST your friends will be amazed! "Dynamic Tension," my easy, 15-minutes-a-day method, will make your chest and shoulders bulge . . . arms and legs surge with power . . . your whole body feel "alive!"

**FREE BOOK** Learn how I became "World's Most Perfectly Developed Man"—Mail coupon! **CHARLES ATLAS**, Dept. 8E, 115 East 23 Street, New York City 10, N. Y.

**CHARLES ATLAS, Dept. 8E,**  
115 East 23rd St., New York 10, N. Y.

Dear Charles Atlas: Here's the Kind of Body I want:

(Check as many as you like)

- |  |  |
|--|--|
| <input type="checkbox"/> More Weight—Solid—in The Right Places | <input type="checkbox"/> Powerful Arms, Legs, Grip |
| <input type="checkbox"/> Broader Chest, Shoulders              | <input type="checkbox"/> Slimmer Waist, Hips       |
|  | <input type="checkbox"/> Better Sleep. More Energy |

Send me absolutely FREE a copy of your famous book showing how "Dynamic Tension" can make me a new man—32 pages, crammed with photographs, answers to vital questions, and valuable advice. No obligation.

NAME \_\_\_\_\_ AGE \_\_\_\_\_  
 ADDRESS \_\_\_\_\_  
 CITY \_\_\_\_\_ STATE \_\_\_\_\_

## WARN HUBS on your

Patented



# Jeep

STOP FRONT DRIVE WEAR  
in 2-Wheel Drive!



Over 100,000 now in use!

That is real proof of their many advantages and rugged dependability. Warn Hubs on 4-wheel drives make steering easier, increase power, speed in high; add life to gears, tires, because the front drive stands still in 2-wheel drive—there is no drag! Use free-wheeling 2 w.d. or tractive 4 w.d. as needed, automatically, as you shift, with Warn Lock-O-matics, through fingertip controls with Warn Locking Hubs. Factory approved. Iron-clad guarantee. Models for all 4 w.ds. to 1½ tons. See your dealer now! Write for free literature.



© 1957 WARN

**WARN MFG. CO.**

Riverton Box 6064-A5  
Seattle 88, Wash.

## Free! SCARCE TRIANGLE COLLECTION



Start TODAY to enjoy an exciting new hobby! Get this big, valuable collection of gorgeous, multi-colored triangle shaped postage stamps . . . brought to you from strange and mysterious lands in the wilds of Africa, enchanting Europe, exotic Latin America, etc. All genuine, all different—picturing man-eating reptiles, jungle birds, action-packed sports, ancient clipper ships; PLUS scarce airmails, fabulous commemoratives, giant and midjet-sized stamps. EXTRA! Bargain Catalog, "Collector's Manual" plus other exciting offers for your inspection. Enclose 10c for mailing costs Supplies limited. ACT NOW! **JAMESTOWN STAMP CO., DEPT. H5PM JAMESTOWN, N. Y.**

## What Every Mason Wants



We have important Masonic books and lodge supplies for Blue Lodge, Chapter, Commandery, Scottish Rite, and Shrine.

**OUR RITUALS ARE USED THE WORLD OVER**

Send for free catalog of books and rituals for Masons, Odd Fellows, Knights of Pythias, Knights of Columbus, etc.

**EZRA A. COOK PUBLICATIONS, INC. P.O. Box 796, 29A, Chicago 90, Ill.**

## YOU BUILD 'EM — WE SELL 'EM EARN UP TO \$50.00 A DAY AT HOME

Participate in our national sales and sub-contract plan—spare time—full time. You assemble special luggage and cases for photographers, musicians, salesmen, and all types of portables. We supply complete instructions—materials—tools—everything. No previous experience necessary. Free details. Abaris Cascraft, Dept. AF, 807 W. Sunset Blvd., Los Angeles 12, Calif.

## Learn ACCOUNTING Business Administration

Bookkeeping, secretarial and allied subjects at home in your spare time or attend nationally approved resident school. Write for FREE Success Book giving complete details on courses, plans, rates and employment opportunities. G.I. approved. Write Dept. A.

**Hills BUSINESS UNIVERSITY AND EXTENSION SCHOOL**  
629 W. MAIN ST. OKLAHOMA CITY 2, OKLAHOMA

## JEEP OWNERS

RE-POWER NOW with your choice of three famous V-8 engines **FORD • CHEVROLET • MERCURY** CONVERSION KITS now available to fit ALL 2 and 4 Wheel-Drive Willys Jeeps. . . . Priced \$43.25 to \$64.75 . . . If you want fast action tell us which V-8 engine you wish to use . . . give us the year . . . 2 or 4 Wheel-Drive . . . body style of your vehicle. Send min. \$15.00 dep. and we will ship correct kit, bal. G.O.D. Send full amount for prepaid shipment. Wire, phone or write for FREE details. **HOOSIER MACHINE PRODUCTS CO.**  
312 S.E. 6th St. Phone 676 Pendleton, Oregon, U.S.A.

## Day or Night Enjoy this HIGH-POWERED 40, 80, 120 TELESCOPE with TRIPOD \$1295

Observe stars, moon, planets. See distant ships, people, etc. appear feet away! Crystal-clear image sharpness at all powers. All images erect. Telescope with five precision lenses and 40" long black leatherette covered tube mounted on 5 ft. hardwood tripod, cast aluminum head. Vertical and horizontal movements machined aluminum, tension controls on each. 3X finder scope attached locates target fast. Telescope completely assembled with tripod PLUS 3 FREE GIFTS only \$12.95 postp. Satisfaction guaranteed. **SUFFOLK SCIENCE SERVICE** Dept. PM-5 Mattituck, N. Y.

- GET THESE GIFTS FREE!**
1. 120 pp. book "Discover the Stars"
  2. Star Finder Dial
  3. 200 & 400X eyepiece lenses

**RCA** offers you the  
 finest training  
 at home in  
**Radio-TV**  
 electronics,  
**TV servicing,**  
**Color TV**

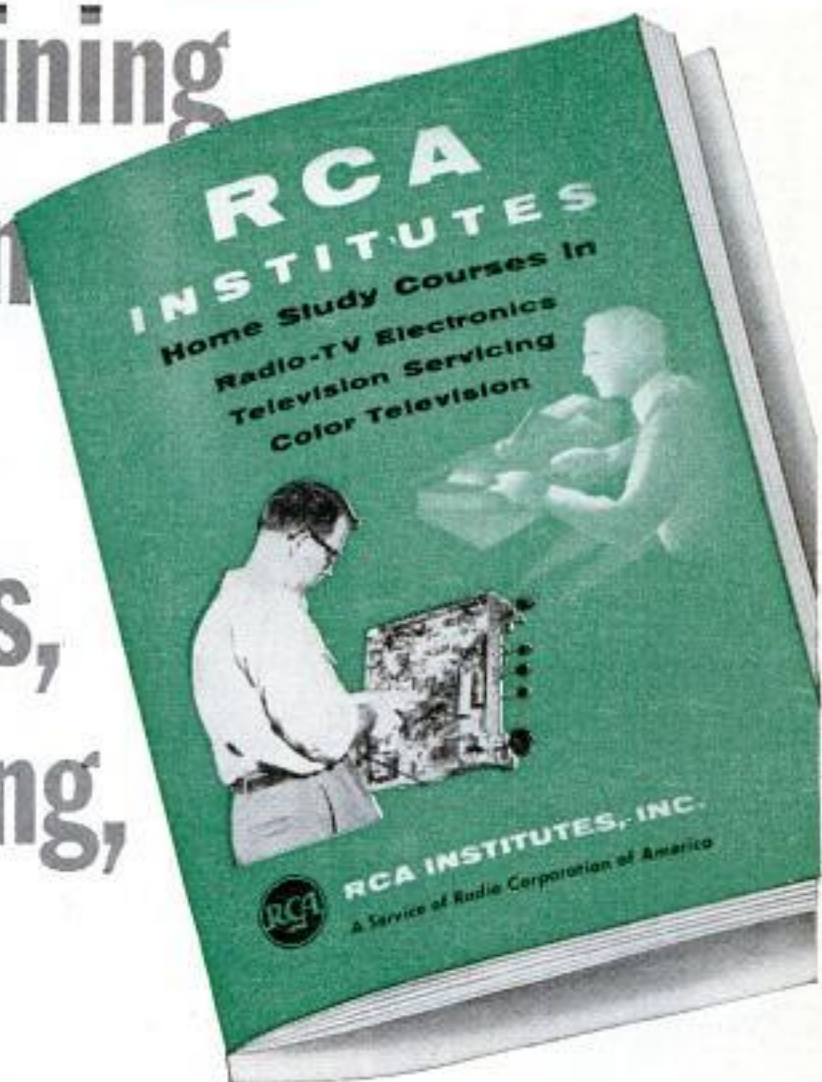

**SEND FOR THIS FREE  
 BOOK NOW!**

The instruction you receive and equipment you get (and keep) will start you on your way. Pay-as-you-learn. You pay for only one study group at a time. This 52 page book contains complete information on Home Study Courses for the beginner and the advanced student.



**RCA INSTITUTES, INC.**  
 A SERVICE OF RADIO CORPORATION OF AMERICA  
 350 WEST FOURTH STREET, NEW YORK 14, N.Y.

In Canada—RCA Victor Company, Ltd.,  
 5001 Cote de Liesse Rd., Montreal 9, Que.

RCA Institutes, Inc., Home Study PM-57  
 350 West Fourth Street New York 14, N. Y.  
 Without obligation, send me FREE CATALOG  
 on Home Study Courses in Radio, Television  
 and Color TV. No salesman will call.

Name..... Please Print  
 Address.....  
 City..... Zone..... State.....

**VETERANS  
 KOREAN G. I.  
 P. L. 550  
 CHECK HERE  
 ( )**

# Inventors

Take these necessary preliminary steps promptly to protect your invention by applying for a United States patent—

Sketch and describe your invention. Sign, date and have this disclosure witnessed by two people who understand your invention. Have us make a preliminary search among U. S. patents already granted for similar types of invention. We then report to you on the probable patentability of your invention and recommend your further course of action.

Write for our instructive booklet, "Patent Protection for Inventors" and our convenient "Evidence of Invention" disclosure form. No obligation.

**VICTOR J. EVANS & Co.** *Merlin M. Evans*  
REGISTERED PATENT ATTORNEY

330-E MERLIN BUILDING, WASHINGTON 6, D. C.

## LEARN UPHOLSTERY

in your spare time  
run your own  
business  
AT HOME



**FREE BOOK** with sample lessons with course

**YOU MAKE** SLIPPER CHAIR CLUB CHAIR OTTOMAN

**PLUS SLIP COVERS** Yours to Keep or Sell

**BE YOUR OWN BOSS**  
Earn more from the start! Set up your own profitable business, in your own home, enjoy steady income, independence for life—in the booming field of Custom Furniture Upholstery. Right off you start learning with tools, complete frames, fabrics and materials, included FREE with practical UTS course. You learn skilled professional custom upholstery, reupholstery, furniture finishing, repairs, how to make beautiful slip covers, window cornices, cushions and draperies. EARN WHILE YOU LEARN, in your spare time AT HOME... the UTS easy way.

**FREE ILLUSTRATED BOOK—FREE SAMPLE LESSON**  
Get ready for well-paid job and big profits, from steady work, as your own boss, running your own business. Mail coupon NOW for FREE BOOK! Training in N. Y. School also available.

**APPROVED FOR VETERAN TRAINING**  
UPHOLSTERY TRADES SCHOOL  
Dept. FE-310, 721 B'way, N. Y. 3, N. Y.

Please send me FREE book "Your New Way to a Successful Career," and FREE sample lesson. No obligation—no salesman will call.  
 Home Study  N. Y. School Training

Name \_\_\_\_\_  
Address \_\_\_\_\_ (Please Print Plainly)  
City \_\_\_\_\_ Zone \_\_\_\_\_ State \_\_\_\_\_  
 Check if Korean Veteran

## SAVE THOUSANDS OF DOLLARS

### "HOME-A-MINUTE" KIT



Not Something To Fool Around With!

Let's be frank. Isn't it ridiculous for you to pay thousands of dollars in excess profits when you build or buy a New Home, simply because you do not know the actual cost of building BY WHY NOT design and build your New Home, Attic Flat, Extra Bedrooms or Remodeling—IN MINUTES—with dozens of fiber partitions, Doors, Windows, Kitchen Cabinets, made to 1/4 inch scale same as blueprints. THEN, BELIEVE IT OR NOT, YOU, THE LAYMAN, who knows nothing about building, can estimate your own costs—IN MINUTES—after you adjust charts to local prices. Don't build anything until you get this "KIT," if you want to save money. Handbook tells you how. Also financing. This information should not pass you by. Complete "KIT"—\$3.95 ppd. Money back guarantee. Return in 10 days.

2825 N. 69th St.  
**B. C. HALL & CO.** MILWAUKEE 10, WIS.

## Secrets of VENTRILOQUISM

### Now Revealed!



Easy to learn in 60 to 90 days with our Home Study Course. RESULTS GUARANTEED. Make Money! Be Popular! Have Fun! Big Opportunity! Radio, Television, Stage Appearances! For FREE information regarding price and terms WRITE. You must state your age. Dummy Catalog 25c.

**MAHER HOME COURSE OF VENTRILOQUISM**  
Box 36, Studio E, PM-5, Kensington Station  
Detroit 24, Michigan

## Catalog of 3100 Novelties 10c



Send 10c for amazing catalog of novelties, live animals, scientific supplies, hobbies, funmakers, planes & boats, toms, magic tricks, joke articles, unusual seeds, gadget time-savers, cameras, optical goods, projectors, movies, lucky jewelry, religious novelties, disguises, musical instruments, stamps, coins, puzzles, fortune tellers, radios, auto & bike accessories, telescopes, magnifiers, compasses, banks, smokers' gadgets, artists' supplies, printing sets, engines, motors, shockers, knives, billfolds, guns, rifles, sports, books, games, plants, etc. Send 10c (3 for 25c—get for friends!).

**JOHNSON SMITH & CO.** Dept. 417 Detroit 7, Michigan

## SALESMEN WANTED

Earnings \$5000 to \$8000 per year, calling on hardware stores and lumber yards, selling and installing Popular Mechanics show windows. No window trimming experience necessary (we train you) but selling experience essential. Must have automobile. Average territory consists of about 5 counties. Salesmen have exclusive territory. Home every night.

Not a get rich quick scheme but steady dignified work by which a skilled, industrious salesman can earn a good living. This company, in cooperation with Popular Mechanics and the leading manufacturers of tools, equipment and materials, offers retailers traffic-stopping window displays to retail hardware stores and lumber yards at a nominal cost. All equipment furnished. Endorsed by many retailers, jobbers and manufacturers. Much repeat business. Extras offer additional earning opportunity. Desirable but not necessary to have knowledge of hardware and lumber lines. Personal training given.

For details write to Window Displays, Inc., giving all the facts about yourself. If your letter indicates that you might qualify, an appointment will be made for an interview.

## WINDOW DISPLAYS, INC.

1609 SHERMAN AVENUE EVANSTON, ILLINOIS



# E-ZEE *Water Powered* TWIN SPIN

*Aerated Action  
Brush*



**EVERY CAR OWNER  
EVERY HOME NEEDS THIS  
WORK SAVING BRUSH**

Connects directly to garden hose. Twin spinning center brushes do aerated cleaning and rinsing. Soft, mar-proof, quality brushes for finest car finishes. Perfected, swivel action, leak-proof valve regulates water flow and prevents hose kinkage. 30" rubber covered handle. Brush head detaches for insertion of detergent cartridges (sample with each brush) Extension handle available (\$1.75 extra) to lengthen unit to 6 ft.

*for washing cars,  
windows, siding,  
screens, etc.*

**\$6.95**

Available at Hardware, Auto Supply and Dept. Stores. If your dealer cannot supply — send check or money order direct to factory. We pay shipping cost.

**LAITNER BRUSH COMPANY**  
2000 Brooklyn Ave. • Detroit 26, Mich.

## Superior's New Model 70 UTILITY TESTER®

# FOR REPAIRING ALL ELECTRICAL APPLIANCES MOTORS • AUTOMOBILES • TV TUBES

As an electrical trouble shooter the Model 70:

- Measures A.C. and D.C. Voltages, A.C. and D.C. Current, Resistances, Leakage, etc.
- Will measure current consumption while the appliance under test is in operation.
- Incorporates a sensitive direct-reading resistance range which will measure all resistances commonly used in electrical appliances, motors, etc.
- Leakage detecting circuit will indicate continuity from zero ohms to 5 megohms (5,000,000 ohms).
- Will test toasters, irons, Broilers, Heating Pads, Clocks, Fans, Vacuum Cleaners, Refrigerators, Lamps, Fluorescents, Fans, Switches, Thermostats, etc.
- Will test all TV tubes for open filaments, inter-plate shorts, burned out tubes, etc.

As an Automotive Tester the Model 70 will test:

- Both 6 Volt and 12 Volt Storage Batteries • Generators • Starters • Distributors • Ignition Coils • Regulators • Relays • Circuit Breakers • Cigarette Lighters • Stop Lights • Condensers • Directional Signal Systems • All Lamps and Bulbs • Fuses • Heating Systems • Horns • Also will locate poor grounds, breaks in wiring, poor connections, etc.

Mechanics read-covered molded heliote case, 3 1/2" x 2 1/2" x 2 1/2". Complete with all test leads. Also included is a **44 page book** giving detailed instructions for testing all electrical appliances, automotive equipment, TV tubes, etc. Only **\$15.85**

**SHIPPED ON APPROVAL  
NO MONEY WITH ORDER — NO C. O. D.**

Try it for 10 days before you buy. If completely satisfied then send \$3.85 and pay balance at rate of \$4.00 per month for 3 months — No Interest or Finance Charge. Additional 5% not completely satisfied, return to us, no explanation necessary.

**MOSS ELECTRONIC DIST. CO., Inc.**  
Dept. D-343, 3849 Tenth Ave., N.Y. 34, N.Y.  
Finance each one one Model 70. If satisfactory I agree to pay \$3.85 within 10 days and balance at rate of \$4 per month until total price of \$15.85 plus postage is paid. If not satisfied, I may return for consideration of amount.

Name \_\_\_\_\_  
Address \_\_\_\_\_  
City \_\_\_\_\_ State \_\_\_\_\_



## TRAIN TO OPERATE HEAVY EQUIPMENT CONTRACTORS NEED MEN NOW

The big federal and state super highways program is now in progress. Trained to operate bulldozers, shovel, motor-grader, scrapers, etc. YOU can make big pay in the construction industry if you learn these skills. NOW contractors WANT our graduates. Write or call TODAY for full information.

**THE MIDDLE-WEST SCHOOL OF HEAVY EQUIPMENT OPERATION**  
SAXTON, KENTUCKY  
(Phone Jellico, Kentucky—Harrison 4-6653)

TV Strong man  
**DAN LURIE**  
KAPL



## \$10,000 REWARD

If correct use of my new body building course fails to build you a "HE-MAN" BODY The secret is in my revolutionary, exclusive Body Mould system. Yours FREE with famous

### DAN LURIE BARBELLS

Scientific! Fastest, surest method known — beats all other training methods. Results guaranteed. Special low prices.  
50 lb. set \$ 8.98 • 100 lb. set \$14.98  
150 lb. set \$21.98 • 200 lb. set \$27.98  
14¢ per Lb. F.O.B. 50¢ Deposit required

**DAN LURIE BARRELL CO.**  
52M5 Bristol St., Dept. 759E, B'klyn 12, N. Y.

**CHILD'S Electric Powered SPORTS CAR!** only \$197.50  
U.S. Factory

Imagine this LOW LOW price for an authentically styled sports car for children 4 to 10 years old. Equipped with battery charger. Electric shift with FORWARD, NEUTRAL, REVERSE.

**SPECIALTY TOY MFG. CO.**  
807 Beatrice Dr., (Dept. 1)  
Akron 10, Ohio TM-5571

Write for FREE CATALOG!

SAFE • EDUCATIONAL • ECONOMICAL  
"Scuttle-bug"

PLEASE  
SEND ME



for the  
time checked.  
I am enclosing . . .

- 1 year \$3.50
- 2 years \$6.00

name \_\_\_\_\_  
address \_\_\_\_\_  
city \_\_\_\_\_ zone \_\_\_\_\_ state \_\_\_\_\_

Hand this order to your newsdealer or send it to  
**POPULAR MECHANICS**  
200 East Ontario St. Chicago 11, Ill.

**SAVE UP TO 70%**  
on **NEW TIRE COST**

**TIRES**  
FACTORY ADJUSTED  
NOT SECONDS!

**90% to 100% ORIGINAL TREAD**  
**NEW TIRE GUARANTEE**

WHITE WALLS Available in 15" Sizes Only **\$2.00** Each Added

670 x 15	\$7.95	800-820 x 15	\$9.95
710 x 15	\$8.45	600 x 16	\$7.95
760 x 15	\$8.95	650 x 16	\$8.95

No Federal Excise Tax Added  
Road hazards not adjusted — No freight paid

**H. & H. TIRE CO.** All prices f.o.b. Chicago  
449 W. 37th St., Dept. P-2, Chicago, Ill.

**MAKE YOUR MARK IN THIS HIGH-PAY FIELD**

**EARN CASH AS YOU TRAIN**

**AUTO SADDLE BAGS**

Snap onto robe rail back of front seat. Handy carrying lots of articles. 9 1/2" x 18-22 inches. 1 wide pocket, 2 divided. Cotan Leatherette. 2-tone, all colors. Order any 2. Olive make and model of car. **\$4.95**, \$9 pair.

**CHECK OR M.O. POSTPAID. MONEY BACK GUARANTEE.**  
If Robe Rail wanted, add \$1.95

**AUTO SADDLE BAGS, 219 N. 22 St., Birmingham 3, Ala.**

**HIGH SCHOOL DIPLOMA**

Earn a High School Diploma at home! Prepare for better job, more pay. Study in spare time. No classes. Materials furnished. Certified teachers. Valuable diploma awarded. Write Today for Complete Information

**SOUTHERN STATES ACADEMY**  
Box 144-A Sta. E Atlanta, Georgia

**Start Your Own Money-Making Business**

Clean rugs on customers' floors—upholstery in their homes—even painted walls—with highly efficient electric machines which are making big money for others and giving them independence. Write today for complete information. It's FREE!

**VON SCHRADER MFG. CO., Dept. 510 "R" PL., Racine, Wis.**

**FIX OUTBOARD MOTORS  
POWERMOWERS, AND ALL SMALL  
2 & 4-CYCLE GASOLINE ENGINES**

Repair your own equipment or MAKE EXTRA MONEY in this growing field. Fully illustrated, easy-to-understand, Home Study Course. Write for FREE information.

**LINCOLN TECHNICAL INSTITUTE**  
SUITE 5-E, 472 MARKET STREET, NEWARK 5, N. J.

**GIANT 6 FT. BALLOONS**  
**59c**



Wow! Genuine Neoprene government surplus (never used) . . . giant 6 ft. across, 21 ft. around . . . at a fraction of original cost. Durable. Can paint on advertising message. Inflate and fly. Visible for miles. Great for attracting crowds to fairs, openings, school proms, gas stations. Fun for young and old in backyards or picnics, at the beach, etc. use as water markers & buoys. Order today —only 59c each.  
Special: 2 for \$1.00; 5 for \$2.00; 13 for \$5.00. No C.O.D.

**BALLOONS, P.O. Box 27104, Hollywood 27, Calif.**

**Train AT HOME for a GOOD JOB in  
AUTO MECHANICS**

A better job with more pay will mean *better living* for you. It can mean a fine home, a new car, nice vacations, and good educations for the kids. If you would like to earn up to \$125 a week and more—and be able to afford better living, *train yourself* in Auto Mechanics. You can do it with CTI showing you how—and you can learn at home in spare time!

**GOOD JOBS ARE WAITING EVERYWHERE** because there are over 60 million cars and trucks on the road—7 million new ones each year. One-third are in the heavy-repair classification. Skilled mechanics are needed to keep these cars operating. You can be one of them—make big money, enjoy lifetime security—even open a shop!

**EARN AS YOU LEARN** just as many CTI students do. They make up to \$15 a week and more in spare time. Some start their own shops by graduation time. CTI Shop-Method Home training, based on resident school practice, makes every step easy.

**DIESEL MECHANICS OR BODY-FENDER TRAINING** is also yours at no extra cost. A wonderful chance to give yourself a well-rounded education. Only CTI gives you this extra choice! Get the facts: Mail coupon.



**YOU PRACTICE WITH THIS TUNE-UP KIT**

Kit includes a Compression Tester, a Vacuum Gauge and Fuel Pump Tester, an Ignition Timing Light, and a portable steel case. These professional instruments help you locate engine troubles, let you get useful practice. You keep this kit!

**MECHANIC'S TOOLS TOO**

You'll use these tools to get real experience. They'll increase your interest, stamp you as a "pro." You'll earn spare time cash with them. No extra cost for tools—you keep them.



**MAIL COUPON TODAY!**

**MAIL TODAY FOR 2 FREE BOOKS**

**COMMERCIAL TRADES INSTITUTE**  
1400 Greenleaf Ave., Chicago 26  
Dept. A-539

Send your new Auto Mechanics book and Sample Lesson. BOTH FREE.

Name \_\_\_\_\_ Age \_\_\_\_\_

Address \_\_\_\_\_

City \_\_\_\_\_ Zone \_\_\_\_\_ State \_\_\_\_\_



# ... TURN CONCRETE INTO GOLD!



**MAKE UP TO \$75 A DAY IN YOUR OWN BUSINESS**

If you want to have your own business — to start a business on your own — here's your big opportunity! New high speed, low cost General block machine produces up to 1,000 concrete blocks a day. Sell all you make to builders, supply houses, and others for homes, factories, buildings, garages. Cash in on the building boom! You can make profits of 100% to 150% — up to \$75. a day! General block machine equipped with 1/2 h.p. electric motor — or can be supplied with gasoline engine — works anywhere, in little space, indoors or out. Operates from ordinary house light socket. Simple, foolproof 3 step operation — so easy a child can do it. Makes superior 3 core blocks any size from 4" to 12". Also makes chimney, ash, corner and other types. Blocks meet any building code anywhere in the country. Materials — sand, water, cement, available anywhere. Simple illustrated operating instructions and mixing formulas for cement and cinder blocks supplied with each machine. Write for FREE folder with full information.

**MOTOR DRIVEN**

R. L. T. of New York City reports: "MY GENERAL BLOCK MACHINE PAID FOR ITSELF IN FIRST 2 WEEKS!" Hundreds now in use the world over! Write for FREE details today!

### EXTRA

Amazing illustrated book gives floor plans for 6 sensational concrete block bungalows. Tells how to lay blocks, lay out building lines, mix concrete, build steps, porch and concrete floors all at great savings. Written by experts. Can save many times the cost of the material! Get it now! No strings attached. Send \$1.

BOOK SENT FREE IF YOU BUY MACHINE.  
\$1 REFUNDED IF YOU BUY LATER.

## GENERAL ENGINES CO.

DEPT. M-57, ROUTE 130, THOROFARE, N.J.



# Amazing PRESTO SELLS ITSELF FOR YOU WHILE YOU SLEEP!



**MAKE UP TO \$1,000<sup>00</sup> IN A MONTH Without "Selling"!**

Raw beginners . . . veteran salesmen . . . clean up unbelievable profits with Miracle Presto Fire Extinguisher. Lightweight, low-priced, yet does work of ordinary extinguishers costing 4 times as much and 8 times as heavy. No bigger than flashlight. Secret of Presto's compact power is a startling chemical 1 1/2 to 6 times more effective than equal weight of ordinary extinguisher chemicals. Easy to use; just twist knob and flames disappear. GUARANTEED 20 YEARS! Owners of homes, farms, stores, offices, cars, boats, etc. order 1 to 12 at a time at \$4.95 each. You make up to \$2.70 on each. Others make up to \$1000 and more in a month, and so can you, without hard selling or cold canvassing, thanks to my amazing "No Selling" Plan.

### Tremendous "Easy Chair" Profits!

While you relax in your easy chair at home and while you're asleep, Presto can make big profits for you . . . thanks to new, dramatic field-tested "No-Selling" Plan. Even a child can use successfully. We provide powerful sales tools you leave with prospects. When you return, money's waiting for you!

## FREE Exciting Fully Illustrated "No-Selling" Plan Kit

Rush name, address TODAY for complete details of amazing new easy money-making plan for "Easy Chair" profits. Everything FREE, no obligation. Write now to Marlite Industries, Dept. X-15W, Presto Div., 114 East 32nd St., New York 16, N. Y. (In Canada: Mapa Co., Ltd., 371 Dowd St., Montreal 1, P.Q.)

# New HOME-IMPORT BUSINESS!



Men — Women. We show you how to import big-profit items at amazing low foreign prices (examples at left). Your home is your office. Get list of 157 Imports FREE! Full or spare time business by Mail Order. Or take volume orders from stores. Import jewelry, clothing, sporting goods, hardware, etc. NO EXPERIENCE OR INVESTMENT IN PRODUCTS NEEDED. Without obligation send today for complete details and list of 157 imports FREE! Air mail reaches us over night. THE MELLINGER CO., 1717 Westwood Boulevard, Dept. G255, Los Angeles 24, California.

Clocks 65¢ in Germany — \$5 value in U.S.A.

## BECOME AN EXPERT IN TRAFFIC

Traffic men earn \$4,000 to \$10,000 and up. Thousands of firms need experts on rates, tariffs, regulations. We train you thoroughly in spare time at home for executive traffic job. Personal training under traffic authorities. Placement counsel and help. Write for free 48-page book "Traffic Management—the Fast Growing Profession."

LASALLE Extension University, 417 So. Dearborn St. A Correspondence Institution Dept. 564-T Chicago 5, Ill.



### 3" "PALOMAR, JR." TELESCOPE 60 & 120 Power—An Unusual Buy!

Assembled—ready to use! You'll see the Rings of Saturn, fascinating planet Mars, huge craters on Moon, Star Clusters, Moons of Jupiter in detail. Aluminized and overcoated 3" diameter high-speed f/10 ventilated mirror. An Optical Finder Telescope is also included. Sturdy, hardwood, portable tripod. Order by Stock No.—Send check or M.O. —Money-back guarantee! Stock No. 85,050-H. . . . . \$29.50 f.o.b. (Shipping wt. 10 lbs.) Barrington, N.J.

Ask for FREE catalog H EDMUND SCIENTIFIC CO., Barrington, N. J., U. S. A.

## Write Like This

MIRACULOUS IMPROVEMENT in your Penmanship in six hours practice with Greased Letters. No failures. Inexpensive. No charges unless you're satisfied after 6 hours practice.

WRITE OZMENT BOX 665 34-P, ST. LOUIS, MISSOURI

**Complete OUTLINE FREE!**

## FREE AMAZING NEW BOOK "HOW TO ANSWER ADS"

Never before have you seen anything like this. Tells you in simple language the correct way to answer ads. Gets you quicker replies—better results, and greater satisfaction. Will save you time and money and it's ABSOLUTELY FREE. No obligation whatever. Every reader of advertising should have this booklet. Send a postcard for your copy NOW. F. W. JOHNSON, Popular Mechanics Magazine, Room 600-A, 204 East Ontario Street, Chicago 11, Ill.

### Be an industrial designer

Combine your design abilities with technical aptitudes in Industrial Design training at Art Center School in California. Work under practicing professionals for upper level jobs as automotive stylists, product and package designers. Design offices, stores, motels, showrooms, shopping centers. Constant demand for graduates. Recent placements with Ford, G.M., Kaiser Aluminum, G.E., Raymond Leovy and other leading design studios. 700 students. Co-ed. Accredited. B.P.A. Degree. Four-year course can be completed in 2 yrs. 8 mos. by year-round training. New terms Feb., June, Sept. Enroll early. Write Mr. Mead for new catalog. 5353 West 3rd St., Los Angeles 5, California.

## ART CENTER SCHOOL

## TERMITES IN YOUR HOUSE? GET RID OF THEM YOURSELF!

DON'T PAY \$300.00 AND UP TO ERADICATE TERMITES FROM YOUR HOME OR PREVENT INFESTATION. DO IT YOURSELF IN ONE AFTERNOON. EASILY! QUICKLY! INEXPENSIVELY WITH "TERM-OUT"! SEND STAMP FOR HANDBOOK.

**COMPASS RESEARCH**  
4700-A CLAIRTON BLVD., PITTSBURGH 36, PA.





# WAR SURPLUS BARGAINS

# WAR SURPLUS BARGAINS

**\$500,000.00 INVENTORY for QUICK LIQUIDATION**

Surplus items—hundreds of them for home, shop, factory, farm and outdoor use. New items, used items, reconditioned items—all at tremendous savings—all priced for quick sale.

**Page After Page of Values**

This big catalog shows page after page of amazing money saving values. Write for your copy today. Send 10¢ to cover postage, mailing, etc. Write today! **SEND TODAY FOR YOUR COPY**

# 10c

**STARK'S** 212 W. Madison St.  
Dept. PM-575  
CHICAGO 6, ILL.

## Finish HIGH SCHOOL AT HOME

Complete 4 Yrs. in 12 Months

Learn More! Earn More! Enter professional or technical schools. Advance Socially. Live a Happier, Fuller Life. Individual Courses or complete schedule. **WRITE FOR SCHOOL BULLETIN.**

**ACADEMY FOR ADULTS**  
30 W. Washington, Dept. PM-57, Chicago, Ill.

## BE A CAMERA CRAFTSMAN...

Send for **FREE** book!

Many are needed in this big paying field and now you can learn to repair cameras using manufacturer's serial or methods at home... In your spare time! Instruments, tools, practice equipment - everything you need is included in this approved course! Write for big FREE illustrated booklet that tells you HOW!

**national camera repair school - DEPT. V-5** ENGLEWOOD, COLORADO

## LEARN PLASTICS

COMPLETE LOW COST SHOP METHOD HOME TRAINING NOW AVAILABLE

Get in on Big Money opportunities in Plastic molding, casting, forming, carving, etc. Earn as you learn with Interstate's professionally prepared course. All plastic materials furnished.

**WRITE FOR FREE BOOKLET**

**INTERSTATE TRAINING SERVICE**  
DEPT. C-3, PORTLAND 13, OREGON

## REPAIR ANY WATCH

... Swiss or American

Unique Sweeney System starts you making repairs right away. Develops your skill step-by-step. Teaches modern methods... professional short cuts. Learn by personal attendance or spare time home study. Free Sample Lesson. No obligation. Write today!

**CHICAGO SCHOOL OF WATCHMAKING**  
2330 Milwaukee, Dept. 157, Chicago 47, Ill.

## GOOD YEAR

GOODRICH, U. S. General, Firestone & others, worn slightly. We try to ship your favorite brand (not recaps)

### 12 MONTH GUARANTEE

I replace FAST any defective tire, frt. excl.

READ THIS FIRST! You can't buy a \$20 bill for \$10. FREE TIRES & big discounts sound good but you can't buy quality, family-safe tires cheaper than my prices below! I buy in carloads, nobody undersells **MARVIN BLATT!** (What a difference in safety a few cents make!)

600-16	\$5.28	710-16	\$8.38	700-20	\$10.95	1100-20	\$20.87
640-15	5.68	760-15	8.38	750-20	13.00	600-16(1)	6.75
650-16	5.68	800-15	8.68	825-20	18.86	650-16(1)	7.75
700-16	6.78	820-15	8.88	900-20	18.99	700-16(1)	8.75
700-15	4.98	700-17	8.98	1000-20	19.99	700-15(1)	8.75
670-15	5.18	750-17	11.98	900-16 Mil. Mud Grip	\$17.59		

**TRUCKOWNERS**—a cheap quality tire can cost you a fortune. I'll never send you a tire I wouldn't use myself. We've 42 years' experience!

**MARVIN BLATT** & Spring Garden  
6th Philadelphia, Pa.

**CO. ADJUSTED TIRES with new tire service guaranteed.** **\$7.95** any car

Send Chk. or M.O. Shipped F.O.B. Phila.

# MEN PAST 40

## Afflicted With Getting Up Nights, Pains in Back, Hips, Legs, Nervousness, Tiredness.

If you are a victim of the above symptoms, the trouble may be due to Glandular Dysfunction. A constitutional Disease for which it is futile for sufferers to try to treat themselves at home. Medicines that give temporary relief will not remove the cause of your trouble.

Most men, if treatment is taken before malignancy has developed, can be successfully **NON-SURGICALLY** treated for Glandular Dysfunction. If the condition is aggravated by lack of treatment, surgery may be the only chance.

## NON-SURGICAL TREATMENTS

The **NON-SURGICAL** treatments afforded at the Excelsior Institute are the result of 20 years research by scientific Technologists and Competent Doctors.

The War brought many new techniques and drugs. These added to the research already accomplished has produced a new type of treatment that is proving of great benefit to man as he advances in years.

The Excelsior Institute is devoted particularly to the treatment of diseases of men of advancing years. Men from all walks of life and from over 3,000 cities and towns have been successfully treated. They found soothing and comforting relief and a new health in life.

### EXAMINATION AT LOW COST

On your arrival here, our Doctors who are experienced specialists, make a complete examination. Your condition is frankly explained to you with the cost of treatment you need. Your decision is then made. Treatments are so mild that hospitalization is not necessary — a big saving in expense.

**RECTAL-COLON** associated with Glandular Dysfunction. We can treat these for you at the same time.

# FREE ILLUSTRATED BOOK

The Excelsior Institute has published a New **FREE** Book that deals with Diseases peculiar to men. It could prove of utmost importance to your future life.

Write today. No obligation.



**Excelsior Institute**  
Dept. B-975  
Excelsior Springs, Mo.

Gentlemen: Kindly send me at once your New **FREE** Book on Diseases peculiar to men. I am.....years old.

Name.....  
Address.....  
City..... State.....

# TELEPHONES, TELEPHONE PARTS and WIRE & CONSTRUCTION SUPPLIES



**BATTERY OPERATED TELEPHONES** for Inter-House, House to Barn or Office to Shipping Room telephone service. Handset style or Desk Stand style.

**MAGNETO TELEPHONES** for Rural telephone lines, construction jobs, factories, farms, camps or summer homes, etc.

**MOTEL TELEPHONE SYSTEM** — Simple economical telephone service between office and each cabin. Suitable for roadside Drive-In food service, etc.

**ANTIQUATE TELEPHONE CABINETS** — complete with all parts except generator. Ideal for Home Hobby Shops. Make beautiful Radios, Spice Cabinets, Liquor Chests and Flower Boxes.

**TELEPHONE LAMPS.** Make your own. Beautiful. Different. Lamp, if you prefer. We furnish the parts or a complete

**WORM HARVESTER** — Dan Mac Magneto — gathers fish-worms by electricity.

WRITE FOR ILLUSTRATED BULLETIN "AA-13" which gives full facts on all of the above.

**TELEPHONE REPAIR & SUPPLY CO.**  
DEPT. AA-13 1760 LUNT AVE., CHICAGO 26, ILL.  
"America's Largest Independent Telephone Repair Shop"

**HOW I MADE A FORTUNE IN CHEMISTRY**

PRICE \$100000

← The price of this book is \$1000<sup>00</sup>

## IT CAN BE YOURS FREE!

NOW, for the first time published, the exact details, complete formulas and methods—nothing omitted! The author reveals how he made a fortune in Chemistry; the whole simple truth: Over a million dollars in sales in 6 years without EVER LEAVING HOME! The ideas in this unusual book may change the course of your entire life, as they did his! No special talent, knowledge, equipment or skill required! The author is handicapped; that's why his achievements can be duplicated and bettered by those who are not! Write for free details how you can acquire this precious book FREE! Only a limited number of these valuable books will be given away, so act NOW! If you are also interested in earning a diploma in Chemistry through HOME STUDY, ask for our Catalog of Chemistry Courses!

**NATIONAL SCHOOL OF CHEMISTRY**  
P.O. BOX 606-P REDWOOD CITY, CALIF.



## BUILD and FLY Bensen HELICOPTER

Glider type 'copter—easy to build, simple to fly. Can also be mounted on floats or boat. No pilot's license required. Order 3-view drawings, specs and photo for \$1. Motor powered Gyro-Copter drawings \$2.

Ask about detailed plans and construction kits.  
**BENSEN AIRCRAFT CORP., Dept. PM-57**  
P. O. Box 2725, Raleigh, N. C.

Name.....  
Address.....

# NEW Self-Contained SPRAY GUN FOR HOUSEHOLD JOBS!

Requires NO Hoses,  
Cords or Compressors

Completely Portable . . . Goes to the Job Without Attachments!

It's unique — this amazing spray gun you can carry as easily as a water pistol! Powered by inexpensive CO<sub>2</sub> cartridges! Container holds 21 oz., reloads in a flash. Nozzle adjusts from stream to finest spray. Sprays paints, insecticides, etc. At your dealer's or order direct. Remit in full and we'll ship postpaid. Or send \$2, pay postman balance plus COD fee.



ONLY \$19<sup>95</sup>  
with 10 cartridges

**SULLIVAN-BECKER CO., Dept. 117-E, Kenosha, Wis.**

**Own and Play the ACCORDION**

for fun...for popularity...for profit!

Buy direct at amazing savings from America's biggest importer of fine Italian made accordions. **5 DAY FREE TRIAL!** Easy Terms. Free Lessons—Easy to learn. Post-paid selection service. Profits plus accepted. Write today for big Color Catalog and our low wholesale prices. **FREE!** Accordion Manufacturers & Wholesalers Outlet

**SAVE UP TO 50% on famous ITALIAN MAKES**

**5 DAY FREE TRIAL**

2003 West Chicago Avenue - Dept. R-57 - Chicago 22, Illinois

**BUILD YOUR OWN AIR CONDITIONERS**

From Junked Refrigerators for a Few Dollars INSTRUCTION BOOKS SHOW YOU HOW... 75c EACH

**SPECIAL OFFER**  
2 Books—\$1.00  
3 Books—\$1.50  
or all 5 for \$2.00

- "HOW TO BUILD a Low Cost Air Conditioner"
- "HOW TO BUILD an Automobile Air Conditioner"
- "HOW TO BUILD a Low Cost Home Freezer"
- "HOW TO BUILD an Electrostatic Precipitator"
- "HOW TO BUILD a Low Cost Dehumidifier"

Complete "Install-It-Yourself" Air Conditioner kits for home and automobile, 2 Ton capacity, Brand New Parts—\$124.40 and up.

**FREE!**  
Instructions and Literature on kits.

**KOOL ENGINEERING CO., Dept. R-5, 3716 Belmont, Chicago 18, Ill.**

**NEW! BUILD MUSCLES & HEALTH with BODY BUILDER**

Only \$100 Postpaid

This new Chest Pull Body Builder develops powerful he-man muscles F-A-S-T. Ideal for the beginner to give him a real start in championship muscularity and perfect for the more advanced bodybuilder to combine with his regular training for faster, all around muscle growth. Body Builder is wonderful for developing massive arms, shoulders, chest and back. Mail your order today. Only \$1.00 postpaid. No C.O.D.

**MEDFORD PRODUCTS, Inc.**  
Dept. PM4, P.O. Box 39, Bethpage, New York

**FREE "How To Start Your Own MAIL ORDER BUSINESS"**

Earn from \$10,000 to \$20,000 spare time. We'll put you in business and furnish you with everything needed. Exclusive new catalogs every three months. Offer your customers one item free for every two they buy! Free advertising and no stock for you to buy. We ship for you under your own name. No experience required. Write today for free booklet and franchise data.

**MAIL ORDER ASSOCIATES, PARAMUS 58, NEW JERSEY**

**100 BEST Woodworking Projects**

The "Must" for All Home Workshops

Selected by Popular Mechanics Editors

Enjoy the fun of making things. Revel in the pride of the craftsman when neighbors and friends admire your handiwork. Get 100 BEST WOODWORKING PROJECTS, complete with simplified instruction, plans, diagrams and more than 400 how-to-do-it pictures. Make all kinds of furniture — chairs, tables, desks, bed room furniture. Make baby carriages, clock cases, lamps, book shelves, fireplaces, attic ladder, folding screen, kitchen accessories, games, swings, storage bins, garden sets, etc., at little or no cost. Send only \$2.00 with name and address today. Money back if not pleased.

**POPULAR MECHANICS PRESS, Dept. PM-557**  
200 E. ONTARIO STREET CHICAGO 11, ILL.

These men are getting practical training in . . .

# ELECTRICITY

## ELECTRONICS

ON REAL

A.C. and D.C. Motors  
Generators  
Switchboards  
Controllers  
Appliances  
Electronic Units



# TELEVISION

## COLOR-TV

ON REAL

Television  
Receivers  
Including Color TV  
AM and FM Radios  
Auto Radios  
Test Equipment



# Train in Great Shops of COYNE

in Chicago—Prepare for a better job and a real future in TOP OPPORTUNITY FIELDS. Train on real full-size equipment at COYNE where thousands of successful men have trained for nearly 60 years—largest, oldest, best equipped school of its kind—est. 1899. Trained instructors show you how, then do practical jobs yourself. No previous experience or advanced education needed. Employment Service to Graduates.

**START NOW—PAY LATER**—Liberal Finance and Payment Plans. Part-time employment help for students. **GET FREE BOOK**—"Guide to Careers in ELECTRICITY-ELECTRONICS and TELEVISION-RADIO"—no obligation; no salesmen will call. Vets and Non-Vets get vital facts now.

Coyne Electrical School 500 So. Paulina Street  
Chartered Not For Profit Chicago 12, Dept. 57-72H



MAIL COUPON TODAY!

COYNE ELECTRICAL SCHOOL

500 S. Paulina St., Chicago 12, Ill., Dept. 57-72H

Send BIG FREE book and details of your training offer by return mail. I am interested in:

Electricity-Electronics  Television-Radio

Name \_\_\_\_\_

Address \_\_\_\_\_

City \_\_\_\_\_ State \_\_\_\_\_

## JITTERBUG • CATCHES MORE FISH

Noisy surface bait. World's best hooker—day or night. Gurgling, paddling action of the double-labeled lip makes fish strike hard. 5/8 oz. or 3/8 oz. or 1/4 oz. spinning size \$1.35. Musky size \$2.00.

FRED ARBOGAST Co., Inc., 2245 W. North Street, Akron 3, Ohio



**FREE** WRITE TODAY FOR YOUR BIG FREE ARBOGAST COLOR CATALOG—FULL OF PICTURES OF CATCHES

## Learn To MOUNT BIRDS

Here's!  
Best  
Hobby  
for  
Fun &  
Profit

**TAN SKINS, MAKE UP FURS**  
Be a Taxidermist. We teach you at Home. Mount Birds, Animals, Pets, common specimens. Save your hunting trophies. Decorate home and den. Make genuine **KROME LEATHER**, tan and make up furs for sparetime profit. **INVESTIGATE TODAY** 48 pages—tells all about it. Hunters, get your copy. It's Now Free. Send your card. State your AGE. IN. W. SCHOOL OF TAXIDERMY, DEPT. 2505, Omaha, Nebr.



## MEN! Make UP TO \$1000 IN A MONTH

without "SELLING"  
Sensational Demand for Low-Priced Fire Alarm  
PLUS Sure-Fire "No-Selling" Plan Offers  
Ambitious Men Huge Profit Opportunities

Even beginners are clearing up unbelievable profits with first effective low-priced Merlite Fire Alarm. Needed in homes, stores, offices, farms. Hangs on wall like picture, no installation, no plug-in. Always on guard, HOWLS 1 1/2-mile blast, automatically, when fire starts, allows up to 5 minutes escape-time. \$4.95 seller with up to \$2.70 profit for you!

Nearest Thing to Automation Selling. On exciting "No-Selling" Plan, customers sell themselves. No hard selling, no cold canvassing. We give you powerful sales tools you leave with prospects. They sell for you while you sleep!

**FREE!** Rush, name, address NOW for big Illustrated Sales Kit, with easy "No-Selling" Plan. Learn how only 20 Fire Alarms a day pay you \$1,080.00 a month. Everything, FREE, no obligation. Write NOW to MERLITE, Alarm Div., 114 E. 32nd St., Dept. S-15W, N.Y. 16  
In Canada: Mopa Co., Ltd., 371 Dowd St., Montreal 1, P. Q.

## Sig Spaeth Says: My Amazing New Easy Method Shows You HOW TO PLAY THE HOHNER HARMONICA The Very First Day!



Here's the magic key to popularity! Following Dr. Spaeth's simple diagrams anyone can play popular tunes on a Hohner Marine Band Harmonica right off. No knowledge of music is required. If you can read this ad you can play!

This 35¢ Book  
**FREE** for a limited time

M. HOHNER, INC., Dept. M-57  
351 Fourth Avenue, New York 10, N. Y.  
Please send me New Easy Method Book.

Name \_\_\_\_\_

Address \_\_\_\_\_

City \_\_\_\_\_ Zone \_\_\_\_\_ State \_\_\_\_\_

MAY 1957

33

start a big profit business  
with a small investment  
**EARN UP TO  
\$200 a DAY**

Manufacturing Exciting New  
**RAINBOW ROCK**  
Concrete Slump Brick  
in your back yard

Earn big building boom profits with Rainbow Rock, the colorful new building brick that's taking the country by storm. Sell all you can make to contractors, builders, building supply houses. **RAINBOW ROCK CUTS LABOR COSTS BY 1/3!** Amazing low cost machine makes modern slump brick 2 1/4" long (3 times the length of ordinary brick) in a variety of widths and pastel colors . . . up to 1500 bricks a day! **NEEDS NO SPECIAL SKILL.** Operates indoors or out. Full instructions and valuable mixing formulae supplied. **YOU CAN START EARNING BIG MONEY NOW. PAY AS YOU PROFIT!** A limited number of machines available on easy payment terms. **NOW** is the time to start. Write today for free literature and full information.

**GENERAL ENGINES CO., INC.**  
Dept. MR-57 — Route 130,  
Throfare, N. J. — Tilden 5-5401



**STEEL PIER SENSATION**  
Luxurious **RAINBOW ROCK** fireplace wall in living room of the "Home of the Century" in Atlantic City, N. J.'s *Steel Pier* . . . acclaimed by over 500,000 Summer, 1933 visitors as the most beautiful they'd ever seen. Endorsed by the Pier's famous architect, William F. B. Koelle.



Make beautiful, decorative fences, garden walls, garages, outside walls, room separators, etc.

**NOW SAVE 40% ON . . .  
OUTDOOR ELECTRIC LIGHTS**

**1957 Model POST & LANTERN**



**SOLID BRASS**, Lantern Inc'l. chimney. Completely Weatherproof. 9" sq. 13" high; Black Finish on Solid Brass. Solid Alum. Telescopic Post; Adj. 4' to 8'. Reg. \$26.45 Retail. Now **BOTH** for only \$16.95 F.O.B. N.Y.

**OUTDOOR WALL LANTERN**



**SOLID BRASS**, Satin Black Finish 5 1/2" wide, 8 1/2" high. Extends 6 1/2". Beautiful brass trim. Reg. \$7.25 Retail—Only \$4.95 F.O.B. N.Y.—**SPECIAL 2 for \$9.50.**

**FREE** wire stripper & cutter with each order for post, lantern & wall lite.

Mail check or M.O. today or \$5 deposit. Balance C.O.D. **MONEY BACK** guarantee.

**W. P. ELECTRIC CO., Box 263, Hartsdale, N.Y.**

**BRONZE FOUNDRY**



Schools • Home Workshops • Inventors

Make your own castings of aluminum, copper, bronze, silver. Foundry sets are available in three sizes including 2400 Deg. F. blast Furnaces. \$26.50; \$33.50; and \$46.00 f.o.b. Marysville or Lakewood. Free Circular.

**KANSAS CITY SPECIALTIES CO.** Dept. Box 8022, Marysville, Kans. P-5 or Box 7543, Lakewood, Colo.

**MEN WANTED**

Earn \$100 Per  
Week and up  
**AUTO DIESEL  
MECHANICS**

Master a trade with a future—learn Auto-Diesel mechanics in our shops. You learn with tools on real equipment. Earn while you learn. Many of our graduates earn \$100 per week and up. No previous experience necessary. Day and night courses. Approved for veterans. Write for free bulletin.

**NASHVILLE AUTO-DIESEL COLLEGE**

226 7th Ave., N., Dept. 75

Nashville 3, Tenn.

**GET RESULTS!  
RUPTURE RELIEF GUARANTEED!**



**RESULTS—OR YOUR MONEY BACK**  
Write now for free booklet and pictures of rupture care. You can be helped . . . work steady, with low cost, easy-to-wear Web Truss. Thousands satisfied.

**WEB TRUSS CO. Dept. M-5, Hagerstown, Maryland**

**SAVE 50% & MORE!  
GENUINE  
DIAMONDS**



Buy diamonds and diamond jewelry half-priced from Kaskel's, America's foremost Diamond Specialists. Every diamond is set in a luxurious new mounting . . . graded according to nationally accepted standard . . . and bonded to this effect. For over 70 years, we've served over 1,000,000 satisfied customers.

SEND FOR BIG  
**FREE**  
ILLUSTRATED  
**CATALOG**

**10 DAY UNCONDITIONAL MONEY-BACK GUARANTEE**  
References: Your bank, or any Rating Agency

**KASKEL'S**, 41 West 57 St., N. Y. 19, N. Y., Dept. 707-E  
Send FREE CATALOG and Advice about DIAMONDS without obligation. No Salesman Will Call.

NAME.....  
ADDRESS.....  
CITY..... STATE.....

**KEEP YOUR... ON BENJAMIN**  
for HIGH H.C. COMP  
"First in POWER and ACCURACY"  
**AIR GUNS & CO2 GAS GUNS—Top Quality at LOWEST PRICES!**



**BENJAMIN SUPER**  
CO2 Gas Carbine **\$14.95**  
with Reg. Stock as low as \$11.95  
DeLuxe Model with Custom Stock (Shows) as Low as \$17.95

Benjamin Air Rifles and Benjamin Air Pistols are Recognized All Over the World for Finest Workmanship and Highest Quality at Lowest Prices. Adjustable Power with Amazing Optimum Force. Fully Guaranteed—Safe—Accurate—Economical. Easy to Use anywhere—12 Models for Target and Small Game BB or 177 or 22.

All Models Benjamin CO2 Carbine Gas Rifles and Benjamin CO2 Rocket Gas Pistols Use Standard Size CO2 Cartridges (available everywhere). 2-Stage Hi-Lo Jet Power—High for Small Game—Low for Target—Up to 50 Shots from each Cartridge. No Pumping—Safe—Accurate—Economical—Non Toxic—12 Models BB or 177 or 22.

**FREE!** Catalog All Models Benjamin Air Guns & CO2 Guns & Supplies. Also, Money-Saving Offer on Hunting & Fishing Accessories.

Send Free Gas Catalog and Special Offer!  
**BENJAMIN AIR RIFLE CO., MAIL TODAY!**  
896 MARION ST., ST. LOUIS 4, MO., U.S.A.  
Name.....  
Address.....  
City..... State.....

**BUY WHOLESALE!**

30-80% Discounts! Appliances, Gifts, Typewriters, Tools, Watches, Sporting Goods, Jewelry, Cameras, Housewares, etc.

**CONSOLIDATED DISTRIBUTORS** CLIFTON 1, NEW JERSEY

**FOR BETTER WATER SKIING**



Fit your outboard motor with the **MICHIGAN PROPELLER** designed to give you greater thrust, quicker pull-ups, more skiing buoyancy. Send post-card for your **FREE** copy of our new 1957 **OUTBOARD CATALOG**. NOW! It contains propeller recommendations carefully engineered to provide better performance for every specific motor-boat-load combination—whether for skiing, speed, cruising or all around operation; also, fine line of skis, boat accessories.

**MICHIGAN WHEEL COMPANY** Dept. P-5  
Grand Rapids 3 Michigan

## ELECTROPLATING EQUIPMENT

SUPPLIES & INSTRUCTIONS for  
HOME WORKSHOPS  
JEWELRY MFRS.  
BABY SHOE METALIZERS  
INDUSTRIAL PLATERS

Complete Assemblies of  
COPPER, NICKEL, CHROME  
GOLD, SILVER. Chemicals  
& Anodes — small or large  
quantities.



COMPLETE COPPER, NICKEL,  
CHROME PLATING ASSEMBLY  
ONLY \$275.00

RECTIFIERS: 10 to 1000 amps.  
TANKS: Steel, Stainless,  
P.V.C., Rubber-Lined

FREE  
CATALOG

Complete line of metal and onyx baby shoe mountings.

**HOLLYWOOD BRONZE SUPPLY**

1624A East 1st St., Los Angeles 33, Calif.

## SHORTHAND IN 6 WEEKS

Famous SPEEDWRITING shorthand. 120 words  
per minute. No symbols; no machines; uses ABC's.  
Easiest to learn, write and transcribe. Low cost.  
250,000 graduates. For business and Civil Service.  
Typing available. 34th Year. Schools in over 400  
cities. Write for FREE booklet to:

**Speedwriting**  
Dept. 1505-7  
85 W. 42 St., N.Y. 36, N.Y.

6  
WEEKS

**\$2.95 OR 2 FOR \$5.00!**

TESTED AND GUARANTEED

Write for free list on all types of telephones.  
Shipments F.O.B. Simpson, Pa.  
TELEPHONE ENGINEERING CO., Dept. B57, Simpson, Pa.



New 1957  
SPORTABOUT  
CARS and  
GOLF CARS.  
Write for  
literature.

**ESHELMAN TRACTORS**

LOW AS \$99

Plows-Cultivates-Saws  
Dozer-Harrow-Rolls  
Hauls-Snow Plow  
Eshelman Tractors,  
Tillers, Riding Rotary  
Mowers for Better  
Lawns and Gardens.  
Advertised in GOOD  
HOUSEKEEPING. Thousands of  
satisfied users.  
Write for Free Literature.  
Dept. 134, ESHELMAN, Balto. 2, Md. \$491.25



Shipping Points: MILWAUKEE • CHICAGO • BANGOR

MAKE MORE \$ IN  
SPARE TIME HOURS!

Use "IDEAL"

Lawnmower Sharpener

New attachment makes  
Model 300 "Ideal" a  
perfect reel and rotary  
blade grinder—also  
sharpens shears, other  
tools! Ideal's exclusive  
"hook" grinding method  
insures quick, easy re-  
sults every time. Com-  
pare all facts and you'll  
buy "Ideal"—leading  
mower sharpener for 55  
years. Make more money  
—write for free catalog.

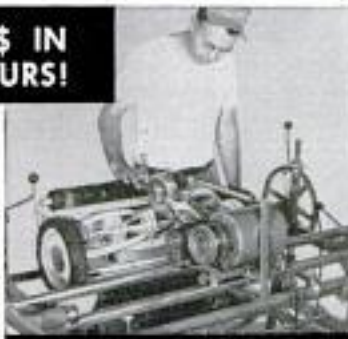

**Sharpens All Mowers**

• REEL TYPE • HAND  
• ROTARY • POWER

The FATE-ROOT-HEATH Co., Dept. PM-5, Plymouth, Ohio

MAKE MORE MONEY  
get into

TELERAMA • ALL 8 BRANCHES OF  
TELEVISION • ELECTRONICS  
• RADIO •  
IN ONE DYNAMIC, MODERN SHOP METHOD,  
HOME TRAINING COURSE

You get and keep  
ALL this modern, newest,  
practical equipment!

\*Registration  
applied for



YOU COVER ALL  
8 BRANCHES IN  
ONE MASTER COURSE,  
ONE LOW TUITION

1. Television—including color TV
2. Radio — FM & AM
3. Industrial electronics
4. Sound recording and Hi-Fidelity
5. Preparation for FCC License
6. Automation
7. Radar & Sonar
8. Communications

- Parts to build a modern TV set, including large screen Picture Tube.
- Parts to build a powerful Superhet Receiver, standard broadcast and short wave.
- Parts to conduct many experiments and build — • Continuity Checker • RF Oscillator • TV Circuits • Audio Oscillator • TRF Receiver • Signal Generator
- Professional Multitester
- A MUST for all technicians

FOR MEN WHO WANT TO EARN MORE MONEY!  
Another great advance in Home Study  
Training. Let National Schools, of Los  
Angeles, a practical Technical Resident  
Trade School for over 50 years, train you at home by Shop-Method,  
for today's unlimited opportunities in ALL 8 BRANCHES of the Tele-  
vision, Electronics, Radio industry.

YOU DO MANY PRACTICAL JOBS — including servicing, circuit analy-  
sis. Build a modern TV set from ground up, with equipment kits we  
send you, including a new large-screen picture tube and professional  
Multitester, at no additional charge. You receive an experiment les-  
son with each kit. **EARN AS YOU LEARN.** Graduate Employment Service.

SEND FOR FREE  
FACT-BOOK  
AND SAMPLE LESSON

RESIDENT TRAINING AT LOS ANGELES  
If you wish to take Resident Training at Los  
Angeles in our big, modern Shops, Labs, and  
Studios check special box in coupon for full  
information.



**NATIONAL SCHOOLS**

4000 S. FIGUEROA ST., LOS ANGELES 37, CALIF.

**NATIONAL SCHOOLS**

TECHNICAL TRADE TRAINING SINCE 1905  
Los Angeles, California

GET FAST SERVICE — MAIL NOW TO

NATIONAL SCHOOLS, DEPT. RB-57  
4000 S. FIGUEROA ST.  
LOS ANGELES 37, CALIF.

Rush free TV-Radio "Opportunity" Book and sample  
lesson. No salesman will call.

NAME \_\_\_\_\_ BIRTHDAY \_\_\_\_\_ 19 \_\_\_\_\_

ADDRESS \_\_\_\_\_

CITY \_\_\_\_\_ ZONE \_\_\_\_\_ STATE \_\_\_\_\_

Check if interested ONLY in Resident School Training at Los Angeles  
VETERANS: Give date of discharge.

**AT YOUR  
NEWSSTAND  
NOW!**



**KEEP UP-TO-DATE ON  
THE MARVELOUS  
WORLD OF SCIENCE  
WITH THIS  
WONDERFUL MAGAZINE**

Pick up a copy of SCIENCE DIGEST today . . . and become acquainted with the pocket-sized magazine that tells you "what this Changing World means to you."

Expert editors choose the finest articles on atomic science, chemistry, anthropology, medicine, electronics, etc., from the magazines and books of the world . . . and present them to you in easy-to-understand form.

You'll like this magazine. At your newsstands . . . only 35¢. One year subscription: \$3.50.

**ADDRESS: DEPT. X-21, SCIENCE DIGEST  
200 East Ontario Street • Chicago 11, Illinois**

**INVENTORS**

**PROTECT YOUR INVENTION BY A U. S. PATENT. SEND FOR FREE "INVENTION RECORD" FORM AND "PATENT INFORMATION EVERY INVENTOR SHOULD HAVE."**

**CARL MILLER**  
REGISTERED PATENT ATTORNEY  
WOOLWORTH BLDG., 36th FLOOR, 57A  
NEW YORK CITY

**INVENTORS**

Whether an invention is patentable can be substantially determined by a search of the U. S. Patent records. Without obligation, write for information explaining the steps you should take to secure a patent.

**JOHN N. RANDOLPH**  
Registered Patent Attorney  
201 Columbian Building, Washington 1, D. C.

**INVENTORS**

Send for **PATENT INFORMATION** Book and **INVENTOR'S RECORD** without obligation  
**GUSTAVE MILLER**  
57-PM WARNER BUILDING  
WASHINGTON 4, D. C.

**REGISTERED PATENT ATTORNEY**  
ASSOCIATE EXAMINER  
U.S. PAT. OFF. 1922-1929  
Patent Attorney & Advisor  
U. S. NAVY DEPT. 1930-1947  
**PATENT LAWYER**

**INVENTORS** consult **GEORGE SPECTOR**  
MASTERS DEGREE IN ENGINEERING  
FORMER U. S. PATENT OFFICE ASSISTANT EXAMINER (1948-51)  
18 JOHN STREET — N. Y. C. 38, N. Y. — RE 2-1464



**YOU CAN BUILD A VIOLIN FOR PLEASURE OR PROFIT**

Now you can build a rich toned mellow violin modeled after a famous "Strad." YOU CAN MAKE A STRADIVARIUS VIOLIN contains 8 full scale plans plus complete instructions. You work directly from the plans with no confusing scale of dimensions to translate. Detailed instructions for each step including varnishing and strutting—even shows how to build your own tools. Cloth bound. Order today from

**POPULAR MECHANICS PRESS** . . . \$3.50  
Dept. 457, 200 East Ontario Street, Chicago 11, Illinois



**INVENTORS**

U. S. Patents protect your inventions. Our free book of "Instructions on Patent Procedure for Inventors," also "Certificate of Invention" form sent without obligation.

**C. A. SNOW & CO.**  
REGISTERED PATENT ATTORNEYS  
428 SNOW BUILDING WASHINGTON 1, D. C.

**INVENTORS**

I shall be pleased to furnish you, upon request, with full information relative to patent procedure—without any obligation on your part.

**PATRICK D. BEAVERS**  
Registered Patent Attorney  
934 Columbian Building Washington 1, D. C.

**CONFISCATED  
RUSSIAN**

**RED  
ARMY RIFLE**

**EXCELLENT FOR BIG GAME**

**GOLDEN STATE ARMS CORP.**

"The Rifle of the Comintern." Used in Spain (1937), Korea, French Indo-China, Egypt and Hungary. These confiscated from revolutionaries. Their tale benefits no iron curtain country. A hard-hitting accurate big game rifle. The Russian won the international meet at Caracas (1954) with this gun, known as the *Mosin-Nagant*. 6-shot, bolt action, 7.62MM. Bore fair, mechanically perfect. Powerful 2820 FPS w/150 gr. ammo. A game collector's item. Red Russian ordinance and proof marks on receiver. **FREE**: 30 rd. mil. ammo with each gun. **ADD**: AMMO: military, 100 rds., \$7.50 **SPORTING AMMO**: softnose, 20 rds., \$2.95. **TO ORDER**: send check, cash or M.O. \$5 dep. for COD. Calif. send. add 4% state tax. **DEALERS INQUIRE.**

**\$14.95**

386 W. Green St., Pasadena 56, Calif.

**AMAZING NEW "TI-NEE" RADIO!**

**GUARANTEED TO WORK FOR YOUR LIFETIME!** USES NO TUBES. BATTERIES OR ELECTRICAL PLUG-INS. Never runs down! **SMALLER THAN A PACK OF CIGARETTES!** RECEIVES LOCAL RADIO STATIONS MOST ANYTIME. ANYWHERE WITHOUT EXTRA ANTENNA. Uses crystal diode Hi-Q Tuner. Beautiful black gold speaker-phone grill—plastic cabinet.



**SEND ONLY \$2.00** (bill, ck, mo) and pay postman \$4.99 COD on arrival or send \$6.99 for postpaid delivery. **SENT COMPLETE READY TO LISTEN**—NOTHING EXTRA TO BUY EVER! Aerial kit included free for distant stations. Available only from:

**MIDWAY COMPANY, Dept. GPM-5, Kearney, Nebraska**



**119 JIG SAW PATTERNS**

**FULL-SIZE . . . trace on wood and saw out. Clever, ORIGINAL designs, things you can make to SELL.** Wall shelves, lawn signs, planters, book ends, others. **\$1 postpaid**

**BURGESS VIBROCRRAFTERS, INC.**

Rush \$1 today. **DEPT. C-28, Grayslake, Illinois**

**FRANCHISES**

Learn about the big profit field! Opportunities everywhere for distributors, dealers, agency operators. Write today for interesting letter giving free details.

**NATIONAL FRANCHISE REPORTS, C-528, 333 N. Michigan, Chicago 1**

**OWN a BUSINESS!**



**Earn \$8,750.00 your First Year!**

Start part time if you wish. We locally train you, furnish everything to clean and mothproof rugs, upholstery on location by world-wide process. Quickly established. No shop needed. Just 2 average jobs a day bring \$8,750 net profit in year. Employ others and multiply profits. You get National Advertising, Parents' Seal, 25 other regular services. Easy terms. Send today for free booklets.

**DURACLEAN CO., 7-165 Duraclean Bldg., Deerfield, Ill.**

Pyroil "A" add to gas . . . 3 oz. can 30c . . .

at your service station.

35c in Canada

**TUNE UP YOUR ENGINE  
WHILE YOU DRIVE**

**Pyroil Stops Ping Quick!**

freed sticky valves and gives your motor more pep and power. Lubricates the hottest, driest part of your engine, makes it run better and last longer. Write for trial offer. Pyroil Co., Inc., Dept. PM-57, La Crosse, Wis.—Toronto, Can.



Manufacturers of Super Lubricants  
Flex-O-Fix • Champ and Silver  
Bullet Oil Filter Cartridges  
World Famous Since 1929

**High School  
at Home**

**MANY FINISH IN 2 YEARS**

No classes. No time wasted going to and from school. Progress as fast as your time and abilities permit. Standard H. S. texts supplied. Thousands enroll each year in this 60-year-old school. Send for **FREE** descriptive booklet.

**AMERICAN SCHOOL, Dept. H545  
Drexel at 58th St., Chicago 37, Ill.**

Without obligation, please send **FREE** descriptive booklet.

Name.....

Address.....

Complete Canadian Courses available. Write American School, Dept. H545, 6083 Sherbrooke St. W., Montreal

**Get info.. PLASTIC LAMINATING AT HOME!**



**THIS MAN . . .**  
... is taking out of the machine a Plastic Sealing Job—ordered by mail—only 11c in material cost brings back \$2.58 in cash by mail. Capacity of machine: **\$25.00 profit per hour of operation.**

Get **ORDERS** and **CASH** from your mailman—do work in **SPARE TIME** at home—or expand into **FULL TIME** business. Send coupon for Free facts about the newest and most fascinating of all home operated businesses. For the first time a simplified machine brings the fabulous profits of **Plastic Sealing and Plastic Laminating** within the reach of the small operator. Anyone can learn to operate the machine with a few minutes practice—then with our **Magic Mail Plan** can get mail orders pouring in daily with cash in every envelope. **No canvassing—no selling.** We even

**Make \$20 to \$30 a Day by..  
MAGIC MAIL PLAN!**

supply the circulars you mail to bring back cash and orders. Don't waste a minute. Rush your name. We'll send you **FREE** and postpaid, pictures, prices, details, and all the facts you need to start. Mail coupon or send name on postcard. No charge. **Warner Electric Co., 1512 Jarvis Av., Dept. L-10-F, Chicago 26, Ill.**

**Make Thousands of Beautiful Art Creations**  
**COSTUME JEWELRY • CIGARETTE BOXES  
TRAYS • CANDLESTICKS • COASTERS  
LAMP BASES • BOOK ENDS...ALL IN  
SPARKLING COLORED PLASTIC**



**WARNER ELECTRIC CO., 1512 Jarvis Av.  
Dept. L-10-E, Chicago 26, Ill.**  
At no cost to me, please rush complete details postage prepaid. I am under no obligation.

Name.....

Address.....

City..... Zone..... State.....

Make Your Own...

## WATER SKIS and SAVE MONEY

FIBRE GLASS REINFORCED TIP



**JUNIOR SIZE** \$19.95  
52" Complete only..... Pair

**SENIOR SIZE** \$21.95  
70" Complete only..... Pair

(Add \$1.00 west of Denver)

**NO DELIVERY CHARGES!**

**KIT INCLUDES EVERYTHING  
NO EXPERIENCE NECESSARY  
FIBRE GLASS TIP**

- ★ ADDS EXTRA STRENGTH!
- ★ ASSURES TOP PERFORMANCE!
- ★ GREATER MANEUVERABILITY!

Kit includes moulded foot harnesses—all necessary hardware and easy-to-follow illustrated assembly instructions. All holes are predrilled and skis are sanded and sealed, ready for painting in your own individual way. They are of the very latest design and styling and are guaranteed against defective factory workmanship. If you are not satisfied in every way, return the kit within 15 days and all of your money will be returned to you. Immediate delivery. **ORDER TODAY.**

SEND CHECK OR M.O.—No C.O.D.'s  
**M-B CORPORATION**  
New Holstein, Wisconsin



**WHY**  
3 out of 4  
**PELLET GUN SHOOTERS**  
ASK FOR **Crosman**  
**Super Pellets®**

... the better ammunition for all pellet guns ... top accuracy and safety. Factory sealed in exclusive self-dispenser metal box. **FREE** ... new colorful 32-page Gun Book.

WRITE Crosman Arms Co., Inc.  
Dept. PM-5, Fairport, New York.

SAVE 1/2 - 2/3 THE PRICE OF FACTORY-BUILT BOATS

**BOAT  
KIT  
CATALOG  
Free!**

Write:



**LUGER INDUSTRIES, INC.** DEPT. 3404 Lyndale S.  
B-5 Minneapolis 8, Minn.

## Take the ache out of GUMS RUBBED SORE BY FALSE TEETH

Get quick-soothing relief of sore, throbbing gums by applying medically-formulated **NUM-ZIT Adult Strength**. Thousands of false teeth wearers have already had this blessed relief. Pleasant-tasting **NUM-ZIT** eases discomfort while you break in new false teeth. Works wonders, too, for relief of toothache, neuralgic pains. Keep it handy for quick first aid. *At all drug counters.*

**Adult NUM-ZIT**

Another fine Purepac product

**ENGINEERING  
DEGREE IN  
27 MONTHS**

B. S. Degree, Aero., Chem., Civil, Elec., Mech. & Electronic Eng. (inc. Radio & TV). B.S. degree in 36 mo. in Math., Chem., Physics, Prep. courses. Low rate. Earn board, large industrial center. Students from 48 states, 21 countries. Demand for grads. G.I. app. Enter June, Sept., Dec., March. Catalog 1657 E. Washington Boulevard Fort Wayne 2, Indiana

**INDIANA TECHNICAL COLLEGE**



**WANTED-USED  
ACCORDIONS**

**SPOT CASH!** Any style, make or size. Need at once for schools, hospitals, institutions. Highest prices paid. Fast service. Free appraisal by bonded appraiser. Insured while in our possession. No risk. We pay freight charges. Write at once for **FREE** shipping kit. Include brief description of accordion. Write **CHICAGO ACCORDION CENTER** Dept. PM, 754 N. Damen Av., Chicago 22, Ill.

**TASOPE PHOTO-ENGRAVING PLANTS**



Establish your own profitable **PHOTO-ENGRAVING** business. Make cuts for newspapers, printers, and advertisers. Make etched name plates, plaques etc. Instructions furnished, no experience necessary. Sold direct from factory since 1931. First five hundred cuts sold locally or by mail will pay for plant and pay you well for your time. Write for **FREE** catalog.

Material Cost Of This Cut 36c Selling Price \$1.00 And Up

TASOPE, DEPT. PM-5, AURORA, MO.

**250 POWER . . . .**



**Complete Telescope Lens Kit** **PLUS** **only \$3.49** postpaid

Conquer Space, Explore the Universe, Planets, Moon Craters, New Stars, etc. Complete Lens Kit consists of 80 inch focal length ground and polished objective lens, eyepiece lenses for 50 POWER, 100 POWER, 150 POWER, 200 POWER, 250 POWER, and all necessary lens fittings. Easy to make from simple step by step instructions. (Tripod and mount not included.) Money back guarantee.

**BUSSE SALES CO., Hartford, Conn., Dept. PM 57**

**NOW! It's EASY To REMOVE  
STUMPS** With "MAGIC"  
**STUMP REMOVER**

All you do is pour "Magic" Stump Remover—a new, quick-acting chemical compound—into hole drilled in center of stump. Wood fibres soon decompose all way to root tips, making removal easy—even for women and youngsters!

**SPECIAL TRIAL OFFER:** 8-oz. Can (enough for one stump)—  
\$1.50; 16-oz. — \$2.50; 3 lbs. \$5.00. Send no money! Pay postman. Plus postage. (Or send full amount with order for postpaid delivery.)

**No Digging! No Chopping!  
No Blasting!**



**FREE!** Generous sample of "GRO-GREEN," new liquid lawn fertilizer, with each Stump Remover order.  
**H. D. CAMPBELL CO.** Rochelle 43, Ill.



# Make SURE, SAFE INSULATED ELECTRICAL CONNECTIONS

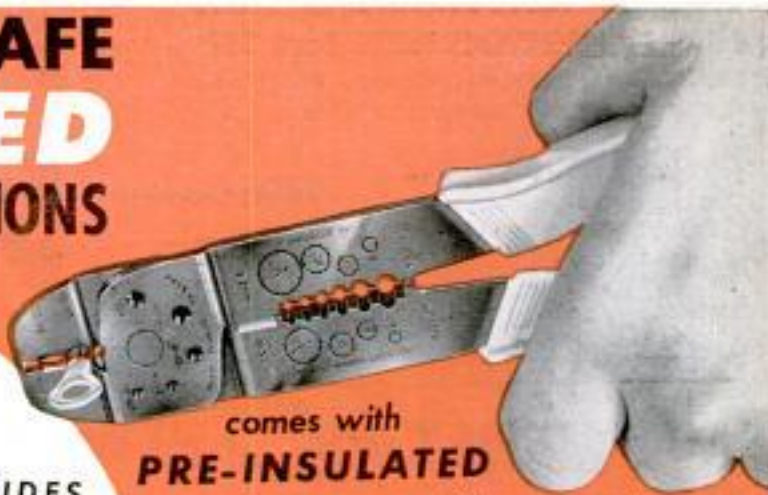

## The New SUPER ~~CHAMP~~ Hand Tool

The ONE Tool for ALL Wire Sizes used in Home Wiring, Appliances, Automobiles.

### DOES ALL THESE THINGS BESIDES

**CRIMPS** Solderless Terminals and Connectors without solder or tape for safe connections.

**CUTS** Wire, making clean, sharp cut through Insulation and Conductor.

**STRIPS** Wire sizes #22-#10. Gauges assure proper length for sure, safe crimp.

**SHEARS** Bolts and screws without damaging threads — no filing or hack sawing.

comes with  
**PRE-INSULATED**

Splices

Connectors

Terminals

**FREE with Each TOOL**

### ORDER DIRECT—USE COUPON

Only  
**\$3.95**  
Post Paid

Satisfaction guaranteed or money back. Send check or money order for \$3.95.

T. W. Berger  
National Distributor  
Manufactured by  
**AMP INCORPORATED**

T. W. Berger  
National Distributor Champ Tool  
Suite 401, 1700 Walnut St., Phila. 3, Pa.

Send me post paid the new Super Champ Hand Tool. I am enclosing \$3.95. (Incl. state sales tax where applicable)

check  money order

NAME .....

ADDRESS .....

CITY ..... ZONE ..... STATE .....

**make your own Gems** <sup>32.50</sup><sub>P.O.B.</sub>

The Gem Maker comes complete with all necessary equipment, including a super-charged diamond blade for sawing, and all wheels for grinding, shaping and polishing; also complete instructions. The complete equipment as shown, less motor and belt, for only \$32.50, f.o.b., Burlington, Wisconsin. Write today for information and literature.

**B & I MANUFACTURING CO.**  
Dept. P, Burlington, Wis.



# PLAY RIGHT AWAY

## ANY INSTRUMENT

—even if you don't  
know a single note now!

**N**OW it's EASY to learn ANY instrument. No boring exercises. Even if you don't know a single note now, we'll have you playing delightful pieces RIGHT AWAY—right from your FIRST lesson! And properly, BY NOTE. Simple as A-B-C. Make amazing progress. No special "talent" needed. Learn at home in spare time, without a teacher. Only a few cents per lesson. Soon you can play any piece you wish. 900,000 students. (Now in our 59th successful year.)

### FREE 36-PAGE ILLUSTRATED BOOK

—just send this ad, with your name and address filled in below to: **U. S. School of Music, Studio A305, Port Washington, N. Y.** (No obligation, no salesman will call.)

Name .....

Address .....



## RHEUMATISM

NEURITIS • SCIATICA • LUMBAGO

Why continue to suffer agonizing pains when usual remedies have failed. Learn how thousands have been successfully treated by an amazing new method which is fully explained in our New FREE Book. Don't wait. Write today. No obligation.  
EXCELSIOR INSTITUTE, Dept. C9806, Excelsior Spgs., Mo.

Personal

JIM:

I found the machine we've been looking for. The name is UNIMAT and it's a complete 10 in 1 workshop that's no bigger than a typewriter. It quickly converts from precision lathe into 10 different tools and you just can't beat it for machining small parts made of steel, brass, aluminum, wood and plastics. The price is right, too. Get the whole story. For free catalog write to: American Edelstaal, Inc. Unimat Division, Dept. 357, 350 Broadway, N.Y.C. 13, N. Y.

**POPULAR MECHANICS PRESS, Dept. 557****200 E. Ontario Street, Chicago 11, Illinois**

Gentlemen: Please send copies of book nos.:

1 2 3 4 5 6 7 8 9 10 11 12 13 14  
15 16 17 18 19 20 21 22 23 24 25 26  
27 28 (circle numbers desired) Remittance enclosed Send C.O.D. (\$2.00 or more) I enclose \$\_\_\_\_\_

Name \_\_\_\_\_

Address \_\_\_\_\_

City \_\_\_\_\_ Zone \_\_\_\_\_ State \_\_\_\_\_

**FILL-IN and  
MAIL THIS  
← COUPON!****SAVE MONEY *with these* NEW DO-IT-YOURSELF BOOKS**

1. **HOW TO PAINT INSIDE AND OUT:** Step-by-step instructions. Easy to follow illus.
2. **HOW TO LAY LINOLEUM AND TILE:** How to get the best from your labors. Diagrams.
3. **HOW TO REMODEL YOUR BASEMENT AND ATTIC:** Planning ideas, hints, instructions. Illus.
4. **HOW TO TAKE CARE OF YOUR LAWN:** Detailed guide to a perfect lawn and healthy shrubs.
5. **HOUSE WIRING AND ELECTRICAL REPAIRS:** Ideas and instructions for the homemaker. Diagrams.
6. **SMALL BOATS YOU CAN BUILD:** Plywood dinghy, 15-ft. sailing knockabout, 8-ft. duckboat, etc.
7. **PLUMBING REPAIRS MADE SIMPLE:** Fix faucet noises, water hammer, clogged pipes yourself.
8. **FENCES, GATES, TRELLISES AND WALKS:** Variety of fences, etc., with instructions, diagrams.
9. **BUILT-IN FURNITURE FOR YOUR HOME:** Wall cabinet, wardrobe, linen closet, crib, etc.
10. **BUILD YOUR OWN BARBECUE:** Stone and brick fireplaces, grills, barbecue pits, etc.
11. **LAWN AND GARDEN PROJECTS:** Picnic furniture, folding chairs, garden pool, etc.
12. **THREE LOW-COST HOMES YOU CAN BUILD YOURSELF:** Build your own home—save half the cost.
13. **125 SIMPLE HOME REPAIRS:** Stop faucet leaks, replace sash cords, cut glass, etc.
14. **SIMPLE TELEVISION REPAIRS:** Only a screwdriver, pliers and soldering iron necessary.

15. **MODERNIZE YOUR KITCHEN:** Planning for convenience and economy. Ideas, diagrams.
16. **30 ONE-EVENING PROJECTS:** Decorative, easy-to-make chairs, lamps, tables, shelves, etc., for the home.
17. **HOW TO WINTERIZE YOUR HOME:** Prepare for bad weather. Make storm windows, repair roofs, etc.
18. **HOW TO SET UP YOUR HOME WORKSHOP:** Detailed layout plans for basement conversion. Diagrams.
19. **LANDSCAPING YOUR HOME AT LOW COST:** How to plan and plant beautiful home surroundings.
20. **CONCRETE CONSTRUCTION AROUND THE HOME:** How to make steps, walks, driveways, fireplaces, etc.
21. **REFINISHING FURNITURE, FLOORS AND WOODWORK:** What you need and how to do the job properly.
22. **HOW TO USE POWER TOOLS IN YOUR HOME WORKSHOP:** Basic and advanced operations, ideas, tips.
23. **HOW TO CURE YOUR LEAKY BASEMENT:** Causes of, and how to stop, dampness and water seepage.
24. **MONEY-SAVING HOUSEHOLD FORMULAS:** Safe, efficient polishes, cosmetics, etc., you can make.
25. **UPHOLSTERING AT HOME:** Using foam rubber, upholster chairs, benches, etc., at a big saving.
26. **HOW TO GET THE MOST OUT OF YOUR CIRCULAR SAW:** How to build and use this tool for best results.
27. **HOW TO MODERNIZE HARDWOOD FLOORS:** Step-by-step instructions and diagrams for renovation.
28. **HOW TO MODERNIZE WALLS AND CEILINGS:** Ideas for wall and ceiling treatments and how to carry them out.

**ONLY  
25¢ EACH****PLEASE NOTE**

Minimum Order Five (5) Books

**5 for  
\$1.00**

# YOUNG FAMILY MAN LOOKING AHEAD



That's an I.C.S. textbook in his hip pocket. Good to have handy. On the way to and from work, during lunch, after supper, whenever there are a few free moments, a man can train himself—in engineering, modern business, any one of 257 technical and academic courses. You learn fast because you set your own pace.

You really master your subject because you can apply what you learn directly to your job. It's a method that works! I. C. S. trained men go on to become foremen, supervisors, managers, leaders in business and industry. It's smart to look ahead. Start now by looking over the list of subjects in the coupon below.

For Real Job Security—Get an I. C. S. Diploma! I. C. S., Scranton 9, Penna. Member, National Home Study Council

## INTERNATIONAL CORRESPONDENCE SCHOOLS



BOX 17953E, SCRANTON 9, PENNA.

(Partial list of 257 courses)

Without cost or obligation, send me "HOW TO SUCCEED" and the opportunity booklet about the field BEFORE which I have marked X (plus sample lesson):

- |  |   |  |   |   |
|--|---|--|---|---|
| <p><b>ARCHITECTURE and BUILDING CONSTRUCTION</b></p> <ul style="list-style-type: none"> <li><input type="checkbox"/> Air Conditioning—Refrig.</li> <li><input type="checkbox"/> Architecture</li> <li><input type="checkbox"/> Architectural Interiors</li> <li><input type="checkbox"/> Building Contractor</li> <li><input type="checkbox"/> Building Estimator</li> <li><input type="checkbox"/> Building Maintenance</li> <li><input type="checkbox"/> Carpentry and Mill Work</li> <li><input type="checkbox"/> Heating</li> <li><input type="checkbox"/> Painting Contractor</li> <li><input type="checkbox"/> Plumbing</li> <li><input type="checkbox"/> Reading Arch. Blueprints</li> </ul> <p><b>ART</b></p> <ul style="list-style-type: none"> <li><input type="checkbox"/> Cartooning</li> <li><input type="checkbox"/> Commercial Art</li> <li><input type="checkbox"/> Fashion Illustrating</li> <li><input type="checkbox"/> Magazine Illustrating</li> <li><input type="checkbox"/> Show Card and Sign Lettering</li> <li><input type="checkbox"/> Sketching and Painting</li> </ul> <p><b>AUTOMOTIVE</b></p> <ul style="list-style-type: none"> <li><input type="checkbox"/> Auto Body Rebuilding</li> <li><input type="checkbox"/> Auto Elec. Technician</li> <li><input type="checkbox"/> Auto-Engine Tune Up</li> <li><input type="checkbox"/> Automobile Mechanic</li> </ul> | <p><b>AVIATION</b></p> <ul style="list-style-type: none"> <li><input type="checkbox"/> Aeronautical Engineering Jr.</li> <li><input type="checkbox"/> Aircraft &amp; Engine Mechanic</li> </ul> <p><b>BUSINESS</b></p> <ul style="list-style-type: none"> <li><input type="checkbox"/> Advertising</li> <li><input type="checkbox"/> Bookkeeping and Accounting</li> <li><input type="checkbox"/> Business Administration</li> <li><input type="checkbox"/> Business Correspondence</li> <li><input type="checkbox"/> Public Accounting</li> <li><input type="checkbox"/> Creative Salesmanship</li> <li><input type="checkbox"/> Federal Tax</li> <li><input type="checkbox"/> Letter-writing Improvement</li> <li><input type="checkbox"/> Office Management</li> <li><input type="checkbox"/> Professional Secretary</li> <li><input type="checkbox"/> Retail Business Management</li> <li><input type="checkbox"/> Sales Management</li> <li><input type="checkbox"/> Stenographic-Secretarial</li> <li><input type="checkbox"/> Traffic Management</li> </ul> <p><b>CHEMISTRY</b></p> <ul style="list-style-type: none"> <li><input type="checkbox"/> Analytical Chemistry</li> <li><input type="checkbox"/> Chemical Engineering</li> <li><input type="checkbox"/> Chem. Lab. Technician</li> <li><input type="checkbox"/> General Chemistry</li> <li><input type="checkbox"/> Natural Gas Prod. &amp; Trans.</li> <li><input type="checkbox"/> Petroleum Engineering</li> <li><input type="checkbox"/> Plastics</li> <li><input type="checkbox"/> Pulp and Paper Making</li> </ul> | <p><b>CIVIL, STRUCTURAL ENGINEERING</b></p> <ul style="list-style-type: none"> <li><input type="checkbox"/> Civil Engineering</li> <li><input type="checkbox"/> Construction Engineering</li> <li><input type="checkbox"/> Highway Engineering</li> <li><input type="checkbox"/> Reading Struct. Blueprints</li> <li><input type="checkbox"/> Sanitary Engineering</li> <li><input type="checkbox"/> Structural Engineering</li> <li><input type="checkbox"/> Surveying and Mapping</li> </ul> <p><b>DRAFTING</b></p> <ul style="list-style-type: none"> <li><input type="checkbox"/> Aircraft Drafting</li> <li><input type="checkbox"/> Architectural Drafting</li> <li><input type="checkbox"/> Electrical Drafting</li> <li><input type="checkbox"/> Mechanical Drafting</li> <li><input type="checkbox"/> Mine Surveying and Mapping</li> <li><input type="checkbox"/> Plumbing Drawing and Estimating</li> <li><input type="checkbox"/> Structural Drafting</li> </ul> <p><b>ELECTRICAL</b></p> <ul style="list-style-type: none"> <li><input type="checkbox"/> Electrical Engineering</li> <li><input type="checkbox"/> Electrical Maintenance</li> <li><input type="checkbox"/> Electrician <input type="checkbox"/> Contracting</li> <li><input type="checkbox"/> Lineman</li> </ul> <p><b>HIGH SCHOOL</b></p> <ul style="list-style-type: none"> <li><input type="checkbox"/> Commercial <input type="checkbox"/> Good English</li> <li><input type="checkbox"/> High School Subjects</li> <li><input type="checkbox"/> Mathematics</li> </ul> | <p><b>LEADERSHIP</b></p> <ul style="list-style-type: none"> <li><input type="checkbox"/> Foremanship</li> <li><input type="checkbox"/> Industrial Supervision</li> <li><input type="checkbox"/> Leadership and Organization</li> <li><input type="checkbox"/> Personnel-Labor Relations</li> </ul> <p><b>MECHANICAL AND SHOP</b></p> <ul style="list-style-type: none"> <li><input type="checkbox"/> Gas—Electric Welding</li> <li><input type="checkbox"/> Heat Treatment <input type="checkbox"/> Metallurgy</li> <li><input type="checkbox"/> Industrial Engineering</li> <li><input type="checkbox"/> Industrial Instrumentation</li> <li><input type="checkbox"/> Industrial Supervision</li> <li><input type="checkbox"/> Internal Combustion Engines</li> <li><input type="checkbox"/> Machine Design-Drafting</li> <li><input type="checkbox"/> Machine Shop Inspection</li> <li><input type="checkbox"/> Machine Shop Practice</li> <li><input type="checkbox"/> Mechanical Engineering</li> <li><input type="checkbox"/> Quality Control</li> <li><input type="checkbox"/> Reading Shop Blueprints</li> <li><input type="checkbox"/> Refrigeration</li> <li><input type="checkbox"/> Sheet Metal Worker</li> <li><input type="checkbox"/> Tool Design <input type="checkbox"/> Toolmaking</li> </ul> <p><b>RADIO, TELEVISION</b></p> <ul style="list-style-type: none"> <li><input type="checkbox"/> Industrial Electronics</li> <li><input type="checkbox"/> Practical Radio TV Eng'ng</li> <li><input type="checkbox"/> Radio and TV Servicing</li> <li><input type="checkbox"/> Radio Operating</li> </ul> | <ul style="list-style-type: none"> <li><input type="checkbox"/> Television Technician</li> </ul> <p><b>RAILROAD</b></p> <ul style="list-style-type: none"> <li><input type="checkbox"/> Air Brake Equipment</li> <li><input type="checkbox"/> Car Inspector</li> <li><input type="checkbox"/> Diesel Engineer &amp; Fireman</li> <li><input type="checkbox"/> Section Foreman</li> </ul> <p><b>STEAM AND DIESEL POWER</b></p> <ul style="list-style-type: none"> <li><input type="checkbox"/> Combustion Engineering</li> <li><input type="checkbox"/> Diesel—Elec. <input type="checkbox"/> Diesel Eng'g</li> <li><input type="checkbox"/> Electric Light and Power</li> <li><input type="checkbox"/> Stationary Fireman</li> <li><input type="checkbox"/> Stationary Steam Engineering</li> </ul> <p><b>TEXTILE</b></p> <ul style="list-style-type: none"> <li><input type="checkbox"/> Carding and Spinning</li> <li><input type="checkbox"/> Cotton, Rayon, Woolen Mtg.</li> <li><input type="checkbox"/> Finishing and Dyeing</li> <li><input type="checkbox"/> Loom Fix'g <input type="checkbox"/> Textile Des'ing</li> <li><input type="checkbox"/> Textile Eng'g <input type="checkbox"/> Throwing</li> <li><input type="checkbox"/> Waring and Weaving</li> </ul> <p><b>MISCELLANEOUS</b></p> <ul style="list-style-type: none"> <li><input type="checkbox"/> Domestic Refrigeration</li> <li><input type="checkbox"/> Marine Engineering</li> <li><input type="checkbox"/> Ocean Navigation</li> <li><input type="checkbox"/> Professional Engineering</li> <li><input type="checkbox"/> Short Story Writing</li> <li><input type="checkbox"/> Telephony</li> </ul> |
|--|---|--|---|---|

Name \_\_\_\_\_ Age \_\_\_\_\_ Home Address \_\_\_\_\_

City \_\_\_\_\_ Zone \_\_\_\_\_ State \_\_\_\_\_ Working Hours \_\_\_\_\_ A.M. to P.M. \_\_\_\_\_

Occupation \_\_\_\_\_ Canadian residents send coupon to International Correspondence Schools, Canadian, Ltd., Montreal, Canada. . . . Special tuition rates to members of the U. S. Armed Forces.

# Gas-Turbine Rover Presages Future

British engineers have built what may be the first "normal" car expressly designed for a gas-turbine. It's not ready for production yet, but Rover Motor Company officials cautiously predict it will be in three years. The two-seater has a four-wheel drive. It will exceed 150 miles per hour and accelerate from 0 to 60 in 10.5 seconds.



## Sunspot Activity May Bring TV Overseas

Sunspot activity, now at a peak in an 11-year cycle, may "bounce" European television programs across the Atlantic to the United States. Sunspots affect the earth's magnetic field and disrupt long-distance radio communications. When the sun is very active, a layer of ionized air about 200 miles above the earth's surface is affected so that it often reflects radio signals sharply, causing erratic long-distance reception. The foreign telecasts are already being monitored by NBC engineers.

## Sound "Paralyzes" Bees Until Beekeeper Gets Honey

Sound vibrators may replace the use of smoke in protecting beekeepers while they remove honey from hives. The vibrator frees both hands for work but makes ear plugs necessary. With a frequency of 600 cycles per second (about second E above middle C on a piano) at a level of 120 decibels (equivalent to hammer blows on a steel plate two feet from your ears), honeybees stand motionless. When the sound stops, normal hive activity resumes, say University of Pennsylvania scientists.

## SPEED REDUCER CLUTCH COMBINATION TRANSMISSION

GOVT. COST  
\$262.00  
SPECIAL  
SALE!

**\$4950**  
PRE-PAID



BRAND NEW  
SURPLUS

Speed Reducer  
alone worth  
triple this  
low price!

FULLY  
GUARANTEED

- Reduces speed at a 3-to-1 Ratio—These units hard to get at any price!
  - 2 Independent Output shafts, each separately controlled by its adjustable clutch
  - Rated up to 3.6 HP (electric), or 7.5 HP (gas engine)
  - Ball and Taper Roller Bearings throughout (smooth, quiet)
  - Input shaft 1-3/16" diameter, Output shaft 1-3/8" diameter
  - Weight 108 lbs.—Dimensions approx. 17 1/2" long x 8" wide x 8" high
- This SPEED REDUCER-CLUTCH COMBINATION can be utilized when low speeds are required . . . for starting heavy loads . . . or, for engaging and disengaging machine operation without stopping input drive. Supply limited!

ORDER DIRECT FROM THIS AD! WE PAY SHIPPING!

FREE Catalog of Hydraulics, Generators, Surplus

ROBERTS ELECTRIC CO., Dept. PM-624, 849 W. Grand, Chicago 22, Ill.

Do a Real Professional-Like Job  
Yourself and SAVE

## HOW to PAINT With Brush and Spray

Covers All Painting Methods and  
Materials

You can do professional-like painting and finishing jobs yourself and save about two-thirds of the cost. Sam Brown, noted craft authority, makes it so easy for you in his book, **HOW TO PAINT WITH BRUSH AND SPRAY**. Order your copy now and enjoy this tremendous saving. It covers exterior painting, wall and interior decorating, furniture finishing, concrete painting — every type of painting with brush, spray gun, roller and other methods. Tells what finish is best; what materials to use, etc. No previous experience needed. Fully illustrated. Order by mail. Only \$2.50. Money back if not pleased.

POPULAR MECHANICS PRESS, Dept. PMS57  
300 E. ONTARIO ST., CHICAGO 11, ILL.



You buy better when you buy brands advertised in POPULAR MECHANICS

PM TAG of  
INTEGRITY

## AUTHENTIC REMINGTON-RIDER ANTIQUE RIFLE



**\$1295**

In beautiful condition. These 11MM Antique Single Shot Rolling Block Rifles made by Remington, patented May 3, 1864. First full metallic cartridge rifle made in U.S. One of the simplest and strongest actions ever devised. A rare collector's item 55 1/2" bl. Sold somewhere in 19th cent. was standard arm of Central and S. Am. countries during this period. Carefully kept in government arsenal in grease possibly for 75 yrs. Gun, serviceable. We degrease and oil lightly. An impressive piece over your fireplace or on den wall. ALSO IN 7MM — we also have some of a later model Rem. Rolling Block in 7MM at \$14.95 each. Made about ten of center. Guaranteed serviceable, clean and well kept. You can bag everything from turkey to deer with this powerful single shot rifle. 7MM ammo. is made by Rem. and Win. AMMO: We have some modern military ammo for 7MM Model above at \$7.50 per 100 rd. TO ORDER: Send check, cash or M.O. 1/3 or more for C.O.D. Calif. res. add 4% state tax. 10-day money back guarantee.

GOLDEN STATE ARMS CORP.

386 W. Green St., Pasadena 52, Calif.

**BIGGER! BETTER! FINER! FASTER!**

**PENN  
YAN  
boats**

... this year's line of leaders includes luxury outboard runabouts, Trailboats, Cartops® and canoes. Types for cruising, fishing, skiing, racing. New work-free, leak-proof constructions, new treatment with germicide under pressure that proof-tests, adds years to boat life.

**FREE  
CATALOG:**  
44 pages, color  
illustrations.

Write Today!

**PENN YAN BOATS, Inc.**  
34th St., Penn Yan, N.Y.



**Find HIDDEN TREASURES**

GOLD, SILVER, PRECIOUS METALS with the Famous Model 27 Metal Detector. Lightweight, ultra-sensitive, low cost. None finer. Also GEIGER COUNTERS for uranium and the VIOLITE for tungsten. INFORMATION FREE

THE *Detection* CORP.

5528 Vineland Ave., No. Hollywood, Calif.



**RUPTURED?**  
NEW LASTING RELIEF

ENJOY NEW FREEDOM of action, peace of mind and comfort at work or play. Proven, patented MILLER holds your rupture back Day and Night—will bring you lasting relief. For free facts in plain wrapper, send name and address to: FRED B. MILLER, Manufacturer, Dept. 1-E, Hagerstown, Maryland.

Entirely  
Different

**100 BEST Woodworking Projects**

SELECTED FOR YOU BY POPULAR MECHANICS EDITORS. Enjoy the fun — the pride — of making things. Get 100 BEST WOODWORKING PROJECTS, complete with simplified instruction, plans, diagrams and more than 400 how-to-do-it pictures. Make all kinds of furniture, baby carriages, clocks, lamps, book shelves, fireplaces and other useful articles at little or no cost. Send only \$2.00 with name and address. Money back if not pleased.

POPULAR MECHANICS PRESS, Dept. 557, 200 E. Ontario St., Chicago 11



**New 1957  
SPORTABOUT  
CARS and  
GOLF CARS.**  
Write for  
literature.

**ESHELMAN TRACTORS** LOW AS \$99

For Better Lawns and Gardens investigate Eshelman Riding Rotary Mowers, Tillers, Tractors. Advertised in GOOD HOUSEKEEPING. Thousands of Satisfied Users. Write for Free Literature.

Dept. 135,  
ESHELMAN,  
Baltimore, Md.



**CHROME VANADIUM  
29 Pc. DRILL SET**



Specialty made for speed drilling. In sturdy plastic tool roll. Finest precision ground to the sharpest, longest lasting cutting edge obtainable; will easily and cleanly bite through hardwoods, plastics, aluminum, iron and the toughest steels. Unconditionally guaranteed for thousands of drillings. Full jobber length. Sizes by 6ths from 1/16" to 1/2". NOW... \$6.49 ppd. Also available with Turned Down Shanks to fit all 1/4" drills. In individual pocket roll... \$8.95 ppd.

**60 Pc. Set WIRE GAUGE  
CHROME VANADIUM DRILLS**

Top quality German import high test Chrome Vanadium Drills designed for speed drilling through toughest steels, woods, plastic, iron and aluminum. Precision ground, long-lasting cutting edges. Guaranteed to give years of satisfaction. A full 60 pc. set. Nos. 1 through 60. A \$14.95 value... \$5.40 NOW ONLY PLUS 30¢ PP. & HDLG. Same set above with Hest Metal Index... \$6.65 PLUS 30¢ PP. & HDLG. Also Available

20 Pc. Set — Nos. 61-80  
**WIRE GAUGE DRILLS**  
In plastic kit with marked pocket for each drill. ONLY ppd.

Send Check or M.O. C.O.D. fee extra. MONEY BACK GUARANTEE  
**SCOTT-MITCHELL HOUSE, INC.** DEPT. M-355, 611 BROADWAY  
NEW YORK 12, N. Y.

**DIESEL  
MECHANICS IN DEMAND**

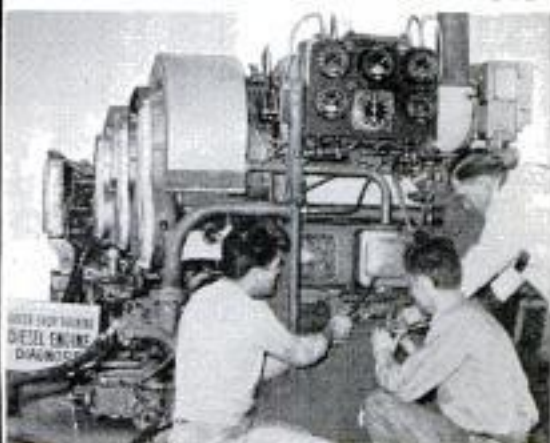

Learn to earn big pay in DIESEL in our large, modern equipped Chicago school and shop. No previous experience or training necessary. We help you find living quarters and part time job while in school. Complete, practical courses taught in the following trades, under the supervision of experienced, expert technicians.

APPROVED FOR CIVILIANS  OR GI'S

— CHOOSE YOUR TRADE —

CHECK HERE	WEEKS
<input type="checkbox"/> DIESEL MECHANICS	20
<input type="checkbox"/> AUTO MECHANICS	20
<input type="checkbox"/> BODY & FENDER	16 1/2
<input type="checkbox"/> GAS-ARC WELDING	4-12
<input type="checkbox"/> REFRIGERATION	13 1/2
<input type="checkbox"/> AIR CONDITIONING	8 1/2
<input type="checkbox"/> MACHINIST TRADE	30
<input type="checkbox"/> ADVANCED MACHINIST (includes tool & die)	32 1/2
<input type="checkbox"/> PIANO TUNING & REPAIR	36

**CHOOSE YOUR ENGINEERING COURSE**

These courses are intended as terminal education for men who wish to enter the Diesel-Automotive and Refrigeration-Air Conditioning fields as technicians. These courses are designed to prepare men for supervisory positions. Students with a high school education, or equivalent, will be accepted.

DIESEL AUTOMOTIVE ENGINEERING.....2 years  
 REFRIGERATION & AIR COND.  
ENGINEERING.....18 months

HEAVY CONSTRUCTION EQUIPMENT OPERATORS  
TRAINING SCHOOL FOR CIVILIANS—Road Building,  
Terracing, Land Clearing, etc. Reservations accepted now!

**FREE EMPLOYMENT HELP**

Start your career with Greer by checking your interest above and mail coupon for complete information at no obligation.

NAME \_\_\_\_\_ AGE \_\_\_\_\_

STREET \_\_\_\_\_

TOWN \_\_\_\_\_ ZONE \_\_\_\_\_ STATE \_\_\_\_\_

Established 1902 — Over 50,000 Graduates.  
55 years of continuous trade school experience  
to guide your training.

**GREER SHOP  
TRAINING**  
Box E, 2236 S. Michigan Ave.  
Chicago 16, Illinois

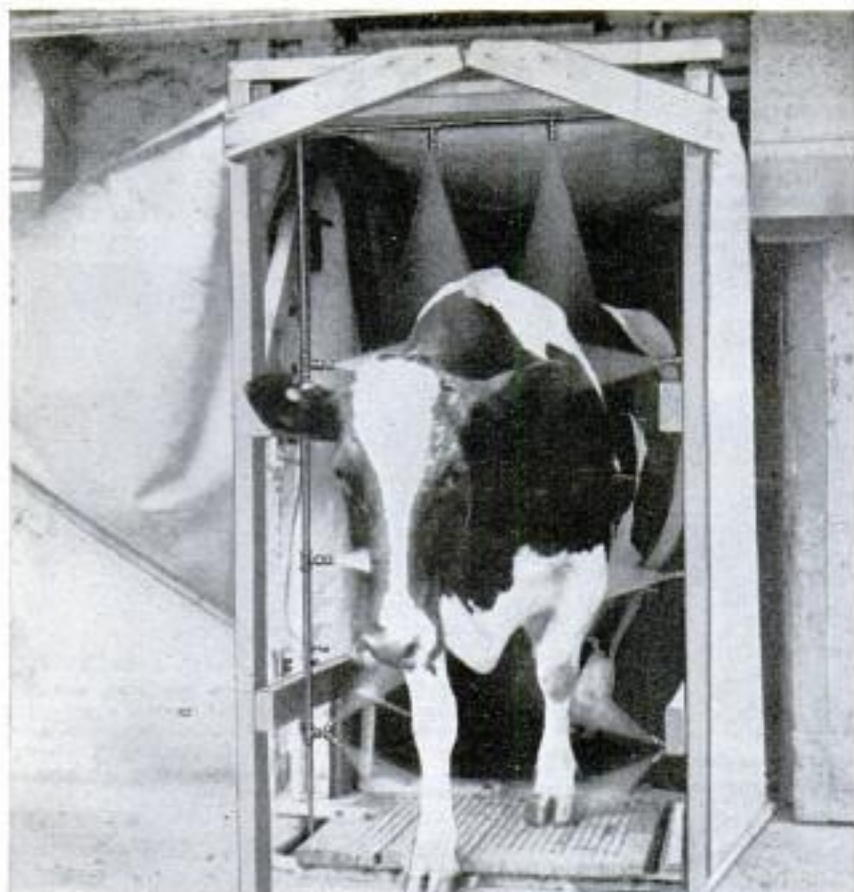

### Treadle for Cow Turns on Spray

Cows have a new weapon in fighting off flies. Dr. Tien-Hsi Cheng, professor of zoology at Pennsylvania State University, has developed a treadle to be installed as a sill at the barn door. When a cow steps on the treadle, it triggers a pump which squirts an insect spray through nozzles. The nozzles are positioned so they spray the chemical all over the cow's body. Professor Cheng's research has shown that horn flies are such a nuisance to cows that they hold back the animals' weight. When horn flies are eliminated, cows may gain from 40 to 70 pounds apiece. The treadle-operated spray reduces horn flies from 50 to 99 percent.

### Homemade Diesel Tractor Packs a Wallop

Plenty of power is packed into a tractor built by an Ohio farmer. A 200-horsepower diesel engine powers the four-wheel-drive tractor. The machine will pull five 16-inch

plows, a 10-foot double disk and a cultivator-mulcher simultaneously. Other features of the homemade tractor are hydraulic steering and bigger-than-average tires.



## DANGER AHEAD!

It's a life saver — the Delta Flashing Powerlite. Brilliant red flashing top light. Powerful side spotlight — all in one compact unit! 4-way switch. 6-volt battery. Get one! **\$5.69** Less battery, only **\$5**  
Delta Electric Co., Marion, Ind.



## Delta FLASHING POWERLITE ELECTRIC LANTERN

SPARE-TIME MONEYMAKING OPPORTUNITIES  
READ OUR CLASSIFIED ADS

HUNDREDS OF BARGAINS AMAZING OFFERS

Drawers float like a feather—with

## AMAZING NYLON BEARING DRAWER ROLLERS

Now, in minutes, give a lift instead of a drag to drawers in your home, office, trailer, etc., with amazing "Tiny Tots." Lifetime nylon rollers give finger tip float-action to even the heaviest, stubborn drawers. Stops sawdust from sifting down in drawers, too. Midget in size, but giant in strength! Use 2 on average drawers; 3 or 4 on heavier types. Simple to attach; directions included, 8 rollers \$1, SPECIAL 30 for only \$2.99 post. No C.O.D.'s. Order NOW!



2319K West Washington Blvd.  
Los Angeles 18, California

EDSCO PRODUCTS

## SEND ME



every month so I am sure to see each new issue. Here's

- \$3.50 for 1 year  
 \$8.00 for 3 years

name \_\_\_\_\_

address \_\_\_\_\_

city \_\_\_\_\_ zone \_\_\_\_\_ state \_\_\_\_\_

Hand this order to your newsdealer or send it to

POPULAR MECHANICS  
200 East Ontario St. Chicago 11, Ill.

## BUILD THE BEST FOR LESS!

BUILD ALLIED'S OWN ELECTRONIC

## knight®-kits

IT'S EASY  
IT'S FUN—  
and you save!

You'll marvel at how easy it is to build KNIGHT-KITS (with "step-and-check" instructions, it's like having a good instructor at your side). You'll be thrilled by KNIGHT-KIT performance—you'll be proud of your work—and you'll save money!

### 2-Transistor Pocket Radio Kit

Build this pocket-size, two-transistor radio—enjoy loud, clear broadcast-band reception wherever you go! Completely self-contained with built-in ferrite loop antenna—no external antenna needed. Printed-circuit board for easiest assembly. Efficient reflex-type circuit operates for months and months on long-life alkaline battery supplied. Super-sensitive miniature earpiece gives remarkably good tone. With all parts, including simulated leather case, earpiece and transistors. 4 x 3 1/4 x 1 1/4". Shpg. wt., 1 1/4 lbs.

83 Y 262. Pocket Radio Kit..... \$14.65



### Transistorized Electronic 10-in-1 Lab Kit

Sensational—work with transistors! Assemble the basic parts, then complete project after exciting project (10 of them in all) just by plugging leads into proper jacks on printed-circuit board—no wiring changes needed. Make the following: AM radio, amplifier, wireless broadcaster, code practice oscillator, electronic timer, switch, or flasher, or any of 3 other electronic relays. Includes all parts, 2 transistors, battery, headphones and instructions, for each project. 3 lbs.

83 Y 299. Electronic Lab Kit..... \$15.45



### Famous 2-Band "Space-Scanner"

Thrilling new bandswitching receiver. Selects exciting short wave on 6 to 18 mc (foreign, amateur, aircraft, police, marine); and full standard broadcast. Sensitive regenerative circuit; 4" PM speaker; beam-power output. Easy to build. All parts supplied (less cabinet). 4 1/2 lbs.

83 Y 243. "Space-Scanner" Kit.... \$15.95

83 Y 247. Cabinet for above..... \$2.90



### 2-Way Intercom Kit

It's easy and inexpensive to build your own 2-station intercom! Use it in home or office. Makes ideal "baby sitter". Extra high gain—delivers full output from only a whisper. Complete with 50 ft. cable (up to 200 ft. may be added), antique-white cases, tubes and all parts. For AC-DC. 7 lbs.

83 Y 295. 2-Way Intercom Kit... \$14.75



## FREE ALLIED SUPPLEMENT

Send for our special Supplement No. 165 featuring the complete line of KNIGHT-KIT Hobby, Hi-Fi, Amateur and Test Instrument Kits. See hundreds of special values in Hi-Fi systems and equipment, recorders, Amateur gear, test instruments, parts, tubes and tools. FREE—send for it today.



## ALLIED RADIO

World's Largest  
Electronic  
Supply House  
Our 36th Year

ALLIED RADIO CORP., Dept. 5-E7  
100 N. Western Ave., Chicago 80, Ill.

Send FREE ALLIED Supplement No. 165

Send the following KNIGHT-KITS:

83 Y 262.  83 Y 243.  83 Y 295.

83 Y 299.  83 Y 247. \$\_\_\_\_\_encl.

(All prices Net F. O. B. Chicago)

Name \_\_\_\_\_

Address \_\_\_\_\_

City \_\_\_\_\_ Zone \_\_\_\_\_ State \_\_\_\_\_

# Popular Mechanics Precut House

Build a Livable Shell from a Precut Kit for Only \$1800

Build a Summer Home With All Conveniences for Only \$2800

Build a Luxury Home for Year 'Round Living for Only \$3800



Designed by Wilson and Christie, Architects, Towson, Md.

## Build This House Yourself!

Save 65% Easily!

New Popular Mechanics Book and Plans — New Precut Materials Kit — Packaged Plumbing, Heating, Chimney, Etc. — Make Amateur Carpenter's Job Easy

Here is the newest Popular Mechanics "Build-It-Yourself" house. You can build it in three stages, with or without an available kit of materials precut to actual size and shape, for the amazing low price of only \$1800. The first stage will give you the start of a grand home that you can live in while you progress with building. The second stage will give you a fine summer home, with all wanted conveniences, for a total of only \$2800 for both stages. When you add the third stage you have a real luxury home for year 'round living in any climate for only \$3800 total cost. Richard Dempewolf, author of the "Precut House" book and a Popular Mechanics editor built the test house pictured above for even less. Today, the appraised value, including the land is \$12,000.00.

Simplified How-To-Do-It Instructions—Hundreds of Pictures—Working Blueprint Plans!

You can build the house with the book alone. The plans make it easier. The book gives lists of materials required, all measurements and dimensions, suggestions for financing, and tells in words and shows in pictures every detail of construction. Like thousands of others who have built their homes themselves, you can do it too and save up to 70% of the cost. The dream home that seemed impossible is here. This fabulous, economical house, designed by famous architects, especially for amateur builders, is your answer to the home you always wanted.

### Features of Expensive Homes

The unusual features of the Precut House are: adaptability to various interior arrangements; use of materials designed especially for amateur builders; easy construction; unusual amount of closet and storage space; built in furniture; house that is suitable for city, country and resort; low maintenance cost; complete insulation. All this at a cost so low no other house of similar size can compare with it.

### Money Back Offer

The coupon will bring you the "Precut House" book and plans. Mail it Today. If you do not like what you get or decide not to build this fine house, return either or both within 10 days for full refund of purchase price. Mail coupon today.

### Building the Test House

The test house pictured above was built in eastern Pennsylvania by the author and his wife, neither of whom had any previous building experience. It is a year 'round home, insulated, modern heating and plumbing, fireplace, redwood interior finish, dozens of built-in features and floor-to-ceiling, 9-foot wide picture window. Total man hours required to build — 1650. Total cost not including ground and inexpensive foundation — \$3731.23



Build It to Your Own Plan in The Same Shell — 2 Bedrooms or 3 With or Without Fireplace—Install Windows Where You Want Them!

Overall size 24 x 46 feet. Note the two typical floor plans shown. Above: Two bedrooms, bath, kitchen, dining room, living room, car port or porch. Below: Three bedrooms, bath, utility room, kitchen, dining area, living room, porch. The "Precut House" book shows many other variations.

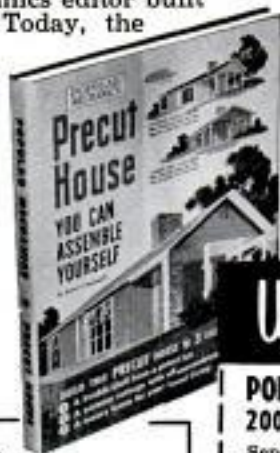

Use This Coupon To Get Book and Plans

POPULAR MECHANICS PRESS, Dept. 557  
200 E. ONTARIO ST., CHICAGO 11

Send at once:

- Popular Mechanics Precut House book \$2.50
- Complete set of ten blueprints \$12.50
- Sets duplicate blueprints @ \$5.00 per set
- I enclose remittance for \$\_\_\_\_\_ Send postpaid.
- Send COD. I will pay postman plus charges. I understand I may return either book or plans, or both, within 10 days if not satisfactory and you will refund full purchase price.

Name \_\_\_\_\_

Address \_\_\_\_\_

City \_\_\_\_\_ State \_\_\_\_\_



## Free! ISRAEL Stamp Collection

Usually selling for \$1.00 and more, this packet of 25 ALL DIFFERENT ISRAEL stamps is yours FREE! Your chance to own a good basic collection including the various ancient HEBREW COIN SETS, 12 TRIBES ISSUE, HIGH HOLY DAYS, RUNNING STAG ISSUE, AIRPOST, and CHILDREN'S ISSUE. EXTRA: 48 PAGE STAMP DICTIONARY & GUIDE included Free. Send 10 cents to help cover mailing costs.

STAMPEX CO., Box 47-MM, White Plains, New York



## BARGAINS

Lists Every Month Hundreds of Terrific Buys in—  
 • BANKRUPT, Closeout, Surplus Goods • New and UNUSUAL Items • WHOLESALE ITEMS • BELOW

WHOLESALE • Sources of 100,000 items wholesale • Rare Money-Makers opportunities • HUNDREDS of TERRIFIC offers in Toys, Books, Household goods, Jewelry, Greeting cards, etc. . . . SAMPLE BARGAINS • Famous \$16.00 Perfume at 60¢ • 50¢ boxes Everyday, Xmas cards, 7¢ box • \$1.00 toys, 20¢ • \$1.95 silk ties, 12 1/2¢ • Penicils, 99¢ gross • \$17.50 talking dolls at \$7.50! PLUS MANY, MANY OTHERS!

BIG SPECIAL ISSUE NOW OUT! Subscribe NOW! BARGAINS let you BUY BETTER, CHEAPER, NEWER things for yourself or for resale at TREMENDOUS PROFITS.

**\$1.00** Buys 6 Big issues—1 Yr. \$2. Reg. Price \$3 year. Spec. Limited time offer to get 10,000 new subscribers. The only magazine of its kind published!  
 TOWER PRESS, INC., P.O. Box 591-DDH, Lynn, Mass.



## ENGINEERING

DEGREE IN  
27 MONTHS

### B. S. DEGREE IN

**Aeronautical, Chemical, Civil, Electrical, Mechanical and Electronic Engineering (inc. Radio and TV)**  
**Big Demand for Graduates**

Hundreds of young men are earning B. S. ENGINEERING DEGREES annually in this recognized institution—year around classes optional. Also B.S. in 36 mo. in Mathematics, Chemistry, Physics. New terms start quarterly. Many students earn a major part of their college expenses in this large industrial center. Low tuition. Competent instruction. Thorough, intense practical program. Modern, well-equipped laboratories including new physics laboratory and modern wind tunnel. Individualized instruction emphasized. Government approved for G.I.'s. Engineering Science preparatory courses. Students from 48 states and 21 foreign countries. Enter June, September, December and March. Send coupon for free catalog and full information. Enroll now.

## INDIANA TECHNICAL COLLEGE

557 E. Washington Boulevard, Fort Wayne 2, Indiana

Please send me free information on 27 MO. B.S. DEGREES in:

Aeronautical  Chemical  Civil  Electrical   
 Mechanical  Electronics

on 36 MONTH B.S. DEGREES in:  
 Mathematics  Chemistry  Physics

Name \_\_\_\_\_

Address \_\_\_\_\_

## MANUFACTURE THIS BEAUTIFUL CONCRETE OUTDOOR FIREPLACE

Right In Your Own Backyard

\$4.00 Worth of Sand & Cement produces this Attractive Fireplace.

Sells on Sight from \$60. to \$80. Easy to start your own Profitable Business.

The General Fireplace Molds and Process are the most amazing and foolproof ever invented. Simple to operate. Two men can produce five fireplaces a day.

### BIG DEMAND!!

Sell all you produce to Department Stores, Homeowners, Parks, Nurseries and Picnic Groves. Fireplaces sell on sight. No experience necessary. We supply full operating instructions and equipment plus the know-how that spells BIG PROFITS. This is an outstanding opportunity for men of vision and small capital to get into a busy rich paying field. Don't delay, be the only exclusive manufacturer in your own home town. Mail coupon at once for full details as to how you can reserve your territory. Molds sold only on exclusive franchise.

**GENERAL ENGINES CO., Inc., Dept. MF-57**  
 ROUTE 130, THOROFARE, N. J.

Mr. Tor of Philadelphia writes: Sold 250 in first 4 months. Selling to Sears Roebuck, John Wanamaker, and Gimbel Bros. in Philadelphia area.

Name \_\_\_\_\_  
 Address \_\_\_\_\_  
 City \_\_\_\_\_ Zone \_\_\_\_\_  
 State \_\_\_\_\_



## Fight CEREBRAL PALSY

Join the



## GOLDEN DEED CRUSADE

Send Your Gift to Your Local United Cerebral Palsy Affiliate



## It's the Goggomobil Sports Coupe

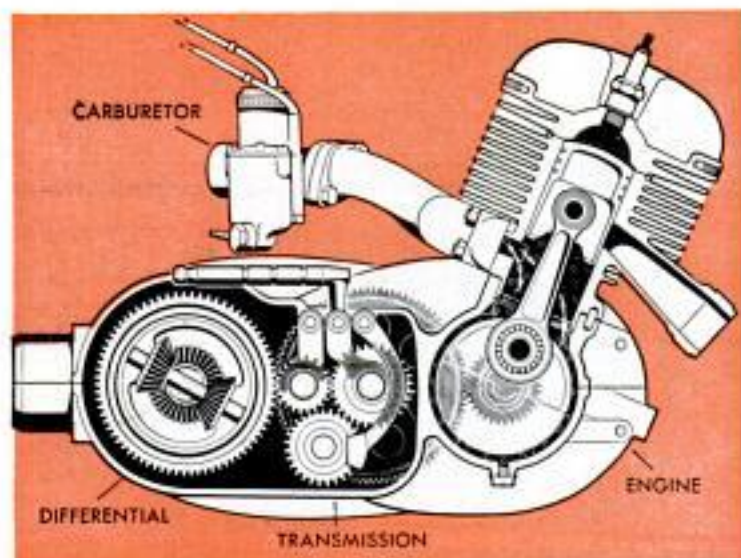

The power plant is simplicity itself, as the cutaway drawing shows. Below, photo of the entire power package and rear axles. Coil springs are used all around. Right, interior details are done with great care. Rear seat is suitable for children only

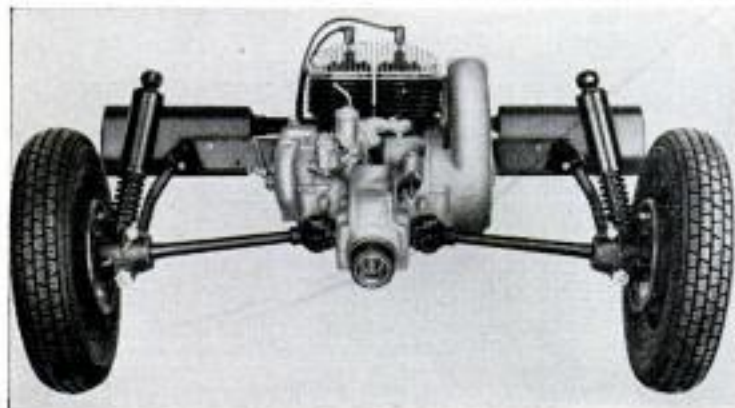

**TINY BUT HANDSOME** is the Goggomobil sports coupe made in Germany. It has, among other features, a four-wheel independent suspension, firm enough to allow fast cornering with little roll, plus an electric-preselector gearshift.

Gear changes are accomplished by a short toggle switch that sticks out of the dashboard. To upshift through four forward speeds, you flip the switch clockwise around the center neutral position. Depress the clutch pedal and each gear change is made electrically.

The rear engine is a two-stroke, two-cylinder, air-cooled design.



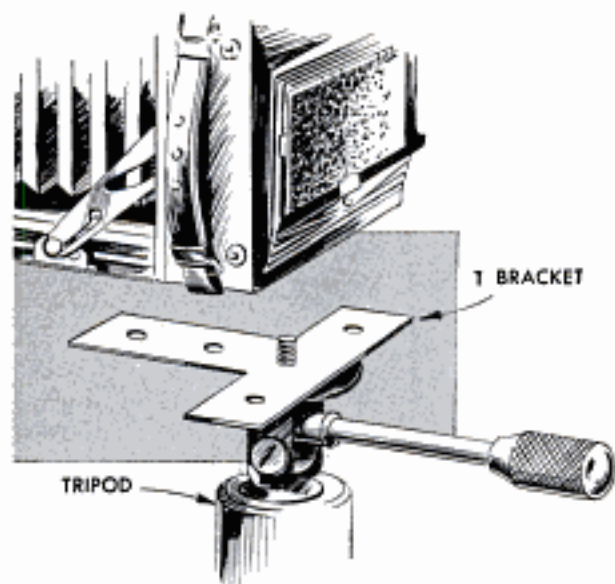

### T-Bracket Supports Press Camera And Prevents It From Wobbling

If your press-type camera wobbles when mounted on a tripod, insert a T-shaped bracket between the camera and the tripod. Drill a hole through the bracket, as shown, and fit the bracket over the tripod screw. If the front bed of the camera is higher than the main body, bend up the front flange to support it.

A. Zanelli, Wyckoff, N. J.

INCREASED PRODUCTION brings NEW LOW PRICES

## "SEA-HORSE" DIVING LUNGS

\$169 VALUE

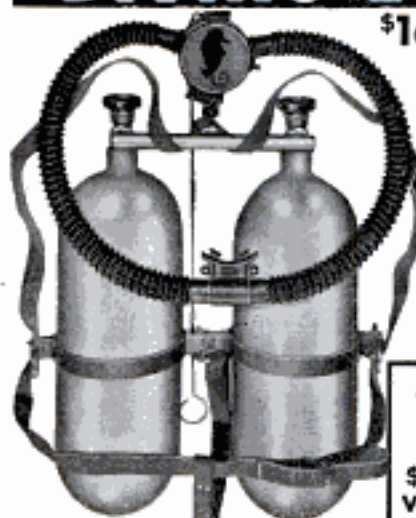

2-TANK UNIT

**89<sup>75</sup>**

COMPLETE  
Approx. 2 Hours Underwater Time

Ready to Use

SINGLE TANK  
Outfit Complete

\$110 Value **69<sup>95</sup>**  
Approx. Time 1-Hour

2-Stage Demand Regulator

Send Check or Money Order. If C.O.D., 25% with order  
Shipping Points: Chicago, Pittsburgh, New York

Write for Free Literature including All Swim Accessories

**DIVING INDUSTRIES** Division of  
813 LIBERTY AVE. DEPT. PM-5 HONUS WAGNER CO.  
PITTSBURGH 22, PA.

Advertised products are backed by their manufacturers. Select them from POPULAR MECHANICS advertising pages



### YES! SEND



directly  
to my door  
every month

I am enclosing

- \$3.50 for 1 year  
 \$8.00 for 3 years

name \_\_\_\_\_

address \_\_\_\_\_

city \_\_\_\_\_ zone \_\_\_\_\_ state \_\_\_\_\_

Hand this order to your newsdealer or send it to  
**POPULAR MECHANICS**  
200 East Ontario St. Chicago 11, Ill.

## TRAINED MEN NEEDED!

**BIG PAY!—GOOD FUTURE!**

- DIESEL                       ELECTRONICS  
 AUTO                         AUTOMATION

NEVER BEFORE has the opportunity been so good for the properly trained mechanic and technician to step into BIG PAY POSITIONS with rapid advancement and future security virtually assured.

YOUR SUCCESS depends on the quality of training you receive... and the reputation of the school you attend.

YOUR GUARANTEE we are giving the best in mechanical and technical training is proved by the fact... we have a waiting list of good pay positions for our graduates, with leading companies throughout the United States.

RESIDENT SHOP TRAINING is easier and costs less than you may think! We provide you with housing and part-time jobs while in school, plus free nation-wide placement service for graduates.

Check subject above in which you are interested and mail for

FREE BOOKLET

Your Future in ELECTRONICS AND AUTOMATION

**BAILEY Technical Schools**  
Veteran Approved

Your Future in 3 DIESEL and AUTO MECHANICS

1634 S. Grand, St. Louis 4, Mo.

Name \_\_\_\_\_ Age \_\_\_\_\_  
Street \_\_\_\_\_  
Town \_\_\_\_\_ Zone \_\_\_\_\_ State \_\_\_\_\_



Become an  
**Electrical  
 Engineer at  
 MSOE**  
 in Milwaukee

Electronics Communications  
 Electrical Power  
 Industrial Electronics

Join the Engineering team! Over 50% of the nation's industrial leaders began their careers with engineering training. Jobs are waiting for well-trained men.

Milwaukee School of Engineering's educational program of technical institute and collegiate engineering courses offers you step-by-step advancement. Save a valuable year through MSOE's optional year-round study system. Prepare yourself for the opportunities ahead in one of these MSOE courses:

- Engineering**  
 Bachelor of Science degree in Electrical Engineering
- Engineering Technician**  
 Associate in Applied Science degree  
 MSOE also offers courses in Mechanical Engineering.

MSOE's complete, modern facilities include specialized technical laboratories and equipment, visual aid theater, and amateur radio station. Courses approved for veteran training. 50,000 former students. Excellent placement record for graduates. Previous educational, military, and practical experience evaluated for advanced credit.

QUARTERS BEGIN JANUARY, APRIL, JULY, SEPTEMBER

Mail coupon today!



**MILWAUKEE**  
 School of Engineering

Dept. PM557, 1025 N. Milwaukee St. MS-36  
 Milwaukee, Wis.

I'm interested in: (Please print)

- Electrical Engineering  
 Mechanical Engineering  
 Engineering Technician courses

Name \_\_\_\_\_ Age \_\_\_\_\_

Address \_\_\_\_\_

City \_\_\_\_\_ State \_\_\_\_\_

Are you eligible for veterans educational benefits? \_\_\_\_\_ Discharge date \_\_\_\_\_

**LAY BRICKS or BLOCKS**

like an expert!

- save high labor costs!
- accuracy guaranteed!

Amazing new  
**"MASON MASTER" SPACERS**

"MASON MASTER" SPACERS automatically give you perfect, uniform joints—beautifully accurate, strong walls of brick, tile or block. No experience needed! Just begin with level foundation, apply mortar, press these precision steel 3-point spacers into mortar bed. It's fast, it's easy. Assures full brick-to-mortar contact, stronger bond. Think of it—now you can build that fireplace, that wall or entire building, with professional results. Spacers are 2" long, 3/8" high, 1/2" wide, packed 500 in carton, enough to lay 250 bricks, \$10.00 PPD. Order today—satisfaction guaranteed!

Self-levelling!

only  
**2¢**  
 each!

**SIGL PLUMBING & MANUFACTURING CO.**

430 Delaware Avenue  
 Buffalo 2, New York

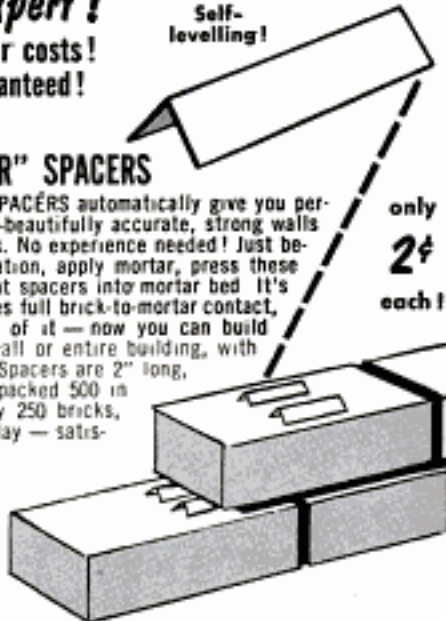

**FIND HIDDEN RICHES!**

NOW—find buried treasure, gold, silver, and metal objects, with sensational 3 1/2-lb. locator—GOLDAK'S "FIND-IT" . . . only \$69.50 complete with earphones, batteries, instructions.



Manufacturers of metal detection devices since 1933.

Write for FREE literature full line metal, mineral locators, geiger and scintillation counters.

**GOLDAK CO.** 1542-5 W. Glenoaks Blvd., Glendale, Calif.

**GROW MINIATURE TREES**  
**FREE! SEEDS & PLAN**



New fascinating HOBBY! \$\$\$ OPPORTUNITY! Real LIVING "Ming" Trees—Beautiful elm, orange, oak, cypress—any kind! Full grown but miniature. Take orders from Interior Decorators, Offices, Hotels, etc. FREE Seeds (8 kinds)—Illustr. Plan, write: **LIVING MINIATURE NURSERIES**, Dept. K-5, Home Growers Div., Gardena, California.

**FIX home & car APPLIANCES YOURSELF**



**NEW! EICO REDI-TESTER KIT \$12.95** Factory-wired **\$15.95**

Multi-range ac/dc voltmeter, ammeter, ohmmeter, wattmeter, leakage checker. Locates defects in appliances, air-conditioning, furnace control, TV, radio, car batteries, generators, etc. Easy step-by-step instruction book. Send Check or M.O., specify Kit or Wired. Or write for neighborhood distributor's name & FREE catalog P26-5 describing EICO's 50 professional Kits & Instruments.

Electronic Instrument Co., Inc., 81 Withers St., Bklyn 17, N. Y.

**MEN—WOMEN! BIG PROFIT HOME BUSINESS!**



**RETOUCH NEGATIVES**  
 for **PHOTOGRAPHERS**  
 NO ART ABILITY NEEDED—EASY TO LEARN

- TAKES MINUTES**
- CHARGE \$\$\$**
- DO BUSINESS BY MAIL**
- WE TEACH YOU HOW**
- EQUIPMENT INCLUDED**

DUVAL SCHOOL, Dept. 55, 100 So. Vermont, Los Angeles 4, Calif.

WORLD'S  
BEST  
WANT-AD  
MEDIUM

# CLASSIFIED ADVERTISEMENTS



Advertisements in this section \$1.25 per word, each insertion, minimum 10 words, payable in advance.  
To be inserted under proper classification, copy must be in our office the  
20th of the second month preceding date of issue  
F. W. Johnson, Manager, Classified Advertising  
Popular Mechanics Magazine, 200 East Ontario Street, Chicago 11, Illinois

## YOU'LL PROFIT

By reading and answering the classified ads in this section. Hundreds of opportunities for you to make and save money

### AUTOMOBILES, MIDGET CARS

**VOLKSWAGEN** Owner's Handbook, 144 pages, 150 photos, charts, drawings. Full details repairing, maintenance. Every owner, enthusiast needs this fabulous authentic book covering all models. Just published. \$2.00 postpaid. Floyd Clymer Publications, 1268 S. Alvarado, Dept. PM, Los Angeles 6, Calif.

**NEW 1957 Automobiles**—Up to 25% off retail prices. Meder, 550-PM Fifth Avenue, New York City 36.

**1957 SUPERIGNITIONER**, Starting, pep, mileage—\$4.50. Barbells, 1957 Kaisers. EG, Elmford, New York.

**CROSLY** Parts and accessories. Van's Sales & Service, Midlothian, Illinois.

**HUNDREDS** Of automobile catalogs—Old, new and foreign; dealer books, glossy photographs, shop manuals; free motor magazines listed by non-profit club. Write to get on free mailing list. Auto Maniacs, Stockbridge, Mich.

**MAOAZINE** About antique automobiles. Send for free sample copy. Pranson's Motor News, Box 276, Woodland Hills, California.

**JEEP** Tops, American-foreign convertible tops, clear plastic seat covers. Free catalogue. Mor-Nan, Box 123, Boston 14, Mass.

**BOYS'** Power-driven auto. Build your own. Plans 25 cents. Sypber Co., Sta. F., Toledo, Ohio.

**MIDGET** Roadster plans, easy to follow, \$1.00. Details free. T & L Mfg., 4020 Linden, White Bear Lake, Minnesota.

**WORLD'S** Lowest price children's motorized automobiles. Also fiberglass bodies, power units, parts, etc. Free literature. Sportillac Co., P.O. Box 6263, Philadelphia 38, Penna.

### AUTO SUPPLIES AND EQUIPMENT

**SAVE** On parts, accessories, gadgets, tools, dress-up items not in stores. Giant 1957 catalog—25¢ (refunded first order). Newhouse Automotive Industries, 5803-PM Beverly, Los Angeles 22, Calif.

**SAVE** Money on Jeep and army truck parts. Large inventory. Catalogs for Jeep or G.M.C. owners. American Auto Parts Co., 1830 Locust, Kansas City, Mo.

**FREE!** New catalog. Speed, power, mileage increasing equipment. Discount! Almqvist Engineering, Milford PM5, Penna.

**NEW** And used parts at savings. Complete guaranteed parts service for all models cars and trucks—1924 and later. Largest in the West. Army parts specialists. No catalog. Submit your needs for quotations. Fast mail order service. Pioneer Auto and Truck Parts Co., 734 W. 13th Ave., Denver 17, Colorado.

**LEOPARD** Design car robe with carrying case. Very attractive \$5.25 ppd. Castle Creations, Box 82-M, Lyons, Illinois.

**FORD** T and A parts? Try best source old car parts anywhere. Wisneski, Milwaukee 7, Wis.

**AUTO** Accessory and parts catalog. 1957 edition, all new! 228 pages. Save up to 50%. 75,000 items, including Hollywood accessories, hi-speed equipment, rebuilt engines, all parts and accessories for all cars and trucks! Hard-to-get parts! Send 25¢, refundable. J. C. Whitney, 1919 PM Archer, Chicago 16, Ill.

**MONOFLEX** — Double-acting helper springs control overload and torque. Write MonoFlex Spring, Reading, Penna.

**AMAZING** New motor compound "Compression-Seal" makes old motors young again! Adds years to motor! Stops oil waste, costly repairs; increases gas mileage, gives new car power! \$3.95 postpaid. Safe! Proven! Fully guaranteed! Details free. Pazer Sales Co., Dept. 11-E, 198 East 52nd St., Brooklyn 3, New York.

**RING-Valve** job while you drive. \$6.00 postpaid. World's only product of its kind! Safe, proven, guaranteed. Literature. Motaloy, Grantham, Penna.

**FORD "T"** parts headquarters, free catalog. Ernie Hemmings, Quincy, Ill.

**STOP** Wasting oil, gas. Details. Smallwood, West Broadway, Ocala 2, Florida.

**AUTOMOBILE** Safety strap. Metal to metal buckle; Nylon webbing in all standard colors; \$7.00 plus 50¢ handling and postage. Breen's, Rutherford Ave., Charlestown, Mass.

**AURILLIUM** Car sealer, protects the finish, never polish ever, just wash. Guaranteed \$5.98. Lawrence Oliver, 222—2nd Ave. So., Jacksonville Beach, Fla.

**10 ACRES** Of antiques, classic and modern cars for parts. Also new gaskets, rebuilt transmissions and a million other parts. We buy old cars and parts. Bill's Auto Parts, Bill Gregory, Valley Falls, Rhode Island.

**GLAMORIZE** Your car. Cleaning. Polishing 25¢ only. Does excellent job. Formula 50¢. Stern, Box 1191, San Bernardino, Calif.

**TIRES.** Save up to 50%. Goodyear, etc. Guaranteed not seconds. First line only. Write free price sheet. Bussier Tire Co., 1730 Broadway, Lorain, Ohio.

**"NO-Kro"** stops battery and cable corrosion. Lasts years. Liberal supply \$1.00. Guaranteed. 200% profits. Protected territories. No-Kro Company, Chanute, Kans.

**AUTO** Top lift, for all removable hardtops. Free T-bird accessory brochure. James Auto Specialties, Dept. PM, Box 151, Pasadena, Calif.

**MOTORIST** \$2.98 Overhauls your engine. Literature free. R. S. Co., 15218 Shiloh Rd., Cleveland 10, Ohio.

### AUTO TRAILERS

**CAMP** Trailer, collapsible, sleeps 4, easily constructed. Plans \$1.00 complete. Mussung, Box 74, Bethel, Connecticut.

**TRAILER** Building manual \$1.00. Booklet 30¢. Kamcraft, Box 1153, Milwaukee 1, Wis.

**BUILD** Expanding eight foot trailer. Accommodates five. Literature 10¢. Fra-Mac Company, Wilmington, Mass.

**MARATHON** Mobile homes are your answer to that vacation cottage, second family home, new tenant house. Models include King Size (10 ft. wide) 41, 45 and 49 ft. long. Other models 29 to 49 ft. 1, 2 and 3 bedroom—luxury at a price. Details free. Write Dept. 100, Har-Mac, Inc., Stratford, Wisconsin.

### MOTORCYCLES, BICYCLES, MOTORSCOOTERS AND SUPPLIES

**PARTS** For Cushman, Doodle-Bug, Salisbury, etc. Send make, model, 25¢ for price list. Motor Scooter Parts Co., Dept. P4, Box 7211, Indianapolis 1, Indiana.

**HARLEY** - Davidsons — Used bargains. New, used parts, accessories for all models. Bulletin, catalog 25¢. Knuth's (Factory Dealer), 1753 Muskego, Milwaukee, Wis.

**RECONDITIONED** Motorcycles and motors. Chromium accessories. Complete stock Indian parts. Expert rebuilding. Fast service. Indian Motorcycle Sales, Kansas City 27, Missouri.

**PARTS.** New, used. List 10¢. Ballak, 811 N. 9th, St. Louis 1, Mo.

**BICYCLES.** Parts, accessories. Everything you need. United Cyclery, Union Square-P5, Somerville 43, Mass.

**BUILD** Suitcase size motorscooters. Instruction booklet, 60¢. Houser, Box 108, Piqua, Ohio.

**CUSHMAN** Motorscooter \$30. Doodlebug \$30. James motorcycle \$35. Indian less engine \$20; Whizzer engine \$7.50. Briggs \$5. Maytag \$3, outboard engine \$8. (Mail-order only.) Send 25¢ (35¢ for first class mailing) for new Directory-Catalogue Number 77, listing these and hundreds of other bargains, homebuilders' midget car parts, plans, etc. Midget Motor Directory, Athens, Ohio.

**MOTORCYCLES** And supplies, all makes, new and used. Factory dealer. Tell us your needs. Wichita Cycle Co., 813 Ohio, Wichita Falls, Texas. Our 32nd year.

**MIDGET** Auto \$25.00; 1954 Whizzer \$20.00; Cushman motorscooter \$25.00; motorcycle \$10.00. Rush 25¢ (35¢ first class mail) for new catalog #960 listing amazing bargains in motors, midget cars, motorcycles, motorbikes, construction plans. Associated, Box 534, Toledo, Ohio.

**BANKRUPT** Motorcycle, \$35 up. Bicycles \$12.50 up. Gasoline motors, \$4.00 up. Catalogue bulletin 25¢. Bunico, 146-C, Covington, Virginia.

### AVIATION

**PROPELLERS.** Plans, supplies for airboats and snowplanes. Latest designs, prompt delivery. Catalog 25¢. Banks-Maxwell, Box 3301E, Ft. Worth 5, Texas.

**TREMENDOUS** Government sales now on. Buy direct from Uncle Sam. Surplus aircrafts; fuselages; accessories; engines; instruments; electronics; radiotelephones. Government depot list and procedure \$1.00. Brody, Box 8-PMK, Sunnyside 4, New York.

**NEW** Lightplane circulars, illustrated 30¢. Kamcraft, Box 1153, Milwaukee 1, Wis.

**AVIATION** Surplus bargain catalogue. One dime. Box 22PM8, Thomasville, Penna.

#### BATTERIES, GENERATORS

**NEW** 120-240 V.a.c. generators—60 cyc., 300 watts. Drive with 1½-3 h.p. engine. \$24.50 f.o.b. Aviation & Electronics Suppliers, Box 4062, Ft. Worth, Texas.

**EDISON** Nickel storage batteries. Any voltage, any amperage. Unconditionally guaranteed. Power plants, generators, motors. Literature. Hawley Smith Co., Croton Falls 1, N. Y.

#### ELECTRICAL SUPPLIES

**OVER** 1000 Surplus bargains. Catalog 10¢. Dunbar Company, Houston 23, Texas.

**ELECTRIC** Pencil: Engraves all metals \$2.00. Beyer Mfg., 16511-H Springfield, Chicago 43.

**LAMP**, Electrical parts, wholesale. Thousands of items for repairing, converting. Catalog 25¢. Brown Lamp, Box 305, Clayton 5, Mo.

#### WELDING, SOLDERING, PLATING

**A.C.** Welders, 4 sizes, lowest prices. Free literature. Holgeron's Service, Canton, Kansas.

**WELDERS**, 110/220, \$39.50. Morris, 1670 Inner Drive, Schenectady 3, New York.

**ELECTROPLATING** Equipment, anodes and solutions for all types of plating. Instructions. Assemble your own plater and save. Free catalog. Ramyr, Dept. E-4, 1624 East First Street, Los Angeles 33, California.

**ACETYLENE** Welding outfits new \$54.50; used \$34.50; arcwelders \$56.50. Eagle Welding, Dept. PM, 5085 Broadway, Chicago 40, Ill.

**"BUILD-UR-OWN"** a.c. welder and a.c. power plant with a good used engine and low cost Hobart generator. Welds anywhere and supplies 5KW stand-by power for any emergency. Write Hobartweld, Box M-573, Troy, Ohio.

**BUY** Welding supplies direct from manufacturer. Cable, welding rods, helmets, etc. Portable arc-welders and kits at tremendous savings. Free factory catalog! LeJay Mfg. Co., 2927 Emerson Ave. So., Minneapolis, Minn.

#### MACHINERY, TOOLS, SUPPLIES

**DRILLS**, Blade sharpener, glass cutter. All tungsten carbide tipped. Free circular. Malone's, 3370-N. 53, Milwaukee 16, Wis.

**BEST** U.S. and European price and quality mikes, lathes, drills, magnetic tools, etc. Discount catalog 50¢ (returned on first \$5 order). Elisha Penniman, Elmwood, Conn.

#### SURVEYING INSTRUMENTS

**NEW** And guaranteed factory rebuilt transits and levels, sale or rent, with purchase option. We will repair, trade or buy old instruments. Write for list M-75. Warren-Knight Co. (Manufacturers of Surveying Instruments), 136 N. 12th St., Philadelphia 7, Penna.

#### ENGINES, MOTORS, DYNAMOS

**AIR** Compressors half price. Free folder. IMSCO, 1829 South State, Chicago 16.

**SMALL** Electric motors, accessories. Kitco, Dept. 13, Box 212, Monroe, Wis.

**THERMO-Nuclear** molecular engine. Generates powerful thrust from external heat. One moving part. Not a toy. Completely safe. Plans \$2. Novod, 4421 N. 14th Street, Phoenix, Arizona.

½ **HORSEPOWER** Electric motors, a.c. 110, used, good \$5.00 each, f.o.b. Plant Machinery Corp., Richmond & Norris Sts., Philadelphia 25, Penna.

**REWIND** Motors yourself. Complete instructions \$1.00. Lewis Mfg., Howell, Michigan.

**WINDING** Data. 275 motors, single and three phase, \$1.10. Data Company, Box 7631, Kansas City 28, Mo.

**A. C. Generators**. 750 watt \$42.50; 1500 watt \$47.50. Motors, 5 horse \$110; 3 horse \$87.50; 1 horse \$38.50. Butler, 1885 Milwaukee, Chicago.

**REBUILT** Motors. State requirements. 30-60% new motor prices. Richardson Electric, Monroe, Wisconsin.

**NEW** And used Diesel engines, generators, all capacities, 30 years experience. Glenmoore Diesel Mfg. Company, Glenmoore, Pennsylvania.

**DIESEL** Injector parts wanted, GM71-110. Bares, 7120 Carnegie, Cleveland 3, Ohio.

#### BOATS, OUTBOARD MOTORS

**FORDS** And Jeeps 100% marine engines with famous Convo-Kits. Deluxe catalogue 25c coin. Oscomotors, 3627B Lawrence, Philadelphia 40, Penna.

**MARINE** Conversion, Willlys to Cadillac engines, kits and parts. Catalogue and conversion hints free. Barr Marine, 2706 Castor Avenue, Philadelphia 34, Penna.

**FIBERGLAS** Boat coating. Plexiglas boat windshields—Clear, blue, green tints. Wholesale-retail. Instructive information catalog free! Gem-O'-Lite, 5529 Cahuenas, North Hollywood, California.

**STEEL**-Wood, boat plans, cruisers—sail, 21-42 feet. Free information. Please specify size-type. John B. Clark, N.A., Box 51, Bay Village, Ohio.

**MARINE** Conversions for Ford and Jeep engines. Catalog 25c. Lehman Manufacturing Company, 972D Broad Street, Newark 2, New Jersey.

**SAVE** Money. New, used outboard motor parts. Send wants. Stamp appreciated. Outboard Motor Mart, 229-M State, Boston 9, Mass.

**BOAT** Plans. Full size patterns. Frame kits. Modern inboards and outboards for amateur builders. Complete new catalog 50¢ or specify requirements. Glen Designs, Box 668, Compton, Calif.

**NEW**, Used, rebuilt marine motors. Marine conversions, fittings. Free catalog. Stokes Marine Supply, Dept. 24, Coldwater, Michigan.

**FIBERGLAS** Permanent boat waterproofing. Special 25% winter discount. Complete kits, \$9.45 up. Guaranteed materials. Easy application. Full instructions. Free literature. Ajax Plastics, Dept. PM, P.O. Box 1323, Fort Worth, Texas.

**BIG** New 1957 catalog, 72 pages. Just out. "Everything for Your Boat" illustrated. Low prices. We manufacture, guarantee. Mail 25¢ postage today. Henry Dahmer, Inc. Factory, Keyport 7, N. J.

**BOAT** Covers and tops, free catalog. Barker Manufacturing Co., 65 Main St., Honeoye Falls, N. Y.

**FREE** Catalog! Boat kits, trailers, fiberglass, marine hardware. Lager Industries, Dept. M5, 3404 Lyndale South, Minneapolis, Minnesota.

**A-1** Marine engines bought and sold. Manifolds; clutches; diesel starters; new, \$20. Helweg, 741 S. Ocean, Freeport, N. Y.

**NEW!** "How to Build Your Own Fiberglass Boats" and "How to Make Old Boats New with Fiberglass." Send 10¢. Cassette, Marine Division, Dept. EM-101, Woodstock, Illinois.

**ALUMINUM** Boats and canoes. Quality aircraft-type design and construction. Safe, durable, beautiful. No maintenance. 100% boating pleasure. New 1957 catalog free. Grumman Boats, Inc., 3757 South, Marathon, N. Y.

**BARGAINS** Galore—Boat kits, custom hardware, steerer \$9.95, plex-shield \$12.95, skis \$14.95. Save dollars folder. Box 681, Mendota, Minnesota.

**FIBERGLAS** Boat coverings. Top marine grade. Direct prices and literature free. Lukas, 17W386 Karben, Villa Park, Illinois.

**FIBER** Glass—Buy direct, save 40%. Complete polyester and epoxy resin boat covering kits and supplies. Highest quality guaranteed. Send for prices and brochure. Marine Fiber Glass Corp., Dept. PM-1, 6308 San Fernando Rd., Glendale 1, Calif.

**300 PLANS**, Patterns, kits. Catalog 50¢. 2.5 h.p. outboards \$69.95. Marinecraft, Box 161-M, Brighton, Mass.

**MARINE** Conversions, all makes. Free catalogue. Wallace Marine Co., Box 5001, Philadelphia 11, Penna.

**FIBERGLASS** Boat cloth \$1.20 yd. Resin \$5.95 gal. 3/16 plexiglas \$1.20 sq. ft. Send 10¢ for literature. United Plastics, Dept. 4, Roebling, N. J.

**BUILD** Small boats. Booklet 25¢. Catalog free. Popular Mechanics Press, 633 N. St. Clair St., Chicago 11.

#### ATHLETIC EQUIPMENT, BODY BUILDING COURSES

**BARBELLS**, Dumbbells. Courses. Free catalogue. Good Barbell Co., Reading, Penna.

**4 MUSCLE** Courses 25¢. Fully guaranteed. Sid's System, Southgate, California.

**STRENGTH**, Health, muscles. Gain, reduce. All you need is a rope! Valuable booklet free. Ropercise, 4834-A Art St., San Diego 15, California.

**BE** Taller! Coach's "Inch-At-A-Time" system \$1, complete. Marty Snyder, Box 195-MK Union City, New Jersey.

**GREAT** Strength easily obtained. Complete course, apparatus \$2.00. Joseph Dryer, Box 3327-P, Chicago 80.

**FEET**, Leg muscles hurt? We can help you! Famous Perrins method rebuilds and renews tired muscles. Activates and normalizes circulation. Intensifies nervous forces. No electricity. No internal medication. No massage. No special or expensive equipment. No continuing treatment. Increase your efficiency and complete health. Results are lasting. Write for free information. No obligation. Ornin Company, 1617 13th Street, Des Moines, Iowa.

**DISABLE** Any bully, with two fingers. Secrets, Ju-Jitsu, 96 pages, illustrations, \$1.50. Special chapter for women. Seico, Box 38, Cooper Station, New York 3, N. Y.

#### SPORTING GOODS, GUNS, FISHING TACKLE, ARCHERY, TRAPPING

**FREE**. Below wholesale fishing catalog. Fishing Tackle Mart, Dept. 55, Box 6737, Chicago, Ill.

**TENTS**, Camping equipment; tremendous selection. Send 20¢ for 136 page tent, camping equipment catalog-handbook listing all national camping sites. Print name, address. Morsan, 10-21R 50th Ave., Long Island City 1, New York.

**AUTHENTIC** Primitive weapon reproductions! Spears, crossbows, edged weapons, etc. Colorful. Deadly. Decorative. Catalog 10¢. Primitive Weapons, Pevely MB, Missouri.

**FISHERMEN**. Catch more fish! Old Indian bait scent secret makes all fish bite. \$1.00 bottle. King Company, Asheville, New York.

**PORTABLE** Two-way radio. Details free! Hart, 467 Park, Birmingham, Michigan.

**HUNTERS**. 30 Caliber Männlicher carbines. Military salvage. Perfect, with hundred rounds ammunition, \$18.95 f.o.b. here. Express collect. Shipahoy Armory, Ontario, Calif.

**FISHERMEN!** Scent up live or artificial baits with sensational "Strike" liquid fishing lure. Makes fish ravenous! Any waters. Money-back guarantee. \$1.25 ppd. (2 bottles \$2.00). Rush check, m.o. or cash. Modern Products Distributing Co., Dept. PM-5, 560 Lafayette Bldg., Syracuse, N. Y.

**FISHING** Method, bass, northern, wall-eye. \$3.99. Satisfaction or money back. S. R. Blackstone, Wisconsin Guide, 403 Powers Ave., Madison 4, Wisconsin.

**1,000,000 GUNS**, Accessories, Colts, Lugers, Mausers, Kentuckies, P38's, Winchester. Catalog 50¢. Agramonte's, Yonkers 2G, N. Y.

**CAMPING**, Hunting, diving! Free equipment catalog. McCanna, PM-5, Tarrytown, N. Y.

**JAP** Rifle altering to 30-06, \$6.00. Jap-shells, \$3.95. Catalog 5¢. T. P. Shop, West Branch 11, Mich.

**"THE** Silent Fisherman" adjustable, automatic fishing tackle with die and stock. Edward Zielinski, 7107 W. 16th Street, Berwyn, Illinois.

**GRAY Crickets:** Special advertising material (limited offer) free to fishbait dealers ordering crickets. Use material for your advertising. Crickets shipped immediately, any quantity. Live delivery guaranteed. Scientifically raised. Write for free literature and price list. Owen Crickets, Farm 2, 2818 25th, Lubbock, Texas.

**FREE Sporting goods catalogs!** Save 70%. Econ-O-Mart, Whippany 2, New Jersey.

**MOLDS** For fisherman's sinkers, jigs, squids, casting and spinning lures. Free catalog. Sweet's Molds, Tonawanda 1, New York.

**FREE Fishing scent secrets.** Johnston's, 312 Lake Avenue, Ithaca, New York.

**ARROWS—Unsurpassed for speed, accuracy.** 25 kinds. Accessories, raw materials. Free catalog. Marlin Archery, Ames, Iowa.

**100 PROFUSELY** illustrated pages antique pistols, swords, daggers, armor, etc. 50¢. Robert Abels, M860 Lexington Ave., New York City 21.

**BUILD Barbecue.** Complete plans. Booklet 25¢. Free catalog. Popular Mechanics Press, 633 N. St. Clair St., Chicago 11.

**RIFLES, Shotguns, pistols, scopes, ammunition.** Dealers prices. Berkshire Gun Rack, Six Lakes, Michigan.

**GUNSMITH—400 Page** illustrated course \$4. Pioneer Press, Harriman, Tennessee.

**17,000,000 GUN Parts** stocked—Modern, obsolete, foreign. Send tracing, description for quotation, 44/40 instant gun-reloader, takes second, largest selling, absolutely guaranteed, \$2.00 bottle. Junked guns wanted for parts, \$1-\$5 each plus postage, any kind, condition. Ship off-check airmailed. Numrich Arms, West Hurley 16, N. Y.

**FREE!** Write for Klein's wholesale tackle and accessory circular. Why pay retail prices when you can buy wholesale at Klein's on credit and pay only \$2 down? Klein's, 227 W. Washington, Chicago 6, Ill.

**BIG Money** raising crickets and 12 inch African fishworms. Free literature. Carter Ranch, Plains, Georgia.

**5000 BARGAINS, Firearms, binoculars, war relics.** Catalog 50¢. Smith Firearms, Runnemede, N. J.

**SAMPLE:** 25¢ Copy of "The Archers' Magazine." Send 10¢. 1200 Walnut Street, Philadelphia 7, Pennsylvania.

### **BINOCULARS, TELESCOPES, MICROSCOPES, MAGNIFIERS**

**BINOCULARS, Telescopes, microscopes.** Terrific values \$3.98 up. Request free money-saving catalog. Criterion, Dept. P54, Hartford, Conn.

**SEE-Sharp binocular and instrument repair.** Estimates submitted. 25 years experience. 12534 Elm Dale, Detroit, Mich.

**BUILD Your own reflector telescope.** Complete kit; mirrors, eyepieces, tripod, all other accessories. Request free illustrated literature. Criterion Manufacturing, Dept. DPM 29, Hartford, Conn.

**AMAZING Prices, precision binoculars.** Folder, "Binocular Selecting" catalog free. Dealers write. Prentiss Importers, Mercury Bldg., West Los Angeles 25, Calif.

**MICROSCOPE Catalog** free. Research Scientific Supplies, 60 Wall St., New York City 5.

**DYNASCOPE—Sensational new reflector telescope.** Send for details. Criterion Co., Dept. DP 32, Hartford, Conn.

**SPECTACLE Binoculars!** Wear like eyeglasses. Close-up view of all sports events. \$1.00 postpaid. DuPont Distributors, Box 695, New York 1, N. Y.

**300 POWER Reflector telescopes** complete with finder scope and tripod, \$24.95. 400X telescopes easily made. Kit includes focusing tube, erector, five finished lenses, building instructions, \$3.75. Free telescope booklet. Suffolk Science, Mattituck 4, New York.

**WAR Surplus bargains:** Millions of lenses, instruments, telescopes, binoculars, components and complete line of astronomical telescope items. World's greatest optical market place! Send only \$1.00 for beginner's 16-lens kit and big instruction booklet Stock 2-CH. Write for catalog CH, free! Edmund Scientific Co., Barrington, New Jersey.

**REFLECTING Telescope, 60X, completely assembled** \$29.75. Guaranteed observatory clearness. Free information. Skyscope, 475 Fifth Avenue, New York City 17.

**REFLECTOR Telescope kits \$7.25 (3") to \$175 (12").** Mirrors, cells, focusing mounts, tripods, eye systems. Anything, everything in telescopes. Free catalog. Also ready to use telescopes from \$25. Esco Products, Oakridge, N. J.

### **PLANTS, SEEDS, BULBS, NURSERY AND GARDEN SUPPLIES**

**WORLD'S Greatest cash crop.** Free information. Write Ginseng Gardens, Asheville, N. C.

**GINSENG, Golden Seal Roots** bring up to \$14 pound. Full information. F. M. Collins, Viola, Iowa.

**EVERGREEN Trees** from seed. Free folder. 1500 blue spruce or Scotch pine seeds \$1.00. Strom's, Bellaire 23, Michigan.

**EARTHWORM Castings** for African violets and other houseplants, quart \$1.25; ½ gallon \$2.00, postpaid. Redland Worm Hatchery, P.O. Box 132, Homestead, Fla.

**TRAIN, Protect plants.** 100-12" covered copper plant ties, \$1.00. Plant-Tie Company, 344 Norton Street, New Haven, Connecticut.

**GROW Dwarf trees.** Instructions and seeds—25¢. Mail Order Specialties, 1439 Sabraton Ave., Morgantown, W. Va.

### **PETS—DOGS, BIRDS, RABBITS, HAMSTERS, ETC.**

**HAMSTERS—Golden:** young, \$3.00 pair. Fully developed \$4.00 pair. Adirondack Hamstery, Prospect 10-E, N. Y.

**AQUATIC Life—Oldest** aquarium magazine. \$2.00 yearly, 12 issues. Copy 20¢. Baltimore 6, Maryland.

**BABY Skunks, raccoons.** Catalog, 25¢. Shady Fur Farm, Springfield, Minnesota.

**BEAUTIFUL Golden** collies. Greatest child's pet. Barnes, M., Collier, Kans.

**RAISE Rabbits** successfully by knowing facts. 48 page illustrated book describing 25 breeds. Housing, feeding, breeding, marketing, etc. Plus bulletin, 25 cents. American Rabbit Association, 35 Arba Building, Pittsburgh, Penna.

**STANDARD Rabbit Journal.** Milton 3, Penna. Year \$1.00. Sample dime. Beginners manual 25¢.

**MAKE Money** raising chinchillas, mink, nutria, rabbits, cavies for us. Free catalog. Keeney Brothers, New Freedom 2, Penna.

**RAISE Rabbits** on \$500 month plan. Plenty markets. Free details. White's Rabbitry, Mount Pleasant, Michigan.

**HAMSTERS—Young Golden** pairs, \$2.95. breeders \$3.95. Free booklet. Jer-Fre's Hamstery, 2425 Hoyt, Muskegon Heights 13, Mich.

**GROW Mushrooms.** Cellar, shed. Spare, full time, year round. We pay \$3.50 lb. We have over 25,000 customers. Free book. Mushrooms, Dept. 171, 2954 Admiral Way, Seattle, Wash.

**HEALTHY Wild animals, birds, reptiles** from our foreign compounds. Free list. Specializing baby Calmans. Jungle World, Box 947, Miami 48, Florida.

**PETS Postpaid.** Alligator or Iguana \$3.00. Box turtle \$1.50. Two chameleons \$1.00. Snakes, mammals, curios. Catalog 10¢. Ray Singleton, Rattlesnake, Fla.

**WORLD'S Finest small dogs.** Free literature. Herb Miller, 513 Kent, Lubbock, Texas.

**STOP!** Investigate earthworm raising first! Exciting details free! Oakhaven-4, Cedar Hill, Texas.

**BREED Red squirrels, chipmunks.** Information free. Balchs Squirrels, Castleton, Vt.

### **FUR BEARING ANIMALS**

**AMAZING Profits** converting greens into nutria fur. Nutria carcasses into mink. Voight Farms, Atlanta 2, Texas.

**MINK Raising** information free. Complete. Lake Superior Mink Farm, Superior, Wis., Wisconsin.

**RAISE Rabbits—Nutria.** Choice breeders. Bob Madsen, Lyndon 2, Illinois.

### **FARMS, FARM LANDS, REAL ESTATE**

**FLORIDA.** Nice homesites, \$345 at \$10 monthly. Folder free. Howard Vernon, DeLand, Florida.

**FLORIDA Pleasure center—Desirable** homesites 80x135 feet, \$240, payable \$10 monthly. High, dry, beautifully wooded. Near famous Panama City Gulf resort. Finest deep sea, surf and freshwater fishing, boating, bathing. Unexcelled hunting. Illustrated booklet free. Wendell Wood, Fountain, Florida.

**FLORIDA State government lands,** low as \$10 acre bid. Complete bulletin, \$3. Big free map included. Guaranteed! I. D. Hall, Silver Springs 3, Florida.

**GENUINE Opportunities!** Government land, U. S., Alaska, Canada. Write Sledge Surveys, Macon, Mississippi.

**FREE Strout catalog!** Farms, homes, businesses, resorts, retirement properties. Over 2900 values in 34 states. 57 years' service. World's largest! Write Strout Realty, 7-MF So. Dearborn, Chicago 3, Ill.

**TEXAS Land:** Write for literature, photos and maps on beautiful resort sites near mammoth lake. Boating, hunting and fishing. Total cost \$149.50. Hugh Matlock, Dept. P.M., Pipe Creek, Texas.

**MINNESOTA Waterfront tracts** \$10 down. Norstates, Box 645-T, Houston 1, Texas.

**SAVE Hundreds of dollars** when selling your real estate. Full instructions \$2.00. Norman Realty, 80 Lovell St., Worcester, Mass.

**CANADIAN Tax sale lands** for three dollars an acre and up. Small monthly payments. Farms, timber, hunting and fishing camps, minerals. Limited number of properties. Write at once for free catalogue. Tax Sale Service, Room 105, 120 Bloor St., W., Toronto 5, Canada.

**FLORIDA Lakefront homesites.** Easy monthly payments. Complete literature free. Write Box 1311, Eustis, Florida.

**FLORIDA—50'x125' Homesites;** \$10 down, \$10 monthly; full price \$395. Outskirts Bushnell; Highway 301. City conveniences, no city taxes. High elevation. Free information. Austin and Dawson Realty, Brooksville, Fla. Dept. PM.

**OZARKS! \$9 Acre.** Listings, information free. Write: Armstrongs, Shook, Missouri.

### **PROFITABLE OCCUPATIONS**

**START Christmas production.** Assemble 16" electric stars. Sell for \$3.95, sample \$2.00. Leitch, Park Drive, West Orange, N. J.

**LEARN Locksmithing** from licensed experts at home in your spare time. High pay. Earn as you learn. Locksmithing Institute, Rutherford 13, N. J.

**BUY Wholesale** thousands nationally advertised products at big discount. Free "Wholesale Plan." American Buyers', Hertel Station, Buffalo 16-B, N. Y.

**WE Establish you** in your own mail order discount business. Supply catalogs, letters, envelopes printed with your name and ship your orders. Sell gifts, appliances, watches, housewares, silverware, etc., at discounts to 75%. Catalog and details free. Topval Corp., Lindenhurst 217, N. Y.

**MAGAZINE Subscriptions—Largest** commissions. Bonus. Qualified Agency, 451TA Kingston, Brooklyn 25, N. Y.

**MONEY** in mail order business. Work at home. Free details. Box 448, Anaheim, Calif.

**WELDING Pays big money.** Learn easily at best equipped school in country. Non-profit school with low cost training. O.I. approved. Write Hobart Trade School, Box M-373, Troy, Ohio.

**FOREIGN Jobs—Latin America, Alaska, Canada,** up to \$1500 monthly. Up-to-date 1957 foreign service directory gives complete information; hot list of firms hiring for military and civilian construction, aircraft, oil, exporters-importers, mining, \$1.00. How-when-where to apply. 9th successful year! Global Reports, Box 833-S, Hollywood 28, Calif.

**MAKE Flexible molds.** Cast plaques, figurines. Free sample. Tooker, 1045-M Fairview, Hamilton, Ohio.

**VENDING Machines—No selling.** Operate a route of coin machines and earn amazing profits. 32-page catalog free. Parkway Machine Corporation, Dept. 25, 715 Ensor Street, Baltimore 2, Maryland.

**AUCTIONEERING—Home study** course. Diploma granted. Auction School, Ft. Smith, Ark.

**BE** The Popular Mechanics representative in your neighborhood and earn big profits in your spare time. Write Popular Mechanics Magazine, Room 408M, 200 E. Ontario St., Chicago, Ill.

**RAISE** Pheasants on \$100 week plan. Little capital and space can make you independent. Free details. Great Central System, Columbus 1, Kansas.

**FREE** Book "505 Odd, Successful Businesses." Work home. Pacific, Oceanside, Calif.

**BUILD** Large portable barbecue under \$5.00, sell for \$25.00. Plans, instructions, recipes \$1.00. Casimir, 1735 Indiana, Houston 8, Texas.

**REPAIR** Porcelain on appliances. Much needed service! Profitable! Free information. Enamel Repair, 466 Potomac, Buffalo 13, New York.

**NOW** Grow mushrooms with standard commercial fertilizers. Marketing "how-to," free facts. Luxur, 641 South 19th, Newark 3, N. J.

**FREE!** "\$3,000 Yearly Sparetime. Backyard, Raising Earthworms!" Oakhaven-39, Cedar Hill, Texas.

**FREE** Folio "\$5,000-\$45,000; Unlimited Vacations." No merchandise. Unknown! Work home, sparetime! Haylings, Carlsbad, Calif.

**BIG** Money raising fishworms and crickets. Free literature. Carter Wormery, Plains, Georgia.

**YOUR** Own wholesale business without investment. Bargain catalog. Send 25¢. \$1.00 refunded with first order. Norris, 487-M Broadway, New York City.

**BUY** Wholesale! Discounts to 80%! Appliances, cameras, sporting goods, housewares, watches, tools, clothing, etc. Buy-Rite, Hawthorne 3, New Jersey.

**BAKE** New greaseless doughnuts in kitchen. Sell stores. Free recipes. Michael Ray, 3605 South 15th, Minneapolis 7, Minn.

**BOTTLES**, Vases, etc. Have permanent rainbow colors. How 50 cents. A. M. Cummings, Box 3073, Temple, Texas.

**HOME** Mailorder beginner's manual, sources, methods, opportunities. 25¢. Carnahan Bros., 9610 Acacia, Fontana, Calif.

**GROW** Mushrooms. Cellar, shed. Spare, full time, year round. We pay \$3.50 lb. We have over 25,000 customers. Free book. Mushrooms, Dept. 99, 2954 Admiral Way, Seattle, Wash.

**THEY** Hand him \$100! Free packet. "Secret Journal." 919 secrets-plans! Work home. Publicco, Oceanside, Calif.

### BOOKS, PERIODICALS, PICTURES, POSTCARDS

**FLYING** Saucer books, rented, sold. New Era, BM-11 Melrose Building, Houston 2, Texas.

**NATIONAL** Geographic Magazines, 1888-1956. Periodical Service, Box 463-PM, Wilmington, Delaware.

**"HOME** Improvement Guide." New, amazing 192 page volume. Packed with ideas, plans for remodeling, decorating, landscaping, built-in projects. \$2.50 prepaid. Popular Mechanics Press, 200-HG East Ontario St., Chicago 11.

**RARE** Magazines, catalog 10¢. Nationwide Exchange, Box 1375-F, San Antonio 6, Texas.

**BOOKFINDERS!** All subjects. Send wants! Jaher Book Service, 163 Hazelwood Drive, Westbury, N. Y.

**BOOKHUNTERS!** Scarce, rare, miscellaneous books. Atlantic Book Service, Cedar Street, Charlestown 29, Mass.

**JOHN** Friend, bookfinder, can get the book you want. Free search service. Box 197PM, Cardiff, Calif.

**60** PAGE Booklets! "Electricity," "Radio," "Chemistry," "Physics," "Tables," "Relativity," "Astronomy," "Light," "Heat," "Scientific Oddities." 10¢ each. Franks, 3121 South Racine, Chicago 8.

**SAMPLE:** 30¢ copy of "The Aquarium." Send 10¢ to 12th and Cherry Sts., Philadelphia 7, Penna.

**"SCIENCE** Milestones." Records march of science starting 400 years before Christ, right up to date. Amazing facts revealed. 312 pages packed with startling information that will thrill you. A real history of science. \$5.00. Literature free. Popular Mechanics Press, 200-SM East Ontario St., Chicago 11, Ill.

**BARGAIN**, Exciting Little Library booklets, 25¢ each. How to use tools, painting, welding, home improvement, games, models, plastics, lamp making, glass blowing, boats, photographs. Free catalog. Popular Mechanics Press, 200-LB East Ontario St., Chicago 11.

**OUT-Of-Print** books at lowest prices! You name it—we find it! Fast service. No obligation. International Bookfinders, Box 3003-PM, Beverly Hills, Calif.

**FREE:** Catalog. Many titles. Treasure-Site Books, 279 South Aiden, Philadelphia 29.

**FREE:** Exciting catalog packed with books covering most everything. Think of it—From cover to cover you will find described and illustrated hundreds of books telling how to fix and how to build almost anything. How to remodel your home; do your own decorating, plumbing, electrical work. Simplified books covering concrete work, carpentry, painting, furniture making and refinishing. How to build your own boat, home workshop tools. Best books on photography, welding, hobbies, homecraft. How to make a home freezer. Send for your free copy now. Popular Mechanics Press, 200-BO East Ontario St., Chicago 11, Ill.

### MAGIC TRICKS, PUZZLES, JOKER NOVELTIES

**100** COST Of living gags \$1. Eddie Gay, 242 West 72nd St., New York 23, N. Y.

**INDIA** Rope trick free with 25¢ magic catalog. Hocus Pocus, 317 North State, Jackson, Mississippi.

**CATALOGUE** 1000 Bargains; five tricks, 25¢. Ross, 41 Union Square, New York City.

**FREE** Illustrated magic catalog! Entertain. Great opportunities. Write. Great Heaney, Oakkosh, Wis.

**SENSATIONAL** Magician's wand 25¢. Vanishes handkerchief! Catalog included. Box 1352-PM, Philadelphia 5.

**BE** A magician! Large professional catalog of latest tricks. 35¢. Ireland, C-109 North Dearborn, Chicago 2, Illinois.

**1957** COMPLETELY Illustrated 500 trick catalog 25¢. Stowell, Woodstock, New York.

**VENTRILLO**, Professional voice-throwing instrument and catalog 25¢. Box 971-PM, Philadelphia 5.

**MAGIC** Catalog 25¢. Eastern, P.O. Box 81, No. Westport, Mass.

**WHOLESALE!** Thirty 10¢ trick novelties \$1.00! Profits! 1748-W Market, Philadelphia 3.

**ANCIENT** Molten metal drinking act explained. Metal sample \$1.00. Alchemist, Box 11182, Ft. Worth, Texas.

**DOLLAR** Magic set free with catalog 25¢. 4482-PM Germantown, Philadelphia.

**WORLD'S** Finest professional magic. Joker novelties. Giant illustrated catalog 10¢. Top Hat, Evanston 12, Illinois.

**500** TRICKS, Douglas famous 120-page catalog, only 10¢. Fastest service to magicians for 30 years. Send 10¢ today. Douglas Magicland, Dept. 1, Dallas, Texas.

**SMOKEBOMBS** 25c, 7 For \$1.00. Terrific! 4483-PM Greenc, Philadelphia 44.

**PROFESSIONAL** Catalog, 175 pages, 25¢. Williams, 900 Plymouth, Edinwood City, Penna.

### COINS, TOKENS, CURRENCY

**FLYING** Eagle plus large cent \$2.00. Rhode, 105 Windsor, Reading, Penna.

**40** DIFFERENT Uncirculated coins, \$1.00. Oddehon, Box 482, St. Louis, Mo.

**SWITZERLAND**, Yugoslavia, Finland, Austria, Mexico—All 10¢. Jolie, 136B, Roslyn Heights, N. Y.

**COINS** 35 Different countries \$1.00; large lists 10¢. Benson, 2526 Middle Road, Davenport, Iowa.

**MORGAN** Dollars; 1878-87-90-91-97s, \$2.00 ea. Coin catalogue, 25¢. Shultz, Salt Lake 10, Utah.

**GIANT** U. S. coin catalog 25¢. Acecoin, 314 So. Clark, Chicago 4.

**FREE!** Foreign coin, banknote and coin collectors illustrated catalog to approval service applicants. Send 3¢ postage. Tatham Coinco, Springfield 30, Mass.

**U. S.** Coin approvals. Reasonable. Hutchinson, 3463 "I" Street, Philadelphia 34, Pennsylvania.

**COINS** From Formosa, Vatican, etc.; plus foreign banknote, 10¢ with coin approvals. Littleton Coin Co., Littleton St, New Hampshire.

**BARGAIN** Lists, Indianhead cent, 10¢. Economy Sales, 156-A Dean, Mansfield, Mass.

**GET** Profit and pleasure in collecting old coins. Send 10¢ for 56-page illustrated coin catalog. You'll be delighted with it. Send for it now. B. Max Mehl, 370 Mehl Building, Fort Worth, Texas. Largest rare coin establishment in U. S. Established 40 years.

**BARGAINS**, U. S. coins; 1893 Columbian world's fair half dollar, \$1.00. Ten different Indian pennies, 75¢. Two-cent piece, and 3-cent piece, \$1.00. Gold 1/4 eagle, \$9.00. Gold 1/2 eagle, \$12.50. Beautiful coin bracelet, \$1.00. Many coins available. What do you need? Rare Coin Company, 31 North Clark, Chicago 2.

**LARGEST** Coin magazine, 180 pages, 33¢. Scrapbook, 7320-J Milwaukee, Chicago 31.

**SAN** Francisco mint closed! Made only cents and dimes in 1955. In short supply and great demand. One each, brilliant uncirculated, for 25¢. Free coin lists with order. Bryson Stamp & Coin Company, 612 White, Toledo 5, Ohio.

**13** DIFFERENT Indian cents, coin list, \$1.00. Pounds, North Wales, Penna.

**U. S.** large cent and coin bargain lists, only \$1. Delmaco Products, Box 1123, Wilmington, Del.

**OLD** Money wanted. Do you know that coin collectors pay up to \$100.00 for certain U. S. cents? And high premiums for all rare coins? We buy all kinds. Send 4¢ for large coin folder. May mean much profit to you. Numismatic Co., Dept. 20, Fort Worth, Texas.

**LINCOLN** Cents 1910-S, 1913-S, 1921-S, 1923-S, 1924-S, all for \$2. Gasser's, Box 34615, Los Angeles 34, California.

**SET** Confederate facsimile currency (\$1.00, \$5.00, \$10.00, \$20.00, \$50.00, \$100.00 and \$1000.00 bills) \$1.00. Price list free. Joray's, Box 38C, Shosons, Tenn.

**LINCOLN** Cents wanted. Complete list 25¢. Refundable. Harlan Gates, Scio, New York.

### STAMP COLLECTING

**5** MINT British colonies and 100 others 10¢ with approvals. Miller, 219 Fowler Ave., Jersey City 5, N. J.

**AUSTRALIA**, Fifty different, 10¢ with approvals. Molzan, 720 Pomona, El Cerrito 8, California.

**TOPS!** Free book, "How to Collect Stamps." Send for your copy today! Approvals. Littleton Stamp Co., Littleton El, N. H.

**U. S.** Stamps. Giant bargain catalog, 10¢. Raymax, 25-VZ Maidenlane, New York City 38.

**CONGO** Flowers 10 different 10¢. Approvals. Emory Mead, 65 Krumkill, Albany 8, N. Y.

**U. S.** Commemorative packet plus hinges 5¢. Approvals. Midwest, Oklee, Minnesota.

**300** HUNGARY 80¢; 500 Germany \$1.20; 300 Turkey \$3.50. No approvals included. Free pricelist over 1000 packets. Banthos, Box 122-PM, New York 4, N. Y.

**DEALERS**—Wholesale list. Postage 3¢. Frank, 5631 Queensberry, Baltimore 15, Maryland.

**OLYMPIC**, Sport sets, 11 colorful stamps, 10¢ with approvals. Norton, Box 326, San Antonio 6, Texas.

**WOW!** 135 All different Germany 10¢. Zeppelins, semi-postals, airmails, high values. Big bargain lists and approvals included. Jamestown Stamp, Dept. A5PMO, Jamestown, N. Y.

**QUEEN** Elizabeth mint sets! Barbados, Caymans, Dominica, Tristan, Grenada, Gibraltar. 21 bicolors—25¢! Approvals. Gannon Stamps, Box 931, Canton 1, Ohio.

**FREE!** 9 Armenia bi-colored, (50¢ value) with approvals. Diane, Box 65-M, Myrtle Beach, South Carolina.

**100** DIFF. Foreign, 50 diff. U.S.A. 10¢. Approvals. Kem, 670 W. Florence, Los Angeles 44, Calif.

**NOW!** 200 Different stamps including F.D.R. triangle also scarce war ration stamps. Only 10¢ to approval applicants. Avalon Stamp Co., Dept. M, Springfield, Mass.



**ECONOMICAL** 1 1/4-3¢ Approvals, 33,000 varieties. Dressel, Box 128-N, West Englewood, New Jersey.

**100 LATIN America** 25¢. Plus surprise packet. Packet list free. Econopackets, Box 168, Riverside 9, Calif.

**FREE!** Amazing list! Two feet long! All countries! Stampmart Company, Hartford 1, Connecticut.

**GIANT Stamp zoo free!** Snakes, leopards, rhinoceros, zebu, koalabar and other fierce jungle beasts. Approvals. Send 10¢ for handling. Free stamp magazine. Lincoln Stamp Co., St. Catherine's 518, Ontario.

**FREE!** 107 British Colony stamps. All different, from Britain's farflung colonial empire. Catalog value \$2.50. Free stamp magazine, approvals. Send 10¢ for handling. Act now! Niagara Stamp Co., St. Catherine's 71, Ontario.

**FREE!** 50 British Colonies. 5¢ handling. Approvals included. Kensington Stamps, Buffalo 15, N. Y.

**UNITED States.** Fine mint airmails, #C7, #C8, #C9, #C10. Only \$1.00. Approvals accompany. Whiton Paine, Westport 11, Connecticut.

**UNITED States commemorative collection** containing 33 different—10¢. Approvals. White, 518-A Avenue L, Brooklyn 30, New York.

**TWO \$5.00 U.S. stamps** plus 20 different, 10¢ with U.S. approvals. Irwin, Box 1105, Brooklyn 30, N. Y.

**SELL** Your surplus good grade stamps. Write, describing fully what you have. Vanroy Shirk, Lebanon, Pennsylvania.

**FREE** United States price list. Mark Hanna, 335 Fifth Ave., Pittsburgh 22, Penna.

**50 DIFFERENT Argentine** 10¢. Approvals. Reuter, 611 W. 40th Pl., Los Angeles 37.

**U. S. Classics.** Over 50 yrs. old. 15 selected old-timers. Missing in biggest collections. All 15 at less than 1¢ each. 10¢ with approvals. Jaro, Box 246-T, New York City 8.

**50 DIFFERENT United States** 5¢ with bargain approvals. Lists. Bookman, Box 8245-M, Madelra Beach, Fla.

**AMAZING Offer!** 200 United States stamps—including commemoratives, airmails, high denominations to \$1.00. Only 10¢ for approval applicants! Illustrated bargain lists free. Mystic Stamp Co., Dept. 80, Camden, New York.

**100 STAMPS, 10¢** with approvals. Smith, 508A Brooks, College Station, Texas.

**OLD Scarce U.S. seconds** on approvals. Slight imperfections, lowest prices. Hernefield, Clintonhill Sta., Newark 8, N. J.

**100 OLD United States** between 1861 and 1935, \$1.00. Roush Stamps, 51 Chestnut, Mansfield, Ohio.

**UNITED States approvals.** Select copies, used—mint. Kingsbury, Fairfax, Vermont.

**ICELAND** 10 Different beautiful stamps for only 10 cents to applicants for our good old fashioned approvals. Old Colony Stamp Co., Dept. A, Milford, Connecticut.

**1-2¢ EACH!** Thousands of exciting worldwide stamps. Free examination. Cole, Box 223-A, Buffalo 21, N. Y.

**SELL** Stamps to our readers. Your ad in this space will be read by thousands of stamp buyers. I'll prove that to you. Write now for Folder "S." P. W. Johnson, Classified Advertising Manager, Popular Mechanics, 200 E. Ontario St., Chicago 11, Ill.

**FREE** United States illustrated catalog. Bailey, 45 Bromfield, Boston, Mass.

**225 STAMPS** For only 10¢! This mammoth value includes airmails, pictorials; stamps from strange countries cataloging up to 25¢ each! Also approvals. Mystic Stamp Company, Camden 80, New York.

**PICTORIAL Packet** from Antigua, Barbados, British Guiana, British Honduras, Burma, Curacao, Leewards, Rhodesia, Trinidad, Tobago, and many other hard to get countries. Bi-colors, topicals. Tremendous value. Each stamp a beauty. 10¢ with inexpensive, attractive approvals. Roseland Stamps, Spring Lake 2, Michigan.

**100 DIFFERENT Austria, 10¢.** Approvals. Aronson, Box F, Newton Centre 59, Mass.

**FREE** Stamp collection! 100 different stamps from Europe, Africa, Asia, Scandinavia, Balkans, etc. 3¢ for approval applicants. Tatham Stamp Co., Springfield 30, Mass.

**GIANT Approvals, thousands different, 1¢ and 2¢ each.** Wahl's Stamp Exchange, 7008P Farragut, Chicago 31, Ill.

**MINT U. S. at face value!** All different older commemoratives! Send 25¢ for yours with first selection mint U. S. approvals. Western, Box 1689P, Salinas, California.

**14,000 DIFFERENT!** Fascinating new club plan systematically builds your collection. Only 50¢ weekly. Details free. L. G. Ware, Baldwin 75, New York.

**WONDERFUL Offer.** 7 complete mint sets only 10¢ with approvals. Reich (M28), 1033 Lawrence, Chicago 40.

**70 DIFFERENT U.S.,** included 35 commemoratives, 25¢. No approvals. Seidenberg, Appleton, Wisconsin.

**U. S. Revenues** on approval. El Jay Stamps, Box 286, New York 36, New York.

**WEIRD Diamond shape coffee stamps.** Lovely flower triangle! First American big commemorative. Greenland, idol dancer, etc. Free with approvals. Capital Stamp Co., Ferrysburg 2, Mich.

**WANT Lists filled.** 100,000 varieties available. References. Downey Stamp Service, Box 70A, Bell, California.

**FIVE Different sets French Colonies, 10¢** with approvals. Banner, Box 65, Park Forest, Illinois.

**FREE Sample!** Interesting, informative, illustrated. National Stamp News, Anderson, South Carolina.

**ADEN To Zanzibar!** A special collection of over 200 different stamps from Aden, Barbados, Cyprus, Dahomey, Egypt, Falkland Is., Guadeloupe, Hejaz, Israel, etc., to Zanzibar. Very unusual collection, catalog value easily \$5.00. Some really scarce ones included! Only 25¢ for approval applicants! Write today and receive free—Eisenhower, Grace Kelly and Geo. Washington stamps from Monaco! Lyle Clark, Muskegon 2, Michigan.

**FREE!** Your choice any volume Scott's International, Master Global albums, Scott's 1957 catalogues when you buy our sensational foreign approvals. Write for details with trial selection. Bargain Stamps, Redlands, California.

**25 BEAUTIFUL Ceylon pictorials 25¢!** Giant illustrated catalog free. James, Box 1111P, North Redondo Beach, Calif.

**1500 STAMPS \$1.00** On and off paper. Good variety. World wide. Many pictorials. No approvals follow. Satisfaction guaranteed. Whalen, 1435 First Ave., Oakland 8, Calif.

**FIRST U.N. set.** Among world's prettiest. Only 10¢. Approvals. Welles, Box 1246-R, New York City 8.

**CANADA—100 Different.** 35¢ with bargain approvals. K. S. Holmes, London, Canada.

**2 NUDES Sets 25¢** to adult stamp approval applicants. Atlas, 1326 Vilas, Madison 5, Wisconsin.

**FREE!** Flower, sport triangles! East Indies. Others. Free gift. Approvals. Delton Page, Box 201, East Paterson, New Jersey.

**FREE!** Eight sided stamp, triangle, diamond, midget, mammoth; to approval buyers. Plymouth, Dept. 80, Bell, California.

**U. S. \$5 Coolidge (S. D.)—25¢.** approvals. Gatewood, Box 348, Winston-Salem, N. C.

**FREE!** New sensational picture frame stamp mounts. Plus 51 different stamps, plus stock album. 10¢ handling. Approvals. Surf Stamps, Box 443-P Wildwood, New Jersey.

**OLD U. S. from 1879, Famous Americans, flags, presidents, commemoratives** with approvals plus free premiums for 10¢ handling. Metropolitan Stamps, Box 312HC, Jackson Heights, N. Y.

**QUALITY Approvals** at 2¢ each. Hadrian, 12 East 31st, New York City 16.

**100 DIFFERENT Netherlands, 10¢;** inexpensive approvals. Mattenson, Box 985, Philadelphia 5, Penna.

**102 DIFFERENT, including triangles, pictorials, animals, 10¢** with approvals. Finney, Box 89, El Monte, Calif.

**TRAVELRAMA! 50 Countries—50 stamps, 10¢** with approvals, exciting bonus. Brookside Stamps, Box 485, New Rochelle, N. Y.

**DIRECTORY Listing 125 philatelic agencies** throughout world, \$1.00. Bedard, Box 837-A, Detroit 31.

**EXTRAORDINARY Antarctic set** free with approvals. Variety Stamps, 57-A Circuit, Newton Highlands 61, Mass.

**CANADA—10 Large pictorials** and 100 world wide, free with approvals. Rand A, 16524 St. Charles, Montreal, Que., Can.

**300 DIFFERENT** Given free with approvals. Particulars. Windsor Stamps, 8834 Cornell Ave., Chicago 17.

**FREE!** Large new profusely illustrated catalog of United States postage issues complete; 64-page Stamp Collectors' Guide; other unusual offers. Write today! Harrisco, 3783 Transit Bldg., Boston 17, Mass.

**FREE!** Giant catalog offering thousands of bargains. Sent with beautiful approvals. Jamestown Stamp Co., Dept. E5PMC, Jamestown, N. Y.

**ROOSEVELT Triangle, 27 others, 3¢.** Approvals. Marstamp, Arlington, Baltimore 15, Maryland.

**STAMP Finder, world map** and encyclopedia of stamp issuing countries only 5¢. Approvals. Goliath Company, Bethlehem K1, New Hampshire.

**CANADA—Newfoundland collection** including early issues, commemoratives, pictorials and high values. Plus set of fascinating triangle stamps. Plus set of unused British Colonies. Plus large stamp book. All four offers free. Send 10¢ to cover postage. Empire Stamp Corp., Dept. PM, Toronto, Canada.

**U. S. Mint specials!** 13 different commemoratives, 25¢; flags, #909-21, \$1.00; four different souvenir sheets, \$1.00. Free price list. Brooks, 2352-C East 23rd Street, Brooklyn 29, New York.

**ASCENSION, Antigua, Cooks, Tristan, St-Kitts, Montserrat, free!** Excellent, bargain approvals. May Stamp Service, Box 988-B, Coral Gables 34, Florida.

**EVERYTHING Goes.** Tremendous accumulation. Collections, lots, albums, miscellaneous. Closing out cheap. Lists free. Alatelo, Maynard, Mass.

**FREE** Mint set with approvals. Brinkman, 4241 Live Oak, Arcadia, California.

**FREE.** 35 Different Turkey to approval applicants. Sevel, 12317 Brackland, Cleveland 8, Ohio.

**ALBUMS, Catalogues, premiums** free as you buy. From our approvals. Truevalue, P.O. Box 2098, Santa Ana, Calif.

**BUTTERFLY Set, Madagascar set** plus Monaco, Washington, 10¢ with approvals. Bennett, Candor 3, N. Y.

**KENYA—Queen set** to 1/—Free with approvals. Lee Hoover, Box 3594, Portland 8, Oregon.

**60 PAGE U.S., U.N. illustrated catalogue** free. Stone, 192 Washington, Boston 8, Mass.

**FREE!** Singapore, St. Helena, Victoria, Pakistan, Israel, Seychelles; rare approvals. Box 632A, Miami 33, (Coconut), Florida.

**75 DIFFERENT U.S.—10¢.** Approvals. Edgar, Box 437M, Punxsutawney, Penna.

**FREE!** 14 British Ceylon bi-colored (60¢ value), with temptingly priced approvals. Bishmann's, 116 Mississippi Ave., Joliet, Illinois.

**UNITED Nations.** Five different 10¢. Approvals. Anderson, 1112 Harrison, San Francisco 3, Calif.

**FOREIGN Stamps 1¢ to 5¢.** Aircraft first days approvals. Barr, 467 Oneida, Pittsburgh, Penna.

**UNITED States high grade mix, \$1.00** post paid. Small, 1331 Tyler, Topeka, Kansas.

**25 DIFFERENT Commemoratives 1893** up 10¢. U. S. approvals. K&B, Box 70, Brooklyn 23, N. Y.

**BARGAIN.** Return postage gets (10¢) Confederate (facsimiles) and British Empire packet list free. Additional dime gets 50 different British Colonials, Canadian and British Colonial approvals accompany. Gene's, 1707 Congress, Austin 1, Texas.

**40¢ SCOTT, Or less.** Fine foreign. Hummer, 4308 Allan, Burbank 1, Calif.

**GIFT** With foreign approvals. Smith, 504 Water Street, Warren, Penna.

**UNITED Nations sets, human rights, world meteorological, all 50¢.** Mailed from U.N. Gradin, 163-48 22nd Ave., White-stone 57, N. Y.

**GRAB Bags, \$1.00 each.** Satisfaction guaranteed. Simon, M57, 125 Dewbourne, Toronto 10, Canada.

**MOZAMBIQUE Company set** free. Approvals. Weitz, Box 83F, Orange, N. J.

**FREE!** Monaco triangles! Madagascar! Togo! Iberia airmails! Approvals. Keating, 2320-P Boulevard, Jersey City, New Jersey.

U. S. mint commemoratives 907-1089 face plus 1¢ each and postage. Wilhelm, 16566 Mendota, Detroit 21, Michigan.

ONE Pound world mixture, \$1.25. United Nations list, 3¢. Rainy Day, Wellsville, N. Y.

UNITED States and United Nations price and check list, 25¢, deductible. Fred Ohl, Woodstock, N. Y.

FRANCE, 10 Beautiful large pictorials 10¢ with approvals. Goley, P.O. Box 95, Oaklyn, N. J.

MEXICO, Twenty different 5¢. Approvals. Stampercraft, Box 935A, Brownsville, Texas.

FREE Stamps with approvals. Roy, 160 St. Johns Place, Brooklyn 17, N. Y.

FREE! Seven short sets! Approvals. Gernert, 4335-X Alton, Louisville 7, Ky.

BEAUTIFUL Vatican set 10¢ with approvals. Lee Richards, Radcliffe, Iowa.

JAPAN (B6-7) "Bombing Pearl Harbor." 10¢. Approvals. William Deems, Ravenswood, West Virginia.

BRITISH Colonials, wholesale prices, free bonuses. Tanglewood, 5401 Clarkston, Tacoma 41, Washington.

ARGENTINE, 60 Different mint 32. Cutri, Casilla 244, Rosario (Argentina).

SEVEN Complete sets from fascinating foreign lands, 10¢ with approvals. Olympic Stamp Co., 1215 20th North, Seattle 2, Wash.

APPROVALS—U. S. and foreign. Poland a specialty. Chas. Alexander, 7980 Jericho Road, Rockford 4, Michigan.

MONACO Nudes 10¢ with approvals. Royal Stamp Company, Tamaqua, Penna.

100 DIFFERENT China 10¢. Approvals. Cossel, P.O. 2187H, Santa Ana, California.

275 STAMPS—10¢ With approvals. Wm. Rice, 87 Washington Ave., Kingston 87, N. Y.

TEN Mint triangles, diamonds only 10¢. approvals. Balter, Box 19484, Los Angeles 19, Calif.

10 ISRAEL 10¢. Coral, Box 224, Riverside Sta., Miami, Fla.

FIRST German almost set complete. Ten cents. Approvals. Boger, Box 154, North Wales, Penna.

#### HOBBIES AND COLLECTIONS

COLLECTORS Matchbook covers, 100 different unused, \$1.00. Catalog 25¢. Album \$3.00. Charles Edelman, 1311-C East 84, Cleveland 3, Ohio.

INVENTING Can be an interesting and profitable hobby. Write for complete particulars. Institute of American Inventors, Dept. 40-E, 635-F St., N.W., Washington 4, D. C.

NAZI Insignia, 12 different \$1.00. Medals, patches, armbands, flags, daggers. Illustrated lists, 15 cents. Medcrafts, Box 532, Victoria, B. C. 2, Canada.

MILITARY Miniatures, Civil War. Custer's Cavalry, American Revolution and U. S. Marines. Illustrated catalog 35¢. Bussler Miniatures, Dept. Z, 40 Howe St., Quincy 69, Mass.

#### PRECIOUS STONES, MINERALS

GENUINE Cabachon cut star sapphires: 1 kt. \$10; 2 kt. \$22; 3 kt. \$36. Postage prepaid. Merrin, 530 Madison Ave., New York 22, N. Y.

SEMI-Precious gem stones. Sent on approval. Paul Fryer, Dover, Mass.

MAPS And handbooks for rockhounds, treasure hunters, prospectors. List 25¢ (refunded). Simpson Publishing Company, 6029 Ridgeview Place, Spokane 16, Washington.

SAPPHIRE, Topaz, tourmaline, garnet, peridot. Five uncut gem specimens, \$1.00. Ten polished gems, baroque shaped, \$1.00. Free bargain list jewelry, gems. Profitable, easy "do-it-yourself" projects. O'Brien's, 1116M Wilcox, Hollywood 38, Calif.

CUT Gems, make jewelry—For profit or fun. 100 page magazine tells how: where to get supplies. Sample 25¢ or request free literature. Lapidary Journal, Del Mar 2, Calif.

EARTH Science, the Rockhounds' national magazine. Subscription \$3.00, sample 25¢. Box 1357, Chicago 90.

#### ANTIQUES, RELICS, INDIAN GOODS, CURIOS

SELLING 100,000 Ancient arrowheads, spearheads, tomahawks, etc. List free. Lear's, Glenwood, Arkansas.

SCALPING Knife, spearhead, thunderbird \$4.00. Catalog free. Arrowhead, Glenwood, Arkansas.

#### CAMERAS, PHOTO SUPPLIES

FREE New bargain book! Big savings. Central Camera Company mail order headquarters since 1899. Dept. 131, 230 South Wabash Avenue, Chicago 4, Illinois.

BUY Wholesale nationally advertised cameras, photo supplies, thousands other products at big discount. Free "Wholesale Plan." American Buyers, Hertel Station, Buffalo 16-E, N. Y.

BELL & Howell, Kodak, Graflex, discounts to 40%. Photo equipment, appliances. Free catalog. Mailers Mart, Box 135-KG, Pelham, New York.

NEEDED Amateur or professional photographers, full or part time. Any age. No special equipment required. Apply now. International Press Assn. Inc., 30 North La Salle, Chicago 2.

REPAIR All cameras, binoculars. Free estimate. Modern Technical Supply PM, 55 West 42nd Street, New York City 36.

PHOTOGRAPHY For pleasure or profit. Learn at home. Practical basic training. Long established school. Free booklet. American School of Photography, 835 Diversey Parkway, Dept. 3442, Chicago 14.

#### PHOTO FINISHING

FAST—One day service. 8 brilliant over-size prints 45¢. 12—60¢. Reprints 5¢. Speed, satisfaction guaranteed. PicSure, Box 899-M, Philadelphia, Penna.

100 GLOSSY Postage stamp size photos for \$2.00. Any size photo duplicated. Straw's, 1120 Sixth Avenue, Altoona, Penna.

ANY Size roll film (except 35mm.) jumbo printed 50¢ per roll. Friendly Photos, Jacksonville, Alabama.

ENLARGEMENTS, Heavyweight seven 5x7's or four 8x10's \$1.00. Jack Koons, Huntington Mills, Luzerne County, Penna.

FREE 5x7 Enlargement with each roll. 8's, 35¢; 12's, 50¢. Smith, Box 511-3, Marshall, Texas.

FREE! Color snapshot folder. Offers, lists, mailers. Houghton's, Erving, Mass.

PHOTOS Sealed in plastic, wallet size, 30¢ each. Box 8641, Chicago 80, Ill.

FREE Roll film with your first order. Send 50¢ and 1 roll of exposed film or 10 negatives for reprints and you will receive one roll of guaranteed camera film free your size with your pictures. Send ad. Cher-O-Kee Scout, Athens, Tenn.

COLOR Processing—High quality, fast service and low prices. Kodacolor developing 85¢; prints 27¢. Kodachrome: 35mm. processing, 20 exposures, \$1.45; 36 exposures, \$2.25. Send for complete price list and free mailers. Photo-Mail, Box 216M, Madison Square Station, New York City 10.

WE Custom develop and print your films. Get the most from your photographic effort. Kradwells Photo Service, Greenlake, Wisconsin.

QUALITY Kodak finishing, 8 exposure roll 40¢; 12 exposure 60¢; 16 exposure 70¢. Reprints 5¢. Fast service. Guaranteed quality. 40 years continuous operation. Be a satisfied customer. We do color. Send for mailers. Mail Order Photo Service, Box 297, Watertown, Wisconsin.

5-HOUR Service on deluxe jumbo prints. 8-exposure roll developed and 8 jumbo prints 40¢, 12 exposure 55¢, 16 exposure 70¢, 35mm. 20 exposure 75¢, 36 exposure \$1.25. Jumbo deckle-edge reprints 4¢ each. Contact prints made if specified. Bay Photo Service, P.O. Box 210, Oakland, California.

SUPERIOR Quality. Prompt service. 8 jumbos in album 40¢, 16 contacts 50¢. Jumbo reprints 5¢. Satisfaction guaranteed. Also complete color film finishing service. Write for free circulars and mailers. Fast-X-Photo, Box A, Jersey City, N. J.

8-12 EXPOSURE Rolls 39 cents jumbo prints. Free 5x7 enlargement with each roll developed. Guaranteed work, one day service. Lincoln Studios, Dept. K, Box 13, Lincoln, Nebraska.

30 WALLET Fotos for \$1.00 from one pose, portrait or negative. Add 10¢ for mailing. No copy negative charge. Send ad. Scout Wallet Fotos, P.O. Box 37, Athens, Tenn.

#### MOTION PICTURES AND SOUND EQUIPMENT

MOVIE Camera film: 8mm. roll \$1.50, 16mm. 100' \$3.00. Free processing. Better Films, 742 New Lots, Brooklyn, N. Y.

RECORDERS, Tapes; wholesale. Free catalogue. Carstan, 215 E. 83, New York City 28.

8-16MM. Films. Free catalogue, with sample film 10¢. Garden, 630 Howard Avenue, Brooklyn, N. Y.

SAVE 50%! Guaranteed-fresh color, b.&w. movie film! 8mm., 16mm. Free catalog! Eco-R, 47th Holly, Kansas City 12, Missouri.

5,000 8-16MM. Movie films. Free catalogue. International, Greenvale, N. Y.

TAPE Recorders, tape. Unusual values. Free catalog. Dressner, 69-02M 174 St., Flushing 65, N. Y.

MOVIES—Color slides. Catalog, sample slide dime. Eddings, R-3, Corning, N. Y.

16MM Sound films. Free lists. Crawford Films, 412 Page St., Ft. Worth 10, Texas.

FREE Catalog. Save dollars. Fresh 8mm., 16mm. b.&w and color film. Home processing equipment. Superior Bulk Film Company, 448 No. Wells, Chicago 10.

#### MUSIC AND MUSICAL INSTRUMENTS

GUITARS — Wholesale. Photographic catalog. 36 page book "How To Play Any Instrument," sample lesson, free. Ed. Sale, SSM8, Bradley Beach, N. J.

ACCORDIONS Wholesale—10 day trial. Free catalog. American Accordion Center, 5329-PM-5 Belmont, Chicago.

MARVEL Piano course. Play in one half hour! Send for free first lesson. Empire Music School, Box 1332, Denver 1, Colo.

ACCORDIONS. Direct from importer. Save 50% and more! Free trial. Lifetime guarantee. Trades accepted. Free catalog. Write Accordion Manufacturers Outlet, Dept. 57R, 2003 Chicago, Chicago 22, Ill.

DISCOUNTS Instruments, accessories, national brands. Tempo Music, 37 Cutler, New London, Connecticut.

VIOLINMAKERS. Repairers. Fine tone wood, and all violin supplies. Send for free wholesale price list. International Sales, 414-MPM E. Baltimore St., Baltimore 2, Maryland.

POEMS, Songs wanted! Recording, publishing. Bengol, 93 Jefferson, Chelsea 50, Massachusetts.

ACCORDIONS, Wholesale to everyone. Save up to 60%. All national known brands. Free catalogue. Del Principe, 29 South Cicero, Chicago 44.

WRITE Songs. Big money and reputation. Write for information. J. Gordon Pub. Co., 4700 South California Avenue, Chicago.

SONGPOEMS And lyrics wanted. Mail to: TinPan Alley, Inc., 1650 Broadway, New York 19, N. Y.

SONGS Into dollars. Share \$29 million dollars yearly for new songwriters, song-poets. Songs composed, published, promoted by famous firm. Information, appraisal free. Send to Nordyke Publishing, 6000 Sunset, Hollywood 28PM, California.

POEMS Wanted for new songs. Send poems. Free examination. Immediate consideration. Songcrafters, 2734 Arcade Station, Nashville, Tenn.

SONG Poems wanted. Five Star Music Masters, 630 Beacon Building, Boston.

POEMS Wanted for new songs. Send poems. Immediate consideration. Crown Music Company, 49-C West 32 Street, New York City.

SONGWRITERS — Send 25¢ for list of song publishers. Laura Dickson, 1804 Green Street, Columbia, South Carolina.

IF You like to collect records, you should send for our free catalog of wrought iron record cabinets, holding over 250 albums. Leslie Creations, Dept. C67, Lafayette Hill, Penna.

ELECTRIC Guitars, amplifiers, wholesale. Free catalog. Carvin PMM, Covina, California.

LEARN Piano quickly at home. Send only \$2 for easy, illustrated instructions, simplified piano music, rapid key finders and other brilliant piano revelations. Robbins Way—52, Box 25, Vancouver, Wash.

### RADIO, TELEVISION AND ELECTRONICS

MONITORADIO Police receiver PR9 \$49.95. Ladd, 111 North 41st, Omaha 31, Nebraska.

CRYSTAL Radio experimenters write to Hulet, 305 Hope, Lakewood, N. J.

U. S. Navy's Basic "Electricity," 684 pages, \$2.25; "Electronics," 728 pages, \$2.25. Capitol, Box 703, Silver Spring, Maryland.

ELECTRIC Guitars, amplifiers, wholesale. Free catalog. Carvin PMR, Covina, California.

### BUSINESS OPPORTUNITIES

START Your own business on credit. Your own boss. 1527 dealers sold \$5,000 to \$32,000 in 1956. We supply stocks, equipment on credit. 200 home necessities. Sales experience unnecessary. Pleasant profitable business backed by world-wide industry. Write Rawleigh's, Dept. E-U-PPM, Freeport, Ill.

WHOLESALE—Thousands nationally advertised products. Buy, sell. Amazing profits. New, free plan. Associated Wholesalers, 1016-D Starr, Burlington, Iowa.

WANTED! Home workers to assemble luggage and cases for ready market. Instructions, materials, tools, everything supplied. Free details. Abaris, #07-BF Sunset, Los Angeles 12.

PROFITABLE Mail order methods, ideas, opportunities. Clearly, authentically revealed in amazing new publications now available. Free details. Write: Wellington Publishing, Box 4157, Austin 51, Texas.

START A buying service, buy wholesale thousands nationally advertised products. Make big profits selling at sizable discounts. Postcard brings details. American Buyers, Hertel Station, Buffalo 16-C, New York.

MOTELS, Free bulletin describing 70 motels. Continental, 604 Grand, Kansas City, Missouri.

IMPORT-Export opportunity, profitable, world-wide, mail-order business from home, without capital; or travel abroad. Established world trader ships instructions for no-risk examination. Experience unnecessary. Free details. Mellinger G705, Los Angeles 24.

OPERATE Your own mail order discount business at home spare time. Sell gifts, appliances, housewares, cookware, cutlery, dinnerware, silverware, jewelry, watches, etc., at discounts to 75%! No stock investment. We ship order under your name. Catalogs, sales letters, order blanks, envelopes printed with your name can cost you nothing. Postcard brings free sample catalog, all details. Topval Corp., Lindenhurst 418, N. Y.

PRINT Without a printing press! Amazing new method! Print colorful signs, banners, cards, posters, glassware; anything at home. Big profits. Money-making opportunity! We supply everything. Beautiful sample, home-business plan free! Write Screen-Print Company, MY, Los Angeles 61, California.

SELL By mail. Tested methods. Alfano, 19 Pine Street, Closter 1, New Jersey.

MAKE Extra money. Cash commissions. Everybody buys easy-to-sell advertising book matches. Union label. All sizes. Cuts for all businesses. Powerhouse selling kit free. Steady repeat business. No experience necessary. Superior Match Co., Dept. MX-557, 7526 S. Greenwood, Chicago 19.

WANTED: Home producers, to be subcontractors. Cast plastic products for manufacturers in our clearing house service. Thousands of easily made items required. Cash in at home, without previous experience. Plastic Service Associates, Dept. 5PM, East Boston 23, Massachusetts.

SELL Brass name plates for houses. Make \$20 day easy! Sample \$1. Lindo, Watertown, Mass.

60% PROFIT Cosmetics \$25 day up. Hire others. Samples, details. Studio Girl-Hollywood, Glendale, Calif., Dept. 1275H.

"HOW To Start a Business" booklet sent free! If you know any trade, go into business for yourself! Learn the 8 easy steps to follow. We've guided 3,000 others to success. Revealing free booklet yours for the asking! Write! National Business Consultants, Office MY, Los Angeles 61, Calif.

LIQUID Rubber. Make flexible molds. Free sample. Chaney, 1907 East Rd., Jacksonville 11, Fla.

GROW Expensive herbs for us! Big profits home-business of your own. Year around profitability! We supply everything necessary! Send for free rare seeds and revealing plan. National Herb Exchange, Dept. MY, Gardena, Calif.

UNUSUAL Mailorder opportunity. Tested, profitable. We supply everything. No obligation, send name. Hackmann, 2004 1/2 Griffin Ave., Los Angeles 31, Calif.

OPPORTUNITIES Making money in spare time. Catalog 25¢. R & H Co., Box 31077, Los Angeles 31, Calif.

START Your own business for \$20.00. We send you 15 samples of our best selling items. Reorder only the numbers you can sell. Money back if not completely satisfied. Division Sales, 3341 W. Roosevelt Rd., Chicago 24, Illinois, Dept. K.

MAIL Order advertising agency executive reveals sensational no-risk advertising and merchandise methods. Start in office or home; minimum capital; positive profits. Free details: Impact! 3407 Prospect Avenue, Dept. 11-5, Cleveland 15, Ohio.

BUY Wholesale! Resell at big profits. Brand name merchandise—Appliances, cookware, housewares, watches, jewelry, dry goods, clothing, sporting goods, toys, gifts, etc. Free 1957 color catalog with confidential cost sheet. Merit Home Products, Dept. PM-3, 107 Manhattan Ave., Brooklyn 6, New York.

HOW To obtain needed capital fully explained. Write Enterprise Bureau, SAK Bldg., Syracuse 2, N. Y.

NEWEST Spare, full-time home business \$5 to \$10 hour possible. Paint with suede—The finish with touch and eye-appeal. Beautify auto dashboards, signs, radios, toys, figurines, lamps—1001 others. Complete, step-by-step instructions sent for no-risk examination. Free details. Coast MY, Los Angeles 61.

MAKE Perfumes, cosmetics. Work home. Sell mailorder. International, 6347 Parnell PM-57, Chicago 21, Illinois.

CANDIED Popcorn and potato chip equipment. Eakins, Box 933-A7, Springfield, Ohio.

GAME Warden, government hunter, forestry, park and wildlife services announce job openings. All states. Enjoy outdoor work, good pay, real security. Complete information free! Write Home-Study Educators, A175C, Los Angeles 19, Calif.

LEARN Professional TV servicing in one week! Fabulous new simplified system. No big expense. No studying. No tools or equipment. Spare, full time. Own your own big profit business! Save! Amazing but true! Free! Write, Electronic Engineering, Dept. A-175C, 1038 So. LaBrea, Los Angeles 19, California.

PROFITABLE Future in your own mail order business. Free details. Zed Gwartzney, Desert Hot Springs, Calif.

VENDING Machines—Every description. New or used. Lowest prices. Start a route or sell outright. Established 29 years. Mack Postal, 2952 Milwaukee, Chicago 18.

RELIABLE Men, women wanted for profitable mail order work. Wabash Products, Box 165, Cayuga, Indiana.

WHOLESALE Catalog! Discounts to 80%! Clothing, appliances, tools, housewares, jewelry, etc! Midwest, 156-MM2, Pontiac, Illinois.

OPERATE Mailorder folio business! Free details. Ballard's, 425 East Catherine, Louisville 3, Ky.

MAKE Flexible molds. Cast plaques, figurines. Free sample. Tooker, 1045-R Fairview, Hamilton, Ohio.

WANT To make big money at home? \$10.00 profit in an hour possible with invisible reweaving. Make tears, holes disappear from clothing, fabrics. Steady year-round demand from cleaners, laundries, homes. Details free. Fabricon, 8334-S Prairie, Chicago 19, Illinois.

NATURAL Molding rubber, extra thick. Free sample. W. Wooley, 1016-A Donald, Peoria, Illinois.

INTERNATIONAL Mailorder business. Complete setup service—Not just instructions. Hermes, 152 West 42, New York City 38.

BIG Money raising fishworms and crickets. Free literature. Carter Farms, Plains, Georgia.

INTERESTED Mail order? Samples leading mail order magazines 10¢. Palma, Box 1221, Baton Rouge, La.

START Home business making statuary, plaques, novelties, garden furniture, artificial marble flooring, liquid marble. Make your own flexible molds. Amazing profits. Only \$1.98. Free literature. Popular Mechanics Press, 631 No. St. Clair St., Chicago 11.

UNUSUAL Mailorder opportunity. Tested. We supply everything. Girard's, Azusa, Calif.

WANT More business? Here's an amazing opportunity to increase your sales. Talk to thousands of interested readers of "Mechanics Popular." Our Spanish Edition covers the Latin American countries like a blanket. They're real mailorder buyers. Classified rate 75¢ per word. Try an ad in our next issue. Classified Advertising Department, Popular Mechanics Magazine, 200 East Ontario Street, Chicago 11, Ill.

VENDING Machines—No selling. Operate a route of coin machines and earn amazing profits. 32-page catalog free. Parkway Machine Corporation, Dept. 26, 715 Ensor Street, Baltimore 2, Maryland.

HOME Workshop books. Free catalog. Popular Mechanics Press, 631 N. St. Clair St., Chicago 11.

MONEY In saw and lawnmower sharpening sparetime at home. Free book. Virgil Foley Company, Columbia Heights, Minnesota.

FREE Folio "\$5,000-\$45,000. Unlimited Vacations." No merchandise, equipment. Unknown! Work home, sparetime! Haylings, Carlsbad, Calif.

\$250 WEEK Cleaning venetian blinds. Patented machinery. Free literature. Robinson, 7213B, Indianapolis 1, Indiana.

\$70 WEEKLY—Home, spare time. Simplified mail bookkeeping. Immediate income—easy! Auditax, 34757A, Los Angeles 34.

BRUSH Plating outfits for plating articles in the home and shop. No tanks necessary. Good income spare or full time. Free particulars. Gunmetal Co., Ave. H, Decatur, Illinois.

\$1,000 MONTHLY Possible in collection agency business. Free details. Write Cole Associates, Syracuse 2, N. Y.

TO \$100.00 Weekly. Sparetime, home operated mailorder business. Successful beginner's plan. Everything supplied. Lynn, 10420-M National, Los Angeles 34.

FREE Book "505 Odd, Successful Businesses." Work home. Expect something odd! Pacific, Oceanside, Calif.

PLASTERCRAFT Molds, liquid rubber, plasters, floccs, candle supplies. Catalog and manual free. Blue Rapids Supply, Blue Rapids, Kansas.

EARN \$10,000 Yearly raising Angora rabbit wool for us. Information 25¢ coin. American Angora Company, Malta 12, Montana.

BREED Rare tropical fish at home. Earn big money! Learn secrets! Help fill huge demand. Amazing opportunity! Free plan. Tropical Fish Breeders, Los Angeles 61, Calif.

MINK Raising information free. Complete. Lake Superior Mink Farm, Superior, EE1, Wisconsin.

COPUBLISH Mail Sale Advertiser, leading mail order paper. Details, latest copy, dime. Vanroy Shirk, Lebanon, Penna.

LEARN Real estate by listening to records. Lee Institute, Brookline 46, Mass.

I Want to send you proof of the wonderful pulling power of Popular Mechanics classified pages. What's your proposition? Write me today. Include literature if possible. F. W. Johnson, Manager Classified Advertising, Popular Mechanics Magazine, 200 E. Ontario St., Chicago 11, Ill.

LEARN Sewing machine repairing. To \$125.00 weekly. Sparetime. Supplies. "Add to present business." Write today! Taylor Service, Box 2126, San Bernardino, Calif.

**FREE "Franchise Profit Letter"** describes nationwide opportunities. Exclusive distributorships, dealerships, agency operations. Write today. National Franchise Reports, 333 North Michigan, Chicago 1.

**LEARN** Photo-negative portrait retouching. Men, women. \$5 hour possible spare or full time at home. Easy, glamorous. Work for photographers by mail order. Full details sent free. Duval, 100 So. Vermont, Los Angeles 4.

**YOUR** Own name brand business. No investment; no inventory. Part time or full time. Sell famous brands of appliances, housewares, silverware, radios, vacuum cleaners, lamps, tools, clocks, watches, jewelry, etc., etc., over 1000 items. Join thousands of successful independent dealers. Send for free catalog and dealer price list. H. B. Davis Corp., Dept. 11, 145 W. 15 St., New York City.

**11,000 NEW** Prospects daily. Baby record books, shoes, albums. Sell mailorder. Use our literature. Write: No-Co-Ro, Capitola, California.

**COLORGLAZED** Concrete pottery made without molds. Patented method. Cemetery products, novelties, tiles. Basement leak-sealing. Money-making projects. Booklet, details free. Men only. National Pottery Company, Grand Rapids, Minnesota.

**FREE** Cadillac, \$10,000 yearly. Cars, appliances wholesale. Straley, 6228E, Charlotte 7, N. C.

**OPERATE** Profitable mailorder business! Splendid opportunity. For details write: Thomas Bond, 1437H West Vernon, Phoenix, Arizona.

**COLOR** Concrete with chemicals. Marble-glass cement benches, pottery. Home-shop. Hundred beautiful designs, made without molds. Birdbaths to waterfalls. Your chance for fame, fortune. 10¢ brings sample, pictures. Hollywood Cementcraft, 8327-R Wonderland, Hollywood 46, Calif.

**CASH** From sawdust, seventy methods. Tin-cans, thirty methods. Newspapers, eighteen methods. Instructions 50¢ each. All three \$1.00. Charles Company, 12-DXT, Norwood, Ohio.

**AMAZING** Sign system. Earn while learning. Straley, 410 S. Western, Springfield, Ohio.

**MONEY** Comes easy to owners of Acme saw sharpeners. Send for free literature. Max Mfg. Co., 138 Stockton Ave., San Jose 28, Calif.

**BE** Appointed state notary public now. Write, Stationers, Boerne, Texas.

**10,000 WORD** Booklet "How To Build Own Mail Business." 25¢. Hamm, 3001 North Spaulding, Chicago 18, Illinois.

**GROW** Mushrooms. Cellar, shed. Spare, full time, year round. We pay \$3.50 lb. We have over 25,000 customers. Free book. Mushrooms, Dept. 172, 2954 Admiral Way, Seattle, Wash.

**BIO** Profits raising earthworms. Literature free. Lund's Hatchery, Olathe, Kansas.

**BOOKKEEPERS.** Accountants. Operate a bookkeeping service. Part or full time. Amazing simplified system. Wonderful money-making opportunities. Complete information free. National Bookkeeping Publishing Co., Suite 307, 3435 Broadway, Kansas City 11, Mo.

**MAKE** Money fast! Buy nationally-advertised products at factory prices—Sell for up to 500% profit! Bi-monthly publication tells all. Write now for sample copy details. Home Business Digest, G.P.O. Box 972-PM, New York 1, N. Y.

**WE** Love our mailman—He leaves over \$1000.00 monthly in our rural mailbox. My college professor husband drafted a scientific home mailorder method. We bought a Texas ranch, live as we always wanted. Now we sell the Ranch Mailorder Method. Operates anywhere. Inquire: Eveningshade Ranch, Boerne, Texas.

**BAKE** New greenless doughnuts in kitchen. Sell stores. Free recipes. M. Ray, 3805 South 15th, Minneapolis 7, Minnesota.

**TAPE** Recording! Exceptionally profitable opportunity in your area. Free information. Baron's, Lynden, Washington.

**BUY** Wholesale! Discounts to 80%! Appliances, cameras, sporting goods, housewares, watches, tools, clothing, etc. Buy-Rite, Hawthorne 1, New Jersey.

**FIX** Typewriters. Inexpensive home course teaches factory secrets. Free booklet. Athey, Tarentum, Penna.

**TOP** Flight mailorder business opportunity. Modest capital. Request convincing details. Stav, 147 Victoria Street, Kamloops 18, B. C., Canada.

**MAKE** Money in sparetime at home by mail. 20 lesson course by nationally known expert teaches how. Request convincing details. Stephens Enterprises, Hartstown 1, Pennsylvania.

**THEY** Hand him \$100! Free plan "Secret Journal Hidden Dollars." Work home! Publics, Oceanside, Calif.

**MONEY.** Raise hybrid worms. 250—\$2.00. Book \$1.00 postpaid. Brandt's Wormery, Century Apartments, Davenport, Iowa.

**WORLD** Wide business from your home. 100 names, addresses foreign manufacturers seeking distributors. Import-export instructions, lists, \$1.00 full price. M.J.R. Co., 317 Lorton, Burlingame, California.

**IMPORT-Export!** Modern dropship method. Details. Warner, Box 6, Fort Scott, Kansas.

**IMPORT** Your own products in small lots. Start profitable mail order business using international drop shipment method. Capital unnecessary. Free details. Georgia Overseas Trading Co., Dept. W, 115 Persons Bldg., Macon, Ga.

**MAKE** \$46 From square foot plywood; jig saw necessary. Free information. Woodarts, X-7, Bridgewater, Mass.

**STATUARY** Molds! Super quality liquid rubber. Ajax Products, 734 East 236th Street, Cleveland 23, Ohio.

**\$5,000 YEARLY.** Spare time at home. Nothing to buy. No local selling. Dignified. Guaranteed. Home Harvest, Rt. 3, Box 3491-A, Albuquerque, New Mexico.

**"MAILORDER** Laws and Regulations." \$1.00. Explains necessary licenses, different taxes, legal requirements, etc. "Mail-order Rules for Beginners," \$1.00 additional. Tasker, 1603 Peach Street, Alexandria, Virginia.

**MIMEOGRAPHING** Pays sensational local profits. Exclusive secret plans exposed! Start free. Moele Mimeo Shoppe, Bonham, Texas.

**PLASTIC** Laminating. Pleasure and profit. Self-sealing. No machines. Complete home kit, \$1.00. Mountainside 1, Springwater, New York.

**OPERATE** Your own merchandise mailorder business. Everything furnished! B. Mann, Woodcliff Lake, N. J.

**PIANO** Tuning learned quickly at home. Tremendous field! Musical knowledge unnecessary. Free information. Empire School of Piano Tuning, Champaign, Ill.

**CLASSIFIED:** Many business opportunities, considering abilities, finances. Free questionnaire. Connolly, 131 Parkhurst, Kenmore 23, N. Y.

**WE** Train people for sparetime businesses. Nationwide Business Institute, 618 Savannah, Columbus 4, Ohio.

**MONEY** For you! Big profits! Cast plaster figurines, bookends, plaques at home with XL rubber molds. No experience needed! Write for illustrated, 40-page catalog, only 25¢! Plastic Arts Studio, 3463 So. Madison Street, Department 5, Muncie, Indiana.

**EXCLUSIVE** Distributorship available in most areas for world-famous Cadmium battery guaranteed to outlast your car. Tremendous profit opportunity. Investment for merchandise only. Free franchise. Cadmium Battery Corporation, Dept. 102, El Segundo, California.

**EARTHWORM** Growers needed! Send for free booklet "How You Can Make Money Raising Earthworms!" National Worm Co-Op, 4163 Pedley Avenue, Norco, California.

**GROW** Orchids at home. Profitable, fascinating. Year 'round, Maine to California. No greenhouse. Successful home grower shows you how to provide proper temperature and air conditions in any well lighted room. Full details and real orchid seeds free. Orchardland, 100 So. Vermont, Los Angeles 4.

**PLATE** Baby shoes, jewelry, gifts, bronze and colored pearl. Free booklet. Platex, 11029 South Vermont, Los Angeles 44.

**LEARN** Appliance service and repair. Motors, washers, refrigeration, cleaners, everything. Free booklet. Armstrong, 11627-A South Vermont, Los Angeles 44.

**MADE** \$10,000.00 Typing at home. Guaranteed proof. Amazing information 10¢. Lenore Felgen, Box 1125-PM, Oak Park, Illinois.

**EARN** \$4.00 Hour at home. Make concrete units for builders, home owners. One day's profit pays for equipment. Free details. West Shore Concrete Works, Shiremanstown, Penna.

**OPERATE** Profitable food supplement business from your home. Splendid opportunity. Start sparetime. Future unlimited. For free details, write: Leland Manning, Box 8338, Chattanooga, Tenn.

**MAIL** Order business with a future. Make money in a "collective mail order business." With repeat income. Orders come direct to you with big profit on every sale. Send \$1.00 now. Free circulars with your order. Collective Enterprises, P.O. Box 179-F, New York 16, N. Y.

**WASH** Outside windows in 1/2 time. No wiping. Make 100%. Sample 25¢. 419 Vilet, Milwaukee 12.

**MAILORDER** Envelope business. No investment. Omaha Envelope, 4721-E California, Omaha 3, Nebr.

**BUY** Wholesale! 7,000 secret sources revealed. George Lucas, Bellevue 5, Wash.

**START** Your own subscription service. Every family buys magazines. No capital needed. We tell you how, furnish all supplies free. Liberal commissions. Write McGregor Magazine Agency, Dept. 110, Mount Morris, Illinois.

**\$1000 MONTHLY.** Start cut-rate nutritional specialty store your home. 100 repeat items. Wholesalers, 2510 S.E. Clinton Street, Portland, Ore.

**NOW** Grow mushrooms with standard commercial fertilizers. Marketing "how-to," free facts. Luxur, 641 South 19th, Newark 3, N. J.

**\$10.00 PER** Hour net profit in monument cleaning business. Free details. X-Port Monument Cleaning Company, 466 Potomac, PM-4, Buffalo 13, New York.

**BUILD** Fascinating hobby or business engraving plastics! "DupliScaler" engraving, carving machines. Sample engraving, details 25¢. Desco Distr's., 5252-Y Van Nuys, Van Nuys, Calif.

**EARN** To \$90.00 up weekly sparetime. Mailorder operated. This business works! Test proves profits. Free plan. Bariskill, 1715 Julian, El Cerrito, California.

**BOOK** On culture crickets and earthworms. Excellent information. \$1.00. Kean, Ladonia, Texas.

**FREE!** "\$3,000 Yearly Sparetime. Backyard, Raising Earthworms!" Oakhaven-38, Cedar Hill, Texas.

**MAGICAL** Home steam coffee brewer, 5 healthful, individual cupfuls 1¢. Just rinse. Prepaid \$1. New. Help. Inventor, 3503 Chestnut, Baltimore 11, Md.

**\$200 PER** Day! Made operating stands or concessions at fairs and carnivals. Write! Globe Sales Co., Macon 3, Georgia.

**GERMAN** Novelties directly! Gives big business. Free list. Novelties-Export, Karlsruhe/B 280, Germany-W.

**BUY** Direct from factories—Appliances, cameras, watches! Free details! Cam Company, 6810PM—20th Ave., Brooklyn 4, N. Y.

## **MONEYMAKING OPPORTUNITIES**

**LEARN** Technical metaphysics and insure your future. Easy, inexpensive correspondence course. Simplest method known. Diploma. Write: Premier College of Technical Metaphysics, 2532 McKenzie St., Vancouver 8, B. C., Canada.

**BUY** Wholesale! 30-80% discounts! Appliances, gifts, typewriters, tools, watches, sporting goods, jewelry, cameras, housewares, etc. Consolidated Distributors, Clifton 28, New Jersey.

**THEY** Hand him \$100! Free plan "Secret Journal Hidden Dollars." Work home! Publics, Oceanside, Calif.

**"HOW** To Win Prize Contests." Free information. National, 9128-P S.W. 26th, Portland 19, Oregon.

**WHOLESALE!** Sell yourself, sell neighbors aluminum awnings; beautiful baked enamel finish. Write: Jack, Box 10254, Tampa, Fla.

**HOTTEST** Mail order plan ever! Sell photos, films, art novelties. Huge proven profits! Free details! Ampro, 429 South Western Ave., Dept. 1, Los Angeles 5, California.

**AMAZING** Successes through franchises! Become exclusive franchise holder your territory. Information rushed. National Franchise Reports, 333 North Michigan, Chicago 1.

**FREE** Folio "\$5,000-\$45,000, Unlimited Vacations." No merchandise. Unknown! Work home, sparetime! Haylings, Carlsbad, Calif.

**GROW** Mushrooms. Cellar, shed. Spare, full time, year round. We pay \$3.50 lb. We have over 25,000 customers. Free book. Mushrooms, Dept. 173, 2964 Admiral Way, Seattle, Wash.

"HOME Business Digest" has money-making opportunities galore. Sample 25¢. Donovan, 79-PM Greenbelt, Levittown, New York.

**EARN \$50.00** Daily making mats, shoes and mud guards from old tires. S and S Patents Inc., 1307 North Clark St., Chicago 10, Ill.

**ATTENTION** Typewriter owners. Make handsome profits. Write today. Groves Company, 632, Hastings 8, Nebraska.

**DOLLARS** Every day! Amazing new magic mail plan. Set-up free. Miller, Box 588X, Oshkosh, Wis.

**GENERAL** Contest Bulletin. Lists contests monthly. Sample, 25¢. 1609 1/2 East 5th, Duluth, Minn.

**READ** Progressive Mailtrade, the magazine that tells how to make money by mail. Dime brings sample and special offer. Progressive Mailtrade, Box 357, Sheboygan, Wisconsin.

**RAISE** Rabbits on \$500 month plan. Plenty markets. Free details. White's Rabbitry, Mount Pleasant, Michigan.

**BIG** Money raising, fishworms and crickets. Free literature. Carter Hatchery, Plains, Georgia.

**EARN** Money evenings copying and duplicating comic cartoons for advertisers. Adservice, Argyle 1, Wisconsin.

**SELL** Titania gems. Far more brilliant than diamonds. Catalog 10¢. Diamonite, 2420-M 77th, Oakland 5, California.

**VENDING** Machines—No selling. Operate a route of coin machines and earn amazing profits. 32-page catalog free. Parkway Machine Corporation, Dept. 27, 715 Ensor Street, Baltimore 2, Maryland.

**FREE** Book "505 Odd, Successful Businesses." Work home. Pacific, Oceanside, Calif.

**PRIZE** Contests provide fabulous and confidential home income opportunities! Here's how and where to win your share! Send stamp! National Contest Bulletin, Box 2685-P, Miami 18, Florida.

**MEN—Women!** Start money-making plastic laminating business at home in spare time. Material that costs 11¢ brings back \$2.58. No canvassing or selling but mail orders bring in \$20 a day. Write for full particulars free. Rush name on postcard to Warner, Room 7-E, 1512 Jarvis, Chicago 26, Ill.

**START** A buying service, buy wholesale thousands nationally advertised products. Make big profits selling at sizable discounts. Postcard brings details. American Buyers, Hertel Station, Buffalo 16-D, New York.

**YOU** Too, can make money in mail order, successfully. Tested plans. Information free. Hoxeyville Appliance, Hoxeyville Rte., Cadillac, Michigan.

**MAKE** Money writing short paragraphs! No tedious study. I tell you what to write, where and how to sell; and supply list of editors buying from beginners. Many small checks add up quickly. Write to sell, right away. Send for free facts. Benson Barrett, Dept. C-27-E, 7464 Clark, Chicago 26.

**60% PROFIT** Cosmetics \$25 day up. Hire others. Samples, details. Studio Girl-Hollywood, Glendale, Calif., Dept. 1275H.

**START** Big-pay business at home in spare time. No experience needed to operate little table-top machine for bronzing baby shoes. Make \$5.48 profit on every pair. Full particulars free. Send postcard to Mason, 1512 Jarvis, Room 7-E, Chicago 26, Ill.

**WHOLESALE** Name brands catalogue \$1.00. Credit \$2.00 on first order. Star Industries, Box 461, Nashua, New Hampshire.

**FOOD** Supplement sales booming! Opportunities unlimited, 700% profit with super-potent "Supervite." Details free: Vitamin Specialties, 5522 1/2 Hollywood Blvd., Los Angeles 28, Calif.

**MAKE** Top money collecting snakes, lizards, turtles, toads, frogs. We pay guaranteed prices. Details 25¢. Biological Exchange, Dept. 13b, Box 5302, El Paso, Tex.

**MAKE \$5,000** Yearly sparetime raising mink, chinchillas, nutria, etc. Free booklet reveals proved plans. Write Pura, 588 Mt. Pleasant Road, Toronto 1, Canada.

**\$100.00 WEEKLY** Spare time with a tape recorder! Proven facts free! Dixieland Publishers, Asheville 2, N. C.

**MEN** And women wanted to start home business in spare time with little table-top rubber stamp machine. Easy to earn up to \$9.80 an hour without previous experience. Full particulars free by mail. Send postcard to Roberts, 1513 Jarvis, Room 7-E, Chicago 26, Ill.

**100% PROFIT** Mailing postcards. Details. Stamp. P.C.O. 322 1/2 Brady, Davenport, Iowa.

**PRINTING** Office supplies wholesale. Save 50%. Royal, Box 368-A, Cleveland 27, Ohio.

**SELL** Engraved brass name plates for desk or door. No investment. Free sales kit. Nameplate, Box 634, Rochester, Minnesota.

**INCREASE** Income selling or operating vending machines. Free details. Pasco Corporation, Box 1016-A, Minneapolis, Minnesota.

"MAIL Order on Shoestring" 75¢. Details free. Blen Gee, Box 2171, Charleston, S. C.

**MAKE** Money with small capital mail-order. Write. Pine Agency, Birch Harbor, Maine.

**OPENINGS:** Spare-time. Work home. Coleman's, 1350 Carol, Aurora, Illinois.

**MONEYMAKING** Opportunities. free offers. Tom Carson, Box 1685, Ardmore, Okla.

**WHOLESALE!** Discounts to 60%. Postcard gets catalogue. United, 450 Broad, Newark, N. J.

**START** Your worm project with the best. Free literature. Dewey's Worm Ranch, Henderson, Colorado.

**NOW** Grow mushrooms with standard commercial fertilizers. Marketing "how-to," free facts. Luxur, 641 South 19th, Newark 3, N. J.

**FREE!** "\$3,000 Yearly Sparetime. Backyard, Raising Earthworms!" Oakhaven-48, Cedar Hill, Texas.

**REFLECTIVE** Sign letters, ornaments. Free samples. E-Z-On Sign Letters, Pell Lake, Wis.

**MAKE** Money selling our graphology charts. Carnivals—Mailorder. Details, sample 25¢. Ben Kandel, Eatonton, Georgia.

**NEW**, Original, profitable home projects that make big-money. Details, working drawings, actual photos. 50¢. Shutt, 643 Wanamaker Road, Jenkintown, Penna.

**RETIRED** Mechanics: Your expert advice worth money. Complete plan \$1. Creative Research, 3317 Lees Ave., Long Beach 8, California.

"SHUT-Ins" wonderful money-making home-opportunity. Spare hours. Schneider, 36 Wendover, Kenmore 23, N. Y.

**SAVE** A \$100 overhaul! Make your own motor cylinder liner and ring tightener, 10¢ a tube. Sell at big profits. Millions sold at \$3.95. Complete, easy, two-ingredient, patented formula only \$1.00. Donlin, Box 3560-A, North Las Vegas, Nevada.

**MAIL** Postcards. Receive \$1.00 orders. You keep dollars. Free details. Snowball, 9534P Lemturner, Jacksonville 8, Florida.

**LIFETIME** Income, heirs too. Guaranteed product everyone needs. Mail or agent operated. Cash for helping others who automatically help you earn bonus. Details and starter, possibly total investment, \$2.00. Economart, Dept. PM, P.O. Box 444, Iowa City, Iowa.

**BUY** Wholesale! Save 66%! 100,000 name brand appliances, housewares, clothing, furniture, tools, sporting goods. Everything! Free prices, illustrations! National Buyers Service, Box 3338EB, San Francisco.

**PRINTING** Wholesale—Save 50%. Start agency. Ellchs, 3035 Marvin(B), Toledo, Ohio.

#### FORMULAS, PLANS, ETC.

**FORMULAS:** All kinds, latest, best. Literature free. Kemikal, Park Ridge, Ill.

**FREE** Formula catalog. Anything analyzed \$35.00. Western Chemical, Salem, Oregon.

**PRACTICAL** Formulas. Lists free. Cummings, Chemist, Gordon Ave., Syracuse 4, N. Y.

**LATE**, Modern manufacturing formulas. List free. Moon Chemical, Martville, New York.

**FORMULAS** For latest money-making discoveries. New! Good! Valuable literature free! Miller, Chemist, 1517-D, Tampa, Florida.

#### CHEMISTRY

**CHEMICALS** And apparatus for industrial, analytical, and private laboratories. Catalog 25¢. Dept. M-50, Biological Supply Co., 1175 Mt. Hope Ave., Rochester 20, N. Y.

**ILLUSTRATED** Catalog: Chemistry, mineralogy, biology 20¢. Tracey Laboratories, Evanston, Illinois.

**60 PAGE** Booklets! "Beginners Chemistry," "Chemistry," "Physics," "Relativity," "Light," "Astronomy," "Electricity," "Radio," "Useful Tables," "Scientific Oddities," 10¢ each. Franks, 3121 South Racine, Chicago 8.

**CHEMICALS**, Glassware. Catalog 25¢. Laboratory Sales, Box 161-E, Brighton, Mass.

**LOOK!** Low priced chemicals, sets, apparatus, biologicals, microscopes, laboratory supplies in small quantities. Catalog 25¢. John H. Winn, 124Z West 33 St., New York City 11.

**AMAZING** New Book of Science. Experiments, formulas, and catalogue of laboratory supplies. Only 25¢. National Scientific Co., Dept. PM-5, 500 West Road, Lombard, Illinois.

**FREE!** Chemical experiments, element table. Send 3¢ stamp. Experimenter, 713 Second, Canonsburg, Pennsylvania.

#### PLASTICS

**LEARN** Plastics fabrication for spare time income. Low cost home training now available. Write for free booklet. Interstate Training Service, Dept. D-3, Portland 13, Ore.

**PLEXIGLAS**, Fiberglass, polyester, acetate. Instructive wholesale-retail catalog free! Gem-O-Lite, 3529 Cahuenga, North Hollywood, California.

**BOXES**, Plastic. Free list. Althor, 170 Bay 23 Street, Brooklyn, N. Y.

**NEW** Liquid casting plastic, clear, colors. Embed real flowers, coins, photos. New manual shows fine things you can make at home and sell at big profit. Send 25¢. Castolite, Dept. E-101, Woodstock, Illinois.

**LAMINATING** Supplies. Free price list. Solomonson, 46 Cornhill, Boston 8, Mass.

**REPAIR** Kit welds broken plastic. Restores original finish. Standard kit \$2.00. Special trial kit \$1.00. Rayther Co., Box 271, Station B, Toledo, Ohio.

**FIBERGLASS** Patio sheets 58¢ sq. ft. Plexiglas 95¢ sq. ft. Liquid casting plastic \$1.95 qt. Send 10¢ for literature. United Plastics Products Co., Dept. 7, Roebling, N. J.

**PLEXIGLAS**. Square foot cost, 1/16", \$1.20; 1/8", \$1.52; 3/16", \$1.86; 1/4", \$2.21; 3/8", \$3.23; 1/2", \$4.36. Colors add 10%. Send 15¢ for postage. Aristocrat Plastics, 23-25 Sussex Avenue, Newark, N. J.

#### AGENTS WANTED

**MEN, Women**, make money spare time plus new car as bonus for encouragement. Amazing hosiery guaranteed to wear without holes, snags, and runs, or replaced free. For example, lovely 60 gauge nylons guaranteed for as long as 1 1/2 years or replaced free. Write Wilknit, 1775 Wash., Greenfield, Ohio.

**\$1,000.00** A Month for making dramatic 3-second demonstration for amazing lightweight Presto fire extinguisher. New chemical used by Airforce snuffs out fires instantly. Only \$4.95. Terrific commissions. Millions want it. Free kit. Merrite, 114 E. 32nd, Dept. P-51W, New York 16.

**BUY** Wholesale thousands nationally advertised products at big discount. Free "Wholesale Plan." American Buyers, Hertel Station, Buffalo 16-A, N. Y.

**60% PROFIT** Cosmetics \$25 day up. Hire others. Samples, details. Studio Girl-Hollywood, Glendale, Calif., Dept. 1275H.

**RACK Jobbers! Agents!** Sell complete line of fast selling plastic household products. Big profits. Buy direct from manufacturer. Greysen, Inc., 713 12th Street, Altoona, Penna.

**GRAN Auto pouch.** Practical, five-pocket multi-purpose accessory serves car, truck, boat owners. Proven money maker. Vinyl \$1.95. Deluxe \$2.95. Gran Novelty Mfg., Box 103, Elkton, Md.

**"SUNBOW Sun shields"** replace sunglasses everywhere. Thousands buy on sight. Enormous profits. Write immediately. Houston Co., Box 1413-PH, Fairmont, W. Va.

**SELL Hose Gard, steel prong rubber protected.** Designed to stop hose drag through flower beds, etc. Big profit, free details. Cannon-Kocka, Inc., 1844 Columbus Road, Cleveland 13, Ohio.

**WHOLESALE Catalogue!** General merchandise, imports! Nelson's Import Co., 3773-30th Street, San Diego 4, Calif.

**IMPORTED French perfumes** give you big profits! Rogers-Hansen, Salem, W. Va.

**LINE Tightener.** New, amazing. Slipping impossible. Hundreds uses. Whirlwind seller. Demonstration sells. Free sample offer. Eflex Distributors, 3017-B Moffat Road, Toledo 8, Ohio.

**HOTTEST Automotive product ever offered.** Unlimited prospects. Amazing profits. Write. Gregory Sales, 316 Marlon Bldg., Cleveland 13, Ohio.

**AGENTS! Dealers!** Sell our Readicut dress kits—85% profit. Use our literature, sure-fire mail order plan. Readicut Manufacturers, Loganville 81, Wisconsin.

**AGENTS—300% Profit** selling genuine gold window letters; stores and offices. Free samples. Metallic Sign Letter Co., 1217-D West Newport, Chicago.

**YOUR Ad in this space** will get some good agents for you. Yes, I'll prove it. Write for Folder "A" right now. F. W. Johnson, Classified Advertising Manager, Popular Mechanics Magazine, 200 E. Ontario St., Chicago 11, Ill.

**GOLDMINE Of 600 money makers.** Copy free. Specialty Salesman Magazine, Desk 5-B, 307 N. Michigan, Chicago 1.

**GOLD Or silver letters, numbers.** Windows, doors, trucks. 1" to 6". 500% profits. Free samples. Atlas-T, 544 West 79th, Chicago 20.

**PRINTING, Advertising salesmen—Excellent moneymaking sideline** selling decalcomania name plates, small quantities. Automobile initials, sign letters. Free samples. Balco, XL, Boston 19, Mass.

**EXCLUSIVE Line of personal initialed** buckles, belts, cap badges, 3,000 emblems, etc. Hook-Fast, Dept. PM, Roanoke, Va.

**YOUR Own business—Used suits \$1.50,** overcoats 65c, mackinaws 35c, shoes 12½c, ladies coats 30c, dresses 15c. Enormous profits. Catalog free. Nathan Portnoy Associates, 605-AA West 12th Place, Chicago 7.

**EASY Handwork makes fast-selling** articles. Sample free. Sunmade Company, Brockton 84, Massachusetts.

**FREE! Beautiful feather pictures.** 200% profit! Apartado 9036, Mexico 1, D. F.

**SELL Famous \$3 fire extinguishers.** Fast sales, liberal profits. Write Fire-Killer, Box 182, Hazleton, Penna.

**EARN An extra \$100 a week** demonstrating the latest hit games Teeko, I.Q. Solitaire and Scar-Nee. Nationally advertised, millions seeking them. Terrific opportunity. John Scarne Games, Fairview, N. J.

#### BUY IT WHOLESALE

**WHOLESALE Catalog!** Discounts to 80%! Clothing, appliances, tools, housewares, jewelry, etc.! Midwest, 156-MMM, Pontiac, Illinois.

**HUGE Discounts!** Nationally known brands. Catalog \$1 (refundable). Douglass, Box 171, Ontario, Calif.

**FREE Wholesale catalog.** Watches, cameras, luggage, appliances, fans, power mowers, sporting goods, graduation-wedding gifts. Housewares, 924-P West 79th St., Chicago.

**BIG Wholesale catalog.** 30 to 75% discount. \$1.00. Refundable on first order. R & R Sales, Dept. B, 833 Westover Drive, Danville, Va.

**FREE Wholesale catalog.** Gifts, appliances, housewares, cookware, cutlery, watches, dinnerware, silverware, jewelry, etc. Discounts to 80%. Topval Corp., Lindenhurst 224, N. Y.

**SELLING Direct to consumer.** Save 50% on guaranteed men's, ladies' watches and other jewelry. Literature free. Spiegel, 6219 N. Kedvale, Chicago 30.

**MEN'S Slacks,** retail \$7.95, cost \$4.25. All colors, sizes. Cosmos, 81 East 125th Street, New York City.

**BIG Multicolor wholesale catalog!** Housewares, appliances, clothing, silverware, cookware, luggage, binoculars, radios, phonographs, cameras, recorders, projectors, typewriters, shavers, sporting goods, toys, tools, sewing machines, watches, jewelry. Name brands. Huge discounts. Just postcard: Selbyco, Decatur 156, Illinois.

**WATCHES Like new** from \$2.95 up. Free folder. Cosmos, 81 East 125th Street, New York City.

**AUTOMOBILES—40% Savings** guaranteed! All models! Jakicla, 2644-CNO Western, Chicago 47.

**ELECTRIC Guitars, amplifiers,** wholesale. Free catalog. Carvin PMW, Covina, Calif.

**BIG Wholesale catalog.** 20 to 80% discount. Send \$1.00 which will be refunded on first order. R & R Sales Company, 833 Westover Drive, Danville, Va.

**USED And new watches \$2 up.** Free list. Southern Watches, Gray, Georgia.

**BUSINESS Gifts, wholesale.** J. J. Davis Co., Englewood Ave., Englewood, New Jersey.

**BUY Wholesale! Discounts to 80%!** Appliances, cameras, sporting goods, housewares, watches, tools, clothing, etc. Buy-Rite, Hawthorne 4, New Jersey.

#### SALESMEN—DISTRIBUTORS

**WILL You wear new suits and topcoats** without one penny cost and agree to show them to friends? You can make up to \$30.00 in a day even in spare time, without canvassing. J. O. Field & Son, Inc., Dept. H-1826, Harrison & Throop Sts., Chicago 7, Illinois.

**AD Matches! Sell amazing designs—10,** 20, 30, 40 and 240-light book matches. Bigger spot cash commissions: every business a prospect. Low prices for high quality. Repeats. Start without experience; men, women; full, part time. Buy nothing! Sales kit furnished. Match Corp., Dept. PM-89, Chicago 32, Illinois.

**GET New shirt outfit free.** Make \$90.00 weekly on 5 average orders a day. Famous quality made-to-measure dress and sport shirts at \$3.95 up sell fast to all men. No experience needed. Full or part time. Write: Packard Shirt Co., Dept. 454, Terre Haute, Ind.

**CALENDARS, Advertising novelties,** matches. All styles, including religious, varnished, 12 sheet, girls. Hundreds of advertising novelties, book matches, etc. Fleming Calendar Co., Sales Division, 6539 Cottage Grove, Chicago 37, Ill.

**CALLING On businessmen? Double your** profits with exclusive advertising-embroidered uniforms, jackets, pants, shirts, coveralls, sportswear. Every business big-order prospect! Free outfit. Master Co., B-25 Water, Ligonier, Indiana.

**SALESMEN Add extra profits to your** income. Sell trading stamps and stamp saver books, printed with merchant's name, to your present retail store accounts, supermarkets, gas stations, etc. Boosts business up to 40%. Worthmore, Dept. I, 1825 South Michigan Avenue, Chicago 16, Illinois.

**\$1,000.00 A Month** for making dramatic 3-second demonstration of amazing lightweight Presto fire extinguisher. New chemical used by Airforce snuffs out fires instantly. Only \$4.95. Terrific commissions. Millions want it. Free kit. Merlite, 114 E. 32nd, Dept. P-51W, New York 16.

**MAKE Extra money.** Cash commissions. Everybody buys easy-to-sell advertising book matches. Union label. All sizes. Cuts for all businesses. Powerhouse selling kit free. Steady repeat business. No experience necessary. Superior Match Co., Dept. M-557, 7528 S. Greenwood, Chicago 19.

**MAKE Big money** taking orders for unusual imports. Selling like hotcakes. Sample, details free. Baer, Andover 7, Mass.

**DISTRIBUTORS Wanted** for nationally advertised "Strike" liquid fishing lure. Sensational seller! Send 50¢ for \$1.25 bottle and details liberal offer. Zerek Laboratories, 210-A East Fayette St., Syracuse, N. Y.

**BIG Profits** selling quality imported cigarette lighters! \$1 brings sample, details. Full refund on first order! Rogers-Hansen, Salem, W. Va.

**EXTRA Profits** demonstrating modern cleaning appliance. Artmoore, Milwaukee 12, Wis.

**BE Your own boss.** Make \$35 and more each sale! Dynamic home massage and reducing vibrator requires no long sales talk. Sells on sight. Details free. Dynamic, P-5, 1558 Watson Ave., New York 72, N. Y.

**WHOLESALE—Get the big merchandise.** Furniture, appliances, housewares, clothing, tools, auto accessories, new products. Save half. Literature free. Associated Wholesalers, 1016-DY Starr, Burlington, Iowa.

**ONE Monument sale** weekly earns \$200 or more. Jones Monumental Works, St. Cloud, Minn.

**INCREASE Present income \$75-up weekly.** Dealers, farmers, agents—demonstrate nationally known Gro-Green liquid fertilizer nutrients. Results guaranteed. Full-part time. Samples free. Campbell Co., Rochelle 209, Illinois.

**NEW Jobs open in selling!** Send name, address for five free issues of Opportunity Magazine's money-making guide, listing hundreds of companies who'll pay you well, full or part-time. No experience needed. Opportunity, 850 N. Dearborn, Dept. 17, Chicago 10, Ill.

#### EMPLOYMENT INFORMATION

**ALASKA Jobs, information, opportunities,** conditions, true facts on last frontier \$1.00. Alaska Reports, Rt. #1, Box 253, Ketchikan, Alaska.

**FLORIDA.** Current listings. Jobs, housing, food prices. \$1.00. Carl Baughman, 2221 Corillas Drive, PM1, Orlando, Florida.

**COPYRIGHTED Reports** on best paying jobs with travel, adventure, promotions, construction, aviation, shipping, laborers, clerical, trades, supervisory, factory, unusual opportunities. Many types of work. Skilled and unskilled. Foreign and state-side openings for men and women. Only \$2.00 (\$2.25 airmail), including registration-advisory service. Satisfaction guaranteed. Included absolutely free: special reports on Alaska, Spanish airbase construction, South American opportunities and husband-wife foreign jobs. Research Services, Suite 207-PMQ Brown Building, St. Louis 5, Missouri.

**VENEZUELA'S Latest job opportunities** \$2.00. F. Leonardo, Anaco, Box 10, Anzoategui, Venezuela.

**FOREIGN, Alaskan, U.S.A. jobs!** To \$1500.00 monthly! Million Americans employed overseas. Copyrighted reports. Who to contact for highest paying jobs. Laborers, trades, truck drivers, office, engineers, many others. 52 countries—St. Lawrence project, Spain, Latin America, Northern project, Europe. Year registration-advisory service. Application forms. Unconditional money-back guarantee! \$2.00 (airmailed \$2.25). C.O.D.'s accepted. International Reporter, St. Louis 1-PV, Missouri.

**MANY Job opportunities** are being offered through the Los Angeles Sunday newspaper want ads sent airmail \$1.00. Donald Wheeler, Box 4213, Pasadena 4, California.

**ALASKA.** Classified ads from Fairbanks airmailed \$1.00. Letters remailed 50¢. Ronco Enterprises, 813 Fifth, Fairbanks, Alaska.

**HIGH Paying jobs: Foreign, USA.** All trades. Travel paid. Information. Application forms. Write Dept. 21H, National, 1620 Broad, Newark, N. J.

**SOUTHERN California opportunities** unlimited. World's largest classified airmailed \$1.00. World Wide Co., 8418 Canby, Northridge, California.

**JOBS On ships!** Experience unnecessary. Transoceanic, Box 494, Baltimore 3, Md.

#### EDUCATIONAL AND INSTRUCTION

**DIESEL!** Learn to install, operate and maintain all type engines, spare time. Write for free book. Utilities Diesel Training, Dept. DC-65, 2521 Sheffield, Chicago 14.

**LEARN** To earn big money in specialized automotive service! Under our proven plan we train you in our up-to-date school, help you get started in wheel alignment, balancing, tire truing, or related safety and car comfort services. Nationally advertised! Small investment brings immediate return. Equipment pays for itself out of profits. Write for full details, Bear Manufacturing Co., Rock Island, Ill.

**WELDING** Training pays at Hobart Welding School, Box M-571, Troy, Ohio. VA contract. Best equipment. Catalog free.

**FINISH** High school at home, spare time. No classes. Diploma awarded. Write for free catalog. Wayne School, Catalog HF-74, 2527 Sheffield, Chicago 14.

**U. S. Civil Service tests.** Training until appointed. Men-women, 18-55. Start high as \$340.00 month. Experience often unnecessary. Get free 36-page book showing jobs, salaries, requirements, sample tests, benefits. Write today: Franklin Institute, Dept. Q-24, Rochester, N. Y.

**FREE Trial**—Complete language course for home study by Linguaphone, the world's standard conversational method. At home, easily, quickly learn to speak French, Spanish, German, Italian, Japanese, Russian, Modern Greek. Any of 34 languages. It's like living in another land. Send for free book and details of free trial. No obligation. Try, don't buy. Linguaphone Institute, T-83-057 Radio City, New York 20.

**WANTED:** More new writers for TV-radio, magazines, business publications, motion pictures. Learn at home for extra income or exciting full time career. Many students earn while learning. Professional instruction. Send today for free lesson and book. Palmer Institute of Authorship, Desk TM-57, 1680 N. Sycamore, Hollywood 28, Calif.

**COMPLETE** Your high school at home in spare time with 60-year-old school. Texts furnished. No classes. Diploma. Information booklet free. American School, Dept. X345, Drexel at 58th, Chicago 37, Illinois.

**LEARN** While asleep! Details free. Research Association, Box 610-NK, Omaha, Nebraska.

**EARN** College degrees, correspondence. Metropolitan University, Box 88, Glendale 5, California.

**ENGINEERING** Degrees. EE option electronics earned through home study. Residence classes also available. Pacific International University (American College of Engineering), 5719-B Santa Monica Boulevard, Hollywood 38, California.

**EARN** More money—Astound your boss, customers, friends with a better memory. Amazing new method of memory training now available by mail. Case histories prove any average person, regardless of age or education, can achieve tremendous memory improvement, greater self-confidence the easy Dr. Bruno Furst way. Featured in leading national magazines. The cost is small, the benefits huge. Write today for free details: Dr. Bruno Furst Course in Memory and Concentration, Dept. A1, 355 West End Avenue, New York 24, New York.

**SPEAK**, Sing with power. Amazing voice training course. Easily mastered at home. Free details. Voice Builders, 425 West Ave., Wayne, Penna.

**UNIVERSITY** Degrees by correspondence. residence. Golden State University, Box 2883, Hollywood, Calif.

**STUDY** Plan to suit needs. Woodworth, Box 4857, Detroit 19, Mich.

**EARN** College degree. Remain employed. Sequoia University, 5625-P Melrose, Los Angeles 38, California.

**TRANSFORM** Yourself via subconscious. Free brochure. Box 847 (H-5), Ocean Park, Calif.

**DRAFTING** — Design. Architectural. Mechanical. Electrical. Structural. Aircraft. Mathematics. Physics. Estimating. Surveying. Veteran approved. Mendell Institute, 230 West 41 St., New York City.

**PIANO** Tuning pays. Big money in spare time. Learn at home in 30 days. No musical knowledge necessary. Phonograph records, tools and instructions furnished. Personal instructions available. Free catalog. Capital Tuning School, 16 Southwest Second, Fort Lauderdale, Fla. York City.

**BOOKS.** Free 1957 catalog. 160 pages. Text, vocational, educational, instructional subjects. Millions of volumes, new and used. Bargain prices. Books bought. Est. 1902. Long's College Book Co., Dept. PM, Columbus 1, Ohio.

**LEARN** Appliance service and repair. Motors, washers, refrigeration, cleaners, everything. Free booklet. Armstrong, 11027-A South Vermont, Los Angeles 44.

**STUDY** For Doctor's degree of psychology, metaphysics and divinity. Correspondence courses only. College of Divine Metaphysics, Dept. P-M, 2811 North Illinois, Indianapolis 8, Indiana.

**LEARN** Mineralogy at home. Diploma course. Fortunes now being made in uranium and other minerals. Free catalog. Mineral Science Institute, Desk 2, 159 East Ontario, Chicago 11.

**HIGH** School diploma at home. Licensed teachers — Approved materials. Southern States Academy, Box 144-MX, Station E, Atlanta, Georgia.

**BE** A real estate broker. Study at home. Write for free book today. GI approved. Weaver School of Real Estate, 2018P Grand, Kansas City, Missouri.

**USED** Correspondence courses and books sold and rented. Money back guarantee. Catalog free. (Courses bought.) Lee Mountain, Pisgah, Alabama.

**EARN** While you learn. Auto and diesel mechanics master this top paying trade. Many graduates earn \$160 a week and up. Approved for Korean veterans. For free information write Dept. No. 256, Nashville Auto-Diesel College, Nashville 3, Tenn.

**HELP** Yourself to abundant living. Our courses have aided students to richer fuller lives. Learn secret of contentment, happiness. Earn degrees Ps.D., M.S.D. Write for free book. College of Universal Truth Correspondence School, 23-C E. Jackson, Chicago.

**SECRET** Investigation. Experience unnecessary. Investigators particulars free. George Wagner, M125 West 86th, New York 24.

**BOOKKEEPERS!** Increase your earnings! Operate your own simplified "Dollar-A-Week" bookkeeping and tax service. Full or spare time. Details free. No obligation. Ellis, Box 300, Cedar Grove, North Carolina.

**WANT** A diesel job? New opportunities to increase income. Higher pay. More money. We can help you qualify. Tools. Shop method home training. Write today! Diesel, Tractor, Heavy Equipment Division, Interstate Training Service, Dept. B-3, Portland 13, Oregon.

**I** want to send you proof of the wonderful pulling power of Popular Mechanics classified pages. What's your proposition? Write me today. Include literature if possible. F. W. Johnson, Manager Classified Advertising, Popular Mechanics Magazine, 200 E. Ontario St., Chicago 11, Ill.

**INVESTIGATOR** Training. Phillips Secret Service System, 1917-B North Kenneth, Chicago 39.

**ENGINEERING**, Home study. Midwest Engineering School, 10923 Hillcrest, Hickman Mills, Missouri.

**PHYSICAL** Therapy and massage. We train you at home. Earn big profits from your own private practice or work with hospitals and doctors. Free catalogue. National Institute, Desk 4, 159 E. Ontario, Chicago, Ill.

**STUDENTS**—The Maxwell Simplified Method of Study will help you get better grades. Simple, efficient, proven. Only one dollar. Study Methods, Box 419, Pacific Grove, California.

**MEMORY** Education. Additional mental power. Memorology, lesson one free. Memorology Studio, 2016-M Sunnyside, Chicago 25, Ill.

**SIMPLIFIED** Analytics teach algebra clearly. \$1; guaranteed. Ziemba, H-6123 Orchard, Dearborn, Mich.

**GROW** Mushrooms. Cellar, shed. Spare, full time, year round. We pay \$3.50 lb. We have over 25,000 customers. Free book. Mushrooms, Dept. 174, 2954 Admiral Way, Seattle, Wash.

**LEARN** Camera repair. Easy, complete, approved home-study course. Free illustrated booklet. National Camera Repair School, Dept. L-4, Englewood, Colo.

**PLAYS, STORIES, MANUSCRIPTS**

**WANTED:** Book manuscripts, all subjects considered. Greenwich Book Pub., Attn. Mr. Zealand, 489 Fifth Ave., New

**WRITERS.** Sell your rejects. Write Harvey Todd, 6082 Pedley, Riverside, Calif.

**WANT** Your book published? Learn how we publish, advertise, promote, distribute. Many successes. Free booklet PM. Vantage, 120 West 31, New York City.

**WRITERS!** Know your way around the literary world. Avoid literary doom. Read, "The New Author's Dilemma." Here is a valuable combination, reference, advisory and protective guide recommended for new unpublished writers. Explains the surest and safest methods of publishing. Send \$1.00 to Dobran Publications, 2816 Jean St., Youngstown 2, Ohio.

#### SPECIAL SERVICES

**INFORMATION** On anything. Ferguson Research Specialists, 115-14 141 St., South Ozone Park 26, N.Y.

**CARTOONING, COMMERCIAL ART, SHOWCARD & SIGN PAINTING, TATTOOING**

**YOU** Can entertain with chalk talks. Catalog 10c. Balda The Cartoonist, Oshkosh, Wis.

**LEARN** Sign painting at home. Free talent test. Ben Kerns, Box 812-PM, Greenville, S.C.

**TATTOOING** Outfits, licensed course. Brochures 25c. Zeis, 728 Leslie, Rockford, Illinois.

**BASIC** Art training at home. New plan. Free talent test. Students' Art Club, Kennebunkport, Maine.

**CARTOON** Your way to fame. Minimum age seventeen. Write Cartoons-of-the-Month, Roslyn, New York.

**BARGAINS!** Wonderful courses. Drawing, painting, signs, cartooning. Free literature. Art Book Shop, Arnold, Missouri.

**PAINT** Signs — Master die cut, outline letter patterns. Complete assortment 1 1/2" to 12" high, prepaid \$2.00. Eyerly, 583, Newton, Iowa.

**"HOW** To Make Money With Simple Cartoons." A book everyone who likes to draw should have. It is free; no obligation. Simply address Cartoonists' Exchange, Dept. 95, Pleasant Hill, Ohio.

**ADVERTISING AGENCIES, LETTER WRITERS, FOR ADVERTISERS**

**FREE!** 1957 Advertisers Rate and Data Directory. 52 pages! E. H. Brown Advertising Agency, 20 N. Wacker, Chicago 6.

**ADVERTISING** Ratebook leading newspapers, magazines, free. Chicago Advertising Agency, Chicago 4.

**ADVERTISING.** Result-getting ads prepared, placed newspapers, magazines, radio, anywhere! Lowest rates. Catalogue free. Baker Advertising Agency, 189 W. Madison, Chicago 2.

**MAILING** Lists most any classification \$5.00 1000. Your circulars mailed with ours \$4.00 1000. Write for our literature. Dixie Mailers, King, N. C.

**ADVERTISE:** 24 Words, 100 Canadian newspapers \$5.50. Lists free. Advertising Bureau, 10511-C Springfield, Chicago 43.

**WANT** More business? Here's an amazing opportunity to increase your sales. Talk to thousands of interested readers of "Mechanics Popular." Our Spanish Edition covers the Latin American countries like a blanket. They're real mailorder buyers. Classified rate 75¢ per word. Try an ad in our next issue. Classified Advertising Department, Popular Mechanics Magazine, 200 East Ontario Street, Chicago 11, Ill.

#### RUBBER STAMPS AND OFFICE SUPPLIES

**POCKET** Stamps, 3 lines—\$1.00 postpaid self-inking guaranteed. W.J.W. Specialty, 8464 Manhattan, Detroit 11, Michigan.

**QUALITY** Rubber stamps! Distinctive lettering, 3 lines \$1.00. Prompt service. Money-back guarantee. Campfield, 14 Beaufort Circle, Springfield 4, Mass.

**PLASTIC** Pocket printer. Name and address rubber stamp in plastic case with ink pad. Only \$1.00 postpaid. Hall & Riggins, Dept. 5, New Castle, Penna.

**POCKET** Or regular 3 line stamp \$1.00. Burch, 14827 Champaign, Allen Park 10, Michigan.

**RUBBER Stamps.** \$1.25 c.o.d. Samples. George's Printing, Box 85, Wrenonah, N. J.  
**DELUXE Quality stamps** at wholesale. Three lines 2" long \$1.50, 3" long \$1.80. Milford House, Salem, W. Va.

#### TYPEWRITERS, DUPLICATORS, OFFICE DEVICES

**PORTABLE Mimeograph!** Carriable. The newest, cleanest, smallest and cheapest spirits machine. Weight 15 pounds. DuPont Distributors, Box 695, New York 1, N. Y.

\$1.00 DEPOSIT, \$1.00 Weekly buys Remington typewriter. #200 Allen, New York City 2.

**RECONDITIONED Typewriters,** duplicating, printing devices, \$25.00 up. Supplies. Appliances. DixieGraph, King, N. C.

#### PRINTING, MULTIGRAPHING, MIMEOGRAPHING, GUMMED LABELS

**1000 EMBOSSED Business cards,** \$3.99. Samples. Danlee, Box 135, Batavia, N. Y.

**BUSINESS Printing,** rubber stamps. Free catalog. Brose, 196 Clerk Street, Jersey City 5, N. J.

**FREE!** America's first discount printing catalog. Try us on 1,000 better-looking business cards, \$3.49 postpaid, case included free. No CODs. Discount Printing Center, 1116-D National Press Building, Washington 4, D. C.

**PRINTING Presses,** supplies. Send for list. Printex, 120 Noble, Roanoke, Va.

**50 PERSONALIZED Stationery,** 25 envelopes, \$1.00. Belmont Stamps, Washington 15, D. C.

**DISPLAY Circulars.** Low prices. Samples. Golden Rule Press, Woodbridge, Va.

**500 NAME And address gummed labels,** 3 lines \$1.00. No c.o.d.'s. Print clearly. Addison, PM-3, 1840 Addison, Chicago 13.

**OFFSET Printing,** 1,000, 8 1/2 x 11 padded, \$7.65. Rose Printed Products, 769 National, Memphis, Tenn.

**WATERMARKED Letterheads** 8 1/2 x 11, envelopes 6 1/2. 100 each \$2.25 postpaid. 100 business cards \$1.00. H. Hudson, Centredale 11, R. I.

**MIMEOGRAPHING.** Reasonable rates, prompt service. Free pricelist, samples. Mimeo, Box 40-B, Adelaide Street Station, Toronto 1, Canada.

**PERSONALIZED Labels,** stationery. Reasonable. Loedco, 697-A Pavement Road, Lancaster, New York.

**BUSINESS Printing,** samples, catalog free. Offset printing, mimeographing. Stuber's, 18 E. Walnut, Ephrata, Penna.

**125 QUALITY Letterheads,** 125 6 1/2 envelopes \$3.00, postpaid. 1000 raised printing business cards \$3.50 postpaid. Quality Press, Indian Valley, Va.

**EYE-Catching — Letterheads,** envelopes. Samples free. Ink-Daubers, 933 Longfellow, Jackson, Michigan.

**1000 RAISED Letters** business cards \$3.50. Samples. Pioneer, Island Park 13, New York.

**125 LETTERHEADS** 8 1/2 x 11, 125 Envelopes, 6 1/2, \$2.45. Merit, Box 1984, Jacksonville 1, Fla.

**1000 NAME And address gummed labels,** quality printed, 3 lines \$1.00. Guaranteed. No c.o.d. Print clearly. Castle Company, 10509 Voltaire Ave., Oakland 5, Calif.

**NAME And address gummed labels** in rolls. 3 lines 1 1/2 x 1 3/4, 500 \$1.00. Alexander, Box 474, Pomona, California.

**100 8 1/2 x 11 LETTERHEADS Or envelopes** postpaid, P. C. Miller, Box 143M, Dover, N. J.

**NATIONWIDE Printing Service.** Wholesale price catalog. 4047E Westway, Toledo 12, Ohio.

**1000 CARDS — \$2.95.** Booklet, circular printing. Samples. Morey's B94, Redwood City, Calif.

**PHOTOGRAPH Reproduced** on stationery. Catalog free. Brown's, Bryant, Ithaca, N. Y.

**YOUR Name and address labels** 500—\$1.00. Quick. Guaranteed. Houghton's, Irving, Massachusetts.

**STATISTICAL And technical typewriting.** Specifications, lists, letters, reports, instructions, formulas, resumes, expertly done. Fast service, reasonable rates, free estimates. R. Roberts, 8 Brookfield Way, Morristown, New Jersey.

**LOVELY Correspondence paper,** 100 name-address \$3. Each a souvenir. Rare type. Samples. Printer McKeown, Liberty Building, Indianapolis.

**1000 PERSONALIZED Labels** in rolls \$1.00—1 1/2" x 1 3/4". Please print. No c.o.d.'s. Hamilton-Ward, Westfield 10, Mass.

**TOP Quality printing, mimeographing.** Free literature. Carrier, PM, New Lebanon Center, N. Y.

**CATALOG Free.** Distinctive printing. Reasonable prices. Yosacek Printing, 4444A Ute, San Diego 17, Calif.

**ECONOMICAL Printing** of books, catalogs, publications. Catalog free. Adams Printery, 30 West Washington, Chicago 2, Illinois.

**MIMEOGRAPHING—Letters,** pricelists, formulas, instructions. Lowest prices. Lem's Letter Shop, 5710 Stanton, Detroit 8.

**CIRCULARS, Booklets, letterheads,** statements. Estimates, anything! Lonelm Printers, Paulding, Ohio.

**FREE Catalog business, personal printing.** D.M. Press, Sebastopol, California.

**OFFSET Printing — \$6.50 1000,** 8 1/2 x 11, 18 lb. National Letter, 251 W. 42 St., New York City 36.

**RICH Boy printing, poor boy prices.** Offset, letterpress. Quality. Success Printers, Rockwall, Texas.

**100 BUSINESS CARDS \$1.00.** Print Shop, 1418 Broadway, Rockford, Illinois.

**BUSINESS Printing.** Price list free. Harold Eisert, 335 Peninsula Blvd., Cedarhurst, New York.

**MAIL Dealers—Save dollars** on supplies. Free list. Sellers, Box 221-S, Covington, Ky.

#### PRINTING OUTFITS AND SUPPLIES

**RUBBER Stamp making presses,** hydraulic operated, electrically heated. Sizes 5"x8", 8"x12", 10"x15" starting outfits. All kinds supplies. Custom Manufacturing, 601 N. Jefferson, Springfield, Missouri.

**DO Your own printing.** Save money, simple rules. We supply everything. Print for others; good profit. Raised printing like engraving too. Have home shop. Details free. Kelsey Presses, V-11, Meriden, Connecticut.

**PRESSES, Type cabinets, supplies.** List for stamp. Lincoln Press Company, 220-E Hartwell, Fall River, Mass.

**PRINTING Presses, type, supplies, lists** 3¢. Turnbaugh Service, Mechanicsburg, Penna.

**MAKE Your own self-molding rubber stamps** and printing cuts. Flexirubber, Argyle 1, Wisconsin.

#### PATENT ATTORNEYS

**INVENTORS:** Learn how to protect your invention. Unless the inventor is familiar with patent matters, he should engage a competent registered patent attorney or agent to represent him. We are registered to practice before the U. S. patent office and prepared to serve you in handling your patent matters. "Patent Guide for the Inventor" containing detailed information concerning patent protection and procedure with "Record of Invention" form will be forwarded to you upon request—without obligation. Clarence A. O'Brien & Harvey Jacobson, Registered Patent Attorneys, 718-D District National Building, Washington, D. C.

**CANADA—Ramsay Company Registered,** 273 Bank Street, Ottawa, Canada.

**INVENTORS:** Without obligation, write for information explaining the steps you should take to secure a patent. John Randolph, Registered Patent Attorney, 203 Columbian Bldg., Washington 1, D. C.

**INVENTION Record form free** and "Patent Information Every Inventor Should Have." Carl Miller, Registered Patent Attorney, Woolworth Building, New York.

**INVENTORS:** When you are satisfied that you have invented something of value write me, without obligation, for information as to what steps you should take to secure a patent. Write Patrick D. Beavers, Registered Patent Atty., 935 Columbian Bldg., Washington 1, D. C.

**C. A. Snow & Co.—M427, Snow Building,** Washington 1, D. C. Registered Patent Attorneys. Write for information.

**PATENTS. "Proof of Invention" free.** E. E. Vrooman, Registered Patent Attorney, 507 McKim Building, Washington 5, D. C.

**"INVENTOR'S Guide" and "Record of Invention" free** on request. Frank P. Ledermann, Registered Patent Attorney, 154 Nassau Street, New York City.

**REGISTERED Patent attorney offers services.** Sanders, 6430 Evans, Chicago 37, Illinois.

**MECHANICAL Skill alone is not enough** to entitle you to patent protection; your invention must clearly show your exercise of the inventive faculties. As patent attorneys we feel better qualified than the inventor to recognize patentable invention. Sketch and describe your invention. Sign, date and have this disclosure witnessed by two people who are capable of understanding your invention. Have us make a preliminary search among U. S. patents already granted for similar types of invention. We report on the probable patentability of your invention and recommend your further course of action. Write for our instructive booklet, "Patent Protection for Inventors" and convenient "Evidence of Invention" disclosure form. Victor J. Evans & Co., 331-E Merlin Building, Washington 6, D. C.

**INVENTORS—If you believe you have an invention,** you should find out how to protect it. The firm of McMorro, Berman & Davidson with offices in Washington, D. C., is qualified to take the necessary steps for you. Send for copy of our patent booklet "How to Protect Your Invention." We will also send you an "Invention Record" form. No obligation. They are yours for the asking. McMorro, Berman & Davidson, Registered Patent Attorneys, 134-T Victor Building, Washington 1, D. C.

#### FOR INVENTORS

**SEARCHES—Put your patent searches** in the hands of a registered patent attorney or agent, as he qualifies to give a worthwhile patentability report. Record of invention form upon request and information on patent protection. Patrick D. Beavers, Registered Patent Attorney, 935 Columbian Bldg., Washington 1, D. C.

**INVENTORS:** Information on patent procedure furnished on request, without obligation. John Randolph, Registered Patent Attorney, 203 Columbian Building, Washington 1, D. C.

**PATENT Searches, including copies** of nearest patents, \$6.00. Reports airmailed within 48 hours. More than 100 registered patent attorneys use my service. For free invention protection forms, write Miss Ann Hastings, P.O. Box 178, Washington 4, D. C.

**"INVENTOR'S Guide" and "Record of Invention" free** on request. Frank P. Ledermann, 154 Nassau Street, New York 38, N. Y.

**INVENTORS:** Test the commercial value of your patented or unpatented inventions, quickly and inexpensively. Write for free information. Institute of American Inventors, Dept. 40-B, 635-F St., N.W., Washington 4, D. C.

**INVENTORS, Don't sell your invention** patented or unpatented until you receive our offer. Write Cowgill, Box 298, Marion, Ohio.

**INVENTORS! Have you good, patentable ideas?** Write Mr. Metaler, 11 West 42nd Street, New York City.

**PATENT Searches \$5.00.** 48-hour airmail service. Invention protection forms free. Write Patent Engineering Service, 711 14th Street N. W., Washington 5, D. C.

**INVENTION Record form free** and "Patent Information Every Inventor Should Have." Carl Miller, Registered Patent Attorney, Woolworth Building, New York.

**PATENT Searches.** Information and free forms on request. Evelyn B. Surles, P.O. Box 75, Washington, D. C.

**PATENT Searches \$5.00.** 48-hour service. Free invention protection forms. Write Raymond L. Smith, Patent Searcher, 620 Sheraton Building, Washington 5, D. C.

**PATENT Drawings, construction details** of your inventions made by experts from sketches, photos. Patent Service Associates, Haverhill, New Hampshire.



**PROTECT Ideas!** Free form. ABC Inventions, Box 402-A, West Covina, Calif.

**INVENTORS**—If you believe you have an invention, you should find out how to protect it. The firm of McMorrow, Berman & Davidson with offices in Washington, D. C., is qualified to take the necessary steps for you. Send for copy of our patent booklet "How to Protect Your Invention." We will also send you an "Invention Record" form. No obligation. They are yours for the asking. McMorrow, Berman & Davidson, Registered Patent Attorneys, 134-V Victor Building, Washington 1, D. C.

**INVENTIONS** And ideas designed for your profit and patented for your best protection at low definite fees. Thirty years experience in developing and patenting inventions in U.S. and foreign countries. Patent searches with valuable report \$15.00. Joseph O'Brien, 132 Nassau Street, New York 38, N. Y.

**INVENTORS**—This firm is registered to practice before the United States Patent Office and available to assist you in the preparation and prosecution of your patent application. "Patent Protection for Inventors" booklet containing detailed information and steps to take toward patent protection sent promptly upon request. No obligation. Victor J. Evans & Co., 332-E Merlin Building, Washington 6, D. C.

**INVENTORS**—Send for free patent information book and inventor's record. Registered Patent Attorney, Associate Examiner. Patent Office 1922-29, Patent Attorney & Advisor, Navy Department 1930-47. Gustave Miller, 57A Warner Building, Washington 4, D. C.

**INVENTORS:** Learn how to protect your invention. Unless the inventor is familiar with patent matters, he should engage a competent registered patent attorney or agent to represent him. We are registered to practice before the U. S. patent office and prepared to serve you in handling your patent matters. "Patent Guide for the Inventor" containing detailed information concerning patent protection and procedure with "Record of Invention" form will be forwarded to you upon request—without obligation. Clarence A. O'Brien & Harvey Jacobson, Registered Patent Attorneys, 71A-D District National Building, Washington, D. C.

#### INVENTIONS WANTED

**INVENTIONS** Wanted. Patented or patent pending. 26 years experience promoting inventions. National Service Bureau, 3120 Meramec, St. Louis 18, Mo.

**INVENTIONS** Wanted. Patented; unpatented. Tremendous manufacturers lists. Global Marketing Service, 2420 77th, Oakland 5, California.

**SUPERIOR** Promotions. Patented; unpatented inventions. Information booklet free. Superior, 338-344 North Rodeo, Beverly Hills, Calif.

**CASH** Buyers for inventions. Write National Inventors Institute, Box 7097, Cleveland 28, Ohio.

**INVENTORS:** Hundreds of manufacturers have requested our assistance in locating marketable new products. Complete information free. Institute of American Inventors, Dept. 40-D, 635-P St. N.W., Washington 4, D. C.

**INVENTORS,** Don't sell your invention patented or unpatented until you receive our offer. Write Cowgill, Box 298, Marion, Ohio.

**INVENTIONS** Wanted now by my manufacturer-clients. Patented, unpatented. Write Adams, Patent Broker, 80-S Wall Street, Financial District, New York City.

**MANUFACTURERS** Will consider any invention. Deal direct. Colburn, 920 So. Robertson, Los Angeles 35, California.

**INVENTORS:** If you have an invention for sale, patented or unpatented, write for free brochure outlining manufacturers' requirements, royalty rates. Kessler Corporation, 551W, Fremont, Ohio.

**BEST** Market for selling your invention is "Gadgets Patents Invention News" readers. Inventors' Service, 107 W. Van Buren, Chicago 5, Illinois.

**CASH** Or royalty settlements for new unusual products with mass market appeal. Royal-T Products Div., 811 Wyandotte, Kansas City, Mo.

#### MODELS, MODEL SUPPLIES

**SHIP** Models and yacht supplies complete. Large 68 page catalogue 50¢. Bill Wild's, 510 East 11 St., New York City 9.

**POWER** Models. Unusual steam gasoline and traction engines, fittings, metals. Comprehensive catalog \$1.00. Chas. Cole, Ventura, Calif.

**BUILD** Miniature passenger hauling live steam locomotive with file and drillpress. We do machine work, you bolt it together. Catalog 50¢. Little Engines, Lomita, Calif.

**SHIP** And yacht model fittings; blueprints. Send 35¢ for illustrated catalog listing hundreds of items. A. J. Fisher, 1002-1 Etowah Ave., Royal Oak, Mich.

**SHIP** Models. Most complete line in New England. Kits, fittings, plans, books, tools, engines, motors. Illustrated catalog 30¢. James Bliss & Co., Inc., Dept. SM, 342 Atlantic Ave., Boston 10, Mass.

**BALSA** Wood and model aircraft. 40-page catalog 25¢. Sig Co., Montezuma, Iowa.

**SHIP** Model kits and fittings including clippers, trawler, fishermen, frigates, privateer, radio control tug, etc. Send 25¢ for 1957 catalog. Model Shipways, Box 85, Bogota, N. J.

**STEAM** Park trains. Photographs, details \$1.00. Murray Railroads, Rehoboth, Massachusetts.

**MODEL** Builders Cyclopaedia—railroads; airplanes; ships; crafts; guns; autos; tools; engines and parts. 310 illustrated pages. 25,000 items. Price \$1.00 (refundable). National Sales, Dept. 7-PM, Box 143, DuBois, Pennsylvania.

#### MANUFACTURING

**MODELS**—Small lot manufacturing. Metals, plastics, etc. Milburn, Burlington, Kentucky.

#### HOME CRAFTSMEN

**FREE.** New catalog, 1,868 patterns, designs. Craftplans, 1322-A S. Wabash Avenue, Chicago 5.

**"OLD** Whittler." Ready-cut figures make whittling fun! Send \$1.00 for set. Box 219, Baraboo, Wisconsin.

**WOOD** Veneers. Excellent for inlays. 20 sq. ft. one kind, \$1 postpaid. C. D. Looney, Fieldale, Virginia.

**FREE.** Complete illustrated catalog. Leathercraft kits, supplies. J. C. Larson Co., 520 S. Tripp, Dept. 7027-L, Chicago 24.

**BUY** Wholesale nationally advertised power, hand tools, thousands of other products at big discounts. Free "Wholesale Plan." American Buyers', Hertel Station, Buffalo 16-F, N. Y.

**LEATHERCRAFT,** Copper enameling, mosaic tile, shellcraft, metal tooling, breadcraft, many more crafts. Free big catalog. Kit Kraft, Dept. 225, Studio City 1, Calif.

**101** FULL Size patterns. Smart, new, gifts, novelties, lawn figures, shelves, action windmills, alphabets. Plus "Make Money Jig Sawing." Only \$1.00. Mastercraft 35M, 7041 Olcott, Chicago 31, Illinois.

**LEATHERCRAFT.** Send 10¢ for new 76-page catalog of tools, supplies, kits, including metalcrafts, enameling, ceramics, all other crafts. Complete stock. Reasonable. Since 1910. Sax Bros., Dept. PM-5, 1111 N. 3rd, Milwaukee, Wis.

**QUALITY** Leathercraft and 16 other crafts at big savings. Send 10¢ for large catalog. Russo Handicrafts, Box 29-D, Los Angeles, California.

**STYLECRAFT** Sure fire hits. "Pre-traced" leather kits. Handbags, billfolds, filigree belts, over fifty other projects. Patterns on leather. Why trace? Just carve, assemble and lace. Large assortment "precarved" kits also available. Send 25¢ for catalog, free folder. Refunded first order. Apache Leather Company, 2804 E. Washington St., Phoenix, Arizona.

**DO-It-Yourself** booklets 25¢. 24 subjects. Free catalog. Popular Mechanics Press, 631 N. St. Clair St., Chicago 11.

**ALL** Crafts, supplies. Large free catalog. National Handicraft, 199 William Street, New York City 38.

**WOODWORKING** And cabinetmaking course for beginning and advanced home craftsmen. Only complete low-cost home training program available. Write for free booklet. Interstate Training Service, Dept. G-3, Portland 13, Ore.

**LEATHERCRAFT,** Kits, copper, artist's supplies. New catalog, Midas, 7705 State, Huntington Park, California.

**KNOCKDOWN** Cedar chests. Lumber and veneers. Free price list. Giles & Kendall Company, Huntsville, Ala.

**FREE** "Do-it-yourself" leathercraft catalog. Tandy Leather Company, Box 791-019, Fort Worth, Texas.

**KNOCKDOWN** Cedar chests and lumber. Free price list. Bedford Lumber Company, Shelbyville, Tennessee.

**LEARN** Art metalcraft and jewelry making. Complete, inexpensive, home training course now available. Special tools and materials furnished. Write for free booklet. Interstate Training Service, Dept. L-3, Portland 13, Oregon.

**SELL** Your handcrafts. How! Where! Continental Publications, 192-A N. Clark, Chicago 1.

**LEATHERCRAFT,** Copper, silversmith complete do it yourself kits. Handbags, belts, billfolds many others. Leathers, tools. Catalogue 25¢ refunded with first order. Art Handicrafts, PM, 194 William St., New York 38, N. Y.

**PATTERNS** Flying ducks, man sawing wood. Dutch maid churning butter, and 30 lawn ornaments, only \$1.00. Lincoln Studio, Columbia, Conn.

I want to send you proof of the wonderful pulling power of Popular Mechanics classified pages. What's your proposition? Write me today. Include literature if possible. P. W. Johnson, Manager Classified Advertising, Popular Mechanics Magazine, 200 E. Ontario St., Chicago 11, Ill.

**LAMP** Size cypress knee with nipple installed \$2.00. Cy Products, Dept. 2-J, Lafayette, La.

**PROFITS!** Sell gift shops your handcrafts. Listings, Box 437, Fort Madison, Iowa.

"CREATE Portrait Marionettes." "Win Flower Show Sweepstakes." "Metalize Nature's Art Forms." Art teacher's secrets. \$1.00 each. Anne Fifield, Pierre, S. D.

#### DO IT YOURSELF

**BUILD** Your own cupola from our kit. Select white pine, cut to fit perfectly. Sheet-metal roof ready to install. Easy to assemble. Dress up your garage, house or breezeway. Size 20"x20"x30" high. Kit \$12.95. Send for free details. H. L. Hoy, P.O. Box 777, Bensenville, Ill.

**NEW** Amazing sprinkler system. Make it yourself. Free details. Prix (PM), Box 864, San Jose, Calif.

**BUILD** Your own hi-fidelity kits. Details. Arkay Dist. Co., P.O. Box 581, Church St. Sta., New York 6, N. Y.

**SIMPLIFIED** Paint sprayer. Economical to build. Easy to read plans. Only 50¢. Nerppo, Box 72, Wollaston, Mass.

**WOOD** Drills—Make them yourself. Instructions and samples \$1.00. Box 53, Lewistown, Penna.

**BUILD** Inexpensive concrete blockmaker. Motor, hand. Write. C. Lee, Mountain View, Oklahoma.

**NEVER** Wax floors. Use "Slick" in varnish. Guaranteed, \$3.00. American Chemical Products, Box 7768, Kansas City 22, Mo.

**ROTATE** Your T.V. roof antenna for less than \$6. Plans \$1. Norig Co., P.O. Box 117, San Francisco 1, Calif.

**AIR** Conditioners, homes, automobile. See Kool Engineering ad page 32.

**GRANDFATHER** Clock shop tested plans \$1. Astonishingly simple. Thousands built for 40 years. Movements \$39. Gorgeous dials. Red-1-Kut kits. See February issue page 325. Kuempel Klocks, Minneapolis 16, Minn.

**MOWER** Kits and parts, also complete mowers. Write for free plans and literature. Triangle Mfg. Co., Dept. M-7, Fort Scott, Kansas.

**MELT** Cast iron, brass, aluminum. Make castings for profit. Free literature. Urutz Burner Co., Box 566-M, Tempe, Arizona.

**GRANDFATHER** Clock movements, blueprints, kits. Wholesale catalog 25¢. Mason-Sullivan, Noroton, Conn.

**BUILD** Your own optical instrument! New book—"Fun With Optics" tells you how! 32 exciting pages. Full diagrammed instructions on how to build telephoto lenses, telescopes, microscopes, slide viewers, artist drawing projectors, binoculars, magnifiers, riflescopes, etc. We can furnish the lenses, prisms and parts you'll need. To get this terrific book send your name and address and only 50¢, full price. Request Stock No. 9050-CY. Edmund Scientific Company, Barrington, New Jersey.

#### WATCHES, OLD GOLD, JEWELRY

**RHINESTONES**, Pearls, costume jewelry supplies. Catalog 10¢. J & M Novelties, Dept. CE-3, Box 173, Broadway, Illinois.

**WATCHMAKER'S** Journal contains instructive articles on watch repairing. \$1.00 year. Sample copy 20¢. Dean Co., Box 3218-M, Daytona Beach, Fla.

**WATCHES**, Ladies', men's, 17 Jewels \$12.50. New unjeweled movements \$1.50. Mitzmacher, 1324 St. Johns Pl., Brooklyn 13, N. Y.

**WATCHMAKERS'** Tools, materials, supplies, watches. Catalog. Gales, Box 1000, Chicago 90, Illinois.

**GOLD**, Silver, platinum, diamonds wanted. Cash immediately, highest prices; appraisals made. Wilmoth's, 1067 Bridge, N. W., Grand Rapids 4, Mich.

**WATCH** And clock repairing books. Free catalog. North American, 2320-AE Milwaukee, Chicago 47, Ill.

**WRIST** Watches, 17 Jewel. Two year unconditional guarantee. Free pamphlets. Demco, Box 263, Sheffield, Alabama.

**NEW—25** Jewel, selfwinding Hallmark, Waltham watches, 1/2 price, with factory guarantee. T&M Distribut'g, 401 So. 12th, McAllen, Texas.

**10 WATCHES** \$18.00. Minor repairs. Catalog 20¢. Berkwit, 1150 Castle Hill, New York City 62.

**COSTUME** Jewelry supplies, Catalog and samples. 35¢. Largest line in America. Milady-Pair Co., G.P.O. Box 1328, New York City 1.

**WATCHMAKERS'**—Jewelers', machinists' tools. Watchmaking course. Catalog 25¢. Bengale, Culver City, California.

**PREFERRED** Source for quality settings and stones. Manufacture costume jewelry at home. Extensive catalog 25¢. A. V. Cull Co., 210-F Fifth Ave., New York 10, N. Y.

**HIGHEST** Cash for old gold, broken jewelry, gold teeth, watches, diamonds, silverware, spectacles, platinum, mercury, gold coins. Free information. Rose Refiners, Heyworth Building, Chicago 2.

#### TOBACCO, SMOKERS' SUPPLIES

**PIPE** Smoker's delight. New tobacco pouch fills pipe automatically. \$1.98. East-ern World Products, Box 61, Newark, N. J.

#### FOR THE HOME

**ALUMINUM** Roll-up awnings. Door hoods. Prepaid, direct from distributor. Lowest prices. Installation instructions. Barry, Box 815, Manchester, New Hampshire.

**AWNING** Prices fractured! Aluminum, rolling. You install. Fifth Avenue Awnings, 210 Fifth Avenue, New York City 10.

**NEW** Wireless fire alarm. Free information. Write Murphy's, Woodstock, N. Y.

**BE** Your own plumber. You can. Few inexpensive tools and our instructive book, "Home Plumbing Guide," shows and tells you how. Hundreds of photographs and diagrams. Easy to follow. 160 pages. \$3.50. Catalog free. Popular Mechanics Press, 200PG East Ontario St., Chicago 11, Ill.

**FOAM** Rubber furniture cushions. Factory seconds. 50% discount. Free catalog. Perma-Foam, 236C Rhode Island Ave., East Orange, New Jersey.

**"HOME** Improvement Guide." New, amazing 192 page volume. Packed with ideas, plans for remodeling, decorating, landscaping, built-in projects. \$2.50 prepaid. Popular Mechanics Press, 200-HG East Ontario St., Chicago 11.

#### OF INTEREST TO WOMEN

**GROW** Mushrooms. Cellar, shed. Spare, full time, year round. We pay \$3.50 lb. We have over 25,000 customers. Free book. Mushrooms, Dept. 178, 2954 Admiral Way, Seattle, Wash.

**WANT** To make big money at home? \$10.00 profit in an hour possible with invisible mending. Make tears, holes, disappear from clothing, fabrics. Steady year-round demand from cleaners, laundries, homes. Details free. Fabricon, 8332-B Prairie, Chicago 19, Illinois.

**SELL** Fine fabrics. Get yours wholesale. Box 863, Norwalk, Conn.

**MAKE** New greaseless doughnuts in kitchen. Sell stores. Free recipes. Morgan Ray, 3605 South 15th, Minneapolis 7, Minn.

**BOOKS:** Hundreds of subjects. Big catalog free. Popular Mechanics Press, 200-BC East Ontario St., Chicago 11.

**60% PROFIT** Cosmetics \$25 day up. Hire others. Samples, details. Studio Girl-Hollywood, Glendale, Calif., Dept. 1275H.

**RICH**, Creamy, lanolin hand and skin lotion, in concentrated form. Mix it yourself. \$1.00 package makes a quart. Colonial Chemical, Box 8367, Denver 10, Colo.

#### PERSONAL

**ENJOY** Health. Free booklet. Ruth's Nutrition, 152 Kearny, PM, San Francisco, Calif.

**"HOW** Can I find out?" You can! Information confidentially developed. Any matter, person, problem. Worldwide. Officially licensed. Established 1922. William Herman, 170 Broadway, New York City.

**BOOKS:** Hundreds of subjects. Big catalog free. Popular Mechanics Press, 200-BC East Ontario St., Chicago 11.

**PHOTOSTAMPS**—Your photo on stamps. 100 for \$2.00. Samples free. Alcor's, 2005 Bergenline, Union City, N. J.

**BORROW** Money—By mail. \$100 to \$600 from Postal Finance. Employed men, women easily obtain \$100 to \$600 fast, entirely by mail. Repay in small monthly payments. Friends, relatives, employer, tradespeople will not know you are applying for loan. Advise occupation, amount wanted. Postal Finance Company, 200 Keeline Bldg., Dept. T-H, Omaha, Nebr.

**LEASE** Beautiful campsite, \$10 year. Rodgers, Manor, Gagetown, N.B., Canada.

**"RUMPLESTILTSKIN"** Papers to sign at Aunt Sallie's. Write Mother there.

**ALWAYS** Broke? Send for our family budget system. Can be used in business too. Postpaid anywhere in world. Send postcard. Budget Plan, 318 Riebeling, Columbia, Ill.

**BIBLE** Questions answered. Stamped envelope. Hylon, 17167 Bentler, Detroit 19, Michigan.

**VITAMINS!** Let us prove we can save you 40% or more. New free catalogue lists all brands and formulas. Compare then save. Mention vitamins now using for free sample. Vitamin Specialists, Philadelphia 40, Penna.

**FREE** Only Alberta government giving individual residents substantial cash dividends from oil revenues. Classifieds, specialists airmailed \$1.00. Evergreens, 2308 Macleod Trail, Calgary, Alberta, Canada.

**EASILY** Analyze handwriting with Dial-U-Write! Guaranteed. \$2. Warner, Box 862, Ithaca, New York.

**SIMPLE** Television repairs. Marvelous booklet 25¢. Free catalog. Popular Mechanics Press, 633 N. St. Clair St., Chicago 11.

#### REMAILING SERVICE

**AIR** Remails 35¢. I affix stamps. Confidential mailing \$3 month. Ross Hancock, 83 Belhaven Rd., Toronto 8, Canada.

**REMAILS** Air 25¢. Confidential monthly \$3. Walter, 3916 St. Zotique, Apartment One, Montreal, Canada.

**REMAILING** 25¢; Receiving-forwarding, monthly rates. Enterprises, Box 180, Hialeah, Florida.

**SECRET** Mail receiving, forwarding system. \$3 month. Hedgpath, Box 830, Alhambra 23, California.

**LETTERS** Remailed 25¢. Receiving-forwarding address available. Details free. William McLaughlin, 800 Stewart, Columbus 6, Ohio.

**REMAILS** 25¢. Forwarding \$2.75 monthly. Gerken, P.O. Box 2508, San Francisco 26, California.

**HONOLULU** Remailing 25¢. Receiving-forwarding, postcards. Gifts available! Details free. Fobel, 3132-M George Street, Honolulu.

**DETROIT**, Confidential remailing 25¢ each. Wandrie, 3078 Garland, Detroit 13, Mich.

**BOSTON:** Remails 25¢. Postcards. 15¢. Cranston, Box 23, Boston 12, Mass.

**REMAILING:** 25¢ Regular, 35¢ air mail. Surprise your neighbor! Bobbie Johnson, Chatham Apts. #9-O, Savannah, Georgia.

#### TREASURE FINDERS

**TREASURE**, Metal, mineral detectors. M-Scope. Used worldwide for treasure hunting. Mineralights, Geiger, scintillation counters. Prices from \$14.75. Fully guaranteed. Use our time payment plan. Free booklets on treasure hunting, uranium prospecting. Free catalog. Fisher Research Lab, Inc., Dept. PM-C1, Palo Alto, Calif.

**FORTUNES** For the taking. Gold, silver treasures. Light weight, guaranteed, power-packed metal detectors. Kits and assembled models from \$39.90. Geiger counters and mineralights. Free literature. Electronic Applications, Dept. M, Box 8, Arlington 10, Virginia.

**FIND** Buried treasure, gold and silver, with Goldak's sensational 3 1/2 lb. "find-it" locator, only \$49.50. Write for free literature on complete line of mineral, metal locators; Geiger and scintillation counters. Goldak, 1341 W. Glenoaks Blvd., Glendale, Calif.

**GOLD**, Silver, metal detectors. Geiger counters for uranium, Violites. Sensational new fully guaranteed models. None finer. Information free. Detectron Corp., 5528 Vineland Ave., North Hollywood, Calif.

**URANIUM** Finding made easy! High efficiency, low cost transistorized geiger counters. Extremely sensitive and light-weight. Scientifically engineered. Unconditionally guaranteed. Free information. Universal Atomic, Dept. PM57, 143 East 49th Street, New York City.

#### FOR SALE—MISCELLANEOUS

**HEARING** Aid batteries, wholesale. Free list. Habs, Box 51, York, Penna.

**BIG** Radar kites, \$1.00 post paid. Army Surplus, Morrilton, Ark.

**SMOKERS**, Nature's sweetest, Missouri Meerschmum pipes. Selected cobs, rubber bits, aluminum cleaners expertly crafted. Regularly \$1.00 each. Three for \$2.50 ppd. Mail check or money order to Ed. Locke, Lac du Flambeau, Wis.

#### WANTED—MISCELLANEOUS

**SCRAP** Mercury (quicksilver) containers supplied — Tantalum, tungsten, silver, platinum. Metallurgical Products Company, Established 1909, 35th & Moore Sts., Philadelphia 45, Penna.

**WANT** Something to manufacture. Bishop, 326 Thorn, Hastings, Michigan.

**OLD** Wireless gear, radio sets, radio tubes. Geo. Delaplaine, Box 861, New Brunswick, N. J.

**WELL** Established manufacturing company desires additional products, light industrial field. Nationwide sales organization. Would handle outright purchase or royalty basis. Wayne Ross, 4723 Broadway, Kansas City 12, Missouri.

**WANTED:** New, unique, items, not yet on market. \$3-\$10 retailers. Send literature, lowest quantity prices. Marcol Nu-Products, 2801 Colerain Ave., Cincinnati 25, Ohio.

#### MISCELLANEOUS

**CHAMOIS** Skins, approx. 8"x10", 60¢ each, 4 for \$2.00. Robert Schumacher, 1358 Juneway Terrace, Chicago 26, Illinois.

**JAPAN:** Gifts by mail. Kimonoes, lighters, pictures, jackets, toys, novelties, etc. Business informations, \$1.00. Send money orders. Clarence Yamagata, Room 202, Naka 7, Bldg., Marunouchi, Tokyo.

**LEARN** While asleep! Details free. Research Association, Box 610-NK, Omaha, Nebraska

**MAGIC Key case.** Finds keys in dark. \$1.00. Green, P.O. Box 146, Cathedral Station, New York.

**CLOGGED Drains,** cesspools and septic tanks cleaned by new powerful chemical. Sursolvent removes grease, soap, tree roots, etc., without expensive digging and electric rodding machines. No pumping necessary. Mix with water and pour down drain. Free details. Electric Drain Cleaning Co., Boston 34, Mass.

**WE Pay \$20.00** for only 89 Lincoln head pennies. Send \$1.00 for album (to hold pennies). Fill dated spaces. Return completed album, receive \$20.00 plus album refund. Pasco, Box 1016-A, Minneapolis, Minnesota.

**GERMAN Address lists!** Anything manufactured, 25¢. Burke Associates, Manchester, Mass.

**FREE Catholic leaflets.** "Hail Mary." Coyle, 27, Iona Road, Dublin, Ireland.

**300 HOUSEHOLD Hints.** Save money. 25¢. Gibbins, 312-B W. 11th, Amarillo, Texas.

**REMODEL Your own home.** Save hundreds of dollars. New, amazing book shows you how. Written so you can understand it. Step by step instructions make it easy. Fully illustrated, 400 photographs, hundreds of diagrams, 160 pages, \$2.95. Literature free. Popular Mechanics Press, 200-RH East Ontario St., Chicago 11, Ill.

**MAKE Decals** from magazine pictures. Full instructions \$3.00. D. Sidden, Box 214, Sparta, N. J.

**BE Your family barber.** Send \$1.00 for complete illustrated manual to: Barber, Box 586, Minneapolis, Minn.

**PUZZLE Hobbyists:** Legitimate contest helps. Allowable in all contests. Unique treatise \$1.00. Refundable. Unique, Box 99, Mt. Vernon, Ill.

**FREE!** "\$3,000 Yearly Sparetime. Backyard, Raising Earthworms!" Oakhaven-49, Cedar Hill, Texas.

**CARRY The Erie Pol-Kushion** when attending sport events, fishing, concerts, church. It folds, very smart. Carried in pocket or woman's bag. \$2.00 prepaid. Allan Products, 1830 Lakeview, St. Petersburg, Florida.

**BUY Wholesale!** Discounts to 80%! Appliances, cameras, sporting goods, housewares, watches, tools, clothing, etc. Buy-Rite, Hawthorne 2, New Jersey.

**CIGARETTES.** Make 20 for 9¢. Facts free. Moberly, Box 810, Owensboro, Ky.

**HOW To remodel, basement, attic.** Booklet 25¢. Free catalog. Popular Mechanics Press, 633 N. 86, Clair St., Chicago 11.

**RECEIVE Magazine samples, mails, catalogues, offers** from everywhere. Get listed 25¢. Rorick, Cincinnati 26, Ohio.

**YOUR Name wanted.** We'll send 1000 publishers, mailers, wholesalers your name, on our list one year 25¢. Dixie Mailers, King, N. C.

**STUPENDOUS Mental power.** Adults, Details 3¢. Delmar Wisdom, 846 Sunny-side, Chicago 40.

**BEAUTIFUL Portraits** done in oils from photographs. Very reasonably priced. Free particulars. Elmer Brunow, 2452A No. 17 St., Milwaukee 8, Wisconsin.

**FRESH Kodak Film,** 3 rolls \$1.00. Sizes 620, 120 127. Guaranteed. PicSure, Box 899-M, Philadelphia, Penna.

**BIO Mails,** four months listing, 25¢. Wright Publications, 2270 Hubbard, Memphis 8, Tenn.

**70 BIBLE Lessons,** 25¢. Bulletin, Box 87, Cathedral Station, New York City 25.

**SAMPLES, Magazines, catalogs, opportunities.** Year, 25¢. Star Directory, Leming, Texas.

**GROW Mushrooms,** Cellar, shed. Spare, full time, year round. We pay \$3.50 lb. We have over 25,000 customers. Free book, Mushrooms, Dept. 175, 2954 Admiral Way, Seattle, Wash.

**I Want to send you proof of the wonderful pulling power of Popular Mechanics classified pages.** What's your proposition? Write me today. Include literature if possible. F. W. Johnson, Manager Classified Advertising, Popular Mechanics Magazine, 200 E. Ontario St., Chicago 11, Ill.

**SHARPEN And service lawnmowers** \$10.00 hour possible, build your own grinder, small cost, 26th year. Wirt's, 2419 Gnahn, Burlington, Iowa.

**WANT More business?** Here's an amazing opportunity to increase your sales. Talk to thousands of interested readers of "Mechanics Popular." Our Spanish Edition covers the Latin American countries like a blanket. They're real mailorder buyers. Classified rate 75¢ per word. Try an ad in our next issue. Classified Advertising Department, Popular Mechanics Magazine, 200 East Ontario Street, Chicago 11, Ill.

**NEW MAGIC RADIO WALKIE TALKIE!**  
YOUR OWN POCKET SIZE RADIO STATION!  
BROADCASTS TO ANY HOME OR CAR RADIO WITHOUT WIRES OR HEADPHONES. We only 9 oz. Size, 1 1/2" x 1 1/2" x 1 1/2". Built-in telescoping antenna. Powerful Transistor-sensitive microphone, frequency setter, break-in switch! Runs for weeks on self-contained flashlight batteries. Durable plastic case. With this Radio Talkie you CAN TALK TO YOUR FRIENDS UP TO A BLOCK OR MORE AWAY! Talk up to 1 mile or more between two units. COMPLETELY INSTANT OPERATOR! Just push button to talk! No license needed. Uses inductive field magnetic radiation. Useful and real fun in a million ways GUARANTEED TO WORK, 1 YEAR SERVICE GUARANTEE.  
SEND ONLY \$2.00. (cash, c.o. d.) and pay postman \$5.35 C.O.D. postage or send \$11.36 for insured delivery. COMPLETE READY TO OPERATE with instructions and hundreds of ways and tricks for broadcasts thru any radio you desire. Price may go up soon, so get your NEW POWERFUL RADIO-WALKIE TALKIE NOW. Available only from WESTERN RADIO, Dept. RPM-5, KEARNEY, NEBR.



**STOP COSTLY TV & HI-FI REPAIRS**  
with the WUERTH TUBE-SAVER  
TRIPLE the LIFE of ALL TUBES...including the EXPENSIVE PICTURE TUBE...Eliminate 2 out of 3 SERVICE CALLS. TUBE-SAVER automatically reduces inrush currents when set is first turned on...SAVES TRANSFORMERS, CAPACITORS, & RECTIFIERS, too...Just plug in to operate.  
SEND ONLY \$2.00 and pay postman \$7.95 C.O.D. postage, or send \$9.96 for p.p. del.  
WUERTH TUBE-SAVER CORP., Dept. PM-1, 9125 Livernois, Detroit 4, Mich.



**Shrinks Hemorrhoids**  
**New Way Without Surgery**  
Science Finds Healing Substance That Relieves Pain—Shrinks Hemorrhoids  
For the first time science has found a new healing substance with the astonishing ability to shrink hemorrhoids and to relieve pain—without surgery.  
In case after case, while getting relieving pain, actual reduction (shrinkage) took place.  
Most amazing of all—results were so thorough that sufferers made astonishing statements like "Piles have ceased to be a problem!"  
The secret is a new healing substance (Bio-Dyne\*)—discovery of a world-famous research institute.  
This substance is now available in suppository or ointment form under the name Preparation H.\* Ask for it at all drug counters—money back guarantee. \*Reg. U. S. Pat. Off.

MAY 1957

**NEW 14 & 16 FT. SPORT RUNABOUT KIT**  
Modern swept-back design for outboards up to 60 h.p. Other models as low as \$42 (Freight included). Fiberglass covering kits, marine supplies, etc.  
14 Ft. Only \$239. Freight included.  
**TAFT MARINE WOODCRAFT**  
PM-557 • 636 30th Ave. N. E. • Minneapolis 21, Minn.



**PREPARE FOR BETTER JOB, BIGGER PAY IN SPARE TIME AT HOME**  
Today, choose the job you want—and prepare for it in time you might otherwise waste. Or if you are already in the work you like best, start training now for quicker promotion and increased pay. During the past 60 years AMERICAN SCHOOL has helped ambitious people to reach higher goals. Check subject that interests you and mail coupon for full information.  
**AMERICAN SCHOOL, Dept. G545, Drexel at 58th, Chicago 37, Ill.**  
Without obligation, please send FREE and postpaid, full particulars about the subject checked below.

<input type="checkbox"/> Accounting	<input type="checkbox"/> Contracting	<input type="checkbox"/> Mechanical Engineering
<input type="checkbox"/> Apprenticeship Courses	<input type="checkbox"/> Diesel Technician	<input type="checkbox"/> Mechanical Technology
<input type="checkbox"/> Architecture & Building	<input type="checkbox"/> Drafting—Building	<input type="checkbox"/> Metalworking Courses
<input type="checkbox"/> Automotive Technician	<input type="checkbox"/> Drafting—Machine	<input type="checkbox"/> Plumbing—Practical
<input type="checkbox"/> Better Foremanship	<input type="checkbox"/> Electrical Engineering	<input type="checkbox"/> Private Secretary
<input type="checkbox"/> Blueprint Reading	<input type="checkbox"/> Electricity—Practical	<input type="checkbox"/> Retail Merchandising
<input type="checkbox"/> Bookkeeping	<input type="checkbox"/> Electronics—Industrial	<input type="checkbox"/> Salesmanship—Outside
<input type="checkbox"/> Business Management	<input type="checkbox"/> HIGH SCHOOL COURSES	<input type="checkbox"/> Sheet Metal Work
<input type="checkbox"/> Civil Engineering	<input type="checkbox"/> Machinists	<input type="checkbox"/> Tool Making

NAME \_\_\_\_\_ OCCUPATION \_\_\_\_\_  
HOME ADDRESS \_\_\_\_\_ AGE \_\_\_\_\_  
CITY \_\_\_\_\_ STATE \_\_\_\_\_  
Consent: Write American School, Dept. G545, 4083 Sherbrooke St. W., Montreal

**MAIL COUPON NOW**

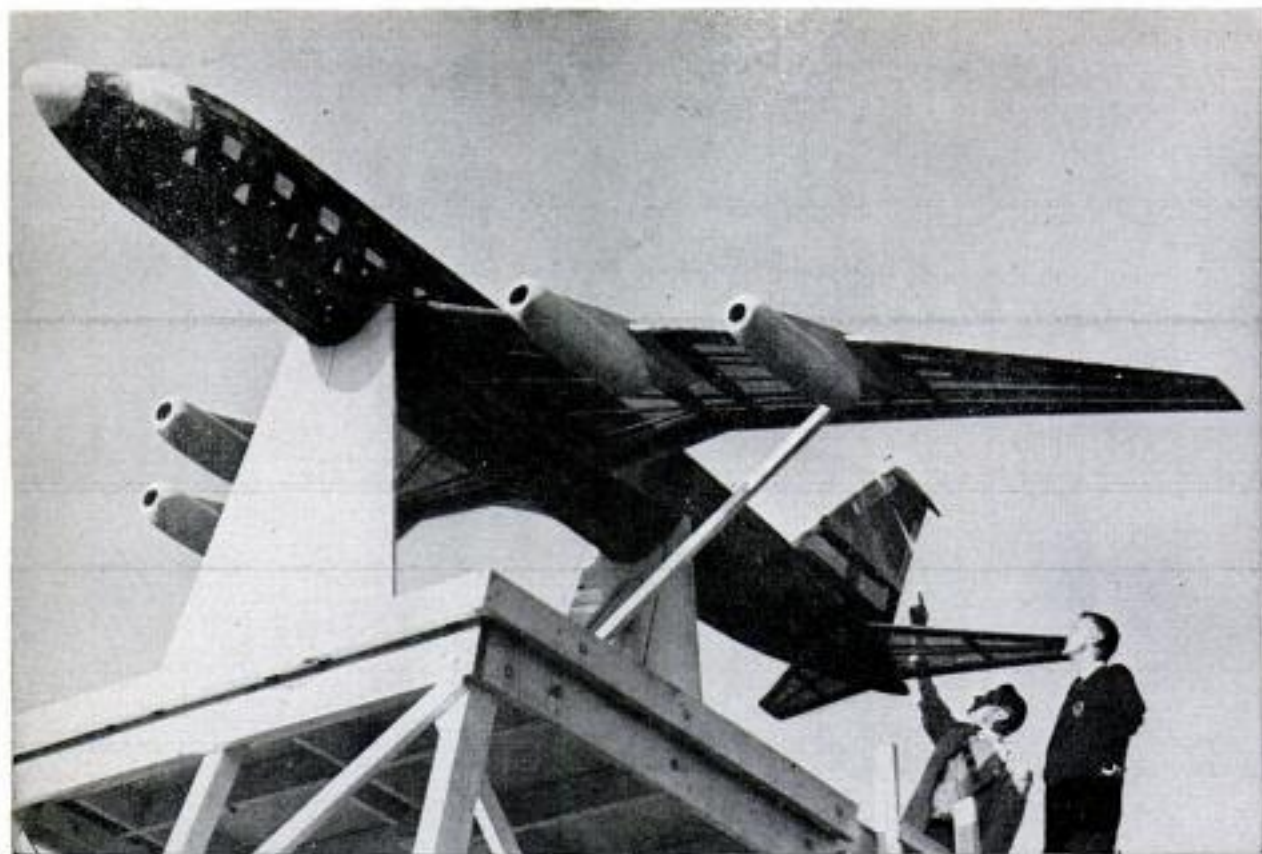

## Radio Antenna Built Into Airliner Airframe

Entire airframe of Convair's new "880" jet airliner is a built-in antenna ground. The top four feet of the vertical tailfin will be used to send and receive messages. A model of the 880, above, is covered with bronze screening to duplicate electrical properties of the plane and also houses a transmitter to generate test signals.

## Trucks Tow Mobile Fluid Transporters

Rolling fluid transporters with a 500-gallon capacity have been developed for the U. S. Army Transportation Corps. In a demonstration at Fort Eustis, Va., an eight-by-eight cargo truck towed two of the new transporter units, leaving the truck's body free for other cargo.





## This man is looking into your future

How does it look? Rosy? Free of cancer? You hope! But hoping isn't enough. Of every 6 Americans who get cancer this year, 3 will die because science still has no cure for them. It will take research . . . lots of research . . . to find that cure. And research, let's face it, takes money. Pitch in and help. Send a generous check . . . right now . . . to "Cancer" in care of your local Post Office.

**American Cancer Society**

## HELPFUL BOOKS

Send post card asking for FREE catalog

Popular Mechanics Press, 200 E. Ontario, Dept. 601, Chicago 11

## BUILD YOUR OWN

Walks · Driveway · Outdoor Fireplace, etc.

At very little cost, you can lay foundations, sidewalks and driveways, build steps, outdoor fireplaces, sandboxes, tennis courts, pools — all concrete work. And it's easy to do! Just follow this PM book that tells and shows all: how to make the right mixture, plan and apply. Contains 50 professional short cuts, hundreds of pictures. Only \$2.50 post-paid. Money back if not pleased. Order today!

The terrific high costs of even little concrete jobs are mostly for labor. Now save all the labor costs with . . .



POPULAR MECHANICS PRESS  
Dept. 557, 200 E. Ontario  
Chicago 11, Illinois

# HI-FI TOOLS

by **UTICA**

Now for the Hi-Fi enthusiast, a complete set of quality hand tools designed for the assembly of Hi-Fi components.

Backed by an unconditional guarantee. Use UTICA, the tools the experts use.

**UTICA DROP FORGE & TOOL DIVISION**

Kelsey-Hayes Co., Utica 4, N.Y.



46-4 — midget diagonal

819-12\*  
long shank  
screwdriver



262-5½ — transverse end-cutter



654-6 — long nose with cutter

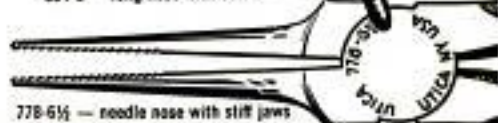

778-6½ — needle nose with stiff jaws

## PREPARE FOR THE BEST JOBS IN INDUSTRY

**TRAIN**  
at HOME  
in Your Spare Time  
or at  
**ALLIED INSTITUTE**  
in Chicago

- MECH. ENGINEER
- DRAFTSMAN
- TOOL DESIGNER
- TOOL ENGINEER
- MASTER MACHINIST
- AIR CONDITIONING  
HEAT & REFRIGERATION

### MORE JOBS THAN GRADUATES

Shortages of Draftsmen, Designers, Tool Engineers, Machinists, Air Conditioning technicians are so widespread that you can pick a highly paid key job and look forward to Achievement and Security. You can begin your training in Short Courses at home or at Allied Institute, and continue progressively toward an Engineering Degree in 36 months. Allied is approved by Industry, National Home Study Council, Central Schools Association, Dept. of Education, Office of Public Instruction, State of Illinois, U. S. Veterans Admin., U. S. Dept. of Justice.

SEND FOR  
**FREE**  
BOOKS

**ALLIED SCHOOL OF MECHANICAL TRADES**  
1338-42 South Michigan Ave., Dept. PM-5, Chicago 5, Ill.

Send me without obligation information on your courses:

- HOME STUDY  RESIDENT  VETERAN  NON VETERAN  
 DRAFTING  ENGINEERING  AIR CONDITIONING

NAME \_\_\_\_\_

ADDRESS \_\_\_\_\_

CITY \_\_\_\_\_ COUNTY \_\_\_\_\_ STATE \_\_\_\_\_

# '57 Kit Boats



Suitable for 15-horsepower motors and up, this 14-foot Tern runabout, made by U.S. Molded Shapes, Inc., has a 66-inch beam and can seat four persons

Lapstreak skiff model Monterey, weighs 341 pounds and is 14 feet, 6 inches in length. It is 5 feet, 6 inches wide and is made by U-Mak-It Products Co.



Chris-Craft 19-foot Sports Express Cruiser is designed for outboard or inboard power and as a factory-finished boat or prefab-kit cruiser

Custom-Craft Victory Twin Trunk Express is 21 feet long with an 8-foot beam. Headroom of 5 feet, 9 inches is provided in the 9-foot-long cabin



# Make Every Job Easier with a **COLUMBIAN** **GYRO-VISE**



Works in any position... on either side upright... at any angle

The Gyro-Vise operates around a base on which it locks automatically. Ideal for carpentry, sanding, sawing, plumbing, tool sharpening... all home

and shop jobs. Smooth, positive-grip, mar-free jaw faces. 7 1/2 sq. in. gripping area. Removable, replaceable pipe jaws. See your dealer!

Jaw Width ..... 3 1/2 in.  
Jaw Depth ..... 2 1/2 in.  
Jaw Opening ..... 5 in.  
Pipe Capacity ... 1/4-1 1/2 in.  
Height ..... 8 1/2 in.  
Weight ..... 16 1/2 lbs.



**\$13.95\***  
delivered

WRITE FOR FREE CATALOG

\*add \$1 west of Rockies.

**COLUMBIAN VISE & MFG. CO.**

DEPT. PM 73 • CLEVELAND 4, OHIO



## Every Boy Should Have This Build-It-Yourself Book for Boys!

It's natural for boys to want to make things—to fuss with tools—to fashion the kind of things "kids"

want. So give boys the Build-It-Yourself Book for Boys. Encourage a youngster to express himself through the sensational new Popular Mechanics book that shows how to make 56 different things every boy dreams about. It covers science, mechanics, electricity, modeling and other fields. 192 pages of easy-to-follow instruction and 469 how-to-do-it pictures.

### 56 Toys, Games, Gadgets, Models, Boats, Electrical Devices, Cars and Other Things Boys Can Make at Home

How to make—Airplane Models, Aquaplane, Archery Kit, Bird Houses and Shelter, Boats, Bobsleds, Bomberang, Cannon Toy, Electric game, Electric Motors, Garage Toy, Helicopter Toy, Hunting Knife, Hydroplane Model, Kites, Log Cabins, Marble Game, Microscope, Printing Press, Radio Sets, Rafts, Railroad Modeling, Shooter, Scooter, Sidewalk Cars, Sprinkler

Truck, Squirt Gun, SS United States Model, Surfboard, Tank Toy, Taxidermy, Telegraph Set, Telephone, Tree House, Water Skis, Weather Instruments, Toboggan, Worktable. Build-It-Yourself for Boys sent postpaid for \$2.50 or COD, charges additional. Money refunded if you are not pleased after 5 days' use. Mail order to address below.

Toy motors

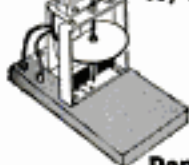

Boomerangs



"Ju-be"—the punt.

POPULAR MECHANICS PRESS  
Dept. 557, 200 E. Ontario St., Chicago 11

MAY 1957

**NEW DROPTOP**

- WORK BENCH
- COUNTER
- TABLE

**FOLDS FLAT ON THE WALL!**

**\$1888**  
COMPLETE

### EXTRA SPACE FOR YOUR WORK SHOP, HOBBY and countless household uses!

Mount the DROPTOP work top and brackets on any wall — brick, cement block, concrete or wood. OPEN — it's a full-size, heavy-duty work bench or multi-purpose wall table for the garage, den, kitchen, children's room, etc. The DROPTOP, 4 ft. long, 2 ft. wide, 1 1/2 inches thick, is seamless, splinter-proof, warp-proof! Folding brackets of heavy steel lock in horizontal position — no sway, wiggle or bounce. Comes complete, including all hardware, ready to install. Nothing more to buy. Ask for the DROPTOP at building and lumber supply, hardware dealers. If your dealer does not yet have it — use coupon below.

**DROPTOP FOLDING BRACKETS ONLY**

Make any top or table a folding wall unit. Complete with wrench and screws for all types of walls. \$7.95

**STURDI-BILT STEEL PRODUCTS, INC.**  
2501 Peterson Ave., Dept. PM4, Chicago 45, Ill.

I enclose  Check  Money Order for \$\_\_\_\_\_ Please ship:

Complete DROPTOPS (work top, 2 brackets, hardware) at \$18.88 each. Shipp. wt. 45 lbs.  
 DROPTOP brackets only @ \$7.95 pair. Shipp. wt. 11 lbs.

NAME \_\_\_\_\_

ADDRESS \_\_\_\_\_

CITY \_\_\_\_\_ ZONE \_\_\_\_\_ STATE \_\_\_\_\_

MY DEALER IS \_\_\_\_\_

No C.O.D.'s. Shipped from Manmouth, Ill. Express collect.



### SEE YOUR DEALER

Two steps to professional results in your workshop: (1) check POPULAR MECHANICS for helpful

"how to" suggestions; (2) discuss your project with your dealer. He knows the importance of working with quality products. They're advertised in POPULAR MECHANICS

## IMPERIAL—easiest operating of all tube cutters!



**Hi-Duty @ No. 274-F** tube cutter has free-wheeling action. Makes clean, right-angle cuts on hard or soft tubing, 1/8 to 1" O.D.

Retractable reamer. No. 274-FW has extra cutting wheel. Other Imperial cutters to 2-1/4" O.D. Also benders, flaring tools, sawing vises.

Sold by leading Industrial, Refrigeration, Plumbing and Automotive Supply Houses everywhere.

SEND 10c for VALUABLE HANDBOOK and CATALOG

THE IMPERIAL BRASS MFG. CO.  
1212 W. Harrison St. Chicago 7, Ill.  
Send 36-page Imperial Tube Working Handbook and Catalog. Also name of nearest dealer.

Name \_\_\_\_\_  
Address \_\_\_\_\_  
City \_\_\_\_\_ Zone \_\_\_\_\_ State \_\_\_\_\_



Imperial Quality

When you buy TOOLS, EQUIPMENT and MATERIALS

*remember . . .*

you buy  
better

when you buy . . .

*Quality*

from your **QUALITY** dealer

**You buy best when you buy nationally advertised brands.**

You can be sure the tools, equipment and materials you buy are right for the job when you select nationally-advertised brands sold by your quality dealer.

Nationally advertised brands cost no more and assure longer life with better results. They are backed by the manufacturers and dealers who sell them.

Make it a point to talk with your dealer about the products best suited for your needs. He makes it his business to know what products will do the job best. Your dealer is your workbench partner. Let him help you.



**Home is what you make it  
— and your dealer can help.**



You'll save time and money, too, if you'll look through **POPULAR MECHANICS** for information and suggestions that will help in your selection. Products advertised in **POPULAR MECHANICS** are among the finest made. You can be sure of their quality. **POPULAR MECHANICS** publishes more product information on tools, equipment and materials than any magazine of its kind. Ask your dealer. He reads **POPULAR MECHANICS**, too.

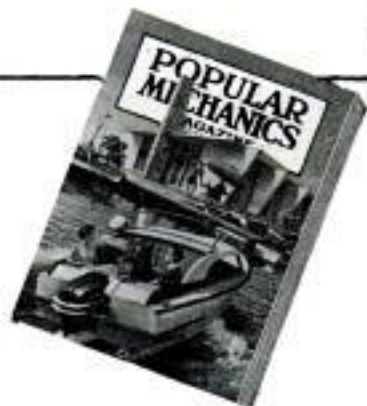



**HUNTERS!**  
SPECIAL SPRING  
GUN SALE



SPECIAL  
**\$19.95**

**ENFIELD RIFLES**

Cost British about \$85. Ours is the lowest price ever placed on a modern first quality military rifle! This is the British Lee Enfield Army rifle, used today by British troops throughout the Empire. High velocity, powerful .303 cal. ammo is ideal for all N. American big game (sold everywhere in U.S.). Adjustable sights, 10-shot bolt action, 361, 25", w/ 8 1/2 lbs. Bears British endurance and royal proofhouse marks. Great good boys and exterior. We are also offering a few in Very Good cond. at \$25.50 and a very few specially selected for superior finish at \$28.75. FREE—with all guns. 20 rds. ammo. OFFICIAL BAYONET, \$3.95. TARGET AMMO, \$1.50 per 100 rds. HUNTING AMMO, \$2.85 per 20 rds. FACHMAYR LO-SWING SCOPE MOUNT for this rifle, \$28.00.

TO ORDER: Send check, cash or money order, by deposit for C.O.D. Shipped Exp. Coll., F.O.B. Pasadena, Calif. resd. add 4% state tax. (Include money back guarantee.)

CANADIANS: Order (without red tape) rifle Sped. from G.K. Harper, 16 Baywater, Ottawa.

**GOLDEN STATE ARMS CORP.**  
1340 W. Green St., Pasadena 30, Calif.

**LUBRIPLATE**  
LUBRICANTS



**LUBRIPLATE**  
2-C  
MOTOR OIL

MADE IN U.S.A.  
SPECIALLY PREPARED  
FOR OUTBOARDS  
LUBRICATED BY  
LUBRIPLATE  
LUBRICANTS DIVISION  
FISKE BROTHERS REFINING CO.  
NEWARK 5, N. J.

**Make Motors  
Run Better... Last Longer**

LUBRIPLATE 2-C MOTOR OIL is processed for use in both two and four cycle motors. Will mix easily with gasoline and stay mixed. Does a better lubricating job. Burns completely, keeps the motor clean. Does not foul spark plugs, thus assures quicker and surer starting.

Your equipment deserves the best.  
Use **LUBRIPLATE** . . . You'll see  
the difference immediately!

At Hardware, Sporting Goods and Marine Stores

OTHER LUBRIPLATE PRODUCTS

- LUBRIPLATE OUTBOARD GREASES for underwater gears
- LUBRIPLATE H.D.S. MOTOR OIL for cars, trucks and tractors
- LUBRIPLATE AUTO-LUBE "A" for general automotive lubrication
- LUBRIPLATE in handy tubes for sports and household uses
- LUBRIPLATE INDUSTRIAL LUBRICANTS for every application

LUBRIPLATE DIVISION, Fiske Brothers Refining Co.  
Newark 5, N. J., Toledo 5, Ohio.

NEW 1957 CATALOG **200 MODELS—SAVE 2/3**  
**BOAT KITS** EASY TO BUILD—Designed for the amateur. Over 200 Models. Plans to Cruisers, 8 to 21 ft. Formed hulls Semi and Custom finished. Save 50%... Now NEW Sea Ray Molded FIBERGLAS BOAT KITS, Truly professional results. NO upkeep. SAVE 2/3 assembly time. 12 to 16 ft. Utilities and Runabouts. SEND 35c for 64 page Boat Kit & 24 page Sea Ray Catalogs. SEND \$1.00 for both plus "Boating Handbook". Dealers inquire for franchise.

**BOAT PLANS & PATTERNS**  
World's largest selection; over 200 plans, full-size patterns, frame-pac kits! Designed strictly for amateurs! All types: prams, kayaks, racers, runabouts, catamarans, houseboats, cruisers - inboard-outboard 6-40' wood-plywood-steel!  
**Frame-Pac Kits** Send 35c for PLAN CATALOG Catalog PLUS "Boatbuilding Handbook" \$1.00

WRITE NOW! CUSTOM CRAFT, BUFFALO 7, N. Y.

**ELECTRIC STARTER KIT**  
For small air cooled engines up to 12 horsepower—All kits designed for easy installation on lawn-mowers, garden-tractors, etc.  
Write for details regarding Dealerships and Distributorships  
**CHIEF INDUSTRIES, Dept. A, Dowagiac, Michigan**

**3 CU. FT. MIXER 3975**  
DIRECT FROM MFR.



Fills long felt need for small mixer for concrete, feed, fertilizer, seed and many other materials. Saves 1/3 cost of ready mixed concrete. Pays for itself on first job.

3 Cu. Ft. Drum—Mixes 2 Cu. Ft. Concrete ..... \$39.75  
5 Cu. Ft. Drum—Mixes 3 Cu. Ft. Concrete ..... 59.50

FOR Details, N. Y. Cash, Check or M. O. Money back guarantee.

**UNITED STATES FORGE AND FOUNDRY CO.**  
CONSTRUCTION EQUIPMENT DIV., PULASKI, NEW YORK

**BOATING PLEASURE begins with** *Holsclaw* **BOAT TRAILERS** **MORE SAFETY, VALUE, PLEASURE**  
through latest in a long line of engineering firsts!



NEW variable pitch coil springs give soft ride to any weight boat. NEW longitudinal roller set protects vital planing zone. NEW trailer tilt tongue solves unusual loading problems. **LARGEST, MOST POWERFUL AXLE OF ANY TRAILER EVER BUILT!**  
**FULL 6-MONTH GUARANTEE**

See your Holsclaw dealer or write for new free catalog.  
**HOLSCLAW BROS., Inc.**  
464 North Willow Road  
EVANSVILLE, INDIANA

from **\$99.00** up





## Bed in a Wagon Built in Minutes

In minutes you can build a bed in your station wagon that will be big enough to take a full-size innerspring mattress. All you need is a four-by-six sheet of plywood (at least  $\frac{5}{8}$  in. thick) and a length of two by four. Cut the two by four so it fits across the body atop the rear-wheel housings. Pad the ends of the cross piece to protect the side panels. Trim the plywood to fit and slide it on the cross piece so its forward end rests firmly on the folded rear seat (the plywood end should be padded to protect the seat). Tack the two pieces together and the job is done.

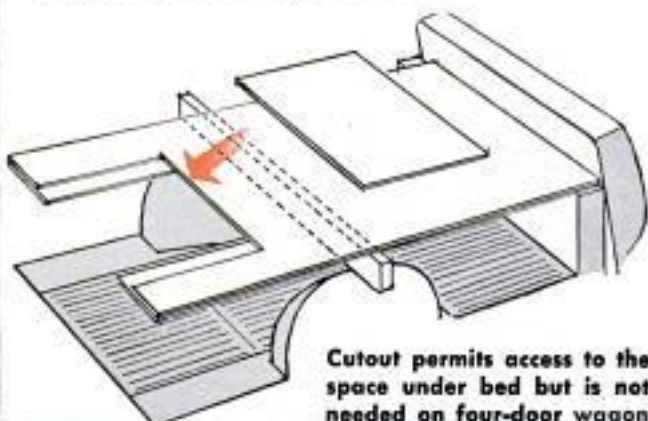

Cutout permits access to the space under bed but is not needed on four-door wagon

**Amazing  
CAR POLISH  
Discovery!**  
*FAST as a car wash!*



Now! MAC'S new Resin Coat. A long-lasting polish that's quick and easy to apply. Fast-acting Solvent Action does it...loosens surface film harmlessly while special resins produce a hard, high gloss that lasts up to 6 months. Just rub on, wipe off. Do a perfect job in minutes—not hours. Nothing like it.

**"DON'T WAX IT—MAC'S-IT"**  
...with MAC'S RESIN COAT!

AT  
YOUR  
SERVICE  
STATION

**MAC'S SUPER GLOSS CO., INC.**  
Los Angeles 42, California

## "SEA KNIGHT"



### A Build-It-Yourself PLYWOOD CRUISER Designed Especially for PM Readers

Construct this beautiful 17-foot cabin cruiser yourself in your spare time. It's exceptionally easy to build even with little or no experience! Has cruising accommodations for two, including two full berths, complete kitchen and toilet facilities and a fast bottom for single or twin-motor installation.

Beautifully designed—roomy open cockpit, hatch in forward deck, and with two aboard it makes 26 m.p.h. with a 35-hp. motor. As a cruiser, runabout or utility boat, it will give you many hours of wonderful outdoor enjoyment for a minimum investment of time and money. Complete, fully detailed plans only \$10.00. Order below today!

**POPULAR MECHANICS PRESS, Dept. 557**  
200 E. Ontario St., Chicago 11, Ill.

Send me complete set of seven large-size blueprints for "SEA KNIGHT" cruiser, including plans for easy-to-make boat trailer.

- I enclose \$10.00 check or money order  
 Send C.O.D. (U.S.A. only)

Name \_\_\_\_\_

Address \_\_\_\_\_

City \_\_\_\_\_ Zone \_\_\_\_\_ State \_\_\_\_\_



# NOW IS GOOD TIME TO PLANT BLUE-GREEN MONDO "GRASS"

Trade Mark Registration applied for U. S. Patent Office  
**REQUIRES NO MOWING — MAKES  
WORLD'S MOST BEAUTIFUL LAWN**

View of one of the lawns surrounding the lovely \$200,000.00 home of Spurgeon Pickering, owner of Mondo Grass and Nursery Company, on the beautiful beach of the Gulf of Mexico; the entire seven lawns, sidewalk shoulders and neutral grounds are planted solidly in Mondo "Grass," truly one of the most attractive show places of the South.

Our Blue-Green Mondo "Grass" is described by the U. S. Department of Agriculture as "Ophiopogon Japonicus (formerly called Mondo Japonicus)," is native to Northern China and should withstand severe degree of freezing; drought tolerant, evergreen, commonly called Mondo "Grass."

It is a "grass" relative to the lily with paper thin blades 1/16" wide. This sod-forming EVERGREEN, low-growing oriental genus is currently used by many owners of distinctive homes in America for lawn grass. Now we can offer this exclusive Blue-Green Mondo "Grass" at popular prices.

SO HARDY IT CAN BE PLANTED ANYTIME. It is recommended for beautiful lawns where mowing is not desired. Blue-Green Mondo "Grass" retains its color the year-round; thrives in shade or sun; extremely hardy, rarely requires watering; fantastically beautiful, drooping low to the ground in weeping style year after year. **REQUIRES NO MOWING AND SHOULD NEVER BE MOWED.**

Guaranteed to withstand severe freezing or money refunded. Ideal for heavy shaded areas, dry or wet. FREE folder of testimonials and many photos of Mondo "Grass" lawns sent on request.

Mondo is resistant to diseases; insects and animals will not feed on it. Stops erosion; grows compactly, crowding out other grass and weeds; multiplies rapidly, approximately 100 times (10,000%) first year. Enhances property value. So sensational we expect to revolutionize lawn-making. For good coverage first year plant 4" to 12" apart. Numerous rooted blades to sprig.

Planting and culture instructions with each order. Shipped now or when desired. Remittance with order. Shipped prepaid. **MONEY-BACK GUARANTEE;** If not completely delighted you may return at once for refund. Open account to A-1 rated firms buying 1,000 sprigs or more, FOB Biloxi.

**ORDER TODAY . . . YOU CAN'T LOSE!!**

Sprigs packed in damp moss. Guaranteed to grow or we will replace.

**25 SPRIGS \$2.98**

50 Sprigs	..... \$ 5.00	1,000 Sprigs	..... \$79.00
100 Sprigs	..... 9.00	5,000 Sprigs or more	
500 Sprigs	..... 40.00	per 1,000	..... 50.00

**MONDO GRASS & NURSERY CO.**

Dept. PM, Biloxi, Miss.

Please send prepaid \_\_\_\_\_ Sprigs of Mondo "Grass," for which I enclose \$ \_\_\_\_\_

NAME \_\_\_\_\_

ADDRESS \_\_\_\_\_

CITY \_\_\_\_\_ STATE \_\_\_\_\_



## HAVE A BIGGER — MORE EFFICIENT HOME WORKSHOP

Popular Mechanics **PLANNING YOUR HOME WORKSHOP** shows you how to make use of every inch of space in your work shop; detailed floor plans, wiring layouts and power tool hookups plus actual photographs of famous home workshops you can use as models. Save money by building your own shop furniture. Special Where-to-Buy-It Guide, 450 Illustrations, Clerk Board, Working Diagrams. Order **\$2.50** your copy today from **POPULAR MECHANICS PRESS** Dept. 557, 200 E. Ontario St., Chicago 11

**BEFORE YOU PAINT seal cracks with**



**Handi-calk**  
**SO EASY TO USE!** For a better paint job seal BEFORE you paint. With Handi-calk you can seal damaging cracks and gaps for good. It's so easy you can do-it-yourself with this inexpensive Handi-calk cartridge and gun. Use inside or out. Will not sag or stain. Can be painted over.

For Better Glazing — Use Handi-glaze!  
**HANDI-CALK DIVISION DEPT. HC1**  
2366 WOODHILL RD., CLEVELAND 6, OHIO

**FREE!**  
Home Calk Check List...Where and How to Calk. Send for a copy today.

## a PERFECT power tool set-up!

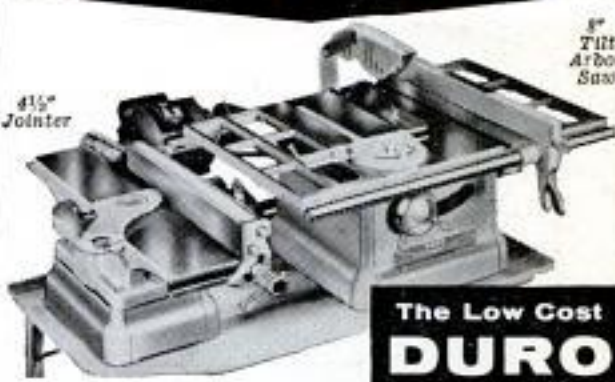

Saw Jointer Only  
**\$136.00**

The Low Cost  
**DURO**  
Combination  
Saw-Jointer

Now, you can do 90% of your woodworking—accurately, easily, safely—including dadoing, cross cutting, ripping, tenoning, jointing, bevel and moulding cutting, rabbeting, sanding, etc. This versatile power tool has every important operating feature including exclusive "motor shift" which permits economical and convenient operation of both units from a single motor. Also has patented "quick change" motor mount for rapid switching of same motor to other power tools.

Write for **FREE Power Tool Catalog** giving details on the **BIG DURO** line of drill presses, circular, band and scroll saws, jointers, sanders, lathes, etc. Write today.

**DURO METAL PRODUCTS COMPANY**  
2674 N. Kildare Ave. Chicago 39, Illinois

# How to select a paintbrush

A good brush performs better... wears longer... saves you money



In selecting a good paintbrush, the first thing to look for is a full head of bristles in a firm setting. Then, look closely at



several individual bristles. They should be finely tapered with slightly curled tips. Make sure a generous portion of the bristles have tips that are split or "flagged."

Finally, look for a brush that has bristles of different lengths. A brush with these qualities will give you excellent performance. It has a greater working and paint-holding capacity—eliminates excessive dipping. The brush will release a finish smoothly and evenly on any surface. You save time, paint with ease, do a professional-looking job.



## Now, better performance with improved TYNEX® nylon bristles

When buying a paintbrush, look for the trademark TYNEX on the handle. Quality paintbrushes made with bristles of TYNEX nylon give you better performance. They pick up a full load of paint at every dip and lay on a smooth, streak-free coat. And brushes with TYNEX have durable bristles that clean easily . . . rinse thoroughly . . . dry quickly—are always ready for re-use.

**FREE** — additional facts you should have on choosing and using a paintbrush. To get this information without cost or obligation, send name and address to E. I. du Pont de Nemours & Co. (Inc.), Polychemicals Dept., Room 655, Du Pont Building, Wilmington 98, Del.

TYNEX is the registered trademark for Du Pont nylon bristles



**TYNEX®**  
NYLON BRISTLES

Better Things for Better Living... through Chemistry

## We're Still Not Used to Billions

Tremendous dollar figures are apt to stagger us, despite the multibillion-dollar government budgets and industrial sales figures. So maybe you'll forgive the error we discovered after press time on the article "What Does It Cost to Own a Boat?" on page 154 of this issue. We said the outboard-motorboat enthusiasts of America would spend \$1,000,000 on boats and accessories this year. A paltry sum, indeed. The figure should be \$1,000,000,000. A billion dollars!

## WHERE-TO-BUY-IT INDEX

Source of supply appears after items commercially available

### AUTOMOTIVE

Gremlins on your windshield.....	89
Mobile cafeteria (Hodges Auto Sales, Ferndale, Mich.).....	106
Safety car bumper is true wrap-around.....	106
Umbrella shades tourists riding in convertible.....	131
Turntable car carries autos.....	131
Tractor turns in its own length (J. I. Case Co., Racine, Wis.).....	137
Clipboard desk fastens to car (Product Development Corp., P. O. Box 789, Norwalk, Conn.).....	137
Miniature car has clutch to save gear shifting (Eshelman Motors Corp., 109 Light St., Baltimore, Md.).....	143
Motorized scooter has plastic body.....	147

### AVIATION

GI flies strap-on-back helicopter without pilot training.....	86
World's largest bomber carries world's fastest bomber.....	86
Britain's 5-jet "VTO" plane.....	90
Russia's answer to the F104 "Starfighter".....	110
Horsepower goes up.....	121
Seaplane take-off made in 175 yards (Hello Aircraft Corp., Norwood, Mass.).....	131
Tiny planes on wires show factory production (Chance Vought Aircraft, Inc., Dallas, Tex.).....	138
Plane cushions protect passengers (Micro-Moisture Control, Inc., Mineola, L. I., N. Y.).....	142
Windshield with rubber interlayers resists supersonic friction (Dow Corning Corp., Midland, Mich.).....	143

### BOATS

'57 kit boats.....	68
Boat on stilts (Dynamic Developments, Inc., Babylon, N. Y.).....	100
Fold-up boat packs flat (Higgs Marine Service, 300 Zerega Ave., Bronx, N. Y.).....	100
Canoe catamaran for fishing, hunting.....	136
Antiroil fins help small power craft.....	142
Rear-view mirror for motorboats (Roger H. David, Inc., 636 Rossmore Bldg., St. Paul 1, Minn.).....	142
"Tailed" boat comes in kit (Glen-L Marine Designs, Box 568, Compton, Calif.).....	142
What does it cost to own a boat?.....	154
What's new in boating.....	162

### CONSTRUCTION

Over and under highway "spans" Hampton Roads.....	87
Electronic ingenuity builds Missouri dam.....	112

### MISCELLANEOUS

Exterior stair to basement uses preformed steel stringer (Bilco Co., 37 Water St., West Haven, Conn.).....	78
Steel forceps aids removal of fishhook (Ardmore Specialties, Tittenhouse Pl., Box 188, Ardmore, Pa.).....	78
Transistors for Signal Corps.....	78
Camp unfolds from trailer (Kwik Kamp, Box 95, Clovis, N. M.).....	91
Exhaust mufflers "silence" mowers (Power Products Corp., Grafton, Wis.).....	121
Floating "warehouse" can carry 2900 short tons of freight (Draco Corp., Neville Island, Pittsburgh 25, Pa.).....	130
Automatic dialing assists callers.....	131
Amputee's bike.....	131
Bowling-alley set is portable (Cosom Ind. Inc., 6012 Wazata Blvd., Minneapolis 16, Minn.).....	138
Portable electric typewriter weighs about 19 pounds (Smith-Corona, Inc., Syracuse, N. Y.).....	142
Ruler on wheels cuts work in drawing parallel lines (U. S. Rollux Sales, P. O. Box 44, Ft. George Station, New York City 40).....	146
Flexible plastic "see through" double doors prevent collisions.....	146
Model steam engine serves as trash burner.....	147
Superlocomotives tow canal ships.....	147
Horizontal rolling doors slide into small space (Waddell Door Mfg. Co., P. O. Box 420, Niles, Mich.).....	138
Flashlight horn (Johnson Smith & Co., 8615 E. Jefferson Ave., Detroit 7, Mich.).....	255
Cream served in pouch (Chesham Corp., 684 Nepperham Ave., Yonkers 2, N. Y.).....	258

**SCIENCE**

Guidance system directs artillery missile to target..... 88  
 Radar and computer pinpoint enemy mortars within seconds. 88  
 Giant weed burner keeps railroad right-of-way free of over-  
 growth.....112  
 X-ray movies of running engine.....121  
 Built-in measuring system assists jig-boring machine.....125  
 Self-use oxygen inhalator.....125  
 "Yellow spider" streamers point to crash victims in jungle.....125  
 Portable radar uses its "ears".....130  
 Diesel plants to aid defense (Consolidated Diesel Electric  
 Corp., Stamford, Conn.).....136  
 Giant "dishpans" locate deep crevasses in Greenland ice cap.....146  
 Machine translates Russian to English.....147

**Craftsman and Shop Notes Index**

**AUTOMOTIVE**

Cabinet-bunk for your station wagon.....182  
 Battery care.....202

**CONSTRUCTION**

Jig marks siding to fit gable.....190  
 Raising lintel singlehanded.....195  
 Fitting siding or shingles around doors and windows.....200

**FARM**

Sun shade for livestock easily moved to different locations...207  
 Two-wheeled chore cart holds bushel basket.....208  
 Portable speed jack assembled from farm-machine parts.....212

**HOUSE AND HOME**

Louverize your panel doors.....173  
 Patio table.....175  
 Lavatory platform and cabinet accommodates small children...178  
 Modified screen-door hook protects younger children.....178  
 Wooden frame supports tarpaulin wading pool.....192  
 Block shelves display curios.....196  
 Dovetail insets save old doors.....196  
 Snack trays on porch glider solve problem of limited space...196  
 Paint in nail-polish bottle used to touch up scratches.....200  
 Emergency plumb bob levels pictures on wall.....204

**MISCELLANEOUS**

Chalk writes in vivid hues when tinted with food color.....178  
 Paper pool for the kids.....179  
 Rate of water flow checked with watch and bottle.....180  
 Wigwag smoker.....181  
 Scrap piece used as gauge for laying wall tile.....184  
 Thrills galore on this roller coaster.....184  
 How to pack market eggs.....190  
 Simple play bench for child.....190  
 Replaster with tile.....191  
 The jack-of-all-trades wax.....194  
 Screen-door spring stabilizes steering of coaster wagon.....195  
 Wall rack holds rubber stamps.....196  
 Your watch tells direction.....200  
 "Spring type" bulletin board.....200  
 Small fry bunk cots.....201  
 Heat thermometer to reunite separated mercury column.....204  
 Loud clock chimes muted by small pieces of tape.....204  
 How to rebalance clock hands.....206  
 Stick with clay.....208

**PHOTOGRAPHY**

Developer cooled by running water through tubing.....174  
 Mask for print border made from black photo-paper envelope...180  
 Focusing negative for enlarger.....190  
 Sink-trap lens mount.....197

**WORKSHOP HINTS**

Vertical ruling with T-square.....177  
 Durable wren house easily made from auto-tire casing.....178  
 Refrigerator provides storage in home workshop.....180  
 Thin strips attached to sides "refit" loosened drawers.....184  
 Blackboard eraser is used as pumice pad.....192  
 Magnet holds jointer knives when resetting in head.....192  
 Shingle plumbs cabinet quickly.....195  
 How would you do it?.....198  
 Broomstick is chisel sheath.....200  
 Ready-made nailing shield is scrap of perforated hardboard...201  
 Spring-type door catch clamps jig-held work.....204  
 Bench vise holds small worktable.....207  
 Fillister-head screw made by filing round-head screw.....207  
 Slit tubing protects cutters of multiple hand punch.....208

**NOTICE**—It is the intention of this magazine to provide its readers with information regarding the latest developments in the mechanical arts. Except where otherwise indicated, this magazine has no information as to any unexpired patents in respect of the developments reported herein. In the event that commercial use is to be made of any of the developments reported herein, it is suggested that legal counsel be consulted to avoid liability for patent infringement. It is not the purpose of this magazine to encourage patent infringement but, as indicated, it is the intention of this magazine to report on the latest developments in the mechanical arts.

**NOW AVAILABLE!**  
**The Fabulous New**  
**GIBBERELLIN**

**Makes Plants**

**GROW**

**NEW DISCOVERY**  
**ASTOUNDS SCIENTISTS!**

A feature article in the April '57 issue of Popular Mechanics Magazine describes some of the truly amazing properties of the new "magic" chemical—Gibberellin. Botanists have been unable to determine the exact chemical composition of this "miracle" substance, but one thing is certain—"It will create a plant revolution."

**PHENOMENAL GROWTH**

Gibberellin has stimulated growth beyond belief in virtually all plants on which it has been tried. Look at these examples: Geraniums grow into giants! Rose bushes climb to more than three times their normal height. Asters, petunias, poinsettias, dwarf dahlias are all increased in size by the fantastic chemical. It causes tomato plants to flower and even bear more tomatoes! Soybeans grow 100 percent in a single week. Celery doubles its stalk and leaf growth. Beans grow six to eight inches per day! The growth of young trees may double or triple in three weeks!

**RESEARCH CONTINUES**

Right now scientists and botanists are working feverishly to find out more about this amazing discovery. It is known that an unbelievably small amount of the chemical—a dose as small as one millionth of a gram—can cause a plant to grow to four or five times its normal height. Less than an ounce would treat an entire acre of vegetables. And it works fast. Its effects have been observed within 10 hours of treatment! Furthermore, it is nontoxic to plants even at high dosages.

**TEST IT YOURSELF**

Apply it to young household plants and watch the results. They will amaze you. It's unbelievable! The strange growing power seems to affect almost anything—plants, flowers, fruit, trees, etc.

**SPECIAL INTRODUCTORY OFFER**

Our special introductory price is only \$2.98 per package. One package dissolved in a pint of water makes enough to treat over 100 plants. But Act Now! Join scientists and botanists all over the country in this astounding experiment. You'll agree that there has never been anything like this — Absolutely Nothing! Special Introductory Price..

**\$2.98**

per package



UNTREATED PLANT

TREATED PLANT

Dealer  
 Inquiries  
 Invited

**—MONEY BACK GUARANTEE!—**

**GIBBERELLIN SALES CO.**  
 440 Rochelle Ave.  
 Rochelle Park 1, New Jersey.

- Enclosed is \$\_\_\_\_\_ for \_\_\_\_\_ packages of GIBBERELLIN @ \$2.98 ea. Include reprint of P.M. feature article free of extra cost.
- Please rush reprint of P.M. article free, without obligation.

NAME \_\_\_\_\_

STREET \_\_\_\_\_

CITY \_\_\_\_\_ STATE \_\_\_\_\_



## SPORTMATE

5 Times Normal Gripping & Cutting Power.

A Vise, Wrench, Outside Cutter, Sleeve & Shot Crimper.

Only 4½" long. (Slips into pocket easily) **\$2.95**

For Fishing & Hunting (Gun or Bow) The SPORTSET **\$8.35**



## "One Shot" Flame Thrower

"One shot" flame throwers for use in close-range combat are now standard equipment for U. S. Army paratroopers. This unit weighs 26½ pounds in comparison to the 72-pound multiple-shot model. Fuel capacity of the smaller flame thrower is two gallons. Rugged and waterproof, it can be fired from any position.

## "Whiskers" Grow on Metals

Telephone maintenance men have been plagued for some time by tiny "whiskers" that grow on some types of metal equipment and cause short circuits. As a result, Bell Laboratories has been studying the natural growth of metal whiskers and has discontinued certain platings that foster these formations in critical applications where they could cause short circuits.

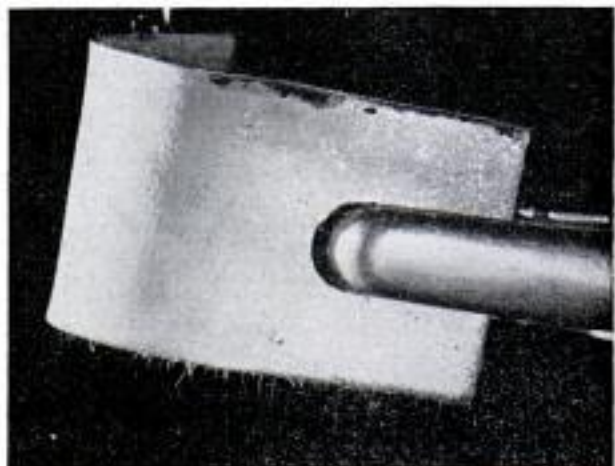

## PARROT-HEAD PRUNER

Hooked Blade, Split Anvil. Shear Action Cuts Clean . . . Won't Slip.

Safety Lock. 8" long.

**\$2.95**

**MONEY SAVING**  
Matched Set  
**\$9.95**



Can't Get Lost . . . Bright Yellow Handles

ASK DEALER FOR "DIAL-IT" PRUNING GUIDE (or send 25¢)

# S A R G E N T

HAND TOOL DIVISION • NEW HAVEN 9, CONNECTICUT



### Bonding Film

Bonding film replaces rivets in the fuselage, wings and tail surfaces of the new supersonic, four-jet B-58 bomber. This is believed to be the world's first military aircraft using material capable of strong, light, vibration and heat-resistant adhesion of aluminum to aluminum, according to B. F. Goodrich Industrial Products Company.

### Shave, Anyone?

Mechanical hands are now so deft they can even give you a shave. The hands are part of a manipulator used in handling radioactive substances. In England recently, the mechanical hands, operated by a scientist several feet away, gave a close shave to a volunteer.

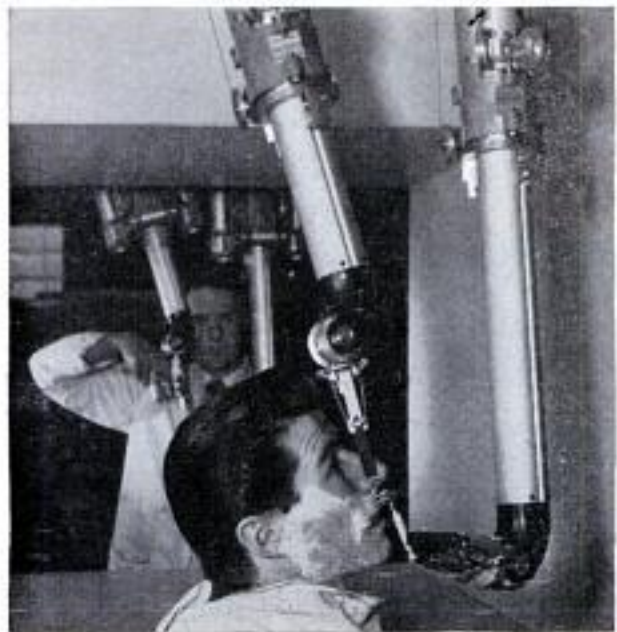

MAY 1957

**There are 765,000 Mechanics  
in the U.S. and Canada**

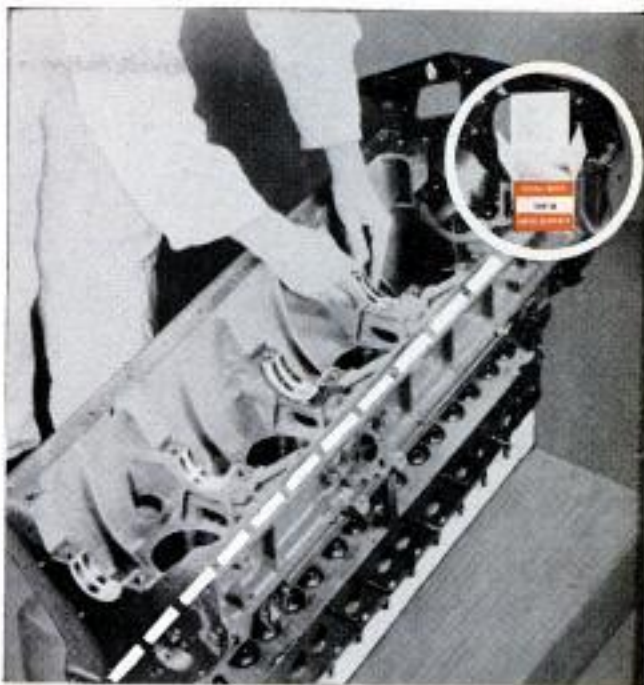

**Most of them prefer to  
replace with Federal-Mogul  
engine bearings**

There are good reasons, too. The critical point in engine reconditioning is installation of exactly the right sizes and types of main and connecting rod bearings. With 5,800 bearing "models" to select from, Federal-Mogul provides the only *complete*, top-quality line of replacement bearings. The good mechanic can select exactly the right bearings to restore "like new" performance to any engine. They prefer Federal-Mogul because they know from experience that fine bearings *make* fine performance!

### FEDERAL-MOGUL SERVICE

*Division of*

**Federal-Mogul-Bower Bearings, Inc.**

#### Mechanics Know . . .

that the black and red Federal-Mogul box identifies the service bearing line as modern as today's engines.

RESEARCH • DESIGN  
METALLURGY • PRECISION  
MANUFACTURING • SERVICE



77

Copyrighted material

IT'S TRUE

**DURO** THE ORIGINAL  
**PLASTIC ALUMINUM**  
in the big 5 1/2 oz. Tube



Is Wonderful

Real Metal in PUTTY FORM — It's the FAMILY HANDYMAN

Testimonials from all over the country prove DURO Plastic Aluminum's ability to perform hundreds of fix-it wonders. Use it in your home, auto, boat and shop. DURO Plastic Aluminum, the original metal in putty form, in the big 5 1/2 oz. tube, only **\$1**



HOME • AUTO • BOAT

Be Sure You ask for DURO, the Original Plastic Aluminum Pigmented with ALCOA aluminum

USE **DURO** handy-patch

THE SELF-SOLDERING PATCH

For Repairing Large

Rusted Out Areas

COMPLETE KIT . . . . .



EASY TO USE CUT DIP PATCH



Works Like Magic on all colors, makes and models of cars. Removes surface scratches and paint blemishes. Restores the original finish to your car in a matter of minutes. Easy to use. Large Tube **75¢**

Buy these 3 fine DURO products at all better hardware, auto accessory, paint and variety stores. If not available, write

**WOODHILL CHEMICAL MFG. CO.**

1395 EAST 33rd STREET CLEVELAND 14, OHIO

"Originators and World's Largest Mfrs. of Plastic Aluminum"



### Exterior Shaft to Basement Uses Prefomed Steel Stringers

Stairs leading from the basement to outside the house can be made easily by nailing steel stringers to the cheeks of the stair well. Concrete cut nails are used. The stringers have supporting slots designed to hold 2 by 10-inch wood treads, which can be hammered into place.

### Transistors for Signal Corps

All-transistor voice-multiplexing equipment developed for the U. S. Army Signal Corps provides 23 communications channels with only 1/20 the power needed to toast a slice of bread.

### Steel Forceps Aids Removal of Fishhook

Similar to a surgeon's forceps for throat surgery, a new fishing tool reaches into the fish's gullet or mouth to remove the hook. The tool has a squeeze-handle grip that operates the two jaws. Made of steel, it is also useful to auto mechanics for retrieving small parts from places difficult to reach.





# "Do-it-yourself" experts praise

## **DURO** PLASTIC ALUMINUM



According to enthusiastic letters from users, one of the best friends in many home repair shops today is a 5½-oz tube of Duro Plastic Aluminum (pigmented with ALCOA® Aluminum by Woodhill Chemical Co., Cleveland, Ohio).

Metal in putty form, Duro Plastic Aluminum is applied like paste, dries metal-hard in three hours. It's mixed... ready and easy to use, and is available in cans as well as the 5½-oz tube. Users say it repairs anything, adheres to any-

thing. Here's a sampling from those letters:

*Wisconsin motorist:* "... fender had rusted through . . . used Duro Plastic Aluminum . . . worked perfectly . . . can't see where the hole was."

*New York homeowner:* "... fixed all my gutters and leaders with no effort . . . just spread it on and let dry . . . Duro is wonderful."

*Wisconsin man:* "... repaired storm windows, toys; patched screens; filled in countersunk screws in a boat . . . I'll never be without Duro Plastic Aluminum."

*New Jersey mother:* "No amount of glue or even nails would hold my 3-year-old's playpen together . . . Duro made it good as new."

*Seattle nomad:* "... waterproofed the seams of our house trailer . . . very easy to apply . . . not a leak since."

*New York housewife:* "I have an antique pewter-and-brass urn that no fix-it shop could repair . . . Duro did the trick."

*California motorist:* "Duro sealed my radiator after a fan blade went through it . . . saved a \$15-20 charge at a radiator shop."



Just fill in around leaks and let set—in five minutes your troubles are over

Rusted spots or leaking joints can be quickly repaired with dab of plastic aluminum



**ALCOA does not make aluminum putties,** but ALCOA Aluminum Powders are used in all the best brands. Cold solders are easy to use, require no tools, heat or flame. They adhere to metal, wood, plastic, glass or concrete . . . are not affected by water, oil or gasoline . . . can be burnished to a high luster or even painted. Write today for more information. Use the coupon.



**THE ALCOA HOUR**  
TELEVISION'S FINEST LIVE DRAMA  
ALTERNATE SUNDAY EVENINGS

Aluminum Company of America  
1718-E Alcoa Building, Pittsburgh 19, Pa.

Please send me more information on cold solders made with Alcoa Aluminum Powders.

Name \_\_\_\_\_

Address \_\_\_\_\_

City \_\_\_\_\_ Zone \_\_\_\_\_ State \_\_\_\_\_



If your engine  
feels  
like  
this...

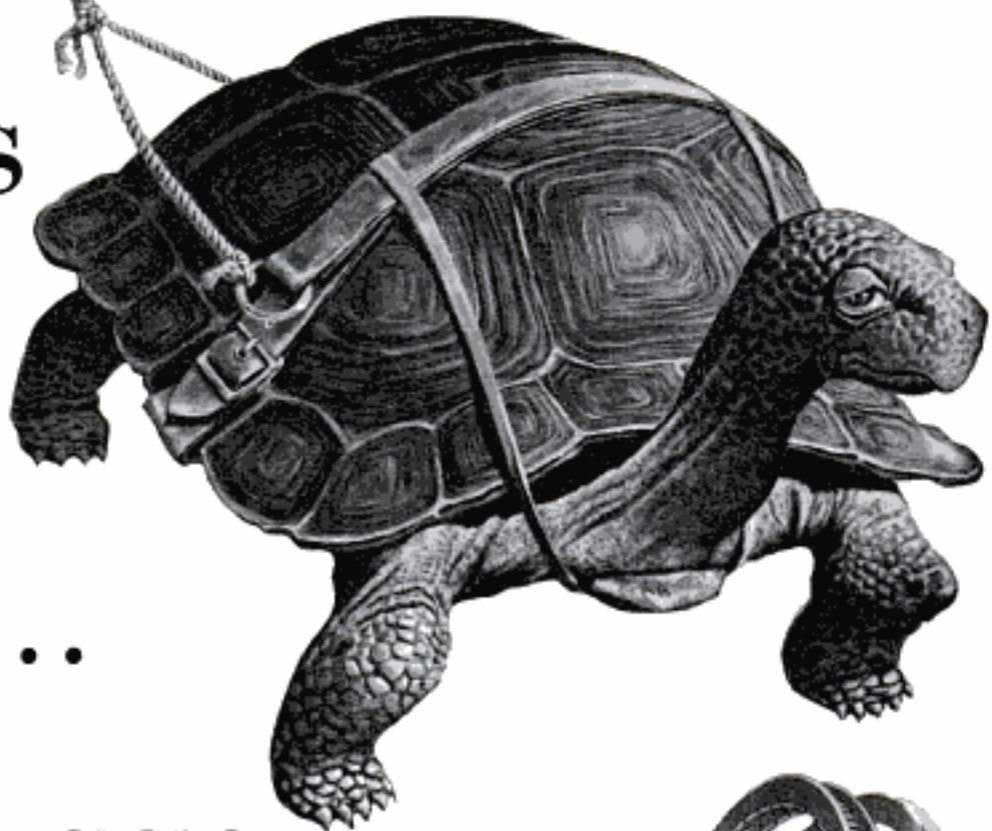

See your

## DOCTOR OF MOTORS

It's no fun to drive a car that's as sluggish as a "tired turtle"—and it's so unnecessary! Your skilled Doctor of Motors knows how to diagnose what ails a tired engine—and equally important—he has a remedy.

Skilled mechanics everywhere also know that there is no better way to restore

full responsive power, with positive oil control, than to install Perfect Circle 2-in-1 Chrome piston rings. Perfect Circles are plated with thick, solid chrome that resists wear, *more than doubles the life of cylinders, pistons and rings.* Perfect Circle Corporation, Hagerstown, Indiana; The Perfect Circle Co., Ltd., Don Mills, Ontario.

You'll be surprised how quickly and how economically your Doctor of Motors can bring back a "New Car Feel" to your car. Drive in for a checkup today!



## PERFECT CIRCLE

2-IN-1 CHROME PISTON RINGS

*restore that New Car Feel*

# POPULAR MAY 1957 MECHANICS

WRITTEN SO YOU CAN UNDERSTAND IT  
VOL. 107 NO. 5



One of John Hamlet's falcon "students" is being taught to come to hand on signal. Same glove is always used

From collecting monkeys for polio research  
this Florida scientist turned to

## **TEACHING SCHOOL FOR FALCONS**

By Max Hunn

SOME 35 YEARS AGO in South Dakota, John Hamlet's grandmother viewed with alarm her grandson's penchant for falconry, one of the world's oldest hunting arts.

Strong talk failing to dissuade young John, granny decided sterner measures were needed. When some neighboring cow hands caught an evil-tempered eagle, granny persuaded them to give it to the boy, hoping the sharp beak and talons would effectively convince him he should seek other hobbies. The plan failed. Young John enthusiastically tamed and trained the eagle.

Today, Hamlet is still enthusiastic about falconry—the 5000-year-old sport which reached its height before the refinement of hunting weapons in the Middle Ages.

And he's still pursuing his hobby, combining business

Homemade earphones made of two funnels help find falcons in the brush





After being trained to attack leather lure, a bird is cast off in free test flight to find his "prey"

with pleasure at Ocala, Fla., where he's assembled the largest collection of birds of prey in the United States—a total of 201 from all over the world. His collection includes owls, hawks, falcons and vultures. He calls his establishment "Birds of Prey."

But not all birds of prey can be trained for falconry. Owls, for example, while birds of prey, have such tiny brains—and no memory—that they cannot be taught to hunt. Vultures have not been trained for hunting, but Hamlet feels they can be taught, and he plans to prove his theory.

Eventually he hopes to collect an example of each of the 68 species of hawks that can be trained as falcons. He has 41 species already.

Hamlet holds bird wearing traditional hood which he uses only during the earliest stages of training





Falcon swoops down on lure which has meat in pocket. Inset, above, shows the bird removing his reward

"Falconry," says Hamlet, "wasn't introduced in Europe until the time of the Crusades, when returning Crusaders brought captive Saracens back with them as falcon trainers and handlers.

"And the hunting art spread throughout Europe until the improvement of weapons, which made this form of hunting less important. Now it's a sport which has relatively few followers. Like the bow and arrow, it's no longer of practical use."

Practical or not, falconry did play a small part in World War II. The RAF used 15 peregrine falcons—officially known as Interceptor Unit No. 2—to patrol the wild reaches of the English Channel. The falcons were trained to down carrier pigeons and they are credited with having a real disrupting effect upon Hitler's cross-channel spy service.

Hamlet is recovering some of the art of falconry which dwindled as it was transported from China, province of Chekiang, generally believed to have been the original home of falconry, to India, the Middle East and eventually to Europe.

"It's known," relates Hamlet, "that the Chinese developed the art of falconry so highly they could give verbal control commands to birds in flight. Emperor Frederick II of Hohenstaufen, who wrote the first European book on falconry in the 13th Century fails to mention this ability, so we assume it was lost in transit before this time."

Hamlet's training system is simple. His first step is to accustom the falcons, eagles

or hawks to the presence of humans. Gradually the birds learn not to fear people and become gentle enough to handle.

After his falcons have become accustomed to humans, he walks them while they're perched on his heavily gloved hand and wrist. This is to familiarize them with movement without any motion on their part.

When falcons are first carried, they flap continuously until their middle ear—their center of equilibrium—becomes used to the motion not supplied by themselves. Then they perch on the hunter's wrist patiently.

However, there's one quirk in the bird's nature. The same glove must be used throughout the training and handling. Change the color of the glove, and the falcon will refuse to return to the handler.

Hamlet's next step is teaching the falcon to take food from the hand instead of swooping down on it. By nature, birds of prey instinctively swoop on their meals. This instinct must be curbed in the training program.

His fourth step is teaching them to come to the hand when called. Calling consists of a shrill whistle which the birds have been taught to recognize. Next, he teaches them to come to lure at perch (the trainer's wrist). And the final step: To fly hand to hand at a signal. In real hunting this step would be actually to hunt game. The falcon kills the game and stays with it until the handler arrives. Bells on the bird enable the handler to find it in the underbrush.



This photo proves hawks can be tamed. Gradually, they learn not to fear humans and permit some handling



Hamlet teaches falcon to take food from his hand upon special signal—a loud and shrill whistle

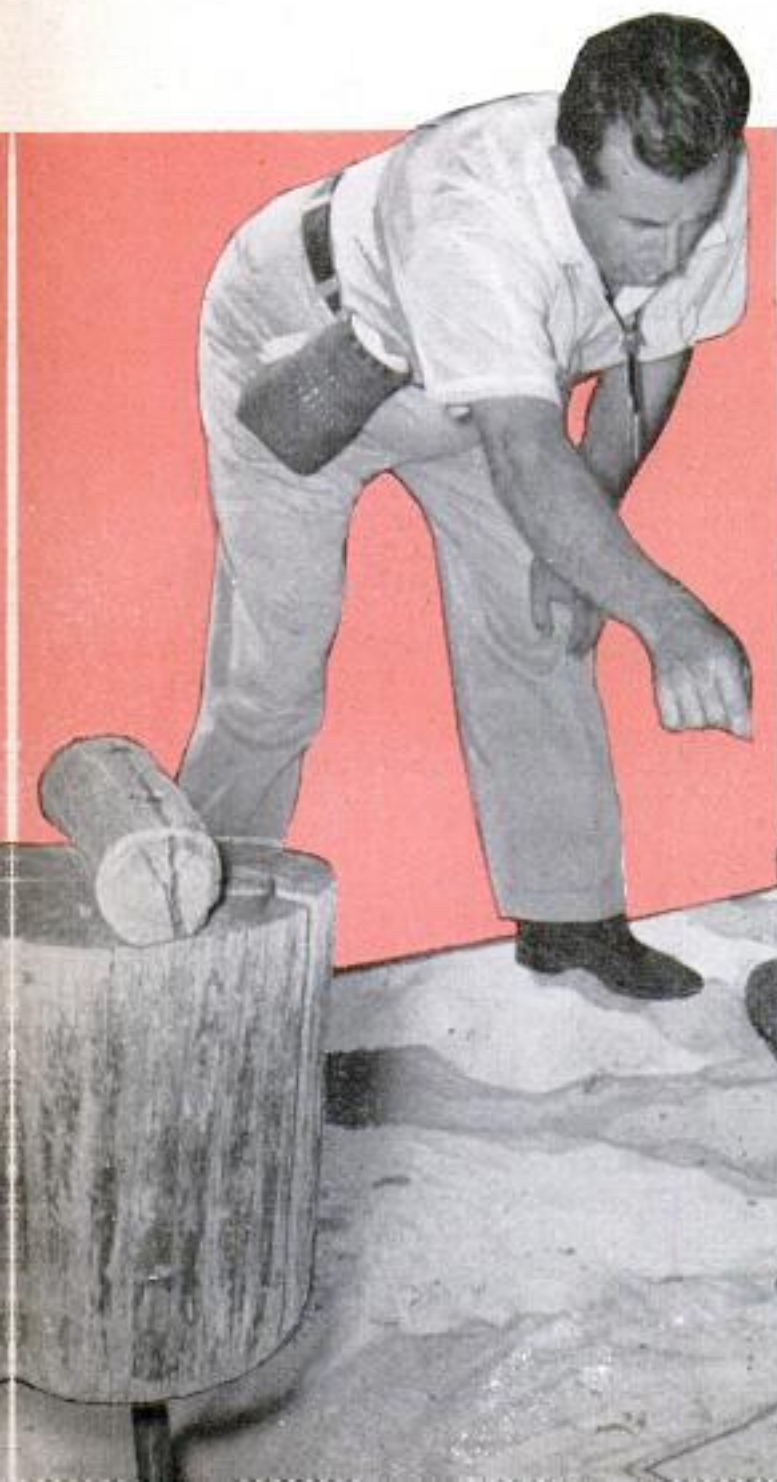

Hamlet does not train his falcons to hunt living creatures—although it would be no great task. He does, however, teach them to hunt a leather lure—which is actually more difficult. Their reward for swooping at the leather lure (which is swung at the end of a leather thong) is a piece of meat carried in a little pocket in the lure. So well does he train them that they swoop just as viciously on the lure as they would on a live meal in the forest. And when they swoop, they really travel.

#### **Power Dive at 275 M.P.H.**

Ordinarily, a peregrine falcon cruises at 40 to 60 miles per hour. However, they have been clocked in dives as fast as 275 miles per hour. This figure was computed during wartime experiments at the Naval Research Laboratory.

Currently, Hamlet is using trained

Not all of Hamlet's birds are gentle. This harpy eagle with sharp bill resists all friendly moves



golden eagles, prairie falcons, red-tailed hawks, Cooper's hawks, goshawks, peregrine falcons and other birds of prey in his program.

Unlike most falconers, Hamlet minimizes the use of the hood. He uses it only during the earliest stages of training and does not use it when they are on perch, unless more than one bird is being handled. Hoods were used by the ancient falconers to enable them to control their birds when they were hunting with large flocks of falcons. The Sultan of Bayazid, for example, used 7000 hawks. They were released individually to hunt, hence hoods were necessary to prevent free-for-alls.

Neither does Hamlet use castings—feathers and bones—to feed his birds, although many falconers do. "They claim this gives the falcon his normal diet," explains Hamlet. "I've found no need for such procedure. In fact, I take the birds off the so-called normal diet just as soon as possible. I find it keeps them healthier because disease and parasites are transmitted from bird to bird through castings. I find it better to feed them beef hearts and a vitamin mixture with added calcium gluconate. The birds live much longer and are much healthier."

Hamlet holds a bachelor of science degree from the North Dakota State University and a master's degree in zoology from Northwestern University. In addition, he's probably poked into more remote corners of the earth than most men. He spent four years with the U.S. Biological Survey and 10 years with the U. S. Fish and Wildlife Service. From 1947 until 1952, he worked for the National Foundation for Infantile Paralysis.

He built the Primate Research Laboratory for the Foundation at Pritchardville, S. C., and traveled the tropical world, establishing

(Continued to page 256)

Each with his special perch, from top down: plumbeous kite from South America, harpy eagle from Amazon River basin, a white-breasted sea eagle and an African vulture. Perches fit tails and talons





### GI Flies Strap-on-Back Helicopter With Rocket Engines

Human legs are landing gear in the world's first rocket-powered copter. At 60 miles per hour, this craft has a range of over 15 miles and lifts more than 300

pounds at a climb rate of 2000 feet per minute. Fuel is liquid hydrogen peroxide, converted to steam and oxygen released from tiny rocket engines in the rotor tips.

### World's Largest Bomber Carries World's Fastest Bomber

Slung under a B-36 intercontinental bomber, a supersonic, delta-wing B-58 bomber without its four jet engines has been flown from Fort Worth, Tex., to Day-

ton, Ohio, for strength tests. Two inboard propellers were removed from the B-36 engines to provide a space to carry the B-58 bomber.







## Over and Under Highway "Spans" Hampton Roads

ENGINEERS now are putting finishing touches on an expressway that carves through water and land to link Norfolk and Hampton, Va. This route crosses Hampton Roads, a vast inlet through which move massive warships, huge tankers, freighters and ocean-going merchant-marine vessels.

It was seen that no conventional-size bridge of any design could be built to escape towering superstructures of ships passing beneath. Draw and turnstile-type bridges clearly would have failed to meet demands of waiting traffic.

The resulting four-mile, double-lane highway, when completed, will cross half of Hampton Roads to a manmade island before ducking into a tunnel and burrowing for 6860 feet to another island. Here, the highway surfaces again and crosses the remaining water on another bridge. In the channel above the vehicle tunnel, ship traffic will proceed unobstructed.

Work crews dredged material from the bottom of Hampton Roads and built up the two islands,  $4\frac{1}{2}$  acres apiece in area. Twenty-three prefabricated tunnel sections—each 300 feet long and wide enough for a two-lane highway—were floated into position and sunk into a trench-type underwater crossing. With its inner lining of concrete, individual sections have a dead weight of 12,000 tons.

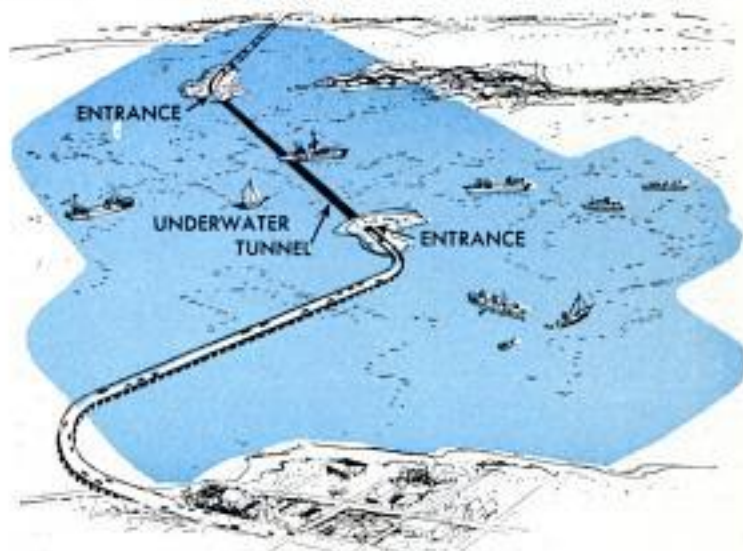

Above, build-up of the two islands at ends of the tunnel required  $5\frac{1}{2}$ -million cubic yards of "fill." Below, double-shell steel tunnel casing is wide enough for 23-foot, two-lane road





### Guidance System Directs Artillery Missile to Target

"Lacrosse," a field-artillery guided missile, is now in full production for the Army. The all-weather missile is designed to destroy enemy strong points, supplementing

air and artillery attacks. Lacrosse is fired from a launcher mounted on a standard Army truck. A guidance system directs it with "high accuracy" to the target.

### Radar and Computer Pinpoint Enemy Mortars Within Seconds

Within a few seconds a new Army instrument can pinpoint enemy mortars. The radar has an antenna "shaped like a bulldozer blade." When a mortar shell comes zooming in, it appears as blips on a radar screen. The operator centers the blips on

hairlines. An automatic computer then calculates the trajectory and gives a direct map-coordinate reading of the enemy position. The mortar spotter is mounted on a two-wheel trailer, and can be operated by remote control.





## Gremlins On Your Windshield



Australian artist Lahm (top left photo) and a photographer friend produced the pictures on this page by placing cutout silhouettes on the windows of an automobile and then photographing passing scenes. Lahm's skier (top right) uses windshield wiper for a ski jump. Center photos show a jaywalker in the midst of the city traffic and a fisherman against a proper harbor background. The streets and nearby countryside of Sydney, Australia, were used as background for these pictures which could be duplicated almost anywhere

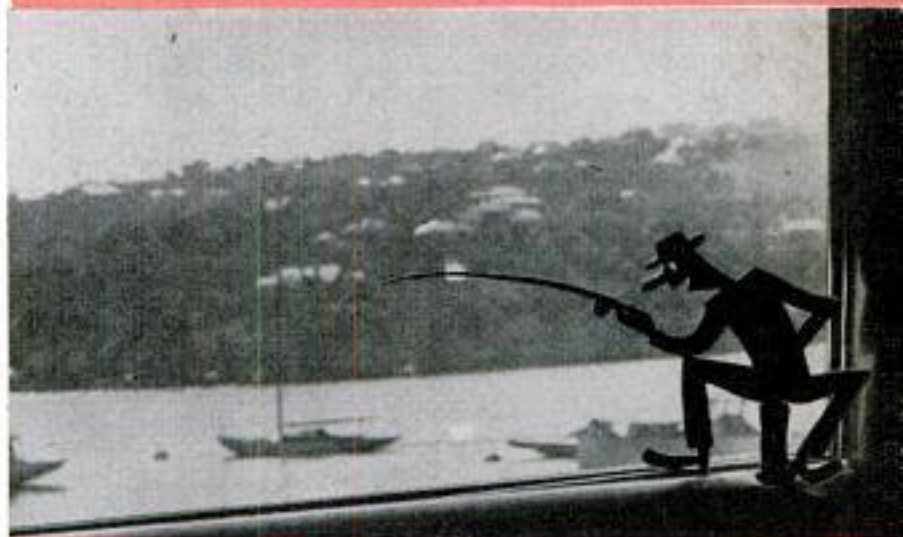
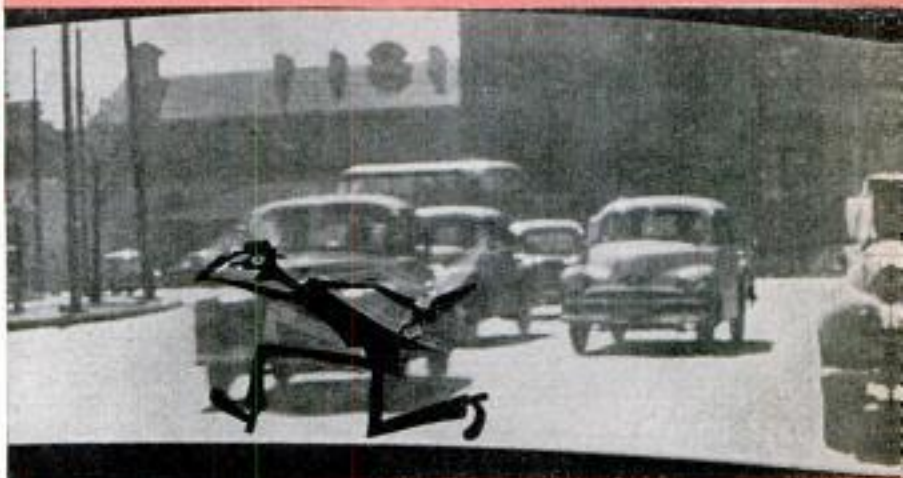

One of Lahm's favorites is the tightrope walker who appears to be doing his stunt above a city street. Prayerful diver (below, right) is posed before a real waterfront



# BRITAIN'S 5-JET "VTO" PLANE

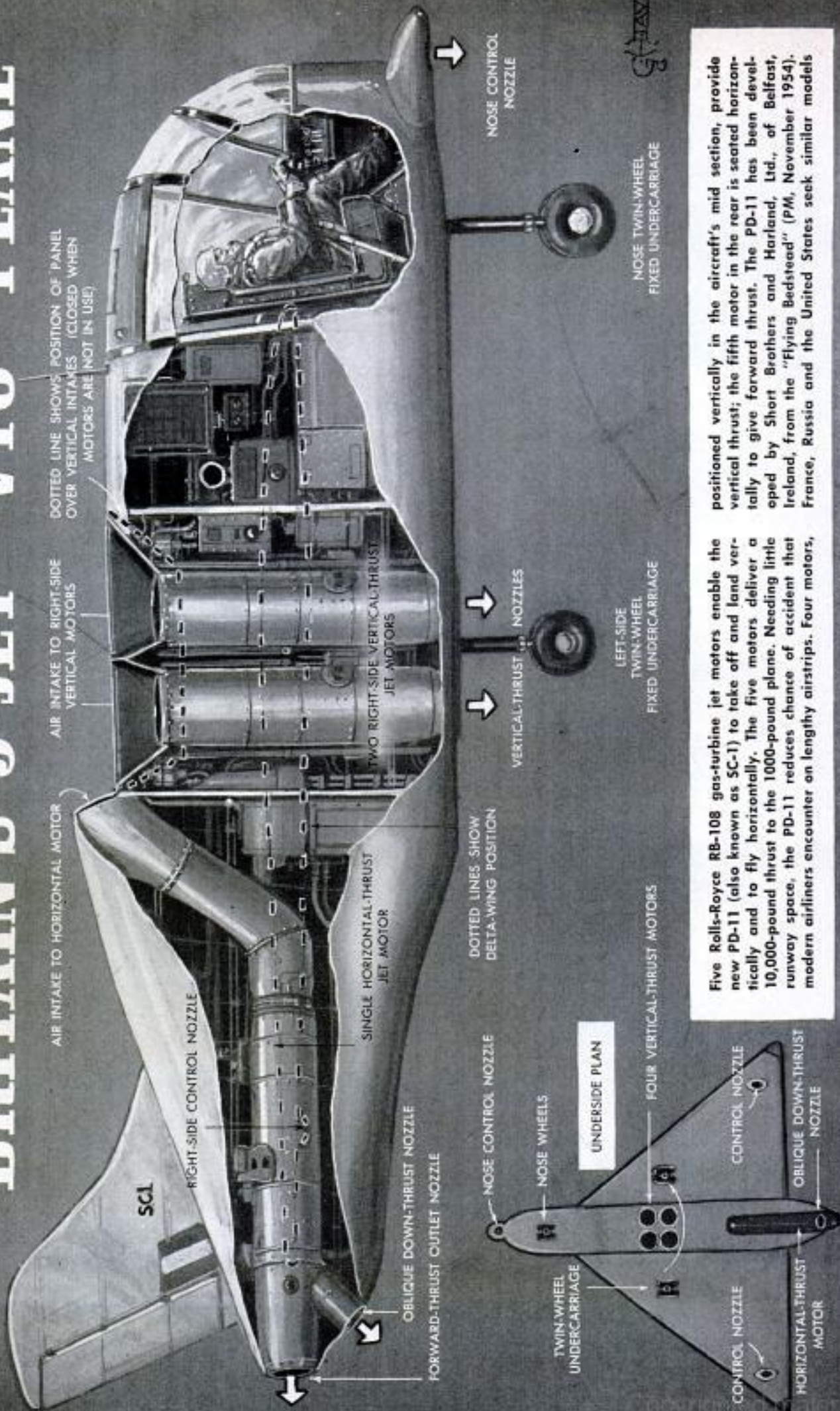

Five Rolls-Royce RB-108 gas-turbine jet motors enable the new PD-11 (also known as SC-1) to take off and land vertically and to fly horizontally. The five motors deliver a 10,000-pound thrust to the 1000-pound plane. Needing little runway space, the PD-11 reduces chance of accident that modern airliners encounter on lengthy airstrips. Four motors,

positioned vertically in the aircraft's mid section, provide vertical thrust; the fifth motor in the rear is seated horizontally to give forward thrust. The PD-11 has been developed by Short Brothers and Harland, Ltd., of Belfast, Ireland, from the "Flying Bedstead" (PM, November 1954). France, Russia and the United States seek similar models



## Camp Unfolds From Trailer

IN JUST TWO MINUTES you can convert a new car trailer into a camp home. The top deck of the trailer folds over and down to form the floor. At the same time, waterproof canvas unfolds like a convertible top to form a tent. Inside the tent are two large innerspring mattresses to sleep four adults. A snap-on canopy provides a sheltered "porch" for cooking and eating. Included with the trailer are a three-burner stove, a cooking kit, folding table, four folding camp chairs, a camp lantern and an icebox mounted on the hitch.



Trailer body is only 44 inches high, permitting full vision to rear. The first step is to lift the cover



Cover of trailer pivots down to form floor of tent. Meanwhile, canvas unfolds automatically on ribs



Camping gear is unpacked from storage bins. Basic items, among them a stove and icebox, are included

Home on the road is ready for occupancy in two minutes. Snap-on canopy provides a "porch" for campers

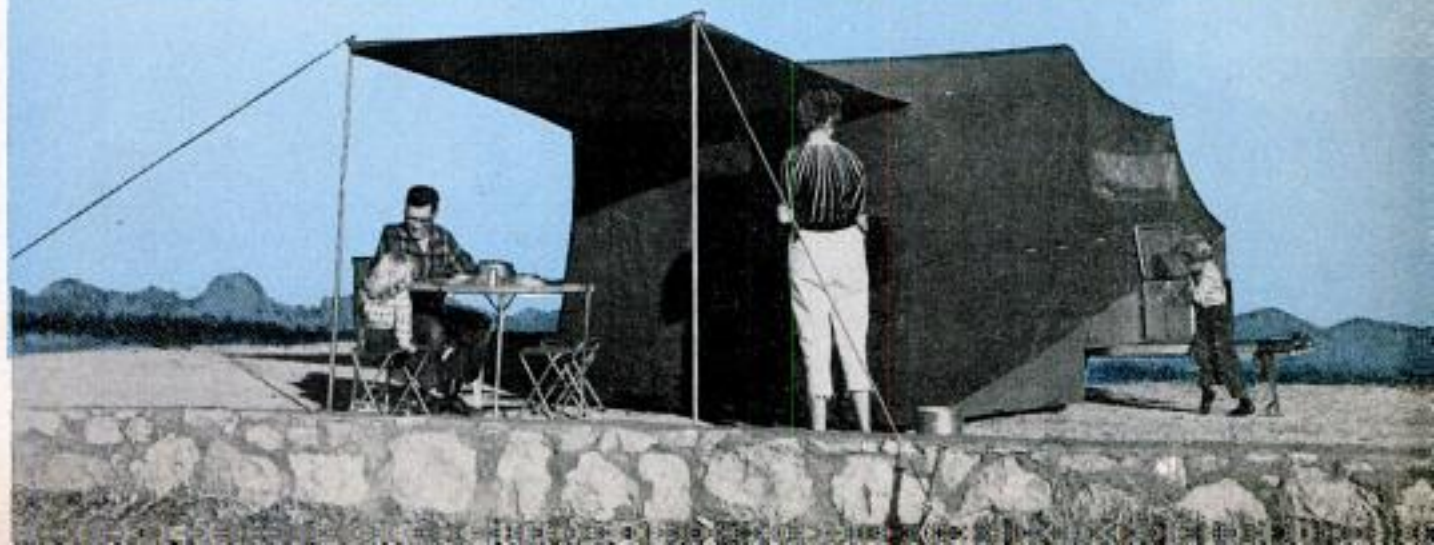

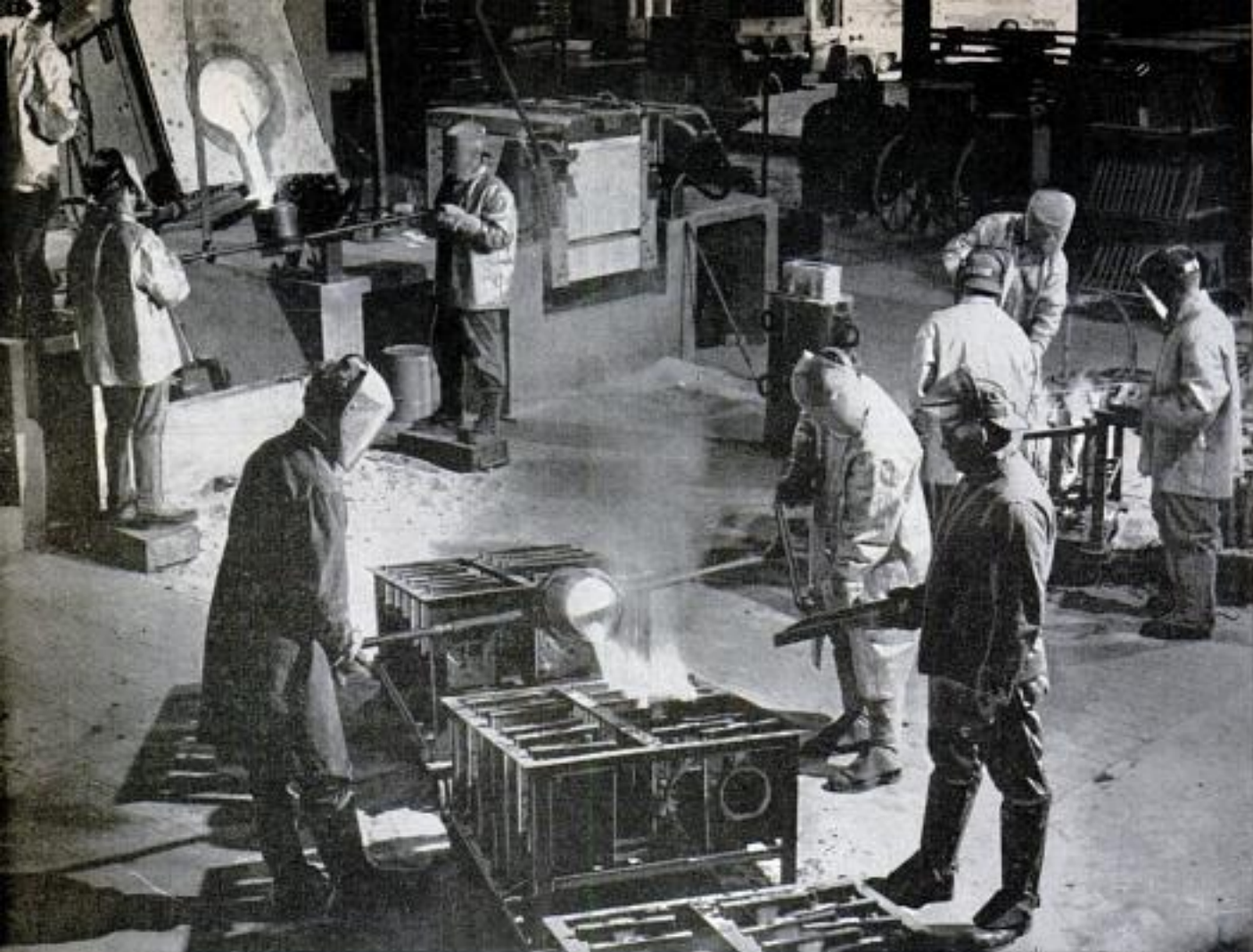

Westinghouse photo

Molten metal flows into molds at Westinghouse metals plant, where new production techniques are developed

In a unique process preventing contamination, titanium is purified inside a bar of the metal itself

Westinghouse photo

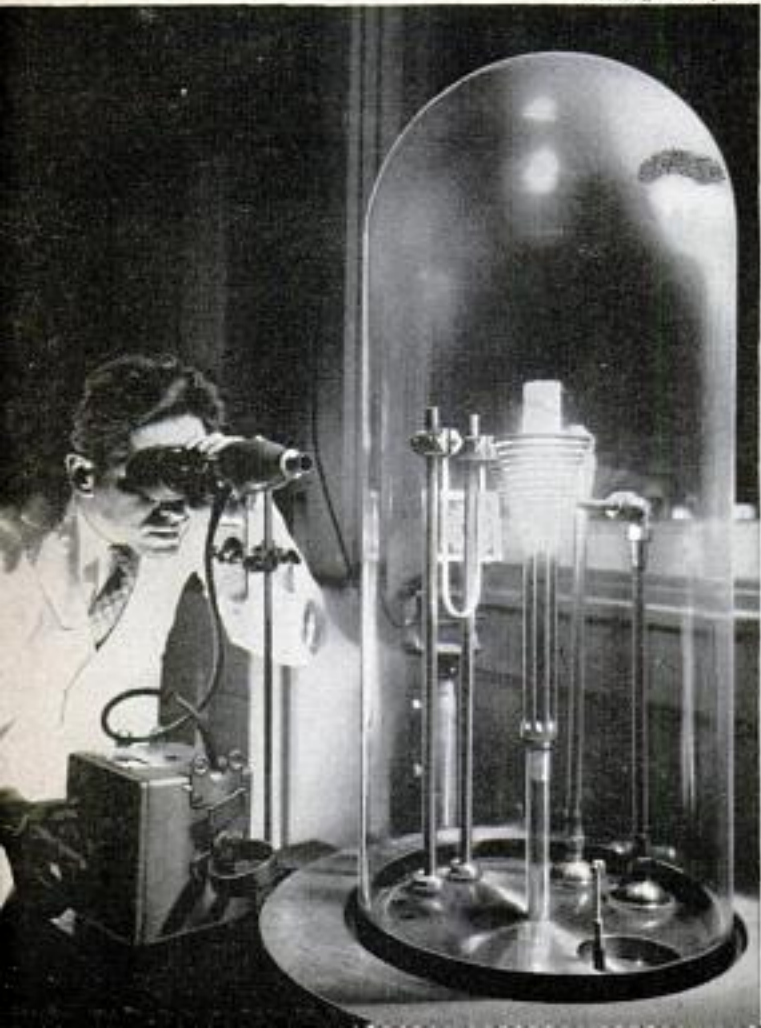

# Tailor-Made Metals for Tomorrow

*By Clifford B. Hicks*

**N**OW THAT MAN has shattered the sound barrier, he finds himself spang up against a far more formidable opponent. This relentless foe to high speed is heat.

Heat accompanies speed like an ever-lengthening shadow. As you drive down the highway at 60 miles per hour, the surface temperature of your car increases by  $\frac{1}{10}$  degree. A missile, at 3000 miles per hour, generates a sizzling 1600 degrees of heat, a temperature above the melting point of most metals. Thus heat may well stop missile designers cold.

One of the biggest questions facing scientists and engineers today is: Can they find new alloys to withstand high temperatures, or will the heat barrier inevitably turn missiles into glowing embers?

We need supermetals in other fields, too. Take the combustion liners and turbine-wheel blades of jet engines. They are subject to such high temperature and stress that the atoms begin to slip, to "creep." Creep can distort engine parts, painstakingly machined to close tolerances, into caricatures of their shapes. Even gas turbines for electrical generators operate at such high temperatures that metals are drastically altered. And the design of nuclear reactors depends upon the development of brand-new alloys to solve brand-new problems.

One man — the metallurgist — thus holds the key to tomorrow. He is just beginning to turn it in the lock. Thanks to a new technique he has developed, he can create alloys that were undreamed of a few years ago, tailor-made metals that not only will hurdle the heat barrier but other barriers as well.

Tailor-making metals long has been a dream, but now it is beginning to be a reality.

Recently this problem was pitched to the General Electric Research Laboratory: Create a brand-new alloy for a heating coil, one that will develop a special personality under high temperatures and the flow of an electric current. To find the answer Dr. Walter R. Hibbard, Jr., sat down at his desk and picked up his research tools—a pencil, a slide rule and a pad of paper. An hour later, without ever stepping



Purified manganese-bismuth, a material for making supermagnets, bursts into fiery waterfall when scattered in air. Because it catches fire spontaneously, it must be prepared in atmosphere of helium. Below, sample of it is weighed in a gas chamber





Westinghouse photo

Scientists "see" atoms by studying soap bubbles, which join in groups similar to atomic-crystal structures

into a laboratory, he came up with the answer—details of a resistance alloy, with instructions for producing it. The stuff turned out just as he predicted, too.

What is this startling new technique in metallurgy?

#### Atom-Age Metallurgy

Metallurgists simply are using basic knowledge of atomic structure to create new alloys. Not long ago they began to realize that the theoretical calculations of the physicist could be applied to the field of metals. The old-time blacksmith knew how *metals* behaved. The modern metallurgist knows how *atoms* behave.

Without this approach, the metallurgist of yesterday was a man literally lost in infinity. Consider his problem: In his kitchen were 74 known metals and 9 semimetals, a total of 83 ingredients. Suppose he wanted to whip up some new alloys containing seven different elements. Working with his 83 ingredients, he found he could come up with *more than four billion different seven-element recipes*, completely ignoring the fact that he could vary the amount of each ingredient!

And what were the possibilities of 10-element alloys? Fifteen? Fifty? In a lifetime he might investigate all the possible combinations of only three ingredients. Where could the old-time metallurgist start

in his bewildering search for new alloys?

He started with an educated guess and proceeded on a trial-and-error, add-a-pinch-more-of-this basis.

#### Atoms as Building Blocks

Today the metallurgist has shucked off his blacksmith apron and changed himself from an industrial artist into a scientist. He now is using atoms as building blocks, piling them into precise structures, *predesigning* alloys. He knows, to some extent, what kind of a molecule he'll get by combining certain atoms of this, that and the other, and how the molecule will behave. Instead of a forge and a ringing anvil he may use an electron microscope and a humming digital computer in his work.

His new technique has paid off. Today you'll find the metallurgist's showcase filled with a whole new batch of goods made from bewildering recipes and bearing such odd-sounding names as Dynamax, Kanigen, Boral, Hiperco, Hipernik, Conpernik, Discaloy, Trodaloy and Zncube.

Take a close look at some of these strange alloys, for they'll be popping up in your future:

- Hiperco, a Westinghouse alloy of iron and cobalt, has magnetic properties that are astonishing. Magnets made from it are a whopping one third stronger than conventional magnets. The alloy now is pull-





Westinghouse photo

ing broken drill bits from oil wells, and giving you better telephone service.

- Another new Westinghouse alloy with unique magnetic properties is virtually 100 percent pure manganese-bismuth, a material valuable for its unusual resistance to demagnetization.

- A new alloy may give jet planes a 100-mile-per-hour boost by permitting an increase in the operating temperatures of jet engines of about 100 degrees F. The metal is an alloy of iron, nickel, chromium, molybdenum, titanium and boron.

- Created in the laboratories of U. S. Steel is a new alloy steel for ordinary building construction that is regarded as one of the most important developments in steel research in years. The alloy is *three times* as strong as regular carbon steel.

- Appliances you buy in the future may contain two new types of stainless steels. They are considered as good in every respect as existing steels, yet they contain only half as much nickel. Thus scarce nickel is saved for more essential uses in high-temperature alloys.

- And it is in this field, the field of sizzling heats, that the metallurgist is beginning to hit his stride. Nivco, a brand new super-alloy for high-temperature steam-turbine blades, definitely was predesigned through the new atomic-building-block technique. Its behavior is indeed strange when compared to existing metals. At temperatures

Test shows how new metal, right, minimizes vibration, while steel, left, vibrates freely. This metal is first of the predesigned metals

Metallurgist prepares ceramic sample for possible combination with a metal

General Electric photo



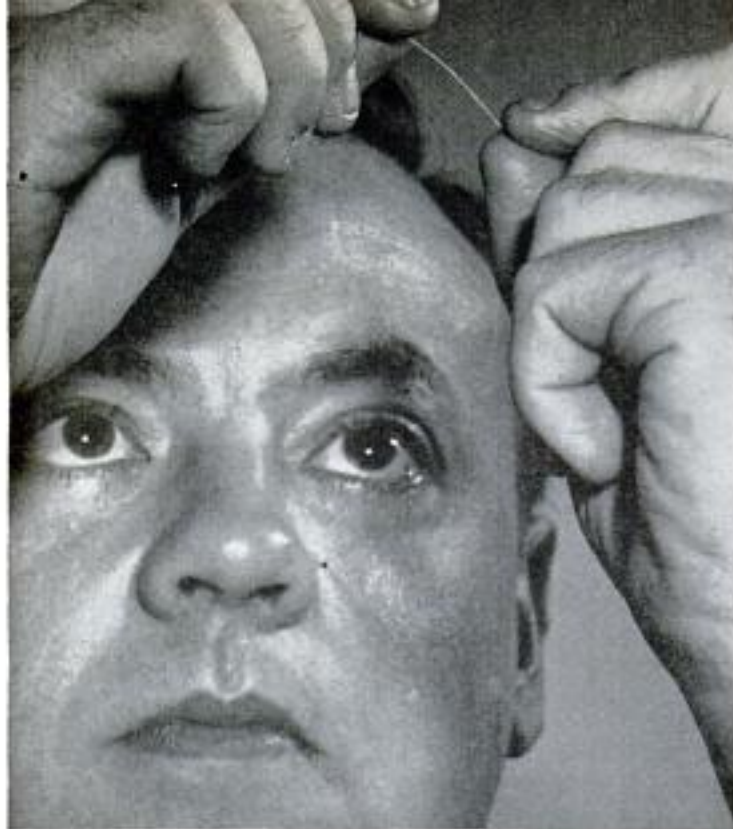

General Electric photo

Whisker of perfect iron "grown" by new technique is free from defects and 150 times as strong as ordinary crystals of iron

of 1200 degrees it retains its high strength and resists mechanical vibration. This ability, called damping, was theoretically "built into" the metal by magnetic arrangement of the atoms before the alloy ever saw the light of day. Its structure simply dictates that it can't vibrate. Thus it promises much

longer life for turbine blades operating at temperatures that would turn alloys of the past into putty.

#### Metals Born in a Vacuum

To make many of the new alloys, metallurgists have been forced to do their work in a vacuum. Why? Because the air we breathe contaminates molten metal to give it new characteristics. Nitrogen, oxygen and hydrogen all can produce strange effects. University of Michigan engineers have found, for example, that by melting a nickel-base alloy in a high vacuum and pouring it in an atmosphere of argon gas (which is inert), the metal has a tensile strength almost 40 percent higher, and ductility two to ten times greater than prized cobalt-base alloys, which are some four times as expensive. According to Prof. Richard A. Flinn, the new uncontaminated alloy "may make gas-turbine autos practical within two to five years" and give longer life to jet engines.

Jet-turbine blades made of alloys melted in a vacuum, according to Westinghouse, last up to four times as long as blades made from the same alloys melted in air. Vacuum metals are giving ball bearings three to four times longer life, and metallurgists

(Continued to page 252)

Instrument called a metallograph magnifies 1000 times, permits studies of microscopic abnormalities in metals

Westinghouse photo

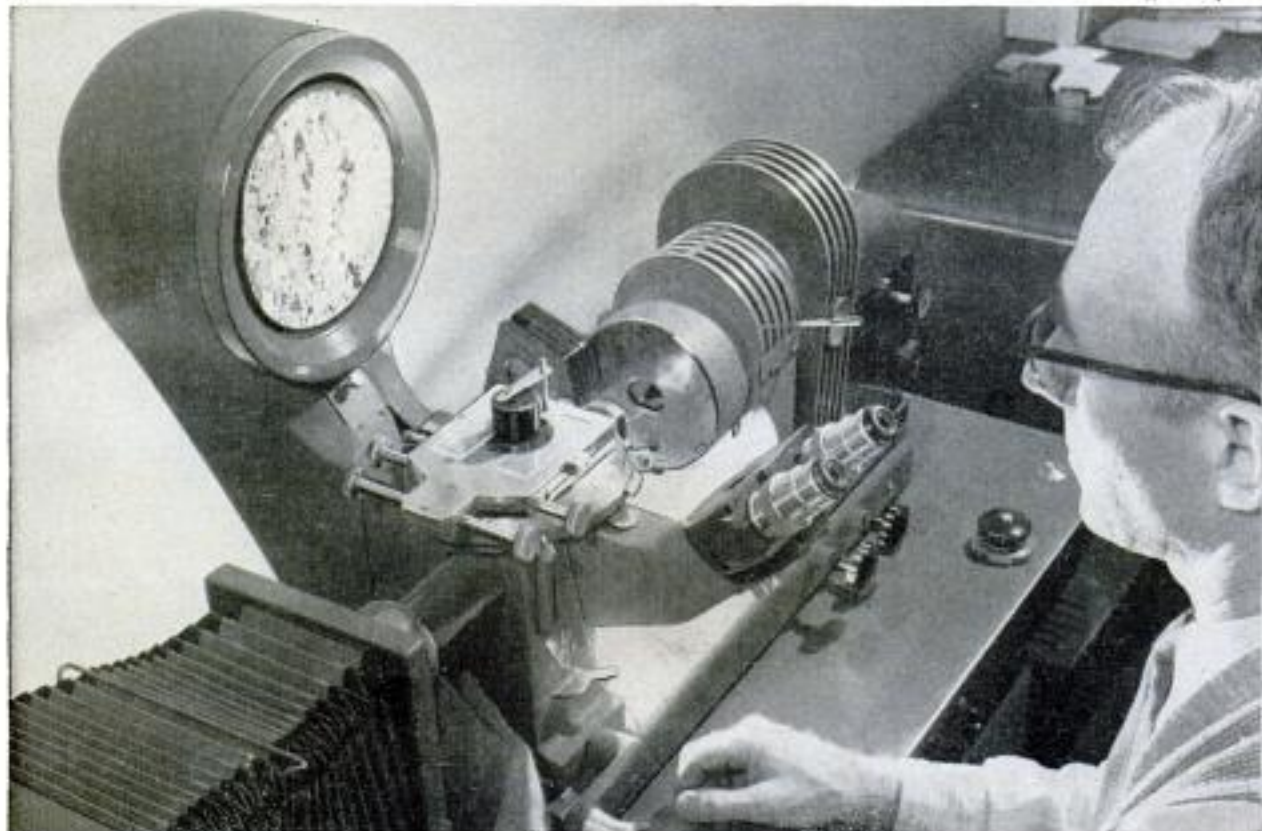

**I**T DEPENDS ON what you're used to—take tailfins, for example. When the 1957 cars first came out, the Chrysler family looked radical and, no doubt to some, even bizarre. Today chest-high tailfins appear quite normal, in fact rather stylish.

That's the advantage in styling five different cars (Plymouth, Dodge, De Soto, Chrysler and Imperial) with similar character. It's another advantage of bigness.

Mercury, which came out with an equally striking and, no doubt to some, bizarre appearance has had to go it alone. It shares no similarity with Ford or Lincoln. So it seems to be taking longer for Mercury's bold contouring to become stylish.

That is why you can expect Edsel to have something of the Mercury character in it. Not that they will look alike, but it will take the same styling road as Mercury. Together they will help each other.

### Chrysler Fuel Injection

Chrysler won't do much to change its styling for 1958. The current Imperial is doing so well it may not change a thing! Other lines will have grille changes, four headlights on all models, new door handles and probably other minor changes.

But the big story will be mechanical. Chrysler Division will offer the Bendix electronic fuel-injection system, at extra cost, of course. Rambler doesn't seem to be going ahead with it. Too many engine changes were required to make it work right, it seems. Instead the Rebel (the Rambler that was to be fuel-injected) is now being built in respectable volume (around 1500 units this year) with four-barrel carburetors.

So instead of American Motors, it will be Chrysler that goes electronic. With injection, Chrysler may have enough power potential to last into the turbine era without a new block. It claims to be able to push 430 horsepower out of its present basic engine.

**De Soto will have a new engine in 1958, according to so-called informed sources.**

Pontiac will also offer fuel injection for 1958, but not the electronic variety. It will be an improved version of the system publicized (but sparsely produced) by both Pontiac and Chevrolet this year.

Word from informants is that Hudson-Nash will share the Rambler shell in 1958, as guessed here last month. Big-car wheel-bases will be made about nine inches longer by adding structure ahead of the cowl.

Studebaker-Packard has 1958 models in final form and little, if any, change is expected in engines. The Clipper line will offer an additional body style or two—probably hardtops. The real concern here is not looks but public confidence.

MAY 1957

# Detroit Listening Post



By Art Railton

This year will be remembered for several great disappearing acts. These "revolutionary" innovations seem to have been lost in the shuffle: Ford's supercharger; Chevrolet's fuel injection; Rambler's fuel injection; Pontiac's fuel injection; Eldorado's fuel injection. All but the Rambler and Ford items are expected to be "revolutionary" again in 1958.

### Air vs. Steel

You'll be hearing a lot about air suspension, a lot on both sides. You can expect General Motors and Ford to plug it, Chrysler (which is taking the torsion-bar road) will play it down. It's the same lineup that took part in the turbine vs. free-piston debate. At this moment, Chrysler, the turbine advocate, seems to be winning that argument. The results of the air-suspension battle are still unknown.

**Ford will have its all-new V8 engine in 1958. You can be sure it will have some sharp styling changes, too. It won't make the same mistake it made in 1956 when Chevrolet pinned its ears back. Ford is riding in front now and enjoys it. It aims to stay there despite the all-new Chevrolet for 1958. We'll see.**

American Motors' Metropolitan sales are improving and it is expected to offer a third body style in 1958—a four-door, four-passenger station wagon. This car may make the Metro a top-dog in the import market. It'll have two bench seats with luggage space behind the rear seat accessible through the back window. The current models have inadequate rear-seat room and inconvenient luggage space.

Edsel plans two different engines among its four series and 18 different body styles, including wagons and convertibles. There will be two different roof treatments to separate the top and bottom-price classes. It aims to sell to the up-and-coming young executive. It doesn't intend to appeal to the young speedster or the conservative stick-in-the-mud. It wants the trend-setter who is "on the way up." Watch out—that could be you! ★ ★ ★

97

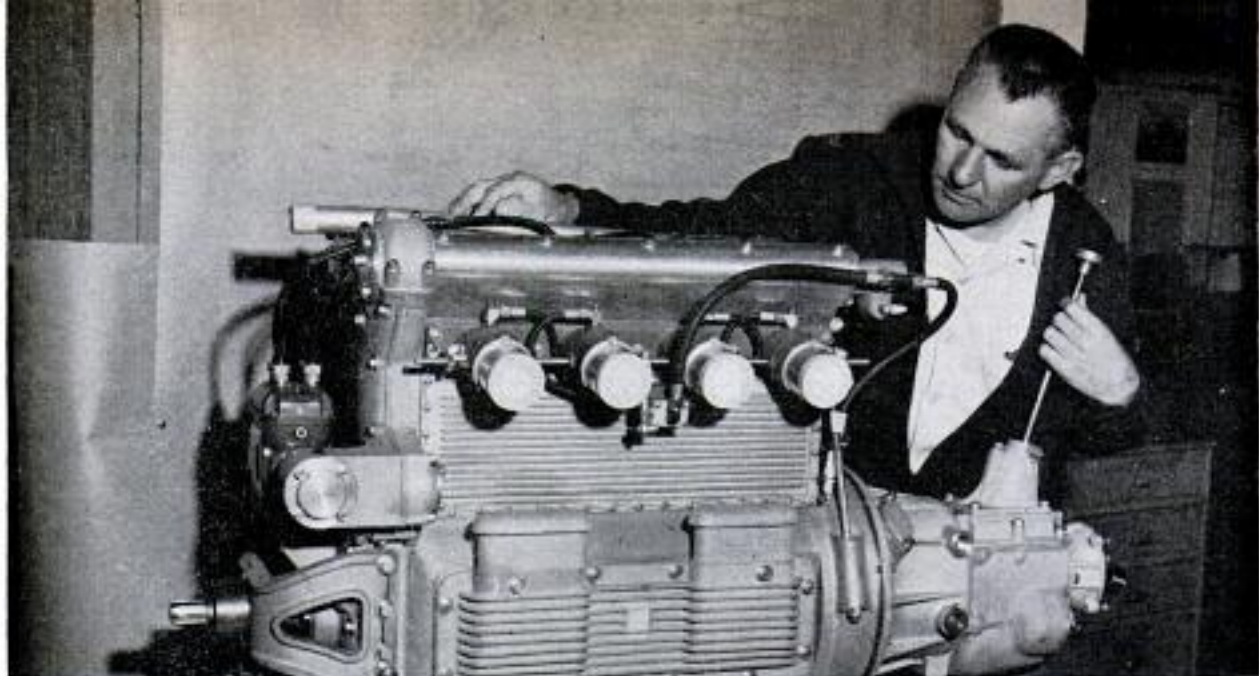

As usual, this engine (a Meyer & Drake) is the odds-on favorite to win the "500" at Indianapolis this year

## Experts Disagree on Race-Engine Mounting

By Thomas E. Stimson, Jr.

ONE OF THE CARS built for this year's Indianapolis race has its engine tipped over on its side. In another, the engine is mounted diagonally across the chassis and is attached to the drive shaft by a constant-velocity universal joint.

Some cars have engines five inches to the left of center and in others the engines are on the right and tipped to the left with driver and fuel on the left.

Each of these ideas is aimed at getting the car through the turns faster. Owners and designers figure that by placing the engine in an unorthodox location they will get better weight distribution and won't have to slow down so much for the four left turns on the Brickyard. They want the weight as low as possible and most of it on the left front wheel. In the past the left front wheel on most cars has lifted off the ground in the turns.

Speeds will be faster than ever if these ideas work even though engines are smaller this year. The new rules limit displacement to 255 cubic inches (down from 274 previously). Supercharged engines are limited to 170 cubic inches (down from 183).

Standard Meyer & Drake engines are being built at 251 cubic inches instead of 255 to allow several rebores without going oversize. ★ ★ ★

Here's the stock Kurtis Indianapolis chassis with the 251-cubic-inch engine to the left of center line

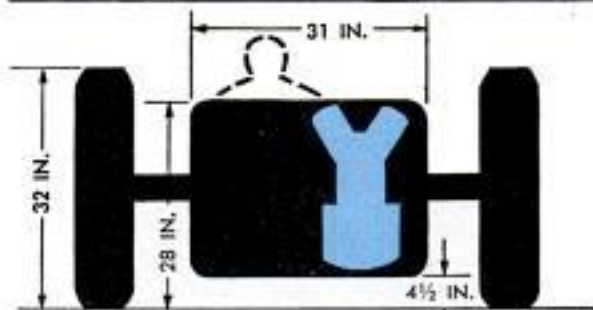
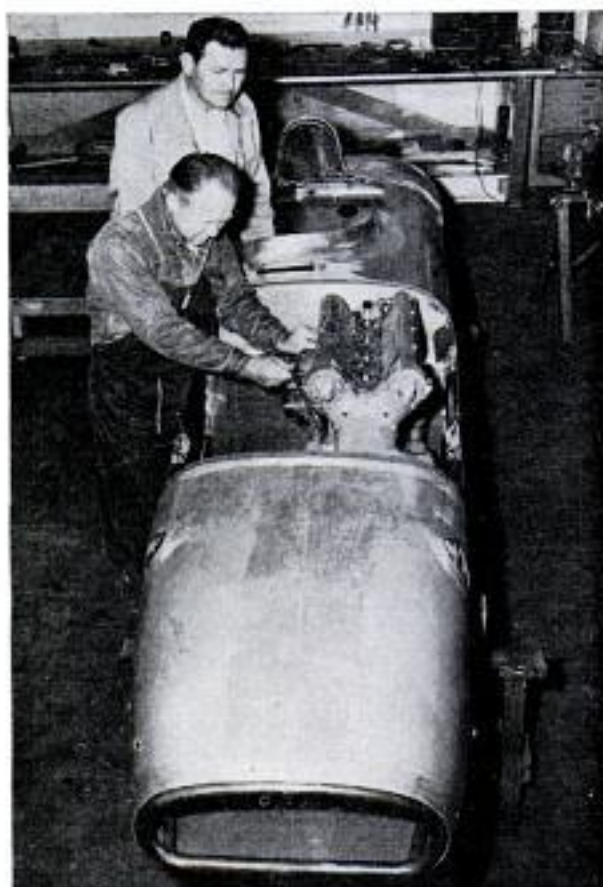

STANDARD KURTIS INDIANAPOLIS CHASSIS

POPULAR MECHANICS

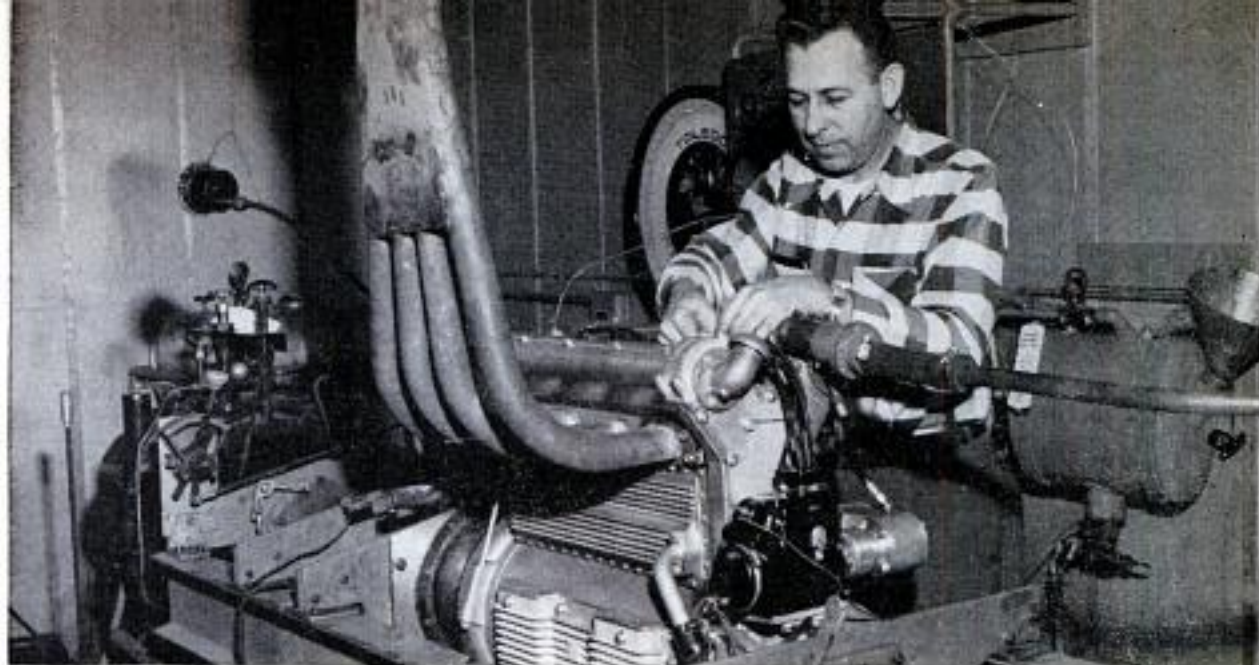

Dynamometer horsepower is down (309 from 330 last year) in the smaller engine, but race speeds may be up

In the Bardahl car, the engine is moved five inches to the right and tipped 18 degrees. Driver sits on left

Salih's car has crankshaft on left, driver on right. Engine lies on its side to lower center of gravity

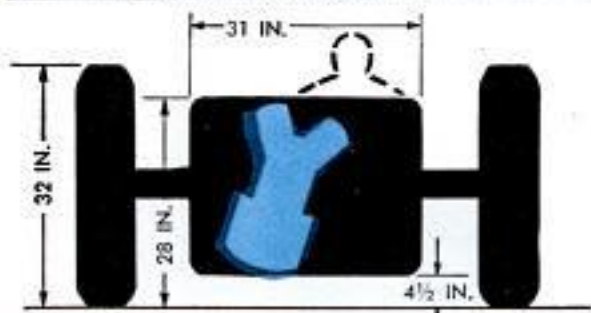
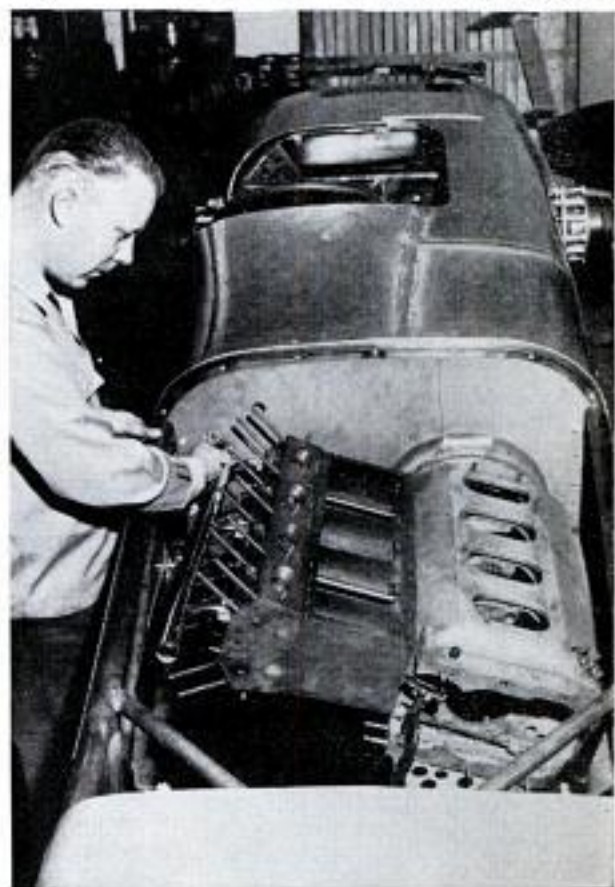
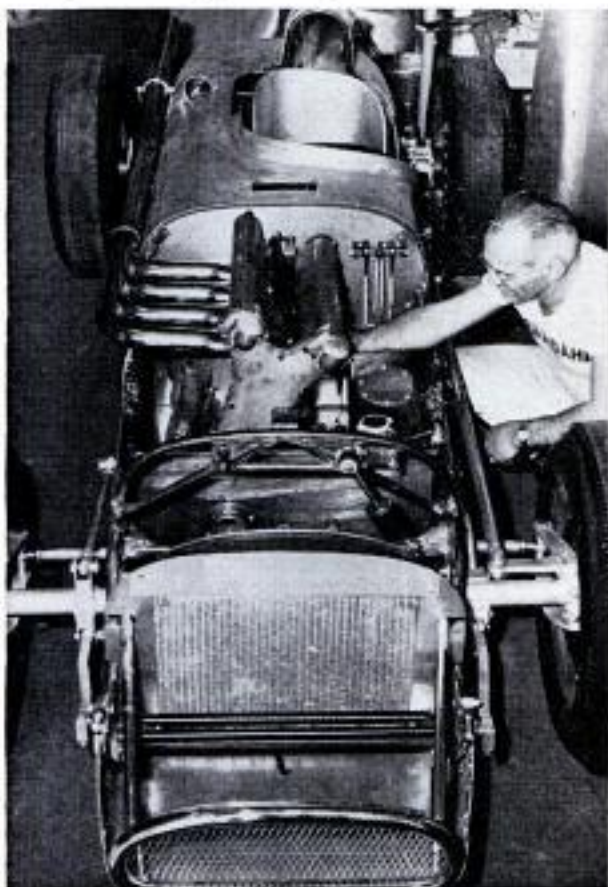

BARDAHL TEAM CHASSIS

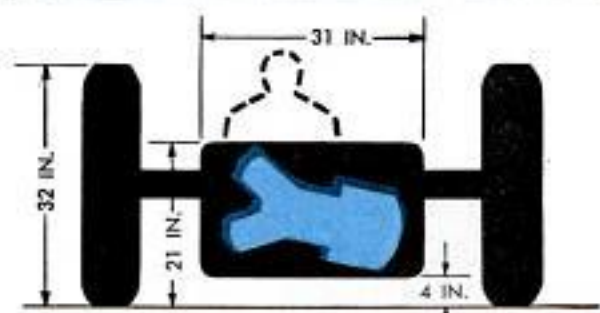

GEORGE SALIH LOW-CENTER-OF-GRAVITY CHASSIS



## Fold-up Boat Packs Flat

Carrying a new boat to the water is as easy as carrying a plank. The boat folds flat for easy transportation and storage. At the water's edge, the boat can be unfolded and made ready for use in less than one minute. Three seats lock the craft in its unfolded, ready-for-use position. A brace, slipped into place to lock open the transom, also serves as an outboard-motor bracket. The boat, available in eight and ten-foot models, is made of marine plywood covered with a vinyl-coated material. A ring bolt and oarlocks are standard equipment with the boat.



## Boat on Stilts

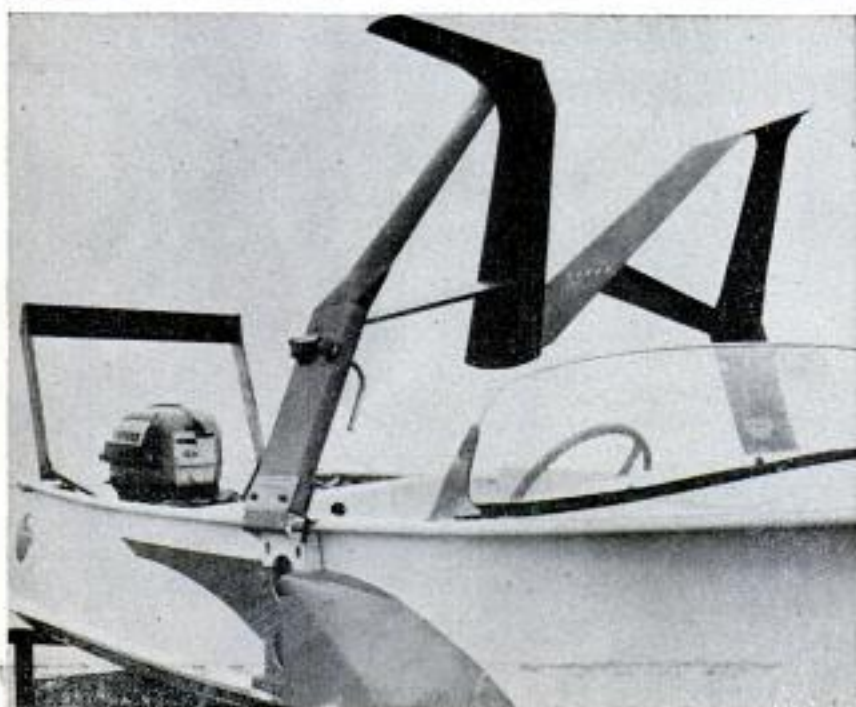

At 15 miles per hour a new type of retractable hydrofoil will lift a 15½-foot boat out of the water. At 30 miles per hour the hydrofoils will carry a pay load of 850 pounds in addition to the boat's weight of 510 pounds. The hydrofoils are made of Bakelite epoxy-resins reinforced with glass-fiber cloth. The two main foils are attached to the hull beside the driver, and a tail foil is attached behind the motor. All three foils swing up above the boat for easy transportation. Shear pins permit the foils to break away if they happen to strike a solid object.

# HERE'S HOW PONTIAC WINS RACES

By George Moore

**Once a tame, Sunday-afternoon softie, the dark horse came to life on Florida sands.**

**H**OW DO YOU breathe fire into a family car? Pontiac, by reputation a quiet, pleasant car for Sunday drivers, reared up and spit fire when it scalped the favorites at Daytona's Speed Week.

What were the hormones the experts pumped into the Pontiacs? It takes more than luck to average 131.7 miles per hour over the two-way mile, or to win the 160-mile rough-and-tough Grand National race with a record speed of 101.6 miles per hour, or to be tops in its class in acceleration.

Pontiac did it the smart way. It went all out to win. To do it, the Indian called on two mighty fine experts in the specialized business of setting up stock cars.

These two experts are John Zink and Ray Nichols. Let's look at the Nichols team to see what it does to win races. Ray Nichols has been racing automobiles since he was 14 years old and he has on his staff at Highland, Ind., some top-notch men in their own right.

The story of the record-breaking Indian starts when the production-line cars arrive at the front door of the Nichols Engineering lab weeks before the race.

There begins the transformation that changes the Pontiac from a docile, gentle-handling family car to a roaring, hard-charging 3600-pound metal projectile.

First to get the treatment is the suspension. For safety reasons (as well as providing better performance), suspension parts are reinforced. The lower front-control arms take terrific punishment when the car tears around hard corners or plows

Right, check marks show where chassis is altered to win races (all within rules of NASCAR). Below, John Zink hits 143 m.p.h. at Daytona, but he was disqualified because head was milled a bit too much

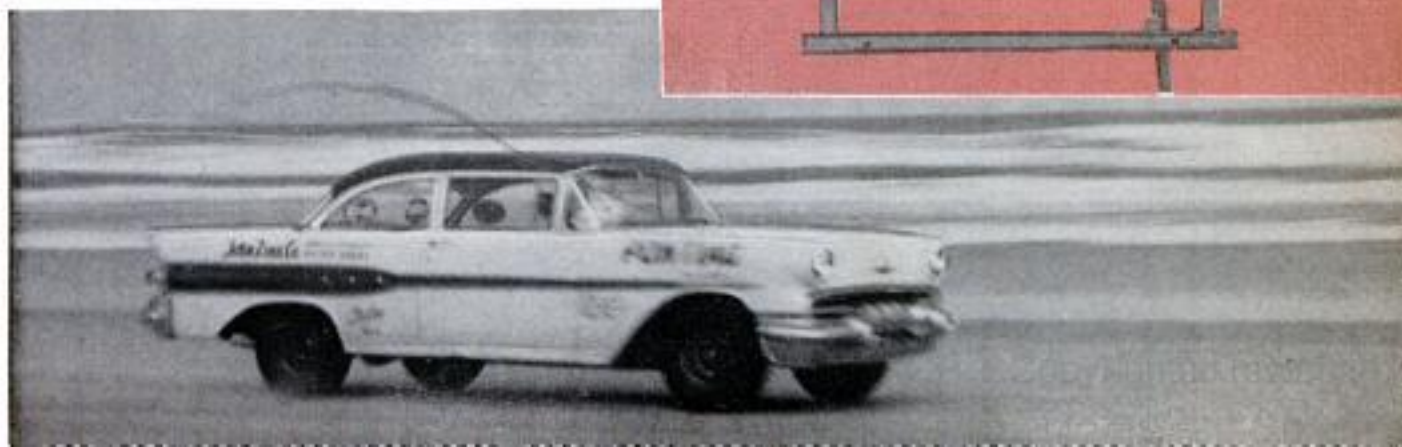

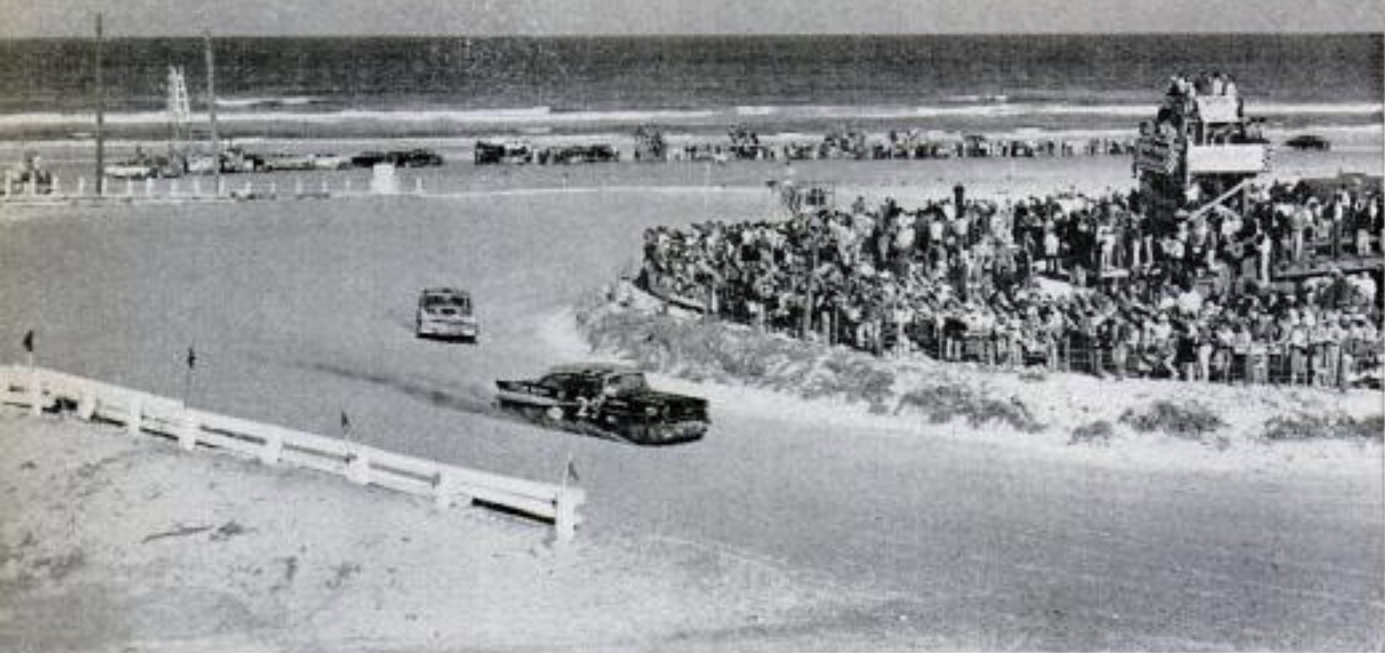

Pontiac corners nicely on Daytona's north turn. It won the 160-mile race, averaging a record 101.6 m.p.h.

through chuckholes on the beach. Twin truss rods are run along the bottom of arms to prevent them from buckling back under the frame.

The upper arm is strengthened by laying a steel plate over it and welding the whole assembly into a unit. The frame is reinforced by welding a plate where the suspension arms attach to it. The same thing is done where the steering assembly bolts to the frame rails.

Stiff, high-oscillation-rate coil springs and heavy-duty shocks are mounted. Like most competitors, racing Pontiacs have two

shocks on each wheel, double the normal number.

At the rear, flat, heavy-duty springs with extra-wide clips to prevent the leaves from spreading replace stock springs. The shackles have bolts running through them so they won't split.

Regulations require that all extra seats and floor mats be removed. Headlights and parking lights are removed as are any accessories that might work loose. The spare tire, tool kit and matting are removed from the trunk.

Body modification begins with the lock

Driver Cotton Owens, fourth from left, gets trophies after Daytona win. At left is Ray Nichols, team setup man, and beside him is S. E. Knudsen, Pontiac's general manager







Pontiac Number 8, driven by Banjo Matthews, qualified at 134 m.p.h. to take the pole position at Daytona

on the hood. In a race where hard jolts and actual body contact batter cars around, the production hood latch sometimes flies open. So a safety lock (standard on most race cars) is used. It consists of a rubber shock cord mounted through two eyes fastened to the bumper. The cord slips over a hook bolted in the nose of the hood. The hood stays closed no matter what.

Sheet-metal covers are attached to the headlight wells and, of course, roll bar and seat belt are installed.

The driver's door is bolted shut to prevent accidental opening.



There's nothing fancy about the dash of a Pontiac when it's ready for the race. Everything unnecessary has been removed

Standard parts and heavy-duty racing parts are compared. Especially interesting is the split brake lining

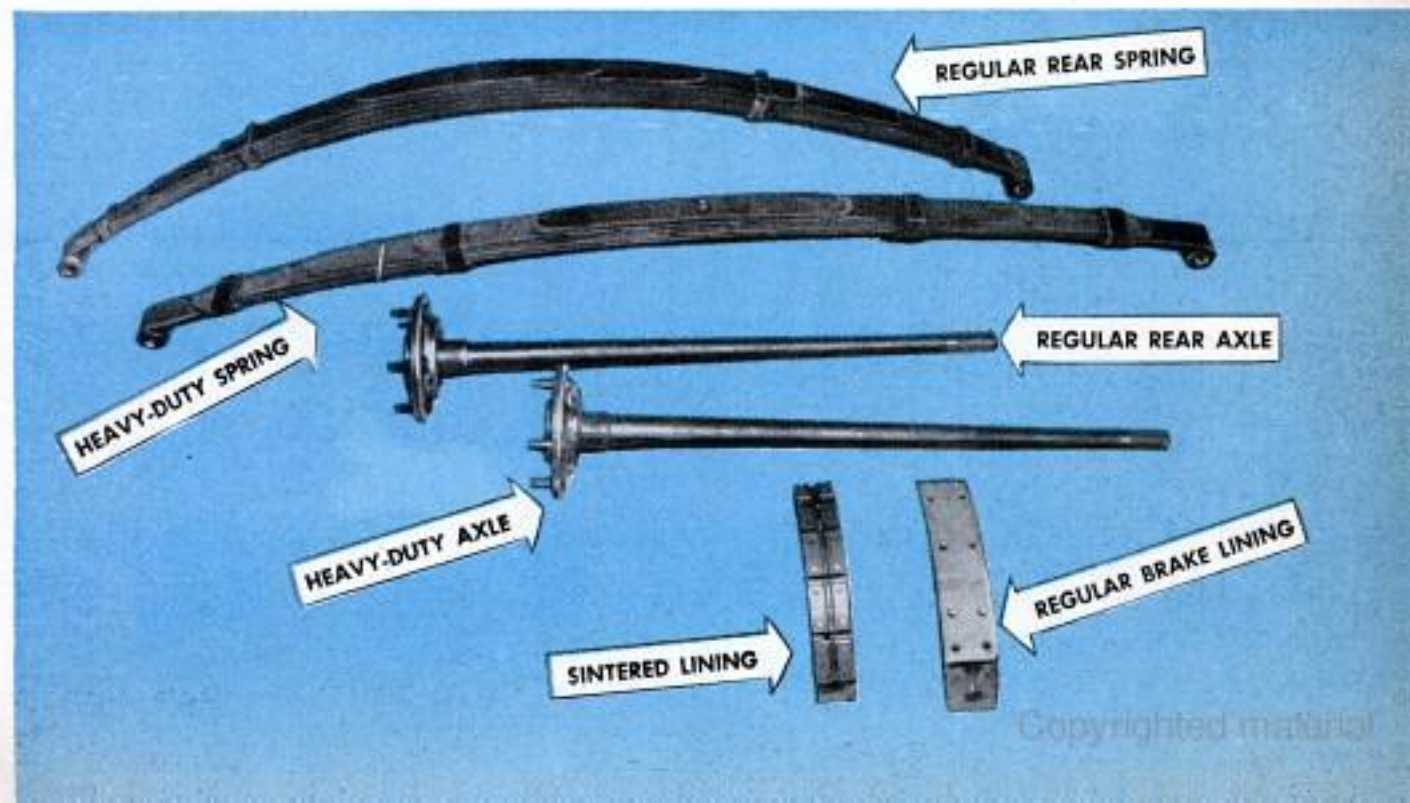

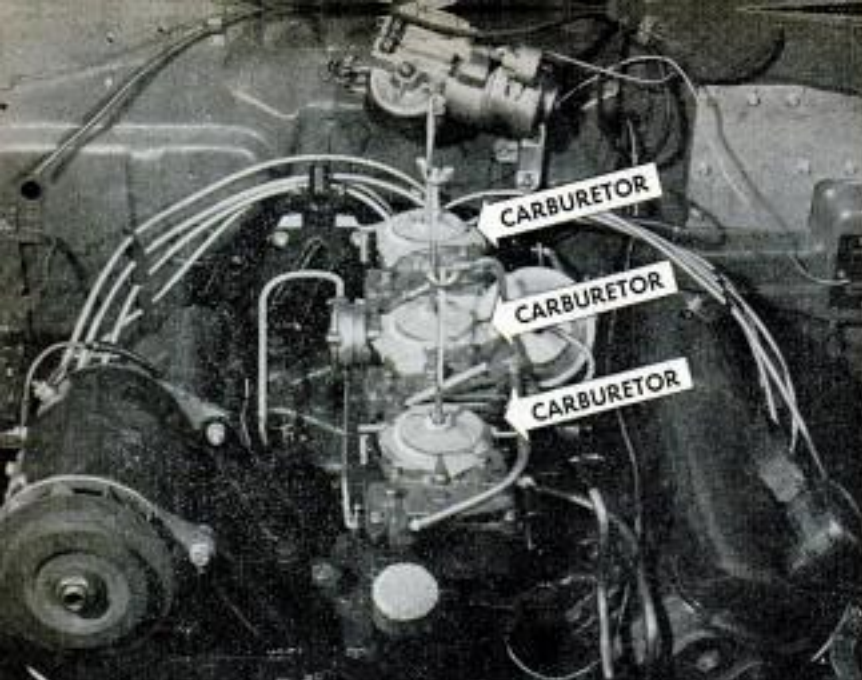

Three carburetors just about cover the top of the V8 engine. You can buy these for your Pontiac for about \$90 additional

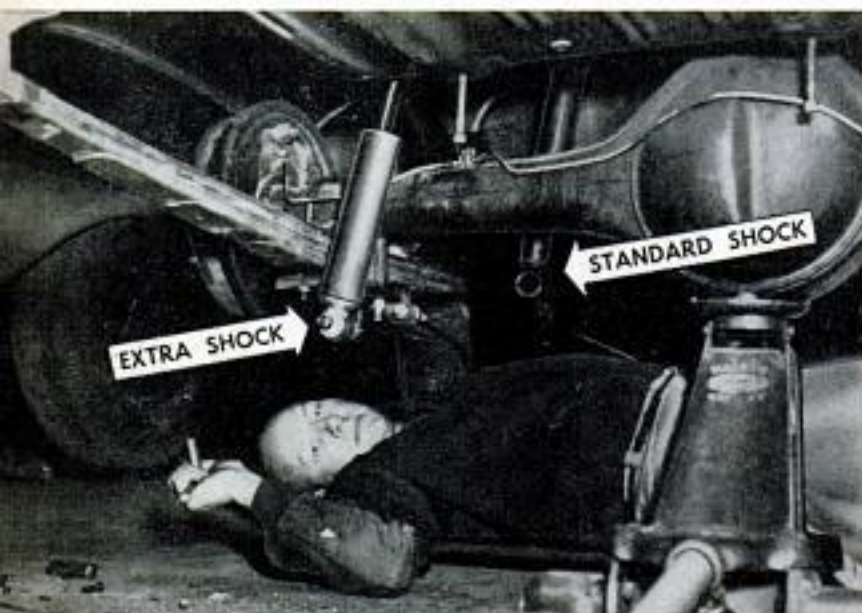

Two shocks on each wheel help provide the sure-footedness so necessary to win. Rear springs are heavy duty (as are front)

Nonessentials are stripped from the trunk of highly tuned race cars. Additional mounts are needed for the beefed-up suspension



Three separate locks are used. Plates are placed on the inside and outside of the door with two bolts running through them. Unless the entire body panel is ripped off, the locks keep the left side sealed tight. The right door is not bolted and it permits rescuers to get the driver out in case of an accident.

The trunk lid is tied down with a shock cord and two additional mounting straps are used around the gas tank to prevent it from being torn loose.

Most important, of course, is the "go power," but setup men don't forget the stopping power. Pontiac uses a brake lining made up of 10 small blocks riveted to the production shoe. These blocks are  $\frac{3}{4}$  inch wide and are mounted crossways on the shoes, slightly higher than standard. The heat built up in braking is dumped into the air that flows through the valleys between the blocks. This cools the brakes more efficiently and prevents fade under heavy loads.

But, you ask, what about the engine? Isn't that important? Of course it is and it is tuned as fine as a hypodermic needle.

Block and cylinder heads must be production, but the heads can be milled if they are oversize as they come off the line (it was here that over-enthusiasm resulted in too much shaving and one Zink Pontiac was disqualified after making the fastest run of all stock cars). The crankshaft is precisely balanced. Pistons and rods are handpicked from thousands of production parts to get beautifully balanced sets—so well matched that they make the pistons in your engine appear to be strangers!

Solid valve lifters replace hydraulic lifters to eliminate valve float at high engine speeds. Over-boring prevents piston scoring as well as slightly raising the displacement and compression (there is a limit to this, set by the rules).

Finally (and perhaps most important) there is the optional camshaft. The cam is often called the heart of an engine and the grind is left to the discretion of the engine setup man. He can come up with some wild combinations to take full advantage of acceleration and torque potentials.

Nichels personally worries this

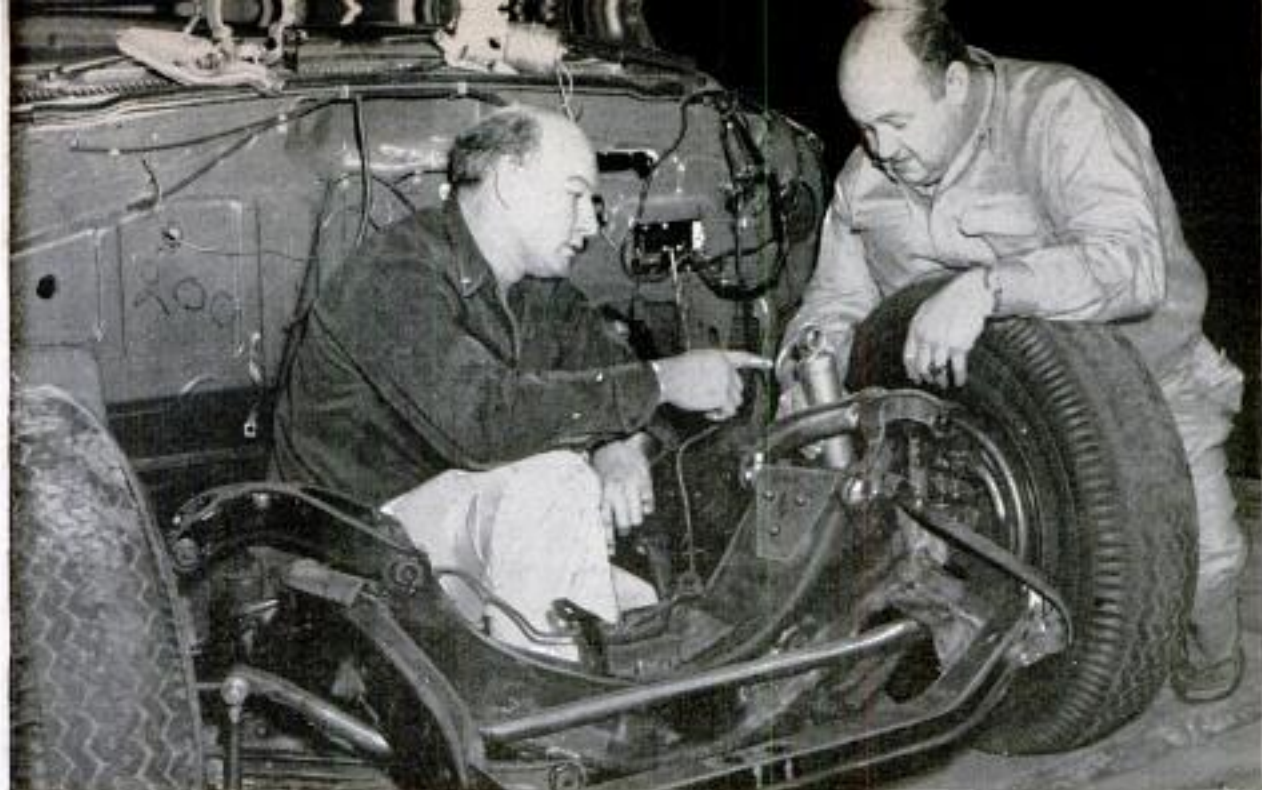

Space around the front end is at a premium and it takes ingenuity to find room for the two extra shocks

part through, drawing on his Indianapolis experience to supertune the Pontiac's 347 cubic inches.

He then puts the individual engines on the dynamometer (and the number of engines necessary to keep a racing team in business is an industry secret). He experiments with carburetor and spark settings for future reference.

The three-speed manual transmission is okay without change. However, rear axles are replaced by heavy-duty units that have larger tapered shafts.

Now the car is ready for the track. And, if previous experience is any guide, all this work is completed with only minutes to spare before qualification time. It is always that way in the race business—nothing is

ever finished until the last possible minute.

What is this rebuilt, hormone-laden Pontiac like?

It's a car you wouldn't want to drive. It's strictly for racing. It rides hard, it is noisy, the camshaft gives the impression that the engine is about to jump out of the chassis as it idles (at full throttle, though, it sings as beautiful a song as ever heard).

But the car does what it is meant to do. It goes precisely where the driver points it. When the accelerator is floored, it takes off like a rock from a slingshot.

So watch Pontiac this summer as it wins races. Watch the Indian on the warpath. It aims to destroy forever the notion that Pontiac is a docile creature fit to be driven only by Casper Milquetoast! ★★★

They may look smaller here, being farther from camera, but there's muscle built into the heavy-duty parts

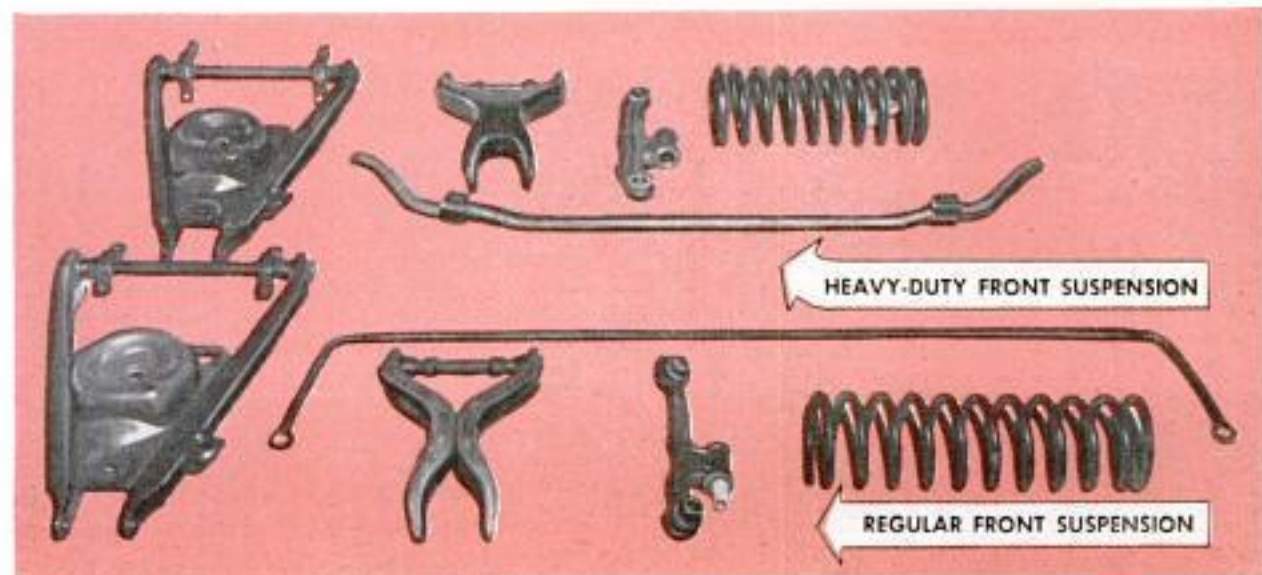

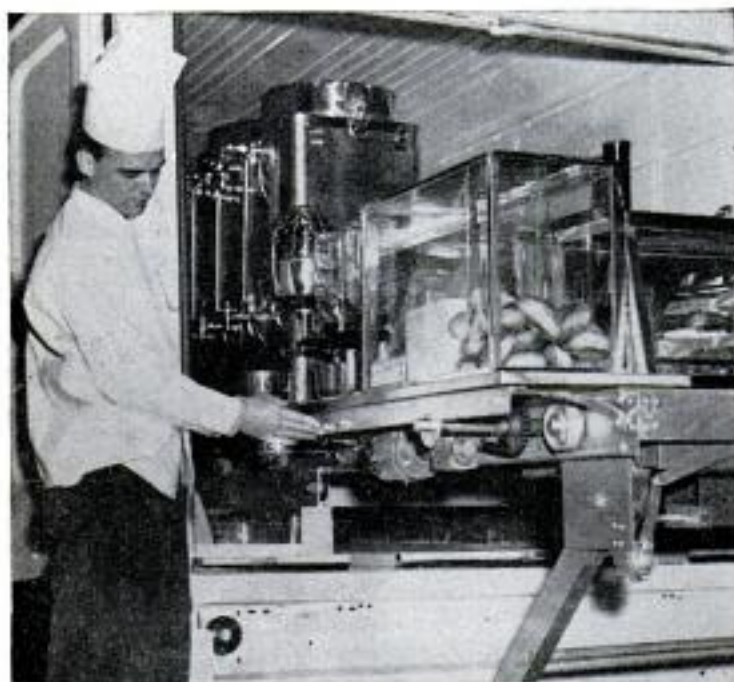

## Mobile Cafeteria

Hot meals for 1000 persons can be served in two hours by one man using a mobile cafeteria. This unit contains a hot oven, steam table, coffee urns, refrigerator, pastry and candy compartments. In 40 seconds the operator parks the one-ton covered truck, presses a button to open the van's rear doors, and presses another button to make the cafeteria slide into fixed position for serving. The cafeteria is 10 feet 7 inches long by 5½ feet wide and is mounted on a rolling rail in the van. Sliding from the truck on chain-driven power from a battery, the cafeteria's wheels work like aircraft landing gear to support the front; the rear rests in the van.



## Safety Car Bumper Is True Wrap-Around

Wrapped around in two directions, a bumper built by W. W. Lininger of Denver, Colo., protects the car from all angles. Six inches wide, the chrome-plated U-beam weighs 160 pounds and is welded to the frame at six points. The front and rear portions come to a shallow point to deflect the other car on impact. The bumper wraps entirely around the car and is hinged to allow the doors to open. A roll-over bar wraps over the roof.



Crowd surrounds Boeing 707 at O'Hare Field, after flight from Baltimore in one hour and 28 minutes

# **Silent, Smooth, Swift**

## **...the "707"**

By Richard F. Dempewolff

**F**LIGHT 707" roared down the runway of Baltimore's International Friendship Airport at 8:12 one morning recently. At 8:40 Chicago time we heard and felt the eight big wheels of her main landing gear kiss the concrete of the Windy City's O'Hare Field.

"With the help of a little tail wind," someone quipped, "we'd have made Chicago before we left Baltimore." Not counting time difference, the 616-mile trip had consumed only one hour and 28 minutes' flying time.

Boeing's 707 jet airliner is a \$16,000,000 hand-built forerunner of the mighty four-jet transports on which you'll be booking air passage when deliveries are made to major airlines two years from now.

### Press Preview of Jet Travel

On the trial spins in March she was showing her stuff to representatives of magazines, newspapers, radio and TV networks. In one leap, carrying 51 writer and photographer passengers, the plane spanned the 2320 miles between Seattle and Baltimore in a record three hours and 48 minutes—averaging 612 miles per hour, and hitting a top ground speed of 692 miles per hour.

The flight from Baltimore to Chicago was actually a preview of the age of jet air travel. No propeller-driven airplane ride you ever had is remotely like it. The demonstration was run off with all the details of any ordinary commercial ride—even to special tickets and flight calls. Out on the ramp, straggling passengers approached a sleek giant of a 190,000-pound plane, with swept wings stretching 130 feet from tip to tip and a 128-foot fuselage.



Above, Pilot Johnston said it was a "routine" trip. Author Dempewolff, below, stands beside one of the jet engines



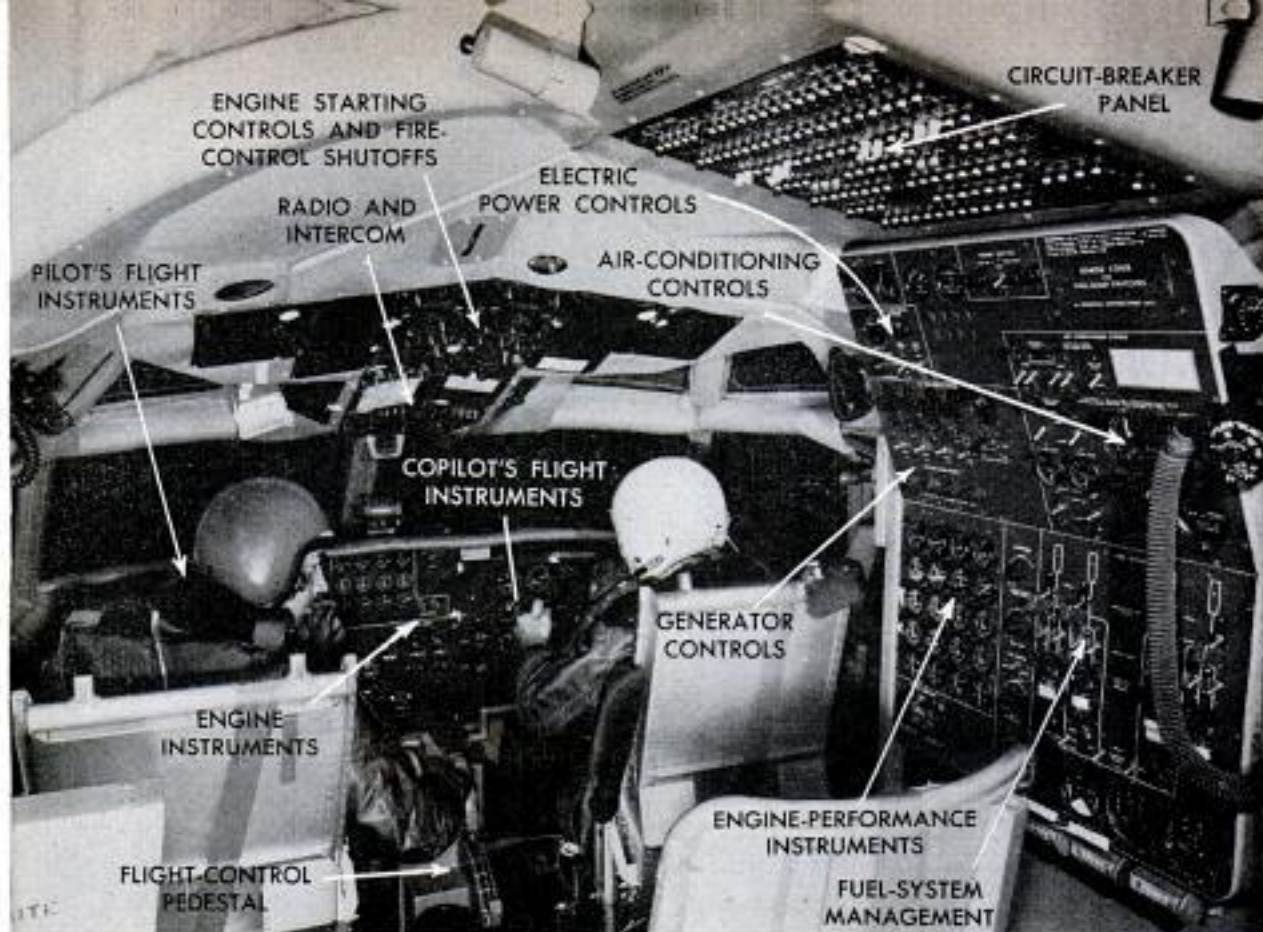

Cockpit seems a nightmare of instruments, but actually there are less than in the big piston-engine planes

Four Pratt & Whitney turbojet engines slung on out-thrust arms beneath and ahead of the wings looked small for the more than 10,000 pounds of thrust each puts out. Inside, the plush corridor of the plane's interior seemed to diminish to infinity in the distance. A man up front who wants something from his luggage in the rear takes a walk that seems like half a city block.

First-class versions of the 707 will carry 131 passengers. But the tourist version, with three seats on each side of the aisle, will carry 162 persons with room to spare.

Flight 707 began with a typical PA-sys-

tem announcement from Pilot Tex Johnston revealing we'd fly at 32,000 feet and our flight time would be about an hour and a half. An instant later the jets were lit. Standing still during check-out, the sound inside the plane was what you might experience standing near the foot of a roaring cataract like Niagara.

#### 42,000 Pounds of "Push"

Then, with a surge backed by about 42,000 pounds of thrust that buried us deep in the cushioned seat backs, 707 thundered down the runway for 5000 feet. The big plane lifted up its "feet" at 135 miles per

Boeing's 707 will average twice the passenger load and fly almost twice the speed of today's modern planes



hour, and the jet roar diminished.

"We are climbing 3000 feet a minute at 350 miles per hour," droned Tex. A glance at a stop watch told us the take-off run had taken slightly more than a minute.

The roar of the jets was loud but not uncomfortable during the steep climb. At 25,000 feet we began to level off, bouncing and bobbing slightly as we bucked a strong, turbulent headwind. "The jet stream has a hook in it," came Johnston's voice over the speakers. "We just crossed it at 90 degrees to the flow."

Just 15 minutes and 30 seconds after take-off, 707 steadied at 32,000 feet and shot out for Chicago at a loping air speed of 570 miles per hour. At 8:36 EST, Pittsburgh drifted past beneath us—a gray patch on a blue-green cloud-spattered canopy.

### Speed of Sound

The roar of the jets diminished again—this time to a whisper as the plane's speed approached the speed of sound and power was cut to about 93 percent of capacity. We could talk in conversational tones above a hum no greater than the sound of a room air conditioner.

The plane was as steady and vibrationless as your own living room. On a table in the lounge, several passengers were standing pencils, cigarettes and coins on end. The objects stayed that way for 15 minutes of flight until someone going past bumped the table and toppled them.

At this altitude, the sky outside the ports grows darker in the thin air under the bottom of outer space. Instead of the familiar pale blue seen from earth, the sky is the gray-blue of slate. The outside temperature was minus 55 degrees F., according to the PA system.

Up front, Tex Johnston, his copilot, navigator and engineer, watched the dizzy array of instruments that crawled up the walls and across overhead. Special counters clicked away the fantastic fuel poundage being gobbled by the four powerhouses out on the wings.

At our cruising speed we were using 1800 gallons per hour of the kerosene-gasoline type of fuel used by these jets. With the plane's

(Continued to page 250)



This 707 prototype has only a dozen windows while the passenger model will have more window area than any other plane



Mock-up cabin shows first-class seating for 131 passengers. Tourist version with three seats on each side will carry 162

Huge tanks hold 12,000 gallons of fuel. Using 1800 gallons an hour, plane can span the nation and still have plenty left



# RUSSIA'S ANSWER TO THE F104 "STARFIGHTER"

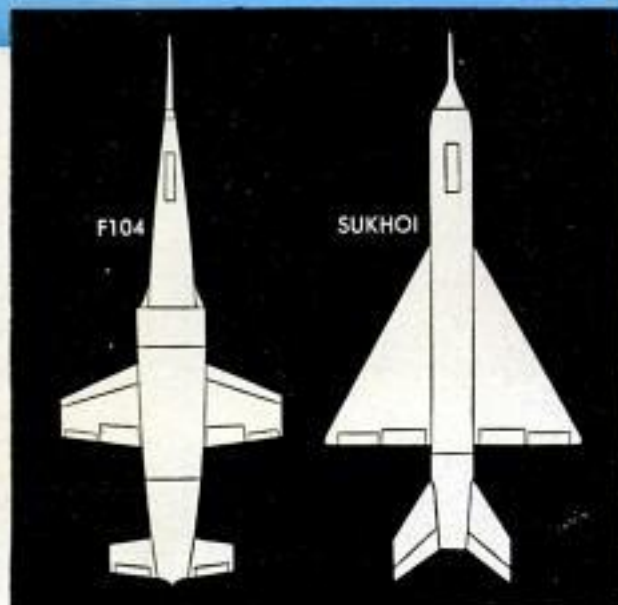
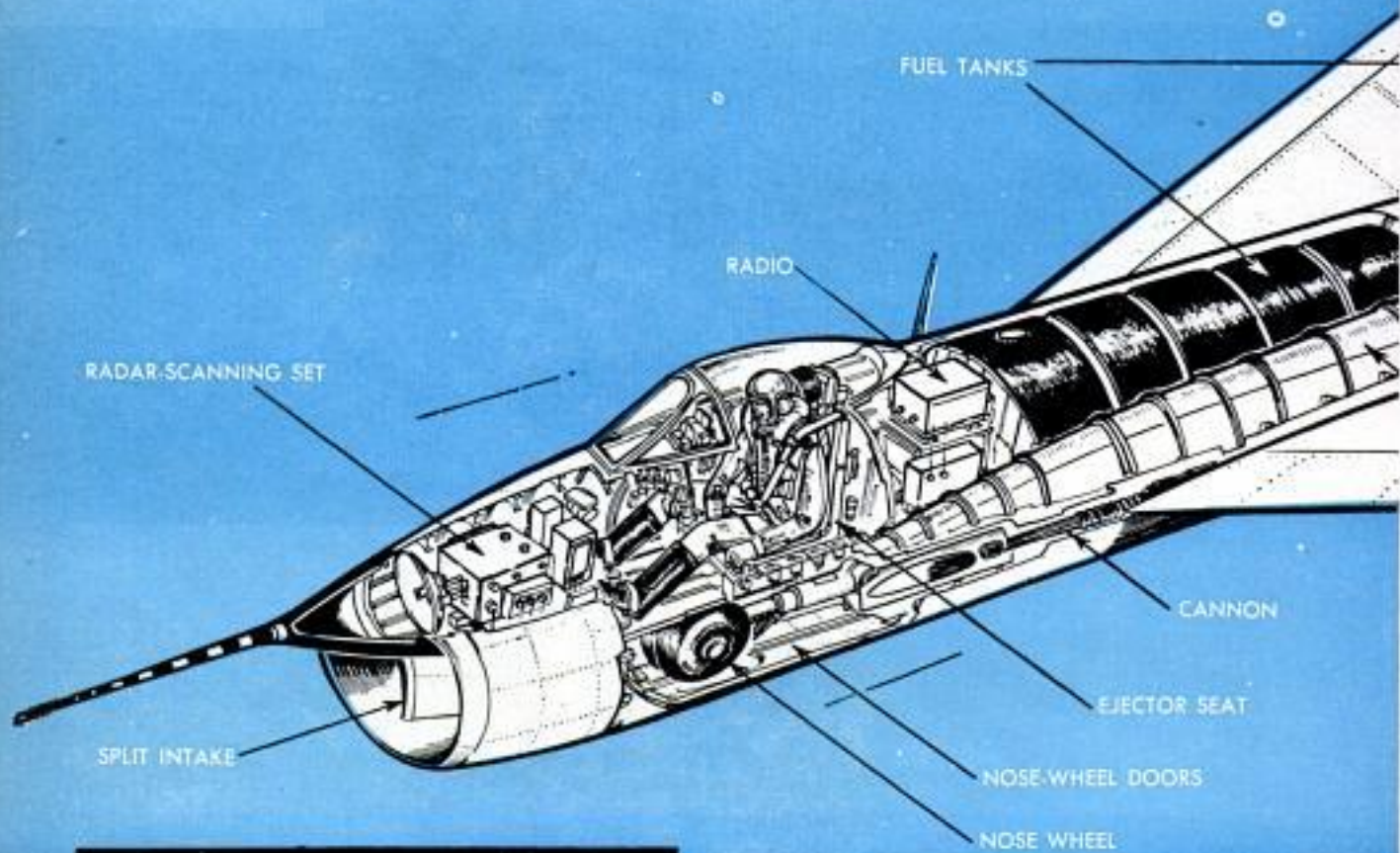

Sukhoi, Russia's first delta-wing production aircraft, has a different shape but the same function as F104

Illustration and text by Thomas Turner

**R**ED AIR FORCE PILOTS are testing a modern piece of flying equipment called the Sukhoi. It is not unlike the breed of aircraft of which the U.S. Air Force's F104 is a member. Both planes (see drawings at left) are lightweight interceptors with similar characteristics, mounting similar armament and capable of similar high speed and maneuverability.

The new Russian aircraft first came to the notice of the West when three prototypes zoomed low over the heads of top research and development brass of the U.S. Air Force last year. Available photographs of the Sukhoi reveal streamlined thinking on the part of Russian designers.

Nearest resemblance to an American plane is in the nose intake of the Red aircraft, which is identical in function to the U.S. Navy's 1000-mile-per-hour F-8U Crusader. In essence, the pointed radar nose is placed over and ahead of the cheek



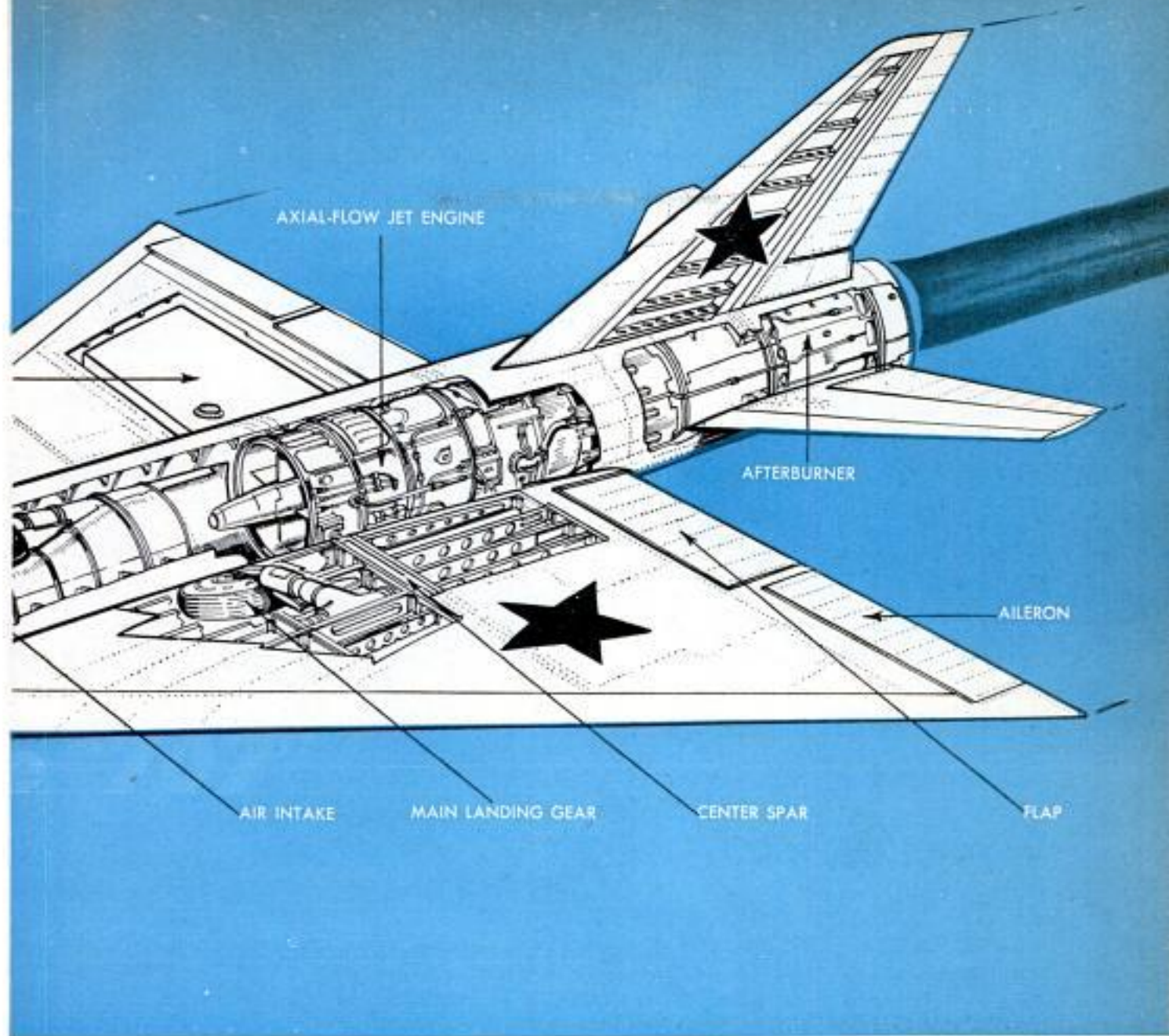

intake in a position where it can produce a shock wave that strikes the lower intake lip. This has the effect at supersonic speeds of providing a much more efficient low-speed air flow into the engine.

As in most Russian combat aircraft, visibility is good. The pilot sits forward of the wing's leading edge. A conventional tear-drop canopy with rear vision sits high on the fuselage. The cockpit is probably fitted with an open-type ejection seat, as in the MIG-15.

The Sukhoi is a clean, long tube with a delta wing of about 60-percent sweepback, plus a sweptback tail. Few delta-wing planes flying today have the luxury of a tail, with the notable exception of the British Royal Air Force Javelin, an all-weather fighter. Stability obstacles associated with pure delta, and its inherent problem of high landing angles, probably influenced Russian engineers to add a tail

in spite of higher resulting drag. The wing is small and appears to be thin. Landing-gear legs are housed in the wing but retract so wheels are stowed in the lower fuselage ahead of and below the engine. Two large cannons are mounted, one on each side of the fuselage, well back from the nose. Ammunition is near the Sukhoi's center of gravity.

The rear lower line of the fuselage has a slight upsweep to give ample ground clearance and to make a shorter landing gear. Weight has been cut to a minimum, possibly by eliminating duplication of hydraulic systems. Safety devices are reduced, as in the MIG-Falcon which in the Korean War was two tons lighter than our Sabre Jet. If the Sukhoi's designers adhere to the minimum-weight philosophy, this aircraft may come up to a performance level equivalent to the Starfighter, possibly in the Mach-2 category.



Above, cabledway operator watches loading from control house. Right bottom, cables pick up concrete buckets from railroad cars. Right top, bucket is guided to the dam for dumping and return to siding

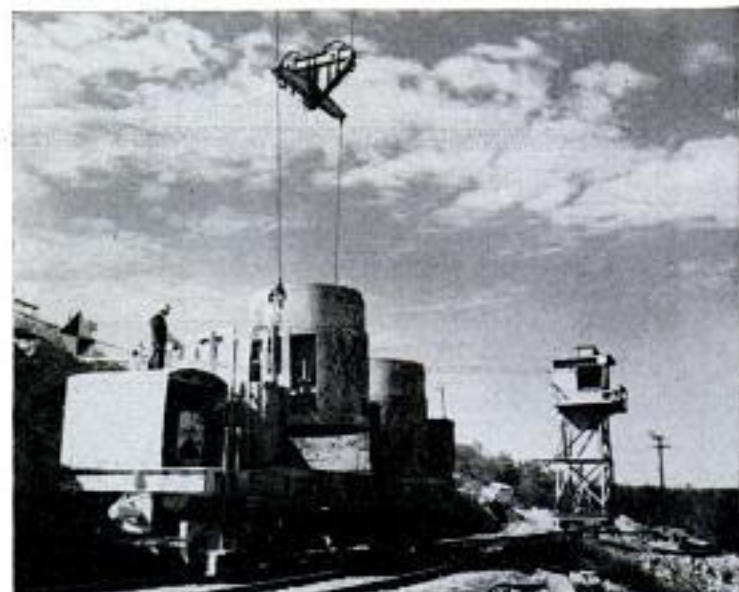
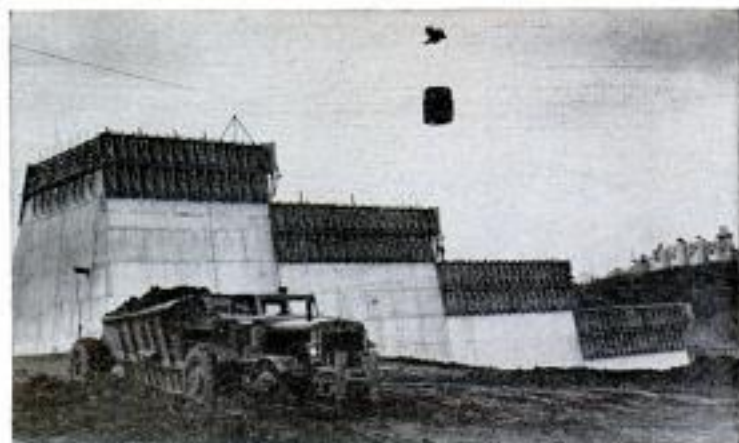

## Electronic Ingenuity Builds Missouri Dam

TV and short-wave radio are helping to build Table Rock Dam in southwestern Missouri. Hoisting drums control a cable system that carries huge buckets of concrete from a railway siding to the dam. An operator in a control house at the siding watches loading of concrete into the buckets, while through a 17-inch TV receiver

above his head he can oversee the hoisting drums one half mile away. The TV image is transmitted by coaxial cable from a camera focused on the drums. Also, radio receivers, installed on the buckets, activate hydraulic dumping mechanisms on the buckets in response to signals from a portable radio transmitter.

## Giant Weed Burner Keeps Railroad Right-of-Way Free of Overgrowth

With its flame cutting a 16-foot swath with 3000-degree heat, a mammoth flame-throwing weed burner is being used by Western railroads to scour weeds and shrubs from overgrown right-of-ways. The intense heat destroys weeds and weed seed, and prevents regrowth for more than a

year. The burner uses propane and butane fuels, is 22 feet long and travels at four to eight miles per hour. It consumes 43 gallons of fuel per mile, making its cost of operation about \$20 per mile—half that of comparable weed-control programs using chemicals or burning oil.





## *An Artist in Glass Shapes a* **MENAGERIE FOR YOUR WINDOW**

*By Lilyan Schavey*

**I**T LOOKS AS EASY as taffy pulling, but it's not that simple to make colorful animals of solid glass.

The deft, practiced hands of expert Henry C. Johnson make it look easy as you watch him pull, push, twist and squeeze molten glass to form transparent animals.

Johnson practices this rare occupation in Pentwater, Mich., to the delight of tourists who watch him work.



Most popular of the "critters" is the deer family, below. Most difficult to make is the ballerina, right. Flared skirt often cracks apart as it cools

Color photos by PH photographer Don Honick



Above, Johnson begins work on a striped fish by heating a green rod to form the first stripe, No. 1 below

He is not a glass blower (the more spectacular, carnivalish approach to working with glass, Johnson explains). His figures are formed by heating colored glass rods to temperatures up to 3000 degrees Fahrenheit and drawing them into shapes that range from the spindly, delicate legs of a fawn to the rotund belly of a hippopotamus.

This art has been a long-kept secret of a few European families. But Johnson, a glass collector for years, decided to master it alone just as a hobby.

He soon learned it was not so simple as it appeared. Each color of glass has a different melting temperature. While heating one color enough to work it, he found he was melting the part he had already finished. Different glasses expand and contract at varying rates and many, many times Johnson's self-congratulations on a just-finished animal were jolted by a sharp snap as tensions built up inside the glass, cracking it apart.

Colors are a problem, too. He found that heating the glass too much changes its color—indeed in some cases it removes the color completely. Reheating it brings back the color, but excessive reheating crystallizes it and makes it worthless.

He had to learn which colors could be used for which shapes. This obviously restricts his designs which have to be compatible with the glass he plans to use.

Tools and equipment for his work are simple: A pair of cross-fire burners, a supply of bottled gas and compressed air, a

Series of photos on opposite page shows main steps in the forming of this fish. There is a total of 10 operations

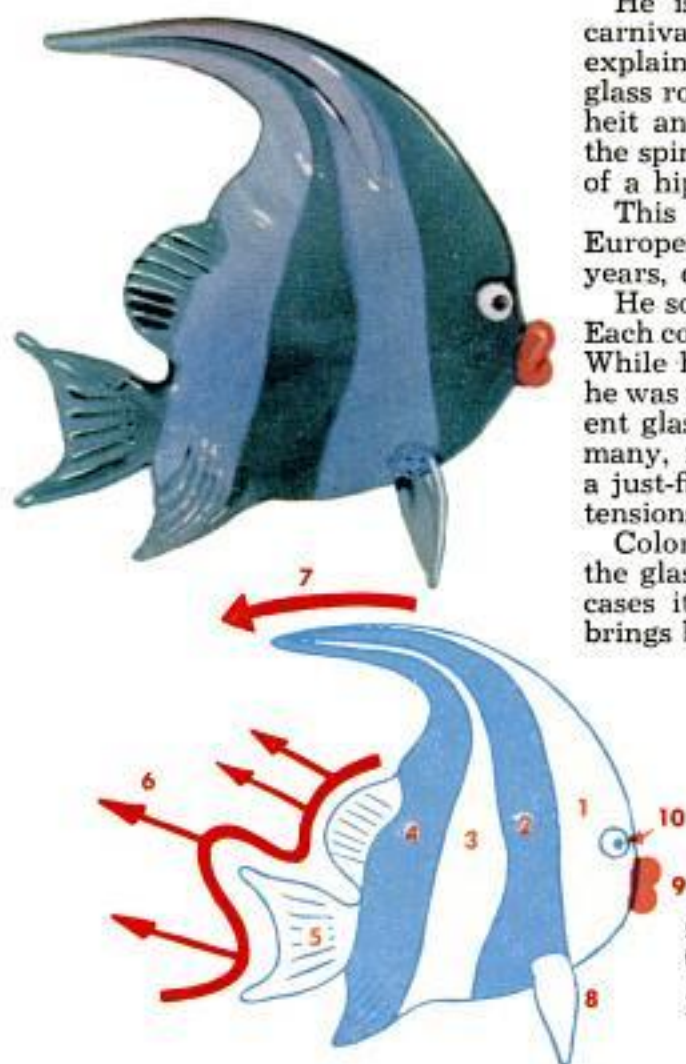



1. Johnson squeezes hot glass to begin shaping fish



2. He "flows" a stripe of molten blue onto the green



3. Additional stripes of green and blue glass are fused to body which must be kept hot all the time



4. With pliers he draws and forms a fin and tail

pair of pliers, a jackknife and a few dies he fabricated himself to form the fins of a fish or the bumps on a turtle.

With no more than these tools, Johnson converts rods of glass into attractive animals with color, detail and a surprising resistance to breakage. The "critters," as Johnson calls them, survive rough handling amazingly well. He shocks customers by dropping them on the glass counter "accidentally."

Most of the glass is transparent and under correct lighting the animals sparkle brilliantly. Occasionally he uses opaque glass, but it does not fuse properly with other glass so its principal use is to form the pupils of the eyes. Johnson goes into such detailing that an inch-high pink elephant has to have black pupils in its tiny eyes.

There can be no mass production in this work, he explains. Each critter is a separate operation and should be finished while it is still hot. "Most of my time is spent waiting for the glass to get hot,"

Below, tiny penguin is a mere inch tall



5. A small blob of red glass is stuck to the body to form the lips. Earlier he had added the lower fin

6. With the blade of a jackknife, Johnson molds the lips. Finally, he adds the eyeballs and black pupils

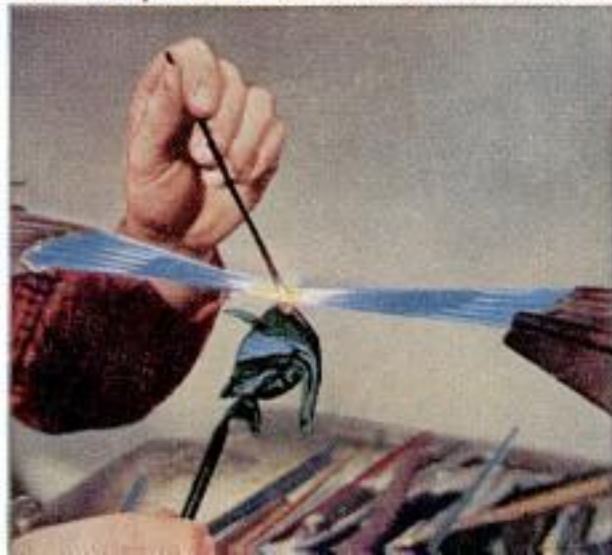

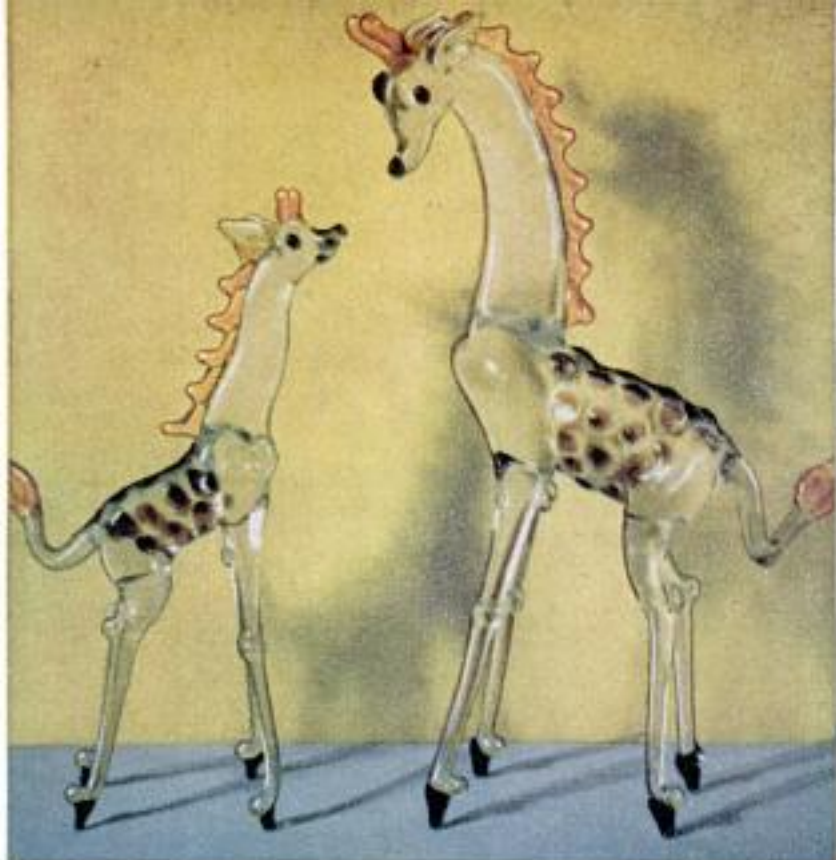

Above, a giraffe family made of clear glass. Note careful detailing of the knobby knees, hoofs and heads. While the most popular pieces are animals, Johnson also makes figures like this angel with the two doves

says Johnson. It takes anywhere from five minutes (for a tiny one-color animal) to more than an hour (for a big multicolor piece) to make each figure.

His is the only art form that provides a fluid medium which hardens instantly. There is no "setting time." In the intense flame the glass flows like heavy molasses, out of the flame it is a solid almost instantly.

When he started to work glass, Johnson searched unsuccessfully through reference libraries. Europeans have made glass flowers and animals of solid glass for years, but nobody had written anything on the art. He started from scratch. His biggest trouble was heat and until a helpful neon-sign maker told him about the cross-fire

burner he wasted plenty of time and glass!

This burner shoots five needle-shaped flames to a common center point which is intensely hot. This hot point raises the glass temperature to as much as 3000 degrees, yet it is focused enough so the worker doesn't have to wear protective gloves.

Johnson tends to make light of the skill now that he has developed it.

"Glass is glass," he says. "It's all a question of heat. You melt it, stick it, push it or pull it and let it cool."

But to those of us who have trouble forming cooperative modeling clay into anything recognizable, working red-hot glass into precise, delicate figures is a real art and Johnson a real artist—an artist in three dimensions. ★ ★ ★

Close-up shows extremely fine details of the small "critters." All the colors are glass, no paint is used



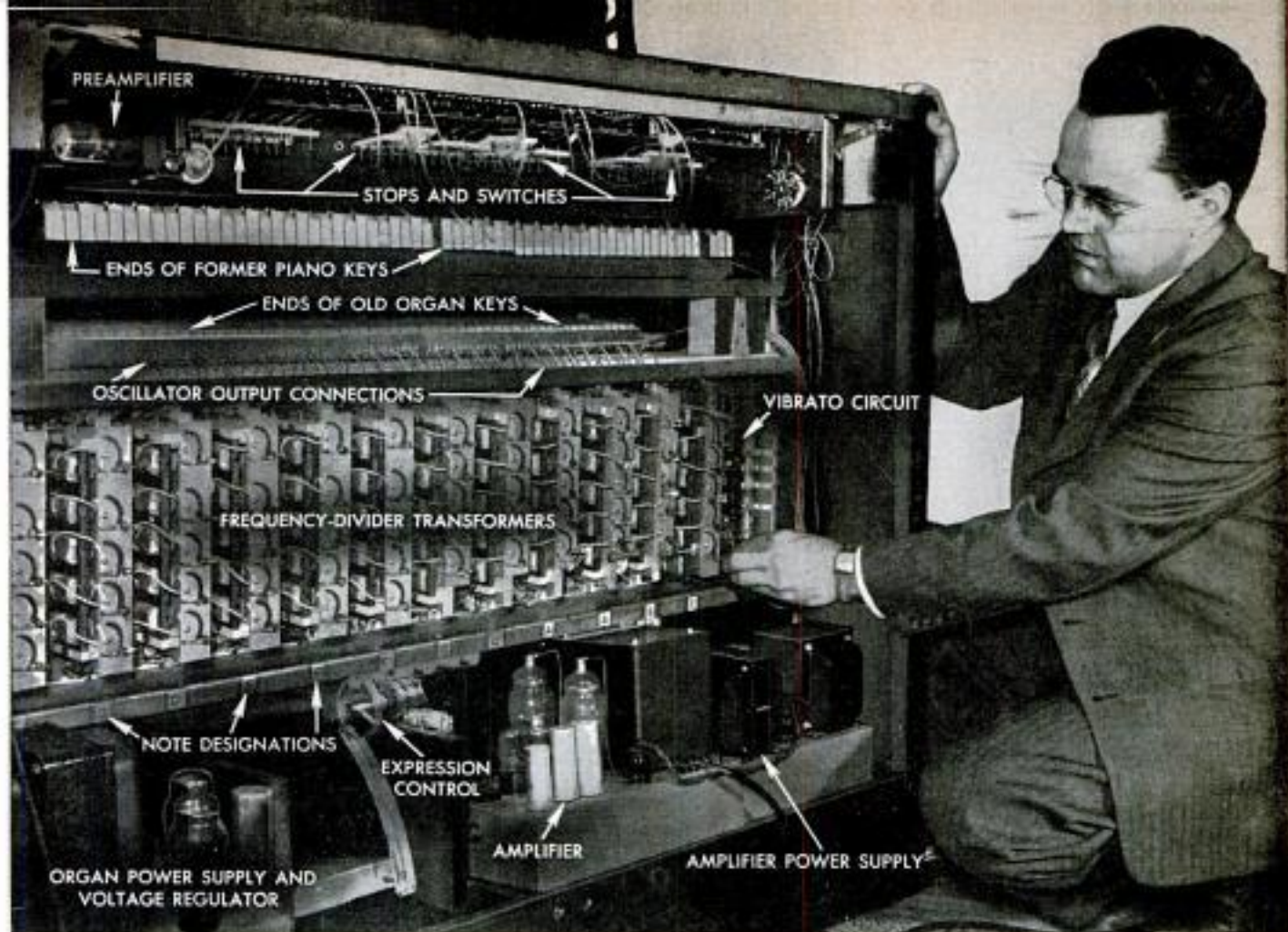

This maze of electronic components uses more than 800 feet of wire. The project took 1000 hours to build

By Walter E. Burton

FROM an old mahogany piano, the keyboard of a 19th-Century organ, one sixth mile of insulated wire and more than 700 electrical parts, Paul R. Sommer, of Uniontown, Ohio, has assembled an electronic organ valued at \$3000 to \$5000. He made this involved instrument purely in the interests of hobby craft and his next major project is to learn to play it.

If Sommer, a tool engineer at the Goodyear Aircraft Corporation in Akron, succeeds as well in his efforts to play the organ as he has in the difficult field of organ building, his home should never lack music. When he tackled the organ project, he considered himself a beginner in the field of organ electronics. He says that during the 1000 working hours, extending over

Having built this intricate organ, Sommer now intends to learn to play the instrument

## He Built an Electronic Organ From an Old Piano



a period of 1½ years he has worked on this project, he has acquired a liberal education in the theory and practical application of electronics, and in organ science and art. In electronics alone Sommer has learned a great deal from the selection and installation of the 46 radio tubes, more than 30-dozen custom-built switches and 61 special transformer assemblies.

Sommer's starting point was an ancient upright piano and the general idea that he wanted to build an organ. After dismantling the piano virtually to the last board, he rebuilt the case to accommodate two rows of keys instead of the original one row. Each of the two organ manuals, or banks of keys, has a range of 61 notes, or five octaves, and is played like the keyboard of a piano. Sommer made the upper, or swell, manual from the piano keyboard, shortening the black keys a little in order to keep the unit compact. For the lower, or great, manual he obtained keys from an old organ he purchased for one dollar. In addition to the manuals there is a clavier of 13 foot pedals which produces bass notes; Sommer uses only 13 pedals, as compared to 32 pedals on a conventional organ.

#### Twelve Basic Frequencies

He started with a group of 12 basic frequencies produced by conventional oscillator tubes and circuits. These notes are played by the right-hand dozen keys on the swell manual. All other notes are developed by splitting these basic notes in two (that is, halving their frequencies), and then resplitting the split notes until the required number of octaves are covered—a feat accomplished with the aid of the 61 frequency-divider circuits. To tune the organ, it is necessary to tune only the 12 basic notes; all other notes will fall into line automatically.

Tones developed by the oscillators are fed through a preamplifier and a high-quality audio amplifier of standard design and then to the speakers in a separate cabinet. There are two power-supply units (rectifiers) and these are energized from the standard 110 to 120-volt house lines through a voltage regulator that prevents power-line fluctuations from causing off-shade notes.

The simple operation of closing a circuit each time a manual key is pressed represents a lot of work on Sommer's part. A conventional switch that merely makes or breaks contact would produce an annoying click each time a note is played.

#### Builds 363 "Roll" Switches

So he built by hand 363 "roll" switches which involve curved metal strips (formed with a homemade die setup) that make



Above, Sommer solders connection to choke unit in the organ-stop circuit. Plastic stops at top operate "roll" switches similar to those actuated by keys. Keyboard from piano shows shortened black keys

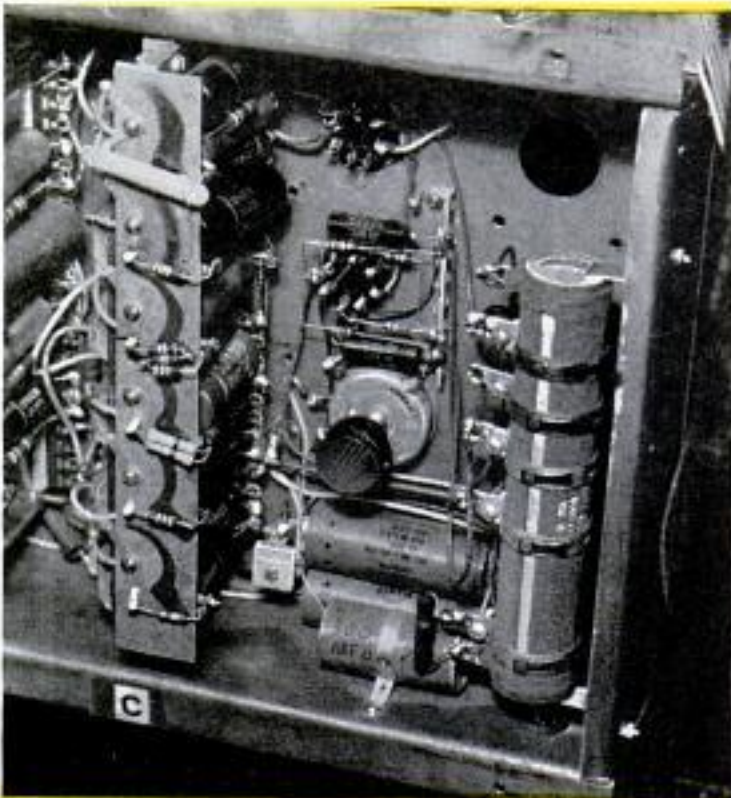

Above, vibrato circuit has adjusting knob in center. At left is vertical bank of six "frequency dividing transformer" assemblies for "C" notes of the organ

Below, voltage regulator prevents line fluctuations from affecting organ's notes. This organ, with more than 700 electrical parts, draws 500 watts of current

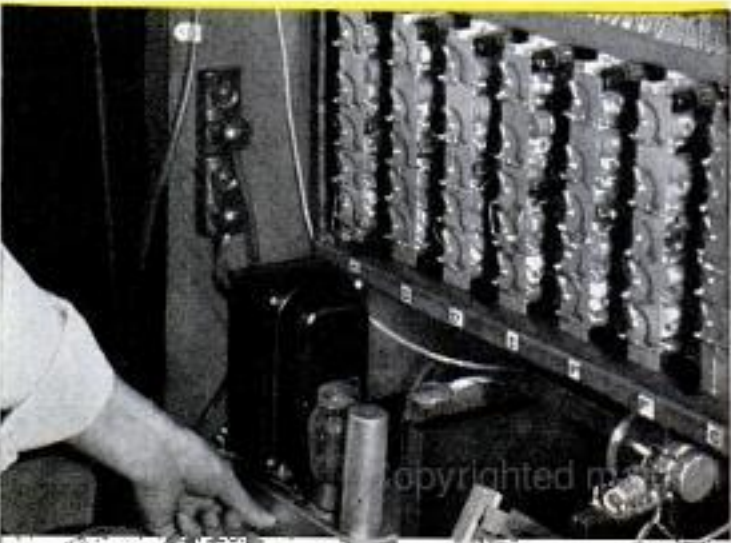



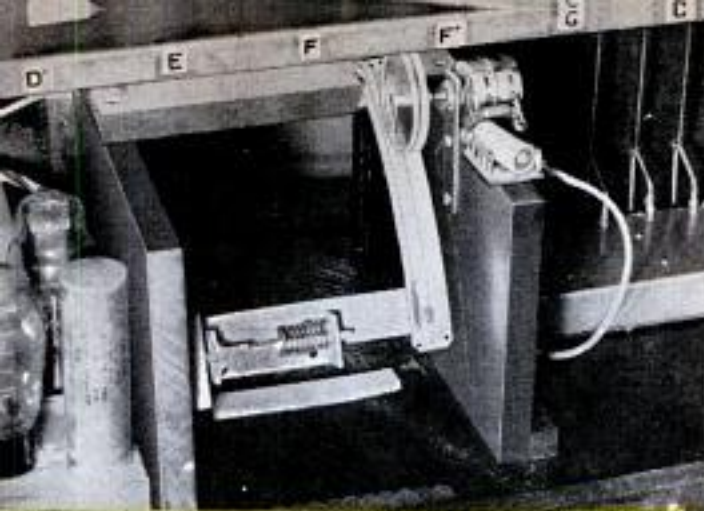

Above, when expression-control pedal is moved, a curved arm rotates a plastic wheel mounted on shaft of potentiometer unit. Spring-loaded latch produces friction that holds the pedal in any position

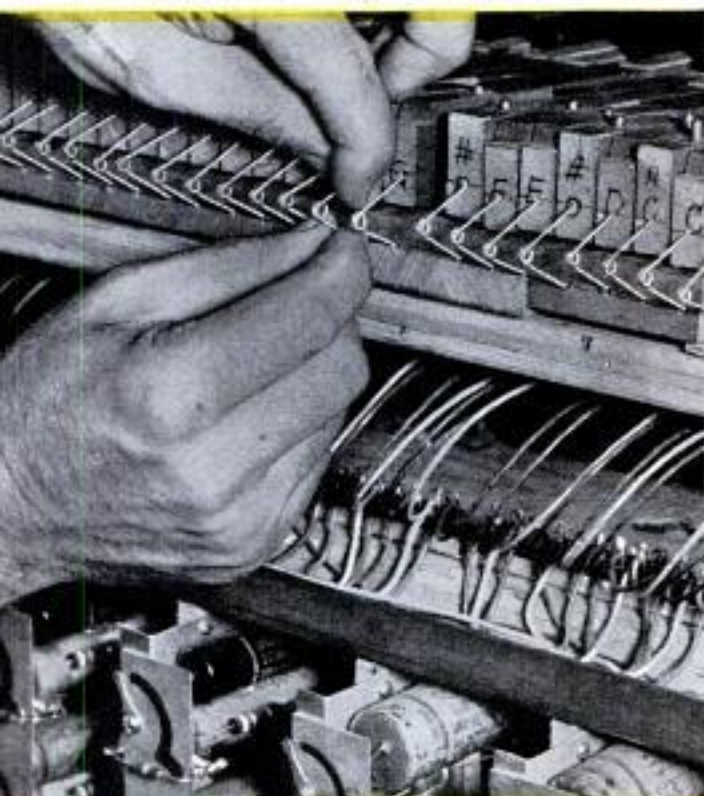

Above, springs which give the right action to former piano keys are fashioned from safety pins. Wires in row below keys are oscillator output connections

Below, tone-color circuits operated by stops are at top. White strips with bolts are stops. Next below are swell-manual keys, oscillator circuits, other wiring

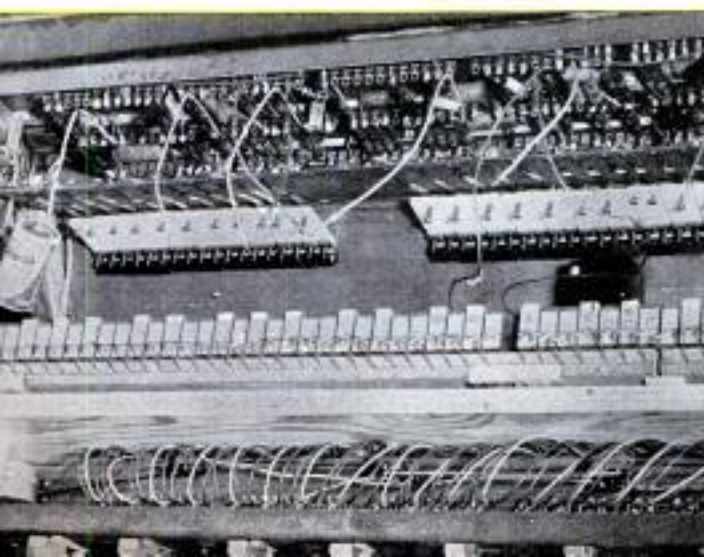

contact with a graphite coating. When a key is pressed slightly, contact is first made with the graphite at a point where the maximum resistance is in the circuit. This results in a note that is soft and muted. Further depressing of the key causes the contact to move along the coated area so that less and less graphite, and therefore resistance, is in the circuit, and the note swells to full volume and brilliance.

At the upper left-hand side of the organ front is a vibrato switch that adds a tremulous, or pulsating, effect to the tone. Vibrato effect is produced by a circuit involving a phase-shift oscillator and a capacitor-resistor network. Reverberation rate is three to six cycles per second.

The 61 special transformers, with accessory resistors and condensers, are arranged in 11 banks of five transformers each, and one bank of six. Each bank represents all divisions into which a basic note is split. For instance, the group marked "D" consists of one transformer that halves the basic D frequency; a second that halves the frequency produced by the first transformer, and so on.

#### Musical Instruments Imitated

Besides the two manuals of 61 keys each, the 13 bass pedals, and vibrato control, the organ controls include 26 stops fashioned from ivory-like plastic, arranged in a row above the swell manual. These stops control circuits that alter the wave form of the organ notes, so as to imitate various musical instruments, such as violins, woodwinds and brass horns. There is a tone-variant control that permits the operator to accentuate some tones and suppress others. The player's right foot operates an expression pedal whose movement regulates over-all volume.

In many ways Sommer was able to cut corners in order to keep cost down. He found old radios and other electronic devices rich sources of parts. Some of the resistors and other elements are more than 20 years old, but so long as they met Sommer's testing standards, he considers them as satisfactory as new pieces of equipment. He had to make a good many parts from "scratch," largely because he could not locate ready-made units. Numerous mechanical pieces started out in life as something far removed from organ service. For instance, the friction device on the expression pedal was originally a type of spring-loaded latch. Springs that return manual keys to their positions look suspiciously like safety pins—because they once were!

Sommer's extraordinary degree of skill in working wood and metal constantly shows up in the way in which he has combined this wide assortment of parts and



Most of the case of this organ was made from an old mahogany piano, which also furnished upper keyboard (swell manual). Lower keyboard is from an old organ

materials into one of the most intricate musical instruments a hobbyist could build.

Anticipating that some servicing may be required from time to time, Sommer grouped many of the organ parts in compact units that are hinged so they can be swung into more accessible positions.

When demonstrating his hobby project, Sommer turns the organ around and begins swinging out the various compartmentalized sections; a visitor, glimpsing the maze of wiring and parts, is likely to declare that it would seem much easier to work at

Sommer prepares to test a group of "roll" switches used in conjunction with the organ's keys and stops



something else and earn the money to buy a factory-built organ.

Although Sommer has spent more than 1000 working hours planning and building his organ, he still has a lot of finishing touches to put on it. After he had the instrument completed to a point where one manual and all of the bass notes could be played, he set the organ aside for the summer, because he had another building project under way—this time a new home.

It's questionable whether the new Sommer home will contain an organ loft, but a more definite possibility is that father, mother, sister and brother will each take lessons on the organ. The final product may not be of the caliber music played by Albert Schweitzer—famed musician-philosopher-theologian—but Sommer and his family expect to receive much enjoyment from their "reborn" piano.

Of course, there will come times when this instrument may lose its allure, such as when it has to be lifted or moved. Contrary to Sommer's expectations, the "new" organ weighs at least as much as a piano of similar size. Regardless, this electronic music maker is presenting a real opportunity to the Sommer family—the chance to participate in a play-it-yourself project, one that teaches and entertains. ★ ★ ★

## X-Ray Movies Of Running Engine

Using a new technique called "strobodiagraphy," a team of engineers from General Electric and the Detroit Arsenal has succeeded in making motion pictures of the inside of an engine while the engine is running. Strobodiagraphy consists of taking slow-motion X-ray movies, which enable engineers for the first time to see the complete cycle of engine operation, and to see what causes wear and faulty performance.



## Umbrella Shades Tourists Riding in Convertible

One carload of tourists in Rome, Italy, found a way to have shade and breeze at the same time. They lowered the roof on their British convertible and raised a huge beach umbrella over the entire passenger compartment. Under the umbrella they enjoy breezes and once at the beach they have welcome shade.

## Horsepower Goes Up

From the 12-horsepower engine of the 1903 Wright brothers' plane with a weight-horsepower ratio of 12 to 1, aircraft engines of today's turbojets deliver six horsepower for every pound of weight.

## Exhaust Mufflers "Silence" Mowers

Week-end nappers can sleep uninterrupted by the near-silent power lawn mowers equipped with exhaust mufflers. A single instrument-panel knob on top of the engine controls starting, running, idling and stopping functions. Use of premixed fuel eliminates the messy job of checking, adding or draining oil in the crankcase. Double-power action makes starting easier and prevents stalling in tall, wet or rough grass. Streamlined aluminum shrouds completely enclose all moving parts of the engine.

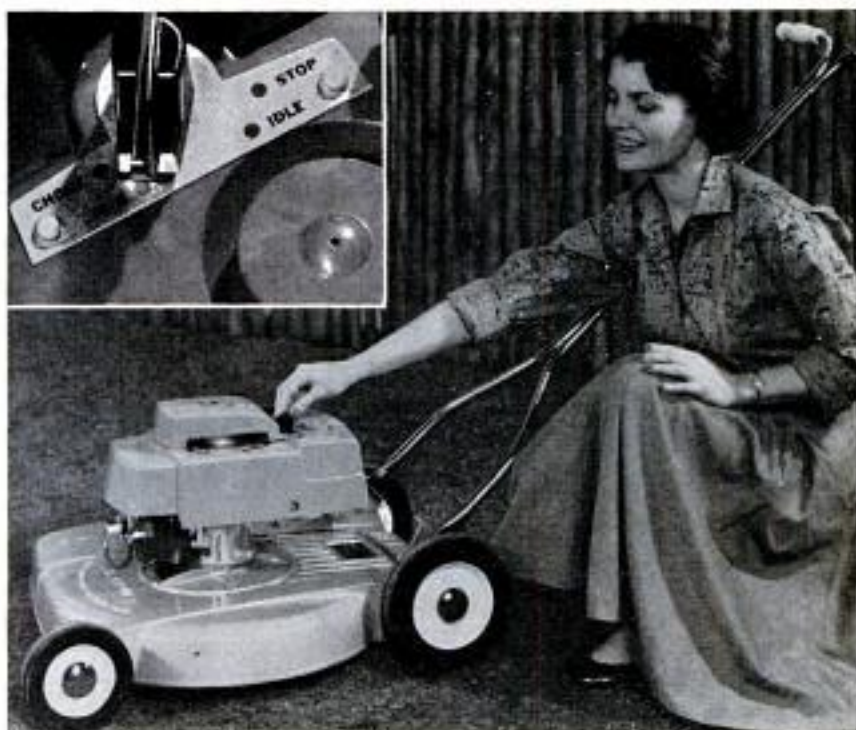

# HIS BUSINESS THRIVES ON GRASS

By William Sheppard

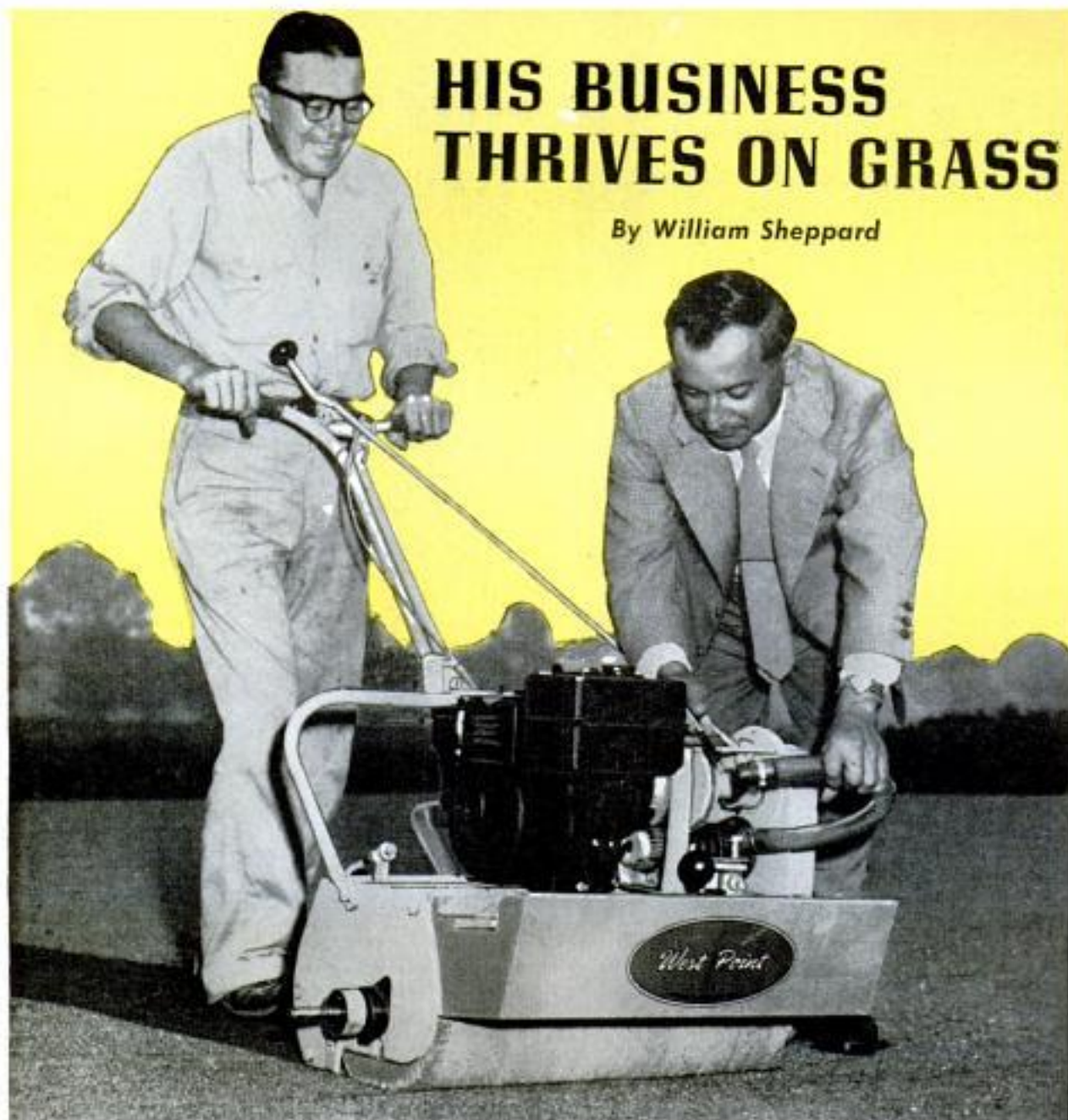

Aeri-Dryer sponge roller soaks excess moisture from turf in a dry, dark path behind man operating machine

Sponge roller acts as pump when hose is removed from the sump pan and placed in puddle or cup

Reservoir pan on sponge-roller unit can be detached and the water dumped in area selected by operator

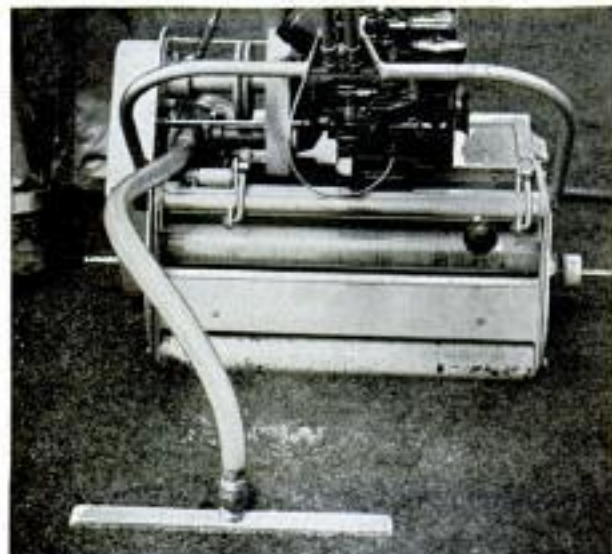



Soil ventilator "spoons" slice into dirt and lifts out earth for deep fertilization

**A** MACHINE that ventilates the soil—a mower that cuts grass vertically—a power-driven sponge that soaks up excess moisture from golf-course greens. These are the products which in 10 years of pioneering and persevering have given Tom Mascaro and his West Point (Pa.) Products Corporation an important place in the turf-grass industry. Though the machines of West Point are now working in 16 countries, the situation was something else again a few years ago when Tom and his brother Toney were desperately searching for a way to make a living.

### Turf-Grass Problems

In the course of selling various soil-building materials to golf-course superintendents in the Philadelphia area, Tom and Toney had come to know about some of the turf-grass problems. An idea occurred to them that these greens keepers would welcome a machine that could gather up the fallen leaves, which are such a nuisance on greens and fairways. The two men went to Beltsville, Md., to sound out Dr. Fred V. Grau, nationally known agronomist to whom other grass experts turn for advice.

### Compaction Hurts Fairways

After Tom presented the idea, Doctor Grau leaned back in his chair and said, "You know, one of the greatest problems in turf today is compaction. Many fairways are like rock. The soil of most of them has become so compacted that playing conditions are poor, and the grass itself is in bad shape. If

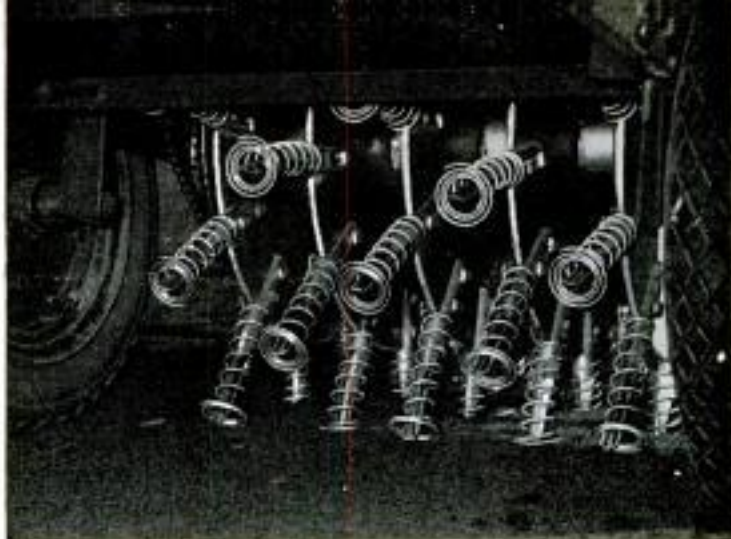

Above, springs surround Aerifier spoons to keep spoons from scooping out too much dirt or turf in golf-course maintenance



Above, with such power-driven maintenance units as this, a green is cultivated without destroying the valuable turf

Below, after aerification and fertilization for deeper root systems and greener grass, the golf green is rolled out





Verti-Cut unit slices into turf and trims runners and outspread leaves to get better putting green

you can come up with a machine that can renovate fairways with only a short interruption of play, you'll make a million!"

Back home at West Point, Tom and Toney struggled to devise a leaf-removing contraption. As the two of them worked, they talked and thought about a tool that could eliminate fairway compaction without plowing everything under. One day, eight months after the chat with Doctor Grau, Tom was toying with a section of  $\frac{3}{4}$ -inch iron pipe. For no apparent reason he scratched a line and cut the pipe accordingly. Just before tossing these two pipe halves on the scrap heap, the thought came to Tom that the pipes might scoop up soil.

He hurriedly cut several more of the "spoons." Mounting them on a disk, he took it outside where he revolved it across some sand. The pipe halves bit into the sand, and it was evident they could attack compaction. It was also discouragingly clear that they would rip their way through turf.

Then one of the two brothers grabbed a hammer and attacked one of the pipe sections to see if a bend in the spoon would

make any difference. He stopped when the angle reached 15 degrees. The disk was revolved again and this time the bent spoon lifted out a clean core of sand. The brothers excitedly hammered the other spoons to the same angle and set the disk in motion. The result: a long row of cleanly cut cores of sand. Here was a way to ventilate the soil without ruining the turf. Here was the start of the West Point Aerifier.

The first greens keeper who saw the first handmade Aerifier snorted, "What in tarnation is that?" The first golf-club president shouted, "Get that thing out of here!" Even after people became enthusiastic on seeing an aerification demonstration, orders were slow to come. After a couple of lean and anxious years Tom Mascaro and his company were on their way.

Having discovered the advantages of producing a needed turf-grass tool, Tom Mascaro went looking for another equipment gap that golf-course superintendents wanted filled. He found that there was a serious problem on most putting greens because of the accumulation of old grass leaves. Regular mowers, making the standard horizontal cut, control the height of the grass. But they can do nothing about the runners and long grass blades that don't grow upright. Rakes didn't do the job. The need was for a vertical mower that could cut loose the runners and slice off the blades missed by horizontal mowing. To fill this need West Point Products developed its Verti-Cut machine.

Another look at golf courses showed Mascaro that the No. 1 problem which remained was caused by water. The superintendent's carefully planned water-management program becomes useless when nature takes over. Not only is play disrupted but the sensitive grass used on the velvetlike greens can be destroyed in a matter of hours when high temperatures and a blazing sun follow a downpour. The sooner the excess moisture is removed, the better it is for the green and for the golfer. Also, mowing, which superintendents want to do early in the morning before many golfers arrive, is best done when the turf is dry. Yet early morning dew prevents proper mowing.

To remove excess water from putting greens and other turf-grass areas, West Point Products now has the Aeri-Dryer. Self-propelled, it attacks surface moisture with its 24-inch-long sponge roller. To keep the sponge water-hungry, a wringer whisks the water to a removable reservoir.

The company is confident the Aeri-Dryer will make its way to baseball fields, grass tennis courts, football gridirons and many other turf areas in addition to its first target, the putting greens. ★ ★ ★

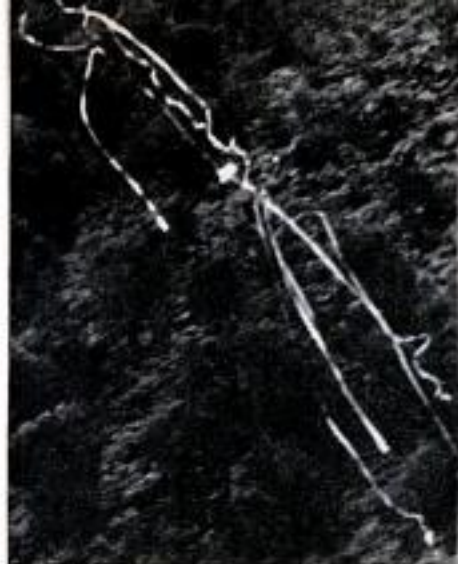

## "Yellow Spider" Streamers Point to Crash Victims in Jungle

Strips of yellow plastic, jettisoned from an aircraft immediately before it crashes in the jungle, will assist rescuers. Contained in a canister fitting in the tail of a plane, these "Yellow Spiders" are coupled to small parachutes and fall in the shape of arrows pointing to the crash. These perforated pieces are visible from 1000-foot alti-

tude even at dusk. From 1500-foot altitude the streamers look like yellow blobs on trees. The strips are 18 inches wide and can be precut between 500 and 1000 feet long. If a pilot is conscious, he can fire the streamer unit; if the pilot is unconscious, the unit fires automatically when the plane strikes treetops in the jungle.

## Self-Use Oxygen Inhalator

Oxygen from a portable, one-pound inhalator and resuscitator can be self-administered. Manipulating two thumb-size cylinders, a person can make six liters of pure oxygen available in the rebreathing bag within seconds.



## Built-in Measuring System Assists Jig-Boring Machine

To assist in the manufacture of precision-control parts for small gas-turbine engines used by the U. S. Navy and Air Force, General Electric has developed a jig-boring machine with a built-in measuring system. After determining the desired distance between points where holes are to be drilled, the machine's optical measuring system takes over and assures accurate spacing. The machine operator sees the measurement made by the machine reflected on a screen by means of a photoelectric indicator. The machines are accurate to  $\frac{1}{40}$  the diameter of an average human hair (about  $\frac{1}{100,000}$  inch).



# OWNERS REPORT:

We asked Plymouth owners in these 28 states about their new cars. Here is what they had to say:



Right now, I think my next car will be a above average  Above average  Average  Poor

18. Over-all, I rate this Plymouth as Excellent  don't like  this. Why? Looks and stability

19. The Plymouth is very low. I like  don't like  this. Why? Looks

The Plymouth is very long. I like  don't like  this. Why? If you need it - you have it!

The Plymouth is very fast. I like  don't like  this. Why? Help me when backing + they look nice

20. I like  don't like  the tailfins. Comment: Help me when backing + they look nice

Write additional comments on reverse side. Your name will be held in confidence.

MAIL PROMPTLY IN ENCLOSED POSTPAID ENVELOPE TO:  
 Popular Mechanics Owners Poll, 200 East Ontario St., Chicago 11, Illinois  
 City [redacted] State Missouri  
 Occupation Farmer

17. I traded a 1957 ply (year and make) to buy this car. The trade-in allowance was above average  Above average  Average  Below average

18. Over-all, I rate this Plymouth as Excellent  Average  Poor

19. The Plymouth is very low. I like  don't like  this. Why? Hard to get in + out

The Plymouth is very long. I like  don't like  this. Why? Hard to park

The Plymouth is very fast. I like  don't like  this. Why? Not fast on pickup

20. I like  don't like  the tailfins. Comment: too easy to damage + expensive to repair

Write additional comments on reverse side. Your name will be held in confidence.

MAIL PROMPTLY IN ENCLOSED POSTPAID ENVELOPE TO:  
 Popular Mechanics Owners Poll, 200 East Ontario St., Chicago 11, Illinois  
 Name [redacted] State New York  
 Occupation IBP Operator

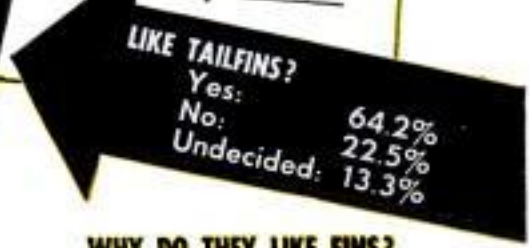

**WHY DO THEY LIKE FINNS?**  
 Help in parking  
 Look stylish  
 Stabilize car

**WHY DON'T THEY LIKE FINNS?**  
 Too big, bulky  
 Easy to damage  
 Block rear vision





# Plymouth Owners Praise Handling, New Styling

By Plymouth Owners

**I**F THIS IS THE YEAR of the tailfins, it should be a great year for Plymouth.

Plymouth has tailfins and, *PM* learns in its survey of Plymouth owners from coast to coast, its tailfins are well-liked by the folks who buy the cars.

Nearly two thirds of the owners like the canted rear fenders, 22.5 percent do not and another 13.3 percent are undecided on the subject.

Here are some typical owners' opinions:

"Tailfins are attractive and distinctive."—Virginia federal employee.

"Fins help in backing and are very stylish."—New York owner.

"I like the lines but at times the fins are annoying."—New York telephone clerk.

"I like tailfins, but not Plymouth's."—Ohio barber.

"Did not like them at first, but would miss the tailfins now that I'm accustomed to them."—Colorado owner.

"Don't like fins. May require lots of repairs."—New Jersey businessman.

"Plymouth should lower the fins. You see them in the mirror and can't see the road. They are nonsense."—Michigan cook.

## Best-Liked Features

This being a year of major styling change, you would expect Plymouth owners to rate exterior styling first on the best-liked list. But handling ease, long a Plymouth attribute, tops the list with over 40 percent mentioning it. Second is styling with 31 percent and third is riding comfort with 28 percent.

Here are some quotations to illustrate the owners' likes:

"I like handling. Taking corners or traveling corkscrew roads is effortless."—Ohio machine operator.

"Can drive cross-country day after day and feel no fatigue. No road shock."—Missouri painting contractor.

"Plymouth has the best styling of any car on the road. It's terrific. Out of this world!"—New York salesman.

"Revolutionary styling. Smartest looking car on the road."—New York owner.

"Crisp lines."—Michigan draftsman.



Owners approve the new Plymouth styling, but top praise goes to its fine handling. Acceleration is far down list

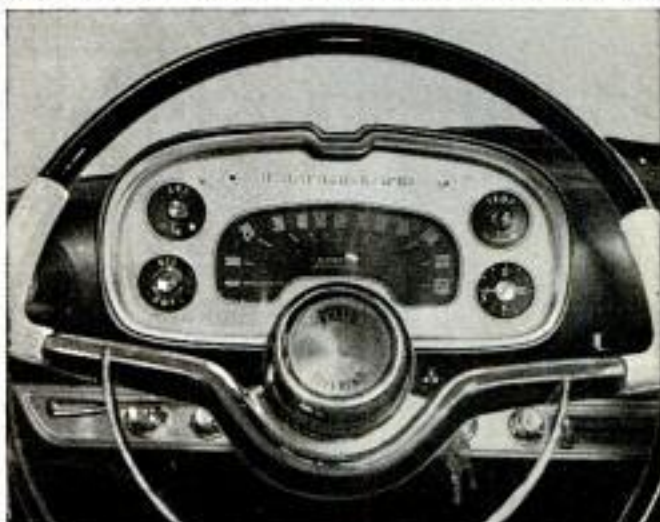

Best-liked interior feature is the neat, easy-to-read instrument panel. Least-liked is the rear-view mirror



Above, there's the view the driver gets when backing up. Tailfins act as reference points for close maneuvering

Below, high on list of complaints is the difficulty of getting in and out, especially for rear-seat passengers





ORIGINAL GRILLE



CURRENT GRILLE

Above, Plymouth changed the styling of lower front grille early in the model run. Here's the difference. Owners put that part of grille on least-liked list



Above, the transmission hump makes the center of the front seat uncomfortable, say owners. Seat is a mere 4.2 inches high there. Below, another complaint is the location and design of glove compartment (arrow)



"Looks like a much more expensive car."  
—New Jersey postman.

"Smooth ride without dip or sway. Certainly takes the wrinkles out of back-country roads."  
—Maine minister.

"Rides very well. I go over rough country roads every day and can say it is very good. I have gone 65 miles per hour over these roads and haven't hit bottom yet."  
—South Dakota rural mail carrier.

### Most-Frequent Complaints

Plymouth owners complain more often this year than last. Only 22 percent of the 1957 owners made no complaints at all compared with 32 percent in 1956.

Despite the major body change, the most-frequent complaint involves the engine and especially the six-cylinder model. This is the first time in years that engine trouble ranks highest on the complaint list. The troubles mentioned by the owners are usually not serious, but are annoying and inconvenient. This owner, however, is an exception:

"This six-cylinder engine gave me no service whatsoever. I spent half of my time at the garage. Had bearings changed twice and the engine changed once. When the second engine blew up, I took the car back and the dealer gave me full allowance on a De Soto which I now have."  
—Maryland inspector.

"I have returned the car at least eight times, especially for low-speed miss and hard starting. Installed a '56 carburetor and a new coil. This seems to have corrected the trouble."  
—New Jersey six-cylinder owner.

"Hard starting in cold weather. Twelve-volt battery wears down too fast."  
—North Dakota V8 owner and farmer.

"The reason my car (six-cylinder) would not start when cold was a faulty coil. After trying five that did not work, the sixth one works fine."  
—Maryland crane operator.

"Car (a six) wouldn't start when cold

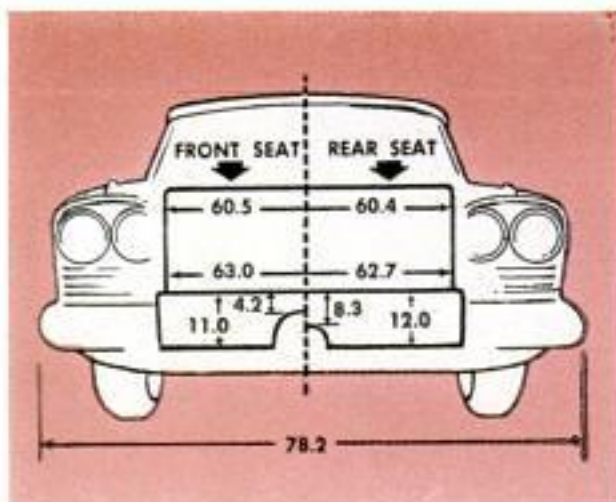

# The OWNERS' OPINION of the PLYMOUTH

## Had trouble with engine?

No trouble.....	70.7%
Some trouble.....	21.8%
Considerable trouble....	7.5%

## What was the trouble?

<b>Six-cylinder owners:</b>	
Coil .....	11.3%
Carburetor .....	9.6%
Stalling .....	8.1%
<b>V8 owners:</b>	
Stalling .....	4.8%
Carburetor .....	4.8%
Oil leaks .....	2.3%

## Performance

### Would like faster acceleration?

Yes, would .....	23.4%
No, would not.....	68.6%
Undecided, no answer...	8.0%

### Would like more top speed?

Yes, would .....	8.0%
No, would not.....	68.1%
Undecided, no answer...	23.9%

### What is car's horsepower?

Knew horsepower .....	42.0%
Did not know.....	58.0%

## Styling

### Like Plymouth tailfins?

Yes, do .....	64.2%
No, do not .....	22.5%
No answer .....	13.3%

### Best-liked exterior feature?

Front grille .....	20.7%
Low body .....	17.6%
Tailfins .....	17.0%
Dual lights .....	9.0%

### Least-liked exterior feature?

Tailfins .....	14.4%
Lower front grille.....	8.0%
Body too low.....	3.2%

## OVER-ALL RATING

Excellent	Average	Poor
69.1%	25.4%	5.5%

### Best-liked interior feature?

Dashboard .....	26.1%
Upholstery, fabric.....	13.3%
Seat design .....	5.3%

### Least-liked interior feature?

Rear-view mirror .....	10.1%
Glovebox inconvenient..	9.0%
Seats too low.....	6.4%
Floor hump .....	5.9%

## Miscellaneous

### What car will buy next time?

Plymouth .....	54.8%
General Motors make....	8.5%
Another Chrysler make..	6.9%
Ford Motor Co. make....	2.1%
Other makes .....	3.2%
No answer .....	24.5%

### How is dealer service?

Excellent .....	44.3%
Average .....	38.4%
Poor .....	17.3%

### Would buy from him again?

Yes, would .....	50.0%
No, would not.....	20.3%
Undecided, no answer...	29.8%

### What make car was traded?

Plymouth .....	45.2%
General Motors make....	14.9%
Another Chrysler make..	11.2%
Ford Motor Co. make....	8.0%
Other makes .....	8.0%
No trade, no answer....	12.8%

## What should be changed?

Nothing at all.....	22.3%
Rear tailfins .....	6.9%
Improve gas economy....	5.3%
Rear-view mirror.....	4.3%
Floor wells, hump.....	3.7%
Improve body work.....	3.7%
Shorten it .....	3.2%
Redesign ash tray.....	3.2%

## Best-Liked Features

Handling ease .....	40.4%
Styling .....	31.4%
Riding comfort .....	28.2%
Roadability .....	20.7%
Visibility .....	16.5%
Push-button transmission.	12.2%
Power, performance .....	10.1%

## Most-Frequent Complaints

None at all .....	22.3%
Engine troubles .....	24.5%
Water leaks .....	11.2%
Door locks, handles.....	8.5%
Hard to get in, out.....	8.5%
Poor assembly .....	7.4%
Rattles .....	6.9%
Cramped interior .....	5.9%

## Plymouth is very low

Like this lowness....	80.3%
Don't like it.....	17.6%
No answer .....	2.1%

## Plymouth is very long

Like this length....	75.0%
Don't like it.....	16.5%
No answer.....	8.5%

## Plymouth is very fast

Like this speed.....	77.1%
Don't like it.....	4.8%
No answer.....	18.1%

until dealer turned coil upside down."—New York electrician.

"Carburetor trouble on my V8 (\$95 worth)."—Maine salesman.

Second on the complaint list is water leaks with 11 percent reporting them:

"After a rain my floor mats, front and rear, and trunk are soaked so you can hear a squish when you step on them."—Connecticut inspector.

"Moisture forms in the trunk and stays there, keeping things wet."—New Jersey engineer.

Next on the complaint roster is the quality of door handles and locks:

"Lousy hardware as far as locks staying in place."—Minnesota salesman.

"One door lock fell off while being unlocked and another jammed and key could not be removed, locking us outside car while we were 30 miles from home late at night."—New York housewife.

"Doors can be opened from outside even if locked. Turn the key too far and you bust lock completely."—Michigan draftsman.

(Continued to page 244)

Plymouth has excellent interior dimensions despite extreme lowness. Owners do complain of the hump in floor

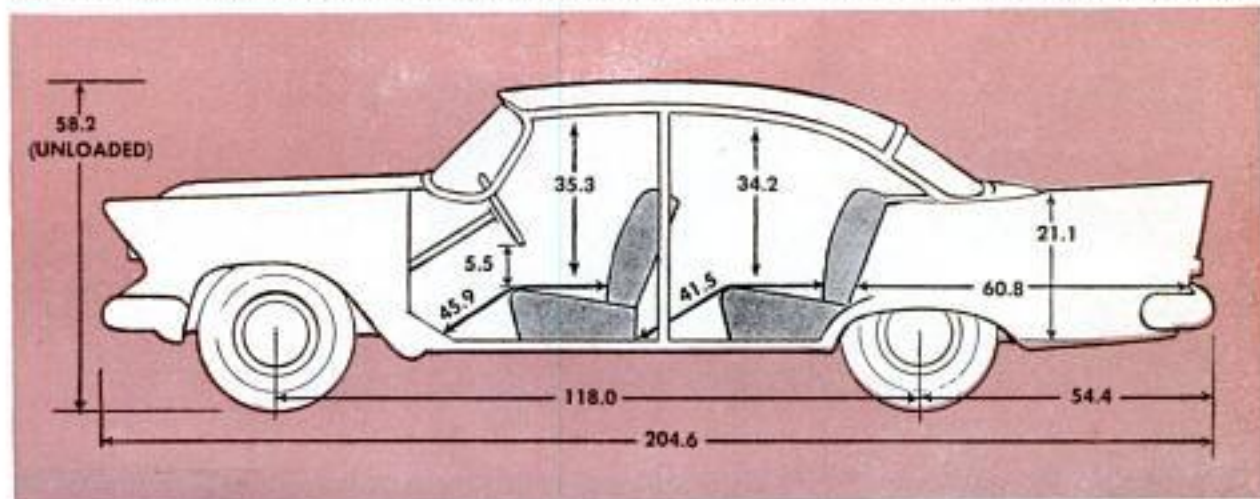



## Floating "Warehouse" Can Carry 2900 Short Tons of Freight

Hauling freight on the Atlantic Inter-coastal Waterway, a new barge is virtually a floating warehouse capable of carrying 2900 short tons of cargo. It is designed for push towing or pull towing. In the stern is a V-shaped notch which holds the

bow of a tug for push towing. The barge is 256 feet long, 43 feet wide and has an 11-foot draft when fully loaded. The covers for the cargo compartments can be telescoped to provide a single opening for almost half the barge's hopper length.



## Portable Radar Uses Its "Ears"

"Seeing with their ears," exposed ground troops now operate lightweight, portable radar sets to uncover enemy movements despite smoke, darkness or fog. These sets produce distinctive sounds when contact is made with vehicles or soldiers up to 6000 yards away. Data revealed include the direction of movement, elevation and range and whether the moving object is man or vehicle. Contained in a metal case 14 inches in diameter by 14 inches long, the unit has a lightweight motor generator for power. A two-man team carries and works the set and generator, which total 85 pounds. Most Army radar units weigh one ton or more.



☛ Amateurs in photography can now process their own Kodacolor film with a kit introduced recently by Eastman Kodak.

## Seaplane Take-Off Made in 175 Yards

Believed to be the first seaplane of its kind to receive a CAA approved-type certificate, the Helio Courier takes off at 15 to 30 miles per hour and will clear 50-foot obstacles after a run of 175 yards. It cruises at 139 miles per hour, yet can maintain level flight at speeds as low as 25, and lands at 20 to 25 miles per hour. The secrets of the plane's low-speed, stallproof flight are: An automatic leading-edge slat, which extends when the plane approaches stalling speed; high-lift slotted flaps on the trailing edge, and an all-moving, aerodynamically positive hori-



zontal stabilizer which replaces the usual elevators. Power comes from a geared 260-horsepower Lycoming engine turning a constant-speed propeller which provides extra thrust for short take-off.



## Automatic Dialing Assists Callers

Automatic dialing will save callers the trouble of dialing frequently used telephone numbers. A coded, tapelike directory apparatus contains up to 850 names and numbers, all located by an alphabetical finder with a hand crank. To make a call, the tape is turned to place the desired name in a viewing frame. Pressing a button results in automatic dialing of the number and conventional telephone contact.

## Turntable Car Carries Autos

German motorists wishing to avoid long drives check their autos with their baggage on the German Federal Railway. Driving his vehicle via turntable into a double-floored freight car, the motorist rides in a railroad passenger car to his destination and drives from the station. This service extends between Hamburg-Altona, Hameln, and Munich, and between Munich, Ostende and Brussels.



7000 FEET

6000 FEET

5000 FEET

# Slower Landings

 CONVENTIONAL JET

By Michael Gladych, Aeronautical Engineer

**T**HE MOTTO of the jet age is "faster." Already our fighters have overtaken the roar of their jets and now reach for the glass-melting heat barrier. Even the airlines are switching to powerful jets for more speed. But before we can go much faster, we must overcome another crucial barrier—we must make our hot speedsters slow down and land short.

Breaking the speed records, modern airplanes forgot how to slow down for landing. Small wings and powerful, heavy motors are the formula for speed—high speed, that is. To reach flying speed, a modern jet needs at least  $1\frac{1}{2}$  miles of runway. Coming in to land at 150 miles per hour, a fast "fire can" needs a drag parachute or a tough nylon net to bring it to a stop.

The slower jet airliners aren't doing much better. At New York International Airport, completed only a few years ago, present runways will be too short for the jetliners. And runways are costly—\$28,000 per 100 feet. A 1000-foot main-runway extension already planned will cost the taxpayers \$280,000. A similar extension at Long Beach, Calif., will come to \$450,000 dollars. All in all, over \$8,000,000 will be needed for longer runways to make room for the faster jets.

The plane builders are having problems, too. The Douglas DC8 jetliner has landing-gear problems. The gear will have to be beefed-up to take the impact. Of course this means extra weight and again higher landing speed.

"That's the penalty of progress," said an aircraft engineer. "You can't go fast and land slow, too."

That has been the aviation rule, but years of research in aerodynamics—and a few brainstorms—are now breaking in the fast jet broncos to a new way of flight. I. M. Davidson and his engineering colleagues of the National Gas Turbine Establishment in England asked themselves a question: "We've given airplanes tremendous power to make them go fast. Would it be possible to tap that power to make them slow down?" And they did just that.

## Jet-Engine Braking

The first step was to make the planes land short. This was relatively simple. Already there are several devices to make the hot jet gases blow *forward* on landing, thus providing a form of jet-engine braking with negative thrust. But this was only a partial remedy—it still left the problem of the long and fast takeoff.

Experimental Meteor has jet-deflection pipes beneath engine cowlings, enabling it to land in confined space

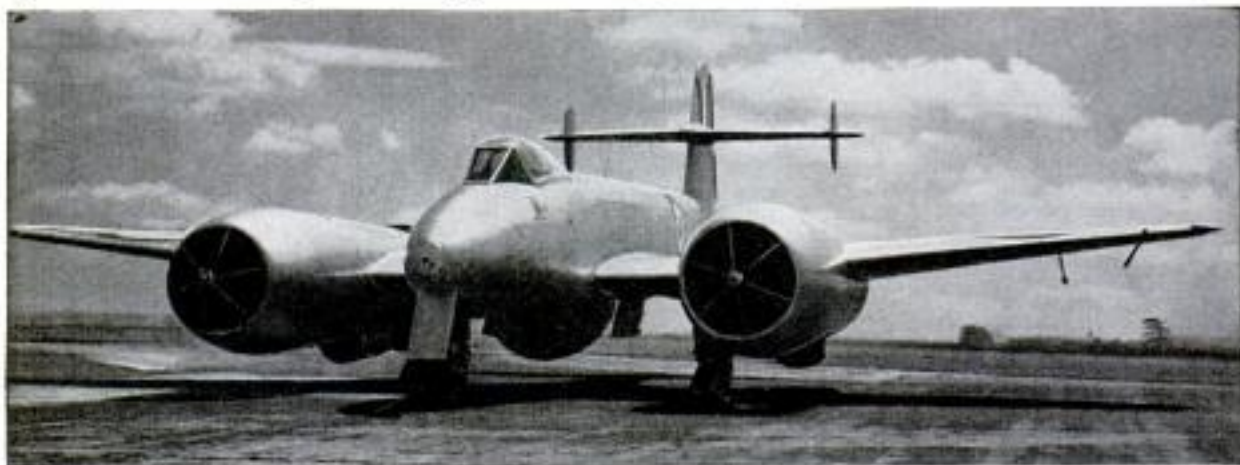

# for Jet Planes



JET FLAP

Diagram shows comparative landing and take-off areas of ordinary jetliner and a similar jet-flap aircraft

However, experiments with the jet-thrust reversal gave Mr. Davidson a hot idea. If the jet exhaust could be made to blow downward, it would offset some of the airplane's weight by providing an upward thrust. And a heavy plane, now made lighter, could slow down both for the take-off and landing. The result of this reasoning was a revolutionary concept of jet propulsion—the "jet flap."

Instead of shooting out the round tail pipe, the jet exhaust is piped to a long slot on the trailing edge of the wing. For level flight, the flat sheet of hot gases fires straight to the rear, giving a forward thrust and high speed. But for a take-off and landing, the gases are deflected down for an

"up" thrust plus an extra-high wing lift due to the jet-flap effect (Fig. D, page 134).

## Air Clings to Wing

The extra-high lift for landing had already been used in aviation under another guise. Some 40 years ago aircraft engineers came up with several high-lift, slow-flight devices. They were based on the so-called "boundary-layer control." The boundary layer is a one-inch-thick layer of stagnant air close to the airplane's wing. Air, the same as any other gas or fluid, has certain viscosity or stickiness. It clings to the wing surface. At flying speed, that clinging air of the boundary layer does the plane no harm (Fig. A). But at lower speeds, when

Compressed air is taken from jet engine of the Navy Panther and blown through slots over landing flaps

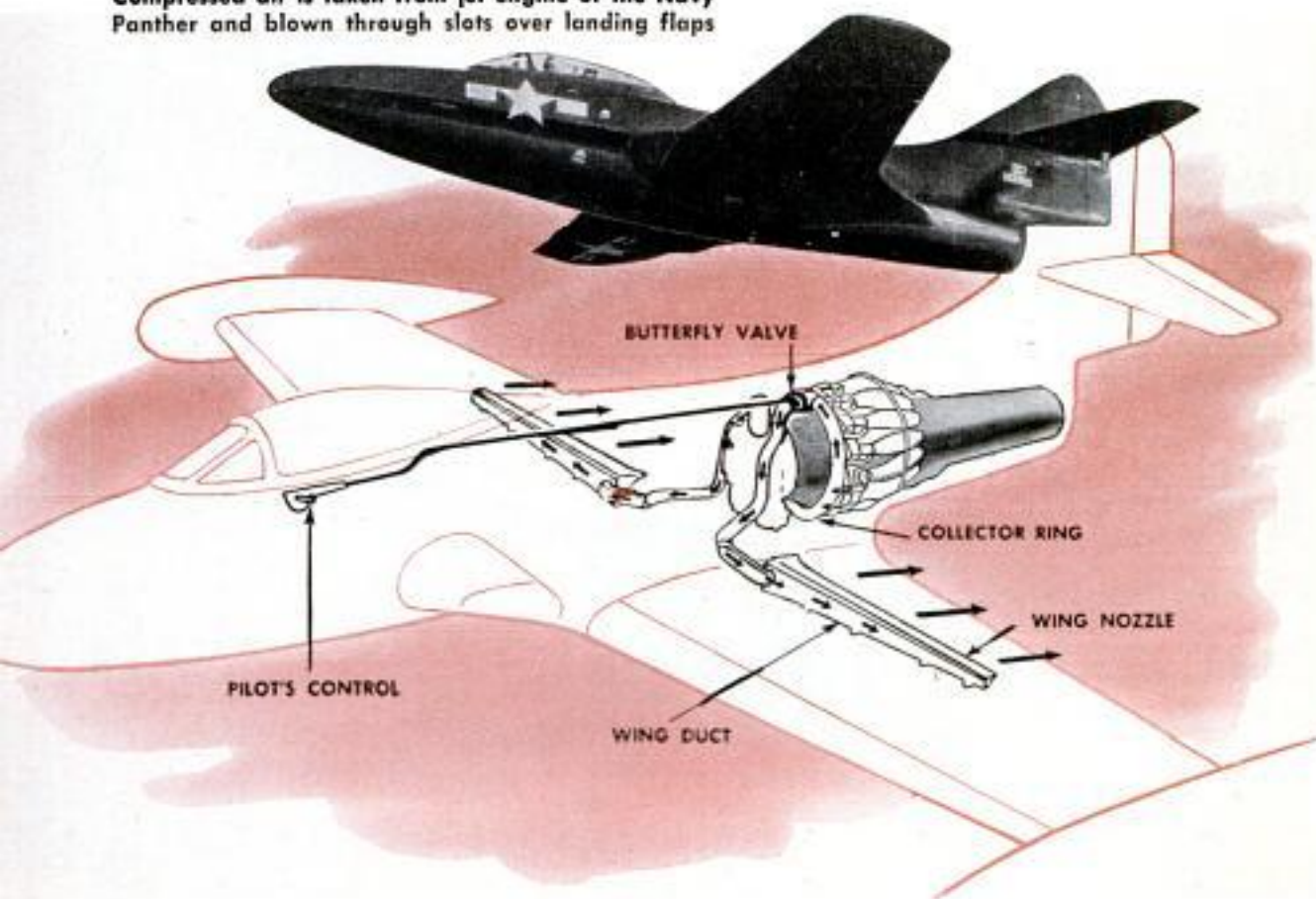

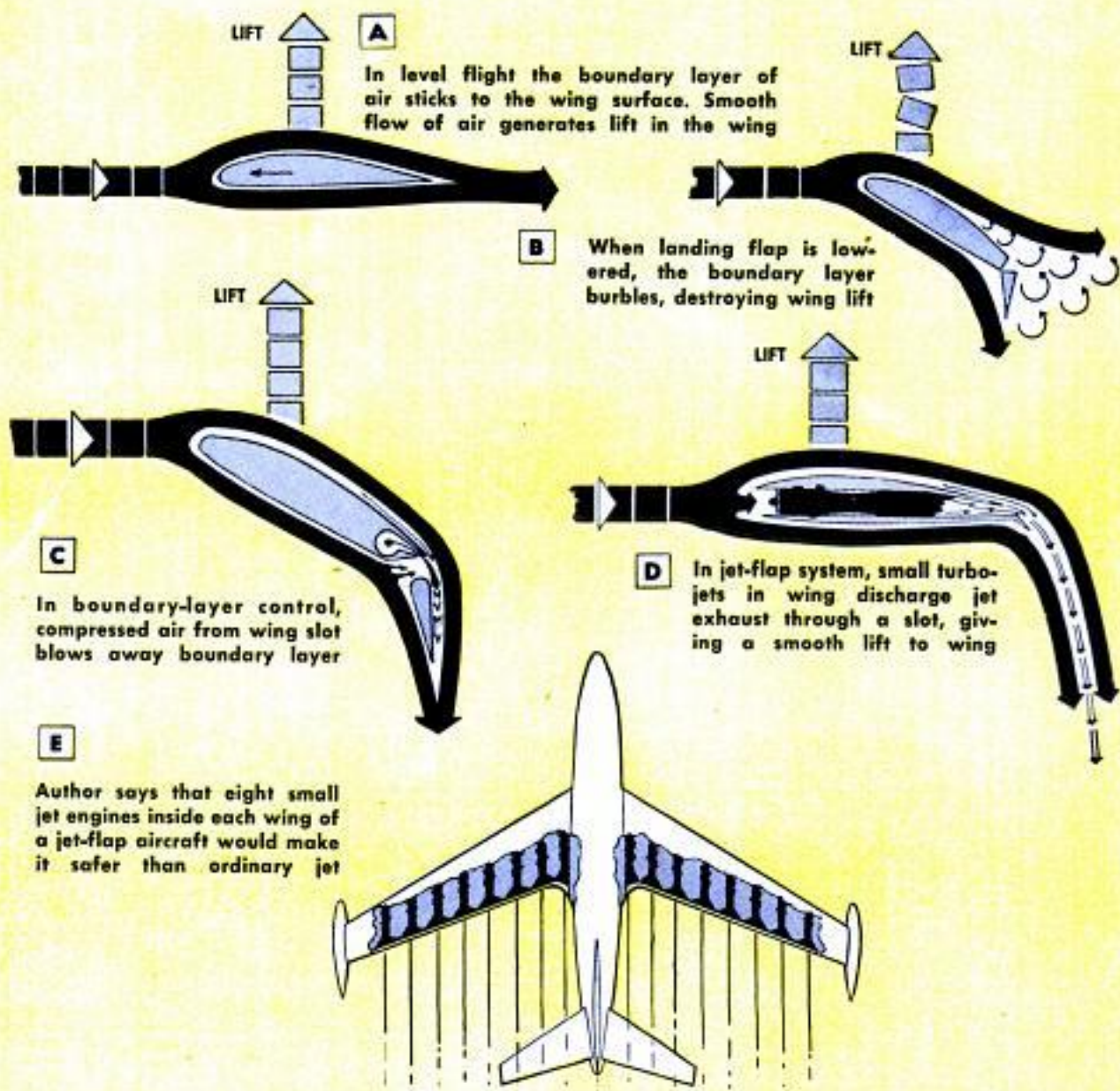
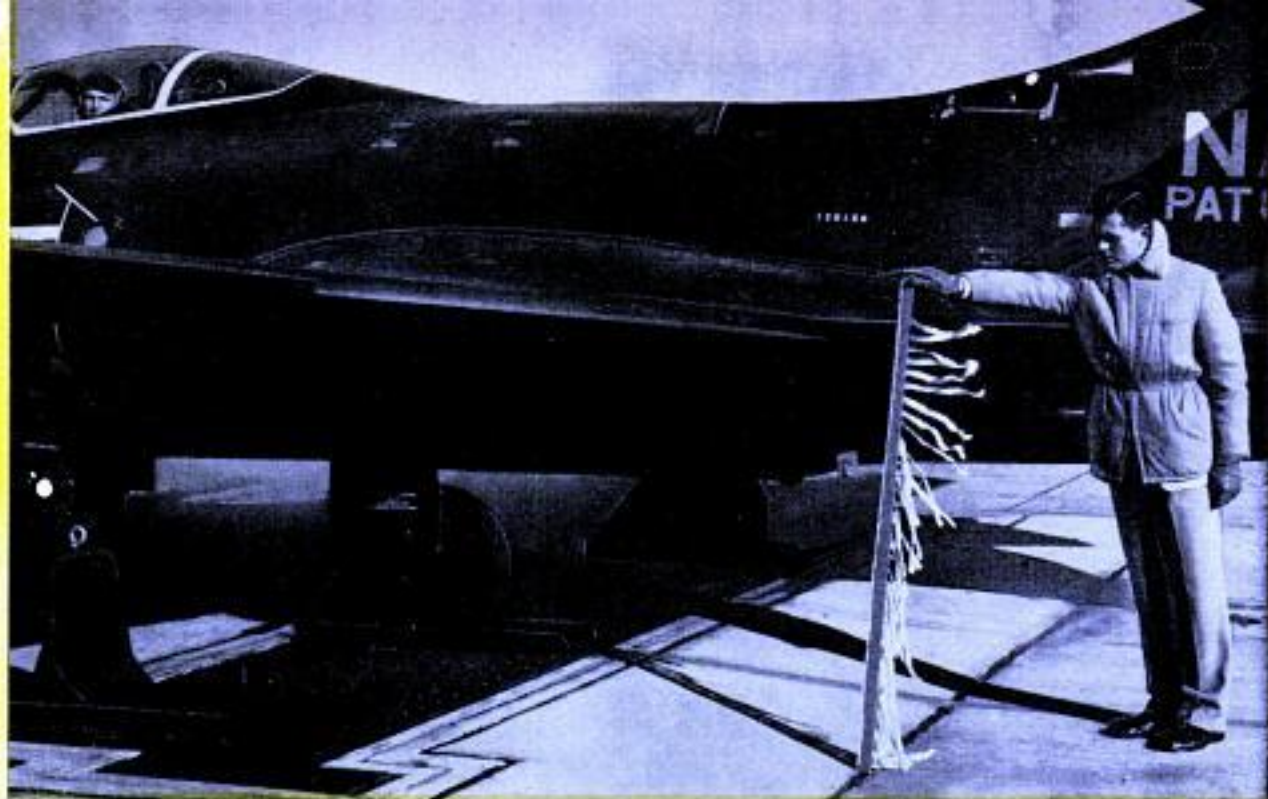



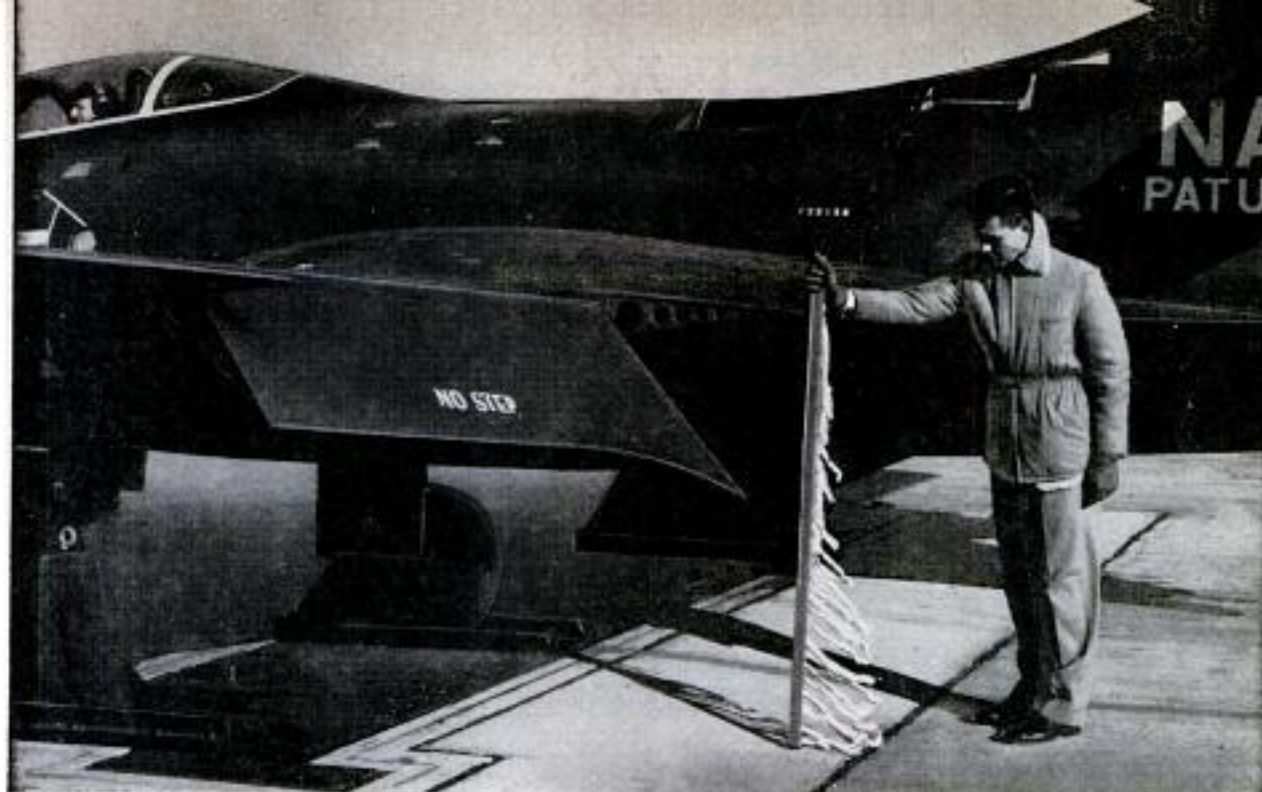

How the jet flap works on the Grumman Panther: In photo on the opposite page, flap is in the up position and affects only the upper streamers. Above, flap is fully deflected and air still follows the flap contour

the wing is at a higher angle, the stagnant air "gets unstuck"—burbles—pushes the air flowing over the wing away and upsets the wing's lifting power (Fig. B).

The problem was to get that boundary layer on the run. The first of many gadgets to do that was a leading-edge wing slat invented 'way back in 1918. Later came other devices. The lazy layer was sucked into the wing through small holes on the top of the wing, or was prodded by air jets fed from a special compressor. The latest such boundary-layer control was designed by John Attinello and used on the Grumman Panther—a shipboard jet fighter of the Navy. Now the Panther can land slower by 20 knots and carry an extra 3000 pounds of lethal hardware. To accomplish this, Attinello tapped the compressor of the Panther's jet, piped the air through thin slots into the wings and blew it out over the landing flap already extended (Fig. C).

#### "Hot Foot" for the Boundary Layer

And this is where the jet flap adds to the boundary-layer control. The jet exhaust rushing out the slot gives the boundary layer a "hot foot"—draws it on. Thus, the wing itself becomes more efficient—gets even more lifting power. Besides, the sheet of hot gases acts like the ordinary landing flap of the Panther or any other aircraft, only better. The air flow under the wing meets the jet flap and is deflected downward. This creates a pressure pushing the wing up. On top of the wing and behind the jet flap, a giant suction area pulls the wing up and the combination of that pull and push produces a tremendous lift.

In order to start the jet-flap effect, the aircraft must move forward first, but it doesn't have to go fast. A jetliner the size of the new Boeing 707 has to roll at 120 miles per hour before its wings produce enough lift to get it off the ground. The same jetliner with a jet-flap device would take off and land at 50 miles per hour. And the landing space for the flapping jets is no problem. Davidson claims that the jet flap will shrink the required runway length to a mere 300 yards.

#### Easier to Fly

A jet-flapped aircraft of tomorrow will be easier to fly, too. Instead of the intricate controls of ailerons, rudders and elevators, the pilot will control both aircraft attitude and speed with the engine-throttle controls. Reducing the thrust and tilting the jet flap on both wings simultaneously will make the aircraft descend. For climb, the pilot will just "pour on the coal" while deflecting the jet flap downward. To bank and turn to the right, he will direct the left jet flap down; the reverse will produce a left-hand bank and turn.

A jet-flap aircraft will also be safer. In order to produce an even sheet of jet exhaust over the wing span, there will be several small turbojets buried in each wing instead of the usual two or four big engines (Fig. E). A power failure on one of the present jets may be fatal, but one or even more smaller engines out of commission will not affect the power seriously.

The "lazy boundary layer" and the jet flap may yet solve the problem of slower landing speeds. ★ ★ ★

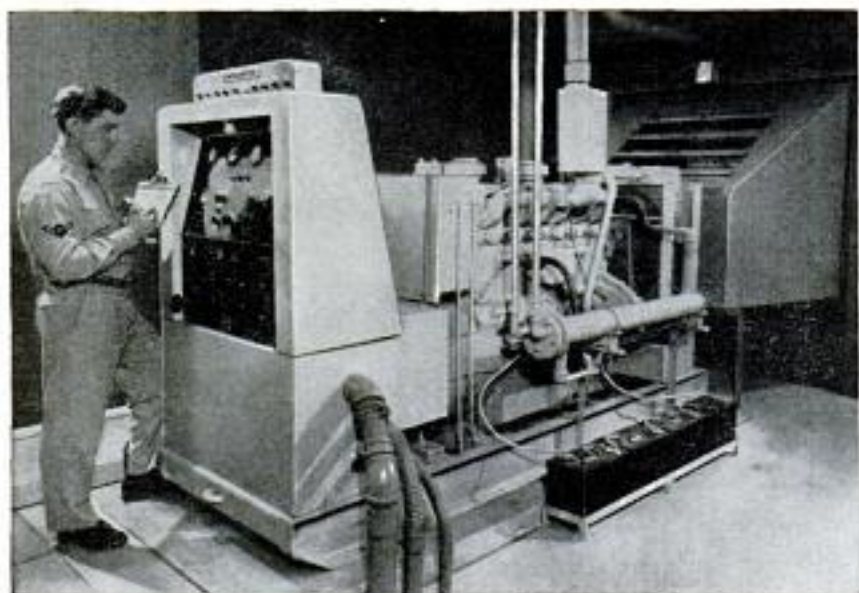

## Diesel Plants To Aid Defense

Automatic diesel power plants will provide energy for four fifths of all unmanned, gap-filler radar installations in this country's SAGE (Semi-Automatic Ground Environment) defense system. Each diesel plant will monitor itself, take measures to remedy any power failure, and will notify personnel at a control center miles away of trouble encountered or new parts needed.



## Canoe Catamaran For Fishing, Hunting

Looking more like a waterborne speaker's platform than the canoe catamaran it is, a homemade craft in Canada's Laurentian Mountain lakes serves for fishing, hunting and hauling. Ken Harrison, Canadian hotel official, built the catamaran by bolting the corners of a plywood rectangle to the gunwales of two canoes.



## Amputee's Bike

Robert "Butch" Tipton of McConchie, Md., has no arms, but he still can guide his special bicycle just by moving his shoulders. The bike is the result of six months' experimentation by 28 scientists at the Diamond Ordnance Fuze Laboratories, Washington, D. C. The 20-inch-high model has no handle bars and is steered by a breastplate and spring-tensioned shoulder harness which connects with a chain-and-sprocket device. Butch merely sits on the seat, pushes himself into the harness and pedals away in the direction he wants to go. With this bike he is as independent as other boys of his age.



*Material came from Pittsburgh from Glass*

## Cantilevered "Treehouse" School Is Attended by 770 Students

Classrooms for 770 students are suspended in mid-air at the Phyllis Wheatley School in New Orleans. A series of 12 cantilevered trusses holds up the 22-classroom building while providing 28,000 square feet of sheltered play area underneath. Built on

a two-acre site for students from kindergarten through sixth grade, the school consists of the raised, cantilevered structure for classrooms and an adjacent administration-assembly building at ground level for cafeteria, offices, clinic and lounge.

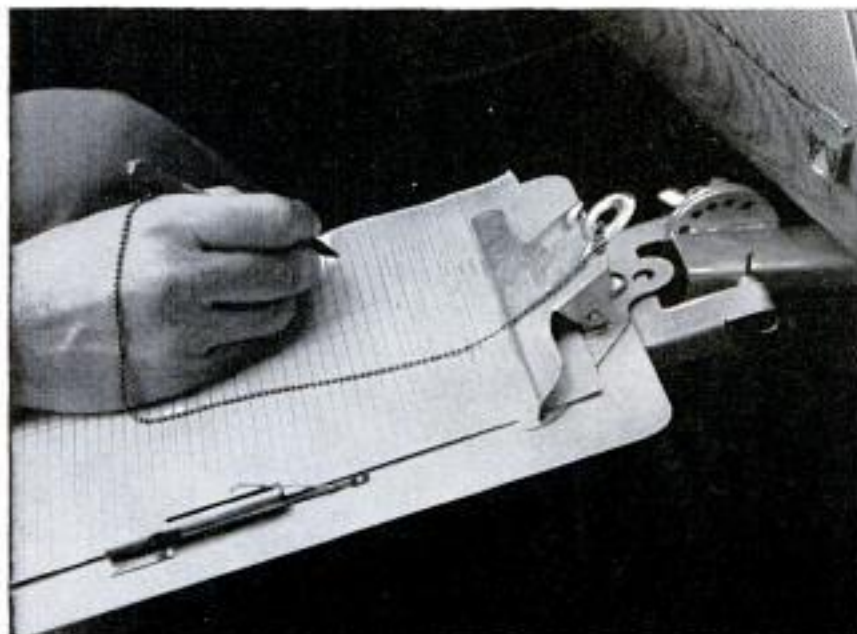

## Clipboard Desk Fastens to Car

Drivers needing a portable desk can attach an aluminum clipboard unit to the flange under the vehicle's dashboard. Eight by twelve inches in area, this desk has a one-inch-deep basket welded to its underside. A spring wire mounted in a pencil holder retains completed papers in the basket. The desk can be folded under the dashboard or extended for paperwork, and can also be slipped off its U-shape mounting bracket for use elsewhere.

## Tractor Turns In Its Own Length

J. I. Case Co. now makes 80 and 100-horsepower crawler tractors that turn almost in their own length. This tractor has a transmission that gives the operator independent control of each track in speed and direction. He moves two hydraulic levers, and one track drives forward and the other reverses to turn the tractor. A torque-converter drive and torsion-bar track suspension also are installed.





## Tiny Planes on Wires Show Factory Production

Production status of planes is shown by moving numbered metal models along horizontal wires on each side of an interior office window at Chance Vought Aircraft, Inc., Dallas. The window is marked as a chart to indicate various production stages through which each plane must pass. Persons in both rooms can see simultaneously the progress of a certain unit in fuel-system check, gun check, hydraulic, shakedown, preflight controls inspection and check flights.

## Bowling-Alley Set Is Portable

Weighing 20 pounds, a portable bowling-alley set with Bakelite polyethylene pins and two-pound ball can be enjoyed on any level stretch indoors or outside. The hollow pins are 15 inches in height. The ball has finger-gripping holes for large or small hands. Pins and ball are carried in the portable backstop. A triangular pin-spotting sheet is included in the set. Chalk, tape or lines scratched in the dirt mark off an alley.

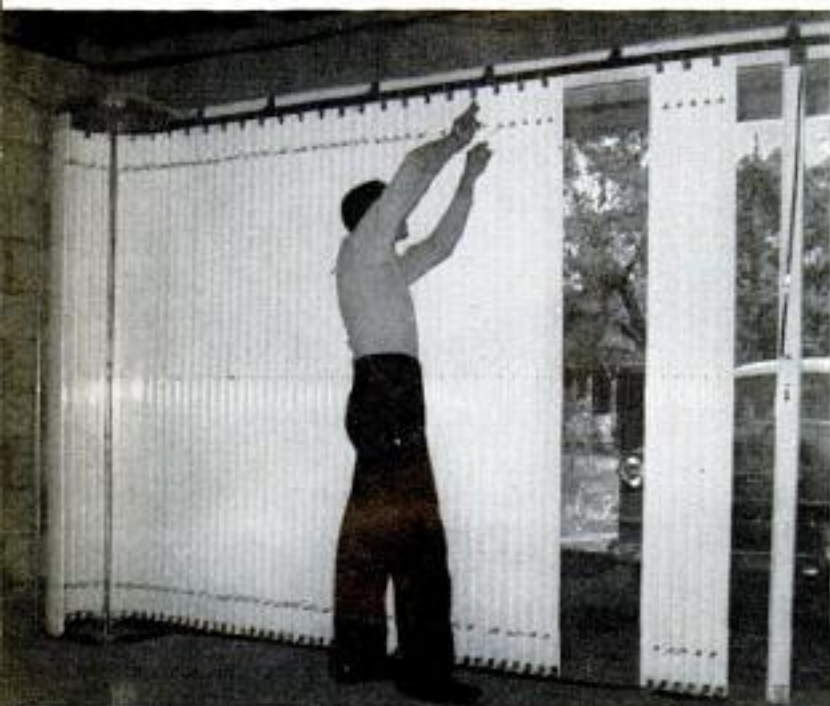

## Horizontal Rolling Doors Slide Into Small Space

Horizontally moving metal doors for home and industry slide easily around wall corners or into spiral storage space. Spiral doors require floor space 14 inches square in a corner. Wall doors need a six-inch-curve track radius in a corner, if used on a side wall. Each type of door must have four inches of headroom. In homes, spiral doors fit closures 9 feet wide by 9 feet high, and wall doors close spaces 18 feet wide by 9 feet high. Industrial doors partition spaces 14 feet wide by 12 feet high. Installed by one man in two hours, these doors move on adjustable monorail track. Exterior weather-proof coatings include zinc-coated steel, aluminized steel or baked enameled zinc-base steel.



Scientists pack plant specimens for shipment from base camp on Venezuelan river

**M**OST PEOPLE THINK of a botanical garden as a sedate little park, where flower lovers gather to admire the petunias or exclaim over a budding rose. Hardly the most exciting spot in town.

It's a grave error to apply such terms to the New York Botanical Garden. This world-famous institution has beauty, but it also has drama and adventure. It's a headquarters for men who plunge into steaming tropic jungles to track down unknown plants. They are conducting what may be the last great exploration on earth. It's also a headquarters for men who

Machine blasts seeds with ultrasonic waves. Seeds are planted to observe changes

## Headquarters for Jungle Explorers

By George W. Groh



Copyrighted material



As New York Botanical Garden explorers seek plants overseas, a Holland bulb show goes on at "home"

Dr. Alexander P. Anderson, Garden staff member, developed "puffed wheat" in this stove 55 years ago



seek exciting new uses for plants already known. That operation may turn up new sources of food and medicine for a sick and hungry world. And this garden combines the features of a great park, plant museum and botanical zoo.

The public sees only one phase of the operation—the flowering park—but that in itself is a spectacular show. The Garden grows and shows more than 300,000 individual plants (about 12,000 varieties), which have been gathered from every corner of the globe. It draws crowds ranging up to 1,500,000 a year. The Garden's real drama, however, is bound up in the research work which goes on backstage. Dr. William J. Robbins, director, says that scientists have collected and classified about 350,000 plant species, but an estimated 150,000 more are waiting to be discovered. Man has so far put only 1000 plants to practical use. All the rest represent a vast storehouse of still-untapped natural wealth.

During World War II, Garden experts taught our fliers how to find plant food, if forced down over jungle, desert or arctic waste. They also combed the wild regions of South America to find new supplies of quinine, rubber and other much-needed plant products.

The Garden's quinine scout was Dr. W. H. Camp, now with the University of Connecticut, whose mission led him to

Test tube held by Garden scientist contains a slice of infected carrot, which could give cause of cancer

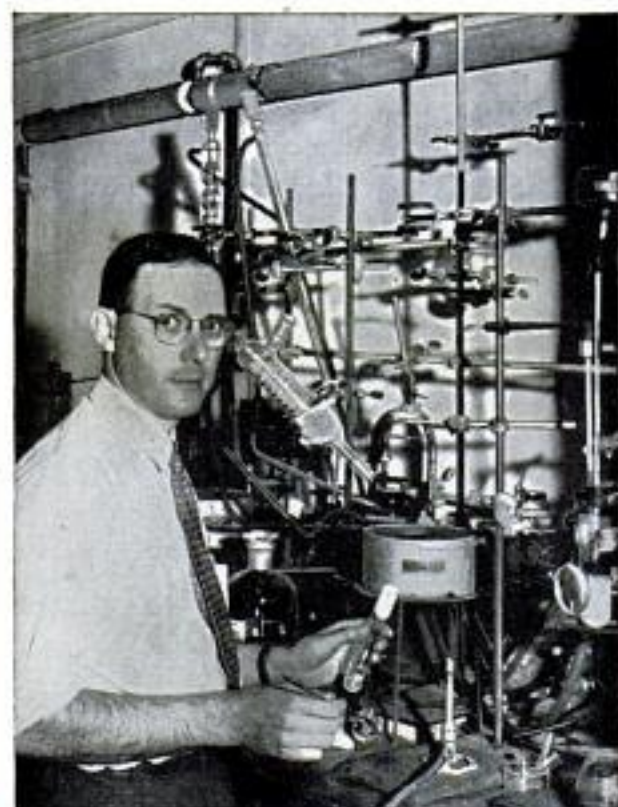

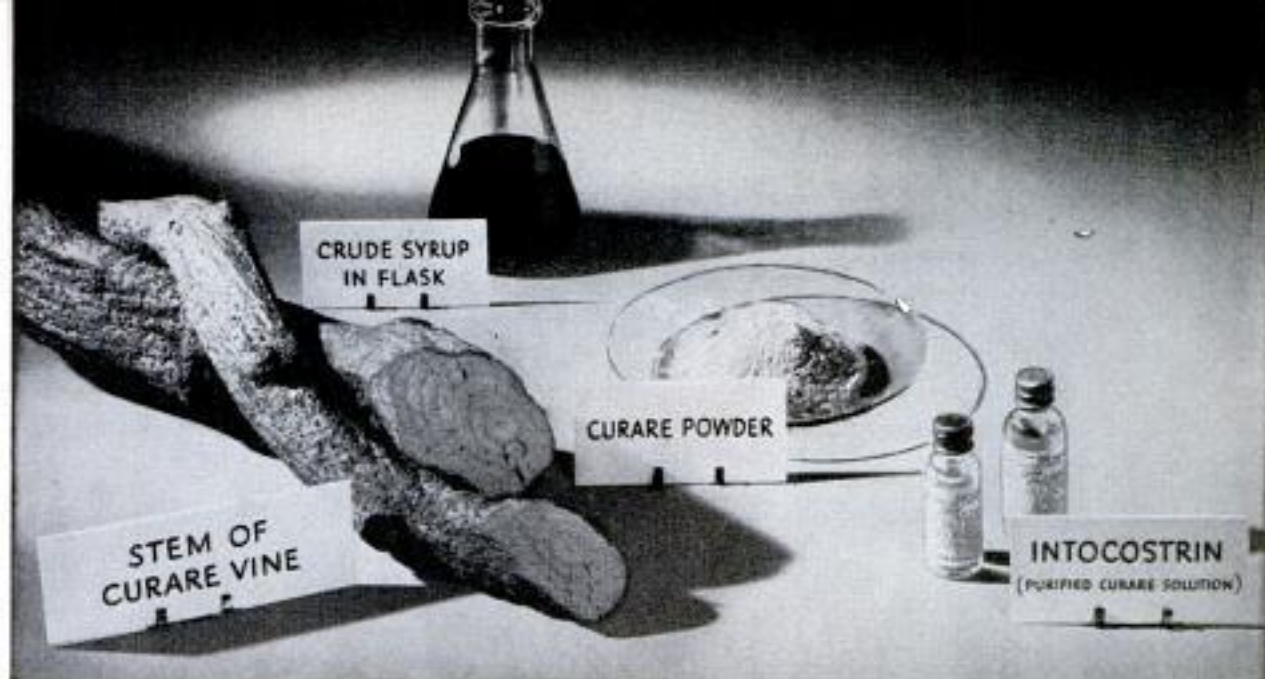

Curare is taken from vine, left, then converted into syrup or powder and refined into medicine, right

spend many months among the head-hunting Jivaro Indians of Ecuador. In Doctor Camp's case, that was even more reckless than it sounds. He sported a handsome crop of reddish, almost orange-colored hair on scalp and chin, and the Jivaros must have regarded his head as a real collector's item. They exercised admirable restraint; Doctor Camp found that a head-hunter, when not working at his trade, is as nice a savage as you'd care to meet. He described them as "a swell bunch of Joes."

Dr. Bassett Maguire, the Garden's chief plant hunter now, filled another defense

assignment just a few months ago. While working in the Venezuelan rain forest, he checked a theory that certain plants may act as natural geiger counters in indicating the presence of uranium ore. He filled another special order on the same trip by collecting 200 gourds full of curare, a deadly plant poison which Indians use to give their arrows a fatal sting. This 50-pound batch is a type previously unknown to science and is so powerful it could kill a million people. It's being checked at the University of Rochester in the hope of

(Continued to page 232)

Dr. W. J. Robbins, Garden director, examines curare gourds obtained by Doctor Maguire and Doctor Wurdack

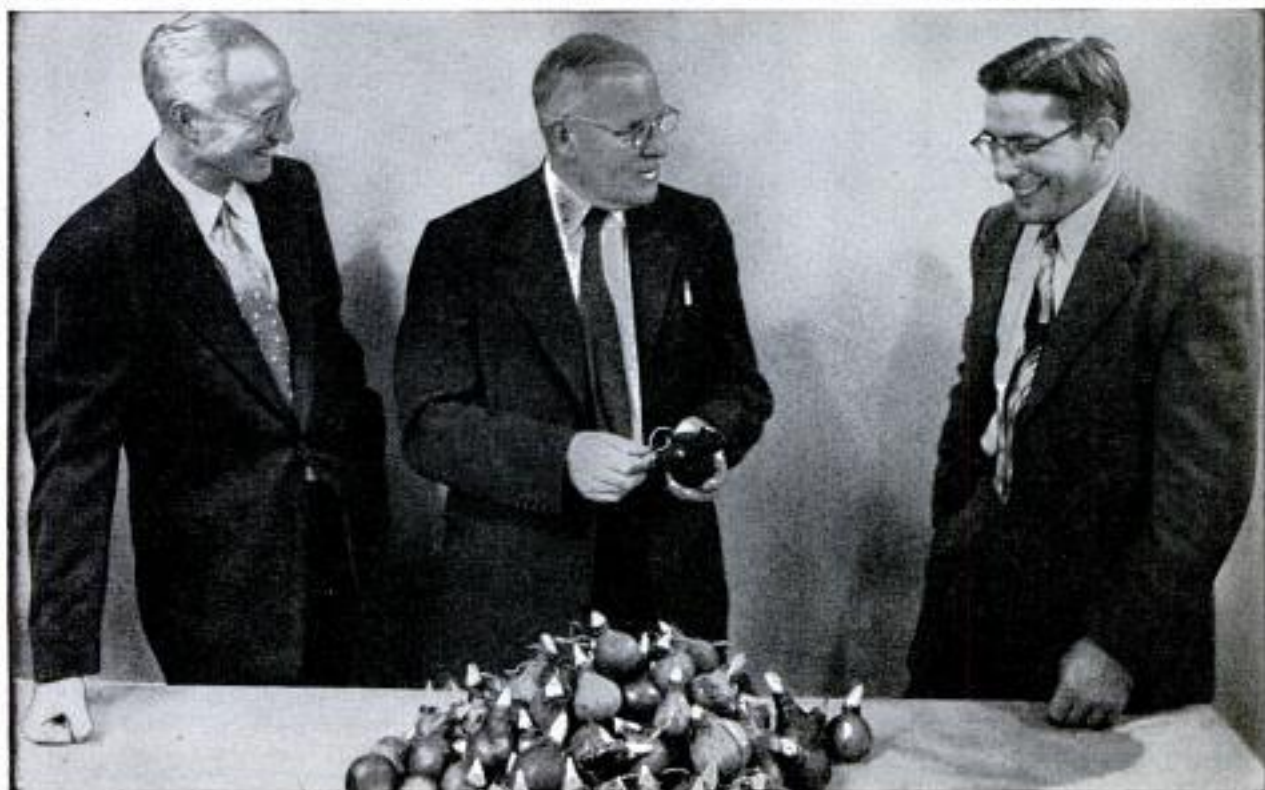



## "Tailed" Boat Comes in Kit

Amateur outboard-boat builders can assemble a model with "tails." The L. Dorado frame kit, made by Glen-L Marine Designs, Compton, Calif., includes plans and materials, with the exception of longitudinals and the plywood "skin." This boat is 13 feet long.

## Rear-View Mirror for Motorboats

Motorboat drivers, using a new rear-view mirror on their craft, can see 170 degrees to the rear and sides of their boat without turning their heads. The metal mirror has a universal swivel for adjustment and is screwed to the boat deck inside the windshield near the steering wheel.



## Plane Cushions Protect Passengers

Pneumatic safety cushions will give passengers in air crashes and forced landings a better chance to survive the impact. The plane's pilot, pushing one button, inflates every "crash pillow" in the aircraft in three seconds. These cushions are rubberized nylon bags weighing less than two pounds. They are stored in the back of each plane seat in normal flight, but during emergency inflation they fill most of the space between the passenger and the seat in front. The cushion is designed to protect the passenger's head, chest and legs.

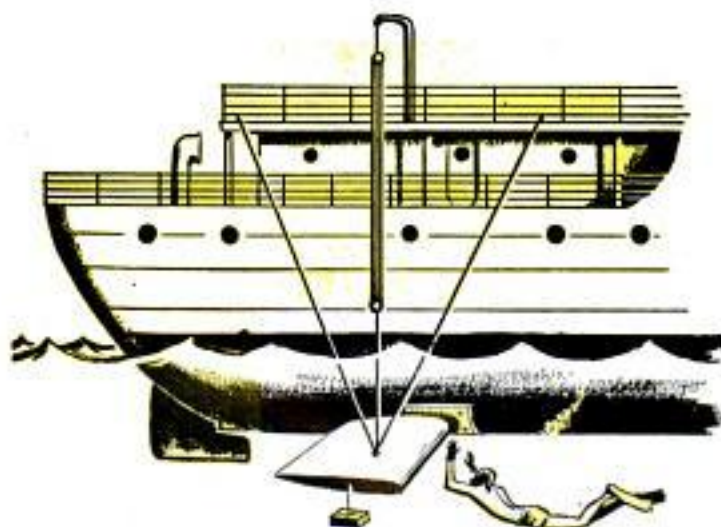

## Antiroll Fins Help Small Power Craft

Hydraulically controlled fin systems, installed on many ocean liners to reduce rolling, are being adapted to smaller craft measuring 50 feet or longer. The system consists of a pair of fins attached to the vessel's hull below the water line and a hydraulic gyroscope unit in the engine room, both of which are operated automatically from engine-room controls. On ships smaller than ocean liners, the fins can be installed or removed by a diver without docking or dry-docking the craft. Fins reportedly reduce 80 percent of rolling.





Windshield glass with older plastic interlayers at 375 degrees F. shatters when hit by foreign matter



Windshield with transparent-rubber interlayer holds glass in place after being hit by a sharp object

### Windshield With Rubber Interlayers Resists Supersonic Friction

Transparent rubber, serving as an interlayer in windshields of supersonic aircraft, may give these windshields ability to withstand twice as much heat from high-speed air friction as with present plastic interlayers. The rubber retains strength up to

350 degrees F., in comparison to the 180-degree-F. limit on current plastic substances. Shatter-resistant properties of the new rubber extend to minus 65 degrees F. This material has a silicone base and is cured at high temperatures.

### Miniature Car Has Clutch To Save Gear Shifting

Miniature cars with automatic clutches do not require shifting of gears. A touch on the accelerator and the vehicle starts. Weighing 675 pounds, these new vehicles are 72 inches long, 40 inches wide and 60 inches high. With an air-cooled, four-cycle gasoline engine, this automobile gets 50 miles per gallon and cruises at 30 miles per hour. Equipment includes a 12-volt electric starter, generator and lighting system, pneumatic tires, coil springs and reverse.

### Portable Electric Typewriter Weighs About 19 Pounds

Portable electric typewriters are good news for tired typing fingers. Weighing 18 pounds 10 ounces, the typewriter has an impression-control dial and has three automatic repeat actions. When the hyphen key, underline key or space bar is pressed, the typewriter automatically continues printing until the desired number of repeats has been obtained. A 110-volt, 60-cycle a.c. circuit is necessary. Raising of the housing over the keys automatically cuts off power.



# WHAT'S NEW FOR Your Home



**COOKING ODORS** (above), grease and smoke are destroyed by an electrically heated wire catalyst fitted into the center of a 12-inch-diameter aluminum cover. Without flame, the catalyst burns the objectionable by-products of cooking as they rise through the opening in the center of the appliance. The housewife plugs the appliance into an outlet before using; otherwise she uses the utensil as she would any other. The catalytic element can be ejected

Oxy-Catalyst, Inc., Wayne, Pa.



**ELECTRIC HONE** for kitchen, left center, or home shop puts a keen edge on cutting tools without grinding away excessive metal. Hone consists of permanent oilstone disk moved horizontally by a geared-down motor. The disk can be used on either side; one side is "fine," the other "extra fine." Slanted guide holds chisels at the right angle. A plastic cover for the hone has angled slots for holding tools at correct angles to get a standard bevel

Warren Sales Co., P.O. Box 161, Cranford, N.J.



**HOSE UNIT**, left, enables user to put out fires, wash the car or care for the lawn or garden. Twist of attachment produces a misty spray or solid jet. This fog nozzle has no internal parts and cannot clog. The unit is made of aluminum alloy and shock-proof plastic handle

Bete Fog Nozzle, Inc.,  
Greenfield, Mass.



**CHOPPER** for vegetables and cooked meats, right, works easily and consists of six sharp stainless-steel knives attached to a nylon-clutch spring plunger and enclosed in a shell or cup made of transparent polystyrene plastic. Juice and fumes remain in cup

Popeil Brothers, Inc.,  
14 N. Sangamon, Chicago 7



**RECORD HOLDER**, right, holds 90 seven-inch records. The holder measures 15 inches across with all records inserted. A locator record has titles and numbers of records keyed to numbers on top of the holder. A person refers to the locator for a certain record, spins the holder to that number and withdraws the desired record. The holder rotates on bronze ball bearings, has a brass knob for carrying and can be mounted on cabinet, door or wall.

Conrad Corp., 176 S. Atlantic Blvd., Los Angeles 22, Calif.



**BELT RACK**, right center, holds 30 belts, hanging by their buckles. It is not necessary to remove other belts to make a selection. Move the chosen belt to the center of the bar, slide a retractable latch and remove the belt. Release of the latch instantly closes the opening. The belt rack, polish-finished in chrome, is fastened to the wall or door with two screws. The continuous-bar arrangement makes selection of a belt very convenient and timesaving.

Omnitech Co., 811 47th St., Brooklyn 20, N. Y.

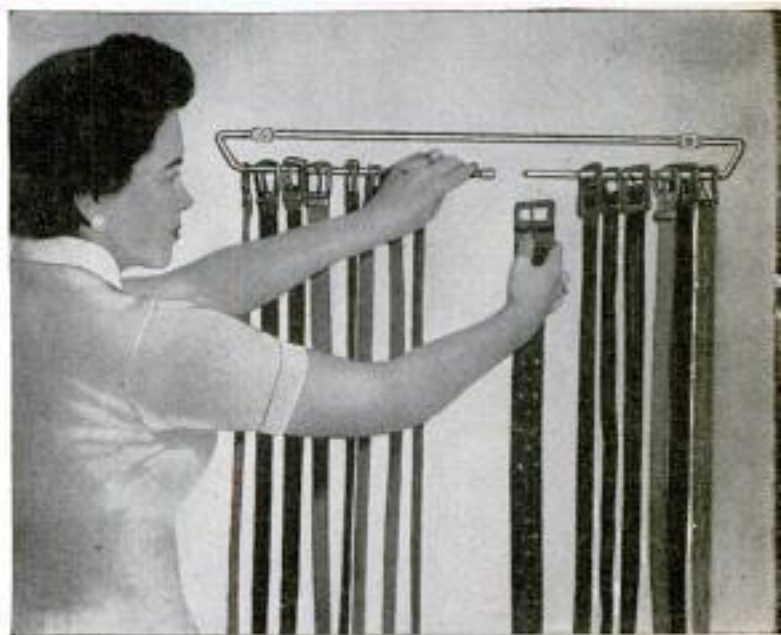

**CLOTHES RACK**, below right, is large U-shaped rod which slips on the end of the ironing board without requiring tools, screws or bolts to install or hold it in place. The rack can hold 20 garments at a time and will not harm the pad. When ironing has been completed, the housewife can slip the unit from the board and use it to carry ironed items to a closet. Clothes, hung on standard hangers from this rack, hang clear of the actual ironing work area.

Post-House, P.O. Box 176, Camden, N.J.

**CLOTHESLINE TIGHTENER**, below, can be used on flagpole and awning lines, for overhead ladder storage, to anchor or secure boats, for truck tarpaulins, dog runs, game nets and tents. The unit is made of steel. Any size rope up to 7/16-inch can be drawn tight in this device. The tightener can be mounted with rust-resistant screws on almost any object. Pull the rope in the fastener and the rope holds; it can be detached in one or two seconds.

Efess Distributors, Dept. 301, 3017 Moffat Rd., Toledo 6, Ohio





## Flexible Plastic "See Through" Double Doors Prevent Collisions

Translucent plastic doors eliminate collisions caused by conventional swinging doors. The double doors consist of draft-proof, self-closing flexible panels hung from steel-tube frames. They cover doorways up to eight by six feet in area. A

smooth-grained surface conceals scratches and is unaffected by dust, oily substances, most chemicals and weathering. The doors can be cleaned with soap and water or polished with hard wax. They are for warehouses, hospitals, restaurants and schools.

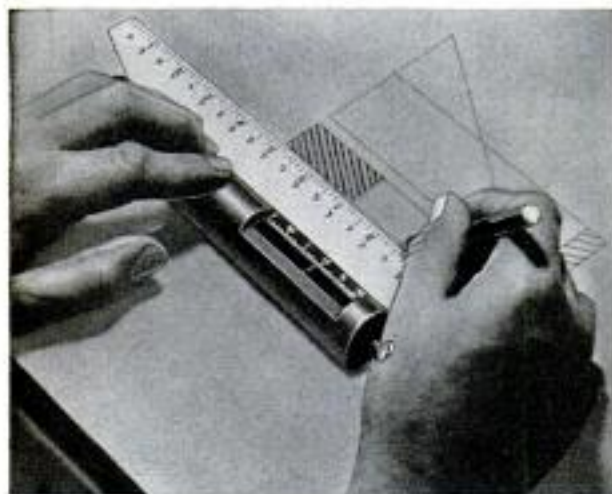

## Ruler on Wheels Cuts Work In Drawing Parallel Lines

Parallel lines can be drawn quickly with the assistance of a new ruler on wheels. A cylinder underneath the ruler has a wheel at each end. As the ruler is rolled along the drawing board, the edge is always parallel to the last line drawn. A spiral wire around the cylinder serves as an index line, measuring on a scale the distance that the ruler has been rolled. Holes spaced every half inch easily permit lines to be drawn at right angles to the edge of the ruler as the convenient drawing device is rolled across the board.

## Giant "Dishpans" Locate Deep Crevasses in Greenland Ice Cap

A series of experiments by the Engineer Research and Development Laboratories, Fort Belvoir, Va., has involved the use of special detection equipment to locate dangerous crevasses in the Greenland Ice Cap area

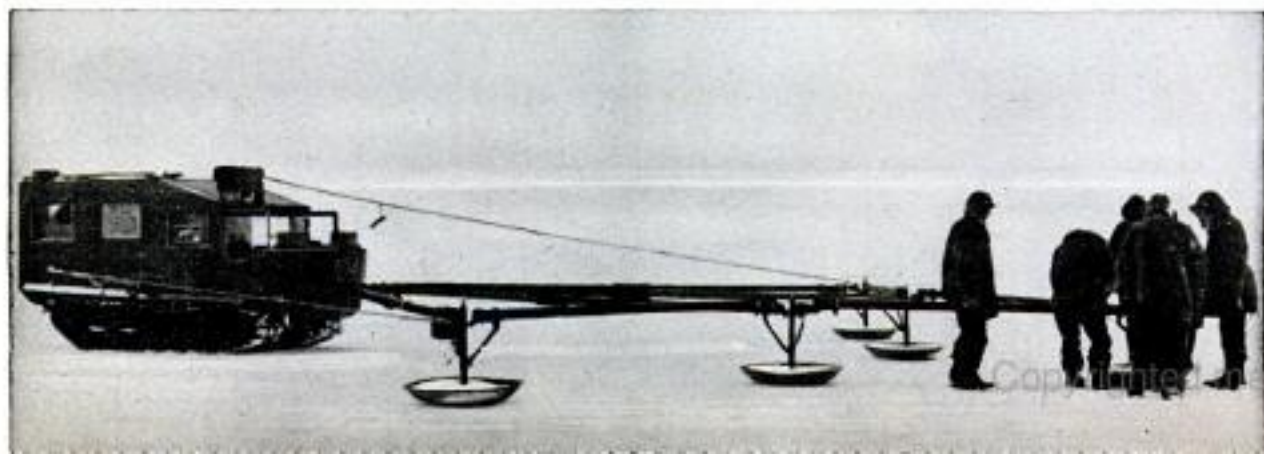

## Model Steam Engine Serves as Trash Burner

Love of bygone steam-engine days has prompted O. W. Strand of Clarissa, Minn., to build a model steam engine that burns trash. The engine's tank is an old hot-water heater. One end pulls out as a huge sliding bin containing trash and fire bed. A round metal can is the "boiler" at the front of the engine, while grain-binder wheels serve as traction wheels. Typical levers, wheels, a pressure gauge and an operator's platform are installed for realism.

## Machine Translates Russian to English

Engineers at the University of Michigan have developed a system in which an electronic computer translates Russian papers into readable English. It is not necessary to edit the Russian paper before placing it in the machine.

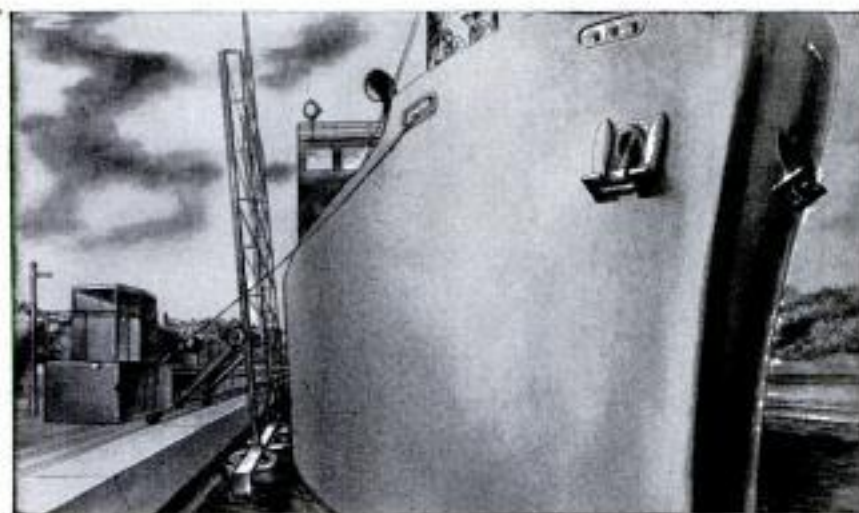
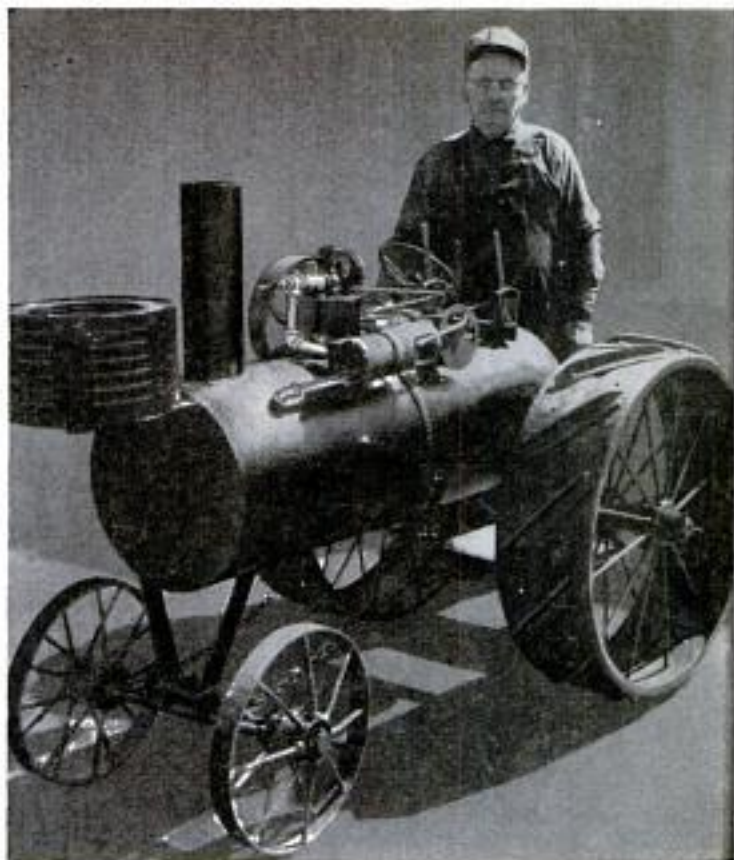

## Superlocomotives Tow Canal Ships

More powerful locomotives will speed ships through the Panama Canal. Each towing locomotive has a 75-foot boom that deposits towlines on a ship's deck as the vessel approaches the lock. Working in pairs, the locomotives pull the ship next to the canal wall against a battery of rubber-tired wheels as the craft proceeds through the locks.

## Motorized Scooter Has Plastic Body

Japan now makes a \$600, three-wheeled, two-seater cabin scooter that goes 37 miles per hour. It has a molded plastic body and a 5.5-horsepower air-cooled one-cylinder engine.

ⓈA patent has been issued on a method of embedding chopped corn kernels in rubber to produce skidproof tires.



*A*MERICANS are taking to boating as never before. Some 25 million people now are heading for the waterways regularly. The small craft, which once served only to move the man of the house from shore to his favorite fishing hole, now has become the focal point of the family's recreation. About 500,000 new pleasure boats are added to this huge family fleet each year. The following pages show some of the fun, the new products and the costs of owning small boats. On page 164 begins a series of articles on the construction of the *Sea Knight*, a 17-foot cruiser designed especially for *Popular Mechanics* readers.

# *We Took Our Vacation in a Boat*

By Leonard S. Osborne  
Photos by the Author

*At home on the Mississippi*



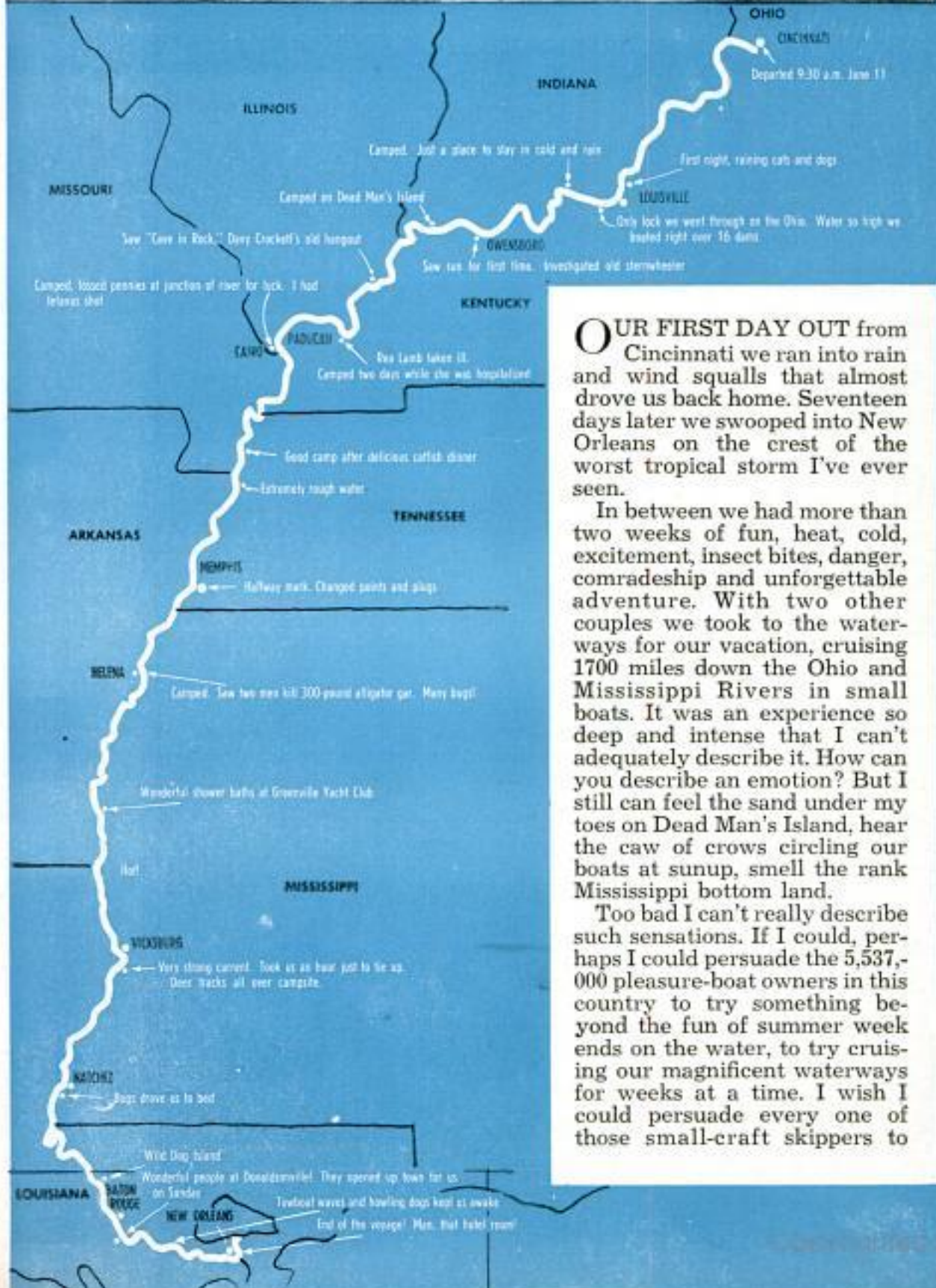

**O**UR FIRST DAY OUT from Cincinnati we ran into rain and wind squalls that almost drove us back home. Seventeen days later we swooped into New Orleans on the crest of the worst tropical storm I've ever seen.

In between we had more than two weeks of fun, heat, cold, excitement, insect bites, danger, comradeship and unforgettable adventure. With two other couples we took to the waterways for our vacation, cruising 1700 miles down the Ohio and Mississippi Rivers in small boats. It was an experience so deep and intense that I can't adequately describe it. How can you describe an emotion? But I still can feel the sand under my toes on Dead Man's Island, hear the caw of crows circling our boats at sunset, smell the rank Mississippi bottom land.

Too bad I can't really describe such sensations. If I could, perhaps I could persuade the 5,537,000 pleasure-boat owners in this country to try something beyond the fun of summer week ends on the water, to try cruising our magnificent waterways for weeks at a time. I wish I could persuade every one of those small-craft skippers to



We found our best camp sites at down-river ends of islands or points, in calm waters away from the channel



In navigating locks, move slowly and keep the motor running. Have a rope handy and wear a life jacket

take a vacation in a boat, with the wife and kids as crew. They'd have the time of their lives.

It's true we left our children home on this 1700-mile voyage. But we've taken them on other satisfying cruises, and our only reason for leaving them home this time was because we knew we'd be pushing all the way to maintain our schedule. Somehow kids and schedules don't jibe.

And it was quite a schedule. Each day we were on the water we averaged 100 miles at 20½ miles per hour. We saw the heart of America, from lonely Kentucky waters to the bustle of New Orleans.

Six of us made the cruise—Ken and Rea Lamb, Wilson and Ruth Crawford, my wife Georgia and myself, all residents of Cincinnati. The bug to make the voyage started buzzing around Wilson's head a full year before we cast off. He passed on the

From upstream, this type of dam is difficult to see. Best advice: study waterway before you start a cruise







This much gear went in two of the boats, with the third similarly loaded. It amounted to half a ton per boat

fever to Ken and myself. The gals went along with the gag, figuring a 1700-mile trip by small boat was just a pipe dream. They should have known better.

According to the navigation charts, we made a 1495-mile cruise. We figure we put at least 1700 miles of water under the boat hulls, counting side trips and the search for a camp site each night.

We were all experienced boaters, having cruised the Ohio River and some of the

Kentucky waterways. Two of our boats are 15-foot Lymans with 25-horsepower outboard motors. The third is an 18-foot Lyman with an inboard engine. In preparation for the trip, we altered all three boats so we could sleep in them. In effect, we built a removable false deck in the forward compartment of each boat. We packed gear under the deck and made up two bunks with air mattresses on top.

All three boats have convertible canvas

Water vagabonds: left to right, Wilson Crawford, my wife Georgia, myself, Rea Lamb, Ruth Crawford, Ken Lamb

*Here we are*



LYMAN BOAT WORKS, INC.  
SANDUSKY, Ohio



*Buttoned up*

We slept aboard, tying up with the bow anchored toward the river channel so we could ride out towboat waves



*Hot water*

Before long we discovered that the exhaust water from an idling motor is just right for shaving

Georgia checked every foot of progress on the navigation maps, which were our most valuable possession



*Chief navigator*

tops and side curtains. We added canvas right on back to the transom. At night we put up this "tent," plugged up any small holes with mosquito netting and slept snug, dry and mosquitoless.

In preparing for the cruise and actually taking it, we learned a good many lessons. We feel, with that 1700-mile cruise under our nautical belts, that we may be able to make some suggestions of value to others in planning similar cruises.

To help plan the trip (mainly, I think, to humor us menfolk) the gals wrote the Corps of Engineers for flood-control and navigation maps of every stretch of water we'd see. In addition, they addressed a letter to the Chamber of Commerce of every town and village on the route, asking for information on fuel, food, ice and laundry (we used self-service laundries). We were deluged with information, and transferred the important items to the navigation maps. Only one of our letters drew a blank—a reply from a farmer brought the news that the town hadn't been in existence since the great Ohio River flood of 1937!

**Study your route:** Learn everything you can about the waterway before you start your cruise. Navigation charts are your most valuable item of equipment. You can obtain them from the Corps of Engineers. Go to your post office and ask for the address of the nearest district office. These charts, plus the mile and channel markers, will tell you exactly where you are on every foot of the waterway.

We had almost half a ton of gear per boat,

POPULAR MECHANICS

including the 38 gallons of gas each boat carried. (Our equipment list appears on page 240.) The first day out we took a heavy pounding from a river lashed by rain and wind. The boats walled in the water, and before long our wives were ready to head back. It took us a full hour of shifting weight in rough water to find the right balance so the hulls would rise up in the water and plane properly.

**Dress rehearsal:** Try making a practice cruise, carrying all your gear, before you cast off on the real voyage.

That night, the rain found the first flaw in our equipment. Our kitchen consisted of a two-burner Coleman stove under a lightweight tarpaulin which we rigged up on poles. Somebody saw us coming when they sold us that thin tarp. I've always understood that the purpose of a tarp is to keep things dry. Not this one. It didn't leak like a sieve, it leaked like the nozzle of a fire hose. Ruth and Rea did most of the cooking, and every time they'd lift the lid to peek in at the spaghetti, cold water deluged the pot. Did you ever eat cold, watery spaghetti in the rain? We did, and we tried unsuccessfully to make ourselves think we were having fun.

**Trial before error:** Test every item of equipment before you leave. Don't assume anything will work. And, speaking specifically of camp

*Continued to page 236)*

Before we shoved off we made arrangements to have boats hauled back home

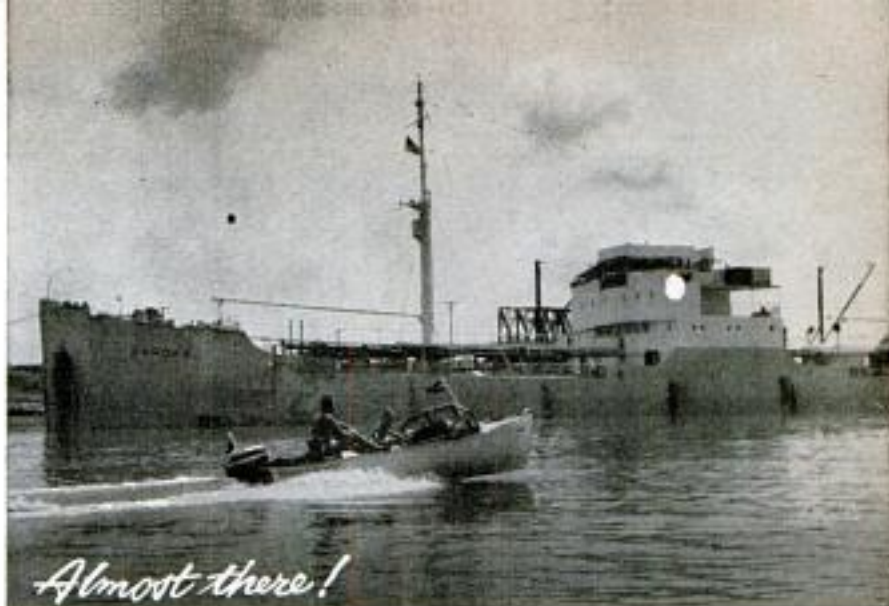

*Almost there!*

We knew we were almost there when we saw the first ocean-going vessel. Below, we navigated tropical swamps last day out



*Swamp water*

*End of the Trip*



# What Does It Cost to Own a Boat?



METAL



WOOD

Fishermen use Southwest Mfg. Co. aluminum 12-footer, top, and Thompson Bros. plastic-over-wood hull, above

AMERICAN outboard-motorboat enthusiasts will buy an estimated \$1,000,000 worth of boats and accessory equipment this year. *Popular Mechanics* has charted the approximate '57 prices for utility boats, runabouts and cruisers in metal, plastic and wood. Estimated costs of hulls (with minimum accessories and at the factory), motors (manual and electric-starting) and operating expenses are indicated. Price ranges are approximate and a few boats are priced above or below the indicated range. For kit boats, see page 250.

Length (Feet)	HULL COSTS				MOTOR COSTS		
	Metal	Plastic	Wood	Recommended Horsepower	Horsepower	Price*	Operation (Cost Per Hour)
12	\$160	\$325	\$215	Up	3	\$135 to \$160	\$ .15
	to	to	to	to	5	\$180 to \$230	.40
	\$270	\$425	\$365	16	7.5	\$260 to \$265	.43
14	\$190	\$320	\$260	Up	10	\$335 to \$345	.57
	to	to	to	to	16	\$380 to \$470	.72
	\$395	\$565	\$540	33	25	\$465 to \$570	1.14
16	\$360	\$355	\$495	Up	33	About \$630	1.26
	to	to	to	to	40	\$505 to \$750	1.47
	\$470	\$895	\$715	50			

\*Electric starting has added approx. \$90 to prices for certain motors.

PLASTIC

Lone Star Angler has glass-fiber hull that repels rust, rot, corrosion, heat, oils, acids, marine growth



Copyrighted material



PLASTIC

Futuristic 19-foot runabout by Lone Star has a glass-fiber hull with upswept rear "fenders" reminiscent of the '57 automobiles. The boat has a covered housing for two motors. Steering cables and pulleys are nylon



WOOD

Lines of this Aristo-Craft runabout are designed for speed. The framing is Honduras mahogany, and the hull has a baked-on resin finish. The boat weighs only 335 pounds, yet is built to take motors up to 60 hp.

Length (Feet)	HULL COSTS				MOTOR COSTS		
	Metal	Plastic	Wood	Recommended Horsepower	Horsepower	Price*	Operation (Cost Per Hour)
14	\$380	\$540	\$405	Up	16	\$380 to \$470	\$ .72
	to \$595	to \$870	to \$1025	to 50	25	\$465 to \$570	1.14
15	\$605	\$770	\$495	Up	30	\$480 to \$605	1.22
	to \$725	to \$1095	to \$1235	to 60	35	\$495 to \$775	1.29
16	\$445	\$565	\$555	Up	40	\$505 to \$750	1.47
	to \$890	to \$1145	to \$1265	to 80	60	About \$975	1.79

\*Electric starting has added approx. \$90 to prices for certain motors.



This aluminum 18-footer, made by Cadillac Marine and Boat Co., slides through water on 78-inch beam

METAL



PLASTIC

Bell Boy 18-foot Express Cruiser has two berths forward, an enclosed motor well, and weighs 1250 pounds



WOOD

Above, Larson 21-foot craft has motor hood, convertible hardtop and is cedar-planked with glass-fiber finish

Length (Feet)	HULL COSTS				MOTOR COSTS		
	Metal	Plastic	Wood	Recommended Horsepower	Horsepower	Price*	Operation (Cost Per Hour)
16	\$995	\$1295	\$800	Up	16	\$380 to \$470	\$ .72
	to \$2480	to \$1495	to \$1095	to 70	25	\$465 to \$570	1.14
19	\$1290	About	\$1585	Up	30	\$480 to \$605	1.22
	to \$1895	\$1895	to \$1825	to 120	35	\$495 to \$775	1.29
21	\$1895	About	\$1790	Up	40	\$505 to \$750	1.47
	to \$1950	\$4295	to \$2575	to 120	60	About \$975	1.79

\*Electric starting has added approx. \$90 to prices for certain motors.



METAL

Cruiser Crafts have built-in bunks and transoms adaptable for single, twin, bracket, or inboard motors

No racing boats or special motors required. All you need is a run-about, plenty of nerve and super-human stamina to win the



## World's Toughest Outboard Race

By Thomas E. Stimson, Jr.

**S**TAMINA IS THE KEY to winning the race. You have to crouch in a bucking, plunging boat for 7½ hours to take the cup in this, the world's longest, toughest outboard marathon.

It's the annual 316-mile dash up the Sacramento River. To the winner goes a diamond-studded cup, \$1000 in cash and the sure knowledge that he has as much perseverance as any boater alive.

At the end of the Sacramento River Race some of the drivers have to be lifted from their boats, carried up to the beach and

their legs massaged to restore circulation.

You also must be able to read a chart accurately. One wrong turn in the maze of islands near the start will send you toward San Francisco instead of up the river to Redding. Last year a driver failed to see the signs on an anchored patrol boat and turned left instead of right. A dozen others followed his lead. They fell so far behind they dropped out of the race and went ashore for coffee.

And a driver needs a good eye for shallow water. You can easily grind off the

They're off! Roaring past starting line, boaters must find way through maze of islands to reach main stream





Skippers assemble just prior to race. Motors are finely tuned and some pit crews are already on the road

Map shows the ever-changing 316-mile route. Smaller boats stop at Colusa, take two days for race



propeller if you churn across a sand bar.

All the bad hazards are marked, including the jagged rocks in Iron Canyon a few miles above Red Bluff, and the reefs under the surface a few miles farther upstream. Officials in patrol boats will wave you off the worst spots. If you do get in trouble, a cruising crash boat will tow you to the nearest control point.

Hidden dangers are not the only hazards. Down along the Stockton Ship Canal there may be freighters to dodge in the morning mist. Near Sacramento a driver must beware of fast pleasure boats and water skiers. And around any sharp bend he may encounter a leisurely fisherman put-putting across the river.

The big-engined DU-class boats complete the race in one day; the smaller racing classes and the pleasure boats take two days. They make a stopover at Colusa, halfway to Redding.

Aside from the \$1000 that goes to the DU winner there are \$500 prizes for the winners of the AU (7½ to 15 cubic inch), BU (15 to 20 cubic inch), and the 36-cubic-inch class (30 to 36 cubic inch), as well as cash prizes down to fourth place in each group. In addition, trophies are awarded the winners in five classes of pleasure craft.

Hydroplanes are not permitted and all entries must be of runabout design. Engines must be stock and without modifications although the racing classes are permitted to use "quicksilver" lower units as these are standard factory accessories. With such a lower unit a very small propeller of steep pitch is used. Running half out of water much of the time, this type of propeller allows an engine to wind up in excess of 7000 revolutions per minute, far over its design speed.

This is a race that anyone can enter provided his boat meets safety require-



ments. You don't need to own a racing boat and you don't need a membership in a club. As a pleasure-boat skipper you will be entered in one of four speed classes: From 15 to 20 miles per hour, 20 to 25, 25 to 30, and 30 miles per hour and up. The race officials determine your class from the length of your boat, type of bottom, overall weight and engine horsepower. Drivers must be 16 years of age or over, no single cockpit boats are eligible, nor are narrow, unstable craft.

Some of the pleasure-boat drivers don't especially care whether they win. They take their families with them and make a pleasure cruise out of the race. The annual August event gives them a unique opportunity to explore one of the West's largest rivers in comfort and safety. Only during the two-day race period is the entire river patrolled. In addition to the crash boats and the anchored marker boats there are low-flying aircraft on watch. A communications net, made up of amateur mobile radio stations, connects all the control points.

The race starts at Stockton on the San Joaquin River. From there the boats follow the deep-water ship channel through the islands that make up the Sacramento's inland delta, and turn up narrow Georgiana Slough where they must beware of old sunken pilings that once supported wharves for loading potatoes. From the

White segment of red timing disk gradually disappears. When there's nothing left, flagman starts race

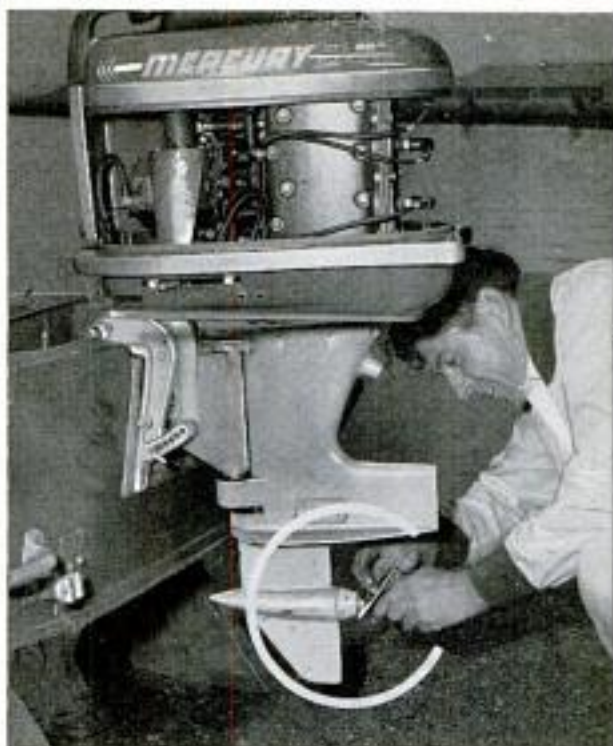

Boater checks the speeds of different propellers and installs racing prop, much smaller than standard ones





Driver takes continual pounding as he crouches in DU-class boat. Some drivers have to be lifted from boats at finish line

slough they follow other channels to the river, then head upstream.

The Sacramento has the characteristics of three different rivers. Its lower reaches can be compared to the Hudson because of the shipping and the industry on its banks. In the vicinity of the city of Sacramento the many bends and islands and wooded shores are reminiscent of the Mississippi.

Still farther upstream, beginning at

about Red Bluff, the river becomes a mild counterpart of the wild Rogue. There are rapids to climb, rocky points to navigate and narrow canyons to penetrate. The river departs from civilization and cuts through mountainous, volcanic country that is as wild as it was a century ago.

Only a few dirt roads pierce the area. Occasionally a bear is seen at the water's edge, hunting for an early salmon making its way upstream. Deer are numerous.

Last year, of the 156 boats that started the race, less than half crossed the finish line at Redding. One driver who finished reported that he broke a dozen shear pins, damaged two propellers and that his fuel tank broke loose. On another boat the steering assembly failed and the boat smashed into a tree on the bank before the driver could chop his throttle.

The entire bottom of one boat pounded loose and the driver hardly dared slow down for fear he would sink. He spent that night, during the Colusa layover, in cutting and fitting a new plywood bottom—and finished the race the next day!

The Sacramento is relatively mild and smooth, but a fast boat traveling against the current can take a beating. One driver failed to throttle down when he entered rough water. His boat stood up on its stern and tossed him backward into the river. It's possible to flip, too, when making a tight turn with the nose high unless power is reduced.

As in most long-distance racing, motor failures accounted for many of the boats

Boat bounces across rough water in the rapids of Iron Canyon, one of the wildest stretches on the entire route





At some points river is calm as a millpond, welcome relief to drivers who have been punished for hours

that didn't finish. Crankshafts and connecting rods are bound to break when motors are driven wide open, hour after hour. Magnetos short out, engine blocks fly apart, propeller shafts bend and snap.

The drivers who win are the ones who have little trouble. They slow down in the

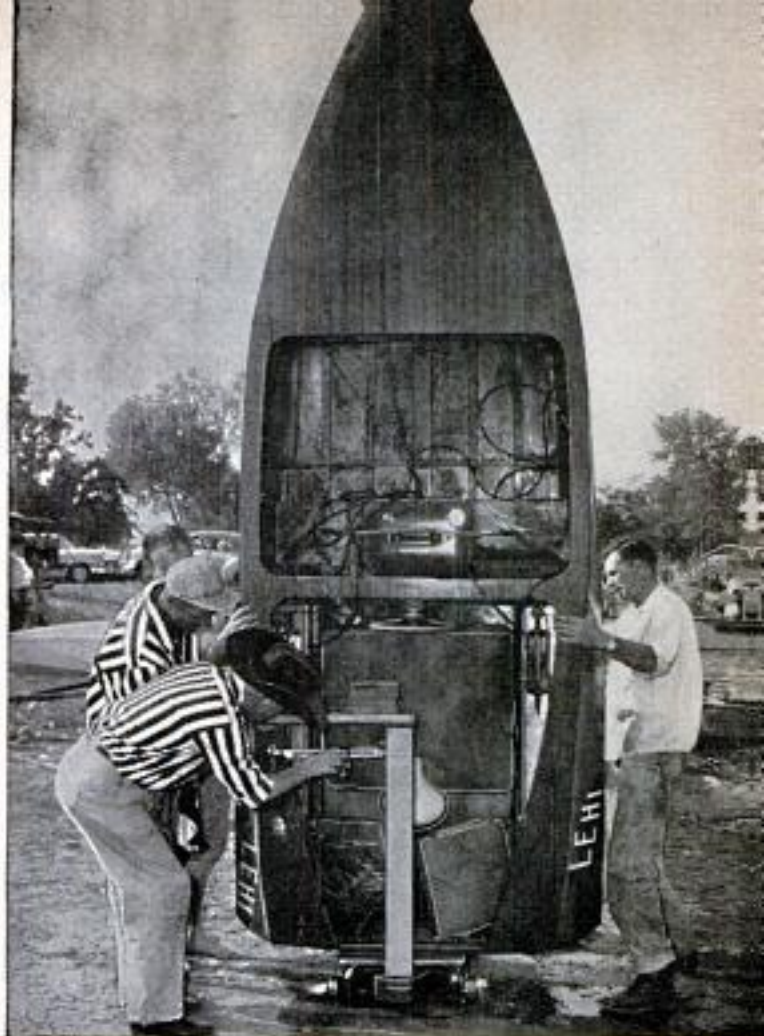

Officials weigh one of the boats at conclusion of the race to confirm the class in which it belonged

rougher stretches and conserve their engines whenever possible. Dave Hart of Temple City, Calif., last year's DU winner, averaged 42 miles per hour for the whole run and had a minimum of trouble. He actually reached the halfway point ahead of his pit crew in a car that was towing

(Continued to page 228)

Stamina—and luck—may pay off at the finish line. This driver, who had crouched in his boat for more than seven hours, had to be helped to his feet



## WHAT'S NEW IN BOATING



1



2

**1. "SOUPED-UP IRONING BOARD"** zooms the waterways with outboard motors of 5 to 16 horsepower. Called the Waterbug, this craft weighs 90 pounds, is 10 feet long and 42 inches wide. It can be used for boating, skiing or surfboarding and comes ready-built or in kit form. Hollow side panels stuffed with Styrofoam give great buoyancy to the miniature craft

Waterbug Co., Bayport, Minn.

**2. ECHO DEPTH SOUNDER** for small boats works on 6 or 12-volt battery. Sounder indicates depths from 2 to 120 feet and shows if bottom is hard or soft, depth of mud on soft bottom and whether hard bottom is smooth sand or rocky. Unit detects large single fish or small fish in schools. Sounder weighs 9½ pounds

Raytheon Mfg. Co., Waltham 34, Mass.

**3. OUTBOARD-MOTOR CARRIER** fits front or rear car bumper and handles motors up to 15 horsepower. The parts are cadmium-plated. Motor rides high enough that it won't be hit by bumper of another car. Two bolts hold the carrier in place. Motor is taken out of the trunk, saving room for stowage of luggage

Kicker-Karier, 510 W. Hildebrand, San Antonio 12, Tex.

**4. INFLATED-TUBE BOAT** is light and can easily be launched by one person in shallow water. The boat consists of a tubular-aluminum frame, reclining chair made of plastic cloth, and three rubber tubes. When in water, the little craft is difficult to upset and can be used for fishing, exercising or relaxing. The tubes can be deflated and the framework folded to permit compact stowage in a car trunk

Indiana Stamping and Mfg. Corp., 3827 Southeastern Ave., Indianapolis 3, Ind.



3



4

Copyright



3

**5. MOTOR MOUNT** permits boater to swing motor into boat for servicing without detaching it from the transom. Mount handles motors up to 30 horsepower  
Standard Pattern Co., 610 E. DeWald St., Fort Wayne 5, Ind.



6

**6. HUPP HYDROMOBILE** consists of nine parallel aluminum, six-inch-diameter tubes welded to form a hull 21 feet long and 54 inches wide. With a 40-horsepower motor the craft speeds 30 to 35 miles per hour. Mahogany side wings and decking fill out the hull  
Hupp Engineering Associates, Bloomington, Ill.

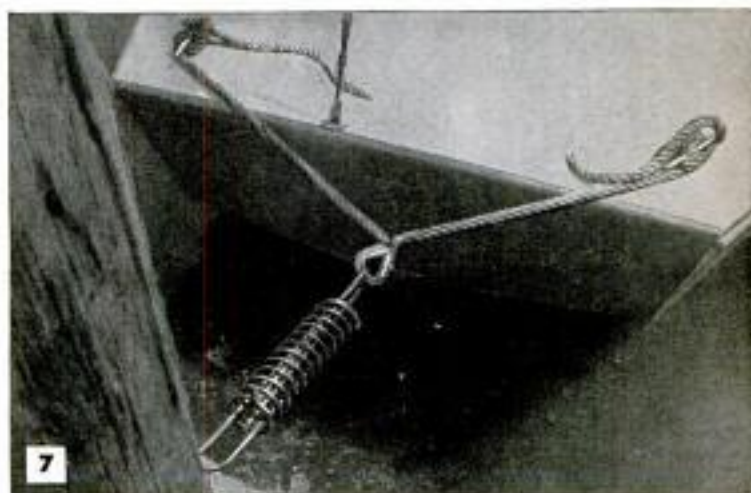

7

**7. DOCK SPRINGS** prevent damage to boats from surge, wash, tides and storm by eliminating the danger of broken lines. The springs are attached by splicing to dock lines, and ease strain on transom, cleats  
Riverside Tool Co., Chagrin Falls, Ohio

**8. BOAT LIFT** raises craft up to 15 feet long and 800 pounds in weight. The unit includes two marina walkways, telescoping leg supports, reinforced tubular-steel boat cradle and lever-operated hydraulic lift  
Standard Steel Prod. Mfg. Co., 2836 South 16th St., Milwaukee 15, Wis.

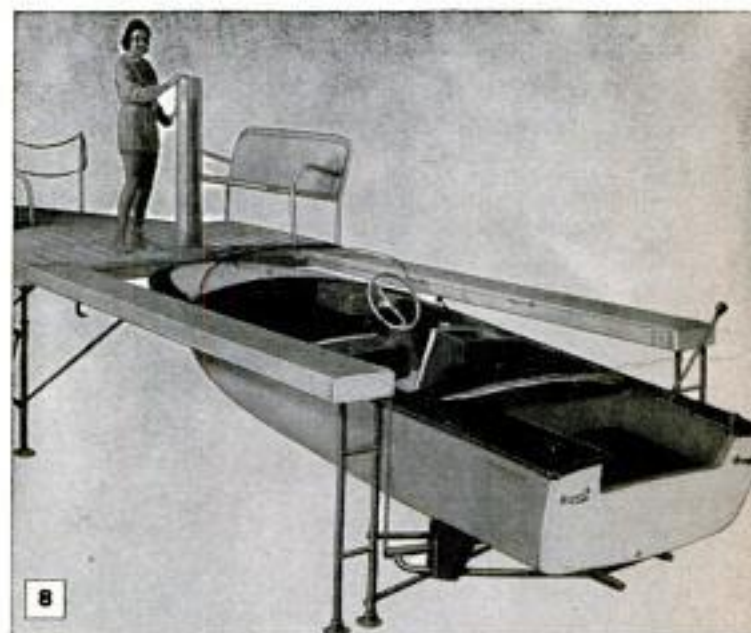

8

**9. INBOARD RUNABOUT**, the boater's answer to the sports car, has sweeping rear "fenders" and wrap-around windshield. With two 300-horsepower engines it zips along at 60 miles per hour. Deluxe fittings of the 24-foot craft include a fire-extinguishing system, depthometer, running lights, electric trumpet  
Ancarrow Marine Inc., R.F.D. 13, Richmond, Va.



9



# SEA KNIGHT

## -17-Ft. Plywood Cruiser

*Use it as a cruiser, runabout or utility boat. With two aboard, she makes 26 m.p.h. with a 35-hp. outboard. An exceptionally easy boat for amateurs to build*

### PART I

**S**PECIALY DESIGNED for *PM* readers by Glen L. Witt, naval architect, *Sea Knight* is a proven boat that is basically simple in construction. She has cruising accommodations for two, including two full berths, complete kitchen and toilet facilities, and has a fast bottom that will hold either a single or twin-motor installation. Roomy open cockpit adds to dining pleasure and to comfort of helmsman, and allows a sleeping bag to be rolled out for an extra overnight guest. Hatch in forward deck provides safe and handy place from where to handle bowlines when anchoring or mooring. Beam measures 84 in.

**Frames:** Half patterns of the five frames

and the transom are detailed in Figs. 1, 2, 3, 4, 7 and 8. With the exception of the transom, a full-size pattern of each frame should be made on heavy wrapping paper. In drawing the frames, note that all width dimensions are taken from a center line.

In springing-in the arcs on the side and bottom members, observe that dimensions are given at mid-points between chine and sheer, and chine and keel. To strike the arcs use a light  $\frac{1}{4}$ -in. batten, such as a kite stick, and bow it to coincide with the three points at chine, sheer and mid-point. Do not attempt to use a short batten that will simply reach the three points, but use a long one that will assure a smooth sweeping

### RECOMMENDED MATERIALS

White oak, Philippine mahogany, Sitka spruce and even vertical-grain fir can be used optionally. White oak is preferred for its holding power and strength but has the disadvantage of being heavy. Philippine mahogany holds fastenings well, is fairly lightweight, finishes well and is considered the best all-around wood to utilize for boat construction.

All lumber specified and noted as 1-in. thickness will be "four quarters" stock finished as full as possible. All other thicknesses are listed as net, as are all widths. All plywood must be marine or exterior type, the planking being AA

grade. The rest may be AB or even AC in the case of flooring and other points where only one side will show.

All fastenings should be bronze, hot-dipped galvanized or brass. Of the three, bronze fastenings are the best, but expensive. The galvanized type is strong and inexpensive and ideal for use in a boat of this type. Glue should be applied to all joints both in the hull and interior construction. Resorcinol-type glue is best, urea resin is the next best. The term "nails" refers to annular (ring-type) monel or bronze boat nails. Standard boat nails are not recommended for fastening plywood.



curve between the points. The frames are fabricated from 1-in. oak or mahogany. To transfer the pattern to the wood, simply lay your pattern over the lumber and make punch marks at  $\frac{1}{2}$ -in. intervals along the lines. Carbon paper can be used if you wish. At the chine junction of the side and bottom members, a  $\frac{3}{8}$ -in.-plywood gusset is used on both sides of each frame. An exception to this is in frame 3. The aft side of this frame will have a bulkhead fastened to it. Consequently, the gusset should be applied on the aft side with screws instead of nails and without glue, so it later can be removed. Note that all frames of the boat are assembled from a setup level which actually is the top edge of the bottom frame member. Be sure to keep this height accurate and true. At frame 4, Fig. 7, a temporary 2-in. blocking strip is added to



the height of the floor timber to obtain the correct level. Assemble the cutout parts directly over the full-size paper patterns. Coat the plywood gussets liberally with glue and nail in place with a minimum of five  $1\frac{3}{4}$ -in. ring-type nails. On frames 4 and 5, the bottom frame members are in two parts and are fastened to floor timbers which are cut from the same material as the frame members. Apply glue liberally and screw the frame members to the floor

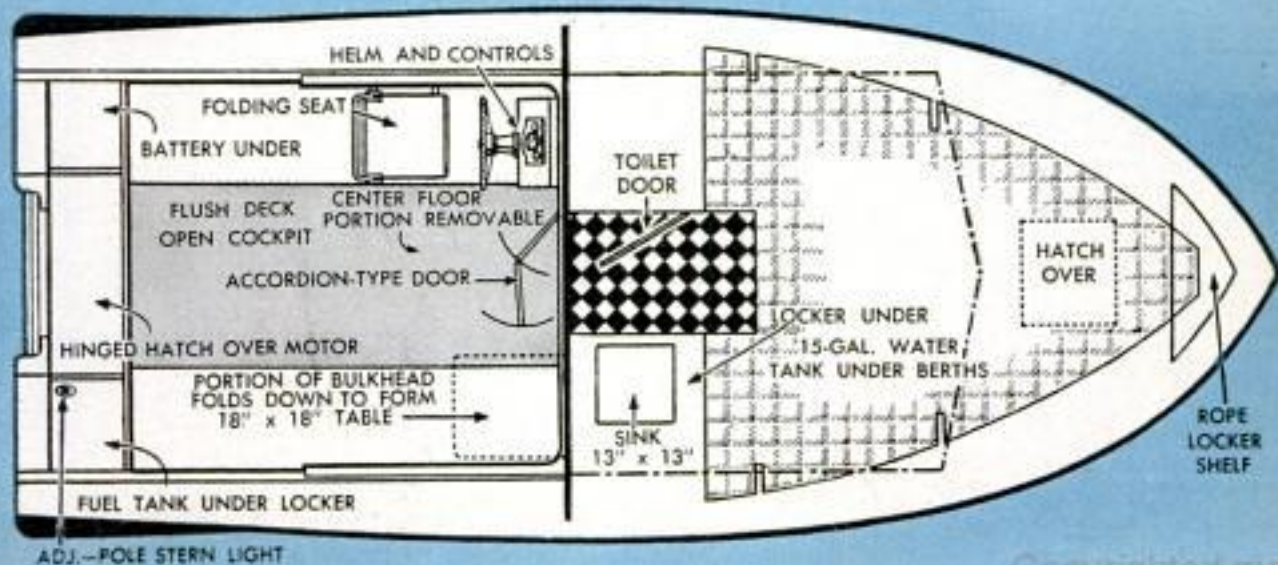

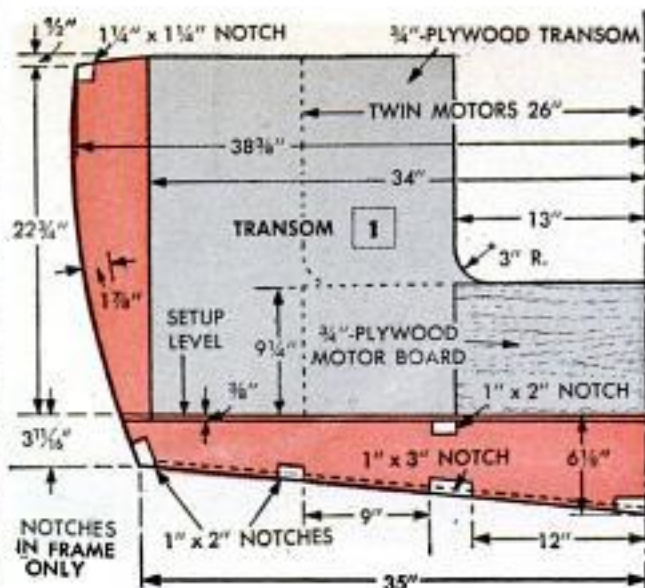

timbers with at least four 1 1/2-in. No. 8 screws per member. Notches can be cut at the time of assembly for the floor battens, chine log, sheer clamp and keel. The keel notch is cut 4 in. wide and the thickness of the keel plus 3/8 in. deep. It is best, however, to cut the batten notches later.

**Transom:** The transom must be laid out full size too, but since the rear side of the transom frame is covered with 3/4-in. plywood, the pattern may be drawn directly on the plywood. Take special note that the transom must be angled 13 deg., as will the notches for keel, battens and chine. Coat the framing members liberally with glue and fasten to the plywood transom with 1 1/2-in. No. 8 screws, spacing them a

**To Save Both Time and Work**  
 If you wish, you can buy the patterns for the stem, frames, transom, breasthook and chine blocking already drawn full size. And, to further simplify construction, you can buy these parts in kit form accurately cut in mahogany from Glen-L Marine Designs, P.O. Box 568, Compton, Calif.

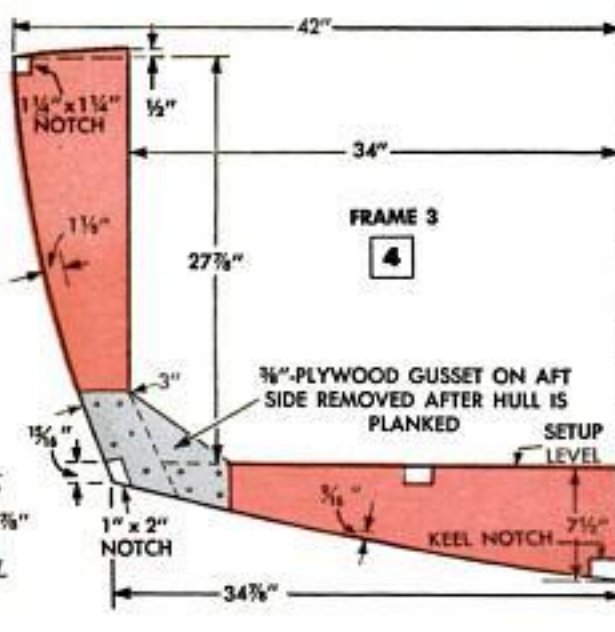
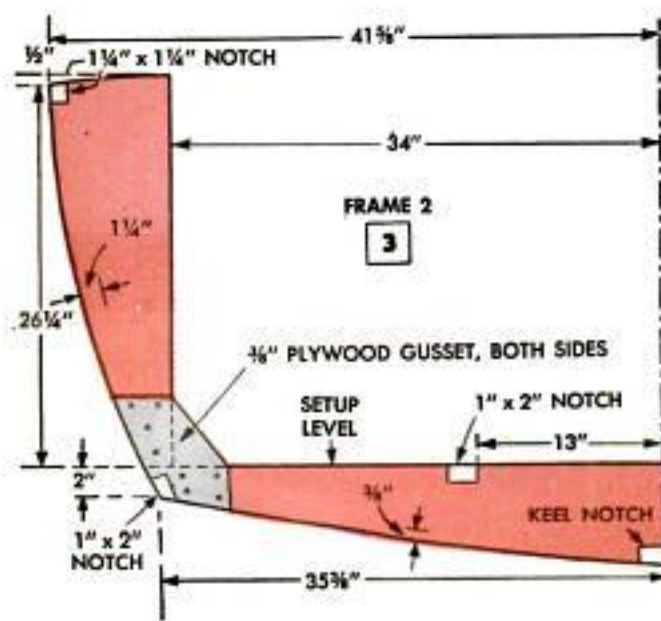
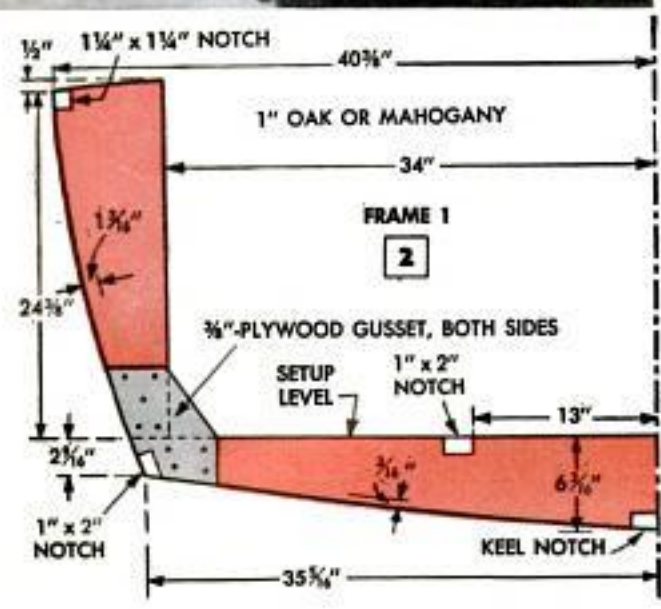



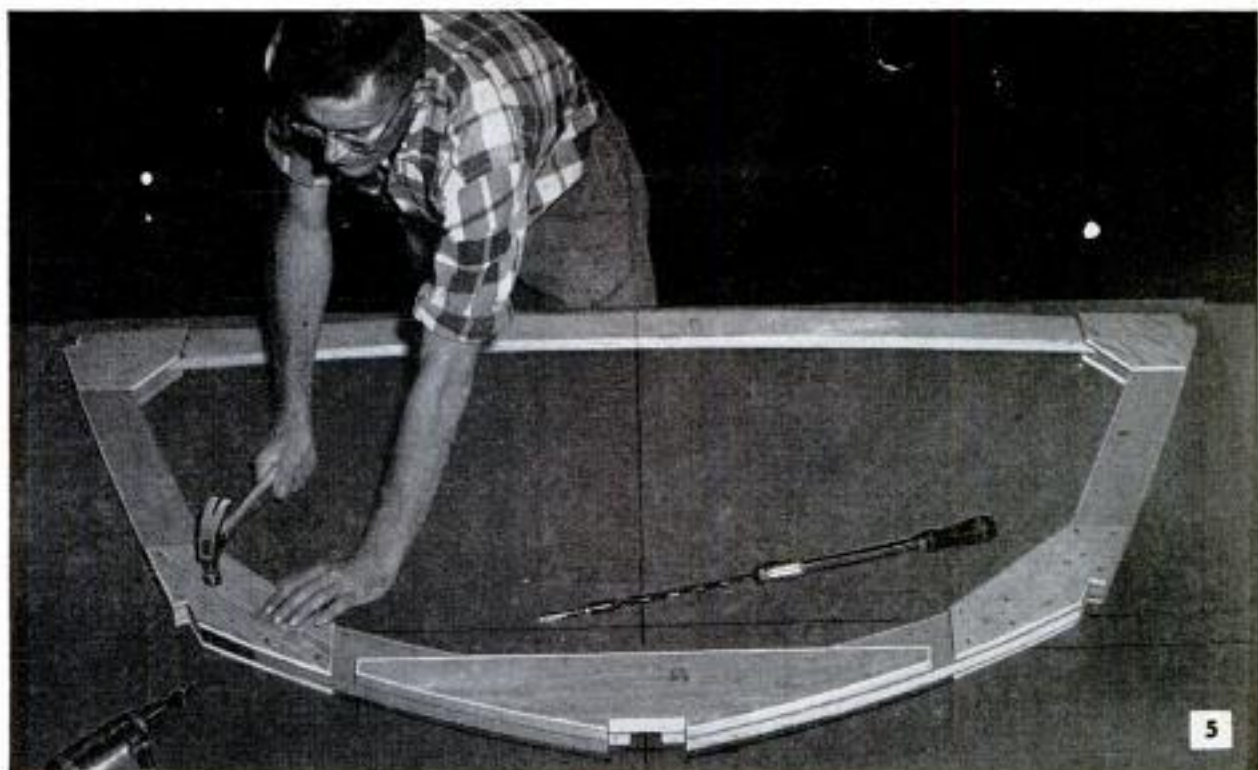

Parts of each frame, with exception of transom, are assembled over full-size paper patterns prepared from the five half-patterns of frames detailed here

maximum of 6 in. apart. The transom can be cut out for the motor if motor brackets are not to be used. For twin motors, the width of the cutout is usually 52 in. although this may vary with the type of motor used. For single motors, the width is usually 26 in. The motor-cutout height for standard motors is 15 in. For the long-shaft type, the cutout is 20 in. It is advisable to check the particular motor or motors to be used before cutting the transom. If undecided, leave it solid for the time being and cut it later. For twin power, the locations of the battens are interchanged, that is, the 1 x 3-in. battens closest to the

#### TYPICAL FRAME ASSEMBLY

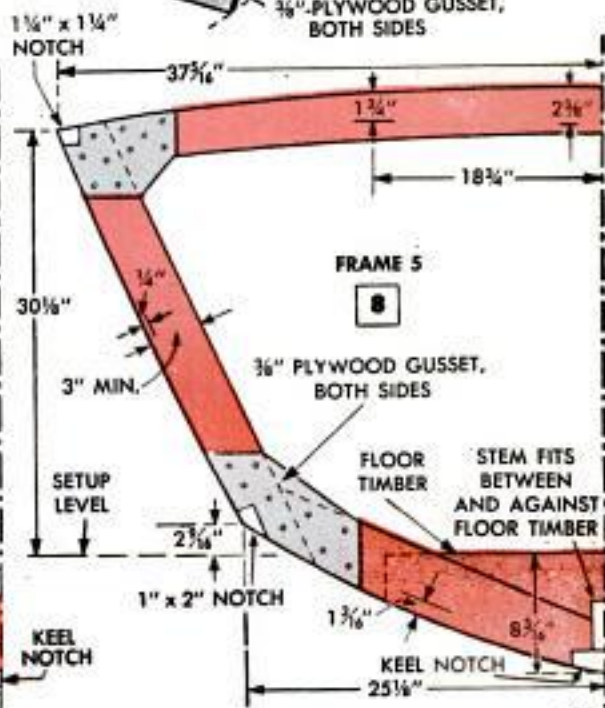
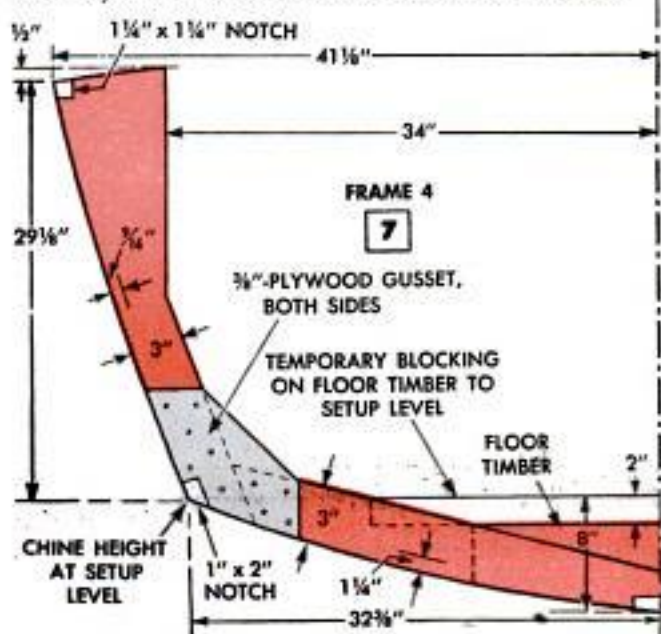
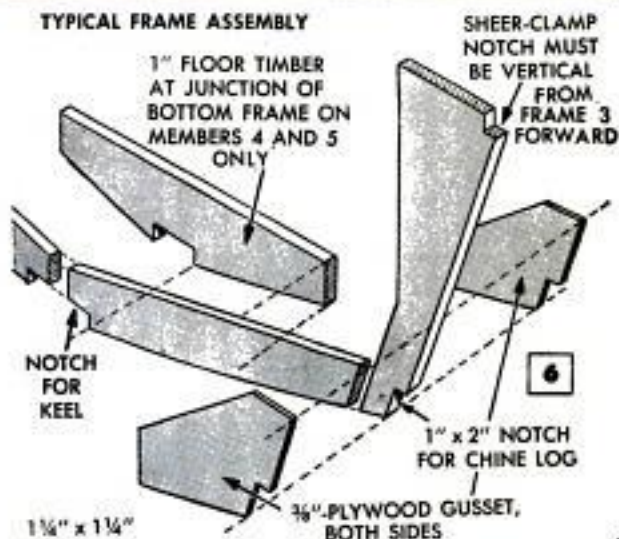

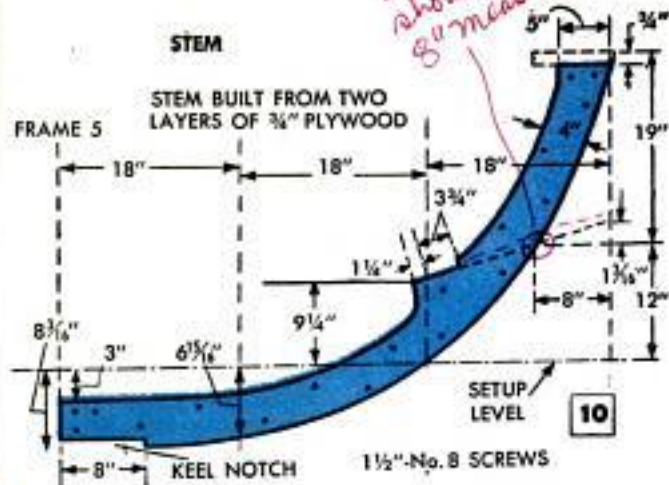
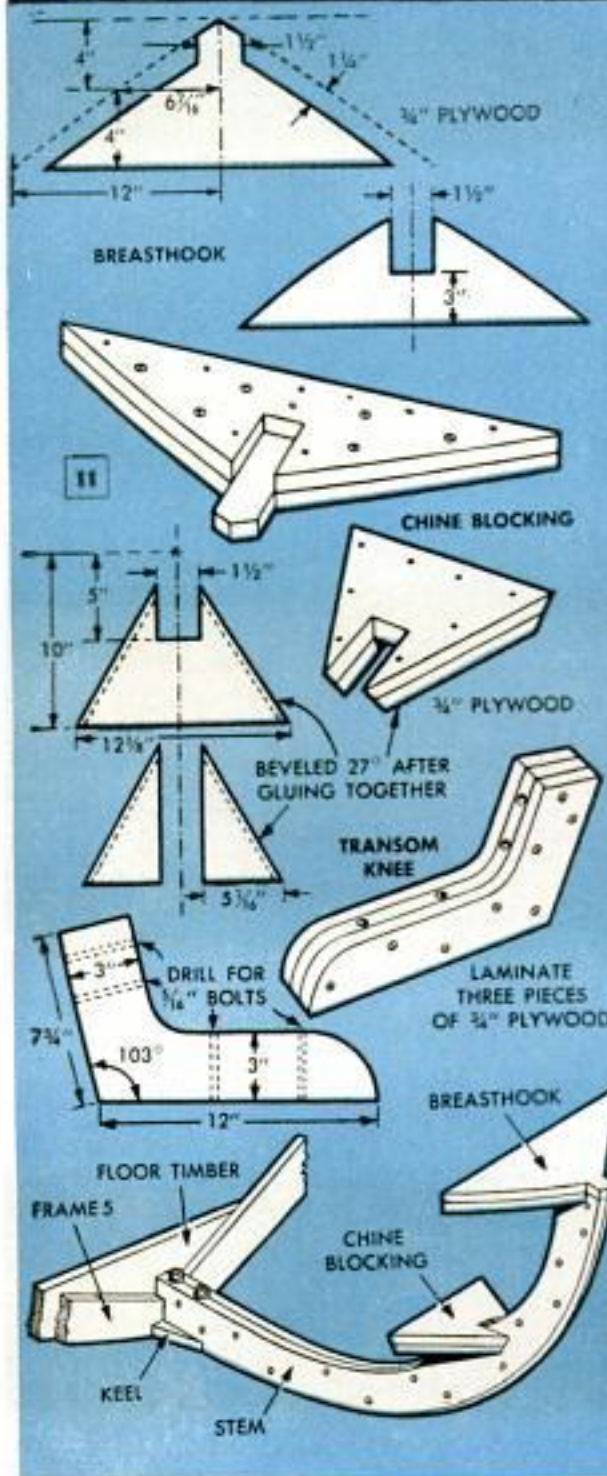

Upper left, bottom frame member of frame 5 is in two pieces to form a notch in which the stem fits and butts against a floor timber fastened to aft side

keel are moved to the position of the 1 x 2-in. battens. By this method the construction of the motor well and area will be similar for either single or twin-motor installations. The 3/4-in.-plywood motor board is liberally coated with glue and fastened to the plywood transom with 1 1/2-in. No. 8 screws, 6 in. apart.

**Stem:** The stem is laid out full size as given in Fig. 10. It is fabricated from two layers of 3/4-in. plywood and laid out directly on the wood. Coat the mating surfaces liberally with glue and fasten together with 1 1/2-in. No. 8 screws spaced a maximum of 6 in. apart.

**Breasthook:** The breasthook is detailed in Fig. 11. It is made in two layers from 3/4-in. plywood. Note that a 1 1/2-in. notch is provided in the bottom layer to hook around the stem. Assemble the two parts with plenty of glue between and fasten with at least eight 1 1/4-in. ring-type nails or 1 1/2-in. No. 8 screws.

**Chine blocking:** The chine blocking is a new answer to the old problem of fitting the chine to the stem at the proper point and angle. It is laid out directly on 3/4-in. plywood, following the dimensions. Like the breasthook, it is assembled in two layers and is designed to notch around the stem on the ledge provided. Use at least eight ring-type nails to fasten both layers.

**Transom knee:** The transom knee is laminated from three layers of 3/4-in. plywood. Coat each layer liberally with glue and fasten to the adjacent layer with at least five 1 1/2-in. No. 8 screws. In assembly, the knee is bolted to the keel and transom with 5/16-in. bolts. You should now have completed the basic frame members of the boat. These parts can now be laid aside while the building form is constructed.

**Building form:** Don't attempt to "spare the hosses" on the building form. This is

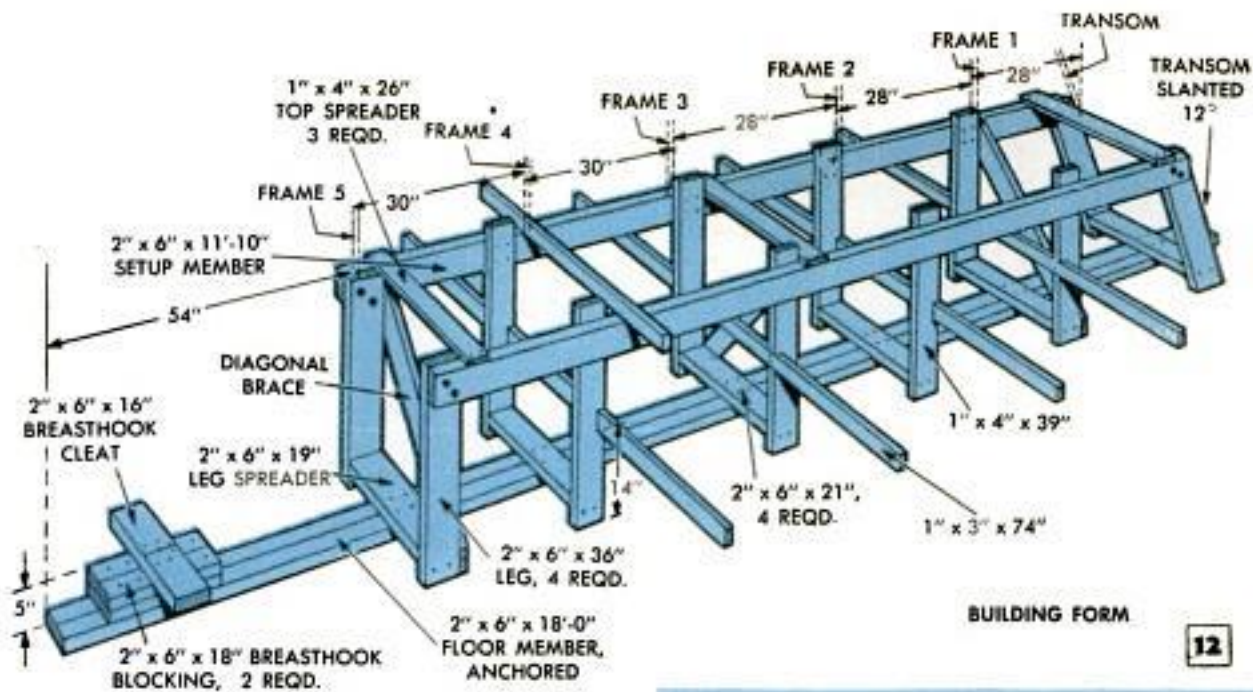

one of the most important factors to assure an accurate hull. Probably more builders attempt to skimp and save on a building form than on any other point. Fig. 12 details the form. Sizes of the lumber may be varied if desired, but don't make the structure flimsy. The building of the boat should be done on a cement slab, wooden floor or a fairly level dirt area. The form should be anchored to the floor, either by expansion bolts in the concrete or by stakes driven into the ground with cleats nailed to them. The entire form *must* be level both lengthwise and athwartship. It is important that the height from the top of the breasthook to the setup level must be 31 in. The frames are mounted bottom-side-up and spaced as shown. Be sure to space

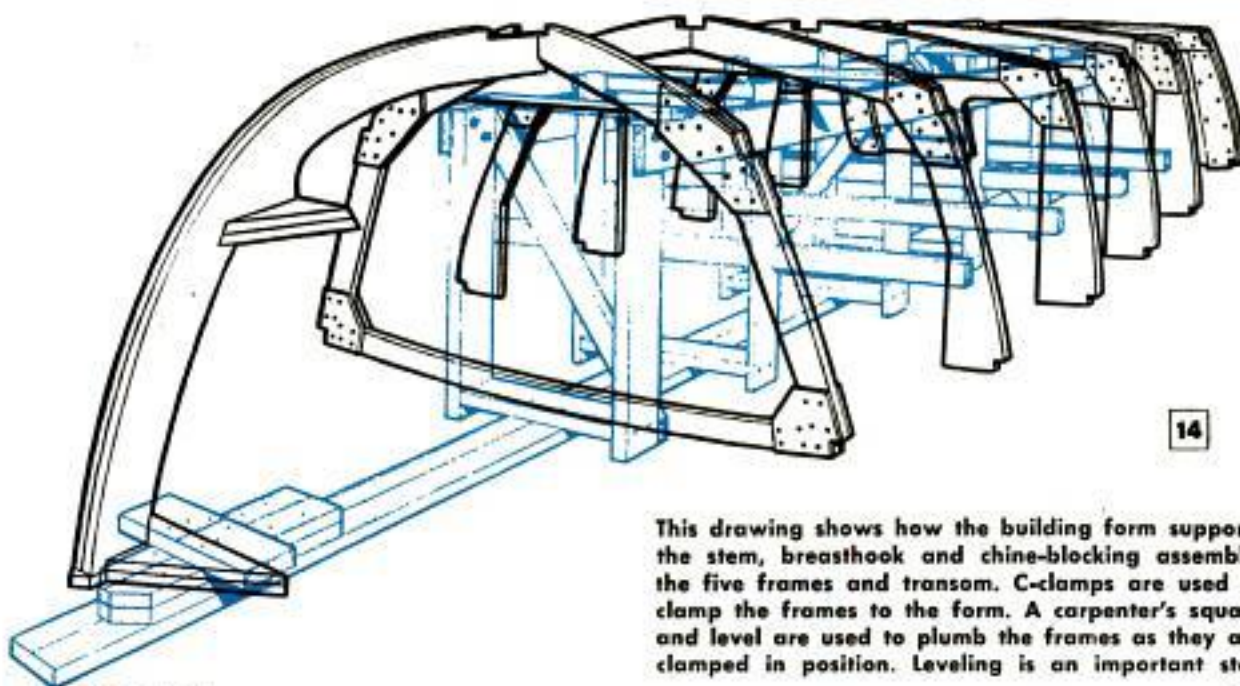
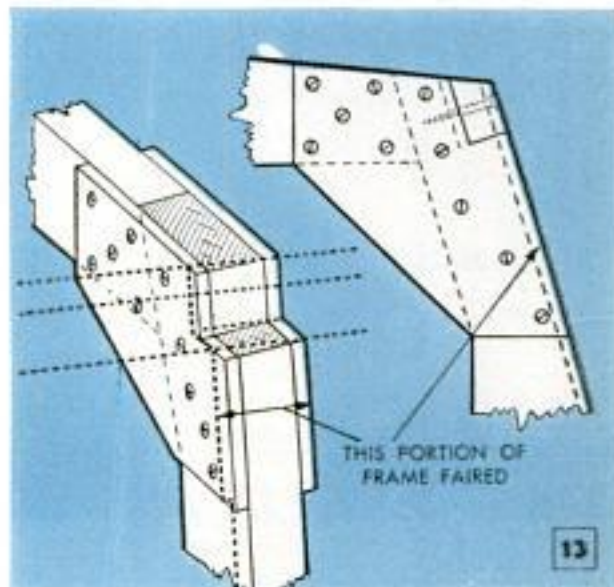

This drawing shows how the building form supports the stem, breasthook and chine-blocking assembly, the five frames and transom. C-clamps are used to clamp the frames to the form. A carpenter's square and level are used to plumb the frames as they are clamped in position. Leveling is an important step

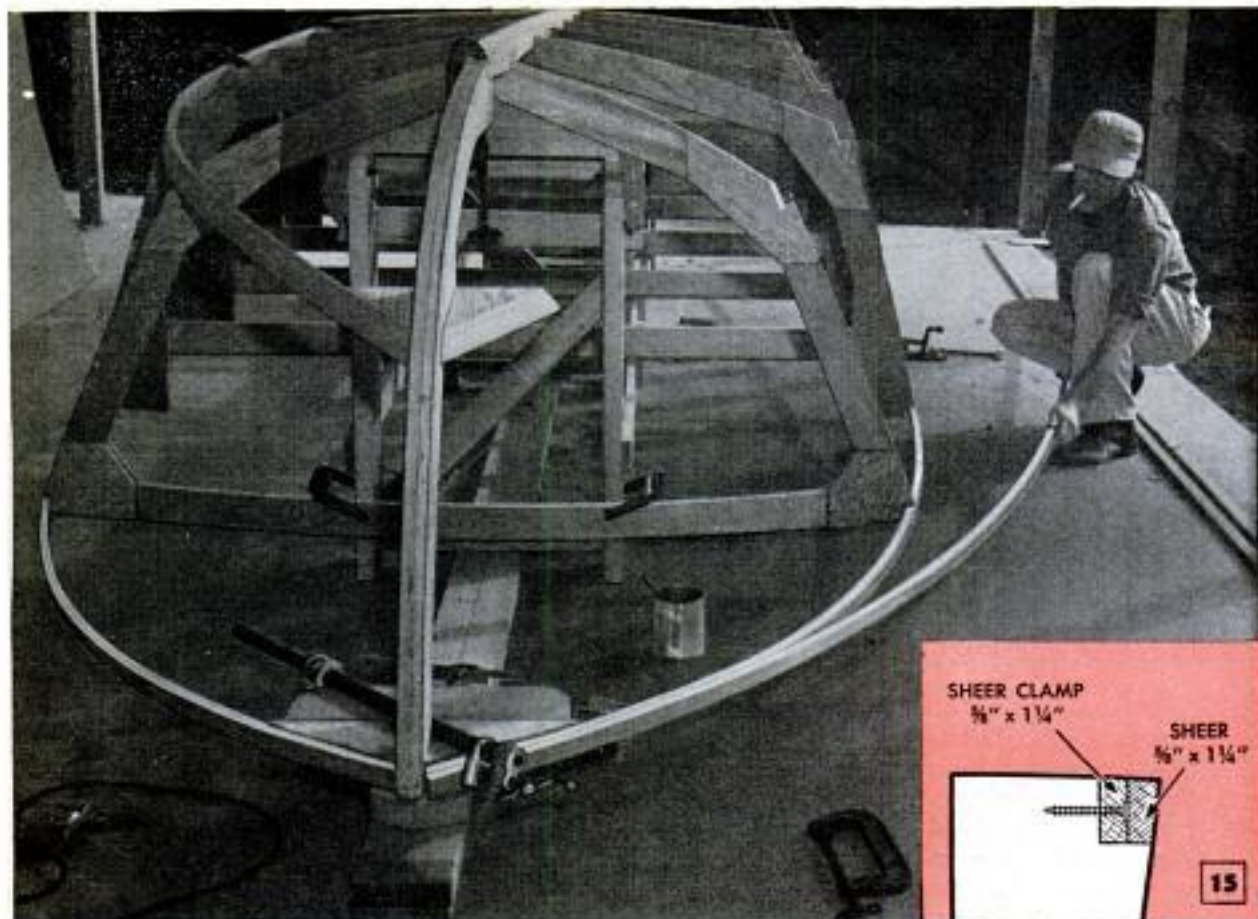

After sheer clamp is sprung into position, a second member, called the sheer, is bent and clamped to it

the frames accurately and anchor them rigidly to the form with clamps or screws. If the form is accurate and level, a carpenter's square and level may be used to plumb the frames. The temporary blocking for frame No. 4, shown in Fig. 7 is also shown on the building form to indicate its position. The chine blocking and breasthook can now be assembled to the stem, gluing and fastening them with at least two 2-in. No. 10 screws. The heel of the stem is slipped into the slot between the bottom frame members of frame 5, butted against the floor timber and glued and fastened to it with at least two 2-in. No. 10 screws, Fig. 9.

The stem and breasthook assembly must be bolted or screwed to the building-form blocking at exactly the height shown. The transom is aligned in place and angled 12 deg. from the building form. Note that the dimension from frame 1 to the transom is to the back face of the plywood at the setup level. The height of the transom may have to be jockeyed a bit to be sure that the keel from frame 4 to the transom is in a straight line. After aligning the entire assembly on the form, Fig. 14, anchor the members in position and brace them rigidly to prevent movement. When the time comes for springing the longitudinals around the boat, a good deal of stress is on the form.

**Keel:** The keel is a single length of 1 x 4-in. oak or mahogany laminated on the inside face with a  $\frac{3}{8}$  x 4-in. plywood strip. The plywood need not be a single length but may be joined as required with a simple butt joint. Its purpose is to prevent splitting of the keel member so prevalent on plywood boats. The plywood is liberally coated with glue and nailed to the keel with  $\frac{3}{4}$ -in. ring-type nails spaced about 4 in. apart. Be careful in the placement of the nails, as much of the keel is later beveled away. The keel is screwed to the transom and the frames with 2-in. No. 10 screws countersunk about  $\frac{1}{4}$  in. deep. The keel is bolted to the stem with two  $\frac{5}{16}$ -in. carriage bolts. The heads are recessed and flat washers placed under the nuts. The transom knee is also bolted to the keel and transom with  $\frac{5}{16}$ -in. carriage bolts. Sink the heads of the carriage bolts.

**Chine log:** The junction of the side planking and bottom planking is the chine point and the backing member is called the chine log. The chine log is 1 x 2-in. (net) oak or mahogany in a single length from stem to transom. This is fitted into the notch at the transom and sprung around the notches in the frames. The notches in the frames will have to be beveled up forward so that the chine log will lie flat against the frames. See Fig. 13. Bevel the



To assure flat contacting surfaces for plywood planking, all members must be faired, or planed away. Use wood rasp at stem and hand plane for other parts

chine log to fit against the stem at the chine blocking. Coat the notches with glue and fasten with a single 2-in. No. 10 screw at each of the frames and at the transom. Fasten it to the chine blocking with several 2-in. No. 10 screws. The same operation must be performed on the other side to equalize the stresses.

**Sheer clamp:** The junction of the side planking and the decking is the sheer, while the backing member is called the sheer clamp. The sheer clamp is built up from two laminations of  $\frac{5}{8}$  x  $1\frac{1}{4}$ -in. oak or mahogany in single lengths if possible. If full lengths are not available, make splices in the after third of the boat with simple butt joints, but in no case should these splices be made between the same

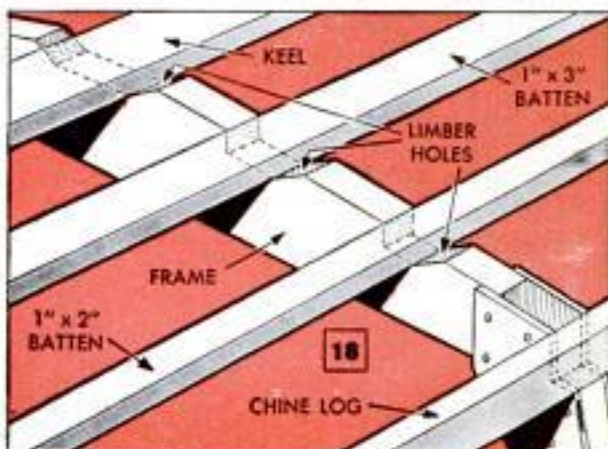

Below, fairing of the keel and chine logs is checked with a flat strip placed across the bottom battens

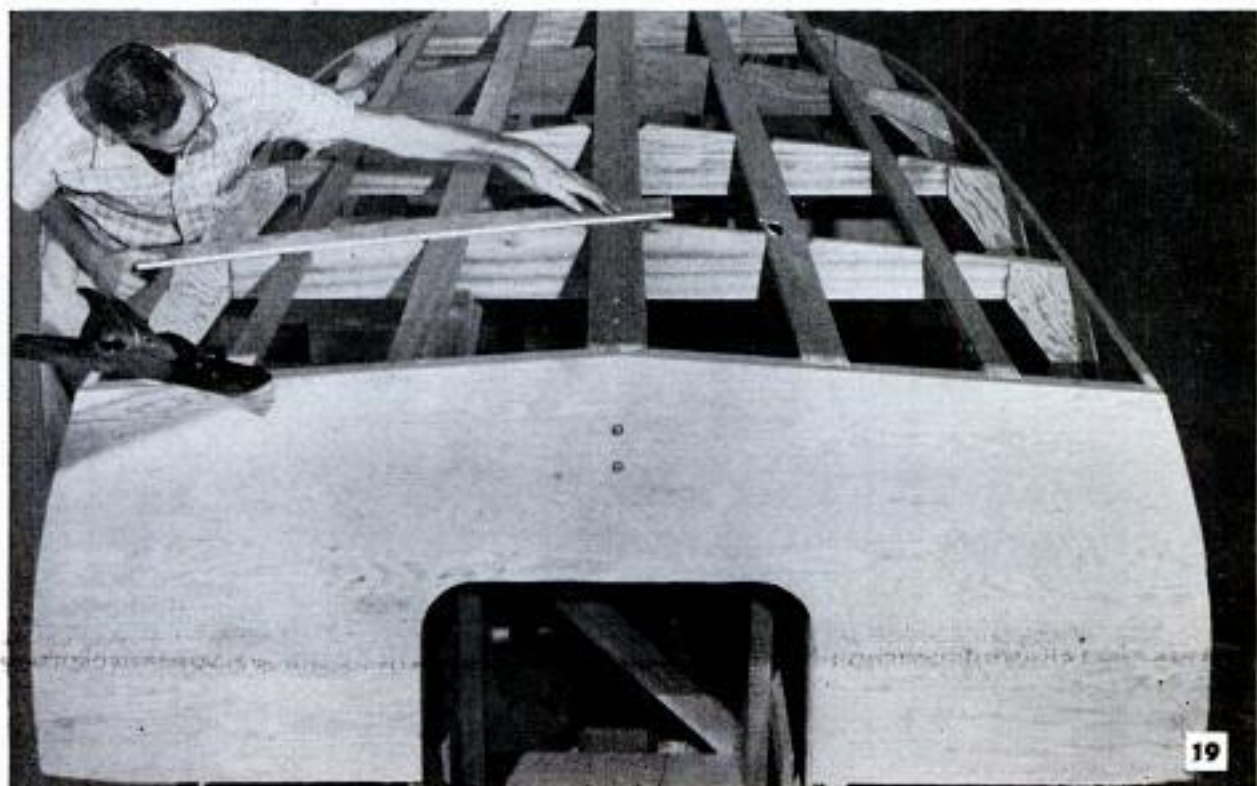

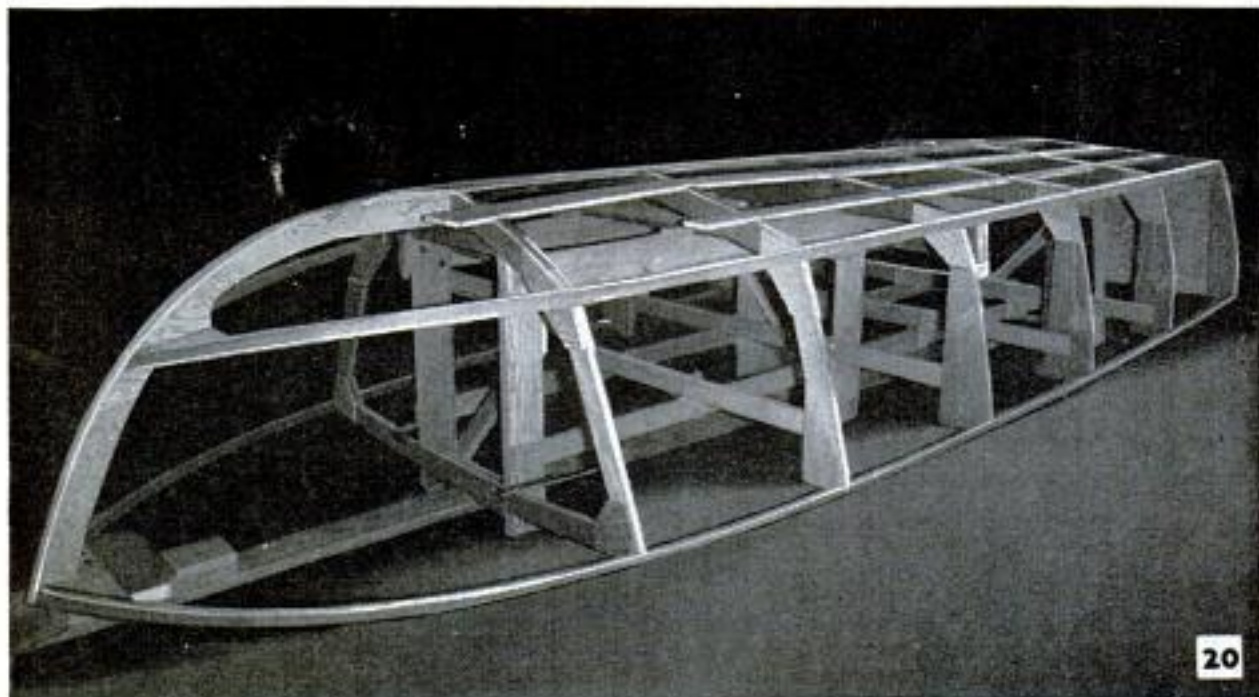

Skeleton framework ready for plywood planking. Note that it is left on building form while it is planked

frames. The notches for the sheer clamp must be beveled similarly to the chine log. Actually all of the beveling of notches will take place on the forward frames, 3, 4 and 5. Spring the first lamination of the sheer clamp around, fastening it to all members with a single 1¼-in. ring-type nail. The second layer is then coated liberally with glue and laminated to the first, Fig. 15. Screw through both layers at the frames and transom with 2 in. No. 10 screws. Use several at the breasthook. The laminations may be held together with clamps if enough are available. If not, nail from the inside with 1-in. ring-type nails spaced 4 in. apart. Be careful up forward to keep the nails to the decking side of the sheer clamp, as much of this member is planed off, particularly up forward during the fairing operation. The builder will note that the sheer clamp follows the contour of the side planking from midship aft. However, up forward the sheer clamp must be set in vertically. Attempting to twist the member up forward will probably result in a lot of kindling wood for your next fire. The bends usually can be made cold.

**Fairing:** All of the members, frames, stem, transom, keel, chine log and sheer clamp must now be beveled so that the planking will lay flat, or mate to all members, Figs. 16 and 17. The difficult part here will again be up forward. A wood rasp is handy at the stem and for the roughing-in, but a plane should be used in the long sweeps and final finishing to avoid dips or hollows. Probably one of the most difficult portions to understand is usually the chine log up forward. Studying

the section at the chine at various points should help to clear this up. In fairing, always stand back every so often and sight along the hull lines where you are working. The lines should be fair and even without humps or bumps. The use of a portion of ¼-in.-plywood sheet, large enough to go from chine to keel or chine to sheer over several frames, will be of great help.

**Battens:** We have held off mentioning the installation of the battens until after fairing. By waiting until now, the notches for them can be accurately made from the faired lines of the frames. The inner batten closest to the keel is 1 x 3-in. oak or mahogany. In twin installations, as previously mentioned, the positions of the battens are interchanged. The outboard batten is 1 x 2 in. Both members are in single length and will extend about 6 in. forward of frame No. 5 for the inner batten, and No. 4 for the outer batten. The slitting or kerfing edgewise of the battens closest to the keel, back about 18 in. from the forward ends, will make them spring in easier. These inner battens should be allowed to float free in oversize gains, or notches, in frame 5. Fasten the battens to the balance of the frames and transom with 2-in. No. 10 screws after first coating each notch with glue. The fairing should again be checked, Fig. 19, to be sure that the planking skin will still lay flat to all members. Note in Fig. 18 that limber holes are provided in the frames on each side of the battens and keel. Fig. 20 shows the hull framework ready to be planked.

(To be continued)

WTM 58

# THE POPULAR MECHANICS CRAFTSMAN



Sloane-Ilabon photo

## LOUVERIZE YOUR PANEL DOORS

By E. R. Haan

**P**ANEL DOORS are ugly ducklings when it comes to home modernizing. There's little one can do with paint alone to erase their dated look. However, the handy homeowner can convert such doors to smart-looking ones without even removing them from their hinges. Essentially, it requires cutting out the upper portion of the door and inserting a preassembled louver.

Cutting the opening in the door is a fairly simple job which first requires drilling  $\frac{3}{4}$ -in. holes at the corners of the panel to admit a keyhole saw. After the cut is started, a regular handsaw is used to complete the sawing. The frame itself, which holds the  $\frac{1}{4}$ -in. slats, is made of  $\frac{1}{2}$ -in. strips, 2 in. wide. Since the frame sides must be made as right and left-hand members, both pieces cannot be grooved at the same time; the grooves in one have to be cut at a reverse angle so they face in the right direction. A jig like the one in Fig. 3, which is used in conjunction with the saw miter gauge as in Fig. 2, assures uniform spacing of the grooves. The jig is altered to space the second set of grooves. Where the regular saw blade is used, two stop blocks are attached to the rear side of the jig to limit the cut.

MAY 1957

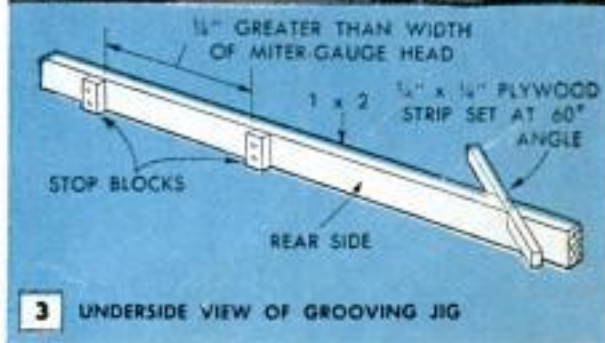

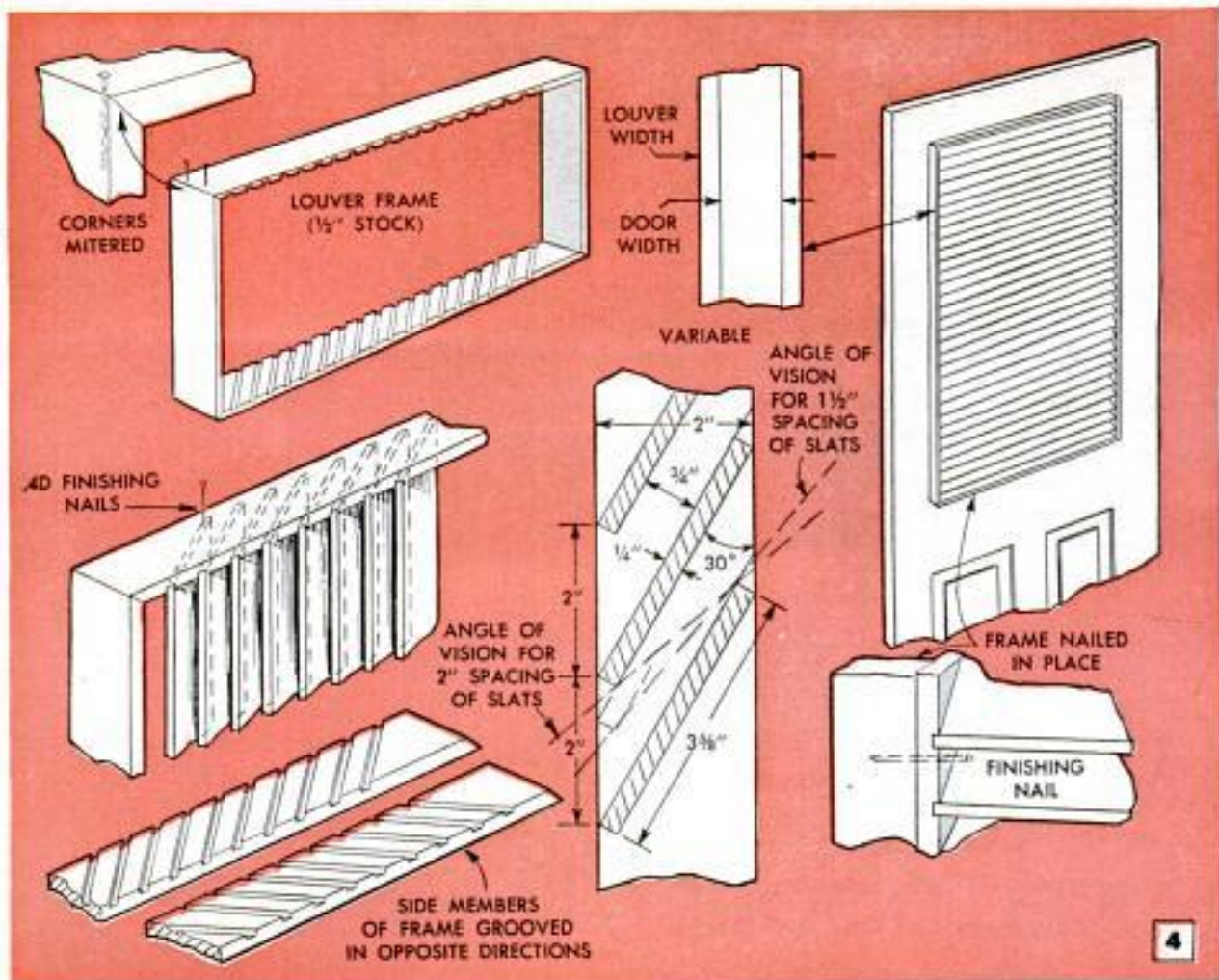

Here is how the jig is used: After a starting groove is cut in the side piece with the miter gauge set at 60 deg., the jig is placed against the face of the miter gauge and the starting groove is positioned over the index strip. Then with one stop block bearing against the end of the miter gauge, the work is passed through the saw. Then the jig is shifted sidewise to bring the other stop against the opposite end of the miter gauge and a second cut is made. Finally, a third cut is made to clear out the waste between the two outside cuts. If a 1/4-in. dado head is used on the saw arbor, there is no need for the stop blocks

as the jig can then be attached directly to the miter gauge and each groove cut with one pass of the work.

Fig. 4 details how the frame is put together, the corners being mitered, glued and nailed. Over-all dimensions of the frame are taken from the opening itself, and the louver is fastened in place with finishing nails driven between the slats. You have a choice of letting the frame project a little on each side of the door or keeping it flush on one side. The crack between the sawed edge of the door and the louver frame should be filled before the door and louver are painted. ★ ★ ★

## Developer Cooled by Running Cold Water Through Tubing



Constant passage of cold water through a length of flexible tubing coiled down and out through a developing tank will speed up the cooling of a developer solution. Use a long enough tube so that it can be coiled a couple of times in the tank and still have the open end out in the sink. By partly plugging the drain in the sink so that a cold water jacket is formed around the tank, the cooling process can be completed even faster. Be sure to wash all the developer off the tubing before using it to cool other processing solutions.



WTM 58 X470

# PATIO TABLE



By Tom Riley

**T**HIS IS FOR YOU if you want a better barbecue table. The top is built up of fired floor tile which results in a fully weatherproof surface, and gives a genuine outdoor feel to the design. Leg construction permits persons to sit comfortably in chairs at the ends. Seats 8 to 10 persons. For a smaller table version, reduce the length of the top and benches 1 ft. (one tile), all other dimensions, except length of center stretcher, remaining the same.

Before beginning construction, obtain

standard 1 x 12 x 12-in. red floor tiles, commonly used on patios and in vestibules. Lay the tiles out on the floor, press tightly together and measure their over-all length and width. The tiles in your completed table can be left loose or they can be cemented in place. If not cemented, dimension the table-top recess to take the tiles snugly. If tiles are to be cemented, add  $\frac{7}{8}$  in. to the length and  $\frac{3}{8}$  in. to the width of the table. This will allow for a  $\frac{1}{8}$ -in. cement joint between the tiles.

Colored tiles, 12 in. square, inlaid in natural redwood are a distinctive feature of this modern patio table



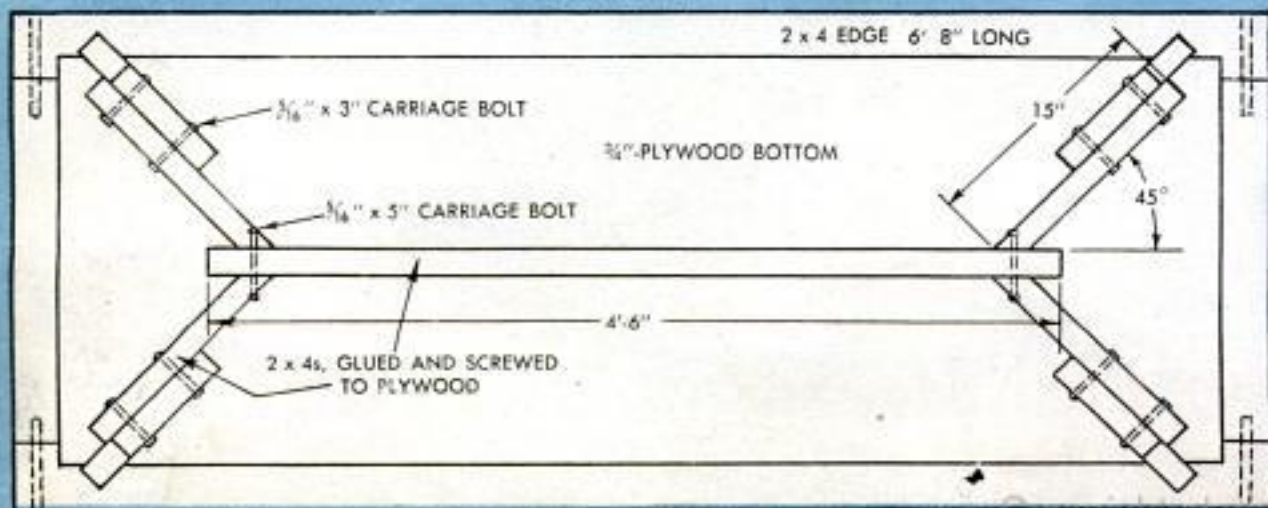
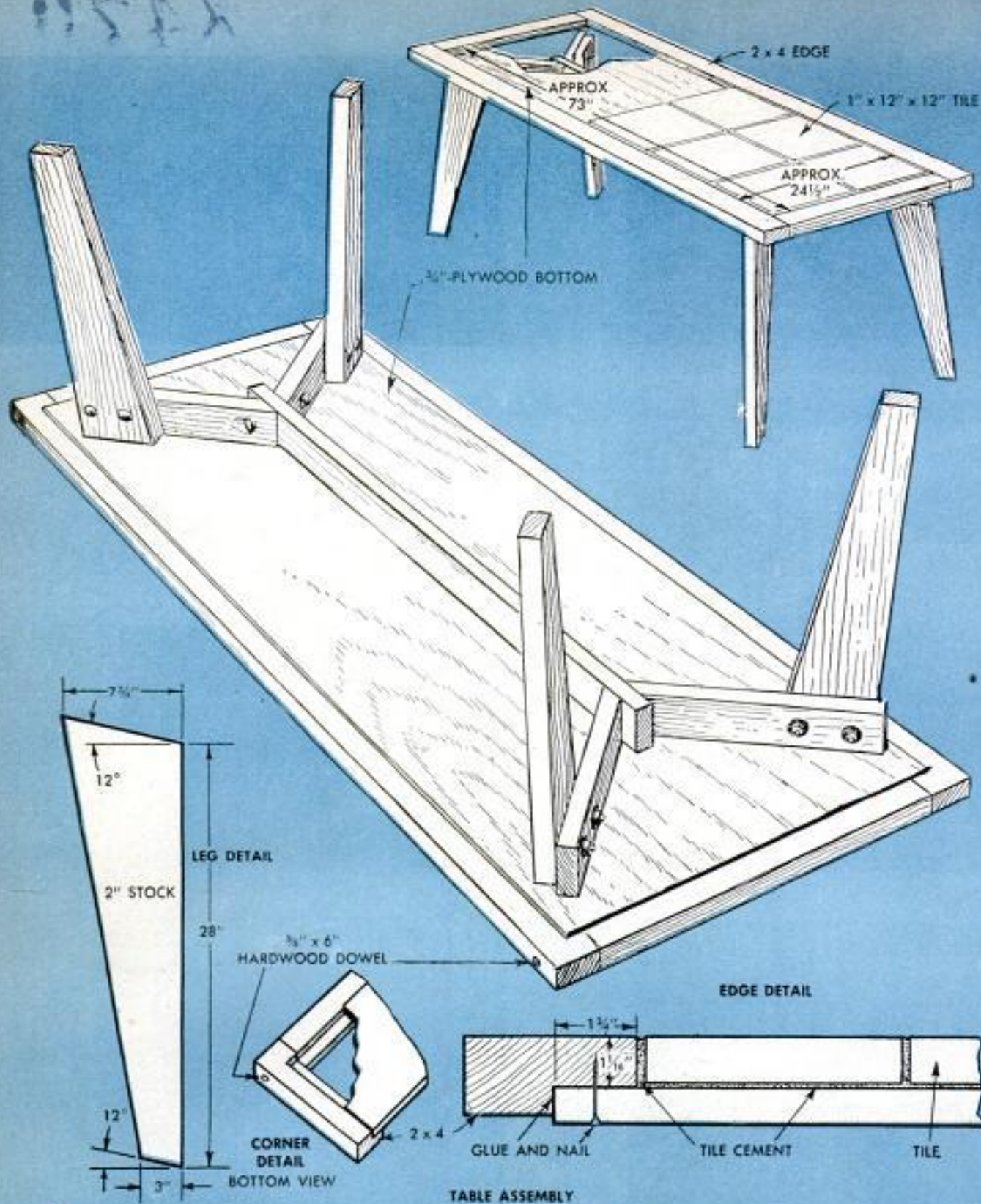

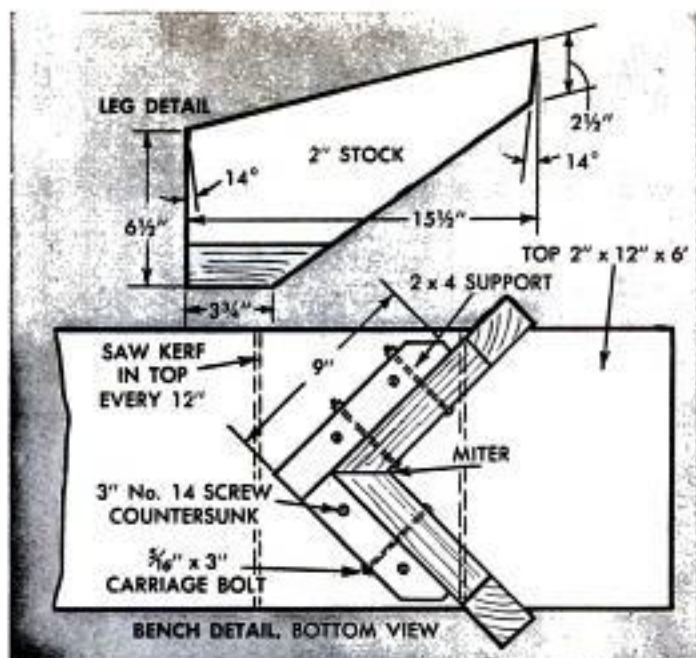

The  $\frac{3}{4}$ -in. exterior-plywood bottom piece which forms the recessed table top is cut to the dimensions given plus  $1\frac{3}{4}$  in. on each side. The 2 x 4-in. edging of redwood is rabbeted to receive the plywood. Note that the rabbets do not extend to the ends of the two side members. The rabbets are stopped and the cuts squared with a chisel. Corners of the table-top frame are doweled as in the corner detail, using one  $\frac{5}{8}$  x 6-in. dowel in each corner. Assemble with the dowels and waterproof glue.

The bottom view on page 176 shows the location of the table-top support and one method of assembling the legs. Both the center support and the leg rails, located at a 45-deg. angle with the center member, are attached with glue and screws. Use glue and  $\frac{5}{16}$  x 5-in. carriage bolts to secure the inner ends of the leg rails to the center support. Each of the table legs, cut to dimensions from 2-in. stock, is attached to the rails with  $\frac{5}{16}$  x 3-in. carriage bolts. Do not glue these joints as you may wish to remove the legs for wintertime storage. Position the legs on the rails so that their bottom ends are equally  $1\frac{1}{2}$  in. in from the edge of the table top.

The two 2 x 2-in. bench tops are cut exactly 6 ft. long, and a  $\frac{1}{8}$ -in.-deep saw kerf is cut every 12 in. across their tops to simulate tiles. Secure the 2 x 4-in. leg supports with glue and 3-in. screws in countersunk holes. Cut the bench legs to dimensions in the detail. Note how each leg is mitered, the operation being pictured in the upper photo. Assemble the pairs of legs with nails and glue in the joints.

Apply a first coat of either redwood or clear resin sealer to the table and benches and then follow with two coats of spar varnish. If the tiles are to be left loose in

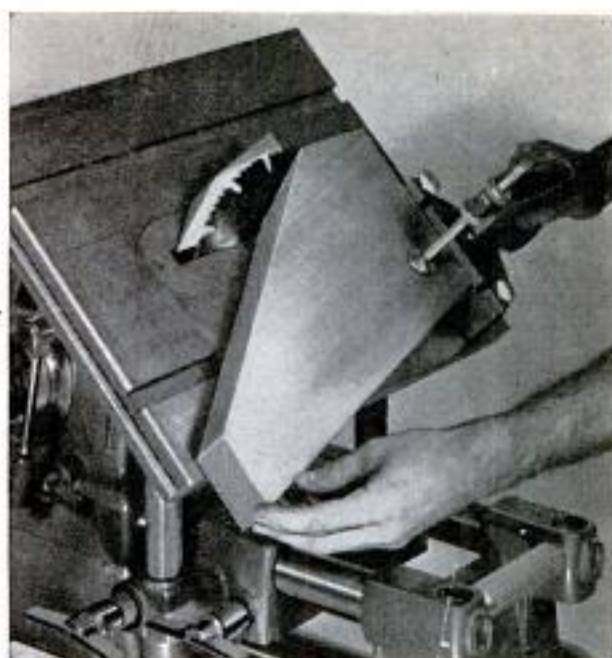

Above, running the miter cuts at the top ends of the bench legs. Below, using the circular-saw blade to cut the rabbet in the end pieces of table frame

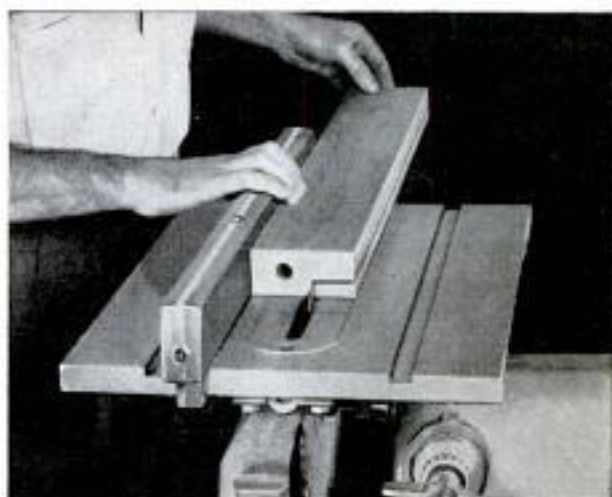

the top, lay them in place and give them several coats of wax of the type recommended for tile. If the tiles are to be cemented, give the tops of the tiles a coat of the wax beforehand to prevent spotting them with cement. Using a suitable tile cement, trowel a  $\frac{1}{16}$ -in.-thick layer over the top of the plywood. Place the tiles in position and press them down firmly. The joints between tiles are then also filled with the cement. ★ ★ ★

### Vertical Ruling With T-Square

Small equidistant holes in the blade of a T-square simplify ruling of vertical lines. Holes are laid out carefully and drilled to take a pencil point.

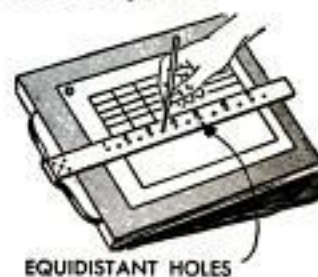

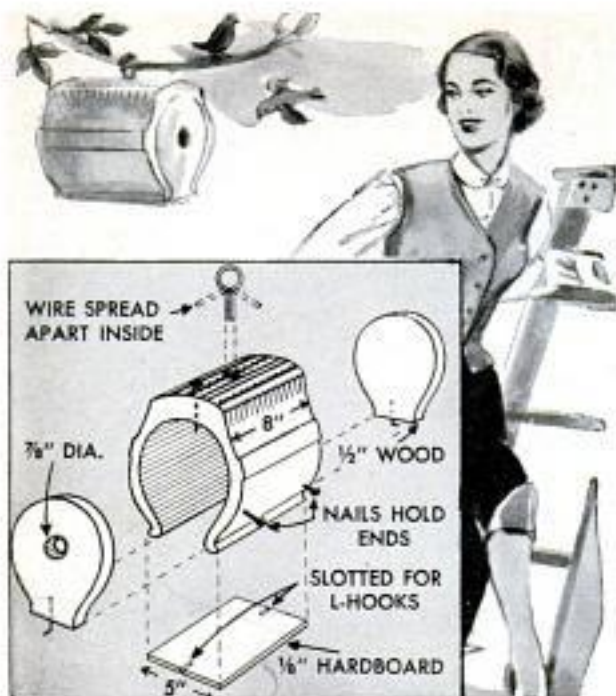

### Durable Wren House Easily Made From Auto-Tire Casing

The roof and sides of this novel wren house are cut from an auto-tire casing and the wooden ends are scrollsawed to fit flush inside the ends of the casing where they are nailed in place. The bottom is a piece of tempered hardboard slotted at the ends so that it can be held in place by an L-hook driven into each end piece. A length of wire bent in the shape of a cotter pin, permits easy hanging.

### Modified Screen-Door Hook Protects Younger Children

To prevent youngsters from unhooking screen doors and window screens, and possibly endangering their lives, modify the hooks so they can be released only by an adult. Simply bend the hook back slightly as indicated by the lower hook in the photograph so that it will bend in the screw eye and require more strength to release than a child will have.

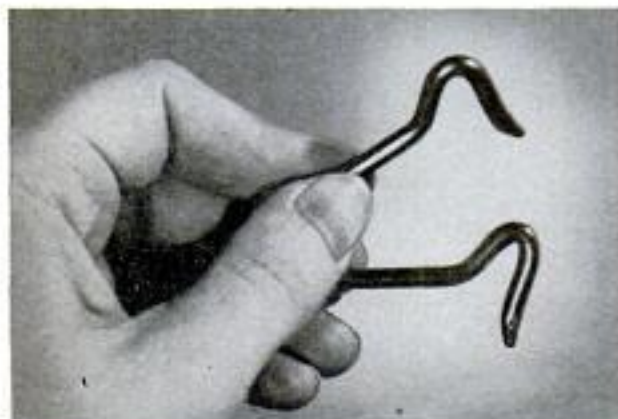

### Lavatory Platform and Cabinet Accommodates Small Children

For the convenience of small children, this plywood platform and cabinet can be temporarily fitted under the lavatory so that a toothbrush and other articles can be easily reached and used without assistance. The platform is simply an open-bottom box with a slot cut in one end and part of the front cut away as shown, for toe space. Also, the cabinet is a handy place for storing articles used in the bathroom.

### Chalk Writes in Vivid Hues When Tinted With Food Color

Lacking colored chalk, you can easily tint ordinary white chalk so it will write in color by saturating it with liquid food color of the desired shade. In concentrated form, the food color will permit writing in deep, vivid shades. Diluting it with rubbing alcohol you can make pastel or lighter shades. Label bottles of food color mixed with alcohol and store them with the chalk.





Completed pool being enjoyed by whole family. Top layer of liner can be colored, slate-surfaced roll roofing

## PAPER POOL FOR THE KIDS

IF ROOFING PAPER will keep water out, it should keep water in and Larry O'Rourke of Trenton, N. J., proved his point by using it to make a king-size wading pool for his kids for as little as \$15.00. This paid for three rolls of 45-lb. asphalt roofing and a 5-gal. can of roofing cement, all that was needed to make a 15 x 15-ft. pool, 18 in. deep. The roofing, which should be the smooth-surface type, is used to make a "pie crust" liner inside a shallow excavated area in the yard. The dirt is piled around the edge to form a bank and tamped firm, after which the bottom of the excavation is covered with four separate layers of roofing paper. The strips of each layer are lapped about 6 in. and sealed with roofing cement. Each layer, in turn, is coated with tar and laid at right angles to the other. Separate strips are laid in at the corners. The important thing is to wind up with a watertight liner. Several large stones placed over the seams of the top layer will weight them to assure good contact. The edges of the layers are trimmed off evenly and then weighted all around the pool with large flagstones. It takes about 4 hr. to fill the pool with a garden hose and it can be drained in about 30 min. with a bucket and broom. Since freezing will not damage the pool, it can be partially filled with water during cold weather and used as a small skating rink.



Above, flagstones weight the edge of the paper liner and help decorate pool. Below, short-handle broom will be found handy for applying the roofing cement to the lapped roofing seams





### Rate of Water Flow Checked With Watch and Bottle

If you would like to know the rate of flow in gallons through a faucet or sill cock, it can be determined by using a quart milk bottle and a watch with a second hand. Open the faucet to the usual rate of flow and thrust the empty bottle under it. Time the number of seconds required to fill the bottle and multiply the number by four to get the time for a gallon. Multiplication of this latter figure will tell the number of gallons discharged during any given period. When a faucet is used fully open, it may be necessary to use a gallon container when timing the flow of water.



### Refrigerator Provides Storage In Home Workshop

An old refrigerator may be converted into an ideal storage cabinet for use in your shop. To reduce weight, remove the motor and compressor. The freezer trays provide good compartmented storage trays for small parts, such as screws and nails. The vegetable-storage bin lends itself to storing larger tools, such as electric drills and tools of similar size. The remainder of the storage space can be fitted with shelves and drawers to suit individual needs. A cabinet of this type is dustproof and moistureproof if the door gasket provides a good seal.

### Mask for Print Border Made From Black Photo-Paper Envelope

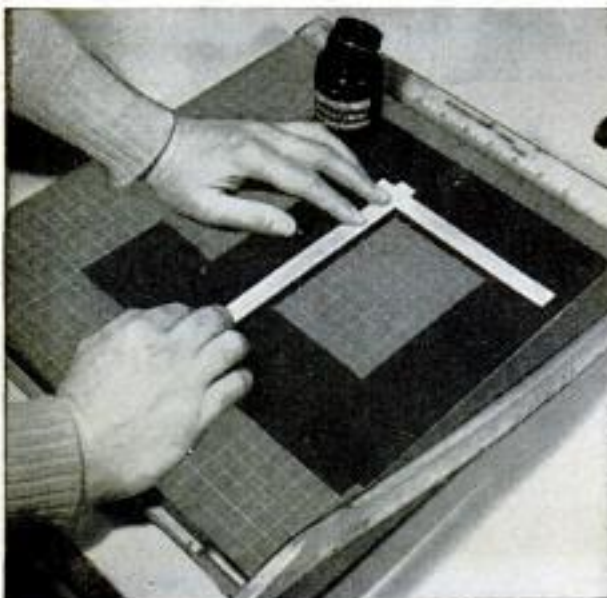

A mask for obtaining a uniform white border on photos made on a contact printer is easy to make and costs nothing, when four strips of black paper 2½ in. wide are cemented together according to the width of the border desired. The protective wrapper from an empty package of photographic paper is ideal for the strips, which should be cut and assembled on a trimming board, using the guide lines to align them at right angles. Two narrow strips of heavy white paper cemented to the mask as shown, serve as a guide for positioning the printing paper.—Russ Whitaker, Altadena, Calif.

☞ To determine the mileage obtained from a new tire, paint the speedometer reading on the inside of the casing so it can be checked when the tire is replaced.

# WIGWAM SMOKER—

*Preserves that possession-limit catch of fish for the trip home*

*By Clinton R. Hull*

WHEN YOU'RE ON a back-country fishing trip or a float trip in warm weather, there's always the problem of how to preserve a big catch when you're many miles from the home freezer. This wigwam smoker does the trick and you can set it up in a few minutes, using whatever is at hand—driftwood, green boughs, small saplings cut from the nearby forest and a tent or trailer tarpaulin.

The detail below shows the setup, using a length of stovepipe from the camp stove to conduct smoke from the fire into the wigwam. If stovepipe is not at hand, then build a suitable flue by using a number of flat stones. The wigwam, or tepee, is framed with four or more saplings, the top ends being tied together as pictured at the right. The platform on which the fish fillets are placed is made as pictured, the height from ground level being about 30 in. Start the fire with kindling, add dry wood and allow to burn down to live coals. Then add green wood, using any nonaromatic variety available in the locality. Place the fish fillets on the platform of green boughs and wrap the tent or tarpaulin around the poles as pictured, leaving an opening at the top for the slow escape of smoke. Fish to be smoked in this fashion should be filleted and the fillets salted well and placed on the platform with the skin side down.



A good smoking fire is started with seasoned dry wood which is allowed to burn down to bright coals. Then add green wood of whatever nonaromatic variety the locality affords. It may be necessary to restrict the air inlet somewhat when smoking. This may be done with a flat stone or green bough

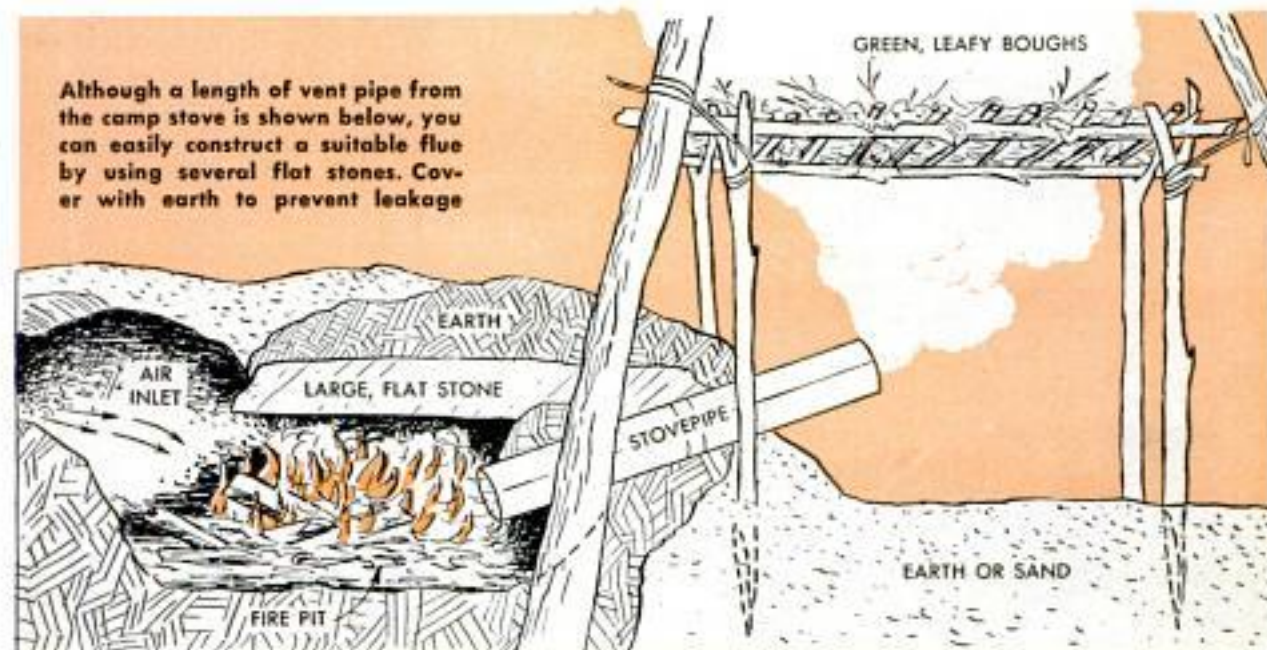

Although a length of vent pipe from the camp stove is shown below, you can easily construct a suitable flue by using several flat stones. Cover with earth to prevent leakage

WJM 58  
X651

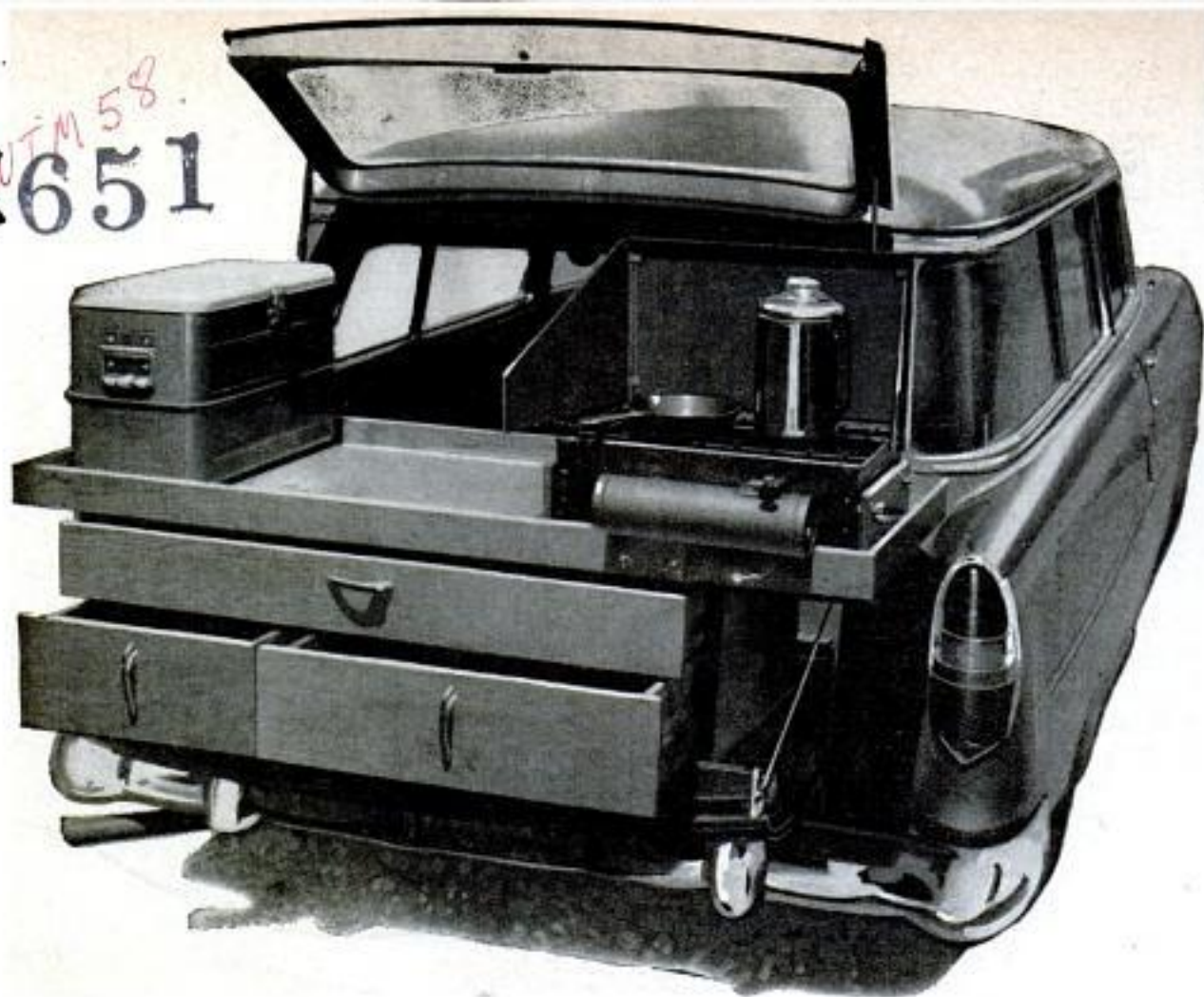

## Cabinet-Bunk for Your Station Wagon

By E. W. Bird

**C**ONVERT your station wagon into a comfortable "home on wheels" whenever you want to take it on a hunting, fishing or camping trip by simply lifting this cabinet into the cargo space. Storage for food, clothes and personal effects is provided by the two lower drawers, while fish-

ing rods, guns and other equipment will fit in the long upper drawer. The cabinet top is designed to be extended to form a 6-ft. bunk, and is wider than the cabinet base so a wider sleeping area is provided both for the person using the bunk and the other person who sleeps on the floor alongside

the cabinet. When traveling on the road, the cabinet is placed crosswise in the wagon behind the front seat, as shown in the lower photo on the opposite page. This leaves the rear portion of the station wagon clear for carrying other equipment and gear. At night this equipment can be placed on the front seat or left outside, and the cabinet is placed lengthwise for sleeping as shown in the lower photo on this page and the upper photo on the next page. A camp stove or portable icebox can be used to support the end of the extended bunk. At a campsite the cabinet is pulled out on tail gate of the wagon to provide a worktable. Combined

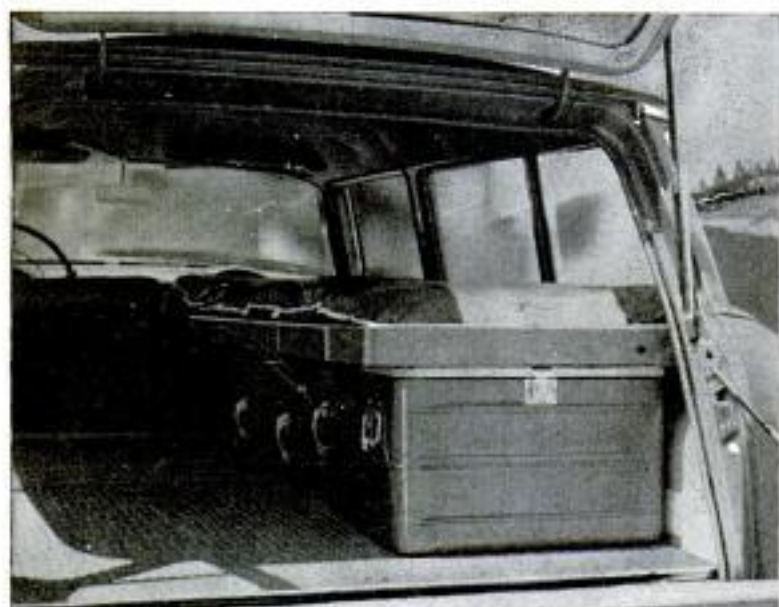



Upper photo shows cabinet top extended to form bunk and supported on portable icebox. Lower photo shows cabinet placed crosswise behind front seat so rear of station wagon can be used for additional storage



with a camp stove and portable icebox it provides a kitchen that is complete except for a sink.

All stock used in making the cabinet is 1/2-in. plywood. It is assembled with 1-in. No. 6 wood screws and all joints are glued for additional strength. Dimensions for the cabinet must be determined by the interior measurements of a particular station wagon, so dimensions shown in the details are only approximate. However, the height of the cabinet should be such that the bunk top clears the tops of the wheel wells of the station wagon, and the length of the finished cabinet base should be 5 in. less than the width of the inside of the wagon so it can be turned easily. This spare 5 in. can be utilized for storing a camp stove as shown in the lower photograph on this page. A plywood facing has been bolted to the metal of the stove so that it matches the rest of the cabinet for neater appearance. The top extension of the cabinet is slotted as indicated, and is held by a bolt and washer with a wing nut turned on from beneath. The wing nut is reached by opening the top drawer. To prevent the cabinet drawers from sliding open when the station wagon is on the road, they should be fitted with locking pulls or cabinet latches. Large rubber-headed tacks prevent the cabinet from sliding. ★ ★ ★



DEPTH AND HEIGHT DETERMINED BY STATION WAGON (WIDTH 5" LESS TO PERMIT CABINET TO BE TURNED)

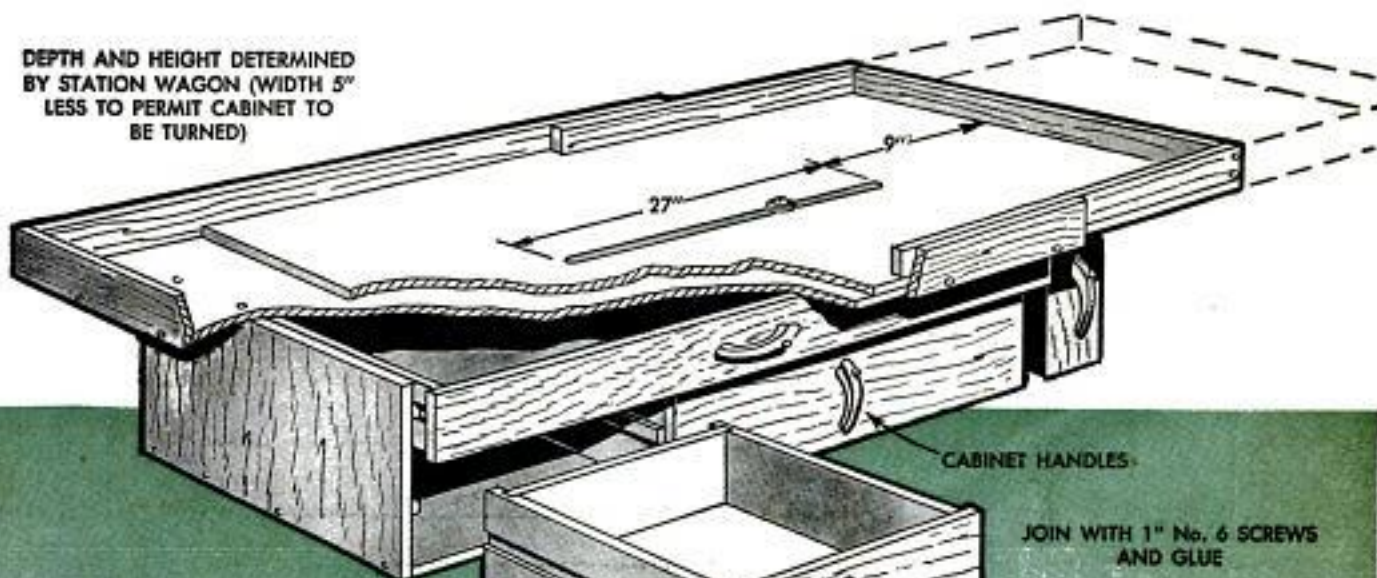

THIS HEIGHT SUFFICIENT TO CLEAR REAR-WHEEL WELLS

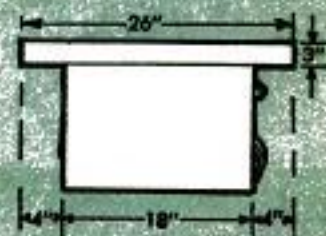
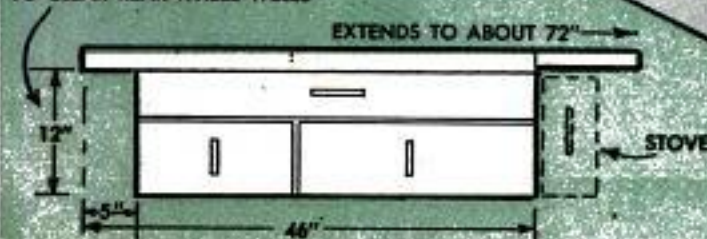

# X538 THRILLS GALORE ON

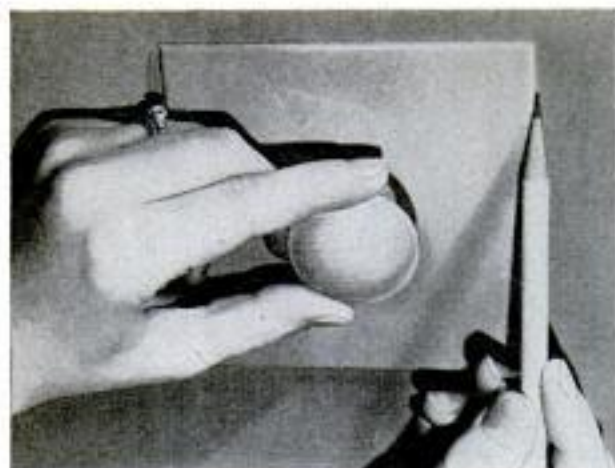

## Spare Tile Used as Gauge For Laying Wall Tile

When installing plastic tile, a spare tile fitted with a knob will prove helpful as a gauge for laying out hard-to-get-at corners. The gauge is easy to hold and manipulate behind pipes and radiators and in other places difficult to measure. Tiles to be cut can be marked by guiding a pencil along the edge of the gauge, and the width of fill-in tile can be measured by making a mark on the gauge.

## Thin Strips Attached to Sides "Refit" Loosened Drawers

Wooden drawers that have shrunk so that they fit loosely in the slides and twist and jam easily, can be made to fit snugly by attaching a thin wooden strip to the outer surface of each side near the lower edge as indicated in the photograph. Use a strip of equal thickness on each side so the drawer is centered, and wax the strips to assure easy operation. Use small brads and glue to attach the strips.



☐ Varnish and wax the lower ends of hair-pin-type chair legs and they will be less likely to mark linoleum floors.

HERE IS a miniature version of one of the most popular of amusement-park rides, the roller coaster. You can set it up in the back yard or basement in less than an hour, once the members for the track and supporting structure are cut and assembled into one straight and one contoured section as shown in the drawing and details. Slight slopes and a relatively short over-all length permit rides on the one-passenger car that are exciting for small children, yet completely safe. There are no curves or high track, and guide rails on both sections prevent the car from jumping the track. If a longer track is desired, a second contoured section may be added.

The car is of wooden construction with the front half of a roller skate screwed to the underside just forward of the front crossbar as shown in the detail. The other half of the skate is attached similarly at the rear of the car. Except for the 1/2-in. plywood bottom, the car is made of 1-in. lumber as shown in the details. Exactly 5/16 in. clearance should be allowed between the track and the members nailed to the ends of the crossbars on the underside of the car as shown in the end view. These members, which serve as stabilizers, enable the car to glide over the track without tip-

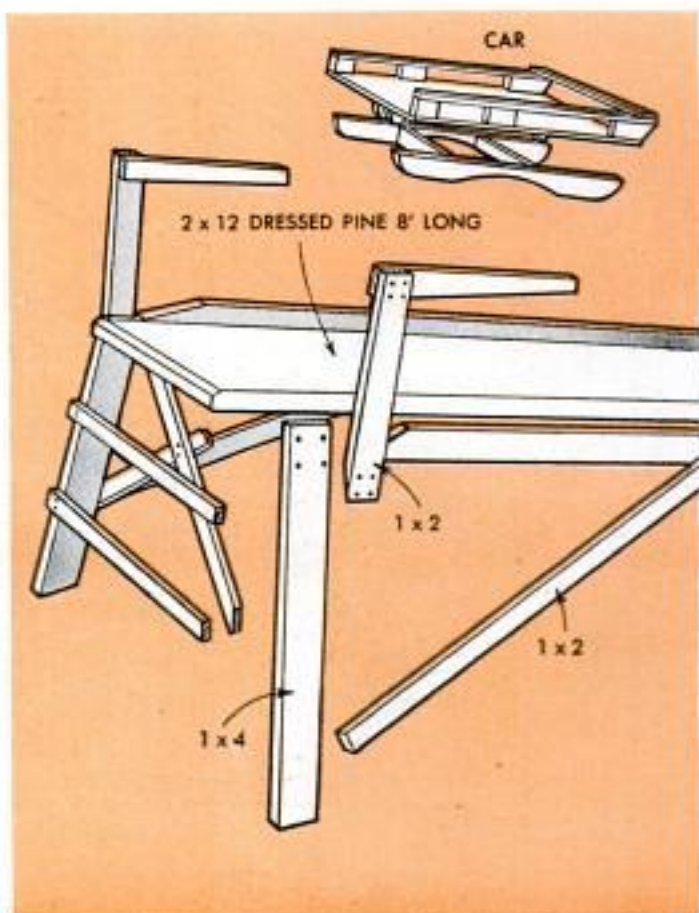

POPULAR MECHANICS

# THIS ROLLER COASTER



ping and prevent it from climbing over the guide rails. A footrest at the front of the car provides added safety.

For the straight section of the track, an 8-ft. length of 2 x 12-in. pine is elevated 2 ft. at one end by two 1 x 4-in. supports braced by four 1 x 2s. A bevel cut on the upper end of the track prevents the car from rolling forward when boarding it. The lower end of the track rests on a crossbar and the ends of the sideboards of the contoured section and is joined to the latter

section by two lag screws turned through the guide rails and into the 2 x 12.

After cutting the 1/4-in.-plywood track for the contoured section, the pieces should be primed with linseed oil on both sides, then nailed to the sideboards and crossbars as shown in the details. Plywood or 1/2-in. lumber can be used for completing the contoured track. The guide rails should be well sanded and the car and track structure painted as desired to avoid injury from splinters and protect the wood. ★★★

Over-all length of track can easily be increased by adding one or more contoured sections for longer ride

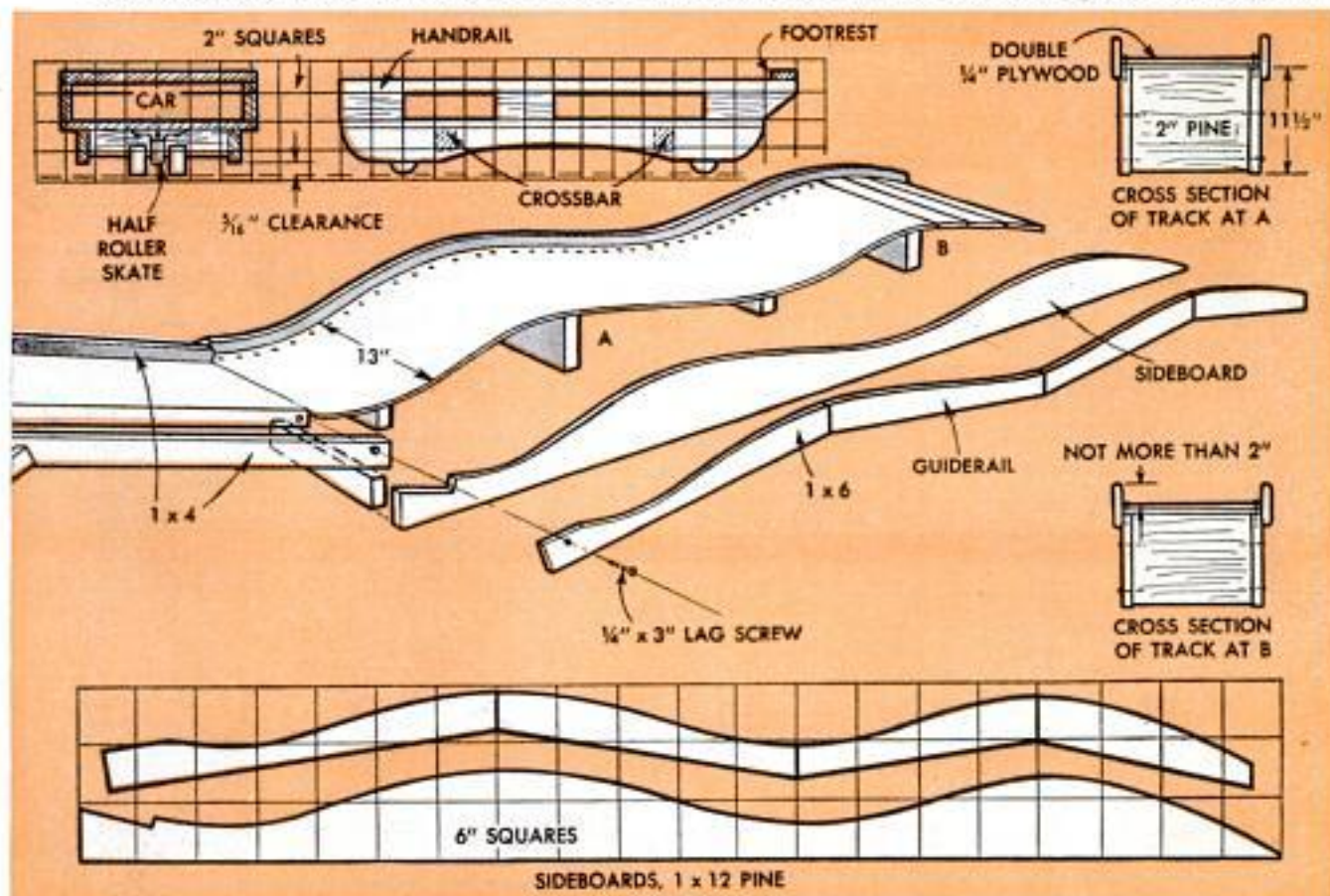

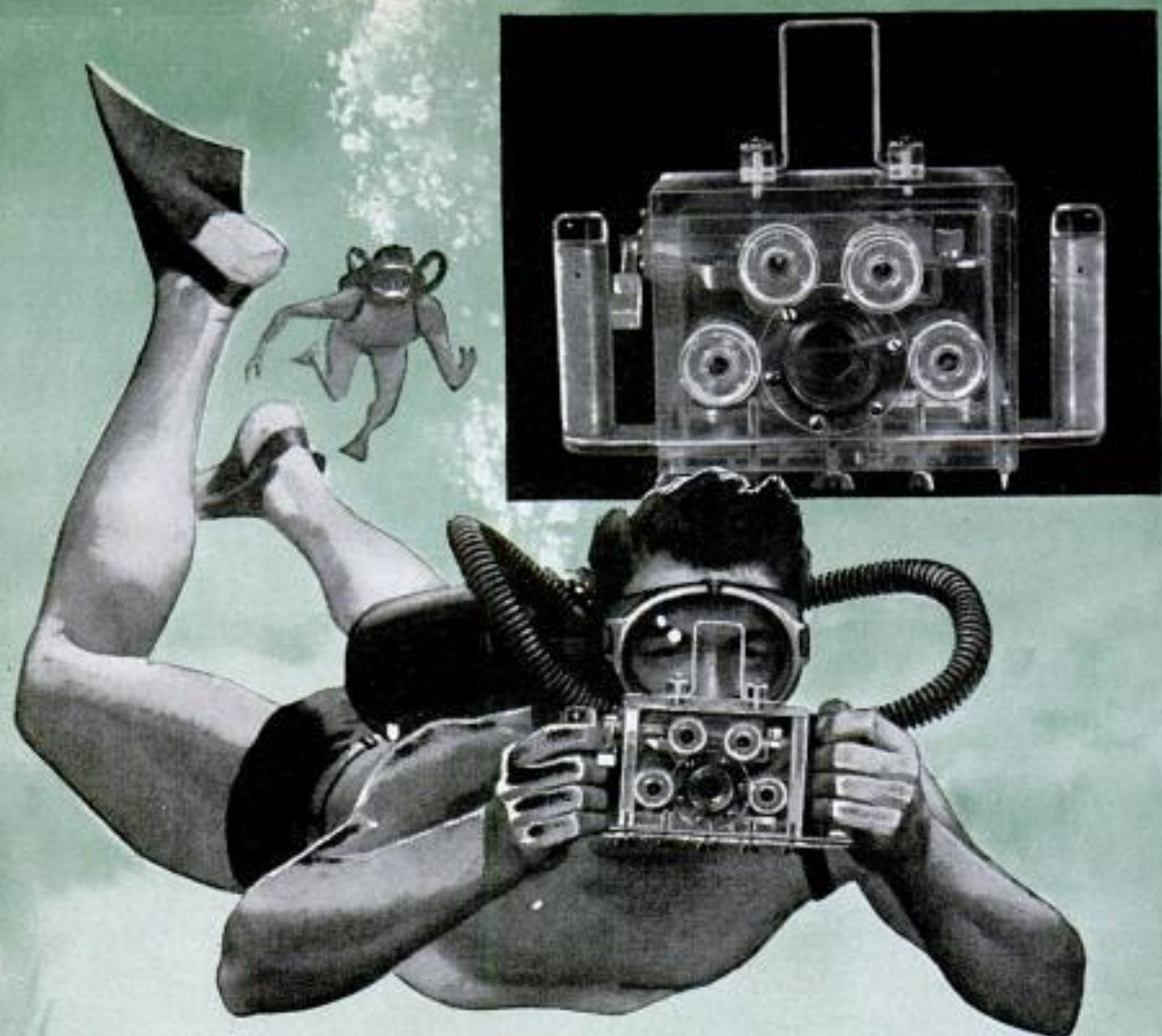

Plastic case designed for Mercury II camera can be used with other cameras when controls are relocated

## TAKE YOUR CAMERA UNDERWATER

By Hampden Banks, Jr.

WITH YOUR 35-mm. camera in this watertight plastic case you can photograph marine life in black-and-white or color just as easily as taking pictures on land. The case described in this article is designed for a Mercury II camera, because this model enables one to take 72 split-frame pictures on a 36-exposure roll without disassembling the case to reload. However, almost any 35-mm. camera can be used simply by relocating the controls.

When making the case, first cut the sides, ends, top and bottom from  $\frac{1}{2}$ -in. plastic and machine to size, leaving the protective paper on the material to prevent scarring its surface. After grooving the inner sur-

faces of the ends as shown in Figs. 1 and 2, for positioning the camera, the sides, ends and top are cemented together. When cementing two pieces of plastic, the interfaces need not be polished. It is sufficient to sand the machined edges only with No. 400 grit sandpaper. If clamps are used, they should be pulled up not too tightly, to permit the cement to spread evenly. When applying cement, use an eye dropper. A well-cemented joint is completely transparent.

Next, a rectangle is cut from  $\frac{1}{4}$ -in. plastic to fit snugly inside the bottom of the case. This piece, when cemented to the bottom member of the case, serves as a base plate for the camera and provides for proper

positioning and clearance for the camera controls. After drilling the bolt hole in the base assembly, it is counterbored  $\frac{3}{16}$  in. deep to accept two rubber gaskets and the head of the camera-clamping screw, after which the camera is bolted in place. Four  $\frac{1}{4} \times \frac{5}{16}$ -in. plastic guides are then cemented to the base plate as shown in Fig. 1, to aid in positioning the camera each time it is placed in the case.

### Assemblies for Camera Controls

The brass fittings for the film-advance, shutter-cock and shutter-speed controls are cut and machined from brass tubing and rod as required and the gears silver-soldered to them as shown in Fig. 4, detail C. The brass collar for the film advance is machined to provide a press fit directly on the camera knob, while the shutter-speed control merely replaces the original knob on the camera.

When making the metal collar for the aperture control, Fig. 3, detail E, the f-numbers and calibrations should be re-

produced on a strip of paper and glued on the collar after the latter is positioned properly over the lens barrel with the pin and offset control rod attached. Then, the small knob on the camera body used for focusing is tapped and a control rod, the same as the one used for the aperture control, screwed to it. Next, control-knob holes are machined in the front and one end of the case as shown in Fig. 4, detail B, and all plastic control-knob fittings are machined and polished. When drilling, tapping, milling or turning plastic, use liberal amounts of kerosene for lubricating it. After the rubber gaskets are cut from a piece of inner tube about  $\frac{1}{16}$  in. thick, holes for fastening the cover plates are tapped, and parts for the controls made as shown in Figs. 2 and 3, after which each control is assembled and inserted in its respective hole in the case. When the inside assemblies are completed as shown in the details, each is secured to the shaft cut for it, Fig. 4, detail D. Also, the focus and lens-aperture controls are connected to

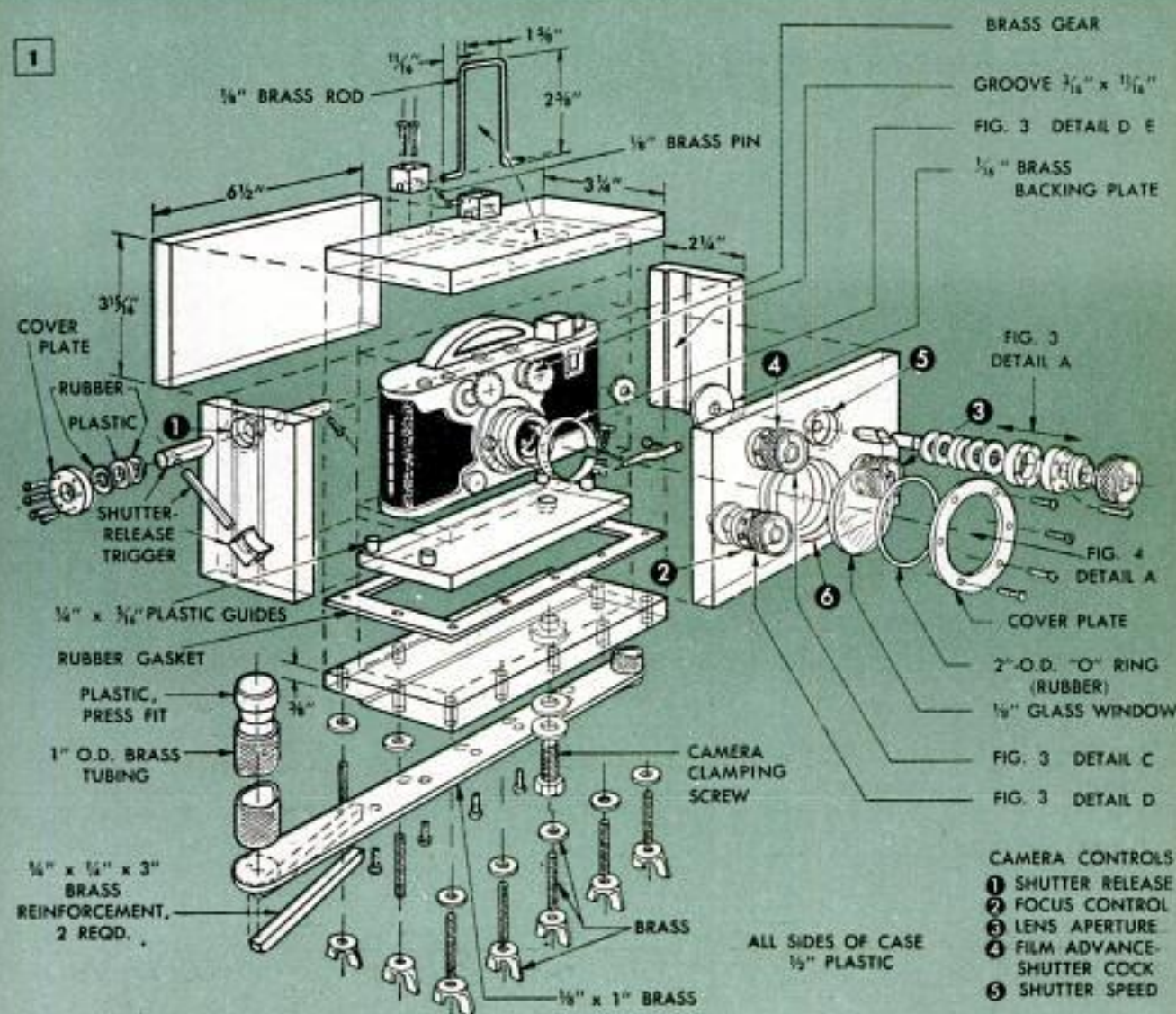

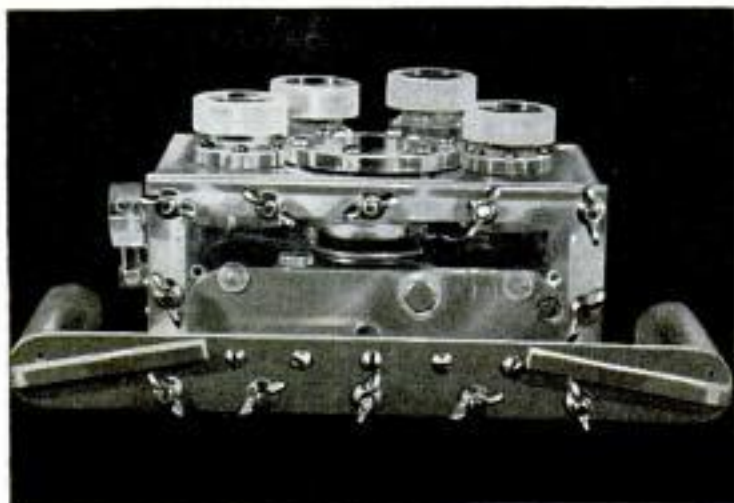

When inserting camera in case, be sure trigger-release screw is out of way and gears mesh, then secure base with wing nuts

their respective controls on the camera and checked for proper alignment at this time. The outside assemblies are the same for all controls except that a trigger-release arm is used in place of a knob on control No. 1. Only one rubber gasket is required on each side of the plastic disk for controls 1, 2, 3 and 4, and the plastic chamber extension is needed on the shutter-speed control only. This is necessary to permit the gears on the

latter to be disengaged for unobstructed action of the shutter-gear train.

When satisfied that all controls work smoothly, cement the plastic disk in position on each shaft so the rubber gaskets fit flush in their chamber after the gaskets are coated with silicone grease and secured by the cover plate. All parts for the controls are made from plastic stock except the gaskets, control rods, aperture-control collar and gear parts.

### Lens-Cover Plate

For a watertight installation of the lens-cover plate, machine the aperture accurately to the specifications shown in Fig. 4, detail A, and screw the parts into position. The "O" ring needs no silicone grease. It is wise to keep this grease away from parts to be cemented since presence of the material will prevent a bond between surfaces.

To accommodate the  $\frac{1}{8} \times 1 \times 10\frac{1}{16}$ -in. length of flat brass to which the reinforcement bars and handles are silver-soldered, the camera is removed from the base plate and a rabbet is cut in the bottom member,

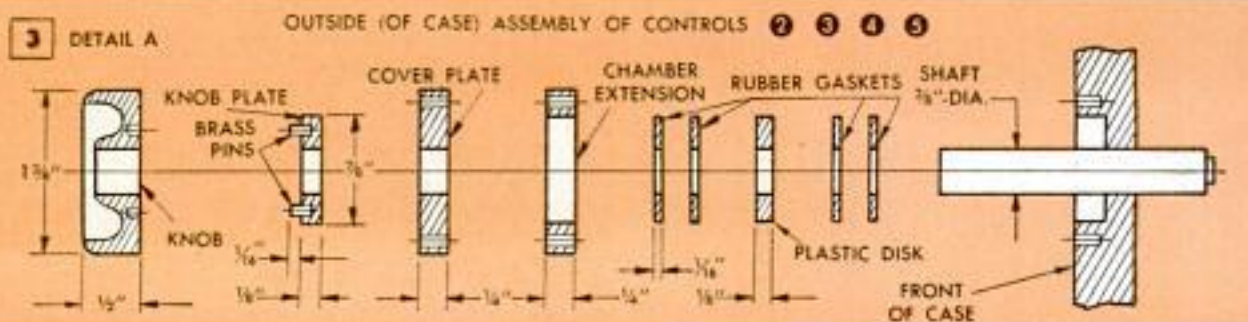
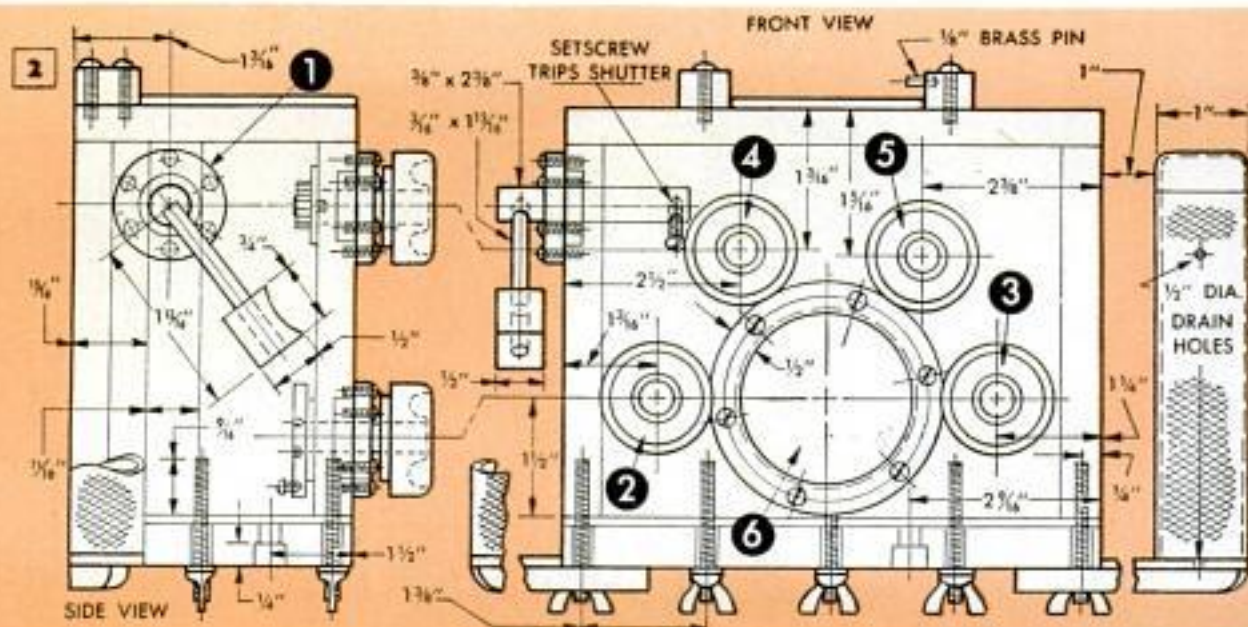

Fig. 1. The handle assembly is then screwed to the bottom and holes for securing the latter to the case are drilled, spaced  $1\frac{3}{8}$  in. on center as shown in Figs. 1 and 2. The holes drilled in the vertical members of the case are tapped to receive  $1\frac{1}{2}$ -in. studs cut from 8-32-threaded brass rod. The studs are then coated with cement and screwed in position. A rubber gasket cut from an inner tube and coated with silicone grease on both sides provides a watertight seal when the bottom is screwed in place. When fastening the bottom, only moderate pressure should be applied on the wing nuts, tightening those at the center first and working outward. The grease on the gasket will appear to change color when a watertight seal is made. If the case is not to be used for a time, the cover-plate screws should be loosened to prevent slow seepage of the grease out of the fittings.

The design of the plastic case provides for a slight buoyancy for easier operation of the camera. If no buoyancy is desired, the hollow handles may be filled with small pieces of brass, copper or stainless steel. ★ ★ ★

Right, view finder mounted on  $\frac{5}{8} \times \frac{3}{8}$ -in. plastic screwed to top of case folds flat when not in use



Above, after brass gears are silver-soldered to appropriate fittings for film advance and speed controls, the latter two are installed in place of knobs

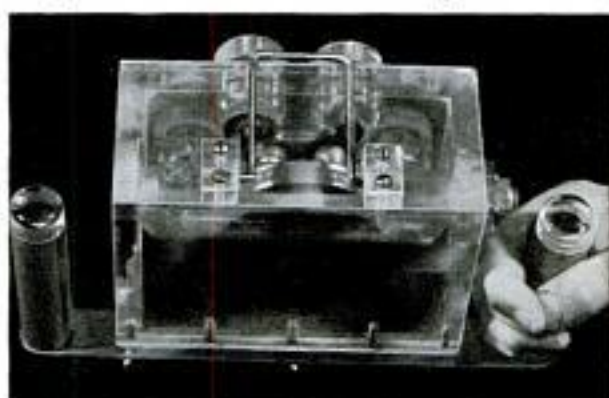

4 DETAIL A

LENS COVER-PLATE ASSEMBLY

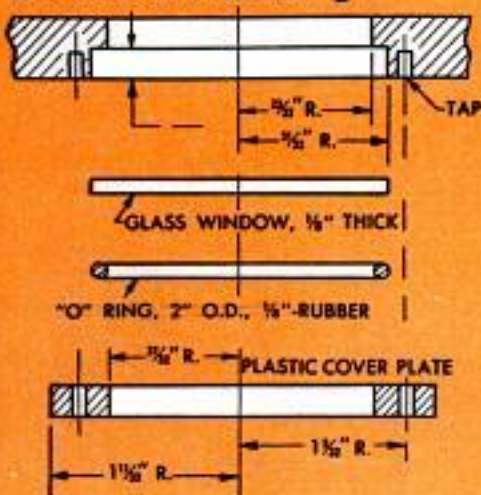

DETAIL B

GUIDE FOR MACHINING HOLES IN CASE FOR CONTROLS

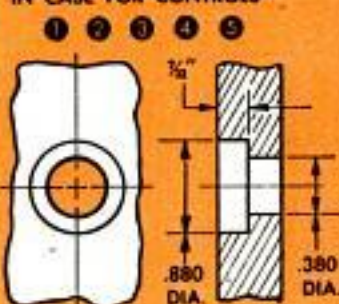

SHAFT LENGTHS FOR CONTROLS (FROM  $\frac{3}{8}$ " PLASTIC DOWEL)

- NUMBER 1 -  $2\frac{3}{8}$ "
- NUMBERS 2 3 4 -  $1\frac{1}{2}$ "
- NUMBER 5 -  $2\frac{1}{2}$ "

DETAIL D

DETAIL C

GEAR PARTS SECURED TO CAMERA

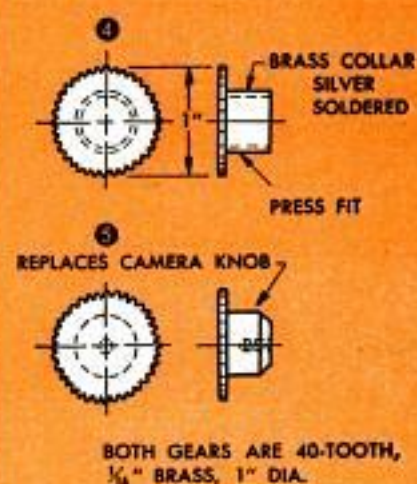

INSIDE ASSEMBLIES FOR CONTROLS 2, 3, 4, 5 DETAIL C

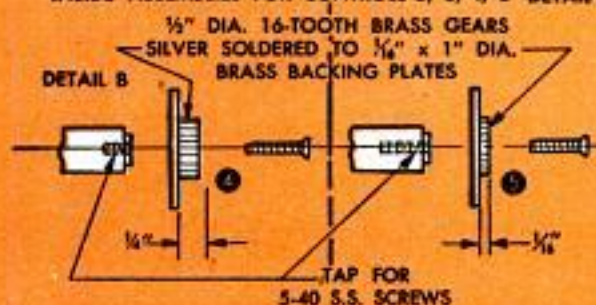

INSIDE ASSEMBLIES SAME FOR 2 AND 3

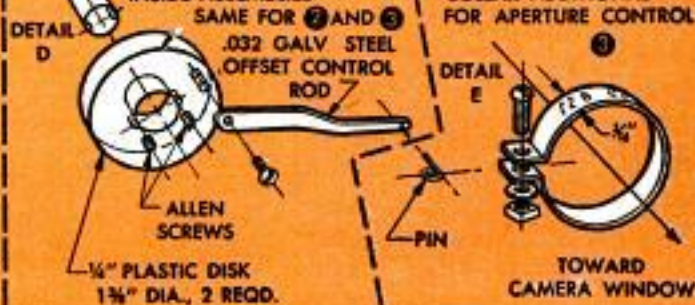

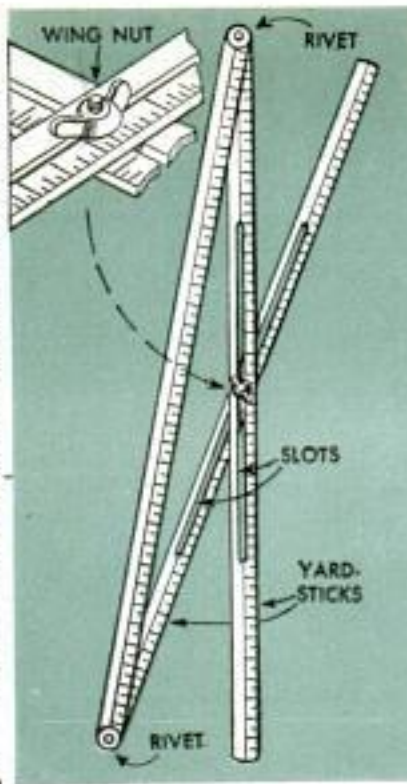

## Jig Marks Siding To Fit Gable

If you are installing siding or shingles on a gable, a handy jig made from three yardsticks speeds fitting material along the trim boards as shown in the illustration. When making the jig, cut a slot 18 to 24 in. long in two of the yardsticks and then rivet or bolt the slotted sticks to a third one as shown in the detail. A carriage bolt with wing nut provides a means of adjusting the yardsticks to the desired angle. When siding is marked from the jig, it will fit perfectly against the fascia board.—W. J. Shupenia, Smoky Lake, Alta., Can.

## Focusing Negative for Enlarger

When making enlargements a sharp focus can be obtained quickly if a focusing negative, made by photographing a page from a newspaper, is used to check on the focus of the enlarger lens. The surface of the newspaper must be parallel with the surface of the camera's lens and the lens focused sharply to prevent distortion of the image on the focusing negative.

Ken Murray, Colon, Mich.

## How to Pack Market Eggs

According to the Department of Research of the Pennsylvania State College, eggs packed with the large ends up arrive at the market with more than three times as many AA and A grades as when this precaution is ignored entirely. Eggs packed other than with the large ends up cause the yolks to float off center so that when candled they may appear not to be fresh, thus giving them a lower grading.

## Simple Play Bench For Child

Any child would be proud to have this attractive and sturdy bench which can be easily made in one evening. To build it, first make two full-size paper templates, one for the legs and one for the brace that fits between them. Place them on  $\frac{3}{4}$ -in. stock, draw the outlines and cut the pieces. Sand all surfaces and round all edges before assembly. Glue the pieces together and reinforce the joints with nails or screws. Finish the bench with varnish or paint that matches the child's room.

Ted Fenn, Chicago.

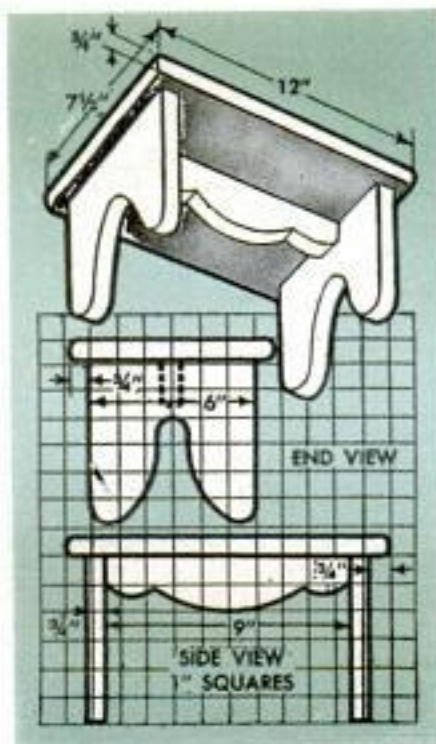



# "REPLASTER" WITH TILE

WHY BOTHER patching a badly cracked plastered ceiling, when you can install decorative tile directly over the old plaster in about the same time required to make the repair? Ceiling tiles are prefinished in 12 and 16-in. sizes and should be nailed on a level wooden base, such as furring strips, as shown in the lower photo.

To insure symmetrical design having equal borders and also to show proper location of furring strips, first establish a center line that is at right angles to the ceiling joists by determining the mid-points of the ceiling at opposite ends and stringing a chalk line between the two points as shown in the photos at right. Then, draw a line across the ceiling at right angles to the center line. This can be done accurately by scribing an arc from a point 3 ft. from the midway point on the center line, using a line with a radius of 5 ft. Next, with one end of the line on the midway point on the center line, an arc with a 4-ft. radius is scribed so that it will intersect the arc with the 5-ft. radius at two points. A line drawn through the latter two points and extended to the opposite walls will be at right angles to the center line. Divide the two lines into 12 or 16-in. units, depending upon the size of tile used, for placement of the furring strips. Should the last unit for either line be less than a full unit, add the number of inches allowed for a full unit and divide by two, thus giving a tile large enough to apply at the two appropriate ends of the ceiling for an even border. Any stock cornice or cove molding obtainable from a lumber dealer is satisfactory for trim around the ceiling. Prepainting the trim strips before nailing them in position saves time and results in a neater job. Holes are easily filled with wood putty and painted later.



Photos and information courtesy The Uppson Co.  
Above, for equal borders and correct location of furring strips, first establish center line at right angles to joists

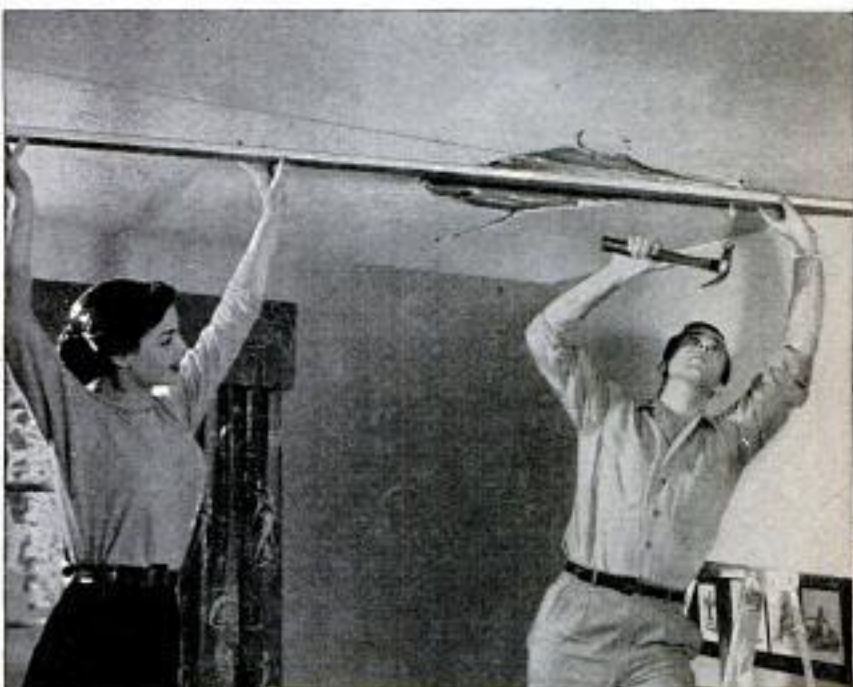

Above, furring strips are nailed to ceiling joists for safe support of tile. Below, after correct positioning of all strips, tiles are applied starting at center of ceiling



# Wooden Frame Supports Tarpaulin Wading Pool

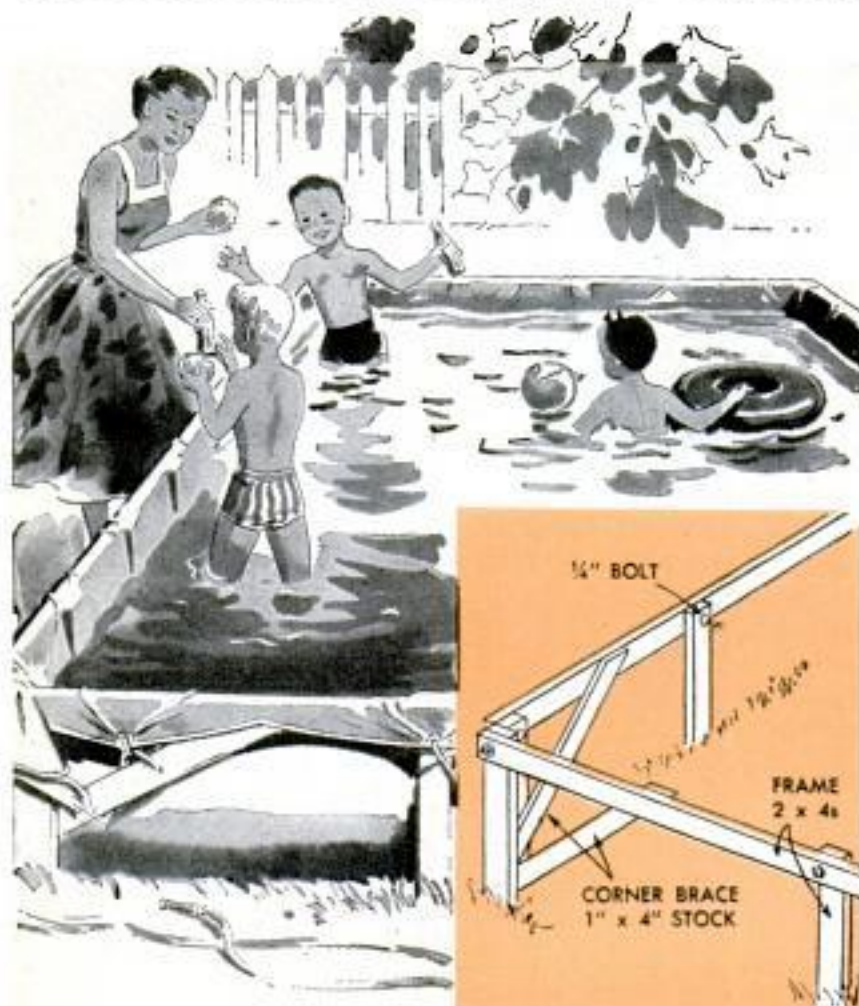

Here is a wading pool for children that you can assemble and fill in less than an hour, once the wooden frame is cut and drilled for assembly. After the uprights are driven into the ground, the horizontal members are bolted to them and the corner braces nailed in place. A waterproof tarpaulin then is tied to the frame and filled with water as shown. The bottom of the water-filled tarpaulin should rest squarely on the ground to prevent damage to it. When the pool is to be emptied, one corner of the tarpaulin is simply lowered or, if the location of the pool prevents this, a garden hose can be used to siphon most of the water into a sewer. The tarpaulin should be thoroughly cleaned and dried before it is stored away.—G. R. Harrison, Valparaiso, Ind.

## Blackboard Eraser Is Used As Pumice Pad

When rubbing down a finish with pumice, an inexpensive blackboard eraser used as a pad as shown, will do the job faster and better than a felt pad of the type commonly used for this purpose. Although the bottom of the eraser is made of felt also, its stiff back and other construction features afford a more comfortable grip and prevent curling of the working surface, an annoyance commonly encountered in using felt pads.

Frank A. Javor, Newark, N. J.

## Magnet Holds Jointer Knives When Resetting in Head

Replacing the knives at a uniform height in the cutterhead of a jointer is fairly easy with the use of a large horseshoe magnet. The magnet holds each knife suspended in its slot in the head while the clamping screws are tightened. With the magnet resting on the rear table, each knife is held precisely level with the table surface. A point to remember in positioning each knife is to rotate the cutterhead so the knife slot is at the very top.





Left, small tack is easy to start with wax-coated hammer. Right, beeswax is good medium for statue-model carving



Left, coating of beeswax on painting preserves colors and prevents cracking. Right, protective film of wax wiped on infrequently used iron retards corrosion



# the JACK-of-all-TRADES WAX

By Walter E. Burton

**J**UST AS PEOPLE thousands of years ago devised numerous uses for beeswax—which is at the same time a lubricant, adhesive, candle fuel, preservative, sealant, polish and modeling medium—you, too, can find many jobs for it around the shop and home.

Some of the new uses described in this article involve the preparation of a beeswax paste for polishing jobs and a wax-saturated cloth for applying a thin film of wax on metal surfaces to retard corrosion. To make the paste, simply mix one part turpentine with a slightly smaller volume of melted beeswax. Avoid mixing the paste near an open flame, and keep it stored in a closed jar. A wax-impregnated cloth is prepared by saturating a piece of cotton material with the paste further thinned with turpentine. The cloth is ready for use after the turpentine has been allowed to evaporate.

When used as a polish, beeswax is said to produce an excellent and durable gloss on almost any surface that will support a wax finish. Producing a good gloss with

the beeswax paste may require more work than some commercial waxes, but the beautiful finish produced is worth it. After the wax preparation has been wiped on the surface and allowed to dry, a polished finish can be worked up with a brush and a clean cloth pad, following the same procedure as with most commercial furniture waxes.

When a lubricant is needed that will remain nonfluid at normal temperatures, (melting point of beeswax is 140 to 145 deg. F.) beeswax is a good product to use. Beeswax used for lubricating the striker on a door latch, as shown in one of the photos, is not likely to soil clothing since it will remain nonfluid. Centuries ago, a cabinet-maker found that wooden pegs coated with wax could be driven into tight holes with less effort than unwaxed ones, because of the lubricating effect.

Certain of the properties of beeswax render it a most convenient medium for making figures or models, either by modeling or by casting in molds. At room temperature it can be shaped and cut with ease



Above, cardboard tube "soldered" to wooden disk with beeswax, using heated steel rod to melt the wax, demonstrates its usefulness as an adhesive



Beeswax, a nonconductor of electricity, forms protective coating over receiver-coil windings, holds wires in place and seals other radio parts



Above, cloth saturated with mixture of wax and turpentine is used for coating metal surfaces of cutting tools to protect them from corrosion



Above, wax holds small gears on steel plate temporarily while precise arrangement of gear train is developed. Below, wax lubricates closet-door latch

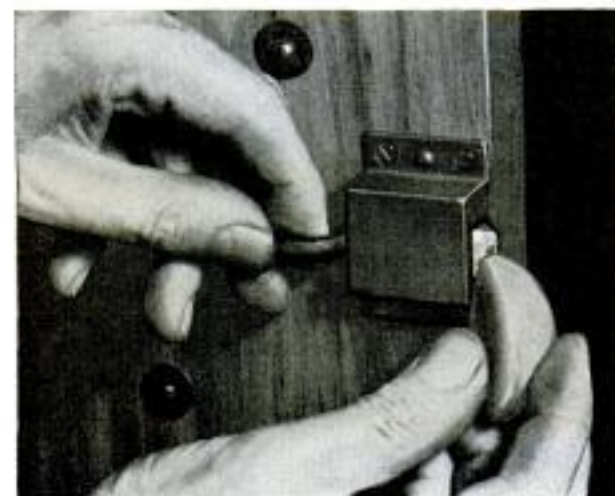

and it mixes with most types of coloring matter. Also, the wax takes surface tints as well, and its texture and consistency may be modified by a number of substances.

Because of its ability to adhere readily to metals and many other materials, beeswax can be used as an effective adhesive when extreme holding power is not demanded. It is excellent for holding together parts of cardboard or wooden display arrangements and novelties, or the components of a model or pattern. Also, it is used for anchoring labels to glass, fastening wires of small electrical equipment to each other, and all types of holding applications, particularly temporary ones for experimental work.

As a preservative, sealant and rust retardant, beeswax is preferred over other products by many users because of its higher melting temperature. It is ideal for sealing condensers and other electrical parts and making container lids and cardboard containers moistureproof. A thin film of wax applied on cutting tools used in the shop and on the bottom of a steam iron after each use, prevents formation of rust. ★ ★ ★

Coating of wax is applied on coarse thread used for sewing pieces of leather or heavy fabric together for easier sewing and stronger stitches

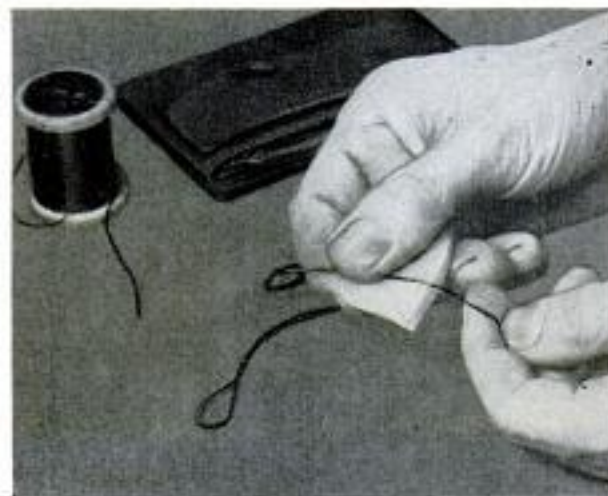

## Raising Lintel Singlehanded

Because he could not lift it alone, one man who had to raise a 12-ft.-long, concrete lintel to a point 7 ft. above the floor of the concrete-block garage he was building, used a jack and some extra blocks to provide the extra "muscle." A block was placed on each side of the doorway and the lintel ends were pried up onto the blocks. A jack then was used to alternately raise the ends so more blocks could be stacked under the lintel. The operation was repeated until the lintel was at the correct height for swinging into place. Notice how braced vertical timbers keep the lintel in place safely.

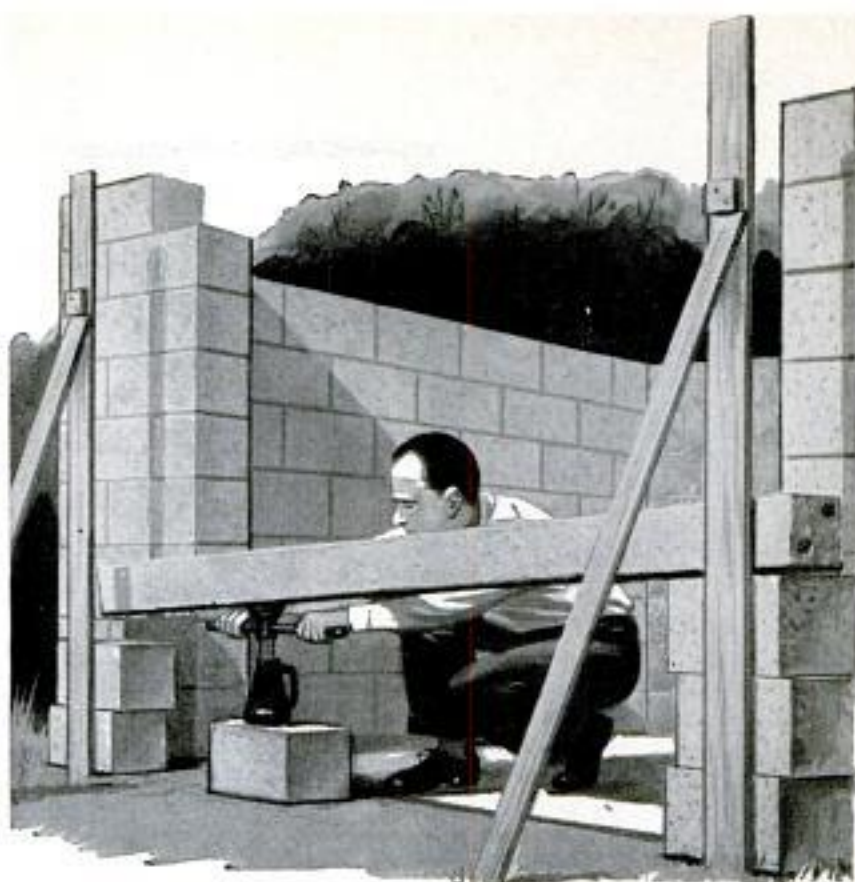

## Screen-Door Spring Stabilizes Steering of Coaster Wagon

Take the shimmy, with its resulting upsets and possible injuries, out of steering a coaster wagon by using a screen-door spring as indicated. Attach the ends of the spring to the front axle and then attach the center of the spring to the coaster box 8 or 10 in. back of the axle. The exact distance will depend on how far back the spring must be pulled to make it fairly taut.—G. E. Hendrickson, Argyle, Wis.



MAY 1957

## Shingle Plumbs Cabinet Quickly

There is no "fussing around" when leveling a base cabinet on an uneven floor if you plumb it with a piece of wooden shingle. Just insert the shingle and then tap it lightly with a hammer while holding a level against the cabinet. When level, break off the shingle and leave it under the cabinet. Drive a brad or small nail into the shingle to hold it in place.

Courtesy Western Pine Association.



195

Copyrighted material

## Snack Trays on Porch Glider Solve Problem of Limited Space

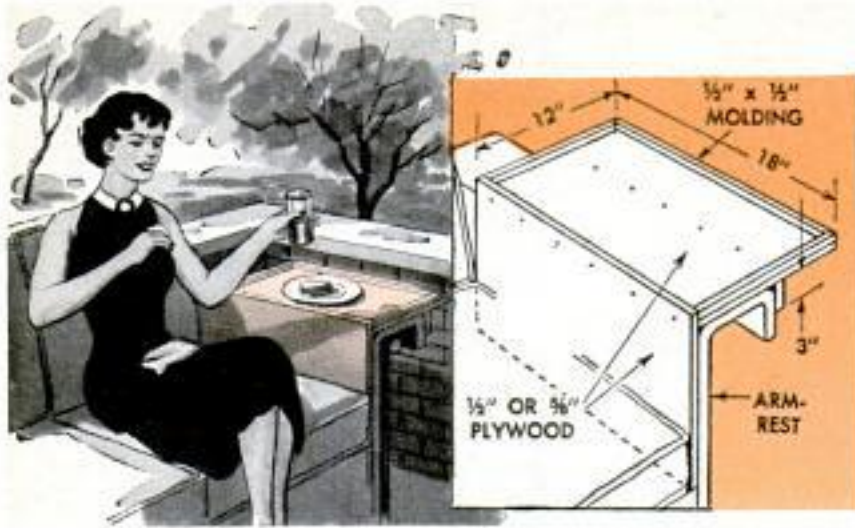

When limited floor space on a porch does not permit locating a table in front of a glider, fitting snack trays to the arms of the glider will provide the needed table area. Each table is cut from plywood and dimensioned to fit snugly over the glider arms. Sides of the trays extend downward so the seat cushions help keep them in position. Molding strips fitted along the tray edges will prevent dishes from sliding off.

## Dovetail Insets Save Old Doors

Old doors on which the hinge or lock areas have been damaged can be salvaged for reuse by fitting dovetail insets of new wood. Saw and chisel a dovetail slot of sufficient size to remove all of the damaged wood. Then cut and trial-fit a dovetail inset of new stock to match that of the door. Spread glue on joining surfaces, press the piece in place, and allow time for the glue to harden before sanding flush. Then replace hinges on the new wood.

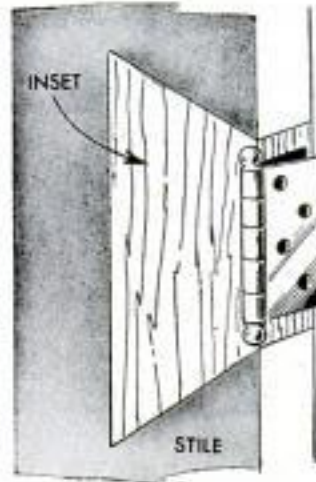

## Block Shelves Display Curios

That choice figurine or curio takes on a new stature and decorative importance when you display it on a block shelf. Used either singly, in pairs or in groupings, block shelves add a novel decorative detail to any wall space. As a rule, the blocks appear best when cut to a rectangular rather than square shape. For example, if you use 2 x 2-in. blocks, cut them about 2 1/2 in. long. Attach them with shelf hangers.

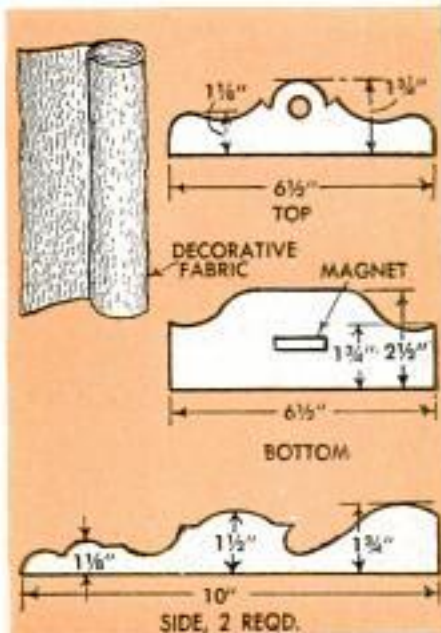

## Wall Rack Holds Rubber Stamps

Attractive and practical, this wall rack holds a number of rubber stamps and a stamp pad by means of magnets. A piece of light sheet steel is concealed beneath the fabric back by first tacking the fabric to the back edges of the sides then tacking the steel over it. Magnets fitted in mortises in the stamp bases hold the stamps against the back of the rack. A magnet countersunk in the shelf holds the stamp pad.

WTM 58 +  
PhotoKink's 58

# SINK-TRAP

## Lens Mount

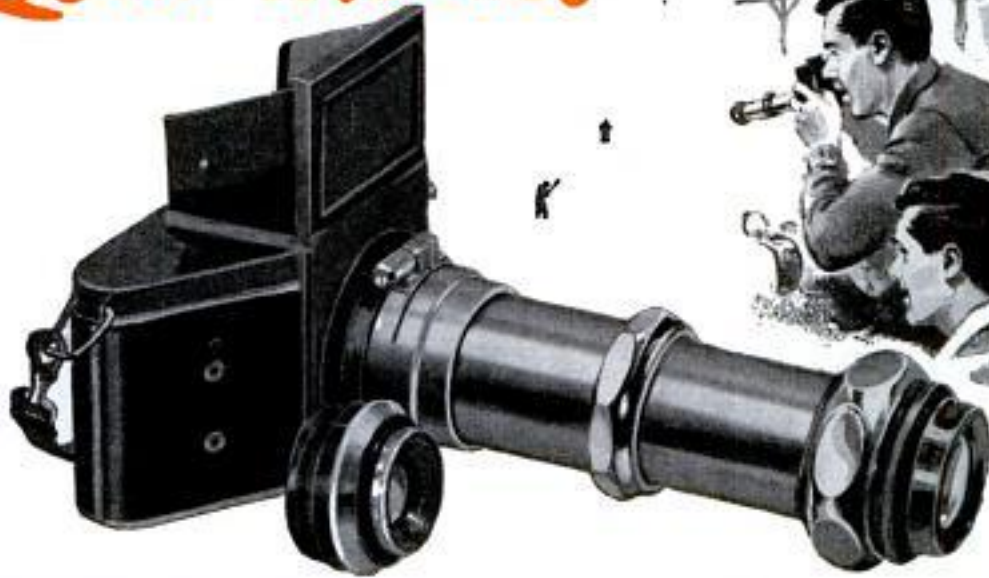

TELESCOPING SECTIONS of chrome-plated sink trap can be used to provide a long-focus lens mount for a small single-lens reflex camera. Diameters and lengths of tubing should be selected to suit the lens focal length as well as the lens mount and lens opening in the camera. Movement of the lens tube should cover a focusing range from about 15 ft. to infinity when fitted with a "telephoto" lens. A 7½-in.-focal-length lens was used in above camera.

The outer or larger tube section fits over the lens tube with enough clearance to accommodate a black-cloth lining which is cemented inside the outer tube. A pin in this tube engages a spiral slot in the lens tube so that positive focusing can be done by merely turning the lens tube. If desired,

the pin and slot can be omitted and focusing done by simply sliding the lens tube in and out. Note in the detail that both tubes are lined with cloth, black velvet being used in the lens tube to prevent reflections.

Regular slip-joint nuts are fitted at the ends of the tube sections, the one at the end of the lens mount being adapted to hold the long-focus lens and soldered in place. A special adapter ring machined to suit the camera opening, is used to attach the completed mount. This may be made to clamp on or threaded to fit a threaded lens opening as the case may be. In the clamp-on type, the top of the adapter is slotted to provide a clamping action when a knurled lock screw is tightened against lugs sweat-soldered to the slotted portion.

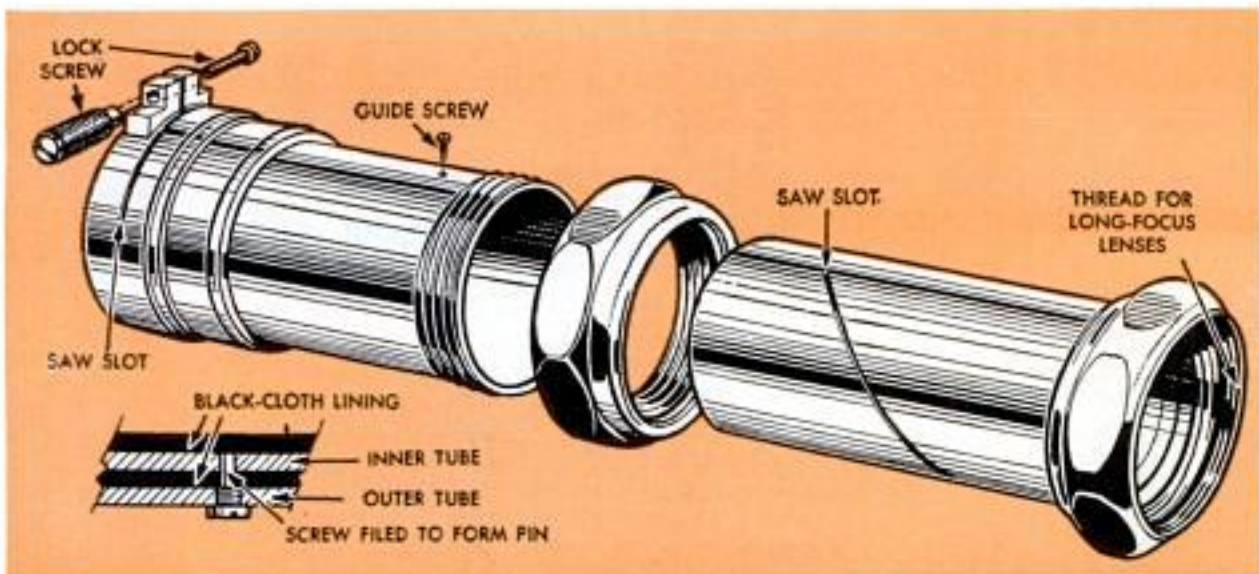

SN 58



# HOW WOULD

*Illustrated on these pages are tips for better use of a bandsaw, including adjustments to be made*

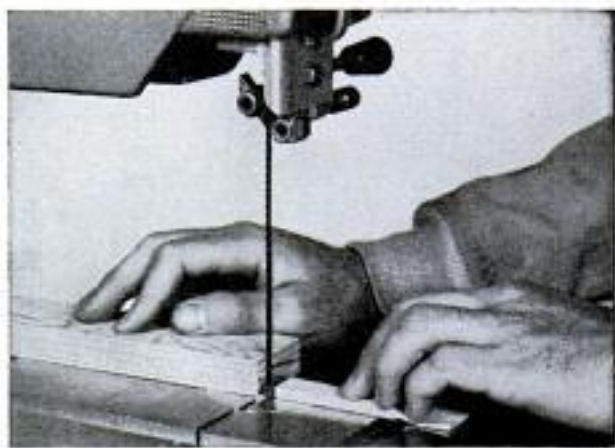

**Q—How would you set up a bandsaw for cutting off duplicate pieces, such as blocks or dowels?**

A—The easiest method is to clamp a stop block to the saw table as indicated. End of dowel should clear block before engaging blade. Use a miter gauge to feed the work into the saw blade to assure a square cut. A bandsaw is especially ideal for cutting off dowels, as it is much safer than a circular saw for this job. When latter saw is used, there is chance that dowel will be spun and "kicked back" by blade

**Q—What is wrong when saw will not cut straight, although blade guides are adjusted properly?**

A—Generally when cut made by saw blade is not straight and parallel with edge of table it means that blade teeth have incorrect set, or blade is dull. If blade is not too dull, set may be corrected by holding an oilstone against the lead side to hone it lightly. Back up the blade with a block of wood. In the photograph the oilstone is wrapped in a piece of paper so it can be gripped more firmly

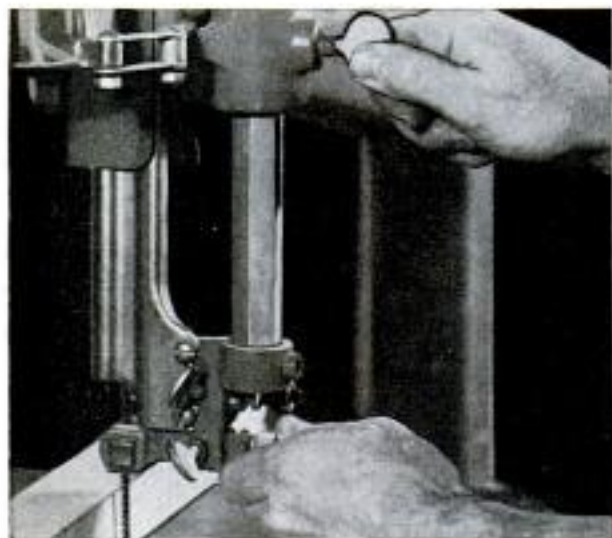

**Q—Is it important to have the upper blade guides of a bandsaw at a given height above the stock?**

A—Setting the upper blade guides at a recommended height above the stock is very important, especially from a safety standpoint. Adjust the guides, as shown, so that they are about  $\frac{1}{4}$  to  $\frac{1}{2}$  in. above the stock, leaving a minimum of the blade exposed. There is no advantage in having the guides high, which permits the blade to be bowed and cut in a curve



**Q—If a bandsaw is running and blade makes a scraping sound, what adjustment is indicated?**

A—Most likely the upper and lower blade guides need to be adjusted properly, the scraping sound being caused by the blade bearing heavily against one side of the guides. Use a strip of newspaper or cellulose film as a gauge to provide the required  $\frac{1}{64}$ -in. clearance. Right-hand photo shows how guides are adjusted forward to contact back of blade



# YOU DO IT?

for correcting troubles, and ways to fully utilize the capabilities of this extremely versatile power tool

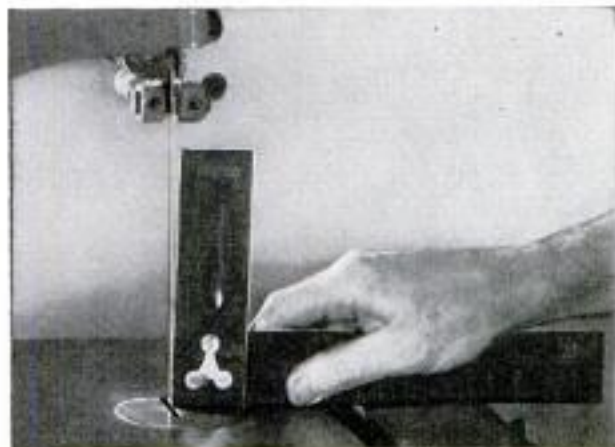

**Q—What adjustment is needed when a bandsaw cuts straight, but not at right angles to work?**

A—Adjustment of the table-leveling mechanism is required to correct this condition, which is caused by the table not being at right angles to the blade. As indicated in the photograph, a try square can be used to check the angle between the blade and table. To assure constant accuracy of cuts on a bandsaw, check the table-blade angle frequently to make sure the table mechanism does not loosen



**Q—When cutting long curves, why is it necessary to visualize position of the stock at end of cut?**

A—If the cut is not planned ahead, the stock may be in a position as in the upper photograph, so that it strikes throat of bandsaw. If cut had been started from opposite end of stock as in lower photo, stock would clear throat easily. In some instances, of course, the shape of the curve and size of stock will require that work be cut from each end to the center, or waste stock first must be sawed out of way

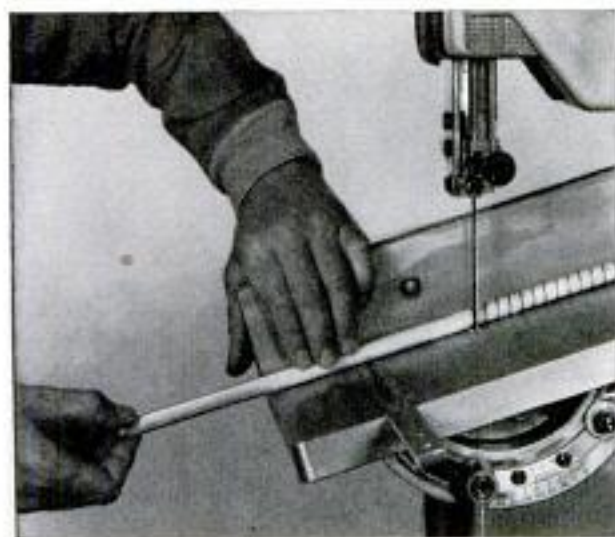

**Q—How can a bandsaw be used to cut spiral grooves in dowels for gluing, or decoration?**

A—Tilt the saw table at an angle of 10 or 20 deg., depending on the pitch you want on the spiral. Set fence to depth of cut you want and turn the dowel slowly as shown. If uniformity is not important, as on dowels used for gluing, let the blade itself turn the dowel as it cuts. Decorative grooves on wooden cylinders are cut using the same method



**Q—In what way can bevel-cutting on a bandsaw be used to save work when lathe-turning bowls?**

A—Wooden bowls can be rough-cut to shape by sawing the stock to a cone shape as illustrated, thus removing much of the stock that ordinarily would be cut away with a chisel after the stock is chucked in a lathe. Make sure the table is positioned to permit cutting a cone that at no point is smaller in diameter than corresponding diameters of the bowl

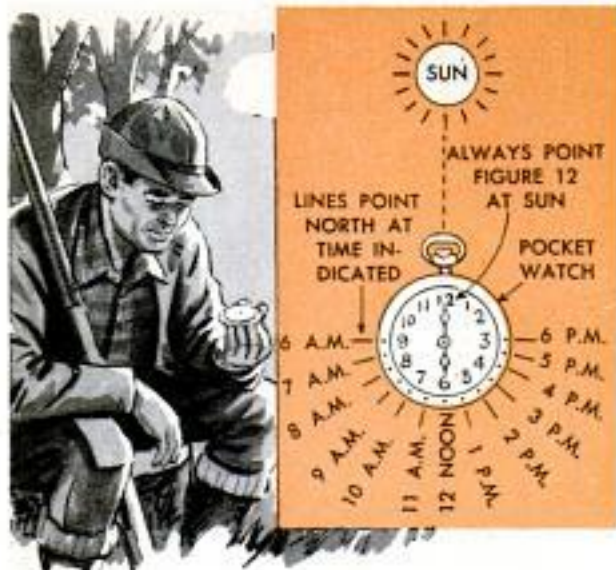

### Your Watch Tells Directions

If you ever get lost in the woods and nervously look at your watch, wondering if you will get out before darkness sets in, remember that that same watch will also give you the directions if the sun can be seen. The detail tells the story. Naturally, this method of using your watch is not 100 percent accurate, but it is close enough to get you home in most cases.

Herbert E. Fey, New Braunfels, Tex.

### "Spring Type" Bulletin Board

A novel way of attaching cards and notices to a wall or bulletin board is to drill a shallow hole and press a short length of screen-door spring into it.

Just lifting the end of the spring slightly will open the spring for easy insertion or removal of papers and cards.

Ken Murray, Colon, Mich.



### Broomstick Is Chisel Sheath

To protect the cutting edge of a small chisel or other cutting tool, drill a hole in a short length of broomstick or dowel to provide a snug fit, and use it as a "sheath" for the tool. Label each sheath to permit easy selection and return of the tool to the correct sheath. A few drops of oil in each sheath will help prevent rust.



### Paint in Nail-Polish Bottle Used to Touch Up Scratches

Next time you finish painting, save a little of the leftover paint in a clean nail-polish bottle. When chips or scratches show up in the painted woodwork or walls, simply apply paint from the bottle with the self-contained

brush. The bottle and brush can be cleaned of nail polish by soaking them in ordinary lacquer thinner.



### Fitting Siding or Shingles Around Doors and Windows

For best appearance, when applying siding or shingles, the horizontal lines should line up with the tops and bottoms of door and window frames. This can be done by increasing or decreasing the exposed width of the courses encompassed by distances A and B as the top or bottom of the window or door is approached. Making a slight adjustment in each course will not be noticeable if the adjustments are spread uniformly over the courses.

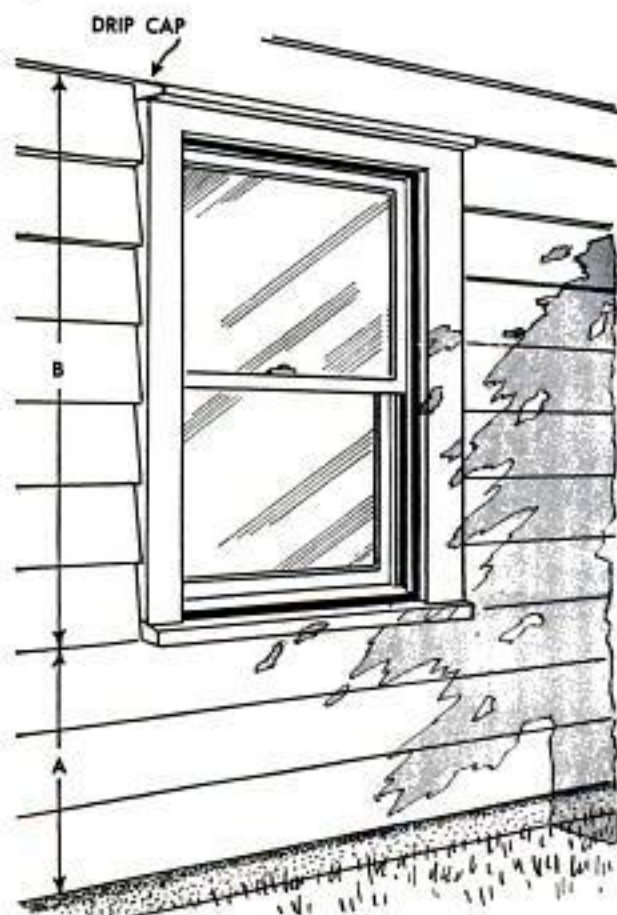

WTM 50

# SMALL-FRY

# BUNK COTS

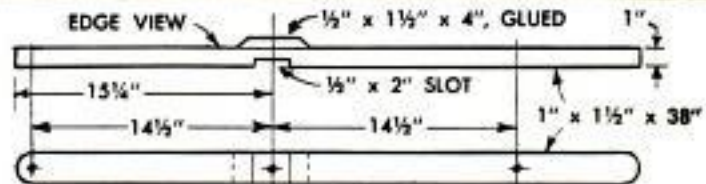
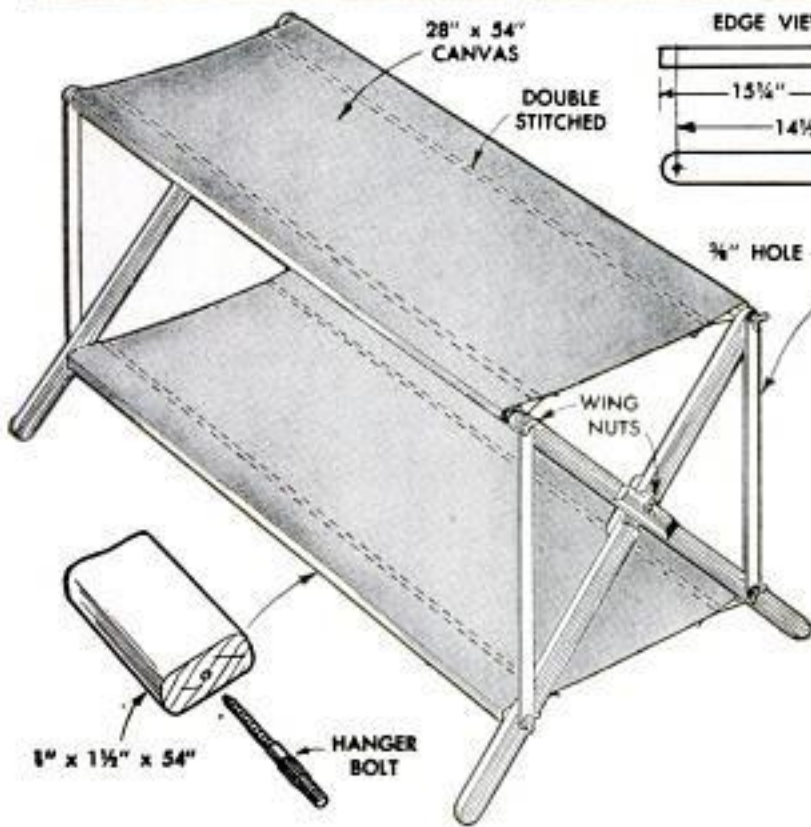
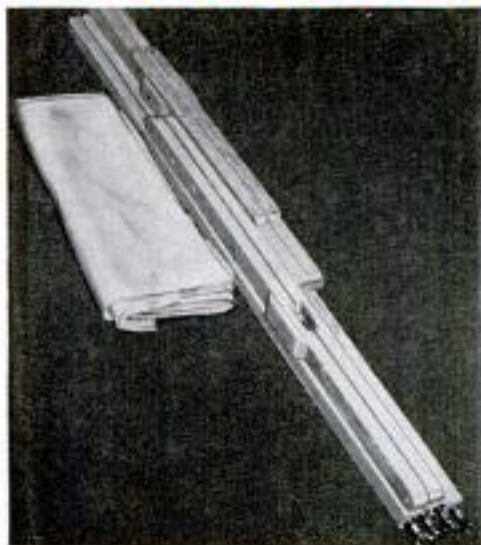

END RAILS (4 REQD.)

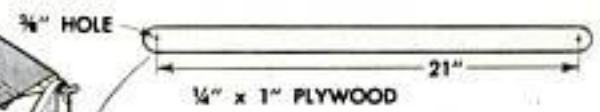

By Thomas J. Meehan

During the years when your children are young a camping trip is a wonderful way of spending a vacation. But like most families we had the problem of sleeping them until I made this double-decker. It actually takes less space than a cot and comes completely apart by loosening 10 wing nuts. The legs lap and pivot at the center and are drilled to fit over hanger bolts turned in the ends of the four side rails. The latter slip through 4-in. hems in the canvas and are braced with plywood stretchers which keep canvas taut

## Ready-Made Nailing Shield Is Scrap of Perforated Hardboard

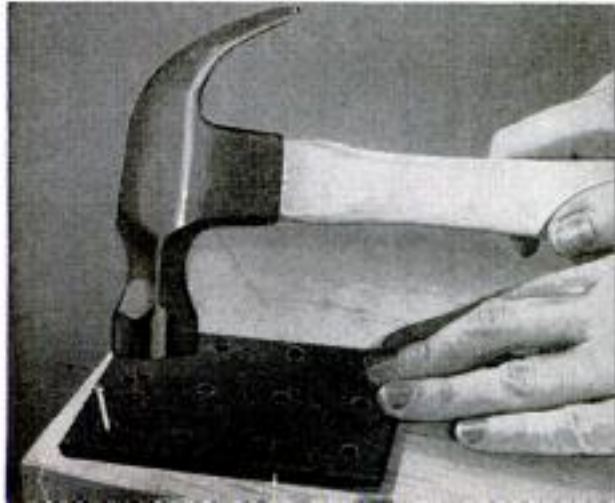

Save a scrap piece of perforated hardboard the next time you finish installing some of this material, and you will have a ready-made shield to protect a finished surface from accidental damage by a hammer blow. To use, just drop the hardboard over the started nail and drive the nail as far down as possible. The thickness of the hardboard will require the use of a nail set for setting the nail.

Frank A. Javor, Newark, N. J.

# BATTERY CARE

By  
Morton J. Schultz

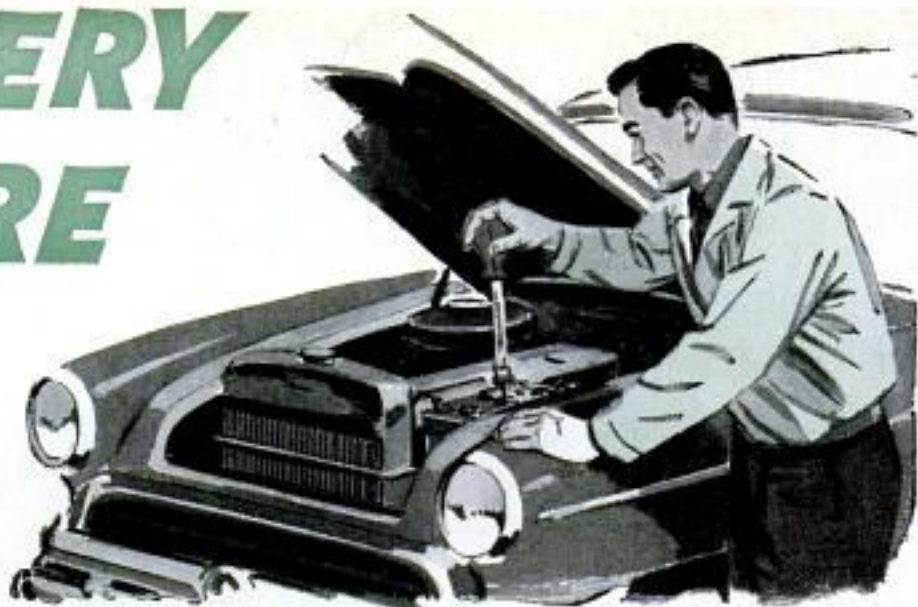

**M**ILLIONS OF MOTORISTS will have trouble with "dead" batteries this year, and a large percentage of the battery failures will be due, not to normal use and wear, but to lack of simple maintenance.

Every 2000 miles a battery should be brushed or wiped with a solution of baking soda,  $\frac{1}{2}$  lb., and water, 1 gal., Fig. 5, then rinsed with clear water, Fig. 6. The invisible "dirt" that the soda solution removes is a deposit of acid salts that condense on the battery from acid fumes discharged through the battery-cap vents. Moisture from the air combines with the salt to provide an electrical-conducting film through which the battery slowly discharges. Be careful to allow neither soda solution nor water to enter the battery. Soda will neutralize the electrolyte and water will dilute it.

To simplify cleaning, and also to prevent possible damage to the car finish, remove the battery from its holder. But first, clean the battery posts and cable clamps with soda and water, Fig. 1, then loosen the clamp bolts with a wrench or battery pliers, Fig. 2. After the bolts are loose, spread the clamps with a screwdriver, Fig. 3, and remove the ground cable first to prevent accidental sparks. After cleaning the battery with baking soda and rinsing it, scrape the top to remove accumulations of grease and grime. While the battery is

out of its holder, scrape the holder clean of rust and corrosion and paint it, Fig. 8. Finally, replace the battery, connecting the "hot" cable first, then tightening both cable clamps firmly. Coat them with petroleum jelly or light grease.

Do not overfill a battery with water, and do not allow it to run dry. Overfilling dilutes the electrolyte, lowering the efficiency of the battery. Also, when the electrolyte heats and expands from charging, it is forced out the vent holes in the filler caps and blown around the engine compartment by the fan. Distilled water is best for a battery, but if none is available, use plain drinking water, as it will do less damage than leaving the battery dry. During freezing weather, do not add water to a battery unless the car is to be driven immediately. Water not mixed with the rest of the electrolyte can freeze and break the battery case, ruining the battery completely.

The state of charge of a battery—not its condition—can be determined by checking the specific gravity of the electrolyte with a hydrometer. Although a difference of .025 gravity points between cells means that the lower cell is shorted, a battery that shows full charge can have a dead cell. Because the specific gravity of electrolyte varies with temperature, a direct reading of a hydrometer is correct only at 80 deg. F. For every 10 deg. below 80 deg., subtract .004 points from the actual reading. For every 10 deg. above 80 deg., add .004 points to the reading. As specific gravity of electrolyte drops, its freezing point goes up. See the chart to check the freezing point of electrolyte at various readings of specific gravity. Because the electrolyte in a battery that is not fully charged can freeze readily in cold weather, a hydrometer test should be made of a battery every two weeks during the winter. ★ ★ ★

## FREEZING POINTS OF ELECTROLYTE

SPECIFIC GRAVITY	FREEZING POINT (DEG. F.)
1.000	+32
1.100	+19
1.150	+ 5
1.200	-16
1.250	-62
1.280	-90



**1.** Battery posts and cable clamps are cleaned with soda-water solution before removing. 4. Twist cables loose and remove carefully from battery posts to prevent damage



**2.** Wrench or battery pliers is used to loosen clamps. 5. Battery is washed thoroughly with solution of water and baking soda to remove acid-crystal material



**3.** Cable clamps are pried open with screwdriver, not hammered loose. 6. Clear water is used to flush away baking-soda solution used to clean battery case



**7.** After battery has been cleaned with soda solution and flushed with water, scrape off all grease and grime, then reclean with soda and rinse again with clear water



**8.** While battery is out of the car, scrape and wire brush the holder to remove rust and corrosion. Use paint or undercoating to protect the metal against future damage



**9.** After cable clamps are firmly tightened, coat tops of posts and clamps with light grease or petroleum jelly. Do not put insulating grease inside the cable clamps

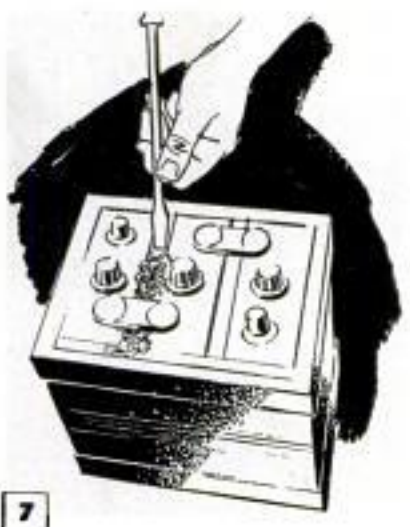

**7** MAY 1957



**8**



**9**



### Emergency Plumb Bob Levels Pictures on Wall

If you have difficulty leveling a large picture or mirror on a wall, and there is no level at hand, try using this method. Tape a folded post card or greeting card to the lower edge of the picture. Then suspend a small weight from the picture with a piece of thread centering it exactly with the fold. When the thread parallels the fold, the picture is level.

Charles Baldwin White, Summit, N. J.

### Heat Thermometer to Reunite Separated Mercury Column

When a portion of the mercury column in a thermometer separates, it can be made continuous again by carefully heating the mercury slowly until the column just fills the space inside the tube and all gaps are eliminated. Then allow to cool. It is advisable to return important laboratory thermometers to the manufacturers for repair.—Walter E. Burton, Akron, Ohio.

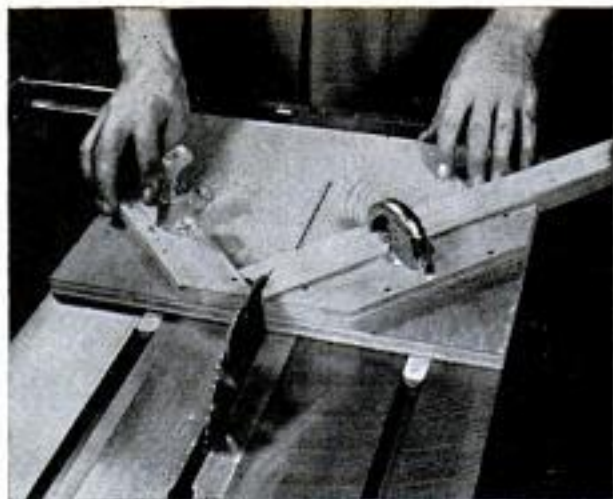

### Spring-Type Door Catch Clamps Jig-Held Work

A common roller-type screen-door catch can be put to good use in the workshop to serve as a third hand in performing many woodworking operations. Here a couple of such catches are being used as holddown clamps on a sliding table jig. By peening the ends of the shafts so the rubber rollers won't turn, a more positive clamping pressure will be had and there is less chance of the work creeping out of position.

R. J. DeCristoforo, Los Altos, Calif.

### Loud Clock Chimes Muted By Small Pieces of Tape

Softening the sound of clock chimes usually is done by covering the hammer heads with resilient material, which requires that the hammers be removed from the clock. Delicate readjustments often are necessary to obtain uniformity of striking. A much simpler method is to press small pieces of adhesive or other tape on the chimes at the points where the hammers strike them. The degree of muting varies with the kind of tape and its thickness.

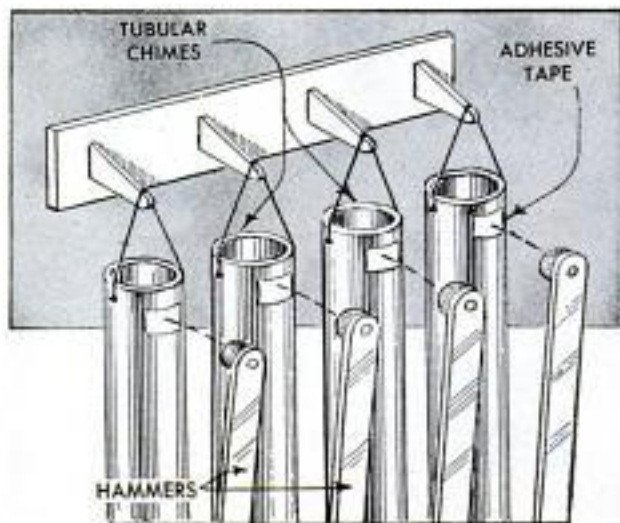

# Disk Sander for Your Lathe

By C. W. Woodson

**D**EVELOPED FOR USE in a small shop where the outlay for a large sander-grinder was not warranted, this unit is designed to fit on the compound of a 9 or 10-in. metal lathe, the disk being mounted on the lathe spindle. By utilizing the built-in accuracy and the wide range of spindle speeds afforded by the lathe it is possible to sand small parts of hardwood and also to handle fine grinding and deburring of metal parts. When used on the metal lathe for grinding metal it is necessary to protect the ways, carriage, headstock and lead screw from abrasive dust. This can be done by wrapping a cloth tightly around the base of the sander and allowing it to hang over

the front edge of the bed. Cut a hole in a square of cardboard and place the cardboard between the disk and the lathe headstock. This will deflect dust and prevent it from collecting on the back gears and in the spindle bearings. For the sake of clarity neither of these protective measures is pictured in the photo of the sander-grinder in use on the lathe.

The disk should be made from steel at least  $\frac{3}{8}$  in. thick to provide the necessary resistance to deflection. You can order it from your supplier flame-cut to the rough dimension, then mount it on an extra lathe faceplate and turn and face it accurately, Fig. 1. Or, if you can make use of a disk somewhat smaller in diameter than the maximum swing of the lathe, you can turn it round from the square. Make sure that the square plate will clear the lathe bed when mounted on the faceplate for turning.

Figs. 2 to 6 inclusive show construction of the base, table and supporting brackets, which are pivoted to permit the table to be tilted. The base, Fig. 5, is dimensioned as 3 x 3 in. square, but this dimension and also the thickness will depend on the swing of the lathe. Also, the method of attaching the base to the saddle will depend on the type of mounting used for the compound rest. For this reason these parts have not been fully dimensioned.

The table, Fig. 2, is built up by using three pieces of flat steel, the top pieces being spaced  $\frac{3}{4}$  in. apart to permit the guide bar to slide easily in the groove thus



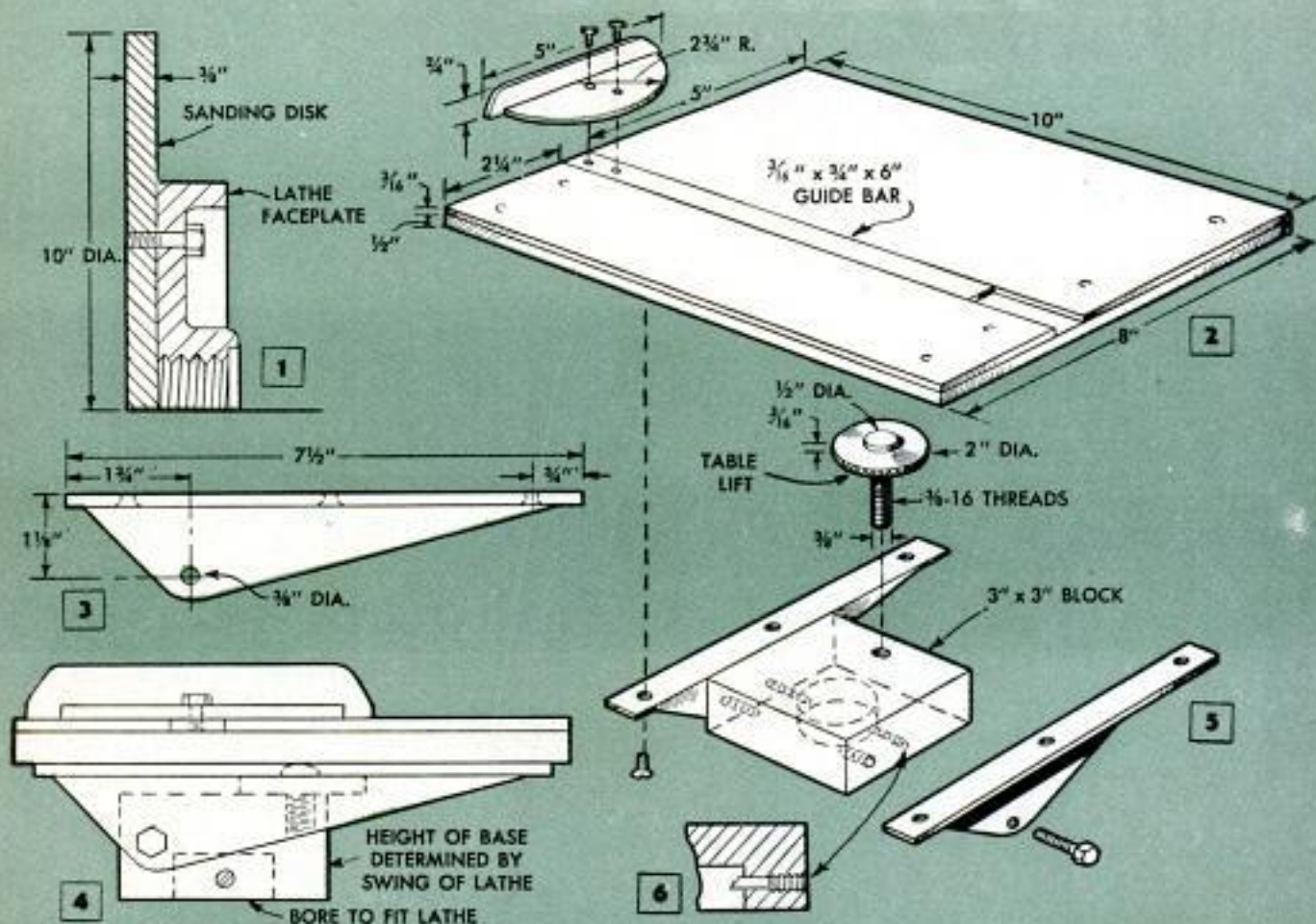

formed. Parts can be assembled with rivets or flatheaded screws. If you have a circular saw at hand, it is possible to adapt the miter gauge for use on this table simply by assembling the parts to form a groove of the required width and depth to take the miter-gauge guide bar.

Note that the base is fitted with a table-lifting screw having a knurled head 2 in. in diameter, Fig. 5. The upper end of the screw bears against the underside of the

table as shown by the dotted lines in Fig. 4. Care should be taken in locating the holes for the table brackets, both in the table and the base, to assure that the table tilts to various angles and returns to the level position without binding. After assembling, run lightly over all exposed edges of the table and other parts with a file to remove sharp edges and burrs that may score the work as it is moved over the table or cause injury to the fingers. ★ ★ ★

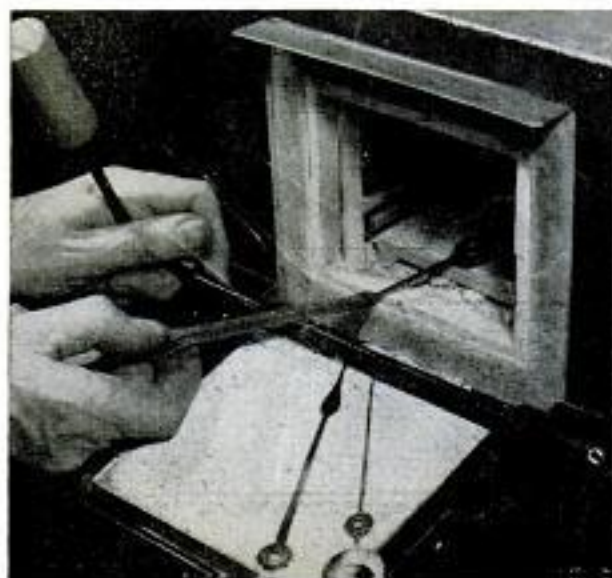

## How to Reblue Clock Hands

When restoring a clock, the original bluing on the hands often will be found imperfect, possibly damaged by rust. To restore the color, first polish the hands with fine abrasive cloth or paper until they are bright. Then heat them carefully until they take on a deep blue-oxide color. If you should "bleach out" the color by accidentally overheating, cool the steel, repolish and reheat. Heating should be done preferably in a furnace, or kiln, whose temperature can be accurately controlled.



## Bench Vise Holds Small Worktable

Especially useful for the man who builds models or electronic equipment, this 12 x 18-in. "vise table" holds the work at a height that is comfortable for working in a standing position. It also provides a clean working surface when, of necessity, the bench may be cluttered with tools, parts and sub-assemblies. If it is necessary to use the vise, or if another subassembly is to be worked on, the table and its contents can be removed from the vise and set aside.



## Fillister-Head Screw Made by Filing Round-Head Screw

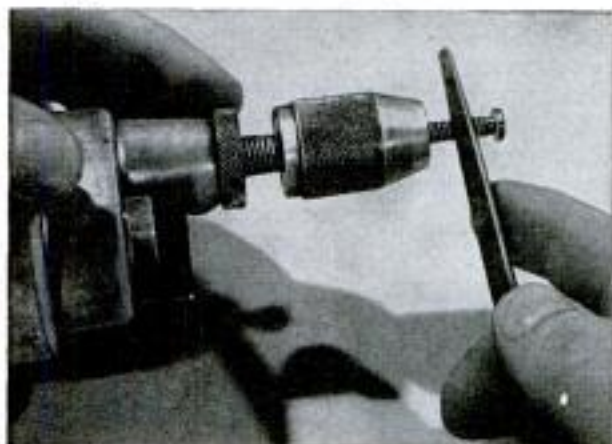

A fillister-head screw can be made by filing the head of a standard round-head screw. This is easily done if the thread end of the screw is chucked in a power drill and the file held against the head. After shaping the head, polish it with a piece of steel wool to remove file marks.

## Tank Has 3-Point Suspension To Reduce Strain on Seams



Cut from a truck frame, this arch-shaped cross member provides a rocking support for the front end of a portable water tank. Because it reduces the twisting and racking of the tank, the resulting 3-point suspension between tank and trailer is said to produce fewer problems of leakage due to ruptured seams.

## Sunshade for Livestock Easily Moved to Different Locations

Welded boiler pipes supporting a roof of shiplap boards on 2 x 4-in. stringers comprise this movable sunshade for livestock. The horizontal pipes on the sides and the ones supporting the roof are spliced end-to-end to make the shelter 24 ft. long by 16 ft. wide. Diagonally welded pipes between the uprights brace the structure, while spreader pipes welded across the bottom runners keep the frame rigid. The sunshade is 6 ft. high so that it can be used by cattle and hogs.

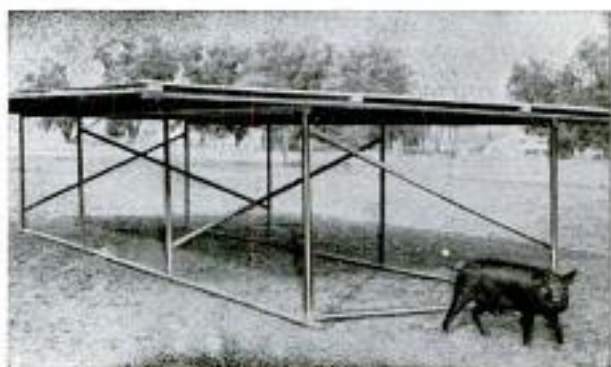

SN 58

# STICK WITH CLAY

By Clifford T. Bower



## Slit Tubing Protects Cutters Of Multiple Hand Punch

When one or more of the cutters of a multiple punch fails to cut clean holes, it generally is because it has been damaged when the punch was stored in a toolbox or on a shelf with other tools. Protect the cutting edges against damage by cutting slits along one side of a length of rubber tubing and pulling it over the cutters as indicated in the illustration shown above.

## Two-Wheeled Chore Cart Holds Bushel Basket

Designed to hold a metal bushel basket, this two-wheeled cart is ideal for chores around the farm. Cleaning the poultry house would be one job for which the cart is well suited. Because of its lightweight frame and rubber-tired wheels the cart is easily handled by women and youngsters.

A. M. Wettach, Mt. Pleasant, Iowa.



**C**HILDREN'S MODELING CLAY has a useful place in the shop for making many difficult jobs easy. Here are eight ways clay can come to the rescue.

**Determining the depth** of recessed and shouldered lathe work is simple to do with a carriage-travel gauge rigged up as in Fig. 1. A short steel rule is stuck to the lathe bed and a wire pointer stuck to the lathe saddle with clay. By presetting the pointer at the one-inch graduation on the rule and the tool bit at the beginning of the cut, you can easily check the amount of travel by merely watching the pointer.

**To cut a precision thread** the best way of measuring the thread size is by the three-wire method. The tricky job is holding the wires in the threads, but by first embedding them in a ball of clay as shown in Fig. 2, it is an easy matter to hold them while measuring over the tops with a micrometer.

**The thimble** of a micrometer that does not have a barrel lock can be held stationary with a piece of clay as in Fig. 3. This permits the micrometer to be used as a gap gauge.

**Several bits and other tools** that are used in succession in a certain machining operation can be conveniently kept at finger tips by standing them in a piece of clay as in detail A, Fig. 4. A disk of clay will also be handy for keeping tiny parts from becoming misplaced during an assembly job.

**Tapping a blind hole** with a bottoming tap always presents the problem of chips packing solidly in the bottom of the hole. However, by first filling the flutes of the tap with clay the chips will embed in the clay and be carried up out of the hole auto-



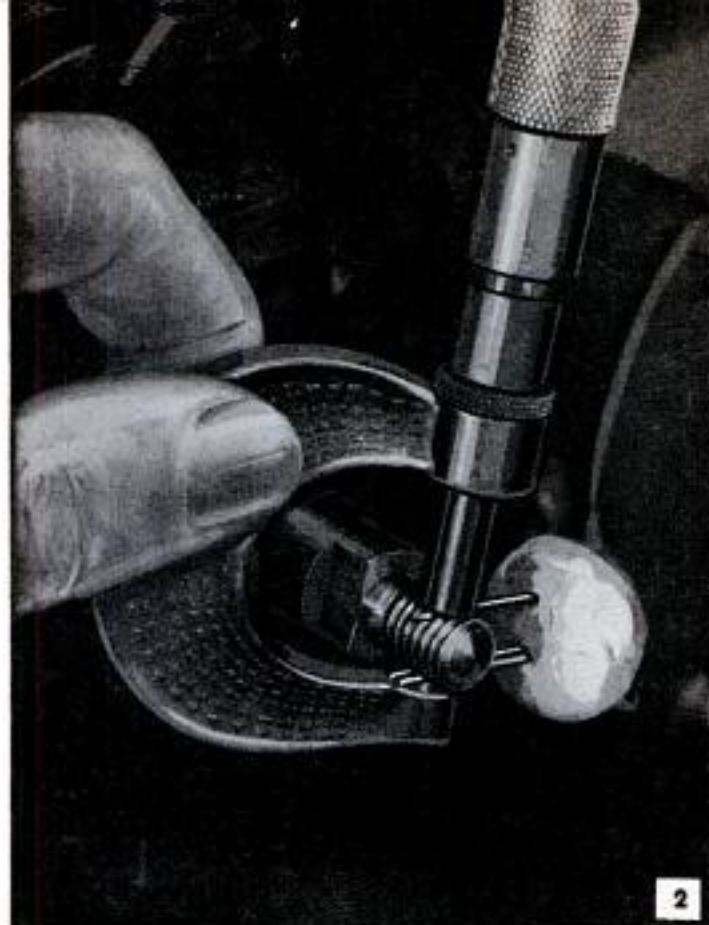

2

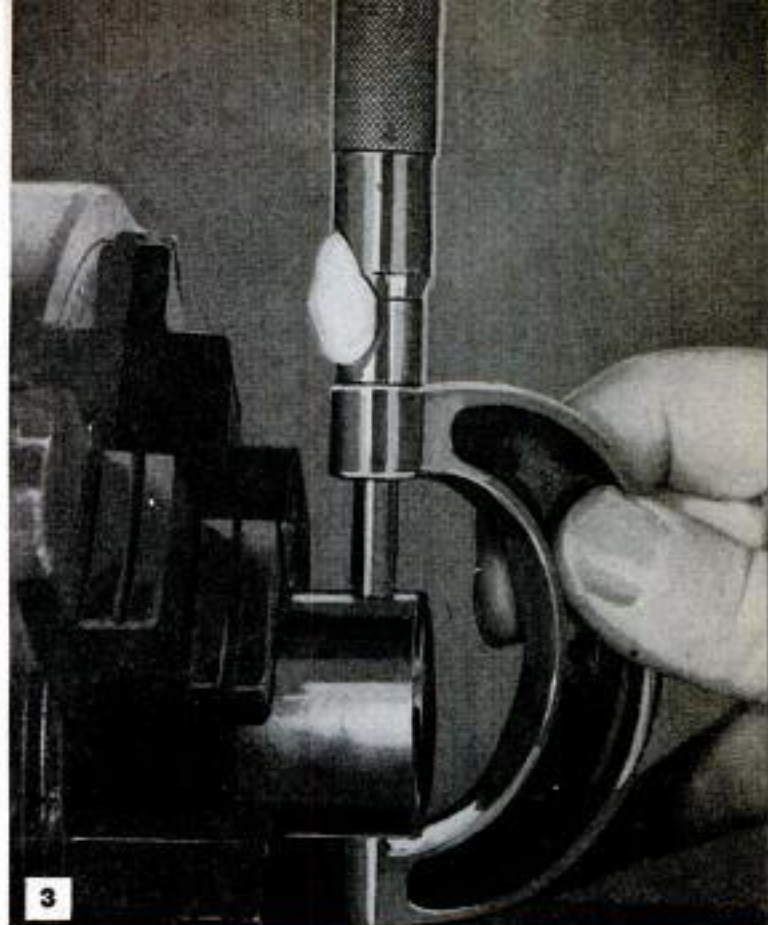

3

matically as the tap is turned as in detail B, Fig. 4.

Clay as a third hand will be found helpful when it comes to soldering small work. Inserted in a piece of putty as shown in detail C, Fig. 4, the work can be held just where you want it.

Inserting setscrews in awkward places inaccessible to the fingers is another "chewing gum" use for clay. Simply hold the screw to the end of the wrench, or screwdriver as the case may be, with clay as shown in Fig. 5.

A wiggler to center drilled work on the lathe can be improvised with a common pin which is stuck with clay to the end of a twist drill as pictured in Fig. 6. ★ ★ ★

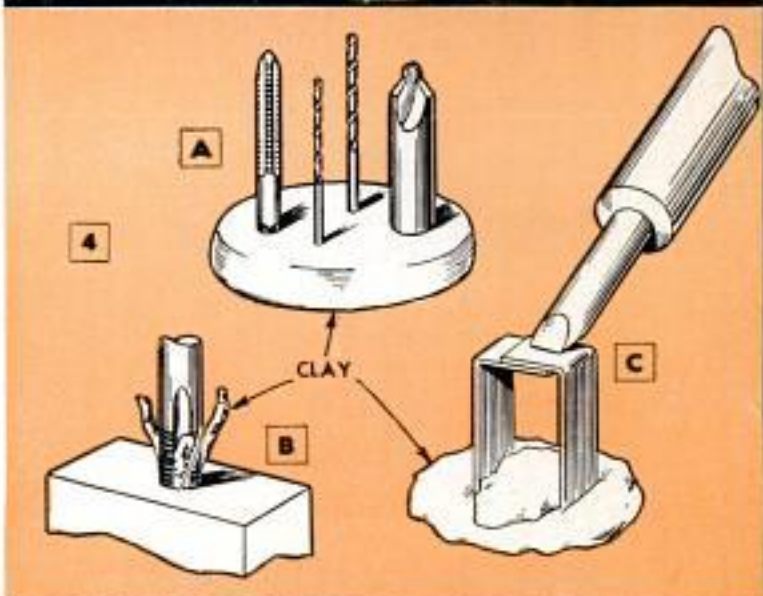

4

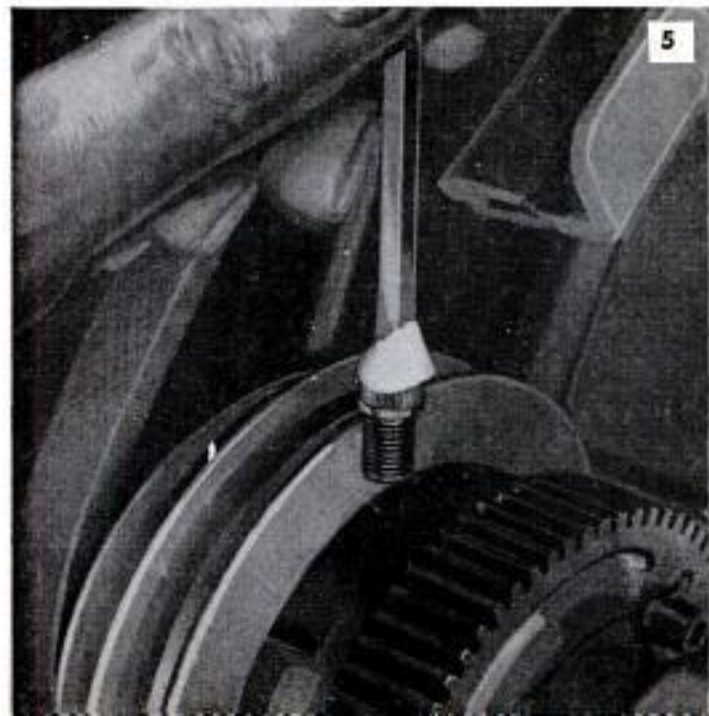

5



6

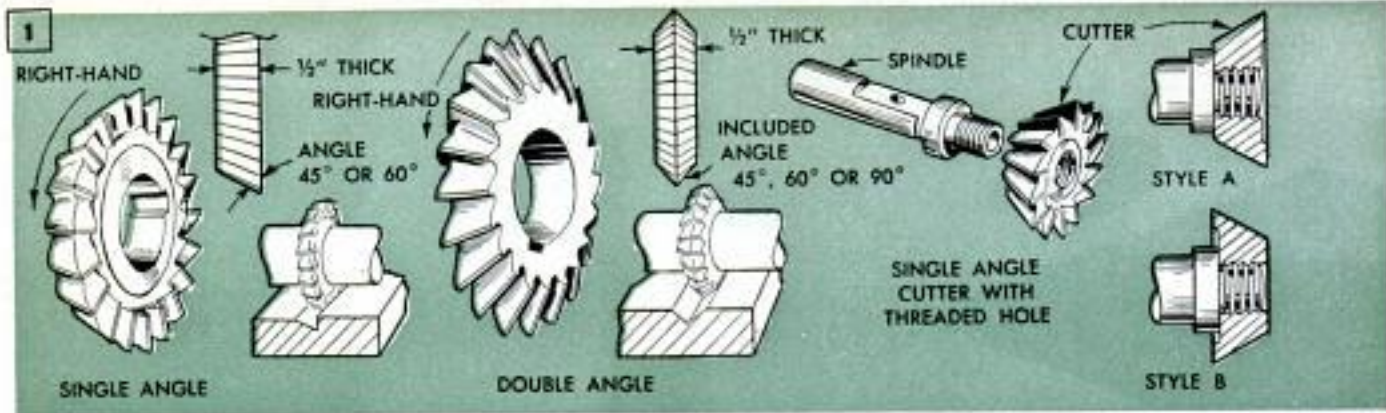

# MILLING WITH ANGULAR CUTTERS

By Sam Brown



Chamfer is most common cut made with angular cutter. Stop clamped to machine table assures accuracy

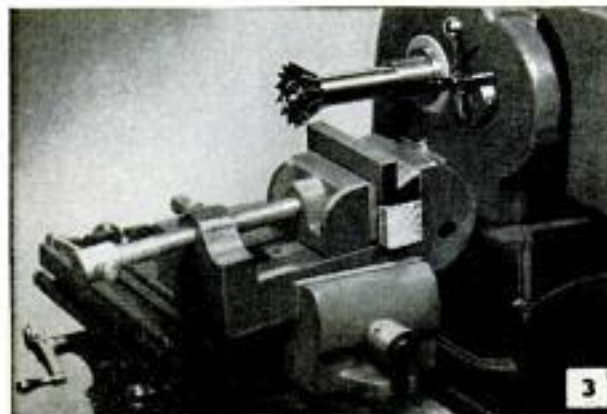

Vises used in combination permit work to be tilted to desired angle. Note stub spindle carrying cutter

BEVEL, VEE AND DOVETAILED cuts necessary when making ratchet wheels, racks, dovetail slides and similar work in metal are made with angular cutters. These include both the single and double-angle cutters, Fig. 1, and are intended for use on the overarm spindle of a milling machine, Fig. 7. Angular cutters of smaller diameter have threaded holes and fit a threaded stub spindle as in Fig. 3. These cutters are available in two common styles, A and B in Fig. 1, and come in two stock sizes, 1 1/4 and 1 5/8 in. in diameter. Although both styles are useful, the style designed to be run with the larger diameter to the outside has the greater number of applications. As a rule right-hand cutters are used on a lathe (with milling attachment), small milling machines and drill presses. A right-hand cutter is one which rotates clockwise when viewed from the driven end of the spindle.

The simplest angular cut is the plain chamfer, an example of which is shown in Fig. 2 and also in the details at the bottom of the page. Note in Fig. 2 that a stop clamped to the machine table locates each edge so that the depth of cut on the four edges is precisely the same dimension. The cut is made in one pass at a cutter speed of 450 r.p.m. and a work feed of .012 per revolution. Using a 12-tooth cutter this feed rate will give a chip thickness of about .001 per tooth, a good standard value.

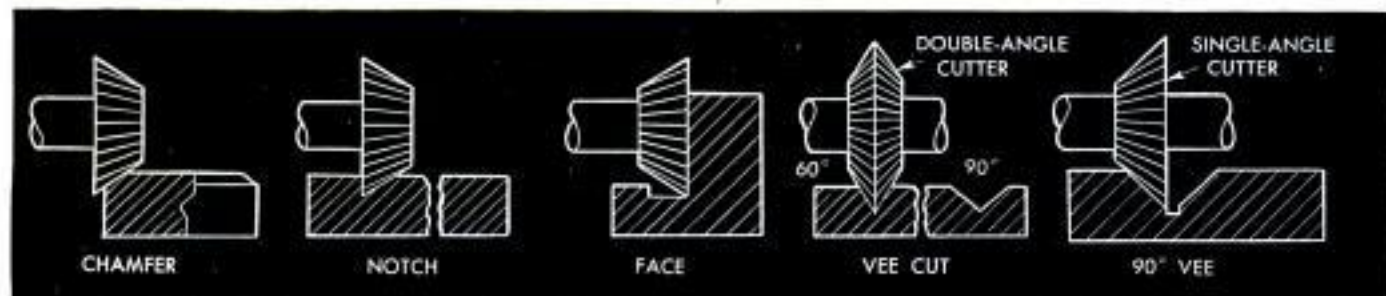

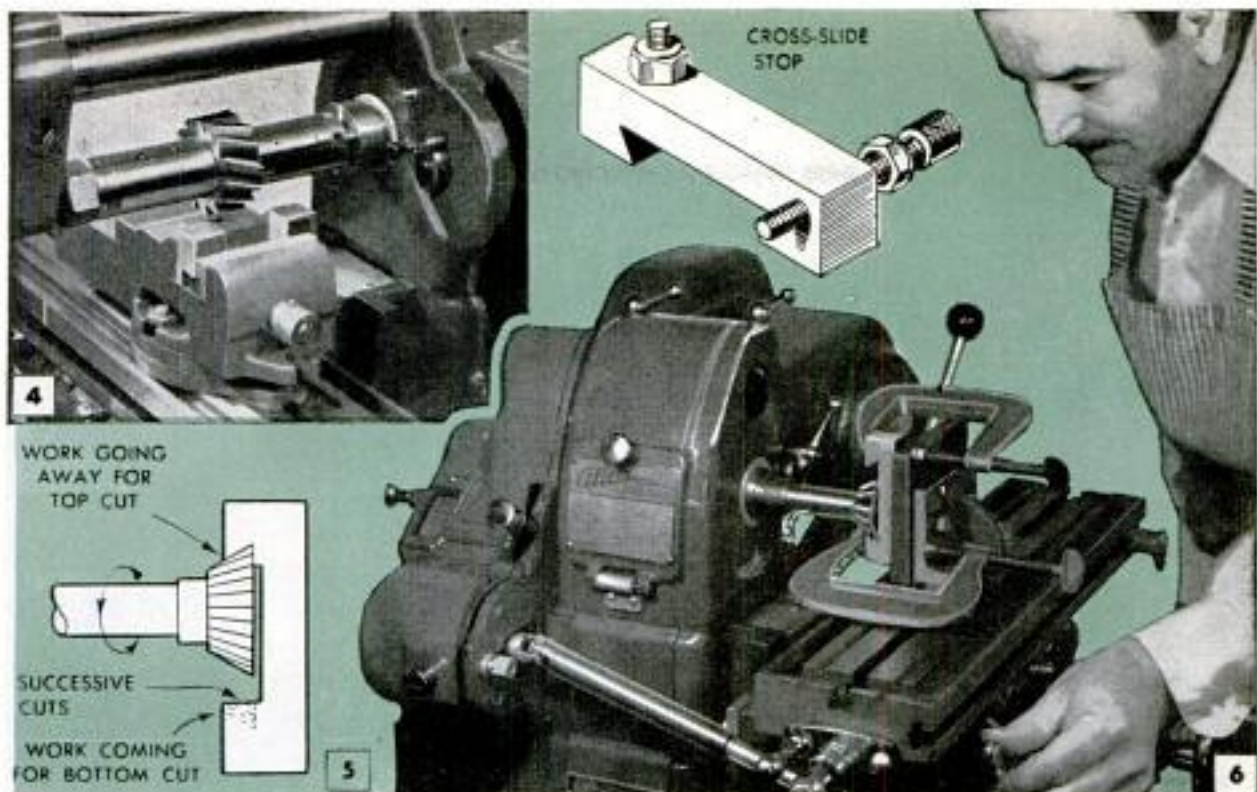

Although the principal use of the 60-deg. angular cutter is to make angle cuts of exactly 60 deg., it also can be used for angles of more than 60 deg. but less than 90 deg. This is done by making the 60-deg. cut first, then tilting the work and running a second cut to finish the work face to the desired angle with the surface. Fig. 3 pictures a convenient way of setting up for this operation, using a drill-press vise clamped in a regular milling-machine vise.

Figs. 5 and 6 show how a 60-deg. dovetail cut is made, a typical example of the internal dovetail being the cross-slide stop in Fig. 6. The same cutter is used for both internal and external cuts. When making the internal cut, the waste stock is first removed with a straight cutter as in Fig. 4. Then the angular cutter is used to run both sides of the dovetail as in Fig. 5, the work being clamped in position as in Fig. 6. The external cut is made in much the same manner, using the same cutter and the same direction of rotation but feeding from opposite directions for the top and bottom faces of the work.

Above, when milling wide dovetail, Fig. 6, first step is to rough out waste, Fig. 4. Below, vees usually are milled in three operations as in Figs. 7 and 8

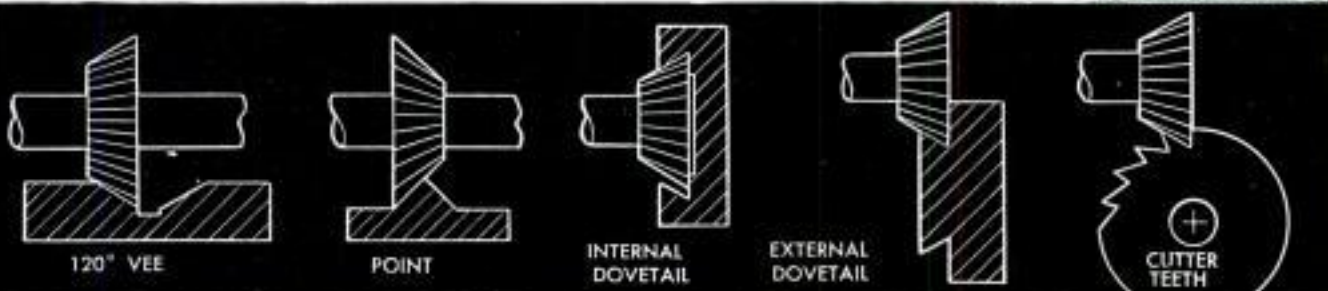
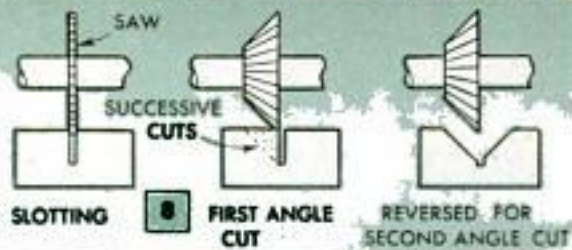
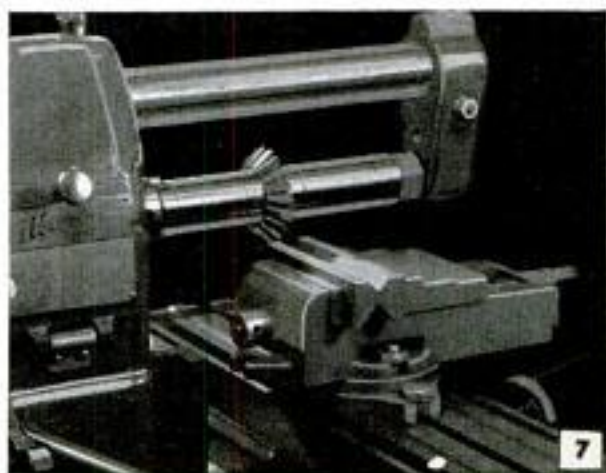

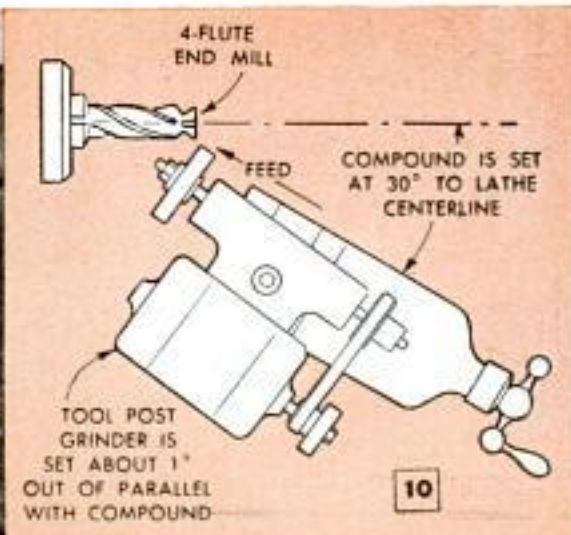
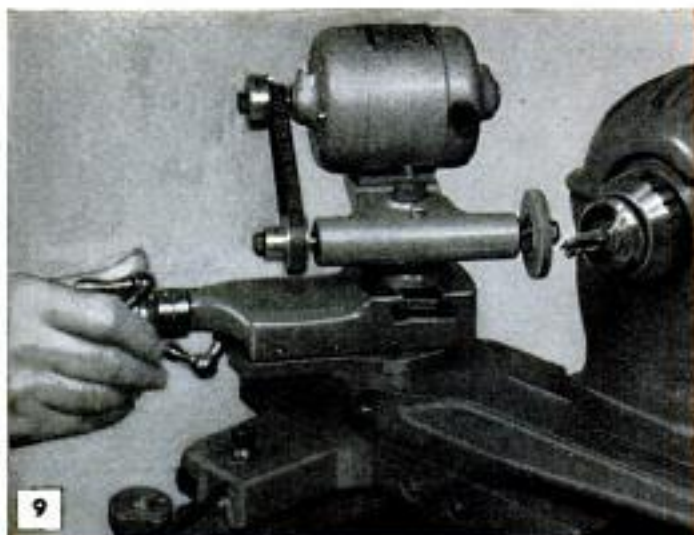

Dovetail cutters smaller than  $1\frac{1}{4}$  in. in dia. usually are made by grinding 4-flute end mills to required angle, Figs. 9 and 10. Work is rotated while grinding. Shallow dovetail cuts  $1/16$  in. or less in depth, can be run in one pass as shown in Fig. 12

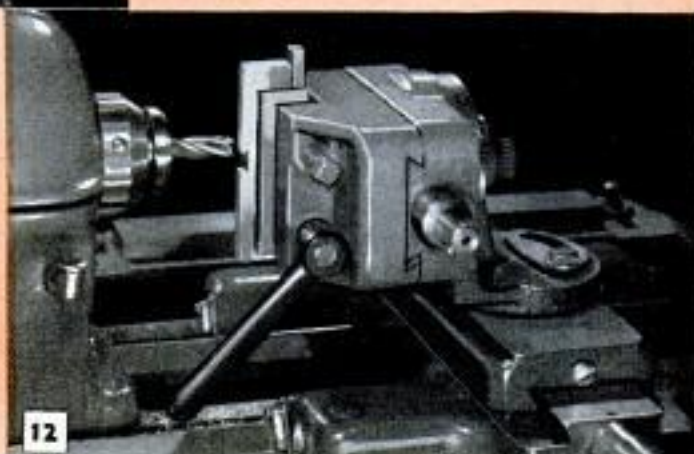
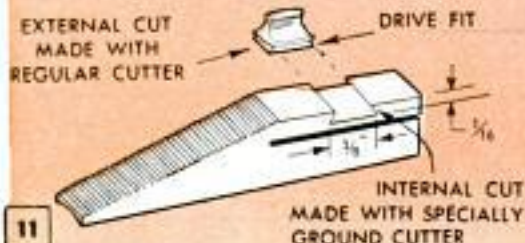

It's regular practice to make V-cuts with a single-angle cutter, Fig. 7, but small vees can be run with a double-angle cutter. When the bottom of the vee requires a chip-clearance groove, as required when making a V-block, this is first run with a slotting, or slitting, saw as in Fig. 8. Then the first angle cut is run in successive passes to the required depth and the work is reversed for the final cut, Fig. 8.

Dovetails smaller than  $1\frac{1}{4}$  in. are usually cut with 4-flute end mills ground to the angle required, Figs. 9 and 10. The end mill is rotated at slow speed while grinding is being done. After grinding it is necessary to back off each tooth for clearance.

This can be done on a bench grinder. When properly made these small cutters work very well on one-pass cuts up to  $1/16$  in. in depth. If the required depth is greater it is best to rough out the waste by straight milling. Figs. 11 and 12 show typical operations with a small, specially made milling cutter.

Angular cutters generally are operated at slower feeds than are normally used for straight cutters. Cutters  $2\frac{1}{2}$  in. or larger should be operated at about 60 r.p.m. with a feed ranging from .012 to .025 per revolution. The cutting depth per pass should not exceed  $1/16$  in. for best results on small machines. ★★★



### Portable Speed Jack Assembled From Farm-Machine Parts

Using a friction-clutch pulley salvaged from a discarded stationary engine, reduction gears and self-aligning bearings, one farmer built this portable speed jack for driving bale and grain elevators located at various points on his farm. The driven machine can be started and stopped simply by engaging or releasing the clutch pulley. Engine and jack are mounted on skids so that the unit can be moved to any point.

A. M. Wettach, Mt. Pleasant, Iowa.

# SHOPPING FOR TOOLS



**TOOL LOCKER** is designed with an open back for attaching to a perforated-hardboard wall panel. It also is available with cut-to-size panels of perforated hardboard attached to back and doors. Comes also in a one-door size. Both sizes have door locks  
Eclipse Metal Mfg. Corp., Eden, N. Y.



**SHORT SCREWDRIVER** comes with a sliding handle similar to that of a tap wrench. The handle greatly increases the efficiency of a short screwdriver, especially in those places where it is not possible to turn the driver with one hand on the handle in the regular way  
J. Stead & Co., Ltd., Sheffield 2, England

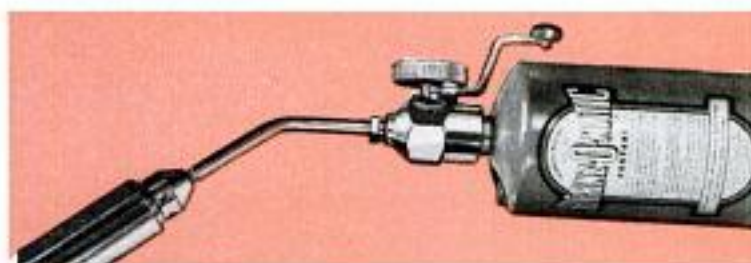

**SOLDERING TORCH** has pilot light which eliminates the need for burning the large flame continuously on jobs where torch is used only intermittently. Full flame is controlled by push-button valve. Burner shield is larger, giving higher temperature  
Otto Bernz Co., Rochester, N. Y.



**SLEEVING CUTTER** cuts all types of insulating tubing such as glass fiber and silicon-coated nylon, also small-gauge wire and soft solder in wire form. Cuts lengths ranging from 1/32 in. to 2 in.  
Macdonald & Co., 1324 Ethel St., Glendale 7, Calif.

**MAGNETIC TOOL RACK** solves the misplaced-tool problem, keeps small tools handy and always in full view. Regular size is 24 in. long and comes complete with brackets for shelf or wall mounting. Permanent magnets hold common small tools securely  
Magnetrode Corp., 1615 Main St., Kansas City 8, Mo.

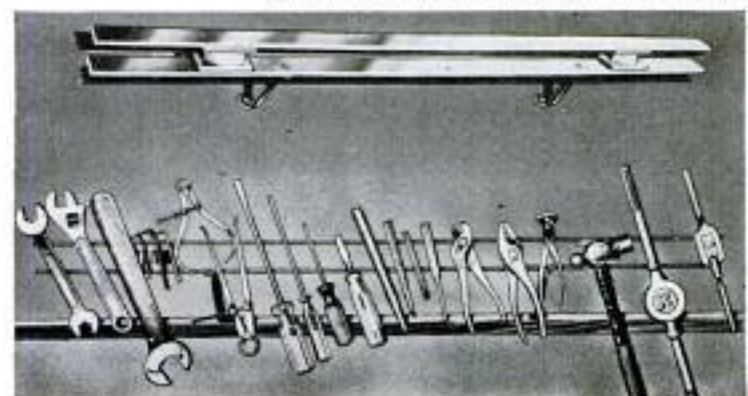

**PRESSURIZED PAINT SPRAYER** comes with separate container for paint or enamel. Handles any sprayable liquid. Uses nontoxic and nonflammable propellant. Just the thing for touch-up work  
Met-L-Chek Western, 11919 S. Western Ave., Los Angeles 47, Calif.



(Continued on next page)

## SHOPPING FOR TOOLS

(Continued)



**SAW-JOINTER COMBINATION** consists of 10-in. tilting-arbor saw with a 5-in. jointer mounted on floor stand. Both machines are driven by a single 1-hp. motor. When not in use, jointer can serve as saw-table extension by removing the fence and leveling tables

Duro Metal Products Co., 2651 N. Kildare Ave., Chicago 30.



**DIAL-READING POINT INDICATOR** comes with magnetized V-base and centering punch. Automatically determines angles and center points, entirely eliminates measuring and computing on many jobs. Magnets hold indicator in contact with metal parts

Tracine Instrument Co., 500 College Ave., Racine, Wis.



**WIRE-CABLE CUTTER** not only cuts cable up to 1/2 in. in diameter, it also provides a means of capping cut ends to prevent fraying and possible injury. Blades are replaceable. Over-all length is 24 in. Weight 6 1/2 lb.

Aktiebolaget Lundquists Patent, Stockholm, Sweden

**BUMPING TOOLS** for auto-body work are made from hard fiber, can be used on metal surfaces without damage to surface finish. Set consists of five tools: Concave, convex, chisel-point, square and a special tool designed to reach hard-to-get-at places

Penn Fiber & Specialty Co., Inc.,  
2024 E. Westmoreland St., Philadelphia 34, Pa.



**VERNIER GAUGE** accurately measures longitudinal travel of lathe carriage. Saves time on internal-boring and threading jobs. Gives a positive depth reading up to 4 in. Can also be used on milling machine to check table travel. It is accurate within .001

Lloyd Tool Corp.,  
P.O. Box 647, Burbank, Calif.

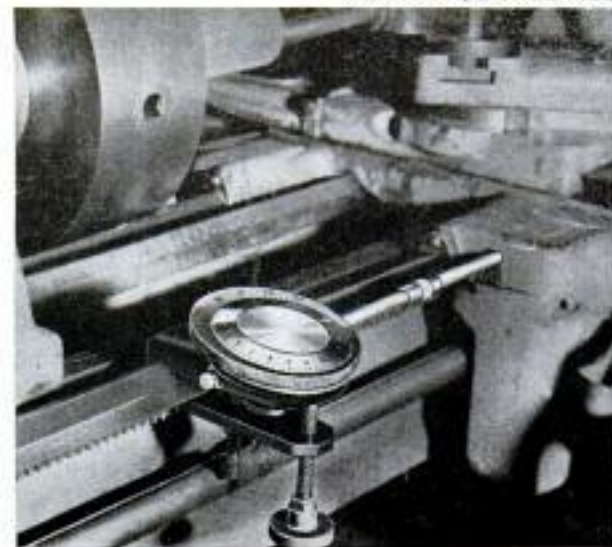



*On the*  
**MARKET**  
*for Do-It-Yourselfers*



**FINISHING KIT** comes in a choice of seven colors. Includes a combination sealer and stain which stains and seals the wood in one application. Steel-wool pads and wax complete the kit. No brushes are needed as finish is applied with cloth or steel-wool pad, rubbed down and then wax-finished

Yield House, North Conway, N. H.



**TEXTURED WALL TILES** are 10 in. square, come in a wide variety of patterns and colors. Surface resists damage by grease, oils, chemicals, water and household stains. Won't shrink, fade or peel. Easily washed with warm water and a mild detergent. Applied with a special adhesive that bonds tile to almost any clean, dry surface such as plaster, masonry, wood, glass and ceramics. Can be used in combinations of textures and colors

Bakelite Co., Div. of Union Carbide & Carbon Co.,  
280 Madison Ave., New York City 16.

**HIGH-SPEED BUFFER** is said to be especially well adapted to removing fine scratches from glass or plastic. High-speed, off-center rotation eliminates swirl marks. Motor is air-driven and has sensitive air valve for positive control. Also operates as a disk sander on wood or metal. Just the thing for featheredging painted surface before repainting

Detroit Surfacing Machine Co., 1333 E. Eight Mile Rd.,  
Detroit 20, Mich.

**GALVANIZING PAINT** contains 95 percent metallic zinc. Affords cathodic protection to metals as metallic-zinc particles are in contact with each other and also with metal surface under paint film. For full protection old paint coating should be removed, exposing bare metal, otherwise effectiveness of the new paint is greatly reduced. Rust should be removed

American Solder & Flux Co., 10th and Willard Sts.,  
Philadelphia 40, Pa.



## ON THE MARKET

(Continued)



**CLOSURE STRIPS** are molded in colors from plastic and are shaped to provide a tight seal for the ends and edges of corrugated plastic sheets used on porch roofs, outdoor walls and inside the house for room dividers. Colors to match those of most corrugated sheets are molded into the closure strips. The latter are fastened by nails

Hansen Plastics Co., 805 S. Good-Lattimer  
Expressway, Dallas 10, Tex.

**GROUT STRIP**, upper-right photo, assures uniform joints in plastic-tile walls. Strip is of white plastic with a matte finish. Horizontal strips are 18 in. long and the vertical strips 4 1/4 in. After the first tile has been correctly located, a portion of cement is raked away from one edge and a vertical grout strip is pressed into place

Arterrest Plastics Co., Inc.,  
255 W. 79th St., Chicago 20.

**EXPANSION STRIP** is made from tough black plastic, ribbed on both sides so that when used as an expansion joint between pourings of concrete, the latter will run between the ribs and produce a lock joint that is watertight. Cut ends of the material can be spliced by heating with a soldering iron as pictured at the right

Progress Unlimited, Inc.,  
15 W. 44th St., New York City 30.

**LIQUID "SANDPAPER"** cleans by surface activating action rather than abrasive action. Removes heel marks, stains and grime from linoleum and hardwood floors, cuts gloss on painted surfaces preparatory to repainting. Applied with brush or cloth pad

General Liquids Corp.,  
4730 Reisterstown Rd., Baltimore 15, Md.



**NEWLY DEVELOPED COATING** incorporates a special ingredient designed to neutralize galvanic action of zinc, permits coating galvanized gutters and downspouts immediately after placement without waiting for weathering and without etching the galvanizing. Also used on new aluminum and terneplate. Available in nonfading red, gray, green and metallic colors

Rust-Oleum Corp., 2799 Oakton St., Evanston, Ill.



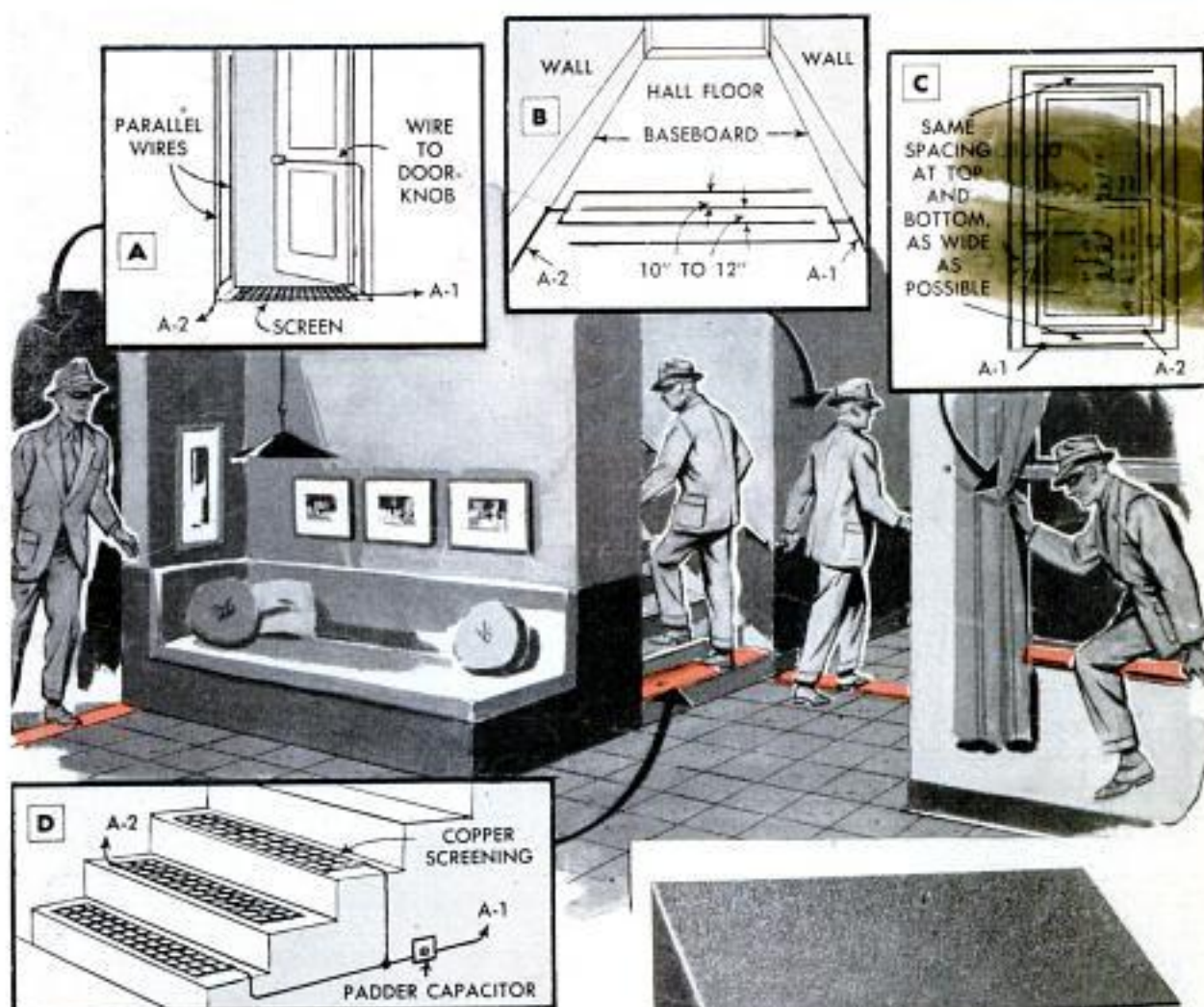

## SILENT SENTINEL

### Novel Frequency-Shift Alarm

By James A. McRoberts

**I**NSIDE OR OUT, day or night, this unusual control circuit can help protect your property against burglars or intruders by sounding an alarm at the approach of an unexpected visitor. It is inexpensive to build, costs next to nothing to operate and, when properly installed, offers foolproof, tamperproof performance.

Technically, the Silent Sentinel operates on a change in capacity brought about by the approach of a person to two antenna leads. It differs from the normal type of capacity-operated relay, however, in that

much longer antennas (up to 500 ft.) can be used for the protection of a greater area. Furthermore, the circuit is absolutely safe and provides neither a shock nor a fire hazard.

#### Principle of Operation

The operating principle of this circuit is as interesting as it is unusual (see Fig. 1). A transistor oscillator, TR1, generates a very low power r.f. signal voltage whose

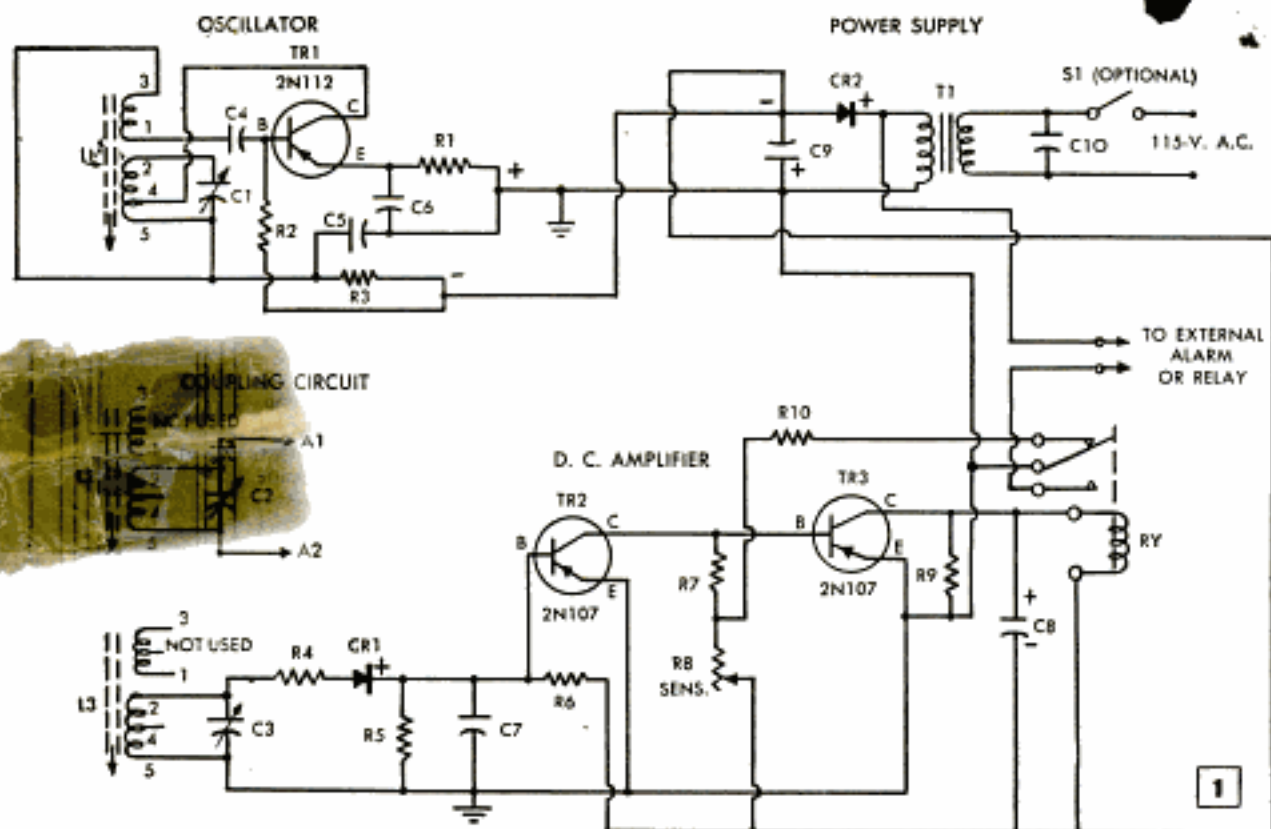

frequency is determined by adjustment of the tank circuit L1 and C1. This signal energy is transferred to the tuned circuit L3-C3 through the coupling circuit L2-C2 by means of magnetic coupling. Maximum energy transfer takes place when L2-C2 and L3-C3 are tuned to the oscillator frequency.

Any signal appearing at L3-C3 is rectified by diode CR1 and the resultant d.c. signal is amplified by the transistor TR2 before being applied to the control transistor, TR3. When sufficient energy is transferred from the oscillator to L3-C3, the current flowing through the base-emitter elements of TR3 will cause enough collector current to flow through the relay coil, RY, to close the normally open contacts of this unit. As a result, the stepped-down line voltage appearing at the secondary winding of T1 will be applied to an external alarm device.

Now here's the important point. In the actual operation the coupling circuit L2-C2 is adjusted to a frequency higher than that of the oscillator, so that little or no signal is transferred to the input of the d.c. amplifier (L3-C3). The relay, therefore, will remain unenergized. But, when the antenna wires are approached, additional capacity is introduced into the coupling circuit so that its resonant frequency approaches that of the oscillator. The resultant increase in the strength of the signal coupled to the amplifier causes the relay to close and activates an alarm.

The circuit is so designed that the alarm, once tripped, remains activated even if the intruder leaves the immediate vicinity of the antenna. This is accomplished by latching resistor R10, which is disconnected from ground by the opening of the normally closed relay contacts. This increases the bias current through TR3 so that the

#### LAYOUT DIAGRAMS

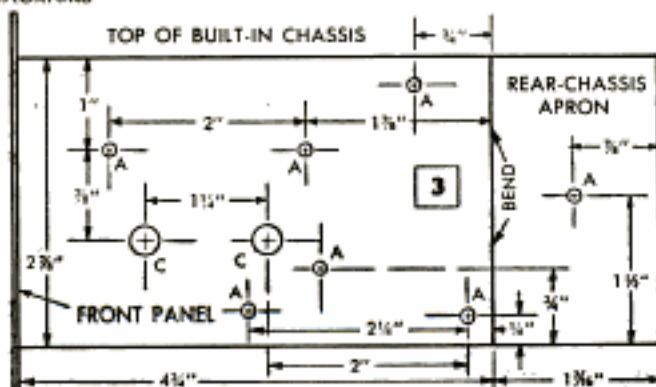
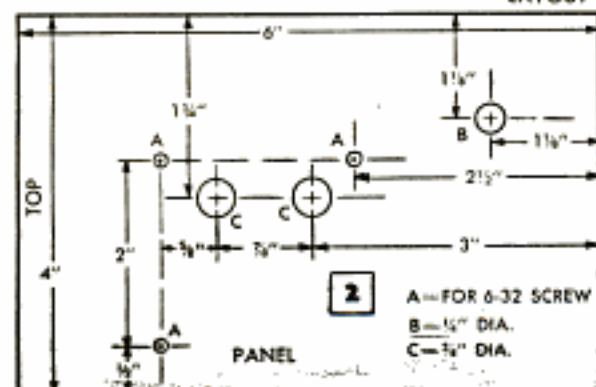

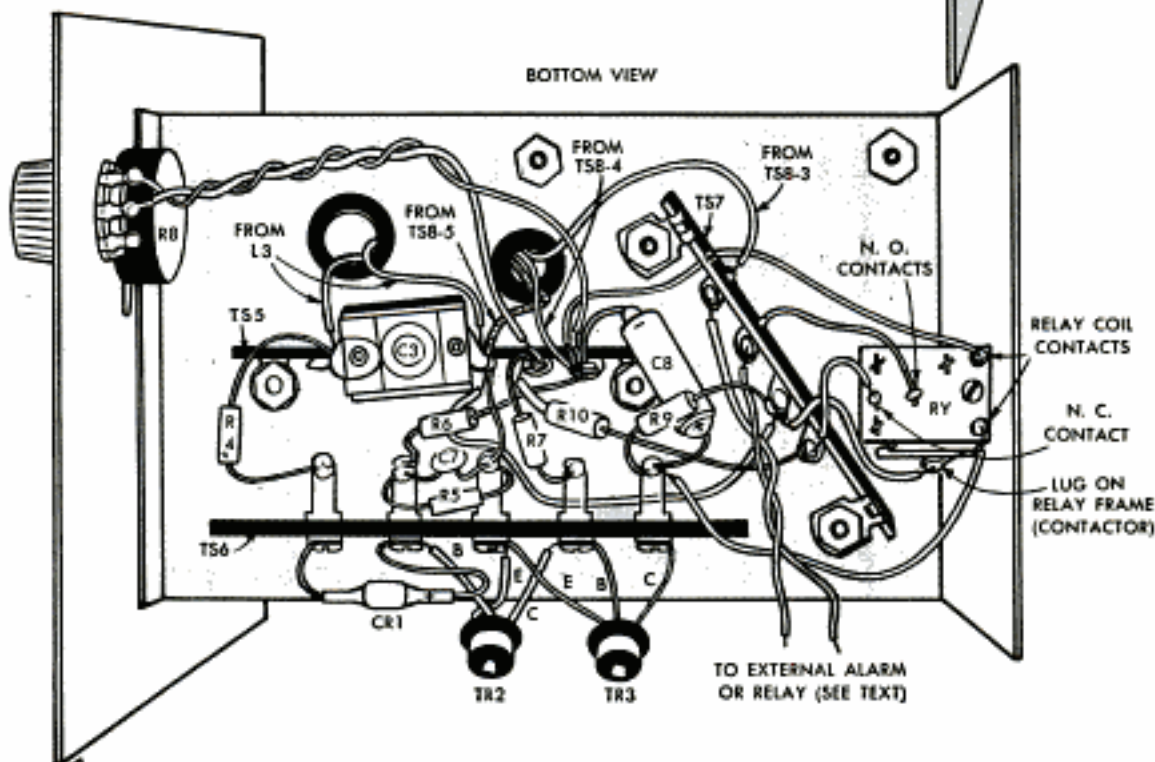
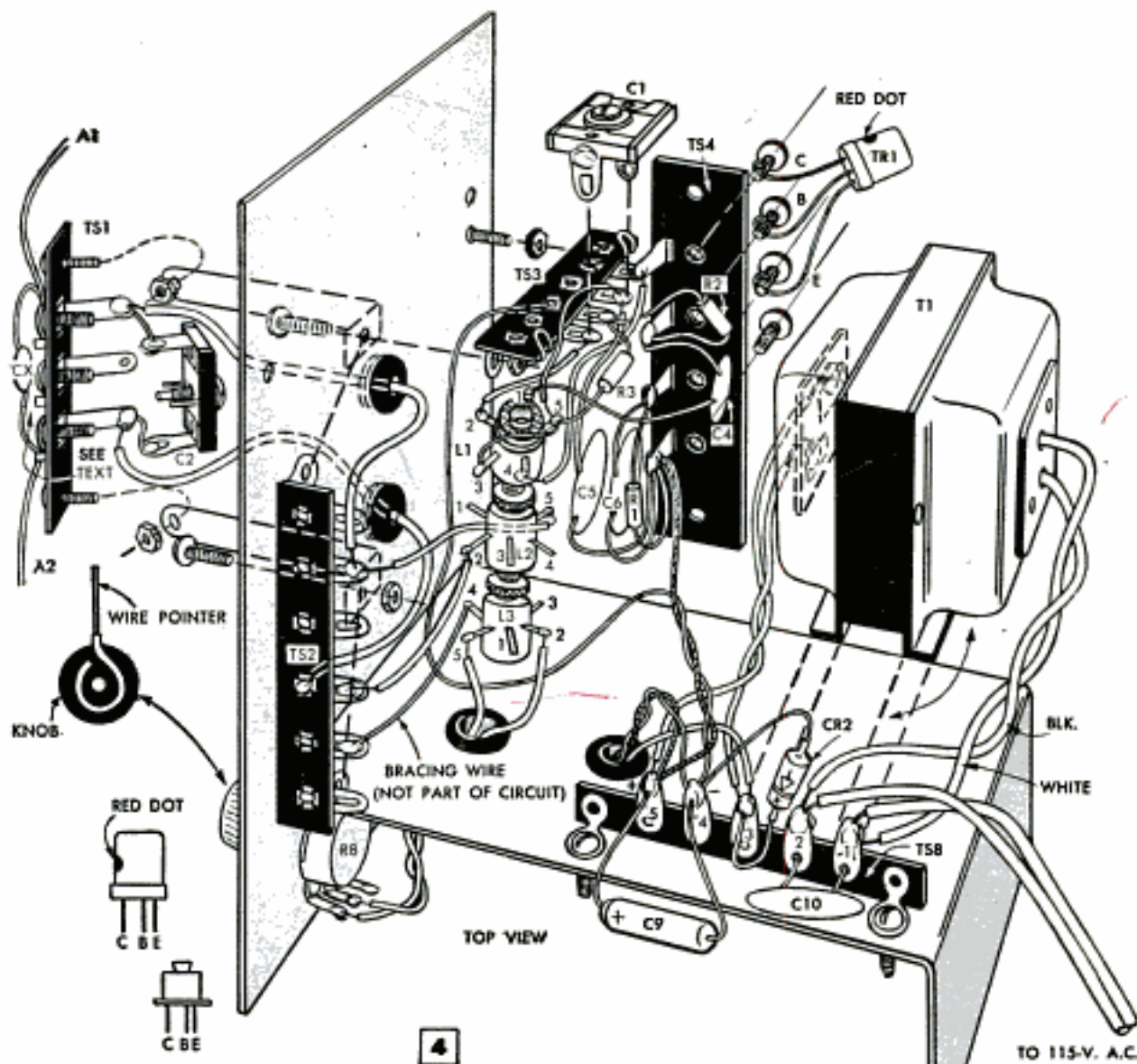

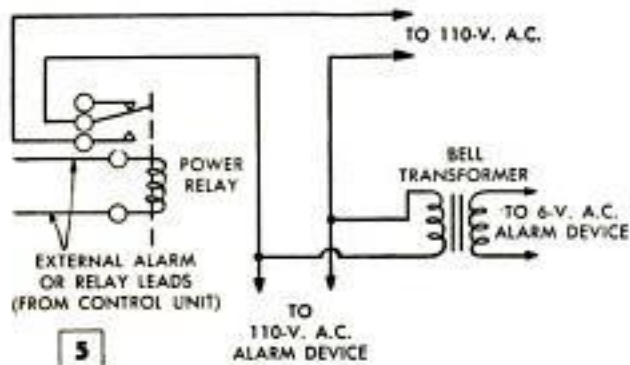

current through the relay coil is sufficient to hold the relay closed even in the absence of an oscillator signal. The alarm can be deactivated only by the interruption of the a.c. line voltage to the control unit.

### Construction

The control unit is housed in a commercially available metal box with a built-in chassis. Panel and chassis-layout diagrams for the parts in the list of materials are shown in Figs. 2 and 3.

The wiring is illustrated pictorially in Fig. 4. This wiring should begin with the power-supply circuit which consists of transformer T1 and the parts and wires mounted on terminal strip TS8. The two leads from lugs 1 and 2 of this strip to the 115-volt a.c. line are those of a line cord which is temporarily connected for testing purposes. Upon completion, the line cord should be disconnected and the final connection to the a.c. line should be made through BX connectors and electrical conduit.

The oscillator and coupling circuits consist of parts mounted to the front panel. The point-to-point wiring of this section is shown in the exploded portion of Fig. 4, while the exact placement of these parts can be seen from the photograph in Fig. 6.

### LIST OF MATERIALS

**RESISTORS**—all  $\frac{1}{2}$ -watt (K=1000 ohms) R1=560 ohms; R2, R6=220K; R3=2.2K; R4=1K; R5=470K; R7, R10=4.7K; R9=33K; R8=15K potentiometer, Lafayette No. VC-35 or equiv.

**CAPACITORS**—(all disk ceramic unless otherwise specified) C1, C3=9—180 mmfd. mica padder; C2=2—30 mmfd. mica trimmer; C4, C6=.005 mfd.; C5=.01 mfd.; C7=470 mmfd.; C8, C9=10 mfd. 25-v. electrolytic; C10=.0047 mfd.; Cx=150 mmfd.

**TRANSISTORS**—TR1=Raytheon 2N112/CK-760; TR2, TR3=GE 2N107.

**MISCELLANEOUS**—T1=Bell transformer, prl. 115-v., sec. 14-v., Snapit No. 2302 or equiv.; L1, L2, L3=Transistor oscillator coils, Lafayette No. MS-265; D1, D2=Type 1N34A crystal diode; RY=Sensitive s.p.d.t. relay, 5000 ohm coil, Lafayette No. F-260.

**TERMINAL STRIPS**—TS1=3-lug, screw type; TS2, TS3, TS7=4-lug, chassis mntg.; TS4, TS6=5-lug, screw type; TS5, TS8=5-lug, chassis mntg.

**HARDWARE**—"L" brackets to hold TB1, about 2 in. long x  $\frac{1}{4}$  in. wide; utility cabinet with built-in chassis, ICA type 3819; Rubber grommets for  $\frac{1}{8}$ -in. holes (4); knob for R8; dial plate; BX connectors (see text); machine screws, nuts and lock washers; hookup wire (Use No. 20 solid, or heavier, for wiring L1, L2, L3 and C2. Lighter, multicolored wire can be used for rest of wiring); spaghetti (as needed); rosin-core solder.

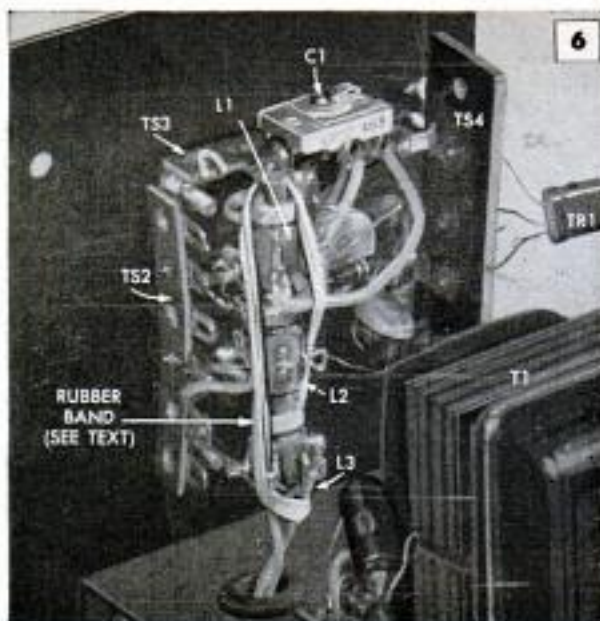

The three coils used for the tuned circuits are slug-tuned transistor oscillator coils. These are normally shipped with their slugs in the all-out position. Turn each of the slugs in about three turns. The coils are mounted in line with one another (top of L3 to bottom of L2 and top of L2 to bottom of L1) and are held in position by the wires to their terminals. A rubber band (see Fig. 6) will hold the three coils tightly together in order to provide maximum coupling. TS4 is held in place by having its outer lug soldered to that of TS3. Do not mount any of the transistors, or diode CR1, until all soldering has been completed.

The d.c. amplifier circuit consists of parts mounted beneath the chassis. The wiring is conventional except that TS6 is held in position only by the wires and parts which connect it to TS5. All connections must be securely soldered.

Modify relay RY before installation by bending its fixed, normally open contact with a pair of pliers until the spacing between it and the contactor (movable contact) is about twice the original spacing. Several thicknesses of paper can be used as a substitute for feeler gauges for this operation. Make all connections shown in the bottom view of Fig. 4 with the exception of R10. This resistor will be installed after initial adjustments have been made.

Complete the initial assembly by installing the transistors and diode CR1, using spaghetti where necessary to prevent short circuits between the various leads.

### Initial Adjustments

The control unit can be adjusted quickly and easily with the use of a high-resistance d.c. voltmeter such as a V.T.V.M. or 20,000 ohms/volt instrument. (You can obtain

(Continued to page 262)



**NEW PLASTIC  
SQUEEZE CONTAINER**

*Easier to use in every way*

Can't spill

Can't scratch finish

It's Homogenized—  
can't settle

—no shaking necessary

It cleans as it polishes—in  
**ONE** quick easy operation

# MORE SHINE LESS WORK

just **SQUEEZE** on —  
**WIPE** off

**REMOVES DIRT AND FILM IN ONE EASY  
OPERATION, Leaves longer lasting luster**

## **4** *MAGIC INGREDIENTS*

1. One ingredient gets rid of dirt.
2. Another removes dulling traffic film and oxidation.
3. Another makes Polish easy to wipe off.
4. Still another produces a long lasting brilliant luster.

**IF your dealer can't supply you write us for name  
of conveniently located Bowes dealer.**

**BOWES "SEAL FAST" CORP., INDIANAPOLIS 7, INDIANA • HAMILTON, ONTARIO, CANADA • LONDON, ENGLAND  
BOWES PACIFIC CORPORATION, RIVERSIDE, CALIFORNIA**

# NEW—Kodak 300

It's ultraportable—yet shows any popular-size color slides big-as-life in your living room!

Here's a color slide projector *designed* for modern living! So lightweight, you can carry it like a portable radio . . . so compact, you can store it on a bookshelf. Best of all, it lets you enjoy thrilling *big-screen* projection even in a small room. At a distance of 10 feet, for example, your favorite color slide will *completely* fill a 40-inch-wide screen!

You really have to see and handle the Kodak 300 Projector to appreciate its remarkable versatility. Try the focusing and elevating mechanism . . . the smooth glide of the new Kodak Readymatic Slide Changer. Notice how simply, how precisely, everything works. That's the secret of the Kodak 300 Projector's exceptional handling ease!

Now slip in a slide, switch on the lamp, and focus the lens. Notice that the rock-steady

picture you get is brilliantly lighted *clear to the corners!* Your Kodak dealer will be glad to show you the new lamp-condenser system and superb 4-inch, *f/3.5* lens that produce these superior screen results. Ask him, too, about the Kodak 300 Projector's ultra-quiet cooling system . . . built-in cord and slide storage space. Complete with self-cover.

Kodak 300 Projector with Readymatic Slide Changer (holds 36 slides in cardboard mounts), **\$59.50** . . . or as little as \$5.95 down.

Kodak 300 Projector with 36-slide self-storing magazine changer, **\$69.50** . . . as little as \$6.95 down.

*Prices are list, include Federal Tax, and are subject to change without notice.*

The only projector with Kodak's completely



**SO LIGHT, SO COMPACT**, so easy to carry! Has self-cover, measures only 5 x 11 inches square, weighs only 9 pounds.



**FOCUSING AND ELEVATION** adjustments are fast . . . precise . . . with all essential control knobs at your finger tips.

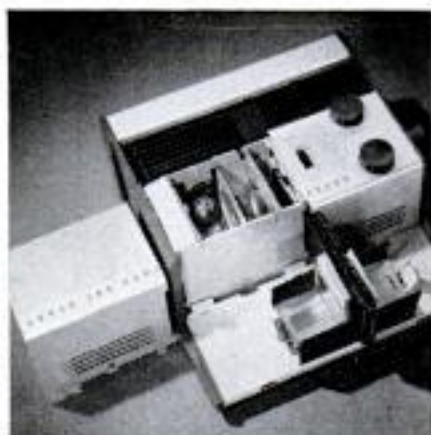

**QUICK, E-A-S-Y ACCESS** to lamp and condenser compartment—built-in storage space for your lamp cord and color slides.

**EASTMAN KODAK COMPANY,**

POPULAR MECHANICS



# Projector

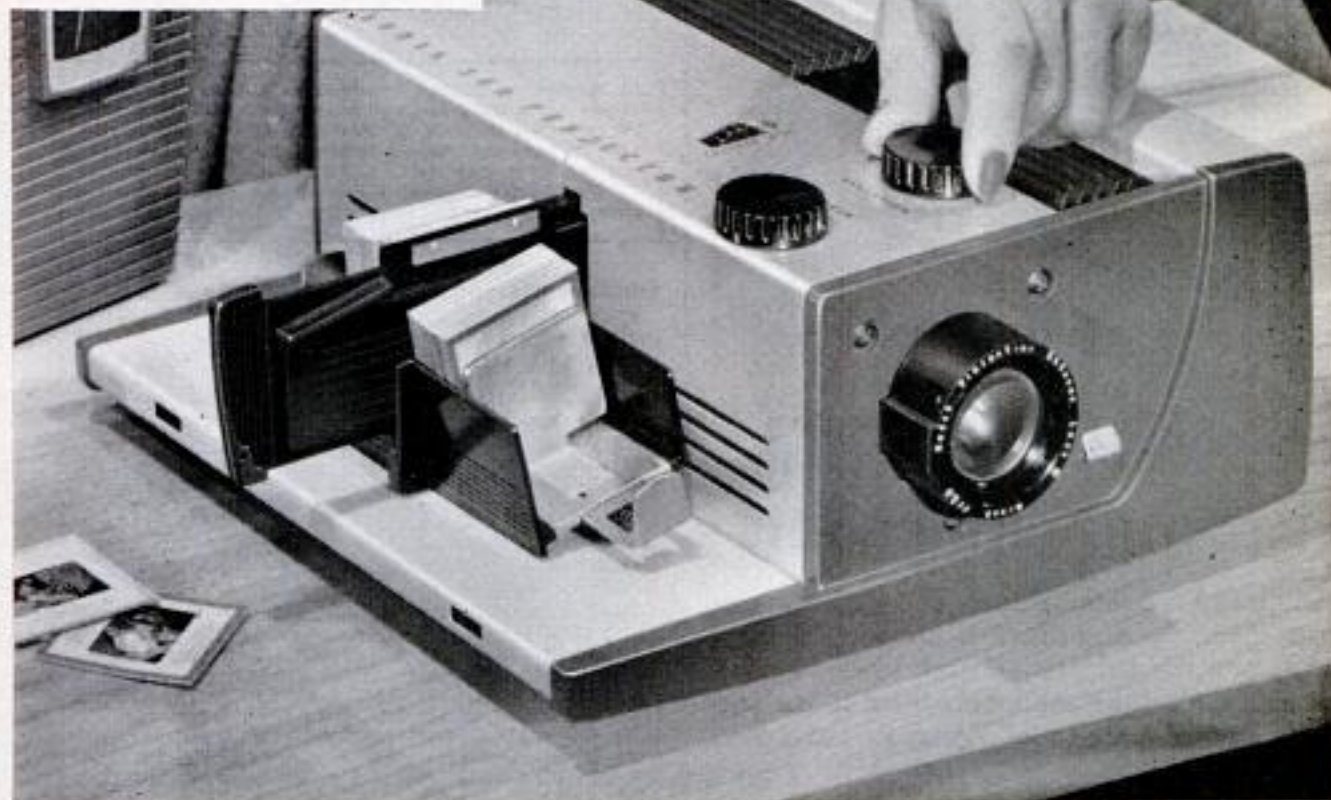

## new **READYMATIC SLIDE CHANGER**



**PROJECTS 35MM, BANTAM,** or the new, big  $1\frac{1}{2} \times 1\frac{1}{2}$  slides. Also (with an adaptor) single frames of your stereo slides.

**Rochester 4, N. Y.**

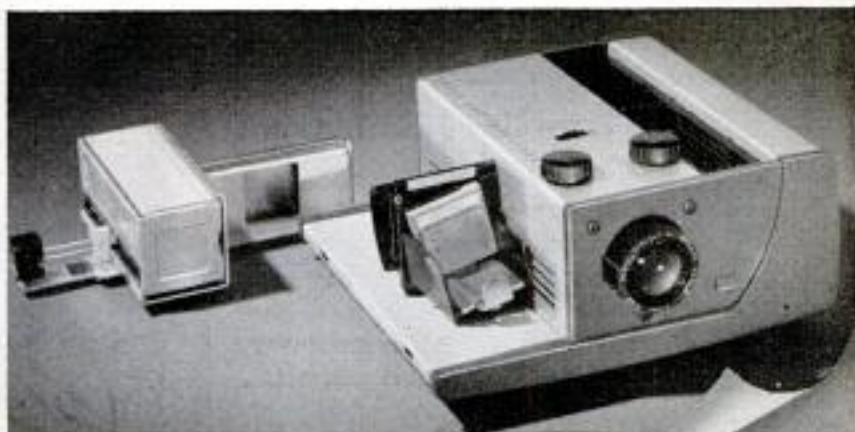

**CHOICE OF EXCLUSIVE** new Kodak Ready-matic Slide Changer which accepts up to 36 slides per loading, or self-storing, magazine-type slide changer.

**Kodak**  
TRADE MARK

J.W. MORTZELL Co.  
522 BURCH  
KANKAKEE, Ill.

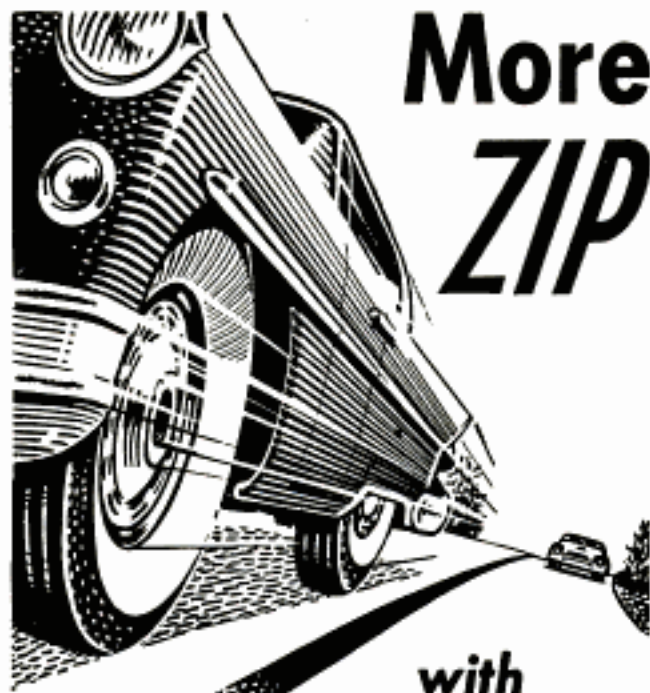

# More ZIP

with

## Sealed Power KromeX Ring Sets

Put that high compression zip and surge back in your engine's performance. If it's worth re-ringing, it's worth the best—Sealed Power. Sealed Power Piston Rings are approved for *all* car and truck engines made by *all* American automobile manufacturers!

### Save Oil! Save Gas!

Solid chrome plating on top compression ring and oil ring side rails fights heat, friction, and corrosion, gives double ring life. These sets control oil instantly, break in fast, make pistons and cylinders wear longer. Sealed Power KromeX Ring Sets are the finest ring sets ever made.



### You need this FREE Manual

"Care and Feeding of Engines" is an illustrated manual of engine care which is yours for the asking. Highly informative, it may save you a lot of money. For your free copy, address Sealed Power, Dept. G-5, Muskegon, Mich.

## Sealed Power PISTON RINGS

BEST IN NEW CARS! • BEST IN OLD CARS!

## Clinic for Homemakers



As a service to our readers in solving the hundreds of problems pertaining to a home—inside or out—the editors of *Popular Mechanics* invite you to present your problems to The Clinic Editor for help and advice. Address your questions to The Clinic Editor, *Popular Mechanics Magazine*, 200 East Ontario Street, Chicago 11, Ill.

### Condensation on Pipes

Q—I have recently installed a bathroom upstairs, the pipes from the basement passing through an inner wall to the upstairs room. Now I notice that the wall downstairs is being discolored by dampness. This area is very nearly in line with the water pipes. Could my trouble be caused by condensation?—C. N., Miss.



A—Judging from your description it seems quite likely that condensation is the cause, but one might wonder just how the water resulting from condensation is reaching the wall above the baseboard. Of course, it is possible that the pipe is inclined slightly. This could cause water to drip from the pipe onto the wall at some point. The possibility of a slow leak should not be overlooked. Undoubtedly the plumber installed the pipes in sections joined with unions. A leak could develop at any one of these joints. Due to the nature of the installation it may prove rather difficult to determine beforehand just what is causing the trouble. No practical preventive measures can be taken without removing the pipes. When this has been done and the cause determined, recoat the threads with pipe-thread compound, tighten the unions to maximum allowable tension and, as the pipe is assembled and replaced, coat it with a mastic material designed to prevent condensation.

### Peeling Paint

Q—I have an older home in which the woodwork was originally finished with a dark-colored stain and varnish. Desiring a lighter color, I refinished the woodwork using three coats of semigloss enamel. Now the enamel is peeling in places. It comes off in large flakes, leaving the old finish exposed. In some places the paint will break up when tapped with the fingernail. What is the cause?—K. H., Calif.



A—Old woodwork often was finished with stain and shellac, a very durable finish, but one which requires a rather thorough preparation before applying new finishing materials. The surface should be cleaned with a solvent to remove accumulated

(Continued to page 226)

**“My Army recruiter  
showed me how to choose  
my foreign travel”**



Sgt. 1st Class James E. Pfrommer  
Army Recruiter, Lafayette, Ind.



**“He got me the overseas  
assignment I wanted”**

“My Army Recruiter was more than just friendly, he was really helpful. He showed me how I could go to Europe through the Army's Unit Rotation Program. My travel was guaranteed *before* I enlisted. Now I'm in Germany with plenty of free time to explore foreign countries. I've seen castles and historic landmarks, learned different customs and met wonderful people everywhere. It's a great enlistment deal because you know just where you're going and you stay with the same buddies all through service. The Army's given me an opportunity I could never have afforded otherwise. If you want to travel, why not see your local Army Recruiter and find out what opportunities are open for you?”

*Howard E. Lasley*

Howard E. Lasley  
Graduate, Romney High School  
Romney, Indiana

**YOUR ARMY RECRUITER WILL HELP YOU  
GET A SPECIAL TRAVEL DEAL**

The Army Recruiter in your town can help you get the kind of deal Howard got. There are always new travel opportunities opening up that let you *choose* your own foreign travel *before* you enlist! Europe, the Far East, the Pacific, the Caribbean or Alaska—any one of these exciting areas may be available to you! The wonders of the

World may well be as near to you as your local Army Recruiting Station. When you enlist under the Army's special travel options, you know *exactly* where you're going! Your foreign service is *guaranteed*! You see the world at government expense. For your passport to adventure, see your Army Recruiter. There's no obligation!



**GET CHOICE, NOT CHANCE, FROM YOUR ARMY RECRUITER**

# your best buy...



- stretches the years between painting ...
- right paint for every type of surface ...
- endorsed by leading painters ...



**FREE!** Beautiful 44-page "Home Decorator" book. At your dealer, or write The Sherwin-Williams Co., 1236 Midland Building, Cleveland 1, Ohio.

**SHERWIN-WILLIAMS**  
**HOUSE PAINT**

(Continued from page 224)

grime and finger marks. Then the surface should be "cut" lightly with fine steel wool to provide a tooth for the new finish. To prevent any possibility of the stain bleeding through the new finish, follow the preparatory steps with an undercoater. Be sure to allow this plenty of time to dry, especially if you are working during the warmer months when the humidity is likely to be high. In your case, it probably will be best to remove the finish from the affected areas and then follow through with the procedure outlined. As a first step, scrape off all loose material and sand to feather the edges of the areas from which the loose paint has been removed. This is necessary in order to obtain smooth finish coats. Then apply undercoater to the scraped areas and follow with one or two finishing coats of enamel in the type and color desired.

#### Soil for Window Box

**Q**—What type of soil, or soil mixture, should I use in a window box? Some of my neighbors who have had the soil tested in garden plots say that it is moderately acid. What is done to correct this? The box I have built is of average size and I plan to place it on a window near the northeast corner of the house. It will be in direct sunlight only about an hour or so each day. What plants grow best in this location?

—L. H., Ind.



**A**—Soil mixture for a window box should consist of approximately equal parts of sharp sand, fine peat moss and enriched garden soil. The ingredients should be thoroughly mixed before placing in the box. When mixing, add a half pound or so of a complete chemical fertilizer and a cupful or so of hydrated lime to correct excess acidity. According to your description of the location of the box, it will be in direct sunlight only during the early morning and possibly late evening of each day. In effect, it has a northern exposure and plants should be selected accordingly. Plants which ordinarily do best in boxes with a northern exposure are asters, hydrangeas, geraniums, pansies, lobelias and violas. Wax begonias and petunias can be added to this list, although they are not ordinarily selected for this location.

#### Petunia Blooms

**Q**—Can I plant petunia seeds and expect the plants to bloom the same year? Or, is it better and surer to purchase transplants? I had originally planned to broadcast the seed in geometrically arranged plots as early in the spring as possible, but now I am told that the plants from this sowing will not bloom.—L. S., Minn.

**A**—It is possible that plants grown outdoors from seed will bloom in your locality, but we would be rather doubtful if the method can be relied on from season to season. To assure yourself of blooms we think perhaps it would be better to purchase transplants.

#### Controlling the White Fly

**Q**—Last season, and beginning again this present season, I have noticed that my broad-leaved evergreens seem to be infested with tiny insects. They fly away in clouds when the foliage is shaken lightly. Can you identify them? Do they cause damage?—T. N., Fla.

**A**—If we can judge correctly from your description the insects are what are known as white flies. They can cause rather severe damage to certain plants native to the South, such as gardenias, camellias and also azaleas. They feed mostly on the undersides of leaves, causing the foliage to take on a mottled appearance. There are several insecticides available as sprays which are said to be quite effective in controlling this pest.

# New Stanley Heavy Duty Sanders

*they do more... cost less*

The big new H31 Heavy Duty Belt Sander  
*does more —*

- *Because* it sands faster than other belt sanders... 3" x 24" or 3" x 23 $\frac{3}{4}$ " belt.
- *Because* the ball bearing motor runs cool and stays cool... never too hot to handle.
- *Because* the drive belt delivers full power to the sanding belt.
- *Because* it doesn't need constant lubrication.

*It costs less —*

less than any comparable heavy duty belt sander sold today.

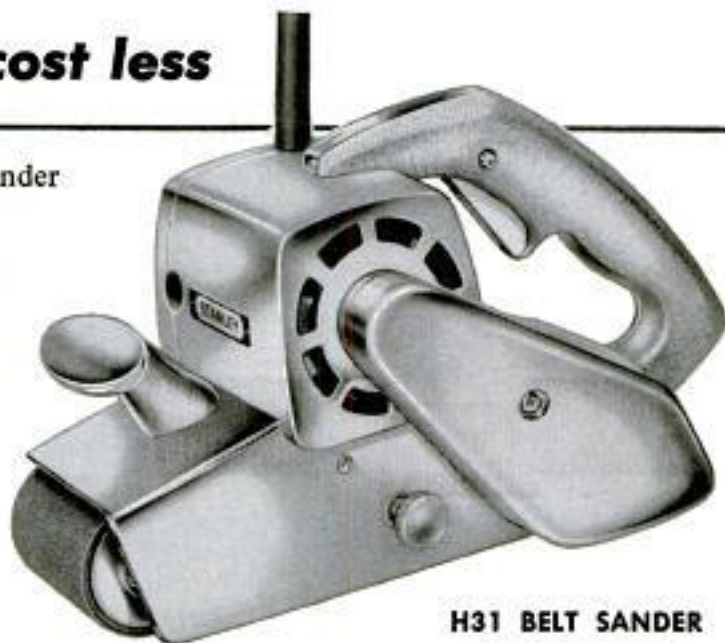

H31 BELT SANDER

**\$84<sup>95</sup>**

The smooth new H36 Heavy Duty  
Orbital Sander *does more —*

- *Because* it sands faster than other orbital sanders.
- *Because* the ball bearing motor runs cool and stays cool.
- *Because* the pad is wide and absolutely flat... 3 $\frac{5}{8}$ " x 9" paper size —  $\frac{1}{3}$  of standard sheet.
- *Because* full power is delivered to the pad.

*It costs less —*

less than any comparable heavy duty orbital sander sold today.



H36 ORBITAL SANDER

**\$49<sup>95</sup>**

Try these fine new sanders. Your Dealer has them or can get them for you. Stanley Electric Tools, Division of The Stanley Works, New Britain, Conn.

AMERICA BUILDS BETTER AND LIVES BETTER WITH STANLEY

## STANLEY

This famous trademark distinguishes over 20,000 quality products of The Stanley Works—hand and electric tools • drapery, industrial and builders hardware • door controls • aluminum windows • metal parts • coatings • steel and steel strapping—made in 24 Stanley plants in the United States, Canada, England and Germany

**no other plier  
does so many jobs  
SO WELL**



**CHAN NEL LOCK**

**No. 420**

**GRIPS LIKE A PIPE WRENCH**

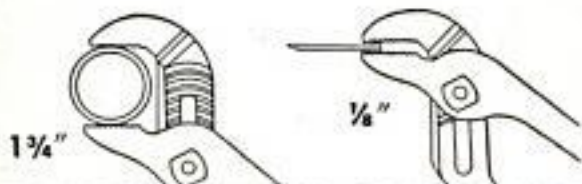

Help yourself to a Channellock No. 420 . . . the handiest plier of them all. With this handy plier, you can grip anything from a cotter pin to a 1 3/4" hex nut. And what gripping power! Just like a pipe wrench. What's more, Channellock is streamlined . . . easy to use in hard-to-get-at places. This all 'round usefulness is the reason why Channellock is the favorite plier of craftsmen everywhere. It'll be your favorite, too . . . for the same reason. Ask your hardware man for a Channellock No. 420.

**BE SURE IT'S A GENUINE CHANNELLOCK**



**CHAMPION DEARMENT TOOL Co. MEADVILLE, PA.**

## World's Toughest Outboard Race

(Continued from page 161)

the boat trailer on a parallel highway. He took seven hours and 34 minutes to run the 316 miles, including stops for fuel, two propeller changes and time consumed in making a wrong turn up the Feather River.

His elapsed time also included an agonizing 15 minutes when he broke a shear pin within sight of the finish line and started to drift back downstream. He had lost his tools overboard earlier in the race and finally hammered a new pin into place with a rock that was lying in the boat. Then he fired up the engine and roared across the finish line.

Minimum mechanical trouble, too, was experienced by Marvin Powell of Stockton, a highway patrol officer who won a year's possession of the perpetual trophy for pleasure boats. He had his 11-year-old daughter along as crew in his stock 14-foot aluminum boat. He used two propellers, two sets of spark plugs and encountered no other troubles en route. The day after the race he cruised down the river to Stockton instead of trailering his boat by road.

One second-prize winner among the pleasure classes carried two passengers in addition to the driver, plus sleeping bags and camping gear. This was a heavy load but the boat made the entire distance without trouble.

### More Reliable Engines

Long-distance marathon racing is the latest kind of competition for outboards. It's made possible by the fact that outboard engines are now far more reliable than they used to be. Some drivers, in fact, now rate them as more dependable than the average inboard engine.

Power is way up this year, and for some racing purposes motors can be reworked to develop even greater power. And outboards are now quiet, unless the muffling devices are removed for competition.

Aside from the pleasure boats that are allowed in the Sacramento River race, practically all marathon racing these days is on a semiprofessional basis. Engines must be stock, but hulls are designed strictly for racing purposes.

Sixteen major marathons were sanctioned by the American Power Boat Association last year. The most famous is the annual WinnebagoLand in Wisconsin. This 88-mile contest on Lake Winnebago is so popular that entries are now limited to 300, and some applicants must be denied entry.

Another race that offers all kinds of obstacles to a driver is the 115-mile marathon

(Continued to page 248)



**X-RAY ON CHEVROLET**

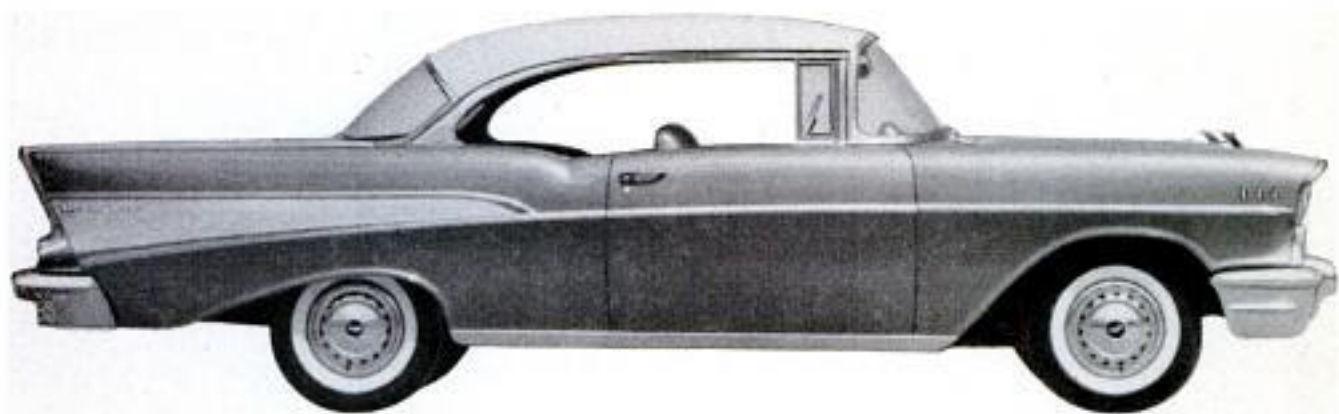

## HOW DO YOU BUILD IN BALANCE?



Fifty-fifty weight distribution is the automobile designer's aim—and his nightmare! It's easy to understand why: Balancing the weight equally between front and rear wheels is fundamental if you want stability and sure-footed control on curves and solid driving traction at the rear. But (and this is the joker) the passenger space has to be *ahead* of the rear axle if you want a soft rear seat ride and full rear seat hip room.

On most cars, that means too much weight on the front wheels. But not in Chevrolets. For example, a Chevrolet "Two-Ten" four-door sedan with Turbo-glide has from 207 to 240 pounds *less* dead weight on the front end than comparable cars in the low-price field.

That makes a big difference in handling

ease and road security. It explains why Chevy's steering is so light and precise, why its traction is better (light rear ends tend to spin and skid under power thrust). It is the basic engineering principle behind Chevrolet's famous roadability. It is a basic design fact that can be proved *on the scales*. But there's an easier proof for you—just see your dealer and drive a new Chevrolet. You'll find there's a whale of a lot more pleasure in bossing the best balanced car in its field! . . . Chevrolet Division of General Motors, Detroit 2, Michigan.



# NEW DU PONT DISCOVERY KEEPS

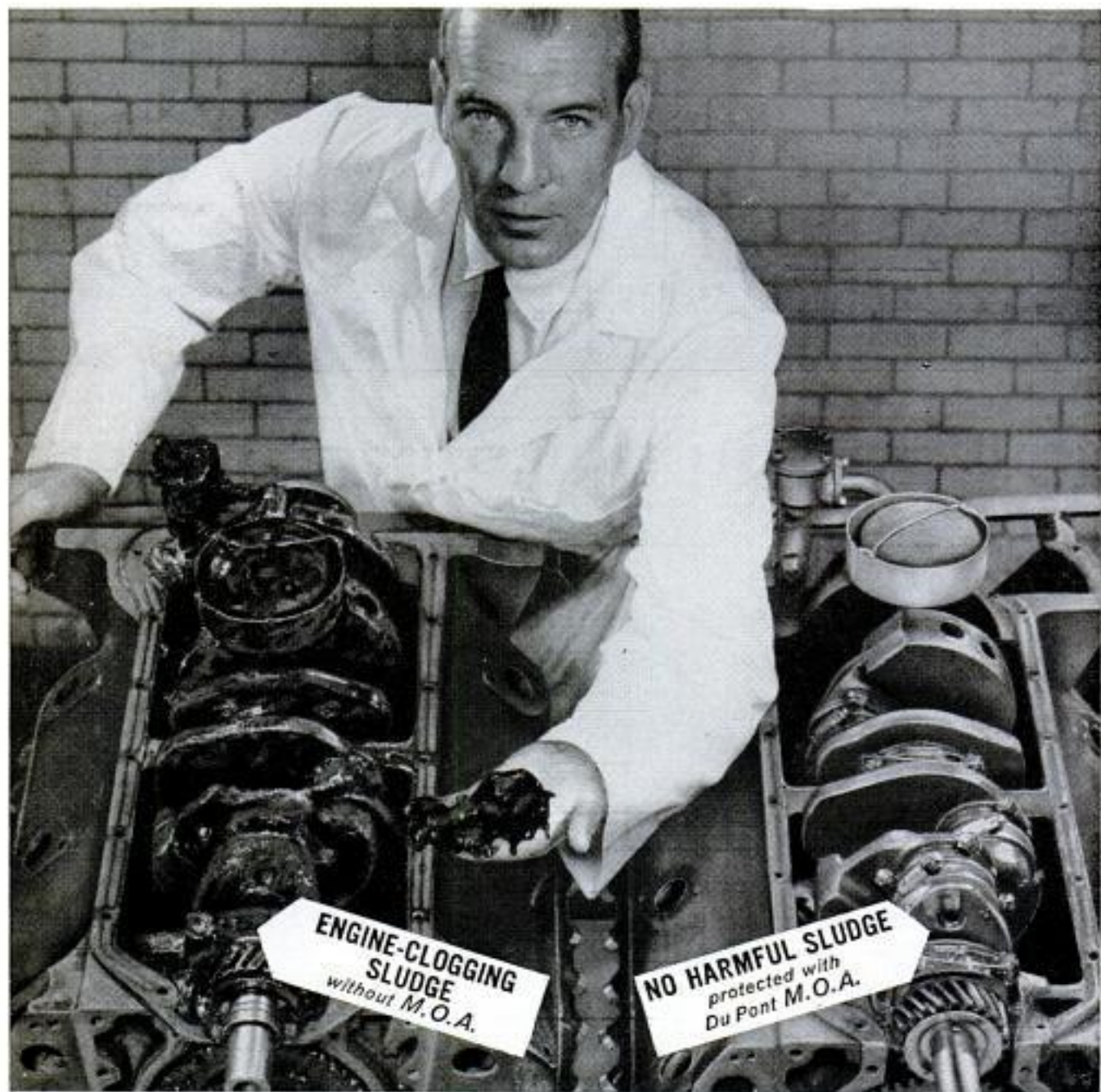

**Here's what 4,000,000 miles of road testing proves M.O.A. can do**

- Prevents clogging of oil screens and filters—reduces wear
- Keeps sticky gum from clogging valves and piston rings... helps prevent noisy valve lifters
- Maintains more constant viscosity... saves oil
- Keeps engine running smoothly—saves gas
- Maintains oil pressure
- Cuts costly engine repair

*New patented chemical discovery*



# ENGINES CLEAN, CUTS REPAIRS

Du Pont M.O.A. keeps vital engine parts free of harmful sludge... prevents noisy valves, sticky rings. Saves gas, oil and costly repairs

Imagine keeping your engine operating efficiently for the life of your car! A radically different motor-oil conditioner discovered by Du Pont helps make this possible.

Developed through 12 years' research and over 4 million miles of testing, new Du Pont M.O.A. is effective under *all* driving conditions. Road tests have shown it extends the life of vital engine parts and saves costly repairs.

## Engines rated in lab



Without M.O.A.



With M.O.A.

In one 48,000-mile test of automobiles operated under severe sludging conditions, engines run without M.O.A. were brought into the laboratory, taken down, and compared with engines operated with M.O.A.

M.O.A.-protected engines were still almost as clean as new, and their oil screens were much cleaner than those in many other engines.

In test engines that didn't use M.O.A., oil lines to rocker arms were repeatedly clogged by sludge. These lines had to be cleaned twice during the test to correct oil starvation. But oil lines in all engines with M.O.A. stayed clean.

## Up to 90% less wear



On engines operated *without* M.O.A., camshaft exhaust lobe wear was found to be up to 10 times greater. Camshaft intake lobe wear ranged up to seven times greater. And rocker arm shaft wear ranged from approximately equal to scoring so badly, due to sludge plugging, that no accurate measure could be made.



## You'll notice the difference

Quieter valves, smoother-running engine, gas and oil savings are to be expected with M.O.A. And you may notice that your oil turns dark. This is because M.O.A. keeps microscopic "sludge formers" in circulation instead of letting them grow and stick to engine parts. With M.O.A., dark oil means your engine is being kept clean and bright.

Add a can of new Du Pont M.O.A. to your crankcase at each oil change and feel the difference every mile you drive. Available at your service station, car dealer's or wherever auto supplies are sold.



BETTER THINGS FOR BETTER LIVING . . . THROUGH CHEMISTRY

**DUNLOP  
APPLIES**

# ATOMIC ENERGY for Safer Tires



*Thanks to the peacetime atom, the vital heart of the Dunlop tire is strengthened through application of AccuRay®...a revolutionary precision nucleonic process.*

On cooler running AccuRated tires, you get many extra miles of safer driving. What's more, every Dunlop tire is more perfectly balanced to bring you new stability, control and comfort on super highways or rugged by-ways.

Through AccuRay's precise nucleonic action, an exact amount of protective rubber is uniformly applied to every cord ply. This eliminates two major causes of premature tire failure; the dangerous heat build-up caused by excessive ply-rubber coating and the equally critical ply separation and shearing action between plies resulting when rubber coatings are too thin.

For your own protection, get a matched set of Dunlop AccuRated tires...in Nylon or Super Hi-Test Rayon. See the complete line at your Dunlop dealer's.



**YOU'LL GO FARTHER,  
SAFER... ON TIRES BY**

## **DUNLOP**

**THEY'RE AccuRated®**

DUNLOP TIRE AND RUBBER CORPORATION, BUFFALO 5, N. Y.

## Headquarters for Jungle Explorers

(Continued from page 141)

extracting drugs for useful applications.

Those are just side lines to Doctor Maguire's main business of finding out which plants grow where. In 16 trips to South America, he's tracked down more than 10,000 species, some of them never seen by a white man before, and has packed out more than 100,000 specimens for study.

Another kind of discovery takes place in the Garden laboratory. A staff of 15 works there to learn how plants live, why they die and what relation these activities have to life and death in the human body.

You see a dramatic illustration of that research in a row of test tubes at one corner of the lab. Each test tube contains a slice of carrot, and on each slice there's a small, ugly growth. Dr. Richard M. Klein tells you that the growth is a plant tumor. He's trying to trace the cause. Experiments have shown that bacteria produce tumors in some carrots but not in others, and the difference has been traced to some still unknown element in the chemical make-up of the susceptible plants. To prove that it is a chemical, Doctor Klein took the juice from a susceptible plant and removed all cells by passing it through a filter which contains five million pores to the square inch. When he injected the filtered juice into a resistant carrot, it became susceptible, too. Now he's trying to track down the mysterious chemical and learn how and why it contributes to tumors. If he can find it, it may be a long step toward learning how cancer takes root in the human system.

Another experiment centers around two fungi which are identical in all but size. One of them just covers the bottom of a test tube; the other is four times as large. "We've been feeding this big one on a special diet," Doctor Robbins says. "When we find out why it works, we may get hold of some pretty useful information." By pretty useful, he means this experiment may yield clues to sources of human growth and vigor.

Working with small and primitive plant-life forms, Doctor Robbins and assistants in the lab have discovered 10 new antibiotics. They haven't hit any really big ones yet, but they're looking in places where big ones might turn up. In still another department, plant pathologist P. P. Pirone tends vegetable seeds which have been blasted by ultrasonic waves. He's trying to develop new kinds of plants.

The Garden serves as one of the world's great collection points for botanical knowledge already gained. That operation includes the herbarium where Dr. David D.

(Continued to page 234)

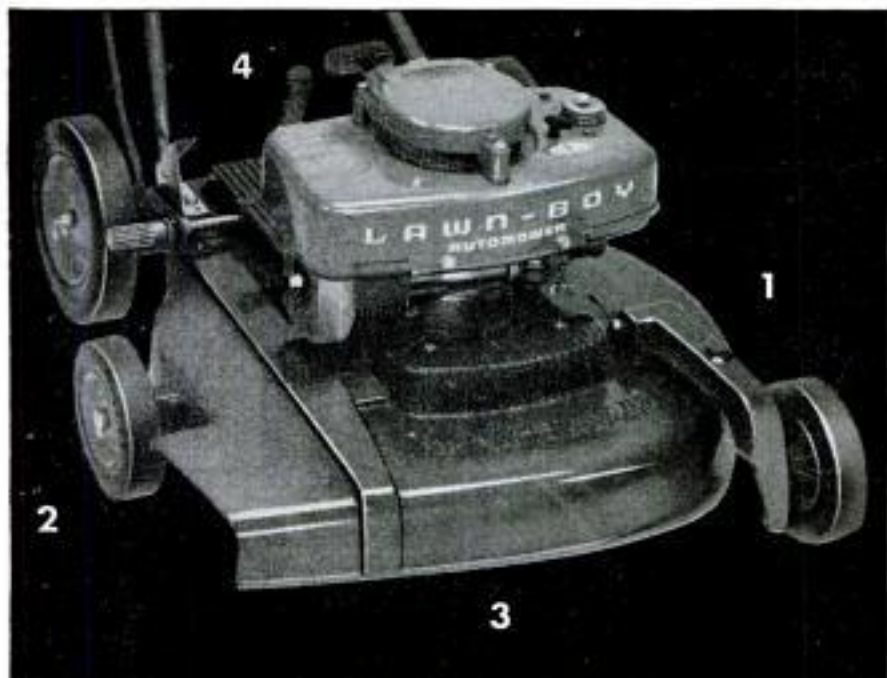

① Exclusive "Activated" Pilot Wheel keeps LAWN-BOY level . . . even on rough turf grass surface is cut level.

② Staggered Front Wheels let LAWN-BOY go right up and over high spots without leaving scalped patches.

③ Aluminum Die-cast Housing and specially close-machined blade with stabilizer lets LAWN-BOY trim to  $\frac{3}{8}$ ".

④ *Lightweight* Automower . . . it's self-propelled! With the surest, simplest control ever . . . no oily chains, no clanking gears . . . a forward roll of the wrist starts LAWN-BOY out at a steady even pace . . . a backward roll—it stops.

## LAWN-BOY "KNOW-WHY" DESIGN GIVES THAT FAMOUS **LEVEL-CUT** TO LAWNS

Every detail of LAWN-BOY is designed to give that LEVEL-CUT. To make absolutely sure each detail is right LAWN-BOY makes almost all their parts and assemblies.

### "KNOW-WHY" DESIGN DEMANDED THE LAWN-BOY 2-CYCLE ENGINE



#### Created and made for LAWN-BOY by LAWN-BOY

Naturally efficient. . . LAWN-BOY operates at 3200 r.p.m. . . . the truly efficient speed for rotary mowing. No adjustments needed! Ideal mowing speed is LAWN-BOY's natural speed.

Power on every stroke gives instant response to additional loads . . . starts quicker with twice as many firing chances.

Rugged, Lightweight . . . fewer moving parts means lighter weight, less friction, less maintenance. LAWN-BOY aluminum die-casting gives great strength and wear to all parts.

No lubrication problems . . . pre-mixing fuel and oil eliminates messy crankcase drain and refill . . . you never have to worry about proper lubrication with LAWN-BOY.

Easier to start . . . because LAWN-BOY 2-cycle has fewer moving parts, there is less friction, lighter weight, more firing chances; easier pull through and more revolutions per pull.

LAWN-BOY IS DESIGNED IN EVERY DETAIL TO LEVEL-CUT LAWNS—EASILY!  
Prove it to yourself—try a LAWN-BOY today!

# LAWN-BOY

LAWN-BOY, Lamar, Mo. • Division of Outboard Marine Corp., makers of *Johnson* and *Evinrude* Outboard Motors • In Canada: LAWN-BOY, Peterborough, Ontario

LAWN-BOY dealers are listed in the yellow pages under Lawn Mowers, or call Western Union, by number, and ask for Operator 25.



if you have to glue it . . .

**LET ELMER  
DO IT!**



Repair or build  
quickly with strong

**ELMER'S®  
GLUE-ALL**

Use Elmer's modern plastic glue for any porous material such as wood, paper, cloth or pottery. It's easy to apply, fast drying and won't stain. Takes the goo out of gluing. Perfect for the home workshop.



Get a completely waterproof bond with  
**ELMER'S® WATERPROOF GLUE**

It's the glue that boating experts use. Apply on any joint subject to water, weather, acids or alkalis. Super bond is stronger than wood itself!



Bond plastic laminates or plywood wall panels with **ELMER'S® CONTACT CEMENT**

No clamps, nails or presses needed to do professional job quickly. Highly resistant to heat and water. Available in regular or non-flammable type to meet every need.



Check **ELMER'S Glue Chart**  
for the right glue for the job.

IF IT'S **Borden's**  
IT'S GOT TO BE GOOD



The Borden Company, Chemical Division

Keck presides over file cases stuffed with more than 2½ million carefully classified plant specimens. The South American files are so good that a Venezuelan scholar came to the Garden to study the plant life of his own country. Another collection holds 75,000 plant fossils.

The Garden's library contains more than 60,000 botanical books—some of them rare manuscripts from the 15th and 16th centuries—and more than 300,000 plant pictures and pamphlets. Librarian Elizabeth Hall gets about 5000 requests for information every year.

A frantic mother called the library and said she'd caught her child munching on a privet hedge, and was it poisonous? It wasn't. An artist, asking what sort of plants Noah might have seen when he stepped off the Ark, was designing stage sets for the Biblical play, "The Flowering Peach." A man in Arizona wanted to know what kind of wood he should use in a divining rod for water. A nurse in Iceland asked about Arctic flowers—she was getting sick and tired of the barren, snowswept landscape outside her door—and a woman once asked for a list of man-eating plants. Another 2500 people write, phone or just drop in every year to ask expert advice from Thomas H. Everett, horticulturist, on the problems which plague a back-yard gardener.

The Garden maintains these and many other activities with a staff of 150 persons and on a current budget of \$872,000 a year. It's operated as a quasi-public corporation with supplemental help coming from endowment funds, research grants and the dues paid by 1800 contributing members.

With these facilities the Garden exhibits plants from around the world. For example, one of the rare tropical plants is just a 25-pound bulb, but it will blossom into a bell-shaped bloom measuring 13 feet in circumference. From Sumatra, it goes by the name of *Amorphophallus titanum* and is also distinguished by an overpowering odor.

The Garden has 15,000 orchids. Little thimble-sized orchids from the Himalayan mountains and enormous jungle orchids which fit into a bushel basket. There are 7000 roses; over 3500 chrysanthemums; acres of daffodils, pansies and azaleas.

The grounds include 57 acres of virgin hemlock only a 20-minute hike from the sidewalks of the Bronx; yet it's so natural that stern measures must be taken sometimes to keep foxes from killing birds.

Half a dozen times each year, from fall until Easter, the Garden presents a special show. Louis P. Politi, head gardener, calls a show a success if it draws 50,000 persons in a week's run. It's a smash hit when he packs in 80,000. ★ ★ ★

ROCKWELL-BUILT

# DELTA POWER TOOLS



Mr. Staples' shop is equipped with these Delta tools: Unisaw, 17" drill press, 14" band saw, 24" scroll saw, 12" wood lathe, 8" jointer, industrial shaper, 13" planer, grinder.

**"... finest built for home workshops,"**

*says H. A. Staples, Chico, California*

Shown above is Mr. Staples' well-planned home workshop. Notice especially the excellent placement of tools to facilitate work-flow, and the ample drawer and cabinet space. Mr. Staples has good reason to be proud of his shop—and of his Delta Power Tools. Here's why:

**EASY OPERATION**—"Delta tools are so simple to operate," says Mr. Staples. "Even a beginner can turn out precision work with no trouble at all."

**RUGGED, DEPENDABLE**—"I also like Delta tools because I can rely on them to give

me trouble-free operation without constant expensive maintenance and repair."

**ACCESSORIES IMPORTANT, TOO**—"Delta Accessories enable one tool to do the work of several, permit me to do a wide range of jobs with minimum investment," says Mr. Staples.

**SEE THE ENTIRE DELTA LINE**—Compare and see why Delta is *first* in the nation's *finest* home workshops. Your Delta Dealer is listed under "TOOLS" in the Yellow Pages. Or see Delta Homecraft tools at leading department and hardware stores.

**Send coupon for complete catalog!**



another product by  
**ROCKWELL**



Delta Power Tool Division, Rockwell Manufacturing Co.  
502E N. Lexington Ave., Pittsburgh 8, Pa.

- Please send catalog on entire Delta Industrial line.
- Please send catalog on entire Delta Homecraft line.
- Please send names of my nearest Delta Dealers.

Name \_\_\_\_\_

Address \_\_\_\_\_

City \_\_\_\_\_ County \_\_\_\_\_ State \_\_\_\_\_

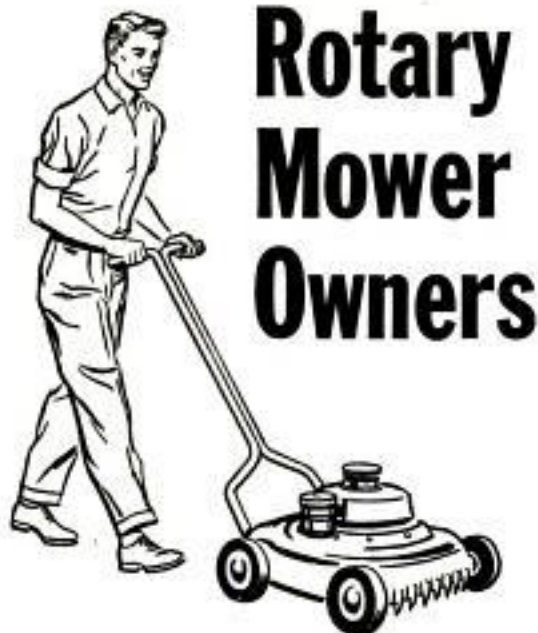

# Rotary Mower Owners

Keep your blade keen, clean-cutting all season long with the new

## Nicholson Rotary Mower File

The first file designed especially for sharpening rotary mower blades.

- Sharpens your blade to knife-like edge
- Smooths nicks that tear grass
- Maintains blade balance for smooth efficiency

Only **89¢**

Look for it in the colorful display carton at your hardware store: the new Nicholson Rotary Mower file. Comes in its own durable plastic envelope; hangs conveniently in your garden tool shed.

**FREE:** New 61-page edition of "FILE PHILOSOPHY," on care and use of files. Write for your copy.



**NICHOLSON FILE COMPANY**  
Providence, R. I.



(In Canada: Nicholson File Company of Canada Ltd., Port Hope, Ontario)

**NICHOLSON FILES**  
A FILE FOR EVERY PURPOSE



Kitchen was a four-burner stove under a tarpaulin. We soon found that the tarp was far from waterproof.

### We Took Our Vacation in a Boat

(Continued from page 153)

kitchens, here's another tip. You need X-ray eyes to see what's inside any one of a dozen cans of food when all the labels are soaked off. We learned to fasten every label with cellulose tape.

That first evening was our low point. From then on we started having fun. We investigated an old stern-wheeler at Owensboro, camped on Dead Man's Island and saw Cave-in-Rock, made famous by the Davy Crockett story. Then disaster struck. Rea Lamb was taken very ill with a strange headache. The pain was so intense we had to give her codeine tablets from our first-aid kit (wishing we had something stronger) and rush her to the hospital at Paducah. We camped two days while the doctors pinned down her trouble (it was an allergy) and put her back on her feet.

**Be prepared:** Be ready for any medical emergency, particularly in strange and lonely waters. Make up a complete first-aid kit. In addition, visit your family doctor before you pack, explain the possible emergencies, and ask him for emergency medicines. I think these should include codeine, morphine or some other hypodermic sedative, snake-bite medicine and tetanus shots, with instructions for administering them. Later, I suffered an ugly puncture in the flesh of my leg. We had to stop three times so I could get a tetanus shot and other medication.

Because of the time lost through Rea's illness, we felt we really had to push to make New Orleans on schedule. None of us could afford to return a day late, and we wanted to see New Orleans. For this

(Continued to page 238)

**MAY 31<sup>ST</sup> IS YOUR LAST  
CHANCE TO WIN YOUR  
DREAM WORKSHOP IN THE  
OLD CRAFTSMAN PINE PLYWOOD**

**\$10,000  
Contest**



**DELTA TOOLS**



**BLACK & DECKER TOOLS**



**STANLEY TOOLS**

**LOOK FOR  
THIS LABEL  
ON EVERY PANEL**

There's nothing to buy and nothing to build! And you can win any of 147 valuable prizes by simply completing this statement in 25 words or less — "I like Weldwood Old Craftsman Pine Plywood because \_\_\_\_\_."

**FIRST PRIZE** is your dream workshop with nearly \$930 worth of fine quality Delta, Black & Decker, and Stanley tools plus \$350 worth of Weldwood plywood or other products.

**SECOND PRIZE** is \$450 worth of tools and \$250 worth of Weldwood products.

**5 THIRD PRIZES**—each one is over \$270 of tools plus \$50 of Weldwood products.

**140 MORE PRIZES** of Black & Decker, and Stanley tools and Weldwood products!

**DON'T DELAY** Get complete rules and official entry blank at your lumber dealer's! Entries must be postmarked no later than May 31.

**GET YOUR ENTRY BLANK  
AT YOUR LUMBER DEALER'S**

(If your dealer does not have entry blanks available, write to Old Craftsman, c/o United States Plywood Corp., 55 West 44th Street, N. Y. 36, N. Y.)



**MECHANICS, MACHINISTS, CRAFTSMEN**  
**Here's the Indicator**  
**Holder For You**



**NEW Starrett® No. 657**  
**MAGNETIC BASE**  
**INDICATOR HOLDER**

For quick, easy indicator setups, you want this new Starrett No. 657 Magnetic Base Indicator Holder. The off-on push button lets you position the base with one hand, leaving the other free to hold the indicator. Universal adjustments including a fine adjusting screw for final adjustment simplify locating the indicator for easiest reading, greatest accuracy. The powerful permanent magnet holds firmly to iron or steel — clings to any surface in any position. Designed for use with any Starrett No. 711 "Last Word," No. 196 or No. 25 Series dial indicator.

No. 657 is only one of many new tools in the complete Starrett line. Your distributor or tool store will gladly demonstrate them or write for big, new illustrated catalog.

**BIG NEW CATALOG — FREE**

Describes and illustrates over 3000 Starrett Tools. Write for it. Address Dept. AP



**THE L. S. STARRETT CO., ATHOL, MASS., U. S. A.**  
*Since 1880 — World's Greatest Toolmakers*



**Starrett**

MECHANICS' HAND MEASURING TOOLS AND PRECISION INSTRUMENTS  
DIAL INDICATORS • STEEL TAPES • PRECISION GROUND FLAT STOCK  
HACKSAWS • HOLE SAWS • BAND SAWS • BAND KNIVES

reason we didn't have time for the exploring that was a constant temptation.

**Don't be overambitious:** Give yourself lots of time for your cruise. Set a leisurely pace, and give in to your temptations. (We all agree this was our biggest mistake.)

Each day we'd start looking for a good camp site at midafternoon, and travel until we found one. The night we camped at the confluence of the Ohio and the Mississippi, we tossed pennies into the swirling waters in accordance with the old superstition that pennies not only will bring you luck, but bring you back safely.

**Finding a camp site:** Always look for a camp site on the down-river end of an island or a point. This puts you in calmer waters where it's easier to tie up. The perfect camp site is open to the prevailing wind (which drives away insects), has a sand floor and is high enough so a sudden rise in the river will not inundate it. There aren't many such camp sites, so you have to settle for what you can find.

We'd tie up for the night with the bow pointing out into the river, stern toward the bank. An anchor line would hold the bow in position, and we'd tie up the stern to a tree. Thus the boat could ride out towboat waves and other rough water during the night, taking them bow first.

Another discovery we menfolk made was that exhaust water from the outboard motors was ideal for shaving—hot enough without being too hot. We idled the motors in neutral and lathered up every morning.

In our cruise down mid-America we ran into all kinds of weather from near-freezing temperatures to 120-degree heat, from unbelievably still air to sudden squalls. In strange waters, every change in the weather is a potential threat.

**Be your own weatherman:** Carry instruments to help you predict the weather and keep track of your progress. Our instruments included a thermometer, barometer (which we watched closely), clock and water-speed indicator. We also had a portable radio to pick up local weather forecasts. In my opinion, these instruments are essential. Also, learn the Coast Guard's weather-signal flags, so you'll know when to head for shore. *Don't take chances!*

The water was so high on the Ohio that we boated right over 16 dams and had to pass through only one lock. However, you can take dams and locks in stride if you

(Continued to page 240)



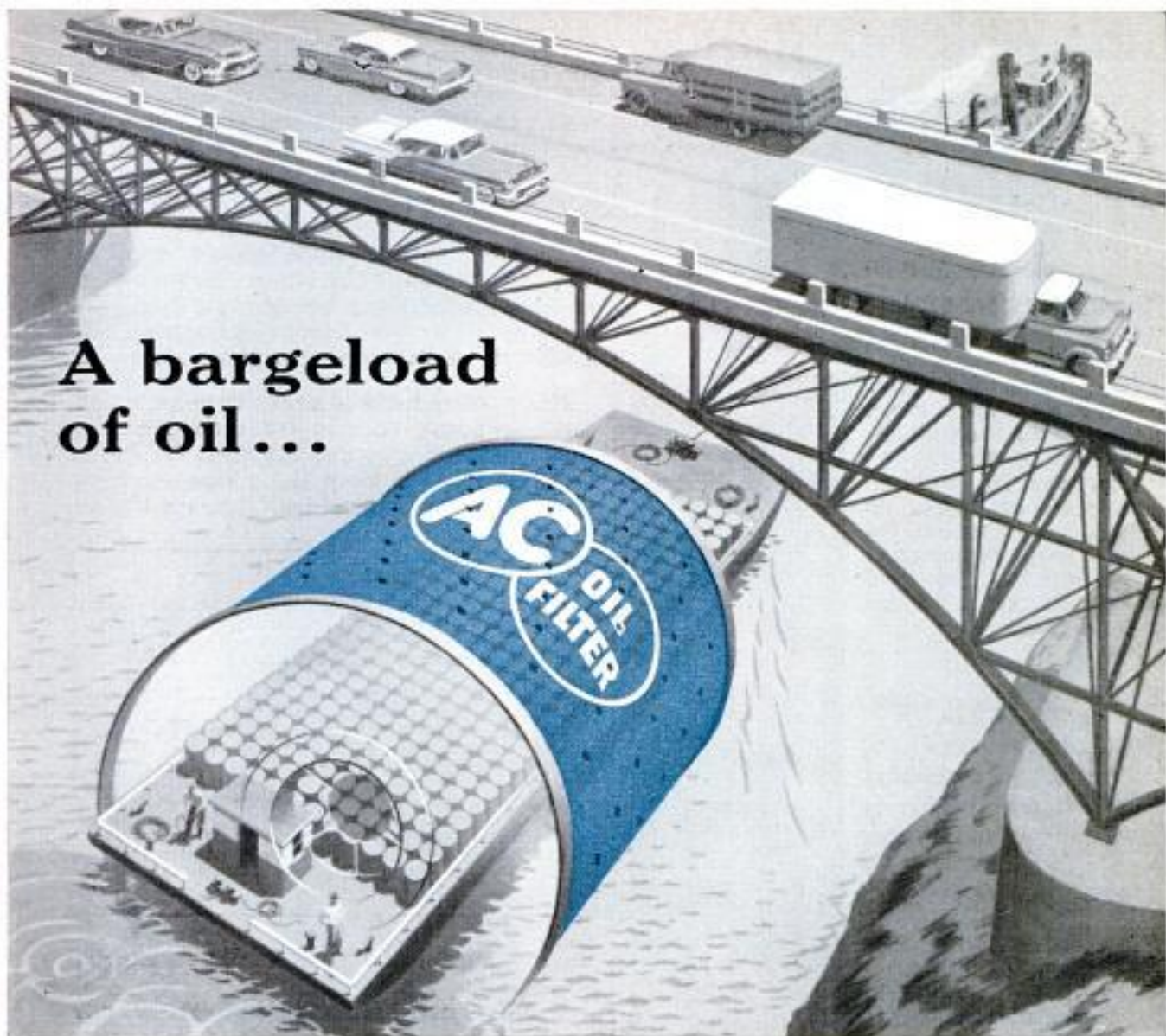

**A bargeload  
of oil...**

**...flows through your AC  
Oil Filter every 5,000 miles!**

In just 30 seconds while your car's engine is running, all of the oil in the crankcase is pumped through a full-flow oil filter. That's a tremendous total of 36,000 gallons every 5,000 miles. That's why you need a new AC Oil Filter every 5,000 miles to protect your car's engine from damaging dirt, grit, carbon and bits of metal. Any of these can ruin an engine in a matter of a few miles! But an AC Oil Filter removes all traces of foreign matter, as small as 1/100,000 of an inch, without removing the valuable detergents found in most modern motor oils. So, play it safe... change your oil filter every 5,000 miles, and insist on a new AC Oil Filter. Your nearby AC dealer has them.

Watch  
"WIDE WIDE  
WORLD"  
NBC-TV

**GM**  
GENERAL  
MOTORS

**Change your OIL FILTER  
every 5000 miles**

AC SPARK PLUG  THE ELECTRONICS DIVISION OF GENERAL MOTORS

# Soft water can save every home owner \$100 a year

**Reduces water heating costs, saves plumbing, adds 33% longer wear to clothes**

Clear, filtered soft water is more efficient, more economical for every water-using need: photo developing, car washing, bathing, laundry, dishes. Saves up to 60% on soaps and detergents, keeps drains open and trouble-free. No hard water scale in plumbing, appliances, utensils.

**New Culligan®**  
**AUTOMATIC WATER SOFTENER**—provides an unlimited supply of hot and cold soft water regardless of family size or water usage.

Completely automatic! Electronic Regen-a-rator quickly, quietly, automatically regenerates at night, while you sleep. Compact! Softener is 57 in. high x 10½ in. square. Low operating cost; salt supply lasts 6 to 12 months. 10-year Warranty.

About **\$330** plus installation  
Slightly higher west of Rockies and in Canada

CROSS SECTION VIEW

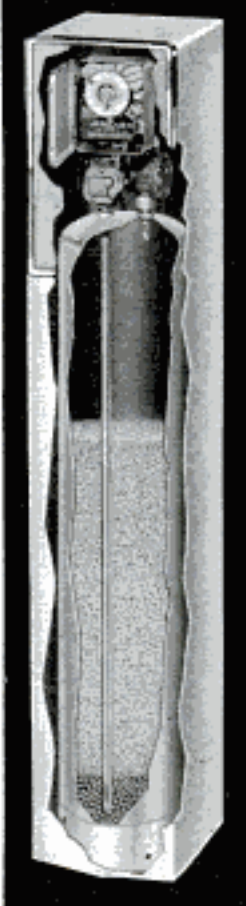

**FREE!**

3,000 page, 12-volume \$20 Popular Mechanics DO-IT-YOURSELF ENCYCLOPEDIA SET. Send coupon for certificate which your Culligan dealer will redeem for \$20 Popular Mechanics Encyclopedia Set with your purchase of Culligan Automatic.

CULLIGAN, INC., NORTHBROOK, ILLINOIS  
Gentlemen: Please send free Popular Mechanics Do-it-yourself Encyclopedia Certificate.

Name \_\_\_\_\_

Address \_\_\_\_\_

City \_\_\_\_\_ State \_\_\_\_\_

(This offer void wherever taxed or otherwise restricted. Offer may be withdrawn or modified at any time.)

know how to go about it, but to the careless skipper they can be a source of danger.

**Be ready:** In strange waters, always spot the next dam on the navigation map. Riding low in the water, you can be right on top of a dam before you see it. Two or more boats should approach a dam quite close together. Have at least 50 feet of stout rope handy in each boat. Then if a boat suddenly develops motor trouble, *don't try to repair the motor!* You may be on top of the dam before you know it. Another boat should come alongside immediately and tow the victim to safety.

Negotiating locks is a matter of rope and common sense. As you enter the lock, be sure you are wearing life jackets. Move very slowly and keep the motor running throughout the procedure. Throw a line to

#### EQUIPMENT LIST

Two cameras and equipment for both color and black-and-white photography, binoculars, flashlights, searchlight, gasoline lantern, toolbox, three remote fuel tanks, four GI gas cans, 200 feet of rope, a ball of heavy twine, set of maps, fenders, canvas boat tops and side curtains, anchors, fishing equipment, insect repellents, waterproof tarpaulins, spare parts for motor, portable radio, folding tables and chairs, two-burner gasoline stove with folding stand, water jugs, skillets, ice cooler, bucket, nesting pots and pans, dinnerware, coffee pot, boxes of food, blankets, raincoats and parkas, pillows, sheets, air mattresses, dish and bath towels, rifle, hatchet, first-aid kit, basic toilet articles, suitcases of clothing, life jackets and life cushions.

the lockmaster and he will tell you exactly what to do.

Excitement? Man, we had it on our cruise, from seeing a couple of fishermen kill a 200-pound-alligator gar to beating out the roughest of water and driving off a pack of wild dogs. One of the dogs, incidentally, got under the canvas and into the Crawfords' boat early one morning. Rea Lamb saw its tail disappear inside, and her shrieks not only drove off the animal but scared the Crawfords over the side.

We found that strange waters can be dangerous waters. "Boils" are a phenomenon of the Mississippi—strange geysers, some of them many feet in diameter, that suddenly thrust up two or three feet above the water level. Each such boil has a whirlpool in the center. Boils have been known to snap a big barge right out of the middle of a tow and suck it to the bottom.

Another danger is from bank slides. Huge land areas, particularly on bends, can be undercut by the current and suddenly fall into the river. We saw one such slide that dropped three or four acres of land into the water. The biggest danger

(Continued to page 242)

Sand to a perfect finish with

*Flexbac*® ... never a swirl mark

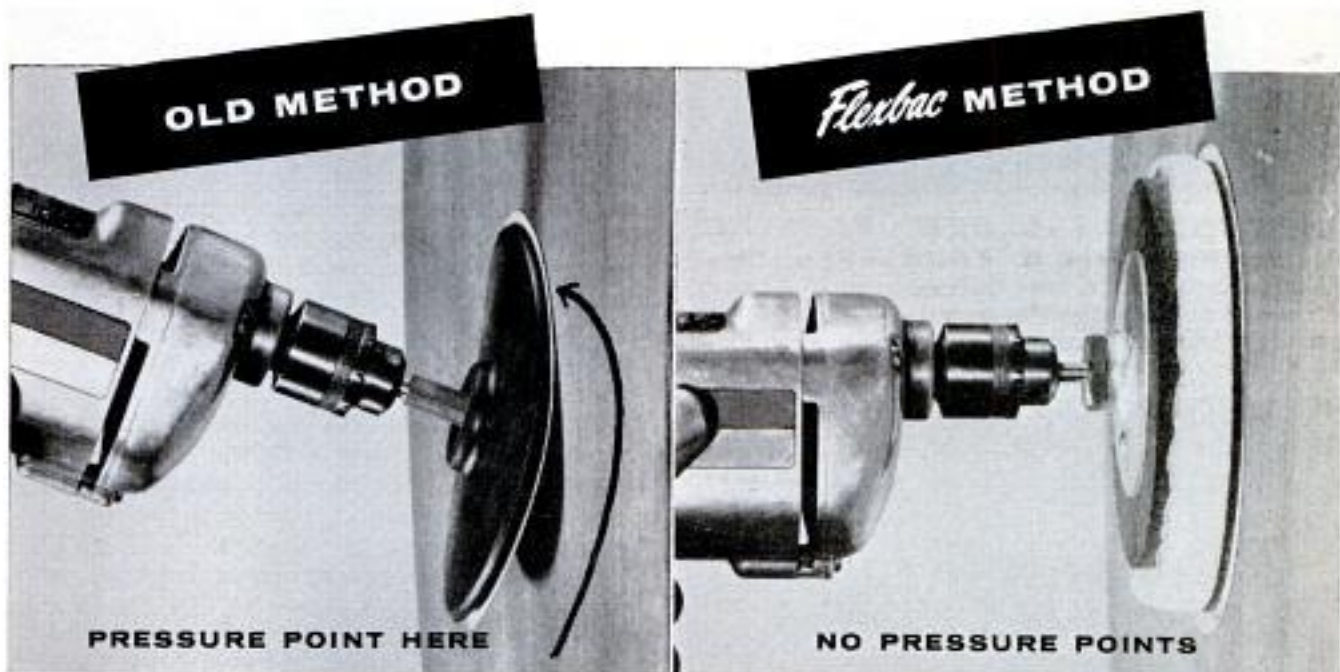

• With ordinary disc sanders, center nut allows only partial contact of sanding disc—causes swirl marks.

• Full contact of disc to work surface with FLEXBAC—pressure absorbed and evenly distributed—no swirl marks.

● **NOW YOU CAN** sand professionally on every workshop project with your electric drill and the FLEXBAC pad. This new convenient attachment will save you hours of tiresome hand sanding on both rough and final finish operations. The FLEXBAC pad is soft and flexible. Its cushion-type action eliminates pressure points on either flat surfaces or on complex curves and contours. Sanding discs cling to face of pad with a pressure-sensitive adhesive—no center nut. The discs can be peeled off and replaced in seconds. You can use the FLEXBAC pad for finishes on wood, metal or plastic.



Cushion-type resilient pad sands with smooth, even pressure on contour or flat surfaces without leaving swirl marks.



You save time with

*Flexbac* when...

- Refinishing furniture
- Featheredging joints and seams
- Sanding between paint and varnish coats
- Refinishing boats
- Removing rust from metal
- Removing old paint and varnish

**COMPLETE FLEXBAC KIT** contains FLEXBAC pad assembly, adapter for electric drill motor, five assorted sanding discs, plus can of adhesive restorer.

**ONLY**  
**\$6.95**

➔ Ask your local Carborundum Hardware or Building Supply Dealer for

*Flexbac*® **PAD ASSEMBLY**  
by **CARBORUNDUM**  
REGISTERED TRADE MARK

# NEW Black & Decker Saws... designed with you in mind!

4 models from \$69<sup>50</sup>

**NEW POWER**—Cooler running Black & Decker-built motor, custom-engineered for tough sawing jobs, continuous operation.

**NEW HANDLING EASE**—Streamlined lightness and balance, easy depth and bevel adjustments... guaranteed better control in the wood.

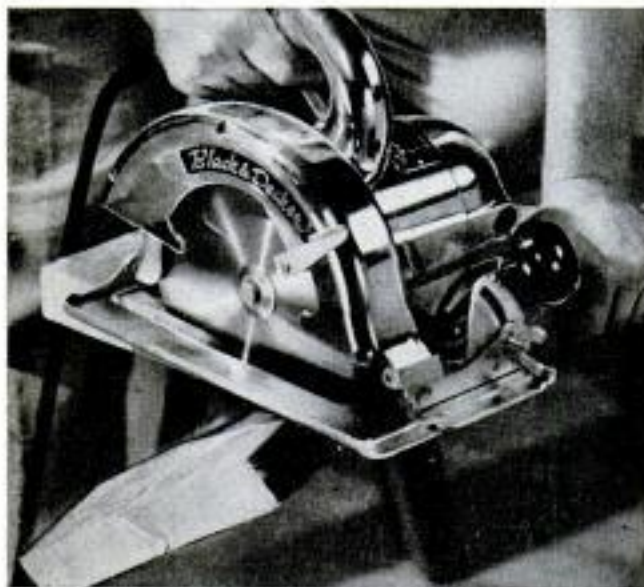

**NEW RUGGEDNESS**—From the motor out... your B&D Saw is built to last for years of rugged, dependable sawing. Unsurpassed B&D quality.

**NEW VISIBILITY**—New picture-window view makes line-of-cut, cutting edge of blade visible at all times. Sawdust is blown clear of job and your eyes.

## SAW TABLE adds versatility

Converts your new B&D Saw into a tilting arbor saw. Larger work surface. Mitre gauge. Rip fence. Knee-action safety switch. For more information see your dealer, or write to: THE BLACK & DECKER MFG. Co., Dept. M-057, Towson 4, Md.



Look in Yellow Pages under "Tools-Electric" for Nearest Dealer

 **Black & Decker®**  
World's Largest Maker of Portable Electric Tools

from such slides is not the earth itself, but the wave, of tidal proportions, which can easily swamp a small boat.

**Learn from natives:** Find out all you can about local waters. We questioned everyone—farmers, dock hands, storekeepers and the Army engineers. (As a matter of fact, one of the engineers told Georgia that he "wouldn't make that trip in an outboard boat for a million bucks"—almost scaring her home.)

I can only touch on the fun we had and the fine people we met. At Donaldsonville, La., we came across a man who managed to open up the town for us on Sunday morning. He found us a wonderful meal, ice, fuel and taxi service, all operated by his "cousins." That town must be one big family!

We saved the best for the last. Before leaving Cincinnati we had made reservations in one of New Orleans' swankiest hotels. We walked into the lobby, clothes rumpled, lips cracked, our skin burned a "lovely aged creosote" (as one dock hand observed), carrying our dirty laundry in transparent bags. Every bellhop in the place suddenly disappeared. I'm sure the desk clerk was about to throw us out until I gave him our names. Never have I seen such fast hotel service. When the desk clerk moved into action, bellhops popped out of every corner and whisked us to our rooms before other patrons could see us.

We spent four days seeing New Orleans, a fitting climax to a trip that was the biggest challenge of our lives.

**Frost the cake:** Plan something extra, a special event of some sort, to crown the fun of your cruise.

We found that from the day we left Cincinnati until we arrived at New Orleans the six of us spent a total of \$369, or \$123 per couple. Of this, \$264 was for gas and oil. It was the best—and cheapest—vacation we ever had.

Perhaps my strangest experience came in New Orleans at the end of the voyage. A girl reporter from one of the local newspapers made an appointment to see us in our hotel room for a story about the cruise. We let her in and started talking. About 30 minutes later, still talking, I suddenly realized that I was clad in my shorts. I retired in complete confusion, shouting to Georgia to toss me my pants. I'd been living in shorts for so long I'd forgotten what a pair of pants felt like!

**Suggestion:** When you return to civilization after your cruise, give a little thought to its customs! ★ ★ ★

The Total-Contact Brakes\*  
on all Chrysler Corporation  
cars require far less pedal  
effort than other cars...  
give up to 200% longer lining  
life...and give you smoother,  
controlled straight-line stops.  
This is engineering leadership.  
Plymouth, Dodge, De Soto,  
Chrysler and Imperial.

\*Another big reason why The Switch is On to the cars of *The Forward Look*

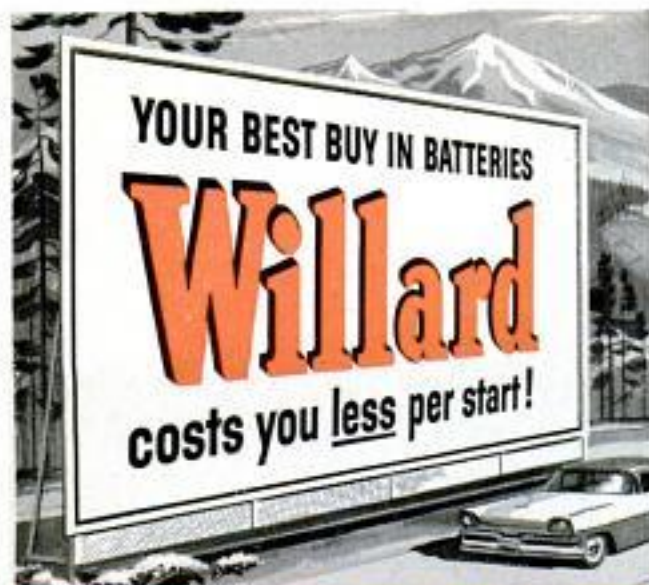

ALL NEW *Super Master*  
WITH SILVER-METALEX GRID ALLOY



The most dependable battery your money can buy. Retains factory-fresh power in your car. Guaranteed up to 4 years. In both 6- and 12-volt models...

as low as \$27.95 Exchange\*

ALL NEW *Heavy DeLuxe*  
FOR HEAVY-DUTY DRIVING



Premium quality at regular price. Available factory-fresh wet or Charged Bone-Dry®. Guaranteed up to 36 months... in both 6- and 12-volt models...

as low as \$19.95 Exchange\*

ALL NEW *Auton*  
FOR LOW-COST, DEPENDABLE STARTING



Genuine Willard dependability for both hot and cold weather driving. Guaranteed a full 18 months. Both 6- and 12-volt models...

as low as \$12.95 Exchange\*

\*In most areas of the United States

# Willard

Sold, serviced and guaranteed by competent dealers throughout the U.S. and Canada. See your Telephone Directory for the name and address of your nearby Willard Dealer.



## Plymouth Owners Praise Handling, New Styling

(Continued from page 129)

### More Plymouth Good Points

Here, in order of frequency of mention by the owners, are quotations describing best-liked features:

"Doesn't roll in a fast, tight turn."—Illinois salesman.

"Have driven it 105 miles per hour on a curve that I wouldn't try with any other car."—Ohio mechanics teacher.

"I like the visibility front and rear."—West Virginia foreman.

"Push-button transmission makes driving so easy."—Missouri farmer.

"Quick acceleration. Good performance."—West Virginia electrician.

"Lots of room. Has a large trunk."—New York shipfitter.

"The car has 'guts.' It stands up well in all kinds of driving."—New York salesman.

### And More Complaints

Here are quotations describing other complaints, in order of frequency of mention by the owners:

"My chief complaint is the difficulty older people have in getting in and out of the rear seat and the necessity of using a vacuum cleaner to sweep the floor because of the step-down. But feel that the lowness and good styling more than compensate for this inconvenience."—New York lumber dealer.

"More time should be taken when car is in production. My car was delivered with faulty wiring which took some time to correct. Moldings on side of car didn't line up and had to be taken off which left holes to be leaded in and repainted."—New Jersey salesman.

"The next car I buy will be gone over with a magnifying glass in a strong light before I accept it. Car was slapped together. Steering wheel is set so it is necessary to drive with legs spread apart. Wheel is in my lap."—Connecticut dentist.

"Without doubt the nicest handling and noisiest car I have ever ridden in. At 70 it drives like a charm, but you are forced to scream at your companions. Body rattles."—Missouri photofinisher.

"Because of lowness the car now becomes a four-passenger car. Driveshaft is too high. This makes it uncomfortable for persons sitting in the middle, front or rear. Mirror is useless if anyone sits in the middle of either seat."—Massachusetts priest.

"No legroom in the back seat."—Michigan engineer.

(Continued to page 246)



More deluxe features than ever before. Windshields and upholstered walk-thru decks and other extras as standard equipment in many models. Designed for beauty as well as better performance with highest H.P. motors. Send for our new Free literature today.

**WAGEMAKER COMPANY**

Dept. 27-57 Grand Rapids, Michigan



**10" TILT/ARBOR SAW  
BUILD-IT-YOURSELF  
from GIL-BILT KITS-PLANS**

Sturdy wood, steel, and aluminum construction. NEW DEPARTURE ball bearings. Capacity and performance of floor saws selling for \$150.00 and up. Plans, all metal parts in kit with 10" comb. blade **\$25.95**, less blade **\$22.95**, P.O.B. St. Louis. Detail PLANS-PATTERNS only \$1.00 postpaid.

Build-it-yourself 12" and 18" Bandsaws, 6" Belt Sander, Shaper. Simplified plans, build easily with hand tools only. Advertised and sold for 10 years, over 33,000 units in use. Money back guarantee. **FREE CATALOG.**

**GILLIOM POWER TOOLS,** Dept. 80-E, Lambert Field, St. Louis 21, Mo.



**DRAINS** cellars, cisterns, wash tubs; **\$7.95**  
**IRRIGATES - CIRCULATES - SPRAYS**

Up to 3,000 GPH; 450 GPH 80' high; or 1800 GPH from 25' well. Use 1/8 to 3/4 HP motor. Coupling included free. 1" inlet; 3/4" outlet. Stainless steel shaft. Won't rust or clog. . . . . Type P—\$7.95.

**CELLAR DRAINER KITS (less motor)**

"Low Boy"—15" high, 1500 GPH . . . . . \$12.95  
"High Boy"—32" high, 3,000 GPH . . . . . \$15.95  
Postpaid if cash with order. **MONEY BACK GUARANTEE**  
**LABAWCO PUMPS, Belle Mead 7A, N. J.**



**BEST DEAL FOR THE MAN AT THE WHEEL  
HULL AUTO COMPASS**

While passengers enjoy scenery, the driver has to watch directions—unless he has a Hull to show the way, constantly, accurately. Driving is a pleasure with Hull, world's most widely used auto compass. \$4.95 and \$6.50. At your dealer's or write for literature.

**A Favorite Boating Accessory, too!**

**HULL MANUFACTURING CO., P. O. BOX 246-05, WARREN, O.**

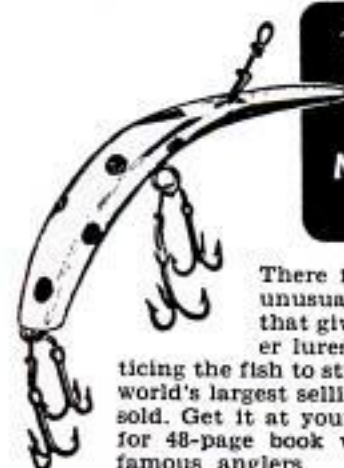

*The Flatfish*  
**MAKES FISHING  
A BIG DEAL**

There is something about the unusual action of the Flatfish that gives it the edge over other lures when it comes to enticing the fish to strike. That's why it's the world's largest selling plug. Over 18,000,000 sold. Get it at your tackle dealer's. Write for 48-page book with fishing secrets of famous anglers.

**Free CATALOG**

**HELIN TACKLE CO.**  
4099 Beaufait Detroit 7, Mich.

**NOW! CUT ALMOST ANYTHING**

with **WISS** "Mighty Midget" Snips!  
No. V-13



1. Metal
2. Vinyl Tile
3. Rubber
4. Leather
5. Fish
6. Poultry
7. Shrubs

**ONLY \$2.10!** "Mighty Midget" Solid Steel Snips fit easily into your pocket or fishing tackle box. Make straight and curved cuts. At leading hardware and tool stores. Get a pair soon!

**CIRCULAR and STRAIGHT CUT**  
**\$2.80 and \$3.80**



Versatile as "Mighty Midget" snips. 10" model cuts 24 gauge metal; 13" model cuts 21 gauge.

**OTHER WISS SNIPS FOR HOME, FARM, AND PROFESSIONAL CRAFTSMEN**

**REGULAR \$2.35 to \$3.50**



For powerful straight cutting. Four different sized models. Good for all sheet metal work, 25-20 gauge.

**METAL MASTER M-3 \$4.25\***



Tremendous power! Only 10" long. Make intricate straight or curved cuts in 18 gauge metal, with half the normal effort!

\* Slightly higher in Denver and West. Vinyl handle grips optional and extra.

**J. WISS & SONS CO., NEWARK 7, N. J.**

**WISS . . . always a cut above competition**

**TAKE IT  
WITH  
YOU!**



Fairbanks-Morse H555M3 pump.  
Available with 12-gal. tank.

## F-M portable pump for cottages, camps

Enjoy running water under pressure at your summer cottage or sports camp this year with a Fairbanks-Morse portable shallow well pump. Fits easily in trunk of car and weighs 75 lb. Easily installed. Attach to present well pipe, or use plastic pipe as drop line to creek, pond, lake or well. Can be converted to deep well service.

F-M line includes larger water systems, both shallow and deep well units. Mail coupon for *free booklet*, "How to Plan an Ideal Water System," and name of F-M dealer.



**FAIRBANKS-MORSE**

a name worth remembering when you want the BEST

PUMPS • WATER SYSTEMS • GENERATING SETS  
MOWERS • MAGNETOS • MOTORS • SCALES  
DIESEL LOCOMOTIVES AND ENGINES

Fairbanks, Morse & Co., Dept. PM-5, Chicago 5, Ill.  
Gentlemen: Please send me your free booklet, "How to Plan an Ideal Water System," and name of nearest F-M dealer.

Name.....

Address.....

City.....State.....

"It seems that Chrysler Corporation as well as others have forgotten the price of gasoline. The Plymouth is no longer an economy car. It should do better than 12 miles per gallon."—Michigan tool designer.

"Long overhang in rear makes it drag when coming out of driveways into road where there is a sharp curbing."—Connecticut salesman.

"Front bumper exactly under headlight visors. Have same point of impact."—Maryland naval officer.

"Glove compartment is too shallow and small. Will hold little. Seems it should open from top some way."—New York telephone operator.

"One of my peeves in all cars is the location of the ash trays. While driving, you must take your eyes off the road to find the ash tray. If not driving, you must use your left hand or lean over to reach it. In the Plymouth it is most inconvenient. It seems to be too far under the round of the dash."—Michigan factory worker.

"I don't like bottom of front grille. Very cheap looking. Doesn't fit."—Connecticut automobile worker.

(Incidentally, the Plymouth Division apparently thought the lower part of its front grille was not meeting with public approval because it soon added some vertical bars inside the wide openings—see two photos on page 128. As a result you see some Plymouths with the original grille, some with the restyled version.)

"It needs a defroster with more force and window contact."—Minnesota minister.

"Has an awkward proportioning of interior spacing and trunk dimensions. For someone desiring to carry any amount of luggage or objects, it is very difficult."—New Jersey plant manager.

"Take away some of the trunk space. Push the rear seat back to make more room for entering and leaving the car."—New Jersey communications technician.

### What About Long, Low Cars?

We asked the Plymouth owners if they like the new style in automobiles: The long, low car that goes very fast. There are some complaints that the industry is not giving the public what it wants. However, apparently the industry is in tune with the people because over 80 percent of the owners like the Plymouth's extreme lowness, 75 percent like its length and 77 percent like its power and speed.

This is certainly an approval by the buying public of the way the industry is going.

For these percentages and others equally interesting turn back to page 129. *Popular Mechanics* published a road test on the 1957 Plymouth in January 1957, page 111. ★★





# INSTANT FLAME

for soldering, wiring, paint removing, melting and sweating

## CRAFTSMAN JET ACTION PROPANE TORCH

FROM PILOT LIGHT

TO HEAVY DUTY FLAME

AT THE TOUCH OF THE BUTTON  
Instant Flame Control  
for maximum fuel economy  
and greater safety.

TILE SETTING



Jet Action Torch and Accessories

Now only **995** COMPLETE



SWEATING COPPER FITTINGS



SOLDERING

Press Button -  
LARGE FLAME  
Release Button -  
PILOT FLAME



includes:  
Pencil Burner Head for  
Fine Work and Handy  
Soldering Tip

S-377



**CRAFTSMAN** Hand and Power Tools by **SEARS, ROEBUCK and CO.**  
Famous for fine quality . . . precision performance . . . low price!



## Your Boat...UP FOR REPAIRS... or OUT ON THE WATER?

**III** Fasteners by Southern are the choice of more and more boat owners because they are wear and weather resistant—built to hold! Ask your dealer for Southern and he will reach for the brand with the built-in Quality and Dependability.

Especially stocked Wood Screws for marine use include:

Brass	Aluminum
Chrome Plated Brass	Stainless Steel
Everdur Silicon Bronze	Hot Galvanized Steel

Write today for your free copy of Southern's Technical Chart No. 4 showing how to select proper Wood and Sheet Metal Screws, drill correct size of pilot holes, etc. Southern Screw Company, Box 1360-57, Statesville, North Carolina.

### Warehouses:

- NEW YORK
- CHICAGO
- DALLAS
- LOS ANGELES



Sold Through Leading Wholesale Distributors



**LIFTS  
BOAT  
FAST  
WITH**

**'Tugit'**



**BOAT OWNERS — SAVE YOUR BACKS!** Use the handy "Tugit" lever-operated hoist to lift and pull heavy loads. The small size weighs only 16½ lbs. but can lift a ton with just 40 lbs. of pull on the handle. It operates smoothly in close quarters at all angles. Flick the fingertip lever and you get controlled lowering. And, a powerful brake holds the load safely where you want it. "Tugit" easily does 1000's of jobs like these:

Lifts engines, propellers, shafts, outboard motors, masts. Pulls boats up ramps • Gets cars out of snow and mud • Moves dock piling, stumps, boulders • Stretches cable • Lays pipe and concrete slabs.

Save time, effort and expense. Get a portable 1 or 2-ton "Tugit" for your boat, car, truck or tool box. Prices start at \$63.50. See your "Shaw-Box" Distributor or write us for Bulletin 388.



57B-4

**MANNING, MAXWELL & MOORE, INC.**  
SHAW-BOX CRANE & HOIST DIVISION  
354 W. BROADWAY • MUSKEGON, MICHIGAN

held on the Colorado River, starting and finishing at Needles, Calif. Two other races of greater-than-ordinary interest are the Gold Coast Marathon in Florida that crosses open ocean as well as inland waters, and the Sammamish Slough race out of Seattle, part of which is along a channel so narrow that there's no chance for one boat to pass another in some stretches.

The longest marathon of all, dubbed a "wildcat" by most drivers because it is unsanctioned, is a 1000-mile-plus race on the Mississippi. Also a wildcat is the world's toughest race, the wild dash down the Klamath along the Oregon-California border. Some parts of the river must be portaged and smart drivers hire an Indian guide as crew. Even so, few boats ever finish without smashing into a few rocks somewhere along the course. ★ ★ ★

## Polyethylene-Wrapped House

Polyethylene stripping, wrapped around a two-story farmhouse in Lafayette, Ind., has altered winter room temperatures inside the building from freezing to comfortable. A polyethylene film 16 feet wide, 100 feet long and  $\frac{3}{1000}$  inch thick stretches around the home under the eaves. Overlapping and covering the bottom eight feet of the first layer is a second strip. Lath battens, nailed to the house, hold the film in place. Openings have been cut for essential door and window ventilation. Purdue University is evaluating this project.



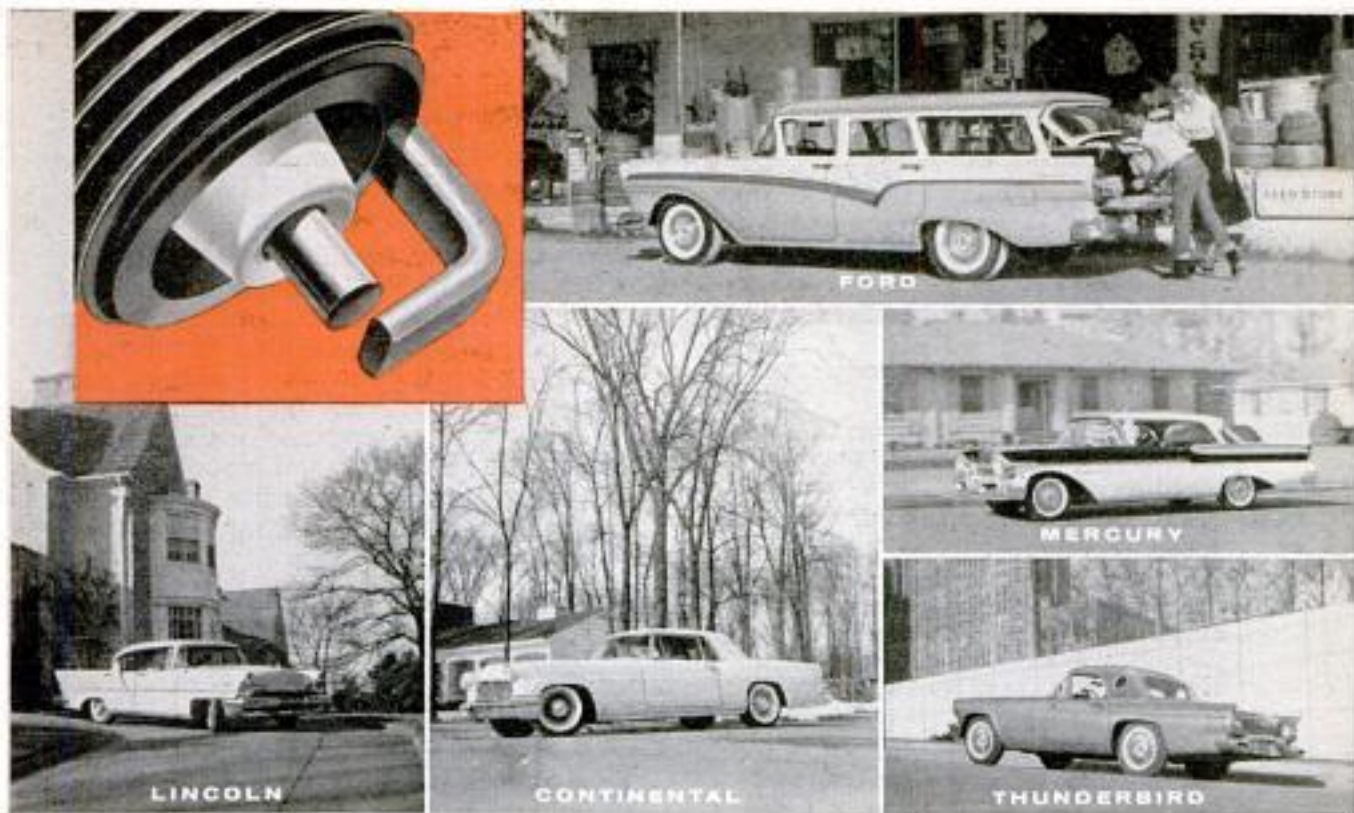

Some spark plugs are designed for high speeds, some spark plugs are designed for low speeds, but . . .

## AUTO-LITE **POWER TIP** "fires up" Ford Motor Company cars at all speeds!

The first spark plug ignition-engineered  
for today's engines\* and today's driving

Today's higher-horsepower, higher-compression engines and today's driving demand *more* from spark plugs, and Power Tip gives more! Performance tests prove Power Tip "fires up" engines of Ford Motor Company cars for top performance and economy at *all speeds!* Here's why...

At *low* speeds, the projecting Power Tip gets hot *fast*, operates hotter to burn away fouling deposits which impair engine performance in city driving. At *high* speeds, the Power Tip is actually cooled by the richer air-fuel mixture to check dangerous pre-ignition caused by over-heated spark plugs.

Ask your dealer to install a set of Auto-Lite Resistor Spark Plugs with Power Tip in your car *today!*

\*Power Tip is ignition-engineered for overhead-valve V-8's and for most overhead-valve 6's in all these cars: Buick, Cadillac, Chevrolet, Chrysler, De Soto, Dodge, Ford, Hudson, Imperial, Lincoln, Mercury, Nash, Oldsmobile, Packard, Plymouth, Pontiac, Rambler, Studebaker.

THE PROTRUDING TIP  
MAKES THE  
BIG DIFFERENCE!



Ordinary Tip    Power Tip

# AUTO-LITE<sup>®</sup> RESISTOR SPARK PLUG WITH **POWER TIP**

Auto-Lite makes a complete line of spark plugs, including Standard, Resistor, Small-Engine, Transport, Aircraft, and Diesel-Starting.

you know  
this means  
quality\*...



**NOW LET'S TALK PRICE!**

- YOU:** Can I get a better 6½" power saw at any price?
- US:** Not to our knowledge, or to the knowledge of a famous research institute.
- YOU:** Well, how much do I save?
- US:** Anywhere from \$10 to \$20! And it has ball bearings for smooth running, a full horsepower motor and the exclusive Automatic Safety Clutch, which increases the work life of the Pet saw up to 15 times.
- YOU:** How?
- US:** It eliminates motor burnout, the major cause of saw damage, and kickback, the major cause of accidents. This Pet saw is really the best buy on the market. Only \$49.95. At your hardware dealer's.

\* report by a famous research institute proves that this Pet saw equals or excels any other make, regardless of price!



*Those who depend  
on their tools depend on*

**JOB  
TESTED**



**PORTABLE ELECTRIC TOOLS, Inc.**  
Chicago 20, Illinois

## Silent, Smooth, Swift - - - the "707"

(Continued from page 109)

capacity of 12,000 gallons, we could fly across the continent and still have an hour and a half worth of fuel left.

We didn't have to think about fuel on this hop. At 9:18 EST—barely more than an hour after take-off—"Flight 707" began let-down only 60 miles out of Chicago. A few miles from the runway lip, flaps and landing gear rumbled. Jet spoilers rose from the wings, giving the trailing edge the look of a long Y-shaped trough. A moment later came the bruising screech of rubber and we were wheeling toward the aprons.

The crowd watching our arrival reported only a vague hum as we made our first pass 300 yards from the airport depot, but a shriek from the jet air intakes as we rolled slowly across the concrete aprons to our parking place a few minutes later.

Tomorrow's jet travelers, if the 707 is any indication, will experience rides of amazingly steady, vibrationless comfort as they speed almost silently through the thin air at the top of the earth's atmospheric envelope. The vistas beneath them will unfold scenery entirely strange to a low-altitude frame of reference. At 32,000 feet (actually the 707 has a 42,000-foot ceiling) you can understand why our earth is known as "the blue planet." Lakes, meadows and buildings merge into an aqua, cloud-smearred map without division lines, but providing color and changing beauty of a new kind.

When 707 Jet Stratoliners begin flying the airplanes of the world, they will be equipped with thrust reversers and sound suppressors, enabling them to stop quickly on the ground, and to produce less external noise on take-off. Noise created by these big jets led New York to ban them from its airports. With the suppressors, Boeing hopes to make the planes acceptable anywhere. High-lift devices now being tested will also enable them to use little more runway—even on icy, high-speed approaches—than current planes. ★ ★ ★

### "Heartening" Fallout Study

In the fall of 1955 the worldwide average strontium-90 content in man was about 1/10,000 the accepted maximum permissible concentration. This was the "heartening conclusion" of three Columbia University scientists after a comprehensive study. Strontium-90 is considered the most dangerous fallout product of nuclear tests.

# Let fast, easy Strypeeze remove paint!



BEFORE

AFTER

Get right down to bare wood fast with the *guaranteed* paint remover—Strypeeze—the fastest selling paint remover in America.



Kwikzeeze cleans all brushes fast! Even the hardest brush softens in a jiffy with KWIKZEEZE. No rinsing, no mess. Perfect for all bristles.



- ✓ Stays wet—stays put
- ✓ Removes all finishes
- ✓ Harmless to hands or wood
- ✓ Cuts every layer

Available at paint and hardware stores everywhere

Just off the press! SAVOGRAN'S booklet, "How to Remove and Restore All Finishes". Write SAVOGRAN, Dept. 504, 25 Huntington Ave., Boston, Mass., enclosing 25¢.

SAVOGRAN

The Remover Corporation of America

## HOME REPAIR TIP No. 31



**COVER TORN PLASTIC** chair seats with tough, stretchy "SCOTCH" Colored Plastic Tape. Use tape in a design to make a decoration of the repair. Tape is waterproof, washable,

sticks like skin. Handy for hundreds of home repairs. Choose red, yellow, green, white, blue, brown, black or new clear.  $\frac{3}{4}$ " width 25¢,  $1\frac{1}{2}$ " width 50¢—at stores everywhere. ©1957, Minnesota Mining & Mfg. Co., St. Paul 6, Minn.

Protect your home against power interruptions with an...

## ONAN Emergency ELECTRIC PLANT

Provides dependable stand-by electricity for heating system, pumps, freezer, lights, appliances. Keeps home safe, livable. Automatic start and stop. Find out how little it costs!

Write for Folder!

**D. W. ONAN & SONS, INC.**  
3247 University Ave. S. E. • Minneapolis 14, Minnesota

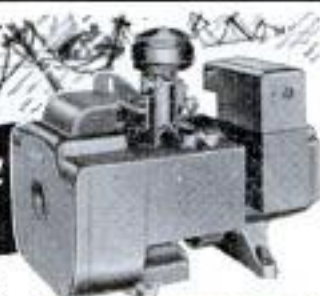

A SIZE FOR EVERY NEED  
500 to 75,000 watts.  
Compact, quiet-running.  
Gasoline-powered.  
Priced from \$269.00

## it's NEW! it's ALL IN ONE LEVEL · SQUARE · TAPE

IT'S A LEVEL!  
Built-in, accurate unbreakable Level.



IT'S A SQUARE!  
Accurate Square.  
Easy to use.

IT'S A TAPE!  
10 ft., replaceable WYTEFACE® Tape.

Only \$1.98  
at your hardware store



**KEUFFEL & ESSER CO.**  
Hoboken, N. J.

MAY 1957

251

# How would your car ride with this load?



**MOOG PH OVERLOADS\* add  
1200 lbs. extra capacity!**

That "soft spring" ride is fine when you ride *alone*. But to enjoy the same roadability and handling ease when your auto or station wagon is *loaded*, you need Moog PH Overload Helper Springs.

You'll drive with **added confidence** because these rugged overloads restore correct height to sagging rear springs... stabilize the ride... and improve cornering on turns.

**Low-cost installation** takes only 15 to 20 minutes using a single wrench!

\*Patent Pending



**MAIL  
THIS**

... for more information on  
Moog PH Overloads and  
name of nearest dealer.

Name.....

Address.....

City..... State.....

Moog Industries, Inc. • St. Louis 14, Mo.

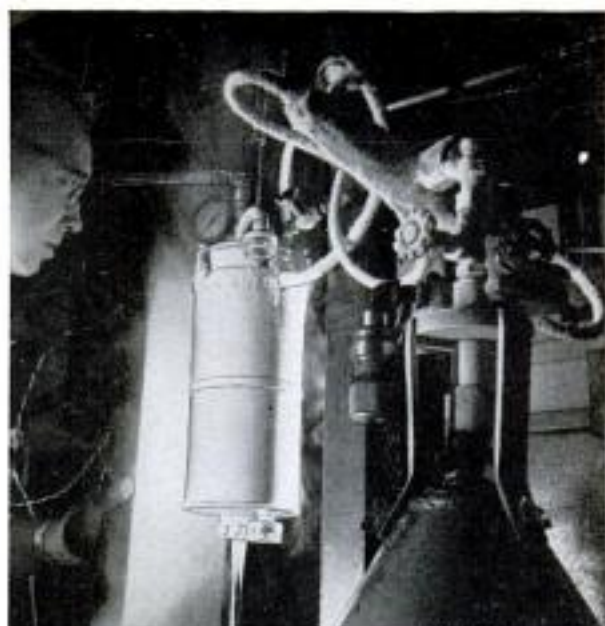

Westinghouse photo

"Tug of war" test of a new metal goes on inside a chamber where temperature is minus 452 degrees

## Tailor-Made Metals for Tomorrow

(Continued from page 96)

now are working on new vacuum alloys that will give vastly longer life to vacuum tubes. When such metals hit the market—which will happen soon—they'll mean longer-lasting light bulbs for your home and significantly better reception on your hi-fi, radio and TV. Metallurgists are so enthused about vacuum melting that they are confident "the presence of nothing" will produce whole new families of superalloys.

Still another big event of the near future is the wedding of metal and ceramics. A

(Continued to page 254)

Sample of a new metal is weighed inside a sensitive balance which can measure 1/100,000,000 ounce

Westinghouse photo



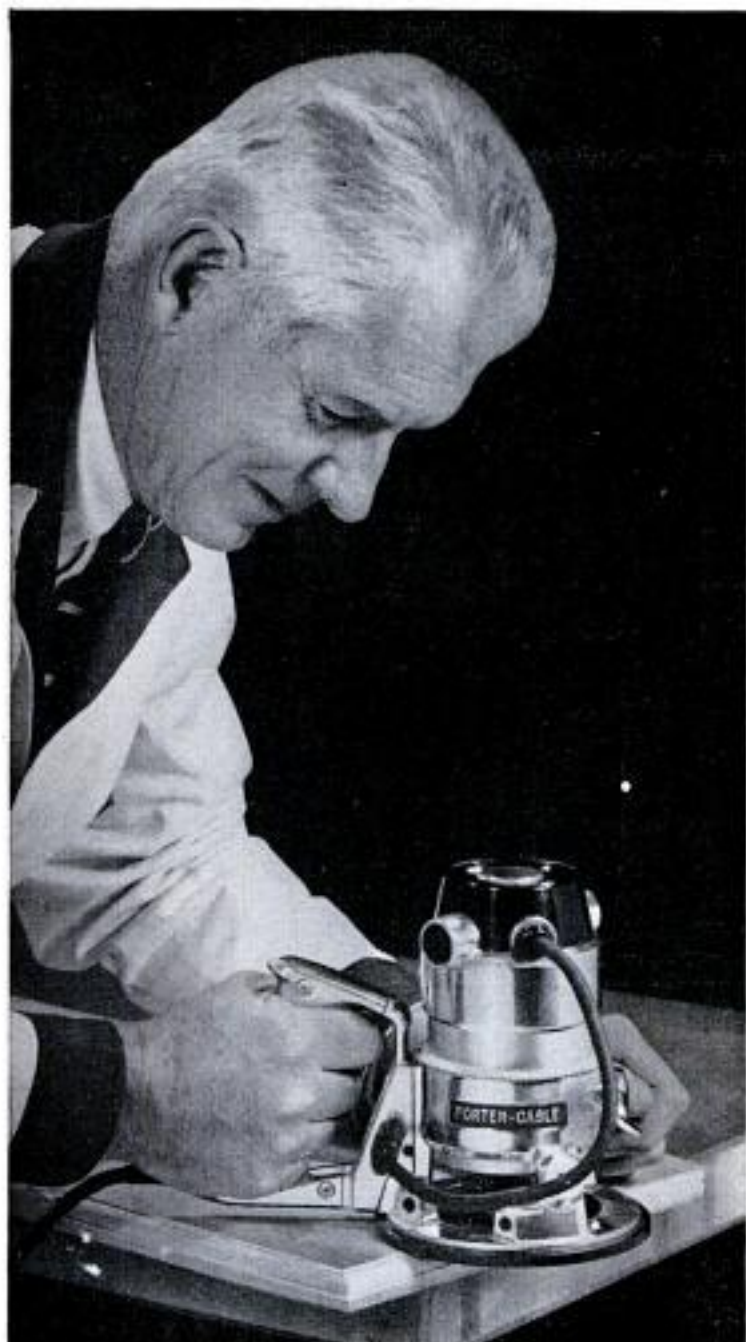

Now - Porter-Cable offers  
**the newest,  
 most complete  
 router line  
 anywhere!**

*There never has been a quality line of Routers and accessories so complete, so outstanding in design, in versatility, in solid value.*

- A full 1 $\frac{1}{4}$  h.p. Router at \$79.50
- A full 5 amp. Router at \$49.50
- Famous Model 100 Router—now full  $\frac{7}{8}$  h.p.—still \$57.50
- New 1 $\frac{1}{2}$  h.p. Router—revolutionary pistol grip and trigger switch—\$130

Plus the only big capacity Shaper Table using interchangeable motors; two outstanding new Plane Attachments; six new door-hanging and Router-Plane kits; and a full line of accessories for each.

See these new professional quality tools at your Porter-Cable dealer today —or write for full information now.



**Famous Model 100 Router**  
 now with full  $\frac{7}{8}$  h.p.

Designed with more power than ever. Does all professional cuts with greater ease and accuracy. Features include: non-marking base, precision ball bearings and a high-speed, interchangeable motor that may be used for Power Plane and Shaper. An outstanding value at only \$57.50.



**New Model 150-P**  
 16" Plane Attachment

World's finest production plane. Use with your choice of 3 router motors. Trigger switch for safer, instant-power control. Planes up to 2 $\frac{1}{4}$ " wide. Fingertip depth control is adjustable up to 3/32" cut. Only \$49.50 complete with cutter. Without trigger switch, only \$44.50.

**Porter-Cable**

*Quality Electric Tools*

**PORTER-CABLE MACHINE COMPANY**  
 7145 N. Salina Street, Syracuse 8, N. Y.

**sanders • routers • saws  
 drills • shapers • planes**

In Canada: write Porter-Cable Ltd., Box 5019,  
 London, Ont. Canadian prices slightly higher.

good example is research on the metal molybdenum.

"Tremendous strength at red-hot temperatures makes 'moly' one of the best materials for tomorrow's jet engines," says Dr. J. Herbert Hollomon, manager of the metallurgy and ceramics department at the GE Research Laboratory. "Ideal, except that it goes up in smoke when it gets in the vicinity of air, or oxygen in any form. What we have to do is put a coating on moly to keep oxygen away. Eventually jet-engine parts may be made of cermets—metal-ceramic combinations. The age of ductile, forgeable 'pottery' is a distinct possibility."

#### Whiskers of Pure Metal

To the metallurgists themselves, perhaps the most fascinating of all developments are pure metals, so pure that thus far they are only laboratory curiosities. Both GE and Westinghouse are turning out tiny whiskers of these pure metals. GE's Doctor Hollomon explains why they are exciting to the metallurgist:

"For a long time theoretical physicists have been saying that metals ought to be a hundred times stronger than they are. Most of us blacksmiths said the trouble lay with the theoretical physicist; he had some kind of defect that made him think that

way. He answered by saying that he was not defective—the metal was. And if the defects could only be removed, the metal would be as strong as he said it was.

"Now we are producing tiny whiskers of metal, free from defects. Sure enough, they are strong almost beyond belief."

A whisker of iron is a pure iron crystal, essentially free of defects that make metals weak. Billions of iron atoms "grow" into this crystal which is exactly square in cross section, a thousandth of an inch thick, and up to two inches long.

Tests show that these tiny slivers of pure iron are more corrosion-resistant than stainless steel and have a breaking strength of millions of pounds per square inch, far greater than any other known metal. GE metallurgists have succeeded in growing "perfect" whiskers of gold, silver, platinum, copper, nickel and cobalt.

#### Metals in Shattering Cold

In addition to invading the high-temperature and high-purity fields, metallurgists are dipping deep into low temperatures. Scientists say that tomorrow's aircraft may operate on fuels stored as liquefied gases in metal containers at extremely low temperatures. Foreseeing such a need, Westinghouse has a testing chamber that will reduce metals to minus 452 degrees F., only

## AS A TUNE-UP\*

- frees sticky valves
- increases pick-up
- improves performance

\* through air intake or add to gasoline



## ADDED TO MOTOR OIL

- cleans out engine
- increases power
- gives quick starts

☆ At your service station, garage or accessory store

### SATISFACTION GUARANTEED OR DOUBLE-YOUR-MONEY-BACK

HASTINGS MANUFACTURING CO.  
HASTINGS, MICH.

Also makers of H-W-R, Piston Rings, Oil Filters, Spark Plugs



a few degrees from absolute zero. In this shattering cold, normal steels become brittle as glass.

Still another field where superalloys are required is in nuclear reactors, and here again the atomic structure of the metal determines its suitability. In some cases solid metals must be "transparent" to neutrons, permitting them to pass through like a ray of light through a pane of glass. Still others are highly prized because they tend to stop neutrons. Until a few years ago, little was known about the metal zirconium. Now, because it is highly transparent to neutrons, it is being widely used in the construction of reactors, and a whole new technology has grown up around it.

Who are these magicians with metals, these Merlins who create new alloys? They are well-grounded in nuclear physics, metallurgy and chemistry. For the most part they are young; the metallurgists at Westinghouse Research Laboratories have been there only five years, on the average, and many came there straight from their universities.

But the most significant thing about these men is their scarcity. Despite the amazing spurt of progress in this field, there are only about 50,000 metallurgists in the entire country, and only 650 young men are graduating in this field each year. GE's

Doctor Hollomon states flatly that the demand for metallurgists with advanced degrees during the next several years will be roughly twice the available supply.

The man who holds the key to tomorrow is quietly working in a laboratory or studying in one of the nation's universities. Trouble is, there isn't enough of him to go around. ★ ★ ★

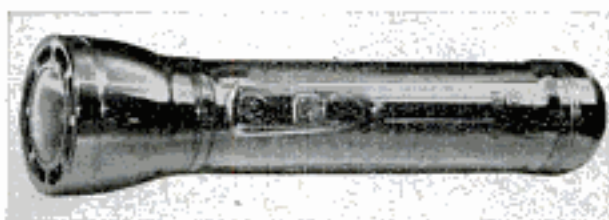

### Flashlight Horn

Warning sound or light can be produced by a new flashlight, depending on which of two buttons is pushed. Sound is heard through a grille around the flashlight's lens. Power for both the light and the sound comes from two standard flashlight batteries inside the unit.

☞ An ice island some 200 miles long and 60 miles wide, the largest ever seen, was discovered recently by the Navy icebreaker *Glacier* in the Antarctic.

## Be Your Own Boss in the Profitable Excavating Business!

### Custom Operators of Sherman Power Diggers Earn Up to \$1,000 and More Per Month

Wherever you live, you'll find plenty of profitable work the whole year 'round for this versatile outfit . . . not just a "trencher" but an all-purpose excavating machine! Custom operators everywhere are making big money with Sherman Power Diggers. One bought a farm with just 3 years' profits! Work for builders, contractors, utilities, and municipalities on such jobs as • SEPTIC TANKS and DRAINFIELDS • SEWER LINES • FUEL TANK INSTALLATIONS • FOUNDATIONS and FOOTINGS • GAS and WATER LINES • FIELD TILLING and many others. The Sherman Power Digger travels quickly from job to job, digs at a fraction of the cost of manual labor. It's simple to operate, easy to maintain, built to last.

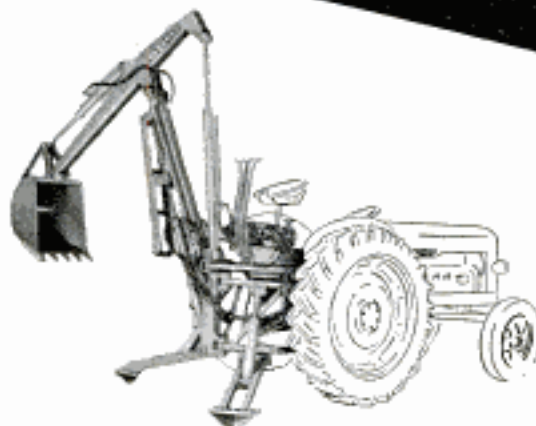

Send now for complete information about the easy-to-get jobs for your Sherman Power Digger. Let us tell you—without obligation—how you can go into business for yourself with an investment of less than \$5000. Or make a small down payment and pay the balance from your earnings.

**SHERMAN PRODUCTS, Inc.**  
Dept. 1736 Royal Oak, Michigan

# Learn these new skills... with all-purpose **BERNZ O-MATIC<sup>®</sup> TORCH KIT**



**BRAZE AND SOLDER** . . . kit includes soldering tip and high-heat burner units . . . you can also sweat copper fittings . . . fix appliances . . . make jewelry . . . repair gutters.

**CUT AND LAY TILE** . . . kit has cutting tip and utility burner for heating underside before laying tile . . . cutting tip also helps you: carve wood, tool leather, cut linoleum, etc.



**BURN PAINT** . . . flame spreader in your Bernz-O-Matic kit gives broad, clean flame . . . for burning paint, antiquing furniture, heating tile.



## **BERNZ O-MATIC<sup>®</sup> TX-888**

### **All-purpose TORCH KIT . . .**

Instant-lighting Bernz-O-Matic Torch with all these accessories:

Pencil Burner Unit, Utility Burner Unit, Flame Spreader, Soldering Tip, Cutting Tip

Regular value \$13.15 **ONLY \$8.88** At your favorite hardware store.

Uses the amazing Bernz-O-Matic disposable propane cylinder—miracle of modern convenience that makes possible:

**BERNZ-O-MATIC LANTERN**—No pumping or priming. Lightweight, easy to use. . . . . \$12.95



**BERNZ-O-MATIC STOVE**—One or two burners. Lights instantly, cooks a meal in minutes, won't blacken pans.  
1-BURNER STOVE \$11.95—2-BURNER STOVE \$19.95

At your hardware or sporting goods store.

## **OTTO BERNZ CO., INC.**

Driving Park and Ramona St. • Rochester 13, N. Y.

## Teaching School for Falcons

(Continued from page 85)

collecting stations for the special type of apes needed for the research. One project required 600 monkeys every two weeks for five years.

When the project was completed, he decided it was time to renew his first love—falconry—now made more interesting by information he'd collected in the odd corners of the globe.

### A Flame Thrower Helps

Unusual problems have been his lot since he decided to play host and keeper of his assortment of birds of prey. He's learned that hawks and owls are susceptible to a fungus disease. To combat this, he discovered the sand around the birds' perches must be regularly sterilized with a flame thrower.

Also, he found his varied feathered guests had different roosting requirements—and that not just any old log or piece of lumber would suffice. Concrete seemed a natural material with which to construct permanent perches, but ordinary concrete didn't work. He found it did not adjust to temperature changes and his birds were uncomfortable, or became infected from too-hot or too-cold perches. He solved this finally by constructing the permanent perches of concrete and Vermiculite.

He had to design and build different perches for each type of bird. For the birds accustomed to rocky cliffs, such as the peregrine falcon, he had to construct a perch flat on top but high enough to permit the tail feathers to hang over the edge without injury. The harpy eagle and the monkey-eating eagles of South America, as well as the great Crowned Eagles of Africa required a perch consisting of a large, round rock atop the flat perch, enabling their curved talons to get a firm hold. He uses a concrete and wood-branch perch for goshawks, Coopers and red-tails. All rests had to be designed so the leg straps (called jesses) wouldn't catch on the perches as the birds moved about.

### Homemade Earphones

Not the least of his gimmicks are homemade earphones which enable him to locate a bird in the bush by the falcon's bells if there's a training mishap. The earphones, which he learned about in the Philippines, are made of two old funnels. The degree to which they magnify sounds is amazing. And they're highly directional.

Hamlet's one peeve about falconry is the famous tale *Swiss Family Robinson*. "I'd

(Continued to page 258)

## SAVE MONEY on LUMBER

with the **LOW-COST BELSAW PLANER**

### Convert Rough and Random Size Lumber into Cabinet Finished Stock

Now anyone can make perfect cabinet finished stock from low-cost rough lumber... any size up to 12 3/4 inches wide and 6 inches thick. Turn out high grade finished material at a fraction of the cost you pay lumber yards. Big 42-inch-long bed makes it easy to plane heavy, wide and long pieces... BELSAW self-feeds at 14 to 34 feet per minute.

**USE THIS ONE LOW-COST MACHINE for Planing, Jointing, Sawing, Milling, Tongue and Groove.**

You can easily make flooring, siding and many other popular patterns with your Belsaw. Your Belsaw quickly pays for itself with savings on raw materials and profits on finished stock... a highly profitable machine for custom work. Compare Belsaw with any 12-inch planer on the market... Belsaw gives you more essential features—yet costs you \$50 to \$125 less than others.

**Send Today for Free Literature on the Belsaw Multi-Duty Planer.**

**BELSAW MACHINERY CO 2057 Field Bldg. Kansas City 11, Mo.**

**1957 CATALOG BOAT KITS** WOOD and FIBERGLAS

EASY TO BUILD - DESIGNED for professional results by the amateur. World's largest selection of top performance, latest design, prams, skiffs, racers, runabouts, sailing boats, cruisers. 8 to 20 ft. Mahogany decks, frames. **FREE FREIGHT. SEND FOR FREE CATALOG**

**Boat Plans-Patterns-Frame Kits** Includes fiberglass paints, accessories

Build over 50 modern boats from large scale plans, available with **FULL-SIZE** patterns, new **PRE-FAB** frame kits! All types: prams to cruisers, 6 to 25 ft. Best buy for Amateurs! **SEND 10¢ for CATALOG.**

**Craig Craft**  
Tonawanda, N. Y.

## New! Magna-Line Power Tools

The biggest advance in engineering since introduction of SHOPS MITH. Get your *free* MAGNA-LINE Catalog; get the full story on this brilliant new line of single-purpose power tools!

Write Dept. 805-M, MAGNA POWER TOOL CORPORATION  
Box 2808, Ft. Wayne, Indiana, OR Menlo Park, California

**NEW, IMPROVED CALCULATOR FOR WOODWORKERS only 25¢**

Instantly gives information on lumber, nails, concrete mixes, painting materials, etc. Convenient, simple to read. Just set dial for nail specifications, to convert linear to board feet, find bit sizes for screws, compare characteristics of woods. 6" diameter heavily varnished cardboard. Send **25¢, no stamps, please to Greenlee Tool Co., 2105 Columbia Avenue, Rockford, Illinois.**

## stock your shop

**ELCO SCREWS • BOLTS • NUTS**



Look for this in your hardware store—the newest, cleverest, most convenient method for buying your screws and bolts, and for keeping them handy for quick use! Sparkling clear-plastic boxes, brilliantly labeled, are packed with generous quantities of top-quality screws. **NOT** an assortment. Each box contains one size only. Available in 40 most-wanted sizes and types. Start to "STOCK your SHOP" now!

**59¢ PER BOX**



**5-BOX Display**  
USED IN MANY WAYS

**ELCO TOOL & SCREW CORP., Rockford, Ill.**

MAY 1957

# MAKE MINE KLEINS



Your skill—the quality of work you do—is controlled in no small measure by the quality of the tools you use.

That's why electricians and good workmen everywhere insist on Klein Pliers—standard of quality by which others are judged "since 1857."

In the complete Klein line you will find pliers exactly suited for every job you do. See your hardware store or Klein distributor for the Klein Pliers you need.



Your hardware store has Kleins in stock or can get them for you quickly. Look for this new display board. It shows the most popular items in the Klein line.

**Mathias KLEIN & Sons**  
Established 1857 **Chicago, Ill., U.S.A.**

7200 McCORMICK ROAD • CHICAGO 45, ILLINOIS

257



## KLEAN-STRIP Remover makes any refinishing job easier

- Breaks bond between any finish and surface
- One application removes many coats
- Fast-acting, non-messy, easy to use
- Leaves surface smooth, dry, ready to refinish
- Needs no neutralizing or afterwash
- Buy Klean-Strip where you buy paint

**NON-INFLAMMABLE**  
**KLEAN-STRIP**  
**PAINT REMOVER**

The Klean-Strip Co., Inc.  
 2340 S. Lauderdale, Memphis 6, Tenn.



### GRAVELY Gets It Done Faster! . . . Better!

New Steering Sulky, with Rotary Mower Attachment, provides the easiest, most efficient mowing ever!

With Gravely, you fit your jobs perfectly with a choice of 30 performance-proved attachments . . . Do every lawn and garden job better, faster, easier!

All-gear drive, power reverse, optional electric starter. Nation-wide sales and service . . . *Easy Payment Plan.*

Write today for FREE 24-page "Power vs Drudgery" Booklet.

**GRAVELY TRACTORS, INC.**  
 BOX 563 DUNBAR, W. VA.

**FIELD-TESTED SINCE 1922**

certainly like to meet the author of that book, if it were possible," he remarks. "What he didn't know about bird training is pitiful. Remember the incident in which the Swiss family trained an eagle by first blowing tobacco smoke at it in a small cage? Well, it doesn't work. I tried it when I was a small boy. When the cowboys first gave me that eagle, I talked our Chinese cook into letting me have some tobacco. I took the eagle to the chicken coop, and lighted up. After blowing smoke at the eagle for half an hour, I tried to pet him. I got well clawed for my efforts. I also got sick, but the eagle didn't. I'd certainly like to meet that author."

Hamlet may have become sick from the tobacco, but he never lost interest in falconry. And today he's as eager in training a new bird as in those distant years in the Black Hills. Falconry is in his blood. ★★

### Cream Served in Pouch

Cream in your coffee now can come from an individual, three-quarter-ounce, transparent pouch made of cellophane lined with Bakelite polyethylene. When a corner is torn off, the small plastic sack permits cream to flow only when pressure is applied to the pouch. A partly empty pouch can be set aside for future use without loss of cream by leakage. Other applications include packaging of liquid food and sauces.



At Last... a **LIGHTWEIGHT**  
**EASY-TO-INSTALL**  
**Bathtub**



**SAVES MONEY**

**\$49<sup>75</sup>**  
WE PAY the shipping

Costs far less than cast iron and no more than ordinary stamped steel tubs.

**NOW** you can have that extra bath . . . replace that old-fashioned or damaged tub . . . put in your new home or summer cottage bath at a big saving.



**CHIP-PROOF.** Surface is an integral part of the tub and cannot peel or chip like an applied finish. In fact, surface can withstand blows that would ruin an ordinary tub.



**LIGHTWEIGHT.** (46½" tub weighs only 18 lbs.) Can be carried in your car and into your home without the slightest difficulty or fear of damage to tub or home.



**WARM, QUIET.** Surface and material entirely different from any other tub giving a "quieting" effect and a pleasantly warm, velvety touch. Keeps bath water warm lots, lots longer.

- **LIGHT** — Carry it with one hand. Less floor load.
- **STRONG** — Glass fiber material eight times stronger than structural steel.
- **BEAUTIFUL** — Eye-filling high gloss finish. Popular color tones. Belongs in the finest bathrooms.

*Time Tested! Thousands in Use!*

**MADE BY NEW EXCLUSIVE PROCESS**—Fiber Glass...the miracle material used in rugged safety helmets, beautiful sports car bodies and lightweight airplane panels...is now molded into Strandglas bathtubs by a new exclusive Sterling process. The result is a beautiful, durable, lightweight, low-priced, strong-as-steel, chip-proof, comfort-designed tub *that you could even install yourself if desired.*

**TWO SIZES ALL COLORS**

46½" and 54" models weigh 18 and 25 lbs. (54" Strandglas tub has leg room of standard 60" tubs.) Right and left hand drains. Gloss white and all standard colors.

**EASY TO INSTALL**

Simple, easy-to-follow installation instructions furnished with each tub.



**STAIN RESISTANT.** Sanitary and easily cleaned with soap and water, unharmed by household solvents and chemicals. Hard water stains readily washed off.

**FULLY GUARANTEED**

Every Strandglas® tub is Guaranteed in Writing.

**SAVE TIME—ORDER TODAY—USE THIS COUPON**

**STERLING PRECISION CORP.,** Fiber Glass Plastics Division  
1302 Expressway Drive, Toledo 8, Ohio

Send me a Strandglas® bathtub as follows (Please fill in and mail with check or money order):

- 46½" tub @ \$49.75     Right side drain  
 54" tub @ \$54.75     Left side drain.    Color \_\_\_\_\_

Name \_\_\_\_\_

Address \_\_\_\_\_ PLEASE PRINT

City \_\_\_\_\_ Zone \_\_\_\_\_ State \_\_\_\_\_

I'd Like More Information. Send me full color literature and dimensional drawings without obligation. PM

**SATISFACTION GUARANTEED IN WRITING**



# The '57 Motors



West Bend 2-hp. motor has an automatic rewind starter and weighs only 28 pounds



Johnson Sea-Horse, 5 1/2-hp., weighs 56 pounds, features slip clutch to protect propeller



Fageol's 35-hp. model is a high-power, four-cylinder, four-cycle unit



Mercury Mark 75 heads the list, powerwise, with 60-hp. rating

Scott-Atwater's 7 1/2-hp. motor has new automatic bailer, carburetor silencer



Buccaneer deluxe, 3-hp., can push an average boat 1 1/2 to 8 m.p.h.



Neptune Mighty Mite, 1.7-hp., weighs 17 pounds

Dragonfly 2 and 4-hp. motors are for shallow waters



Oliver, 16-hp., now has the optional electric starting

Evinrude Fastwin, with 18-hp., produces speeds up to 27 m.p.h. Fastwin has slip clutch principle and the new weed-cutting apparatus





**"Stop paying the traffic toll . . . save gas the way professionals do!"**

*Mauri' Ross* . . . top professional driver, three-time Indianapolis 500-mile winner.

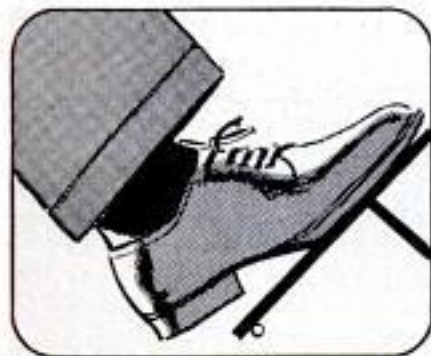

"Always drive with a steady foot. Uneven pedal pressure . . . slowing, then speeding up . . . burns far more fuel than cruising at a steady pace. And, take it from me, the steady pace is more relaxing and safer."



"In traffic, watch what's happening about 5 car-lengths ahead. This helps you maintain steady, thrifty speeds . . . avoid sudden stops and gas-consuming starts! And it lets you steer clear of dangerous situations."



"Remember, it's up to you to keep your car at peak efficiency. When most of your driving is in city traffic, it's a good idea to have your carburetor and other vital engine parts checked every 8,000 miles or so."

The way you drive may be costing you money! You can gain up to 5 miles per gallon of gas with thrifty driving habits and proper maintenance. And proper maintenance means regular carburetor and engine checks by a qualified, factory-trained mechanic. That's why more folks every day rely on Rochester Carburetor specialists . . . they know their cars are in the capable hands of experts. Rochester Carburetors are precision-engineered to give you top economy and high-compression power . . . precision-serviced to stay that way!

**R** **ROCHESTER**  
**CARBURETORS**  
Rochester Products Division of  
General Motors, Rochester, N.Y.



Standard equipment on  
Cadillac,  
Buick,  
Oldsmobile,  
Pontiac and  
Chevrolet

**Paint comes off  
IN A FLASH**

**Washed off  
with water**

**NO SCRAPING · NO SANDING**



WONDER, the miracle remover, acts with amazing speed on any type of finish. Simply apply with a paint brush, let it work a few minutes. Then wash off the old finish with water. Apply new finish as soon as surface is dry. You're through in no time!

Non-flammable. Stays put on uprights. Use indoors or out. At paint and hardware stores.

● **Write for free Wonder Remover folder**

or send 25¢ for illustrated Manual on Refinishing.

Wilson-Imperial Co., 119 Chestnut St., Newark 5, N. J.

**WONDER**  
water wash off Paint Remover

Long on Quality... Short on Price!

**Evans L-O-N-G  
WHITE-TAPES**

25-50-75-100 FOOT LENGTHS

50 Ft.  
Only  
**\$4<sup>98</sup>**



**Built-In  
HANDY  
HOOK-RING  
COMBINATION**

For easy one-man measuring. Comes with every Evans Long White-Tape as a standard feature... you pay not a penny more!

**A FINE-QUALITY PRECISION  
MEASURING TOOL**

- Snow-white bonded steel blade
- Sharp jet-black precision markings — for clear, easy reading
- Heavy leather-grained cover... of moisture, scuff and stain-resistant DuPont Vinyl
- Stainless steel edge band
- Double roller mouthpiece, recessed crank, winding reel... all heavily chrome plated for rust resistance, handsome appearance
- FREE plastic utility case

EVANS, Elizabeth, N. J.

**Silent Sentinel**

(Continued from page 220)

adjustment instructions which do not involve the use of any test instruments by writing to the Radio, TV and Electronics Dept. of *Popular Mechanics Magazine* and enclosing a stamped, self-addressed envelope.) To do this, connect a 150-mmfd. ceramic capacitor, CX in Fig. 4, across the two outside terminals of TS1.

Set sensitivity control R8 to the maximum counterclockwise position and connect the voltmeter leads across the relay coil lugs. Tighten the trimmer screw on C2 and open the screws of C1 and C3 about three turns. Now plug the line cord into a 110-volt a.c. outlet. The meter should indicate between 2 and 2.5 volts.

Using an insulated screwdriver, slowly close trimmer C1 until a rise in voltage is indicated by the meter. Adjust for maximum voltage. Now, close trimmer C3 until maximum meter deflection is obtained. At this point all three tuned circuits are resonant at the same frequency and the meter should indicate between 13 and 15 volts. At some time during the above adjustment you will hear a soft click indicating that the relay has pulled in. This should occur at a meter reading of 7 or 8 volts.

Slightly loosen trimmer C2 until the meter reads about 4 volts, and reopen the relay contacts by prying them apart with a pencil or by momentarily pulling out the line cord.

Rotate the sensitivity control for a 6-volt reading and touch one end of C2 with your finger. This should cause a rise in voltage and consequently the closing of the relay.

Complete the chassis wiring by inserting latch resistor R10 as shown in Fig. 4.

**Antenna, Trip-Circuit Installation**

Final adjustment and installation of the control unit can be made only after the antennas and the necessary trips have been connected. The trips may take various forms as shown in the title illustration on page 217. Plan the location of the trips carefully so that maximum protection can be obtained. Several pair of antenna leads may be connected to a single control unit, and each antenna pair may have several trips connected to it. The limiting factor is the amount of external capacity that the antennas themselves introduce into the coupling circuit. The smaller this capacity, the greater will be the sensitivity of the system. It is desirable, therefore, to space the antenna leads A1 and A2 at least two or three feet apart, except at the points where the trips are connected. In the event

(Continued to page 264)



now, in power tools, too...

# if it's Remington, it's right!

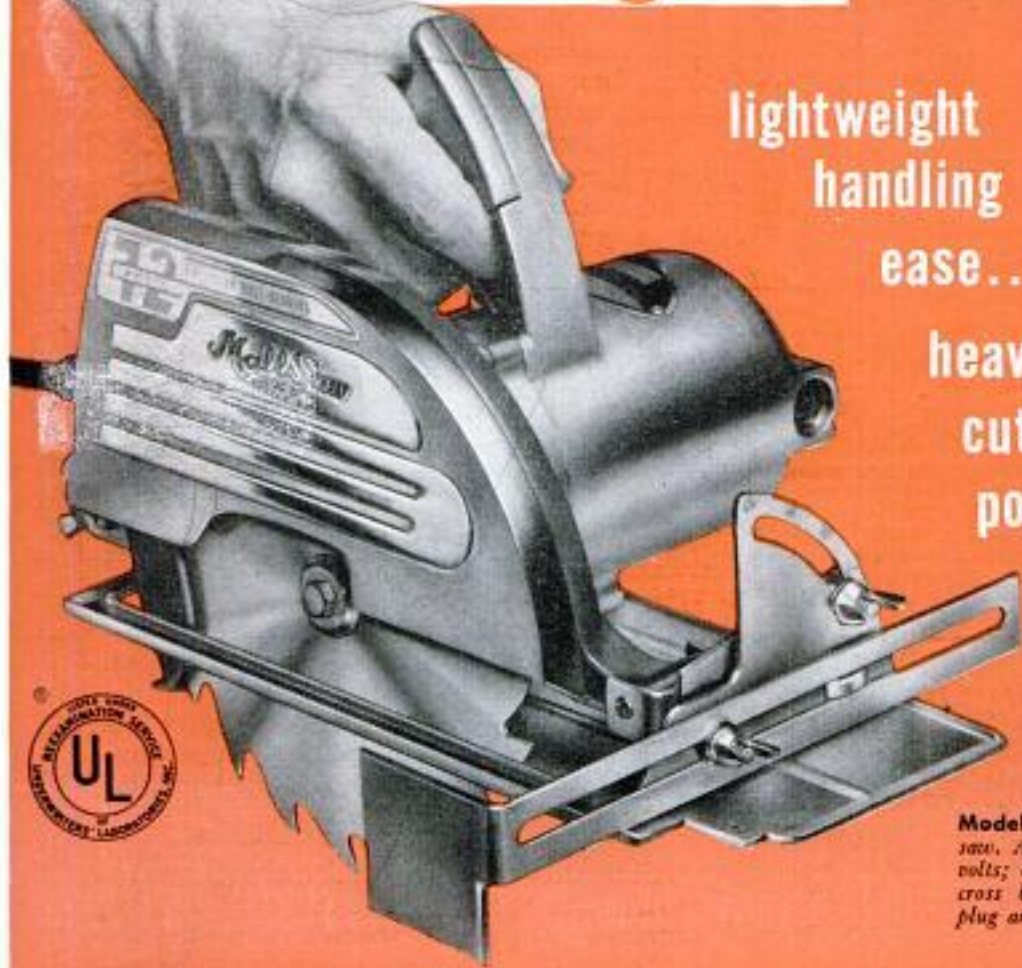

lightweight  
handling  
ease...

heavyweight  
cutting  
power!



**Model 72.** 7-inch blade standard saw. AC-DC, 25 to 60 cycles; 115 volts; 8 3/4 lbs. Comes with 7" rip-cross blade, wrench, 10 ft. cord, plug and ground. \$74.95\*.

*these great features make our Model 72 Saw right for you!*

- Cutting capacity of 2 1/4 inches.
- Cuts 2 x 4 at 45° angle.
- Precision ball and needle bearings for more blade power.
- Automatic telescoping blade guard.
- Heat treated gears for longer life.



Belt and Orbital type sanders.



Electric Drills of many capacities.

\*Prices and specifications subject to change without notice.

## Cuts tile and metal with quick blade change!

This rugged, compact saw is the favorite of many carpenters because it has the power and performance of a heavy duty model. Yet it has the handling ease of a lightweight tool—an ideal power saw for the home workshop!

Blade changing is quick and easy for plasterboard, tile, sheet metal and other tough cutting jobs. Try it yourself! When you feel its power you'll know the Remington Model 72 Saw by Mall is no ordinary saw. It is built with the quality and precision that have made Remington famous for 141 years in sporting firearms and ammunition.

# Remington

**Mall**<sup>®</sup> MALL TOOL COMPANY, Division of Remington Arms Company, Inc., 25000 S. Western Ave., Park Forest, Ill.

In Canada: Mall Tool Ltd., 36 Queen Elizabeth Blvd., Toronto, Ont.



**MALL TOOL COMPANY,**  
Division of Remington Arms Company, Inc., Dept. E6,  
25000 S. Western Ave., Park Forest, Illinois.

Please send your new, fully-illustrated FREE Power Tool catalog.

NAME \_\_\_\_\_

ADDRESS \_\_\_\_\_

CITY \_\_\_\_\_ ZONE \_\_\_\_\_ STATE \_\_\_\_\_

## Which Irwin bit bores holes fastest?

**Fastest cutting new Speedbor "88"** for electric drills. Bore 1" holes 2½" deep in just 60 seconds. Increases the average boring range of small power drills. Sizes ¼" to 1". Only \$.75 each.

**Fastest Boring 62T Hand Brace Type.** Only 16 turns to bore 1" holes through 1" wood. Double cutter action. Sizes ¼" to 1½". As low as \$1.

**Fastest Boring Expansive Bit Type.** Bore up to 35 standard holes with just one bit. Two sizes give ½" to 3" boring range. America's most versatile bit for home and farm. Only \$3.80 for largest size.

### Balanced cutting heads do the job in seconds

Every Irwin wood bit gives faster, cleaner boring in any wood — no matter the type. Spurs and cutters are precision-balanced to give free and easy cutting action. Made to last for years. Irwin is the wood bit hardware dealers recommend.

**Free Booklet** tells how to use, select and take care of wood bits. Many pictures. Write Irwin, Dept. 7D, Wilmington, Ohio.

**IRWIN** • the original solid center auger bit  
• screw drivers • screw driver bits  
Wilmington, Ohio



that the antennas do introduce excessive capacity, small padder capacitors, like those used for C1 and C3, may be added in series with the antenna leads, as indicated by the dotted capacitor in the schematic diagram.

If a particular plate or screen used as a trip has excessive capacity to ground, a series padder may be used between it and the antenna lead to which it is connected. This is shown in inset D of the title illustration. Trips may be concealed under carpeting, floor mats or similar coverings.

The antenna wires, and those connecting the trips to the antennas, need be only enamel-insulated of a rather fine gauge (No. 30 is ample) and can easily be hidden. Plastic insulation is desirable, however, for outdoor installations or in damp locations such as basement stairs.

### Alarm Systems

The alarm or signal device is connected to the two leads marked "to external alarm or relay" in the various diagrams. The power for the alarm device is obtained from the secondary winding of the bell transformer, T1, which is rated at about ½ amp. If more current is needed, the circuit in Fig. 5 should be added to the schematic in Fig. 1. The power relay shown should have a 12-volt coil and its contact rating should be sufficient to handle the required current. A second bell transformer supplies any low-voltage requirements.

### Final Adjustment, Installation

After the various trips have been installed, the antenna leads A1 and A2 are fastened to terminal strip TS1 in place of capacitor CX. This capacitor must be removed since the capacity of the antenna and trips now takes its place. C2 must be readjusted by the voltmeter method described earlier so that the coupling circuit, with the antennas connected, is tuned to a frequency slightly higher than the oscillator frequency. If the capacity of the external circuit is too high, series padders must be added. If too low, the trimmer C2 may be replaced with one having a higher maximum value than originally specified.

Final connections to the a.c. line and to the alarm device should be made through BX connectors mounted on the side of the control-unit case. The line cord can be removed and two wires should be run through conduit directly to a 110-volt a.c. source. Switch S1 shown in the schematic diagram may be a lock switch such as used in an automobile-ignition system. Such a switch must be used in the final installation since it represents the only way of turning the alarm off and resetting the control unit once it has been tripped. ★ ★ ★



Give your lawn that  
"ESTATE LOOK"  
— in 5 minutes!

# Trim Master



**ELECTRIC  
LAWN  
TRIMMER  
AND EDGER**

TRIMS LAWNS right up to walls and trees . . .  
EDGES LAWNS and TRIMS HEDGES! You do an  
hour's trimming and edging in minutes . . . standing  
up! Powerful motor is rubber mounted, insulated.  
Cutter blade whirls at 8,500 r.p.m. Built-in edging  
guide for professional results.

**TRIM MASTER** for heavy duty cutting, \$39.95 **BANTAM**, \$24.95  
ORDER BY MAIL UNDER MONEY-BACK GUARANTEE.

**WARREN SALES CORP.**

A Product of E. F. Britten & Co. Box 161A, Cranford, N.J.

# MECHANIC'S FAVORITE!

Here's the number one choice—



It's the Huot Model 100 DeLuxe Chest—custom designed for mechanics who want the finest protection plus maximum accessibility for fine tools. Eleven drawers—seven of them cork-lined for protection. Three heavy-duty drawers for large tools—1 extra deep drawer for power tools. Single latch locks entire cabinet. Two-tone oil-resistant finish. *Free bulletin describes 12 tool chests.*

**HUOT MFG. CO.**

555 No. Wheeler Street, St. Paul 4, Minnesota

**WELD** **BRAZE**  
**SOLDER** **CUT**

**4WAY**  
ONLY **\$14.75**  
f.o.b. factory

**WELDER**

Complete with Twin Carbon Arc Torch and accessories... to handle all metal-craft work.

Acclaimed by thousands of Homeowners, Mechanics and Hobbyists as the welder of 1001 uses. Easily operated from properly wired 110 volt AC or DC line. The ideal gift with a life-long use....Order today on 10 day money back guarantee.

**FOUR-WAY WELDER CO., Dept. F2-E**  
1810 S. Federal St. • Chicago 16, Ill.

**Metal Turning Lathe for Model Makers**

SEND FOR FREE FOLDER describing the new Lathe for Model Makers. 15 1/4" bed with 4 1/2" swing; 7" between centers. Guaranteed. Only **\$35.00** f.o.b. Lansing.

Rosemar Manufacturing Co.,  
2501 Bernice Rd., Lansing, Ill.

**BUY GREAT NECK HAND TOOLS**  
... for long-lasting performance

**Precision Balanced NAIL HAMMER**

One-piece, forged steel, rubber-cushioned, no-slip grip

**GREAT NECK SAW MFRS., Inc.**  
MINEOLA, N. Y. — SEE YOUR LOCAL STORE

**NOW!** **Grumman** "AIR-BORNE" BOAT RIDE "SEA WINGS"

**NEW FOR '57**

Boating Enthusiasts Are Talking About The New GRUMMAN Hydrofoil System!

GRUMMAN'S "SEA WINGS" bring you a new sensation in boating pleasure! An entirely different, faster boat ride. ABOVE the water, cutting down water drag, choppy waves, and spray.

FREE Catalog—Complete line of GRUMMAN Boats and Canoes. NEW FOR '57, the GRUMMAN Inboard Runabout! With streamlined fin-tails for Fageol vertical inboard motor.

37-57 South St.  
**GRUMMAN BOATS, Inc.** Marathon, N. Y.

# REPLACE YOUR

## OLD WOOD CELLAR DOOR



## WITH A MODERN ALL-STEEL BILCO DOOR

# DO IT YOURSELF

IN JUST 3 TO 4 HOURS

Think of it! Only a few hours of pleasant work to replace your unsightly, troublesome wood hatchway with a lifetime, weathertight BILCO... the door installed on tens of thousands of new homes.

**PAYS FOR ITSELF!** Cost so little, yet never needs repair or replacement. Operates at a touch. Smooth, trim appearance adds amazing new beauty to your home.

Rush coupon TODAY for free folder "How to replace your wornout wood hatchway" showing sizes and prices.

**Bilco**®

**AMERICA'S FINEST BASEMENT DOOR**

THE BILCO CO.  
DEPT. 963C  
NEW HAVEN, CONN.

Gentlemen: Please send me free folder and name of nearest dealer.

Name \_\_\_\_\_  
Street \_\_\_\_\_  
City \_\_\_\_\_ State \_\_\_\_\_

# A man who loves engines..



Jim and Rosina Sprinkel of Lake Alfred, Fla. take their daughters for a cruise with their 6-cylinder 60 hp Mercury Mark 75, world's most powerful production outboard. At the controls is family friend, Buddy Boyle, champion water skier from Florida's Cypress Gardens. Jim's hobby is motors. He tells above what he thinks of his Mercury outboard.

# .. talks about outboards

BY JIM SPRINKEL

*Former Flight Captain, Pan American World Airways*

As an airlines captain, I've lived with airplane engines. I piloted them for 10 years on the Atlantic run, and to South America. I've flown them over a million miles.

It's hard to tell anyone else how you feel about an engine. You might say I respect them. I know the feel of a fine engine. And I like it.

This year I began thinking about outboards. Being used to aircraft engines, I guess I was plenty critical when I started shopping around. I wanted a motor like I was used to—not a gadget or toy.

I decided on the new six cylinder Mercury Mark 75. It's a great engine. I'm sold on it for a lot of reasons. Many of them are things you can't see. They are engineering and quality standards that have to start right at the drafting board. To me, they're the difference between an engine I'd buy and one I wouldn't.

\* \* \* \*

Take safety. Like every airlines pilot, I put safety first. Naturally, that's as true of my family as it was of my passengers. Mercury has many safety features that appeal to me. I didn't find them in any other outboard.

My Mercury has drop-forged aluminum pistons. They're strong as steel. They're like the pistons in a plane.

My clamp and swivel brackets are made of drop-forged aluminum and high tensile alloys, like many structural parts on passenger planes.

The connecting rods and crankshafts are made of "moly" alloy chrome nickel. They're aircraft quality.

The drive and propeller shafts and gears are high tensile alloy steel. They're protected by a propeller clutch that slips when it hits an underwater object. There are no shear pins or propeller drive pins to break. You can drive my Mark 75 over a sand bar at 40 miles an hour without damaging the lower unit. That meets my ideas of safety.

The aircraft-grade ignition is another feature I like. It's waterproofed for all-weather operation. So is the entire electrical system. The generator is a honey. No rotating copper, no brushes, no commutator, no drive belts—and no voltage regulator to conk out in our salt water atmosphere here in Florida.

Another thing I like is that Mercurys have ball and roller bearings at friction points, like aircraft engines.

\* \* \* \*

I'm sold on Mercury's multi-cylinder Fours and Sixes. They remind me of aircraft engineering practice—multi-cylinders for lower stress, longer life and quiet operation.

My Mark 75 has dual ignition and a six cylinder power plant. It gives me power for a big

family-size boat. No oversized twin can do that.

It's easy to handle, too. Real gentle on take-off and so maneuverable my wife and children can run my boat. Everything operates on one control. There's no gear shifting. You just press the thumb-button on the control to start and push forward for speed. To reverse, you just pull the control back and press the thumb-button again. Anybody can drive a cruiser with a motor like this.

My Ride-Guide remote steering and the single lever control make maneuvering real easy.

The 12-volt electrical system gives me enough power to use a ship-to-shore radio, navigation instruments and bilge pumps. With the reserve output of my generator, I can use spot lights besides navigation lights without running down my battery.

I like the way my Mercury power plant is secured by aircraft type engine mounts. They insulate vibration and shock from the boat without affecting the steering.

Normally, I can cruise my Mark 75 at half its maximum rpm. That gives me a service factor no other outboard approaches. It reminds me again of aircraft engineering practice.

Flying taught me to watch fuel consumption. At cruising throttle, I can make more miles an hour and get more miles per gallon with my 60 hp Mark 75 than most twin-cylinder dual rigs can deliver.

I keep coming back to the alternate-firing four and six cylinder Mercurys. Being two-cycle, their power flow is the same as an eight or twelve cylinder engine. Those six cylinders sure make my Mark 75 idle sweet and smooth.

Any flyer knows the importance of balance and trim for cruising efficiency. I was surprised at the attention that is paid to balance in Mercurys. The center of gravity on my Mark 75 is lower and farther forward in relation to the boat's transom than on less powerful outboards . . . even though my motor pulls at least 20 more horsepower.

I like the streamlined narrowness of the Mercury. It lets me mount two motors side by side and still get maximum steerage and turning radius. My Mark 75 is so compact I could put it in my car trunk. It's got the looks that only good design can give a motor.

\* \* \* \*

As you can guess by now, I'm 100% sold on my Mercury. So are many of my pilot friends. For my money, Mercury is the best outboard you can buy—from the 6 hp model to my 60 hp Mark 75.

If you go for good engines, I think you'd like a Mercury. ©1957 KIEKHAEFER CORP., FOND DU LAC, WISCONSIN.



**MERCURY OUTBOARDS FOR 1957**  
Kiekhaefer Corporation, Fond du Lac, Wisconsin



### Combination Teakettle-Coffee Pot

You can make a coffee pot out of a teakettle by inserting a coffee-making attachment. This combination coffee-tea unit has been designed by Count Sigvard Bernadotte (above), son of Sweden's king.

### Tumble Tub for Youngsters

Children can have a tub full of fun with this new toy. Resembling a washtub with rounded bottom, the youngster can whirl himself around using one foot or rock and roll himself along holding on to the rope handles.



Four modern guided-missile battalions deliver more firepower than all the U. S. artillery (761 battalions) in 1945.



**Anti-rust and lubricant for water pumps.** Special Du Pont formula prevents corrosion, neutralizes acid in cooling system. Helps eliminate pump squeaks. Works in water or anti-freeze. Won't harm rubber hose or metal. (79513) .....89c



**Clean, wax, glaze in one operation** with Du Pont New "7" Car Wax. Built-in cleaner and silicone to give better, longer-lasting wax job in one easy step. Saves hours of time, gives car better all-around protection. (37120) .....\$1.95



**New DuPont Oil Additive** keeps out sludge, assures quieter, more efficient engine performance, better gasoline mileage, reduced oil consumption, complete crankcase lubrication. Also improves viscosity of any motor oil. (41196) .....\$1.39



**New Wind Silencer** clamps on door edge . . . breaks up air flow, carries it away from car body. No more annoying wind "roar" even with windows down! Chrome-plated, rust-proof. Easily installed. Fits most cars. (C23993).....Pair \$1.79

**Wizard De-Sludge-Er** Oil Filter Cartridge. 100% cellulose filter. Absorbs moisture better, keeps oil cleaner longer. Won't clog, channel or by-pass. Easy to remove. For most cars, trucks, tractors. (S1812-5000) From \$1.42  
Westline Filter (S5900-5000) .....From 98c

**Wizard "Twin-Fire"** Spark Plugs . . . guaranteed 18,000 miles! Give top performance twice as long as single electrode plugs. (Alternate firing twin electrodes stay accurately gapped up to twice as long.) Sets of 4 or more, ea. (L3070-951).....79c

## Tune Up... Tone Up Your Car For Spring



Choose from over 4,000 guaranteed top quality parts and accessories at

# Western Auto

Stores and Associate Stores



**Repair your brakes**, quickly, easily — with Wizard Master and Wheel Cylinder Kits. Includes live rubber cups, boots, pistons, springs, etc. For most cars, trucks. Master Cyl. Kits, with piston (S2750-85).....from \$1.15  
Wheel Cyl. Kits (S2605-41).....from 48c



**Wescote Whitewall Paint.** Makes dress whitewalls out of regular black tires. Renews discolored whitewall tires. Adds life by preventing cracks, preserving rubber. Weatherproofs.  
White, 1/2 pint (C24481).....45c  
Black, 1/2 pint (C24482).....45c



**Guaranteed leakproof,** blowout-proof. Wizard Muffler protects against carbon monoxide gas fumes . . . gives "new car" silence. Original equipment specifications. Heavy, long-lasting steel. All popular cars. (T1148-1586) From \$6.85

NOTE: In some areas of the U.S., Hawaii, Alaska, Mexico, and Puerto Rico, prices slightly higher. Western Auto Associate Dealers set their own prices, terms and conditions. (PMS7)

# TOP VALUE SPECIALS!

SURPLUS ITEMS AT FRACTION OF ORIGINAL GOV'T. COST  
AT GROBAN'S

BRAND NEW — WALKER

## 5 TON HYDRAULIC LIFT KIT



ITEM  
#KW-  
116

FOR — • SNOW PLOWS • TO  
DUMP FARM WAGONS • ADJUST  
DEPTH OF PLOWS • HYDRAU-  
LIC PRESS • HYDRAULIC JACK.  
THE COMPLETE KIT CONSISTS  
OF: 1—Walker Hydraulic Hand  
Pump—Rated 1500 lbs. per sq. inch  
with 2 gal. hydraulic reservoir • Re-  
lease valve • Filler plug and air vent  
• 28" steel handle. Fine for hydrau-

lic presses; snow plows, jacks. Dimensions: 6" Diameter, 29"  
long with 3/4" pipe thread port.

Pump Assembly Item #P449..... **23.50**

1—6 Ft. length double wire braid rubber covered  
hydraulic hose—tested to 20,000 lbs. Item #27B4... **3.95**

1—Hydraulic Cylinder, 3" bore, 6" stroke. Husky 3/4" solid steel  
shaft. Will lift 10,000 lbs. using 1500 lbs. of pump pressure.

Clevis mountings that take 3/4" diameter pins. May be used for  
single or double action service. Overall length..... **12.50**

17 1/4"—retracted. Item #C419.....

1-Gallon Hydraulic fluid furnished free with each kit.

Plus all necessary hydraulic fittings. Total ship. wt.—40 lbs.

**COMPLETE KIT PRICE..... 38.95** F.O.B. CHICAGO

(ALL OF ABOVE INCLUDED)

## 1/4" METAL STAMPING SET

STAMP YOUR NAME ON WOOD OR METAL!

Full alphabet A to Z, "&" and period.

Precision hand trimmed deep cut.

hardened STEEL STAMPS—in

fitted Wooden Box—made to

rigid U.S. Navy specifications

by Young Bros.—Comparable to

sets selling for \$27.00.

Shipping Wt. 5 lbs. **5.95**

F.O.B. Chicago.....



ITEM  
#390

## HIGGINS BRONZE

### CENTRIFUGAL PUMP

PUMPS ALMOST ANYTHING

ITEM  
#414

Fine for: — • Irrigation • Sump

Pumping • Sewer Drainage • 75 gal-

lons per minute @ 2400 R. P. M.

Higgins Type PNB, Model R, marine

bilge pump. Open impeller design for handling

muddy water. Delivers 75 gallons per minute,

30 foot head with 1/4 H.P. motor.

Pump body and impeller are made of solid

bronze, with alloy steel 1/2" diameter shaft,

13 1/4" long. Rotation of the pump is clockwise. Inlet has 1 1/2"

pipe thread. Plain 1 1/2" outlet for hose connection. Dimensions

12"x7"x8". Shipping weight

23 lbs. F.O.B. Chicago..... **23.50**

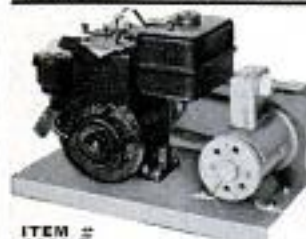

ITEM  
1008-B

## PORTABLE 1000 WATT A.C. LIGHT PLANT

Electricity for Your Comfort

COMPACT—

Fits in the trunk of your car

FAST STARTING

ENGINE: BRIGGS-STRATTON 2 1/4 H.P.—Equipped

with recoil Starter.

GENERATOR: Ball bearing construction 1000 Watts,

115 Volts A.C. 60 cycles.

SAME AS HOUSEHOLD CURRENT

SIZE: 20 1/2" x 12" x 16"

Shipping Weight 100 lbs. boxed

PRICE: Save \$100.00 from \$259.50 list **159.50**

price. Now! F.O.B. Chicago...NET

MONEY BACK GUARANTEE, SEND CHECK OR M.O.

FREE—NEW CATALOG 1957 EDITION, 60 PAGES,

chuck-full of unsurpassed War

Surplus and newly manufactured Equipment Bargains for farm,

home, factory, workshop. Write letter today.

To place phone orders call WEBster 9-3793

**GROBAN SUPPLY CO.** Dept. PM-5

1139 S. WABASH AVE., CHICAGO 5, ILL.



## Centrifuge Drier

You can give your washed laundry a whirl in a centrifuge to get rid of dirt and soap. Made in Switzerland, this machine weighs 18 1/2 pounds and has a noiseless electric motor that does not jam radio reception.

## Milk-Can Cooler

In Germany, milk is water-cooled and air-conditioned in milk cans fitted with internal piping and connected to a water tap. An asymmetrical coil assures uniform cooling throughout the milk. Additional cooling results from the circulation of water through the piping into the can cover and over the can's exterior. Holes in the can cover produce an air-conditioning effect inside the can.





# New! VISE-GRIP

## WITH EASY RELEASE

NOW, THE WORLD'S MOST USEFUL HAND TOOL EVEN EASIER TO USE!

A squeeze of the hand locks jaws with 2,000 lbs. grip.



Now, light pressure on Easy Release unlocks bulldog grip!



PRESS HERE

.. and Jaws **CLICK** Open!

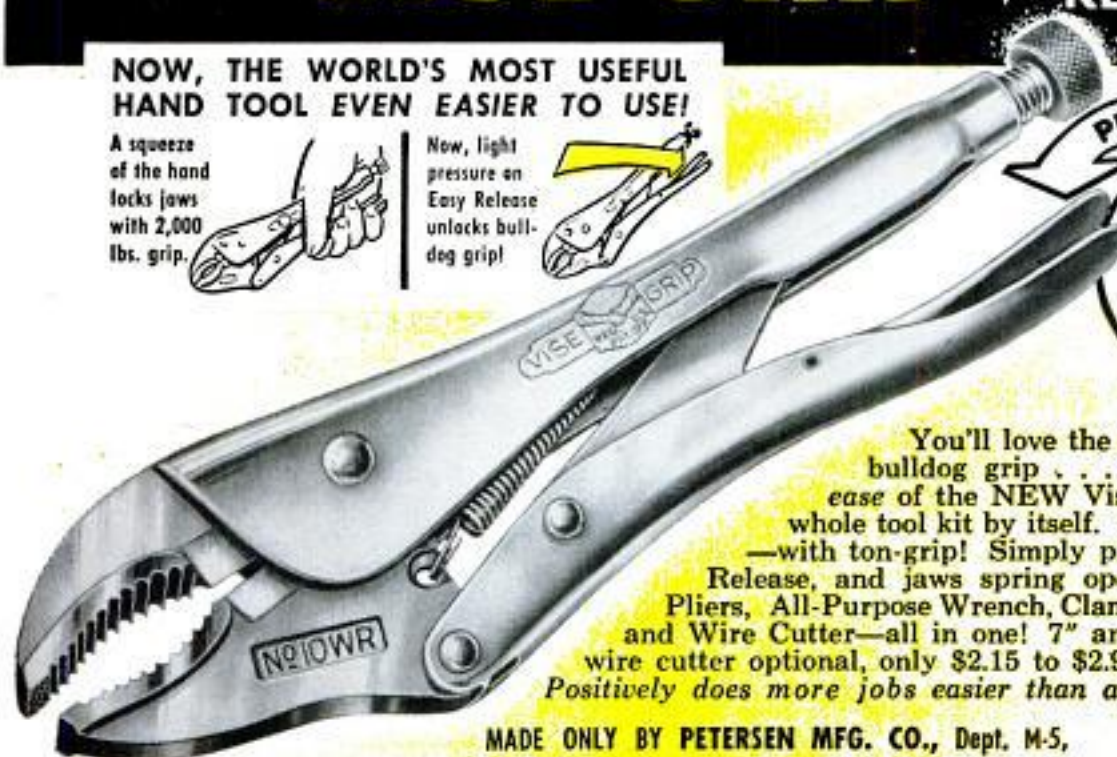

You'll love the power . . . the bulldog grip . . . the every-job ease of the NEW Vise-Grip! It's a whole tool kit by itself. Locks on tight—with ton-grip! Simply press new Easy Release, and jaws spring open. A Super-Pliers, All-Purpose Wrench, Clamp, Hand Vise, and Wire Cutter—all in one! 7" and 10" models, wire cutter optional, only \$2.15 to \$2.95. Get yours! *Positively does more jobs easier than any other tool.*

MADE ONLY BY PETERSEN MFG. CO., Dept. M-5, DE WITT, NEBR.

**"ARCO-SAW" CUTS GROOVES AND 2x4's!**

Exclusive "Dado-Arbor" swivels blade to cut grooves up to 1/2" wide x 1" deep in 1 cut. Rips, Crosscuts, cuts angles with gages. Fits any 1/4" drill. Incl. 5" blade. . . . **\$12.95**

At your Dealer or order direct (ppd.) C.O.D. + post. Money Back Guarantee.

**ARROW METAL PRODUCTS CO.**  
Dept. PM-5, 140 West 87th St., N. Y. 13, N. Y.

**Craftsman WOOD and Woodworking MATERIALS**

**Get New 132 Page Catalog of WOOD AND WOODWORKING MATERIALS**

WORLD'S LARGEST SELECTION—Lowest Prices Your buying guide for finest kiln dried domestic and rare imported woods, inlays, bendings, matched plywood, moldings, ornaments, etc. Biggest selection of tools and hard-to-find hardware. Filled with scroll saw patterns, projects, wood facts and money making ideas. Enclose 25c (refunded on first order) to help pay mailing and handling costs. Write today to **CRAFTSMAN WOOD SERVICE CO.**

2729 S. Mary St., Dept. A-5, Chicago 8, Ill.

**BOAT PLANS PATTERNS—FRAME KITS**

BY THE DESIGNERS OF "SEA KNIGHT"

CURRENTLY FEATURED IN POPULAR MECHANICS

We have a complete selection of designs INBOARDS and OUTBOARDS especially for the amateur builder. Send for our COMPLETE CATALOG. 50¢.

**GLEN**  
marine designs  
BOX 568T  
COMPTON, CALIF.

**Soldering is Easy**

with INSTANT STARTING

**Lenk**

LIQUEFIED LP PETROLEUM  
**Torch**

only **\$2.95**

THE ONLY THROW-AWAY FUEL-CONTAINER WITH SELF-SEALING SAFETY VALVE.

Here's what you can do:

- regular soldering, sweat fittings,
- silver soldering, refinish furniture,
- remove paint and putty.

Available at Hardware Counters Everywhere

Write for FREE Soldering Instructions

**THE Lenk MFG. CO.**  
BOSTON 15, MASS.

**GIGANTIC  
SAVE-TO-70%**

**MAIL SALE**

**WAR SURPLUS  
EXCESS INVENTORY  
BANKRUPT STOCK**

**ELECTRIC WATER PUMP**



• Hi-capacity, small centrifugal. Operates on 6-12 or 24v AC or DC. Excellent badge-sump pump; circulating water display; cellar drain, etc. Ball bearing explosion-proof motor 8 to 15 gal. per minute. Outlet 1" O.D. 7" high, 3" diam. Govt. cost \$64. SALE, \$12.95 F.O.D.

**CONTRACTOR-FARMER  
LEVELS**



• Precision instruments, achromatic optics. Ideal for leveling, contouring, foundation construction, etc. Each complete with tripod, rod, target, case, instructions.  
• No. 1 Level. Popular slide focus model. SALE, \$47.00 F.O.D.  
• No. 2 Level — Back & pinion focusing. SALE, \$54.75 F.O.D.  
• No. 3 Level-Transit. Combination unit suitable for leveling, lining up, rack & pinion focus. SALE, \$84.90 F.O.D.

**IRRIGATION PUMPS**



2 1/2" Size, 16,500 gph  
• Brand new, bronze, ball bearing. Wonderful farm, contractor, industry pump.  
• Capacity to 280 g.p.m. Pressure to 65'. Speed 2100-2700. Clockwise rotation. Complete with 6" pulley. Wt. 40 lbs. Size 10"x11"x9". Inlet 2 1/2", outlet 2". Nat'l. Adv. List \$98.00. SALE, \$39.95 F.O.D. 2" hose, 2 1/2" plastic pipe available (Write.)

**HYDRAULIC BARGAINS**

• Special purchase! Brand new hydraulic cylinder, 3 1/2" bore, 24" stroke, single acting. 9621 lbs. push. Rod diam. 1 3/8". List price \$45.95. SALE, \$27.95 F.O.D.  
• 2-way Cyl. 3" bore, 6" stroke. Ppd. \$14.95  
• Hyd. Valve for 1 & 2-way cyl. Ppd. \$12.95  
• Hyd. Pump, 1000 psi 12 g.p.m. Ppd. \$48.90  
• Hyd. Gauge, 1000, 1500, 3000 psi (Specify) Ppd. \$3.40  
Many hydraulic bargains in catalog.

**SPECIAL OF THE MONTH!**

**CENTRIFUGAL BLOWER with BUILT-IN MOTOR**



• Brand new, motor and blower in a single self-contained unit. Ideal for heating, ventilating and air conditioning uses.  
• 115-v, 60-c motor integral mounted with double inlet blower wheel. Displaces 725 cfm at 800 rpm, 7" diameter blower wheel. Outlet 7 1/2"x9 1/2". Overall dim. 13"x10 1/2"x12 1/2". Wt. 23 lbs. List price \$40.75. SALE, \$24.95 F.O.D.

**ARMY POWER PLANTS**

Amazing buys. Fully guaranteed.  
• 1000-w, 115v, 60-c, \$179.50 Ppd. • 2000-w, 115v, 60-c, \$269.95 Ppd. • 3000-w, 115v, 60-c, \$299.95 F.O.D. • 5000-w, 115v, 60-c, \$487.50 F.O.D.  
• G.E. Generator 3000-w, 115v, DC. Fine for portable tools. \$49.71 F.O.D.  
Many other plants, generators. Get catalog.

**AIR COMPRESSORS, TANKS, PARTS**

• Stainless steel tank, 12"x24". Capacity 2160 cu. in. 400 psi. 3/4" pipe thread ports. Brand new. Cost Govt. over \$40. Shipping wt. 19 lbs. SALE, \$16.95 F.O.D.  
• Compressor, 1 cyl. 2.80 cfm \$19.95 Ppd.  
• Compressor, 2 cyl. 10.4 cfm \$49.95 Ppd.  
• Gauges 60 to 300 psi (Specify) \$1.89 Ppd.  
• Pres. Regulator 0-250 psi... \$3.29 Ppd.  
• Air Kit, complete... \$39.49 F.O.D.  
Also puna hose, fittings, switches. Get catalog.  
ORDER FROM AD or write for big new FREE CATALOG tremendous savings. We say frt. except where FOB.  
**BURDEN SALES COMPANY**  
807 '40' ST., LINCOLN, NEBRASKA

**DUAL RATIO, BATTERY GEAR MOTOR**

• Powerful ball-bearing reversible gear reduction motor. Operates on 4 or 12-v batteries. Has 2 output shafts. Shaft 1, 80 to 1 reduction. Shaft 2, 40 to 1 reduction. Precision machined steel gears.  
• Use for children's autos, winches, elevators, garage door closers, etc. Available r.p.m. at 6v, 60 and 120; at 12v, 124 and 248.  
• Shafts 3/4" and 5/8" diam. Overall dim. 5 1/2"x9"x12". Net wt. 10 lbs. Cost Govt. \$145. SALE, \$14.50 F.O.D.

**ELECTRIC WINCH 6-12 VOLT DC**

• Powerful, fully reversible, all ball-bearing gear reduction winch. Tugs from car, truck or boat battery.  
• Load capacity 1000-lbs. at 6v, 2000-lbs. at 12v. Holds 40' of 3/4" cable. Cable speed 8 to 10 ft. per min.  
• Cuts truck loading time in half. For wagon dumps, machinery hoist, on heaps, cars to pull out of mud, etc. Dim. 7"x9"x17 1/2". Net wt. 40 lbs. Govt. cost \$280. SALE, \$46.75 F.O.D.

**CLEANS  
IN SECONDS**



**PAINT BRUSH AND ROLLER CLEANER**  
Cleans in seconds — keeps 'em like new. Switch from one color to another in 33 seconds. Re-usable — keeps original strength! ONLY 69¢ FT.  
AT HARDWARE & DEPARTMENT STORES



**★ FRAME KITS ★**  
PLANS and PATTERNS  
Runabouts, Utilities, Cruisers  
Inboard & Outboard  
especially for the amateur builder  
27 MODERN DESIGNS  
Large new illustrated Catalog 50¢  
**CULVER CRAFT, Box 381P, Downey, Calif.**

**HELPFUL BOOKS**

Send post card asking for FREE catalog  
Popular Mechanics Press, 200 E. Ontario, Dept. 601, Chicago 11



You get 'em all...  
**BEAUTY — FUN  
— CONVENIENCE  
— ECONOMY**  
with the  
**ALL-NEW**  
**Cushman ROAD KING**  
Years ahead body styling. Two-tone colors. Ruggedly built. Greater comfort, riding ease. Cushman Husky 4-cycle engine. Up to 50 miles per hour, 100 miles per gallon. Ride it anywhere, everywhere for just 3/4 cent per mile.  
• Sold and serviced nationally; replacement parts available immediately  
• Ask your Cushman dealer for FREE demonstration  
• Dealer inquiries invited.  
**Write for new FREE booklet today**  
**CUSHMAN MOTOR WORKS, INC.**  
909 No. 21st, Lincoln, Nebraska

Works in seconds!  
**Loosens Rusted Bolts  
nuts, screws, "frozen" parts!**  
**LIQUID WRENCH**  
The super-penetrating rust solvent that quickly loosens rust and corrosion.  
3 oz. CAN 30c  
AT HARDWARE STORES, GARAGES SERVICE STATIONS, EVERYWHERE  
**RADIATOR SPECIALTY CO.**  
Charlotte, N. C.

**UP'IN.IN OUTBOARD MOTOR MOUNT**  
**HEAVY DUTY**  
WILL RAISE OR LOWER MOTOR  
SWING MOTOR IN BOAT FOR EASY SERVICING  
**\$95.00**  
SEE YOUR DEALER OR WRITE DIRECT TO  
**Standard Pattern Co.**  
610 E. DeWald St.  
**FORT WAYNE, INDIANA**  
POPULAR MECHANICS

# LUFKIN

## MICROMETERS

### With NEW CAM LOCK

#### LOCK EASIER FASTER

#### MORE SECURELY

Now, you can lock faster, more securely with just a flick of the thumb. This new cam-action lock positively secures the thimble from movement until the reading is made or transferred. An exclusive new feature, available only on Lufkin Big Barrel Micrometers.



BUY **LUFKIN** TAPES • RULES • PRECISION TOOLS 396  
AT YOUR HARDWARE OR TOOL STORE

BETTER MEASURE WITH **LUFKIN**

THE LUFKIN RULE CO., SAGINAW, MICHIGAN

## Easy Access To Photo Paper

Photographers who dispense printing paper directly from the envelope in which it is purchased can simplify the job by cutting the open end of the outer envelope to the shape shown. This will make it easier to reinsert the inner envelope in the outer one after removing paper in the dark.



## Hose as Stop on Drill Press

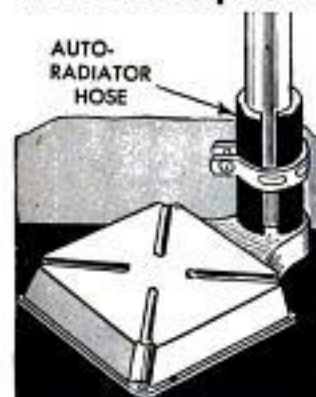

Using a piece of radiator hose on a floor-type drill press, as indicated, will prevent any possibility of injury to your foot if the table is dropped accidentally. Slit the hose to get it in place and then clamp it securely.

# FREE PLAN

## Tells How to Start Your Own Business

# FILING SAWS



Saws come  
from 20 and  
30 miles

Files Thousands of Saws  
in Spare Time

"I rented a two-car garage and have all the work I can do. Some days I start 6:30 in the morning. I get work 20 and 30 miles from my place of business."  
—Charles H. Smith

"I have done 4 or 5 thousand saws in my spare time in the 4½ years since I got the outfit, and they are all coming back with repeat orders."  
—Len Crego.

## FOLEY FILED SAWS BRING NEW CUSTOMERS

Here is a steady repeat CASH business that pays up to \$3 to \$5 an hour, and you can start in your own basement or garage in your spare time. Every saw you sharpen with the machine accuracy of the Foley Saw Filer is an ad that brings more customers. S. M. Hollingshead wrote to us: "I am doing very well with my Foley Filer, and I am glad I invested in your machinery. It is very satisfactory and works very well in the small community in which I live."

You can file all hand saws, also band and crosscut circular saws on the Foley Saw Filer. The adjustments are simple—there is no eyestrain—and you can start right away to turn out perfect cutting saws. "The first saw I sharpened with my Foley Saw Filer came out 100%. I think it is a marvel of perfection."  
—writes Clarence E. Parsons.

"**MONEY MAKING FACTS**" explains how you can get business from hardware stores, home owners, farmers, carpenters, schools, mills, factories, etc. Just think—with a modest investment, no overhead, no stock of goods to carry, you can start right in on a cash business that will help pay the rent, buy groceries, or a new car. Get the facts—send coupon today for this practical, money making plan. No salesman will call.



### Send for FREE BOOK

FOLEY MFG. CO., 516-7 Foley Bldg.,  
Minneapolis 18, Minn.

Send me free book "MONEY MAKING FACTS"

Name \_\_\_\_\_

Address \_\_\_\_\_

## 24 Drilling Combinations with Parker No. 4 Wood Screw COUNTERSINK BIT SET

**Parker** COUNTERSINK BITS  
No. 4 for WOOD SCREWS

*For all classes of soft, well-seasoned hard woods*

Drills and Countersinks  
2 depths for flush or recessed screws  
— in 1 operation —  
4 bits for the 8 most popular  
screw sizes

Automatic stop  
adjusts to 3 depths

TO ADJUST STOP  
Press spring and slide the stop to one of the three marks on the bit shank. Stop holds automatically.

PARKER MANUFACTURING CO.  
WORCESTER 1, MASS., U.S.A.

Drills and countersinks to flush, putty or plug depths for 8 most popular screw sizes. Depth-a-dapter adjusts easily on all 4 bits.

At your  
hardware  
Dealer's  
Only  
**\$1.70**  
per set

**PARKER MANUFACTURING CO.**  
WORCESTER 1, MASS., U.S.A.

Get your free copy now!

### HOW TO PROTECT THE NATURAL BEAUTY OF EXTERIOR REDWOOD



An informative, factual guide to applying finishes to all redwood and other types of exterior woodwork. Written by experts at McCloskey's—one of the nation's oldest varnish manufacturers.

McCloskey Lumber Life—a lasting, natural exterior finish that shields against fading and weathering. One of the few finishes approved by leading lumber associations after testing more than 260 exterior finishing systems.

**McCLOSKEY VARNISH CO.**  
7600 State Road, Philadelphia 36, Pa.

Name \_\_\_\_\_  
Street & No. \_\_\_\_\_  
City and State \_\_\_\_\_  
(I buy my paint from this store)  
(store is located at this address)

MAIL THIS COUPON

**SOLVE YOUR STORAGE PROBLEM**

With TURNBUCKLES Perforated Board fixtures you can easily end space-wasting clutter and keep everything neatly in place until needed.

TURNBUCKLES do-it-yourself fixtures come in a wide variety of shapes and sizes... fit easily into any wall-hung perforated board... and hold everything from clothing and kitchen utensils to hand tools and garden equipment.

**TURNBUCKLES, INC.**  
BOX 333, MICHIGAN CITY, IND.

Send for your free copy of space saving suggestions for home, farm and workshop.

65

## DO EVERY FASTENING JOB 10 TIMES FASTER!

Amazing one-hand operation, 10 times faster than hammer & nails. Can't jam.



At your local hardware dealer or lumber yard

**ARROW**  
DO-IT-YOURSELF  
TACKER, No. T-50  
for ceiling tile, insulation, wire fence & every home job

Arrow Fastener Co., Inc., 1 Junius St., Brooklyn, N. Y.

## "MOLDED FIBER GLASS" BOAT



Write for free literature.  
**MOLDED FIBER GLASS  
BOAT COMPANY**  
71 Fourth Ave., Union City, Pa.

... only boat in the world with popular lapstrake design molded right into one-piece seamless hull, with matched metal dies. Tough, fast, smooth, beautiful. Mahogany-trimmed. Three 15' 7" models, priced from \$495.

## Wholesale! TOOLS! GUNS! CAMERAS!

AGENTS — BUY TOOLS, PHOTO EQUIP., SPORTING GOODS, JEWELRY AND THOUSANDS OTHER NATIONALLY ADVERTISED PRODUCTS AT BIG DISCOUNTS. BIG PROFITS SELLING TO OTHERS.

POSTCARD BRINGS FREE COPY "THE WHOLESALE PLAN!"

**AMERICAN BUYERS SERVICE**

Get up to  
**40% off**

HERTEL STATION, DEPT. 15, BUFFALO 16, NEW YORK

## \$40 for 1 1/2 DAY'S SPARE TIME WORK GRINDING LAWNMOWERS

Yes, J. H. B. writes, "not bad for a 76 year old young fellow earning \$40 for a day and a half's work" . . . and others are making even bigger money with the Universal Model B Lawnmower Grinder. You, too can make good spare or full time profits in your own business in your garage or basement. We furnish everything you need. Write today. No cost or obligation. Dept. M-57



**ROGERS**  
MANUFACTURING CO.  
LINDSEY, OHIO

## Easy-to-Read EMPIRE Levels

Make Your Jobs Easier to Do

Exclusive Magnified Crystal Vision, free of shadows and reflections, makes Empire three times easier to read than other levels. Shock-absorbing mounts prevent damage by accidental fall. Unmovable adjustment guarantees accuracy. It's today's big buy in levels . . .

**ACT NOW! 10% Discount  
INTRODUCTORY OFFER**  
expires July 1st

No. 152M,  
magnesium, 78" . . . **\$24**  
No. 152M,  
magnesium, 48" . . . **\$14**  
No. 152M,  
magnesium, 28" . . . **\$9**  
No. 152M,  
magnesium, 24" . . . **\$8**

ORDER DIRECT  
Send check or money order!

Dept. PM

**EMPIRE LEVEL MFG. CO.** 10930 W. Potter Road  
Milwaukee 13, Wis.



## • BUILD YOUR OWN FANS •

Motor & Fan Blade Combinations For Stand Fans, Room Coolers—Windows, Evaporative Coolers, Etc. Motors all 110 V. 50/60 cy. 1500 rpm. Fan Duty.  
10 in. 800 cfm Blade & Motor . . . **FREE GUARD**  
. . . \$5.50; 12 in. 900 cfm Blade & Motor . . .  
**FREE GUARD** . . . \$7.50; 16 in. 1700 cfm Blade  
& Motor, \$11.50. Guard \$3.50; 20 in. 2500  
cfm Blade & Motor, \$13.50. Guard \$4.50.

ALL ITEMS SHIPPED PREPAID  
FREE FAN CIRCULAR listing Fan Kits, Motors,  
Timers, Thermostats, Shutters, etc., etc.

C. MARSHALL SALES, 3546 Fullerton Ave., Dept. P-5, CHICAGO 47



Buy nationally advertised products.  
Ask with confidence for the brands  
advertised in POPULAR MECHANICS

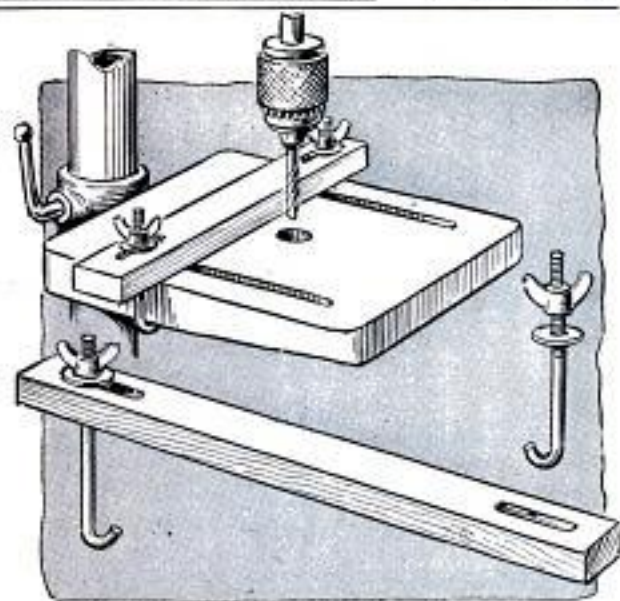

## Quickly Made Hardwood Fence For Drill Press or Bandsaw

Requiring only a few minutes to make, this hardwood fence is a useful accessory for drill press or bandsaw. It has two slots to accommodate J-bolts which hook under the edges of the table of either tool. Fences such as this are ideal for guiding work when router bits or sanding drums are used in a drill press.

MAY 1957

# arc welding PAYS BIG!

This "easy to own"  
**LOW COST**

200 amp. air-cooled engine  
drive arc welder  
welds ANYWHERE!



"Husky Boy"

## CASH IN on the increasing demand for emergency repair and construction work



AC Power-  
AC Welder  
Combination

**WELD ANYWHERE.** Double your earnings doing construction and emergency repair work. Big and constant demand for this type of welding service. Any one of these low cost, high efficiency Hobart Welders puts you in business.

### INVESTIGATE these money makers TODAY!



AC Transformer

"HUSKY BOY," 200 amp., rugged, compact—easily mounts on your truck or trailer.

**200 AMP. AC WELDER-AC POWER COMBINATION** weld or run tools, lights, motors, etc.

**TRANSFORMER TYPE AC WELDER,** 200 amp., for production and repair work in shops having only single phase power.



"Bantam  
Champ"

"BANTAM CHAMP," 250 amp. electric motor driven welder for general shop use.

Mail coupon today for further details  
**HOBART BROTHERS COMPANY, Box M-57  
TROY, OHIO** PHONE FE 21223

### Valuable Welding Lessons Book

200 pages fully illustrated, complete with charts and diagrams. Self teaching... only **\$1.00**

**HOBART** Use the Coupon!  
"one of the world's largest builders of  
arc welding equipment."

Hobart Brothers Co., Box M-57, Troy, Ohio

Please send additional information on items checked.

- "Husky Boy"  AC Power-AC Welding  
 AC Transformer  "Bantam Champ"  
 WELDING LESSONS BOOK—\$1.00  
 Cash herewith  Send C.O.D.

**free!**

Welder's  
Vest Pocket  
Guide

Name \_\_\_\_\_

Address \_\_\_\_\_

City \_\_\_\_\_

State \_\_\_\_\_

**Holt's HAVE THE ANSWER!**

HOLT'S ORIGINAL  
**Piston Seal**  
*it's Easy*  
 \$4.95 Tube for most cars

does help in  
**6**  
 important ways

- 1 - reduces oil consumption
- 2 - restores compression
- 3 - stops piston slap
- 4 - increases miles per gallon
- 5 - improves performance
- 6 - makes engine quieter

20 years on the market. No one else can claim this. Effective interim treatment for worn cylinders. Forms self-lubricating seal around pistons. Lasts for thousands of miles. Get yours NOW. Delay is costly.

Ask for Piston Seal at nearest garage or auto store . . . or

**TREGLOWN CO., Inc.**  
 Fanwood 128, N. J.  
 ® TRADE MARK REGD.

*Write for full details*

**"DO IT YOURSELF"**  
 IT'S EASY WITH  
**KESTER SOLDER**

Soldering's really a "cinch" . . . when you use time-tested, reliable KESTER . . . available everywhere.

**FREE!** "Soldering Simplified" . . . 16-page how-to-solder booklet. At your dealer or write direct.

**KESTER SOLDER COMPANY**  
 4251 Wrightwood Avenue Chicago 39, Illinois

**FREE WHOLESALE CATALOG** *get up to 50% off*

**MAKE MONEY!! SAVE MONEY!!**  
 Buy Tools, Hardware, appliances, photo equipment, sporting goods, power tools, paints and thousands of other nationally advertised products at WHOLESALE COST TO YOU.

**"SEND FOR FREE 1957 WHOLESALE CATALOG TODAY"**  
**SILVO HARDWARE COMPANY**  
 Dept. PM 5, P. O. Box 266, Philadelphia 5, Pa.

don't say glue . . . say "Yoo-Hoo"

**UHU®** **GLUES EVERYTHING BETTER!**

At variety, hardware, magazine & newspaper stores



# You Support Yourself And Your Community

When You Repair,  
 Repaint or  
 Remodel Your Home

May has been designated by President Eisenhower as "Better Your Living Month." Support this nationwide campaign by starting necessary home improvements now!

# WAR SURPLUS AND OTHER BARGAINS SAVE UP TO 90%

## BENDIX PUMP & MOTOR

Can be used for pumping fuel, oil or where ever hydraulic pressure is required. Pump has 1" connections, built-in relief valve, adjustable up to 1500 lbs. Max. capacity 6 GPM. 1 1/2 H.P., 24 volt motor, 4000 RPM. Can be used on 12 to 36 volts. Approx. GOVT. COST \$350. NEW — \$10.95.



**140-1 REDUCTION GEAR** Make your own winches, hoists, wagon unloaders, stump pullers or fence stretcher. Sturdy aircraft quality. Built-in removable 24 Volt DC motor & clutch. High torque. Low speed. 100's of uses. Wt. 42 lbs. Approx. GOVT. COST \$300. Like NEW. Only \$12.95. 225-1 Reduction Gear, same as above — \$13.50.



**ARC WELDER KIT \$27.95** — build your own complete make-up package consisting of 1 Aircraft DC Generator, Electric Arc-Lite, 160-240 Amperes, 24 Volt. RPM from 2600 up. 1 Rheostat, 1 Giant Toggle Switch, 1 Ammeter, 1 Shunt, 0 to 240 Amperes, 1 Voltmeter, 0 to 30 Volts, 1 Electrode Holder, 1 Welder's Shield, 1 Voltage Regulator. Wiring diagram for hookup as welder. Wt. under 100 lbs. Approx. GOVT. COST \$475. Like new, perfect . . . \$27.95.



DC Generator (only) — same as above . . . if purchased separately: \$12.50.

**R1 GENERATOR KIT** Jack & Heintz or GE. Rated 300 Amps. 24-32 Volts. With same items as above incl. 300 Amp Ammeter. Approx. GOVT. COST for kit \$600. Complete kit only \$39.95. Wt. 60 lbs.

**HEAVY-DUTY RHEOSTAT** Designed for heavy-duty use with Air Force heated suits. Ideal for regulating voltage on electric welders, model trains, lights, generators; controls soldering irons, etc. Rated 5-75 ohms, 100 watts with double windings and dual female 25 amp, 125 volt receptacles. Size: 7" H x 5 1/4" W x 1 3/4" D. Shpg. Wt. 2 1/2 lbs. Approx. GOVT. COST \$25. Brand new, only \$1.95.



**DUPONT EXPLOSIVE RIVETS!** A must for the man who works with sheet metal. A hot soldering iron placed on the head of the rivet will explode and mushroom the other end of the rivet self-locking itself. 1/8" - 5/32" - 3/16". Round and flat heads. Approx. GOVT. COST \$50.00 a 1,000. NEW. 1,000 assorted, \$5.00 pzd.

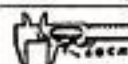

## "HELIOS" ORIGINAL TOOLMAKERS VERNIER CALIPERS

**ULTRAPRECISION** — Imported. Used by machinists at Lockheed, Douglas, Bendix, GM, RCA, GE. Model 51/2E. Genuine Helios. Hardened lapped precision surfaces. 1/1000" and 1/128" graduations. Handy slide roll and thumb lock. Quick, accurate depth. A \$35 value. Be Luxe finish. ALL NEW. Just \$6.95. Leather carrying case, \$1 extra.



## PRECISION GROUND SQUARES

Production engineer's squares. Accuracy guaranteed. Mfg. by Wright & Moore, Sheffield, England. Square blades, hardened & tempered. BRAND NEW. Fraction of original cost. 2" — \$2.75. 3" — \$3. 4" — \$3.25. 6" — \$3.75. 8" — \$7. 12" — \$9.95.



## LONG FLUTE, HIGH SPEED DRILLS

20 assorted, numbers & fractions. Like NEW. Approx. GOVT. COST \$30. Only \$3.00 pzd.

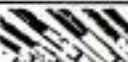

## HIGH SPEED HAND TAPS

10 assorted, precision-ground thread. National mfr. Like NEW. Up to 1/2". Approx. GOVT. COST \$25. Now \$2.50 pzd.

## NEW! BIG CATALOG

Send 25c for your copy. Postpaid prices in U.S.A. only. Other prices F.O.B., Culver City, Calif. Send check, cash or money order. 50% deposit required for C.O.D. orders.

**AIRBORNE SALES CO., INC. DEPT. PM 557**  
8501 Stellar Drive, Culver City, Calif.

## MONEY MEN ALL FREE

THE PLASTEX Industry needs manufacturers on small scale and for big production of Lamp and Clock Stands, Art Goods and Novelties in Plastex and Marble imitation. Experience unnecessary. The material makes regular 10c store sellers. Rubber moulds furnished for speed production. Small investment brings good returns. We are now placing big Chain Store Orders with manufacturers. Ambitious men have chance for real prosperity. Our Free booklet will interest and benefit you.

**PLASTEX INDUSTRIES, Dept. A**  
3400 Third Ave. New York 88, N. Y.

## BUILD A BOAT AT 1/3 THE COST!



with CLEVELAND'S full size, cut-to-shape boat patterns, detailed blueprints, and specifications. All classes and styles of modern Naval Architect-designed boats from 1 1/2

to 38 ft. **BIG NEW 86-PAGE ILLUSTRATED CATALOG**, 50c (incl.). "How to Build a Boat" Booklet, \$2.50. Hardware & Equipment catalog, \$1.50.

**CLEVELAND BOAT BLUEPRINT CO.**  
Dept. A-166 Box 1851 Cleveland, Ohio



## REMODEL YOUR KITCHEN OR BATH WITH A TRADE-WIND VENTILATOR

ELIMINATES HEAT, ODORS, GREASE . . . ADDS LASTING BEAUTY

It's easy to install a Trade-Wind Ventilator in a cabinet over the stove or in the ceiling in the kitchen or bath. Highest rated dual centrifugal blowers whisk away fumes and odors — you can even slice onions without crying! Choice of 3 hoods in copper and stainless steel, pre-wired with switch and light, ready to install in your kitchen. Also 6 top performance ventilators for kitchen, bath, laundry, workroom. Complete instructions with each unit.



MAIL COUPON NOW FOR FULL INFORMATION

Trade-Wind Motorfans, Inc.  
7755 Paramount Blvd., Dept. PM, Rivera, Calif.  
Please send full color brochure on Trade-Wind equipment.

Name \_\_\_\_\_  
Address \_\_\_\_\_

## SUPERIOR PERFORMANCE



You can rely on Gerstner Chests to provide proper care for your precision tools. Free Catalog to machinists and toolmakers.

## GERSTNER TOOL CHESTS

457 Columbia St., Dayton 7, Ohio



## SAVE 60% ON SAW BLADE COST

WITH HEINEMANN'S **HARD-TIP SAWS**

HEINEMANN SAWS  
STA. B, CANTON, OHIO

## HOLD-F-ZEE®

the Original AUTOMATIC GRIP SCREWDRIVERS



FINEST MATERIALS AND WORKMANSHIP

LOK-BLOK® makes blade twist and impact proof.  
GRIPPER recedes deep into handle, giving full blade use.  
SPECIAL BIT fits both types cross-point screws.

—YET COST NO MORE THAN ORDINARY SCREWDRIVERS!

At Leading Dealers Everywhere

UPSON BROS., INC., ROCHESTER 14, N. Y.

# MODERN

## IMPROVED LAWN MOWER SHARPENER AND BED KNIFE GRINDER

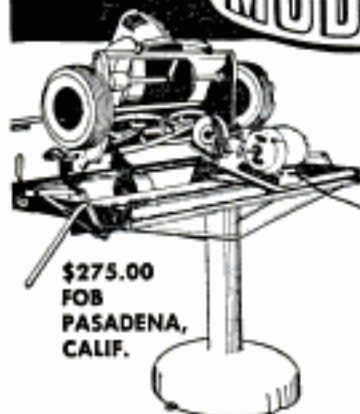

\$275.00  
FOB  
PASADENA,  
CALIF.

Grinds any reel type mower. Hollow grinds or flat grinds bed knives. New micro feed grinding head. Sharpens hand and power mowers. No disassembly of wheels, roller, handle or gasoline engine. No draining of gasoline or oil. Precision sharpens more mowers per hour. Costs less. Compare before you buy. If it isn't a MODERN it can't be MODERN.

WRITE FOR FREE BOOKLET 10A

The Modern Lapping Machine is designed to fit the needs of any large user of mowers and the lawn mower shops. Laps any reel type mower. 1/2 H.P. motor, \$67.95 fob, Pasadena, Calif.



MODERN MFG. CO., 160 N. FAIR OAKS, PASADENA, CALIFORNIA

## Handy Nail Guide

HELPS YOU

SAVE TIME AND MONEY

- Tells right nail for each job
- Tells amount of nails per pound
- Tells right hammer to use



YOURS FOR JUST 10¢ Send coin direct to Estwing

Estwing

UNBREAKABLE TOOLS

CHOICE OF  
CRAFTSMEN  
FOR 30 YEARS



ESTWING MFG. CO., DEPT. PM-2, ROCKFORD, ILLINOIS

## Jet King

POCKET-SIZE

# BUTANE BLOW TORCH

SOLDERS!  
BRAZES!  
FIXES LEAKS!



ONLY  
**\$1.95**  
WITH CHARGER

Every do-it-yourself and hobby fan needs this Kidde JET KING butane Blow Torch. Just the tool you've been looking for to do dozens of jobs in home or hobby...TV, appliance, lamp, radio or plumbing repairs...precision soldering, brazing or metal craft. Useful, too, for starting charcoal fires. A tiny, clean, safe charger does the job.

Each charger gives 30 minutes of intense 3500° pinpoint flame; turns on and off. Extra chargers, 39¢ per box of 2. Money back guarantee. At leading hardware and hobby stores...or send check or money order, we pay postage.

## Kidde

KIDDE MANUFACTURING CO., INC.  
Dept. PM-5  
42 Farrand Street, Bloomfield, N. J.

Please send me \_\_\_\_\_ JET KING BLOW TORCHES plus:

\_\_\_\_\_ boxes extra chargers (limit 2 boxes per torch).

My check , money order  for \$\_\_\_\_\_ is enclosed.

Name \_\_\_\_\_

Street \_\_\_\_\_

City \_\_\_\_\_

State \_\_\_\_\_

## DRILL-IT—THREAD-IT—BOLT-IT

New kit idea simplifies threading. you order by bolt size. you receive a tube containing drill and tap inside and the correct size of drill, tap, die and bolt printed on the outside. Handles not included. Here are a few 3/16—\$2.89. 1/4—\$2.99. 5/16—\$3.69. Die \$2.00 extra. Or order empty cartons at \$1.00 each and have filled at hardware. Write complete list. Specify no or ni.

V. FAUSTINE WELDING, 1838 High St., Erie, Penna.



Lowest Cost  
RIDING CRAWLER  
In U. S. \$895

## LAYTRAC RIDING CRAWLER

OUTWORKS ANY TRACTOR ITS SIZE

MORE POWER—MORE TRACTION!

Laytrac works where others bog down! No slipping, drifting, tipping on slopes. Rugged, easy to operate. Big tractor quality! Borg-Warner 3-speed and reverse trans., cone clutch steering, 925 lbs. including blade. Floating drawbar. PTO. Guaranteed. Accessories available. At dealers or direct. Write for literature.

LAYTRAC, 2548A Airport Way, Seattle 4, Wn.

BUILD  
YOUR  
OWN

## ARC-WELDER

WE SHOW YOU HOW to build powerful D.C. Welders from surplus aircraft generator. Light or heavy work. Easy to build at low cost. Worth hundreds of dollars. PLANS 35c. SEND TODAY. Includes FREE Surplus, Welder, Electrical catalogs.



LEJAY MFG. CO., 2907 EMERSON AVE. 50., MINNEAPOLIS, MINN.

DOES YOUR WATER RUN SLOW?



See Why  
**BURKS  
PUMPS**

DELIVER FULL PRESSURE

DECATUR PUMP CO., 61H ELK ST., DECATUR, ILL.



The Modern PLASTIC  
for lasting Home Repairs

PERMANENTLY mends cracks or holes in wood, tile, stone or plaster. Sticks and stays put—Does not chip, shrink or fall out. Easy to use. Economical. Mold it, chisel it, polish or paint it. The big 4-lb. can is obtainable from your lumber, paint or hardware dealer at \$1.25; or will be shipped direct postpaid (in U. S.) for \$1.50. Complete satisfaction guaranteed or your money refunded.

DONALD DURHAM CO.  
Box 804-T Des Moines, Iowa



**WOLVERINE GLOVES**

NOW,  
**TOUGH  
GLOVES**  
*made even  
tougher!*



Longest wear gloves made. Tough vinyl plastic on Super-Soft Wolverine Pigskin. Waterproof. Resist acids. Stand up under rough abrasive wear. Cost less per day.

*feel that tanned-in softness*

rockford, michigan

**Drive with Confidence**

**DINSMORE Auto Compasses**

Shows you the right way—the short cuts. Saves time, money. Write for new compass history folder, "Pants—Knives—Compasses," and name of nearest dealer.

DINSMORE INSTRUMENT CO., 1802-29 Kelso St., Flint 1, Mich.



ONLY COMPASS  
APPROVED BY  
AUTO MAKERS

**BEWARE**

of cleaners that leave paint brushes limp and flabby. Use safe, fast-acting **IMPERIAL Rapid Brush Cleaner**.

At paint and hardware stores.

Wilson-Imperial Company, 119 Chestnut St., Newark 5, N. J.



**PORTABLE POWER**

**Winco®**

**POWER-TAKE-OFF  
GENERATOR**

Electric Power to run welders, tools, lights and vital household equipment when power lines are down. Inexpensive. Convenient. Write for facts on Winco 10,000-watt or 6,500-watt models.

Write Dept. PM-57



**WINCHARGER CORPORATION**  
SIOUX CITY, IOWA  
Subsidiary of Zenith Radio Corporation

**HAVE FUN!**

**SAVE  
MONEY**



**TRY SUPERSHOP FREE  
Factory To You — \$79.95**

Think of the fun you'll have and the money you'll save with your own big capacity workshop. Picture yourself sawing with the 8" ball bearing saw. Or drilling in steel with the vertical drill press. You bore with the horizontal drill — exclusive with SUPERSHOP. You sand with the 3" disc sander. You turn with the 30" lathe. You sharpen tools on the 5" grinder.



**VERTICAL  
DRILL PRESS**

You are invited to **TRY SUPERSHOP FREE**. We will pay all shipping expense. Write for full details of this amazing **FREE TRIAL PLAN**. Mail postcard now.

**POWER TOOLS INC.**

195 Yates Ave.  
Beloit, Wisc.

**SUPREME  
Versamatic**

**REVERSIBLE SCREW DRIVER  
AND SPEED REDUCER**



fits all  
power  
drills

**First time ever! It REVERSES!**



Drive and remove screws with Supreme Versamatic. Versamatic reduces speed 7 to 1, increases power 7-fold. Reverses with one twist. Handles even the largest screws with ease. Also for nut running (adapter furnished); tapping; and all heavy duty drilling where speed reduction is needed. Fingertip control means safe, fast work. Complete set \$14.95.

( $\frac{1}{2}$ " chuck extra). At hardware stores or direct from

**SUPREME PRODUCTS Corp., 2222 S. Calumet, Chicago 16**



Just pull the trigger...  
**spray paint!**

The easier, better way to paint! Job's done in minutes. Finish is smooth, flawless. Speedy Sprayer is a real professional tool, favorite of craftsmen for over 35 years! At stores everywhere. 890 Outfit, including gun, hose, less motor, only \$39.95



**Speedy Sprayer** Wheel it to the job!

**FREE!** "How to Spray" booklet and literature. Write!

WHEEL KIT \$7.50 EXTRA

W. R. BROWN CORP., 2635 N. Normandy, Chicago 35

**DO-IT-YOURSELF**  
WITH

**REDI-RODS®**  
**STEEL BARS**



**COLD DRAWN ROUNDS**      **HOT ROLLED FLATS ANGLES**

Use these handy steel bars for your repair and construction jobs around farm and home.  
**ROUNDS:** 36" long— $\frac{1}{4}$ " to  $\frac{3}{4}$ " diam.  
**FLATS:** 36" long,  $\frac{1}{8}$ " x  $\frac{3}{4}$ ", 1" & 1 $\frac{1}{4}$ " wide.  
**ANGLES:**  $\frac{1}{8}$ " x 1 $\frac{1}{4}$ " x 1 $\frac{1}{4}$ ", in 36", 48", and 60" lengths.

5330 Indianapolis Blvd.  
**REDI-BOLT, Inc.** East Chicago, Indiana

**NOW... at Your Hardware Store!**

**WILHOLD®**  
**WATERPROOF GLUE**



- full bodied
- easier to use
- sure to hold
- requires less pressure

Exceeds D.F.P.A. and MIL-A397A for class 1 Waterproof Adhesive

Paint, Hardware, Lumber, Marine Supply Dealers

**WILHOLD PRODUCTS CO.**

ALWAYS DEPENDABLE

T.M. Reg.

Los Angeles 31, Calif.; Chicago 44, Ill.

**Do-It-Yourself WHEELS**



For Homecraft, Replacement, Repair 6-, 8-, 10- and 12-inch dia. wheels to build and repair mowers, barrows, carts, toys, garden and home eqpt. Sturdy steel hubs, rubber tires, ball bearings. Write for Free Plan Book.



GLEASON CORP. • 286 North 12th Street., Milwaukee 3, Wis.



**ELECTRIC WELDER**

AC or DC 110 Volts

The "Little Marvel" all-metal welder, 5-year written guarantee. Welds  $\frac{1}{8}$ " metal or money bark. Repairs tanks, tools, fenders, machine parts, etc. Complete with everything—rods, unit, eye shield, directions. \$7.95 plus 50c postage. Flame torch accessory for soldering, cutting, brazing \$3.95 complete with carbons, brass rods, flux. \$2.00 Deposit on C.O.D. 75 ampere  $\frac{1}{4}$  inch Transformer Welder \$24.95 F.O.B.

**\$795** Complete

ESSAY MFG. CO., Dept. 51, Quincy 69, Mass.

**Print Your Own**



Cards, stationery, circulars, etc. Save money. Print for Others, Good Profit; easy rules sent. Raised Printing like engraving, too. Junior press \$15; Senior \$29 up. Sold direct from factory only. We furnish everything. Write for free details. **KELSEY PRESSES, Y-37 Meriden, Connecticut**

**Enjoy RUNNING WATER at LOW COST**

Buy Water System Direct from Factory & SAVE



DuraBronze System costs little, gives "city water" service. No more hand pumping! Only minutes to install. Pumps 275 G.P.M. Draws from 25' well. Fully automatic, 20-40 lbs. Bronze pump, plastic lined galv. tank, pressure switch, air volume control, pressure gauge, bronze foot valve, bronze relief valve. Fitted for  $\frac{3}{4}$ " pipe,  $\frac{1}{2}$  HP. Only \$65.95 complete, or \$49.95 less motor.

Postpaid if cash with order. 1 Year Guarantee. Write and describe pump for over 60 years. **LABAWCO PUMPS, Belle Mead 8, New Jersey**

**NEW! 6" Chimney Fan**



No installation required. Just push into chimney flue and plug in. Kid kitchen, dark-room, cellar or office of smoke, fumes, odors, heat. Handsome chrome grill. Fully guaranteed for 1 year, 110 v. AC, 60 cycles.

Introductory price only \$15.95 postpaid.

Send Check or Money Order today. Dealer Inquiries Invited

Fargo Electric Co. • 257-X Niagara St. • Buffalo 1, N.Y.

**MAGNETS**  
PERMANENT ALNICO

- |  |        |
|--|--------|
| 10 Assorted Magnets.....                       | \$1.00 |
| Bulletin Board Magnets.. 10 for \$1.00; 50 for | \$3.95 |
| Hot Pad Magnets..... 12 for \$1.00; 50 for     | \$3.50 |
| Retrieving Magnets, 25 lb. pull.....           | \$3.85 |
| Retrieving Magnets, 60 lb. pull.....           | \$5.00 |
| Horseshoe Magnets, 8 lb. pull... 65c; 10 for   | \$5.00 |
| Rod Magnets, 5 pair (10 magnets).....          | \$2.00 |

Send M.O. or check. We pay postage. No C.O.D.

**HOLLYWOOD HOUSE OF MAGNETS**  
6912 HOLLYWOOD BLVD., HOLLYWOOD 28, CALIF.

# FORGED IRON BRACKETS

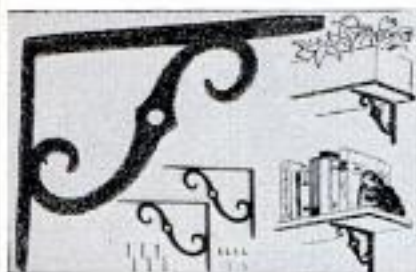

At last, an attractive shelf bracket artistically designed in authentic ornamental forged iron. Hundreds of uses inside and outside. Beautiful shelves can be yours in minutes.

—Ideal for window flower boxes or planters. Many practical ideas included with each pair. Free set of clips for glass shelves. Order now, each set complete with all forged square-head screws—Colonial Black finish. Size 6" x 4 1/2" only \$2.98 the pair. 8" x 6" only \$3.49 the pair, postpaid. FREE CATALOG. Satisfaction guaranteed or money back. Order from:

**CAR-ART SPECIALTY CO.**

P.O. Box 488

West Hartford 7, Conn.



the finest  
**WOOD SCRAPERS**

are

# Red Devil Tools.

**MAKE \$10-\$20 AN HOUR**

Full or part time, work anywhere.

Serrate and sharpen table, steak knives. Every restaurant, hotel, etc., repeat customers. Write today for proven daily profit plan. Guaranteed.

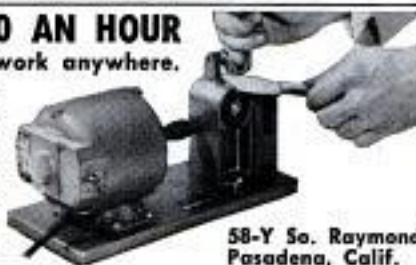

**CUTTER-CRAFT**

58-Y So. Raymond  
Pasadena, Calif.

ADD WATER

# SAKRETE

STIR

USE!

Build, remodel and repair the easy way . . . with SAKRETE, dry-mixed concrete and mortar in a bag. See your building supply dealer, lumber dealer or hardware store — today!



Look for the Bag with the Yellow Diamond!



## KING MIDGET

ALL NEW. First model change in six years. New bodies, new chassis, new engine. Four wheel hydraulic brakes. Still World's Lowest Priced Car. Drive it for 75c per week. Rider Agents Wanted. Earn your own car. Get the facts. Send 25c for 32 page picture book with complete details, dealers price, etc.

**MIDGET MOTORS CORPORATION, Athens 1, Ohio**



**3400 RPM - 1/2 HP POWER SAW**

**RIPS - CROSSCUTS**

**CUTS A FINISHED 2x4 LIKE A KNIFE THROUGH BUTTER**

COMPARES TO SAWS SELLING UP TO \$49.50 **1998** Complete with 5-1/2" Blade

A rugged, professional type, adjustable saw. Will cut any angle from 0 to 45°. Has an adjustable (0 to 6") rip fence. Safety-trigger switch on handle. Full 1/2 HP Universal AC-DC, 110-120 Volt, 60 cycle motor. Weighs only 6 1/2 lbs. Thousands already sold. Your satisfaction guaranteed.

**NEW EXTRA SAW BLADES** - Available in Rip, Crosscut **225** ea. or Combination. Please Specify.

**NEW DRILL DRIVEN BAND SAW**

Easily driven by any 1/4" electric drill or other similar power source. Has full 10" throat, cuts to center of a 20" board. Table tilts for angle or bevels. Drive pulleys are high impact phenolic and run on oilite bearings. 3/16" saw-steel blade. Oil-coat housing and many other fine features. Ideal for "do-it-yourself-ers". **1288**

**PHILIPPINE MAHOAGNY LUAN PLYWOOD**

For Paneling Decks, Offices, etc. Use in Cabinets, Furniture, etc. Rotary cut. Both sides sanded. Bonded with finest resin adhesive. Face side unjointed. Shipped at lowest rates.

**SAVE 50%**

**FREE SAMPLE ON REQUEST**

**3MM (1/8") x 3FT. x 6FT. \$500 VALUE PER SHEET MINIMUM ORDER 8 SHEETS 179**

**1/2" x 4FT x 8FT 950 VAL. MIN. ORDER 4 SHEETS 449**

**SAVE 50% ON TRANSLUCENT FIBERGLAS PANELS**

Ideal for the home or office and in new construction. Finest quality in many widths and lengths. A variety of colors to suit every taste. Send for a FREE SAMPLE and booklet. Worth 65c per sq. ft. **ONLY 49c**

**HEAVY WROUGHT IRON RATIO SUPPORTS**

Use them indoors or outdoors! Heavy 1-1/8", black, tubular supports with beautiful wrought iron filigree. 8 ft., high, 12" wide. Can be cut to 7 ft. You'll find many uses for this attractive item. Mtg. flanges included. **FLAT TYPE ... 995**

**CORNER TYPE ... 1795**

**NEW NAVY KNIFE**



Dogger design with laminated leather handle. Blade is 4-1/2" long, hollow ground on the cutting edge - double edged for 3-1/2" at the point. Ideal for skinning or hunting knives. Comes in a genuine leather bob holster. Overall length 11". **298**

**FINEST STEEL BAYONET**

Genuine infantryman's bayonet. Made of the very finest tool steel. Fluted sides and precision honed edge. Blade length is 17" long but many owners are having them ground to shorter lengths for diving and hunting knives. Comes complete with reinforced leather scabbard. **298**

**NEW 2 1/2 x 4 or 6x RIFLES**

**Only 995**

**WELDING MOUNT**

For **TARGET - BENCH REST** or **HUNTING**  
Positive Adjustments on Windage and Elevation - Top Quality **OPTICAL GLASS LENSES**, Hard Coated - Safe Eye Relief - Cross Hair Reticle - Lock-Tight Focus - Rust-proof Steel Barrel - **GUARANTEED** to perform on ANY RIFLE!! Specify type rifle and Model No. We will send proper mount.

**NEW ARMY CANTEEN & ISSUANCE CUP AND BELT**

A one quart canteen and aluminum cup fit into the insulated canvas cover. Choice of web type pistol belt or cartridge belt with pockets. The **229** canteen is new Korean War Surplus.

**NEW ALUMINUM MAGNIFIER**

His full 5 power magnification with brilliant illumination for precise, clear inspection of any substance or material. Holds two flashlight batteries. **349**

**WORLD'S MOST AMAZING CATALOG**

**396 PAGES OF BARGAINS**

NATIONALLY ADVERTISED MERCHANDISE - NEW and USED GOVERNMENT SURPLUS - FACTORY CLOSEOUTS and EXCITING IMPORTS!! From all these sources Polley's now bring you items of every description! This fabulous catalog contains Hand and Power Tools for industry as well as the home mechanic, Industrial and Building materials and supplies, Housewares, Clothing, Sporting Goods, Camping Equipment, Cameras, Photo Supplies, Hobby Kits & "Gadgets", Microscopes, Electrical Supplies and motors, A huge selection of Surplus Hydraulic Cylinders, Pumps, Valves, etc., and so many more items its impossible to list them all. You have to see it to believe it!

**Only 50c** Order Your Copy Today! We refund your 50c on your first order of \$1.00 or more.

**Polley's**  
2243 E. VERNON AVE. DEPT. P-2105, LOS ANGELES, 38, CALIF.



**FIX IT YOURSELF**

**WITH DEVCON THE PLASTIC STEEL**  
80% STEEL — 20% PLASTIC

... AS EASY TO USE AS MODELING CLAY

DEVCON, the mending marvel is simple to use, handles like putty ... hardens in 2 hours even under water ... no shrinkage ... bonds iron, steel, brass, aluminum, wood, glass, concrete, etc., to itself or each other. For home, farm, garage or marine use ... DEVCON fixes leaks, cracks and breaks in radiators, pipes, washing machines, cracked motor blocks, broken furniture ... just about any type of repair! DEVCON will save you hundreds of dollars on home fix-up jobs.

\$1.98 per kit enough for several projects

Also—1 lb. packages for big jobs—\$3.95

At leading hardware and hobby stores—write for free literature



**DEVCON CORPORATION**

175 Endicott Street, Danvers, Mass.

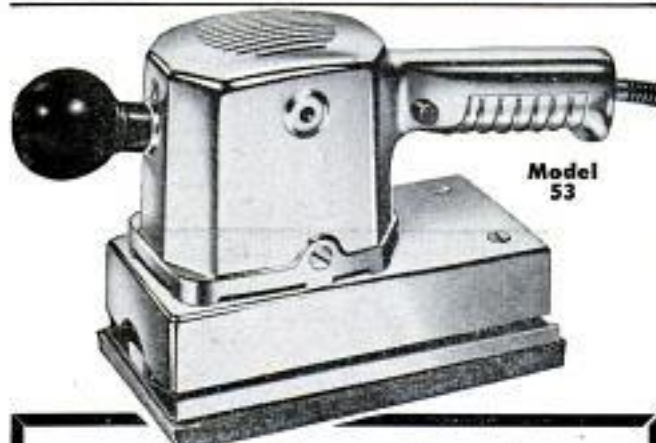

Model 53

## The Secret of Scratch-free Sanding!

Ask any expert—the secret of a perfect finish is to sand with the wood grain! The old-time craftsman did when he sanded by hand. And so do you, when you use a Dremel Straight-Line Action Sander—except that a powerful motor does all the work.

With Dremel Straight-Line Action, you leave no cross-grain scratches or orbital swirl marks to mar the finish of your project. Three models to choose from.

Get a Dremel from your local power tool dealer. If he can't supply you, order direct from factory on 5-DAY TRIAL, money back guarantee. We ship postpaid.

Dremel Straight-Line Action Power Sanders — 3 popular models — \$14.85 to \$34.85

**FREE** Power Tool catalog. Write today!

**DREMEL MFG. CO.**

DEPT. 117E

RACINE, WIS.



## SAW SHARPENING IS EASY

Super Filer No. 11 joints and sharpens hand and circular saws 6" to 10" with all teeth correct in height, depth, pitch, bevel. When file hits steel roller, teeth are finished. Saw runs true with no side pull. Includes 8" file. **\$9.95** PPD.



### "TRU-CIRCLE"

saw set automatically sets teeth at 10° or more. **\$2.95** PPD.



### SUPER SAW FILER No. 6

Automatically controls depth, angle, pitch for all saws. Precision made and calibrated. Use in any vise or clamp. Includes 6" file. **\$6.50** PPD.



### DOWEL CENTERS

Centers inscribe exact location for opposite holes. Pairs for 1/4", 3/8", 1/2" holes. **\$1.00** PPD.

MONEY BACK GUARANTEE—CATALOG FREE

A. D. McBURNEY, 5908 Hollywood Blvd., Hollywood 28, Cal., Dept. A-57

## GENUINE ALNICO MAGNETS

AMAZING, PERMANENT, NON-ELECTRIC, HIGHLY PRACTICAL. Conduct interesting experiments. Hundreds of uses. Retrieve valuable steel items such as guns, tackle from fresh or salt water; tools from tanks & drains. **GUARANTEED.** Try any magnet one week. Money back if you are not well-pleased.

- No. M-710 (Wt. 53 oz.) Has pull of 225 lbs. on steel block... \$16.50
- No. M-625 (Wt. 70 oz.) Has pull of 125 lbs. on steel block... \$9.50
- No. M-575 (Wt. 18 oz.) Has pull of 75 lbs. on steel block... \$6.50
- No. M-500 (Wt. 13 oz.) Has pull of 50 lbs. on steel block... \$4.50
- No. M-300 Kit of Flat Bars 5 Pairs (10 Magnets)... \$3.00
- No. M-250 Kit of Round Rods 5 Pairs (10 Magnets)... \$2.50
- No. M-47 Hot Pad Magnets, 10 for \$1.00... \$1.00 for \$4.87
- No. M-35 Hobbyist assortment of 8 small magnets... \$1.50

Send N.O. or check. We pay postage. Sorry no C.O.D.'s. MIAMI MAGNET COMPANY, 3240 N.W. 27th Ave., Miami 42, Fla.

## ROAD TO RICHES

You can be the next uranium millionaire! Government guarantees huge bonus! PRI instruments from \$29.95. See your local dealer today! **FREE CATALOG!** Write PRI, 4223 PM W. Jefferson Los Angeles 16, California **DEALERS WANTED**

## MAKE JIGSAW PUZZLES

We put you in the business of making and selling colorful Wood Jigsaw Puzzles for children. This offer is limited to ambitious men with sales ability... who are looking for a profitable "do-it-yourself" business on a full or part-time basis. We supply everything. Can be handled from your own home workshop, basement or garage. Simply send \$2 for samples with complete information. This opportunity can make you rich... so act fast!

**A. M. WALZER COMPANY**  
924 Lincoln Road Miami Beach, Fla.

## YOU SHOULD EQUIP YOUR TRAILER WITH

**why...**  
**BULL DOG**  
• AXLE ASSEMBLIES  
• JACKS • COUPLERS

Straight or drop axles in single or tandem—capacity up to 10,000 lbs.—any width. Also Torq-Less Axles for all types of trailers.

**JACKS**—Bull Dog Jacks make hitching and parking a one-man job.

**COUPLERS**—Bull Dog Couplers hitch or unhitch to trailer in a moment.

Write today for **FREE** Descriptive folder 13E.

**HAMMER BLOW TOOL COMPANY**  
WAUSAU, WISCONSIN



POPULAR MECHANICS

## PORTABLE LIGHT PLANTS

### GIANT 2500 WATT PLANT

110-120 v. 60 cyc. AC. absolutely the best made—exclusive dynamically balanced armature; heavy windings develop up to 5000 watt overload for motor starting. Skid mounted—portable. Powered by an easy starting Briggs or Wisconsin 6 HP engine—complete with all accessories; engine easily disconnected for other uses. Big outlet box, voltmeter, no wiring necessary. Ample current for all purposes. Factory warranty. (Item 31) Wt. 210 lbs. Reg. price \$585. Special at..... **\$299.50**

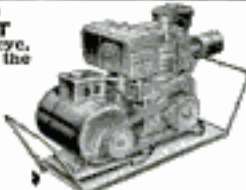

Same plant with electric self starter (Item 31a)..... **\$359.50**  
Generator only and control box..... **\$169.50**

### DUAL VOLTAGE 110-220

Available on any of above models for \$28.00 additional.  
**POWER-FLO 3800-4000 WATT**  
115-230 v. 60 cyc. AC. A rugged power plant for heavy duty use. Duplex power distribution provides both 115 and 230 v. output at the same time if desired. Powered by a big 8.25 HP Wisconsin engine with triple V belt drive. Has built-in over-load protection. A dependable plant for either standby or regular service. Equipped with electric self-starter. (Can also be started by rope) and plug-in outlet box. (Item 108) Wt. 310 lbs. Factory price..... **\$439.50**  
Generator only belt driven..... **\$239.50**

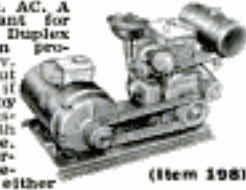

(Item 108)

## Double Acting Hydraulic Cylinder

A powerful cylinder mfr'd. by Massey Harris which develops both a pushing and a pulling action. Will push 8,100 lbs., with a 1000 PSI pump pressure. Cylinder is 3 3/4" O.D. with 6 3/4" stroke—standard heavy duty clevises on both ends. Has standard 1/2" pipe thread openings. Can be used for tilting buckets or blades, raising or lowering implements, hydraulic presses, etc. Can also be used as 40 air cylinder. (Item 80) Wt. 17 lbs. Reg. \$68 value, special..... **\$14.95**

**OTHER DOUBLE ACTING CYLINDERS**  
8" stroke — 3" bore..... **\$24.00**  
10" stroke — 3" bore..... **\$34.80**  
14" stroke — 3" bore..... **43.00**  
24" stroke — 3" bore..... **47.50**

**HYDRAULIC CONTROL VALVE**—4 way open center valve with built-in adjustable relief. Controls 1 double, or 2 single acting cylinders. Equipping feature permits easy control even under heavy loads. 3/4" pipe thread on inlet & outlet, on cylinder outlets. Easily mounted, finger tip control. Wt. 16 lbs. (Item 82)..... **\$21.50**

**EXTENSION CORD**  
Heavy duty and very flexible. Neoprene 142 cable, 20 year quality. Wt. 12 lbs. (Item 185) 100 ft. Complete with rubber plug and outlet. A terrific buy at only **\$8.95**

No. 10-2 Power Cable. Heavy duty, very flexible. 20 ft. with male and female fittings. Wt. 4 lbs. (Item 818)..... **\$5.45**  
20 ft. without fittings (R18a)..... **\$4.15**  
50 ft. (Item 592) with fittings..... **\$13.45**  
100 ft. (Item 135) with fittings..... **\$25.95**  
No. 12-2 Power Cable. Very flexible rubber covered, special outside shield for grounding power tools. 50 ft. (Item 199) Wt. 3 lbs. **\$6.95**. 100 ft. (Item 200)..... **\$12.95**  
No. 8-2 Conductor Power Cable. 30 ft. heavy duty, very flexible rubber covered with male & female plug (Item 817)..... **\$12.95**

## JET STEAM MASTER

Now, a super efficient portable steam generator that produces live steam in 100 lbs. pressure in 60 seconds from a cold start! Produces large volume of high pressure steam on 2 pints of fuel oil. Instantly cleans sticky grease, dirt, rust, old paint, etc. off implements and road machinery. Pays for itself in a few weeks. Steamizes cans, sterilizes as it cleans—milk equipment, etc. Fully automatic—oil fired with new, built-in lifetime bronze water circulating pump. Draws water from faucet or bucket. Simple and safe—anyone can use it; built-in safety valve. Complete with 12 ft. of hi-pressure steam hose and new triple efficiency steam gun that automatically mixes in soap solution if desired. Wt. 250 lbs. Item 463. Special factory price..... **\$349.50**



Send check or M.O. Prices f.o.b. Factory. 10 day Money back guarantee. SEND 10c for... **MASTER MECHANIC MFG. CO., DEPT. 52-C Burlington, Wis.**

## GET MASTER MECHANIC'S BEDROCK FACTORY PRICES

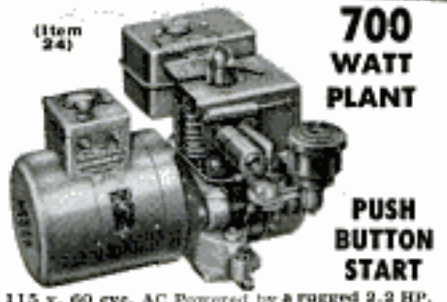

**700 WATT PLANT**  
**PUSH BUTTON START**  
115 v. 60 cyc. AC. Powered by a **FREDER 2.2 HP.** easy starting Briggs engine. No wiring necessary. Just plug in and operate. Plenty of current for any oil burner, freezer, brooder, emergency lights, etc. which require up to 700 watts. Ideal for television and radios. Complete with voltmeter and built-in winding to charge 6 v. auto batteries. (Item 24) Wt. 75 lbs. Easily fits in car trunk. Be prepared if storm knocks out power lines..... **\$143.50**  
1200 Watt Plant (Item 45) same as Item 24 but larger generator and engine..... **\$199.50**  
We make every type and size of light plants—Write, giving us your requirements!

## LESS THAN WHOLESALE

**PORTO-POWER 1750 Watt Plant**  
115/130 v. 60 cyc. AC. Push button start. Powered by a 4.5 HP Briggs engine. Combines compactness and easy portability with higher output for handling heavier starting loads. Ideal for operating oil burners, sump pumps, freezers, television, lights, communication systems, etc. Perfect for contractor's power tools. (Item 20) Wt. 150 lbs. Factory Special Price..... **\$279.50**



(Item 20)

**MASTER-LITE 2500 Watt Plant**  
110/120 v. 60 cyc. AC. A portable plant, ruggedly constructed and yet designed for easy portability. Can be started by rope or built-in 12 v. electric push button starter. Built-in winding to charge battery. Powered by a big 4.10 HP Briggs engine, complete with all accessories. Includes control box, voltmeter, and handy plug-in power receptacle. An ideal plant for permanent or stand-by service. Wt. 225 lbs. Reg. price \$645.00 (Item 23) Factory Price..... **\$329.50**



(Item 23)

**1500 WATT PLANT—Push Button Start** 115 v. 60 cyc. AC. Powered by a big 3 1/2 HP Clinton engine. Combines big output with easy portability. Provides emergency power for operating any oil burner, sump pump, freezer, television, lights, communication systems, etc. which require up to 1500 watts. Includes voltmeter, duplex power receptacle and built-in winding for battery charging. (Item 22) Wt. 110 lbs. Reg. \$475 value, factory price..... **\$239.50**  
Dual Voltage 110/220 for Item 21—\$30 additional.

## FAUCET WATER HEATER

Instant hot water from any faucet for just pennies—sounds unbelievable—but it's true! You just slip **MASTER MECHANIC'S** new Faucet Water Heater over any water faucet, plug it in a wall outlet—and you've got steaming hot running water instantly for dishes, shaving, washing baby's bottle, etc. Simple and safe—operates on ordinary 110v. house current—costs only 2 1/2 cents per hour for hot water. Ideal for homes, bars, cabins, trailers, etc. Easily regulated from lukewarm to full hot. Fully guaranteed! (Item 408) Wt. 2 lbs. Factory price F.O.B. Burlington, only..... **\$4.95**



## Rugged, ball bearing WINCH

Sturdy ball bearing winch—super tough aluminum alloy construction. Powered by an easy starting 2 1/2 HP Briggs gas engine thru gear reduction drive—it exerts up to 3000 lbs. of terrific force for hoisting materials or pulling. Combination gear and pulley reduction results in tremendous multiplication of engine power. Idler pulley clutch arrangement and built-in drum brake (with ratchet hand lever) enables operator to ease loads down gently and lock at any point desired. Drum handles 400 ft. of 3/8" cable or 600 ft. of 1/2" cable. Ideal for contractors, farm implement trailers and unlimited other uses! (Item 795) Wt. 125 lbs. Only..... **\$149.50**  
**HAND WINCH**—Same winch with large crank handle for extra leverage and 2 speed drive. (Item 794) Wt. 60 lbs..... **\$59.50**



(Item 795)

## MASTER AIR COMPRESSOR

**COMPARE!** This is the only compressor built with a **NO RUST** stainless steel tank. Safe up to 500 lbs. (Item 209) High pressure type (4 c.f.m.) Large volume of air for heavy duty service. For paint spraying, inflating truck & auto tires, greasing, sand blasting, etc. Piston type 2" bore compressor with built-in air filter. Master built with high strength alloys and precision bearings. Tank, 12"x24", 2100 cu. in. cap. Equipped with automatic switch that starts and stops motor to maintain desired pressure (up to 150 lbs.) and check valve, safety valve, gauge, shut-off valve, 20 ft. air hose and tire chuck. Beautifully balanced on ball bearing wheels and rubber tires. Don't take chances with used or surplus equipment. Our compressors are factory new and are guaranteed **SAFE**. Low factory prices. 2 1/2 HP Model (exp. 85 lbs.) Reg. \$175. (Item 209)..... **\$109.50**  
1 1/2 HP heavy duty model, Reg. Ind. motor & unloader switch (Item 209a)..... **\$129.50**



Tank Tested up to 500 lbs. per sq. in.

## SCREW-TYPE PRESS

A tremendously powerful press capable of exerting nine tons of pressure. Pays for itself straightening bent parts, or pushing out bearings and bushings. Ideal for manufacturing because of precise control. Massive 1 1/2" screw permits precise control over vertical travel. Extra heavy ribbed yoke has a throat 21" high. Depth capacity for working to the center of an 11" object. Includes 8" x 15 1/2" vise-type table and two pushing arbors. Wt. 150 lbs. (Item 791) Reg. \$149.50. Special..... **\$49.50**  
**HYDRAULIC PRESS.** Nine ton capacity. See April Pop. Mech., for details or write. Complete. Wt. 110 lbs. (Item 464)..... **\$69.50**

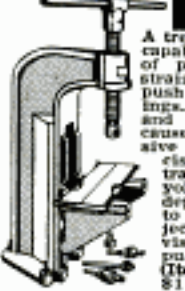

## GIANT METAL SHEARS

**"PEXTO"**  
Nine inch cutting blade made of special high carbon alloy steel, perfectly aligned and ground. Easily cuts sheet up to 12 gauge or 1/4" thick. Overall length 40". Wt. 23 lbs. (Item 136) Regular..... **\$14.95**  
\$49.50. While they last..... **\$14.95**



## MASTER DC ARC WELDERS

Now a portable rugged industrial type welder with terrific performance, yet at a price hundreds of dollars less than you'd expect. Senior model made for years of trouble-free, continuous service. High capacity DC welding unit enables you to tackle any job with confidence—easily welds anything up to 2" plate using from 1/16" to 1/4" rods. Built-in stabilizer and cooling system makes arc easy to strike and hold. Dual control rheostat provides low heat soldering, brazing and welding from 30 to 300 amps. Complete with instructions, guarantee and triple V-belt or flat pulley. Easy to hook up and easy to operate.  
**WELDER ONLY — DUAL CONTROL MODEL.** Same as above, but drive with your tractor, jeep or gas engine of 14 HP or more. (Item 35a.) Wt. 110 lbs. \$450 value..... **\$119.50**  
**WELDER ONLY—INDUSTRIAL MODEL** same as above but with ceramic rotary type rheostat providing 74 different heat settings for all types of welding (Item 35b) \$500.00 value..... **\$139.50**  
**COMPLETE POWER MASTER** (Illustrated above) powered by a 14.6 hp. air cooled Wisconsin engine. Wt. 480 lbs. (Item 280) Complete with welder costing \$1200. Factory Special..... **\$449.50**



(Item 280)

**WELDING KIT** Two 10 ft. leads. Welding helmet, electrode holder, ground clamp. Sold only with welder at..... **\$10.50**

# LARGE or SMALL

## SOUTH BEND MACHINE TOOLS are Top Quality

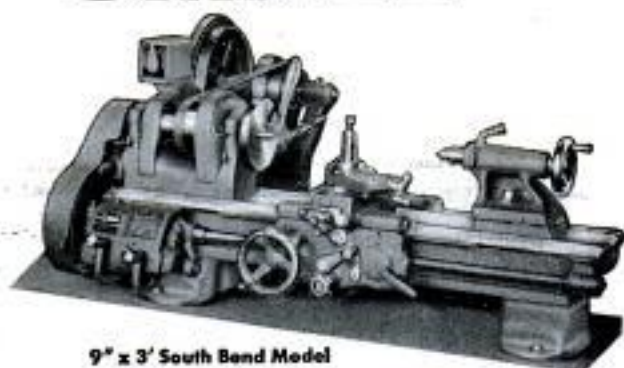

9" x 3' South Bend Model  
A Bench Lathe

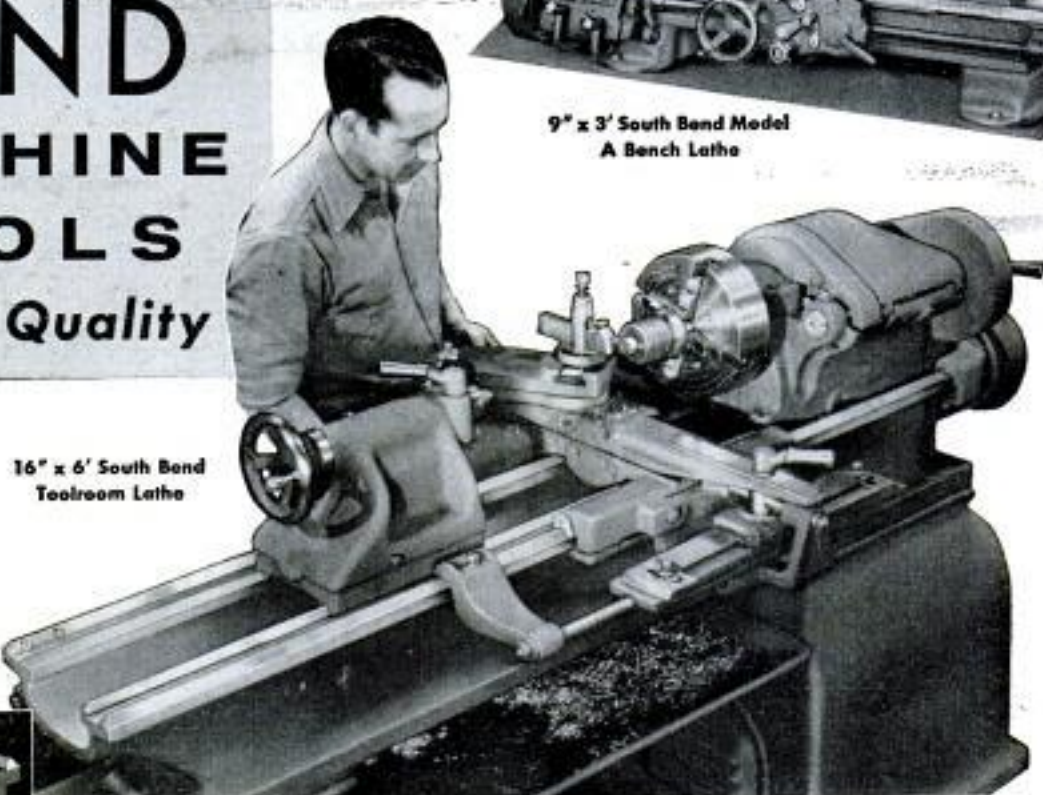

16" x 6' South Bend  
Toolroom Lathe



**HARDENED  
BED WAYS**

Available on South Bend Lathes at small extra cost.



**FREE NEW CATALOG**  
Describes 9" to 16-24" Lathes; Turret Lathes; Vertical Mill; 7" Shapers; 14" Drill Presses; Pedestal Grinders. Ask for Catalog 5700.

Among men who know machine tools best, South Bend holds an unchallenged reputation for fine performance on difficult jobs in the toolroom, laboratory and production shop. Accurate, versatile, powerful, they all handle close tolerance work with speed and efficiency. They have a wide range of speeds and feeds which make them practical for machining all classes of materials from plastics to the toughest tool steels. Their built-in safety features, ease of operation and ruggedness recommend them for manufacturing, repair, maintenance and experimental work. Write for catalog.

### PRICES f.o.b. South Bend, less electrical equipments

9" x 3" Model C Bench Lathe... \$ 276	16" x 6' Engine Lathe..... \$2350
9" x 3' Model A Bench Lathe... 444	16" x 6' Toolroom Lathe..... 2930
10" x 3' Engine Lathe (floor)... 1221	13" x 5' Turret Lathe..... 2438
13" x 4' Engine Lathe..... 1595	20" x 20" x 20" Vertical Mill... 1742*
13" x 5' Toolroom Lathe..... 2139	7" Bench Shaper..... 573
14 1/2" x 5' Engine Lathe..... 1975	14" Bench Drill Press..... 127
14 1/2" x 5' Toolroom Lathe..... 2504	10" Pedestal Grinder..... 270

\*Includes 3-phase motor and control



## SOUTH BEND LATHE

South Bend 22, Indiana—Building Better Tools Since 1906

# Faster paste waxing!

# Easier paste waxing!



Start right in waxing!  
Johnson's new J-wax  
does the cleaning work for you!

No extra cleaner needed  
—nothing else to buy!

**J-Wax** has just what paste wax needed—a built-in cleaner! The exclusive J-Wax formula goes to work fast. Cleans while it waxes—saves you hours of work. J-Wax replaces grime with a glistening coat of wax. *Tough wax. Hard-finish wax* that protects your car in any weather. J-Wax puts more wax on your car—leaves

more wax on your car than other one-step waxes. And J-Wax goes on smoothly, easily—evenly. Leaves no dull spots or streaks. You are sure of more all-around protection with J-Wax in any weather—from bumper to bumper, including the chrome!

Look for Johnson's J-Wax in this new key-opening can. Only J-Wax guarantees sealed-in freshness. It's the fastest, easiest way to genuine wax protection—*paste wax protection!*

"Johnson's Wax" and "J-Wax" are registered trademarks of S. C. Johnson & Son, Inc.

Copyrighted material



Seems almost everyone knows the good word for **WINSTON**

AND THE WORD IS "TASTE"... *good* taste! See if you don't think that Winston is the best-tasting cigarette you've ever smoked! Part of the reason is the exclusive snow-white filter, carefully made to let you enjoy Winston's rich, full flavor. It's no wonder, really, that Winston is America's best-selling filter cigarette—and by a *wider margin than ever!* Try a pack real soon!

R. J. REYNOLDS TOBACCO CO., WINSTON-SALEM, N.C.

Enjoy **WINSTON**...with the snow-white filter in the cork-smooth tip!

Copyrighted material