

APRIL 1957

35 CENTS

POPULAR MECHANICS MAGAZINE

WRITTEN SO YOU CAN UNDERSTAND IT

REG. U.S. PAT. OFF.

A PM Round Table Conference Looks at
THE ATOMIC AIRPLANE
—page 100

Read!

**WHAT OWNERS SAY
ABOUT '57 CHEVROLET**



Faster paste waxing!

Easier paste waxing!



Start right in waxing!

Johnson's new J-wax

does the cleaning work for you!

No extra cleaner needed
—nothing else to buy!

J-Wax has just what paste wax needed—a built-in cleaner! The exclusive J-Wax formula goes to work fast. Cleans while it waxes—saves you hours of work. J-Wax replaces grime with a glistening coat of wax. *Tough wax. Hard-finish wax* that protects your car in any weather. J-Wax puts more wax on your car—leaves

more wax on your car than other one-step waxes. And J-Wax goes on smoothly, easily—evenly. Leaves no dull spots or streaks. You are sure of more all-around protection with J-Wax in any weather—from bumper to bumper, including the chrome!

Look for Johnson's J-Wax in this new key-opening can. Only J-Wax guarantees sealed-in freshness. It's the fastest, easiest way to genuine wax protection—*paste wax protection!*

"Johnson's Wax" and "J-Wax" are registered trademarks of S. C. Johnson & Son, Inc.

Copyrighted material



NEW PLYMOUTH MILL MAKES BIG NEWS!

290-hp FURY V-800 engine...8-barrel carburetion...now available on ALL Plymouths!

You don't need the most expensive body model to get your kicks from the tremendous power of Plymouth's terrific new FURY V-800 engine... dual quads... direct fuel flow to each cylinder!

Plymouth gives it all 8 barrels in this new engine that lets you scratch off as if a carrier catapult had shoved you...move in the quarter like a jet pilot in a rush!

And every Plymouth is built to handle this

raging power! Every one has racing-type torsion bars up front... ball-joints... asymmetrical rear springs... for flat cornering and level, no-dive haul-downs. Every one has no-fade brakes (when the drum expands from heat, the shoe follows its contours, maintaining full lining-to-drum contact). See your dealer and drive a Plymouth soon!

Want FURY V-800 specs? Just write Plymouth Division, Chrysler Corporation, P.O. Box 1518, Detroit 31, Mich.

When you drive a *Plymouth* you're 3 full years ahead



21" ALUMINUM-LIGHT AUTOMOWER . . . IT'S SELF-PROPELLED!

Optional Electric Starting . . .
No batteries needed . . . works on any 110V House outlet . . . and LAWN-BOY recoil starter, always ready—anywhere, anytime.



Surest, Simplest Control . . .
Just a forward roll of the wrist starts LAWN-BOY out at a steady, even pace . . . no chains, no gears.



"Activated" Pilot Wheel
keeps LAWN-BOY (and your lawn) level, automatically . . . even on rough turf the lawn surface is cut level.



Staggered Front Wheels let LAWN-BOY go up and over high spots without leaving scalped patches. And precision-cast and -machined LAWN-BOY trims to $\frac{3}{8}$ " too.



THE LIGHTWEIGHT LAWN-BOY AUTOMOWER GIVES THAT FAMOUS LEVEL-CUT AUTOMATICALLY

FOR EASY RELIABLE OPERATION NOTHING COMPARES WITH LAWN-BOY 2-CYCLE ENGINE



DESIGNED AND BUILT FOR LAWN-BOY BY LAWN-BOY

LIGHTWEIGHT—Fewer moving parts, plus LAWN-BOY precision-die-cast aluminum, plus "KNOW-WHY" design gives LAWN-BOY more power per pound.

NATURALLY EFFICIENT—LAWN-BOY needs no adjustments because LAWN-BOY naturally operates at the most efficient speed for rotary mowing—3200 r.p.m.; and power every stroke means quicker recovery from additional loads.

EASIER, QUICKER STARTING—Fewer parts mean less friction . . . firing every stroke gives twice as many starting opportunities. You get easier pull through, too.

NO LUBRICATION PROBLEMS—Pre-mixing fuel and oil eliminates messy crankcase drain and refill . . . and with LAWN-BOY you never have to worry about proper lubrication.

PROVE IT TO YOURSELF . . . TRY A LAWN-BOY ON YOUR LAWN

LAWN-BOY

LAWN-BOY, Lamar, Mo. • Division of Outboard Marine Corp., makers of *Johnson* and *Evinrude* Outboard Motors • In Canada: LAWN-BOY, Peterborough, Ontario

LAWN-BOY dealers are listed in the yellow pages under "Lawn Mowers," or call Western Union, by number, and ask for Operator 25.



Popular Mechanics Magazine

Registered in U. S. Patent Office and Canada

H. H. WINDSOR, Founder

H. H. WINDSOR, JR., Editor and Publisher

INTERNATIONAL EDITIONS: MECANIQUE POPULAIRE (French) MECANICA POPULAR (Spanish) POPULAER MEKANIK (Danish) POPULAR MEKANIK (Swedish) POPULARE MECHANIK (German) MECCANICA POPOLARE (Italian)

Managing Editor

RODERICK M. GRANT

Assistant Managing Editor

WAYNE WHITTAKER

Shop Notes and Crafts Editor

JAMES R. WARD

Associate Editor

CLIFFORD B. HICKS

Associate Editor, Automobiles

ARTHUR R. RAILTON

Associate Editor,

Shop Notes and Crafts

WAYNE C. LECKEY

Associate Editor, Shop Notes

W. CLYDE LAMMEY

Radio-Television, Electronics Editor

LOTHAR STERN

Assistant Editor, Crafts

JAY W. HEDDEN

Assistant Editor, Makeup

JOHN DALEN

Art Director

FRANK BEATTY

Assistant Editors

ROBERT M. HENDRICKSON

ROBERT E. DORSETT **EARL F. WOBECK**

Eastern Editor

RICHARD F. DEMPEWOLFF

Empire State Bldg., Room 2006, N.Y.C. 1

Western Editor

THOMAS E. STIMSON, JR.

Suite 1010, 3460 Wilshire Blvd.,

Los Angeles 5, Calif.

London Manager

DOUGLAS W. WEDDERSPOON

Eagle House, Jermyn St.,

London S.W. 1, England

Director, Bureau of Information

ALLAN CARPENTER

200 E. Ontario St., Chicago 11

Advertising Offices

Chicago: 200 E. Ontario St., Whitehall 4-0100;

New York: Empire State Bldg., 350 Fifth Ave.,

LONGacre 5-7580; Detroit: General Motors

Bldg., TRinity 5-8711; Cleveland: Hanna

Bldg., 1422 Euclid Ave., PRospect 1-0456; Los

Angeles: 3460 Wilshire, DUnkirk 2-8458; San

Francisco: Russ Bldg., 235 Montgomery St.,

YUkon 2-0823.

Sources of further information not listed in the index, starting on page 74, about articles in this issue, frequently are shown in the Where-to-Find-It List prepared for each issue. A copy may be obtained by readers, without charge, from Bureau of Information, Popular Mechanics, 200 East Ontario Street, Chicago 11, Illinois.

Published monthly by Popular Mechanics Company, 200 E. Ontario St., Chicago 11, Ill. H. H. Windsor, Jr., president; Wm. Harrison Petridge, exec. vice-pres.; Franklin S. Forsberg, operations vice-pres.; D. P. Windsor, vice-president and secretary-treasurer; H. H. Windsor III, vice-president; W. T. Windsor, vice-president; Joseph R. Buell, Jr., advertising manager; Alan M. Deyoe, circulation manager. Single copy in the United States and Canada, 35 cents; subscription rates in the United States and possessions, Canada and countries of the Pan-American Postal Union, 1 year \$3.50; 2 years, \$6.00; 3 years, \$8.00, to all other countries add \$1.00 a year over United States prices for overseas postage. If you plan to move, notify us at least 30 days in advance so you will not miss an issue. Give both your old and new addresses. Entered as Second Class Matter, September 15, 1903, at the Post Office at Chicago, Illinois, under Act of March 3, 1879. Entered as Second Class Matter at Post Office Dept., Canada, Registered as Second Class Matter at the Post Office at Mexico, D.F., Mexico, June 20, 1950. Copyright 1957 by Popular Mechanics Company. Copyright under International Copyright Union. Copyright in France. All rights reserved under Pan-American Copyright Union. Printed in the United States of America.

Volume 107

APRIL 1957

Number 4

Address all communications to: 200 E. Ontario St., Chicago 11, Ill.

In This Issue...

Who Ever Heard of a Diesel Engine?	-	-	-	81
Gibberellic Acid—It Makes Plants Grow	-	-	-	93
A PM Panel Looks at the Atomic Airplane	-	-	-	100
The Owners Report on the '57 Chevrolet	-	-	-	108
The Voice of Emergency	-	-	-	114
Reprieve for a Freighter	-	-	-	122
Tapping the Devil's Cauldron for Power	-	-	-	135

OUTDOOR-LIVING SECTION —

PM's Landscaping Plan for the Small Yard	-	144
Adapt Your Garage for Summer Living	-	154
Get Out of the Midday Sun	-	158
Convertible Settee-Lounge Has Plastic Upholstery	-	161

For the Craftsman...

Swing-Apart Headboard	-	-	-	165
Paddle Boat for Summer Fun	-	-	-	174
Keep It From Cracking	-	-	-	182
Easy to Make Movie Titles	-	-	-	191
This Motor Drives Four Machines	-	-	-	201
Safe Brakes for Your Trailer	-	-	-	205

Regular Departments...

Detroit Listening Post	-	-	-	99
What's New for Your Home	-	-	-	130
Keeping Up With the Atom	-	-	-	141
Solving Home Problems	-	-	-	178
How Would You Do It?	-	-	-	214
Radio, TV and Electronics	-	-	-	217
Clinic for Homemakers	-	-	-	224

Next Month...

THERE'S A bonanza for boaters in the May issue—27 pages on nautical subjects from taking your vacation in a boat to the world's toughest outboard race. At right is the Sea Knight, a 17-foot cabin cruiser designed especially for PM craftsmen. A series of articles on building the craft begins in May



**"My Army recruiter
showed me how
to choose my branch"**



Sgt. 1st Class Edmund L. Reel
Army Recruiter, Sutton, W. Virginia

**YOUR ARMY RECRUITER CAN GIVE YOU
THIS SAME SPECIAL DEAL**

The Army Recruiter in your home town will show you how to pick your spot in the Army the same way Tom did. He'll show you how you can choose your Army branch *before* you enlist. Infantry, Armor, Signal Corps, Army Medical Service, Engineers, Artillery, Ordnance, Airborne—name it,

and it's *yours!* You'll get great leadership training right in your field—be in a position to climb to an important job of responsibility and decisions. Your Army Recruiter is ready to help you, so visit your local Army Recruiting Station today! Remember, there's no obligation!

GET CHOICE, NOT CHANCE, FROM YOUR ARMY RECRUITER

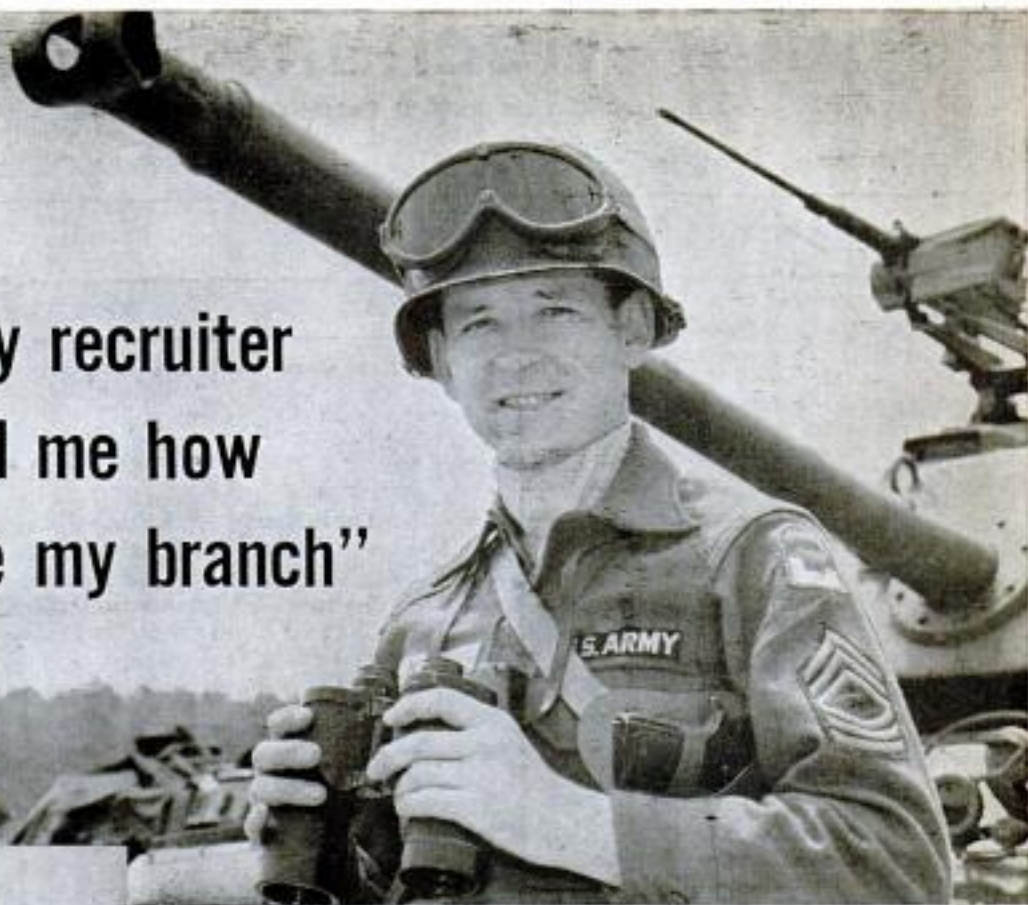

***"He got me the leadership
training I wanted"***

"I entered service just the way I wanted to, thanks to my Army Recruiter. He was a nice fellow and gave me the straight talk on enlistment opportunities. With his help, I chose my branch of service *before* I enlisted. Now I'm a tank commander in Armor. It's plenty exciting to have all that power at your command. But, more than that, I got real leadership training—great instruction and schooling that's taught me to handle responsibility, make important decisions. You really owe it to yourself to see your Army Recruiter and find out the best way for *you* to plan your service career. I'm sure glad I did, because I've found being a leader is a real mark of prestige!"

Thomas R. Cogar
M/Sgt. Thomas Cogar
Gassaway, West Virginia
Graduate, Gassaway High School





OLDSMOBILE



CADILLAC



BUICK



PONTIAC



CHEVROLET

Some spark plugs are designed for high speeds,
Some spark plugs are designed for low speeds, but...

POWER TIP "fires up" GM cars at all speeds!

The first spark plug ignition-engineered
for today's engines* and today's driving

Today's higher-horsepower, higher-compression engines and today's driving demand *more* from spark plugs, and Power Tip gives more! Performance tests prove Power Tip "fires up" engines of General Motors cars for top performance and economy at *all speeds!* Here's why . . .

At *low* speeds, the projecting Power Tip gets hot *fast*, operates hotter to burn away fouling deposits which impair engine performance in city driving.

At *high* speeds, the Power Tip is actually cooled by the richer air-fuel mixture to check power-wasting pre-ignition caused by overheated spark plugs.

Ask your dealer to install a set of Auto-Lite Resistor Spark Plugs with Power Tip in your car *today!*

*Power Tip is ignition-engineered for overhead-valve V-8 engines and for most overhead-valve 6-cylinder engines in all these cars: Buick, Cadillac, Chevrolet, Chrysler, De Soto, Dodge, Ford, Hudson, Imperial, Lincoln, Mercury, Nash, Oldsmobile, Packard, Plymouth, Pontiac, Rambler, Studebaker.

The
Protruding Tip
makes the
big difference!



Ordinary Tip

Power Tip

AUTO-LITE®

This One



RT58-CPE-RSA7

Auto-Lite makes a complete line of spark plugs, including Standard, Resistor, Small-Engine, Transport, Aircraft and Diesel-Starting.

FOR HARDWARE WEEK ONLY
APRIL 25 through MAY 4

NICHOLSON HANDY FILE

only 75¢

(regularly 96¢)

Amateur Cabinetmakers
Boatbuilders
Model Railroaders
Week-end Carpenters

... every handy man needs a Handy file. And at this low price, you should get several ... one for the garage, one for the shop, one for the kitchen drawer tool collection.

One side of the versatile Handy file is single-cut for sharpening and finishing. The other side is double-cut for fast filing. Needs no handle, because it's forged with a convenient grip and hang-up hole.

Take advantage of this double-barreled offer: it's like getting *two* files for the new low price of one... during Hardware Week, April 25 through May 4. Don't miss this offer at your hardware store.

 Nicholson File Co. 
Providence, R.I.
(In Canada: Nicholson File Company of Canada Ltd.,
Port Hope, Ontario)

NICHOLSON FILES
A FILE FOR EVERY PURPOSE

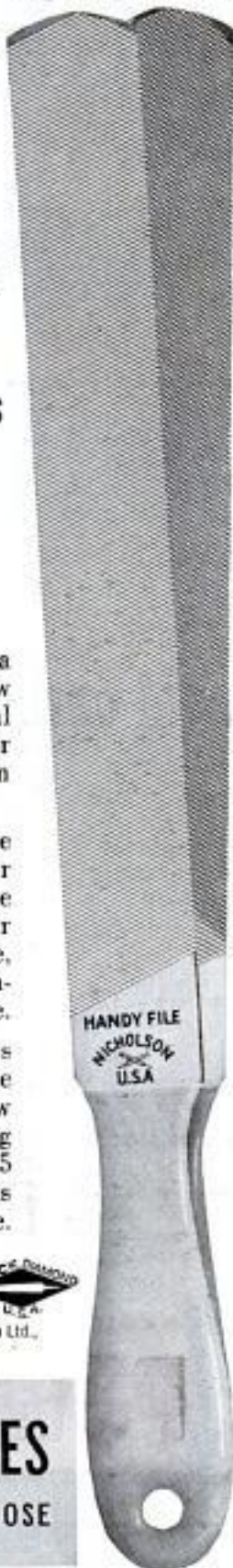

ACROSS THE DESK



Italians are now reading *Popular Mechanics Magazine* in their own language. The new Italian edition, *Meccanica Popolare*, is the sixth foreign-language edition in the *Popular Mechanics* family and, like the other five, is a direct translation of the American parent magazine.

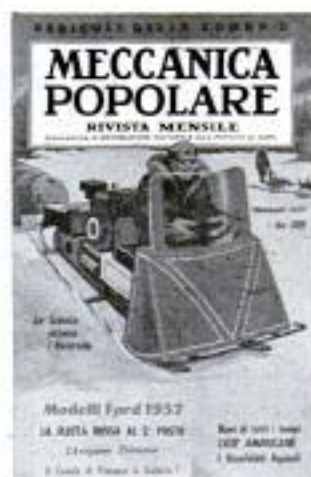

Already in circulation in Europe, Latin-America and Canada are *Mecanica Popular*, Spanish; *Mecanique Populaire*, French; *Popular Mekanik*, Swedish;

Populaer Mekanik, Danish and *Populare Mechanik*, German. The Italian edition is published at Milan under the direction of two well-known figures in Italian publishing circles, Dr. Gianni Mazzocchi and Enrico Amante and its first-issue sales are estimated at 50,000. Among the advertisers in the inaugural issue are Ford, Fiat, Ficep, Ducetone (Du Pont), Lambretta, Didone and Lips-Vago.

To the Editor:

I was very much interested by the article "They Sail on Sand" in the January number. The writer places the origin (of sand yachting) in 1895 to 1900.

May I call your attention to the name of Simon Stevin (1548-1620), mathematician and physician who, as far as known, invented and constructed the first sand yacht. He actually sailed with it on the beaches of the North Sea, Holland, often in the presence of Prince Maurits of the Netherlands, whose tutor he was.

He introduced calculating with tenth-part fractions (arithmetic) and in 1608 wrote a book on "Mathematic Thoughts." Stevin had the rare combination of a very theoretical and very practical mind. [Recently] a new hall was put into use at the Technical University of Delft, Holland, the "Stevin Laboratories," named after the above-mentioned physician.

B. J. M. Veth,
Roermond, Holland

(Continued to page 10)

WHAT HAPPENS WHEN A MAN DECIDES TO DO SOMETHING! ABOUT HIS FUTURE!

The proven rule of "learn more to earn more" took M.E.F. (name on request) from a position of truck driver to that of an accounting executive in sixteen months. Listen to what M.E.F. says:

"I was driving a truck—working long hours and not making much money. I had a burning desire to better myself in life, and decided to enroll with LaSalle. I went along driving my truck days and studying nights and got my first break after completing 35 assignments. I took a cost accounting position. Within one month after starting full-time, I received my first raise, thereafter followed more. One of the greatest thrills of my life came just nineteen months after I started with LaSalle. When our firm opened up a branch office, I was assigned to take charge of the Accounting Department and my salary is doubled."

M.E.F. took a proved road to success—and his letter is typical of the thousands we have in our files from men and women in all walks of life.

YOU DESERVE SUCCESS

There is no reason why you can't win success through LaSalle's Accounting Training. Today the demand for good accountants far exceeds the supply. This spells real opportunity to the man who is prepared.

You need no special talents to become a success in Accounting. You do not even need a preliminary knowledge of bookkeeping. All you need is the will to work—to achieve success perhaps years sooner.

Under the LaSalle Problem Method you can acquire a thor-



ough knowledge of Accounting—you can master its fundamental principles—become expert in the practical application of those principles. You learn by doing—without losing any time from your present work. You train directly under the supervision of a competent staff of Certified Public Accountants and accounting experts.

Our book "Accountancy, The Profession That Pays" is FREE. It explains how we train you from the ground up—or from where you are now—according to your individual needs. The cost is low—terms easy.

Send the coupon RIGHT NOW. Don't lay it aside and say you'll do it later. It can be the means of your SUCCESS—perhaps larger success than you have ever dreamed. At least it's worth considering.

CHARTER MEMBER OF NATIONAL HOME STUDY COUNCIL

LEU

SEND FOR FREE BOOK

LaSalle EXTENSION UNIVERSITY
A Correspondence Institution

DEPT. 464H, 417 SOUTH DEARBORN STREET, CHICAGO 5, ILLINOIS



Please send me, free of all cost or obligation, your illustrated book, "Accountancy, the Profession That Pays."

Name

Age

Address

City, Zone, State



OVER 4,400 CPA'S HAVE BEEN TRAINED
BY THE FAMOUS LASALLE
PROBLEM METHOD

BURIED ALIVE!



SIX YEARS ON THE SAME JOB WITH NEVER AN ACCIDENT... AND THEN ONE MORNING...

2 A CAVE-IN PUT ME SIX FEET UNDER FOR SIX LONG MINUTES

QUICK! GET HIM OUT OF THERE!



3 IN THE HOSPITAL, I HAD PLENTY OF TIME TO THINK

SIX YEARS I'VE BEEN BURIED ALIVE IN THAT SAME OLD JOB, JANE!

WELL, NOW'S A GOOD TIME TO DO SOMETHING ABOUT IT



4 I'D PASSED OVER DOZENS OF I.C.S. ADS IN POPULAR MECHANICS. BUT I SAW THIS ONE IN A NEW LIGHT

I.C.S. SUCCESS PLAN... SPARE-TIME TRAINING... 256 COURSES TO CHOOSE FROM... THIS COULD BE THE ANSWER... WON'T HURT TO FIND OUT



FREE!

I.C.S. CAREER KIT

Send coupon now...
get all three books

INTERNATIONAL CORRESPONDENCE SCHOOLS
BOX 21953D

SCRANTON 9, PA.

HOW'S IT GOING, DARLING?

FAST! I'M INTO HYDRAULICS ALREADY. AND I THOUGHT I WAS TOO OLD TO LEARN

5 SIGNING UP FOR THAT I.C.S. COURSE WAS THE SMARTEST THING I EVER DID

6 ONE MONTH LATER...

GOOD TO SEE YOU BACK ON YOUR FEET, JIM. IT'LL BE AWHILE BEFORE YOU'RE BACK IN THE FIELD. SO WE'LL FIX A TEMPORARY DESK FOR YOU IN THE OFFICE WHEN YOU'RE READY

I'M READY NOW, MR. WALSH

7 THEY GAVE ME SOME SIMPLE ASSIGNMENTS... AND I SURE SURPRISED THEM!

SAY, WHERE DID YOU LEARN ABOUT PUMPS?

SAME PLACE YOU DID, JOE... I. C. S.

8 THEN A FEW DAYS LATER, MR. WALSH CALLED ME IN...

JIM, I'M KEEPING YOU HERE AND PUTTING YOU ON SALARY. YOU'LL BE GETTING ABOUT \$20 MORE A WEEK. AND AT THE RATE YOU'RE GOING, I EXPECT I'LL HAVE TO RAISE THAT IN SIX MONTHS

9 THAT EVENING, JANE AND I WENT HOUSE HUNTING

OH, JIM! IT'S A DREAM HOUSE!

AND THANKS TO I. C. S. IT'S A "DREAM" THAT CAN COME TRUE!

MODEL HOUSE

- 1 "HOW TO SUCCEED" A 32-page gold mine of ideas
- 2 CAREER CATALOG Opportunities in the field that interests you most
- 3 SAMPLE LESSON (MATH) Shows the famous step-by-step I. C. S. teaching method



HERE'S WHERE YOU COME IN! LET I.C.S. SHOW YOU THE WAY TO MORE PAY, RAPID ADVANCEMENT, REAL JOB SECURITY! MAIL THIS COUPON TODAY!

INTERNATIONAL CORRESPONDENCE SCHOOLS



BOX 21953-D, SCRANTON 9, PENNA.

(Partial list of 257 courses)

Without cost or obligation, send me "HOW TO SUCCEED" and the opportunity booklet about the field BEFORE which I have marked X (plus sample lesson):

- | | | | | |
|---|--|---|---|---|
| <p>ARCHITECTURE and BUILDING CONSTRUCTION</p> <p><input type="checkbox"/> Air Conditioning-Refrig.</p> <p><input type="checkbox"/> Architecture</p> <p><input type="checkbox"/> Architectural Interiors</p> <p><input type="checkbox"/> Building Contractor</p> <p><input type="checkbox"/> Building Estimator</p> <p><input type="checkbox"/> Building Maintenance</p> <p><input type="checkbox"/> Carpentry and Mill Work</p> <p><input type="checkbox"/> Heating</p> <p><input type="checkbox"/> Painting Contractor</p> <p><input type="checkbox"/> Plumbing</p> <p><input type="checkbox"/> Reading Arch. Blueprints</p> <p>ART</p> <p><input type="checkbox"/> Cartooning</p> <p><input type="checkbox"/> Commercial Art</p> <p><input type="checkbox"/> Fashion Illustrating</p> <p><input type="checkbox"/> Magazine Illustrating</p> <p><input type="checkbox"/> Show Card and Sign Lettering</p> <p><input type="checkbox"/> Sketching and Painting</p> <p>AUTOMOTIVE</p> <p><input type="checkbox"/> Auto Body Rebuilding</p> <p><input type="checkbox"/> Auto Elec. Technician</p> <p><input type="checkbox"/> Auto-Engine Tune Up</p> <p><input type="checkbox"/> Automobile Mechanic</p> | <p>AVIATION</p> <p><input type="checkbox"/> Aeronautical Engineering Jr.</p> <p><input type="checkbox"/> Aircraft & Engine Mechanic</p> <p>BUSINESS</p> <p><input type="checkbox"/> Advertising</p> <p><input type="checkbox"/> Bookkeeping and Accounting</p> <p><input type="checkbox"/> Business Administration</p> <p><input type="checkbox"/> Business Correspondence</p> <p><input type="checkbox"/> Public Accounting</p> <p><input type="checkbox"/> Creative Salesmanship</p> <p><input type="checkbox"/> Federal Tax</p> <p><input type="checkbox"/> Letter-writing Improvement</p> <p><input type="checkbox"/> Office Management</p> <p><input type="checkbox"/> Professional Secretary</p> <p><input type="checkbox"/> Retail Business Management</p> <p><input type="checkbox"/> Sales Management</p> <p><input type="checkbox"/> Stenographic-Secretarial</p> <p><input type="checkbox"/> Traffic Management</p> <p>CHEMISTRY</p> <p><input type="checkbox"/> Analytical Chemistry</p> <p><input type="checkbox"/> Chemical Engineering</p> <p><input type="checkbox"/> Chem. Lab. Technician</p> <p><input type="checkbox"/> General Chemistry</p> <p><input type="checkbox"/> Natural Gas Prod. & Trans.</p> <p><input type="checkbox"/> Petroleum Engineering</p> <p><input type="checkbox"/> Plastics</p> <p><input type="checkbox"/> Pulp and Paper Making</p> | <p>CIVIL STRUCTURAL ENGINEERING</p> <p><input type="checkbox"/> Civil Engineering</p> <p><input type="checkbox"/> Construction Engineering</p> <p><input type="checkbox"/> Highway Engineering</p> <p><input type="checkbox"/> Reading Struct. Blueprints</p> <p><input type="checkbox"/> Sanitary Engineering</p> <p><input type="checkbox"/> Structural Engineering</p> <p><input type="checkbox"/> Surveying and Mapping</p> <p>DRAFTING</p> <p><input type="checkbox"/> Aircraft Drafting</p> <p><input type="checkbox"/> Architectural Drafting</p> <p><input type="checkbox"/> Electrical Drafting</p> <p><input type="checkbox"/> Mechanical Drafting</p> <p><input type="checkbox"/> Mine Surveying and Mapping</p> <p><input type="checkbox"/> Plumbing Drawing and Estimating</p> <p><input type="checkbox"/> Structural Drafting</p> <p>ELECTRICAL</p> <p><input type="checkbox"/> Electrical Engineering</p> <p><input type="checkbox"/> Electrical Maintenance</p> <p><input type="checkbox"/> Electrician <input type="checkbox"/> Contracting</p> <p><input type="checkbox"/> Lineman</p> <p>HIGH SCHOOL</p> <p><input type="checkbox"/> Commercial <input type="checkbox"/> Good English</p> <p><input type="checkbox"/> High School Subjects</p> <p><input type="checkbox"/> Mathematics</p> | <p>LEADERSHIP</p> <p><input type="checkbox"/> Foremanship</p> <p><input type="checkbox"/> Industrial Supervision</p> <p><input type="checkbox"/> Leadership and Organization</p> <p><input type="checkbox"/> Personnel-Labor Relations</p> <p>MECHANICAL AND SHOP</p> <p><input type="checkbox"/> Gas-Electric Welding</p> <p><input type="checkbox"/> Heat Treatment <input type="checkbox"/> Metallurgy</p> <p><input type="checkbox"/> Industrial Engineering</p> <p><input type="checkbox"/> Industrial Instrumentation</p> <p><input type="checkbox"/> Industrial Supervision</p> <p><input type="checkbox"/> Internal Combustion Engines</p> <p><input type="checkbox"/> Machine Design-Drafting</p> <p><input type="checkbox"/> Machine Shop Inspection</p> <p><input type="checkbox"/> Machine Shop Practice</p> <p><input type="checkbox"/> Mechanical Engineering</p> <p><input type="checkbox"/> Quality Control</p> <p><input type="checkbox"/> Reading Shop Blueprints</p> <p><input type="checkbox"/> Refrigeration</p> <p><input type="checkbox"/> Sheet Metal Worker</p> <p><input type="checkbox"/> Tool Design <input type="checkbox"/> Toolmaking</p> <p>RADIO, TELEVISION</p> <p><input type="checkbox"/> Industrial Electronics</p> <p><input type="checkbox"/> Practical Radio TV Eng'ing</p> <p><input type="checkbox"/> Radio and TV Servicing</p> <p><input type="checkbox"/> Radio Operating</p> | <p><input type="checkbox"/> Television Technician</p> <p>RAILROAD</p> <p><input type="checkbox"/> Air Brake Equipment</p> <p><input type="checkbox"/> Car Inspector</p> <p><input type="checkbox"/> Diesel Engineer & Fireman</p> <p><input type="checkbox"/> Section Foreman</p> <p>STEAM AND DIESEL ENGINEERING</p> <p><input type="checkbox"/> Combustion Engineering</p> <p><input type="checkbox"/> Diesel-Elec. <input type="checkbox"/> Diesel Eng's</p> <p><input type="checkbox"/> Electric Light and Power</p> <p><input type="checkbox"/> Stationary Fireman</p> <p><input type="checkbox"/> Stationary Steam Engineering</p> <p>TEXTILE</p> <p><input type="checkbox"/> Carding and Spinning</p> <p><input type="checkbox"/> Cotton, Rayon, Woolen Mtg.</p> <p><input type="checkbox"/> Finishing and Dyeing</p> <p><input type="checkbox"/> Loom Fix'g <input type="checkbox"/> Textile Des'ing</p> <p><input type="checkbox"/> Textile Eng'g's <input type="checkbox"/> Throwing</p> <p><input type="checkbox"/> Warping and Weaving</p> <p>MISCELLANEOUS</p> <p><input type="checkbox"/> Domestic Refrigeration</p> <p><input type="checkbox"/> Marine Engineering</p> <p><input type="checkbox"/> Ocean Navigation</p> <p><input type="checkbox"/> Professional Engineering</p> <p><input type="checkbox"/> Short Story Writing</p> <p><input type="checkbox"/> Telephony</p> |
|---|--|---|---|---|

Name _____ Age _____ Home Address _____

City _____ Zone _____ State _____ Working Hours _____ A.M. to P.M. _____

Occupation _____

Canadian residents send coupon to International Correspondence Schools, Canadian, Ltd., Montreal, Canada... Special tuition rates to members of the U. S. Armed Forces.

No Ping-Just Purr

from high compression engines



ONE OF **5** GREAT KENDALL FEATURES FOR YOUR DRIVING PLEASURE

In a class by itself, this exceptional All-Weather SAE 10W-30 motor oil offers five extra performance features that assure you the Economy of Kendall SuperB quality. In addition to quieting engine ping, Kendall SuperB brings you these benefits.

- stops lifter sticking
- lowers oil consumption
- reduces wear and prolongs engine life
- multiplies gasoline mileage

By the Refiners
of the Famous . . .

KENDALL REFINING COMPANY
BRADFORD, PENNA.



(Continued from page 6)

Speed: Half Mile Per Hour

H. L. Bolton of Reese, Kans., writes us that his model of the 65-horsepower Case steam engine really runs—at a speed of



about a half mile per hour. He built it on a scale of two inches to the foot, and says it weighs 175 pounds, burns coal and "has every gadget that the 65 Case had."

To the Editor:

Your report on the 1957 cars (February) was very good and told many interesting facts. There is one very important measurement, however, that you never gave us. Next time you have three men in the front seat look and see how much hiproom you are using. I think you will find that you are three to four inches from the door on each side. Now look where your shoulders are. That's where the room really means something. Why not a report on shoulder room?

Howard Sauder,
Roanoke, Ill.

To the Editor:

In the January *Popular Mechanics* I was quite interested in the article on center-line steering. This was incorporated in the Marmon "48" in 1913 and 1914. Similar claims were made for it then, and they worked out okay in practice as road shocks and flat tires did not affect the steering as they did in other cars. It was only used in the large "48," an expensive, heavy car selling for \$5000 and weighing in excess of 5000 pounds. The smaller "32" of the same years did not incorporate it. Marmon dropped this feature in 1915. I have often wondered why.

Carl R. Foster,
Port Tampa, Fla.

To the Editor:

In the January '57 PM, a channel-wing plane is expected to be tested for take-off

(Continued to page 14)

You Can Train at Home in Spare Time Be a Highly Paid Technician



Radio and Television are big, still growing. Color TV, Hi-Fi are adding opportunities. More than 4000 Radio and TV stations on the air, 150 million home and auto Radios, 40 million TV sets to be serviced. There are opportunities in Police and Aviation Radio, Two Way Radio Communications for buses, taxis, etc.



Electric Appliance Repairing is a big and growing field. Millions of electric appliances are sold every year. Every wired home now has an average of 8. The trained man is respected, well paid for what he knows and can do. Mail coupon, learn what NRI Electric Appliance training offers you.

NRI — Oldest and Largest Home Study Radio-TV School — Has Trained Thousands for Success

LEARN RADIO-Television Servicing or Communications

Training PLUS opportunity is the ideal combination for success. Today's OPPORTUNITY field is Radio-Television. Plan now to train for good pay, a bright future in Radio-TV Servicing or Broadcasting. The skilled technician enjoys prestige. He does important work, gets high pay for it. NRI can supply training quickly, you benefit from our 40 years experience. Keep your job and learn in spare time. Get practical experience with kits NRI sends.

Start Spare Time Earnings Soon

Soon after enrolling many NRI students start earning extra money fixing neighbors' sets. Many earn \$10 to \$15 a week extra this way. Find out what NRI training can mean to you. No experience needed. Send coupon today.

LEARN TO FIX ELECTRIC APPLIANCES—Boost Your Pay

To build a better future, get into a field where important work and security comes to the trained technician. Electrical Appliance Repair is such a field. No need to give up your present job. You can train at home in your spare time. Start soon to increase your income fixing electric toasters, clocks, fans, and other appliances. Work in your basement, garage or spare room. Build your own spare time or full time business. Cost of NRI courses low . . . easy terms.

Learn by Doing with Kits NRI Sends

NRI sends kits of parts for practical experience. You use equipment you build to "bring to life" things you study. Mail coupon now. **NATIONAL RADIO INSTITUTE**, Dept. TDA, Washington 9, D. C.

MAIL NOW



What NRI Graduates Do and Say



"Am Chief Engineer with KCCU. Also have my own spare time servicing business." — R. BARNETT, Bismarck, N. D.

"Doing very well in spare time servicing. Paid for instruments out of earnings." — G. F. SEAMAN, New York, N. Y.

"We now have our own servicing business. During Army NRI training helped get me top rated job." — W. M. WEIDNER, Fairfax, S. D.

NATIONAL RADIO INSTITUTE, Dept. 7DA, Washington 9, D. C. (CHECK ONE PLEASE—NO SALESMAN WILL CALL)

Radio-Television—Please send me FREE Sample Lesson and 64 Page Catalog on Radio-Television Servicing and Communications.

Electric Appliance—Please send me FREE Sample Lesson and Catalog on your Electric Appliance Servicing Training.

Name _____

Address _____

City _____ Zone _____ State _____

ACCREDITED MEMBER, NATIONAL HOME STUDY COUNCIL

AMAZING BARGAINS!

DIRECT FROM IMPORTER TO YOU! \$115,000 worth of new, first-quality merchandise at discounts up to 75%! Don't pass up these sensational values. Act now! New shipment from abroad will cost more!
THORESEN, Inc., Dept. 6-D, 585 Water Street, New York 2, N. Y.



SPY CAMERA
 Reg. \$2.98
\$1.98

Take Secret Pictures!
 3 FREE GIFTS! Handy pigskin leather case & 2 rolls of film! Precision-made camera, fits in palm of hand. Designed for detective work. Sharp pictures! All metal, chrome plated, genuine coated Minus lens! Speed shutter, professional viewfinder, instant & time settings. Thousands sold at much higher prices!
 No. 48 \$1.98



ELECTRIC MOTOR
99c

Little Giant. Fits in palm of hand! Speeds up to 5,600 RPM's. Works on any battery. Drives model boats, toy trains, erector sets, etc. Permanent magnetic field, bronze bushings, steel housing. Fantastic value! NO. 44.



3 TURRET MICROSCOPE
 100X
 200X
 300X
\$7.99

Reg. \$12.95 Value
 SAVE \$5.00! All metal, precision-tooled threading, polished achromatic lenses. Excellent optical instrument for technician or student's gift. Thousands sold at \$12.95. You pay \$7.99. No Tax.
 No. 198 \$7.99



Hi-Power - All Purpose
PAINT SPRAYER
 Complete—No Extras to Buy!
 Lowest price ever! Famous make! Cuts painting time 75%. Takes paints, oils, enamels, etc. Needs no tank or compressor. Cannot clog or drip. People everywhere paid up to \$29.95 for this type unit. Our factory-price to you—for complete kit—~~NOT \$29.95~~ only \$9.95.
 NOW \$9.95
 NO. 102 \$9.95 ONLY



Amazing, Extra-Long Range
POWERHOUSE TELESCOPE
 Everything You Can See Brought 15 Times Closer ... from 1 to 50 MILES!
 Reg. \$12.95
 Now Only **\$4.99**
 Optical instrument imported direct from Germany. METAL draw tubes. Contoured eyepiece. Interior coated objective lenses. High luminosity for moonlight viewing. Jet subal trim. Precision ground lens. 225 times area magnification. Formerly \$12.95. Save nearly \$8.00! FREE table tripod and case. While supply lasts! No. 43 \$4.99



New 4 x 40
POWERHOUSE "77"
 \$12.95 Value
\$4.98
 Everything 4 times closer—up to 40 MILES AWAY! Adjusts at once to eye width. Folds in center on swirling pivot. Clearer, sharper views—even in moonlight! UNBREAKABLE LENSES! Made by optical craftsmen in West Germany. \$1.98 case FREE. Hurry! Powerhouse "77" is a sell-out everytime at this low price.
 NO. 160 \$4.98

Black Forest

HUNTING KNIFE



OVER 100,000 SOLD AT
\$3.95
 NOW ONLY

99c
 LIMIT OF TWO TO CUSTOMER

This is the original and genuine Black Forest—the World's most famous hunting knife. Its rugged beauty has won recognition for design throughout Europe and America. Hand-forged by old world steelsmiths famed for their high standards of craftsmanship! Blade is sharp enough to shave with! Use the Black Forest in skin moose, rabbit, deer, bear, etc. To cut hump, underbrush, branches, etc. To hunt small game—it makes a silent, accurate weapon! Use it in a hunting emergency—when seconds really count! Use it at home, to carve roasts, turkeys. It makes a handsome den decoration, too!
 10 full inches long. Over 100,000 sold at \$3.95—now yours for only 99c! YOU SAVE \$3.00! Limit of two to family.
 NO. 76 99c

Leather Sheath Given FREE!

MONEY BACK GUARANTEE!
THORESEN INC., Dept. 6-D
585 Water Street, New York 2, N. Y.
 RUSH items listed below on 10-day home trial. My money back if I'm not satisfied.
 Check, cash or money order enclosed. Send prepaid. Send C.O.D., plus postal charges.

Number	Quantity	ARTICLE	Price

NAME _____
 ADDRESS _____
 CITY _____ ZONE _____ STATE _____
 Canadian Address 46 St. James St., West, Montreal 1, P.Q.

MORE THAN 50,000 SOLD AT \$3.98
IMPORTED SWISS ARMY TYPE KNIFE

Made famous by the Swiss army because it's virtually a lifesaver in many emergencies. 10 practical, quality tools! Each tool is separate; easy to open and close. No jamming! No slipping! Replaces multitude of tools & gadgets you can never find when you need them. Will give lifetime of rugged use. Ideal for outdoor men, "do-it-yourselfers," or just plain Mrs. Housewife!

NO. 18
\$1.98
 Over 50,000 sold at \$3.98—now yours at HALF PRICE!

- Saw • File • Scissors
- Jackknife • Screwdriver
- Awl • Can Opener • Bottle Opener • Corkscrew • Small Knife



INVENTORS

Learn how to protect your invention. The U. S. Patent Laws provide that any new and useful art, machine, article of manufacture, or composition of matter, or any new and useful improvement thereof, may be patented if the act of invention is involved. Therefore, every inventor with a valuable invention should take advantage of the Patent Laws and proceed for patent protection in order to safeguard his rights.

A patent gives the inventor the exclusive right to prevent others from making, using, or selling the invention claimed in the patent for a period of seventeen years.

The Patent Laws were enacted for the benefit of the inventor to give him protection for the features of his invention which are patentable. These features must be properly and concisely set forth and claimed in a formal application for patent, in order to comply with the requirements of the Patent Laws. For that reason, unless the inventor is familiar with patent matters, he should engage a competent registered patent attorney or agent to represent him. We are registered to practice before the U. S. Patent Office and are prepared to serve you in the handling of your patent matters.

A specially prepared booklet entitled "Patent Guide for the Inventor", containing detailed information with respect to patent protection and procedure, together with a "Record of Invention" form will be promptly forwarded to you without obligation upon request.

CLARENCE A. O'BRIEN & HARVEY JACOBSON

Registered Patent Attorneys

71-D DISTRICT NATIONAL BUILDING

WASHINGTON 5, D. C.

WHAT SECRET POWER DID THIS MAN POSSESS?



BENJAMIN FRANKLIN
(A Rosicrucian)

WHY was this man great? How does anyone—man or woman—achieve greatness? Is it not by mastery of the powers within ourselves? Know the mysterious world within you! Attune yourself to the wisdom of the ages! Grasp the inner power of your mind! Learn the secrets of a full and peaceful life!

Benjamin Franklin—like many other learned and great men and women—was a Rosicrucian. The Rosicrucians (NOT a religious organization) first came to America in 1694. Today, headquarters of the Rosicrucians send over seven million pieces of mail annually to all parts of the world. Write for YOUR FREE COPY of "The Mastery of Life"—TODAY. No obligation. No salesmen. A non-profit organization. Address: Scribe Z.J.C.

**THIS BOOK
FREE!**



The ROSICRUCIANS

SAN JOSE • (AMORC) • CALIFORNIA

—SEND THIS COUPON—

Scribe Z.J.C.
The ROSICRUCIANS (AMORC)
San Jose, California
Please send me the free book, *The Mastery of Life*, which explains how I may learn to use my faculties and powers of mind.

Name _____

Address _____

City _____

(Continued from page 10)

and landing at five miles per hour. If a sturdy small plane of this type proves successful, that alone would make every other light plane obsolete. Making an automobile-convertible out of it, too, seems to be too much of an improvement, if any. The highway patrolman could really cite the driver for "flying low," if the driver-pilot could be stopped before taking off again.

Maurice Akre,
Kennewick, Wash.

To the Editor:

I am one of a number of ship modelers throughout the world who are, due to geographical situation, lone modelers who have no access to modeling clubs.

To overcome this I have a few friends with whom I correspond regularly on our mutual interest, ship models. As this has been so successful we have decided to start a correspondence club for ship modelers on a world-wide basis. In this way all the lone modelers can get together and discuss their mutual interests to their benefit and the benefit of ship modeling in general.

Popular Mechanics Magazine is so widely read throughout the world that we are hoping you will be able to help us bring our idea before the public.

I am prepared to receive letters from anyone interested. All correspondence received will be acknowledged and persons with mutual interests will be put in touch with one another.

Frederick W. Bishop,
P.O. Box 648,
Windhoek,
S.W. Africa

To the Editor:

On page 179 of the February issue you state that the maximum horsepower for a Buick Special is 210. Actually it is 250 horsepower. I know this to be true. I just wonder how many other mistakes there are in this issue? It's a shame your magazine doesn't represent the true facts, especially when they are so hard to find. An ex-reader,

J. O. Wikstrom,
San Francisco, Calif.

Editor's Note:

The horsepower ratings referred to are for standard-equipment models only, as mentioned in the notes on page 179. The Buick Special has a handshift transmission and 210-horsepower engine as standard equipment. Dynaflo-equipped Specials (extra-cost equipment) have the 250-horsepower engine. We assure ex-reader Wikstrom that the statement was correct as published.

DeVry Tech Specializes in Training Men

IN THEIR SPARE TIME AT HOME TO BECOME

Electronic Technicians

Did you ever stop to think how much your happiness depends on having the right job? Getting your bills paid, living the life you want, doing the kind of work you like . . . ?

The right job (a promotion) with your present employer, or a good job with a new employer, would help solve such problems for you, wouldn't it?

DeVry Tech, with a successful 26-year record of training men for industry, offers you a real opportunity for a better job or your own profitable service shop . . . in one or more branches of the fast-growing field of Electronics.

We can show you a way to a more interesting and brighter future without interfering with your present job. We can give you all of this in your spare time at home . . . or in our well-equipped Chicago or Toronto training centers.

Find out how Electronics may give you a brighter and more profitable tomorrow. It will cost you nothing to get the facts. Fill in coupon below. We think this information is worth a postage stamp, don't you?

ELECTRONICS AT WORK AT DeVRY TECH

Jack Dempsey, T.J. Lafeber, President, watch student Joe Skala solve a problem with the Electronic Analog Computer in DeVry Tech's Chicago training center.



AN INDEX TO A BETTER JOB, BRIGHTER FUTURE

Radar	Industrial Electronics
Automation Electronics	Computers
Guided Missiles	Radio
Television	Remote Control Systems
Communications	Broadcasting
Micro-Waves	Your Own Service Shop

NO PREVIOUS TECHNICAL EXPERIENCE, NO ADVANCED EDUCATION REQUIRED

Live-Wire Employment Service

DeVry Tech's Placement Department is in contact with some of the best-known employers in the Electronics field. The service is free to all graduates — and DeVry Tech's record in helping to place men has been outstanding.



DRAFT AGE?

We have valuable information for every man of draft age; so if you are subject to military service, be sure to check the coupon.

A SAMPLE LESSON FREE!

See for yourself how DeVry Tech trains you for real opportunities in Electronics. We'll also give you a free copy of an interesting booklet, "Electronics and YOU."



"One of North America's Foremost Electronics Training Centers"



Accredited Member of National Home Study Council

DEVRY TECHNICAL INSTITUTE

CHICAGO 41, ILLINOIS

FORMERLY

DEFOREST'S TRAINING, INC.



MAIL COUPON TODAY

DeVry Technical Institute
4141 Belmont Avenue, Chicago 41, Ill., Dept. PM-4-N

Please give me a FREE Sample Lesson and your booklet, "ELECTRONICS AND YOU," and tell me how I may prepare to enter one or more branches of Electronics as listed above.

Name _____ Age _____

Please Print

Street _____ Apt. _____

City _____ Zone _____ State _____

Check here if subject to military training

±1092 DeVry Tech's Canadian Training Center is located at 626 Roselawn Avenue, Toronto 12, Ontario

DIESEL MECHANICS IN DEMAND

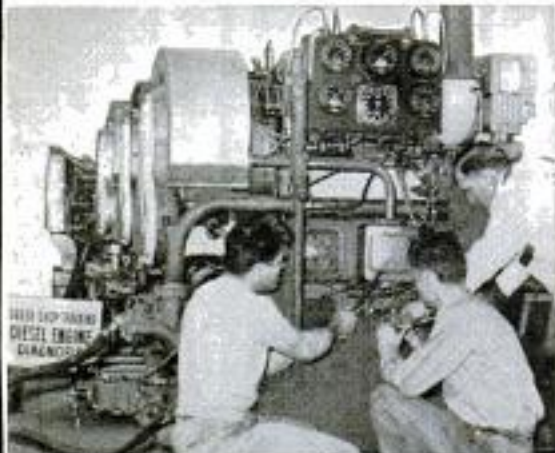

Learn to earn big pay in DIESEL in our large, modern equipped Chicago school and shop. No previous experience or training necessary. We help you find living quarters and part time job while in school. Complete, practical courses taught in the following trades, under the supervision of experienced, expert technicians.

APPROVED FOR CIVILIANS OR GI'S

— CHOOSE YOUR TRADE —

CHECK HERE	WEEKS
<input type="checkbox"/> DIESEL MECHANICS	20
<input type="checkbox"/> AUTO MECHANICS	20
<input type="checkbox"/> BODY & FENDER	16½
<input type="checkbox"/> GAS-ARC WELDING	4-12
<input type="checkbox"/> REFRIGERATION	13½
<input type="checkbox"/> AIR CONDITIONING	8½
<input type="checkbox"/> MACHINIST TRADE	30
<input type="checkbox"/> ADVANCED MACHINIST (includes tool & die)	32½
<input type="checkbox"/> PIANO TUNING & REPAIR	36

Heavy Construction Equipment Operators Training School
Road Building, Terracing, Land Clearing, etc. Reservation for starting classes now being accepted.

CHOOSE YOUR ENGINEERING COURSE

These courses are intended as terminal education for men who wish to enter the Diesel-Automotive and Refrigeration-Air Conditioning fields as technicians. These courses are designed to prepare men for supervisory positions. Students with a high school education, or equivalent, will be accepted.

<input type="checkbox"/> DIESEL AUTOMOTIVE ENGINEERING.....	2 years
<input type="checkbox"/> REFRIGERATION & AIR COND. ENGINEERING.....	18 months

FREE EMPLOYMENT HELP

Start your career with Greer by checking your interest above and mail coupon for complete information at no obligation.

NAME _____ AGE _____

STREET _____

TOWN _____ ZONE _____ STATE _____

Established 1902 — Over 50,000 Graduates.

55 years of continuous trade school experience to guide your training.

GREER SHOP TRAINING

Box D, 2236 S. Michigan Ave.
Chicago 16, Illinois

MAGIC MAIL PLAN

that comes with this Little Machine CAN MAKE YOU \$5.00 AN HOUR

The machine is turning out a job that will bring operator \$2.58, by mail. Material cost, only 11¢!



Write today for free facts about the newest and most fascinating of all new home operated businesses. For the first time, a simplified machine brings the fabulous profits of Plastic Sealing and Plastic Laminating within reach of the small operator. Anyone can learn to operate it with a few minutes practice. Then—with our MAGIC MAIL PLAN—can get mail orders pouring in daily with cash in every envelope.

No Canvassing or Selling

Fill orders at home in spare time to start. Then expand to full time business. We even supply circulars to bring back cash and orders. Rush name for all the facts you need to start. A postcard will do. No charge.

WARNER ELECTRIC CO., Dept. L-10-1
1512 Jarvis, Chicago 26, Illinois

RETRACT-A-PEN RIOT! Prices Slashed to New Low!

REFILLS (49¢ Value Each)

10 for only \$1.00

to fit ALL retractable pens (except Parker Jotter). Choice of Red, Blue, Black, Green or Brand New BROWN Ink.

RETRACTABLE PENS

5 for \$1.00 (100 for \$18)

Choice of Red, Blue, Black or Green Ink! Barrels in asst'd colors. Will not leak, smear or transfer. Send check or M.O. Add 10¢ for shipping. Money back guarantee. Quantity and imprint prices on request.

Barclay Distributors, Dept. 622, P. O. Box 45, Forest Hills, N.Y.

REAL ESTATE

BE A BROKER

PAYS BIG! SEND FOR FREE, BIG, ILLUSTRATED CATALOG NOW! Graduates report making substantial incomes. Start and run your own business quickly. Men, women of all ages, learn easily. Course covers Sales, Property Management, Appraising, Loans, Mortgages, and related subjects. STUDY AT HOME or in classrooms in leading cities. Diploma awarded. Write TODAY for free book! No obligation. Approved for World War II and Korean Veterans.

WEAVER SCHOOL OF REAL ESTATE (Est. 1936)
2020R Grand Avenue Kansas City, Mo.

FREE BOOK TELLS NOW

LAW FREE BOOK

THE LAW TRAINED MAN

Write today for a FREE copy of illustrated law book, "THE LAW TRAINED MAN," which shows how to earn the professional Bachelor of Laws (LL.B.) degree through home study of the famous Blackstone Law Course. All necessary books and lessons provided. Moderate cost; convenient monthly terms. Write for FREE law training book today.

Blackstone School of Law, 225 N. Michigan Ave.

Founded 1890 Dept. 54 Chicago 1, Ill.

Subscribe to TRAILER TOPICS MAGAZINE

6-Month Trial Subscription \$1



Discover how you can enjoy every modern convenience in your own home for just pennies a day. Read the true-life stories of those who live in mobilehomes and love it.

Only \$3.00 for 2 years.
TRAILER TOPICS MAGAZINE
Suite 1574, 28 East Jackson Blvd., Chicago 4, Illinois

INVENTORS

If you believe that you have an invention, you should find out how to protect it. The first step is to have a search made of the prior pertinent U. S. patents. If a report on this search indicates that the invention appears patentable you can apply for a patent, and the specifications and claims should be prepared.

The firm of McMorrow, Berman & Davidson, with offices in Washington, D. C., is qualified to take the necessary steps for you. We can make a preliminary search on your invention, advise you whether we think it can be patented, and prepare your application for patent.

Unless you are fully familiar with the U. S. Patent Laws, we recommend that you engage the services of a Registered Patent Attorney to protect your interests. The patent laws are *your* laws. A patent gives you the right to prevent others from making, using or selling the invention claimed in your patent for a period of 17 years.

Use these patent laws for your protection. Investigate whether your invention can be patented. If you have what you believe to be an invention, we suggest that you have this firm make a search for you:

Send for a copy of our Patent Booklet entitled "How To Protect Your Invention," containing information about patent protection and patent procedure. Along with this we will also send you an "Invention Record" form, for your use in writing down and sketching details of your invention. We will mail them promptly. No obligation. They are yours for the asking.

McMORROW, BERMAN & DAVIDSON

Registered Patent Attorneys

PATENTS • COPYRIGHTS • PATENTS

135-D VICTOR BUILDING, WASHINGTON 1, D. C.

AUDELS Carpenters and Builders Guides

4 vols. \$8



Inside Trade Information for Carpenters, Builders, Joiners, Building Mechanics and all Woodworkers. These Guides give you the short-cut instructions that you want—including new methods, ideas, solutions, plans, systems and money saving suggestions. An easy progressive course for the apprentice... a practical daily helper and Quick Reference for the master worker. Carpenters everywhere are using these Guides as a Helping Hand to Easier Work, Better Work and Better Pay. ACT NOW... fill in and mail the FREE COUPON below.

Inside Trade Information On:

How to use the steel square—How to file and set saws—How to build furniture—How to use a mitre box—How to use the chalk line—How to use rules and scales—How to make joints—Carpenters arithmetic—Solving mensuration problems—Estimating strength of timbers—How to set girders and sills—How to frame houses and roofs—How to estimate costs—How to build houses, barns, garages, bungalows, etc.—How to read and draw plans—Drawing up specifications—How to excavate—How to use settings 12, 13 and 17 on the steel square—How to build hoists and scaffolds—skylights—How to build stairs—How to put on interior trim—How to hang doors—How to lath—lay floors—How to paint.



MAIL ORDER



AUDEL, Publishers, 49 W. 23 St., NEW YORK 10, N. Y.
Please send me for FREE EXAMINATION books marked (x) below. If I decide to keep them I agree to mail \$2 in 7 days on each book or set ordered and further mail \$2 monthly on each book or set until I have paid price plus shipping charges. Otherwise I will return them.

- HOME APPLIANCE SERVICE GUIDE, 800 Pages \$6
- AUTOMOBILE MECHANICS GUIDE, 1664 Pages. 6
- TRUCK & TRACTOR GUIDE, 1299 Pages . . . 5
- DIESEL ENGINE MANUAL, 575 Pages . . . 3
- MACHINISTS HANDY BOOK, 1650 Pages . . . 6
- WELDERS GUIDE, 400 Pages . . . 3
- BLUE PRINT READING, 416 Pages . . . 3
- MATHEMATICS & CALCULATIONS, 700 Pages. 3
- SHEET METAL PATTERN LAYOUTS, 1100 Pgs. 7.50
- SHEET METAL WORKERS HANDY BOOK, 388 Pgs. 2
- MECHANICAL DRAWING GUIDE, 160 Pages . . . 2
- MECHANICAL DRAWING & DESIGN, 480 Pages . . . 3
- TELEVISION SERVICE MANUAL, 434 Pages. . . 3
- RADIOAMANS GUIDE, 1040 Pages. . . . 3
- ELECTRONIC DEVICES, 216 Pages 5
- ELECTRIC MOTOR GUIDE, 1000 Pages . . . 2
- WIRING DIAGRAMS (Light & Power), 272 Pgs. 2
- ELECTRICIANS EXAMINATIONS, 250 Pages. . . 2
- ELECTRIC POWER CALCULATIONS, 425 Pages. 3
- HANDY BOOK OF ELECTRICITY, 1440 Pages. . . 5
- ELECTRIC DICTIONARY, 9000 Terms 3
- ELECTRIC LIBRARY, 7000 Pages (10 Book Set) 20
- REFRIGERATION & Air Conditioning, 1280 Pgs. 6
- MILLWRIGHTS & MECHANICS GUIDE, 1200 Pgs. 5
- POWER PLANT ENGINEERS GUIDE, 1500 Pages 5
- ENGINEERS & FIREMANS EXAMS, 525 Pages . 2
- PUMPS, Hydraulics & Air Compressors, 1658 Pgs 6
- OPERATING ENGINEERS LIBRARY (3 Books). . 12
- GARDENERS & GROWERS GUIDES (4 Book Set) 6
- CARPENTERS & BUILDERS GUIDES (4 Book Set) 8
- PLUMBERS & Steamfitters Guides (4 Book Set) 8
- MASONS AND BUILDERS GUIDES (4 Book Set) 8
- PAINTERS & DECORATORS MANUAL, 450 Pgs. 2
- HOUSE HEATING GUIDE, 1000 Pages 5
- OIL BURNER GUIDE, 384 Pages 2

Check NOW!

You Can Look Over Any Guide In Your Own Home

SAVE SHIPPING CHARGES! Enclose Full Payment With Coupon and We Pay Shipping Charges!

Name _____
Address _____
Occupation _____
Employed by _____

FORTUNES IN DIVING

Train at Home in Spare Time
Write Today for Amazing Free Booklet

Here is one of the greatest opportunities of our time. Make big money fast in Skin and Lung Diving. Trained divers needed in hundreds of industries and by government. Build a successful business of your own. Hourly rates among highest paid in any field. Training program by E. R. Cross, world famous master diver. Instruction directly under supervision of former Navy frogman. Get the facts now. Write for FREE BOOKLET TODAY!

U. A. S. CORPORATION
Dept. PM-4 5837 W. 63rd Place, Chicago 38, Ill.

\$6,000-\$10,000 YEARLY OPERATING AUTO RADIATOR SERVICE SHOP

World's largest radiator shop equipment mfr. will assist responsible individuals in setting up radiator shops. Opportunity to own secure profitable business. First year averages \$6,000 to \$10,000. Garage or service station can operate as dept. Over 1,000 INLAND shops now operating. An little as \$295 down for equipment starts you. INLAND will finance balance and furnish training. Write to

INLAND MFG. CO., Dept. PM-4, 1108 Jackson St., Omaha 2, Nebr.

SEND FOR THIS FREE!

HOW TO BREAK and TRAIN HORSES

Make money. Know how to break and train horses. Write today for this book FREE, together with special offer of a course in Animal Breeding. If you are interested in Galting and Riding the saddle horse, check here () Do it today—now.

BEERY SCHOOL OF HORSEMANSHIP
Dept. 1104-D Pleasant Hill, Ohio

IT'S EASY... MAKE MONEY IN PHOTOGRAPHY

If you are over 17—good pay and fascinating work await you in photography! Start making money quickly in spare-time—step into your own studio or exciting career job. LEARN-TO-DOING method trains you at home! Write TODAY for FREE catalog. Also Resident Training. Co-ed. 47th Year. Approved for Veterans.

NEW YORK INSTITUTE OF PHOTOGRAPHY
Dept. 49, 10 West 33 Street, New York 1, New York
47th YEAR

INSURED TIRE SERVICE POPULAR BRANDS

FREE INSURANCE POLICY given with each used tire sold. We guarantee the amount of service you pay for.

YOU CAN'T LOSE!!

Nowhere can such quality be found at such low price!

Supper Quality — Rugged Performance — 6 Months Insured Service		Supreme Quality — Nothing Finer — 12 Months Insured Service	
600x16	\$3.65 670x16	\$3.95 700x16	\$4.45 780x16
650x16	3.85 670x16	4.05 710x16	4.35 820x16
680x16	4.25 700x16	3.95 760x16	4.45 850x17
600x16	\$5.25 475x19	\$5.45 700x15(8)	\$10.45 700x20
600x16(8)	6.75 640x18	4.95 750x15(8)	15.95 750x20(8)
680x16	5.75 670x18	5.35 700x17	11.95 750x20(10)
650x16(8)	7.25 710x18	6.45 780x17	16.45 825x20
700x16	6.35 760x18	5.95 780x18	10.95 900x20
750x16(8)	8.45 800x18	6.35 30x5	11.25 1000x20
580x18	4.95 820x18	6.35 600x20	10.95 1100x20
550x17	4.75 550x18	8.35 650x20	11.75 1000x22
650x18	8.25 670x18	8.15 32x8(8)	11.95 1100x22
700x18	8.35 700x18(8)	10.25 32x8(10)	12.75 1100x24

Whitewalls \$1.00 extra.

Speedy shipments on Mail Orders. F.O.B. Chicago. Insurance policy sent with each order. Deduct 10% on orders for 2 or more used tires. Send CHECK or MONEY ORDER—No COD's.

MIDLAND TIRE SALES
3701 S. Normal, Dept. PM-57, Chicago 9, Ill.

**GREATEST
ADVANCE IN
SHOP-METHOD
HOME TRAINING**

EARN MORE MONEY...GET INTO TELEVISION ELECTRONICS-RADIO

Learn ALL 8 PHASES in ONE MODERN HOME-STUDY COURSE
At Home - In Spare Time

YOU GET ALL THIS NEWEST PRACTICAL EQUIPMENT

- Parts to build a modern TV set, including all tubes plus a large screen Picture Tube
- Parts to build a powerful Superhet Receiver, standard broadcast and short wave
- Parts to conduct many experiments and build Continuity Checker, RF Oscillator, TV Circuits, Audio Oscillator, TRF Receiver, Signal Generator
- A Valuable Professional Multitester



**19 BIG KITS
YOURS TO KEEP**

YOUR NATIONAL SCHOOLS TELERAMA COURSE COVERS ALL 8 PHASES

- | | |
|------------------------------------|--------------------------------|
| 1. TELEVISION, INCLUDING COLOR TV | 5. PREPARATION FOR FCC LICENSE |
| 2. RADIO, FM AND AM | 6. AUTOMATION |
| 3. INDUSTRIAL ELECTRONICS | 7. RADAR AND MICRO WAVES |
| 4. SOUND RECORDING AND HI FIDELITY | 8. COMMUNICATIONS |

YOU ARE NEEDED IN THE TELEVISION-ELECTRONICS-RADIO INDUSTRY!
You can build a secure future for yourself if you get into Electronics NOW! Today's shortage of trained technicians creates tremendous opportunities. National Schools Shop-Method trained technicians are in constant and growing demand for high-pay jobs in Broadcasting and Communications, Electronic Research, Servicing and Repair, and many other branches.

Let National Schools, a Resident Technical School for over 50 years train you for today's unlimited opportunities in electronics! Our Shop Method trains you to be a MASTER-TECHNICIAN. Completely up to date, developed by experienced instructors and engineers, your Telerama Course will teach you all phases of the industry quickly, clearly and correctly. You can master the most modern projects, such as Color TV, printed circuits - even prepare for FCC License without taking a special

course. You can handle sales, servicing, manufacturing, or make good money in your own business. SEND FOR FACTS TODAY!

EARN AS YOU LEARN. Many of our students earn their entire tuition and more in Spare Time jobs we show them how to do while learning.

YOU GET EVERYTHING YOU NEED - Clear, profusely illustrated lessons, shop-tested manuals, modern circuit diagrams, practical job projects - all the valuable equipment shown above

- many other materials and services
- consultation privilege with our qualified staff, and Graduate Employment Service. EVERYTHING YOU NEED for outstanding success in Electronics

RESIDENT TRAINING AT LOS ANGELES

If you wish to take your training in our Resident School at Los Angeles, the world's TV capital, start NOW in our big, modern Shops, Labs and Radio-TV Studios. Here you work with latest Electronic equipment - professionally installed - finest, most complete facilities offered by any school. Expert, friendly instructors. Personal attention. Graduate Employment Service. Help in finding home near school - and part time job while you learn. Check box in coupon for full information.



FREE! Fully illustrated "Career" Book in TV-Radio-Electronics. PLUS actual sample lesson - yours at no cost, no obligation. CLIP COUPON NOW... MAIL IT TODAY!



MEMBER

APPROVED FOR G.I. TRAINING NATIONAL SCHOOLS

4000 S. FIGUEROA ST., LOS ANGELES 37, CALIF.
187 N. LA SALLE ST., CHICAGO 1, ILL.
IN CANADA: 811 W. HASTINGS ST., VANCOUVER, B. C.

NATIONAL SCHOOLS

TECHNICAL TRADE TRAINING SINCE 1905
LOS ANGELES 37, CALIFORNIA

GET FAST SERVICE - MAIL NOW TO OFFICE NEAREST YOU!

NATIONAL SCHOOLS, DEPT. RB-47
4000 S. FIGUEROA ST. LOS ANGELES 37, CALIF. OR 187 N. LA SALLE ST. CHICAGO 1, ILL.
Rush free TV-Radio "Opportunity" Book and sample lesson. No salesman will call.

NAME _____ AGE _____
ADDRESS _____
CITY _____ ZONE _____ STATE _____

Check if interested ONLY in Resident School training at Los Angeles.
VETERANS Give date of Discharge _____

Inventors

If you consider your invention valuable, take these necessary preliminary steps promptly to protect it by applying for a United States patent.

Sketch and describe your invention. (For convenience in starting action on your invention, use "Evidence of Invention" form offered below.)

Sign, date and have this invention disclosure witnessed by two people capable of understanding your invention.

Have us make a preliminary search among U. S. patents already granted for similar types of invention.

We then prepare a report for you on the probable patentability of your invention and recommend your further course of action.

This firm is registered to practice before the U. S. Patent Office. We are available to assist you in the preparation and prosecution of your application for patent.

We shall be glad to send you promptly and without obligation, an instructive booklet—"Patent Protection for Inventors"—and our convenient "Evidence of Invention" form.

VICTOR J.
EVANS & Co. *Merlin M. Evans*
REGISTERED PATENT ATTORNEY
330-D MERLIN BUILDING, WASHINGTON 6, D. C.

Tense, Nervous Headaches Need This Relief

A survey shows 3 out of 4 doctors recommend the famous ingredients of Anacin to relieve pain. Here's why Anacin® gives better total effect in pain relief than aspirin or any buffered aspirin:

- ➔ **ACTS INSTANTLY:** Anacin goes to work instantly. Brings fast relief to source of your pain.
- ➔ **MORE EFFECTIVE:** Anacin is like a doctor's prescription. That is, Anacin contains not one, but a combination of medically proven ingredients.
- ➔ **SAFER:** Anacin simply can not upset your stomach.
- ➔ **LESSENS TENSION:** Anacin also reduces nervous tension, leaves you relaxed, feeling fine after pain goes. Buy Anacin Tablets today!

Learn ACCOUNTING
Business Administration
Bookkeeping, secretarial and allied subjects at home in your spare time or attend nationally approved resident school. Write for FREE Success Book giving complete details on courses, plans, rates and employment opportunities. G.I. approved. Write Dept. A.

Hills BUSINESS UNIVERSITY AND EXTENSION SCHOOL
619 W. MAIN ST. OKLAHOMA CITY 2, OKLAHOMA

CABINET MAKING
LOW COST HOME TRAINING COURSE FOR BEGINNERS & ADVANCED CRAFTSMEN
Make money. Learn skills and secrets of fine woodworking and tool use. Professionally prepared shop method training tells and shows how. Covers everything. Easy to master.

INTERSTATE TRAINING SERVICE
DEPT. F3, PORTLAND 13, OREGON

3" "PALOMAR, JR." TELESCOPE
60 & 120 Power—An Unusual Buy!
You'll see the Rings of Saturn, the fascinating planet Mars, huge craters on the Moon, Star Clusters, Moons of Jupiter in detail, Galaxies! Aluminized and overcoated 3" diameter high-speed f/10 ventilated mirror. An Optical Finder Telescope, always so essential, is also included. Sturdy, hardwood, portable tripod. Order by Stock No.—Send check or M.O.—Money-back guarantee! \$29.50 f.o.b. antea! Stock No. 85,050-H. (Shipping wt. 10 lbs.)
Barrington, N.J.

See Stars Close Up!
Ask for FREE catalog W
EDMUND SCIENTIFIC CO., Barrington, N. J., U. S. A.

make it with 60¢ worth of sand & cement
SELL IT FOR \$2000
every home a prospect for these patented "LIFETIME" **CONCRETE INCINERATORS**

Make big profits manufacturing rust proof, fire proof, almost indestructible concrete incinerators in your own backyard or garage... full or part time. Sell to home-owners, hardware, department and garden supply stores. Phil's, manufacturer doing big volume with Sears, Roebuck; large department stores. Easy to follow instructions and all needed equipment supplied. Exclusive protected franchise—No competition! Territories going fast. Write immediately for full details. Dept. PM47, T. C. TOR, 2113 Bellevue St., Phila. 40, Pa.

Train yourself to be a top-pay mechanic in Air Conditioning and Refrigeration by practicing at home with real equipment!

R. C. ANDERSON
President
COMMERCIAL TRADES
INSTITUTE



Job experts agree that opportunities for success are best in old, established industries which continue to grow. This is very true of the Air Conditioning and Refrigeration field. It is expanding so rapidly that thousands of good jobs are created each year. Yet, there's practically no competition for many of these well-paid openings because *not enough trained men are available!*

It's easy to get that vital training. You need not give up your present work nor leave your family. You can learn at home in spare time by practicing with real equipment. Yes, CTI sends you 23 big training kits, along with valuable "here's how" instruction. For full information, just fill out and mail coupon below.

Why thousands of mechanics are needed

Over 150 million refrigerating units are in use today—are in need of repair and service. And the industry keeps booming! Each year, 3 million refrigerators, 1 million freezers and 2 million air conditioners are produced. You see these units in homes, stores, offices, restaurants, hotels—the applications are endless. Even autos now come with built-in air conditioners. *No wonder trained refrigeration mechanics are in demand—are so well-paid!*

CTI offers a quick, easy way to learn

You learn *fast*—you learn *right*—because you get all parts and tools to build a complete, heavy-duty, commercial-type, 1/4 h.p. condensing unit (shown at left). You do 10 service and troubleshooting jobs. You keep this equipment.

You get experience by training with kits



Above left is photo of tools in just one kit. You get other tools, tubing, much equipment. In another kit (right), you get motor, fan, pulley, service tools. Kits are sent on planned schedule so that you learn in easy stages. Kits develop skill, speed training. *No extra cost for kits!*

You may earn extra cash as you train

CTI training is so practical that many students do repairing in spare time. They work with local dealers or "on their own." They earn extra cash, get added experience. Some land full-time jobs while students, others open shops.

Mail coupon for two FREE booklets

The story on job and business opportunities in the vast Air Conditioning and Refrigeration industry is fascinating. It's told in an interesting booklet which you can have free. We'll send it, along with training information, if you mail coupon. *Act today!*



BE YOUR OWN BOSS

The Air Conditioning and Refrigeration industry is one of the easiest in which to start a repair and sales business. You mail coupon—we'll send facts.

Get all the facts first—Then decide—

COMMERCIAL TRADES INSTITUTE

1400 GREENLEAF AVENUE
CHICAGO 26, ILLINOIS

DEPT. R-356

Tell me how I can qualify for a better job or a business of my own. Send booklet, *Success in Air Conditioning & Refrigeration*, and Lesson Sample. Both FREE

Name _____ Age _____

Address _____

City _____ Zone _____ State _____



DRAFTSMEN



**CASH BIG
PAY CHECKS!**

**Train Now for
more success,
greater security**

**LEARN AT HOME IN SPARE TIME
(or at college in Chicago)**

Check the want ads in any newspaper—SEE the big-pay opportunities open to you as a draftsman. What's more, you can learn this well-paid, prestige profession at home — quickly, easily! No special talent needed. Get complete, step-by-step Chicago Tech lessons in the mail, spend a few pleasant hours studying each week. In a short time you'll be a well-trained draftsman, ready to take your pick of many good jobs. Act now!



Free Information—Mail Coupon Today!

Get **FREE TRIAL LESSON** plus information about C.T.C. practical training. Learn what successful Chicago Tech graduates say about high pay and opportunities in drafting. No charge, or obligation.

CHICAGO TECHNICAL COLLEGE

D-215 Tech Bldg., 2000 So. Michigan Ave.
Chicago 16, Illinois

Mail me **FREE** lesson with facts about big opportunities in **DRAFTING**.

Name _____ Age _____

Address _____

City _____ Zone _____ State _____

DIESEL MEN WANTED

**Earn \$100 per week and up
AUTO-DIESEL MECHANICS**

You learn fast in our school and shops because you learn with tools on real equipment. Experienced instructors explain WHY and show you HOW, then you DO IT YOURSELF with tools on various makes and models. One of the best equipped technical schools of its kind in the United States. Thirty-seven years' experience training men. Successful graduates in 48 states and many foreign countries. Approved for veterans. Day and evening classes. Earn While You Learn. Write for free bulletin.

NASHVILLE AUTO-DIESEL COLLEGE
226 7th Ave. N., Dept. 86, Nashville, Tenn.

RAZOR BLADE PLANES

3-WAY CURVE
PLANE



LITTLE GIANT

**JUST USE
A
DOUBLE-EDGE
RAZOR
BLADE**



FLAT
PLANE



FOR JOBS OTHER
PLANES CAN'T DO
For Short Curves
and Shaping
For Long Curves
and Flat Surfaces



Adjust
Here.

ADJUSTS
INSTANTLY
FOR
DESIRED
DEPTH
OF CUT

ONLY 98¢ each AT HARDWARE DEALERS
If not yet available in your area, you may order by mail. Include 25¢ additional for postage and handling.
— DEALERS WRITE FOR INFORMATION —
WILSON BROS. Dept. PM-4 SPRINGFIELD, MISSOURI

BE A **CAMERA CRAFTSMAN...**

Send for **FREE** book!

Many are needed in this big paying field and now a YOU can learn to repair cameras using manufacturer's service methods. ... In your spare time! Instructions, tools, practice equipment — everything you need is included in this approved course! Write for big FREE illustrated booklet that tells you HOW!

national camera repair school - DEPT. V-4 SINGLE HONO. COURSE

MAKE MONEY AS A LOCKSMITH

A RESPECTED, PROFITABLE
TRADE FULL OR PART TIME.
AGE OR HANDICAP IS NO
RESTRICTION. UNCROWDED
FIELD. EASY TO LEARN!



LEARN AT HOME FROM
LICENSED SCHOOL EVERY-
THING SUPPLIED BY US.

Licensed by N. J. State Board
of Education. Approved by V.A.

Send For
**FREE BOOKLET
NOW!**

INSTITUTE OF LOCKSMITHING, Dept. P89
15 PARK AVENUE, RUTHERFORD, NEW JERSEY

LEARN PLASTICS



**COMPLETE LOW COST SHOP METHOD
HOME TRAINING NOW AVAILABLE**

Get in on Big Money opportunities in Plastic molding, casting, forming, carving, etc. Earn as you learn with Interstate's professionally prepared course. All plastic materials furnished.

**WRITE FOR
FREE
BOOKLET**

INTERSTATE TRAINING SERVICE
DEPT. C-3, PORTLAND 13, OREGON

TERMITES IN YOUR HOUSE? GET RID OF THEM YOURSELF!

DON'T PAY \$300.00 AND UP TO ERADICATE
TERMITES FROM YOUR HOME OR PREVENT
INFESTATION. DO IT YOURSELF IN ONE AFTER-
NOON. EASILY! QUICKLY! INEXPENSIVELY WITH
"TERM-OUT"! SEND STAMP FOR HANDBOOK.



COMPASS RESEARCH
4700-A CLAIRTON BLVD., PITTSBURGH 36, PA.



WORLD'S LOWEST PRICED ADDING MACHINE

Counts up to 999,999,999
IDEAL FOR BUSINESS AND PERSONAL USE—GUARANTEED ACCURATE.

Not a toy. Operates with only a finger flick. Adds, subtracts, multiplies, divides. Counts up to one billion. Pays for itself over and over. Ideal Gift—for Business, Income Tax and School use. **MONEY BACK GUARANTEE.** Send name and address. Pay Postman only \$2.95 plus postage. Beautiful rich-looking Leatherette Case included at no extra cost. Money back in 10 days if not delighted. **AGENTS WANTED.**

CALCULATOR MACHINE COMPANY
P.O. Box 126, Dept. J-57, Huntingdon Valley, Penna.

POPULAR MECHANICS

CAVITEX

Superfine
Masonry



X-5

Manufacturing Rights Now Available in 427 Territories

CaviteX offers building owners the ultimate in masonry at sensationally low costs. Designed in line with today's architecture. Long and low. Large color range. Modular in all dimensions. Strong—safe—enduring. Suited to all types of wall construction—8" solid, cavity, partition, veneer.

As a local manufacturing opportunity, CaviteX has tremendous potentials. Local materials are processed by local labor for local consumption. Vast economies effected. That's why CaviteX has price-appeal to buyers and profit-appeal to producers. Hundreds of territories are open.

CaviteX manufacturers operate in franchise-protected territories and with exclusive privileges. Extensive sponsor cooperation. Basic machinery available on lease. Write or wire for book "Opportunity, Unlimited" and tentative reservation of territory.

W. E. DUNN MFG. CO.
409 W. 24th St., Holland, Mich.
In Canada
Dunn Masonry Machinery, Ltd.
844 Dundas Highway
Cooksville, Ontario



BUILD YOUR OWN OPTICAL INSTRUMENT "FUN with OPTICS" TELLS YOU HOW

Just out! 32 exciting pages! Wonderfully illustrated. Shows you how to build telephoto lenses, telescopes, microscopes, close-up camera lenses, artist drawing projectors, slide viewers, binoculars, riflescopes, etc. Plenty of diagrams—any 10-year old can easily follow the instructions. We can furnish the lenses, prisms and parts you'll need. Right now—order your copy of "FUN WITH OPTICS." Just send your name and address, along with only 50c in coin. **EDMUND SCIENTIFIC CO., Barrington 30, New Jersey.**

ARTHRITIS—RHEUMATISM VITAL FACTS EXPLAINED

FREE DESCRIPTIVE BOOK
How crippling deformities may be avoided. This amazing FREE BOOK explains why ordinary methods give only temporary relief—if that. Describes a drugless method of treatment successfully applied in thousands of cases. Write for this 36-page FREE BOOK today. No obligation.
BALL CLINIC, DEPT. 766, EXCELSIOR SPRINGS, MO.

LEARN UPHOLSTERY in your spare time run your own business AT HOME

BE YOUR OWN BOSS

Earn more from the start while learning! Set up your own profitable business at home, enjoy steady income, independence—in the booming field of Custom Furniture Upholstery.

Right off you start with tools, complete frames, fabrics, materials, included FREE with your UTS course. You earn as you learn skilled professional custom upholstery, reupholstery, furniture finishing, repairs; to make slip covers, window cornices, cushions, draperies in your spare time... the UTS easy way. Send for FREE Illustrated Book, Sample Lesson

Get ready for well-paid job, steady work and big profits as your own boss. Write today. No obligation. Also Training in N.Y. School. APPROVED FOR VETS.

UPHOLSTERY TRADES SCHOOL
Dept. FD-310 721 B'way N. Y. 3, N. Y.



HOW TO FIX ANY PART OF ANY CAR

QUICKLY--EASILY--RIGHT!



FREE 7-DAY TRIAL

Whether you're a beginner or an expert mechanic—now you can "breeze through" any "fix-it" job from simple carburetor adjustment to complete overhaul. Just look up job in index of MOTOR'S Brand-New Auto Repair Manual. Follow simple step-by-step directions, clear pictures. Presto—the job is done!

No guesswork! MOTOR'S MANUAL takes you from "scratch"—shows WHERE to start. WHAT tools to use. Covers EVERY job on EVERY car built from 1949 thru 1957!



Everything You Need to Know "Bailed Down" from 160 Official Shop Manuals

BIG NEW, REVISED, ENLARGED. Edition contains the "meat" from over 160 OFFICIAL shop manuals—simplified for YOU. 25,436 essential repair specifications. Over 1,000 big pages. More than 2,900 "this-is-how" pictures, 225,000 service and repair facts. Leads beginners every step of the way. Time-saving factory repair procedures for experts. Instructions and pictures so clear you CAN'T go wrong. Used by U. S. Army and Navy.

Brand-New—Covers All These Makes

- | | |
|-------------|-------------|
| Buick | Jeep |
| Cadillac | Lincoln |
| Chevrolet | Mercury |
| Chrysler | Nash |
| Clipper | Oldsmobile |
| Continental | Packard |
| De Soto | Plymouth |
| Dodge | Pontiac |
| Ford | Rambler |
| Hudson | Studebaker |
| Imperial | Thunderbird |
| | Willys |

Try Book FREE 7 Days

SEND NO MONEY! Pay postman nothing. Make Manual show you what it's got. Unless you agree this is the greatest time and work saver you've ever seen—return book in 7 days and pay nothing. Mail coupon today to: MOTOR—Book Dept., Desk 14, 250 W. 55th St., New York 19, N. Y.

Same FREE Offer On MOTOR'S New Truck Repair Manual

Covers EVERY job on EVERY popular make gasoline and Diesel Truck made since 1946. FREE 7-Day Trial. Check proper box in the coupon below.

MAIL COUPON NOW FOR 7-DAY FREE TRIAL

MOTOR BOOK DEPT.
Desk 14, 250 W. 55th St., New York 19, N. Y.

Rush to me at once (check box opposite book you want):

MOTOR'S New AUTO REPAIR MANUAL. If O.K., I will remit \$2 in 7 days, \$2 monthly for 2 months and a final payment of 35c (plus 35c delivery charge) one month after that. Otherwise I will return the book postpaid in 7 days. (Foreign price, remit \$9 cash with order.)

MOTOR'S New TRUCK REPAIR MANUAL. If O.K., I will remit \$2 in 7 days, and \$2 monthly for 3 months, plus 35c delivery charges with final payment. Otherwise I will return book postpaid in 7 days. (Foreign price, remit \$20 cash with order.)

Print Name.....Age.....

Address.....

City.....State.....

Check box and save 35c delivery charge by enclosing WITH coupon entire payment of \$6.95 for Auto Repair Manual (or \$8 for Truck Repair Manual.) Same return-refund privilege.

Check the Kind of Body You Want

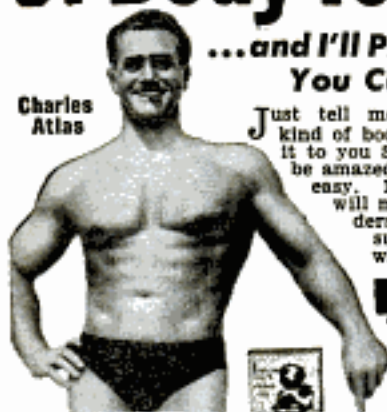

Charles Atlas

...and I'll Prove How EASILY You Can Have It!

Just tell me, in coupon below, the kind of body you want—and I'll give it to you SO FAST your friends will be amazed! "Dynamic Tension," my easy, 15-minutes-a-day method, will make your chest and shoulders bulge... arms and legs surge with power... your whole body feel "alive!"

FREE BOOK Tell how I became "World's Most Perfectly Developed Man"—Mail coupon! CHARLES ATLAS, Dept. 8D, 115 East 23rd Street, New York 10, N. Y.

CHARLES ATLAS, Dept. 8D
115 East 23rd St., New York 10, N. Y.

Dear Charles Atlas: Here's the Kind of Body I want:

(Check as many as you like)

- | | |
|--|--|
| <input type="checkbox"/> More Weight—Solid—in The Right Places | <input type="checkbox"/> Powerful Arms, Legs, Grip |
| <input type="checkbox"/> Broader Chest, Shoulders | <input type="checkbox"/> Slimmer Waist, Hips |
| | <input type="checkbox"/> Better Sleep, More Energy |

Send me absolutely FREE a copy of your famous book showing how "Dynamic Tension" can make me a new man—32 pages, crammed with photographs, answers to vital questions, and valuable advice. No obligation.

NAME _____ AGE _____
(please print or write plainly)
ADDRESS _____
CITY _____ STATE _____

Learn ELECTRIC APPLIANCE REPAIR IN YOUR SPARE TIME AT HOME

START YOUR OWN BUSINESS

ONE BUSINESS THAT IS NOT AFFECTED BY STRIKES, DEPRESSIONS OR POLITICS

WITH A POTENTIAL MARKET OF 50,000,000 CUSTOMERS

New shop-method, home-training system gives you electrical know-how that used to take years to learn. Learn at home by building valuable testing kits, repairing your own and neighbors' appliances. It is not unusual for appliance repairmen to charge on the basis of \$5.00-\$6.00 an hour.

FREE ILLUSTRATED BOOK
Shows you how you learn every phase of electrical appliance. How to make money while you learn. Write today for your FREE copy.

CHRISTY TRADES SCHOOL
Dept. D-6503
4804 North Kedzie Ave., Chicago 25

Let Me Show You How I Made \$20,000 a Year Buying Junk Jewelry

Learn at home in one evening



No selling. Pay friends and neighbors good prices for old rings, watches, chains and bridges. U. S. Gov't pays you \$35 an ounce for the gold this junk contains.

THERE'S gold to be picked up on any street in any town any day of the year if you know my secrets. I teach you how to find it, how to buy it, what to pay for it, how to test and how to ship to Uncle Sam for cash. I supply you with testing outfit and weighing scale. Takes only one evening to learn at home. Next day you are ready to fill your pockets with gold at junk prices. I'll teach you the secrets by which I made \$20,000 a year. No charge for facts. Send name on postcard—no money. Leslie Patton, 335 W. Madison Street, Dept. P-94, Chicago 6, Illinois.

BECOME AN EXPERT IN TRAFFIC and TRANSPORTATION

Traffic men earn \$4,000 to \$10,000 and up. Thousands of firms need experts on rates, tariffs, regulations. We train you thoroughly in spare time at home for executive traffic jobs. Personal training under traffic authorities. Write for free book "Traffic and Transportation."

LASALLE Extension University, 417 So. Dearborn St. A Correspondence Institution Dept. 464T, Chicago 5, Ill.

TASOPE PHOTO-ENGRAVING PLANTS



Establish your own profitable PHOTO-ENGRAVING business. Make cuts for newspapers, printers, and advertisers. Make etched name plates, plaques etc. Instructions furnished, no experience necessary. Sold direct from factory since 1931. First five hundred cuts sold locally or by mail will pay for plant and pay you well for your time. Write for FREE catalog.

Material Cost Of This Cut 2¢
Selling Price \$1.00 And Up

TASOPE, DEPT. PM-4, AURORA, MO.

SALE

20 X 50 REGULARLY \$74.50
SAVE \$44.55!

High powered, whisper-weight (27 oz.) color corrected, Achromatic binoculars. 7" high EZ to hold, EZ to focus. Instant finger-tip adjustment. **SALE PRICE FOR THIS SALE ONLY** (including case and straps) Made in Japan. **USE 30 DAYS. \$29.95** If not satisfied return for full refund. Add tax.

UNITED BINOCULAR CO., 8041 S. Western, AHP-1408, Chicago 20. DEALERS WANTED

SAVE 1/2 on WATER SKIS

\$18.00

Simply assemble and finish our new water ski kit and you have a pair of skis worth twice the price of the kit. Skis are 7 ply moulded plywood, 67 1/2" long, 7" wide, 3/16" thick. Sturdy rubber foot pieces. All parts plus instructions included — \$18.00. Order from your Michigan dealer or MICHIGAN WHEEL CO., Dept. P-4, Grand Rapids, Mich. C.O.D. orders accepted.

RCA offers you the
 finest training
 at home in
 Radio-TV
 electronics,
 TV servicing,
 Color TV

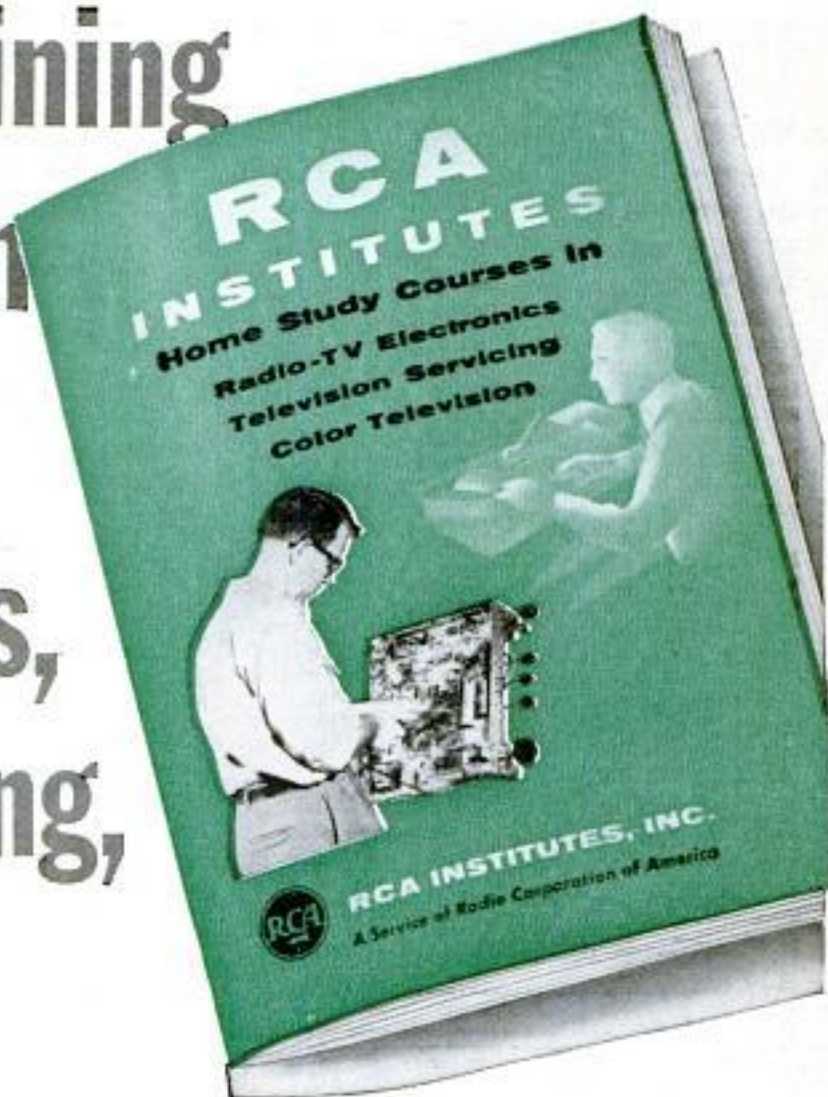

**SEND FOR THIS FREE
 BOOK NOW!**

The instruction you receive and equipment you get (and keep) will start you on your way. Pay-as-you-learn. You pay for only one study group at a time. This 52 page book contains complete information on Home Study Courses for the beginner and the advanced student.



RCA INSTITUTES, INC.

A SERVICE OF RADIO CORPORATION of AMERICA
 350 WEST FOURTH STREET, NEW YORK 14, N.Y.

In Canada—RCA Victor Company, Ltd.,
 5001 Cote de Liesse Rd., Montreal 9, Que.

RCA Institutes, Inc., Home Study PM-47
 350 West Fourth Street New York 14, N. Y.
 Without obligation, send me FREE CATALOG
 on Home Study Courses in Radio, Television
 and Color TV. No salesman will call.

Name
 Please Print
 Address
 City Zone State

VETERANS
 KOREAN G. I.
 P. L. 550
 CHECK HERE
 ()



YOU
can
acquire

LAW NIGHTS AT HOME! LL. B. DEGREE

LaSalle's famous Law Library—used as reference in many Law libraries and Law offices—has enabled thousands to master Law surprisingly fast, in spare hours at home, for business and professional advancement.

These 14 remarkable volumes, compiled by leading professors and lawyers, cover the whole basic field of Law in condensed, orderly, simplified manner.

You advance rapidly with this great library, plus special lectures furnished. We guide you step-by-step with personalized Problem Method of instruction . . . you learn by doing—handling legal problems—not by memorizing rules.

Send for two FREE booklets, "Law Training for Leadership," and "Evidence," answering questions about Law and its value to you, and telling how LaSalle Law graduates are winning rapid advancement in business and public life. Mail coupon below. No obligation.

LA SALLE EXTENSION UNIVERSITY A Correspondence Institution

417 S. Dearborn St. Dept. 464L Chicago 5, Ill.

Send me your two FREE booklets described above, without obligation.

Name.....Age.....

Street.....

City, Zone & State.....

PAINTING IS EASY!

with the famous **BURGESS**
electric **SPRAYER**

Just plug in and Spray:

- paint • varnish • enamel
- shellac • mothproofers
- garden sprays • water
- insecticides

PAINT 3 to 7 TIMES FASTER!

For the fastest, smoothest painting or spraying job you ever saw, try the Burgess Sprayer. Completely self-contained . . . just plug into regular household outlet, pull the trigger, and paint furniture, floors, walls, screens, cabinets, fences. Fine for mothproofing and garden spraying, too. Sapphire nozzle, handy spray adjuster, new convenient hanging hook, 25 oz. graduated jar. Easier to clean than a brush.



only **\$12.95** AT YOUR FAVORITE DEALER

If not available locally send \$12.95 for postpaid delivery. Money-back guarantee.

SEND FOR FREE BOOKLET
"HOW TO PAINT THE EASY WAY"

BURGESS VIBROCRRAFTERS, INC.
DEPT. A-65 • GRAYSLAKE, ILLINOIS

BIGGER! BETTER! FINER! FASTER!

PENN YAN boats

. . . this year's line of leaders includes luxury outboard runabouts, Trailboats, Cartops® and canoes. Types for cruising, fishing, skiing, racing. New work-free, leak-proof constructions, new treatment with germicide under pressure that proof-tests, adds years to boat life.

FREE
CATALOG:
44 pages, color
illustrations.

Write Today!

PENN YAN BOATS, Inc.
34th St., Penn Yan, N.Y.



SCIENTIFIC CRIME DETECTION



IT'S EASY TO LEARN

Let us teach you in your own home. Learn Fingerprinting, Firearms Identification, Police Photography, Criminal Investigation Methods thoroughly, quickly, at small cost. Over 800 Bureaus of Identification in the U. S. employ I. A. S. students or graduates. Write today, stating age.

INSTITUTE OF APPLIED SCIENCE, 1920 Sunnyside Ave., Dept. 1354
(A Correspondence School Since 1916) Chicago 40, Ill.

Now! **TEST YOUR OWN TV - RADIO TUBES!**
EVEN THE PICTURE TUBE

Checks fuses, appliances, etc. Easy, safe to use. Inserts tube in socket. Pilot light instantly indicates if tube needs replacement. Rugged metal case (not plastic). AC or DC. One service call saved pays for tester. Only \$3.95 ppd. or C.O.D. plus charges. Deluxe Model \$4.95. Instructions. 3-yr. guarantee. **GEIGER ENGINEERING CORP., Dept. AB-101, 6249 N. Western Ave., Chicago, Ill.**

FIX OUTBOARD MOTORS POWERMOWERS, AND ALL SMALL 2 & 4-CYCLE GASOLINE ENGINES

Repair your own equipment or MAKE EXTRA MONEY in this growing field. Fully illustrated, easy-to-understand. Home Study Course. Write for FREE information.

LINCOLN TECHNICAL INSTITUTE
SUITE 4-E, 472 MARKET STREET, NEWARK 5, N. J.

Do FALSE TEETH Rock, Slide or Slip?

FASTEETH, an improved powder to be sprinkled on upper or lower plates, holds false teeth more firmly in place. Do not slide, slip or rock. No gummy, gooey, pasty taste or feeling. **FASTEETH** is alkaline (non-acid). Does not sour. Checks "plate odor" (denture breath). Get **FASTEETH** at any drug counter.

Day or Night Enjoy this **HIGH-POWERED**
40, 80, 120 TELESCOPE
with **TRIPOD**

\$12.95 ppd.

Observe stars, moon, planets. See distant ships, people, etc. appear feet away! Crystal-clear image sharpness at all powers. All images erect. Telescope, with five precision lenses and 40" long black leatherette covered tube mounted on 5 ft. hardwood tripod, cast aluminum head. Vertical and horizontal movements machined aluminum, tension controls on each. 3X finder scope attached locates target fast. Telescope completely assembled with tripod **PLUS 3 FREE GIFTS** only \$12.95 postpd. Satisfaction guaranteed. **SUFFOLK SCIENCE SERVICE** Dept. PM-6 Mattituck, N. Y.

GET THESE GIFTS FREE!

1. 120 pg. book "Discover the Stars"
2. Star Finder Dial
3. 200 & 400X eyepiece lenses

WHY PICK YOUR FUTURE BLINDFOLDED ?



THE MOST IMPORTANT decision you will make in your life will be selecting a training in the field offering you the highest degree of success.

EDUCATORS AGREE we do not all have the qualifications required for success in the same field. Despite this fact many people select a training in the mechanical and technical field chiefly because it offers outstanding opportunities . . . later to find that they have wasted both time and money on a training

for which they are not suited.

WE HAVE A LARGE and growing waiting list of high paying positions for our graduates. That's because we have developed, tested and perfected an examination and aptitude test which removes all guesswork.

WHEN WE ACCEPT a student in our school, we know . . . and industry has learned . . . that he is qualified to pursue the training and become successful in the field.

REMEMBER—if you are planning to enter one of the big paying fields listed below, don't take chances . . . write for entrance examination, aptitude test and complete information. No cost or obligation. No salesman will call.

- DIESEL
- AUTO
- ELECTRONICS
- AUTOMATION

Your Future
IN
ELECTRONICS
AND
AUTOMATION

FREE BOOKLET

Your Future
in
DIESEL and
AUTO
MECHANICS

BAILEY

Technical Schools

Veteran Approved

1633 S. Grand, St. Louis 4, Mo.

Name _____ Age _____
Street _____
Town _____ Zone _____ State _____

NEW RUBBER STAMP BUSINESS PAYS BEGINNERS UP TO \$9.20 AN HR.

**START AT HOME
IN SPARE TIME**
with Table Top Machine!

The multi-million dollar Rubber Stamp business—once controlled by a few big companies—is now being taken over by small operators—one in each community throughout the United States. Men and Women who have this inexpensive machine can turn out huge quantities of Rubber Stamps with special wording that buyers once were forced to buy from big cities. Material costing only 27c makes a stamp that sells for \$1.80. The machine that does the work is simple and easy to operate and it turns out as many as six Rubber Stamps at a time, each with different wording such as names, addresses, notices, stock numbers, prices and other "copy" needed by offices, factories and individuals. Working full capacity, it can earn as much as \$9.20 an hour for the operator! Now you can get into the big-pay business yourself, with your own home as headquarters. You don't need experience. We supply everything, including complete instructions and eight ways to get business coming in fast. Start making up to \$9.20 an hour from the very beginning. Cash in on the profitable Rubber Stamp business in your community, right away. We'll mail full particulars FREE and no salesman will call. Be first in your locality. Rush coupon today or send your name on postcard to

RUBBER STAMP DIV., Dept. R-2-D
1512 JARVIS AVENUE • CHICAGO 26, ILLINOIS



RUBBER STAMP DIV.
1512 Jarvis Ave., Dept. R-2-D
Chicago 26, Illinois

FREE!

Please rush full particulars about the little machine that can get me started in the profitable Rubber Stamp business at home in spare time. Everything you send me is FREE and no salesman will call.

NAME _____

ADDRESS _____

CITY _____ ZONE _____ STATE _____

FREE!

TO SECURE NAMES FOR OUR MAILING LIST

Treasure Chest OF PRIZED STAMPS

FROM
PIRATE STRONGHOLDS



IMAGINE! You receive FREE this whole "treasure chest" of valuable stamps from countries and islands famous in history as PIRATE hideouts! Your imagination will be carried back to the days of Jean La Fitte, Blackbeard, Captain Kidd, by these colorful stamps from the Bahamas, Barbados, Haiti, Trinidad, Liberia, Madagascar, St. Pierre and Miquelon . . . etc. You may want to sell them to envious friends. Or start a priceless "pirate country" stamp collection. ALSO FREE - Stamp Collector's MAP OF THE PIRATE WORLD and helpful, informative "How to Collect Stamps." Other interesting offers included for your inspection. Mail this ad now (with your name and address and 10¢ to help cover handling, mailing) to:
LITTLETON STAMP COMPANY,
Dept. PM-4, Littleton, N. H.

not everyone does as well, but E. O. Lockin, who started a business of his own, reports . . .

for 12 months I've averaged
\$800 PER MONTH
INCOME -
most of it clear profit for me!

Many men have discovered how to be independent, to be free of bosses and layoffs. L. A. Eagles grossed more than \$200 his first week. Others report gross up to \$12,000 per year. How much you make depends largely on you. You need no special skill, no large investment.

No shop necessary. Our ELECTRIC RUG WASHER cleans rugs, carpets right on floor . . . helps to show their natural color, beauty. So efficient and safe, used by largest hotels and railroads.

You take no risk. Machines fully guaranteed. Write for full information including how to make big profits in YOUR OWN business.



MAIL COUPON TODAY FOR FREE BOOK

VON SCHRADER MFG. CO., 410 "R" PL, Racine, Wis.

Without obligation, send your FREE booklet containing information about your ELECTRIC RUG WASHER and how I can start my own permanent, profitable business.

Name _____

Address _____

City _____ Zone _____ State _____

DIVING EQUIPMENT SPECIALISTS

New catalog lists surplus bargains in diving equipment. Complete gear for commercial operators and construction work. NEW deep-water and shallow-water gear. Compressors, Telephones, Lungs, etc.

Immediate shipment from our large stocks.
Write for illustrated diving catalog - 20c

M & E MARINE SUPPLY CO.
P.O. Box 601-Y Camden 1, N.J., U.S.A.

TV Strong man
DAN LURIE
1937s



\$10,000 REWARD

If correct use of my new body building course fails to build you a "HE-MAN" BODY The secret is in my revolutionary, exclusive Body Mould system. Yours FREE with famous

DAN LURIE BARBELLS
Scientific! Fastest, surest method known - beats all other training methods. Results guaranteed. Special low prices.
50 lb. set \$ 8.98 • 100 lb. set \$14.98
150 lb. set \$21.98 • 200 lb. set \$27.98
14c per Lb. F.O.B. 50% Deposit required

DAN LURIE BARBELL CO.
52M4 Bristol St., Dept. 759D, B'klyn 12, N. Y.

Would You Like to Make \$1,000 A MONTH?



That's what Stanley Hyman made selling the amazing new Presto Fire Extinguisher! Many others "cleaning up" - so can you! Amazing tiny new extinguisher ends fires fast as 2 seconds.

Guaranteed for 20 years! Sells for only \$4.95! Write for Free sales kit. Merlite Industries, Presto Div., 114 E. 32nd St., Dept. P-15U, New York 16, N.Y.



MONEY in WORMS

Big money made raising fishworms and crickets. Billions used yearly - unlimited market - Sell by mail - We teach you how to raise and where to sell. Learn about our new, tremendous 6 to 12 inch African Redworms - in demand everywhere. Free Literature. CARTER WORM RANCH, PLAINS, GEORGIA



Easy to make your own BOWS - ARROWS - EQUIPMENT

Illustrated Hand-Book 84 pgs. \$1, tells you how! Large Colored Catalog 5c - Send for it!

Ask your dealer for "Stemmler's Archery" (Oldest Mfr. in U.S.A.)

L. E. STEMMLER CO.
Manorville (Box 1) L. I., N. Y.

BE A CLAIM INVESTIGATOR



INVESTIGATE ACCIDENTS! Many earning \$750 to \$1000 a month. Thousands of insurance companies, airlines, steamship lines and Government Offices need Claim Investigators. Also big opportunities for your own spare time business. We train you at home. National Placement Service FREE of extra charge. Bill King writes: "Your course has paid off for me with large earnings. You can quote me - your Adjuster Training Course is worth many times the cost." Write TODAY for FREE book.

UNIVERSAL SCHOOLS
University Park, Dept. PM-4, Box 8202, Dallas 5, Texas

POPULAR MECHANICS



DRAFTING is the way to *Big Income* OPPORTUNITIES!

Learn at home in your spare time. Become a professional Draftsman. Enjoy good pay, respected position in an ever growing field. CHRISTY TRAINING is easy and clear. You learn by making actual drawings, planning production, see things develop. You learn the interesting, easy-to-remember way by doing.

PAY AS YOU LEARN PLAN

CTS will send you 50 illustrated drafting manuals, set of professional drafting instruments, equipment and supplies plus a portable drafting table . . . everything you need! Send name for **FREE BOOK** and **PAY LATER FORM**. CHRISTY TRADES SCHOOL, 4804 N. Kedzie, Dept. DB-3403, Chicago 25.

ME A MANAGER?

Yes. If you are ambitious we will train you for a management position. Qualified, trained men are needed now to fill big pay management positions in business and industry. The Thomas Method of Individual Correspondence Instruction trains you at home under expert supervision. Business men approved. 15 thorough Management Courses—in Business Administration, Industrial, Retail, Office Management, Advertising, Personnel, Salesmanship, Human Relations, other business fields. Write for **FREE BOOK**, "Opportunities in Business Management," and complete details. No obligation.

THOMAS SCHOOLS, Dept. A4, 1428-11th, Seattle 22, Wash.

**BOOK
SENT
FREE**

STUDY TO BE A DOCTOR of Psychology or Metaphysics

Obtain a Ph.D., M.D., or Ph.D. Be a Teacher, Lecturer or Accredited Practitioner. Teach others how to achieve Health, Happiness and Contentment. Chartered by State. Correspondence Courses only. Write for **FREE** book telling how.

THE NEOTARIAN FELLOWSHIP

Desk B, Pickwick Building Kansas City 6, Missouri

★ WORK FOR UNCLE SAM ★

TRAIN FOR GOV'T. JOBS! AS HIGH AS \$4,080.00 YEAR TO START. Men, women, 18-55. Experience often unnecessary. Write immediately for **FREE 36-PAGE BOOK** with list of many positions, salaries, sample tests, and full particulars telling how to qualify for them. (Not Gov't. Sponsored)

Franklin Institute, Dept. F-93, Rochester 4, N. Y.



KING MIDGET

ALL NEW. First model change in six years. New bodies, new chassis, new engine. Four wheel hydraulic brakes. Still World's Lowest Priced Car. Drive it for 75c per week. Rider Agents Wanted. Earn your own car. Get the facts. Send 25c for 32 page picture book with complete details, dealers price, etc.

MIDGET MOTORS CORPORATION, Athens 1, Ohio

Superior's New Model 70 UTILITY TESTER® FOR REPAIRING ALL ELECTRICAL APPLIANCES MOTORS · AUTOMOBILES · TV TUBES

AS AN ELECTRICAL TROUBLE SHOOTER THE MODEL 70:



- Measures A.C. and D.C. Voltages, A.C. and D.C. Current, Resistances, Leakage, etc.
- Will measure current consumption while the appliance under test is in operation
- Incorporates a sensitive direct-reading resistance range which will measure all resistances commonly used in electrical appliances, motors, etc.
- Leakage detecting circuit will indicate continuity from zero ohms to 5 megohms (5,000,000 ohms)
- Will test Toasters, Irons, Broilers, Heating Pads, Clocks, Fans, Vacuum Cleaners, Refrigerators, Lamps, Fluorescents, Fans, Switches, Thermostats, etc.
- Will test all TV tubes for open filaments, inter-element shorts, burned out tubes, etc. (Will not test TV tubes

for quality. An emission type tester such as the Model TV-11 described below is required to test tubes for quality).

AS AN AUTOMOTIVE TESTER THE MODEL 70:

- Tests both 6 Volt and 12 Volt Storage Batteries
- Generators
- Starters
- Distributors
- Ignition Coils
- Regulators
- Relays
- Circuit Breakers
- Cigarette Lighters
- Stop Lights
- Condensers
- Directional Signal Systems
- All Lamps and Bulbs
- Fuses
- Heating Systems
- Horns
- Also will locate poor grounds, breaks in wiring, poor connections, etc.

Handsome round-cornered molded bakelite case, 3 1/2" x 5 1/2" x 2 1/4". Complete with all test leads. Also included is a 64 page book giving detailed instructions for testing all electrical appliances, automotive equipment, TV tubes, etc. Only

15⁸⁵

Superior's New Model TV-11 STANDARD PROFESSIONAL

TUBE TESTER



Uses the new self-cleaning Lever Action Switches for individual element testing.

Because all elements are numbered according to pin-number in the IMA base numbering system, the user can instantly identify which element is under test. Tubes having tapered filaments and tubes with filaments terminating in more than one pin are truly tested with the Model TV-11 as any of the pins may be placed in the neutral position when necessary.

The Model TV-11 does not use any combination type sockets. Instead individual sockets are used for each type of tube. Thus it is impossible to damage a tube

by inserting it in the wrong socket.

Free-moving built-in roll chart provides complete data for all tubes.

Phone Jack on front panel for plugging in either phones or external amplifier will detect microphonic tubes or noise due to faulty elements and loose external connections.

Operates on 105-130 Volt 60 Cycles A.C.
Hand-rubbed oak cabinet complete with portable cover

47⁵⁰

SHIPPED ON APPROVAL NO MONEY WITH ORDER — NO C.O.D.

Try either of the above instruments for 10 days before you buy. If completely satisfied then send down payment and pay balance as indicated on coupon. **No Interest or Finance Charge Added!** If not completely satisfied, return unit to us, no explanation necessary.

MOSS ELECTRONIC DIST. CO., INC.

Dept. D-338, 3849 Tenth Ave., New York 34, N. Y.

Please rush the units checked. If satisfied, I agree to remit the down payment within 10 days and to pay the monthly indicated rate. If not satisfactory, I will return within 10 days for cancellation of account.

Model 70 . . . Total Price \$15.85 Model TV-11 . . . Total Price \$47.50—\$11.50 within 10 days. Balance \$4.00 monthly for 3 months.

Address _____

Name _____

City _____

Zone _____ State _____

All prices net, F.O.B., N.Y.C.

**TO THE MAN LOOKING FOR A
SECURE FUTURE**
Learn **OIL
BURNER
SERVICING**



**AT HOME IN
YOUR SPARE TIME**

Enjoy real security . . .
earn top wages . . . get ahead faster.

Learn a trade where Trained Men are always in demand. High starting salary, plus hundreds of opportunities for advancement in the fast-growing Oil Burner industry, which U. S. Government predicts will double in size in next few years. We teach you Installation, Operation, Maintenance and Servicing. Complete course. Remember, Trained Men command best jobs — highest wages. Our Oil Burner graduates are 100% employed.

LEARN AND EARN IN YOUR SPARE TIME

Put your spare time to work. Learn a specialized trade. No previous experience or special education necessary. Act today! Cash in tomorrow! Earn while you learn, doing repair jobs in your own area. Low tuition, only \$5 starts you! Tools furnished. Send coupon now! No obligation.

Mass Trades has trained thousands for success since 1938.

RESIDENT SCHOOL — APPROVED FOR VETERANS

WRITE NOW FOR FREE SAMPLE LESSON AND BOOKLET

MASS. TRADES

161 High Street, Boston 10, Mass.

Please send me FREE sample lesson and booklet

NAME _____ AGE _____

ADDRESS _____

CITY _____ ZONE _____ STATE _____

**Makes
\$216.00 A MONTH
IN SPARE TIME!**



M. M. REARICK SAYS: "I AVERAGE UP TO \$216.00 A MONTH OPERATING MY BELSAW SHARP-ALL AFTER WORK AND ON SATURDAYS"
YOU can start your own spare-time business in your own home. With the new Belsaw Sharp-All you can sharpen all knives, scissors, shears, snips, ice skates, mower blades, hedge trimmers, grass whips, axes, chisels, screw drivers, scrapers and saws . . . just about any household, garden and shop tool. Your own CASH business with no inventory. No calls to make. No experience needed.

Learn how easily you can start your own spare-time business. Amazing low cost, easy-payment plan. Send postcard for **FREE BOOK**.

BELSAW SHARP-ALL CO

717 Field Building • Kansas City 11, Missouri



**WAR
SURPLUS
BARGAINS**

STAR'S

**WAR
SURPLUS
BARGAINS**

**\$500,000.00 INVENTORY
for QUICK LIQUIDATION**

Surplus items—hundreds of them for home, shop, factory, farm and outdoor use. New items, used items, reconditioned items—all at tremendous savings—all priced for quick sale.

Page After Page of Values

This big catalog shows page after page of amazing money saving values. Write for your copy today. Send 10c to cover postage, mailing, etc. Write today! **SEND TODAY FOR YOUR COPY**

10c

STAR'S 212 W. Madison St.
Dept. PM-574
CHICAGO 6, ILL.

POWER OF WORDS

if YOU want to be —

An interesting conversationalist . . .
Good speaker before groups . . .
Pareful in use of words . . .
Confident and correct in the use of written and spoken English

find out about Functional Training in English. Amazing booklet. **THE POWER OF WORDS**, is yours free. Write for it today.

PRINCIPLE INSTRUCTION CENTER, Dept. D-6
2955 PETERSON AVE. CHICAGO 45, ILL.

YOU BUILD 'EM — WE SELL 'EM
EARN UP TO \$50.00 A DAY AT HOME

Participate in our national sales and sub-contract plan—spare time—full time. You assemble special luggage and cases for photographers, musicians, salesmen, and all types of portables. We supply complete instructions—materials—tools—everything. No previous experience necessary. Free details. Abarst Cascraft, Dept. AD, 807 W. Sunset Blvd., Los Angeles 12, Calif.

DRAINS cellars, cisterns, wash tubs; **\$7.95**
IRRIGATES - CIRCULATES - SPRAYS

Up to 3,000 GPH; 450 GPH 80' high; or 1800 GPH from 25' well. Use 1/6 to 8 1/2 HP motor. Coupling included free. 1" inlet; 3/4" outlet. Stainless steel shaft. Won't rust or clog. . . . Type P—\$7.95.

CELLAR DRAINER KITS (less motor)
"Low Boy"—15" high, 1500 GPH, . . . \$12.95
"High Boy"—32" high, 3,000 GPH, . . . \$15.95
Postpaid if cash with order. **MONEY BACK GUARANTEE**
LABAWCO PUMPS, Belle Mead 7A, N. J.



**LEARN METALCRAFT
and JEWELRY MAKING**

Low Cost Home Training Now Available

Make money. Learn profitable skills and arts of decorative metal and jewelry crafts. Course is complete. Professionally prepared. Easy to master. Special tools and materials furnished.

Write for **INTERSTATE TRAINING SERVICE**
Free Booklet DEPT. K-3 PORTLAND 13, OREGON



Enjoy the Fascinating Story
of the Horseless Carriage in

Popular Mechanics

AUTO ALBUM 166 Illustrations

The most intriguing book about the automobile ever printed. It's thrilling, fascinating and informative. From the very first gasoline-propelled buggy to the cars of today and the atomic auto of the future. The first cars — the men who made them — the scrambled start and the development of the fabulous auto industry—the story of auto racing—the growth of the Nation's highways. 166 thrilling action pictures—old-time cars—racing cars—early auto advertising—automotive oddities. Roll call of names of more than 2000 autos made in the U.S. included. Ideal gift book. Cloth bound, only \$3.00 by mail. Money back if not pleased.

POPULAR MECHANICS PRESS, Dept. PM-457
200 East Ontario Street Chicago 11, Illinois



POPULAR MECHANICS



college graduates get ahead faster!

You see it in your own city. They have higher incomes . . . advance more rapidly. Grasp your chance for a better life. Industrial growth . . . automation . . . technical advances create career opportunities for engineers, accountants, management experts. Share rewards awaiting college-trained men. Important firms visit campus regularly to employ Tri-State College graduates. Start any quarter in this world-famed college. Approved for veterans.

Bach. of Science degree in 27 months

In Mechanical, Civil, Electrical, Chemical, Aeronautical, Radio (TV-Electronics) Engineering. In 24 months a B.S. in Business Administration (General Business, Accounting, Motor Transport Management majors). Superior students may accelerate. 36-week course in Drafting. Intensive program: technical fundamentals stressed; comprehensive courses with more professional class hours. Small classes; personalized instruction. Enrollment limited to 1650. Preparatory courses. Residential campus. Well-equipped, new and modernized buildings and laboratories. Enter June, Sept., Jan., Mar. Earnest, capable students (whose time and budget require accelerated courses and modest costs) are invited to write Jean McCarthy, Director of Admissions, for catalog and book "Your Career in Engineering and Commerce."



TRI-STATE COLLEGE

447 College Avenue • • • Angola, Indiana

The finest of Gifts...

ENCYCLOPAEDIA BRITANNICA

250 POWER



Complete Telescope Lens Kit only \$3.49 postpaid

Conquer Space. Explore the Universe, Planets, Moon Craters, New Stars, etc. Complete Lens Kit consists of 80 inch focal length ground and polished objective lens, eyepiece lenses for 50 POWER, 100 POWER, 150 POWER, 200 POWER, 250 POWER, and all necessary lens fittings. Easy to make from simple step by step instructions. (Tripod and mount not included.) Money back guarantee.

BUSSE SALES CO., Hartford, Conn., Dept. PM 56



MECHANICAL DENTISTRY

To make Crowns, Plates, Bridgework, etc., for Dentists. Easy practical way to learn mechanical dentistry at home in spare time. FULL EQUIPMENT OF TOOLS AND MATERIALS INCLUDED WITH COURSE. Low tuition. Easy terms. Write for FREE BOOK about this money making profession that is not affected by machine age.

MCCARRIE SCHOOL OF MECHANICAL DENTISTRY
207 N. Broad St., Dept. 64, Philadelphia 7, Pa.

SHORTHAND IN 6 WEEKS

Famous SPEEDWRITING shorthand. 120 words per minute. No symbols; no machines; uses ABC's. Easiest to learn, write and transcribe. Low cost. 250,000 graduates. For business and Civil Service. Typing available. 34th Year. Schools in over 400 cities. Write for FREE booklet to:

Speedwriting
Dept. 1504-7
85 W. 42 St., N.Y. 36, N.Y.

RUPTURED? Write for New Relief FACTS FREE!

ENJOY NEW FREEDOM

of action, peace of mind and comfort at work or play. Proven, patented MILLER holds your ruptured back Day & Night—will bring you lasting relief! Has helped thousands of others!

For FREE facts in plain wrapper—Send Name and Address to

FRED B. MILLER, DEPT. 1-D
Manufacturer, HAGERSTOWN, MARYLAND



ENTIRELY DIFFERENT

Make your interest in AUTO MECHANICS & DIESEL PAY OFF!



OUR FAMOUS SHOP METHOD HOME TRAINING PREPARES YOU FOR BIG TIME PAY AT HOME IN SPARE TIME

YOU GET AND KEEP ALL THIS EQUIPMENT



Complete set of professional tools and All-Metal Tool Box. Same top-quality equipment used by expert mechanics everywhere. Use them, display them proudly.



"Motor Analyzing Set" contains Standard Engine Vacuum Fuel Pump Tester, Remote Starter Switch, Modern Timing Light, Standard Compression Tester. Plus compact carrying case & instructions.



Top-quality Socket Wrench with Fittings. Real professional tools you'll use during your lifetime career in repairing all types of engines, from foreign cars to big diesel jobs.

Nearly 60 million cars and trucks on our roads! If you could talk to owners of garages, service stations and car dealerships (as we do every day), you'd realize America's DESPERATE NEED FOR TRAINED MECHANICS.

Take your choice—One modern course prepares you for Auto-Mechanic jobs, Airplane Mechanics, Farm Machinery Repair, all Diesel Jobs, Experimental Labs, Government Work, Engine Specialties, etc. A qualified, ALL-AROUND Mechanic always has a good job.

Every phase is Shop-Tested! Streamlined lessons, diagrams, manuals are easy to understand. Earn as you learn. Free Graduate Employment Service.

FREE!
VALUABLE BOOK
& SAMPLE LESSON
JUST SEND COUPON



RESIDENT TRAINING AT LOS ANGELES! If you wish to take Resident Training at Los Angeles, in our big, modern Shops & Labs, check special box in coupon for full information.

APPROVED FOR GI TRAINING
NATIONAL SCHOOLS
Los Angeles 37, California
Canada: 811 W. Hastings St., Vancouver, B. C.

NATIONAL SCHOOLS
TECHNICAL TRADE TRAINING SINCE 1905
LOS ANGELES 37, CALIFORNIA

NATIONAL SCHOOLS, Dept. DB-47
MAIL NOW TO OFFICE NEAREST YOU

4000 S. FIGUEROA ST. LOS ANGELES 37, CALIF. OR 187 N. LA SALLE ST. CHICAGO 1, ILLINOIS
Send for FREE Auto-Diesel Opportunity Book and Sample Lesson.

NAME _____ AGE _____
ADDRESS _____
CITY _____ ZONE _____ STATE _____

Check if interested ONLY in Resident School Training at Los Angeles
VETERANS: Give date of discharge _____

HOW I MADE A FORTUNE IN CHEMISTRY

PRICE \$100000

The price of this book is \$1000⁰⁰

IT CAN BE YOURS FREE!

NOW, for the first time published, the exact details, complete formulas and methods—nothing omitted! The author reveals how he made a fortune in Chemistry; the whole simple truth; over a million dollars in sales in 6 years without EVER LEAVING HOME! The ideas in this unusual book may change the course of your entire life, as they did his! No special talent, knowledge, equipment or skill required! The author is handicapped; that's why his achievements can be duplicated and bettered by those who are not! Write for free details how you can acquire this precious book FREE! Only a limited number of these valuable books will be given away—so act NOW! If you are also interested in earning a diploma in Chemistry through HOME STUDY, ask for our Catalog of Chemistry Courses!

NATIONAL SCHOOL OF CHEMISTRY
P.O. BOX 606-P REDWOOD CITY, CALIF.

WHOLESALE Electric Guitars - Parts - Factory to You

Solid-body Spanish, amplifiers, pedal harp-chord guitars, double-necks, single-necks, triple necks, solid-body mandolin, pickup mikes, non-electric instruments, etc. 1957 Models wholesale, FREE CATALOG. Free home study course with instruments. Parts & plans available to build your own.

CARVIN CO., Box 287, PM-4, Covina, Calif.

AMAZING! Secret Spy CAMERA



**It's a CAMERA!
It's a LIGHTER!
ONLY \$2.98**

Complete with roll film

TAKE PICTURES UNDETECTED!! Now you can take pictures while lighting your own or someone else's cigarette—WITHOUT BEING SUSPECTED! Others think you're just using the lighter, BUT ACTUALLY YOU'RE TAKING PICTURES WITHOUT THEIR KNOWLEDGE! Patterned after the long-secret spy camera used by secret agents, it's a dependable lighter in addition to being a precision-made camera that takes 20 clear, detailed pictures at a moment's notice. Same size as an ordinary cigarette lighter; fits vest pocket.

SATISFACTION GUARANTEED OR MONEY BACK
High quality lens takes close-up or distance photos that enlarge beautifully. Allows you to get natural, unposed pictures at parties, home or out-of-doors. No complicated adjustment necessary; easy to operate camera takes 20 photos per roll, that can be developed anywhere. Comes to you complete, ready to operate. Send check, money-order or cash. Add only 20c to each order for postage and handling. No C.O.D.'s please. **\$1.00 SPECIAL**—Extra Film, 4 rolls for only
DOBBS PRODUCTS CO., 1255 So. Wabash Ave., Dept. 473, Chicago 5, Ill.

Free! AIRMAIL COLLECTION



Get this spectacular collection of all-different, genuine Airmails from strange, far-away countries in Asia, Africa, Europe, the exotic Orient! World's largest airmail, scarce \$27 stamp, old Zeppelin, many, many others. A truly remarkable collection containing stamps worth up to 40c each at catalog prices! **EXTRA:** new illustrated booklet "Men Against the Sky." **PLUS** Bargain Catalog and other unusual offers. Send 10c for mailing costs. **ACT NOW!**
JAMESTOWN STAMP CO. DEPT. F4PM JAMESTOWN, N.Y.

SAVE THOUSANDS OF DOLLARS

"HOME-A-MINUTE" KIT

Not Something To Fool Around With!

Let's be frank. Isn't it ridiculous for you to pay thousands of dollars in excess profits when you build or buy a New Home, simply because you do not know the actual cost of building it? **WHY NOT design and build your New Home, Attic Flat, Extra Bedrooms or Remodeling—IN MINUTES—** with dozens of fiber partitions, Doors, Windows, Kitchen Cabinets, made to 1/4 inch scale same as blueprints. **THEN, BELIEVE IT OR NOT, YOU, THE LAYMAN, who knows nothing about building, can estimate your own costs—IN MINUTES—** after you adjust charts to local prices. Don't build anything until you get this "KIT," if you want to save money. Handbook tells you how. Also financing. This information should not pass you by. Complete "KIT"—\$3.95 ppd. Money back guarantee. Return in 10 days.

2825 N. 69th St. B. B. HALL & CO. MILWAUKEE 10, WIS.

Print Your Own



Cards, Stationery, Advertising, Circulars, labels, photo and movie titles, church work, tags, etc. Save money. Sold direct from factory only. Raised printing like engraving, too.

Own a Printing Business

Print for Others, Good Profit. Have home shop. Junior press \$15; Senior \$29 up. We supply everything. Easy rules. Pays for self in short time. Write for free catalog of outfits and all details.

KELSEY PRESSES, C-37 Meriden, Conn.

BUY WHOLESALE!

30-80% Discounts! Appliances, Gifts, Typewriters, Tools, Watches, Sporting Goods, Jewelry, Cameras, Housewares, etc.

CONSOLIDATED DISTRIBUTORS CLIFTON 1, NEW JERSEY

PLEASE SEND ME



for the time checked.
I am enclosing . . .

- 1 year \$3.50
- 2 years \$6.00

name _____

address _____

city _____ zone _____ state _____

Hand this order to your newsdealer or send it to
POPULAR MECHANICS
200 East Ontario St. Chicago 11, Ill.

Train in Great Shops of COYNE for better jobs in

ELECTRICITY - TELEVISION

ELECTRONICS

RADIO - COLOR TV



TWO TOP OPPORTUNITY FIELDS

Whether 17 or up to 45 years of age, train the Coyne way for a better job and a real future in **ELECTRICITY-ELECTRONICS** or **TELEVISION-RADIO**, fields that offer a world of opportunities. Train on real, full-size equipment at COYNE where thousands of successful men have trained for nearly 60 years—largest, oldest, best equipped school of its kind—established 1899. No advanced education or previous experience needed. Employment service to graduates. **START NOW—PAY LATER**—Liberal Finance Plans and Easy Payment Plans. Also part-time employment help for students. Training in Refrigeration and Electric Appliances can be included.

B. W. COOKE Jr., President

COYNE
ELECTRICAL SCHOOL

FOUNDED 1899

A Technical Trade Institute Operated Not For Profit
500 S. Paulina Street, Chicago, Dept. 47-72H

ELECTRICITY • RADIO • TELEVISION • REFRIGERATION • ELECTRONICS

MAIL COUPON FOR FREE BOOK

Send coupon for 48-page illustrated book "Guide to Careers in Electricity-Electronics and Television-Radio." No cost; no obligation; no salesman will call. Vets and Non-Vets get vital facts now!



B. W. COOKE Jr., President
COYNE ELECTRICAL SCHOOL
500 S. Paulina St., Chicago 12, Ill., Dept. 47-72H

Send BIG FREE book and details of your training offer. This does not obligate me and no salesman will call. I am interested in:

() Electricity-Electronics () Television-Radio

Name _____

Address _____

City _____

State _____

Secrets of VENTRILOQUISM Now Revealed!

Easy to learn in 80 to 90 days with our Home Study Course. **RESULTS GUARANTEED.** Make Money! Be Popular! Have Fun! Big Opportunity! Radio, Television, Stage Appearances! For FREE information regarding price and terms WRITE. You must state your age. Dummy Catalog 375.
MAHER HOME COURSE OF VENTRILOQUISM
Box 36, Studio E, PM-4, Kensington Station
Detroit 24, Michigan

WHEELS WHEELS WHEELS

7" Disc Wheel 3/4" Tire 3/4" sleeve	45c ea.
8" Disc Wheel 1 1/8" Tire 1 1/2" sleeve	70c ea.
7" Disc Wheel 1" Tire 1 1/2" ball bearing	80c ea.
8" Disc Wheel 1 1/8" Tire 1 1/2" ball bearing	\$1.00 ea.
8" Disc Wheel 1.50 semi-pneum. Tire 1 1/2" B.S.	\$1.25 ea.
8" Disc Wheel 2" semi-pneum. Tire 1 1/2" B.S.	\$1.50 ea.
10" Disc Wheel 1.75 semi-pneum. Tire 1 1/2" B.S.	\$1.50 ea.
10" Disc Wheel 2.75 semi-pneum. Tire 1 1/2" B.S.	\$3.50 ea.
12" Disc Wheel 1.75 semi-pneum. Tire 1 1/2" B.S.	\$1.85 ea.

Above wheel prices includes hub caps, excepting 10 x 2.75. Postage extra. C.O.D.'s accepted, Axles extra. Sizes, 5/16", 3/8", 1/2" dia. Cut to size per inch long. End holes drilled.

UNITED WHEEL STAMPING CO.
11915 S. MARSHFIELD AVE., PM-4, CHICAGO 43, ILLINOIS

OUR AD HAS BEEN IN THIS MAGAZINE LONGER THAN ANY OTHER TIRE CO., NEARLY EVERYONE BUYS FROM STANDARD.

50 Years of Combined family experience in High Quality tires.

23 YEARS AT THIS ADDRESS
TUBE FREE WITH EVERY PASSENGER TIRE

Our entire stock of very slightly worn **EXTRA MILEAGE TOP GRADE Tires**, (Written Insurance Guarantee). **SEND AD**

EVERYBODY MAY DEDUCT 10% off ON EVERY TIRE

FREE if you buy 2 or more Passenger 4-ply tires, WE GIVE ONE tire FREE, on each order. Does not include W.W. or Truck Tires, or Snow Tires.

12 MOS. WRITTEN GUARANTEE WITH EVERY TIRE					
600-16	\$5.52	640-16	\$4.52	700-16(6)	\$7.52
600-16(6)	5.52	640-16	4.52	750-16(8)	10.72
650-16	5.72	670-15	5.52	700-17	9.82
650-16(6)	6.62	710-15	5.52	750-17	10.32
750-16(6)	7.52	760-15	5.82	825-20	18.92
550-17	3.72	800-15	5.92	600-20	9.02
650-15	5.52	820-15	5.92	650-20	9.82
700-15	4.92	700-16(6)	7.32	750-15	10.72

"EXTRA SPECIAL" SOME NEAR NEW all size 4-ply pass. \$7.92 FREE TIRE with 2 or more of these also.—W.W. \$1.00

Extra Factory Tested Tube given—GIANT TIRE SALE. EA.

Thousands of tires shipped all over the U.S.A. All tires shipped F.O.B. Phila. Send Check or M.O. with this ad. Dept. 2. No C.O.D.

STANDARD 834 N. Broad St., Philadelphia 30, Pa.



BE YOUR OWN MUSIC TEACHER

Send for Free Book Telling How Easily You Can Learn Piano, Guitar, Accordion, ANY Instrument This EASY A-B-C Way



Now IT'S EASY to learn music at home. No tiresome "exercises." No teacher; just **START RIGHT OUT** playing simple pieces. Thousands now play who never thought they could. Our pictured lessons make it easy as A-B-C to learn to play popular music, hymns, classical, and any other music. Only a few cents a lesson. Over 900,000 students! (Our 59th successful year.)

Mail Coupon for FREE BOOK

Find out why our method can teach you quickly, easily, inexpensively. Write for Book. No obligation. No salesman will call. Mention your favorite instrument. Mail coupon.



U. S. SCHOOL OF MUSIC
Studio A304
Port Washington, N. Y.



U. S. SCHOOL OF MUSIC, Studio A304, Port Washington, N. Y.

Please send me Free 30-page Illustrated Book. I would like to play (Name instrument).

Instrument _____ Have you _____

Name _____ (Please Print)

Address _____

... TURN CONCRETE INTO GOLD!

MAKE UP TO \$75 A DAY IN YOUR OWN BUSINESS

If you want to have your own business — to start a business on your own — here's your big opportunity! New high speed, low cost General block machine produces up to 1,000 concrete blocks a day. Sell all you make to builders, supply houses, and others for homes, factories, buildings, garages. Cash in on the building boom! You can make profits of 100% to 150% — up to \$75 a day! General block machine equipped with 1/2 h.p. electric motor — or can be supplied with gasoline engine — works anywhere, in little space, indoors or out. Operates from ordinary house light socket. Simple, foolproof 3 step operation — so easy a child can do it. Makes superior 3 core blocks any size from 4" to 12". Also makes chimney, ash, corner and other types. Blocks meet any building code anywhere in the country. Materials — sand, water, cement, available anywhere. Simple illustrated operating instructions and mixing formulae for cement and cinder blocks supplied with each machine. Write for FREE folder with full information.

MOTOR DRIVEN

R. L. T. of New York City reports: "MY GENERAL BLOCK MACHINE PAID FOR ITSELF IN FIRST 2 WEEKS!"

Hundreds now in use the world over! Write for FREE details today!

EXTRA Amazing illustrated

Book gives floor plans for 6 sensational concrete block buildings. Tells how to lay blocks, lay out building lines, mix concrete, build steps, porch and concrete floors all at great savings. Written by experts. Can save many times the cost of the machine! Get it now! No strings attached. Send \$1.

BOOK SENT FREE IF YOU BUY MACHINE.
\$1 REFUNDED IF YOU BUY LATER.



GENERAL ENGINES CO.
DEPT. M-47, ROUTE 130, THOROFARE, N. J.

327 Different STAMPS—25¢



Plus: Smallland Desert Flower; Nigeria Tin Mines; Malta Great Siege; Israel Lost Tribes and hundreds more! Grand total of 327 all-different stamps. Catalog value \$7.45—yours for 25¢ to introduce our Bargain Approvals. Included FREE, Midget Encyclopedia of Stamps.

Send 25¢ Today. ASK FOR LOT FO-27

ZENITH CO.,
81 Willoughby St., Brooklyn 1, N. Y.

High School at Home

MANY FINISH IN 2 YEARS

No classes. No time wasted going to and from school. Progress as fast as your time and abilities permit. Standard H. S. texts supplied. Thousands enroll each year in this 60-year-old school. Send for FREE descriptive booklet.

AMERICAN SCHOOL, Dept. H445
Drexel at 58th St., Chicago 37, Ill.

Without obligation, please send FREE descriptive booklet.

Name.....

Address.....

Complete Canadian Courses available. Write American School, Dept. H445, 6083 Sherbrooke St. W., Montreal

23 BOATS YOU CAN BUILD



You Can Build These Boats Without Experience With Few Tools, and Little Time to Spare!

And the best part is that after you have completed your boat, you will know it is seaworthy as well as eye-worthy. This book, a few tools, and some time each day in your garage or basement, is all you'll need to complete the boat of your dreams. Nothing is left to the imagination. Everything is planned for you before you turn back the cover of the book. All you do is follow simple step-by-step instructions and show how photos and drawings.

tion rowboat, and 12-foot plywood outboard, are available in this one chapter alone. All are easy to construct, and beautiful to own. Step-by-step instructions, photographs and illustrations, plus important material lists carry you right through from the forming of the keel to the last coat of paint and varnish.

Building and Service Hints Provided

You'll learn how to build your boat right the first time. Success in building a boat depends on two things. Knowing beforehand exactly what type boat you want to build and then getting started correctly on the construction. With this book it's simple. Material lists are supplied where essential, listing lumber required, hardware, sailcloth, fittings, etc. Also included are hundreds of hints for building your boat right, the best boat for beginners, and tips on servicing boats after they are built.

Half a Million Persons Build Their Own

There are more than half a million persons in the United States who regularly build boats for pleasure or for profit. They form a cross section of American life. And theirs is a double reward—the fun of building the boat, and the thrill of using it when it is finished.

Special Chapter on Boats for Sportsmen

If you are a sportsman, hunter, fisherman, trapper, or just plan to use your boat for pleasure, this chapter contains ideal craft for your use. Perhaps you have a canoe in mind, or a rowboat that can be carried on your auto. Maybe you have always wanted a duckboat but have been reluctant to purchase one because of the expense. All these boats plus a 3-sec-

Partial Listing of Boats

Think of being able to build and own the following boats: "Su-Lu" the PT-type Plywood Dinghy, 11-ft. Skiff, "Sport" a V-Bottom Inboard, "Tramp" a 15-ft. Sailing Knockabout, "Sea Craft" a 25-ft. Cabin Cruiser, "Zephyr" a 14-ft Sailing Dinghy, "Arrowhead" a 21-ft. Sloop, a bicycle Boat, Motor-driven Paddle Board, "Skimmer" a Sturdy Plywood Kayak, "Skip" a Pram-Type Dinghy, "Tiny" a 6-ft. Training Ship, and many more, from large to small and at a fraction of the purchase cost!

7-Day Money Back Guarantee

Send for your copy of 23 BOATS YOU CAN BUILD today. Read and use it for 7 days. If it isn't entirely satisfactory return it for a full refund.

Use This Handy Order Coupon

POPULAR MECHANICS PRESS
200 E. Ontario St., Chicago 11, Illinois

Gentlemen:

Please send my copy of 23 BOATS YOU CAN BUILD Enclosed is my remittance of \$2.75. If I am not completely satisfied with the book I will return it for a full refund after 7 days.

Name.....

Address.....

City..... Zone..... State.....

For the Best Jobs Be an ALLIED TRAINED MAN



Mr. Harry Lebeson, President
Allied School of
Mechanical Trades

Allied's resident school is outstanding for the high quality of its vocational training. People from all over America and even from foreign countries come to Allied. And behind every bit of Allied's home study instruction is the practical know-how that has been made possible by more than a quarter of a century of training thousands of men for good paying jobs.



MORE JOBS THAN GRADUATES

As an Allied trained man you can go up fast — to higher and still higher pay or as a successful owner of a business. Due to the great present day industrial expansion programs throughout the country, industry has been clamoring for Allied trained men to fill important jobs. Shortages of Draftsmen, Designers, Tool Engineers, Machinists, Air Conditioning, Refrigeration and Heating Technicians are so widespread that you can pick a highly paid key job and look forward to Achievement and Security. You can begin your training in Short Courses at Home or at Allied Institute, and continue progressively toward an Engineering Degree in 26 months.

Train at Home or in the Great Allied Shops

Allied's training program permits you to study right at home in your spare time or at the Allied Institute's fully equipped shops and laboratories. Free employment service and housing assistance all through your training period and after your graduation. Our industrial contacts cover the U.S.A.

"The best jobs go to Allied trained men" is a statement so often heard that it is important to you. Your chances for success are naturally greater when you get the best training of its kind available. Allied is approved by Industry, National Home Study Council, Central Schools Association, Dept. of Education, Office of Public Instruction, State of Illinois, U. S. Veterans Administration, U. S. Department of Justice. **BE AN ALLIED TRAINED MAN — GET THE FACTS — MAIL COUPON BELOW TODAY!**

- MECH. ENGINEER
- DRAFTSMEN
- TOOL DESIGNER
- TOOL ENGINEER
- MASTER MACHINIST
- AIR CONDITIONING
HEATING and
REFRIGERATION



FREE BOOKS

tell how YOU can become an ALLIED TRAINED MAN. Write TODAY!

ALLIED School of Mechanical Trades
ALLIED INSTITUTE OF TECHNOLOGY
1338-42 South Michigan Avenue
Dept. PM-4, Chicago 5, Illinois

ALLIED SCHOOL OF MECHANICAL TRADES

ALLIED INSTITUTE OF TECHNOLOGY
1338-42 South Michigan Avenue, Dept. PM-4, Chicago 5, Illinois

Gentlemen:

Mail me FREE BOOKS explaining ALLIED'S courses of instruction and FREE SAMPLE lesson.

Vets write date of discharge _____

I am interested in the training I have checked below: Resident Home Study

- | | |
|---|---|
| <input type="checkbox"/> MECH. ENGINEER | <input type="checkbox"/> MASTER MACHINIST |
| <input type="checkbox"/> DRAFTSMEN | <input type="checkbox"/> AIR CONDITIONING |
| <input type="checkbox"/> TOOL DESIGNER | <input type="checkbox"/> HEATING & |
| <input type="checkbox"/> TOOL ENGINEER | <input type="checkbox"/> REFRIGERATION |

NAME _____

ADDRESS _____

CITY _____

COUNTY _____

STATE _____

YOUR
NEIGHBORHOOD
NEEDS AN
**ELECTRICAL
APPLIANCE**



TROUBLE SHOOTER

Man needed to repair and service all kinds of Electrical Appliances—AUTOMATIC WASHERS - DRYERS - IRONS - VACUUMS - TOASTERS - REFRIGERATORS - FANS - HOME FREEZERS - AIR CONDITIONERS —home and industrial meters, etc.—also home and industrial wiring.

Big, Year-'Round Profits!
HELP US FILL HUGE DEMAND

MODERN BIG PROFIT ONE-MAN BUSINESS TOURS AT HOME — SPARE OR FULL TIME.

No previous experience needed. New, visual "Shop-Practice" method quickly shows you how. Hundreds of plain-as-day "How to" photos and drawings make it easy. A corner of garage, porch, attic, or basement is all the space needed. No costly leases—no big overhead. We show you how to make business come to you.

**NEW 30-DAY
INCOME PLAN!**
Shows you how
to start your own
Big Profit Business
without investment
—no big overhead

BIG MONEY, SECURE FUTURE—INDEPENDENCE.
F. V. in N. Y. says, "I made \$300 in 3 months while studying." T. E. H. in W. Va. says, "Made \$14 a day while learning."

EVERYTHING FURNISHED—Including BIG TOOL KIT
Instructions are complete and include a Tool Kit and Appliance Tester. Everything furnished to help you build your own big-profit business at home. Our new 30-day income plan shows you how to start making money almost at once. Send no money—just your name and address on coupon below. I will rush you FREE complete success plan with full details. Do it NOW—BE FIRST!

PACIFIC TRAINING SCHOOL, Dept. P-574
11029 So. Vermont Ave., Los Angeles 44, Calif.

PACIFIC TRAINING SCHOOL, Dept. P-574
11029 So. Vermont Ave., Los Angeles 44, Calif.

Gentlemen: Rush me postpaid your FREE plan for success in the Appliance Repair Business and the Free Book Entitled "The Appliance Repair Business and You" and remember I am under no obligation.

Name _____
Address _____
City _____ Zone _____ State _____

Write Like This **Complete OUTLINE FREE!**

MIRACULOUS IMPROVEMENT in your Penmanship in six hours practice with Grooved Letters. No failures. Inexpensive. No charges unless you're satisfied after 6 hours practice.

WRITE OZMENT BOX 685
34-P, ST. LOUIS, MISSOURI

You can make money in

WATCH REPAIR

Learn at home the low cost Sweazey Way

Watch repairing pays up to \$8 an hour, part time watch makers report on survey. Unique and modern Sweazey home study System starts you making repairs right away on Swiss and American watches. Professionally prepared training. No previous experience needed. Special tools provided for practice. Tuition only \$5 a month. Free sample lesson and opportunity book give all facts. Write today. No obligation.

CHICAGO SCHOOL OF WATCHMAKING
2330 N. Milwaukee Ave., Dept. 147, Chicago 47, Illinois

INVENTORS

PROTECT YOUR INVENTION BY A U. S. PATENT. SEND FOR FREE "INVENTION RECORD" FORM AND "PATENT INFORMATION EVERY INVENTOR SHOULD HAVE."

CARL MILLER
REGISTERED PATENT ATTORNEY
WOOLWORTH BLDG., 36th FLOOR, 47A
NEW YORK CITY

INVENTORS

Whether an invention is patentable can be substantially determined by a search of the U. S. Patent records. Without obligation, write for information explaining the steps you should take to secure a patent.

JOHN N. RANDOLPH
Registered Patent Attorney
201 Columbian Building, Washington 1, D. C.

INVENTORS

U. S. Patents protect your inventions. Our free book of "Instructions on Patent Procedure for Inventors," also "Certificate of Invention" form sent without obligation.

C. A. SNOW & CO.
REGISTERED PATENT ATTORNEYS
428 SNOW BUILDING WASHINGTON 1, D. C.

INVENTORS

Send for **REGISTERED PATENT ATTORNEY**
Book and **ASSOCIATE EXAMINER**
INVENTOR'S RECORD U.S. PAT. OFF. 1922-1929
without obligation
GUSTAVE MILLER Patent Attorney & Advisor
47-PM WARNER BUILDING U. S. NAVY DEPT. 1930-1947
WASHINGTON 4, D.C. **PATENT LAWYER**

Buy nationally advertised products. Ask with confidence for the brands advertised in **POPULAR MECHANICS**



INVENTIONS WANTED

If you want to market, or sell, your invention for cash or royalties, Write for our Free Booklet. Send no drawings. We also welcome bearing from firms, or private capital, wishing to review inventions in any field. We will be glad to send notice of our clients' inventions.

GLOBAL MARKETING SERVICE
2420 77th Ave. Dept. PD Oakland 5, Calif.

INVENTORS

I shall be pleased to furnish you, upon request, with full information relative to patent procedure—without any obligation on your part.

PATRICK D. BEAVERS
Registered Patent Attorney
934 Columbian Building Washington 1, D. C.

YOU, TOO, CAN BE A WIZARD at FIGURES

MAIL COUPON for New Book that Makes Mathematics EASY READ 5 DAYS FREE!

Had trouble with MATHEMATICS, like so many other people? You probably were taught incorrectly. Try this new step-by-step method, with easy-to-understand examples right in your own home in spare time. Makes learning MATH a snap. It's all due to proper presentation, and you'll now find it not only easier, but actually fascinating. To get ahead on any job, you need to know your mathematics. It's a social asset, too. Why not try this method and see?

SEND NO MONEY. Just mail the coupon, and we'll send you "Practical Mathematics" for 5 days FREE EXAMINATION. If I decide to keep the Book, I will send you \$3.95 within 5 days, plus shipping costs. Otherwise I will return it and owe you nothing.

AMERICAN TECHNICAL SOCIETY, Dept. AE-4
848 E. 58th St., Chicago 37, Ill.

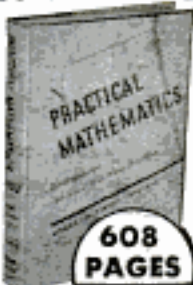

Only **\$3.95**

COMPLETE
Contents includes: Basic arithmetic simplified. How to solve problems with fractions quickly. Short cuts to figuring weights and measures. Methods for figuring areas and volume. How to use logarithms and figure square root.

AMERICAN TECHNICAL SOCIETY, Dept. AE-4 JUST MAIL THIS
848 E. 58th St., Chicago 37, Ill.

Please send me "Practical Mathematics" for 5 days FREE EXAMINATION. If I decide to keep the Book, I will send you \$3.95 within 5 days, plus shipping costs. Otherwise I will return it and owe you nothing.

NAME.....
ADDRESS.....
CITY..... ZONE..... STATE.....
 If you prefer to enclose \$3.95 with coupon, check here, and we pay all shipping costs. Money refunded if not delighted.

SAVE \$0000's on your HOME

YOU can do it! YOURSELF
HOMEWAY SHOWS YOU HOW!

Do as thousands do! Enjoy basementless home comfort plus economy! **SAVE . . . SAVE . . . SAVE.** Construct foundation and slab yourself by methods designed for most severe climates. Used by our company—one of Iowa's largest builders of basementless homes—in VA and FHA-approved housing. Whether you build yourself or contract, you'll **SAVE MANY TIMES** the small cost.

You get complete plans for laying out home on lot . . . pouring footing and concrete floors . . . leveling and pouring cap footing with same materials you'll use later in construction . . . insulating floor . . . installing perimeter heat runs, plumbing and vapor barrier.

Order our "Do-It-Yourself Slab Construction" plans. Written in layman's language anyone can understand. Cost you only \$5.00. **GET FREE AS BONUS** your choice of our best-selling slab house plans. Bonus alone **WORTH FAR MORE** than \$5. Includes complete set of 1 house plan, 4 elevations, wall sections, cabinet details, foundation and floor plan, complete approved specifications—**EVERYTHING** needed for construction.

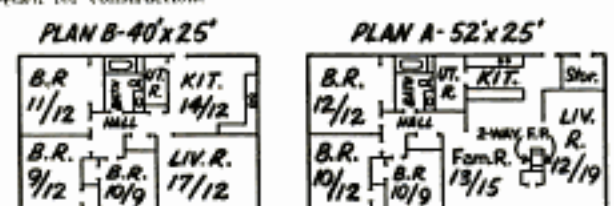

MAIL THIS COUPON

HOMEWAY CONSTRUCTION, 533 Ansbrough, Waterloo, Iowa

I enclose \$5 for "Do-It-Yourself Slab Construction" plans and **FREE** Bonus of House Plan A or B .

I would like more **FREE** info on Homeway Plans.

Name.....
Address.....

MAKE STRIPES with new PAINT PEN



Single 1/16" stripe model **\$1.25**

Straight, curved, single or double
With any color paint, stripe furniture, bikes, autos, model planes, toys, linoleum, wall-board. Clean, crisp decorative lines. Can't clog or smear. Also use with glue, tempera, textile paint or underglaze . . . on wood, glass plastic, ceramics, metals, fabrics and paper. Ask your dealer or order direct.

DEALERS Master paint striping tool in display carton. Write for discounts. Order now.
HOBBY "Professional" results every time. Simple, easy to use. Order now.
MFRS Ask about heavy duty industrial striping tools.

DOUBLE STRIPE MODEL \$3.25
5 COMBINATIONS. . . .

Other single **\$1.75**
stripe models **1 EA**
1/64", 1/32", 3/64",
5/64", 3/32" & 1/8"

Complete Kit \$5.00
(all 7 tips)

Extra tips **90c ea.**

Extra 1/4" tip **\$1.20**

WENDELL MFG. CO. 4234 LINCOLN AVE., Dept. 328
CHICAGO 18, ILLINOIS



GIANT BALLOONS — 3 for \$1.25

Surplus US Govt. (New Overage) Neoprene Weather Target Balloons. **FOR FUN** in the backyard; at parties, picnics, etc.!

FOR ADVERTISING—Attracts crowds to civic events, business openings, trade shows, fairs. Paint on sales message, seen for miles!
FOR PROMS—Makes any dance more festive. Ideal for high school or college affair!

Approx. Inflated Sizes
3 ft. dia. 49c ea. (**SPECIAL! 3 for \$1.25**)
5 ft. dia. 99c ea. (**SAVE! 3 for \$2.75**)

Postage paid on prepaid orders. Calif. res. add sales tax.
VOLUME SALES CO., War Assets Division
3930 Sunset Blvd., Dept. PM-457, Los Angeles 29, Calif.

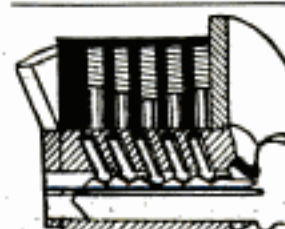

Locksmithing AND KEY MAKING

Now Made Easy! Practical up-to-date course teaches you how to pick locks, de-code, make master keys, repair, install, service, etc. New self-instruction lessons for every handyman, homeowner, carpenter, mechanic, service station operator, fix-it shop, hardware dealer, gunsmith. 55 easy illustrated lessons. Full price only \$6.50 postpaid or C.O.D. plus postage. Satisfaction or refund guaranteed.

Complete course **\$5.95** . . . now only
Nelson-Hall Co., Dept. DT-2
210 S. Clinton St. Chicago 6, Ill.

BUY IT WHOLESALE!

GET UP TO 40% OFF
★ Agents-Start Buying Service at Home. Get big-name merchandise for clients up to 40% off. Sales easy as you can give sizeable discounts, still make fat commissions. Postcard brings **FREE COPY** "The Wholesale Plan."
FREE! "THE WHOLESALE PLAN"

American Buyers Service
HERTEL STATION, DEPT. R, BUFFALO 16, N. Y.

FREE "How To Start Your Own MAIL ORDER BUSINESS"

Earn from \$10,000 to \$20,000 spare time. We'll put you in business and furnish you with everything needed. Exclusive new catalogs every three months . . . Offer your customers one item free for every two they buy! Free advertising and no stock for you to buy. We ship for you under your own name. No experience required. Write today for free booklet and franchise data.
MAIL ORDER ASSOCIATES, PARAMUS 50, NEW JERSEY

RUPTURED

BE FREE FROM TRUSS SLAVERY

Now there is a new modern Non-Surgical treatment designed to permanently correct rupture. These Non-Surgical treatments are so certain, that a Lifetime Certificate of Assurance is given.

Write today for our New **FREE** Book that gives facts that may save you painful and expensive surgery, and tells how non-surgically you may again work, live, play and love and enjoy life in the manner you desire. There is no obligation. **Excelsior Hernia Clinic, Dept. 8305, Excelsior Spgs., Mo.**

Art Talent Test FREE!

Find out if you have the talent for a career in commercial art. Take this simple Art Talent Test at home. It was devised by professional artists at our school as a test of natural talent. We will advise you, free and without obligation, whether your talent is worth training. We're the world's largest home study art school. For over 40 years, we've been preparing talented beginners for successful careers in art.



WRITE FOR YOUR
FREE COPY TODAY!

ART INSTRUCTION, INC., STUDIO 4137
500 South 4th Street • Minneapolis 15, Minnesota

Please send me your Talent Test, without cost or obligation.
(PLEASE PRINT)

Name _____ AGE _____ Phone _____

Address _____ City _____ Zone _____

State _____ County _____ Occupation _____

Reflector or Refractor TELESCOPES

\$3.98 TO \$198.00

Send for FREE illustrated catalog.

CRITERION CO., Dept. CPM2

331 Church St.

Hartford, Conn.



GET LATEST OFFICIAL AIRCRAFT PHOTOS

SPECIAL INTRODUCTORY OFFER!

- 4 3 1/2 x 5 photos, world's fastest Jets.
 - 4 3 1/2 x 5 World War II planes.
 - 4 3 1/2 x 5 of Rockets, Missiles.
 - 1 8x10 Boeing B-52 Jet Bomber.
 - 1 8x10 Lockheed F-104A Starfighter.
- Only 25¢ a set. Send \$1 for all 5.
(\$2 value)

Illustr. CAT. with order. Money back guar.



AVIATION PHOTO EXCHANGE

DEPT. PE BOX 75084
LOS ANGELES 5, CALIFORNIA

BIG MONEY AWAITS MEN TRAINED IN

TELEVISION — RADIO — ELECTRONICS — RADAR

Only CTS offers COMPLETE TRAINING in all phases of Electronics. Why be satisfied with less? You learn by working with actual equipment. Comprehensive Training Program allows you to EARN AS YOU LEARN.

19 TRAINING KITS INCLUDED!

You receive a Multi-Tester, Oscillator, Signal Tracer, Oscilloscope, Signal Generator, Electronic Timer, Regenerative Radio, 24" TV set (optional) and other valuable testing equipment. FREE BOOK and TWO FREE LESSONS sent on request. No obligation.



Send for 3
FREE
BOOKS!

CHRISTY TRADES SCHOOL, 4804 N. Kedzie, Dept. T-1203, Chicago 25

Sig Spaeth Says: My Amazing New Easy Method Shows You HOW TO PLAY THE HOHNER HARMONICA The Very First Day!



Here's the magic key to popularity! Following Dr. Spaeth's simple diagrams anyone can play popular tunes on a Hohner Marine Band Harmonica right off. No knowledge of music is required. If you can read this ad you can play!

This 35¢
Book
FREE
for a
limited
time

M. HOHNER, INC., Dept. M-47
351 Fourth Avenue, New York 10, N. Y.
Please send me New Easy Method Book.

Name _____

Address _____

City _____ Zone _____ State _____

Amazing 100-Year-Old Gypsy Bait Oil MAKES FISH BITE OR NO COST



PICTURES PROVE IT REALLY WORKS! Look at 1295 lbs. fish, those big hard to catch small-feeders landed by Roy Martin party, Destin, Fla. Gypsy Fish Bait Oil used on all bait. Hundreds of pictures like these on file.

Mystery Scent Makes Smell Feeding Fish Go Crazy

Fishing scientists are just learning what wandering Gypsies knew 100 years ago... many kinds of the most wanted fish such as catfish, bullheads, carp, snappers, are "smell" feeders. Gypsies invented this amazing scented oil formula that excites these fish through the thousands of tiny smell organs covering their bodies. A whiff while feeding and these fish streak madly for your bait. They all fight over it and usually the largest fish wins. Just dab mystery scented Gypsy Fish Bait Oil on your bait... fish lakes, rivers, creeks, ponds, or the ocean... still fish with pole and bobber, cast, troll or spin... if you're not the biggest catch in the entire party, your money back. Say we're crazy, be skeptical as you like. But let us send you the **DOUBLE STRENGTH GYPSY FISH BAIT OIL** to try at our risk.

Catch 300 Big Fish or Money Back

Send for the new **DOUBLE STRENGTH GYPSY FISH BAIT OIL** (double size) for \$1.98 or 3 for \$4.98. On arrival deposit your money plus C.O.D. postage thru postman. Cash orders sent prepaid. If you don't catch at least 300 small feeding fish (big ones too) before all the Gypsy is used up return empty bottle for money back. **FREE!** Handy water-resistant fisherman's pouch for matches, lunch, tobacco, etc. included free to keep even if you return empty bottle. Accept this friendly challenge. Write today to

WALLING KEITH CHEMICALS, INC.
DEPT. 49-D BIRMINGHAM 1, ALABAMA

TELEPHONES, TELEPHONE PARTS and WIRE & CONSTRUCTION SUPPLIES



BATTERY OPERATED TELEPHONES

for Inter-House, House to Barn or Office to Shipping Room telephone service. Handset style or Desk Stand style.

MAGNETO TELEPHONES for Rural telephone lines, construction jobs, factories, farms, camps or summer homes, etc.

MOTEL TELEPHONE SYSTEM — Simple economical telephone service between office and each cabin. Suitable for roadside Drive-In food service, etc.

ANTIQUE TELEPHONE CABINETS — complete with all parts except generator. Ideal for Home Hobby Shops. Make beautiful Radios, Spice Cabinets, Liquor Chests and Flower Boxes.

TELEPHONE LAMPS. Make your own. Beautiful. Different. Lamp, if you prefer.

WORM HARVESTER — Dan Mac Magneto — gathers fish-worms by electricity.

WRITE FOR ILLUSTRATED BULLETIN "AA-12"
which gives full facts on all of the above.

TELEPHONE REPAIR & SUPPLY CO.
DEPT. AA-12 1760 LUNT AVE., CHICAGO 26, ILL.
"America's Largest Independent Telephone Repair Shop"

AMAZING NEW PERSONAL POCKET RADIO



LISTEN IN PRIVATE WHILE YOU WALK!

SMALLER AND LIGHTER THAN ANY TRANSISTOR "POCKET RADIO" WL only 1/2 lb. Size 1 1/2" x 2 1/4" x 1 1/4" complete. Black Gold breakproof plastic case. POSITIVELY NO HOOKUPS OR WIRES NEEDED! BUILT IN 1000 MILE ANTENNA! Snap in flashlight batteries lasts for months. "Glow in the Dark!" Easy to use tap controls (while walking, riding, etc.). Has special tiny, soft plastic almost invisible ear-pieces—LETS YOU ALONE LISTEN ANYTIME ANYWHERE without anyone else knowing you are hearing radio music, sports, news, weather, etc. GUARANTEED TO WORK ANYWHERE RADIO CAN BE USED. ONE YEAR SERVICE GUARANTEE.

SEND ONLY \$5.00 (48, mo) and pay postman \$14.95 plus postage on delivery or send \$19.95 for postpaid delivery. A REAL \$29.95 VALUE! AVAILABLE NOW ONLY FROM US AT HALF PRICE! WHILE OUR SUPPLY LASTS. American made! You can always get parts if ever needed. NOT AN UNWORKABLE INCOMPLETE KIT OF PARTS OR PLAYTHING. A REAL MIDGET PERSONAL POCKET SIZE RADIO. Get yours now—Listen when you want without bothering others. Price will go up soon so rush your order now for YOUR TINY TONE POCKET PERSONAL RADIO. Available only from:

WESTERN RADIO Dept. APR-4 KEARNEY, NEBR.

Build a Boat at 1/3 the Cost!

— with CLEVELAND'S full size, cut-to-shape boat patterns, detailed blueprints, and specifications. All classes and styles of modern Naval Architect-designed boats from 7 1/2 to 38 feet. **BIG NEW 86-PAGE ILLUSTRATED CATALOG**, 50c (coin). "How to Build a Boat" booklet, \$2.50. Hardware & Equipment Catalog, \$1.50.



24 ft. Cabin Cruiser

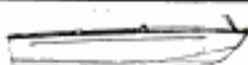

14 ft. Runabout

CLEVELAND BOAT BLUEPRINT CO.
Dept. B-166, Box 1651, Cleveland, Ohio

ENGINEERING DEGREE IN 27 MONTHS

B. S. Degree, Aero., Chem., Civil, Elec., Mech., & Electronic Eng. (10c. Radio & TV), B.S. degree in 36 mo. in Math., Chem., Physics, Prep. courses. Low rate. Earn board. Large industrial center. Students from 48 states, 21 countries. Demand for grads. G.I. appr. Enter June, Sept., Dec., March. Catalog, 1647 E. Washington Boulevard Fort Wayne 2, Indiana

INDIANA TECHNICAL COLLEGE

MONEY MAKING HOME HOBBY BOOKS

- METAL NOVELTIES.** How to make attractive desk sets, ash tray, book ends, serving tray, candlesticks and other items of hand-wrought copper, pewter, brass, iron, etc. 37 different articles. More than 200 photographs and easy-to-follow instructions. 88 pages \$1.00
- PROJECTS IN METAL.** 44 make-it-yourself articles on: fire-place sets, chimney and shutter ornaments, lanterns and lamps, iron tables, mail boxes, decorative novelties, etc. More than 300 photographs and working drawings. 96 pages \$1.00
- LEATHER PROJECTS.** A series of better than average articles on tooled leather in the modern manner. 8 items on tooled leather; 11 items for the ladies; 3 interesting descriptive pieces on leather chasing. Over 400 photos and drawings. 88 pages. \$1.00
- BIRD HOUSES, FEEDERS, BATHS.** Hundreds of fine designs which you can easily make with simple tools from a wide range of materials: scraps, logs, celluloid, concrete, metal, etc. Illustrated. 80 pages \$1.00
- HOW TO SUCCEED WITH BEES.** More than 190 successful plans to produce big crops of honey. A fascinating, lucrative hobby. 96 pages \$1.00

SEND FOR FREE CATALOG!

BOOK CATALOG. Describes the complete line of Popular Mechanics books: Do-It-Yourself Books—Home Improvement—Sports—Farming—Construction—Books for Boys and Girls—Automotive—Home Workshop—Crafts and Hobbies.

POPULAR MECHANICS PRESS, Dept. 457
200 E. Ontario Street, Chicago 11, Illinois

Check the books you want, write your name and address below, and mail this advertisement with money order or check. Outside U.S.A. include 15% additional for shipping charges.

Books selected will be mailed promptly. Money back if you are not pleased.

Name _____
Address _____
City _____ State _____

AMMUNITION



for a fraction of
regular cost

Reload a whole carton for the cost of a few rounds of factory ammunition. Shotgun shells, rifle and pistol cartridges can be reloaded safely and easily with an inexpensive set of famous IDEAL Reloading Tools. 164 page IDEAL Reloaders Handbook ... \$1.00, postpaid. Free folder on request.

THE LYMAN GUN SIGHT CORP.
MIDDLEFIELD, CONN.

LIFT THE HOOD TO A BRIGHT FUTURE

That better job you've always wanted is waiting for you in the auto industry. Over 50,000 mechanics are needed—because about two-thirds of the 60 million cars and trucks on the road are in the "heavy repair" classification. *That spells opportunity for you!*



Want a good job? Your own shop? Learn

Auto Mechanics

Easy to train by practicing at home



Yes, Auto Mechanics offers interesting work, high hourly wages, security. You could even go in business for yourself when qualified! Best way we know to learn this respected craft is to let CTI bring its original Shop-Method training to you at home. Based on resident-school experience,

this method trains you in every phase of mechanics, including: tune-up; overhaul; automatic transmissions; power systems; electric and cooling systems—"the works." *Mail coupon for two free books!*

EARN MONEY AS YOU TRAIN. Many students repair cars in spare time; others get jobs in local garages; some open shops by the time they graduate. Easy to learn-and-earn because CTI offers practical Shop-System training.

DIESEL MECHANICS OR BODY-FENDER REBUILDING is included at no extra cost. Only CTI offers this extra choice. Get this fully-rounded mechanic's training. *Send coupon for two free books. Get facts now; decide later.*



YOU PRACTICE WITH THIS TUNE-UP KIT

Kit includes a Compression Tester, a Vacuum Gauge and Fuel Pump Tester, an Ignition Timing Light, and a portable steel case. These professional instruments help you locate engine troubles, let you get useful practice. You keep this kit!

MECHANIC'S TOOLS TOO

You'll use these tools to get real experience. They'll increase your interest, stamp you as a "pro." You'll want to earn spare time cash with them. No extra cost for tools—you keep them.



MAIL COUPON TODAY!

COMMERCIAL TRADES INSTITUTE

1400 Greenleaf Ave., Dept. A-514
Chicago 26, Ill.

Mail book "Big Money in Auto Mechanics" and Sample Lesson. Both free.

Name _____ Age _____

Address _____

City _____ Zone _____ State _____



**NOW NO ONE CAN KEEP
A SECRET FROM YOU!** 20x-40x-60x only \$299
TELESCOPE postpaid

Amaze your friends... See what they're doing—without being seen!

Special Order now, get Free carrying case.

3-range all metal telescope magnifies up to 60 power. Watch ball games, look at the moon, stars, animals, distant buildings... up close. Bright aluminum tube, made for long use. Good on hikes, camping trips, can use either 20x, 40x, or 60x power instantly. Variable focus eyepiece. No assembling, ready-to-use, no special instructions required.

I. J. STONE, Dept. T-B-4 • 1816 Oak St. • Santa Monica, Calif.

DEVELOP A HE-MAN VOICE!

Write for FREE book "How to Strengthen Your Voice for Greater Success" by Eugene Fruchtinger. No obligation. Book will be mailed at once in plain wrapper, postpaid. Just send your name and address. State age.

PERFECT VOICE INSTITUTE, 210 S. Clinton St., Studio DT-2, Chicago 6, Ill.

Be an industrial designer

Combine your design abilities with technical aptitudes in Industrial Design training at Art Center School in California. Work under practicing professionals for upper level jobs as automotive stylists, product and package designers. Design offices, stores, motels, showrooms, shopping centers. Constant demand for graduates. Recent placements with Ford, G.M., Kaiser Aluminum, G.E., Raymond Loewy and other leading design studios. 700 students. Co-ed. Accredited. B.P.A. Degree. Four-year course can be completed in 2 yrs. 8 mos. by year-round training. New terms Feb., June, Sept. Enroll early. Write Mr. Mead for new catalog, 5353 West 3rd St., Los Angeles 5, California.

ART CENTER SCHOOL

SAVE 1/2 - 2/3 THE PRICE OF FACTORY-BUILT BOATS

**BOAT
KIT
CATALOG
Free!**

Runabouts, cruisers, convertibles, fishing; 43 models, 8 through 18 ft. Freight paid, \$39.25 up. Assembled and finished by experienced owners. Luger boats equal factory-built in speed, handling, style, beauty; yet save you 1/2 to 2/3. Owners say: "Fastest boat on river." "Pleasure to assemble." "Everyone admires my Luger." Thousands in use. Send for big, free boat kit catalog; also lists fiberglass, hardware, accessories, trailers, paint. Write for catalog today.



Write:

LUGER INDUSTRIES, INC. DEPT. B-4 3404 Lyndale S. Minneapolis 8, Minn.

New PROFIT-PROVEN* Home-Business!

"I make \$400⁰⁰
a week!"



*Proves MR. J. T. ANDERSON, Inglewood, Calif.
(Notarized statement on file in our
office and open to inspection)

Run your name and
address today and we
will mail you FREE
complete REVEALING
DETAILS, SAMPLES,
OPPORTUNITY PLAN,
HOW TO BOOKLET
etc. absolutely FREE
to you—NO OBLIGATION

FREE!
SAMPLES &
BOOKLET



Big Money?—sure it is—because Huge Profits
are waiting to be "tapped" with this MIRACLE
NEW PRINTING METHOD. Now, you may share
the exciting secrets and build a big-paying FULL
OR SPARE TIME Screen Printing Business right
IN YOUR OWN HOME. Yes, we'll teach you,
too, how to turn pennies into dollars in this
newest, most sensational printing method ever
invented. WHAT IS SCREEN-PRINT? It's an ex-
citing new printing technique—amazingly sim-
ple and fascinating. (It may soon revolutionize
the entire printing industry) NO EXPENSIVE
EQUIPMENT, no printing press, no "cuts," no art
ability, no experience is necessary—yet you can
print beautiful professional jobs on PAPER,
GLASS, LEATHER, CLOTH—ANYTHING! You print
in all colors—even new "glowing" FLUORESCENT
COLORS. It's amazing—but true! EARN PROFITS
IMMEDIATELY—IN YOUR OWN HOME! Start
in your garage, basement, kitchen, spare room
—anywhere! It's much easier than you think.
Then expand as this new printing industry
grows. 300% PROFIT on some jobs—earn up to
\$12.50 per hr. HELP FILL THE HUGE GROWING
DEMAND. No selling because every business in
your area needs Screen-Printing. You can save
them up to 50% on printing, too. WE SUPPLY
EVERYTHING YOU NEED. Never before has such
a profitability been offered to anyone wishing to
start a full-time or spare-time "business of his
own." Don't Hesitate! **WRITE!**
Screen-Print Co., Dept. 24
15127 S. Broadway, L.A. 61, Calif.

"MOLDED FIBER GLASS" BOAT



Write for free literature.
**MOLDED FIBER GLASS
BOAT COMPANY**
71 Fourth Ave., Union City, Pa.

... only boat in the world
with popular lapstrake de-
sign molded right into one-
piece seamless hull, with
matched metal dies. Tough,
fast, smooth, beautiful.
Mahogany-trimmed. Three
15' 7" models, priced from
\$495.

BIG PAY JOBS
for men who qualify in
DIESEL



TRAIN NOW FOR A DIESEL FUTURE. Steady, high-pay jobs
await men qualified in Diesel, Tractor, and Heavy Equipment.
Are you qualified for job and advancement opportunities in this
fast-growing field? You can qualify!

COMPLETE DIESEL COURSE NOW AVAILABLE. If you are
ambitious and want to get ahead in this big money field, you'll
want to know about the complete Diesel home training course
now offered by Interstate Training Service. Covers all phases of
operation, repair, service. Easy to master in spare time. No inter-
ference with present job. Up-to-the-minute. Regularly revised
to cover new developments. We invite comparison of material
offered. Advisory placement service for our students.



YOU OWE IT TO YOURSELF to investigate
Interstate Training Service Diesel Training. Thousands
agree it has helped them to better jobs...better pay.
It can do the same for you!

WRITE FOR FREE INFORMATION TODAY

INTERSTATE TRAINING SERVICE, Portland 13, Ore.
Please see that I receive FREE 24-page book,
"Getting Ahead in Diesel." (A-3)

NAME _____ AGE _____
ADDRESS _____
CITY _____ TOWN _____ STATE _____



New HOME-IMPORT
BUSINESS!

Men - Women. We show you how to
import big-profit items at amazing low
foreign prices (examples at left). Your
home is your office. Get list of 157
Imports FREE! Full or spare time busi-
ness by Mail Order. Or take volume
orders from stores. Import jewelry,
clothing, sporting goods, hardware, etc.
NO EXPERIENCE OR INVESTMENT IN
PRODUCTS NEEDED. Without obligation
send today for complete details and list
of 157 imports FREE! Air mail reaches us
over night. THE MELLINGER CO.,
1717 Westwood Boulevard, Dept. G254,
Los Angeles 24, California.

Clocks 65¢
in Germany—
\$5 value
in U.S.A.

GET LOADS OF MAIL!
Get Offers, Catalogs, magazines, folders Galore!



Want your mail box stuffed with interesting,
attractive offers, catalogs, samples, magazines,
etc.? NO OBLIGATION FOR YOU TO BUY
ANYTHING! We'll list your name and ad-
dress with 1000 firms for mail for just \$1.00.
Rush \$1.00 & name and address TODAY!
TOWER PRESS, INC., P.O. Box 591, Lynn 280, Mass.



**YOU CAN BUILD A VIOLIN
FOR PLEASURE OR PROFIT**

Now you can build a rich toned mellow violin modeled after a
famous "Strad." YOU CAN MAKE A STRADIVARIUS VIOLIN
contains 8 full scale plans plus complete instructions. You work
directly from the plans with no confusing scale of dimensions
to translate. Detailed instructions for each step including
varnishing and stringing—even shows how to build your own
tools. Cloth bound. Order today from
POPULAR MECHANICS PRESS . . . \$3.50
Dept. 457, 200 East Ontario Street, Chicago 11, Illinois

SALESMEN WANTED

Earnings \$5000 to \$8000 per year, calling on
hardware stores and lumber yards, selling and
installing Popular Mechanics show windows.
No window trimming experience necessary (we
train you) but selling experience essential. Must
have automobile. Average territory consists of
about 5 counties. Salesmen have exclusive ter-
ritory. Home every night.

Not a get rich quick scheme but steady dignified
work by which a skilled, industrious salesman
can earn a good living. This company, in co-
operation with Popular Mechanics and the lead-
ing manufacturers of tools, equipment and mate-
rials, offers retailers traffic-stopping window dis-
plays to retail hardware stores and lumber yards
at a nominal cost. All equipment furnished. En-
dorsed by many retailers, jobbers and manufac-
turers. Much repeat business. Extras offer addi-
tional earning opportunity. Desirable but not
necessary to have knowledge of hardware and
lumber lines. Personal training given.

For details write to Window Displays, Inc., giving
all the facts about yourself. If your letter indi-
cates that you might qualify, an appointment
will be made for an interview.

WINDOW DISPLAYS, INC.

1609 SHERMAN AVENUE EVANSTON, ILLINOIS

POPULAR MECHANICS

Copyrighted material

Who Couldn't MAKE UP TO \$1,500 in a Month with this Proven "MIRACLE FOR MOTORS?"

Daring "You-Be-Judge" Guarantee Wins Fast Big Orders from Motorists for Sensational New MOTOR OVERHAUL!

Make biggest money of your life, spare time or full time, introducing amazing new Motor Overhaul in your locality. Needed by 60 million cars and trucks. Just add to oil, drive at once; see, hear, feel immediate improved engine performance, more pep, power, and pickup. Motorists and fleet owners order fast when you say, "Your money back if, **IN YOUR OPINION**, you don't get the improvement you expect. You be the judge!" MOTOR OVERHAUL surprises them, gives more than they expect, and they give you big automatic REPEAT ORDER BUSINESS that grows bigger every month! Fleet owners order 6 to 12 dozen at a time at \$2.98 each and you make up to \$1.78 profit each! Who couldn't make up to \$1,500 and more in a month with miraculous MOTOR OVERHAUL?

Independent Testing Lab Proves MOTOR OVERHAUL Increases:

- Motor Compression up to 58%
 - Gas Mileage up to 34%
 - Oil-Saving Efficiency up to 900% . . . and
- EXTENDS ENGINE LIFE FOR YEARS!**



FREE Write NOW for big-profit Sales Kit, everything you need for lifetime business introducing MOTOR OVERHAUL. In your area—money-making plans, copy of Lab Test Report, "You-Be-Judge" Guarantee. All FREE.

POPE CHEMICAL CO. 224 W. HURON ST., DEPT. S-3 CHICAGO 10, ILL.

SHEET METAL BRAKES

Forms angles, locks, pans, etc. Quick eccentric clamp. All steel construction.

15" - 16 gauge steel.....	\$28.00
36" - 22 gauge steel.....	\$37.00
48" - 21 gauge steel.....	\$32.00
Floor stand.....	\$ 8.00
15" - 24 gauge Folder.....	\$16.50
36" Pan and Box brake.....	\$60.00
3/4 x 3 Adjustable Bender.....	\$11.50
16 gauge 7" Bench Shear 3 adj. gauge.....	\$16.50
36" - 20 gauge Curve Former.....	\$11.50

ORDER DIRECT OR SEND FOR FREE CATALOG
VYKE MFG. CO., P-4158 Jason St., Denver 11, Colo.

SURPLUS SALE

\$39.50 NEW TOOL POST GRINDERS
REGULAR PRICE \$125.00

Less 1-6 H.P. MOTOR
Grinding Wheel TAKES WHEELS UP TO 4 1/2" x 4"
EXTRA QUILL EXTERNAL OR INTERNAL \$19.50
MONEY BACK GUARANTEE

EDWARD J. NOLAN, PULASKI, NEW YORK

75 POWER TELESCOPE \$3.98

VARIABLE EYEPIECE 25X-45X-75X — BRASS BOUND

NEW! Three telescopes in one. 3 different magnifications. 25 power for "ultra-bright" images with 45 and 75 power for extra long range. Guaranteed to bring distant objects, people, sports events, ships, moon, stars, etc. 75 times as close.

Most powerful for any-where near the moon. 27. 5 sections. Close to 1 ft. long. Contains 4 ground and polished lenses. Also used as a powerful compound microscope. Directions included. Mass production enables us to offer this instrument at amazing price of \$3.98 complete. Money back guarantee. We pay postage. Get yours now.
CRITERION CO., 331 Church St., Hartford, Conn., Dept. PMB 44

SAVE & MORE
HALF on Famous Brand

NEW TIRES

ABSOLUTELY NEW! Not used, or recaps or retreads!

Our tremendous buying power enabled us to get these new factory reject tires below wholesale & pass the savings on to you.

LIFETIME Golden GUARANTEE Instant replacement on any defective tire, frt. excl.

600-15	\$6.95	710-15	\$7.25	750-20	\$15.50	800-20	\$22.50
670-15	\$7.00	780-15	\$7.25	750-20(10)	\$18.50	1000-20	\$33.50
White Walls \$1 ext.		800-15		828-20	\$20.25	1100-20	\$41.50

ALSO ALL OTHER SIZES & TYPES IN STOCK. FULL PRICE. Pa. buyers add 3% sales tax

12 MO. GUAR. Very slightly used. Any Car White Walls \$1 Extra **\$3.25**

Rush Ck. or Money Order today. Stock Limited. Shipments sent F.O.B. Phila.
MARVIN 6th & Spring Garden
BLATT Philadelphia, Pa. Mil. Mud Grip Guar. 12 Mos. 900-16 (8 ply) **\$17.50** 900-20 (8 ply)



Engineers Needed!

— say national industrial leaders

Become a
MECHANICAL ENGINEER
or
ENGINEERING TECHNICIAN
at

MSOE in Milwaukee

Yes, engineers are needed — and for every professional engineer, industry also requires five trained engineering technicians.

Choose MSOE to prepare yourself for a worth-while career in mechanical engineering or technology.

Complete laboratories, and field trips to some of the largest and most progressive industrial plants in Milwaukee—machine shop of the world.

Courses approved for veterans — A non-profit institution of higher learning.

Governing board and advisory committees of leading industrialists.

Previous educational, practical, and military experience evaluated for advanced credit.

Choose from these courses —

MECHANICAL ENGINEERING
BS Degree in 36-42 mos. Options in plant engineering, industrial engineering, design.

ENGINEERING TECHNOLOGY
Associate in Applied Science Degree in 18 mos. Options in air conditioning, industrial engineering technology.

TECHNICAL SERVICE
Service certificate in 6 mos. Optional study in refrigeration or metals fabrication.

A complete series of courses in Electrical Engineering in electronics or electrical power, is also available.

TERMS OPEN OCTOBER, JANUARY, APRIL, JULY

MILWAUKEE SCHOOL OF ENGINEERING

Mail coupon for more information

MS-30

Milwaukee School of Engineering
Dept. PM-457, 1025 N. Milwaukee St.
Milwaukee, Wisconsin

Please send the new illustrated career booklet on Mechanical Engineering and Technology. (Please print)

Name _____ Age _____

Address _____

City _____ State _____

Eligible for vet. educational benefits? Yes ___ No ___

HUNTERS CONFISCATED MODEL "MN" RUSSIAN RIFLES

IDEAL FOR BIG GAME

FREE
AMMO

\$14⁹⁵

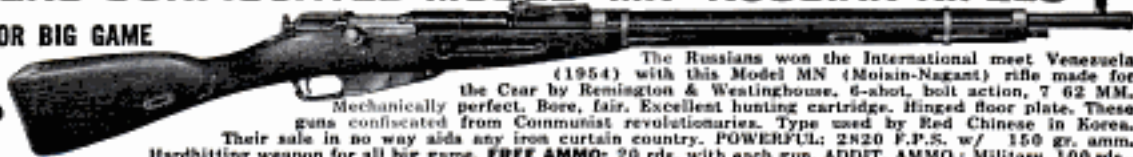

The Russians won the International meet Venezuela (1954) with this Model MN (Moisin-Nagant) rifle made for the Czar by Remington & Westinghouse. 6-shot, bolt action, 7.62 MM. Mechanically perfect. Bore, fair. Excellent hunting cartridge. Hinged floor plate. These guns confiscated from Communist revolutionaries. Type used by Red Chinese in Korea. Their sale in no way aids any iron curtain country. POWERFUL: 2820 F.P.S. w/ 150 gr. amm. Hardhitting weapon for all big game. FREE AMMO: 20 rds. with each gun. ADDIT. AMMO: Military, 100 rds., \$7.50. Softnose Sporting Load, 20 rds. \$2.95 TO ORDER MODEL MN: Send check, cash, m.o. \$5 dep. for C.O.D. Calif. read, add 4% state tax. DEALERS INQUIRE.

GOLDEN STATE ARMS CORP. 204 Armory Bldg., 386 West Green Street, Pasadena 13, Calif.

NEW MAGIC RADIO WALKIE TALKIE!

YOUR OWN POCKET SIZE RADIO STATION!

BROADCASTS TO ANY HOME OR CAR RADIO WITHOUT WIRES OR HOOKUPS! Wt. only 6 oz. Size, 1 1/2 x 2 1/2 x 3/4". Built-in telescoping antenna. Powerful Translator—sensitive microphone, frequency stabilizer, break-in switch! Runs for weeks on self-contained flashlight batteries. Durable plastic case. With this Radio Talkie you CAN TALK TO YOUR FRIENDS UP TO A BLOCK OR MORE AWAY! Talk up to 1 mile or more between two automobiles. INSTANT OPERATION! Just push button to talk! No license needed. Uses inductive field magnetic radiation. Useful and real fun in a million ways! GUARANTEED TO WORK. 1 YEAR SERVICE GUARANTEE.

SEND ONLY \$2.00. (cash, ck. mo) and pay postman \$3.95 COD postage or send \$11.95 for prepaid delivery. COMPLETE READY TO OPERATE with instructions and hundreds of ways and tricks for broadcasts thru any radio you desire. Price may go up soon, so get your NEW POWERFUL RADIO WALKIE TALKIE NOW. Available only from



W. W. WESTERN RADIO, Dept. RPN-4, KEARNEY, NEBR.

LEARN TO MOUNT BIRDS



ANIMALS, FISH, PETS

Be a Taxidermist. Save your hunting TROPHIES. Have a fine home-museum. Hunters save and MOUNT your beautiful DUCKS, QUAIL, DEER, TAN skins, FOXES. Great Fun. Spare-time PROFIT. FREE BOOK Tells ALL about it. 100 fine wild-game pictures, 48 pages. SEND TODAY, don't delay. Get this WONDERFUL FREE BOOK, MEN AND BOYS. Learn Taxidermy. Double your hunting pleasure. Rush letter or POSTAL ORDER. STATE YOUR AGE. N. W. SCHOOL OF TAXIDERMISTRY, Dept. 2504, Omaha, Neb.

MANUFACTURE THIS BEAUTIFUL CONCRETE OUTDOOR FIREPLACE

Right In Your Own Backyard

\$4.00 Worth of Sand & Cement produces this Attractive Fireplace.



Sells on Sight from \$60. to \$80. Easy to start your own Profitable Business.

The General Fireplace Molds and Process are the most amazing and foolproof ever invented. Simple to operate. Two men can produce five fireplaces a day.

BIG DEMAND!!

Sell all you produce to Department Stores, Homeowners, Parks, Nurseries and Plant Groves. Fireplaces sell on sight. No experience necessary. We supply full operating instructions and equipment plus the know-how that spells BIG PROFITS. This is an outstanding opportunity for men of vision and small capital to get into a busy rich paying field. Don't delay, be the only exclusive manufacturer in your own home town. Mail coupon at once for full details as to how you can reserve your territory. Molds sold only on exclusive franchise.

GENERAL ENGINES CO., Inc., Dept. MF-47
ROUTE 130, THOROFARE, N. J.

Mr. Tor of Philadelphia writes: Sold 250 in first 4 months. Selling to Sears Roebuck, John Wanamaker, and Gimbel Bros. in Philadelphia area.

Name
Address
City Zone
State

44

BUY WHOLESALE 100,000 ITEMS

Buy At 20%, 30%, 50% and More Off On Everything You Buy!

For yourself or for resale! SAVE MONEY! EARN MONEY selling to others. Famous brand merchandise—Thousands of items. Buy singly or in quantity. New 1957 "Buy-It-Wholesale" Directory tells you WHERE & HOW to buy everything you need at lowest WHOLESALE PRICES. Just \$1 per copy—you may save that much on your 1st buy! FREE! \$1 credit voucher with each wholesale directory. Can be applied toward number of items on special merchandise list. HOW CAN YOU LOSE? Rush \$1 at once for your copy.

TOWER PRESS, Inc., Box 591, Lynn 520, Mass.

- Toys
- Sewing Equip.
- Gifts
- Books
- Jewelry
- Housewares
- Furniture
- Appliances
- Novelties
- Etc., Etc., Etc!

What Every Farmer Should Know About Taking Care of Farm Animals



The Most Popular Veterinary Guide Ever Printed

Written in plain understandable language. It covers symptoms, causes of disease and prevention, and treatment of cattle, swine, sheep, horses and poultry and warns when to call in the professional veterinarian. Names, terms and phrases made clear in a separate section. Over 100,000 copies of this book are in use on American farms. 275 pages. Fully illustrated. Only \$3.95. Order today under money-back guarantee. This practical and helpful VETERINARY GUIDE FOR FARMERS prepares the farmer to perform many routine veterinary tasks—provides quick information that can often save the life of an animal—prevents disease in herds—saves money on the farm in a hundred different ways.

POPULAR MECHANICS PRESS, Dept. 457
200 E. Ontario St. Chicago 11, Ill.

BREED RARE TROPICAL FISH FOR PROFIT!... AT HOME!

HELP US FILL HUGE DEMAND... Wonderful \$555 Opportunity. No experience. No expensive equipment needed. SOME SELL FOR \$75 PAIR AND MORE! Fascinating! Beautiful! Entertaining! We supply everything. Make Big Money spare-time at home.

FREE! HOME-BUSINESS PLAN, Illustrated Folder, all DETAILS Write: TROPICAL FISH BREEDERS OF AMERICA Dept. D-4, Los Angeles 15, California

\$8 750 FIRST YEAR—IN YOUR OWN BUSINESS

Start Part Time—We Furnish Everything
We locally train you to run your own business, furnish all equipment and supplies to clean and moth-proof rugs and upholstery on location by world-wide process. No shop needed, you become quickly established. Just 2 average jobs a day bring \$8,750.00 NET profit in year. Employ others and multiply your earnings. As member of world's largest organization of its kind you are backed by National Advertising, receive 25 regular services to help build your business. You'll be only one in town whose process bears famous Parents' seal. Business grows rapidly due to recommendations and repeat jobs. EASY TERMS. Send TODAY for fascinating FREE BOOKLET with complete details.

DURACLEAN CO.
7-164 Duraclean Building • Deerfield, Illinois

POPULAR MECHANICS

LEARN MEAT CUTTING AT NATIONAL

Pay After Graduation



The steady dependable trade of Meat Cutting taught easily in 8 short weeks. YOU LEARN BY DOING under actual meat market conditions in big modern school at Toledo.

For beginners or men with experience. Get a profitable store of your own. Remember, PEOPLE MUST EAT! Big pay jobs. Free employment help. Thousands of successful graduates.

Buying, cutting, percentage, pricing, advertising, selling, etc. A complete retail meat education. National School established 35 years. Get National training NOW. Pay your tuition in easy weekly payments

after you graduate. Send coupon for FREE 52 page school catalog — TODAY. G.I. approved.

National School of Meat Cutting, Inc., Dept. 50-Q, Toledo 4, Ohio

Send me your FREE school catalog on National Training at Toledo in Meat Cutting, Meat Merchandising and Self Service Meats. No obligation. No salesman will call.

Name _____ Age _____

Address _____

City _____ State _____

Approved for training Korean Veterans

BOAT KITS 28 MODELS—8 to 19 ft.

SAVE 2/3! Easy-to-build MAHOGANY FRAMES—DECKS

19' CRUISER KIT \$499.50!

SEND 10¢ for KIT CATALOG! Includes Hardware—Trailers—Fiberglass

BOAT PLANS—Patterns—Frame Kits

Build over 50 modern boats from large scale plans, available with FULL-SIZE patterns, new PRE-FAB frame kits! All types; from cruisers, 6 to 25 ft. Best buy for Amateurs! SEND 10¢ for CATALOG.

Craig Craft
Tonawanda, N. Y.

ESHELMAN TRACTORS

LOW AS \$99

Plows—Cultivates—Saws
Dozer—Harrow—Rolls
Haul—Snow Plow
Kabelman Tractors,
Trillers, Riding Rotary
Mowers for Better
Lawns and Gardens.
Advertised in GOOD
HOUSEKEEPING. Thousands of
satisfied users.

Write for Free Literature.
Dept. 97, ESHELMAN, Balto. 2, Md. \$453.75

Shipping Points: BALTIMORE - CHICAGO - KENOSHA

MAKE JIGSAW PUZZLES

We put you in the business of making and selling colorful Wood Jigsaw Puzzles for children. This offer is limited to ambitious men with sales ability... who are looking for a profitable "do-it-yourself" business on a full or part-time basis. We supply everything. Can be handled from your own home workshop, basement or garage. Simply send \$2 for samples with complete information. This opportunity can make you rich... so act fast!

A. M. WALZER COMPANY
924 Lincoln Road Miami Beach, Fla.

NEW MIRACLE MONEY SPRAY

EARN Up To \$15 per hour in your OWN HOME!

Startling NEW "Velvet-Like" spray discovery! Instantly, you can spray ordinary objects (lamps, figurines, signs, cards, glasses — anything!) and change them into beautiful expensive masterpieces that feel like rich velvet to the touch. It's amazing but true! Men and women urgently wanted to introduce this new process to their areas. Work at home during spare time and earn big money. It's fun, fascinating to do! No big investment needed—we supply everything.

FREE Booklet and Actual Samples Includes revealing Home-Business profit plan secrets and Real samples in 16 different colors—all Free! **RUSH YOUR NAME & ADDRESS TODAY**—supply limited!

Coast Industries, Dept. B-4, Los Angeles 61, California

PREPARE FOR BETTER JOB, BIGGER PAY IN SPARE TIME AT HOME

Today, choose the job you want—and prepare for it in time you might otherwise waste. Or if you are already in the work you like best, start training now for quicker promotion and increased pay. During the past 60 years AMERICAN SCHOOL has helped ambitious people to reach higher goals. Check subject that interests you and mail coupon for full information.

AMERICAN SCHOOL, Dept. G445, Drexel at 58th, Chicago 37, Ill.

Without obligation, please send FREE and postpaid, full particulars about the subject checked below.

<input type="checkbox"/> Accounting	<input type="checkbox"/> Contracting	<input type="checkbox"/> Mechanical Engineering
<input type="checkbox"/> Apprenticeship Courses	<input type="checkbox"/> Diesel Technician	<input type="checkbox"/> Mechanical Technology
<input type="checkbox"/> Architecture & Building	<input type="checkbox"/> Drafting—Building Trades	<input type="checkbox"/> Metalworking Courses
<input type="checkbox"/> Automotive Technician	<input type="checkbox"/> Drafting—Machine Trades	<input type="checkbox"/> Plumbing—Practical
<input type="checkbox"/> Better Foremanship	<input type="checkbox"/> Electrical Engineering	<input type="checkbox"/> Private Secretary
<input type="checkbox"/> Blueprint Reading	<input type="checkbox"/> Electricity—Practical	<input type="checkbox"/> Retail Merchandising
<input type="checkbox"/> Bookkeeping	<input type="checkbox"/> Electronics—Industrial	<input type="checkbox"/> Salesmanship—Outside
<input type="checkbox"/> Business Management	<input type="checkbox"/> HIGH SCHOOL COURSES	<input type="checkbox"/> Sheet Metal Work
<input type="checkbox"/> Civil Engineering	<input type="checkbox"/> Machinists	<input type="checkbox"/> Tool Making

NAME _____ OCCUPATION _____

Home Address _____

City _____ STATE _____

Send to: Write American School, Dept. G445, 6083 Sherbrooke St. W, Montreal

MAIL COUPON NOW

BUY DIRECT and
SAVE UP TO 1/2
on ITALIAN ACCORDIONS
EASY TERMS



Accordions of famous makes and breath-taking beauty now can be yours! Mail coupon for FREE Color Catalog and amazing Wholesale Prices.

Act NOW!

5 DAYS FREE TRIAL
 •
MONEY BACK GUARANTEE
 •
MAIL COUPON NOW

TRY BEFORE YOU BUY

World's largest selection direct from Importer to you! 30 models to choose from. **SATISFACTION GUARANTEED** or your money back. Trade-ins accepted. Terms as low as \$10 monthly. Write today!

Accordion Manufacturers & Wholesalers Outlet
 2003 W. Chicago Av., Dept. R-47, Chicago 22, Ill.

Send For **FREE Color Catalog**

Accordion Manufacturers & Wholesalers Outlet
 2003 W. Chicago Av., Dept. R-47, Chicago 22, Ill.
 Send me Free Color Catalog—full details.

Name _____
 Address _____
 City _____ State _____

ENGINEERING DEGREE IN 27 MONTHS

B. S. DEGREE IN

Aeronautical, Chemical, Civil, Electrical, Mechanical and Electronic Engineering (inc. Radio and TV)
Big Demand for Graduates

Hundreds of young men are earning B. S. ENGINEERING DEGREES annually in this recognized institution—year around classes optional. Also B.S. in 36 mo. in Mathematics, Chemistry, Physics. New terms start quarterly. Many students earn a major part of their college expenses in this large industrial center. Low tuition. Competent instruction.

Thorough, intense practical program. Modern, well-equipped laboratories including new physics laboratory and modern wind tunnel. Individualized instruction emphasized. Government approved for O.I.'s Engineering Science preparatory courses. Students from 48 states and 21 foreign countries. Enter June, September, December and March. Send coupon for free catalog and full information. Enroll now.

INDIANA TECHNICAL COLLEGE

547 E. Washington Boulevard, Fort Wayne 2, Indiana

Please send me free information on 27 MO. B.S. DEGREES in:
 Aeronautical Chemical Civil Electrical
 Mechanical Electronics
 on 36 MONTH B.S. DEGREES in:
 Mathematics Chemistry Physics

Name _____
 Address _____



"I just thought it would make you feel better to know that I'm satisfied with what I bought."

The products that satisfy most are the brands that have made a name for themselves. That's why advertisers in this magazine are good names to know. They're proud of their brands 'cause they satisfy so.

FOUR WAYS BRANDS SATISFY

- 1. BUY WITH TRUST!** Spend *confidently* on known quality. Brand Names wear best, work best, taste best, are best.
- 2. SHOP WITH EASE!** Spend *efficiently* on proved value. Brand Names save time "puzzling" over labels, models, prices, etc.
- 3. ENJOY MORE CHOICE!** Spend *shrewdly* among widest selections. Brand Names offer the most in sizes, types, colors, flavors, etc.
- 4. GET THE "LATEST"!** Spend *smartly* on up-to-date products. Brand Names keep improving, modernizing, introducing new things.

BRAND NAMES FOUNDATION, INC.
 437 FIFTH AVENUE, NEW YORK 16, N. Y.

pack pounds and inches of
STEEL MUSCLE ON YOUR BODY
IN 30 DAYS—OR MONEY BACK!



15 minutes of fun a day... that's all it takes... with tested and proved HERCULES progressive weight training—today's fastest, surest system. The secret is in HERCULES scientific barbell exercises—never before available—that go to work deep down in flabby muscles and organs. Results guaranteed.

ORDER HERCULES BARBELLS DIRECT FROM FACTORY AT SPECIAL LOW PRICES
50 lb. Set—\$9.98 100 lb. Set—\$19.98
150 lb. Set—\$26.00 200 lb. Set—\$25.98

Each set complete with wall charts, instructions plus lifetime bodybuilding advice.

FREE! Special Muscle Building Exercise Booklet with Photos—Act Today!

HERCULES BODYBUILDING INSTITUTE
188P1 Woodward Street, Jersey City, N. J.

\$9.98 UP

Unconditionally guaranteed, money back in 10 days if not satisfied.



Mechanically Inclined?

EARN BIG MONEY ASSEMBLING AND SELLING AMERICA'S FINEST ALUMINUM STORM WINDOWS, DOORS, JALOUSIES

Buy All-Time 3 channel aluminum combination storm windows and screens at 1/3 retail price—assemble in 18 minutes—sell up to 200% profit.

The tightest storm window in the country. Beautiful 1" thick door is strongest of its type. \$67.50 buys special tools, finished window & door samples, and K. D. practice window.

ALL-TIME MFG. CO.
MONTVILLE, CONN.



Every Boy Should Have This Build-It-Yourself Book for Boys!

It's natural for boys to want to make things—to fuss with tools—to fashion the kind of things "kids"

want. So give boys the Build-It-Yourself Book for Boys. Encourage a youngster to express himself through the sensational new Popular Mechanics book that shows how to make 56 different things every boy dreams about. It covers science, mechanics, electricity, modeling and other fields. 192 pages of easy-to-follow instruction and 469 how-to-do-it pictures.

56 Toys, Games, Gadgets, Models, Boats, Electrical Devices, Cars and Other Things Boys Can Make at Home

How to make—Airplane Models, Aquaplane, Archery Kit, Bird Houses and Shelter, Boats, Bobsleds, Bomerangs, Cannon Toy, Electric game, Electric Motors, Garage Toy, Helicopter Toy, Hunting Knife, Hydroplane Model, Kites, Log Cabins, Marble Game, Microscope, Printing Press, Radio Sets, Rafts, Railroad Modeling, Shooter, Scooter, Sidewalk Cars, Sprinkler

Truck, Squirr Gun, SS United States Model, Surfboard, Tank Toy, Taxidermy, Telegraph Set, Telephone, Tree House, Water Skis, Weather Instruments, Toboggan, Worktable.

Build-It-Yourself for Boys sent postpaid for \$2.50 or COD, charges additional. Money refunded if you are not pleased after 5 days' use. Mail order to address below.

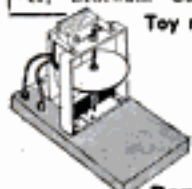

Toy motors



Boomerangs



"Ju-be"—the punt

POPULAR MECHANICS PRESS

Dept. 457, 200 E. Ontario St., Chicago 11

HOW TO DO YOUR OWN CEMENT, BRICK, STONE, CONCRETE BLOCK WORK

FREE 5-DAY TRIAL



2 VOLUMES
Over 800 pages, 400 illustrations both only
\$10.65

Shows How to Put in Such Things as Walks, Terraces, Driveways, Floors, Steps, Chimneys, Outdoor Fireplaces, Septic Tanks, Foundations, and Basements.

Just TRY *MASONRY SIMPLIFIED* for 5 days at our risk. Send no money until sure it offers what you need.

Here, all in one big 2-volume set, is the professional know-how of the best men in masonry. Page after page of clear, how-to-do-it pictures. Every step clearly explained for the amateur. Includes everything you need to know about tools and materials. How to Read Blue-

prints, Setting Structural Clay Tile, Building Brick Walls and Terraces, Making Mortar, Water Proofing Basements. Even includes an illustrated dictionary of building terms.

SEND NO MONEY—USE IT 5 DAYS FREE

We will ship books postage paid. Examine them for 5 days FREE. Then, if not delighted, return without further obligation. If you decide to keep after 5 days, we bill you later.

CUT OUT HERE

ORDER BY MAIL—FREE 5-DAY TRIAL

AMERICAN TECHNICAL SOCIETY, Dept. AB-4
848 E. 58th St., Chicago 37, Illinois

Please send me for 5-DAY FREE TRIAL the books I have marked (x) below. If I decide to keep them, I will pay the low purchase price for each book, plus shipping costs. Otherwise, I will return them with no obligation.

- MASONRY SIMPLIFIED.** (Described above.) Two big volumes, both for only \$10.65.
- FUNDAMENTALS OF CARPENTRY.** Newly revised and expanded. Professional know-how on all phases of carpentry, construction and building. Two big volumes, over 800 pages, hundreds of illustrations. Both for only \$8.90.
- BUILDING TRADES BLUEPRINT READING.** No previous knowledge of drafting and only simple arithmetic necessary. Specific applications to masonry, carpentry, plumbing, etc. 2 vol. 134 illus. 13 full size blueprints. \$5.15.
- CABINET MAKING AND MILLWORK.** Layout and construction of cabinets, windows, doors. The trade secrets of expert cabinet workers in simple terms for beginners. 352 pgs. 400 illus. \$6.50.
- HOW TO PLAN A HOUSE.** All the basic and authoritative information one needs to build the best possible house for the money. 584 pages. Over 400 illus. Only \$6.95.
- HOW TO ESTIMATE FOR BUILDING TRADES.** Accurate methods of estimating materials and labor based on experiences of successful contractors. Modern construction practices. 699 pgs. 318 illus. \$6.75.

SEND NO MONEY—NOTHING TO PAY POSTMAN!
CHECK BOOKS WANTED, MAIL FOR FREE 5-DAY TRIAL

PRINT NAME.....

ADDRESS.....

CITY.....ZONE.....STATE.....

Check here if you enclose full payment. We then pay all shipping costs. Same return privilege—refund guarantee.

TRAINED MEN NEEDED!

BIG PAY!—GOOD FUTURE!

- DIESEL ELECTRONICS
 AUTO AUTOMATION

NEVER BEFORE has the opportunity been so good for the properly trained mechanic and technician to step into BIG PAY POSITIONS with rapid advancement and future security virtually assured.

YOUR SUCCESS depends on the quality of training you receive... and the reputation of the school you attend.

YOUR GUARANTEE we are giving the best in mechanical and technical training is proved by the fact... we have a waiting list of good pay positions for our graduates, with leading companies throughout the United States.

RESIDENT SHOP TRAINING is easier and costs less than you may think! We provide you with housing and part-time jobs while in school, plus free nation-wide placement service for graduates.

Check subject above in which you are interested and mail for

FREE BOOKLET

Your Future
in
ELECTRONICS
AND
AUTOMATION

BAILEY

Technical Schools

Veteran Approved

1634 S. Grand, St. Louis 4, Mo.

Your Future
in
3
DIESEL and
AUTO
MECHANICS

Name _____ Age _____
 Street _____
 Town _____ Zone _____ State _____



Do You Like art?

DRAW FOR MONEY!

Our Simple Method Proves You Can Learn to Draw at Home in Spare Time

YOU can learn Commercial Art, Designing, Illustrating, Cartooning, etc. . . . right at home, in spare time. No previous art training necessary. Soon be your own boss — work at home, pick your own working hours. Or earn big money as staff artist for advertising agency, newspaper, magazine, dept. store, TV, etc. Or make Art a profitable hobby. Earn while you learn. 22-piece art outfit given with your first lesson AT NO EXTRA CHARGE. (School est. 1914.)

FREE BOOK, "ART FOR PLEASURE AND PROFIT." Describes our methods.

Lists opportunities, also free Talent Test. No obligation. So mail coupon at once.



Washington School of Art
 Studio 144, Port Washington, N. Y.
 Send me—FREE—your valuable Illustrated Book, "Art for Pleasure and Profit," and FREE TALENT TEST.
 Name _____ Age _____
 (PLEASE PRINT PLAINLY)
 Street _____
 City _____ Zone _____ State _____

Personal

JIM:

I found the machine we've been looking for. The name is UNIMAT and it's a complete 10 in 1 workshop that's no bigger than a typewriter. It quickly converts from precision lathe into 10 different tools and you just can't beat it for machining small parts made of steel, brass, aluminum, wood and plastics. The price is right, too. Get the whole story. For free catalog write to: American Edelstaal, Inc. Unimat Division, Dept. 346, 350 Broadway, N.Y.C. 13, N. Y.

MAKE UP TO \$20 A DAY WITH

EASISHARP



Big profits in your spare time sharpening scissors. We show you how to start making money immediately. This is your chance now to have your own business and a steady income. Sharpen a pair of scissors in less than two minutes. A child can operate it. Weighs only 10 lbs. Every home, barber, tailor, dressmaker—everybody uses scissors and all need sharpening two to four times a year. Don't let some one else beat you to this opportunity. Write immediately to

MONEY MAKING SALES PLAN FREE

SERR-EDGE MACHINE CO., 9731 Lorain Ave., Cleveland, Ohio

GERMANIUM DIODE (as used in Radar)

ONE OF THE WORLD'S SMALLEST RADIOS ppd. \$3.98

No tubes, batteries or electricity needed to enjoy your favorite radio program. Static free, this germanium diode powered radio is less than one inch long, yet will pick up your strongest local station. Makes perfect gift and proud possession. A scientific oddity originally developed for radar. BEA SALES, Dept. RA-100, 125 E. 46th St., N. Y. 17

HOW TO BUILD Your Own GARAGE

Save Up to 50% of Usual Cost!

Get Popular Mechanics' brand new book *How to Build Your Own Garage* by Wayne Lecker, Assistant Shop Notes Editor, and find out how you can build your own garage at savings of 50% of usual cost. Lecker tells in clear step-by-step instructions and shows in big, clear photos, drawings and diagrams how to perform every building operation from laying the concrete to installing the final trim. There are 25 designs. Brick, frame, and concrete block fully covered. Send \$3.50 for your copy. 7-day money back guarantee.

POPULAR MECHANICS PRESS, 200 E. Ontario, Chicago 11, Ill.

GROW ORCHIDS AT HOME

World's most thrilling hobby — profitable home business. Successful home grower shows you how to start—how to provide proper temperature & air conditions in any well lighted room—how to market Orchid flowers and plants for fine profits in friends, neighbors, hotels, florists. Also MAIL ORDER from big city, small town, or farm. FILL YOUR HOME WITH NATURE'S MOST FABULOUS FLOWER. Many grow without soil, getting food from the air. Purple, white, yellow, green, every rainbow color. Illustrated instructions include blooming-size Orchid plant—Everything you need to start. Hundreds of home growers Coast to Coast using our plan successfully. Send name & address on postcard for real ORCHID SEEDS & full details, including "Quick-Profit" Plan all FREE. Tropical Flowerland, Dept. 314, 100 So. Vermont, Los Angeles 4, Calif.

YEAR 'ROUND MAINE TO CALIF. NO GREENHOUSE

BIG PROFITS SPARE OR FULL TIME



MAKE BIG PAY!

Make big pay in the construction industry as an operator of Bulldozers, Draglines, Back Hoes, Scrapers, and Motor Graders. Learn these skills NOW! Contractors need operators of earthmoving machines and pay high wages to our graduates. Don't be satisfied with just a job . . . learn a career!

Write TODAY for FREE School Catalog, no obligation, to either address

National School
of Heavy Equipment
Operation

Western National School
of Heavy Equipment
Operation

P.O. Box 8243, Dept. D-14
Charlotte, N. C.

P.O. Box 527, Dept. D-14
Weiser, Idaho

Finish HIGH SCHOOL AT HOME

Complete 4 Yrs. in 12 Months

Learn More! Earn More! Enter professional or technical schools. Advance Socially. Live a Happier, Fuller Life. Individual Courses or complete schedule. WRITE FOR SCHOOL BULLETIN.

ACADEMY FOR ADULTS

30 W. Washington, Dept. PM-47, Chicago, Ill.

FREE AMAZING NEW BOOK "HOW TO ANSWER ADS"

how to
answer
ads

Never before have you seen anything like this. Tells you in simple language the correct way to answer ads. Gets you quicker replies—better results, and greater satisfaction. Will save you time and money and it's ABSOLUTELY FREE. No obligation whatever. Every reader of advertising should have this booklet. Send a postcard for your copy NOW. F. W. JOHNSON, Popular Mechanics Magazine, Room 600-A, 204 East Ontario Street, Chicago 11, Ill.

RHEUMATISM

NEURITIS • SCIATICA • LUMBAGO

Why continue to suffer agonizing pains when usual remedies have failed. Learn how thousands have been successfully treated by an amazing new method which is fully explained in our New FREE Book. Don't wait. Write today. No obligation.

EXCELSIOR INSTITUTE, Dept. C9806, Excelsior Spgs., Mo.

Catalog of 3100 Novelties 10c

Send 10c for amazing catalog of novelties, live animals, scientific supplies, hobbies, funmakers, planes & boats, looms, magic tricks, joke articles, unusual seeds, gadget time-savers, cameras, optical goods, projectors, movies, lucky jewelry, religious novelties, disguises, musical instruments, stamps, coins, puzzles, fortune tellers, radios, auto & bike accessories, telescopes, magnifiers, compasses, banks, smokers' gadgets, artists' supplies, printing sets, eye glasses, motors, shockers, knives, billfolds, guns, rifles, sports, books, games, plants, etc. Send 10c (3 for 25c—get for friends!).
JOHNSON SMITH & CO. Dept. 549 Detroit 7, Michigan

12-Foot BULL WHIP

HARD HITTING! LOUD CRACKING! Experts knock ashes off cigarette. Yank people off feet. Used by trainers, ranchmen. Loud cracker like shot-gun blast. 4-ply hand plaited all leather. With loop handle.
6-ft. \$1.98. 8-ft. \$2.69. 10-ft. \$3.29. 12-ft. \$5.45.
Johnson Smith Company, Dept. 549, Detroit 7, Mich.

1 I SHOW YOU HOW TO MAKE MONEY AT ONCE

2 START YOUR OWN BUSINESS

IN 2 WEEKS—
AT HOME
IN SPARE TIME



PLATE
Baby Shoes
IN
BRONZE
AND
COLORED
PEARL

MILLIONS OF
NEW PROSPECTS
EVERY YEAR



Now is the time to cash in on this ever growing, big profit field. No previous experience needed. Baby Shoe metalizing (bronzing, some call it) is EASY to do and HIGHLY PROFITABLE. Materials cost you 50c—you get \$6. You can metalize Baby Shoes in a corner of your basement, attic, or service porch—even in your kitchen—NO BIG OVER-HEAD. Our plan shows you how to START AT ONCE spare time without quitting your present job—have two paychecks instead of one. No investment in equipment necessary. A few hours pleasant occupation can bring you more money than many make working a full week. Big profit orders come from friends, neighbors, gift shops, dept. stores. No face to face selling—you can operate by MAIL ORDER. Send for our FREE Booklet and complete money making plan. No salesman will call. MAIL COUPON below TODAY sure.

IMMEDIATE RESULTS

- Big Income
- Huge Demand
- Sales Plan
- Future Security
- Your Own Business

We will send you full details absolutely free.

FREE!

MONEY
MAKING
PLAN

Full Details
Without
Obligation

MAIL COUPON
TODAY!

KIKTAVI COMPANY, Dept. PM-574
11029 S. Vermont, Los Angeles 44, Calif.

KIKTAVI COMPANY, Dept. PM-574
11029 S. Vermont, Los Angeles 44, Calif.

Send me FREE Booklet and plan for making money in the Baby Shoe metalizing business. Remember I am under no obligation.

NAME _____

STREET _____

CITY _____ ZONE _____ STATE _____

the Captain shows off his ship!



U.S.S. BOSTON Guided Missile Cruiser - BUILT FROM A REVELL AUTHENTIC KIT

"The Revell model is kept on display in my cabin and is invaluable in describing the characteristics of the ship to our many visitors."*

(signed) K. S. MASTERSON, Capt. U.S.N. Commanding Officer, U.S.S. Boston

**from a letter on file at Revell Inc.*

When a 17-inch ship model is so authentic that the Captain of the real ship uses it to locate points of interest for visitors—that's about as real as you can get. And that's how real the detail is on this scale model of the U.S.S. Boston, built from a Revell Authentic Kit. Terrier launchers, guided-missiles, gun turret batteries, even radar and radio antenna, are reproduced in exact scale from Navy blueprints. Now—add this authentic model of the world's first guided-missile cruiser to your own collection, with the new Revell Authentic Kit. You get precision-made plastic parts, with step-by-step plans, and a display stand to mount your finished model on. **U.S.S. Boston \$1.69**



H.M.S. BOUNTY—The famous fated ship of "Mutiny on the Bounty," shipyard accurate in every scale detail, even to mounted cannon, ship's launch, 5 sculptured figures of crew. With display stand and nameplate. **14 3/8". \$2.98**



CONVAIR "TRADEWIND"—Largest "flying-boat" ever built by Convair, scaled down to 10 1/8" from official blueprints. Excitingly detailed with hinged nose door, loading ramp, 8 propellers. Includes swivel base. **98¢**

NOW! See all the other models you can build, including 19 different ships. Send this coupon to get big 32-page Revell Collectors Catalog—only 25¢ (Stamps or Coin)

Packed with photos, real-life details about 89 different models: ships, planes, sportcars, trucks, guns, dozens of other models you can make from Revell Authentic Kits.

Please check

I have built plastic kits before.



Revell

WORLD'S
BEST
WANT-AD
MEDIUM

CLASSIFIED ADVERTISEMENTS



Advertisements in this section \$1.25 per word, each insertion, minimum 10 words, payable in advance.
To be inserted under proper classification, copy must be in our office the
20th of the second month preceding date of issue
F. W. Johnson, Manager, Classified Advertising
Popular Mechanics Magazine, 200 East Ontario Street, Chicago 11, Illinois

YOU'LL PROFIT

By reading and answering the classified ads in this section. Hundreds of opportunities for you to make and save money

AUTOMOBILES, MIDGET CARS

BUILD The best midget roadster. Complete easy to follow plans, assembly instructions and parts list only \$1.00. T & L Manufacturing, 4020 Linden, White Bear Lake, Minnesota.

FLYING Auto 8x10 photo 50¢. Jess Minick, 3532 Col Hts., Longview, Wash.

CROSLLEY Parts and accessories. Van's Sales & Service, Midlothian, Illinois.

HUNDREDS Of automobile catalogs—Old, new and foreign; dealer books, glossy photographs, shop manuals; free motor magazines listed by non-profit club. Write to get on free mailing list. Auto Maniacs, Stockbridge, Mich.

MAGAZINE About antique automobiles. Send for free sample copy. Franson's Motor News, Box 276, Woodland Hills, California.

JEOP Tops, American-foreign convertible tops, clear plastic seat covers. Free catalogue. Mor-Nan, Box 123, Boston 14, Mass.

BOYS' Power-driven auto. Build your own. Plans 25 cents. Sypher Co., Sta. F., Toledo, Ohio.

SAVE Gasoline ten ways. Send 25¢ to Norman Summers, P.O. Box 84, Mercer Island, Washington.

WORLD'S Lowest price children's motorized automobiles. Also fiberglass bodies, power units, parts, etc. Free literature. Sportillac Co., P.O. Box 6263, Philadelphia 36, Penna.

AUTO SUPPLIES AND EQUIPMENT

JEEPS And four wheel drive trucks need hubs that free wheel for two wheel drive and locking for four wheel drive. Guaranteed satisfaction. Willy's Jeeps \$39.95. Dodge Power Wagon, GMC 150 Series, 1 HCS Series, \$46.50. See nearest tractor supply store, or order direct from Tractor Supply Co., 2700 North Halsted, Chicago 14, Illinois.

JIPPY. Fuel pump repair kit. Without removing pump. State make and year. \$1. Guaranteed. Directions included. H. A. Tool Co., Millville, Mass.

CHECK Your own car ignition points, coils, condensers. Free details. Lerche Industries, 744½ E. Eldorado St., Appleton, Wis.

RECHROME Entire car, any metal. Sensational new process. Money back guarantee. Rush order. State Stores, 11-65 Beach Channel Drive, Far Rockaway 91, N. Y. \$4.98 or c.o.d. plus postage.

SPRINGS—One hundred assorted sizes postpaid \$1.00. Spring Service, North Warren, Penna.

SEAT Covers—Buy direct. Save 50%. Custom jobs a specialty \$7.95 up. Information and swatches. Bill Booth, Wildwood, N. J.

DUAL Carburetion, save dollars on gasoline expense. Use cheap fuel oil. Blue prints, instructions. \$1.00. Northland Metal Products Co., Grawn, Michigan.

FORD—Mercury—1952-1956. Terrific new hinge holds license plate open while filling tank. Salesmen make \$30-\$40 day. Sample \$1.00. Card of 8—\$3.00. Kwik-Fit Corp., Box 277, Altadena, Calif.

NEW Nashall reflectorized radiator bug screen protects radiator from bugs, leaves, etc. Protects car and life, when your lights fail, or car is parked at night. 18½" x22", \$1.98; 22"x24", \$2.49. Order early. PPP, Inc., 3838 So. State, Salt Lake City, Utah.

AUTO Air-conditioner, easy "make it yourself" booklet. \$1 postpaid. Highway Air Conditioning, 167P West 22, New York City.

700% PROFIT Service stations, garages, dealers only. Free information. Hardy's, 878 East Waterloo, Akron 6, Ohio.

TRIPLE Protection for today's car, truck, tractor engines. New "Electric Reclaimo" filters, re-refines, stabilizes crankcase oil. Prevents destructive acid-sludge formation; makes oil changing unnecessary. Folder free. Reclaimo, 6251-M Touhy, Chicago 20.

SAVE On parts, accessories, gadgets, tools, dress-up items not in stores. Giant 1957 catalog—25¢ (refunded first order). Newhouse Automotive Industries, 5803-PM Beverly, Los Angeles 22, Calif.

SAVE Money on Jeep and army truck parts. Large inventory. Catalogs for Jeep or G.M.C. owners. American Auto Parts Co., 1830 Locust, Kansas City, Mo.

FREE! New catalog. Speed, power, mileage increasing equipment. Discounts! Alquist Engineering, Milford PMS, Penna.

RING-Valve job while you drive \$5.00 postpaid. Safe, proven, guaranteed. Literature. Motaloy, Grantham, Penna.

NEW And used parts at savings. Complete guaranteed parts service for all models cars and trucks—1924 and later. Largest in the West. Army parts specialists. No catalog. Submit your needs for quotations. Fast mail order service. Pioneer Auto and Truck Parts Co., 734 W. 13th Ave., Denver 17, Colorado.

AUTO Accessory and parts catalog. 1957 edition, all new! 228 pages. Save up to 50%. 75,000 items, including Hollywood accessories, hi-speed equipment, rebuilt engines, all parts and accessories for all cars and trucks! Hard-to-get parts! Send \$4. refundable. J. C. Whitney, 1919 PM Archer, Chicago 16, Ill.

AUTO TRAILERS

MARATHON Mobile homes are your answer to that vacation cottage, second family home, new tenant house. Models include King Size (10 ft. wide) 41, 45 and 49 ft. long. Other models 29 to 49 ft. 1, 2 and 3 bedroom—luxury at a price. Details free. Write Dept. 160, Har-Mac, Inc., Stratford, Wisconsin.

TRAILER Building manual \$1.00. Booklet 304. Kamcraft, Box 1153, Milwaukee 1, Wis.

BUILD Expanding eight foot trailer. Accommodates five. Literature 10¢. Pramar Company, Wilmington, Mass.

MOTORCYCLES, BICYCLES, MOTORSCOOTERS AND SUPPLIES

MIDGET Racer \$10, motorscooter \$15, less engines. Whizzer motorbike engine \$7.50, Briggs \$4, Maytag \$3, Doodlebug \$8, (mailorder only). Send 25¢ (35¢ for first class mailing) for new 36-page, illustrated directory-catalogue 76, listing these and hundreds of other bargains, homebuilders plans, parts, etc. Midget Motors Directory, Athens, Ohio.

PARTS For Cushman, Doodle-Bug, Salisbury, etc. Send make, model, 25¢ for price list. Motor Scooter Parts Co., Dept. P4, Box 7211, Indianapolis 1, Indiana.

WHIZZER Motors \$20.00; midget race car reasonable; motorscooter \$5.00; Cushman two-speed \$20.00. Send 25¢ (35¢ first class mail) for catalog #30 jammed with sensational bargains in wheels, motors, motorscooters, midget cars, motorbikes, construction plans, etc. Gail, 1313 Jefferson, Toledo, Ohio.

BICYCLES. Parts, accessories. Everything you need. United Cyclery, Union Square—P4, Somerville 43, Mass.

NSU And BMW motorcycles, 2 to 35 h.p., singles and twins, chaindrive and shaft-drive. Butler & Smith, P.O.B. 45, New York 24, N. Y.

HARLEY - Davidsons — Used bargains. New, used parts, accessories for all models. Bulletin, catalog 25¢. Knuth's (Factory Dealer), 1753 Muskego, Milwaukee, Wis.

RECONDITIONED Motorcycles and motors. Chromium accessories. Complete stock Indian parts. Expert rebuilding. Fast service. Indian Motorcycle Sales, Kansas City 27, Missouri.

MOTORCYCLES And supplies, all makes, new and used. Factory dealer. Tell us your needs. Wichita Cycle Co., 813 Ohio, Wichita Falls, Texas. Our 31st year.

PARTS. New, used. List 10¢. Ballak, 811 N. 9th, St. Louis 1, Mo.

AVIATION

PROPELLERS, Plans, supplies for airboats and snowplanes. Latest designs, prompt delivery. Catalog 25¢. Banks-Maxwell, Box 3301E, Ft. Worth 5, Texas.

PLANE Photographs—artificial large size. Also color reproductions. Decorate desk, etc. War planes in action. Six assorted. Send \$1.00. Jarvis, Box 1261, Bostonia, California.

TREMENDOUS Government sales now on. Buy direct from Uncle Sam. Surplus aircrafts; fuselages; accessories; engines; instruments; electronics; radiotelephones. Government depot list and procedure \$1.00. Brody, Box 8-PMK, Sunnyside 4, New York.

AVIATION Surplus bargain catalogue. One dime. Box 22 PM7, Thomasville, Penna.

BATTERIES, GENERATORS

EDISON Nickel storage batteries. Any voltage, any amperage. Unconditionally guaranteed. Power plants, generators, motors. Literature. Hawley Smith Co., Croton Falls 1, N. Y.

ELECTRICAL SUPPLIES

ELECTRIC Pencil: Engraves all metals \$2.00. Beyer Mfg., 10511-H Springfield, Chicago 43.

LAMP, Electrical parts, wholesale. Thousands of items for repairing, converting. Catalog 254. Brown Lamp, Box 305, Clayton 5, Mo.

LAMPS—Parts catalog showing wiring instructions, 234. Gyro Lamps, 5402P Clark, Chicago 40.

WELDING, SOLDERING, PLATING

PLATING Solutions. Strictly guaranteed. Pure gold \$6.00 pint, silver \$3.00, rhodium \$20.00, copper, nickel \$2.50. Louric Mfg. Co., 1809 Callowhill, Philadelphia, Penna.

"BUILD-UR-OWN" a.c. welder and a.c. power plant with a good used engine and low cost Hobart generator. Welds anywhere and supplies 5kw stand-by power for any emergency. Write Hobartweld, Box M-473, Troy, Ohio.

NEW All-in-one oxyacetylene outfit welds sheet, plate; cuts heavy steel; heats; brazes. Uses interchangeable tips. Portable, easy to operate. Complete with instructions, \$78.50. Gas cylinders on special money-saving plan. Write for free information: Dept. M, Linde Air Products Company, 30 East 42nd Street, New York 17, New York.

WELDER Headquarters—Free catalog, welders, welder kits. Build 300-ampere welder using aircraft generator—plans 254, catalog included. Dunbar Manufacturing, Houston 23, Texas.

ALUMINUM Soldering, easy with "Bondit" flux and solder. \$1.00 postpaid. Money-back guarantee. Product Research Company, Box 181, Arlington, Virginia.

A.C. Welders, 4 sizes, lowest prices. Free literature. Holgeron's Service, Canton, Kansas.

WELDERS, 110/220, \$39.50. Morris, 1070 Inner Drive, Schenectady 3, New York.

ELECTROPLATING Equipment, anodes and solutions for all types of plating. Instructions. Assemble your own plater and save. Free catalog. Ramyr, Dept. E-4, 1624 East First Street, Los Angeles 33, California.

ACETYLENE Welding outfits new \$54.50; used \$34.50; arcwelders \$56.50. Eagle Welding, Dept. PM, 5085 Broadway, Chicago 40, Ill.

MACHINERY, TOOLS, SUPPLIES

SCREWDRIVERS—(Six), wall holder, \$1.95. Trowbridge, 312 West 75th, Chicago 21.

WHOLESALE Tool catalog. Send \$1.00. Yuhas, 3350 Theodore, Detroit 11, Mich.

ROLL Barb and smooth wire with car or pickup. Total cost 50¢ to \$3.00. Patent pending. Plans \$1.00. Box 625, Lawton, Okla.

"MACHINE Tool Reconditioning." Amazing manual for machinists. Simplifies preventive maintenance. Free circular. Machine Tool Publications, 382 Holly, St. Paul 2, Minnesota.

ENGINES, MOTORS, DYNAMOS

REBUILT Motors. State requirements. 30-60hp. New motor prices. W. Davidson Electric, Monroe, Wisconsin.

6 VOLT D.C. motors heavy duty 1/15 h.p. \$4.95 p.p. Guaranteed. Greyhound Co., 2303 Surf Avenue, Brooklyn 24, N. Y.

NEW And used Diesel engines, generators, all capacities, 30 years experience. Glenmoore Diesel Mfg. Company, Glenmoore, Pennsylvania.

DIESEL Injector parts wanted, GM71-110. Bares, 7120 Carnegie, Cleveland 3, Ohio.

1/2 HORSEPOWER Electric motors, a.c. 110, used, good \$5.00 each, f.o.b. Plant Machinery Corp., Richmond & Norris Sts., Philadelphia 25, Penna.

REWIND Motors yourself. Complete instructions \$1.00. Lewis Mfg., Howell, Michigan.

WINDING Data. 275 motors, single and three phase, \$1.10. Data Company, Box 7631, Kansas City 28, Mo.

THERMO-Nuclear hydraulic engine plans are now available in response to thousands of requests. Externally applied heat generates powerful mechanical energy via molecular thermo-nuclear explosions. Has one moving part. No special tools or materials. Not a toy. Completely safe. \$2. Novoid, Box 10,133, Phoenix, Arizona.

A. C. Generators. 750 watt \$42.50; 1500 watt \$67.50. Motors, 5 horse \$110; 3 horse \$87.50; 1 horse \$38.50. Butler, 1885 Milwaukee, Chicago.

BOATS, OUTBOARD MOTORS

ALUMINUM Boats and canoes. Quality aircraft-type design and construction. Safe, durable, beautiful. No maintenance. 100% boating pleasure. New 1957 catalog free. Grumman Boats, Inc., 3747 South, Marathon, N. Y.

NEW Aerojet and Fageol inboard motor kits, with vee drive \$450.00. Vans Sales & Service, Middletown, Ill.

FREE Catalog! Boat kits, trailers, fiberglass, marine hardware. Luger Industries, Dept. M4, 3404 Lyndale South, Minneapolis, Minnesota.

INEXPENSIVE Two-way radio for your motorboat. Write: Hart, 467 Park, Birmingham, Michigan.

300 PLANS, Patterns, kits. Catalog 504. Outboards, 2.5 h.p. \$79.95! Marinecraft, Box 161-M, Brighton, Mass.

DELUXE Catalogue. Actual 10 inch photographs. Ford and Jeep marine conversions. Catalogue \$1.00. Refundable. Gershel, Oceanside, N. Y.

FIBERGLASS Boat coverings, wholesale prices. Free literature, samples. Seifert's, Box 31M, DePere, Wisconsin.

NEW! "How to Build Your Own Fiberglass Boat" and "How to Make Old Boats New with Fiberglass." Send 10¢. Castolite, Marine Division, Dept. DM-101, Woodstock, Illinois.

FORDS And Jeeps 100% marine engines with famous Convo-Kits. Deluxe catalogue 25c coin. Oscometers, 3627B Lawrence, Philadelphia 40, Penna.

MARINE Conversion, Willys to Cadillac, engines, kits and parts. Catalogue and conversion hints free. Barr Marine, 2706 Castor Avenue, Philadelphia 34, Penna.

FIBERGLAS Boat coating, Plexiglas boat windshields—Clear, blue, green tints. Wholesale-retail. Instructive information catalog free! Gem-O'-Lite, 5529 Cahuenga, North Hollywood, California.

STEEL-Wood, boat plans, cruisers—sail 21-42 feet. Free information. Please specify size-type. John B. Clark, N.A., Box 51, Bay Village, Ohio.

FIBERGLASS Your boat! Complete kits including color resin. Low as \$8.50. Aqua-Glas, Box 99, Altadena, Calif.

FIBER Glass—Buy direct, save 40%. Complete polyester and epoxy resin boat covering kits and supplies. Highest quality guaranteed. Send for prices and brochure. Marine Fiber Glass Corp., 6308 San Fernando Rd., Glendale 1, Calif.

MARINE Conversions for Ford and Jeep engines. Catalog 25c. Lehman Manufacturing Company, 972D Broad Street, Newark 2, New Jersey.

SAVE Money. New, used outboard motor parts. Send wants. Stamp appreciated. Outboard Motor Mart, 229-M State, Boston 9, Mass.

BOAT Plans. Full size patterns. Frame kits. Modern inboards and outboards for amateur builders. Complete new catalog 50¢ or specify requirements. Glen Designs, Box 568, Compton, Calif.

NEW, Used, rebuilt marine motors. Marine conversions, fittings. Free catalog. Stokes Marine Supply, Dept. 24, Coldwater, Michigan.

FIBERGLAS Permanent boat waterproofing. Special 25% winter discount. Complete kits, \$9.45 up. Guaranteed materials. Easy application. Full instructions. Free literature. Ajax Plastics, Dept. PM, P.O. Box 1323, Fort Worth, Texas.

BUILD Small boats. Booklet 254. Catalog free. Popular Mechanics Press, 633 N. St. Clair St., Chicago 11.

ATHLETIC EQUIPMENT, BODY BUILDING COURSES

BIGGER Muscles, faster! Seven courses, 35 exercises, \$1.00, 30-day money-back guarantee. Buckley, Box 638D, North Miami, Florida.

BE Taller! Coach's "Inch-At-A-Time" system \$1, complete. Marty Snyder, Box 195-MH, Union City, New Jersey.

BARBELLS, Dumbbells, Courses. Free catalogue. Good Barbell Co., Reading, Penna.

STRENGTH, Health, muscles, gain, reduce. All you need is a rope! Free details. Roperice, 4834-A Art St., San Diego 15, California.

4 MUSCLE Courses 25¢. Fully guaranteed. Sid's System, Southgate, California.

SPORTING GOODS, GUNS, FISHING TACKLE, ARCHERY, TRAPPING

RIFLES, Shotguns, pistols, scopes, ammunition. Dealers prices. Berkshire Gun Rack, Six Lakes, Michigan.

WHY Dig worms? New improved Worm-master rod. Results guaranteed! \$2.29 postpaid. Gelfuss Associates, 1888 Carroll, St. Paul 4, Minnesota.

FREE 152 Page fishing catalog. Includes latest "do it yourself" kits. Netcraft Company, Dept. B4, Toledo 13, Ohio.

FREE Below wholesale fishing catalog. Fishing Tackle Mart, Dept. 54, Box 6737, Chicago, Ill.

CAMPING, Hunting, diving! Free equipment catalog. McCanna, PM-4, Tarrytown, N. Y.

SOLINGEN Steel knives, 7 inch original Bowie knife \$5.00. German Jugend dagger \$3.50. Swedish pattern hunting knife \$3.00. Throwing knife \$2.00. George McCarty, 3251 W. Washington, Chicago, Ill.

MAKE Smoke fish bits. Easy, delicious! Profitable too. Use any eatable fish. Printed instructions \$1.00. Acc. Box 7, Maywood, Ill.

GUNSMITH—400 Page illustrated course \$4. Pioneer Press, Harriman, Tennessee.

WATER Skis \$21.95. Kits \$11.50 up. Finest quality. Enterprise Products, 28460 Gilchrist, Willoughby, Ohio.

17,000,000 GUN Parts stocked—Modern, obsolete, foreign. Send tracing, description for quotation. 44/40 instant gun-reloader, takes second, largest selling, absolutely guaranteed, \$2.00 bottle. Junked guns wanted for parts, \$1-\$3 each plus postage, any kind, condition. Ship off—check airmailed. Numrich Arms, West Hurley 16, N. Y.

FREE! Write for Klein's wholesale tackle and accessory circular. Why pay retail prices when you can buy wholesale at Klein's on credit and pay only \$2 down? Klein's, 227 W. Washington, Chicago 6, Ill.

OWN The fastest gun going, and the most accurate. New lightning. .22 cal., L.R. automatic pistol 23 oz. 10 shot. Aims better, fires faster, shoots straighter than any pistol. Possible only with monobloc construction. Floating action. Only \$39.95. Recommended by leading gun experts. Order now and get a free holster. \$5.00 down, balance c.o.d. Godfrey Corp., 201 Broadway, New York 7, New York. Write for free 2 color illustrated catalogue.

BIG Money raising crickets and 12 inch African fishworms. Free literature. Carter Ranch, Plains, Georgia.

JAP Rifle altering to 30-06, \$6.00. Jap-shells, \$3.75. Catalog 5¢. T. P. Shop, West Branch 11, Mich.

Free Catalog: New Items: Bargains, Gadgets, Beads, Spinners, Lure parts, Sinker molds. FinnySports, MC, Toledo 6, Ohio.

5000 BARGAINS, Firearms, binoculars, war relics. Catalog 50¢. Smith Firearms, Runnemed, N. J.

SAMPLE: 25c Copy of "The Archers' Magazine." Send 10c. 1200 Walnut Street, Philadelphia 7, Pennsylvania.

FISHERMEN. Amazing secret Indian Fish Lure Oil attracts all fish! One drop on bait, pool, fly guaranteed to catch more fish or money back. Send \$1.00 for bottle now! King & Company, Asheville, New York.

GRAY Crickets: Special advertising material (limited offer) free to fishbait dealers ordering crickets. Use material for your advertising. Crickets shipped immediately, any quantity. Live delivery guaranteed. Scientifically raised. Write for free literature and price list. Owen Crickets, Farm Z, 2818 25th, Lubbock, Texas.

NIGHTCRAWLERS Raised easily anywhere. Soilless method. Charlie Morgan, Box 258D, Sheridan, Wyoming.

TENTS, Camping equipment; tremendous selection. Send 20¢ for 136 page tent, camping equipment catalogue-handbook listing all national camping sites. Morsan, 10-21R 50th Ave., Long Island City 1, New York.

FREE Sporting goods catalogs! Save 70%. Econ-O-Mart, Whippany 2, New Jersey.

MOLDS For fisherman's sinkers, jigs, squids, casting and spinning lures. Free catalog. Sweet's Molds, Tonawanda 1, New York.

FREE Fishing secret secrets. Johnston's, 312 Lake Avenue, Ithaca, New York.

ARROWS—Unsurpassed for speed, accuracy. 26 kinds. Accessories, raw materials. Free catalog. Marlin Archery, Ames, Iowa.

180 PROFUSELY Illustrated pages antique pistols, swords, daggers, armor, etc. 50¢. Robert Abels, MB60 Lexington Ave. New York City 21.

BUILD Barbecue. Complete plans. Booklet 25¢. Free catalog. Popular Mechanics Press, 633 N. St. Clair St., Chicago 11.

BINOCULARS, TELESCOPES, MICROSCOPES, MAGNIFIERS

AMAZING Prices precision binoculars, special slow season winter reductions. Free trial. Folder "Binocular Selection," catalog free. Prentiss Importers, Mercury Bldg., West Los Angeles 25, Calif.

DYNASCOPE—Sensational new reflector telescope. Send for details. Criterion Co., Dept. DP 31, Hartford, Conn.

REFLECTING Telescope, 80X, completely assembled \$29.75. Guaranteed observatory clearness. Free information. Skyscope, 475 Fifth Avenue, New York City 17.

BINOCULARS, Riflescopes, etc. Exclusive models! Tremendous selection. \$100,000.00 stock! Free 56 page illustrated catalog. United, 9043 S. Western, A-1308, Chicago 20. Dealers wanted.

BUILD Your own reflector telescope. Complete kit; Mirrors, eyepieces, tripod, all other accessories. Request free illustrated literature. Criterion Manufacturing, Dept. DPM 28, Hartford, Conn.

300 POWER Reflector telescopes complete with finder scope and tripod, \$24.95. 450X telescopes easily made. Kit includes focusing tube, erector, five finished lenses, building instructions, \$3.75. Free telescope booklet. Suffolk Science, Mattituck 4, New York.

BINOCULARS, Telescopes, microscopes. Terrific values \$3.98 up. Request free money-saving catalog. Criterion, Dept. P 53, Hartford, Conn.

WAR Surplus bargains: Millions of lenses, instruments, telescopes, binoculars, components and complete line of astronomical telescope items. World's greatest optical market place! Send only \$1.00 for beginner's 10-lens kit and big instruction booklet Stock 2-CH. Write for catalog CH, free! Edmund Scientific Co., Barrington, New Jersey.

REFLECTOR Telescope kits \$7.25 (3") to \$175 (12"). Mirrors, cells, focusing mounts, tripods, eye systems. Anything, everything in telescopes. Free catalog. Also ready to use telescopes from \$25. Esco Products, Oakridge, N. J.

PLANTS, SEEDS, BULBS, NURSERY AND GARDEN SUPPLIES

500 SWEET Onion plant assortment. \$2.00 prepaid. Fresh from Texas Plant Company, Box 8711, Farmersville, Texas—"Home of the Sweet Onion."

EVERGREEN Trees from seed. Free folder. 1500 blue spruce or Scotch pine seeds \$1.00. Strom's, Belaire 23, Michigan.

TREES And shrubs—Raise your own from seed for shade, windbreak, snow fence, ornament, erosion control, etc. For free planting guide, price list, write Wood-let Seed Company, Norway 9, Michigan.

OPERATE Profitable garden. Write: Regal Industries, Spring Lake Road, Streator-PP, Illinois.

WORLD'S Greatest cash crop. Free information. Write Ginseng Gardens, Asheville, N. C.

GINSENG, Goldenseal, Roots bring up to \$14 pound. Full information. F. M. Collins, Viola, Iowa.

EARTHWORMS For house plants 50—\$1.00. earthworm castings one gallon \$3.25 postpaid. Redland Worm Hatchery, P.O. Box 132, Homestead, Fla.

PETS—DOGS, BIRDS, RABBITS, HAMSTERS, ETC.

RAISE Rabbits successfully by knowing facts. 48 page illustrated book describing 25 breeds. Housing, feeding, breeding, marketing, etc. Plus bulletin. 25 cents. American Rabbit Association, 36 Arba Building, Pittsburgh, Penna.

STANDARD Rabbit Journal, Milton 3, Penna. Year \$1.00. Sample dime. Beginners manual 25¢.

MAKE Money raising chinchillas, mink, nutria, rabbits, cavies for us. Free catalog. Keeney Brothers, New Freedom 2, Penna.

BEAUTIFUL Pure white pedigreed police puppies. Ansonia Kennels, McHenry, N. Dak.

RAISE Rabbits on \$500 month plan. Plenty markets. Free details. White's Rabbitry, Mount Pleasant, Michigan.

HAMSTERS—Young Golden pairs, \$2.95, breeders \$3.95. Free booklet. Jer-Fre's Hamstery, 2425 Hoyt, Muskegon Heights 13, Mich.

GROW Mushrooms. Cellar, shed. Spare, full time, year round. We pay \$3.50 lb. We have over 25,000 customers. Free book. Mushrooms, Dept. 171, 2954 Admiral Way, Seattle, Wash.

PETS, All kinds. Catalog \$1. Carroll Blakey, Florida 4, Ala.

HAMSTERS—Golden: young, \$3.00 pair. Fully developed \$4.00 pair. Adirondack Hamstery, Prospect 10-D, N. Y.

RAISE Nutria: Registered breeding stock, all colors, all ages. Get the "Facts" \$1.00. Lund's Ranch, 9725 Sunland Blvd., Sunland 2, Calif.

SACRIFICING 165 First quality chinchillas with equipment. Illness forces sale. Arthur Sladek, 1936 N. Sawyer, Chicago, Illinois.

FUR BEARING ANIMALS

NUTRIA Fur farming for big profits. Free information. Write Nutria, 4112 Stoneway, Seattle, Wash.

MINK Raising information free. Complete. Lake Superior Mink Farm, Superior, EEL, Wisconsin.

1000 BRED Mink. Booklet, plans 25¢. Lake Ontario Ranch, Gravel Road, Webster, N. Y.

RABBIT Raising booklet-magazine 10¢. Stahl, Hickman Mills 1, Mo.

AMAZING Profits converting greens into nutria fur. Nutria carcasses into mink. Voight Farms, Atlanta 2, Texas.

FARMS, FARM LANDS, REAL ESTATE

STROUT Spring catalog! Mailed free! 34 states, coast-to-coast, bargains galore! Farms, homes, businesses. World's largest; 57 years service. Strout Realty, 7-MF So. Dearborn St., Chicago 3, Ill.

CANADIAN Tax sale lands for three dollars an acre and up. Small monthly payments. Farms, timber, hunting and fishing camps, minerals. Limited number of properties. Write at once for free catalogue. Tax Sale Service, Room 105, 120 Bloor St. W., Toronto 5, Canada.

FLORIDA Lakefront homesites. Easy monthly payments. Complete literature free. Write Box 1311, Eustis, Florida.

FLORIDA—50'x125' Homesites: \$10 down, \$10 monthly; full price \$395. Outskirts Bushnell; Highway 301. City conveniences, no city taxes. High elevation. Free information. Austin and Dawson Realty, Brooksville, Fla. Dept. PM.

HOMESITES \$15 Monthly—California's finest garden section. Morro Bay's scenic shores. Wonderful fishing, boating. Fertile soil, softest water, temperate climate, congenial community. Free literature. Richard Otto, Department M. San Luis Obispo, California.

OZARKS! \$9 Acre. Listings, information free. Write: Armstrongs, Shook, Missouri.

FLORIDA—Nice homesites, \$345 at \$10 monthly. Folder free. Howard Vernon, DeLand, Florida.

FLORIDA—Beautiful homesites. 80 by 125 feet, only \$240, payable \$10 monthly. High, dry, amid sheltering pines. Near famous Panama City gulf resort. Outstanding deep sea, surf and freshwater fishing. Finest hunting, boating, bathing. Illustrated booklet free. Wendell Wood, Fountain, Florida.

GENUINE Opportunities! Government land, U. S., Alaska. Write Sledge Surveys, Macon, Mississippi.

SOUTH Carolina—Homesites \$235 up; terms. Development adjoining beautiful Lake Greenwood. Write Hollingsworth, Box 824, Greenwood, S. C.

MINNESOTA Waterfront tracts \$10 down. Norstates, Box 645-T, Houston 1, Texas.

CALIFORNIA, Florida information. Free questionnaire. Surveys, 26 Wendover, Kenmore 23, N. Y.

SAVE Hundreds of dollars when selling your real estate. Full instructions \$2.00. Norman Realty, 80 Lovell St., Worcester, Mass.

POULTRY, FARM SUPPLIES

GUINEAS, Ducks, pheasants, eggs and babies; 50 varieties chicks. Low prices, gorgeous book free. Berry's Farm, Route 12, Clarinda, Iowa.

PROFITABLE OCCUPATIONS

YOUR Own wholesale business without investment. Bargain catalog. Send 25¢. \$1.00 refunded with first order. Norria, 487-M Broadway, New York City.

BUY Wholesale! Discounts to 80%! Appliances, cameras, sporting goods, housewares, watches, tools, clothing, etc. Buy-Rite, Hawthorne 3, New Jersey.

BAKE New greaseless doughnuts in kitchen. Sell stores. Free recipes. Michael Ray, 3665 South 15th, Minneapolis 7, Minn.

BUY Wholesale thousands nationally advertised products at big discount. Free "Wholesale Plan." American Buyers', Hertel Station, Buffalo 16-B1, N. Y.

WELDING Pays big money. Learn easily at best equipped school in country. Non-profit school with low cost training. O.I. approved. Write Hobart Trade School, Box M-472, Troy, Ohio.

BOTTLES, Vases, etc. Have permanent rainbow colors. How 50 cents. A. M. Cummings, Box 3073, Temple, Texas.

TV Rental business operated successfully by telephone from home. Detailed instructions \$1.00. Satisfactory or money refunded. Alpha Television Rental, Box 9082, Austin, Texas.

SILHOUETTE Painting on glass. Fascinating, profitable hobby. Details free. Jack Rothbart, R.F.D. 4, New Brunswick, N. J.

FREE Folder: "How to Make \$3,000 Yearly Sparetime, Backyard, Raising Earthworms;" Oakhaven-39, Cedar Hill, Texas.

HOME Mailorder beginner's manual, sources, methods, opportunities, 25¢. Car-nahan Bros., 9610 Acacia, Fontana, Calif.

\$60 WEEKLY, Spare time—Easy! Home Venetian blind laundry. Free book. Burt, 2434A, Wichita 13, Kansas.

LEARN Locksmithing from licensed experts at home in your spare time. High pay. Earn as you learn. Locksmithing Institute, Rutherford 11, N. J.

BIG Profits raising—Fishworms, crickets. Free literature. Three Oaks Ranch, Dresden, Tenn.

SPARETIME Repeat profits taking magazine subscriptions. Special offers. Cassell Agency, Boynton Beach, Florida.

MUSHROOMS In 14 days. Preplanted trays, 3 for \$4.50 f.o.b. Spawn plus newest manureless methods, \$1.00. Literature. Luxur, 641 South 19th, Newark 3, N. J.

GROW Mushrooms. Cellar, shed. Spare, full time, year round. We pay \$3.50 lb. We have over 25,000 customers. Free book. Mushrooms, Dept. 99, 2954 Admiral Way, Seattle, Wash.

THEY Hand him \$100! Free packet. "Secret Journal," 919 secrets-plans! Work home. Publicoe, Oceanside, Calif.

FREE! "301 Profitable Small Businesses!" Amazing shoestring plans! Work home! Start sparetime! Deumant Surveys, Kenmore 23-R, N. Y.

FOREIGN Jobs—Latin America, Alaska, Canada, up to \$1500 monthly. Up-to-date 1967 foreign service directory gives complete information; hot list of firms hiring for military and civilian construction, aircraft, oil, exporters-importers, mining, \$1.00. How-when-where to apply, 9th successful year! Global Reports, Box 883-B, Hollywood 28, Calif.

MAKE Flexible molds. Cast plaques, figurines. Free sample. Tooker, 1045-M Fairview, Hamilton, Ohio.

VENDING Machines—No selling. Operate a route of coin machines and earn amazing profits. 32-page catalog free. Parkway Machine Corporation, Dept. 23, 715 Ensor Street, Baltimore 2, Maryland.

BE The Popular Mechanics representative in your neighborhood and earn big profits in your spare time. Write Popular Mechanics Magazine, Room 408M, 200 E. Ontario St., Chicago, Ill.

RAISE Pheasants on \$100 week plan. Little capital and space can make you independent. Free details. Great Central System, Columbus 1, Kansas.

AUCTIONEERING—Home study course. Diplomas granted. Auction School, Ft. Smith, Ark.

FREE Book "503 Odd, Successful Businesses." Work home. Pacific, Oceanside, Calif.

FREE Folio "\$5,000-\$45,000; Unlimited Vacations." No merchandise. Unknown! Work home, sparetime! Haylings, Carlsbad, Calif.

BIG Money raising fishworms and crickets. Free literature. Carter Wormery, Plains, Georgia.

MAGAZINE Subscriptions. Largest commissions. Bonus. Qualified Agency, 451RA Kingston, Brooklyn 25, N. Y.

INVESTIGATE Accidents—Earn \$750 to \$1,000 month. Thousands of airlines, insurance companies, steamship lines urgently need claim investigators. We train you home spare time. Placement course, GI approved. Free book, now! No obligation. Universal Schools, T-4, Box 6202, Dallas 5, Texas.

WE Establish you in your own mail order discount business. Supply catalogs, letters, envelopes printed with your name and ship your orders. Sell gifts, appliances, watches, housewares, silverware, etc., at discounts to 75%. Catalog and details free. Topval Corp., Lindenhurst 117, N. Y.

BOOKS, PERIODICALS, PICTURES, POSTCARDS

LATEST Books on raising cattle, hogs, sheep, horses and poultry. Also veterinary, farm mechanics, tractors, fruits, crops, gardening, bees, soils, conservation, etc. Over 700 titles. Send for new listing, free. National Farm Book Co., Viroqua, Wisconsin.

FREE: Catalog. Many titles. Treasure-Site Books, 279 South Alden, Philadelphia 39.

TALKING Birthday card, 25¢. Variety House, 1930 Filbert, Oakland 7, California.

SEND 10 Pocket size books and \$1.00. We will return you 10 different ones. Mitchell's, Box 422, Cedar Rapids, Iowa.

BRITISH Book bargains. Any subject. Catalog free. Transbooks, Box 22-PMK, Brooklyn 26, N. Y.

WORLD'S Smallest Bible 50¢; three \$1.00. Rader, Walnut, Richwood, W. Va.

"SCIENCE Milestones." Records march of science starting 400 years before Christ, right up to date. Amazing facts revealed. 312 pages packed with startling information that will thrill you. A real history of science. \$5.00. Literature free. Popular Mechanics Press, 200-SM East Ontario St., Chicago 11, Ill.

OUT-Of-Print books at lowest prices! You name it—we find it! Fast service. No obligation. International Bookfinders, Box 3063-PM, Beverly Hills, Calif.

BOOKS, Essays, lectures, plans. Experimental information. Free list. Tipp Scientific Co., Tipp City 5, Ohio.

INTENSELY Interesting Alaska magazine! True experiences on "The Last Frontier." Send \$1.00 for six back issues. The Alaska Sportsman, Kelchikan, Alaska.

NATIONAL Geographic Magazines, 1888-1956. Periodical Service, Box 463-PM, Wilmington, Delaware.

"HOME Improvement Guide." New, amazing 192 page volume. Packed with ideas, plans for remodeling, decorating, landscaping, built-in projects. \$2.50 prepaid. Popular Mechanics Press, 200-HG East Ontario St., Chicago 11.

RARE Magazines, catalog 10¢. Nationwide Exchange, Box 1373-F, San Antonio 6, Texas.

BOOKFINDERS! All subjects. Send wants! Jaher Book Service, 163 Hazelwood Drive, Westbury, N. Y.

BOOKHUNTERS! Scarce, rare, miscellaneous books. Atlantic Book Service, Cedar Street, Charlestown 29, Mass.

JOHN Friend, bookfinder, can get the book you want. Free search service. Box 197PM, Cardiff, Calif.

LIMITED Offer! Four popular self-instruction books for homecraftsmen: "Concrete and Masonry," "Electricity in the Home," "Home Repairs and Improvements," "Woodworking," worth \$6.75 when sold separately, now specially priced at \$4.98 set (postpaid) as an advertising test. Barnes & Noble, Inc., 105 Fifth Ave., New York City.

BARGAIN, Exciting Little Library booklets. 25¢ each. How to use tools, painting, welding, home improvement, games, models, plastics, lamp making, glass blowing, boats, photographs. Free catalog. Popular Mechanics Press, 200-LB East Ontario St., Chicago 11.

GUNSMOKE, Deadline, many other old west pictures. Large picture and list \$1.00. Henry Sissen, Luray, Missouri.

SHIPS, Photographs, lists 10¢. Scozava, 1648 59th St., Brooklyn 4, N. Y.

SAMPLE: 30¢ copy of "The Aquarium." Send 10¢ to 12th and Cherry Sts., Philadelphia 7, Penna.

FREE: Exciting catalog packed with books covering most everything. Think of it—From cover to cover you will find described and illustrated hundreds of books telling how to fix and how to build almost anything. How to remodel your home; do your own decorating, plumbing, electrical work. Simplified books covering concrete work, carpentry, painting, furniture making and refinishing. How to build your own boat, home workshop tools. Best books on photography, welding, hobbies, homecraft. How to make a home freezer. Send for your free copy now. Popular Mechanics Press, 200-BO East Ontario St., Chicago 11, Ill.

MAGIC TRICKS, PUZZLES, JOKER NOVELTIES

AMAZE Friends! Five best magic tricks, including two mind reading tricks, carefully explained, \$1. Smiths, 2702 Franklin, Seattle 2, Wash.

FREE Illustrated magic catalog! Entertain. Great opportunities. Write. Great Heany, Oshkosh, Wis.

SENSATIONAL Magician's wand 25¢. Vanishes handkerchiefs! Catalog included. Box 1352-PM, Philadelphia 5.

BE A magician! Large professional catalog of latest tricks. 35¢. Ireland, C-109 North Dearborn, Chicago 2, Illinois.

3100 NOVELTIES, Jokes, tricks, gadgets, funmakers, hobbies. Big catalog 10¢. Johnson-Smith, D-407, Detroit 7.

VENTRILLO, Professional voice-throwing instrument and catalog 25¢. Box 971-PM, Philadelphia 5.

ANCIENT Alchemist metal. Looks like lead. Solid at room temperature, melts at 150° F. (hot coffee). Used by ancient magicians in molten metal drinking acts. Sample and literature \$1.00. Alchemist, Box 11182, Ft. Worth, Texas.

MAGIC Catalog 25¢. Eastern, P.O. Box 81, No. Westport, Mass.

WHOLESALE! Thirty 10¢ trick novelties \$1.00! Profits! 1746-W Market, Philadelphia 3.

DOLLAR Magic set free with catalog 25¢. 4462-PM Germantown, Philadelphia.

WORLD'S Finest professional magic, Joker novelties. Giant illustrated catalog 10¢. Top Hat, Evanston 12, Illinois.

500 TRICKS, Douglas famous 120-page catalog, only 10¢. Fastest service to magicians for 30 years. Send 10¢ today. Douglas Magicland, Dept. 1, Dallas, Texas.

SMOKEBOMBS 25¢. 7 For \$1.00. Terrific! 4463-PM Greene, Philadelphia 44.

PROFESSIONAL Catalog, 175 pages, 25¢. Williams, 900 Plymouth, Ellwood City, Penna.

COINS, TOKENS, CURRENCY

COINS 35 Different countries \$1.00; large lists 10¢. Benson, 2526 Middle Road, Davenport, Iowa.

OLD Money wanted. Will pay fifty dollars for nickel of 1913 with liberty head (no buffalo). We pay cash premiums for all rare coins. Send 4¢ for large coin folder. May mean much profit to you. Numismatic Co., Dept. 20, Fort Worth, Texas.

100 DIFFERENT Coins, \$2.50. 100 different bills, \$2.50. 25 coins, 25 different countries, \$1.00. Oddehon, Box 482, St. Louis, Mo.

FIFTY Indianhead cents \$3.00. Bargain lists free. Sayers, 1000 East Unaka, Johnson City, Tennessee.

2 DIFFERENT Brilliant uncirculated silver dollars \$3.00. Price list free. Joray's, Box 38C, Shoups, Tenn.

MORGAN Dollars; 1878-87-90-91-97a, \$2.00 ea. Coin catalogue, 25¢. Shultz, Salt Lake 10, Utah.

GIANT U. S. coin catalog 25¢. Atccoln, 314 So. Clark, Chicago 4.

FREE! Foreign coin, banknote and coin collectors illustrated catalog to approval service applicants. Send 3¢ postage. Tatham Coinco, Springfield 30, Mass.

COINS From Formosa, Vatican, etc., plus foreign banknote, 10¢ with coin approvals. Littleton Coin Co., Littleton 51, New Hampshire.

U. S. Coin approvals. Reasonable. Hutchinson, 3463 "I" Street, Philadelphia 34, Pennsylvania.

BARGAIN Lists, Indianhead cent, 10¢. Economy Sales, 156-A Dean, Mansfield, Mass.

GET Profit and pleasure in collecting old coins. Send 10¢ for 56-page illustrated coin catalog. You'll be delighted with it. Send for it now. B. Max Mehl, 370 Mehl Building, Fort Worth, Texas. Largest rare coin establishment in U. S. Established 40 years.

BARGAINS, U.S. coins: 1893 Columbian world's fair half dollar, \$1.00. Ten different Indian pennies, 75¢. Two-cent piece, and 3-cent piece, \$1.00. Gold 1/4 eagle, \$9.00. Gold 1/2 eagle, \$12.50. Beautiful coin bracelet, \$1.00. Many coins available. What do you need? Rare Coin Company, 31 North Clark, Chicago 2.

LARGEST Coin magazine, 180 pages, 25¢. Scrapbook, 7320-J Milwaukee, Chicago 31.

SAN Francisco mint closed! Made only cents and dimes in 1955. In short supply and great demand. One each, brilliant uncirculated, for 25¢. Free coin lists with order. Bryson Stamp & Coin Company, 612 White, Toledo 5, Ohio.

LINCOLN Cents 1910-S, 1913-S, 1921-S, 1923-S, 1924-S, 1933-D all for \$2. Gasser's, Box 34615, Los Angeles 34, Calif.

CONFEDERATE And southern states currency catalogue and value list. 288 pages, finest ever printed. \$6.00 postpaid. Criswell's, Pass-A-Grille 9, Florida.

12 DIFFERENT Indian cents, coin list, \$1.00. Pounds, North Wales, Penna.

U. S. large cent and coin bargain lists, only \$1. Delmaco Products, Box 1123, Wilmington, Del.

40 DIFFERENT Foreign coins \$1.00. Claud Denney, 3406 S. Harwood, Dallas 15, Texas.

GIANT 80 Page bargain catalogue (only one like it in America) \$1.00. Fine \$5 gold \$10.95. Beebe's, 4514 North 30th, Omaha 11, Nebraska.

\$4,000.00 FOR 1913 Liberty head nickel. Uncirculated dollars 1804 to 1839, 1893-S, 1895-P, 1903-O pay \$100.00 — \$5,000.00. Certain dates — Small cents before 1915, \$325.00; dimes before 1917, \$2,000.00; quarters before 1924, \$1,000.00; half dollars before 1905, \$1,000.00; 2¢ pieces, \$70.00; 3¢ pieces, \$90.00; halfdimes, \$500.00. Hundreds of others worth \$10.00-\$1,000.00. Canadian coins, 1921; 3¢ silver, \$50.00. 1889, dimes, \$25.00. 1875 quarters, \$50.00. 1921, 50¢, \$200.00. Wanted—20¢ pieces, gold coins, paper money, etc. Our large illustrated guarantee buying-selling catalogue, giving complete alicoin information. Send \$1.00. Purchase catalogue before sending coins. Worthycoin Corporation, Leaders Numismatic Quotations K-212-C, Boston 3, Massachusetts.

FREE "Franchise Profit Letter" describes nationwide opportunities. Exclusive distributorships, dealerships, agency operations. Write today. National Franchise Reports, 333 North Michigan, Chicago 1.

LEARN Sewing machine repairing. To \$125.00 weekly. Sparetime. Supplies. "Add to present business." Write today! Taylor Service, Box 2126, San Bernardino, Calif.

LEARN Photo-negative portrait retouching. Men, women, \$5 hour possible spare or full time at home. Easy, glamorous. Work for photographers by mail order. Full details sent free. Duval, 100 So. Vermont, Los Angeles 4.

YOUR Own name brand business. No investment; no inventory. Part time or full time. Sell famous brands of appliances, housewares, silverware, radios, vacuum cleaners, lamps, tools, clocks, watches, jewelry, etc., etc., over 1600 items. Join thousands of successful independent dealers. Send for free catalog and dealer price list. H. B. Davis Corp., Dept. 11, 145 W. 15 St., New York City.

FREE! "301 Profitable Small Businesses!" Amazing shoeing plans! Work home! Start sparetime! Deumant Surveys, Kenmore 23-R, N. Y.

WHOLESALE Catalogue! Appliances, cameras, watches! Cam Company, 6806PM 20th Ave., Brooklyn 4, N. Y.

HIGH Profits selling trailer awnings, carports. Canvas Center, Tampa 10, Fla.

SPECIALIZED Magazines—3,166 publications—current copies. Also 1,148 self-help books. All trades, professions, sports, hobbies, etc. List free. Publications, 34C North Ritter, Indianapolis 19, Indiana.

11,000 NEW Prospects daily. Baby record books, shoes, albums. Sell mailorder. Use our literature. Write: No-Co-Ro, Capitola, California.

COLORGLAZED Concrete pottery made without molds. Patented method. Cemetery products, novelties, tiles. Basement leak-sealing. Money-making projects. Booklet, details free. Men only. National Pottery Company, Grand Rapids, Minnesota.

FREE Cadillac, \$10,000 yearly. Cars, appliances wholesale. Strawley, 6228E, Charlotte 7, N. C.

OPERATE Profitable mailorder business! Splendid opportunity. For details write: Thomas Bond, 1637H West Vernon, Phoenix, Arizona.

COLOR Concrete with chemicals. Marble-glaze cement benches, pottery. Home-shop. Hundred beautiful designs, made without molds. Birdbaths to waterfalls. Your chance for fame, fortune, 10¢ brings sample, pictures. Hollywood Cementcraft, 8527-R Wonderland, Hollywood 46, Calif.

CASH From sawdust, seventy methods. Tin-cans, thirty methods. Newspapers, eighteen methods. Instructions \$0¢ each. All three \$1.00. Charles Company, 12-DXT, Norwood, Ohio.

HIGHEST Profits all magazines. Sure success plan. Free catalogue, supplies, prizes. Subscription Service Co., Box 2070, Birmingham, Ala.

OPERATE Home mailorder (folio) bookshop. Write Ballard's, 425 East Catherine, Louisville 3, Ky.

AMAZING Sign system. Earn while learning. Straley, 410 S. Western, Springfield, Ohio.

MONEY Comes easy to owners of Acme saw sharpeners. Send for free literature. Max Mfg. Co., 138 Stockton Ave., San Jose 28, Calif.

BE Appointed state notary public now. Write, Stationers, Boerne, Texas.

10,000 WORD Booklet "How To Build Own Mail Business." 25¢. Hamm, 3001 North Spaulding, Chicago 18, Illinois.

GROW Mushrooms. Cellar, shed. Spare, full time, year round. We pay \$3.50 lb. We have over 25,000 customers. Free book. Mushrooms, Dept. 172, 2954 Admiral Way, Seattle, Wash.

BIG Profits raising earthworms. Literature free. Lund's Hatchery, Olathe, Kansas.

BOOKKEEPERS, Accountants. Operate a bookkeeping service. Part or full time. Amazing simplified system. Wonderful money-making opportunities. Complete information free. National Bookkeeping Publishing Co., Suite 307, 3435 Broadway, Kansas City 11, Mo.

COSMETICS, Perfumes, your label, local, mailorder. Farrand Chemical, Tyrone, Penna.

MAKE Money fast! Buy nationally-advertised products at factory prices—Sell for up to 500% profit! Bi-monthly publication tells all. Write now for sample copy details. Home Business Digest, G.P.O. Box 972-PM, New York 1, N. Y.

WE Love our mailman—He leaves over \$1000.00 monthly in our rural mailbox. My college professor husband drafted a scientific home mailorder method. We bought a Texas ranch, live as we always wanted. Now we sell the Ranch Mailorder Method. Operates anywhere. Inquire: Eveningshade Ranch, Boerne, Texas.

WHY Make less than \$600 monthly? UL approved portable garbage disposal unit made by multi-million dollar concern guarantees you a minimum of \$44.50 clear on every \$94.50 sale. No installation, works anywhere. Unlimited market. Choice territories going fast. Rush request for complete sales plan. New Home Disposal, Dept. 44, Box 840, Beverly Hills, California.

BAKE New greaseless doughnuts in kitchen. Sell stores. Free recipes. M. Ray, 3605 South 15th, Minneapolis 7, Minnesota.

AMAZING Earnings, sharpening shears and knives. No errors. Built-in angle electric sharpener \$14.95 prepaid. Free descriptive circular. George Page, 1830 Cleveland Ave., Niagara Falls, N. Y.

NEWEST Spare, full-time home business \$5 to \$10 hour possible. Paint with suede—The finish with touch and eye-appeal. Beautiful auto dashboards, signs, radios, toys, figurines, lamps—1001 others. Complete, step-by-step instructions sent for no-risk examination. Free details. Coast AL, Los Angeles 61.

IMPORT-Export opportunity, profitable, world-wide, mail-order business from home, without capital; or travel abroad. Established world trader ships instructions for no-risk examination. Experience unnecessary. Free details. Mellinger G704, Los Angeles 24.

START Your own business on credit. Your own boss. 1598 dealers sold \$5,000 to \$32,000 in 1959. We supply stocks, equipment on credit. 200 home necessities. Sales experience unnecessary. Pleasant profitable business backed by world-wide industry. Write Rawleigh's, Dept. D-U-PPM, Freeport, Ill.

OPPORTUNITIES Galore. Literature free. H L Products, 756 South Normandie, 308, Los Angeles 5, California.

MAKE Extra money. Cash commissions. Everybody buys easy-to-sell advertising book matches. Union label. All sizes. Cuts for all businesses. Powerhouse selling kit free. Steady repeat business. No experience necessary. Superior Match Co., Dept. MX-457, 7528 S. Greenwood, Chicago 19.

OPERATE Profitable mail order business. Write Walter Service, 4159A East 112th, Cleveland 5, Ohio.

BECOME Tax consultant. Graduates earn \$3,000 every tax season preparing returns evenings. State approved. Union Institute, 68 Hudson, Hoboken 2W, N. J.

PRINT Without a printing press! Amazing new method! Print colorful signs, banners, cards, posters, glassware; anything at home. Big profits. Moneymaking opportunity! We supply everything. Beautiful sample, home-business plan free! Write Screen-Print Company, AL, Los Angeles 61, California.

TAPE Recording! Exceptionally profitable opportunity in your area. Free information. Baron's, Lynden, Washington.

50% PROFIT Cosmetics \$25 day up. Hire others. Samples, details. Studio Girl-Hollywood, Glendale, Calif., Dept. 1274H.

BUY Wholesale! Discounts to 80%! Appliances, cameras, sporting goods, housewares, watches, tools, clothing, etc. Buy-Rite, Hawthorne 1, New Jersey.

BEAUTIFUL Feather pictures. 200% profit! Free details; sample 20¢ stamps. Sylviap, Apartado 3036, Mexico City.

WANTED! Home workers to assemble luggage and cases for ready market. Instructions, materials, tools, everything supplied. Free details. Abarsi, 807-BD Sunset, Los Angeles 12.

"HOW To Start a Business" booklet sent free! If you know any trade, go into business for yourself! Learn the 8 easy steps to follow. We've guided 5,000 others to success. Revealing free booklet yours for the asking! Write! National Business Consultants, Office AL, Los Angeles 61, Calif.

GROW Expensive herbs for us! Big profits home-business of your own. Year around profitability! We supply everything necessary! Send for free rare seeds and revealing plan. National Herb Exchange, Dept. AL, Gardena, Calif.

START A buying service, buy wholesale thousands nationally advertised products. Make big profits selling at sizable discounts. Postcard brings details. American Buyers, Hertel Station, Buffalo 16-C1, New York.

FIX Typewriters. Inexpensive home course teaches factory secrets. Free booklet. Athey, Tarentum, Penna.

MAIL Order advertising agency executive reveals sensational no-risk advertising and merchandise methods. Start in office or home; minimum capital; positive profits. Free details: Impact! 3407 Prospect Avenue, Dept. 11-4, Cleveland 15, Ohio.

FREE! "How To Turn Rags Into Riches!" Metro, Box 151, Oak Park, Ill.

TOP Flight mailorder business opportunity. Modest capital. Request convincing details. Stav, 147 Victoria Street, Kamloops 18, B. C., Canada.

MAKE Money in sparetime at home by mail. 20 lesson course by nationally known expert teaches how. Request convincing details. Stephens Enterprises, Hartstown 1, Pennsylvania.

INVESTIGATE How you can earn up to \$2000.00 or more monthly with automatic hot beverage and food dispensers. Proven plan. No obligation. Information free. Superior, 4555-F East Warren, Denver, Colorado.

THEY Hand him \$100! Free plan "Secret Journal Hidden Dollars." Work home! Publicos, Oceanside, Calif.

MONEY. Raise hybrid worms. 250—\$2.00. Book \$1.00 postpaid. Brandt's Wormery, Century Apartments, Davenport, Iowa.

WORLD Wide business from your home. 100 names, addresses foreign manufacturers seeking distributors. Import-export instructions, lists, \$1.00 full price. M.J.R. Co., 317 Lorton, Burlingame, California.

IMPORT-Export! Modern dropship method. Details. Warner, Box 6, Fort Scott, Kansas.

\$10.00 PER Hour net profit in monument cleaning business. Free details. X-Pert Monument Cleaning Company, 466 Potomac, PM-3, Buffalo 13, New York.

FREE Wholesale name brands catalogue. Be a dealer, part or full time salesman. Savings, profits to 75%. Star Industries Co., P.O. Box 461, Nashua, New Hampshire.

FREE Folder: "How to Make \$3,000 Yearly Sparetime, Backyard. Raising Earthworms!" Oakhaven-38, Cedar Hill, Texas.

PRINTING Office supplies wholesale. Save 50%. Royal, Box 368-A, Cleveland 27, Ohio.

UNPAINTED Figurines, 25% discount. Free list. Ward Plastercraft, 111 Grandview, Brookhaven, Penna.

IMPORT Your own products in small lots. Start profitable mail order business using international drop shipment method. Capital unnecessary. Free details. Georgia Overseas Trading Co., Dept. W, 715 Persons Bldg., Macon, Ga.

MAKE \$46 From square foot plywood; jig saw necessary. Free information. Woodarts, X-7, Bridgewater, Mass.

STATUARY Molds! Super quality liquid rubber. Ajax Products, 734 East 238th Street, Cleveland 23, Ohio.

\$3,000 YEARLY. Spare time at home. Nothing to buy. No local selling. Dignified. Guaranteed. Home Harvest, Rt. 3, Box 3491-A, Albuquerque, New Mexico.

BUILD Fascinating hobby or business engraving plastics! "Duplicator" engraving, carving machines. Sample engraving, details 25¢. Desco Distr's., 5262-A Van Nuys, Van Nuys, Calif.

MAKE Perfumes, cleaners, polishes, cosmetics. Sell mailorder. International, 6347 Farnell PM-47, Chicago 21, Illinois.

500% PROFIT Mailorder item, 60,600,600 daily users. Free sample offer. Auroi Laboratories, Philadelphia 33.

"MAILORDER Laws and Regulations." \$1.00. Explains necessary licenses, different taxes, legal requirements, etc. "Mailorder Rules for Beginners," \$1.00 additional. Tasker, 1603 Peach Street, Alexandria, Virginia.

MAILORDER! How to make up to \$100 weekly in sparetime by mail. Menick, 19831 Enadta Way, Canoga Park 1, Calif.

SELL Merlin electronic garage door operators. Make from \$50 to \$75 on every sale. Operate from your home. M. J. Fitzgerald Co., 2815 West Violet Street, Milwaukee 8, Wisconsin.

WANTED: Home producers, to be subcontractors. Cast plastic products for manufacturers in our clearing house service. Thousands of easily made items required. Cash in at home, without previous experience. Plastic Service Associates, Dept. 4PM, East Boston 28, Massachusetts.

BUY Wholesale! Resell at big profits. Brand name merchandise—Appliances, cookware, housewares, watches, jewelry, dry goods, clothing, sporting goods, toys, gifts, etc. Free 1957 color catalog with confidential cost sheet. Merit Home Products, Dept. PM-4, 107 Manhattan Ave., Brooklyn 6, New York.

COCKFIGHTS! From Mexico. \$2 per hour selling beautiful feather pictures. No capital. Samples \$2.00. Wright Imports, 817 Esperanza, San Bernardino, Calif.

POWER Lawnmowers—\$39.00. World's cheapest. Smith Agency-1, Excelsior Springs, Missouri.

PROFITABLE—Tested sparetime, mail-order opportunity! Everything supplied. Jackson, Newfoundland, Kentucky.

MIMEOGRAPHING Pays sensational local profits. Exclusive secret plans exposed! Start free. Mozeille Mimeo Shoppe, Bonham, Texas.

PLASTIC Laminating. Pleasure and profit. Self-sealing. No machines. Complete home kit, \$1.00. Mountainside 1, Springwater, New York.

WHOLESALE Catalog! 30-80% discounts! Appliances, clothing, tools, housewares, etc. Midwest, 156-MA, Pontiac, Illinois.

OPERATE Your own merchandise mail-order business. Everything furnished! B. Mann, Woodcliff Lake, N. J.

PIANO Tuning learned quickly at home. Tremendous field! Musical knowledge unnecessary. Free information. Empire School of Piano Tuning, Champaign, Ill.

MAKE Proved product. Sell mailorder to drycleaners. Proof, formula, advertising, prospect list. \$1.00. Ro-Wash, 643 Wanamaker Road, Jenkintown, Penna.

LIQUID Rubber, make flexible molds. Free sample. Chaney, P.O. Box 8589, Jacksonville 11, Florida.

WASH Outside windows in 1/2 time. No wiping, just hose rinse. No spots. Sample 25¢. Riesen, 419 Violet, Milwaukee 12.

THIS May be your opportunity. Free literature. Quill Industries, 3607-09 So. Hamilton Avenue, Chicago 9, Illinois.

CLASSIFIED: Many business opportunities, considering abilities, finances. Free questionnaire. Connelly, 131 Parkhurst, Kenmore 23, N. Y.

OPERATE Your own mail order discount business at home spare time. Sell gifts, appliances, housewares, cookware, cutlery, dinnerware, silverware, jewelry, watches, etc., at discounts to 75%! No stock investment. We ship order under your name. Catalogs, sales letters, order blanks, envelopes printed with your name can cost you nothing. Postcard brings free sample catalog, all details. Topval Corp., Lindenhurst 318, N. Y.

WE Train people for sparetime businesses. Nationwide Business Institute, 618 Savannah, Columbus 4, Ohio.

FLEXIBLE Rubber molds for plaster and Marble figurines. Sample and large illustrated catalog 25¢, refunded on first order. K-C Novelities, Dept. 46, Southampton, Massachusetts.

MONEY For you! Big profits! Cast plaster figurines, bookends, plaques at home with XL rubber molds. No experience needed! Write for illustrated, 40-page catalog, only 25¢! Plastic Arts Studios, 3403 So. Madison Street, Department 5, Muncie, Indiana.

EXCLUSIVE Distributorship available in most areas for world-famous Cadmium battery guaranteed to outlast your car. Tremendous profit opportunity. Investment for merchandise only. Free franchise. Cadmium Battery Corporation, Dept. 102, El Segundo, California.

START Your own business, local or mail order, folders describe 137 money-making plans free. Write R. Taylor & Co., 4834 N. Lincoln, Chicago 25, Ill.

EARTHWORM Growers needed! Send for free booklet "How You Can Make Money Raising Earthworms!" National Worm Co-Op, 4163 Pedley Avenue, Norco, California.

GROW Orchids at home. Profitable, fascinating. Year 'round, Maine to California. No greenhouse. Successful home grower shows you how to provide proper temperature and air conditions in any well lighted room. Full details and real orchid seeds free. Orchidland, 100 So. Vermont, Los Angeles 4.

PLATE Baby shoes, jewelry, gifts, bronze and colored pearl. Free booklet. Platex, 11629 South Vermont, Los Angeles 44.

LEARN Appliance service and repair. Motors, washers, refrigeration, cleaners, everything. Free booklet. Armstrongs, 11027-A South Vermont, Los Angeles 44.

MONEymaking OPPORTUNITIES

NEW Way to make money in automotive service! A wanted service, needed by one out of every three cars on the road. Minimum capital investment—equipment pays for itself out of profits. Our accredited school will train you and issue diploma. No prior automotive experience necessary. Write for profit facts today—no obligation. Bear Manufacturing Co., Rock Island, Illinois.

REFLECTIVE Sign letters, ornaments. Free samples. E-Z-On Sign Letters, Pell Lake, Wis.

MAKE Top money collecting snakes, lizards, turtles, toads, frogs. We pay guaranteed prices. Details 25¢. Biological Exchange, Dept. 12b, Box 5302, El Paso, Tex.

OPERATE Your own merchandise mail-order business! Everything furnished. Wm. Mann, Woodcliff Lake, New Jersey.

MEN—Women! Start money-making plastic laminating business at home in spare time. Material that costs 11¢ brings back \$2.58. No canvassing or selling but mail orders bring in \$20 a day. Write for full particulars free. Rush name on postcard to Warner, Room 7-D, 1512 Jarvis, Chicago 26, Ill.

MAKE Money writing short paragraphs! No tedious study. I tell you what to write, where and how to sell; and supply list of editors buying from beginners. Many small checks add up quickly. Write to sell, right away. Send for free facts. Benson Barrett, Dept. C-27-D, 7464 Clark, Chicago 26.

EARN High and steady income indenting knives on revolutionary Solingen Welschschiff system. Every hotel, restaurant, ironmonger your delighted customer. Free information from European cutlery-expert Kuckertz, Singel 161, Amsterdam, Holland.

LEARN Technical metaphysics and insure your future. Easy, inexpensive correspondence course. Simplest method known. Diploma. Write: Premier College of Technical Metaphysics, 2532 McKenzie St., Vancouver 8, B. C., Canada.

EARN Money repairing Ronson lighters. Free parts price list. Mary's Trading Post, 420 Willis Ave., New York 54, N. Y.

START A buying service, buy wholesale thousands nationally advertised products. Make big profits selling at sizable discounts. Postcard brings details. American Buyers, Hertel Station, Buffalo 16-D1, New York.

60% PROFIT Cosmetics \$25 day up. Hire others. Samples, details. Studio Girl-Hollywood, Glendale, Calif., Dent. 1274H.

MEN And women wanted to start home business in spare time with little table-top rubber stamp machine. Easy to earn up to \$9.80 an hour without previous experience. Full particulars free by mail. Send postcard to Roberts, 1512 Jarvis, Room 7-D, Chicago 26, Ill.

ATTENTION! Big profits! Learn making new, famous beautiful wood-fiber flowers using Magic Maker! Correspondence course free! Enclose \$1.00 for details today! Loneta's Flower Arts School, Rt. 1, Box 15-B, Belmont, N. C.

WEAVE Rugs—Make big profits! No experience necessary! Free catalog, sample card, and low prices on carpet warp, rug filler, looms, parts, inexpensive beam counter. If you have loom—give make, weaving width please. Or. Rug Company, Dept. 4746, Lima, Ohio.

BUY Wholesale! 30-80% discounts! Appliances, gifts, typewriters, tools, watches, sporting goods, jewelry, cameras, housewares, etc. Consolidated Distributors, Clifton 28, New Jersey.

PROFIT Raising worms. \$1.00 tells how! 1,000—\$4.00. Hybrids, Henderson, Tenn.

SELL Books by mail. 400% profit. Royal, Box 368-X, Cleveland 27, Ohio.

\$18.00, \$36.00 WEEKLY Possible. Hand-painting novelty plates. Flocraft, Farrell, Penna.

THEY Hand him \$100! Free plan "Secret Journal Hidden Dollars." Work home! Publica, Oceanside, Calif.

"HOW To Win Prize Contests." Free information. National, 9128-P S.W. 26th, Portland 19, Oregon.

ACQUIRE A protected territory for building grease-smoke-less barbecue grills according to "patented Great Outdoors Co. plans. Leads furnished by national advertising. Make 300% to 400% over costs on every job. Earnings unlimited. Rush name and 25¢ for details to The Great Outdoors Co., 16261 Northlawn, Detroit 21, Mich. *Pat. pend.

SUCCEED With graphology! Make money analyzing handwriting. Details free. Kandel, Eatonton 1, Georgia.

WHOLESALE! Sell yourself, sell neighbors aluminum awnings; beautiful baked enamel finish. Write: Jack, Box 16254, Tampa, Fla.

START Big-pay business at home in spare time. No experience needed to operate little table-top machine for bronzing baby shoes. Make \$5.46 profit on every pair. Full particulars free. Send postcard to Mason, 1512 Jarvis, Room 7-D, Chicago 26, Ill.

BEGINNERS—250 Hybrids, instruction book, \$3. Lucky Strike Earthworms, Dubberly, La.

SELL Snowballs. You make them. 400% profits. Outfits \$4.00 up, Postpaid. Catalog. Snowball, 9534-P Lemturner, Jacksonville 8, Florida.

NEW Fabulous business! Get into tape recording for profit, pleasure. New, uncrowded field. Record weddings, sports events, parties, radio commercials, etc. Entire country wide open! Hundreds of money-making ways! Free facts! Dixieland Publishers, Asheville 1, N. C.

MAIL Postcards. Receive dollar orders. Keep dollars. Details free. Gryder, Box 187, Barberton, Ohio.

HOTTEST Mail order plan ever! Sell photos, films, art novelties. Huge proven profits! Free details! Ampro, 429 South Western Ave., Dept. 1, Los Angeles 5, California.

BUY Wholesale! Save 66%! Appliances, furniture, jewelry, toys, sporting goods, tools. Free details. National Buyers Service, Box 3338EB, San Francisco.

KILL Pests for profit! New shortcut methods. Rid homes, farms, resorts, businesses of termites, roaches, rodents, etc. Ideal spare, full time business. Nationwide need. Huge profits! Free business plan. Contrex, Dept. 4, 429 South Western Avenue, Los Angeles 4, Calif.

PROSPERITY Plans, schemes, money-making mailorder ideas. Valuable formulas, educational information, 25¢ for list. Con-Mar Sales Company, 1945 N.W. 9, Oklahoma City, Okla.

AMAZING Successes through franchises! Become exclusive franchise holder your territory. Information rushed. National Franchise Reports, 333 North Michigan, Chicago 1.

EXCEPTIONAL Opportunity, home work spare time. Daugherty's Service, Lincoln, Illinois.

\$100.00 WEEKLY Spare room. Raise red-worms soilless way. Odorless. Charlie Morgan, Box 258E, Sheridan, Wyoming.

FREE Folio "\$5,000-\$45,000. Unlimited Vacations." No merchandise. Unknown! Work home, sparetime! Haylings, Carlsbad, Calif.

GROW Mushrooms, cellar, shed. Spare, full time, year round. We pay \$3.50 lb. We have over 25,000 customers. Free book. Mushrooms, Dept. 173, 2954 Admiral Way, Seattle, Wash.

AMAZING New fascinating electric plastic drawing desk with easy instructions in animated cartooning for television, movies. Per-C-A Products, 950 Barry Pl. N.W., Washington 1, D. C.

EXECUTIVES Tell who gets hired and why. Details free. National Publications, Box 3731, Washington 7, D. C.

"HOME Business Digest" has money-making opportunities galore. Sample 25¢. Donovan, 79-PM Greenbelt, Levittown, New York.

EARN \$50.00 Daily making mats, shoes and mud guards from old tires. S and S Patents Inc., 1307 North Clark St., Chicago 10, Ill.

100% PROFIT. No investment. Stamp brings details, samples. Miller, Box 584, Brooklyn 1, New York.

ATTENTION Typewriter owners. Make handsome profits. Write today. Groves Company, 682, Hastings 8, Nebraska.

DOLLARS Every day! Amazing new magic mail plan. Set-up free. Miller, Box 585X, Oshkosh, Wis.

GENERAL Contest Bulletin. Lists contests monthly. Sample, 25¢. 1609½ East 5th, Duluth, Minn.

READ Progressive Mailtrade, the magazine that tells how to make money by mail. Dime brings sample and special offer. Progressive Mailtrade, Box 357, Sheboygan, Wisconsin.

FREE! "301 Profitable Small Businesses!" Amazing shoestring plans! Work home! Start sparetime! Deumant Surveys, Kenmore 23-R, N. Y.

RAISE Rabbits on \$500 month plan. Plenty markets. Free details. White's Rabbitry, Mount Pleasant, Michigan.

BIG Money raising, fishworms and crickets. Free literature. Carter Hatchery, Plains, Georgia.

EARN Money evenings copying and duplicating comic cartoons for advertisers. Adservice, Argyle 1, Wisconsin.

\$60 WEEKLY, Spare time—easy! Home Venetian blind laundry. Free book. Burt, 2434A, Wichita 13, Kansas.

SELL Titania gems. Far more brilliant than diamonds. Catalog 10¢. Diamondite, 2420-M 77th, Oakland 5, California.

VENDING Machines—No selling. Operate a route of coin machines and earn amazing profits. 32-page catalog free. Parkway Machine Corporation, Dept. 27, 715 Ensor Street, Baltimore 2, Maryland.

FREE Book "505 Odd, Successful Businesses." Work home. Pacific, Oceanside, Calif.

PRIZE Contests provide fabulous and confidential home income opportunities! Here's how and where to win your share! Send stamp! National Contest Bulletin, Box 2685-P, Miami 16, Florida.

FORMULAS, PLANS, ETC.

METAL That melts at less than 150° F. Looks like lead when solid, like mercury when molten. Ancient alchemist and magician formula 50¢. Alchemist, Box 11182, Ft. Worth, Texas.

LIFETIME Business! Manufacture extremely profitable products! Lists free! Thermolab, Peoria 4, Ill.

PRODUCT Analysis, manufacturing formulas, processes developed. Moderate fees. Plastics, Box 1374, Boston 4, Mass.

PRACTICAL Formulas. Lists free. Cummings, Chemist, Gordon Ave., Syracuse 4, N. Y.

LATE, Modern manufacturing formulas. List free. Moon Chemical, Martville, New York.

FORMULAS For latest money-making discoveries. New! Good! Valuable literature free! Miller, Chemist, 1517-D, Tampa, Florida.

FORMULAS: All kinds, latest, best. Literature free. Kemikal, Park Ridge, Ill.

FREE Formula catalog. Anything analyzed \$35.00. Western Chemical, Salem, Oregon.

CHEMISTRY

AMAZING New Book of Science. Experiments, formulas and catalogue of laboratory supplies. Only 25¢. National Scientific Co., Dept. PM-4, 500 W. Road, Lombard, Illinois.

HOME Laboratory and apparatus kits, laboratory supplies. Catalog 25¢. Established 1931. John H. Winn, 124B West 23rd Street, New York, N. Y.

CHEMICALS And apparatus for industrial, analytical, and private laboratories. Catalog 25¢. Dept. M-50, Biological Supply Co., 1176 Mt. Hope Ave., Rochester 20, N. Y.

ILLUSTRATED Catalog: Chemistry, mineralogy, biology 20¢. Tracey Laboratories, Evanston, Illinois.

60 PAGE Booklets! "Beginners Chemistry," "Chemistry," "Physics," "Relativity," "Light," "Astronomy," "Electricity," "Radio," "Useful Tables," "Scientific Oddities." 10¢ each. Franks, 3121 South Racine, Chicago 8.

PLASTICS

USE Liquid plastics, which pour like water, to make tools, dies, gadgets: Imbed butterflies, flowers, photos, etc., in spare time at home. 25¢ brings 108 page catalog. Included free "Wonders of Liquid Plastics" book. Plastics Co., 6612 N. Clark, Dept. CL-101, Chicago 28.

CREATE Colorful tiles, mosaics, jewelry with new Castoglas for yourself, gifts, profit. No tools, heat, experience needed. Manuals 10¢ each. All three only 25¢. Castolite, Dept. DT-101, Woodstock, Ill.

PHOTOS, Cards, sealed in plastic. Wallet size 40¢, 4 for \$1.00. Keepsake Plastics, P.O. Box 44, Providence, R. I.

PLEXIGLAS. Square foot cost, 1/16", \$1.18; 1/8", \$1.52; 3/16", \$1.86; 1/4", \$2.21; 3/8", \$3.23; 1/2", \$4.38. Colors add 10%. Send 15¢ for postage. Aristocrat Plastics, 23-25 Sussex Avenue, Newark, N. J.

LEARN Plastics fabrication for spare time income. Low cost home training now available. Write for free booklet. Interstate Training Service, Dept. D-3, Portland 13, Ore.

PLEXIGLAS, Fiberglass, polyester, acetate. Instructive wholesale-retail catalog free! Gem-O-Lite, 5528 Cahuenga, North Hollywood, California.

WALLET Cards, photos, plastic sealed by machine 50¢. Box 518, Davenport, Okla.

NEW Liquid casting plastic, clear, colors. Embed real flowers, coins, photos. New manual shows fine things you can make at home and sell at big profit. Send 25¢. Castolite, Dept. D-101, Woodstock, Illinois.

BOXES, Plastic. Free list. Althor, 170 Bay 23 Street, Brooklyn, N. Y.

PLASTIC, Sheet, rod, tubing. Catalog 10¢. Coleman Sales, 5926 Cornell, Dearborn, Michigan.

AGENTS WANTED

MEN-Women agents: Sensational new money-makers — Beautifully hand-painted, plastic personalized photo enlargements, compacts, rings, bracelets, lockets, etc. Simply take orders, pocket 40% commission. We deliver and collect. Sales outfit free. Novello, 3343 North Avenue, Chicago 47.

HOTTEST Automotive product ever offered. Unlimited prospects. Amazing profits. Write, Gregory Sales, 316 Marion Bldg., Cleveland 13, Ohio.

MEN, Women, make money spare time plus new car as bonus for encouragement. Amazing hosiery guaranteed to wear without holes, snags, and runs, or replaced free. For example, lovely 60 gauge nylons guaranteed for as long as 1½ years or replaced free. Write Wilkmit, 1774 Wash., Greenfield, Ohio.

MAKE Extra cash—Quickly! Show newest big value \$1, \$1.25, \$1.50 assortments of birthday, get well, greeting cards, gift wrappings, stationery, gifts—in spare time. Big profits, bonus. Friends, others buy on sight. Write for samples on approval, free gift offer, details. Hedenkamp, 361 Broadway, Dept. PM-48, New York City.

\$1000.00 A Month for making dramatic 3-second demonstration of amazing lightweight Presto fire extinguisher. New chemical used by airforce snuffs out fires instantly. Only \$4.95. Terrific commissions. Millions want it. Free kit. Merlite, 114 E. 32nd., Dept. P-770, New York City 16.

AGENTS! Dealers! Sell our Readicut dress kits—85% profit. Use our literature, sure-fire mail order plan. Readicut Manufacturers, Loganville 81, Wisconsin.

BUY Wholesale thousands nationally advertised products at big discount. Free "Wholesale Plan." American Buyers, Herchel Station, Buffalo 15-A1, N. Y.

80% PROFIT Cosmetics \$25 day up. Hire others. Samples, details. Studio Girl-Hollywood, Glendale, Calif., Dept. 1274H.

AGENTS — 300% Profit selling genuine gold window letters; stores and offices. Free samples. Metallic Sign Letter Co., 1217-D West Newport, Chicago.

PROTECT-OR Cover holder. Amazing new item. Nothing like it. Whirlwind seller. Wonderful profits. Easily demonstrated. Free details, Coopers, 4-6 N. Main, Englewood, Ohio.

BUY Wholesale! 100,000 name brand products! Save 60%!! Big profits selling others spare time! Free details! National Buyers Service, Box 3338EE, San Francisco.

YOU Can make money at home in spare time taking magazine renewal subscriptions. No capital or experience necessary. All supplies furnished. Write today! McGregor Magazine Agency, Dept. 500A, Mount Morris, Illinois.

YOUR Ad in this space will get some good agents for you. Yes, I'll prove it. Write for Folder "A" right now. F. W. Johnson, Classified Advertising Manager, Popular Mechanics Magazine, 200 E. Ontario St., Chicago 11, Ill.

GOLDMINE Of 600 money makers. Copy free. Specialty Salesman Magazine, Desk 5-B, 307 N. Michigan, Chicago 1.

GOLD Or silver letters, numbers. Windows, doors, trucks. 1" to 6". 500% profits. Free samples. Atlas-T, 544 West 79th, Chicago 20.

PRINTING, Advertising salesmen—Excellent moneymaking sideline selling decalcomania name plates, small quantities. Automobile initials, sign letters. Free samples. Balco, XL, Boston 19, Mass.

EXCLUSIVE Line of personal initialed buckles, belts, cap badges, 3,000 emblems, etc. Hook-Fast, Dept. PM, Roanoke, Va.

YOUR Own business—Used suits \$1.50, overcoats 65¢, mackinaws 35¢, shoes 12½¢, ladies coats 30¢, dresses 15¢. Enormous profits. Catalog free. Nathan Portnoy Associates, 805-AA West 124th Place, Chicago 7.

CALIFORNIA Sweet smelling beads. Sensational sellers. Particulars free. Mission, 2528-PM W. Pico, Los Angeles 6, California.

EASY Handwork makes fast-selling articles. Sample free. Sunmade Company, Brockton 64, Massachusetts.

BIG, Easy commissions taking orders for beautiful door name plates! Home owners buy like mad! Sure-fire, money-maker! Sample plate and details, 25¢. Zax Corporation, Box 401-C, Nashua, N.H.

FREE! Beautiful feather pictures. 200% profit! Apartado 9036, Mexico 1, D. F.

EARN To \$4 hour writing orders for appliances, gifts, housewares, etc., at big discounts. Confidential wholesale prices and details free. Bond Specialties, 1637B West Vernon, Phoenix, Arizona.

SELL Famous \$3 fire extinguishers. Fast sales, liberal profits. Write Fire-Killer, Box 182, Hazleton, Penna.

EARN An extra \$100 a week demonstrating the latest hit games Teeko, I.Q. Solitaire and Scar-Nece. Nationally advertised, millions seeking them. Terrific opportunity. John Scarne Games, Fairview, N. J.

CHRISTMAS Box assortment, \$3.00 value only 75¢. Williams Paper, 19 Hudson, N. Y. C.

SELL Famous "Sunbow Sun Shields." Thousands buy on sight. Replacing sunglasses everywhere. Enormous profits. Write Houston Co., Box 1413P, Fairmont, W. Va.

DRYCLEANING Clothing for only 10¢ per garment. Lightning seller. Saves dry-cleaning bills. Samples sent on trial. Kristee 85, Akron, Ohio.

BIG Profits selling ties (\$2.00 value) \$6.50 dozen. Free catalog. Empire Cravats, 611-PM Broadway, New York 12.

SELL Housewives eyeglass caddy. Sample \$1.00. Ohio, North Madison 2, Ohio.

SELL Gasoline syphons. Car to mower, outboard. Free information. Wilton-Woods, Inc., 1837 Cadwell Road, Cleveland 18, Ohio.

BE In business for yourself. For \$2.00 postpaid, we will ship you 12 pairs assorted earrings. \$10 value. Greysen Company, Inc., 713 12th Street, P.O. Box 28, Altoona, Penna.

BUY IT WHOLESALE

USED And new watches \$2 up. Free list. Southern Watches, Gray, Georgia.

BUSINESS Gifts, wholesale. J. J. Davis Co., Englewood Ave., Englewood, New Jersey.

BUY Wholesale! Discounts to 80%! Appliances, cameras, sporting goods, housewares, watches, tools, clothing, etc. Buy-Rite, Hawthorne 4, New Jersey.

1001 WHOLESALE Items. Name brands. Postcard gets \$1.00 credit and catalog. United Plan, 450 Broad, Newark, N. J.

LAMPS—Write for illustrated brochure. Midwest Distributors, Box 1656, Worcester 7, Mass.

BIG Multicolor wholesale catalog! Housewares, appliances, clothing, silverware, cookware, luggage, binoculars, radios, phonographs, cameras, recorders, projectors, typewriters, shavers, sporting goods, toys, tools, sewing machines, watches, jewelry. Name brands. Huge discounts. Just postcard: Selbyco, Decatur 155, Illinois.

BUY Wholesale! Nationally advertised appliances, radios, watches, etc. Catalog \$1.00 (refundable). D'Auria, Box 355-PM, Jackson, Michigan.

BARGAINS, Joblots, closeouts. 2000 items. Tremendous savings, clothing, toys, gifts, jewelry, television, etc. 25¢ brings wholesale catalog. \$1.00 merchandise certificate included free. Reliable Jobbing, 311-B North Desplaines, Chicago.

CATALOG! 30-80% Discounts! Appliances, clothing, tools, housewares, etc. Midwest, 156-MP, Pontiac, Illinois.

FREE Wholesale catalog. Gifts, appliances, housewares, cookware, cutlery, watches, dinnerware, silverware, jewelry, etc. Discounts to 80%. Topval Corp., Lindenhurst 124, N. Y.

BIG Wholesale catalog. 20 to 80% discount. Send \$1.00 which will be refunded on first order. R & R Sales Company, 833 Westover Drive, Danville, Va.

FREE! 25 Wholesale catalogs. List 25¢. Bartz, 912A Autumn, Albert Lea, Minn.

SALESMEN—DISTRIBUTORS

ONE Monument sale weekly earns \$200 or more. Jones Monumental Works, St. Cloud, Minn.

INCREASE Present income \$75-up weekly. Dealers, farmers, agents—demonstrate nationally known Gro-Green liquid fertilizer nutrients. Results guaranteed. Full-part time. Samples free. Campbell Co., Rochelle 209, Illinois.

CASH In on Chestlite, successor to flashlight. Profit over 100%. Protected territories still open for this patented money-maker. Write for details right now. Chestlite, 620 W. Anaheim, Long Beach, Calif.

NEW Jobs open in selling! Send name, address for five free issues of Opportunity Magazine's money-making guide, listing hundreds of companies who'll pay you well, full or part-time. No experience needed. Opportunity, 850 N. Dearborn, Dept. 17, Chicago 10, Ill.

MAKE \$5 Hour. New. Write Noiseless, 220 Edison, Salt Lake, Utah.

WILL You wear new suits and topcoats without one penny cost and agree to show them to friends? You can make up to \$30.00 in a day even in spare time, without canvassing. J. C. Field & Son, Inc., Dept. G-1862, Harrison & Throop Sts., Chicago 7, Illinois.

MAKE \$20 Daily wearing new footwear sensation sent on approval. No experience needed to cash in with amazing "dollar-a-second" demonstration. Send shoe size. Flexiclogs, Box 27X-D, New Holstein, Wis.

SALESMEN To sell well known high-grade savings banks to banks, loan associations. Automatic Recording Safe Co., 35 East Wacker, Chicago 1.

BUSINESS Kit free! Postcard puts you in business! Complete line. 160 shoe styles, also jackets. New discoveries pay big commissions. No investment. Send for free kit. Mason Shoe, Dept. C-48, Chippewa Falls, Wisconsin.

GET New shirt outfit free. Make \$90.00 weekly on 5 average orders a day. Famous quality made-to-measure dress and sport shirts at \$3.95 up sell fast to all men. No experience needed. Full or part time. Write: Packard Shirt Co., Dept. 453, Terre Haute, Ind.

MAKE Extra money. Cash commissions. Everybody buys easy-to-sell advertising book matches. Union label. All sizes. Cuts for all businesses. Powerhouse selling kit free. Steady repeat business. No experience necessary. Superior Match Co., Dept. M-457, 7528 S. Greenwood, Chicago 19.

CALLING On businessmen? Double your profits with exclusive advertising-embroidered uniforms, jackets, pants, shirts, coveralls, sportswear. Every business big-order prospect! Free outfit. Master Co., B-13 Water, Ligonier, Indiana.

COUNTRY Salesmen. Automatic fire extinguisher. Huge profits. Out-O-Matic Co., 1737 E. 31st, Dept. 280, Denver, Colo.

\$1000.00 A Month for making dramatic 3-second demonstration of amazing light-weight Presto fire extinguisher. New chemical used by airforce snuffs out fires instantly. Only \$4.95. Terrific commissions. Millions want it. Free kit. Merlite, 114 E. 32nd, Dept. P-77U, New York City 16.

AD Matches! Sell amazing designs—10, 20, 30, 40 and 240-light book matches. Bigger spot cash commissions: every business a prospect. Low prices for high quality. Repeats. Start without experience; men, women; full, part time. Buy nothing! Sales kit furnished. Match Corp., Dept. PM-88, Chicago 32, Illinois.

WHOLESALE—Get the big merchandise. Furniture, appliances, housewares, clothing, tools, auto accessories, new products. Save half. Literature free. Associated Wholesalers, 1016-DY Starr, Burlington, Iowa.

MOTH Control pads. Retail \$1.00. Dozen \$6.00. Joe's Products, Southwick Street, Fitchburg, Mass.

BRUSH Salesmen—Extra profits daily. Write Artmoore Company, Milwaukee 12, Wis.

BULOVA, Benrus watches, like new, \$5.95 up. Illustrated folder free. Cosmos, 81 East 125 Street, New York.

2 FAST Selling quality golf balls. Repeat business. Good profits. Golfer's Ruff, Lynbrook, N. Y.

HOW Much money can you make with amazing new product giving 58% more power, 54% gas saving, to cars, trucks. Proved by laboratory test. \$1,500 in month possible. Write for free money-making plans and proof. Pope Chemical, 224 W. Huron, Dept. S-58, Chicago.

EMPLOYMENT INFORMATION

UNLIMITED Job opportunities. Details free. Personnel Associates, Box 889, Wheeling, W. Va.

LEARN Business equipment service. Write George Underwood, Remington Rand, New York City 10.

SOUTHERN California opportunities unlimited. World's largest classified airmailed \$1.00. World Wide Co., 8412 Canby, Northridge, California.

JOBS On ships! Experience unnecessary. Transoceanic, Box 494, Baltimore 3, Md.

JOBS On ships and yachts going to foreign countries. Davenport Seamens Service, Box 1354, GPO, New York 1, N. Y.

COPYRIGHTED Reports on best paying jobs with travel, adventure, promotions. Construction, aviation, shipping, laborers, clerical, trades, supervisory, factory, unusual opportunities. Many types of work. Skilled and unskilled. Foreign and state-side openings for men and women. Only \$2.00 (\$2.25 airmail), including registration-advisory service. Satisfaction guaranteed. Included absolutely free: Special reports on Alaska, Spanish airbase construction, South American opportunities and husband-wife foreign jobs. Research Services, Suite 207-PMP Brown Building, St. Louis 5, Missouri.

ALASKA. Classified ads from Fairbanks airmailed \$1.00. Letters remailed 50¢. Ronco Enterprises, 813 Fifth, Fairbanks, Alaska.

FOREIGN, Alaskan, U.S.A. Jobs! To \$1500.00 monthly! Million Americans employed overseas. Copyrighted reports. Who to contact for highest paying jobs. Laborers, trades, truck drivers, office, engineers, many others. 52 countries—St. Lawrence project, Spain, Latin America. Northern project, Europe. Year registration-advisory service. Application forms. Unconditional money-back guarantee! \$2.00 (airmailed \$2.25). C.O.D.'s accepted. International Reporter, St. Louis 1-PS, Missouri.

SOUTHLAND Boom! Jobs for all. Houston classifieds air-mailed to you \$1.00. Ricker Enterprises, Dept. 2B, Box 329, Bacliff, Texas.

HIGH Paying jobs: Foreign, USA, All trades. Travel paid. Information. Application forms. Write Dept. 21H, National, 1020 Broad, Newark, N. J.

WESTERN Dude ranches and cattle ranches. Jobs galore. Full active list for \$2.00. Guaranteed. Free room and board with pay. Wranglers, horseshoers, cooks, waitresses, and cabin girls. McCue, Rt. 1, Veneta, Oregon.

THOUSANDS Of highest paying construction jobs. Skilled, unskilled. Nationwide contract lists, \$2.00. Pengad, Bayonne 2, New Jersey.

EDUCATIONAL AND INSTRUCTION

BOOKS. Free 1957 catalog, 100 pages. Text, vocational, educational, instructional subjects. Millions of volumes, new and used. Bargain prices. Books bought. Est. 1902. Long's College Book Co., Dept. PM, Columbus 1, Ohio.

LEARN While asleep! Details free. Research Association, Box 610-MC, Omaha, Nebraska.

PIANO Tuning pays. Learned easily at home. GI approved. 29th year. Free booklet. Miles Bryant School, Dept. P, 3731 Stockton, Sacramento 20, Calif.

PIANO Tuning pays. Big money in spare time. Learn at home in 30 days. No musical knowledge necessary. Phonograph, records, tools and instructions furnished. Personal instructions available. Free catalog. Capital Tuning School, 16 Southwest Second, Fort Lauderdale, Fla.

EXCEPTIONAL Home study plan. F. Woodworth, Box 4867, Detroit 19, Mich.

STUDY For Doctor's degree of psychology, metaphysics and divinity. Correspondence courses only. College of Divine Metaphysics, Dept. P-M, 2811 North Illinois, Indianapolis 8, Indiana.

LEARN Mineralogy at home. Diploma course. Fortunes now being made in uranium and other minerals. Free catalog. Mineral Science Institute, Desk 2, 159 East Ontario, Chicago 11.

HIGH School diploma at home. Licensed teachers—Approved materials. Southern States Academy, Box 144-MX, Station E, Atlanta, Georgia.

BE A real estate broker. Study at home. Write for free book today. GI approved. Weaver School of Real Estate, 2018P Grand, Kansas City, Missouri.

USED Correspondence courses and books sold and rented. Money back guarantee. Catalog free. (Courses bought.) Lee Mountain, Pisgah, Alabama.

EARN While you learn. Auto and diesel mechanics master this top paying trade. Many graduates earn \$100 a week and up. Approved for Korean veterans. For free information write Dept. No. 256, Nashville Auto-Diesel College, Nashville 3, Tenn.

HELP Yourself to abundant living. Our courses have aided students to richer fuller lives. Learn secret of contentment, happiness. Earn degrees Ps.D., M.S.D. Write for free book. College of Universal Truth Correspondence School, 23-C E. Jackson, Chicago.

SECRET Investigation. Experience unnecessary. Investigators particulars free. George Wagner, M125 West 86th, New York 24.

BOOKKEEPERS! Increase your earnings! Operate your own simplified "Dollar-A-Week" bookkeeping and tax service. Full or spare time. Details free. No obligation. Ellis, Box 200, Cedar Grove, North Carolina.

WANT A diesel job? New opportunities to increase income. Higher pay. More money. We can help you qualify. Tools. Shop method home training. Write today! Diesel, Tractor, Heavy Equipment Division, Interstate Training Service, Dept. B-3, Portland 13, Oregon.

I want to send you proof of the wonderful pulling power of Popular Mechanics classified pages. What's your proposition? Write me today. Include literature if possible. F. W. Johnson, Manager Classified Advertising, Popular Mechanics Magazine, 200 E. Ontario St., Chicago 11, Ill.

INVESTIGATOR Training. Phillips Secret Service System, 1917-B North Kenneth, Chicago 39.

ENGINEERING, Home study. Midwest Engineering School, 10923 Hillcrest, Hickman Mills, Missouri.

PHYSICAL Therapy and massage. We train you at home. Earn big profits from your own private practice or work with hospitals and doctors. Free catalogue. National Institute, Desk 4, 159 E. Ontario, Chicago, Ill.

STUDENTS—The Maxwell Simplified Method of Study will help you get better grades. Simple, efficient, proven. Only one dollar. Study Methods, Box 419, Pacific Grove, California.

MEMORY Education. Additional mental power. Memorology, lesson one free. Memorology Studio, 2016-M Sunnyside, Chicago 25, Ill.

SIMPLIFIED Analytics teach algebra clearly, \$1; guaranteed. Ziemba, H-6123 Orchard, Dearborn, Mich.

ENGINEERING Degrees earned by home study. (Residential courses also available.) Pacific International University (American College of Engineering), Box 27724-B, Hollywood 27, California.

GROW Mushrooms. Cellar, shed. Spare, full time, year round. We pay \$3.50 lb. We have over 25,000 customers. Free book. Mushrooms, Dept. 174, 2954 Admiral Way, Seattle, Wash.

WANTED: More new writers for TV-radio, magazines, business publications, motion pictures. Learn at home for extra income or exciting full time career. Many students earn while learning. Professional instruction. Send today for free lesson and book. Palmer Institute of Authorship, Desk TM-47, 1680 N. Sycamore, Hollywood 28, Calif.

COMPLETE Your high school at home in spare time with 60-year-old school. Texts furnished. No classes. Diploma. Information booklet free. American School, Dept. X443, Drexel at 58th, Chicago 37, Illinois.

BLUEPRINT Reading—Train at home. Learn to read blueprints with confidence in 10 easy lessons. Write today Belton School, 1059-M North Lawndale, Chicago 51.

U. S. Civil Service tests! Training until appointed. Men-women, 18-55. Start high as \$340.00 month. Experience often unnecessary. Get free 36-page book showing jobs, salaries, requirements, sample tests, benefits. Write today: Franklin Institute, Dept. F-24, Rochester, N. Y.

HIGH School diploma. Spare time. Reliable. Capital School, 803 Hanover, Denver 8, Colorado.

ANGLE Trisector. Mechanical, trisects angles without measurement in degrees. Advances knowledge quickly on famous classical problem and many geometrical principles. For mathematicians, engineers, designers, students. Durable plastic construction: blade, pivotable arm, sliding head. Approximately 11" overall. Guaranteed. \$3.69 postpaid. V-Trisector Co., 241 So. La Brea Ave., Inglewood, California.

WELDING Training pays at Hobart Welding School, Box M-471, Troy, Ohio. VA contract. Best equipment. Catalog free.

LEARN Camera repair. Easy, complete, approved home-study course. Free illustrated booklet. National Camera Repair School, Dept. L-4, Englewood, Colo.

USED Radio-TV correspondence courses sold. Money back guarantee. Free list. Courses bought. Nafziger, 3566-A1 Diamond Ave., Oakland 2, Calif.

MIDLAND Linotype School. Charles City, Iowa. Civilian and veteran courses. Free placement. Established 1908.

LEARN To use slide rule. Rule and instruction booklet \$1.25. Rodgers, Box 52, St. Ann, Mo.

EARN Degree from college abroad, taking test. No travelling. Numerous fields. Aureab, Central Valley, New York.

USED Correspondence courses, educational books. Catalog ten cents. Bayles, 211 Essex, Hackensack, New Jersey.

TRANSFORM Yourself via subconscious. Free brochure. Box 847, H-4, Ocean Park, Calif.

PAINT Oil portrait, first lesson. "Miracle Method" home study portrait course. Raydee Studios, Studio P, Box 3202, Reading, Pennsylvania.

USED Correspondence courses, books bought, sold, rented. Catalog free. Vernon, 624 Mohawk, Rossville, Ga.

ABACUS \$2.00. Instructions 50¢. Literature free. Comoney, 45 E. 28, New York City 16.

BALANCE Your checking account perfectly every time. Accountant's method. Free details. William Pike, 29 Slocum Crescent, Forest Hills, New York.

THINK Clearly. Avoid mistakes. Learn the seven easy steps. Read "Magic of Clear Thought." Send \$1.00. Martin Dale Research, Box 293, Jackson, Mich.

EARN College degree. Remain employed. Sequoia University, 5625 Melrose, Los Angeles 38, California.

LEARN Appliance service and repair. Motors, washers, refrigeration, cleaners, everything. Free booklet. Armstrong, 11027-A South Vermont, Los Angeles 44.

DRAFTING—Design. Architectural. Mechanical. Electrical. Structural. Aircraft. Mathematics. Physics. Estimating. Surviving. Veteran approved. Mondell Institute, 230 West 41 St., New York City.

GOREN "Point Count System Digest." Streamlined, indexed, easy to use! Plus "slam bidding," "leads," and "contract score pad." Arranged by Sylvia Muntz. Goren master teacher. All four only \$1.00 ppd. Bodine, Box 5032, Columbus 12, Ohio.

PLAYS, STORIES, MANUSCRIPTS

WANTED: Book manuscripts, all subjects considered. Greenwich Book Pub., Attn. Mr. Zealand, 489 Fifth Ave., New York City.

WANT Your book published? Learn how we publish, advertise, promote, distribute. Many successes. Free booklet PM. Vantage, 120 West 31, New York City.

WRITERS. Sell your rejects. Write Harvey Todd, 6092 Pedley, Riverside, Calif.

SPECIAL SERVICES

INFORMATION On anything. Ferguson Research Specialists, 116-14 141 St., South Ozone Park 36, N.Y.

CARTOONING, COMMERCIAL ART, SHOWCARD & SIGN PAINTING, TATTOOING

"HOW To Make Money With Simple Cartoons." A book everyone who likes to draw should have. It is free; no obligation. Simply address Cartoonists' Exchange, Dept. 94, Pleasant Hill, Ohio.

HAND Portrait painted from photograph. Write for example, Art Reynolds, 1320 Barnett St., Harrisburg, Illinois.

LEARN Cartooning. Sensible prices. 10¢ a lesson. Includes male and female figure drawing, where to sell, etc. Write Herco, Box 382, St. Petersburg, Florida.

YOU Can entertain with chalk talks. Catalog 10¢. Balda The Cartoonist, Oshkosh, Wis.

LEARN Sign painting at home. Free talent test. Ben Kerns, Box 812-PM, Greenville, S.C.

SIGN Letters. Masonite cutouts, all sizes. Catalogue free. Eversly Co., Newton, Iowa.

TATTOOING Outfits, licensed course. Brochures 25¢. Zeis, 728 Leslie, Rockford, Illinois.

BASIC Art training at home. New plan. Free talent test. Students' Art Club, Kennebunkport, Maine.

CARTOON Your way to fame. Minimum age seventeen. Write Cartoons-of-the-Month, Roslyn, New York.

ADVERTISING AGENCIES, LETTER WRITERS, FOR ADVERTISERS

BEFORE Advertising—Get instructive Ad-Guide and newspaper-magazine rate-book, free. Chicago Advertising Agency, Chicago 4.

ADVERTISING. Result-getting ads prepared, placed newspapers, magazines, radio, anywhere! Lowest rates. Catalogue free. Baker Advertising Agency, 189 W. Madison, Chicago 2.

MAILING Lists most any classification \$5.00 1000. Your circulars mailed with ours \$4.00 1000. Write for our literature. Dixie Mailers, King, N. C.

LIVE Midwest names. Real mailorder buyers. \$5.00-1000. Trade Winds, Box 173, Sioux City, Iowa.

ADVERTISE: 34 Words, 100 Canadian newspapers \$5.50. Lists free. Advertising Bureau, 10511-C Springfield, Chicago 43.

WANT More business? Here's an amazing opportunity to increase your sales. Talk to thousands of interested readers of "Mechanica Popular." Our Spanish Edition covers the Latin American countries like a blanket. They're real mailorder buyers. Classified rate 75¢ per word. Try an ad in our next issue. Classified Advertising Department, Popular Mechanics Magazine, 290 East Ontario Street, Chicago 11, Ill.

100 NAMES Any classification. Births, teachers, agents. \$1.00. Box 246, Twin Lakes, Wis.

RUBBER STAMPS AND OFFICE SUPPLIES

3 LINES, \$1.00. Cushioned—Indexed. Satisfaction guaranteed! Campfield, 14 Beaufort Circle, Springfield 4, Mass.

POCKET Stamps. 3 lines—\$1.00 postpaid self-inking guaranteed. W.J.W. Specialty, 8464 Manhattan, Detroit 11, Michigan.

TYPEWRITERS, DUPLICATORS, OFFICE DEVICES

RECONDITIONED Typewriters, duplicating, printing devices, \$25.00 up. Supplies. Appliances, DixieGraph, King, N. C.

PORTABLE Mimeograph! Uses no stencil, no ink. The newest, cleanest, smallest, lightest and cheapest. Weight 15 pounds. DuPont Distributors, Box 695, New York 1, N. Y.

PRINTING, MULTIGRAPHING, MIMEOGRAPHING, GUMMED LABELS

RICH Boy printing, poor boy prices. Offset, letterpress. Quality. Success Printers, Rockwall, Texas.

HUNDRED Business cards and case \$1.00. Boyle Kellogg, Clinton, New York.

BUSINESS Cards, fine embossed. Reasonable. Free sample, style chart. Biz-Cards, 122-M, Noblesville, Indiana.

1000 RAISED Letter business cards \$4.25 postpaid. Free samples. Bredin, Turley, Okla.

GENERAL Printing. Samples, price list. E. C. Miller, Box 143M, Dover, N. J.

OFFSET—Copy preparation folio 25¢. Refundable. Coupon. Litho. Madison, Tennessee.

100 BUSINESS Cards \$1.00. Print Shop, 1418 Broadway, Rockford, Illinois.

"ZIP-OUT" carbon invoices; garage forms. Two-color letterheads. Decals, cellophane labels. Yale Printing, San Antonio 1, Texas.

250 8 1/2 x 11 LETTERHEADS And 250 6 1/2 envelopes, \$4.95 postpaid. W. A. Simons, 1027 Madison, Henderson, Ky.

125 LETTERHEADS 8 1/2 x 11 And 125 6 1/2 envelopes, four lines, \$2.50. Hickman Company, Coalgate, Oklahoma.

1000 RAISED Letters business cards \$3.50. Samples. Pioneer, Island Park 12, New York.

CATALOG "Ideas" for builders—Lumberman's forms 10¢. Yale Printing, San Antonio 1, Texas.

100 BUSINESS Cards \$1.00. Edison's, 421 West 18th St., Jacksonville, Fla.

100 LETTERHEADS, 8 1/2 x 11. Watermarked, and 100 6 1/2 envelopes, carefully printed. \$2.00. Postpaid. Race Printers, Hudson, New York.

BUSINESS Printing. Price list free. Harold Eisert, 335 Peninsula Blvd., Cedarhurst, New York.

MAIL Dealers—Save dollars on supplies. Free list. Sellers, Box 221-S, Covington, Ky.

TAGS Of every description printed, die cut, strung. Commercial printing. Samples, estimates. Fitz, 347 Worthington St., Springfield, Mass.

PRINTING Bargains. Stamp for list. Robinson's, Box 31, Sebastopol, Calif.

1000 NAME And address printed gummed labels, 3 lines \$1.00. No c.o.d.'s. Print clearly. Addison. PM-3, 1840 Addison, Chicago 13.

TOP Quality printing, mimeographing. Free literature. Currier, PM, New Lebanon Center, N. Y.

CATALOG Free. Distinctive printing. Reasonable prices. Vosacek Printing, 4444A Ute, San Diego 17, Calif.

500 NAME And address printed gummed labels, 3 lines \$1.00. No c.o.d.'s. Print clearly. Addison. PM-3, 1840 Addison, Chicago 13.

ECONOMICAL Printing of books, catalogs, publications. Catalog free. Adams Printery, 30 West Washington, Chicago 2, Illinois.

MIMEOGRAPHING—Letters, pricelists, formulas, instructions. Lowest prices. Lem's Letter Shop, 5710 Stanton, Detroit 8.

CIRCULARS. Booklets, letterheads, statements, Estimates, anything! Loneim Printers, Paulding, Ohio.

FREE Catalog business, personal printing. D.M. Press, Sebastopol, California.

OFFSET Printing — \$6.50 1000, 8 1/2 x 11, 16 lb. National Letter, 251 W. 42 St., New York City 36.

BUSINESS Printing. Samples, prices free. Howprint, 723-G Eunice, Webster Groves 19, Missouri.

PRINTING OUTFITS AND SUPPLIES

HOBBY Printers—Join non-profit American Amateur Press Association, 822 South Orleans, Tampa 6, Florida. Hobby papers exchanged.

PRINTING Presses, type, supplies, lists 34. Turnbaugh Service, Mechanicsburg, Penna.

MAKE Your own self-molding rubber stamps and printing cuts. Plexirubber, Argyle 1, Wisconsin.

RUBBER Stamp making presses, hydraulic operated, electrically heated. Sizes 5"x8", 8"x12", 10"x15" starting outfits. All kinds supplies. Custom Manufacturing, 601 N. Jefferson, Springfield, Missouri.

DO Your own printing. Save money. Simple rules. We supply everything. Print for others; good profit. Raised printing like engraving too. Have home shop. Details free. Kelsey Presses, V-11, Meriden, Connecticut.

PRESSES, Type cabinets, supplies. List for stamp. Lincoln Press Company, 230-D Hartwell, Fall River, Mass.

PATENT ATTORNEYS

PATENTS — Irving L. McCathran, 315 McLachlen Bldg., Washington 1, D. C. Registered Patent Attorney.

MECHANICAL Skill alone is not enough to entitle you to patent protection; your invention must clearly show your exercise of the inventive faculties. As patent attorneys we feel better qualified than the inventor to recognize patentable invention. Sketch and describe your invention. Sign, date and have this disclosure witnessed by two people who are capable of understanding your invention. Have us make a preliminary search among U. S. patents already granted for similar types of invention. We report on the probable patentability of your invention and recommend your further course of action. Write for our instructive booklet, "Patent Protection for Inventors" and convenient "Evidence of Invention" disclosure form. Victor J. Evans & Co., 331 D Merlin Building, Washington 6, D. C.

INVENTORS—If you believe you have an invention, you should find out how to protect it. The firm of McMorro, Berman & Davidson with offices in Washington, D. C., is qualified to take the necessary steps for you. Send for copy of our patent booklet "How to Protect Your Invention." We will also send you an "Invention Record" form. No obligation. They are yours for the asking. McMorro, Berman & Davidson, Registered Patent Attorneys, 134-S Victor Building, Washington 1, D. C.

INVENTORS: Learn how to protect your invention. Unless the inventor is familiar with patent matters, he should engage a competent registered patent attorney or agent to represent him. We are registered to practice before the U. S. patent office and prepared to serve you in handling your patent matters. "Patent Guide for the Inventor" containing detailed information concerning patent protection and procedure with "Record of Invention" form will be forwarded to you upon request—without obligation. Clarence A. O'Brien & Harvey Jacobson, Registered Patent Attorneys, 71B-D District National Building, Washington, D. C.

CANADA—Ramsay Company Registered, 273 Bank Street, Ottawa, Canada.

INVENTORS: Without obligation, write for information explaining the steps you should take to secure a patent. John Randolph, Registered Patent Attorney, 203 Columbian Bldg., Washington 1, D. C.

INVENTION Record form free and "Patent Information Every Inventor Should Have." Carl Miller, Registered Patent Attorney, Woolworth Building, New York.

INVENTORS: When you are satisfied that you have invented something of value write me, without obligation, for information as to what steps you should take to secure a patent. Write Patrick D. Beavers, Registered Patent Atty., 935 Columbian Bldg., Washington 1, D. C.

C. A. Snow & Co.—M437, Snow Building, Washington 1, D. C. Registered Patent Attorneys. Write for information.

PATENTS. "Proof of Invention" free. E. E. Vrooman, Registered Patent Attorney, 507 McKim Building, Washington 5, D. C.

"INVENTOR'S Guide" and "Record of Invention" free on request. Frank P. Ledermann, Registered Patent Attorney, 154 Nassau Street, New York City.

REGISTERED Patent attorney offers services. Sanders, 6430 Evans, Chicago 37, Illinois.

FOR INVENTORS

SEARCHES—Put your patent searches in the hands of a registered patent attorney or agent, as he qualifies to give a worthwhile patentability report. Record of invention form upon request and information on patent protection. Patrick D. Beavers, Registered Patent Attorney, 935 Columbian Bldg., Washington 1, D. C.

INVENTORS: Information on patent procedure furnished on request, without obligation. John Randolph, Registered Patent Attorney, 203 Columbian Building, Washington 1, D. C.

PATENT Searches, including copies of nearest patents, \$6.00. Reports airmailed within 48 hours. More than 100 registered patent attorneys use my service. For free invention protection forms, write Miss Ann Hastings, P.O. Box 176, Washington 4, D. C.

"INVENTOR'S Guide" and "Record of Invention" free on request. Frank P. Ledermann, 154 Nassau Street, New York 38, N. Y.

INVENTORS: Test the commercial value of your patented or unpatented inventions, quickly and inexpensively. Write for free information. Institute of American Inventors, Dept. 40-B, 635-P St., N.W., Washington 4, D. C.

INVENTORS, Don't sell your invention patented or unpatented until you receive our offer. Write Cowgill, Box 298, Marion, Ohio.

INVENTORS! Have you good, patentable ideas? Write Mr. Metzler, 11 West 42nd Street, New York City.

PATENT Searches \$5.00. 48-hour airmail service. Invention protection forms free. Write Patent Engineering Service, 711 14th Street N. W., Washington 5, D. C.

IDEAS Developed for products and your profit with effective patent protection at low definite cost. Foreign patents: Canadian patents filed \$100.00. Patent development costs now deductible from tax payments. 30 yrs. in business. Joseph O'Brien, Patent-Development Engineer, 132 Nassau St., New York 38, N. Y.

PATENT Searches \$5.00. 48-hour service. Free invention protection forms. Write Raymond L. Smith, Patent Searcher, 620 Sheraton Building, Washington 5, D. C.

INVENTION Record form free and "Patent Information Every Inventor Should Have." Carl Miller, Registered Patent Attorney, Woolworth Building, New York.

DRAWINGS, Patent, Wm. A. Winters, Sr., 137 Winchester Ave., Glendale 1, California.

PATENT Searches. Information and free forms on request. Evelyn B. Surles, P.O. Box 75, Washington, D. C.

INVENTORS—Send for free patent information book and inventor's record. Registered Patent Attorney. Associate Examiner, Patent Office 1923-29, Patent Attorney & Advisor, Navy Department 1930-47. Gustave Miller, 47A Warner Building, Washington 4, D. C.

INVENTORS: Learn how to protect your invention. Unless the inventor is familiar with patent matters, he should engage a competent registered patent attorney or agent to represent him. We are registered to practice before the U. S. patent office and prepared to serve you in handling your patent matters. "Patent Guide for the Inventor" containing detailed information concerning patent protection and procedure with "Record of Invention" form will be forwarded to you upon request—without obligation. Clarence A. O'Brien & Harvey Jacobson, Registered Patent Attorneys, 71A-D District National Building, Washington, D. C.

INVENTORS—If you believe you have an invention, you should find out how to protect it. The firm of McMorro, Berman & Davidson with offices in Washington, D. C., is qualified to take the necessary steps for you. Send for copy of our patent booklet "How to Protect Your Invention." We will also send you an "Invention Record" form. No obligation. They are yours for the asking. McMorro, Berman & Davidson, Registered Patent Attorneys, 134-R Victor Building, Washington 1, D. C.

INVENTORS—This firm is registered to practice before the United States Patent Office and available to assist you in the preparation and prosecution of your patent application. "Patent Protection for Inventors" booklet containing detailed information and steps to take toward patent protection sent promptly upon request. No obligation. Victor J. Evans & Co., 332-D Merlin Building, Washington 6, D. C.

INVENTIONS WANTED

IF Your invention is adaptable to promoting we will contract for selling on cash or royalty. Free booklet outlines royalty rates, requirements. Kessler Corporation, 541W, Fremont, Ohio.

HIGHEST Cash and royalties. Inventors having patented, patent pending inventions for sale write Inventors Creative Service, 354 South Spring Street, Los Angeles 13, California.

INVENTIONS Wanted. Patented or patent pending. 26 years experience promoting inventions. National Service Bureau, 3120 Meramec, St. Louis 18, Mo.

INVENTIONS Wanted. Patented; unpatented. Tremendous manufacturers lists. Global Marketing Service, 2429 77th, Oakland 5, California.

SUPERIOR Promotions. Patented; unpatented inventions. Information booklet, free. Superior, 338-344 North Rodeo, Beverly Hills, Calif.

CASH Buyers for inventions. Write National Inventors Institute, Box 7007, Cleveland 26, Ohio.

INVENTORS. Give us the opportunity to explain our selling plan for your invention, gadget or device, patented or unpatented; free particulars available upon request. Demarest and Demarest, Box 95, Battle Creek, Michigan.

INVENTORS: Hundreds of manufacturers have requested our assistance in locating marketable new products. Complete information free. Institute of American Inventors, Dept. 40-D, 635-P St. N.W., Washington 4, D. C.

INVENTORS, Don't sell your invention patented or unpatented until you receive our offer. Write Cowgill, Box 298, Marion, Ohio.

INVENTIONS Wanted now by my manufacturer-clients. Patented, unpatented. Write Adams, Patent Broker, 85-S Wall Street, Financial District, New York City.

MANUFACTURERS Will consider any invention. Deal direct. Colburn, 929 So. Robertson, Los Angeles 35, California.

INVENTORS! Free book, "Selling Your Invention." Inventors Exchange-D, Hartford 1, Connecticut.

YOUR Invention manufactured in our large factory and distributed through our nation-wide organization. Royalty or otherwise. Mitchell, P.O. Box 771, Des Moines, Iowa.

INVENTIONS Wanted. We buy for cash and royalties, inventions you desire to sell. Send brief description of what you have. Champlain-Hudson Corporation, Room 1428, 185 Broadway, New York 6, N. Y.

ORGANIZATION Active various countries South America, particularly Argentina, Brazil, Venezuela, Chile, Uruguay, offers development patents originating United States. Complete references. Write PM-926, 125 W. 41 St., New York City.

PATENTS FOR SALE

CONCEALED Hinges. Link type. Original design. Highest quality. Most durable. Best offer. Wonderful money-making opportunity. Schnur, 2117 N. Meade, Chicago 39.

MODELS. MODEL SUPPLIES

JUMBO Modelcraft catalogs: Airplanes, boats, cars, 25¢; railroad, 25¢. 10,000 items. Bargains list free. America's Hobby Center, 146K West 22nd Street, New York 11, N. Y.

GEARS And model supplies for the inventors. Send 10¢ for catalog. Pierce Model Works, Tinley Park, Illinois.

SHIP Models and yacht supplies complete. Large 68 page catalogue 50¢. Bill Wild's, 510 East 11 St., New York City 9.

POWER Models. Unusual steam gasoline and traction engines, fittings, metals. Comprehensive catalog \$1.00. Chas. Cole, Ventura, Calif.

BUILD Miniature passenger hauling live steam locomotive with file and drillpress. We go machine work, you bolt it together. Catalog 50¢. Little Engines, Lomita, Calif.

SHIP And yacht model fittings; blueprints. Send 35¢ for illustrated catalog listing hundreds of items. A. J. Fisher, 1002-1 Etowah Ave., Royal Oak, Mich.

SHIP Models. Most complete line in New England. Kits, fittings, plans, books, tools, engines, motors. Illustrated catalog 30¢. James Bliss & Co., Inc., Dept. SM, 342 Atlantic Ave., Boston 10, Mass.

BALSA Wood and model aircraft. 40-page catalog 25¢. Sig Co., Montezuma, Iowa.

SHIP Model kits and fittings including clippers, trawler, fishermen, frigates, privateer, radio control tug, etc. Send 25¢ for 1967 catalog. Model Shipways, Box 85, Bogota, N. J.

MANUFACTURING

MODELS — Small lot manufacturing. Metals, plastics, etc. Milburn, Burlington, Kentucky.

HOME CRAFTSMEN

STYLECRAFT Sure fire hits. "Pre-traced" leather kits. Handbags, billfolds, filigree belts, over fifty other projects. Patterns on leather. Why trace? Just carve, assemble and lace. Large assortment "precarved" kits also available. Send 25¢ for catalog, free folder. Refunded first order. Apache Leather Company, 2804 E. Washington St., Phoenix, Arizona.

DO-IT-YOURSELF booklets 25¢. 24 subjects. Free catalog. Popular Mechanics Press, 631 N. St. Clair St., Chicago 11.

ALL Crafts, supplies. Large free catalog. National Handicraft, 199 William Street, New York City 38.

WOODWORKING And cabinetmaking course for beginning and advanced home craftsmen. Only complete low-cost home training program available. Write for free booklet. Interstate Training Service, Dept. G-3, Portland 13, Ore.

LEATHERCRAFT, Kits, copper, artist's supplies. New catalog. Midas, 7705 State, Huntington Park, California.

KNOCKDOWN Cedar chests. Lumber and veneers. Free price list. Giles & Kendall Company, Huntsville, Ala.

FREE. New catalog, 1,668 patterns, designs. Craftplans, 1321-A Michigan Ave., Chicago 5.

FREE "Do-it-yourself" leathercraft catalog. Tandy Leather Company, Box 791-019, Fort Worth, Texas.

KNOCKDOWN Cedar chests and lumber. Free price list. Bedford Lumber Company, Shelbyville, Tennessee.

DRIFTWOOD—All kinds. Finest for homecrafters. Free details. Beachcomber, Rt. 1, Box 3250, Florence, Oregon.

LEATHERCRAFT, Copper enameling, mosaic tile, shellcraft, metal tooling, beadcraft, many more crafts. Free big catalog. Kit Kraft, Dept. 234, Studio City 1, Calif.

LEARN Art metalcraft and jewelry making. Complete, inexpensive, home training course now available. Special tools and materials furnished. Write for free booklet. Interstate Training Service, Dept. L-3, Portland 13, Oregon.

LEATHERCRAFT. Send 10¢ for new 76-page catalog of tools, supplies, kits, including metalcrafts, enameling, ceramics, all other crafts. Complete stock. Reasonable. Since 1910. Sax Bros., Dept. PM-4, 1111 N. 3rd, Milwaukee, Wis.

FREE. Complete illustrated catalog. Leathercraft kits, supplies. J. C. Larson Co., 820 S. Tripp, Dept. 6927-LB, Chicago 24.

YOUR Handmade articles advertised, 200 gift shops, \$1.00. Lists, Box 437, Fort Madison, Iowa.

101 **PULL** Size patterns. Smart, new, gifts, novelties, lawn figures, shelves, action windmills, alphabets. Plus "Make Money Jig Sawing." Only \$1.00. Mastercraft 45M, 7041 Olcott, Chicago 31, Illinois.

BUY Wholesale nationally advertised power, hand tools, thousands other products at big discounts. Free "Wholesale Plan." American Buyers', Hertel Station, Buffalo 16-F1, N. Y.

SELL Your handcrafts. How! Where! Continental Publications, 192-A N. Clark, Chicago 1.

JIGSAW Patterns 101, \$1.00. Full size. Plus alphabets, Barebo, O'Fallon, Mo.

LEATHERCRAFT, Copper, silversmith complete do it yourself kits. Handbags, belts, billfolds many others. Leathers, tools. Catalogue 25¢ refunded with first order. Art Handicrafts, PM, 194 William St., New York 38, N. Y.

PATTERNS Flying ducks, man sawing wood. Dutch maid churning butter, and 30 lawn ornaments, only \$1.00. Lincoln Studio, Columbia, Conn.

I want to send you proof of the wonderful pulling power of Popular Mechanics classified pages. What's your proposition? Write me today. Include literature if possible. F. W. Johnson, Manager Classified Advertising, Popular Mechanics Magazine, 200 E. Ontario St., Chicago 11, Ill.

PICTURES For framing, List 25¢. Fox Crafts, Box 143, Jackson, Michigan.

MAKE Money making picture frames. Write for free catalog of all styles of moldings. International Sales, 414-PM East Baltimore St., Baltimore 2, Md.

PIX Loose furniture joints quickly. See glue injector page 306.

DO IT YOURSELF

GRANDFATHER Clock shop tested plans \$1. Astonishingly simple. Thousands built for 40 years. Movements \$39. Gorgeous dials. Red-I-Kut kits. See February issue page 325. Kuempel Klocks, Minneapolis 16, Minn.

BUILD A loom. Weave rugs, drapes, cloth! Complete instructions with 3 drawings \$1.00. OR. Rug Company, Dept. 4747, Lima, Ohio.

BARBECUE Pit. No grease fire! Plans \$1.00. Department A, Box 53, Detroit 21, Michigan.

NEW Amazing sprinkler system. Eliminates hand watering. Reaches hard-to-water areas. Saves time. Saves water. Make it yourself in 20 minutes. Free details. Frix, 352 Hull Ave., San Jose 25, Calif.

AWNING Prices fractured! You install! Aluminum, roll-up. Free literature. Fifth Avenue Awnings, 210 Fifth Avenue, New York 10C.

MOWER Kits and parts, also complete mowers. Write for free plans and literature. Triangle Mfg. Co., Dept. M-7, Fort Scott, Kansas.

DIFFERENT, Decorative, inexpensive fence. Free literature. 2205 Eveningside, Topeka, Kansas.

MELT Cast iron, brass, aluminum. Make castings for profit. Free literature. Ursutz Burner Co., Box 566-M, Tempe, Arizona.

GRANDFATHER Clock movements, blueprints, kits. Wholesale catalog 25¢. Mason-Sullivan, Noroton, Conn.

BUILD Your own optical instrument! New book—"Fun With Optics" tells you how! 32 exciting pages. Full diagrammed instructions on how to build telephoto lenses, telescopes, microscopes, slide viewers, artist drawing projectors, binoculars, magnifiers, riflescopes, etc. We can furnish the lenses, prisms and parts you'll need. To get this terrific book send your name and address and only 50¢, full price. Request Stock No. 9050-CY. Edmund Scientific Company, Barrington, New Jersey.

WATCHES. OLD GOLD, JEWELRY

10 **WATCHES** \$18.00. Minor repairs. Catalog 20¢. Berkwit, 1150 Castle Hill, New York City 62.

COSTUME Jewelry supplies. Catalog and samples. 35¢. Largest line in America. Milady-Fair Co., G.P.O. Box 1328, New York City 1.

WATCHMAKERS'—Jewelers', machinists' tools. Watchmaking course. Catalog 25¢. Bengale, Culver City, California.

PREFERRED Source for quality settings and stones. Manufacture costume jewelry at home. Extensive catalog 25¢. A. V. Cull Co., 210-F Fifth Ave., New York 10, N. Y.

HIGHEST Cash for old gold, broken jewelry, gold teeth, watches, diamonds, silverware, spectacles, platinum, mercury, gold coins. Free information. Rose Refiners, Heyworth Building, Chicago 2.

WATCH And clock repairing books. Free catalog. North American, 2320-AD Milwaukee, Chicago 47, Ill.

COPPER Enameling supplies, rhinestones, pearls, jewelry settings. Catalog 10¢. J & M Novelties, Dept. CD-3, Griffith, Indiana.

CUCKOO Clock, Germany to you with valuable stamps, \$5.95. Allied, 106 Catherine, Red Bank, N. J.

RAZORS. BLADES. SHARPENING

FROM Europe. Finest quality Solingen razors. \$1.95, postpaid, prepaid. Kuckert, Singel 161, Amsterdam, Holland.

FOR THE HOME

FOAM Rubber furniture cushions. Factory seconds. 50% discount. Free catalog. Perma-Foam, 236C Rhode Island Ave., East Orange, New Jersey.

GRIDDLES, Thick cast aluminum, silver frost finish. Eleven inches diameter. Only \$3.98 postpaid. Sherwoods, 4215 Prospect Road, Peoria Heights, Illinois.

"**HOME** Improvement Guide." New, amazing 192 page volume. Packed with ideas, plans for remodeling, decorating, landscaping, built-in projects. \$2.50 prepaid. Popular Mechanics Press, 200-HG East Ontario St., Chicago 11.

WHY Gamble with your loved ones' lives or your own. Merlite Fire Alarm. Information free. Murphy's, Woodstock, N. Y.

BE Your own plumber. You can. Few inexpensive tools and our instructive book, "Home Plumbing Guide," shows and tells you how. Hundreds of photographs and diagrams. Easy to follow. 160 pages. \$3.50. Catalog free. Popular Mechanics Press, 200PG East Ontario St., Chicago 11, Ill.

OF INTEREST TO WOMEN

KEEP The kiddies entertained. Illustrated Fables about Doodlewhangs, 1 book, 10¢; 6 books, 50¢. Knee, 921 S. Jackson, Tulsa, Okla.

"**8 MISTAKES** Parents Make." Every parent should have this new book about child training. It is free; no obligation. Simply address Parents Association, Dept. 674, Pleasant Hill, Ohio.

60% PROFIT Cosmetics \$25 day up. Hire others. Samples, details. Studio Girl-Hollywood, Glendale, Calif., Dept. 1274H.

EARN Money throughout the year. No selling, no canvassing, no telephoning, no samples to buy, no investment. It's new! Write for sensational details! MacPherson Manufacturing, 8974 St. Charles Road, St. Louis 14, Mo.

CREAMY Hand lotion. Ingredients for full quart, \$1.00. Colonial Chemical, Box 8367, Denver 10, Colo.

GROW Mushrooms. Cellar, shed. Spare, full time, year round. We pay \$3.50 lb. We have over 25,000 customers. Free book. Mushrooms, Dept. 176, 2954 Admiral Way, Seattle, Wash.

JERSEY Loop pot holders 29¢. Four for dollar. Johnson's, 139 Tower St., West Sacramento, Calif.

GOOD Money in weaving. Weave rugs at home for neighbors on \$39.50 Union loom. Thousands doing it. Booklet free. Carcraft Co., Polk St., Boonville, N. Y.

WANT To make big money at home? \$10.00 profit in an hour possible with invisible mending. Make tears, holes, disappear from clothing, fabrics. Steady year-round demand from cleaners, laundries, homes. Details free. Fabricon, 8332-S Prairie, Chicago 19, Illinois.

SELL Fine fabrics. Get yours wholesale. Box 863, Norwalk, Conn.

MAKE New greaseless doughnuts in kitchen. Sell stores. Free recipes. Morgan Ray, 3605 South 15th, Minneapolis 7, Minn.

BOOKS: Hundreds of subjects. Big catalog free. Popular Mechanics Press, 200-BC East Ontario St., Chicago 11.

PERSONAL

WILLS. Make your own. Valid all states. Complete instructions and will forms \$2.00. Best's, Box 92, Detroit 31, Mich.

MACK'S Earplugs let you sleep if noise disturbs. No drugs! Waterproof, swimming. \$1.00 box (3 pairs) prepaid. McKeon Products, Box 2269P, Cleveland 9, Ohio.

UNITED Nations! Six viewcards \$1.50. I remail free with United Nations stamp. Culp, 55 Cooper, New York 34, N. Y.

EXPECTANT Mothers, fathers. Baby deserves the best care. 3 books only \$1.00. Handy Size Books, Box 451, Radio City P.O., New York 19, N. Y.

ENJOY Health. Free booklet. Ruth's Nutrition, 152 Kearny, PM, San Francisco, Calif.

MAKE Your own will! Legally drawn, copyrighted form. \$1.00. Conlon, 1331P Osage, Bartlesville, Oklahoma.

"**HOW** Can I find out?" You can! Information confidentially developed. Any matter, person, problem. Worldwide. Officially licensed. Established 1922. William Herman, 170 Broadway, New York City.

BOOKS: Hundreds of subjects. Big catalog free. Popular Mechanics Press, 200-BC East Ontario St., Chicago 11.

REMAIL By pony express. 25 cents. Kirby, Memorial Pony Express, 1637 Pennsylvania, Denver, Colorado.

ARE You in debt? Up to \$5000 in debts past due or current can be consolidated by mail. No payments sent to us! Low weekly or monthly payments to fit your income. Payments made directly to bank in your area. No endorsers. No credit check. We are not a loan company. Send for free copy of "How to have money—always" and complete information on how you can get out of debt without borrowing. National Budget Associates, 105 Halsey St., Newark, N. J. Dept. 102.

"**TRUTH** About Hearing Aids." — Revealing facts, money-saving tips. Free details. Aureo, Central Valley, New York.

JACKSONVILLE, Fla. Remailing 25¢. Helpwanted \$1.00. Edson's Service, 421 West 18th St., Jacksonville, Fla.

POSTMARKING! Letters discreetly remailed! Any U.S.A. postmark \$1.00! Box 872, Santa Barbara, Calif.

BORROW Money—By mail. \$100 to \$600 from Postal Finance. Employed men, women easily obtain \$100 to \$600 fast, entirely by mail. Repay in small monthly payments. Friends, relatives, employer, tradespeople will not know you are applying for loan. Advise occupation, amount wanted. Postal Finance Company, 200 Keeline Bldg., Dept. 7-E, Omaha, Nebr.

SIMPLE Television repairs. Marvelous booklet 25¢. Free catalog. Popular Mechanics Press, 633 N. St. Clair St., Chicago 11.

REMAILING SERVICE

LETTERS Reairmailed from Canada 30¢. Toronto Sunday classifieds \$1.00. Mail received-forwarded \$3.00 month. Aero-mails, 22 Brighton Ave., Toronto, Ontario.

INDIANA Remailing cards, letters. 25¢; 6, \$1.00. Fall's, 624 E. Main St., Lebanon, Indiana.

SECRET Mail receiving, forwarding system. \$3 month. Hedapeth, Box 830, Alhambra 23, California.

ALASKA Remails — 25¢. View cards. Mae Armstrong, Box 491, Ketchikan, Alaska.

AIR Remails 35¢. I affix stamps. Confidential mailing \$3 monthly. Ross Hancock, 83 Belhaven Rd., Toronto 8, Canada.

REMAILING 25¢. View-cards 10¢. Totems \$2.00. Travel information—Shopping \$1.00. Alaska Enterprises, 328 Carlianna, Ketchikan, Alaska.

LETTERS Remailed 25¢. Receiving-forwarding address available. Details free. William McLaughlin, 800 Stewart, Columbus 6, Ohio.

REMAILS 25¢. Forwarding \$2.75 monthly. Gerken, P.O. Box 2508, San Francisco 26, California.

ARABIAN Reairmails. \$1. Use airmail. Shock friends. Aramco, Box 81, Abqaiq, Saudi Arabia.

ATLANTA, Ga.: Letter remailed 25¢. Atlanta Journal-Constitution classified, \$1.00 service charge. Evans, 1325 Clearview Dr. N.E.

LETTERS Remailed 25¢. Monthly rates. Confidential handling. Martin Dale, Box 293, Jackson, Michigan.

LETTERS Remailed 25¢ each. Korsl, Box 7652, Kansas City 28, Mo.

WASHINGTON Twelve cherry blossom Kodachrome viewcards \$1.00. Remailed free. Letters remailed 25¢. Joanco, Box 3006, Arlington 2, Va.

TREASURE FINDERS

FREE. 16-Page manual from world's largest manufacturer of prospecting equipment. Detron Corp., 5528 Vineland, North Hollywood, Calif.

FOR Treasure locators, geiger, scintillation counters, mineralights, M-Scope. Fisher Research Laboratory. See advertisement page 271.

FORTUNES For the taking. Gold, silver treasures. Light weight, guaranteed, power-packed metal detectors. Kits and assembled models from \$39.90. Geiger counters and mineralights. Free literature. Electronic Applications, Dept. M, Box 8, Arlington 10, Virginia.

FIND Buried treasure, gold and silver, with Goldak's sensational 3½ lb. "find-it" locator, only \$49.50. Write for free literature on complete line of mineral, metal locators; Geiger and scintillation counters. Goldak, 1541 W. Glenoaks Blvd., Glendale, Calif.

LITHIUM. The wonder metal. Free booklet describes prospecting information, uses, etc. Nu Age, Box 142, North Battleford, Sask., Canada.

FOR SALE—MISCELLANEOUS

FOR Sale—Tire business. Northern highway. Apply J. P. Ziegler, Vanderhoof, British Columbia, Canada.

HEARING Aid batteries, wholesale. Free list. Habs, Box 51, York, Penna.

DOG Tags—Snappy designs. Your name and address indented 40¢; 3 for \$1. Capital, Jensen Beach, Florida.

"**ROCK N Roll!**" sun glasses. Send \$1.00 for pair. Standard size. Guaranteed quality. Agents wanted. Smith's Camera Shop, 21 North 3rd St., Clearfield, Penna.

SMOKERS. Nature's sweetest, Missouri Meerschau pipes. Selected coals, rubber bits, aluminum cleaners expertly crafted. Regularly \$1.00 each. Three for \$2.50 ppd. Mail check or money order to Ed. Locke, Lac du Flambeau, Wis.

FLYING Saucer toy, unique design like real thing. Children go wild for it wherever flown. Simple construction of wood, plastic or aluminum. Patent pending. Inquire P. O. Box 2605, Los Angeles 53, California.

BOOKS: Hundreds of subjects. Big catalog free. Popular Mechanics Press, 200-BC East Ontario St., Chicago 11.

WANTED—MISCELLANEOUS

CASH For Indian bird stones; antique northwest coast totem, masks, carvings. Send photos. Robert Stolper, 8632 Cynthia Street, Los Angeles, California.

\$100.00 FOR Certain old stamps. Price-list picturing stamps wanted. 25¢. Lincoln Stamps D-1229, Glendale, Arizona.

SCRAP Mercury (quicksilver) containers supplied — Tantalum, tungsten, silver, platinum. Metallurgical Products Company, Established 1909, 35th & Moore Sts., Philadelphia 45, Penna.

QUICKSILVER. Sterling, silver solders, precious metals. Wholesale Terminal, Norwood, Massachusetts.

MISCELLANEOUS

BUY Wholesale! Discounts to 80%! Appliances, cameras, sporting goods, housewares, watches, tools, clothing, etc. Buy-Rite, Hawthorne 2, New Jersey.

HOBBYISTS—Swappers; get free listing-advertising in widespread hobby publication. Sample copy 15¢. Write Box 197, Hazleton, Penna.

YOUR Portrait oil painted, free! Write for details. Bryson's, P.O. Box 537, Omaha, Nebraska.

FRESH Kodak Film. 3 rolls \$1.00. Sizes 620, 120, 137. Guaranteed. PicSure, Box 899-M, Philadelphia, Penna.

ALL John, Luke, James, etc. Whitcomb, 308 Sycamore, Newport News, Va.

RECEIVE Mails, magazines, samples. Get listed 25¢. Dave Hoffman, Clarence, New York.

BEAUTIFUL Portraits done in oils from photographs. Very reasonably priced. Free particulars. Elmer Brunow, 2452A No. 17 St., Milwaukee 6, Wisconsin.

BIG Mails, four months listing. 25¢. Wright Publications, 2270 Hubbard, Memphis 8, Tenn.

70 BIBLE Lessons, 25¢. Bulletin, Box 87, Cathedral Station, New York City 25.

FREE Booklet, "Enjoyable Paying Hobbies." Let me help you. Laura Dickson, 1804 Green St., Columbia, S. C.

SAMPLES. Magazines, catalogs, opportunities. Year, 25¢. Star Directory, Leming, Texas.

COFFEE Costs cut 50% anywhere, anytime. Guaranteed. Caldwell, Barwick, Georgia.

SAVE Money on furniture repairs. See glue injector page 306.

SUPER Memory overnight! Success guaranteed! Bijou, Box 1727-M5, Hollywood 28, California.

GROW Mushrooms. Cellar, shed. Spare, full time, year round. We pay \$3.50 lb. We have over 25,000 customers. Free book. Mushrooms, Dept. 175, 2954 Admiral Way, Seattle, Wash.

BUY Gifts direct from Japan. Kimono, lighters, orgels, jackets, slides, novelties, etc. Business information fee \$1.00. Clarence Yamagata, 202 Naka 7 Bldg., Marunouchi, Tokyo, Japan.

I want to send you proof of the wonderful pulling power of Popular Mechanics classified pages. What's your proposition? Write me today. Include literature if possible. F. W. Johnson, Manager Classified Advertising, Popular Mechanics Magazine, 200 E. Ontario St., Chicago 11, Ill.

SHARPEN And service lawnmowers \$10.00 hour possible, build your own grinder, small cost, 26th year. Wirt's, 2419 Grahn, Burlington, Iowa.

WANT More business? Here's an amazing opportunity to increase your sales. Talk to thousands of interested readers of "Mechanica Popular." Our Spanish Edition covers the Latin American countries like a blanket. They're real mailorder buyers. Classified rate 75¢ per word. Try an ad in our next issue. Classified Advertising Department, Popular Mechanics Magazine, 200 East Ontario Street, Chicago 11, Ill.

CIGARETTES. Make 20 for 8¢. Facts free. Moberly, Box 810, Owensboro, Ky.

FREE Wood preserving guide. What and where to use for home and yard. Rot Stoppers, 978 Ellicott, Buffalo 9, N. Y.

REMOVE Paint, grease, printing ink from hands. Lanolized waterless cream \$1.25 postpaid. Relisa Company, 21 Ravine Rd., Great Neck, N. Y.

FREE: "\$3,000 Yearly Sparetime. Backyard, Raising Earthworms!" Oakhaven-M, Cedar Hill, Texas.

LEARN While asleep! Details free. Research Association, Box 610-MC, Omaha, Nebraska.

FREE Vitamin catalogue. Quality capsules for better, healthier living. Feel younger, more vigorous. Buy direct, save! Vitamin-Center, Drawer 2318P, Detroit 31.

HOW To remodel, basement, attic. Booklet 25¢. Free catalog. Popular Mechanics Press, 633 N. St. Clair St., Chicago 11.

RECEIVE Magazine samples, mails, catalogues, offers from everywhere. Get listed 25¢. Rorick, Cincinnati 26, Ohio.

YOUR Name wanted. We'll send 1000 publishers, mailers, wholesalers your name, on our list one year 25¢. Dixie Mailers, King, N. C.

CESSPOOLS. Septic tanks, outhouses, clogged drains, cleaned, deodorized without digging, pumping. Sursolvent reduces contents. Reclaims leachability. Old systems work like new. Free details. Electric Sewer Cleaning, Allston 34, Mass.

STUPENDOUS Mental power. Adults. Details 3¢. Delmar Wisdom, 846 Sunny-side, Chicago 40.

**Stop Pushing Doorbells!
SELL MASTER UNIFORMS
TO BUSINESS MEN**
—and make up to \$50 in a day!

Say "goodbye" to tiresome, unprofitable house-to-house canvassing! Sell in volume to business men and pocket volume profits fast! Customers buy from 1 to 100 uniforms for employees all at one time! You make big money on the spot! You'll cash in big, because your line of attractive, well-made Master advertising uniforms builds company pride and prestige. Company name or trademark is embroidered right on uniforms—employees become "walking advertisements" of tremendous value to the firm. That's why your prospects buy fast... in volume... again and again! Your profits zoom to new heights in a hurry! And you never invest one cent. We carry the stock; we ship and collect. All you do is show the line and take Big Profit orders! Rush coupon now to get—FREE—your powerful Sample Outfit that has everything you need to start making big money right away!



GEO. MASTER GARMENT CO., Dept. A23
Ligonier, Indiana

You bet I want to make up to \$50 in a day selling Master Advertising Uniforms to business men! Rush my FREE profit-packed Sample Outfit right away!

NAME _____

ADDRESS _____

TOWN _____ STATE _____

WHAM-O Sports are FUN!

POWERMASTER HUNTING CROSSBOW Kills Deer, Bear, etc. 80 lb. thrust! Powerful silent, accurate, 34" hardwood stock, 33" bow. Harpoon fish. Anyone can target-shoot right in backyard! Target arrows 60¢ Hunting and fishing \$1 each. \$24.95

WHAM-O HUNTING SLINGSHOT. Hits like rifle-kills rabbits, squirrels. 40 heavy steel balls, extra rubber, target, adapter for arrows \$1.50
275 heavy extra steel balls 98¢

FENCING SWORDS carbon spring steel, polished metal guards, solid alder grips, blood red and silver cordons, and safety ties, with two Fencing masks \$4.95

WHAM-O BLOWGUN SET. For target and hunting. 30" precision metal barrel, rubber mouthpiece, four 5" steel darts and range target. Rifle accuracy. Can shoot over 200 ft. \$2.95
Extra darts 5 for \$1 • Extra-powerful 5 ft. rifle blowgun, collapsible to 2 1/2 ft. \$6.95

FREE FOLDER of other products. Satisfaction guaranteed. At sports dealers or send:
WAMO MFG CO., Box M 93, San Gabriel, Calif.

AMAZING NEW "LIFETIME" RADIO

GUARANTEED TO WORK FOR YOUR LIFETIME! USES NO TUBES, BATTERIES OR ELECTRICAL PLUG-INS. Never runs down! SMALLER THAN A PACK OF CIGARETTES! RECEIVES LOCAL RADIO STATIONS MOST ANYTIME ANYWHERE WITHOUT EXTRA ANTENNA. Uses perma-crystal diode Hi-Q Tuner — Built-in SPEAKER-PHONE. Beautiful Black gold plastic case.

Send only \$2.00 (bill, ck. mo.) and pay postman \$4.99 COD on arrival or send \$6.99 for post-paid delivery. **SENT COMPLETE READY TO LISTEN—NOTHING EXTRA TO BUY EVER!** (Extra long distance aerial kit included free to receive stations up to 1,000 miles away!) Available only from:
MIDWAY COMPANY DEPT. WPM-4 KEARNEY, NEBR.

**Men: Get Into
AUTO MECHANICS & DIESEL**

Good jobs, high pay, security are yours as a qualified Auto-Diesel mechanic. Train NOW in the big famous Shops at National Schools in Los Angeles. Over 50 years experience, since 1905, in successfully training ambitious men. Here you work on ALL ENGINES. You master fuel injection, motor tune-up, general mechanics, automatic transmissions, all power equipment, in shortest possible time. Most complete, up-to-date equipment offered by any school. Expert, friendly instructors and engineers. Help in finding home near school. Part time job while in training. Mail coupon NOW, TODAY, for all the facts.

NATIONAL SCHOOLS

National Schools Dept. DXB-47
4000 So. Figueroa Los Angeles 37, Calif.
Send Free Auto-Diesel Opportunity Book Today.

Name _____ Age _____

Address _____

City _____ State _____

MINERALOGY

Offers unlimited opportunity for rock collector or Uranium prospector. Make it your career or hobby. We train you at home. Diploma course. Send for Free Catalog.
MINERAL SCIENCE INSTITUTE
Desk N • 159 E. Ontario • Chicago 11

FREE WHOLESALE CATALOG get up to 50% off

MAKE MONEY!! SAVE MONEY!! Buy Tools, Hardware, appliances, photo equipment, sporting goods, power tools, paints and thousands of other nationally advertised products at **WHOLESALE COST TO YOU.**

"SEND FOR FREE 1957 WHOLESALE CATALOG TODAY"
SILVO HARDWARE COMPANY
Dept. PM 4, Box 266, Wm. Penn Annex, Phila. 5, Pa.

KEEP YOUR... on BENJAMIN "First in POWER and ACCURACY"

for HIGH H.C. COMP

AIR GUNS & CO₂ GAS GUNS—Top Quality at LOWEST PRICES!

BB or 177 or 22

BENJAMIN SUPER CO₂ Gas Carbine with Reg. Stock as low as **\$14.95**
Deluxe Model with Custom Stock (Shown) as low as \$17.95

Benjamin Air Rifles and Benjamin Air Pistols are Recognized All Over the World for Finest Workmanship and Highest Quality at Lowest Prices. Adjustable Power with Amazing Optimum Force. Fully Guaranteed—Safe—Accurate—Economical. Easy to Use anywhere—12 Models for Target and Small Game BB or 177 or 22.

All Models Benjamin CO₂ Carbine Gas Rifles and Benjamin CO₂ Rocket Gas Pistols Use Standard Size CO₂ Cartridges (available everywhere). 2-Stage Hi-LO Jet Power—High for Small Game—Low for Target—Up to 50 Shots from each Cartridge. No Pumping—Safe—Accurate—Economical—Non Toxic—12 Models BB or 177 or 22.

FREE Catalog All Models Benjamin Air Guns & CO₂ Guns & Supplies. Also, Money-Saving Offer on Hunting & Fishing Accessories.

Send Free Gun Catalog and Special Offer!

BENJAMIN AIR RIFLE CO., MAIL TODAY!
896 MARION ST., ST. LOUIS 4, MO., U.S.A.

Name _____

Address _____

City _____ State _____



National Society
for
Crippled Children and Adults
11 So. LaSalle Chicago 3

NEW INVENTION AUTO CHROME

REPLATES with PERMANENT PLATING

MAKE MONEY! SAVE MONEY!

FACTORY-NEW BRILLIANCE FOR CAR CHROME

Here at last is the car-owner's answer to all chrome problems . . . a dramatic new invention — SPEEDPLATER. It actually plates NEW METAL as you brush. And the plating you apply becomes an INDESTRUCTIBLE part of the bumper, grille or trim itself. How your car will shine! You'll be mighty proud when you remove ugly rust spots and replat metal to a NEW SPARKLE . . . when you bring new, gleaming beauty to worn, dull, even blistered chrome areas of your car. This fast sensational method of brush-plating gives FACTORY-NEW BRILLIANCE that bonds itself onto your car. It forms a hard, sparkling surface that defies all elements!

BUMPERS—GRILLWORK—ALL CAR TRIM RESTORED TO NEW BRILLIANCE!

Here is how easily you replat your car . . . You simply attach SPEEDPLATER'S clamps to your car's battery, then dip SPEEDPLATE Brush into miracle solution. You PLATE WITHOUT REMOVING PARTS FROM YOUR CAR. Works Fast — yet uses less battery juice than the tiniest light on your car.

CAR DEALERS & SERVICE STATIONS— Make BIG Profits with Special HEAVY-DUTY OUTFIT!

FACTORY RESULTS and Big Volume Business can make Terrific Profits For You with this Heavy-Duty Outfit. Do your own replating without removing bumpers or grillwork! Increase the value of used cars! Heavy-Duty Outfit Electroplates on current from standard 12 volt storage battery. ENTIRE KIT COMPLETE — Only \$34.95 with enough material to plate dozens of cars! You quickly make back cost on your very first job! Re-order solutions always available from us at rock-bottom cost to you. MONEY-BACK GUARANTEE. Order Now — If C.O.D. send \$5 deposit.



TRY AT OUR RISK

If you want to put a new permanent gleam on YOUR CAR'S CHROME—you can do it right away and not risk a dime. If you are not satisfied with great results it doesn't cost you a penny! Just mail coupon with only \$1 deposit — then pay postman \$13.05 plus postage when your kit arrives. If you send \$14.95 we ship prepaid. Either way you must be COMPLETELY SATISFIED or you may return all in 10 days for FULL CASH REFUND. ACT NOW — Here's What You Get: SPEED-PLATER Brush with Permanent Anode; Wires and Clamps for battery hook-up; Special Buffs and Buffing Compound; Special Metal Polish; Fast, Simple Instructions.

Quickly Builds-up a Thick, New, Plating With Each Application

SPEED PLATES YOUR CAR!

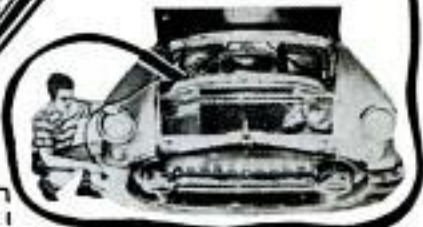

Make Big Money Plating Other Cars!

Now you can add to your income during spare time . . . because 8 out of 10 cars on the road today NEED REPLATING. You can charge from \$7 for touch-up to \$74 for replating an entire car. It's easy and there's good money in it for you. When your neighbors see the brilliant plating on your car, they'll surely want you to do the job for them! Replate other things for profit too — faucets, tools, home appliances, cutlery, doctor's and dentist's instruments.

EMPIRE MERCHANDISING CO., 4 North 3rd Ave., Mt. Vernon, N. Y. Dept. P-47

Please rush the electroplating kit I have checked
 Regular Kit, \$14.95 (If C.O.D. send \$1 deposit)
 Heavy-Duty Service Station Outfit, \$34.95 (If C.O.D. send \$5 deposit)
 I enclose full price, send postpaid,
 I understand that I must be COMPLETELY SATISFIED or I may return kit in 10 days for immediate CASH REFUND.

Name _____
 Address _____
 City _____ State _____

MONEY MEN ALL FREE

THE PLASTEX Industry needs manufacturers on small scale and for big production of Lamp and Clock Stands, Art Goods and Novelties in Plastex and Marble imitation. Experience unnecessary. 12¢ material makes regular 10¢ store sellers. Rubber moulds furnished for speed production. Small investment brings good returns. We are now placing big Chain Store Orders with manufacturers. Ambitious men have chance for real prosperity. Our Free booklet will interest and benefit you.

PLASTEX INDUSTRIES, Dept. A
 3400 Third Ave. New York 56, N. Y.

SAVE UP TO 70% on NEW TIRE COST

TIRES

FACTORY ADJUSTED NOT SECONDS!
 90% to 100% ORIGINAL TREAD
NEW TIRE GUARANTEE

WHITE WALLS Available in 15" Sizes Only	\$2.00 Each Added
670 x 15	\$7.95
710 x 15	\$8.45
760 x 15	\$8.95
800-820 x 15	\$9.95
600 x 16	\$7.95
650 x 16	\$8.95

No Federal Excise Tax Added
 Road hazards not adjusted — No freight paid

H. & H. TIRE CO. All prices f.o.b. Chicago
 449 W. 37th St., Dept. P-1, Chicago, Ill.

SELF-GRIPPING • SELF-LOCKING

P-M NUT

PATENT APPLIED FOR

ELIMINATES LOCK WASHERS, WRENCHES

Can be reused or permanently fastened. Turn-down corners on spring tempered concave P-M Nut bite into seating surface as screw is tightened. Corner grip and tension on threads provide safe, vibration proof assembly. Good for blind applications. Concave underside leads screw into threads. Industry approved. Ideal for do-it-yourself use with autos, appliances, furniture, machinery, toys, bikes, wagons, playground equipment, etc. Send \$1.00 today for complete assortment. Money back guarantee.

100 for \$1.00

POST PAID
 20 each of 5 popular sizes

P-M NUT DIV., WATERBURY PRESSED METAL CO.
 300 CHASE AVE., WATERBURY, CONN.

Please send 5-pack assortment of 100 self-locking P-M Nuts, cadmium plated, sizes $\frac{1}{8}$ -32 through $\frac{1}{4}$ -20. My dollar is enclosed.

NAME _____
 ADDRESS _____
 CITY _____ STATE _____

How To Test For *PROPER TENSION*

... the "Anti-Bind" Secret of

SANDVIK Swedish HAND SAWS

Bend saw and hold a straight edge across blade as shown. If tension is correct, the gap which appears between the straight edge and the blade will make a uniform arc from the center to both edges. An uneven arc indicates poor tension which causes binding.



In SANDVIK saws special care is given to proper static tension. This assures superior balance and flexibility ... two of the factors which have made SANDVIK world famous for smooth, fast-sawing ease. Ask to see a SANDVIK.

SEND FOR THIS FREE 16 PAGE BOOKLET
On How To Choose and Use Hand Saws

SANDVIK STEEL, INC.

Saw & Tool Division

1704 Nevins Road, Fair Lawn, N. J.

In Canada: P. O. Drawer 1339,
Station "O", Montreal 9, P. Q.



Glide LIKE AN INDIAN GUIDE

Down the twisting streams, across the ruffled lakes, your Old Town Canoe is your dependable friend for fishing and hunting. Sturdy and strong for long trips, yet light and easy to carry. Perfectly balanced. An Old Town is designed like a birchbark, but built for many years

of adventure and sport. Easy to own.

FREE CATALOG shows all kinds of canoes and outboards, sailboats, dinghies, rowboats.

OLD TOWN CANOES

Old Town Canoe Co., 444 Middle St., Old Town, Maine

PLEASE SEND ME FREE CATALOG

Name _____

Address _____

City _____

State _____

BUILD THIS HOUSE Yourself



Designed by Popular Mechanics and Famous Architects. Every Detail Simplified and Explained. No Previous Experience Needed!

Can you use everyday tools as well as the average Popular Mechanics reader? Then you, too, can easily build this modern house in any of its five designs, doing every part of the job yourself. The new Popular Mechanics Book, "Your Home—How to Build It Yourself" will show you how.

Space for Living and Family Growth

This beautiful, modern house is 1½ stories, with basement, living room, kitchen, dining room, two bedrooms, bath, plenty of closets and space for two additional bedrooms on second floor. The house itself is 33' 9" x 28' 11"; breezeway 20' 10" x 8"; garage 20' 10" x 12'.

The House That Has Everything

Designed for easy construction and the most living space for the least cost, the Build-It-Yourself House is also most attractive and suitable for any community and most income groups. The basic plan is adaptable to four other exterior designs.

Get Book and Plans Now—Build When You Can

You may never have thought about actually building a house yourself, but now that building restrictions have been lifted, it is easier than you think. So order book and plans today. Even if you engage a contractor to build for you, you will need the plans. And you certainly will want the book which can easily save you hundreds of dollars, whether you build this or any other house.

The Famous Popular Mechanics House

The picture below is from an actual photograph of the Build-It-Yourself House with breezeway and garage, as built by Jack Brownson, 23-year-old veteran, in Aurora, Illinois.

Mail Coupon for New Book and Plans!

Build It Yourself
or Have It Built
—Save Hundreds
of Dollars!

PLANS YOU CAN READ AND FOLLOW

Plans consist of ten working-size blueprints—floor plans, elevations, construction notes, framing, joints, lumber and mill list, specifications, plumbing and wiring diagrams. Every measurement is marked—every detail made clear as ABC. Book has 100 pages—three-fifths are photographs and drawings. Some sections in colors, showing just how your house will look when finished.

BIG BOOK
8½ x 11 inches



MAIL COUPON FOR BOOK AND PLANS

POPULAR MECHANICS PRESS, Dept. 457
200 E. Ontario St., Chicago 11

I enclose \$_____ Send me the items checked at once.

- Your Home and How to Build It Yourself..... \$ 3.00
 Complete set of plans for Popular Mechanics Home... 12.50
 Book and plans at reduced price..... 14.00
 Duplicate sets of plans..... 5.00

Name _____

Address _____

City _____

Zone _____

State _____

POPULAR MECHANICS

DuPont Nylon Cords

Gov't. Surplus Below Mfrs. Cost
Light, strong, durable, quick-drying.
Will not rot or mildew. Ideal for
indoor or outdoor use. Camping, boat-
ing, hunting, clothes line and venetian
blinds. Perfect for tent ropes,
light anchors, deer cord, trot lines,
crabbing, etc. Unusual.

Outwears Ordinary Rope 10 to 1
Nylon Braided Cord 1/16" dia.,
100 lb. test, white, per ft. 1 1/2c
3/16" dia., 375 lb. test, white, per ft. 2c
5/16" dia., 550 lb. test, olive drab,
per ft. 2 1/2c
In 50, 100, 200, 300, 400,
500 ft. & over lengths

Nylon Braided Line 1/4" dia.,
1600 lb. test, olive drab, per ft. in
30, 50 & 100 ft. lengths. 3c
3/4" dia., 1250 lb. test, two-tone
per ft. 4c

In 20, 25, 30, 35, 40,
45, 50 ft. lengths only.
1/2" dia., 1500 lb. test, two-tone,
per ft. 5c
In 20, 25, 30, 35, 40, 45 ft. lengths only

Nylon Rope 1/2" dia., 1200 lb. test,
per foot 8c
5/16" dia., 1800 lb. test, per foot 12c
3/8" dia., 2700 lb. test, per foot 17c
7/16" dia., 3800 lb. test, per foot 20c
1/2" dia., 4700 lb. test, per foot 28c
5/8" dia., 7300 lb. test, per foot 45c
3/4" dia., 10,000 lb. test, per ft. 60c
All in any length up to 1200 feet.

Nylon Fish Line Proven
best by experienced fisher-
men. Heat stretched. Will not
kink, twist or unravel. 25
lb. test, 300 ft. Reg. 50c
\$1 per spool NOW... 50c

NYLON WEB STRAPS
with sturdy steel buckle
Perfect for passenger safety
belts, luggage straps, car
towlines, car carrying straps,
boat trailer straps, etc. Tie
heavy equipment and machin-
ery with greater ease
and safety... at far less
cost. Just the thing for the
garage or workshop.

1" wide, 3000 lb. test, per
foot 10c
1 1/4" wide, 6000 lb. test,
per foot 16c
In 5, 6, 8, 10, 12 foot lengths

**5 Pc. Chrome Vanadium
SCREW EXTRACTOR SET**

\$1.98 ppd.

Removes broken
screws fast,
easy. One of the
highest quality,
lowest price tool
sets we've ever
offered! Each piece
specially hard-
ened, beautifully
machined chrome
vanadium steel. Comes in var-
nished hardwood case with
sliding cover. You get sizes
1-5 screw extractors that re-
move 1/8" to 3/4" screws.
Limited supplies. Hurry!



75c ea. for Finest Imported PRECISION PLIERS!

Flat Nose • Combination • Diagonal Cutter • End Cut-
ting Nippers • Round Nose • One Side Flat-
One Side Round • Slips

**FOR JEWELERS, OPTICAL WORKERS, HOBBYISTS,
CHAFFMANS OF ALL KINDS!** These superb German
instruments are of deep-forged, heat-treated high qual-
ity tool steel, fabricated to most exacting specifica-
tions. All-over ground and polished to smooth hard
surfaces. Smooth working joints with just the right
tension. Jaws meet perfectly to safely and securely
hold even the most delicate objects in the hard-to-
reach corners and angles. Each plier is 4" long and
a veritable gem of precision and strength.

75c each... ALL 7 for \$5.00 ppd.

Minimum order \$1.00. Send Check or M.O. C.O.D. plus fee.
Money Back Guarantee.

SCOTT-MITCHELL HOUSE, INC. Dept. M-334, 611 Broadway
New York 12, N. Y.

FREE AMAZING NEW BOOK "HOW TO ANSWER ADS"



Never before have you seen anything like this.
Tells you in simple language the correct way to
answer ads. Gets you quicker replies—better re-
sults, and greater satisfaction. Will save you
time and money and it's ABSOLUTELY FREE.
No obligation whatever. Every reader of adver-
tising should have this booklet. Send a postcard
for your copy NOW. F. W. JOHNSON, Popular
Mechanics Magazine, Room 600-A, 204 East
Ontario Street, Chicago 11, Ill.

Shrinks Hemorrhoids New Way Without Surgery

Science Finds Healing Substance That
Relieves Pain—Shrinks Hemorrhoids

For the first time science has found a
new healing substance with the astonishing
ability to shrink hemorrhoids and to relieve
pain—without surgery.

In case after case, while gently relieving
pain, actual reduction (shrinkage) took
place.

Most amazing of all—results were so
thorough that sufferers made astonishing
statements like "Piles have ceased to be a
problem!"

The secret is a new healing substance
(Bio-Dyne*)—discovery of a world-famous
research institute.

This substance is now available in sup-
pository or ointment form under the name
Preparation H.* Ask for it at all drug count-
ers—money back guarantee. *Reg. U. S. Pat. Off.

APRIL 1957

PUT POWER BACK IN YOUR ENGINE!

MOTOR CURE



GET RESULTS YOU CAN
"Feel at the Wheel"
OR MONEY BACK!

It's a promise! You'll feel new power
... hear new smoothness... see new perform-
ance! Pour MOTOR CURE in the engine oil and
let the amazing "Cushion Plating Action" restore
compression, increase oil pressure, quiet noisy tap-
pets, valves and lifters... AND INSTANTLY
STOP OIL BURNING!
There's only one MOTOR CURE—the safe, pure
petroleum base sealant. Try it... be happy...
or money back. 16 fl. oz. \$1.95

Trans-CURE

Restores
smoothness to
your transmission!



Add it to transmission oil and drive with
NO NO NO NO
SLIP! JERK! HOWL! GRIND!
MONEY BACK GUARANTEE
16 fl. oz. \$2.45

Write for
descriptive
literature.

At Service Stations, Garages, Accessory Stores

THE KAPRO CORPORATION

2329 S. Michigan Ave., Chicago 16, Ill.

HELPFUL BOOKS

Send post card asking for FREE catalog

Popular Mechanics Press, 200 E. Ontario, Dept. 601, Chicago 11



Top Pay Jobs in TV-ELECTRONICS-RADIO

High pay, opportunity, prestige, security
... all yours, as a qualified Electronics

Technician! Get your training NOW in the big, recog-
nized shops, Labs, and TV-Radio Studios at National
Schools in Los Angeles, foremost since 1905. Here
you work with latest Electronics equipment—pro-
fessionally installed—finest, most complete facilities
offered by any school. Expert, friendly instructors.
Personal attention. Graduate Employment Service.
Help in finding home near school. Part time job while
you learn. Mail coupon NOW, TODAY... for full
information.

NATIONAL SCHOOLS

National Schools Dept. RXB-47
4000 So. Figueroa Los Angeles 37, Calif.
Send Free Electronics Opportunity Book Today

Name _____ Age _____
Address _____
City _____ State _____

69

LUBRIPLATE LUBRICANTS



Make Outboard Motors Run Better—Last Longer!

LUBRIPLATE 2-C MOTOR OIL mixes easily and stays mixed. Lubricates better, burns completely. Keeps spark plugs clean for faster, surer starting. LUBRIPLATE OUTBOARD GREASES make underwater gears run smoother. They are waterproof, won't wash off or leak out. LUBRIPLATE 105 (Grease type) for non-gear shift types, Hypoid 90 (Fluid type) for gear shift types.



YOUR OUTBOARD DESERVES
THE BEST—USE LUBRIPLATE.
YOU'LL SEE THE DIFFERENCE
IMMEDIATELY!

At Marine, Sporting Goods and Hardware Stores.

OTHER LUBRIPLATE PRODUCTS

**LUBRIPLATE
H.D.S. MOTOR OIL**
for cars, trucks
and tractors

**LUBRIPLATE
IN HANDY TUBES**
for sports and
household uses

**LUBRIPLATE
AUTO-LUBE "A"**
for general
automotive lubrication

**LUBRIPLATE
INDUSTRIAL LUBRICANTS**
for every application.

LUBRIPLATE DIVISION, Fiske Brothers Refining Co.
Newark 5, N. J., Toledo 5, Ohio.

You buy better when you buy brands
advertised in POPULAR MECHANICS



BRAND NEW SURPLUS!



115-Volt, A.C. ELECTRIC GENERATOR

1750 Watts, 60 Cycle
A.C., Single Phase
Government Cost \$185.00

FULLY GUARANTEED Only \$99.50

Ideal as a permanent or stand-by unit for electricity IDENTICAL to your house current. Perfect for farms, camps, aboard ship, oil fields, mines, etc. Easily handles lights, refrigerator, deep freeze, oil burner, radio; power for saws, floodlights, drills, pumps, etc. ALL BALL BEARING! Operates at 3600 RPM. Drive with 3 1/2 HP or larger engine—or use power take off. Voltage self regulating. Standard base mtg. Two outlets. Size 15" lg., 8" dia. Wgt. 58 lbs. Delivers 1750 watts CONTINUOUSLY! Operates in either direction!

SUPPLY LIMITED! ORDER DIRECT FROM AD

Free Catalog of other Surplus, Hydraulics

ROBERTS ELECTRIC CO., Dept. PM-601, 849 W. Grand, Chicago 22, Ill.

OUTDOOR KITCHEN



Written Step-by-Step For You!

Now you can have a beautiful outdoor kitchen to enjoy all summer long. Tom Riley, well-known building authority, tells and shows you how you can build your own outdoor fireplace, Chinese oven, barbecue pit or grill. There are complete building instructions included.

A Standard Piece of Equipment

Once the almost exclusive luxury of Western ranches, the outdoor barbecue now is a coast-to-coast American institution. Every year more families take to this pleasant and gracious way of outdoor dining and entertaining. Now with this book, you can join in with a minimum of expense and the utmost in results. Mr. Riley, an old hand around the barbecue ovens of Oregon, has prepared this complete book, in order that you may find the ideal outdoor fireplace for your particular back yard. He not only gives you many fireplaces from which to choose, but he also gives you money-saving short cuts in construction, hints on firing up and cooking and for extra good measure a collection of fire-tested recipes ranging from tasty frankfurters to filet of sole al fresco.

No Experience or Special Tools Needed

Complete step-by-step building instructions with diagrams, photos and drawings make construction a cinch. There are designs for brick, field country stone, cement, concrete block and poured concrete, and many examples of each. With the know-how gained from this book, yours can be the most popular back yard in town and, besides you'll have lots of fun.



Special Section of 40 Tested Recipes!

Here are some secrets of successful barbecuing—the best fuels to use, ways to maintain proper draft, and hints on firing up and cooking that will enable you to capture the authentic barbecue flavor in the foods you serve to family and friends. So that your fare won't be confined to wieners and hamburgers, Tom Riley also tells you how to prepare and serve such barbecued delicacies as ribs, roasts, fowl, fish, special sauces, and various vegetables.

Partial Contents

Which Barbecue for you? Barbecue Fireplaces, Portable Grill, Masonry Grill, Barbecue Pits, Chinese Ovens, Infra Red Roasters, Combination Barbecues. Construction plans, Basic Fireplace Foundation, Barbecue Fireplace of poured concrete, stone construction, Piring Up! Types of Charcoal, Hardwood, Softwood, Compressed Sawdust, Cooking Temperature, Flame Tested Recipes, Charcoal Broiled Steaks, Barbecued Spareribs, special section of cooking methods employing various vegetables not usually associated with outdoor cooking, and much more.

7-Day Money Back Guarantee

Send for your copy of OUTDOOR KITCHEN, today. Read and use it for 7 days. If it isn't entirely satisfactory, return it for a full refund. We know once you have looked your copy over, and found the fireplace for your backyard, you won't part with this book under any conditions.



Use This Handy Order Coupon

POPULAR MECHANICS PRESS
200 E. Ontario St., Chicago 11, Illinois

Gentlemen:
Please send my copy of HOW TO BUILD AND USE YOUR OWN OUTDOOR KITCHEN, now. Enclosed is my remittance of \$2.00. If I am not completely satisfied with the book I will return it for a full refund after 7 days.

Name _____

Address _____

City _____ Zone _____ State _____

Send C.O.D. I will pay postman

POPULAR MECHANICS

Copyrighted material

MEND METAL AT HOME with DEVCON

The Plastic Steel

80% STEEL—20% PLASTIC

DEVCON and a putty knife . . . tools for 1001 home repairs. DEVCON bonds steel to itself or to aluminum, bronze, brass, iron, wood, porcelain, glass, concrete and other surfaces. For home . . . farm . . . garage . . . or marine use, DEVCON fixes radiators, washing machines, cracked engine blocks . . . just about anything! Easy to use, DEVCON saves dollars!



AS EASY TO USE AS MODELING CLAY

HARDENS IN 2 HOURS EVEN UNDER WATER



\$1.98 per kit enough for several projects
Also—1 lb. packages for big jobs—\$3.95
At leading hardware and hobby stores—write for free literature

DEVCON CORPORATION
175 Endicott St., Danvers, Mass.

it's NEW! it's ALL IN ONE LEVEL · SQUARE · TAPE

IT'S A LEVEL!
Built-in, accurate unbreakable Level.



IT'S A TAPE!
10 ft., replaceable WYTEFACE® Tape.

IT'S A SQUARE!
Accurate Square. Easy to use.

Only \$1.98
at your hardware store



KEUFFEL & ESSER CO.
Hoboken, N. J.

APRIL 1957

Chris-Craft BOAT KITS FOR '57

- New Flite-Speed styling
- New flashing performance
- Low budget prices from \$61
- 16 models, 8' thru 22'
- Fun to assemble



12' Meteor. Kit \$224



14' Comet. Kit \$286



16' Sports Express. Kit \$438



16' Sports Cruiser. Kit \$632

Packed with new design, performance features: Flite-Speed styling, sleek comings, tail fins, self-draining motor wells, 16 models—utilities, runabouts, cruisers, outboards, inboards— from \$61. Easy-to-assemble kits. Save 1/2 or more! See your dealer or send for full-color catalog. Distributors, dealers—valuable franchises available, write for data.

Prices subject to change.

Boat Kit Division, Chris-Craft Corporation, Algonac, Michigan

WE DON'T NEED ENGINEERS

... but they write to us daily to order our GENIAC Electric Brain Construction Kits.

So do TEACHERS, SCIENTIFIC AMATEURS, INDUSTRIAL FIRMS and schools. (See list below.)

THOUSANDS OF SATISFIED CUSTOMERS have bought GENIACS on a 7 DAY REFUND guarantee

We are proud to offer our 1957 Model, with up to the minute improvements for the thousands of new customers who can use them.



WHAT IS A GENIAC?

Here is a picture of the 1957 Model GENIAC in the display rack (\$53.00 separately) which comes with every kit.

GENIAC stands for Genius Semi-automatic Computer. A kit of specially designed switch decks and racks which permit the user to construct more than thirty different machines (following directions and wiring diagrams) and as many more as he is able to design himself. These machines demonstrate the applications of electric circuitry.

APPLICATIONS OF GENIAC

SIMPLE COMPUTER CIRCUITS for binary, decimal adding, subtracting, dividing, multiplying machines, PROBLEMS in symbolic logic, reasoning, comparing, PSYCHOLOGICAL TESTING and EXPERIMENT GAME PLAYING CIRCUITS for tic-tac-toe and domino, ACTUARIAL ANALYSIS.

SOME OF OUR CUSTOMERS

Allis-Chalmers • Remington-Rand • International Business Machines • Manual Missionary College • Barnard College • Westinghouse Electric • Phillips Laboratories • General Insurance Co. of America • Lafayette Radio • Ronr Aircraft Co. • Albert Einstein Medical College • Naval Research Laboratories • Board of Education, Tecumseh, Nebraska • Los Angeles Public Schools • Jefferson Union High School • Oklahoma A & M • Courtland Jr. High School • Bell Telephone Laboratories.

WHAT COMES WITH THE KIT?

BOOKS—1. SIMPLE ELECTRIC BRAINS, AND HOW TO MAKE THEM . . . 64 page experiment manual.—NEW! 2. MINDS AND MACHINES . . . 200 page text on computers, automation and cybernetics.—NEW! 3. WIRING DIAGRAMS for basic GENIAC circuits.—NEW! 4. Beginners Manual for the person who has little or no familiarity with electric circuits.—NEW! 5. GENIAC study guide . . . the equivalent of a full course in computer fundamentals, lists additional readings.

PARTS—PANELS, DISCS, RACK (for easy assembly and display). Hardware, wire, tools, battery, holder etc. for more than thirty machines. SEND for your GENIAC now. At only \$19.95, a bargain, comes complete with over 400 parts and components. \$2.00 and manuals. We guarantee that if you do not want to keep GENIAC after one week you can return it for full refund.

Add 80c west of Miss. \$2 outside U.S. Mail Name & Address with check or Money Order to

OLIVER GARFIELD CO., DEPT. PM-47 126 LEXINGTON AVE. NEW YORK 16, N.Y.



Lashed to a house mover's trailer, the *Sirius*' hull is hauled to a site near Lake Champlain, 24 miles away

The *SIRIUS* Follows the *SPRAY*

Below, Carr and brother hoist mainsail. Bottom, the *Sirius* at the fitting-out dock near Vergennes, Vt.



THIS SPRING, Vermont farmer and ex-sailor Bob Carr will take to sea the yawl *Sirius* that he built alone in 6½ years with nothing but hand tools. The craft is a replica of the nine-ton *Spray*, sailed singlehanded around the world in 1898 by Capt. Joshua Slocum of Massachusetts (see *Popular Mechanics*, June 1956).

Trial runs by the *Sirius* last fall in Lake Champlain have shown the two-master to be the equal of the *Spray* in watertightness and sailability. And when waterways open between the lake and ocean, Carr will be ready to navigate his boat to the salt-water sailing lanes, where she belongs.

Built 24 miles overland from the lake, the hull of the *Sirius* was loaded one day many months ago on the trailer of a local house mover. Carr and volunteer helpers transported the hull to a quiet stream called Otter Creek at a point near Vergennes, Vt., seven miles upriver from Lake Champlain. In these calm waters, the 36-foot *Sirius* was outfitted with masts and necessary gear.

One hitch almost made Carr and his boat miss the trial runs. When he was ready to



lower the mainmast into the new craft, he discovered the mast was too small at the top to take strains which would be put on it. The mast tapered in too quickly at its tip, making a weak spot four feet below the top. This vital flaw induced Carr to get a new mainmast and cost him two weeks' extra work, in addition to delaying transfer of the *Sirius* downstream to Lake Champlain so long that the boat barely missed being frozen into Otter Creek for the winter.

Traveling into the hills in search of a straight spruce tree with ample diameter to its top, Carr found one, felled it and then discovered at the dock that the log had a twist in it. He returned to the woods, cut another spruce and, with a horse, dragged it to the ship. Adz, ax, "slick" and sweat produced a serviceable mast, to which Carr transferred the original hardware and fittings. In setting the mast in place on the boat, the amateur shipbuilder didn't forget to slip a silver coin under the foot of the mast for luck.

Takes to the Water

Just before winter closed in on Otter Creek, Carr arranged to have the craft towed the seven miles to Lake Champlain. Under sail the vessel handled like a dream and was so tight in the planking that Carr has "thrown a little water in her just to keep her bilges wet." Although he could sail the *Sirius* safely across three-mile-wide Lake Champlain, Carr hadn't actually completed all interior details of his boat. He decided not to take leave of the lake until spring. Guiding the *Sirius* to Shelburne Harbor, famous for sidewheel steamers built there, he put her into wet storage for the winter. He has been living aboard the *Sirius* since the launching. ★ ★ ★



Above and below, with all canvas on main and jigger masts, *Sirius* is ready for trial run



FREE! 1957 ALLIED ELECTRONIC SUPPLY CATALOG

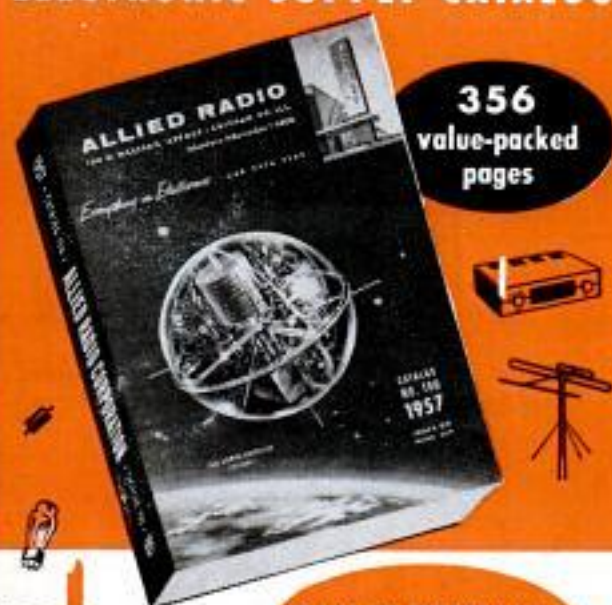

SAVE ON EVERYTHING IN ELECTRONICS

Everything for Experimenters, Builders & Amateurs, Servicemen, Engineers & Hi-Fi Hobbyists

Send for ALLIED'S money-saving guide to *everything* in Radio, Hi-Fi and Electronics! Select from the world's largest stocks: High Fidelity systems and components; latest builders' kits (see the famous KNIGHT-KIT line); recorders and phono equipment; TV tubes, antennas, accessories; Amateur station equipment; P.A. Systems; test instruments; industrial electronic supplies—plus *everything* in parts, tubes, transistors, tools and books. Get more for your money—send for your FREE 1957 ALLIED Catalog!

Everything in Electronics from One Reliable Source
OUR 36TH YEAR

Send for FREE CATALOG

ALLIED RADIO

ALLIED RADIO CORP., Dept. 5-D-7
100 N. Western Ave., Chicago 80, Ill.

Rush FREE 1957 ALLIED 356-Page Catalog

Name _____

Address _____

City _____ Zone _____ State _____

WHERE-TO-BUY-IT INDEX

Source of supply appears after items commercially available

AUTOMOTIVE

Norway's first production car is hardtop sports model.....	86
Aluminum and magnesium keep Lotus' weight down.....	89
Three-wheeled car guided by handle bar.....	97
Jet racer "eats" gas like glutton.....	97
Willlys truck has cab forward (Willlys Motors, Inc., Toledo, Ohio)	107
Headrest for car seat.....	112
Tire cover has pockets (House of Schiller, 180 N. Wacker Drive, Chicago.)	112
Trailer hitch is easily removed (Miles Inc., 333 E. Hennepin Ave., Minneapolis 14, Minn.).....	112
You can add "feelers" to front and rear of your automobile (Sinko Mfg. & Tool Co., 3135 W. Grand Ave., Chicago 22).....	112
Car vacuum cleaner uses exhaust pipe (Witkin-Wolf Inc., 5148 W. Washington St., Los Angeles, Calif.).....	117
Rebuilt Buick becomes housecar (Paul Hagenbuch, 718 S. Veitch St., Arlington, Va.).....	118
Gold-coated windshields	132

AVIATION

Combat transport plane tries out giant skis with help of TV (Lockheed Aircraft, Georgia Div., Marietta, Ga.).....	86
Huge C-132 air transport may never leave the ground.....	88
Pusher propeller fits in plane's tail.....	107
New jet-landing method permits aircraft to stop within 100 yards (All-American Engineering Co., Box USS 2668, Du Pont Airport, Wilmington 5, Del.).....	119
Copter flight-control system (Sperry Corp., Great Neck, N. Y.)	129
Aircraft-engine test cell.....	140
Highest simulated height.....	143
Electronic reservation recorder (IBM Corp., 1933 W. Wisconsin, Milwaukee, Wis.).....	276

CONSTRUCTION

Triangular steel beam has notches for joists (Triangle Beam Co., 25 Essex St., Youngstown 2, Ohio).....	113
Portable concrete mixer (C. L. Graybill, N. 2907 Monroe, Superior, Mont.)	119
"Walking" dredge cuts drainage canal.....	133
Concrete roof to go on building (American Concrete Institute, 13263 W. McNichols Rd., Detroit 19, Mich.).....	134

WHAT'S NEW FOR YOUR HOME

Lawn mower starter.....	130
Lever-operated ice ejector.....	130
Push-button garden duster.....	130
Sash fastener	130
Folding tub-shower door.....	131
Flexible suspension rod.....	131
T-brackets make storage space in shelf and cabinet areas.....	131
Travel iron serves as automatic steam or dry iron.....	131

MISCELLANEOUS

Who ever heard of a diesel engine? (Little Engines, Box O, Lomita, Calif.)	81
"Taxi service" to a mountaintop.....	87
Infrared heating unit creates "sunshine" outdoors.....	89
Inflatable skiers' belt also an aid to fishermen (Plastimayd Products Corp., 931 S. E. Sixth Ave., Portland 14, Ore.).....	89
Elevator carries fireman up ladder.....	92
"Growth" spray kills.....	92
Fifty-men GI cooker weighs only 114 pounds.....	92
Safety valve for gas supply (George W. Franzheim, 424 Dove St., Dunkirk, N. Y.).....	92
British "fill 'er up" with methane gas.....	97
Kerosene lamp powers batteryless radio for Dutch engines....	98
Jeep shifts lane divider to meet demands of traffic (Larry Mariotti, 2329 Cottage Grove Ave., Chicago).....	98
King-size paper bags contain earth (Le Tournieu-Westinghouse Co., Peoria, Ill.).....	98
For the photo fan (Eastman Kodak Co., Rochester 4, N. Y.).....	106
Portable hoist for hunters (Hunter Mfg. Co., Box 376, Pratt, Kans.)	107
Inflatable tube floats angler (Pueblo Tent and Awning Co., Santa Fe at First St., Pueblo, Colo.).....	113
Angular blackboard challenges players (Smash, 4700 Woodland Ave., Western Springs, Ill.).....	117
Quick-start fuel made from ether (Start Pilot Corp., 258 Herricks Rd., Mineola, N. Y.).....	118

(Continued to page 76)



DON'T THROW IT AWAY

FLEX-O-FIX . . . Fixes just plain everything! Squeezes out in liquid form, dries to tough elastic rubber. Fantastic the things it does. **REPAIRS** and patches overshoes, boots, rubbers, floor mats. Makes rugs non-slip. **PATCHES** work clothing, leather jackets, canvas. **MENDS** hot water bottles, rubber girdles. **WATERPROOFS** boots. **SEALS** windshield leaks. **INSULATES** cords, terminals. 89c a tube at automotive, hardware, sporting goods and shoe repair shops or send \$1.00 direct. Prepaid.

PYROIL COMPANY, INC., Dept. PM-47
La Crosse, Wis. U.S.A. • Toronto, Canada



HAWAIIAN WIGGLER #1

WORLD-FAMOUS FISH-CATCHER

Deep runner. Effective in weeds or open water. No snag-up in pads or brush. Easy to cast. Live-action Hula Skirt. 5/8 oz. or 1/4 oz., \$1.25 each.



FRED ARBOGAST Co., Inc.
2214 W. North St., Akron 3, Ohio

FREE WRITE TODAY FOR YOUR BIG FREE ARBOGAST COLOR CATALOG—FULL OF PICTURES OF CATCHES



New 1957 SPORTABOUT CARS and GOLF CARS. Write for literature.

ESHELMAN TRACTORS LOW AS \$99

For Better Lawns and Gardens investigate Eshelman Riding Rotary Mowers, Tillers, Tractors. Advertised in GOOD HOUSEKEEPING. Thousands of Satisfied Users. Write for Free Literature.

Dept. 98
ESHELMAN,
Baltimore 2, Md.



Riding Mower \$187.50

Shipping Points: BALTIMORE • CHICAGO • RENO

Enjoy RUNNING WATER at LOW COST
Buy Water System Direct from Factory & SAVE



DuraBronze System costs little, gives "city water" service. No more hand pumping! Only minutes to install. Pumps 275 GPH. Draws from 25' well. Fully automatic, 20-40 lbs. Bronze pump, plastic-lined galv. tank, pressure switch, air volume control, pressure gauge, bronze foot valve, bronze relief valve. Fitted for 3/4" pipe, 1/4 HP. Only \$65.95 complete, or \$49.95 less motor.

Postpaid if cash with order. 1 Year Guarantee. Water supply and drainage pumps for over 60 years.
LABAWCO PUMPS, Belle Mead 8, New Jersey

NEW 14 & 16 FT. SPORT RUNABOUT KIT

Modern swept-back design for outboards up to 60 h.p. Other models as low as \$42 (Freight included). Fiberglass covering kits, marine supplies, etc.



TAFT MARINE WOODCRAFT
PM-457 • 636 39th Ave. N.E. • Minneapolis 21, Minn.

NEW MODEL 400 SIMPLEX LAWNMOWER SHARPENER

Many Exclusive Features

The NEW SIMPLEX is the fastest, most accurate straight-line lawnmower grinder ever built . . . gives you all these advantages:

- Grinds all mowers—real type, rotary, hand or power, any size.
- No dis-assembly needed, gas and oil remain in engine, support bar rotates.
- Grinding head feeds both horizontally and vertically, turns 90° for bed knives.
- Fast, positive adjustments, 4-point support on steel base with leveling screws.
- Rugged, long life construction and many other features.

Get the facts on the new SIMPLEX 400 before you buy any sharpener. Send for free brochure today



Small investment returns big profits!

The Fate-Root-Heath Company
Dept. PM-4 • Plymouth, Ohio

CAR CLEAN-UPS!

More fun - easier - with **LACO**

Action Brushes



WATER POWERED E-ZEE

TWIN SPIN
Action Brush

CONNECTS DIRECT TO GARDEN HOSE for Washing CARS WINDOWS SIDING SCREENS PORCHES BOATS ETC.

Connects directly to garden hose and gives a brilliant wash job. Twin spinning center brushes do aerated cleaning and rinsing. Soft, mar-proof, quality brushes for finest car finishes. Perfected, swivel action, leak-proof valve regulates water flow and prevents hose kinkage. 30" rubber covered handle. Brush head detaches for insertion of detergent cartridges (sample with each brush) Extension handle available \$6.95 (\$1.75 extra) length-ens unit to 6 ft.

JUST SQUEEZE & SCRUB

LAITNER'S CAR & HOME

Upholstery
CLEANER

BRUSH IS RIGHT ON THE BOTTLE



Also
WHITE WALL Tire CLEANER IN SQUEEZE BOTTLE

Squeeze - sprayer bottle generates foam; brush attached to bottle spreads foam for easy cleaning of seats, seat covers, door pads, safety belts, etc. Softens, protects, sanitizes, and stops mildew. For plastic vinyl genuine and imitation leather, carpets, matting and other fabrics. **\$1.69**

Available at Hardware, Auto Supply and Dept. Stores. If your dealer cannot supply - send check or money order direct to factory. We pay shipping cost.

LAITNER BRUSH COMPANY
2000 Brooklyn Ave. • Detroit 26, Mich.

if you have to glue it . . .



LET ELMER DO IT!

Repair or build quickly with strong **ELMER'S® GLUE-ALL**

Be a real home "do-it-yourselfer." Build this fold-away work bench easily from Easi-Bild pattern #576 with Elmer's Glue-All. It's easy to apply, fast drying. Glue-All is also ideal for dozens of other uses around the home. Bonds any porous material such as wood, pottery, paper or cloth.

Send 50¢ in cash or money order for full-size Easi-Bild* Fold-away Bench Pattern No. 576 to Elmer's Pattern Dept., P. O. Box 26, Pleasantville, N. Y.

*T. M. Reg. Easi-Bild Pattern Co., Inc.



Get a completely waterproof bond with **ELMER'S® WATERPROOF GLUE**

It's the glue that boating experts use. Apply on any joint subject to water, weather, acids or alkalis. Super bond is stronger than wood itself!



Bond plastic laminates or plywood wall panels with **ELMER'S® CONTACT CEMENT**

No clamps, nails or presses needed to do professional job quickly. Highly resistant to heat and water. Available in regular or non-flammable type to meet every need.



IF IT'S **Borden's** IT'S GOT TO BE GOOD!

The Borden Company, Chemical Division

©1957, The Borden Company

(Continued from page 74)

Air conditioner in basement ventilates 25-room building (Trane Co., La Crosse, Wis.).....	118
Robot policeman directs traffic on busy Mexican street.....	125
World's fastest typewriter.....	125
Kansas turnpike uses UHF.....	125
Lawn mower without wheels skids across turf (Moto-Mower Div., Richmond, Ind.).....	129
Electric mousetrap (Admiration Plastic Co., Box 273, Deerfield, Ill.).....	132
Horizontal cyclist rests while he rides.....	132
Superbike has a lot of special equipment (Charles E. Adams, 4740 Greenwood, Chicago).....	132
Fire cart protects ranch.....	134
Ointment bandage lasts two weeks (Dr. Glen J. Sperandio, Purdue University, Lafayette, Ind.).....	140
Two-way iron.....	140
All-weather tractor (Cockshutt Farm Equipment, 42 Main St., Irvington, N. Y.).....	142
German phono bar.....	142
Maintenance machine (Warner and Swasey Co., Cleveland, Ohio).....	142
Instrument measures the "bend" in 400 pound granite plate (Bausch & Lomb Optical Co., 635 St. Paul St., Rochester, N. Y.).....	143
Standard spinning reel fits bow (Great Lakes Products Inc., 5160 Lakeshore Rd., Lexington, Mich.).....	143
Garden of rock.....	152
Electronic typewriter (International Business Machines Corp., 590 Madison Ave., New York City 22).....	236
It may look old but it's jet powered.....	256
World's brightest lamp (General Electric Co., Cleveland 12, Ohio).....	270
Sling keeps gun at "ready" (L. G. Arpin Co., P. O. Box 284, Caldwell, N. J.).....	272
Tapes for graph making (American Chart Service Inc., 101-103 Dover St., Somerville 44, Mass.).....	272
Power-driven roller skates.....	274
Screw-on cleats (E. I. DuPont de Nemours and Co., Wilmington, Del.).....	274
Circuit-testing flashlight (A. V. Olson, 1608 N. Hollywood Way, Burbank, Calif.).....	276

SCIENCE

Silicone rubbers versatile.....	89
Measure nerve-cell voltage.....	106
Palmetto yields tannin gum (Dr. Robert B. Bennett, Chemical Engineering Professor, University of Florida, Gainesville, Fla.).....	106
Uranium detector sets off alarm (Gardiner Electronics Co., 2345 E. Indian School Rd., Phoenix, Ariz.).....	113
Underwater beam tracks whales.....	117
Electrical device for breathing.....	129
Tracker for rockets mounted on warship.....	129
Thin skin for copper wire.....	134
Scientist is "guinea pig".....	232
PM "wooden lung" saves lives in India.....	280

Radio-Television, Electronics

"Little Handy" signal tracer simplifies servicing.....	217
--	-----

Craftsman and Shop Notes Index

AUTOMOTIVE

Checking engine oil level in hot weather.....	169
Tire bead broken loose with aid of brake drum.....	180
Replacing tire on rim.....	181
Folding snack table spans car seat.....	194
Rubber-bulb windshield washer.....	196
Gauges on instrument panel supplement indicator lights.....	203
Emery board is feathered-edged for touching up auto finish.....	204

BOATS

Casters are "retractable" rollers on boat trailer.....	169
Smaller propellers restore outboard power on hot days.....	177
Broken pin from outboard reinstated for emergency.....	185
Trailer fitted with telescoping drawbar.....	203

HOUSE AND HOME

Dustpan keeps brush clean when painting picket fence.....	172
Draining window sills.....	173
Vent hood for modern kitchens.....	173

(Continued to page 78)

"You have more to say about gas mileage than you think!"



Mauri Rose

One of America's top professional drivers for over 25 years, three-time Indianapolis 500-mile winner.

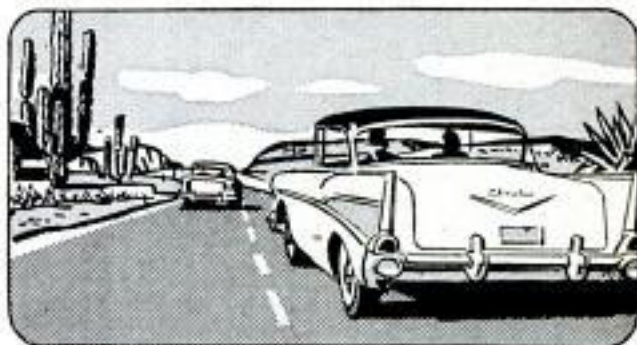

"Speed plays an important part in your car's gas consumption. Stock cars are built for peak efficiency at cruising speed, not top speed. Speeders not only take unnecessary chances, but also waste gas."

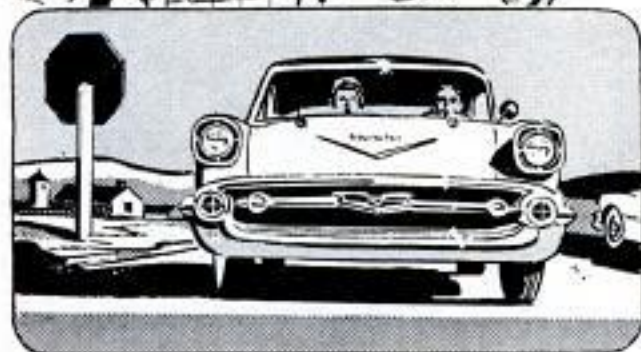

"A pro knows it doesn't pay to race away from stops. Accelerating hard in low gears eats holes in gas mileage. And it's not worth the wear on your engine... you get there just as soon taking it easy."



"And to be sure you have the final say on gas mileage, have your carburetor and other vital engine parts checked regularly by a factory-trained mechanic. Don't wait until your car starts to act up!"

When tune-up time rolls around for your car, be sure to see a Rochester Carburetor specialist. He is thoroughly trained in all phases of carburetion by GM and UMS experts. He'll give your car the kind of care that only a factory-trained mechanic can. When it comes to long life and dependable

service, he knows that Rochester Carburetors are second to none. They're precision-built for top performance on high-compression engines. And Rochester Carburetors deliver just the right mixture, at just the right time, to squeeze extra mileage out of every gallon of gas.



Standard equipment on Cadillac, Buick, Oldsmobile, Pontiac and Chevrolet.

ROCHESTER CARBURETORS

ROCHESTER PRODUCTS DIVISION OF
GENERAL MOTORS CORPORATION, ROCHESTER, N. Y.



NEW Mossberg 410 ga. top loading single shot

MODEL **173**

"Terrific! Fastest loader ever!"

"Yeah! And love that Price \$24.95"*

"And Mossberg's Top Quality"

The only single shot shotgun you don't have to "break" to re-load. Just open the action and drop in the shell. Quick as a flash, where split seconds count! Genuine walnut stock, Monte Carlo design—thumb operated safety. 24" full choke barrel. Weighs only 5½ lbs. Quality guaranteed. An unbeatable price!

Better see your Mossberg dealer today. Once he has 'em, they won't last long.
*\$25.95 west of Rockies

Mossberg
for accuracy

FREE Catalog showing all Mossberg rifles, shotguns, scopes and Covey hand trap. Send today.

O. F. MOSSBERG & SONS, INC.
79704 St. John St., New Haven 5, Conn.

NAME _____
STREET _____
CITY _____ STATE _____

(Continued from page 76)

Corrugated "platform" protects merchandise stored on basement floor 177
Footings save your foundation..... 186

SOLVING HOME PROBLEMS—

Adhesive-tape container 178
Battery filler used to water small plants..... 178
Drip cup for ice-cream bar..... 178
Cardboard mailing tube provides protection for umbrella... 178
Checking freshness of eggs..... 178
Corner irons make sturdy hinges..... 179
Candles kept dustfree..... 179
Deodorizer made from dry mustard..... 179
Emergency lubricant for electric-shaver head..... 179
Removing paint from fly screen..... 179
Scissors case 179
Shoelace-tip replacement easily made..... 179

LAWN AND GARDEN

Patio-table cover stored on window-shade roller..... 168
Starting vines on masonry walls..... 172
Lawn chair fitted with wheels eases shade-hunting task 172
Row markers from coat hangers..... 180
Tubing modifies rake teeth for cleaning lawn surface..... 196
Tricycle power mower carries rider..... 197

MISCELLANEOUS

Quill from India-ink bottle is emergency ruling pen..... 177
Barbecue pit made from tank for emergency use..... 180
Fishing-lure bag carried on trouser belt..... 181
Fire extinguisher improvised from insecticide duster..... 181
Small glass holds egg in position for painting..... 185
Eye-catching sign rocks in slightest breeze..... 190
Detachable cords on reflector save setup time..... 190
French curve is timesaver on scrollwork layout..... 190
Tape "skidproofs" paper cutter..... 194
Holes in plastic pool sealed with bandage..... 196
Oil can primes space heater..... 196
Parallel wavy lines drawn with aid of celluloid guide..... 196
Cone coil spring "snagproofs" trolling sinker..... 200
Pen-light battery fires flash bulb..... 200
Pour hole in screw-top can..... 200
Guards on heat-lamp reflectors add safety in farrowing pens..... 203
Corn sped to cribs from picker by "four-wagon" hauling system 204
Radiator elevated to protect it from passing wheel-trucks..... 204
Clothespins hold shop drawings..... 210

TOOLS

Raking and finishing tools for mortared joints..... 168
This motor drives four machines..... 201
Arbor press 211

WORKSHOP HINTS

Hammered wooden knobs have handwrought look..... 157
Plastic strip protects hubband against perspiration stains..... 157
Chalk is substitute metal polish..... 168
Guide block prevents screwdriver from marring work surface..... 168
Rubber bands combine yardsticks for long measurements..... 169
Lightweight seeder-spreader 170
Torch supplies gas for burner..... 172
Blocks under nailheads permit easy removal..... 173
Spring improves operation of worn bench vise..... 177
Chalk better than pencil for marking hardboard..... 180
Brush wrapped in wax paper need not be cleaned..... 185
Ladder transported on wheelbarrow..... 185
Coffee tables from sink cutouts..... 188
Mousetrap dispenses sandpaper..... 188
"Twinned" containers store nuts and bolts..... 188
Block helps in planing edge..... 190
Punched hole is sealed with sheet-metal screw..... 190
Glass cutter scores ceramic tile..... 194
Latch eye marks its own location..... 194
Sandpaper restores squeegee edge..... 194
Rope handles on stepladder make it easier to tote..... 195
Sturdy saw has grease-lubricated "axle"..... 195
Shower-curtain ring on belt loop used to carry hammer..... 200
Magnetic retriever on handle..... 204
Safety goggles stored in jar kept free of shop dust..... 204
Angle-bracket "legs" on motor permit universal mounting..... 210
Hinge-mounted tray keeps tools handy..... 210
Tubes supported in steady rests..... 210
Double-marked yardstick cuts end-for-end turning..... 213
Utility clamps made from steel channel..... 213
Electrical junction box makes handy small-parts tray..... 213
V-block jig for accurate cross-drilling of round stock..... 213
How would you do it?..... 214
Bicycle grip on file handle assures better control..... 216
Carburetor-idle system cleaned by using compressed air..... 216
Cellulose tape cleans magnet..... 216
Kerosene loosens frozen wrench..... 216
Mirror enables combine operator to check grain level in hopper 216

NOTICE—It is the intention of this magazine to provide its readers with information regarding the latest developments in the mechanical arts. Except where otherwise indicated, this magazine has no information as to any unexpired patents in respect of the developments reported herein. In the event that commercial use is to be made of any of the developments reported herein, it is suggested that legal counsel be consulted to avoid liability for patent infringement. It is not the purpose of this magazine to encourage patent infringement but, as indicated, it is the intention of this magazine to report on the latest developments in the mechanical arts.

How to select a paintbrush



A good brush performs better . . . wears longer . . . saves you money

 There are several qualities to look for when selecting a good paintbrush. First, see if there is (1) a full head of bristles in a firm setting. Then look closely at several individual bristles. They should be (2) finely tapered with slightly curled tips. Make sure a generous portion of the bristles have (3) tips that are split or "flagged." Finally, look for a brush that

 has (4) bristles varying in length. A brush with these qualities will give you excellent performance. It has a greater working and paint-holding capacity — eliminates excessive dipping. The brush will (5) release a finish smoothly and evenly on any surface. You save time, paint with ease, do a professional-looking job.

Now, better performance with improved TYNEX® nylon bristles

 When buying a paintbrush, look for (6) the trademark TYNEX on the handle. Quality paintbrushes made with bristles of TYNEX nylon give you better performance. They pick up a full load of paint at every dip and lay on a smooth, streak-free coat. And brushes bristled with TYNEX have durable bristles that (7) clean easily . . . rinse thoroughly . . . dry quickly — are always ready for re-use.

FREE — additional facts everyone should have on choosing and using a paintbrush. Tips on painting unusual surfaces, holding a brush, the correct painting stroke.



Learn how professional painters dip their brushes, how they clean them.

You can have this valuable information without cost or obligation. Just send your name and address to E. I. du Pont de Nemours & Co. (Inc.), Polychemicals Department, Room 65-4, Du Pont Bldg., Wilmington 98, Delaware.

TYNEX is the registered trademark for Du Pont nylon bristles

DU PONT **TYNEX**[®]
NYLON BRISTLES

BETTER THINGS FOR BETTER LIVING . . . THROUGH CHEMISTRY

Operation:

SPARK PLUG TORTURE TEST: streaming subtropical rain with the humidity as high as it can go. Nightmare conditions for any spark plug, but ACs deliver hot, high-power sparks for full service life . . . help keep engines in tune.



... quick starts, full power with humidity ranging between 90 and 100%!

Bayou country, Louisiana. Altitude: sea level or less. Humidity: nearly 100%. General conditions: wet and muggy.

It's hard to imagine a more humid atmosphere than the Louisiana bayou country, selected for the latest—and in many ways, the most trying—spark plug test AC has conducted.

In such an area, hard starting and spark plug flash-over are to be expected, yet this AC test proves that AC Hot Tips operate at full efficiency throughout recommended service life. Even under conditions such as these, you can expect full acceleration with no measurable loss of power . . . full economy with no measurable loss of efficiency!

Install a set of climate-engineered AC Spark Plugs in your car now.

- **BUTTRESS TOP**—Extra long "electrical length" of AC's buttress top insulator reduces chance of moisture-caused flash-over.
- **HOT TIP**—Exclusive AC Hot Tip design cuts spark plug fouling, which can be caused by excess moisture, to a minimum.
- **CONDUCTASEAL**—Only AC uses positive metal-ceramic seal to prevent compression leakage and power loss under the most extreme driving conditions.



KEEP IN TUNE

with a new set of

hot tip
spark plugs



Be sure to change every 10,000 miles or in accordance with engine manufacturer's recommendations.

AC SPARK PLUG  THE ELECTRONICS DIVISION OF GENERAL MOTORS

POPULAR MECHANICS

APRIL
1957

WRITTEN SO YOU CAN UNDERSTAND IT
VOL. 107 NO. 4

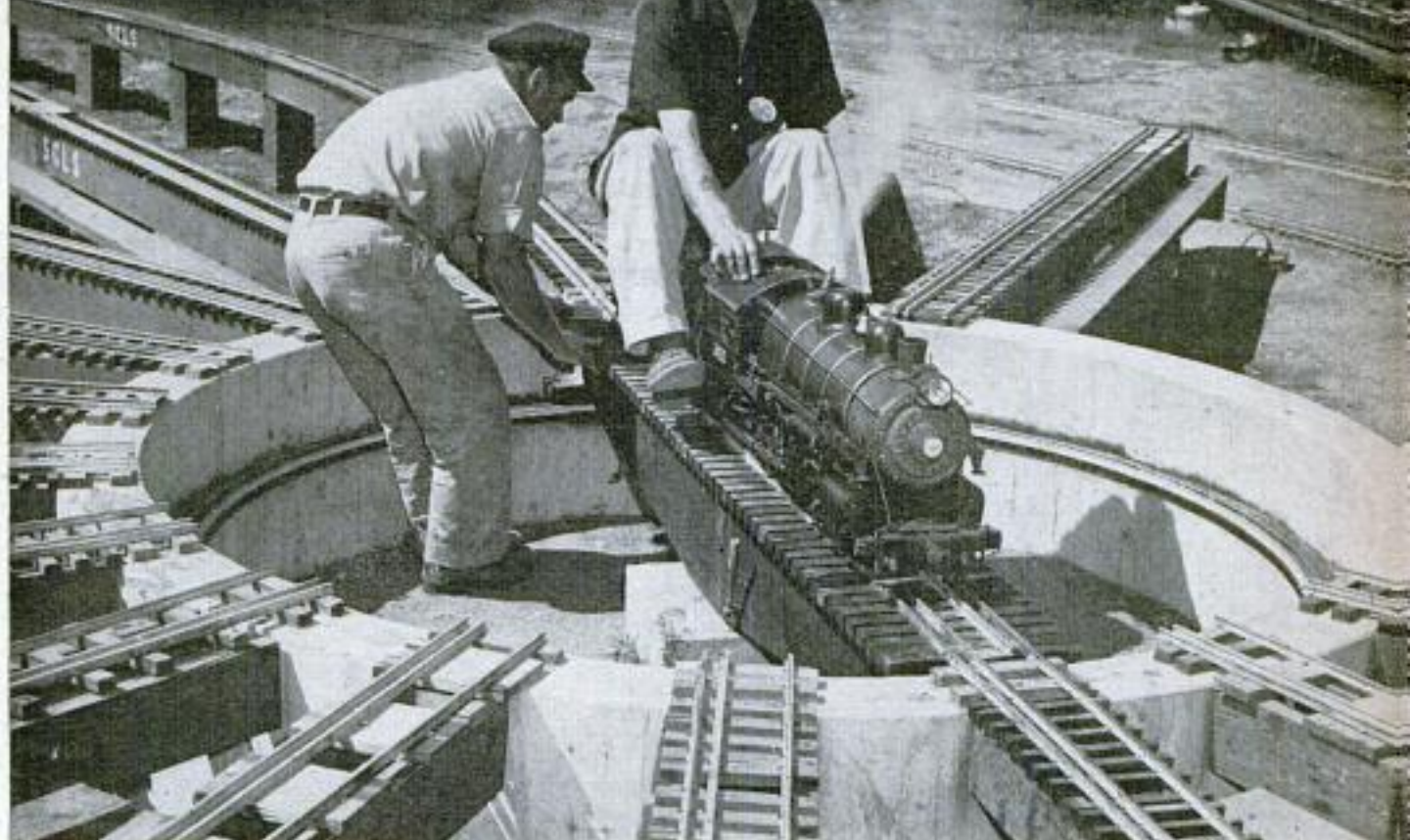

Three-rail tracks radiate from "steaming rack" with 10-wheeler on deck. Tracks fit $\frac{3}{16}$ -inch and 1-inches

Who Ever Heard of a Diesel Engine?

—Not the railroad fans, whose back-yard lines are burgeoning with snorting steam locomotives.

BIG NEWS at the Goleta Valley Railroad is that an automatic block-signal system is going to be installed along the entire line and that a tunnel is to be driven through a mountain. Seymour F. Johnson, president of the railroad, says the improvement program also includes installing a river under an existing trestle.

Instead of being a multi-million-dollar program, total costs will only

Switchman throws switch and displays flag to bring Goleta locomotive onto passing track

By
Thomas E. Stimson, Jr.

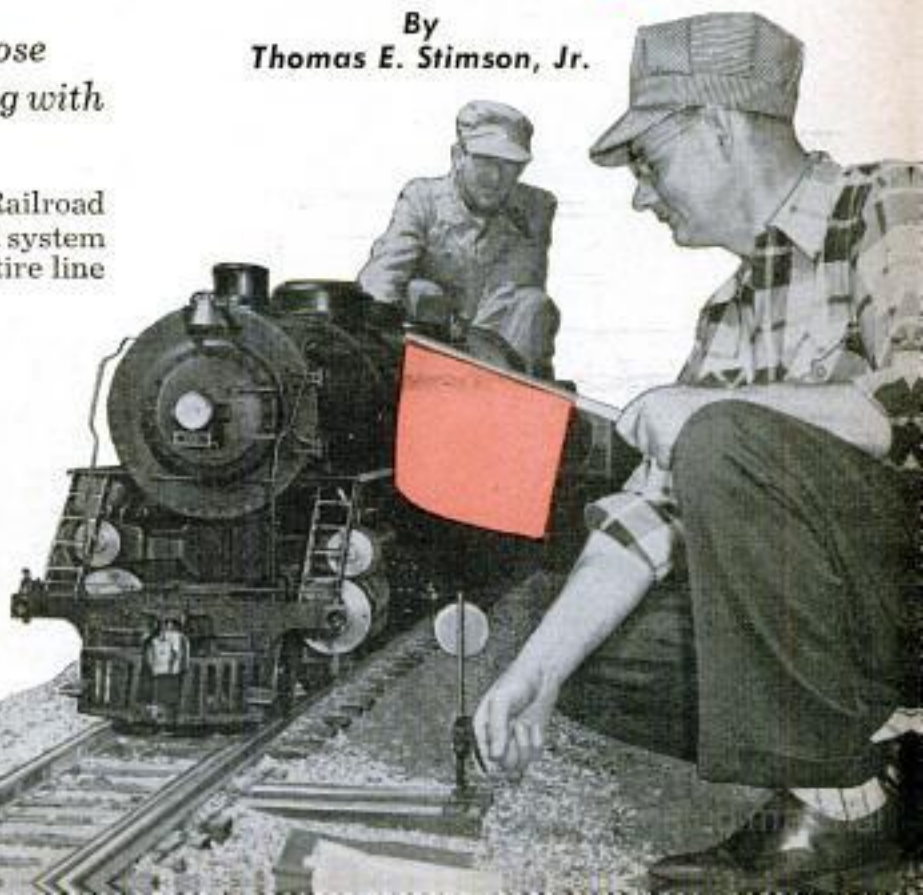

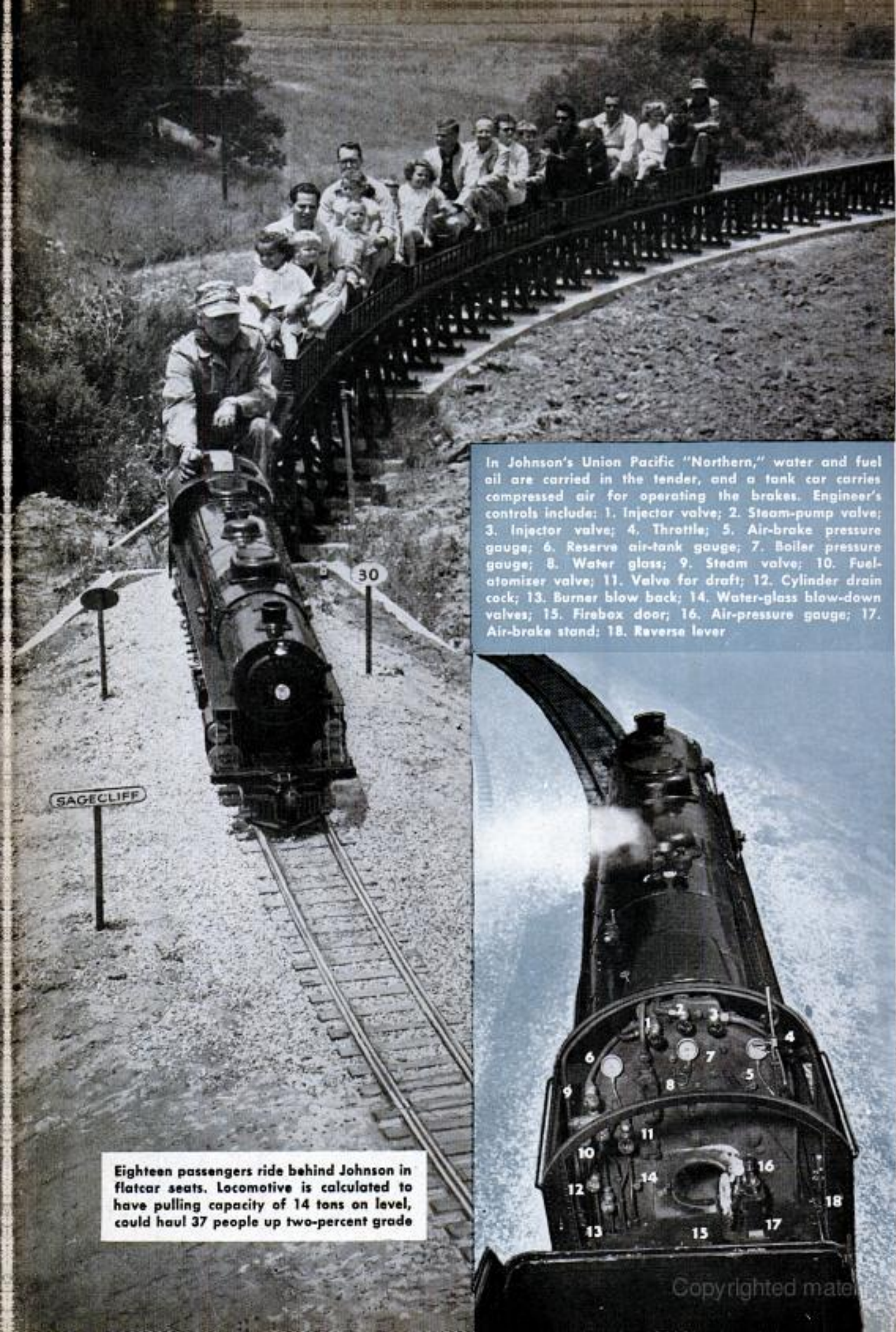

In Johnson's Union Pacific "Northern," water and fuel oil are carried in the tender, and a tank car carries compressed air for operating the brakes. Engineer's controls include: 1. Injector valve; 2. Steam-pump valve; 3. Injector valve; 4. Throttle; 5. Air-brake pressure gauge; 6. Reserve air-tank gauge; 7. Boiler pressure gauge; 8. Water glass; 9. Steam valve; 10. Fuel-atomizer valve; 11. Valve for draft; 12. Cylinder drain cock; 13. Burner blow back; 14. Water-glass blow-down valves; 15. Firebox door; 16. Air-pressure gauge; 17. Air-brake stand; 18. Reverse lever

Eighteen passengers ride behind Johnson in flatcar seats. Locomotive is calculated to have pulling capacity of 14 tons on level, could haul 37 people up two-percent grade

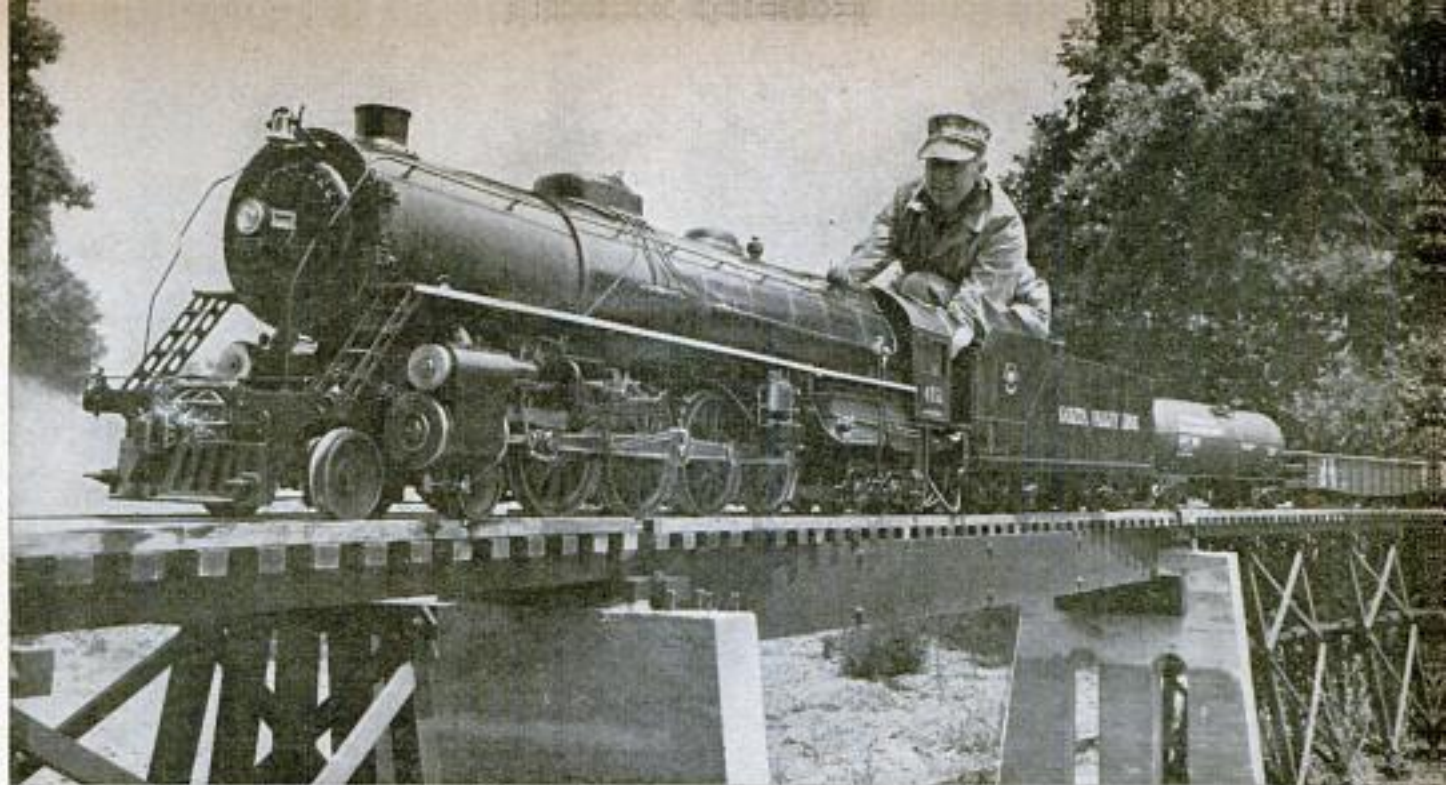

Well-built trestle carries Johnson and his big-model live steamer over picturesque section of his railroad

amount to a mere hundred dollars or so.

This railroad has only one locomotive, an oil burner of the Union Pacific 825 class, and when traffic is heavy the presidents of other nearby railroads bring over their own engines. That's why the automatic block signals are wanted. An engineer feels safer if he has a green board in front of him when several trains are operating on the half mile of track. Goleta Valley is proud of its safety record. It hasn't hurt a

passenger from the time operations began.

And it isn't likely to. Located near Santa Barbara, Calif., the railroad is a 1½-inch-scale model of a full-sized system. Its "live steam" locomotive operates at scale speeds of up to 85 miles per hour but actually this amounts to only 10 miles per hour. The engine develops 10 horsepower and is calculated to be able to pull 14 tons on level track. It can haul 37 people up a two-percent grade.

Goleta Valley Railroad meanders around Johnson's home, complete with trestles, bridges and engine house

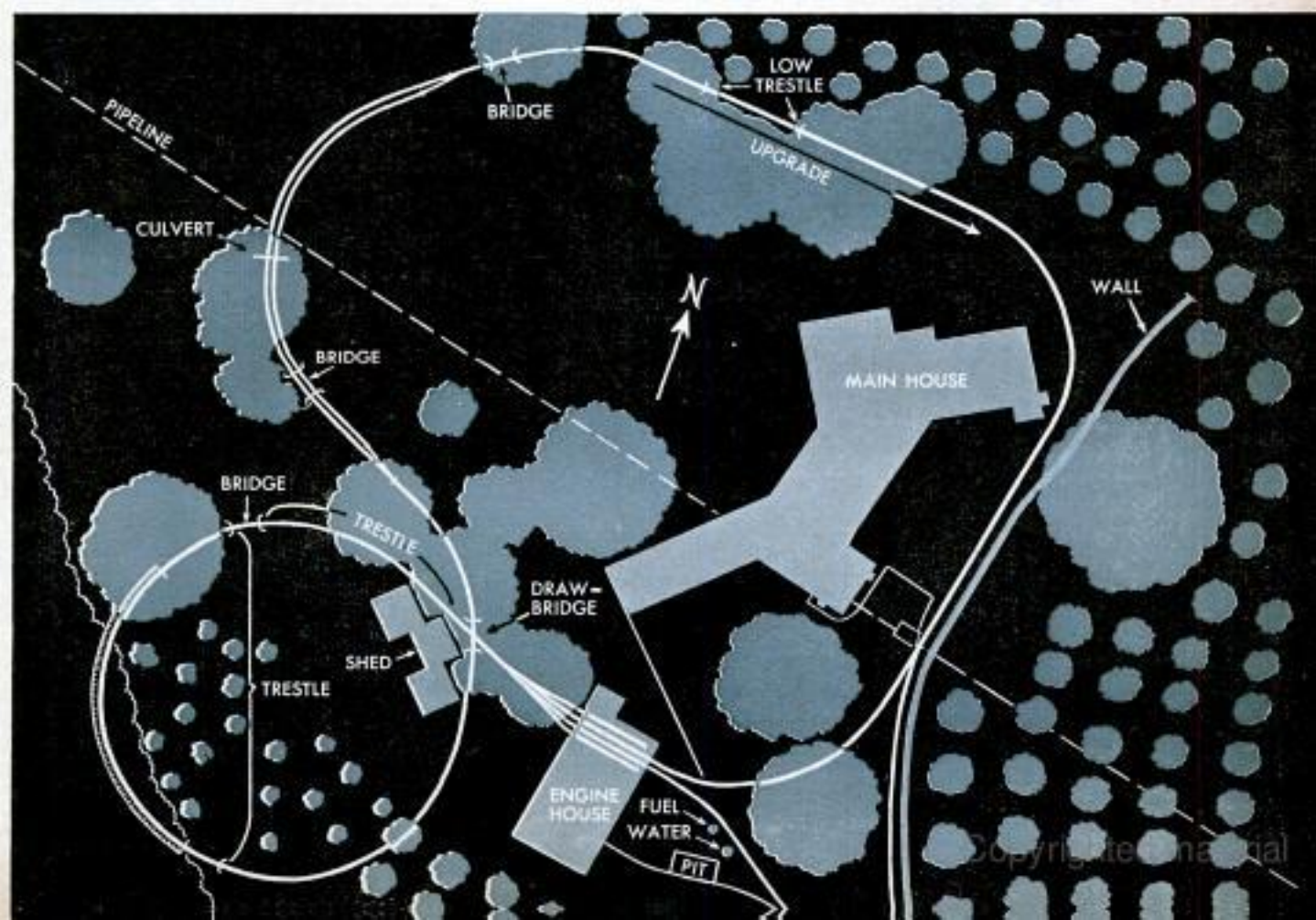

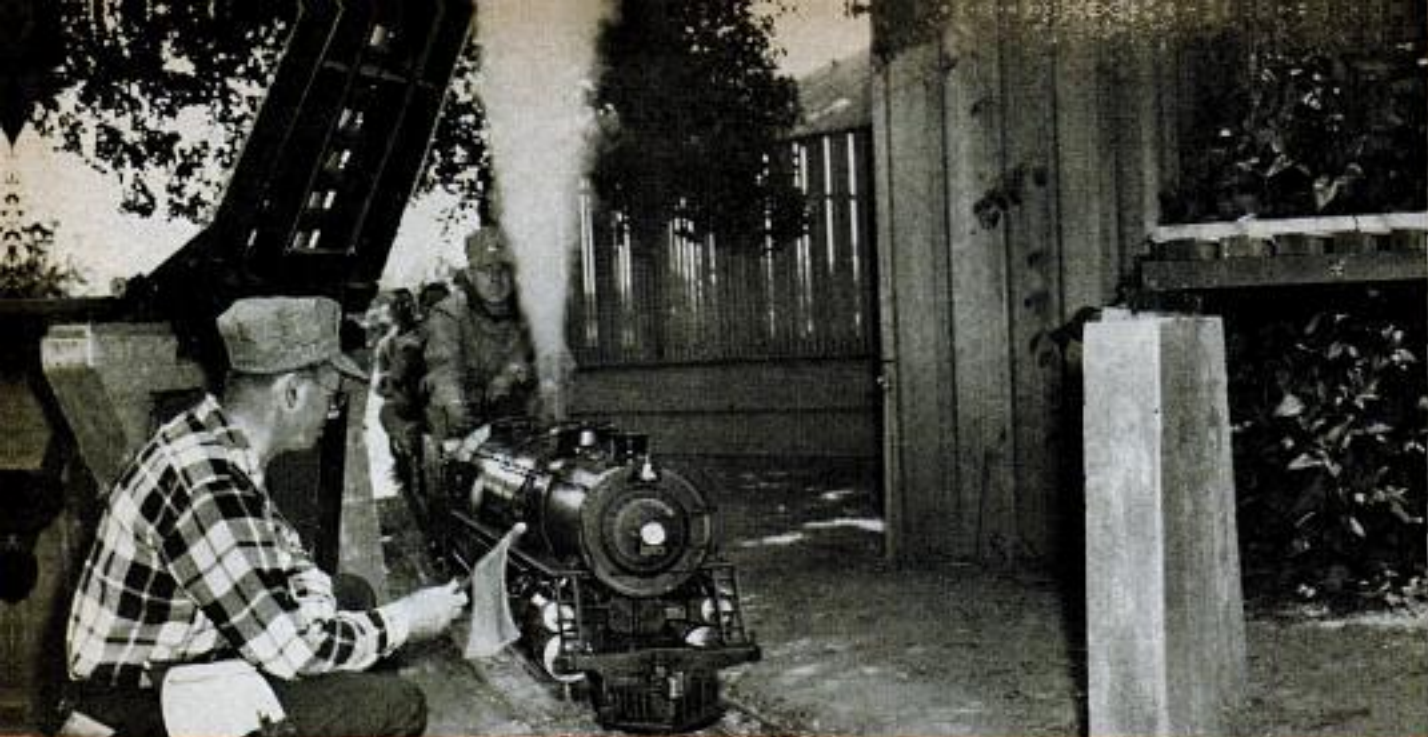

With drawbridge open, switchman gives signal for Engineer Johnson to proceed with his load of passengers. Below, live-steam fan is shown at work in his shop on a 1/2-inch-scale model. This one is a copy of a Union Pacific 4-8-4 "Northern" type of engine

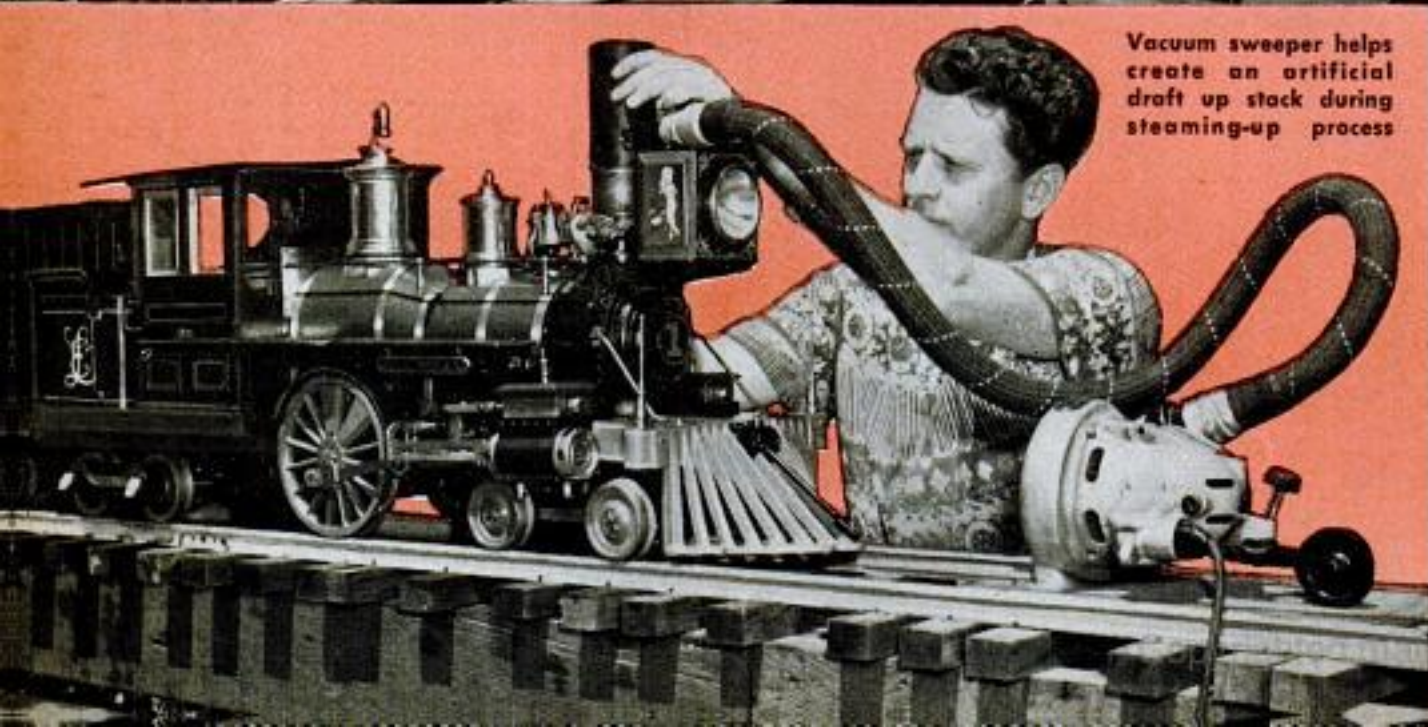
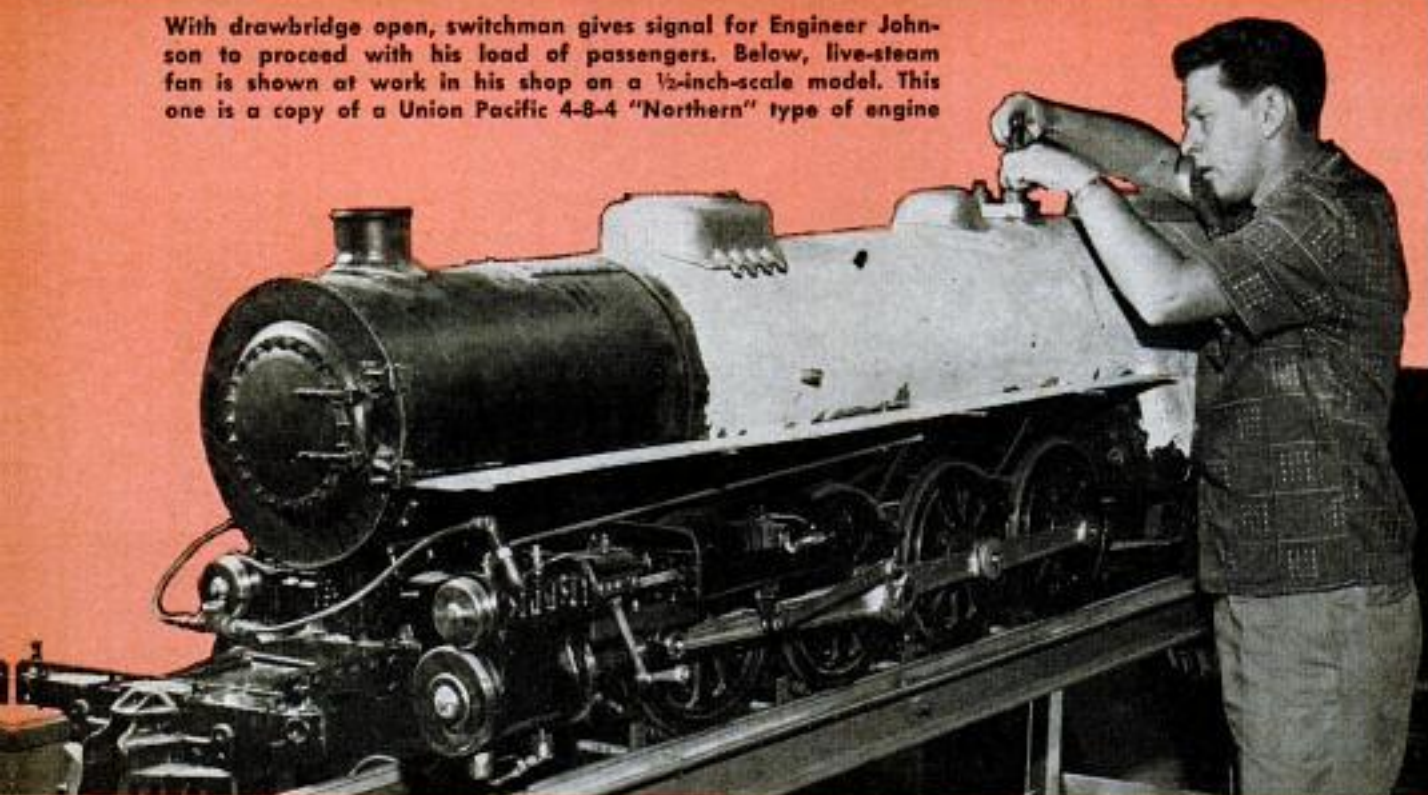

Vacuum sweeper helps create an artificial draft up stack during steaming-up process



Walt Disney hauls passengers with his scale-model live steamer *Lilly Belle* over railroad on his estate

Johnson started work on his engine in 1947 and finished it in 1951, thus by live-steam tradition the engine bears the number 4751. Building the engine was only the start, however. Next he needed a track on which to operate the live steamer and some cars for it to pull. Today he has 2500 feet of track consisting of Duralumin rails spaced $7\frac{1}{2}$ inches apart and attached by 30,000 tiny aluminum spikes to the 7500 small wooden ties in the ballasted road bed.

This track starts out by making a big loop, partly on a curved trestle and partly through a cut, returning under itself by means of a drawbridge, and continuing on across garden areas to make a big sweep around Johnson's residence.

The engine shed consists of a garage built across the tracks, with an overhead door at each end. Typical railroad water-and-fuel tanks scaled down to size are located alongside the track for servicing the engine. The track system includes a long passing track, various short trestles and bridges, and the usual railroad warning signs, informational signs and signboards that announce the approach to towns. There is a "Y" track that permits turning the engine or a train around.

A spur track runs down Johnson's entrance driveway and this is handy on those afternoons when he holds open house. While Johnson is hauling one trainload of visitors around the system, Dr. J. W. Newton and his $1\frac{1}{2}$ -inch-scale diesel switcher (powered by a storage battery at present) are making up a new train and loading

(Continued to page 248)

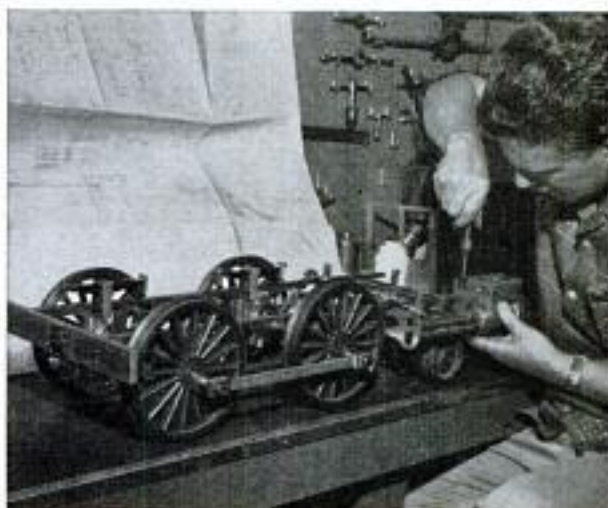

Above, assembling running gear of "American" type engine. Below, cleaning flues of an old-time engine





Wide-angle lens in TV camera shows crew how the skis are operating. Below, at left, is the boatlike ski

Combat Transport Plane Tries Out Giant Skis With Help of TV

Closed-circuit TV has helped the crew of a 62-ton Hercules propjet transport plane watch in-flight behavior of the largest skis yet fitted to a military aircraft. A TV camera mounted in a pod under a wing

transmits pictures of the skis via coaxial cable along the wing's trailing edge to a 10-inch monitor screen inside the plane. Weighing 1700 pounds each, the craft's main skis are 19½ feet long and nearly 5½ feet wide. The nose ski, turning in a 60-degree arc like a nose wheel, is 9½ feet long and 5½ feet wide. By flicking a switch, the pilot can use conventional wheels or skis for landing, depending on terrain. Individual spring suspension of forward and aft supporting arms of the skis gives both ends of the ski 18 inches of upward or downward pitch to adapt to landing surfaces; the nose ski can deflect 15 percent up or down. Wheels or skis retract without impairing the plane's 370-mile-per-hour speed or 20-ton load.

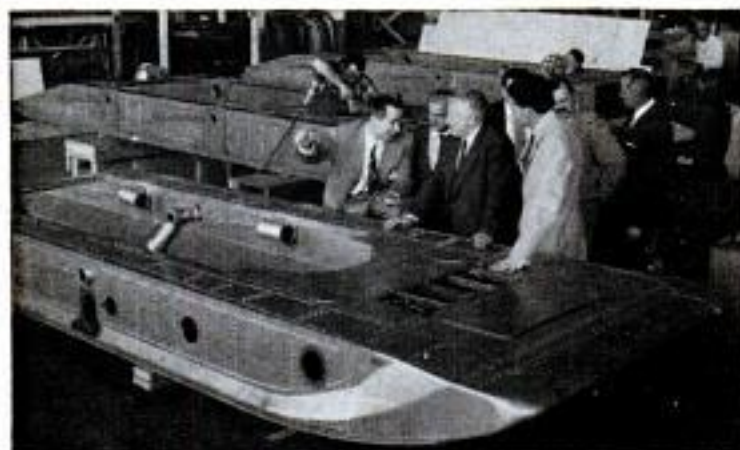

Norway's First Production Car Is Hardtop Plastic Sports Model

Norway's first production car is a sports model named "Troll," which slightly resembles the Porsche and Citroen DS-19 vehicles. To be built for export to Germany, this car eventually will be exported to other countries. The Troll has a hardtop plastic body made in Norway. Its 30-horsepower, direct-fuel-injection, two-stroke engine and chassis are shipped from Germany to Norway where the body is added. Then the completed car is returned to Germany for sale.





"Taxi Service" to a Mountaintop Furnished by Venezuelan Hotel

Resembling a huge hurricane lamp, a six-passenger cable car carries guests to a mountaintop hotel in Caracas, Vene-

zuela. The cable to the hotel is a spur of a five-mile cable-car system, one of the longest in the world.

Pressure Suit for Pilot

Wearing one "omnienvironment suit" instead of several superimposed garments, today's high-altitude pilot achieves at least five lifesaving functions. He breathes 100 percent oxygen during flight; this saves him from the "bends" in rapid climbs. The suit gives him protection against sudden low pressures and guards against heavy gravitational forces during maneuvers. When high speeds heat the cockpit, the suit provides cooling ventilation. And, if bailing out over water is necessary, the suit shields him from the cold while floating.

Concrete-Winged Aircraft

Aircraft wings of concrete reinforced with prestressed wire have been patented in this country under the name of Louis Breguet, French engineer and inventor who died two years ago. Breguet stated that a fighter-plane wing configuration of this construction differed only slightly in weight from that of a conventional light-metal wing.





Artist's conception shows the mighty C-132 as it would appear in flight with a pay load of 200,000 pounds

Huge C-132 Air Transport May Never Leave the Ground

Plans for production of a huge air transport, the C-132, able to carry 50 tons for 3500 miles at more than 460 miles per hour have diminished to the making of a wooden mockup with an uncertain future, U.S. Air Force announcements revealed. Speed, range and cargo capacity reportedly might have shortened aerial-supply pipelines to insignificance and eliminated supply storage problems at the "using end" of the line. The C-132 is said to double cargo-carrying potential of its nearest rival, the C-133, which has a wingspan of 180 feet, length of 153 feet and diameter of 16 feet. As con-

ceived, maximum take-off weight of the C-132 would have been 500,000 pounds and maximum pay load nearly 200,000 pounds. A representative pay load of 100,000 pounds theoretically would have enabled the plane to reach maximum range. Main landing gear was to have included 16 wheels arranged as two coaxial quadruple wheel units in tandem on each side of the fuselage, plus a dual nose-wheel assembly. The giant transport, using four engines with 15,000 horsepower each, was to have tremendous range without refueling. Use of current runways and ramps had been anticipated.



Radio-Phonograph Powered by Sun

Sunlight powers a new radio-phonograph unit that plays records at 16, 33 $\frac{1}{3}$, and 45 revolutions per minute. A 48-cell solar battery in the combination is activated by direct sunlight or, on cloudy days, by two floodlights held three feet from the cells. Lacking sun or incandescent light, the set is powered by six rechargeable flashlight-size stand-by batteries, which operate the phonograph for two hours or the radio for 10 hours. This sun-operated device contains a printed-circuit radio and phonograph amplifier with seven transistors. The solar battery delivers 200 milliwatts of audio-power output. Also included in the unit is a switch for adjusting the turntable motor speed to compensate for variations in the intensity of the light.

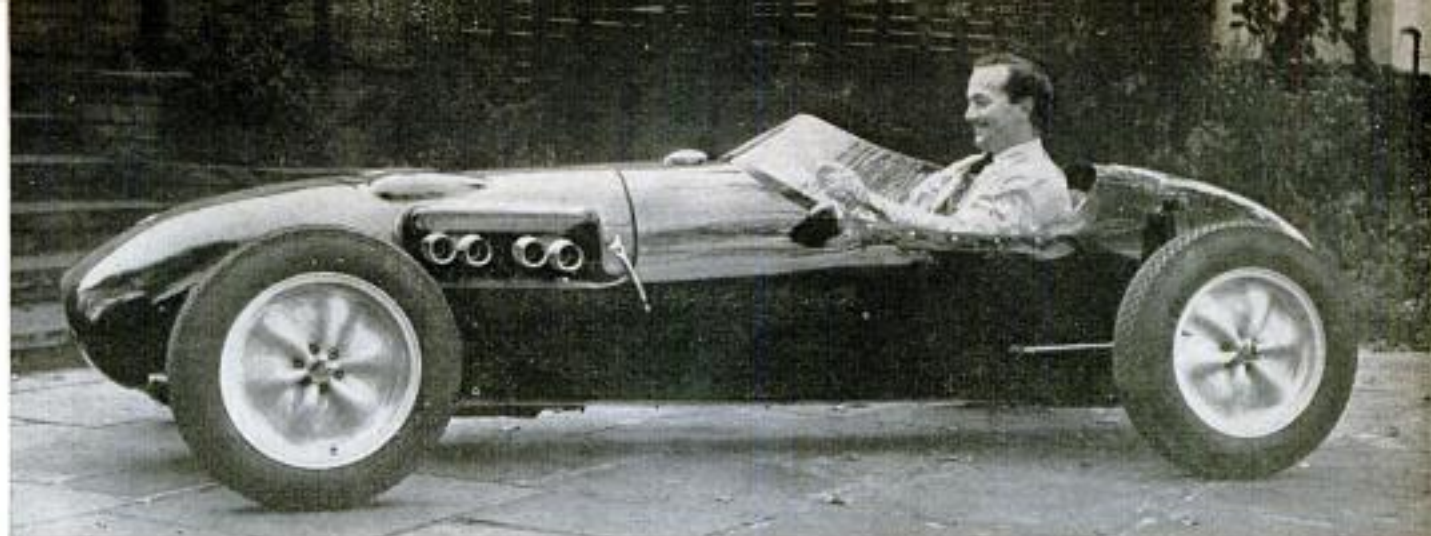

Aluminum and Magnesium Keep Lotus' Weight Down

Britain's newest Formula II racing car, Lotus Eleven, has a lightweight tubular frame, combined torsion bar and coil-spring suspension and cast magnesium wheels. The 91-cubic-inch, four-cylinder, 141-horsepower engine is aluminum and has twin overhead camshafts.

Infrared Heating Unit Creates "Sunshine" Outdoors

Outdoor enthusiasts who won't give in to cold weather will find a German-made infrared heating unit their source of "sunshine." This device operates with butane gas stored in the basketlike base of the lamp. The heater also can be used effectively indoors in the conventional sun-lamp method.



Inflatable Skiers' Belt Also an Aid to Fishermen

Water skiers who ski better than they swim can use a new inflatable plastic belt to buoy up their body and their confidence. Helpful in deep-water skiing starts, the yellow belt cushions falls and serves as a marker for the pick-up boat. The belt ties on, can be inflated by blowing and does not shrink, rot, mildew or become waterlogged. It also can be used as a seat cushion and folds into a pocket-size package.

Silicone Rubbers Versatile

Silicone rubber, once a laboratory oddity, may soon be applied to a wide variety of uses. One advantage of the material is that it is electrically conductive. It retains this characteristic after repeated flexing. Applications suggested for silicone rubber include heater pads for aircraft cameras, completely flexible heating blankets and heated rolls to warm the inks on printing presses. Because silicone rubber also dissipates static electricity, it may be used in tubing for hospital operating rooms.



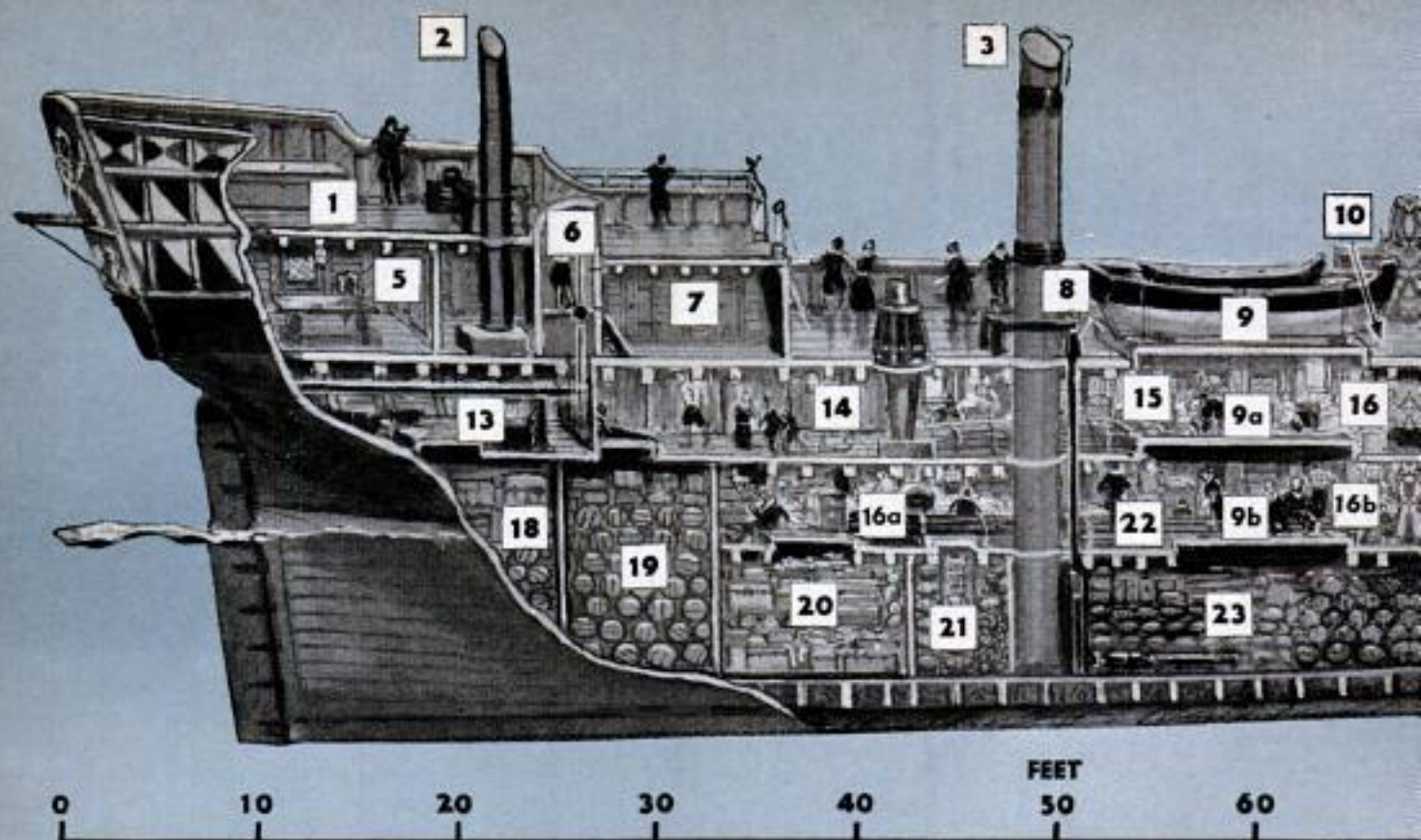

1. Poop deck; 2. Mizzenmast; 3. Mainmast; 4. Foremast; 5. Great cabin; 6. Helmsman; 7. Private cabins; 8. Pumps; 9., 9a., 9b. Main hatches; 10. Waist deck; 11. Forecastle; 12. Galley; 13. Tiller room; 14. Semiprivate cabins; 15. First hold; 16., 16a., 16b. Steerage quarters; 17. Crew's quarters; 18. Biscuit; 19. Fresh water; 20. General stores; 21. Powder magazine; 22. Repair parts; 23. Main hold; 24. Sail locker

ONCE AGAIN a *Mayflower* is braving the stormy Atlantic. If all goes well, a modern replica of the little sailing ship that brought the first Pilgrim settlers from England to America will be heading into the port of Plymouth, Mass., in late May after a two months' voyage from England.

Manned by a twentieth-century skipper and crew, the new *Mayflower* is following the same historic route traveled 337 years ago by the original *Mayflower*. In salute

Built of English oak, this 90-foot hull of the *Mayflower* will weigh 180 tons when it sails the Atlantic "again"

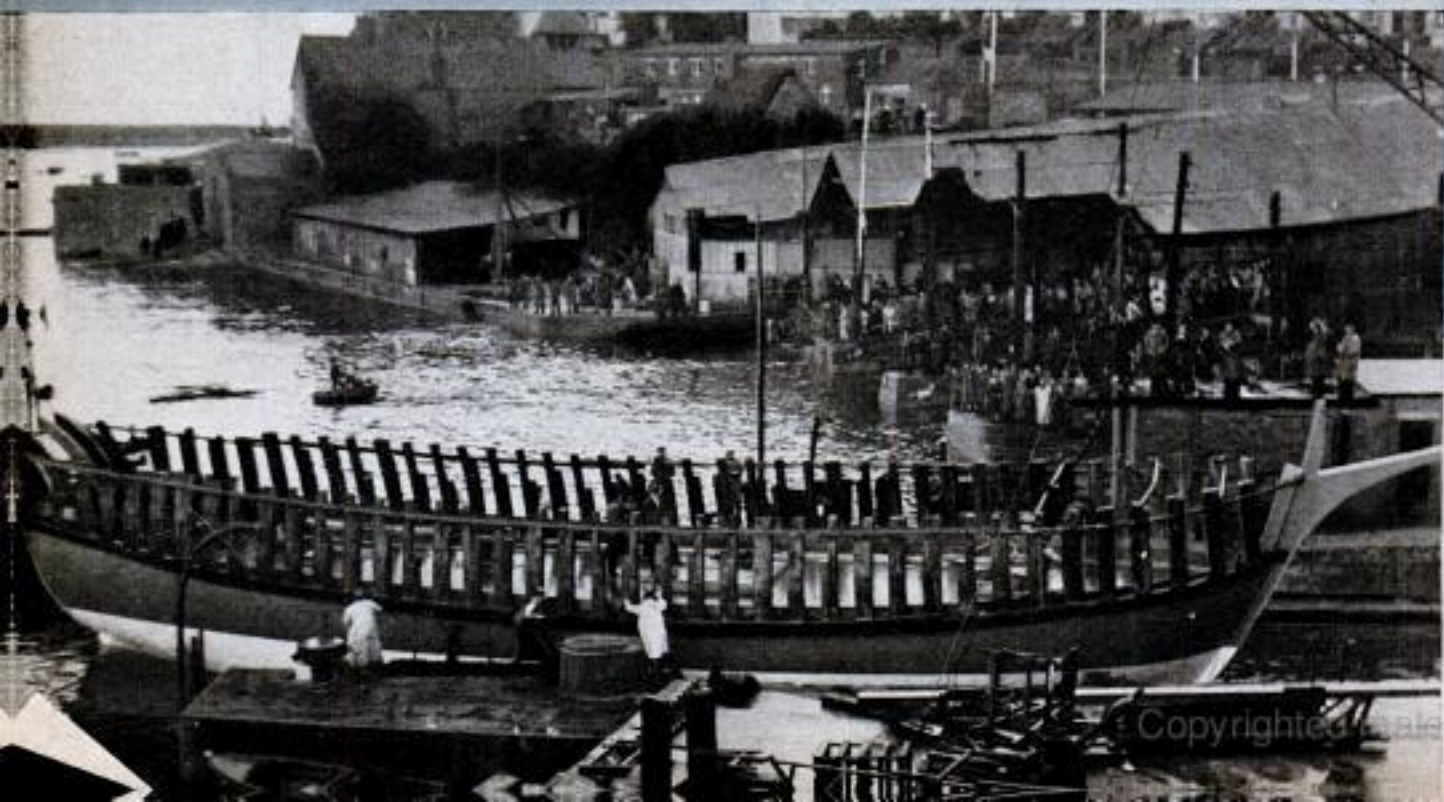

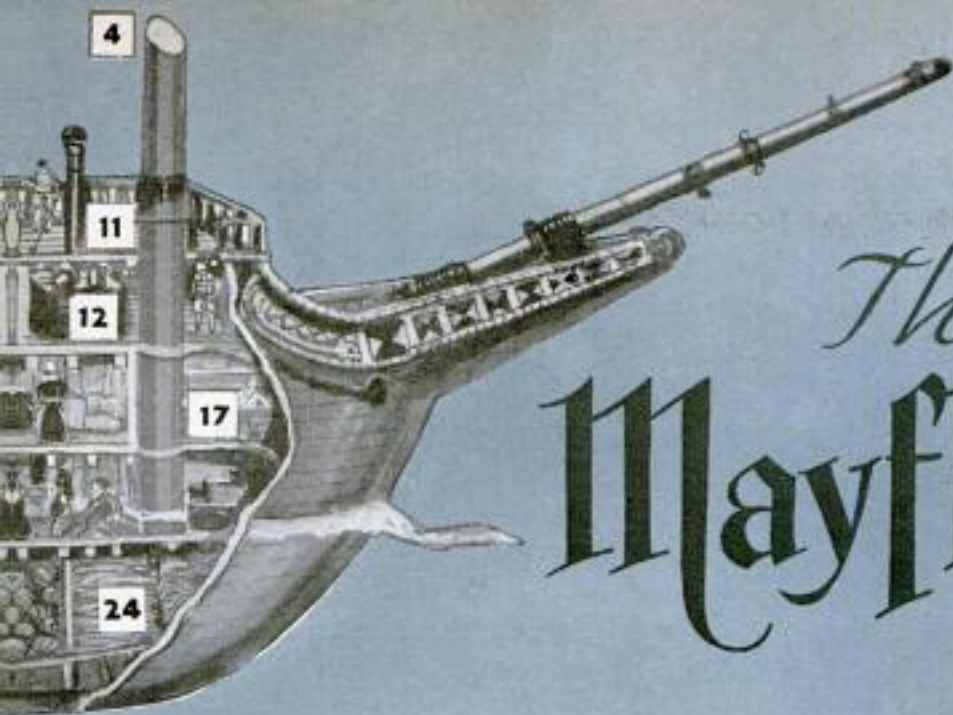

The Mayflower

Text and drawings by George H. Davis,
noted English artist

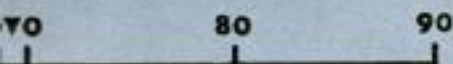

to the 70 men, 20 women and 33 children who made that historic voyage, the people of Britain are presenting the ship to the people of the United States as a goodwill gesture.

W. A. Baker, naval architect of Hingham, Mass., designed the replica from ancient records, and it was built largely of 250-year-old English oak by British shipwrights wielding tools identical with those of 1620.

Records at the National Maritime Museum in Greenwich, England, describe the *Mayflower* as 80 to 90 feet long, 24 feet wide, with a mainmast 80 feet high. Alan Villiers, Australian sailing skipper, was chosen captain for the 1957 voyage. Capt. Christopher Jones, master of the 1620 *Mayflower*, usually piloted her to European ports; an Atlantic crossing could well have ended in disaster.

Captain Jones occupied the "great cabin." There were four other private cabins, several canvas-walled cubicles, no privacy at all for most. Open gun ports, hatches and ladder passageways offered inadequate ventilation; "sealed" for storms, the ship was a hothouse. Tuberculosis spread, and half the group died the first year. ★ ★ ★

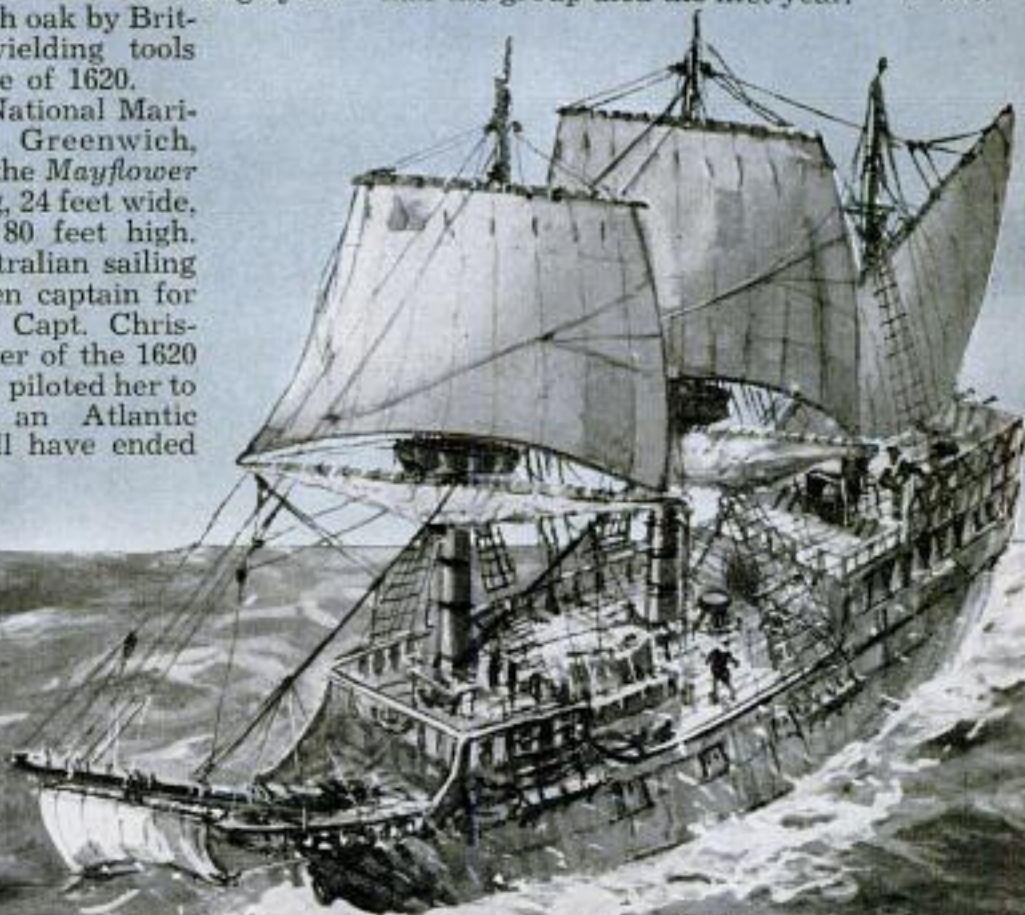



Elevator Carries Fireman up Ladder

If a fireman in Barcelona, Spain, wants to climb the department's giant extension ladder during a blaze, he waits for the elevator. Then, he stands on the platform and is taken to the desired height on the ladder.

"Growth" Spray Kills

Water lilies, strangling Florida's inland navigation and fishing waterways, are now made to "grow themselves to death" by a new spray. To supplement efforts of trucks, aircraft and airboat spraying in open lakes and streams, helicopters are laying the 2,4-D and diesel-fuel mixture in inaccessible swampy breeding pockets surrounded by high tree barriers. The new spray causes tremendous cellular growth in water lilies, ending in death and disintegration of the plants.

Fifty-Man GI Cooker Weighs Only 114 Pounds

Even the Army's field range, unchanged since the 1937 model, has been given a new design. It is a 114-pound unit that will cook a meal for 50 soldiers anywhere, anytime. Enough of the features of the old unit are retained to make it look familiar to nostalgic veterans of World War II.



Safety Valve for Gas Supply

Your home is protected from the hazard of gas explosions by an automatic safety valve. The device not only shuts off the gas in case of fire in the house, but also sets off an alarm. If pressure in the main drops dangerously low or if the basement becomes flooded enough to endanger furnace operation, the valve also shuts off the gas.



Jack's famous beanstalk must have had a shot of this fantastic chemical.

GIBBERELIC ACID MAKES PLANTS

GROW

By Clifford B. Hicks

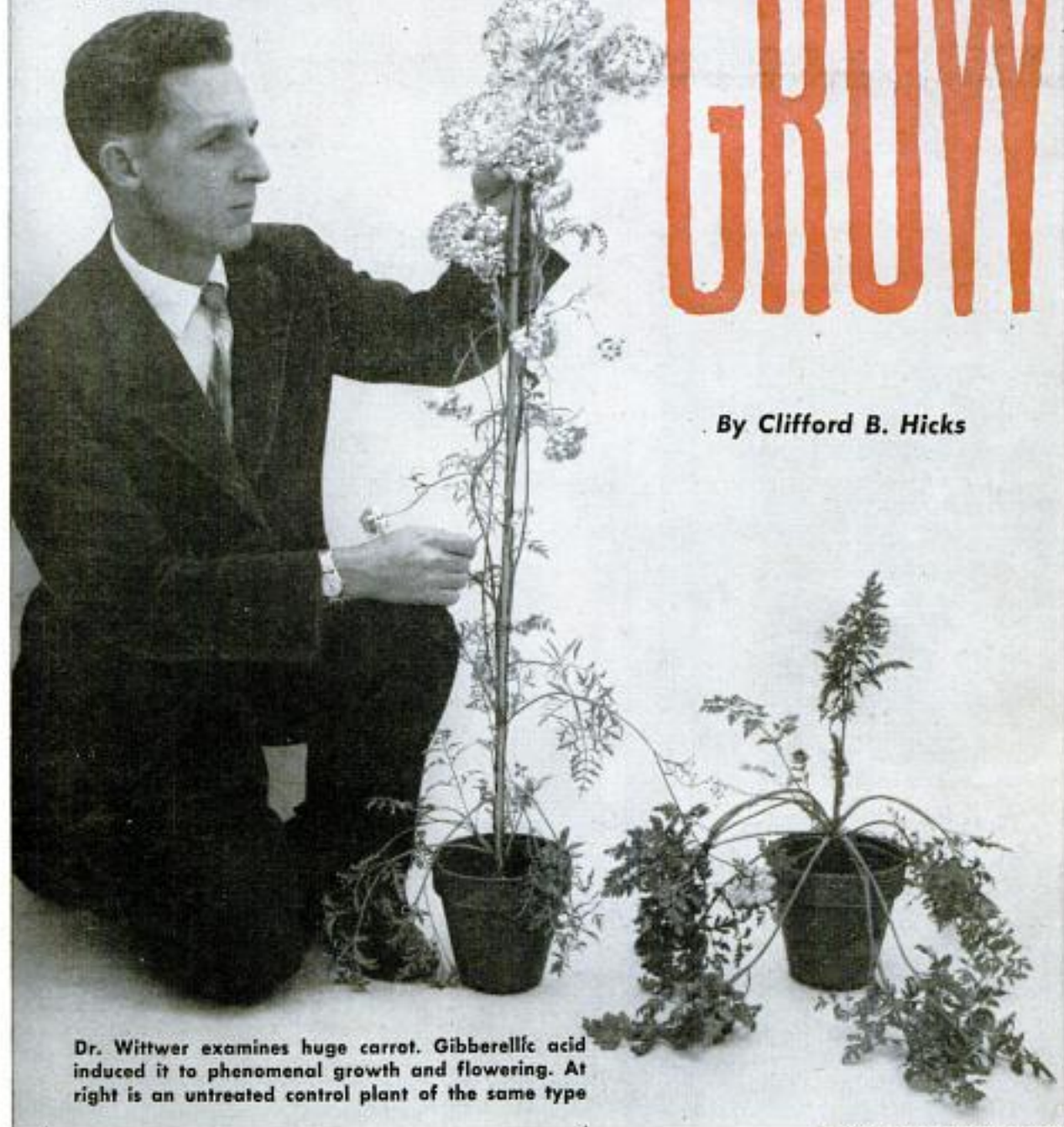

Dr. Wittwer examines huge carrot. Gibberellic acid induced it to phenomenal growth and flowering. At right is an untreated control plant of the same type

Michigan State University photo

SURPRISED BOTANISTS suddenly find themselves spang in the middle of what may prove to be the tallest science tale of the decade—and the most significant. They have discovered the magic chemical that must have spurred on Jack's famous beanstalk. It makes plants grow, and how!

The weird stuff has stimulated growth beyond belief in virtually all the plants on which it has been tried. Here are just a few examples:

Low-growing bush beans shoot up as high as the tallest pole beans.

Rose bushes and sunflowers climb up to



Michigan State University photo
Head lettuce bypassed head, shot up and formed seed. Untreated lettuce at right

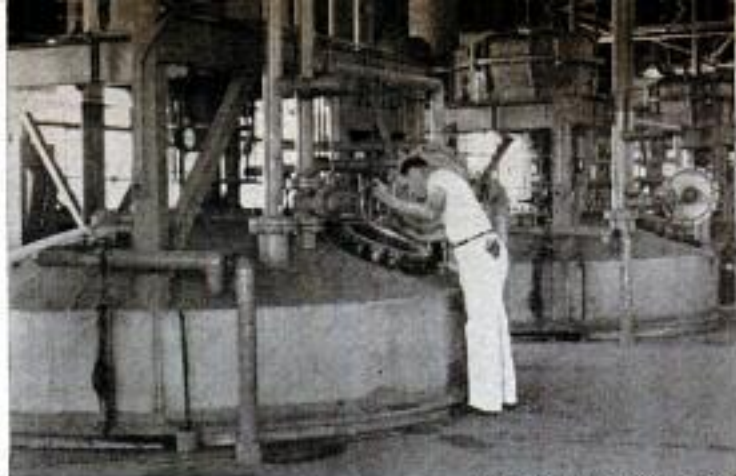

Eli Lilly & Company photo
"Ga" is produced in tanks similar to those used for penicillin



Paste containing Ga was smeared around stem of pepper plant at left four days before photo was taken
 U.S. Department of Agriculture photo

Pea seedling touched with gibberellic acid shoots up to twice the height of untreated seedling in four days

Eli Lilly & Company photos

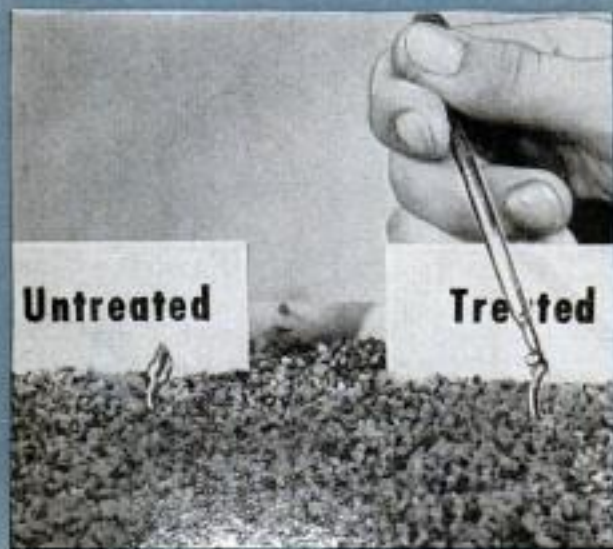

more than three times their normal height.

Geraniums grow into giants.

Soybeans grow 100 percent in a single week.

Dwarf corn, which normally grows only a foot or two high, shoots up to eight or nine feet.

Celery doubles its stalk and leaf growth.

The growth of young trees may double or triple in three weeks.

An unbelievably small amount of the chemical—a dose as small as a *millionth* of a gram—can cause a plant to grow to four or five times its normal height. Less than an ounce of the stuff would treat an entire acre of vegetables. And it works fast. Within 10 hours treated plants may start shooting up above their untreated neighbors.

To the botanist, other effects of the chemical are still more amazing. It induces some plants to flower far out of season, slashes the time required for others to produce seed, and forces dormant seeds to germinate pronto. It can persuade a "long day" plant to bloom when the days are short and a "short day" plant to blossom when they are long.

Sound like gibberish? Well, gibberellic acid is such strange stuff it has even the cautious botanists excited. So excited, in fact, that they are having trouble making up their minds what experiments to tackle next.

The story of gibberellic acid—or "Ga" as it has been tagged—starts with a diseased rice plant. For many years, Japanese farmers have been plagued with a disease that attacks their rice. The disease is called "Bakanae," which means "foolish seedling." The name was given the disease because Japanese scientists observed that diseased plants far outgrew healthy ones, shooting up to unusual and spindly heights before they succumbed. Research over a period of years showed that the disease



Michigan State University photo

Dr. Wittwer checks growth of a bean plant two weeks after treatment with only 10 millionths gram of gibberellic acid. At lower left is untreated plant



Michigan State University photo

Gibberellic acid induced tomato plants to flower in this experiment. At left is an untreated plant. The center plant received 10 micrograms of Ga. Plant at right had a 20-microgram dose and began flowering





Growth is particularly great in dwarf varieties. Dwarf corn at left shot up above untreated corn



Alternate pea plants were treated with gibberellins, and this photo was taken three weeks later. Below, this was the response 120 hours after bean plants were given varying amounts of gibberellin solution
Michigan State University photos

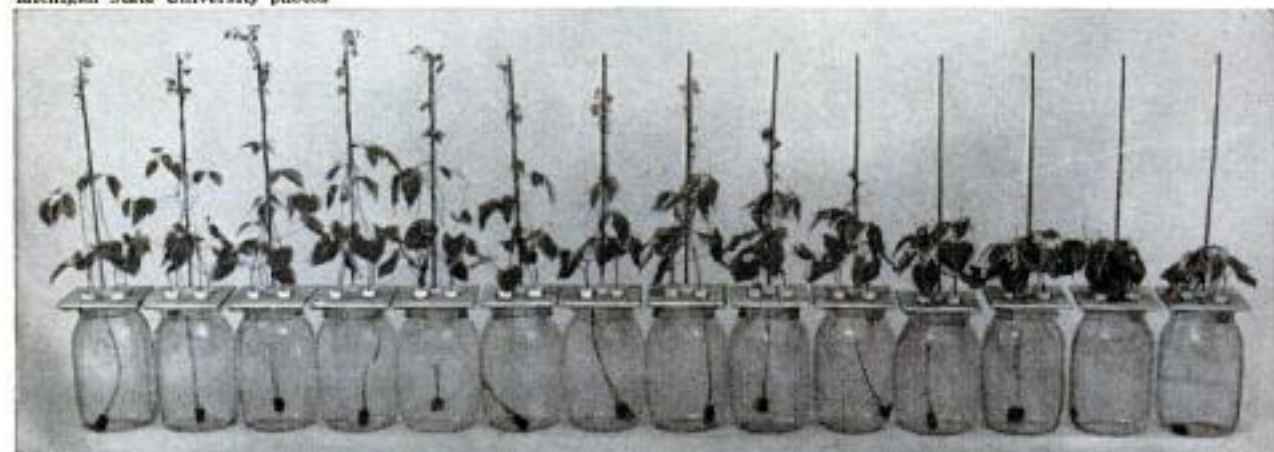

occurred only in plants infected by a soil-borne fungus called *Gibberella fujikuroi*.

By 1926 the Japanese discovered they could induce rice to grow much taller—and without disease—by applying the liquid culture in which the fungus had grown. Finally in 1938 they isolated the particular growth-stimulating substance and found it to be a colorless crystalline acid. Potent? It was amazing. One part in a million would touch off towering growth in rice, wheat, barley, cucumbers, tobacco and other plants. They named the substance gibberellin A.

Despite the steady research of the Japanese, their scientific papers went relatively unobserved in this country. Then World War II cut off all reports of their progress. Shortly after the war, British scientists began experimenting with Ga, and not long ago a few botanists in this country took up the chase.

Ups-a-Daisy Chemical

What the botanists discovered may, as a spokesman has stated, "create a plant revolution." Today hundreds of researchers in this country are trying to run down the strange and spectacular properties of the ups-a-daisy chemical.

Actually scientists have been able to pin down several different growth-stimulating substances from cultures of the fungus. Among them are gibberellin A, gibberellin B and gibberellin X (gibberellic acid). Scientists are testing all three, but Ga is receiving the most attention.

Scientists of the U.S. Department of Agriculture—among the first in this country to experiment—found that Ga would spur the growth of virtually all the ornamental plants on which it was tried. These included many of the housewife's old friends: Asters, petunias, geraniums, poinsettias, roses, salvia, sunflowers and dwarf dahlias. More important, they also discovered that Ga would double or triple the height of snap beans, soybeans, peanut and

(Continued to page 266)

Jet Racer "Eats" Gas Like Glutton

Two gallons of fuel per minute are consumed by a new jet racing car. Owned by J. L. M. Meikle of Bangor, Ireland, the vehicle has only two operating controls, the brake and the accelerator. Jet power is said to provide smooth, instantaneous acceleration to maximum speed for racing cars, plus a minimum of control devices.



British "Fill 'Er Up" With Methane Gas

Methane "marsh gas," recovered from sludge by English workers at the Isleworth, Middlesex, sewage plant, furnishes fuel for company and private cars. The gas, obtained from sludge in huge tanks heated by hot-water pipes, is drawn off and stored under pressure. Cost of converting an auto to use methane gas is reported at about \$225. The gas also provides the sewage works with power, heat and light, saving the firm 85,000 gallons of fuel yearly.



Three-Wheeled Car Guided by Handle Bar

Bruetsch Mopetta, a three-wheeler, is now in the midget-car line-up. Made in Germany, it has a 2.5-horsepower, three-gear engine, plus front-wheel drive and spring suspension. The car is guided by a handle bar in the driver's cockpit. The gearshift, brake pedal (for rear wheels), and hand brake (for front wheel) are also in the cockpit. Weighing about 130 pounds, the tiny vehicle is five feet, eight inches long, three feet wide and three feet, four inches high. The auto's chassis is only seven inches off the ground.

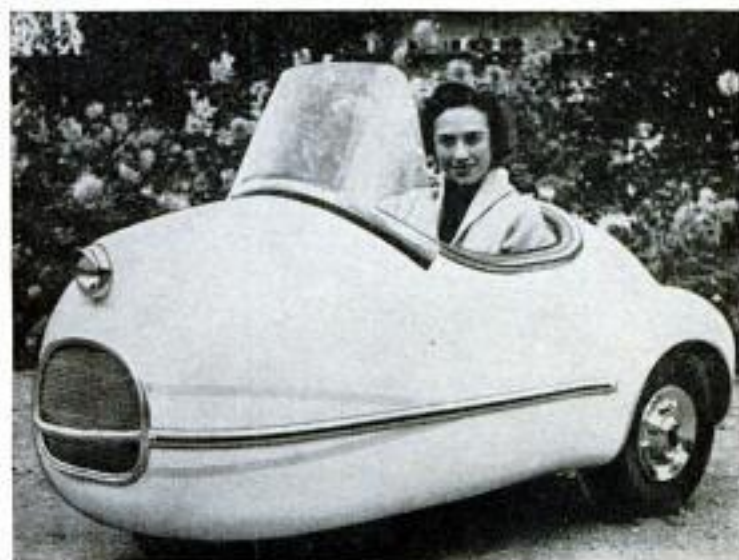



Above left, highway official shows how links fit together. Above right, Jeep driver switches lane divider

Jeep Shifts Lane Divider to Meet Demands of Traffic

Like water flowing under a bridge, a flexible traffic divider flows from one lane to another under a Jeep as it moves slowly along the street. The divider is made up of separate links that fit together to form a long, easily seen marker. As the Jeep drives alongside the divider, a two-wheeled

dolly scoops up the links and feeds them under the vehicle and deposits them neatly on the other side. With the device, four-lane streets can be made to handle three lanes in one direction during rush-hour periods. It was developed in Chicago by a county highway official.

Kerosene Lamp Powers Batteryless Radio for Dutch Engineers

Dutch engineers have mounted thermocouples on top of a burning kerosene lamp to convert heat into electricity for a batteryless radio. These thermocouples form a stack of open-centered disks made of a series of wires of two electrical conductors with different resistances. Welded end-to-

end alternately, these conductors discharge a small electric current when one end of the joint is heated and the other end is cooled. With the 2.2 volts created, seven transistors and a loudspeaker enable the radio to produce adequate room volume. The lamp burns $\frac{1}{8}$ pint of fuel hourly.



King-Size Paper Bags Contain Earthmovers

Nine paper bags concealed huge earthmoving units from curious eyes and the weather while the machinery was being shipped to a display area in Chicago. Largest of the bags was 15 by 15 by 43 feet and weighed 113 pounds; the smallest bag was 8 by 8 by 14 feet. The nine bags contained nearly a mile of 10-foot-wide glass-fiber-reinforced laminated paper. An overhead crane placed the bags on the earthmovers, which had been put on railroad flatcars. Bemis Brothers Bag Co. made the bags.

THE HEATS ON, but the corn's not popping—at least it's not popping the way it was expected it would.

Already industry leaders are revising their predictions downward as sales drag. It had been hoped that 1957 styling would hop up the market sharply. It had some effect, but not a great one.

Instead of a 6,800,000-car year, it is now expected to be a 6,250,000-car year. Some say as low as 6,000,000.

What's the reason? It is possible that dealers are finding it more to their liking to sell 10 cars at a decent profit than 15 cars by cutthroat discounts. Last year's circus may have taught them something.

Maybe warm weather will stimulate sales. That's the industry's hope.

Biggest drop seems to be in the middle-price models although Dodge and De Soto are doing well, they say. Imperial is in good demand as are big Chryslers. Cadillac and Chevrolet are doing best at GM, then Pontiac, followed by Olds and Buick. Mercury is not setting records as of this writing.

One explanation of the drop-off is that low-price cars are so lush, marginal buyers are moving down from middle-price lines.

If there is a big drop in this field, it will bring furrows to foreheads at Edsel Division, out to sell over 200,000 cars in that price class next year.

More Air Springs?

Don't expect the Edsel to look like a Ford or a Mercury, although it will have interchangeability of some under-the-skin parts. Richard E. Krafve, Edsel's top man and a former Mercury executive, remembers well when Mercury was just a "big" Ford and he's supersensitive to look-alikes.

Edsel may have air suspension in limited models, but it is not expected to be ready across-the-board by announcement time. Edsel needs a bombshell to start off its sales campaign and air suspension may be it. Look for spectacular styling of such parts as bumpers and grille.

L. H. Middleton, top engineer for Auto-Lite, states there will be no radical electrical changes in 1958. But, he says, by 1960 all accessories may be electrically operated. This would require a generator output several times greater than today's. Perhaps the automatic transmission (which, after all, rotates like a big generator) may supply alternating current of high voltage. Or an auxiliary electrical supply like those used on buses might be the answer.

A central hydraulic system, he predicts, will be introduced by some American maker in 1958 (is this Edsel's bombshell?).

Somebody's thinking fast at American Motors. After gloomy speculation about

Detroit Listening Post



By Art Railton

Hudson and Nash at the stockholders' meeting it is reassuring to learn that the big cars will have station wagons in 1958.

Hudson-Nash volume is not enough to pay for the all-new tooling this would require. It could be that the Rambler shell will be adapted to the longer cars. Doing this would solve a big AM problem: Its parts inventory for three cars would be reduced sharply, bringing promised economies in production costs.

If this is true (and it's only a guess), it means that Hudson-Nash will be all-new for 1958 at a bargain price to the company. Look for tailfins (sedate not spectacular) and four headlights on all AM cars—the in-a-grille-headlight idea seems dead.

More Small-Car Talk

A financial paper said Studebaker-Packard may make a small car retailing for under \$1800. Don't expect anything like that out of South Bend for years. At this time there are no prototypes of such a car and from prototype to production is a long way in fact if not in the dictionary.

Another rumor is that Volkswagen is going to restyle for 1958. It can be said with certainty that this is not true. With buyers standing in line for the little car in 114 countries, VW feels it would be foolish to step onto an expensive restyling treadmill. It will not restyle for 1960 either. ★ ★ ★

DAYTONA NASCAR SPEED RUNS

You've heard many claims about Daytona. Here, for the record, are the fastest two-way averages (miles per hour) by each make:

Chrysler 300C...134.108	Oldsmobile127.074
Pontiac131.747	Plymouth126.205
Chevrolet131.076	Mercury125.567
Buick130.766	Ford
Ford (super-charged)130.058	(not blown)...125.239
Cadillac113.780	
Dodge D500129.753	Lincoln110.565

Many, if not all, of the above cars had special high-speed equipment. Here are top speeds of three sedans without modifications. They had automatic transmissions, single carburetors, standard cams and suspensions:

Chevrolet118.460
Ford111.836
Plymouth110.328

A Round Table Conference Looks at THE ATOMIC AIRPLANE

Taking part on this panel are three of our country's leading experts in the fields of nuclear physics and aircraft design:

Dr. Lyle B. Borst, chairman of the physics department, New York University; Mr. Frederick K. Teichmann, assistant dean of NYU's College of Engineering; and Mr. Lee A. Ohlinger, radiation expert and head of the computer center, Northrop Aircraft, Inc.

QUESTION: Recently we've been hearing about nuclear-powered planes that will fly 80 times around the world without refueling, carry hordes of passengers to remote places at supersonic speeds, pull trains of gliders all over the skies. In your opinion, will the atom plane be capable of these things?

Dr. Borst: Some recent guesses are plausible, but they'll hardly be combined in one package. Certainly not in the first nuclear aircraft. The first problem will be to get one off the ground.

Question: What is your best estimate of when we'll see A-planes flying?

Dr. Borst: Ten years is a realistic estimate of the time it might take to put the first atom-powered plane in the air. That plane probably will be a long-range bomber. At best, it may be the prototype for a cargo ship that could ferry supplies to some far-off, roomy place, like Antarctica. But it will be a long time—maybe 20 years after that, as a grab-bag guess—before any kind of commercial nuclear aircraft will be economical and safe enough to fly passengers.

Mr. Ohlinger: I would estimate from 3 to 10 years for the first atomic plane. Technically, it should be possible to build a

Artist's conception of a delta-wing atomic plane places two reactors near center and crew atop tailfin

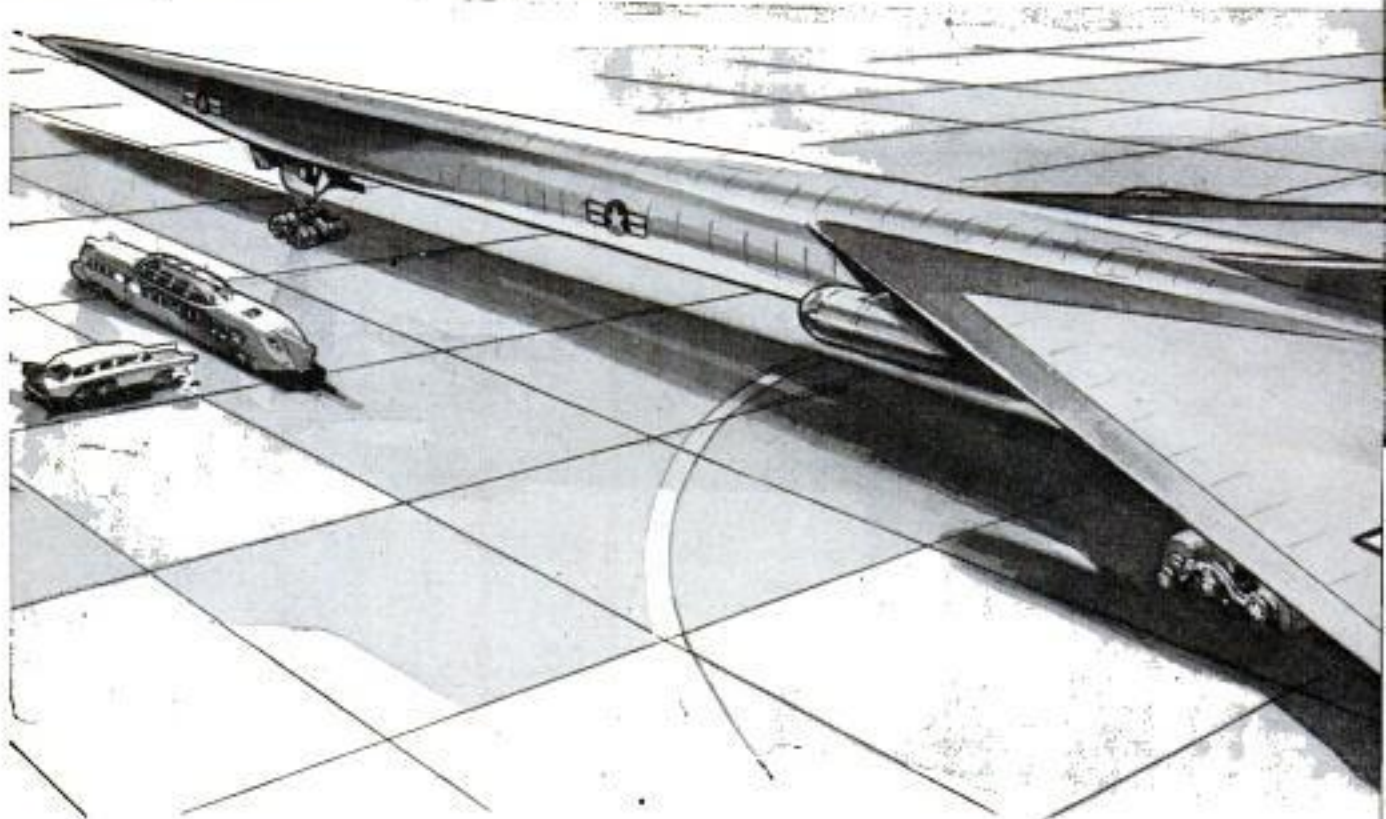

safe nuclear-powered commercial plane in 10 years, if the economics were favorable.

Question: Can you give us a general description of what the first nuclear-powered plane might look like?

Mr. Ohlinger: From outside, it probably will not look vastly different from a conventional plane. The most desirable place for the crew is in the nose and, since the crew should be as far away from the reactor as possible, the nose may be exceptionally long. It can be offset by "heavying up" the shielding. The reactor and shielding will be heavy enough to bring the plane into the 250,000 to 500,000-pound gross-weight class. So, the size of a normal fuselage (such as in the XB36H, where the fuselage is around 13 feet in diameter) will be plenty large enough to hide the reactor and shielding without special bulges.

Hot gases from the reactor to the jet engines must pass through ducts where heat loss can occur, so it will be desirable to keep the power plants close to the reactor. Therefore, all of the power plants will be clustered close to the fuselage and not out on wing pods.

Finally, if we are to take advantage of the unusual "endurance" and high-speed characteristics of the nuclear-powered plane, we can expect the same problems we face in high-speed combustion-powered



Above, F. K. Teichmann's work includes research on landing gear, high-lift devices and hulls. Below, Dr. Lyle B. Borst adjusts his "pickle-barrel reactor"

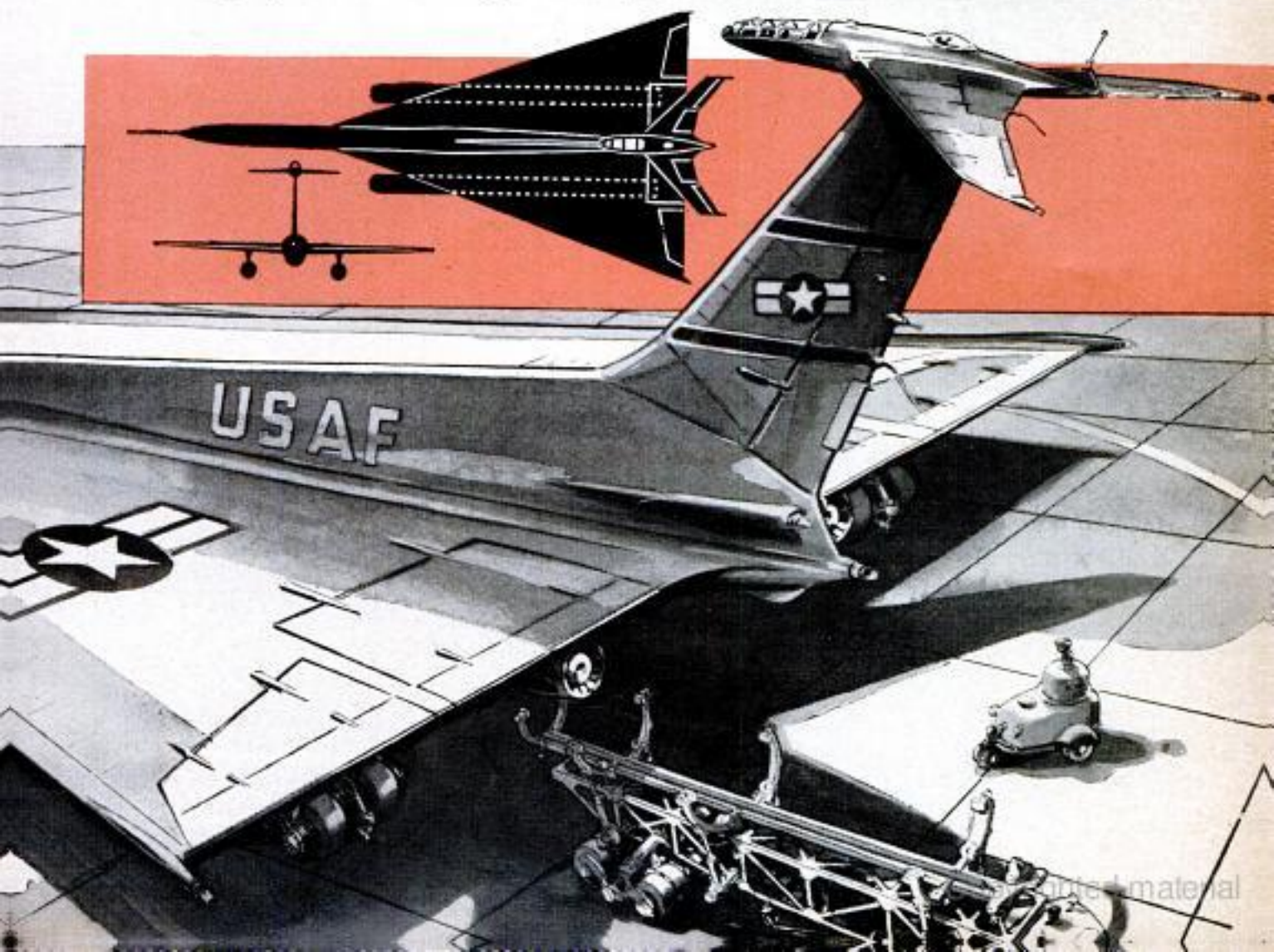

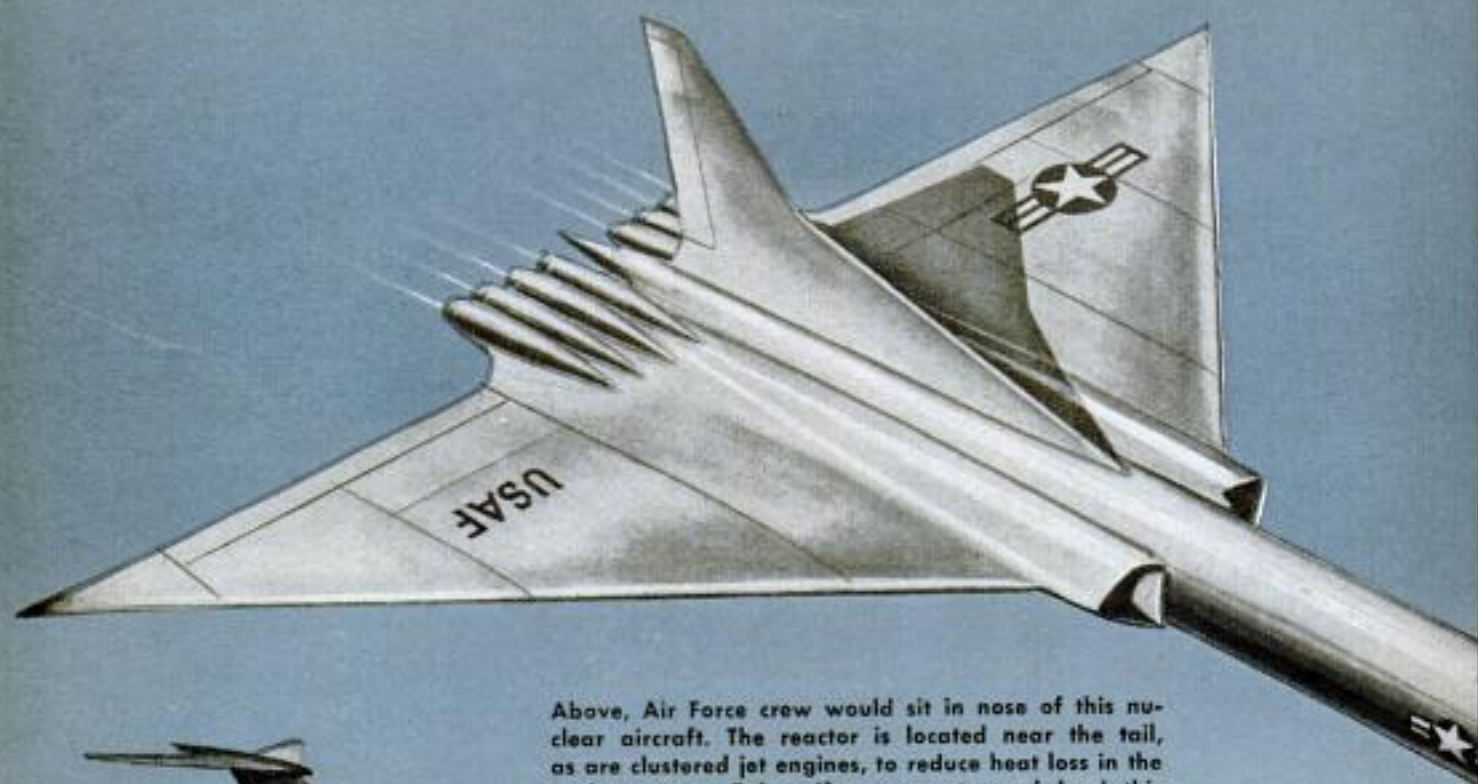

Above, Air Force crew would sit in nose of this nuclear aircraft. The reactor is located near the tail, as are clustered jet engines, to reduce heat loss in the nuclear system. Below, if necessary to crash land, this flying boat could "bury" radiation hazard in water



planes—aerodynamic heating and protection of such vulnerable parts as, for example, the windshield.

Question: What is the biggest problem in the development of the plane?

Dr. Borst: Shielding is the paramount problem. One can build jet planes that will work; one can build a reactor that will provide the heat and the power. But whether one can put a suitable shield around the reactor is the big question. Research reactors generally have shields between 5 and 10 feet thick. They are all made of concrete with special ingredients, which makes the concrete both very strong and very heavy. But these massive shields run up to 200 tons, which is much too heavy for an aircraft. So newer and more dense materials will be used.

Question: Can you give estimates on the size and weight of an airborne reactor?

Dr. Borst: The reactor could be a three or four-foot sphere. It would contain uranium, probably a moderator to slow down the neutrons, and would require a cooling system which would have to be large and elaborate. Taking that much heat out of a three-foot sphere is a difficult job. That combination would perhaps weigh a few tons. Then we would need pumps to circulate the cooling material between the reactor and the jet engines. That would take a few tons. Then, if you put a shield around the reactor, the total power package runs close to 50 tons, and would probably have a diameter of something between 10 and 15 feet. There might be a little more shielding in the direction of the crew.

Right top, atomic bomber would carry fighter escort to enemy territory, where escort would be released. Right bottom, Lee Ohlinger of Northrop Aircraft holds sketch of future atomic-powered seaplane

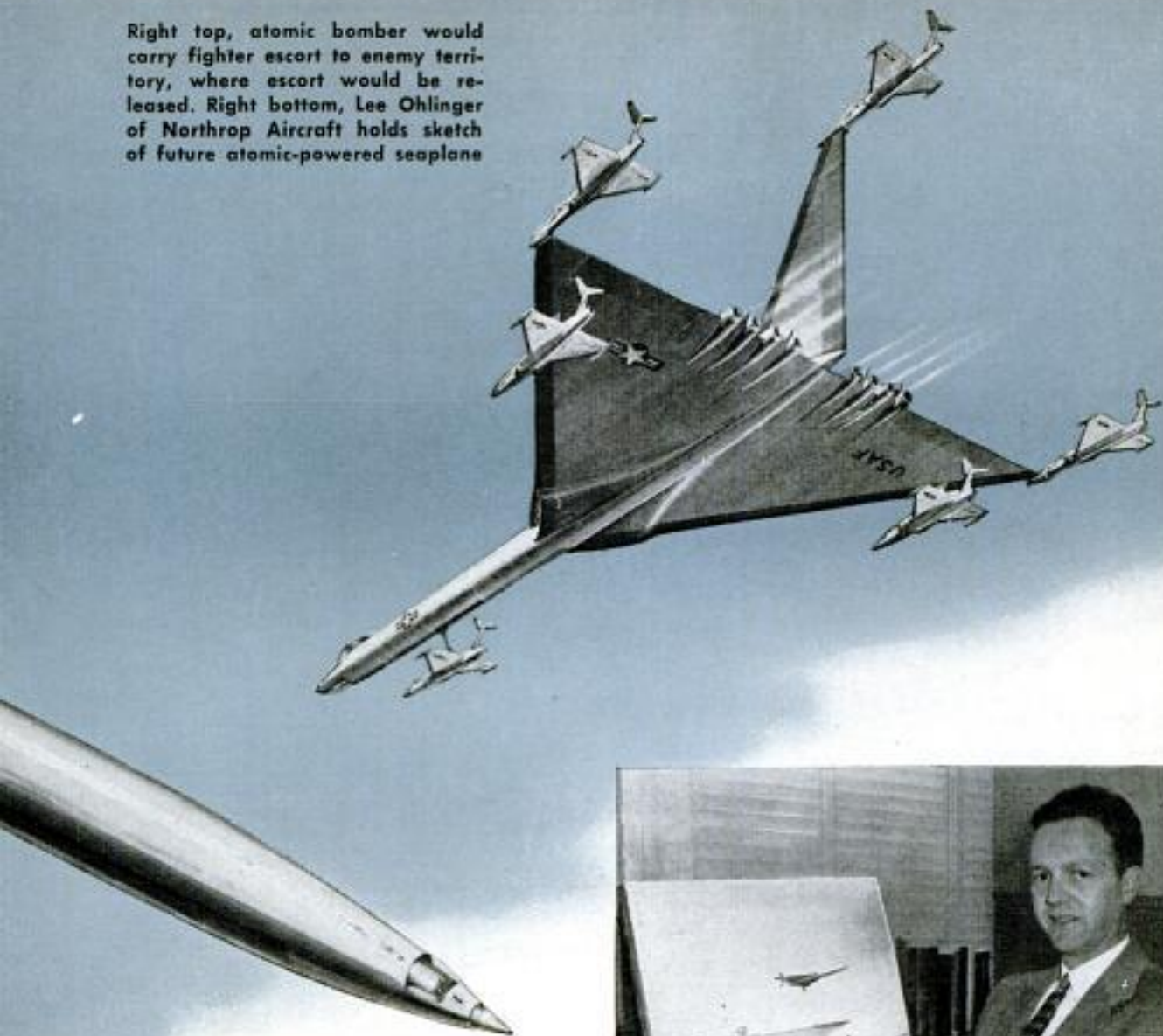

Mr. Ohlinger: I would bet it's more likely to be cylindrical, to facilitate getting out the heat.

Question: Will the shielding problem dictate any unusual features in the crew's quarters of a nuclear airplane?

Dr. Borst: To minimize shield weight, there would probably be an advantage to putting part of the shielding at the reactor, and part around the crew. Since the crew wants to be as far from the reactor as they can get, the plane would be built to get them far away. And crew quarters would have to be as small as possible to minimize the weight of the crew shield. So, one thinks sometimes about what is practically a flying arrow, with the reactor near the tail feathers and the crew near the arrow head. One would probably not want to use a crew of more than three and they would be very confined; they would not have walkways, galleys, bunks or anything like that. We may be going back to the very

old planes, where you had tandem cockpits.

Question: How far from the reactor will the crew have to be?

Mr. Ohlinger: This is related to the amount of shielding around crew and reactor. The farther away we put the crew, the more fuselage is required. Therefore, we must balance the additional weight of fuselage against the weight of shielding required if the fuselage were shortened, and make some compromise. Reaching out into the blue, one might guess the separation distance at not less than 20 feet nor more than 100 feet.

Question: Is there any advantage in having the crew's cabin in a wing tip, or the tail fin as you have proposed, Mr. Ohlinger?

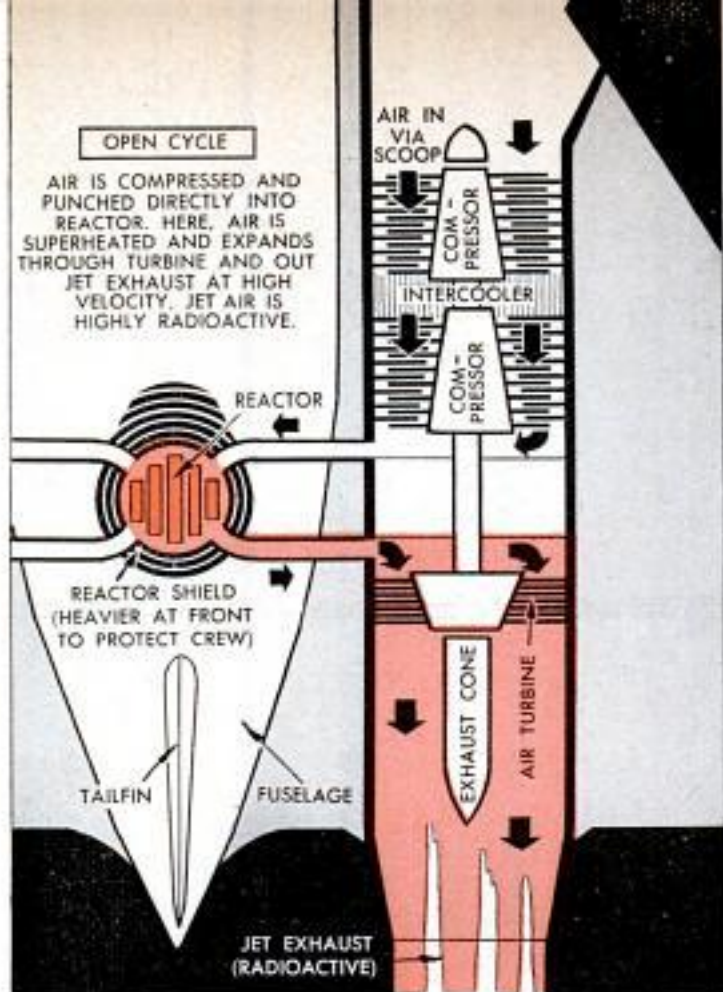
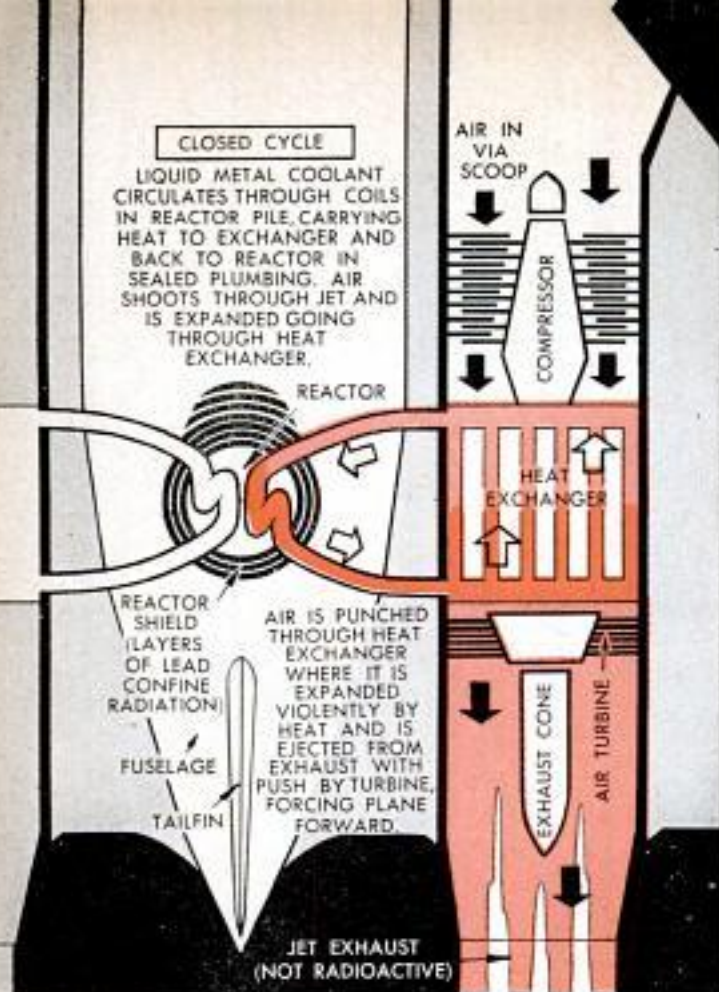

Diagrams compare the closed-cycle and open-cycle reactor systems. Open-cycle system has radioactive exhaust

Mr. Ohlinger: Wing-tip pod locations for crews are not practical except in straight, level flight. The only practical locations are in the extended nose of the fuselage or in an elevated, extended position in the tail.

Question: How long would crewmen be in their compartment on a 14,000-mile round trip?

Dr. Borst: At the speed of sound, that works out about 18 hours.

Question: What will it be like for a crew flying the first atomic plane?

Mr. Ohlinger: Flying the A-plane should be simpler because we have power to spare and can operate our plant more leisurely.

Question: Will the crew be completely shielded from all radiation, or will they take doses of radiation within allowable tolerances?

Dr. Borst: They can't possibly be shielded from all radiation. The next part to the question involves a military judgment as to how much radiation you permit the crew to take in order to improve the performance of the plane. If you want to improve crew protection, then the weight of the plane rises, maneuverability diminishes and it is a less-good fighting weapon. So military engineers must define their objectives and their permissible radiation levels. The radiation that a crew can take is a design factor, like range, speed and bomb load.

Question: How much radiation can a man take safely?

Dr. Borst: The National Academy of Sciences has determined that the average person reaching maturity has taken between 5 and 10 roentgens of radiation. Ten roentgens per trip by A-plane would seem to be acceptable. Generally speaking, 400-R is considered deadly. Half of those who receive 400-R will die, half will live.

Question: Will radiation impose any problems on the mechanical structure of the airplane?

Dr. Borst: It is true that lubricating oils turn to tar under reactor radiation, and in some cases metals deform and lose their original strength. You keep the materials which deteriorate in a place where the radiation level is low. This means that no lubricant can be used inside the reactor itself. All bearings must be outside, unless a solid lubricant, such as a graphite slideway, were used. Glass and ceramics cannot be used. Plastics are not a possibility for permanent parts. So one has to build the structure primarily out of good metals. But the technology that is being developed for the power industry is directly convertible, and the information serves just as well for this plant.

Question: Will any unusual configurations be imposed by the power source on things such as shape of airfoils, landing gear and the fact that there is no weight loss in flight due to fuel consumption?

Mr. Ohlinger: The power source will have

little or no effect upon airfoil shape, which is dictated by the performance of the overall airplane. There is no reason to believe that the first nuclear-powered plane will be exclusively powered by atomic energy. It is possible that take-off and landing would be by conventional combustion power to reduce the nuclear-power-plant size and the danger of ground contamination or ground-crew irradiation. Since the landing weight is as great as the take-off weight, the landing field probably will be large—as indicated by the special strip for nuclear-powered planes in Idaho.

Mr. Teichmann: If you are going into high speed, you need an airfoil designed for high-speed considerations. You would have a sharper leading edge than the normal. The wing would probably incorporate devices to reduce speed for landing purposes, such as boundary-layer control, or flaps or other high-lift-increase devices. This airplane has to land at a speed the pilot can handle, so the wing must be large, or have unusually high lift capacity. And since there is no loss of fuel weight in flight, we will need a more rugged landing gear, with perhaps many additional wheels to distribute the load on runways.

Question: Might this be so difficult that this would become a seaplane?

Mr. Teichmann: Yes. In a seaplane we would distribute the load over a larger area, which would permit a slightly lighter structural weight for the aircraft itself. And we wouldn't have to worry about

Artist's sketch of an A-plane conceived by Ohlinger of Northrop Aircraft (also on cover in full color) shows one solution for replacing the atomic reactor

the thickness or the length of the runway.

Question: What do some proposed A-plane designs look like, and how do they work?

Mr. Teichmann: Grover Loening has suggested a huge seaplane. It might be compared to a flying aircraft carrier with a flat deck for the smaller airplanes to land. It has disappearing elevators, to carry planes up from and down to the storage hold.

Mr. Ohlinger: A nuclear-powered towing plane could perform the function of a sky locomotive circling the globe. It would ferry freight, with parachute-drop unloading. It could tow passenger planes with large pay loads and only enough fuel to take off and cruise, until they hooked on to the big atomic plane for a ride. At destination the small planes would cut loose and land. You might even transfer crews, using shuttle planes and retractable locks. This same concept can be extended to an aerial tanker that carries a group of jet fighters to a combat theater and then stays aloft to refuel the fighters.

(Continued to page 258)

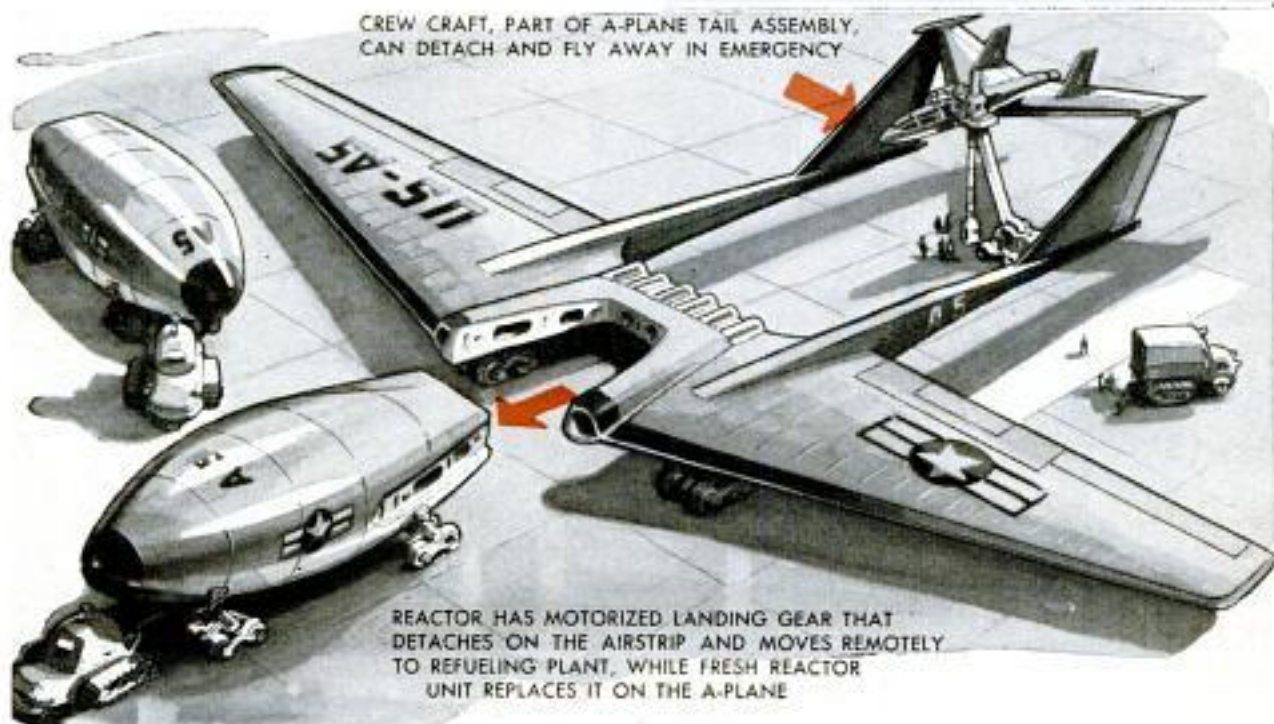
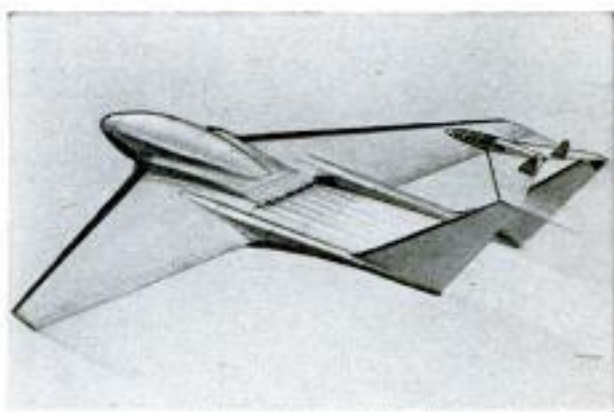

For the Photo Fan—

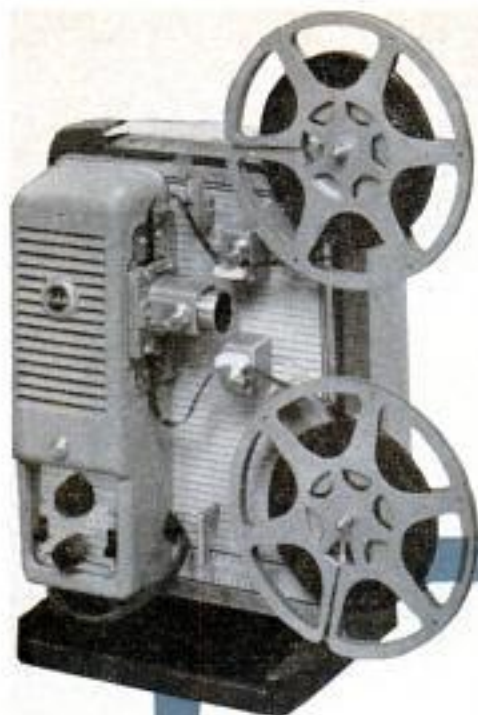

Showtime eight-millimeter projector can be reversed or stopped for showing a single frame. Permitting fast or slow-motion presentation of home movies, this projector has a shutter that transmits up to 60 percent more light than do current models

Magazine-loading rotary flash holder lets photographer shoot six pictures in rapid succession without reloading bulbs. With extra disk and one change of magazine, the holder permits taking of 12 shots quickly. Carrier disk holds six midget bulbs



Kodak 300 projector has on-the-top controls. Projector has two slide-changer systems: One rotating each slide to projection position; the other using an automatic magazine-changer for storage

Medallion eight-millimeter movie camera has a three-lens turret, giving telephoto, wide-angle and standard lens coverage. Camera has a prefocused f:1.9 lens and takes a 25-foot film magazine



Florida Scrub Palmetto Yields Tannin, Gum

Fifteen million acres of worthless scrub palmetto in Florida may prove to be a new domestic source of tannin and gum, now imported at great expense into the United States. Tannin is used primarily for tanning leather. Gum serves as an emulsifying agent in cosmetics, paints and inks; in processing silks, textiles and latex, and in treatment of paper products. Parts of the palmetto trunk are put in boiling water. The resulting liquor is drawn off and filtered. The water is evaporated or spray dried, leaving gum and tannin.

Measure Nerve-Cell Voltage

Manipulating a probe $\frac{1}{25,000}$ inch in diameter, a modern scientist can measure the voltage generated by an individual nerve cell. Detailed observation of nerve-cell behavior in normal and diseased situations may result in the solution of neurological and mental disorders. Dr. Ernest B. Wright, associate research professor at the University of Florida, is conducting these nerve-cell investigations.

☞ Scientists have found that pencillin destroys bacteria by stopping the formation of the hard wall around bacterial cells.

Willys Truck Has Cab Forward

"Jeep FC-150" is the designation of a four-wheel-drive utility truck that has an 81-inch wheel-base and a cab forward of the engine. Powered by a Willys F-head Hurricane engine, this truck is 147½ inches long and 58¾ inches wide. The FC-150 can turn in a radius of 18 feet and nets about 19 miles per gallon for highway travel. Spare tire and fuel tank are mounted on the cargo box, which has a six-foot payload bed 24 inches from the ground. Up-front visibility is said to be 200 percent greater than in other vehicles. The brake-fluid



tank access cover is on the instrument panel for checking and filling. Power-take-off points can be installed at front, center and rear locations on the truck.



Portable Hoist For Hunters

Made to solve the hunter's problem of dressing out deer and elk, a portable hoist no longer than a pistol has a capacity of 750 pounds. The hoist can be used also for pitching a tent, as a bumper "jack," lifting a boat or doing other heavy lifting chores around camp. It features a rotproof nylon rope and a lock which enables a load to be lowered or lifted a few inches at a time and which can be locked at any height to hold the load without tying the rope. The hoist weighs 12 ounces and has brass bearings, sturdy pulleys, aluminum plates, steel hooks and folds into a pocket-sized unit.

Pusher Propeller Fits in Plane's Tail

Powered by a 65 or 100-horsepower engine with a pusher-type propeller connected to the plane's vertical tailfin is a new German-made aircraft, the Fischer RW-3. This model can be fitted with long-span wings as a powered glider or with short-span wings as a conventional light aircraft. The RW-3 cruises at 124 miles per hour, has a ceiling of 13,000 feet and a range of 1180 miles. It seats two persons. Landing gear is retractable tricycle. A 55-horsepower modified Porsche automobile engine powered the prototype.



OWNERS REPORT:



We sent questionnaires to '57 Chevrolet owners in these 31 states from coast to coast. Here's what they told us about their cars:

39.7% DON'T KNOW HORSEPOWER OF THEIR CARS

POPULAR MECHANICS OWNERS REPORT (8-1183)

Mark an in the square after the most accurate answer. Write as many comments as you wish.

1. I own a 1957 Chevrolet V8 Six . Its horsepower is 270. I don't know .

2. It has been driven 3284 miles to date. It has handshift overdrive Powerglide Turboglide .

3. It averages 15 miles per gallon in city driving 17 1/2 miles per gallon on long trips. How much?

4. It uses no oil one quart or less per 1000 miles more than that .

5. Here's what I like most about the car: Has the most terrific kick-up standing start. It is longer ahead of any other from a motor cut back. Has too much gas. Had the best it still.

6. Here are my specific complaints: Has too much gas. Had the best it still.

7. The pop... convince me to buy a Chevrolet California actress

BEST-LIKED FEATURE: PERFORMANCE, POWER SAY 44.4%

MOST-FREQUENT COMPLAINT: POOR GAS MILEAGE SAY 15.9%

SHOULD IT BE LOWER? LONGER? 63.6% SAY NO LOWER 76.2% SAY NO LONGER

15. Here YOU HAVE TO LEAN OVER TO SEE PAST IT

16. My dealer service is Excellent Average Poor . I would would not buy from him again W MIRROR

17. I traded a 1954 CHEV (year and make) to buy this car. The trade-in allowance was Above average Average Below average .

18. Right now, I think my next car will be a CHEV.

19. Overall, I rate this Chevrolet as Excellent Average Poor . Why? I'VE NEVER HAD A BAD ONE

20. The 1957 Chevrolet is not as low as its competitors. I object to this Do not object . Why? Garage will be too small and it's harder to park.

Write additional comments on reverse side. Your name will be held in confidence.

MAIL PROMPTLY IN ENCLOSED POSTPAID ENVELOPE TO:
 Popular Mechanics Owners Poll, 200 East Ontario St., Chicago 11, Illinois

Name [REDACTED] City [REDACTED] State ILLINOIS
 Street [REDACTED] Occupation PAINTER

CHEVROLET OWNERS PRAISE ITS POWER AND SAY IT IS STILL THE "HOT" ONE

By Chevrolet Owners

DOES A CAR have to be the longest, lowest and widest in its field to sell?

Chevrolet is out to prove it does not. And owners seem to agree, although there are some dissenters.

We asked owners if they object to the fact that the 1957 Chevrolet is not as low as competitive makes. A big majority (63.6 percent) say they do not; another 13.9 percent have no opinion; 22.5 percent do object to this fact.

We asked if they would like their Chevrolets longer (competitive makes are longer by as much as eight inches). Here the opinion is even more definite: 76.2 percent say they do not want the car any longer; 9.9 percent have no opinion; 13.9 percent would prefer it longer.

Among the reasons given are that if longer it would be harder to park, too long for their garage, more awkward to handle in traffic. Those who want it longer say it would therefore ride better, look better and have more road stability.

"Nothing to be gained by adding length. Hard enough to park now."—Tennessee traveling salesman.

"Parking spaces have not grown."—Illinois printing estimator.

"Would have to add on to garage."—North Carolina textile worker.

"Would be too awkward to park. I am emphatic about this!"—Florida housewife.

"If longer it would ride better."—North Carolina farmer.

"It should be longer—that's the style of tomorrow."—Colorado truck driver.

"Being longer it would have more inside room."—Louisiana sales engineer.

Best-Liked Features

It looks as though Chevrolet is still a "hot one," at least in the judgment of the folks who should know—the owners.

Chevrolet owners from coast to coast give top billing to the car's performance and acceleration:

"Has the most terrific pickup I've ever seen on a car. It's lengths ahead of any other from a standing start. Goes up hills like a mountain goat."—California actress.

"I like its smooth effortless performance and terrific getaway. If it had wings, it would take off."—New York farmer.

(For road-test data on the 1957 Chevrolet V8 see page 106 of the January 1957 issue of *Popular Mechanics*.)

Second on the best-liked list is Chevy's ease of handling:

"It does not have power steering but handles like it does."—New Jersey machine operator.

"Handles nice in traffic. Also on any type of road."—Tennessee mechanic.

Third of the best-liked features is exterior styling:

"I think the best feature is the exterior lines. It is the best-looking car in the low-price field."—New York electrician.

"Has low appearance yet it has good

Chevrolet is still "hot," say the owners, who rate performance and acceleration as the best-liked feature



The OWNERS' OPINION of the CHEVROLET

Had trouble with engine?

No trouble.....79.2%
Some trouble.....20.1%
Considerable trouble... 0.7%

What was engine trouble?

Valves, valve system... 9.4%
Carburetor, choke..... 8.1%
All others.....4.7%

Performance

Would like faster acceleration?

Yes, would.....15.9%
No, would not.....73.5%
Undecided, no answer...10.6%

Would like more top speed?

Yes, would..... 6.6%
No, would not.....70.9%
Undecided, no answer...22.5%

What is car's horsepower?

Knew correct horse-
power.....60.3%
Did not know.....39.7%

Styling

Best-liked exterior feature?

Grille.....22.5%
Tailfins.....11.9%
Hood.....9.9%
Conservative style..... 9.3%

Least-liked exterior feature?

Dual hood ornaments...11.9%
Tailfins.....11.3%
Rear bumper..... 6.0%
Taillights..... 4.0%

Best-liked interior feature?

Dashboard design.....24.5%
Upholstery.....18.5%
Colors..... 9.9%
Roominess..... 5.3%

Least-liked interior feature?

Floor mats..... 6.6%
Ash tray..... 6.6%

OVER-ALL RATING

Excellent Average Poor
72.4% 24.8% 2.8%

Dashboard design..... 5.3%
Headlining quality..... 3.3%

Fuel Injection

Would like fuel injection?

Yes, would.....34.4%
No, would not.....43.0%
Don't know, no answer...22.6%

Did dealer have demonstrator equipped with fuel injection?

Yes, did..... 6.0%
No, did not.....80.1%
Don't know, no answer...13.9%

Miscellaneous

Will buy a Chevy next time?

Yes, will.....71.5%
No, will not.....13.9%
Undecided, no answer...14.6%

How is dealer service

Excellent.....61.1%
Average.....29.5%
Poor..... 9.4%

Would buy from him again?

Yes, would.....51.7%
No, would not..... 8.6%
Undecided, no answer...39.7%

What make of car was traded?

Chevrolet.....74.2%
Other GM makes..... 6.0%
Ford Motor product.... 6.0%
Chrysler Corp. product.. 2.6%
All others..... 2.0%
No trade, no answer.... 9.2%

Why did they pick Chevrolet?

Previous ownership....24.5%
Exterior styling.....16.6%
Workmanship..... 6.0%
Economy, price..... 6.0%

What should be changed?

Nothing at all.....35.8%
More room inside..... 6.6%
More economy..... 6.0%
Lower body..... 4.6%
Improve seats..... 3.3%

Best-Liked Features

Performance, acceleration...44.4%
Handling ease.....39.1%
Exterior styling.....25.8%
Riding comfort.....19.9%
Economy.....12.6%
Visibility.....11.9%
Roadability..... 6.0%

Most-Frequent Complaints

No complaints at all....41.7%
Poor gas mileage.....15.9%
Poor body assembly.....10.6%
Rattles..... 7.3%
Too big, too low, too fast.. 6.0%
Poor paint job..... 5.2%
Tubeless tires..... 4.6%

Chevy is not as low as competitors

Object to this.....22.5%
Do not object.....63.6%
No opinion.....13.9%

Would like Chevy to be longer?

Yes, would.....13.9%
No, would not.....76.2%
No opinion..... 9.9%

headroom."—Colorado parts man for a Chevrolet dealer.

"Smart lines, yet not extreme."—North Dakota office worker.

They Complain, Too

Chevrolet owners are, in the main, more satisfied with their new cars this year than they were in 1956: 41.7 percent state that they have no complaints at all compared with 30.1 percent on the 1956 Chevrolet.

But there are those who complain and they most frequently mention poor gasoline mileage:

"Gas mileage is low. I have had it back to the garage three times and they can't seem to help it. I get about the same mile-

age (14.5) in city driving as on trips."—Tennessee engineer.

"Getting only 10 miles per gallon in town. Had it in for checkup four times. They changed the needle valves and installed new float system but hasn't done any good."—New Mexico radio announcer.

"I went from automatic to standard shift to get more mileage, but so far haven't received it. I miss the automatic and next time shall go back to it."—Kentucky owner.

Second on the complaint list is poor assembly work:

"Thrown together. Things not aligned right."—Massachusetts clerk.

"Poor assembly. Doors had to be reset. Paint scratches."—New Jersey machinist.

Although it's the shortest of the Big Three, Chevrolet has more inches of room in many interior dimensions

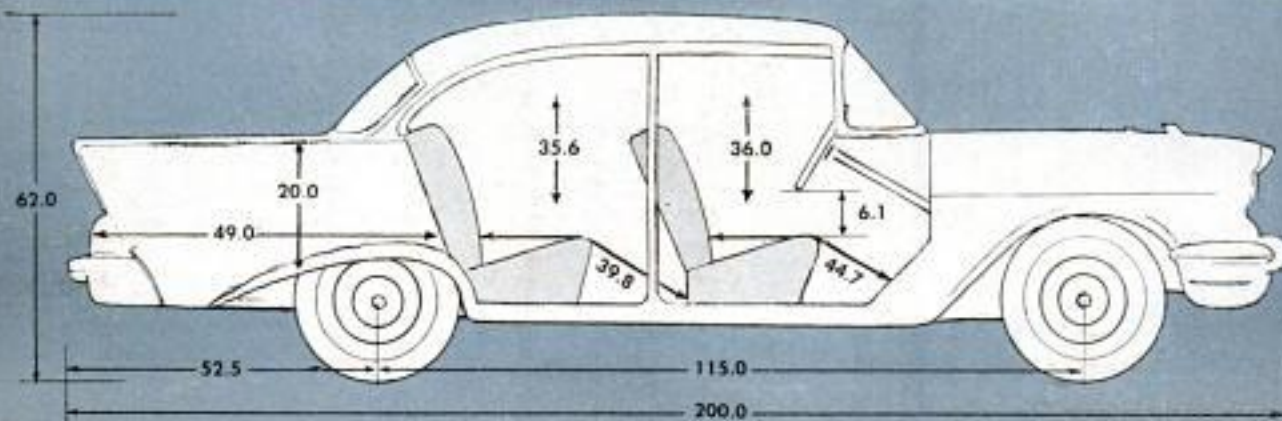

Third most-frequent complaint is the presence of body noises.

"Certain body rattles. They were corrected at 1000-mile checkup."—Colorado housewife.

Fourth complaint is that the car is too long, or too low, or too fast. This is a new complaint among car owners and it is especially interesting in the case of the Chevrolet which is the shortest and the highest car of the Big Three.

"In order to get into this car it is necessary to take off my hat. The roof is too low. Once I am seated, it's okay. All new cars are too difficult to enter and too low to the ground."—Nebraska conductor.

"Not enough road clearance. I can't drive off the highway."—California barber.

"All manufacturers are putting too much engine in these cars. Absolutely unnecessary. Instead of a pleasure car, they become a death-dealing instrument. People are not educated to such power."—North Dakota farmer.

What Should Be Changed?

Each month we ask the owners what they think should be changed in their new cars. Chevrolet owners want increased gasoline mileage more than any other change.

Here are some other changes they would like in order of frequency of mention:

"Should have two ash trays on dashboard."—Illinois salesman.

"Would like more room inside, especially in the back seat. Not enough legroom."—California minister.

"Make the body lower."—Colorado sales executive.

"Seats should be more comfortable. No support under your legs and no comfort to back."—Missouri zone manager.

What About Chevy Styling?

We asked the owners what they don't like about this year's styling, interior and exterior. Here are their dislikes in order of frequency of mention:

"Do not like the two hood ornaments."—West Virginia bus driver.

(Continued to page 254)

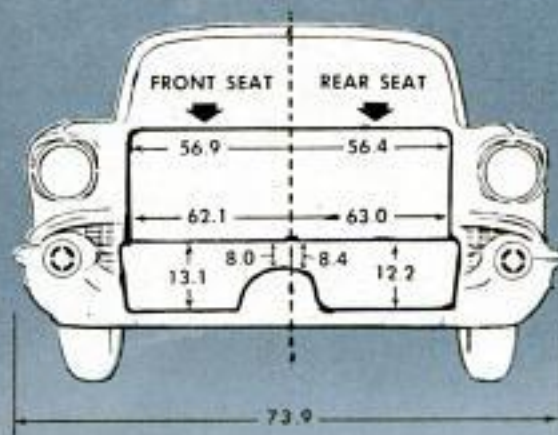

What do owners say about styling?



Instruments with well-marked dials are practical, say owners, but thick, luxurious carpeting is not



Owners like the integral grille-bumper, but dual hood ornaments top the list of least-liked features

In this, the year of the tailfin, Chevy owners are evenly divided in their opinion of the current fad





Trailer Hitch is Easily Removed

In seconds you can remove the drawbar from a trailer hitch so there is no unattractive projection when the trailer is not being pulled. The drawbar is held in its carrier by a safety catch that tightens itself as the load increases. When the drawbar is not in use it is replaced by a neat chrome cap.

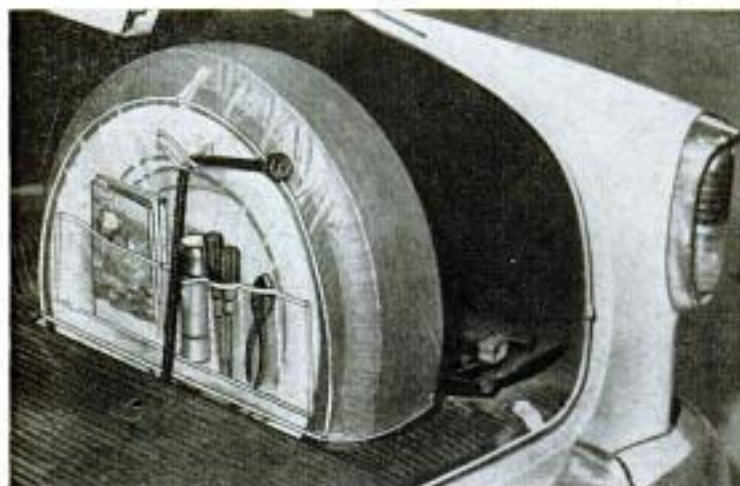

You Can Add "Feelers" to Front and Rear of Your Automobile

Drivers who are not certain where their fenders are as they maneuver in tight spaces can protect their cars from damage by mounting light-transmitting "feelers"

front and rear. The front-fender rod is made of plastic and it glows as it picks up light from the headlights. The rear-mounted feeler has its own base-mounted bulb.



New Products for The Family Car



Headrest for Car Seat

Clamped to the back of the front seat, a foam-rubber cushion provides relaxed rest for the passenger on long drives. It can be swung to various positions from straight up to straight down.

Tire Cover Has Pockets

Pulled over the spare like a stocking cap, a plastic cover has compartments for tools, flashlight, maps and other items. It stretches to accommodate all wheel sizes. It will also prevent luggage from being soiled by a dirty spare tire.





Inflatable Tube Floats Angler

Sportsmen can float into hunting or fishing spots in a new inflatable tube. The tube is held in place around the waist by a special harness. It supports the body high enough that water will not enter chest-high waders. If desired, the sportsman can use swim fins to help maneuver himself to a particular spot. The harness leaves his arms free to manipulate a fishing rod or a gun. Additional equipment can be strapped to the float.

Triangular Steel Beam Has Notches for Joists

Floor joists are held securely in notches in a new steel beam for residential or commercial construction. The beam is triangular in cross section. The notches tend to increase the rigidity of the floor as the load builds up. According to the manufacturer, the beam can be used over longer spans than a conventional I-beam with a minimum number of posts to support it.

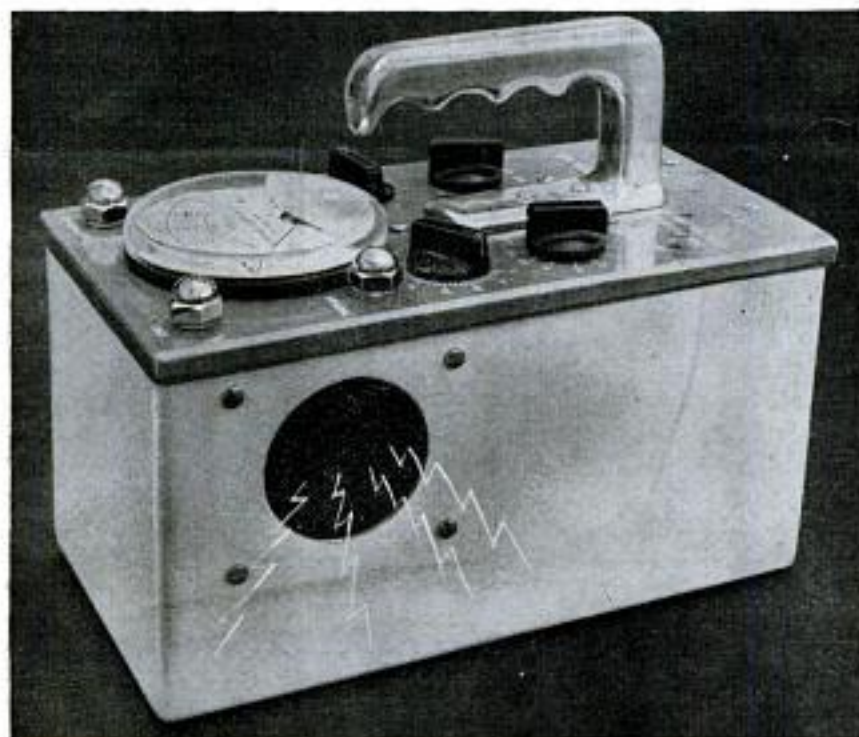

Uranium Detector Sets Off Alarm

You can search for uranium while driving or flying by taking along a detector that sounds an alarm when radiation hits a preset level. Continuous watch of the meter is unnecessary. Silent until a given intensity of radiation is reached, the instrument sounds at an increasing pitch as the gamma intensity mounts. Headphones permit use of this convenient apparatus in planes and noisy surroundings. The instrument has a built-in battery tester and also is equipped with standard radio tubes.

The Voice of EMERGENCY

for War or Peace

By Ted Krec

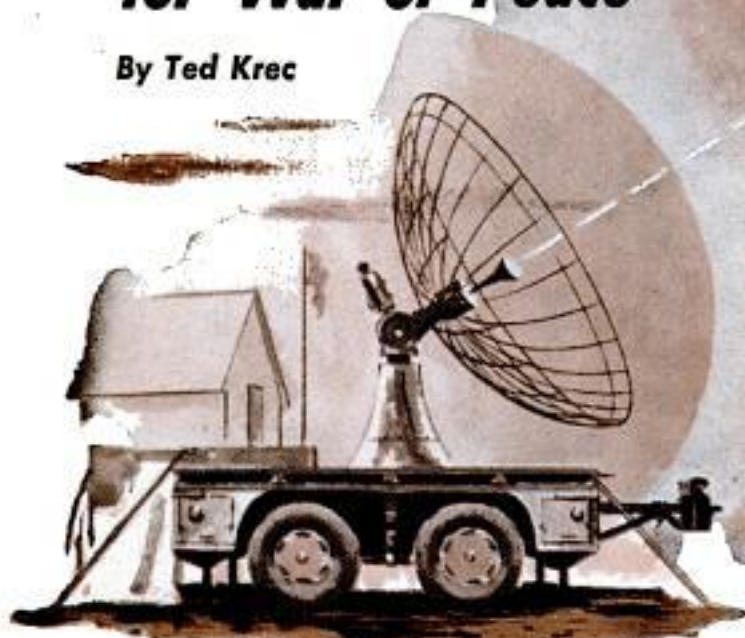

RADAR OUTPOSTS



COMMANDING GENERAL

THEY'RE BUYING a new kind of radio receiver on the West Coast today. It receives no disk-jockey broadcasts or soap operas, for the receiver isn't intended for entertainment—it's "life insurance."

This new kind of radio is a Sigalert receiver—"the voice of emergency."

The Sigalert system of instantaneous emergency alerting was developed by Loyd C. Sigmon, vice-president and assistant general manager of radio station KMPC in Los Angeles. "Sig" is his nickname, so it was given to his brainchild.

Sigalert was developed to fill a great need in southern California. For years the law-enforcement agencies had maintained radio communication with each other, but there was no rapid contact with the public for emergency situations—such as the big fires of last December.

The director of the Technical Service Bureau of Los Angeles Police Department, Deputy Chief Arthur C. Hohmann, had an idea that commercial radio could be utilized, so he consulted the Southern California Broadcasters Association. The president of that group vowed cooperation, but said that at the time no technical equipment had been developed which could do

the particular job. However, he turned it over to Sigmon for research, for Sigmon is recognized as a wizard by many of his colleagues.

Sigmon demonstrated for Civil Defense and military officials a system for breaking into a broadcast by pressing a button at a given location, taking away control of radio stations and turning on radio receivers—for use in Civil Defense emergencies. The problem of direct, rapid public contact was solved and from this demonstration Sigalert was born.

A few months later, Sigalert was put into operation as a public service in Southern California. The savings in time, money and human life effected by Sigalert would be a staggering figure if it could be completely calculated.

Here's how the alerting system works: On the spectrum of radio frequencies there are not enough frequencies for radio stations, police and military use; yet there are unused or wasted portions. Radio engineers always have known about them but did not know what to do with them, for they are subaudible to the human ear.

Sigalert for the first time takes part of this unused, subaudible portion—the area

ALL CIVIL DEFENSE
CONTROL CENTERS

RADIO STATIONS

SIRENS

CIVIL DEFENSE
PERSONNEL

EMERGENCY SERVICE

HOME

MOTORIST

HIGHWAY PATROL

PLANT PROTECTION

SHIPS

SIGALERT





Dispatcher in police department reaches for Sigalert switch to activate receivers in all TV and radio stations



Lives are saved at scene of disaster because Sigalert helped speed ambulance and doctors when minutes count

from 0 cycles to 40—and puts it to work, using an extremely low percentage of modulation. These subaudible frequencies are superimposed on a radio-frequency carrier when a Sigalert bulletin is to be given, activating special Sigalert receivers.

The entire Sigalert procedure takes place without interfering with the normal operation of the radio station. Because it is subaudible, listeners are unaware of it until it is broadcast to them directly. In other words, the Sigalert bulletin gets a “free ride” on standard-broadcast facilities.

Forty-eight southern California communities and some in Nevada and Arizona are hooked up by land lines, teletypewriter and radio. Authority to originate a Sigalert bulletin rests in any responsible officer who is on duty in an area at the time of an emergency. However, the situation must constitute a hazard to or otherwise affect a large number of persons for a significant amount of time.

The officer on the scene contacts the Los Angeles Police Department and orders a Sigalert. At the LAPD control center, there is not a moment's hesitation. The chief dispatcher flips a switch marked Sigalert on his control board and at the same time cuts into all lines. Flipping of the switch applies the subaudible tone to the carrier of the broadcasting station. The subaudible tone is applied at a very low percentage of modulation so as not to interfere with the normal program content.

The result is instantaneous, for radio waves travel at the speed of light—186,000 miles per second. In each of the radio and TV stations equipped with Sigalert receivers a buzzer sounds and a light flashes on. In addition, a tape recorder also is activated and the message is recorded. Then a bulletin can be prepared for broadcast or the program is interrupted at once (if the situation is critical enough) and the tape is played right over the air.

The original demonstration showed how, by merely pressing a button, program control could be taken away from broadcast stations automatically, in event of grave emergency. This, of course, does not apply at the present time on the police Sigalert, but it could be done easily.

The fact that radio stations broadcast the bulletins to the public would appear to obviate the need for special receivers or, at best, to limit the need for them—but not so.

Consider this—a trucking firm would be very interested in obtaining all information about emergencies along the routes its trucks travel. A special receiver would give the firm this information without the

(Continued to page 234)

Angled Backboard Challenges Players

Elements of table tennis, handball and squash are combined in a fast-paced game that can be played indoors or out. The court has a backboard built of several pieces set at different angles, giving the plastic ball unusual rebounds. Two to four persons can play the game. The paddles are slightly larger than table-tennis paddles. The plywood backboard can be dismantled and stored flat.

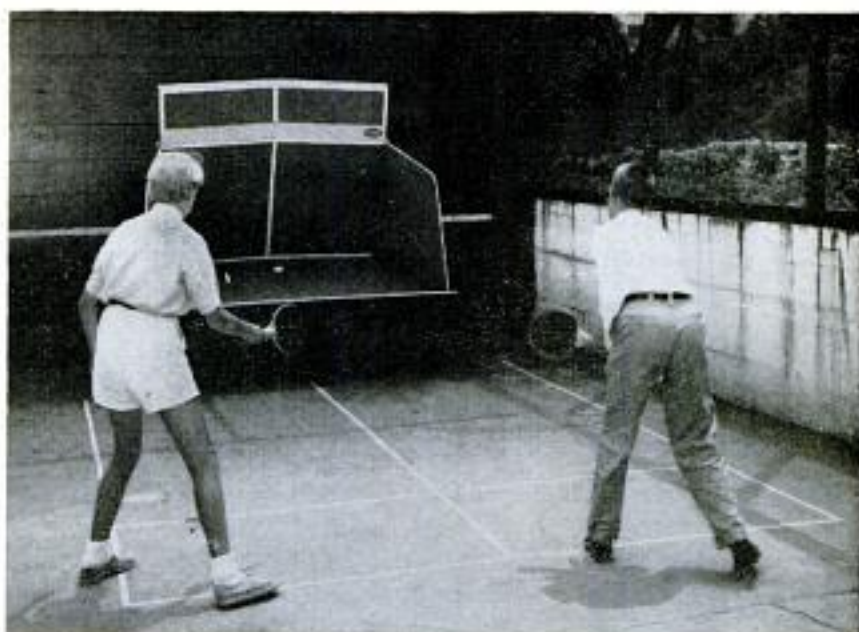

Car Vacuum Cleaner Uses Exhaust Pipe

Operating at the exhaust pipe while the automobile's engine idles, a vacuum-cleaning device can rid vehicle interiors of dust, dirt and gravel. The venturi effect provides the necessary suction. This cleaning unit includes an aluminum housing with a tapered rubber plug which fits into the exhaust pipe, 12 feet of flexible wire-wound hose and an aluminum nozzle.

Underwater Beam Tracks Whales

Electronic gear now assists hunter-killer ships to follow their prey during whaling season in Antarctic waters. Ultrasonic sound pulses are sent from an electro-acoustic transducer mounted in a retractable, sound-transparent dome projecting below the ship's keel. A one-man console gives constant bearings of the pulse beam. Range of whales, interrupting the beam, is found by translating into distance the time interval between pulse transmission and reception of the echo.

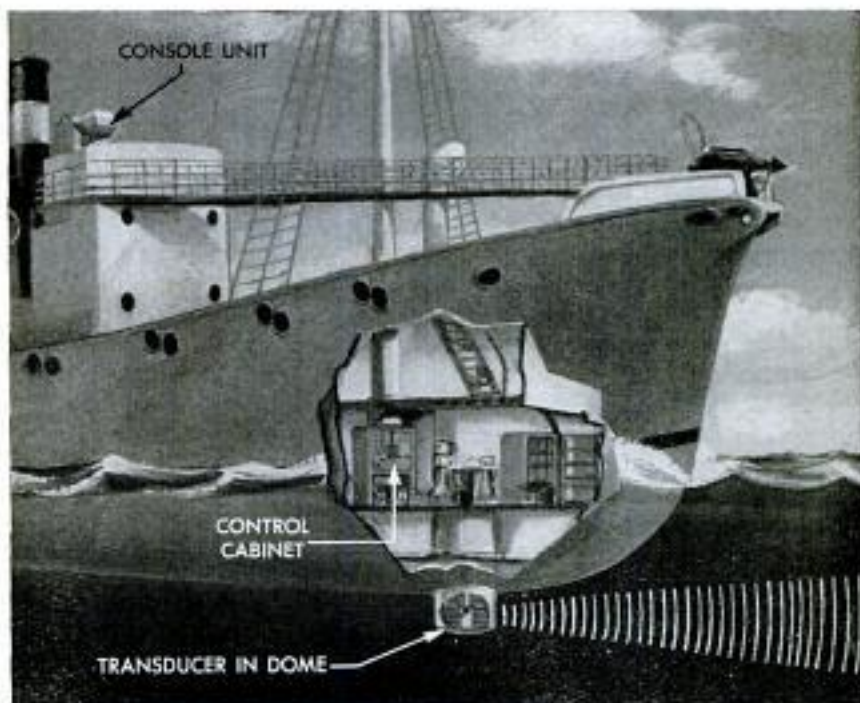

Air Conditioner in Basement Ventilates 25-Room Building

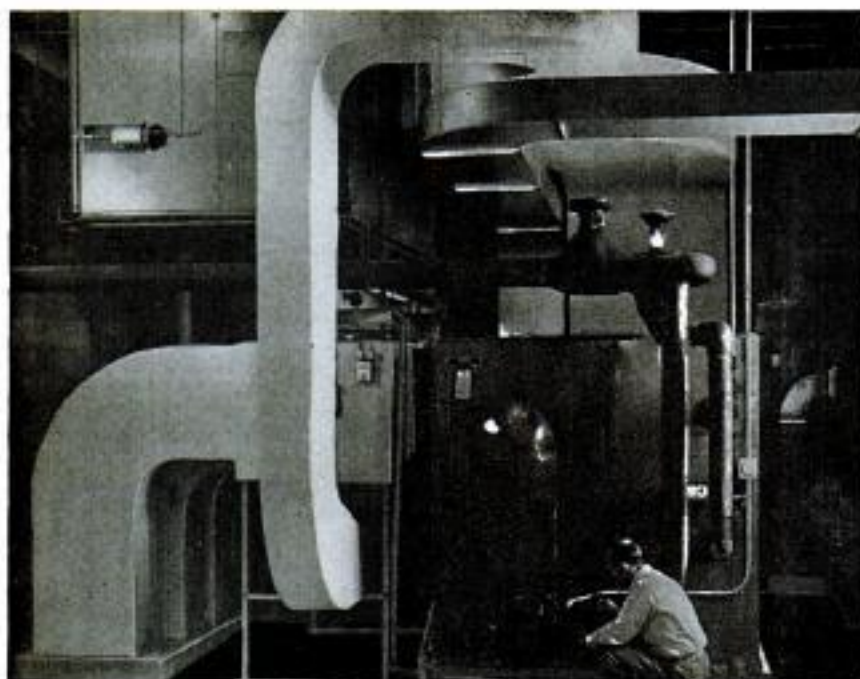

Individual rooms in a 2 to 25-room building can receive year-round cooling or heating from a centralized unit in the basement. The conditioning system consists of cold-producing and heat-making mechanisms and blowers, with dampers controlling flow of hot or cold air in ducts going to each room. Air leaves through "decks" of dampers, one deck directing hot air, another deck guiding cold air, with hot or cold air mixed, if needed. Combinations involve cooling, heating, ventilating or humidifying elements in nine sizes.

Quick-Start Fuel Made From Ether

Blended low ether, a special fuel mixed with air and injected as a fine spray into the engine intake manifold, provides quick starting at low temperatures for gasoline and diesel motors. This fuel sustains the engine until regular fuel becomes operative. The starting device can be installed on the dashboard, and hermetically sealed fuel can be stored indefinitely in its special capsule. Corrosion inhibitor and lubricating qualities are in this blended fuel.



Rebuilt Buick Becomes Housecar

With \$400 worth of junk-yard parts, Paul Hagenbuch of Arlington, Va., remade his 1949 Buick automobile into a "housecar" that sleeps two persons. His vehicle has a double bed, bath with shower, hot and cold running water, a kitchen sink, hot plate, dining space and small dining chairs. Hagenbuch rebuilt his car in six months.





Portable Concrete Mixer

Concrete can be mixed in a portable unit built on a wheelbarrow-type frame to operate from a $\frac{1}{4}$ -horsepower electric motor with V-belt drive. This mixer has $1\frac{3}{4}$ -cubic-foot capacity. It also has curved tubular steel handles for easier pouring of concrete through a "nonsplash" chute. Ten-inch semi-pneumatic wheels support the 82-pound mixer, which will fit into most passenger-car trunks and can be wheeled through the standard doorway of a home. Accessories include a slip-on gravel screen, blade for mixing mortar or plaster, drum



cover, wheelbarrow pan attachment and an adapter bracket for powering the mixer with a $\frac{1}{4}$ -inch electric drill. Larger wheels are optional.

New Jet-Landing Method Permits Aircraft to Stop Within 100 Yards

Jet fighters landing on airstrips of 1000 to 2500 feet can be stopped within 100 yards without damage or injury, if the jet uses one of two arresting cables connected to a tapered, water-filled pipe in a ditch alongside the runway. A landing jet engages

one of the arresting cables, which pulls a piston through the water-filled pipe to absorb landing energy of the aircraft. The plane stops and is disengaged from the cables which snap back into place. No adjustment is necessary for speeds or weights.

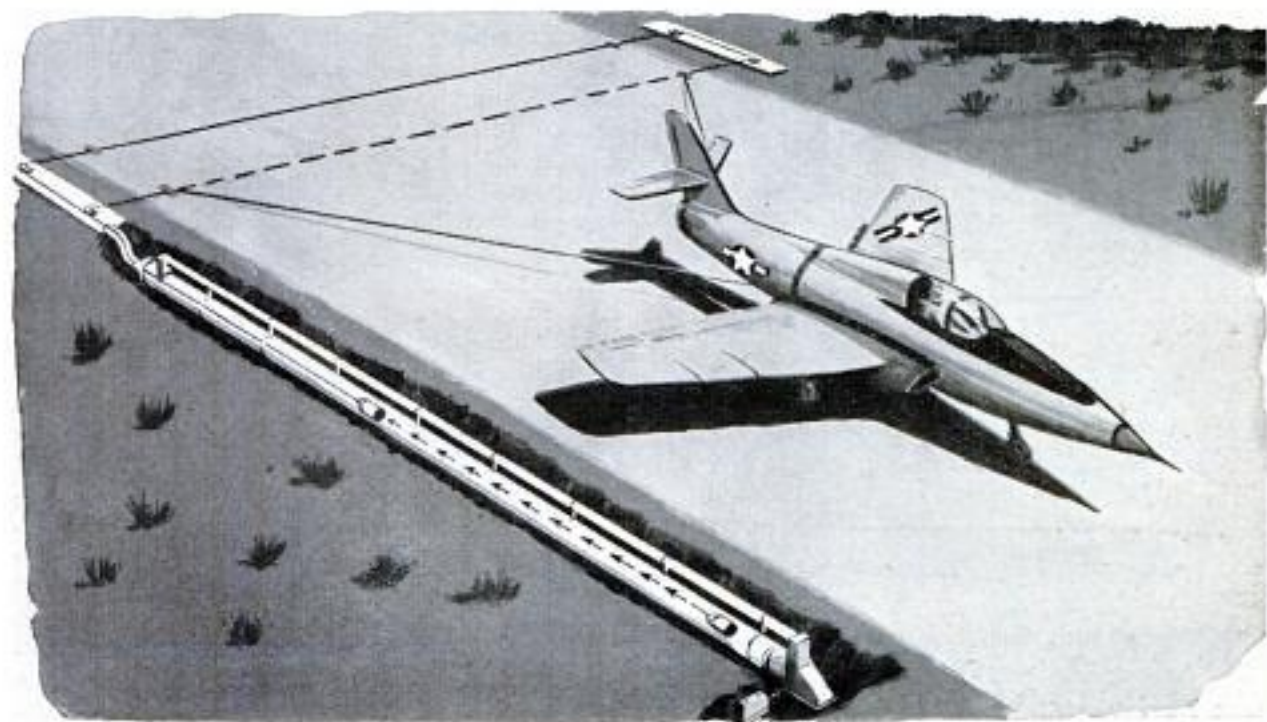

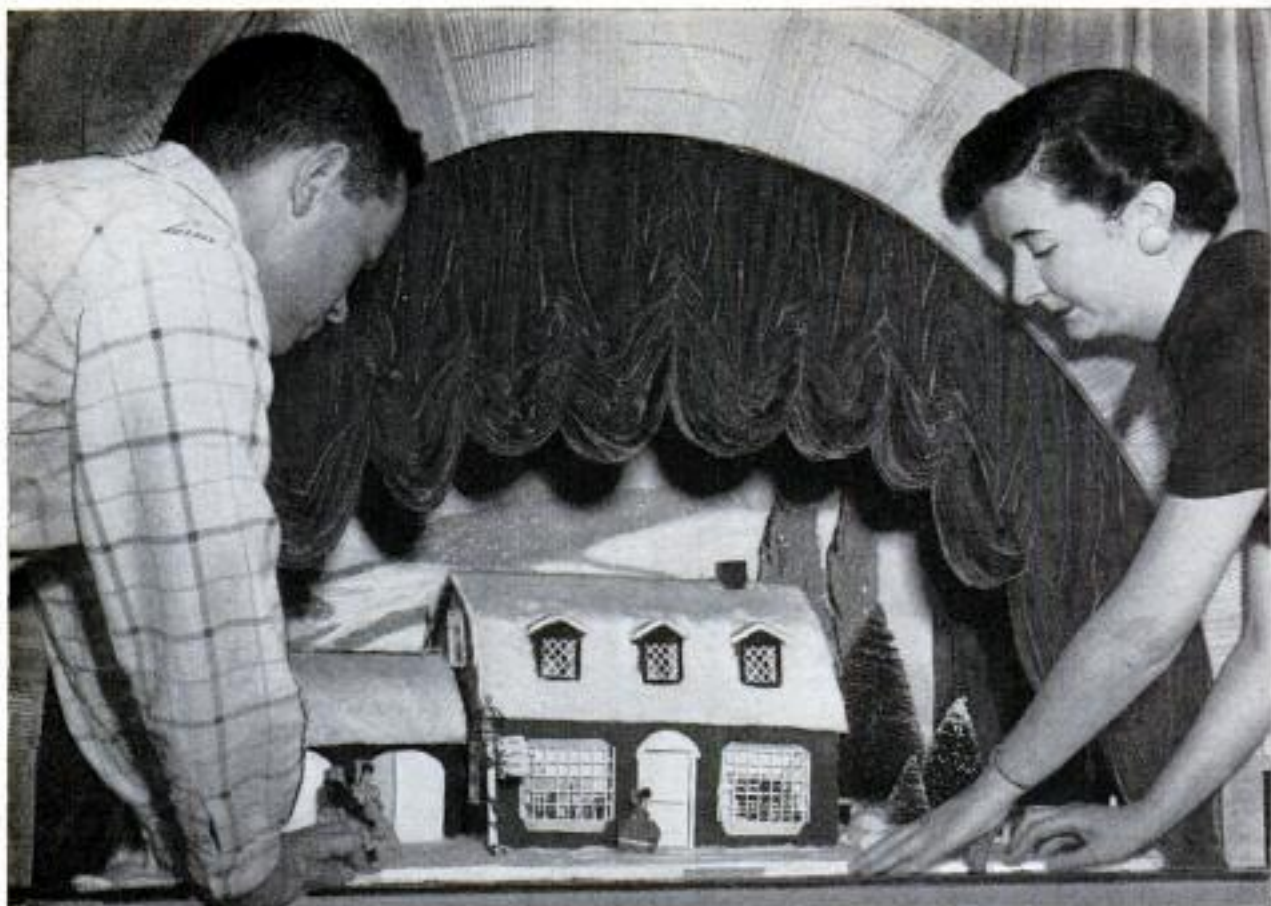

Producer Robert Eagle of The Little Music Hall oversees shifting of scene for popular Holly Time show

Radio City Music Hall In Miniature

Eagle and helper, Clare Murphy, clean up steamboat as important scenery for the Showboat production



By Leslie H. Horn

BIG SATISFACTIONS come in miniature packages for 21-year-old Robert Eagle, of Waltham, Mass.

Eagle is the builder of the Little Music Hall, a scale model of the famed Radio City Music Hall in New York City. He is also the producer of a dozen shows throughout the year—miniature, of course—on his six-foot-wide stage.

His shows usually play to a full house of 11 persons, a capacity crowd for the small basement room in his home which he has turned into a pint-sized theater. At Christmastime for the last two years people have traveled from all over Boston to see his Holly Time shows.

Eagle, a newly graduated elementary-school teacher, has been arranging miniature shows since he began with an orange-crate stage some 10 years ago. He visited the Radio City Music Hall three years ago and was so impressed he came home and planned his scale-model copy.

"I wrote the management," he recalls,



Backstage of the Little Music Hall is a jumble of scenery and "actors" designed and built by young Eagle

"and they sent me a 60-page detailed manuscript of the Music Hall's construction. I followed it closely."

He took the elaborate measurements of the curtain, stage and proscenium arch and reduced them to the present over-all six-foot front width. To build the wood portions of the arch and stage floor he hand-cut, sandpapered and finished 571 balsa-wood sticks, each about six inches long, half an inch wide and a quarter inch thick, and used 49 tubes of glue.

Dolls Become Actors

Eagle's actors are dolls which he either buys or makes and outfits with costumes. As assistants he has a staff of nine close friends and interested neighbors. Shows run about an hour and are presented as tableaux. Each has a number of different sets which are changed in total darkness. Scripts are written by the producer and recorded music is edited on a tape from one or more records. The result is finally copied on Eagle's standard record player.

In Holly Time, 64 pieces of scenery, 25 scenes and backdrops plus 77 hand-dressed dolls are used. This extravaganza took 350 hours to produce. Backdrops are painted in oils. Scenes in this elaborate show include "In the Sleigh," "Grandma's House," "Country Store," "Gristmill," "Decorating the Tree" and the "Little White Church."

The final act, "The Nativity," has a dozen set changes and was copied from a Radio City Music Hall production. Props, scenery and furniture are made from odd materials including tin cans, cardboard and lots of glue. ★ ★ ★

Curtain going up! Helper Murphy operates lights and sound while Eagle raises curtain and manages sets





Etrusco was tossed high and dry in front of summer cottages. "Fan Club" cheered slightest movement of ship

REPRIEVE

FOR A FREIGHTER

By Calvin Campbell

THE FREIGHTER *Etrusco* had a last-minute reprieve from death on the scrap pile because a newly organized company dared to make a million-dollar business gamble. That gamble paid off and made maritime salvage history as well as an additional bonus estimated at several hundred thousand dollars.

The 7000-ton ship was hurled on a rocky shelf at Cedar Point, Scituate, Mass., 20 miles south of Boston, after she lost her rudder during a raging northeaster.

The Coast Guard had to battle through man-high snowdrifts with a snowplow to reach the scene in the middle of the night, and the 30-man crew was dramatically

One of the jubilant owners congratulates Admiral Curtis as the freighter finally floats free again



rescued by breeches buoy at daybreak.

The *Etrusco* was on its way from Emden, Germany, to take on a cargo of grain at East Boston for shipment to Yugoslavia. Already seven days overdue because of rough weather, she was riding high in the water and was no match for the torrential seas as she was tossed ashore only a few hundred yards from some summer cottages. She ended up completely high and dry at low tide.

The \$1,250,000 ship was declared a total loss. Eighty percent of the 441-foot double-hulled bottom was damaged and ripped open. Four gaping holes were torn in the inner hull. Top marine salvage concerns decided that refloating was impossible. The insurance underwriters declared that any attempt would cost more than the ship could possibly be expected to make in its lifetime. It was just a scrap heap and the only solution seemed complete demolition.

Tourist Attraction

Rust and weather bored into the plate as the ship rested majestically as a tourist attraction all summer.

Agents for the General Insurance Company of Italy advertised for bids. Highest bidder was the newly created Ocean Shipping Company, formed by a group of New York brokers, agents, captains and promoters, headed by Gordon Mosvold as

Originally parallel to shore,
ship had to be swung into
a bulldozer-cleared channel
with her bow toward the sea

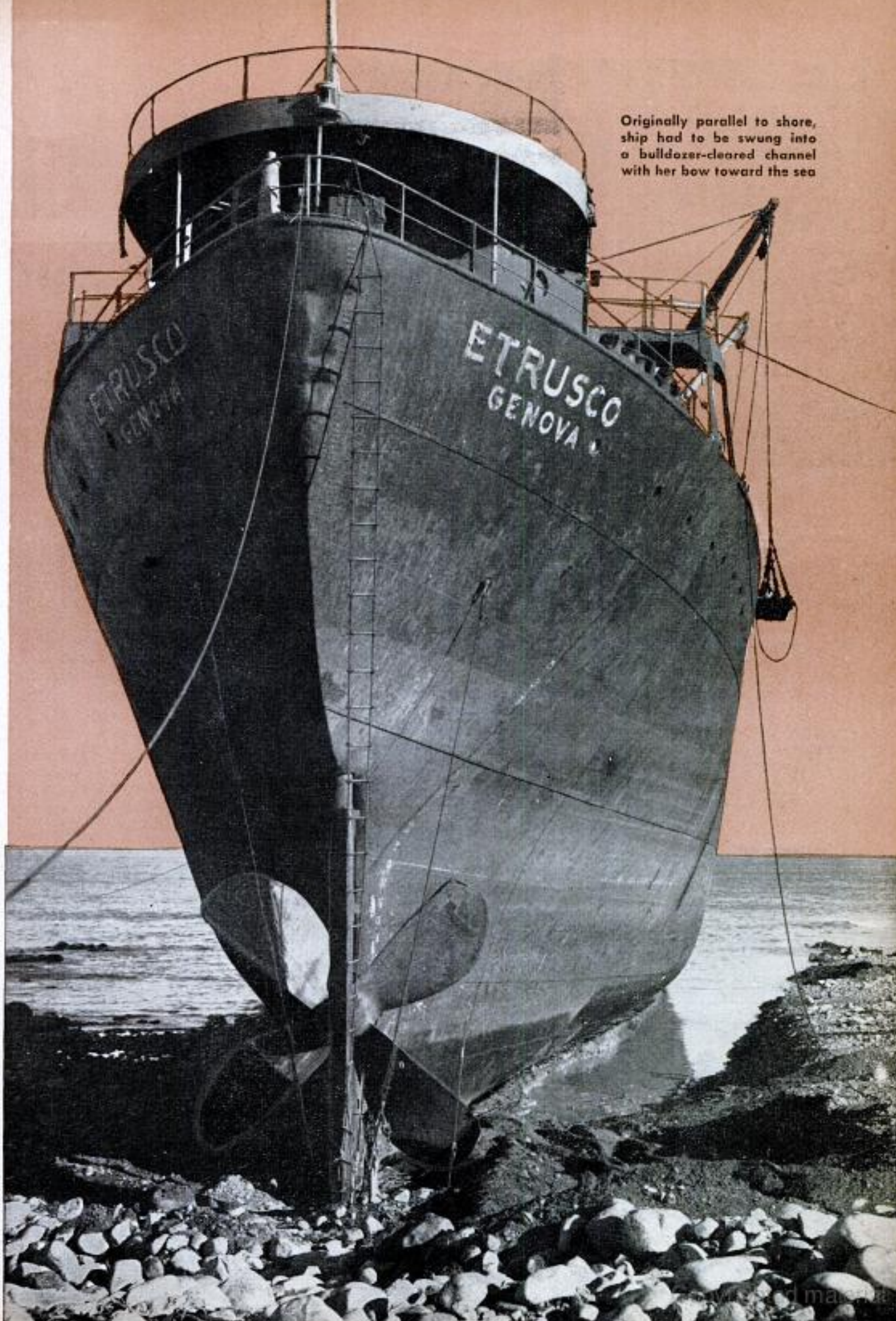



Kedge anchors were laid in deep water offshore. Heavy cables then were attached to the ship's winches so the freighter could pull herself free

president. They paid \$121,211 for the stranded freighter and surprised the maritime industry by announcing their intention of refloating the hulk. They called in a 70-year-old retired admiral, Lebbeus Curtis, director of the Pacific Trailer Ships Company, to head the operation. He was

Three five-ton kedge anchors and one weighing eight tons were laid in deep water 300 yards offshore. Cables, $1\frac{3}{8}$ inches in diameter were attached from them to the ship's winches through an intricate block-and-tackle system. Their pulling power was more than 400 tons, more than enough, the admiral figured, for the ship to pull itself free.

Salvage workers had to crawl under the ship to clear away boulders. Logs and sheets of steel were placed in the bulldozed channel to ease the movement of the ship. Much of the salvage work had to be done in rain



Bulldozers cleared the rocky bottom at low tide and huge boulders were blasted. It took three weeks of intensive work, testing equipment, tightening cables and patching leaks before the first pulling attempt was made.

Plans were to swing the freighter a full 80 degrees from its parallel position with the shore line. By working the vessel's bow into 15 feet of water, Admiral Curtis reasoned that he could then flood the bow, and thus lighten the stern for the final pull.

With the fall tide at its peak and a west wind to give the ship an added lift, the first tugging resulted in the almost unnoticeable movement of $1\frac{1}{2}$ degrees.

They worked every high tide, morning and

(Continued to page 244)



Robot whistles, produces music and directs traffic under the control of two university engineering students

Robot Policeman Directs Traffic on Busy Mexican Street

Remotely controlled, an 8½-foot robot policeman directed traffic for one week in Guadalajara, Mexico. The robot also whistled and produced music and advertisements for a University of Guadalajara dance. Made in 100 hours from parts scavenged by two engineering students, the internal workings of the robot included a built-in loudspeaker connected to a turntable, microphone and amplifier. Power

originated from two ⅛-horsepower motors operating on alternating current from a nearby house. The turntable motor was geared 450-to-1, using a tricycle wheel, bicycle sprocket and chain and the gears from a hand-powered tool grinder. To raise the robot's arms the motor from an electric drill rotated a mechanism similar to a centrifugal governor, actuating cords and levers connected to the robot's arms.

World's Fastest Typewriter

Typing 12 characters per second, a French electric typewriter has keys for alphabet letters, syllables, common phrases and salutations, such as "Dear Sir" and "Sincerely Yours." One-eighth-second touch will strike an individual key. Electronic components of the machine include 57 valves, 12 relays and 45 cells joined by 40 miles of wiring.

Kansas Turnpike Uses UHF

Ultra-high-frequency, multichannel radio communications will control administrative, maintenance and police operations along the 236-mile Kansas Turnpike. This microwave system includes two terminal stations and nine repeater stations located 20 miles apart on the toll road, in addition to fixed and mobile transmitting and receiving equipment. Four separate circuits will handle two-way communications.



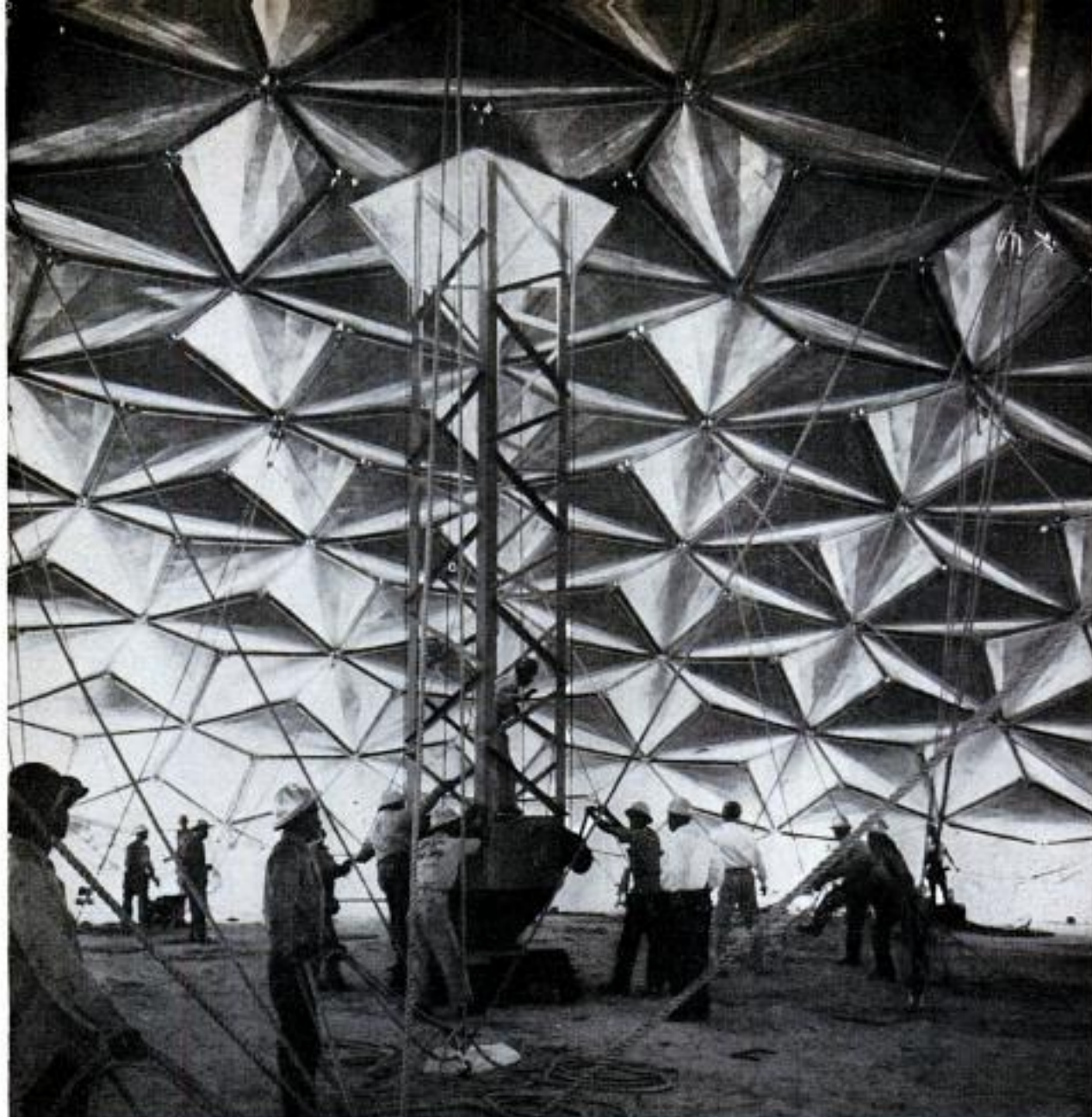

Kaiser Aluminum photos

Aluminum-domed auditorium was built around a portable mast which lifted dome as sections were bolted on

Patchwork Dome

Diamond-shaped panels are bolted together at edges and later calked. Each panel curves in and has a strut for strength

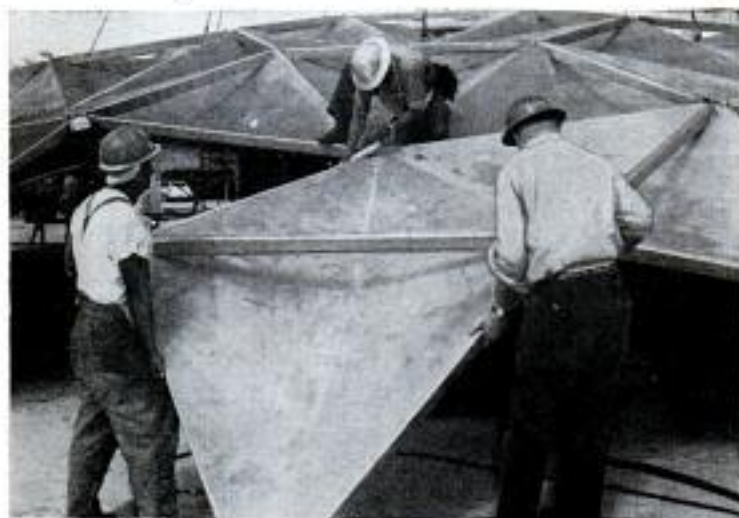

MADE of diamond-shaped aluminum panels, geometrically arranged and bolted together at their edges, a revolutionary domed auditorium looks like a silver patchwork quilt tossed over a giant mushroom. It was recently built—in just 20 hours by 38 workmen—near the site of Henry J. Kaiser's Hawaiian Village Hotel in Honolulu.

The huge aluminum shell is 49½ feet high and 145 feet in diameter. It has a seating capacity of 1800 to 2000. The unusual design eliminates pillars or any other interior support. Its diamond-shaped panels vary in length from 9 to 11½ feet and each panel is curved inward and strengthened with an aluminum strut. The dome was designed by the product development department of Kaiser Aluminum & Chemical Corporation.

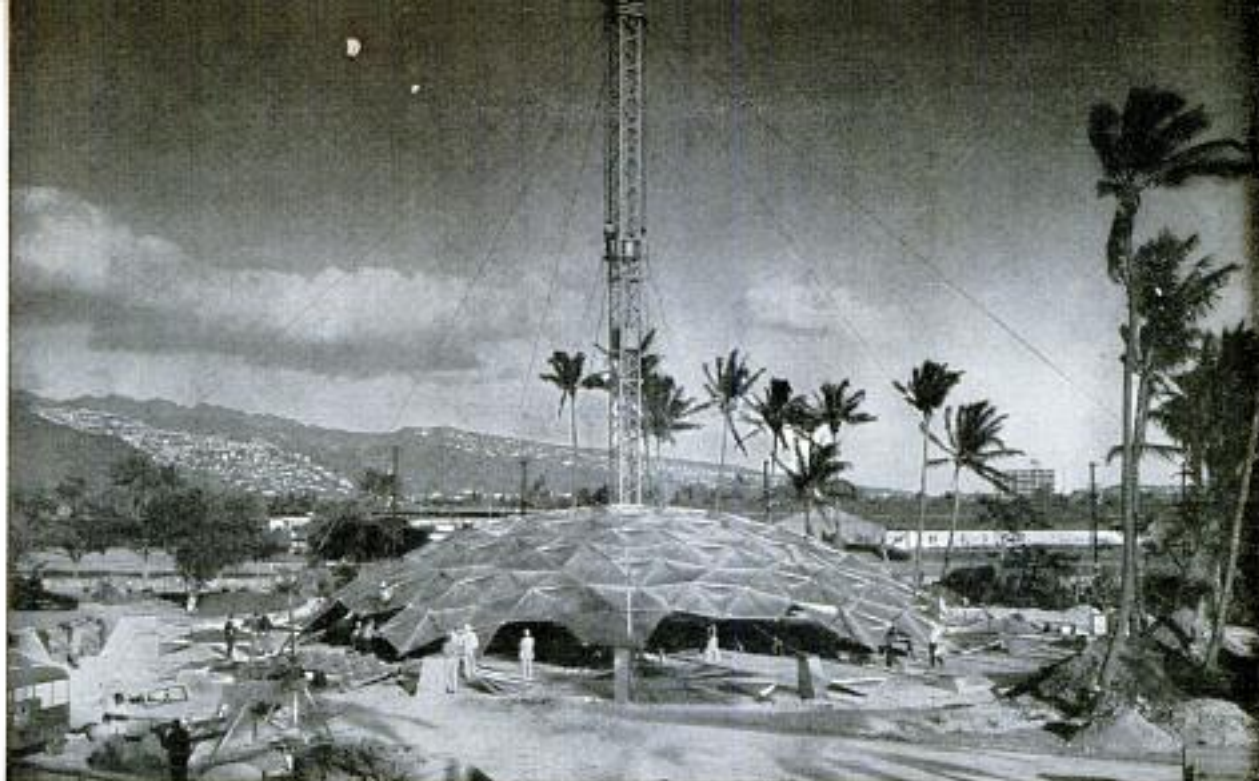

The 96-foot construction mast towers above uncompleted dome which took 38 men just 20 hours to erect

The panels were fabricated at the Kaiser plant in Permanente, Calif., shipped to Hawaii and preassembled at the site. The dome was erected around a 96-foot-high portable mast equipped with rigging. The top ring of aluminum panels was assembled around the mast and then lifted a sufficient height off the concrete floor to allow another perimeter of panels to be installed. This process was repeated until the entire dome was completed. The panels are held together by special aluminum bolts.

The dome is anchored to 25 concrete piers spaced around the floor. An opening

was left at the bottom of the dome to provide for landscaping.

A sealing material was used to calk the dome and make it waterproof. An opening 50 feet square at the top of the dome aids ventilation. The opening is fitted with a specially designed cover. Advantages of the dome stressed by the Kaiser engineers include low cost (\$4 or less per square foot), speed of erection, high strength (structural tests show the dome can support loads of over 100 pounds per square foot), and extra space due to the elimination of pillars. ★ ★ ★

Panels at lower edge of dome are anchored to concrete piers. Gaps will be filled with shrubs and flowers

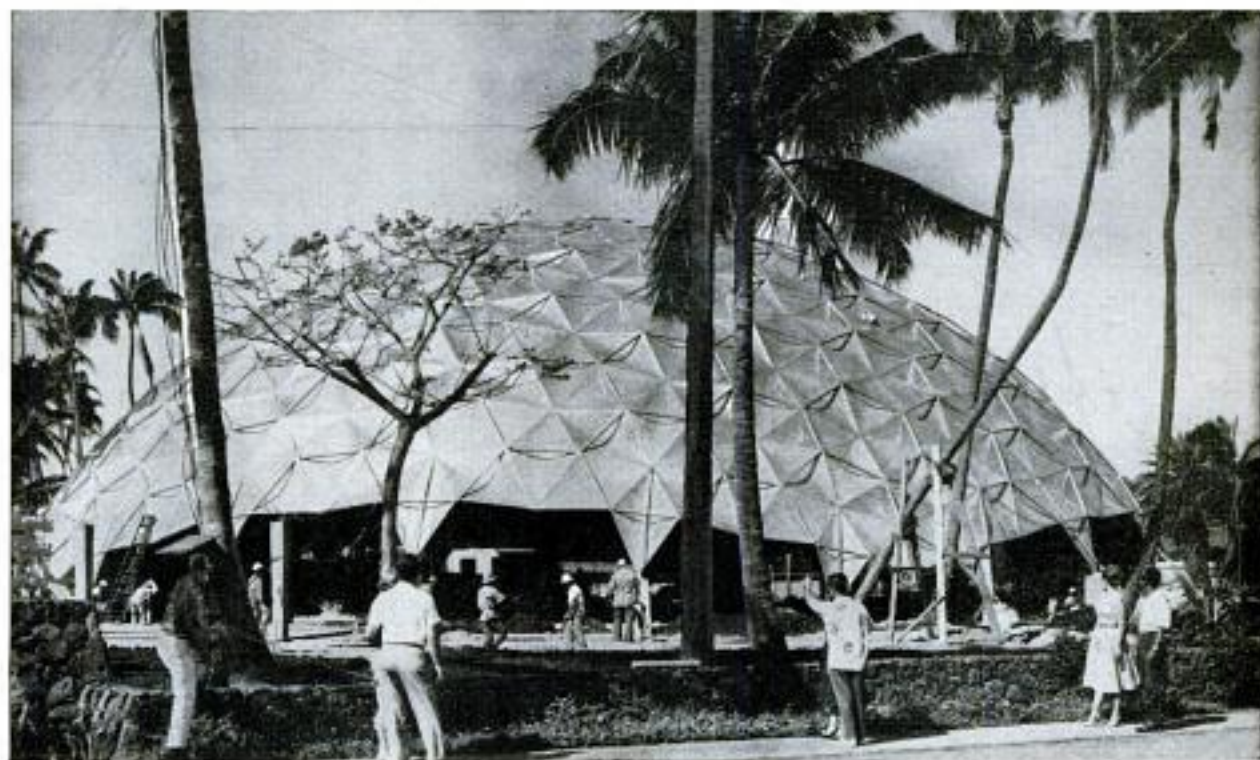



"Pillow Tire" Mobile Missile Launcher

Two new "pillow tire" vehicles permit the U. S. Air Force to carry rocket-launching equipment over terrain previously impassable to standard military transportation. Each tire on these vehicles has from 3 to 15 pounds' pressure, which can be altered by the driver to adapt to changing terrain. The Teracruz, an eight-wheel-drive truck, tows behind it the semitrailer Translauncher, which carries Matador missile-launching apparatus. The Teracruz has eight tires and the Translauncher four,

each about 3½ feet in diameter. Connected, the entire unit can travel 40 miles per hour over smooth country and 25 miles per hour on rough terrain. The Teracruz has a 250-horsepower, air-cooled engine, weighs 15,000 pounds, and is 30 feet long and 9 feet wide. The Translauncher weighs 15,000 pounds, and is 34 feet long and 9 feet wide. Both vehicles can be carried by air and will operate in temperatures from 125 degrees F. to minus 65 degrees F. on tundra, snow, sand, swamp, mud and rocky areas.

Portable Power Auger Aids Posthole Digger

Most of the arm-wrenching labor is taken out of posthole digging by a portable power auger. A two-cycle air-cooled engine carried on the operator's back provides the power. The operator has instant control over starting and stopping through a remote throttle and centrifugal clutch. Additional augers are available for drilling stumps and sampling soils.



Electronic Computers

More than 10,000 electronic computers will be operating in the United States in the next 10 years, according to International Business Machines Corp. experts.

Aviation-Compass Tester

Tester of aviation compasses is a device, perfected by General Electric, that twists and turns like an aircraft while duplicating the magnetic pull of any point on earth. Banking, pitching and turning are among gyrations possible with the apparatus.

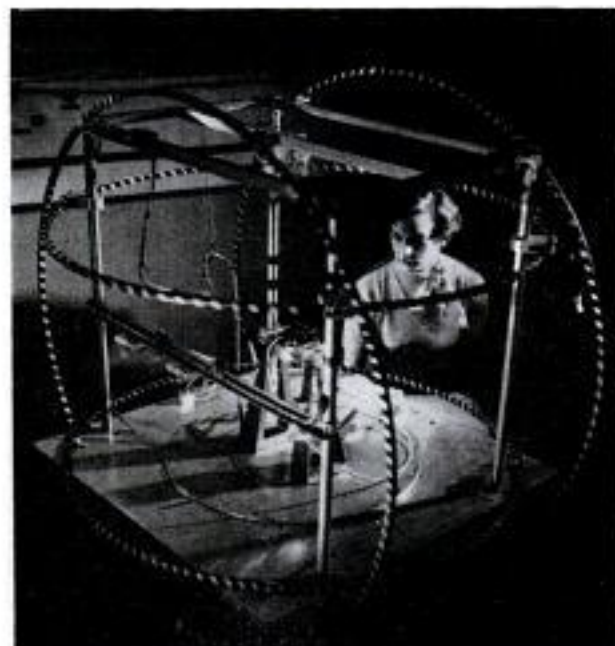

Tracker for Rockets → Mounted on Warship

Combining features of a step-ladder and TV antenna, an apparatus will track rockets that are borne aloft via balloon and released by radio signal to gather scientific data. Plastic balloons, 69 feet in diameter and supporting 12-foot-long rockets with 20 pounds of instruments enclosed, are to be sent far above the earth. Released, the rockets will radio or telemeter information to tracking gear on a Navy vessel at sea.

Electrical Device For Breathing

When cerebral-palsied children breathe so rapidly that continuous speech is impossible, an "electro lung" apparatus can be applied to stimulate and regulate their breathing muscles in forming correct speech habits. Termed a "movable respiratory brace," this machine has bands with electrodes. One band is strapped around the child's chest. Another band is strapped around the child's abdomen. An electrical charge makes these muscles contract, pushing internal organs up against the diaphragm, causing the patient to exhale. Rate and depth of breathing can be slowed down so that speech habits improve.

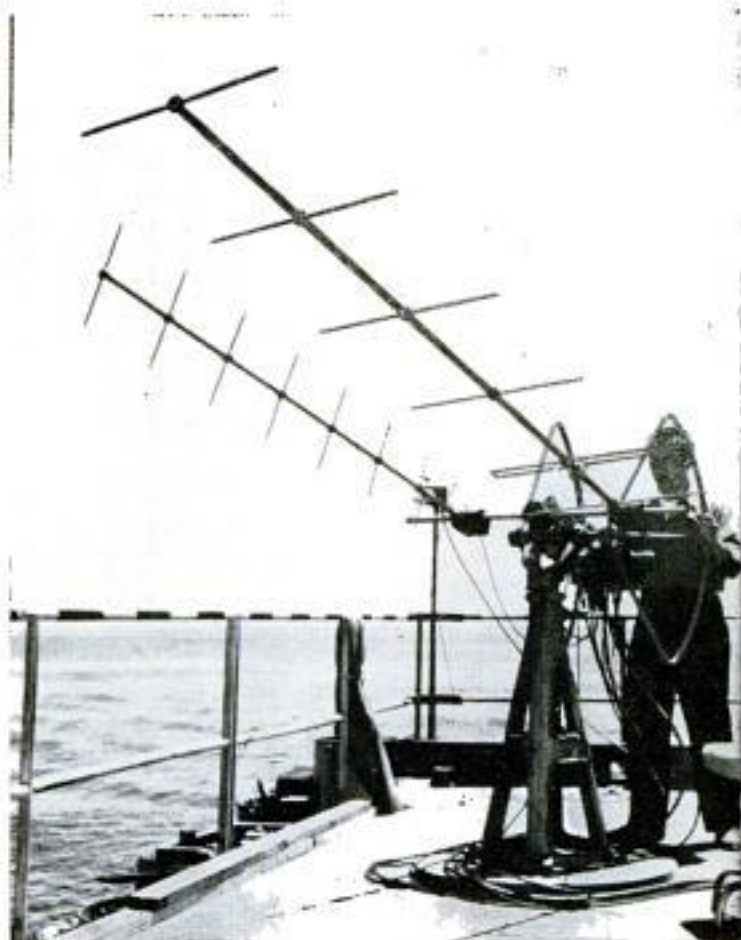

Copter Flight-Control System

Rotary aircraft now have a miniaturized flight-control system that automatically stabilizes them during normal take-off, flight, hovering and landing maneuvers regardless of weather.

Lawn Mower Without Wheels Skids Across Turf

There are no wheels on a new reel-type power mower. A large-diameter driving roller moves the mower and at the same time smooths the lawn behind the cutting reel. The roller is built in three sections to avoid scuffing the lawn on turns. The 21-inch reel slides along on two skids in front of the roller. Power from the gasoline engine goes to the traction roller and the reel independently, making it possible to vary the speed of one without changing the speed of the other. Available as an attachment is a sulky to convert the mower into a riding model.



WHAT'S NEW FOR Your Home



1. LAWN MOWER STARTER works by downward pressure of the foot on a long lever. Controls to start, stop, choke and idle are on the mower handle. Mulcher plate locks in grass until grass is chewed in fine bits for ejection. Safety guard protects the operator from debris struck by blade

Propulsion Engine Corp.,
South Milwaukee, Wis.

2. LEVER-OPERATED ICE EJECTOR permits a homemaker to slide an ice-cube tray into ejector, pull a lever and watch an entire tray of cubes fall into a storage or serving bin. The ice-ejector unit is built into the freezer door of the refrigeration appliance. One operation gives one pound of ice

Frigidaire Div., General Motors Corp.,
Dayton, Ohio

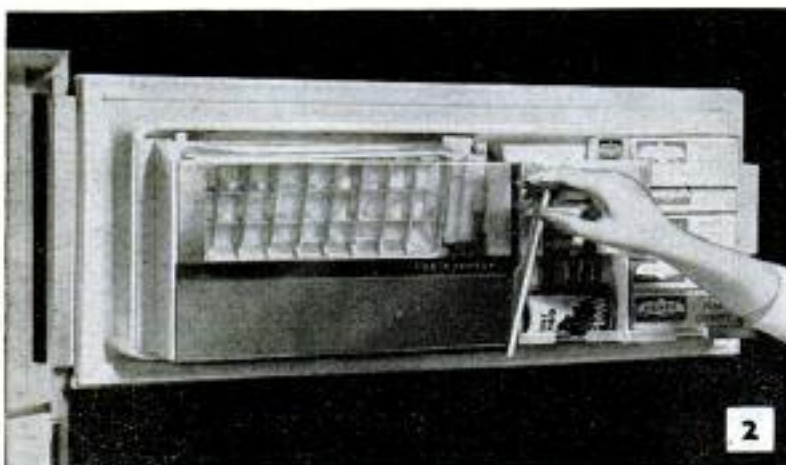

3. PUSH-BUTTON GARDEN DUSTER; motor receives power from two flashlight batteries which work for one summer's operation. High-speed blower spreads insecticide and other dusts. Mechanical agitator controls the feeding of dust to the blower. The dust chamber holds eight ounces of material

The E. C. Brown Co.,
10 Chapin St., Canandaigua, N. Y.

4. SASH FASTENER can lock window and fix it in one of three ventilating positions at the same time. The ventilating arm is 5 inches long and 2½ inches wide across the top sash fastener and lies flat when the window is locked closed. The top sash fastener will fit average-size locks

Slaymaker Lock Co., Lancaster, Pa.

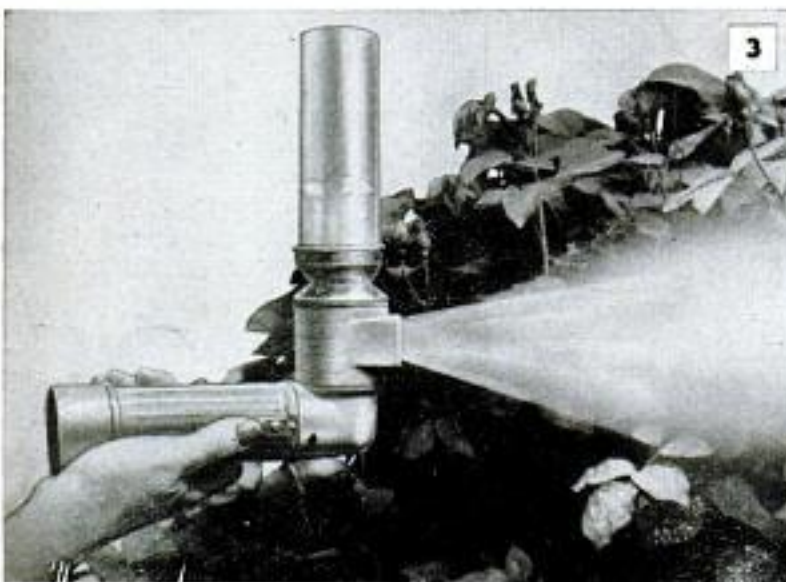



5. FOLDING TUB-SHOWER DOOR works like a conventional rigid bypass door at shower time or folds out of the way when tub is in use. Made of dylene plastic, the door fits any standard recessed tub with a 4-foot 6-inch to 5-foot 6-inch opening. Doors will not break, shatter, splinter or chip and come in five colors

Newcastle Products, Newcastle, Ind.



6. FLEXIBLE SUSPENSION ROD for electric-light fixtures hanging from the ceiling consists of four-inch sections. Rod can be made longer or shorter, as needed. This rod does away with dust-collecting chains and visible wires, facilitates cleaning and minimizes harmful blows. Rod is polished brass

Globe Lighting Products Inc., 16 E. 40th St., New York City

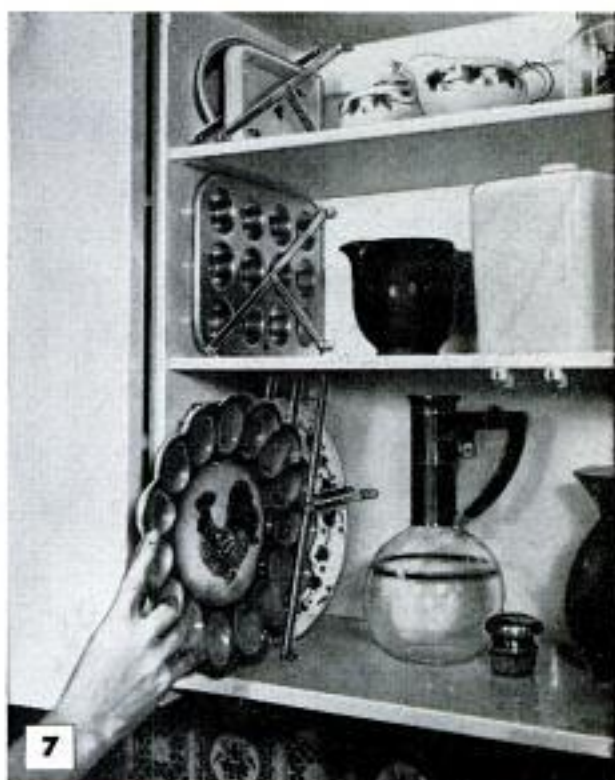

7. T-BRACKETS make storage space more usable in shelf and cabinet areas. The brackets are made of rust-resistant strap steel and are installed at 45-degree angle on wood or metal shelves. The "T" fastens to the front edge, and top and bottom backboard of shelf. Spacing can be varied according to item stored

The Bee Bracket Co., 5312 Westminister Ave., Philadelphia, Pa.

8. TRAVEL IRON serves as automatic steam or dry iron. For steam, water-reservoir bulb is filled and attached to iron. Steam stops when iron is placed upright on heel rest. For dry ironing, the bulb reservoir is removed. Operating on alternating or direct current, this 27-ounce iron has folding handle and fabric controls

General Electric Co., 1285 Boston Ave., Bridgeport, Conn.



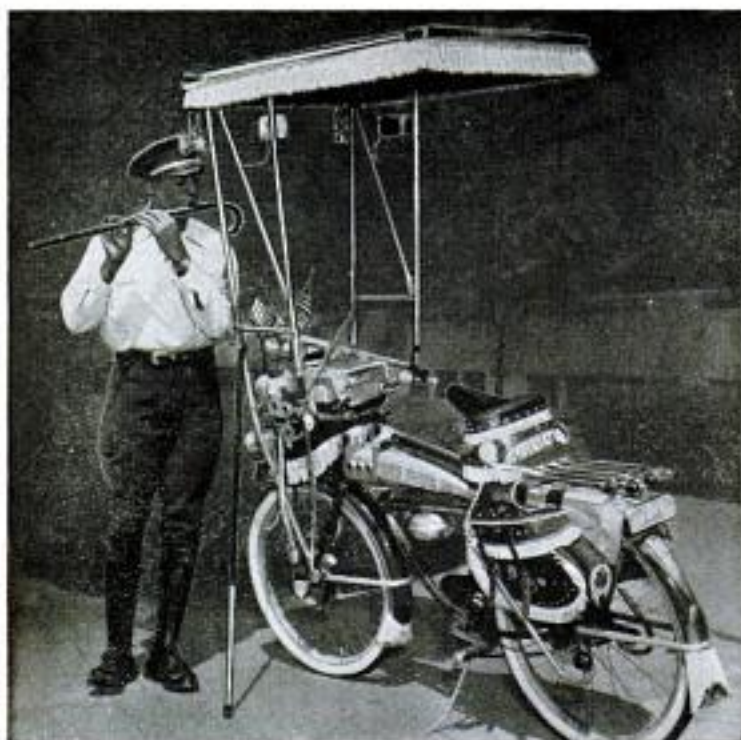

Superbike Has a Lot Of Special Equipment

Perhaps the fanciest bicycle in existence belongs to Charles E. Adams of Chicago. Three years ago Adams bought a bicycle and started adding his own special equipment to it. Now it has an overhead canopy for shade, a car radio, 15 lights, built-in holder for cigarettes, an ash tray, a cigar lighter, three bells with five different tones, direction signals, two rear-view mirrors and a tool kit. Two motorcycle batteries provide electricity for the radio and lights. An accomplished musician, Adams also carries along a flute he made from a length of bamboo and an umbrella handle. He rides the bike to work each day and a meter on the front wheel shows he has pedaled 9532 miles in three years.

Electric Mousetrap →

Rodents kill themselves in an electric mousetrap that can be connected to any house outlet. Electricity flows through the cage's zinc-coated walls and floor. When a mouse crawls into a hole in the top of the trap, he completes the circuit and is electrocuted. Up to five rodents can be killed before resetting the trap.



Person Generates Heat

Even when sitting still, a person generates enough heat (100 watts) to bring a quart of water to a boil in one hour.

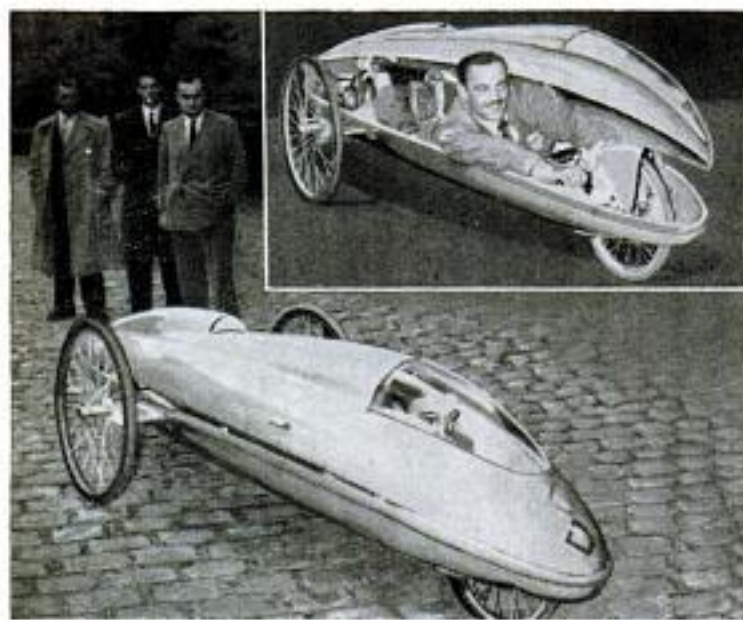

Horizontal Cyclist Rests While He Rides

Motor-bicyclists preferring to drive in a horizontal position look with envy at a three-wheel, rocket-shaped vehicle recently unveiled in Paris. Power-wise, this speedster is about equal to its motor-bike counterpart.

Gold-Coated Windshields

Gold coating insulates automobile windshields against summer heat rays. Ford scientists find that glass, covered with a gold film 30,000 times thinner than a human hair, filters the heat rays.

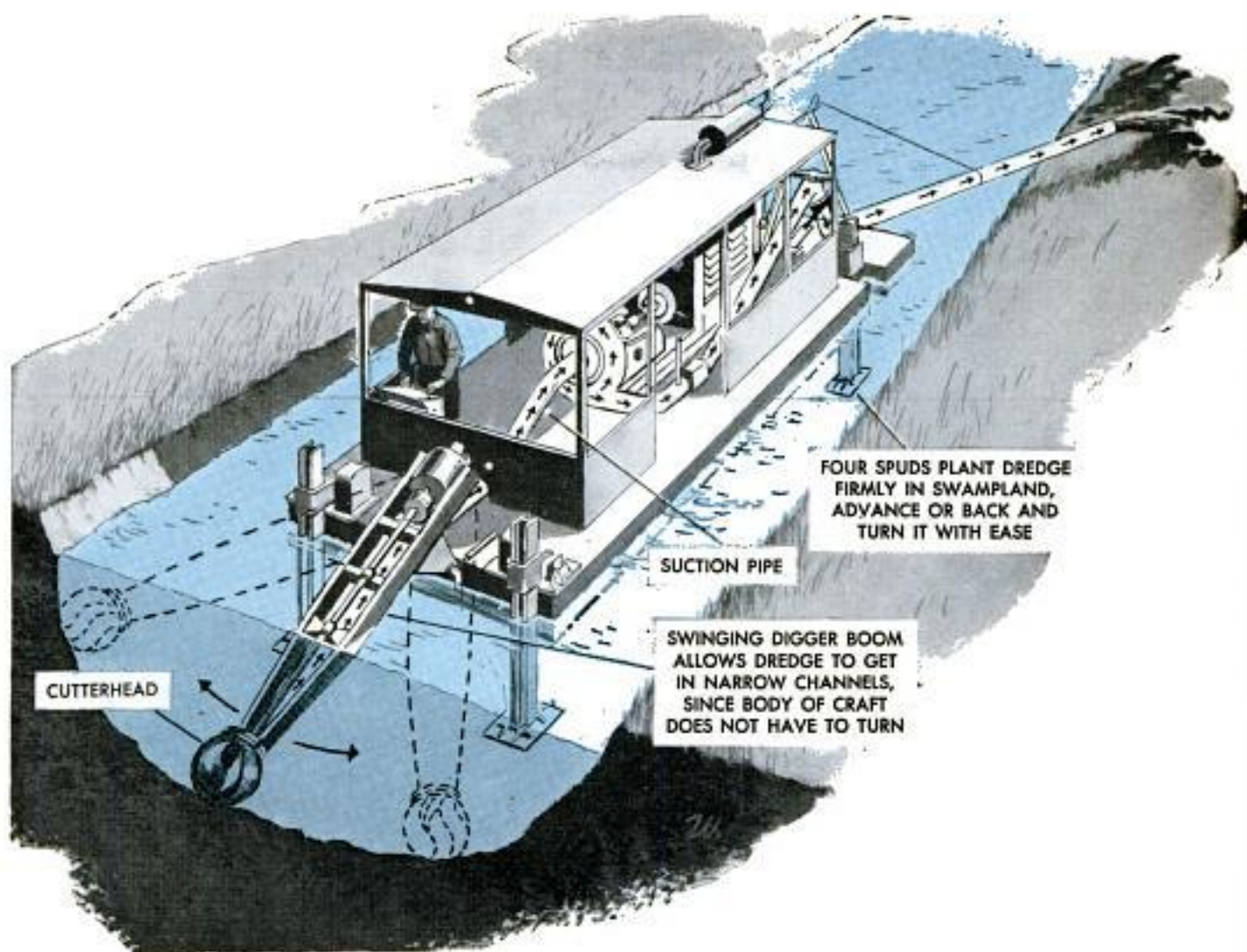

"Walking" Dredge Cuts Drainage Canal

ONE MAN operates a dredge built to carve a drainage canal extending eight feet deep and 16 to 17 feet wide through a swamp. Mounted on its bow is a boom that not only swings up and down, but sidewise as a cutterhead chews away the mud and a suction pipe carries the sludge to the rear of the boom, through a pump and out a discharge pipe at the stern. Four adjustable steel spuds (legs) brace the dredge during

digging, and advance or back and turn it. Every movable part of the machine is operated hydraulically by one man from a central control panel. The craft is 11 feet wide, three feet deep and 28 feet long, and can cruise under its own power by using the jet thrust and steering action of the discharge pipe floating in the water. It digs 100 cubic yards per hour of silt or 80 cubic yards hourly of sand.

First dredge of this design went to work cutting a drainage canal through a swamp near Baltimore airport





Fire Cart Protects Ranch

Fire protection on a ranch near Merced, Calif., is assured with a home-made cart to carry the hose. When the roof of the cart is removed, the sides fall and expose the sides for attachment to a hydrant. The hose can be fastened to a hydrant and then unwound, as the cart is pulled to the fire. The cart has four square feet of tongue-and-groove flooring, in addition to a handle and two legs at the front and two small rubber-tired wheels at the rear. Mounted on the floor is a revolving platform. A shaft in the center rides in a bearing in the floor. The shaft extends upward and is used as a base around which to coil the hose on the platform.



Thin Skin For Wire

Copper wire is being coated with an aluminum skin $\frac{1}{40}$ as thick as human skin to prevent oxidation. The process, developed by Westinghouse, will increase the life of electrical equipment.

Concrete Roof

Even the roof of the building planned to house the American Concrete Institute near Detroit will be made of concrete. Thin, folded plates of reinforced concrete, cantilevered front and rear from the concrete interior walls, will cover the building. A system of triangular skylights down the middle of the roof will light up the corridor below. A perforated screen of colored pipe sections, backed up by glass, make up the end walls while concrete panels and glass form the side walls.

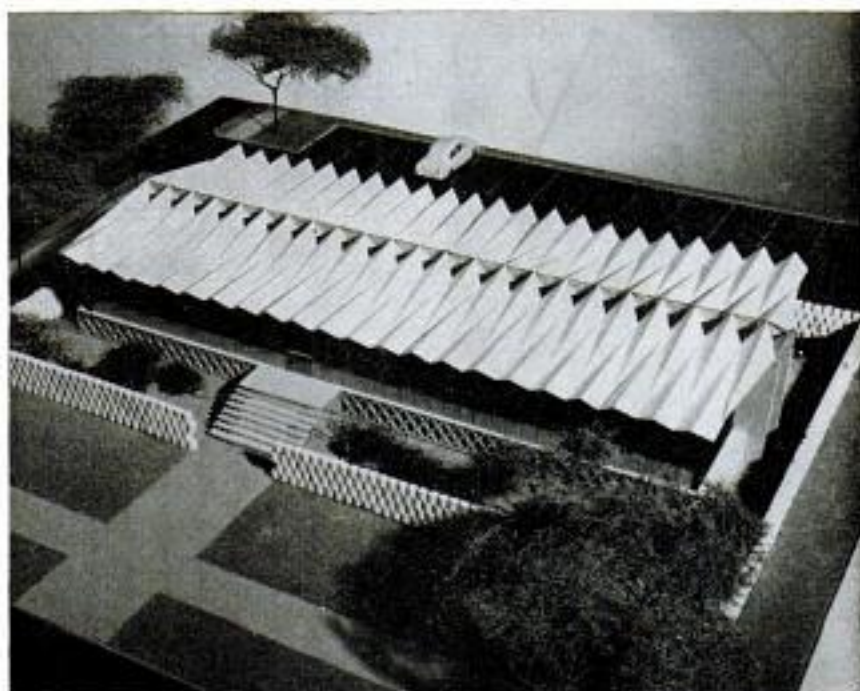

Ministry of Works
Geothermal Investigations

The PUBLIC are WARNED
that ALL PITS may contain
TOXIC GASES
and should
KEEP CLEAR of ALL
PIPES and EQUIPMENT

BY OFFER



New Zealand's Ministry of Works posts signs to keep public aware of toxic steam

Tapping the Devil's Cauldron for Power

*Reprinted
in PM HIGHLIGHTS*

By Richard F. Dempewolf

Photos by Richard Harrington

YOU HEAR AND SMELL Wairakei long before you get to it. The sulphurous breath of Hades hangs in the picturesque valleys of northern New Zealand's uplands—fuming from hundreds of boiling mudholes, steaming pits and fissures in the earth's crust on the Waikato River plain. Here, more than 40 shrieking manmade geysers are sending white jets of steam billowing hundreds of feet up and across the scalded valley floor. The ground trembles and the noise is deafening. The landscape is dusted with





Steam from a "cleaned" well is deflected into horizontal pipes and shoots 100 yards across countryside

pumice and crusted with heavy white deposits of silica. Trees kissed by those infernal jets glitter like white-sprayed Christmas decorations. They soon become

dead snags under the heat and the fumes.

Wairakei lies in the center of a vast thermal region stretching 170 miles north-eastward through villages with colorful Maori names like Tongariro, Waiotapu, Rotorua and Tikitere. In Rotorua, boiling geysers have ripped through the floors of stores and sent hot mud 25 feet into the air, steam puffs from gutter drains, asphalt streets develop hot patches and the golf course boasts unique natural hazards—small open steam vents that grunt puffs of vapor and are known as "grunting pigs." Homes and public buildings get their hot water and heat from shallow wells. One resident grows orchids in a greenhouse heated with geothermal steam.

None of this is new to the Maoris, who have been using the subterranean steam since A.D. 1500 to cook their food, wash clothing and bathe. But neither Maoris nor British colonials who followed them were aware, until recently, of the full potential of the forces beneath them.

At Wairakei, hard-hatted crews are drilling through the earth's crust to tap nature's boiler for the high-pressure, superheated steam. Already it is turning generators to produce electrical power for northern New Zealand's growing domestic and industrial

Diagram shows how Wairakei volcanic steam will help generators create 100,000 kilowatts of electric power

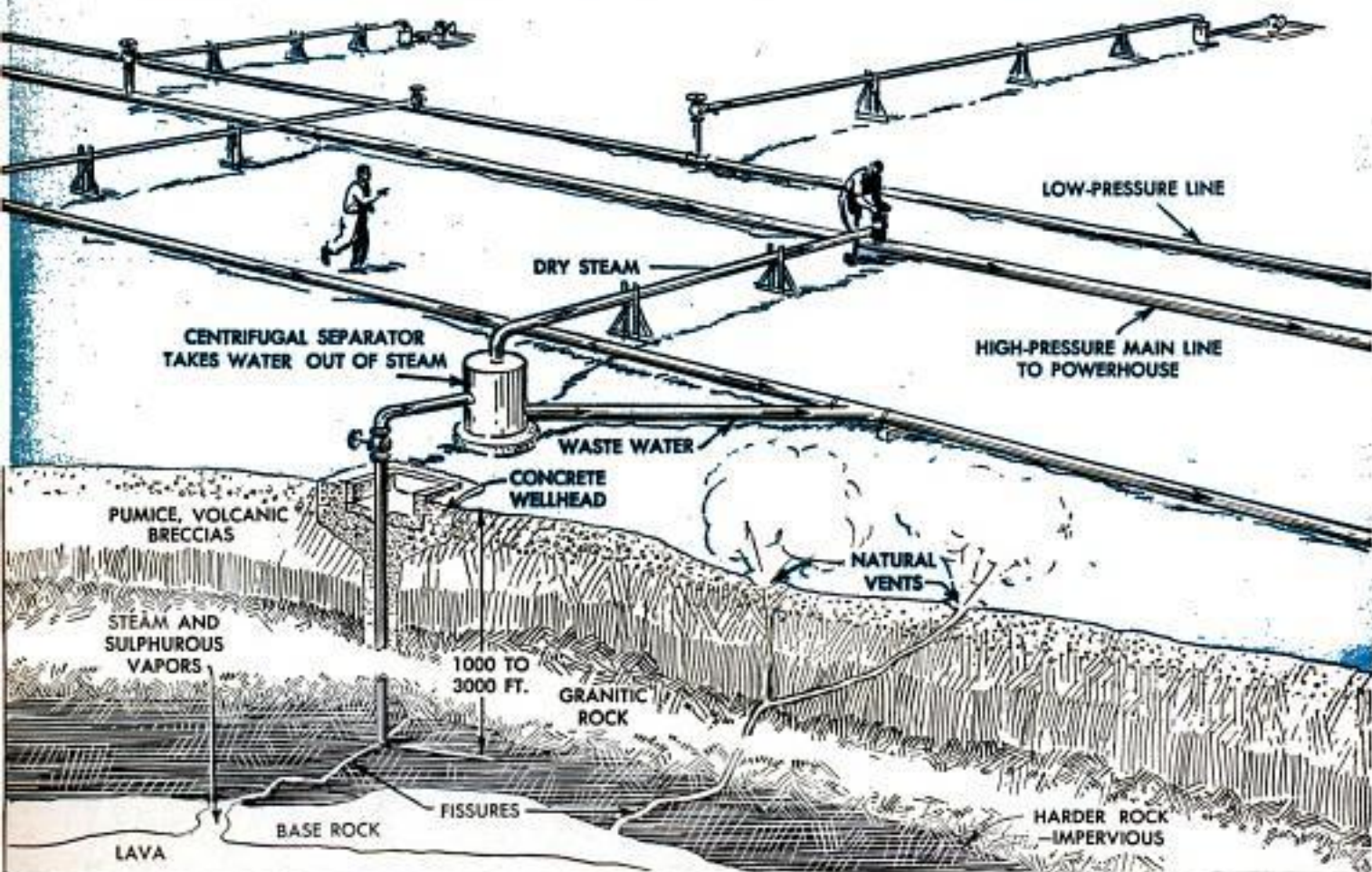

needs. Mr. L. Fooks, energetic superintendent of the Wairakei Geothermal Project, explains that the \$12,000,000 job of turning volcanoes into volts is not just a frightening experiment. "We've about reached the end of North Island's hydroelectric potential," he points out, "and coal-fired power stations are impossibly expensive here. But now we've got ready-made steam power without any fuel cost. Right here in Wairakei there's a proven potential of 250,000 kilowatts—and it may even go to 500,000."

As you drive down the valley of roaring smokes, Fooks passes you a pair of ear plugs. Without them, you may bleed from the ears, as you move close to the mammoth uncapped jets. The shriek of steam at a freshly blown well opening has been clocked at 150 decibels—10 more than you'd get from the tail pipe of a jet plane. Close beside one of the openings, the earth shudders and the smell of sulphur is everywhere. Most of the pipes lie flat on the ground, with big cylindrical openings at the end—some of them five feet in diameter. These are "mufflers." "The smaller ones," Fooks explains in shouts and sign language, "have baffles inside. The big ones of concrete are a series of pipes increasing



Huge mud lakes near Wairakei steam, boil and bubble leaving tremendous steaming potholes and craters

in size—like the barrel of an extended telescope." The latter have no baffles, and are buried under piles of earth to hold them steady. Both types cut down the

Eventual capacity of this electric-power generating station at Wairakei may run to 500,000 kilowatts

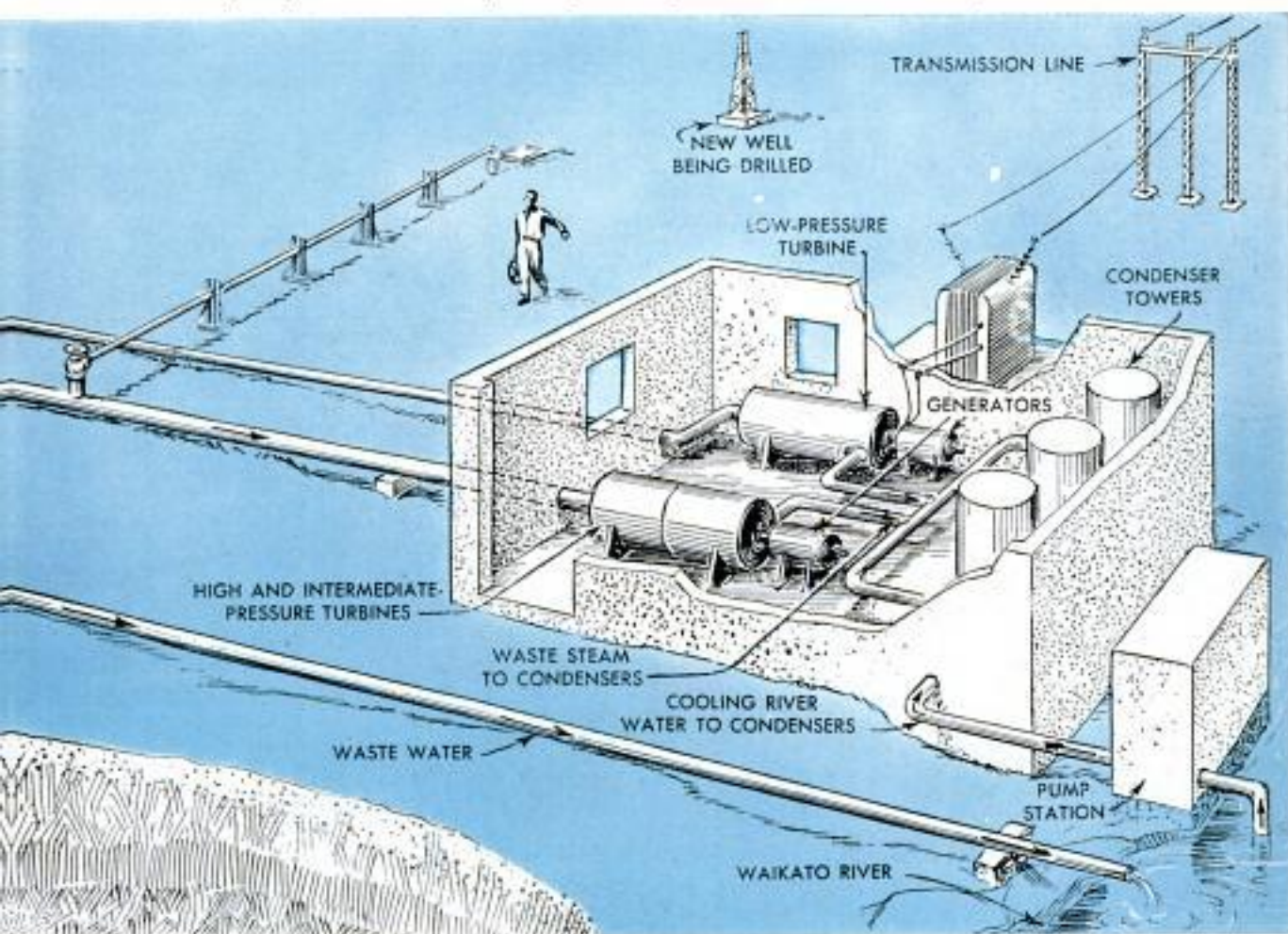



Maori Indians of Rotorua in Geothermal Valley guide the warm water into pools for laundry and bathing

high frequencies which are the most unpleasant, but the actual noise level is only cut about 15 decibels—"from unbearable to uncomfortable," says Fooks.

No one on the project knew what he'd be getting into when the first bores were drilled at Wairakei in 1949. Sulphurated hydrogen is combined with the steam rising from vents in the Tongariro and Rotorua areas. Last year two ditch diggers in Wairakei village collapsed and died from

fumes. "We could and did take precautions against fumes," says Fooks. "But our biggest hazard was from blowouts—and still is. Underground vapors are still forced up through fissures in new places. They turn the country to scalding mud that undermines buildings and drill rigs. So far we've been lucky." The first 4-inch test hole struck hot water at 200 feet. Thirteen others were sunk to depths reaching 1100 feet. One produced a steam jet capable of spin-

Vegetables are cooked by a Maori housewife who ties them in a woven bag and suspends them in hot spring



Steam from man-drilled geysers shoots hundreds of feet into air in Valley of 40 Smokes, New Zealand



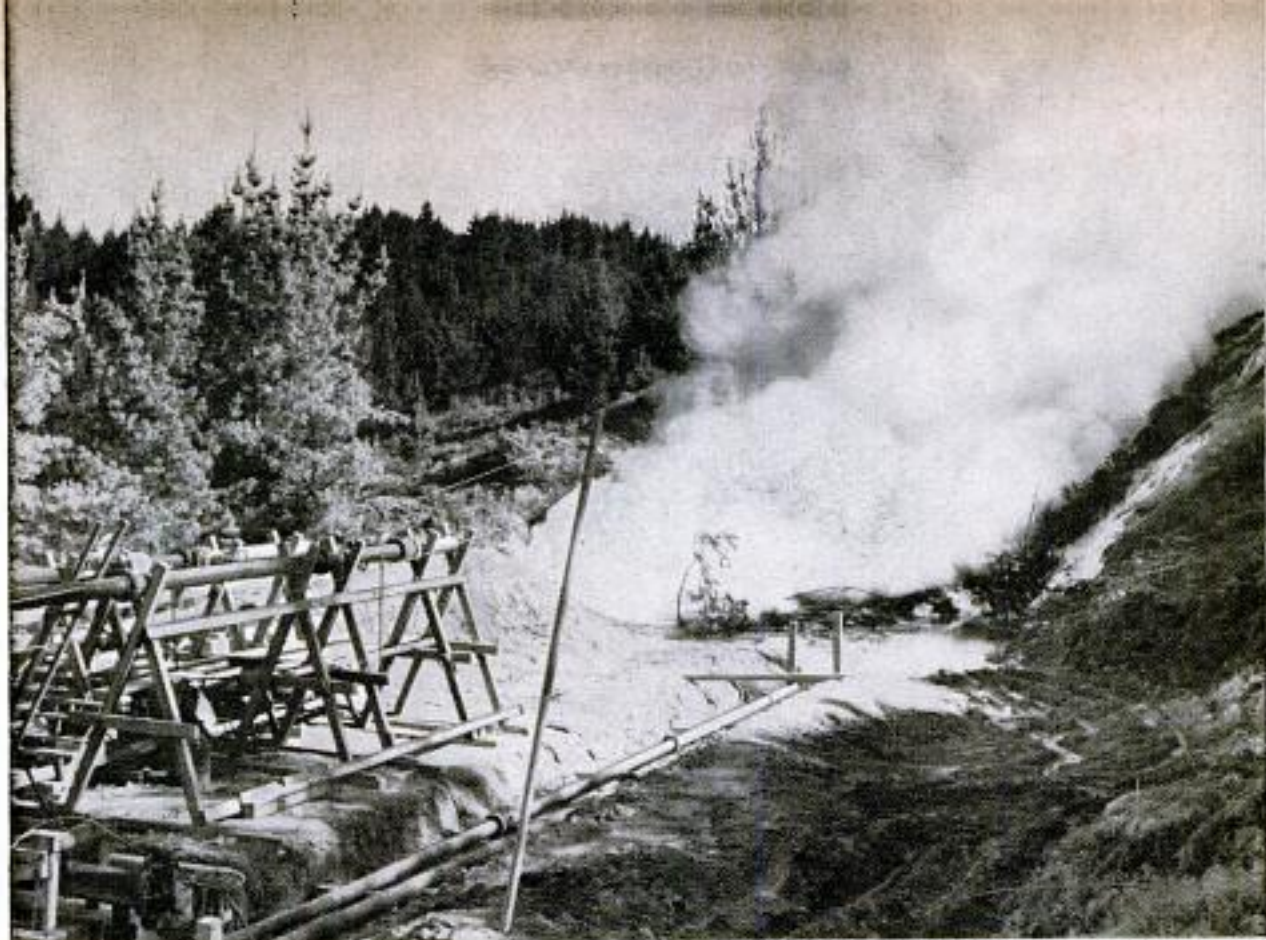

Deep-well geyser shows how sulphurous steam roars through vegetation of a valley to stunt and kill plants

ning a 1000-kilowatt generator, and the engineers went on to deeper, wider holes. The largest hole, a 10-incher, came in with enough steam for 6000 kilowatts. But the granddaddy of them all was an 8-inch bore that geysered in to the tune of a potential 20,000 kilowatts of power.

Drilling is accomplished much the same way an oil-drilling crew brings in black gold in Texas or Oklahoma. In fact, the drilling rigs came from Oklahoma. Water and mud are poured into the hole as the drill grinds down, and pulverized rock is washed out periodically. No one knows exactly when the hole will "blow." "Any bore more than 200 feet deep may suddenly send everything sky-high," Fooks reports. "We control them by pouring cold water down the hole while drilling. An 8-inch column of water in a 1000-foot stand of pipe exerts enough

(Continued to page 238)

Sulphurous steam fumes, issuing from caves and cracks in the side of a cliff, created this tremendous sulphur deposit in Geothermal Valley





Ointment-Bandage Lasts Two Weeks

Purdue University has announced a new development which will be a boon to burn and poison-ivy sufferers and to those who take care of them. A plastic bandage and an ointment have been perfected, either of which will release a constant level of medication to the skin for as long as two weeks, and work by an ion-exchange process. Through this new treatment, persons suffering burns, poison ivy and similar ailments need not undergo the pain connected with frequent changes of bandages.

Two-Way Iron

Remove the heating plate from a new flatiron device, and the plate can be used as an immersion heater for boiling water. Reinstalled in the flatiron, the plate performs conventionally. Consumption of current is small. This heater is available for 110 and 220 volts.

☐ Radio signals from Venus, possibly electrical storms on the planet, have been picked up by Ohio State's radio observatory.

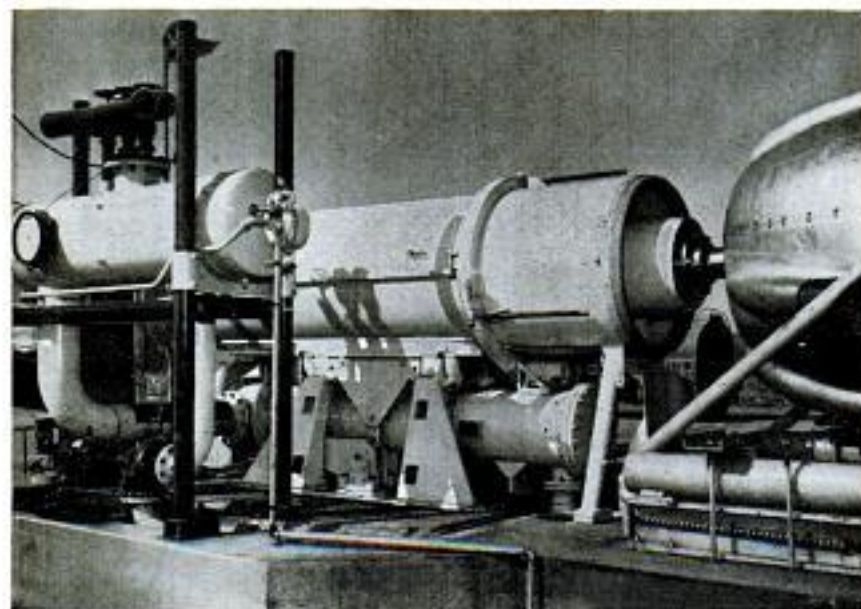

Aircraft-Engine Test Cell

After overhaul, aircraft engines at the TWA Overhaul Base at Kansas City, Mo., are dollyed into the test hangar and attached to a monstrous test cell recently put into operation. The cell is a hydraulic dynamometer in which the propeller shaft is fastened to a series of turbine wheels spinning in oil which absorb all power of the tested unit. All engine-performance data concerning the engine are automatically recorded.

KEEPING UP WITH THE ATOM

BEHIND THE HEADLINES: The Suez crisis, according to one report, has forced oil-hungry Britain to accelerate its nuclear-energy program. As each power reactor goes critical in England, that nation becomes slightly less dependent upon oil as a power source. It is believed that the British will build three nuclear-power stations which have not been previously announced, two in England and one in Scotland.

Britain already leads all nations in expenditures for nuclear-power plants.

☆ ☆ ☆

A FOURTH KIND of nuclear reaction is possible, according to Dr. L. W. Alvarez of the University of California. The three types previously known are the bombardment of atoms with atomic particles in giant accelerators; fission, in which atomic particles split apart other atoms (the A-bomb); and fusion, the thermonuclear reaction of the hydrogen bomb.

The new kind of reaction, called a "catalyzed nuclear reaction," somewhat resembles fusion but occurs at much lower temperatures than those required to touch off the H-bomb. An atomic particle, the negative mu meson, is the heart of the reaction. It is not affected itself, but it helps along a reaction that releases 5,400,000 electron volts of energy.

Trouble is, the mu meson has such a short lifetime that the reaction isn't very likely to occur. The discovery is of considerable interest to physicists but will not be of any practical importance unless other sub-nuclear catalysts with longer lifetimes can be found.

☆ ☆ ☆

ONE OF THE MOST IMPORTANT fields for peacetime use of the atom has been largely overlooked, according to S. L. Nelson of General Electric.

While scientists have been trying to wrest electric power and motive power from the atom, they have done little to use raw energy from the atomic nucleus for space heating.

Nelson points out that heating with atomic energy is relatively simple compared to obtaining electrical power from the atom. To drive a steam turbine effectively you need high temperatures and pressures, but many materials which meet these requirements become highly radio-

active in a reactor. On the other hand, low pressures and temperatures suffice nicely for space heating.

A good example of this is at the Hanford atomic plant. For years, hot water (carrying heat from the reactor) has been dumped into the river, while coal was being burned to heat the plant. A new heat-exchanger system now is stealing heat from the reactor to heat several of the buildings.

Nelson foresees no reactor inside your home to replace your furnace, but he does see the possibility of atomic energy heating large hotels, office buildings, city centers and factories. And, as he points out, such buildings "may be heated without a speck of soot, an ounce of ash or a cubic foot of smog."

☆ ☆ ☆

WANTED: Cans of food at least 11 years old.

The Food and Drug Administration is making a survey to determine how much radioactivity gets into the foods we eat. As one part of the survey, the FDA is collecting samples of food that have been canned recently. However, the year 1945 is the "year one" of the atomic age, points out Commissioner George P. Larrick, and samples of canned food packed prior to 1945 are needed for comparison.

The goals of the program are to determine the background radioactivity of foods from various parts of the country, and to learn whether the radioactivity has been increased by the testing of nuclear weapons and other applications of atomic energy.

☆ ☆ ☆

THE ATOM-POWERED CAR is a plain impossibility unless some basic new scientific principle is discovered.

This belief, long held by the scientists, has been given new expression by C. R. Lewis of the Chrysler Corporation's engineering division. He points out that according to one estimate a 3000-pound automobile would require a nuclear-power plant weighing 80,000 pounds to move it along the highway.

The only hope for an atom-powered car or "atomobile," Lewis states, is the possibility that an efficient means of storing energy might be developed. Then stored nuclear energy could power our cars.



German Phono Bar

Here's a new way of promoting records which may eliminate the disk jockey. It's a music bar at a German fair where a record firm introduces its latest recordings to the public via this ingenious earphone method. Patrons can use either one or two earphones for listening.

TV in Nicaragua

Nicaragua is the latest of the Latin American nations to introduce television programs.

Maintenance Machine

Retractable wheels permit a track-maintenance machine to ride along the rails, on a highway or cross-country. The operator, if he chooses, can take a highway to the maintenance site, riding along on huge rubber tires. Flanged guide wheels lift the front tires clear of the ground and rails and carry 40 percent of the weight normally on the rear traction wheels. The rubber tires ride up and over crossings.



All-Weather Tractor

Comfortably encased in the steel and glass cabin of his tractor, today's farmer flicks a switch for air conditioning in summer or warmth in winter. Push-button radio is another advantage enjoyed by atomic-age tractor toilers.

Busy Airport

Chicago Midway airport, the world's busiest, handles more traffic in a year than Amsterdam, Copenhagen, London, Paris and Zurich combined.

Instrument Measures the "Bend" in 400-Pound Granite Plate

"Bending" in such flat, solid surfaces as a 400-pound granite plate can be measured to $\frac{3}{4},000,000$ inch by the alignment interferometer. This device has a main body (light source) and a mirror. A ray of light shoots from the main body and is reflected by the mirror, which may be set 14 feet away. Light waves act as "rulers" by which minute variations are measured. Through the machine's eyepiece the operator sees three dark parallel lines at zero setting. As mirror position alters, the field of view is crowded with lines. This change in basic line pattern indicates a change in angle of light reflected from the mirror to the main body. Readjustment of the instrument returns the original three lines to the field. Total departure from zero is read from the graduated control dial.

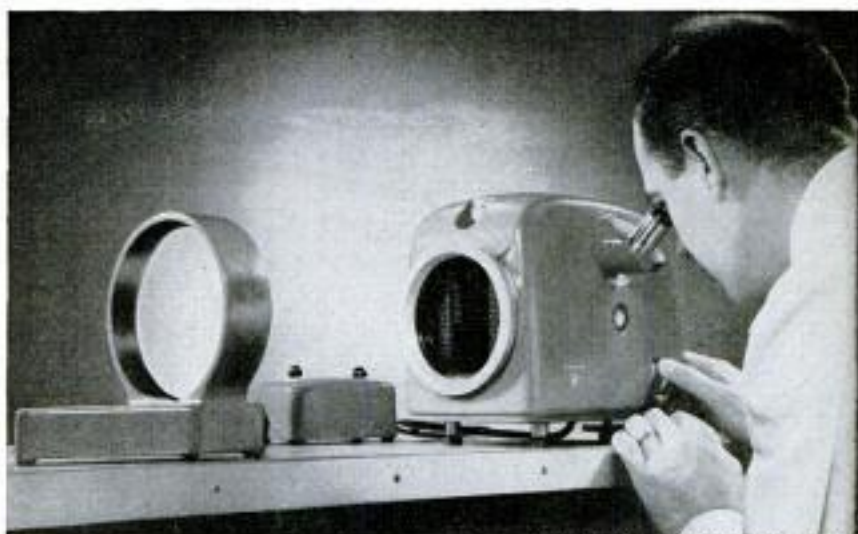

Bausch & Lomb Optical Co. photos

Reflected light waves act as rulers by which minute variations in surface are measured. Below right, three dark parallel lines show zero setting. Below left, crowded lines show change in light and surface



Standard Spinning Reel Fits Bow

Sportsmen who like to fish with archery equipment now can mount a standard spinning reel on a bow. A special mounting holds the reel at the center of the bow just above the archer's hand. The end of the line goes back to the feathered tip of the arrow, and the line pays out easily behind the arrow. All the archer has to do to retrieve the arrow—or fish—is reel in the line.

Highest Simulated Height

Simulated altitude of 198,770 feet—about 38 miles—has been reached by a U.S. Air Force major in an aero-medical test chamber at Wright Air Development Center, Dayton, Ohio. Maj. Arnold I. Beck, wearing a partial pressure suit and pressure helmet, attained record height in near-vacuum atmosphere. Pressure at ascent peak was .0048 pounds per square inch, compared to 14.7 pounds per square inch at ground level.

EXISTING CHAIN-LINK FENCE

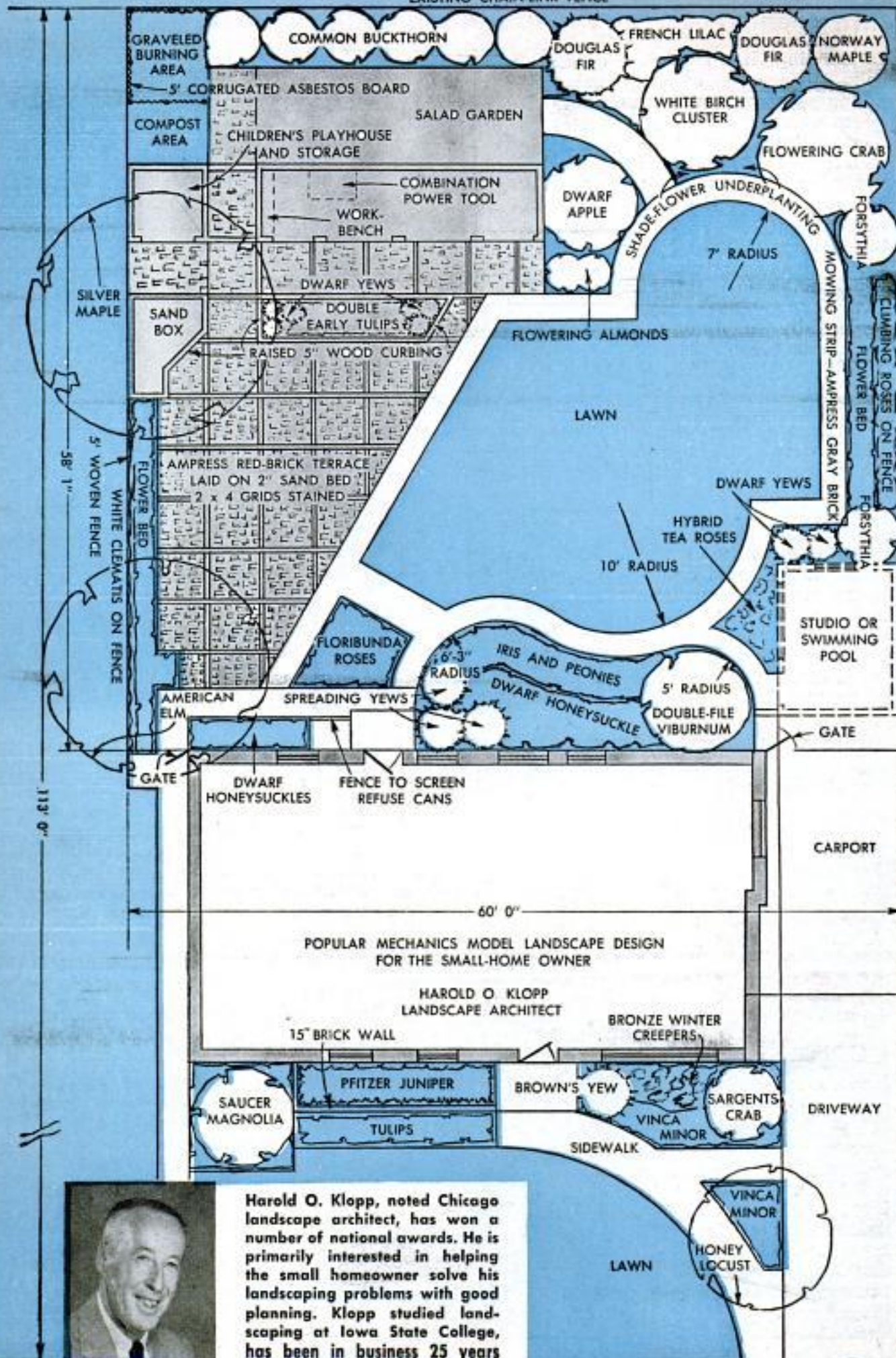

Harold O. Klopp, noted Chicago landscape architect, has won a number of national awards. He is primarily interested in helping the small homeowner solve his landscaping problems with good planning. Klopp studied landscaping at Iowa State College, has been in business 25 years



Color photo and black-and-white inset were taken from same corner of Hedden yard—two years apart

*A 60-foot lot can be transformed into a place
for outdoor living on a grand scale with*

PM's Landscaping Plan for the Small Yard

By Jay W. Hedden

MIRACLES are not a part of this modern world, but a near-miracle can happen in a couple of years when it comes to landscaping. I know, because we worked one in our yard to transform it from a mudhole to a showplace in just 24 months. Like most worthwhile projects it took a lot of time and hard work, but we could not have obtained the results we did without the most important ingredient—a good plan.

When we moved into our new home in a Chicago suburb, no landscaping had been





This plastic pool set in a sand pile in one corner of the yard proved to the Hedden children and their young friends that good landscaping provides for kids, too



Mrs. Hedden admires spring tulips before new planting box at front of house. Below, this same bed became a showplace in the summer with a riot of colorful blooms



done on our lot which measures 60 by 113 feet. This is a typical situation; like the average family, my wife and I figured on doing the work ourselves. As soon as spring had thawed the ground we planted grass in the front yard. You can't go wrong planting grass; it's green and keeps down the mud when it rains and prevents blowing dust when it's fair.

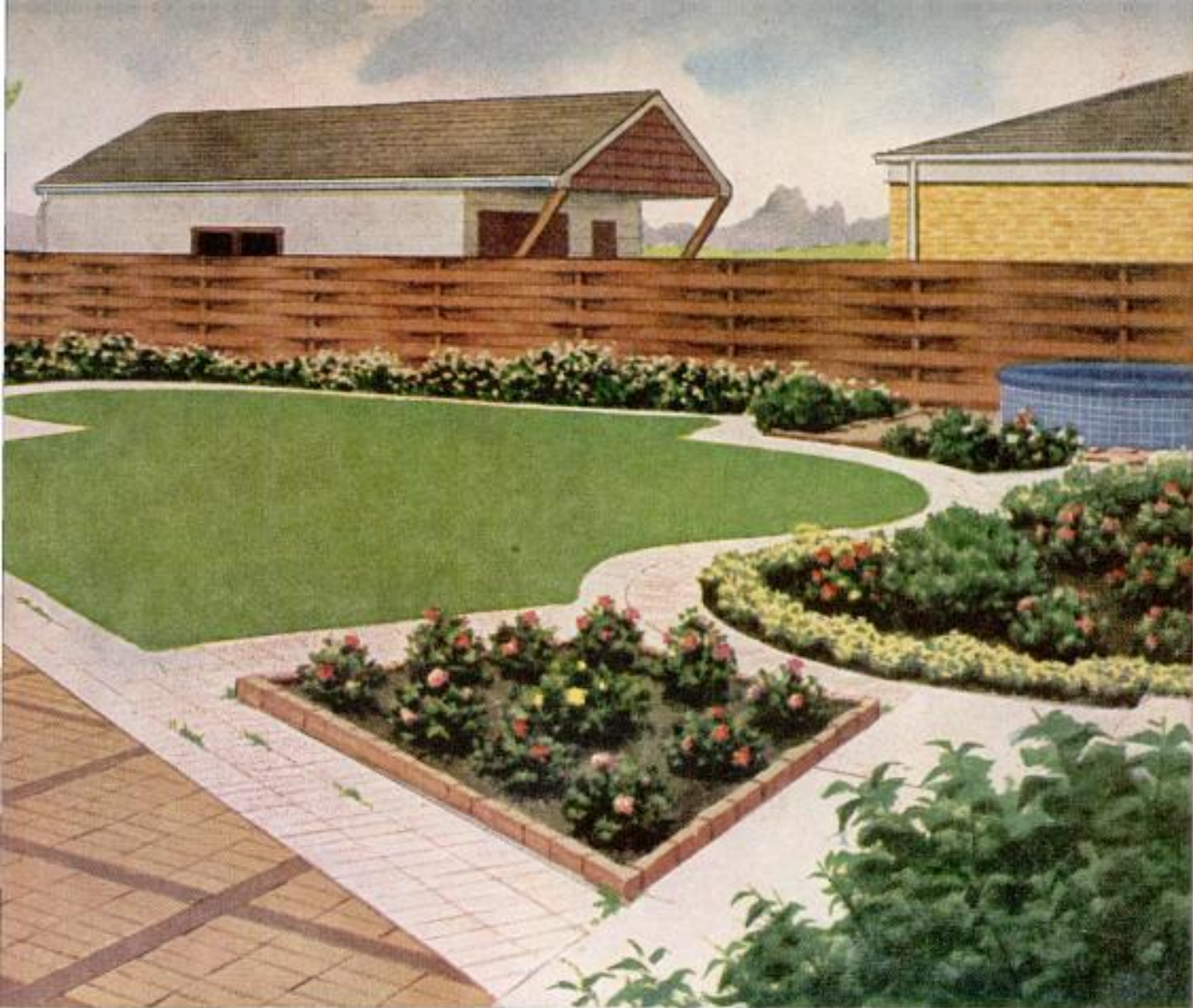

Brick patio, walks and general "framing" of landscaping are designed to give small yard a spacious look

Landscaping the back yard presented more of a problem than the front, since we wanted a patio for outdoor parties and a place for our 10-year-old son, Dick, and 6-year-old daughter, Dana, to play. Also, we needed storage space for garden tools, patio furniture and the children's bicycles because the house had neither basement nor attic.

Since the back yard was to be an "outdoor living room" it needed a wall, which we provided by building a five-foot basket-weave fence. This required the friendly cooperation of our neighbors, since their properties also would be affected.

At this point in our landscaping program we had a fenced-in area of sun-baked clay. I took photographs of this desolation and showed them around the *Popular Mechanics* office where I work to demonstrate what a new homeowner has to face. This was when ideas started germinating for a landscaping story.

We started with questions and answers:

"How many families have this same problem every year?" Thousands.

"How do you determine what to plant so your yard is largely self-maintaining and permits you leisure time to enjoy it?" We didn't know.

"How can you be sure that toolhouses, storage walls and the like are compatible with the house architecture, and that they are arranged for greatest convenience and will add to, rather than detract from, the over-all appearance of the yard?" We didn't know this, either.

When the questions and answers were boiled down we came up with these facts: Most homeowner landscaping jobs are a combination of advice from well-meaning friends and over-enthusiasm when looking through seed catalogues. Since the results seldom are satisfactory, we knew there must be a better way. Our ranch-type home with its small yard is typical of thousands of others across the country. It occurred to the *Popular Mechanics* staff



This picture and the one on the opposite page show tremendous contrast created by a good landscape plan

that the landscaping of my yard might serve as a model or guide for others.

There are experts — professionals — in every field. In landscaping, it's the landscape architect. Few homes are built without the aid of an architect. His knowledge and experience make it possible for him to design a structure for a particular need so that it can be built with a minimum of wasted time and material. The savings thus gained outweigh the cost of his fee. We were to discover this also was true with a landscape architect.

Popular Mechanics contacted the Chicago Horticultural Society which recommended Harold O. Klopp. When I contacted

Children's salad garden delighted them all summer



Klopp I told him that we wanted a landscape design for a small yard and asked what the fee would be. For large estates and developments Klopp said that he charged a percentage of the over-all cost of home and grounds. For the small yard of a suburban home his flat rate was \$65.

My wife and I had a list of requirements for the yard and Klopp carefully noted them. He made suggestions for arranging the storage area so that a workshop and the children's playhouse-storage area could be consolidated, saving both space and materials. At the end of our talk he knew what we wanted and that my wife and I would do most of the work ourselves. This latter fact determines, in some cases, the type of materials to be used. For example, it would not be feasible for one man to pour a large area of concrete unaided. Materials that can be handled easily by one man are a requisite in a situation such as mine.

The major differences between modern landscaping and the older, formal landscaping, Klopp told us, is that modern landscaping integrates the house and yard. Formal landscaping treated house and yard as separate entities, so that the house and landscaping had little or no relation to each other. Also, today's landscaping first considers the "frame," which consists of the walks, fences, walls,

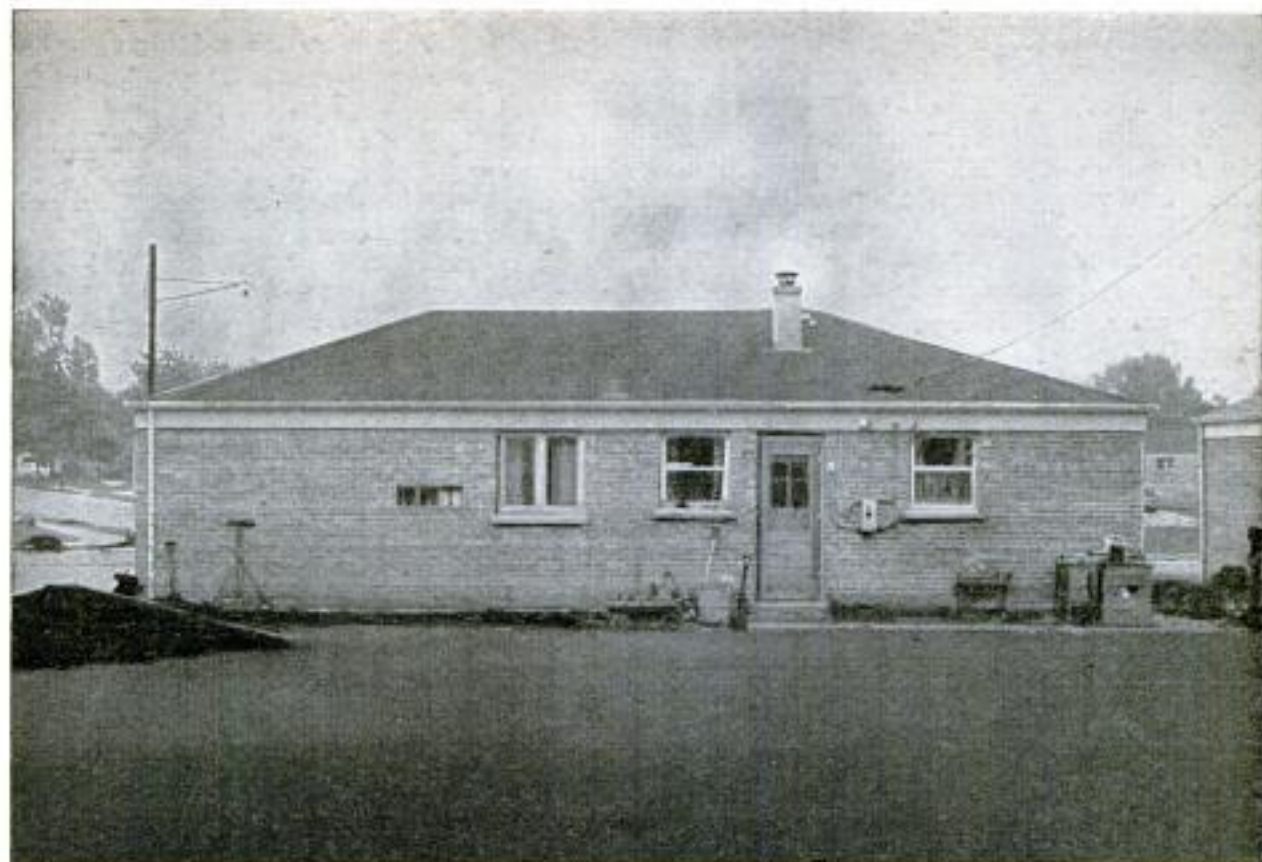

Before landscaping, rear view of house and yard was nondescript and depressing. Klopp changed all that

planting beds and the like, and finally the "picture," which includes the flowers, shrubs and other plantings. The eyes follow the frame more quickly than the picture, so optical illusions can be designed into the frame to make a yard appear larger, longer or wider as desired.

Following Klopp's instructions, I carefully measured the yard and house, noting the position of the house in relation to the yard. Next, I measured all windows and doors and sketched their locations on a rough drawing. Finally, I drew an elevation of each side of the house and drew in the windows with their dimensions and heights from the ground. From the house and yard dimensions, and the direction in which the house faces, Klopp determined where to locate shade trees and plantings. The height of the windows above ground determined the height of plantings under them. Since there is a railroad track running behind the yard, planting at the rear of the yard was designed to act as a sound baffle in conjunction with the storage wall that runs parallel to the planting. This type of planting also could be used to screen and muffle the sound emanating from a busy street, highway or even a dusty alley.

A few days after Klopp received my sketches he returned the finished plan, pretty much as it appears on the first page of this article. We now had the first step in the landscaping. As noted on the plan,

ground cover such as *Vinca minor* is used under trees and between low-growing shrubs. The *Vinca* keeps down the weeds, thus minimizing the need for weeding. *Ajuca genevensis* does the same job under the saucer magnolia tree in front. The magnolia tree is used to balance the planting at the front of the house, which tapers down from the magnolia, through the junipers in the planting box and down to the winter creepers which are a ground-hugging evergreen. The latter plants are directly under a large picture window that is only a few inches above the ground. The umbrella-shaped honey locust provides shade and shelter for people entering and leaving automobiles parked on the drive at that point. Tulips and crocuses in the bed in front of the planting box provide color in early spring, then are replaced by white annuals, such as peonies, white geraniums and petunias.

In the back yard, roses are grouped in clusters, both to provide large splashes of color and to discourage weed growth beneath them. The "forest" in the far corner of the yard serves to screen sound from the railroad and to act as a windbreak in winter. Shade-flower underplantings of lily of the valley and violets, and ground-covering rose moss aid in minimizing the need for weeding in this area. White clematis is used on one fence and climbing roses on the other to add color to the solid-tone

stained wood. Flower beds and planting boxes in the back yard also have tulips for early spring color and are replaced by colorful annuals.

Since the soil in the yard was heavy clay, sand was mixed with it to make a workable loam, and all flower beds were enriched with Vigoro. Instant Vigoro was used in several instances where newly planted shrubs showed signs of wilting.

The plan indicates specific materials for the patio and walks, as well as the planting. Concrete bricks from the Ampress Brick Co. of Des Plaines, Ill., were chosen for the walks and patio because the standard brick size, two by four by eight inches is handled easily. The bricks are available in a variety of attractive colors and are held to fairly close tolerances which makes them ideal for setting without mortar for a patio. For my yard, Klopp chose coral red for the patio and gray-white for the mowing strip or walk. The mowing strip is impor-

tant in that it keeps the grass and plants separated and permits one wheel of a lawn mower to run on it so that no grass need be cut with hand clippers.

Our first job was to lay out the patio and excavate to a depth of four inches. Fine sand then was leveled in the area to a depth of two inches. Bricks were fitted tightly together on top of the sand and leveled by adding or removing sand beneath them. After some experimenting, a pattern of bricks was decided on to be five bricks lengthwise on one side and 12 bricks the narrow way on the other, which produced an almost square grid. Redwood two by fours were cut and fitted to hold tightly against the bricks in this pattern. Dry sand then was swept across the bricks until all crevices between them were filled. The main advantage of using grids, other than for appearance, is that each new square provides a fresh chance to realign the rows of bricks. Along the edge of the patio

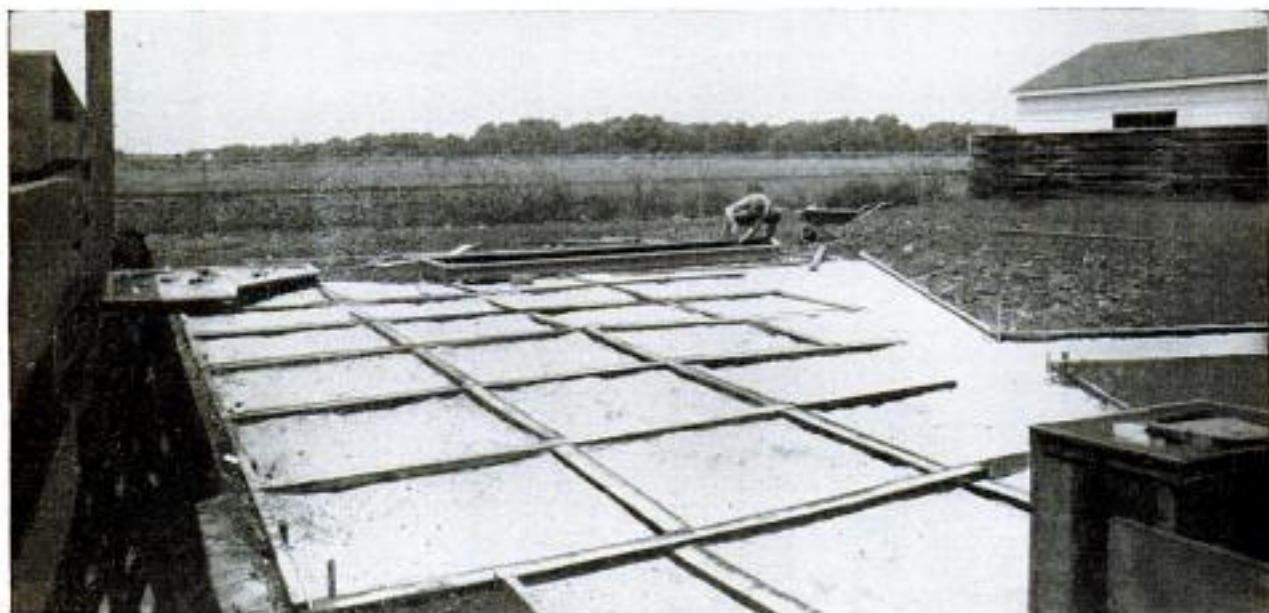

These are progress photos showing how the patio, walks and planting boxes carefully followed Klopp plan

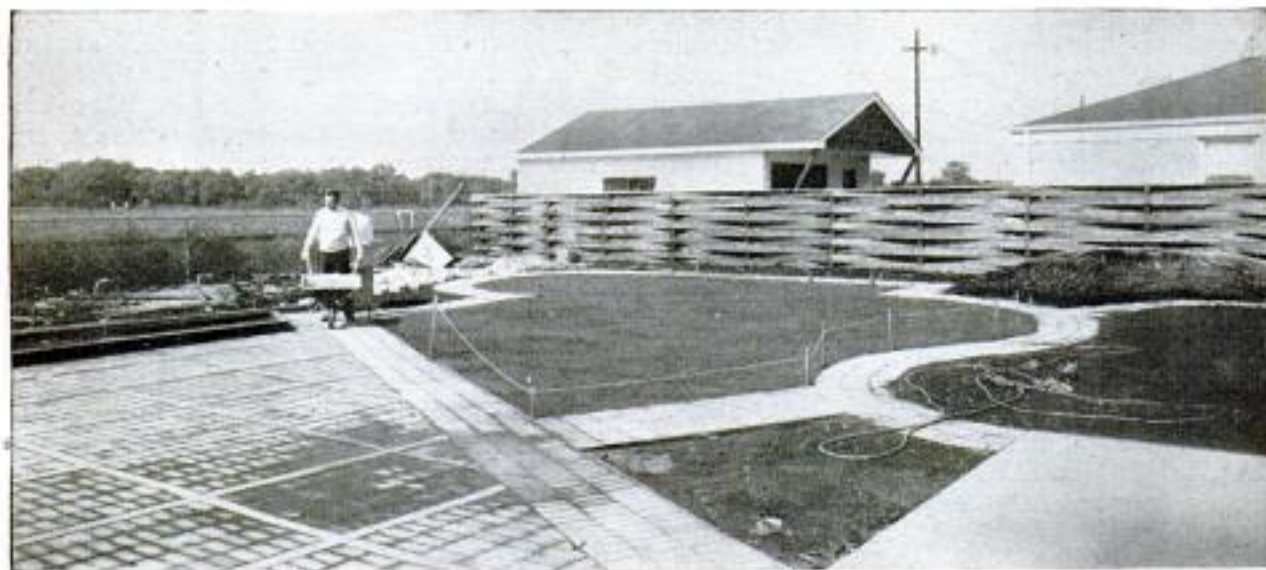

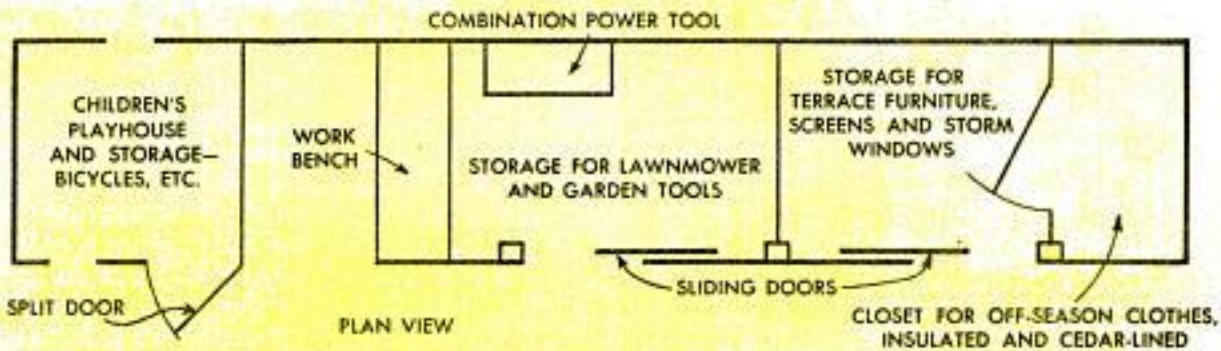

Finished storage wall provides playhouse, workshop and convenient storage for garden tools and supplies

bricks had to be cut to meet the mowing strip. The bricks were cut by using an abrasive cut-off wheel in a radial saw. Because the work is held stationary and the blade passed through it, the radial saw is ideal for the job. Despite the unorthodox method of laying the bricks in the patio and

walks two Midwestern winters have produced very little heaving or buckling. Along the edges of the patio, one-inch strips of lumber four inches wide were used to hold the fine sand. Curved portions of the mowing strips required four-inch-wide

(Continued to page 228)

As storage wall takes shape behind him, Hedden operates radial saw which is helping build its own home

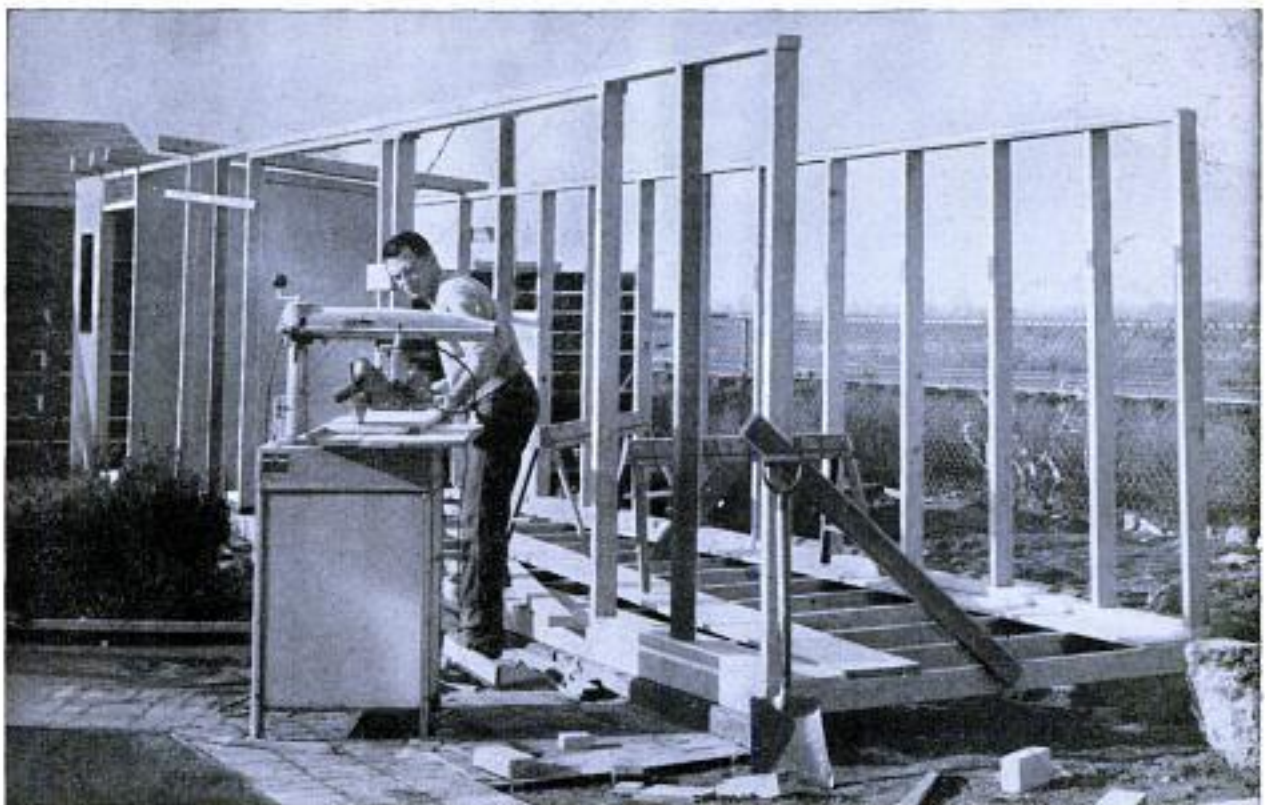

GARDEN OF ROCK

By Grover Brinkman

TONS OF FIST-SIZED ROCKS, creek-bed pebbles and field boulders might add up to just a pile of rocks for some people—but not to Mr. and Mrs. Arthur Martin, who live on a farm near Arcola, Ill. They have gathered rocks of every size and shape to decorate their seven-acre garden. They call their place Rockome. Last year several thousand visitors came to inspect their unusual gardens.

Here you will find 35 lily pools, an inviting swimming pool and more than 1000 different kinds of roses—all enclosed in rock fences of intricate design. For 20 years, the Martins have worked at beautifying this tract. They have built fences galore, unique garden enclosures, a "mission" garden, wishing wells, birdhouses on towering pedestals, huge ornamental baskets, gateways, a barbecue grill, arches, benches and pathways—all from rocks found on the farm.

Literally tons and tons of rocks have been broken into bits to make the displays. Usually this work was done in the winter when there was time to spare from farm chores. The Martins sometimes have to remind their friends that their principal job is raising broomcorn. The rocks are embedded in concrete and cast in molds. Each fence at Rockome is of a different design including inverted hearts, scrolls, diamonds



Rock settee has a chicken-wire skeleton. Below, the 10-foot Cupid's heart with arrow has served as altar for many weddings. Bottom, sample of stone fences

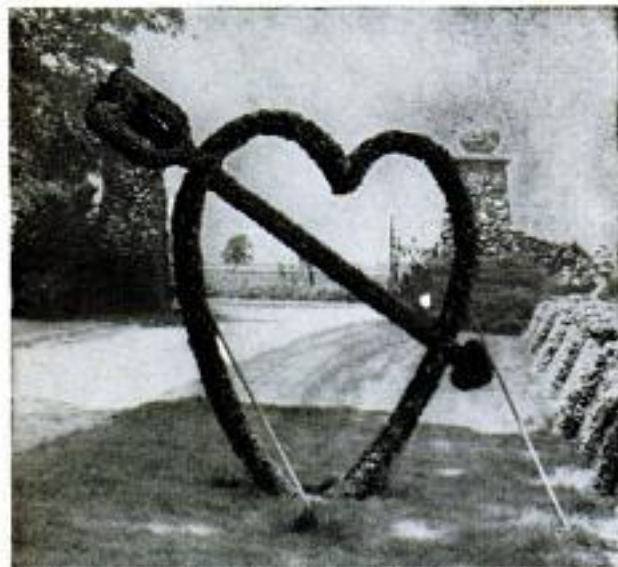

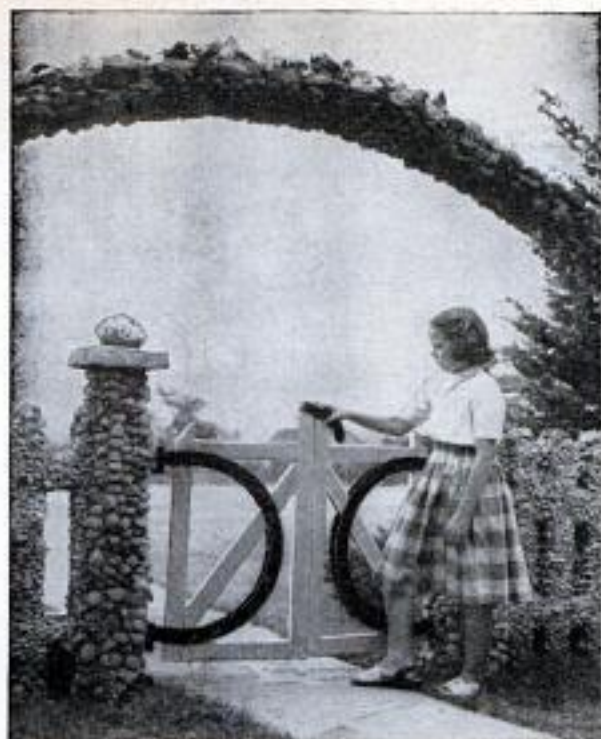

Swinging gate at one of the entrances to the Martin gardens has impressive arch overhead. Iron frame of the arch was covered with concrete and then carefully embedded with rocks of many sizes, colors and shapes

and many others. Some of the fences were made by applying concrete over iron frames bent in the proper shape. Rocks were then embedded, like mosaic, before the concrete hardened, a time-consuming task that had to be done quickly.

A prize ornament in the garden is a huge Cupid's heart, 10 feet tall. It is so symbolic of romance that dozens of local couples have been married before this

Rock fences of odd and intricate design weave in and out among the seven acres of gardens on the Martin farm. Arthur Martin is at work here in one of the gardens near the house. He started project back in '37



Picturesque barbecue grill and oven in one corner of the garden was made entirely of rocks picked up on the Martins' Illinois farm. Nowadays they have so many visitors there is little time for barbecues

stonework altar since it was erected.

The Martins view life through humorous glasses, as is attested by the many tongue-in-cheek placards that line the pathways in their gardens. One reads: "Growing old is no more than a bad habit, which a busy person has no time for."

If that prediction holds true, the Martins will never grow old because hands are never idle at Rockome. ★ ★ ★

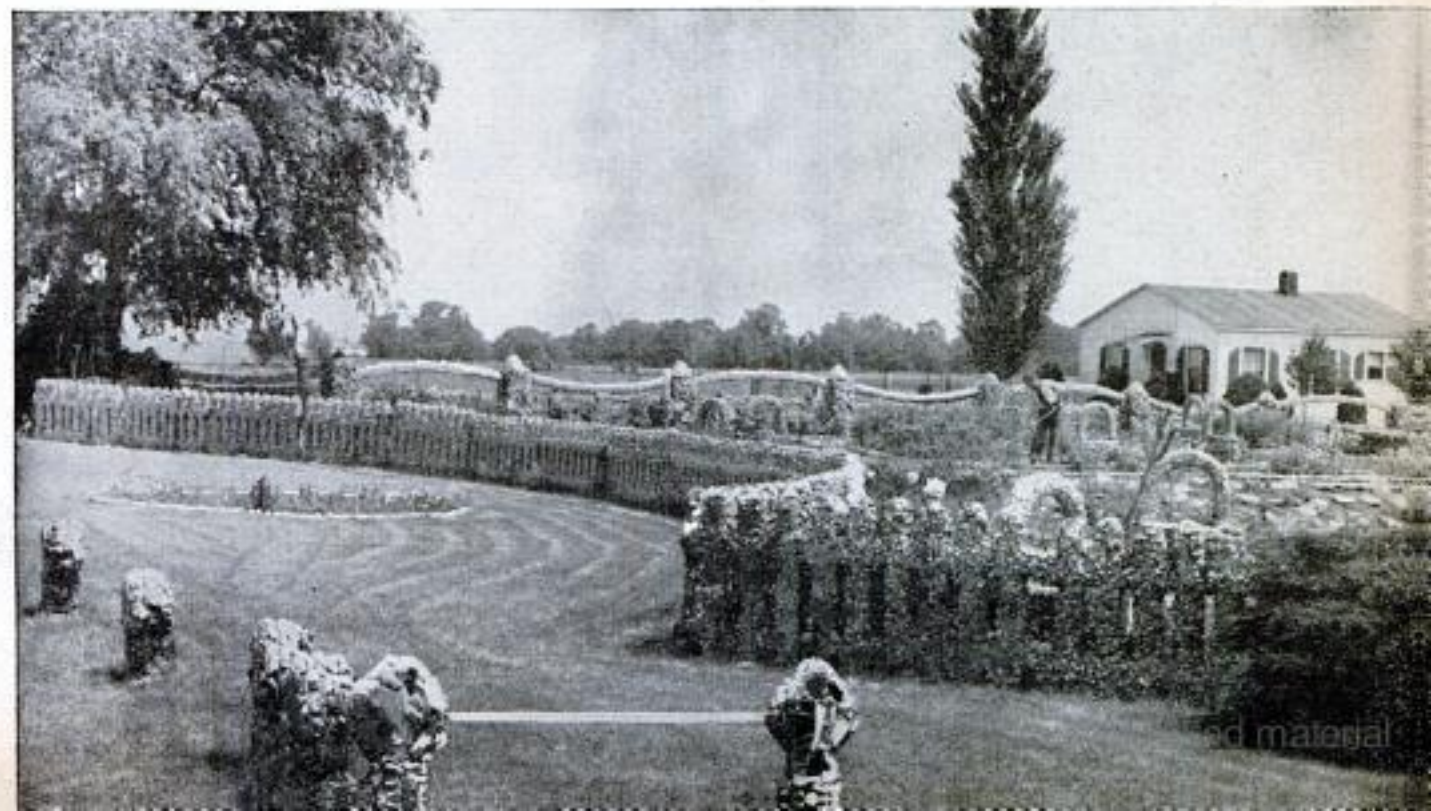

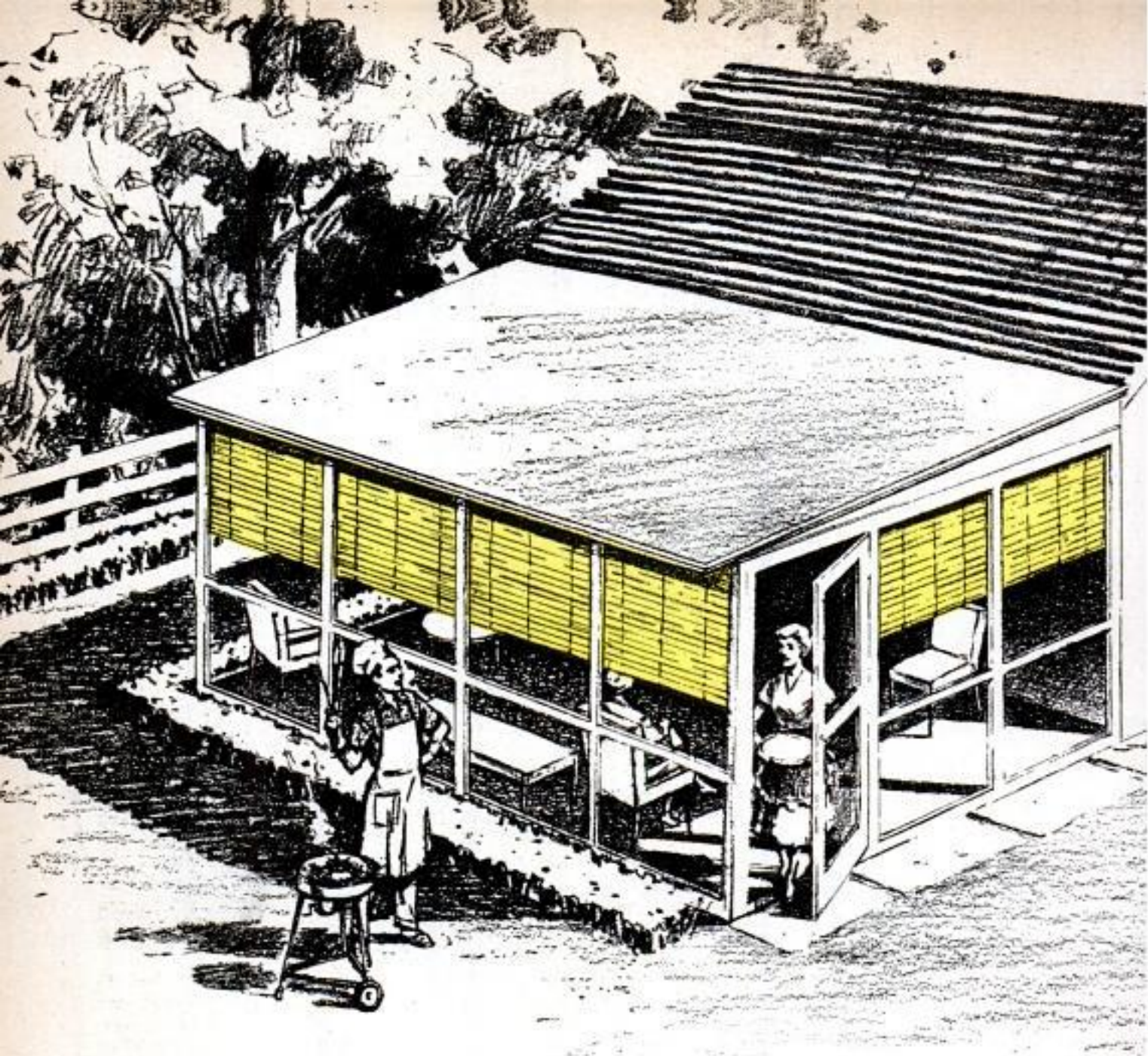

ADAPT YOUR GARAGE FOR SUMMER

By Wayne C. Leckey

REMEMBER WHEN every home had a front porch? Such dated porches are gradually giving way to a new trend in living—outdoor living. The old-fashioned porch has been taken off the front of the house, so to speak, and hitched to the garage where, in the privacy of the back yard, summer entertaining and dining can be enjoyed by the entire family.

This exodus to the back yard is a natural one, stemming from the popularity of barbecue cookouts, and the need for shelter

and protection from insects has resulted in a screened lean-to, a sort of covered patio, hitched to the side of the garage.

You can buy a garage today with a screened enclosure built right in it, half being devoted to car space and the other to summer living. But if you have the yard space, one of these popular screened patios can be attached to your present garage in the form of a simple lean-to structure and screened on three sides. Such an enclosure need not be too difficult or costly to build as the garage already provides one side.

Fig. 1 details an enclosure in its simplest

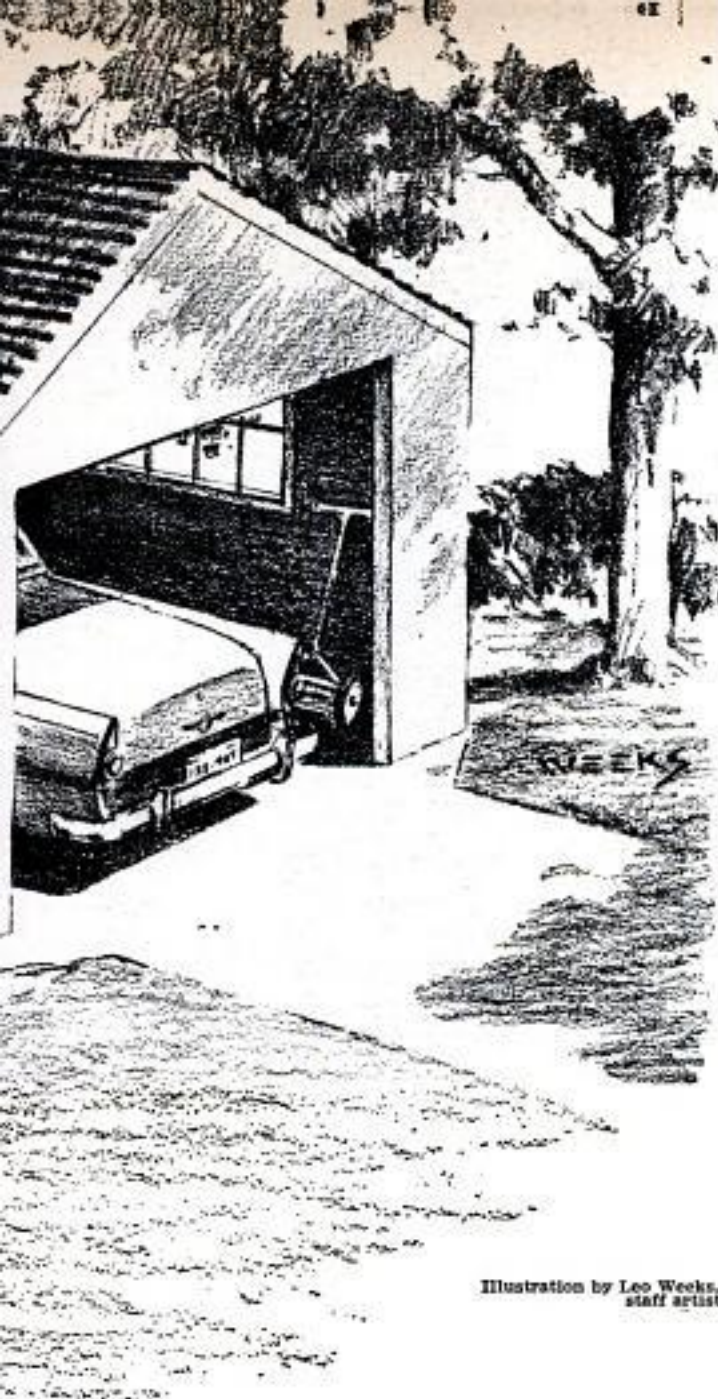

Illustration by Leo Weeks, staff artist

LIVING

form in which the screen wire is tacked directly to the framing members rather than to separate removable frames. The latter may still be preferred by some, but with the new plastic screening, and other nonrusting kinds, the wire will last indefinitely even if left exposed the year 'round. For obvious reasons, it is advisable to erect the framing over a slab floor rather than a wooden one. This can be from 8 to 10 ft. wide, depending upon yard space, and the length of the garage. Dig down about 18 in. around the outside to assure a good footing for the 4-in. slab. Readymix concrete

APRIL 1957



Popular in new garage design is this one which devotes a portion of a conventional two-car model to include a screened enclosure with a door at the end. Entrance to some is gained through the garage itself



Similar in treatment, the screened-porch area in this garage also has been fitted with window sash to make the space usable the year 'round for storage. Note how lower part has been boxed-in with siding



The garage itself can be converted to an extra summer room by leaving the car parked outside, rolling up the overhead door and fitting the opening with removable screens. Screens are so fitted as to allow door to be lowered in the event of driving rain

155

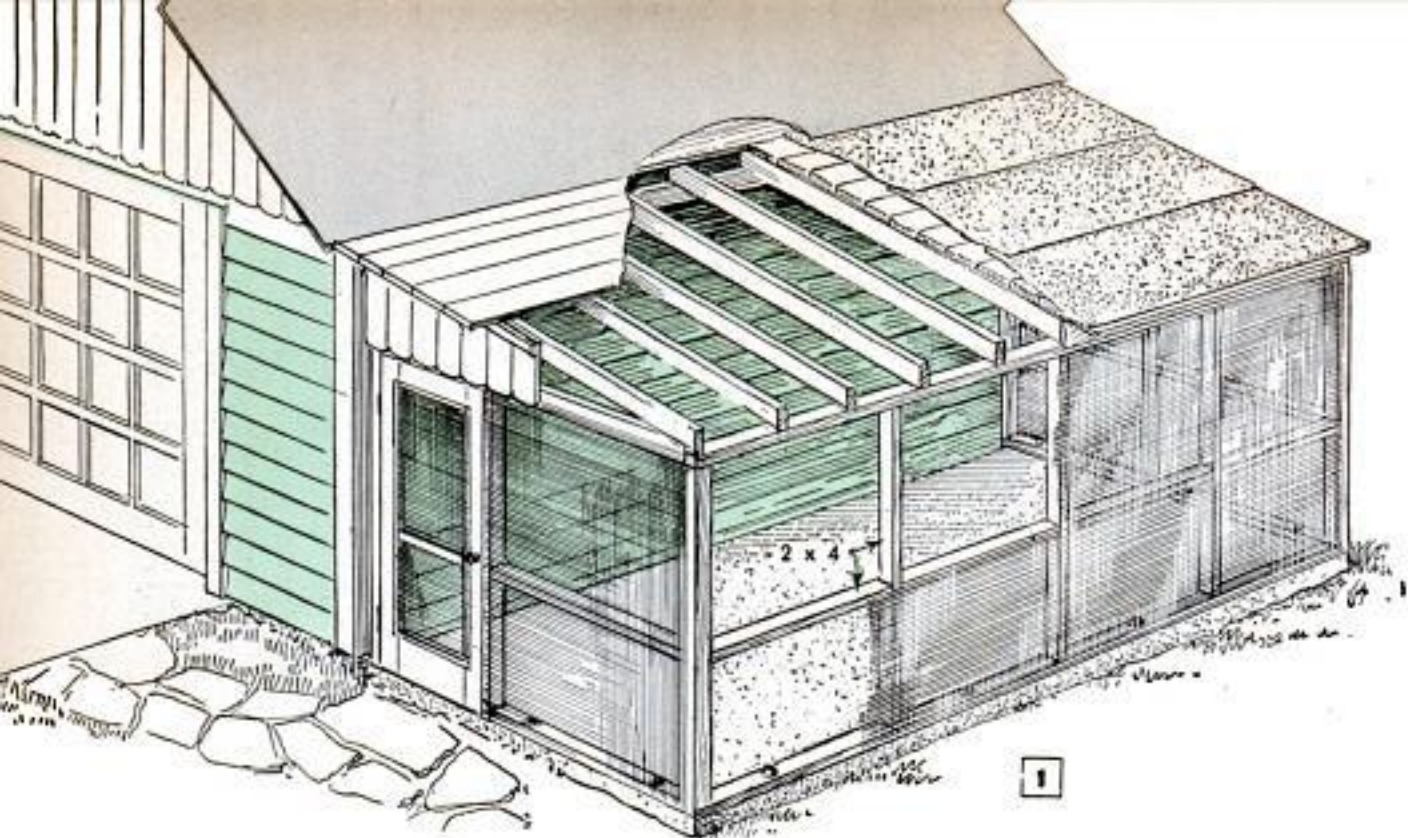

simplifies this part of the job to the point where the homeowner can pour the slab himself, or this part can be left to the professional. In either case, $\frac{1}{2}$ -in. anchor bolts, 10 in. long, should be embedded in the concrete along the outside, $1\frac{3}{4}$ in. from the edge to anchor the framing.

How the rafters are attached to the garage is an individual problem, dependent upon the amount of garage-roof overhang. If there is little or none, the rafters can be supported by a 2 x 4 ribband, a ledger strip, as shown in Fig. 2. Here, as you can see, the 2 x 4 is lag-screwed to the garage wall

and into the wall studs. Where the overhang is 12 in. or more, the 2 x 4 rafters can be tied to the garage rafters by nailing securely to the faces of the extending members. The roof should have some pitch rather than be perfectly flat, 2 in. of rise in each foot of run being adequate. Avoid sloping it too much, otherwise you'll have low headroom at the outside. The slope of the roof governs the height of the wall studs and corner posts. These rest on a 2 x 4 plate which is bolted to the slab around the edge on three sides. The corner posts are 4 x 4s and the intermediate ones are 2 x 4s,

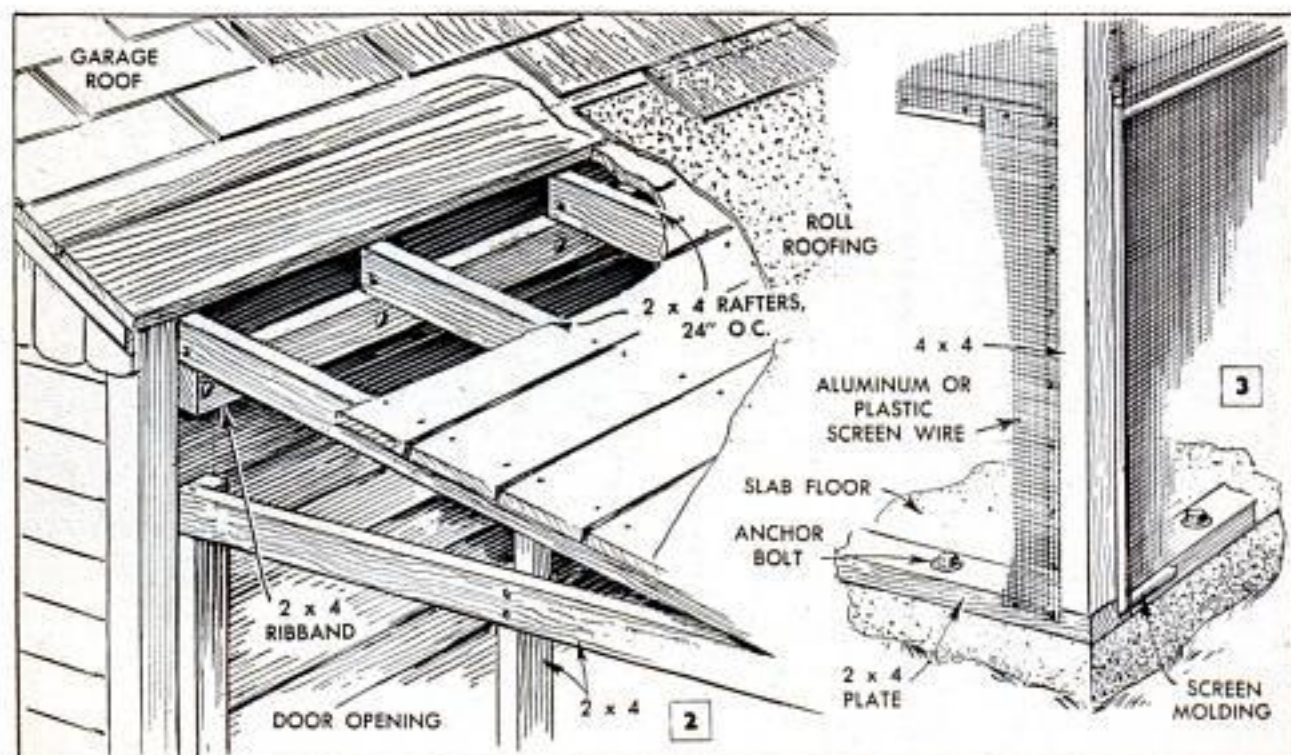

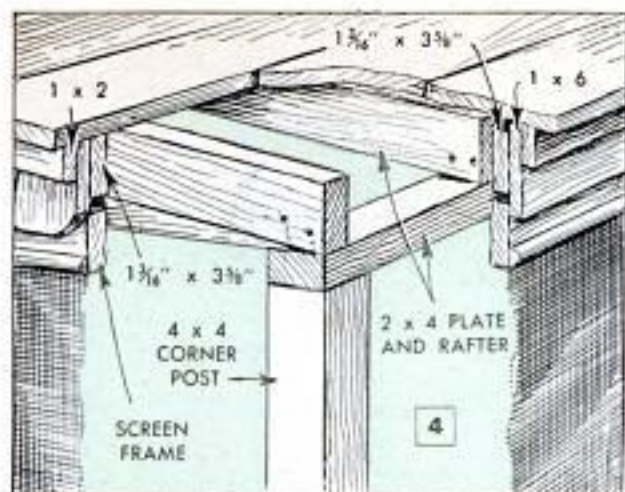

toenailed to the plate at the bottom and to a similar plate at the top. Crossrails, 24 in. up, are used to brace the 2 x 4 studs. The doorway is framed in the manner shown in Fig. 2.

The 2 x 4 rafters are placed 24 in. o.c. and then decked over with 1 x 6 roof boards. Since it is not practical to apply asphalt shingles to a roof with so little pitch, the roof should be covered with regular roll-type roofing, sealing the lapped edges with cement and working it up under the shingles on the garage. The screen wire is applied horizontally, lapping it on the crossrails and covering the edges with common screen mold, Fig. 3. This, of course,

Typical lean-to structure added to side of garage. Wide full-length screens admit maximum air. Stone fireplace at end makes cookouts highly convenient

should be done after painting the framing with two coats of house paint. Where separate screens are preferred, Fig. 4 shows how a track can be formed for the screens at the top, using a 1 x 2, a 1 x 6 and a 1 3/4-in. member in the order shown. Here the screens go around the corner posts and, where they center on the intermediate posts, battens are provided to cover the joints at the butting edges. At the corners, the screen frames lap the edges of the adjacent ones and are fastened with three or four screws, top to bottom. ★★★

Hammered Wooden Knobs Have Handwrought Look



Plain wooden knobs can be given a handwrought appearance by denting the knob face with a ball-peen hammer. To do this, drill a hole in a block of scrap wood to secure the shank of the knob and tap the face lightly to dent the wood fibers. Paint the knob a dull "iron" black or apply stain for an antique finish.

Plastic Strip Protects Hatband Against Perspiration Stains



Thin kitchen plastic cut in a 2-in. strip and placed in back of the leather sweatband of a hat, as shown, will prevent staining the hatband and exterior of the hat. The strip is easily removed when the hat is sent out for cleaning and blocking.



Courtesy of Kaiser Aluminum & Chemical Sales, Inc.

Sheet-aluminum roof of this attractive patio in Hawaii has embossed finish that reflects sun's rays

*For more enjoyable outdoor living—
here's shade for yard or patio when you want to*

GET OUT OF THE MIDDAY SUN

Blue-green-glass roof on this suburban patio cuts glare of the midsummer sun and absorbs heat rays

Libbey-Owens-Ford Glass Company





Sketch from *Canvas Products Review*

Lace-on shades are made of ordinary canvas laced to vertical metal frames. These are made to rotate



Lace-on canvas canopy extends from overhang on side of garage. It is neat in appearance and easy to make

DEVOTEES OF OUTDOOR LIVING may argue about the best way to lay a patio or cook a steak, but there is one subject on which there is unanimous approval: The need for some kind of shelter from rain, wind and, above all—the scorching midday sun.

Alert to this need are scores of manufacturers, architects and decorators who have come up with an amazing array of shelter devices for the home. Materials range from canvas and synthetic fabrics to redwood, glass, aluminum, steel, glass fiber or plastics and special shade screens.

One of the simplest and most effective of shelters is the canvas lace-on awning or shade. The canvas is laced to a metal frame and is easy to put up or take down. This type of shelter can be used to extend the overhang of a house or as a vertical awning at one end of a patio.

Architects are making good use of metal coverings for patios. One popular new product is crimped sheet aluminum with an embossed finish which is said to reflect the sun's rays. Another interesting product is

Aluminum shade screen on this porch keeps out direct rays of sun, also insects, and gives some privacy
Kaiser Aluminum & Chemical Sales, Inc.

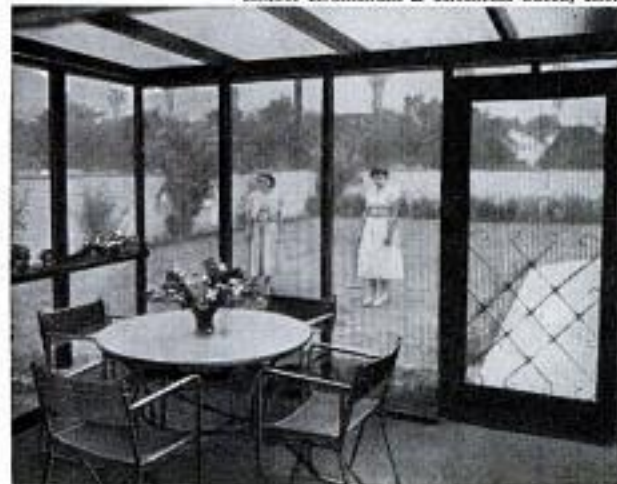

APRIL 1957

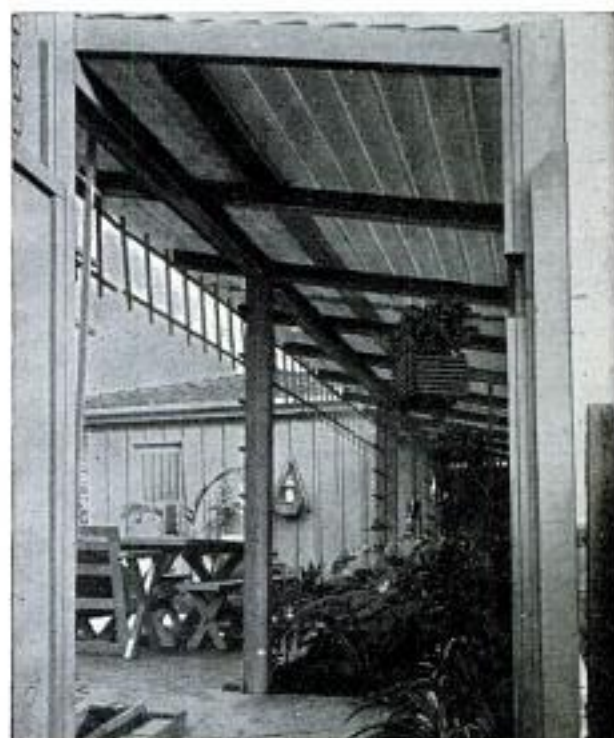

Alsynite Company of America

Steplap glass-fiber panels are used here as overhead protection for the plants bordering on patio

Parts for the patio below are available in kit form. They include glass-fiber panels and steel tubing



159

*Mafer Steel Co.
San Diego, Calif*



Alsynite Company of America

Glass-fiber roof over patio is easy to build with panels supported on a framework made of two by fours

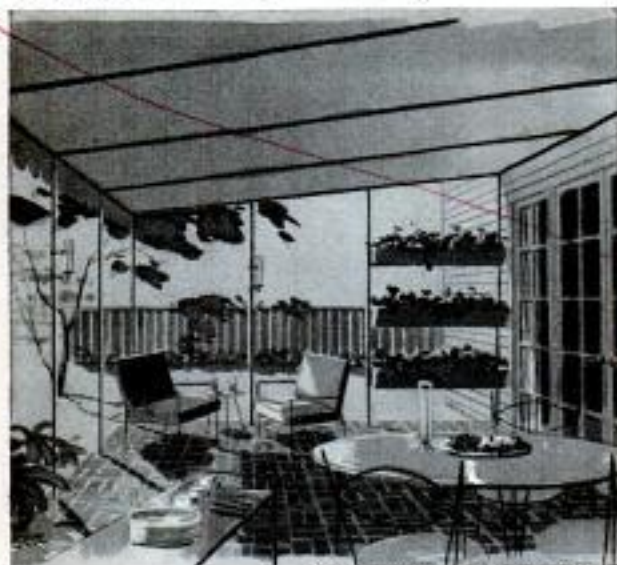

Courtesy of Canvas Products Review

Patio above is shaded in summer by canvas which is removed in winter to admit sun to home. Below, overhead canvas canopy slides back and forth on wire and can be adjusted for total or partial shading of area

the shade screen that not only keeps out insects but deflects the sun's rays and definitely cools a porch. This screen provides the perfect solution for the people who like to do their outdoor living in a screened area.

One manufacturer of translucent glass-fiber panels is offering a shelter kit for do-it-yourselfers. The kit includes corrosion-resistant steel tubing, metal wall brackets and an assortment of hardware. The panels, available in a variety of colors, are nailed in position and sealed with mastic.

Another patio covering that lets in the light but keeps out the heat-bearing infrared rays of the sun, is blue-green frosted glass that is wired for extra strength.

With the variety of shading devices available, every homeowner should be able to find the right one for his house. ★ ★ ★

Even the car gets out of the midday sun! This portable carport is made of metal supports and canvas

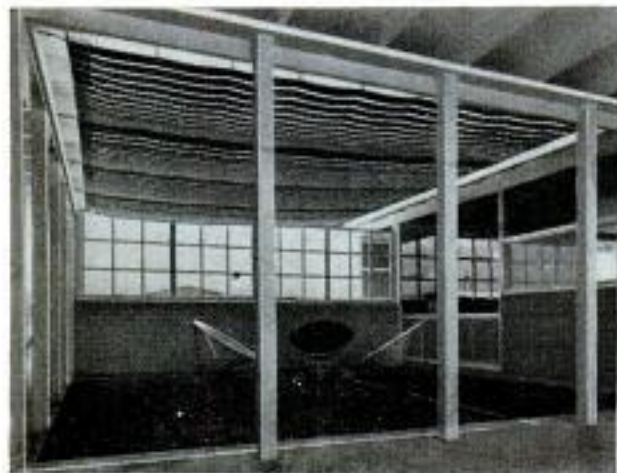

Convertible Settee-Lounge Has Plastic "Upholstery"

By Willard Allphin

IDEAL FOR USE on a porch or lawn, at a summer cottage or camp, this attractive settee converts to a comfortable chaise longue when the end "cushion" is raised and positioned at one of several angles by means of a wooden bracket. Because the bright, colorful plastic webbing used on the cushions is waterproof and the wooden frame of the settee is weatherproofed, rainstorms will not require that this piece of furniture be covered or taken indoors.

Although the finished settee is extremely strong, its construction involves no mortised or doweled joints. Hand tools are adequate if power tools are not available. To avoid stretching the plastic webbing over too great a span, which might permit it to sag excessively, six individual cushions are built and fitted together. Three cushions form the seat and three the back. This also makes attachment of the webbing easier. Hard pine was used in making the original settee, but any hard or semihard wood can be used. Plastic webbing 2 in. wide, of the type shown, is available in many solid and mixed colors. In this particular case, solid ivory and red were the colors chosen. For the long way of the cushions, 36 yards of 2-in. webbing are required, for the short way, 42 yards. The seeming discrepancy in lengths results from the fact that there are more strips running the short way than the long. Screws and hinges used in the settee can be galvanized,



but brass fittings will prove longer-lasting if the settee is located near a seashore where salt air causes rapid corrosion.

Construction details for the settee in Fig. 7 show that mostly stock lumber sizes are used. Although the arms and legs are shown to be 4½ in. wide, either 1 x 4 or 1 x 6 stock can be substituted. If this is done, the space between the arms and legs must be kept the same as shown on the detail, to permit fitting the back cushions in place.

Cut diagonal half-laps on the ends of the back-support strip, as shown in the detail in Fig. 7, so the back cushions slant properly, then assemble the main frame with glue and wood screws. Next, make the six cushion frames with outside dimensions of 20 x 24 x 2¼ in. Mortise the edges of the

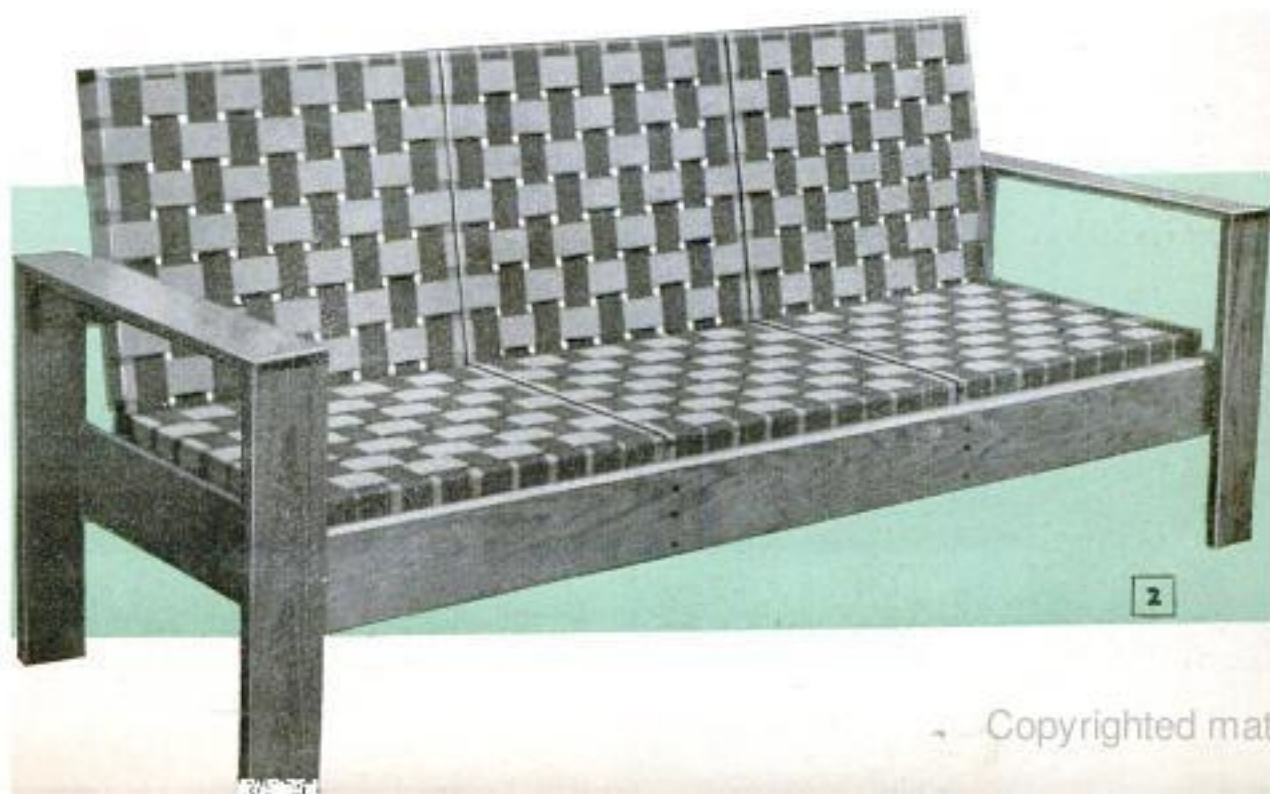

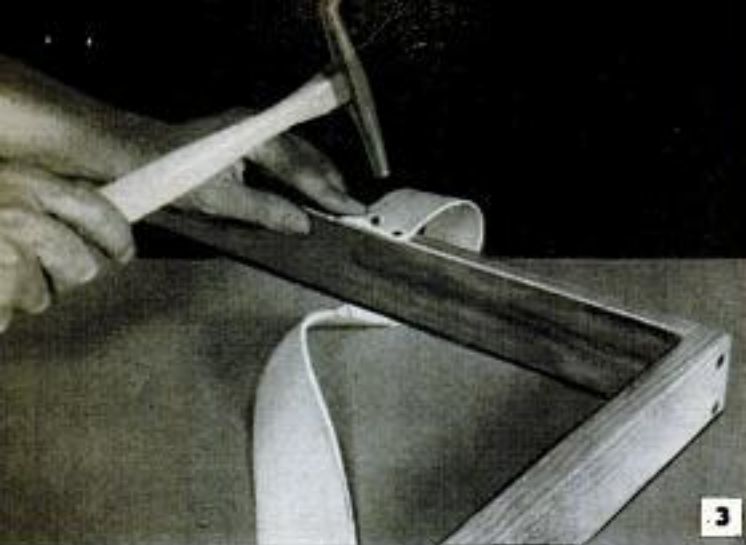

3
Above, end of webbing strip is doubled and tacked to lower edge of cushion frame with five tacks

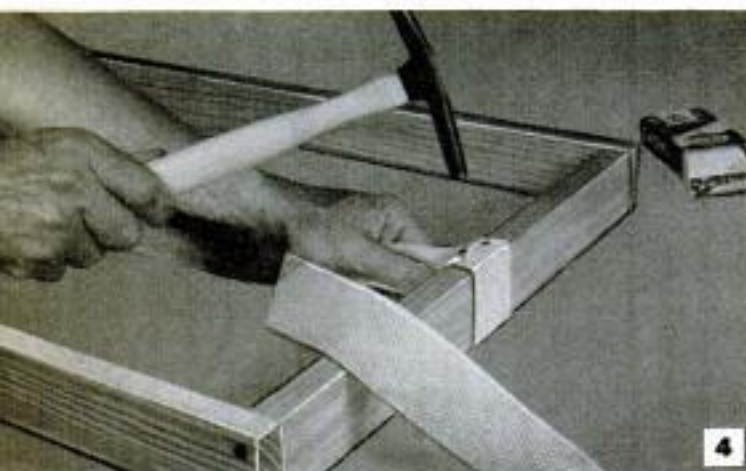

4
Above, free end of webbing strip then is stretched across cushion frame and tacked to opposite side

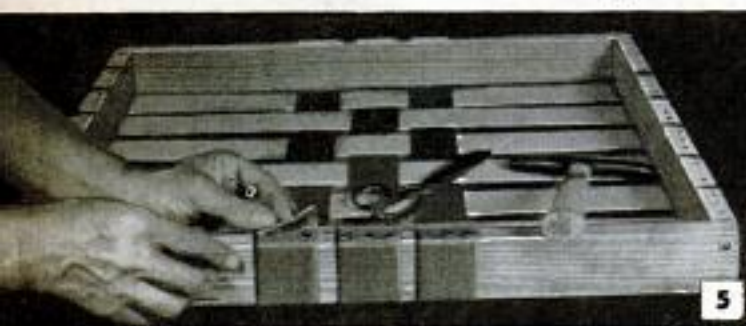

5
Above, after cutting off webbing strip, it is folded double and three more tacks are driven through it. Pivoting support bracket for end cushion is hinged to the inside of the cushion frame as shown below

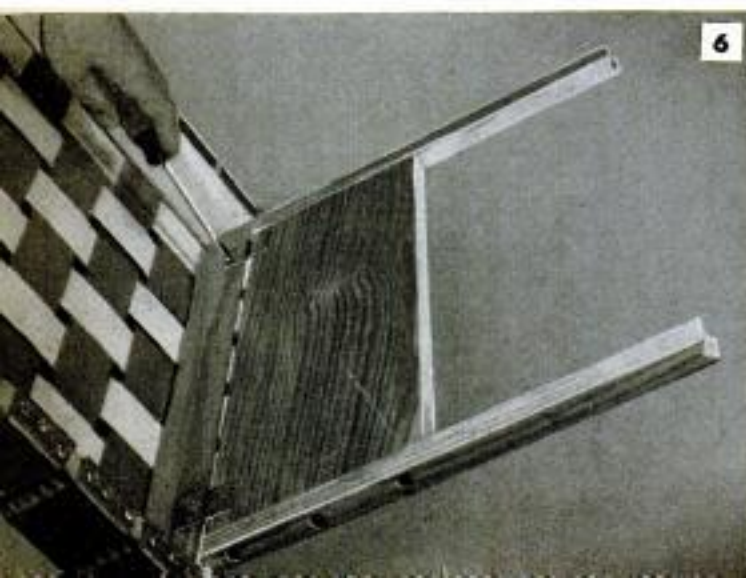

6

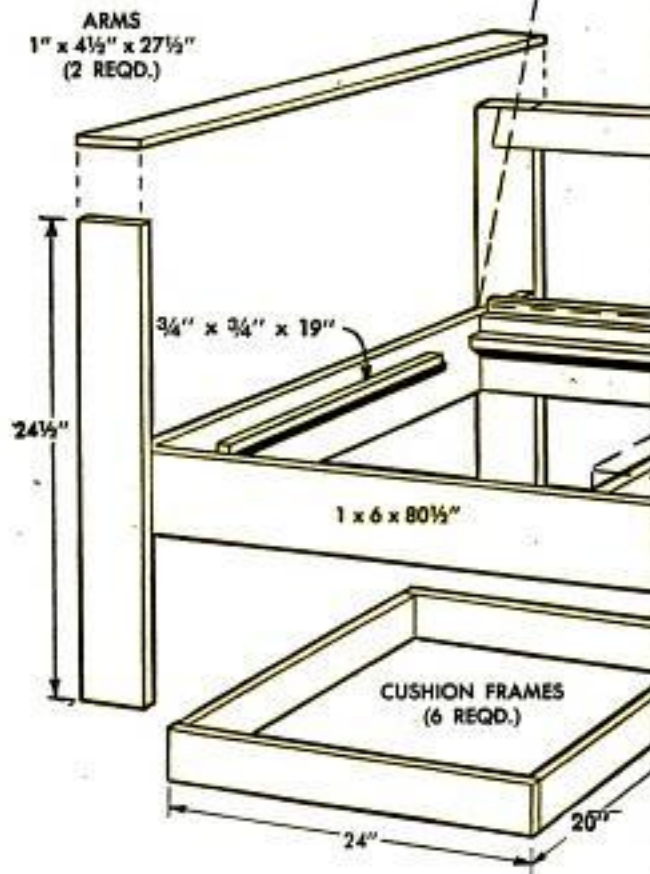

two cushions on which the hinges will be fastened slightly deeper than the thickness of the hinges. The webbing then will pull into the mortises under the hinges and permit the cushions to fit tightly together. Also bevel the end of the end cushion so it will clear the arm when it is pivoted upward. With assembly of the settee and cushions at this stage, weatherproof all wood surfaces, so areas covered by the webbing will be protected. One coat of spar oil, plus two coats of spar varnish should be applied, each coat being sanded lightly before applying the next.

When "upholstering" the seat frames, start with the middle strip and work each way, alternately, to the edges. There are seven strips going the long way, spaced $\frac{3}{4}$ in. apart, and nine strips going the short way, with $\frac{1}{16}$ in. between strips. Double the end of each strip of webbing and tack it to the lower edge of each cushion frame with five No. 6 copper tacks, Fig. 3. Stretch the strip over the top of the cushion and tack it to the lower edge of the opposite cushion frame with two tacks, Fig. 4. Cut the webbing, fold it over and drive in three more tacks, Fig. 5. When the cushions all are finished, hinge the wooden bracket, Fig. 7, to the end cushion, Fig. 6. Now install all cushions, driving screws up through the settee frame into the seat cushions, and through the back rail and

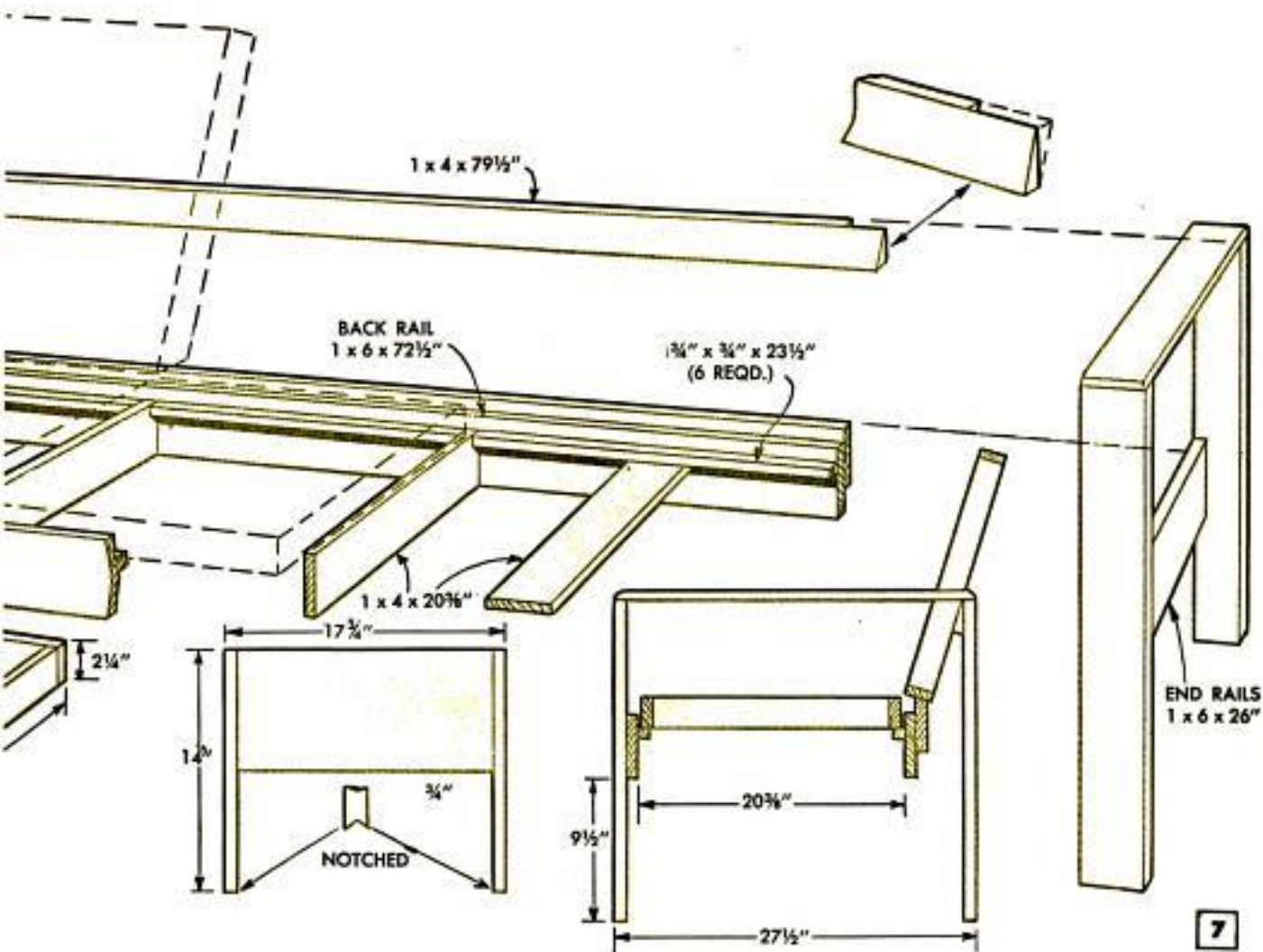

back-support strip into the back cushions. Also, screw the back cushions to each other near the tops. When installing the hinged seat cushion, be sure it has clearance for swinging upward.

When the hinged cushion bracket is folded flat against the cushion, the settee will appear as in Fig. 2. When the bracket is swung upward and the cross brace rested on the cushion support on the end rail, the settee appears as in Fig. 8. Raising the bracket to the next position requires that

When cross piece of cushion-support bracket is rested on cushion-support strip, settee appears as shown

the ends of the bracket legs be fitted on the end rail as in Fig. 9. The young lady in Fig. 1 has adjusted the bracket so the notched ends are located on the edge of the arm, positioning the cushion at the highest angle.

When finishing the settee, cover the countersunk screwheads that are located on horizontal surfaces with putty, to prevent rain from collecting on them. All other screwheads can be left uncovered, but brushed heavily with varnish. ★ ★ ★

End cushion assumes angle shown when ends of notched bracket legs are fitted on top edge of end rail

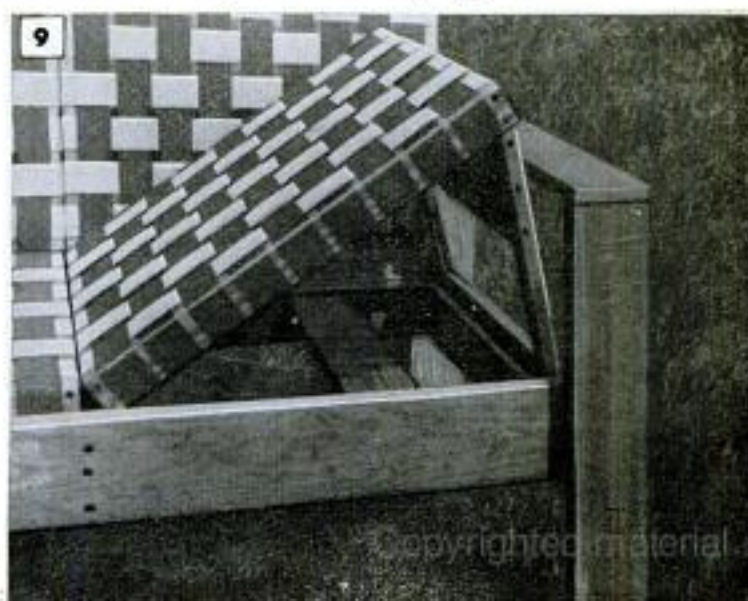
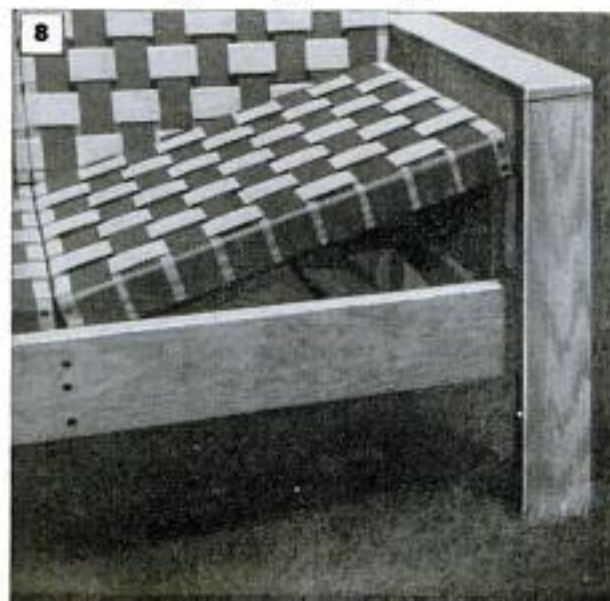

BLITZ THOSE SKEETERS!



FOG GUN, right, attaches to any four-cycle power mower. You blitz the mosquitoes while you are mowing the lawn. Average lawn can be fogged in about 20 minutes in preparation for a lawn party.



←**MOSQUITO BULB** screws into a standard socket, is yellow to drive away cowardly insects. Tablets placed in cup in top generate vapor to eliminate brave ones.



←**CANNED FOG** kills mosquitoes and other insects. You pry off lid and ignite chemicals with a match. Fog spreads downwind, settles, does its job, disperses within 10 minutes.



BLITZ CANDLES, right, are made in a variety of forms. Some fit candle holders, others are marketed in bowls. They say "Stay away!" to mosquitoes but won't kill.



←**REPELLENTS** are for individual use and are periodically improved to eliminate odor and increase the time they are effective. Repellents are available in liquids, rub-on sticks and in pressurized spray cans.

VAPOR GENERATOR, right, is another repellent, not a killer. A candle in the bowl provides heat to convert the can of chemicals into long-lasting vapor.



←**SMOKE GENERATOR** burns small wick tablets, produces pine-scented smoke that drives away insects. Can be hung in boat.





THE **POPULAR MECHANICS** WTM 58
CRAFTSMAN



SWING-APART HEADBOARD

By Tom Riley

IF YOU HAVE twin beds, hinging them to the headboard shown will convert them to the popular swing-apart type. Attractive and practical, they provide the individual sleeping comfort of twin beds, require less floor space, are made up easily and, if desired, one double-size spread can be used to cover both beds.

Except for the sliding doors and back panel, $\frac{3}{4}$ -in. hardwood-faced plywood is used throughout, with the exposed front edges of the plywood covered with veneer tape of matching grain. Construction of the headboard is simple, but does require the use of a circular saw with a dado blade.

First, rip the top and two sides to an 8-

in. width, then rip the shelf to a width of $7\frac{3}{4}$ in. Now, with a $\frac{3}{4}$ -in. dado blade, cut the rabbets at the ends of the top and also dado the sides and shelf as shown in the details. Next, rabbet the rear edges of the top and sides to receive the $\frac{1}{4}$ -in. back, which can be plywood or hardboard. Note that this back should extend about 4 in. below the shelf. For the sliding doors, use a $\frac{1}{4}$ -in. dado and cut a $\frac{1}{4}$ -in.-deep groove in the shelf and a $\frac{1}{2}$ -in.-deep groove in the underside of the top. The doors then can be installed or removed by lifting them up into the top groove to clear the shelf. If the headboard is to fit flush against a wall, notch the two sides at the bottom to clear

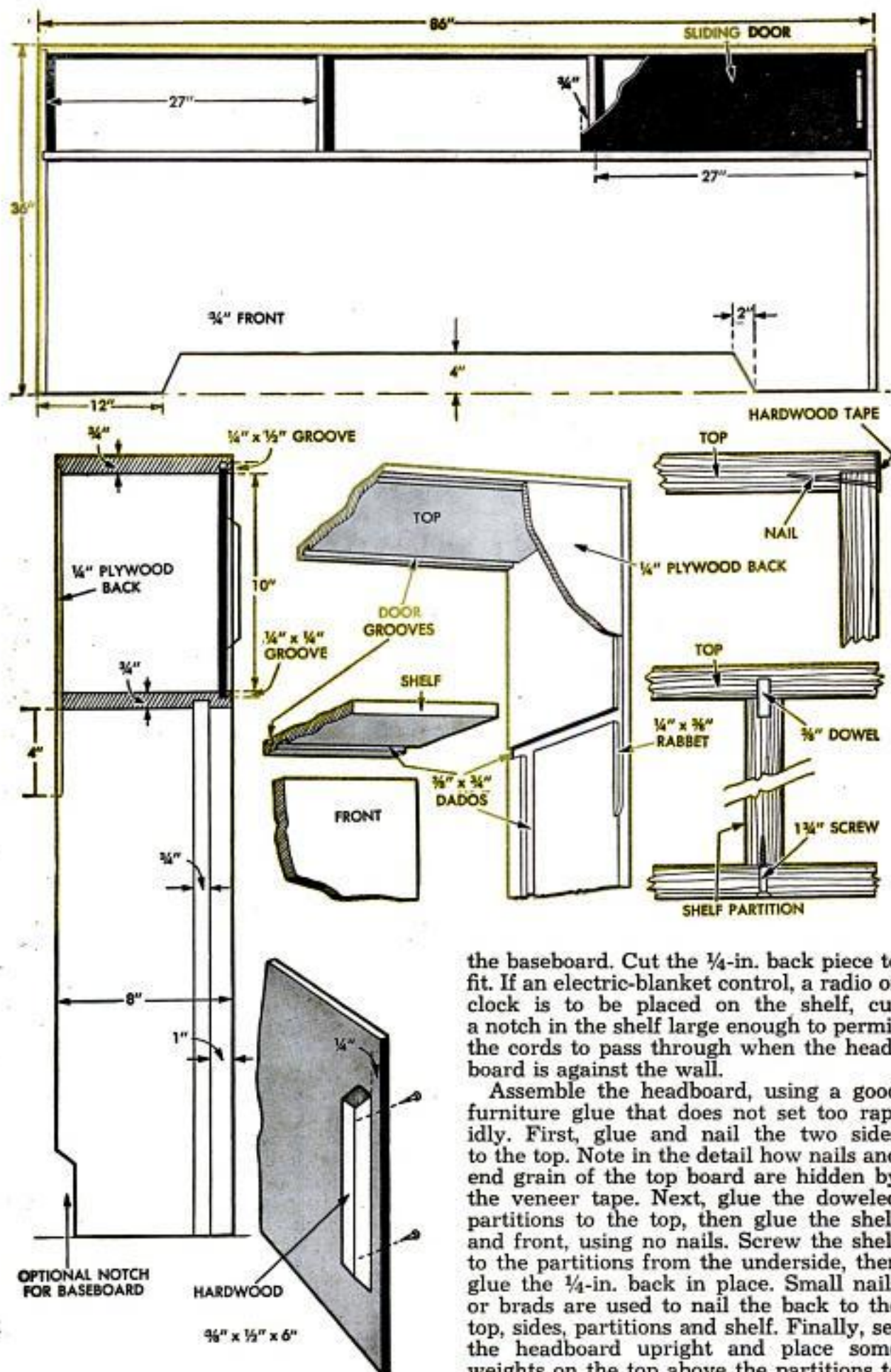

the baseboard. Cut the 1/4-in. back piece to fit. If an electric-blanket control, a radio or clock is to be placed on the shelf, cut a notch in the shelf large enough to permit the cords to pass through when the headboard is against the wall.

Assemble the headboard, using a good furniture glue that does not set too rapidly. First, glue and nail the two sides to the top. Note in the detail how nails and end grain of the top board are hidden by the veneer tape. Next, glue the doweled partitions to the top, then glue the shelf and front, using no nails. Screw the shelf to the partitions from the underside, then glue the 1/4-in. back in place. Small nails or brads are used to nail the back to the top, sides, partitions and shelf. Finally, set the headboard upright and place some weights on the top above the partitions to press it down on the dowels. If the sides

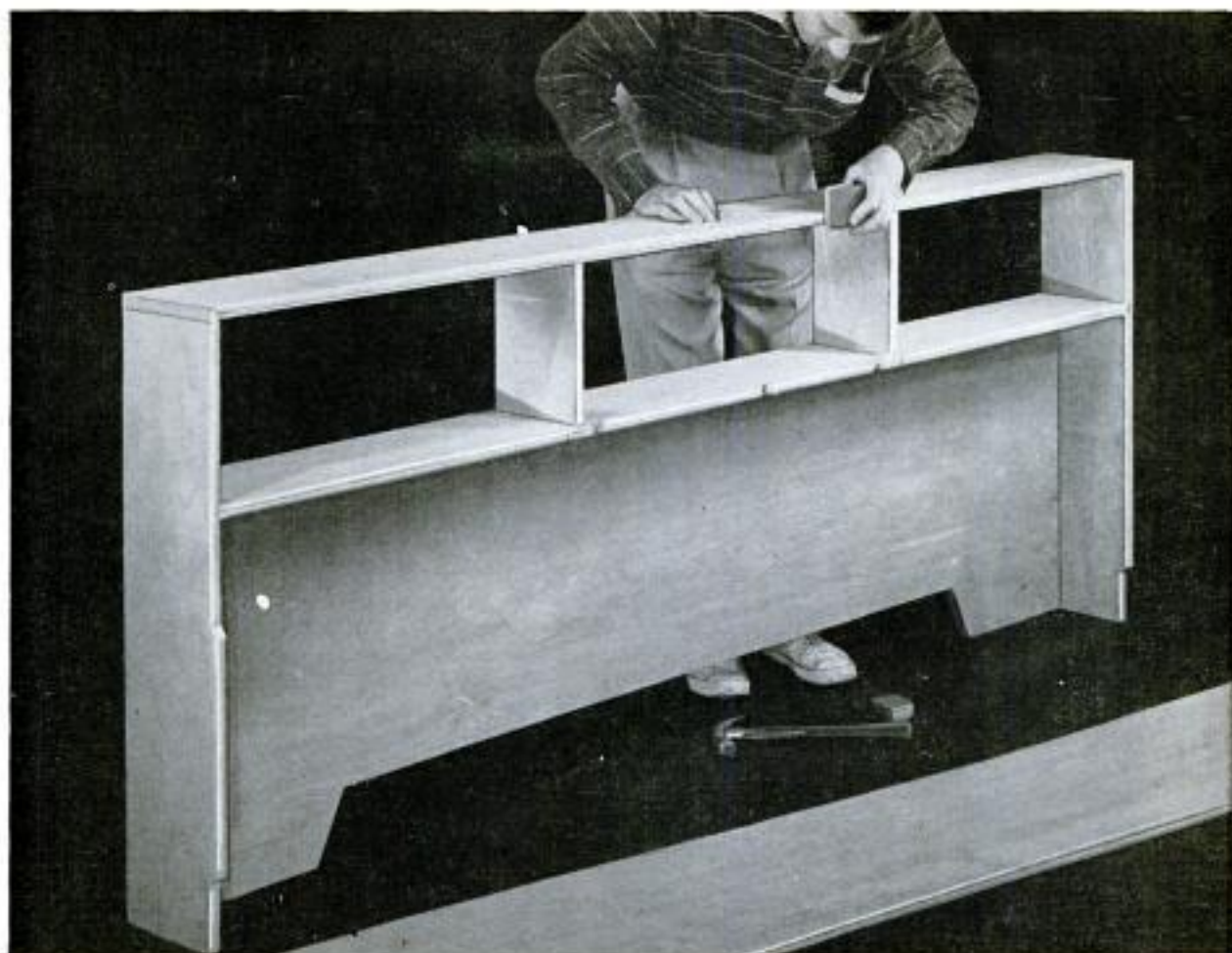

After veneer tape has been applied over end grain, finished headboard is sanded lightly, then varnished

tend to bow away from the front, wrap clothesline around the assembly and pull it tight. Let the assembly dry overnight, then cement the veneer tape along the front edges of the plywood. The two sliding doors can be $\frac{1}{4}$ -in. hardwood-faced plywood or $\frac{1}{4}$ -in. hardboard. If the latter is used, cover it with paint, wallpaper, plastic sheeting or other decorative material. Because these materials may increase the thickness of the hardboard so that the doors bind in the dado grooves, either taper the upper and lower edges of the doors, or cut a shallow rabbet along the front edges to reduce the thickness. Also, wax the portions of the doors that fit in the grooves to assure easy operation.

If your twin-bed frames did not come equipped with special hinges for use as a swing-apart assembly, two of the hinges can be obtained from most furniture stores. If necessary, loose-pin strap hinges can also be used. It is important that the bed-frames have easy-rolling ball-bearing casters. Replace them when necessary. Now make up the two beds, blankets and all. With the beds centered on the headboard and quite close together, mark the headboard for the hinge-bolt holes. Drill them and attach the hinges with $\frac{1}{4}$ -in. bolts,

using washers on the back of the headboard. If desired, the headboard can be located against the wall and screwed in place so that it will not move when the beds are swung apart. ★ ★ ★

Special hinge on outside corner of each twin bed is screwed to headboard so beds can be swung apart

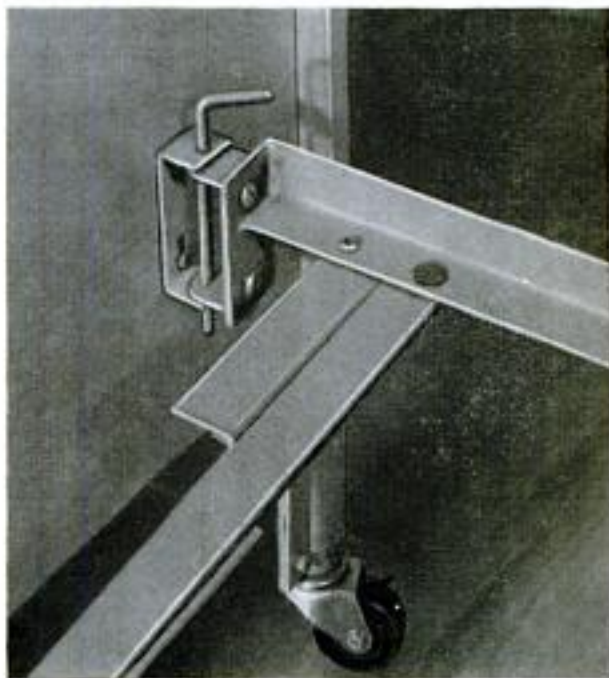



Patio-Table Cover Stored On Window-Shade Roller

This housewife keeps a table cloth for her patio table rolled on a window-shade roller when it is not in use. Fittings for mounting the roller are screwed to the underside of the table as shown in the detail, while the cover is installed on a roller of the required length in the same manner as a shade.

A. L. Most, Los Angeles, Calif.

Chalk Is Substitute Metal Polish

When regular metal polish is not at hand, a stick of blackboard chalk will prove to be a good substitute. Just rub a little soft-grade chalk onto a dry or damp cloth and apply it to the surface that needs polishing. The chalk dust is sufficiently abrasive to remove dirt and grease and does so without scratching, leaving a good gloss finish on the surface being polished.



Guide Block Prevents Screwdriver From Marring Work Surface

This guide block will help you to avoid marring work surfaces when a screwdriver slips off a screw-head. Several holes of graduated sizes are drilled through the block to accommodate screwdrivers of various sizes. In use, the block is held with one hand while the screwdriver is manipulated with the other.

Being confined in the hole in the block, the screwdriver cannot get beyond the screwhead even if it slips out of the slot.

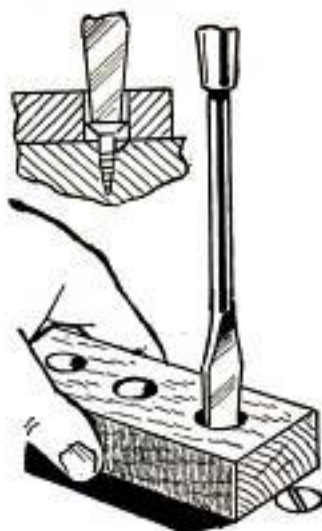

Raking and Finishing Tools For Mortared Joints

A raking tool to remove loose mortar, can be improvised by driving a roofing or shingle nail into a short length of hardwood so the head projects a distance equal to the desired depth of the joint. For compacting freshly mortared joints, small troweling tools called "slickers" can be made from lengths of wood or steel as shown in the detail. Wider at one end for broader recesses, these tools are used to finish fresh joints before the mortar sets.

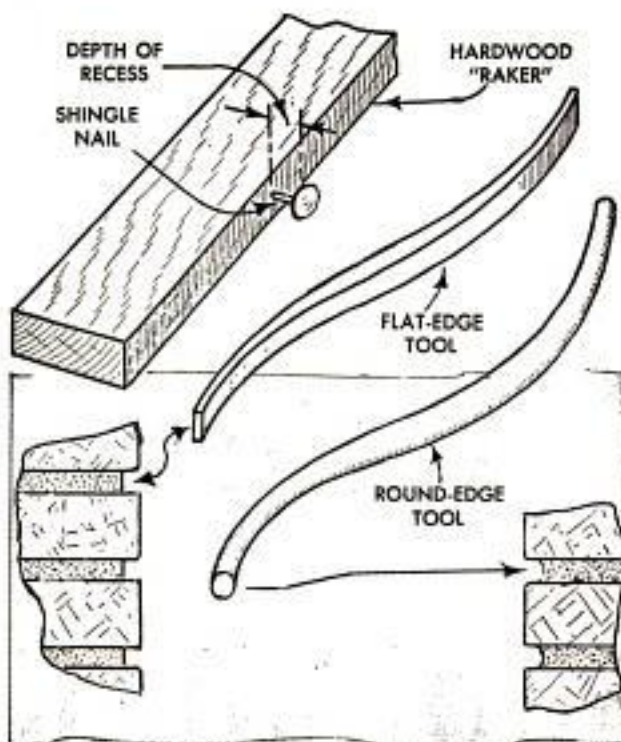

Casters Are "Retractable" Rollers on Boat Trailer

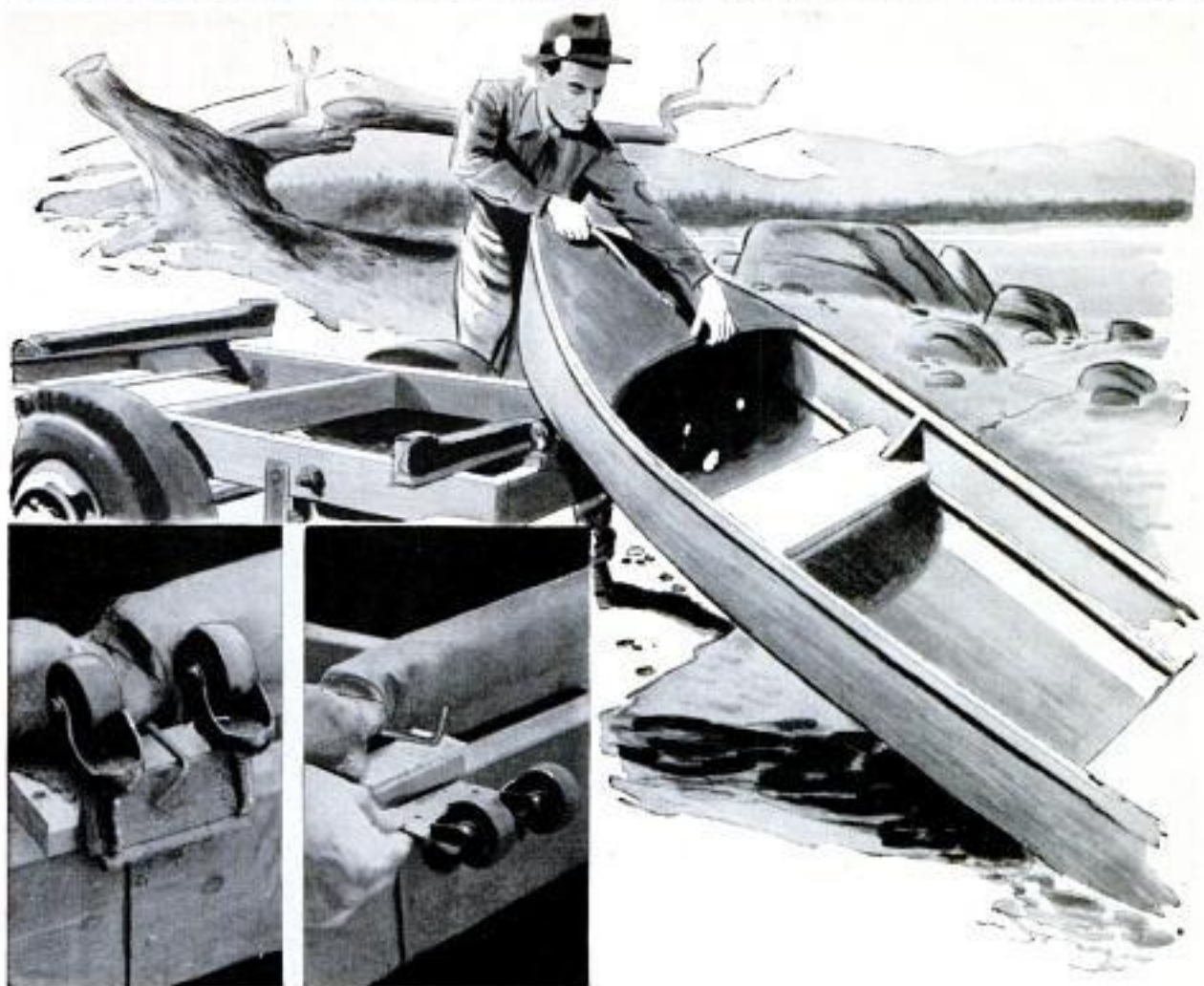

Many boat trailers, especially the home-built types, are not equipped with rollers, and loading a boat on these trailers is a two-man job, even when the outboard motor first is removed. To modify such a trailer for one-man loading, fit two large casters at the rear, attached so they can be pivoted down out of the way when not in use. Casters used on the installation shown are 1½ in. in diameter. The caster sleeves were discarded and the caster stems welded solidly to a large T-hinge, which then was screwed to the center of the rear cross member of the trailer as indicated. A "lock rod" to hold the hinge up is formed

from a length of ¼-in. steel rod, threaded at one end and bent to an L-shape. The rod is fitted through a hole drilled in the rear of the trailer as shown and held with a nut and washer. The end of the rod is peened slightly to prevent the nut from turning off due to vibration. When the lock rod is turned downward, it holds the hinge up, which positions the casters for loading the boat, left-hand photo. When the rod is turned upward, it permits the hinge and casters to pivot down out of the way, right-hand photo. The boat hull then rests solidly on the trailer pads for hauling.

James E. Gray, Savannah, Tenn.

Checking Engine-Oil Level In Hot Weather

In extremely hot weather it sometimes is difficult to detect the thin layer of oil on a hot dip stick. To overcome this, remove the stick from the engine, wipe it clean and then immerse it in cold water. When thus cooled, the stick will show a definite film of oil that readily can be seen.

Perry W. Trout, Kansas City, Mo.

Rubber Bands Combine Yardsticks For Long Measurements

To simplify measuring dimensions longer than a single yardstick but less than 5 ft., wrap a few rubber bands around two of the sticks, with the calibrations on both facing upward and the ends reversed. The sticks are easy to adjust and remain in position for later reading of the measurement if desired.

W.T.M. 58

X596 Lightweight Seeder-Spreader

By Clarence A. Martin

MADE MOSTLY of aluminum, this lawn seeder and fertilizer spreader is lightweight, rugged and has fairly large capacity. Wheels for the seeder can be from a discarded baby buggy, tricycle or other small-wheeled vehicle. An axle of $\frac{3}{8}$ -in. dia. is shown in the detail, but this dimension can be changed to suit the wheels.

Two ends and the body of the seeder are cut and bent from 18-ga. sheet aluminum, with a $\frac{3}{4}$ -in. flange being bent on the edges of the end pieces and along the long edges of the body as shown in the details. The feed-control adjustment consists of an aluminum strip $2\frac{1}{2} \times 22\frac{1}{2}$ in. long. Holes are drilled in this strip $\frac{3}{8}$ in. in dia. and spaced $\frac{7}{8}$ in. apart, $\frac{7}{16}$ in. from one edge. A bend then is made in this strip $\frac{7}{8}$ in. from the same edge, the angle matching that of the bottom of the feeder body. The opposite edge is bent in the opposite direction to provide a $\frac{1}{2}$ -in. flange, in which a slot is cut to accommodate the end of the feed-control lever. Three slots, $\frac{1}{4} \times \frac{3}{4}$ in., are cut in the bent strip so it can be moved

back and forth on three machine screws on the seeder body as indicated in the right-hand detail. After attaching the feed-control adjuster strip to the seeder body, move it to the "open" position and drill through the holes to provide corresponding holes in the bottom of the seeder body. An L-shaped strip now is bent and attached to the lower edge of the body front so that it supports the edge of the feeder control.

The agitator for the seeder is made from two 3×23 -in. strips of 18-ga. aluminum, drilled and folded as indicated in the detail, then bent to a W-shape and screwed to the axle. Bearings for the axle are cut from $\frac{1}{2}$ -in. stock or built up from pieces of 18-ga. aluminum. The feed-control adjustment lever is a 12-in. length of 1-in. aluminum tubing that is hammered flat for all but 5 in. of its length. The $\frac{1}{4}$ -in. lever guide strip is shimmed at the ends.

Hold a metal scriber against the lever and swing it so the feed-adjustment goes from full-open to closed, and scribe an arc on the feeder body. Divide this arc into five

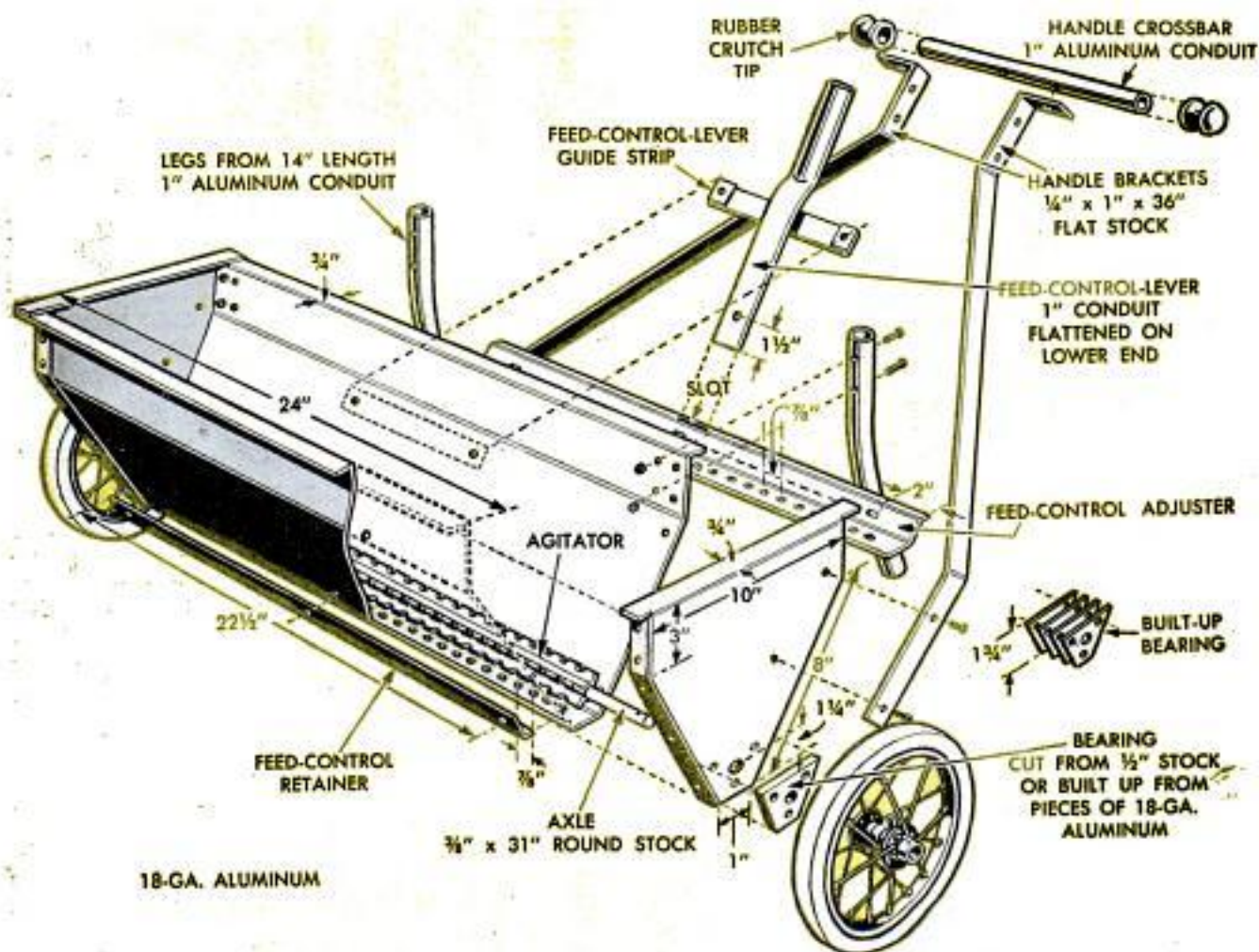

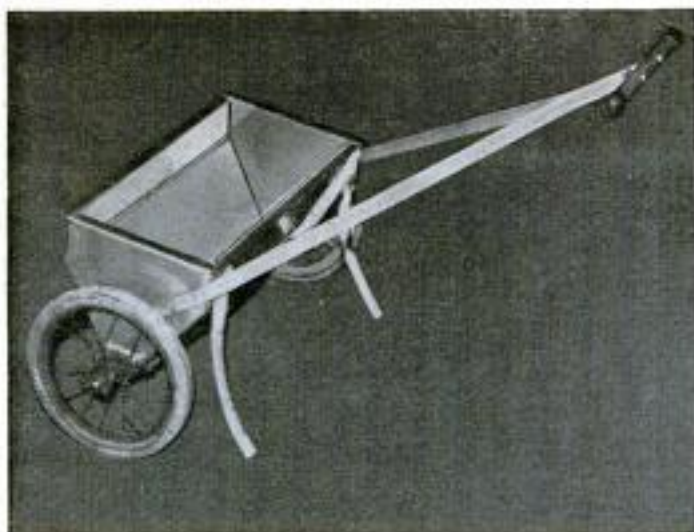

sections so that the feed-control table included in this article can be used to adjust the seeder to discharge the correct amount of material, whether it be seed, fertilizer or top dressing. When attaching the handle, which is shaped from aluminum flats, first drill the top holes in the body for the handle, then try various angles to determine a comfortable height before drilling the lower holes. ★ ★ ★

FEED-CONTROL TABLE

HOLE OPENING	GRASS SEED 1000 SQ. FT.	COMMERCIAL FERTILIZER 100 SQ. FT.	SALT, TOP DRESSING, LIME, ETC.
$\frac{1}{8}$	2 LB.	1 LB.	USE WIDE OPEN
$\frac{3}{8}$	2½	2	
$\frac{7}{8}$	3	3	
$\frac{4}{8}$	5	4	
$\frac{5}{8}$	10	5	

Feed-control table above shows different feed adjustments to be made for distributing various types of materials with the spreader. Below, upper hole for attaching handle is drilled first, then handle position is checked for height before drilling the lower holes in the seeder ends

AGITATOR
3" x 23" 18-GA. STOCK
2 REQD.

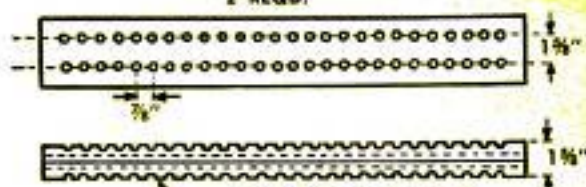

BEND INTO "W" SHAPE
AND FASTEN TO AXLE
WITH 10-24 $\frac{3}{4}$ " M. SCREWS

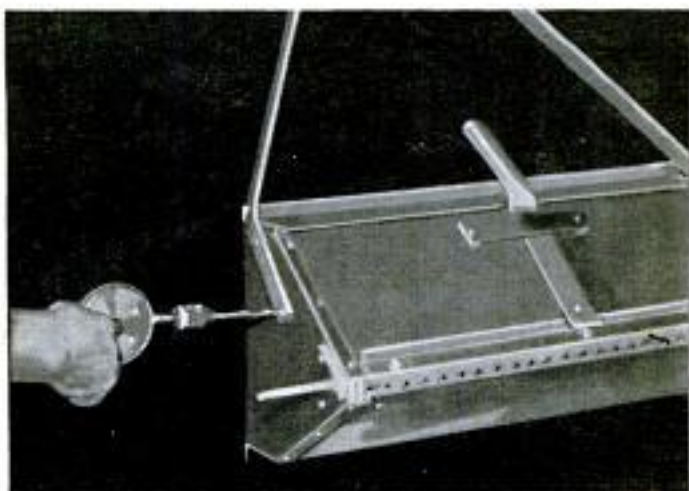
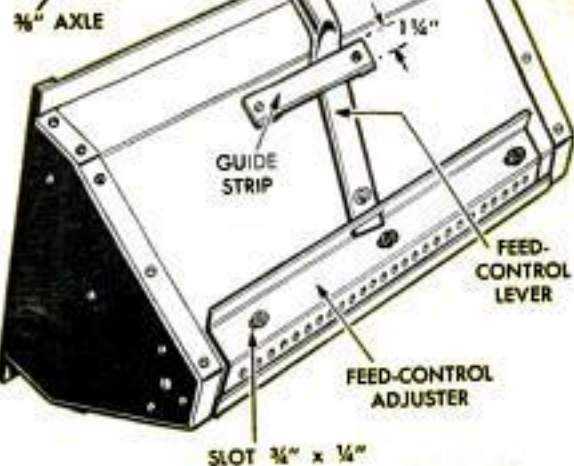



Dustpan Keeps Brush Clean When Painting Picket Fence

When painting a picket fence you can avoid having the brush pick up dirt or grass and also save much of the paint that may drip from the lower ends of the pickets by slipping a dustpan under each picket as it is painted. Excess paint easily is picked up from the dustpan with the paint brush, and cleaning with solvent allows the pan to be used for its normal job.

G. E. Hendrickson, Argyle, Wis.

Lawn Chair Fitted With Wheels Eases Shade-Hunting Task

Lawn chairs fitted with wheels are easy to move around the yard when shade-hunting, or when cutting the grass. Wheels for the chair shown in the illustration came from an old hand mower, but extra wheel sets may be purchased at a hardware store. The axle for the wheels was made from a metal rod with a hole drilled across each end to accommodate a cotter pin.

C. F. Marley, Nokomis, Ill.



Torch Supplies Gas for Burner

When you need a Bunsen burner or a gas plate at a distance from the gas outlet, a portable propane torch may easily be adapted as a fuel supply. Just unscrew the torch tip and fit the tube inside the end of the hose from the Bunsen burner. The method has proved practical for special, heavy-duty burners, which are designed for heating larger pieces of laboratory equipment and for which the smaller concentrated flame of the propane torch is not always satisfactory.

Ken Murray, Colon, Mich.

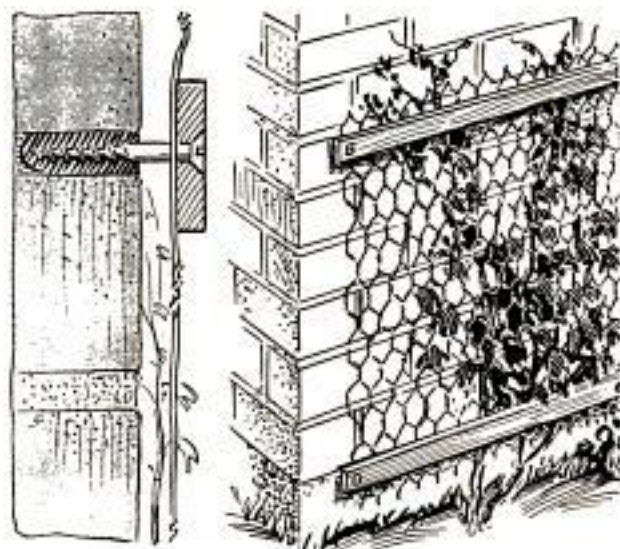

Starting Vines on Masonry Walls

Certain vines, such as Boston ivy, Virginia creeper, woodbine and similar vines have difficulty in clinging to masonry walls, but once started will stay and spread. To help them take hold, clamp the vine to the wall with poultry netting stretched between strips of wood that are screwed to the masonry. The screws may be anchored in lead sleeves or wooden plugs driven into the masonry joints.

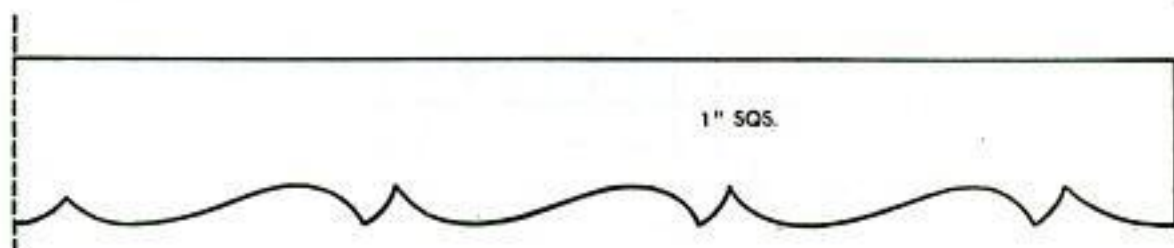
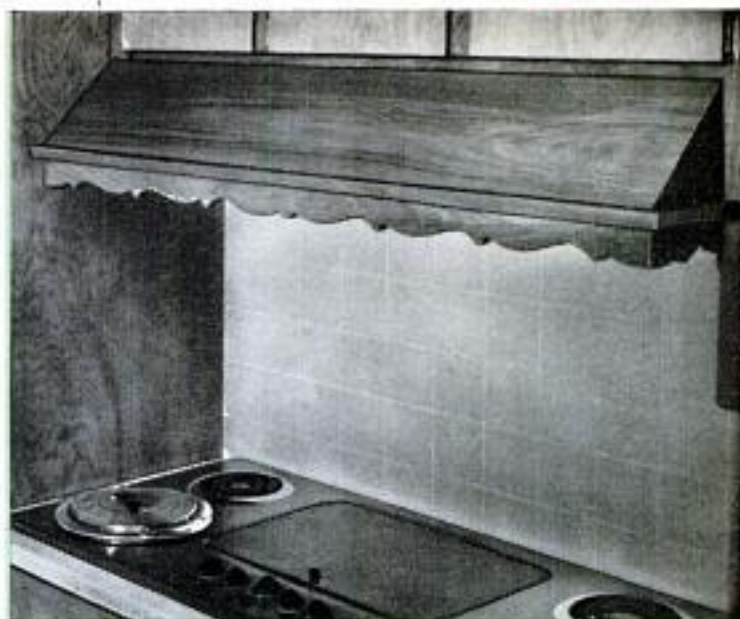
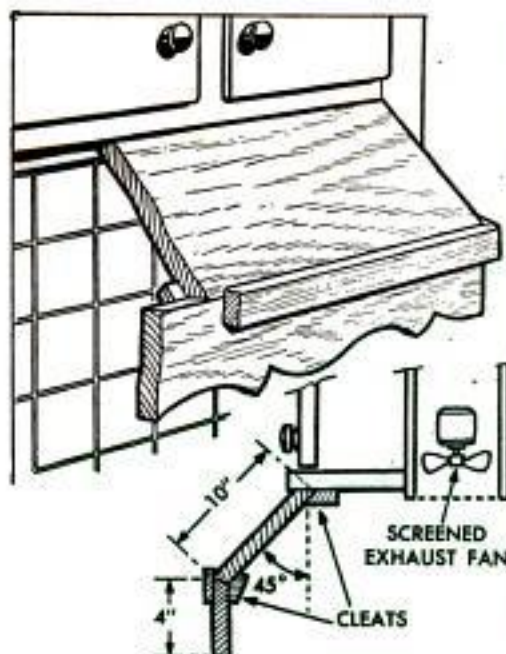

Vent Hood for Modern Kitchens

Here is a really efficient vent hood installed under a kitchen cabinet through the back of which is carried a flue with a screened exhaust fan as shown in the detail. The material used for construction of the hood is 1-in. stock redwood but any other material matching the kitchen woodwork will be suitable. The vertical trim

strip or valance is scrollsawed as shown in the squared pattern, or it can be purchased in a number of stock patterns at most building-supply stores. For use over a gas stove, the hood should be located as high as possible above the burners and the inside lined with sheet asbestos.

Hi Sibley, Nuevo, Calif.

Blocks Under Nailheads Permit Easy Removal

When nails are used to fasten frame members together temporarily, first drive the nails through thin wooden blocks and then into the framing. The nails are then easily removed with a claw hammer after splitting away the blocks.

Walter E. Burton, Akron, Ohio.

Draining Window Sills

If paint peels from an exterior window sill because the screen fits so tight that rain blown through it cannot run off, drive two upholstery nails into the lower edge of the screen to raise it up off the sill. The opening provided by the nails will enable the water to drain off and yet is small enough so that most insects are kept out.

Leslie K. Schultz, Cicero, Ill.

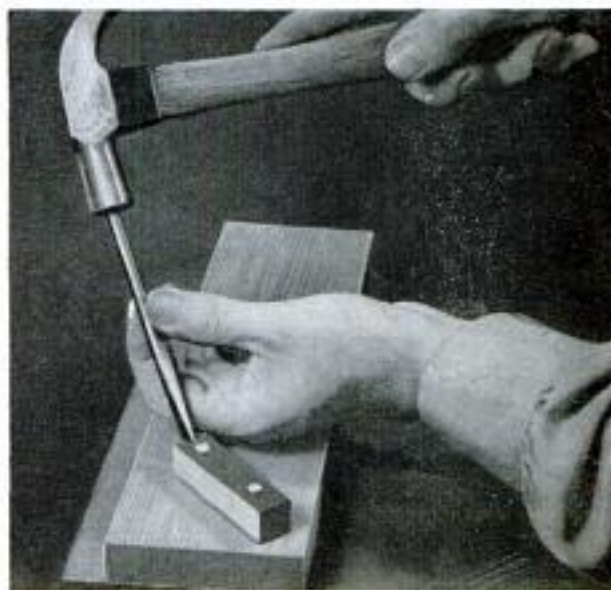

WTA 58 # 84

Paddle Boat for Summer Fun

By Bill Kersey

DO YOU WANT something different in a water sport at your lake cottage this summer? Then build this twin-hull paddle-wheel boat that will provide hours of safe fun and healthful exercise for children and adults alike. Constructed almost entirely of metal, the durable craft will retain its initial buoyancy all season and withstand unusually rough treatment.

The pontoons are made of 24-ga. galvanized steel, cut, bent and nailed to 1 1/8 x 12 x 96-in. pine lumber as shown in the detail below. Four wooden bulkheads in each pontoon and a 5-ft. length of 2 x 2 bolted to the bottom act as reinforcement, while riveted and soldered seams at the bow and stern make the pontoons watertight. A drainage plug is fitted in the forward end

of each pontoon as shown, so that water can be removed in the event a leak develops. Heavy-duty drawer pulls screwed to the bow and stern of each pontoon facilitate tying up at a dock and carrying of the craft. All wooden parts are prepainted on all surfaces before assembly to reduce water absorption.

Chassis, Steering, Pedal Assemblies

The chassis is made of welded steel angles fastened to the pontoons with lag screws. The metal folding chair is held rigidly in place by welding the legs to two crosspieces, the after crosspiece of which is welded to the chassis and the forward one bolted to the chassis and pontoons. The latter crosspiece also supports the chassis.

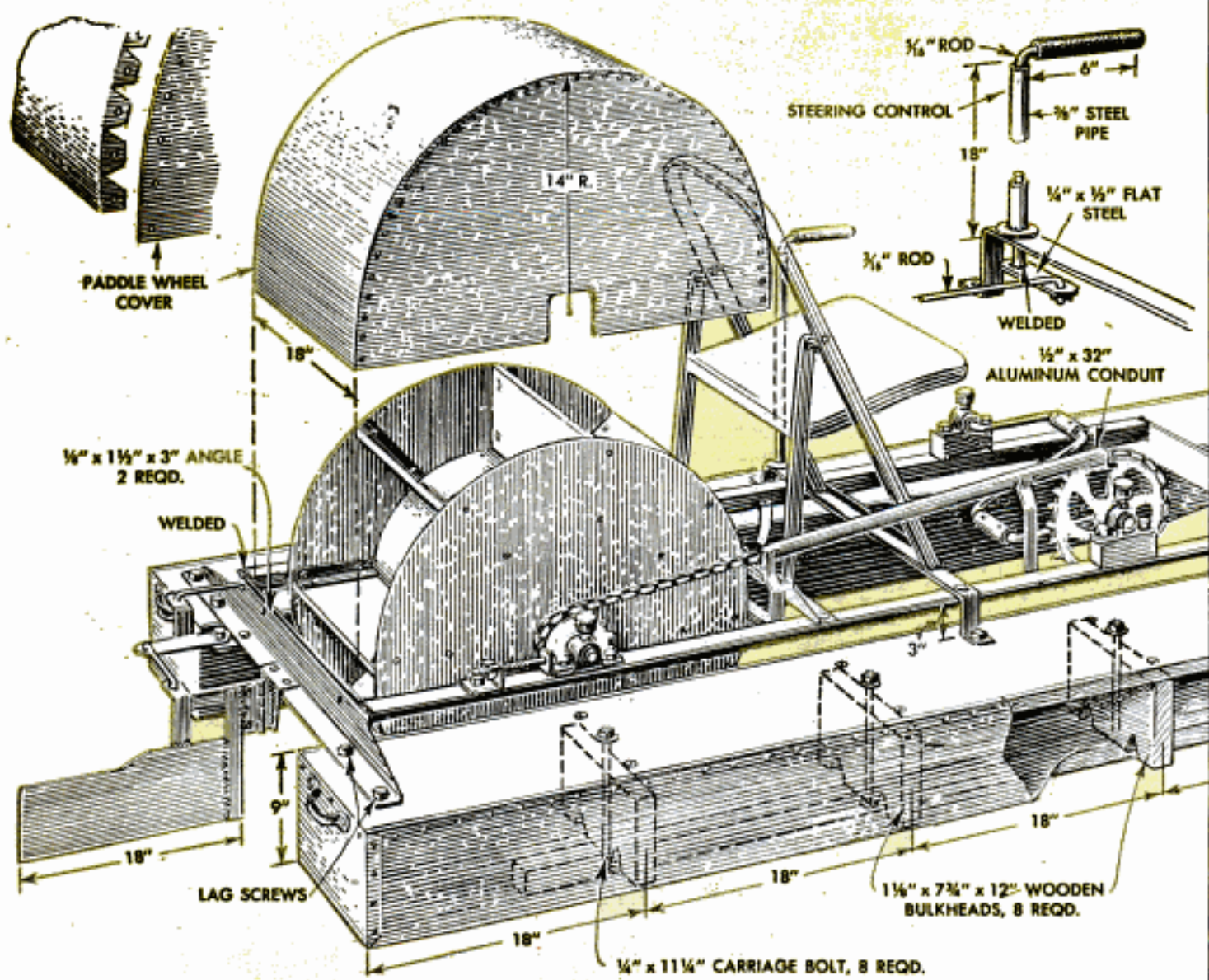



CHAIR ON BOAT MADE BY
 LYON METAL PRODUCTS INC.
 535 MOUND AVE.
 AURORA, ILL.

Considerable overhang at the bow ends of the pontoons, and shoal draft of this stable paddle boat permit navigating shallow streams and lakes and easy launching and bearding whether from beach or dock

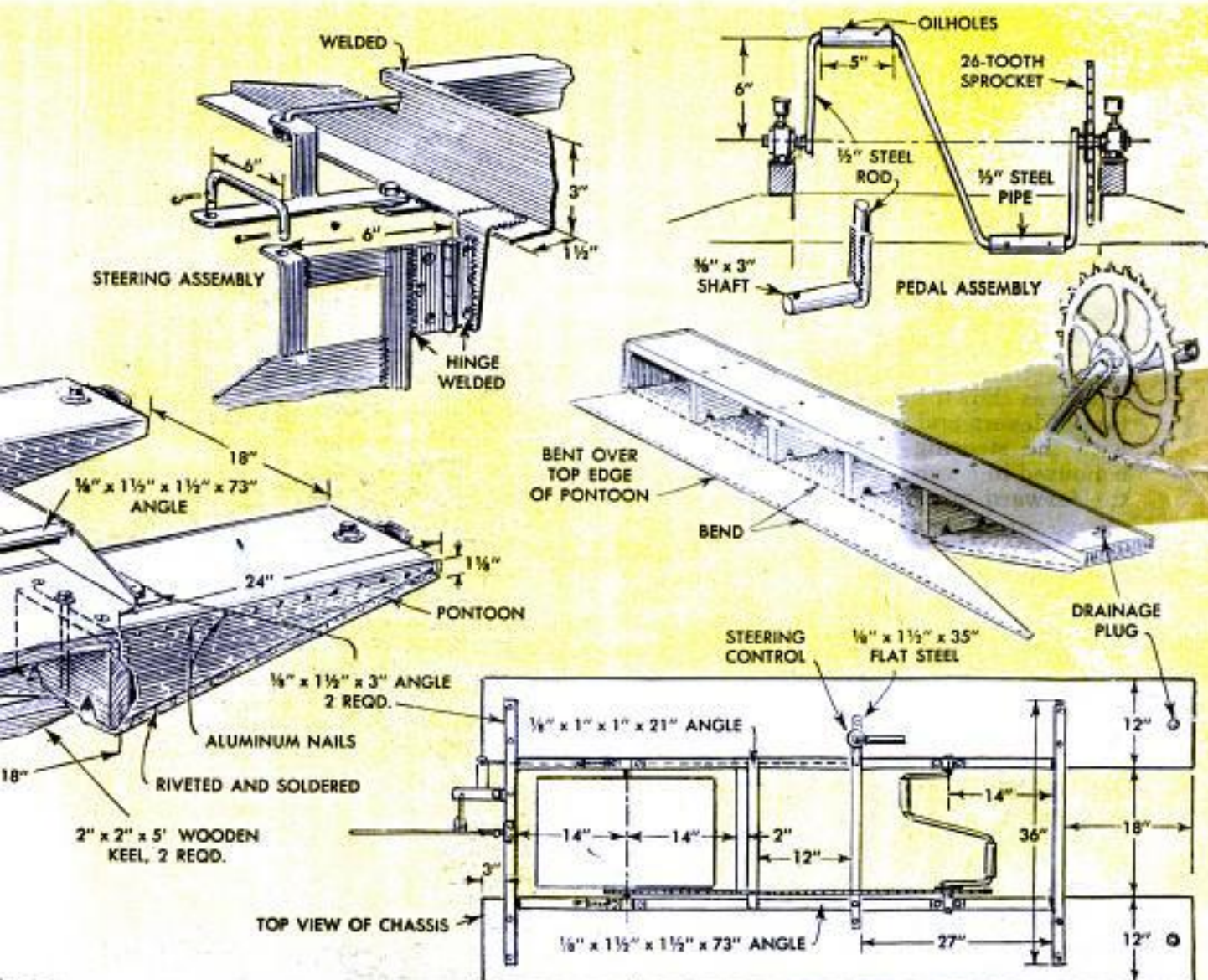

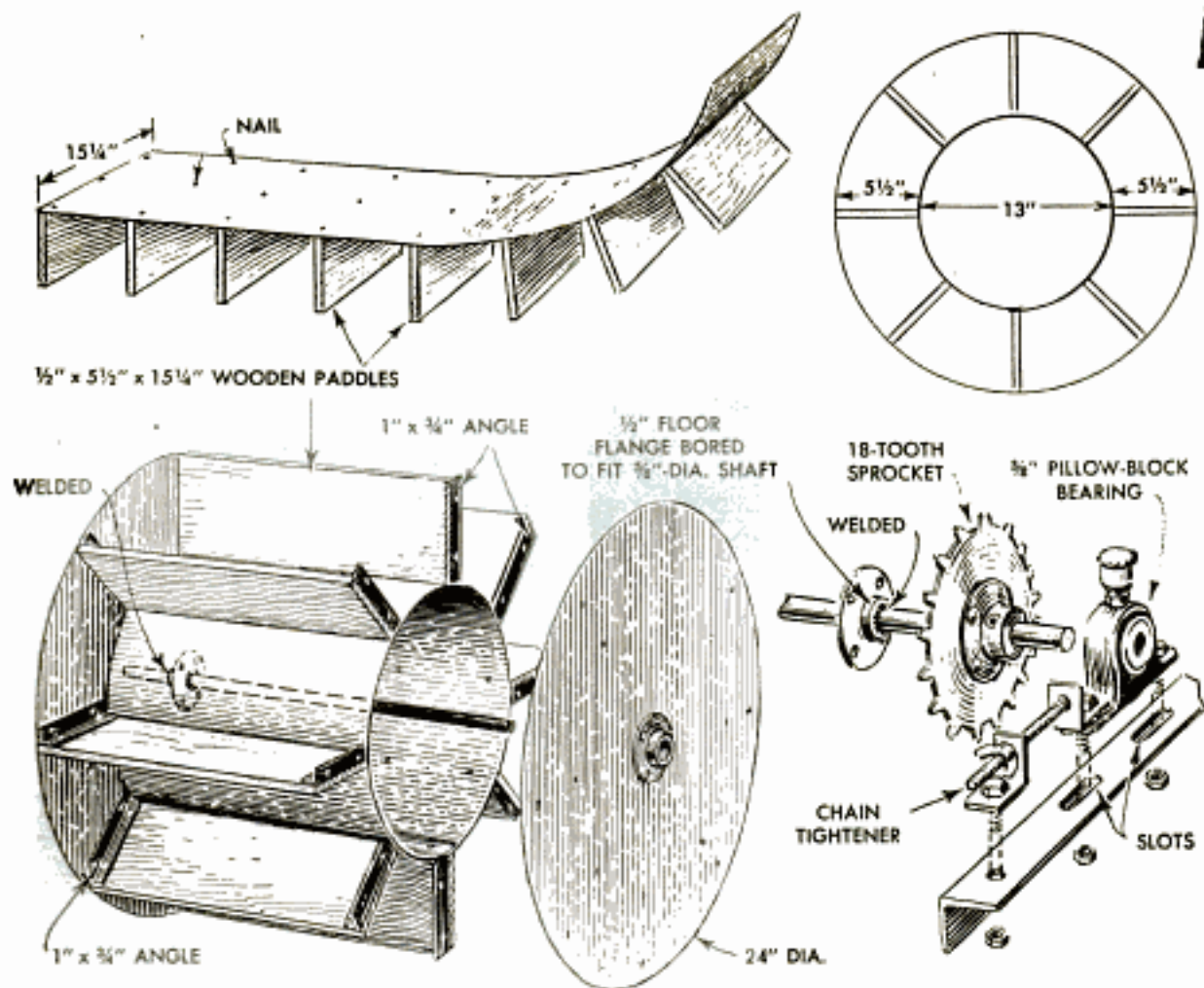

When mounting paddle wheel on chassis, assemble sprocket and pillow blocks on shaft before securing blocks

The rudder is made of four pieces of 18-ga. sheet steel and a T-hinge welded into a unit as shown in the detail. A combination of levers and rods connect the rudder with the steering-control rod. The latter is housed in a vertical steel pipe welded to the forward crosspiece.

Two sprockets, one with 18 teeth and the other with 26 teeth, taken from an old bicycle, provide a favorable ratio for easy pedaling and sufficient speed. Before bending the steel rod for the pedal crank, it is necessary to drill oil holes in the lengths of steel pipe used for pedals and slide the latter into position on the rod. Then, the $\frac{5}{8}$ x 3-in. shafts are welded on the ends of the crank and the joints reinforced by welding a U-shaped rod over the first weld of each as shown in the detail. After the pedal assembly is completed, it is mounted on pillow-block bearings, top view of the chassis.

Paddle Wheel

Constructing the paddle wheel is easy. Simply nail the eight wooden paddles to the strip of galvanized steel that forms the

hub as shown in the detail. The strip should be long enough to provide a diameter of 13 in. when it is formed into a circle and the ends overlapped $\frac{1}{2}$ in. and nailed to the appropriate paddle. All the sheet metal for the paddle wheel and cover is 24-ga. galvanized steel, including the 1 x 4-in. angles that secure the paddles to the end pieces. The top of the paddle-wheel cover is screwed to the side pieces as shown in the detail. When the paddle wheel is completely assembled, the floor flanges are riveted to the ends and welded to the shaft as shown. Then, the small sprocket is slipped on the shaft for later positioning and securing, and the entire paddle-wheel unit is mounted on the pillow blocks. After the chain is installed, the chain tightener is bolted in place and given proper adjustment for efficient operation of the chain.

A chain guard made from $\frac{1}{2}$ -in. thin-wall aluminum conduit, is welded to the chassis for protection of the rider's leg. Removal of the 10 lag screws that secure the chassis to the pontoons permits quick disassembly into three major parts for easy transport to and from the place of use. ★★★

Corrugated "Platform" Protects Merchandise Stored on Basement Floor

To protect boxes and barrels of merchandise stored in a basement against moisture from damp floors, set them on sheets of corrugated metal or plastic. The corrugations permit air circulation between the floor and the sheets and under the boxes and barrels.

Smaller Propeller Restores Outboard Power on Hot Days

An outboard engine that runs at reduced efficiency because of high atmospheric temperature and humidity and low barometric pressure can be made to run properly by switching to a smaller propeller when these conditions prevail. Assuming that at the beginning of the season the engine was equipped with a propeller that would permit it to turn at its rated r.p.m. at full throttle, the smaller propeller will offset this weather-inspired power loss and permit the engine to run at its rated r.p.m. for maximum boat speed. If the propeller change fails to restore the engine's efficiency, servicing or a complete overhaul may be needed.

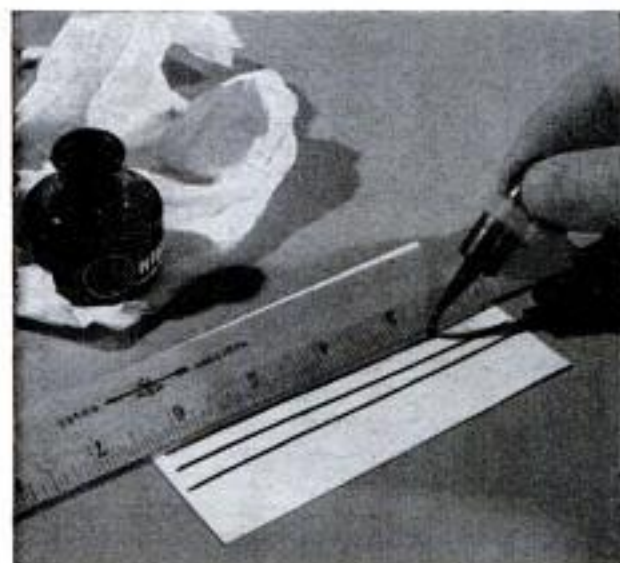

Quill From India-Ink Bottle Is Emergency Ruling Pen

The quill stopper from a bottle of India ink serves as an emergency ruling pen when drawing heavy lines. Similar to a medicine dropper in construction, the stopper holds a large quantity of ink that flows in an unbroken line of uniform width when the opening in the quill is held flat against the paper and drawn along the edge of a ruler as shown.

Spring Improves Operation Of Worn Bench Vise

The tendency of a worn bench vise to remain closed during the first three or four turns of the handle can be eliminated by slipping a heavy compression spring on one of the guide rods, as shown, to take up the slack caused by a loose-fitting vise screw and movable jaw. If the vise has a square guide or beam, a similar type spring can be wound from heavy spring wire.



SOLVING Home Problems



BATTERY FILLER is just the thing to water small plants, also succulents and rooted cuttings, where only a few drops under or over is either too little or too much for the plant. With the filler you also do the job without splashing water over window seat or on table

ICE-CREAM BAR won't be a total loss on a hot day if you have a paper baking cup handy to catch drippings and flakes of chocolate coating that break away from the bar before you get to them. Cut a short slit in bottom of cup and slide over stick to provide drip cup

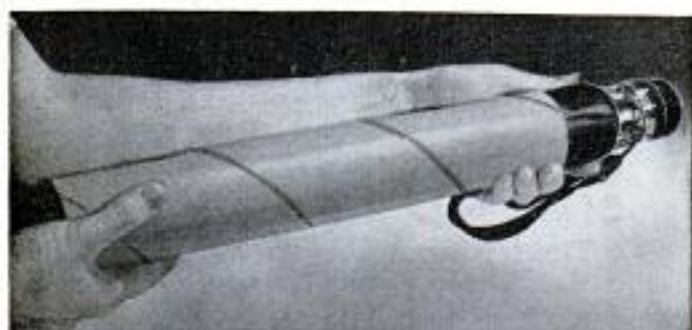

CARDBOARD MAILING TUBE provides protection against wear and damage for that umbrella you carry in the car or store in a crowded clothes closet. Select a tube that will take the umbrella in a snug fit. Then cut to length required

SALT SOLUTION, made by adding two teaspoonfuls of salt to a cup filled with water, makes a fairly accurate test solution for checking freshness of eggs. Fresh egg will sink to bottom of the cup but a doubtful egg will float



ADHESIVE-TAPE CONTAINER, the kind with a friction cover, keeps postage stamps always under control in the desk or on a trip where storage space must be reduced to the minimum. Tear stamps into strips and wind on tape spool





SAFE SCISSORS CASE is made by slipping a length of rubber tubing over the blades. Protects both you and the scissors. You won't get a hand pricked by the sharp blade points and scissors are not likely to be damaged if they are accidentally dropped

CANDLES that gather dust over a period of time can be cleaned by wiping lightly with a cloth dipped in alcohol. The latter softens the surface of the wax and removes the accumulation of dust without impairing the usefulness of the candle in any way



PAINT that collects in the mesh of fly screen when painting is easily blown out with a syringe. Clogging of the mesh most frequently occurs when you apply a fresh dip of paint from the brush or when working near screen frame. That's when syringe is handy



CORNER IRONS, also referred to as mending plates, make sturdy hinges for cover of a toy box or tool chest. To attach, locate cover and clamp in place so it cannot shift. Then attach irons to cover with two screws and to box with one screw each



DRY MUSTARD is a good deodorizer for glass tumblers, vases and bottles. First, wash container in soapy water, then fill about half full with clean water. Add a teaspoonful of dry mustard and stir thoroughly. After an hour or so, rinse with clear water



REPLACEMENT SHOE-LACE TIPS are easily made with cellulose tape and nail polish. Wind several turns of tape around end of lace, two to three turns will usually do it, and then seal with an application of nail polish. Will last nearly as long as regular tip

WAX PAPER can supply a good emergency lubricant for an electric-shaver head, that is, until there's time to have the shaver properly serviced. Disassemble the head and lightly wipe the inside shearing cutter with a small piece of wax paper

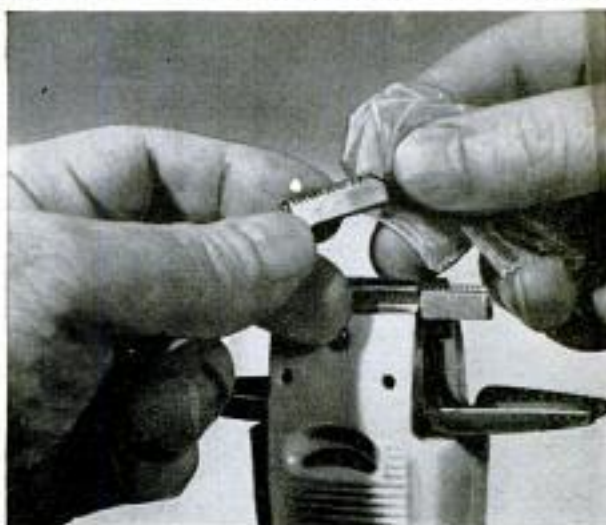



Barbecue Pit Made From Tank For Emergency Use

This portable barbecue pit was made by one farmer from an old stock tank, with heavy chicken wire stretched over the top for a grill. The bottom of the tank is lined with rocks, which hold the heat and raise the charcoal bed to within 18 in. of the grill. The barbecue is easily moved to any desired location when the rocks are taken out.—Ben Brown, Collinsville, Ill.

Chalk Better Than Pencil For Marking Hardboard

When marking hardboard for cutting or layout work, lines drawn with a piece of tailor's chalk are easier to see than pencil marks because of the slickness and dark color of the material. Also, light-colored crayons are a good marking medium for use on material of this type.

Frank A. Javor, Newark, N. J.

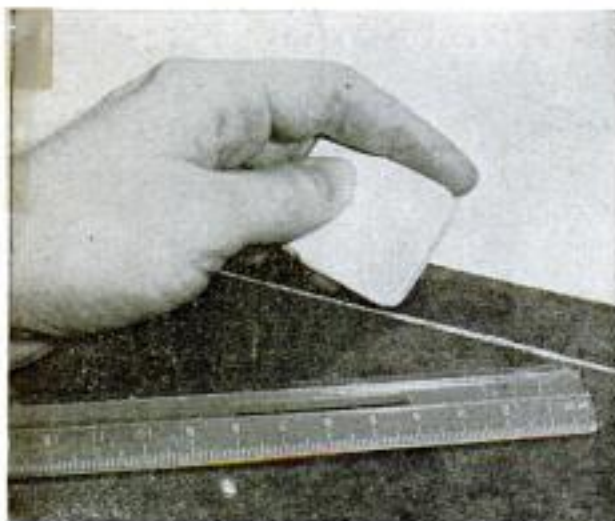

180

Row Markers From Coat Hangers

Markers for newly planted rows of vegetables or flowers can be made by bending a number of wire garment hangers to the shape indicated. The empty seed packets may be slipped over the tops of the markers to identify the seeds planted. The markers are forced into the ground.



Tire Bead Broken Loose With Aid of Brake Drum

When a second flat tire leaves you with no spare, and it is necessary to remove the tire from the wheel to patch the tube, here is a quick, easy way of breaking the tire bead loose from the rim. Place the tire in position under the brake drum as indicated, then gradually lower the jack until the bead is broken loose. If the brake drum is quite high, place a piece of lumber or other object suitable for this purpose between it and the tire.

A. C. West, Chula Vista, Calif.



Disposable, heatproof ash trays can be made for a party by shaping pieces of aluminum foil over a regular ash tray. When through using, fold the edges in to the center and discard them with the ashes and butts still inside.

Mrs. Rose Mayover, Sarasota, Fla.

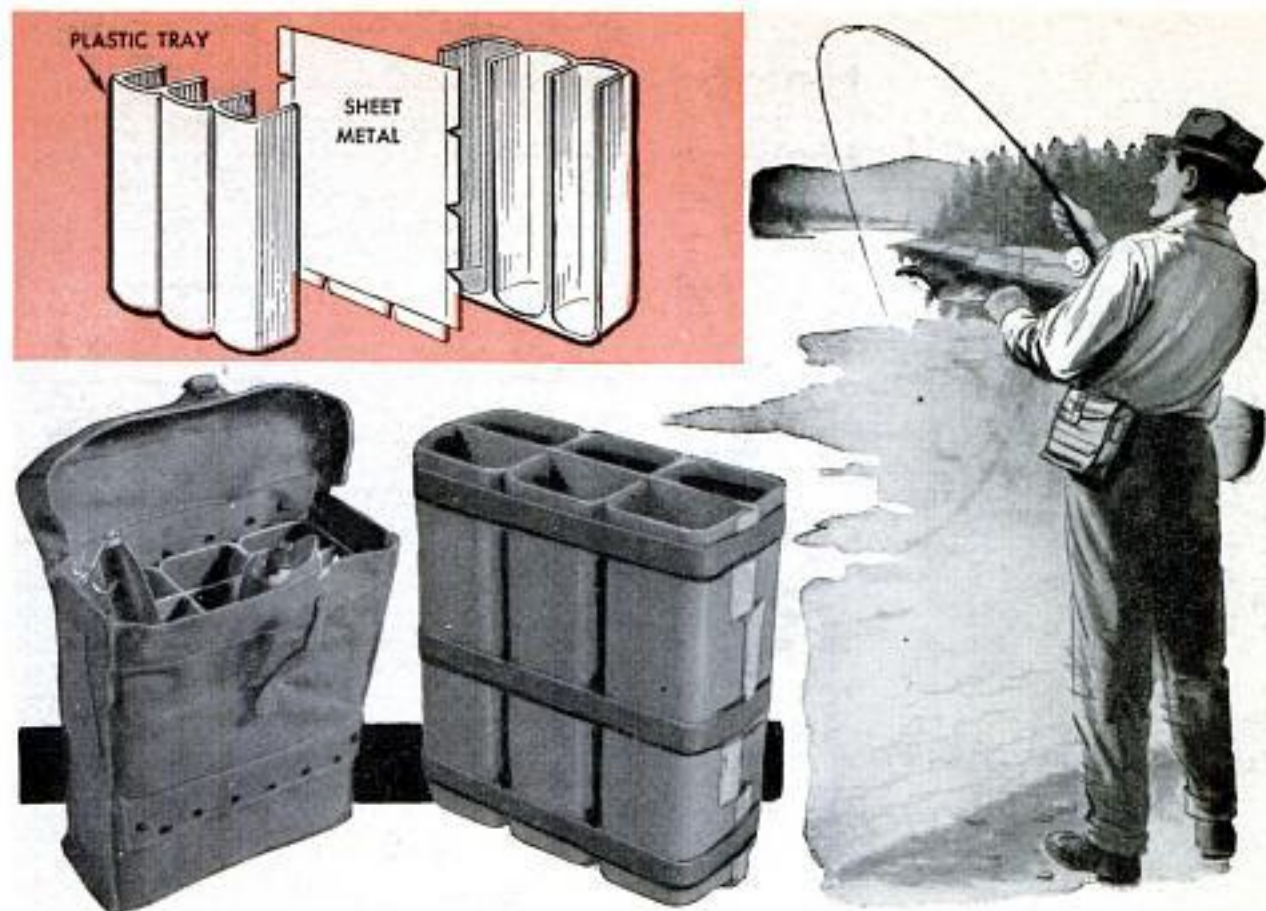

Fishing-Lure Bag Carried on Trouser Belt

Ideal for carrying large-size lures, such as are used for salt-water fishing and surf casting, this compartmented canvas bag also can be modified and used for carrying the smaller-type lures used in fresh-water fishing. The bag itself is the type sold in war-surplus stores and measures 8½ in. wide and 10½ in. high. It also could be cut and sewn from light-weight canvas. Compartments in the bag are formed by using two plastic silverware trays that can be purchased in a ten-cent store. They measure about 8 x 13 in. and have three long, parallel compartments with a shorter one across the end. This latter compartment is cut off when the trays are shortened to fit the canvas bag. A piece of light sheet metal then is cut to fit between the shortened trays as indicated in

the detail, allowing a ½-in. flange on the bottom and two sides. Notches are cut in the flange and the sections are bent alternately at right angles to the partition so the plastic trays are held in alignment. A few turns of tape are used to hold the trays and sheet metal together as a unit. The unit then simply is slipped into the bag. If smaller lures are to be carried, the purchased bag is designed so the lower end can be rolled and laced to make the bag only about 6 in. deep. The plastic trays and sheet metal then are cut to fit. If the shoulder strap with which the bag is fitted does not permit comfortable carrying, a short strap can be sewed to the bag so that it may be worn on a belt in the manner shown in the illustration.

Vlad Evanoff, Brooklyn, N. Y.

Fire Extinguisher Improvised From Insecticide Duster

For an inexpensive but quite effective household or automobile fire extinguisher, fill an insecticide duster with a charge of chemical of the type used in dry-chemical extinguishers. Since the chemical is pumped on the fire by hand as needed, there is no costly expelling charge to be replaced at each filling of the extinguisher.

Replacing Tire on Rim

Whenever you replace a tire on a rim be sure the balance mark, usually a red dot, is in line with the valve stem. Also, when wheel-balancing weights are installed, mark their position on the tire. Check the marks occasionally to see that the weights do not shift. One oz. of unbalance becomes 12 lb. of pounding force at 60 m.p.h.—Roger Darling, Revere, Mass.

X196



Keep It From CRACKING

Reinforcing concrete driveways, sidewalks, patios and basement floors with welded-wire fabric adds 30 percent greater strength

TO ASSURE yourself a concrete job that will take years of the hardest wear without cracking or breaking up, reinforce it with welded-wire fabric at the time of pouring. This is true not only of flat work in contact with the ground such as basement and grade-level floor slabs, walks, patios and driveways, but also of walls and other vertical structures either above or below grade.

As concrete cures after the initial set, slight shrinkage often develops stresses which, under certain conditions, may crack concrete alone. A steel fabric made especially for the purpose and placed at the center of the slab or vertical member, tends to absorb and distribute these stresses and thus control the formation of cracks which not only are unsightly and damaging, but may admit water, dirt and such insects as



On flat work such as the driveway pictured above, welded-wire fabric is placed at the center of the slab with the meeting edges lapped as in the inset

termites. Nonreinforced slabs and foundation walls of concrete in contact with the ground or fill, also are subjected to the action of frost in the colder climates and to expansion and contraction due to temperature and moisture variations of the air and the ground throughout the seasons. Exposed flat work such as driveways, walks and patios may warp and crack due to temperature variations between the top and bottom surfaces of the slab itself, or to structural stresses which develop due to settling of the soil or fill under the slab. Wire reinforcement adds the tensile strength necessary to control cracking of the slab under such conditions.

The table on page 184 lists commonly recommended types of welded-wire fabric for home projects in poured concrete. For average purposes the fabric regularly

comes in rolls 60 and 72 in. wide. Note in the table under the heading "Recommended Styles" that there are two pairs of figures in the various designations. These refer to the gauge and spacing of the longitudinal and transverse wires that form the mesh. As an example, 6x6-10/10 indicates fabric having 10-ga. longitudinal and transverse wires spaced 6 in. in each direction, the first of each pair of figures referring to the longitudinal wire.

The fabric is easily cut to the required size by using wire cutters (or small bolt nippers on the larger sizes) as in the photo, page 184. When placing, pictured on the opposite page, it's common practice to cut the fabric with $1\frac{1}{2}$ to 3-in. clearance between the edges of the fabric and the inside face of the form. Where more than one width of fabric must be used to span the slab, it's regular practice to lap the meeting edges 6 in., or one wire spacing, as in the inset photo on the opposite page. Some masons wire the meeting edges together at the lap to keep both widths at the same level at the joint.

Placing the fabric reinforcement in position in the freshly poured concrete usually is done in one of two ways. By the first procedure concrete is poured to about one half the finished thickness of the slab and struck off level. Then the wire fabric is placed as in the upper photo on the opposite page and the final batch of concrete is poured without delay. A second method, often used for home projects involving slabs of considerable size, such as driveway sections, eliminates the need for two pours, an important consideration when

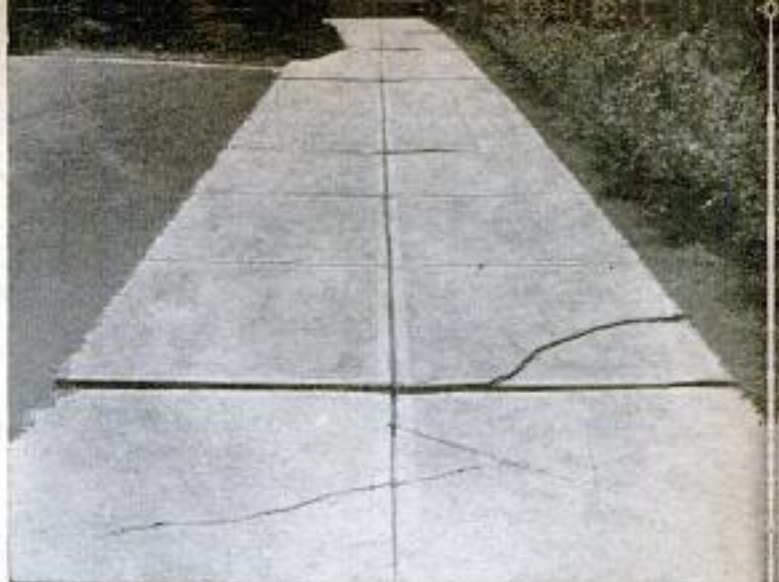

Note the cracks in this concrete driveway. These result from pouring concrete slabs on subgrade without reinforcing to control cracking and warping



This wire-reinforced driveway has withstood wear and erosion for many years and is still intact, no cracks or frost damage visible throughout the length

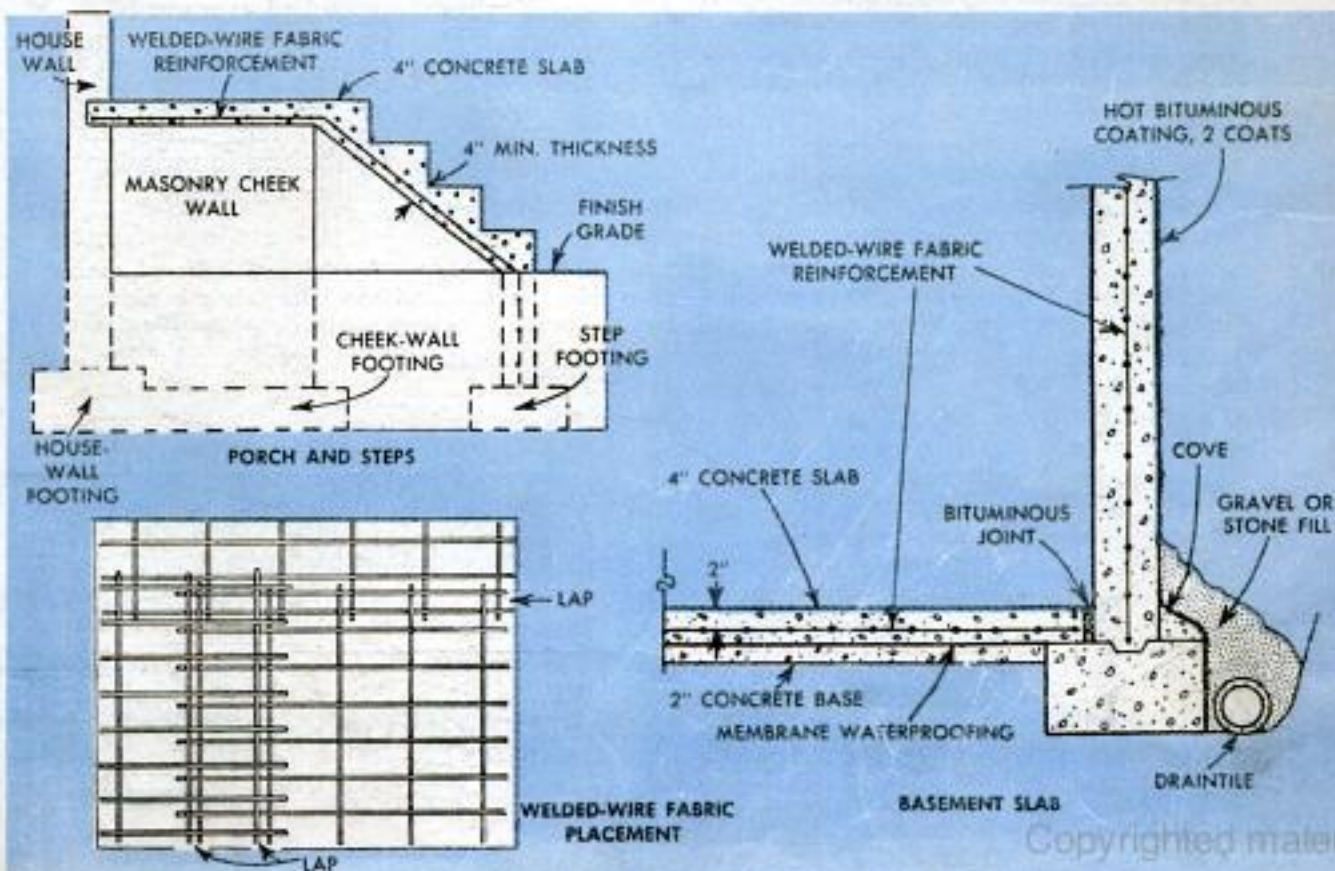



RECOMMENDED STYLES OF WELDED WIRE FABRIC FOR VARIOUS REINFORCED CONCRETE PROJECTS AROUND THE HOME

Type of Construction	Recommended Style	Remarks
Barbecue foundation slab	6x6-6/6 to 4x4-6/6	Use heavier style fabric for heavier, more massive fireplaces or barbecue pits.
Basement floors	6x6-10/10 or 6x6-6/6	For small areas (15' maximum dimension) use 6x6-10/10. As a rule of thumb, the larger the area, the poorer the subsoil, the heavier the gauge. Fabric must not pass through joints.
Driveways	6x6-6/6	Continuous reinforcement between 25 to 30' contraction joints, 1 1/2-3" clearance at sides and joints.
Foundation slabs (Residential only)	6x6-10/10	Use heavier gauge over poorly drained subsoil, when maximum dimension is greater than 15', or when heating ducts are embedded.
Garage floors	6x6-6/6	Fabric must not pass through joints.
Patios and terraces	6x6-10/10	Use 6x6-6/6 if subsoil is poorly drained.
Porch floor a. 6" thick slab up to 6' span b. 6" thick slab up to 8' span	6x6-6/6 4x4-4/4	Position on nails or blocks one inch from bottom form to resist tensile stresses.
Sidewalks	6x6-10/10 6x6-6/6	Use heavier gauge over poorly drained subsoil. Construct 25 to 30' slabs as for driveways, but form "dummy" joints for appearance. For narrow walk, cut lengths of fabric in half longitudinally.
Steps (Free span)	6x6-6/6	Use heavier style if more than 5 risers. Position fabric 1" from bottom form.
Steps (On the ground)	6x6-6/6	Use 6x6-6/6 for unstable subsoil.

Wire fabric comes in rolls in convenient lengths and widths, 60 and 72 in. being average widths

handling ready-mixed concrete. As the material comes from the ready-mix truck, a quantity of it is placed in small piles about 3 ft. apart and equally spaced over the subgrade. These are leveled so that the height is about one half the slab thickness. Then the wire fabric is placed and the slab poured to full thickness. The piles of ready-mixed concrete will keep the wire fabric in the correct position at the center of the slab. The details below show how the two methods are carried out.

Sketches on preceding page show recommendations for wire-reinforcement of concrete steps with a free span, the horizontal slab of the stoop being carried on a cheek wall. It is recommended that on free-span steps the wire fabric be placed only 1 in. from the bottom of the form. The lower detail shows correct placement of the wire fabric when the size of the slab makes it necessary to lap-join the fabric in two directions. The detail below shows recommended procedures in wire-reinforcing basement floor slabs and foundations. ★ ★ ★
Photos and information courtesy Wire Reinforcement Institute, Inc.

When placing wire fabric at the center of slab two methods are used. In the first, piles of concrete are placed on the subgrade and leveled to one half the thickness of slab. Then wire fabric is placed on piles and slab is poured to full thickness. Second method requires two pourings, is shown in lower detail

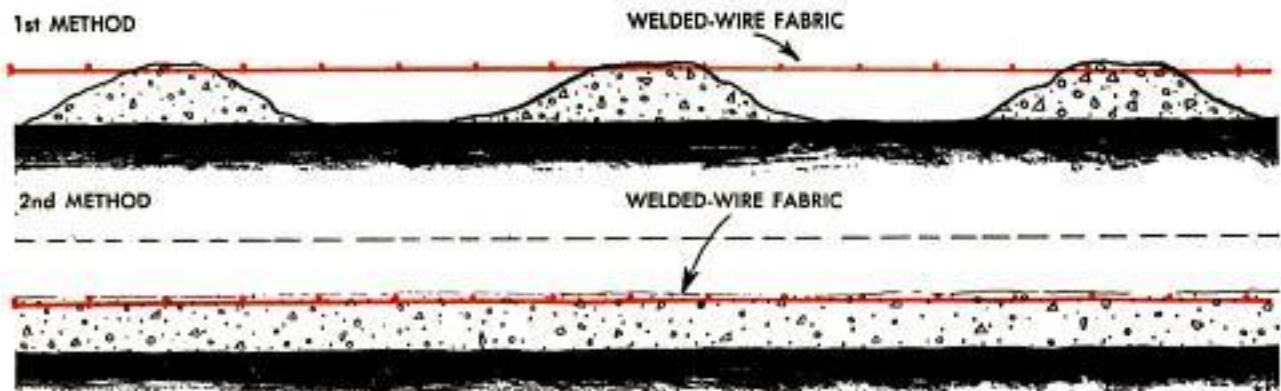

Ladder Transported on Wheelbarrow

Finding a long, wooden ladder was too heavy to carry singlehanded for a great distance, one homeowner transported it with a wheelbarrow. The ladder is centered on the wheelbarrow and tied securely to the handles and wheel frame. For best maneuverability, the person wheeling it should stand between the rungs behind the handles of the wheelbarrow. However, it is easier to walk at the back end of the ladder, using the ladder rails as handles. From this position you can keep the front end from striking the ground.

Broken Pin From Outboard Reinstalled for Emergency

If the shear pin on your outboard motor breaks while far from shore and no other replacement or substitute is available, the three pieces of the broken pin can be reinstalled to allow slow-speed operation of the motor. To do so, fit the pieces back into the hole placing the longest piece in last so it bridges the gap between the propeller hub and shaft on one side. Then remount the propeller and start the engine. By running at no more than half the normal cruising speed, the repair should last until you reach shore.—Henry Josephs, Gardenville, Pa.



Small Glass Holds Egg In Position for Painting

When decorating an egg with a painted design, such as those used at Easter time, place the egg in the top of a small glass similar to the type shown. As a result, both hands will be free to work with the paint and decorative material, and drying of the paint will be possible without any possible damage from rolling on a flat work surface.



Brush Wrapped in Wax Paper Need Not Be Cleaned

It is not necessary to clean a paintbrush that is to be set aside for a few hours or overnight if the bristles are protected from the air. To do this, wrap them tightly in wax paper or aluminum foil, twisting and taping the ends of the sheet around the brush handle. The paper will prevent paint in the bristles from hardening. Aluminum foil can be used in the same manner, eliminates the need for taping in place and will do an even better job.



☞ A ladder should not be painted. Give it two or three coats of boiled linseed oil to preserve the wood.

X294

FOOTINGS SAVE YOUR FOUNDATIONS

By Louis Martin Reitz

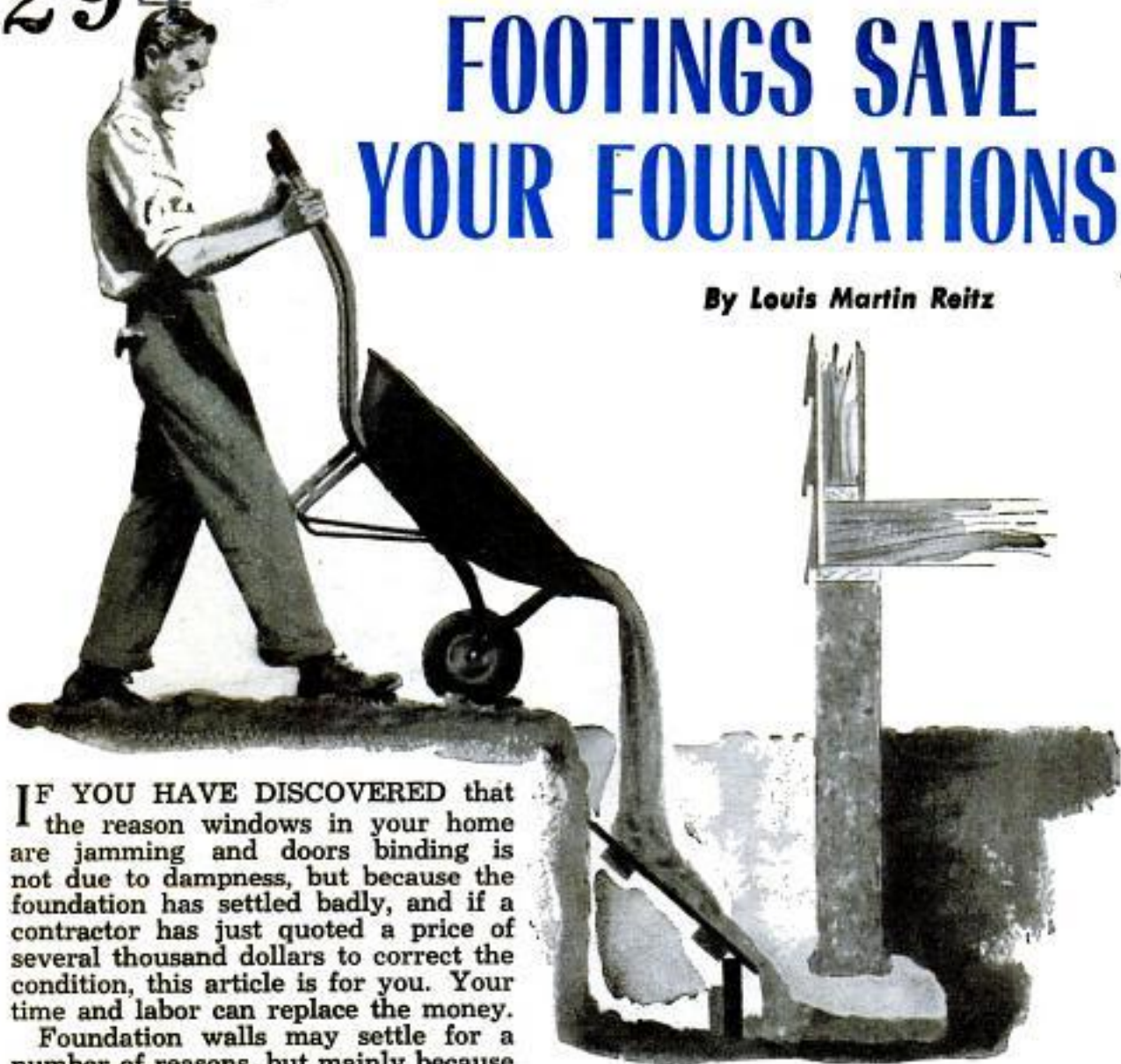

IF YOU HAVE DISCOVERED that the reason windows in your home are jamming and doors binding is not due to dampness, but because the foundation has settled badly, and if a contractor has just quoted a price of several thousand dollars to correct the condition, this article is for you. Your time and labor can replace the money.

Foundation walls may settle for a number of reasons, but mainly because there are no footings under the walls or because they are not of adequate size. If the footings are too small, a period of extremely heavy rains may soften the ground enough to permit the foundation walls to settle, even though the house has been standing several years and no previous trouble has been encountered. This latter condition is more likely to occur in areas where a large amount of fill has been used to level the ground, and not allowed sufficient time to compact before building on it.

You, the homeowner, can install the necessary footings by undermining the foundation walls and pouring the footings in short sections, so that only a small portion of a wall is unsupported at any one time. To minimize the possibility of the wall collapsing or cracking when it is undermined, do not dig under the walls when the ground is wet.

Crawl-Space Foundations

If the building has a crawl space, as indicated in Figs. 1 and 2, the footings are

installed from outside the walls. First, a narrow ditch is dug down alongside the foundation, just wide enough to permit a man to work. If the foundation is poured concrete and the building resting on it is of frame construction, the wall can be undermined at one point for a distance of about 4 ft. However, if the building or foundation wall is masonry construction, undermine the wall for a distance of no more than 2 ft. at one time. The undermined sections should be no closer than 6 to 8 ft. apart. To provide good forms for the footing sections, keep the bottoms of the excavated areas as flat as possible. Also, keep the side of the excavation that is on the opposite of the foundation wall straight, since it is difficult to position a form board in the restricted space available. A hand ax can be used to loosen the dirt and cut the sides and bottom straight, while a hoe with a shortened handle or a small flat-bottom coal shovel can be used to remove the loosened dirt. Be sure to dig

past the opposite side of the wall and up, so that the poured concrete will form a footing slightly higher than the lower surface of the foundation wall. This will assure that the footing will bear solidly against the wall. A sawed-off baseball bat or similar-sized piece of wood should be used to tamp the poured concrete so that it will be compacted firmly in the form. The new footing should be from 18 to 24 in. wide and from 8 to 12 in. thick, depending on the load to be carried. The higher figures will provide a footing sufficient to support the foundation under a 2-story brick house. If the soil under a foundation appears damp or loose, the high figures also should be used for a 1-story house to assure positive support for the foundation.

Wherever possible, center the footing sections or "pads" under cracks or faults in the foundation walls, Fig. 4. In all cases, avoid aligning a joint in the footings with a crack in the walls. After the dirt has been scraped out of the hole under the wall, stake a board in the ditch, Figs. 1 and 2, to provide a side to the footing form. This will save concrete and make a neater job.

If the bottom of the hole is rough or rocky, level it with some fine sand over which is placed a strip of building paper. The paper will help prevent the water and cement from draining out of the concrete and making it weak. For added strength, place a $\frac{3}{8}$ -in.-steel reinforcing rod at the front and back corners of the footing pad, Fig. 1. Allow them to extend about 6 in. beyond the pad so the pad will be "keyed" to the next one by the rods. Make a pocket in the soil at each end of the hole for each rod and pack crumpled newspapers around the ends of the rods, Fig. 3, to prevent the concrete from filling the cavity. The ir-

regular surface caused by the newspapers also will provide a rough surface that will aid in making a good bond when the adjacent pads are poured.

Basement Foundations

When a basement is located under the part of the house that has settling foundations, the footings can be installed from inside the wall, and during cold weather, if necessary. The basement floor must be broken up along the edges to permit undermining the foundation walls, Fig. 4. The concrete is poured under the walls in the same manner as previously described.

After a footing pad has been poured, it should not be disturbed for one or two months so that the concrete is well seasoned. Pads adjacent to it then can be installed. Concrete used for the pads should be a rich mixture and a minimum of water should be used to assure that when compacted it will completely fill the space under the foundation wall.

When working from the outside of a foundation wall, where piled-up dirt will damage the lawn or landscaping, dispose of the dirt removed from the first hole, or store the dirt in some corner of the yard out of the way. When the second hole is dug, drop the dirt from it into the first hole. This can be repeated all the way around the house so that the mess can be kept to a minimum.

In some cases, where part of a foundation is in firm or rocky soil and has not settled, that part will require no new footing. If a wall is strong, footing pads spaced a few feet apart may be sufficient. However, footings should be located under each corner of the foundation and under cracks or faults in the foundation walls. ★ ★ ★

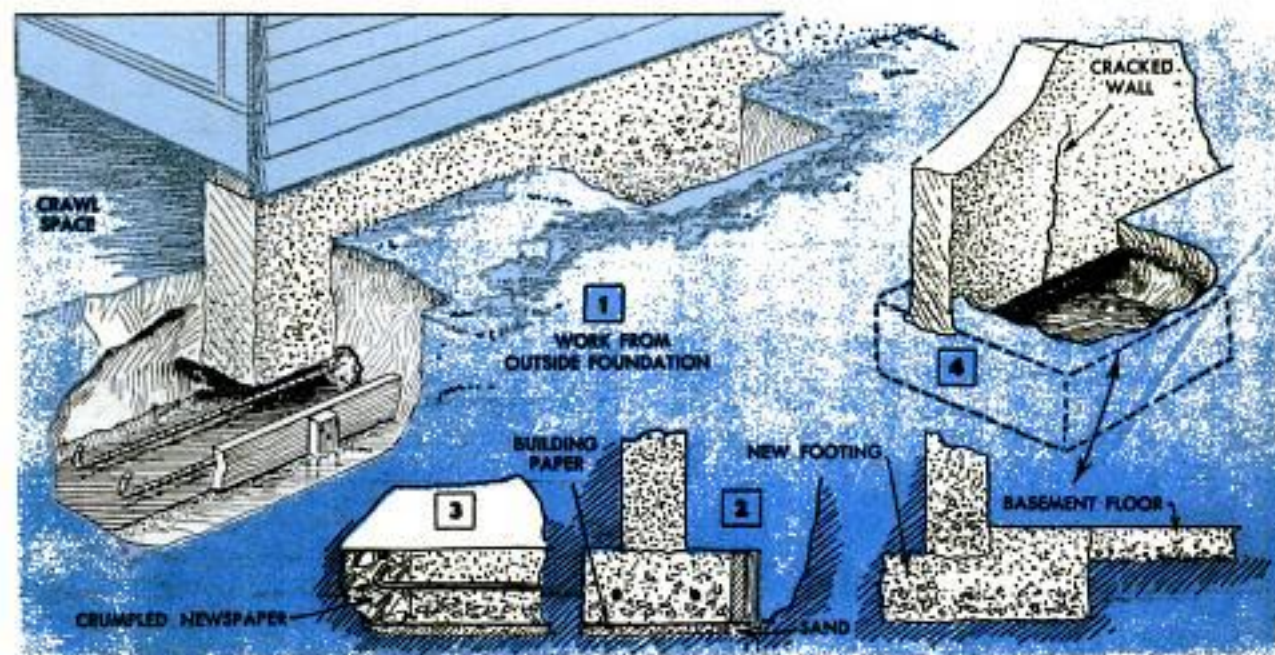

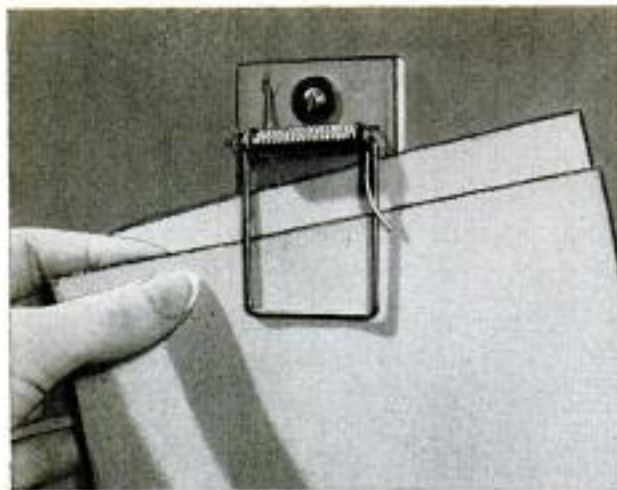

Mousetrap Dispenses Sandpaper

A mousetrap of the type shown, screwed to the wall next to a workbench, provides an excellent means of keeping sheets of sandpaper in various grades within easy reach. Also, valuable drawer space is saved and the desired grade of sandpaper can be selected quickly.

"Twinned" Containers Store Nuts and Bolts

No more looking for a nut to fit the bolt if you keep these used-together items in screw-top containers joined top to top as pictured. Place the nuts in one container, the bolts in the other and join the tops with a single wrapping of cellulose tape. Small clear-plastic containers of the type in which screw-and-bolt assortments are sold are just the thing for keeping short stove bolts and nuts handy. Large containers, such as peanut-butter jars, with metal or plastic screw tops should be joined top to top with short stove bolts.



Coffee Tables From

By Tom Riley

SINK-TOP CUTOUTS make smart-looking and serviceable coffee tables when wrought-iron legs are screwed to them and the edges trimmed. Available at most building-supply stores at very low cost, the cutouts are waste pieces resulting when openings are cut in sink tops made from panels of colorful plastic laminate bonded to plywood. Rectangular pieces can be used as is or the edges can be sanded smooth and the corners rounded as shown in Fig. 1, followed by application of the desired finish. The two longer sides are trimmed with 1 x 3-in. hardwood which is beveled and grooved, Fig. 2, and glued to the table as shown in the drawing.

The round table is rough-cut on a jig-saw, using a very fine-toothed blade to prevent chipping the plastic top. Then the 30-deg. bevel is cut on the edge and sanded smooth, Fig. 3. The latter operation, "pivot sanding," involves drilling a shallow $\frac{3}{8}$ -in. hole in the center of the underside of the table top to accept a pivot pin, a short $\frac{3}{8}$ -in. bolt turned into a threaded hole near the end of the miter-gauge bar. The bolt serves as the pivot point when the miter-gauge bar is locked in place in its table slot. With some disk sanders it may be necessary to build a jig to permit sanding at a 30-deg. angle. When using the sander for this purpose, first make several light passes around the edge of the table, revolving the work slowly as it is being sanded. Use coarse or medium-grit sandpaper and finish it by running the sander at a higher speed. If the table is to be used outdoors, give the underside a sealer coat to prevent entry of moisture. Finally, installation of the wrought-iron legs is easy and requires no bulky supports. ★ ★ ★

Sanding edges and corners of rectangular sink-top cutout on disk sander assures squared edges

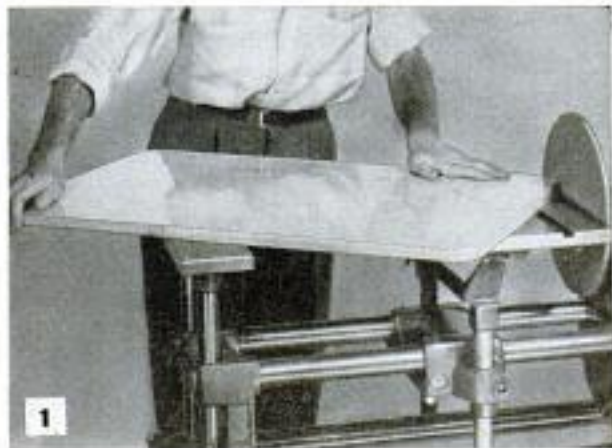

WTM 58

Sink Cutouts

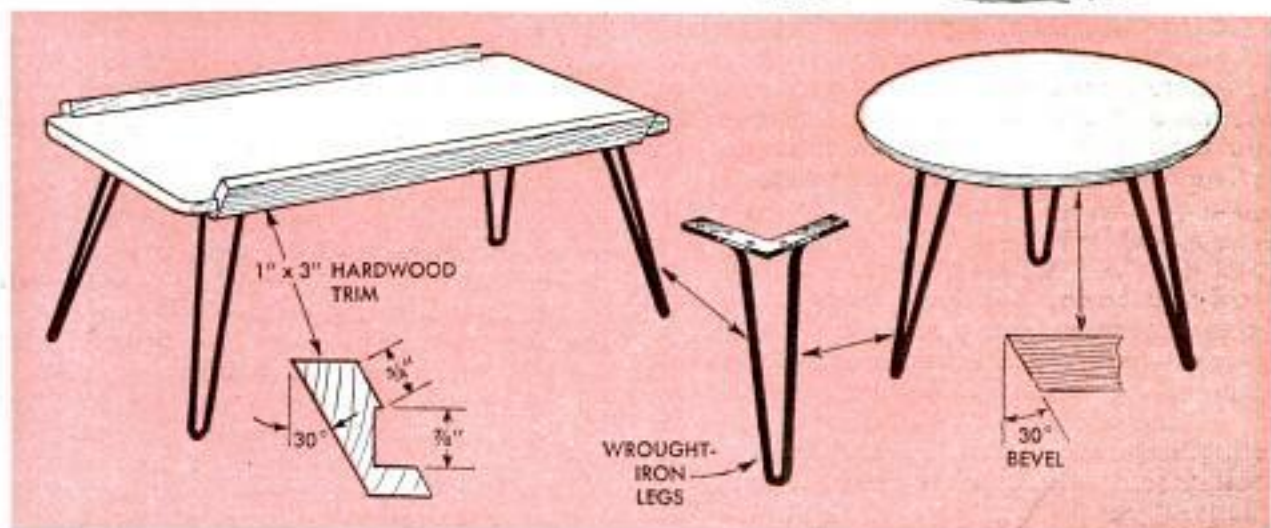

Groove is cut in hardwood-trim pieces by making several passes with combination blade or using dado

Accurate sanding of 30-deg. bevel on round top is accomplished by "pivot sanding" it on disk sander

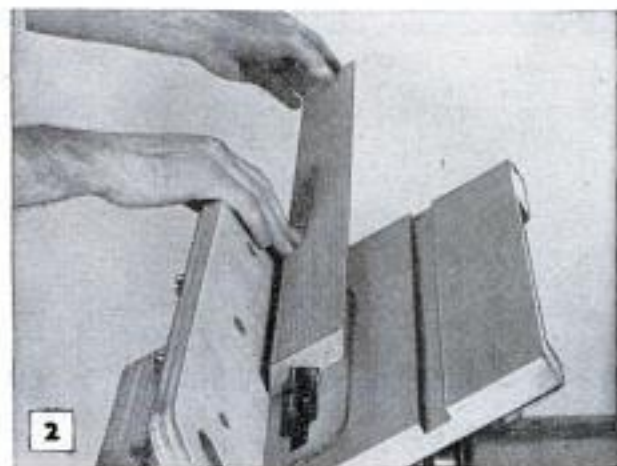



Detachable Cords on Reflectors Save Setup Time

Photo reflectors without long cords are a lot easier to pack and carry since the cords can be coiled separately and stored in much less space. A staff photographer shortened the 10-ft. cords by cutting them off about 4 in. from the reflector sockets and then fitting plugs on one end and sockets on the other of the severed cords.

Block Helps in Planing Edge

If you have trouble planing a narrow edge square with the sides try holding a square wooden block under the plane and against the work. Held firmly in place, the block will prevent the plane from wobbling. If the idea is to be used frequently, bolt or screw the block to the bottom of the plane.

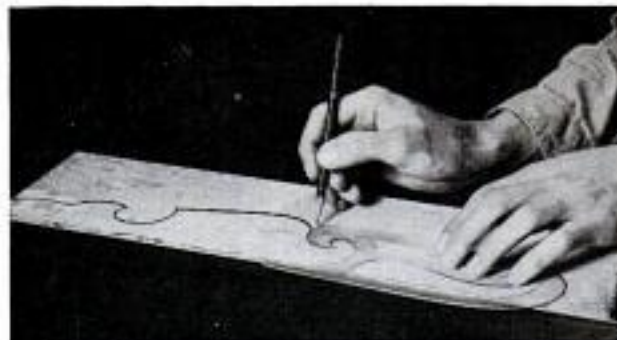

French Curve Is Timesaver On Scrollwork Layout

Homecraftsmen who have occasion to work out their own scroll designs will find a draftsman's French curve a great help in drawing graceful curves accurately and quickly. Even when enlarging magazine patterns by the square method, a French curve will come in handy to correct any irregularities in the freehand lines.

Darrell Huff, Sonoma, Calif.

Eye-Catching Sign Rocks In Slightest Breeze

Because a moving object always is more eye-catching than a stationary one, the owner of a tire shop mounted a curbside sign on rockers. A slight breeze causes the sign to move. The rockers are bandsawed from $\frac{3}{4}$ -in. stock.



Punched Hole Is Sealed With Sheet-Metal Screw

Instead of using a wooden plug or wad of paper to seal a can of solvent or other liquid that has been "punch opened," turn a sheet-metal screw into the hole. The screw will not deteriorate as will wood or paper and cannot be removed without being turned.

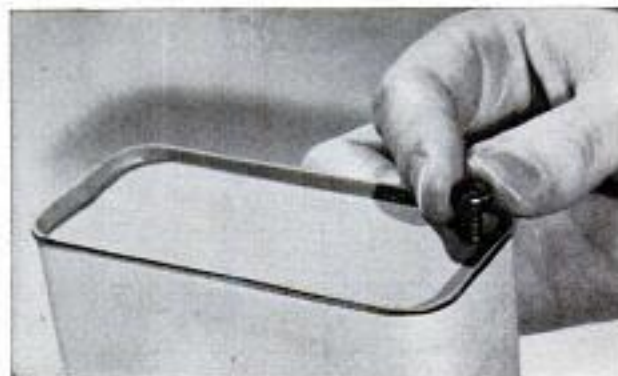

Easy to Make MOVIE TITLES



When filming title superimposed on projected scene, avoid direct glare from projector into camera lens

By E. R. Haan

PART II

THERE'S PRACTICALLY no limit to the number of novel and ingenious titles that you can make to improve your home movies. In addition to arranging simple titles on artificial backgrounds, as explained in Part I, attractive titles also can be superimposed on real scenery backgrounds, either still or moving. Then, for an added touch of professionalism, you can make the titles appear and disappear by "fade" and "wipe" effects.

Title Superimposed on Scenery

If you own a camera of the universal-focusing type, both a close-up title and background scenery can be filmed at the same time. To do this, cement a title to a pane of transparent glass having no imperfections. Rubber cement should be used for easy removal of letters later. Set the glass vertically in front of the camera at a suitable distance so that the background scenery seen through the glass can be brought into good focus. The glass should not be closer than 4 ft. from the camera for satisfactory definition of the title. It is essential to have both camera and title centered and aligned on a rigid holder. The holder can be mounted on a tripod or held "free" with a special support for "panning." An excellent holder for this purpose is the titling stand shown in Part I. The glass simply slips into the grooves. It is advisable

to have the background scenery illuminated more than the title on the glass to avoid reflections.

Titles and scenery cannot be photographed simultaneously in the manner explained when a focusing-type camera is used, since the latter can be focused on either the title or background but not on both. If a small background, such as a corsage of flowers, is mounted immediately behind the glass, both title and corsage can be given sharp definition by reducing the lens aperture and increasing the exposure time to obtain a suitable depth of field.

Double-Exposure Method

You can superimpose a white title on a scene already filmed but not processed, if a roll-loading type of movie camera that permits turning back the film in a dark-room is used. This procedure does not apply to a magazine-loading camera since an amateur should not attempt rewinding the film in a magazine.

To shoot titles on real scenery by the double-exposure method, it is essential to first note the exact film footage before you start to shoot the background scenery. Select a dark or medium-dark background that will contrast with white letters. Next, in total darkness turn back the film to the beginning and then reload the film into the camera with the film-footage indicator



pointing to zero. With the lens capped to prevent exposure, run the film slightly beyond the point where the footage was first noted. Now remove the lens cap, align the camera with the title, focus and shoot.

Title on Projected Scene

A black or dark-colored title can be superimposed on a still picture projected on a sheet of ground glass placed between

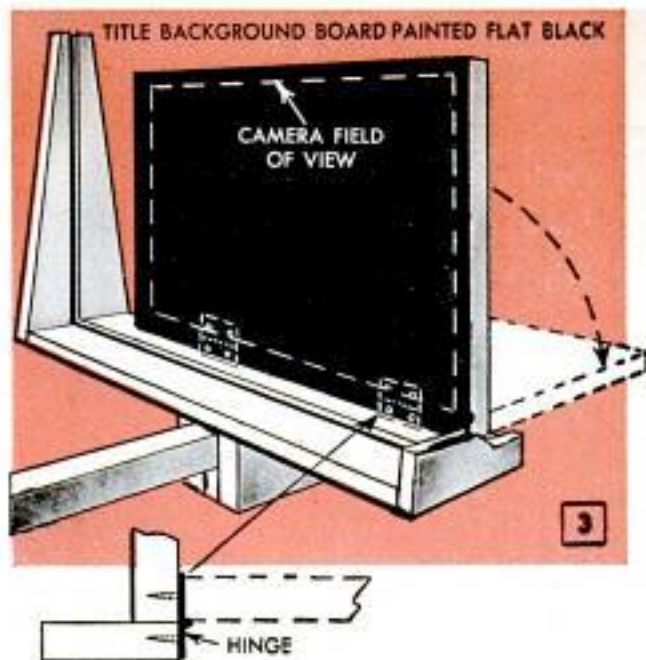

Above, hinged, black background board permits swinging attached title in or out of focus of camera. Fig. 2, cigarette smoke gently blown across camera's field of view simulates clouds floating over title

the camera and the projector as shown in Fig. 1. The film or transparency should be reversed if it is desired to duplicate the original scene. Thin letters of paper, cardboard or plastic are much better than block letters for this type of titling. The letters are cemented to the smooth side of the ground glass, which should face the camera, while the projector is tilted at a slight angle to the glass to prevent direct glare from the projector into the camera lens.

The title should be located in the lighter portion of a picture to produce adequate contrast. Tracing paper taped to a pane of transparent glass provides an inexpensive substitute for ground glass.

Title Fading

Titles can be made to appear or disappear gradually in scenery backgrounds.

Dye produces gradual fade at beginning and end of film and titles when the latter are spliced into film

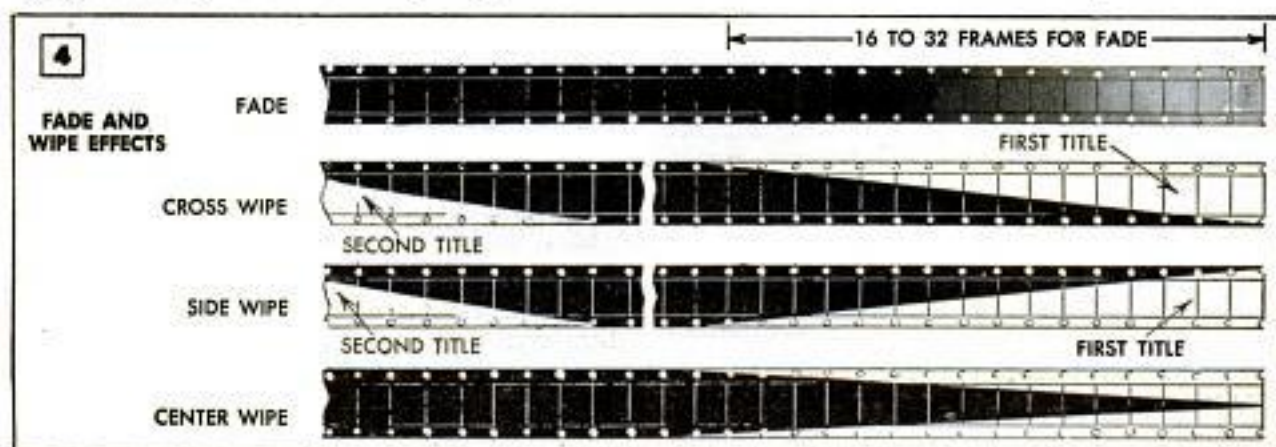

Also, this type of fading can be used when one scene follows another without a title between the scenes. One of the simplest ways to produce a title fade-in is to open the camera-lens aperture very slowly from a completely closed position to the point of proper exposure, while shooting the title. To make a fade-out, the procedure is reversed. Fade effects should be done in about 2 sec. To be sure of proper timing and sequence, it's a good idea to rehearse the steps before making the actual exposure. Time needed for reading a title is about 1 sec. per word.

To produce fades on film already processed, you can use a dye which is made especially for this purpose. This process will darken both a title and the scene on which it is superimposed. Some examples of using this method, where a title is spliced between two scenes, are illustrated in Fig. 4. The end of the first scene is made entirely opaque for about 8 frames, and then the film is gradually lightened for about 16 to 32 frames. The same is done at both ends of the title strip and also at the beginning of the following scene strip, after which the title is spliced between the two scenes.

Another method of fading a title into a white rather than a black background consists of gently blowing a cloud of cigarette smoke in front of the title which is adequately illuminated by front lighting, Fig. 2. This will obliterate the title and the background for several frames. Also, you can use such a fade for changing from one title to another, simply by stopping the camera when the full fade-out is reached, after which the next title is arranged for filming. The camera is not started again until after a similar dense cloud of smoke completely conceals the new title. Then, with the camera running, this cloud is gently blown aside to expose the new title.

If your camera has a focusing-type lens, a title of white letters on a flat-black background can be faded by swinging it in or out of focus as shown in Fig. 3. The title background board is hinged so that it can be swung out of view completely. A second, larger black background placed immediately behind the title background (not shown in Fig. 3) provides a black background even after the title background swings out of the camera's field of view.

An alternate technique to fading, similar to the fade and wipe effects shown in Fig. 4, utilizes a sheet of dull-black cardboard that is placed vertically in front of the title to conceal it. Removing the cardboard slowly while the title is being filmed gradually reveals the title in an effect of professional quality. ★ ★ ★



Gardening Accessories Stored In Discarded Shoe Bag

An old shoe bag attached to a wall in your garage or tool shed will provide convenient storage for small garden tools, seed packets, plant markers, gloves and other gardening accessories. All these things can be kept together in the shoe bag, which can be carried to the garden and hung on a fence or placed on the ground.

Mrs. Michael Fey, New York City.

Hardboard Gauge Measures Wood Thickness

For a handy gauge to quickly and accurately check and compare wood thicknesses when matching or planing to size, cut a half-V-shaped slot in a scrap of hardboard or plywood, place a mark on the upper edge of the slot for the desired thickness and slip it over one edge of the board as shown. The bottom cut should be parallel with the bottom edge of the gauge and the top cut about 35 deg. from the horizontal.

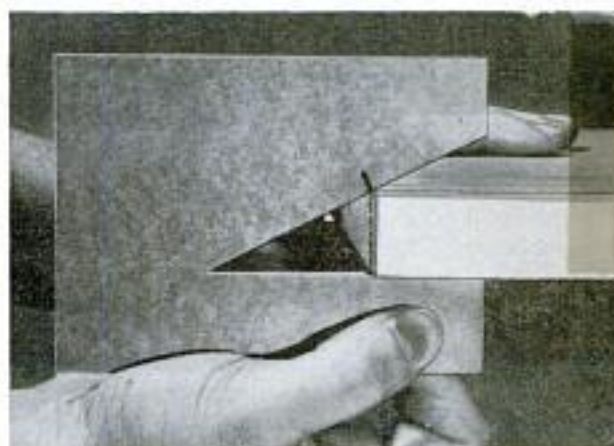

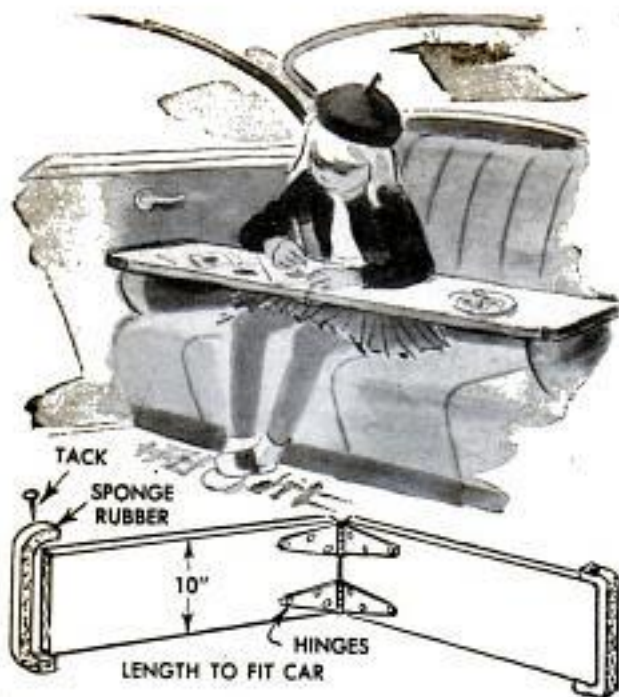

Folding Snack Table Spans Car Seat

Originally designed as a snack table, it also doubles as a play table to keep the small fry occupied during long auto trips. Placed across the rear-seat armrests it's just the right height for paper and coloring crayons, or games. The board is cut at the center and hinged, using two heavy strap hinges, mounted with $\frac{3}{4}$ -in. screws. The hinges must be positioned so that when the board is opened (hinges down) the cut ends of the board will meet to make a straight, level table top. Tack sponge rubber strips over the outer ends to protect the upholstery.—Karl Greif, Vestal, N. Y.

Tape "Skidproofs" Paper Cutter

To keep narrow strips of paper from slipping on a paper cutter when the knife is brought down against them, use a strip of adhesive tape along the edge of the lower cutting bar. The tape provides enough friction to prevent the paper from being pulled from beneath your fingers.

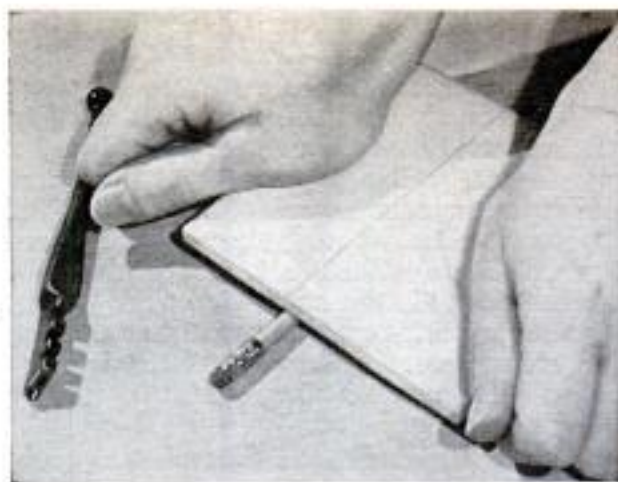

Glass Cutter Scores Ceramic Tile

Next time you have ceramic tile to fit, try using an ordinary glass cutter. With the cutter held against a straightedge, score the tile heavily through the glaze on the face side. Place the tile, score line up, over a pencil or large nail and press down on both sides with the hands.

Latch Eye Marks Its Own Location

When installing a hook-and-eye latch on a door, let the screw eye mark its own location by slipping it on the hook as shown and rubbing it against the doorframe. Install the eye at the center of the arc line.

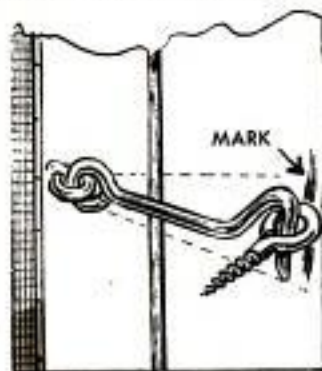

Sandpaper Restores Squeegee Edge

You can give a rubber squeegee a new lease on life by rubbing the worn edge over a sheet of fine-grit sandpaper. Sanding restores the squareness of its edges and exposes a fresh surface of rubber. The sandpaper must lie perfectly flat.



Sturdy Seesaw Has Grease-Lubricated "Axle"

Stock 2-in. lumber is used to construct this seesaw that is sturdy enough to withstand years of abuse by active youngsters. The main board is a 10-ft. length of 2 x 8 and the two uprights are 30-in. lengths of 2 x 8. Lag bolts are used to assemble the 2 x 4 base on the uprights. A 24-in. length of 1½-in. pipe is clamped to the lower surface of the seesaw board as indicated in the detail, then a 26-in. length of 1-in. pipe is fitted inside this and the assembly packed with grease. A flange then is screwed to each end of the 1-in. pipe and the flanges lag-screwed to the seesaw uprights.

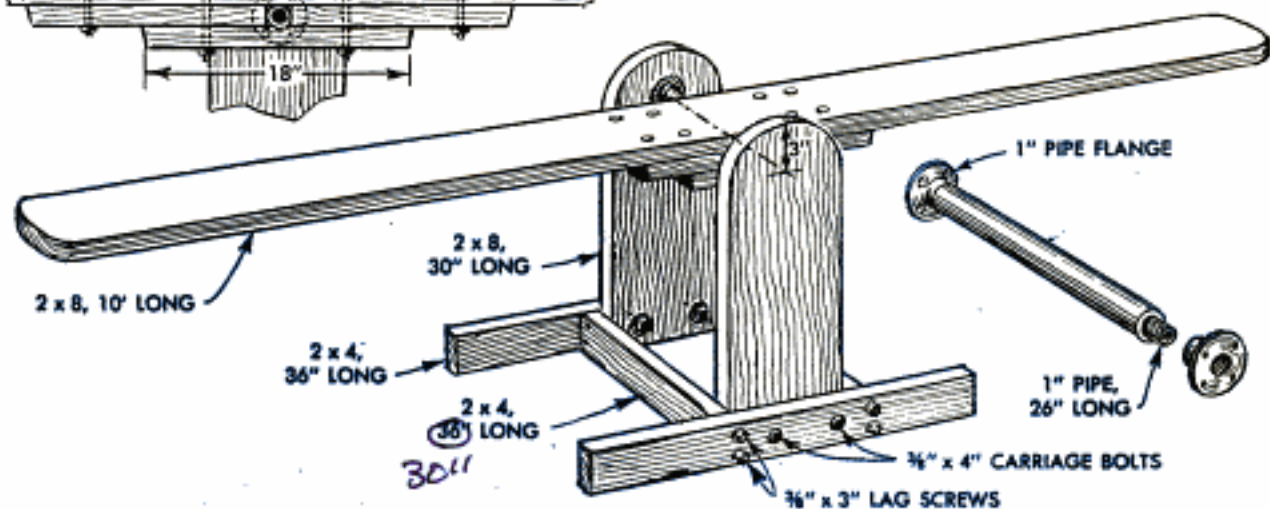
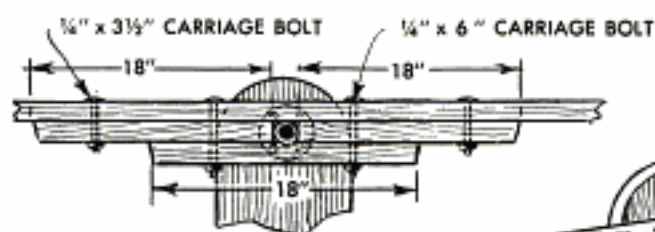

Rope Handles on Stepladder Make It Easier to Tote

Two rope handles located at the balancing point of a stepladder make it a lot more convenient to carry singlehanded. One handle is fastened to each part of the ladder so that when both are gripped, the ladder cannot spread apart. Sash cord is used as a handle in the step portion and inserted through holes and knotted at the ends. The other handle is of lighter drapery cord and held with two staples. The sash-cord handle actually carries nearly all the weight while the smaller one serves mainly to keep the legs of the ladder together. A screen-door hook also could be used to hold the legs together.

☐ If a large quantity of India ink is to be used, it is cheaper to purchase it in dry stick form. The sticks are broken into small pieces and dissolved in a weak ammonia-and-water solution, a process which takes several days.





Rubber-Bulb Windshield Washer

If your car is not equipped with an automatic windshield-washer attachment, why not carry a rubber bulb in the glove compartment as an inexpensive substitute? In the summer fill the bulb with clear water, and in the winter use an ice-dissolving solvent. A few squirts on the windshield while the wipers are going and you too can have a clear view of the road ahead. Keep a bottle of water or solvent handy for refilling the bulb.

Edward L. Fisher, Milwaukee, Wis.

Parallel Wavy Lines Drawn With Aid of Celluloid Guide

By using a celluloid guide, one draftsman draws parallel wavy lines to indicate broken sections in a perspective drawing in a fraction of the time previously necessary with the two lines indicating the broken sections matching each other perfectly. One edge is cut wavy as shown and the other edge has an irregular contour. After using it to draw the first line, the strip is moved the desired distance and a matching second line drawn. The celluloid should be thin enough to be cut with a pair of scissors.

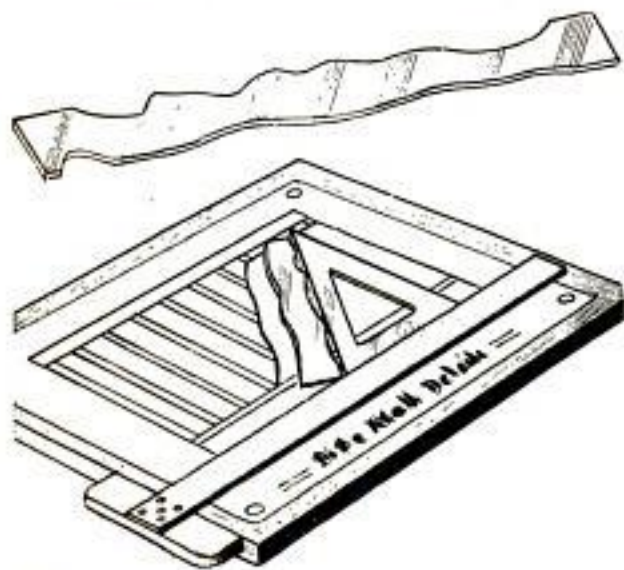

Oil Can Primes Space Heater

Before starting an oil-burning space heater, prime the burner pot with a few squirts of fuel from an oil can. The heater will then ignite immediately, and the pot will be heated by the time oil reaches it from the supply tank.

Holes in Plastic Pool Sealed With Bandage

Small punctures in a plastic beach ball or wading pool can be repaired by using a patch cut from a plastic adhesive bandage. Larger holes or tears can be similarly repaired but generally require an additional patch applied to the inner surface to provide extra strength.—Samuel B. Rentsch, Jr., Glastonbury, Conn.

Tubing Modifies Rake Teeth For Cleaning Lawn Surface

Grass clippings and surface trash are easily removed from the lawn without having the rake teeth entangle in the grass when short lengths of copper tubing are fitted over the end teeth as shown. Bend the tubing as indicated so the rake teeth ride slightly above the surface of the ground while being pulled through the grass.—E. V. Reyner, Townsend, Mont.



Tricycle Power Mower Carries Rider

IF POOR HEALTH prevents you from cutting your lawn even with the aid of a power mower, or if you want to rest while cutting a big lawn, this seat-over-mower tricycle assembly may be the answer to your problem. Construction details will vary with different makes of power mowers, but the over-all design will remain basically the same. Also, various types of tricycles will require minor modification in the forward portion of the frame.

The mower used for the original assembly shown was a 20-in. model about 8 years old. Before starting assembly of the riding frame, the gasoline engine was torn down and completely overhauled to assure dependable operation and sufficient power to pull the additional weight of the riding frame and the rider. Any mower that is more than a couple of years old should be rebuilt for the same reasons. If you cannot do this work yourself, there are shops that specialize in servicing small gasoline engines.

Modification of the tricycle consists of cutting off the pedal cranks and removal of the rear wheels and seat. Also, an auxiliary frame of flat steel and pipe or tubing spacers is assembled on the fork as indicated in the detail, to accommodate the forward ends of the frame tubes. The main frame is bent from 1-in. or $\frac{3}{4}$ -in. electrical conduit or $\frac{3}{4}$ -in. steel pipe. At the rear of the frame, the tube ends are



flattened and drilled so they can be bolted to the mower in place of the handle which is removed. The clutch and throttle controls are brought forward and fastened to the tricycle frame in a location convenient for the rider. Plywood or hardboard is used to make the seat. Flat-steel cross braces at the back of the frame provide rigidity for the frame members above the mower, and will have to be installed to clear the engine for normal operation. When the engine is to be worked on, the riding frame is removed.

Amy F. Gilmore, Metairie, La.

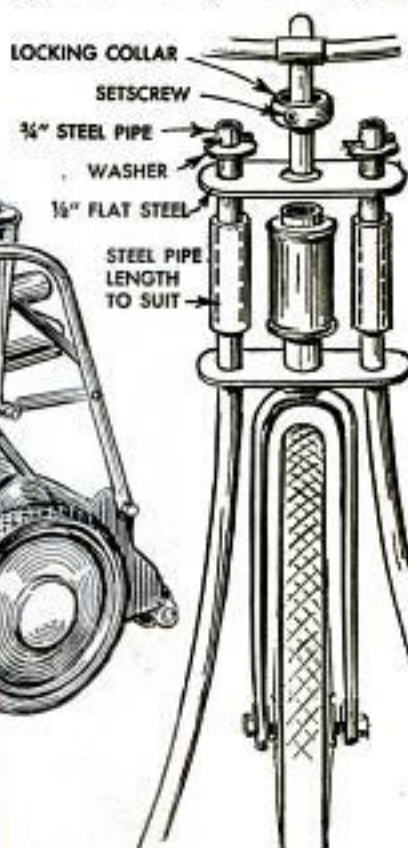
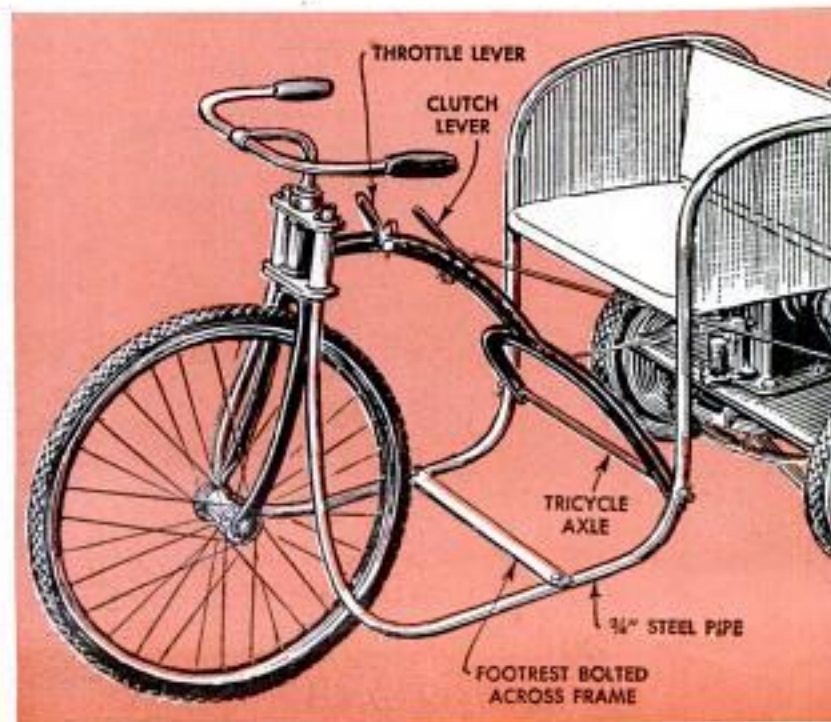

HOW TO PROCESS

START WITH

By Robert Hertzberg



For the advanced amateur photographer considering purchase of a professional-type "press" camera, here is a method of processing sheet film that will help to produce good negatives

Fig. 1. Before unloading exposed film, organize work area in darkroom. Stack film holders at center of table, place film hangers on pegs with retainers flipped open, be sure developing solution is at 68 deg. F.



Fig. 2. Before turning off lights, turn locking pins on holders to center position so slides can be readily withdrawn in dark. Room must be totally dark from now until film is removed from hypo

Fig. 3. When removing film, anchor holder to table by pressing along bottom edge with right hand. Draw out slide about 2 in. with left hand and remove film, being careful not to touch emulsion with fingers

Fig. 4. Hold film hanger upright with left hand, slide film into channels and close loading flap. If film doesn't fit loosely in guide channels, open flap and remove and reinsert film properly

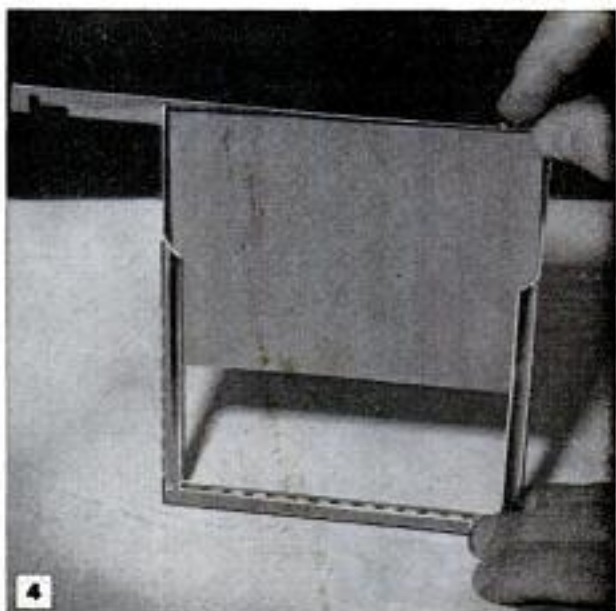



Fig. 5. Place loaded film hanger in empty tank. Repeat with successive hangers, using hand as spacer to prevent scratching film. Later, transfer entire group to developing tank at once. If fast-acting developer (3 to 5 min.) is used, stay with films until timer rings, immerse them in water 2 min., hardener-hypo bath 10 min., and water wash 30 min.

Fig. 6. Daylight tank permits processing sheet film outside of darkroom. After loading grooved reel with exposed film in total darkness, place reel in tank, secure lid, fill with developer and agitate with rod



Fig. 7. Before loading film, insert slides $\frac{1}{2}$ in. into holder. In darkroom open bottom flap and slide film in guides with notches in upper-right corner, emulsion side up. **Fig. 8,** after film is inserted, press end flap down and push slide in until flap is engaged. Then turn locking pin to closed position to prevent slide from being pulled out of flap accidentally



Cone Coil Spring "Snagproofs" Trolling Sinker

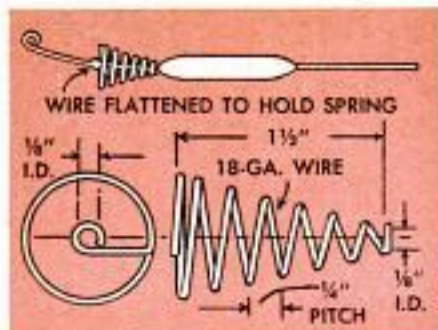

When fitted with a conical coil spring of the dimensions given, a trolling sinker will be almost snagproof. The spring causes the sinker to bounce when it contacts most small obstacles. Should the spring become snagged, a heavy pull on the line will compress it, and when the line suddenly is slackened, the spring recoil, plus the weight of the sinker, generally will free the sinker. —Donald Fox, Bucyrus, Ohio.

Pour Hole in Screw-Top Can



Pouring liquid from a screw-top metal can is much simpler if a small hole is punched in the screw top. This permits pouring the liquid into a container without the need for a funnel. Plug the hole with a wooden match. —Carl S. Bates, Chicago.

Shower-Curtain Ring on Belt Loop Used to Carry Hammer

A loop for carrying a hammer on a pair of work trousers not fitted with one can be improvised by using a shower-curtain hook slipped through a belt loop as indicated. When working on a scaffold attach hook to a key-ring holder.



Pen-Light Battery Fires Flash Bulbs

When using the "open shutter-flash-close shutter" method of taking nighttime shots outdoors, a flash bulb often is used in a regular photoflood reflector and is fired by using 110-v. house current. To eliminate the bother and potential hazard of running an extension cord from the house, use a pen-light battery to fire the flash bulb. Set the shutter for a time exposure and turn the lamp-socket switch to the "on" position. Then tear off a bit of paper on the side of the battery and place it across the plug contacts as in the detail. This will fire the bulb.



SN 5-5

THE

**POPULAR
MECHANICS**

SHOP NOTES

This Motor Drives Four Machines

By Dick Hutchinson

BY MOUNTING one double-shaft motor on a swiveling base, or turntable, you can arrange a complete power shop—drill press, jigsaw, circular saw and wood lathe—in a minimum of space. With careful planning, individual machines can be arranged so that long stock can be handled on the circular saw and drill press without interference from the jigsaw and lathe.

First, place the machines on the floor, using the general arrangement shown in Fig. 1. By locating the machines in this manner, you can determine the three requirements: Size of the bench top, length of the belts and the necessary clearances. Build a bench to these specifications, using



Swiveling base, or turntable, permits the motor to be positioned to drive any one of the four machines

4 x 4s for the legs and two pieces of 5/8-in. plywood for the top. Glue and screw the two pieces of plywood together for greatest rigidity.

Next, build the motor turntable as in Fig. 4. The diameter of the turntable base and the size of the swiveling member must be determined by measurement of the motor base. For this reason these dimensions are not given in Fig. 4. If you use a 1/2-hp. motor, place a large washer or a 4-in. disk of 1/8-in. plywood on the pivot bolt between

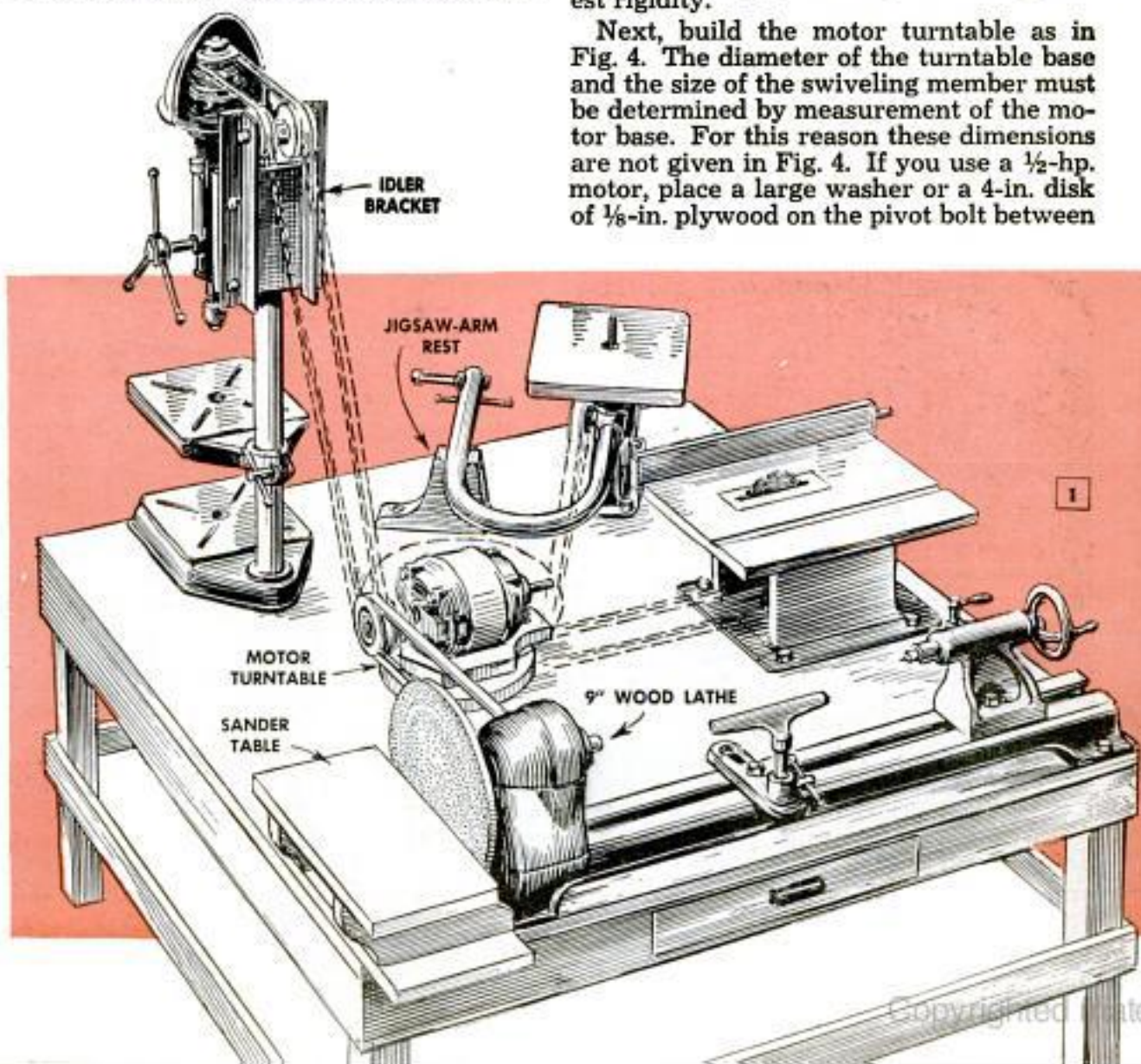

1



Jigsaw of the type having a swiveling arm, or gooseneck, requires an arm support attached to bench top

the two members of the turntable. Round the squared portion of the head of the carriage bolt so that it will permit the swiveling member to turn easily when the motor is shifted. The locking pin, Fig. 4, should fit the holes snugly, as otherwise the pull of the belts may tend to shift the motor.

A drill press of the type pictured will require an idler bracket and two idler pulleys. This unit can be made as detailed



Stock support for the circular saw permits ripping long boards. Need not be removed after attaching

in Fig. 5, using two lengths of steel angle, a shouldered $\frac{1}{2}$ -in. steel spindle, hex nut and two pulleys turned from hardwood. The unit is bolted to the motor base supplied with the drill press.

Figs. 2 and 3 detail a backrest for supporting long stock when ripping on the circular saw and a sanding table for the lathe, also a jigsaw-arm support which is necessary on some machines. ★ ★ ★

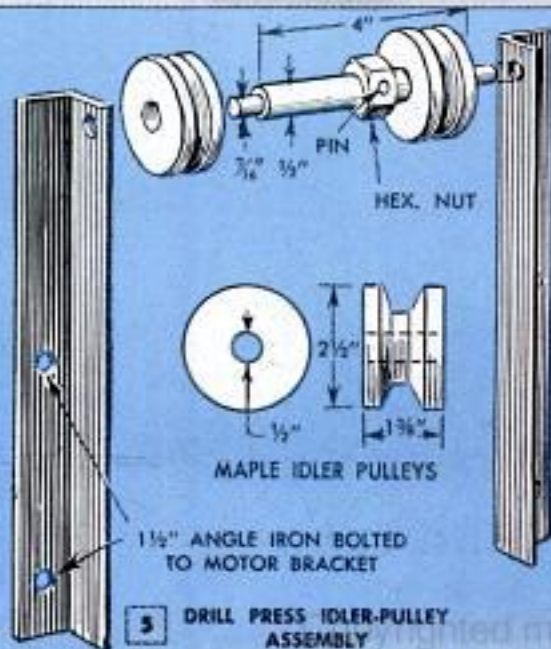
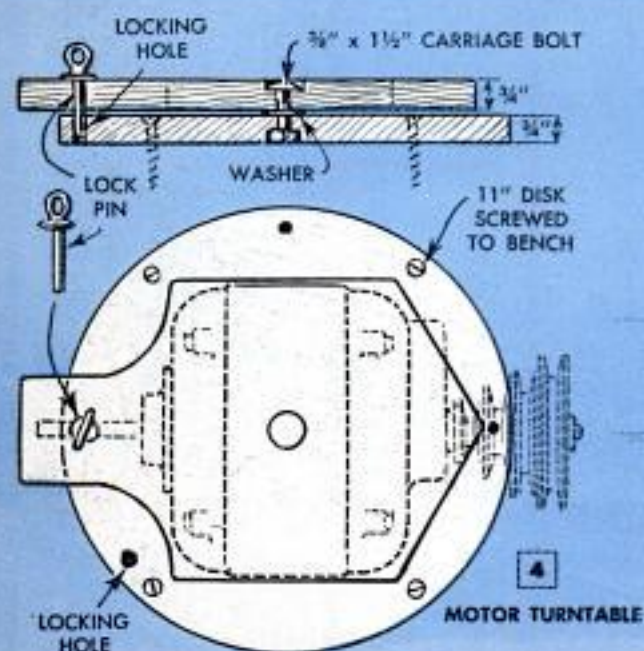
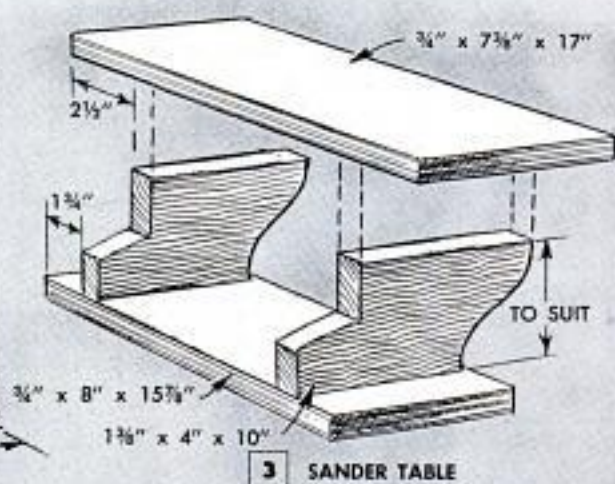
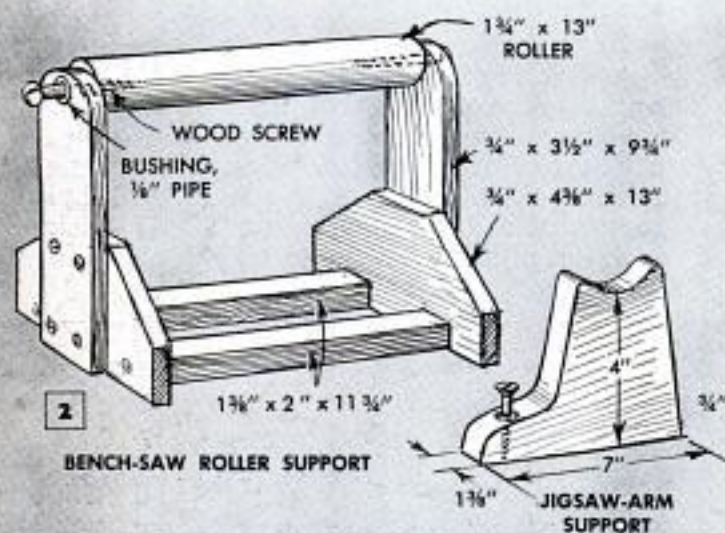

Trailer Fitted With Telescoping Drawbar

When launching his boat from a trailer, one boating enthusiast no longer has to worry about his car being bogged down in the sandy beach at the water's edge. A telescoping drawbar on his home-built trailer extends to 7 ft. from the car. The drawbar, which is the center member of the trailer frame, consists of a 2-in. pipe sliding in a length of 3-in. pipe. Holes drilled through both pipes permit them to be locked in the desired position with a bolt and lock nuts. As an added safety feature it may be advisable to drill holes for two locking bolts, or a cross pin held in place with a cotter key that can be removed quickly.

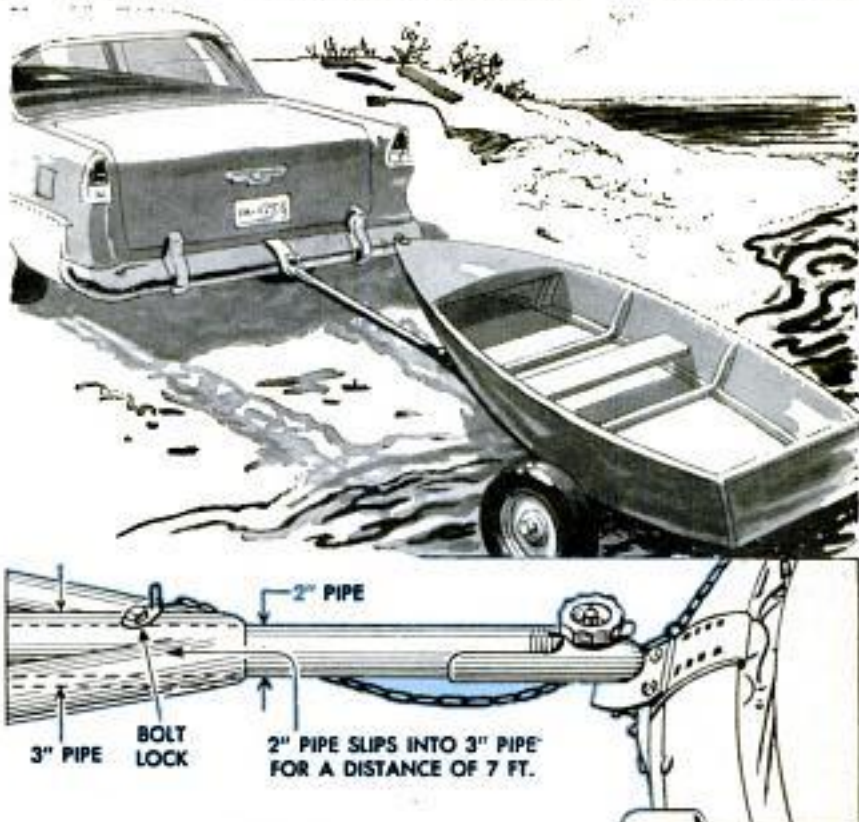

Gauges on Instrument Panel Supplement Indicator Lights

Because he felt that the red indicator lights on the instrument panel of his car were not accurate enough, one motorist installed an oil-pressure gauge and an ammeter. Both gauges were purchased at an auto-wrecking yard and came from a late-model car. The oil-pressure gauge was connected by installing a T-fitting in the oil-pressure line, and the ammeter was wired by using a wiring diagram from an earlier model of the car in which it was installed. The indicator lights were not removed from the instrument panel, as they would leave holes.

Leon R. Mann, Delta, Ohio.

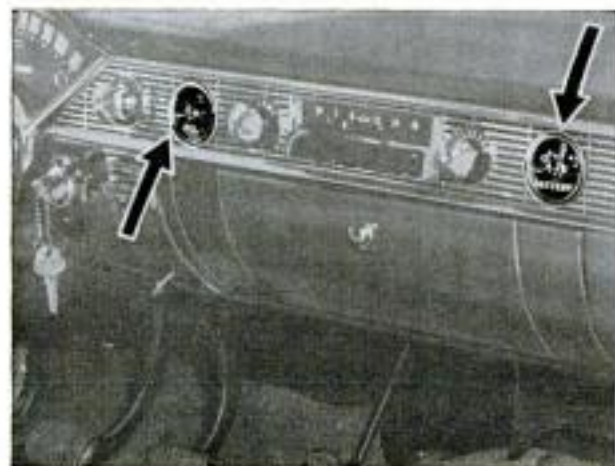

Guards on Heat-Lamp Reflectors Add Safety in Farrowing Pens

As a safety measure, flat-steel guards are bolted to the reflectors of heat lamps used in the farrowing pens of one farm. The upper ends of each of the U-shaped guards are welded to a large washer that is attached to the suspension chain. This latter attachment takes the strain off the light cord which is passed through the washer.



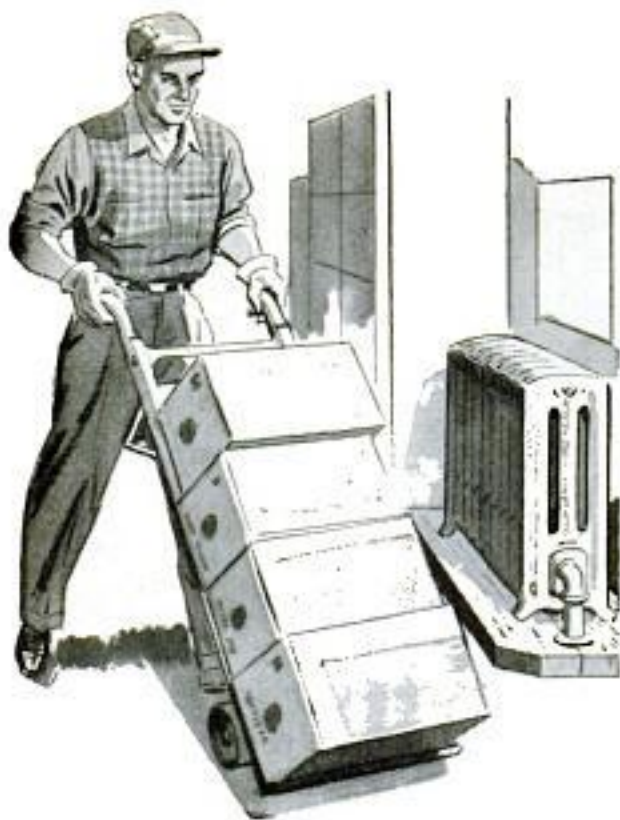

Radiator Elevated to Protect It From Passing Wheel-Trucks

To prevent steam radiators from being damaged by heavy wheel-trucks, one shop foreman had them elevated on planks. Cut to project several inches beyond the ends and sides of the radiators, the planks deflect the truck wheels.

Corn Sped to Cribs From Picker By "Four-Wagon" Hauling System

Hauling corn between the picker and distant cribs is speeded up by using four wagons, with two at a time being pulled behind the picker. When one wagon is loaded, it is uncoupled from the picker and left standing until the second wagon is filled. One man and a tractor shuttles between the picker and cribs, hauling away two filled wagons that are unloaded by conveyor and quickly returned to the picker.



Safety Goggles Stored in Jar Kept Free of Shop Dust

Safety goggles remain free of shop dust and grime, and there will be less chance of having them damaged, if they are stored in a glass jar when not in use. Punch a few holes in the jar lid with a nail to provide adequate ventilation.

Emery Board Is Feather-Edger For Touching Up Auto Finish

Touched-up spots on the finish of an automobile will be much less noticeable if the areas to be painted first are feather-edged. An emery board, such as is used for manicuring, is an ideal tool for this job. The coarse side of the board will remove the paint quickly, while the fine side is used to smooth the edges.

Ed Packer, Oak Park, Ill.

Magnetic Retriever on Handle

A small magnet fitted to the end of a hammer handle will prove handy for picking up brads, staples and small parts from narrow-mouthed containers. The magnet also is useful in retrieving a nail which has been dropped into a crack or corner.



SAFE BRAKES FOR YOUR TRAILER

By Clinton R. Hull



TESTS HAVE SHOWN that synchronized braking systems on a car and trailer enable you to stop faster and smoother than with the car alone. Of course, before such peak performance can be expected it's essential that the trailer be equipped with a load-equalizing hitch, the car with helper springs (overloads) and that both braking systems be properly adjusted mechanically and timed to "wrap in" simultaneously when you hit the pedal. If the trailer brakes come in too early or

too late you are in for a rough stop, if nothing worse. Jackknifing, even ditching, of the two vehicles is always a possibility on slippery roads, and in mountain driving uneven brakes are a definite hazard on every turn and grade.

Uneven or inadequate braking systems subject both vehicles to undue stresses and greatly accelerate wear of brake parts and tires. Most state laws require that any trailer coach weighing 1500 lb. or more must be equipped with its own braking

Typical electrically actuated trailer brake system diagrammed to show position of parts and the wiring
Courtesy Warner Electric Brake & Clutch Co.

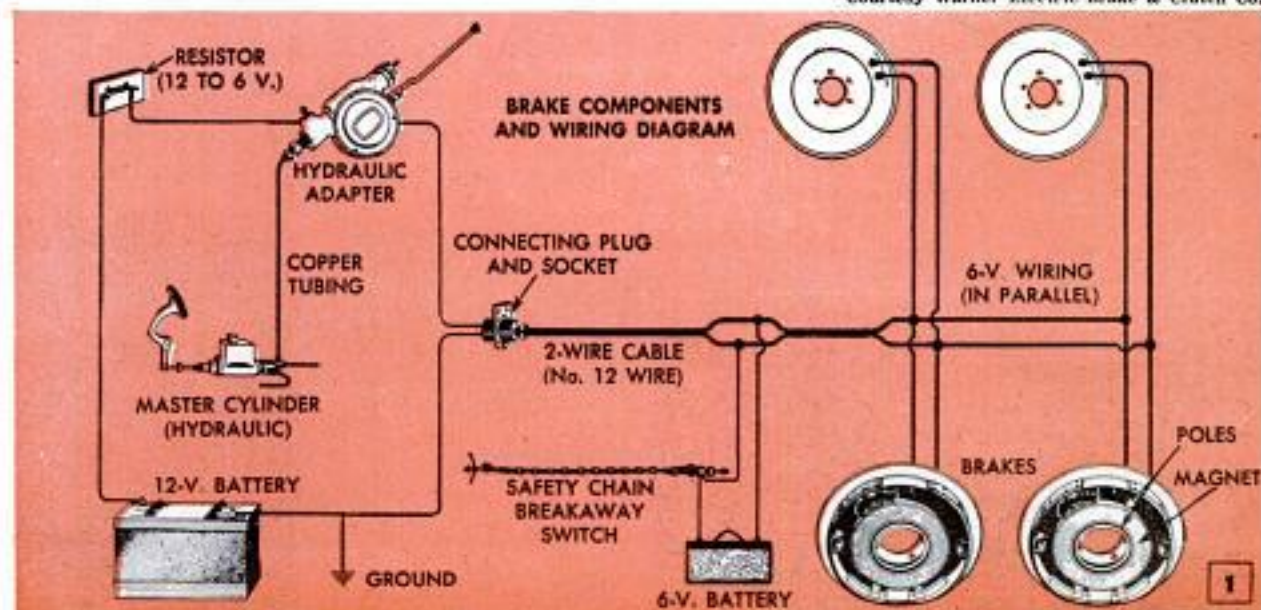

Master-cylinder and slave-cylinder assembly shown in section. Slave cylinder is arranged to break away if trailer accidentally becomes detached from car while vehicles are in motion. This action sets its brakes

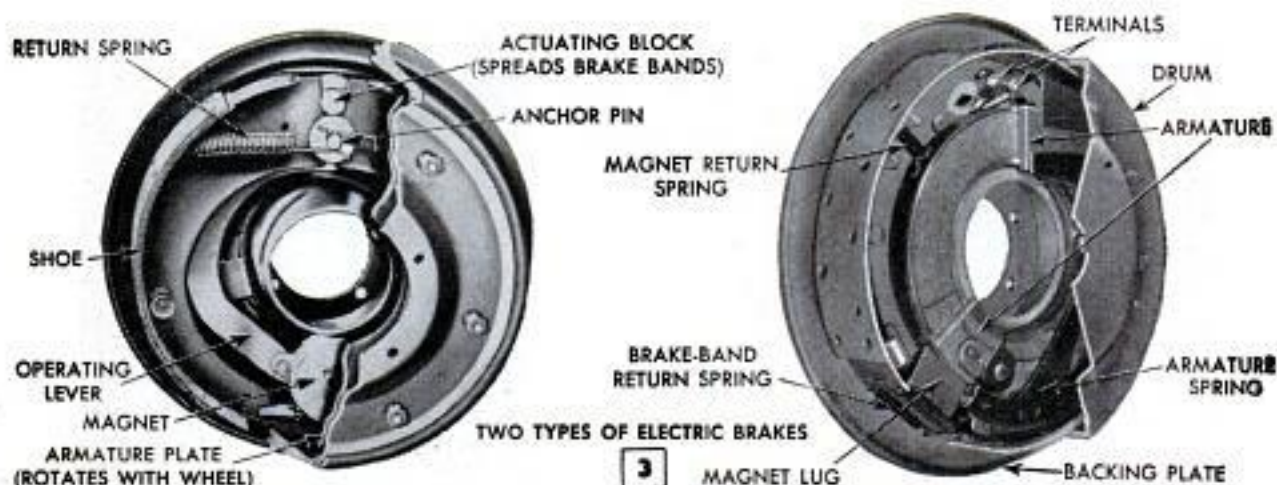
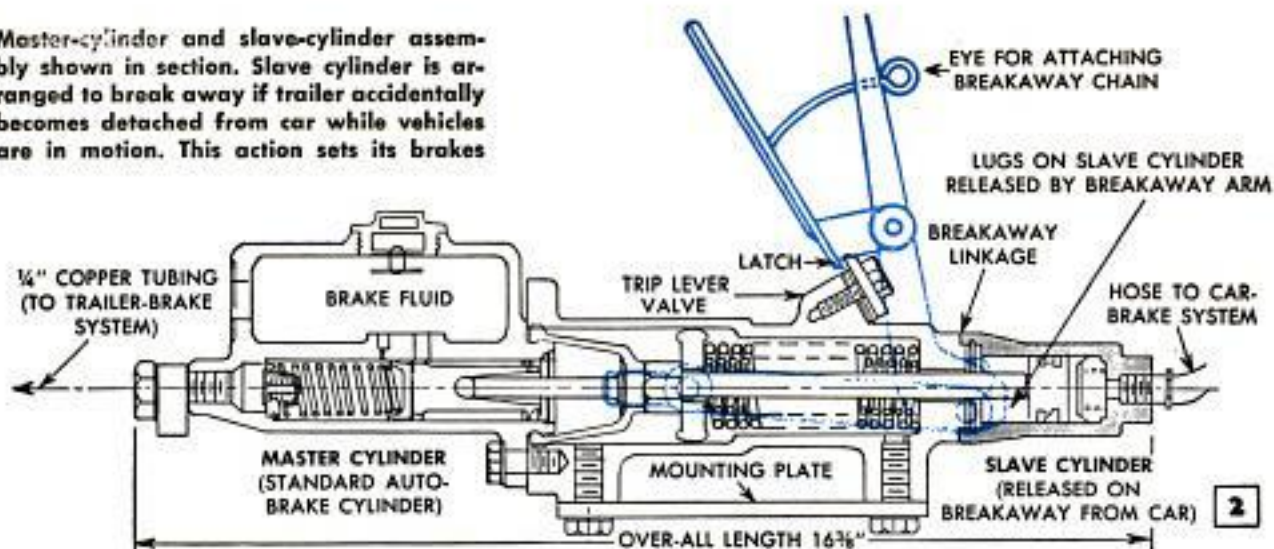

Courtesy Kelsey-Hayes Wheel Co.

Courtesy Warner Electric Brake & Clutch Co.

Electric-brake magnet is carried on operating lever. Latter moves on pivot, forces shoes against drums

In this brake, construction differs only in minor details. Both types are especially designed for trailers

Manual-control unit is mounted either on steering column or dash so that it is within easy reach of driver

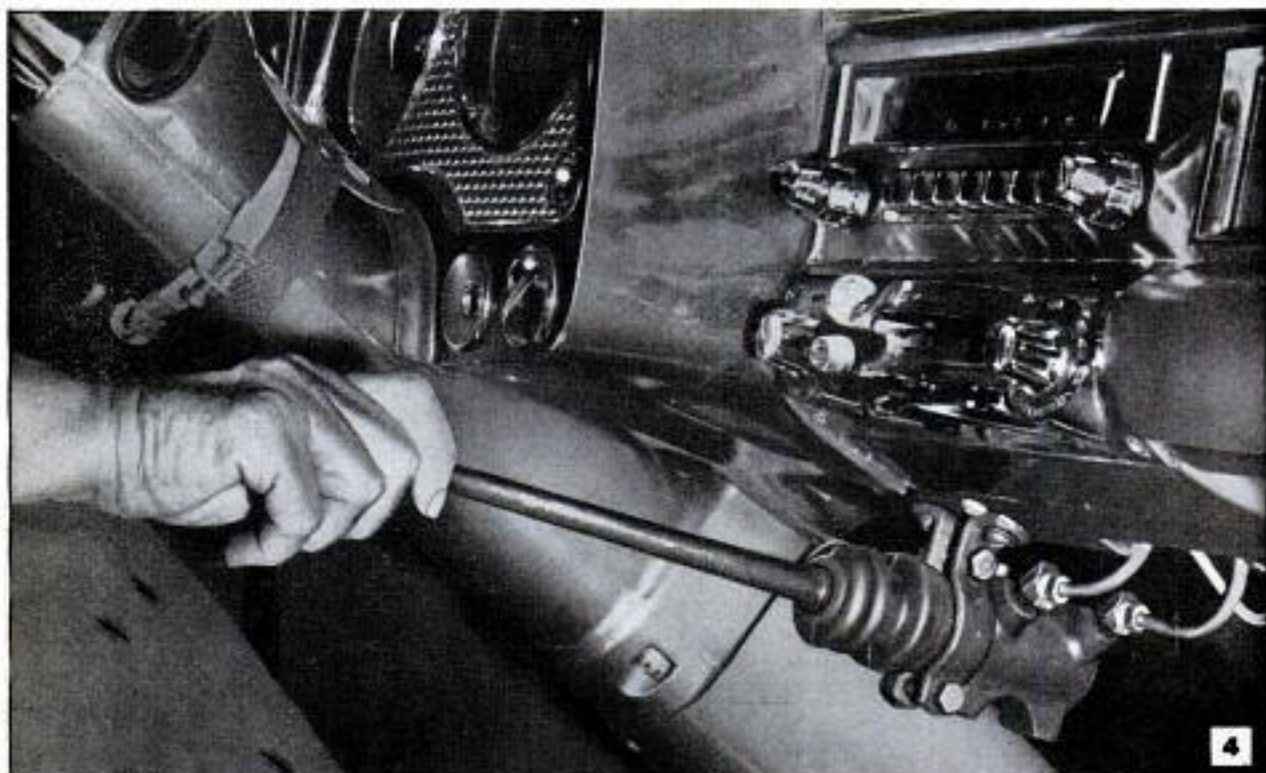

system so arranged that it can be controlled positively by the driver of the towing vehicle. Also, in some states any conventional trailer coach must be equipped with a device for applying trailer brakes automatically should the vehicle break away from the towing car. A breakaway system is shown diagrammatically in Fig. 1. In this system, having electrically operated brakes, a separate 6-v. battery carried in the trailer is cut into the line by a breakaway switch and energizes the brakes to stop the trailer automatically should it accidentally break away from the towing car. Another system, hydraulically operated, is provided with a slave cylinder, Fig. 2, which is released from the master cylinder on breakaway from the car. This arrangement also is designed to set the brakes on the towed vehicle should it accidentally become detached from the towing car. A cylinder of this type is shown in position on the trailer in Fig. 5. One common type of breakaway switch and control chain is shown in Figs. 1 and 6. Other types of switches and controls are shown in Figs. 7, 10 and 14. Fig. 14, detail A, shows a switch which incorporates both turn and tail-light wiring in one unit. Such a switch requires little space for installation and has the advantage of concentrating wiring and terminals in an easy-to-get-at location. Fig. 14, detail B, shows a weatherproof car-to-trailer receptacle of the breakaway type while Fig. 7 details a single-unit control for both manual and automatic operation. It is connected to the car's hydraulic-brake system and is actuated by the brake pedal in normal use. Another type, similar in construction and purpose, is shown in Figs. 1 and 8. It also permits manual control of the trailer braking system in an emergency. Controls of



Above, hydraulic cylinder mounted on trailer drawbar. Below, breakaway switch sets brakes on trailer
 Courtesy Warner Electric Brake & Clutch Co.

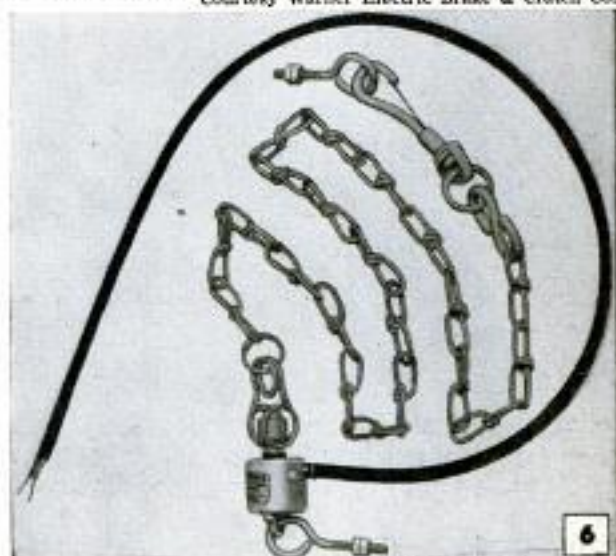

Courtesy Kelsey-Hayes Wheel Co.

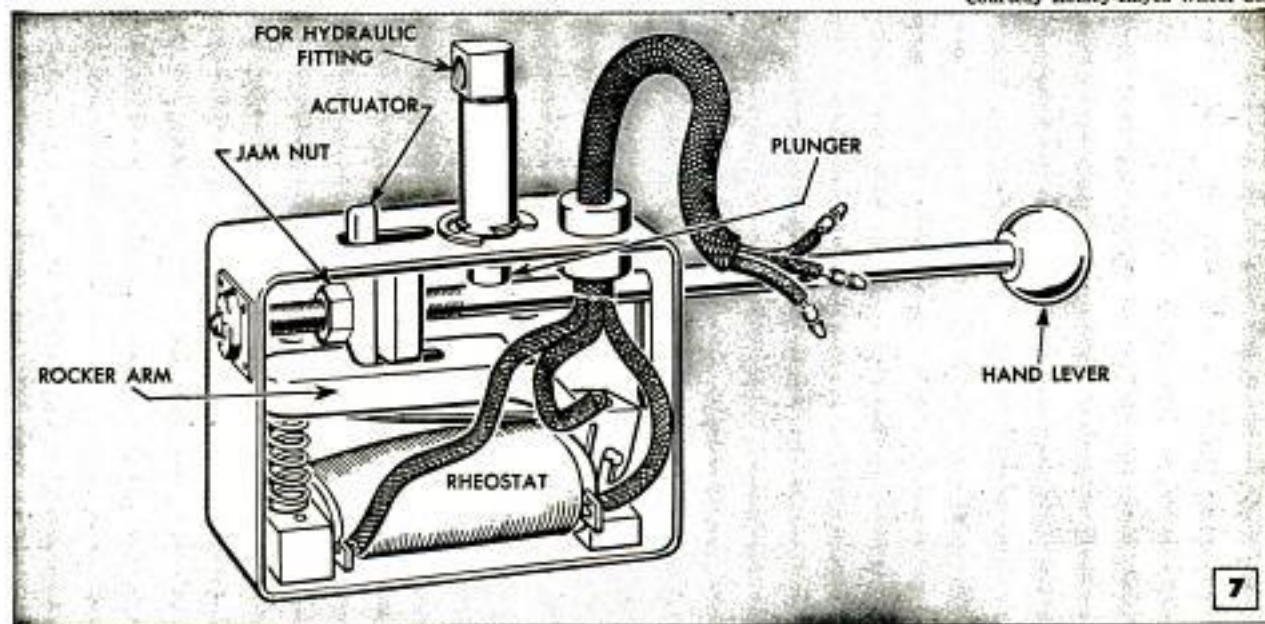



HYDRAULIC ADAPTER
(TO ELEC. BRAKE CONTROLLER)

8

This hydraulic adapter for manual control of trailer brakes is also shown in the diagram of brake parts and wiring in Fig. 1. These units are connected into the brake system for emergency use should the braking system of car fail due to accident or other cause

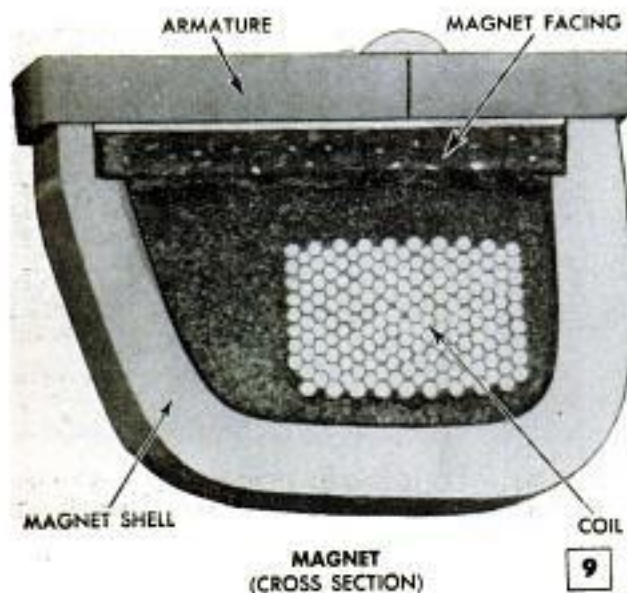

MAGNET
(CROSS SECTION)

9

This sectional view shows construction of an electric-brake magnet and consists of the magnet shell, coil, magnet facing and armature. This is the unit built into the brake in the right-hand view in Fig. 3

This type of electric control unit requires a minimum of space and is easily synchronized with car brakes

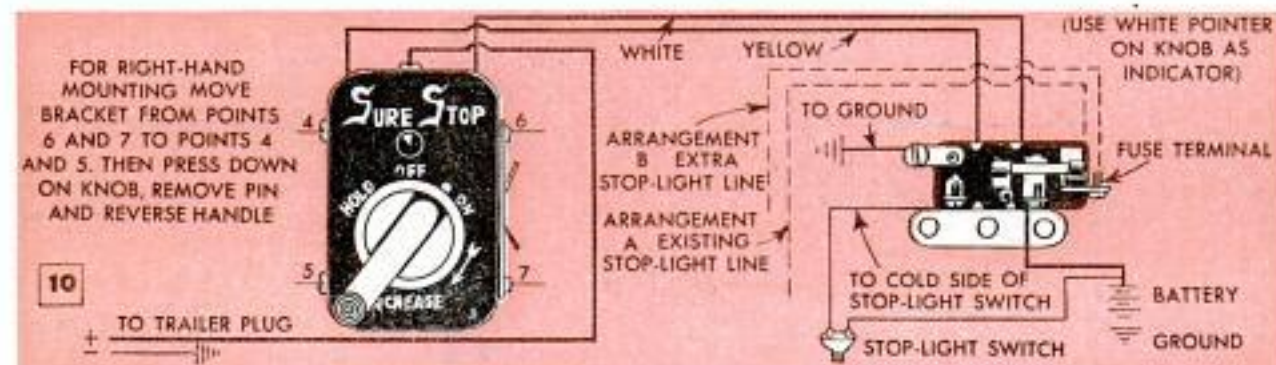

10

these types are commonly designed to be mounted on the steering column or dash as in Fig. 4, the manual-control lever being located so that it is within easy reach of the driver. On late-model cars equipped with 12-v. electrical systems a simple resistor, Fig. 13, is placed in the wiring between the battery and hand control to reduce 12-v. current to 6 v. It should be kept in mind that these controls are safety equipment, the manual control being intended for use only in emergency.

Two types of electric-brake mechanisms are pictured in Fig. 3. These, it will be noted, are quite similar mechanically to the conventional hydraulically operated brake, except that the parts are actuated electrically. Main electrical parts are pictured in Figs. 9 and 11. Some owners of tandem-axle trailers prefer to use hydraulic-brake units on one axle and electric brakes on the other. The three braking systems, the one on the car and the two on the trailer, are arranged to work together as the brake pedal is depressed. Should one system fail, the heaviest trailer still can be brought to a safe stop within a reasonable distance, even under difficult conditions. It's a general recommendation among experienced owners and servicemen alike that tandem-axle trailers be equipped with brakes on both axles. Manufacturers of trailer brakes, both electric and hydraulic, say that brakes on all four wheels of a tandem-axle job are essential under present traffic and road-speed conditions, and that they provide the highest safety factor in emergency stops. To make certain that the trailer brakes do not lag behind those of the towing car, some manufacturers preset the brake controls. In addition, they generally provide specific instructions for adjusting the controls to suit load, driving conditions and preferences of individual drivers, along with the complete installation instructions.

Individual preferences provide perhaps the only reason for choosing between hydraulic and electric trailer-brake systems. Both types provide safe, smooth stops when

installed correctly and regularly serviced. Both are equally reliable. When installing, the important thing is to follow installation instructions in all details and to take special note of manufacturer's recommendations on gross trailer weight, the type of hitch to be used, and tire types and sizes. Most cars used for towing are equipped with hydraulic brakes and for this reason many trailerists prefer hydraulic brakes on the trailer. Others obtain equally satisfactory service from the use of electric brakes on the trailer working in synchronization with hydraulics on the towing car.

There are other factors which directly or indirectly affect peak performance of trailer braking systems. Improper load distribution, use of a hitch inadequate for the load requirement, trailer axles out of alignment, a soft tire on either of the two vehicles are some of the common defects that can materially reduce efficiency of braking systems. Failure to check the brakes periodically for wear of the shoes can result in a gradual lowering of efficiency to the danger point. If the brake shoes show any variations in wear at the time of relining, reline or replace all shoes rather than only those which show the greatest wear. On tandem-axle trailers it's important to check axle alignment occasionally. Axles out of line can cause rapid tire wear and a lateral thrust on the hitch which may develop into a tendency to sway. Misalignment of the axles can seriously affect the braking systems of both vehicles. One other point sometimes overlooked in a routine check is the condition of the trailer wheel bearings. Properly conditioned wheel bearings, Fig. 12, are especially important when the trailer is equipped with electrically actuated brakes. This is due to close fitting individual members and to the low tolerances between moving and stationary parts of the mechanisms. Wheel bearings must be kept tight and properly lubricated to prevent undue wear and possible damage to brake parts. And while you're servicing the trailer wheels don't forget to include the front wheels of the towing car. Also check wheel alignment periodically. ★ ★ ★

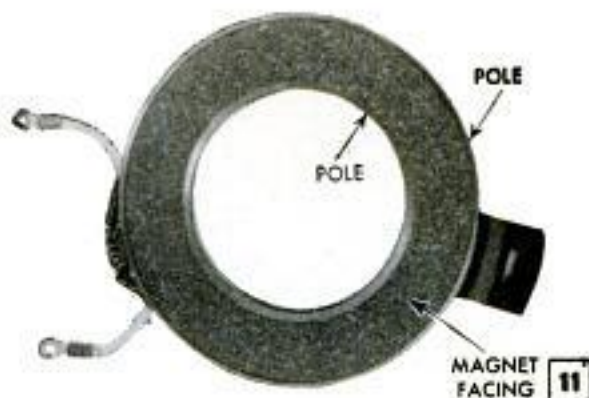

This is a view of the complete magnet shown in section in Fig. 9 and in the brake assembly at the right in Fig. 3. Current from car battery energizes this unit



Above, tight wheel bearings are essential on trailer equipped with electric brakes. Below, resistor in circuit between battery and hand control reduces voltage



Courtesy Sure-Stop Brake Control, Inc.

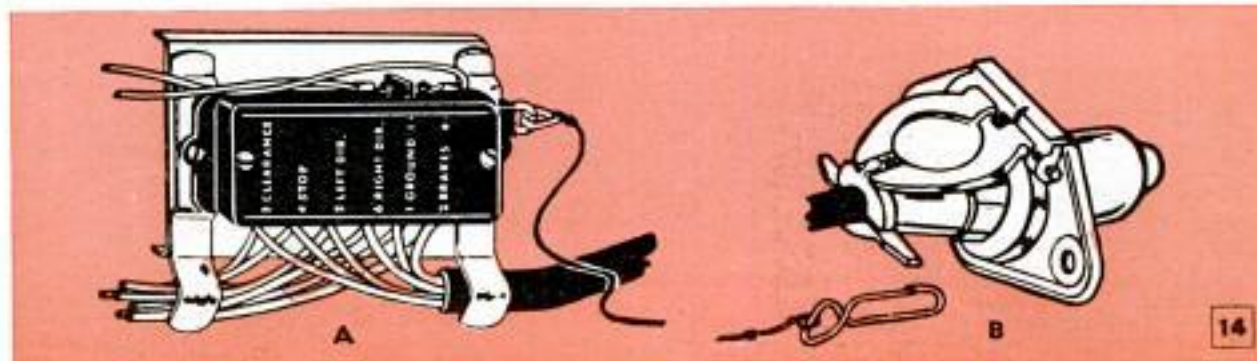



Hinge-Mounted Tray Keeps Tools Handy

A portable tool tray is kept within convenient reach in the shop of one home-craftsman by attaching one half of a hinge to one corner of the tray and the other half to a leg of the workbench and inserting the hinge pin as shown. When the tray is removed for outdoor use, the pin is removed and inserted in the part of the hinge on the bench. With this accommodation, tools need not be returned to the drawer or cabinet each time they are used.

Angle-Bracket "Legs" on Motor Permit Universal Mounting

Electric motors salvaged from machinery in which they have been held in special mountings can be adapted for universal mounting by adding angle-iron "legs." As indicated, sections of angle are drilled to permit fastening them to the end-housing bolts of the motor. Holes in the opposite legs of the angles allow the assembly to be bolted to bench or power tool.

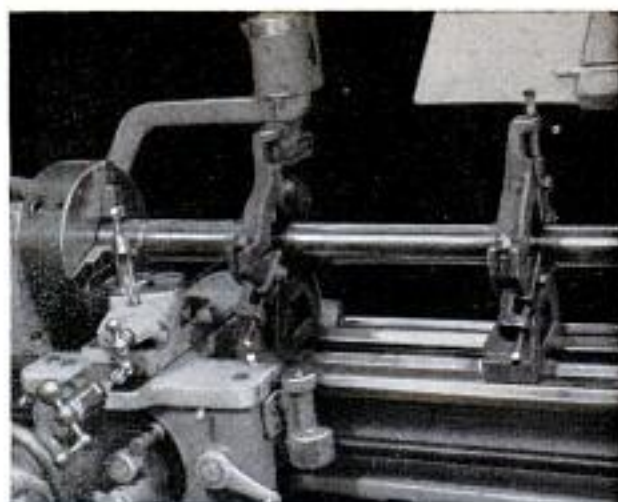
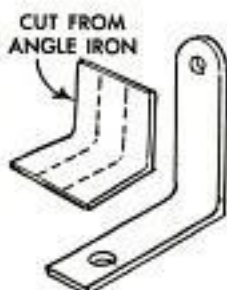
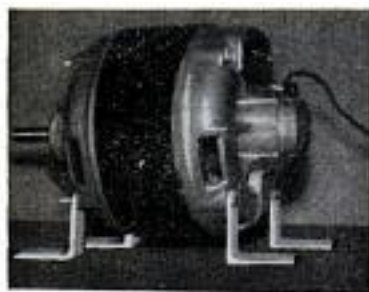

Tubes Supported in Steady Rests

Occasionally it is necessary to use a lathe to cut off short lengths from a long piece of tubing or pipe. When the tube is too large in diameter to pass through the headstock spindle the setup illustrated is a practical solution. The tailstock is removed from the lathe and two steady rests are set up to support the stock. The tube is gripped in the jaws of the chuck with the left end against the face of the chuck. The cutoff tool is positioned by measuring the correct distance from the side of the tool to the chuck face. The carriage is then locked and is left in this position for gauging each succeeding piece of work to identical length.

H. J. Gerber, Stillwater, Okla.

Clothespins Hold Shop Drawings

Spring clothespins strung on a length of furnace wire nailed or screwed to the wall are used by one small machine shop to hold working drawings. The wire should be fastened to the wall at a height that will bring the center of the prints at eye level or slightly below. This method is especially handy where the prints have to be changed frequently as in a school shop or job shop.

C. C. Cooley, New Buffalo, Mich.

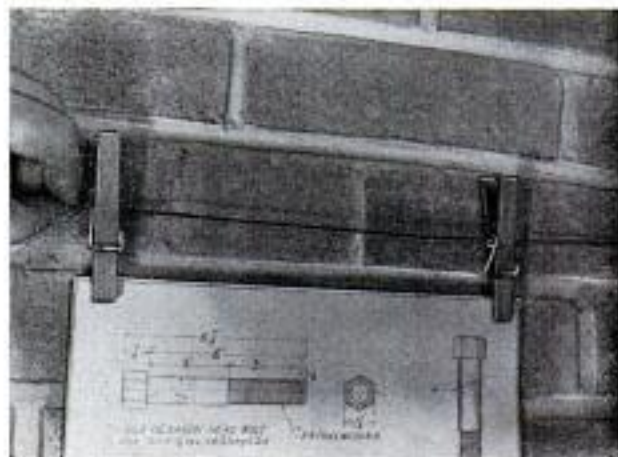

ARBOR PRESS

For Small Shop

By C. W. Woodson

WHEN THERE IS NEED for an arbor press in the small shop it is not always practical or advisable to improvise a substitute using the lathe or drill press, especially when the work to be done calls for press-fitting bushings and other parts which require considerable pressure. That's where this shop-built arbor press comes in handy. You won't have much money invested in material, about the only outlay being in the time required to build the press from steel flats, squares and rounds.

The ram of this press is of the threaded type. It is somewhat more sensitive on certain types of work than the regular rack-and-pinion ram and is equally positive in action. On the original press the end of the ram was simply faced off as detailed. If desired, a nonrotating, ball-bearing pad can be fitted. When this is done the end of the ram is shouldered and grooved $\frac{1}{16}$ by $\frac{1}{16}$ in. and the pad turned and drilled to fit easily over the shouldered end, a single steel ball being placed between the pad and the end of the ram at the time of assembly. Drill a $\frac{1}{16}$ -in. hole through the pad sleeve to register with the groove in the ram. Drive in a $\frac{1}{16}$ -in. pin to serve as a keeper.

The two arms, which are duplicates, can be ordered flame-cut from $\frac{1}{2}$ -in. stock to the shape indicated. Then the edges are cleaned up and the corners rounded slightly with a file. The table can be ordered



This arbor press is what would rate as small bench size and has a screw-type ram. Although slower than rack-and-pinion type, ram is more sensitive to pressure

from your supplier cut in the same manner. As detailed, it is round, 7 in. in diameter, but it also can be cut square if desired. The hole pattern detailed for the table is, of course, optional. Lay out the hole pattern on one arm, drill and use as a jig for drilling a duplicate pattern of holes in the remaining arm. Cut two lengths of steel angle, clean the cut ends with a file and round the corners slightly. Use one arm as a jig for drilling the holes in the angles and spacers. When the press is assembled the steel angles serve as mounting pads for bolting the press to the bench.

The length of the $1\frac{1}{2}$ x $1\frac{1}{2}$ -in. steel spacers need not be precise. The lower one

When built according to dimensions, press frame has a throat opening about $3\frac{1}{2}$ x 4 in. No castings are used

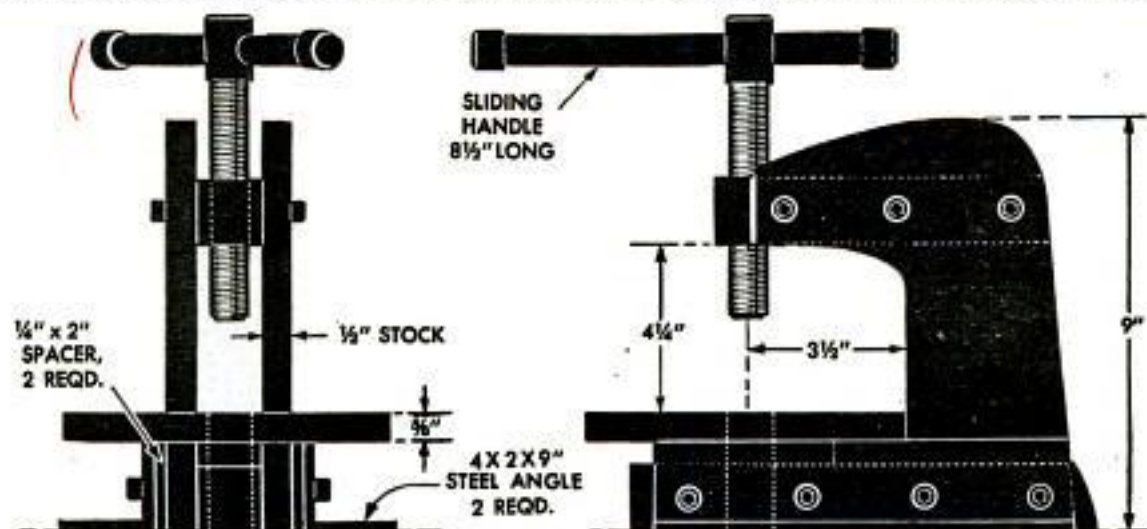

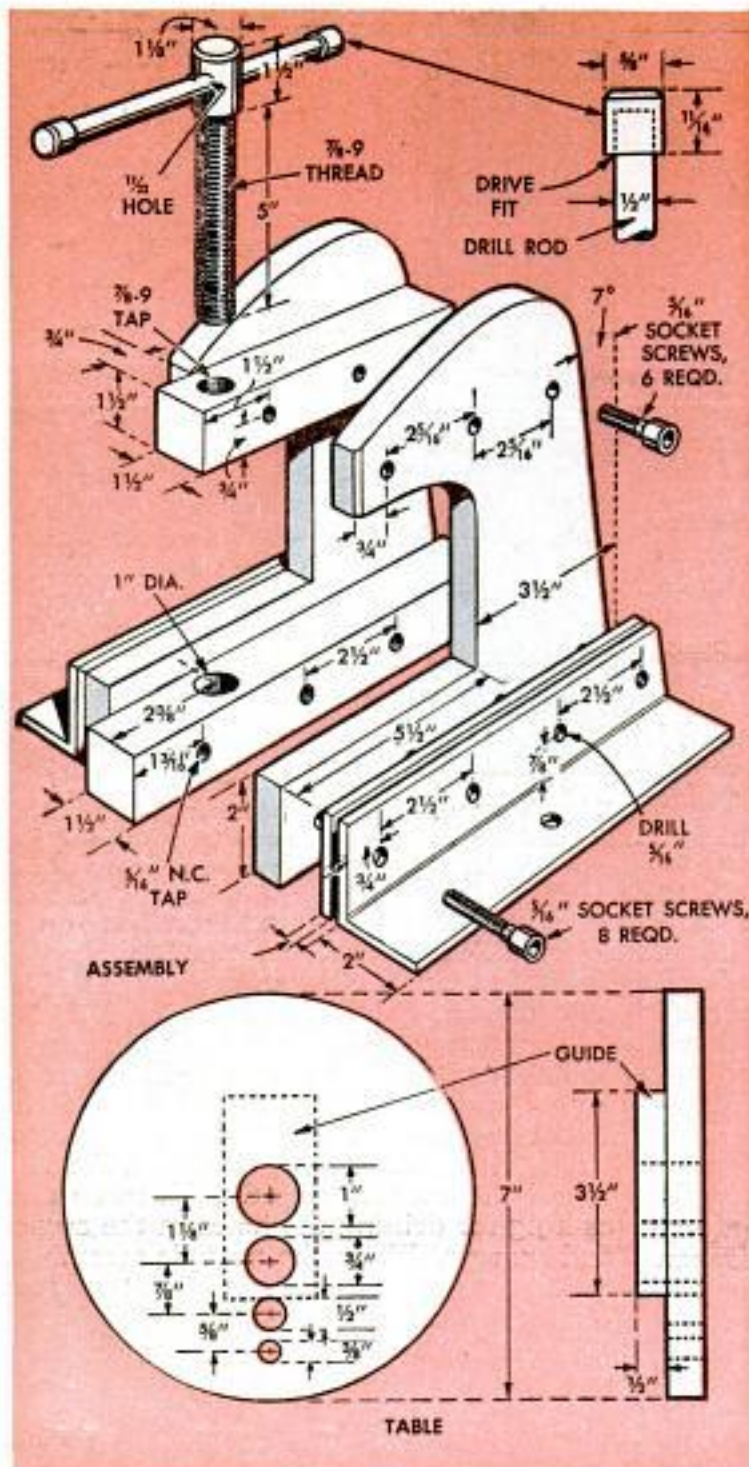

Screw-type ram, as detailed at left, should be shouldered from $\frac{5}{8}$ -in. stock and threads cut in lathe to assure accuracy

can be cut approximately 10 in. long and the upper one approximately 6 in. long. Lay out and drill the tap holes, using one of the arms as a drilling jig. Drill and tap the hole for the arbor screw and drill the 1-in. clearance hole in the lower spacer. Note that in the assembly the variation in dimensions between the lower spacer and the arm extensions leaves a groove $\frac{1}{2}$ in. deep and $1\frac{1}{2}$ in. wide. The guide, which is screwed or welded to the bottom of the table, rides in this groove formed by the three members. This permits the table to be adjusted in or out to bring any one of the four clearance holes into the desired position. In assembling it may be necessary to file the lower face of the guide so that it clears the spacer, as otherwise the table may tend to tilt slightly. This could result in burring or deformation of bushings or other parts being press-fitted into place.

The screw should be shouldered and the thread cut in a lathe to assure accuracy. When cutting the thread use special care in the lathe setup so that you finish with a tight, smooth-running thread. If the threaded screw takes the tapped hole loosely, it may tend to cant sidewise when pressure is applied and thus destroy the accuracy of the press. Cross-drill the big end of the screw, shoulder the handle to $\frac{1}{2}$ in. from $\frac{5}{8}$ -in. stock and turn, drill and ream a cap to a drive fit as indicated in the detail. ★ ★ ★

Double-Marked Yardstick Cuts End-for-End Turning

A second row of numbers added below the original numbers on a yardstick, but in reverse order, will eliminate end-for-end turning or counting the numbers backward. The extra set of numbers permits reading measurements directly without the chance of making an error.

Frank A. Javor, Newark, N. J.

When framed, glass-covered pictures are to be transported, pack them in pairs, face to face, placing bottle corks between them at the corners of the glass fronts.

Blanche Campbell, Los Angeles, Calif.

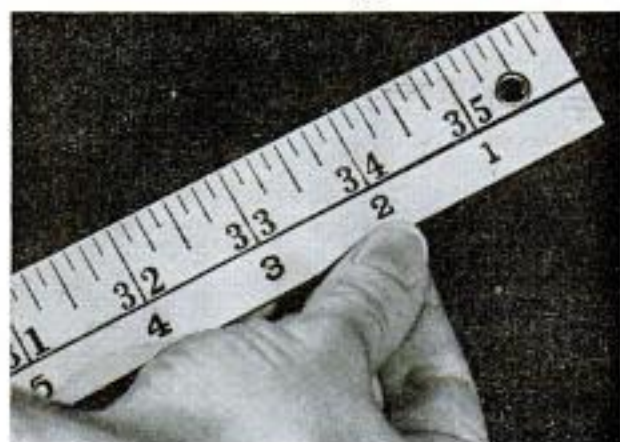

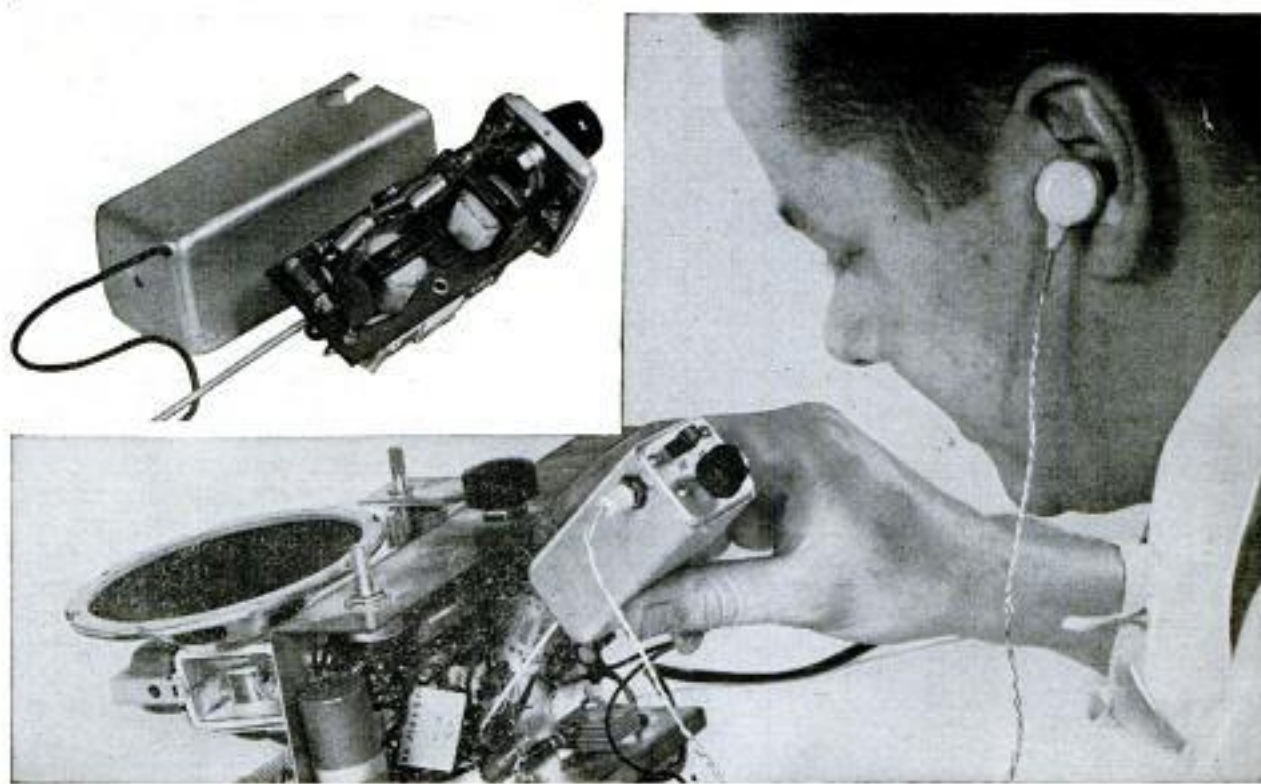

"LITTLE HANDY" SIGNAL TRACER SIMPLIFIES SERVICING

By Samuel Sosenko,

Transistor Components Eng. Dept., Thordarson Meissner Mfg. Div.

FOR YEARS the signal tracer has been a favorite test instrument with many radio servicemen and electronics technicians. Its simplicity and relatively low cost coupled with its ability to locate in minutes the defective section of multistage electronic devices have earned it a commanding niche on most service benches. But because of its large size the ordinary signal tracer is generally considered a shop instrument and remains tied to the bench. The "Little Handy," however, is a completely self-contained and portable unit which, taking advantage of transistors and other miniature components, can be carried easily in a tube caddy for home service calls and frees valuable bench space in the already overcrowded shop.

Despite its small size, the Little Handy has adequate sensitivity for servicing all types of radios, amplifiers, television sets and other electronic circuits. Its power re-

quirements are so low (about 2 ma.) that two ordinary penlight batteries will provide months of reliable service.

How It Works

Like all signal tracers, the Little Handy consists of an untuned radio detector followed by an audio amplifier. When the tracer probe contacts a point in a radio where a signal is present, either modulated r. f. or audio, the signal is amplified in the tracer and can be heard in a headset plugged into the output jack.

The schematic diagram of the Little Handy is shown in Fig. 1. Any signal appearing at the tracer probe is coupled to the volume control, VC1, through coupling capacitor C1 and isolation resistor R1. If the signal at the probe is modulated r. f., switch S2 should be closed, permitting the diode, CR1, to "detect" the signal. For audio-signal tracing the switch should be

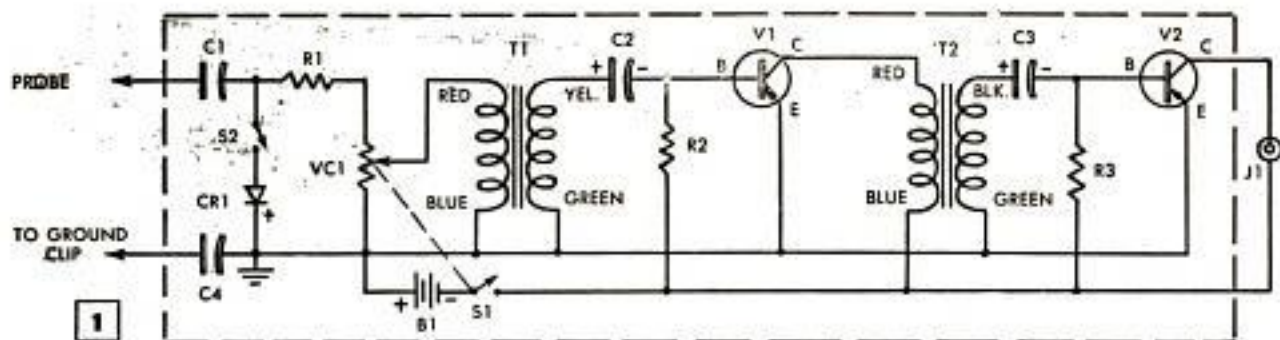

open so that the diode is disconnected.

Transformer T1 matches the relatively low input resistance of the transistor V1 to the high-resistance volume control for maximum signal transfer. Bias resistor R2 establishes the correct operating point for V1 and coupling capacitor C2 prevents the bias current from being shorted out.

After being amplified by V1, the signal is applied to a second amplifier stage, V2, before being applied to the output jack. Components associated with V2 serve the same functions as their V1 counterparts.

Isolation capacitor C4 eliminates any serious shock hazard when the tracer is used for servicing a.c.-d.c. equipment.

Construction

A prepunched and drilled can-and-cover set for housing the Little Handy, as well as all other required parts, are readily available from leading radio-parts distributors, and the unit can be built in a few hours.

Begin the construction by cutting and drilling the required holes in a piece of $3\frac{3}{8} \times 1\frac{1}{16} \times \frac{1}{16}$ Bakelite or polystyrene material as illustrated in Fig. 2. The illustration is full-sized and may be used as a template. The rectangular cutouts can be made with a flat needle file after as much as possible of the unwanted material has been drilled out. Drill sizes for the round holes are given in the legend.

The two No. 31 holes near the center (lengthwise) of the board are used for fastening the battery holder to the board. Small rivets should be used for this pur-

pose and the size of the holes may be changed to fit any rivets you may have on hand. Similar considerations apply to the two No. 31 holes near the left-hand edge of the board. These holes are used for mounting small metal eyelets to which the probe and ground lead will be soldered. (Rivets and eyelets are usually supplied with inexpensive radio hardware kits.)

The transformers are mounted first, by inserting their mounting tabs through the narrow rectangular slots and bending these inward below the chassis board. Study Fig. 4A to determine correct positioning of these units for shortest possible lead lengths. Then, rivet the battery holder in place. (You will have to drill two small holes, corresponding to the aforementioned rivet holes, in the center of the holder. The original mounting holes cannot be used since they are located directly beneath the transformers.)

The transistor sockets are inserted in the larger slots and held in place by retainer clips supplied with these units. Insert sockets so that the pin spacing corresponds with that shown in Fig. 4A.

Now study Fig. 3 and mount the indicated parts in the predrilled can-cover as shown. Be sure to place a ground lug under one of the angle-bracket mounting screws. Then fasten the chassis board to the angle brackets with 4-36 x $\frac{3}{16}$ screws and nuts. Another ground lug is placed under one of these nuts, as shown in 4A.

A unique wiring method is used here for firmly joining two wires without the use

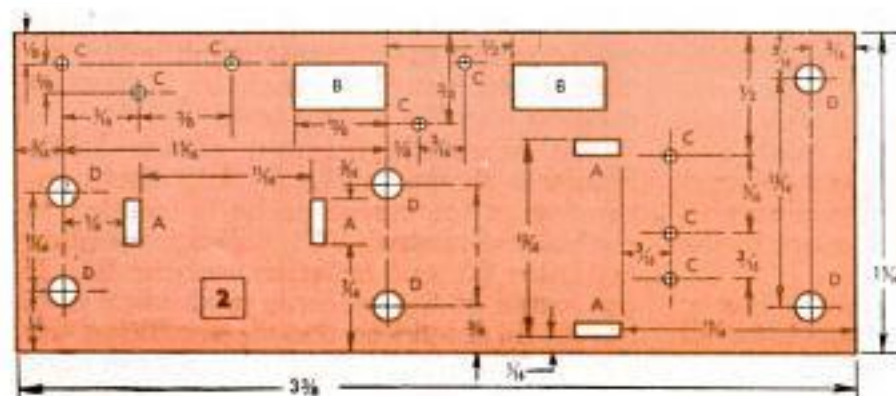

LEGEND	
A	$\frac{3}{16} \times \frac{3}{16}$ " SLOTS
B	$\frac{1}{4} \times \frac{3}{16}$ " SLOTS
C	USE NO. 54 DRILL
D	USE NO. 31 DRILL

LIST OF MATERIALS

R1=100,000-ohm, 1/2-watt resistor; R2=150,000-ohm, 1/2-watt; R3=270,000-ohm, 1/2-watt.
C1=1500-mmfd. ceramic capacitor; C2, C3=2-mfd., 6-v. electrolytic, Sprague No. 1081; C4=.005-mfd. disk ceramic.

VC1, S1=miniature 1/2-megohm volume control with switch, Stackpole No. FD-16 or equiv.

V1, V2=Raytheon CK722 transistors. CR1=crystal diode, type 1N34 or 1N64.

T1=50,000:500-ohm matching transformer, Thor-darson TR-26 (cut off black CT lead).

T2=20,000:1200-ohm matching transformer, Thor-darson TR-14.

S2=8-p.s.t. slide switch; J1=midget phone jack with insulating washers, Telex 9240.

B1=penlight cells, 1 1/2-v. (2 required), Burgess No. 7 or equiv.

MISCELLANEOUS: 1—magnetic, high impedance (1000-ohm or more) headset or earpiece with phone plug to match J1; 1—battery holder for two penlight cells; 1—j.f. can and cover, prepunched, Meissner Nos. 25-8282 and 25-8283 respectively; 2—transistor sockets with retainer clips; 1—knob for 1/8-in. shaft; 6—4-36x3/16 screws and matching nuts; 2—angle brackets, 1/2-in. wide, 3/8-in. long (each leg); 2—solder (ground) lugs; 4—eyelet rivets; material for chassis board and probe (see text); 1—alligator clip; 1—ground lead (see text); hook-up wire (No. 22 solid).

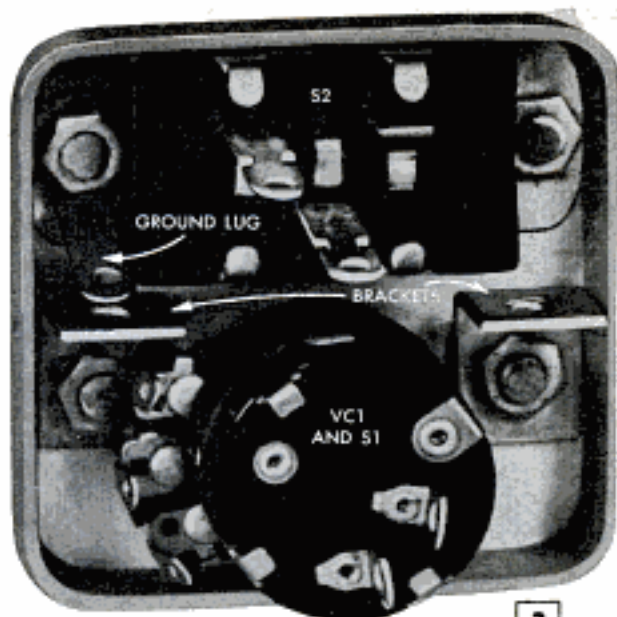

of space-consuming terminal strips. The wires are brought through a small (No. 54) hole to bottom of the chassis board and are soldered after being firmly twisted together. The small blob of solder prevents the wires from being pulled back through the hole, thus making a rigid assembly.

Great care should be used in soldering and the use of a small-point 20 or 40-watt pencil iron, or solder gun, is recommended.

Start the wiring at the probe eyelet. The

probe is a 5-in. piece of 18-gauge steel rod obtainable at hobby shops. Bend a small 90-deg. hook in one end of the rod and insert this, as well as one lead from capacitor C1, through the eyelet and solder the connection. Work progressively to the right making certain that all wires leading to a particular junction have been connected before soldering. The pictorial of Fig. 5 can be used to check your work.

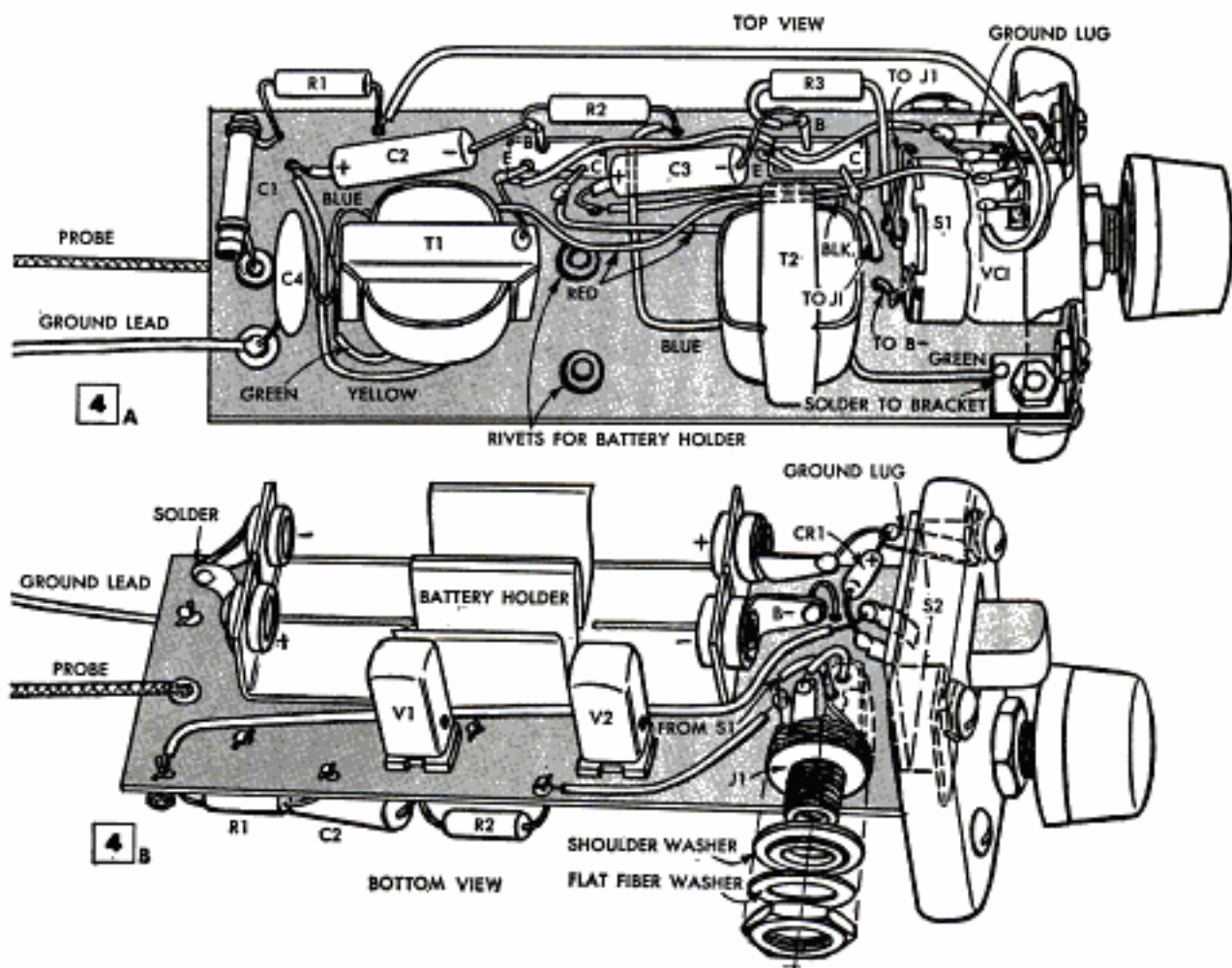

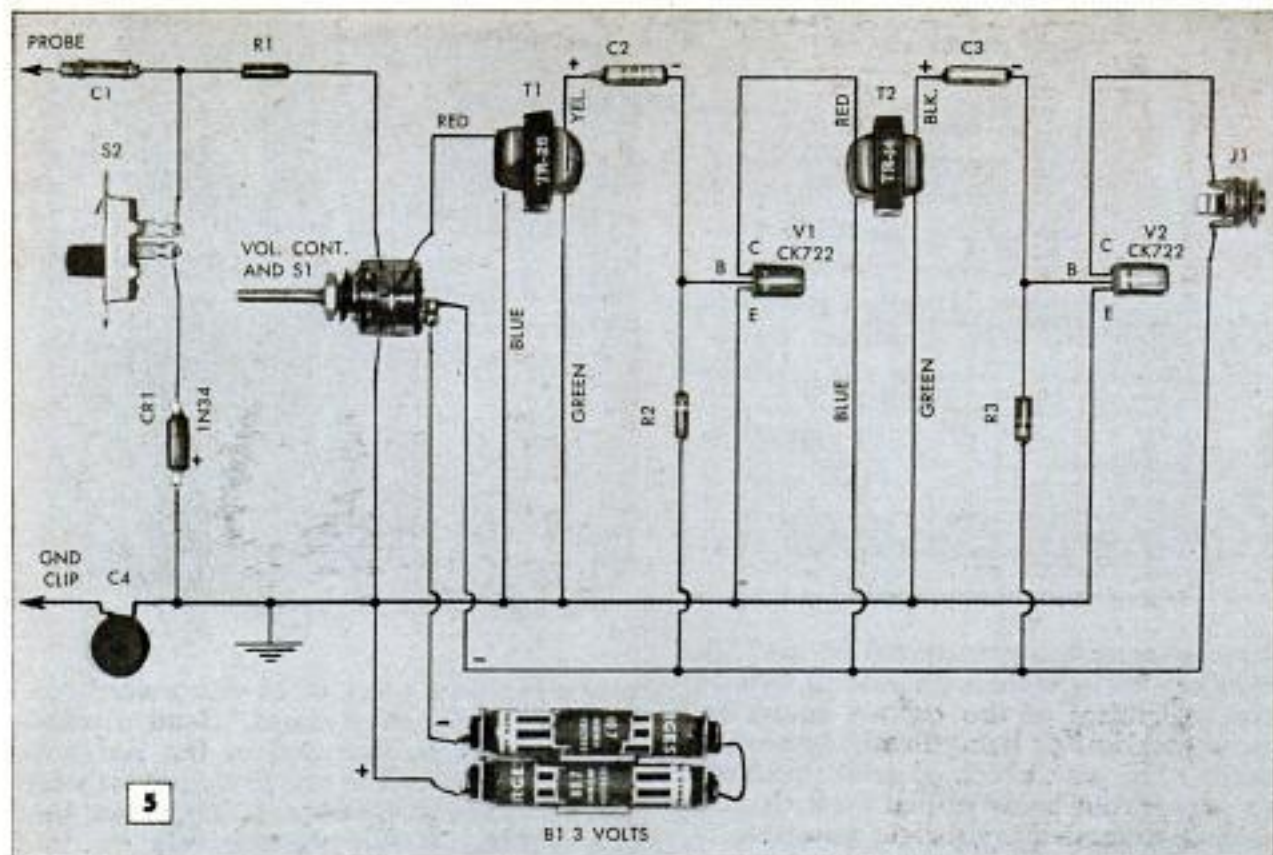

Transformer T1 is statically shielded and its frame must be grounded. This is done by soldering a wire from the transformer frame to the emitter lugs of the transistor sockets and, from there, to a ground lug, see Fig. 4A. The frame of T1 is then used as a ground point for the green and blue transformer leads and C4.

Output jack, J1, is supported only by the leads connected to its terminals and can be positioned easily to fit the cutout in the can housing. The jack must be insulated from the can with a shouldered and a flat fiber washer.

The ground lead consists of about two feet of flexible, insulated ground wire, which should be threaded through the pre-drilled hole in the front of the can before having an alligator clip connected to its free end. The probe must be covered with a tight-fitting piece of spaghetti tubing to prevent its shorting to the can.

Insert the transistors and batteries after all wiring is complete. Carefully observe battery polarity and insert the transistors correctly by observing the position of the dot on the transistor bodies in Fig. 4B.

Using the Little Handy

To get acquainted with the characteristics of the signal tracer it is suggested that you first try the unit on a normally operating radio. Tune the receiver to a strong local station, and then unsolder one of the speaker leads so that there is no

sound output from the receiver. Now, connect the ground lead of the tracer to the B-point of the radio, set switch S2 to the r. f. (closed) position, and touch the grid of the first radio stage with the tracer probe. A very weak signal will be heard through the phones at this point with the tracer volume control set nearly to maximum. Move the tracer probe to the grid and plate of the second stage respectively and note the volume increase at each point.

Now, set S2 to the a. f. (open) position and touch the hot side of the volume control, the grid and plate pins of the audio voltage amplifier and the grid and plate pins of the power amplifier with the probe. Note the volume difference at each point.

Remember that the signal strength at the tracer probe increases with progressive advances from the antenna through the final audio stage. If the input signal to the Little Handy is too great the output will sound garbled, or distorted. The volume control of the tracer should be turned down when the probe is touched to the plate of each successive stage.

The procedure for testing a defective receiver is identical to that outlined above, except that you will reach a point in the radio where there is no signal, or the signal is distorted. It is evident that the defective part in the radio must be between that point and the preceding one where a good signal was obtained. The troublesome part can then be located with a test meter. ★ ★ ★

From the world's finest filtration laboratories comes the new

FRAM Easy Change Oil Filter

Screws in like
a light bulb



Pat.
Pend.

TWO EASY STEPS TO CHANGE NEW FRAM EASY CHANGE OIL FILTER:

1. Unscrew dirty filter from base and throw away.
2. Screw new FRAM Easy Change Oil Filter on base until gasket contacts base. Then tighten at least $\frac{1}{2}$ turn more—use no tools. Turn by hand only.

Now original equipment on '57 cars*

CONVERSION KITS FOR EARLIER MODELS

Here's the latest in protection for your car's engine—from FRAM, the pioneer in filter research and development! Designed by FRAM Filter engineers to meet the exacting requirements of automotive designers, the new FRAM Easy Change Oil Filter is safer, simpler to install, remove and replace.

Complete in one unit: no housing, no cover, no separate gasket, no oil lines. No connections or adjustments. Screws into place as easily as a light bulb! No tools needed. Fingertip pressure is all that's necessary. Permanent built-in gasket insures positive, leak-proof seal.

And, as always, your engine is guarded by FRAM quality—the kind of quality motorists everywhere have depended on for decades.

*Now original equipment on these 1957 Cars

Continental • Thunderbird • Lincoln • Mercury • Ford • Turnpike Cruiser
• Packard • Studebaker Golden Hawk • Studebaker President

COMPLETE LINE OF CONVERSION KITS FOR THE FOLLOWING CARS:

Ford 6-1952-57† • Ford V-8 1954-57† • Mercury 1954-57† • Lincoln 1952-56 •
Thunderbird 1954-1957† • Continental 1955-57† • Studebaker Commander 1955-57
• Champion 1946-57 • †Early '57 models. All other '57 models FRAM original
equipment.



It's Filter Change Time!

Remember *both* oil and filter need changing to give you greatest engine protection!

FRAM®
OIL • AIR • FUEL • WATER
FILTERS

FRAM Corporation, Providence 16, R.I., Fram Canada Ltd., Stratford, Ontario

From Kodak—a wonderful



Here are 8 exciting new Kodak Cameras and photo aids that can make your picture-taking easier — more satisfying — than ever! They're made by Kodak — so you know they're good! See them all soon at your photo dealer's.

NEW BROWNIE STAR CAMERAS take color slides, too! First Brownie Cameras ever designed to take gorgeous color slides (use "Daylight Type" Ektachrome Film in bright sunlight, "Type F" with flash)... as well as lifelike color and black-and-white

snapshots. Only setting is for the kind of film you're using (color or black-and-white). Then aim and shoot! Two Brownie models to choose from:



Brownie Starflex Camera—Hooded viewfinder shows your picture big *before* you shoot. Camera only, \$9.95. Flashholder, \$3.50.

Brownie Starflash Camera—Eye-level finder makes it easy to aim each shot just right. Built-in flashholder for M2 bulbs. Only \$8.50.



NEW KODAK ROTARY FLASHHOLDER lets you take 6 flash shots without reloading! Accepts six M2 bulbs at a single loading, changes bulbs instantly by rotating the turret, ejects all spent bulbs simultaneously—and can be reloaded in split seconds! Equipped for B-C battery power. New, simplified flash calculator. Available in two

models to fit most shutter-synchronized cameras. Complete with two carrier discs, each of which accepts 6 flashbulbs per



loading. Only \$9.95 or \$11.95, depending upon the model required for your camera. (Batteries extra.)

NEW KODAK SIGNET 40 CAMERA—gets color slides with remarkable ease. Exclusive dual-reflector flash system and a wide range of 8 shutter speeds take full advantage of today's fast films, new midget

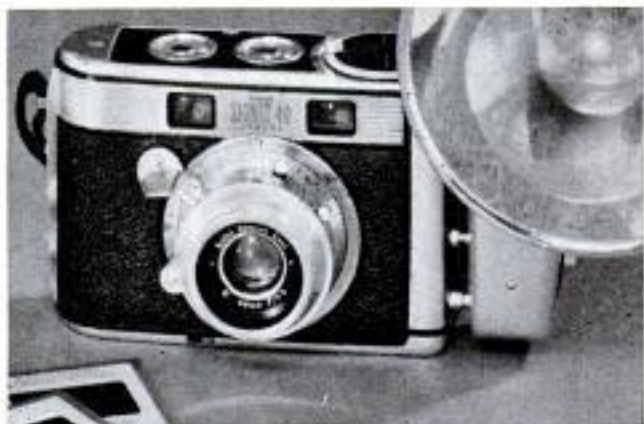

Prices are list, include Federal Tax where applicable, and are subject to change without notice

new world of picture-taking!

flashbulbs. Ask your Kodak dealer to show you how easy it is to sight, focus, shoot, and advance the film in a Signet 40—with *all controls* at your finger tips! Superb Ektanon $f/3.5$ Lens . . . 1/5 to 1/400 Synchro Shutter . . . combined rangefinder-viewfinder. Kodak Signet 40 Camera complete with flashholder, dual reflectors, only \$69 . . . or as little as \$7 down.

NEW KODAK 300 PROJECTOR is *ultra portable—yet shows your color slides bigger!* You can carry this handsome, compact new projector like a portable radio—show any popular-size color slide in it. Sharp 4-inch, $f/3.5$ lens, *plus* a superb new lamp-condenser system, gives your slides brilliant big-screen projection even in a

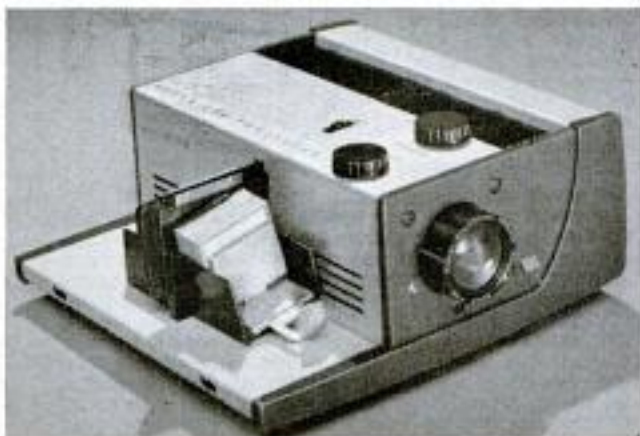

small room. Handy finger-tip controls . . . fast, smooth slide changing. Complete in carrying case. Projector with Readymatic Changer, \$59.50 . . . \$5.95 down. With magazine changer, \$69.50 . . . \$6.95 down.

NEW KODAK MEDALLION 8 MOVIE CAMERA, $f/1.9$ is the *easiest-to-use movie camera Kodak ever built!* Small enough to slip in a jacket pocket. Takes only 3 seconds to load with a magazine of film—lets you switch from indoor to outdoor

color film any time. You just set the exposure dial to match the light condition . . . aim and shoot. Pre-focused lens accepts low-cost converters for wide-angle or telephoto views. Choice of speeds includes slow-motion and single frame. With $f/1.9$ lens, only \$99.50 . . . or as little as \$10 down.



Kodak Medallion 8 Movie Camera, Turret $f/1.9$, is as easy to use as the standard model. Completely equipped for regular, wide-angle, and telephoto movies, only \$149.50 . . . or as little as \$14.95 down.

NEW CINE-KODAK SHOWTIME 8 PROJECTOR shows 8mm movies 5-feet wide! New de luxe model features a handy variable-speed control. Projects extra-brilliant half-hour shows with one simplified loading; "stills," reverse action, too! Illuminated control panel. Lubricated for life. Complete in built-in case, \$129.50, or \$12 down.

Standard model (without variable-speed control) lists at \$115, or \$11 down.



Ask your dealer about small down payment, easy terms
EASTMAN KODAK COMPANY, Rochester 4, N. Y.

Kodak
TRADE-MARK

Unique Tribute to 
Engineering and Performance

Sealed Power Piston Rings
are approved for

NOT 1/2 NOT 3/4 NOT 99%

-but ALL car and truck
engines and automatic
transmissions made by
ALL American
automobile
manufacturers

Your car deserves a
Sealed Power
KROMEX RING SET

Save Oil! Save Gas!
Gain Power!

Write for free manual, "Care and Feeding of Engines." Sealed Power, Dept. G-4, Muskegon, Mich.

Sealed Power
PISTON RINGS
BEST IN NEW CARS! BEST IN OLD CARS!

Clinic for Homemakers



As a service to our readers in solving the hundreds of problems pertaining to a home—inside or out—the editors of *Popular Mechanics* invite you to present your problems to The Clinic Editor for help and advice. Address your questions to The Clinic Editor, *Popular Mechanics Magazine*, 200 East Ontario Street, Chicago 11, Ill.

French Polishing

Q—I have an old tool chest, an heirloom, which I would like to refinish. Structurally it seems to be sound but the finish is in very bad condition. I scraped off a small area and the wood appears to be walnut, but I am not certain about this. I'm told that many old pieces were finished by a process known as French polishing. What type of finish is this and is it easy to apply? — Y. E., Conn.



A—French polishing is a very old method of finishing wood and, as originally practiced, involves several steps. Properly carried out this method produces a very fine finish of exceptional beauty and durability, especially when used on quality cabinet woods. However, its application requires both time and labor to produce a top-quality job. The finish is laid on the bare wood with a pad made from a ball of cotton and a square of lintless cloth. The cotton, carrying a small quantity of the finishing material is placed in the center of the square of cloth, the corners of which are then gathered and held in the hand. A few drops of linseed oil are applied to the surface of the pad thus formed to prevent it from sticking. Then the pad is stroked over the surface of the wood, first in a rotary motion, using considerable pressure. Then before the finishing material contained in the pad is used up completely, the area covered is gone over with long, sweeping strokes of the pad. This completes the first application. Several are generally necessary to build a suitable finish. No filler is used on open-grained woods. There is now available a newly developed padding finish which is said to simplify the old process. All old finish must be removed and the wood thoroughly sanded before applying a padding finish. Space does not permit a complete step-by-step description of the procedure in French polishing, or padding as it is now often referred to, but full directions for application are available with the finishing material.

Training Grapevine

Q—A grapevine is now growing at the corner of our back porch. I would guess that the vine is very old and it is now spread over most of one side of the porch and is working up onto the roof. The trellis in which the vine is intertwined is rotting and I fear the vine will damage the roof if not removed. Is it possible to train the vine to grow on an arbor as grapevines do in a commercial vineyard?—F. R., Ohio.

(Continued to page 226)



Build them a "Cowboy Corral"

free MASONITE plan shows how!

Yippee! A real Western-style bunkhouse, with some modern-type improvements the kids will go for!

You start with Masonite Seadrift, the brand-new grooved panel with the texture of well-weathered wood. It's easy to cut and fit and you can finish the surface in solid colors or two-tone combinations.

Then you add famous Masonite®

Peg-Board® panels for plenty of pin-up space. Work in some Western decorations and you'll have a room the boys will enjoy for years.

Free plans with detailed construction helps are yours for the asking. Just send the coupon. Get Seadrift, Peg-Board and Masonite's many other sturdy hardboard panels at your lumber dealer's.

©Masonite Corporation—manufacturer of quality panel products.

MASONITE[®]
PRODUCTS

MASONITE CORPORATION
Dept. PM-4, Box 777, Chicago 90, Ill.

In Canada: Masonite Corporation, Gatineau, Quebec
Please send me a free plan of the "Cowboy Corral" and more information about Masonite panels.

Name.....

Address.....

City..... State.....

Zone..... County.....

Aluminum Living
is maintenance-FREE

with
nichols
NEVER-STAIN

ALUMINUM trellis

to accent the Beauty of your Flowers



- RUSTPROOF — lasts indefinitely
- Never requires painting — maintenance-free
- Attractive "LUSTRE-BRITE" silver-like finish accents beauty of flowers and vines
- Reflects sun's heat and provides numerous surfaces for vines to grip
- Easy to put up — complete instructions in each package
- Ideal for interior treatments such as room dividers, etc.
- Available in 10 ft. and 25 ft. packages complete with hardware. Look for the red-white-blue displays at your favorite store.



ALUMINUM grass stop

for the neatest lawn in your neighborhood



- RUSTPROOF—lasts for years and years
- NEW "safety edge" makes installation easy — no sharp edges. No joints or clips.
- Ideal for use around trees, shrubs, sidewalks and driveways
- Substantially reduces tedious lawn work
- Won't interfere with mowing
- Available in 40 ft. coils in 4" and 8" girth



ALUMINUM clothesline



- RUSTPROOF — lasts indefinitely
- Once up — always up, summer and winter
- Will not rot, rust, chip or crack
- Solid or stranded in 50 ft. and 100 ft. coils

nichols WIRE & ALUMINUM COMPANY
DAVENPORT, IOWA



(Continued from page 224)

A—You cannot safely prune the vine, that is, cut away excess canes during the period of seasonal growth. It will "bleed" badly. Wait until it is dormant, which is during the winter months. Then it will be possible to cut away whatever is necessary in order to remove it from the trellis and train the canes and shoots to grow on the new arbor. In this we are assuming that you wish to train the vine for ornamental growth rather than for maximum fruit production. Because of this it generally is best to remove only the canes necessary to release the vine from the existing trellis, rather than cut it back to the four-cane systems which are a common practice in commercial vineyards.

Planting Dormant Shrubs

Q—I sold my home last fall and at the time I dug and stored several choice shrubs. I was careful when digging to remove as much of the root systems as possible and succeeded with a minimum of damage to each shrub. They were, of course, stored when dormant and now both bark and root systems appear to be in good condition. Now I'm wondering when is the best time to plant them. Is there a special time in the spring months when soil and temperature conditions are just right for planting? — E. N., Wis.



A—You did not say what kind of shrubs you refer to, but in general most dormant shrubs of the common ornamental varieties can be planted in the spring with a good chance of success. As a rule they should be planted as soon as the soil can be worked readily and special care must be taken to prevent the newly worked soil from drying out and thus injuring the root system. Usually it's a good idea to cover the freshly dug earth over the roots with 1½ to 2 in. of peat moss. In replanting shrubs in this manner it usually is best to set the trunk slightly lower than it was originally. Fill the hole with clean soil, pack it lightly, then water and after settling, fill the depression flush with the level of undisturbed soil with peat moss. Keep this damp until growth starts, and water as required.

Top-Dressing Lawn

Q—My lawn is rather rough, low spots here and there, and I suspect the soil is not too good. The grass is poor, a thin stand and lots of weeds. The weeds I can eliminate but I'm wondering about the turf. I had thought of top-dressing with black soil as a first step in rebuilding. But should I reseed before top-dressing, or after? How do I prevent the top-dressing from smothering the existing grass? When does one apply fertilizer? — M. E., Ind.



A—Top-dressing a poor lawn is a good first step in improving it. Usually it's best to wait until after growth starts in the spring (top-dressing also can be done in the fall) and at the first mowing, cut the grass shorter than usual, about 1 in. Then rake and seed and apply a fertilizer especially compounded for lawn grasses. Sprinkle lightly to assure that both seed and fertilizer reach the soil, then wheel the top-dressing material onto the lawn and dump in small piles equally spaced over the whole area to be treated. Then use the back of the rake to spread the material to a uniform thickness over the lawn.

How to get summer air conditioning out of your warm air heating system



Use present furnace register and ducts



Add new Lennox air conditioner (installs anywhere)



Cool your whole house (every room of it)

You can do it for cigarette money with the new Lennox Stowaway Air Conditioner... now available for custom-installation by your local Lennox Comfort Craftsman

Remarkable engineering break-throughs by Lennox, world leader in the science of conditioning air, have led to a new *whole-house* air conditioner that hooks right up to furnace ducts and registers.

It's the new Lennox Stowaway air conditioner, and it costs no more over the years than you spend on cigarettes—even if your family smokes as little as two packs a day.

NOT ONLY FOR WARM AIR SYSTEMS!

If you don't have a warm air heating system, installation is still economical—in an attic, basement or crawl space; or outside on a roof or concrete slab. Air-cooled, the Lennox Stowaway requires no plumbing, no water tower, no expensive wiring. Simple ductwork is all that's needed with hot water, steam or radiant heat; a space heater, wall heaters or floor furnace.

Operating cost is amazingly low. The Lennox Stowaway uses as much as 40% less electricity than many other air-cooled air conditioners of similar

capacity. Two compressors assure a constant balance of temperature and humidity—one for normal cooling, the other for extra-hot spells. Lennox Stowaway units of 2-ton, 3¼-ton capacities—also 5-ton single-compressor model—are now available for custom-installation.

BUY NOW ON EASY PAY PLAN

Call your Lennox Comfort Craftsman, listed in the Yellow Pages. He's factory-trained, deals directly with Lennox, has a factory service team on call for special problems. He'll be glad to give you a free air conditioning estimate.

CAN YOU QUALIFY AS A LENNOX COMFORT CRAFTSMAN?

Opportunities open in some localities for heating and air conditioning specialists who can meet our high standards. Write: Lennox, Marshalltown, Iowa.

More families buy

LENNOX



world leader in all-season

air conditioning for the home

© 1957 Lennox Industries Inc., Heating and Air Conditioning, founded 1895; Marshalltown and Des Moines, Ia.; Syracuse, N.Y.; Columbus, O.; Decatur, Ga.; Ft. Worth; Los Angeles; Salt Lake City. In Canada: Toronto, Montreal, Calgary, Vancouver

Looking for Something?



SPORTING
GOODS

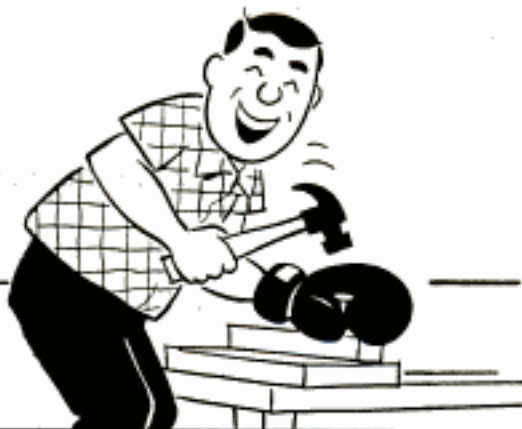

FROM HARDWARE
TO SPORTING GOODS
whatever you need-

Find It Fast
In The
Yellow Pages



Ads with this emblem make your shopping easier

PM's Landscaping Plan For the Small Yard

(Continued from page 151)

strips of $\frac{1}{4}$ -inch hardboard to keep the sand in place. After several seasons the lumber and hardboard will rot away and the earth will be packed firmly enough so the sand will stay.

Planting boxes and sand boxes shown on the plan are made by using two by sixes or two by eights on edge. The inside and bottom edges are coated with liquid asphalt to protect the wood. Creosoted or pressure-treated lumber would be even better.

When the patio was finished we planted grass in the "frame" of the yard. Golden Vigoro assured a healthy lawn with a high-quality grass seed that was a Merion-blue combination. Fast-growing grasses in the mixture gave us a fairly quick lawn and protection for the slower-growing Merion varieties. Depending on the area of the country, the correct grass seed could be any one of a number of varieties. The Vaughan Seed Company provided the seed, as well as all trees, shrubs and plants for the yard.

When working with any landscape architect in any part of the country you will find that he probably insists on working with a nursery such as Vaughan's for a number of reasons: The large variety of plants and stock available, assurance of healthy stock that will grow in a particular area and a guarantee of replacement of stock.

Building the fences, installing the patio and planting the grass required a full summer. Trees and evergreens were planted in the fall. Here another advantage of working by a plan became apparent. Time and money can be budgeted so that a certain portion of the landscaping can be done each year for a number of years. The yard is attractive at all stages, and you have the knowledge that the finished yard will be an integrated whole.

My wife started planting flowers and bulbs the first year, so that the following spring tulips and crocuses came up almost as soon as the last snow melted, filling the planting boxes and flower beds with color early in the year.

The next step was to build the storage wall. The same radial saw that had cut all the bricks now had a change of blades and the storage wall was constructed quickly. I used standard building procedures: Wall studs and roof joists on 16-in. centers, as were the floor joists. Because the wall was only six feet wide, two by fours were used

(Continued to page 230)

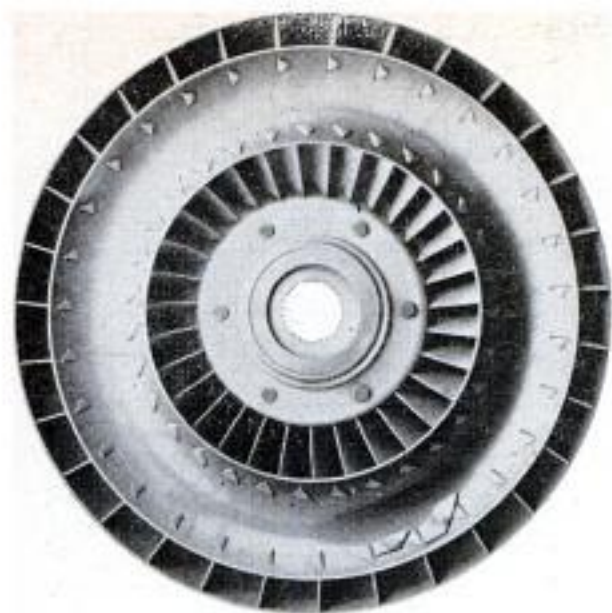

X-RAY ON CHEVROLET

TURBOGLIDE: forecast of the future

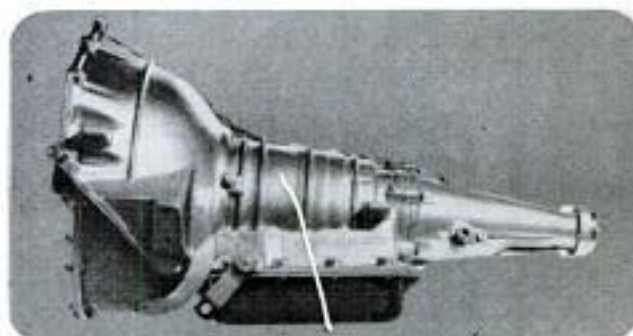

You don't have to look on the drawing boards—the answer is plain in any Turboglide-equipped 1957 Chevrolet. Here is tomorrow's drive, with an absolutely shift-free sweep of power, smooth as a plume of steam. Here is a quadrant that doesn't say "LO"—because there is *no* auxiliary planetary gear system needed. Here are *three* turbines for full-torque take-off, brilliant passing power and ultra-thrifty cruising. Here is the finger-flick Hill Retarder for safer slowing on grades . . . all this in a transmission that weighs 30 percent less than any other automatic drive (thanks to the largest production aluminum die casting in the world), with fewer parts, far fewer external openings and absolutely no delicate automatic shift valves. It's an engineering triumph—because it moves without a hint of mechanism. Try it and see! . . . *Chevrolet Division of General Motors, Detroit 2, Michigan.*

take the
MAXAW
to the job

...take the
job to the
MAXAW

"at home"
ANYWHERE!

Cummins
MAXAW®

makes all cuts in 2" dressed lumber!

BALANCED HAND GRIP
gives "feel" of hand saw!

EXCLUSIVE TRUE
COURSE GUIDE
keeps blade on line,
cut open.

TELESCOPING SAFETY
GUARD — with snap-back
action... oversize
safety level.

CLUTCH-LIKE BLADE ACTION
eliminates kickback, prevents
blade or motor damage.

FULL SIZE SAW SHOE
no wobble, calibrated
for short cut-offs.

BLADE SIGHTING SLOT
see cut without straining.

INSTANT CALIBRATED
BEVEL ADJUSTMENT
for accurate 0° to
45° angle cuts.

PEDESTAL BASE
simplifies blade changing.

MAXAW 717... \$4995

6 3/4" blade cuts 1 3/4" @ 45°, 2 1/4" @ 90°. Quickly inserted in table becomes tilt-arbor table saw — equals standard 8" table saw!



\$39.95

MAXAW 777 SAW TABLE

Steel construction, 24" x 20" oversize top. Cam Lock rip fence guide, calibrated miter gauge, convenient switch, outlet box. 46 lbs. without saw.

FOUR MAXAWS TO CHOOSE FROM — \$49.95 to \$84.95. For complete details write:

Cummins Portable Electric Tools

5055 N. Lydell Ave., Milwaukee 17, Wis.

Made by *John Oster* MANUFACTURING CO. © 1957 I.O.M.C.
Prices slightly higher in Canada.

throughout. The building is placed on railroad ties for a foundation. To simplify construction and assure strength, four by four-foot sheets of 1/4-inch hardboard were nailed directly to the studs and all joints covered with wood battens. The battens provide a pleasing pattern and the few joints resulting from the use of hardboard sheets offered little trouble. Sliding doors were used in the storage wall to avoid the problem of a swinging door clearing the planting box. Also the doors were made larger for easier entrance with bulky items such as chairs and tables. Old roller skates were screwed to the tops of the doors and run on two wooden tracks. The doors themselves are frames of one by two stock on edge covered with sheets of hardboard. The roof of the storage wall first was covered with asphalt-impregnated sheathing, then sealed with graveled roll roofing of a pleasing shade of green. Lime yellow was the color chosen for the wall itself. Bright colors are another feature of modern landscaping, and definitely add to its beauty and cheerfulness. While I was building the storage wall, and my wife was putting the "pictures into the frames" by planting flowers, Dick and Dana did their share of landscaping by planting and tending the salad garden behind the storage wall. The yard is designed to be enjoyed by the family, and the more each member can participate in its construction and maintenance, the more it fulfills its most important objective: Being a place for the family to have fun.

Dick and Dana take turns having friends over to play in the playhouse end of the storage wall. The six-foot-square room can be anything from a palace for the queen to the control room of a moon-bound rocket. Cutting the playhouse door in half horizontally solved a number of problems. The lower half opens out and is beneath the window. The upper half opens in, and is high enough to clear the tops of bicycles stored here. The door could not be hinged to open outward, since it then would project into the passageway. Lights for the playhouse, as well as the workshop and the rest of the storage wall are provided by an underground cable from the house to a fuse box in the workshop. Lights are wired from the fuse box.

More trees, evergreens and shrubs were planted as time and money were available. The studio—which could be a home office or workshop, depending on circumstances—was delayed a year when the children's swimming pool was found to fit its location so neatly.

When the back yard was well along the

(Continued to page 232)

THE WONDER PAINT REMOVER

Strypeeze strips all finishes - fast, safe, easy



Whatever you refinish, let Strypeeze do the hard work for you. Harmless to hands or wood. Available at paint and hardware stores everywhere.



Easy. Just brush on and watch Strypeeze go to work on shabby furniture, floors, woodwork!



Fast. Str - r - i - p - p - p! Cuts deep through every layer - even on vertical or curved surfaces.



Kwikleeze cleans all brushes fast! Even the hardest brush softens in a jiffy with KWIKLEEZE. No rinsing, no mess. Perfect for all bristles.

SAVOGRAN, The Remover Corporation of America

SAVOGRAN

Dept. 404, 25 Huntington Ave., Boston, Mass.

Please send me new illustrated booklet, "How to Remove and Restore All Finishes". Enclosed find 25¢.

Name _____

Address _____

City _____ Zone _____

State _____

way we moved operations to the front yard. The original S-shaped sidewalk that had split the yard in two was torn up and replaced by a walk as designed by Klopp. The new walk gave the yard the appearance of greater size, and is dimensioned so that people entering or leaving an automobile step directly onto the walk no matter where the car is parked. Note also that the end of the drive touching the back yard has a walk so that groceries carried from a car can be delivered directly to the back door of the house.

The planting box in the front of the house required a concrete foundation, formed simply by digging a ditch below the frost line and pouring it full of concrete. Ampress red bricks were used for the planting box, being mortared together. For an added touch of color, the lower part of the wall was painted a bright coral red to match the front door. Gray Ampress brick used for a cap on the planting box were left natural color.

After two years of hard work we have a beautiful yard with a patio that is ideal for outdoor parties in the summer. In winter we bank the edge with snow, flood it and have our own ice-skating pond. Our children have a playhouse and readily accessible storage for their bicycles. Because ground cover is used in many areas of the

yard, very little weeding is required. The mowing strips keep grass maintenance to a minimum, and my wife has fun with her flowers from early spring to early winter. I have a workshop and soon will have an office of my own. Later will come the carport; a few two by fours and some hard-board sheets will make it an easily built, inexpensive and attractive structure. The value of our home has been increased considerably. But most important, my family had fun doing the job and we continue to have fun using the yard for what it was designed to do—bring pleasure to the whole family the year 'round. ★ ★ ★

Scientist Is "Guinea Pig"

To see how much ozone a man could stand, Dr. Hans-Georg Clamann, U.S. Air Force physiologist, breathed eight parts of ozone to one million of air for one hour in a controlled-ozone chamber. His lungs became irritated and began to fill with fluid. His breathing was cut to 50 percent capacity. His sense of smell was impaired. But he survived. Safety level for humans working with ozone in industrial applications is considered to be $\frac{1}{10}$ part ozone per million parts air. The Air Force is interested because future pilots will encounter ozone layers.

IT'S SUPER, SUPER... I'LL AGREE!

AND THANKS FOR ASKING BUT, YOU SEE...

SMELLS GRAND!
PACKS RIGHT!
SMOKES SWEET!
CAN'T BITE!

A PIPE SMOKING MAN ALWAYS WINS WITH ME!

IT'S SIR WALTER RALEIGH—NATURALLY!

SIR WALTER RALEIGH'S BLEND OF CHOICE KENTUCKY BURLEYS IS EXTRA-AGED TO GUARD AGAINST TONGUE BITE.

FREE!

24-PAGE BOOKLET ON PIPE CARE. JUST WRITE TO: SIR WALTER RALEIGH DEPT. 124-D LOUISVILLE, KY.

IF YOU *"like to get under the hood . . ."*



*you can get a great training . . . and
start a great future . . .*



in the **U.S. AIR FORCE!**

Your talent with engines—or any mechanical ability—can pay big dividends, when it is backed up with solid training. And that's what you get when you serve in the U. S. Air Force. The Air Force offers you opportunities to learn one of over 40 career fields—training that will stand you in good stead, wherever your future may lie.

Start developing your valuable talents today—and go places *faster*—in the U. S. Air Force. See your local Air Force Recruiter—or mail the attached coupon.

M-79-PM3

Paste Coupon on Postcard and mail to:

Airman Recruiting Information Branch
Box 2202, Wright-Patterson AFB, Ohio

Please send more information on my opportunities for enlisting in the U. S. Air Force. I am between the ages of 17-34 and reside in U.S.A. or possessions.

NAME _____

ADDRESS _____ AGE _____

CITY _____ ZONE _____ STATE _____



Can you match the HARLEY-DAVIDSON **HUMMER?**

This is the season you'll want to go more places, do more things. On a Hummer travel to work or play is fast, safe, fun — and so inexpensive!

100 miles to a gallon

One gallon of fuel takes you up to 100 miles . . . tire wear, service costs are negligible. Depreciation is unusually low.

So easy to own

After a small down payment, you can own a Hummer for only \$17 per month — and that includes fire, theft and collision insurance; local taxes; freight and carrying charges. Hummer owners everywhere hail this economical fun-filled way to avoid that daily traffic struggle.

Call now for details

Call the dealer listed in the classified section of the phone book or write direct. No obligation, of course.

HARLEY-DAVIDSON MOTOR COMPANY
Dept. P, Milwaukee 1, Wis.

The Voice of Emergency For War or Peace

(Continued from page 116)

necessity of having a standard radio playing constantly in the office. When the Sig-alert sounds off, it is an emergency.

The same is true with taxi fleets. And many big industrial and utility firms are installing Sigalerts as a service for the workers and as selective-calling systems.

Consider, also, what a Sigalert receiver means to newspapers and newsreels. And let's not forget old John Q. Citizen—he's the one who installs short-wave radio sets in his home and listens to police calls. Sigalert gives John Q. a new set to listen to—one that speaks with authority and really says something when it does speak. John Q. can get the news first.

The broadcasters' cooperation in the airing of bulletins has been amazing. Network shows have been cut into without a moment's hesitation—and the average time for broadcast of a bulletin is two minutes from the instant it is first flashed until it has been delivered to the public.

Another feature of Sigalert which makes it so valuable in event of emergency is that while it is designed to operate from regular electric current, in the event of power failure it can switch automatically to battery. Thus, it is not dependent on any ground lines. This feature has endeared it to Civil Defense authorities.

Sigalert is in daily use on the crowded highways and freeways in and around Los Angeles. Motorists are kept informed of any serious accidents or other traffic pile-ups on their way to or from work, thus enabling them to take evasive action and skirt the snarled and congested area.

And now many big corporations are installing Sigalert receivers as a service to their employees. The bulletins are monitored and played over the plant public-address system, thus saving workers a lot of headaches commuting through difficult areas.

In addition to his radio-station duties, Sigmon is president of Federal Electronics Corporation, Los Angeles, which makes the Sigalert receivers. This set is in a metal case about nine by seven by eight inches. It is plugged into an ordinary light socket to operate and a window screen can be used for antenna.

The set is fix-tuned and left on, so it is next to impossible to miss a bulletin—especially in view of the fact that it is a simple matter to attach a tape recorder to the little receiver. Plans are in the works for a smaller set in a plastic case, especially

(Continued to page 236)



introducing the new
**CRAFTSMAN JET ACTION
 PROPANE TORCH**
 with **PUSH-BUTTON
 Flame Control**

**FROM
 THIS**

**TO
 THIS**

**AT THE TOUCH
 OF THE BUTTON**
 Instant Flame Control
 for maximum fuel economy
 and greater safety.

TILE SETTING



Jet Action Torch and Accessories

Now only 995
COMPLETE

The new Craftsman Jet Action Propane Torch Kit with the disposable fuel cylinder, pencil burner head, and soldering tip plus push button control is just the ticket for hundreds of jobs around home or shop from soldering to lighting your charcoal broiler. Items sold separately total over \$13.50. It's a real savings during this sale.



**Press Button -
 LARGE FLAME**
**Release Button -
 PILOT FLAME**



includes:
 Pencil Burner Head for
 Fine Work and Handy
 Soldering Tip

S-377



CRAFTSMAN Hand and Power Tools by **SEARS, ROEBUCK and CO.**
 Famous for fine quality . . . precision performance . . . low price!

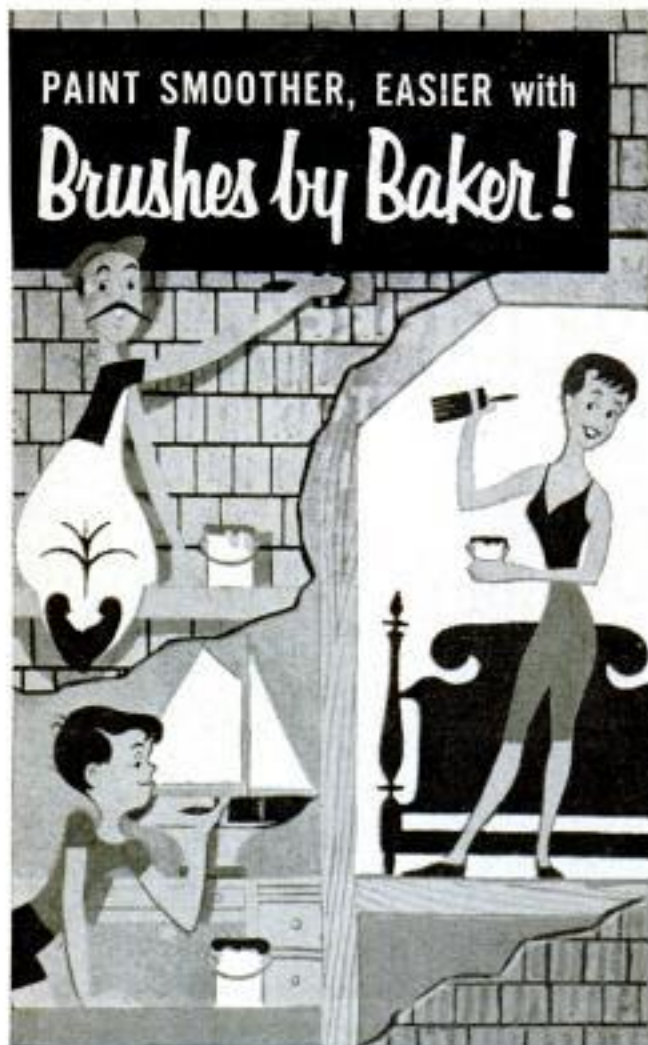

PAINT SMOOTHER, EASIER with
Brushes by Baker!

Use Baker Brushes and paint easier, faster, better! Enjoy smoother painting, use fewer strokes, get more coverage. Next time you paint choose the right Baker Brush size most practical for the job.



learn
to paint
like an
expert . . .

Free booklet tells "HOW TO DO A GOOD PAINT JOB." Today, send card to Baker Brush Co., Inc., 83 Grand Street, New York 13.



**BRUSHES BY
BAKER**

AMERICA'S FINEST PAINTING TOOLS

for use at home by the private citizen. Within a few years it is conceivable that every home may be equipped with a Sigalert receiver—particularly if Civil Defense regulations are tightened up.

Another phase of the Sigalert operation which is attracting the notice of industry and utility-service facilities is its adaptability to a selective-calling system.

A crew of trouble shooters could be assembled simply by flipping a switch and giving the message—instead of making dozens of phone calls with the familiar delays of busy signals and wrong numbers. Sigalert gets the right number every time.

Although Sigalert is a radically new electronic development, it now is taken for granted by southern Californians. They have grown used to the Sigalert operation; they expect and depend upon the service it renders just as much as they expect a dial tone when they pick up their phones.

This has come about because Sigalert, utilizing for the most part existing facilities, has proved its worth time and time again in fire, flood and disaster and in the humdrum but vital daily jobs of traffic control and smog warnings.

And, best of all, it hasn't cost the taxpayers a dime!

★ ★ ★

Electronic Typewriter

Electronic tabulation on electric typewriters is making the filling-in of forms much easier. Eliminating tabulation-stop adjustment, an electronic "reading" unit automatically halts the typewriter carriage at the correct typing point in response to electrically sensitive ink lines printed on the form. The reading unit is three by six inches and is mounted under the typewriter keyboard. To change from straight typing to form typing, the secretary flicks a lever activating the reading device.



Here's the **BIG** **DIFFERENCE**

in HEADLAMPS today!

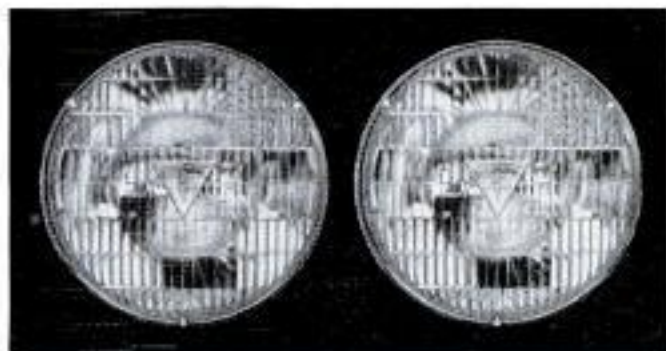

NOT THE POWER!

All headlamps built today "see" farther down the road, because the power has been increased by a full 10% on the high beam. Objects that formerly blended with the background should now stand out in bold relief. STILL, POWER IS NOT THE BIG DIFFERENCE!

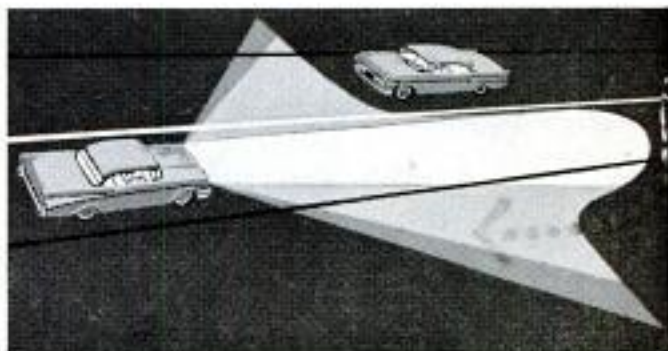

NOT THE LIGHT PATTERN!

More "seeing distance" along the right side of the road is another big industry advance. On the lower beam, you see farther (eighty feet farther) than was ever possible before. This means, of course, more light on the right. YET, PATTERN IS NOT THE BIG DIFFERENCE EITHER!



BUT, THE AIM!

Power and pattern are unimportant unless headlamps are properly aimed. Only Guide gem-grinds three reference points, or "Guide Points", into each lens, providing positive aiming accurate within a few thousandths of an inch. TODAY, PERFECT AIM IS THE BIG DIFFERENCE IN HEADLAMPS!

Standard equipment on all General Motors cars and trucks.

GM **GUIDE**

Buy In Pairs

Where You See



AC SPARK PLUG  THE ELECTRONICS DIVISION OF GENERAL MOTORS

APRIL 1957

T-3

Safety-Aim

HEADLAMPS

237

At Last!

**A "TOOTHLESS" PLIER
THAT GRIPS
WITHOUT GOUGING**



CHANNELLOCK

No. 415 Smoothjaw PLIER

Just
The Thing
For Chrome
Fixtures and
Fittings



One of the handiest tools you'll ever use . . . the new "toothless", smooth-jaw plier that grips without gouging. Just the ticket for gripping chrome-plated fittings, plastic, wood and other smooth surfaces. Especially handy on chrome sink-fixtures and other hard-to-handle jobs. Jaws quickly adjustable to full 2" opening. Get yourself a Channellock No. 415 Smoothjaw Plier. You'll find it's "the right tool" on scores of jobs in home and shop.

**Ask Your Hardware Man For A
CHANNELLOCK Smoothjaw PLIER**

MADE ONLY BY

**CHAMPION DEARMENT TOOL CO.
MEADVILLE, PENNSYLVANIA**

Tapping the Devil's Cauldron for Power

(Continued from page 139)

pressure to hold the steam down for a while." These holes must have much more substantial wellheads and valving than oil wells. No less than 100 tons of concrete are poured at the wellhead to hold the pipe steady when nearly one million pounds of steam and water per hour come gushing through it.

Ground Shakes and Thunders

Drillers know that things are about to happen when the bottom temperature begins to soar and the mud coming out of the hole is boiling. Even when drenched with cold water, bits come up searing hot from bores that log temperatures from 300 to 500 degrees F. Underlying "base" rock is estimated to run between 1300 and 1800 degrees F. The ground for miles around thunders and shakes when a bore comes in. First out is a towering cascade of water—and everyone runs for cover. Steam mixed with mud spews from the hole to heights of 500 feet or more. With an explosion like the boom of heavy artillery, the fireworks begin. A roaring cascade of red-hot rocks is fired skyward like a small volcano. The rocks explode in mid-air with a high-pitched crackling noise as they emerge to atmospheric pressure. The eruption may last for days. "When our first 6-inch bore was uncapped in March 1951," recalls Fooks, "she spewed rocks and debris 600 feet high for more than 2 days, kicking 500 cubic yards of material out of the earth's innards."

Pressure Flings Pebbles Skyward

More recently, a 3000-foot bore shot hot pebbles and pumice skyward for three days. The temperature at the bottom of the hole, just before the drill train was pulled, measured 512 degrees F. The steam came at a pressure of 400 pounds per square inch. Most of the bores at Wairakei go down 2000 or 3000 feet, with wellhead pressures of about 300 pounds per square inch wide open. Wellheads are capped with massive valves that are opened when a bore comes in. The hole is permitted to spew vertically until it has blown itself clean; then the top valve is shut and the steam is diverted to a horizontal pipe with a muffler on the end. After tests are made, it is shut down to await connection with the 20-inch insulated main line that will feed it to the generators. "One 8-inch bore," says Fooks, "came in with such tremendous pressure we couldn't shut the valve. It may have

(Continued to page 240)

NEW AP "DRI-FLOW" MUFFLER DESIGN SLOWS RUST-OUT AND CORROSION, LASTS LONGER

In this test the new AP "Dri-Flow" model and a muffler of earlier design were installed on an engine dynamometer. Four candles were placed on the mufflers, and the engine was run at a driving speed of 25 mph for a period of 10 minutes. The melting candles show heat distribution.

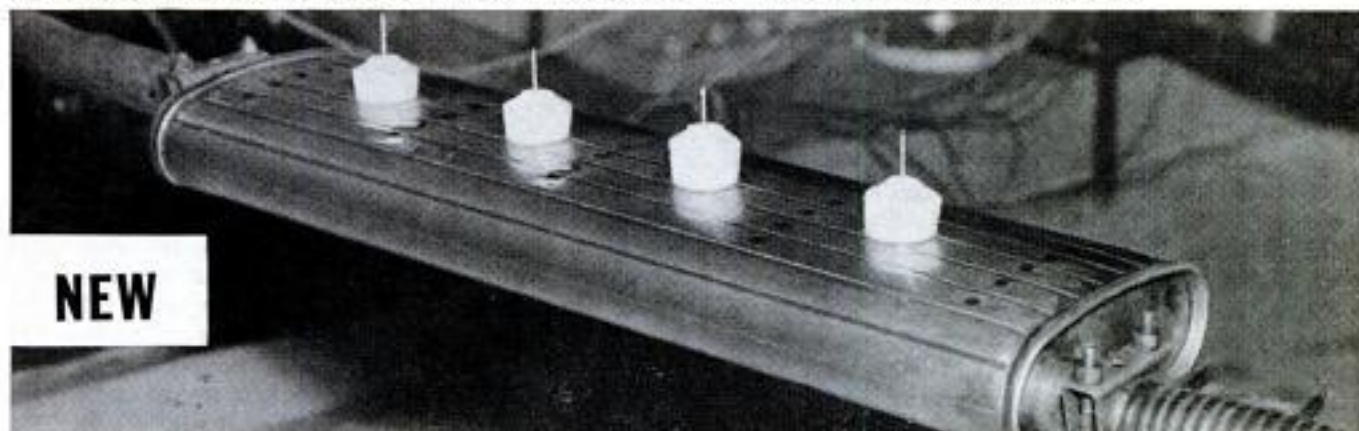

NEW

New AP "Dri-Flow" Design has uniform heat over its entire area, as shown by the evenly melted candles. Keeping all chambers at the same heat eliminates cold spots where excessive corrosive moisture collects. This new design, latest example of AP leadership, insures a much drier muffler. And with AP's heavier steels, this means an even longer-lasting muffler.

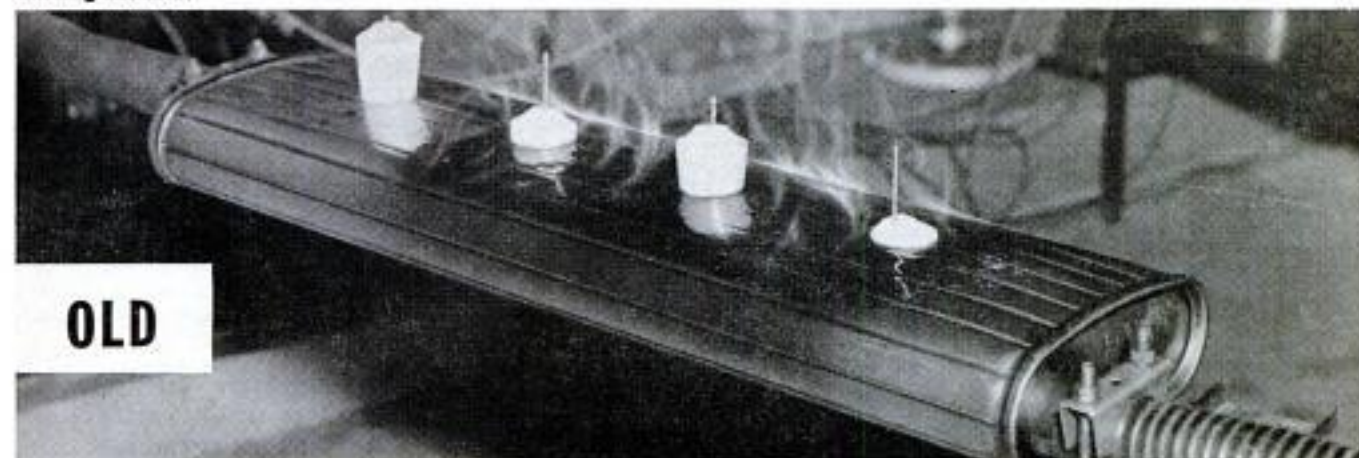

OLD

Hot-spot, cold-spot design of most mufflers, including this earlier AP model, is shown by the unevenly melted candles and the heat-darkened areas. Corrosive moisture from the exhaust fumes condenses in the cold spots, while the hot spots tend to burn out metal. This combination attacks mufflers from the inside, results in short life. The new AP design greatly increases muffler life.

Short muffler life has become a major problem on millions of late-model cars. To solve this problem, AP makes a much stronger muffler. For years, AP mufflers have had up to $\frac{2}{3}$ heavier heads, $\frac{1}{3}$ thicker shells. And many have asbestos liners or corrosion-resistant aluminized and zinc coated steels. Now the new "Dri-Flow" Design, which cuts down rust-out and internal corrosion, is on more than 50 popular numbers, and is being added to others as fast as production permits. Insist on AP mufflers for this unbeatable combination: longer-lasting inside, longer-lasting outside.

You can depend on AP mufflers for longer life, more power, better gas mileage, surer protection from carbon monoxide. And remember, *they cost no more!*



Look for the sign of the AP Muffler Specialist in your neighborhood today. You'll find him a good friend to your car.

THE AP PARTS CORPORATION

14-Q AP Building, Toledo 1, Ohio

Mufflers and Pipes • Miracle Power • dgt 123

AP Longer-Lasting Mufflers—Designed for Today's High-Compression Engines

been damaged by rocks during the blowout. Men, working with ears plugged and muffed, had to go into the wellhead pit and weld a new 10-inch section with a heavier valve over the open hole."

Magma Pushes Upward

Backgroundwise, our planet's core is believed to be a white-hot mass of matter called magma, with temperatures soaring above 7000 degrees F. In most places an impervious crust of rock and sediments 50 miles thick insulates us from this furnace. In a few places, however, the crust is weak and still "settling." Great cracks form. Through these cleavages, magmatic masses are squeezed upward. As pressures lessen, the magma liquefies into lava, which may burst through to the surface. If so, a volcano is born. More often it is trapped deep in the crust, and the proof of its presence is seen in volcanic steam, geysers and hot springs. Steam also may come from surface water seeping down through fissures until it reaches the lava, where it is superheated and driven up by its own pressure. Many scientists believe there is also a "magmatic steam" from water in molecular form which is present in rocks and actually may be part of the magma itself.

No two wells are likely to produce exactly the same type of steam. Nor is it

"pure." Wairakei's steam is laden with hydrogen sulfide, carbon dioxide, silica, salt and "wetness." Wet steam with impurities will corrode turbines quickly, so New Zealand engineers have had to pipe their steam through "U" turns that whip off some of the water, then feed it through centrifugal driers to remove the rest. "It's an expensive, complicated process," Fooks reveals, "but it still gives us power at about one cent per kilowatt, about the same as hydropower and half the cost of using coal."

Steam Develops Power

Already steam enough to develop 100,000 kilowatts of power is roaring away in Wairakei's smoky valley. Two rigs are working around the clock, each putting down an eight-inch bore every six weeks. Each bore is producing steam capable of turning up another 5000 kilowatts of electricity. Next year, the initial powerhouse will start pumping 140,000 kilowatts into northern New Zealand's power lines. What makes New Zealanders happiest is the "continuous load" factor. Unlike hydroplants that drop to 60-percent capacity in dry seasons, or coal plants affected by strikes, volcanic steam goes screaming along at 100 percent of capacity year in and year out. Furthermore, Wairakei is

(Continued to page 242)



Built-in of Western Pine combines beauty, convenience

You can build this handsome cabinet easily, economically with Western Pine woods.

Soft-textured, even-grained, carefully dried, these fine woods fit any décor, modern or traditional. They are easy to work, take any paint, stain or enamel, or can be left natural, then waxed and rubbed to a satiny glow.

You'll find the Western Pines ideal for practically every building and remodeling project to *better your living*. See your lumber dealer for complete details.



FREE! New edition of bright ideas!

"FRIENDLY HOME IDEAS"—85 photographs, many in color, feature traditional and contemporary ideas for building, decorating and remodeling using cheerful Western Pines. Also new modern finishes. Write for your FREE copy to WESTERN PINE ASSOCIATION, Dept. 202-N, Yeon Building, Portland 4, Oregon.

The Western Pines

Idaho White Pine

Ponderosa Pine

Sugar Pine

and these woods from the Western Pine mills

WHITE FIR • INCENSE CEDAR
RED CEDAR • DOUGLAS FIR
ENGELMANN SPRUCE
LODGEPOLE PINE • LARCH

are manufactured to high standards of seasoning, grading, measurement

TODAY'S WESTERN PINE TREE FARMING GUARANTEES LUMBER TOMORROW

NEW!

MAGNA SAW-JOINTER gives you PROFESSIONAL CAPACITY!



ANOTHER
CREATIVELY
ENGINEERED
MAGNA-LINE
TOOL

THE NEW MAGNA Saw-Jointer combination gives you the finest 9-in. Saw and 4-in. Jointer ever made! It's the *only* tilt arbor saw with a built-in extension ("The Helping Hand") at no extra cost, giving you the largest (32" x 24") effective table on the market! Single-knob control — push for blade height, pull for tilt • Speed-gear control gives you 45° tilt with only 10 turns of knob (40 to 60 turns on other saws!) • Many other completely new, *creatively engineered* features! The big, heavy-duty MAGNA 4-in. Jointer operates at *any height* of saw blade! It has the longest (28") table, largest (21 $\frac{3}{4}$ " x 3") fence in its class • 3 high-speed,

safety-tapered knives are micro-adjustable • One-piece fence casting is far more rigid, larger!

You can even buy the Saw now and add the Jointer later, with the MAGNA Saw-Jointer Adaptor Kit!

\$199²⁰

(less motor)
Panels, Pistol-Grip,
Casters optional.

**YOU CAN OWN IT FOR
ONLY \$2.07 A WEEK!**



MAGNA POWER TOOL CORPORATION
America's Finest Power Tools

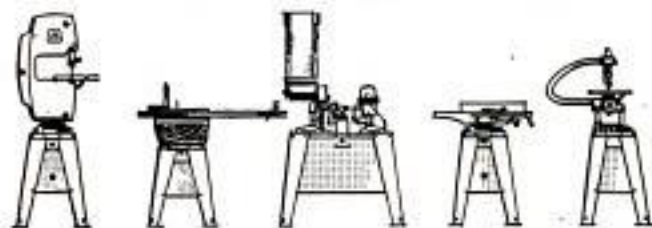

See these other all-new MAGNA-LINE tools: (l to r) 11" Band Saw, 9" Saw, 6" Belt Sander, Compressor-Sprayer, 4" Jointer, 18" Jigsaw.

MAGNA POWER TOOL CORPORATION

Dept. 807-M, at factory nearest you:
Menlo Park, Calif., OR Box 2808, Ft. Wayne, Ind.
*Please send me a free 16-page catalog describing the
Magna Saw-Jointer and the complete Magna-Line.*

NAME _____
ADDRESS _____
CITY _____
ZONE _____ STATE _____



... the world's most popular pipe wrench is the best one in your tool kit. At your nearest Hardware Store.



only one little 2-square-mile area in that 170-mile-long volcanic trough. Engineers know that dozens of other hot spots will prove equally suitable for power production. "We don't believe from what we've seen so far that the supply is exhaustible," says Fooks.

New Zealand is not the first country to use volcanic-steam power. Right after World War II, engineers developed a tremendous volcanic-power project at Larderello, Italy. Today, some 150 wells produce enough dry steam to develop more than 15 percent of all Italy's electrical power needs. Engineers at Larderello have found it necessary to keep drilling new wells, since the volume of steam does decrease, not because the infernal steam is giving out, but because fissures in the earth become caked with deposits from the steam and gradually choke off. New wells drilled within 100 yards of old ones come in with original force and volume, and have no effect on the volume of the old well nearby. With the supply of volcanic steam available, the electric station can generate 260,000 kilowatts of power. Also, in an effort to conserve chemical products in the steam, Italian engineers have recovered about 30 tons of sulphur daily. The steam is passed through dry boxes to remove carbon dioxide and hydrogen sulfide. The sulfide is reduced to elemental sulphur with iron oxide, and sulphur is extracted with carbon disulfide.

UN Assists in Drilling

Mexico already has parties in the field, investigating hot springs on the high central plateau under the shadow of Popocatepetl. Exploratory drilling with the cooperation of a United Nations technical-assistance program has resulted in a successful bore in Hidalgo, 80 miles north of Mexico City, and plans are proposed for a 25,000-kilowatt generating plant. Volcanic energy programs are gaining headway in the tiny Central American republic of El Salvador and on Britain's Caribbean island of St. Lucia. In Iceland—volcanic isle of fire, ice and virtually no fuel—subterranean steam has been used by inhabitants for 25 years to heat most of Reykjavik's homes, buildings and swimming pools.

Last February, the Magma Power Company announced that a test bore had been drilled by them in the Big Geyser area of California, 85 miles south of San Francisco. What came out of that hole set Magma to work on the first such power plant in the United States. If everything goes as planned, California soon will have a 100,000-kilowatt generating plant, operating wholly on volcanic steam. ★ ★ ★

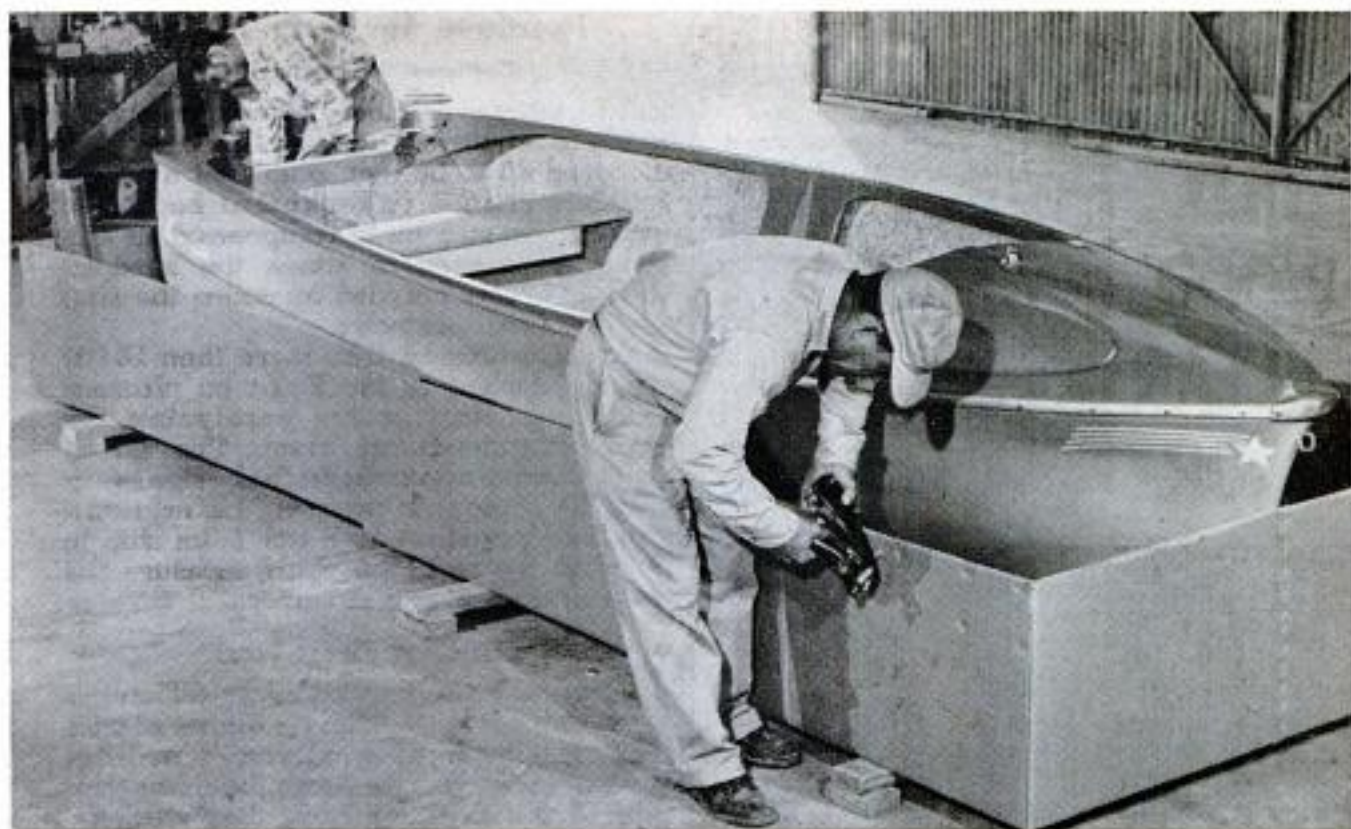

Lone Star boat travels shipshape in corrugated cartons fastened with Bostitch staples

Huge stapled carton cuts boat packing time 50%

Even in Texas, where you expect things on a grand scale, a corrugated carton big enough to hold a boat is big.

A Texas boat builder wanted to replace heavy wood crates for packaging 14-foot boats. He preferred the smooth surface of paperboard, so the boats' finish wouldn't be marred. But he had to have strength enough to support the boat's ¼-ton weight. Rugged Bostitch staples solved the problem.

The carton—biggest the box manufacturer makes—arrives flat with its center seam already securely stitched with a Bostitch stitcher. Then using Bostitch staples, boat packers form the corners and join the telescoped sections.

Finally, corrugated cushions are installed and bottom and top sections stapled together—all in *half* the time needed to nail a wood crate.

The boat company likes the Texas-size assembly and freight savings of stapled cartons. Dealers like the way stapled cartons protect the boats. Of 3000 shipments, 2998 arrived in perfect condition. The other two were only slightly marred.

Your fastening problem needn't be *this* big for big savings. 800 Bostitch models save time and money in home, factory and office.

A call from you will bring one of 375 Bostitch Economy Men located in 123 U.S. and Canadian cities, who will be glad to show you how.

**Fasten it better
and faster with**

BOSTITCH®
STAPLERS AND STAPLES

Bostitch, 544 Mechanic Street, Westerly, R. I.

- Please send me information on ways stapling helps shippers.
 Please send free bulletins that show how stapling cuts other costs.

I fasten: cartons leather wood rubber
 fabric plastic bags roofing light metals

Name _____

Company _____

Address _____

City _____ Zone _____ State _____

REPLACE YOUR

OLD WOOD CELLAR DOOR



WITH A MODERN ALL-STEEL BILCO DOOR

DO IT YOURSELF

IN JUST 3 TO 4 HOURS

Think of it! Only a few hours of pleasant work to replace your unsightly, troublesome wood hatchway with a lifetime, weathertight BILCO . . . the door installed on tens of thousands of new homes.

PAYS FOR ITSELF! Cost so little, yet never needs repair or replacement. Operates at a touch. Smooth, trim appearance adds amazing new beauty to your home.

Rush coupon TODAY for free folder "How to replace your wornout wood hatchway" showing sizes and prices.

Bilco®

**AMERICA'S FINEST
BASEMENT DOOR**

THE BILCO CO.
DEPT. 931C
NEW HAVEN, CONN.

Gentlemen: Please send me free folder and name of nearest dealer.

Name _____

Street _____

City _____ State _____

Reprieve for a Freighter

(Continued from page 124)

night, whenever there were favorable winds to create a ground swell. Some days it moved 40 to 50 feet, often not an inch.

Cables snarled or broke and had to be welded. Jet streams of compressed air and water were used to attack the hardpan clay. Workers crawled in under the ship to clear away obstacles.

Police estimated that more than 50,000 persons flocked to the Point on pleasant week ends, completely paralyzing the small, summer-resort town. The crowd cheered Admiral Curtis on the bridge every time the ship made progress. He acknowledged and even set up a line from ship to shore so his audience could measure the movement by white streamers.

Boulders Pierce Hull

Progress was slow and many difficulties were encountered. After a number of tries with no movement whatever, it was discovered that several huge boulders had pierced the *Etrusco's* hull; they stuck up through the bottom in number-two hold. Dynamiting was impossible, but frogmen eventually chained the rocks and they were pulled out by the ship's winches. Steel sheets and logs were placed underneath to give it more skid and roll. The giant kedge anchors had to be picked up and moved to different positions for more leverage.

The ship overshot the channel during one Sunday northeast storm and had to be jockeyed back on course.

Curtis did not have his customary audience the day the ship was finally set free. It was Thanksgiving Day and he munched on cold turkey sandwiches as the ship gave a polite curtsy on the first pull at high tide. Then she started sliding with ease. The ropes to the shore were sliced off and the *Etrusco* kept on going until she finally reached deep water.

Within an hour the "*Etrusco* Fan Club" arrived by the thousands and there was jubilation at Cedar Point.

At dusk tugboats took her in tow. The *Etrusco's* lights were turned on. She gave three blasts on her whistle and a course was set for Boston. She was nine months late in making port.

With the shortage of ships, the Suez crisis and the international situation, the value of the *Etrusco* has increased considerably since salvage operations began, and the owners expect to clear even more than \$1,000,000 for their efforts.

When the *Etrusco* again sails on the high seas she will proudly carry the new name of the SS *Scituate*. ★★★

New Feature-Loaded Power Mower Cuts Mowing Time in Half!



The
"RIVIERA"
Self-Propelled
Rotary

MOTO-MOWER®

Made by a famous producer of automotive components, Moto-Mower is mechanically the finest power mower ever built! Styled and engineered with the same care and precision as a fine sports car, these distinguished Moto-Mower power mowers include a long list of exclusive advancements which cut normal lawn mowing time in half, assure years of dependable, trouble-free service. There are 16 ultra-modern Moto-Mower reel and rotary models priced as low as \$59.95*—one tailored to fit your mowing needs exactly. Available at your Moto-Mower dealer's on easy payment terms. Send for full-color descriptive literature.



DIAL-A-MATIC® CUTTING-HEIGHT ADJUSTORS

Just press the Dial-A-Matic lever and change mowing heights in one second! No tools are required.

ENCLOSED TRANSMISSION DRIVE



In Moto-Mower self-propelled rotaries, modern silent worm-gear drive provides a variety of mowing speeds. No slippage; delivers full power to the driving wheels. Completely enclosed; no exposed moving parts.



ANTI-BENDING CRANKSHAFT CONSTRUCTION

On most models special cone construction at the blade end of the crankshaft guards against bending in case blade strikes large stones or other obstructions.

STAGGERED WHEEL DESIGN



New wheel arrangement prevents lawn scalping. High speed front discharge sprays cuttings evenly over a wide area; prevents "clumping", eliminates raking.



VACU-MOW BLADE DESIGN

Exclusive blade design and high blade speed provide an upward air current which lifts each grass blade erect for clean, even mowing. Gives lawns that "vacuum cleaned" appearance.



See the Sensational New "LAWNMASTER"

Not just a lawn mower but a precision mowing instrument—a professional, trimmer-type mower that mows lawns as smooth as a golf course putting green! Yet it's priced for the average home.

Find Your
Nearest Dealer
In The
Yellow Pages

*Fed. tax incl. Slightly higher in Far West and Canada.

Send for FREE Lawn Care Brochure

Moto-Mower Division, Detroit Harvester Co. (PM)
Richmond, Indiana

Please send, without charge, your new brochure on developing new lawns, caring for established lawns, with special tips on mowing, watering, types of grass—and a complete description of the 1957 Moto-Mower line.

NAME _____

ADDRESS _____

CITY _____ ZONE _____ STATE _____

\$10,000

NOTHING TO BUY! ENTER AT YOUR

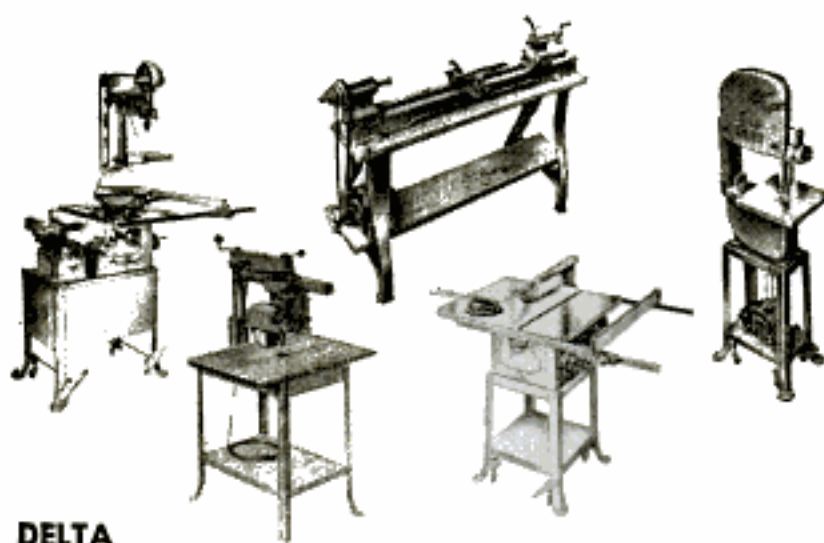

DELTA



BLACK & DECKER

1ST PRIZE

Your Dream Workshop!

Almost \$1300 in top quality merchandise! Winner gets (1) a Delta 11" lathe, 10" bandsaw and a complete "Deltashop"; (2) Black & Decker Orbital Sander, Jig Saw, Heavy-Duty Saw and $\frac{1}{4}$ " Drill; (3) your choice of \$100 worth of Stanley hand tools—saws, hammers, planes, etc; (4) your choice of \$350 worth of Weldwood plywoods, paneling, glues and finishing materials.

SECOND PRIZE—worth over \$700! Winner gets (1) a complete Delta "900" Radial Saw Workshop; (2) Black & Decker Orbital Sander, Jig Saw, and Utility Drill; (3) your choice of \$50 worth of any Stanley hand tools; (4)

your choice of \$250 worth of Weldwood products.

5 THIRD PRIZES—each worth more than \$330! Winners get (1) complete Delta 9" Tilting Arbor Circular Saw; (2) Black & Decker Heavy-Duty Saw; (3) your choice of \$50 worth of Weldwood products.

60 FOURTH PRIZES—each worth more than \$70! Winners get (1) Black & Decker Utility $\frac{1}{4}$ " Drill; (2) your choice of \$30 worth of Stanley hand tools; (3) your choice of \$25 worth of Weldwood products.

80 FIFTH PRIZES—each winner to get his choice of \$25 worth of Weldwood products.

(All prizes approximate retail value.)

ACT NOW! CONTEST CLOSSES MAY 31ST!

Weldwood® Old Craftsman

in Prizes!

LUMBER DEALER'S! 147 CHANCES TO WIN!



STANLEY

HERE'S ALL YOU HAVE TO DO:

Weldwood is offering \$10,000 in prizes—quality power tools, hand tools and Weldwood products—to introduce Weldwood Old Craftsman Pine Plywood. We want you to get to know this easiest working, easiest painting plywood ever! And all you have to do is go to your lumber dealer's—take a look at Old Craftsman Pine Plywood—pick up an Official Entry Blank—and, in 25 words or less, tell us "I like Weldwood Old Craftsman Pine Plywood because—"

If you buy Old Craftsman Pine Plywood, you'll discover plenty to like about it—for it combines all the advantages of pine lumber, with all of the advantages of rugged plywood construction. So don't delay! Get to your lumber dealer's now and see and try Weldwood Old Craftsman Pine Plywood. (If your dealer does not have entry blanks available, write to Old Craftsman, c/o United States Plywood Corp., 55 West 44th Street, N. Y. 36, N. Y.)



To tell you even more about Old Craftsman—and to make your next project easy to build—leading lumber dealers are offering this special book: "Projects You Can Build With Old Craftsman Pine Plywood." 96 pages. Full of hints and ideas; 18 projects with complete instructions. Build furniture, cabinets, built-ins, toys—easily!

LOOK FOR THIS LABEL ON EVERY PANEL



GET FULL RULES AT YOUR LUMBER DEALER'S!

Pine Plywood Contest

Now! Cover plywood edges with real wood



New Flexible **Weldwood Wood-Trim**

Avoid unsightly edges in building any plywood project—tables, desks, cabinets, etc. Give them a "pro" finish with Weldwood Wood-Trim. So flexible you can beautify any edge—straight, curved, angled. In handy rolls. Wood-Trim is a cinch to apply. No clamps, nails, hot iron, etc. Just use Weldwood Contact Cement or Presto-Set® Glue.

Countless Decorating Uses!

Trim lamp shades with Wood-Trim! Decorate picture frames! Smarten coffee tables, clocks, waste baskets, etc. 8 ft. rolls 1" wide, 89¢ ea. Oak, African Mahogany, Walnut, Birch, Fir, Korina®.

For perfect wood finishing jobs, use **FIRZITE®** and **SATINLAC®**



At hardware, paint, lumber dealers. Write for free leaflet to Dept. PM4-7WT.

®Trade Mark

UNITED STATES PLYWOOD CORP., Box 525, New York 46

Cadillac trim-tough- TERRIFIC!



Light, all-aluminum Cadillacs are care-free, give you extra hours on the water, extra speed per h.p. Extremely strong, they handle like silk, won't skid or trip on turns, can't sink. Buy Cadillac—you'll get more boat for your money! Write for free catalog—aluminum and molded plywood models for every sport.

CADILLAC MARINE & BOAT CO.
388 Seventh Avenue • Cadillac, Michigan

Who Ever Heard of a Diesel Engine?

(Continued from page 85)

passengers on the spur, ready for the next trip.

"Running a live steamer is fun," says Johnson, "but don't think for a minute that the engine is a toy. Far from it. The locomotive alone weighs 1250 pounds, the tender another 500 pounds. Drive wheels on the locomotive are 10 inches in diameter. Just like its prototype, the miniature engine has all the standard controls for the engineer to operate. These include throttle, reverse lever and air brake. There are gauges in the locomotive cab that show boiler pressure, air-brake pressure and the pressure in the reserve air tank. The reserve air supply is carried in a tank car behind the tender."

Rolling stock on the Goleta Valley Railroad includes half-a-dozen steel gondolas, a wooden gondola, a "beet" car and three flats. All have ball-bearing trucks; each is fully sprung; all have standard automatic couplers. Except for size they are true duplicates of actual railroad cars.

The Goleta Valley line is an outstanding example of a mechanical hobby that once had few enthusiasts but that is now growing rapidly in many parts of the world. Once it took special skills and know-how to build a small engine that would actually steam under its own power along a track; today almost anyone with mechanical ability and access to a few tools can build a live steamer.

The hobby is actually a kind of double-barreled pastime. First there's the satisfaction of building an intricate piece of machinery that works just like its prototype; then there's the thrill of operating the engine and listening to the "chuff chuff" of the exhaust and the roar of steam when the safety valve pops.

The smallest practical live steamers are built to 1/4-inch scale and operate on ordinary O-gauge track. Next is the 1/2-inch-scale class, using a 2 1/2-inch track, then the 3/4-inch-scale on 3 1/2-inch track, the 1-inch scale on 4 1/4-inch track, and finally the big 1 1/2-inch-scale models. The 1-inch scale is the most popular. An engine built one inch to the foot is large enough for easy construction and for riding on the tender comfortably, yet small enough to transport in an average automobile.

Down around Los Angeles the 120 members of the Southern California Live Steamers have built nearly 100 different engines and have some 60 more under construction. The club maintains its own layout with two main tracks, each with three

(Continued to page 250)

Glue-It-Yourself

with one of these

4 Weldwood® Wizards



Make sure you use the right glue for the job. Weldwood has developed four different types of adhesives to help you on any gluing job. Keep all 4 of these Weldwood Wizards handy at your workbench. They'll solve your gluing problems speedily, easily, successfully!

For gluing that boat of yours, use **WELDWOOD WATERPROOF RESORCINOL GLUE**



100% waterproof! Defies the elements! Use it for every gluing job that needs *complete protection* from climate, weather, water (even boiling, freezing or salt!), mold, fungus, etc. On boats, in damp basements, for outdoor furniture, or fixing golf clubs, etc., you can always depend on Weldwood Waterproof Glue.

¼ pts., \$1.00. Also available in pts., qts., gals.

Ready to use, for fast, all-around gluing — **WELDWOOD PRESTO-SET® GLUE**

Yes, ready to use; sets fast and glues like magic. Presto-Set is the Weldwood-perfected white glue that bonds any combination of wood, cloth, paper, fabrics, leather, etc. Odorless — and so clean to work with. New, easy-to-use plastic dispensers. 19¢, 29¢, 49¢ and larger.



For applying plastic surfaces without clamps — use **WELDWOOD CONTACT CEMENT**



Bonds instantly, permanently, on contact — without clamps or presses. Easy new way to surface table tops, kitchen counters, etc., with Micarta and other plastic laminates. Easy new nail-less way to install plywood panels. Scores of other uses in home, hobby, garage. 29¢, 40¢, 70¢ and larger.

For gluing wood joints like a pro — use **WELDWOOD Plastic Resin GLUE**

Powerful powder — easy to mix. Actually makes glued joints stronger than the wood itself. Favorite of top furniture-makers. America's most popular glue. Highly water-resistant, stain and rot-proof. 15¢, 35¢, 65¢ and larger.



Remember —

There's a special Weldwood Wizard for every gluing job. Ask your lumber, paint or hardware dealer... or mail coupon for FREE leaflets.

UNITED STATES PLYWOOD CORPORATION

Box 525 — New York 46, N. Y.

PM4-7G

Send me leaflets on:

- Weldwood Plastic Resin Glue
 Weldwood Waterproof Resorcinol Glue
 Weldwood Presto-Set Glue
 Weldwood Contact Cement

NAME _____

ADDRESS _____

CITY _____ ZONE _____ STATE _____

FREE BOOKLET



A man's mower
all the family
can use!



FAIRBANKS-MORSE '57 RIDING MOWER

Everybody in the family will want to mow the lawn if you own a '57 F-M rotary riding mower! It's fun! All you do is steer. Mower does the work. Gets you out of the sun sooner.

A 2 $\frac{3}{4}$ hp. engine drives 21" lift-type bar cutter through high grass with ease. Has 3 forward speeds and reverse. Cutting height adjustable. Cuts within $\frac{1}{2}$ " of walls, walks, etc. Equipped with silencer. Tires, 3" x 10" and foam rubber seat provide a comfortable ride. Finished in blue and chrome trimmed.



FAIRBANKS-MORSE

a name worth remembering when you want the BEST

MOWERS • MAGNETOS • MOTORS • SCALES
WATER SYSTEMS • GENERATING SETS • PUMPS
DIESEL LOCOMOTIVES AND ENGINES

Mail coupon for free booklet

Fairbanks, Morse & Co., Dept. PM-4, Chicago 5, Ill.
Gentlemen: Mail me your free junior power mower catalog, and name of nearest F-M dealer.

Name.....

Address.....

City..... State.....

rails so that the various gauges can be accommodated. The system includes a turntable from which radiate a number of steaming tracks that take the place of a roundhouse. On the steaming tracks the individual engines are fueled and watered and fired up before moving out onto the main lines. Sometimes it's hard to get a good fire going in a diminutive engine and often a vacuum cleaner is used to create a forced draft through the firebox. Coal is the favorite fuel, though fuel oil or butane gas may be used with special installations.

Like other live-steamer clubs in other parts of the country, the Southern California Live Steamers consists of members from a dozen or so different trades and professions, all drawn together by their love for the little engines. Bob Furlong, the president, is a diesel engineer. He started out by building a $\frac{1}{2}$ -inch B & O steamer, now has completed a 1-inch Atlantic type. Member Walt Disney has his own Carolwood Pacific Railroad, a half mile long, at his home. On this he operates his 1 $\frac{1}{2}$ -inch-scale model *Lilly Belle*, a copy of the old Central Pacific's engine No. 173 that was built in the Sacramento shops in 1872. David Rose, the composer, has a 1-inch-scale model; Ward Kimball, cartoonist who also maintains a full-sized old-time locomotive at home, has a $\frac{3}{4}$ -inch-scale model live steamer.

Makes Own Drawings

Few enthusiasts start from scratch these days the way Ray Gifford, a Los Angeles toolmaker, built his engine. Gifford started out with nothing more than a few ancient shop prints of a 10-wheeler once built for the Denver & Rio Grande line. From these drawings Gifford made his own drawings scaled down to 1 $\frac{1}{2}$ inches to the foot, then designed and built his own patterns, made his own castings and, bit by bit, made all the rest of the parts.

In the past, anyone who wanted to build a live steamer had to do it that way. Sometimes you could borrow the patterns from someone else who had built a small engine but usually you had to start in at the beginning. Often an engine took years of part-time work to complete.

It's a lot easier today. A number of concerns, notably Little Engines of Lomita, Calif., will supply you with individual parts or will make up a kit from which you can build an entire locomotive. You can build as many parts as you like, buy the rest. You can buy the entire engine in the form of rough castings and do your own machine work. For this you need a lathe, drill press, grinder and miscellaneous hand

(Continued to page 252)

SALESMEN

GET IN ON THIS BONANZA ...aluminum asphalt roof coating is new industrial money-maker

Aluminum asphalt roof coating is today's sales sensation in the field of industrial maintenance. On factories, mills, schools, public buildings—all over the country—the swing is to this weather-defying combination of high-grade aluminum pigment and processed asphalt.

Aluminum asphalt roof coating provides *all-weather* protection. The secret is in the addition of pure aluminum flakes to a tough asphalt base. These minute particles form a metal shield that protects the vital oils from the sun, keeps the coating pliable and waterproof, prolongs roof life. As a reflective agent, aluminum asphalt coating turns back 70 per cent of the sun's heat, reduces inside temperatures as much as 15 degrees.

Aluminum asphalt coatings can be applied with an ordinary roofing brush or spray gun . . . come ready mixed . . . require no thinning or heating. Once applied, the coating remains firm on top, but soft and pliable beneath its reflective, protective shield of aluminum. It will not sag or run under tropic sun, or crack under frigid cold.

Today, hundreds of salesmen report aluminum asphalt roof coating a booming full-time business, or a highly profitable side line. But, actually, the potential has been barely touched. Acres and acres of roofs need this protection, now! Join this promising new industry while it's young—while sales can go only one way—up.

ALCOA does not make roof coating or hire salesmen to sell roof coating.

Write for more information. Use the coupon.



THE ALCOA HOUR
TELEVISION'S FINEST LIVE DRAMA
ALTERNATE SUNDAY EVENINGS



HEAT TEST SHOWS HOW ALUMINUM ASPHALT COATING PROTECTS ROOFS



Unprotected heavy roofing paper softens after 30 seconds of simulated sunlight from lamp. Right side of sample has been protected with aluminum asbestos roof coating. Summer sun often raises roof temperatures above the melting point of asphalt, draws out the oils, shortens roof life.

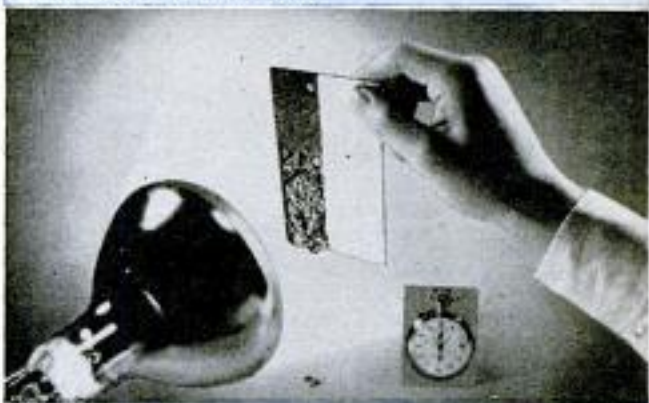

Asphalt becomes fluid, drips to table after 120 seconds. On roofs, this means leaks, leads to costly repairs. Aluminum pigment prevents this, enables coating to be used over any previous roof paint or coating without bleeding through. And aluminum asbestos coatings assure cooler under-roof temperature.

Aluminum Company of America, Paint Service Bureau
1718-D Alcoa Building, Pittsburgh 19, Pennsylvania

- I am interested in selling aluminum roof coatings.
 I am interested in using aluminum roof coatings.

Please send me your free booklets:

- Painting With Aluminum*
 Aluminum Asphalt Roof Coatings Make Time Stand Still

Name _____
Company _____
Address _____
City _____ Zone _____ State _____

YOU can earn **BIG MONEY** in **ARC WELDING**

with this "EASY-TO-OWN" combination arc welder and power plant

Weld!
or run
TOOLS
LIGHTS
MOTORS



Cash in ON THE BIG DEMAND FOR EMERGENCY REPAIR WORK
USE THE COUPON! No obligation.



HUSKY BOY



TRANSFORMER AC WELDER



BANTAM CHAMP

See how it pays with the new low cost Hobart welder. One of these easy to use models can become your key tool, in fact, the very method of putting you in business and more money in your pocket.

INVESTIGATE these money-makers TODAY!

200 amp. "HUSKY BOY" welds anywhere. It's light, rugged, compact—easily mounts on your tractor or trailer for traveling to emergency repair jobs. Portable mountings also available.

295 amp. TRANSFORMER AC welder for operating on single phase 220 volt power. Ideal for shops that would like to do production and repair work.

200 amp. lightweight, low cost "BANTAM CHAMP" is specially designed to let you do production and repair work in your own shop.

Write for complete details to: HOBART BROTHERS CO., BOX M-47, Troy, Ohio, Phone Federal 2-1223.

Get the valuable **WELDING LESSONS BOOK \$100**

200 pages, self-teaching

HOBART

"One of the world's largest builders of arc welding equipment"

HOBART BROTHERS CO., BOX M-47, TROY, OHIO

Without obligation, send complete details on:

AC Power-AC Welder Combination Husky Boy Welder's vest pocket guide

Transformer AC Welder Bantam Champ

Name _____

Address _____

City _____

State _____

free

Welder's vest pocket guide

tools. Or you can buy most of the parts already machined and put them together with nothing more than hand tools and a 1/4-inch power drill. A few engines such as the 1 1/2-inch model of the old C. P. Huntington can be purchased on a virtual bolt-together basis.

Little Engines stocks the parts for a score of different models ranging from a 4-8-4 Hudson in 1/4-inch scale to the big 1 1/2-inch-scale 4-8-4 Northern and 4-8-2 Pacific types. Depending on size and on how much of the work you plan to do yourself, a live steamer will cost you anywhere from around \$120 to as much as \$800. Most enthusiasts buy a few parts, do the machine work that is called for in the drawings that are furnished with the parts, then order the parts that they need next. That way, they space out the costs all the time the engine is under construction.

Frames Cost \$14

As examples, here are a few prices for parts for a 1-inch-scale 4-6-2 Pacific-type engine that weighs 225 pounds when completed: Main frames, \$14 per set with no machining required; drive wheels, \$15 per set as rough castings, an additional \$3.25 per wheel if completely machined for you. Steam-boiler parts ready for assembly by brazing the parts together are available as a package for \$33. Cylinder heads cost \$3 each; cylinder-head covers are priced at \$5.

Counting all the castings, sheet-metal shapes and small parts including bolts and nuts, there are some 500 parts in an average live steamer. On an average, a year's spare-time work is needed to put one of them together.

In a few respects a miniature live steamer is not a precise scale model of a big engine. If a boiler were fully scaled down, for instance, its walls would be too thin for safety. So the boiler shell is always built thicker and stronger than scale. Too, the valve gear is usually oversize so that the engine can pull heavy loads without breaking down. And some of the boiler fittings and piping are a little oversize because otherwise they would not be practical.

These details can hardly be detected, even by an old locomotive engineer who has spent years operating the same engine, full size. The more one of these veterans studies a scale model of a type that he used to drive, the more he marvels at the skill and patience of the enthusiast who put the little engine together. ★ ★ ★

German motorists may be summoned to the nearest telephone by a bell ringing in their car. The Federal Post Office of West Germany is planning to install this system.



Now's the time to
trade-in
that
old saw!

**Get an extra big trade-in allowance
on a famous Porter-Cable quality saw!**

Here's a wonderful opportunity to get any famous Porter-Cable saw illustrated here, at a saving! Trade-in your old saw and get a liberal allowance toward the purchase of a Porter-Cable saw that best fits your cutting needs and requirements. No matter what model you choose, you're getting Porter-Cable quality that can't be beaten for design, construction, versatility and solid value. Check the yellow pages of the telephone book and see these professional quality saws at your Porter-Cable dealer—or use coupon to get complete information. (Offer expires May 31, 1957.)



SAVE \$5 ON MODEL 125 SAW!
A standard duty 6" saw featuring Kickproof Clutch, instant depth and bevel adjustments and a safe telescoping guard. List Price \$49.50—**with any saw trade-in, \$44.50.**



SAVE \$20 ON MODEL 528 SPEEDMATIC!
World's finest professional saw. Big capacity 8 3/4" blade with new telescoping guard, Kickproof Clutch and many more features. List Price \$135—**with electric saw trade-in, \$115.**



SAVE \$15 ON MODEL 521 SAW!
Famous Speedmatic saw with 7 1/2" blade, Kickproof Clutch, depth and bevel adjustments, and other professional features. List Price \$117.50—**with electric saw trade-in \$102.50.**



SAVE \$15 ON MODEL 108 SAW!
Rugged 8 3/4" saw for the builder who needs extra speed and power on all cutting jobs. Features Kickproof Clutch. List Price \$99.50—**with electric saw trade-in, \$84.50.**



SAVE \$15 ON MODEL 157 SAW!
Heavy duty 7 1/4" saw with blade on left. Weighs only 13 lbs. Professional features throughout include exclusive Kickproof Clutch. List Price \$95—**with electric saw trade-in \$80.**

SEE YOUR DEALER — OR MAIL COUPON TODAY!

PORTER-CABLE MACHINE CO.
7144 N. Salina St., Syracuse 8, N. Y.

Please send me complete information on your Saw trade-in offer and name of my nearest dealer.

Name _____

Address _____

City _____ Zone _____ State _____

Porter-Cable

Quality Electric Tools

saws • routers • finishing sanders
belt sanders • drills • planes

In Canada: write Porter-Cable, Ltd.,
Box 5019, London, Ontario.
Canadian prices slightly higher.

FIRST CHOICE IN ADJUSTABLE WRENCHES



CRESCENT and CRESTOLOY outsell all other Adjustable Wrenches for good reason. Crescent Wrenches, forged from selected carbon steel, have been the world's favorite for 50 years and sell at popular prices. The thinner, trimmer Crestoloy Wrenches, forged from special alloy steel and chrome-plated, cost only slightly more. There is no finer or stronger adjustable wrench made. Both patterns are available in all popular sizes and are fully guaranteed. Ask your hardware dealer.



Crescent is our trade-mark, registered in the United States and abroad, for wrenches and other tools. Sold by leading distributors and retailers everywhere and made only by

CRESCENT TOOL COMPANY, JAMESTOWN, N. Y.

Chevrolet Owners Praise Its Power And Say It Is Still the "Hot" One

(Continued from page 111)

"Don't let the fins go any higher."—California housewife.

"Would prefer larger taillights and higher too. They are difficult to see sometimes."—Colorado farmer.

"Don't like way the backup lights protrude beyond bumper."—West Virginia lampman.

"Would rather have rubber mats on the floor."—Ohio pottery worker.

More Best-Liked Features

Here are the rest of the best-liked features, in order of frequency of mention:

"Like the way it glides up and down the streets."—Illinois chef.

"Cheapest upkeep."—North Dakota owner.

"High seats give plenty of visibility."—Idaho rancher.

"Good on mountain curves."—Colorado carpenter.

"Dependable."—California lumberman.

"Started right off at 20 below zero."—South Dakota county worker.

"Good headroom and other interior room."—Maine owner.

And More Complaints

"Tires freeze in flat position after running warm."—New Jersey inspector.

"Several paint flaws around rear fenders. Crack in fender seam."—Florida salesman.

"Have Bel Air sport coupe. Not enough legroom in back. Can't even put luggage on back floor."—Idaho insurance agent.

"Heater of 1937 vintage. Burns the driver's foot while back-seat occupants are cold. Where are the under-seat heaters?"—Illinois heating contractor.

"Ash tray can't be seen at night. It is too small."—Illinois bartender.

"Rear springs too soft for six persons in car."—Vermont salesman.

"Why 14-inch wheels? I had to buy some 1956 wheels to use my snow tires."—New Jersey engineering manager.

"Windshield wipers stop at least acceleration."—Arkansas welder.

"Gas-filler pipe overflows too easily."—New York engineering aide.

"Why do all cars have so much trunk space and so little room in the back seat? You will find that 90 percent of the people don't use the trunk as often as the companies seem to think they do."—New York landscaper.

There you have it—the good and the bad as told by the owners. For a summary of this report see page 110. ★ ★ ★

**Why users expect
(and get!) more
from
Eclipse mowers**



IT CAN BE assumed that almost any mower will cut grass. But folks who buy an Eclipse expect more than this minimum performance. They expect — and get — low cost, trouble-free mowing year after year. That's why Eclipse is recognized as the standard of comparison . . . the brand most mower users plan to buy "the next time" for sure. User experience quickly points up the need for the kind of built-in quality only Eclipse offers.

The Eclipse extras

Feature for feature and dollar for dollar, you get more value from Eclipse. This is a direct result of the factory policy of building up to performance standards instead of paring quality down to meet a price. It stands to reason that skilled craftsmen — specializing in quality mowers — can provide a master touch not possible in factories where mowers are only a "sideline" product.

Easy Terms! Low as

\$12 *per month*

(Based on average dealer finance plan — 10% down.)

Lowest "per year" cost

It may cost just a few dollars more when you first buy an Eclipse. But user reports prove conclusively that the total cost of owning an Eclipse is less than for ordinary mowers. Eclipse mowers are built to last years longer and it's not at all uncommon for families to use an Eclipse for 15, 20 or even 30 years with very little maintenance expense. The rugged

construction, the craftsmanship that is acquired only by half a century of specialized manufacture pays off for the user.

A typical letter reported a total expense of 87¢ for maintenance of an Eclipse power mower over a period of 5 years. When you consider ALL your costs, you see why we say, "Eclipse costs you less to own per year."

Free check list to help you choose your power mower

Many families have been confused by mower claims and are not certain as to what type of mower they should buy. Some people insist that a rotary mower is best, while others just as emphatically say the reel type can't be beat. Eclipse makes *both* kinds — has no special "ax to grind." A check list of 8 easily answered questions will indicate the type of mower that's best for you. Write for your free copy of the folder, "How to select your power mower." The Eclipse Lawn Mower Co., Div. of Buffalo-Eclipse Corporation, 4714-C Railroad St., Prophetstown, Ill.

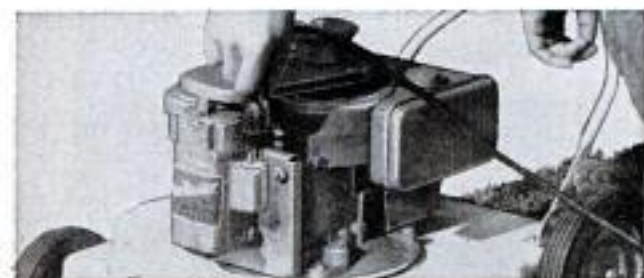

Easiest starting

Most people prefer the rope or recoil starter. But for those who prefer (or for health reasons require) completely effortless starting, an electric starter is available on many models. A gentle touch of the plug starts the engine: no work, no strain!

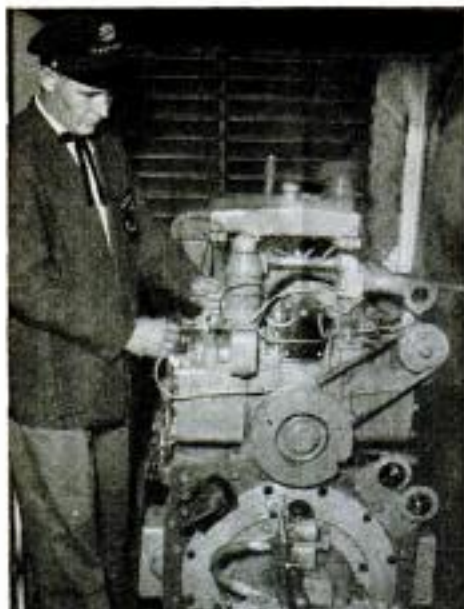

Left, the main engine. Right, the jet unit permits turning the boat around in such narrow inlets as this

It May Look Old But It's Jet Powered!

BUILT TO RESEMBLE an old-time stern-wheeler, the all-steel *Mark Twain* is as new as jet propulsion.

Mounted under the bow is an 1100-gallon-per-minute hydrojet that can spin the boat around in its own length and, if necessary, can propel the boat unassisted. Normal forward propulsion is provided by the huge, slow-turning paddle wheel at the stern with the jet reserved for emergencies and for maneuvering.

The boat has a draft of only two feet and a cruising speed of about 10 miles per hour. Its hull is made of surplus military pon-

toons built with many airtight compartments filled with foam plastic so they are unsinkable even if ruptured.

It was built as a sight-seeing boat on Indian Lake, Ohio, and can accommodate 175 passengers on its two decks.

The stern wheel is powered by a D-4400 Caterpillar tractor engine. A Chrysler marine engine powers the jet unit.

Island residents on Indian Lake have developed a fondness for the *Mark Twain*. Its jet unit is also designed to provide fire-boat protection for their homes—the first such protection they have had.

Drawing only two feet of water, the *Mark Twain* moves along the Ohio lake scarcely rippling its surface



NOW YOUR
CAR CAN HAVE
NEW BEAUTY

WITH MOPAR'S
4 IN 1
CAR CARE KIT



Special Introductory Offer— all four for \$2.25!

Here's just what you need to spruce up your car for spring! It's all in one handy carrying kit, and at a special new low price. Included in this MoPar

Car Care Kit are: (1) Fast-acting MoPar Automobile Polish. Apply . . . let dry . . . wipe clean, (2) MoPar Liquid Chrome Polish. Quickly removes tarnish . . . restores original brilliance, (3) MoPar Glass Cleaner. Spray on . . . wipe off . . . leaves no streaks or blurs, (4) MoPar Lint-free Polishing Cloth.

Buy a kit, and other easy-to-use MoPar Car Care materials, from your local Plymouth, Dodge, De Soto, Chrysler, or Imperial dealer, or better repair shops today! MoPar means highest quality!

MOPAR
PARTS & ACCESSORIES

CHRYSLER CORPORATION  PARTS DIVISION
DETROIT 31, MICHIGAN



Touch up scratches in seconds with new MoPar Paint Applicator — \$1
Comes complete with self-storing brush and built-in paint supply. Stops rust before it starts. Dries evenly and quickly to a sparkling finish.

your best buy...



- stretches the years between painting ...
- right paint for every type of surface ...
- endorsed by leading painters ...



FREE! Beautiful 44-page "Home Decorator" book. At your dealer, or write The Sherwin-Williams Co., 1235 Midland Building, Cleveland 1, Ohio.

SHERWIN-WILLIAMS
HOUSE PAINT

The Atomic Airplane

(Continued from page 105)

Under my "Project Opossum" a nuclear-powered bomber could carry half a dozen swift fighters on its missions. This huge bomber would travel to its target at high subsonic speeds unless alerted by its own radar to imminent enemy attack, when it would cut loose its escort and "shift into high." The supersonic fighters would then set up a fighter screen to take the mother ship through heavily defended areas.

The tow-plane concept solves the shielding problem of the atomic engine for passengers. A comparatively small crew working in shifts could man the tow plane while amply shielded from radiation. The atomic craft need land only when necessary to change crews.

Other usages of atom-powered airplanes of the future include: Search and patrol missions in which the ability to stay aloft for indefinite periods of time is important; special missions of plane groups that must rendezvous but must be capable of meeting delayed elements of the rendezvous.

Question: What performance characteristics will probably be featured in our first atomic plane?

Mr. Teichmann: Its top speed could compare favorably with more conventional planes. Its altitude, or ceiling, could also compare. It would have the advantage of a far longer range or endurance than existing aircraft.

Question: Can you give us an estimate of the maximum range possibility for an atom plane?

Dr. Borst: Maximum range has nothing to do with the power plant. It has only to do with the endurance of the crew. We can build a power plant that will go around the world three or four times, if you want. But what is the point if the crew can't take it? You are limited by the endurance of the crew, which probably is between 15 and 20 hours.

Question: Do you think it unlikely that we will ever try to achieve an atomic plane that can fly for days or weeks?

Dr. Borst: If it is an observation ship, you must either transfer a crew, or keep two or three crews aboard. The crew quarters in this ship are going to be very confined, and I don't think you can carry a change in crew. Changing crews in midair, as Mr. Ohlinger suggests, is a possibility. But for our first planes it may be a little on the glamorous side, especially at 700 miles per hour.

Question: What type engine will most likely be used with the nuclear plant?

(Continued to page 260)



Here's the smart way to save time and take the back-breaking work out of the Spring overhaul on your boat. Try a Thor model 150 SpeedSander, just \$34.50 at your hardware dealer's. Photographed at H. C. Grebe Shipyard, Chicago.

Boats to bookcases—refinish easier with

THOR SPEEDSANDERS

Whether it's a boat or a bookcase, it's easy to get things trim and shipshape with a Thor SpeedSander. Now you can get fun out of refinishing—save time and elbow grease.

You just name the job—Thor's got a SpeedSander. Choose from the handy home shop model 15T at \$24.95, easy enough for the lady of the house to handle—or the light duty model 150 at \$34.50—just right for that boat refinishing job.

For the advanced home workshop, carpenter shop or furniture

refinisher, Thor offers industrial model 16 at \$39.95 and the big, rugged heavy duty model 1500 at \$54.50.

All Thor SpeedSanders are equipped with durable Thor-built motors and have all ball bearing construction. Models 15T, 150 and 16 are available in complete kits.

See them all and Thor Speed-Drills, SpeedGrinders and polishers at your hardware dealer's. SpeedWay Manufacturing Co., division of Thor Power Tool Co., Prudential Plaza, Chicago 1, Ill.



THOR POWER TOOL COMPANY, CHICAGO

Branches in all principal cities

World's largest exclusive manufacturer of portable air and electric tools

Make Child's Play of Gluing Jobs



Filabond—T. M. The Goodyear Tire & Rubber Company, Akron, Ohio

NO MORE VAPOR LOCK!

Got vapor lock troubles with your car, Mister? Pretty aggravating, isn't it? And it can be mighty expensive! But there's a simple answer. Install a Bendix* Electric Fuel Pump and you'll positively eliminate vapor lock. Good idea, don't you think? Get a Bendix Electric Fuel Pump at any independent garage or service station. (If you wish, write us first for illustrated folder.)

*REG. U.S. PAT. OFF.



Bendix ELECTRIC FUEL PUMP

BENDIX AVIATION CORP.
(Eclipse Machine Div.), Elmira, N.Y.

Mr. Teichmann: Probably the turbojet. Ramjet, in which air is compressed by forward speed of the craft, would require a terrific rocket-launching device or some secondary power system to get going. Prop-jet, in which heated air or steam operates a turbine geared to a propeller shaft, adds additional weight problems.

Mr. Ohlinger: Granted, such a system weighs more. But it has the advantage of avoiding radioactive-contamination hazards.

Question: How will the reactor tie in to the system?

Dr. Borst: There are two ways of doing it. One is to take the air into the reactor and heat it so it will expand and shoot out through the engine, spinning the turbines and pushing the plane. That's an "open" system. The other way is to use an intermediate heat-transfer loop. This is similar to an automobile radiator. In the atomic plane, liquid metal would circulate through the uranium pile, pick up heat, carry it to heat exchangers that would heat and expand the air through jet turbines, spinning them. This is a "closed" system.

Question: Could the reactor generate electricity for propulsive power?

Dr. Borst: It's possible, but you take power losses in the conversion of heat to electric current. Besides, motor and generator would make the power plant excessively heavy.

Question: Is there any problem disposing of heat in the reactor when shutting off power to land?

Dr. Borst: No. In $\frac{1}{10}$ second, shutdown power, or heat, drops to $\frac{1}{10}$ operating power in a reactor, then dribbles off. It's relatively easy to handle five percent power. You must keep some heat to prevent your liquid-metal coolant from "freezing."

Question: If we had a nuclear-powered bomber of about 250,000 pounds with a 14,000 mile range, traveling at the speed of sound, how much nuclear fuel would it burn on a round trip, carrying its pay load of a nuclear bomb?

Dr. Borst: It would probably consume about half a pound of nuclear fuel. But in a reactor, one cannot burn fuel as one burns coal in a furnace, so that there is very little ash left. Ash is generated with the nuclear fuel and contaminates the fuel. So it is rare that one can burn more than 10 percent of the fuel in the reactor. That means you require at least 5 pounds, and perhaps 20 to 30 pounds, in order to use up half a pound.

Question: Does that mean, after every 14,000-mile mission it would be necessary to refuel?

(Continued to page 262)

All automobile parts wear out. When the brake linings, carburetor, battery, tires, muffler, spark plugs, or other such parts fail, you know immediately that they should be replaced. However, the suspension parts (springs and shock absorbers) wear out more gradually and the need for replacement, in many instances, is unnoticed—even beyond the point of efficiency and safety.

As springs grow weaker, more burden is placed upon the shocks to maintain stability and to compensate for road, load, and steering requirements. Naturally, if the shocks are too worn to perform this function, car comfort and control are impaired. Tires wear quicker, front end alignment is a problem, riding is uncomfortable, steering is harder, wheel fight increases... every bump and rut seems bigger and deeper. Yes, driving with worn shocks is more work, more dangerous, more costly.

Why do shocks wear out? Ordinary direct-acting shock absorbers like those currently being supplied as original equipment on practically all American cars operate on the suction principle. A small piston acts as a friction plunger within the working chamber, sucking in fluid from the reservoir as the piston moves up and being cushioned by the fluid on the downstroke. Piston and working chamber wall soon wear. Frictional contact—and holding power—are lost.

Columbus Shock Absorbers give the best ride, best control, for the longest period of time. Columbus shocks are mounted right side up with fluid on all sides of the piston providing a cushion of fluid for wheel movement in both the up and down directions. The piston doesn't rely upon friction for proper operation and the single working chamber stays cooler. The air trap dome at the top of the Columbus shock keeps the fluid air free, eliminating fade and sudden "air filled" dead spots. The larger Columbus piston is valved to give "just-right" holding power for rough or smooth roads, slow or fast speeds.

Worn shock absorbers should be replaced for safety, economy and comfort. Check them every time your car is on the hoist for routine service. For maximum performance, install Columbus, priced as low as \$7.95 each.

Should Car Shock Absorbers be Replaced?

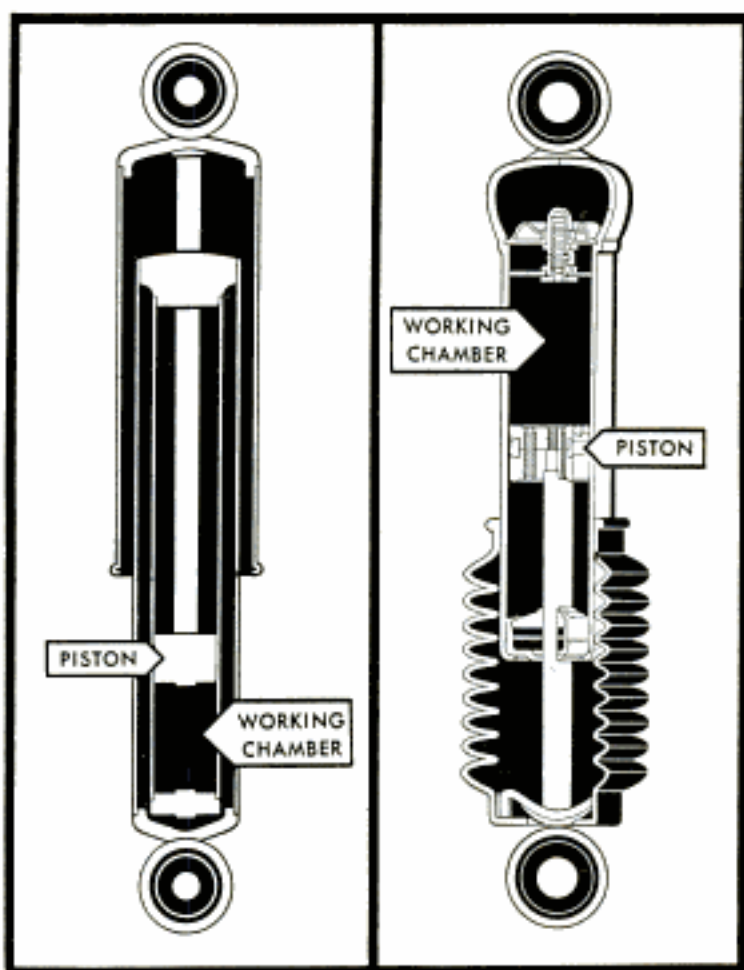

ORDINARY SHOCK ABSORBER

COLUMBUS SHOCK ABSORBER

COLUMBUS[®]
SHOCK ABSORBERS

DESIGNED BY DR. CARSON

HECKETHORN MANUFACTURING & SUPPLY CO.
Littleton, Colorado



NEW
**JET
ROCKET**
ONLY
\$3.95

Built like the famous original ROCKET hammer, the tubular boron alloy steel handle won't bend or break. It's permanently locked to jet-black head. Black cushion grip soaks up shock, won't slip wet or dry or in gloved hand. Ask to see all the JET ROCKETS at your hardware store today. True Temper Corp., Cleveland 15, Ohio.



BELT AXE, AND
HATCHET ALSO
AVAILABLE IN JET
ROCKET MODELS

TRUE TEMPER®



Finest quality in Hammers, axes, hatchets
Shears • Shovels • Garden, lawn and farm
tools • Fishing tackle • Golf-club shafts

Dr. Borst: Without question. It is possible that they would simply replace the reactor each trip. A fresh unit could be adjusted, and checked out without the radiation problem.

Question: Something like taking the fire-box out of a locomotive and fixing it up in a special place somewhere, and then putting the unit back after it is fixed? Or would you destroy the reactor?

Dr. Borst: That is a question of economics. I personally would put in a completely new unit. If the reactor breaks down, the plane is lost. Besides, it is difficult to work on a reactor which is highly radioactive. The best thing to do is start with a new one, so you would probably use one reactor for one trip. The shield would be usable again. The interior of the reactor would be sent to a chemical-processing plant, all the uranium recovered and re-fabricated into new fuel.

Mr. Ohlinger: Using a remote-controlled robot it would also be possible to extract the old uranium slugs and recharge the reactor with fresh fuel. An odd design is a separable power plant with its own independent landing gear that can be wheeled away from the plane and replaced by another such unit.

Then there's the piggyback concept in which the landing gear is on a separate plane which takes off from the landing field to meet the nuclear-powered plane in mid-air, hooks on to the big plane underneath so that the nuclear-powered plane rides the "flyable landing gear" in piggyback fashion. The big plane would use the flyable landing gear for take-off and landing but would cruise under nuclear power, detached.

Question: Isn't it going to be a tough job to service a nuclear aircraft?

Dr. Borst: It is the kind of problem one has in servicing any reactor. It is very difficult and costly to replace a bolt, or a nut. The aircraft will require a complete maintenance operation and base such as the industry has never dreamed of.

For this reason, it seems to me, the best procedure would be to remove the reactor and maintain the plane in normal fashion. The removal of a reactor would have to be done, either by having the reactor integrated with its own remote powered dolly or by a remote-control crane. Everybody would be hiding behind five-foot walls of concrete, using TV sets to see what is going on, or using mirrors or periscopes.

Once the reactor is out of the way, the rest of the plane becomes a normal-maintenance problem. When you are ready for the next trip, you put in a new reactor that

(Continued to page 264)



Only \$239 delivered, complete with 9" saw blade and 3/4 hp motor (Price subject to change without notice)

Only the De Walt Power Shop makes all "home work" so easy!

With a versatile AMF DeWalt® Home Power Shop, you can make home repairs, build furniture, handle even major projects like a *professional*!

AMF DeWalt is the *first* all-purpose power tool designed on the modern mechanical arm principle that outmodes all other power tools. It's actually 12 professional power tools in 1—a *complete home workshop*!

◊ **Arm swings and locks at any position** for miter cuts—gives easier, safer *top-side cutting* that eliminates errors... you see your mark *and* your cut.

◊ **Builds into workbench!** Because entire arm *swings clear* of work area, you can cut and assemble on the same work bench! *Save valuable space* and get *extra convenience too!*

◊ **Powerful 3/4 hp motor is U.L. Approved**—guaranteed for full year—tilts and turns to any angle.

Motor carriage rolls smoothly on ball bearings in protected trackways. Simply change circular tool on direct-drive motor shaft and you have another power tool—at *no added cost!*

◊ **Superior safety and accuracy!** Exclusive DeWalt Safety Key Switch prevents unauthorized use. DeWalt's patented design and rugged precision construction provides *safety and unmatched accuracy* that assures years of superior workmanship.

INSIST ON A DEMONSTRATION. See why, *feature by feature*, AMF DeWalt is the finest home power shop you can buy. A small down payment on DeWalt's Easi-Budget Payment Plan will put an AMF DeWalt in *your workshop now.*

OWNERS! Valuable new Owner's Manual just off the press, "Easy Ways to Expert Woodworking," \$3.95 postpaid. Order yours today!

SEND COUPON FOR FREE ILLUSTRATED BOOKLET!

AMF De Walt Inc., Dept. PM-704, Lancaster, Pa., Subsidiary of AMERICAN MACHINE & FOUNDRY COMPANY

Another **AMF** Product

Please send FREE colorful illustrated 20-page Booklet

Name _____

Address _____

City _____

Zone _____ State _____



NEW! CARTER

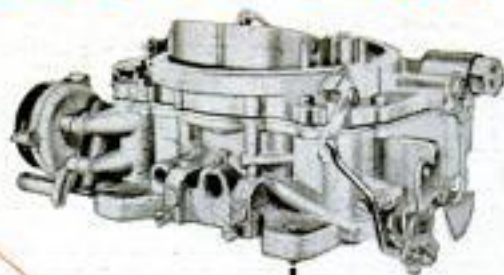

POWER CENTER

AFB Four-Barrel

CARBURETER

designed to the low lines of the newest cars

The low contours of modern cars and Carter's new AFB Four-Barrel Carbureter are on the go together! At slow speeds, two barrels remain closed. When your toe touch signals, all four barrels go into action, feeding just the right mix for full horsepower!

**FOR COMPLETE
MODERN FUEL SYSTEMS
COUNT ON CARTER**

Have your car serviced regularly wherever you see this sign ... or look in the phone book yellow pages.



CARTER CARBURETOR
DIVISION OF **CCF** INDUSTRIES
INCORPORATED
ST. LOUIS 7, MISSOURI

is all checked out and ready to go and couple it up under normal conditions, because the reactor will not be radioactive. Then you start the plane up. From then on, you have a radioactive object. Everything has to be maintained and manipulated by remote control. Even though the reactor has been in operation for only 5 or 10 seconds, it will be hot enough that you can no longer do direct maintenance.

Question: While we are on the subject of radiation, is there likely to be any danger to people underneath the plane when it is flying? Won't the exhaust from the jet be radioactive?

Dr. Borst: If we use the open cycle and push the air through the reactor so it is heated in the reactor, then the air would become radioactive. If, however, we use liquid metal as a heat-transfer medium, then the liquid metal becomes radioactive; but since it is never mixed with the air, the air does not become radioactive. Using the closed-cycle heat-exchange system, there would be no significant radioactivity produced in the air surrounding the plane and no danger to people who are far enough away so that they don't get the radiation coming out of the reactor directly.

One would have to investigate very carefully the open-cycle system to determine what the radioactive wake would be like from an airplane, and whether it would be a hazard, and under what circumstances.

Question: If a nuclear plane should crash, would it create a hazard?

Dr. Borst: It would create a tremendous contamination problem, depending on the way in which the plane crashed. If the fission products were all released, the area around the crash would be seriously contaminated and would not be accessible for a long time.

Question: Would there be a radiation problem during take-off and landing?

Dr. Borst: If somebody stands alongside the reactor, he is going to get a lot of radiation. Certainly during the take-off, with fresh power plant and little ash, people would have to be kept perhaps a quarter of a mile away. One would evacuate the region around the runway.

Question: Is there any question, in expert circles, about whether or not this plane is going to have enough performance to be worth all the trouble?

Mr. Teichmann: There is some feeling that you can't get enough performance out of it to make it worthwhile. If your cruising range or endurance were short, there would be no advantage, because you could have a conventional power plant with its fuel that would be far lighter. If it is long range, you have some advantage. ★ ★ ★

New "PULL-GEAR"
SPEED-REDUCING PULLEY

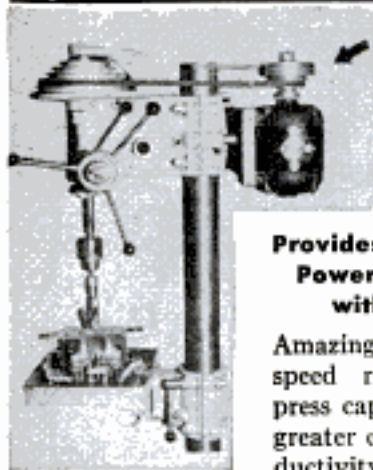

Provides Correct Speed and Power to Drill Up to 1 3/8" with 1/2 H.P. Motor

Amazing new internally geared speed reducer doubles drill press capacity. Greater power, greater efficiency, greater productivity.

Provides the correct speed and power for larger drilling, reaming, tapping and boring on light presses. Easily installed in five minutes. Adaptable to all type machines. Spindle speed range approx. 45 to 3000 RPM. Made in 3 motor shaft sizes: 1/2" - 5/8" - 3/4". Write for literature.

WRITE FOR LITERATURE

THE PULL-GEAR CO.

25427 Mound Road
Center Line, Mich.



BUY GREAT NECK HAND TOOLS
... for long-lasting performance

Precision Balanced NAIL HAMMER



One-piece, forged steel, rubber-cushioned, no-slip grip

GREAT NECK SAW MFRS., Inc.

MINEOLA, N. Y. — SEE YOUR LOCAL STORE

most amazing blade you ever saw!

Tyler SPYRAL BLADE

SAWS METAL, WOOD, PLASTIC, ETC.
up or down, right or left, even in circles!

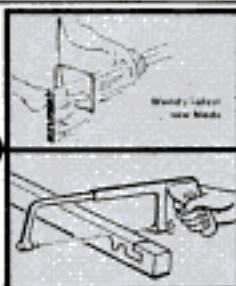

Does what no other Blade can Do. Fits Standard Coping Saw or Hacksaw Frames. NO special adapters needed! World's safest saw blade.

You'll find hundreds of uses for Tyler Spyrall Blades. There's nothing like them! The first important improvement in blades since the invention of the saw. Fun to use... cuts so fast and easy; no chipping or tearing—leaves clean smooth edge.

Ask for TYLER SPYRAL BLADES at
HARDWARE, LUMBER, AUTO & VARIETY STORES
Everywhere

TYLER MANUFACTURING CO., 1005 W. Arbor Vitae Ave., Inglewood, Calif.

DUNLOP APPLIES

ATOMIC ENERGY for Safer Tires



Thanks to the peacetime atom, the vital heart of the Dunlop tire is strengthened through application of AccuRay®... a revolutionary precision nucleonic process.

On cooler running AccuRated tires, you get many extra miles of safer driving. What's more, every Dunlop tire is more perfectly balanced to bring you new stability, control and comfort on super highways or rugged by-ways.

Through AccuRay's precise nucleonic action, an exact amount of protective rubber is uniformly applied to every cord ply. This eliminates two major causes of premature tire failure; the dangerous heat build-up caused by excessive ply-rubber coating and the equally critical ply separation and shearing action between plies resulting when rubber coatings are too thin.

For your own protection, get a matched set of Dunlop AccuRated tires... in Nylon or Super Hi-Test Rayon. See the complete line at your Dunlop dealer's.



YOU'LL GO FARTHER, SAFER... ON TIRES BY

DUNLOP

THEY'RE AccuRated®

DUNLOP TIRE AND RUBBER CORPORATION, BUFFALO 5, N. Y.

Gibberellic Acid Makes Plants GROW

(Continued from page 96)

pepper plants, eggplants, corn and barley. And perhaps still more important, they learned that the strange stuff would greatly increase the growth of many trees including willow oak, tulip poplar and maple.

Despite this intensive research, botanists aren't even sure of what they're working with. There are some doubts as to the exact chemical composition of gibberellic acid. Dr. F. H. Stodola of the USDA, who has done more work in this field than other scientists, at last feels he has pinned down the precise nature of the stuff, and most authorities believe his formula to be correct. If so, it is such a complicated one it might be difficult to produce synthetically. But manmade Ga may not be necessary, as the stuff can readily be produced in culture.

"Commercial production would present no problems," says Doctor Stodola.

Because the fungus mold grows in a culture similar to that used in the production of penicillin, drug manufacturers have become intensely interested in Ga. Three different houses, Eli Lilly & Company, Merck & Company and the Charles Pfizer Company are now turning out the stuff in big fermentation vats identical to those

used in the production of penicillin. Each 160-gallon batch of cultivated liquor yields a bare 12 grams of the stuff in three days. This is turned over to research workers for experiments. In addition, just within the past few weeks quantities of the gibberellins have been turned over to formulators, who will incorporate them into products which will be available to you this spring and summer.

Twelve grams—less than half an ounce—may seem a very small yield from a single batch. Actually it represents a tremendous amount of potential growth because a little goes—and grows—a mighty long way. Doctor Stodola, for example, prepared a gram of pure gibberellin A and pure gibberellic acid. He sent out 100 samples to other scientists and still had some left over.

Several Ways to Apply Ga

These scientists have tried applying Ga to plants in several different ways. Rubbed onto the plant stems in a lanolin paste, it makes the plants grow like fury. Dr. Bernard Phinney and Dr. Anton Lang of UCLA tried spraying the leaves with a solution of one part of Ga to several million parts of water. It worked. Ga has been fed to the plants in nutrient solutions, dropped

(Continued to page 267)

**HOW TO BUY ADJUSTABLE
WRENCHES:** There's a big
difference in tools. Here's
what to look for when you
buy adjustable wrenches:

Extra thin
strong jaws

No Corner Lip Gives
You More Power

Precision made,
heat treated knurl

P&C Trademark, your
guarantee of all
these qualities

Quality Forged
Alloy Steel

Buy your adjustable
wrenches from the
famous P&C Tool Mer-
chandisers. Send 10c
for tool catalog.



TOOL COMPANY
Box 5926, Portland 22, Oregon



'Budget'® ELECTRIC HOIST OPERATES ON TRUCK BATTERY

Speeds loading
and unloading
of trucks

Provides effort-
less electric
lifting where
only 12-V. battery
power is available

Makes it safe to
lift heavy loads

Saves time and
money

You can operate the 'Budget' Hoist on a regular 12-V. truck battery, or by adding another 6-V. battery to a 6-V. system. Current consumption is low. Slight step-up in generating rate keeps battery charged. The ½-ton size can lift a full load at 17 feet per minute and make over 500 five-foot lifts without exhausting battery.

'Budget' Electric Truck Hoists have two brakes, either one alone holds full load even if power is cut off. Forged steel hooks won't fracture even if overloaded. Safety stops prevent chain from over-traveling. Sizes ½, 1 and 2 tons. Priced from \$269. See your Shaw-Box Distributor or write for Bulletin 404.



MANNING, MAXWELL & MOORE, INC.
SHAW-BOX CRANE & HOIST DIVISION
354 W. BROADWAY MUSKEGON, MICHIGAN

Dr. R.G. Fuller
Battelle Memorial Inst.
505 King Ave, Columbus, O.

Dr. S.H. Wittwer
Mich. State Univ.
Cott. East Lansing
Mich.

onto seedlings, injected into plant stems and applied to seeds. In virtually all cases it makes plants grow. There are some differences, though, in the effects of the various methods of application. On some plants, one big dose is more than successful, it's phenomenal. On others, as Doctor Lang and Doctor Phinney have discovered, repeated small doses are best.

In any case, the effects are amazing. Dr. S. H. Wittwer, one of the top authorities in the field, found that Ga would make beans grow six to eight inches per day, reach a mature height four times that of untreated plants, and produce edible pods two to five days earlier. Lilly scientists have found that when pea seedlings are treated with the stuff, the growth rate in some cases is multiplied five times.

R. G. Fuller of Battelle Memorial Institute, investigating gibberellic acid for Lilly, recently discussed Ga's characteristics and what is known about its effects.

"Several of its properties will have an important bearing on its potential usefulness in horticulture," he reports. "It should be simple to formulate and apply. It is readily absorbed by the roots, stems and leaves, and moves rapidly through the entire plant. At very low dosages it evokes useful plant-growth responses, yet it ap-

pears to be relatively nontoxic to plants at much higher dosages."

What makes Ga work? What happens inside the plant?

Plant Cells Stretch

Fuller points out that we still have little to go on in trying to answer these important questions. Evidence indicates that plants shoot up under the spell of Ga mainly through the stretching of existing cells, rather than a boost in the number of cells. This suggests that Ga makes the cell walls more elastic—or keeps them elastic for a longer period. Usually, though not always, an increase in dry weight goes hand in hand with the increase in height. A large part of this added weight comes from a boost in the plant's assimilation of carbon. There is also an increase in the proportion of soluble carbohydrates, which could be an important factor in several commercial crops.

Does Ga's effect carry over to succeeding generations of a plant? So far there is no evidence that there is any genetic effect. Dwarf varieties of some plants have been treated with Ga and have grown to phenomenal heights. Yet seeds from these tall plants have produced the original dwarf varieties, the same as untreated plants.

Doctor Wittwer and his associates at
Continued to page 268)



Black & Decker 3/8" Utility Drill for Your Tougher Drilling Jobs!

Complete with geared chuck— **YOU SAVE \$5.00**

Specially geared and powered for tougher jobs. Small, compact and handy as a 1/4" drill, but with extra capacity for heavier work. Drives up to 3/8" twist drills, 3/4" wood augers, 1/2" masonry bits, 1 1/4" hole saws. And your 3/8" drill is ideal for driving B&D Screw Driving Attachment and Saw Attachment . . . for hundreds of home repair or building jobs. Ask your dealer how this drill can help you on jobs at home or work!

EXTRA! 4 B&D Hole Saws and Mandrel . . . \$4⁹⁵ SAVE 50c

Four Hole Saws, from 3/4" to 1 1/8". Fit your 3/8" Drill perfectly. Cut clean, round holes in any material a hack saw will cut. Ideal for home or professional use. THE BLACK & DECKER MFG. Co., Dept. R-047, Towson 4, Maryland.



Look in the Yellow Pages under "Tools-Electric" for Nearest Dealer.



Black & Decker®
World's Largest Maker of
Portable Electric Tools

IT'S FUN TO RIDE
MOW
 BY MUSGRAVE *cycle*

the mower
 that's built
 to ride



Makes kids eager to cut the grass

Teen agers actually beg for the chance to ride that comfortable seat, manipulating clutch, gear shift and throttle while *MOW Cycle* speedily tames the grass. Grownups too find lawn chores really pleasant with *MOW Cycle* to eliminate heavy exertion. Twin rotary blades beneath strong steel platform do the mowing; cut 24" swath. Attachments pulled behind offer complete lawn care without walking. On the market since 1950; thousands now in use. Safe for even inexperienced operators. All moving parts shielded. Unique 3-point suspension allows travel across 30% slopes without tipping. Husky 3½ hp engine with recoil starter; speeds to 5 mph. Available also with

electric starter. See improved 1957 models at nearest dealer.



MOW Cycle '24'
\$289.50

**MOW Cycle
 'Cadet'**
\$219.50

Prices F.O.B. factory. Dealer adds freight and local taxes. Slightly higher in far west.

Mail the coupon TODAY

Musgrave, Inc., Dept. 147, Springfield, O.
 You may send free circulars on the latest *MOW Cycle* models and attachments for same.

Name _____

Address _____



Michigan State University have become authorities on some of the other odd effects of gibberellic acid. In many cases, they've found, plants not only grow much taller but mature ahead of schedule. Broccoli, for example, matures several weeks ahead of untreated plants. Beans will flower and produce edible pods several days earlier.

This ability to push a plant into flowering is apparently one of the strongest effects of Ga. When Doctor Wittwer tried treating head lettuce, the seedstalks pushed right up through the heads and produced seed 31 days earlier than could be expected.

Other plants that bloom rarely—and sometimes never—have been made to flower consistently under the spell of gibberellic acid. And flowers tend to be converted into fruit much more readily. At Michigan State, Doctor Wittwer tried spraying the flowers of tomato plants and found that the number of tomatoes was strikingly increased. In this experiment, one part of Ga per million parts of water was as effective as 500 parts per million.

Still stranger is gibberellic acid's effect on biennials, those plants such as carrots, sugar beets and most other root crops that flower and produce seed only in alternate years. Doctor Wittwer has discovered that Ga persuades biennials to flower soon after treatment, regardless of their normal life cycle. To the producer of vegetable seed, this could be highly important.

Seeds Germinate Early

The seed itself falls under the spell. When Doctor Wittwer and his associates treated pea and bean seeds with Ga, the seeds germinated considerably earlier than untreated ones. Furthermore, the seedlings pushed up with astonishing speed.

Dormancy is affected, too. Lettuce seed normally requires a short exposure to light in the red band of the spectrum before it will germinate; a touch of gibberellic acid will substitute for the light. In another experiment, several toothpicks were soaked in water, others in a solution of Ga. They then were inserted in potatoes held at room temperature. In four weeks the treated potatoes developed active sprouts. Five more weeks passed before sprouts appeared on the untreated ones.

"Gibberellic acid seems to affect more diverse plant processes than any other known chemical," says Fuller. "We can only guess at the potential uses of this unique substance. Gibberellic acid eventually may boost the production of food and fiber crops significantly. We may be able to increase the dry weight of forage crops substantially. We may be able to extend

(Continued to page 270)

The only really new design
concept for 1957 again comes
from Chrysler Corporation.
Full-fledged fin styling is
functional—making your ride
steadier at highway speeds.
This New Shape of Motion*
is styling leadership.
Plymouth, Dodge, De Soto,
Chrysler and Imperial.

*Another big reason why The Switch is On to the cars of The Forward Look

STANLEY "SURFORM"®

An all new surface-forming tool
Does 1001 jobs



Stanley SURFORM
Plane Type — \$3.69

Saves time on all
kinds of materials!



Stanley SURFORM
File Type — \$2.69

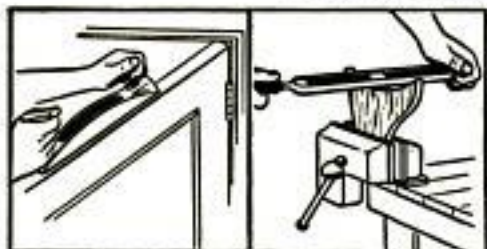

Fitting . . . Forming . . .

Stanley SURFORM forms the surface of wood, plywood, floor tile, hard rubber, plastics, copper, aluminum — even mild steel. It smooths down wood . . . cross grain, with grain, end grain — 12 times faster than other wood forming tools without clogging! It's easy! It's fast! It's safe! It's another Stanley first!

450 sharp edges work together!

This cutting strip is the secret of Stanley SURFORM. The tool steel strip has 450 tough, razor-sharp teeth that really cut, and 450 holes that take the cuttings away from the work. No skill is required . . . you can't go wrong. Nothing to adjust. Depth of cut is automatically controlled.



**Tough, long-lasting replacement
blade fits both tools — 98¢.**

Your hardware dealer has Stanley SURFORM now. Look for it. Try it. For free descriptive Stanley SURFORM folder, write Stanley Tools, Division of The Stanley Works, 624 Elm Street, New Britain, Conn.

STANLEY

The Tool Box of the World

the range of many plants by cutting the time required to bring them to maturity.

"We may be able to raise ornamental trees to shade size on our lawns in a much shorter time. The yield of pulpwood and lumber may be boosted. Seed production of some crops such as sugar beets could, in effect, be doubled if the plants can be made to produce seed in a single season, as evidence indicates.

"Keep in mind, though, that these are only possibilities on the basis of present research. We need to answer a lot of questions about gibberellic acid before we'll be able to predict with any accuracy its ultimate worth."

Here are a few of those questions:

How much Ga should be administered to each species, in what manner and how frequently? (Over-application produces elongated spindly plants, which is the effect the Japanese observed.) Precisely what happens to the cell structure of a plant, and what is the effect on the sugar content? Can we be certain there is no genetic influence which will be carried through to future plant generations?

Why does Ga affect, in different ways, different varieties of the same plant? Is gibberellic acid naturally present in some plants? (Young bean seed has yielded a substance which, so far, is indistinguishable from the gibberellins.)

Will a touch of the stuff in a glass of milk make Junior grow? (Certainly not!) But other remotely possible effects on humans must be investigated. As far as evidence goes, all authorities believe it to be completely harmless, but where edible crops are concerned this must be pinned down beyond question.

So far, gibberellic acid seems too good to be true. The strangest part of this tall tale from the world of science is that the botanists themselves are the most optimistic about the future of Ga. ★ ★ ★

"World's Brightest Lamp"



Light from a new 25-million-candlepower photoflash tube, activated for $\frac{1}{1000}$ second, can illuminate interiors of 12,500 homes and can be seen 50 miles away. Used in graphic arts, the flash tube lights when a powerful arc travels via gas through tubing.

HARLEY-DAVIDSON DEALER OPPORTUNITIES

A few excellent opportunities are available to sell and service the world-famous Harley-Davidson motorcycle for pleasure, police, and commercial work. If you are mechanically inclined, like outdoor activities, enjoy selling and are willing to work to build a successful business for yourself, we want to hear from you.

Tell us about yourself; your age, business background and how much money you have to start — motorcycle experience desirable but not essential. You'll receive a prompt reply telling you about our franchise, factory co-operation and our extensive national advertising support.

Write Department P

HARLEY-DAVIDSON MOTOR CO.
MILWAUKEE 1, WISCONSIN

NEW, IMPROVED CALCULATOR FOR WOODWORKERS only 25c

Instantly gives information on lumber, nails, concrete mixes, painting materials, etc. Convenient, simple to read. Just set dial for nail specifications, to convert linear to board feet, find bit sizes for screws, compare characteristics of woods. 6" diameter heavily varnished greenboard. Send 25c, no stamps, please to Greenlee Tool Co., 2104 Columbia Avenue, Rockford, Illinois.

Exclusive Double-Bearing HEAVY-DUTY PUMPS

IRRIGATE • DRAIN • CIRCULATE • SPRAY
Up to 7,500 GPH, 3,000 GPH from 25" well. Use 1/4 to 1 HP motor. 1 1/4" inlet; 1" outlet. Stainless shaft.
TYPE X—2 oilless bronze bearings. **\$10.95**
Won't rust.
TYPE XB—Ball bearing model. **\$12.95**
Footpad if cash with order. Rush your order today
MONEY BACK GUARANTEE
Centrifugal and Gear Pumps in All Sizes

LABAWCO PUMPS, Belle Mead 2, N. J.

EXPLORE FOR TREASURE!

Find gold, silver, coins, jewelry, battle relics! Treasure-Metal-Mineral Detectors. M-SCOPE. Used worldwide for Treasure Hunting, Minerals, Geiger, Scintillation Counters. Prices from \$14.75. Fully GUARANTEED. Time Payment Plan. FREE Treasure and Uranium booklets. New outfitting catalog. FISHER RESEARCH LAB., INC., Dept. PM-1, Palo Alto, Calif.

**UP
DOWN
AHEAD**

Head swivels 180°. Throws a brilliant 800-foot beam. Yours, less 6-volt battery for only... **\$4.19**
Sealed Beam Model... \$5.50

Delta Electric Co., Marion, Ind.
Delta POWERTOP ELECTRIC LANTERNS

The handiest electric lantern yet. You'll really go for its size, design and features!



APRIL 1957

Made
\$900
IN SPARE TIME

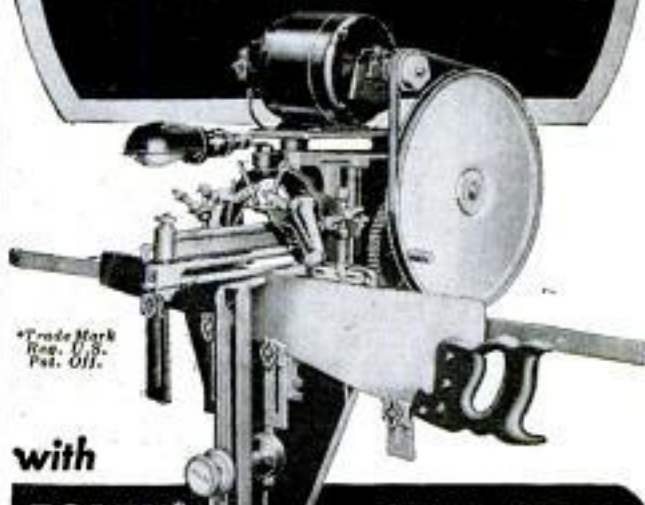

with

FOLEY automatic SAW FILER

"I did very well last year with my Foley equipment, sharpening about 950 saws in my spare time. About \$900 for me."

Leo H. Mix

"I have done 4 or 5 thousand saws in my spare time in the 4 1/2 years since I got the outfit, and they are all coming back with repeat orders."

Len Crego

Make up to \$3 or \$5 an hour in Spare Time

With the high prices of food, clothing and everything else, just think what you could do with extra money every week! With a Foley Automatic Saw Filer you can file hand, band and circular saws better than the most expert hand filer. "The first saw I sharpened with my Foley Filer came out 100%" — writes Clarence E. Parsons. Cash business, no canvassing. No eyestrain — no experience needed.

FREE BOOK Shows How to Start

"MONEY MAKING FACTS" tells just what to do to start your own spare time business in your basement or garage. Just think — with a small investment, no overhead, no stock of goods to carry, you can get right into a cash business. Send coupon today — no salesman will call.



Send for **FREE BOOK**

FOLEY MFG. CO.,
416-7 Foley Bldg., Minneapolis 18, Minn.
Send FREE BOOK — "Money Making Facts"

Name _____

Address _____

271



Fast, Safe
No Wash
Non-inflammable

How you can get perfect paint jobs every time!

Klean-Strip is totally unlike ordinary paint removers that dissolve the finish and are so messy to use. Klean-Strip actually breaks the bond between finish and surface . . . removes many coats with one application. It's clean, fast-acting and easy to use . . . leaves the surface smooth and dry, ready to paint without neutralizing or afterwash.

Use Klean-Strip on furniture, woodwork, walls, metal. Klean-Strip peels off any finish. Buy it when and where you buy paint.



KLEAN-STRIP

Paint Remover

THE KLEAN-STRIP CO., INC.
2340 S. Lauderdale, Memphis 6, Tenn.



It's here... the ALL-NEW, YEARS-AHEAD Cushman ROAD KING

Designed-for-tomorrow body lines in two-tone colors. Ruggedly built. Greater comfort and riding ease. Powered by Cushman Husky 4-cycle engine. Up to 50 miles per hour, up to 100 miles per gallon. Ride it anywhere, everywhere for just 3/4 cent per mile.

- Sold and serviced nationally replacement parts available immediately
- See your Cushman dealer for FREE demonstration ride or write for illustrated booklet
- Dealer inquiries invited

Write for new FREE booklet today CUSHMAN MOTOR WORKS, INC. 908 No. 21st, Lincoln, Nebraska



Sling Keeps Gun at "Ready"

Hunters with rifles or scatter guns can shoot more quickly and safely if they wear an adjustable shoulder strap attached to a special gun-butt stirrup. Made of vinyl and steel, this assembly does not mar wood and fits any type of gun. The sling is adjustable for tall or short hunters, for left or right-hand shooters, and can be used for standing or running shots.

Tapes for Graph Making

Self-adhesive acetate-fiber tapes enable graph makers to use straight or curved-line illustrations on any surface. Graphs can be changed by peeling off this tape and replacing it with new tape in any one of 15 colors, 6 widths or 9 striped designs. Tape widths range from 1/32 inch to 1 inch.

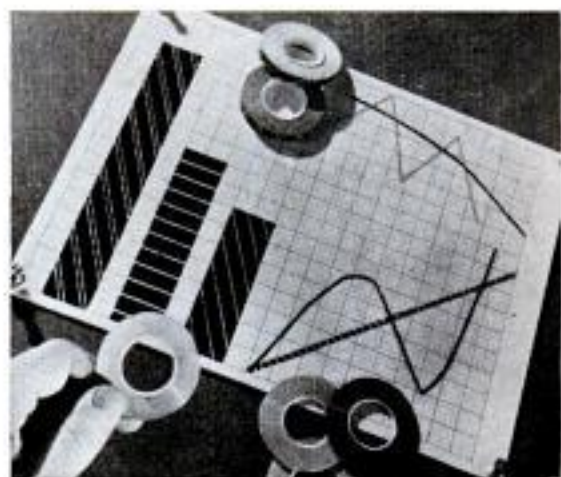

CAR OWNERS:
Get More Than
Just "Warning Light"
Indications!

For really safe engine protection
install a

STEWART-WARNER

AMMETER AND OIL PRESSURE GAUGE



only
\$8.40

Fits all cars! Easy to install!

In addition to battery and oil warning lights, your car needs these Stewart-Warner gauges! A battery warning light tells you only if the generator is working—not how much current is being used. An ammeter tells RATE of current flow—indicates when there is danger of burning out a generator. And, unlike an oil warning light, an oil pressure gauge tells EXACT oil pressure—helps to assure safe engine operation!

Complete "do-it-yourself" kit

Consists of:

Ammeter • Oil Pressure Gauge
Twin-gauge Panel for under-dash
mounting • Installation instructions



See your dealer today—or write

STEWART-WARNER

Instrument Division

Dept. AM-47, 1840 Diversey Parkway, Chicago 14, Illinois



THE ROUTER . . . what it is and does

This 40-page book with 100 illustrations tells you. Write Stanley Electric Tools, 624 Myrtle St., New Britain, Conn., enclosing 50¢. Ask for ROUTER BOOK.

STANLEY

NEW! GUMFINGER LAWN RAKE



Here's an efficient and safe tool for the gardener who is proud of his lawn. Tough flexible rubber teeth won't dig up roots or pull and tear the grass. Use it for raking up leaves, excess grass clippings and tree seeds, for spreading peat moss and top dressing, for removing straw mulch from seed beds and shrubbery. Rubber teeth won't clog and they keep their shape. Sizes—8", \$2.29; 12", \$2.49; 16", \$2.69; 20", \$2.95; 24", \$3.29; 32", \$3.69. Complete with sturdy handles. Postpaid, check with order. Manufactured and Guaranteed by Kay Products Industry, Dept. PM4, 1389 Sloane Ave., Lakewood 7, Ohio.

YOU can build this

WILSON AIR-FLOAT PATENT APPLIED FOR CEILING in any room



• covers any area, without a break • a continuous, crackproof ceiling • handsome, yet low in cost

Here is the newest method of installing a ceiling—so simple it beats conventional procedures. Wilson Air-float is a dry-wall ceiling of any size without visible joints or moldings. The secret: it is suspended from joists, as a unit!

Wilson Air-float eliminates the structural requirements that involve only extra work. It does away with unnecessary bearing walls, unnecessary furring-up of unlevel joists, unnecessary nailing, unnecessary moldings. The Wilson Air-float Ceiling is completely decorative—seamless, free of expansion and contraction problems, and crackproof.

The materials are inexpensive; erection is exceptionally fast. Two people can easily put a new ceiling over any room. Complete application details in a fully illustrated folder are yours for the asking.

Many other worthwhile, up-to-date projects like this are possible with Homasote Boards and Homasote know-how. Homasote dealers also offer Easi-Bild® Patterns—for buildings, garages, cabinets, furniture, boats, toys, and holiday figures—projects that save you 25% the cost! Look for the Easi-Bild emblem on your dealer's counter—and use the coupon for your free copies of the Homasote Handbook and Wilson Air-float Ceiling folder.

*T. M. Reg. Easi-Bild Pattern Company



HOMASOTE COMPANY, Department D-5, Trenton 3, N. J.
Send me, without cost or obligation, the 68-page Homasote Handbook and the illustrated literature on Wilson Air-float Ceilings.

Name.....
Address.....
City.....Zone.....State.....

AMAZING METAL in PUTTY FORM

APPLIED COLD . . . HARDENS INTO METAL

Ask For



IT'S THE ORIGINAL



Fix Boat Leaks



Repair Gutters



Repair Car Bodies



BIG 5½ oz. tube... \$1.00

Hundreds of money saving uses for home, auto, boat and shop. No mixing — Ready to use. At all leading hardware and auto accessory stores and leading department stores. Ask for DURO!

WOODHILL CHEMICAL CO. 1393 E. 33rd St. CLEVELAND 14, OHIO
"Originators and World's Largest Mfrs. of Plastic Metals"

NEW! *Evans*
POWER-TAPE



No More Pushing Blade Back Into Case!

Here's the greatest single mechanical advance in steel tape history! Press the button gently with your thumb — blade returns smoothly. You control the speed. Release the button — blade stops instantly. No "creep," no lost measurements! Chrome-plated case, GIANT sliding end hook — far inside-outside measuring. White steel blade, marked in inches and feet-and-inches — no figuring! Free Tenite carrying case with magnifying lens.

Only
\$1.69
(10 ft.)

Unconditionally Guaranteed
6, 8, 10, or 12 ft. lengths
Get POWER-TAPE today!

Available only at hardware stores

Evans RULE CO. Elizabeth, N. J.
Montreal, Que.



Power-Driven Roller Skates

Power-driven roller skates have been made by Bernie Schmidt of Ecorse Township near Detroit. He mounted a gasoline engine on a padded metal plate and fitted straps to hold the rig on his back. The engine and one skate are connected by a flexible drive shaft.

Screw-On Cleats

Any conveyor or elevator belt can be converted into a cleated belt by attaching new Neoprene cleats. A punch and a screwdriver are the only tools needed to install the cleats. Originally designed for the food industry, the cleats are also being used in grain mills, rendering plants and clay-processing plants. They are available in a variety of sizes.

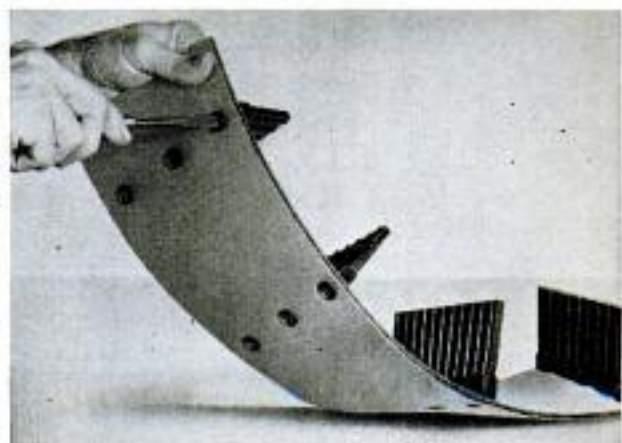

POPULAR MECHANICS

ELECTRIC MOTORS—POWER KITS for HOBBY-RESEARCH-INDUSTRY

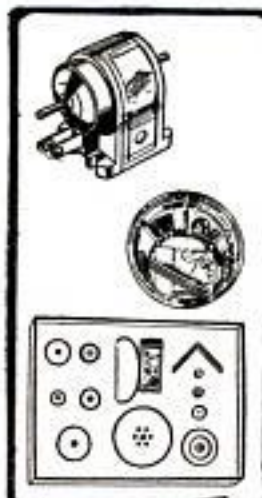

The Wilson's line offers complete motorizing service—1½ to 12 volt motors—powerful low speed and variable speed gear trains—parts for all types of drives—complete kits—for driving toys, models, research projects and industrial devices. This list may help solve a gift or technical problem for you.

- No. 8-100 Hi-Drive Motor, 3-6V. \$2.50
- No. 9-100 Same for 12V. \$3.00
- *No. 3-100 Tiny Atom Motor, 1½-3V. \$2.00
For higher voltage. \$2.50
- No. 3113N Tiny Atom motor assembly kit with many acc. \$3.50
- *No. 1300N Small accessories kit \$1.00
- *No. 3700 Large accessories kit \$3.00
- No. 4000 Deluxe accessories kit with motor. \$5.00
- No. 700 Super-Power kit with motor, speed reducer, all accessories. \$10.00
- No. 88 Kit of 8 pulleys—2 belts \$2.00
- No. 3000 Variable-speed gear unit. \$4.00
- No. 1049 Gear train with Hi-Drive motor No. 8-100. \$5.95
- Same with No. 9-100 Motor. \$6.45

* Item illustrated. Ask for FREE Cat. All Wilson's motors have Permanent Alnico Magnets.

Remit with order and we pay postage in U.S.A. No. C.G.D. Add 3% Sales Tax for delivery in Ohio. Write Dept. PM.



WILSON'S OF CLEVELAND

425 Lakeside Ave., N.W. • Cleveland 13, Ohio

For quick delivery see your local dealer — or order direct

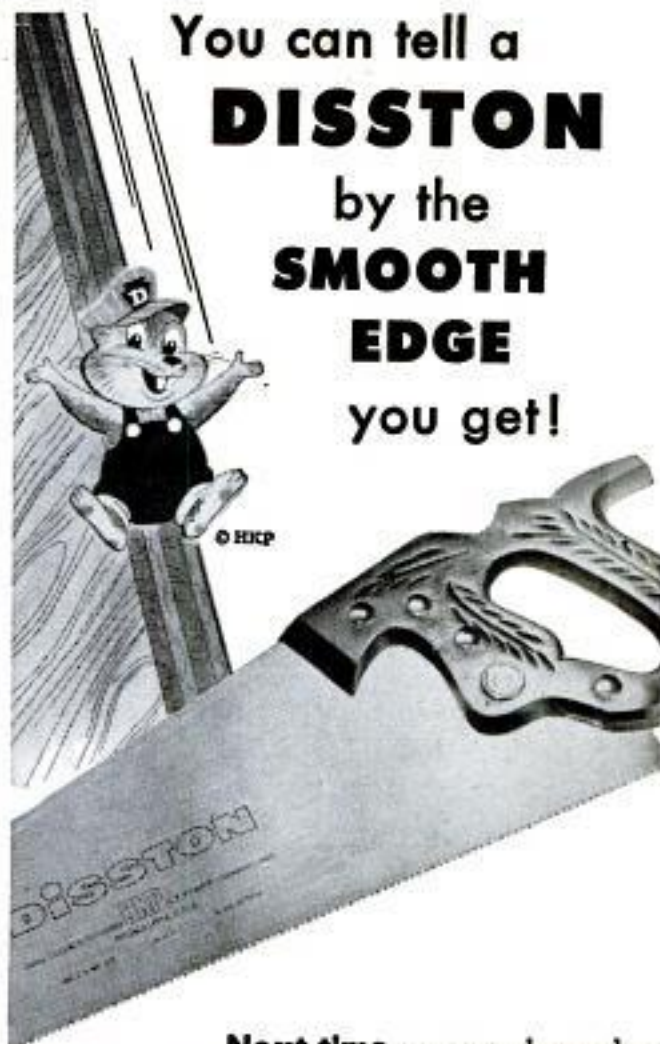

You can tell a
DISSTON
by the
**SMOOTH
EDGE**
you get!

Next time you cut plywood or other well-seasoned woods, use a 10-, 11- or 12-point Disston Hand Saw. Note how easily it cuts . . . what a beautifully smooth finished edge it leaves! That's because these fine-toothed saws are specifically designed for finishing work. Made of fine tool steel, with perfectly tempered and double taper ground blade, Disston Saws give years and years of service, too.

At better hardware dealers... everywhere!



Choose a 5½-point Disston Hand Saw for cutting with the grain.

Choose a 7-, 8- or 9-point Disston Hand Saw for cutting across the grain.

FREE ILLUSTRATED BOOKLET! 64-page Disston Saw, Tool & File Manual. Tells how to choose and use tools; how to care for them. Helpful hints on wood and metal working, and selection of materials. For your free copy write today to: *Henry Disston Division, H. K. Porter Company, Inc., Philadelphia 35, Pa.*

DISSTON · HKP

Works in seconds!



**Loosens Rusted Bolts
nuts, screws, "frozen" parts!**

**LIQUID
WRENCH**

The super-penetrating rust solvent that quickly loosens rust and corrosion.

AT HARDWARE STORES, GARAGES
SERVICE STATIONS, EVERYWHERE
RADIATOR SPECIALTY CO.
Charlotte, N. C.

**DOES YOUR WATER SYSTEM
LOSE ITS PRIME?**

See Why
**BURKS
PUMPS
ARE SELF-PRIMING**

DECATUR PUMP CO., 61G ELK ST., DECATUR, ILL.

**WOODWORKERS
CONSTANTINE'S CRAFT
SUPPLY CATALOG . . .**

CONSTANTINE has supplied woodworkers, craftsmen and industry for over 145 years at America's lowest prices. This manual is new from cover to cover. Contains many items not available elsewhere. Tells how to veneer, make inlays and inlay pictures. Lists over 2,000 hard-to-get hardware and craftsmen items. Section on hand and power tools. Invaluable do-it-yourself book. Send 50c now to pay mailing and handling (refunded on first order).

126 pages — shows rare and fancy woods and inlay in full color. Carvings, hardwood, veneers, moldings, pine, oak, inlay pictures, projects, hardware, specialty items, finishing materials. Everything for any hobbyist.

ALBERT CONSTANTINE AND SON, INC.
2056-J EASTCHESTER ROAD, NEW YORK 61, N. Y.



a touch of your toe
and you're ready to mow

Step-O-Matic Starting

DRAMATICALLY NEW ON

BOLENS

Power Mowers



See Your
Dealer Today

No bending . . . no pulling!
Just step down on the
Step-O-Matic starter
and you're ready to
mow. Bolens safety-
engineered rotary
mowers cut
fine lawns
smooth, tough
weeds fast. 5
models from \$54.95.
Easy time payments.



SEND POSTCARD FOR CATALOG

BOLENS PRODUCTS DIVISION

Food Machinery & Chemical Corp.
Port Washington 4, Wisconsin

SAKRETE

Dry-mixed concrete and mortar in a bag. No mess . . . no guess . . . just add water, stir and use. See your building supply dealer, lumber dealer or hardware store — today!

Look for the Bag with the Yellow Diamond!



HOME REPAIR TIP No. 28



WRAP SPLINTERED HANDLES of tools or implements with tough, waterproof "Scotch" 33 Plastic Tape. Thin, stretchy plastic tape sticks tightly and makes a smooth, splinter-free

grip. Good for electrical repairs, mending rainwear, too. 39¢, 75¢ sizes at stores everywhere. © 1957, Minnesota Mining & Mfg. Co., St. Paul 6, Minn.



Electronic Reservation Recorder

Reservations on 300 daily flights for consecutive 100-day periods will be memorized for one-second recall on a new electronic brain. Two such units are being installed in United Air Lines customer-service offices in Denver. Able to reduce present processing time by 60 percent, the machine at any given moment will contain data on almost 600,000 flight reservations made in 80 different cities. The apparatus will refuse to accept reservations on filled flights.

Circuit-Testing Flashlight

Electrical circuits can be tested with a flashlight having a tail-end socket plus a 30-inch cord-and-clips attachment. Powered by standard flashlight batteries, the bulb in the flashlight shines off or on to indicate condition of the circuit under test. No burns or shocks can take place, as all checks are made with the regular power shut off. Tests can be made on circuits for coils, lamps, cords, connections, grounds.



There were television sets in 37,410,000 American homes in late 1956, or 76.2 percent of all households, up from 32,000,000 homes in 1955.

SAVE MONEY THREE WAYS WITH A SILENTONE MUFFLER!

The moment you install a Silentone on your car, you start saving money in three ways. Look at this!—

1. LONGER MUFFLER LIFE— Silentone is a heavier muffler, with double-wrapped, up to $\frac{1}{2}$ heavier shell, heavier outer heads and tubes; this gives you thousands of extra driving miles.

2. BETTER MILEAGE—Silentone's scientific design lets your car run quieter—more efficiently, too, reducing exhaust back pressure to give more pickup and smooth acceleration. And with improved performance you get real savings on gas.

3. LOWER FIRST COST—Despite their extra performance and longer life, Silentones actually cost you less. Many stores will install a Silentone for you at big savings. Ask about one today. They're individually engineered for your car.

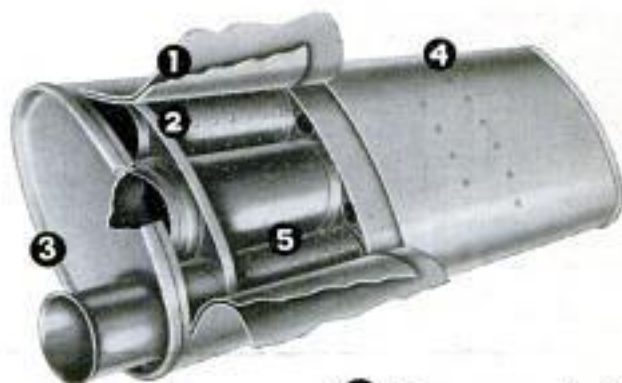

1 Double shell—26 gauge inner shell, 22 gauge outer shell—lasts longer

2 Nonclogging extruded holes—no whistling, no restriction

3 16 gauge spun locked, blowout-proof steel heads

4 Crimped seams eliminate weak points

5 High and low frequency tuning chambers

SOLD ONLY BY AMERICA'S LEADING AUTOMOTIVE CHAIN STORES

SILENTONE MUFFLERS • DYNATONE • GLASS-PACKED
Dept. 2D, Toledo 1, Ohio

"GETTING THE MOST OUT OF YOUR RADIAL SAW"

NEW DELTA hard bound book covers all phases of Radial Saw operations with over 300 photographic illustrations and line drawings—only \$1.00. Send for FREE folder on complete Delta Library. Delta Power Tool Division, Rockwell Mfg. Co., 502D N. Lexington Ave., Pittsburgh 8, Pa.

Nationally advertised products are backed by their manufacturers. Select them from POPULAR MECHANICS advertising pages

PM TAG of INTEGRITY

SAVE MONEY on LUMBER with the LOW-COST BELSAW PLANER



Convert Rough and Random Size Lumber into Cabinet Finished Stock

Now anyone can make perfect cabinet finished stock from low-cost rough lumber... any size up to 12 $\frac{3}{4}$ inches wide and 6 inches thick. Turn out high grade finished material at a fraction of the cost you pay lumber yards. Big 42-inch-long bed makes it easy to plane heavy, wide and long pieces... BELSAW self-feeds at 14 to 34 feet per minute.

USE THIS ONE LOW-COST MACHINE for Planing, Jointing, Sawing, Milling, Tongue and Groove.

You can easily make flooring, siding and many other popular patterns with your Belsaw. Your Belsaw quickly pays for itself with savings on raw materials and profits on finished stock... a highly profitable machine for custom work. Compare Belsaw with any 12-inch planer on the market... Belsaw gives you more essential features—yet costs you \$50 to \$125 less than others.

Send Today for Free Literature on the Belsaw Multi-Duty Planer.

BELSAW MACHINERY CO 2057 Field Bldg. Kansas City 11, Mo.



HARGRAVE

The Complete Line of Tested TOOLS

INDUSTRIAL QUALITY TOOLS FOR EVERY WORKSHOP



WRITE FOR FREE CATALOG

Showing a complete line of Clamps for all purposes, openings from $\frac{3}{4}$ " to 12" and depths from 1 $\frac{1}{16}$ " to 10", also Chisels, Punches, Masonry Drills for hand and power hammers, Carbide Rotary Drills, Gasket Cutters, File Cleaners, etc.

See Your Local Hardware Dealer

THE CINCINNATI TOOL CO.

1987 WAVERLY AVE.

CINCINNATI 12, OHIO



WONDER-PASTE

... makes paint removing EASY

Just spread it over the surface with a paint brush. Softens any finish right down to the wood or metal. Use on furniture, woodwork, trim—indoors or out. Will not run on uprights. At paint and hardware stores. Over 5 million cans sold—long a favorite of painters.

- Write for free Wonder-Paste folder or send 25¢ for illustrated Manual on Refinishing. Wilson-Imperial Co., 119 Chestnut St., Newark 5, N. J.

Half a turn...
and a Southern Screw
holds firm!



This simple test proves the superior quality of precision-built Southern wood screws . . . Against a small piece of rough scrap lumber, place the point of a Southern wood screw. Apply firm pressure while making a half-turn of the screw . . . See how Southern takes hold quickly, holds tight!

This simple test DOES NOT mean you should discard your screwdriver, or forget that pilot holes help make for better craftsmanship . . . But the test does prove that quality-plus Southern Screws are gimlet pointed, to give a firm, fast start—makes driving easier.

Buy Southern Screws and Bolts by the box—or buy 'em in Southern's Home Shop Screw Dept., No. 1 or 2. Each Dept. contains over 1400 bright plated pieces that save you time and trips to the store, and cuts fastener costs up to 30%!

Write today for our FREE TC-4 folder, showing how to select and use wood screws and sheet metal screws, drill pilot holes, etc., P.O. Box 1369-PM47, Statesville, N. C.

WOOD SCREWS • MACHINE SCREWS & NUTS • TAP-
PING SCREWS • DOWEL SCREWS • DRIVE SCREWS •
STOVE BOLTS • CARRIAGE BOLTS • HANGER BOLTS

Warehouses:
NEW YORK
CHICAGO
DALLAS
LOS ANGELES



Sold Through Leading Wholesale Distributors



Line Meter for Fishing Rod Reveals Depth of Hook

With a new meter that clamps to the fishing rod, an angler can determine the depth of his hook or the length of his trolling line. The line is looped around a spool on the meter. As the spool turns, a dial registers up to 100 feet of line. Fish can be played without removing the line from the spool.

4000-Year-Old Pine Tree

Three bristlecone pine trees in California are revealing facts on the climate of that state as it existed 4000 years ago. This information goes back 800 years further into the past than data gleaned from California's giant sequoia trees. A cross section from one of these bristlecone pines, measuring 42 inches in its largest diameter, will go on display at The American Museum of Natural History in New York City late this year. A specimen will be taken from the ancient trio of trees at the 10,000 to 11,000-foot level of the White Mountains in eastern California. A 20-inch-diameter hunk of a 20-year-old slash pine will be compared in the display with the older piece of timber. Where the bristlecone pine, as shown by its annual rings, grew a little more than an inch per century in diameter, the slash pine averaged an inch per year in diameter growth. Dr. Edmund Schulman of the University of Arizona Laboratory of Tree-Ring Research discovered the aged bristlecone pines.

When you buy a power workshop— make sure you get everything you need to complete the job!

Some important facts you should know about power tools!

FACT: You need more than a saw to have a complete home workshop. True, there are many operations you perform on a saw that are important to every project—ripping, crosscutting, dadoing, beveling, etc.—but, you cannot *complete* your average home project from beginning to end with just a saw.

FACT: To complete your projects (building furniture or built-ins, remodeling a kitchen, or even adding a room) you need: a saw, disc sander, vertical drill press, lathe and a horizontal drill. To see why, take even the simplest project you might want to build—a coffee table:



You Need A Saw, for ripping and crosscutting. You might also use a molding head for making decorative edges.

You Need A Disc Sander for sanding to length, or edge-sanding. For rounded corners (or a round table), set up a pivot jig and sand the workpiece to a perfect circle.

You Need A Vertical Drill Press for making angular leg sockets in the bottom of the

table, peg holes, or as a "V" block jig for drilling into the round table legs for cross supports.

You Need A Lathe to turn the legs of the coffee table. For modern design, offset tail stock center to turn perfect tapered legs; for antique or period legs, turn any design to suit your taste.

You Need A Horizontal Drill for doweling the two or more-boards that form the table top, if you want professional results. And, if you make a drawer for the table, use the horizontal drill for making extra-strong pegged joints.

FACT: All the woodworking operations cannot be performed safely at the same motor speed. In fact, you need different speeds just for sawing—slower speeds for green or tough wood. In drilling, too, you need different speeds for different operations—3800 rpm for 1/4" drills, but you should change to 700 rpm for a 1" drill.

SUMMARY: To complete the average job, you need the above five basic tools and different speeds for different operations. The advantage of a true multi-purpose tool is having all the tools you need in one compact unit, for one price. If you do not get *all* the tools you need to complete the job, or if these tools are available only as extra-cost attachments, you are not getting a complete power workshop.

IMPORTANT FACTS YOU SHOULD KNOW ABOUT SHOPSMITH: Only Shopsmith is specifically designed as a multi-purpose power workshop. It is not a one-speed saw that requires extra-cost attachments to convert it to other uses. Everything you need to use Shopsmith as a 9" saw, 12" disc sander, 16 1/2" drill press, 34" lathe and horizontal drill, including built-in 3/4 hp motor, variable speed selector and bench, is included in the one low price—\$298.50. You can own SHOPSMITH for as little as \$3 a week on Magna Tool-Time Plan.



Before you buy any power tool—single or multi-purpose—get all the facts and a demonstration at your nearest SHOPSMITH dealer (you'll find SHOPSMITH on display at leading hardware and department stores, lumber yards, or at any Montgomery Ward Store). Or—send your name and address to department 506-M, MAGNA POWER TOOL CORP., at office nearest you: Menlo Park, Calif., OR Box 2808, Ft. Wayne, Ind.

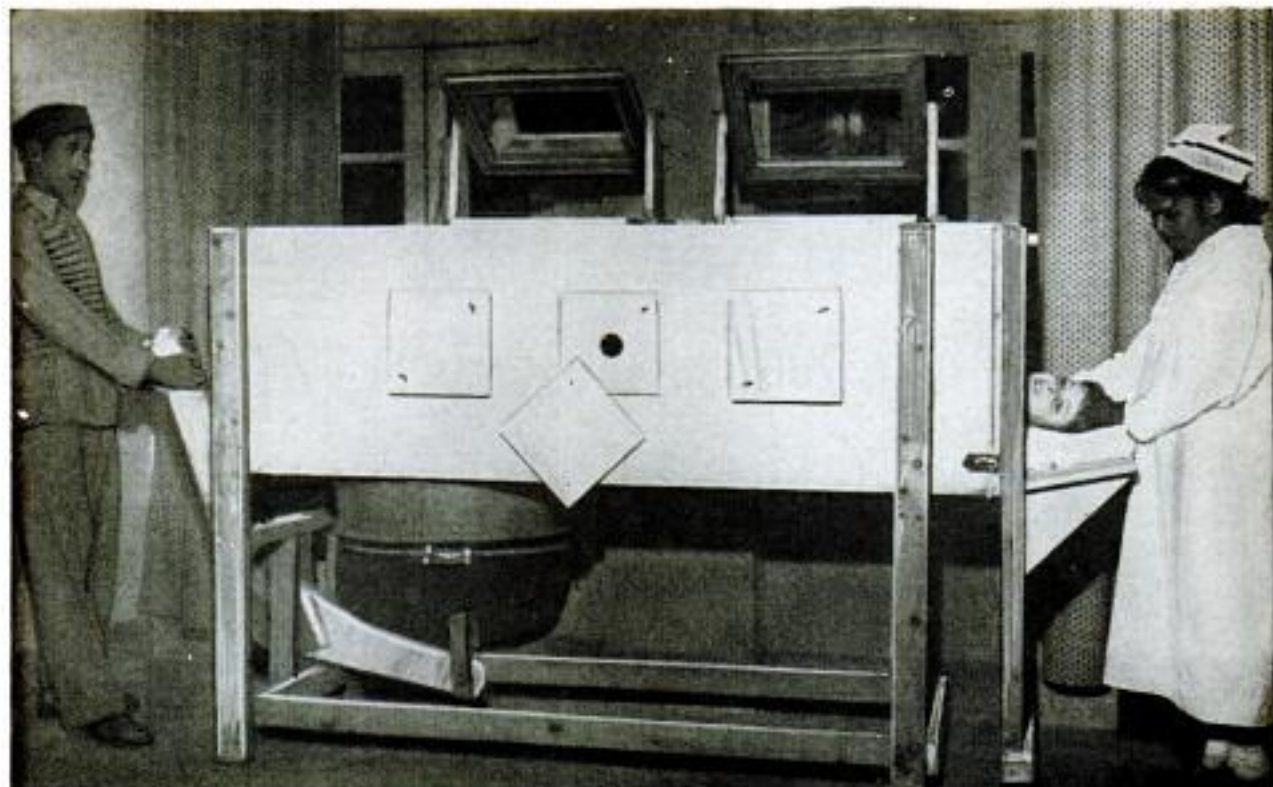

PM "WOODEN LUNG" SAVES LIVES IN INDIA

By Jean Thompson

A HOMEMADE "LUNG," improvised from a steel packing drum, two inner tubes, some lumber and other common materials, is helping save lives of polio patients at Landour Community Hospital on the Tibetan frontier.

Dr. Zerne Chapman, who built the wooden lung, flew to the United States recently with a Presbyterian missionary whose life was saved by the respirator.

When this patient was admitted last August, the hospital borrowed a professional chest respirator from the U. S. embassy in Karachi, Pakistan, a thousand miles away. One day the respirator suddenly stopped, and an Indian nurse excitedly called to Doctor Chapman: "The patient's stopped breathing!"

Doctor Chapman rushed to the room and began artificial respiration while others made the wooden lung ready. The patient was transferred to it and the 12-hour ordeal of hand pumping the improvised respirator began. Meanwhile, Doctor Chapman and others were repairing the commercial respirator.

"If we hadn't had that wooden lung, the patient would have died," said Chapman.

The wooden lung was first built at Landour in 1954. Three polio patients were admitted that summer.

"When I saw one boy, I knew we'd need a respirator to save him, and there wasn't one," said Doctor Chapman.

Confronted with this emergency, he remembered reading a short article in a medical journal which gave brief instructions for building a wooden lung. Fortunately he had saved that journal and found that complete plans had been published in the January 1952 *Popular Mechanics*.

The doctor recruited the help of two other missionaries, a former cabinetmaker and a college physics professor. The three men worked day and night on the machine. Plans called for a large tractor inner tube. None was available, so they vulcanized two small inner tubes together. They couldn't buy sponge-rubber gaskets, so they used crepe soles from shoes. Three-quarter-inch plywood isn't made in India, so they sawed planks for lumber.

"For five hours before we put the boy in the lung, we worked frantically putting up cracks so the air wouldn't escape," Doctor Chapman recalls.

The improvised wooden lung has been pressed into service many times to save lives. It was designed only for emergency situations, according to *Popular Mechanics*, but the hospital has not yet been able to buy its own respirator.

"I hope to take back a commercial respirator with me," Doctor Chapman says, "but we're going to keep improving our wooden one. We never know when we may have two polio patients at once."

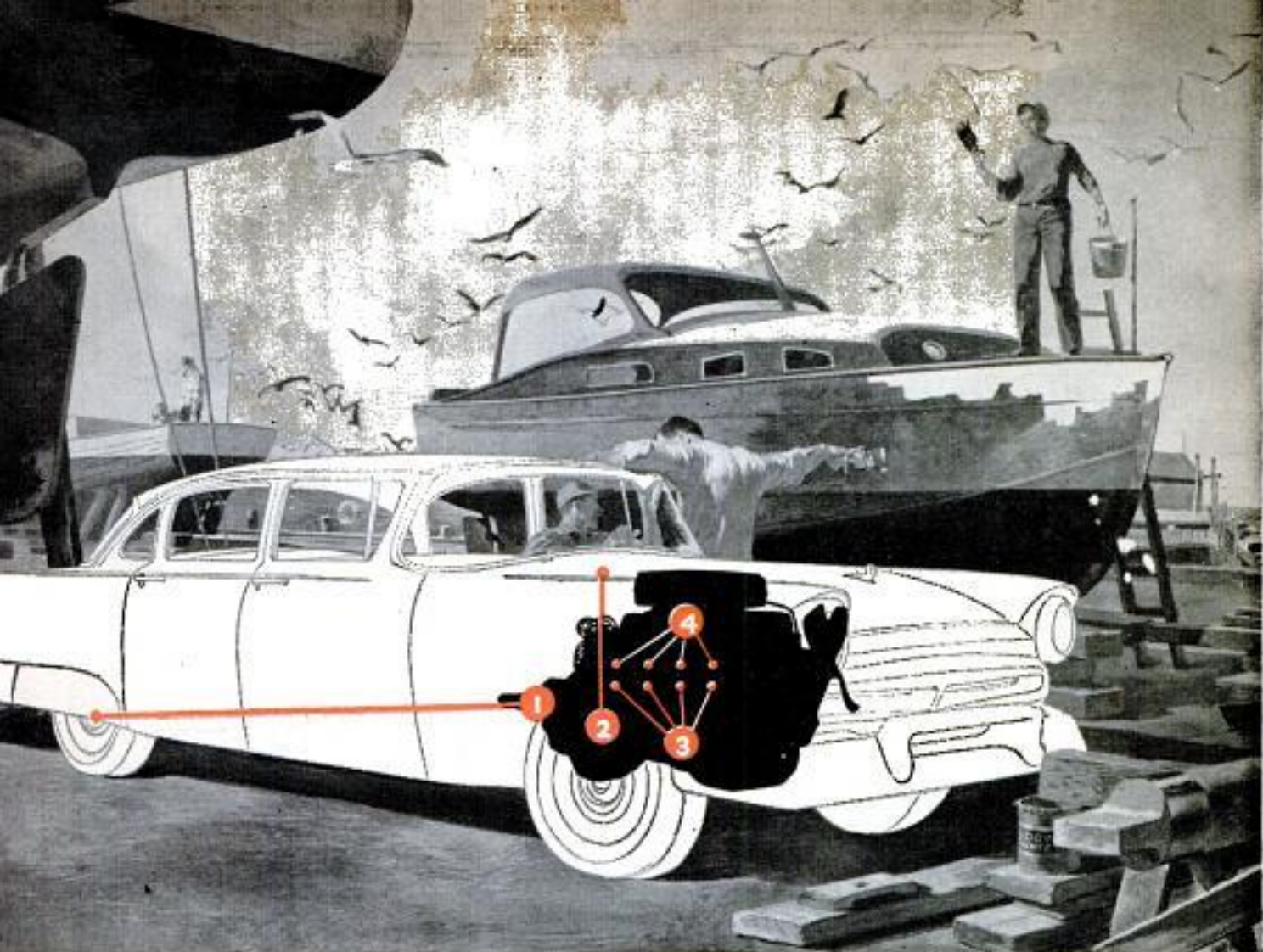

More road horsepower—You get all the engine power you paid for when you replace old plugs with 5-rib Champions! Independent

ent tests proved new Champions give cars of all makes an *immediate* boost in the real power actually delivered at rear wheels.

Most cars gained 6% to 31%—for better hill climb and safer passing. No wonder 9 out of 10 racing drivers insist on Champions!

How Champion spark plugs can make your car 4 ways newer

If you haven't changed your plugs in about 10,000 miles, read why Champions will make a big difference in your car's performance



Quicker starts—You'll get quicker starts, . . . save wear and tear on your battery. Tests with major makes cars showed new 5-rib Champions cut starting time as much as 71%—with an average of 39%!

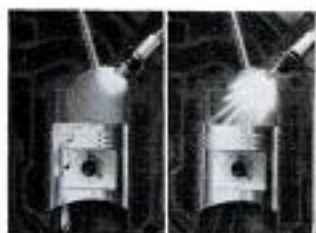

3 Less engine wear—You avoid costly repairs. Misfiring plugs (left) dilute your oil with raw gasoline. New full-firing Champions (right) protect the oil. *When changing oil—check your spark plugs!*



4 Lower cost per mile—You get top power and gas economy for life of the plug. Photo shows that Champion's great new Powerfire electrode stands up better than ordinary types. *Insist on Champions!*



CHAMPION

LOOK FOR THE 5 RIBS



**Get 'em...
with Blazing Speed,
Pin-Point Accuracy!**

MARLIN 56 LEVERMATIC .22

The Model 56 Levermatic—the small-game hunter's favorite—"gets the ones that used to get away".

It's the world's only rifle with revolutionary short-stroke action that lets you fire at almost semi-automatic speed, keeping your finger on the trigger . . . and your sights glued on your target. Micro-Groove Rifling*, with its 20-25% accuracy bonus, puts your shots exactly where you aim them.

Now this trail-blazing design embodies several brand-new improvements: NEW BISHOP-STYLE STOCK provides perfect "feel" and balance. Special finishing gives stock greater beauty and toughness. Modern in design, the Marlin 56 measures only 41" overall and weighs about 6½ lbs., for faster handling.

\$49.95** without scope



The Marlin Pay-Later Plan puts your 56 Levermatic in your hands immediately, for only \$4.95 down-payment! You choose the monthly payment

schedule that fits your budget. Ask your Marlin dealer for the simple details.

THE NAME FOR GAME

Marlin

FINE GUNS SINCE 1870

*Patent applied for. **Slightly higher west of the Rockies. Subject to change without notice.

MARLIN FIREARMS CO. 6-47
P.O. Box 965, New York 17, N. Y.

Please send me your catalog with photo illustrations and complete descriptions of all Marlin Guns. Also send me the new, profusely illustrated 16 page "Marlin Target and Game Record Book", for my personal shooting records. I enclose 25¢ for handling.

Name.....
Address.....
City.....Zone.....State.....



Solar Cooker Folds Like Umbrella

Steak can be cooked in less than 20 minutes on a "750-watt," solar-heated unit that folds and unfolds like an umbrella. Actually a parabolic reflector, the device is a four-foot curved "mirror" made of a new plastic film covered with a reflecting finish almost as effective as the finish in a real mirror. Built as a series of ribs sliding on a collar along shafts, the cooker works by zipping it open, thrusting its pointed end into the ground and tilting it to collect solar rays. The stove focuses rays into a 10-inch circle to generate about 450 degrees of heat. On a bright day the 10 square feet of reflecting space available gathers 1000 watts of sun power with about 25 percent of the rays reflected or absorbed.

Automatic Rememberer Turns Lights Out for You

It would take a lot of conniving to fool a memory switch that makes it impossible for you to drain your car battery by leaving the headlights on. A wire from the generator keeps the lights burning as long as the engine runs. A thermostat keeps the lights burning as long as the engine is hot. A switch under the driver's seat keeps the lights on as long as somebody's sitting at the wheel. When none of these conditions exists, the headlights are turned off automatically. The thermostat switch provides the added convenience of permitting you to leave the car lights on while you enter the house—the switch turns them off when the engine cools.



GRAVELLY

offers
NEW EASE
for
Country Living!



An Amazing New Experience Awaits You!

You, too, will be mighty proud when everyone marvels at the beauty of your Gravelly-kept place! . . . (If they but knew the ease and speed with which you do every lawn and garden job with your versatile Gravelly! . . .) Whatever the job, summer or winter, your Gravelly turns in a perfect performance, with power to spare!

Now! 30 Tools for Every Year-Round Job!

Unmatched versatility! . . . 30 performance-proved attachments to choose from. Plus All-Gear Drive, Power Reverse, Push-Button Starter. Don't be satisfied with less than Gravelly offers!

Write today for FREE Booklet,
"Power vs Drudgery!"

GRAVELLY TRACTORS, INC.
BOX 463 DUNBAR, W. VA.

**EASY
PAY
PLAN**

FREE! CALIFORNIA GARDEN BOOK

New 1957 pictorial round-up of latest ideas in garden arrangement and structures, by famous landscape architects. Dramatic new planters, terraces, fences, arbors, shelters and patios. Write for **Garden Book**, California Redwood Assn., 572 Sacramento St., San Francisco 11.

Find HIDDEN TREASURES

GOLD, SILVER, PRECIOUS METALS with the Famous Model 27 Metal Detector. Lightweight, ultra-sensitive, low cost. None finer. Also GEIGER COUNTERS for uranium and the VIOLITE for tungsten. INFORMATION FREE

THE **Detectron** CORP.
5528 Vineland Ave., No. Hollywood, Calif.



Protect your home against
power interruptions
with an...

ONAN Emergency ELECTRIC PLANT

Provides dependable stand-by electricity for heating system, pumps, freezer, lights, appliances. Keeps home safe, livable. Automatic start and stop. Find out how little it costs!

Write for Folder!

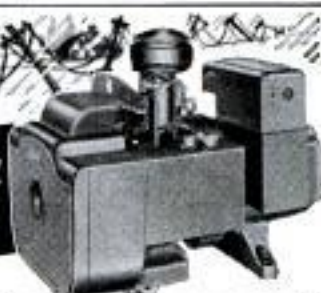

A SIZE FOR EVERY NEED
500 to 75,000 watts.
Compact, quiet-running.
Gasoline-powered.
Priced from \$269.00

D. W. ONAN & SONS, INC.
3245 University Ave. S. E. • Minneapolis 14, Minnesota

Holt's WORLD FAMOUS "Do-It-Yourself" PRODUCTS

HOLT'S ORIGINAL PistonSeal

20 years on the market. No one else can make such a claim. Next best thing to complete motor overhaul... at 1/20 the cost. Good for 10,000 miles.

Only \$4.95 a Tube

- 1 - reduces oil consumption
- 2 - restores compression
- 3 - stops piston slap
- 4 - increases miles per gallon
- 5 - improves performance
- 6 - makes engine quieter

REPAIR MUFFLER AND EXHAUST LEAKS in 10 min.



The plastic gas-tight seal sets hard, withstands heat and vibration. Prevents carbon monoxide gas poisoning.

SETS LIKE A WELD—NO TOOLS NEEDED

Holt's GUN-GUM

MUFFLER SEAL

\$1.69
Per Can

Ask for Piston Seal and GUN GUM at nearest garage or auto store . . . or
TREGLOWN CO., Inc.
Fanwood 121, N. J.

® TRADE MARK REGD.

Write
for full
details



STOP WASTING MONEY on worn-out piston rings!

Oil-pumping is the first sign of worn-out piston rings. And worn-out piston rings mean power drop-off—costly wastage of gas and oil—expensive repairs later on.

The sooner you act, the less it will cost. See your motor specialist the minute oil-pumping warns you there's trouble ahead. When he recommends new piston rings, ask him for Hastings. They're engineered exclusively for replacement service . . . to provide the additional lubrication worn engines need . . . to stop oil-pumping, save gasoline and restore lost performance. Truly the best money you can spend on your car.

HASTINGS MANUFACTURING CO. • HASTINGS, MICH.

HASTINGS

PISTON RINGS

TOUGH on oil-pumping • **GENTLE** on cylinder walls

Buy these Hastings Products with confidence:
Piston Rings, Casite, Wear Reducer,
Oil Filters, Spark Plugs



Self-Service Hospital Facilities Pamper Patients

Self-service, push-button pampering is available to patients at the Boulder Colorado Sanitarium. A partially prefabricated hospital room has a compact unit that includes a fold-away washbasin, personal ice-water spigot, coffee pot, toaster and a miniature refrigerator.

Bark Converted Into New Soil Builder

Tree bark, formerly an inexpensive fuel or waste product, is now combined with fertilizer to turn clay or sand into rich loamy soil in which plants thrive. This bark soil builder loosens soil and improves its moisture-holding capacity; it serves as a base for fertilizer and controls the rate at which plants obtain soil food. The average lifetime for this soil builder in the soil is five years. Home gardeners and professional growers will use this substance, according to Armour Research Foundation of Illinois Institute of Technology, Chicago. The bark is ground up, the tannin condensed from it, and water and excess chemicals removed before the material is washed and dried for inclusion with fertilizer.

Tractor Wheel Warms Hands

Tractor drivers can keep their hands warm by holding tightly to a steering wheel with a built-in heating element which, the British inventor says, can be added to existing wheels as well.

If your headlamps look like these—

**YOU NEED A PAIR OF NEW G-E *All-Weather* HEADLAMPS
YOU'LL GET LOTS MORE LIGHT!**

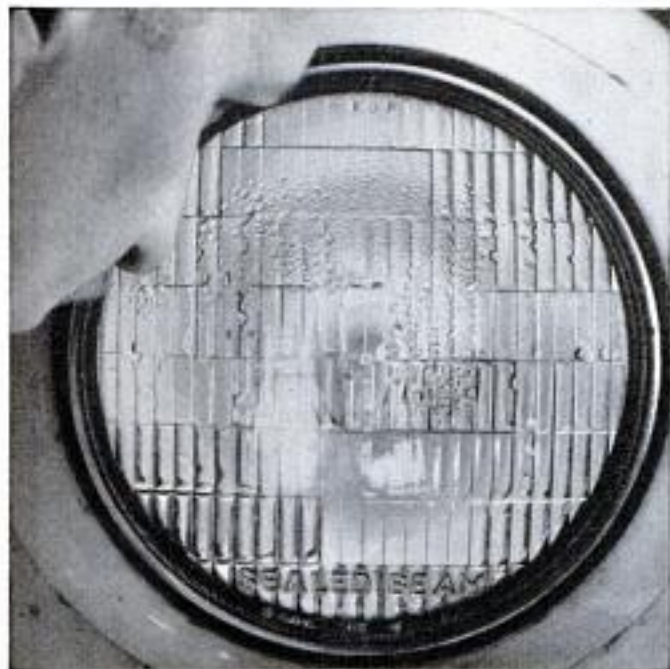

WATER DROPLETS inside the lens not only scatter the light, but they also help discolor metal reflectors. This can't happen with G-E *All-Weather* Headlamps—moisture can't possibly get inside.

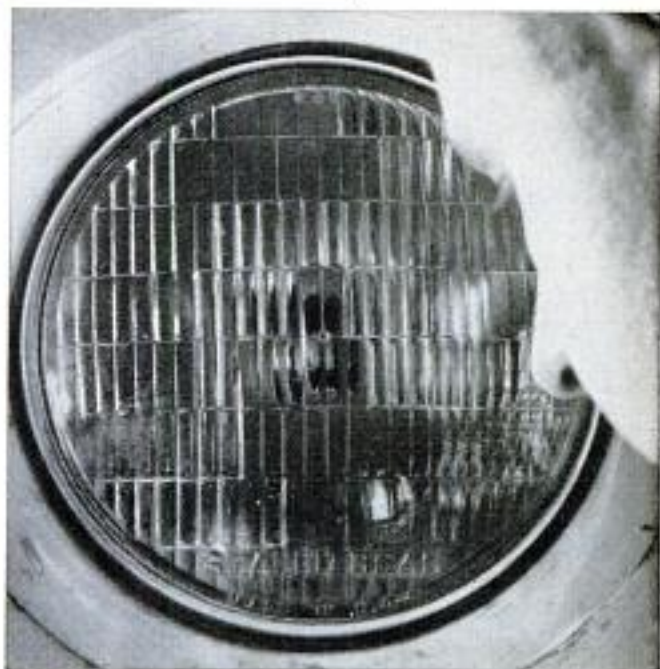

DISCOLORED REFLECTORS absorb light rather than reflect it, causing a loss of up to 50% of the original light output. Dirt and moisture can never enter G-E *All-Weather* Headlamps so the reflectors always stay shiny.

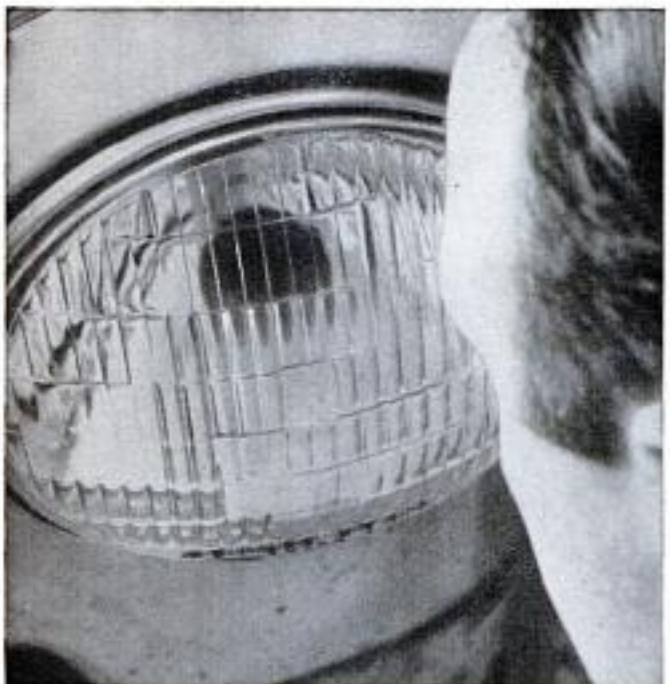

BLACKENED BULBS in old-style headlamps block out the light from the filament and cause a dangerous drop in light output. This can't happen with G-E *All-Weather* Headlamps because *there are no inner bulbs!*

G-E *All-Weather* HEADLAMPS NOT ONLY GIVE YOU LOTS MORE LIGHT... BUT YOU ALSO GET:

Better seeing in fog, rain, snow—The lower beam filament has a special shield that cuts down reflected glare and lets you see better in any weather.

Lower beam puts twice the light 300 feet ahead at the curb—You can see much better against the glare of oncoming traffic.

Upper beam that reaches far and wide—For open road driving, the upper beam filament is left unshielded to let you see curves, dips—even side roads.

So, for safer night driving, get a pair of new G-E *All-Weather* Headlamps today — and have your dealer aim them when he puts them in. You'll see the difference tonight. General Electric Co., Miniature Lamp Dept., Nela Park, Cleveland 12, Ohio.



GENERAL  ELECTRIC

Don't just shave... Use

AERO SHAVE!

(and save 20¢)

Never before a lather so rich, so creamy, so fast-acting—for so little money! Get AERO-SHAVE Push-Button Lather.

Not ~~79¢~~ Not ~~69¢~~ Only **59¢**

The **NEW** Hi-torque

HANDEE®

The Newest of all Hand Tools

A COMPLETE WORKSHOP IN YOUR HAND

The perfect power tool for model building, wood carving, costume jewelry making, costume jewelry making, plastics engraving, gift initialing, etc. Grinds, polishes, cuts, saws, routs, engraves, cleans and burnishes. Packed with speed (25,000 r.p.m.) and power.

Perfectly balanced, cool running, fits the hand for pencil point precision in delicate work. 110 volt or 220 volt (if specified) 25 to 60 cycles AC or DC.

With every type of cutting tool in metal case—\$32.95 Unconditionally Guaranteed

with 6 accessories
\$23.95

SEND ORDER TODAY!

Chicago Wheel & Mfg. Co., 1101 W. Monroe St., Chicago 7 PM-4
Rush Postpaid the following:

- Handee with every type of cutting tool in metal case @ \$32.95
- Handee with 6 Accessories @ \$23.95
- Check Money Order Enclosed Send COD
- Send Literature

Name.....
Address.....
City..... Zone..... State.....



Homemade Scoop for Tractor

For just \$20 worth of material, 17-year-old George Powell of Spraggs, Pa., built a labor-saving farm implement of his own design. The implement is a tractor-mounted scoop, buck or earth leveler, depending upon the attachment he uses. Two steel tubes eight feet long serve as framing members. The arms are raised or lowered by cables running through pulleys to the power take-off.

Disposable Flashlight

Disposable flashlights with sealed-in bulbs and batteries can be used up to 1½ years without replacement. Resembling a woman's compact, this flashlight does not open. Bulb, lens and switch are set into its edge. The operator directs the lens at the target and presses the switch for illumination, which is comparable to that of the standard flashlight.



50% OFF on National's **NEW 1957**
22" Rotary Power Mower

3 H.P. Clinton 4-Cycle or
Briggs & Stratton Engine
with Recoil Starter

Mfr's. List
Price \$139.75

69⁵⁰

Delivered



FREE Leaf Mulcher

• **LIFETIME GUARANTEE** - All Steel Unbreakable housing
• Cuts full 22" Swath • Automatic Governor • Trimming
action on both sides of mower • Double Discharge chutes
• Adjustable cutting height, 1" to 3" • Saber Steel blade,
detachable, reversible • Shockproof clutch, protects blade
• No shimmy - no vibration • Full floating handle.

• **LAY-AWAY PLAN** - \$10 deposit - reserves mower until
needed - State date. Balance, C.O.D.

• Pay in full, receive an extra **FREE** bonus - 50 ft. Plastic
Garden Hose, Value \$4.95.

• **Guaranteed Satisfaction** for 90 days after delivery.

• **Money-Back Guarantee** - return unused within 10 days.

NATIONAL FARM EQUIPMENT CO., INC.
142 GREENE ST. • Dept. 22 • NEW YORK 12, N.Y.



SAVE 60%
ON SAW BLADE COST

WITH
**HEINEMANN'S
HARD-TIP
SAWS**

Deep hardened for hard to
penetrate. In resins,
oil, they stay in bite.
It's practical in re-
place blades when you
do some reworking work.
See your nearest dealer, or
request literature from...

HEINEMANN SAWS
STA. B, CANTON, OHIO

**CUT EXACT CIRCLES
CURVED PATTERNS**

"ARCO JIG-SAW"

With Circle-Cutter (up to 20" dia.)
& Rip Gauge fits any 1/4" drill. Has
speed of 555 saws. Cuts 2x4's, ply-
wood, metals, etc. Incl. blade. At your
dealer or try it on our 10-day trial.
Send check, M.O. (ppd.) C.O.D. + post.
ARROW METAL PRODUCTS CO., Dept.
PM-4, 140 West Broadway, N.Y. 13, N.Y.



\$10.95

DIGS 2" TRENCHES to 18" DEEP

New Model B DITCH WITCH digs 2-in. trenches
to 18-in. deep. Perfect for lawn sprinkler
systems, utility service lines. Digs straight,
curved and cornered trenches in
all soils, even rocky and frozen.
Low Cost! Write for new Bulletin.
THE CHARLES MACHINE WORKS
620 B Street Perry, Oklahoma



**SAVE MONEY ON YOUR
COMPRESSED AIR**

buy this complete
SMITH 45-P air compressor

Right for spray painters, plumbers, contractors,
monument shops, tire changing trucks, maintenance
shops, quarries, utilities, many other users. De-
livers 45 plus cu. ft. per minute; pressure up to
150 PSI. Powered by Wisconsin 4-cyl. air-cooled
engine; uses less than 1 gal. gasoline an hour!
Most compact, biggest-value compressor for its
capacity anywhere! Other models to 230 cfm.



write for
**FREE
brochure**

GORDON SMITH & COMPANY, Inc.
411 College Street, Bowling Green, Ky.

You can build
almost anything with
FIR PLYWOOD

but
remember -



**1 - LOOK FOR THE DFPA QUALITY
TRADEMARK**



When you see the letters DFPA on panel you
know you're getting plywood quality-tested to
meet rigid industry standards. DFPA trade-
marks attest quality, performance and value.

**2 - CHOOSE THE RIGHT GRADE
FOR EACH JOB**

EXT-DFPA
Exterior plywood for
outdoor & marine use

EXT-DFPA



PlyPanel® for paneling,
most indoor uses

INTERIOR-TYPE

PLY PANEL



PlyScord® (unsanded
economy panel) for
sheathing, backing

**GENUINE
BIRCH PLYWOOD**

PLYSCORD

FOR SHEATHING

**DFPA
TESTED
QUALITY**

Choose Exterior-type (waterproof glue) for
outdoor and marine uses; Interior-type for in-
side jobs. Within each type are several
appearance grades (panels with one good side,
two good sides, etc.). See your lumber dealer.
He'll help you choose the right grade, help
with ideas and plans.

SPECIALTY PANELS include 1. *textured plywood* with
smart grooved, striated or brushed surfaces for special
decorative effects; 2. *overlaid plywood* (smooth, durable
resin-fiber surfaces) for extra quality work.



FREE: Helpful booklets that show how to buy,
use and finish plywood. Also, list of available
homecraft plans. Write (USA only) Douglas
Fir Plywood Assoc., Tacoma 2, Wash., Dept. 9.

**SELECTED
TOP VALUE SPECIALS!**
SURPLUS ITEMS AT FRACTION OF ORIGINAL GOV'T. COST
AT GROBAN'S



**BRAND NEW 1957!
FACTORY-TO-YOU-VALUE
PORTABLE
ELECTRIC
LIGHT
PLANTS**

ITEM #1008-B

Dimensions:
Length 20 1/2"
Width 12"
Height 16"

POWER TO OPERATE:
• Water pump, Radio, Lights, Air-conditioner • Refrigerator, Deep Freezer, Incubator • Electric Saw, Electric Drills, Pipe Bender

Compact—Fits in the Trunk of Your Car

FULL 1000 WATTS continuous duty. 115 Volts, A.C. 60 cycles, 9 amps. Powered by husky Briggs-Stratton engine with recoil starter. Engine and generator operate at 3600 R.P.M. for maximum efficiency at minimum weight. Both units are mounted on steel base, with heavy sheet metal belt guard. Generator is self-regulating, and is equipped with outlet box containing fuse and 2 A.C. convenience receptacles. Cost only 5¢ an hour to operate. Shipping wt. 100 lbs. (Regular price \$225). You save \$65.50. Now only **159.50**

F.O.B. Chicago.

700 WATT — GENERATOR SET — same as above, slightly smaller—with Briggs-Stratton Engine—**129.50**
Model 708—F.O.B. Chicago

ITEM #2008—**2000 WATTS** 115 V. A.C. generator set, powered by husky, fast starting Briggs-Stratton engine. Mounted on portable steel carrying base for easy handling.—Just right for small cottage and cabins needing inexpensive 2000 Watts of electricity. Ship. Wt. 190 lbs. F.O.B. Chicago. **295.00**

**HIGGINS BRONZE
CENTRIFUGAL PUMP**

PUMPS ALMOST ANYTHING



ITEM #414
Fine for: — • Irrigation • Sump Pumping • Sewer Drainage • 75 gallons per minute @ 2400 R. P. M. Higgins Type PNB, Model B, marine bilge pump. Open impeller design for handling muddy water. Delivers 75 gallons per minute, 30 foot head with 3/4 H.P. motor.

Pump body and impeller are made of solid bronze, with alloy steel 1/2" diameter shaft, 13/4" long. Rotation of the pump is clockwise. Inlet has 1 1/2" pipe thread. Plain 1 1/2" outlet for hose connection. Dimensions 12"x7"x8". Shipping weight 23 lbs. F.O.B. Chicago. **23.50**

1/4" METAL STAMPING SET

STAMP YOUR NAME ON WOOD OR METAL!

Full alphabet A to Z, "&" and period.

Precision hand trimmed deep cut, hardened STEEL STAMPS—in fitted Wooden Box—made to rigid U.S. Navy specifications by Young Bros.—Comparable to sets selling for \$27.00. Shipping Wt. 5 lbs. F.O.B. Chicago. **5.95**



ITEM #390

FREE—NEW CATALOG 1957 EDITION, 60 PAGES, check-full of unsurpassed War Surplus and newly manufactured Equipment Bargains for farm, home, factory, workshop. Write letter today.

GROBAN SUPPLY CO. Dept. PM-4
1139 S. WABASH AVE., CHICAGO 5, ILL.

**COUNTRY
SQUIRE
TRACTOR**
with
ROTARY,
REEL TYPE
or SICKLE
MOWER

**CUT GRASS
THE EASY WAY**



ALSO plows, harrows, cultivates, plants, rakes hay, sprays, bulldozes, plows snow, saws cord-wood. Write for FREE CATALOG.

**COUNTRY SQUIRE
TRACTOR CO.**

P.O. Box 107, K-4A
Muskego, Wisconsin

**KEEP YOUR
WORKSHOP TOOLS
SAFE AND ORDERLY**



This 7-drawer machinist's chest has a place for every tool. Extra durable heavy gauge steel. Felt lined drawers protect delicate edges... operate easily. Size: 8 1/2" x 13 1/2" x 20 1/4". \$27.95 at leading hardware stores. Slightly higher west. Other home workshop models from \$1.25 up.

WATERLOO VALVE SPRING COMPRESSOR CO.
Waterloo, Iowa



**GENUINE ALNICO
MAGNETS**

AMAZING, PERMANENT, NON-ELECTRIC, HIGHLY PRACTICAL. Conduct interesting experiments. Hundreds of uses. Retrieve valuable steel items such as guns, tackle from fresh or salt water; tools from tanks & drains. **GUARANTEED.** Try any magnet one week. Money back if you are not well-pleased.

- No. M-710 (Wt. 53 oz.) Has pull of 225 lbs. on steel block... **\$16.50**
- No. M-625 (Wt. 70 oz.) Has pull of 125 lbs. on steel block... **\$9.50**
- No. M-575 (Wt. 18 oz.) Has pull of 75 lbs. on steel block... **\$6.50**
- No. M-500 (Wt. 13 oz.) Has pull of 50 lbs. on steel block... **\$4.50**
- No. M-300 Kit of Flat Bars 5 Pairs (10 Magnets)... **\$3.00**
- No. M-250 Kit of Round Rods 5 Pairs (10 Magnets)... **\$2.50**
- No. M-47 Hot Pad Magnets, 10 for \$1.00... **50¢ for \$1.00**
- No. M-35 Hobbyist assortment of 8 small magnets... **\$1.50**

Send M.O. or check. We pay postage. Sorry no C.O.D.'s.
MIAMI MAGNET COMPANY, 3240 N.W. 27th Ave., Miami 42, Fla.

NEW LIFE for old brushes



IMPERIAL Rapid Brush Cleaner

cleans hard-caked brushes in a jiffy. Acts instantly—no long soaking. Leaves bristles like new—never flabby.

At paint and hardware stores.

Wilson-Imperial Co., 119 Chestnut St., Newark 5, N. J.

**Guaranteed original equipment
Replacement Auto Parts... at
Western Auto**

**DO IT
YOURSELF**

It's Easy
With...



Soldering's really a "cinch"
... when you use time-tested, reliable KESTER... available everywhere.

FREE! "Soldering Simplified"
... 16-page how-to-solder booklet. At your dealer or write direct.

KESTER SOLDER COMPANY
4251 Wrightwood Avenue Chicago 39, Illinois



Wheels Are Tested In 40-Foot Trough

Scale-model wheels, towed through a 40-foot trough containing sand, mud, clay and rocks, are to be measured for data on resistance, slippage and sinking. University of Michigan engineers will correlate this information to predict performance of a full-scale vehicle. Tests will vary the size and number of wheels, size and direction of loads on wheels, amount of wheel "drive" and material in the trough.

World's Weather Records Charted

Official world's weather records for highest and lowest temperatures, greatest and least rainfall and snow show: Highest temperature, 136 degrees F., Azizia, Tripolitania, in northern Africa, 1922; lowest temperature, minus 90 degrees F., Oimekon, Siberia, 1933, and twice at Verkhoyansk, Siberia, in 1892; highest average annual temperature, 88 degrees F., Lugh, Italian Somaliland, Africa; lowest average annual temperature, minus 22 degrees F., South Polar Icecap; greatest average annual rainfall, 471.68 inches, Mt. Waialeale, Kauai, Hawaii; greatest rainfall for one minute, 0.69 inch, Jefferson, Iowa, 1955; greatest rainfall in one hour, 12 inches, Holt, Mo., 1947; least average annual rainfall, 0.02 inch, Arica in northern Chile; greatest average annual snowfall, 575.1 inches, Paradise Ranger Station, Rainier Park, Wash., which also had the greatest snowfall in one season, 1000.3 inches in 1955-56.

NOW
It's As Easy To Enamel
As It Is To Paint

THANKS TO
LUMINALL

THE ORIGINAL MIRACLE PAINTS

Ready-to-use!
No undercoat!
Odorless!



No brush or lap
marks! Truly
self-leveling!



One Coat
Plenty for
Most Surfaces!



Looks
hand-rubbed!
Washes like
ceramic tile!



Just apply like
wall paint—it
does the rest!



COLOR-
MATCHES
two famous
wall paints!



If you've ever used ordinary enamel, you know it was hard to apply. Only the most skilled person could avoid brush and lap marks, irregularities and blemishes. But now, thanks to Luminall, you merely "paint" on your enamel... as easily as applying modern wall paint. In a scant four hours the surface magically transforms itself into a durable, smooth coating as beautiful as a cabinet-maker's finest hand-rubbed finish. Makes an artist out of a casual painter. You'll admire your craftsmanship. You'll say, "How incredibly perfect! Now I know why Luminall Paints are called miracles!" And later you'll add, "How easily it washes! How long-lastingly beautiful!"

FAMOUS SATIN LUMINALL

The concentrated interior paint with bonus quart per gal.



READY-TO-USE LUMINALL

Easiest to use on all interiors. Washable, durable.



OUTSIDE LUMINALL

The All-Climate Finish for brick, concrete, masonry.



LUMINALL CONCRETE FLOOR PAINT

Quick-drying for heavy-duty floors, decks.



FREE

LUMINALL PAINTS, Dept. 57 J, 3617 S. May St., Chicago 9, Illinois
Please send FREE 62-clip chart featuring lovely Luminall Satin Enamel, Satin Luminall, Ready-to-Use Luminall, Outside Luminall and Luminall Concrete Floor Paint Colors.

Name _____

Address _____

City _____ Zone _____ Store _____

Luminall Paints • Chicago 9, Newark 2, Los Angeles 1, Dallas 7



OVER 8,000 STOCK ITEMS

Gears, Sprockets
 $\frac{1}{8}$ " to 168"
Worms, Chains, etc.



Change Gears, Bevel Gears, Miter Gears.

Spur Gears, steel or Formica.
 Worms and Worm Gears.
 Sprockets, all types.
 Roller Chain, single or double.



Flexible Chain Couplings, Shaft Collars, Universal Joints, Worm Gear Speed Reducers, Spur Gear Reducers, Surface Plates, Straight Edges, Cubes, Angles, Right Angles, Drill Presses and Accessories, Coolant Pump Systems, Dust Collectors, Motors, etc.

Complete engineering and manufacturing departments to design or build anything made of metal.



LOW PRICES

Send 25c for 206-page CATALOG

Universal Gear & Machine Co.
 1301 E. McNichols Road
 Detroit 3, Mich.

Fast cutting
 Top quality

GENSCO



SWEDISH WOOD CHISELS

Woodworking projects have that little extra professional touch when Gensco Swedish Wood Chisels are used. They're tops: hand ground, razor sharp blades, Tenite II handles are unbreakable and fire resistant . . . won't pull loose, sizes from $\frac{1}{4}$ " to 2".

Buy these accurate cutting, easier to use Gensco Wood Chisels at all leading hardware stores today. Available in sets of 4, 6 or 11 chisels in vinyl coated canvas rolls.



Set 300-4

$\frac{1}{4}$ ", $\frac{1}{2}$ ", $\frac{3}{4}$ " and 1"



Bushman ALL-PURPOSE 21" Bow Saw

GENSCO

GENSCO TOOLS

A DIVISION OF
 GENERAL STEEL WAREHOUSE CO., INC.
 1832 N. Kostner Ave., Chicago 39, Illinois

JEEP & 4-WHEEL DRIVE OWNERS

FRONT DRIVE WITH
FREE-LOCK HUBS

FRONT DRIVE-NO
FREE-LOCK HUBS

LOW OPERATING COSTS
 ALL PARTS STOP ONLY WHEELS MOVE!



IN 2-WHEEL DRIVE NO PARTS MOVING STOPS GEAR WHINE



HIGH OPERATING COSTS
 ALL THESE PARTS MOVE WHEELS MOVE



IN 2-WHEEL DRIVE OVER 100 PARTS MOVING -WEARING!

Stop front drive wear Increase power
 Reduce engine wear Tires last longer
 Save gasoline Easier steering

UNCONDITIONALLY GUARANTEED!

Benefit now from this money-returning investment.

© FLC Ask dealer to order yours now. Write for **FREE FOLDER**

FREE-LOCK CORPORATION
 6301 NORTH FEDERAL BLVD., DENVER 11, COLORADO

BUILD YOUR OWN AUTOMATIC AIR COMPRESSOR

K-33 Complete Automatic Air Compressor Unit: Knocked Down, 3 CFM Air Compressor $\frac{1}{2}$ HP AC Motor 8x20 Tank on Wheels: Pressure Switch, Air Regulator, Gauge, Check Valve, Safety Valve, Hose & Tire Chuck. **UNIT COMPLETE (\$100 Value) ONLY \$67.50.** Same as above $\frac{3}{4}$ HP Unit 5 CFM Compressor 12x24 Stainless Tank on Wheels. All Accessories. You Assemble \$3K-75. **SPECIAL LOW PRICE ONLY \$99.00.**



Order from THIS AD. GUARANTEED. FOB Chicago

C. MARSHALL SALES, 3546 Fullerton Ave., Dept. P-4, CHICAGO 47

TWO WAYS TO BUY BETTER

Your dealer knows the right products for your needs—quality products that are nationally advertised. **POPULAR MECHANICS** brings you a monthly roundup of valuable "how to" information and product advertising. Read **POPULAR MECHANICS** every month—then talk to your dealer.



FUN-WORK YARD TRACTOR
WHEEL-HORSE RIDE-AWAY



SENSATIONAL LOW PRICE

Turn work into FUN! Do a dozen back-breaking jobs in a jiffy. Yard-size tractor with 5 forward speeds and 1 reverse. $3\frac{1}{2}$ hp (or $2\frac{1}{2}$ hp) engine. Heavy channel steel chassis. Mow 5-foot swath at 5 mph. Plow snow, cultivate, haul compost, pull any of 22 attaching tools for yard and garden. Write for details, and name of dealer.

WHEEL-HORSE PRODUCTS

2644-E Dixie Way North

South Bend, Indiana

POPULAR MECHANICS

Copyrighted material



You know those rare days when *everything's* right? Air smells good. Food tastes terrific. Even the old face looks good in the mirror. *Today* can be that kind of day. Just do two things. Call your doctor for a thorough medical checkup for cancer. Then write out a check—a nice fat one—to the American Cancer Society, and mail it to "Cancer" in care of your local Post Office.

AMERICAN CANCER SOCIETY

100 BEST Woodworking Projects

Selected by Popular Mechanics Editors

Enjoy the fun of making things. Revel in the pride of the craftsman when neighbors and friends admire your handiwork. Get 100 BEST WOODWORKING PROJECTS, complete with simplified instruction, plans, diagrams and more than 400 how-to-do-it pictures. Make all kinds of furniture—chairs, tables, desks, bed room furniture. Make baby carriages, clock cases, lamps, book shelves, fireplaces, attic ladder, folding screen, kitchen accessories, games, swings, storage bins, garden sets, etc., at little or no cost. Send only \$3.00 with name and address today. Money back if not pleased.

POPULAR MECHANICS PRESS, Dept. PM-457
200 E. ONTARIO STREET CHICAGO 11, ILL.

The "Must" for All Home Workshops



BUY DIRECT from MAKER and SAVE! COMPLETELY AUTOMATIC "SEA-HORSE" DIVING LUNGS

INCREASED PRODUCTION brings NEW LOW PRICES
A SCUBA with the Famous BENDIX REGULATOR

\$169 VALUE



New Improved

2-TANK UNIT
89⁷⁵

COMPLETE
Approx. 2 Hours
Underwater Time

Ready to Use

SINGLE TANK
Outfit Complete
\$110 Value
69⁹⁵
Approx. Time 1-Hour

The 2-stage demand REGULATOR automatically releases air as needed; effortless breathing in any position, includes emergency device to release reserve air for surfacing; I.C.C. approved tanks . . . 84 cu. ft. cap. at 2000 psi; non-return mouthpiece keeps water out of hose; adjustable harness. 2-Tank wt. 55 lbs. 1-Tank 30 lbs.

GUARANTEE of SATISFACTION of PERFECT PERFORMANCE with each "Sea-Horse" Diving Lung

FREE Valuable Booklet on SAFETY in Skin Diving with each Diving Lung. Full instructions included.

Send Check or Money Order. If C.O.D., 25% with order

Shipping Points: Chicago, Pittsburgh, New York

Also available: Re-Breather type Diving Lungs, Spear Guns, Diving Suits and All Swim Accessories

Write for Free Literature Today . . . Club Inquiries Invited

DIVING INDUSTRIES Division of HONUS WAGNER CO.
Quality Sports Products Since 1918
813 LIBERTY AVE. DEPT. PM-4 PITTSBURGH 22, PA.

2 WAY PORTABLE RADIO SET SENDS - RECEIVES UP TO 10 MILES AS SHOWN

with built-in antenna or hundreds of miles with outside antenna! 80 and 40 meter amateur radio bands (voice) also Aircraft and overseas broadcasts (3 to 8 mc.) PORTABLE SELF-CONTAINED POWERED WITH STANDARD LOW COST PORTABLE RADIO BATTERIES. NO AC PLUG-INS NEEDED! Take it with you everywhere you go—on trips, vacations, camping—Keep in contact with home, friends. Has 5 watt crystal controlled transmitter—Sensitive Regenerative Receiver. Send receive switch. Wt. only 3 lbs. Size, only 10" x 4" x 4". TESTED. PROVEN—SIMPLIFIED—PRACTICAL—Full information given on quick easy to get license. SEND ONLY \$3.00 (incl. cr. mo) and pay postman \$11.95 COD postage on arrival or send \$14.95 for postpaid delivery. Complete kit includes all parts, tube, coils, plastic cabinet, easy instructions. (Set of batteries—\$2.75; crystal \$1.25). COMPLETELY WIRED AND TESTED POSTPAID \$19.95. A regular \$49.95 value—Order now before price goes up. GUARANTEED — AVAILABLE ONLY FROM:



WESTERN RADIO Dept. BNM-4 KEARNEY, NEBR.

WELD IT YOURSELF IN A JIFFY!

Weld, Cut, Brazo, Solder; Iron, Steel, Brass, Bronze, Aluminum and other metals safely and easily. Make your wrought iron furniture, porch railings, fences, knick-knacks and other metal specialties. With this fine equipment anyone can do professional-like work with little practice. Tool and equipment breakdowns are annoying and costly. Don't let them bother you. The Dynamic will pay for itself quickly in both time and money and is designed to operate from any properly wired 110 volt AC line.

Order your Dynamic Industrial type transformer Arc Welder for Workshop or Industrial use today. Order from this ad.

Literature on larger equipment available on request.

DYNAMIC WELDER COMPANY, 1808 S. Federal Street, Dept. D2-D, Chicago 16, Illinois

EASY PAY PLAN

Low down-payment. Pay as you weld. Money back guarantee. Send for details. Complete outfit.

Only \$38.50
F.O.B. Factory



NUMBER ONE!



© Wynn Oil Company 1956

and
what

was **YOUR** answer?

In the Sixth Popular Mechanics Automotive Study to find brand preferences among its readers, WYNN'S FRICTION PROOFING was voted the *number one* additive on the market. These people -- people who *really* know cars -- know that today's high compression engines *require* an additive for top efficiency . . . and they selected WYNN'S FRICTION PROOFING as the number one additive to deliver that top engine efficiency.

Wynn's Friction Proofing actually impregnates metal -- doesn't merely coat it with a film that soon disappears. Its unique *sealing action* drastically reduces friction between moving metal parts -- and friction is the main cause of engine wear.

Your service station, garage, or new car dealer has Friction Proofing* products especially designed for radiator, upper cylinder, engine and transmission. Ask for the finest -- the can with the red and black bull's eye -- and discover why Popular Mechanics readers prefer WYNN'S FRICTION PROOFING over all other additives.

Also available in Canada and everywhere in the free world.

Friction Proofing is Wynn's trademark for its exclusive metal conditioner which reduces friction between moving metals by chemically smoothing and sealing the surfaces. Manufactured by Wynn Oil Company, 1151 W. Fifth St., Azusa, California, U. S. A.

He Fashions Lamps From Cores of Ancient Rock



CANADIAN MACHINIST Rudy Carlson makes modern lamps out of billion-year-old rock cores extracted from gold miners' diamond drills. When he made his first lamp, he was working in the machine shop of the Wright-Hargraves Mine at Kirkland Lake, gold-mining community 380 miles north of Toronto. With an emery stone and a square to pit against the tough rocks the drillers had taken from the rich pre-Cambrian rock strata, he struggled two months before finishing the project.

Carlson sought to cut down labor time and effort. Answering an ad in *PM*, he sent a \$14 money order to a firm in the United States and ordered a diamond-impregnated circular-saw blade. Although to the layman the blade might look too dull to cut butter, it helped Carlson manufacture his second lamp in four hours. Powered by a half-horsepower motor, the circular saw chews smoothly through a core in about one minute, cutting it into required lengths varying from one inch to two feet.

Canadian girls admire rock lamp made by Carlson





Diamond-impregnated blade works off 1/2-hp. motor

When he is cutting rock, the machinist often dons rubber coat and boots, for the saw blade creates havoc in Carlson's basement by throwing water on ceiling, floor and walls. The spray comes from a water-filled can hanging from the ceiling and dripping friction-lessening liquid on the cutting point.

Once the proper lengths have been sawed, the cores are varnished or polished. Finishing touches are given on a lathe with a soft polishing cloth against the surface.

For gluing polished cores together in the shape of a lamp, Carlson uses a windshield-glass sealer. Tough and transparent, it lends itself well to the task of "welding" lamp components into one unit. The cores are tightly clamped in a wooden form for 24 hours. Before they are clamped together, a hollow metal tube threaded to receive a socket is placed between the four upright core posts of the lamp. Carlson is now producing this product at his home in Haileybury, Ont., Canada. ★ ★ ★

Lathe and soft polisher put bright finish on a core



T-BIRD

owners swear by

AJUSTOMATIC

shock absorbers

More and more owners of high-performance automobiles are demanding what only Gabriel "AjustOmatic" shocks offer:

- A choice of *three* positive settings—soft, normal or firm—to be made in installation.

Gabriel
SHOCK ABSORBERS

**24 Drilling Combinations with
Parker No. 4 Wood Screw
COUNTERSINK BIT SET**

Parker COUNTERSINK BITS
No. 4 for WOOD SCREWS
Fits all electric drills, drill presses and hand drills

Drills and Countersinks
3 depths for flush or recessed screws
— in 1 operation —
4 drills for the 8 most popular
screw sizes

Automatic stop
adjusts to 3 depths

TO ADJUST
STOP

PARKER MANUFACTURING CO.
WORCESTER 1, MASS., U. S. A.

Drills and countersinks to flush, putty or
plug depths for 8 most popular screw sizes.
Depth-a-dapter adjusts easily on all 4 bits.

At your hardware Dealer's **Only \$1.70** per set
PARKER MANUFACTURING CO.
WORCESTER 1, MASS., U.S.A.

YOU CAN COUNT on the quality of products advertised in POPULAR MECHANICS



ANYONE can be an **EXPERT** with
deft

WOOD FINISH

Deft SEALS, PRIMES,
FINISHES. Dries in 30
min. No thinning, nothing
else to use. BAR
TOP, semi-gloss interior
finish.

Free Booklet

Be **GOOD** to your **WOOD**, **DEFT**-finish it.
DESMONDS, 1826 W. 54, LOS ANGELES 62, CALIF.



**\$40 for 1 1/2 DAY'S SPARE TIME WORK
GRINDING LAWMOWERS**

Yes, J. H. B. writes, "not bad for a 76 year
old young fellow earning \$40 for a day and
a half's work" . . . and others are making
even bigger money with the Universal
Model B Lawnmower Grinder. You, too
can make good spare or full
time profits in your own
business in your garage or
basement. We furnish
everything you need.
Write today. No cost
or obligation. Dept. M-47

ROGERS
MANUFACTURING CO.
LINDSEY, OHIO



Metal Turning Lathe for Model Makers



SEND FOR FREE FOLDER
describing the new Lathes for
Model Makers. 15 1/4" bed
with 4 1/2" swing; 7" between
centers. Guaranteed. **\$35.00**
Only f.o.b. Lansing.

Rosemoor Manufacturing Co.,
2501 Bernice Rd., Lansing, Ill.

ROAD TO RICHES

You can be the next uranium mil-
lionaire! Government guarantees
huge bonus! PRI instruments from \$29.95.
See your local dealer today! **FREE CATALOG!**
Write PRI, 4223 PM W. Jefferson
Los Angeles 16, California
DEALERS WANTED



Fight

CEREBRAL PALSY

Join the



**GOLDEN DEED
CRUSADE**

Send Your Gift to Your Local
United Cerebral Palsy Affiliate

POPULAR MECHANICS

Copyrighted material

WAR SURPLUS AND OTHER *BARBAINS* **SAVE UP TO 90%**

SPECIAL ON \$4770 NAVY AUXILIARY POWER UNITS AIR COOLED



Ideal for your shop, camp, cottage, farm, trailer, home, boat or mines. Makes a terrific welder for any size job. Also excellent for auxiliary power in pumping wells, operating saws, or wherever power is needed. 300-1A Lawrence, 24V, 2 Cylinder opposed 4-cycle 10 1/2 H.P. comes complete with various generators which can be attached to standard stud mounting. Shpg. wt. cased 350 lbs. Like New. Type 2 CM70-BD-140 amps., 24V - \$125. Type P1, 200 amps., 24V - \$137.50. AC-DC NEAS IDC side 24V, 200 amps., AC side 10.5 amps., 1200 watts, 800-cycle 2400 RPM - \$142.50.

FAMOUS B-16 KOLLSMAN AIRCRAFT COMPASS



Finest compass ever made. For use on planes, boats, cars, trucks. In current use on small & large aircraft. Can be hand carried on expeditions, weighs 1 1/2 lbs. Graduated in 2° increments. Liquid filled, lighted poly-plane compensator. Panel mounting. 3 1/2" dia. face, 4 1/2" in depth. Like NEW. Approx. GOVT. COST \$150. Only \$13.95 ppd.

ASTRO COMPASS MARK II A standard instrument used by U. S. Air Force & Navy & commercial airline navigators for obtaining true heading, checking & adjusting magnetic compasses, taking bearings of celestial & terrestrial objects & identifying stars. Makes a satisfactory pelorus & azimuth circle for either air or marine navigators. Perfect for amateur astronomers. Complete with carrying case. Approx. GOVT. COST \$400. NEW \$12.95 ppd.

OLDAK DIAL INDICATOR Finest quality. Made to AGD standards except in range. Continuous or balanced graduations as required. All parts interchangeable. Made in England. Spares available. Totally enclosed case. Detachable contact point with hard steel ball. Model ALS14. Graduated in 1/1000 in. Full scale hand records the number of revolutions of large hand. NEW. Terrific value. \$11.95 ppd.

"HELIOS" ORIGINAL TOOLMAKERS VERNIER CALIPERS



ULTRAPRECISION - Imported. Used by machinists at Lockheed, Douglas, Bendix, GM, RCA, GE. Model 51/2E. Genuine Helios. Hardened lapped precision surfaces. 1/1000" and 1/128" graduations. Handy slide roll and thumb lock. Quick, accurate depth. A \$35 value. De Luxe finish. ALL NEW. Just \$6.95. Leather carrying case. \$1 extra.

BENDIX PUMP & MOTOR



Can be used for pumping fuel, oil or wherever hydraulic pressure is required. Pump has 1" connections, built-in relief valve, adjustable up to 1500 lbs. Max. capacity 6 GPM. 1 1/2 H.P., 24 volt motor, 4000 RPM. Can be used on 12 to 38 volts. Approx. GOVT. COST \$350. NEW - \$10.95.

LONG FLUTE, HIGH SPEED DRILLS 20 assorted, numbers & fractions. Like NEW. Approx. GOVT. COST \$30. Only \$3.00 ppd.

HIGH SPEED HAND TAPS 10 assorted, precision-ground thread. National mfr. Like NEW. Up to 1/2". Approx. GOVT. COST \$22. Now \$2.50 ppd.

BUILD YOUR OWN ARC WELDER, LIGHT PLANT OR BATTERY CHARGER



Complete Kit \$39.95

Kit consists of: 1 Famous Navy NEA-3 Generator. New! Combination AC-DC Type. AC voltage-113 V. DC voltage-24 V, 200-300 Amps. 2 complete generators in 1... 2 separate fields & 2 separate armatures on same shaft yet no larger than regular aircraft generator. Ideal for home, farm & shop lighting plants by hooking wires to AC side which will give 1200 watts. DC side can be used for charging batteries, welding & operating war surplus low voltage hobby motors & equipment. Also in kit: 1 Voltage Regulator DC, 1 Voltage Regulator AC, 1 Reverse Current Relay, 1 Ammeter and Shunt, 1 Voltmeter, 0 to 30 Volts, 1 Rheostat, 1 Electrode Holder, 1 Giant Toggle Switch, Welder's shield, Wiring diagram for hookup as welder. Wt. under 100 lbs. Approx. GOVT. COST \$600. Kit. \$39.95. Navy NEA-3 Generator (only) - same as above... if purchased separately: \$27.50.

R1 GENERATOR KIT Jack & Heintz or GE. Rated 300 Amps. 24-32 Volts. With same items as above incl. 300 Amp Ammeter. Approx. GOVT. COST for kit \$600. Complete kit only \$39.95. Wt. 60 lbs.

HEAVY-DUTY RHEOSTAT Designed for heavy-duty use with Air Force heated suits. Ideal for regulating voltage on electric welders, model trains, lights, generators; controls soldering irons, etc. Rated 5.75 ohms, 100 watts with double windings and dual female 25 amp, 125 volt receptacles. Size: 7" H x 5 1/4" W x 1 3/4" D. Shpg. Wt. 2 1/2 lbs. Approx. GOVT. COST \$25. Brand new, only \$1.95.

PRECISION GROUND SQUARES Production engineer's squares. Accuracy guaranteed. Mfd. by Wright & Moore, Sheffield, England. Square blades, hardened & tempered. BRAND NEW. Fraction of original cost. 2"-\$2.75, 3"-\$3, 4"-\$3.25, 6"-\$3.75, 8"-\$7, 12"-\$9.95.

140-1 REDUCTION GEAR Make your own winches, hoists, wagon unloaders, stump pullers or fence stretcher. Sturdy aircraft quality. Built-in (removable) 24 Volt DC motor & clutch. High torque. Low speed, 100's of uses. Wt. 42 lbs. Approx. GOVT. COST \$300. Like NEW. Only \$12. \$225-1 Reduction Gear, same as above - \$12.50.

REVERSIBLE RACHET WRENCH For diesels, ships, farm machinery, trucks, bridges, oil fields, all heavy equipment. Terrific leverage, 4" Lowell, safety steel, sockets for 2 3/8", 2 9/16" & 3 1/8" hexagon nuts. Navy surplus. Approx. GOVT. COST \$215 a set. Wt. 50 lbs. NEW! Now \$10.95 per set.

MICROMETERS Black crackle finish frame. Easy-to-read graduations in .001, NEW. 0-1" cap. \$2.89 ppd. 1-2" cap. \$3.79 ppd.

NEW! BIG CATALOG Send 25c for your copy. Postpaid prices in U.S.A. only. Other prices F.O.B., Culver City, Calif. Send check, cash or money order. 50% deposit required for C.O.D. orders.

AIRBORNE SALES CO., INC. DEPT. PM457
8501 Stellar Drive, Culver City, Calif.

PAGE FOR TILLING, PLOWING, MOWING

FULL LINE 2 to 6 HP with complete gear drive and reverse.

Free Catalog LOW PRICES EASY TERMS Over 30 Years Experience

FULLY GUARANTEED! Over 60 attachments available!

PAGE 1904-A S. 81st STREET MILWAUKEE, WIS.

the finest
PUTTY KNIVES
are
Red Devil Tools.

Is Your House Running a FEVER?

Keep Your Home 15° Cooler this Summer!

check these 3 insulation ailments...reinsulate...do it yourself...

- With a ruler check attic insulation. Gravity and vibration may have caused it to settle to less than 3".
- Check for possible water leaks. Water-logged material doesn't insulate... may rot, mold.
- Some materials, including sawdust, attract destructive pests. Check for rodents, vermin.

• If insulation is in "bad shape" or lacking entirely, put your home in tip-top condition with miracle mineral ZONOLITE. Keep your home up to 15° cooler in summer. Slash winter fuel bills up to 40%! Zonolite is fireproof, rodentproof, rotproof. Low as \$67.60 for average attic. Mail coupon for booklet.

ZONOLITE (BRAND) VERMICULITE INSULATION

Mail This Coupon Today!

Zonolite Company, Dept. PM47
135 S. LaSalle St.
Chicago 3, Illinois

Please send me free booklet HI-47, "Safety, Comfort, Savings In Your Home."

Name.....
Address.....
City.....
Zone..... State.....

NOW ON SALE WHEREVER LUMBER AND BUILDING MATERIALS ARE SOLD

CUT-TO-FIT HOMES CUT BUILDING COSTS

CHOICE OF 57 DESIGNS

ORDER NOW

SAVE UP TO 1/3

Build your own home and save the builders' profit—plus savings in lumber and labor with Sterling Ready-Cut-Homes. Anyone can assemble with simple, easy to follow plans furnished. Every house complete with all lumber, roofing, nails, glass, hardware, paint, doors and windows marked ready to erect. Freight paid. Complete building plans ready for filing at low cost. Sold separately if desired. Write today!

PRICED FROM \$2150 up

Five Easy Payment Plans

Send 25c for NEW COLOR CATALOG

INTERNATIONAL MILL AND TIMBER CO.
DEPT. PM-47, BAY CITY, MICHIGAN



Heavy Duty, All Steel

TOOL CHEST

\$25⁹⁰ F.O.B. ST. PAUL

WHERE ELSE

can you get 4 drawers with built-in locking system, sliding on compound glides—at this price! Baked blue-gray enamel. 26" x 12 1/4" x 12 1/4". Your money back if not satisfied! Write for bulletin, describing this and 12 other models.

HUOT MANUFACTURING CO.

555 No. Wheeler St., St. Paul 4, Minn.



Handy Nail Guide

HELPS YOU

SAVE TIME AND MONEY

- Tells right nail for each job
- Tells amount of nails per pound
- Tells right hammer to use



YOURS FOR JUST 10¢ Send coin direct to Estwing

Estwing

UNBREAKABLE TOOLS

CHOICE OF CRAFTSMEN FOR 30 YEARS



ESTWING MFG. CO., DEPT. PM-3, ROCKFORD, ILLINOIS

NOW...WASH OFF OLD PAINT WITH WATER!

brush it on . . . wash it off

SHERWIN-WILLIAMS WASH-AWAY PAINT REMOVER

You'll be amazed how easy it is to use this miracle new WASH-AWAY Paint Remover. Just brush it on . . . wash it off, and the surface is ready to re-finish. Removes layer after layer of old paint from wood, metal, glass or plaster surfaces. No scraping! Nonflammable! Guaranteed to perform as described or money refunded.



GET IT FROM YOUR **SHERWIN-WILLIAMS** PAINT DEALER



SMALL! POWERFUL!

ECONOMY TRACTOR



Unequaled value! Low price! America's finest tractor. Ruggedly built. Easy to operate. 790 lbs. Borg-Warner clutch, trans. and diff. 140 to 1 reduction. 40% more drawbar pull than ordinary tractors 8-1/4 H. P. engine. 20 quick change implements. HOOD, FENDERS.

Thousands In Use

Write for complete details.

Engineering Products Co.
915-K-4 Niagara Ct.
Waukesha, Wisconsin

HELPFUL BOOKS

Send post card asking for FREE catalog

Popular Mechanics Press, 200 E. Ontario, Dept. 601, Chicago 11

PORTABLE POWER

WINCO®

POWER-TAKE-OFF GENERATOR



Electric Power to run welders, tools, lights and vital household equipment when power lines are down. Inexpensive. Convenient. Write for facts on Winco 10,000-watt or 5,500-watt models.

Write Dept. PM 47

WINCHARGER CORPORATION
SIOUX CITY, IOWA
Subsidiary of Zenith Radio Corporation



Good Craftsmanship

starts with a

COLUMBIAN VISE



You can't really do any job well without a dependable vise. Columbian D43 1/2 Workshop Vise is

guaranteed by the world's largest vise builder. Channel steel beam, cold-rolled steel screw, replaceable heat-treated steel jaw faces, permanent pipe jaws... many more features.

Jaw Width... 3 1/2 in.

Pipe Capacity... 1/2-1 1/4 in.

Jaw Opening... 4 in.

Weight... 16 lbs.

Vises are also available with 4-inch jaws (D44) and 5-inch jaws (D45). See your Dealer.

WRITE FOR FREE CATALOG

*add \$1 west of Rockies.

\$11.90*
delivered

COLUMBIAN VISE & MFG. CO.
CLEVELAND 4, OHIO



Screws and
Nails Fail?

WALLGRIPS

Hold Fast Where Nothing Else Will!

Expansion feature of Star Wallgrips enables you to securely fasten all kinds of fixtures (such as mirrors, pictures, cabinets) to hollow plaster walls, wallboard and thin panels of wood or metal—wherever ordinary screws or nails fail to hold.

Star Wallgrips are easy to use. Simply drill a hole, insert a Wallgrip and lock in place with screwdriver. Wallgrips remain secure. Fixtures can be removed quickly, easily for painting or redecorating. Write for FREE copy of "The Hang of Things," which shows how to fasten every kind of fixture to any type of wall.



Expanded
Wallgrip

STAR EXPANSION
142 Liberty Street (Dept. PM)
New York 6, New York

Send me a free copy of your booklet, "The Hang of Things."

Name _____

Address _____

City _____ Zone _____ State _____

STAR WALLGRIPS are available at hardware stores, chain stores and building supply dealers.

APRIL 1957

Get this helpful "HOW TO FINISH" BOOK

FINISHING SCHOOL

For "DO-IT-YOURSELF" Folks

Simple instructions for doing your own sanding and finishing of wood and metal.



PRICE 25¢

- FINISHING NEW WOOD
- LEADERSHIP AND HOME USE
- NATURAL WOOD FINISHES
- STAINING, PAINTS AND ENAMELS
- RESTORING WOOD
- FINISHING WOOD FLOORS
- FINISHING METAL

SIMPLE INSTRUCTIONS FOR DOING YOUR OWN SANDING AND FINISHING OF WOOD AND METAL. 32 pages of easy, down-to-earth data. Get a copy at your hardware, building material, or paint dealer's... or send 25¢ and coupon below. And when you finish, do it right! Get the best...

BEHR-MANNING

Sandpaper, sanding discs and belts... Behr-Cat Masking Tape and Electrical Tape... NORTON sharpening stones.



BEHR-MANNING CO.

Troy, N. Y.



BEHR-MANNING CO., Troy, N. Y. PM-4
Enclosed is 25¢. Please send "Finishing School" book.

Name _____

Address _____

City _____ Zone _____ State _____

297

Copyrighted material

It's easy . . .
you do all 3



with the

BOLENS

CONVERTIBLE *Power-Pak*

Here's real economy . . . one engine does the work of three! Bolens Power-Pak engine-handle unit changes from mower . . . to tiller . . . to snow plow . . . in a jiffy—makes fun of your outdoor chores. 5 attachments—3 rotary mowers, rugged tiller and efficient rotary snow caster. *Easy time payments.*

Try the Power-Pak . . . See Your Bolens Dealer

SEND POSTCARD FOR CATALOG

BOLENS PRODUCTS DIVISION

Food Machinery & Chemical Corp.
Port Washington 4, Wisconsin

Auto Industry Leaders Praise

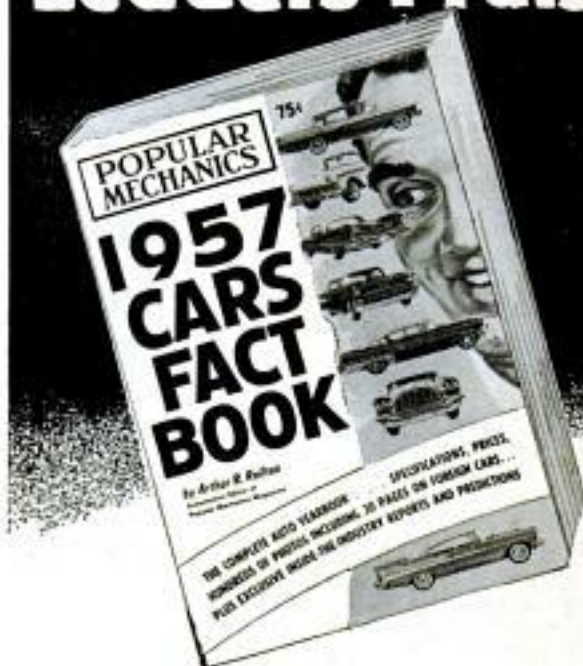

Here's what they say:

Volkswagen of America, Inc. —

“May we congratulate you on the concise way you have described the 1957 models. In so many publications today it is sometimes difficult to get to the real facts. Since you have succeeded where others have failed, we know that the book will be enthusiastically received.”

American Motors Corp., John R. Pichurski, Press Relations Mgr., Automotive Divisions —

“I just received your ‘1957 Cars Fact Book’ and must agree it is one of the finest pieces of reference material that has come across my desk this year.”



GET IT AT YOUR NEWSSTAND TODAY!



10" TILT/ARBOR SAW BUILD-IT-YOURSELF from GIL-BILT KITS-PLANS

Sturdy wood, steel, and aluminum construction. NEW DEPARTURE ball bearings. Capacity and performance of floor saws selling for \$150.00 and up. Plans, all metal parts in kit with 10" comb. blade \$25.95, Jess blade \$22.95. P.O.B. St. Louis. Detail PLANS-PATTEINS only \$1.00 postpaid.

Build-it-yourself 12" and 18" Bandsaws, 8" Belt Sander, Shaper. Simplified plans, build easily with hand tools only. Advertised and sold for 10 years, over 33,000 units in use. Money back guarantee. FREE CATALOG.

GILLIOM POWER TOOLS, Dept. 80-D, Lambert Field, St. Louis 21, Mo.

WELD **BRAZE**
SOLDER **CUT**



Acclaimed by thousands of Homeowners, Mechanics and Hobbyists as the welder of 1001 uses. Easily operated from properly wired 110 volt AC or DC line. The ideal gift with a life-long use. . . . Order today on 10 day money back guarantee.

FOUR-WAY WELDER CO., Dept. F2-D
1810 S. Federal St. • Chicago 16, Ill.

WELDER
Complete with
Twin Carbon Arc
Torch and ac-
cessories . . . to
handle all metal-
craft work.

Outdoor Living is Fun



only
\$11⁹⁸

Lenk

LP COOK STOVE

- Easy to use — Easy to Carry
- Complete with 2 king size fuel containers
- Up to 9 hours cooking time on each burner

Available at Hardware Counters Everywhere

THE LENK MFG. CO. FRANKLIN, KENTUCKY



Self-Powered Flash Gun

No battery or outside source of power is needed for a new photographic flash gun. Weighing six ounces, this German-made unit is activated by moving a lever to the right and letting it snap back to its original position. One such action generates a current sufficient to charge a condenser, which stores six volts for a half hour.

"Cyclosteel" Process

Producing steel directly from raw iron ore—a dream since the days of Bessemer—is accomplished with a revolutionary "cyclosteel" process. This includes whirling a hot mixture of ore and gases around at high speed to separate finished metal from slag. Almost any kind of ore can be used. By eliminating need for coking plants and blast furnaces, British developers of this technique have telescoped steelmaking into reactions that can be carried out at one plant in one vessel. However, sulphur contamination is still a problem and cyclosteel-furnace linings must be replaced every few weeks due to great temperatures involved.

"Young Rocks" Dated

Rocks a million or so years old can be dated by a process that involves decay of potassium-40 through radioactivity into argon. Scientists know the rate at which argon accumulates in rocks. A rock sample is dissolved in molten sodium hydroxide. Released argon, collected and measured, indicates the age of the rock.

Get your free copy now!

HOW TO PROTECT THE NATURAL BEAUTY OF EXTERIOR REDWOOD



An informative, factual guide to applying finishes to all redwood and other types of exterior woodwork. Written by experts at McCloskey's—one of the nation's oldest varnish manufacturers.

McCloskey *Lumber Life*—a lasting, natural exterior finish that shields against fading and weathering. One of the few finishes approved by leading lumber associations after testing more than 260 exterior finishing systems.

McCLOSKEY VARNISH CO.
7600 State Road, Philadelphia 36, Pa.

Name _____

Street & No. _____

City and State _____

(I buy my paint from this store)

(store is located at this address)

MAIL THIS COUPON

Use 'em together



No. 10
only \$1.89

the **STAR** Hack Saw Blade
& the **STAR** "Lever-Lock" Frame ...

Get Better Metal Cutting Results
Change Blades Faster



Exclusive!
One-piece solid Heat-Treated Back



Exclusive!
"Lever-Lock"...change Blades Instantly.



Exclusive!
Tenite handle molded around steel back for greatest strength...perfect balance!

AT ALL LEADING HARDWARE STORES



It's Yours!
...Info-packed booklet on metal cutting.
Send 10¢ in coin.

Clemson Bros., Inc., Middletown, N. Y., U. S. A.

FREE!

TO SECURE NAMES FOR OUR MAILING LIST

Treasure Chest OF PRIZED STAMPS FROM PIRATE STRONGHOLDS



IMAGINE! You receive **FREE** this whole "treasure chest" of valuable stamps from countries and islands famous in history as **PIRATE** hideouts! Your imagination will be carried back to the days of Jean La Fitte, Blackbeard, Captain Kidd, by these colorful stamps from the Bahamas, Barbados, Haiti, Trinidad, Liberia, Madagascar, St. Pierre and Miquelon . . . etc. You may want to sell them to envious friends. Or start a priceless "pirate country" stamp collection. **ALSO FREE** - Stamp Collector's **MAP OF THE PIRATE WORLD** and helpful, informative "How to Collect Stamps." Other interesting offers included for your inspection. Mail this ad now (with your name and address and 10¢ to help cover handling, mailing) to:

LITTLETON STAMP COMPANY,
Dept. PM-4A, Littleton, N. H.

BEST DEAL FOR THE MAN AT THE WHEEL

HULL AUTO COMPASS

While passengers enjoy scenery, the driver has to watch directions—unless he has a Hull to show the way, constantly, accurately. Driving is a pleasure with Hull, world's most widely used auto compass. \$4.95 and \$6.50. At your dealer's or write for literature.

A Favorite Boating Accessory, too!



HULL MANUFACTURING CO., P. O. BOX 246-D4, WARREN, O.

ELECTRIC WELDER

AC or DC
110 Volts

The "Little Marvel" all-metal welder, 5-year written guarantee. Welds 1/8" metal or money back. Repairs tanks, tools, fenders, machine parts, etc. Complete with everything—rods, unit, eye shield, directions. \$7.95 plus 50¢ postage. Flame torch necessary for soldering, cutting, brazing \$9.95 complete with carbons, brass rods, flux. \$2.00 Deposit on C.O.D. 75 ampere 1/4 inch Transformer Welder \$24.95 P.O.B.

ESSAY MFG. CO., Dept. 51, Quincy 69, Mass.

\$7.95
Complete

ROTO-HOE

FAST,
SMOOTH-HANDLING,
EASY

Makes Gardening FUN!



ROTO-HOE doesn't jump around, doesn't have to be fiddled, joggled, and bounced along. It's smooth, easy, pulls itself along. You'll enjoy growing fresh vegetables and beautiful flowers—without backaches, weeding problems—ROTO-HOE tills, cultivates between the rows, helps you have a better garden, more time to relax. Complete 2 h.p. ROTO-HOE only \$129.50. 22" Self-Propelling ROTO-CUTTER and many other low-cost attachments use same power unit, change so quickly. Write for **FREE** color folder, nearby dealer's name.

ROTO-HOE & SPRAYER CO., Dept. P-19, Newbury, Ohio

ARROW'S AUTOMATIC NAILING KIT

FOR 1001 DO-IT-YOURSELF JOBS!

The perfect gift! Handsome tool chest carry-carton contains:

- Arrow's T-50 Automatic Gun Tacker!
- Supply of 5000 staples in 4 sizes!
- Arrow's handy staple remover!

All for only **\$15.50!** Available at leading hardware and lumber yard dealers



FAST! SAFE! HOLDS!
One squeeze and you've nailed it! Ideal for ceiling tile, insulation, wire fencing, carpentry, carpeting, padding, etc.

ARROW FASTENER CO., INC. | ONE JUNIUS STREET, BROOKLYN 12, N. Y.

FORGED IRON BRACKETS



At last, an attractive shelf bracket artistically designed in authentic ornamental forged iron. Hundreds of uses inside and outside. Beautiful shelves can be yours in minutes.

—Ideal for window flower boxes or planters. Many practical ideas included with each pair. Free set of clips for glass shelves. Order now, each set complete with all forged square-head screws—Colonial Black finish. Size 6" x 4½" only \$2.98 the pair. 8" x 6" only \$3.49 the pair, postpaid. **FREE CATALOG.** Satisfaction guaranteed or money back. Order from:

W. & M. SALES

P.O. Box 4268

Pittsburgh 3, Penna.

MAGNETS

PERMANENT ALNICO

10 Assorted Magnets \$1.00

Bulletin Board Magnets..... 10 for \$1.00
Hot Pad Magnets..... 12 for \$1.00. 50 for \$3.50
Pencil Type Magnets..... 2 for 90¢. 6 for \$2.50
Retrieving Magnets, 25 lb. pull..... \$3.85

Send M.O. or check. We pay postage. No C.O.D.

HOLLYWOOD HOUSE OF MAGNETS

6912 HOLLYWOOD BLVD., HOLLYWOOD 28, CALIF.

THE
FINEST



Everywhere Gerstner Chests are acclaimed the finest. Send for Free Catalog to toolmakers and machinists.

GERSTNER TOOL CHESTS

457 Columbia St., Dayton 7, Ohio

3 CU. FT. MIXER 3975
DIRECT FROM MFR.

Fills long felt need for small mixer for concrete, feed, fertilizer, seed and many other materials. Saves 4¢ cost of ready mixed concrete. Pays for itself on first job. Combination belt pulley and crank for hand operation. Also power mixers. Write for circular.

3 Cu. Ft. Drum—Mixes 2 Cu. Ft. Concrete \$39.75

5 Cu. Ft. Drum—Mixes 3 Cu. Ft. Concrete \$59.50

FOR PULASKI, N. Y. Cash, Check or M. O. Money back guarantee.

UNITED STATES FORGE AND FOUNDRY CO.
CONSTRUCTION EQUIPMENT DIV. PULASKI, NEW YORK



Automatic Saw Set...

MAKE EXTRA PROFITS!

Set 400 teeth per minute on hand or band saws, 4 to 16 point, with the BeMaCo Automatic Saw Set. Fast, accurate, true hammer-anvil action sets teeth uniformly, eliminates tooth breakage. Used profitably by saw shops and manufacturers everywhere. Every machine positively guaranteed! Write for details—today!

Saw
Machine
Division
27-C

BEAVER MFG. CO.
800 ISIS AVENUE • INGLEWOOD, CALIF.

HAVE FUN!

SAVE
MONEY



TRY SUPERSHOP FREE
Factory To You — \$79.95

Think of the fun you'll have and the money you'll save with your own big capacity workshop. Picture yourself sawing with the 8" ball bearing saw. Or drilling in steel with the vertical drill press. You bore with the horizontal drill—exclusive with SUPERSHOP. You sand with the 8" disc sander. You turn with the 30" lathe. You sharpen tools on the 5" grinder.



VERTICAL
DRILL PRESS

You are invited to TRY SUPERSHOP FREE. We will pay all shipping expense. Write for full details of this amazing FREE TRIAL PLAN. Mail postcard now.

POWER TOOLS INC.

194 Yates Ave.
Beloit, Wisc.

WHY SHOULD Your Power Mower HAVE BIG WHEELS?

You can challenge any other mower to a cutting duel! Exclusive bicycle-type wheels make Yazoo outlook, outperform, outwear any other!

Yazoo **BIG WHEELS** glide easier . . . mean greater operator control. Won't bog down as small wheels do!

Yazoo grooms the most luxurious lawns—is a mule for rural work, high cutting! See your dealer or write now for his name! You've got a brand new experience in store for you!

FREE! Send for illustrated booklet "Are You Killing Your Grass?" to: Yazoo Manufacturing Co., Dept. PM, Jackson, Miss.



YAZOO MASTER
MOWERS

(YAZZ-200)

NEW!

SHAW RM 24 MOWER WITH AMAZING MAGIC DRIVE



Three Speeds
forward
neutral & reverse

Wide range of speeds, complete gear selection gives you outstanding mowing control for any type terrain, any type mowing. Low cost!

3 sizes, cut 24, 32 and 36"

Riding Mowers 2½ to 8 H.P. low as.....\$199.00

Riding Tractors 3 to 14 H.P. low as.....\$299.00

Walking Type Tractors 2 to 5 H.P. low as..... \$99.00

Bargains in Rotary Pulverizers also.

See your Shaw dealer or write for free literature.

Dealer inquiries invited.



SHAW Mfg. Company

4504 Front Street, Galesburg, Kansas
668-G4 N. 4th Street, Columbus, Ohio

SUPREME Versamatic

REVERSIBLE SCREW DRIVER
AND SPEED REDUCER



fits all
power
drills

First time ever! It REVERSES!



Drive and remove screws with Supreme Versamatic. Versamatic reduces speed 7 to 1, increases power 7-fold. Reverses with one twist. Handles even the largest screws with ease. Also for nut running (adapter furnished); tapping; and all heavy duty drilling where speed reduction is needed. Fingertip control means safe, fast work. Complete set \$14.95.

(½" chuck extra). At hardware stores or direct from

SUPREME PRODUCTS Corp., 2222 S. Calumet, Chicago 16

**AT YOUR
NEWSSTAND
NOW!**



KEEP UP-TO-DATE ON THE WONDERFUL WORLD OF SCIENCE WITH THIS WONDERFUL MAGAZINE

Pick up a copy of SCIENCE DIGEST today . . . and become acquainted with the pocket-sized magazine that tells you "what this Changing World means to you."

Expert editors choose the finest articles on science, medicine, geography, psychology from the magazines and books of the world . . . and serve them up to you in easy-to-understand form.

You'll like this magazine. At your newsstands . . . only 35¢. One year subscription: \$3.50.

ADDRESS: DEPT. X-21, SCIENCE DIGEST
200 East Ontario Street • Chicago 11, Illinois

POPULAR MECHANICS

MODERN

IMPROVED LAWN MOWER SHARPENER AND BED KNIFE GRINDER



\$275.00
FOB
PASADENA,
CALIF.

Grinds any reel type mower. Hollow grinds or flat grinds bed knives. New micro feed grinding head. Sharpens hand and power mowers. No disassembly of wheels, Roller, handle or gasoline engine. No draining of gasoline or oil. Precision sharpens more mowers per hour. Costs less. Compare before you buy. If it isn't a MODERN it can't be MODERN.

WRITE FOR FREE BOOKLET 10A

The Modern Lapping Machine is designed to fit the needs of any large user of mowers and the lawn mower shops. Laps any reel type mower. 1/2 H.P. motor, \$67.95 fob, Pasadena, Calif.



MODERN MFG. CO., 160 N. FAIR OAKS, PASADENA, CALIFORNIA

HOLD-E-ZEE SCREWDRIVERS

The Original
AUTOMATIC GRIP

Top Quality—Plus!

Finest materials and workmanship plus exclusive, much-wanted features

—YET COST NO MORE THAN
ORDINARY SCREWDRIVERS!

At Leading Dealers Everywhere

UPSON BROS., INC., ROCHESTER 14, N. Y.



Pat'd.

WARN HUBS on your

Patented



Jeep

STOP FRONT DRIVE WEAR in 2-Wheel Drive!



Over 100,000 now in use!

That is real proof of their many advantages and rugged dependability. Warn Hubs

on 4-wheel drives make steering easier, increase power, speed in high; add life to gears, tires, because the front drive stands still in 2-wheel drive—there is no drag! Use free-wheeling 2 w.d. or tractive 4 w.d. as needed, automatically,

as you shift, with Warn Lock-O-matics, through fingertip controls with Warn Locking Hubs. Factory approved. Iron-clad guarantee. Models for all 4 w.ds. to 1 1/2 tons. See your dealer now! Write for free literature.



© 1957
WARN

WARN MFG. CO.

Riverton Box 6064-A4
Seattle 88, Wash.

GLUE INJECTOR



Handy 4 in. all-metal injector forces any good liquid glue at high pressure into loose furniture joints, veneer, etc. Repairs tables, chairs, toys, models without disassembly. Dozens of uses in home and shop. Directions sent. Satisfaction or your money back.

\$200
ppd.
2 for
\$375

DRUMCLIFF CO., DEPT. H-36, TOWSON 4, MD.

NEW! PLUMB BOB REEL



PLUMBS, CENTERS, ALIGNS EXACTLY!

You can't miss with Line-Master! No re-set! Unbreakable point drives into wood, mortar, holds fixed distance from vertical surface. Suspends perfectly from overhead line. Non-fouling reel, adjustable line drag, cast alloy case, beaded aperture, 50' nylon line. \$3.25 postpaid. Guaranteed. Send cash, check, M.O. today. No C.O.D.

LINE-MASTER, Box 3821-A4, Seattle 24, Wn.

ONE-BAG MIXER THAT TRANSPORTS



Universal Transmix® transports, mixes and dumps cement, silage, dirt, etc. P. T. O. driven—no gears or chains. Can be installed or removed in 15 minutes. Fits Ford, Ferguson, AC-WD, IHC Super C, H&M, Case VAC, J.D.-40, Oliver 55, and other 2- and 3-plow tractors. Unconditionally guaranteed. See your dealer or write, giving tractor model, to

UNIVERSAL PULLEYS COMPANY
365 NORTH MOSLEY • WICHITA, KANSAS

JEEP OWNERS

RE-POWER NOW with your choice of three famous V-8 engines

FORD • CHEVROLET • MERCURY

CONVERSION KITS now available to fit ALL 2 and 4 Whl-Drive Willys Jeeps. . . . Priced \$43.25 to \$64.75 . . . If you want fast action tell us which V-8 engine you wish to use . . . give us the year . . . 2 or 4 Whl-Drive . . . body style of your vehicle. Send min. \$15.00 dep. and we will ship correct kit, bal. C.O.D. Send full amount for prepaid shipment. Wire, phone or write for FREE details.

HOOSIER MACHINE PRODUCTS CO.

312 S.E. 6th St. Phone 676 Pendleton, Oregon, U.S.A.

Drawers float like a feather—with

AMAZING NYLON BEARING DRAWER ROLLERS

Now, in minutes, give a lift instead of a drag to drawers in your home, office, trailer, etc., with amazing "Tiny Tots." Lifetime nylon rollers give finger tip float-action to even the heaviest, stubborn drawers. Stops sawdust from sitting down in drawers, too. Midget in size, but giant in strength! Use 2 on average drawers; 3 or 4 on heavier types. Simple to attach; directions included. 6 rollers \$1. SPECIAL, 30 for only \$2.99 ppd. No C.O.D.'s. Order NOW!



EDSCO PRODUCTS 23190 West Washington Blvd.
Los Angeles 18, California

More for Your Money

If there is any one reason why South Bend Lathes are so popular it is because they represent the maximum value per dollar of cost. We invite comparison feature-by-feature with any other make, and are confident you will find South Bend gives you more for your money. Send coupon for catalog.



HARDENED BED WAYS

Hardened and precision ground bed ways can be supplied in lieu of regular at small extra cost—also hardened and ground cross-feed screw.

TIME PAYMENTS

only 3¼% interest

Yes, only 3¼% percent per annum on original unpaid balance. Low down payment and balance in up to 24 monthly payments.

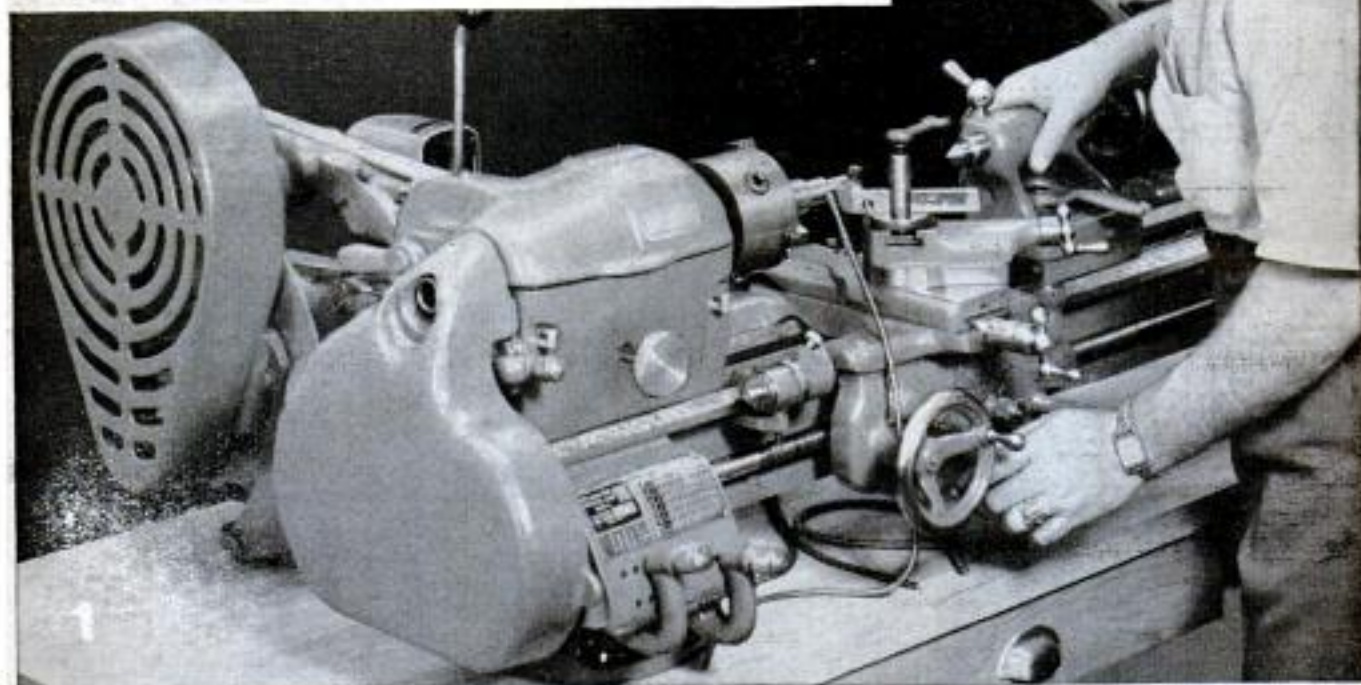

PLEASE SEND INFORMATION CHECKED:



9" and 10" BENCH LATHES



10" to 16" FLOOR LATHES



DRILL PRESSES



½" & 1" Collet TURRET LATHES



TOOL GRINDERS



7" BENCH SHAPERS



MILLING MACHINES

Name _____ Street _____

City _____ State _____

Building Better Tools Since 1906 • SOUTH BEND LATHE • South Bend 22, Indiana



“Sunday drivers” never had it so good!

SUNDAY DRIVING IS FUN AGAIN! A happy refuge from crowded highways awaits you with an Evinrude. Quietly, swiftly it takes you into the enchanted world of sun and spray and cool blue waters. So much to see, so much to do—cruising—skiing—picnicking on secluded beaches. All so easy, so inexpensive to enjoy!

Whatever your choice of boating fun, there's

an Evinrude to match it... *most fun afloat* in every power class. Nine superb models for '57. Thrilling new high-performance 18 and 35 horsepower models that set new standards of big-load capability. New 12-volt electric starting. New high duty generator system. New fuel economy. A magnificently styled new Lark model.

SEE YOUR EVINRUDE DEALER—He will gladly help you choose the right Evinrude for any type of boat. Time payments available. For big full-color catalog of the complete Evinrude line, write EVINRUDE MOTORS, 4416 N. 27th St., Milwaukee 16, Wis.



A Division of Outboard Marine Corporation
In Canada: Mfd. by Evinrude Motors, Peterborough



Evinrude

quiet outboard motors

Copyrighted material

HAVE A REAL CIGARETTE— HAVE A Camel

"I want a real cigarette... no fads or fancy stuff. That's why it's Camels for me. They taste good all the time — never let you down."

Paul O'Shea

Sports Car Driver and
Consultant Engineer



R. J. Reynolds Tobacco Company, Winston-Salem, N. C.

Discover the difference
between "just smoking" ... and Camels!

Taste the difference! You'll find that Camels taste rich, full-flavored, and deeply satisfying—pack after pack.

Feel the difference! The exclusive Camel blend of quality tobaccos has never been equalled for *smooth* smoking.

Enjoy the difference! More people today smoke Camels than any other cigarette. Try Camels—they've really got it!

America's real smoke is **Camel**—the largest-selling cigarette today!